

MARKS PUBLISHED FOR OPPOSITION

The following marks are published in compliance with section 12(a) of the Trademark Act of 1946. Applications for the registration of marks in more than one class have been filed as provided in section 30 of said act as amended by Public Law 772, 87th Congress, approved Oct. 9, 1962, 76 Stat. 769. Opposition under section 13 may be filed within thirty days of the date of this publication. See rules 2.101 to 2.105.

A separate fee of two hundred dollars for opposing each mark in each class must accompany the opposition.

SECTION 1.— INTERNATIONAL CLASSIFICATION

The short titles associated below with the international class numbers are terms designed merely for quick identification and are not an official part of the international classification. The full names of international classes are given in section 6.1 of the trademark rules of practice.

The designation "U.S. Cl." appearing in this section refers to the U.S. class in effect prior to Sep. 1, 1973 rather than the international class which applies to applications filed on or after that date. For adoption of international classification see notice in the OFFICIAL GAZETTE of Jun. 26, 1973 (911 O.G. TM 210).

Application in more than one class

SN 74-228,940. IPC INFORMATION SYSTEMS, INC., STAMFORD, CT. FILED 12-10-1991.

SN 75-166,671. SA SA OVERSEAS LIMITED, ROAD TOWN, TORTOLA, BR. VIRGIN ISLANDS, FILED 9-16-1996.



NO CLAIM IS MADE TO THE EXCLUSIVE RIGHT TO USE "INFORMATION SYSTEMS", APART FROM THE MARK AS SHOWN.

THE LINING IS A FEATURE OF THE MARK AND NOT INTENDED TO DESIGNATE COLOR.

CLASS 37—CONSTRUCTION AND REPAIR

FOR VOICE AND DATA COMMUNICATIONS SYSTEMS INTEGRATION SERVICES, NAMELY MAINTAINING COMMUNICATIONS INFRASTRUCTURES WHICH INTEGRATE VOICE AND DATA COMMUNICATIONS SYSTEMS USED IN TRADING ROOM ENVIRONMENTS (U.S. CLS. 100, 103 AND 106).

CLASS 42—SCIENTIFIC, COMPUTER AND LEGAL SERVICES

FOR VOICE AND DATA COMMUNICATIONS INTEGRATION SERVICES, NAMELY DESIGNING AND IMPLEMENTING COMMUNICATIONS INFRASTRUCTURES WHICH INTEGRATE VOICE AND DATA COMMUNICATIONS SYSTEMS USED IN TRADING ROOM ENVIRONMENTS (U.S. CLS. 100 AND 101).



OWNER OF HONG KONG REG. NO. 13131, DATED 9-10-1996, EXPIRES 9-10-2003.

OWNER OF HONG KONG REG. NO. 04057, DATED 2-5-1998, EXPIRES 2-5-2005.

CLASS 3—COSMETICS AND CLEANING PREPARATIONS

FOR MAKE-UP, NAMELY, LIPSTICKS, LIPLINERS, LIP PENCILS, LIP CONDITIONERS, FACIAL POWDER, COMPACT CASES FILLED WITH FACIAL POWDER, LOOSE POWDER, FOUNDATION MAKE-UP, POWDER FOUNDATION MAKE-UP, LIQUID FOUNDATION MAKE-UP, BLUSH, POWDER EYESHADOW, CREAM EYESHADOW, EYELINER, EYEBROW PENCIL, MASCARA, WATERPROOF MASCARA, EYE PENCIL, EYE MAKEUP REMOVER, NAIL POLISH, BASE COAT POLISH FOR NAILS, NAIL POLISH REMOVER, NAIL CARE, NAMELY, ENVIRONMENTAL PROTECTIVE NAIL CREAM; NAIL HARDENER, CONCEALER; SKIN CARE, NAMELY, CLEANSING GEL, CLEANSING CREAM, CLEANSING LOTION, CLEANSING WATER, FOAMING CLEANSER, CLEANSING BAR, MOISTURIZING LOTION, MOISTURIZING CREAM, DAY CREAM, NIGHT CREAM, FIRMLING CREAM, BUST CREAM, BUST LOTION, SLIMMING CREAM, SLIMMING GEL, SLIMMING LOTION, ANTI-WRINKLE LOTION, FIRMLING WRINKLE CREAM, HAND CREAM, HAND LOTION, MAKEUP REMOVER, NECK CREAM, THROAT CREAM, EYE CREAM, WHITENING CREAM, WHITENING TONER, WHITENING LOTION, WHITENING ESSENCE, BODY AND FACIAL EMULSIONS, BODY MASKS LOTION AND CREAMS, PURIFYING MASK, RELAXING MASK, CLEANSING MASK, SKIN TONER, STIMULATING TONER, NAMELY, SKIN SOOTHING LOTION, ANTI-AGING CREAM, ANTI-AGING LOTION; CERAMIDE, NAMELY, SKIN CARE INGREDIENT TO PREVENT MOISTURE LOSS TO FACE AND EYE AREAS; FRUITION, NAMELY, AN INGREDIENT TO INCREASE SKIN CLARITY; SERUM, NAMELY, AN IMMEDIATE ACTION FLUID GEL FOR SOFTENING AND HYDRATING SKIN, NAMELY, THE FACE AND

EYE AREAS; NON-MEDICATED EXFOLIATING CREAM AND GEL, SKIN LOTION, SUN BLOCK CREAM, SUN BLOCK LOTION, UV DEFENSE CREAM, UV DEFENSE GEL, AFTER SUN BODY CREAM, AFTER SUN BODY LOTION, AFTER SUN MILK, HYDRATION CREAM, HYDRATION LOTION; SELF TANNING MILK, SELF TANNING BODY GEL; HAIR CARE, NAMELY, SHAMPOO, RINSER, NOURISHING CLEANSER, CONDITIONER, HAIR TREATMENT, REVITALIZER, BOOSTER, NAMELY, A PRODUCT WHICH INCREASES PROTEIN IN HAIR; STYLING AND FINISHING LOTION, FIXING GEL, FIXING/STYLING SPRAY, FINISHING SPRITZ, MOUSSE, SHAPING MIST, STYLING WHIP, SHAPING LOTION; FRAGRANCES, NAMELY, PERFUME, EAU DE TOILETTE, EAU DE PARFUM, EAU DE COLOGNE, MINIATURES, NAMELY, FRAGRANCES IN MINIBOTTLES; MINIATURE SETS, NAMELY, FRAGRANCES IN A SET OF MINIBOTTLES; GIANT DUMMY, NAMELY, FRAGRANCES IN A LARGE BOTTLE; SHOWER GEL, BODY LOTION, BODY OIL, DUSTING POWDER, SKIN SOAP, BODY CREAM, BODY MILK, PERSONAL DEODORANT, AFTER SHAVE, AFTER SHAVE CREAM, AFTER SHAVE FOAM; ACCESSORIES, NAMELY, COTTON FOR COSMETIC PURPOSES; EYE MASKS, BLUSHERS, COSMETIC MIRRORS FOR USE IN COSMETIC CASES, PUMICE STONES FOR PERSONAL USE SPRAY WATER, NAMELY, MINERAL WATER IN SPRAY FORM FOR SKIN FRESHENING AND MOISTURIZING (U.S. CLS. 1, 4, 6, 50, 51 AND 52).

CLASS 21—HOUSEWARES AND GLASS

FOR FACE BRUSHES, LIP BRUSHES, EYESHADOW BRUSHES, HAIR BRUSHES, HAIR COMB, SPONGES FOR APPLYING BODY POWDER, COSMETIC MIRRORS, DISPOSABLE APPLICATORS FOR COSMETICS, BOTTLES, NAMELY, EMPTY COSMETIC BOTTLES FOR THE PURPOSE OF FILLING THE BOTTLES WITH VARIOUS COSMETIC PRODUCTS AS DESIRED BY THE INDIVIDUAL CONSUMER (U.S. CLS. 2, 13, 23, 29, 30, 33, 40 AND 50).

SN 75-167,972. ARGUS HEALTH SYSTEMS, INC., KANSAS CITY, MO. FILED 9-18-1996.

ARGUS

OWNER OF U.S. REG. NO. 2,374,098.

CLASS 35—ADVERTISING AND BUSINESS

FOR PROVIDING BUSINESS INFORMATION MANAGEMENT TO PHARMACY BENEFIT PROGRAMS AND TO THE MANAGED HEALTHCARE INDUSTRY (U.S. CLS. 100, 101 AND 102).
FIRST USE 4-0-1986; IN COMMERCE 4-0-1986.

CLASS 36—INSURANCE AND FINANCIAL

FOR PROVIDING PRESCRIPTION CLAIMS PROCESSING TO PHARMACY BENEFIT PROGRAMS AND TO THE MANAGED HEALTHCARE INDUSTRY (U.S. CLS. 100, 101 AND 102).
FIRST USE 4-0-1986; IN COMMERCE 4-0-1986.

SN 75-314,935. ARVUS.COM LLC, TIGARD, OR. BY ASSIGNMENT TIGER PRESS, L.L.C., TIGARD, OR. FILED 6-25-1997.

GOD CAN

CLASS 6—METAL GOODS

FOR SLOTTED METAL CONTAINERS SOLD EMPTY USED FOR DEPOSITING WRITTEN PERSONAL THOUGHTS (U.S. CLS. 2, 12, 13, 14, 23, 25 AND 50).
FIRST USE 1-1-1984; IN COMMERCE 1-1-1984.

CLASS 16—PAPER GOODS AND PRINTED MATTER

FOR SLOTTED CARDBOARD CONTAINERS SOLD EMPTY USED FOR DEPOSITING WRITTEN PERSONAL THOUGHTS (U.S. CLS. 2, 5, 22, 23, 29, 37, 38 AND 50).
FIRST USE 1-1-1984; IN COMMERCE 1-1-1984.

SN 75-391,165. PATSY'S BRAND, INC., NEW YORK, NY. FILED 11-17-1997.

PATSY'S

OWNER OF U.S. REG. NO. 1,874,789.

CLASS 29—MEATS AND PROCESSED FOODS

FOR OLIVE OIL; EXTRA VIRGIN OIL; CHEESE; STUFFED CALAMARI; CHICKEN CACCIATORE; MEATBALLS MADE OF BEEF, PORK AND VEAL; ROASTED PEPPERS; PROCESSED EGGPLANT; CAPONATA; PROCESSED OLIVES; FROZEN ENTREES CONSISTING PRIMARILY OF CHICKEN, FISH, BEEF OR VEAL (U.S. CL. 46).

CLASS 30—STAPLE FOODS

FOR CHEESE RAVIOLI; LOBSTER RAVIOLI; BEEF RAVIOLI; VEAL RAVIOLI; MANICOTTI; LASAGNA; PASTA; VINEGAR; PASTRIES, NAMELY, CHEESECAKES, TIRAMISU AND CANNOLI (U.S. CL. 46).

SN 75-402,390. FELISSIMO CORPORATION, KOBE 650, JAPAN, FILED 12-9-1997.



PRIORITY CLAIMED UNDER SEC. 44(D) ON JAPAN APPLICATION NO. 9-140083, FILED 7-19-1997, REG. NO. 4276022, DATED 5-28-1999, EXPIRES 5-28-2009.

OWNER OF U.S. REG. NOS. 1,927,232, 2,119,669 AND 2,119,980.

CLASS 9—ELECTRICAL AND SCIENTIFIC APPARATUS

FOR PHONOGRAPH RECORDS FEATURING SONGS AND MUSIC, AND PRE-RECORDED EDUCATIONAL AND INSTRUCTIONAL VIDEO TAPES, AUDIO TAPES, COMPACT DISCS, OPTICAL DISCS AND AUDIO/VIDEO DISCS FEATURING LECTURES AND INSTRUCTION ON COOKING, DANCING, AND ECONOMICS (U.S. CLS. 21, 23, 26, 36 AND 38).

CLASS 15—MUSICAL INSTRUMENTS

FOR MUSICAL INSTRUMENTS, NAMELY, FLUTES, TRUMPETS, VIOLINS, GUITARS, PIANOS, AND ORGANS (U.S. CLS. 2, 21 AND 36).

CLASS 28—TOYS AND SPORTING GOODS

FOR TOYS, NAMELY, TOY BUILDING BLOCKS, PAPER DOLL FIGURES, PLUSH TOYS, CHILDREN'S TOY NECKLACES, MARBLES, BEANBAGS FOR A BEANBAG THROWING GAME, ARTIFICIAL CHRISTMAS TREES, DOLLS, FISHING TACKLE AND ARTIFICIAL FISHING BAIT (U.S. CLS. 22, 23, 38 AND 50).

CLASS 35—ADVERTISING AND BUSINESS

FOR SHOPPERS GUIDE INFORMATION SERVICES; COMPUTERIZED ON-LINE ORDERING SERVICES FOR GOODS AND SERVICES OF OTHERS IN THE FIELD OF CONSUMER GOODS AND SERVICES; COMPILATION OF ADVERTISEMENTS FOR OTHERS FOR USE AS WEB PAGES ON A GLOBAL COMPUTER NETWORK FOR OTHERS; DISSEMINATION OF ADVERTISING MATTER FOR OTHERS VIA AN ON-LINE ELECTRONIC COMMUNICATIONS NETWORK (U.S. CLS. 100, 101 AND 102).

CLASS 36—INSURANCE AND FINANCIAL

FOR CHECK CASHING; CHECK VERIFICATION; INVESTMENT CONSULTATION; CREDIT AND DEBIT CARD SERVICES; AND TRAVEL AGENCY SERVICES, NAMELY, ISSUING TRAVELER'S CHECKS ALL PROVIDED VIA THE GLOBAL COMPUTER INFORMATION NETWORK (U.S. CLS. 100, 101 AND 102).

SN 75-588,052. ASSOCIATED NEWSPAPERS LIMITED, KENSINGTON, LONDON W8 5TT, ENGLAND, FILED 11-13-1998.

FMOS

PRIORITY CLAIMED UNDER SEC. 44(D) ON ERPNTY TM OFC APPLICATION NO. 000831214, FILED 5-15-1998, REG. NO. 831214, DATED 3-30-2000, EXPIRES 5-15-2008.

CLASS 9—ELECTRICAL AND SCIENTIFIC APPARATUS

FOR ELECTRONIC PUBLICATIONS, NAMELY, BOOKS, MAGAZINES, NEWSPAPERS, MANUALS, PERIODICALS, BROCHURES AND SUPPLEMENTS THEREFOR RECORDED ON ELECTRONIC, ELECTROMAGNETIC, OPTICAL AND ELECTRO-OPTICAL DATA CARRIERS, CD-ROMS AND PRERECORDED VIDEO TAPES FEATURING INFORMATION AND ADVICE RELATING TO NEWS, POLITICS, CULTURAL AFFAIRS, CAREERS, FASHION, HEALTH, BEAUTY, GARDENING, MEDICAL MATTERS, SPORTS, ENTERTAINMENT, MUSIC, TELEVISION, THEATRE, EDUCATION, FOOD AND DRINK, COOKERY, TRAVEL, HOLIDAYS, SCIENCE, CURRENT AFFAIRS, BUSINESS, INSURANCE AND FINANCIAL MATTERS, HOTELS, HOTEL AND ACCOMMODATION RESERVATION SERVICES, THE WEBSITES OF OTHERS AND THE WORLDWIDE WEB (U.S. CLS. 21, 23, 26, 36 AND 38).

CLASS 16—PAPER GOODS AND PRINTED MATTER

FOR PRINTED MATTER AND PRINTED PUBLICATIONS, NAMELY, BOOKS, MAGAZINES, NEWSPAPERS, PERIODICALS, BROCHURES, MANUALS, AND SUPPLEMENTS THEREFOR FEATURING INFORMATION AND ADVICE RELATING TO NEWS, POLITICS, CULTURAL AFFAIRS, CAREERS, FASHION, HEALTH, BEAUTY, GARDENING, MEDICAL MATTERS, SPORTS, ENTERTAINMENT, MUSIC, TELEVISION, THEATRE, EDUCATION, FOOD AND DRINK, COOKERY, TRAVEL, HOLIDAYS, SCIENCE, CURRENT AFFAIRS, BUSINESS, INSURANCE AND FINANCIAL MATTERS, HOTELS AND HOTEL AND ACCOMMODATION RESERVATION, THE WEBSITES OF OTHERS AND THE WORLDWIDE WEB; MAPS; HOLIDAY AND TRAVEL GUIDE BOOKS (U.S. CLS. 2, 5, 22, 23, 29, 37, 38 AND 50).

CLASS 38—COMMUNICATION

FOR TELECOMMUNICATIONS GATEWAY SERVICES; TELECOMMUNICATIONS SERVICES, NAMELY ISDN AND PERSONAL COMMUNICATION SERVICES; PROVIDING ON-LINE CHAT ROOMS FOR TRANSMISSION OF MESSAGES AMONG COMPUTER USERS CONCERNING TOPICS OF GENERAL INTEREST; PROVIDING MULTIPLE-USER ACCESS TO A GLOBAL COMPUTER INFORMATION NETWORK FOR THE TRANSFER AND DISSEMINATION OF A WIDE VARIETY OF INFORMATION, WEBSITES AND HOME PAGES OF OTHERS; COMPUTER SERVICES - NAMELY, PROVIDING AN ON-LINE ELECTRONIC BULLETIN BOARD FOR THE TRANSMISSION OF MESSAGES AMONG COMPUTER USERS FEATURING NEWS, POLITICS, CULTURAL AFFAIRS, CAREERS, FASHION, HEALTH, BEAUTY, GARDENING, MEDICAL MATTERS, SPORTS, ENTERTAINMENT, MUSIC, TELEVISION, THEATRE, EDUCATION, FOOD AND DRINK, COOKERY, TRAVEL, HOLIDAYS, SCIENCE, CURRENT AFFAIRS, BUSINESS, INSURANCE AND FINANCIAL MATTERS, HOTELS, HOTEL AND ACCOMMODATION RESERVATION SERVICES, THE WEB SITES OF OTHERS AND THE WORLDWIDE WEB (U.S. CLS. 100, 101 AND 104).

CLASS 41—EDUCATION AND ENTERTAINMENT

FOR PUBLISHING SERVICES AND ELECTRONIC PUBLISHING SERVICES, NAMELY PUBLICATION OF TEXT AND GRAPHIC WORKS OF OTHERS IN HARD COPY, ON CD-ROM AND ON A COMPUTER DATABASE OR A GLOBAL COMPUTER NETWORK INFORMATION AND ADVICE RELATING TO NEWS, POLITICS, CULTURAL AFFAIRS, CAREERS, FASHION, HEALTH, BEAUTY, GARDENING, MEDICAL MATTERS, SPORTS, ENTERTAINMENT, MUSIC, TELEVISION, THEATRE, EDUCATION, FOOD AND DRINK, COOKERY, TRAVEL, HOLIDAYS, SCIENCE, CURRENT AFFAIRS, BUSINESS, INSURANCE AND FINANCIAL MATTERS, HOTELS, HOTEL AND ACCOMMODATION RESERVATION SERVICES, THE WEBSITES OF OTHERS AND THE WORLDWIDE WEB (U.S. CLS. 100, 101 AND 107).

CLASS 42—SCIENTIFIC, COMPUTER AND LEGAL SERVICES

FOR PROVIDING INFORMATION AND ADVICE RELATING TO NEWS, POLITICS, CULTURAL AFFAIRS, FASHION, HEALTH, BEAUTY, GARDENING, MEDICAL MATTERS, FOOD AND DRINK, COOKERY, SCIENCE, CURRENT AFFAIRS, HOTELS, HOTEL ACCOMMODATION RESERVATION SERVICES, THE WEBSITES OF OTHERS AND THE WORLDWIDE WEB; TRAVEL AGENCY SERVICES, NAMELY MAKING RESERVATIONS AND BOOKINGS FOR TEMPORARY LODGING AND ACCOMMODATION; ALL THESE SERVICES ALSO PROVIDED ON-LINE FROM A COMPUTER DATABASE OR FROM A GLOBAL COMPUTER NETWORK; COMPUTER SERVICES, NAMELY, PROVIDING SEARCH ENGINES FOR OBTAINING DATA ON A GLOBAL COMPUTER NETWORK (U.S. CLS. 100 AND 101).

SN 75-636,423. FORD MOTOR COMPANY, DEARBORN, MI. FILED 2-8-1999.

AUTOCONCIERGE**CLASS 35—ADVERTISING AND BUSINESS**

FOR PROVIDING INFORMATION, CONSULTING SERVICES AND CUSTOMER-SPECIFIC INFORMATION MADE AVAILABLE THROUGH AUTOMOTIVE DEALERSHIPS IN THE FIELDS OF NEW OR USED MOTOR VEHICLES AND MOTOR VEHICLES FOR SALE, INCLUDING VEHICLE MODEL SUITABILITY PROFILES FOR PURCHASERS AND/OR LESSEES, RESEARCH REGARDING VEHICLE AVAILABILITY AND PRICING, SAFETY AND RELIABILITY RATINGS, PROVIDING MARKET VALUE INFORMATION FOR VEHICLE TRADE-INS, LOCATING DEALERSHIPS, AND LOCATING VEHICLES; PROVIDING INFORMATION, CONSULTING SERVICES AND CUSTOMER-SPECIFIC INFORMATION MADE AVAILABLE THROUGH AUTOMOTIVE DEALERSHIPS IN THE FIELDS OF OR WITH RESPECT TO VEHICLE PURCHASES AND SALES IN THE NATURE OF FACILITATING AGREEMENTS BETWEEN DEALERS AND CUSTOMERS, ARRANGING AND SCHEDULING CLOSINGS, AND ATTENDING CLOSINGS FOR THE BENEFIT OF OTHERS; PROVIDING INFORMATION, CONSULTING SERVICES AND CUSTOMER-SPECIFIC INFORMATION MADE AVAILABLE THROUGH AUTOMOTIVE DEALERSHIPS IN THE FIELDS OF OR WITH RESPECT TO SELLING OF PREVIOUSLY-OWNED VEHICLES; PREPARING AND/OR PLACING ADVERTISEMENTS FOR OTHERS; ASSISTING WITH MARKETING OF VEHICLES; AND BUSINESS MANAGEMENT SERVICES, NAMELY, MOTOR VEHICLE MANAGEMENT; INCLUDING MANAGEMENT OF FLEETS OF VEHICLES FOR OTHERS; PROVIDING INFORMATION, CONSULTING SERVICES AND CUSTOMER-SPECIFIC INFORMATION MADE AVAILABLE THROUGH AUTOMOTIVE DEALERSHIPS IN THE FIELDS OF SELLING PREVIOUSLY-OWNED VEHICLES; CONSULTING SERVICES AND CUSTOMER-SPECIFIC INFORMATION MADE AVAILABLE THROUGH AUTOMOTIVE DEALERSHIPS IN THE FIELDS OF LOCATING AUTOMOBILE PARTS FOR OTHERS, VEHICLE PARTS, EQUIPMENT, OR ACCESSORIES; PROVIDING INFORMATION, CONSULTING SERVICES AND CUSTOMER-SPECIFIC INFORMATION MADE AVAILABLE THROUGH AUTOMOTIVE DEALERSHIPS IN THE FIELD OF OR WITH RESPECT TO CHECKING AND COMPLETING MAKE OR MODEL RECALL NOTICES; AND PROVIDING INFORMATION, CONSULTATION AND CUSTOMER-SPECIFIC INFORMATION MADE AVAILABLE THROUGH AUTOMOTIVE DEALERSHIPS IN THE FIELDS OF OR WITH RESPECT TO VEHICLE PARTS, EQUIPMENT OR ACCESSORIES (U.S. CLS. 100, 101 AND 102).

SN 75-622,981. INTERNATIONAL SKATING UNION, CH 1007 LAUSANNE, SWITZERLAND, FILED 1-19-1999.

INTERNATIONAL SKATING UNION

NO CLAIM IS MADE TO THE EXCLUSIVE RIGHT TO USE "SKATING", APART FROM THE MARK AS SHOWN. SEC. 2(F).

CLASS 9—ELECTRICAL AND SCIENTIFIC APPARATUS

FOR PRE-RECORDED VIDEO TAPES AND AUDIO TAPES FEATURING THE SPORT OF SKATING; FILMS REGARDING THE SPORT OF SKATING (U.S. CLS. 21, 23, 26, 36 AND 38).

CLASS 16—PAPER GOODS AND PRINTED MATTER

FOR PRINTED MATTER, NAMELY, MAGAZINES, CATALOGUES, NOTE CARDS, POST CARDS, GIFT CARDS, POSTERS, MOUNTED AND UNMOUNTED PHOTOGRAPHS AND PICTURES, AND PERIODICALS IN THE NATURE OF BROCHURES, NEWSLETTERS, NEWSPAPERS AND BOOKS, ALL REGARDING THE SPORT OF SKATING (U.S. CLS. 2, 5, 22, 23, 29, 37, 38 AND 50).

CLASS 41—EDUCATION AND ENTERTAINMENT

FOR EDUCATIONAL SERVICES, NAMELY, ORGANIZING AND CONDUCTING WORKSHOPS, SEMINARS, CONFERENCES AND EXHIBITS REGARDING FIGURE AND SPEED SKATING; INSTRUCTION IN THE FIELD OF SKATING; PROVIDING FACILITIES FOR FIGURE AND SPEED SKATING COMPETITIONS AND SHOWS (U.S. CLS. 100, 101 AND 107).

CLASS 36—INSURANCE AND FINANCIAL

FOR PROVIDING MOTOR VEHICLE INFORMATION, CONSULTING SERVICES AND CUSTOMER-SPECIFIC INFORMATION MADE AVAILABLE THROUGH AUTOMOTIVE DEALERSHIPS IN THE FIELDS OF FINANCING INFORMATION, AND INSURANCE INFORMATION, AND PROVIDING MOTOR VEHICLE INFORMATION, CONSULTING SERVICES AND CUSTOMER-SPECIFIC INFORMATION MADE AVAILABLE THROUGH AUTOMOTIVE DEALERSHIPS NAMELY, ARRANGING FOR AND OBTAINING INSURANCE ESTIMATES, CONSULTING SERVICES AND CUSTOMER-SPECIFIC INFORMATION MADE AVAILABLE THROUGH AUTOMOTIVE DEALERSHIPS IN THE FIELDS OF VALUATION OF VEHICLES FOR TRADE-INS VIS A VIS SALES PRICE; PROVIDING INFORMATION, CONSULTING SERVICES AND CUSTOMER-SPECIFIC INFORMATION MADE AVAILABLE THROUGH AUTOMOTIVE DEALERSHIPS IN THE FIELDS OF OR WITH RESPECT TO BUYER PROTECTION PROGRAMS;

PROVIDING MOTOR VEHICLE INFORMATION, CONSULTING SERVICES AND CUSTOMER SPECIFIC INFORMATION MADE AVAILABLE THROUGH AUTOMOTIVE DEALERSHIPS IN THE FIELDS OF SERVICE CONTRACTS IN THE NATURE OF EXTENDED WARRANTIES; PROVIDING MOTOR VEHICLE INFORMATION, CONSULTING SERVICES AND CUSTOMER SPECIFIC INFORMATION MADE AVAILABLE THROUGH AUTOMOTIVE DEALERSHIPS IN THE NATURE OF ADVICE CONCERNING THE VALUATION OF VEHICLES FOR TRADE IN VIS A VIS SALES PRICE (U.S. CLS. 100, 101 AND 102).

CLASS 37—CONSTRUCTION AND REPAIR

FOR PROVIDING MOTOR VEHICLE INFORMATION, CONSULTING SERVICES AND CUSTOMER-SPECIFIC INFORMATION MADE AVAILABLE THROUGH AUTOMOTIVE DEALERSHIPS IN THE FIELDS OF REPAIRS, REPAIR INFORMATION, REGULAR SERVICING REMINDERS, MAINTENANCE INFORMATION, AND CLEANING AND DETAILING; PROVIDING MOTOR VEHICLE INFORMATION, CONSULTING SERVICES AND CUSTOMER SPECIFIC INFORMATION MADE AVAILABLE THROUGH AUTOMOTIVE DEALERSHIPS IN THE FIELD OF SERVICE CONTRACTS IN THE NATURE OF MAINTENANCE AGREEMENTS; PROVIDING MOTOR VEHICLE INFORMATION, CONSULTING SERVICES AND CUSTOMER-SPECIFIC INFORMATION MADE AVAILABLE THROUGH AUTOMOTIVE DEALERSHIPS IN THE FIELDS OF VEHICLE CLEANING AND WASHING; PROVIDING MOTOR VEHICLE INFORMATION, CONSULTING SERVICES AND CUSTOMER-SPECIFIC INFORMATION MADE AVAILABLE THROUGH AUTOMOTIVE DEALERSHIPS IN THE NATURE OF ADVICE CONCERNING MECHANICAL REPAIRS, MAINTENANCE, BODY REPAIRS, BUYER PROTECTION PROGRAMS, ODOMETER, ACCIDENT AND HISTORY MAINTENANCE, AND PROVIDING INFORMATION, CONSULTATION AND CUSTOMER-SPECIFIC INFORMATION MADE AVAILABLE THROUGH AUTOMOTIVE DEALERSHIPS IN THE FIELDS OF OR WITH RESPECT TO VEHICLE MAKE OR MODEL RECALL NOTICES, SAFETY AND RELIABILITY INFORMATION RATINGS (U.S. CLS. 100, 103 AND 106).

CLASS 39—TRANSPORTATION AND STORAGE

FOR PROVIDING INFORMATION, CONSULTING SERVICES AND CUSTOMER-SPECIFIC INFORMATION MADE AVAILABLE THROUGH AUTOMOTIVE DEALERSHIPS IN THE FIELD OF MOTOR VEHICLES, NAMELY, PROVIDING INFORMATION AND ARRANGING FOR TRANSPORTATION OF VEHICLES; DELIVERING VEHICLES TO CUSTOMERS FOR TEST DRIVES; LEASING OF VEHICLES; RENTAL OF VEHICLES; TRANSPORTATION OF PASSENGERS TO AIRPORTS BY MOTOR VEHICLES; LIMOUSINE SERVICES; VEHICLE FLEET MANAGEMENT SERVICES; AND PROVIDING MOTOR VEHICLE INFORMATION, CONSULTING SERVICES AND CUSTOMER-SPECIFIC INFORMATION MADE AVAILABLE THROUGH AUTOMOTIVE DEALERSHIPS IN THE FIELDS OF RENTAL INFORMATION AND LEASING INFORMATION (U.S. CLS. 100 AND 105).

CLASS 42—SCIENTIFIC, COMPUTER AND LEGAL SERVICES

FOR PROVIDING INFORMATION, CONSULTING SERVICES AND CUSTOMER-SPECIFIC INFORMATION MADE AVAILABLE THROUGH AUTOMOTIVE DEALERSHIPS IN THE FIELD OF MOTOR VEHICLES, NAMELY, PROVIDING INFORMATION, CONSULTATION AND CUSTOMER-SPECIFIC INFORMATION MADE AVAILABLE THROUGH AUTOMOTIVE DEALERSHIPS IN THE FIELDS OF VEHICLE INSPECTIONS AND EMISSIONS CONTROL INSPECTIONS; PROVIDING INFORMATION, CONSULTATION AND CUSTOMER-SPECIFIC INFORMATION MADE AVAILABLE THROUGH AUTOMOTIVE DEALERSHIPS IN THE FIELDS OF OR WITH RESPECT TO SELLING PREVIOUSLY OWNED VEHICLES, NAMELY, VEHICLE INSPECTIONS AND CONSULTATION SERVICES AND WITH RESPECT TO CHECKING AND COMPLETING MAKE OR MODEL RECALL NOTICES; AND PROVIDING INFORMATION, CONSULTATION AND CUSTOMER-SPECIFIC INFORMATION MADE AVAILABLE THROUGH AUTOMOTIVE DEALERSHIPS IN THE FIELDS OF OR WITH RESPECT TO VEHICLE PARTS, EQUIPMENT, OR ACCESSORIES (U.S. CLS. 100 AND 101).

SN 75-676,523. DECISIONONE CORPORATION, FRAZER, PA. FILED 4-7-1999.

AllianceOne

CLASS 35—ADVERTISING AND BUSINESS

FOR BUSINESS SERVICES, NAMELY, OFFERING MANAGEMENT, ANALYSIS AND AUDIT OF COMPUTER AND NETWORK PROJECTS; CONSULTING SERVICES ON COMPUTERIZED INVENTORY TRACKING SERVICES; INVENTORY MANAGEMENT AND TRACKING AND WARRANTY MANAGEMENT (U.S. CLS. 100, 101 AND 102).

CLASS 37—CONSTRUCTION AND REPAIR

FOR INSTALLATION, MAINTENANCE, REPAIR AND REFURBISHMENT OF HARDWARE, PERIPHERALS, ASSEMBLIES AND PARTS THEREFOR, AND COMPUTER NETWORKS (U.S. CLS. 100, 103 AND 106).

CLASS 42—SCIENTIFIC, COMPUTER AND LEGAL SERVICES

FOR PROVIDING COMPUTER CONSULTATION SERVICES, NAMELY, COMPUTER DIAGNOSTIC SERVICE AND COMPUTER PERFORMANCE MONITORING SERVICES TO USERS OF COMPUTER HARDWARE AND PERIPHERALS, COMPUTER NETWORKS AND COMPUTER SOFTWARE; CONSULTING SERVICES ON THE SELECTION, ACQUISITION, INSTALLATION, DEINSTALLATION, UPGRADE AND RECONFIGURATION OF COMPUTER HARDWARE AND PERIPHERALS, COMPUTER NETWORKS, COMPUTER SOFTWARE AND ON DATA RESTORATION AND COMPUTER DISASTER RECOVERY; AND, INSTALLATION, MAINTENANCE, REPAIR AND REFURBISHMENT OF COMPUTER SOFTWARE (U.S. CLS. 100 AND 101).

SN 75-694,486. THYSSEN KRUPP AG, 40211 DUSSELDORF, FED REP GERMANY, FILED 4-29-1999.

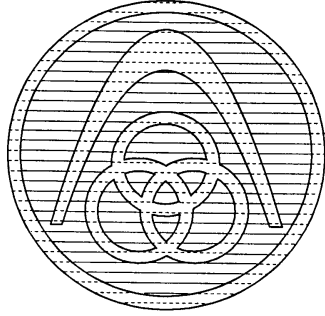

PRIORITY CLAIMED UNDER SEC. 44(D) ON FED REP GERMANY APPLICATION NO. 39862306.6, FILED 10-29-1998, REG. NO. 39862306, DATED 9-16-1999, EXPIRES 10-31-2008.

THE DRAWING IS LINED FOR THE COLORS GREY AND BLUE AND COLOR IS CLAIMED AS A FEATURE OF THE MARK.

CLASS 1—CHEMICALS

FOR CHEMICALS AND CHEMICAL ADDITIVES FOR USE IN THE PRODUCTION OF METALS AND ALLOYS OF THE SAME; SAND FOR FOUNDRIES AND; METALLURGICAL WORKS, METALLURGICAL SLAG AND SLAG LIME; SOLDERING CHEMICALS, SOLDERING FLUX; GASES FOR WELDING; TEMPERING CHEMICALS FOR USE IN METALWORKING; FIRE EXTINGUISHING COMPOSITIONS; PLASTIC MOLDING COMPOUNDS FOR USE IN INSULATING AND FORMING SEALS IN DOORS, WINDOWS, AUTOMOBILES, AND TRUCKS; PLASTIC MOLDING COMPOUNDS FOR USE IN THE MANUFACTURE OF MOLDED AUTOMOTIVE COMPONENTS (U.S. CLS. 1, 5, 6, 10, 26 AND 46).

CLASS 4—LUBRICANTS AND FUELS

FOR INDUSTRIAL OILS AND GREASES; INDUSTRIAL LUBRICANTS; PETROLEUM BASE DUST ABSORBING COMPOSITIONS FOR USE IN STEEL PRODUCTION; WETTING AND BINDING COMPOSITIONS FOR USE IN STEEL PRODUCTION; FUEL FOR AUTOMOBILES; COMBUSTIBLES, NAMELY KEROSENE, KINDLING, LAMP OIL, LIGHTER FLUID (U.S. CLS. 1, 6 AND 15).

CLASS 6—METAL GOODS

FOR COMMON CRUDE METALS, NAMELY, IRON, NICKEL AND TITANIUM; PARTIALLY PROCESSED METALS AND METAL ALLOYS USED FOR FURTHER MANUFACTURING; ALLOYS USED FOR CASTING, METAL CLADDING FOR CONSTRUCTION AND BUILDING; METAL BUILDING FLASHING; TRANSPORTABLE BUILDINGS OF METAL; MATERIALS OF METAL FOR RAILWAY TRACKS; NON-ELECTRIC CABLES, METAL CABLE WIRE; WIRE MESHING AND OTHER WIRE PRODUCTS, METAL HARDWARE, NAMELY NUTS AND SPRINGS; METAL PIPES AND FITTINGS THEREFOR; METAL ORES, NAMELY, PERMANENTLY MAGNETIC RAW MATERIALS FOR USE IN THE METAL-PRODUCING, RAILWAY AND AUTOMOTIVE INDUSTRIES, VACUUM INSULATED FLAT ELEMENTS IN STEEL AND ALUMINUM; METAL WIRES ENCASED IN PLASTIC (U.S. CLS. 2, 12, 13, 14, 23, 25 AND 50).

CLASS 7—MACHINERY

FOR METAL WORKING MACHINES, NAMELY, MACHINING CENTERS FOR THE METAL-PRODUCING INDUSTRY, BALANCING CRANK SHAFT MACHINES, ROD ALIGNMENT CONNECTOR MACHINES; MACHINE TOOLS AND PARTS THEREFORE, NAMELY ROLLING MILLS, STRAIGHTENING AND BENDING MACHINES, INDUSTRIAL MACHINE PRESSES AND PARTS THEREFORE, FORGING MACHINES, NAMELY, FORGE BELLOWS, CRUSHERS AND MILLING MACHINES, ROTARY AND SUCTION PUMPS, COMPRESSORS FOR MACHINES, CONCRETE MIXERS AND PARTS THEREFORE, PLASTICS PROCESSING MACHINES, INJECTION MOLDING MACHINES; PACKING MACHINES, NAMELY MACHINES FOR MANUFACTURING AND DISPENSING PACKING MATERIAL; DRILLING MACHINES; ELECTRIC MOTORS FOR MACHINES, MOTORS FOR BOATS, TRACK-BORN VEHICLES AND AIRPLANES AND PARTS THEREFORE, NAMELY, ROCKER ARM BEARING BRACKETS, COMPACT HOLDERS, CRANKSHAFTS, ENGINE CRADLES, OIL AND WATER PUMP HOUSINGS, OIL PANS, FLY-WHEELS, TIMING CASES, INTERMEDIATE HOUSINGS, CYLINDER BLOCKS, VALVE COVERS, CRANKSHAFT PULLEYS SPROCKETS, NOZZLE HOLDERS, CAM RINGS, ROTORS, CAMSHAFT ADJUSTERS; ENGINES FOR BOATS, TRACK-BORN VEHICLES AND AIRPLANES AND PARTS THEREFORE, NAMELY, FLUID INJECTORS, FUEL INJECTORS, FUEL PUMPS FOR AUTOMOBILES, TRUCKS AND TRACK-BORN VEHICLES, STARTING FLUID INJECTORS, CIRCULATING PUMPS AND STRUCTURAL PARTS FOR VEHICULAR ENGINES; TRANSMISSIONS FOR BOATS, TRACK-BORN VEHICLES AND AIRPLANES, MACHINES FOR MANUFACTURING VEHICLE BODIES FOR AUTOMOBILES, TRUCKS AND AIRPLANES; DRIVES OTHER THAN FOR LAND VEHICLES; ELECTRIC WELDING MACHINES; GAS-OPERATED SOLDERING IRONS (U.S. CLS. 13, 19, 21, 23, 31, 34 AND 35).

CLASS 9—ELECTRICAL AND SCIENTIFIC APPARATUS

FOR APPARATUS AND INSTRUMENTS FOR SCIENTIFIC, ELECTRIC, SURVEYING, CINEMATOGRAPHIC, OPTICAL, WEIGHING, MEASURING, AND SIGNALING, NAMELY, STOCK OF MAGNETIC LAMINATIONS AND 3-PHASE CABLE COILS; ELECTRICAL CABLES; ELECTRODES FOR SPARK EROSION; NEUTRON TUBE, DETECTOR UNIT, MODERATORS, RADIATION SHIELD, HIGH VOLTAGE SUPPLY FOR NEUTRON TUBES AND EVALUATION ELECTRONICS; COMPUTER NUMERIC CONTROLS (CNC) AND SOFTWARE FOR MEASURING, CONTROLLING AND MONITORING AUTOMATED MACHINERY; INDUSTRIAL ROBOTS; LEAK TESTERS; PHOTOVOLTAIC CELLS; EQUIPMENT FOR RECORDING, TRANSMITTING, PROCESSING, REPRODUCING AND DISPLAYING IMAGES, SOUND AND DATA, NAMELY, BLANK MAGNETIC COMPUTER, AUDIO AND DIGITAL TAPES, BLANK DISKS FOR COMPUTERS; COMPUTERS; ELECTRICAL COMPONENTS, NAMELY WIRES, SWITCHES, SEMICONDUCTORS, INTEGRATED CIRCUITS AND INSULATED ELECTRICAL CONNECTORS; TRACK COMPONENTS OF MAGNETIC CUSHION RAILWAYS, NAMELY TRACKS, SWITCHES, CABLES; SUPPORTS AND CONNECTORS; ELECTRICAL WELDING EQUIPMENT, NAMELY ELECTRIC ARC WELDERS AND WELDING ELECTRODES; ELECTRICAL WIRES AND ELECTRICAL CABLES; FIRE EXTINGUISHERS (U.S. CLS. 21, 23, 26, 36 AND 38).

CLASS 11—ENVIRONMENTAL CONTROL APPARATUS

FOR ELECTRIC LIGHTING FIXTURES; ELECTRIC HEATERS FOR COMMERCIAL AND INDUSTRIAL USE; HEATING SYSTEMS, CONSISTING OF COKE OVEN BATTERIES, HEAT EXCHANGERS, DRYERS AND SOLAR COLLECTORS AND PANELS; HEATERS FOR VEHICLES; STEAM-GENERATORS; EVAPORATIVE AIR-COOLING UNITS AND PARTS THEREFOR FOR DOMESTIC, COMMERCIAL AND INDUSTRIAL USE; VENTILATING FANS FOR DOMESTIC, COMMERCIAL AND INDUSTRIAL USE; WATER PIPING SYSTEMS CONSISTING OF TUBES, HOSES, VACUUMS, FILTERS AND PARTS THEREFOR, FURNACES AND BOILERS FOR INDUSTRIAL AND COMMERCIAL USE (U.S. CLS. 13, 21, 23, 31 AND 34).

CLASS 12—VEHICLES

FOR AUTOMOBILES, TRUCKS, AND BUSES AND STRUCTURAL PARTS THEREFOR, NAMELY, SHOCK ABSORBERS, COIL SPRINGS IN CYLINDRICAL, BARREL AND CONICAL FORM, TORSION BARS, LEAF AND TAPERED LEAF SPRINGS, PARABOLIC CONTROL ARMS, HOT AND COLD FORMED STABILIZERS, WELDED STABILIZERS, AXLE GUIDES, STEERING SHAFTS, STEERING COLUMNS, DECOUPLERS, TUBE AND DISK ISOLATORS, ELECTRICAL POWER-ASSISTED STEERING SHAFTS AND COLUMNS, CAM-SHAFTS, UNIVERSAL-JOINT CROSS-PINS, YOKES, SHAFTS, CAMS, LATERALLY EXTRUDED COLD FORGINGS, STEERING JOINT SPIDERS, TRIPODS, TRISPHERES, BALL HUBS, PINION GEARS, PROFILE SHAFTS, SPUR GEARS, HELICAL GEARS, BEVEL AND DIFFERENTIAL GEARS, MACHINE COUPLING AND TRANSMISSION COMPONENTS, CIRCULATING PUMPS, ELECTRIC DIP STICK HEATERS, ELECTRIC HEADBOLT HEATERS, ELECTRIC FROST PLUG HEATERS, ELECTRIC EXTERNAL TANK HEATERS, ELECTRIC OIL PAN HEATERS, ELECTRIC DIESEL ENGINE BLOCK HEATERS, ELECTRIC BATTERY WARMERS, ELECTRIC RADIATOR HOSE HEATERS, ELECTRIC INTERIOR CAB WARMERS, DIESEL FUEL POWERED ENGINE AND CAB HEATERS, DOOM, CHASSIS, FRAME MEMBERS QUARTER PANELS, HOODS, FLOOR PANS, APERTURE PANELS, FENDERS, DECK LIDS, LIFT GATES, ROOFS, TRAILING AXES, ASSEMBLY FRAMES, EXHAUST MANIFOLDS FOR ENGINES, EXHAUST SILENCERS FOR INTERNAL COMBUSTION ENGINES INCLUDING INDUSTRIAL GAS AND DIESEL ENGINES, BRAKE HARDWARE, BRAKES, CAB SUSPENSION ROCKERS, COUPLING JAWS, STEERING KNUCKLES FOR TRUCK FRONT, AXLES AND TRAILER AXLES, FRAMES, COUPLING JAW CROSS MEMBERS, STAMPED SIDE MEMBERS FOR LIGHT/HEAVY TRUCKS, ROLL-FORMED SIDE MEMBERS, CROSS MEMBERS, FRAME EXTENSIONS, FRAME HEAD PARTS; POWER TRAIN FOR AUTOMOBILES, NAMELY, BEVEL GEAR SETS, DIFFERENT BEVEL GEARS, BEVEL GEARS, SYNCHRONIZER, SYNCHRONIZER RINGS AND CONES, STUB AXLES, BRAKE SUPPORTS, HUBS, CONNECTING RODS, SEGMENTS, SHAFTS, SPRING BRACKETS, WHEEL HUBS, STEERING KNUCKLES, COVERS FOR DIFFERENTIAL CASES, HUBS FOR SHAFT BRAKE DISKS; STUB AXLES, WHEEL HUBS, STUB SHAFTS, GEAR BLANKS, GEARS, TRANSMISSION SHAFTS FOR MANUAL AND AUTOMATIC TRANSMISSIONS, SPLINED SHAFTS, STEERING PINIONS, DIFFERENTIAL PARTS, BRAKE BAND DRUMS FOR AUTOMATIC TRANSMISSIONS, TRANSMISSION COVERS, TRANSMISSION HOUSINGS, CLUTCH PARTS, STATORS FOR TORQUE CONVERTERS, CENTER SUPPORTS FOR AUTOMATIC TRANSMISSIONS, PLANET CARRIERS, SHIFT FORKS FOR MANUAL TRANSMISSIONS, VALVE HOUSINGS FOR AUTOMATIC TRANSMISSIONS, TIMING CASES FOR AUTOMATIC TRANSMISSIONS, SEALING FLANGES, HOUSING FOR ENGINE CONTROL UNITS, HOUSINGS, HOUSING COVERS, COOLING ELEMENTS, STEERING GEAR AND ENGINE HOUSINGS, RADIATOR FAN COWLS, AXLE CASINGS, AXLE PARTS, CROSS MEMBERS, TRAILING ARMS, SUBFRAMES, CONTROL ARMS, WHEEL KNUCKLES, SEMI-TRAILING ARMS, CROSS MEMBERS AND TIE RODS, TWIST BEAM AXLES, FRONT AXLE MODULE, AXLE BRACKETS, BRAKE DRUMS, SUSPENSION BRACKETS, REAR AXLE HOUSINGS, REAR AXLES, SIDE MEMBERS,

CROSS MEMBERS, TORQUE ARMS, FRONT AXLES, ACTUATORS FOR TRUCK BRAKES, PROTOTYPE FRAMES AND FRAME PARTS, PROTOTYPE STAMPED CHASSIS PARTS, PROTOTYPE CAST CHASSIS PARTS, PROTOTYPE BODY PARTS, PEDAL BRACKETS, ENGINE HOODS, DOOR INNER AND OUTER PANELS, DOOR ASSEMBLIES, LIFTGATE ASSEMBLIES, HOOD ASSEMBLIES, A-PILLAR PANELS, ROOF PANELS, FENDERS, SIDE PANELS, HEAT SHIELDS, PILLARS, BUMPERS, BRACES, DASH PANELS, FLOOR PANELS, PILLAR REINFORCEMENTS, SIDE INTRUSION BEAMS, AIR SUSPENSION SYSTEMS, FRAMES, AXLE PANS, AXLE ASSEMBLIES, TRACK SIDE RAILS, SHOCK ABSORBERS, CAR JACKS, SPRINGS AND STABILIZER GEARS, DOORS, CLOSURE, HOODS; BOATS AND STRUCTURAL PARTS THEREFOR; AIRPLANES AND STRUCTURAL PARTS THEREFOR, NAMELY, JET ENGINES AND PARTS THEREFOR, JET ENGINE BLADES, JET ENGINE DISKS, TURBINE PARTS; TRACK-BORNE VEHICLES, MOBILE CRANES AND FORKLIFTS AND STRUCTURAL PARTS THEREFOR, NAMELY, HYDRAULIC JAW-TYPE RETARDERS, RUBBER RETARDERS, GRADE RETARDERS, PISTON RETARDERS, SMALL RETARDERS, CENTRAL OIL-HYDRAULIC SUPPLY UNITS, TUBE DUCTS AND TUBING, SIDE MEMBERS FOR TRACTORS; AERIAL CABLE CARS AND STRUCTURAL PARTS THEREFOR, FINISHED PLASTIC COMPONENTS FOR CABLE CARS AND SKI LIFTS; MOTORS FOR AUTOMOBILES, TRUCKS; ENGINES FOR AUTOMOBILES, TRUCKS; TRANSMISSIONS FOR AUTOMOBILES, TRUCKS (U.S. CLS. 19, 21, 23, 31, 35 AND 44).

CLASS 16—PAPER GOODS AND PRINTED MATTER

FOR PAPER, CARDBOARD AND PACKAGING MATERIALS IN PAPER AND CARDBOARD AND PLASTIC, NAMELY CARDBOARD BOXES, PAPER BAGS FOR PACKAGING; PRINTING PRODUCTS, NAMELY PRINTING BLOCKS AND PRINTING TYPE (U.S. CLS. 2, 5, 22, 23, 29, 37, 38 AND 50).

CLASS 17—RUBBER GOODS

FOR RUBBER, GUTTA-PERCHA, GUM, ASBESTOS IN EXTRUDED FORM FOR USE IN MANUFACTURE, AND GOODS MADE FROM THESE MATERIALS, NAMELY RINGS OF RUBBER FOR USE AS PIPE CONNECTION SEALS RUBBER SHOCK ABSORBERS FOR INDUSTRIAL MACHINERY MICA FOR USE AS A FITTER IN PLASTICS, IN THE MANUFACTURE OF ELECTRONIC INSTRUMENTS; PLASTIC IN EXTRUDED FORM FOR USE IN MANUFACTURE; PACKAGING MATERIAL FOR FORMING SEALS, NAMELY CELLULOSE ACETATE, ADHESIVE TAPE, BANDS, PLASTIC TAPE, DUCT TAPE, RUBBER SEALANT, FILM; PLASTIC PACKING FOR SHIPPING CONTAINERS; FIBERGLASS INSULATION; GLASS FIBER WITH CARBON FIBER REINFORCED PLASTIC STOPPING COMPONENTS FOR USE IN CONSTRUCTION; PLASTIC PIPES FOR PLUMBING PURPOSES (U.S. CLS. 1, 5, 12, 13, 35 AND 50).

CLASS 19—NON-METALLIC BUILDING MATERIALS

FOR NON-METAL BUILDING FLASHING; NON-METAL BUILDING MATERIALS, NAMELY NON-AGRICULTURAL LIME, SAND, BRICK, BITUMEN ASPHALT, AND CEMENT; TAR-BASED SEALANTS FOR ROOFING, PITCH; PREFABRICATED NON-METAL BUILDINGS, PORTABLE NON-METAL BUILDINGS (U.S. CLS. 1, 12, 33 AND 50).

CLASS 37—CONSTRUCTION AND REPAIR

FOR BUILDING CONSTRUCTION; INSTALLATION OF COKE AND COAL BY-PRODUCT PLANTS, PLANTS FOR TREATING COAL, COKE AND COKE FURNACE GAS AND PLANTS FOR THERMAL TREATMENT OF RESIDUAL MATERIALS; CONSTRUCTION ENGINEERING; CIVIL ENGINEERING; INDUSTRIAL FURNACE CONSTRUCTION, INSTALLATION, MAINTENANCE AND REPAIR WORK, IN PARTICULAR FOR COKE AND COAL BY-PRODUCT PLANTS, PLANTS FOR TREATING COAL, COKE AND COKE FURNACE GAS AND PLANTS FOR THERMAL TREATMENT OF RESIDUAL MATERIALS (U.S. CLS. 100, 103 AND 106).

CLASS 39—TRANSPORTATION AND STORAGE

FOR TRANSPORT BY BOAT, RAIL AND AIR AND TRUCK; PACKAGING ARTICLES FOR TRANSPORTATION; WAREHOUSE STORAGE, STORAGE OF GOODS (U.S. CLS. 100 AND 105).

CLASS 42—SCIENTIFIC, COMPUTER AND LEGAL SERVICES

FOR TRAVEL ARRANGEMENT SERVICES, NAMELY MAKING RESERVATIONS AND BOOKING FOR TEMPORARY LODGING (U.S. CLS. 100 AND 101).

SN 75-710,826. WING WAH FOOD MANUFACTORY LTD., YUEN LONG, HONG KONG, FILED 5-20-1999.



PRIORITY CLAIMED UNDER SEC. 44(D) ON CANADA APPLICATION NO. 1,003,552, FILED 1-29-1999, REG. NO. 559860, DATED 4-3-2002, EXPIRES 4-3-2017.

NO CLAIM IS MADE TO THE EXCLUSIVE RIGHT TO USE "1950", APART FROM THE MARK AS SHOWN.

THE TRANSLITERATION OF THE CHINESE CHARACTERS IS "RONG HUA" AND THE ENGLISH TRANSLATION OF "RONG HUA" IS "FAME". THE ENGLISH TRANSLATION OF "WING WAH" IS "PROSPERITY".

CLASS 29—MEATS AND PROCESSED FOODS

FOR (BASED ON 44(E)) BEAN CURD; DRIED AND FROZEN BEAN CURD; CURED SAUSAGES; CURED PORK BELLY; CURED DUCK, MARINATED FISH AND OTHER CURED MEATS; (BASED ON INTENT TO USE) PROCESSED SOY BEANS (U.S. CL. 46).

CLASS 30—STAPLE FOODS

FOR (BASED ON 44(E)) CAKES, COOKIES, EGG ROLLS, PHOENIX ROLLS, TEAS, SAUCES, AND MOON-CAKES; (BASED ON INTENT TO USE) RICE (U.S. CL. 46).

SN 75-763,657. KABUSHIKI KAISHA SONY COMPUTER ENTERTAINMENT, TA SONY COMPUTER ENTERTAINMENT INC., TOKYO, 107-0052, JAPAN, FILED 7-29-1999.



OWNER OF JAPAN REG. NO. 4352010, DATED 1-14-2000, EXPIRES 1-14-2010.

CLASS 9—ELECTRICAL AND SCIENTIFIC APPARATUS

FOR LABORATORY APPARATUS AND INSTRUMENTS, NAMELY, CENTRIFUGES; LASERS FOR MEASURING PURPOSE; ELECTRICAL POWER CONTROLLERS; ELECTRIC ROTARY INVERTORS; PHASE MODIFIERS; FUEL CELLS, PHOTOVOLTAIC CELLS; ELECTRIC METERS, GAS METERS; ELECTRONIC TESTER FOR QUARTZ WATCHES AND MECHANIC WATCHES FOR MEASURING THE ACCURACY THEREOF; ELECTRIC WIRES AND CABLES; PHOTOGRAPHIC APPARATUS AND INSTRUMENTS, NAMELY, PHOTOGRAPHIC CAMERAS, PHOTOGRAPHIC PROJECTORS, AND PHOTOGRAPHIC SLIDE TRANSPARENCIES; CINEMATOGRAPHIC APPARATUS AND INSTRUMENTS, NAMELY, MOTION PICTURE CAMERAS AND VIDEO RECORDERS; OPTICAL APPARATUS AND INSTRUMENTS, NAMELY, OPTICAL INSPECTION APPARATUS FOR INDUSTRIAL USE, OPTICAL LENS SIGHTS, OPTICAL MIRRORS, AND CONTACT LENSES; GLASS TUBES FOR SCIENTIFIC PURPOSES, EYEGLASS LENSES, LIFE BELTS, LIFE JACKETS, LIFE PRESERVERS; TELEPHONE ANSWERING MACHINES, TELEPHONES; PHONOGRAPH RECORDS FEATURING MUSIC; METRONOMES; CALCULATORS; ELECTRONIC PERSONAL ORGANIZERS; ELECTROLYSERS, NAMELY, ELECTRIC SWITCH PLATES, WELDING ELECTRODES, AND ELECTROMAGNETIC COILS, ELECTROLYSERS FOR PURIFICATION OF WATER; SLOT MACHINES; SPORTS TRAINING SIMULATORS; VEHICLE DRIVING TRAINING SIMULATORS; ELECTRIC IRONS FOR HOUSEHOLD USE; ELECTRIC HAIR CURLERS FOR HOUSEHOLD USE; ELECTRIC BUZZERS FOR HOUSEHOLD USE, NAMELY, ELECTRIC DOOR BELLS; VEHICLE BREAKDOWN WARNING TRIANGLES; ELECTRIC AND LUMINOUS ROADS SIGNS; RAILWAY SIGNALS; FIRE ALARMS; THEFT ALARMS; GLOVES FOR PROTECTION AGAINST ACCIDENTS; FIRE EXTINGUISHERS; FIRE HOSE NOZZLES; SPRINKLERS SYSTEMS FOR FIRE PROTECTION; FIRE BOATS; FIRE ENGINES; ELECTRIC CIGARETTE LIGHTERS FOR AUTOMOBILES; PROTECTIVE HELMETS; PROTECTIVE CLOTHING AGAINST FIRE; DUST MASKS; GAS MASKS; WELDING MASKS; MAGNETIC CORES; ELECTRICAL WIRES, NAMELY, RESISTANCE WIRES; WELDING ELECTRODES; EXPOSED CINEMATOGRAPHIC FILMS; EXPOSED SLIDE FILMS AND PHOTOGRAPHIC SLIDE TRANSPARENCIES; SLIDE FILM MOUNTS; METERED GASOLINE PUMPS FOR SERVICE STATION USE; VENDING MACHINES; COIN OPERATED GATE FOR CAR PARKS OR PARKING LOTS; CASH REGISTERS; COIN COUNTING AND/OR SORTING MACHINES; PHOTOCOPYING MACHINE; MANUAL OPERATED COMPUTING APPARATUS, NAMELY, CALCULATORS; TIME STAMPING MACHINES; TIME RECORDERS; COMPUTERS; PUNCHED CARD OFFICE MACHINES; VOTING MACHINES; BILLING MACHINES; SLIDE RULES; WEIGHT BELTS FOR DIVING; DIVING SUITS; REGULATORS FOR DIVING; MELT CUTTING MACHINES FOR METAL WORKS; MAGNETIC DISKS, OPTICAL DISKS AND MAGNETIC OPTICAL DISKS ENCODING INFORMATION OF PORTRAITS AND CHARACTERS OF MAGAZINES, BOOKS, NEWSPAPERS, MAPS AND PICTURES; ELECTRIC CIRCUIT, VIDEO GAME SOFTWARE RECORDED ON MAGNETIC DISKS, OPTICAL DISKS, MAGNETIC OPTICAL DISKS, CD-ROMS AND MAGNETIC TAPES; CONTROLLERS,

MEMORY CARDS, COMPUTER MOUSE; MEASURING AND SCIENTIFIC EQUIPMENT, NAMELY, EGG-CANDLERS; ELECTRIC DOOR OPENERS; DIGITAL VERSATILE DISC RECORDER; DIGITAL VERSATILE COMPACT DISC VIDEO PLAYERS; ROM CARTRIDGE ENCODING PROGRAMS FOR ELECTRONIC VIDEO GAMES (U.S. CLS. 21, 23, 26, 36 AND 38).

CLASS 14—JEWELRY

FOR GOLD ALLOY INGOTS; SILVER ALLOY INGOTS; PLATINUM ALLOY; TABLE WARE, NAMELY, DISHES AND PLATES OF PRECIOUS METAL; DRINKING CUPS OF PRECIOUS METAL; TEAPOTS OF PRECIOUS METAL; NUT CRACKERS OF PRECIOUS METAL; PEPPER POTS OF PRECIOUS METAL; SUGAR BOWLS OF PRECIOUS METAL; SALT SHAKERS OF PRECIOUS METAL; EGG CUPS OF PRECIOUS METAL; NAPKIN HOLDERS OF PRECIOUS METAL; NAPKIN RINGS OF PRECIOUS METAL; SERVING TRAYS OF PRECIOUS METAL; TOOTHPICK HOLDERS OF PRECIOUS METAL; FLOWER VASES AND FLOWER BOWLS OF PRECIOUS METAL; BOXES OF PRECIOUS METAL FOR NEEDLES; JEWEL CASES OF PRECIOUS METAL; CANDLE EXTINGUISHERS AND CANDLESTICKS OF PRECIOUS METAL; POUCHES AND PURSES OF PRECIOUS METAL; SHOE ORNAMENTS OF PRECIOUS METAL; COMPACTS OF PRECIOUS METAL; SMOKERS' ARTICLES OF PRECIOUS METAL, NAMELY, ASH TRAY, CIGAR AND CIGARETTE CASES, AND SNUFF BOXES; TRINKETS OTHER THAN CUFF LINKS; SEMI-WROUGHT PRECIOUS STONES AND THEIR IMITATIONS; ROUGH PRECIOUS STONES; CLOCKS AND WATCHES; PRECIOUS METAL TROPHIES; COMMEMORATIVE SHIELDS OF PRECIOUS METAL; KEY HOLDERS OF PRECIOUS METAL (U.S. CLS. 2, 27, 28 AND 50).

CLASS 16—PAPER GOODS AND PRINTED MATTER

FOR PRINTING PAPER; NEWSPRINT PAPERS; PACKAGING CONTAINERS OF PAPER; FOOD WRAPPING FILM OF PLASTIC FOR HOUSEHOLD USE; GARBAGE BAGS OF PAPER FOR HOUSEHOLD USE; GARBAGE BAGS OF PLASTICS FOR HOUSEHOLD USE; HYGIENIC PAPER, NAMELY, TOILET PAPER; TOWELS OF PAPER; HANDKERCHIEFS OF PAPER; TABLE CLOTHS OF PAPER; BLINDS OF PAPER; PAPER BANNERS; DISPOSABLE DIAPERS; FLAGS OF PAPER; PAPER BAGGAGE TAGS; PICTURE POSTCARDS; MAGAZINES; NEWSPAPERS; DIARIES; CALLIGRAPHY AND PAINTINGS; MOUNTED PHOTOGRAPHS; UNMOUNTED PHOTOGRAPHS; PHOTOGRAPH STANDS; KARUTA CARDS; JAPANESE PLAYING CARDS; UTAGARUTA CARDS, JAPANESE PLAYING CARDS OF VERSES; PLAYING CARDS; HANAFUDA CARDS, JAPANESE PLAYING CARDS ILLUSTRATED WITH FLOWERS AND/OR ANIMALS; STATIONERY NOT INCLUDING INSECT COLLECTING IMPLEMENTS; PASTES AND SYNTHETIC ADHESIVES FOR STATIONERY OR HOUSEHOLD PURPOSES; BLUEPRINTING MACHINES; ADDRESSING MACHINES; INKING RIBBONS OR TYPEWRITER RIBBONS; HECTOGRAPH DUPLICATING MACHINES; AUTOMATIC STAMP APPLYING MACHINES; PAPER STAPLERS; ENVELOPING SEALING MACHINES FOR OFFICES; STAMP CANCELLING MACHINES; DRAWING INSTRUMENTS; TYPEWRITERS; CHECKWRITERS; MIMEOGRAPHS; LETTER PRESS DUPLICATING MACHINES; PAPER SHREDDERS; POSTAL FRANKERS; ROTARY DUPLICATORS; PRINTING TYPES; DECORATORS' PAINT-BRUSHES; SEALING WAX; MARKING TEMPLATES; INDOOR AQUARIUM AND AQUARIUM COVERS (U.S. CLS. 2, 5, 22, 23, 29, 37, 38 AND 50).

CLASS 18—LEATHER GOODS

FOR ANIMAL SKIN; LEATHER SOLD IN BULK; FUR PELTS; LEATHER STRAPS FOR BAGS, LEATHER THONGS, LEATHER LEASHES FOR ANIMALS; OVERNIGHT BAGS, BOSTON BAGS, DRAWSTRING POUCHES; VANITY CASES SOLD EMPTY; PURSE CLASPS; UMBRELLAS; PARASOLS AND THEIR PARTS; WALKING STICKS; CANES; METAL CANE FITTING; WALKING STICK OR CANE HANDLES; SADDLERY; WEAR FOR HOUSEHOLD PETS (U.S. CLS. 1, 2, 3, 22 AND 41).

CLASS 25—CLOTHING

FOR NON-JAPANESE STYLE OUTERWEAR, NAMELY OVERCOATS, RAINCOATS, DRESSES, JACKETS, SUITS AND TROUSERS; SHIRTS AND BLOUSES; NIGHTWEAR; UNDERWEAR; BATHING CAPS; SWIM WEAR; JAPANESE TRADITIONAL CLOTHING NAMELY KIMONOS; APRONS; COLLAR PROTECTORS; SOCKS AND STOCKINGS; GAITERS; FUR STOLE; SHAWLS; SCARVES; TABI, JAPANESE STYLE SOCKS; TABI COVERS; GLOVES AND MITTENS; INFANT CLOTH DIAPERS; NECKTIES; NECKERCHIEVES; MUFFLERS; EAR MUFFS; HOODS; SUGE-GASA, JAPANESE STYLE SEDGE HATS; NIGHTCAPS; HATS AND CAPS; GARTERS; GARTER BELTS; SUSPENDERS; WAISTBANDS; BELTS; SHOES AND BOOTS; JAPANESE STYLE SANDALS; MASQUERADE COSTUMES; SPECIAL SPORTING WEAR, NAMELY, SPORTS SHIRTS, SPORTS JACKETS, SHORTS AND SPORTS SUITS; SPECIAL SPORTING FOOTWEAR NAMELY ATHLETIC FOOTWEAR, SKI-BOOTS, GOLF SHOES AND BASEBALL SHOES, EXCLUDING HORSE-RIDING BOOTS (U.S. CLS. 22 AND 39).

CLASS 28—TOYS AND SPORTING GOODS

FOR HAND-HELD ELECTRONIC UNITS FOR PLAYING ELECTRONIC GAMES; HAND-HELD UNIT FOR PLAYING ELECTRONIC VIDEO GAMES; EARPHONE FOR ELECTRONIC VIDEO GAMES; EARPHONE CONNECTED TO GAMES WITH LIQUID CRYSTAL; STAND ALONE GAME MACHINES; ELECTRICALLY-DRIVEN TOYS; STUFFED TOYS; BILLIARD GAME PLAYING EQUIPMENT; GO GAME, A JAPANESE BOARD GAME; SHOGI, JAPANESE CHESS; DICE; SUGOROKU GAMES; OR JAPANESE PARCHEESI; DICE CUPS; DIAMOND GAMES; CHESS GAMES; CHECKERS; MAGIC TRICKS; DOMINOES; MAHJONG GAMES; DOLLS; TOYS FOR DOMESTIC PETS; BASEBALL GLOVES; RACKETS FOR TENNIS; GOLF CLUBS; SKIS; GYMNAS TIC APPARATUS; WAX FOR SKIS; FISHING TACKLE (U.S. CLS. 22, 23, 38 AND 50).

SN 75-788,109. GENOVISION AS, 0486 OSLO, NORWAY, FILED 8-30-1999.

GENOPREP

PRIORITY CLAIMED UNDER SEC. 44(D) ON NORWAY APPLICATION NO. 199902732, FILED 3-3-1999, REG. NO. 206067, DATED 12-13-2000, EXPIRES 12-13-2010.

CLASS 1—CHEMICALS

FOR CHEMICAL REAGENTS FOR MANUAL AND AUTOMATED USE IN DNA SEQUENCING, CYTOKINE GENOTYPING, DNA ISOLATION FROM BLOOD SAMPLES, MITOCHONDRIA SPECIFIC GENE AMPLIFICATIONS, DNA ISOLATION FROM BUCCAL CELLS AND DNA ISOLATION FROM TISSUE SECTIONS; CHEMICAL REAGENTS FOR MANUAL AND AUTOMATED USE IN RNA ISOLATION FROM SERUM AND BLOOD PLASMA; CULTURED CELLS, HUMAN TISSUE, ANIMAL TISSUE, PLANT TISSUE AND YEAST CELLS; CHEMICAL REAGENTS FOR MANUAL AND AUTOMATED USE IN BIOLOGICAL ANALYSIS SYSTEMS AND BIOCHIPS; CHEMICAL REAGENTS FOR MANUAL AND AUTOMATED USE IN DETERMINING AND SURVEYING OF GENE SEQUENCES; CHEMICAL REAGENTS USED FOR MANUAL AND AUTOMATIC ISOLATION, PREPARATION AND ANALYSIS OF GENE MATERIAL FROM BIOLOGICAL SAMPLES; CELL CULTURES FOR USE IN SCIENTIFIC OR MEDICAL RESEARCH; CHEMICAL REAGENTS AND PRESERVATIVES FOR STORAGE OF ISOLATED DNA, RNA, CELL AND TISSUE SAMPLES, BLOOD SAMPLES, ORGANS AND ORGANISMS; CHEMICAL TISSUE HOMOGENIZERS; CHEMICAL REAGENTS FOR ISOLATION AND PREPARATION OF GENE MATERIALS FROM BIOLOGICAL SAMPLES; STREPTAVIDIN BEADS AND MRNA BEADS FOR USE IN DNA AND RNA ISOLATION AND ANALYSIS; RED CELL LYSIS SOLUTIONS; BINDING SOLUTIONS; LYOPHILIZED POWDER; SEQUENCE SPECIFIC PRIMERS FOR USE IN DNA AND RNA ISOLATION AND ANALYSIS (U.S. CLS. 1, 5, 6, 10, 26 AND 46).

CLASS 5—PHARMACEUTICALS

FOR PHARMACEUTICALS AND PHARMACEUTICALS REAGENTS FOR MANUAL AND AUTOMATED USE IN DNA SEQUENCING, CYTOKINE GENOTYPING, DNA ISOLATION FROM BLOOD SAMPLES, MITOCHONDRIA SPECIFIC GENE AMPLIFICATIONS, DNA ISOLATION FROM BUCCAL CELLS AND DNA ISOLATION FROM TISSUE SECTIONS; PHARMACEUTICALS AND PHARMACEUTICAL REAGENTS FOR MANUAL AND AUTOMATED USE IN RNA ISOLATION FROM SERUM AND BLOOD PLASMA, CULTURED CELLS, HUMAN TISSUE, ANIMAL TISSUE, PLANT TISSUE AND YEAST CELLS; PHARMACEUTICALS AND PHARMACEUTICAL REAGENTS FOR MANUAL AND AUTOMATED USE IN BIOLOGICAL ANALYSIS SYSTEMS AND BIOCHIPS; PHARMACEUTICALS AND PHARMACEUTICAL REAGENTS FOR MANUAL AND AUTOMATED USE IN DETERMINING AND SURVEYING GENE SEQUENCES; PHARMACEUTICALS AND PHARMACEUTICAL REAGENTS USED FOR MANUAL AND AUTOMATIC ISOLATION, PREPARATION, AND ANALYSIS OF GENE MATERIAL FROM BIOLOGICAL SAMPLES; CELL CULTURES FOR USE IN SCIENTIFIC OR MEDICAL RESEARCH; PHARMACEUTICALS, PHARMACEUTICAL REAGENTS AND PRESERVATIVES FOR STORAGE OF ISOLATED DNA, RNA, CELL AND TISSUE SAMPLES, BLOOD SAMPLES, ORGANS AND ORGANISMS; PHARMACEUTICAL TISSUE HOMOGENIZERS; PHARMACEUTICALS AND PHARMACEUTICAL REAGENTS FOR ISOLATION AND PREPARATION OF GENE MATERIALS FROM BIOLOGICAL SAMPLES; STREPTAVIDIN BEADS AND MRNA BEADS FOR USE IN DNA AND RNA ISOLATION AND ANALYSIS; RED CELL LYSIS SOLUTIONS; BINDING SOLUTIONS; LYOPHILIZED POWDER; SEQUENCE SPECIFIC PRIMERS FOR USE IN DNA AND RNA ISOLATION AND ANALYSIS (U.S. CLS. 6, 18, 44, 46, 51 AND 52).

SN 75-800,987. KARENS FOR PEOPLE + PETS LTD., NEW YORK, NY. FILED 10-30-1999.

KARENS FOR PEOPLE + PETS

NO CLAIM IS MADE TO THE EXCLUSIVE RIGHT TO USE "PETS", APART FROM THE MARK AS SHOWN.

CLASS 18—LEATHER GOODS

FOR CLOTHING FOR PETS, NAMELY, SWEATERS, HATS, BAGS AND PET ACCESSORIES, NAMELY, LEASHES AND COLLARS (U.S. CLS. 1, 2, 3, 22 AND 41). FIRST USE 12-31-1982; IN COMMERCE 12-31-1986.

CLASS 20—FURNITURE AND ARTICLES NOT OTHERWISE CLASSIFIED

FOR PORTABLE BEDS FOR PETS (U.S. CLS. 2, 13, 22, 25, 32 AND 50). FIRST USE 12-31-1982; IN COMMERCE 12-31-1986.

CLASS 25—CLOTHING

FOR CLOTHING, NAMELY, SWEATERS (U.S. CLS. 22 AND 39). FIRST USE 12-31-1982; IN COMMERCE 12-31-1986.

CLASS 42—SCIENTIFIC, COMPUTER AND LEGAL SERVICES

FOR ANIMAL GROOMING, PET SITTING AND KENNEL SERVICES (U.S. CLS. 100 AND 101). FIRST USE 12-31-1982; IN COMMERCE 12-31-1986.

SN 75-803,081. GREAT BRANDS OF EUROPE, INC., STAMFORD, CT. FILED 9-16-1999.

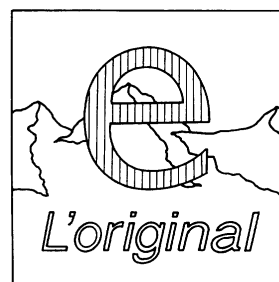

NO CLAIM IS MADE TO THE EXCLUSIVE RIGHT TO USE "L'ORIGINAL", APART FROM THE MARK AS SHOWN.

THE DRAWING IS LINED FOR THE COLOR RED.

THE WORDING "E L'ORIGINAL" COMPRISING APPLICANT'S MARK MAY BE TRANSLATED INTO ENGLISH AS "E THE ORIGINAL."

CLASS 4—LUBRICANTS AND FUELS

FOR CANDLES (U.S. CLS. 1, 6 AND 15). FIRST USE 9-0-1999; IN COMMERCE 9-0-1999.

CLASS 6—METAL GOODS

FOR TIN CASES FOR CORK COASTERS (U.S. CLS. 2, 12, 13, 14, 23, 25 AND 50). FIRST USE 9-0-1999; IN COMMERCE 9-0-1999.

CLASS 25—CLOTHING

FOR CLOTHING, NAMELY, HATS, JOG BRAS AND RAIN JACKETS (U.S. CLS. 22 AND 39).
FIRST USE 9-0-1999; IN COMMERCE 9-0-1999.

SN 75-846,196. OKOLOGISCHE BAUSYSTEME B.I. MALL GMBH & CO. KG, D-68723 SCHWETZINGEN, FED REP GERMANY, FILED 11-10-1999.

SN 75-825,846. LEXINGTON-FAYETTE URBAN COUNTY GOVERNMENT, LEXINGTON, KY. FILED 10-18-1999.

LEXINGTON-FAYETTE COUNTY HORSE CAPITAL OF THE WORLD

NO CLAIM IS MADE TO THE EXCLUSIVE RIGHT TO USE "LEXINGTON-FAYETTE COUNTY", APART FROM THE MARK AS SHOWN.

CLASS 16—PAPER GOODS AND PRINTED MATTER

FOR BUMPER STICKERS, POSTCARDS, POSTERS, STATIONARY, COMIC BOOKS, PENS, PENCILS, PAPER PENNANTS, PAPER TABLE CLOTHS, PAPER AND PLASTIC PLACE MATS, PAPER NAPKINS, PAPER COASTERS, PAPER FLAGS AND DECALS (U.S. CLS. 2, 5, 22, 23, 29, 37, 38 AND 50).

CLASS 25—CLOTHING

FOR T-SHIRTS, JACKETS, SHORTS, SWEATPANTS, SWEATSHIRTS, INFANTWEAR, SCARVES, HATS, TIES, AND BELTS (U.S. CLS. 22 AND 39).

CLASS 26—FANCY GOODS

FOR ORNAMENTAL NOVELTY BUTTONS (U.S. CLS. 37, 39, 40, 42 AND 50).

SN 75-840,639. AVCJ HOLDINGS LIMITED, WANCHAI, HONG KONG, FILED 11-3-1999.

EQIOSK.COM

CLASS 9—ELECTRICAL AND SCIENTIFIC APPARATUS

FOR DOWNLOADABLE ELECTRONIC PUBLICATIONS IN THE NATURE OF JOURNALS IN A WIDE RANGE OF FIELDS (U.S. CLS. 21, 23, 26, 36 AND 38).

CLASS 41—EDUCATION AND ENTERTAINMENT

FOR ELECTRONIC PUBLISHING SERVICES, NAMELY PUBLICATION OF TEXT AND GRAPHIC WORKS OF OTHERS ON A GLOBAL COMPUTER NETWORK (U.S. CLS. 100, 101 AND 107).

CLASS 42—SCIENTIFIC, COMPUTER AND LEGAL SERVICES

FOR PROVIDING ON-LINE JOURNALS IN A WIDE RANGE OF FIELDS (U.S. CLS. 100 AND 101).

SOLITEX

PRIORITY CLAIMED UNDER SEC. 44(D) ON ERP N CMNTY TM OFC APPLICATION NO. 123658, FILED 7-9-1999, REG. NO. 1236538, DATED 12-11-2000, EXPIRES 12-11-2010.

CLASS 1—CHEMICALS

FOR ADHESIVES FOR USE IN THE BUILDING INDUSTRY, NAMELY ADHESIVES FOR USE IN AIR-TIGHT SEALING SHEETS, FLOORS AND WALL COVERINGS, AND ROOF BASE SHEETING (U.S. CLS. 1, 5, 6, 10, 26 AND 46).

CLASS 17—RUBBER GOODS

FOR SOUND INSULATION FOR BUILDINGS MADE OF PLASTIC, RENEWABLE RAW MATERIALS, PLANT FIBERS, ANIMAL HAIR, AND/OR PAPER MATERIALS; FILMS MADE OF PLASTIC FOR LINING ROOFS AND WALLS; INSULATION AND REINFORCEMENT MATERIALS FOR USE IN THE CONSTRUCTION, EARTHWORKING, AND LANDSCAPING SECTORS MADE OF PLASTIC, RENEWABLE RAW MATERIALS, PLANT FIBERS, ANIMAL HAIR, AND/OR PAPER MATERIALS IN WOVEN, NON-WOVEN, AND WEB FORM; GEOTEXTILE FABRICS FOR USE AS INSULATION AND REINFORCEMENT MATERIALS FOR THE CONSTRUCTION, EARTHWORK AND LANDSCAPING SECTORS; ADHESIVE TAPE FOR INDUSTRIAL AND COMMERCIAL USE, NAMELY FOR SEALING SHEETS FOR FILM, CARDBOARDS, SLABS AND PAPER MATERIALS; THERMAL INSULATION MATERIALS FOR BUILDINGS MADE OF PAPER, PLASTIC, MINERALS, AND/OR FOAMED PLASTIC; ADHESIVE TAPES, ADHESIVE STRIPS AND ADHESIVE FILMS FOR INDUSTRIAL USE; ADHESIVE TAPES FOR USE IN THE CONSTRUCTION INDUSTRY; BUILDING INSULATION MATERIALS MADE OF PLANT FIBER AND/OR ANIMAL HAIR; FIBER-BASED INSULATION MATERIALS MADE OF SYNTHETIC AND/OR RENEWABLE RAW MATERIALS (U.S. CLS. 1, 5, 12, 13, 35 AND 50).

CLASS 19—NON-METALLIC BUILDING MATERIALS

FOR NON-METAL WALL AND ROOF LINING FOR BUILDINGS; PLASTIC DOORS AND WINDOWS; NON-METAL ROOF COVERINGS, NAMELY FELT ROOF COVERINGS FOR BUILDINGS, NON-METAL SHEETING WITH VAPOR BARRIER PROPERTIES MADE OF PLASTIC SHEETS AND FILMS OTHER THAN FOR WRAPPING FOR USE IN THE RESIDENTIAL BUILDING INDUSTRY; NON-METAL SHEETING WITH AIR-TIGHT SEALING PROPERTIES, NAMELY NON-METAL ROOF TRUSSES FOR USE IN THE CONSTRUCTION OF RESIDENTIAL BUILDINGS; ROOF COVERINGS MADE OF WOOD, PLASTIC, SLATE AND STONE MATERIALS, FIBERS MADE OF PLASTIC, RENEWABLE RAW MATERIALS, PLANT FIBERS, ANIMAL HAIR AND/OR PAPER MATERIALS FOR THERMAL INSULATION; BASEBOARDS MADE OF WOOD, WOOL, WIRE AND STRAW; UNDER-ROOF SLABS AND UNDER-CEILING SLABS MADE OF WOOD, WOODEN MATERIALS, AND/OR WOODEN SOFT FIBERS; WALL-COVERINGS MADE OF WOOD AN/OR WOOD MIXTURES (U.S. CLS. 1, 12, 33 AND 50).

CLASS 27—FLOOR COVERINGS

FOR WALL COVERINGS MADE OF PLASTIC, WALL COVERINGS WHICH CAN BE PUT TOGETHER AND JOINED FROM INDIVIDUAL PARTIES AND THAT ARE SPRAYED OR APPLIED WITH A SPATULA, NAMELY, TEXTILE LINED WALLPAPER; WALL COVERINGS, NAMELY WALL PAPER; WALL COVERINGS MADE OF RAW FIBERS AND TEXTILE PLASTERS (U.S. CLS. 19, 20, 37, 42 AND 50).

SN 75-866,561. RICHGROVE PTY LTD, CAIRNS, QUEENSLAND. 4870, AUSTRALIA, FILED 12-9-1999.



SN 75-852,363. SALA, ANDRE, 74430 ANNECY, FRANCE, FILED 11-19-1999.

PRIORITY CLAIMED UNDER SEC. 44(D) ON AUSTRALIA APPLICATION NO. 805361, FILED 8-30-1999, REG. NO. 805361, DATED 8-30-2000, EXPIRES 8-30-2009.

CLASS 35—ADVERTISING AND BUSINESS

FOR RETAIL STORE SERVICES FEATURING CLOTHING, FOOTWEAR AND HEADWEAR, BAGS, KEY RINGS, BADGES, JEWELRY, LOCKS AND OTHER SECURITY APPARATUS, TRAVEL KITS, FIRST AID KITS, PUBLICATIONS, TRAVEL GUIDES, AND BOOKLETS, MAPS, POST CARDS, COLLECTOR CARDS, TRANSFERS AND STICKERS, SOUVENIRS, AND FOOD AND BEVERAGES; BUSINESS MANAGEMENT CONSULTATION; RENTAL OF ADVERTISING SPACE, ADMINISTRATION OF LOYALTY AND INCENTIVE PROGRAMS FOR OTHERS, NAMELY, PROMOTING THE GOODS AND SERVICES OF OTHERS THROUGH THE DISTRIBUTION OF DISCOUNT CARDS (U.S. CLS. 100, 101 AND 102).



OWNER OF FRANCE REG. NO. 99775338, DATED 2-11-1999, EXPIRES 2-11-2009.

NO CLAIM IS MADE TO THE EXCLUSIVE RIGHT TO USE "CREPES" AND "DE FRANCE" AND "PARIS", APART FROM THE MARK AS SHOWN.

THE WORDS IN FRENCH, "DE FRANCE" MEAN "OF FRANCE" OR "FROM FRANCE".

CLASS 39—TRANSPORTATION AND STORAGE

FOR TOURIST AND TRAVEL AGENCY SERVICES, ARRANGING TRAVEL AND TOURS, MAKING RESERVATIONS AND BOOKINGS FOR TRAVEL AND TOURS, PROVIDING TRAVEL AND TOUR INFORMATION (U.S. CLS. 100 AND 105).

CLASS 42—SCIENTIFIC, COMPUTER AND LEGAL SERVICES

FOR ACCOMMODATION PROVIDING TEMPORARY LODGING, RENTAL OF TEMPORARY ACCOMMODATION, MAKING RESERVATIONS AND BOOKINGS FOR TEMPORARY LODGING; RESTAURANTS, BARS, CAFES, INCLUDING GLOBAL COMPUTER NETWORK CAFES; TAKE-OUT RESTAURANTS; RENTAL AND/OR LEASING ACCESS TIME TO COMPUTER NETWORKS AND DATABASES, RENTAL OF COMPUTER SOFTWARE (U.S. CLS. 100 AND 101).

CLASS 11—ENVIRONMENTAL CONTROL APPARATUS

FOR ELECTRIC GRIDDLES (U.S. CLS. 13, 21, 23, 31 AND 34).

CLASS 30—STAPLE FOODS

FOR CEREAL-BASED SNACK FOOD, BREAD, PASTRIES, CONFECTIONERY CHIPS FOR BAKING, PANCAKES, WAFFLES, ICE CREAM, EDIBLE CAKE DECORATIONS; WAFERS (U.S. CL. 46).

SN 75-871,938. MAGENTA DESIGNS LTD., NORTH VANCOUVER, BRITISH COLUMBIA, FILED 12-16-1999.

CLASS 42—SCIENTIFIC, COMPUTER AND LEGAL SERVICES

FOR RESTAURANT SERVICES (U.S. CLS. 100 AND 101).

PRIORITY CLAIMED UNDER SEC. 44(D) ON CANADA APPLICATION NO. 1,030,130, FILED 9-24-1999, REG. NO. TMA568430, DATED 10-2-2002, EXPIRES 10-2-2017.

WILD COAST

CLASS 18—LEATHER GOODS

FOR FASHION ACCESSORIES FOR MEN, WOMEN AND CHILDREN, NAMELY COIN PURSES, WAIST-PACKS, SACHELS, GYM BAGS, COSMETIC BAGS SOLD EMPTY AND TOTE BAGS, UMBRELLAS, WALLET, BAGS MADE OF FLEECE, NAMELY GYM BAGS, SACHELS AND TOTE BAGS (U.S. CLS. 1, 2, 3, 22 AND 41).

CLASS 24—FABRICS

FOR KITCHEN TEXTILES, NAMELY, TEA TOWELS, HOT PADS, OVEN MITTS, POT HOLDERS, NAPKINS, PLACEMATS AND COASTERS (U.S. CLS. 42 AND 50).

CLASS 25—CLOTHING

FOR CLOTHING FOR MEN, WOMEN AND CHILDREN, NAMELY SHIRTS, T-SHIRTS, VESTS, SHORTS, SWEATSHIRTS, OUTERWEAR, NAMELY RAIN JACKETS, WIND RESISTANT JACKETS, COATS AND VESTS; INFANT CLOTHING, NAMELY JUMPERS, SLEEPERS, PYJAMAS, OVERALLS, SOCKS AND HATS; FLEECE CLOTHING, NAMELY SHIRTS, VESTS, JACKETS, COATS; FASHION ACCESSORIES FOR MEN AND WOMEN AND CHILDREN, NAMELY SCARVES; OUTDOOR FASHION ACCESSORIES, NAMELY MITTENS, CAPS, KNITTED HATS, FLEECE FASHION ACCESSORIES FOR MEN, WOMEN AND CHILDREN, NAMELY HATS, GLOVES, SCARVES; AND APRONS (U.S. CLS. 22 AND 39).

SN 75-888,383. NIIT LIMITED, NEW DELHI-110 020, INDIA, FILED 1-6-2000.

Brick & Portal**CLASS 41—EDUCATION AND ENTERTAINMENT**

FOR EDUCATIONAL SERVICES, NAMELY CONDUCTING CLASSES, SEMINARS, AND CONFERENCES AND WORKSHOPS IN THE FIELD OF COMPUTER HARDWARE AND SOFTWARE USAGE AND INFORMATION TECHNOLOGY (U.S. CLS. 100, 101 AND 107).

CLASS 42—SCIENTIFIC, COMPUTER AND LEGAL SERVICES

FOR COMPUTER CONSULTING SERVICES, TECHNICAL CONSULTATION FOR OTHERS IN THE FIELD OF COMPUTER AIDED ENGINEERING AND ENGINEERING DRAWINGS, DESIGN OF COMPUTER SOFTWARE AND COMPUTER AHRWARE FOR OTHERS AND COMPUTER PROGRAMMING FOR OTHERS; COMPUTER SOFTWARE CONSULTING SERVICES; COMPUTER SOFTWARE WRITING SERVICES FOR OTHERS (U.S. CLS. 100 AND 101).

SN 75-888,282. NIIT LIMITED, NEW DELHI-110 020, INDIA, FILED 1-6-2000.

SN 75-888,387. NIIT LIMITED, NEW DELHI-110 020, INDIA, FILED 1-6-2000.

Century of the Mind

NO CLAIM IS MADE TO THE EXCLUSIVE RIGHT TO USE "OFFSHORE DEVELOPMENT CENTER", APART FROM THE MARK AS SHOWN.

CLASS 41—EDUCATION AND ENTERTAINMENT

FOR EDUCATIONAL SERVICES, NAMELY CONDUCTING CLASSES, SEMINARS, AND CONFERENCES AND WORKSHOPS IN THE FIELD OF COMPUTER HARDWARE AND SOFTWARE USAGE AND INFORMATION TECHNOLOGY (U.S. CLS. 100, 101 AND 107).

CLASS 42—SCIENTIFIC, COMPUTER AND LEGAL SERVICES

FOR COMPUTER CONSULTING SERVICES, TECHNICAL CONSULTATION FOR OTHERS IN THE FIELD OF COMPUTER AIDED ENGINEERING AND ENGINEERING DRAWINGS, DESIGN OF COMPUTER SOFTWARE AND COMPUTER HARDWARE FOR OTHERS AND COMPUTER PROGRAMMING FOR OTHERS; COMPUTER SOFTWARE CONSULTING SERVICES; COMPUTER SOFTWARE WRITING SERVICES FOR OTHERS (U.S. CLS. 100 AND 101).

CLASS 41—EDUCATION AND ENTERTAINMENT

FOR EDUCATIONAL SERVICES, NAMELY CONDUCTING CLASSES, SEMINARS, AND CONFERENCES AND WORKSHOPS IN THE FIELD OF COMPUTER HARDWARE AND SOFTWARE USAGE AND INFORMATION TECHNOLOGY (U.S. CLS. 100, 101 AND 107).

CLASS 42—SCIENTIFIC, COMPUTER AND LEGAL SERVICES

FOR COMPUTER CONSULTING SERVICES, TECHNICAL CONSULTATION FOR OTHERS IN THE FIELD OF COMPUTER AIDED ENGINEERING AND ENGINEERING DRAWINGS, DESIGN OF COMPUTER SOFTWARE AND COMPUTER AHRD WARE FOR OTHERS AND COMPUTER PROGRAMMING FOR OTHERS; COMPUTER SOFTWARE CONSULTING SERVICES; COMPUTER SOFTWARE WRITING SERVICES FOR OTHERS (U.S. CLS. 100 AND 101).

SN 75-904,672. KYOCERA CORPORATION, FUSHIMI-KU, KYOTO, 612-8501, JAPAN, FILED 1-22-2000.

KYOCERA

OWNER OF U.S. REG. NOS. 1,411,056, 1,704,428 AND OTHERS.

CLASS 2—PAINTS

FOR DYESTUFF FOR USE IN THE MANUFACTURE OF TONER; COLOR PIGMENTS AND MONOCHROME PIGMENTS; PAINTS FOR USE IN THE MANUFACTURE OF COLOR TONERS AND MONOCHROME TONERS; PRINTER'S INKS; INKS FOR MIMEOGRAPHS; DEVELOPER AND TONER FOR COPYING MACHINES; DEVELOPER AND TONER FOR FACSIMILES; DEVELOPER AND TONER FOR PRINTERS AND PRINTING MACHINES FOR USE WITH COMPUTERS AND WORD PROCESSORS (U.S. CLS. 6, 11 AND 16).

CLASS 9—ELECTRICAL AND SCIENTIFIC APPARATUS

FOR OZONIZERS; PISTONS AND SLEEVES FOR ION CHROMATOGRAPHS; LABORATORY INSTRUMENTS, NAMELY, VALVES FOR BLOOD ANALYZERS; SIGNALING BUOYS; ELECTRONIC COMPONENTS, NAMELY, RESISTORS, SUPERCONDUCTORS, CAPACITORS, FILTERS, RESONATORS, OSCILLATORS, VARISTORS, AND AUDIBLE TONE GENERATORS; MICROELECTRONIC PRODUCTS, NAMELY, SEMICONDUCTOR CHIP PACKAGES FOR MOUNTING ELECTRONIC COMPONENTS AND SEMICONDUCTOR CHIPS; SEMICONDUCTOR DEVICES; CIRCUIT BOARDS; LIQUID CRYSTAL DISPLAYS; HIGH-FREQUENCY COMPONENTS, NAMELY, OSCILLATORS, FILTERS, AND RESONATORS; ELECTRICAL CONNECTORS; SOLAR BATTERIES; PHOTOVOLTAIC SYSTEMS CONSISTING OF PHOTOVOLTAIC SOLAR MODULES, VOLTAGE REGULATORS, CONTROLLERS, INVERTERS, AND WIRING; BATTERY CHARGERS; ELECTRICAL STORAGE CELLS AND THEIR TERMINALS; PHOTORECEPTOR DRUMS, NAMELY, AMORPHOUS SILICON PHOTORECEPTOR DRUMS AND ORGANIC PHOTORECEPTOR DRUMS; PHOTORECEPTOR PLATES, NAMELY AMORPHOUS SILICON PHOTORECEPTOR PLATES AND ORGANIC PHOTORECEPTOR PLATES; PHOTORECEPTOR BELTS, NAMELY, AMORPHOUS SILICON PHOTORECEPTOR BELTS AND ORGANIC PHOTORECEPTOR BELTS FOR COPYING MACHINES, ELECTRONIC PRINTERS AND FACSIMILES; THERMAL PRINTER HEADS, INK JET PRINTER HEADS, LED PRINTER HEADS AND IMAGE SENSORS FOR COPYING MACHINES, ELECTROSTATIC COMPUTER PRINTERS, AND FACSIMILES; ELECTROSTATIC COPYING MACHINES; PHOTOCOPYING MACHINES; DIAZO COPYING MACHINES; DIGITAL COPYING MACHINES; FACSIMILES; PARTS AND FITTINGS FOR ELECTROSTATIC COPYING MACHINES, PHOTOCOPYING MACHINES, DIAZO COPYING MACHINES, DIGITAL COPYING MACHINES, AND FACSIMILES AND PARTS AND FITTINGS THEREFORE, NAMELY, TONER CONTAINERS, PAPER FEEDERS, PAPER CASSETTES, SORTERS, DUPLEX UNITS, AND STACKERS; TELEPHONE APPARATUS, NAMELY, INTERCOMS, TELEPHONE RECEIVERS, AND WIRELESS TELEPHONES; RADIO COMMUNICATION EQUIPMENT, NAMELY, SATELLITE COMMUNICATION SYSTEMS CONSISTING OF TRANSMITTERS, RELAYS, AND RECEIVERS; SATELLITE NAVIGATIONAL SYSTEMS, NAMELY, GLOBAL POSITIONING SYSTEMS CONSISTING OF COMPUTERS, COMPUTER SOFTWARE, DISPLAY MONITORS, RECEIVERS AND ANTENNAS; CELLULAR PHONE SYSTEMS CONSISTING OF CELLULAR TELEPHONES, TRANSMITTERS, SWITCHES, RELAYS, AND CELLULAR BASE STATIONS; WIRELESS LOCAL LOOP SYSTEMS CONSISTING OF WIRELESS TELEPHONES, TRANSMITTERS, SWITCHES, RELAYS, AND ANTENNAS; TELEGRAPHY AND TELECOMMUNICATIONS APPARATUS, NAMELY, TELEPHONES, TELEGRAPH TRANSMITTERS AND RECEIVERS, AND FACSIMILE TRANSMITTERS AND RECEIVERS; VIDEO CONFERENCE SYSTEMS CONSISTING OF VIDEO MONITORS, CAMERAS, MICROPHONES, SPEAKERS, COMPUTERS, AND NETWORK INTERFACE DEVICES; VIDEO CAMERAS; ELECTRONIC STILL PHOTOGRAPHIC CAMERAS; ARC ELECTRIC WELDING MACHINES; NOZZLES FOR ELECTRIC ARC WELDING MACHINES; PHOTOGRAPHIC CAMERAS; PHOTOGRAPHIC LENSES; SLIDE PROJECTORS; PHOTOGRAPHIC ACCESSORIES, NAMELY, MOTOR DRIVE UNITS, WINDERS, ELECTRONIC FLASH UNITS, TIMERS, BELLOWES, FILTERS, LENS HOODS, STRAPS, AND CAMERA CASES; CINECAMERAS; VIDEO AND LIQUID CRYSTAL PROJECTORS; OPTICAL LENS

SIGHTS AND MAGNIFYING GLASSES; BINOCULARS; EYEGASSES; MAGNIFYING GLASSES; FIBER OPTIC DEVICES, NAMELY, OPTICAL FIBERS, OPTICAL ISOLATORS, OPTICAL COUPLERS, OPTICAL CONNECTORS, OPTICAL WAVELENGTH DIVISION MULTIPLEXERS, OPTICAL WAVELENGTH MULTIPLEXERS, OPTICAL WAVEGUIDES, OPTICAL FIBER ARRAYS, LASER DIODE MODULES, AND OPTICAL ATTENUATORS; MEASURING MACHINES AND INSTRUMENTS, NAMELY, STRAIGHTNESS MEASURING MACHINES, AND FLATNESS MEASURING MACHINES; ELECTRICAL LIGHTING CONDUCTORS; ELECTRONIC COMPONENTS, NAMELY, ELECTRIC BUZZERS; AUDIO AND VIDEO EQUIPMENT, NAMELY, SOUND AND STEREO AMPLIFIERS, STEREO TUNERS, PHONOGRAPH RECORD PLAYERS, AUDIO AND VIDEO TAPE RECORDERS, LOUDSPEAKERS, RADIOS, COMPACT DISC PLAYERS, VIDEO DISC PLAYERS, AND CASSETTE TAPE PLAYERS AND RECORDERS; MAGNETIC OPTICAL DISCS; ELECTRONIC CASH REGISTERS; POINT OF SALE CREDIT CARD TERMINALS; POINT OF SALE CASH REGISTER TERMINALS; DATA PROCESSING APPARATUS, NAMELY, COMPUTER TERMINALS FOR USE IN PROCESSING DATA; CALCULATORS; WORD PROCESSORS AND ELECTRONIC COMPUTERS; LASER BEAM PRINTERS; LED PRINTERS; ELECTRONIC PRINTERS FOR USE WITH COMPUTERS, ELECTRONIC TYPEWRITERS AND WORD PROCESSORS, AND PARTS AND FITTINGS THEREFORE, NAMELY, TONER CONTAINERS, PAPER FEEDERS, PAPER CASSETTES, SORTERS, DUPLEX UNITS AND STACKERS INTEGRATED CIRCUIT MEMORY CARDS; COMPUTER HARDWARE, NAMELY, COMPUTER DISC DRIVES FOR HARD OR FLOPPY DISCS, COMPACT DISC PLAYERS, AND MAGNETIC TAPE DRIVES; OPTICAL RECORDING AND REPRODUCING DEVICES, NAMELY, OPTICAL IMAGE SCANNERS AND IMAGE SENSORS FOR USE THEREWITH, DIGITAL CAMERAS, VIDEO MONITORS, COMPUTER TERMINALS, AND COMPUTER KEYBOARDS; MAGNETIC CODED CARD READERS; BAR CODE READERS; PLOTTERS; MODEMS; COMPUTER MICE; VISUAL DISPLAY UNITS, NAMELY, LIGHT EMITTING DIODE DISPLAYS AND LIQUID CRYSTAL DISPLAYS (U.S. CLS. 21, 23, 26, 36 AND 38).

CLASS 35—ADVERTISING AND BUSINESS

FOR DOCUMENT PRODUCTION, DUPLICATING, COPYING, AND FILING SERVICES; RENTAL SERVICES FOR OFFICE MACHINES, EQUIPMENT, AND OFFICE SUPPLIES; RENTAL SERVICES FOR PHOTOCOPYING MACHINES, PRINTERS FACSIMILE MACHINES, COMPUTERS, TYPEWRITERS, WORD PROCESSORS AND DATA PROCESSORS; FACSIMILE TRANSMISSION SERVICES (U.S. CLS. 100, 101 AND 102).

CLASS 37—CONSTRUCTION AND REPAIR

FOR REPAIR, CLEANING, MAINTENANCE, AND INSTALLATION SERVICES FOR BUSINESS AND OFFICE MACHINES AND EQUIPMENT, COMPUTERS, DATA PROCESSING APPARATUS, TELEPHONE APPARATUS, TELEPHONE RECEIVERS, WIRELESS TELEPHONES, RADIO COMMUNICATION EQUIPMENT INCLUDING SATELLITE COMMUNICATION SYSTEMS AND PERSONAL RADIOS, CELLULAR PHONE SYSTEMS, CELLULAR BASE STATION SYSTEMS, WIRELESS LOCAL LOOP SYSTEMS, WIRELESS DATA COMMUNICATION SYSTEMS, PHOTOGRAPHIC CAMERAS AND THEIR PARTS AND DIGITAL CAMERAS AND THEIR PARTS (U.S. CLS. 100, 103 AND 106).

SN 75-916,587. THE REGENTS OF THE UNIVERSITY OF CALIFORNIA, OAKLAND, CA. FILED 2-11-2000.

SEC. 2(F).

CLASS 14—JEWELRY

FOR ORNAMENTAL LAPEL PINS (U.S. CLS. 2, 27, 28 AND 50).
FIRST USE 8-0-1986; IN COMMERCE 8-0-1986.

CLASS 21—HOUSEWARES AND GLASS

FOR MUGS, BEVERAGE GLASSWARE (U.S. CLS. 2, 13, 23, 29, 30, 33, 40 AND 50).
FIRST USE 8-0-1988; IN COMMERCE 8-0-1988.

CLASS 25—CLOTHING

FOR T-SHIRTS, SHORTS, TANK TOPS, SWEAT SHIRTS, SWEAT PANTS, POLO SHIRTS, RUGBY SHIRTS, CAPS, VISORS, JACKETS, NIGHTSHIRTS, MUFFLERS, TIES (U.S. CLS. 22 AND 39).
FIRST USE 12-0-1952; IN COMMERCE 12-0-1952.

SN 75-982,554. SCHOTTENSTEIN STORES CORPORATION, DBA VALUE CITY FURNITURE, COLUMBUS, OH. FILED 12-7-2001.

AMERICAN SIGNATURE DESIGNS

OWNER OF U.S. REG. NOS. 2,386,599, 2,472,445 AND 2,553,760.

NO CLAIM IS MADE TO THE EXCLUSIVE RIGHT TO USE "AMERICAN" AND "DESIGNS", APART FROM THE MARK AS SHOWN.

CLASS 9—ELECTRICAL AND SCIENTIFIC APPARATUS

FOR CD STORAGE UNITS (U.S. CLS. 21, 23, 26, 36 AND 38).

CLASS 11—ENVIRONMENTAL CONTROL APPARATUS

FOR LAMPS AND FLOOR LAMPS (U.S. CLS. 13, 21, 23, 31 AND 34).

CLASS 14—JEWELRY

FOR CLOCKS (U.S. CLS. 2, 27, 28 AND 50).

CLASS 18—LEATHER GOODS

FOR LEATHER FOR UPHOLSTERED FURNITURE (U.S. CLS. 1, 2, 3, 22 AND 41).

CLASS 20—FURNITURE AND ARTICLES NOT OTHERWISE CLASSIFIED

FOR COMPUTER FURNITURE; COMPUTER WORK CENTERS COMPRISING DESK RETURNS, HUTCH TOPS, KEYBOARD TRAYS, FILING CABINETS, DESKS, SHELVES, BOOKCASES, COMPUTER ARMOIRES, AND CD STORAGE UNITS (U.S. CLS. 2, 13, 22, 25, 32 AND 50).

CLASS 24—FABRICS

FOR BED LINENS, NAMELY, BED SHEETS, PILLOW-CASES, BEDSPREADS, DUVET COVERS, BLANKETS, COMFORTERS, MATTRESS COVERS; UNFITTED FURNITURE COVERS, FABRIC FOR UPHOLSTERED FURNITURE (U.S. CLS. 42 AND 50).

SN 76-048,562. BEST MADE DESIGNS, L.L.C., MONAHANS, TX. FILED 5-15-2000.

SPEC.-OPS.

CLASS 13—FIREARMS

FOR MILITARY GEAR, NAMELY, GUN CASES, CASES FOR CARTRIDGES, AMMUNITION AND AMMUNITION MAGAZINES, POUCHES AND PACKS FOR GUNS, CARTRIDGES, AMMUNITION AND AMMUNITION MAGAZINES (U.S. CLS. 2 AND 9).

CLASS 18—LEATHER GOODS

FOR MILITARY GEAR, NAMELY, RUCKSACKS, DRAWSTRING POUCHES, TOOL POUCHES SOLD EMPTY AND DOCUMENT CASES FITTING WITHIN ASSAULT PACKS AND RUCKSACKS, POUCHES FOR HYDRATION UNITS, DRAWSTRING POUCHES, TOOL POUCHES SOLD EMPTY AND DOCUMENT CASES FOR ATTACHMENT TO SHOULDER STRAPS OF PACKS AND RUCKSACKS, DRAWSTRING POUCHES, TOOL POUCHES SOLD EMPTY AND DOCUMENT CASES FITTING WITHIN SIDE CARGO PANT POCKETS, DRAWSTRING POUCHES, TOOL POUCHES SOLD EMPTY AND DOCUMENT CASES FOR ATTACHMENT TO STERNUM STRAPS OF PACKS AND RUCKSACKS (U.S. CLS. 1, 2, 3, 22 AND 41).

SN 76-056,966. CASEY, DAVID MICHAEL, LONDON NW10 7JQ, ENGLAND, FILED 5-26-2000.

OFFICE LONDON

OWNER OF ERPN CMNTY TM OFC REG. NO. 437,715, DATED 4-20-2000, EXPIRES 12-19-2006.

NO CLAIM IS MADE TO THE EXCLUSIVE RIGHT TO USE "LONDON", APART FROM THE MARK AS SHOWN.

CLASS 18—LEATHER GOODS

FOR BRIEFCASES, HANDBAGS, RUCKSACKS, SHOULDER BAGS, LUGGAGE (U.S. CLS. 1, 2, 3, 22 AND 41).

CLASS 25—CLOTHING

FOR ARTICLES OF CLOTHING, NAMELY SHIRTS, PANTS, AND SWEATERS; BELTS; FOOTWEAR; HEADWEAR (U.S. CLS. 22 AND 39).

SN 76-059,341. LAWRENCEPUR WOOLLEN & TEXTILE MILLS LIMITED, LAHORE-54000, PAKISTAN, FILED 5-30-2000.

LAWRENCEPUR**CLASS 24—FABRICS**

FOR TEXTILE AND TEXTILE PRODUCTS, NAMELY, COTTON, WOOLEN, MIXED BLEND AND POLYESTER FABRICS (U.S. CLS. 42 AND 50).

CLASS 25—CLOTHING

FOR CLOTHING, NAMELY, SUITS, JACKETS, TROUSERS, SHIRTS, HEADWEAR, T-SHIRTS, UNDERGARMENTS, SOCKS (U.S. CLS. 22 AND 39).

SN 76-065,588. CASTEK INC., TORONTO, ONTARIO, CANADA, BY CHANGE OF NAME CASTEK SOFTWARE FACTORY INC., TORONTO, ONTARIO, CANADA, FILED 6-8-2000.



PRIORITY CLAIMED UNDER SEC. 44(D) ON CANADA APPLICATION NO. 1057647, FILED 5-4-2000, REG. NO. TMA579471, DATED 4-11-2003, EXPIRES 4-11-2018.

CLASS 9—ELECTRICAL AND SCIENTIFIC APPARATUS

FOR SOFTWARE PROGRAMS, SUPPORT DOCUMENTATION AND USER MANUALS PACKAGED AS A UNIT WITH PROGRAMS FOR USE IN ALL ASPECTS OF THE INSURANCE INDUSTRY, NAMELY POLICY ADMINISTRATION, CLAIMS HANDLING AND BILLING IN CONNECTION WITH LIFE, COMMERCIAL, PROPERTY AND CASUALTY INSURANCE AND REINSURANCE (U.S. CLS. 21, 23, 26, 36 AND 38).

CLASS 41—EDUCATION AND ENTERTAINMENT

FOR TRAINING IN THE USE AND OPERATION OF COMPUTER SOFTWARE FOR THE INSURANCE INDUSTRY BY PERSONAL TRAINING THROUGH WORKSHOPS AND COURSE SEMINARS (U.S. CLS. 100, 101 AND 107).

CLASS 42—SCIENTIFIC, COMPUTER AND LEGAL SERVICES

FOR COMPUTER SERVICES, ALL FOR THE INSURANCE INDUSTRY, NAMELY INSTALLING, MAINTAINING AND TESTING OF COMPUTER SOFTWARE, ANALYZING CUSTOMERS' EXISTING SOFTWARE AND BUSINESS OBJECTIVES WITH REGARD TO INDIVIDUAL SOFTWARE REQUIREMENTS, COMPUTER SOFTWARE CONSULTATION, DESIGNING AND CUSTOMIZATION OF SOFTWARE PROGRAMS AND MANUALS FOR USE THEREWITH FOR THEIR SPECIFIC FIELD OR INDUSTRY; FIXED-PRICE SOFTWARE DEVELOPMENT FOR OTHERS, PROVIDING TECHNICAL INFORMATION OVER A GLOBAL COMPUTER NETWORK, CREATING CUSTOMIZED APPLICATIONS AND APPLICATION COMPATIBILITIES FOR OTHERS; COMPUTER SOFTWARE MAINTENANCE AND PERIODIC RELEASE OF MAINTENANCE SOFTWARE; SOFTWARE DEVELOPMENT METHODOLOGY, NAMELY PROVIDING METHOD SKILLS, PROCESSES AND APPROACHES TO CUSTOMS FOR THE USE AND DEVELOPMENT OF SOFTWARE COMPONENTS AND THE DEVELOPMENT OF THEIR REQUIRED SOFTWARE SYSTEMS; COMPUTER CONSULTING SERVICES, NAMELY PROVIDING ACCESS BY TELEPHONE OR FACSIMILE TO TECHNICIANS CAPABLE OF SOLVING ANY PROBLEMS, INTERPRETING WRITTEN MATERIALS AND EXPLAINING FUNCTIONS OF FEATURES OF SOFTWARE AND CORRECTING PROGRAMMING ERRORS (U.S. CLS. 100 AND 101).

SN 76-065,784. BOCK, ELIZABETH, ENCINITAS, CA. FILED 6-7-2000.

ALL WE DO IS GOLF**CLASS 35—ADVERTISING AND BUSINESS**

FOR COOPERATIVE ADVERTISING AND MARKETING; MARKETING AND PROMOTION OF THE REAL ESTATE, GOLF COURSE COMMUNITIES AND GOLF RESORTS OF OTHERS (U.S. CLS. 100, 101 AND 102).
FIRST USE 3-20-1999; IN COMMERCE 6-10-1999.

CLASS 36—INSURANCE AND FINANCIAL

FOR REAL ESTATE AGENCY SERVICES (U.S. CLS. 100, 101 AND 102).
FIRST USE 3-20-1999; IN COMMERCE 6-10-1999.

SN 76-072,772. FIRST AMERICAN COMMERCIAL BANK CORP., INC., CHICAGO, IL. FILED 6-19-2000.

FIRST AMERICAN EQUIPMENT LEASING

OWNER OF U.S. REG. NOS. 2,301,545 AND 2,305,412.
NO CLAIM IS MADE TO THE EXCLUSIVE RIGHT TO USE "AMERICAN EQUIPMENT LEASING", APART FROM THE MARK AS SHOWN.

CLASS 36—INSURANCE AND FINANCIAL

FOR FINANCING SERVICES FOR COMMERCIAL EQUIPMENT (U.S. CLS. 100, 101 AND 102).
FIRST USE 12-12-1994; IN COMMERCE 12-12-1994.

CLASS 37—CONSTRUCTION AND REPAIR

FOR LEASING OF COMMERCIAL CONSTRUCTION EQUIPMENT (U.S. CLS. 100, 103 AND 106).
FIRST USE 12-12-1994; IN COMMERCE 12-12-1994.

CLASS 39—TRANSPORTATION AND STORAGE

FOR LEASING OF COMMERCIAL TRUCKS (U.S. CLS. 100 AND 105).
FIRST USE 12-12-1994; IN COMMERCE 12-12-1994.

CLASS 42—SCIENTIFIC, COMPUTER AND LEGAL SERVICES

FOR LEASING OF COMPUTERS (U.S. CLS. 100 AND 101).
FIRST USE 12-12-1994; IN COMMERCE 12-12-1994.

SN 76-074,134. DAIMLERCHRYSLER AG, 70567 STUTTGART, FED REP GERMANY, FILED 6-20-2000.

MRCM

PRIORITY CLAIMED UNDER SEC. 44(D) ON FED REP GERMANY APPLICATION NO. 39985380.4, FILED 12-22-1999, REG. NO. 39985380, DATED 2-1-2000, EXPIRES 12-31-2009.

CLASS 9—ELECTRICAL AND SCIENTIFIC APPARATUS

FOR AIR-LAND-SEA BATTLEFIELD COMMUNICATIONS EQUIPMENT, NAMELY, TRANSMITTERS AND RECEIVERS OPERATING IN THE MEDIUM FREQUENCY, HIGH FREQUENCY, VERY-HIGH FREQUENCY, ULTRA-HIGH FREQUENCY, AND SUPER-HIGH FREQUENCY RANGES FOR SHIP AND STATIONARY AND ASSOCIATED EQUIPMENT, NAMELY, MODEMS, PROCESSORS AND COMMUNICATIONS SERVERS, DATA TERMINALS SYSTEM-OPERATING HANDSETS, REMOTE-CONTROL PACKAGES, FREQUENCY AND KEY MANAGEMENT SYSTEMS, VOICE AND DATA INTERCOM SYSTEMS FOR SHIPS; ANTENNAS; ELECTRONIC WARFARE AND SPECTRUM-CONTROL EQUIPMENT, NAMELY, INTERCEPTORS, RECEIVERS, RADIO DIRECTION FINDERS, TRANSMISSION JAMMERS AND DEMODULATORS/DECODERS (U.S. CLS. 21, 23, 26, 36 AND 38).

CLASS 41—EDUCATION AND ENTERTAINMENT

FOR TRAINING SERVICES IN THE FIELD OF MILITARY COMMUNICATION AND ELECTRONIC WARFARE (U.S. CLS. 100, 101 AND 107).

CLASS 42—SCIENTIFIC, COMPUTER AND LEGAL SERVICES

FOR DESIGN AND MAINTENANCE OF PROGRAMS FOR DATA PROCESSING, PROVISION OF TECHNICAL OPINION, CONSULTING ENGINEER SERVICES (U.S. CLS. 100 AND 101).

SN 76-074,131. DAIMLERCHRYSLER AG, 70567 STUTTGART, FED REP GERMANY, FILED 6-20-2000.

MRCM

PRIORITY CLAIMED UNDER SEC. 44(D) ON FED REP GERMANY APPLICATION NO. 39985381.2, FILED 12-22-1999, REG. NO. 39985381, DATED 2-14-2000, EXPIRES 12-31-2009.

CLASS 9—ELECTRICAL AND SCIENTIFIC APPARATUS

FOR AIR-LAND SEA BATTLEFIELD COMMUNICATIONS EQUIPMENT, NAMELY, TRANSMITTERS AND RECEIVERS OPERATING IN THE MEDIUM FREQUENCY, HIGH FREQUENCY, VERY-HIGH FREQUENCY, ULTRA-HIGH FREQUENCY, AND SUPER-HIGH FREQUENCY RANGES FOR SHIP AND STATIONARY AND ASSOCIATED EQUIPMENT, NAMELY, MODEMS, PROCESSORS AND COMMUNICATIONS SERVERS, DATA TERMINALS SYSTEM-OPERATING HANDSETS, REMOTE-CONTROL PACKAGES, FREQUENCY AND KEY MANAGEMENT SYSTEMS, VOICE AND DATA INTERCOM SYSTEMS FOR SHIPS; ANTENNAS; ELECTRONIC WARFARE AND SPECTRUM-CONTROL EQUIPMENT, NAMELY, INTERCEPTORS, RECEIVERS, RADIO DIRECTION FINDERS, TRANSMISSION JAMMERS AND DEMODULATORS/DECODERS (U.S. CLS. 21, 23, 26, 36 AND 38).

CLASS 41—EDUCATION AND ENTERTAINMENT

FOR TRAINING SERVICES IN THE FIELD OF MILITARY COMMUNICATION AND ELECTRONIC WARFARE (U.S. CLS. 100, 101 AND 107).

CLASS 42—SCIENTIFIC, COMPUTER AND LEGAL SERVICES

FOR DESIGN AND MAINTENANCE OF PROGRAMS FOR DATA PROCESSING, PROVISION OF TECHNICAL OPINION, CONSULTING ENGINEER SERVICES (U.S. CLS. 100 AND 101).

SN 76-078,912. INNOVATIVE TECHNOLOGY APPLICATION, INC., SPRINGFIELD, VA. FILED 6-28-2000.

**EXPERT KNOWLEDGE
MANAGEMENT THROUGH
CREATIVE MULTIMEDIA**

CLASS 40—MATERIAL TREATMENT

FOR DOCUMENT DATA TRANSFER AND PHYSICAL CONVERSION SERVICES FROM ONE MEDIA TO ANOTHER, NAMELY, ELECTRONIC SCANNING AND CONVERSION SERVICES OF PHOTOGRAPHIC IMAGES, ELECTRONIC IMAGES, AUDIO AND PRINTED MATERIAL FOR USE IN ARCHIVING, RETRIEVING AND PRESERVATION; ELECTRONIC IMAGING, SCANNING, DIGITIZING, ALTERATION AND/OR RETOUCHING OF PHOTOGRAPHIC IMAGES, CARTOONS, 3-D MODELS, ANIMATION AND ARTWORK; VIDEO TRANSFER, NAMELY, PROVIDING COLOR CORRECTION AND CONVERSION OF MOTION PICTURE FILM TO VIDEO FILM (U.S. CLS. 100, 103 AND 106).

FIRST USE 6-15-1997; IN COMMERCE 6-15-1997.

CLASS 41—EDUCATION AND ENTERTAINMENT

FOR AUDIO RECORDING AND PRODUCTION AND VIDEOTAPE PRODUCTION; ANIMATION PRODUCTION SERVICES (U.S. CLS. 100, 101 AND 107).
FIRST USE 6-15-1997; IN COMMERCE 6-15-1997.

CLASS 42—SCIENTIFIC, COMPUTER AND LEGAL SERVICES

FOR COMMERCIAL ART DESIGN, NAMELY, CUSTOM DESIGN OF POSTERS, BROCHURES, FLYERS AND 3-DIMENSIONAL MODELS; AND ANIMATION AND SPECIAL-EFFECTS DESIGN FOR OTHERS (U.S. CLS. 100 AND 101).
FIRST USE 6-15-1997; IN COMMERCE 6-15-1997.

SN 76-083,944. GEMSTAR DEVELOPMENT CORPORATION, PASADENA, CA. FILED 7-5-2000.



NO CLAIM IS MADE TO THE EXCLUSIVE RIGHT TO USE "EBOOK", APART FROM THE MARK AS SHOWN.

CLASS 9—ELECTRICAL AND SCIENTIFIC APPARATUS

FOR HAND-HELD DISPLAY DEVICES FOR RECEIVING AND DISPLAYING ELECTRONICALLY PUBLISHED WORKS, AND SOFTWARE FOR SAME (U.S. CLS. 21, 23, 26, 36 AND 38).

CLASS 35—ADVERTISING AND BUSINESS

FOR DISTRIBUTORSHIP SERVICES IN THE FIELD OF NON-FICTIONAL AND FICTIONAL ELECTRONIC PUBLICATIONS (U.S. CLS. 100, 101 AND 102).

CLASS 41—EDUCATION AND ENTERTAINMENT

FOR ELECTRONIC PUBLISHING SERVICES, NAMELY, ELECTRONIC PUBLICATION OF NON-FICTION AND FICTION TO REMOTE HAND-HELD DISPLAY DEVICES FOR STORAGE AND DISPLAY (U.S. CLS. 100, 101 AND 107).

SN 76-088,661. KABUSHIKI KAISHA HITACHI SEISAKUSHO, DBA HITACHI, LTD., TOKYO 101-8010, JAPAN, FILED 7-13-2000.

HITACHI CAPITAL

OWNER OF U.S. REG. NOS. 1,685,089, 2,267,606 AND OTHERS.

NO CLAIM IS MADE TO THE EXCLUSIVE RIGHT TO USE "CAPITAL" IN CLASS 42 ONLY, APART FROM THE MARK AS SHOWN.

CLASS 35—ADVERTISING AND BUSINESS

FOR COMPUTERIZED DATABASE MANAGEMENT; BUSINESS MANAGEMENT IN THE FIELD OF PRODUCT TRANSPORTATION AND DELIVERY (U.S. CLS. 100, 101 AND 102).

CLASS 37—CONSTRUCTION AND REPAIR

FOR MAINTENANCE OF COMPUTER HARDWARE (U.S. CLS. 100, 103 AND 106).

CLASS 38—COMMUNICATION

FOR PROVIDING MULTIPLE-USER ACCESS TO GLOBAL COMPUTER INFORMATION NETWORKS; ELECTRONIC TRANSFER OF DATA AND DOCUMENTS VIA COMPUTER TERMINALS; PROVIDING ONLINE ELECTRONIC BULLETIN BOARDS FOR TRANSMISSION OF MESSAGES AMONG COMPUTER USERS CONCERNING BUSINESS, FINANCE, CURRENT NEWS, HISTORY, SCIENCE, SPORTS, COMPUTER HARDWARE, COMPUTER SOFTWARE, EDUCATION, GAMES, MUSIC, THEATER, ART, MOVIES, TRAVEL, EDUCATION, LIFESTYLES, AND HOBBIES; ELECTRONIC DATA INTERCHANGE SERVICES FOR BUSINESS ENTERPRISES (U.S. CLS. 100, 101 AND 104).

CLASS 42—SCIENTIFIC, COMPUTER AND LEGAL SERVICES

FOR PROVIDING COMPUTER CONSULTING SERVICES FOR OTHERS RELATING TO THE DESIGN, DEVELOPMENT, IMPLEMENTATION AND SUPPORT OF COMPUTER SYSTEMS, DATA STORAGE, DATABASES, AND COMMUNICATIONS SYSTEMS, ALL IN THE FIELD OF ELECTRONIC COMMERCE; APPLICATION SERVICE PROVIDER SERVICES, NAMELY, HOSTING THE COMPUTER SOFTWARE PROGRAMS OF OTHERS IN THE FIELD OF ELECTRONIC COMMERCE ON A COMPUTER SERVER FOR OTHERS TO ACCESS; TECHNICAL SUPERVISION AND INSPECTION BY MEANS OF ELECTRONIC COMPUTER NETWORKS IN THE FIELD OF PRODUCT QUALITY CONTROL; TECHNICAL SUPPORT SERVICES, NAMELY, TROUBLESHOOTING OF COMPUTER HARDWARE AND SOFTWARE PROBLEMS VIA TELEPHONE, E-MAIL, GLOBAL COMPUTER NETWORKS, AND IN PERSON; DESIGN AND DEVELOPMENT FOR OTHERS OF COMPUTER HARDWARE AND SOFTWARE FOR TELECOMMUNICATION NETWORKS; MAINTENANCE OF COMPUTER SOFTWARE; DESIGN AND DEVELOPMENT OF COMPUTER MONITORING SYSTEMS FOR OTHERS FOR SECURITY PURPOSES, NAMELY, DESIGN AND IMPLEMENTATION OF COMPUTER FIREWALLS, USER AUTHENTICATION SYSTEMS, INTERNAL AND EXTERNAL SECURITY ASSESSMENTS, SYSTEMS TO SECURE WEB SITES, AND SYSTEMS TO SECURE REMOTE ACCESS TECHNOLOGIES; PRODUCT DESIGN AND DEVELOPMENT FOR OTHERS IN THE FIELD OF ELECTRONIC INFORMATION COMMUNICATION SYSTEMS; DESIGN AND DEVELOPMENT OF TELECOMMUNICATIONS EQUIPMENT FOR OTHERS; PROVIDING COMPUTER NETWORK SYSTEMS INTEGRATION SERVICES; DATABASE DEVELOPMENT SERVICES; RESEARCH AND DEVELOPMENT OF NEW PRODUCTS FOR OTHERS IN THE FIELDS OF ELECTRONIC MONEY, COMPUTER NETWORK PAYMENT SYSTEMS, COMPUTER NETWORK SECURITY, TELECOMMUNICATIONS AND INFORMATION TECHNOLOGY NETWORKS AND SYSTEMS; COMPUTER NETWORK DESIGN CONSULTATION, NAMELY, ASSISTING OTHERS IN THE DESIGN OF COMPUTER NETWORK SITES; TECHNICAL SUPPORT SERVICES, NAMELY, ASSISTING OTHERS IN THE OPERATION AND MAINTENANCE OF NETWORKED COMPUTER SYSTEMS VIA MAINTENANCE OF COMPUTER SOFTWARE AND PROVISION OF COMPUTER PROGRAMMING; PROTECTING THE SECURITY OF DATA TRANSMITTED OVER COMPUTER NETWORKS BY MEANS OF AUTHENTICATION OF USER IDENTITY AND MESSAGE CONTENT, VERIFICATION OF NON-REPUDIATION OF TRANSMISSIONS AND ACCESS CONTROL; COMPUTER CONSULTATION, NAMELY, PROVIDING INFORMATION ON COMPUTER NETWORK SYSTEMS AND COMPUTER

NETWORK SERVICES FOR SENDING AND RECEIVING PRODUCT ORDERS, PRODUCT INFORMATION, MANUFACTURING ESTIMATES, DRAWINGS, DOCUMENTS AND INVENTORY LISTS; MAINTENANCE OF COMPUTER SOFTWARE FOR ELECTRONIC DATA INTERCHANGE AND TELECOMMUNICATIONS NETWORKS FOR OTHERS; DATA ENCRYPTION SERVICES, NAMELY, PROTECTING THE SECURITY OF DATA TRANSMITTED OVER COMPUTER NETWORKS BY MEANS OF ENCRYPTION AND CRYPTOGRAPHY; PRODUCT DEVELOPMENT FOR OTHERS, NAMELY, DEVELOPMENT OF GLOBAL COMPUTER NETWORK SYSTEMS, INTRANET AND EXTRANET SYSTEMS AND OF COMPUTER FIREWALL SYSTEMS; TECHNICAL SUPPORT SERVICES, NAMELY, TROUBLESHOOTING OF COMPUTER HARDWARE AND SOFTWARE PROBLEMS RELATING TO A GLOBAL COMPUTER NETWORK, INTRANET, EXTRANET, AND OTHER ELECTRONIC COMMUNICATION SYSTEMS VIA TELEPHONE, E-MAIL, AND IN-PERSON CONSULTATION; COMPUTER PROGRAMMING FOR OTHERS; INSTALLATION AND MAINTENANCE OF COMPUTER SOFTWARE; LEASING OF COMPUTER HARDWARE AND SOFTWARE; PROVIDING TEMPORARY USE OF ONLINE NON-DOWNLOADABLE SOFTWARE FOR ELECTRONIC NOTARY AND AUTHENTICATION OF DOCUMENTS AND DATA TRANSMISSIONS (U.S. CLS. 100 AND 101).

SN 76-088,663. KABUSHIKI KAISHA HITACHI SEISAKUSHO, DBA HITACHI, LTD., TOKYO 101-8010, JAPAN, FILED 7-13-2000.

HITACHI CAPITAL

OWNER OF U.S. REG. NOS. 701,266, 1,893,353 AND OTHERS.

NO CLAIM IS MADE TO THE EXCLUSIVE RIGHT TO USE "CAPITAL", APART FROM THE MARK AS SHOWN.

CLASS 35—ADVERTISING AND BUSINESS

FOR PROMOTING GOLF TOURNAMENTS, BOXING MATCHES, BASEBALL GAMES, HORSE RACES, BICYCLE RACES, BOAT RACES AND GO-CART RACES OF OTHERS; OPERATION OF A BUSINESS FOR OTHERS, NAMELY, LENDING LIBRARIES (U.S. CLS. 100, 101 AND 102).

CLASS 41—EDUCATION AND ENTERTAINMENT

FOR EDUCATIONAL SERVICES, NAMELY, PROVIDING CLASSES, SEMINARS, CONFERENCES, AND WORKSHOPS IN THE FIELDS OF COMPUTERS, MANUFACTURING, CONSTRUCTION, INDUSTRIAL MACHINERY, ENGINEERING, MATHEMATICS, PHYSICS, CHEMISTRY, TELECOMMUNICATIONS, TRANSPORTATION, LOGISTICS, EMPLOYMENT, AND BUSINESS MANAGEMENT; TRAINING SERVICES IN THE FIELDS OF COMPUTERS, MANUFACTURING, CONSTRUCTION, INDUSTRIAL MACHINERY, ENGINEERING, MATHEMATICS, PHYSICS, CHEMISTRY, TELECOMMUNICATIONS, TRANSPORTATION, LOGISTICS, EMPLOYMENT, AND BUSINESS MANAGEMENT; ENTERTAINMENT SERVICES, NAMELY, PROVIDING ONLINE COMPUTER GAMES AND PROVIDING PRE-RECORDED MUSIC VIA A GLOBAL COMPUTER NETWORK; PROVIDING ONLINE MAGAZINES AND NEWSLETTERS IN THE FIELDS OF COMPUTERS, MANUFACTURING, CONSTRUCTION, INDUSTRIAL MACHINERY, EMPLOYMENT, BUSINESS, FINANCE, CURRENT NEWS, HISTORY, SCIENCE, SPORTS, COMPUTER HARDWARE, COMPUTER SOFTWARE, EDUCATION, GAMES, MUSIC, THEATER, ART, MOVIES, TRAVEL, EDUCATION, LIFESTYLES, AND HOBBIES; ORGANIZING EXHIBITIONS FOR SPORTING EVENTS, NAMELY, GOLF, BASEBALL, FOOTBALL, HOCKEY, TENNIS, AND BASKETBALL AND ORGANIZING EXHIBITIONS FOR CULTURAL ACTIVITIES, NAMELY, OPERAS, PLAYS, MUSICAL CONCERTS AND FESTI-

VALS AND ART EXHIBITIONS; PRODUCTION AND DISTRIBUTION OF ENTERTAINMENT AND EDUCATIONAL PROGRAMS FOR DISTRIBUTION VIA A GLOBAL COMMUNICATIONS NETWORK, COMPUTERS, TELEVISION, CABLE AND SATELLITE BROADCASTING; PUBLICATION OF BOOKS, JOURNALS, AND MAGAZINES; PROVIDING INFORMATION IN THE FIELDS OF EDUCATION, TRAINING, ENTERTAINMENT, SPORTING AND CULTURAL ACTIVITIES VIA A GLOBAL COMPUTER COMMUNICATIONS NETWORK; RENTAL OF SPORTING EQUIPMENT, NAMELY, GOLF, BASEBALL, FOOTBALL, HOCKEY, TENNIS, AND BASKETBALL EQUIPMENT; RENTAL OF VIDEO GAMES AND VIDEO GAME PLAYERS; RENTAL OF VIDEOTAPE PLAYERS; RENTAL OF CINEMA PROJECTION APPARATUS; RENTAL OF AUDIO AND VIDEO EQUIPMENT FOR USE IN FILM PROJECTION; RENTAL OF VIDEOTAPES AND SOUND RECORDINGS IN RECORD AND COMPACT DISC FORM; RENTAL OF LIGHTING EQUIPMENT AND APPARATUS FOR STAGE PRODUCTIONS, OPERAS, PLAYS, MUSICAL CONCERTS AND FESTIVALS; EDUCATIONAL SERVICES, NAMELY, CONDUCTING CLASSES, SEMINARS, CONFERENCES, WORKSHOPS IN THE FIELDS OF ARTS, CRAFTS, SPORTS AND SCIENCE; ANIMAL TRAINING; ANIMAL EXHIBITIONS; ART EXHIBITIONS; PLANT EXHIBITIONS; LIBRARIES; PRODUCTION OF FILMS, PLAYS, CONCERTS, RADIO PROGRAMS AND TELEVISION PROGRAMS; DISTRIBUTION OF RADIO AND TELEVISION PROGRAMS FOR OTHERS; ENTERTAINMENT IN THE NATURE OF LIVE PERFORMANCES BY A MUSICAL BAND, ORCHESTRAL PERFORMANCES, OPERAS, PLAYS, MUSICAL CONCERTS AND FESTIVALS; ENTERTAINMENT IN THE NATURE OF GOLF TOURNAMENTS, BOXING MATCHES, BASEBALL GAMES, HORSE RACES, BICYCLE RACES, BOAT RACES AND GO-CART RACES; PROVIDING AUDIO AND VIDEO RECORDING STUDIOS; PROVIDING FACILITIES FOR SPORTING ACTIVITIES, NAMELY, GOLF, BASEBALL, FOOTBALL, HOCKEY, TENNIS, AND BASKETBALL; PROVIDING FACILITIES FOR RECREATION ACTIVITIES; ENTERTAINMENT BOOKING SERVICES, NAMELY THEATRICAL, SPORTING, CONCERT, AND MUSIC BOOKING AGENCY SERVICES; RENTAL AND LEASING OF MUSICAL INSTRUMENTS, SKIING EQUIPMENT AND SKIN DIVING EQUIPMENT (U.S. CLS. 100, 101 AND 107).

CLASS 42—SCIENTIFIC, COMPUTER AND LEGAL SERVICES

FOR RENTAL OF PHOTOGRAPHIC EQUIPMENT; RENTAL AND LEASING OF COMPUTERS AND COMPUTER SOFTWARE FOR COMPUTER-AIDED INSTRUCTION IN THE FIELDS OF COMPUTERS, MANUFACTURING, CONSTRUCTION, INDUSTRIAL MACHINERY, ENGINEERING, MATHEMATICS, PHYSICS, CHEMISTRY, TELECOMMUNICATIONS, TRANSPORTATION, LOGISTICS, EMPLOYMENT, AND BUSINESS MANAGEMENT, AND FOR USE BY PRIMARY, SECONDARY AND COLLEGE-LEVEL EDUCATORS (U.S. CLS. 100 AND 101).

SN 76-090,478. KABUSHIKI KAISHA HITACHI SEISAKUSHO, DBA HITACHI, LTD., TOKYO 101-8010, JAPAN, FILED 7-17-2000.

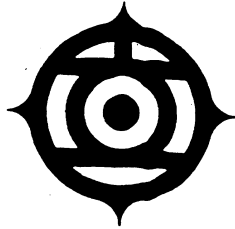

OWNER OF U.S. REG. NOS. 1,878,903 AND 1,937,818.

CLASS 35—ADVERTISING AND BUSINESS

FOR COMPUTERIZED DATABASE MANAGEMENT; BUSINESS MANAGEMENT IN THE FIELD OF PRODUCT TRANSPORTATION AND DELIVERY (U.S. CLS. 100, 101 AND 102).

CLASS 37—CONSTRUCTION AND REPAIR

FOR MAINTENANCE OF COMPUTER HARDWARE (U.S. CLS. 100, 103 AND 106).

CLASS 38—COMMUNICATION

FOR PROVIDING MULTIPLE-USER ACCESS TO GLOBAL COMPUTER INFORMATION NETWORKS; ELECTRONIC TRANSFER OF DATA AND DOCUMENTS VIA COMPUTER TERMINALS; PROVIDING ONLINE ELECTRONIC BULLETIN BOARDS FOR TRANSMISSION OF MESSAGES AMONG COMPUTER USERS CONCERNING BUSINESS, FINANCE, CURRENT NEWS, HISTORY, SCIENCE, SPORTS, COMPUTER HARDWARE, COMPUTER SOFTWARE, EDUCATION, GAMES, MUSIC, THEATER, ART, MOVIES, TRAVEL, EDUCATION, LIFESTYLES, AND HOBBIES; ELECTRONIC DATA INTERCHANGE SERVICES FOR BUSINESS ENTERPRISES (U.S. CLS. 100, 101 AND 104).

CLASS 42—SCIENTIFIC, COMPUTER AND LEGAL SERVICES

FOR PROVIDING COMPUTER CONSULTING SERVICES FOR OTHERS RELATING TO THE DESIGN, DEVELOPMENT, IMPLEMENTATION AND SUPPORT OF COMPUTER SYSTEMS, DATA STORAGE, DATABASES, AND COMMUNICATIONS SYSTEMS, ALL IN THE FIELD OF ELECTRONIC COMMERCE; APPLICATION SERVICE PROVIDER SERVICES, NAMELY, HOSTING THE COMPUTER SOFTWARE PROGRAMS OF OTHERS IN THE FIELD OF ELECTRONIC COMMERCE ON A COMPUTER SERVER FOR OTHERS TO ACCESS; TECHNICAL SUPERVISION AND INSPECTION BY MEANS OF ELECTRONIC COMPUTER NETWORKS IN THE FIELD OF PRODUCT QUALITY CONTROL; TECHNICAL SUPPORT SERVICES, NAMELY, TROUBLESHOOTING OF COMPUTER HARDWARE AND SOFTWARE PROBLEMS VIA TELEPHONE, E-MAIL, GLOBAL COMPUTER NETWORKS, AND IN PERSON; DESIGN AND DEVELOPMENT FOR OTHERS OF COMPUTER HARDWARE AND SOFTWARE FOR TELECOMMUNICATION NETWORKS; MAINTENANCE OF COMPUTER SOFTWARE; DESIGN AND DEVELOPMENT OF COMPUTER MONITORING SYSTEMS FOR OTHERS FOR SECURITY PURPOSES, NAMELY, DESIGN AND IMPLEMENTATION OF COMPUTER FIREWALLS, USER AUTHENTICATION SYSTEMS, INTERNAL AND EXTERNAL SECURITY ASSESSMENTS, SYSTEMS TO SECURE WEB SITES, AND SYSTEMS TO SECURE REMOTE ACCESS TECHNOLOGIES; PRODUCT DESIGN AND DEVELOPMENT FOR OTHERS IN THE FIELD OF ELECTRONIC INFORMATION COMMUNICATION SYSTEMS; DESIGN AND DEVELOPMENT OF TELECOMMUNICATIONS

EQUIPMENT FOR OTHERS; PROVIDING COMPUTER NETWORK SYSTEMS INTEGRATION SERVICES; DATABASE DEVELOPMENT SERVICES; RESEARCH AND DEVELOPMENT OF NEW PRODUCTS FOR OTHERS IN THE FIELDS OF ELECTRONIC MONEY, COMPUTER NETWORK PAYMENT SYSTEMS, COMPUTER NETWORK SECURITY, TELECOMMUNICATIONS AND INFORMATION TECHNOLOGY NETWORKS AND SYSTEMS; COMPUTER NETWORK DESIGN CONSULTATION, NAMELY, ASSISTING OTHERS IN THE DESIGN OF COMPUTER NETWORK SITES; TECHNICAL SUPPORT SERVICES, NAMELY, ASSISTING OTHERS IN THE OPERATION AND MAINTENANCE OF NETWORKED COMPUTER SYSTEMS VIA MAINTENANCE OF COMPUTER SOFTWARE AND PROVISION OF COMPUTER PROGRAMMING; PROTECTING THE SECURITY OF DATA TRANSMITTED OVER COMPUTER NETWORKS BY MEANS OF AUTHENTICATION OF USER IDENTITY AND MESSAGE CONTENT, VERIFICATION OF NON-REPUDIATION OF TRANSMISSIONS AND ACCESS CONTROL; COMPUTER CONSULTATION, NAMELY, PROVIDING INFORMATION ON COMPUTER NETWORK SYSTEMS AND COMPUTER NETWORK SERVICES FOR SENDING AND RECEIVING PRODUCT ORDERS, PRODUCT INFORMATION, MANUFACTURING ESTIMATES, DRAWINGS, DOCUMENTS AND INVENTORY LISTS; MAINTENANCE OF COMPUTER SOFTWARE FOR ELECTRONIC DATA INTERCHANGE AND TELECOMMUNICATIONS NETWORKS FOR OTHERS; DATA ENCRYPTION SERVICES, NAMELY, PROTECTING THE SECURITY OF DATA TRANSMITTED OVER COMPUTER NETWORKS BY MEANS OF ENCRYPTION AND CRYPTOGRAPHY; PRODUCT DEVELOPMENT FOR OTHERS, NAMELY, DEVELOPMENT OF GLOBAL COMPUTER NETWORK SYSTEMS, INTRANET AND EXTRANET SYSTEMS AND OF COMPUTER FIREWALL SYSTEMS; TECHNICAL SUPPORT SERVICES, NAMELY, TROUBLESHOOTING OF COMPUTER HARDWARE AND SOFTWARE PROBLEMS RELATING TO A GLOBAL COMPUTER NETWORK, INTRANET, EXTRANET, AND OTHER ELECTRONIC COMMUNICATION SYSTEMS VIA TELEPHONE, E-MAIL, AND IN-PERSON CONSULTATION; COMPUTER PROGRAMMING FOR OTHERS; INSTALLATION AND MAINTENANCE OF COMPUTER SOFTWARE; LEASING OF COMPUTER HARDWARE AND SOFTWARE; PROVIDING TEMPORARY USE OF ONLINE NON-DOWNLOADABLE SOFTWARE FOR ELECTRONIC NOTARY AND AUTHENTICATION OF DOCUMENTS AND DATA TRANSMISSIONS (U.S. CLS. 100 AND 101).

SN 76-090,543. KABUSHIKI KAISHA HITACHI SEISAKUSHO, DBA HITACHI, LTD., CHIYODA-KU, TOKYO 101-8010, JAPAN, FILED 7-17-2000.

HITACHI

OWNER OF U.S. REG. NOS. 1,685,089, 2,267,606 AND OTHERS.

CLASS 35—ADVERTISING AND BUSINESS

FOR COMPUTERIZED DATABASE MANAGEMENT; BUSINESS MANAGEMENT IN THE FIELD OF PRODUCT TRANSPORTATION AND DELIVERY (U.S. CLS. 100, 101 AND 102).

CLASS 37—CONSTRUCTION AND REPAIR

FOR MAINTENANCE OF COMPUTER HARDWARE (U.S. CLS. 100, 103 AND 106).

CLASS 38—COMMUNICATION

FOR PROVIDING MULTIPLE-USER ACCESS TO GLOBAL COMPUTER INFORMATION NETWORKS; ELECTRONIC TRANSFER OF DATA AND DOCUMENTS VIA COMPUTER TERMINALS; PROVIDING ONLINE ELECTRONIC BULLETIN BOARDS FOR TRANSMISSION OF MESSAGES AMONG COMPUTER USERS CONCERNING BUSINESS, FINANCE, CURRENT NEWS, HISTORY, SCIENCE, SPORTS, COMPUTER HARDWARE, COMPUTER SOFTWARE, EDUCATION, GAMES, MUSIC, THEATER, ART, MOVIES, TRAVEL, EDUCATION, LIFESTYLES, AND HOBBIES; ELECTRONIC DATA INTERCHANGE SERVICES FOR BUSINESS ENTERPRISES (U.S. CLS. 100, 101 AND 104).

CLASS 42—SCIENTIFIC, COMPUTER AND LEGAL SERVICES

FOR PROVIDING COMPUTER CONSULTING SERVICES FOR OTHERS RELATING TO THE DESIGN, DEVELOPMENT, IMPLEMENTATION AND SUPPORT OF COMPUTER SYSTEMS, DATA STORAGE, DATABASES, AND COMMUNICATIONS SYSTEMS, ALL IN THE FIELD OF ELECTRONIC COMMERCE; APPLICATION SERVICE PROVIDER SERVICES, NAMELY, HOSTING THE COMPUTER SOFTWARE PROGRAMS OF OTHERS IN THE FIELD OF ELECTRONIC COMMERCE ON A COMPUTER SERVER FOR OTHERS TO ACCESS; TECHNICAL SUPERVISION AND INSPECTION BY MEANS OF ELECTRONIC COMPUTER NETWORKS IN THE FIELD OF PRODUCT QUALITY CONTROL; TECHNICAL SUPPORT SERVICES, NAMELY, TROUBLESHOOTING OF COMPUTER HARDWARE AND SOFTWARE PROBLEMS VIA TELEPHONE, E-MAIL, GLOBAL COMPUTER NETWORKS, AND IN PERSON; DESIGN AND DEVELOPMENT FOR OTHERS OF COMPUTER HARDWARE AND SOFTWARE FOR TELECOMMUNICATION NETWORKS; MAINTENANCE OF COMPUTER SOFTWARE; DESIGN AND DEVELOPMENT OF COMPUTER MONITORING SYSTEMS FOR OTHERS FOR SECURITY PURPOSES, NAMELY, DESIGN AND IMPLEMENTATION OF COMPUTER FIREWALLS, USER AUTHENTICATION SYSTEMS, INTERNAL AND EXTERNAL SECURITY ASSESSMENTS, SYSTEMS TO SECURE WEB SITES, AND SYSTEMS TO SECURE REMOTE ACCESS TECHNOLOGIES; PRODUCT DESIGN AND DEVELOPMENT FOR OTHERS IN THE FIELD OF ELECTRONIC INFORMATION COMMUNICATION SYSTEMS; DESIGN AND DEVELOPMENT OF TELECOMMUNICATIONS EQUIPMENT FOR OTHERS; PROVIDING COMPUTER NETWORK SYSTEMS INTEGRATION SERVICES; DATABASE DEVELOPMENT SERVICES; RESEARCH AND DEVELOPMENT OF NEW PRODUCTS FOR OTHERS IN THE FIELDS OF ELECTRONIC MONEY, COMPUTER NETWORK PAYMENT SYSTEMS, COMPUTER NETWORK SECURITY, TELECOMMUNICATIONS AND INFORMATION TECHNOLOGY NETWORKS AND SYSTEMS; COMPUTER NETWORK DESIGN CONSULTATION, NAMELY, ASSISTING OTHERS IN THE DESIGN OF COMPUTER NETWORK SITES; TECHNICAL SUPPORT SERVICES, NAMELY, ASSISTING OTHERS IN THE OPERATION AND MAINTENANCE OF NETWORKED COMPUTER SYSTEMS VIA MAINTENANCE OF COMPUTER SOFTWARE AND PROVISION OF COMPUTER PROGRAMMING; PROTECTING THE SECURITY OF DATA TRANSMITTED OVER COMPUTER NETWORKS BY MEANS OF AUTHENTICATION OF USER IDENTITY AND MESSAGE CONTENT, VERIFICATION OF NON-REPUDIATION OF TRANSMISSIONS AND ACCESS CONTROL; COMPUTER CONSULTATION, NAMELY, PROVIDING INFORMATION ON COMPUTER NETWORK SYSTEMS AND COMPUTER NETWORK SERVICES FOR SENDING AND RECEIVING PRODUCT ORDERS, PRODUCT INFORMATION, MANUFACTURING ESTIMATES, DRAWINGS, DOCUMENTS AND INVENTORY LISTS; MAINTENANCE OF COMPUTER SOFTWARE FOR ELECTRONIC DATA INTERCHANGE AND TELECOMMUNICATIONS NETWORKS FOR OTHERS; DATA ENCRYPTION SERVICES, NAMELY, PROTECTING THE SECURITY OF DATA TRANSMITTED OVER COMPUTER NETWORKS BY MEANS OF ENCRYPTION AND CRYPTOGRAPHY; PRODUCT DEVELOPMENT FOR OTHERS, NAMELY, DEVELOPMENT OF GLOBAL COMPUTER NETWORK SYSTEMS, INTRANET AND EXTRANET SYSTEMS AND OF COMPUTER FIREWALL SYSTEMS; TECHNICAL

SUPPORT SERVICES, NAMELY, TROUBLESHOOTING OF COMPUTER HARDWARE AND SOFTWARE PROBLEMS RELATING TO A GLOBAL COMPUTER NETWORK, INTRANET, EXTRANET, AND OTHER ELECTRONIC COMMUNICATION SYSTEMS VIA TELEPHONE, E-MAIL, AND IN-PERSON CONSULTATION; COMPUTER PROGRAMMING FOR OTHERS; INSTALLATION AND MAINTENANCE OF COMPUTER SOFTWARE; LEASING OF COMPUTER HARDWARE AND SOFTWARE; PROVIDING TEMPORARY USE OF ONLINE NON-DOWNLOADABLE SOFTWARE FOR ELECTRONIC NOTARY AND AUTHENTICATION OF DOCUMENTS AND DATA TRANSMISSIONS (U.S. CLS. 100 AND 101).

SN 76-111,065. ORGANISED 1ST PTY LTD, PERTH WA 6000, AUSTRALIA, FILED 8-17-2000.

ORGANISED 1ST

PRIORITY CLAIMED UNDER SEC. 44(D) ON AUSTRALIA APPLICATION NO. 833532, FILED 5-1-2000, REG. NO. 833532, DATED 5-1-2000, EXPIRES 5-1-2010.

CLASS 9—ELECTRICAL AND SCIENTIFIC APPARATUS

FOR COMPUTERS, COMPUTER HARDWARE; COMPUTER SOFTWARE FOR DATABASE MANAGEMENT; COMPUTER PERIPHERALS; INTEGRATED CIRCUITS; ELECTRONIC PUBLICATIONS, NAMELY, MANUALS FEATURING INFORMATION ON DATABASE MANAGEMENT RECORDED ON SOFTWARE; DOWNLOADABLE SOFTWARE FOR USE IN DATABASE MANAGEMENT IN THE FIELD OF BUSINESS MANAGEMENT AND BUSINESS ADMINISTRATION; INTERACTIVE COMPUTER SOFTWARE FOR USE IN DATABASE MANAGEMENT IN THE FIELD OF BUSINESS MANAGEMENT AND ADMINISTRATION (U.S. CLS. 21, 23, 26, 36 AND 38).

CLASS 16—PAPER GOODS AND PRINTED MATTER

FOR PRINTED MATTER, NAMELY, MANUALS IN THE FIELD OF BUSINESS MANAGEMENT AND BUSINESS ADMINISTRATION; BOOKS, MAGAZINES, NEWSLETTERS, BROCHURES, BOOKLETS, PAMPHLETS, MANUALS, JOURNALS AND LEAFLETS, ALL IN THE FIELD OF BUSINESS MANAGEMENT AND BUSINESS ADMINISTRATION; GREETING CARDS (U.S. CLS. 2, 5, 22, 23, 29, 37, 38 AND 50).

CLASS 35—ADVERTISING AND BUSINESS

FOR PLACING AND PREPARING ADVERTISEMENTS FOR OTHERS; BUSINESS MANAGEMENT; BUSINESS MANAGEMENT SUPERVISION; COOPERATIVE ADVERTISING AND MARKETING AGENCIES; ADVERTISING AGENCIES, NAMELY, PROMOTING THE SERVICES OF BUSINESS MANAGEMENT AND ADMINISTRATION THROUGH THE DISTRIBUTION OF PRINTED AND AUDIO PROMOTIONAL MATERIALS AND BY RENDERING SALES PROMOTION ADVICE; COMPUTER DATABASE MANAGEMENT SERVICES; BUSINESS INFORMATION IN THE FIELD OF BUSINESS ADMINISTRATION AND MANAGEMENT PROVIDED VIA A GLOBAL COMPUTER NETWORK; PREPARING AND PLACING ADVERTISEMENTS FOR OTHERS ON WEB PAGES; CONDUCTING BUSINESS AND MARKET RESEARCH SURVEYS; ANALYSIS OF ADVERTISING RESPONSE AND MARKET RESEARCH; COMPUTERIZED DATABASE MANAGEMENT; PROVIDING INFORMATION IN THE FIELD OF BUSINESS ADMINISTRATION AND MANAGEMENT VIA WEBSITES ON A GLOBAL COMPUTER NETWORK (U.S. CLS. 100, 101 AND 102).

CLASS 41—EDUCATION AND ENTERTAINMENT

FOR ENTERTAINMENT AND EDUCATION SERVICES, NAMELY, PROVIDING MOTIVATIONAL AND EDUCATIONAL SPEAKERS; ARRANGING AND CONDUCTING BUSINESS CONFERENCES, SEMINARS, EXHIBITIONS AND SYMPOSIUMS; EDUCATION SERVICES, NAMELY CONDUCTING TRAINING COURSES IN THE FIELD OF BUSINESS ADMINISTRATION AND BUSINESS MANAGEMENT, CONDUCTING TRAINING CLASSES IN THE FIELDS OF BUSINESS, BUSINESS MANAGEMENT, INDUSTRY AND INFORMATION TECHNOLOGY, AND DISTRIBUTING COURSE MATERIALS IN CONNECTION THEREWITH (U.S. CLS. 100, 101 AND 107).

CLASS 42—SCIENTIFIC, COMPUTER AND LEGAL SERVICES

FOR COMPUTER SERVICES, NAMELY, PROVIDING ON-LINE MAGAZINES, BOOKS, AND JOURNALS ALL IN THE FIELD OF ADVERTISING; COMPUTER SERVICES, NAMELY, PROVIDING WEB PAGE FEATURING PUBLICATIONS THAT CAN BE BROWSED, IN THE FIELD OF BUSINESS ADMINISTRATION AND MANAGEMENT; COMPUTER PROGRAMMING FOR OTHERS; COMPUTER HARDWARE AND SOFTWARE SYSTEMS DESIGN FOR OTHERS; GRAPHIC ART DESIGN, NAMELY, DESIGNING IMAGES DISPLAYED ON WEB PAGES; CREATING AND MAINTAINING WEBSITES FOR OTHERS; COMPUTER CONSULTATION (U.S. CLS. 100 AND 101).

SN 76-115,061. LUCKY CHARMS ENTERTAINMENT, INC., RAMSEY, NJ. FILED 8-23-2000.

ROSIE

"ROSIE" O'DONNELL IS A LIVING INDIVIDUAL WHOSE CONSENT IS OF RECORD.

CLASS 16—PAPER GOODS AND PRINTED MATTER

FOR PENCILS (U.S. CLS. 2, 5, 22, 23, 29, 37, 38 AND 50). FIRST USE 6-0-1996; IN COMMERCE 6-0-1996.

CLASS 41—EDUCATION AND ENTERTAINMENT

FOR ENTERTAINMENT IN THE NATURE OF A LIVE TELEVISION SHOW; PROVIDING INFORMATION ABOUT A TELEVISION PERSONALITY AND HER TELEVISION SHOW VIA A GLOBAL COMPUTER NETWORK (U.S. CLS. 100, 101 AND 107). FIRST USE 6-10-1996; IN COMMERCE 6-10-1996.

SN 76-121,396. BJK HOLDINGS, INC., WILMINGTON, DE. FILED 9-5-2000.

YORK LABEL

NO CLAIM IS MADE TO THE EXCLUSIVE RIGHT TO USE "LABEL", APART FROM THE MARK AS SHOWN. SEC. 2(F).

CLASS 16—PAPER GOODS AND PRINTED MATTER

FOR PRESSURE SENSITIVE LABELS AND BAR CODE LABELS (U.S. CLS. 2, 5, 22, 23, 29, 37, 38 AND 50). FIRST USE 9-0-2000; IN COMMERCE 9-0-2000.

CLASS 42—SCIENTIFIC, COMPUTER AND LEGAL SERVICES

FOR PRINTING SERVICES (U.S. CLS. 100 AND 101). FIRST USE 9-0-2000; IN COMMERCE 9-0-2000.

SN 76-121,485. SERPA, DARLENE, SANTA BARBARA, CA. AND SERPA, MARYANN, SANTA BARBARA, CA. FILED 9-5-2000.



NO CLAIM IS MADE TO THE EXCLUSIVE RIGHT TO USE "SKIN", APART FROM THE MARK AS SHOWN. THE STIPPLING IS FOR SHADING PURPOSES AND DOES INDICATE THE COLOR GRAY.

CLASS 3—COSMETICS AND CLEANING PREPARATIONS

FOR NON-MEDICATED SKIN CARE PRODUCTS, NAMELY, MOISTURIZERS, BALMS, NAMELY, RED WINE BALM, ANTI-AGING AND FIRING FACIAL SERUMS, FACIAL HYDRATION AND FIRING MASQUES, SUNSCREENS, EYE CREAMS, LIP BALMS, HAND LOTION, FOOT CREAMS, MAKEUP, LIQUID FOUNDATION, MINERAL POWDERS, MAKEUP REMOVERS, EYE SHADOWS, BRONZERS, EYE LINERS, MASCARA, BLUSHES, LIPSTICKS, LIP LINERS, CONCEALERS, SKIN LIGHTENERS (U.S. CLS. 1, 4, 6, 50, 51 AND 52).

CLASS 5—PHARMACEUTICALS

FOR MEDICATED SKIN CARE PRODUCTS, NAMELY, EXFOLIANTS, MOISTURIZERS, BALMS, ANTI-AGING FACIAL SERUMS, EYE CREAMS, BODY LOTION, FOOT EXFOLIANTS (U.S. CLS. 6, 18, 44, 46, 51 AND 52).

SN 76-127,461. SPADAFORA, ROBERTA LYNN, WATTLE
PARK 5066 SA, AUSTRALIA, FILED 9-13-2000.



CLASS 9—ELECTRICAL AND SCIENTIFIC APPARATUS

FOR COMPUTER GAME PROGRAMS, COMPUTER GAME SOFTWARE, INTERACTIVE MULTI MEDIA COMPUTER GAME PROGRAMS (U.S. CLS. 21, 23, 26, 36 AND 38).

CLASS 28—TOYS AND SPORTING GOODS

FOR ELECTRONIC BOARD GAMES, ELECTRONIC EDUCATIONAL BOARD GAMES AND BOARD GAMES (U.S. CLS. 22, 23, 38 AND 50).

CLASS 41—EDUCATION AND ENTERTAINMENT

FOR ENTERTAINMENT SERVICES, NAMELY, PROVIDING ON-LINE COMPUTER GAMES BY MEANS OF A GLOBAL COMPUTER NETWORK (U.S. CLS. 100, 101 AND 107).

SN 76-132,010. ANIDRAL S.R.L, 28100 NOVARA, ITALY,
FILED 9-19-2000.



PRIORITY CLAIMED UNDER SEC. 44(D) ON ITALY APPLICATION NO. 2000C00032, FILED 4-21-2000, REG. NO. 00822090, DATED 8-31-2000, EXPIRES 4-21-2010.

NO CLAIM IS MADE TO THE EXCLUSIVE RIGHT TO USE "PROBIOTICAL", APART FROM THE MARK AS SHOWN.

CLASS 1—CHEMICALS

FOR MICROORGANISMS CULTURES, NAMELY LACTIC BACTERIA AND YEAST HAVING PROBIOTIC ACTIVITY ON THE HUMAN ORGANISM AND ON FARMED ANIMAL SPECIES, FOR USE IN THE MANUFACTURE OF FOODS (U.S. CLS. 1, 5, 6, 10, 26 AND 46).

CLASS 5—PHARMACEUTICALS

FOR MICROORGANISMS CULTURES FOR CLINICAL MEDICAL USE, NAMELY LACTIC BACTERIA AND YEAST HAVING PROBIOTIC ACTIVITY ON HUMANS FOR THE TREATMENT OF DISEASES INCLUDING INTESTINAL DISORDERS, DIARRHEA AND TO REEQUILIBRATE THE INTESTINAL BACTERIAL FLORA (U.S. CLS. 6, 18, 44, 46, 51 AND 52).

CLASS 31—NATURAL AGRICULTURAL PRODUCTS

FOR MICROORGANISMS CULTURES, NAMELY LACTIC BACTERIA AND YEAST HAVING PROBIOTIC ACTIVITY ON THE HUMAN ORGANISM AND ON FARMED ANIMAL SPECIES, SOLD AS AN INTEGRAL COMPONENT OF DRIED FEEDS FOR ANIMALS SUCH AS CATS AND DOGS (U.S. CLS. 1 AND 46).

SN 76-136,032. UBS AG, CH-8001 ZURICH, SWITZERLAND,
FILED 9-27-2000.



PRIORITY CLAIMED UNDER SEC. 44(D) ON SWITZERLAND APPLICATION NO. 08087/2000, FILED 7-6-2000, REG. NO. 477411, DATED 10-23-2000, EXPIRES 7-6-2020.

OWNER OF U.S. REG. NOS. 1,573,828, 1,654,665 AND OTHERS.

NO CLAIM IS MADE TO THE EXCLUSIVE RIGHT TO USE "DIRECT", APART FROM THE MARK AS SHOWN.

CLASS 9—ELECTRICAL AND SCIENTIFIC APPARATUS

FOR BLANK MAGNETIC AND OPTICAL DATA CARRIERS; COMPUTER SOFTWARE IN THE FIELDS OF BANKING, INSURANCE AND FINANCIAL SERVICES, NAMELY, FOR ACCESSING FINANCIAL AND ACCOUNT INFORMATION AND FOR TRANSACTING BANK BUSINESS; COMPUTER SOFTWARE FOR ACCESSING AND CONDUCTING ELECTRONIC BANKING SERVICES VIA A GLOBAL COMPUTER NETWORK AND TELECOMMUNICATIONS NETWORKS; COMPUTER SOFTWARE FOR USE IN THE COMMUNICATION OF DATA BETWEEN COMPUTERS AND OTHER COMPUTERS OR COMPUTER PERIPHERALS; COMPUTER SOFTWARE FOR USE IN THE FIELD OF PERSONAL AND BUSINESS FINANCE AND ACCOUNTING, NAMELY, FOR ELECTRONIC FUND TRANSFERS, ACCOUNTING AND ACCOUNT MANAGEMENT, TRADE ENTRY, EXECUTION AND CLEARANCE, FINANCIAL ANALYSIS, FORECASTING AND RESEARCH, FINANCIAL STATEMENTS, AND REPORTS, RISK AND ANALYSIS AND MANAGEMENT, MANAGEMENT AND REPORTING OF FINANCIAL INFORMATION; AND COMPUTER SOFTWARE FOR USE IN INVESTMENT BANKING; INVESTMENT MANAGEMENT, INVESTMENT RESEARCH AND ANALYSIS, INVESTMENT ADVICE, FINANCIAL INFORMATION SERVICES, FINANCIAL PROJECTIONS, COMPILATION OF MARKET INDICES, PAYMENT SYSTEMS, ON-LINE BANKING, FINANCIAL PLANNING, INSURANCE TRANSACTIONS, AND THE TRADING OF SECURITIES, CURRENCIES, OPTIONS, FOREIGN EXCHANGE, FUTURES, FUNDS AND COMMODITIES (U.S. CLS. 21, 23, 26, 36 AND 38).

CLASS 16—PAPER GOODS AND PRINTED MATTER

FOR PRINTED MATTER, NAMELY, BOOKLETS, MAGAZINES, NEWSLETTERS, BROCHURES, MANUALS, HANDBOOKS, GUIDES, BOOKS, NEWSPAPERS, REPORTS, CATALOGUES, LISTS, PAMPHLETS, LEAFLETS, AND FLYERS, IN THE FIELDS OF BANKING, INSURANCE, AND FINANCIAL SERVICES (U.S. CLS. 2, 5, 22, 23, 29, 37, 38 AND 50).

CLASS 35—ADVERTISING AND BUSINESS

FOR TAX PREPARATION AND CONSULTATION; TELEPHONE ANSWERING SERVICES; AND DATA PROCESSING SERVICES VIA GLOBAL COMPUTER; AND BUSINESS RESEARCH (U.S. CLS. 100, 101 AND 102).

SN 76-144,969. ICM BREAKPOINT, INC., BEVERLY HILLS, CA. FILED 10-11-2000.

BREAKPOINT**CLASS 35—ADVERTISING AND BUSINESS**

FOR BUSINESS DEVELOPMENT SERVICES, NAMELY, BUSINESS CONSULTING, ANALYSIS AND ADVISORY SERVICES PROVIDED TO EMERGING AND DEVELOPING COMPANIES, MEDIA/ENTERTAINMENT COMPANIES, TECHNOLOGY COMPANIES, AND INTERNET AND DIGITAL ENTERPRISES; ANALYZING MARKET POSITION AND RECOMMENDING KEY STRATEGY PARTNERSHIPS AND KEY CUSTOMERS TO EMERGING AND DEVELOPING COMPANIES, MEDIA/ENTERTAINMENT COMPANIES, TECHNOLOGY COMPANIES, AND INTERNET AND DIGITAL ENTERPRISES; STRATEGIC BUSINESS PLANNING AND BUSINESS CONSULTING SERVICES PROVIDED TO EMERGING AND DEVELOPING COMPANIES, MEDIA/ENTERTAINMENT COMPANIES, TECHNOLOGY COMPANIES, AND INTERNET AND DIGITAL ENTERPRISES; BUSINESS DEVELOPMENT AND CONSULTATION SERVICES REGARDING USE OF BROADBAND MEDIA, WIRELESS, INTERNET COMMUNICATIONS, RADIO, TELEVISION, MOTION PICTURE, PUBLISHING AND OTHER NEW MEDIA; COMPUTER DATABASE MANAGEMENT IN THE NATURE OF COMPILING AND AGGREGATING CONTENT AND TECHNOLOGIES OF OTHERS AND CREATING NEW CONTENT FOR USE BY OTHERS ON BEHALF OF EMERGING AND DEVELOPING COMPANIES, MEDIA/ENTERTAINMENT COMPANIES, TECHNOLOGY COMPANIES, AND INTERNET AND DIGITAL ENTERPRISES INCLUDING BROAD BAND, INTERNET, CELLULAR, INTERACTIVE CABLE AND SATELLITE COMPANIES (U.S. CLS. 100, 101 AND 102).

CLASS 36—INSURANCE AND FINANCIAL

FOR INSURANCE BROKERAGE; INSURANCE CONSULTATION; FINANCIAL MANAGEMENT; FINANCIAL ANALYSIS AND CONSULTATION; BANKING SERVICES; ELECTRONIC BANKING SERVICES, STOCK EXCHANGE SERVICES; DERIVATIVES EXCHANGE SERVICES; INVESTMENT MANAGEMENT; INVESTMENT BROKERAGE, NAMELY, SECURITY BROKERAGE, STOCK BROKERAGE, MUTUAL FUND BROKERAGE, COMMODITY BROKERAGE, MORTGAGE BROKERAGE, STOCK BROKERAGES AND REAL ESTATE BROKERAGE; REAL ESTATE MANAGEMENT SERVICES; REAL ESTATE MANAGEMENT CONSULTATION; TRUSTEESHIP REPRESENTATIVES; FINANCIAL SPONSORSHIP OF CULTURAL EVENTS, SPORTING EVENTS AND SCIENTIFIC RESEARCH; AND FINANCIAL RESEARCH (U.S. CLS. 100, 101 AND 102).

CLASS 36—INSURANCE AND FINANCIAL

FOR CAPITAL INVESTMENT CONSULTATION; FINANCIAL INVESTMENT IN THE FIELDS OF TECHNOLOGY, CONTENT AND INTELLECTUAL PROPERTY IN EMERGING AND DEVELOPING COMPANIES, BROADBAND AND DIGITAL MEDIA COMPANIES AND INTERNET BASED COMPANIES; INVESTMENT MANAGEMENT; INVESTMENT, FINANCIAL AND CAPITAL MANAGEMENT AND CONSULTATION SERVICES FOR EMERGING AND DEVELOPING COMPANIES, BROADBAND AND DIGITAL MEDIA COMPANIES, AND INTERNET BASED COMPANIES (U.S. CLS. 100, 101 AND 102).

CLASS 38—COMMUNICATION

FOR TELECOMMUNICATIONS SERVICES, NAMELY, ELECTRONIC TRANSMISSION OF DATA; TELEGRAM TRANSMISSION; ELECTRONIC TRANSMISSION OF DATA AND DOCUMENTS VIA COMPUTER TERMINALS; ELECTRONIC MAIL SERVICES; VIDEOTEXT SERVICES; PROVIDING MULTIPLE-USER ACCESS TO A GLOBAL COMPUTER NETWORK (U.S. CLS. 100, 101 AND 104).

SN 76-146,358. EXP PRODUCTIONS, L.P., REDWOOD CITY, CA. BY CHANGE OF NAME SANTELER MARKETING GROUP, REDWOOD CITY, CA. FILED 10-13-2000.

EXP**CLASS 35—ADVERTISING AND BUSINESS**

FOR EVENT PLANNING CONSULTATION FOR PUBLIC AND PRIVATE EVENTS, EXHIBITS, TRADESHOWS, EXPOSITIONS, AND CONFERENCES; CONDUCTING BUSINESS AND MARKET RESEARCH IN CONNECTION WITH THE DESIGN AND PRODUCTION OF PUBLIC AND PRIVATE EVENTS, EXHIBITS, TRADESHOWS, EXPOSITIONS, AND CONFERENCES; PREPARING AUDIO-VISUAL DISPLAYS IN THE FIELDS OF ENTERTAINMENT, MUSIC, ARTS, FILM, TECHNOLOGY, COMPUTERS AND CULTURAL AND CIVIC EVENTS; PREPARING AUDIO-VISUAL PRESENTATIONS FOR USE IN PUBLIC AND PRIVATE EVENTS, EXHIBITS, TRADESHOWS, EXPOSITIONS, AND CONFERENCES (U.S. CLS. 100, 101 AND 102).

CLASS 42—SCIENTIFIC, COMPUTER AND LEGAL SERVICES

FOR LEGAL SERVICES RELATING TO THE FOUNDING AND ADMINISTRATION OF COMPANIES; SCIENTIFIC RESEARCH; COMPUTER DATA PROCESSING FOR OTHERS; COMPUTER PROGRAMMING FOR OTHERS; AND INTELLECTUAL PROPERTY CONSULTATION (U.S. CLS. 100 AND 101).

CLASS 38—COMMUNICATION

FOR BROADCASTING PROGRAMS VIA ELECTRONIC, OPTICAL, AND WIRELESS COMMUNICATIONS NETWORKS; WEB-CASTING SERVICES IN CONNECTION WITH EVENTS, CONFERENCES, TRADESHOWS AND EXHIBITS (U.S. CLS. 100, 101 AND 104).

CLASS 41—EDUCATION AND ENTERTAINMENT

FOR PRODUCTION OF AUDIO, VIDEO, ONLINE CONTENT, GRAPHICS, STILL IMAGES AND MOVING PICTURES FOR USE IN PUBLIC AND PRIVATE EVENTS, EXHIBITS, TRADESHOWS, EXPOSITIONS, AND CONFERENCES; SPECIAL EVENT PLANNING, NAMELY, PLANNING, DESIGNING AND CONDUCTING PUBLIC AND PRIVATE EVENTS, EXHIBITS, TRADESHOWS, EXPOSITIONS, AND CONFERENCES; SPECIAL EVENT PLANNING, NAMELY, PLANNING, DESIGNING AND CONDUCTING NEW PRODUCT LAUNCHES; SPECIAL EVENT PLANNING, NAMELY, PLANNING, DESIGNING AND CONDUCTING PUBLIC AND PRIVATE EVENTS, EXHIBITS, TRADESHOWS, EXPOSITIONS, AND CONFERENCES, ALL BROADCAST OVER ELECTRONIC, OPTICAL, AND WIRELESS COMMUNICATIONS NETWORKS; SPECIAL EVENT PLANNING, NAMELY, PLANNING, DESIGNING AND CONDUCTING NEW PRODUCT LAUNCHES VIA ELECTRONIC, OPTICAL, AND WIRELESS COMMUNICATIONS NETWORKS (U.S. CLS. 100, 101 AND 107).

SN 76-151,599, TOK BEARING CO., LTD., ITABASHI-KU, TOKYO 174-8501, JAPAN, FILED 10-23-2000.

TOK

OWNER OF JAPAN REG. NO. 2418622, DATED 5-29-1992, EXPIRES 5-29-2012.

CLASS 7—MACHINERY

FOR (BASED ON USE IN COMMERCE) MACHINE PARTS, NAMELY BEARINGS, ROLLERS, ONE-WAY CLUTCHES, TORQUE LIMITERS AND ROTARY DAMPERS (U.S. CLS. 13, 19, 21, 23, 31, 34 AND 35).

FIRST USE 0-0-1959; IN COMMERCE 0-0-1959.

CLASS 12—VEHICLES

FOR (BASED ON 44(E) MECHANICAL PARTS FOR LAND VEHICLES, NAMELY BEARINGS, ROLLERS, ONE-WAY CLUTCHES, TORQUE LIMITERS, ROTARY DAMPERS (U.S. CLS. 19, 21, 23, 31, 35 AND 44).

CLASS 19—NON-METALLIC BUILDING MATERIALS

FOR (BASED ON USE IN COMMERCE) PARTS FOR NON-METAL WINDOW FRAMES, NAMELY NON-METAL WINDOW PULLERS; PARTS FOR NON-METAL DOORS, NAMELY NON-METAL SLIDING DOOR WHEELS AND NON-METAL ROLLERS FOR SLIDING DOORS (U.S. CLS. 1, 12, 33 AND 50).

FIRST USE 0-0-1980; IN COMMERCE 0-0-1980.

SN 76-155,343, HK RUOKATALO OYJ, 20520 TURKU, FINLAND, FILED 10-27-2000.

LINOBE

PRIORITY CLAIMED UNDER SEC. 44(D) ON FINLAND APPLICATION NO. T200001515, FILED 5-5-2000, REG. NO. 220291, DATED 2-15-2001, EXPIRES 2-15-2011.

CLASS 5—PHARMACEUTICALS

FOR DIETETIC FOODS FOR MEDICAL USE FOR CONSUMPTION BY HUMANS; FOODS FOR BABIES (U.S. CLS. 6, 18, 44, 46, 51 AND 52).

CLASS 29—MEATS AND PROCESSED FOODS

FOR FOODS, NAMELY, MEAT, FISH, POULTRY AND GAME FOODS; MEAT EXTRACTS; PRESERVED DRIED AND COOKED FRUITS AND VEGETABLES; JELLIES, JAMS, FRUIT SAUCES; EGGS, MILK AND MILK PRODUCTS, NAMELY, CREAM, CONDENSED MILK, MILK POWDER, YOGURTS, BUTTER, CHEESE, CHEESE SPREADS, COTTAGE CHEESE AND CREAM CHEESE; EDIBLE OILS AND FATS (U.S. CL. 46).

CLASS 30—STAPLE FOODS

FOR COFFEE, TEA, COCOA, SUGAR, RICE, TAPIOCA, SAGO, INSTANT COFFEE; FLOUR, PROCESSED CEREALS, BREAD, PASTRY AND CONFECTIONERY, NAMELY CANDY, FLAVORED ICES, ICE CREAM, ICE MILK, FROZEN YOGURT; HONEY, TREACLE; YEAST, BAKING POWDER; SALT, MUSTARD; VINEGAR, SALAD DRESSING AND SAUCES; SPICES; AND ICE (U.S. CL. 46).

CLASS 31—NATURAL AGRICULTURAL PRODUCTS

FOR AGRICULTURAL PRODUCTS, NAMELY FLOWER SEEDS; AGRICULTURAL GRAINS FOR PLANTING LIVE ANIMALS; FRESH FRUITS AND VEGETABLES; SEEDS, NATURAL PLANTS AND FLOWERS, AND MALT FOR BREWING AND DISTILLING (U.S. CLS. 1 AND 46).

SN 76-163,104, GROTS, JURGEN ALEXANDER, MIDDLESEX, GREAT BRITAIN, AND GOLDBECK, DIRK DAVID, MIDDLESEX, GREAT BRITAIN, AND SYKORA, THOMAS, MIDDLESEX, GREAT BRITAIN, FILED 11-9-2000.

PVA

PRIORITY CLAIMED UNDER SEC. 44(D) ON FED REP GERMANY APPLICATION NO. 30037532.8/0, FILED 5-17-2000, REG. NO. 30037532, DATED 8-21-2000, EXPIRES 5-31-2010.

CLASS 9—ELECTRICAL AND SCIENTIFIC APPARATUS

FOR ELECTRONIC APPARATUS, NAMELY, MICROPHONES, AUDIO TRANSDUCERS, CIRCUITRY FOR TRANSLATING AUDIO DATA TO TEXT DATA, VIDEO DISPLAY DRIVER CIRCUITRY, LIQUID CRYSTAL TEXT DISPLAYS, SPEECH RECOGNITION CIRCUITRY, COMPUTERS THAT ENABLE SPEECH-TO-TEXT TRANSLATION, HAND-HELD COMPUTERS THAT ENABLE SPEECH-TO-TEXT TRANSLATION, ELECTRONIC PERSONAL ORGANIZERS, AND COMPUTERS FOR THE ELECTRONIC AND DIGITAL TRANSMISSION AND RECEPTION OF AUDIO AND TEXT DATA AND MESSAGES; HAND-HELD COMPUTERS FOR THE ELECTRONIC AND DIGITAL TRANSMISSION AND RECEPTION OF AUDIO AND TEXT DATA AND MESSAGES; APPARATUS FOR RECORDING, TRANSMISSION, AND DISPLAY OF AUDIO DATA, NAMELY, ELECTRONIC PERSONAL ORGANIZERS, PAGERS, AND TELEPHONES WITH VOICE RECOGNITION CAPABILITY; DATA PROCESSING EQUIPMENT; COMPUTER HARDWARE; COMPUTER SOFTWARE FOR RECEIVING AUDIO DATA, CONVERTING AUDIO DATA TO TEXT DATA, AND DISPLAYING TEXT DATA; AND COMPUTER SOFTWARE TO ENHANCE THE AUDIO-VISUAL CAPABILITIES OF MULTIMEDIA APPLICATIONS, NAMELY, FOR THE DISPLAY AND INTEGRATION OF TEXT, AUDIO, GRAPHICS, STILL IMAGES, AND MOVING PICTURES (U.S. CLS. 21, 23, 26, 36 AND 38).

CLASS 38—COMMUNICATION

FOR VIDEOTEXT SERVICES; TELETXT SERVICES; TELEPHONE COMMUNICATION SERVICES; DATA AND VIDEO TRANSMISSION VIA COMPUTER; ELECTRONIC DATA TRANSMISSION; RENTAL OF DATA TRANSMISSION EQUIPMENT; PAGING VIA RADIO OR TELEPHONE; SATELLITE TRANSMISSION; TELEGRAM TRANSMISSION AND COMMUNICATION; TELEGRAM TRANSMISSION; TELEGRAPH SERVICE; TELEGRAPH TRANSMISSION; TELECOMMUNICATION SERVICES, NAMELY, PERSONAL COMMUNICATION SERVICES; TELECOPYING SERVICE; RENTAL OF TELEFAX EQUIPMENT; RENTAL OF DATA TRANSMISSION EQUIPMENT; RENTAL OF TELEPHONES; RENTAL OF TELECOMMUNICATION EQUIPMENT; RADIO BROADCASTING (U.S. CLS. 100, 101 AND 104).

CLASS 42—SCIENTIFIC, COMPUTER AND LEGAL SERVICES

FOR DEVELOPMENT OF COMPUTER SOFTWARE FOR OTHERS; UPDATING OF COMPUTER SOFTWARE FOR OTHERS; DESIGN OF COMPUTER SOFTWARE FOR OTHERS; RENTAL OF COMPUTER SOFTWARE; COMPUTER CONSULTING SERVICES; MAINTENANCE OF COMPUTER SOFTWARE; RENTAL OF COMPUTER SOFTWARE; RENTAL OF COMPUTER HARDWARE (U.S. CLS. 100 AND 101).

SN 76-165,316. PLAYSTREAM, L.L.C, SEATTLE, WA. FILED 11-15-2000.

**CLASS 38—COMMUNICATION**

FOR PROVIDING MULTIPLE-USER ACCESS TO A GLOBAL COMPUTER INFORMATION NETWORK; BROADCASTING PROGRAMS VIA A GLOBAL COMPUTER NETWORK; AND ELECTRONIC STREAMING OF MULTIMEDIA DATA VIA A GLOBAL COMPUTER NETWORK (U.S. CLS. 100, 101 AND 104).

FIRST USE 7-25-2000; IN COMMERCE 7-25-2000.

CLASS 39—TRANSPORTATION AND STORAGE

FOR ELECTRONIC STORAGE OF MULTIMEDIA DATA (U.S. CLS. 100 AND 105).

FIRST USE 7-25-2000; IN COMMERCE 7-25-2000.

CLASS 42—SCIENTIFIC, COMPUTER AND LEGAL SERVICES

FOR HOSTING MULTIMEDIA WEB SITES OF OTHERS ON A COMPUTER SERVER FOR A GLOBAL COMPUTER NETWORK (U.S. CLS. 100 AND 101).

FIRST USE 7-25-2000; IN COMMERCE 7-25-2000.

SN 76-166,199. INTRIEVE, INCORPORATED, CINCINNATI, OH. FILED 11-16-2000.

GEM SOLUTION

OWNER OF U.S. REG. NO. 2,113,257.

NO CLAIM IS MADE TO THE EXCLUSIVE RIGHT TO USE "SOLUTION", APART FROM THE MARK AS SHOWN.

CLASS 9—ELECTRICAL AND SCIENTIFIC APPARATUS

FOR COMPUTER HARDWARE; AND COMPUTER SOFTWARE FOR FINANCIAL INSTITUTIONS, NAMELY, FOR CORE ACCOUNT PROCESSING, FOR ELECTRONIC FUNDS TRANSFER PROCESSING, FOR COMMUNICATIONS, FOR THE HIGH-SPEED TRANSMISSION OF DATA, TEXT, VOICE AND AUDIO, FOR FINANCIAL ITEM PROCESSING INCLUDING THE PROCESSING OF CHECKS AND FINANCIAL INSTRUMENTS; AND MANUALS SOLD AS A UNIT WITH SUCH COMPUTER SOFTWARE (U.S. CLS. 21, 23, 26, 36 AND 38).

FIRST USE 12-0-2000; IN COMMERCE 12-0-2000.

CLASS 35—ADVERTISING AND BUSINESS

FOR DATA PROCESSING IN THE FIELD OF FINANCIAL INSTITUTIONS; MANAGEMENT SERVICES, NAMELY, MANAGING FINANCIAL FACILITIES FOR OTHERS; AND BUSINESS MANAGEMENT AND CONSULTATION (U.S. CLS. 100, 101 AND 102).

FIRST USE 12-0-2000; IN COMMERCE 12-0-2000.

CLASS 36—INSURANCE AND FINANCIAL

FOR CHECK PROCESSING; FINANCIAL SERVICES IN THE NATURE OF PROCESSING SERVICES, NAMELY, THE PROCESSING OF CHECKS AND FINANCIAL INSTRUMENTS; FINANCIAL INFORMATION PROCESSING CONSULTING SERVICES IN THE FIELD OF FINANCIAL INSTITUTIONS; FINANCIAL ANALYSIS AND CONSULTATION; FINANCIAL ACCOUNT INFORMATION MANAGEMENT SERVICES IN THE FIELD OF FINANCIAL INSTITUTIONS (U.S. CLS. 100, 101 AND 102).

FIRST USE 12-0-2000; IN COMMERCE 12-0-2000.

CLASS 38—COMMUNICATION

FOR COMMUNICATION SERVICES, NAMELY, HIGH-SPEED TRANSMISSION OF DATA, TEXT, VOICE AND AUDIO; PROVIDING MULTIPLE-USER ACCESS TO A GLOBAL COMPUTER INFORMATION NETWORK (U.S. CLS. 100, 101 AND 104).

FIRST USE 12-0-2000; IN COMMERCE 12-0-2000.

SN 76-166,728. ONVENTIS GMBH, D-70596 STUTTGART, FED REP GERMANY, FILED 11-16-2000.

ONVENTIS

PRIORITY CLAIMED UNDER SEC. 44(D) ON FED REP GERMANY APPLICATION NO. 30036848.8/9, FILED 5-16-2000, REG. NO. 30036848, DATED 7-20-2000, EXPIRES 5-31-2010.

CLASS 9—ELECTRICAL AND SCIENTIFIC APPARATUS

FOR COMPUTER SOFTWARE IN THE FIELD OF ELECTRONIC COMMERCE, NAMELY, SOFTWARE USED TO MANAGE ELECTRONIC DATABASES, AND COMPUTER E-COMMERCE SOFTWARE TO ALLOW USERS TO PERFORM ELECTRONIC BUSINESS TRANSACTIONS VIA THE INTERNET (U.S. CLS. 21, 23, 26, 36 AND 38).

CLASS 35—ADVERTISING AND BUSINESS

FOR COOPERATIVE MARKETING AND ADVERTISING; DISSEMINATION OF ADVERTISING FOR OTHERS VIA AN ON-LINE COMMUNICATIONS NETWORK; COMPUTERIZED DATABASE MANAGEMENT, NAMELY COLLECTING, STORING, RETRIEVING, AND PROVIDING DATA, TEXT, GRAPHICS, IMAGES, AUDIO, AND VIDEO SIGNALS; BUSINESS MANAGEMENT; BUSINESS MARKETING CONSULTING SERVICES; BUSINESS NETWORKING; BUSINESS MARKETING CONSULTING SERVICES, NAMELY, THE PRODUCTION OF CONCEPTS, LAYOUTS, GRAPHICS, TEXTS AND SCRIPTS FOR INTERACTIVE AND MULTIMEDIA INFORMATION, IN PARTICULAR FOR THE INTERNET; BUSINESS SERVICES, NAMELY, PROCUREMENT OF GOODS AND SERVICES ON BEHALF OF THIRD PARTIES, VIA THE INTERNET; AND JOB PLACEMENT (U.S. CLS. 100, 101 AND 102).

CLASS 36—INSURANCE AND FINANCIAL

FOR BUSINESS FINANCE PROCUREMENT SERVICES (U.S. CLS. 100, 101 AND 102).

CLASS 42—SCIENTIFIC, COMPUTER AND LEGAL SERVICES

FOR MEDIATION AND RELATED FINALIZATION OF CONTRACTS; PRINTING AND GRAPHIC ART DESIGN, NAMELY, THE PRODUCTION OF CONCEPTS, LAYOUTS, GRAPHICS, TEXTS, AND SCRIPTS FOR INTERACTIVE AND MULTIMEDIA INFORMATION SYSTEMS; COMPUTER SOFTWARE DESIGN, DEVELOPMENT AND PROGRAMMING FOR ELECTRONIC DATA PROCESSING PROVIDED FOR OTHERS; AND APPLICATION SERVICE PROVIDER FEATURING SOFTWARE FOR USE IN DATABASE MANAGEMENT (U.S. CLS. 100 AND 101).

SN 76-167,731. EMI RECORDS LIMITED, LONDON W6 7EF, ENGLAND, FILED 11-17-2000.

ANGEL

PRIORITY CLAIMED UNDER SEC. 44(D) ON UNITED KINGDOM APPLICATION NO. 2233483, FILED 5-23-2000, REG. NO. 2233483, DATED 8-17-2001, EXPIRES 5-23-2010.

OWNER OF U.S. REG. NOS. 731,157, 1,992,401 AND OTHERS.

CLASS 9—ELECTRICAL AND SCIENTIFIC APPARATUS

FOR APPARATUS AND INSTRUMENTS FOR RECORDING, REPRODUCING AND/OR TRANSMITTING SOUND AND/OR VISUAL INFORMATION OR RECORDINGS, NAMELY HIGH FIDELITY STEREOs, VIDEO PLAYERS, DVD PLAYERS, CD PLAYERS, MINI DISC PLAYERS, MP3 PLAYERS, CASSETTE PLAYERS; SOUND RECORDINGS, NAMELY, PRE-RECORDED AUDIO CASSETTES FEATURING MUSIC AND MUSICAL ENTERTAINMENT; VISUAL RECORDINGS, NAMELY, PRE-RECORDED VIDEO CASSETTES FEATURING MUSIC AND MUSICAL ENTERTAINMENT; ENHANCED SOUND RECORDINGS, NAMELY, PRE-RECORDED AUDIO CASSETTES, COMPACT DISCS, MINI DISCS, FEATURING MUSIC AND MUSICAL ENTERTAINMENT; ENHANCED VIDEO RECORDINGS, NAMELY PRERECORDED DVDS, VIDEO CASSETTES FEATURING MUSIC AND MUSICAL ENTERTAINMENT; INTERACTIVE SOUND RECORDINGS, NAMELY, CD ROMS, DVDS FEATURING MUSIC AND MUSICAL ENTERTAINMENT; INTERACTIVE VIDEO RECORDINGS, NAMELY, CD ROMS, DVDS, VIDEO CASSETTES FEATURING MUSIC AND MUSICAL ENTERTAINMENT; SOUND AND/OR VISUAL RECORDING MEDIA, NAMELY, BLANK VIDEO CASSETTES, DVDS, CDS, MINI DISCS AND AUDIO CASSETTES; VIDEO GAMES, NAMELY, INTERACTIVE VIDEO GAMES OF VIRTUAL REALITY COMPRISED OF COMPUTER HARDWARE AND SOFTWARE; INTERACTIVE COMPUTER SOFTWARE FOR USE IN CONNECTION WITH THE PROVISION OF INFORMATION RELATING TO MUSIC AND MUSICAL ENTERTAINMENT; DOWNLOADABLE ELECTRONIC PUBLICATIONS IN THE NATURE OF REVIEWS AND MAGAZINES AND PUBLICATIONS IN THE FIELD OF MUSIC AND MUSICAL ENTERTAINMENT; BLANK DVDS; BLANK CD ROMS; VIRTUAL REALITY SYSTEMS COMPRISED OF COMPUTER HARDWARE AND VIRTUAL REALITY GAME SOFTWARE; DOWNLOADABLE DIGITAL MUSIC RECORDINGS (U.S. CLS. 21, 23, 26, 36 AND 38).

CLASS 35—ADVERTISING AND BUSINESS

FOR PROMOTION IN THE FIELD OF ENTERTAINMENT, NAMELY, PROMOTING THE MUSIC CONCERTS OF OTHERS; MANAGEMENT OF PERFORMING ARTISTS; LICENSING OF MUSICAL AND/OR LYRICAL WORKS; COPYRIGHT MANAGEMENT IN THE FIELD OF MUSICAL AND/OR LYRICAL WORKS; PROVIDING AN ONLINE COMPUTER DATABASE IN THE FIELD OF COPYRIGHT MANAGEMENT AND LICENSING OF MUSICAL AND/OR LYRICAL WORKS (U.S. CLS. 100, 101 AND 102).

CLASS 41—EDUCATION AND ENTERTAINMENT

FOR ENTERTAINMENT SERVICES, NAMELY, LIVE MUSICAL PERFORMANCES, CONCERTS AND SHOWS, AND PROVIDING DIGITALLY PRERECORDED MUSIC ONLINE VIA A GLOBAL COMPUTER NETWORK; RECORD PRODUCTION AND VIDEOTAPE PRODUCTION; MUSIC PUBLISHING SERVICES; RECORDING STUDIOS; PROVIDING AN ON-LINE COMPUTER DATABASE IN THE NATURE OF INFORMATION IN THE FIELD OF MUSIC AND MUSICAL ENTERTAINMENT (U.S. CLS. 100, 101 AND 107).

CLASS 42—SCIENTIFIC, COMPUTER AND LEGAL SERVICES

FOR COMPUTER SERVICES, NAMELY, CREATING AND MAINTAINING WEB SITES FOR OTHERS; HOSTING THE WEB SITES OF OTHERS ON A COMPUTER SERVER FOR A GLOBAL COMPUTER NETWORK; LICENSING OF INTELLECTUAL PROPERTY (U.S. CLS. 100 AND 101).

SN 76-171,667. CLUBFIXIT, INC., NEW YORK, NY. FILED 11-28-2000.

CLUBFIXIT**CLASS 38—COMMUNICATION**

FOR PROVIDING HARD WIRED AND WIRELESS MULTIPLE USER ACCESS TO A GLOBAL COMPUTER INFORMATION NETWORK AND ELECTRONIC MAIL SERVICES (U.S. CLS. 100, 101 AND 104).

CLASS 42—SCIENTIFIC, COMPUTER AND LEGAL SERVICES

FOR DESIGNING WEB SITES FOR OTHERS; HOSTING WEB SITES FOR OTHERS; TECHNICAL SUPPORT SERVICES OF WEB SITES, NAMELY, TROUBLESHOOTING OF COMPUTER HARDWARE AND SOFTWARE VIA TELEPHONE, EMAIL AND IN PERSON; COMPUTER SOFTWARE DESIGN FOR OTHERS; AND TECHNOLOGY CONSULTING SERVICES (U.S. CLS. 100 AND 101).

SN 76-178,878. EPRIVACY GROUP, INC., PAOLI, PA. BY CHANGE OF NAME POSTIVA, INC., BERWYN, PA. FILED 12-11-2000.

POSTIVA**CLASS 9—ELECTRICAL AND SCIENTIFIC APPARATUS**

FOR COMPUTER SOFTWARE FOR TRANSMISSION, RECEIPT AND DELIVERY OF ELECTRONIC MAIL; COMPUTER SOFTWARE FOR MAKING PAYMENTS AND FOR RECORDING PAYMENTS MADE AND PAYMENTS DUE; COMPUTER SOFTWARE FOR MANAGING ON-LINE AUCTIONS, INCLUDING BIDDING, AUTOMATED NEGOTIATION, AND AUCTION CONCLUSION; AND COMPUTER SOFTWARE AND HARDWARE FOR PROVIDING ON-LINE STORED VALUE ACCOUNTS (U.S. CLS. 21, 23, 26, 36 AND 38).

CLASS 35—ADVERTISING AND BUSINESS

FOR ELECTRONIC AUCTION SERVICES IN AN ON-LINE ENVIRONMENT (U.S. CLS. 100, 101 AND 102).

CLASS 36—INSURANCE AND FINANCIAL

FOR ON-LINE FINANCIAL SERVICES, NAMELY PROVIDING ON-LINE STORED VALUE ACCOUNTS (U.S. CLS. 100, 101 AND 102).

CLASS 38—COMMUNICATION

FOR ELECTRONIC MAIL SERVICES; AND AUTHENTICATION AND DELIVERY OF MESSAGES BY ELECTRONIC TRANSMISSION (U.S. CLS. 100, 101 AND 104).

SN 76-181,463. FRANKLIN, JOSHUA, NEW YORK, NY. FILED 12-15-2000.

RECON**CLASS 18—LEATHER GOODS**

FOR BACKPACKS AND WALLETS (U.S. CLS. 1, 2, 3, 22 AND 41).
FIRST USE 3-0-1998; IN COMMERCE 3-0-1998.

CLASS 25—CLOTHING

FOR CLOTHING FOR MEN AND WOMEN, NAMELY T-SHIRTS, SHORTS, JACKETS, PANTS, SWEATERS, HATS, SHOES AND SNEAKERS (U.S. CLS. 22 AND 39).
FIRST USE 3-0-1998; IN COMMERCE 3-0-1998.

SN 76-185,323. BUDD-MORGAN ALARM COMPANY, INC., BELLMORE, NY. FILED 12-22-2000.



NO CLAIM IS MADE TO THE EXCLUSIVE RIGHT TO USE "WARNING-PROTECTED BY", "CENTRAL STATION" AND "ALARM CO.", APART FROM THE MARK AS SHOWN.

CLASS 37—CONSTRUCTION AND REPAIR

FOR INSTALLATION OF SECURITY SYSTEMS AND PROTECTION PRODUCTS SUCH AS FIRE ALARMS AND SMOKE DETECTORS (U.S. CLS. 100, 103 AND 106).
FIRST USE 0-0-1980; IN COMMERCE 0-0-1980.

CLASS 42—SCIENTIFIC, COMPUTER AND LEGAL SERVICES

FOR MONITORING SECURITY SYSTEMS AND PROTECTION PRODUCTS SUCH AS FIRE ALARMS AND SMOKE PROTECTORS (U.S. CLS. 100 AND 101).
FIRST USE 0-0-1980; IN COMMERCE 0-0-1980.

SN 76-188,234. C.G.M. ELECTRONICS S.A.S. DI GIOVANNI MARIANI & C., 20135 MILANO, ITALY, FILED 1-2-2001.

SN 76-201,309. SIAM SANITARY WARE CO, LTD., BANGKOK METROPOLIS, THAILAND, FILED 1-29-2001.



OWNER OF ITALY REG. NO. 498940, DATED 11-2-1988, RENEWED AS REG. NO. 796950, DATED 4-7-1997, EXPIRES 4-7-2007.

NO CLAIM IS MADE TO THE EXCLUSIVE RIGHT TO USE "LIVORNO", APART FROM THE MARK AS SHOWN.

THE MARK CONSISTS, IN PART, OF A STYLIZED DEPICTION OF A BIRD WITH WINGS UNFOLDED INSIDE A STYLIZED RING.

"LIVORNO" IS A CITY IN NORTHWEST ITALY. THE ENGLISH TRANSLATION OF "LIVORNO" IS "LEGHORN".

CLASS 12—VEHICLES

FOR CARS; TRUCKS; MOTORCYCLES; BICYCLES; TRICYCLES; TIRES AND INNER TUBES FOR VEHICLES AND CARS IN GENERAL; TRACTORS; AUTOBUS; VEHICLES, NAMELY, AUTOMOBILE BODIES; AND AUTOMOBILES; AIRPLANES; HELICOPTERS; GLIDERS; BOATS; CANOES; SHIPS; MOTORS FOR LAND VEHICLES; STRUCTURAL PARTS FOR BOATS AND PLANES (U.S. CLS. 19, 21, 23, 31, 35 AND 44).

CLASS 18—LEATHER GOODS

FOR BAGS, NAMELY, ALL PURPOSE SPORT BAGS, SCHOOL BOOK BAGS, SHOULDER BAGS, TRAVELING BAG; HANDBAGS; SUIT-CASES; KNAPSACKS; BRIEF-CASES; PURSES; DOCUMENT PORTFOLIOS IN LEATHER AND LEATHER IMITATION; LUGGAGE TRUNKS; LEATHER AND IMITATION LEATHER SOLD IN BULK; PARASOLS; SEA-SIDE SUNSHADES IN THE NATURE OF PARASOLS OR UMBRELLAS; UMBRELLAS; WALKING STICKS; HARNESS AND SADDLERY (U.S. CLS. 1, 2, 3, 22 AND 41).

CLASS 25—CLOTHING

FOR CLOTHING, NAMELY, SUITS MADE OF LEATHER, SHIRTS, BLOUSES, SKIRTS, TAILLEURS, JACKETS, TROUSERS, SHORTS, JERSEYS, PAJAMAS, STOCKINGS, SINGLET, CORSETS, GARTERS, PANTS, BRAS, PETTY COATS, HATS, FOULARDS, NECK-TIES, RAINCOATS, OVERCOATS, GREATCOATS, BATHING COSTUMES, SPORTS OVERALLS, WIND RESISTANT JACKETS, SKI-PANTS, BELTS, SCARVES, GLOVES, DRESSING-GOWNS; FURS, NAMELY, FUR JACKETS; SHOE WEAR, NAMELY, SLIPPERS, SHOES, SPORTS SHOES, BOOTS AND SANDALS (U.S. CLS. 22 AND 39).

COTTO

OWNER OF THAILAND REG. NO. 45639, DATED 3-19-1986, RENEWED AS REG. NO. 45639, DATED 3-19-1996, EXPIRES 3-19-2006.

OWNER OF THAILAND REG. NO. 151002, DATED 9-27-1990, RENEWED AS REG. NO. 151002, DATED 9-27-2000, EXPIRES 9-27-2010.

THE ENGLISH TRANSLATION OF "COTTO" IS "COOKED".

CLASS 11—ENVIRONMENTAL CONTROL APPARATUS

FOR (1B AND 44E) TOILETS AND PARTS THEREOF, BATHTUBS; TOILET SEATS; TOILET TANKS; SANITATION FIXTURES, NAMELY URINALS AND BIDETS; (1B) FAUCETS; MANUALLY OPERATED PLUMBING VALVES; AND SHOWERS (U.S. CLS. 13, 21, 23, 31 AND 34).

CLASS 21—HOUSEWARES AND GLASS

FOR WASH BASINS; BATHROOM ACCESSORIES, NAMELY, TOWEL RINGS, TOWEL BARS, SOAP HOLDERS AND TOILET PAPER HOLDERS (U.S. CLS. 2, 13, 23, 29, 30, 33, 40 AND 50).

SN 76-206,922. PARTEC AG, MUNCHEN 81679, FED REP GERMANY, FILED 2-8-2001.

PARA SAFE

OWNER OF FED REP GERMANY REG. NO. 30059157.8, DATED 8-9-2000, EXPIRES 8-8-2010.

CLASS 9—ELECTRICAL AND SCIENTIFIC APPARATUS

FOR ELECTROTECHNICAL, ELECTRONIC DEVICES, NAMELY, COMPUTERS, COMPUTER HARDWARE, PARALLEL COMPUTERS, DEVICES FOR DATA ENTRY, NAMELY KEYBOARDS, MICE, TRACK BALLS, COMPONENTS FOR VOICE RECOGNITION SYSTEMS, DRAWING PANELS, NAMELY, DIGITIZERS, INPUT INTERFACES, LIGHT PENS, SCAN PENS, CAMERAS, WEBCAMS, DATA PROCESSING EQUIPMENT, DATA TRANSMISSION EQUIPMENT, NAMELY MODEMS, SOFTMODEMS, INTERNET ACCESS CARDS, DATA TRANSMISSION CABLES, BLANK FLOPPY DISCS, BLANK ZIP DISCS, BLANK CD-ROM DISCS, BLANK DVD DISCS, WIRELESS LAN DEVICES, DATA STORAGE AND DATA OUTPUT DEVICES, NAMELY BLANK HARD DISCS, BLANK FLOPPY DISCS, BLANK ZIP DISCS, BLANK CD-ROM DISCS, BLANK DVD DISCS, MONITORS, DISPLAYS, PRINTERS, PLOTTERS, LOUDSPEAKERS; COMPUTER SOFTWARE FOR USE IN OPERATING SYSTEMS, WORD PROCESSING, DATABASE MANAGEMENT, CHART CALCULATION, FILE ADMINISTRATION, TRANSLATION AND VOICE RECOGNITION, PROJECT MANAGEMENT, GRAPHICS AND PRESENTATION, DESKTOP AND WEB PUBLISHING, NETWORK COMMUNICATION BY ELECTRONIC MAIL, NETWORK MANAGEMENT, REMOTE ACCESS COMPUTING AND SERVER SECURITY, NAMELY, VIRUS DETECTION AND ENCODING, INTRANET AND BACKING UP, SYSTEM MANAGEMENT AND PROGRAMMING ENVIRONMENTS (U.S. CLS. 21, 23, 26, 36 AND 38).

CLASS 35—ADVERTISING AND BUSINESS

FOR COMPUTERIZED DATABASE MANAGEMENT SERVICES PROVIDED VIA A GLOBAL NETWORK; PROJECT MANAGEMENT (U.S. CLS. 100, 101 AND 102).

CLASS 38—COMMUNICATION

FOR TELECOMMUNICATION GATEWAY SOURCE, NAMELY TRANSMISSION OF PROGRAMMING SOURCE CODE FOR INTERCONNECTED NETWORK NODES ESPECIALLY IN A PARALLEL COMPUTER SYSTEM (U.S. CLS. 100, 101 AND 104).

CLASS 42—SCIENTIFIC, COMPUTER AND LEGAL SERVICES

FOR COMPUTER SERVICES, NAMELY, DEVELOPING OF PROGRAMS FOR DATA PROCESSING; TECHNICAL CONSULTING AND SUPPORT IN THE FIELDS OF COMPUTER HARDWARE AND COMPUTER SOFTWARE; PROVIDING INFORMATION FOR THE OPERATION OF DATA PROCESSING EQUIPMENT; AND PROGRAMMING SOURCE CODE FOR INTERCONNECTED NETWORK NODES ESPECIALLY IN A PARALLEL COMPUTER SYSTEM (U.S. CLS. 100 AND 101).

SN 76-208,971. BIWATER PLC, DORKING, SURREY RH4 1TZ, UNITED KINGDOM, FILED 2-13-2001.



OWNER OF ERPN CMNTY TM OFC REG. NO. 231878, DATED 11-12-1998, EXPIRES 4-18-2006.

CLASS 6—METAL GOODS

FOR METALLIC BUILDING MATERIALS, NAMELY, METALLIC COVERINGS FOR ROOFS AND BUILDINGS, METALLIC GUTTERS, METALLIC TUBES, METALLIC PIPES, AND METALLIC FITTINGS THEREFOR; METAL SWIMMING POOLS; METAL PENSTOCKS AND GATES FOR CONTROLLING WATER (U.S. CLS. 2, 12, 13, 14, 23, 25 AND 50).

CLASS 7—MACHINERY

FOR PUMPS, NAMELY, WATER PUMPS FOR USE IN SWIMMING POOLS, WATER PARKS, WATER TREATMENT PLANTS AND WASTE WATER TREATMENT PLANTS, ROTARY PUMPS, SUCTION PUMPS, SUMP PUMPS, VACUUM PUMPS, AND FITTINGS THEREFOR; HYDRAULIC TURBINES (U.S. CLS. 13, 19, 21, 23, 31, 34 AND 35).

CLASS 9—ELECTRICAL AND SCIENTIFIC APPARATUS

FOR ELECTRICAL APPARATUS AND INSTRUMENTS FOR USE IN SWIMMING POOLS, WATER PARKS, WATER TREATMENT PLANTS AND WASTE WATER TREATMENT PLANTS, NAMELY, ANALYZERS, TEMPERATURE MONITORS, AND FLOW MEASUREMENT DEVICES (U.S. CLS. 21, 23, 26, 36 AND 38).

CLASS 11—ENVIRONMENTAL CONTROL APPARATUS

FOR WATER PURIFICATION UNITS; WATER CIRCULATION UNITS FOR SWIMMING POOL AND SEWAGE TREATMENT PLANTS; SEWAGE TREATMENT PLANTS; PLUMBING FITTINGS, NAMELY, BIBBS, COCKS, TRAPS AND VALVES; HEAT EXCHANGERS; HEATERS AND PUMPS SOLD IN COMBINATION FOR USE IN SWIMMING POOLS (U.S. CLS. 13, 21, 23, 31 AND 34).

CLASS 17—RUBBER GOODS

FOR CANVAS HOSE PIPES FOR USE IN SWIMMING POOLS, WATER PARKS, WATER TREATMENT PLANTS AND WASTE WATER TREATMENT PLANTS; PLASTIC PIPES FOR PLUMBING PURPOSES; PLASTIC HOSES FOR SWIMMING POOLS, WATER PARKS, WATER TREATMENT PLANTS AND WASTE WATER TREATMENT PLANTS; NON-METAL FITTINGS FOR COMPRESSED AIR DUCTS (U.S. CLS. 1, 5, 12, 13, 35 AND 50).

CLASS 19—NON-METALLIC BUILDING MATERIALS

FOR NON-METALLIC BUILDING MATERIAL, NAMELY, CONCRETE AND EARTHENWARE DRAIN PIPES, CONCRETE SLABS, CONCRETE BLOCKS, CONCRETE PANELS, AND CONCRETE BRICKS; NON-METAL SWIMMING POOLS; PENSTOCKS AND GATES MADE OF PLASTIC MATERIAL FOR CONTROLLING WATER (U.S. CLS. 1, 12, 33 AND 50).

CLASS 37—CONSTRUCTION AND REPAIR

FOR INSTALLATION OF WATER PURIFYING PLANTS AND SEWAGE TREATMENT PLANTS; CONSTRUCTION AND REPAIR OF DAMS, RESERVOIRS, AND TOWERS TO COLLECT AND STORE WATER; CONSTRUCTION AND REPAIR OF WATER, SEWAGE, AND INDUSTRIAL EFFLUENT TREATMENT PLANTS, SWIMMING POOLS, WATER PARKS, ROADS, AND INDUSTRIAL BUILDINGS (U.S. CLS. 100, 103 AND 106).

CLASS 40—MATERIAL TREATMENT

FOR WATER TREATMENT; WASTE WATER TREATMENT (U.S. CLS. 100, 103 AND 106).

SN 76-215,872. LAWSON BROTHERS, INC., SUPERIOR, WI. FILED 2-26-2001.

CLEARSTORE**CLASS 9—ELECTRICAL AND SCIENTIFIC APPARATUS**

FOR (BASED ON INTENT TO USE) SOFTWARE FOR USE IN ENABLING MERCHANTS TO OFFER GOODS AND SERVICES FOR SALE TO CUSTOMERS AND OTHER BUSINESSES VIA THE WORLD WIDE WEB ON THE INTERNET AND THROUGH INTRANETS AND EXTRANETS (U.S. CLS. 21, 23, 26, 36 AND 38).

CLASS 42—SCIENTIFIC, COMPUTER AND LEGAL SERVICES

FOR (BASED ON USE IN COMMERCE) PROVIDING TEMPORARY USE OF ON-LINE NON-DOWNLOADABLE SOFTWARE FOR USE IN ENABLING MERCHANTS TO OFFER GOODS AND SERVICES FOR SALE TO CUSTOMERS AND OTHER BUSINESSES VIA THE WORLD WIDE WEB ON THE INTERNET AND THROUGH INTRANETS AND EXTRANETS (U.S. CLS. 100 AND 101).

FIRST USE 4-3-2000; IN COMMERCE 6-10-2000.

SN 76-228,383. PLURAL ENTERTAINMENT ESPANA, S.L.,
28006 MADRID, SPAIN, FILED 3-21-2001.

PLURAL ENTERTAINMENT

PRIORITY CLAIMED UNDER SEC. 44(D) ON ERPN
CMNTY TM OFC APPLICATION NO. 002129435, FILED 3-
5-2001, REG. NO. 002129435, DATED 6-17-2002, EXPIRES 3-5-
2011.

NO CLAIM IS MADE TO THE EXCLUSIVE RIGHT TO
USE "ENTERTAINMENT", APART FROM THE MARK AS
SHOWN.

CLASS 9—ELECTRICAL AND SCIENTIFIC APPARATUS

FOR VIDEO RECORDINGS, DVDS, AND DOWN-
LOADABLE VIDEO RECORDINGS, FEATURING EN-
TERTAINMENT IN THE FORMS OF MOTION
PICTURES AND TELEVISION PROGRAMS IN THE
FIELDS OF DRAMA, COMEDY, DOCUMENTARIES,
NEWS, ANIMATION, AND VARIETY; DOWNLOAD-
ABLE MUSICAL SOUND RECORDINGS; MULTI-MEDIA
SOFTWARE RECORDED ON CD-ROMS FEATURING
ENTERTAINMENT IN THE FORMS OF MOTION PICT-
URES AND TELEVISION PROGRAMS IN THE FIELDS
OF DRAMA, COMEDY, DOCUMENTARIES, NEWS,
ANIMATION, AND VARIETY (U.S. CLS. 21, 23, 26, 36
AND 38).

CLASS 35—ADVERTISING AND BUSINESS

FOR BUSINESS MANAGEMENT, NAMELY, OPERAT-
ING TELEVISION STATIONS, MOTION PICTURE COM-
PANIES AND OTHER MULTIMEDIA AND
BROADCASTING ENTERPRISES, NAMELY, WEB SITE
PROVIDER OR ONLINE BROADCASTER (U.S. CLS. 100,
101 AND 102).

CLASS 38—COMMUNICATION

FOR OPERATING TELEVISION STATIONS, NAMELY,
TELEVISION BROADCASTING; BROADCASTING,
STREAMING AUDIO AND VIDEO VIA GLOBAL COM-
PUTER NETWORKS (U.S. CLS. 100, 101 AND 104).

CLASS 41—EDUCATION AND ENTERTAIN- MENT

FOR PRODUCTION OF TELEVISION PROGRAMS
AND MOTION PICTURES; PROVIDING A WEBSITE
ON THE INTERNET FEATURING INFORMATION IN
THE FIELDS OF TELEVISION PROGRAMS, MOTION
PICTURES, ENTERTAINERS, ACTORS, ACTRESSES,
AND OTHER INFORMATION ABOUT THE TELEVISION
AND MOTION PICTURE BUSINESSES (U.S. CLS. 100,
101 AND 107).

SN 76-236,416. INTEGRATED PRODUCTION AND TEST
ENGINEERING, BELGIUM, FILED 4-6-2001.

IPTE

OWNER OF BENELUX REG. NO. 0961689, DATED 4-5-
2000, EXPIRES 4-5-2010.

CLASS 7—MACHINERY

FOR MACHINES, NAMELY, AUTOMATED ASSEM-
BLY MACHINES, INDUSTRIAL ROBOTS AND CELLS
FOR HANDLING, ASSEMBLY AND TESTING OF
PRINTED CIRCUITED BOARDS AND FINAL PRO-
DUCTS; MACHINES TOOLS, NAMELY, TRANSPORT
MODULES FOR MOVING PRODUCTS IN POSITION,
INDUSTRIAL ROBOTS FOR HANDLING PRODUCTS
AND APPLICATIONS FOR WORKING PROCESSES;
MOTORS, NAMELY, ELECTRIC MOTORS FOR MA-
CHINES; ENGINES NOT FOR LAND VEHICLES; MA-
CHINE COUPLING AND TRANSMISSION
COMPONENTS, NAMELY FINAL PRODUCT TRANS-
PORT MODULES, CONVEYORS AND LINKING EQUIP-
MENT AND MACHINES, FOR MOVING PRINTED
CIRCUITED BOARDS OR PRODUCTS FROM ONE
MACHINE/PROCESS TO THE NEXT MACHINE/PRO-
CESS IN AN AUTOMATED LINE, TO LOAD AND
UNLOAD PRODUCTS ONTO AN AUTOMATED PRO-
DUCTION LINE; AND TO INVERT, TURN, DIVERT
PRINTED CIRCUITED BOARDS OR CARRIERS IN A
PRODUCTION LINE (U.S. CLS. 13, 19, 21, 23, 31, 34 AND
35).

CLASS 9—ELECTRICAL AND SCIENTIFIC APPARATUS

FOR SCIENTIFIC, ELECTRIC APPARATUS AND IN-
STRUMENTS, NAMELY, COMPUTERS FOR USE IN
THE HANDLING, ASSEMBLY AND TESTING OF
PRINTED CIRCUIT BOARDS AND FINAL PRODUCTS;
APPARATUS FOR RECORDING, TRANSMISSION AND
REPRODUCTION OF SOUND OR IMAGES, NAMELY,
BLANK MAGNETIC DATA CARRIERS, AND BLANK
COMPUTER RECORDING DISCS; DATA PROCESSING
EQUIPMENT, NAMELY, COMPUTER HARDWARE AND
SOFTWARE FOR MEASURING DATA, TEST AND
MEASURING DATA OF TESTED OR ASSEMBLED
PRINTED CIRCUIT BOARDS AND FINAL PRODUCTS;
COMPUTER SOFTWARE FOR USE IN OPERATING
AND STEERING MACHINERY; COMPUTER SOFT-
WARE FOR USE IN TEST AND MEASUREMENT PRO-
CESSING; COMPUTERS; PRINTED CIRCUIT BOARDS
BEING MACHINE COUPLING AND TRANSMISSION
COMPONENTS (U.S. CLS. 21, 23, 26, 36 AND 38).

CLASS 42—SCIENTIFIC, COMPUTER AND LEGAL SERVICES

FOR SCIENTIFIC AND INDUSTRIAL RESEARCH,
COMPUTER PROGRAMMING FOR OTHERS, ENGI-
NEERING, NAMELY, MECHANICAL AND COMPUTER
ENGINEERING FOR THE ELECTRONICS MANUFAC-
TURING INDUSTRY (U.S. CLS. 100 AND 101).

SN 76-241,029. CHILDREN'S MUSIC NETWORK, INC.,
EVANSTON, IL. FILED 4-16-2001.

THE CHILDREN'S MUSIC NETWORK

SEC. 2(F).

CLASS 16—PAPER GOODS AND PRINTED MATTER

FOR MAGAZINES AND BROCHURES IN THE FIELD
OF MUSIC FOR CHILDREN (U.S. CLS. 2, 5, 22, 23, 29, 37,
38 AND 50).

FIRST USE 1-0-1987; IN COMMERCE 1-0-1987.

CLASS 42—SCIENTIFIC, COMPUTER AND LEGAL SERVICES

FOR ASSOCIATION SERVICES, NAMELY, PROMOTING THE INTERESTS OF PERFORMERS, SONGWRITERS, TEACHERS, RECORD PRODUCERS, RECORD DISTRIBUTORS, BROADCASTERS, FAMILIES, AND CHILDREN, AND PROMOTING THE FIELD OF CHILDREN'S MUSIC (U.S. CLS. 100 AND 101).
FIRST USE 1-0-1987; IN COMMERCE 1-0-1987.

SN 76-244,612. SLACK ENTERPRISES & ASSOCIATES, INC., INDIANAPOLIS, IN. FILED 4-20-2001.



NO CLAIM IS MADE TO THE EXCLUSIVE RIGHT TO USE "ENTERPRISES & ASSOCIATES, INC.", APART FROM THE MARK AS SHOWN.

CLASS 35—ADVERTISING AND BUSINESS

FOR MANAGEMENT OF PERFORMING ARTISTS AND ATHLETES; BUSINESS CONSULTING AND PLANNING SERVICES FOR PERFORMING ARTISTS AND ATHLETES; PROMOTING THE GOODS AND SERVICES OF OTHERS BY ARRANGING FOR SPONSORS TO AFFILIATE THEIR GOODS AND SERVICES WITH PERFORMING ARTISTS AND ATHLETES; PROMOTING THE CONCERTS OF OTHERS (U.S. CLS. 100, 101 AND 102).

CLASS 41—EDUCATION AND ENTERTAINMENT

FOR ORGANIZING AND PRODUCING COMMUNITY FESTIVALS FEATURING A VARIETY OF ACTIVITIES, NAMELY, PARADES, CARNIVALS, LIVE MUSICAL PERFORMANCES, PLAYS, LIVE DRAMATIC PERFORMANCES, ART EXHIBITIONS AND WORKSHOPS, SELF-IMPROVEMENT SEMINARS AND WORKSHOPS, GAMES, AND THE LIKE; ORGANIZING AND PRODUCING EXHIBITIONS PROMOTING CULTURAL AND ETHNIC HERITAGE AND CIVIC INVOLVEMENT; CONCERT BOOKING; DISC JOCKEYS FOR PARTIES AND SPECIAL EVENTS (U.S. CLS. 100, 101 AND 107).

SN 76-246,937. OMNI INTERNATIONAL, LLC, BEDFORD, NH. FILED 4-26-2001.

PROTECTING PEOPLE AND PRODUCTS

NO CLAIM IS MADE TO THE EXCLUSIVE RIGHT TO USE "PRODUCTS", APART FROM THE MARK AS SHOWN.

CLASS 9—ELECTRICAL AND SCIENTIFIC APPARATUS

FOR PROTECTIVE INDUSTRIAL GLOVES FOR CLEAN ROOM MANUFACTURING, LABORATORY AND INDUSTRIAL USE (U.S. CLS. 21, 23, 26, 36 AND 38).

CLASS 10—MEDICAL APPARATUS

FOR GLOVES FOR MEDICAL AND SURGICAL USE (U.S. CLS. 26, 39 AND 44).

SN 76-252,143. KONAMI CORPORATION, TOKYO, JAPAN, FILED 5-4-2001.

WOLF**CLASS 9—ELECTRICAL AND SCIENTIFIC APPARATUS**

FOR COMPUTER PRODUCTS, NAMELY, COMPUTER GAME PROGRAMS; VIDEO GAME CARTRIDGES; VIDEO GAME CD-ROMS; VIDEO GAME MACHINES FOR USE WITH TELEVISIONS; COMPUTER GAME CD-ROMS; VIDEO GAME PROGRAMS; VIDEO GAME PROGRAMS FOR USE WITH TELEVISION SETS; VIDEO GAME JOYSTICKS (U.S. CLS. 21, 23, 26, 36 AND 38).

CLASS 16—PAPER GOODS AND PRINTED MATTER

FOR BROCHURES AND BOOKLETS RELATING TO COMPUTER AND VIDEO GAMES; VIDEO GAME STRATEGY GUIDE BOOKS; VIDEO GAME STRATEGY GUIDE MAGAZINES; CARD GAME STRATEGY GUIDE BOOKS; CARD GAME STRATEGY GUIDE MAGAZINES; CARD GAME INSTRUCTION BOOKS; CARD GAME INSTRUCTION MAGAZINES; POSTERS; PLAYING CARDS AND INSTRUCTION MANUAL SOLD THEREWITH; COMPUTER GAME INSTRUCTION MANUALS; PRINTED GAME INSTRUCTION SHEETS; PRINTED SCORING SHEETS; TRADING CARDS; CALENDARS (U.S. CLS. 2, 5, 22, 23, 29, 37, 38 AND 50).

CLASS 28—TOYS AND SPORTING GOODS

FOR STAND-ALONE VIDEO GAME MACHINES; HAND-HELD UNITS FOR PLAYING ELECTRONIC GAMES; BOARD GAMES AND INSTRUCTIONAL MANUALS SOLD AS A UNIT THEREWITH; CARD GAMES; DICE; PROMOTIONAL GAME MATERIALS; GAME EQUIPMENT, NAMELY, CHIPS; TOYS, NAMELY, ACTION FIGURES, DOLLS AND PLAYSETS THEREFOR (U.S. CLS. 22, 23, 38 AND 50).

SN 76-253,871. KONAMI CORPORATION, TOKYO, JAPAN, FILED 5-7-2001.

BINDING CHAIN**CLASS 9—ELECTRICAL AND SCIENTIFIC APPARATUS**

FOR COMPUTER PRODUCTS, NAMELY, COMPUTER GAME PROGRAMS; VIDEO GAME CARTRIDGES; VIDEO GAME CD-ROMS; VIDEO GAME MACHINES FOR USE WITH TELEVISIONS; COMPUTER GAME CD-ROMS; VIDEO GAME PROGRAMS; VIDEO GAME PROGRAMS FOR USE WITH TELEVISION SETS; VIDEO GAME JOYSTICKS (U.S. CLS. 21, 23, 26, 36 AND 38).

CLASS 16—PAPER GOODS AND PRINTED MATTER

FOR BROCHURES AND BOOKLETS RELATING TO COMPUTER AND VIDEO GAMES; VIDEO GAME STRATEGY GUIDE BOOKS; VIDEO GAME STRATEGY GUIDE MAGAZINES; CARD GAME STRATEGY GUIDE BOOKS; CARD GAME STRATEGY GUIDE MAGAZINES; CARD GAME INSTRUCTION BOOKS; CARD GAME INSTRUCTION MAGAZINES; POSTERS; PLAYING CARDS AND INSTRUCTION MANUAL SOLD THEREWITH; COMPUTER GAME INSTRUCTION MANUALS; PRINTED GAME INSTRUCTION SHEETS; PRINTED SCORING SHEETS; TRADING CARDS; CALENDARS; LOOSE-LEAF BINDERS AND STATIONERY (U.S. CLS. 2, 5, 22, 23, 29, 37, 38 AND 50).

CLASS 28—TOYS AND SPORTING GOODS

FOR STAND-ALONE VIDEO GAME MACHINES; HAND-HELD UNITS FOR PLAYING ELECTRONIC GAMES; BOARD GAMES AND INSTRUCTIONAL MANUALS SOLD AS A UNIT THEREWITH; CARD GAMES; DICE; PROMOTIONAL GAME MATERIALS; GAME EQUIPMENT, NAMELY, CHIPS; TOYS, NAMELY, ACTION FIGURES, DOLLS AND PLAYSETS THEREFOR (U.S. CLS. 22, 23, 38 AND 50).

SN 76-264,308. NATIONAL CABLE AND TELECOMMUNICATIONS ASSOCIATION, WASHINGTON, DC. BY CHANGE OF NAME NATIONAL CABLE TELEVISION ASSOCIATION, INC., WASHINGTON, NW, DC. FILED 5-30-2001.

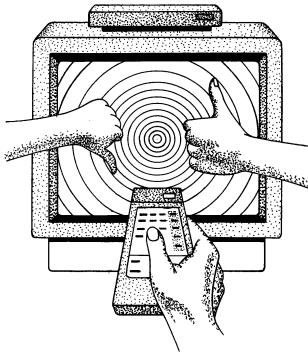

THE STIPPLING SHOWN IN THE DRAWING OF THE SUBJECT MARK IS A FEATURE OF THE MARK AND DOES NOT INDICATE COLOR.

CLASS 9—ELECTRICAL AND SCIENTIFIC APPARATUS

FOR PRE-RECORDED AUDIO AND VIDEO TAPES, CASSETTES AND CD-ROMS IN THE FIELD OF MEDIA LITERACY (U.S. CLS. 21, 23, 26, 36 AND 38).

CLASS 41—EDUCATION AND ENTERTAINMENT

FOR EDUCATIONAL SERVICES, NAMELY, CONDUCTING SEMINARS AND WORKSHOPS IN THE FIELD OF MEDIA LITERACY (U.S. CLS. 100, 101 AND 107).

SN 76-269,965. HOLCIM IP AG, 8750 GLARUS, SWITZERLAND, FILED 6-11-2001.

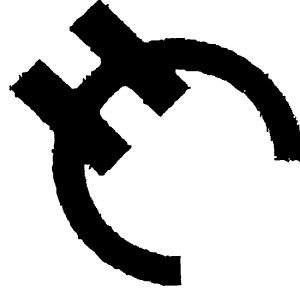

PRIORITY CLAIMED UNDER SEC. 44(D) ON SWITZERLAND APPLICATION NO. 14767/2000, FILED 12-14-2000, REG. NO. 484961, DATED 9-12-2001, EXPIRES 12-14-2010.

THE MARK CONSISTS OF A STYLIZED PRESENTATION OF THE LETTERS "H" AND "C".

CLASS 1—CHEMICALS

FOR ADMIXTURES FOR CEMENT AND CONCRETE; SPRAYED CONCRETE ACCELERATORS (U.S. CLS. 1, 5, 6, 10, 26 AND 46).

CLASS 19—NON-METALLIC BUILDING MATERIALS

FOR NON-METALLIC BUILDING MATERIALS, NAMELY, CEMENT, CONCRETE, AND AGGREGATES FOR CONCRETE COMPOSED OF SAND, GRAVEL, GROUND ROCK, RECYCLED CONCRETE, BLAST FURNACE SAND, EXPANDED CLAY, BRICKS, OR POLYSTYRENE; COMPONENTS USED IN MAKING CEMENT, NAMELY, CLINKER, GYPSUM, GRANULATED BLAST FURNACE SLAG, FLY ASH, POZZOLANS, SILICA FUME, BURNED SHALE, AND LIMESTONE; COMPONENTS USED IN MAKING CONCRETE, NAMELY, SAND, GRAVEL, FIBERS, POZZOLANS, SILICA FUME, FLY ASH, GROUND BLAST-FURNACE SLAG, GROUND TRASS, AND GROUND LIMESTONE (U.S. CLS. 1, 12, 33 AND 50).

SN 76-274,401. RAVAZZINI, CARLO, DBA WARM-UP DI RAVAZZINI DOTT. CARLO, MARANELLO (MODENA), ITALY, FILED 6-19-2001.

WARM UP

PRIORITY CLAIMED UNDER SEC. 44(D) ON ITALY APPLICATION NO. MO2000C00067, FILED 12-22-2000, REG. NO. 848643, DATED 7-12-2001, EXPIRES 12-22-2010.

CLASS 35—ADVERTISING AND BUSINESS

FOR FRANCHISING, NAMELY, OFFERING TECHNICAL ASSISTANCE IN THE ESTABLISHMENT AND/OR OPERATION OF STORES SPECIALIZING IN RACING PARAPHERNALIA, ACCESSORIES AND CLOTHING; BUSINESS MERCHANDISING DISPLAY SERVICES; BUSINESS SERVICES NAMELY FACILITIES MANAGEMENT OF TECHNICAL OPERATIONS; RETAIL STORE SERVICES FEATURING RACING PARAPHERNALIA, ACCESSORIES AND CLOTHING (U.S. CLS. 100, 101 AND 102).

CLASS 42—SCIENTIFIC, COMPUTER AND LEGAL SERVICES

FOR INTERIOR DESIGN CONSULTATION IN THE FIELD OF STORES SPECIALIZING IN RACING PARAPHERNALIA, ACCESSORIES AND CLOTHING (U.S. CLS. 100 AND 101).

SN 76-276,669. CONEI OVERSEAS INVESTMENTS, S.L., BARCELONA, SPAIN, FILED 6-26-2001.

base viva



PRIORITY CLAIMED UNDER SEC. 44(D) ON SPAIN APPLICATION NO. 2.400.887, FILED 5-16-2001, REG. NO. 2.400.887, DATED 10-22-2001, EXPIRES 5-16-2011.

PRIORITY CLAIMED UNDER SEC. 44(D) ON SPAIN APPLICATION NO. 2.400.886, FILED 5-16-2001, REG. NO. 2.400.886, DATED 2-20-2002, EXPIRES 5-16-2011.

THE COLORS BLUE AND WHITE ARE CLAIMED AS A FEATURE OF THE MARK.

THE MARK CONSISTS OF THE WORDS "BASE VIVA" LINED FOR THE COLOR BLUE, ABOVE A SMALL BOX. THE LOWER TWO-THIRDS OF THE BOX IS LINED FOR THE COLOR BLUE AND CONTAINS THE WORDING "BASE VIVA" IN WHITE; THE UPPER PORTION OF THE BOX CONTAINS A SINGLE HORIZONTAL LINE, WHICH IS A FEATURE OF THE MARK AND DOES NOT INDICATE COLOR.

THE ENGLISH TRANSLATION OF THE MARK IS "LIVE BASIS".

CLASS 29—MEATS AND PROCESSED FOODS

FOR FISH (U.S. CL. 46).

CLASS 31—NATURAL AGRICULTURAL PRODUCTS

FOR LIVE FISH (U.S. CLS. 1 AND 46).

SN 76-276,900. BILL SILLS SPORTSWEAR, INC., HUNTINGDON, TN. FILED 6-26-2001.



NO CLAIM IS MADE TO THE EXCLUSIVE RIGHT TO USE "PRODUCTS", APART FROM THE MARK AS SHOWN.

CLASS 12—VEHICLES

FOR FUEL TANK COVER (U.S. CLS. 19, 21, 23, 31, 35 AND 44).
FIRST USE 6-26-2001; IN COMMERCE 6-26-2001.

CLASS 13—FIREARMS

FOR SINGLE GUN CASE, DOUBLE GUN CASE (U.S. CLS. 2 AND 9).
FIRST USE 6-26-2001; IN COMMERCE 6-26-2001.

CLASS 18—LEATHER GOODS

FOR GARMENT BAG, HANGING POCKET ORGANIZER (U.S. CLS. 1, 2, 3, 22 AND 41).
FIRST USE 8-18-1999; IN COMMERCE 8-18-1999.

CLASS 21—HOUSEWARES AND GLASS

FOR PORTABLE COOLERS (U.S. CLS. 2, 13, 23, 29, 30, 33, 40 AND 50).
FIRST USE 6-26-2001; IN COMMERCE 6-26-2001.

CLASS 25—CLOTHING

FOR WINDVEST, LOUNGE PANT, BOXER SHORT, WADER PANTS, FLEECE BIB OVERALL, FLEECE COAT, FLEECE HOOD, FLEECE PANTS, FLEECE VESTS, HATS, NECK GAITER (U.S. CLS. 22 AND 39).
FIRST USE 8-18-1999; IN COMMERCE 8-18-1999.

CLASS 28—TOYS AND SPORTING GOODS

FOR HUNTING WATER FOWL GAME STRAP, DECOY ANCHOR (U.S. CLS. 22, 23, 38 AND 50).
FIRST USE 1-20-2001; IN COMMERCE 1-20-2001.

SN 76-278,607. BIRKO ORTHOPAEDIE GMBH, 53545 LINZ, FED REP GERMANY, FILED 6-29-2001.

Birko Woman

PRIORITY CLAIMED UNDER SEC. 44(D) ON FED REP GERMANY APPLICATION NO. 30127901.2/1, FILED 5-3-2001, REG. NO. 30127901, DATED 11-7-2001, EXPIRES 5-31-2011.

CLASS 10—MEDICAL APPARATUS

FOR ORTHOPEDIC ARTICLES, NAMELY, ORTHOPEDIC FOOTWEAR, ORTHOPEDIC ARCH SUPPORTS, ORTHOPEDIC FOOTBEDS, ORTHOPEDIC SOLES AND INSOLES, PREFORMED ORTHOPEDIC FOOTWEAR SHELLS AND HEEL INSERTS (U.S. CLS. 26, 39 AND 44).

CLASS 25—CLOTHING

FOR INSOLES AND HEEL INSERTS FOR FOOTWEAR, FOOTBEDS, INNER SOLES, PREFORMED SHELLS AND INSOLE SHELLS FOR FOOTWEAR; FOOTWEAR; SHOES, BOOTS, SANDALS, CLOGS, SLIPPERS, MULES; PARTS AND FITTINGS FOR FOOTWEAR (U.S. CLS. 22 AND 39).

SN 76-286,515. MATCHWORK WORLD WIDE A/S, DK-1953
FREDERIKSBERG C, DENMARK, FILED 7-17-2001.

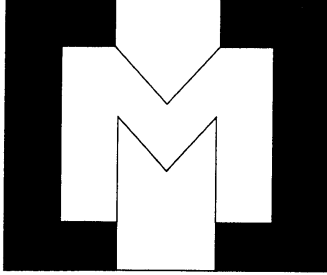

PRIORITY CLAIMED UNDER SEC. 44(D) ON DENMARK
APPLICATION NO. VA200100252, FILED 1-18-2001, REG.
NO. VR200100744, DATED 2-9-2001, EXPIRES 2-9-2011.

CLASS 35—ADVERTISING AND BUSINESS

FOR EMPLOYMENT SERVICES, NAMELY, EMPLOYMENT HIRING, RECRUITING, PLACEMENT, STAFFING AND CAREER NETWORKING THAT MAY BE ACCESSED VIA THE INTERNET; DISSEMINATION OF ADVERTISING FOR OTHERS VIA THE INTERNET AND PRINTED MEDIA; ELECTRONIC BILLBOARD ADVERTISING IN THE FIELD OF EMPLOYMENT; COMPUTERIZED DATABASE MANAGEMENT SERVICES, NAMELY, THE SYSTEMIZATION, UPDATING, MAINTENANCE AND EDITING OF EMPLOYMENT INFORMATION INTO COMPUTER DATABASES; PROVIDING EMPLOYMENT INFORMATION VIA THE INTERNET; EMPLOYMENT CONSULTATION SERVICES (U.S. CLS. 100, 101 AND 102).

CLASS 38—COMMUNICATION

FOR ARRANGING OF ACCESS TO COMPUTER DATA BY PROVIDING MULTIPLE USER ACCESS TO A GLOBAL COMPUTER INFORMATION NETWORK (U.S. CLS. 100, 101 AND 104).

CLASS 42—SCIENTIFIC, COMPUTER AND LEGAL SERVICES

FOR COMPUTER SERVICES, NAMELY, DEVELOPING COMPUTER PROGRAMS FOR OTHERS FOR THE PURPOSE OF ESTABLISHING A CONTACT BETWEEN JOB SEEKERS AND EMPLOYERS; COMPUTER PROGRAMMING FOR OTHERS; UPDATING AND MAINTENANCE OF COMPUTER SOFTWARE; NEWS REPORTING SERVICES; DESIGN OF WEB SITES; OPERATION OF WEB SERVERS AND WEB HOSTING SERVICES FOR LOCAL AND/OR GLOBAL ELECTRONIC NETWORKS (U.S. CLS. 100 AND 101).

SN 76-288,138. MAKE COMMUNICATIONS & COMPUTING,
LLC, LOS GATOS, CA. FILED 7-12-2001.

JOIE DE VIVRE

THE ENGLISH TRANSLATION OF "JOIE DE VIVRE" IS
"JOY OF LIFE".

CLASS 9—ELECTRICAL AND SCIENTIFIC APPARATUS

FOR COMPUTER HARDWARE AND SOFTWARE FOR FACILITATING ELECTRONIC COMMERCE TRANSACTIONS AND ENABLING NAVIGATION OF RETAIL WEBSITES (U.S. CLS. 21, 23, 26, 36 AND 38).
FIRST USE 7-4-2000; IN COMMERCE 7-4-2000.

CLASS 35—ADVERTISING AND BUSINESS

FOR PROVIDING A WEBSITE ON A GLOBAL COMPUTER NETWORK FEATURING ADVERTISEMENTS FOR AND INFORMATION ABOUT THE GOODS AND SERVICES OF OTHERS (U.S. CLS. 100, 101 AND 102).
FIRST USE 7-4-2000; IN COMMERCE 7-4-2000.

CLASS 38—COMMUNICATION

FOR PROVIDING MULTIPLE USER ACCESS TO A GLOBAL COMPUTER NETWORK (U.S. CLS. 100, 101 AND 104).
FIRST USE 7-4-2000; IN COMMERCE 7-4-2000.

SN 76-288,276. ARTHUR ANDERSEN LLP, CHICAGO, IL.
FILED 7-19-2001.

ANDERSEN

OWNER OF U.S. REG. NOS. 1,061,828, 2,129,732 AND
OTHERS.
SEC. 2(F).

CLASS 9—ELECTRICAL AND SCIENTIFIC APPARATUS

FOR COMPUTER SOFTWARE FOR USE IN CALCULATING, INPUTTING, REPORTING, INTEGRATING AND FORECASTING BUSINESS DATA AND INFORMATION AND FOR USE IN DATABASE MANAGEMENT, ALL IN THE FIELDS OF ACCOUNTING, AUDITING, TAX, MANAGEMENT CONSULTING, BUSINESS, FINANCIAL MANAGEMENT AND ANALYSIS, AND INFORMATION TECHNOLOGY; COMPUTER SOFTWARE FOR THE DEVELOPMENT AND ADMINISTRATION OF WEBSITES, ON LINE AND INTERACTIVE MEDIA AND COMPUTER NETWORKS (U.S. CLS. 21, 23, 26, 36 AND 38).
FIRST USE 3-19-2001; IN COMMERCE 3-19-2001.

CLASS 16—PAPER GOODS AND PRINTED MATTER

FOR PRINTED MATERIALS, NAMELY, BOOKS, NEWSLETTERS, REPORTS, JOURNALS, MANUALS AND GUIDES IN THE FIELDS OF ACCOUNTING, AUDITING, TAX, MANAGEMENT CONSULTING, BUSINESS, FINANCIAL MANAGEMENT AND ANALYSIS, AND ON LINE BUSINESS ACTIVITIES AND OPERATIONS, INFORMATION TECHNOLOGY, DATABASE MANAGEMENT, AND THE DEVELOPMENT AND ADMINISTRATION OF WEBSITES, ON LINE AND INTERACTIVE MEDIA AND COMPUTER NETWORKS (U.S. CLS. 2, 5, 22, 23, 29, 37, 38 AND 50).
FIRST USE 3-19-2001; IN COMMERCE 3-19-2001.

CLASS 35—ADVERTISING AND BUSINESS

FOR ACCOUNTING SERVICES; BUSINESS AND ACCOUNT AUDITING SERVICES; TAX PREPARATION AND CONSULTING SERVICES; BUSINESS MANAGEMENT CONSULTING SERVICES; BUSINESS PLANNING SERVICES; BUSINESS PROCESS DEVELOPMENT AND RE-ENGINEERING SERVICES; BUSINESS ACQUISITION AND MERGER CONSULTATION; COMPETITIVE AND MARKET ANALYSIS SERVICES; BUSINESS APPRAISALS; ARRANGING AND CONDUCTING TRADE SHOWS, EXHIBITIONS AND CONFERENCES IN THE FIELDS OF ACCOUNTING, AUDITING, TAX, BUSINESS, BUSINESS MANAGEMENT, INFORMATION TECHNOLOGY AND ON LINE BUSINESS ACTIVITIES AND OPERATIONS; BUSINESS INVESTIGATION SERVICES; PERSONNEL MANAGEMENT UTILIZATION AND VALUATION CONSULTATION; PROVIDING INFORMATION IN THE FIELDS OF ACCOUNTING, TAX, AUDITING, BUSINESS, BUSINESS MANAGEMENT, FINANCE, INTERNATIONAL TAX, SECURITIES, CORPORATE AND LABOR LAWS, AND ON LINE BUSINESS ACTIVITIES AND OPERATIONS BY MEANS OF A GLOBAL COMPUTER NETWORK; ON LINE RETAIL SERVICES PROVIDED TO THE BUSINESS COMMUNITY, FEATURING BOOKS, REPORTS, JOURNALS, COMPUTER SOFTWARE, AND DIAGNOSTIC TOOLS, NAMELY, SURVEYS, ANALYSES AND BENCHMARKING ASSESSMENTS; OUTSOURCING SERVICES FOR OTHERS IN FIELDS OF ACCOUNTING, TAX, FINANCE AND INFORMATION TECHNOLOGY (U.S. CLS. 100, 101 AND 102).

FIRST USE 3-19-2001; IN COMMERCE 3-19-2001.

CLASS 36—INSURANCE AND FINANCIAL

FOR INSURANCE CONSULTATION; REAL ESTATE CONSULTATION, NAMELY, CONSULTATION WITH RESPECT TO REAL ESTATE ACQUISITIONS, DIVESTITURES, MANAGEMENT AND PROCESSES, REAL ESTATE FINANCING, AND REAL ESTATE APPRAISAL; FINANCIAL ANALYSIS AND CONSULTATION; ACTUARIAL SERVICES; FINANCIAL VALUATION OF BUSINESS ENTERPRISES, TANGIBLE AND INTANGIBLE PROPERTY AND REAL ESTATE; INVESTMENT CONSULTATION SERVICES TO GOVERNMENT ENTITIES, PRIVATE AND PUBLIC COMPANIES; CAPITAL INVESTMENT CONSULTATION FOR PRIVATE AND PUBLIC COMPANIES; RISK MANAGEMENT SERVICES (U.S. CLS. 100, 101 AND 102).

FIRST USE 3-19-2001; IN COMMERCE 3-19-2001.

CLASS 38—COMMUNICATION

FOR PROVIDING ON-LINE CHAT ROOMS AND OTHER ELECTRONIC RESOURCES VIA A GLOBAL COMPUTER NETWORK FOR THE TRANSMISSION OF MESSAGES AND OTHER INFORMATION TO AND AMONG COMPUTER USERS REGARDING GENERAL BUSINESS TOPICS AND THE DIGITAL COMMUNICATIONS, ENERGY, FINANCE, HEALTHCARE, HOSPITALITY, WHOLESALE DISTRIBUTION, UNIVERSITY AND INTERNAL AUDIT INDUSTRIES (U.S. CLS. 100, 101 AND 104).

FIRST USE 3-19-2001; IN COMMERCE 3-19-2001.

CLASS 41—EDUCATION AND ENTERTAINMENT

FOR EDUCATIONAL SERVICES, NAMELY, CONDUCTING COURSES, SEMINARS, CONFERENCES, WORKSHOPS AND CLASSES, AND DEVELOPING AND DISTRIBUTING EDUCATIONAL MATERIALS IN CONNECTION THEREWITH, IN THE FIELDS OF ACCOUNTING, AUDITING, TAX, MANAGEMENT CONSULTING, BUSINESS, FINANCIAL MANAGEMENT AND ANALYSIS, COMPUTER SOFTWARE DEVELOPMENT AND IMPLEMENTATION, COMPUTER SOFTWARE USAGE, INFORMATION TECHNOLOGY, AND ON LINE BUSINESS ACTIVITIES AND OPERATIONS (U.S. CLS. 100, 101 AND 107).

FIRST USE 3-19-2001; IN COMMERCE 3-19-2001.

CLASS 42—SCIENTIFIC, COMPUTER AND LEGAL SERVICES

FOR PROVIDING INFORMATION IN THE FIELDS OF INFORMATION TECHNOLOGY, COMPUTERS AND COMPUTER SYSTEMS; COMPUTER CONSULTING IN THE AREAS OF COMPUTERS, COMPUTER SYSTEMS, COMPUTER SOFTWARE, COMPUTER NETWORKS AND COMPUTER SYSTEM SECURITY; COMPUTER SERVICES, NAMELY, DESIGN OF COMPUTER SYSTEMS FOR OTHERS, COMPUTER PROGRAMMING FOR OTHERS, AND COMPUTER SOFTWARE SYSTEMS INTEGRATION AND IMPLEMENTATION; INFORMATION TECHNOLOGY CONSULTING SERVICES; INSTALLATION, MAINTENANCE AND REPAIR SERVICES OF COMPUTER SOFTWARE; TECHNICAL SUPPORT SERVICES, NAMELY, TROUBLESHOOTING OF COMPUTER HARDWARE AND SOFTWARE PROBLEMS VIA TELEPHONE, E-MAIL, REMOTE ELECTRONIC CONNECTIONS, POSTINGS ON GLOBAL COMPUTER NETWORKS AND SITE VISITS; MEDIATION SERVICES; LITIGATION AND ALTERNATIVE DISPUTE RESOLUTION SERVICES; DESIGNING, IMPLEMENTING, CREATING, MAINTAINING AND HOSTING WEBSITES FOR OTHERS ON A COMPUTER SERVER FOR A GLOBAL COMPUTER NETWORK (U.S. CLS. 100 AND 101).

FIRST USE 3-19-2001; IN COMMERCE 3-19-2001.

SN 76-288,805. SOLUTIONS PHARMACY, INC., TOA BAJA, PUERTO RICO, FILED 7-20-2001.



NO CLAIM IS MADE TO THE EXCLUSIVE RIGHT TO USE "PHARMACY" AND "RX", APART FROM THE MARK AS SHOWN.

THE MARK CONTAINS THE WORDS "SOLUTIONS" AND "PHARMACY" WITH THE LETTERS "O" REPRESENTED BY CONTAINERS HOLDING A LIQUID, ONE OF THE CONTAINERS BEING MARKED WITH AN "RX" SYMBOL.

CLASS 35—ADVERTISING AND BUSINESS

FOR RETAIL STORE SERVICES, MAIL ORDER SERVICES, TELEPHONE ORDERING SERVICES, AND COMPUTERIZED ON-LINE ORDERING SERVICES IN THE FIELD OF PHARMACEUTICAL PRODUCTS (U.S. CLS. 100, 101 AND 102).

FIRST USE 4-26-1999; IN COMMERCE 4-29-1999.

CLASS 39—TRANSPORTATION AND STORAGE

FOR DELIVERY BY COURIER OF PHARMACEUTICAL PRODUCTS TO OTHERS (U.S. CLS. 100 AND 105).

FIRST USE 4-26-1999; IN COMMERCE 4-29-1999.

SN 76-295,497. KUNICK LEISURE LIMITED, WEST YORKSHIRE LS18 4ER, UNITED KINGDOM, FILED 8-2-2001.

BELL-FRUIT

PRIORITY CLAIMED UNDER SEC. 44(D) ON UNITED KINGDOM APPLICATION NO. 2260137, FILED 2-2-2001, REG. NO. 2260137, DATED 5-24-2002, EXPIRES 2-2-2011.

OWNER OF U.S. REG. NO. 1,144,019.

CLASS 9—ELECTRICAL AND SCIENTIFIC APPARATUS

FOR VIDEO GAME CARTRIDGES; COMPACT DISCS AND OPTICAL DISCS FEATURING ENTERTAINMENT, NAMELY PRERECORDED MUSIC, GAMES, MOVIES, AND GAMING CONTENT; COMPUTER GAME CARTRIDGES; COMPUTER GAME DISCS; COMPUTER GAME EQUIPMENT CONTAINING MEMORY DEVICES, NAMELY DISCS; COMPUTER GAME PERIPHERALS, NAMELY GAME PADS AND JOYSTICKS; COMPUTER GAME PROGRAMS; COMPUTER GAME SOFTWARE; ELECTRONIC VIDEO OUTPUT GAME MACHINES FOR USE WITH TELEVISIONS; ELECTRONIC GAME CARTRIDGES; ELECTRONIC GAME DISCS; ELECTRONIC GAME COMPUTER PROGRAMS; ELECTRONIC GAME SOFTWARE; ELECTRONIC VIDEO GAME MACHINES FOR USE WITH A MONITOR OR TELEVISION; INTERACTIVE ELECTRONIC GAME MACHINES FOR USE WITH A MONITOR OR TELEVISION; VIDEO GAME SOFTWARE; VIDEO GAME COMPUTER PROGRAMS; INTERACTIVE VIDEO GAME CARTRIDGES; INTERACTIVE VIDEO GAME DISCS; INTERACTIVE VIDEO GAME COMPUTER PROGRAMS; INTERACTIVE VIDEO GAME SOFTWARE; VIDEO GAME CARTRIDGES; VIDEO GAME DISCS; GAMING AND ENTERTAINMENT EQUIPMENT CONNECTABLE TO COMMUNICATIONS DEVICES, NAMELY MODEMS, NETWORK ADAPTERS, TELEPHONES, CELLULAR TELEPHONES, PCS TELEPHONES, WIRELESS TELEPHONES AND PAGERS; VIDEO GAME MACHINE ACCESSORIES, NAMELY VIDEO GAME CONTROLLERS AND VIDEO GAME JOYSTICKS; VIDEO GAME MACHINES FOR USE WITH A MONITOR OR TELEVISION; MONITOR- OR TELEVISION-ADAPTED VIDEO GAME MACHINES WITH MEMORY DEVICES, NAMELY NON-VOLATILE MEMORY; VIDEO GAME COMPUTER PROGRAMS; VIDEO GAME SOFTWARE; GAMING MACHINES OPERATED BY COIN, BILL, TOKEN, MACHINE-READABLE DATA-HOLDING CARD, DEBIT CARD, AND CREDIT CARD; CHANGE MACHINES; GAMING MACHINES ACTIVATED BY INFRARED AND CODE; MACHINES FOR PLAYING GAMES OF CHANCE, NAMELY AMUSEMENT-WITH-PRIZES GAMING MACHINES; AND SKILL-WITH-PRIZES GAMING MACHINES; PARTS FOR THE AFORESAID GOODS (U.S. CLS. 21, 23, 26, 36 AND 38).

CLASS 28—TOYS AND SPORTING GOODS

FOR STAND-ALONE VIDEO GAME MACHINES; ELECTRONIC EDUCATIONAL GAME MACHINES FOR CHILDREN; HANDHELD UNIT FOR PLAYING ELECTRONIC GAMES; STAND-ALONE ELECTRONIC GAME MACHINES OPERATED BY COIN, BILL, TOKEN, MACHINE-READABLE DATA-HOLDING CARD, DEBIT CARD, AND CREDIT CARD; INFRARED- AND CODE-ACTIVATED ELECTRONIC GAME MACHINES; STAND-ALONE AMUSEMENT-WITH-PRIZES GAME MACHINES; STAND-ALONE SKILL- WITH-PRIZES GAME MACHINES; PARTS FOR THE AFORESAID GOODS (U.S. CLS. 22, 23, 38 AND 50).

CLASS 9—ELECTRICAL AND SCIENTIFIC APPARATUS

FOR SECURITY AND SURVEILLANCE APPARATUS, NAMELY BURGLAR AND SECURITY ALARMS, MOTION SENSORS, CLOSED CIRCUIT TELEVISION CAMERAS; REMOTE AUDIO AND VIDEO SURVEILLANCE SYSTEMS, ALARM VERIFICATION SYSTEMS, REMOTE AUDIO AND VIDEO ENTRY SYSTEMS AND VIDEO TRAFFIC MONITORING SYSTEMS, ALL COMPRISING; CLOSED CIRCUIT TELEVISION CAMERAS, BURGLAR AND SECURITY ALARMS, MOTION SENSORS, PHOTOGRAPHIC AND VIDEO CAMERAS, VIDEO MONITORS, VIDEO CASSETTE RECORDERS AND PLAYERS, RADIO PAGERS, RADIO TELEPHONES AND TRANSMITTERS, MICROPHONES, AMPLIFIERS, SPEAKERS, TELEPHONES, AUTOMATIC TELEPHONE DIALERS, SWITCHBOARDS, INTERCOMS, COMMUNICATION SERVERS, TRANSMISSION CABLES, OR COMPUTER HARDWARE OR SOFTWARE FOR USE IN AUDIO AND VIDEO SURVEILLANCE AND ALARM VERIFICATION; REMOTE AUDIO AND VIDEO SURVEILLANCE SYSTEMS AS ABOVE APPLIED TO TELEHEALTH, TELEMEDICINE, E-HEALTH, E-MEDICINE, E-HEALTHCARE AND HOME BASED TELEHEALTHCARE; VIDEO CONFERENCING EQUIPMENT, NAMELY TELEPHONES, VIDEO PHONES AND VIDEO MONITORS; VIDEO CONFERENCING EQUIPMENT, NAMELY, TELEPHONES, VIDEO PHONES AND VIDEO MONITORS APPLIED TO TELEHEALTH, TELEMEDICINE, E-HEALTH, E-MEDICINE, E-HEALTHCARE AND HOME BASED TELEHEALTHCARE; TELECOMMUNICATION SYSTEMS COMPRISING AUTOMATIC TELEPHONE DIALERS, TELEPHONE RECEIVERS, TELEPHONE TRANSMITTERS, TELEPHONE ANSWERING SETS, SWITCHBOARDS, INTERCOMS, CALLER IDENTIFICATION BOXES, FACSIMILE MACHINES, COMMUNICATION SERVERS, RADIO PAGERS, RADIO TELEPHONES, TRANSMITTERS; TELECOMMUNICATION SYSTEMS AS ABOVE APPLIED TO TELEHEALTH, TELEMEDICINE, E-HEALTH, E-MEDICINE, E-HEALTHCARE AND HOME BASED TELEHEALTHCARE; COMPUTER SOFTWARE FOR OPERATING, CONTROLLING AND MONITORING AUDIO AND VIDEO SURVEILLANCE SYSTEMS, ALARM VERIFICATION SYSTEMS AND VIDEO TELEPHONY SYSTEMS, IN THE FIELDS OF SECURITY SYSTEMS AND TELEPHONES, RADIO AND VIDEO COMMUNICATIONS; COMPUTER HARDWARE FOR TELEPHONE AND VIDEO EXCHANGE AND TRANSMISSION; TELECOMMUNICATION CABLES, COMPUTER AND ELECTRICAL CABLES AND MODEMS, TRANSMISSION CABLES AND OPTICAL FIBRES AND PERTINENT CONNECTORS; PHOTOGRAPHIC CAMERAS, VIDEO CAMERAS, DIGITAL CAMERAS, VIDEO CASSETTE RECORDERS AND PLAYERS, BLANK VIDEO CASSETTES, TAPE PLAYERS AND RECORDERS, MICROPHONES, AMPLIFIERS AND SPEAKERS; TELEPHONE HAND SETS, TELEPHONE HEAD SETS, KEYPADS, DISPLAY APPARATUS, NAMELY, MONITORS, SLIDE PROJECTORS, PHOTOGRAPHIC PROJECTORS, PROJECTION SCREENS AND TELEVISION SETS; PARTS, MODULES AND COMPONENTS FOR THE AFORESAID GOODS (U.S. CLS. 21, 23, 26, 36 AND 38).

SN 76-299,264. MOTION MEDIA TECHNOLOGY LIMITED,
AUST, BRISTOL, UNITED KINGDOM, FILED 8-14-2001.

CARESTATION

PRIORITY CLAIMED UNDER SEC. 44(D) ON UNITED KINGDOM APPLICATION NO. 2275943, FILED 7-21-2001, REG. NO. 2275943, DATED 3-7-2003, EXPIRES 7-21-2011.

CLASS 38—COMMUNICATION

FOR TELEPHONE COMMUNICATION SERVICES, RADIO COMMUNICATION SERVICES, CELLULAR TELEPHONE SERVICES, PAGING SERVICES, VIDEO ENABLED SERVICES, NAMELY, VIDEO TELECONFERENCING SERVICES; ELECTRONIC TRANSMISSION OF FACSIMILE COMMUNICATION AND DATA FEATURING ENCRYPTION AND DECRYPTION; LEASING OF TELECOMMUNICATIONS EQUIPMENT OTHER THAN COMPUTERS; PROVIDING INFORMATION IN THE FIELD OF TELECOMMUNICATIONS SYSTEMS AND NETWORKS (U.S. CLS. 100, 101 AND 104).

CLASS 42—SCIENTIFIC, COMPUTER AND LEGAL SERVICES

FOR CONSULTATION SERVICES RELATING TO THE DESIGN, INSTALLATION AND OPERATION OF TELECOMMUNICATIONS SYSTEMS AND NETWORKS; CONSULTATION IN THE FIELD OF TELECOMMUNICATIONS DESIGN AND PRODUCT DEVELOPMENT; LEASING OF SURVEILLANCE APPARATUS; REMOTE VISUAL AND AUDIO MONITORING OF ALARM SYSTEMS; MONITORING BURGLAR AND SECURITY ALARMS (U.S. CLS. 100 AND 101).

SN 76-301,869. INIT INNOVATIVE INFORMATIKANWENDUNGEN IN TRANSPORT-, VERKEHRS- UND LEITSYSTEMEN GMBH, FED REP GERMANY, FILED 8-20-2001.



SN 76-299,925. ASCERTECH AG, 60528 FRANKFURT, FED REP GERMANY, FILED 8-14-2001.



PRIORITY CLAIMED UNDER SEC. 44(D) ON FED REP GERMANY APPLICATION NO. 30137195.4/0, FILED 6-19-2001, REG. NO. 30137195, DATED 8-17-2001, EXPIRES 6-30-2011.

CLASS 9—ELECTRICAL AND SCIENTIFIC APPARATUS

FOR APPARATUS FOR RECORDING, TRANSMISSION AND REPLAY OF SOUND AND PICTURE, NAMELY, VIDEO RECORDERS, TAPE RECORDERS, RADIOS, CD-PLAYERS, DVD-PLAYERS, DISC-PLAYERS, TELEVISION SETS, DIGITAL CAMERAS, VIDEO CAMERAS, AND SLIDE PROJECTORS; PHONOGRAPH RECORDS, CDS, DVDS, CD-ROMS, AND COMPUTER SOFTWARE FOR BUSINESS DATABASE MANAGEMENT, WORD PROCESSING, FILE MANAGEMENT, AND ACCOUNTING SERVICES; DATA PROCESSORS AND COMPUTERS; COMPUTER SOFTWARE FOR SYSTEM MANAGEMENT, NETWORK MONITORING, LOAD DATA COLLECTING AND PROCESSING TO BE USED IN THE FIELDS OF BUSINESS MANAGEMENT, INFORMATION TECHNOLOGY MANAGEMENT AND ACCOUNTING SERVICES THAT MAY BE DOWNLOADED FROM THE INTERNET (U.S. CLS. 21, 23, 26, 36 AND 38).

CLASS 35—ADVERTISING AND BUSINESS

FOR BUSINESS MANAGEMENT, IN THE FIELD OF INFORMATION TECHNOLOGY; ACCOUNTING SERVICES FOR OTHERS (U.S. CLS. 100, 101 AND 102).

CLASS 42—SCIENTIFIC, COMPUTER AND LEGAL SERVICES

FOR CONSULTANCY SERVICES IN THE FIELD OF INFORMATION TECHNOLOGY MANAGEMENT; CONSULTING SERVICES IN THE FIELD OF DESIGN, SELECTION, IMPLEMENTATION AND USE OF COMPUTER HARDWARE AND SOFTWARE SYSTEMS FOR OTHERS; COMPUTER NETWORK DESIGN FOR OTHERS (U.S. CLS. 100 AND 101).

PRIORITY CLAIMED UNDER SEC. 44(D) ON FED REP GERMANY APPLICATION NO. 30111755.1/0, FILED 2-21-2001, REG. NO. 30111755, DATED 7-11-2001, EXPIRES 2-28-2011.

CLASS 9—ELECTRICAL AND SCIENTIFIC APPARATUS

FOR ELECTRONIC MEASURING AND CONTROL DEVICES, NAMELY AUTOMATIC PASSENGER COUNTING SYSTEMS COMPRISED OF OPTICAL SENSORS AND ELECTRONIC APPARATUS FOR AUTOMATICALLY DETECTING AND COUNTING PASSENGERS, RECORDING COUNT DATA AND TRANSFERRING THE DATA TO A DATA PROCESSING COMPUTER; DEVICES FOR COLLECTING DATA, NAMELY MAGNETIC CARD AND SMART CARD READERS FOR THE ELECTRONIC COLLECTION OF FARES; ELECTRONIC ROUTE MEASURING APPARATUS, NAMELY ELECTRONIC ODOMETER INTERFACES, SIGN POST SENSORS AND SATELLITE NAVIGATIONAL SYSTEMS, NAMELY, GLOBAL POSITIONING SYSTEMS (GPS); DATA INPUT APPARATUS, NAMELY, ELECTRONIC APPARATUS FOR READING MAGNETIC STRIPS AND CHIP CARDS; TOUCH-SENSITIVE SCREENS FOR DATA PROCESSING, NAMELY ON-BOARD COMPUTERS FOR PUBLIC TRANSPORT FARE COLLECTION; DEVICES FOR PROCESSING PERSONAL DATA AND TRAFFIC AND ROUTE DATA, NAMELY, PLANNING AND SCHEDULING SOFTWARE FOR GEOGRAPHIC PLANNING AND DISPATCH MANAGEMENT; OPTICAL AND MAGNETIC DATA CARRIERS, NAMELY, PLASTIC CARDS WITH MAGNETIC STRIPS AND CONTACT-FREE ENCODED CHIP CARDS WITH STORED CASH VALUE; REAL-TIME PASSENGER INFORMATION SYSTEMS COMPRISED OF ELECTRONIC AND OPTICAL WAYSIDE DISPLAY DEVICES; COMMUNICATION SYSTEMS COMPRISED OF CENTRAL MANAGEMENT SOFTWARE FOR COMPUTERS AND RADIO COMMUNICATION DEVICES, NAMELY, RADIOS, PAGERS, CELLULAR PHONES AND COMMUNICATION NETWORK APPARATUS; TICKET VENDING MACHINES; APPARATUS FOR CASH PAYMENT, NAMELY BILL, NOTE AND COIN ACCEPTING DEVICES; MODULAR CASH SYSTEMS COMPRISED OF TRACKING AND RECONCILIATION SOFTWARE APPLICATIONS; PRINTERS, NAMELY TICKET PRINTERS; MACHINES AND DEVICES FOR WIRELESS DATA TRANSFER, NAMELY RADIO FREQUENCY (RF) MANAGEMENT SYSTEMS COMPRISED OF RADIO CONTROLLERS, TRANSMITTERS, ROUTERS AND WIRELESS NETWORKING GOODS, NAMELY SOFTWARE FOR PROCESSING WIRELESS DATA TRANSFERS, WIRELESS AND LANDLINE NETWORK HUBS, SWITCHES AND ROUTERS, PAGERS, AND CELLULAR PHONES; SOFTWARE FOR SCHEDULING, ROUTE DETERMINATION AND ROSTERING, TRIP PLANNING, OPERATOR BREAK MONITORING, AND OPERATOR PAYMENTS; SOFTWARE FOR STATISTICAL ANALYSIS OF PASSENGER LOADS, TRANSIT VEHICLE SCHEDULE ADHERENCE, AND CENTRAL DISPATCH MANAGEMENT ACTIVITIES (U.S. CLS. 21, 23, 26, 36 AND 38).

CLASS 38—COMMUNICATION

FOR TELECOMMUNICATION SERVICES, NAMELY VOICE AND DATA MESSAGING SERVICES; TELEMETRY, NAMELY TRANSFER OF DATA FOR PUBLIC TRANSIT SYSTEMS VIA COMPUTER NETWORKS, RADIO FREQUENCY (RF) WIRELESS NETWORKS AND COMMERCIAL TELECOMMUNICATIONS NETWORKS; TRAFFIC TELEMATIC SERVICES, NAMELY RADIO FREQUENCY (RF) AND NETWORK-BASED TRANSMISSION OF DATA FOR INFORMATION-BASED TRAFFIC CONTROL (U.S. CLS. 100, 101 AND 104).

CLASS 42—SCIENTIFIC, COMPUTER AND LEGAL SERVICES

FOR CREATION OF SOFTWARE FOR OTHERS FOR THE OPERATION OF PUBLIC TRANSPORT SYSTEMS, NAMELY FOR PREPARING SCHEDULES, ROUTES, TRIP PLANNING, OPERATOR BREAK MONITORING AND OPERATOR PAYMENT (U.S. CLS. 100 AND 101).

SN 76-304,913. KLOCKNER & CO AG, 47057 DUISBURG, FED REP GERMANY, FILED 8-27-2001.

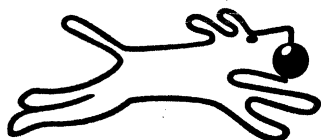

THE MARK CONSISTS OF A STYLIZED DEPICTION OF A DOG RUNNING WITH A BALL IN ITS MOUTH.

CLASS 6—METAL GOODS

FOR STEEL, ALUMINUM AND OTHER METALS, NAMELY, CARBON STEEL, ALLOY STEEL AND STAINLESS IN THE FORM OF STRUCTURALS, NAMELY, BEAMS, CHANNELS, ANGLES, TEES, ZEES, STRUCTURAL TUBES, PIPES, BARS, SHEETS, GRATING AND FLOORING PRODUCTS, NAMELY EXPANDED METAL, FLOOR PLATES (U.S. CLS. 2, 12, 13, 14, 23, 25 AND 50).

CLASS 42—SCIENTIFIC, COMPUTER AND LEGAL SERVICES

FOR TECHNICAL CONSULTATION IN THE FIELD OF PRODUCTION OF STEEL, ALUMINUM, AND METAL PRODUCTS FOR FURTHER MANUFACTURING (U.S. CLS. 100 AND 101).

SN 76-308,502. SWEDISH MATCH INDUSTRIES AKTIEBOLAG, S-52222 TIDAHOLM, SWEDEN, FILED 9-4-2001.

VULCAN

CLASS 4—LUBRICANTS AND FUELS

FOR FLAMMABLE BAGS CONTAINING FUEL FOR USE WITH BARBECUES; REFILL UNITS CONTAINING GAS LIGHTER FLUID FOR REFILLING LIGHTERS; REFILL UNITS CONTAINING LIGHTER FLUID FOR CIGARETTE LIGHTERS (U.S. CLS. 1, 6 AND 15).

CLASS 34—SMOKERS' ARTICLES

FOR SMOKERS' ARTICLES, NAMELY, PIPE CLEANERS, CIGARETTE PAPERS, CIGARETTE FILTERS, CIGARETTE HAND ROLLING MACHINES, PIPES, CIGARETTE HOLDERS NOT OF PRECIOUS METAL, TOBACCO POUCHES, ASHTRAYS NOT OF PRECIOUS METAL AND CIGARETTE BOXES NOT OF PRECIOUS METAL; LIGHTERS FOR SMOKERS AND PARTS THEREFOR, NAMELY, NON-ELECTRIC CIGAR, CIGARETTE AND PIPE LIGHTERS NOT OF PRECIOUS METAL, FLINT LIGHTERS NOT OF PRECIOUS METAL AND FLINTS FOR LIGHTERS (U.S. CLS. 2, 8, 9 AND 17).

SN 76-312,999. DIC ENTERTAINMENT, L.P., BURBANK, CA, FILED 9-15-2001.

SUPER DUPER SUMOS

CLASS 3—COSMETICS AND CLEANING PREPARATIONS

FOR BEAUTY PRODUCTS, NAMELY BODY LOTION, FACE CREAM, SHAMPOO, BUBBLE BATH, AND SOAP (U.S. CLS. 1, 4, 6, 50, 51 AND 52).

CLASS 14—JEWELRY

FOR WATCHES, CLOCKS AND JEWELRY (U.S. CLS. 2, 27, 28 AND 50).

CLASS 16—PAPER GOODS AND PRINTED MATTER

FOR SCHOOL SUPPLIES, NAMELY, PENS, PENCILS, BINDERS, NOTEBOOKS, ERASERS, CARRYING CASES OF PLASTIC AND CANVAS FOR PENS AND PENCILS, ACTIVITY SETS COMPRISING WORKBOOKS AND MODELING CLAY TO ENABLE ONE TO CREATE ORIGINAL CRAFTS AND ACTIVITIES (U.S. CLS. 2, 5, 22, 23, 29, 37, 38 AND 50).

CLASS 18—LEATHER GOODS

FOR LUGGAGE AND BACKPACKS (U.S. CLS. 1, 2, 3, 22 AND 41).

CLASS 20—FURNITURE AND ARTICLES NOT OTHERWISE CLASSIFIED

FOR FURNITURE, BATH AND BEACH FURNITURE, BEDROOM FURNITURE, SLUMBER BAGS, DRINKING STRAWS, AND PILLOWS (U.S. CLS. 2, 13, 22, 25, 32 AND 50).

CLASS 21—HOUSEWARES AND GLASS

FOR HOUSEWARES, NAMELY, PLATES, CUPS, BOWLS, DRINKING GLASSES, GLASS MUGS, TUMBLERS, COOKIE JARS, SERVING PIECES, NAMELY, FORKS, SPOONS AND KNIVES, SERVING PLATTERS, BAKEWARE, NAMELY, CAKE PANS AND CAKE DECORATING ACCESSORIES (U.S. CLS. 2, 13, 23, 29, 30, 33, 40 AND 50).

CLASS 24—FABRICS

FOR BEDDING, NAMELY, BED SHEETS, BED BLANKETS, AND BEDDING SKIRTS (U.S. CLS. 42 AND 50).

CLASS 25—CLOTHING

FOR OUTERWEAR, NAMELY, LEATHER JACKETS, RAIN JACKETS, SWEAT SHIRTS, SWEAT PANTS, JUMPSUITS, INFANT APPAREL, NAMELY, CLOTH BIBS, SLEEPERS, JUMPERS, BONNETS, MITTENS AND BOOTIES (U.S. CLS. 22 AND 39).

CLASS 27—FLOOR COVERINGS

FOR FLOOR COVERINGS, NAMELY, CARPETS, LINOLEUM FOR USE ON FLOORS, HARD SURFACE COVERINGS FOR FLOORS (U.S. CLS. 19, 20, 37, 42 AND 50).

CLASS 28—TOYS AND SPORTING GOODS

FOR SPORTING EQUIPMENT, NAMELY, TENNIS BALLS, TENNIS RACQUETS, SKATE BOARDS, PLAY BALLS, RUBBER BALLS, BOUNCY BALLS, TENNIS BALLS, BASEBALLS, SOCCER BALLS, FOOTBALLS, BASKETBALLS, AND EXERCISE BALLS (U.S. CLS. 22, 23, 38 AND 50).

CLASS 29—MEATS AND PROCESSED FOODS

FOR SALTED ALMONDS, YOGURT (U.S. CL. 46).

CLASS 30—STAPLE FOODS

FOR PACKAGED FOOD PRODUCTS, NAMELY, CANDY, PRETZELS, CHOCOLATES, CAKES, GUMMY CANDY, COMPRESSED SUGAR, POP CORN, COOKIES, CRACKERS, CEREALS, FROZEN YOGURT, GRANOLA BARS, TRAIL MIX CONSISTING PRIMARILY OF GRANOLA, NUTS, PASTA, CHOCOLATES AND MARSHMALLOWS SOLD IN CANS, AND VINYL POUCHES BULK AND INDIVIDUALLY (U.S. CL. 46).

CLASS 41—EDUCATION AND ENTERTAINMENT

FOR ENTERTAINMENT SERVICES IN THE NATURE OF AN AMUSEMENT PARK RIDE, FAN CLUBS, SPORTING EVENTS, MALL TOURS AND TELEVISION AND VIDEO DISTRIBUTION (U.S. CLS. 100, 101 AND 107).

SN 76-313,238. XANSA UK LIMITED, HERTFORDSHIRE, HP2 7TQ, UNITED KINGDOM, FILED 9-17-2001.

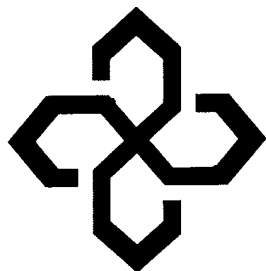

PRIORITY CLAIMED UNDER SEC. 44(D) ON UNITED KINGDOM APPLICATION NO. 2264218, FILED 3-15-2001, REG. NO. 2264218, DATED 8-17-2001, EXPIRES 3-15-2011.

CLASS 9—ELECTRICAL AND SCIENTIFIC APPARATUS

FOR COMPUTER SOFTWARE FOR USE IN THE MANAGEMENT AND DEVELOPMENT OF BUSINESS IN THE BANKING, INSURANCE, UTILITIES, TELECOMMUNICATIONS, GOVERNMENT, MEDIA, TECHNOLOGY, RETAIL, CONSUMER GOODS, TRAVEL, LEISURE, AEROSPACE AND DEFENSE, MANUFACTURING, ENGINEERING, CONSTRUCTION, CHEMICAL AND PHARMACEUTICAL INDUSTRIES (U.S. CLS. 21, 23, 26, 36 AND 38).

CLASS 35—ADVERTISING AND BUSINESS

FOR BUSINESS MANAGEMENT, BUSINESS PROJECT MANAGEMENT, OUTSOURCING IN THE FIELD OF BUSINESS MANAGEMENT, OUTSOURCING IN THE FIELD OF INFORMATION TECHNOLOGY; BUSINESS CONSULTING, MARKET RESEARCH SERVICES, PERSONNEL MANAGEMENT SERVICES, BUSINESS CONSULTATION BY MEANS OF THE GLOBAL COMPUTER NETWORK; BUSINESS CONSULTATION IN THE FIELD OF BUSINESS PROJECT MANAGEMENT AND BUSINESS PROCESS MANAGEMENT; PERSONNEL RECRUITMENT CONSULTANCY AND PERSONNEL RECRUITMENT SERVICES; PREPARATION OF BUSINESS REPORTS RELATING TO THE AFORESAID (U.S. CLS. 100, 101 AND 102).

CLASS 41—EDUCATION AND ENTERTAINMENT

FOR EDUCATIONAL AND TRAINING SERVICES NAMELY, CONDUCTING CLASSES, SEMINARS, CONFERENCES AND WORKSHOPS IN THE FIELDS OF BUSINESS CHANGE MANAGEMENT, MENTORING, COACHING, SKILLS TRANSFER, FACILITATION, COMPETENCY ASSESSMENTS, PROJECT REVIEWS AND METHODOLOGY IMPLEMENTATION SERVICES (U.S. CLS. 100, 101 AND 107).

CLASS 42—SCIENTIFIC, COMPUTER AND LEGAL SERVICES

FOR CONSULTING SERVICES IN THE FIELDS OF DESIGNING, PLANNING AND MANAGING INTEGRATED SOFTWARE PROGRAMS; INFORMATION TECHNOLOGY CONSULTING AND ADVISORY SERVICES RELATING TO DEVELOPING AND INTEGRATING COMPUTER PROGRAMS FOR BUSINESSES, COMPUTER SYSTEM ANALYSIS, COMPUTER PROGRAMMING SERVICES NAMELY DEVELOPING AND INTEGRATING COMPUTER PROGRAMS FOR BUSINESSES; COMPUTER ADVISORY AND CONSULTING SERVICES RELATING THERETO (U.S. CLS. 100 AND 101).

SN 76-314,222. AL SAFA HALAL LTD., SILVER SPRING, MD. FILED 9-19-2001.

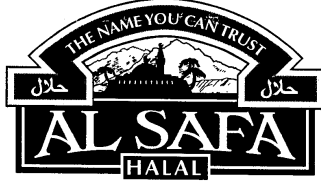

PRIORITY CLAIMED UNDER SEC. 44(D) ON CANADA APPLICATION NO. 1113063, FILED 8-15-2001.

NO CLAIM IS MADE TO THE EXCLUSIVE RIGHT TO USE "HALAL", APART FROM THE MARK AS SHOWN.

THE NAME "AL SAFA" DOES NOT IDENTIFY A LIVING INDIVIDUAL.

THE TRANSLITERATION OF THE ARABIC CHARACTERS IN THE MARK IS "HALAL" WHICH MEANS "IN ACCORDANCE WITH ARABIC DIETARY LAWS".

CLASS 29—MEATS AND PROCESSED FOODS

FOR ALL HALAL MEAT PRODUCTS, NAMELY BEEF, POULTRY, LAMB, VEAL, GOAT, MUTTON AND OTHER HALAL SPECIAL MEATS; ALL PROCESSED HALAL MEAT PRODUCTS, NAMELY BEEF PATTIES, BEEF FRANKFURTERS, CHICKEN FRANKFURTERS, BEEF WIENERS, CHICKEN WIENERS, BEEF SALAMI, TURKEY BOLOGNA, BEEF BOLOGNA, BEEF BACON, CORNED BEEF, ROAST BEEF, PASTRAMI, SMOKED CHICKEN, BREAKFAST LINKS; HALAL BREADED CHICKEN NUGGETS; HALAL BREADED CHICKEN STRIPS; HALAL BREADED CHICKEN PATTIES; HALAL BEEF PATTY ROLLS; HALAL SEAFOOD PRODUCTS, NAMELY BREADED FISH FILLETS AND BREADED FISH STICKS; HALAL PREPARED FALAFEL MIX (U.S. CL. 46).

FIRST USE 10-0-1999; IN COMMERCE 10-0-1999.

CLASS 30—STAPLE FOODS

FOR HALAL PREPARED FROZEN PREPARED FOODS, NAMELY PIZZAS; HALAL CHICKEN POT PIES (U.S. CL. 46).

FIRST USE 10-0-1999; IN COMMERCE 10-0-1999.

SN 76-314,604. LUK LAMELLEN UND KUPPLUNGSBAU BETEILIGUNGS KG, 77815 BUHL, FED REP GERMANY, FILED 9-17-2001.

PSG

PRIORITY CLAIMED UNDER SEC. 44(D) ON FED REP GERMANY APPLICATION NO. 30116984.5/1, FILED 3-14-2001, REG. NO. 30116984, DATED 9-11-2001, EXPIRES 3-31-2011.

CLASS 9—ELECTRICAL AND SCIENTIFIC APPARATUS

FOR ELECTRONIC CONTROLLERS FOR THE AUTOMATED OR AUTOMATIC ACTUATION, STEERING AND CONTROL OF LAND VEHICLE TRANSMISSIONS AND CLUTCHES (U.S. CLS. 21, 23, 26, 36 AND 38).

CLASS 12—VEHICLES

FOR PARTS FOR LAND VEHICLES, NAMELY, MANUALLY OR AUTOMATICALLY SHIFTED TRANSMISSIONS, CONTINUOUSLY VARIABLE TRANSMISSIONS, MANUALLY OR AUTOMATICALLY SHIFTED CLUTCHES, AS WELL AS MECHANISMS AND PARTS, NAMELY, ELECTRO-MECHANICAL, HYDRAULIC AND PNEUMATIC ACTUATORS FOR THE AUTOMATED OR AUTOMATIC ACTUATION, STEERING AND CONTROL OF LAND VEHICLE TRANSMISSIONS AND CLUTCHES (U.S. CLS. 19, 21, 23, 31, 35 AND 44).

SN 76-315,418. SMUTNY, GISELA, D-81375 MUENCHEN, FED REP GERMANY, FILED 9-20-2001.

INTORNO

PRIORITY CLAIMED UNDER SEC. 44(D) ON FED REP GERMANY APPLICATION NO. 30119125.5/2, FILED 3-22-2001, REG. NO. 30119125, DATED 8-16-2001, EXPIRES 3-31-2011.

CLASS 9—ELECTRICAL AND SCIENTIFIC APPARATUS

FOR COMPUTERS, MONITORS, PRINTERS, PLOTTERS, SCANNERS, PROOF READING MACHINES, NAMELY, A SYSTEM COMPRISED OF COMPUTER HARDWARE AND COMPUTER SOFTWARE FOR CHECKING DIGITAL PROOFS FOR ERRORS; ELECTRONICS APPARATUS IN THE FIELDS OF E-BUSINESS AND MOBILE PHONE NETWORKS, NAMELY, TELEPHONES, CORDLESS, WIRELESS OR SATELLITE TELEPHONES, DEDICATED NETWORK COMPUTER TERMINALS FOR TELECOMMUNICATIONS, FACSIMILES AND E-MAIL, TELEPHONES FOR TRANSMITTING DATA, VOICE AND IMAGES, ACCESSING THE INTERNET AND SENDING AND RECEIVING FAXES AND E-MAIL; PAYPHONES; ANTENNAS, BATTERIES, BATTERY CHARGERS, POWER SUPPLIES, HOUSINGS OR CASINGS OR COVERS, CARRYING CASES FOR COMMUNICATION APPARATUS AND ITS ACCESSORIES, CAR KITS FOR THE ADAPTATION OF PORTABLE COMMUNICATION APPARATUS AND INSTRUMENTS FOR VEHICULAR USE, COMPRISING ANTENNAS, ANTENNA TRANSMISSION WIRES, ANTENNA ADAPTERS, CABLES, EARPHONES, HANDS-FREE MICROPHONES, PHONE HOLDERS, SPEAKERS, CAR CHARGERS, DATA CABLES AND ELECTRICAL WIRES; TELEPHONE STANDS BEING PART OF TELEPHONES, TELEPHONE CABLES, MICROPHONES, SPEAKERS, MOBILE TELEPHONES, RADIO PAGERS, BEEPERS, COMPUTERS, ELECTRICAL CABLES, AUDIO SPEAKERS, BATTERY CHARGERS AND ELECTRICAL CABLES FOR SUCH ELECTRICAL APPARATUS; ELECTRICAL CABLES AND OPTICAL FIBERS CABLES, MODEM CABLES, ELECTRIC ADAPTOR CABLES, MICROPHONE CABLES; ACCESS NODES, SWITCHES FOR TELECOMMUNICATION PURPOSES, SERVERS, ROUTERS, PRERECORDED MAGNETIC DATA CARRIERS FEATURING DATA SMART CARDS, MODEMS, MULTIPLEXERS; ELECTRONIC SYSTEMS AND APPARATUS, NAMELY SCRAMBLERS AND DESCRAMBLERS, ENCODERS/DECODERS FOR ENCODING AND/OR DECODING OF VOICE DATA, IMAGE AND VIDEO TRANSMISSIONS, ELECTRONIC DATA INPUT AND OUTPUT APPARATUS, NAMELY TERMINALS, RECEIVERS, TRANSMITTERS, DECODERS, AND TRANSCIEVERS CAPABLE OF PROCESSING BROADCAST, SATELLITE, FACSIMILE, TELEVISION, TELECOMMUNICATION, NETWORK, INFRARED, AND COMPUTER DATA SIGNALS AND FOR TRANSMISSION, REPRODUCING OR RECEIVING OF SOUND IMAGES, VIDEO, MULTIMEDIA OR DATA; BLANK INTEGRATED CIRCUIT CARDS FOR RECORDING TRANSMITTING AND REPRODUCING SOUND AND IMAGES IN MOBILE TELEPHONE SERVICES; DATA PROCESSING EQUIPMENT, NAMELY DIGITAL SIGNAL PROCESSORS; COMPUTERS, COMPUTER SOFTWARE AND PROGRAMS USED FOR TRANSMISSION OR REPRODUCING OR RECEIVING OF SOUND, IMAGES, VIDEO OR

DATA OVER A TELECOMMUNICATIONS NETWORK OR SYSTEM BETWEEN TERMINALS AND FOR ENHANCING AND FACILITATING USE AND ACCESS TO COMPUTER NETWORKS AND TELEPHONE NETWORKS AND THERE BETWEEN; COMPUTER SOFTWARE FOR USE IN GENERAL PURPOSE DATABASE MANAGEMENT; COMPUTER E-COMMERCE SOFTWARE TO ALLOW USER TO SAFELY PLACE ORDERS AND MAKE PAYMENTS IN THE FIELD OF, PERFORM ELECTRONIC BUSINESS TRANSACTIONS VIA A GLOBAL COMPUTER NETWORK OR TELECOMMUNICATION NETWORK; TRAINING AND PRODUCT SUPPORT SOFTWARE FOR COMPUTERS AND MOBILE PHONES IN THE FIELD OF COMMUNICATIONS; COMPUTER UTILITY SOFTWARE FOR PERFORMING COMPUTER MAINTENANCE WORK; COMPUTER SOFTWARE FOR APPLICATION AND DATABASE INTEGRATION; COMPUTER GAME SOFTWARE; COMPUTER SOFTWARE AND PROGRAMS FEATURING MUSIC MOVIES; ANIMATION, ELECTRONIC BOOKS, GAMES IN THE FIELD OF GENERAL ENTERTAINMENT; COMPUTER SOFTWARE TO ENHANCE THE AUDIO VISUAL CAPABILITIES OF MULTI MEDIA APPLICATIONS, NAMELY, FOR THE INTEGRATION OF TEXT, AUDIO, GRAPHICS, STILL IMAGES AND MOVING PICTURES; COMPUTER SOFTWARE AND PROGRAMS FOR MANAGEMENT AND OPERATION OF WIRELESS TELECOMMUNICATIONS DEVICES, COMPUTER SOFTWARE FOR ACCESSING, SEARCHING, INDEXING AND RETRIEVING INFORMATION AND DATA FROM GLOBAL COMPUTER NETWORKS THAT MAY BE DOWN LOADED FROM A GLOBAL COMPUTER NETWORK AND GLOBAL COMMUNICATIONS NETWORKS, AND FOR BROWSING AND NAVIGATING THROUGH WEB SITES ON SAID NETWORKS, AND SOFTWARE FOR SENDING AND RECEIVING SHORT MESSAGES AND ELECTRONIC MAIL AND FOR FILTERING NON-TEXT INFORMATION FROM THE DATA; SYSTEMS AND APPARATUS FOR ELECTRONIC MONEY TRANSACTIONS, NAMELY SMART CARDS, SMART CARD READERS; CALCULATORS; CARDS FOR COMMUNICATIONS PURPOSES, NAMELY, PC DATA CARDS, MODEM CARDS AND FAX MODEM CARDS AND MAGNETIC CODED CARDS FOR COMMUNICATION PURPOSES (U.S. CLS. 21, 23, 26, 36 AND 38).

CLASS 35—ADVERTISING AND BUSINESS

FOR BUSINESS MANAGEMENT CONSULTING VIA THE INTERNET OR INTRANET FIELDS; BUSINESS PLANNING AND INVESTIGATION SERVICES; BUSINESS MARKETING AND CONSULTING SERVICES; ARRANGING BUSINESS CONTRACTS FOR OTHERS FOR THE BUYING AND SELLING OF GOODS AND SERVICES; ELECTRONIC RETAILING SERVICES VIA COMPUTER FEATURING ELECTRONIC ARTICLES, BOOKS AND DIGITAL MEDIA; RETAIL FLORIST SHOPS; BUSINESS INVESTIGATIONS (U.S. CLS. 100, 101 AND 102).

CLASS 36—INSURANCE AND FINANCIAL

FOR INSURANCE AGENCIES; INSURANCE SERVICES, NAMELY, UNDERWRITING IN THE FIELDS OF LIFE INSURANCE, MARINE INSURANCE, HEALTH INSURANCE, ACCIDENT INSURANCE, HOME INSURANCE, FINANCIAL LOSS INSURANCE, MEDICAL INSURANCE, VEHICLE INSURANCE, TRAVEL INSURANCE, FIRE INSURANCE, GUARANTEE INSURANCE, PENSION INSURANCE, LIABILITY INSURANCE, THEFT INSURANCE, SPORTS INJURY INSURANCE, CREDIT CARD INSURANCE, SURETYSHIP INSURANCE, ERECTION ALL RISK INSURANCE, CONSTRUCTION ALL RISK INSURANCE, AVIATION INSURANCE, TRANSPORTATION INSURANCE, MACHINERY BREAKDOWN INSURANCE, LEGAL PROTECTION INSURANCE, AND ASSISTANCE INSURANCE, NAMELY, ALTERNATIVE RISK TRANSFER, CAPTIVE INSURANCE CONSULTING, CAPTIVE INSURANCE MANAGEMENT, ANNUITY UNDERWRITING, INSURANCE BROKERAGE, INSURANCE ADMINISTRATION, INSURANCE ACTUARIAL SERVICES, APPRAISAL FOR INSURANCE CLAIMS OF PERSONAL PROPERTY, REAL ESTATE AND ASSETS, INSURANCE CLAIMS PROCESSING AND ADJUSTMENT, INSURANCE CONSULTATION, INSURANCE

SUBROGATION AND SALVAGE, INSURANCE UNDERWRITING, REINSURANCE UNDERWRITING, INSURANCE ESTIMATION, INSURANCE AMOUNT ASSESSMENT; CREDIT CARD SERVICES; INSTALLMENT CONSUMER LOAN SERVICES, TRAVELERS CHECK ISSUANCE SERVICES; SECURITIES BROKERAGE SERVICES; CURRENCY EXCHANGE SERVICES; CREDIT ADVICE AND CONSULTATION SERVICES; REAL ESTATE MANAGEMENT SERVICES; REAL ESTATE MORTGAGE BROKERAGE SERVICES; REAL ESTATE APPRAISAL AND LEASING OF REAL ESTATE; RENTAL OF APARTMENTS; INSURANCE BROKERAGE; INSURANCE CLAIM INVESTIGATIONS (U.S. CLS. 100, 101 AND 102).

CLASS 38—COMMUNICATION

FOR TELECOMMUNICATION SERVICES, NAMELY TELEPHONE, INTERNET, SATELLITE; ELECTRONIC TRANSMISSION OF MESSAGES AND DATA; MOBILE TELEPHONE SERVICES; STREAMING OF AUDIO AND VIDEO MATERIAL ON THE INTERNET; PROVIDING MULTIPLE USER DIAL-UP AND DEDICATED ACCESS TO A GLOBAL COMPUTER INFORMATION NETWORK (U.S. CLS. 100, 101 AND 104).

CLASS 41—EDUCATION AND ENTERTAINMENT

FOR TRAINING IN THE FIELD OF COMPUTERS AND INFORMATION TECHNOLOGY (U.S. CLS. 100, 101 AND 107).

CLASS 42—SCIENTIFIC, COMPUTER AND LEGAL SERVICES

FOR COMPUTER PROGRAMMING; COMPUTER CONSULTING; DESIGNING WEB SITES FOR OTHERS; TECHNICAL CONSULTING AND UPDATING SERVICES IN THE INTERNET FIELDS; SOFTWARE INSTALLATION AND MAINTENANCE SERVICES; ELECTRONIC SIGNATURE VERIFICATION SERVICES (U.S. CLS. 100 AND 101).

SN 76-318,190. SEW EURODRIVE GMBH & CO., 76646 BRUCHSAL, FED REP GERMANY, FILED 9-26-2001.

DRIVING THE WORLD

PRIORITY CLAIMED UNDER SEC. 44(D) ON FED REP GERMANY APPLICATION NO. 30120933.2/0, FILED 3-29-2001, REG. NO. 30120933, DATED 5-11-2001, EXPIRES 3-31-2011.

CLASS 7—MACHINERY

FOR MOTORS, GEARS, ELECTRIC MOTORS NOT FOR LAND CRAFT, NAMELY BRAKE MOTORS, CONVERTER MOTORS, GEAR MOTORS, NAMELY SPUR WHEEL, WORM, ANGLE, BEVEL, ZYKLO, ECCENTRIC, TUMBLING AND VARIABLE SPEED MOTORS, LINEAR MOTORS, NAMELY ASYNCHRONOUS MOTORS, SYNCHRONOUS MOTORS, RELUCTANCE MOTORS; COUPLINGS, GEARS, AND TRANSMISSION BELTS; DEVICES FOR CONTACTLESS POWER TRANSMISSION FOR MACHINES AND NOT LAND CRAFT; GEARS AND DRIVES FOR POWER TRANSMISSION FOR MACHINES AND NOT LAND CRAFT, NAMELY ADAPTERS AND GEARS, NAMELY SPUR, WORM, BEVEL, ANGLE, SPIROPLAN, ROTARY, PLANETARY AND VARIABLE SPEED GEARS; BRAKES, NAMELY MAGNETIC BRAKES FOR MACHINES; BEARING HOUSING FOR MACHINES AND MOTORS; ACTUATORS, NAMELY LINEAR ACTUATORS; ELECTRIC GENERATORS; MOTOR SLEDS AS MACHINES PARTS; VARIABLE SPEED SLIDES AS MACHINE PARTS AND MOTOR PARTS; BELT PULLEYS BEING PARTS OF MACHINES, V-BELTS FOR MACHINES, FANS FOR MACHINE ENGINES, BRAKE MAGNETS AS MACHINES PARTS AND MOTOR PARTS, DRIVING SHAFTS FOR MACHINES; MACHINES FOR POWER TRANSMISSION; AND PARTS OF ALL AFORESAID GOODS (U.S. CLS. 13, 19, 21, 23, 31, 34 AND 35).

CLASS 9—ELECTRICAL AND SCIENTIFIC APPARATUS

FOR ELECTRO-TECHNICAL AND ELECTRIC APPARATUS, DEVICES, INSTRUMENTS AND COMPONENTS, NAMELY LAPTOP COMPUTERS, DESKTOP COMPUTERS, AND COMPUTERS FORMING PARTS OF FURTHER SYSTEMS, NAMELY CONTROLLERS; VOLTAGE CONVERTERS, PROGRAMMABLE VOLTAGE CONVERTERS; VOLTAGE CONVERTERS WITH RETURN FEEDERS FOR ENERGY RECOVERY; DISTRIBUTORS FOR HIGH VOLTAGE AND LOW VOLTAGE FOR USE IN COMBINATION WITH ELECTRONIC MOTORS, GEAR MOTORS AND DRIVES, POSITION CONTROLLING, VOLTAGE CONVERTS WITH CONTROLLERS, REGULATORS AND/OR POSITION CONTROLLERS; ELECTRIC CONTROLLERS; SOFTWARE FOR CONTROLLING AND REGULATING OF CONVERTERS; INDUSTRIAL PROCESS CONTROL SOFTWARE, DOWNLOADABLE SOFTWARE FOR DIAGNOSING AND MONITORING ELECTRIC MOTORS AND DRIVING GEARS FOR USE IN DATABASE MANAGEMENT, ELECTRONIC DATABASE IN THE FIELD OF DIAGNOSING AND MONITORING ELECTRIC MOTORS AND DRIVING GEARS RECORDED ON COMPUTER MEDIA; PARAMETER BOXES, NAMELY PRE-RECORDED DATA CARRIERS WHICH CONTAIN DATA AND INFORMATION WITH RESPECT TO DRIVE ELECTRONICS; OPERATING SOFTWARE FOR LAPTOPS, CELLULAR PHONES AND ORGANIZERS; SOFTWARE RELATED TO DRIVE ELECTRONICS FOR DEVICES FOR CONTROLLING EVENTS, FOR THE CONTROL OF SYSTEMS, AND FOR MEMORY PROGRAMMABLE CONTROLS; ELECTRICAL CONTROLLERS, ELECTRONIC CONTROLLERS AND ELECTROMECHANICAL CONTROLLERS, AMPLIFIERS, DATA PROCESSORS, ELECTRIC CONVERTERS, ELECTRIC SWITCHES, ELECTRICAL CABLES, ELECTRICAL CIRCUIT BOARDS, ELECTRICAL CONDUCTORS, ELECTRICAL CONNECTORS, ELECTRICAL TRANSFORMERS, SIGNAL PROCESSORS, ELECTRICAL DISTRIBUTIONAL BOXES, PROGRAMMABLE ELECTRICAL DISTRIBUTION BOXES, LOCAL AREA NETWORK NAMELY CIRCUIT BOARD, ALL FOR USE IN THE FIELD OF REMOTE TRANSMISSION OF ELECTRICAL ENERGY AND ELECTRONIC DATA ON MOVEABLE OR IMMOVEABLE MACHINES; ELECTRICAL SENSORS RELATING TO ELECTRIC MOTORS, GEAR MOTORS AND DRIVES FOR SENSING TEMPERATURE, BODY SOUND, OIL LEVEL AND PRESSURE FOR USE IN MACHINE DIAGNOSIS, AND PARTS THEREOF (U.S. CLS. 21, 23, 26, 36 AND 38).

CLASS 12—VEHICLES

FOR TRANSPORT VEHICLES NAMELY AUTOMOBILES, TRUCKS, TROLLEYS AND RAIL CARRIAGES FOR TRANSPORTATION OF GOODS; ELECTRO-MOTORS FOR AUTOMOBILES, MOTORS FOR AUTOMOBILES, COUPLINGS FOR GEAR MOTORS, DRIVE GEARS AND TRANSMISSION BELTS FOR LAND VEHICLES, AND PARTS OF THE AFORESAID GOODS (U.S. CLS. 19, 21, 23, 31, 35 AND 44).

CLASS 37—CONSTRUCTION AND REPAIR

FOR INSTALLATION, ASSEMBLY, MAINTENANCE, REPAIR AND OVERHAUL OF GEARS, NAMELY SPUR WHEELS, WORM, BEVEL, ANGLE, SPIROPLAN, ROTARY, PLANETARY, AND VARIABLE SPEED GEARING, MOTORS, BRAKES, GEAR MOTORS, BRAKING MOTORS, CONVERTER MOTORS, LINEAR MOTORS NAMELY ASYNCHRONOUS MOTORS, SYNCHRONOUS MOTORS, AND RELUCTANCE MOTORS, SYSTEMS FOR NON-CONTACT ENERGY TRANSMISSION, CONVERTERS, ELECTRONIC CONTROLLERS FOR CONTROLLING AND OPERATING DRIVES IN MACHINES AND PLANTS; VEHICLE MAINTENANCE AND REPAIR SERVICES, NAMELY BRAKE MAINTENANCE, MACHINE DIAGNOSIS, BODY SOUND ANALYSIS OF DRIVES CONDUCTED BY USER OR BY AN ELECTRONIC CIRCUIT, ANALYSIS AND/OR DIAGNOSIS OF OTHER SIGNALS, ASSEMBLY SERVICE, STARTING OPERATION SERVICE, LUBRICATION CONTROL, LUBRICATION CHANGE (U.S. CLS. 100, 103 AND 106).

CLASS 39—TRANSPORTATION AND STORAGE

FOR TRANSPORT OF PERSONS AND GOODS BY MOTOR VEHICLES, RAIL, SHIPS AND AIRPLANES, NAMELY THE DELIVERY OF GEARS, NAMELY SPUR WHEEL, WORM, BEVEL, ANGLE SPIROPLAN, ROTARY, PLANETARY, AND VARIABLE SPEED GEARING MOTORS, BRAKES, GEAR MOTORS, BRAKE MOTORS, CONVERTER MOTORS, LINEAR MOTORS NAMELY ASYNCHRONOUS MOTORS, SYNCHRONOUS MOTORS, AND RELUCTANCE MOTORS (U.S. CLS. 100 AND 105).

CLASS 42—SCIENTIFIC, COMPUTER AND LEGAL SERVICES

FOR TECHNICAL CONSULTATION IN THE FIELD OF INSTALLATION, ASSEMBLY, MAINTENANCE, REPAIR AND OVERHAUL OF GEARS AND MOTORS, NAMELY SPUR WHEEL, WORM, BEVEL, ANGLE SPIROPLAN, ROTARY, PLANETARY AND VARIABLE SPEED GEARING, MOTORS, BRAKES, GEAR MOTORS, BRAKE MOTORS, CONVERTER MOTORS, LINEAR MOTORS NAMELY ASYNCHRONOUS MOTORS, SYNCHRONOUS MOTORS, RELUCTANCE MOTORS, SYSTEMS FOR NON-CONTACT POWER TRANSMISSION, CONVERTERS, ELECTRONIC CONTROLLERS FOR CONTROLLING AND OPERATING DRIVES IN MACHINES AND PLANTS; TECHNICAL CONSULTATION IN THE FIELD OF PHOTOGRAPHY AND THERMOGRAPHY OF GEARS AND MOTOR NAMELY SPUR WHEEL, WORM, BEVEL, ANGLE SPIROPLAN, ROTARY, PLANETARY AND VARIABLE SPEED GEARING, MOTORS, BRAKES, GEAR MOTORS, BRAKE MOTORS, CONVERTER MOTORS, LINEAR MOTORS NAMELY ASYNCHRONOUS MOTORS, SYNCHRONOUS MOTORS, RELUCTANCE MOTORS, SYSTEMS FOR NON-CONTACT POWER TRANSMISSION, CONVERTERS, ELECTRONIC CONTROLLERS FOR CONTROLLING AND OPERATING DRIVES IN MACHINES AND PLANTS; TECHNICAL CONSULTATION IN THE FIELD OF DOCUMENTATION, STORAGE AND ADMINISTRATION OF IMAGES AND/OR MEASUREMENT DATA IN CONNECTION WITH THE INSTALLATION, ASSEMBLY,

MAINTENANCE, REPAIR AND OVERHAUL OF GEARS AND MOTORS NAMELY SPUR WHEEL, WORM, BEVEL, ANGLE SPIROPLAN, ROTARY, PLANETARY AND VARIABLE SPEED GEARING, MOTORS BRAKES, GEAR MOTORS, BRAKE MOTORS, CONVERTER MOTORS, LINEAR MOTORS NAMELY ASYNCHRONOUS MOTORS, SYNCHRONOUS MOTORS, RELUCTANCE MOTORS, SYSTEMS FOR NON-CONTACT POWER TRANSMISSION, CONVERTERS, ELECTRONIC CONTROLLERS FOR CONTROLLING AND OPERATING DRIVES IN MACHINES AND PLANTS (U.S. CLS. 100 AND 101).

SN 76-318,191. SEW EURODRIVE GMBH & CO., 76646 BRUCHSAL, FED REP GERMANY, FILED 9-26-2001.

Driving the world

**SEW
EURODRIVE**

PRIORITY CLAIMED UNDER SEC. 44(D) ON FED REP GERMANY APPLICATION NO. 30120934.0, FILED 3-29-2001, REG. NO. 30120934.0, DATED 5-23-2001, EXPIRES 3-31-2011. OWNER OF U.S. REG. NOS. 1,037,090 AND 1,052,267.

CLASS 7—MACHINERY

FOR MOTORS, GEARS, ELECTRIC MOTORS NOT FOR LAND CRAFT, NAMELY BRAKE MOTORS, CONVERTER MOTORS, GEAR MOTORS, NAMELY SPUR WHEEL, WORM, ANGLE, BEVEL, ZYKLO, ECCENTRIC, TUMBLING AND VARIABLE SPEED MOTORS, LINEAR MOTORS, NAMELY ASYNCHRONOUS MOTORS, SYNCHRONOUS MOTORS, RELUCTANCE MOTORS; COUPLINGS, GEARS, AND TRANSMISSION BELTS; DEVICES FOR CONTACTLESS POWER TRANSMISSION FOR MACHINES AND NOT LAND CRAFT; GEARS AND DRIVES FOR POWER TRANSMISSION FOR MACHINES AND NOT LAND CRAFT, NAMELY ADAPTERS AND GEARS, NAMELY SPUR, WORM, BEVEL, ANGLE, SPIROPLAN, ROTARY, PLANETARY AND VARIABLE SPEED GEARS; BRAKES, NAMELY MAGNETIC BRAKES FOR MACHINES; BEARING HOUSING FOR MACHINES AND MOTORS; ACTUATORS, NAMELY LINEAR ACTUATORS; ELECTRIC GENERATORS; MOTOR SLEDS AS MACHINES PARTS; VARIABLE SPEED SLIDES AS MACHINE PARTS AND MOTOR PARTS; BELT PULLEYS BEING PARTS OF MACHINES, V-BELTS FOR MACHINES, FANS FOR MACHINE ENGINES, BRAKE MAGNETS AS MACHINES PARTS AND MOTOR PARTS, DRIVING SHAFTS FOR MACHINES; MACHINES FOR POWER TRANSMISSION; AND PARTS OF ALL AFORESAID GOODS (U.S. CLS. 13, 19, 21, 23, 31, 34 AND 35).

CLASS 9—ELECTRICAL AND SCIENTIFIC APPARATUS

FOR ELECTRO-TECHNICAL AND ELECTRIC APPARATUS, DEVICES, INSTRUMENTS AND COMPONENTS, NAMELY LAPTOP COMPUTERS, DESKTOP COMPUTERS, AND COMPUTERS FORMING PARTS OF FURTHER SYSTEMS, NAMELY CONTROLLERS; VOLTAGE CONVERTERS, PROGRAMMABLE VOLTAGE CONVERTERS; VOLTAGE CONVERTERS WITH RETURN FEEDERS FOR ENERGY RECOVERY; DISTRIBUTORS FOR HIGH VOLTAGE AND LOW VOLTAGE FOR USE IN COMBINATION WITH ELECTRONIC MOTORS, GEAR MOTORS AND DRIVES, POSITION CONTROLLING, VOLTAGE CONVERTS WITH CONTROLLERS, REGULATORS AND/OR POSITION CONTROLLERS; ELECTRIC CONTROLLERS; SOFTWARE FOR CONTROLLING AND REGULATING OF CONVERTERS; INDUSTRIAL PROCESS CONTROL

SOFTWARE, DOWNLOADABLE SOFTWARE FOR DIAGNOSING AND MONITORING ELECTRIC MOTORS AND DRIVING GEARS FOR USE IN DATABASE MANAGEMENT, ELECTRONIC DATABASE IN THE FIELD OF DIAGNOSING AND MONITORING ELECTRIC MOTORS AND DRIVING GEARS RECORDED ON COMPUTER MEDIA; PARAMETER BOXES, NAMELY PRE-RECORDED DATA CARRIERS WHICH CONTAIN DATA AND INFORMATION WITH RESPECT TO DRIVE ELECTRONICS; OPERATING SOFTWARE FOR LAPTOPS, CELLULAR PHONES AND ORGANIZERS; SOFTWARE RELATED TO DRIVE ELECTRONICS FOR DEVICES FOR CONTROLLING EVENTS, FOR THE CONTROL OF SYSTEMS, AND FOR MEMORY PROGRAMMABLE CONTROLS; ELECTRICAL CONTROLLERS, ELECTRONIC CONTROLLERS AND ELECTROMECHANICAL CONTROLLERS, AMPLIFIERS, DATA PROCESSORS, ELECTRIC CONVERTERS, ELECTRIC SWITCHES, ELECTRICAL CABLES, ELECTRICAL CIRCUIT BOARDS, ELECTRICAL CONDUCTORS, ELECTRICAL CONNECTORS, ELECTRICAL TRANSFORMERS, SIGNAL PROCESSORS, ELECTRICAL DISTRIBUTIONAL BOXES, PROGRAMMABLE ELECTRICAL DISTRIBUTION BOXES, LOCAL AREA NETWORK NAMELY CIRCUIT BOARD, ALL FOR USE IN THE FIELD OF REMOTE TRANSMISSION OF ELECTRICAL ENERGY AND ELECTRONIC DATA ON MOVEABLE OR IMMOVEABLE MACHINES; ELECTRICAL SENSORS RELATING TO ELECTRIC MOTORS, GEAR MOTORS AND DRIVES FOR SENSING TEMPERATURE, BODY SOUND, OIL LEVEL AND PRESSURE FOR USE IN MACHINE DIAGNOSIS, AND PARTS THEREOF (U.S. CLS. 21, 23, 26, 36 AND 38).

CLASS 12—VEHICLES

FOR TRANSPORT VEHICLES NAMELY AUTOMOBILES, TRUCKS, TROLLEYS AND RAIL CARRIAGES FOR TRANSPORTATION OF GOODS; ELECTROMOTORS FOR AUTOMOBILES, MOTORS FOR AUTOMOBILES, COUPLINGS FOR GEAR MOTORS, DRIVE GEARS AND TRANSMISSION BELTS FOR LAND VEHICLES, AND PARTS OF THE AFORESAID GOODS (U.S. CLS. 19, 21, 23, 31, 35 AND 44).

CLASS 37—CONSTRUCTION AND REPAIR

FOR INSTALLATION, ASSEMBLY, MAINTENANCE, REPAIR AND OVERHAUL OF GEARS, NAMELY SPUR WHEELS, WORM, BEVEL, ANGLE, SPIROPLAN, ROTARY, PLANETARY, AND VARIABLE SPEED GEARING, MOTORS, BRAKES, GEAR MOTORS, BRAKING MOTORS, CONVERTER MOTORS, LINEAR MOTORS NAMELY ASYNCHRONOUS MOTORS, SYNCHRONOUS MOTORS, AND RELUCTANCE MOTORS, SYSTEMS FOR NON-CONTACT ENERGY TRANSMISSION, CONVERTERS, ELECTRONIC CONTROLLERS FOR CONTROLLING AND OPERATING DRIVES IN MACHINES AND PLANTS; VEHICLE MAINTENANCE AND REPAIR SERVICES, NAMELY BRAKE MAINTENANCE, MACHINE DIAGNOSIS, BODY SOUND ANALYSIS OF DRIVES CONDUCTED BY USER OR BY AN ELECTRONIC CIRCUIT, ANALYSIS AND/OR DIAGNOSIS OF OTHER SIGNALS, ASSEMBLY SERVICE, STARTING OPERATION SERVICE, LUBRICATION CONTROL, LUBRICATION CHANGE (U.S. CLS. 100, 103 AND 106).

CLASS 39—TRANSPORTATION AND STORAGE

FOR TRANSPORT OF PERSONS AND GOODS BY MOTOR VEHICLES, RAIL, SHIPS AND AIRPLANES, NAMELY THE DELIVERY OF GEARS, NAMELY SPUR WHEEL, WORM, BEVEL, ANGLE SPIROPLAN, ROTARY, PLANETARY, AND VARIABLE SPEED GEARING MOTORS, BRAKES, GEAR MOTORS, BRAKE MOTORS, CONVERTER MOTORS, LINEAR MOTORS NAMELY ASYNCHRONOUS MOTORS, SYNCHRONOUS MOTORS, AND RELUCTANCE MOTORS (U.S. CLS. 100 AND 105).

CLASS 42—SCIENTIFIC, COMPUTER AND LEGAL SERVICES

FOR TECHNICAL CONSULTATION IN THE FIELD OF INSTALLATION, ASSEMBLY, MAINTENANCE, REPAIR AND OVERHAUL OF GEARS AND MOTORS, NAMELY SPUR WHEEL, WORM, BEVEL, ANGLE SPIROPLAN, ROTARY, PLANETARY AND VARIABLE SPEED GEARING, MOTORS, BRAKES, GEAR MOTORS, BRAKE MOTORS, CONVERTER MOTORS, LINEAR MOTORS NAMELY ASYNCHRONOUS MOTORS, SYNCHRONOUS MOTORS, RELUCTANCE MOTORS, SYSTEMS FOR NON-CONTACT POWER TRANSMISSION, CONVERTERS, ELECTRONIC CONTROLLERS FOR CONTROLLING AND OPERATING DRIVES IN MACHINES AND PLANTS; TECHNICAL CONSULTATION IN THE FIELD OF PHOTOGRAPHY AND THERMOGRAPHY OF GEARS AND MOTOR NAMELY SPUR WHEEL, WORM, BEVEL, ANGLE SPIROPLAN, ROTARY, PLANETARY AND VARIABLE SPEED GEARING, MOTORS BRAKES, GEAR MOTORS, BRAKE MOTORS, CONVERTER MOTORS, LINEAR MOTORS NAMELY ASYNCHRONOUS MOTORS, SYNCHRONOUS MOTORS, RELUCTANCE MOTORS, SYSTEMS FOR NON-CONTACT POWER TRANSMISSION, CONVERTERS, ELECTRONIC CONTROLLERS FOR CONTROLLING AND OPERATING DRIVES IN MACHINES AND PLANTS; TECHNICAL CONSULTATION IN THE FIELD OF DOCUMENTATION, STORAGE AND ADMINISTRATION OF IMAGES AND/OR MEASUREMENT DATA IN CONNECTION WITH THE INSTALLATION, ASSEMBLY, MAINTENANCE, REPAIR AND OVERHAUL OF GEARS AND MOTORS NAMELY SPUR WHEEL, WORM, BEVEL, ANGLE SPIROPLAN, ROTARY, PLANETARY AND VARIABLE SPEED GEARING, MOTORS BRAKES, GEAR MOTORS, BRAKE MOTORS, CONVERTER MOTORS, LINEAR MOTORS NAMELY ASYNCHRONOUS MOTORS, SYNCHRONOUS MOTORS, RELUCTANCE MOTORS, SYSTEMS FOR NON-CONTACT POWER TRANSMISSION, CONVERTERS, ELECTRONIC CONTROLLERS FOR CONTROLLING AND OPERATING DRIVES IN MACHINES AND PLANTS (U.S. CLS. 100 AND 101).

SN 76-318,678. BIALETTI INDUSTRIE S.P.A., 28887 OMEGNA (VERBANIA), ITALY, FILED 9-27-2001.

KULINAR

PRIORITY CLAIMED UNDER SEC. 44(D) ON ERP CMNTY TM OFC APPLICATION NO. 002380947, FILED 9-18-2001, REG. NO. 002380947, DATED 11-20-2002, EXPIRES 9-18-2011.

CLASS 7—MACHINERY

FOR ELECTROMAGNETIC APPARATUS FOR THE KITCHEN, NAMELY MIXERS (U.S. CLS. 13, 19, 21, 23, 31, 34 AND 35).

CLASS 8—HAND TOOLS

FOR HAND TOOLS AND IMPLEMENTS NOT MADE OF PRECIOUS METAL, NAMELY ICE PICKS, CAN OPENERS, CUTLERY, NAMELY FORKS, KNIVES, SPOONS; SIDE ARMS, NOT INCLUDING FIRE ARMS, NAMELY HUNTING KNIVES; RAZORS (U.S. CLS. 23, 28 AND 44).

CLASS 9—ELECTRICAL AND SCIENTIFIC APPARATUS

FOR ELECTRONIC IRONS (U.S. CLS. 21, 23, 26, 36 AND 38).

CLASS 21—HOUSEWARES AND GLASS

FOR HOUSEHOLD AND KITCHEN UTENSILS AND CONTAINERS, NAMELY LADLES AND DIPPERS, PANS, KETTLES, POTS, SAUCEPANS, PRESSURE COOKERS, BAKING PANS, FRYING PANS, AND COMPONENT PARTS THEREOF, NAMELY LIDS, HANDLES, COLANDERS, STRAINERS, NOT MADE FROM PRECIOUS METAL; HAIR COMBS; SPONGES, NAMELY SCOURING AND CLEANING SPONGES; BRUSHES, NAMELY NAIL AND MUSHROOM BRUSHES; MATERIAL FOR BRUSH MAKING; ARTICLES FOR CLEANING PURPOSES, NAMELY FIREPLACE BRUSHES; STEEL WOOL FOR CLEANING; BEVERAGE GLASSWARE; ARTICLES MADE OF PORCELAIN, NAMELY MUGS AND KNOBS; EARTHENWARE, NAMELY MUGS AND BASINS (U.S. CLS. 2, 13, 23, 29, 30, 33, 40 AND 50).

SN 76-319,858. WHISPER WEAR INC., MARIETTA, GA. FILED 10-1-2001.

WHISPER WEAR**CLASS 10—MEDICAL APPARATUS**

FOR BREAST FEEDING SUPPLIES, NAMELY BREAST PUMPS, BREAST PUMP FLANGES, COLLECTION BAGS (U.S. CLS. 26, 39 AND 44).

CLASS 18—LEATHER GOODS

FOR SHOULDER BAGS ADAPTED FOR USE WITH BREAST FEEDING PUMPS AND BREAST FEEDING SUPPLIES (U.S. CLS. 1, 2, 3, 22 AND 41).

CLASS 21—HOUSEWARES AND GLASS

FOR THERMALLY INSULATED TOTE BAGS AND CONTAINERS ADAPTED FOR BREAST MILK COLLECTION BAGS AND ICE PACKS FOR THERMAL TOTE BAGS AND CONTAINERS (U.S. CLS. 2, 13, 23, 29, 30, 33, 40 AND 50).

SN 76-320,311. FIVE STAR DESTINATIONS, INC., ASPEN, CO. FILED 10-1-2001.

**FIVE STAR DESTINATIONS**

NO CLAIM IS MADE TO THE EXCLUSIVE RIGHT TO USE "FIVE STAR DESTINATIONS", APART FROM THE MARK AS SHOWN.

CLASS 39—TRANSPORTATION AND STORAGE

FOR TRAVEL AGENCY SERVICES, NAMELY, MAKING RESERVATIONS AND BOOKINGS FOR TRANSPORTATION; YACHT CHARTERING (U.S. CLS. 100 AND 105).

FIRST USE 5-9-2001; IN COMMERCE 5-9-2001.

CLASS 42—SCIENTIFIC, COMPUTER AND LEGAL SERVICES

FOR ARRANGING TEMPORARY HOUSING ACCOMMODATIONS WORLDWIDE IN VILLAS, CASTLES AND FINE HOMES (U.S. CLS. 100 AND 101).

FIRST USE 5-9-2001; IN COMMERCE 5-9-2001.

SN 76-326,343. BUSH, IRVING, MARINA DEL REY, CA. FILED 10-16-2001.

GLOVE-UP 'N GO**CLASS 9—ELECTRICAL AND SCIENTIFIC APPARATUS**

FOR PROTECTIVE GLOVES FOR INDUSTRIAL USES (U.S. CLS. 21, 23, 26, 36 AND 38).

CLASS 28—TOYS AND SPORTING GOODS

FOR GLOVES FOR SPORTS, NAMELY INLINE SKATING, ROLLER SKATING, SKATEBOARDING, RUNNING, BICYCLING, SKIING, SNOWBOARDING (U.S. CLS. 22, 23, 38 AND 50).

SN 76-327,510. IX, BERNHARD A., 40667 MEERBUSCH, FED REP GERMANY, FILED 10-19-2001.

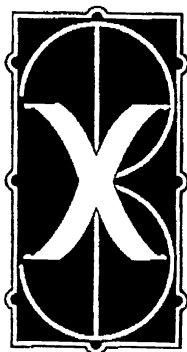

PRIORITY CLAIMED UNDER SEC. 44(D) ON FED REP GERMANY APPLICATION NO. 30126484.8/3, FILED 4-25-2001, REG. NO. 30126484, DATED 1-10-2002, EXPIRES 4-30-2011.

CLASS 31—NATURAL AGRICULTURAL PRODUCTS

FOR LIVE ANIMALS, NAMELY, HORSES AND DRESSAGE HORSES (U.S. CLS. 1 AND 46).

CLASS 36—INSURANCE AND FINANCIAL

FOR HORSE BROKERAGE SERVICES (U.S. CLS. 100, 101 AND 102).

CLASS 41—EDUCATION AND ENTERTAINMENT

FOR ENTERTAINMENT SERVICES, NAMELY, ORGANIZING AND CONDUCTING DRESSAGE HORSE COMPETITIONS, HORSE TRAINING; DRESSAGE TRAINING (U.S. CLS. 100, 101 AND 107).

SN 76-328,777. FREDRICKSON, DAVID FRANK, BELTON, BELL COUNTY, TX. FILED 10-22-2001.



NO CLAIM IS MADE TO THE EXCLUSIVE RIGHT TO USE "LIFTERS", APART FROM THE MARK AS SHOWN.

CLASS 6—METAL GOODS

FOR METAL MOVING AND CARRYING DEVICE, NAMELY A ROD HAVING AT ONE END AT LEAST ONE HANDLE GRIP AND AT THE OTHER END A LIFTING PLATFORM FOR MOVING AND CARRYING AN OBJECT FROM ONE LOCATION TO ANOTHER (U.S. CLS. 2, 12, 13, 14, 23, 25 AND 50).

CLASS 8—HAND TOOLS

FOR HAND-OPERATED MOVING AND CARRYING DEVICE, NAMELY A ROD HAVING AT ONE END AT LEAST ONE HANDLE GRIP AND AT THE OTHER END A LIFTING PLATFORM FOR MOVING AND CARRYING AN OBJECT FROM ONE LOCATION TO ANOTHER (U.S. CLS. 23, 28 AND 44).

SN 76-328,778. FREDRICKSON, DAVID FRANK, BELTON, BELL COUNTY, TX. FILED 10-22-2001.

INNOVATIONS IN MOVING

NO CLAIM IS MADE TO THE EXCLUSIVE RIGHT TO USE "MOVING", APART FROM THE MARK AS SHOWN.

CLASS 6—METAL GOODS

FOR METAL MOVING AND CARRYING DEVICE, NAMELY A ROD HAVING AT ONE END AT LEAST ONE HANDLE GRIP AND AT THE OTHER END A LIFTING PLATFORM FOR MOVING AND CARRYING AN OBJECT FROM ONE LOCATION TO ANOTHER (U.S. CLS. 2, 12, 13, 14, 23, 25 AND 50).

CLASS 8—HAND TOOLS

FOR HAND-OPERATED MOVING AND CARRYING DEVICE, NAMELY A ROD HAVING AT ONE END AT LEAST ONE HANDLE GRIP AND AT THE OTHER END A LIFTING PLATFORM FOR MOVING AND CARRYING AN OBJECT FROM ONE LOCATION TO ANOTHER (U.S. CLS. 23, 28 AND 44).

SN 76-332,620. REED ELSEVIER INC., NEWTON, MA. FILED 10-31-2001.

REED BUSINESS INFORMATION

NO CLAIM IS MADE TO THE EXCLUSIVE RIGHT TO USE "BUSINESS INFORMATION", APART FROM THE MARK AS SHOWN.

CLASS 9—ELECTRICAL AND SCIENTIFIC APPARATUS

FOR COMPUTER DISKS, DVDS, VIDEOTAPES AND CD-ROMS FEATURING INFORMATION IN THE FIELDS OF BUSINESS, INDUSTRY, EDUCATION, ACADEMICS, GOVERNMENT, LAW, TAX, AGRICULTURAL AND BIOLOGICAL SCIENCES, ARTS AND HUMANITIES, HEALTH, CHEMISTRY AND CHEMICAL ENGINEERING, COMPUTER SCIENCE, EARTH AND PLANETARY SCIENCES, ECONOMICS, BUSINESS AND MANAGEMENT, ENGINEERING, ENERGY AND TECHNOLOGY, ENVIRONMENTAL SCIENCES, LIFE SCIENCES, MATERIALS SCIENCES, MATHEMATICS, MEDICINE, NEUROSCIENCE, PHARMACOLOGY, PHARMACEUTICAL SCIENCE AND TOXICOLOGY, PHYSICS AND ASTRONOMY, SOCIAL AND BEHAVIORAL SCIENCES, AUTOMOTIVE AND TRUCKING, BOOK PUBLISHING, BUILDING AND CONSTRUCTION, DESIGN, DESIGN ENGINEERING, ELECTRONICS DESIGN AND COMMUNICATIONS, ELECTRONICS MANUFACTURING, IN-STAT RESEARCH, ENTERTAINMENT COMMUNICATIONS AND MEDIA, FOOD AND PACKAGING, FOODSERVICE AND LODGING, GIFTS, JEWELRY AND HOME TEXTILES, MANUFACTURING PROCESSES, MANUFACTURING PRODUCTS, PRINTING AND CONVERTING, PROCESSING, RETAIL HOME FURNISHINGS, SCIENTIFIC AND MEDICAL INFORMATION, SUPPLY CHAIN, TELEVISION AND TELECOM, VARIETY, ACCOUNTANCY AND BUSINESS INFORMATION, ADMINISTRATION, AGRICULTURE, BUILDING AND CONSTRUCTION INFORMATION, HEALTHCARE, HORTICULTURE, HOTEL AND CATERING, LOGISTICS, RETAIL, TECHNICS, TOURISM, ACCOUNTANCY, AIR TRANSPORT, BANKING, CATERING, CHEMICALS, COMPUTING, CONSTRUCTION, ELECTRICAL, ELECTRONICS, INDUSTRIAL AND COMMERCIAL INFORMATION, MOTOR TRADE, OFFICE EQUIPMENT, OPTICAL, PERSONAL CARE, PERSONNEL AND OCCUPATIONAL HEALTH, PROFESSIONAL, PROPERTY, RAILWAYS, RECRUITMENT, ROAD HAULAGE, SCIENCE, SHIPPING, SOCIAL SERVICES, TELEVISION, UTILITIES, AEROSPACE AND DEFENSE, INFORMATION CONCERNING AGRICULTURAL, FORESTRY AND NATURAL RESOURCES, ARTS AND ENTERTAINMENT, BOOKS AND PUBLISHING, BUILDINGS, PROPERTY AND INTERIOR DESIGN, ELECTRONICS AND ELECTRICAL ENGINEERING, ENGINEERING, MANUFACTURING AND PROCESSING, FOODSERVICE AND HOSPITALITY, INFORMATION TECHNOLOGY AND COMMUNICATIONS, MARKETING, BUSINESS AND TRAINING, SAFETY AND SECURITY, TRADE SHOWS, CONFERENCES, COMPUTERIZED INFORMATION STORAGE AND RETRIEVAL SERVICES, ADVERTISING, NEWS, RESEARCH, EMPLOYMENT, RECRUITING AND A WIDE VARIETY OF TOPICS OF GENERAL INTEREST; COMPUTER SOFTWARE FOR ACCESSING COMPUTERIZED DATABASES; COMPUTER SOFTWARE, NAMELY, WORD PROCESSING SOFTWARE; INTERNET ACCESS SOFTWARE; SOFTWARE FOR PROVIDING ACCESS TO PROPRIETARY DATABASES ONLINE; COMPUTER SOFTWARE FOR ACCESSING DATABASES OF INFORMATION ON A WIDE VARIETY OF TOPICS; SOFTWARE THAT ENABLES USERS TO ELECTRONICALLY FILE DOCUMENTS WITH COURTS AND GOVERNMENT AGENCIES; SPREADSHEET SOFTWARE; SOFTWARE TO SEARCH AND DISPLAY CHARGES INCURRED FOR ONLINE RESEARCH; SOFTWARE THAT PERFORMS LEGAL CITATION VERIFICATION; SOFTWARE THAT SELECTS AND DISPLAYS CITATIONS OF RELATED CASES AND OTHER LEGAL MATERIALS; SOFTWARE FOR PRODUCING TABLES OF AUTHORITIES IN THE FIELD OF LAW; AND BOOK-KEEPING SOFTWARE; COMPUTER PROGRAMS, NAMELY, DATABASE COMPUTER PROGRAMS RECORDED ON MAGNETIC TAPES AND DISCS, FOR USE IN THE FIELDS OF MULTIMEDIA, BUSINESS, PUBLISHING, SCIENCE, ENGINEERING, EMPLOYMENT, RECRUITING, LAW AND RELIGION; MULTIMEDIA SOFTWARE FOR USE IN CREATING PRESENTATIONS, MANAGING DATABASES AND ACCESSING AND DISPLAYING INFORMATION IN THE FIELDS OF BUSINESS, INDUSTRY, EDUCATION, ACADEMICS, GOVERNMENT, LAW, TAX, AGRICULTURAL AND BIOLOGICAL SCIENCES, ARTS AND HUMANITIES, HEALTH, CHEMISTRY AND CHEMICAL ENGINEER-

ING, COMPUTER SCIENCE, EARTH AND PLANETARY SCIENCES, ECONOMICS, BUSINESS AND MANAGEMENT, ENGINEERING, ENERGY AND TECHNOLOGY, ENVIRONMENTAL SCIENCES, LIFE SCIENCES, MATERIALS SCIENCES, MATHEMATICS, MEDICINE, NEUROSCIENCE, PHARMACOLOGY, PHARMACEUTICAL SCIENCE AND TOXICOLOGY, PHYSICS AND ASTRONOMY, SOCIAL AND BEHAVIORAL SCIENCES, AUTOMOTIVE AND TRUCKING, BOOK PUBLISHING, BUILDING AND CONSTRUCTION, DESIGN, DESIGN ENGINEERING, ELECTRONICS DESIGN AND COMMUNICATIONS, ELECTRONICS MANUFACTURING, IN-STAT RESEARCH, ENTERTAINMENT COMMUNICATIONS AND MEDIA, FOOD AND PACKAGING, FOODSERVICE AND LODGING, GIFTS, JEWELRY AND HOME TEXTILES, MANUFACTURING PROCESSES, MANUFACTURING PRODUCTS, PRINTING AND CONVERTING, PROCESSING, RETAIL HOME FURNISHINGS, SCIENTIFIC AND MEDICAL INFORMATION, SUPPLY CHAIN, TELEVISION AND TELECOM, VARIETY, ACCOUNTANCY AND BUSINESS INFORMATION, ADMINISTRATION, AGRICULTURE, BUILDING AND CONSTRUCTION INFORMATION, HEALTHCARE, HORTICULTURE, HOTEL AND CATERING, LOGISTICS, RETAIL, TECHNICS, TOURISM, ACCOUNTANCY, AIR TRANSPORT, BANKING, CATERING, CHEMICALS, COMPUTING, CONSTRUCTION, ELECTRICAL, ELECTRONICS, INDUSTRIAL AND COMMERCIAL INFORMATION, MOTOR TRADE, OFFICE EQUIPMENT, OPTICAL, PERSONAL CARE, PERSONNEL AND OCCUPATIONAL HEALTH, PROFESSIONAL, PROPERTY, RAILWAYS, RECRUITMENT, ROAD HAULAGE, SCIENCE, SHIPPING, SOCIAL SERVICES, TELEVISION, UTILITIES, AEROSPACE AND DEFENSE, INFORMATION CONCERNING AGRICULTURAL, FORESTRY AND NATURAL RESOURCES, ARTS AND ENTERTAINMENT, BOOKS AND PUBLISHING, BUILDINGS, PROPERTY AND INTERIOR DESIGN, ELECTRONICS AND ELECTRICAL ENGINEERING, ENGINEERING, MANUFACTURING AND PROCESSING, FOODSERVICE AND HOSPITALITY, INFORMATION TECHNOLOGY AND COMMUNICATIONS, MARKETING, BUSINESS AND TRAINING, SAFETY AND SECURITY, SPORTS, LEISURE AND HEALTH, TRADE SHOWS, CONFERENCES, COMPUTERIZED INFORMATION STORAGE AND RETRIEVAL SERVICES, ADVERTISING, NEWS, RESEARCH, EMPLOYMENT, RECRUITING AND A WIDE VARIETY OF TOPICS OF GENERAL INTEREST; DOWNLOADABLE ELECTRONIC PUBLICATIONS IN THE NATURE OF JOURNALS, BOOKS, BROCHURES, LEAFLETS, MANUALS, PUBLICITY TEXTS, TEXT BOOKS, REFERENCE MATERIALS, NEWSLETTERS, ATLASES AND MAGAZINES IN THE FIELDS OF BUSINESS, INDUSTRY, EDUCATION, ACADEMICS, GOVERNMENT, LAW, TAX, AGRICULTURAL AND BIOLOGICAL SCIENCES, ARTS AND HUMANITIES, HEALTH, CHEMISTRY AND CHEMICAL ENGINEERING, COMPUTER SCIENCE, EARTH AND PLANETARY SCIENCES, ECONOMICS, BUSINESS AND MANAGEMENT, ENGINEERING, ENERGY AND TECHNOLOGY, ENVIRONMENTAL SCIENCES, LIFE SCIENCES, MATERIALS SCIENCES, MATHEMATICS, MEDICINE, NEUROSCIENCE, PHARMACOLOGY, PHARMACEUTICAL SCIENCE AND TOXICOLOGY, PHYSICS AND ASTRONOMY, SOCIAL AND BEHAVIORAL SCIENCES, AUTOMOTIVE AND TRUCKING, BOOK PUBLISHING, BUILDING AND CONSTRUCTION, DESIGN, DESIGN ENGINEERING, ELECTRONICS DESIGN AND COMMUNICATIONS, ELECTRONICS MANUFACTURING, IN-STAT RESEARCH, ENTERTAINMENT COMMUNICATIONS AND MEDIA, FOOD AND PACKAGING, FOODSERVICE AND LODGING, GIFTS, JEWELRY AND HOME TEXTILES, MANUFACTURING PROCESSES, MANUFACTURING PRODUCTS, PRINTING AND CONVERTING, PROCESSING, RETAIL HOME FURNISHINGS, SCIENTIFIC AND MEDICAL INFORMATION, SUPPLY CHAIN, TELEVISION AND TELECOM, VARIETY, ACCOUNTANCY AND BUSINESS INFORMATION, ADMINISTRATION, AGRICULTURE, BUILDING AND CONSTRUCTION INFORMATION, HEALTHCARE, HORTICULTURE, HOTEL AND CATERING, LOGISTICS, RETAIL, TECHNICS, TOURISM, ACCOUNTANCY, AIR TRANSPORT, BANKING, CATERING, CHEMICALS, COMPUTING, CONSTRUCTION, ELECTRICAL, ELECTRONICS, INDUSTRIAL AND COMMERCIAL INFORMATION, MOTOR TRADE, OFFICE EQUIPMENT, OPTICAL, PERSONAL CARE, PERSONNEL AND OCCUPATIONAL HEALTH, PROFES-

SIONAL, PROPERTY, RAILWAYS, RECRUITMENT, ROAD HAULAGE, SCIENCE, SHIPPING, SOCIAL SERVICES, TELEVISION, UTILITIES, AEROSPACE AND DEFENSE, INFORMATION CONCERNING AGRICULTURAL, FORESTRY AND NATURAL RESOURCES, ARTS AND ENTERTAINMENT, BOOKS AND PUBLISHING, BUILDINGS, PROPERTY AND INTERIOR DESIGN, ELECTRONICS AND ELECTRICAL ENGINEERING, ENGINEERING, MANUFACTURING AND PROCESSING, FOODSERVICE AND HOSPITALITY, INFORMATION TECHNOLOGY AND COMMUNICATIONS, MARKETING, BUSINESS AND TRAINING, SAFETY AND SECURITY, SPORTS, LEISURE AND HEALTH, TRADE SHOWS, CONFERENCES, COMPUTERIZED INFORMATION STORAGE AND RETRIEVAL SERVICES, ADVERTISING, NEWS, RESEARCH, EMPLOYMENT, RECRUITING AND A WIDE VARIETY OF TOPICS OF GENERAL INTEREST; ELECTRONIC PUBLICATIONS, NAMELY, JOURNALS, BOOKS, BROCHURES, LEAFLETS, MANUALS, PUBLICITY TEXTS, TEXT BOOKS, REFERENCE MATERIALS, NEWSLETTERS, ATLASES AND MAGAZINES FEATURING INFORMATION CONCERNING BUSINESS, INDUSTRY, EDUCATION, ACADEMICS, GOVERNMENT, LAW, TAX, AGRICULTURAL AND BIOLOGICAL SCIENCES, ARTS AND HUMANITIES, HEALTH, CHEMISTRY AND CHEMICAL ENGINEERING, COMPUTER SCIENCE, EARTH AND PLANETARY SCIENCES, ECONOMICS, BUSINESS AND MANAGEMENT, ENGINEERING, ENERGY AND TECHNOLOGY, ENVIRONMENTAL SCIENCES, LIFE SCIENCES, MATERIALS SCIENCES, MATHEMATICS, MEDICINE, NEUROSCIENCE, PHARMACOLOGY, PHARMACEUTICAL SCIENCE AND TOXICOLOGY, PHYSICS AND ASTRONOMY, SOCIAL AND BEHAVIORAL SCIENCES, AUTOMOTIVE AND TRUCKING, BOOK PUBLISHING, BUILDING AND CONSTRUCTION, DESIGN, DESIGN ENGINEERING, ELECTRONICS DESIGN AND COMMUNICATIONS, ELECTRONICS MANUFACTURING, IN-STAT RESEARCH, ENTERTAINMENT COMMUNICATIONS AND MEDIA, FOOD AND PACKAGING, FOODSERVICE AND LODGING, GIFTS, JEWELRY AND HOME TEXTILES, MANUFACTURING PROCESSES, MANUFACTURING PRODUCTS, PRINTING AND CONVERTING, PROCESSING, RETAIL HOME FURNISHINGS, SCIENTIFIC AND MEDICAL INFORMATION, SUPPLY CHAIN, TELEVISION AND TELECOM, VARIETY, ACCOUNTANCY AND BUSINESS INFORMATION, ADMINISTRATION, AGRICULTURE, BUILDING AND CONSTRUCTION INFORMATION, HEALTHCARE, HORTICULTURE, HOTEL AND CATERING, LOGISTICS, RETAIL, TECHNICS, TOURISM, ACCOUNTANCY, AIR TRANSPORT, BANKING, CATERING, CHEMICALS, COMPUTING, CONSTRUCTION, ELECTRICAL, ELECTRONICS, INDUSTRIAL AND COMMERCIAL INFORMATION, MOTOR TRADE, OFFICE EQUIPMENT, OPTICAL, PERSONAL CARE, PERSONNEL AND OCCUPATIONAL HEALTH, PROFESSIONAL, PROPERTY, RAILWAYS, RECRUITMENT, ROAD HAULAGE, SCIENCE, SHIPPING, SOCIAL SERVICES, TELEVISION, UTILITIES, AEROSPACE AND DEFENSE, INFORMATION CONCERNING AGRICULTURAL, FORESTRY AND NATURAL RESOURCES, ARTS AND ENTERTAINMENT, BOOKS AND PUBLISHING, BUILDINGS, PROPERTY AND INTERIOR DESIGN, ELECTRONICS AND ELECTRICAL ENGINEERING, ENGINEERING, MANUFACTURING AND PROCESSING, FOODSERVICE AND HOSPITALITY, INFORMATION TECHNOLOGY AND COMMUNICATIONS, MARKETING, BUSINESS AND TRAINING, SAFETY AND SECURITY, SPORTS, LEISURE AND HEALTH, TRADE SHOWS, CONFERENCES, COMPUTERIZED INFORMATION STORAGE AND RETRIEVAL SERVICES, ADVERTISING, NEWS, RESEARCH, EMPLOYMENT, RECRUITING AND A WIDE VARIETY OF TOPICS OF GENERAL INTEREST RECORDED ON COMPUTER DISKS, DVDS, VIDEOTAPES AND CD-ROMS (U.S. CLS. 21, 23, 26, 36 AND 38).

CLASS 16—PAPER GOODS AND PRINTED MATTER

FOR PUBLICATIONS, NAMELY, JOURNALS, BOOKS, BROCHURES, LEAFLETS, MANUALS, PUBLICITY TEXTS, TEXT BOOKS, REFERENCE MATERIALS, NEWSLETTERS, ATLASES, MAGAZINES AND PRINTED GUIDES ON A WIDE VARIETY OF TOPICS; DIARIES; PRINTED TIMETABLES, PRINTED INSTRUCTIONAL AND TEACHING MATERIALS DEALING WITH A VARIETY OF SUBJECTS (U.S. CLS. 2, 5, 22, 23, 29, 37, 38 AND 50).

CLASS 35—ADVERTISING AND BUSINESS

FOR ARRANGING AND CONDUCTING TRADE SHOWS IN THE FIELDS OF AEROSPACE AND DEFENSE, ART, AUTOMOBILES AND AUTOMOTIVE ENGINEERING, AGRICULTURE, BOOKS AND PUBLISHING, BUILDING AND CONSTRUCTION, BROADCASTING AND TELEVISION, CHEMICAL AND PROCESS ENGINEERING, CONVERTING, COMPUTERS AND INFORMATION TECHNOLOGY, TELECOMMUNICATIONS, CRAFTS, DESIGN, EDUCATION AND LANGUAGE TRAINING, ELECTRICAL, ELECTRONICS AND ELECTRICAL ENGINEERING, ENGINEERING, ENTERTAINMENT, ENVIRONMENT AND WATER, ENERGY, FASHION, FINANCE, RETAIL FOOD, HOTEL AND RETAIL FOOD SERVICE, FOOD PROCESSING AND MANUFACTURING, FURNITURE, GIFTS AND SOUVENIRS, HARDWARE, HOUSEWARES AND ALLIED PRODUCTS, HEALTHCARE, COMMERCIAL AND DOMESTIC INTERIOR DESIGN, JEWELRY, LABORATORY EQUIPMENT, MACHINERY AND MANUFACTURING, MARKETING, MINING, MUSIC, MATERIALS HANDLING, TRANSPORTATION AND DISTRIBUTION, OFFICE EQUIPMENT AND SUPPLIES, OPTICAL, OIL AND GAS, PACKAGING, PHARMACEUTICALS AND COSMETICS, PLASTICS, PRINTING, PROPERTY AND REAL ESTATE, SECURITY AND SAFETY, SPORTS AND RECREATION, TEST MEASUREMENT INSPECTION AND QUALITY CONTROL, TEXTILES, WATER ENGINEERING, WOODWORKING AND FORESTRY; ARRANGING AND CONDUCTING BUSINESS CONFERENCES; PUBLICATION OF PUBLICITY TEXTS; PROVIDING ON-LINE PUBLICITY TEXTS OF OTHERS (U.S. CLS. 100, 101 AND 102).

CLASS 39—TRANSPORTATION AND STORAGE

FOR PROVIDING INFORMATION IN THE FIELDS OF TRANSPORTATION AND TRAVEL; PROVIDING INFORMATION IN THE FIELDS OF TRANSPORTATION AND TRAVEL VIA A GLOBAL COMPUTER NETWORK (U.S. CLS. 100 AND 105).

CLASS 41—EDUCATION AND ENTERTAINMENT

FOR ARRANGING AND CONDUCTING EDUCATIONAL CONFERENCES, CONVENTIONS AND EXHIBITIONS; CONDUCTING EDUCATIONAL AND TRAINING CLASSES IN THE USE OF COMPUTERIZED INFORMATION RETRIEVAL SERVICES; PUBLICATION SERVICES, NAMELY, PUBLICATION OF JOURNALS, BOOKS, BROCHURES, LEAFLETS, MANUALS, TEXT BOOKS, REFERENCE MATERIALS, NEWSLETTERS, ATLASES AND MAGAZINES IN HARD COPY, ELECTRONIC FORM AND ON VARIOUS TYPES OF MEDIA; ELECTRONIC PUBLISHING SERVICES, NAMELY, PUBLICATION OF TEXT AND GRAPHIC WORKS OF OTHERS ON CD-ROMS FEATURING INFORMATION IN THE FIELDS OF BUSINESS, INDUSTRY, EDUCATION, ACADEMICS, GOVERNMENT, LAW, TAX, AGRICULTURAL AND BIOLOGICAL SCIENCES, ARTS AND HUMANITIES, HEALTH, CHEMISTRY AND CHEMICAL ENGINEERING, COMPUTER SCIENCE, EARTH AND PLANETARY SCIENCES, ECONOMICS, BUSINESS AND MANAGEMENT, ENGINEERING, ENERGY AND TECHNOLOGY, ENVIRONMENTAL SCIENCES, LIFE SCIENCES, MATERIALS SCIENCES, MATHEMATICS, MEDICINE, NEUROSCIENCE, PHARMACOLOGY, PHARMACEUTICAL SCIENCE AND TOXICOLOGY, PHYSICS AND ASTRONOMY, SOCIAL AND BEHAVIORAL SCIENCES, AUTOMOTIVE AND TRUCKING,

BOOK PUBLISHING, BUILDING AND CONSTRUCTION, DESIGN, DESIGN ENGINEERING, ELECTRONICS DESIGN AND COMMUNICATIONS, ELECTRONICS MANUFACTURING, IN-STAT RESEARCH, ENTERTAINMENT COMMUNICATIONS AND MEDIA, FOOD AND PACKAGING, FOODSERVICE AND LODGING, GIFTS, JEWELRY AND HOME TEXTILES, MANUFACTURING PROCESSES, MANUFACTURING PRODUCTS, PRINTING AND CONVERTING, PROCESSING, RETAIL HOME FURNISHINGS, SCIENTIFIC AND MEDICAL, SUPPLY CHAIN, TELEVISION AND TELECOM, VARIETY, ACCOUNTANCY AND BUSINESS, ADMINISTRATION, AGRICULTURE, BUILDING AND CONSTRUCTION, HEALTHCARE, HORTICULTURE, HOTEL AND CATERING, LOGISTICS, RETAIL, TECHNICS, TOURISM, ACCOUNTANCY, AIR TRANSPORT, BANKING, CATERING, CHEMICALS, COMPUTING, CONSTRUCTION, ELECTRICAL, ELECTRONICS, INDUSTRIAL AND COMMERCIAL, MOTOR TRADE, OFFICE EQUIPMENT, OPTICAL, PERSONAL CARE, PERSONNEL AND OCCUPATIONAL HEALTH, PROFESSIONAL, PROPERTY, RAILWAYS, RECRUITMENT, ROAD HAULAGE, SCIENCE, SHIPPING, SOCIAL SERVICES, TELEVISION, UTILITIES, AEROSPACE AND DEFENSE, AGRICULTURAL, FORESTRY AND NATURAL RESOURCES, ARTS AND ENTERTAINMENT, BOOKS AND PUBLISHING, BUILDINGS, PROPERTY AND INTERIOR DESIGN, ELECTRONICS AND ELECTRICAL ENGINEERING, ENGINEERING, MANUFACTURING AND PROCESSING, FOODSERVICE AND HOSPITALITY, INFORMATION TECHNOLOGY AND COMMUNICATIONS, MARKETING, BUSINESS AND TRAINING, SAFETY AND SECURITY, SPORTS, LEISURE AND HEALTH, TRADE SHOWS, CONFERENCES, COMPUTERIZED INFORMATION STORAGE AND RETRIEVAL SERVICES, ADVERTISING, NEWS, RESEARCH, EMPLOYMENT, RECRUITING AND A WIDE VARIETY OF TOPICS OF GENERAL INTEREST (U.S. CLS. 100, 101 AND 107).

CLASS 42—SCIENTIFIC, COMPUTER AND LEGAL SERVICES

FOR COMPUTER SERVICES, NAMELY PROVIDING ON-LINE JOURNALS, BOOKS, BROCHURES, LEAFLETS, MANUALS, TEXT BOOKS, REFERENCE MATERIALS, NEWSLETTERS, ATLASES AND MAGAZINES IN THE FIELDS OF BUSINESS, INDUSTRY, EDUCATION, ACADEMICS, GOVERNMENT, LAW, TAX, AGRICULTURAL AND BIOLOGICAL SCIENCES, ARTS AND HUMANITIES, HEALTH, CHEMISTRY AND CHEMICAL ENGINEERING, COMPUTER SCIENCE, EARTH AND PLANETARY SCIENCES, ECONOMICS, BUSINESS AND MANAGEMENT, ENGINEERING, ENERGY AND TECHNOLOGY, ENVIRONMENTAL SCIENCES, LIFE SCIENCES, MATERIALS SCIENCES, MATHEMATICS, MEDICINE, NEUROSCIENCE, PHARMACOLOGY, PHARMACEUTICAL SCIENCE AND TOXICOLOGY, PHYSICS AND ASTRONOMY, SOCIAL AND BEHAVIORAL SCIENCES, AUTOMOTIVE AND TRUCKING, BOOK PUBLISHING, BUILDING AND CONSTRUCTION, DESIGN, DESIGN ENGINEERING, ELECTRONICS DESIGN AND COMMUNICATIONS, ELECTRONICS MANUFACTURING, IN-STAT RESEARCH, ENTERTAINMENT COMMUNICATIONS AND MEDIA, FOOD AND PACKAGING, FOODSERVICE AND LODGING, GIFTS, JEWELRY AND HOME TEXTILES, MANUFACTURING PROCESSES, MANUFACTURING PRODUCTS, PRINTING AND CONVERTING, PROCESSING, RETAIL HOME FURNISHINGS, SCIENTIFIC AND MEDICAL, SUPPLY CHAIN, TELEVISION AND TELECOM, VARIETY, ACCOUNTANCY AND BUSINESS, ADMINISTRATION, AGRICULTURE, BUILDING AND CONSTRUCTION, HEALTHCARE, HORTICULTURE, HOTEL AND CATERING, LOGISTICS, RETAIL, TECHNICS, TOURISM, ACCOUNTANCY, AIR TRANSPORT, BANKING, CATERING, CHEMICALS, COMPUTING, CONSTRUCTION, ELECTRICAL, ELECTRONICS, INDUSTRIAL AND COMMERCIAL, MOTOR TRADE, OFFICE EQUIPMENT, OPTICAL, PERSONAL CARE, PERSONNEL AND OCCUPATIONAL HEALTH, PROFESSIONAL, PROPERTY, RAILWAYS, RECRUITMENT, ROAD HAULAGE, SCIENCE, SHIPPING, SOCIAL SERVICES, TELEVISION, UTILITIES, AEROSPACE AND DEFENSE, AGRICULTURAL, FORESTRY AND NATURAL RESOURCES, ARTS AND ENTERTAINMENT, BOOKS AND PUBLISH-

ING, BUILDINGS, PROPERTY AND INTERIOR DESIGN, ELECTRONICS AND ELECTRICAL ENGINEERING, ENGINEERING, MANUFACTURING AND PROCESSING, FOODSERVICE AND HOSPITALITY, INFORMATION TECHNOLOGY AND COMMUNICATIONS, MARKETING, BUSINESS, AND TRAINING, SAFETY AND SECURITY, SPORTS, LEISURE AND HEALTH, TRADE SHOWS, CONFERENCES, COMPUTERIZED INFORMATION STORAGE AND RETRIEVAL SERVICES, ADVERTISING, NEWS, RESEARCH, EMPLOYMENT, RECRUITING AND A WIDE VARIETY OF TOPICS OF GENERAL INTEREST (U.S. CLS. 100 AND 101).

SN 76-332,716. BANCO SANTANDER CENTRAL HISPANO, S.A., 39004 SANTANDER (CANTABRIA), SPAIN, FILED 10-31-2001.



PRIORITY CLAIMED UNDER SEC. 44(D) ON SPAIN APPLICATION NO. 2.425.036, FILED 9-17-2001, REG. NO. 2425036, DATED 1-17-2002, EXPIRES 1-17-2012.

PRIORITY CLAIMED UNDER SEC. 44(D) ON SPAIN APPLICATION NO. 2.425.034, FILED 9-17-2001, REG. NO. 2425034, DATED 1-17-2002, EXPIRES 1-17-2012.

PRIORITY CLAIMED UNDER SEC. 44(D) ON SPAIN APPLICATION NO. 2.425.033, FILED 9-17-2001, REG. NO. 2425033, DATED 1-17-2002, EXPIRES 1-17-2012.

PRIORITY CLAIMED UNDER SEC. 44(D) ON SPAIN APPLICATION NO. 2.425.017, FILED 9-17-2001, REG. NO. 2425017, DATED 1-17-2002, EXPIRES 1-17-2012.

OWNER OF U.S. REG. NOS. 1,013,686, 2,163,182 AND OTHERS.

NO CLAIM IS MADE TO THE EXCLUSIVE RIGHT TO USE "CENTRAL" AND "HISPANO", APART FROM THE MARK AS SHOWN.

APPLICANT CLAIMS THE COLOR RED AS A FEATURE OF THE MARK. THE BACKGROUND FOR THE MARK IS RED; THE DESIGN ELEMENT AND LETTERING ARE WHITE.

THE FOREIGN WORDING IN THE MARK TRANSLATES INTO ENGLISH AS "HISPANIC CENTRAL".

SEC. 2(F) AS TO "SANTANDER".

CLASS 16—PAPER GOODS AND PRINTED MATTER

FOR PAPER GOODS AND PRINTED MATTER, NAMELY, NOTEBOOK PAPER, WRITING PAPER, DRAWING PAPER, STATIONERY, WRITING PADS, WRAPPING PAPER, PAPER GIFT BAGS, CALENDARS, NOTE CARDS, ENVELOPES, MOUNTED AND UNMOUNTED PHOTOGRAPHS, AND PLAYING CARDS; ARTISTS' MATERIALS, NAMELY, BRUSHES, PAINTING SETS, PENCILS, PASTELS, PENS, EASELS, AND CANVASES FOR PAINTING; ELECTRIC TYPEWRITERS; OFFICE REQUISITES, NAMELY CORRECTING FLUID FOR TYPE, PAPER HOLE PUNCHERS, RUBBER BANDS, STAPLERS, PAPER CLIPS, HIGHLIGHTING MARKERS, DESK FILE TRAYS, STAPLE REMOVERS, PENCIL SHARPENERS, LETTER OPENERS, AND TAPER DISPENSERS; PRINTED INSTRUCTIONAL AND EDUCATIONAL MATERIAL IN THE FIELD OF MUSIC, ARTS, GAMES AND SPORTS; PRINTING TYPE; PRINTING BLOCKS (U.S. CLS. 2, 5, 22, 23, 29, 37, 38 AND 50).

CLASS 35—ADVERTISING AND BUSINESS

FOR IMPORT/EXPORT AGENCY SERVICES; BUSINESS MANAGEMENT AND CONSULTATION; PREPARING BUSINESS REPORTS; BOOKKEEPING, ACCOUNTING AND BUSINESS AND ACCOUNT AUDITING; COST PRICE ANALYSIS; CONDUCTING MARKETING RESEARCH STUDIES; AND ADVERTISING AGENCY SERVICES (U.S. CLS. 100, 101 AND 102).

CLASS 36—INSURANCE AND FINANCIAL

FOR COMMUNITY AND PRICE QUOTATIONS; INSURANCE AGENCY SERVICES IN THE FIELD OF HEALTH, LIFE, HOME, DISABILITY, ACCIDENT, FIRE AND AUTO; CURRENCY EXCHANGE SERVICES; FINANCIAL CLEARINGHOUSE SERVICES; CO-OPERATIVE CREDIT SERVICES IN THE NATURE OF COOPERATIVE CREDIT ORGANIZATIONS; INVESTMENT AND TRUST SERVICES FOR HOLDING COMPANIES; BROKERAGE SERVICES RELATING TO STOCKS, BONDS AND REAL ESTATE; REAL ESTATE TRUSTEE SERVICES AND TRUSTEESHIP REPRESENTATIVES; ISSUING OF TRAVELERS CHECKS, CREDIT CARDS AND LETTERS OF CREDIT; FINANCIAL ANALYSIS; BANKING SERVICES; FINANCIAL INVESTMENT IN THE FIELD OF REAL ESTATE AND SECURITIES FOR OTHERS; COLLECTION AND CREDIT AGENCIES; FIDUCIARY REPRESENTATIVES, LEASE-PURCHASE AND LOAN FINANCING SERVICES; REAL ESTATE APPRAISAL AND MANAGEMENT; SAFE DEPOSIT BOX SERVICES (U.S. CLS. 100, 101 AND 102).

CLASS 38—COMMUNICATION

FOR TELECOMMUNICATION SERVICES, NAMELY, CELLULAR TELEPHONE SERVICES AND ELECTRONIC TRANSMISSION OF VOICE, VIDEO, MESSAGES AND DATA, PROVIDING MULTIPLE USER ACCESS TO A GLOBAL COMPUTER INFORMATION NETWORK (U.S. CLS. 100, 101 AND 104).

SN 76-333,172. OCEAN PACIFIC APPAREL CORP., IRVINE, CA. FILED 11-1-2001.

SEVEN2

OWNER OF U.S. REG. NOS. 2,276,520 AND 2,276,521.

CLASS 18—LEATHER GOODS

FOR BAGS, NAMELY, BACKPACKS, BEACH BAGS, BOOK BAGS, CARRY-ON BAGS, DUFFEL BAGS, GYM BAGS, TOTE BAGS, HANDBAGS, LUGGAGE, FANNY PACKS, WALLETS AND BEACH UMBRELLAS (U.S. CLS. 1, 2, 3, 22 AND 41).

CLASS 25—CLOTHING

FOR CLOTHING, NAMELY SHIRTS, T-SHIRTS, SWEATSHIRTS, TANK TOPS, COATS, JACKETS, PULL-OVERS, SWEATPANTS, SHORTS, PANTS, SWIMWEAR, WET SUITS, SOCKS, UNDERWEAR, PAJAMAS, HEADWEAR AND FOOTWEAR (U.S. CLS. 22 AND 39).

SN 76-333,919. WORLDWIDE ENVIRONMENTAL PRODUCTS, INC., ABINGTON, PA. FILED 11-5-2001.

NATURE'S MAID**CLASS 3—COSMETICS AND CLEANING PREPARATIONS**

FOR ALL-PURPOSE CLEANING PREPARATIONS FOR LAUNDRY, HOME, AUTO, MARINE AND AVIATION USE (U.S. CLS. 1, 4, 6, 50, 51 AND 52).

CLASS 5—PHARMACEUTICALS

FOR ALL-PURPOSE DEODORIZING PREPARATIONS FOR LAUNDRY, HOME, AUTO, MARINE AND AVIATION USE (U.S. CLS. 6, 18, 44, 46, 51 AND 52).

SN 76-335,793. PHARMERICA, INC., ORANGE, CA. FILED 11-9-2001.

PHARMA COMPLETE**CLASS 35—ADVERTISING AND BUSINESS**

FOR MAIL ORDER CATALOG SERVICES IN THE FIELD OF MEDICAL EQUIPMENT AND SUPPLIES, MEDICATIONS, ORTHOTICS, PROSTHETICS, MUSCLE STIMULATORS AND BONE GROWTH STIMULATORS (U.S. CLS. 100, 101 AND 102).

FIRST USE 6-1-1998; IN COMMERCE 6-1-1998.

CLASS 36—INSURANCE AND FINANCIAL

FOR INSURANCE CLAIMS ADMINISTRATION, NAMELY, BILLING INSURANCE COMPANIES FOR THE SERVICES OF CONTRACTORS TO MODIFY HOMES FOR CHRONICALLY ILL AND CATASTROPHICALLY INJURED PATIENTS AND WORKERS (U.S. CLS. 100, 101 AND 102).

FIRST USE 6-1-1998; IN COMMERCE 6-1-1998.

CLASS 44—MEDICAL, BEAUTY AND AGRICULTURAL SERVICES

FOR PROVIDING MEDICAL CARE AND HOME HEALTHCARE SERVICES TO CHRONICALLY ILL AND CATASTROPHICALLY INJURED PATIENTS AND WORKERS FOLLOWING HOSPITAL DISCHARGE; NAMELY IV THERAPY, DISPENSING MEDICATIONS, NURSING CARE, AND RESPIRATORY THERAPY (U.S. CLS. 100 AND 101).

FIRST USE 6-1-1998; IN COMMERCE 6-1-1998.

SN 76-337,333. SOFTSPIKES, INC., GAITHERSBURG, MD. FILED 11-14-2001.

SOFTSPIKES

OWNER OF U.S. REG. NOS. 1,773,925 AND 2,278,540.

CLASS 18—LEATHER GOODS

FOR GOLF UMBRELLAS (U.S. CLS. 1, 2, 3, 22 AND 41).

CLASS 28—TOYS AND SPORTING GOODS

FOR GOLF ACCESSORIES, NAMELY GOLF BAGS, GOLF BALL MARKERS, GOLF CLUB HAND GRIPS, GOLF GLOVES AND GOLF TEES (U.S. CLS. 22, 23, 38 AND 50).

SN 76-338,130. SENSORY TECHNOLOGIES, INC., PROVIDENCE, RI. FILED 11-15-2001.

AFFERENT

CLASS 9—ELECTRICAL AND SCIENTIFIC APPARATUS

FOR SCIENTIFIC INSTRUMENTS, NAMELY, ELECTRICAL AND ELECTROMECHANICAL DEVICES COMPRISED OF ELECTRICAL LEADS, SENSORS, ELECTRICAL STIMULATORS, ELECTROMECHANICAL STIMULATORS, AND ELECTRICAL POWER SUPPLIES THAT PROVIDE SENSORY STIMULATION SOLD AS A UNIT FOR USE IN NEURO-MUSCULAR PERSONAL ATHLETIC AND LABORATORY APPLICATIONS SUCH AS CONCERNS JOINT REHABILITATION (U.S. CLS. 21, 23, 26, 36 AND 38).

CLASS 10—MEDICAL APPARATUS

FOR MEDICAL INSTRUMENTS, NAMELY, ELECTRICAL AND ELECTROMECHANICAL DEVICES COMPRISED OF ELECTRICAL LEADS, SENSORS, ELECTRICAL STIMULATORS, ELECTROMECHANICAL STIMULATORS, AND ELECTRICAL POWER SUPPLIES SOLD AS A UNIT INTENDED TO BE WORN ON THE BODY TO PROVIDE SENSORY STIMULATION FOR USE IN NEURO-MUSCULAR APPLICATIONS SUCH AS JOINT REHABILITATION (U.S. CLS. 26, 39 AND 44).

SN 76-339,388. RATH, MATTHIAS, NL-7609 KL ALMELO, NETHERLANDS, FILED 11-16-2001.

DR. RATH'S VITAMIN ZOO

PRIORITY CLAIMED UNDER SEC. 44(D) ON ERPN CMNTY TM OFC APPLICATION NO. 002363695, FILED 9-4-2001, REG. NO. 002363695, DATED 8-23-2002, EXPIRES 9-4-2011.

NO CLAIM IS MADE TO THE EXCLUSIVE RIGHT TO USE "VITAMIN", APART FROM THE MARK AS SHOWN.

CLASS 5—PHARMACEUTICALS

FOR PHARMACEUTICAL PREPARATIONS FOR HUMANS FOR USE IN THE TREATMENT OF HEART DISEASE AND HEART CONDITIONS, DIABETES, MENSTRUAL DISORDERS, BLOOD PRESSURE PROBLEMS, CARDIOVASCULAR PROBLEMS, LIPID METABOLISM DISORDERS, ASTHMA, ARTHRITIS, ARTHROSIS, TINNITUS, PERIODONTOSIS, ANEMIA, CELL DEFICIENCIES, AND CANCER; VITAMINS AND MINERALS FOR MEDICAL PURPOSES; FOOD SUPPLEMENTS FOR HUMANS FOR NON-MEDICAL PURPOSES, CONSISTING PRIMARILY OF VITAMINS, AMINO ACIDS AND TRACE ELEMENTS; DIETETIC SUPPLEMENTS FOR HUMANS FOR NON-MEDICAL USE, NAMELY AMINO ACIDS AND TRACE ELEMENTS IN THE NATURE OF DIETARY SUPPLEMENTS; NUTRITIONALLY FORTIFIED BEVERAGES (U.S. CLS. 6, 18, 44, 46, 51 AND 52).

CLASS 16—PAPER GOODS AND PRINTED MATTER

FOR BOOKS, NEWSPAPERS, JOURNALS, PAMPHLETS, MAGAZINES, PRINTED TEACHING MATERIALS ALL IN THE FIELD OF HEALTHCARE, NUTRITIONAL SUPPLEMENTS, DIETARY SUPPLEMENTS, VITAMIN AND MINERAL SUPPLEMENTS; EDUCATIONS MATERIALS, NAMELY BOOKS, NEWSPAPERS, JOURNALS, PAMPHLETS, MAGAZINES, IN THE FIELD OF HEALTHCARE, NUTRITIONAL SUPPLEMENTS, DIETARY SUPPLEMENTS, VITAMIN AND MINERAL SUPPLEMENTS (U.S. CLS. 2, 5, 22, 23, 29, 37, 38 AND 50).

CLASS 32—LIGHT BEVERAGES

FOR MINERAL AND CARBONATED WATER; OTHER NON-ALCOHOLIC BEVERAGES, NAMELY FRUIT DRINKS AND FRUIT JUICES; PREPARATIONS, NAMELY FRUIT DRINKS AND FRUIT JUICES; PREPARATIONS, NAMELY SYRUPS, POWDERS, AND TABLETS, FOR MAKING FORTIFIED BEVERAGES (U.S. CLS. 45, 46 AND 48).

SN 76-339,401. COMPANY C, INC., CONCORD, NH. FILED 11-16-2001.

COMPANY C

CLASS 24—FABRICS

FOR DUVET COVERS, QUILTS, COMFORTERS, COVERLETS, COVERS FOR CUSHIONS AND BLANKET TROWS (U.S. CLS. 42 AND 50).

FIRST USE 1-31-1994; IN COMMERCE 1-31-1994.

CLASS 27—FLOOR COVERINGS

FOR RUGS, CARPETS, DOOR MATS AND BATH MATS (U.S. CLS. 19, 20, 37, 42 AND 50).

FIRST USE 1-31-1994; IN COMMERCE 1-31-1994.

CLASS 35—ADVERTISING AND BUSINESS

FOR RETAIL STORE SERVICES, MAIL ORDER SERVICES, ON-LINE RETAIL STORE SERVICES AND WHOLESALE DISTRIBUTORSHIPS, ALL FEATURING HOME FURNISHINGS, OFFICE FURNISHINGS AND DECORATIVE ACCESSORIES (U.S. CLS. 100, 101 AND 102).

FIRST USE 1-31-1994; IN COMMERCE 1-31-1994.

SN 76-339,685. TOG SHOP, INC., THE, AMERICUS, GA. FILED 11-20-2001.

THE TOG SHOP

OWNER OF U.S. REG. NO. 1,910,140. SEC. 2(F).

CLASS 25—CLOTHING

FOR CLOTHING; NAMELY, DRESSES, SKIRTS, SPLIT SKIRTS, SHIRTS, BLAZERS, SUITS, BLOUSES, PANTS, PULLOVER SWEATERS, CARDIGAN SWEATERS, T-SHIRTS, SHORTS, HATS, SCARVES, GLOVES, BELTS, BATHING SUITS, COVER-UPS FOR BATHING SUIT, JACKETS, RAINCOATS, JUMPSUITS, JUMPER DRESSES, JEANS, JEAN JACKETS AND COATS; UNDERWEAR; NAMELY, SLIPS, PANTIES, HOSIERY, OVERALLS AND ROMPERS; FOOTWEAR; NAMELY, SHOES, SANDALS, SNEAKERS AND SLIPPERS (U.S. CLS. 22 AND 39).

FIRST USE 12-31-1951; IN COMMERCE 12-31-1951.

CLASS 35—ADVERTISING AND BUSINESS

FOR RETAIL STORE SERVICES FEATURING CLOTHING AND SHOES AND MAIL ORDER CATALOGUE SERVICES FEATURING CLOTHING AND SHOES (U.S. CLS. 100, 101 AND 102).

FIRST USE 12-31-1951; IN COMMERCE 12-31-1951.

SN 76-340,491. SONY MUSIC ENTERTAINMENT INC., NEW YORK, NY. FILED 11-20-2001.

SN 76-340,494. SONY CORPORATION, TOKYO 141, JAPAN, FILED 11-20-2001.



OWNER OF U.S. REG. NO. 1,692,693 AND OTHERS.

CLASS 9—ELECTRICAL AND SCIENTIFIC APPARATUS

FOR (BASED ON INTENT TO USE) DOWNLOADABLE MUSICAL SOUND AND MUSICAL VIDEO RECORDINGS (U.S. CLS. 21, 23, 26, 36 AND 38).

CLASS 35—ADVERTISING AND BUSINESS

FOR (BASED ON USE IN COMMERCE) COMPUTERIZED ONLINE RETAIL STORE SERVICES FOR MUSICAL SOUND AND MUSICAL VIDEO RECORDINGS AND DOWNLOADABLE MUSICAL SOUND AND MUSICAL VIDEO RECORDINGS VIA A GLOBAL COMPUTER NETWORK; MAIL ORDER SERVICES FEATURING MUSICAL SOUND AND MUSICAL VIDEO RECORDINGS (BASED ON INTENT TO USE) SUBSCRIPTION SERVICES, NAMELY, ARRANGING SUBSCRIPTIONS FOR ONLINE MUSIC AND MUSIC VIDEO ENTERTAINMENT (U.S. CLS. 100, 101 AND 102).

FIRST USE 6-11-1997; IN COMMERCE 6-11-1997.

CLASS 38—COMMUNICATION

FOR (BASED ON USE IN COMMERCE) STREAMING OF AUDIO MATERIAL ON THE INTERNET; STREAMING OF VIDEO MATERIAL ON THE INTERNET; AUDIO-ON-DEMAND AND VIDEO-ON-DEMAND TRANSMISSION SERVICES; WEBCASTING SERVICES; (BASED ON INTENT TO USE) TELECOMMUNICATIONS SERVICES, NAMELY, SUBSCRIPTION BROADCASTING OF MUSIC AND MUSICAL VIDEO VIA CABLE, SATELLITE OR THE INTERNET (U.S. CLS. 100, 101 AND 104).

FIRST USE 7-27-1996; IN COMMERCE 7-27-1996.

CLASS 41—EDUCATION AND ENTERTAINMENT

FOR (BASED ON USE IN COMMERCE) PROVIDING ONLINE ENTERTAINMENT NAMELY, PROVIDING SOUND AND VIDEO RECORDINGS IN THE FIELD OF MUSIC AND MUSICAL BASED ENTERTAINMENT; PROVIDING A WEBSITE OVER A GLOBAL COMPUTER NETWORK FEATURING INFORMATION ON MUSICAL ARTISTS, TOURS OF MUSICAL ARTISTS, SOUND RECORDINGS, POPULAR CULTURE AND EVENT AND MUSICAL BASED ENTERTAINMENT; DISTRIBUTION OF DIGITAL PROGRAMS, NAMELY, ONLINE RADIO AND TELEVISION PROGRAMS; (BASED ON INTENT TO USE) ENTERTAINMENT SERVICES, NAMELY, PROVIDING ONLINE MUSIC AND MUSICAL VIDEO ENTERTAINMENT BY SUBSCRIPTION (U.S. CLS. 100, 101 AND 107).

FIRST USE 7-27-1996; IN COMMERCE 7-27-1996.



NO CLAIM IS MADE TO THE EXCLUSIVE RIGHT TO USE "CLASSICAL", APART FROM THE MARK AS SHOWN.

CLASS 9—ELECTRICAL AND SCIENTIFIC APPARATUS

FOR (BASED ON INTENT TO USE) DOWNLOADABLE MUSICAL SOUND AND MUSICAL VIDEO RECORDINGS (U.S. CLS. 21, 23, 26, 36 AND 38).

CLASS 35—ADVERTISING AND BUSINESS

FOR (BASED ON USE IN COMMERCE) ELECTRONIC RETAILING SERVICES VIA COMPUTER FEATURING MUSICAL SOUND AND VIDEO RECORDINGS AND DOWNLOADABLE MUSICAL SOUND AND VIDEO RECORDINGS; COMPUTERIZED ON-LINE RETAIL SERVICES FEATURING MUSICAL SOUND AND VIDEO RECORDINGS AND DOWNLOADABLE MUSICAL SOUND AND VIDEO RECORDINGS BY MEANS OF A GLOBAL COMPUTER NETWORK (U.S. CLS. 100, 101 AND 102).

FIRST USE 2-10-1998; IN COMMERCE 2-10-1998.

CLASS 38—COMMUNICATION

FOR (BASED ON USE IN COMMERCE) ELECTRONIC TRANSMISSION OF AUDIO AND VIDEO CONTENT FEATURING MUSIC AND MUSICAL BASED ENTERTAINMENT VIA A GLOBAL COMPUTER NETWORK; STREAMING OF AUDIO AND VIDEO MATERIAL ON THE INTERNET (BASED ON INTENT TO USE) SUBSCRIPTION BROADCASTING VIA A GLOBAL COMPUTER NETWORK FEATURING MUSICAL SOUND AND VIDEO RECORDINGS (U.S. CLS. 100, 101 AND 104).

FIRST USE 2-10-1998; IN COMMERCE 2-10-1998.

CLASS 41—EDUCATION AND ENTERTAINMENT

FOR (BASED ON USE IN COMMERCE) PRODUCTION AND DISTRIBUTION OF DIGITAL ONLINE PROGRAMS FEATURING AUDIO AND VISUAL CONTENT AND MUSIC AND MUSICAL BASED ENTERTAINMENT; PROVIDING ONLINE ENTERTAINMENT NAMELY, PROVIDING SOUND AND VIDEO RECORDINGS IN THE FIELD OF MUSIC AND MUSICAL BASED ENTERTAINMENT; PROVIDING A WEBSITE OVER A GLOBAL COMPUTER NETWORK FEATURING INFORMATION ON MUSICAL ARTISTS, TOURS OF MUSICAL ARTISTS, SOUND RECORDINGS, POPULAR CULTURE AND EVENTS AND OTHER MUSIC BASED ENTERTAINMENT INFORMATION (U.S. CLS. 100, 101 AND 107).

FIRST USE 2-10-1998; IN COMMERCE 2-10-1998.

SN 76-341,293. NORTH FACE APPAREL CORP., THE, WILMINGTON, DE. BY ASSIGNMENT THE NORTH FACE, INC., SAN LEANDRO, CA. FILED 11-21-2001.



CLASS 9—ELECTRICAL AND SCIENTIFIC APPARATUS

FOR SUNGLASSES, SAFETY GLASSES AND PROTECTIVE EYEWEAR, AND REPLACEMENT LENSES FOR ALL OF THE FOREGOING; OPTICAL FRAMES FOR MEN, WOMEN AND CHILDREN, AND EYEGLOSS CASES, GOGGLES FOR USE IN SWIMMING, SNOW SKIING, SNOW BOARDING, HIKING, CLIMBING, GOLFING, KAYAKING, TENNIS, MOTORCYCLING, BOATING, SKATEBOARDING, IN-LINE SKATING, RACQUET BALL AND BICYCLING, EYEGLOSS AND SUNGLASS CHAINS (U.S. CLS. 21, 23, 26, 36 AND 38).

CLASS 22—CORDAGE AND FIBERS

FOR EYEGLOSS AND SUNGLASS LANYARDS (U.S. CLS. 1, 2, 7, 19, 22, 42 AND 50).

CLASS 25—CLOTHING

FOR MEN'S, WOMEN'S AND CHILDREN'S FOOTWEAR; MEN'S, WOMEN'S AND CHILDREN'S HEADGEAR, NAMELY, HATS, CAPS AND HEADBANDS; MEN'S, WOMEN'S AND CHILDREN'S APPAREL, NAMELY, T-SHIRTS, SWEATSHIRTS, SHIRTS, SKIRTS, DRESSES, SHORTS, PANTS, SWIMSUITS, SWIM TRUNKS, PARKAS, VESTS, JACKETS, ANORAKS, SKI BIBS, SKI SUITS, SWEATERS, GLOVES, MITTENS, UNDERWEAR, BELTS AND SOCKS (U.S. CLS. 22 AND 39).

SN 76-344,352. VOEST-ALPINE INDUSTRIEANLAGENBAU GMBH & CO, A-4031 LINZ, AUSTRIA, FILED 12-4-2001.

LINKMASTER

PRIORITY CLAIMED UNDER SEC. 44(D) ON ERPNTY TM OFC APPLICATION NO. 002318434, FILED 7-26-2001, REG. NO. 002318434, DATED 9-5-2002, EXPIRES 7-26-2011.

CLASS 9—ELECTRICAL AND SCIENTIFIC APPARATUS

FOR COMPUTER SOFTWARE FOR OPTIMIZATION OF PROCESS PARAMETERS INCLUDING PROCESSING AND THROUGHOUT SPEEDS, LOOPER LEVELS AND MANIPULATION TIMES IN LINKED PROCESSING LINES, ESPECIALLY FOR USE IN METALLURGICAL INSTALLATIONS; COMPUTER HARDWARE; SENSORS FOR MEASURING PROCESS PARAMETERS INCLUDING PROCESSING AND THROUGHOUT SPEEDS, LOOPER LEVELS AND MANIPULATION TIMES IN LINKED PROCESSING LINES, ESPECIALLY FOR USE IN METALLURGICAL INSTALLATIONS; ELECTRICAL CONTROLLERS, ELECTRICAL REGULATORS, AND ELECTRICAL MONITORS FOR CONTROLLING, MEASURING, REGULATING AND MONITORING PROCESS PARAMETERS INCLUDING PROCESSING AND THROUGHOUT SPEEDS, LOOPER LEVELS AND MANIPULATION TIMES IN LINKED PROCESSING LINES, ESPECIALLY FOR METALLURGICAL INSTALLATIONS (U.S. CLS. 21, 23, 26, 36 AND 38).

CLASS 37—CONSTRUCTION AND REPAIR

FOR SERVICES IN THE NATURE OF BUILDING, MAINTENANCE AND REPAIR OF LINKED METALLURGICAL INSTALLATIONS, NAMELY, CONSTRUCTION MANAGEMENT, CONSTRUCTION PLANNING, AND CONSTRUCTION OF BUILDINGS AND OF METALLURGICAL MANUFACTURING FACILITIES; INSTALLATION AND REPAIR OF ELECTRONIC LINKS BETWEEN METALLURGICAL INSTALLATIONS WITH THE TARGET OF OPTIMIZING PROCESS PARAMETERS SUCH AS PROCESSING AND THROUGHOUT SPEEDS, LOOPER LEVELS AND MANIPULATION TIMES (U.S. CLS. 100, 103 AND 106).

CLASS 42—SCIENTIFIC, COMPUTER AND LEGAL SERVICES

FOR TECHNICAL CONSULTATION, COMPUTER HARDWARE DEVELOPMENT, AND DESIGN FOR NEW PRODUCT DEVELOPMENT IN THE FIELD OF LINKING METALLURGICAL INSTALLATIONS, ESPECIALLY FOR SPEED OPTIMIZATION OF PROCESS PARAMETERS SUCH AS PROCESSING AND THROUGHOUT SPEEDS, LOOPER LEVELS AND MANIPULATION TIMES; COMPUTER SOFTWARE DEVELOPMENT (U.S. CLS. 100 AND 101).

SN 76-344,566. KISS INSTITUTE FOR PRACTICAL ROBOTICS, NORMAN, OK. FILED 12-3-2001.

BOTBALL

CLASS 9—ELECTRICAL AND SCIENTIFIC APPARATUS

FOR PERSONAL EDUCATIONAL ROBOT (U.S. CLS. 21, 23, 26, 36 AND 38).
FIRST USE 7-21-1997; IN COMMERCE 7-21-1997.

CLASS 16—PAPER GOODS AND PRINTED MATTER

FOR EDUCATIONAL INSTRUCTIONAL MANUALS FOR USE IN TEACHING ENGINEERING, MATH, SCIENCE, AND MEANS FOR BUILDING ROBOTS (U.S. CLS. 2, 5, 22, 23, 29, 37, 38 AND 50).
FIRST USE 7-21-1997; IN COMMERCE 7-21-1997.

CLASS 28—TOYS AND SPORTING GOODS

FOR EDUCATIONAL TOY IN THE NATURE OF A TOY ROBOT AND THE PARTS THEREOF (U.S. CLS. 22, 23, 38 AND 50).
FIRST USE 7-21-1997; IN COMMERCE 7-21-1997.

SN 76-345,179. NORDEA AB, S-105 71 STOCKHOLM, SWEDEN, FILED 12-3-2001.

NORDEA INVESTMENT MANAGEMENT

PRIORITY CLAIMED UNDER SEC. 44(D) ON ERPN CMNTY TM OFC APPLICATION NO. 2357812, FILED 8-30-2001, REG. NO. 2357812, DATED 10-9-2002, EXPIRES 10-9-2012.

NO CLAIM IS MADE TO THE EXCLUSIVE RIGHT TO USE "INVESTMENT MANAGEMENT", APART FROM THE MARK AS SHOWN.

CLASS 9—ELECTRICAL AND SCIENTIFIC APPARATUS

FOR AUTOMATED BANKING MACHINES, AUTOMATIC BANK NOTE DISPENSERS, BANK CARDS INCORPORATING MAGNETIC OR ELECTRONIC DATA CARRIERS, ENCODED AND MAGNETIC BANK CARDS, NAMELY MAGNETICALLY ENCODED BANK CARDS, BANK CARDS BEING MACHINE READABLE, ELECTRONIC CARD READERS FOR CREDIT CARDS, COMPUTER TERMINALS FOR USE WITH CREDIT CARDS AND BANK CARDS, ENCODED AND MAGNETIC CREDIT CARDS, ENCODED AND MAGNETIC CREDIT CARDS FOR USE IN RELATION TO ELECTRONIC TRANSFER OF FUNDS AND FOR USE IN RELATION TO FINANCIAL TRANSACTIONS, APPARATUS FOR PAYMENT WITH MAGNETIC MEMORY CARDS, NAMELY COMPUTER TERMINALS, APPARATUS FOR RECEIVING CASH PAYMENTS, NAMELY AUTOMATIC TELLER MACHINES, AUTOMATIC PAYMENT MACHINES, NAMELY AUTOMATED BANKING MACHINES, ELECTRONIC IDENTIFICATION CARDS, NAMELY MAGNETIC ENCODED IDENTITY CARDS FOR USE IN PAYING FOR SERVICES, MACHINE READABLE DEVICES, NAMELY BAR CODE READERS CONSISTING OF DISKETTES, MAGNETIC TAPES AND BAR CODE CARRIERS FOR CASHLESS PAYMENT SYSTEMS, MAGNETIC AND ENCODED PAYMENT CARDS, PAYMENT CARDS INCORPORATING DATA CARRIERS, NAMELY ELECTRONICALLY AND MAGNETICALLY ENCODED PAYMENT CARDS; EQUIPMENT, NAMELY COMPUTERS, TELEPHONES, RADIOS AND TELEVISIONS FOR TELECOMMUNICATION AND INTERACTIVE COMMUNICATION, COMPUTER COMMUNICATIONS SOFTWARE TO ALLOW CUSTOMERS TO ACCESS BANK ACCOUNT INFORMATION AND TRANSACT BANKING BUSINESS, COMPUTER E-COMMERCE SOFTWARE FOR VERIFYING AND FACILITATING ON-LINE RETAIL SALES AND BUSINESS TO BUSINESS TRANSACTIONS, COMPUTER E-COMMERCE SOFTWARE TO ALLOW USERS TO PERFORM ELECTRONIC BUSINESS TRANSACTIONS VIA A GLOBAL COMPUTER NETWORK (U.S. CLS. 21, 23, 26, 36 AND 38).

CLASS 35—ADVERTISING AND BUSINESS

FOR BUSINESS MANAGEMENT CONSULTING, BUSINESS RESEARCH, MARKET RESEARCH, PROVISION OF BUSINESS STATISTICAL INFORMATION; MANAGEMENT CONSULTING SERVICES RELATING TO E-COMMERCE (U.S. CLS. 100, 101 AND 102).

CLASS 36—INSURANCE AND FINANCIAL

FOR INSURANCE SERVICES; NAMELY, LIFE INSURANCE UNDERWRITING, INDEMNITY INSURANCE UNDERWRITING, REAL ESTATE INSURANCE UNDERWRITING, HOME INSURANCE UNDERWRITING, AUTOMOBILE INSURANCE UNDERWRITING, MARINE INSURANCE UNDERWRITING, FIRE INSURANCE UNDERWRITING, ACCIDENT INSURANCE UNDERWRITING, TRAVEL INSURANCE UNDERWRITING, LOSS OF PROFIT INSURANCE UNDERWRITING, LIABILITY INSURANCE UNDERWRITING, MEDICAL INSURANCE UNDERWRITING, INSURANCE FOR PREPAID LEGAL SERVICES UNDERWRITING, INSURANCE BROKERAGE, INSURANCE CONSULTATION;

FINANCIAL SERVICES; NAMELY BANKING SERVICES, FINANCIAL ANALYSIS AND CONSULTATION, FINANCIAL INFORMATION IN THE NATURE OF RATES OF EXCHANGE, STOCK BROKERAGE, FINANCIAL INFORMATION PROVIDED BY ELECTRONIC MEANS, FINANCIAL MANAGEMENT, FINANCIAL PLANNING, FINANCIAL PORTFOLIO MANAGEMENT, FINANCIAL RESEARCH, FINANCIAL SERVICES IN THE NATURE OF AN INVESTMENT SECURITY, FINANCIAL GUARANTEE AND ASSURANCE UNDERWRITING, CASH MANAGEMENT, INVESTMENT MANAGEMENT, LEASE-PURCHASE FINANCING, ASSET MANAGEMENT, INVESTMENT OF FUNDS FOR OTHERS, INVESTMENT OF SECURITY, FINANCIAL CLEARING HOUSES, CREDIT AND DEBT RECOVERY AND COLLECTION, CREDIT CARD SERVICES, DEBIT CARD SERVICES, BONDING SERVICES, ELECTRONIC PAYMENT, NAMELY, ELECTRONIC PROCESSING AND TRANSMISSION OF BILL PAYMENT DATA, ELECTRONIC FUNDS TRANSFER, MONEY ORDER SERVICES, AUTOMATED TELLER MACHINE SERVICES, TRAVELERS CHECK ISSUANCE, SAFETY DEPOSIT BOX SERVICES; MONETARY SERVICES, NAMELY CURRENCY EXCHANGE SERVICES, CASH MANAGEMENT SERVICES FOR CORPORATE CUSTOMERS; REAL ESTATE SERVICES, NAMELY REAL ESTATE MANAGEMENT, REAL ESTATE LISTING, REAL ESTATE BROKERAGE, REAL ESTATE APPRAISAL, LEASING OF REAL ESTATE, LEASING AND RENTAL OF APARTMENTS, LEASING AND RENTAL OF OFFICE SPACE, REAL ESTATE TRUSTEE SERVICES (U.S. CLS. 100, 101 AND 102).

CLASS 38—COMMUNICATION

FOR TELECOMMUNICATION SERVICES, NAMELY COMMUNICATION SERVICES, BEING TELEPHONE COMMUNICATION SERVICES AND TELECOMMUNICATION GATEWAY SERVICES, PROVIDING TELECOMMUNICATIONS CONNECTIONS TO A GLOBAL COMPUTER NETWORK AND ELECTRONIC TRANSMISSION OF DATA AND DOCUMENTS BETWEEN FINANCIAL INSTITUTIONS, BETWEEN FINANCIAL INSTITUTIONS AND CUSTOMERS, AND BETWEEN INSURANCE INSTITUTIONS, AND BETWEEN INSURANCE INSTITUTIONS AND CUSTOMERS (U.S. CLS. 100, 101 AND 104).

SN 76-346,814. NATIONAL EDUCATION TRAINING GROUP, INC., NAPERVILLE, IL. FILED 11-12-2001.

QUEST FOR KNOWLEDGE

CLASS 9—ELECTRICAL AND SCIENTIFIC APPARATUS

FOR COMPUTER SOFTWARE, NAMELY, CD-ROMS PROVIDING AN INTERACTIVE TUTORIAL ENVIRONMENT IN WHICH LEARNERS ACQUIRE SKILLS THROUGH CONCEPTS AND HANDS-ON SIMULATIONS IN THE FIELD OF COMPUTER TECHNOLOGY (U.S. CLS. 21, 23, 26, 36 AND 38).

CLASS 41—EDUCATION AND ENTERTAINMENT

FOR PROVIDING COMPUTER BASED TRAINING ON COMPUTER TECHNOLOGY SUBJECTS VIA THE INTERNET (U.S. CLS. 100, 101 AND 107).

SN 76-347,003. GET2HAWAII, INC., HONOLULU, HI. FILED 12-7-2001.

GET2HAWAII

CLASS 38—COMMUNICATION

FOR LODGING INDUSTRY INVENTORY ACCESS SERVICES, NAMELY, PROVIDING MULTIPLE USER ACCESS TO LODGING INVENTORY INFORMATION AND LODGING INVENTORY FOR TRAVEL INDUSTRY AND LODGING INDUSTRY SUPPLIERS, PORTALS, RESELLERS, AND PLANNERS VIA A GLOBAL COMPUTER NETWORK (U.S. CLS. 100, 101 AND 104).

CLASS 43—HOTEL AND RESTAURANT SERVICES

FOR LODGING INDUSTRY INVENTORY PACKAGING SERVICES, NAMELY, PROVIDING LODGING INVENTORY INFORMATION AND CONSOLIDATING LODGING INVENTORY FOR TRAVEL INDUSTRY AND LODGING INDUSTRY SUPPLIERS, PORTALS, RESELLERS, AND PLANNERS VIA GLOBAL COMPUTER NETWORK (U.S. CLS. 100 AND 101).

SN 76-348,202. LEFELIS SA, 6900 LUGANO, SWITZERLAND, FILED 12-11-2001.

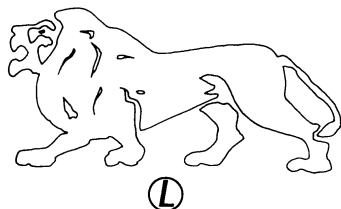

PRIORITY CLAIMED UNDER SEC. 44(D) ON SWITZERLAND APPLICATION NO. 491102, FILED 6-12-2001, REG. NO. 491102, DATED 12-10-2001, EXPIRES 6-12-2011.

CLASS 9—ELECTRICAL AND SCIENTIFIC APPARATUS

FOR EYEGLASSES, LENSES FOR EYEGLASSES AND SUNGLASSES; FRAMES, CHAINS AND CASES FOR EYEGLASSES (U.S. CLS. 21, 23, 26, 36 AND 38).

CLASS 18—LEATHER GOODS

FOR LEATHER AND IMITATIONS OF LEATHER GOODS, NAMELY, ALL-PURPOSE SPORTS AND ATHLETIC BAGS, BARREL BAGS, BEACH BAGS, BOOK BAGS, BOSTON BAGS, CARRY-ON BAGS, CLUTCH BAGS, COSMETIC BAGS SOLD EMPTY, DIAPER BAGS, DUFFEL BAGS, GARMENT BAGS FOR TRAVEL, GYM BAGS, BAGS FOR MERCHANDISE PACKING, SHOPPING BAGS, OVERNIGHT BAGS, ROLL BAGS, SCHOOL BAGS, SCHOOL BOOK BAGS, SHAVING BAGS SOLD EMPTY, SHOE BAGS FOR TRAVEL, SHOULDER BAGS, SOUVENIR BAGS, SUIT BAGS, TOTE BAGS, TRAVEL BAGS, ATTACHE CASES, OVERNIGHT CASES, DOCUMENT CASES, TOILETRY CASES SOLD EMPTY, VANITY CASES SOLD EMPTY, SATCHELS, PURSES, KEY CASES, WALLETS, TRUNKS; UMBRELLAS, PARASOLS AND WALKING STICKS (U.S. CLS. 1, 2, 3, 22 AND 41).

CLASS 24—FABRICS

FOR TEXTILES AND TEXTILE GOODS, NAMELY, LINEN, BATH LINEN, BED LINEN, HOUSEHOLD LINEN, TABLE LINEN, TOWELS, BATH TOWELS, GOLF TOWELS, HAND TOWELS OF TEXTILE, HOODED TOWELS, KITCHEN TOWELS, TEA TOWELS, COTTON FABRICS, FLANNEL FABRICS, SILK FABRICS, UNFITTED FABRIC FURNITURE COVERS, CURTAINS, CURTAIN FABRIC, SHOWER CURTAINS, WINDOW CURTAINS, HANDKERCHIEFS, TABLE MATS NOT OF PAPER, TEXTILE AND VINYL PLACE MATS, TEXTILE NAPKINS (U.S. CLS. 42 AND 50).

CLASS 25—CLOTHING

FOR CLOTHING, NAMELY, BELTS, GLOVES, SCARVES, WRAP-AROUNDS, CORSETS, DUSTERS, FOULARDS, HOODS, JERSEYS, MANTLES, MUFFLERS, SHOULDER PADS FOR CLOTHING, TIES, TOPS, SHIRTS, BRIEFS, UNDERGARMENTS, PANTS, SLACKS, SHORTS, JEANS, BODY SUITS, DRY SUITS, FLIGHT SUITS, GYM SUITS, JOGGING SUITS, PLAY SUITS, RAIN SUITS, SKI SUITS, SUITS, SWEAT SUITS, VESTED SUITS, WARM UP SUITS, WET SUITS, BLOUSES, PARKAS, JACKETS, COATS, SWIM WEAR, BEACHWEAR, SOCKS, KNIT SHIRTS, OVERALLS, SNOW PANTS, SNOW BOOTS, NIGHTGOWNS, PAJAMAS, DRESSING GOWNS, BATHROBES, STOCKINGS, PANTYHOSE, TEE-SHIRTS, VESTS, PULLOVERS, SWEATERS, SKIRTS, DRESSES; FOOTWEAR; HEADWEAR (U.S. CLS. 22 AND 39).

CLASS 28—TOYS AND SPORTING GOODS

FOR GAMES AND PLAYTHINGS, NAMELY, ACTION SKILL GAMES, ACTION TARGET GAMES, ARCADE GAMES, BOARD GAMES, CARD GAMES, DART GAMES, MANIPULATIVE GAMES, PADDLE BALL GAMES, PARLOR GAMES, PARTY GAMES, PINBALL GAMES, ROLE-PLAYING GAMES, SNOW SHOES; GYMNAS TIC AND SPORTING ARTICLES, NAMELY, EXERCISE AND GYMNAS TIC BANNERS, EXERCISE DOORWAY GYM BARS, GYMNAS TIC APPARATUS, GYMNAS TIC HORIZONTAL BARS, GYMNAS TIC PARALLEL BARS, GYMNAS TIC TRAINING STOOLS, GYMNAS TIC VAULTING HORSES; JUNGLE GYMS (U.S. CLS. 22, 23, 38 AND 50).

SN 76-348,749. SUPER LOVERS CO., LTD., TOKYO 108-0071, JAPAN, FILED 12-13-2001.



OWNER OF JAPAN REG. NO. 4490241, DATED 7-13-2001, EXPIRES 7-13-2011.

OWNER OF JAPAN REG. NO. 4490240, DATED 7-13-2001, EXPIRES 7-13-2011.

CLASS 18—LEATHER GOODS

FOR ATTACHE CASES; BABY CARRIERS WORN ON THE BODY; BACK PACKS; SPORTSMAN'S HUNTING BAGS; BEACH BAGS; BRIEFCASES; BUSINESS CARD CASES; CALLING CARD CASES; CREDIT CARD CASES; COMMUTER PASS CASES; CHAIN MESH PURSES; DRAWSTRING POUCHES; DUFFEL BAGS; LEATHER BAGS FOR MERCHANDISE PACKAGING; FEED BAGS FOR ANIMALS; FELT POUCHES; GARMENT BAGS FOR TRAVEL; HANDBAGS; HAT BOXES OF LEATHER; HAVERSACKS; KEY CASES; IMITATIONS OF LEATHER SHOPPING BAGS; LUGGAGE; LUGGAGE TRUNKS; LEATHER DRAWSTRING POUCHES; LEATHER SHOPPING BAGS; MESH SHOPPING BAGS; OVERNIGHT BAGS; POCKET WALLETS; PURSES; RUCKSACKS; SATCHELS; SCHOOL BAGS; SUITCASES; TEXTILE SHOPPING BAGS; LEATHER TOOL BAGS SOLD EMPTY, TRAVELING BAGS; VALISES; VANITY CASES SOLD EMPTY; WHEELED SHOPPING BAGS (U.S. CLS. 1, 2, 3, 22 AND 41).

CLASS 25—CLOTHING

FOR APRONS; BANDANAS; BATHING TRUNKS; BEACH COVERUPS; BEACH SHOES; BELTS; BERETS; CLOTH BIBS, NOT OF PAPER; BREECHES; BRIEFS; CAMISOLES; CLOTHING OF IMITATIONS OF LEATHER, NAMELY, COATS, CAPS, HATS, JACKETS, JUMPERS, PANTS, SHOES, SUITS AND VESTS; CLOTHING OF LEATHER, NAMELY, COATS, CAPS, HATS, JACKETS, JUMPERS, PANTS, SKIRTS, SHOES, SUITS AND VESTS; COATS; COLLARS; COMBINATIONS; CUFFS; EAR MUFFS; FOOT WEAR; FURS, NAMELY, COATS, CAPS, JACKETS, JUMPERS, SKIRTS AND VESTS; GABARDINES, NAMELY, COATS, CAPS, HATS, JACKETS, JUMPERS, SKIRTS, PANTS AND VESTS; GLOVES; GYMNAS TIC SHOES; HALF-BOOTS; HATS; HEADBANDS; HEAD WEAR; HOODS; HOSIERY; JACKETS; JERSEYS; JUMPERS; KNITWEAR, NAMELY, COATS, DRESSES, JACKETS, JUMPERS, PANTS, SKIRTS, SUITS AND VESTS; LACE BOOTS; LAYETTES; MITTENS; NECKTIES; OUTER CLOTHING, NAMELY, COATS, JACKETS, OVERCOATS AND GABARDINES; OVERALLS; OVERCOATS; PANTS; PARKAS; PULL-OVERS; READY-MADE CLOTHING, NAMELY, SHIRTS, PANTS AND JACKETS; SANDALS; SASHES FOR WEAR; SCARVES; SHAWLS; SHIRT FRONTS; SHIRT YOKES; SHIRTS; SHOULDER WRAPS; SKIRTS; SKULL CAPS; SMOCKS; SOCK SUSPENDERS; SOCKS; SPORTS JERSEYS; SPORTS SHOES; STUFF JACKETS; SUITS; SUSPENDERS; SWEATERS; SWIM SUITS; TEDDIES; T-SHIRTS; TIGHTS; TOPCOATS; UNDERWEAR; UNIFORMS; VEILS; VESTS; VISORS; WATER PROOF CLOTHING, NAMELY, COATS, JACKETS, JUMPERS, PARKAS, TOPCOATS, VESTS; LEATHER BELTS; LEATHER SHOE LACES; WRIST BANDS (U.S. CLS. 22 AND 39).

SN 76-349,534. GEOREFERENCE ONLINE LTD., VANCOUVER, BRITISH COLUMBIA, CANADA, FILED 12-18-2001.

MINEMATCH**CLASS 9—ELECTRICAL AND SCIENTIFIC APPARATUS**

FOR COMPUTER SOFTWARE FOR DESCRIBING, COMPARING AND SIMILARITY-RANKING DATA BASED ON STANDARD ONTOLOGY BUILT FROM INTERNATIONALLY-RECOGNIZED GEOLOGICAL TERMS (U.S. CLS. 21, 23, 26, 36 AND 38).

FIRST USE 6-30-2002; IN COMMERCE 3-18-2003.

CLASS 42—SCIENTIFIC, COMPUTER AND LEGAL SERVICES

FOR PROVIDING CUSTOMIZED INFORMATION RELATING TO GEOLOGICAL, ENVIRONMENTAL AND MINING SUBJECT MATTER (U.S. CLS. 100 AND 101).

FIRST USE 6-30-2002; IN COMMERCE 3-18-2003.

SN 76-349,862. YOPLAIT MARQUES INTERNATIONALES, 75014 PARIS, FRANCE, BY ASSIGNMENT SODIAAL INTERNATIONAL - SOCIETE DE DIFFUSION INTERNATIONALE AGRO-ALIMENTAIRE, 75014, PARIS, FRANCE, FILED 12-17-2001.

EVERYDAY YOPLAIT

PRIORITY CLAIMED UNDER SEC. 44(D) ON FRANCE APPLICATION NO. 013108079, FILED 6-21-2001, REG. NO. 013108079, DATED 6-21-2001, EXPIRES 6-21-2011.

CLASS 29—MEATS AND PROCESSED FOODS

FOR MILK AND MILK PRODUCTS, NAMELY BEVERAGES MADE FROM MILK PRODUCTS, YOGURTS, AND FRESH CHEESES (U.S. CL. 46).

CLASS 30—STAPLE FOODS

FOR DESSERTS MADE FROM MILK PRODUCTS, NAMELY ICES, CUSTARDS, FROZEN YOGURTS, MILK SHAKES, DAIRY PUDDINGS, DAIRY JELLIES, CREAM DESSERTS, AND COOKED DAIRY DESSERTS (U.S. CL. 46).

SN 76-351,843. URBAN SCIENCE APPLICATIONS, INC., DETROIT, MI. FILED 12-21-2001.

KNOWLEDGE TO EMPOWER YOU**CLASS 9—ELECTRICAL AND SCIENTIFIC APPARATUS**

FOR COMPUTER SOFTWARE AND INSTRUCTIONAL MANUALS SOLD AS A UNIT FOR MARKET RESEARCH AND ANALYSIS (U.S. CLS. 21, 23, 26, 36 AND 38).

CLASS 35—ADVERTISING AND BUSINESS

FOR BUSINESS CONSULTATION SERVICES, NAMELY, MARKET RESEARCH AND ANALYSIS, STATISTICAL AND QUANTITATIVE ANALYSIS IN THE NATURE OF PROVIDING STATISTICAL INFORMATION FOR BUSINESS OR COMMERCIAL PURPOSES, COMPUTERIZED DATABASE MANAGEMENT, AND BUSINESS CONSULTATION IN THE FIELD OF DIRECT MARKETING (U.S. CLS. 100, 101 AND 102).

CLASS 42—SCIENTIFIC, COMPUTER AND LEGAL SERVICES

FOR COMPUTER NETWORK CONSULTATION SERVICES, DATA AND TECHNICAL CONSULTATION SERVICES FOR SOFTWARE APPLICATIONS, COMPUTER SOFTWARE PROGRAMMING AND DESIGN FOR OTHERS, GRAPHIC ART DESIGN FOR DIRECT MARKETING, AND ARBITRATION SUPPORT SERVICES (U.S. CLS. 100 AND 101).

SN 76-352,175. GENERATION 5 DATA MODELING & STATISTICAL ANALYSIS INC., TORONTO, ONTARIO, M2J 4W8, CANADA, FILED 12-21-2001.

Generation⁵
|Mathematical Technology|in Marketing

NO CLAIM IS MADE TO THE EXCLUSIVE RIGHT TO USE "MATHEMATICAL TECHNOLOGY IN MARKETING", APART FROM THE MARK AS SHOWN.

THE MARK CONSISTS OF THE TERMS "GENERATION 5 MATHEMATICAL TECHNOLOGY IN MARKETING", A SEMI-CIRCLE DESIGN, AND VERTICAL LINES BEFORE THE TERM "MATHEMATICAL" AND AFTER THE TERM "TECHNOLOGY".

CLASS 9—ELECTRICAL AND SCIENTIFIC APPARATUS

FOR COMPUTER SOFTWARE TO MATHEMATICALLY EXPLORE CUSTOMER DATA BASES AND TO SOLVE CUSTOMER DATA BASE PROBLEMS (U.S. CLS. 21, 23, 26, 36 AND 38).

FIRST USE 10-0-2001; IN COMMERCE 10-0-2001.

CLASS 42—SCIENTIFIC, COMPUTER AND LEGAL SERVICES

FOR DESIGNING DATABASES UTILIZING OPERATIONAL RESEARCH AND MATHEMATICAL PROCEDURES IN THE FIELD OF DIRECT MARKETING AND MARKET RESEARCH (U.S. CLS. 100 AND 101).

FIRST USE 4-0-2001; IN COMMERCE 4-0-2001.

SN 76-352,176. GENERATION 5 DATA MODELING & STATISTICAL ANALYSIS INC., TORONTO, ONTARIO, M2J 4W8, CANADA, FILED 12-21-2001.



THE MARK CONSISTS OF THE NUMBER "5" AND A SEMI-CIRCLE DESIGN.

CLASS 9—ELECTRICAL AND SCIENTIFIC APPARATUS

FOR COMPUTER SOFTWARE TO MATHEMATICALLY EXPLORE CUSTOMER DATA BASES AND TO SOLVE CUSTOMER DATA BASE PROBLEMS (U.S. CLS. 21, 23, 26, 36 AND 38).

FIRST USE 10-0-2001; IN COMMERCE 10-0-2001.

CLASS 42—SCIENTIFIC, COMPUTER AND LEGAL SERVICES

FOR DESIGNING DATABASES UTILIZING OPERATIONAL RESEARCH AND MATHEMATICAL PROCEDURES IN THE FIELD OF DIRECT MARKETING AND MARKET RESEARCH (U.S. CLS. 100 AND 101).

FIRST USE 4-0-2001; IN COMMERCE 4-0-2001.

SN 76-352,231. TROPHOS S.A., 13288 MARSEILLE CEDEX 9, FRANCE, FILED 12-21-2001.

TROPHOS

OWNER OF FRANCE REG. NO. 013107086, DATED 6-21-2001, EXPIRES 6-21-2011.

CLASS 1—CHEMICALS

FOR CULTURE BROTH FOR BACTERIOLOGY, NUTRITIVE SUBSTANCES FOR MICROORGANISMS; PURIFIED NEURONE CULTURES USED IN RESEARCH OF NEURO-DEGENERATIVE DISORDERS (U.S. CLS. 1, 5, 6, 10, 26 AND 46).

CLASS 5—PHARMACEUTICALS

FOR PHARMACEUTICAL PREPARATIONS FOR TREATMENT OF NEURO-DEGENERATIVE DISORDERS; VETERINARY PREPARATION FOR TREATMENT OF NEURO-DEGENERATIVE DISORDERS IN LIVESTOCK, NAMELY CATTLE, SHEEP, GOATS, HORSES AND POULTRY; BIOLOGICAL PREPARATIONS FOR USE IN THE TREATMENT OF CENTRAL AND PERIPHERAL NERVOUS SYSTEM DISORDERS FOR HUMAN AND VETERINARY USE, IN PARTICULAR, GENE AND CELL THERAPY; CELL PREPARATIONS FOR THE TREATMENT OF NEURO-DEGENERATIVE DISORDERS, PURIFIED NEURONE CULTURES USED IN THE TREATMENT OF NEURO-DEGENERATIVE DISORDERS; COMPOUNDS, NAMELY, SMALL MOLECULES, PEPTIDES AND PEPTIDES MIMETIC FOR USE ON THE NERVOUS SYSTEMS OF HUMANS AND ANIMALS AND DIETARY SUPPLEMENTS (U.S. CLS. 6, 18, 44, 46, 51 AND 52).

SN 76-352,788. SUCCEED CORPORATION, CHANDLER, AZ, FILED 12-26-2001.

STOREBUILDER

CLASS 9—ELECTRICAL AND SCIENTIFIC APPARATUS

FOR SOFTWARE FOR ELECTRONIC COMMERCE, NAMELY, FOR DEVELOPING AND MAINTAINING ELECTRONIC COMMERCE WEBSITES, INVENTORY MANAGEMENT, SUPPLY CHAIN MANAGEMENT, ORDER FULFILLMENT, PAYMENT PROCESSING, ACCOUNTING, ACCOUNTING INTEGRATION, SALES AND MARKETING, AND AUCTION MANAGEMENT (U.S. CLS. 21, 23, 26, 36 AND 38).

CLASS 42—SCIENTIFIC, COMPUTER AND LEGAL SERVICES

FOR PROVIDING TEMPORARY USE OF ONLINE NON-DOWNLOADABLE SOFTWARE FOR ELECTRONIC COMMERCE, NAMELY, FOR DEVELOPING AND MAINTAINING ELECTRONIC COMMERCE WEBSITES, INVENTORY MANAGEMENT, SUPPLY CHAIN MANAGEMENT, ORDER FULFILLMENT, PAYMENT PROCESSING, ACCOUNTING, ACCOUNTING INTEGRATION, SALES AND MARKETING, AND AUCTION MANAGEMENT (U.S. CLS. 100 AND 101).

SN 76-354,581. ADBEAST, INC., TORONTO, ONTARIO, CANADA, FILED 12-27-2001.

ADBEAST

PRIORITY CLAIMED UNDER SEC. 44(D) ON CANADA APPLICATION NO. 1108353, FILED 7-4-2001.

CLASS 39—TRANSPORTATION AND STORAGE

FOR ELECTRONIC STORAGE FOR OTHERS, NAMELY ELECTRONIC STORAGE OF TEXT AND IMAGES FOR ADVERTISING AGENCIES AND PRINCIPALS (U.S. CLS. 100 AND 105).

FIRST USE 1-5-2001; IN COMMERCE 8-8-2001.

CLASS 42—SCIENTIFIC, COMPUTER AND LEGAL SERVICES

FOR COMPUTER SERVICES, NAMELY, PROVIDING ADVERTISING AGENCIES AND THEIR PRINCIPALS TEMPORARY USE OF NON-DOWNLOADABLE SOFTWARE AND AN INTERACTIVE ONLINE COMPUTER PLATFORM FOR PERMITTING USERS TO CATALOGUE, MANAGE, VIEW, DISTRIBUTE AND SHARE STORED TEXT AND VISUAL ADVERTISING MATERIALS ONLINE (U.S. CLS. 100 AND 101).

FIRST USE 1-5-2001; IN COMMERCE 8-8-2001.

SN 76-354,830. GKD GEBR. KUFFERATH AG, 52353 DUREN, FED REP GERMANY, FILED 1-3-2002.

WORLD WIDE WEAVE

PRIORITY CLAIMED UNDER SEC. 44(D) ON ERP CMNTY TM OFC APPLICATION NO. 002283125, FILED 7-3-2001, REG. NO. 2283125, DATED 11-11-2002, EXPIRES 7-3-2011.

NO CLAIM IS MADE TO THE EXCLUSIVE RIGHT TO USE "WEAVE", APART FROM THE MARK AS SHOWN.

CLASS 6—METAL GOODS

FOR BUILDING AND CONSTRUCTION MATERIALS FROM METAL, NAMELY, WIRE NETTING, WIRE LATTICE, WIRE GAUZE AND WIRE STRIPS, WIRE CABLES AND RODS, WIRE MESH AND SCREENS, SCREEN BANDS, ACOUSTIC WIRE MESH; AEROSPACE INDUSTRY PARTS NAMELY, WIRE CLOTH FOR LIGHTNING PROTECTION (U.S. CLS. 2, 12, 13, 14, 23, 25 AND 50).

CLASS 7—MACHINERY

FOR MACHINE PARTS, NAMELY, CONVEYOR BELTS; FILTER MEDIA NAMELY, SIEVE BELTS AND SIEVE NETTING AND SUPPORTS, FILTER MESH, FILTER FRAMES, FILTER CONES, FILTER CYLINDERS, SCREEN CYLINDERS, FILTER DISKS AND CARTRIDGES, PRESS DRAINING MESH, SIEVES MADE FROM NETTING, GAUZE AND LATTICE; MANUFACTURING PARTS NAMELY, FORMING AND VENTILATION BELTS, TRANSPORTING BANDS AND BELTS, SLING BANDS AND BELTS, SCREEN BANDS AND BELTS, SUPPORT BANDS AND BELTS (U.S. CLS. 13, 19, 21, 23, 31, 34 AND 35).

CLASS 19—NON-METALLIC BUILDING MATERIALS

FOR NON-METAL BUILDING AND CONSTRUCTION MATERIAL NAMELY, WIRE MESH AND WIRE SCREENS FROM SYNTHETIC MATERIAL; PLASTIC WIRE, PLASTIC CABLES, PLASTIC RODS (U.S. CLS. 1, 12, 33 AND 50).

CLASS 20—FURNITURE AND ARTICLES NOT OTHERWISE CLASSIFIED

FOR NON-METAL WIRE NETTING, GAUZE AND LATTICE FOR USE IN FURNITURE CONSTRUCTION (U.S. CLS. 2, 13, 22, 25, 32 AND 50).

SN 76-358,568. AIR ASSETS, INC., LAFAYETTE, CO. FILED 1-14-2002.

AIR ASSETS

SEC. 2(F).

CLASS 35—ADVERTISING AND BUSINESS

FOR RETAIL OUTLETS FEATURING AIRCRAFT PARTS AND AIRPLANE PARTS AND WHOLESALE STORES FEATURING AIRCRAFT PARTS AND AIRPLANES PARTS (U.S. CLS. 100, 101 AND 102).

FIRST USE 1-6-1998; IN COMMERCE 6-3-1998.

CLASS 36—INSURANCE AND FINANCIAL

FOR BROKERAGE OF AIRCRAFT AND AIRPLANES (U.S. CLS. 100, 101 AND 102).

FIRST USE 1-6-1998; IN COMMERCE 6-3-1998.

SN 76-362,844. CWW-GERKO AKUSTIK GMBH, D-33611 BIELEFELD, FED REP GERMANY, FILED 1-25-2002.

PROSIL

OWNER OF FED REP GERMANY REG. NO. 30146570.3, DATED 8-1-2001, EXPIRES 8-1-2012.

CLASS 12—VEHICLES

FOR LININGS FOR WHEEL HOUSINGS AND UNDERBODIES AND THERMAL PROTECTION COMPONENTS, NAMELY, LININGS, THERMAL INSULATION PANELS AND THERMAL TRANSFER DAMPING PANELS WITH ACOUSTIC DAMPING PROPERTIES, ALL FOR VEHICLES; ABSORBERS AND ABSORPTION LAYERS FOR ABSORBING AIRBORNE NOISES, DAMPING, REDUCING STRUCTURE BORNE NOISES AND REDUCING SOUND EMISSIONS, ALL FOR VEHICLES (U.S. CLS. 19, 21, 23, 31, 35 AND 44).

CLASS 17—RUBBER GOODS

FOR INSULATING MATERIAL, NAMELY, LINING MATERIAL FOR WHEEL HOUSINGS AND UNDERBODIES, THERMAL PROTECTION COMPONENTS, NAMELY, INSULATION AND INSULATION PANELS WITH ACOUSTIC DAMPING PROPERTIES, ABSORBERS AND ABSORPTION LAYERS FOR ABSORBING AIRBORNE NOISES, DAMPING, REDUCING STRUCTURE BORNE NOISES AND REDUCING SOUND EMISSIONS (U.S. CLS. 1, 5, 12, 13, 35 AND 50).

SN 76-367,038. EVOLOGIC SA, 9100 EVRY, FRANCE, FILED 2-6-2002.

EVOLOGIC

PRIORITY CLAIMED UNDER SEC. 44(D) ON FRANCE APPLICATION NO. 013115553, FILED 8-6-2001, REG. NO. 013115553, DATED 8-6-2001, EXPIRES 8-6-2011.

CLASS 1—CHEMICALS

FOR CHEMICAL, BIOCHEMICAL, BIOLOGICAL, BIOTECHNOLOGICAL PREPARATIONS NAMELY, REAGENTS USED IN SCIENTIFIC LABORATORY ANALYSIS, CULTURES AND PREPARATIONS OF MICRO-ORGANISMS FOR USE IN SCIENTIFIC AND MEDICAL RESEARCH (U.S. CLS. 1, 5, 6, 10, 26 AND 46).

CLASS 5—PHARMACEUTICALS

FOR PHARMACEUTICAL, VETERINARY, CHEMICAL, BIOCHEMICAL, BIOLOGICAL AND BIOTECHNOLOGICAL PREPARATIONS FOR USE IN THE TREATMENT OF BACTERIAN INFECTIOUS DISEASES AND VIRAL AND FUNGIC DISEASE FOR MEDICAL, PHARMACEUTICAL AND VETERINARY USE; CHEMICAL, PHARMACEUTICAL PREPARATIONS FOR USE IN THE TREATMENT OF BACTERIAN INFECTIOUS DISEASES AND VIRAL AND FUNGIC DISEASES; BACTERIOLOGICAL AND BACTERIAL PREPARATIONS FOR MEDICAL AND VETERINARY USE FOR USE IN THE TREATMENT OF BACTERIAN INFECTIOUS DISEASES AND VIRAL AND FUNGIC DISEASES; CHEMICAL, BIOLOGICAL, BIOCHEMICAL, BIOTECHNOLOGICAL PREPARATIONS FOR USE IN THE TREATMENT OF BACTERIAN INFECTIOUS DISEASES AND VIRAL FUNGIC DISEASES FOR THE MEDICAL AND VETERINARY USE; DIAGNOSTIC REAGENT PREPARATIONS OF MEDICAL AND VETERINARY USE; CULTURES AND PREPARATIONS OF MICRO-ORGANISMS FOR MEDICAL AND VETERINARY USE IN THE TREATMENT OF BACTERIAN INFECTIOUS DISEASES AND VIRAL AND FUNGIC DISEASES (U.S. CLS. 6, 18, 44, 46, 51 AND 52).

CLASS 38—COMMUNICATION

FOR COMMUNICATIONS SERVICES, NAMELY, TRANSMITTING SOUNDS, IMAGES, AUDIO VISUAL RECORDINGS, INFORMATION, MESSAGE AND DATA, IN THE PHARMACEUTICAL AND MEDICAL FIELD VIA TELEMATICS OR SATELLITE; ELECTRONIC MAIL AND ELECTRONIC TRANSMISSION OF MESSAGES AND DATA SERVICES; ELECTRONIC TRANSMISSION OF SOUNDS, IMAGES, AUDIO VISUAL RECORDINGS, INFORMATION, MESSAGE AND DATA IN THE PHARMACEUTICAL AND MEDICAL FIELD VIA THE INTERNET OR THE INTRANET; TRANSMISSION AND DIFFUSION OF DATA, SOUNDS AND IMAGES VIA COMPUTER TERMINALS (U.S. CLS. 100, 101 AND 104).

CLASS 42—SCIENTIFIC, COMPUTER AND LEGAL SERVICES

FOR SCIENTIFIC AND INDUSTRIAL RESEARCH; BIOLOGICAL RESEARCH; VEGETAL AND ANIMAL BIOTECHNOLOGICAL RESEARCH; RESEARCH AND DEVELOPMENT OF BIOCHEMICAL ANALYSIS TECHNIQUES AND BIOLOGICAL TECHNIQUES; GENETIC RESEARCH SERVICES; RESEARCH IN PHARMACOLOGY; CONSULTATION IN THE FIELD OF BIOLOGY AND BIOTECHNOLOGY; RESEARCH AND DEVELOPMENT OF NEW PRODUCTS IN THE FIELD OF PHARMACY, BIOLOGY, BIOTECHNOLOGY, MEDICINE AND SCIENCES; RESEARCH LABORATORIES; RESEARCH AND DEVELOPMENT IN PHARMACOLOGY AND MEDICAL SCIENCE (U.S. CLS. 100 AND 101).

CLASS 44—MEDICAL, BEAUTY AND AGRICULTURAL SERVICES

FOR CONSULTATION IN THE FIELD OF PHARMACY AND MEDICINE (U.S. CLS. 100 AND 101).

SN 76-371,599. ECOPLUMB, LLC, CHICAGO, IL, FILED 2-19-2002.

ECOPLUMB**CLASS 35—ADVERTISING AND BUSINESS**

FOR RETAIL STORES, WHOLESALE DISTRIBUTORSHIPS, MAIL ORDER SERVICES, AND ONLINE ORDERING SERVICES IN THE FIELD OF HEATING, PLUMBING AND BATHROOM SUPPLIES (U.S. CLS. 100, 101 AND 102).

CLASS 37—CONSTRUCTION AND REPAIR

FOR INSTALLATION, CLEANING, MAINTENANCE AND REPAIR OF BATHROOM FIXTURES, COMPRISED OF CONNECTING THE FIXTURES TO THE PLUMBING SYSTEM AND PERIODIC CLEANING AND REPAIR AND/OR REPLACEMENT OF THE FIXTURE AND ITS PARTS TO KEEP THE FIXTURE OPERATIONAL; INSTALLATION AND MAINTENANCE OF WASTEWATER TREATMENT UNITS, COMPRISED OF CONNECTING THE UNITS TO THE PLUMBING SYSTEM AND PERIODIC CLEANING AND REPAIR AND/OR REPLACEMENT OF THE UNIT AND ITS PARTS TO KEEP THE UNIT OPERATIONAL (U.S. CLS. 100, 103 AND 106).

SN 76-372,423. MULTI-AD SERVICES, INC., PEORIA, IL.
FILED 2-20-2002.

MultiAd

CLASS 35—ADVERTISING AND BUSINESS

FOR PROVIDING ADVERTISING AND MARKETING CONSULTING, DEVELOPMENT AND MANAGEMENT SERVICES FOR OTHERS, NAMELY PRODUCT MERCHANDISING; COOPERATIVE ADVERTISING, CREATION AND DEVELOPMENT OF SPEC ADVERTISEMENTS AND READY-TO-USE ADVERTISEMENTS FOR OTHERS; ONLINE COMPUTER DATABASE FEATURING DOWNLOADABLE PRODUCT IMAGES, LOGOS AND PRODUCT DATA, AND CREATIVE ADVERTISING CONTENT; ADVERTISING SERVICES, NAMELY, CREATING CORPORATE AND BRAND IDENTITY FOR OTHERS; PREPARING PROMOTIONAL PLANS AND MATERIALS FOR USE AT TRADE SHOWS; PRODUCT MERCHANDISING SERVICES IN THE NATURE OF PLANNING SUPPORT FOR MANUFACTURERS AND RETAILERS, NAMELY, PREPARING PRODUCT DISPLAYS, INVENTORY CONTROL, PREPARING PROMOTIONAL SHELF DIVIDERS, AND PROVIDING PRODUCT MERCHANDISING STRATEGIES FOR THE ARRANGEMENT OF RETAIL PRODUCTS ON RETAIL SHELVES OR DISPLAYS IN ORDER TO INCREASE CUSTOMER PURCHASES; RECORDS MANAGEMENT SERVICES, NAMELY, DOCUMENT INDEXING FOR OTHERS; DISSEMINATION OF ADVERTISING CONTENT FOR OTHERS VIA THE INTERNET; AND CONSULTING SERVICES RELATED TO ALL OF THE FOREGOING; PRODUCTION OF PRINT, AUDIO, VIDEO, AND MULTIMEDIA MATERIALS, PRESENTATIONS AND PROGRAMS FOR OTHERS TO USE TO PROMOTE THEIR PRODUCTS AND SERVICES; ELECTRONIC PUBLISHING SERVICES, NAMELY PUBLICATION OF TEXT AND GRAPHIC WORKS OF OTHERS ON COMPUTER DISKS AND ONLINE DOWNLOADABLE ELECTRONIC FILES FEATURING PRODUCT IMAGES AND LOGOS AND PRODUCT DATA FOR USE IN PROMOTING, ADVERTISING AND MERCHANDISING PRODUCTS (U.S. CLS. 100, 101 AND 102).

FIRST USE 1-1-1960; IN COMMERCE 1-1-1960.

CLASS 40—MATERIAL TREATMENT

FOR PHOTOGRAPHIC REPRODUCTION OF DOCUMENTS AND IMAGES FOR OTHERS; DIGITAL IMAGING AND PHOTOGRAPHY SERVICES; PRE-PRESS SERVICES, NAMELY, ELECTRONIC IMAGING, SCANNING, SETTING, DIGITIZING, ALTERATION, RESTORATION AND RETOUCHING OF ARTWORK, IMAGES, TEXT, PHOTOGRAPHS, ILLUSTRATIONS AND GRAPHIC DESIGNS; PHOTOCOMPOSITION SERVICES FOR OTHERS; COLOR SEPARATION SERVICES; PREPARING FILM AND DIGITAL FILES, NAMELY, PREVIEWING, PROOFING, MANIPULATING, AND REDUCING FILM AND DIGITAL FILES FOR USE IN PRINTING AND MULTIMEDIA PRODUCTION FOR OTHERS; LAMINATING OF SHEETS; POST-PRODUCTION SERVICES, FEATURING NON-LINEAR EDITING, GRAPHICS PRODUCTION, FILM AND VIDEOTAPE EDITING, FILM SCANNING, COLORING AND DUBBING, MULTI-MEDIA COMPOSITION OF PHOTO IMAGES AND VIDEO MATERIAL, GRAPHIC ART WORK AND ANIMATION, TO THE ORDER AND SPECIFICATION OF OTHERS; PRINTING SERVICES, NAMELY, 1 TO 5 COLOR PRINTING AND LARGE FORMAT PRINTING (U.S. CLS. 100, 103 AND 106).

FIRST USE 1-1-1960; IN COMMERCE 1-1-1960.

CLASS 41—EDUCATION AND ENTERTAINMENT

FOR AUDIO RECORDING AND VIDEOTAPE PRODUCTION SERVICES AND PRODUCTION OF PRINT, PHOTOGRAPHIC, AUDIO, VIDEO, MULTIMEDIA OR ELECTRONIC PRESENTATIONS FOR OTHERS, AND EDITING PROOF-BOOKS AND REFERENCE BOOKS TO THE ORDER AND SPECIFICATION OF PARTICIPATING PRODUCT, FOOD AND BEVERAGE MANUFACTURERS (U.S. CLS. 100, 101 AND 107).

FIRST USE 1-1-1989; IN COMMERCE 1-1-1989.

CLASS 42—SCIENTIFIC, COMPUTER AND LEGAL SERVICES

FOR DOCUMENT, DATA, TEXT, IMAGE, PHOTOGRAPHY AND GRAPHIC WORKS RETRIEVAL AND CONVERSION FROM ONE FORM OF MEDIA TO ANOTHER; GRAPHIC ART DESIGN AND ILLUSTRATION SERVICES FOR OTHERS; INTEGRATION OF COMPUTER SYSTEMS AND NETWORKS, NAMELY DATABASE AND DIRECTORY INTEGRATION; COMPUTER SERVICES FOR OTHERS, NAMELY, DESIGNING, PROGRAMMING, CREATING, IMPLEMENTING, MAINTAINING, AND HOSTING NETWORK WEB PAGES, USER INTERFACES AND WEBSITES FOR OTHERS, HOSTING CONTENT MANAGEMENT SYSTEMS FOR OTHERS; DIGITAL ASSET MANAGEMENT SERVICES FOR OTHERS; AND CREATING PROMOTIONAL KIOSKS, NAMELY, CUSTOM DESIGN OF KIOSKS FOR USE AT TRADESHOWS (U.S. CLS. 100 AND 101).

FIRST USE 1-1-1960; IN COMMERCE 1-1-1960.

SN 76-372,750. SPIRITUALIST CENTER, LOS ANGELES, CA.
FILED 2-19-2002.

SPIRITUALIST CENTER

SEC. 2(F).

CLASS 9—ELECTRICAL AND SCIENTIFIC APPARATUS

FOR VIDEO CASSETTES AND AUDIO CASSETTES FEATURING CHANNELED MESSAGES FROM DECEASED INDIVIDUALS (U.S. CLS. 21, 23, 26, 36 AND 38).

FIRST USE 12-2-1972; IN COMMERCE 12-2-1972.

CLASS 16—PAPER GOODS AND PRINTED MATTER

FOR PRAYER CARDS (U.S. CLS. 2, 5, 22, 23, 29, 37, 38 AND 50).

FIRST USE 12-2-1972; IN COMMERCE 12-2-1972.

SN 76-375,505. NISSAN JIDOSHA KABUSHIKI KAISHA, TA NISSAN MOTOR CO., LTD, YOKOHAMA-SHI, KANAGAWA-KEN, JAPAN, FILED 2-26-2002.

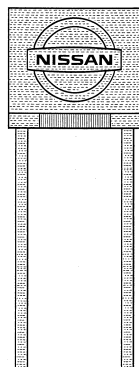

OWNER OF U.S. REG. NOS. 204,840, 2,444,813 AND OTHERS.

THE DRAWING IS LINED FOR THE COLORS SILVER AND RED, AND COLOR IS CLAIMED AS A FEATURE OF THE MARK.

THE MARK COMPRISES A RAISED MARQUEE SIGN CONSISTING OF A SQUARE EDIFICE AND MOUNTED ON VERTICAL PILLARS, ALL IN THE COLOR SILVER. THE MARQUEE SIGN DISPLAYS LETTERING CONSISTING OF "NISSAN" AND A HORIZONTAL BAR ALONG THE BASE OF THE EDIFICE IN THE COLOR RED.

CLASS 35—ADVERTISING AND BUSINESS

FOR MOTOR VEHICLE DEALERSHIP SERVICES (U.S. CLS. 100, 101 AND 102).

FIRST USE 11-0-2002; IN COMMERCE 11-0-2002.

CLASS 37—CONSTRUCTION AND REPAIR

FOR MOTOR VEHICLE REPAIR AND MAINTENANCE SERVICES (U.S. CLS. 100, 103 AND 106).

FIRST USE 11-0-2002; IN COMMERCE 11-0-2002.

SN 76-375,552. THE TAHIRIH JUSTICE CENTER, FALLS CHURCH, VA. FILED 2-26-2002.

THE TAHIRIH JUSTICE CENTER

NO CLAIM IS MADE TO THE EXCLUSIVE RIGHT TO USE "JUSTICE CENTER", APART FROM THE MARK AS SHOWN.

THE ENGLISH TRANSLATION OF THE MARK "TAHIRIH" IS "THE PURE ONE".

CLASS 35—ADVERTISING AND BUSINESS

FOR ASSOCIATION SERVICES, NAMELY, PROMOTING THE INTERESTS OF WOMEN FACING HUMAN RIGHTS ABUSES (U.S. CLS. 100, 101 AND 102).

FIRST USE 8-0-1997; IN COMMERCE 8-0-1997.

CLASS 42—SCIENTIFIC, COMPUTER AND LEGAL SERVICES

FOR PROVIDING LEGAL SERVICES TO WOMEN SEEKING PROTECTION FROM HUMAN RIGHTS ABUSES (U.S. CLS. 100 AND 101).

FIRST USE 8-0-1997; IN COMMERCE 8-0-1997.

SN 76-375,904. BELK STORES SERVICES, INC., CHARLOTTE, NC. FILED 2-27-2002.

HOME ACCENTS GOURMET

OWNER OF U.S. REG. NOS. 1,350,080 AND 1,930,355.

NO CLAIM IS MADE TO THE EXCLUSIVE RIGHT TO USE "HOME" AND "GOURMET", APART FROM THE MARK AS SHOWN.

CLASS 8—HAND TOOLS

FOR FLATWARE; CUTLERY; AND SLICERS, NAMELY, HAND-OPERATED FOOD SLICERS, CHEESE SLICERS, BAGEL SLICERS, FRUIT AND VEGETABLE SLICERS (U.S. CLS. 23, 28 AND 44).

CLASS 21—HOUSEWARES AND GLASS

FOR CULINARY EQUIPMENT AND COOKWARE, NAMELY, SAUCE PANS, DUTCH OVENS, STOCK POTS, SKILLETS, ROASTING PANS, FRYING PANS, LASAGNA PANS, CASSEROLE DISHES, RAMEKINS; BAKEWARE; COOKING UTENSILS, NAMELY, SERVING SPOONS, SPATULAS, TONGS, LADLES, FRUIT SQUEEZERS, POTATO MASHERS, CAN OPENERS, GARLIC SQUEEZERS, WHISKS, GRATERS, STRAINERS, EGG BEATERS, COCKTAIL SHAKERS, COOKIE CUTTERS, CORK SCREWS, FLOUR SIFTERS, ICE BUCKETS, MEAT TENDERIZER, MELON BALLER, PASTRY BRUSH, PEELER, SCOOPS, BARBEQUE BRUSHES, AND BARBEQUE FORKS; KITCHEN ACCESSORIES, NAMELY, CANISTER SETS, COOKIE JARS, MUG TREES, SPICE RACKS, TEA KETTLES, PAPER TOWEL HOLDERS, SERVING TRAYS NOT OF PRECIOUS METAL, DRINKING GLASSES, PITCHERS, BOWLS, NAPKIN HOLDERS, SUGAR AND CREAM CADDIES, CONDIMENT CADDIES, BREAD BOXES, CUTTING BOARDS, RECIPE BOXES, ROLLING PINS, TRIVETS, CONTAINERS FOR FOOD, AND SERVING PLATTERS; DINNERWARE, NAMELY, BOWLS CUPS, MUGS, PLATES, SAUCERS, PLATTERS, CREAMERS, AND TEA POTS (U.S. CLS. 2, 13, 23, 29, 30, 33, 40 AND 50).

SN 76-377,659. TIA MARIA LIMITED, BRISTOL, ENGLAND, FILED 3-4-2002.

TIA MARIA

PRIORITY CLAIMED UNDER SEC. 44(D) ON UNITED KINGDOM APPLICATION NO. 2289155, FILED 1-2-2002, REG. NO. 2289155, DATED 1-2-2002, EXPIRES 1-2-2012.

THE ENGLISH TRANSLATION OF "TIA" IS "AUNT".

CLASS 29—MEATS AND PROCESSED FOODS

FOR JELLIES, JAMS, FRUIT SAUCES; EGGS, MILK AND MILK PRODUCTS EXCLUDING ICE CREAM, ICE MILK AND FROZEN YOGURT (U.S. CL. 46).

CLASS 30—STAPLE FOODS

FOR COFFEE, TEA, COCOA, SUGAR, RICE, BREAD, PASTRY AND CONFECTIONERY NAMELY COOKIES, CANDY, CHOCOLATES, CAKES AND PIES, BAKERY PRODUCTS, BUBBLEGUM, CHEWING GUM, POPPED POPCORN, CARAMEL POPCORN, PROCESSED POPCORN, ICE CREAM, ICE MILK, FROZEN YOGURT, FLAVORED ICES, PUDDINGS, EDIBLE AND CANDY CAKE DECORATIONS (U.S. CL. 46).

SN 76-378,285. CRYSTAL AWARDS, INC., DALLAS, TX. FILED 3-6-2002.

SN 76-383,430. SPARR LLC, FREMONT, CA. FILED 3-18-2002.

AWARDS FROM ANTONIO

NO CLAIM IS MADE TO THE EXCLUSIVE RIGHT TO USE "AWARDS", APART FROM THE MARK AS SHOWN.

CLASS 35—ADVERTISING AND BUSINESS

FOR WHOLESALE DISTRIBUTORSHIPS FEATURING CRYSTAL GOODS, LEATHER GOODS, AND OUTDOOR LEISURE GOODS USED PRIMARILY AS AWARDS AND INCENTIVES (U.S. CLS. 100, 101 AND 102).

FIRST USE 1-6-2002; IN COMMERCE 1-6-2002.

CLASS 40—MATERIAL TREATMENT

FOR CUSTOM SILK SCREENING, ETCHING, ENGRAVING AND EMBOSsing OF CRYSTAL GOODS, LEATHER GOODS, AND OUTDOOR LEISURE GOODS USED PRIMARILY AS AWARDS AND INCENTIVES (U.S. CLS. 100, 103 AND 106).

FIRST USE 1-6-2002; IN COMMERCE 1-6-2002.

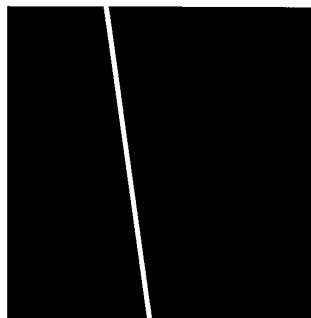

CLASS 16—PAPER GOODS AND PRINTED MATTER

FOR STATIONERY PRODUCTS, NAMELY, NOTEBOOKS, COMPOSITION BOOKS, STATIONERY-TYPE PORTFOLIOS, DIARIES, GUEST BOOKS, TELEPHONE-ADDRESS BOOKS, AND LEGAL PADS; DATE PLANNERS AND CALENDARS; PHOTOGRAPH ALBUMS AND INSERTS; PHOTOGRAPHS, POSTERS, PRINTED ART REPRODUCTIONS, LITHOGRAPHS, LITHOGRAPHIC PRINTS, SOUVENIR BOOKS, GREETING CARDS, TRADING CARDS, POSTCARDS, BUSINESS CARDS, DECALS, HEAT TRANSFERS AND BUMPER STICKERS; BINDERS, BINDER INSERTS, BINDER PAPER, SHEET PAPER, FOLDERS, AND ENVELOPES; INDEX TABS, AND TABBED AND UNTABBED DIVIDER SHEETS FOR BINDERS; ADHESIVE LETTERS, NUMBERS, AND SYMBOLS; EMBOSSABLE SEALS; CARDBOARD TAGS; TRANSPARENT-PLASTIC BINDER PAGES FOR HOLDING AND DISPLAYING PHOTOGRAPHS, TRADING CARDS, POSTCARDS, BUSINESS CARDS; TABBED TRANSPARENT-PLASTIC BINDER PAGES; SHEET PROTECTORS AND SHEET PROTECTOR INDEX DIVIDERS; TRANSPARENT-PLASTIC LAMINATING SHEETS FOR PROTECTING PHOTOGRAPHS, TRADING CARDS, POSTCARDS, BUSINESS CARDS; SELF-ADHESIVE LABEL HOLDERS; SELF-ADHESIVE HOLDERS FOR PHOTOGRAPHS, TRADING CARDS, POSTCARDS, BUSINESS CARDS; ZIPPER POUCHES OF PAPER OR PLASTIC FOR PACKAGING; PENS, CHALK, PENCILS, PENCIL CRAYONS, COLOR MARKERS, HIGHLIGHTING MARKERS, AND ERASERS; PUSH PINS, AND THUMB TACKS; PLASTIC OR PAPER BAGS FOR MERCHANDISE PACKAGING; MAIL ORDER CATALOGS FEATURING CLOTHING, ACCESSORIES, TOILETRIES, JEWELRY, MUSIC, AND STATIONERY PRODUCTS; BOOKS ON POETRY, BOOKS ON ROMANCE, AND BOOK MARKS; GIFT WRAP, GIFT TAGS, GIFT BAGS, AND GIFT BOXES (U.S. CLS. 2, 5, 22, 23, 29, 37, 38 AND 50).

FIRST USE 3-1-2002; IN COMMERCE 3-1-2002.

CLASS 25—CLOTHING

FOR CLOTHING, NAMELY, BATHROBES, BEACH COVER-UPS, BEACHWEAR, BELTS, BLAZERS, BLOUSES, BODY SHAPERS, BODY SUITS, BOXER SHORTS, BRAS, BUSTIERS, CAMISOLES, CAPS, COATS, DRESSES, FOOTWEAR, FOUNDATION GARMENTS, GARTER BELTS, GIRDLES, GLOVES, GOWNS, HALTER TOPS, HATS, HEADBANDS, HOSIERY, JACKETS, JEANS, JOGGING SUITS, KNEE HIGHS, KNIT SHIRTS, KNIT TOPS, LEOTARDS, LINGERIE, LOUNGEWEAR, MITTENS, NEGLIGEEES, NIGHT GOWNS, NIGHT SHIRTS, PAJAMAS, PANTIES, PANTS, PANTYHOSE, RAINWEAR, SARONGS, SCARVES, SHIRTS, SHORTS, SKIRTS, SLACKS, SLEEPWEAR, SLIPS, SOCKS, STOCKINGS, SUITS, SWEAT PANTS, SWEAT SHIRTS, SWEAT SHORTS, SWEAT SUITS, SWEATERS, SWIM WEAR, T-SHIRTS, TANK TOPS, TAP PANTS, TEDDIES, TIES, TIGHTS, UNDERPANTS, UNDERSHIRTS, UNDERWEAR AND VESTS (U.S. CLS. 22 AND 39).

FIRST USE 3-1-2002; IN COMMERCE 3-1-2002.

SN 76-379,909. PETROSSIAN, INC., NEW YORK, NY. FILED 3-7-2002.

ALWYN COURT

CLASS 29—MEATS AND PROCESSED FOODS

FOR MEAT, MEAT EXTRACTS, PATE, FISH, SMOKED FISH, AND MARINATED FISH, FISH ROE, CAVIAR, GOOSE AND DUCK FOIE GRAS, PASTES AND CREAMS MADE FROM FOIE GRAS, TRUFFLES, PRESERVED, DRIED AND COOKED FRUIT AND VEGETABLES, JELLIES, JAMS, EGGS, MILK AND DAIRY PRODUCTS, NAMELY, YOGURT (U.S. CL. 46).

CLASS 30—STAPLE FOODS

FOR COFFEE, TEA, COCOA, SUGAR, PREPARATIONS MADE FROM CEREALS, NAMELY, BLINIS, CREPES, CRACKERS, BREAD, PASTRIES; CONFECTIONERY, NAMELY, CANDY, TOFFEES, CHOCOLATE, ICING, CHOCOLATE BASED ICING, FRUIT BASED ICING, PEARLS OF CHOCOLATE; ICE CREAM (U.S. CL. 46).

CLASS 33—WINES AND SPIRITS

FOR ALCOHOLIC BEVERAGES, NAMELY, WINES, DISTILLED SPIRITS, VODKA, CHAMPAGNE, AND ALCOHOLIC BEVERAGES CONTAINING FRUIT, NAMELY PREPARED ALCOHOLIC COCKTAILS AND PUNCHES (U.S. CLS. 47 AND 49).

CLASS 43—HOTEL AND RESTAURANT SERVICES

FOR RESTAURANT SERVICES (U.S. CLS. 100 AND 101).

SN 76-384,410. HEIDELBERGER DRUCKMASCHINEN AG, D-69115 HEIDELBERG, FED REP GERMANY, FILED 3-18-2002.

INDUSTRIA

THE ENGLISH TRANSLATION OF THE SPANISH WORD "INDUSTRIA" IS "INDUSTRY".

CLASS 9—ELECTRICAL AND SCIENTIFIC APPARATUS

FOR TYPEFACE FONTS RECORDED ON MAGNETIC MEDIA, OPTICAL MEDIA, OPTO-MAGNETIC MEDIA, COMPACT DISCS, DVDS, HARD DRIVES, AND FLOPPY DISKS (U.S. CLS. 21, 23, 26, 36 AND 38).

CLASS 16—PAPER GOODS AND PRINTED MATTER

FOR PRINTING FONTS (U.S. CLS. 2, 5, 22, 23, 29, 37, 38 AND 50).

SN 76-390,889. THE TRUSTEES OF ARAVINDA TRUST, A TRUST OF INDIA, THE TRUSTEES COMPRISING LAURA REDDY, A US CITIZEN AND PAUL PINTHON, A FRANCE CITIZEN, DBA MAROMA, TAMIL NADU, INDIA, FILED 4-3-2002.

ENCENS LITE

NO CLAIM IS MADE TO THE EXCLUSIVE RIGHT TO USE "INCENSE", APART FROM THE MARK AS SHOWN.

THE ENGLISH TRANSLATION OF THE WORD "ENCENS" IN THE MARK IS "INCENSE".

CLASS 3—COSMETICS AND CLEANING PREPARATIONS

FOR INCENSE, SACHETS, PERFUMERY, AND BODY CARE PRODUCTS, NAMELY SOAPS, COSMETICS, ESSENTIAL OILS AND HAIR LOTIONS (U.S. CLS. 1, 4, 6, 50, 51 AND 52).

CLASS 4—LUBRICANTS AND FUELS

FOR CANDLES (U.S. CLS. 1, 6 AND 15).

SN 76-391,169. SOCIETE FRANCAISE D'ASSAINISSEMENT-SFA, F-75002 PARIS, FRANCE, FILED 4-3-2002.

SANIGRIND

OWNER OF U.S. REG. NOS. 1,907,075, 1,921,496 AND 1,929,078.

CLASS 7—MACHINERY

FOR SANITARY INSTALLATIONS, NAMELY GRINDERS AND SHREDDERS FOR TOILETS (U.S. CLS. 13, 19, 21, 23, 31, 34 AND 35).

CLASS 11—ENVIRONMENTAL CONTROL APPARATUS

FOR SANITARY INSTALLATIONS, NAMELY, TOILETS AND PARTS THEREOF, NAMELY, WATER FLUSHING APPARATUS, TOILET SEAT LIDS, TOILET BOWLS, FLUSHING HANDLES, WATER TANKS AND TOILET SEATS (U.S. CLS. 13, 21, 23, 31 AND 34).

SN 76-391,170. SOCIETE FRANCAISE D'ASSAINISSEMENT-SFA, F-75002 PARIS, FRANCE, FILED 4-3-2002.

SANIGRINDER

OWNER OF U.S. REG. NOS. 1,907,075, 1,921,496 AND 1,929,078.

CLASS 7—MACHINERY

FOR SANITARY INSTALLATIONS, NAMELY GRINDERS AND SHREDDERS FOR TOILETS (U.S. CLS. 13, 19, 21, 23, 31, 34 AND 35).

CLASS 11—ENVIRONMENTAL CONTROL APPARATUS

FOR SANITARY INSTALLATIONS, NAMELY, TOILETS AND PARTS THEREOF, NAMELY, WATER FLUSHING APPARATUS, TOILET SEAT LIDS, TOILET BOWLS, FLUSHING HANDLES, WATER TANKS AND TOILET SEATS (U.S. CLS. 13, 21, 23, 31 AND 34).

SN 76-391,389. BUSH-BROGAN 2002, MIAMI, FL. FILED 4-4-2002.

BUSH-BROGAN '02

NO CLAIM IS MADE TO THE EXCLUSIVE RIGHT TO USE "02", APART FROM THE MARK AS SHOWN.

CLASS 35—ADVERTISING AND BUSINESS

FOR PROMOTING THE PUBLIC AWARENESS OF THE CANDIDATE, JEB BUSH, BY PROVIDING INFORMATION ABOUT THE CANDIDATE AND PROMOTING THE ELECTION OF THE CANDIDATE (U.S. CLS. 100, 101 AND 102).

FIRST USE 7-5-2001; IN COMMERCE 7-5-2001.

CLASS 36—INSURANCE AND FINANCIAL

FOR POLITICAL CAMPAIGN SERVICES, NAMELY FUNDRAISING IN THE FIELD OF POLITICS (U.S. CLS. 100, 101 AND 102).

FIRST USE 7-5-2001; IN COMMERCE 7-5-2001.

CLASS 42—SCIENTIFIC, COMPUTER AND LEGAL SERVICES

FOR PROVIDING INFORMATION IN THE FIELD OF POLITICS BY MEANS OF A GLOBAL COMPUTER NETWORK (U.S. CLS. 100 AND 101).

FIRST USE 7-5-2001; IN COMMERCE 7-5-2001.

SN 76-393,402. MCKENNA, BARBARA F., CENTENNIAL, CO. FILED 4-10-2002.

THE MILLION DOLLAR WOMAN

CLASS 9—ELECTRICAL AND SCIENTIFIC APPARATUS

FOR PRERECORDED VIDEOTAPES AND ELECTRONIC BOOKS RECORDED ON COMPUTER MEDIA BOTH IN THE FIELD OF WEALTH BUILDING, FINANCE OR INVESTMENTS; COMPUTER SOFTWARE IN THE FIELD OF WEALTH BUILDING, FINANCE OR INVESTMENTS (U.S. CLS. 21, 23, 26, 36 AND 38).

CLASS 16—PAPER GOODS AND PRINTED MATTER

FOR PRINTED INSTRUCTION, EDUCATIONAL AND TEACHING MATERIALS IN THE FIELD OF WEALTH BUILDING, FINANCE OR INVESTMENTS; PUBLICATIONS IN THE NATURE OF BOOKS, NEWSLETTERS, HOUSE ORGANS, BROCHURES, PAMPHLETS IN THE FIELD OF WEALTH BUILDING, FINANCE OR INVESTMENTS (U.S. CLS. 2, 5, 22, 23, 29, 37, 38 AND 50).

CLASS 36—INSURANCE AND FINANCIAL

FOR PROVIDING INFORMATION ABOUT WEALTH BUILDING, FINANCE OR INVESTMENTS (U.S. CLS. 100, 101 AND 102).

CLASS 41—EDUCATION AND ENTERTAINMENT

FOR EDUCATIONAL SERVICES, NAMELY, CONDUCTING SEMINARS, CLASSES, PRESENTATIONS AND COURSES IN THE FIELD OF FINANCIAL SERVICES, NAMELY, WEALTH BUILDING, FINANCE OR INVESTMENTS AND DISTRIBUTING COURSE MATERIAL IN CONNECTION THEREWITH (U.S. CLS. 100, 101 AND 107).

SN 76-393,906. KASGRO RAIL CORP., NEW CASTLE, PA. FILED 4-11-2002.



CLASS 37—CONSTRUCTION AND REPAIR

FOR REPAIRING, RESTORING, AND REFURBISHING RAILROAD CARS (U.S. CLS. 100, 103 AND 106). FIRST USE 5-15-2001; IN COMMERCE 5-15-2001.

CLASS 39—TRANSPORTATION AND STORAGE

FOR LEASING OF RAILROAD CARS (U.S. CLS. 100 AND 105). FIRST USE 5-15-2001; IN COMMERCE 5-15-2001.

CLASS 40—MATERIAL TREATMENT

FOR MANUFACTURING RAILROAD CARS TO THE ORDER AND SPECIFICATIONS OF OTHERS (U.S. CLS. 100, 103 AND 106). FIRST USE 5-15-2001; IN COMMERCE 5-15-2001.

SN 76-394,148. COUNCIL FOR HIGHER EDUCATION ACCREDITATION, WASHINGTON, DC. FILED 4-11-2002.

COUNCIL FOR HIGHER EDUCATION ACCREDITATION

NO CLAIM IS MADE TO THE EXCLUSIVE RIGHT TO USE "COUNCIL", APART FROM THE MARK AS SHOWN. SEC. 2(F).

CLASS 16—PAPER GOODS AND PRINTED MATTER

FOR PUBLICATIONS, NAMELY, BOOKS, RESEARCH PAPERS, FACT SHEETS, ALMANACS, MONOGRAPHS IN THE FIELDS OF HIGHER EDUCATION AND ACCREDITATION (U.S. CLS. 2, 5, 22, 23, 29, 37, 38 AND 50). FIRST USE 0-0-1996; IN COMMERCE 0-0-1996.

CLASS 35—ADVERTISING AND BUSINESS

FOR ASSOCIATION SERVICES, NAMELY PROMOTING THE INTERESTS OF ACCREDITORS IN THE FIELDS OF HIGHER EDUCATION AND ACCREDITATION (U.S. CLS. 100, 101 AND 102). FIRST USE 0-0-1996; IN COMMERCE 0-0-1996.

CLASS 41—EDUCATION AND ENTERTAINMENT

FOR WORKSHOPS FOR MEMBER COLLEGES, UNIVERSITIES AND ACCREDITORS AND MEMBERS OF ACCREDITING COMMISSIONS IN THE FIELDS OF HIGHER EDUCATION AND ACCREDITATION; RESEARCH IN THE FIELDS OF HIGHER EDUCATION (U.S. CLS. 100, 101 AND 107). FIRST USE 0-0-1996; IN COMMERCE 0-0-1996.

CLASS 42—SCIENTIFIC, COMPUTER AND LEGAL SERVICES

FOR EVALUATION OF COLLEGES AND UNIVERSITIES FOR PURPOSES OF ACCREDITATION AND COORDINATION OF ACCREDITATION ACTIVITIES OF OTHERS, NAMELY ASSIST ACCREDITORS IN QUALITY REVIEW OF THEIR ACCREDITATION ACTIVITIES, NAMELY SELF-EXAMINATION AND PEER REVIEW OF ACCREDITATION ACTIVITIES, STANDARDS AND PROCEDURES, AND CREATE AND IMPLEMENT STANDARDS FOR RECOGNITION OF ACCREDITORS; RESEARCH IN THE FIELD OF ACCREDITATION, NAMELY, STANDARDS FOR RECOGNITION OF ACCREDITORS, AND ACCREDITATION ACTIVITIES, STANDARDS, AND PROCEDURES FOLLOWED BY ACCREDITORS; AND POLICY ANALYSIS IN THE FIELD OF HIGHER EDUCATION AND ACCREDITATION, NAMELY ANALYZE EDUCATIONAL POLICIES OF ACCREDITORS, NAMELY ACCREDITATION ACTIVITIES, STANDARDS AND PROCEDURES (U.S. CLS. 100 AND 101). FIRST USE 0-0-1996; IN COMMERCE 0-0-1996.

SN 76-394,926. APPLE PRODUCTS, INC., MORROW, GA.
FILED 4-12-2002.

SN 76-395,947. LAWSON MARDON NEHER LTD., KREUZLINGEN, SWITZERLAND, FILED 4-15-2002.



NO CLAIM IS MADE TO THE EXCLUSIVE RIGHT TO USE "PRODUCTS, INC.", APART FROM THE MARK AS SHOWN.

CLASS 2—PAINTS

FOR PROTECTANT COATINGS FOR AUTOMOBILE RUBBER TIRES, BUMPERS, SEALS AND MATS, VINYL, LEATHER AND PLASTIC (U.S. CLS. 6, 11 AND 16).
FIRST USE 9-7-1999; IN COMMERCE 9-7-1999.

CLASS 3—COSMETICS AND CLEANING PREPARATIONS

FOR CONCRETE AND ASPHALT CLEANING PREPARATIONS; STRIPPING PREPARATIONS AND EMULSIFYING PREPARATIONS FOR REMOVING GREASE, OIL AND DIRT FROM HARD SURFACES; AUTOMOTIVE CLEANING PREPARATIONS, NAMELY, COATED WHEEL CLEANERS, GRILL CLEANERS, WHITEWALL TIRE CLEANERS; CAR AND TRUCK WASH DETERGENTS AND WAXES; LAUNDRY SOAPS; HAND AND MACHINE DISHWASHING SOAPS; TUB AND TILE BATHROOM CLEANERS FOR INDUSTRIAL USE; TOILET BOWL CLEANING PREPARATIONS FOR INDUSTRIAL USE; POT, PAN, OVEN, GRILL AND FRYER CLEANING PREPARATIONS; ENGINE CLEANING PREPARATIONS; LAUNDRY BLEACH; DEGREASER CLEANING PREPARATIONS; STRIPPING, CLEANING AND FINISHING PREPARATIONS FOR FLOORS; ALL PURPOSE CLEANING PREPARATIONS; HAND AND BODY SOAP, CARPET CLEANING PREPARATIONS; GLASS CLEANING PREPARATIONS; AND FURNITURE POLISH (U.S. CLS. 1, 4, 6, 50, 51 AND 52).
FIRST USE 9-7-1999; IN COMMERCE 9-7-1999.

SN 76-395,135. VIVACE NETWORKS, INC., SAN JOSE, CA.
FILED 4-12-2002.

BUILT TO SCALE

CLASS 37—CONSTRUCTION AND REPAIR

FOR INSTALLATION OF COMPUTER AND DATA NETWORKS (U.S. CLS. 100, 103 AND 106).

CLASS 42—SCIENTIFIC, COMPUTER AND LEGAL SERVICES

FOR COMPUTER SERVICES, NAMELY, NETWORK PLANNING AND SUPPORT FOR OTHERS (U.S. CLS. 100 AND 101).

CERALID

OWNER OF SWITZERLAND REG. NO. 495322, DATED 3-5-2002, EXPIRES 11-28-2011.

CLASS 6—METAL GOODS

FOR IRON, STEEL, ALUMINUM AND ALUMINUM ALLOYS IN SHEET, ROD, BAR AND/OR BILLET FORM; MULTI-LAYER STRIPS, FOILS, RODS AND BARS MADE PRIMARILY OF METALS, NAMELY, STEEL, ALUMINUM OR ALUMINUM ALLOYS, COMBINED WITH AT LEAST ONE LAYER OF NONMETALLIC MATERIALS, NAMELY, PLASTICS, BARRIER LAYERS, NAMELY, VACUUM DEPOSITED THIN GLASS OR CERAMIC LAYERS, METALLIZED LAYERS, SPUTTERED METAL OR CERAMIC LAYERS, OR BARRIER PLASTIC LAYERS, THIN LAYERS OF CERAMIC OR GLASS, PAINT LAYERS AND/OR PAPER; METAL CONTAINERS IN THE FORM OF RECEPTACLES, TRAYS, POUCHES, SLEEVES OR BAGS FOR THE STORAGE AND TRANSPORTATION OF GOODS; CONTAINER CLOSURES OF METAL, IN PARTICULAR IRON, STEEL, ALUMINUM OR ALUMINUM ALLOYS; CONTAINER CLOSURES MADE PRIMARILY OF METAL, IN PARTICULAR IRON, STEEL, ALUMINUM OR ALUMINUM ALLOYS IN COMBINATION WITH AT LEAST ONE LAYER OF NON-METALLIC MATERIALS, NAMELY, PLASTICS, BARRIER LAYERS, NAMELY, VACUUM DEPOSITED THIN GLASS OR CERAMIC LAYERS, METALLIZED LAYERS, SPUTTERED METAL OR CERAMIC LAYERS, OR BARRIER PLASTIC LAYERS, THIN LAYERS OF CERAMIC OR GLASS, PAINT LAYERS AND/OR PAPER; METAL COVER MATERIALS IN THE FORM OF STRIPS, FOILS, BARS, AND RODS MADE OF IRON, STEEL, ALUMINUM OR ALUMINUM ALLOYS FOR LIDDING OF ALL TYPES OF CONTAINERS, PARTICULARLY, RECEPTACLES, CANS, BOXES, POUCHES, TUBES, SLEEVES, BAGS, TRAYS, BOWLS OR BOTTLES; METAL CONTAINER CLOSURES IN THE NATURE OF COVER MATERIALS IN THE FORM OF STRIPS, FOILS, BARS AND RODS MADE OF IRON, STEEL, ALUMINUM OR ALUMINUM ALLOYS FOR LIDDING OF ALL TYPES OF CONTAINERS, PARTICULARLY, RECEPTACLES, CANS, BOXES, POUCHES, TUBES, SLEEVES, BAGS, TRAYS, BOWLS OR BOTTLES IN COMBINATION WITH AT LEAST ONE LAYER OF NON-METALLIC MATERIALS, NAMELY, PLASTICS, BARRIER LAYERS, NAMELY, VACUUM DEPOSITED THIN GLASS OR CERAMIC LAYERS, METALLIZED LAYERS, SPUTTERED METAL OR CERAMIC LAYERS, OR BARRIER PLASTIC LAYERS, THIN LAYERS OF CERAMIC OR GLASS, PAINT LAYERS AND/OR PAPER (U.S. CLS. 2, 12, 13, 14, 23, 25 AND 50).

CLASS 16—PAPER GOODS AND PRINTED MATTER

FOR CARDBOARD, CORRUGATED AND PAPER CONTAINERS, NAMELY, RECEPTACLES, TRAYS, POUCHES, SLEEVES OR BAGS FOR PACKAGING (U.S. CLS. 2, 5, 22, 23, 29, 37, 38 AND 50).

CLASS 17—RUBBER GOODS

FOR LAMINATE MATERIAL FOR USE IN THE MANUFACTURE OF ALL TYPES OF CONTAINERS, PARTICULARLY, RECEPTACLES, CANS, BOXES, POUCHES, TUBES, SLEEVES, BAGS, TRAYS, BOWLS OR BOTTLES, NAMELY, MULTI-LAYER, COMPOSITE MATERIALS COMPRISED PRIMARILY OF PLASTIC HAVING A LAYER OF PLASTIC AND AT LEAST ONE LAYER OF METAL, BARRIER LAYERS, NAMELY, VACUUM DEPOSITED THIN GLASS OR CERAMIC LAYERS, METALLIZED LAYERS, SPUTTERED METAL OR CERAMIC LAYERS, OR BARRIER PLASTIC LAYERS, THIN LAYERS OF CERAMIC OR GLASS, PAINT LAYERS AND/OR PAPER (U.S. CLS. 1, 5, 12, 13, 35 AND 50).

CLASS 20—FURNITURE AND ARTICLES NOT OTHERWISE CLASSIFIED

FOR NON-METAL CLOSURES FOR CONTAINERS USED WITH RECEPTACLES, TRAYS, POUCHES OR BAGS AND MADE OF LAMINATES, NAMELY, MULTI-LAYER MATERIALS MADE PRIMARILY OF PLASTIC (U.S. CLS. 2, 13, 22, 25, 32 AND 50).

SN 76-397,422. ELIZABETH GRADY FACE FIRST, INC., MEDFORD, MA. FILED 4-17-2002.

EXPERIENCE THE BEAUTY OF HEALTHY SKIN**CLASS 35—ADVERTISING AND BUSINESS**

FOR RETAIL STORE SERVICES FEATURING SKIN CARE PRODUCTS AND COSMETICS (U.S. CLS. 100, 101 AND 102).

CLASS 44—MEDICAL, BEAUTY AND AGRICULTURAL SERVICES

FOR SALON AND SPA SERVICES FOR SKIN CARE, MASSAGES, MANICURES, PEDICURES AND BODY TREATMENTS (U.S. CLS. 100 AND 101).

SN 76-397,463. FRITZ SCHAFFER GMBH, 57290 NEUNKIRCHEN, FED REP GERMANY, FILED 4-17-2002.

PICKOMAT

PRIORITY CLAIMED UNDER SEC. 44(D) ON FED REP GERMANY APPLICATION NO. 30162680.4/2, FILED 10-25-2001, REG. NO. 30162680, DATED 2-18-2002, EXPIRES 10-25-2011.

CLASS 7—MACHINERY

FOR ELECTRIC MOTORS FOR SHELVES, CONTROLLED ELECTRIC DRIVE FOR SHELVES, FREQUENCY-CONTROLLED ELECTRIC DRIVE FOR SHELVES (U.S. CLS. 13, 19, 21, 23, 31, 34 AND 35).

CLASS 20—FURNITURE AND ARTICLES NOT OTHERWISE CLASSIFIED

FOR SLIDING SHELVES, MOTOR-DRIVEN SHELVING SYSTEMS, FOR HEIGHT-ORIENTED POSITIONING OF GOODS, CONSISTING OF CONTROLLED DRIVES, SHELF BODIES, STORAGE TABLETS, STORAGE LIFTS, AS WELL AS COMPUTERIZED STORAGE SPACE ADMINISTRATION FOR SHELVING FOR SMALL AND MEDIUM-SIZED PARTS (U.S. CLS. 2, 13, 22, 25, 32 AND 50).

SN 76-398,152. EISAI CO., LTD., BUNKYO-KU, TOKYO, JAPAN, FILED 4-18-2002.

PIVKA - II EISAI

OWNER OF U.S. REG. NOS. 1,033,450, 2,212,335 AND OTHERS.

CLASS 1—CHEMICALS

FOR DIAGNOSTIC PREPARATIONS AND REAGENTS FOR SCIENTIFIC OR RESEARCH USE; AND DIAGNOSTIC MEDIA, NAMELY, REAGENTS AND PREPARATIONS FOR BACTERIAL CULTURES FOR SCIENTIFIC OR RESEARCH USE (U.S. CLS. 1, 5, 6, 10, 26 AND 46).

CLASS 5—PHARMACEUTICALS

FOR DIAGNOSTIC PREPARATIONS AND REAGENTS FOR CLINICAL OR MEDICAL LABORATORY USE AND DIAGNOSTIC MEDIA, NAMELY, REAGENTS AND PREPARATIONS FOR BACTERIAL CULTURES FOR CLINICAL OR MEDICAL LABORATORY USE (U.S. CLS. 6, 18, 44, 46, 51 AND 52).

SN 76-398,342. KABUSHIKI KAISHA TANITA, TOKYO, JAPAN, FILED 4-19-2002.



PRIORITY CLAIMED UNDER SEC. 44(D) ON JAPAN APPLICATION NO. 2001-102557, FILED 11-15-2001, REG. NO. 4610700, DATED 10-4-2002, EXPIRES 10-4-2012.

CLASS 9—ELECTRICAL AND SCIENTIFIC APPARATUS

FOR ELECTRONIC APPARATUS AND INSTRUMENTS FOR MEASURING THE CONCENTRATION OF ALCOHOL IN A PERSON'S BREATH; ELECTRONIC APPARATUS AND INSTRUMENTS FOR MEASURING THE QUANTITY OF CHEMICALS CAUSING A PERSON'S BAD BREATH; BODY WEIGHT SCALES, BABY WEIGHT SCALES, KITCHEN SCALES, BATHROOM SCALES, INDUSTRIAL SCALES, SCALES FOR COMMERCIAL USE, BODY WEIGHT SCALES WITH BODY FAT ANALYZER; PEDOMETERS; ELECTRONIC APPARATUS AND INSTRUMENTS FOR ANALYZING WATER QUALITY, ELECTRONIC APPARATUS AND INSTRUMENTS FOR MEASURING THE QUANTITY OF RESIDUAL CHLORINE AND OTHER CHEMICALS IN WATER; ELECTRONIC APPARATUS AND INSTRUMENTS FOR MEASURING AND CHECKING THE CONDITIONS OF SKIN; ELECTRONIC APPARATUS AND INSTRUMENTS FOR MEASURING THE QUANTITY OF CHEMICALS CAUSING BAD SMELL AND OTHER CHEMICALS IN AIR; ELECTRONIC APPARATUS FOR MEASURING THE QUANTITY OF CHEMICALS CAUSING BODY ODORS; METRONOMES (U.S. CLS. 21, 23, 26, 36 AND 38).

CLASS 10—MEDICAL APPARATUS

FOR APPARATUS FOR MEASURING A PERSON'S PULSE, NAMELY, PULSE RATE MONITORS; CLINICAL THERMOMETERS FOR MEDICAL USE, BONE MINERAL DENSITY MEASURING APPARATUS FOR MEDICAL USE, BODY FAT MEASURING APPARATUS FOR MEDICAL USE, BIOELECTRICAL IMPEDANCE MEASURING APPARATUS FOR MEDICAL USE, SPHYGMOMANOMETER (U.S. CLS. 26, 39 AND 44).

CLASS 44—MEDICAL, BEAUTY AND AGRICULTURAL SERVICES

FOR BEAUTY CARE, NAMELY, BEAUTY SALONS AND HAIR CUTTING; MEDICAL SERVICES, NAMELY, MEDICAL CHECKUPS, PROVIDING INFORMATION ABOUT MEDICAL CHECKUPS, ADVICE AND GUIDANCE FOR HOW TO AVOID BEING OVERWEIGHT AND HOW TO LOSE WEIGHT AND OTHER ADVICE AND GUIDANCE FOR HEALTH CARE AND BEAUTY CARE, AND DIETARY/NUTRITIONAL GUIDANCE (U.S. CLS. 100 AND 101).

SN 76-400,829. FAMILY CENTRAL, INC., FORMERLY EARLY CHILDHOOD DEVELOPMENT ASSOCIATION OF BROWARD COUNTY, INC., NORTH LAUDERDALE, FL. FILED 4-25-2002.

CHANGING LIVES FOR A LIFETIME**CLASS 43—HOTEL AND RESTAURANT SERVICES**

FOR CHILD CARE; COUNSELING IN THE FIELD OF CHILD CARE (U.S. CLS. 100 AND 101).

SN 76-398,613. EDSA GROUP, INC., THE, BATON ROUGE, LA. FILED 4-19-2002.

CLASS 44—MEDICAL, BEAUTY AND AGRICULTURAL SERVICES

FOR COUNSELING INDIVIDUALS, FAMILIES AND CHILDCARE PROVIDERS IN THE FIELD OF EARLY CHILDHOOD DEVELOPMENT (U.S. CLS. 100 AND 101).

MONEY BASICS**CLASS 16—PAPER GOODS AND PRINTED MATTER**

FOR PRINTED INSTRUCTIONAL, EDUCATIONAL AND TEACHING MATERIALS IN THE FIELD OF FINANCIAL PLANNING (U.S. CLS. 2, 5, 22, 23, 29, 37, 38 AND 50).

FIRST USE 9-1-1994; IN COMMERCE 9-1-1994.

SN 76-401,133. RADIXOS, LLC, BELLEVUE, WA. FILED 4-29-2002.

CLASS 41—EDUCATION AND ENTERTAINMENT

FOR EDUCATIONAL SERVICES, NAMELY, CONDUCTING COURSES AND WORKSHOPS IN THE FIELD OF FINANCIAL PLANNING (U.S. CLS. 100, 101 AND 107).

FIRST USE 9-1-1994; IN COMMERCE 9-1-1994.

RADIXOS**CLASS 35—ADVERTISING AND BUSINESS**

FOR COMPUTER SERVICES, NAMELY, DATABASE MANAGEMENT SERVICES; BUSINESS PROJECT MANAGEMENT SERVICES FOR OTHERS, NAMELY, ASSET INVENTORY, DESIGN DOCUMENT REVIEW, EQUIPMENT PLANNING, PROCUREMENT, NAMELY, PURCHASING OF MEDICAL EQUIPMENT, MEDICAL SUPPLIES, FURNITURE, AND OFFICE SUPPLIES FOR HOSPITALS, PURCHASING OF SCHOOL SUPPLIES, CLASSROOM FURNITURE, OFFICE FURNITURE, EDUCATIONAL TEXTS, EDUCATIONAL INSTRUCTIONAL AIDS, AND EDUCATIONAL EQUIPMENT FOR SCHOOL DISTRICTS; AND BUSINESS TRANSITION AND RELOCATION MANAGEMENT (U.S. CLS. 100, 101 AND 102).

SN 76-398,898. NGT, INC., WASHINGTON, DC. FILED 4-22-2002.

ASSIGNMENT DANGER**CLASS 37—CONSTRUCTION AND REPAIR**

FOR INSTALLATION OF COMPUTER NETWORKS, COMPUTER HARDWARE, AND COMPUTER SYSTEMS (U.S. CLS. 100, 103 AND 106).

CLASS 9—ELECTRICAL AND SCIENTIFIC APPARATUS

FOR PRE-RECORDED VIDEO CASSETTES AND DVDS FEATURING DOCUMENTARIES CONCERNING HAZARDOUS PROFESSIONS (U.S. CLS. 21, 23, 26, 36 AND 38).

CLASS 42—SCIENTIFIC, COMPUTER AND LEGAL SERVICES

FOR COMPUTER SERVICES, NAMELY, PROGRAMMING SERVICES; COMPUTER PROJECT MANAGEMENT SERVICES FOR OTHERS, NAMELY, COMPUTER AIDED DRAWING AND COMPUTER AIDED FABRICATION AND MANUFACTURING SERVICES, COMPUTER SOFTWARE INSTALLATION SERVICES, AND TRANSITION SERVICES FROM ONE COMPUTER SYSTEM TO ANOTHER (U.S. CLS. 100 AND 101).

CLASS 41—EDUCATION AND ENTERTAINMENT

FOR ENTERTAINMENT IN THE NATURE OF A SERIES OF TELEVISION DOCUMENTARIES CONCERNING HAZARDOUS PROFESSIONS (U.S. CLS. 100, 101 AND 107).

SN 76-401,661. ECONOMATRIX RESEARCH ASSOCIATES, INC., NEW YORK, NY. FILED 4-29-2002.

SN 76-403,099. AMERICAN NEW CENTURY CO LTD., SOUTH EL MONTE, CA. FILED 5-2-2002.

ECONOMATRIX



CLASS 35—ADVERTISING AND BUSINESS

FOR ECONOMIC CONSULTING SERVICES PROVIDED PRIMARILY TO LAW FIRMS, INSURANCE COMPANIES, AND CORPORATIONS (U.S. CLS. 100, 101 AND 102).

FIRST USE 0-0-1987; IN COMMERCE 0-0-1987.

CLASS 36—INSURANCE AND FINANCIAL

FOR FINANCIAL CONSULTING SERVICES PROVIDED PRIMARILY TO LAW FIRMS, INSURANCE COMPANIES, AND CORPORATIONS (U.S. CLS. 100, 101 AND 102).

FIRST USE 0-0-1987; IN COMMERCE 0-0-1987.

CLASS 12—VEHICLES

FOR (BASED ON USE IN COMMERCE) NON-MOTORIZED SCOOTERS (U.S. CLS. 19, 21, 23, 31, 35 AND 44).

FIRST USE 11-0-2000; IN COMMERCE 11-0-2000.

CLASS 25—CLOTHING

FOR (BASED ON USE IN COMMERCE) FOOTWEAR (U.S. CLS. 22 AND 39).

FIRST USE 11-0-2000; IN COMMERCE 11-0-2000.

CLASS 28—TOYS AND SPORTING GOODS

FOR (BASED ON INTENT TO USE) SKATE SHOES (U.S. CLS. 22, 23, 38 AND 50).

SN 76-403,275. AMERIX CORPORATION, COLUMBIA, MD. FILED 5-2-2002.

SN 76-401,723. PINNACLE PROMOTION GROUP, INC., CHICAGO, IL. FILED 4-30-2002.



CLASS 9—ELECTRICAL AND SCIENTIFIC APPARATUS

FOR PRE-RECORDED VIDEOTAPES FEATURING FAMILY AND SOCIAL ACTION ISSUES SUCH AS CONFLICT AND ANGER RESOLUTION (U.S. CLS. 21, 23, 26, 36 AND 38).

CLASS 41—EDUCATION AND ENTERTAINMENT

FOR EDUCATIONAL SERVICES, NAMELY, CONDUCTING WORKSHOPS AND SEMINARS IN THE FIELD OF FAMILY AND SOCIAL ACTION ISSUES SUCH AS CONFLICT AND ANGER RESOLUTION (U.S. CLS. 100, 101 AND 107).

CLASS 35—ADVERTISING AND BUSINESS

FOR DISCOUNT PROGRAMS, NAMELY, ADMINISTRATION OF A DISCOUNT PROGRAM FOR ENABLING PARTICIPANTS TO OBTAIN DISCOUNTS ON GOODS AND SERVICES THROUGH MEMBERSHIP IN A DISCOUNT PROGRAM; AND LEGAL REFERRALS (U.S. CLS. 100, 101 AND 102).

CLASS 36—INSURANCE AND FINANCIAL

FOR FINANCIAL SERVICES, NAMELY MISCELLANEOUS MORTGAGE PRODUCTS, NAMELY MORTGAGE SERVICING; MORTGAGE COLLECTION; MORTGAGE LENDING; CORRESPONDENT LENDING; MORTGAGE BANKING; TITLE INSURANCE BROKERAGE SERVICES; INSURANCE UNDERWRITING SERVICES FOR ALL TYPES OF INSURANCE; MORTGAGE BROKERAGE SERVICES; MORTGAGE FORECLOSURE PREVENTION; OTHER FINANCIAL PRODUCTS AND SERVICES, NAMELY PROVIDING PERSONAL LOANS; PROVIDING BRIDGE LOANS; GOVERNMENT DEBT NEGOTIATION AND SETTLEMENT SERVICES, NAMELY NEGOTIATION OF DEBT REPAYMENTS WITH THE GOVERNMENT ON BEHALF OF CLIENTS OWING SUCH DEBTS; FINANCIAL COUNSELING; FINANCIAL CONSULTING; DEBT COLLECTION; AND PREPAID PURCHASE CARD SERVICES, NAMELY PROCESSING ELECTRONIC PAYMENTS MADE THROUGH PREPAID CARDS; DISCOUNT BROKERAGE SERVICES; CREDIT REPORTING AND RATING SERVICES, NAMELY, CREDIT REPORT MONITORING AND RESCORING (U.S. CLS. 100, 101 AND 102).

CLASS 41—EDUCATION AND ENTERTAINMENT

FOR EDUCATIONAL SERVICES, NAMELY CLASSES, SEMINARS, CONFERENCES AND WORKSHOPS IN THE FIELD OF FINANCE (U.S. CLS. 100, 101 AND 107).

SN 76-404,325. IPC INFORMATION SYSTEMS, INC., NEW YORK, NY. FILED 5-7-2002.

IPC

OWNER OF U.S. REG. NO. 1,034,698.

CLASS 9—ELECTRICAL AND SCIENTIFIC APPARATUS

FOR VOICE AND DATA COMMUNICATIONS PRODUCTS, NAMELY INTEGRATED DESKTOP AND SWITCHING TURRETS AND PLATFORMS FOR TRADING ENVIRONMENTS, WHICH SUPPORT VOICE, DATA AND VIDEO APPLICATIONS (U.S. CLS. 21, 23, 26, 36 AND 38).

FIRST USE 0-0-1983; IN COMMERCE 0-0-1983.

CLASS 37—CONSTRUCTION AND REPAIR

FOR VOICE AND DATA COMMUNICATIONS SYSTEMS INTEGRATION SERVICES, NAMELY MAINTAINING COMMUNICATIONS INFRASTRUCTURES WHICH INTEGRATE VOICE AND DATA COMMUNICATIONS SYSTEMS USED IN TRADING ROOM ENVIRONMENTS (U.S. CLS. 100, 103 AND 106).

FIRST USE 0-0-1983; IN COMMERCE 0-0-1983.

CLASS 42—SCIENTIFIC, COMPUTER AND LEGAL SERVICES

FOR VOICE AND DATA COMMUNICATIONS SYSTEMS INTEGRATION SERVICES, NAMELY DESIGNING AND IMPLEMENTING COMMUNICATIONS INFRASTRUCTURES WHICH INTEGRATE VOICE AND DATA COMMUNICATIONS SYSTEMS USED IN TRADING ROOM ENVIRONMENTS (U.S. CLS. 100 AND 101).

FIRST USE 0-0-1983; IN COMMERCE 0-0-1983.

SN 76-406,947. RIPON SOCIETY INC., THE, WASHINGTON, DC. FILED 5-9-2002.



NO CLAIM IS MADE TO THE EXCLUSIVE RIGHT TO USE "SOCIETY", APART FROM THE MARK AS SHOWN. THE MARK CONSISTS IN PART OF A STYLIZED DEPICTION OF AN ELEPHANT.

CLASS 35—ADVERTISING AND BUSINESS

FOR PROMOTING PUBLIC AWARENESS OF THE NEED FOR STIMULATING CREATIVE DISCUSSION WITHIN THE AMERICAN POLITICAL SYSTEM REGARDING ISSUES OF CURRENT INTEREST OR RELEVANCE, INCLUDING FISCAL RESPONSIBILITY, NATIONAL DEFENSE AND SECURITY, FOREIGN AFFAIRS, ECONOMIC ISSUES, INTERNATIONAL TRADE AND THE ENVIRONMENT (U.S. CLS. 100, 101 AND 102).

CLASS 42—SCIENTIFIC, COMPUTER AND LEGAL SERVICES

FOR PUBLIC POLICY DEVELOPMENT AND RESEARCH REGARDING ISSUES OF CURRENT INTEREST OR RELEVANCE, INCLUDING FISCAL RESPONSIBILITY, NATIONAL DEFENSE AND SECURITY, FOREIGN AFFAIRS, ECONOMIC ISSUES, INTERNATIONAL TRADE AND THE ENVIRONMENT (U.S. CLS. 100 AND 101).

SN 76-407,331. COLOIDALES DUCHE, S.A. DE C.V., COL. JUAREZ 06600, MEXICO, FILED 5-13-2002.

DUCHE

CLASS 29—MEATS AND PROCESSED FOODS

FOR UNFLAVORED GELATIN (U.S. CL. 46).

CLASS 30—STAPLE FOODS

FOR FLAVORED, SWEETENED GELATIN DESSERTS, SWEETS WHICH CONTAIN GELATIN, NAMELY BAKERY DESSERTS; MARSHMELLOWS; AND FROZEN CONFECTIONS WHICH CONTAIN GELATIN (U.S. CL. 46).

SN 76-407,332. COLOIDALES DUCHE, S.A. DE C.V., COL. JUAREZ 06600, MEXICO, FILED 5-13-2002.

D' DUCHE

CLASS 29—MEATS AND PROCESSED FOODS

FOR UNFLAVORED GELATIN (U.S. CL. 46).

CLASS 30—STAPLE FOODS

FOR FLAVORED, SWEETENED GELATIN DESSERTS, SWEETS WHICH CONTAIN GELATIN, NAMELY BAKERY DESSERTS; MARSHMELLOWS; AND FROZEN CONFECTIONS WHICH CONTAIN GELATIN (U.S. CL. 46).

SN 76-408,445. STAAR SURGICAL COMPANY, INC., MONROVIA, CA. FILED 5-15-2002.



NO CLAIM IS MADE TO THE EXCLUSIVE RIGHT TO USE "TORIC ICL", APART FROM THE MARK AS SHOWN.

CLASS 5—PHARMACEUTICALS

FOR SURGICAL IMPLANTS COMPRISING INGREDIENTS FROM LIVING TISSUE (U.S. CLS. 6, 18, 44, 46, 51 AND 52).

CLASS 9—ELECTRICAL AND SCIENTIFIC APPARATUS

FOR COMPUTER SOFTWARE FOR CALCULATING POWER OF A SURGICAL OCULAR IMPLANT USED IN REFRACTIVE SURGICAL PROCEDURES, OCULAR CALCULATION SOFTWARE RECORDED ON CD-ROMS, COMPACT DISCS FEATURING OCULAR CALCULATION SOFTWARE (U.S. CLS. 21, 23, 26, 36 AND 38).

CLASS 10—MEDICAL APPARATUS

FOR OCULAR IMPLANTS; INSTRUMENTS FOR IMPLANTING SURGICAL OCULAR IMPLANTS (U.S. CLS. 26, 39 AND 44).

CLASS 16—PAPER GOODS AND PRINTED MATTER

FOR PRINTED EDUCATIONAL MATERIALS, NAMELY, BOOKS, MANUALS, BOOKLETS, PAMPHLETS, AND BROCHURES FEATURING INFORMATION REGARDING REFRACTIVE SURGICAL PROCEDURES (U.S. CLS. 2, 5, 22, 23, 29, 37, 38 AND 50).

CLASS 41—EDUCATION AND ENTERTAINMENT

FOR EDUCATIONAL SERVICES, NAMELY, TRAINING DOCTORS TO PERFORM REFRACTIVE SURGICAL PROCEDURES (U.S. CLS. 100, 101 AND 107).

SN 76-408,788. CAMPUS MEDIA HOLDINGS, INC., BALTIMORE, MD. FILED 5-15-2002.



CLASS 35—ADVERTISING AND BUSINESS

FOR PROMOTING SPORTS COMPETITIONS AND TOURNAMENTS FOR COLLEGIATE AND UNIVERSITY STUDENTS (U.S. CLS. 100, 101 AND 102).
FIRST USE 5-15-2002; IN COMMERCE 5-15-2002.

CLASS 41—EDUCATION AND ENTERTAINMENT

FOR ORGANIZING AND SANCTIONING SPORTS COMPETITIONS AND TOURNAMENTS FOR COLLEGIATE AND UNIVERSITY STUDENTS (U.S. CLS. 100, 101 AND 107).
FIRST USE 5-15-2002; IN COMMERCE 5-15-2002.

SN 76-408,903. TED TURNER FILM PROPERTIES, LLC, ATLANTA, GA. FILED 5-16-2002.

GODS AND GENERALS

CLASS 9—ELECTRICAL AND SCIENTIFIC APPARATUS

FOR PRERECORDED AUDIO CASSETTES AND COMPACT DISCS FEATURING LIVE ACTION ENTERTAINMENT; VIDEO CASSETTES AND DIGITAL VIDEO DISCS FEATURING LIVE ACTION ENTERTAINMENT; MOTION PICTURE FILMS FEATURING LIVE ACTION ENTERTAINMENT, INTERACTIVE VIDEO GAMES COMPRISED OF COMPUTER HARDWARE AND SOFTWARE; COMPUTER GAME SOFTWARE (U.S. CLS. 21, 23, 26, 36 AND 38).

CLASS 16—PAPER GOODS AND PRINTED MATTER

FOR PRINTED MATTER AND PAPER GOODS—NAMELY, BOOKS ABOUT THE CIVIL WAR, STATIONERY, WRITING PAPER, ENVELOPES, ADDRESS BOOKS, NOTEBOOKS, BINDERS, DIARIES, NOTE CARDS, GREETING CARDS, TRADING CARDS; LITHOGRAPHS; PENS, PENCILS, CASES THEREFOR, ERASERS, MARKERS, DECALS, HEAT TRANSFERS; POSTERS; MOUNTED AND/OR UNMOUNTED PHOTOGRAPHS; BOOK COVERS, BOOK MARKS, CALENDARS, GIFT WRAPPING PAPER; PAPER PARTY FAVORS AND PAPER PARTY DECORATIONS—NAMELY, PAPER NAPKINS, PAPER DOILIES, PAPER PLACE MATS, CREPE PAPER, PAPER HATS, INVITATIONS, PAPER TABLE CLOTHS, PAPER CAKE DECORATIONS; DESK ACCESSORIES, NAMELY, DESK PADS, PEN AND PENCIL HOLDERS, NOTEPAD HOLDERS, AND DESK SETS, PEN AND PENCIL CASES; RUBBER STAMP SETS AND STICKERS; BUMPER STICKERS; STATIONERY PORTFOLIOS AND LUNCH BAGS (U.S. CLS. 2, 5, 22, 23, 29, 37, 38 AND 50).

CLASS 41—EDUCATION AND ENTERTAINMENT

FOR PRODUCTION AND DISTRIBUTION OF TELEVISION SHOWS AND MOTION PICTURES (U.S. CLS. 100, 101 AND 107).

SN 76-409,127. CLORE AUTOMOTIVE LLC, LENEXA, KS. FILED 5-16-2002.



NO CLAIM IS MADE TO THE EXCLUSIVE RIGHT TO USE "AMERICAN LIFTING", APART FROM THE MARK AS SHOWN.

CLASS 6—METAL GOODS

FOR METAL VEHICLE AND ENGINE STANDS (U.S. CLS. 2, 12, 13, 14, 23, 25 AND 50).

CLASS 7—MACHINERY

FOR HYDRAULIC SERVICE JACKS; HYDRAULIC BOTTLE JACKS; INDUSTRIAL MACHINE PRESSES; AND POWER-OPERATED BODY AND FRAME STRAIGHTENERS FOR AUTOMOTIVE VEHICLES (U.S. CLS. 13, 19, 21, 23, 31, 34 AND 35).

CLASS 8—HAND TOOLS

FOR MANUALLY OPERATED BODY AND FRAME STRAIGHTENERS FOR AUTOMOTIVE VEHICLES (U.S. CLS. 23, 28 AND 44).

CLASS 9—ELECTRICAL AND SCIENTIFIC APPARATUS

FOR PRERECORDED VIDEOTAPES, PRERECORDED AUDIOTAPES, PRERECORDED AUDIO INSTRUCTIONAL CASSETTES AND PRERECORDED VIDEO INSTRUCTION CASSETTES CONTAINING INFORMATION ON STUTTERING (U.S. CLS. 21, 23, 26, 36 AND 38).
FIRST USE 5-15-2001; IN COMMERCE 5-15-2001.

CLASS 16—PAPER GOODS AND PRINTED MATTER

FOR PUBLICATIONS, NAMELY, BOOKS, PAMPHLETS, FLYERS AND NEWSLETTERS RELATING TO STUTTERING (U.S. CLS. 2, 5, 22, 23, 29, 37, 38 AND 50).
FIRST USE 5-15-2001; IN COMMERCE 5-15-2001.

CLASS 35—ADVERTISING AND BUSINESS

FOR ASSOCIATION SERVICES, NAMELY PROMOTING THE INTEREST OF PEOPLE WHO STUTTER (U.S. CLS. 100, 101 AND 102).
FIRST USE 5-15-2001; IN COMMERCE 5-15-2001.

SN 76-409,165. STUTTERING FOUNDATION OF AMERICA, MEMPHIS, TN. FILED 5-17-2002.

STUTTERING FOUNDATION OF AMERICA

NO CLAIM IS MADE TO THE EXCLUSIVE RIGHT TO USE "FOUNDATION", APART FROM THE MARK AS SHOWN.
SEC. 2(F).

SN 76-409,684. DELIA*S GROUP INC., NEW YORK, NY. FILED 5-17-2002.

LIVE IN dELiA*s DENIM

OWNER OF U.S. REG. NOS. 1,908,572, 2,171,631 AND OTHERS.

CLASS 9—ELECTRICAL AND SCIENTIFIC APPARATUS

FOR PRERECORDED VIDEOTAPES, PRERECORDED AUDIOTAPES, PRERECORDED AUDIO INSTRUCTIONAL CASSETTES AND PRERECORDED VIDEO INSTRUCTION CASSETTES CONTAINING INFORMATION ON STUTTERING (U.S. CLS. 21, 23, 26, 36 AND 38).
FIRST USE 12-0-1991; IN COMMERCE 12-0-1991.

CLASS 25—CLOTHING

FOR CLOTHING, NAMELY, SHIRTS, PANTS, JEANS, VESTS, DRESSES, SKIRTS, SHORTS, CAPS, JACKETS, AND COATS (U.S. CLS. 22 AND 39).

CLASS 16—PAPER GOODS AND PRINTED MATTER

FOR PUBLICATIONS, NAMELY, BOOKS, PAMPHLETS, FLYERS AND NEWSLETTERS RELATING TO STUTTERING (U.S. CLS. 2, 5, 22, 23, 29, 37, 38 AND 50).
FIRST USE 12-0-1991; IN COMMERCE 12-0-1991.

CLASS 35—ADVERTISING AND BUSINESS

FOR RETAIL, MAIL ORDER, AND ON-LINE STORE SERVICES FEATURING CLOTHING (U.S. CLS. 100, 101 AND 102).

CLASS 35—ADVERTISING AND BUSINESS

FOR ASSOCIATION SERVICES, NAMELY PROMOTING THE INTEREST OF PEOPLE WHO STUTTER (U.S. CLS. 100, 101 AND 102).
FIRST USE 12-0-1991; IN COMMERCE 12-0-1991.

SN 76-409,644. STUTTERING FOUNDATION OF AMERICA, MEMPHIS, TN. FILED 5-17-2002.

STUTTERING FOUNDATION

NO CLAIM IS MADE TO THE EXCLUSIVE RIGHT TO USE "FOUNDATION", APART FROM THE MARK AS SHOWN.
SEC. 2(F).

SN 76-410,405. TELETECH HOLDINGS INC., ENGLEWOOD, CO. FILED 5-21-2002.

YOUR CUSTOMER MANAGEMENT PARTNER

NO CLAIM IS MADE TO THE EXCLUSIVE RIGHT TO USE "CUSTOMER MANAGEMENT", APART FROM THE MARK AS SHOWN.

CLASS 9—ELECTRICAL AND SCIENTIFIC APPARATUS

FOR COMPUTER SOFTWARE FOR USE IN THE PROVISION OF CUSTOMER CARE AND CUSTOMER RELATIONSHIP MANAGEMENT SERVICES, NAMELY, FOR USE IN MANAGING AND ACCESSING DATABASES FOR RECEIVING AND RESPONDING TO SALES, SERVICE, TECHNICAL SUPPORT AND GENERAL INFORMATION INQUIRIES OF CUSTOMERS OF OTHERS (U.S. CLS. 21, 23, 26, 36 AND 38).

FIRST USE 4-1-2002; IN COMMERCE 4-1-2002.

CLASS 35—ADVERTISING AND BUSINESS

FOR CUSTOMER RELATIONSHIP MANAGEMENT SERVICES AND CUSTOMER CARE SERVICES FOR OTHERS, NAMELY, MANAGING DATABASES AND RECEIVING AND RESPONDING TO SALES, SERVICE, TECHNICAL SUPPORT AND GENERAL INFORMATION INQUIRIES OF CUSTOMERS THROUGH A VARIETY OF MEDIA; EMPLOYMENT AGENCY SERVICES; MANAGEMENT OF CUSTOMER INTERACTION MANAGEMENT CENTERS PROVIDING CUSTOMER CARE AND CUSTOMER RELATIONSHIP MANAGEMENT SERVICES (U.S. CLS. 100, 101 AND 102).

FIRST USE 4-1-2002; IN COMMERCE 4-1-2002.

CLASS 42—SCIENTIFIC, COMPUTER AND LEGAL SERVICES

FOR COMPUTER PROGRAMMING SERVICES FOR OTHERS, APPLICATION SERVICE PROVIDER SERVICES, NAMELY, DESIGNING, INSTALLING, INTEGRATING, NETWORKING, HOSTING, OPERATING AND MAINTAINING COMPUTER SOFTWARE SOLUTIONS FOR OTHERS, DATABASE DEVELOPMENT SERVICES AND TECHNICAL CONSULTATION AND IMPLEMENTATION SERVICES IN THE FIELD OF CUSTOMER CARE AND CUSTOMER RELATIONSHIP MANAGEMENT; PRODUCT RESEARCH AND DEVELOPMENT FOR OTHERS; AND COMPUTER DISASTER RECOVERY PLANNING SERVICES (U.S. CLS. 100 AND 101).

FIRST USE 4-1-2002; IN COMMERCE 4-1-2002.

SN 76-411,852. NEWMONT MINING CORPORATION, DENVER, CO. FILED 5-23-2002.



CLASS 37—CONSTRUCTION AND REPAIR

FOR MINING EXTRACTION (U.S. CLS. 100, 103 AND 106).

CLASS 40—MATERIAL TREATMENT

FOR MINERAL PROCESSING SERVICES, NAMELY, COMMUNUTING, BIO-OXIDIZING, AUTOCLAVING, LEACHING, CONCENTRATING, FLOTATION OF, REFINING, CASTING, SMELTING, AND MELTING PRECIOUS AND BASE METALS AND THEIR ORES (U.S. CLS. 100, 103 AND 106).

SN 76-411,854. NEWMONT MINING CORPORATION, DENVER, CO. FILED 5-23-2002.



CLASS 37—CONSTRUCTION AND REPAIR

FOR MINING EXTRACTION (U.S. CLS. 100, 103 AND 106).

CLASS 40—MATERIAL TREATMENT

FOR MINERAL PROCESSING SERVICES, NAMELY, COMMUNUTING, BIO-OXIDIZING, AUTOCLAVING, LEACHING, CONCENTRATING, FLOTATION OF, REFINING, CASTING, SMELTING, AND MELTING PRECIOUS AND BASE METALS AND THEIR ORES (U.S. CLS. 100, 103 AND 106).

SN 76-411,855. NEWMONT MINING CORPORATION, DENVER, CO. FILED 5-23-2002.



CLASS 37—CONSTRUCTION AND REPAIR

FOR MINING EXTRACTION (U.S. CLS. 100, 103 AND 106).

CLASS 40—MATERIAL TREATMENT

FOR MINERAL PROCESSING SERVICES, NAMELY, COMMUNUTING, BIO-OXIDIZING, AUTOCLAVING, LEACHING, CONCENTRATING, FLOTATION OF, REFINING, CASTING, SMELTING, AND MELTING PRECIOUS AND BASE METALS AND THEIR ORES (U.S. CLS. 100, 103 AND 106).

SN 76-411,856. NEWMONT MINING CORPORATION, DENVER, CO. FILED 5-23-2002.



CLASS 37—CONSTRUCTION AND REPAIR

FOR MINING EXTRACTION (U.S. CLS. 100, 103 AND 106).

CLASS 40—MATERIAL TREATMENT

FOR MINERAL PROCESSING SERVICES, NAMELY, COMMINUTING, BIO-OXIDIZING, AUTOCLAVING, LEACHING, CONCENTRATING, FLOTATION OF, REFINING, CASTING, SMELTING, AND MELTING PRECIOUS AND BASE METALS AND THEIR ORES (U.S. CLS. 100, 103 AND 106).

SN 76-411,861. NEWMONT MINING CORPORATION, DENVER, CO. FILED 5-23-2002.

NEWMONT**CLASS 37—CONSTRUCTION AND REPAIR**

FOR MINING EXTRACTION (U.S. CLS. 100, 103 AND 106).

CLASS 40—MATERIAL TREATMENT

FOR MINERAL PROCESSING SERVICES, NAMELY, COMMINUTING, BIO-OXIDIZING, AUTOCLAVING, LEACHING, CONCENTRATING, FLOTATION OF, REFINING, CASTING, SMELTING, AND MELTING PRECIOUS AND BASE METALS AND THEIR ORES (U.S. CLS. 100, 103 AND 106).

SN 76-412,119. S.O.I. TEC SILICON ON INSULATOR TECHNOLOGIES, 38190 BERNIN, FRANCE, FILED 5-23-2002.

QUASIC

PRIORITY CLAIMED UNDER SEC. 44(D) ON FRANCE APPLICATION NO. 013134120, FILED 11-23-2001, REG. NO. 013134120, DATED 11-23-2001, EXPIRES 11-23-2011.

CLASS 9—ELECTRICAL AND SCIENTIFIC APPARATUS

FOR MICROELECTRONIC COMPONENTS, NAMELY, SEMICONDUCTOR MATERIAL SUBSTRATES FOR USE IN FLAT SCREENS, INTEGRATED OPTICAL WAVE GUIDES, SENSORS AND MICRO-MACHINING (U.S. CLS. 21, 23, 26, 36 AND 38).

CLASS 40—MATERIAL TREATMENT

FOR MATERIAL SUBSTRATES PROCESSING FOR MICROELECTRONICS, NAMELY, SPLITTING SILICON CARBIDE SUBSTRATES BETWEEN LAYERS AND CUTTING AND POLISHING SAID SPLIT SUBSTRATES (U.S. CLS. 100, 103 AND 106).

SN 76-412,376. GREAT LAKES COATING LABORATORY, INC., TROY, MI. FILED 5-22-2002.

CAFE COLLECTION

NO CLAIM IS MADE TO THE EXCLUSIVE RIGHT TO USE "COLLECTION", APART FROM THE MARK AS SHOWN.

CLASS 2—PAINTS

FOR REFLECTIVE COATINGS FOR OPHTHALMIC LENS (U.S. CLS. 6, 11 AND 16).

CLASS 9—ELECTRICAL AND SCIENTIFIC APPARATUS

FOR OPHTHALMIC LENS (U.S. CLS. 21, 23, 26, 36 AND 38).

SN 76-412,844. CORETA GMBH, 01307 DRESDEN, FED REP GERMANY, FILED 5-22-2002.

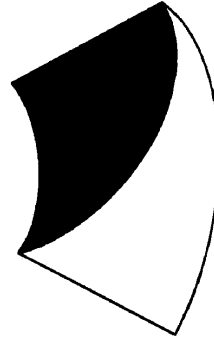

PRIORITY CLAIMED UNDER SEC. 44(D) ON FED REP GERMANY APPLICATION NO. 30167265, FILED 11-23-2001, REG. NO. 30167265, DATED 3-15-2002, EXPIRES 11-30-2011.

THE MARK CONSISTS OF A STYLIZED APOSTROPHE. THE LOWER RIGHT PORTION IS GRAY.

CLASS 6—METAL GOODS

FOR IRON AND METAL GOODS CONTAINING METAL INTERLOCKS, NAMELY, CONTAINERS WITH INTEGRATED BLOCKS, BARS, LATCHES, ANCHORS, BOLTS, GIBS AND PINS FOR STORING GOODS; METAL IDENTITY PLATES; FORMED IDENTITY OBJECTS MADE OF METAL, NAMELY, TAGS FOR IDENTIFICATION; METAL INTERLOCKS FOR DOORS, GATES, LIDS AND ACCESS PROTECTION ELEMENTS; METAL LOCKS; METAL LOCK COMPONENTS, NAMELY, METAL FITTINGS, MOLDINGS, DOOR KNOBS, DOOR HANDLES, PLATES, NON-LUMINOUS AND NON-MECHANICAL METAL SIGNS AND LABELS FOR DOORS; METAL KEYS FOR LOCKS; METAL RINGS, NAMELY, METAL KEY-RINGS AND METAL KEY FOBS (U.S. CLS. 2, 12, 13, 14, 23, 25 AND 50).

CLASS 7—MACHINERY

FOR ELECTRONIC MOTORS FOR MACHINES, ELECTRICALLY DRIVEN ACTUATORS FOR MACHINE TOOLS AND FOR WORK PIECE FEEDING MACHINES, CURRENT GENERATORS, NAMELY, DYNAMOS (U.S. CLS. 13, 19, 21, 23, 31, 34 AND 35).

CLASS 9—ELECTRICAL AND SCIENTIFIC APPARATUS

FOR PERSONAL SECURITY ALARMS; BURGLAR ALARMS FOR HOUSES AND DWELLINGS, AND ANTI-THEFT ALARM DEVICES FOR MOBILE OBJECTS, ITEMS OR ARTICLES CONSISTING OF ELECTRONIC MICROCHIPS OR ELECTRO-MECHANIC MICRO-SYSTEMS THAT EMIT ELECTRIC SOUND OR RADIO SIGNALS; COMPUTER SOFTWARE FOR CONTROLLING AND MONITORING KEY-LOCK MANAGEMENT, THE CORRELATION OF ELECTRONIC LOCKS, AND FOR ACCESS CONTROL SYSTEMS FOR USE IN ELECTRONIC SECURITY AND ELECTRONIC PROTECTION, KEY MANAGEMENT, IDENTIFICATION, CRYPTOGRAPHY AND PASSWORD OR CODE PROTECTION; COMPUTER HARDWARE; DATA INPUT DEVICES, NAMELY, KEY PADS, MOUSE AND READERS CONNECTED TO COMPUTER PORTS, NUMBER PADS, TACTILE INPUT PADS, MAGNETIC CODED CARD READERS, READERS FOR ELECTRONIC KEYS AND ENCODED SMART CARDS, ELECTRONIC KEY FOBS AND FORMED MOBILE OBJECTS CONTAINING SECURITY CHIPS; DATA INPUT DEVICES FOR TACTILE OR MANUAL DATA INPUT USING FINGERS AND FOR TACTILE DATA INPUT USING ULTRASOUND AS DATA TRANSPORT MEDIUM, NAMELY, TRANSCIEVERS; AUTOMATIC VENDING MACHINES; AUTHORIZATION OR PAYMENT TERMINALS OR READERS CONSISTING OF METALLIC CONTACTS, ANTENNAS FOR RADIO FREQUENCIES AND ACOUSTICAL OR OPTICAL SENSORS THAT ARE CONNECTED TO MACHINES, DOORS AND GATES FOR ACCESS; CASH DISPENSERS AND DISPENSERS FOR ELECTRONIC CASH; CARRIER MEDIA FOR INTEGRATED CIRCUITS, NAMELY, BLANK SMART CARDS AND KEY FOBS AND FORMED OBJECTS, NAMELY, TAGS MADE OF METAL, PLASTICS, CERAMICS AND WOOD CONTAINING AN ELECTRONIC CHIP FOR IDENTIFICATION FOR USE IN ACCESS CONTROL SYSTEMS, ELECTRONIC LOCKS, IDENTIFICATION SYSTEMS AND IN ELECTRONIC CASH TRANSACTIONS; ELECTRONIC LOCKS AND KEYS; ELECTRONIC IMMIOBILIZERS FOR VEHICLES AND BIKES DATA VERIFICATION SYSTEM COMPONENTS, NAMELY, ELECTRONIC TAG CARRIERS; BAR CODE READERS FOR ELECTRONIC TAGS; INTEGRATED CIRCUITS FOR USE IN SECURITY APPLICATIONS AND IDENTIFICATION, AND NON-VOLATILE STORAGE INFORMATION CONCERNING THE CIRCUIT CARRIER, NAMELY, ELECTRONIC LABELS, ELECTRONIC TAGS, AND ELECTRONIC CHIPS; ELECTRONIC AND ELECTRIC SWITCHES FOR USE IN SECURITY APPLICATION FOR ELECTRONIC LOCK AND ELECTRONIC CODE PROTECTED ACCESS SYSTEMS; ELECTRONIC ACTUATORS FOR USE IN ELECTRONIC LOCKS AND AS CONSTRUCTION ELEMENT IN ENGINEERING AND AUTOMATION; READING GLASSES WITH PARTS MADE OF PRECIOUS METALS (U.S. CLS. 21, 23, 26, 36 AND 38).

CLASS 14—JEWELRY

FOR JEWELRY CONTAINING ELECTRONIC CIRCUITS, NAMELY, AMULETS, LAPEL PINS, BRACELETS, BROOCHES, FINGER RINGS, EARRINGS, WATCHES, KEY RING PENDANTS, BELT BUCKLES MADE OF PRECIOUS METAL FOR CLOTHING, AND NECKLACES; OBJECTS OF UTILITY MADE OF PRECIOUS METAL CONTAINING ELECTRONIC CIRCUITS, NAMELY, KEYS, FINGER RING KEYS, KEY FOBS, WRITING UTENSILS, SMALL LOCKS, GLASS FRAMES, BELT BUCKLES, AND BUTTONS FOR TEXTILE USE; JEWELRY, NAMELY, AMULETS, LAPEL PINS, BRACELETS, BROOCHES, FINGER RINGS, EARRINGS, WATCHES, KEY RING PENDANTS, BELT BUCKLES MADE OF PRECIOUS METAL FOR CLOTHING, AND NECKLACES; ALARM CLOCKS; SEMI-FINISHED PRODUCTS MADE OF PRECIOUS METAL FOR USE IN JEWELRY; JEWELRY FOR USE ON PARTS OF THE BODY (U.S. CLS. 2, 27, 28 AND 50).

SN 76-413,327. FPL GROUP, INC., JUNE BEACH, FL. FILED 5-23-2002.

NO CLAIM IS MADE TO THE EXCLUSIVE RIGHT TO USE "GROUP", APART FROM THE MARK AS SHOWN.

CLASS 35—ADVERTISING AND BUSINESS

FOR BUSINESS MANAGEMENT AND OPERATION AND MAINTENANCE OF FACILITIES ALL IN THE AREA OF POWER AND GENERATING FACILITIES (U.S. CLS. 100, 101 AND 102).

FIRST USE 9-10-1984; IN COMMERCE 9-10-1984.

CLASS 36—INSURANCE AND FINANCIAL

FOR FINANCIAL MANAGEMENT AND FINANCING FOR POWER AND GENERATING FACILITIES (U.S. CLS. 100, 101 AND 102).

FIRST USE 9-10-1984; IN COMMERCE 9-10-1984.

CLASS 37—CONSTRUCTION AND REPAIR

FOR CONSULTING SERVICES IN CONNECTION WITH PROJECT DEVELOPMENT OF POWER AND GENERATING FACILITIES (U.S. CLS. 100, 103 AND 106).

FIRST USE 9-10-1984; IN COMMERCE 9-10-1984.

CLASS 39—TRANSPORTATION AND STORAGE

FOR PUBLIC UTILITY ELECTRIC SERVICES (U.S. CLS. 100 AND 105).

FIRST USE 9-10-1984; IN COMMERCE 9-10-1984.

SN 76-413,379. CARD COLLECTOR SERVICES, INC., STERLING HEIGHTS, MI. FILED 5-29-2002.

COLLECTION MONSTER

NO CLAIM IS MADE TO THE EXCLUSIVE RIGHT TO USE "COLLECTION", APART FROM THE MARK AS SHOWN.

CLASS 35—ADVERTISING AND BUSINESS

FOR ON-LINE TRADING SERVICES IN WHICH SELLERS POST PRODUCTS AND COLLECTIBLES TO BE AUCTIONED AND BIDDING IS DONE VIA THE INTERNET, AND ON-LINE AUCTIONEERING MANAGEMENT SERVICES OF PRODUCTS AND COLLECTIBLES (U.S. CLS. 100, 101 AND 102).

CLASS 36—INSURANCE AND FINANCIAL

FOR ON-LINE APPRAISAL SERVICES, NAMELY, VALUING AND APPRAISING SPORTS COLLECTIBLES AND NON-SPORTS COLLECTIBLES (U.S. CLS. 100, 101 AND 102).

SN 76-413,808. MVP MEDIA, INC., DOWNERS GROVE, IL. FILED 5-24-2002.

GPX

CLASS 9—ELECTRICAL AND SCIENTIFIC APPARATUS

FOR ELECTRONIC PUBLICATIONS, NAMELY PERIODICALS FEATURING INFORMATION RELATED TO VIDEO GAMES RECORDED ON COMPUTER MEDIA (U.S. CLS. 21, 23, 26, 36 AND 38).

CLASS 16—PAPER GOODS AND PRINTED MATTER

FOR PRINTED PERIODICALS IN THE FIELD OF VIDEO GAMES (U.S. CLS. 2, 5, 22, 23, 29, 37, 38 AND 50).

SN 76-415,046. BURBERRY LIMITED, LONDON SW1Y 4DQ, ENGLAND, FILED 5-30-2002.

BURBERRY

OWNER OF U.S. REG. NOS. 259,571, 1,828,277 AND OTHERS.

CLASS 9—ELECTRICAL AND SCIENTIFIC APPARATUS

FOR SUNGLASSES, COMBINED SUNGLASSES AND GOGGLES, GOGGLES, SPECTACLES, OPTICAL GLASSES, FITTED FRAMES AND LENSES FOR THE AFORESAID GOODS; CASES AND HOLDERS FOR THE AFORESAID GOODS; PARTS AND FITTINGS FOR ALL THE AFORESAID GOODS; CASES AND HOLDERS FOR PORTABLE COMPUTERS AND MOBILE TELEPHONES (U.S. CLS. 21, 23, 26, 36 AND 38).

CLASS 14—JEWELRY

FOR WATCHES, CLOCKS AND PARTS AND FITTINGS FOR ALL THE AFORESAID GOODS, WRIST WATCHES AND STRAPS AND BRACELETS THEREFOR AND POCKET WATCHES, JEWELRY, IMITATION JEWELLERY, TIE-PINS AND CUFF LINKS; AND JEWELRY BOXES, SNUFF BOXES, HAT AND SHOE ORNAMENTS ALL MADE OF PRECIOUS METAL OR COATED THEREWITH (U.S. CLS. 2, 27, 28 AND 50).

SN 76-415,848. BRINK'S FRANCE, 75009, PARIS, FRANCE, FILED 6-4-2002.

B2S

PRIORITY CLAIMED UNDER SEC. 44(D) ON FRANCE APPLICATION NO. 013135073, FILED 12-4-2001, REG. NO. 013135073, DATED 12-4-2001, EXPIRES 12-4-2011.

CLASS 36—INSURANCE AND FINANCIAL

FOR INSURANCE BROKERAGE, INSURANCE CLAIMS ADMINISTRATION, BUSINESS FINANCE PROCUREMENT SERVICES, FINANCIAL ANALYSIS AND CONSULTATION; FINANCIAL MANAGEMENT, MONETARY EXCHANGE; ELECTRONIC FUNDS TRANSFER; SAVINGS BANK SERVICES; INSURANCE ACTUARIAL SERVICES, BANKING SERVICES; CURRENCY EXCHANGE AND ADVICE, FINANCIAL EXCHANGE; FINANCIAL MANAGEMENT OF SECURITIES; PAWN BROKERAGE; DEBT RECOVERING AND COLLECTION AGENCIES; ISSUING OF TRAVELERS' CHECKS AND OF LETTERS OF CREDIT (U.S. CLS. 100, 101 AND 102).

CLASS 37—CONSTRUCTION AND REPAIR

FOR HOME INSTALLATION, REPAIR AND MAINTENANCE OF SECURITY, MONITORING AND REMOTE MONITORING SYSTEMS (U.S. CLS. 100, 103 AND 106).

CLASS 39—TRANSPORTATION AND STORAGE

FOR PACKAGING ARTICLES FOR TRANSPORTATION, TRANSPORTATION OF GOODS BY ROAD, TRUCK, CAR, BOAT AND RAIL, PACKAGING AND STORAGE OF GOODS, GUARDED TRANSPORT OF VALUABLES BY ROAD, TRUCK, CAR, BOAT AND RAIL, TRANSPORTS OF FUNDS BY ROAD, TRUCK, CAR, BOAT AND RAIL; MARINE TRANSPORT; SHIP UNLOADING, REFLOATING OF SHIPS; TRAVEL AGENCY SERVICES, NAMELY, MAKING RESERVATIONS AND BOOKINGS FOR TRANSPORTATION, VEHICLE RENTAL; STORAGE OF GOODS IN A GUARDED WAREHOUSE; PARKING GARAGE SERVICES, PARKING FOR SERVICES, CAR RENTAL (U.S. CLS. 100 AND 105).

CLASS 45—PERSONAL SERVICES

FOR GUARD SERVICES, NAMELY, GUARDING OF CLOTHES, MONITORING SECURITY SYSTEMS, SECURITY, MONITORING AND REMOTE MONITORING CONSULTANCY AND INFORMATION; SECURITY, MONITORING AND REMOTE MONITORING AGENCIES; BODY GUARDING (U.S. CLS. 100 AND 101).

SN 76-416,634. WEBASTO AG, D-82131 STOCKDORF, FED REP GERMANY, FILED 5-31-2002.

DLIGHT

PRIORITY CLAIMED UNDER SEC. 44(D) ON FED REP GERMANY APPLICATION NO. 30170352.3, FILED 12-7-2001, REG. NO. 30170352, DATED 7-15-2002, EXPIRES 12-31-2011.

CLASS 9—ELECTRICAL AND SCIENTIFIC APPARATUS

FOR COMPUTER SOFTWARE FOR USE IN DATABASE MANAGEMENT, COMPUTER AIDED DESIGN (CAD), COMPUTER AIDED MANUFACTURING (CAM), COMPUTER ANIMATION, COMPUTER GRAPHICS, AND PRODUCT DATA MANAGEMENT (PDM), ALL FOR USE IN THE AUTOMOTIVE INDUSTRY; REMOTE CONTROLS FOR USE WITH CONTROLLABLE VEHICLE COMPONENTS, NAMELY, AIR CONDITIONING, COOLING, VENTILATING AND HEATING UNITS; TRANSMITTERS AND RECEIVERS FOR REMOTE OPERATION OF VEHICLE COMPONENTS; MEASURING, TESTING AND CONTROL EQUIPMENT AND APPARATUS FOR USE IN THE AUTOMOTIVE INDUSTRY, NAMELY, THERMOMETERS, ALTIMETERS, NOISE METERS, SPEED CHECKING APPARATUS, HYGROMETERS, PRESSURE GAUGES, PRESSURE INDICATORS, PRESSURE MEASURING APPARATUS, FLOW METERS, HUMIDITY CONTROL APPARATUS, COMBUSTION CONTROL APPARATUS, VOLTAGE REGULATORS, ELECTRIC CURRENT SENSORS, ACCELERATION SENSORS, POSITION SENSORS, RPM SENSORS, TANK CAP SENSORS; CABLE HARNESSSES, ELECTRIC PLUG CONNECTIONS, FUSES, RELAYS, SWITCHES, ELECTRIC PRESSURE CONTROLS, CONTRACTORS, CIRCUIT BREAKERS, THERMOSTATS, TEMPERATURE LIMITING DEVICES, SENSORS; VOLTAGE REGULATORS AND INTERFERENCE SUPPRESSOR SETS FOR AIR-CONDITIONING; DEVICES FOR GENERATING ELECTRICAL ENERGY USING SOLAR CELLS, IN PARTICULAR FOR LAND VEHICLES AND WATERCRAFT AND FOR THEIR COMPONENTS; HEATER BATTERIES; SOLAR BATTERIES; COATED GLASS, GLASS COVERED WITH AN ELECTRICAL CONDUCTOR, AND GLASS FOR USE IN ELECTRICAL DEVICES; APPARATUS FOR CONVERTING ELECTRONIC RADIATION TO ELECTRICAL ENERGY FOR LAND VEHICLES AND BOATS, NAMELY, PHOTOVOLTAIC SOLAR-THERMAL HYBRID MODULES, AND PARTS THEREFORE (U.S. CLS. 21, 23, 26, 36 AND 38).

CLASS 11—ENVIRONMENTAL CONTROL APPARATUS

FOR AIR-CONDITIONING, COOLING, VENTILATING AND HEATING UNITS FOR VEHICLES; WATER AND AIR HEATING UNITS FOR VEHICLES; WINDOW DEFROSTERS, ELECTRIC WATER HEATERS AND ENGINE PREHEATING UNITS FOR VEHICLES; ENGINE-INDEPENDENT AIR CONDITIONERS FOR VEHICLES, ELECTRIC HEATING UNITS FOR VEHICLES, AUXILIARY HEATING UNITS FOR VEHICLES; FUEL CELLS FOR POWERING VEHICLES AND VEHICLE COMPONENTS; REFORMERS USE TO REFORM HYDROCARBON BASED FUELS INTO HYDROGEN GAS; ROOF MOUNTED AIR CONDITIONERS, HVAC (HEATING-VENTILATION-AIR-CONDITIONING UNIT) FOR LAND VEHICLES; LIGHTS FOR VEHICLES; FILTERS, NAMELY, AIR FILTERS FOR AIR-CONDITIONING UNITS, FILTERS FOR GASES AND FOR LIQUIDS; COOLANT COLLECTORS, COOLANT DISTRIBUTORS AND COOLANT EVAPORATORS; HEAT EXCHANGERS, CONTINUOUS FLOW HEATERS, TANK DRAINING DEVICES, AND CONDENSATE SUCTION DEVICES, ALL FOR VEHICLES; FUEL REFORMER (U.S. CLS. 13, 21, 23, 31 AND 34).

CLASS 12—VEHICLES

FOR VEHICLE ROOFS AND TOPS, PARTICULARLY SLIDING, LIFTING AND SLIDING/LIFTING, SPOILER, LOUVERED, SUN, FOLDING AND TILTING ROOFS, ALL-GLASS ROOFS, RETRACTABLE HARDTOPS, CONVERTIBLE ROOFS; SUN SHADES AND VENTILATION FLAPS FOR VEHICLES; ADJUSTABLE VEHICLE WINDOWS, PARTICULARLY SIDE AND REAR WINDOWS, FOLDING, TILTING AND LOUVERED WINDOWS; VEHICLE WINDOW RAISING MECHANISMS; VEHICLE ROOF LINER COMPONENTS AND VEHICLE BODY COMPONENTS; SPOILERS, WIND AND WATER DEFLECTORS, AIR FLOW DEVICES, SKI AND LUGGAGE RACKS FOR VEHICLES; MODULE ROOFS, ROOF MODULES FOR VEHICLES; MOVABLE SURFACES, SLIDING FLOORS AND TELESCOPIC LOADING FLOORS FOR VEHICLES; FINISHED DARKENING

GLASS SURFACES FOR VEHICLES, DOORS FOR VEHICLES; ROOF HATCHES FOR VEHICLES; PANES AND COVERS MADE OF PLASTIC OR GLASS FOR VEHICLES; COVERS, SCREENS, ROOF FRAMES, LINER FRAMES AND COVER FRAMES FITTED FOR VEHICLES, HOUSINGS, CLADDINGS, HOODS, FLAPS, GRILLS, GUIDE TUBES AND GUIDE RAILS AND SLIDING ELEMENTS, GASKETS; PACKING AND INSULATING MATERIALS, PANS, HOSE AND PIPE CLIPS, HINGES, PIPES, TANKS, HOSES, LINES AND MANIFOLDS, ALL FOR VEHICLES (U.S. CLS. 19, 21, 23, 31, 35 AND 44).

SN 76-417,346. KITCHEN SAVER OF BALTIMORE, INC., OWINGS MILLS, MD. FILED 6-6-2002.

WE'RE THE PERFECT FIT**CLASS 11—ENVIRONMENTAL CONTROL APPARATUS**

FOR BATHTUBS, BATHTUB LINERS, BATHTUB WALLS, SHOWER WALLS, BATHTUB ENCLOSURES, SHOWER ENCLOSURES, SHOWER LINERS, SHOWER BASES, SHOWER DOORS, SINKS, AND BATHTUB, SHOWER AND SINK PLUMBING FIXTURES, NAMELY, SHOWER HEADS, FAUCETS, LAVATORY VALVES, VALVE HANDLES, DRAIN STOPPERS AND SPIGOTS (U.S. CLS. 13, 21, 23, 31 AND 34).

FIRST USE 1-15-2002; IN COMMERCE 3-1-2002.

CLASS 37—CONSTRUCTION AND REPAIR

FOR INSTALLATION OF BATHTUBS, BATHTUB LINERS, BATHTUB WALLS, SHOWER WALLS, BATHTUB ENCLOSURES, SHOWER ENCLOSURES, SHOWER LINERS, SHOWER BASES, SHOWER DOORS, BATHTUB AND SHOWER ACCESSORIES, NAMELY, SOAP DISHES, SHOWER CADDIES AND SAFETY GRAB BARS, SINKS, CABINETS, COUNTER TOPS AND BATHTUB, SHOWER AND SINK PLUMBING FIXTURES (U.S. CLS. 100, 103 AND 106).

FIRST USE 1-15-2002; IN COMMERCE 1-15-2002.

SN 76-418,119. RYAN, THOMAS, NEW YORK, NY. FILED 6-4-2002.

VIRTU**CLASS 9—ELECTRICAL AND SCIENTIFIC APPARATUS**

FOR RECORDINGS FEATURING COMPILATIONS OF MUSIC AND MUSIC-RELATED VIDEO, IMAGES AND INFORMATION. (U.S. CLS. 21, 23, 26, 36 AND 38).

CLASS 41—EDUCATION AND ENTERTAINMENT

FOR ENTERTAINMENT SERVICES, NAMELY MAKING AVAILABLE PRERECORDED MUSIC AND MUSIC-RELATED IMAGES, INFORMATION AND EDITORIAL CONTENT VIA THE INTERNET OR OTHER GLOBAL ELECTRONIC COMMUNICATIONS NETWORK. (U.S. CLS. 100, 101 AND 107).

SN 76-419,327. BARNES, MARION R., ORANGE PARK, FL. FILED 6-10-2002.

SN 76-419,504. ION DIGITAL LLP, BLAINE, WA. FILED 6-11-2002.



CLASS 32—LIGHT BEVERAGES

FOR NON ALCOHOLIC COCKTAIL MIXES (U.S. CLS. 45, 46 AND 48).

CLASS 33—WINES AND SPIRITS

FOR PREPARED ALCOHOLIC COCKTAILS (U.S. CLS. 47 AND 49).

SN 76-419,418. SIMUTILITY, INC., WESTFORD, MA. FILED 6-11-2002.

PLUG-IN TO POWER & INNOVATION

CLASS 9—ELECTRICAL AND SCIENTIFIC APPARATUS

FOR COMPUTER SOFTWARE, NAMELY, SCALABLE, EXTENSIBLE, FLEXIBLE, CUSTOMIZABLE, LARGE-SCALE, MULTI-DISCIPLINARY SIMULATION APPLICATIONS SOFTWARE ENABLING THE CREATION AND OPERATION OF COMPLETE TURNKEY HIGH-PERFORMANCE COMPUTING (HPC) APPLICATION SERVICE PLATFORM (ASP) SYSTEMS CAPABLE OF ACCOMMODATING VARYING PEAK AND OVERFLOW COMPUTING CAPACITY NEEDS ON DEMAND, FINITE ELEMENT ANALYSIS SOFTWARE FOR MECHANICAL ENGINEERING AND COMPUTER-AIDED DESIGN APPLICATIONS, AND GENOMIC COMPUTATIONAL SOFTWARE, THAT MAY BE DOWNLOADED FROM A GLOBAL COMPUTER NETWORK (U.S. CLS. 21, 23, 26, 36 AND 38).

FIRST USE 8-1-2000; IN COMMERCE 8-1-2000.

CLASS 42—SCIENTIFIC, COMPUTER AND LEGAL SERVICES

FOR COMPUTER SOFTWARE DESIGN FOR OTHERS NAMELY SCALABLE, EXTENSIBLE, FLEXIBLE, CUSTOMIZABLE, LARGE-SCALE, MULTI-DISCIPLINARY SIMULATION APPLICATIONS SOFTWARE ENABLING THE CREATION AND OPERATION OF COMPLETE TURNKEY HIGH-PERFORMANCE COMPUTING (HPC) APPLICATION SERVICE PLATFORM (ASP) SYSTEMS; TECHNICAL SUPPORT SERVICE, NAMELY OF COMPUTER HARDWARE AND SOFTWARE PROBLEMS RELATED TO SCALABLE, EXTENSIBLE, FLEXIBLE, CUSTOMIZABLE, LARGE-SCALE, MULTI-DISCIPLINARY SIMULATION APPLICATIONS SOFTWARE ENABLING THE CREATION AND OPERATION OF COMPLETE TURNKEY HIGH-PERFORMANCE COMPUTING (HPC) APPLICATION SERVICE PLATFORM (ASP) SYSTEMS (U.S. CLS. 100 AND 101).

FIRST USE 8-1-2000; IN COMMERCE 8-1-2000.

ION

CLASS 9—ELECTRICAL AND SCIENTIFIC APPARATUS

FOR ELECTRONIC SECURITY SYSTEMS AND MONITORING DEVICES, NAMELY, COMPUTER MONITORS, CHIPS, SENSORS, SWITCHES, MAGNETS, RELAYS, AND COILS, ALL FOR WIRED AND WIRELESS TRANSMISSION OF A SIGNAL AND/OR SOUND TO INDICATE SECURITY BREACH (U.S. CLS. 21, 23, 26, 36 AND 38).

CLASS 45—PERSONAL SERVICES

FOR SECURITY SYSTEM MONITORING SERVICES (U.S. CLS. 100 AND 101).

SN 76-419,681. OSSUR HF, 110 REYKJAVIK, ICELAND, FILED 6-12-2002.

ÖSSUR SMART

CLASS 41—EDUCATION AND ENTERTAINMENT

FOR EDUCATIONAL SERVICES, NAMELY, CONDUCTING CLASSES, SEMINARS, CONFERENCES, WORKSHOPS IN THE FIELDS OF MEDICAL PROCEDURES, PATIENT CARE DIAGNOSIS AND REHABILITATION SERVICES RELATED TO AMPUTATION (U.S. CLS. 100, 101 AND 107).

CLASS 44—MEDICAL, BEAUTY AND AGRICULTURAL SERVICES

FOR PRE- AND POSTAMPUTATION DIAGNOSTIC SERVICES AND PRE- AND POSTAMPUTATION PATIENT CARE SERVICES (U.S. CLS. 100 AND 101).

SN 76-419,823. GENPAK, L.L.C., GLENS FALLS, NY. FILED 6-13-2002.

GENPAK

OWNER OF U.S. REG. NOS. 902,841, 933,716 AND OTHERS.

CLASS 20—FURNITURE AND ARTICLES NOT OTHERWISE CLASSIFIED

FOR PLASTIC LIDS (U.S. CLS. 2, 13, 22, 25, 32 AND 50). FIRST USE 2-1-1996; IN COMMERCE 2-1-1996.

CLASS 21—HOUSEWARES AND GLASS

FOR FOAM FOOD CONTAINERS; PLASTIC FOOD CONTAINERS; FOAM PLATES; FOAM BOWLS; FOAM CUPS; PLASTIC PLATES; PLASTIC BOWLS; FOAM FOOD TRAYS; OVENABLE FOAM FOOD TRAYS; OVENABLE PLASTIC FOOD TRAYS; OVENABLE FOAM BAKEWARE; OVENABLE PLASTIC BAKEWARE; AND PAPER PORTION CUPS AND PAPER CONES FOR SERVING FOOD AND BEVERAGES (U.S. CLS. 2, 13, 23, 29, 30, 33, 40 AND 50).

FIRST USE 3-19-1970; IN COMMERCE 3-19-1970.

SN 76-420,445. MARTIN, PETER, VIENNA A-1030, AUSTRIA, FILED 6-11-2002.

SN 76-419,863. PHOENIX INTANGIBLES HOLDING COMPANY, GREENVILLE, DE. FILED 6-12-2002.

KNOWASIS**CLASS 9—ELECTRICAL AND SCIENTIFIC APPARATUS**

FOR COMPUTER SOFTWARE FOR KNOWLEDGE-BASED MANAGEMENT USED FOR ANALYZING DATA OBTAINED BY RETAILERS IN THE RETAILING INDUSTRY (U.S. CLS. 21, 23, 26, 36 AND 38).

CLASS 35—ADVERTISING AND BUSINESS

FOR BUSINESS CONSULTATION SERVICES IN THE FIELD OF KNOWLEDGE-BASED MANAGEMENT (U.S. CLS. 100, 101 AND 102).

SN 76-420,303. BOSCH, W. BRUCE, VANCOUVER, WA. AND BOSCH, M. FRAN, VANCOUVER, WA. FILED 6-11-2002.

NOTHING DOWN THE DRAIN**CLASS 7—MACHINERY**

FOR MACHINES FOR WASHING MACHINE AND INDUSTRIAL PARTS AND FOR DRYING THE PART THEREAFTER, SOLD AS A UNIT (U.S. CLS. 13, 19, 21, 23, 31, 34 AND 35).

FIRST USE 9-17-1993; IN COMMERCE 9-17-1993.

CLASS 11—ENVIRONMENTAL CONTROL APPARATUS

FOR MACHINES FOR EVAPORATING WATER FROM WASHING MACHINE AND INDUSTRIAL PARTS (U.S. CLS. 13, 21, 23, 31 AND 34).

FIRST USE 9-17-1993; IN COMMERCE 9-17-1993.

CONTAÍNA**CLASS 16—PAPER GOODS AND PRINTED MATTER**

FOR PRINTED MATTER, NAMELY DAILY, WEEKLY, AND MONTHLY NEWSPAPERS THAT PRINT SINGLE OR COLLECTIVE STATEMENTS OF THE CARTOON; MAGAZINES IN THE FIELD OF EDUCATION, LIFESTYLE, CHILDREN, ETHICS AND PHILOSOPHY; BOOKS IN THE FIELD OF EDUCATION, LIFESTYLE, CHILDREN, ETHICS AND PHILOSOPHY (U.S. CLS. 2, 5, 22, 23, 29, 37, 38 AND 50).

CLASS 35—ADVERTISING AND BUSINESS

FOR RECORDS MANAGEMENT SERVICES, NAMELY, DOCUMENT INDEXING FOR OTHERS (U.S. CLS. 100, 101 AND 102).

CLASS 38—COMMUNICATION

FOR TELECOMMUNICATION SERVICES, NAMELY TRANSMISSION OF MESSAGES, IMAGES AND SOUND VIA THE INTERNET (U.S. CLS. 100, 101 AND 104).

CLASS 41—EDUCATION AND ENTERTAINMENT

FOR TRAINING SERVICES IN THE FIELD OF EDUCATION, ETHICS AND PHILOSOPHY; ORGANIZING COMMUNITY SPORTING AND CULTURAL EVENTS; CUSTOM WRITING SERVICES; NEWS REPORTING SERVICES; PUBLICATION OF TESTS (U.S. CLS. 100, 101 AND 107).

SN 76-420,751. FEDERALNOE GOSUDARSTVENNOE UNITARNOE PREDPRIYATIE "GOSUDARSTVENNY KOSMICHESKY NAUCHNO- PROIZVODSTVENNY TSENTR IMENI M.V. KHRUNICHEVA"(KHRUNICHEV STATE RESEARCH AND PRODUCTION SPACE CENTER), RU-121087, MOSCOW, RUSSIAN FEDERATIO, FILED 6-13-2002.

SN 76-422,623. COOPERATIVE COMPUTING, INC, AUSTIN, TX. FILED 6-19-2002.



A
H
Г
A
P
A

NO CLAIM IS MADE TO THE EXCLUSIVE RIGHT TO USE "AFTERMARKET", APART FROM THE MARK AS SHOWN.

CLASS 9—ELECTRICAL AND SCIENTIFIC APPARATUS

FOR COMPUTER SOFTWARE FOR USE IN THE AUTOMOTIVE AFTERMARKET INDUSTRIES, NAMELY, SOFTWARE FEATURING PROGRAMS AND COMPUTERIZED DATABASES FOR DETAILING AND MANAGING AUTOMOTIVE PARTS, LABOR AND INVENTORIES AND FACILITATING COMMUNICATION REGARDING SAME THROUGHOUT THE AUTOMOTIVE AFTERMARKET SUPPLY CHAIN (U.S. CLS. 21, 23, 26, 36 AND 38).

FIRST USE 9-19-2000; IN COMMERCE 9-19-2000.

CLASS 35—ADVERTISING AND BUSINESS

FOR INFORMATION NETWORKING SERVICES USED TO FACILITATE EXCHANGE OF INFORMATION AND ELECTRONIC COMMERCE TRANSACTIONS IN THE AUTOMOTIVE AFTERMARKET INDUSTRIES, NAMELY, PROVIDING SEARCHABLE ELECTRONIC DATABASES FEATURING INFORMATION ABOUT AUTOMOTIVE PARTS, LABOR AND INVENTORIES AND PROVIDING AN INTERACTIVE NETWORKING SERVICE TO FACILITATE THE ELECTRONIC SALE, PURCHASE AND MANAGEMENT OF AUTOMOTIVE PARTS, LABOR AND INVENTORIES (U.S. CLS. 100, 101 AND 102).

FIRST USE 9-19-2000; IN COMMERCE 9-19-2000.

OWNER OF RUSSIAN FEDERATIO REG. NO. 206866, DATED 2-9-2000, EXPIRES 2-9-2010.

THE MARK CONSISTS OF A CYRILLIC WORD, WITH THE THIRD LETTER BEING A RUSSIAN ALPHABET LETTER NOT PRESENT IN THE ROMAN ALPHABET, AND THEREFORE, THE LETTER DOES NOT REPRESENT THE LETTER "T".

THE ENGLISH TRANSLATION OF THE CYRILLIC WORD "AHTAPA" IN THE MARK IS "ANGARA", A NAME OF A RIVER IN RUSSIA.

CLASS 6—METAL GOODS

FOR NON-PRECIOUS METAL BADGES FOR WEARING (U.S. CLS. 2, 12, 13, 14, 23, 25 AND 50).

CLASS 12—VEHICLES

FOR SPACE VEHICLES; AIRCRAFT (U.S. CLS. 19, 21, 23, 31, 35 AND 44).

CLASS 14—JEWELRY

FOR MEDALS (U.S. CLS. 2, 27, 28 AND 50).

CLASS 28—TOYS AND SPORTING GOODS

FOR TOY SCALE MODEL VEHICLES (U.S. CLS. 22, 23, 38 AND 50).

CLASS 42—SCIENTIFIC, COMPUTER AND LEGAL SERVICES

FOR ENGINEERING, TECHNICAL RESEARCH IN THE FIELD OF AEROSPACE AND SPACE LAUNCHING; NON-BUSINESS PROFESSIONAL CONSULTING SERVICES, NAMELY CONSULTING IN THE FIELD OF ENGINEERING AND IN THE FIELD OF SPACE LAUNCHING (U.S. CLS. 100 AND 101).

SN 76-422,766. CME TELEMETRIX INC., WATERLOO, ONTARIO, CANADA, FILED 6-20-2002.

CHEMONIR

PRIORITY CLAIMED UNDER SEC. 44(D) ON CANADA APPLICATION NO. 1,138,274, FILED 4-23-2002.

CLASS 9—ELECTRICAL AND SCIENTIFIC APPARATUS

FOR COMPUTER SOFTWARE FOR USE IN CONTROLLING MEDICAL INSTRUMENTS FOR USE IN MEASURING BLOOD CHEMISTRY AND TISSUE CHEMISTRY (U.S. CLS. 21, 23, 26, 36 AND 38).

CLASS 10—MEDICAL APPARATUS

FOR MEDICAL INSTRUMENTS, NAMELY SPECTROPHOTOMETRIC INSTRUMENTS, FOR USE IN MEASURING BLOOD CHEMISTRY AND TISSUE CHEMISTRY (U.S. CLS. 26, 39 AND 44).

SN 76-423,418. IANNACCONI, JAMES T., FORT LAUDERDALE, FL. FILED 6-20-2002.

SN 76-426,592. DRYTIGHT, LLC, JAMUL, CA. FILED 7-1-2002.

SKI CADDY

NO CLAIM IS MADE TO THE EXCLUSIVE RIGHT TO USE "SKI", APART FROM THE MARK AS SHOWN.

CLASS 28—TOYS AND SPORTING GOODS

FOR CARRYING CASE FOR SKI EQUIPMENT (U.S. CLS. 22, 23, 38 AND 50).

CLASS 39—TRANSPORTATION AND STORAGE

FOR STORAGE OF SKI EQUIPMENT AND DELIVERY OF SKI EQUIPMENT BY TRUCK (U.S. CLS. 100 AND 105).

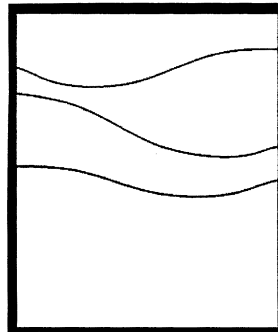

CLASS 9—ELECTRICAL AND SCIENTIFIC APPARATUS

FOR WATERPROOF CAMERA BAGS AND COMPUTER EQUIPMENT BAGS (U.S. CLS. 21, 23, 26, 36 AND 38).

CLASS 18—LEATHER GOODS

FOR WATERPROOF HIP BAGS IN THE NATURE OF FANNY PACKS AND LIGHT DUTY LUGGAGE (U.S. CLS. 1, 2, 3, 22 AND 41).

SN 76-423,832. AMERICAN LEGISLATIVE EXCHANGE COUNCIL, WASHINGTON, DC. FILED 6-21-2002.

AMERICAN LEGISLATIVE EXCHANGE COUNCIL
ALEC

NO CLAIM IS MADE TO THE EXCLUSIVE RIGHT TO USE "AMERICAN LEGISLATIVE EXCHANGE COUNCIL", APART FROM THE MARK AS SHOWN.

CLASS 16—PAPER GOODS AND PRINTED MATTER

FOR PRINTED INSTRUCTIONAL, EDUCATIONAL, AND TEACHING MATERIALS REGARDING THE PRINCIPLES OF FEDERALISM AND JEFFERSONIAN PRINCIPLES OF GOVERNMENT (U.S. CLS. 2, 5, 22, 23, 29, 37, 38 AND 50).

FIRST USE 1-0-2001; IN COMMERCE 1-0-2001.

CLASS 35—ADVERTISING AND BUSINESS

FOR PROMOTING PUBLIC AWARENESS OF THE NEED FOR GOVERNMENT POLICIES THAT REFLECT FEDERALISM AND JEFFERSONIAN PRINCIPLES OF GOVERNMENT (U.S. CLS. 100, 101 AND 102).

FIRST USE 1-0-2001; IN COMMERCE 1-0-2001.

CLASS 41—EDUCATION AND ENTERTAINMENT

FOR EDUCATIONAL SERVICES, NAMELY CONDUCTING CLASSES, WORKSHOPS AND SEMINARS REGARDING THE PRINCIPLES OF FEDERALISM AND JEFFERSONIAN PRINCIPLES OF GOVERNMENT, AND DISTRIBUTING COURSE MATERIALS IN CONNECTION THEREWITH (U.S. CLS. 100, 101 AND 107).

FIRST USE 1-0-2001; IN COMMERCE 1-0-2001.

SN 76-427,245. CLEAN DIESEL TECHNOLOGIES, INC., STAMFORD, CT. FILED 7-3-2002.

LOE-NOX

CLASS 1—CHEMICALS

FOR CHEMICAL ADDITIVES FOR EMULSIFYING WATER WITH DISTILLATE FUELS, SUCH AS DIESEL AND HOME HEATING OIL, TO FORM LIGHT OIL EMULSIONS FOR INCREASING FUEL ECONOMY AND/OR REDUCING NITROGEN OXIDE EMISSIONS, NAMELY, MIXTURES OF NITROGEN OXIDE-REDUCING CHEMICALS, WATER AND SURFACTANTS, EMULSIFIERS AND/OR COUPLING AGENTS EFFECTIVE FOR MIXING WITH DIESEL FUEL OR HOME HEATING OIL, NAMELY, DIESEL FUELS IN THE FORM OF LIGHT OIL EMULSIONS (U.S. CLS. 1, 5, 6, 10, 26 AND 46).

CLASS 4—LUBRICANTS AND FUELS

FOR FUEL FOR MOTOR VEHICLES, NAMELY, DIESEL FUELS IN THE FORM OF LIGHT OIL EMULSIONS; AND HOME HEATING OIL (U.S. CLS. 1, 6 AND 15).

CLASS 7—MACHINERY

FOR POWER OPERATED MECHANICAL MIXING MACHINES, NAMELY, MIXERS USED TO COMBINE CHEMICAL FUEL ADDITIVES WITH DIESEL FUEL OR HOME HEATING OIL, TO FORM LIGHT OIL EMULSIONS, EQUIPPED WITH AN EMULSIFICATION DEVICE (U.S. CLS. 13, 19, 21, 23, 31, 34 AND 35).

SN 76-427.436. GOODE, LARRY EUGENE, WINCHESTER, VA. FILED 7-3-2002.

BIG DICK'S SEAFOOD & MEAT HOUSE

NO CLAIM IS MADE TO THE EXCLUSIVE RIGHT TO USE "SEAFOOD AND MEAT HOUSE", APART FROM THE MARK AS SHOWN.

CLASS 35—ADVERTISING AND BUSINESS

FOR RETAIL STORE SERVICES FEATURING SOUVENIR ITEMS, NAMELY, T-SHIRTS, HATS AND BOTTLE OPENERS (U.S. CLS. 100, 101 AND 102).

CLASS 43—HOTEL AND RESTAURANT SERVICES

FOR RESTAURANT SERVICES (U.S. CLS. 100 AND 101).

SN 76-428,013. SEGAL, JONATHAN, CHICAGO, IL. FILED 7-8-2002.

MINNIE

CLASS 29—MEATS AND PROCESSED FOODS

FOR CONDIMENTS, NAMELY, PEPPER OIL (U.S. CL. 46).

CLASS 30—STAPLE FOODS

FOR MEATS AND PROCESSED FOODS, NAMELY, SANDWICHES; CONDIMENTS, NAMELY, MAYONNAISE, RELISH, MUSTARD AND KETCHUP; SAUCES, SPICES AND SALAD DRESSINGS (U.S. CL. 46).

CLASS 43—HOTEL AND RESTAURANT SERVICES

FOR SERVICES FOR PROVIDING FOOD AND DRINK, NAMELY, RESTAURANT SERVICES FOR CONSUMPTION ON THE PREMISES, AND CARRY-OUT RESTAURANT FOOD AND BEVERAGE SERVICES FOR CONSUMPTION OFF THE PREMISES (U.S. CLS. 100 AND 101).

SN 76-430.151. ABC HOLIDAY EXTRAS LIMITED, KENT TN25 6SR, UNITED KINGDOM, FILED 7-12-2002.

HOLIDAY EXTRAS

PRIORITY CLAIMED UNDER SEC. 44(D) ON ERPN CMNTY TM OFC APPLICATION NO. 2738805, FILED 6-18-2002.

NO CLAIM IS MADE TO THE EXCLUSIVE RIGHT TO USE "HOLIDAY", APART FROM THE MARK AS SHOWN.

CLASS 36—INSURANCE AND FINANCIAL

FOR INSURANCE AGENCY AND BROKER SERVICES, NAMELY, PROVIDING TRAVEL, HOLIDAY, VEHICLE AND STORAGE INSURANCE; ARRANGING TRAVEL, HOLIDAY, VEHICLE AND STORAGE INSURANCE; FOREIGN CURRENCY EXCHANGE SERVICES; INSURANCE BROKERAGE SERVICES; INSURANCE UNDERWRITING IN THE FIELD OF TRAVEL, HOLIDAY, VEHICLE AND STORAGE; ELECTRONIC FUND TRANSFER SERVICES; ELECTRONIC PAYMENT SERVICES; ORGANIZING, ARRANGING AND PROVIDING TRAVEL, HOLIDAY, VEHICLE AND STORAGE INSURANCE; FOREIGN CURRENCY AND MONEY EXCHANGE; PROVIDING ELECTRONIC PROCUREMENT SYSTEMS WHICH ASSIST THIRD PARTIES TO OBTAIN INSURANCE, CURRENCY; CURRENCY EXCHANGE AND CREDIT SERVICES; PROVIDING THE AFORESAID SERVICES USING THE INTERNET AND OTHER ELECTRONIC COMMUNICATIONS NETWORKS; CONSULTATION, ADVICE, ASSISTANCE, RESEARCH AND INFORMATION RELATING TO THE AFORESAID SERVICES (U.S. CLS. 100, 101 AND 102).

CLASS 39—TRANSPORTATION AND STORAGE

FOR ORGANIZING AND ADMINISTERING POINTS/MILES REDEMPTION SYSTEMS RELATING TO TRAVEL, NAMELY, ARRANGING TRAVEL TOURS AS A BONUS PROGRAM FOR CREDIT CARD CUSTOMERS; TRANSPORT OF PEOPLE AND GOODS BY AIR, BOAT, RAIL, BUS, BICYCLE, HORSE AND VEHICLE; BOOKING SERVICES, NAMELY MAKING RESERVATIONS AND BOOKINGS FOR TRAVEL, HOLIDAYS, TOURS AND TRANSPORT; ARRANGING TRAVEL TOURS; TRAVEL BOOKING AGENCIES; BOOKING SERVICES FOR TRAIN TICKETS, AIRPLANE TICKETS, BUS TICKET, SHIP TICKETS AND BOAT TICKETS; TICKET AND TRAVEL RESERVATION SERVICE; ON-LINE AND TELEPHONE TRAVEL BOOKING AND RESERVATION SERVICES FOR TRANSPORTATION; BOOKING SERVICES FOR CARS, CARAVANS, MOBILE HOMES, RECREATIONAL VEHICLES AND OTHER VEHICLES; AIRPORT TRANSFER OF PASSENGERS; VEHICLE HIRE, RENTAL AND LEASING; VEHICLE PARKING SERVICES; VEHICLE PARKING FACILITIES; VEHICLE PARKING RESERVATION SERVICES; VALET PARKING SERVICES; PROVISION OF SECURE PARKING FACILITIES AND SERVICES; SECURE TEMPORARY STORAGE OF VEHICLES; HOLIDAY PARKING; PARKING OF BOATS; RENTAL OF PARKING PLACES; PARKING SERVICES AT TRAIN, BUS, BOAT AND PLANE PORTS AND TERMINALS; CAR, BICYCLE, BOAT AND AIRCRAFT RENTAL, LEASING AND CHARTER; TRUCK AND BUS RENTAL, LEASING AND CHARTER; ORGANIZING, ARRANGING AND PROVIDING TRAVEL BY CAR, BUS, TRAIN, PLANE, BOAT, AND OTHER VEHICLES; TOURIST AGENCY SERVICES, NAMELY, ORGANIZING, ARRANGING AND PROVIDING TRAVEL AND TOURIST SERVICES; ORGANIZING AND OPERATING TOURS, CRUISES, EXCURSIONS AND GUIDED TOURS; ORGANIZING TRAVEL ESCORTS OR TOURISTS; ARRANGING, PROMOTING AND PROVIDING FLIGHTS, CRUISES, HOLIDAYS, TOURS AND TRANSPORT; ORGANIZING VISAS, PASSPORTS AND BOARDER PERMITS; TOURIST OFFICE SERVICES; TRAVEL AGENCY SERVICES, NAMELY, MAKING RESERVATIONS AND BOOKINGS FOR TRANSPORTATION; ARRANGING AND OPERATING SPORTS AND ADVENTURE ACTIVITY HOLIDAYS; PROVISION OF TIME TABLE, FARE, SCHEDULE AND CONNECTING TRANSPORT INFORMATION; PROVISION OF INFORMATION RELATING TO TRAVEL UTILIZING ELECTRONIC COMMUNICATIONS NETWORKS; INFORMATION SERVICES RELATING TO TRAVEL, TRAVEL DESTINATIONS, AIRPORTS, TRAIN STATIONS; PLANNING AND ARRANGING TRAVEL TOURS; RESEARCH, AUTHENTICATION, APPRAISAL AND ADVICE SERVICES RELATING TO TRAVEL, TRAVEL GOODS AND TRAVEL PUBLICATIONS; STORAGE OF GOODS; STORAGE SERVICES FOR ARCHIVING DATABASES, IMAGES AND OTHER ELECTRONIC DATA; PROVIDING ELECTRONIC PROCUREMENT SYSTEMS WHICH ASSIST THIRD PARTIES TO OBTAIN AND USE TRAVEL SERVICES; COURIER SERVICE; ARCHIVING OF ELECTRONICALLY STORED INFORMATION RELATING TO TRAVEL; PROVIDING THE AFORESAID SERVICES USING THE

INTERNET AND OTHER ELECTRONIC COMMUNICATIONS NETWORKS; CONSULTATION, ADVICE, ASSISTANCE, RESEARCH AND INFORMATION RELATING TO THE AFORESAID SERVICES (U.S. CLS. 100 AND 105).

CLASS 43—HOTEL AND RESTAURANT SERVICES

FOR TRAVEL AGENCY SERVICES, NAMELY, MAKING RESERVATIONS AND BOOKING FOR TEMPORARY LODGING AND FOR RESTAURANTS AND MEALS; PROVIDING TEMPORARY HOUSING ACCOMMODATIONS; HOTEL ROOM RESERVATION SERVICES; RESERVATION OF ACCOMMODATIONS; HOTEL AND MOTEL BOOKING SERVICES; AIRPORT ACCOMMODATION HOTEL RESERVATION SERVICES; ARRANGING TEMPORARY HOUSING ACCOMMODATIONS; HOTEL RESERVATION SERVICES; RESERVATION OF SELF-CATERING ACCOMMODATION, NAMELY, FLATS, APARTMENTS, SELF-CONTAINED UNITS, CONDOMINIUMS, CARAVANS, CABINS, HOUSES, MOTELS, BOATS, TENTS, SERVICED APARTMENTS AND UNITS, CHALETS; PROVIDING TEMPORARY HOUSING ACCOMMODATION BUREAU SERVICES; RESERVATION OF TEMPORARY HOUSING ACCOMMODATIONS; TOURIST HOMES; HOTEL AND MOTEL SERVICES; PROVIDING TEMPORARY HOUSING ACCOMMODATIONS; PROVIDING CAMP-GROUND FACILITIES; MANAGING AND PROVIDING AIRPORT, BUS STATION, AND PORT LOUNGE RESTAURANT SERVICES; PROVIDING FOOD AND DRINK IN THE NATURE OF RESTAURANT, CATERING, CAFES, CAFETERIAS, BARS, CANTEENS, SNACK-BARS AND SELF-SERVICE FOOD AND DRINK; BOOKING OF RESTAURANTS; PROVIDING AN ON-LINE COMPUTER DATABASE IN THE FIELD OF TEMPORARY TRAVEL ACCOMMODATIONS; PROVIDING THE AFORESAID SERVICES USING THE INTERNET AND OTHER ELECTRONIC COMMUNICATIONS NETWORKS; CONSULTATION, ADVICE, ASSISTANCE, RESEARCH AN INFORMATION RELATING TO THE AFORESAID SERVICES (U.S. CLS. 100 AND 101).

SN 76-430,685. MUNICIPAL ART SOCIETY, NEW YORK, NY. AND CREATIVE TIME, INC., NEW YORK, NY. FILED 7-12-2002.

TRIBUTE IN LIGHT

CLASS 16—PAPER GOODS AND PRINTED MATTER

FOR PUBLICATIONS, NAMELY, BOOKS, PAMPHLETS, AND NEWSLETTERS IN THE FIELD OF ARCHITECTURE, CHARITABLE FUND RAISING, AND MATTERS RELATED TO THE VICTIMS OF THE TERRORIST ATTACKS OF SEPTEMBER 11, 2001; PHOTOGRAPHS, PRINTS, PAINTINGS, AND POSTERS (U.S. CLS. 2, 5, 22, 23, 29, 37, 38 AND 50).

CLASS 36—INSURANCE AND FINANCIAL

FOR CHARITABLE FUND RAISING; PROVIDING INFORMATION REGARDING CHARITABLE FUND RAISING TO BENEFIT AND HONOR THE VICTIMS OF SEPTEMBER 11, 2001 VIA A GLOBAL COMPUTER NETWORK (U.S. CLS. 100, 101 AND 102).

CLASS 41—EDUCATION AND ENTERTAINMENT

FOR HONORING THE MEMORY OF THE VICTIMS OF THE TERRORIST ATTACKS OF SEPTEMBER 11, 2001 BY MAINTAINING A MEMORIAL TO HONOR THOSE VICTIMS; ORGANIZING ACTIVITIES, NAMELY, CONDUCTING MEETING AND MEMORIAL GATHERINGS, ORGANIZING, SPONSORING, AND COMMISSIONING WORKS OF ART AND OTHER MEMORIALS TO BENEFIT BY PROVIDING RECOGNITION AND HONOR THE VICTIMS OF SEPTEMBER 11, 2001 VIA A GLOBAL COMPUTER NETWORK (U.S. CLS. 100, 101 AND 107).

SN 76-430,833. GENZYME BIOSURGERY CORP., CAMBRIDGE, MA. FILED 7-15-2002.

HYLASOME

OWNER OF U.S. REG. NO. 2,127,497.

CLASS 5—PHARMACEUTICALS

FOR PHARMACEUTICALS FOR USE IN SURGERY, NAMELY, HYALURONIC ACID, HYALURONANS AND DERIVATIVES THEREOF ALONE, OR IN COMBINATION WITH OTHER POLYSACCHARIDES (U.S. CLS. 6, 18, 44, 46, 51 AND 52).

CLASS 10—MEDICAL APPARATUS

FOR MEDICAL DEVICES, NAMELY, SELF-CONTAINED SYRINGES AND AMPULES FOR DISPENSING PREPACKAGED HYALURONIC ACID, HYALURONANS AND HYLAN AND DERIVATIVES THEREOF ALONE, OR IN COMBINATION WITH OTHER POLYSACCHARIDES FOR TOPICAL USE IN SURGERY (U.S. CLS. 26, 39 AND 44).

SN 76-432,415. IIC-INTERSPORT INTERNATIONAL CORPORATION GMBH, CH-3072 OSTERMUNDIGEN, SWITZERLAND, FILED 7-19-2002.

CYTEC

OWNER OF SWITZERLAND REG. NO. 722532, DATED 9-10-1999, EXPIRES 9-10-2009.

CLASS 9—ELECTRICAL AND SCIENTIFIC APPARATUS

FOR WIRELESS AND HARD WIRED MEASURING INSTRUMENTS, NAMELY BICYCLE COMPUTERS ENABLING THE ATHLETES/USERS TO BE INFORMED ON THEIR PERFORMANCE; PULSE METERS, DATA PROCESSORS FOR ANALYZING AND DISPLAYING DATA PRODUCED BY SAID MEASURING INSTRUMENTS AND PULSE METERS; COMPUTER MONITORS FOR DISPLAYING PERFORMANCE RELATED INFORMATION AND ATHLETES'/USERS' BODY RELATED INFORMATION (U.S. CLS. 21, 23, 26, 36 AND 38).

CLASS 12—VEHICLES

FOR BICYCLES, TRAILERS FOR TRANSPORTING BICYCLES, TRAILERS WHICH CAN BE ATTACHED TO BICYCLES, PARTS AND FITTINGS OF BICYCLES, NAMELY, PEDALS, HUBS FOR BICYCLE WHEELS, BICYCLE WHEELS, LOCATION AND ADJUSTING SHAFTS FOR BICYCLE SADDLES, RIMS FOR BICYCLE WHEELS, CONTROLS, NAMELY, HANDLEBARS, GEAR CABLES, GEARS, BRAKE CABLES, MUDGUARDS, BRAKES, HANDLE BAR ENDS, GEAR AND CHAIN PROTECTIVE COVERS FOR CYCLES, FRONT PARTS OF BICYCLES, NAMELY, FRONT FORK AND FRONT FORK JOINTS; BICYCLE CHAINS, BICYCLE BELLS, PUMPS, INNER TUBES, WATER BOTTLE HOLDERS, BICYCLE TIRES, HANDLE BARS, BICYCLE SADDLES (U.S. CLS. 19, 21, 23, 31, 35 AND 44).

SN 76-433,420. STARGLOW PRODUCTIONS INC., WOODLAND HILLS, CA. FILED 7-16-2002.

CYNDI'S SECRETS**CLASS 9—ELECTRICAL AND SCIENTIFIC APPARATUS**

FOR AUDIO TAPES, VIDEO TAPES, CD-ROMS AND DVD'S, ALL IN THE FIELDS OF FITNESS, FASHION, BEAUTY, NUTRITION, HEALTH, MEDICINE, STRESS REDUCTION AND MANAGEMENT AND LIFESTYLE MANAGEMENT (U.S. CLS. 21, 23, 26, 36 AND 38).

CLASS 16—PAPER GOODS AND PRINTED MATTER

FOR POSTERS; PUBLICATIONS AND PRINTED MATTER IN THE FIELDS OF FITNESS, FASHION, BEAUTY, NUTRITION, HEALTH, MEDICINE, STRESS REDUCTION AND MANAGEMENT AND LIFESTYLE MANAGEMENT, NAMELY, BOOKS, BOOKLETS, BROCHURES, CALENDARS, CATALOGS, DIRECTORIES OF SERVICE PROVIDERS, GIFT CARDS, INFORMATIONAL FLYERS, LETTERS AND SHEETS, JOURNALS, MAGAZINES, MEMO PADS, MOTIVATIONAL CARDS, NEWSLETTERS, NOTE CARDS, NOTE PADS, PAMPHLETS, PRINTED INSTRUCTIONAL, EDUCATIONAL, AND TEACHING MATERIALS, AND STICKERS (U.S. CLS. 2, 5, 22, 23, 29, 37, 38 AND 50).

SN 76-433,181. NYS OFFICE OF PARKS, REC., AND HISTORIC PRESERVATION, ALBANY, NY. FILED 7-19-2002.

BETHPAGE BLACK

NO CLAIM IS MADE TO THE EXCLUSIVE RIGHT TO USE "BETHPAGE", APART FROM THE MARK AS SHOWN.

CLASS 16—PAPER GOODS AND PRINTED MATTER

FOR STATIONERY, AND PRINTED SPORTS MEMORABILIA, NAMELY AUTOGRAPH PHOTOS, ART PRINTS, CALENDARS, POSTERS, POSTCARDS AND PAPER BANNERS (U.S. CLS. 2, 5, 22, 23, 29, 37, 38 AND 50).

FIRST USE 6-1-1998; IN COMMERCE 6-1-1998.

CLASS 21—HOUSEWARES AND GLASS

FOR DRINKING GLASSES, MUGS AND SHOT GLASSES (U.S. CLS. 2, 13, 23, 29, 30, 33, 40 AND 50).

FIRST USE 6-1-1998; IN COMMERCE 6-1-1998.

CLASS 24—FABRICS

FOR TOWELS AND CLOTH BANNERS (U.S. CLS. 42 AND 50).

FIRST USE 6-1-1998; IN COMMERCE 6-1-1998.

CLASS 25—CLOTHING

FOR CLOTHING, NAMELY SHIRTS, T-SHIRTS, JACKETS, SHORTS, PANTS, CAPS, SWEATSHIRTS AND GOLF SHIRTS (U.S. CLS. 22 AND 39).

FIRST USE 6-1-1998; IN COMMERCE 6-1-1998.

CLASS 28—TOYS AND SPORTING GOODS

FOR SPORTING GOODS, NAMELY GOLF BALLS, GOLF BALL MARKERS, GOLF BAGS, GOLF TEES, GOLF BAG TAGS, GOLF GLOVES, GOLF BAG COVERS, GOLF CLUB COVERS, AND GOLF BALL MARK REPAIR TOOLS (U.S. CLS. 22, 23, 38 AND 50).

FIRST USE 6-1-1998; IN COMMERCE 6-1-1998.

CLASS 21—HOUSEWARES AND GLASS

FOR MUGS, WATER BOTTLES SOLD EMPTY, SPORTS BOTTLES SOLD EMPTY (U.S. CLS. 2, 13, 23, 29, 30, 33, 40 AND 50).

CLASS 25—CLOTHING

FOR CLOTHING, NAMELY, BEACHWEAR, BLOUSES, BRAS, BUSTIERS, DRESSES, FOOTWEAR, FOUNDATION GARMENTS, GLOVES, GOWNS, HEAD WEAR, HOSIERY, INFANTWEAR, JACKETS, LINGERIE, LOUNGEWEAR, MITTENS, NECKWEAR, PANTS, RAINWEAR, SCARVES, SHIRTS, SHORTS, SKI WEAR, SLEEPWEAR, SLIPS, SOCKS, SUITS, SWEATERS, SWEAT SUITS, SWIM WEAR, TENNIS WEAR, UNDERCLOTHES, UNDER GARMENTS, UNDERWEAR, AND VESTS (U.S. CLS. 22 AND 39).

CLASS 41—EDUCATION AND ENTERTAINMENT

FOR EDUCATIONAL SERVICES, NAMELY CONDUCTING SEMINARS AND PRESENTATIONS IN THE FIELDS OF FITNESS, FASHION, BEAUTY, NUTRITION, HEALTH, MEDICINE, STRESS REDUCTION AND MANAGEMENT AND LIFESTYLE MANAGEMENT; PROVIDING INFORMATION OVER THE INTERNET IN THE FIELD OF FITNESS (U.S. CLS. 100, 101 AND 107).

CLASS 44—MEDICAL, BEAUTY AND AGRICULTURAL SERVICES

FOR PROVIDING INFORMATION OVER THE INTERNET IN THE FIELDS OF BEAUTY, NUTRITION, HEALTH, MEDICINE, STRESS REDUCTION AND MANAGEMENT AND LIFESTYLE MANAGEMENT (U.S. CLS. 100 AND 101).

CLASS 45—PERSONAL SERVICES

FOR PROVIDING INFORMATION OVER THE INTERNET IN THE FIELD OF FASHION (U.S. CLS. 100 AND 101).

SN 76-433,705. DISCOVERY EAST LLC, STAMFORD, CT.
FILED 7-24-2002.

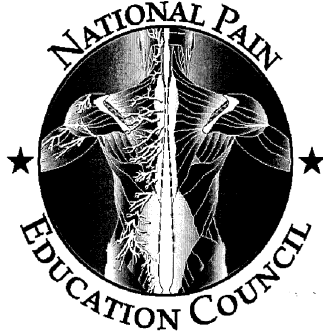

NO CLAIM IS MADE TO THE EXCLUSIVE RIGHT TO USE "NATIONAL PAIN EDUCATION COUNCIL", APART FROM THE MARK AS SHOWN.

CLASS 9—ELECTRICAL AND SCIENTIFIC APPARATUS

FOR PRERECORDED AUDIO TAPES, VIDEO TAPES AND CD-ROMS PROVIDING TRAINING, WORKSHOPS, SEMINARS AND INFORMATION TO PHYSICIANS AND OTHER HEALTHCARE PROVIDERS CONCERNING PAIN MANAGEMENT (U.S. CLS. 21, 23, 26, 36 AND 38).

CLASS 16—PAPER GOODS AND PRINTED MATTER

FOR NEWSLETTERS, BROCHURES, SCIENTIFIC MONOGRAPHS AND LECTURE SLIDES PROVIDING INFORMATION TO PHYSICIANS AND OTHER HEALTHCARE PROVIDERS CONCERNING PAIN MANAGEMENT (U.S. CLS. 2, 5, 22, 23, 29, 37, 38 AND 50).

CLASS 41—EDUCATION AND ENTERTAINMENT

FOR EDUCATIONAL SERVICES, NAMELY, ORGANIZING SYMPOSIA AND SCIENTIFIC MEETINGS, PROVIDING WORKSHOPS, AND SEMINARS TO PHYSICIANS AND OTHER HEALTHCARE PROVIDERS CONCERNING PAIN MANAGEMENT, PROVIDED BOTH IN PERSON AND VIA AN INTERNET (U.S. CLS. 100, 101 AND 107).

CLASS 44—MEDICAL, BEAUTY AND AGRICULTURAL SERVICES

FOR PROVIDING INFORMATION TO PHYSICIANS AND OTHER HEALTHCARE PROVIDERS CONCERNING PAIN MANAGEMENT, IN PERSON OR VIA AN INTERNET WEBSITE (U.S. CLS. 100 AND 101).

SN 76-434,239. TUSCARORA INCORPORATED, WHEELING, IL. FILED 7-25-2002.

THERMO SAFE

OWNER OF U.S. REG. NO. 734,751.
NO CLAIM IS MADE TO THE EXCLUSIVE RIGHT TO USE "THERMO", APART FROM THE MARK AS SHOWN.

CLASS 1—CHEMICALS

FOR (BASED ON USE IN COMMERCE) REFRIGERANT PACKS, NAMELY PACKETS CONTAINING A CHEMICAL SOLUTION OR GEL THAT IS HEATED OR COOLED FOR USE IN AN INSULATED CONTAINER TO KEEP ITEMS IN THE CONTAINER AT A SELECTED TEMPERATURE (U.S. CLS. 1, 5, 6, 10, 26 AND 46).
FIRST USE 8-15-1961; IN COMMERCE 8-15-1961.

CLASS 9—ELECTRICAL AND SCIENTIFIC APPARATUS

FOR (BASED ON INTENT TO USE) LABORATORY CONSUMABLES, NAMELY, ABSORBENT SHEETS, BAGS AND RACKS (U.S. CLS. 21, 23, 26, 36 AND 38).

CLASS 11—ENVIRONMENTAL CONTROL APPARATUS

FOR (BASED ON INTENT TO USE) NON-ELECTRIC DRY ICE MAKERS (U.S. CLS. 13, 21, 23, 31 AND 34).

CLASS 16—PAPER GOODS AND PRINTED MATTER

FOR (BASED ON INTENT TO USE) SPECIMEN MAILERS MADE OF EXPANDED POLYSTYRENE OR CORRUGATED CARDBROAD TO MAIL MEDICAL OR LABORATORY ITEMS, NAMELY, PETRI DISHES, TUBES AND SLIDES; CONTAINERS MADE OF EXPANDED POLYSTYRENE OR CORRUGATED CARDBOARD FOR SHIPPING HAZARDOUS OR OTHER REGULATED MATERIALS (U.S. CLS. 2, 5, 22, 23, 29, 37, 38 AND 50).

CLASS 42—SCIENTIFIC, COMPUTER AND LEGAL SERVICES

FOR (BASED ON INTENT TO USE) TESTING SERVICES FOR OTHERS, NAMELY, TESTING THE PHYSICAL AND THERMAL CHARACTERISTICS OF CONTAINERS; AND CUSTOM PACKAGING DESIGN SERVICES FOR OTHERS (U.S. CLS. 100 AND 101).

SN 76-434,773. GEMEX SYSTEMS, INC., MEQUON, WI.
FILED 7-29-2002.



OWNER OF U.S. REG. NO. 2,560,977.
THE DRAWING FEATURES THE SHAPES OF THE CONTINENTS INSIDE THE SHAPE OF A DIAMOND.

CLASS 9—ELECTRICAL AND SCIENTIFIC APPARATUS

FOR INSTRUMENTS, NAMELY, COMPUTERIZED IMAGING DEVICE USED FOR DISPLAYING AND CATEGORIZING LIGHT REFRACTING CHARACTERISTICS OF GEMSTONES; COMPUTER SOFTWARE FOR FACILITATING THE TRADING OF GEMSTONES (U.S. CLS. 21, 23, 26, 36 AND 38).

FIRST USE 1-0-2002; IN COMMERCE 1-0-2002.

CLASS 35—ADVERTISING AND BUSINESS

FOR COMPUTERIZED INVENTORY LISTING SERVICE IN THE GEMOLOGICAL TRADE, NAMELY, PROVIDING SUBSCRIBERS WITH A MEANS OF POOLING INVENTORIES FOR COMMON ACCESS BY WAY OF A GLOBAL INFORMATION NETWORK WITH PRINTED INFORMATION AND GRAPHIC IMAGES (U.S. CLS. 100, 101 AND 102).

FIRST USE 1-0-2002; IN COMMERCE 1-0-2002.

SN 76-437,361. GROUP PUBLISHING, INC., LOVELAND, CO. FILED 8-5-2002.

**CLASS 9—ELECTRICAL AND SCIENTIFIC APPARATUS**

FOR PRERECORDED VIDEO CASSETTES, PRERECORDED VIDEO DISCS, PRERECORDED AUDIO CASSETTES AND PRERECORDED AUDIO DISCS SOLD SEPARATELY OR WITHIN A MULTI-MEDIA KIT ALL FEATURING CHRISTIAN EDUCATIONAL INFORMATION TO BE USED IN CHURCHES AND OTHER CHRISTIAN EDUCATIONAL SETTINGS (U.S. CLS. 21, 23, 26, 36 AND 38).

FIRST USE 12-31-1998; IN COMMERCE 4-30-1999.

CLASS 16—PAPER GOODS AND PRINTED MATTER

FOR PRINTED PUBLICATIONS, NAMELY BOOKS, INSTRUCTIONAL MANUALS, REPRODUCIBLE MASTERS, POSTERS AND STICKERS SOLD SEPARATELY OR WITHIN A MULTI-MEDIA KIT ALL FEATURING CHRISTIAN EDUCATIONAL INFORMATION TO BE USED IN CHURCHES AND OTHER CHRISTIAN EDUCATIONAL SETTINGS (U.S. CLS. 2, 5, 22, 23, 29, 37, 38 AND 50).

FIRST USE 12-31-1998; IN COMMERCE 4-30-1999.

SN 76-437,362. GROUP PUBLISHING, INC., LOVELAND, CO. FILED 8-5-2002.

KIDSOWN WORSHIP

NO CLAIM IS MADE TO THE EXCLUSIVE RIGHT TO USE "WORSHIP", APART FROM THE MARK AS SHOWN.

CLASS 9—ELECTRICAL AND SCIENTIFIC APPARATUS

FOR PRERECORDED VIDEO CASSETTES, PRERECORDED VIDEO DISCS, PRERECORDED AUDIO CASSETTES AND PRERECORDED AUDIO DISCS SOLD SEPARATELY OR WITHIN A MULTI-MEDIA KIT ALL FEATURING CHRISTIAN EDUCATIONAL INFORMATION TO BE USED IN CHURCHES AND OTHER CHRISTIAN EDUCATIONAL SETTINGS (U.S. CLS. 21, 23, 26, 36 AND 38).

FIRST USE 3-30-2000; IN COMMERCE 5-30-2000.

CLASS 16—PAPER GOODS AND PRINTED MATTER

FOR PRINTED PUBLICATIONS, NAMELY BOOKS AND INSTRUCTIONAL MANUALS SOLD SEPARATELY OR WITHIN A MULTI-MEDIA KIT ALL FEATURING CHRISTIAN EDUCATIONAL INFORMATION TO BE USED IN CHURCHES AND OTHER CHRISTIAN EDUCATIONAL SETTINGS (U.S. CLS. 2, 5, 22, 23, 29, 37, 38 AND 50).

FIRST USE 3-30-2000; IN COMMERCE 5-30-2000.

SN 76-437,427. RATIONAL AG, 86899 LANDSBERG/LECH, FED REP GERMANY, FILED 8-5-2002.

CombiFry

PRIORITY CLAIMED UNDER SEC. 44(D) ON FED REP GERMANY APPLICATION NO. 30217837.6/1, FILED 4-10-2002, REG. NO. 30217837, DATED 5-16-2002, EXPIRES 4-30-2012.

CLASS 11—ENVIRONMENTAL CONTROL APPARATUS

FOR ELECTRIC STOVES FOR THE TREATMENT AND PREPARATION OF FOOD IN COMMERCIAL KITCHENS; ELECTRICAL DEEP FRYERS; ELECTRICAL PRESSURE COOKERS; ELECTRICAL FOOD STEAMERS; AND COMMERCIAL COOKING OVENS (U.S. CLS. 13, 21, 23, 31 AND 34).

CLASS 21—HOUSEWARES AND GLASS

FOR BASKETS FOR DEEP FRYERS; AND STEAMER BASKETS (U.S. CLS. 2, 13, 23, 29, 30, 33, 40 AND 50).

SN 76-438,825. GMCA PTY LTD., CAMPBELLFIELD, VICTORIA 3061, AUSTRALIA, FILED 8-7-2002.

REDEYE

PRIORITY CLAIMED UNDER SEC. 44(D) ON AUSTRALIA APPLICATION NO. 918152, FILED 6-27-2002, REG. NO. 918152, DATED 6-27-2002, EXPIRES 6-27-2012.

CLASS 7—MACHINERY

FOR MACHINES AND POWER TOOLS, NAMELY, AC POWER OPERATED DRILLS, BATTERY OPERATED DRILLS, DRILL BITS, AC POWER OPERATED CIRCULAR SAWS, AC POWER OPERATED JIGSAWS, BATTERY OPERATED JIGSAWS, AC POWER OPERATED MITER SAWS, AC POWER OPERATED BENCH SAWS, AC POWER OPERATED SANDERS, AC POWER OPERATED POLISHERS, AC POWER OPERATED PLANERS, AC POWER OPERATED CHAIN SAWS, GASOLINE OPERATED CHAIN SAWS, AC POWER OPERATED GRINDERS, AC POWER OPERATED ROUTERS, BATTERY OPERATED SCREWDRIVERS, AC POWER OPERATED BRUSH CUTTERS, GASOLINE OPERATED BRUSH CUTTERS, AC POWER GENERATED GRASS CUTTERS, AC POWER OPERATED HEDGE TRIMMERS, BATTERY OPERATED HEDGE TRIMMERS, AC POWER OPERATED LINE TRIMMERS, AC POWER OPERATED VACUUMS AND BLOWERS, BATTERY OPERATED HAND VACUUMS, AND REPLACEMENT PARTS THEREFOR (U.S. CLS. 13, 19, 21, 23, 31, 34 AND 35).

CLASS 8—HAND TOOLS

FOR HAND TOOLS AND HAND OPERATED IMPLEMENTS, NAMELY, SCREWDRIVERS, HAMMERS, WRENCHES, POCKET-KNIVES, RATCHET SETS, SOCKET SETS, WRENCH KEYS, MALLET, CHISELS, CLAMPS AND PLIERS (U.S. CLS. 23, 28 AND 44).

SN 76-439,177. SEGAL, JONATHAN, CHICAGO, IL. FILED 8-12-2002.

MINNIE-CHEESEBURGER**CLASS 29—MEATS AND PROCESSED FOODS**

FOR CONDIMENTS, NAMELY, PEPPER OIL (U.S. CL. 46).

CLASS 30—STAPLE FOODS

FOR MEATS AND PROCESSED FOODS, NAMELY, SANDWICHES; CONDIMENTS, NAMELY, MAYONNAISE, RELISH, MUSTARD AND KETCHUP; SAUCES, SPICES AND SALAD DRESSINGS (U.S. CL. 46).

CLASS 43—HOTEL AND RESTAURANT SERVICES

FOR SERVICES FOR PROVIDING FOOD AND DRINK, NAMELY, RESTAURANT SERVICES FOR CONSUMPTION ON THE PREMISES, AND CARRY-OUT RESTAURANT FOOD AND BEVERAGE SERVICES FOR CONSUMPTION OFF THE PREMISES (U.S. CLS. 100 AND 101).

SN 76-439,424. SEGAL, JONATHAN, CHICAGO, IL. FILED 8-12-2002.

MINNIE-BURGER**CLASS 29—MEATS AND PROCESSED FOODS**

FOR CONDIMENTS, NAMELY, PEPPER OIL (U.S. CL. 46).

CLASS 30—STAPLE FOODS

FOR MEATS AND PROCESSED FOODS, NAMELY, SANDWICHES; CONDIMENTS, NAMELY, MAYONNAISE, RELISH, MUSTARD AND KETCHUP; SAUCES, SPICES AND SALAD DRESSINGS (U.S. CL. 46).

CLASS 43—HOTEL AND RESTAURANT SERVICES

FOR SERVICES FOR PROVIDING FOOD AND DRINK, NAMELY, RESTAURANT SERVICES FOR CONSUMPTION ON THE PREMISES, AND CARRY-OUT RESTAURANT FOOD AND BEVERAGE SERVICES FOR CONSUMPTION OFF THE PREMISES (U.S. CLS. 100 AND 101).

SN 76-439,881. SEGAL, JONATHAN, CHICAGO, IL. FILED 8-13-2002.

MINNIEBURGER**CLASS 29—MEATS AND PROCESSED FOODS**

FOR CONDIMENTS, NAMELY, PEPPER OIL (U.S. CL. 46).

CLASS 30—STAPLE FOODS

FOR MEATS AND PROCESSED FOODS, NAMELY, SANDWICHES; CONDIMENTS, NAMELY, MAYONNAISE, RELISH, MUSTARD AND KETCHUP; SAUCES, SPICES AND SALAD DRESSINGS (U.S. CL. 46).

CLASS 43—HOTEL AND RESTAURANT SERVICES

FOR SERVICES FOR PROVIDING FOOD AND DRINK, NAMELY, RESTAURANT SERVICES FOR CONSUMPTION ON THE PREMISES, AND CARRY-OUT RESTAURANT FOOD AND BEVERAGE SERVICES FOR CONSUMPTION OFF THE PREMISES (U.S. CLS. 100 AND 101).

SN 76-440,544. OFFICEMATE INTERNATIONAL CORPORATION, EDISON, NJ. FILED 8-14-2002.

2200 SERIES

NO CLAIM IS MADE TO THE EXCLUSIVE RIGHT TO USE "SERIES", APART FROM THE MARK AS SHOWN.

CLASS 16—PAPER GOODS AND PRINTED MATTER

FOR DESK TOP ORGANIZERS, ORGANIZERS FOR STATIONERY USE, PAPER CLIP DISPENSERS, ADHESIVE TAPE DISPENSERS, BOOKENDS, DESKPADS, LETTER TRAYS, BUSINESS CARD HOLDERS, CALENDAR HOLDERS, MEMO HOLDERS, PENCIL CUPS AND STAPLERS (U.S. CLS. 2, 5, 22, 23, 29, 37, 38 AND 50).

CLASS 20—FURNITURE AND ARTICLES NOT OTHERWISE CLASSIFIED

FOR MAGAZINE RACKS, BOOK SHELVES AND DESKTOP TELEPHONE STANDS (U.S. CLS. 2, 13, 22, 25, 32 AND 50).

CLASS 21—HOUSEWARES AND GLASS

FOR WASTEPAPER BASKETS (U.S. CLS. 2, 13, 23, 29, 30, 33, 40 AND 50).

SN 76-440,902. BAR GMBH, BIETIGHEIM - BISSINGEN, FED REP GERMANY, FILED 8-16-2002.



OWNER OF U.S. REG. NO. 1,983,242.
THE LINING IS A FEATURE OF THE MARK AND DOES NOT INDICATE COLOR.
THE ENGLISH TRANSLATION OF THE TERM "BAR" IS "BEAR".

CLASS 18—LEATHER GOODS

FOR GOODS OF LEATHER OR IMITATIONS OF LEATHER, NAMELY HANDBAGS, BRIEFCASES, SHOPPING BAGS, SCHOOL BAGS, ALL PURPOSE CARRYING BAGS FOR USE BY CAMPERS AND CLIMBERS, RUCKSACKS, TOILET CASES FOR TRAVELLING SOLD EMPTY, BANDOLIERS, TRUNKS FOR TRAVELLING, TRAVELLING BAGS AND SMALL ARTICLES OF LEATHER, NAMELY PURSES, POCKET WALLET AND KEY CASES (U.S. CLS. 1, 2, 3, 22 AND 41).

CLASS 25—CLOTHING

FOR CLOTHING MADE OF LEATHER, NAMELY BELTS, SHOES, SPORT SHOES, FOOTWEAR, PARTS OF FOOTWEAR, NAMELY SOLES, HEELS AND BOOT UPPERS (U.S. CLS. 22 AND 39).

SN 76-441,130. SISTER TO SISTER EVERYONE HAS A HEART FOUNDATION, INC., WASHINGTON, DC. FILED 8-16-2002.

BECAUSE A WOMAN'S HEART IS DIFFERENT

CLASS 35—ADVERTISING AND BUSINESS

FOR PROMOTING PUBLIC AWARENESS OF THE NEED FOR GOOD CARDIOVASCULAR HEALTH (U.S. CLS. 100, 101 AND 102).
FIRST USE 11-1-2000; IN COMMERCE 12-0-2000.

CLASS 44—MEDICAL, BEAUTY AND AGRICULTURAL SERVICES

FOR PROVIDING HEALTH INFORMATION; PROVIDING HEALTH SCREENING AT HEALTH FAIRS (U.S. CLS. 100 AND 101).
FIRST USE 11-1-2000; IN COMMERCE 12-0-2000.

SN 76-441,507. PROSCAN INVESTMENTS, LLC, CINCINNATI, OH. FILED 8-19-2002.

THE BEST OF SCIENCE AND NATURE

CLASS 16—PAPER GOODS AND PRINTED MATTER

FOR EDUCATIONAL MEDICAL BOOKS; MEDICAL REFERENCE BOOKS; MAGAZINE SUPPLEMENTS TO NEWSPAPERS; NEWSPAPERS IN THE FIELD OF HEALTH CARE AND MEDICAL INFORMATION; MAGAZINE SUPPLEMENTS TO NEWSPAPERS IN THE FIELD OF HEALTH CARE INFORMATION (U.S. CLS. 2, 5, 22, 23, 29, 37, 38 AND 50).

CLASS 41—EDUCATION AND ENTERTAINMENT

FOR PHYSICAL FITNESS INSTRUCTION AND CONSULTATION; PROVIDING CONTINUING MEDICAL EDUCATION COURSES VIA TELEVISION, SATELLITE, AUDIO AND VIDEO MEDIA; PRODUCTION OF RADIO AND TELEVISION PROGRAMS; EDUCATIONAL SERVICES, NAMELY, CONDUCTING SEMINARS AND WORKSHOPS IN THE FIELD OF HEALTH CARE AND MEDICINE; CONDUCTING CONTINUING MEDICAL EDUCATION CLASSES IN PERSON AND BROADCASTED OVER TELEVISION, RADIO, SATELLITE, AUDIO AND VIDEO MEDIA AND THE INTERNET; PUBLICATION OF TEXTBOOKS (U.S. CLS. 100, 101 AND 107).

CLASS 44—MEDICAL, BEAUTY AND AGRICULTURAL SERVICES

FOR PROVIDING INFORMATION IN THE FIELD OF MEDICINE; PROVIDING INFORMATION IN THE FIELD OF MEDICINE VIA THE INTERNET; MEDICAL COUNSELING; MEDICAL SERVICES (U.S. CLS. 100 AND 101).

SN 76-441,574. ROSHAL, EUGENE, CHELYABINSK, RUSSIAN FEDERATIO, FILED 8-14-2002.

WINRAR

CLASS 9—ELECTRICAL AND SCIENTIFIC APPARATUS

FOR COMPUTER SOFTWARE FOR DATA COMPRESSION, COMPUTER PROGRAMS FOR DATA COMPRESSION (U.S. CLS. 21, 23, 26, 36 AND 38).

CLASS 35—ADVERTISING AND BUSINESS

FOR DISSEMINATION OF ADVERTISING MATTER (U.S. CLS. 100, 101 AND 102).

CLASS 42—SCIENTIFIC, COMPUTER AND LEGAL SERVICES

FOR CONSULTING SERVICES IN THE FIELD OF DESIGN, SELECTION, IMPLEMENTATION AND USE OF COMPUTER HARDWARE AND SOFTWARE SYSTEMS FOR OTHERS (U.S. CLS. 100 AND 101).

SN 76-441,625. LG ELECTRONICS INC., SEOUL, REPUBLIC OF KOREA, FILED 8-15-2002.

SN 76-442,193. AMOS CORPORATION, KYUNGKI-DO, REPUBLIC OF KOREA, FILED 8-15-2002.

A Better Life with Digital

CLASS 7—MACHINERY

FOR ROTARY COMPRESSORS; ELECTRIC MIXERS FOR DOMESTIC USE; ELECTRIC FOOD PROCESSORS; AUTOMATIC DISHWASHERS; WASHING MACHINES; ELECTRIC CLEANERS FOR DOMESTIC USE; VACUUM CLEANERS; AND DC GENERATORS (U.S. CLS. 13, 19, 21, 23, 31, 34 AND 35).

CLASS 9—ELECTRICAL AND SCIENTIFIC APPARATUS

FOR CAMCORDERS; THERMOSTATS; CREDIT CARD DEVICES, NAMELY CREDIT CARD VERIFICATION MACHINES; ELECTRIC IRONS; DVD PLAYERS; MP3 PLAYERS; RECORD AND PLAY DEVICES, NAMELY TAPE RECORDERS; RADIOS; MODEMS; VIDEO DISC PLAYERS; VIDEO PHONES; AUTOMATIC SWITCHING APPARATUS FOR TELEPHONES; TELEPHONE SETS; RELAY SWITCHING APPARATUS FOR TELEPHONES; AMPLIFIER; COMPACT DISC PLAYERS; TELEVISION SETS; MOBILE COMMUNICATION DEVICES, NAMELY, MOBILE TELEPHONES; CD-ROM PLAYER; PDA; RECORDED COMPUTER SOFTWARE FOR DATA PROCESSING IN THE FIELD OF DATA PROCESSING; DOWNLOADABLE COMPUTER SOFTWARE FOR DATA PROCESSING IN THE FIELD OF DATA PROCESSING; COMPUTERS; COMPUTER MONITORS (U.S. CLS. 21, 23, 26, 36 AND 38).

CLASS 11—ENVIRONMENTAL CONTROL APPARATUS

FOR WATER PURIFIER FOR DOMESTIC USE; STERILIZERS NOT FOR MEDICAL PURPOSES; GAS RANGES; OVEN RANGES FOR DOMESTIC USE; FREEZERS; AIR CONDITIONERS; AIR PURIFIERS; HEAT EXCHANGERS; ELECTRIC LAMPS; HUMIDIFIERS; HAIR DRYERS; ELECTRIC FANS; REFRIGERATORS; ELECTRIC REFRIGERATED SHOW CASES; ELECTRIC OVENS; ELECTRIC LAUNDRY DRYERS; ELECTRIC PRESSURE RICE COOKERS; ELECTRIC DEHYDRATORS; ELECTRIC TOASTERS; AND MICROWAVE OVENS (U.S. CLS. 13, 21, 23, 31 AND 34).

SN 76-442,102. THE DEAL, LLC, NEW YORK, NY. FILED 8-15-2002.

DEAL EXTRA

CLASS 36—INSURANCE AND FINANCIAL

FOR PROVIDING A WEBSITE ON A GLOBAL COMPUTER NETWORK FEATURING INFORMATION IN THE FINANCIAL FIELD (U.S. CLS. 100, 101 AND 102). FIRST USE 5-15-2002; IN COMMERCE 5-15-2002.

CLASS 42—SCIENTIFIC, COMPUTER AND LEGAL SERVICES

FOR PROVIDING A WEBSITE ON A GLOBAL COMPUTER NETWORK FEATURING INFORMATION IN THE LEGAL FIELD (U.S. CLS. 100 AND 101). FIRST USE 5-15-2002; IN COMMERCE 5-15-2002.

PASNET

CLASS 2—PAINTS

FOR PAINT FOR ARTISTS, NAMELY, DETACHABLE PAINTS HAVING ADHESIVE AND FIXABLE PROPERTIES, WATERCOLORS, LUMINOUS PAINTS, WATER PAINTS AND SYNTHETIC RESIN PAINTS; BLUE COLORANTS, BLACK COLORANTS AND WHITE COLORANTS, ALL FOR USE IN THE MANUFACTURE OF PAINTS; METALS IN THE FORM OF POWDER, NAMELY, ALUMINUM POWDERS AND GOLD POWDERS FOR PAINTERS (U.S. CLS. 6, 11 AND 16).

CLASS 16—PAPER GOODS AND PRINTED MATTER

FOR COLOR PENCILS, PASTELS, COLORED PAPERS, WRITING PAPERS, CRAYON PASTELS, CRAYONS, DRAWING PAPERS, GLUES FOR STATIONERY PURPOSE, LUMINOUS PENS, WRITING BRUSHES, STICKER (U.S. CLS. 2, 5, 22, 23, 29, 37, 38 AND 50).

SN 76-442,203. LAWRENCEBURG DISTILLERS AND IMPORTERS LLC, DBA PERNOD RICARD USA, WHITE PLAINS, NY. FILED 8-21-2002.

SEAGRAM'S

OWNER OF U.S. REG. NOS. 301,726, 2,613,238 AND OTHERS. SEC. 2(F).

CLASS 32—LIGHT BEVERAGES

FOR MALT LIQUOR BASED BEVERAGES (U.S. CLS. 45, 46 AND 48). FIRST USE 12-31-1995; IN COMMERCE 12-31-1995.

CLASS 33—WINES AND SPIRITS

FOR POTABLE DISTILLED SPIRITS AND WINE COOLERS (U.S. CLS. 47 AND 49). FIRST USE 2-9-1934; IN COMMERCE 2-9-1934.

SN 76-443,213. NOVEX PRODUCTS, INC., ELYRIA, OH. FILED 8-19-2002.

NOVEX

CLASS 3—COSMETICS AND CLEANING PREPARATIONS

FOR DISPOSABLE WIPES IMPREGNATED WITH CHEMICALS OR COMPOUNDS FOR PERSONAL HYGIENE AND HOUSEHOLD USE (U.S. CLS. 1, 4, 6, 50, 51 AND 52).

CLASS 16—PAPER GOODS AND PRINTED MATTER

FOR FACIAL TISSUE, TOILET TISSUE, PAPER NAPKINS, DISPOSABLE PAPER TOWELS WITH AND WITHOUT POLY LAMINATION, DISPOSABLE PAPER BIBS WITH AND WITHOUT POLY LAMINATION, DISPOSABLE NON-CLOTH DIAPERS, DISPOSABLE WIPES WITH NO CHEMICAL ADDITIVE (U.S. CLS. 2, 5, 22, 23, 29, 37, 38 AND 50).

CLASS 42—SCIENTIFIC, COMPUTER AND LEGAL SERVICES

FOR COMPUTER CONSULTANCY SERVICES, COMPUTER PROGRAMMING FOR OTHERS, SOFTWARE DEVELOPMENT AND UPDATING OF SOFTWARE FOR OTHERS; RENTAL OF COMPUTER SOFTWARE; WEBSITE MANAGEMENT FOR OTHERS (U.S. CLS. 100 AND 101).

SN 76-445,031. PUBLIGROUPE S.A., LAUSANNE, SWITZERLAND, FILED 8-29-2002.

SN 76-445,404. NANO-TEX, LLC, GREENSBORO, NC. FILED 8-30-2002.

 **PUBLICITAS *Promotion Network***

OWNER OF SWITZERLAND REG. NO. 448432, DATED 12-19-1997, EXPIRES 12-18-2007.

CLASS 9—ELECTRICAL AND SCIENTIFIC APPARATUS

FOR COMPUTER PERIPHERALS; COMPUTER HARDWARE AND SOFTWARE FOR MULTIMEDIA AND TELECOMMUNICATION APPLICATIONS FOR THE MANAGEMENT AND IMPLEMENTATION OF ADVERTISING CAMPAIGNS IN NEWSPAPERS, IN MAGAZINES AND IN ELECTRONIC MEDIA (U.S. CLS. 21, 23, 26, 36 AND 38).

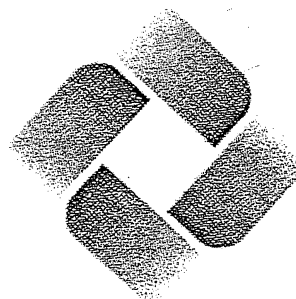
**CLASS 16—PAPER GOODS AND PRINTED MATTER**

FOR PRINTED MATTER, NAMELY, BOOKS FOCUSING ON ADVERTISING TECHNIQUES AND ADVERTISING OPPORTUNITIES; HANDBOOKS FOCUSING ON NEW MEDIA TECHNIQUES USED IN ADVERTISING (U.S. CLS. 2, 5, 22, 23, 29, 37, 38 AND 50).

THE STIPPLING IS FOR SHADING PURPOSES.
THE MARK CONSISTS OF FOUR ROUNDED RECTANGLES FORMING A DIAMOND SHAPE.

CLASS 35—ADVERTISING AND BUSINESS

FOR BUSINESS ORGANIZATION AND MANAGEMENT CONSULTANCY, BUSINESS INVESTIGATIONS AND PROVIDING EFFICIENCY EXPERTS, CONDUCTING BUSINESS AND MARKET RESEARCH SURVEYS, CONDUCTING PUBLIC OPINION POLLING, ADVERTISING AGENCY SERVICES, PREPARATION AND DISSEMINATION OF ADVERTISEMENTS AND MAILINGS FOR ADVERTISEMENT PURPOSES FOR OTHERS, PREPARATION AND DISSEMINATION OF ADVERTISING DOCUMENTATION FOR OTHERS, RENTAL OF ADVERTISEMENT SPACES, ADVERTISING MATERIAL RENTAL, DESKTOP PUBLISHING FOR OTHERS OF ADVERTISING TEXTS; ARRANGING OF SUBSCRIPTIONS FOR THE PUBLICATIONS OF OTHERS; PROMOTING THE GOODS AND SERVICES OF OTHERS BY PROVIDING HYPERTEXT LINKS TO THE WEB SITES OF OTHERS; OPERATING ON-LINE MARKETPLACES FOR SELLERS OF GOODS AND/OR SERVICES, PROVIDING AN ONLINE DATABASE IN THE FIELD OF ADVERTISING (U.S. CLS. 100, 101 AND 102).

CLASS 35—ADVERTISING AND BUSINESS

FOR BUSINESS MARKETING AND CONSULTING SERVICES (U.S. CLS. 100, 101 AND 102).

CLASS 38—COMMUNICATION

FOR COMPUTER-AIDED ELECTRIC, ELECTRONIC AND DIGITAL MESSAGE AND IMAGE TRANSMISSION; PROVIDING ACCESS TO A COMPUTER NETWORK (U.S. CLS. 100, 101 AND 104).

CLASS 40—MATERIAL TREATMENT

FOR TREATMENT OF FABRIC AND SIMILAR MATERIALS (U.S. CLS. 100, 103 AND 106).

CLASS 41—EDUCATION AND ENTERTAINMENT

FOR EDUCATIONAL SERVICES, NAMELY CONDUCTING ON-SITE DEMONSTRATIONS, TRAINING AND WORKSHOPS IN THE FIELD OF HANDLING AND USE OF INDUSTRIAL CHEMICALS AND EQUIPMENT FOR FABRICS AND SIMILAR MATERIALS (U.S. CLS. 100, 101 AND 107).

CLASS 42—SCIENTIFIC, COMPUTER AND LEGAL SERVICES

FOR INTELLECTUAL PROPERTY SERVICES, NAMELY INTELLECTUAL PROPERTY LICENSING AND PRODUCT DEVELOPMENT (U.S. CLS. 100 AND 101).

SN 76-445,523. POWER PAPER LTD., 49 910 KIBBUTZ EINAT, ISRAEL, FILED 8-29-2002.

POWERCOSMETICS

CLASS 5—PHARMACEUTICALS

FOR DERMAL AND TRANSDERMAL DELIVERY DEVICES OF PHARMACEUTICALS, DRUGS, COSMETICS, DERMATOLOGICAL SUBSTANCES AND SKINCARE PRODUCTS, NAMELY ADHESIVE BANDAGES, TRANSDERMAL PATCHES AND DRESSINGS CONTAINING PHARMACEUTICALS, DERMATOLOGICAL SUBSTANCES AND SKINCARE PRODUCTS FOR THE TREATMENT OF FINE LINES, WRINKLES, PUFFY EYES, OILY AND ACME SKIN, DRY AND ROUGH SKIN; MEDICAL PLASTERS IMPREGNATED WITH ACTIVE PHARMACOLOGICAL SUBSTANCES, ADHESIVE PATCHES (U.S. CLS. 6, 18, 44, 46, 51 AND 52).

CLASS 9—ELECTRICAL AND SCIENTIFIC APPARATUS

FOR BATTERIES; PRINTED BATTERIES; BATTERIES MANUFACTURED BY A PRINTING PROCESS; SMART TAGS AND ELECTRONIC TAGS CONTAINING PROGRAMMING FOR THE PROCESSING, TRANSMISSION AND RECEPTION OF DATA; SMART LABELS AND ELECTRONIC LABELS CONTAINING PROGRAMMING FOR THE PROCESSING, TRANSMISSION AND RECEPTION OF DATA; SMART AND MAGNETIC ENCODED CARDS CONTAINING PROGRAMMING FOR THE PROCESSING, TRANSMISSION AND RECEPTION OF DATA; INTEGRATED CIRCUIT CARDS, ELECTRONIC CHIP CARDS, SENSORS AND WIRELESS CARDS, FOR THE LOGGING, MONITORING, PROCESSING, TRANSMISSION AND RECEPTION OF DATA, AUDIO AND VISUAL INFORMATION (U.S. CLS. 21, 23, 26, 36 AND 38).

CLASS 10—MEDICAL APPARATUS

FOR TRANSDERMAL DRUG DELIVERY PATCHES SOLD WITHOUT MEDICATION HAVING EMBEDDED MICROINFUSION PUMPS, TRANSDERMAL DRUG DELIVERY PATCHES SOLD WITHOUT MEDICATION, NAMELY ELECTRICAL STIMULATION PATCHES, PATCHES FOR USE IN DIAGNOSTICS AND MONITORING, PATCHES USED IN ACUPUNCTURE, BODY SHAPING, WEIGHT CONTROL, CELLULITE REDUCTION, AND PAIN CONTROL (U.S. CLS. 26, 39 AND 44).

SN 76-445,595. QUANTUM HEALTH, INC., SAN DIEGO, CA. FILED 8-27-2002.



UNIVERSITY COMMUNITY
MEDICAL CENTER

NO CLAIM IS MADE TO THE EXCLUSIVE RIGHT TO USE "UNIVERSITY COMMUNITY MEDICAL CENTER", APART FROM THE MARK AS SHOWN.

THE MARK CONSISTS OF THE WORDING "UNIVERSITY COMMUNITY MEDICAL CENTER" AND DESIGN OF A COMBINED FANCIFUL AMERICAN FLAG AND CROSS.

CLASS 16—PAPER GOODS AND PRINTED MATTER

FOR NEWSLETTERS AND MAGAZINES DEALING WITH MEDICAL TOPICS (U.S. CLS. 2, 5, 22, 23, 29, 37, 38 AND 50).

CLASS 44—MEDICAL, BEAUTY AND AGRICULTURAL SERVICES

FOR HOSPITAL SERVICES FOR ACUTE CARE PATIENTS; MEDICAL SERVICES, NAMELY, OUT-PATIENT SERVICES; AND HOSPITAL SERVICES FOR PSYCHIATRIC PATIENTS (U.S. CLS. 100 AND 101).

SN 76-446,157. BEST FRIENDS ANIMAL SANCTUARY, KANAB, UT. FILED 9-4-2002.

NO MORE HOMELESS PETS

CLASS 39—TRANSPORTATION AND STORAGE

FOR ANIMAL RESCUE SERVICES (U.S. CLS. 100 AND 105).

FIRST USE 4-0-1996; IN COMMERCE 7-0-1997.

CLASS 44—MEDICAL, BEAUTY AND AGRICULTURAL SERVICES

FOR ANIMAL PHYSICAL REHABILITATION SERVICES; VETERINARY SERVICES; COMPUTER SERVICES, NAMELY, PROVIDING INFORMATION IN THE FIELD OF ANIMAL CARE BY MEANS OF A GLOBAL COMPUTER NETWORKS (U.S. CLS. 100 AND 101).

FIRST USE 4-0-1996; IN COMMERCE 7-0-1997.

CLASS 45—PERSONAL SERVICES

FOR ANIMAL ADOPTION AND ADOPTION PLACEMENT SERVICES (U.S. CLS. 100 AND 101).

FIRST USE 4-0-1996; IN COMMERCE 7-0-1997.

SN 76-446,188. ALPINE, ANDREW, SAN ANSELMO, CA. FILED 8-30-2002.

COMMON GROUND

CLASS 16—PAPER GOODS AND PRINTED MATTER

FOR PERIODICAL MAGAZINE FEATURING A RESOURCES DIRECTORY AND FEATURE ARTICLES ON PERSONAL TRANSFORMATION IN THE NATURE OF INDIVIDUAL DEVELOPMENT AND CHANGE (U.S. CLS. 2, 5, 22, 23, 29, 37, 38 AND 50).

FIRST USE 3-0-1975; IN COMMERCE 3-0-1975.

CLASS 41—EDUCATION AND ENTERTAINMENT

FOR PROVIDING AN ONLINE PUBLICATION FEATURING A RESOURCES DIRECTORY AND FEATURE ARTICLES ON PERSONAL TRANSFORMATION IN THE NATURE OF INDIVIDUAL DEVELOPMENT AND CHANGE (U.S. CLS. 100, 101 AND 107).

FIRST USE 5-0-1996; IN COMMERCE 5-0-1996.

SN 76-446,931. LEVEL 1, INC., ROCKLAND, MA. FILED 9-5-2002.

HEATTQM

CLASS 41—EDUCATION AND ENTERTAINMENT

FOR EDUCATION SERVICES, NAMELY, CONDUCTING COURSES AND SEMINARS FOR HEALTHCARE PROFESSIONALS IN THE FIELD OF HYPOTHERMIA PREVENTION IN THE PERIOPERATIVE SETTING, PATIENT CARE PROCESS IMPROVEMENT, AND THE BENEFITS OF PATIENT TEMPERATURE MANAGEMENT (U.S. CLS. 100, 101 AND 107).

FIRST USE 1-0-2001; IN COMMERCE 1-0-2001.

CLASS 44—MEDICAL, BEAUTY AND AGRICULTURAL SERVICES

FOR CONSULTATION SERVICES IN THE HEALTHCARE INDUSTRY IN THE FIELD OF HYPOTHERMIA PREVENTION IN THE PERIOPERATIVE SETTING, PATIENT CARE PROCESS IMPROVEMENT, AND THE BENEFITS OF PATIENT TEMPERATURE MANAGEMENT (U.S. CLS. 100 AND 101).

FIRST USE 1-0-2001; IN COMMERCE 1-0-2001.

CLASS 36—INSURANCE AND FINANCIAL

FOR PROVIDING GRANTS TO NON-PROFIT ORGANIZATIONS (U.S. CLS. 100, 101 AND 102).

CLASS 41—EDUCATION AND ENTERTAINMENT

FOR ENTERTAINMENT SERVICES IN THE NATURE OF THE PERFORMING AND VISUAL ARTS, NAMELY, LIVE AND PRERECORDED MUSICAL CONCERTS, THEATRICAL, CINEMATIC AND DANCE PERFORMANCES; ORGANIZING CULTURAL EXHIBITS; PROVIDING FACILITIES FOR RECREATIONAL ACTIVITIES IN THE NATURE OF PUBLIC AND PRIVATE SOCIAL FUNCTIONS INCLUDING PARTIES AND SPECIAL EVENTS; EDUCATIONAL SERVICES, NAMELY, PROVIDING FACILITIES FOR EDUCATIONAL FORUMS, WORKSHOPS, MEETINGS, CONFERENCES AND LECTURES (U.S. CLS. 100, 101 AND 107).

CLASS 43—HOTEL AND RESTAURANT SERVICES

FOR RESTAURANT AND BAR SERVICES (U.S. CLS. 100 AND 101).

SN 76-448,208. IDEAL SPA COVERS, INC., ORANGE, CA. FILED 9-4-2002.

IDEAL

CLASS 7—MACHINERY

FOR POWER-OPERATED LIFTS FOR SPA COVERS (U.S. CLS. 13, 19, 21, 23, 31, 34 AND 35).

FIRST USE 5-15-1989; IN COMMERCE 5-15-1989.

CLASS 8—HAND TOOLS

FOR MANUALLY OPERATED LIFTS FOR SPA COVERS (U.S. CLS. 23, 28 AND 44).

FIRST USE 5-15-1989; IN COMMERCE 5-15-1989.

CLASS 11—ENVIRONMENTAL CONTROL APPARATUS

FOR FITTED COVERS FOR HOT TUBS AND SPAS AND SAFETY STRAPS FOR THE AFORESAID COVERS (U.S. CLS. 13, 21, 23, 31 AND 34).

FIRST USE 5-15-1989; IN COMMERCE 5-15-1989.

SN 76-449,271. THE TRUSTEE OF POPPLESTONE FOUNDATION, A MASSACHUSETTS CHARITABLE TRUST, THE TRUSTEES COMPRISING ALAN J. DWORSKY AND SUZANNE E. WERBER, BOTH US CITIZENS, CAMBRIDGE, MA. FILED 9-13-2002.

POPPELSTONE

CLASS 35—ADVERTISING AND BUSINESS

FOR PROVIDING FACILITIES FOR BUSINESS ACTIVITIES IN THE NATURE OF PUBLIC AND PRIVATE FORUMS, WORKSHOPS, MEETINGS, CONFERENCES AND LECTURES (U.S. CLS. 100, 101 AND 102).

SN 76-449,288. AMES TAPING TOOLS SYSTEMS COMPANY, DULUTH, GA. FILED 9-13-2002.



OWNER OF U.S. REG. NO. 1,782,930.

NO CLAIM IS MADE TO THE EXCLUSIVE RIGHT TO USE "TAPING TOOL SYSTEMS CO.", APART FROM THE MARK AS SHOWN.

CLASS 35—ADVERTISING AND BUSINESS

FOR RETAIL STORE SERVICES FOR HAND AND POWER TOOLS AND SUPPLIES FOR DRYWALL INSTALLATION AND FINISHING (U.S. CLS. 100, 101 AND 102).

FIRST USE 9-0-1992; IN COMMERCE 9-0-1992.

CLASS 37—CONSTRUCTION AND REPAIR

FOR RENTAL SERVICES OF SPECIALIZED DRYWALL TAPING AND FINISHING TOOLS (U.S. CLS. 100, 103 AND 106).

FIRST USE 9-0-1992; IN COMMERCE 9-0-1992.

CLASS 41—EDUCATION AND ENTERTAINMENT

FOR EDUCATIONAL SERVICES - NAMELY, PROVIDING INSTRUCTION THROUGH VIDEO TAPES AND PROVIDING SUPPORT INSTRUCTION SERVICES FOR THE DRYWALL TAPING AND FINISHING PROFESSION (U.S. CLS. 100, 101 AND 107).

FIRST USE 9-0-1992; IN COMMERCE 9-0-1992.

SN 76-450,785. NETWORKS ASSOCIATES TECHNOLOGY, INC., SANTA CLARA, CA. FILED 9-18-2002.

SN 76-451,082. AMARAL, MICHAEL A., BLOOMINGTON, IL. FILED 9-13-2002.

IMPERMIA

CLASS 9—ELECTRICAL AND SCIENTIFIC APPARATUS

FOR COMPUTER HARDWARE; COMPUTER UTILITY SOFTWARE; NETWORK MANAGEMENT SOFTWARE; COMPUTER SOFTWARE FOR THE DETECTION AND MANAGEMENT OF UNAUTHORIZED NETWORK ENTRIES AND ACTIVITIES, FOR MANAGING, ADMINISTERING, AND OPTIMIZING COMPUTER NETWORKS AND APPLICATIONS, FOR PROTECTING AND SECURING COMPUTER NETWORKS AND APPLICATIONS, FOR ANALYZING AND MONITORING THE PERFORMANCE OF COMPUTER NETWORKS AND APPLICATIONS, FOR MONITORING AND ANALYZING COMPUTER NETWORK TRAFFIC, FOR DETECTING INTRUSIONS, FOR ENCRYPTING AND AUTHENTICATING DATA; AND MANUALS PROVIDED TOGETHER WITH EACH OF THE FOREGOING GOODS (U.S. CLS. 21, 23, 26, 36 AND 38).

CLASS 42—SCIENTIFIC, COMPUTER AND LEGAL SERVICES

FOR TECHNICAL CONSULTING SERVICES IN THE FIELDS OF COMPUTERS, COMPUTER SOFTWARE AND HARDWARE, COMPUTER AND COMMUNICATIONS NETWORKS, AND COMPUTER, DATA AND NETWORK SECURITY; TECHNICAL SUPPORT SERVICES FOR OTHERS, NAMELY TROUBLESHOOTING OF COMPUTER HARDWARE AND SOFTWARE PROBLEMS, MONITORING OF NETWORK SYSTEMS, AND PROVIDING BACK-UP COMPUTER PROGRAMS AND FACILITIES; PROVIDING INFORMATION ABOUT COMPUTERS, COMPUTER SOFTWARE AND HARDWARE, COMPUTER AND COMMUNICATIONS NETWORKS, AND COMPUTER, DATA, AND NETWORK SECURITY; APPLICATION SERVICE PROVIDER FEATURING SOFTWARE IN THE FIELDS OF COMPUTER, DATA AND NETWORK SECURITY (U.S. CLS. 100 AND 101).

SN 76-451,081. AMARAL, MICHAEL A., BLOOMINGTON, IL. FILED 9-13-2002.

BEING 81, FEELING 18

CLASS 41—EDUCATION AND ENTERTAINMENT

FOR EDUCATIONAL SERVICES, NAMELY CONDUCTING CLASSES, SEMINARS AND WORKSHOPS IN THE FIELDS OF HEALTH AND WELLNESS; AND HEALTH CLUB SERVICES (U.S. CLS. 100, 101 AND 107).

CLASS 44—MEDICAL, BEAUTY AND AGRICULTURAL SERVICES

FOR MEDICAL CLINICS; PROVIDING HEALTH INFORMATION VIA THE INTERNET (U.S. CLS. 100 AND 101).

SMART RABBITS

NO CLAIM IS MADE TO THE EXCLUSIVE RIGHT TO USE "RABBITS", APART FROM THE MARK AS SHOWN.

CLASS 9—ELECTRICAL AND SCIENTIFIC APPARATUS

FOR CHILDREN'S EDUCATIONAL VIDEO TAPES (U.S. CLS. 21, 23, 26, 36 AND 38).

CLASS 16—PAPER GOODS AND PRINTED MATTER

FOR CHILDREN'S EDUCATIONAL BOOKS (U.S. CLS. 2, 5, 22, 23, 29, 37, 38 AND 50).

SN 76-451,174. SPRINT COMMUNICATIONS COMPANY L.P., OVERLAND PARK, KS. FILED 9-19-2002.



THE MARK CONSISTS OF A STYLIZED EYE.

CLASS 9—ELECTRICAL AND SCIENTIFIC APPARATUS

FOR PROVIDING DOWNLOADABLE RING TONES, MUSICAL SOUND RECORDINGS, GAMES AND GRAPHICS VIA A GLOBAL COMPUTER NETWORK AND WIRELESS DEVICES (U.S. CLS. 21, 23, 26, 36 AND 38).
FIRST USE 8-11-2002; IN COMMERCE 8-11-2002.

CLASS 38—COMMUNICATION

FOR COMMUNICATION SERVICES, NAMELY, HIGH SPEED TRANSMISSION OF VOICE, DATA, IMAGES, VIDEO, AUDIO AND INFORMATION IN A VARIETY OF FIELDS VIA A GLOBAL COMPUTER NETWORK, COMPUTERS AND WIRELESS DEVICES; PROVIDING MULTIPLE USER ACCESS TO A GLOBAL COMPUTER NETWORK (U.S. CLS. 100, 101 AND 104).
FIRST USE 8-11-2002; IN COMMERCE 8-11-2002.

CLASS 41—EDUCATION AND ENTERTAINMENT

FOR ENTERTAINMENT SERVICES, NAMELY, PROVIDING RING TONES VIA A GLOBAL COMPUTER NETWORK AND WIRELESS DEVICES (U.S. CLS. 100, 101 AND 107).
FIRST USE 8-11-2002; IN COMMERCE 8-11-2002.

SN 76-452,130. DAIMLERCHRYSLER AG, 70567 STUTTGART, FED REP GERMANY, FILED 9-24-2002.

AIRSCARF

PRIORITY CLAIMED UNDER SEC. 44(D) ON FED REP GERMANY APPLICATION NO. 30216044.2/1, FILED 3-27-2002, REG. NO. 30216044, DATED 4-22-2002, EXPIRES 3-31-2012.

CLASS 11—ENVIRONMENTAL CONTROL APPARATUS

FOR HEATERS AND PARTS FOR HEATERS FOR MOTOR VEHICLES (U.S. CLS. 13, 21, 23, 31 AND 34).

CLASS 12—VEHICLES

FOR MOTOR VEHICLES AND STRUCTURAL PARTS THEREFOR (U.S. CLS. 19, 21, 23, 31, 35 AND 44).

SN 76-452,326. GROUP PUBLISHING, INC., LOVELAND, CO. FILED 9-24-2002.

THE EASY VBS

NO CLAIM IS MADE TO THE EXCLUSIVE RIGHT TO USE "VBS", APART FROM THE MARK AS SHOWN.

CLASS 9—ELECTRICAL AND SCIENTIFIC APPARATUS

FOR PRERECORDED VIDEO CASSETTES, PRERECORDED VIDEO DISCS, PRERECORDED AUDIO CASSETTES AND PRERECORDED AUDIO DISCS SOLD SEPARATELY OR WITHIN A MULTI-MEDIA KIT CONTAINING CHRISTIAN EDUCATIONAL INFORMATION TO BE USED IN CHURCHES AND OTHER CHRISTIAN EDUCATIONAL SETTINGS (U.S. CLS. 21, 23, 26, 36 AND 38).

FIRST USE 12-31-1998; IN COMMERCE 1-30-1999.

CLASS 16—PAPER GOODS AND PRINTED MATTER

FOR PRINTED PUBLICATIONS, NAMELY BOOKS, INSTRUCTIONAL MANUALS, GUIDES, PRINTED POSTERS, STICKERS, AND POSTCARDS SOLD SEPARATELY OR WITHIN A MULTI-MEDIA KIT CONTAINING CHRISTIAN EDUCATIONAL INFORMATION TO BE USED IN CHURCHES AND OTHER CHRISTIAN EDUCATIONAL SETTINGS (U.S. CLS. 2, 5, 22, 23, 29, 37, 38 AND 50).

FIRST USE 12-31-1998; IN COMMERCE 1-30-1999.

SN 76-453,001. HOSIER, KATHY MAY, ALAMEDA, CA. FILED 9-25-2002.

CHICKS FOR JESUS

NO CLAIM IS MADE TO THE EXCLUSIVE RIGHT TO USE "JESUS", APART FROM THE MARK AS SHOWN.

CLASS 16—PAPER GOODS AND PRINTED MATTER

FOR EDUCATIONAL BOOKLETS ABOUT THE DOCTRINE OF THE HOLY BIBLE (U.S. CLS. 2, 5, 22, 23, 29, 37, 38 AND 50).

FIRST USE 10-5-1998; IN COMMERCE 7-1-2002.

CLASS 41—EDUCATION AND ENTERTAINMENT

FOR RELIGIOUS INSTRUCTION SERVICES (U.S. CLS. 100, 101 AND 107).

FIRST USE 10-5-1998; IN COMMERCE 7-1-2002.

SN 76-453,540. NEFF, CARY E., ORO VALLEY, AZ. AND NEFF, PATRICIA, ORO VALLEY, AZ. FILED 9-27-2002.

CONSCIOUS CUISINE

NO CLAIM IS MADE TO THE EXCLUSIVE RIGHT TO USE "CUISINE", APART FROM THE MARK AS SHOWN.

CLASS 41—EDUCATION AND ENTERTAINMENT

FOR PROVIDING TRAINING AND INSTRUCTIONAL COURSES IN THE FIELD OF HEALTHY, LOW FAT, LOW CALORIE FOOD SELECTION AND PREPARATION AND CONSULTING SERVICES RELATED THERETO RENDERED TO RESORTS AND RESTAURANTS (U.S. CLS. 100, 101 AND 107).

FIRST USE 2-1-1997; IN COMMERCE 2-1-1997.

CLASS 43—HOTEL AND RESTAURANT SERVICES

FOR PROVIDING CONSULTING SERVICES, RENDERED TO RESORTS AND RESTAURANTS, IN THE FIELDS OF HEALTHY SELECTION AND HEALTHY PREPARATION OF LOW FAT, LOW CALORIE FOODS (U.S. CLS. 100 AND 101).

FIRST USE 2-1-1997; IN COMMERCE 2-1-1997.

SN 76-454,440. MEDWAY HEALTH, INC., DALLAS, TX.
FILED 9-23-2002.

SN 76-458,564. HANCHETT PAPER COMPANY, AURORA,
IL. FILED 10-16-2002.



CLASS 35—ADVERTISING AND BUSINESS

FOR HEALTH MANAGEMENT SERVICES IN THE NATURE OF MANAGEMENT OF HEALTH CARE CENTERS FOR OTHERS AND PHYSICIAN PRACTICE MANAGEMENT SERVICES, NAMELY, STRATEGIC PLANNING, BUSINESS DEVELOPMENT IN THE NATURE OF START-UP SUPPORT FOR PHYSICIAN PRACTICES, AND OPERATIONAL CONSULTING SERVICES RELATED THERETO (U.S. CLS. 100, 101 AND 102).

CLASS 44—MEDICAL, BEAUTY AND AGRICULTURAL SERVICES

FOR HEALTH CARE SERVICES, INCLUDING PHYSICAL REHABILITATION SERVICES AND HEALTH CARE CENTER SERVICES (U.S. CLS. 100 AND 101).

SN 76-456,492. UNITED NUDE LTD, LONDON, UNITED KINGDOM, FILED 10-7-2002.

UN UNITED NUDE

NO CLAIM IS MADE TO THE EXCLUSIVE RIGHT TO USE "NUDE", APART FROM THE MARK AS SHOWN.

CLASS 18—LEATHER GOODS

FOR LEATHER SOLD IN BULK, IMITATIONS OF LEATHER SOLD IN BULK, PRODUCT MADE WHOLLY OR PRINCIPALLY OF LEATHER OR IMITATIONS OF LEATHER, NAMELY, HANDBAGS AND WALLETS; LINING OF LEATHER FOR FOOTWEAR (U.S. CLS. 1, 2, 3, 22 AND 41).

CLASS 25—CLOTHING

FOR FOOTWEAR, BOOTS, HALF BOOTS, SHOES, SLIPPERS, GALOSHES, SANDALS, FOOTWEAR UPpers FOR BOOTS AND/OR SHOES, HEELS AND/OR HEEL PIECES FOR BOOTS, SHOES AND OR OTHER FOOTWEAR, WELTS FOR BOOTS, SHOES AND/OR OTHER FOOTWEAR, INNER AND/OR OUTER SOLES FOR BOOTS SHOES AND/OR OTHER FOOTWEAR AND SPATS FOR THE AFORESAID GOODS (U.S. CLS. 22 AND 39).

SHORREXPRESS

CLASS 7—MACHINERY

FOR MACHINES, NAMELY CARTONING MACHINES, MACHINES FOR MANUFACTURING AND DISPENSING PACKAGING MATERIAL, AND PACKAGING MACHINES (U.S. CLS. 13, 19, 21, 23, 31, 34 AND 35).

CLASS 16—PAPER GOODS AND PRINTED MATTER

FOR LABEL PRINTING MACHINES, OFFICE LABELING MACHINES, CORRUGATED PAPER, CUSHIONING OR PADDING MADE OF PAPER FOR PACKING PURPOSES, FILLER PAPER, GUMMED PAPER, LINING PAPER, PACKING PAPER, PAPER BAGS FOR PACKAGING, PAPER BOXES, PAPER CARTONS FOR DELIVERING GOODS, PAPER CLOSURES FOR SEALING CONTAINERS, PAPER CLOSURES FOR CONTAINERS, PAPER CONTAINERS, PAPER ENVELOPES FOR CARDBOARD, INCLUDING CARDBOARD BOXES, CARDBOARD CARRIERS FOR FOOD AND BEVERAGES, CARDBOARD CARTONS, CARDBOARD CONTAINERS, AND CARDBOARD MAILING TUBES; PLASTICS, NAMELY, PLASTIC BAGS FOR PACKAGING, PLASTIC BAGS FOR PACKING, PLASTIC BUBBLE PACKS FOR WRAPPING OR PACKAGING, PLASTIC FOOD STORAGE BAGS FOR HOUSEHOLD USE, PLASTIC GARBAGE BAGS, PLASTIC GIFT WRAP, PLASTIC AND PAPER BAGS FOR HOUSEHOLD USE, PLASTIC OR PAPER BAGS FOR MERCHANDISE, PLASTIC SANDWICH BAGS, PLASTIC SHOPPING BAGS, PLASTIC TRASH BAGS, AND PLASTIC WRAP (U.S. CLS. 2, 5, 22, 23, 29, 37, 38 AND 50).

CLASS 17—RUBBER GOODS

FOR PLASTICS, NAMELY, ADHESIVE-BACKED PLASTIC FILMS FOR USE IN THE MANUFACTURE OF DURABLE LABELS AND NAMEPLATES, CUSHIONING OF PLASTIC IN THE NATURE OF STUFFING FOR PACKING OR PACKAGING, PACKING PADDING OF PLASTIC FOR SHIPPING CONTAINERS, PLASTIC PADDING FOR SHIPPING CONTAINERS; PLASTIC FILM FOR INDUSTRIAL AND COMMERCIAL PACKING USE, PLASTIC FILMS USED AS PACKAGING FOR FOOD, PLASTIC STUFFING FOR CARTONS AND BOXES, STUFFING OF PLASTIC, AND PLASTIC TAPE FOR USE IN PACKAGING (U.S. CLS. 1, 5, 12, 13, 35 AND 50).

CLASS 20—FURNITURE AND ARTICLES NOT OTHERWISE CLASSIFIED

FOR CONTAINERS, NAMELY, PACKING CONTAINERS OF PLASTIC MATERIAL, CONTAINER CLOSURES OF PLASTIC, PLASTIC BOXES, PLASTIC TUBES FOR CONSUMER PRODUCTS PACKAGING, PLASTIC INSERTS FOR USE AS CONTAINER LINERS, PLASTIC LABELS, PLASTIC MAILING TUBES, AND PLASTIC MEDICATION CONTAINERS (U.S. CLS. 2, 13, 22, 25, 32 AND 50).

SN 76-459,080. ONLINE KLAUS KOCH GMBH & CO KG, D-35260 STADTALLENDORF, FED REP GERMANY, FILED 10-8-2002.



PRIORITY CLAIMED UNDER SEC. 44(D) ON FED REP GERMANY APPLICATION NO. 30218139.3/2, FILED 4-10-2002, REG. NO. 30218139.3, DATED 9-13-2002, EXPIRES 9-13-2012.

THE MARK CONSISTS OF THE WORDING "ONLINE" IN STYLIZED FORM.

CLASS 23—YARNS AND THREADS

FOR HAND-LABOUR YARNS (U.S. CL. 43).

CLASS 26—FANCY GOODS

FOR KNITTING NEEDLES (U.S. CLS. 37, 39, 40, 42 AND 50).

SN 76-460,099. SCHOEFFEL GMBH, 70619 STUTTGART, FED REP GERMANY, FILED 10-15-2002.

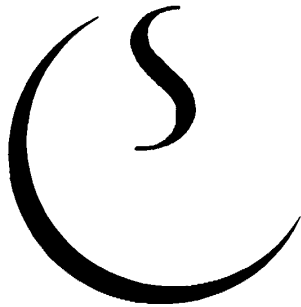

CLASS 3—COSMETICS AND CLEANING PREPARATIONS

FOR COSMETICS (U.S. CLS. 1, 4, 6, 50, 51 AND 52).

CLASS 14—JEWELRY

FOR JEWELRY, ESPECIALLY PEARLS INCLUDING CULTURED PEARLS, PRECIOUS STONES AND SEMI-PRECIOUS STONES (U.S. CLS. 2, 27, 28 AND 50).

CLASS 25—CLOTHING

FOR CLOTHING, NAMELY, SHIRTS, PANTS AND JACKETS; SHOES; HEAD WEAR, NAMELY, HATS AND HEAD BANDS (U.S. CLS. 22 AND 39).

SN 76-460,501. THE DOOBIE BROTHERS CORP., GLEN ELLEN, CA. FILED 10-21-2002.

THE DOOBIE BROTHERS

OWNER OF U.S. REG. NOS. 1,204,464, 1,215,924 AND OTHERS.

CLASS 9—ELECTRICAL AND SCIENTIFIC APPARATUS

FOR SERIES OF PRERECORDED AUDIO AND VIDEO TAPES, COMPACT DISCS, DIGITAL VIDEO DISCS, CD ROMS AND MAGNETIC DATA CARRIERS, ALL FEATURING MUSIC (U.S. CLS. 21, 23, 26, 36 AND 38). FIRST USE 0-0-1971; IN COMMERCE 0-0-1971.

CLASS 41—EDUCATION AND ENTERTAINMENT

FOR ENTERTAINMENT SERVICES, NAMELY, PERFORMANCES BY A MUSICAL GROUP (U.S. CLS. 100, 101 AND 107).

FIRST USE 0-0-1971; IN COMMERCE 0-0-1971.

SN 76-462,222. GET COOKING, INC., WICHITA, KS. FILED 10-28-2002.

GET COOKING

CLASS 35—ADVERTISING AND BUSINESS

FOR RETAIL STORE AND ONLINE RETAIL SERVICES FEATURING KITCHEN ITEMS AND SUPPLIES, NAMELY, COOKWARE, BAKEWARE, POTS, PANS, SILVERWARE, PLUMBING FIXTURES, SINKTOPS, COUNTERTOPS, CABINET HARDWARE, HARDWOOD FLOORING, LIGHTING, CHILDREN'S COOKING AND BAKING SUPPLIES, AND SELF-INSTALLED KITCHEN RENOVATION KITS (U.S. CLS. 100, 101 AND 102). FIRST USE 3-4-2002; IN COMMERCE 3-4-2002.

CLASS 37—CONSTRUCTION AND REPAIR

FOR KITCHEN RENOVATIONS (U.S. CLS. 100, 103 AND 106).

FIRST USE 3-4-2002; IN COMMERCE 3-4-2002.

SN 76-462,244. VERO FOOD IMPORT CORPORATION, BROOKLYN, NY. FILED 10-23-2002.

SAPIO

OWNER OF U.S. REG. NO. 2,609,010. SEC. 2(F).

CLASS 29—MEATS AND PROCESSED FOODS

FOR EXTRA VIRGIN OLIVE OIL, SOY OIL, CORN OIL, 100 (PERCENT) PURE POMACE OIL AND BLENDED OIL (U.S. CL. 46).

FIRST USE 2-17-1989; IN COMMERCE 2-17-1989.

CLASS 30—STAPLE FOODS

FOR BALSAMIC VINEGAR AND PASTA (U.S. CL. 46). FIRST USE 2-17-1989; IN COMMERCE 2-17-1989.

SN 76-463,322. LAWLER, JENNIFER L., LAWRENCE, KS.
FILED 10-31-2002.

DOJO WISDOM

NO CLAIM IS MADE TO THE EXCLUSIVE RIGHT TO USE "DOJO", APART FROM THE MARK AS SHOWN.

CLASS 16—PAPER GOODS AND PRINTED MATTER

FOR BOOKS, PAMPHLETS AND NEWSLETTERS ON THE SUBJECT OF ASIAN MARTIAL ARTS (U.S. CLS. 2, 5, 22, 23, 29, 37, 38 AND 50).

CLASS 41—EDUCATION AND ENTERTAINMENT

FOR EDUCATIONAL SERVICES, NAMELY, PROVIDING SEMINARS, WORKSHOPS AND CLASSES OF STUDY ON THE SUBJECT OF ASIAN MARTIAL ARTS; AND MOTIVATIONAL SPEECHES ON THE SUBJECT OF ASIAN MARTIAL ARTS (U.S. CLS. 100, 101 AND 107).

SN 76-463,444. CHANDARIA, ASHOK V., NORTH YORK, ONTARIO, CANADA, FILED 10-30-2002.

ONE STARTT

CLASS 16—PAPER GOODS AND PRINTED MATTER

FOR DISPENSERS FOR ADHESIVE TAPES FOR STATIONERY OR HOUSEHOLD PURPOSES; AND ADHESIVE TAPES FOR STATIONERY OR HOUSEHOLD PURPOSES (U.S. CLS. 2, 5, 22, 23, 29, 37, 38 AND 50).

CLASS 17—RUBBER GOODS

FOR ADHESIVE TAPE FOR INDUSTRIAL AND COMMERCIAL USE (U.S. CLS. 1, 5, 12, 13, 35 AND 50).

SN 76-463,613. FALES PRODUCTIONS, LLC, SALINAS, CA.
FILED 11-4-2002.



FALES
PRODUCTIONS

NO CLAIM IS MADE TO THE EXCLUSIVE RIGHT TO USE "PRODUCTIONS", APART FROM THE MARK AS SHOWN.

THE MARK CONSISTS OF THE CAPITAL LETTER "A" ABOVE TWO SMALL SYMBOLS OR LETTERS THAT LOOK LIKE UPSIDE DOWN AND BACKWARD "L'S. THE LETTERING IS ENCLOSED WITHIN A CIRCLE. THE CIRCLE IS ADJACENT AND TO THE LEFT OF THE WORDING "FALES PRODUCTIONS".

CLASS 9—ELECTRICAL AND SCIENTIFIC APPARATUS

FOR MUSICAL SOUND RECORDINGS (U.S. CLS. 21, 23, 26, 36 AND 38).
FIRST USE 10-10-2002; IN COMMERCE 10-10-2002.

CLASS 16—PAPER GOODS AND PRINTED MATTER

FOR PRINTED MUSIC BOOKS; SHEET MUSIC (U.S. CLS. 2, 5, 22, 23, 29, 37, 38 AND 50).
FIRST USE 10-10-2002; IN COMMERCE 10-10-2002.

SN 76-464,699. AMERICAN HUMANE ASSOCIATION, ENGLEWOOD, CO. FILED 11-6-2002.



American Humane

*Empowering Action
Since 1877*

NO CLAIM IS MADE TO THE EXCLUSIVE RIGHT TO USE "AMERICAN" AND "SINCE 1877", APART FROM THE MARK AS SHOWN.

CLASS 16—PAPER GOODS AND PRINTED MATTER

FOR PRINTED MATERIAL, NAMELY, PAMPHLETS, BOOKS, FLYERS AND BROCHURES ADVOCATING CHILD AND ANIMAL WELFARE PROTECTION AND EDUCATION (U.S. CLS. 2, 5, 22, 23, 29, 37, 38 AND 50).

CLASS 35—ADVERTISING AND BUSINESS

FOR ASSOCIATION SERVICES, NAMELY, PROMOTING THE WELFARE AND HUMANE TREATMENT OF CHILDREN AND ANIMALS (U.S. CLS. 100, 101 AND 102).

CLASS 41—EDUCATION AND ENTERTAINMENT

FOR EDUCATIONAL SERVICES, NAMELY, CONDUCTING PROGRAMS ASSOCIATED WITH PREVENTING CRUELTY, ABUSE, NEGLECT AND EXPLOITATION OF CHILDREN AND ANIMALS AND DISTRIBUTING COURSE MATERIAL IN CONNECTION THEREWITH (U.S. CLS. 100, 101 AND 107).

SN 76-466,360. JM TRAVEL SELECTIONS, INC., CAMPBELL, CA. FILED 11-4-2002.



NO CLAIM IS MADE TO THE EXCLUSIVE RIGHT TO USE "TRAVEL", APART FROM THE MARK AS SHOWN.

CLASS 39—TRANSPORTATION AND STORAGE

FOR TRAVEL AGENCY SERVICES, NAMELY MAKING RESERVATIONS AND BOOKINGS FOR TRANSPORTATION (U.S. CLS. 100 AND 105).
FIRST USE 12-29-1998; IN COMMERCE 12-29-1998.

CLASS 43—HOTEL AND RESTAURANT SERVICES

FOR TRAVEL AGENCY SERVICES, NAMELY, MAKING RESERVATIONS AND BOOKINGS FOR TEMPORARY LODGING; TRAVEL AGENCY SERVICES, NAMELY, MAKING RESERVATIONS AND BOOKINGS FOR RESTAURANTS AND MEALS (U.S. CLS. 100 AND 101).

FIRST USE 12-29-1998; IN COMMERCE 12-29-1998.

CLASS 44—MEDICAL, BEAUTY AND AGRICULTURAL SERVICES

FOR FOOD, NUTRITION AND WEIGHT LOSS COUNSELING CONDUCTED IN THE FORM OF A NATIONAL CAMPAIGN IN THE FIELDS OF NUTRITION, HEALTH, WEIGHT LOSS, EXERCISE, BODYBUILDING AND WELLNESS TO ELIMINATE OBESITY BY SECURING COMMITMENTS FROM PARTICIPANTS TO LOSE WEIGHT AND IMPROVE THEIR HEALTH (U.S. CLS. 100 AND 101).

SN 76-467,487. KELLY, JIM E., LOS ANGELES, CA. FILED 11-15-2002.



SN 76-469,025. KRAUS PRODUCTIVITY ORGANIZATION LIMITED, SHELTON, CT. FILED 11-21-2002.

CLASS 14—JEWELRY

FOR JEWELRY (U.S. CLS. 2, 27, 28 AND 50).
FIRST USE 10-0-2001; IN COMMERCE 10-0-2001.

CLASS 25—CLOTHING

FOR SHIRTS (U.S. CLS. 22 AND 39).
FIRST USE 10-0-2001; IN COMMERCE 10-0-2001.



SN 76-467,937. HIGH POINT MEDIA, LLC, GOLDEN, CO. FILED 11-18-2002.



NO CLAIM IS MADE TO THE EXCLUSIVE RIGHT TO USE "PRODUCTIVITY", APART FROM THE MARK AS SHOWN.

CLASS 9—ELECTRICAL AND SCIENTIFIC APPARATUS

FOR PRERECORDED AUDIO AND VIDEO TAPES ON NUTRITION, HEALTH, WEIGHT LOSS, EXERCISE, BODY BUILDING AND WELLNESS (U.S. CLS. 21, 23, 26, 36 AND 38).

CLASS 9—ELECTRICAL AND SCIENTIFIC APPARATUS

FOR COMPUTER SOFTWARE RECORDED ON CD ROM, MAGNETIC TAPE, DISKETTES, SERVERS, AND ELECTRONIC DOWNLOAD FOR USE IN TRAININGS AND EDUCATIONAL PROGRAMS AND DATABASE MANAGEMENT TO IMPROVE THE OPERATING EFFICIENCY IN MANUFACTURING INDUSTRIES, EXCLUDING THE FOOD SERVICES INDUSTRY (U.S. CLS. 21, 23, 26, 36 AND 38).

FIRST USE 9-21-1999; IN COMMERCE 9-21-1999.

CLASS 16—PAPER GOODS AND PRINTED MATTER

FOR BOOKS, NEWSLETTERS, PAMPHLETS, MAGAZINES AND BROCHURES HAVING TO DO WITH NUTRITION, HEALTH, WEIGHT LOSS, EXERCISE, BODYBUILDING AND WELLNESS (U.S. CLS. 2, 5, 22, 23, 29, 37, 38 AND 50).

CLASS 16—PAPER GOODS AND PRINTED MATTER

FOR BOOKS, BROCHURES, TRAINING MANUALS, PRINTED CORRESPONDENCE, AND PRINTED ADVERTISEMENTS USED TO IMPROVE OPERATING EFFICIENCY IN MANUFACTURING INDUSTRIES, EXCLUDING THE FOOD SERVICES INDUSTRY (U.S. CLS. 2, 5, 22, 23, 29, 37, 38 AND 50).

FIRST USE 9-21-1999; IN COMMERCE 9-21-1999.

CLASS 41—EDUCATION AND ENTERTAINMENT

FOR TRAINING AND EDUCATIONAL SERVICES, NAMELY, CONDUCTING NATIONWIDE PROGRAMS, SEMINARS AND CONFERENCES IN THE FIELD OF NUTRITION, HEALTH, WEIGHT LOSS, EXERCISE, BODYBUILDING AND WELLNESS, AND DISTRIBUTING WRITTEN MATERIALS AND PRERECORDED AUDIO AND VIDEO TAPES IN CONNECTION THEREWITH (U.S. CLS. 100, 101 AND 107).

CLASS 41—EDUCATION AND ENTERTAINMENT

FOR TRAINING AND EDUCATIONAL SERVICES, NAMELY, CONDUCTING CLASSES, SEMINARS, CONFERENCES, WORKSHOPS, AND ON-SITE PLANT TRAININGS IN THE FIELD OF MANUFACTURING TO IMPROVE OPERATING EFFICIENCY, EXCLUDING THE FOOD SERVICES INDUSTRY (U.S. CLS. 100, 101 AND 107).

FIRST USE 9-21-1999; IN COMMERCE 9-21-1999.

SN 76-470,571. FIRST ACT, INC., NEWTON, MA. FILED 11-27-2002.

SN 76-472,383. TOWN OF PARKER, PARKER, CO. FILED 12-4-2002.

MUSIC INSPIRES LEARNING

CLASS 15—MUSICAL INSTRUMENTS

FOR MUSICAL GOODS AND INSTRUMENTS, NAMELY, RECORDERS, HARMONICAS, GUITARS, DRUMS, BANJOS, AND TAMBOURINES (U.S. CLS. 2, 21 AND 36).

CLASS 16—PAPER GOODS AND PRINTED MATTER

FOR INSTRUCTIONAL MATERIAL, NAMELY, BOOKS FEATURING THE FIELD OF MUSIC (U.S. CLS. 2, 5, 22, 23, 29, 37, 38 AND 50).



CLASS 35—ADVERTISING AND BUSINESS

FOR PROCUREMENT, NAMELY, PURCHASING ALL GOODS AND SERVICES FOR GOVERNMENT AGENCIES; PERSONNEL MANAGEMENT; PERSONNEL PLACEMENT AND RECRUITMENT; PERSONNEL MANAGEMENT AND CONSULTATION IN THE FIELD OF HUMAN FACTORS ENGINEERING; ACCOUNT AUDITING; EMPLOYMENT COUNSELING AND RECRUITMENT; EMPLOYMENT OUTPLACEMENT SERVICES; PROMOTING THE ECONOMIC DEVELOPMENT OF PARKER COLORADO (U.S. CLS. 100, 101 AND 102).

CLASS 37—CONSTRUCTION AND REPAIR

FOR CONSTRUCTION MANAGEMENT; REAL ESTATE DEVELOPMENT; LAND DEVELOPMENT SERVICES, NAMELY, PLANNING AND LAYING OUT OF RESIDENTIAL AND/OR COMMERCIAL COMMUNITIES (U.S. CLS. 100, 103 AND 106).

CLASS 39—TRANSPORTATION AND STORAGE

FOR PUBLIC UTILITIES IN THE NATURE OF SUPPLYING WATER; PUBLIC UTILITY SERVICES IN THE NATURE OF WATER DISTRIBUTION; PUBLIC UTILITY SERVICES IN THE NATURE OF ELECTRICITY DISTRIBUTION; PUBLIC UTILITY SERVICES; PUBLIC UTILITY SERVICES IN THE NATURE OF NATURAL GAS DISTRIBUTION; CHARITABLE SERVICES, NAMELY, PROVIDING TRANSPORTATION TO THE ELDERLY OR HANDICAPPED PERSONS (U.S. CLS. 100 AND 105).

CLASS 41—EDUCATION AND ENTERTAINMENT

FOR PROVIDING FACILITIES FOR RECREATION ACTIVITIES; RECREATIONAL CAMPS; PROVIDING COURSES OF INSTRUCTION AT THE PRIMARY AND HIGH SCHOOL LEVEL; EDUCATIONAL SERVICES IN THE NATURE OF EMPLOYMENT TRAINING FOR GOVERNMENT AGENCIES; RECREATIONAL PARK SERVICES (U.S. CLS. 100, 101 AND 107).

CLASS 42—SCIENTIFIC, COMPUTER AND LEGAL SERVICES

FOR URBAN PLANNING; LEGAL SERVICES (U.S. CLS. 100 AND 101).

SN 76-471,970. THE REGENTS OF THE UNIVERSITY OF COLORADO, BOULDER, CO. FILED 11-15-2002.

THE AMERICAN WEIGH

CLASS 41—EDUCATION AND ENTERTAINMENT

FOR EDUCATIONAL SERVICES, NAMELY, CONDUCTING CLASSES, SEMINARS AND WORKSHOPS IN THE FIELDS OF NUTRITION, WEIGHT LOSS, WEIGHT MANAGEMENT, EXERCISE, AND HEALTHY LIFESTYLES; AND DISTRIBUTION OF NEWSLETTERS, EDUCATIONAL MATERIALS AND OTHER PRINTED MATERIALS IN CONNECTION THEREWITH; COUNSELING SERVICES IN THE AREA OF EXERCISE (U.S. CLS. 100, 101 AND 107).

CLASS 44—MEDICAL, BEAUTY AND AGRICULTURAL SERVICES

FOR COUNSELING SERVICES IN THE AREAS OF NUTRITION, DIET, WEIGHT LOSS, AND WEIGHT MANAGEMENT (U.S. CLS. 100 AND 101).

CLASS 43—HOTEL AND RESTAURANT SERVICES

FOR PROVIDING TEMPORARY HOUSING ACCOMMODATIONS; PUBLIC HOUSING SERVICES; ARRANGING TEMPORARY HOUSING ACCOMMODATIONS; EMERGENCY SHELTER SERVICES, NAMELY, PROVIDING TEMPORARY HOUSING; PROVIDING ELDER CARE AND DAY CARE (U.S. CLS. 100 AND 101).

CLASS 45—PERSONAL SERVICES

FOR CASE MANAGEMENT SERVICES, NAMELY, COORDINATION OF LEGAL, SOCIAL AND PSYCHOLOGICAL SERVICES FOR DOMESTICALLY ABUSED PERSONS; POLICE AND CIVIL PROTECTION SERVICES; POLICE PROTECTION; MONITORING OF COMPUTER SYSTEMS FOR SECURITY PURPOSES; FIRE FIGHTING (U.S. CLS. 100 AND 101).

SN 76-472,469. SCHAGRIN GAS CO., MIDDLETOWN, DE. FILED 12-5-2002.



THE MARK CONSISTS IN PART OF A STYLIZED MAN RUNNING WITH A FLAME.

CLASS 37—CONSTRUCTION AND REPAIR

FOR INSTALLATION AND MAINTENANCE OF PROPANE FUEL EQUIPMENT, STORAGE TANKS AND CYLINDERS AND RELATED PIPING AND GAS DISTRIBUTION EQUIPMENT (U.S. CLS. 100, 103 AND 106). FIRST USE 0-0-1959; IN COMMERCE 0-0-1959.

CLASS 39—TRANSPORTATION AND STORAGE

FOR PROPANE FUEL TRANSPORTATION AND DELIVERY SERVICES BY TRUCK (U.S. CLS. 100 AND 105). FIRST USE 0-0-1959; IN COMMERCE 0-0-1959.

SN 76-472,596. AMERICA ONLINE, INC., DULLES, VA. FILED 12-6-2002.

THE GET IT DONE PAGES

NO CLAIM IS MADE TO THE EXCLUSIVE RIGHT TO USE "PAGES" IN CLASS 35 ONLY, APART FROM THE MARK AS SHOWN.

CLASS 35—ADVERTISING AND BUSINESS

FOR PROVIDING DIRECTORIES FEATURING LISTINGS OF BUSINESSES AND ORGANIZATIONS IN A VARIETY OF FIELDS VIA COMPUTER NETWORKS; PROVIDING REVIEWS OF BUSINESSES AND ORGANIZATIONS IN A VARIETY OF FIELDS VIA COMPUTER NETWORKS (U.S. CLS. 100, 101 AND 102).

CLASS 42—SCIENTIFIC, COMPUTER AND LEGAL SERVICES

FOR PROVIDING GEOGRAPHIC INFORMATION AND MAP IMAGES IN THE FIELD OF CONSUMER-ORIENTED BUSINESSES AND ORGANIZATIONS VIA COMPUTER NETWORKS (U.S. CLS. 100 AND 101).

SN 76-472,891. 2003 FUND, INC., DAYTON, OH. FILED 12-9-2002.

TURBO**CLASS 28—TOYS AND SPORTING GOODS**

FOR PLUSH TOY IN THE NATURE OF A FALCON HAVING HUMAN ATTRIBUTES (U.S. CLS. 22, 23, 38 AND 50). FIRST USE 11-0-2002; IN COMMERCE 11-0-2002.

CLASS 41—EDUCATION AND ENTERTAINMENT

FOR ENTERTAINMENT SERVICES, NAMELY, PERSONAL APPEARANCES BY A COSTUMED INDIVIDUAL ACTING AS A MASCOT (U.S. CLS. 100, 101 AND 107). FIRST USE 11-0-2002; IN COMMERCE 11-0-2002.

SN 76-472,934. THE WOMEN'S ALLIANCE, NORTH MIAMI BEACH, FL. FILED 11-25-2002.

SOMEONE'S FUTURE IS HANGING IN YOUR CLOSET**CLASS 36—INSURANCE AND FINANCIAL**

FOR CHARITABLE FUNDRAISING SERVICES (U.S. CLS. 100, 101 AND 102). FIRST USE 10-17-2000; IN COMMERCE 10-17-2000.

CLASS 45—PERSONAL SERVICES

FOR CHARITABLE SERVICES, NAMELY, PROVIDING CLOTHING TO LOW-INCOME WOMEN TO HELP THEM BECOME EMPLOYED (U.S. CLS. 100 AND 101). FIRST USE 10-17-2000; IN COMMERCE 10-17-2000.

SN 76-474,045. DA DIRECT, INC., DALLAS, TX. FILED 12-4-2002.

LECASA**CLASS 3—COSMETICS AND CLEANING PREPARATIONS**

FOR HOUSEHOLD DECOR ITEMS, NAMELY, POTPOURRI (U.S. CLS. 1, 4, 6, 50, 51 AND 52).

CLASS 4—LUBRICANTS AND FUELS

FOR CANDLES (U.S. CLS. 1, 6 AND 15).

CLASS 21—HOUSEWARES AND GLASS

FOR VASES AND DECORATIVE HOLDERS FOR FLOWERS AND PLANTS (U.S. CLS. 2, 13, 23, 29, 30, 33, 40 AND 50).

CLASS 26—FANCY GOODS

FOR ARTIFICIAL FLOWERS, ARRANGEMENTS OF ARTIFICIAL FLOWERS, ARTIFICIAL FRUIT, ARRANGEMENTS OF ARTIFICIAL FRUIT, ARTIFICIAL PLANTS, ARTIFICIAL WREATHS AND ARTIFICIAL GARLANDS (U.S. CLS. 37, 39, 40, 42 AND 50).

CLASS 28—TOYS AND SPORTING GOODS

FOR CHRISTMAS TREE DECORATIONS AND ARTIFICIAL CHRISTMAS GARLANDS (U.S. CLS. 22, 23, 38 AND 50).

CLASS 31—NATURAL AGRICULTURAL PRODUCTS

FOR FRESH AND DRIED CHRISTMAS GARLANDS; DRIED FLOWERS; ARRANGEMENTS OF DRIED FLOWERS; DRIED FLOWER WREATHS; FRESH CUT GARLANDS (U.S. CLS. 1 AND 46).

SN 76-474,982. HEFNER, KIMBERLY, LOS ANGELES, CA. FILED 12-9-2002.



NO CLAIM IS MADE TO THE EXCLUSIVE RIGHT TO USE "MUTT", APART FROM THE MARK AS SHOWN.

CLASS 3—COSMETICS AND CLEANING PREPARATIONS

FOR SHAMPOOS AND CONDITIONERS FOR DOGS (U.S. CLS. 1, 4, 6, 50, 51 AND 52).

CLASS 18—LEATHER GOODS

FOR DOG APPAREL, NAMELY SWEATERS, BLACK TIE OUTFIT, T-SHIRTS, VESTS, ROBES, SMOKING JACKETS, TOWEL WRAPS, SCARVES, BANDANAS AND PARKAS; DOG COLLARS; DOG LEASHES; TOTE BAGS TO CARRY DOGS; COSMETIC BAGS SOLD EMPTY; CHANGE PURSES; DOG CARRIERS (U.S. CLS. 1, 2, 3, 22 AND 41).

CLASS 20—FURNITURE AND ARTICLES NOT OTHERWISE CLASSIFIED

FOR DOG KENNELS (U.S. CLS. 2, 13, 22, 25, 32 AND 50).

CLASS 21—HOUSEWARES AND GLASS

FOR DOG FEEDING DISHES, BOWLS AND COLLAPSIBLE BOWLS; COFFEE MUGS; COOKIE JARS (U.S. CLS. 2, 13, 23, 29, 30, 33, 40 AND 50).

CLASS 25—CLOTHING

FOR CLOTHING, NAMELY T-SHIRTS, T-SHIRT DRESSES, CAPS, SWEATSHIRTS, SWEAT PANTS, BOXERS, SHORTS, SCARVES AND BANDANAS (U.S. CLS. 22 AND 39).

CLASS 26—FANCY GOODS

FOR BUTTONS FOR CLOTHING (U.S. CLS. 37, 39, 40, 42 AND 50).

CLASS 27—FLOOR COVERINGS

FOR DOG FEEDING MATS (U.S. CLS. 19, 20, 37, 42 AND 50).

CLASS 28—TOYS AND SPORTING GOODS

FOR DOG TOYS; STUFFED TOY ANIMALS (U.S. CLS. 22, 23, 38 AND 50).

CLASS 31—NATURAL AGRICULTURAL PRODUCTS

FOR DOG BISCUITS AND COOKIES (U.S. CLS. 1 AND 46).

SN 76-474,289. MAXIMUM IMPACT, INC., DULUTH, GA. FILED 12-6-2002.

DEVELOPING THE LEADERS AROUND YOU

CLASS 16—PAPER GOODS AND PRINTED MATTER

FOR PUBLICATIONS, NAMELY, SERIES OF BOOKS, NEWSPAPERS, MAGAZINES, NEWSLETTERS, BOOKLETS, BROCHURES, PAMPHLETS, BULLETINS, PRINTED INSTRUCTIONAL AND TEACHING MANUALS, WORKBOOKS, PRINTED INSTRUCTIONAL, EDUCATIONAL AND TEACHING MATERIALS IN THE NATURE OF CURRICULUM, ALL OF THE ABOVE ITEMS IN THE FIELD OF LEADERSHIP DEVELOPMENT; NEWSLETTERS FEATURING TRANSCRIPTS OF LEADERSHIP DEVELOPMENT CONFERENCES; POSTERS; NOTEPADS; CALENDARS AND NOTEBOOKS (U.S. CLS. 2, 5, 22, 23, 29, 37, 38 AND 50).

CLASS 41—EDUCATION AND ENTERTAINMENT

FOR EDUCATIONAL SERVICES, NAMELY, CONDUCTING AND HOSTING CONFERENCES, CLASSES, TRAINING SEMINARS, AND LIVE SATELLITE TRAINING EVENTS AND SIMULCASTS IN THE FIELD OF LEADERSHIP DEVELOPMENT; EDUCATIONAL SERVICES, NAMELY, PROVIDING ONLINE LEARNING MODULES AND WEB-BASED TRAINING IN THE FIELD OF LEADERSHIP DEVELOPMENT (U.S. CLS. 100, 101 AND 107).

CLASS 41—EDUCATION AND ENTERTAINMENT

FOR ENTERTAINMENT SERVICES IN THE FORM OF AN ANIMATED TELEVISION SERIES FEATURING A DOG (U.S. CLS. 100, 101 AND 107).

SN 76-475,352. CELITE SYSTEMS, AUSTIN, TX. FILED 12-13-2002.

CELITE**CLASS 9—ELECTRICAL AND SCIENTIFIC APPARATUS**

FOR TELECOMMUNICATIONS EQUIPMENT, NAMELY, BROADBAND ACCESS MULTIPLEXERS; DIGITAL SUBSCRIBER LINE ACCESS MULTIPLEXERS; DIGITAL SUBSCRIBER LINE HEADENDS; BROADBAND ACCESS HEADENDS; DIGITAL SUBSCRIBER LINE CUSTOMER PREMISE MODEMS; BROADBAND ACCESS MODEMS; COMPUTER HARDWARE (U.S. CLS. 21, 23, 26, 36 AND 38).

CLASS 38—COMMUNICATION

FOR TELECOMMUNICATIONS SERVICES, NAMELY, PROVIDING BROADBAND ACCESS TO THE INTERNET VIA COPPER TWISTED PAIR LINES (U.S. CLS. 100, 101 AND 104).

SN 76-476,698. HYDROFERA, LLC, WILLIMANTIC, CT. FILED 12-17-2002.

HYDROFERA BLUE THE ASPIRIN OF WOUND CARE

OWNER OF U.S. REG. NO. 2,332,072.
NO CLAIM IS MADE TO THE EXCLUSIVE RIGHT TO USE "BLUE" AND "WOUND CARE", APART FROM THE MARK AS SHOWN.

CLASS 5—PHARMACEUTICALS

FOR SURGICAL DRESSINGS (U.S. CLS. 6, 18, 44, 46, 51 AND 52).

CLASS 10—MEDICAL APPARATUS

FOR MEDICAL SPONGES, NAMELY, SURGICAL, WOUND CARE AND GYNCOLOGICAL SPONGES (U.S. CLS. 26, 39 AND 44).

SN 76-476,855. ALPHA GEL INC., ROWLAND HEIGHTS, CA. FILED 12-16-2002.

ALPHA GEL

NO CLAIM IS MADE TO THE EXCLUSIVE RIGHT TO USE "GEL", APART FROM THE MARK AS SHOWN.

CLASS 1—CHEMICALS

FOR CHEMICAL CONDUCTING GEL FOR USE IN ELECTRIC BATTERIES AND BATTERY CHARGING DEVICES (U.S. CLS. 1, 5, 6, 10, 26 AND 46).
FIRST USE 5-1-1999; IN COMMERCE 5-1-1999.

CLASS 2—PAINTS

FOR CORROSION INHIBITING GEL FOR USE ON ELECTRIC BATTERIES AND BATTERY CHARGING DEVICES (U.S. CLS. 6, 11 AND 16).
FIRST USE 5-1-1999; IN COMMERCE 5-1-1999.

SN 76-478,084. HORSE SENSE, INC., DELRAY BEACH, FL. FILED 12-24-2002.

ON THE NUMBER**CLASS 28—TOYS AND SPORTING GOODS**

FOR WAGERING GAME, NAMELY A WAGERING GAME PRINTED IN PROGRAMS INVOLVING PARI-MUTUEL POOLS AT SPECIAL EVENTS AND SPORTING EVENTS (U.S. CLS. 22, 23, 38 AND 50).

CLASS 41—EDUCATION AND ENTERTAINMENT

FOR ENTERTAINMENT SERVICES, NAMELY OFFERING PARI-MUTUEL WAGERING GAMES AT SPECIAL EVENTS AND SPORTING EVENTS (U.S. CLS. 100, 101 AND 107).

SN 76-478,160. J. STEPHEN SCHERER, INC., DBA SCHERER INCORPORATED, ROCHESTER HILLS, MI. FILED 12-18-2002.

CQ

OWNER OF U.S. REG. NO. 2,646,884.

CLASS 3—COSMETICS AND CLEANING PREPARATIONS

FOR LIPSTICKS, NAIL POLISH, COSMETICS, NAMELY, LIQUID FOUNDATION, FACE POWDER, EYELINER, MASCARA, EYEBROW PENCIL, EYE SHADOW, CONCEALER, SKIN LOTION, SKIN MOISTURIZER, ROUGE, EYE CREAM, LIP LINER, BLUSH, EXFOLIANT FOR SKIN, FACIAL CLEANSER, SUNSCREEN, MAKEUP REMOVER, EYE MAKEUP REMOVER, HAIR SHAMPOO, HAIR CONDITIONER, HAIR COLOR, HAIR THICKENER/MOUSSE, HAIR GEL, HAIR SPRAY/SPRITZ, SOAPS, SHOWER GEL, FACIAL CREAM, NAIL CONDITIONERS, AND CUTICLE CONDITIONERS (U.S. CLS. 1, 4, 6, 50, 51 AND 52).

CLASS 8—HAND TOOLS

FOR NAIL CLIPPERS, NAIL AND CUTICLE SCISSORS, CUTICLE PUSHERS, NAIL FILES, TWEEZERS, AND EYELASH CURLERS (U.S. CLS. 23, 28 AND 44).

SN 76-478,444. CORPORATIVO INTERNACIONAL MEXICANO, S. DE R.L. DE C.V., COL. LOMAS DE CHAPULTEPEC, MEXICO, FILED 12-23-2002.



OWNER OF U.S. REG. NO. 1,157,500 AND OTHERS.

CLASS 29—MEATS AND PROCESSED FOODS

FOR PROCESSED VEGETABLES, NAMELY, DEHYDRATED LEGUMES (U.S. CL. 46).

CLASS 30—STAPLE FOODS

FOR FLOUR; CHOCOLATE; BREAD; PROCESSED CEREALS; PROCESSED MIXED CEREALS (U.S. CL. 46).

CLASS 31—NATURAL AGRICULTURAL PRODUCTS

FOR UNPROCESSED CEREALS (U.S. CLS. 1 AND 46).

SN 76-479,433. INVEST IN KIDS, DENVER, CO. FILED 12-31-2002.



OWNER OF U.S. REG. NO. 2,551,787.

CLASS 16—PAPER GOODS AND PRINTED MATTER

FOR PUBLICATIONS, NAMELY NEWSLETTERS AND BROCHURES DIRECTED TO ASSISTING COMMUNITY LEADERS AND ORGANIZATIONS THAT ARE SEEKING TO IMPLEMENT PROGRAMS WHICH FOCUS ON IMPROVING PREGNANCY OUTCOMES FOR LOW-INCOME FIRST-TIME MOTHERS AND IMPROVING PARENTING AND EMPLOYMENT SKILLS FOR LOW-INCOME FIRST TIME MOTHERS (U.S. CLS. 2, 5, 22, 23, 29, 37, 38 AND 50).

CLASS 41—EDUCATION AND ENTERTAINMENT

FOR EDUCATIONAL SERVICES, NAMELY, PROVIDING A CURRICULUM FOR PARENTS, TEACHERS AND CHILDREN DESIGNED TO ENHANCE PARENTING SKILLS AND BEHAVIORAL SKILLS FOR CHILDREN AND PROVIDING IN-HOME CLASSES ON IMPROVING PREGNANCY OUTCOMES FOR LOW-INCOME FIRST-TIME MOTHERS AND IMPROVING PARENTING AND EMPLOYMENT SKILLS FOR LOW-INCOME FIRST-TIME MOTHERS (U.S. CLS. 100, 101 AND 107).

SN 76-479,444. MATTSON, JOHN, KINGSTON, MA. FILED 12-31-2002.



CLASS 32—LIGHT BEVERAGES

FOR MALT BEVERAGES, NAMELY BEER, ALE, LAGER, STOUT AND PILSNER (U.S. CLS. 45, 46 AND 48).

CLASS 43—HOTEL AND RESTAURANT SERVICES

FOR RESTAURANT AND BAR SERVICES (U.S. CLS. 100 AND 101).

SN 76-479,859. MARKOVICH, NATASHA, SEATTLE, WA. FILED 1-2-2003.

HOT PROPERTY

CLASS 3—COSMETICS AND CLEANING PREPARATIONS

FOR COMPACT POWDER FOUNDATION, FOUNDATION, LOOSE POWDER, PRESSED POWDER, LIPSTICK, BLUSH, EYE SHADOW, UNDEREYE CONCEALER, EYE LINER, AND LIP LINER (U.S. CLS. 1, 4, 6, 50, 51 AND 52).

CLASS 9—ELECTRICAL AND SCIENTIFIC APPARATUS

FOR PORTABLE CASES WITH INTEGRAL COMPARTMENT FOR PORTABLE COMPUTER DEVICE, AND WITH INTEGRAL BATTERY CHARGERS FOR PORTABLE COMPUTER DEVICE AND CELL PHONE (U.S. CLS. 21, 23, 26, 36 AND 38).

CLASS 18—LEATHER GOODS

FOR PORTABLE CASES FOR USE IN CARRYING PERSONAL ITEMS AND/OR COSMETICS; PURSES; PORTABLE CASES WITH COMPARTMENTS FOR CARRYING BOTH COSMETICS AND A PORTABLE COMPUTER DEVICE; AND AIRLINE CARRY-ON SUITCASES HAVING ONE OR MORE INTEGRAL COMPARTMENTS FOR CARRYING PORTABLE COMPUTER DEVICES (U.S. CLS. 1, 2, 3, 22 AND 41).

CLASS 25—CLOTHING

FOR LINGERIE (U.S. CLS. 22 AND 39).

SN 76-482,701. TRILEGIANT CORPORATION, NORWALK, CT. FILED 1-16-2003.

PURCHASEADVANTAGE.COM

CLASS 9—ELECTRICAL AND SCIENTIFIC APPARATUS

FOR IDENTITY FRAUD CONSUMER SOFTWARE PRODUCT, NAMELY, COMPUTER SOFTWARE, DOWNLOADABLE FROM THE INTERNET, IN THE NATURE OF, ANTI-VIRUS SOFTWARE AND FIREWALL SOFTWARE FOR PREVENTING INTRUSION AND HACKING (U.S. CLS. 21, 23, 26, 36 AND 38).

CLASS 35—ADVERTISING AND BUSINESS

FOR PROVIDING CREDIT MONITORING SERVICES AND ALERTING CONSUMERS TO CREDIT INQUIRIES AND OTHER CREDIT INFORMATION (U.S. CLS. 100, 101 AND 102).

CLASS 36—INSURANCE AND FINANCIAL

FOR PROVIDING TO CONSUMERS A COMPREHENSIVE PACKAGE WHICH ENTITLES THEM TO EXTENDED WARRANTIES, FULL AND PARTIAL PURCHASE PRICE REIMBURSEMENT, REIMBURSEMENT FOR POST-PURCHASE PRICE REDUCTIONS, SHIPPING COST REBATES, SALES PRICE GUARANTEES, AND REIMBURSEMENT FOR PRODUCT REPAIR AND REPLACEMENT, IN CONNECTION WITH A WIDE RANGE OF CONSUMER MERCHANDISE (U.S. CLS. 100, 101 AND 102).

SN 76-975,045. NATIONAL GEOGRAPHIC SOCIETY, WASHINGTON, DC. FILED 7-2-2002.

**NATIONAL
GEOGRAPHIC
Explorer!**

OWNER OF U.S. REG. NOS. 1,416,981, 1,994,611 AND OTHERS.

CLASS 9—ELECTRICAL AND SCIENTIFIC APPARATUS

FOR DOWNLOADABLE ELECTRONIC PUBLICATIONS IN THE NATURE OF TEACHING GUIDES FOR USE IN THE FIELD OF LITERACY SKILLS DEVELOPMENT THROUGH SCIENCE AND SOCIAL STUDIES CONTENT (U.S. CLS. 21, 23, 26, 36 AND 38).

FIRST USE 9-0-2002; IN COMMERCE 9-0-2002.

CLASS 16—PAPER GOODS AND PRINTED MATTER

FOR PERIODICAL PUBLICATIONS, NAMELY, EDUCATIONAL MAGAZINES FOR CHILDREN AND PRINTED TEACHING GUIDES ASSOCIATED THEREWITH (U.S. CLS. 2, 5, 22, 23, 29, 37, 38 AND 50).

FIRST USE 9-0-2002; IN COMMERCE 9-0-2002.

CLASS 41—EDUCATION AND ENTERTAINMENT

FOR ON-LINE PUBLICATIONS, NAMELY, ON-LINE EDUCATIONAL MAGAZINES FOR CHILDREN (U.S. CLS. 100, 101 AND 107).

FIRST USE 9-0-2002; IN COMMERCE 9-0-2002.

SN 76-975,502. JM FAMILY ENTERPRISES, INC., DEERFIELD BEACH, FL. FILED 5-17-2001.

GALLANT LADY

CLASS 16—PAPER GOODS AND PRINTED MATTER

FOR GIFT WRAPPING PAPER; STATIONERY; BOOKMARKS; PAPERWEIGHTS; PLAYING CARDS; DESK ACCESSORIES, NAMELY, CALENDAR DESK PADS, CALENDAR DESK STANDS, DESK BASKETS FOR DESK ACCESSORIES, DESK CALENDARS, DESK FILE TRAYS, DESK PADS, DESK SETS, DESK STANDS AND HOLDERS FOR PENS, PENCILS, AND INK, DESK TOP DOCUMENT RACKS, DESK TOP DOCUMENT STANDS, DESK TOP ORGANIZERS, DESK TOP PLANNERS, DESK TOP REVOLVING ROTARY CARD FILES, DESK TOP STATIONERY CABINETS, HOLDERS FOR DESK ACCESSORIES; AND PAPER PLACEMENTS AND PLASTIC PLACEMATS (U.S. CLS. 2, 5, 22, 23, 29, 37, 38 AND 50).

FIRST USE 1-1-2001; IN COMMERCE 1-1-2001.

CLASS 21—HOUSEWARES AND GLASS

FOR ORNAMENTS, NAMELY CHINA, CRYSTAL, GLASS, PORCELAIN AND TERRACOTTA ORNAMENTS; CUPS; GLASSES, NAMELY BEVERAGE GLASSES, DRINKING GLASSES, GLASS MUGS, SHOT GLASSES, AND PILSNER DRINKING GLASSES; JARS, NAMELY COOKIE JARS, GLASS STORAGE JARS, INSULATING JARS, AND GLASS, PORCELAIN, EARTHENWARE, AND PLASTIC JAR FOR JAMS AND JELLIES; DISHES; SERVING PLATTERS; PET BOWLS; AND CANDY DISHES (U.S. CLS. 2, 13, 23, 29, 30, 33, 40 AND 50).

FIRST USE 1-1-2001; IN COMMERCE 1-1-2001.

SN 78-034,996. RG INTERNATIONAL LIMITED, WANCHAI, HONG KONG, FILED 11-13-2000.

SN 78-034,998. RG INTERNATIONAL LIMITED, WANCHAI, HONG KONG, FILED 11-13-2000.



CLASS 3—COSMETICS AND CLEANING PREPARATIONS

FOR COSMETICS, NAMELY FOUNDATIONS, FACE POWDERS, COMPACTS AND CONCEALERS; LIPSTICKS AND LIP BALM; EYE SHADOWS AND EYE LINERS; MASCARA; BLUSH; MAKEUP REMOVERS; SKIN CLEANSERS, LOTIONS, AND CREAMS; SKIN MOISTURIZERS; TONERS AND FRESHENERS; MASKS AND SCRUBS; TOILETRIES, NAMELY BODY TALC, BATH FOAM AND BUBBLE BATH; FACIAL AND BODY SCRUBS; FACIAL MASKS, SKIN TONING PREPARATIONS; SKIN EXFOLIANTS; SKIN MOISTURIZERS; PERFUMERY, NAMELY PERFUME OILS AND PERFUME; ESSENTIAL OILS FOR PERSONAL USE; HAIR CARE PREPARATIONS AND HAIR LOTIONS; HAIR CLEANING PREPARATIONS; ANTIBACTERIAL SKIN SOAPS; DENTIFRICES (U.S. CLS. 1, 4, 6, 50, 51 AND 52).

CLASS 24—FABRICS

FOR TEXTILE AND TEXTILE GOODS, NAMELY PILLOW COVERS, PLACE MATS, BATH MATS AND NAPKINS; BED COVERS, NAMELY BLANKETS, SHEETS AND BEDSPREADS; TABLE COVERS, NAMELY TABLE LINEN AND FABRIC TABLE RUNNERS; UNFITTED FURNITURE COVERINGS OF TEXTILE AND PLASTIC; CURTAINS; TOWELS; UPHOLSTERY FABRICS; WALL HANGINGS OF TEXTILE; WOOLEN FABRICS (U.S. CLS. 42 AND 50).

CLASS 25—CLOTHING

FOR CLOTHING, NAMELY, JACKETS, COATS, SUITS, PAJAMAS, ROBES, VESTS, SHIRTS, T-SHIRTS, SWEATERS, DRESSES, PANTS, SHORTS, SKIRTS, JUMPERS, UNDERGARMENTS, SOCKS, HOSIERY AND HATS; FOOTWEAR; AND HEADWEAR (U.S. CLS. 22 AND 39).

CLASS 26—FANCY GOODS

FOR RIBBONS; BRAIDS; HAIR PINS, HAIR BOWS, COLOURING CAPS, NAMELY HAIR PIECES; ORNAMENTS FOR HAIR; BROOCHES FOR CLOTHING NOT OF PRECIOUS METAL AND NOT BEING IMITATION JEWELRY, BUCKLES, NAMELY TO BE USED ON CLOTHING, FOOTWEAR, AND BAGS; DECORATIONS FOR TEXTILE ARTICLES, NAMELY TO BE USED ON CLOTHING, FOOTWEAR AND BAGS (U.S. CLS. 37, 39, 40, 42 AND 50).

CLASS 28—TOYS AND SPORTING GOODS

FOR DOLLS AND DOLL ACCESSORIES; SOFT SCULPTURE TOYS, STUFFED TOYS, CHILDREN'S MULTIPLE ACTIVITY TOYS, ELECTRIC ACTION TOYS, BATH TOYS, INFANT DEVELOPMENT TOYS, MUSICAL TOYS, BOARD GAMES, CARD GAMES, ARCADE GAMES; TOY ACTION FIGURES AND ACCESSORIES THEREFOR; ELECTRONIC EDUCATIONAL GAME MACHINES FOR CHILDREN; DECORATIONS FOR CHRISTMAS TREES (U.S. CLS. 22, 23, 38 AND 50).



CLASS 3—COSMETICS AND CLEANING PREPARATIONS

FOR COSMETICS, NAMELY FOUNDATIONS, FACE POWDERS, COMPACTS AND CONCEALERS; LIPSTICKS AND LIP BALM; EYE SHADOWS AND EYE LINERS; MASCARA; BLUSH; MAKEUP REMOVERS; SKIN CLEANSERS, LOTIONS, AND CREAMS; SKIN MOISTURIZERS; TONERS AND FRESHENERS; MASKS AND SCRUBS; TOILETRIES, NAMELY BODY TALC, BATH FOAM AND BUBBLE BATH; FACIAL AND BODY SCRUBS; FACIAL MASKS, SKIN TONING PREPARATIONS; SKIN EXFOLIANTS; SKIN MOISTURIZERS; PERFUMERY, NAMELY PERFUME OILS AND PERFUME; ESSENTIAL OILS FOR PERSONAL USE; HAIR CARE PREPARATIONS AND HAIR LOTIONS; HAIR CLEANING PREPARATIONS; ANTIBACTERIAL SKIN SOAPS, DENTRIFICES (U.S. CLS. 1, 4, 6, 50, 51 AND 52).

CLASS 24—FABRICS

FOR TEXTILE AND TEXTILE GOODS, NAMELY PILLOW COVERS, PLACE MATS, BATH MATS AND NAPKINS; BED COVERS, NAMELY BLANKETS, SHEETS AND BEDSPREADS; TABLE COVERS, NAMELY TABLE LINEN AND FABRIC TABLE RUNNERS; UNFITTED FURNITURE COVERINGS OF TEXTILE AND PLASTIC; CURTAINS; TOWELS; UPHOLSTERY FABRICS; WALL HANGINGS OF TEXTILE; WOOLEN FABRICS (U.S. CLS. 42 AND 50).

CLASS 25—CLOTHING

FOR CLOTHING, NAMELY, JACKETS, COATS, SUITS, PAJAMAS, ROBES, VESTS, SHIRTS, T-SHIRTS, SWEATERS, DRESSES, PANTS, SHORTS, SKIRTS, JUMPERS, UNDERGARMENTS, SOCKS, HOSIERY AND HATS; FOOTWEAR; AND HEADWEAR (U.S. CLS. 22 AND 39).

CLASS 26—FANCY GOODS

FOR RIBBONS; BRAIDS; HAIR PINS, HAIR BOWS, COLOURING CAPS, NAMELY HAIR FROSTING CAPS, HAIR TRESSES, NAMELY HAIR PIECES; ORNAMENTS FOR HAIR; BROOCHES FOR CLOTHING NOT OF PRECIOUS METAL AND NOT BEING IMITATION JEWELRY, BUCKLES, NAMELY TO BE USED ON CLOTHING, FOOTWEAR, AND BAGS; DECORATIONS FOR TEXTILE ARTICLES, NAMELY TO BE USED ON CLOTHING, FOOTWEAR AND BAGS (U.S. CLS. 37, 39, 40, 42 AND 50).

CLASS 28—TOYS AND SPORTING GOODS

FOR DOLLS AND DOLL ACCESSORIES; SOFT SCULPTURE TOYS, STUFFED TOYS, CHILDREN'S MULTIPLE ACTIVITY TOYS, ELECTRIC ACTION TOYS, BATH TOYS, INFANT DEVELOPMENT TOYS, MUSICAL TOYS, BOARD GAMES, CARD GAMES, ARCADE GAMES; TOY ACTION FIGURES AND ACCESSORIES THEREFOR; ELECTRONIC EDUCATIONAL GAME MACHINES FOR CHILDREN; DECORATIONS FOR CHRISTMAS TREES (U.S. CLS. 22, 23, 38 AND 50).

SN 78-046,693. DADA CORPORATION, SEOUL, REPUBLIC OF KOREA, FILED 2-5-2001.

JUNGLE LOOK

CLASS 18—LEATHER GOODS

FOR SUIT BAGS, BRIEF BAGS, WALLETS, TRAVELING BAGS, SPORTS BAGS, SHOPPING BAGS, SCHOOL BAGS, HANDBAGS, BOSTON BAGS, BEACH BAGS (U.S. CLS. 1, 2, 3, 22 AND 41).

CLASS 24—FABRICS

FOR TEXTILE FABRICS MADE OF NATURAL AND SYNTHETIC FABRICS AND COMBINATIONS THEREOF FOR USE IN THE MANUFACTURE APPAREL, HEADWEAR, BAGS, AND ACCESSORIES (U.S. CLS. 42 AND 50).

CLASS 25—CLOTHING

FOR CLOTHING NAMELY, HATS, BASEBALL CAPS, HEADWEAR, HEADBANDS, BATHING CAPS, SHOWER CAPS, BEACHWEAR NAMELY, BEACH COVER-UPS, BEACH SHOES, JACKETS, JEANS, CASUAL WEAR NAMELY, SKIRTS, PANTS, T-SHIRTS, OVERCOATS, UNDERWEAR, SHOES (U.S. CLS. 22 AND 39).

CLASS 38—COMMUNICATION

FOR TELECOMMUNICATIONS, NAMELY, LOCAL AND LONG DISTANCE TRANSMISSION OF VOICE, DATA, GRAPHICS, BY MEANS OF RADIO, TELEGRAPHIC, CABLE, SATELLITE, AND TELEPHONE TRANSMISSION; TELECOMMUNICATIONS BY COMPUTER TERMINALS, NAMELY, VIDEO AND AUDIO TELECONFERENCING VIA GLOBAL COMPUTER NETWORKS; TELETEXT SERVICES AND TELEPRINTING AND BROADCASTING VIA A GLOBAL COMPUTER NETWORK AND PROVIDING TELECOMMUNICATIONS CONNECTIONS TO A GLOBAL COMPUTER NETWORK, ELECTRONIC MESSAGING, NAMELY, DELIVERY OF MESSAGES BY ELECTRONIC TRANSMISSION; LOCAL AND LONG DISTANCE TRANSMISSION OF SOUNDS, IMAGES AND DATA BY MEANS OF TELEPHONE, TELEGRAPHIC, CABLE AND SATELLITE TRANSMISSIONS; TRANSMISSION OF SOUNDS, IMAGES AND DATA VIA GLOBAL COMPUTER NETWORK AND PRIVATELY ACCESSED AND RESERVED INTRANET COMMUNICATION NETWORKS; TELEMETRIC DATA TRANSMISSION AND TELEMATIC DATA TRANSMISSION BY ACCESS CODE VIA COMPUTER TERMINALS; ON-LINE MESSAGING SERVICES; SERVICES OF TRANSMITTING AND DISPLAYING DATA CONTAINED IN A COMPUTER DATA BANK AND STORED IN A COMPUTER VIA SATELLITE TRANSMISSION; ELECTRONIC EXCHANGE OF DATA BY MEANS OF ELECTRONIC MAIL; TRANSMISSION OF DATA, SOUNDS AND IMAGES BY SATELLITES; DATA TRANSMISSION VIA COMPUTERS GROUPED ON A NETWORK; PROVIDING MULTIPLE-USER ACCESS TO DATABASES AND INFORMATION RETRIEVAL CENTERS ON A GLOBAL COMPUTER INFORMATION NETWORK, SECURED DATA, SOUND OR IMAGE TRANSMISSION VIA RADIO, TELEPHONE, TELEGRAPHIC, CABLE AND SATELLITE TRANSMISSIONS; WEB CASTING AUDIO AND VISUAL PROGRAMS IN THE FIELD OF COMMERCIAL AND ADVERTISING EXHIBITIONS VIA A GLOBAL COMPUTER NETWORK; PROVIDING MULTIPLE-USER ACCESS TO A TELECOMMUNICATIONS NETWORK BY MEANS OF A COMPUTER, TELEPHONE OR TELEVISION SET; SETTING AND USING TELECOMMUNICATION NETWORKS AND TELECOMMUNICATIONS SITES FOR E-BUSINESS, NAMELY, TELECOMMUNICATION GATEWAY SERVICES (U.S. CLS. 100, 101 AND 104).

SN 78-052,674. BOOKMYNAME SAS, LEVALLOIS-PERRET, FRANCE, BY ASSIGNMENT KAPTECH, PARIS, FRANCE, FILED 3-12-2001.

BOOK MY NAME

PRIORITY CLAIMED UNDER SEC. 44(D) ON FRANCE APPLICATION NO. 003051031, FILED 9-12-2000, REG. NO. 003051031, DATED 9-12-2000, EXPIRES 9-12-2010.

CLASS 35—ADVERTISING AND BUSINESS

FOR ADVERTISING, NAMELY, ADVERTISING AGENCY SERVICES, DISSEMINATION OF ADVERTISING FOR OTHERS VIA GLOBAL COMPUTER NETWORKS, BUSINESS MARKETING CONSULTING; MANAGEMENT OF COMPUTER SERVERS, OF DATA, SOUND AND IMAGE TRANSMISSION NETWORKS, NAMELY, COMPUTERIZED DATABASE MANAGEMENT; DATA PROCESSING SERVICES; MANAGEMENT OF COMPUTER SERVERS, NAMELY, DATABASE MANAGEMENT; COPYRIGHT MANAGEMENT CONSULTING; PROVIDING FACILITIES, NAMELY, CONVENTION FACILITIES FOR COMMERCIAL AND ADVERTISING EXHIBITIONS, FOR BUSINESS MEETINGS (U.S. CLS. 100, 101 AND 102).

CLASS 42—SCIENTIFIC, COMPUTER AND LEGAL SERVICES

FOR DESIGNING AND UPDATING COMPUTER AND SOFTWARE PROGRAMS; COMPUTER PROGRAMMING FOR OTHERS, DESIGNING AND UPDATING COMPACT DISKS, INTERACTIVE CD-ROMS, DIGITAL VIDEO DISKS, CD-ROMS IN CONNECTION WITH THE INTERNET NETWORK AND OTHER RECORDING MEDIA, NAMELY, CASSETTE TAPES, VIDEO TAPES, LASER DISKS FOR OTHERS; DESIGNING, PRODUCING, MAINTAINING AND UPDATING INTERNET SITES; DESIGNING AND PRODUCING WEB PAGES DISTRIBUTED BY COMPUTER NETWORKS FOR OTHERS; UPDATING DATABASES FOR OTHERS, CONSULTATION AND ENGINEERING IN THE COMPUTER AND TELECOMMUNICATIONS NETWORK FIELD; DEVELOPING, MAINTAINING AND UPDATING A SEARCH ENGINE FOR TELECOMMUNICATIONS NETWORK; LEGAL ASSISTANCE RELATED TO THE POSSESSION OF DOMAIN NAMES AND ELECTRONIC ADDRESSES; CREATION OF DOMAIN NAMES AND RESERVATION OF DOMAIN NAMES AND ELECTRONIC ADDRESSES (U.S. CLS. 100 AND 101).

SN 78-054,991. TOMSED CORP., FUQUAY-VARINA, NC.
FILED 3-26-2001.

ROBOT

CLASS 6—METAL GOODS

FOR NON-AUTOMATIC METAL TURNSTILES (U.S. CLS. 2, 12, 13, 14, 23, 25 AND 50).
FIRST USE 0-0-1975; IN COMMERCE 0-0-1975.

CLASS 9—ELECTRICAL AND SCIENTIFIC APPARATUS

FOR ELECTRICAL AND ELECTRO-MECHANICAL GATES, AUTOMATIC TURNSTILES, CONTROL HARDWARE AND PARTS THEREFOR (U.S. CLS. 21, 23, 26, 36 AND 38).
FIRST USE 0-0-1975; IN COMMERCE 0-0-1975.

SN 78-058,380. KERN, AUGUSTINE, CONROY & SCHOPPMANN, P.C., BRIDGEWATER, NJ. FILED 4-13-2001.

ProACT
Compliance Services

NO CLAIM IS MADE TO THE EXCLUSIVE RIGHT TO USE "COMPLIANCE SERVICES", APART FROM THE MARK AS SHOWN.

CLASS 35—ADVERTISING AND BUSINESS

FOR BUSINESS CONSULTATION SERVICES RENDERED TO CLIENTS WHO ARE MEDICAL PROVIDERS TO ASSIST IN THEIR MAKING OF WELL-INFORMED BUSINESS DECISIONS (U.S. CLS. 100, 101 AND 102).
FIRST USE 3-1-2001; IN COMMERCE 3-1-2001.

CLASS 42—SCIENTIFIC, COMPUTER AND LEGAL SERVICES

FOR LEGAL SERVICES RENDERED BY ATTORNEYS TO THE MEDICAL PROVIDER COMMUNITY, NAMELY DOCTORS, THEIR ASSISTANTS AND ASSOCIATED PROFESSIONALS (U.S. CLS. 100 AND 101).
FIRST USE 3-1-2001; IN COMMERCE 3-1-2001.

SN 78-059,120. FLAHERTY, MARGARET, DARNESTOWN, MD. FILED 4-18-2001.

IT PIONEERS

NO CLAIM IS MADE TO THE EXCLUSIVE RIGHT TO USE "IT", APART FROM THE MARK AS SHOWN.

CLASS 35—ADVERTISING AND BUSINESS

FOR COMPUTERIZED DATABASE MANAGEMENT, NAMELY, ENTERPRISE SYSTEM DATABASE MANAGEMENT, AND COMPUTERIZED DATABASE MANAGEMENT CONSULTING SERVICES (U.S. CLS. 100, 101 AND 102).
FIRST USE 3-23-1998; IN COMMERCE 4-16-1998.

CLASS 42—SCIENTIFIC, COMPUTER AND LEGAL SERVICES

FOR COMPUTER SOFTWARE DESIGN AND COMPUTER NETWORK DESIGN SERVICES FOR OTHERS FEATURING WEB-BASED DATABASE INTERFACES AND CONCEPTUAL MODELING (U.S. CLS. 100 AND 101).
FIRST USE 3-23-1998; IN COMMERCE 4-16-1998.

SN 78-064,961. PUMPKIN PIE NET LIMITED, BURLEY, UNITED KINGDOM, FILED 5-22-2001.



PRIORITY CLAIMED UNDER SEC. 44(D) ON UNITED KINGDOM APPLICATION NO. 2253597, FILED 11-22-2000, REG. NO. 2253597, DATED 5-11-2001, EXPIRES 11-22-2010.

NO CLAIM IS MADE TO THE EXCLUSIVE RIGHT TO USE "VIRTUAL SOLO SPORTS", APART FROM THE MARK AS SHOWN.

CLASS 9—ELECTRICAL AND SCIENTIFIC APPARATUS

FOR COMPUTER GAME SOFTWARE, ELECTRONIC GAME SOFTWARE; COMPUTER GAME APPARATUS, NAMELY, COMPUTER GAME JOYSTICKS, COMPUTER GAME CARTRIDGES, COMPUTER GAME CASSETTES, COMPUTER GAME DISCS, COMPUTER GAME TAPES AND COMPUTER GAME PROGRAMS USED FOR SIMULATING SPORTS AND SPORTING ACTIVITIES (U.S. CLS. 21, 23, 26, 36 AND 38).

CLASS 28—TOYS AND SPORTING GOODS

FOR HAND-HELD UNITS FOR PLAYING ELECTRONIC GAMES (U.S. CLS. 22, 23, 38 AND 50).

CLASS 41—EDUCATION AND ENTERTAINMENT

FOR ENTERTAINMENT SERVICES, NAMELY, PROVIDING AN ON-LINE COMPUTER GAME IN THE FIELD OF SPORTS AND SPORTING ACTIVITIES (U.S. CLS. 100, 101 AND 107).

SN 78-067,901. WILLIAMS, GUY ANTHONY, SR., BURTONSVILLE, MD. FILED 6-7-2001.

THE PETROS GROUP

CLASS 35—ADVERTISING AND BUSINESS

FOR BUSINESS MANAGEMENT CONSULTATION FOR CHRISTIAN AND SECULAR PERSONS AND ORGANIZATIONS (U.S. CLS. 100, 101 AND 102).

CLASS 41—EDUCATION AND ENTERTAINMENT

FOR EDUCATIONAL SERVICES, NAMELY, CONDUCTING CLASSES, SEMINARS, AND CONFERENCES IN THE FIELDS OF LEADERSHIP AND BUSINESS MANAGEMENT (U.S. CLS. 100, 101 AND 107).

SN 78-072,722. SHANGHAI LI NING ENTERPRISES MANAGEMENT LTD., PUDONG XINQU, CHINA, FILED 7-6-2001.

LI-NING

THE NAME "LI-NING" IDENTIFIES A LIVING INDIVIDUAL WHOSE CONSENT IS OF RECORD.

CLASS 18—LEATHER GOODS

FOR BACKPACKS, CANVAS BACKPACKS, ATHLETIC BAGS, CARRY-ON BAGS, GYM BAGS, TRAVEL BAGS, BEACH BAGS, BRIEFCASES, BUSINESS CARD CASES, BUSINESS CASES, NOTECASES, PURSES, SUITCASES, TRUNKS, LUGGAGE, UMBRELLAS, GOLF UMBRELLAS, WAIST PACKS, AND WALLETS (U.S. CLS. 1, 2, 3, 22 AND 41).

CLASS 25—CLOTHING

FOR CLOTHING, NAMELY, APRONS, CLOTH BABY BIBS, CLOTH DIAPERS, BELTS, BERETS BOOTS, CAPES, CAPS, COATS, SHOES, DISPOSABLE UNDERWEAR, DISPOSABLE SLIPPERS, HATS, FENCING SUITS, GLOVES, SKI GLOVES, GOLF CAPS, BELTS, GOLF JACKETS, GOLF PANTS, GOLF RAIN COATS, GOLF SHIRTS, GOLF SHOES, GOLF SOCKS, GOLF VESTS, GOWNS, JACKETS, KARATE SUITS, INFANTWEAR, JEANS, KNIT SWEATERS, KNIT SHIRTS, PAJAMAS, PANTS, RAIN SUITS, RAIN CAPS, RAIN CAPES, RAIN COATS, SANDALS, SCARVES, SHIRTS, SKIRTS, SLEEPERS, SOCCER SHOES, SOCKS, ATHLETIC UNIFORMS, SPORTS SHIRTS, SWEAT PANTS, STOCKINGS, SUITS, SWIMSUIT, T-SHIRTS, TANK-TOPS, TIES UNDERWEAR, UNIFORMS, SPORT FOOTWEAR, BASEBALL CAPS, AND WRIST BANDS (U.S. CLS. 22 AND 39).

CLASS 26—FANCY GOODS

FOR CLOTHING BUCKLES, BUTTONS FOR CLOTHING, ORNAMENTAL NOVELTY BUTTONS, SHOE BUCKLES, SHOE LACES, AND ZIPPERS (U.S. CLS. 37, 39, 40, 42 AND 50).

CLASS 28—TOYS AND SPORTING GOODS

FOR SPORTING GOODS, NAMELY, KITES, SOCCER BALLS, BASKET BALLS, VOLLEY BALLS, GOLF BALLS, BOWLING BALLS, TENNIS BALLS, GOLF CLUBS, GOLF BAGS, TENNIS RACKETS, VOLLEYBALL NETS, FITNESS EQUIPMENT, NAMELY TREADMILLS, HOME GYMS, AEROBIC RIDERS, ABDOMINAL EXERCISERS, STAIR CLIMBERS, WEIGHT LIFTING BELTS, ROWING MACHINES, EXERCISE WEIGHTS AND BENCHES, HAND GRIPS FOR GYMNASTIC HORIZONTAL BARS, GLOVES FOR ATHLETIC USE IN THE SPORTS OF BASEBALL, GOLF, BOXING, AND GYMNASTICS, FENCING MASKS, AND SHIN GUARDS FOR ATHLETIC USE (U.S. CLS. 22, 23, 38 AND 50).

SN 78-077,731. OPODO LIMITED, LONDON, UNITED KINGDOM, BY CHANGE OF NAME ONLINE TRAVEL PORTAL LIMITED, LONDON, UNITED KINGDOM, FILED 8-6-2001.

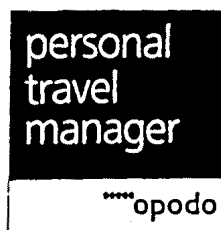

PRIORITY CLAIMED UNDER SEC. 44(D) ON ERPN CMNTY TM OFC APPLICATION NO. 2296010, FILED 7-4-2001, REG. NO. 2296010, DATED 11-28-2002, EXPIRES 7-4-2011.

NO CLAIM IS MADE TO THE EXCLUSIVE RIGHT TO USE "TRAVEL MANAGER", APART FROM THE MARK AS SHOWN.

CLASS 39—TRANSPORTATION AND STORAGE

FOR TRANSPORT BY MEANS OF AIR, SEA, ROAD, AND RAIL; PACKAGING ARTICLES FOR TRANSPORTATION AND STORAGE OF GOODS; ARRANGING FOR TRAVEL VISAS, PASSPORTS AND TRAVEL DOCUMENTS FOR PERSONS TRAVELING ABROAD; ARRANGING TRAVEL TOURS; ARRANGING TRAVEL TOURS AS A BONUS PROGRAM FOR CREDIT CARD CUSTOMERS; TRAVEL AGENCY SERVICES, NAMELY, MAKING RESERVATIONS AND BOOKINGS FOR TRANSPORTATION; TRAVEL BOOKING AGENCIES; TRAVEL CLUBS; BOOKING AGENCY SERVICES FOR TRAVEL; TRAVEL AGENCY SERVICES, NAMELY, MAKING RESERVATIONS AND BOOKINGS FOR TRANSPORTATION; CONDUCTING SIGHTSEEING TOURS FOR OTHERS AND TOUR GUIDE SERVICES INCLUDING PROVIDING PERSONAL SIGHTSEEING TOURS; PROVIDING COMPUTERIZED TRAVEL DATA AND RESERVATIONS SERVICES; ARRANGING OF FLIGHTS, CRUISES, AND TOURS FOR OTHERS; DELIVERY SERVICES, NAMELY, TRANSPORTATION AND DELIVERY SERVICES AND PARCEL DELIVERY; WAREHOUSING AND RENTAL OF WAREHOUSE SPACE; VEHICLE RENTAL INFORMATION; PROVIDING A WEB SITE FEATURING THE AFORESAID SERVICES VIA THE GLOBAL COMPUTER NETWORK; PROVIDING A WEB SITE FEATURING INFORMATION IN THE AFORESAID FIELDS (U.S. CLS. 100 AND 105).

CLASS 41—EDUCATION AND ENTERTAINMENT

FOR EDUCATION AND TRAINING RELATING TO TRAVEL, CULTURE AND GEOGRAPHY, NAMELY, CLASSES, SEMINARS, WORKSHOPS AND CONFERENCES; ENTERTAINMENT SERVICES, NAMELY, PROVIDING TELEVISION AND RADIO PROGRAMS AND MOVIES IN THE FIELD OF TRAVEL VIA THE GLOBAL COMPUTER NETWORK; PRODUCTION AND RENTAL OF EDUCATIONAL AND INSTRUCTIONAL MATERIALS, NAMELY, DEVELOPING EDUCATIONAL MANUALS IN THE FIELD OF TRAVEL FOR OTHERS; PRODUCTION OF EDUCATIONAL VIDEOTAPES AND FILMS; PUBLICATION OF BOOKS, MAGAZINES AND JOURNALS IN THE FIELD OF TRAVEL; PROVIDING ON-LINE ENTERTAINMENT, NAMELY, PROVIDING ON-LINE MOVIES, TELEVISION PROGRAMS, AND RADIO PROGRAMS IN THE FIELD OF TRAVEL VIA A GLOBAL COMPUTER NETWORK AND PROVIDING ON-LINE COMPUTER GAMES; PROVIDING EDUCATIONAL SERVICES ON-LINE, NAMELY, PROVIDING ON-LINE TUTORIAL SESSIONS IN THE FIELD OF TRAVEL (U.S. CLS. 100, 101 AND 107).

CLASS 42—SCIENTIFIC, COMPUTER AND LEGAL SERVICES

FOR CONSULTATION SERVICES IN THE FIELD OF TRAVEL, TOURS, STORAGE AND DELIVERY; PROVIDING TEMPORARY HOUSING ACCOMMODATIONS; PROVIDING TEMPORARY HOLIDAY ACCOMMODATIONS; MAKING HOTEL RESERVATIONS FOR OTHERS; RESTAURANT SERVICES IN HOTELS, BOARDING HOUSES, TOURIST CAMPS, TOURIST HOUSES, DUDE RANCHES, VILLAS, CHALETS, APARTMENTS, LODGES AND BED AND BREAKFAST ACCOMMODATIONS; MAKING RESTAURANT RESERVATIONS FOR OTHERS; MAKING HOTEL RESTAURANT RESERVATIONS FOR OTHERS; MAKING ON-LINE RESTAURANT RESERVATIONS FOR OTHERS, INCLUDING HOTEL RESTAURANT RESERVATIONS; PROVIDING INFORMATION ABOUT RESTAURANTS PROVIDED ON-LINE FROM A COMPUTER DATA BASE OR FROM THE INTERNET OR ACCESSIBLE VIA A MOBILE PHONE UTILIZING WIRELESS APPLICATION PROTOCOL TECHNOLOGY; PROVIDING RESTAURANT MENUS, INCLUDING HOTEL RESTAURANT MENUS, ON-LINE FROM A COMPUTER DATABASE OR FROM THE INTERNET OR ACCESSIBLE VIA A MOBILE PHONE UTILIZING WIRELESS APPLICATION PROTOCOL TECHNOLOGY; MAKING RESERVATIONS FOR OTHERS FOR RESTAURANTS AND HOTEL RESTAURANTS; PROVIDING INFORMATION AND CONSULTATION SERVICES FOR THE AFORESAID FIELDS; PROVIDING INFORMATION VIA A GLOBAL COMPUTER NETWORK IN THE AFORESAID FIELDS (U.S. CLS. 100 AND 101).

SN 78-085,334, TRIPLE DOT COMMUNICATIONS, INC., NEW YORK, NY. FILED 9-24-2001.

BUZZ SQUAD**CLASS 35—ADVERTISING AND BUSINESS**

FOR MARKETING AND ADVERTISING SERVICES, NAMELY, PROMOTING THE SALE OF GOODS AND SERVICES OF OTHERS THROUGH THE DISTRIBUTION OF PRINTED MATERIAL AND PROMOTIONAL CONTESTS; DISTRIBUTION OF PRODUCT SAMPLES AND DISSEMINATION OF ADVERTISING MATTER FOR OTHERS; CONTESTS AND INCENTIVE AWARD PROGRAMS TO PROMOTE THE SALE OF PRODUCTS AND SERVICES OF OTHERS; ORGANIZING EXHIBITIONS FOR TEENAGE AND COLLEGE AGE TO PROMOTE THE SALE OF PRODUCTS AND SERVICES OF OTHERS (U.S. CLS. 100, 101 AND 102).

FIRST USE 8-28-2001; IN COMMERCE 8-28-2001.

CLASS 41—EDUCATION AND ENTERTAINMENT

FOR ENTERTAINMENT SERVICES, NAMELY, CONDUCTING CONTESTS AND PARTIES AT NIGHTCLUBS, HIGH SCHOOL AND UNIVERSITY CAMPUSES AND OTHER GATHERING PLACES FOR STUDENTS AND TEENAGERS; PROVIDING INFORMATION IN THE FIELD OF ENTERTAINMENT VIA THE GLOBAL COMPUTER NETWORK; ORGANIZING EXHIBITIONS FOR EDUCATIONAL OR ENTERTAINMENT PURPOSES (U.S. CLS. 100, 101 AND 107).

FIRST USE 8-28-2001; IN COMMERCE 8-28-2001.

SN 78-085,711, RICH PRODUCTS CORPORATION, BUFFALO, NY. FILED 9-26-2001.

CHOCOLATTE**CLASS 29—MEATS AND PROCESSED FOODS**

FOR DAIRY-BASED CHOCOLATE-FLAVORED AND ARTIFICIAL CHOCOLATE-FLAVORED NON-ALCOHOLIC BEVERAGES (U.S. CL. 46).

CLASS 30—STAPLE FOODS

FOR NON-DAIRY CHOCOLATE-FLAVORED AND ARTIFICIAL CHOCOLATE-FLAVORED NON-ALCOHOLIC BEVERAGES (U.S. CL. 46).

SN 78-094,303, MICHIGAN VIRTUAL UNIVERSITY, LANSING, MI. FILED 11-20-2001.

BEEFREEWAY BUSINESS EDUCATION

NO CLAIM IS MADE TO THE EXCLUSIVE RIGHT TO USE "BUSINESS E-EDUCATION", APART FROM THE MARK AS SHOWN.

CLASS 9—ELECTRICAL AND SCIENTIFIC APPARATUS

FOR PRE-RECORDED INTERACTIVE, MULTI-MEDIA, NAMELY, SOFTWARE FOR DISTANCE LEARNING AT THE PRIMARY, HIGH SCHOOL AND COLLEGE LEVEL EDUCATION AND BEYOND IN THE FIELDS OF ADMINISTRATIVE SUPPORT, BUSINESS LAW, CUSTOMER SERVICE, E-BUSINESS, FINANCE, FINANCIAL SERVICES, HUMAN RESOURCES, INDUSTRY FOUNDATIONS, KNOWLEDGE MANAGEMENT, OPERATIONS, SALES, STRATEGIC PLANNING, COMMUNICATION, LEADERSHIP, MANAGEMENT, PERSONAL DEVELOPMENT, PROJECT MANAGEMENT, TEAM BUILDING, COMPUTING, INFORMATION TECHNOLOGY, NETWORKING, COMMUNICATIONS, INTERNET AND INTRANET AND FOR ACCESSING THE DISTANCE LEARNING SITE; DOWN-LOADABLE SOFTWARE FOR DISTANCE LEARNING AT THE PRIMARY, HIGH SCHOOL AND COLLEGE EDUCATION AND BEYOND IN THE FIELDS OF ADMINISTRATIVE SUPPORT, BUSINESS LAW, CUSTOMER SERVICE, E-BUSINESS, FINANCE, FINANCIAL SERVICES, HUMAN RESOURCES, INDUSTRY FOUNDATIONS, KNOWLEDGE MANAGEMENT, OPERATIONS, SALES, STRATEGIC PLANNING, COMMUNICATION, LEADERSHIP, MANAGEMENT, PERSONAL DEVELOPMENT, PROJECT MANAGEMENT, TEAM BUILDING, COMPUTING, INFORMATION TECHNOLOGY, NETWORKING, COMMUNICATIONS, INTERNET AND INTRANET AND FOR ACCESSING THE DISTANCE LEARNING SITE (U.S. CLS. 21, 23, 26, 36 AND 38).

CLASS 41—EDUCATION AND ENTERTAINMENT

FOR EDUCATIONAL SERVICES, NAMELY, PROVIDING COURSES OF INSTRUCTION AT THE PRIMARY, SECONDARY AND UNIVERSITY LEVELS AND DISTRIBUTING COURSE MATERIAL IN CONNECTION THEREWITH; DISTANCE LEARNING SERVICES, NAMELY, PROVIDING LIVE AND SHOWING PRE-RECORDED INTERACTIVE MULTIMEDIA AT THE PRIMARY, HIGH SCHOOL AND COLLEGE LEVEL EDUCATION AND BEYOND AND TRAINING PROGRAMS IN THE FIELD OF A VARIETY OF SUBJECTS VIA THE WORLD WIDE WEB AND OTHER COMMUNICATION NETWORKS AND CONDUCTING DISTANCE LEARNING WORKSHOPS, SEMINARS, AND CONFERENCES FOR OTHERS IN THE FIELD OF PRIMARY AND HIGH SCHOOL LEVEL COURSE WORK AND COLLEGE LEVEL COURSE WORK AND BEYOND VIA COMMUNICATION NETWORKS (U.S. CLS. 100, 101 AND 107).

CLASS 42—SCIENTIFIC, COMPUTER AND LEGAL SERVICES

FOR PROVIDING CAREER GUIDANCE INFORMATION VIA THE WORLD WIDE WEB AND OTHER COMMUNICATION NETWORKS; PROVIDING TEMPORARY USE OF DOWN-LOADABLE SOFTWARE FOR TRAINING AND EDUCATING PURPOSES AT THE PRIMARY, HIGH SCHOOL, COLLEGE LEVEL AND BEYOND, VIA GLOBAL COMPUTER NETWORKS (U.S. CLS. 100 AND 101).

SN 78-096,424. GENERAL ELECTRIC COMPANY, FAIRFIELD, CT. FILED 12-4-2001.

CYTRA**CLASS 1—CHEMICALS**

FOR CHEMICALS USED IN INDUSTRY, NAMELY STYRENIC ALLOYS TO BE USED IN ENGINEERING AND MANUFACTURING APPLICATIONS; AND UN-PROCESSED ARTIFICIAL AND SYNTHETIC RESINS FOR USE IN A WIDE VARIETY OF AUTOMOTIVE AND MANUFACTURING INDUSTRIES (U.S. CLS. 1, 5, 6, 10, 26 AND 46).

CLASS 17—RUBBER GOODS

FOR PLASTIC IN EXTRUDED FORM FOR GENERAL INDUSTRIAL USE; SEMI-PROCESSED PLASTIC FOR USE IN MANUFACTURING; SEMI-FINISHED ARTIFICIAL AND SYNTHETIC RESINS FOR GENERAL INDUSTRIAL USE (U.S. CLS. 1, 5, 12, 13, 35 AND 50).

SN 78-098,270. LAMBDA PHYSIK APPLICATION CENTER, LLC, FORT LAUDERDALE, FL. FILED 12-13-2001.

CLEAN LASE

NO CLAIM IS MADE TO THE EXCLUSIVE RIGHT TO USE "LASE", APART FROM THE MARK AS SHOWN.

CLASS 9—ELECTRICAL AND SCIENTIFIC APPARATUS

FOR LASER-BASED SYSTEMS COMPRISING ETCHING LASERS, COMPUTER HARDWARE, AND COMPUTER SOFTWARE FOR ETCH PROCESSING AND PARTS THEREFOR, NOT FOR MEDICAL USE (U.S. CLS. 21, 23, 26, 36 AND 38).

CLASS 40—MATERIAL TREATMENT

FOR LASER ETCH PROCESSING, NAMELY, LASER SCRIBING OF METALS, PLASTICS, POLYMERS, INSULATORS AND SEMICONDUCTING MATERIALS (U.S. CLS. 100, 103 AND 106).

SN 78-100,215. WESTERN KENTUCKY UNIVERSITY, BOWLING GREEN, KY. FILED 12-28-2001.



THE MARK CONSISTS OF A SUB-HUMAN CHARACTER STANDING WITH ARMS EXTENDED OUTWARD. THE LETTERS "WKU" ARE IMPRINTED ON ITS CHEST. THE CHARACTER IS IN THE COLOR RED AND OUTLINED IN BLACK.

CLASS 14—JEWELRY

FOR JEWELRY, NAMELY, WATCHES AND LAPEL PINS (U.S. CLS. 2, 27, 28 AND 50).
FIRST USE 7-0-2001; IN COMMERCE 7-0-2001.

CLASS 16—PAPER GOODS AND PRINTED MATTER

FOR PRINTED MATTER, NAMELY, MEDIA GUIDES, ATHLETIC EXHIBITION PROGRAMS AND SCHEDULES, MAGAZINES IN THE FIELD OF COLLEGE ATHLETICS, EMPLOYEE HANDBOOKS, STICKERS, DECALS, BUMPER STICKERS, BINDERS, PENS AND PENCILS (U.S. CLS. 2, 5, 22, 23, 29, 37, 38 AND 50).
FIRST USE 7-0-2001; IN COMMERCE 7-0-2001.

CLASS 21—HOUSEWARES AND GLASS

FOR MUGS, DRINKING GLASSES AND CUPS (U.S. CLS. 2, 13, 23, 29, 30, 33, 40 AND 50).
FIRST USE 7-0-2001; IN COMMERCE 7-0-2001.

CLASS 25—CLOTHING

FOR CLOTHING, NAMELY, T-SHIRTS, LONG SLEEVE SHIRTS, SWEATSHIRTS, SWEATPANTS, SHORTS, WARM-UP SUITS, WIND SUITS, ATHLETIC UNIFORMS, POLO SHIRTS, JACKETS AND HATS (U.S. CLS. 22 AND 39).
FIRST USE 7-0-2001; IN COMMERCE 7-0-2001.

CLASS 41—EDUCATION AND ENTERTAINMENT

FOR (BASED ON SECTION 1(A), USE IN COMMERCE) EDUCATIONAL AND ENTERTAINMENT SERVICES, NAMELY, PROVIDING INSTRUCTION AND COACHING TO THE PUBLIC IN THE FIELD OF ATHLETICS; (BASED ON SECTION 1(B), INTENT TO USE) EDUCATIONAL AND ENTERTAINMENT SERVICES, NAMELY, PROVIDING COURSES OF INSTRUCTION AT THE COLLEGE AND POST-GRADUATE LEVELS; ARRANGING AND CONDUCTING ATHLETIC EVENTS AND TOURNAMENTS, CONFERENCES AND EXHIBITIONS; PROVIDING RECREATION PROGRAMS AND RECREATION FACILITIES (U.S. CLS. 100, 101 AND 107).
FIRST USE 7-0-2001; IN COMMERCE 7-0-2001.

SN 78-103,363. BIOLITEC, INC., EAST LONGMEADOW, MA.
FILED 1-17-2002.

WHELL**CLASS 10—MEDICAL APPARATUS**

FOR OPTICAL INSTRUMENTS FOR MEDICAL AND SURGICAL VASCULAR TREATMENTS, NAMELY, LASERS, LASER PROBES, TIPS FOR LASERS, COLLIMATORS, OPTICAL FIBERS, AND ACCESSORIES THEREFOR, NAMELY, HAND PIECES FOR DELIVERING LASER ENERGY THROUGH OPTICAL FIBERS, CLEAVE TOOLS FOR REMOVING FIBER TIPS, STRIP TOOLS FOR STRIPPING FIBERS, LASER CARRYING CASES, AND FOOT PEDALS FOR CONTROLLING LASERS (U.S. CLS. 26, 39 AND 44).

CLASS 35—ADVERTISING AND BUSINESS

FOR LICENSING OF PROCEDURES FOR THE LASER TREATMENT OF WOUNDS (U.S. CLS. 100, 101 AND 102).

SN 78-104,151. VICTOR EQUIPMENT COMPANY, ST. LOUIS, MO. FILED 1-22-2002.

EXTREME**CLASS 7—MACHINERY**

FOR GAS OPERATED BRAZING TORCHES AND ACCESSORIES THEREFOR, NAMELY, TORCH TIPS AND NOZZLES (U.S. CLS. 13, 19, 21, 23, 31, 34 AND 35).

CLASS 9—ELECTRICAL AND SCIENTIFIC APPARATUS

FOR HAND-HELD GAS OPERATED WELDING TORCHES AND ACCESSORIES THEREFOR, NAMELY, TORCH TIPS AND NOZZLES (U.S. CLS. 21, 23, 26, 36 AND 38).

SN 78-106,554. CURVY CHICK INC., THE, NORTH PALM BEACH, FL. FILED 2-4-2002.

THE CURVY CHICK**CLASS 16—PAPER GOODS AND PRINTED MATTER**

FOR PAPER GOODS AND PRINTED MATERIAL, NAMELY, STATIONERY, CALENDARS AND INSTRUCTIONAL AND TEACHING MATERIAL REGARDING PLUS SIZE ISSUES (U.S. CLS. 2, 5, 22, 23, 29, 37, 38 AND 50).

CLASS 25—CLOTHING

FOR CLOTHING, NAMELY, DRESSES, SKIRTS, BLOUSES, SWEATERS, SHIRTS, T-SHIRTS, PANTS, COATS, JACKETS, SHORTS, VESTS, HATS, HEADWEAR, FOOTWEAR, UNDERWEAR, SLEEPWEAR, BELTS, GLOVES, SCARVES, LEGGINGS, TIGHTS, HOSIERY, SOCKS, SWEATSUITS, SWEATSHIRTS, SWEATPANTS, LEOTARDS AND UNITARDS (U.S. CLS. 22 AND 39).

SN 78-116,999. MEDIACOM COMMUNICATIONS CORPORATION, MIDDLETOWN, NY. FILED 3-22-2002.

MEDIACOM ONDEMAND

NO CLAIM IS MADE TO THE EXCLUSIVE RIGHT TO USE "ON DEMAND", APART FROM THE MARK AS SHOWN.

CLASS 38—COMMUNICATION

FOR PAY-PER-VIEW VIDEO TRANSMISSION SERVICES (U.S. CLS. 100, 101 AND 104).

CLASS 41—EDUCATION AND ENTERTAINMENT

FOR PAY-PER-VIEW VIDEO-PROGRAMMING SERVICES (U.S. CLS. 100, 101 AND 107).

SN 78-117,018. EUREXA FRANCE, PARIS, FRANCE, FILED 3-22-2002.

TAIZA

PRIORITY CLAIMED UNDER SEC. 44(D) ON FRANCE APPLICATION NO. 2397503, FILED 10-2-2001, REG. NO. 99801483, DATED 7-6-1999, EXPIRES 7-6-2009.

CLASS 14—JEWELRY

FOR JEWELRY, PRECIOUS STONES, HOROLOGICAL AND CHRONOMETRICAL INSTRUMENTS, NAMELY, STOPWATCHES, WATCHES AND CLOCKS (U.S. CLS. 2, 27, 28 AND 50).

CLASS 25—CLOTHING

FOR DESIGNER CLOTHING FOR MEN, WOMEN AND CHILDREN, NAMELY, TROUSERS, SKIRTS, SUITS, VESTS, SHIRTS, BLOUSES, SWEATERS, DRESSES, GOWNS, RAINWEAR, LINGERIE, PAJAMAS, SOCKS, STOCKINGS, HOSIERY, BATH ROBES, DRESSING GOWNS, UNDERWEAR, BELTS, TIES AND SHOES, PLAY SUITS, ATHLETIC AND SPORTSWEAR, NAMELY, SWIMWEAR, SHORTS, T-SHIRTS, TOPS AND PANTS, OUTERWEAR, NAMELY, COATS, SPORTCOATS, JACKETS, HATS, WRAPS, SCARVES AND GLOVES; DESIGNER AND COUTURE CLOTHING FOR WOMEN, NAMELY, WOMEN'S DRESSES, GOWNS, SKIRTS, JACKETS, TROUSERS, PANTS, SWEATERS, TOPS, CHEMISES, BLOUSES, SHIRTS, SUITS, COATS, LINGERIE, SPORTSWEAR, SWIMWEAR, WRAPS, SCARVES, GLOVES, BELTS AND SHOES (U.S. CLS. 22 AND 39).

SN 78-119,516. NEORIS LOGISTICS, INC., SUNRISE, FL. FILED 4-4-2002.

ACTIVESUITE

CLASS 9—ELECTRICAL AND SCIENTIFIC APPARATUS

FOR COMPUTER SOFTWARE FOR USE IN MONITORING AND CONFIRMING THE PHYSICAL LOCATION OF PACKAGED PRODUCTS, RAW MATERIALS AND GOODS PRODUCED FROM RAW MATERIALS AT ALL STAGES OF THE ORDERING, MANUFACTURING, PRODUCTION AND DISTRIBUTION PROCESS AND COMPUTER SOFTWARE FOR USE IN DATABASE MANAGEMENT IN THE FIELD OF MONITORING AND CONFIRMING THE PHYSICAL LOCATION OF PACKAGED PRODUCTS, RAW MATERIALS AND GOODS PRODUCED FROM RAW MATERIALS AT ALL STAGES OF THE ORDERING, MANUFACTURING, PRODUCTION AND DISTRIBUTION PROCESS (U.S. CLS. 21, 23, 26, 36 AND 38).

CLASS 35—ADVERTISING AND BUSINESS

FOR COMPUTERIZED TRACKING AND TRACING OF PACKAGED PRODUCTS, RAW MATERIALS AND GOODS PRODUCED FROM RAW MATERIALS AT ALL STAGES OF THE ORDERING, MANUFACTURING, PRODUCTION AND DISTRIBUTION PROCESS; BUSINESS MANAGEMENT IN THE FIELD OF MONITORING AND CONFIRMING THE PHYSICAL LOCATION OF PACKAGED PRODUCTS, RAW MATERIALS AND GOODS PRODUCED FROM RAW MATERIALS AT ALL STAGES OF THE ORDERING, MANUFACTURING, PRODUCTION AND DISTRIBUTION PROCESS (U.S. CLS. 100, 101 AND 102).

CLASS 41—EDUCATION AND ENTERTAINMENT

FOR TRAINING IN THE USE AND OPERATION OF INTERNET BASED TRACKING SYSTEMS (U.S. CLS. 100, 101 AND 107).

CLASS 42—SCIENTIFIC, COMPUTER AND LEGAL SERVICES

FOR DATA COLLECTION AND INFORMATION SERVICES USING PROPRIETARY SOFTWARE TO EVALUATE, ANALYZE AND COLLECT SERVICE DATA; TECHNICAL SUPPORT SERVICES, NAMELY, TROUBLESHOOTING OF COMPUTER HARDWARE AND SOFTWARE PROBLEMS; AND CONSULTING SERVICES IN THE FIELD OF DESIGN, SELECTION, IMPLEMENTATION AND USE OF COMPUTER HARDWARE AND SOFTWARE SYSTEMS FOR OTHERS (U.S. CLS. 100 AND 101).

CLASS 45—PERSONAL SERVICES

FOR TRACKING SERVICES FOR MONITORING AND CONFIRMING THE PHYSICAL LOCATION OF ENCODED PACKAGED PRODUCTS, RAW MATERIALS AND GOODS PRODUCED FROM RAW MATERIALS AT ALL STAGES OF THE ORDERING, MANUFACTURING, PRODUCTION AND DISTRIBUTION PROCESS; PROVIDING INFORMATION IN THE FIELD OF MONITORING AND CONFIRMING THE PHYSICAL LOCATION OF ENCODED PACKAGED PRODUCTS, RAW MATERIALS AND GOODS PRODUCED FROM RAW MATERIALS AT ALL STAGES OF THE ORDERING, MANUFACTURING, PRODUCTION AND DISTRIBUTION PROCESS (U.S. CLS. 100 AND 101).

SN 78-120,224. WORKWISE LLC, PEARL RIVER, NY. FILED 4-8-2002.

CULTIVATING HOW WORK WORKS

CLASS 35—ADVERTISING AND BUSINESS

FOR CONSULTING SERVICES IN THE FIELD OF CORPORATE ORGANIZATIONAL STRATEGIES, EMPLOYMENT SKILLS AND WORK SKILLS (U.S. CLS. 100, 101 AND 102).

CLASS 41—EDUCATION AND ENTERTAINMENT

FOR EDUCATIONAL SERVICES, NAMELY, CONDUCTING SEMINARS, TRAINING SESSIONS AND ROUNDTABLE PROGRAMS TEACHING EMPLOYMENT AND WORK SKILLS AND ORGANIZATIONAL STRATEGIES (U.S. CLS. 100, 101 AND 107).

SN 78-121,230. FLOWER FIELDS, THE, ENCINITAS, CA. FILED 4-11-2002.

DR. BLOOM

CLASS 31—NATURAL AGRICULTURAL PRODUCTS

FOR LIVE FLOWERING GARDEN PLANTS (U.S. CLS. 1 AND 46).

CLASS 44—MEDICAL, BEAUTY AND AGRICULTURAL SERVICES

FOR PROVIDING INFORMATION IN THE FIELD OF PLANT CARE, GARDENING, GARDEN AND PLANT AND CONTAINER DESIGNS AND GARDEN AND PLANT COORDINATION (U.S. CLS. 100 AND 101).

SN 78-122,007. DENDRITE INTERNATIONAL, INC., MORRISTOWN, NJ. BY MERGER; BY MERGER TASMANIA RESOURCE, INC., NEWARK, DE. FILED 4-16-2002.

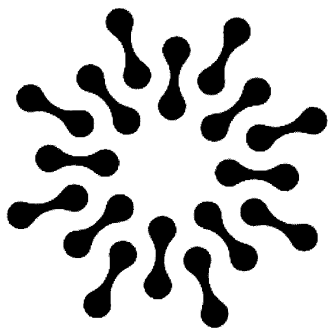

THE MARK CONSISTS OF A STYLIZED STARBURST DESIGN.

CLASS 9—ELECTRICAL AND SCIENTIFIC APPARATUS

FOR COMPUTER SOFTWARE AND INSTRUCTION MANUALS SOLD A UNIT THEREWITH FOR ACCESSING, ANALYZING, REVIEWING, REPORTING AND DISTRIBUTING INFORMATION IN CONNECTION WITH SALES, MARKETING, RETAIL MERCHANDISING AND BUSINESS MANAGEMENT, AND IN CONNECTION THEREWITH ALLOWING SALES AND MARKETING REPRESENTATIVES TO CONDUCT MARKETING RESEARCH; ANALYZE AND FORECAST PRESCRIPTION TRENDS AMONG DOCTORS AND PHARMACIES; TRACK AND ANALYZE DRUG REPRESENTATIVE SALES CALLS TO PHYSICIANS, PRESCRIPTION RATES, DRUG USE AND OTHER PHYSICIAN ACTIVITY RELATING TO DISPENSING PHARMACEUTICALS; SHARE THAT INFORMATION OVER THE GLOBAL COMPUTER NETWORK OR A PRIVATE COMPUTER NETWORK AMONG SALES FORCE MANAGERS AND REPRESENTATIVES IN THE PHARMACEUTICAL INDUSTRY; AUTOMATICALLY REMOVE DUPLICATE RECORDS, FILL EMPTY DATA FIELDS, STANDARDIZE ACCOUNT INFORMATION VERIFICATION, AND UPDATE NEW PRESCRIBER PROFILES FOR NATIONAL SALES DATABASES; CREATE WEB SITES ON THE GLOBAL COMPUTER NETWORK WHICH PROVIDE DISEASE MANAGEMENT SERVICES AND PATIENT SUPPORT, PROVIDE NEWS AND INFORMATION TO PATIENTS, DOCTORS, NURSES, AND PHARMACISTS ABOUT DISEASES, ENCOURAGE PROPER AND PERSISTENT TREATMENT OF DISEASES AND ALLOW VARIOUS PERSONS INVOLVED IN TREATING A PARTICULAR DISEASE TO TRACK DRUG UTILIZATION TRENDS AND COMMUNICATE WITH EACH OTHER AND WITH PHARMACEUTICAL COMPANIES, ALL OF THESE WEBSITES BEING IN THE FIELDS OF PHARMACEUTICALS, MEDICAL DEVICES AND BIOTECHNOLOGY (U.S. CLS. 21, 23, 26, 36 AND 38).

FIRST USE 9-4-2001; IN COMMERCE 9-4-2001.

CLASS 35—ADVERTISING AND BUSINESS

FOR TRADE INFORMATION SERVICES PROVIDED TO SALES REPRESENTATIVES OVER GLOBAL COMPUTER NETWORK IN THE FIELD OF PHARMACEUTICAL PRODUCTS, NAMELY MANAGEMENT OF SALES AND BUSINESS ACTIVITIES OF OTHERS AND SALES, MARKETING, AND BUSINESS CONSULTING IN THE FIELD OF PHARMACEUTICALS; CONSULTING WITH RESPECT TO MARKETING STRATEGIES FOR SALES FORCES IN THE PHARMACEUTICAL INDUSTRY (U.S. CLS. 100, 101 AND 102).

FIRST USE 9-4-2001; IN COMMERCE 9-4-2001.

CLASS 38—COMMUNICATION

FOR TELECOMMUNICATIONS GATEWAY SERVICES, NAMELY PROVIDING ON-LINE LINKS TO NEWS, CURRENT EVENTS, BUSINESS INFORMATION, WEATHER INFORMATION AND REFERENCE MATERIALS; PROVIDING ON-LINE ELECTRONIC BULLETIN BOARD SERVICES AND CHAT ROOMS FOR THE TRANSMISSION OF MESSAGES AMONG PATIENTS, DOCTORS, NURSES, AND PHARMACISTS ABOUT DISEASES; AND PROVIDING MULTIPLE-USER ACCESS TO A GLOBAL COMPUTER NETWORK, ALL OF THE FOREGOING FOR USE BY PERSONS INVOLVED IN THE TREATMENT OF VARIOUS DISEASES INCLUDING THOSE IN THE PHARMACEUTICAL INDUSTRY (U.S. CLS. 100, 101 AND 104).

FIRST USE 9-4-2001; IN COMMERCE 9-4-2001.

CLASS 41—EDUCATION AND ENTERTAINMENT

FOR EDUCATIONAL SERVICES, NAMELY CONDUCTING EDUCATIONAL SEMINARS AND CONFERENCES RELATING TO TOPICS OF INTEREST TO THE PHARMACEUTICAL INDUSTRY, NAMELY, SOFTWARE AND HARDWARE TRAINING, IMPLEMENTATION AND DEPLOYMENT, AND WEB-BASED SALES FORCE TRAINING AND COLLABORATION (U.S. CLS. 100, 101 AND 107).

FIRST USE 9-4-2001; IN COMMERCE 9-4-2001.

CLASS 42—SCIENTIFIC, COMPUTER AND LEGAL SERVICES

FOR COMPUTER SOFTWARE DESIGN AND CONSULTATION FOR OTHERS IN VARIOUS FIELDS INCLUDING THE PHARMACEUTICAL, BIOTECHNOLOGY, CONSUMER PACKAGED GOODS, MEDICAL DEVICE, AND CONTRACT SALES FIELDS; DESIGNING COMPUTER PROGRAMMING SYSTEMS AND SOFTWARE FOR USE IN CONNECTION WITH THE MANAGEMENT OF SALES AND BUSINESS ACTIVITIES; TECHNICAL SUPPORT SERVICES, NAMELY TROUBLESHOOTING OF COMPUTER HARDWARE AND SOFTWARE PROBLEMS VIA TELEPHONE, E-MAIL, REMOTE ACCESS TO AFFECTED EQUIPMENT AND COMPUTER SOFTWARE PROGRAMS, AND IN PERSON; HOSTING, DEVELOPING AND MAINTAINING WEB SITES FOR AND ON BEHALF OF PHARMACEUTICAL COMPANIES WHICH PROVIDE DISEASE MANAGEMENT SERVICES AND PATIENT SUPPORT, PROVIDE NEWS AND INFORMATION TO PATIENTS, DOCTORS, NURSES, AND PHARMACISTS ABOUT DISEASES, ENCOURAGE PROPER AND PERSISTENT TREATMENT OF DISEASES, AND ALLOW VARIOUS PERSONS INVOLVED IN TREATING A PARTICULAR DISEASE TO TRACK DRUG UTILIZATION TRENDS AND TO COMMUNICATE WITH EACH OTHER AND WITH PHARMACEUTICAL COMPANIES; APPLICATION SERVICE PROVIDER SERVICES, NAMELY, HOSTING SOFTWARE APPLICATIONS ON A WEB-SITE FOR OTHERS FOR USE IN MONITORING SALES FORCE EFFECTIVENESS IN THE PHARMACEUTICAL INDUSTRY AND PRESCRIPTION TRENDS AMONG DOCTORS AND PHARMACIES; COMPUTER CONSULTING AND TECHNICAL SUPPORT SERVICES FOR OTHERS, NAMELY, DESIGN, DEVELOPMENT, IMPLEMENTATION, CONFIGURATION AND INTEGRATION OF COMPUTER SOFTWARE IN THE FIELD OF SALES FORCE AND BUSINESS INFORMATION MANAGEMENT AND RELATED COMPUTER HARDWARE AND COMPUTER NETWORKS, AS WELL AS COMPUTER

AND TECHNICAL SUPPORT RELATED THERETO IN THE NATURE OF CONSULTING SERVICES, DATA INTEGRATION SERVICES, AND DATA ANALYSIS SERVICES, ALL OF THE FOREGOING PROVIDED IN-PERSON, VIA TELEPHONE, AND OVER A GLOBAL COMPUTER NETWORK; PROVIDING TEMPORARY USE OF ON-LINE, NON-DOWNLOADABLE SOFTWARE USED TO MANAGE EDUCATIONAL PROGRAMS AND BUSINESS MEETINGS OF OTHERS THAT ARE CONDUCTED OVER A GLOBAL COMPUTER NETWORK (U.S. CLS. 100 AND 101).

FIRST USE 9-4-2001; IN COMMERCE 9-4-2001.

CLASS 44—MEDICAL, BEAUTY AND AGRICULTURAL SERVICES

FOR PROVIDING INFORMATION BY MEANS OF A WEB-SITE ON THE GLOBAL COMPUTER NETWORK RELATING TO THE PHARMACEUTICAL AND HEALTHCARE INDUSTRIES, AND PROVIDING WEB SITE LINKS TO OTHERS SITES ON THE GLOBAL COMPUTER NETWORK THAT PROVIDE INFORMATION RELATING TO THE PHARMACEUTICAL AND HEALTHCARE INDUSTRIES (U.S. CLS. 100 AND 101).

FIRST USE 9-4-2001; IN COMMERCE 9-4-2001.

SN 78-123,265. RESERVEAMERICA HOLDINGS INC., MILTON ONT, CANADA, FILED 4-22-2002.



CLASS 9—ELECTRICAL AND SCIENTIFIC APPARATUS

FOR COMPUTER SOFTWARE, NAMELY SOFTWARE FOR USE IN THE RESERVATION OF LODGING IN HOTELS, MOTELS, RESORTS, AND LODGES AND CAMPGROUNDS LOCATED IN FEDERAL, STATE, AND PROVINCIAL PARKS, AND FOR USE IN THE RESERVATION OF ACCESS TICKETS FOR RECREATIONAL FACILITIES AND THE RECREATIONAL ACTIVITIES CARRIED OUT IN SUCH FACILITIES (U.S. CLS. 21, 23, 26, 36 AND 38).

CLASS 35—ADVERTISING AND BUSINESS

FOR OPERATION OF A TICKET AGENCY IN THE FIELD OF HISTORICAL MONUMENTS, EXHIBITS AND ATTRACTIONS; OPERATION OF A TELEPHONE CALL CENTER FOR OTHERS (U.S. CLS. 100, 101 AND 102).

CLASS 41—EDUCATION AND ENTERTAINMENT

FOR ARRANGING FOR TELEPHONE AND ONLINE TICKET RESERVATION SERVICES FOR RECREATIONAL FACILITIES AND RECREATIONAL ACTIVITIES CARRIED OUT IN SUCH FACILITIES (U.S. CLS. 100, 101 AND 107).

CLASS 43—HOTEL AND RESTAURANT SERVICES

FOR MAKING TELEPHONE AND ONLINE RESERVATION FOR OTHERS FOR LODGING IN HOTELS, MOTELS, RESORTS, AND LODGES AND CAMPGROUNDS LOCATED IN FEDERAL, STATE, AND PROVINCIAL PARKS (U.S. CLS. 100 AND 101).

SN 78-124,151. THOM, LAWRENCE, BROOKLYN, NY. FILED 4-25-2002.

ELECTROCLASH

CLASS 35—ADVERTISING AND BUSINESS

FOR ENTERTAINMENT SERVICES, NAMELY PROMOTION OF MUSIC (U.S. CLS. 100, 101 AND 102).

FIRST USE 6-12-2000; IN COMMERCE 6-12-2000.

CLASS 41—EDUCATION AND ENTERTAINMENT

FOR ENTERTAINMENT SERVICES, NAMELY, RECORDING AND PRODUCTION OF MUSICAL SOUND AND VIDEO RECORDINGS, AND ORGANIZING CONCERTS FEATURING LIVE MUSICAL PERFORMANCES (U.S. CLS. 100, 101 AND 107).

FIRST USE 6-12-2000; IN COMMERCE 6-12-2000.

SN 78-125,058. JONES, WAYNE, FOREST HILLS, NY. FILED 4-30-2002.

V.I. PEAPLES

CLASS 28—TOYS AND SPORTING GOODS

FOR ACTION FIGURES, PLUSH TOYS, BOARD GAMES, INFLATABLE TOYS, CARD GAMES AND DOLLS (U.S. CLS. 22, 23, 38 AND 50).

CLASS 41—EDUCATION AND ENTERTAINMENT

FOR PRODUCTION OF AN ONGOING YOUTH-ORIENTED ANIMATED OR LIVE-ACTION TELEVISION SERIES ON THE SUBJECT OF DIVERSITY (U.S. CLS. 100, 101 AND 107).

SN 78-125,460. PARAGON INTERNATIONAL INC., WICHITA FALLS, TX. FILED 5-1-2002.



CLASS 16—PAPER GOODS AND PRINTED MATTER

FOR ERASERS, PENCILS, GENERAL PLASTIC BAGS, STICKERS, POSTCARDS, COLORING BOOKS, AND RUBBER STAMPS; DENTAL HYGIENE TEACHING DEVICES IN THE NATURE OF STUFFED ANIMALS AND MODELS OF THE JAWS AND TEETH (U.S. CLS. 2, 5, 22, 23, 29, 37, 38 AND 50).

CLASS 21—HOUSEWARES AND GLASS

FOR TOOTHBRUSHES (U.S. CLS. 2, 13, 23, 29, 30, 33, 40 AND 50).

SN 78-125,462. PARAGON INTERNATIONAL INC., WICHITA FALLS, TX. FILED 5-1-2002.

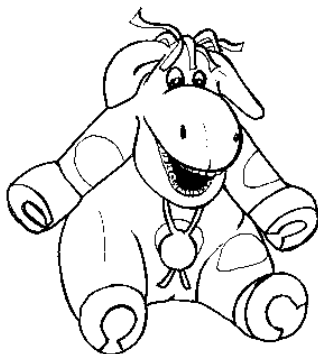
**CLASS 16—PAPER GOODS AND PRINTED MATTER**

FOR ERASERS, PENCILS, GENERAL PLASTIC BAGS, STICKERS, POSTCARDS, COLORING BOOKS, AND RUBBER STAMPS; DENTAL HYGIENE TEACHING DEVICES IN THE NATURE OF STUFFED ANIMALS AND MODELS OF THE JAWS AND TEETH (U.S. CLS. 2, 5, 22, 23, 29, 37, 38 AND 50).

CLASS 21—HOUSEWARES AND GLASS

FOR TOOTHBRUSHES (U.S. CLS. 2, 13, 23, 29, 30, 33, 40 AND 50).

SN 78-126,565. ARGENBRIGHT, INC., PLYMOUTH, MN. FILED 5-6-2002.

ARCHWAY MARKETING SERVICES

NO CLAIM IS MADE TO THE EXCLUSIVE RIGHT TO USE "MARKETING SERVICES", APART FROM THE MARK AS SHOWN.

CLASS 35—ADVERTISING AND BUSINESS

FOR MARKETING SERVICES, NAMELY ORDER FULFILLMENT SERVICES; CUSTOMER RELATIONSHIP MANAGEMENT; INVENTORY CONTROL; TELEPHONE ORDER-TAKING SERVICES FOR OTHERS; OUTSOURCED MAILING OF REFUNDS, REBATES, PREMIUMS, WARRANTIES, PRODUCT SAMPLES, SWEEPSTAKES, GAME AND CONTEST MATERIALS, NAMELY, MAIL SORTING, HANDLING AND RECEIVING; SAMPLE DISTRIBUTION, NAMELY, DISTRIBUTION FOR CLIENTS OF IN-STORE PROMOTION MATERIALS; PROCESSING MANUFACTURER'S REBATES; ISSUING GIFT CERTIFICATES WHICH MAY THEN BE REDEEMED FOR GOODS OR SERVICES (U.S. CLS. 100, 101 AND 102).

FIRST USE 12-19-2002; IN COMMERCE 12-19-2002.

CLASS 42—SCIENTIFIC, COMPUTER AND LEGAL SERVICES

FOR DATA AUTOMATION, COLLECTION SERVICES USING PROPRIETARY SOFTWARE TO EVALUATE, ANALYZE AND COLLECT SERVICE DATA; DATA WAREHOUSING AND DATA MINING SERVICES, ALL IN THE FIELD OF MARKETING (U.S. CLS. 100 AND 101).

FIRST USE 12-19-2002; IN COMMERCE 12-19-2002.

SN 78-128,266. MOSER, RICHARD T., ELGIN, IL. FILED 5-13-2002.

WIDESPARK**CLASS 35—ADVERTISING AND BUSINESS**

FOR MARKETING COMMUNICATIONS SERVICES FOR OTHERS FOCUSED ON STRATEGIC PLANNING, NAMELY MARKETING COMMUNICATIONS PROGRAMMING PLANNING; BRAND ENTITY DEVELOPMENT NAMELY BRAND ENTITY STANDARDS DESIGN AND BRAND ENTITY INTEGRATION; PRINT DESIGN NAMELY COLLATERAL, ADVERTISING, PACKAGING AND DIRECT MAIL; WEB MARKETING NAMELY WEB SITE OPTIMIZATION/SUBMISSION, E-MAIL MARKETING AND WEB SITE PROMOTIONAL PROGRAMMING (U.S. CLS. 100, 101 AND 102).

FIRST USE 5-6-2002; IN COMMERCE 5-15-2002.

CLASS 42—SCIENTIFIC, COMPUTER AND LEGAL SERVICES

FOR WEB DEVELOPMENT NAMELY DESIGN, CONTENT DEVELOPMENT, PROGRAMMING AND DATABASE INTEGRATION; WEB TECHNOLOGY DESIGN NAMELY, CUSTOM E-MAIL, WEB STATISTICS AND CONTENT MANAGEMENT APPLICATION (U.S. CLS. 100 AND 101).

SN 78-128,575. ARMSTRONG MCCALL, L.P., AUSTIN, TX. FILED 5-14-2002.

ARNOLD'S BEAUTY SUPPLIES & EQUIPMENT

NO CLAIM IS MADE TO THE EXCLUSIVE RIGHT TO USE "BEAUTY SUPPLIES & EQUIPMENT", APART FROM THE MARK AS SHOWN.

THE NAME "ARNOLD" DOES NOT IDENTIFY A LIVING INDIVIDUAL.

CLASS 16—PAPER GOODS AND PRINTED MATTER

FOR CATALOGS, BROCHURES, FLYERS, PAMPHLETS AND MAGAZINES FEATURING BEAUTY SUPPLIES AND EQUIPMENT. (U.S. CLS. 2, 5, 22, 23, 29, 37, 38 AND 50).

CLASS 35—ADVERTISING AND BUSINESS

FOR WHOLESALE STORE SERVICES AND DISTRIBUTORSHIP SERVICES FEATURING BEAUTY SUPPLIES AND EQUIPMENT. (U.S. CLS. 100, 101 AND 102).

CLASS 41—EDUCATION AND ENTERTAINMENT

FOR EDUCATIONAL SERVICES; NAMELY, CONDUCTING COURSES OF INSTRUCTION AND LECTURES CONCERNING HAIR CARE, SKIN CARE, NAIL CARE AND COSMETICS. (U.S. CLS. 100, 101 AND 107).

SN 78-131,267. WHO KNEADS IT!, LLC, SEATTLE, WA. FILED 5-26-2002.



SN 78-131,021. BHANDARI, SANJAY, LONDON, UNITED KINGDOM, FILED 5-24-2002.

YOU FOREVER

PRIORITY CLAIMED UNDER SEC. 44(D) ON UNITED KINGDOM APPLICATION NO. 2300571, FILED 5-15-2002, REG. NO. 2300571, DATED 1-24-2003, EXPIRES 5-15-2012.

CLASS 3—COSMETICS AND CLEANING PREPARATIONS

FOR SKIN CREAMS, SKIN LOTIONS, SKIN GELS, HAIR SHAMPOO, HAIR CONDITIONERS, HAIR COLORANTS, HAIR DYES, HAIR STYLING MOUSSES, HAIR STYLING GELS, NAIL POLISH, NAIL POLISH REMOVER, NAIL CREAM; BODY SOAP; PERFUMES, EAU DE COLOGNE, AFTERSHAVES; ESSENTIAL OILS FOR PERSONAL USE; BATH OILS; AROMATHERAPY OILS, CREAMS AND LOTIONS; SUN TAN OILS, CREAMS AND LOTIONS, AFTER SUN CREAMS AND LOTIONS; DEODORANTS AND ANTI-PERSPIRANTS (U.S. CLS. 1, 4, 6, 50, 51 AND 52).

CLASS 5—PHARMACEUTICALS

FOR VITAMINS AND MINERAL SUPPLEMENTS; FOOD SUPPLEMENTS; DEODORIZERS AND AIR FRESHNERS (U.S. CLS. 6, 18, 44, 46, 51 AND 52).

CLASS 35—ADVERTISING AND BUSINESS

FOR RETAIL STORE SERVICES FEATURING COSMETICS, SKIN CARE PRODUCTS AND HEALTHCARE PRODUCTS (U.S. CLS. 100, 101 AND 102).

CLASS 44—MEDICAL, BEAUTY AND AGRICULTURAL SERVICES

FOR PHARMACY, BEAUTY AND AROMATHERAPY ADVICE; MEDICAL CLINICS AND MEDICAL SERVICES, NAMELY, SURGERIES (U.S. CLS. 100 AND 101).

CLASS 16—PAPER GOODS AND PRINTED MATTER

FOR PAPER GOODS AND PRINTED MATTER, NAMELY GREETING CARDS, STATIONERY, STATIONERY TYPE PORTFOLIOS, MEMO PADS, WRITING PADS, NOTEBOOKS, SELF-STICK NOTE PADS, ADDRESS BOOKS, TELEPHONE NUMBER BOOKS, DIARIES, BLANK JOURNALS, AUTOGRAPH BOOKS, PAPER ENVELOPES, WRAPPING PAPER, PAPER GIFT BAGS, CALENDARS, STICKERS, SELF ADHESIVE DECORATIVE SEALS AND STAMPS, DECALS, PICTORIAL PRINTS, PHOTOGRAPHIC PRINTS, POSTERS, PLAYING CARDS, TRADING CARDS, FILE FOLDERS, FILE JACKETS, REPORT COVERS, CLIP BOARDS, PHOTO ALBUMS, BALLPOINT PENS, PENS, FELT TIPPED PENS, PENCILS, MECHANICAL PENCILS, MARKERS, ERASERS, PENCIL SHARPENERS, PEN STANDS, PENCIL CASES, DRAWING RULERS, BOOKMARKS, BOOK-ENDS, NICK-NACK PAPER BOXES, PAPER COASTERS, DECORATIVE PAPER SCULPTURES, PAPER TABLE NAPKINS, PAPER MASKS (U.S. CLS. 2, 5, 22, 23, 29, 37, 38 AND 50).

CLASS 28—TOYS AND SPORTING GOODS

FOR DOLLS, TOYS, AND GAMES, NAMELY SOFT SCULPTURE FIGURES, TOY FIGURES, ACTION FIGURES, STUFFED TOYS, SOFT SCULPTURE PLUSH TOYS, CARD GAMES, PLAYING CARDS, BOARD GAMES, YO-YOS, RUBBER BALLS, FOAM BALLS, BEACH BALLS, PUNCHING BAGS, PUNCH BALLS, PADDLE BALLS, GAG TOYS, DARTS AND DART BOARDS, JIGSAW PUZZLES (U.S. CLS. 22, 23, 38 AND 50).

SN 78-131,766. AMERICAN SPEAKERS BUREAU CORPORATION, ORLANDO, FL. FILED 5-29-2002.

AMERICAN SPEAKERS BUREAU

NO CLAIM IS MADE TO THE EXCLUSIVE RIGHT TO USE "SPEAKERS BUREAU", APART FROM THE MARK AS SHOWN.
SEC. 2(F).

CLASS 35—ADVERTISING AND BUSINESS

FOR SPEAKER BUREAU AND AGENCY SERVICES, NAMELY, REPRESENTATION AND ACTING AS AGENTS FOR INDIVIDUALS IN NEGOTIATING ENGAGEMENTS FOR THEIR SERVICES AS SPEAKERS; AND REFERRAL AND CONSULTING SERVICES, NAMELY, COORDINATION AND PRESENTATION OF BUSINESS SEMINARS AND SPEAKING ENGAGEMENTS. (U.S. CLS. 100, 101 AND 102).

FIRST USE 1-1-1989; IN COMMERCE 1-1-1989.

CLASS 41—EDUCATION AND ENTERTAINMENT

FOR PROVIDING EDUCATIONAL AND ENTERTAINMENT SERVICES, NAMELY, ARRANGING FOR SPEAKERS, LECTURERS, CELEBRITIES, AND TRAINING PERSONNEL IN A WIDE ARRAY OF EDUCATIONAL, ENTERTAINING AND MOTIVATIONAL SUBJECTS FOR CORPORATE AND TRADE MEETINGS, CONFERENCES, CONVENTIONS, BANQUETS AND TRAINING AND EDUCATIONAL PROGRAMS AND FUNCTIONS (U.S. CLS. 100, 101 AND 107).

FIRST USE 1-1-1989; IN COMMERCE 1-1-1989.

CLASS 30—STAPLE FOODS

FOR PREPARED ENTREES CONSISTING PRIMARILY OF PASTA OR RICE (U.S. CL. 46).

CLASS 35—ADVERTISING AND BUSINESS

FOR RETAIL STORES FEATURING PREPARED FOODS (U.S. CLS. 100, 101 AND 102).

CLASS 41—EDUCATION AND ENTERTAINMENT

FOR NIGHTCLUBS (U.S. CLS. 100, 101 AND 107).

CLASS 43—HOTEL AND RESTAURANT SERVICES

FOR COCKTAIL LOUNGE BUFFETS (U.S. CLS. 100 AND 101).

SN 78-132,635. VESSEL INC., BROOKLINE, MA. FILED 6-2-2002.

VESSEL**CLASS 8—HAND TOOLS**

FOR FIREPLACE POKERS AND FIREPLACE SHOVELS (U.S. CLS. 23, 28 AND 44).

CLASS 11—ENVIRONMENTAL CONTROL APPARATUS

FOR ELECTRIC LAMPS (U.S. CLS. 13, 21, 23, 31 AND 34).

CLASS 20—FURNITURE AND ARTICLES NOT OTHERWISE CLASSIFIED

FOR FURNITURE AND CUSHIONS (U.S. CLS. 2, 13, 22, 25, 32 AND 50).

CLASS 21—HOUSEWARES AND GLASS

FOR DISHES, CUPS, AND BOWLS, BEVERAGEWARE, CUTTING BOARDS, SERVING PLATTERS, TRIVETS, CANDLEHOLDERS NOT OF PRECIOUS METAL, INCENSE BURNERS, FIREPLACE BRUSHES, AND NON-METAL BANKS FOR STORING COINS (U.S. CLS. 2, 13, 23, 29, 30, 33, 40 AND 50).

SN 78-133,731. HISAN HOLDING COMPANY, ARLINGTON, VA. FILED 6-6-2002.

CAFE ASIA

NO CLAIM IS MADE TO THE EXCLUSIVE RIGHT TO USE "CAFE", APART FROM THE MARK AS SHOWN. SEC. 2(F).

CLASS 29—MEATS AND PROCESSED FOODS

FOR PREPARED ENTREES CONSISTING PRIMARILY OF MEAT, FISH, POULTRY OR VEGETABLES (U.S. CL. 46).

SN 78-135,171. SHULTZ, LARRY, BEL AIR, CA. FILED 6-12-2002.

CRYOTHERM**CLASS 7—MACHINERY**

FOR ELECTRIC WASTE ENERGY RECOVERY GENERATORS FOR THE PRODUCTION OF ELECTRICITY (U.S. CLS. 13, 19, 21, 23, 31, 34 AND 35).

CLASS 40—MATERIAL TREATMENT

FOR GENERATION OF ENERGY (U.S. CLS. 100, 103 AND 106).

SN 78-135,445. DRYER BUDDY, INC., MERRITT ISLAND, FL. FILED 6-13-2002.

DRYER BUDDY

NO CLAIM IS MADE TO THE EXCLUSIVE RIGHT TO USE "DRYER", APART FROM THE MARK AS SHOWN.

CLASS 11—ENVIRONMENTAL CONTROL APPARATUS

FOR DOORS AND PARTS THEREFORE THAT OPEN AND CLOSE EXHAUST VENTILATION AND VENT LINES FOR ELECTRICAL AND GAS POWERED CLOTHES DRYERS (U.S. CLS. 13, 21, 23, 31 AND 34).

CLASS 35—ADVERTISING AND BUSINESS

FOR ON-LINE RETAIL STORE SERVICES OF DOORS AND COMPONENTS THAT OPEN AND CLOSE EXHAUST VENTILATION AND VENT LINES FOR ELECTRICAL AND GAS POWERED CLOTHES DRYERS (U.S. CLS. 100, 101 AND 102).

SN 78-135,966. DINKHAUSER KARTONAGEN VERTRIEBS GMBH, D-93062 BARBING, FED REP GERMANY, FILED 6-14-2002.



PRIORITY CLAIMED UNDER SEC. 44(D) ON FED REP GERMANY APPLICATION NO. 30200636.2/1, FILED 1-8-2002, REG. NO. 30200636, DATED 2-13-2002, EXPIRES 1-31-2012.

NO CLAIM IS MADE TO THE EXCLUSIVE RIGHT TO USE "SERVICE", APART FROM THE MARK AS SHOWN.

CLASS 16—PAPER GOODS AND PRINTED MATTER

FOR PACKAGING MATERIALS OF PAPER, CARDBOARD, NAMELY ENVELOPES AND POUCHES MADE OF CARDBOARD AND CORRUGATED CARDBOARD, BOOK-WRAPPING MADE OF CORRUGATED CARDBOARD, WRAPPING ENVELOPES FOR SHIPPING AND DISPATCH, EQUIPPED WITH SPECIALLY APPLIED SELF-ADHESIVE SEALS; WRAPPING CASES MADE OF CARDBOARD AND CORRUGATED CARDBOARD, FOR SHIPPING AND DISPATCH; WRAPPING BAGS MADE OF PAPER, CARDBOARD OR CORRUGATED CARDBOARD; PLASTIC MATERIALS FOR PACKAGING, NAMELY ENVELOPES, BAGS AND FILMS; PRINTED MATTER, NAMELY CATALOGUES, BROCHURES, FLYERS AND SPECIALIST JOURNALS FOR THE INDUSTRY, NAMELY PACKAGING INDUSTRY; PRINTED INSTRUCTIONAL AND TEACHING MATERIAL FOR THE PACKAGING INDUSTRY; PUBLICITY OBJECTS MADE OF PAPER, CARDBOARD AND CORRUGATED CARDBOARD (U.S. CLS. 2, 5, 22, 23, 29, 37, 38 AND 50).

CLASS 35—ADVERTISING AND BUSINESS

FOR BUSINESS MARKETING CONSULTING SERVICES; MARKETING RESEARCH AND MARKET ANALYSIS MANAGEMENT CONSULTING, NAMELY IN THE SECTOR OF PACKAGING AND LOGISTICS; NEGOTIATION AND SETTLEMENT OF TRANSACTIONS FOR THE PACKAGING INDUSTRY VIA THE INTERNET; DISTRIBUTION OF SAMPLES, DOCUMENT REPRODUCTIONS; DIRECT MAIL ADVERTISING AND DISSEMINATION OF ADVERTISING VIA THE INTERNET; ARRANGING AND CONDUCTING TRADE SHOWS IN THE FIELD OF THE PACKAGING INDUSTRY (U.S. CLS. 100, 101 AND 102).

CLASS 39—TRANSPORTATION AND STORAGE

FOR PACKAGING ARTICLES FOR TRANSPORTATION; PARCEL DELIVERY; TRANSPORT BY TRUCKS, TRAIN, AIRPLANE, SHIP (U.S. CLS. 100 AND 105).

SN 78-137,610. TERACENTER, INC., SAN DIEGO, CA. FILED 6-21-2002.

IT GUARDIAN

NO CLAIM IS MADE TO THE EXCLUSIVE RIGHT TO USE "IT", APART FROM THE MARK AS SHOWN.

CLASS 9—ELECTRICAL AND SCIENTIFIC APPARATUS

FOR COMPUTER HARDWARE AND SOFTWARE PLATFORM TO PROTECT COMPUTER NETWORKS, TO ALLOW USERS TO PERFORM ELECTRONIC BUSINESS TRANSACTIONS VIA A GLOBAL COMPUTER NETWORK, TO CONNECT REMOTELY LOCATED USERS TO ACCESS NETWORK-BASED COMPUTERIZED DATA VIA A GLOBAL COMPUTER NETWORK (U.S. CLS. 21, 23, 26, 36 AND 38).

FIRST USE 2-19-2002; IN COMMERCE 2-19-2002.

CLASS 38—COMMUNICATION

FOR PROVIDE ELECTRONIC TRANSMISSION OF DATA AND DOCUMENTS FOR OTHERS VIA COMPUTER NETWORKS OVER A GLOBAL COMPUTER NETWORK; ELECTRONIC MAIL SERVICES (U.S. CLS. 100, 101 AND 104).

FIRST USE 2-19-2002; IN COMMERCE 2-19-2002.

SN 78-139,361. PATRIOT HOLDINGS, LLC, WALNUT CREEK, CA. FILED 6-27-2002.



NO CLAIM IS MADE TO THE EXCLUSIVE RIGHT TO USE "HOLDINGS, LLC", "AMERICAN SHIP MANAGEMENT, LLC", AND "CONTRACT SERVICES, LLC", APART FROM THE MARK AS SHOWN.

CLASS 35—ADVERTISING AND BUSINESS

FOR BUSINESS MANAGEMENT AND CONSULTATION IN THE FIELD OF SHIPPING (U.S. CLS. 100, 101 AND 102).

FIRST USE 10-1-2001; IN COMMERCE 10-1-2001.

CLASS 42—SCIENTIFIC, COMPUTER AND LEGAL SERVICES

FOR TECHNICAL CONSULTATION IN THE FIELD OF SHIPPING AND MARITIME MATTERS (U.S. CLS. 100 AND 101).

FIRST USE 10-1-2001; IN COMMERCE 10-1-2001.

SN 78-139,726. F. S. CHOCOLATIERS, LTD., MANSFIELD, OH. FILED 6-28-2002.

SN 78-140,385. PRECISION TECHNOLOGY SERVICES LTD., VANCOUVER, BRITISH COLUMBIA, CANADA, FILED 7-1-2002.



OWNER OF U.S. REG. NO. 1,436,955.
NO CLAIM IS MADE TO THE EXCLUSIVE RIGHT TO USE "CHOCOLATIERS", APART FROM THE MARK AS SHOWN.

THE MARK CONSISTS OF THE STYLIZED LETTERS "F" AND "S" WITHIN A CIRCULAR BORDER CONTAINING THE WORD "CHOCOLATIERS".

THE ENGLISH TRANSLATION OF "CHOCOLATIERS" IS "CHOCOLATE MAKER OR SELLER".

CLASS 30—STAPLE FOODS

FOR CHOCOLATE AND CANDY CONFECTIONS (U.S. CL. 46).
FIRST USE 2-8-2002; IN COMMERCE 4-8-2002.

CLASS 35—ADVERTISING AND BUSINESS

FOR RETAIL STORE SERVICES FEATURING CANDY AND OTHER CONFECTIONS (U.S. CLS. 100, 101 AND 102).
FIRST USE 2-8-2002; IN COMMERCE 4-8-2002.

SN 78-139,955. SEARS, BARRY D., MARBLEHEAD, MA. FILED 6-28-2002.

CANINE ZONE

NO CLAIM IS MADE TO THE EXCLUSIVE RIGHT TO USE "CANINE", APART FROM THE MARK AS SHOWN.

CLASS 3—COSMETICS AND CLEANING PREPARATIONS

FOR NON-MEDICATED SKIN CARE PRODUCTS FOR ANIMALS, NAMELY, SHAMPOOS, LOTIONS, OILS, OINTMENTS, CREAMS, SOAPS, AND CONDITIONERS (U.S. CLS. 1, 4, 6, 50, 51 AND 52).

CLASS 5—PHARMACEUTICALS

FOR FEED SUPPLEMENTS FOR PETS; VITAMINS AND NUTRITIONAL SUPPLEMENTS (U.S. CLS. 6, 18, 44, 46, 51 AND 52).

CLASS 31—NATURAL AGRICULTURAL PRODUCTS

FOR ANIMAL FEED AND ANIMAL FOODSTUFFS; DOG FOOD AND EDIBLE DOG TREATS (U.S. CLS. 1 AND 46).

BE FREE

CLASS 9—ELECTRICAL AND SCIENTIFIC APPARATUS

FOR ORTHOKERATOLOGICAL LENSES AND CONTACT LENSES (U.S. CLS. 21, 23, 26, 36 AND 38).

CLASS 16—PAPER GOODS AND PRINTED MATTER

FOR PRINTED INSTRUCTIONAL, EDUCATIONAL, AND TEACHING MATERIALS IN THE FIELD OF ORTHOKERATOLOGY (U.S. CLS. 2, 5, 22, 23, 29, 37, 38 AND 50).

CLASS 41—EDUCATION AND ENTERTAINMENT

FOR EDUCATIONAL SERVICES, NAMELY, CONDUCTING CLASSES, SEMINARS, CONFERENCES, WORKSHOPS AND INTERACTIVE WEB COURSES IN THE FIELD OF ORTHOKERATOLOGY, AND DISTRIBUTING COURSE MATERIALS IN CONNECTION THEREWITH (U.S. CLS. 100, 101 AND 107).

CLASS 44—MEDICAL, BEAUTY AND AGRICULTURAL SERVICES

FOR MEDICAL SERVICES NAMELY, ORTHOKERATOLOGY SURGICAL AND NON-SURGICAL PROCEDURES, CORNEAL TOPOGRAPHICAL ANALYSIS, ORTHOKERATOLOGY LENS FITTING AND DISPENSING; MEDICAL COUNSELING IN THE FIELD OF ORTHOKERATOLOGY (U.S. CLS. 100 AND 101).

SN 78-140,796. VGS INC., GEORGE TOWN, CAYMAN ISLANDS, FILED 7-2-2002.

THE MARK HAS NO SIGNIFICANCE IN THE RELEVANT TRADE OR INDUSTRY OR AS APPLIED TO THE GOODS OR AS TRANSLATED.

CLASS 9—ELECTRICAL AND SCIENTIFIC APPARATUS

FOR COMPUTER SOFTWARE USED FOR THE EXPLORATION AND PRODUCTION OF HYDROCARBONS. (U.S. CLS. 21, 23, 26, 36 AND 38).

CLASS 42—SCIENTIFIC, COMPUTER AND LEGAL SERVICES

FOR COMPUTER SOFTWARE DESIGN AND DEVELOPMENT SERVICES; TECHNICAL CONSULTING SERVICES IN THE FIELD OF HYDROCARBON EXPLORATION AND PRODUCTION. (U.S. CLS. 100 AND 101).

SN 78-142,033. PEPGEN CORPORATION, ALAMEDA, CA. FILED 7-8-2002.

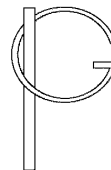

SN 78-141,292. BCD HOLDINGS N.V., WILLEMSTAD-CURACAO, DUTCH ANTILLES, NETHERLANDS, FILED 7-3-2002.



PRIORITY CLAIMED UNDER SEC. 44(D) ON BENELUX APPLICATION NO. 0705926, FILED 12-21-2001, REG. NO. 1002646, DATED 12-21-2001, EXPIRES 12-21-2011.

NO CLAIM IS MADE TO THE EXCLUSIVE RIGHT TO USE "WORLD TRAVEL", APART FROM THE MARK AS SHOWN.

THE MARK CONSISTS OF THE WORD "WORLDTRAVEL" AND THE LETTERS "BTI" IN THE COLOR BLUE, ABOVE WHICH ARE TWO CURVING STRIPES, WITH THE LOWER OF THE TWO IN THE COLOR ORANGE AND THE UPPER ONE IN BLUE.

CLASS 39—TRANSPORTATION AND STORAGE

FOR TRANSPORTATION OF PASSENGERS AND/OR GOODS BY BOAT, AIR, RAIL, CAR AND/OR BUS; TRAVEL AGENCY SERVICES, NAMELY, MAKING RESERVATIONS AND BOOKINGS FOR TRANSPORTATION FOR INDIVIDUALS, BUSINESS OR GROUP TRAVEL; ARRANGING GUIDED TRAVEL TOURS AND/OR EXCURSIONS; ARRANGING FOR TRAVEL VISAS, PASSPORTS AND TRAVEL DOCUMENTS FOR PERSONS TRAVELING ABROAD; RENTAL OF VEHICLES; TRAVEL BOOKING AGENCIES; TRAVEL INFORMATION SERVICES; CONSULTATION WITH RESPECT TO THE AFOREMENTIONED SERVICES (U.S. CLS. 100 AND 105).

CLASS 42—SCIENTIFIC, COMPUTER AND LEGAL SERVICES

FOR LEGAL SERVICES FOR THE APPLICATION AND ISSUING OF VISAS; MEDIATION SERVICES IN THE FIELD OF TRAVEL INSURANCE UNDERWRITING (U.S. CLS. 100 AND 101).

CLASS 43—HOTEL AND RESTAURANT SERVICES

FOR TRAVEL AGENCY SERVICES, NAMELY, MAKING RESERVATIONS AND BOOKINGS FOR TEMPORARY LODGING OR ACCOMMODATION; HOTEL AND CATERING SERVICES; TOURIST HOMES; CONSULTATION WITH RESPECT TO THE AFOREMENTIONED SERVICES (U.S. CLS. 100 AND 101).

THE MARK CONSISTS OF A COMBINATION OF THE LETTERS "P" AND "G".

CLASS 5—PHARMACEUTICALS

FOR BIOPHARMACEUTICALS FOR USE IN THE DIAGNOSIS, PREVENTION, AND TREATMENT OF HUMAN AND ANIMAL DISEASES, NAMELY CANCER, VIRAL INFECTIONS, MICROBIAL INFECTIONS, AUTO-IMMUNE DISEASES, ALLERGIES, IMMUNOLOGICAL DYSFUNCTIONS, NEUROLOGICAL DISORDERS, BLOOD DISORDERS, AND INFLAMMATORY DISEASES (U.S. CLS. 6, 18, 44, 46, 51 AND 52).

CLASS 35—ADVERTISING AND BUSINESS

FOR CONDUCTING MARKETING STUDIES OF DIAGNOSTICS AND PHARMACEUTICALS (U.S. CLS. 100, 101 AND 102).

CLASS 40—MATERIAL TREATMENT

FOR CUSTOM MANUFACTURE OF DIAGNOSTICS AND PHARMACEUTICALS FOR OTHERS IN THE FIELD OF BIOTECHNOLOGY (U.S. CLS. 100, 103 AND 106).

CLASS 42—SCIENTIFIC, COMPUTER AND LEGAL SERVICES

FOR SCIENTIFIC RESEARCH; PRODUCT RESEARCH AND DEVELOPMENT IN THE FIELD OF BIOTECHNOLOGY (U.S. CLS. 100 AND 101).

SN 78-143,062. QUAD/GRAPHICS, INC., SUSSEX, WI. FILED 7-11-2002.

QUADARM

CLASS 40—MATERIAL TREATMENT

FOR PRINTING REPRODUCTION SERVICES (U.S. CLS. 100, 103 AND 106).

CLASS 42—SCIENTIFIC, COMPUTER AND LEGAL SERVICES

FOR GRAPHIC REPRODUCTION SERVICES (U.S. CLS. 100 AND 101).

SN 78-143,103. TRANSKARYOTIC THERAPIES, INC., CAMBRIDGE, MA. FILED 7-11-2002.

DUREPLACE

CLASS 5—PHARMACEUTICALS

FOR PHARMACEUTICALS AND BIOLOGICS FOR USE IN THE TREATMENT OF GENETIC DISORDERS, CANCER, HEMATOLOGIC DISORDERS, ENDOCRINE DISORDERS, REPRODUCTIVE DYSFUNCTION, SHORT STATURE, DIABETES, METABOLIC DISORDERS, DISORDERS OF THE CENTRAL NERVOUS SYSTEM, GASTROINTESTINAL DISORDERS, CARDIOVASCULAR DISORDERS, AUTOIMMUNE DISORDERS AND OTHER DISORDERS OF THE IMMUNE SYSTEM, INFECTIOUS DISEASES AND ENZYME DEFICIENCY DISEASES; GENETICALLY ALTERED CELLS AND CELL LINES FOR USE IN THE PRODUCTION OF HUMAN THERAPEUTIC PROTEINS, FOR MEDICAL DIAGNOSTIC USE, FOR USE IN THE TREATMENT OF A VARIETY OF DISEASES AND DISORDERS AND FOR IMPLANTATION INTO HUMAN PATIENTS (U.S. CLS. 6, 18, 44, 46, 51 AND 52).

CLASS 44—MEDICAL, BEAUTY AND AGRICULTURAL SERVICES

FOR HEALTH CARE SERVICES; DIAGNOSTIC AND GENETIC MEDICAL TESTING SERVICES; MEDICAL PATIENT MONITORING SERVICES (U.S. CLS. 100 AND 101).

SN 78-143,109. TRANSKARYOTIC THERAPIES, INC., CAMBRIDGE, MA. FILED 7-11-2002.

REPLASHAY

CLASS 5—PHARMACEUTICALS

FOR PHARMACEUTICALS AND BIOLOGICS FOR USE IN THE TREATMENT OF GENETIC DISORDERS, CANCER, HEMATOLOGIC DISORDERS, ENDOCRINE DISORDERS, REPRODUCTIVE DYSFUNCTION, SHORT STATURE, DIABETES, METABOLIC DISORDERS, DISORDERS OF THE CENTRAL NERVOUS SYSTEM, GASTROINTESTINAL DISORDERS, CARDIOVASCULAR DISORDERS, AUTOIMMUNE DISORDERS AND OTHER DISORDERS OF THE IMMUNE SYSTEM, INFECTIOUS DISEASES AND ENZYME DEFICIENCY DISEASES; GENETICALLY ALTERED CELLS AND CELL LINES FOR USE IN THE PRODUCTION OF HUMAN THERAPEUTIC PROTEINS, FOR MEDICAL DIAGNOSTIC USE, FOR USE IN THE TREATMENT OF A VARIETY OF DISEASES AND DISORDERS AND FOR IMPLANTATION INTO HUMAN PATIENTS (U.S. CLS. 6, 18, 44, 46, 51 AND 52).

CLASS 44—MEDICAL, BEAUTY AND AGRICULTURAL SERVICES

FOR HEALTH CARE SERVICES; DIAGNOSTIC AND GENETIC MEDICAL TESTING SERVICES; MEDICAL PATIENT MONITORING SERVICES (U.S. CLS. 100 AND 101).

SN 78-144,190. NEW ENERGY BEDROOMS, INC., CHRISTIANSBURG, VA. FILED 7-16-2002.

SENSA

OWNER OF U.S. REG. NO. 2,139,764.

CLASS 20—FURNITURE AND ARTICLES NOT OTHERWISE CLASSIFIED

FOR WATERBEDS; WATERBED MATTRESSES; FLUID SUSPENSION BEDS; FLUID SUSPENSION MATTRESSES; FLUID SUSPENSION MATTRESS FOUNDATIONS; COMBINATION FLUID SUSPENSION AND FOAM MATTRESSES; LATEX MATTRESSES; COMBINATION LATEX AND FOAM MATTRESSES; FOAM MATTRESSES; AIR MATTRESSES FOR HOME USE; COMBINATION AIR AND FOAM MATTRESSES; PILLOWS; FOAM PILLOWS; CONTOUR PILLOWS; CONTOUR FOAM PILLOWS; FUTONS; FUTON MATTRESSES (U.S. CLS. 2, 13, 22, 25, 32 AND 50).

FIRST USE 10-17-1996; IN COMMERCE 11-5-1996.

CLASS 24—FABRICS

FOR MATTRESS COVERS (U.S. CLS. 42 AND 50).
FIRST USE 10-17-1996; IN COMMERCE 11-5-1996.

SN 78-144,362. SUMMERLEE STATEN ENTERTAINMENT, LLC, DALLAS, TX. FILED 7-16-2002.

SUMMERLEE

THE NAME "SUMMERLEE" IDENTIFIES A LIVING INDIVIDUAL WHOSE CONSENT IS OF RECORD.

CLASS 9—ELECTRICAL AND SCIENTIFIC APPARATUS

FOR SERIES OF MUSICAL SOUND AND MUSICAL VIDEO RECORDINGS; COMPACT DISCS AND CD-ROMS FEATURING MUSIC AND MUSIC VIDEOS AND ENTERTAINMENT INFORMATION, NAMELY, INFORMATION ABOUT PERFORMANCES, RECORDINGS, APPEARANCES, THE BIOGRAPHY AND OTHER INFORMATION ABOUT A MUSICAL PERFORMER AND RECORDING ARTIST (U.S. CLS. 21, 23, 26, 36 AND 38).

CLASS 25—CLOTHING

FOR CLOTHING, NAMELY, BATHING SUITS; JEANS; SPORTSWEAR, NAMELY, TOPS, BOTTOMS, SHIRTS, SHORTS, SKIRTS; WORKOUT CLOTHES, NAMELY, JOGGING SUITS, BODY SUITS, RUNNING SHORTS, RUNNING PANTS, SWEATSUITS, SWEAT SHIRTS, SWEAT PANTS; WOMEN'S WEAR, NAMELY, BLOUSES AND DRESSES; FOOTWEAR; HEADWEAR (U.S. CLS. 22 AND 39).

CLASS 41—EDUCATION AND ENTERTAINMENT

FOR ENTERTAINMENT IN THE NATURE OF LIVE MUSICAL PERFORMANCES; PROVIDING A WEB SITE VIA A GLOBAL COMPUTER NETWORK FEATURING INFORMATION ABOUT PERFORMANCES, RECORDINGS, APPEARANCES, THE BIOGRAPHY, AND OTHER INFORMATION ABOUT A MUSICAL PERFORMER AND RECORDING ARTIST (U.S. CLS. 100, 101 AND 107).

SN 78-144,370. SUMMERLEE STATEN ENTERTAINMENT, LLC, DALLAS, TX. FILED 7-16-2002.

SUMMERLEE STATEN

THE NAME "SUMMERLEE STATEN" IDENTIFIES A LIVING INDIVIDUAL WHOSE CONSENT IS OF RECORD.

CLASS 9—ELECTRICAL AND SCIENTIFIC APPARATUS

FOR SERIES OF MUSICAL SOUND AND MUSICAL VIDEO RECORDINGS; COMPACT DISCS AND CD-ROMS FEATURING MUSIC AND MUSIC VIDEOS AND ENTERTAINMENT INFORMATION, NAMELY, INFORMATION ABOUT PERFORMANCES, RECORDINGS, APPEARANCES, THE BIOGRAPHY AND OTHER INFORMATION ABOUT A MUSICAL PERFORMER AND RECORDING ARTIST (U.S. CLS. 21, 23, 26, 36 AND 38).

CLASS 25—CLOTHING

FOR CLOTHING, NAMELY, BATHING SUITS; JEANS; SPORTSWEAR, NAMELY, TOPS, BOTTOMS, SHIRTS, SHORTS, SKIRTS; WORKOUT CLOTHES, NAMELY, JOGGING SUITS, BODY SUITS, RUNNING SHORTS, RUNNING PANTS, SWEATSUITS, SWEAT SHIRTS, SWEAT PANTS; WOMEN'S WEAR, NAMELY, BLOUSES AND DRESSES; FOOTWEAR; HEADWEAR (U.S. CLS. 22 AND 39).

CLASS 41—EDUCATION AND ENTERTAINMENT

FOR ENTERTAINMENT IN THE NATURE OF LIVE MUSICAL PERFORMANCES; PROVIDING A WEB SITE VIA A GLOBAL COMPUTER NETWORK FEATURING INFORMATION ABOUT PERFORMANCES, RECORDINGS, APPEARANCES, THE BIOGRAPHY, AND OTHER INFORMATION ABOUT A MUSICAL PERFORMER AND RECORDING ARTIST (U.S. CLS. 100, 101 AND 107).

SN 78-144,438. BISADORA, LLC, PHOENIX, AZ. FILED 7-16-2002.

CLASS 18—LEATHER GOODS

FOR PURSES, HANDBAGS, SHOULDER BAGS AND TOTE BAGS (U.S. CLS. 1, 2, 3, 22 AND 41).
FIRST USE 2-13-2001; IN COMMERCE 2-13-2001.

CLASS 25—CLOTHING

FOR CLOTHING, NAMELY BELTS (U.S. CLS. 22 AND 39).
FIRST USE 2-13-2001; IN COMMERCE 2-13-2001.

SN 78-144,846. INTERNATIONAL BROTHERHOOD OF PRIZEFIGHTERS S.A., SAN JOSE, COSTA RICA, FILED 7-17-2002.

**THE KEEPER OF THE
LINEAGE**

CLASS 35—ADVERTISING AND BUSINESS

FOR PROMOTING BOXING COMPETITIONS AND/OR BOXING EVENTS OF OTHERS. (U.S. CLS. 100, 101 AND 102).

CLASS 41—EDUCATION AND ENTERTAINMENT

FOR ORGANIZING COMMUNITY SPORTING EVENTS, NAMELY BOXING COMPETITIONS; ENTERTAINMENT IN THE NATURE OF COMPETITIONS IN THE FIELD OF BOXING; PROVIDING INFORMATION IN THE FIELD OF BOXING VIA THE INTERNET; PROVIDING NEWS IN THE NATURE OF CURRENT EVENTS REPORTING, NAMELY NEWS RELATED TO BOXING. (U.S. CLS. 100, 101 AND 107).

SN 78-144,849. INTERNATIONAL BROTHERHOOD OF PRIZEFIGHTERS S.A., SAN JOSE, COSTA RICA, FILED 7-17-2002.

IBOP

CLASS 35—ADVERTISING AND BUSINESS

FOR PROMOTING BOXING COMPETITIONS AND/OR BOXING EVENTS OF OTHERS. (U.S. CLS. 100, 101 AND 102).

CLASS 41—EDUCATION AND ENTERTAINMENT

FOR ORGANIZING COMMUNITY SPORTING EVENTS, NAMELY BOXING COMPETITIONS; ENTERTAINMENT IN THE NATURE OF COMPETITIONS IN THE FIELD OF BOXING; PROVIDING INFORMATION IN THE FIELD OF BOXING VIA THE INTERNET; PROVIDING NEWS IN THE NATURE OF CURRENT EVENTS REPORTING, NAMELY NEWS RELATED TO BOXING. (U.S. CLS. 100, 101 AND 107).

SN 78-145,079. BAYER AKTIENGESELLSCHAFT, LEVERKUSEN-BAYERWERK, FED REP GERMANY, FILED 7-18-2002.

LEVAMELT

CLASS 1—CHEMICALS

FOR SYNTHETIC RESINS AND PLASTICS IN THE RAW STATE FOR USE IN A WIDE VARIETY OF FIELDS; ADHESIVES FOR USE IN A WIDE VARIETY OF FIELDS (U.S. CLS. 1, 5, 6, 10, 26 AND 46).
FIRST USE 4-12-2002; IN COMMERCE 4-12-2002.

CLASS 17—RUBBER GOODS

FOR SYNTHETIC RUBBER IN RAW STATES FOR USE IN A WIDE VARIETY OF FIELDS (U.S. CLS. 1, 5, 12, 13, 35 AND 50).
FIRST USE 4-12-2002; IN COMMERCE 4-12-2002.

SN 78-145,250. KABUSHIKI KAISHA SHUEISHA A/T/A SHUEISHA INC., TOKYO, JAPAN, FILED 7-18-2002.

SHONEN JUMP

NO CLAIM IS MADE TO THE EXCLUSIVE RIGHT TO USE "SHONEN", APART FROM THE MARK AS SHOWN. THE ENGLISH TRANSLATION OF "SHONEN" IS "BOYS".

CLASS 9—ELECTRICAL AND SCIENTIFIC APPARATUS

FOR ELECTRONIC PUBLICATIONS IN THE NATURE OF COMIC BOOKS, COMIC MAGAZINES, AND STORY BOOKS; RECORDED ON COMPUTER MEDIA; DOWN-LOADED COMPUTER GAME SOFTWARE (U.S. CLS. 21, 23, 26, 36 AND 38).

CLASS 16—PAPER GOODS AND PRINTED MATTER

FOR COMIC MAGAZINES, COMIC BOOKS, STORY BOOKS, TRADING CARDS (U.S. CLS. 2, 5, 22, 23, 29, 37, 38 AND 50).

CLASS 28—TOYS AND SPORTING GOODS

FOR TOYS, NAMELY, TOY ACTION FIGURES AND ACCESSORIES THEREFOR; TOY VEHICLES; TOY PISTOLS; TRANSFORMING ROBOTIC TOYS; TOY MASK; DOLLS; HAND HELD HAND- HELD UNITS FOR PLAYING ELECTRONIC DOLLS; HAND-HELD UNITS FOR PLAYING ELECTRONIC GAMES; BOARD GAMES, CARD GAMES (U.S. CLS. 22, 23, 38 AND 50).

CLASS 41—EDUCATION AND ENTERTAINMENT

FOR ENTERTAINMENT SERVICES, NAMELY, PROVIDING ON-LINE COMICS AND COMPUTER GAMES; PROVIDING INFORMATION ON-LINE RELATING TO COMICS, COMPUTER GAMES AND COMPUTER ENHANCEMENTS FOR GAMES (U.S. CLS. 100, 101 AND 107).

SN 78-145,694. ENTERPRISE INTEGRATION, INC., JACKSONVILLE, FL. FILED 7-19-2002.



NO CLAIM IS MADE TO THE EXCLUSIVE RIGHT TO USE "ASSET", APART FROM THE MARK AS SHOWN.

CLASS 9—ELECTRICAL AND SCIENTIFIC APPARATUS

FOR SOFTWARE FOR MANAGING INFORMATION TECHNOLOGY ASSETS (U.S. CLS. 21, 23, 26, 36 AND 38). FIRST USE 3-1-2002; IN COMMERCE 3-1-2002.

CLASS 42—SCIENTIFIC, COMPUTER AND LEGAL SERVICES

FOR INFORMATION TECHNOLOGY ASSET MANAGEMENT SERVICES (U.S. CLS. 100 AND 101). FIRST USE 3-1-2002; IN COMMERCE 3-1-2002.

SN 78-145,573. WEAVER POPCORN COMPANY, INC., INDIANAPOLIS, IN. FILED 7-19-2002.

SN 78-146,918. SMS MEER GMBH, MONCHENGLADBACH, FED REP GERMANY, FILED 7-24-2002.

SHOWTIME

OWNER OF U.S. REG. NO. 1,202,247.

CLASS 30—STAPLE FOODS

FOR MICROWAVE POPCORN (U.S. CL. 46).

CLASS 31—NATURAL AGRICULTURAL PRODUCTS

FOR RAW POPCORN, NAMELY, PLAIN KERNELS (U.S. CLS. 1 AND 46).

WTCL

PRIORITY CLAIMED UNDER SEC. 44(D) ON FED REP GERMANY APPLICATION NO. 30204207507, FILED 1-30-2002, REG. NO. 30204207, DATED 7-1-2002, EXPIRES 1-31-2012.

CLASS 7—MACHINERY

FOR ROLLING MILL MACHINES, ROLLING MILL MACHINE PARTS (U.S. CLS. 13, 19, 21, 23, 31, 34 AND 35).

CLASS 9—ELECTRICAL AND SCIENTIFIC APPARATUS

FOR ELECTRICAL CONTROLLERS FOR ROLLING MILLS; COMPUTER PROGRAMS STORED ON DATA CARRIERS AND CONSTITUTING SOFTWARE FOR CONTROLLING AND OPERATING ROLLING MILL MACHINES (U.S. CLS. 21, 23, 26, 36 AND 38).

SN 78-149,105. SYNGENTA CROP PROTECTION, INC., GREENSBORO, NC. FILED 7-31-2002.

SN 78-153,811. BRION TECHNOLOGIES, INC., SANTA CLARA, CA. FILED 8-13-2002.

TRUCCELL

CLASS 1—CHEMICALS

FOR HERBICIDE-TOLERANT GENES FOR USE IN AGRICULTURE SEED AND CHEMICAL COMPOUNDS FOR USE IN AGRICULTURE (U.S. CLS. 1, 5, 6, 10, 26 AND 46).

CLASS 5—PHARMACEUTICALS

FOR HERBICIDES FOR AGRICULTURAL USE (U.S. CLS. 6, 18, 44, 46, 51 AND 52).

CLASS 31—NATURAL AGRICULTURAL PRODUCTS

FOR AGRICULTURAL SEED (U.S. CLS. 1 AND 46).

SN 78-150,165. SYNGENTA INVESTMENT CORP., GREENSBORO, NC. BY ASSIGNMENT SYNGENTA PARTICIPATIONS AG, BASEL, SWITZERLAND, FILED 8-2-2002.

PRIMO MAXX

OWNER OF U.S. REG. NO. 1,742,090.

CLASS 1—CHEMICALS

FOR PLANT GROWTH REGULATORS FOR AGRICULTURAL USE, NAMELY TURF GROWTH REGULATOR (U.S. CLS. 1, 5, 6, 10, 26 AND 46).
FIRST USE 9-15-1999; IN COMMERCE 9-15-1999.

CLASS 5—PHARMACEUTICALS

FOR FUNGICIDES FOR AGRICULTURAL AND DOMESTIC USE (U.S. CLS. 6, 18, 44, 46, 51 AND 52).
FIRST USE 9-15-1999; IN COMMERCE 9-15-1999.

SN 78-153,384. REDDELL, MICHAEL, SCOTTS VALLEY, CA. AND SONODA, MARGARET, SCOTTS VALLEY, CA. FILED 8-12-2002.

WINDHOOK

CLASS 35—ADVERTISING AND BUSINESS

FOR MANAGEMENT OF VINEYARDS (U.S. CLS. 100, 101 AND 102).

CLASS 41—EDUCATION AND ENTERTAINMENT

FOR EDUCATIONAL RETREAT SERVICES, NAMELY, CONDUCTING WORKSHOPS FOR ARTISTS (U.S. CLS. 100, 101 AND 107).

BRION TECHNOLOGIES

NO CLAIM IS MADE TO THE EXCLUSIVE RIGHT TO USE "TECHNOLOGIES", APART FROM THE MARK AS SHOWN.

CLASS 9—ELECTRICAL AND SCIENTIFIC APPARATUS

FOR COMPUTER HARDWARE AND SOFTWARE FOR DESIGNING AND MANUFACTURING SEMICONDUCTOR WAFERS, MASKS, AND RETICLES; METROLOGY AND INSPECTIONS TOOLS FOR MEASURING, DETECTING, INSPECTING, AND SENSING CHEMICAL COMPOSITIONS, TEMPERATURE, LIGHT IMAGES, THICKNESS, FLATNESS, TEXTURE, LINE WIDTH, AND CONTAMINATION OF SEMICONDUCTOR WAFERS, MASKS, AND RETICLES DURING THE MANUFACTURING PROCESS (U.S. CLS. 21, 23, 26, 36 AND 38).

CLASS 35—ADVERTISING AND BUSINESS

FOR LICENSING OF COMPUTER SOFTWARE (U.S. CLS. 100, 101 AND 102).

CLASS 42—SCIENTIFIC, COMPUTER AND LEGAL SERVICES

FOR LICENSING OF INTELLECTUAL PROPERTY; PATENT LICENSING; TECHNICAL SUPPORT SERVICES, NAMELY, TROUBLESHOOTING OF COMPUTER HARDWARE AND SOFTWARE PROBLEMS; SEMICONDUCTOR DESIGN SERVICES; COMPUTER CONSULTATION; CONSULTING SERVICES IN THE FIELD OF SEMICONDUCTORS, AND IN THE FIELD OF DESIGN, SELECTION, IMPLEMENTATION AND USE OF COMPUTER HARDWARE AND SOFTWARE SYSTEMS FOR OTHERS; ENGINEERING SERVICES RELATED TO THE ARCHITECTURE AND DESIGN OF SEMICONDUCTOR DEVICES (U.S. CLS. 100 AND 101).

SN 78-154,660. JAGER DESIGN, INC., BURLINGTON, VT. FILED 8-15-2002.

DESIGN  JAGER DI PAOLA KEMP

CLASS 35—ADVERTISING AND BUSINESS

FOR ADVERTISING SERVICES, NAMELY CREATION OF ADVERTISING FOR OTHERS; MARKET RESEARCH SERVICES, NAMELY CONDUCTING MARKET SURVEYS, STUDIES AND ANALYSIS FOR OTHERS; CONSULTATION SERVICES, NAMELY PRODUCT, BRAND AND CORPORATE IDENTITY DEVELOPMENT FOR OTHERS (U.S. CLS. 100, 101 AND 102).
FIRST USE 1-1-2002; IN COMMERCE 1-1-2002.

CLASS 42—SCIENTIFIC, COMPUTER AND LEGAL SERVICES

FOR DESIGN SERVICES, NAMELY GRAPHIC ART, COMMERCIAL ART, PRODUCT, INDUSTRIAL AND PACKAGING DESIGN FOR OTHERS (U.S. CLS. 100 AND 101).
FIRST USE 1-1-2002; IN COMMERCE 1-1-2002.

SN 78-155,330. ACREAGE UNLIMITED ASSOCIATION, INC., WAUCHULA, FL. FILED 8-19-2002.

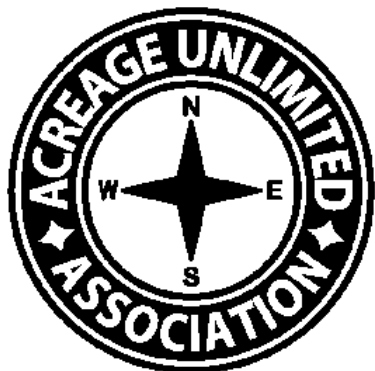

NO CLAIM IS MADE TO THE EXCLUSIVE RIGHT TO USE "ACREAGE", "ASSOCIATION", OR THE REPRESENTATION OF A COMPASS APART FROM THE MARK AS SHOWN, APART FROM THE MARK AS SHOWN.

CLASS 35—ADVERTISING AND BUSINESS

FOR ON-LINE BUYER/SELLER REFERRALS IN THE FIELD OF REAL ESTATE (U.S. CLS. 100, 101 AND 102). FIRST USE 8-8-2002; IN COMMERCE 8-8-2002.

CLASS 36—INSURANCE AND FINANCIAL

FOR REAL ESTATE BROKERAGE SERVICES FEATURING MULTIPLE REAL ESTATE LISTINGS (U.S. CLS. 100, 101 AND 102). FIRST USE 8-8-2002; IN COMMERCE 8-8-2002.

SN 78-156,349. FLORALIFE, INC., WALTERBORO, SC. FILED 8-21-2002.

FLORALIFE THE PROFESSIONAL CHOICE

OWNER OF U.S. REG. NOS. 398,694, 1,181,726 AND 2,084,575.

NO CLAIM IS MADE TO THE EXCLUSIVE RIGHT TO USE "PROFESSIONAL", APART FROM THE MARK AS SHOWN.

CLASS 1—CHEMICALS

FOR CHEMICAL PREPARATIONS FOR MAINTAINING THE LIFE AND BEAUTY OF CUT FLOWERS AND TO REFRESH, HYDRATE AND PROTECT FLORAL ARRANGEMENTS AND POTTED PLANTS; AND FLOWER FOOD, NAMELY, A PRETREATMENT USED TO ENHANCE FLOWER HYDRATION (U.S. CLS. 1, 5, 6, 10, 26 AND 46).

CLASS 5—PHARMACEUTICALS

FOR ANTI-MICROBIAL CLEANER FOR INDUSTRIAL USE BY COMMERCIAL FLORICULTURAL PERSONNEL, NAMELY, WHOLESALE AND RETAIL FLORISTS AND GREENHOUSES; AND DISINFECTANTS FOR GREENHOUSE AND HORTICULTURAL USE (U.S. CLS. 6, 18, 44, 46, 51 AND 52).

CLASS 20—FURNITURE AND ARTICLES NOT OTHERWISE CLASSIFIED

FOR FLORAL FOAM FOR HOLDING CUT FLOWERS AND ARTIFICIAL FLOWER ARRANGEMENTS (U.S. CLS. 2, 13, 22, 25, 32 AND 50).

SN 78-156,957. FLAVIA'S LEGACY, LLC, SANTA BARBARA, CA. FILED 8-22-2002.

LABBIT

CLASS 24—FABRICS

FOR BABY BLANKETS; BED SHEETS; AND BEDDING, NAMELY, CRIB BUMPERS AND QUILTS (U.S. CLS. 42 AND 50).

CLASS 25—CLOTHING

FOR CLOTHES FOR BABIES, NAMELY, SLEEPER SETS IN THE NATURE OF PAJAMAS, BABY BIBS NOT OF PAPER AND SHIRTS (U.S. CLS. 22 AND 39).

SN 78-157,774. GUMP'S CORP., SAN FRANCISCO, CA. FILED 8-26-2002.

SANTA BY THE BAY

CLASS 16—PAPER GOODS AND PRINTED MATTER

FOR HOLIDAY GREETING CARDS AND STATIONERY (U.S. CLS. 2, 5, 22, 23, 29, 37, 38 AND 50).

CLASS 28—TOYS AND SPORTING GOODS

FOR CHRISTMAS TREE DECORATIONS (U.S. CLS. 22, 23, 38 AND 50).

CLASS 35—ADVERTISING AND BUSINESS

FOR RETAIL STORE SERVICES FEATURING CHRISTMAS TREE DECORATIONS, HOLIDAY DECORATIONS FOR THE HOME, HOLIDAY CARDS AND STATIONERY; AND ONLINE RETAIL STORE SERVICES FEATURING CHRISTMAS TREE DECORATIONS, HOLIDAY DECORATIONS FOR THE HOME, HOLIDAY CARDS AND STATIONERY (U.S. CLS. 100, 101 AND 102).

SN 78-158,979. O'SHAUGHNESSY, BETTY, ANGWIN, CA. FILED 8-28-2002.

AMPHITHEATER VINEYARD

NO CLAIM IS MADE TO THE EXCLUSIVE RIGHT TO USE "VINEYARD", APART FROM THE MARK AS SHOWN.

CLASS 29—MEATS AND PROCESSED FOODS

FOR PROCESSED GRAPES (U.S. CL. 46).

CLASS 33—WINES AND SPIRITS

FOR WINES (U.S. CLS. 47 AND 49).

SN 78-161,878. NOKIA CORPORATION, 02150 ESPOO, FINLAND, FILED 9-9-2002.

SN 78-159,004. DEAF WORLDWIDE, INC., AUSTIN, TX. FILED 8-28-2002.

DEAF WAY

NO CLAIM IS MADE TO THE EXCLUSIVE RIGHT TO USE "DEAF", APART FROM THE MARK AS SHOWN.

CLASS 35—ADVERTISING AND BUSINESS

FOR CONDUCTING TRADESHOWS IN THE FIELD OF INFORMATION AND PRODUCTS FOR DEAF AND HARD OF HEARING PEOPLE (U.S. CLS. 100, 101 AND 102).

CLASS 41—EDUCATION AND ENTERTAINMENT

FOR EDUCATIONAL SERVICES, NAMELY, CONFERENCES AND WORKSHOPS FOR DEAF AND HARD OF HEARING PEOPLE; ENTERTAINMENT SERVICES, NAMELY, ORGANIZING EXHIBITIONS FEATURING ART SHOWS, LIVE PERFORMANCES, INCLUDING LANGUAGE, CULTURE AND HISTORY FOR DEAF AND HARD OF HEARING PEOPLE (U.S. CLS. 100, 101 AND 107).

SN 78-159,835. LOWELL, RANDALL, DBA COMPANY-NEEDS.COM, EDMONDS, WA. FILED 8-30-2002.

CUZZYBEAR**CLASS 24—FABRICS**

FOR SPORTS BLANKETS AND COVERINGS, NAMELY, BLANKET THROWS (U.S. CLS. 42 AND 50).

CLASS 28—TOYS AND SPORTING GOODS

FOR TOYS AND PLAYTHINGS, NAMELY, STUFFED TOY ANIMALS (U.S. CLS. 22, 23, 38 AND 50).

SN 78-161,296. FIT BIOTECH OYJ PLC., FIN-33520 TAMPERE, FINLAND, FILED 9-6-2002.

FITKIT**CLASS 1—CHEMICALS**FOR REAGENT SUBSTANCE KITS FOR USE IN INDUSTRY AND SCIENCE; RAPID TESTS COMPRISED OF REAGENTS FOR DETERMINATION OF ALLERGENS (U.S. CLS. 1, 5, 6, 10, 26 AND 46).
FIRST USE 12-0-2001; IN COMMERCE 12-0-2001.**CLASS 5—PHARMACEUTICALS**FOR REAGENT SUBSTANCE KITS FOR MEDICAL USE AND PATIENT DIAGNOSTICS; RAPID TESTS COMPRISED OF REAGENTS FOR DETERMINATION OF ANTIBODIES (U.S. CLS. 6, 18, 44, 46, 51 AND 52).
FIRST USE 12-0-2001; IN COMMERCE 12-0-2001.**STAR CHEF**

PRIORITY CLAIMED UNDER SEC. 44(D) ON FINLAND APPLICATION NO. T200201053, FILED 4-4-2002, REG. NO. 226443, DATED 2-14-2003, EXPIRES 2-14-2013.

CLASS 9—ELECTRICAL AND SCIENTIFIC APPARATUS

FOR COMPUTER GAME SOFTWARE FOR COMMUNICATION DEVICES; COMPUTER GAME SOFTWARE AND PROGRAMS ENABLING USERS TO PLAY GAMES WITH MOBILE PHONES; COMPUTER SOFTWARE AND PROGRAMS ENABLING USERS OF COMMUNICATION DEVICES TO SIMULTANEOUSLY ACCESS DATABASES AND GLOBAL COMPUTER NETWORKS; SOFTWARE ENABLING TRANSFER OF DATA BETWEEN MOBILE COMMUNICATION APPARATUS; VIRTUAL REALITY GAME SOFTWARE (U.S. CLS. 21, 23, 26, 36 AND 38).

CLASS 28—TOYS AND SPORTING GOODS

FOR HAND HELD UNIT FOR PLAYING ELECTRONIC GAMES; HAND HELD UNIT FOR PLAYING VIDEO GAMES, ELECTRONIC GAME EQUIPMENT WITH A WATCH FUNCTION; EQUIPMENT PACKAGED AS A UNIT FOR PLAYING BOARD GAMES, PUZZLES, REMOTE CONTROL TOYS (U.S. CLS. 22, 23, 38 AND 50).

CLASS 41—EDUCATION AND ENTERTAINMENT

FOR ENTERTAINMENT, NAMELY PROVIDING COMPUTER GAMES TO MOBILE PHONES AND COMPUTERS; PROVIDING ONLINE COMPUTER GAMES VIA NETWORK BETWEEN COMMUNICATIONS NETWORKS AND COMPUTERS (U.S. CLS. 100, 101 AND 107).

SN 78-162,366. CHINA PACIFIC GROUP, INC., WOODINVILLE, WA. FILED 9-10-2002.

AMER PRO**CLASS 9—ELECTRICAL AND SCIENTIFIC APPARATUS**FOR EYEWEAR, NAMELY, SAFETY GLASSES, SKI GLASSES AND SUN GLASSES; EYEGLOSS POUCHES (U.S. CLS. 21, 23, 26, 36 AND 38).
FIRST USE 10-0-1992; IN COMMERCE 1-0-1994.**CLASS 28—TOYS AND SPORTING GOODS**FOR SPORTING GOODS, NAMELY, BADMINTON RACKETS, RACQUETBALL RACKETS, SQUASH RACKETS, TENNIS RACKETS; COVERS FOR BADMINTON, RACQUETBALL, SQUASH AND TENNIS RACKETS (U.S. CLS. 22, 23, 38 AND 50).
FIRST USE 10-0-1992; IN COMMERCE 1-0-1994.

SN 78-163,716. HOME DIAGNOSTICS, INC., FORT LAUDERDALE, FL. FILED 9-13-2002.

SN 78-166,716. PFIZER INC., NEW YORK, NY. FILED 9-23-2002.

TRUETRACK

CLASS 5—PHARMACEUTICALS

FOR MEDICAL DIAGNOSTIC TEST STRIPS FOR USE IN MONITORING BLOOD GLUCOSE LEVELS AND CONTROL SOLUTIONS FOR TESTING THE ACCURACY OF BLOOD GLUCOSE METERS FOR MEDICAL USE (U.S. CLS. 6, 18, 44, 46, 51 AND 52).

CLASS 10—MEDICAL APPARATUS

FOR BLOOD GLUCOSE METERS AND LANCING DEVICES FOR MONITORING BLOOD GLUCOSE LEVELS, SOLD INDIVIDUALLY AND AS PART OF BLOOD GLUCOSE DIAGNOSTIC TESTING KITS (U.S. CLS. 26, 39 AND 44).

SN 78-165,559. CHEESEBURGER RESTAURANTS, INC., ORANGE, CA. FILED 9-18-2002.

CHEESEBURGER

OWNER OF U.S. REG. NOS. 1,765,057, 2,418,610 AND 2,511,225.

CLASS 20—FURNITURE AND ARTICLES NOT OTHERWISE CLASSIFIED

FOR NON-METAL KEY CHAINS, PLASTIC KEY CHAINS (U.S. CLS. 2, 13, 22, 25, 32 AND 50).

CLASS 21—HOUSEWARES AND GLASS

FOR MUGS (U.S. CLS. 2, 13, 23, 29, 30, 33, 40 AND 50).

CLASS 25—CLOTHING

FOR CLOTHING, NAMELY, SHIRTS, T-SHIRTS, TANK TOPS, SWEATSHIRTS, BLOUSES, JACKETS, COATS, SWEATERS, SHORTS, PANTS, BEACHWEAR, SWIMWEAR, SWIMSUITS, PAREUS; HEADWEAR AND FOOTWEAR (U.S. CLS. 22 AND 39).

CLASS 26—FANCY GOODS

FOR ORNAMENTAL NOVELTY BUTTONS, ORNAMENTAL NOVELTY PINS, ZIPPER PULLS, BELT CLASPS, HAIR ORNAMENTS, RIBBONS (U.S. CLS. 37, 39, 40, 42 AND 50).

CLASS 35—ADVERTISING AND BUSINESS

FOR ONLINE RETAIL SALE OF NOVELTY AND PROMOTIONAL MERCHANDISE VIA THE INTERNET (U.S. CLS. 100, 101 AND 102).

NEW HOPE FOR SURVIVAL

CLASS 16—PAPER GOODS AND PRINTED MATTER

FOR PRINTED MATERIALS, NAMELY, TRAINING MANUALS, INFORMATIONAL BOOKLETS, BROCHURES, LEAFLETS, CHARTS, DISPLAYS, CATALOGS, CALENDARS AND STICKERS RELATING TO THE CAUSES, DIAGNOSIS AND TREATMENT OF FUNGAL INFECTIONS. (U.S. CLS. 2, 5, 22, 23, 29, 37, 38 AND 50).

CLASS 44—MEDICAL, BEAUTY AND AGRICULTURAL SERVICES

FOR PROVIDING INFORMATION IN THE FIELD OF FUNGAL INFECTIONS. (U.S. CLS. 100 AND 101).

SN 78-169,647. THE COCA-COLA COMPANY, ATLANTA, GA. FILED 10-1-2002.

WELL DONE

CLASS 35—ADVERTISING AND BUSINESS

FOR BUSINESS CONSULTATION, NAMELY, PROVIDING RECRUITING STRATEGIES; CONDUCTING EMPLOYEE INCENTIVE AWARD PROGRAMS TO PROMOTE ON THE JOB QUALITY AND PRODUCTIVITY (U.S. CLS. 100, 101 AND 102).

CLASS 36—INSURANCE AND FINANCIAL

FOR DEBIT ACCOUNT SERVICES FEATURING A COMPUTE READABLE CARD (U.S. CLS. 100, 101 AND 102).

CLASS 41—EDUCATION AND ENTERTAINMENT

FOR EDUCATION SERVICES IN THE NATURE OF COURSES AT THE UNIVERSITY LEVEL PROVIDED VIA A GLOBAL COMPUTER NETWORK; TRAINING SERVICES IN THE FIELD OF RESTAURANT AND HOSPITALITY OPERATIONS AND CUSTOMER SERVICES; AND PROVIDING RECOGNITION AND INCENTIVES BY THE WAY OF AWARDS TO DEMONSTRATE EXCELLENCE IN THE FIELD OF CUSTOMER SERVICES; CONSULTATION IN THE FIELD OF EMPLOYEE TRAINING AND RETENTION (U.S. CLS. 100, 101 AND 107).

SN 78-170,193. MAERSK CONTAINER INDUSTRI A/S, TINGLEV, DENMARK, FILED 10-2-2002.

STAR COOL

PRIORITY CLAIMED UNDER SEC. 44(D) ON DENMARK APPLICATION NO. VA200201842, FILED 4-30-2002, REG. NO. VR200202269, DATED 6-25-2002, EXPIRES 6-25-2012.

CLASS 6—METAL GOODS

FOR METAL CONTAINERS FOR THE TRANSPORTATION AND STORAGE OF GOODS (U.S. CLS. 2, 12, 13, 14, 23, 25 AND 50).

CLASS 11—ENVIRONMENTAL CONTROL APPARATUS

FOR REFRIGERATING PLANTS AND INSTALLATIONS, NAMELY, REFRIGERATORS, FOOD AND BEVERAGE CHILLING UNITS; REFRIGERATED SHIPPING CONTAINERS (U.S. CLS. 13, 21, 23, 31 AND 34).

CLASS 12—VEHICLES

FOR REFRIGERATED TRAILERS (U.S. CLS. 19, 21, 23, 31, 35 AND 44).

SN 78-170,966. NIPPON DENKI KABUSHIKI KAISHA, DBA NEC CORPORATION, TOKYO, JAPAN, FILED 10-4-2002.

VALUMO

SN 78-170,213. MAERSK CONTAINER INDUSTRI A/S, TINGLEV, DENMARK, FILED 10-2-2002.

STAR  **COOL**

PRIORITY CLAIMED UNDER SEC. 44(D) ON DENMARK APPLICATION NO. VA200201841, FILED 4-30-2002, REG. NO. VR200202268, DATED 6-25-2002, EXPIRES 6-25-2012.

PRIORITY CLAIMED UNDER SEC. 44(D) ON DENMARK APPLICATION NO. VA200201841, FILED 4-30-2002, REG. NO. VR200202268, DATED 6-25-2002, EXPIRES 6-25-2012.

PRIORITY CLAIMED UNDER SEC. 44(D) ON DENMARK APPLICATION NO. VA200201841, FILED 6-25-2002, REG. NO. VR200202268, DATED 6-25-2002, EXPIRES 6-25-2012.

THE STIPPLING SHOWN IN THE DRAWING IS A FEATURE OF THE MARK AND IS NOT INTENDED TO INDICATE SHADING.

CLASS 6—METAL GOODS

FOR METAL CONTAINERS FOR THE TRANSPORTATION AND STORAGE OF GOODS (U.S. CLS. 2, 12, 13, 14, 23, 25 AND 50).

CLASS 11—ENVIRONMENTAL CONTROL APPARATUS

FOR REFRIGERATING PLANTS AND INSTALLATIONS, NAMELY, REFRIGERATORS, FOOD AND BEVERAGE CHILLING UNITS; REFRIGERATED SHIPPING CONTAINERS (U.S. CLS. 13, 21, 23, 31 AND 34).

CLASS 12—VEHICLES

FOR REFRIGERATED TRAILERS (U.S. CLS. 19, 21, 23, 31, 35 AND 44).

CLASS 9—ELECTRICAL AND SCIENTIFIC APPARATUS

FOR COMPUTERS, ELECTRONIC COMPUTERS, MAINFRAME COMPUTERS, SMALL BUSINESS COMPUTERS, PERSONAL COMPUTERS, NOTEBOOK COMPUTERS, SUPER COMPUTERS, COMPUTER WORKSTATIONS COMPRISED OF COMPUTERS, COMPUTER MONITORS AND COMPUTER SERVERS, SCANNERS, COMPUTER OUTPUT PRINTERS, COMPUTER COMMUNICATIONS SERVERS, DISK STORAGE CONTAINERS, COMPUTER HARD DISK DRIVES, LIQUID CRYSTAL MONITOR DISPLAYS, PRIVATE BRANCH EXCHANGES, TELEPHONES, TELECOMMUNICATION ASYNCHRONOUS TRANSFER MODE SWITCHES, MULTIPLEXERS, CELLULAR PHONES, MOBILE PHONES, PERSONAL DIGITAL ASSISTANTS AND FACSIMILE MACHINES; COMPUTER SOFTWARE FOR NETWORK MANAGEMENT; COMPUTER SOFTWARE FOR USE IN DATABASE MANAGEMENT; COMPUTER OPERATING PROGRAMS FOR USE IN CONTROLLING THE OPERATION AND EXECUTION OF PROGRAMS AND NETWORK FUNCTIONS; COMPUTER SOFTWARE FOR USE IN SEARCHING, RETRIEVING, CONFIGURATING, EDITING AND FORMATTING DATA INFORMATION STORED IN COMPUTER SERVERS INTERCONNECTED WITH LOCAL AND GLOBAL COMPUTER INFORMATION NETWORKS AND FOR USE IN PROVIDING USERS/CLIENTS WITH THE EDITED DATA-INFORMATION VIA THE AFORESAID NETWORKS (U.S. CLS. 21, 23, 26, 36 AND 38).

CLASS 37—CONSTRUCTION AND REPAIR

FOR INSTALLATION, UPGRADING AND MAINTENANCE OF COMPUTER HARDWARE (U.S. CLS. 100, 103 AND 106).

CLASS 42—SCIENTIFIC, COMPUTER AND LEGAL SERVICES

FOR TECHNICAL SUPPORT SERVICES, NAMELY TROUBLESHOOTING OF COMPUTER HARDWARE AND COMPUTER SOFTWARE PROBLEMS; COMPUTER SOFTWARE AND HARDWARE DESIGN FOR OTHERS; INTEGRATION OF COMPUTER HARDWARE AND SOFTWARE SYSTEMS FOR OTHERS; INSTALLATION, UPDATING AND MAINTENANCE OF COMPUTER SOFTWARE; COMPUTER PROGRAMMING FOR OTHERS; CONSULTING SERVICES IN THE FIELD OF COMPUTER HARDWARE AND SOFTWARE; COMPUTER SYSTEM ANALYSIS (U.S. CLS. 100 AND 101).

SN 78-171,156. HUNT & GATHER, INC., BOSTON, MA.
FILED 10-4-2002.



CLASS 35—ADVERTISING AND BUSINESS

FOR DISSEMINATION OF ADVERTISING MATTER
(U.S. CLS. 100, 101 AND 102).
FIRST USE 5-1-2000; IN COMMERCE 9-1-2000.

**CLASS 42—SCIENTIFIC, COMPUTER AND
LEGAL SERVICES**

FOR COMPUTER SERVICES, NAMELY, DESIGNING
WEB SITES FOR OTHERS (U.S. CLS. 100 AND 101).
FIRST USE 5-1-2000; IN COMMERCE 9-1-2000.

SN 78-171,495. HIP DESIGN, LLC, BURBANK, CA. FILED 10-
7-2002.



Haaland Internet Productions

NO CLAIM IS MADE TO THE EXCLUSIVE RIGHT TO
USE "DESIGN" AND "INTERNET PRODUCTIONS", APART
FROM THE MARK AS SHOWN.

THE MARK CONSISTS OF A BOX SURROUNDING THE
WORDS "HIP DESIGN". "HIP" IS POSITIONED ABOVE
"DESIGN". THE WORD "DESIGN" IS GRAY IN COLOR.
THE BOX AND THE WORD "HIP" ARE BLACK. CEN-
TERED UNDERNEATH THE BOX ARE THE WORDS
"HAALAND INTERNET PRODUCTIONS", ALSO THE COL-
OR OF BLACK. THE FONT OF THE WORDS IS UNIVERS55.

CLASS 35—ADVERTISING AND BUSINESS

FOR ADVERTISING SERVICES, NAMELY CREATING
CORPORATE LOGOS FOR OTHERS (U.S. CLS. 100, 101
AND 102).
FIRST USE 0-0-1998; IN COMMERCE 0-0-1999.

**CLASS 42—SCIENTIFIC, COMPUTER AND
LEGAL SERVICES**

FOR WEBSITE DESIGN, WEBSITE HOSTING, MAIN-
TENANCE OF WEBSITES, AND PRINT MATERIAL
THAT MATCHES WEBSITES (U.S. CLS. 100 AND 101).
FIRST USE 0-0-1998; IN COMMERCE 0-0-1999.

SN 78-171,993. MARTINET ET HIRONDELLE, SAINT MAR-
TIN SUR OUST, FRANCE. FILED 10-8-2002.

ISABEL DERROISNE

PRIORITY CLAIMED UNDER SEC. 44(D) ON FRANCE
APPLICATION NO. 023161365, FILED 4-24-2002, REG. NO.
023161365, DATED 4-24-2002, EXPIRES 4-24-2012.

THE LIKENESS (OR, "PORTRAIT") IN THE MARK DOES
NOT IDENTIFY A LIVING INDIVIDUAL.

**CLASS 3—COSMETICS AND CLEANING PRE-
PARATIONS**

FOR SOAPS FOR PERSONAL USE, NAMELY,
CLEANSING SOAP, SKIN SOAP, DEODORANT SOAP
AND ANTIBACTERIAL SOAP; DEODORANTS FOR
PERSONAL USE; PERFUMERY PRODUCTS, NAMELY,
PERFUMES, EAU DE PARFUM, EAU DE TOILETTE,
AFTER-SHAVE IN THE FORM OF GEL OR LOTION;
BODY CARE PERFUMES, NAMELY SKIN CREAMS
AND DEODORANT SPRAYS; ESSENTIAL OILS FOR
PERSONAL USE; PERFUME OILS; COSMETIC PRO-
DUCTS, NAMELY, PERFUMED BODY MILKS, PER-
FUMED BODY CREAM, AND PERFUMED BODY
LOTIONS; PERFUMES FOR ROOMS, NAMELY, PER-
FUMED CERAMIC STONES, PERFUMED PIECES OF
WOOD FOR THE HOME, POTPOURRI, AND INCENSE;
PRODUCTS TO SCENT HOUSEHOLD LINEN, NAMELY,
SACHETS; HAIR LOTIONS (U.S. CLS. 1, 4, 6, 50, 51 AND
52).

CLASS 4—LUBRICANTS AND FUELS

FOR PERFUMED CANDLES (U.S. CLS. 1, 6 AND 15).

CLASS 5—PHARMACEUTICALS

FOR HYGIENIC PRODUCTS, NAMELY, ALL PUR-
POSE DISINFECTING AND DEODORIZING PREPARA-
TIONS; DEODORANTS AND ATMOSPHERE
DEODORANTS OTHER THAN FOR PERSONAL USE,
NAMELY, ROOM DEODORANTS, AIR DEODORANTS,
HOUSEHOLD DEODORANTS, AND AIR FRESHENERS
(U.S. CLS. 6, 18, 44, 46, 51 AND 52).

CLASS 14—JEWELRY

FOR PRECIOUS METALS AND THEIR ALLOYS
OTHER THAN FOR DENTAL USE; JEWELRY; PRE-
CIOUS GEMSTONES; HOROLOGICAL AND CHRONO-
METRIC INSTRUMENTS, NAMELY, CLOCKS AND
WATCHES; CHARM BRACELETS (U.S. CLS. 2, 27, 28
AND 50).

SN 78-172,557. FONTANA EDUCATIONAL INSTITUTE,
FONTANA, CA. FILED 10-9-2002.

STANDARDS PLUS

NO CLAIM IS MADE TO THE EXCLUSIVE RIGHT TO
USE "STANDARDS", APART FROM THE MARK AS
SHOWN.

**CLASS 9—ELECTRICAL AND SCIENTIFIC
APPARATUS**

FOR SOFTWARE AND DOWNLOADABLE SOFT-
WARE FEATURING LESSON PLANS ON THE SUB-
JECTS OF MATHEMATICS AND LANGUAGE ARTS
FOR USE IN GRADES K-12 (U.S. CLS. 21, 23, 26, 36
AND 38).

CLASS 16—PAPER GOODS AND PRINTED MATTER

FOR PRINTED LESSON PLANS ON THE SUBJECTS OF MATHEMATICS AND LANGUAGE ARTS FOR USE IN GRADES K-12 (U.S. CLS. 2, 5, 22, 23, 29, 37, 38 AND 50).

SN 78-177,823. MEDICAL BENEFITS MUTUAL LIFE INSURANCE CO., NEWARK, OH. FILED 10-24-2002.

The logo for MedBen features the word "MedBen" in a bold, sans-serif font. The letter "n" is stylized with a curved line extending from its bottom right, resembling a medical syringe needle or a stylized leaf.

OWNER OF U.S. REG. NOS. 1,484,734, 2,154,827 AND 2,352,618.

CLASS 35—ADVERTISING AND BUSINESS

FOR UTILIZATION REVIEW OF HEALTH CARE (U.S. CLS. 100, 101 AND 102).

CLASS 36—INSURANCE AND FINANCIAL

FOR HEALTH, LIFE, HOSPITALIZATION AND DISABILITY INSURANCE UNDERWRITING, CLAIMS PROCESSING, BROKERAGE AND CLAIMS ADMINISTRATION SERVICES; INSURANCE ADMINISTRATION SERVICES FOR SELF-INSURED PLANS OF OTHERS (U.S. CLS. 100, 101 AND 102).

SN 78-178,307. QUINNIPIAC UNIVERSITY, HAMDEN, CT. FILED 10-25-2002.

QUINNIPIAC UNIVERSITY

NO CLAIM IS MADE TO THE EXCLUSIVE RIGHT TO USE "UNIVERSITY", APART FROM THE MARK AS SHOWN.

CLASS 35—ADVERTISING AND BUSINESS

FOR PUBLIC OPINION POLLING SERVICES (U.S. CLS. 100, 101 AND 102).
FIRST USE 7-1-2000; IN COMMERCE 7-1-2000.

CLASS 41—EDUCATION AND ENTERTAINMENT

FOR EDUCATIONAL SERVICES, NAMELY, PROVIDING INSTRUCTION AND TRAINING AT THE UNDERGRADUATE, GRADUATE, AND POST-GRADUATE LEVEL; EDUCATIONAL SERVICES, NAMELY, PROVIDING COURSES OF INSTRUCTION AT THE POST-GRADUATE LEVEL IN THE FIELD OF LAW AND DISTRIBUTING COURSE MATERIALS IN CONNECTION THEREWITH; EDUCATIONAL SERVICES, NAMELY, CONDUCTING WORKSHOPS IN THE FIELD OF COMMUNITY SERVICE; ARRANGING AND CONDUCTING EDUCATIONAL CONFERENCES AND SEMINARS; ORGANIZING AND CONDUCTING SPORTS COMPETITIONS AND SPORTS EVENTS; ORGANIZING AND CONDUCTING INTRAMURAL AND INTERCOLLEGIATE ATHLETIC COMPETITIONS AND ORGANIZING AND CONDUCTING ENTERTAINMENT EXHIBITIONS IN THE NATURE OF CRAFT FAIRS, ART SHOWS; ENTERTAINMENT SERVICES IN THE NATURE OF LIVE MUSICAL CONCERTS, THEATER PERFORMANCES; PUBLIC SPEAKERS, MOTION PICTURE FILM SERVICES; TELEVISION AND RADIO SHOW PRODUCTION SERVICES (U.S. CLS. 100, 101 AND 107).

FIRST USE 7-1-2000, 12/31/1929; IN COMMERCE 7-1-2000, 12/31/1929.

SN 78-178,355. INTELLINEX LLC, NEW YORK, NY. FILED 10-25-2002.

The logo for Intellinex features the word "Intellinex" in a bold, sans-serif font. The letters are filled with a stippled or halftone pattern, giving it a textured appearance.

OWNER OF U.S. REG. NO. 2,665,122.
THE STIPPLING ON THE DRAWING IS FOR SHADING PURPOSES AND DOES NOT INDICATE COLOR.

CLASS 9—ELECTRICAL AND SCIENTIFIC APPARATUS

FOR COMPUTER SOFTWARE IN THE NATURE OF DEVELOPMENT TOOLS FOR DEVELOPING CORPORATE TRAINING MATERIALS IN THE FIELDS OF CORPORATIONS, LEADERSHIP, REGULATORY, CORPORATE POLICY, ACCOUNTING, AND BUSINESS; DOWNLOADABLE INTERACTIVE COMPUTER SOFTWARE FOR CORPORATE TRAINING IN THE FIELDS OF CORPORATIONS, LEADERSHIP, REGULATORY, CORPORATE POLICY, ACCOUNTING, AND BUSINESS (U.S. CLS. 21, 23, 26, 36 AND 38).

CLASS 35—ADVERTISING AND BUSINESS

FOR BUSINESS CONSULTING SERVICES ON INCREASING BUSINESS PRODUCTIVITY AND PERFORMANCE (U.S. CLS. 100, 101 AND 102).

CLASS 41—EDUCATION AND ENTERTAINMENT

FOR EDUCATIONAL SERVICES, NAMELY, PROVIDING SEMINARS, INTERNET-BASED COURSES, CLASSES AND SEMINARS IN THE FIELDS OF BUSINESS, LEADERSHIP, REGULATORY ISSUES, INFORMATION TECHNOLOGY, CORPORATE POLICY, FINANCIAL SERVICES, ACCOUNTING, AND USE OF COMPUTER SYSTEMS; PROVIDING AN INTERACTIVE COMPUTER DATABASE CONTAINING INFORMATION ABOUT CORPORATE TRAINING IN THE FIELDS OF CORPORATIONS, LEADERSHIP, REGULATORY, CORPORATE POLICY, ACCOUNTING, AND BUSINESS (U.S. CLS. 100, 101 AND 107).

SN 78-179,900. FIRST FINANCIAL HOLDINGS, INC., CHARLESTON, SC. FILED 10-30-2002.



NO CLAIM IS MADE TO THE EXCLUSIVE RIGHT TO USE "FIRST FEDERAL", APART FROM THE MARK AS SHOWN.

CLASS 9—ELECTRICAL AND SCIENTIFIC APPARATUS

FOR AUTOMATIC TELLER MACHINES; MAGNETICALLY ENCODED CREDIT CARDS; MAGNETICALLY ENCODED DEBIT CARDS; COMPUTER SOFTWARE FOR USE IN BANKING AND FINANCIAL INDUSTRIES, NAMELY, COMPUTER COMMUNICATIONS SOFTWARE TO ALLOW CUSTOMERS TO ACCESS BANK ACCOUNT INFORMATION AND TRANSACT BANK BUSINESS VIA GLOBAL COMPUTER NETWORKS; SOFTWARE ENABLING BANKING CUSTOMERS TO TRANSMIT PAYMENT DIRECTLY; SOFTWARE FOR USE IN CONNECTION WITH ELECTRONIC FUNDS TRANSFERS. (U.S. CLS. 21, 23, 26, 36 AND 38).
FIRST USE 9-28-1999; IN COMMERCE 9-28-1999.

CLASS 36—INSURANCE AND FINANCIAL

FOR BANKING AND RELATED FINANCING SERVICES; FINANCIAL SERVICES, NAMELY, PROVIDING FINANCIAL ANALYSIS, CONSULTATION, PLANNING AND MANAGEMENT, COMMERCIAL AND CONSUMER LENDING SERVICES, MORTGAGE LENDING, AND LOAN FINANCING; CREDIT CARD SERVICES; DEBIT CARD SERVICES; ELECTRONIC PAYMENT SERVICES, NAMELY, ELECTRONIC PROCESSING AND TRANSMISSION OF BILL PAYMENT DATA; SECURITY SERVICES, NAMELY, GUARANTEERING LOANS; CASH MANAGEMENT; MORTGAGE BANKING; SAFETY DEPOSIT BOX SERVICES; CHECKING ACCOUNT SERVICES; SAVINGS ACCOUNT SERVICES; WIRE TRANSFER SERVICES; AUTOMATED TELLER MACHINE SERVICES; INVESTMENT SERVICES, NAMELY, PROVIDING ANNUITY SERVICES AND CERTIFICATE OF DEPOSIT SERVICES; CREDIT LIFE INSURANCE UNDERWRITING SERVICES; PROVIDING BANKING, FINANCIAL AND INVESTMENT CONSULTATION AND INFORMATION VIA GLOBAL COMPUTER NETWORKS; PROVIDING INTERACTIVE BANKING, FINANCIAL AND INVESTMENT CONSULTATION AND INFORMATION VIA GLOBAL COMPUTER NETWORKS; AND PROVIDING BANK ACCOUNT INFORMATION BY TELEPHONE (U.S. CLS. 100, 101 AND 102).
FIRST USE 2-1-1999; IN COMMERCE 2-1-1999.

SN 78-180,143. LOG MAX, INC., VANCOUVER, WA. FILED 10-30-2002.

SIMPLY SMARTER

CLASS 7—MACHINERY

FOR TIMBER HARVESTING MACHINES; ROTATION MOTORS, ROTORS, FOR TIMBER HARVESTING MACHINES (U.S. CLS. 13, 19, 21, 23, 31, 34 AND 35).

CLASS 9—ELECTRICAL AND SCIENTIFIC APPARATUS

FOR PROGRAMMABLE ELECTRONIC CONTROLLERS FOR TIMBER HARVESTING MACHINES (U.S. CLS. 21, 23, 26, 36 AND 38).

SN 78-180,400. 2416 W. SCHUBERT, INC., CHICAGO, IL. FILED 10-31-2002.

FAT WILLY'S

CLASS 30—STAPLE FOODS

FOR SPICES AND SAUCES (U.S. CL. 46).
FIRST USE 10-3-2002; IN COMMERCE 10-24-2002.

CLASS 43—HOTEL AND RESTAURANT SERVICES

FOR RESTAURANT SERVICES; CATERING SERVICES; TAKE-OUT FOOD SERVICES, NAMELY, FOOD AND DRINK (U.S. CLS. 100 AND 101).
FIRST USE 3-1-2002; IN COMMERCE 10-24-2002.

SN 78-181,031. BOOTISM LLC, NEW YORK, NY. FILED 11-1-2002.

BOOTISM

CLASS 16—PAPER GOODS AND PRINTED MATTER

FOR BOOKS ON THE SUBJECT MATTER OF SHOES AND FOOTWEAR, GREETING CARDS, POSTCARDS, CALENDARS, WRAPPING PAPER, POSTERS, STATIONERY, NOTEBOOKS, DATEBOOKS, AND PAPER PRODUCTS, NAMELY PHOTO ALBUMS AND PERSONAL JOURNALS (U.S. CLS. 2, 5, 22, 23, 29, 37, 38 AND 50).

CLASS 25—CLOTHING

FOR CLOTHING, NAMELY, T-SHIRTS, LONG SLEEVE T-SHIRTS, COLLARED SHIRTS, BELTS, HATS, TIES, JACKETS, VESTS, PANTS, SOCKS, SHOES AND BOOTS (U.S. CLS. 22 AND 39).

SN 78-181,036. ALLIANCE MANAGEMENT PARTNERS, L.L.C., ST. LOUIS, MO. FILED 11-1-2002.

ALLIANCE MANAGEMENT TECHNOLOGIES

OWNER OF U.S. REG. NO. 2,604,593.
NO CLAIM IS MADE TO THE EXCLUSIVE RIGHT TO USE "MANAGEMENT TECHNOLOGIES", APART FROM THE MARK AS SHOWN.

CLASS 35—ADVERTISING AND BUSINESS

FOR BUSINESS CONSULTATION, AIDING PARTICIPANTS IN MANAGING INTERCORPORATE ARRANGEMENTS (U.S. CLS. 100, 101 AND 102).

CLASS 42—SCIENTIFIC, COMPUTER AND LEGAL SERVICES

FOR COMPUTER CONSULTATION, NAMELY, CONSULTATION CONCERNING TECHNOLOGY PLATFORMS AND SOFTWARE TOOL KITS FOR SUPPORTING PARTICIPANTS IN MANAGING INTERCORPORATE ARRANGEMENTS (U.S. CLS. 100 AND 101).

SN 78-181,801. STEWART, DAVID BRUCE, SALT LAKE CITY, UT. FILED 11-5-2002.

SN 78-184,968. THE DOW CHEMICAL COMPANY, MIDLAND, MI. FILED 11-14-2002.

GAMEPEACE

CLASS 35—ADVERTISING AND BUSINESS

FOR MARKETING THE BOARD GAMES AND OTHERS (U.S. CLS. 100, 101 AND 102).

CLASS 40—MATERIAL TREATMENT

FOR CUSTOM MANUFACTURE OF BOARD GAMES FOR OTHERS (U.S. CLS. 100, 103 AND 106).

SN 78-183,374. THE ENKEBOLL COMPANY, DBA ENKEBOLL DESIGNS, CARSON, CA. FILED 11-8-2002.

GENERATING INSPIRATION

CLASS 19—NON-METALLIC BUILDING MATERIALS

FOR ARCHITECTURAL WOOD MOLDINGS (U.S. CLS. 1, 12, 33 AND 50).

CLASS 20—FURNITURE AND ARTICLES NOT OTHERWISE CLASSIFIED

FOR ARCHITECTURAL WOOD CRAVINGS (U.S. CLS. 2, 13, 22, 25, 32 AND 50).

SN 78-183,744. SCAN INTERNATIONAL, INC., ROCKVILLE, MD. FILED 11-11-2002.

THE ART OF HOME IMPROVEMENT

CLASS 11—ENVIRONMENTAL CONTROL APPARATUS

FOR LAMPS, NAMELY, FLOOR, TABLE AND DECORATIVE LAMPS (U.S. CLS. 13, 21, 23, 31 AND 34).

CLASS 16—PAPER GOODS AND PRINTED MATTER

FOR ART PRINTS; ART PICTURES; PRINTED ART REPRODUCTIONS (U.S. CLS. 2, 5, 22, 23, 29, 37, 38 AND 50).

CLASS 20—FURNITURE AND ARTICLES NOT OTHERWISE CLASSIFIED

FOR FURNITURE; WOOD STATUES; PLASTER STATUES, IVORY STATUES; WOOD SCULPTURES; PLASTER SCULPTURES AND IVORY SCULPTURES (U.S. CLS. 2, 13, 22, 25, 32 AND 50).

CLASS 27—FLOOR COVERINGS

FOR RUGS (U.S. CLS. 19, 20, 37, 42 AND 50).

OPTISOL

CLASS 1—CHEMICALS

FOR CHEMICALS USED IN INDUSTRY TO REMOVE CONTAMINATES FROM GASES AND LIQUIDS; CHELATING AGENTS; AMINE BASED ABSORBENTS AND SOLVENTS USED IN THE TREATMENT OF GASES (U.S. CLS. 1, 5, 6, 10, 26 AND 46).

CLASS 40—MATERIAL TREATMENT

FOR MATERIAL TREATMENT SERVICES RENDERED IN THE REMOVAL OF CONTAMINATES FROM GAS AND LIQUID STREAMS (U.S. CLS. 100, 103 AND 106).

CLASS 42—SCIENTIFIC, COMPUTER AND LEGAL SERVICES

FOR CHEMICAL ANALYSIS, CHEMICAL RESEARCH AND DEVELOPMENT FOR OTHERS, CHEMISTRY SERVICES, EVALUATION, CONSULTATION, DESIGN AND CHEMICAL ENGINEERING SERVICES, ALL IN THE FIELD OF REMOVAL OF GASES AND LIQUIDS FROM GAS AND LIQUID STREAMS (U.S. CLS. 100 AND 101).

SN 78-185,003. PRECISION DOOR SERVICE, INC., ROCKLEDGE, FL. FILED 11-14-2002.

A NAME YOU CAN TRUST

OWNER OF U.S. REG. NOS. 2,171,000 AND 2,580,904.

CLASS 6—METAL GOODS

FOR METAL GARAGE DOORS (U.S. CLS. 2, 12, 13, 14, 23, 25 AND 50).

CLASS 19—NON-METALLIC BUILDING MATERIALS

FOR NON-METAL GARAGE DOORS (U.S. CLS. 1, 12, 33 AND 50).

SN 78-186,148. NANO-TEX, LLC, GREENSBORO, NC. FILED 11-18-2002.

NANO-STRETCH

CLASS 24—FABRICS

FOR TEXTILE FABRICS FOR USE IN THE MANUFACTURE OF CLOTHING; TEXTILE FABRICS FOR USE IN THE MANUFACTURE OF HOME FURNISHINGS; TEXTILE FABRICS FOR USE IN THE MANUFACTURE OF FURNISHINGS FOR INDUSTRIAL AND COMMERCIAL USE; AND UPHOLSTERY FABRICS FOR HOME, INDUSTRIAL AND COMMERCIAL USE (U.S. CLS. 42 AND 50).

CLASS 25—CLOTHING

FOR FABRIC SOLD AS A COMPONENT OF CLOTHING, NAMELY SUITS, DRESSES, BLOUSES, SHIRTS, SKIRTS, PANTS, JEANS, SHORTS, SWEATERS, SWEATSHIRTS, T-SHIRTS, VESTS, COATS, JACKETS, BLAZERS, COVERALLS, UNIFORMS, ATHLETIC UNIFORMS, MILITARY UNIFORMS, LOUNGEWEAR, SLEEPWEAR, UNDERWEAR, SWIMWEAR, ACTIVEWEAR CONSISTING OF TOPS, BOTTOMS AND COORDINATED SETS OF TOPS AND BOTTOMS, RAINWEAR, APRONS, SOCKS, HOSIERY, GLOVES, SCARVES, BELTS, BIBS CONSISTING OF BABY BIBS NOT OF PAPER, BIB OVERALLS AND SKI BIBS, CLOTH DIAPERS, AND COSTUMES; FOOTWEAR; AND HEADWEAR; CLOTHING, NAMELY SUITS, DRESSES, BLOUSES, SHIRTS, SKIRTS, PANTS, JEANS, SHORTS, SWEATERS, SWEATSHIRTS, T-SHIRTS, VESTS, COATS, JACKETS, BLAZERS, COVERALLS, UNIFORMS, ATHLETIC UNIFORMS, MILITARY UNIFORMS, LOUNGEWEAR, SLEEPWEAR, UNDERWEAR, SWIMWEAR, ACTIVEWEAR CONSISTING OF TOPS, BOTTOMS AND COORDINATED SETS OF TOPS AND BOTTOMS, RAINWEAR, APRONS, SOCKS, HOSIERY, GLOVES, SCARVES, BELTS, BIBS CONSISTING OF BABY BIBS NOT OF PAPER, BIB OVERALLS AND SKI BIBS, CLOTH DIAPERS, AND COSTUMES; FOOTWEAR; AND HEADWEAR (U.S. CLS. 22 AND 39).

SN 78-188,347. LUCKY BRAND DUNGAREES, INC., VERNON, CA. FILED 11-24-2002.

LUCKY SOUNDS

NO CLAIM IS MADE TO THE EXCLUSIVE RIGHT TO USE "SOUNDS", APART FROM THE MARK AS SHOWN.

CLASS 9—ELECTRICAL AND SCIENTIFIC APPARATUS

FOR PRE-RECORDED CD-ROMS AND DVDS FEATURING MUSIC AND MUSICAL PERFORMANCES (U.S. CLS. 21, 23, 26, 36 AND 38).

CLASS 16—PAPER GOODS AND PRINTED MATTER

FOR BOOKS IN THE FIELD OF FASHION AND MUSIC (U.S. CLS. 2, 5, 22, 23, 29, 37, 38 AND 50).

SN 78-189,144. QVC, INC., WEST CHESTER, PA. FILED 11-26-2002.

INTELLICHEF**CLASS 7—MACHINERY**

FOR KITCHEN PRODUCTS, NAMELY JUICE MACHINES, ELECTRICAL PASTA MAKERS FOR DOMESTIC USE AND ELECTRICAL FOOD PROCESSORS, ELECTRIC MIXERS, ELECTRIC BLENDERS, ELECTRIC HAND MIXERS, ELECTRIC STAND MIXERS, ELECTRIC ICE CRUSHERS, ELECTRIC ICE CREAM MACHINES, ELECTRIC ICE SHAVERS, ELECTRIC FRUIT AND VEGETABLE PEELERS, ELECTRIC CAN OPENERS AND VACUUM SEALERS (U.S. CLS. 13, 19, 21, 23, 31, 34 AND 35).

CLASS 11—ENVIRONMENTAL CONTROL APPARATUS

FOR ELECTRIC COOKWARE, NAMELY, ELECTRICAL SKILLETS, ELECTRIC ROTISSERIES, BREAD MACHINES, ELECTRIC DEEP FRYERS, ELECTRIC PRESSURE COOKERS, BARBEQUE GRILLS, ELECTRIC TOASTERS, ELECTRIC TOASTER OVENS, ELECTRIC COFFEE MAKERS, ELECTRIC SLOW-COOK CASSEROLES, ELECTRIC WOKS, ELECTRIC FRYING PANS, ELECTRIC GRILLS, ELECTRIC GRIDDLES, OUTDOOR ELECTRIC GRILLS, SMOKELESS BARBEQUE GRILLS, CONVECTION OVENS FOR DOMESTIC USE, MICROWAVE OVENS FOR COOKING, ELECTRIC WAFFLE IRONS, ROASTER OVENS, ELECTRIC RICE COOKERS AND ELECTRIC FOOD STEAMERS (U.S. CLS. 13, 21, 23, 31 AND 34).

SN 78-189,147. DOWNSTEM MUSIC, INC., ORLANDO, FL. FILED 11-26-2002.

DOWNSTEM**CLASS 16—PAPER GOODS AND PRINTED MATTER**

FOR PAPER GOODS AND PRINTED MATTER, NAMELY POSTERS, CALENDARS, TEMPORARY TATTOOS, STICKERS, SHEET MUSIC, TOUR BOOKS, NOTE PADS, AND MAGAZINES RELATING TO A MUSICAL ARTIST (U.S. CLS. 2, 5, 22, 23, 29, 37, 38 AND 50).

CLASS 25—CLOTHING

FOR CLOTHING FOR MEN, WOMEN, AND CHILDREN, NAMELY T-SHIRTS, TANK TOPS, JERSEYS, SWEATSHIRTS, SWEATPANTS, JACKETS, KNITTED SHIRTS, UNDERWEAR, SHORTS, AND NIGHTSHIRTS; AND HEADWEAR, NAMELY HATS, CAPS, VISORS, AND BANDANNAS (U.S. CLS. 22 AND 39).

SN 78-190,426. EMEMORY TECHNOLOGY INC., HSINCHU, TAIWAN, FILED 12-2-2002.

CLASS 9—ELECTRICAL AND SCIENTIFIC APPARATUS

FOR SEMICONDUCTOR CHIPS AND SEMICONDUCTOR DEVICES, ALL FOR USE IN COMPUTING DEVICES, COMMUNICATION PRODUCTS, WIRELESS COMMUNICATION PRODUCTS AND ELECTRONIC CONSUMER PRODUCTS; INTEGRATED CIRCUITS FOR USE IN COMPUTERS, COMMUNICATION PRODUCTS AND ELECTRONIC CONSUMER PRODUCTS; COMPUTER HARDWARE, NAMELY, DIGITAL MEMORY CARDS USING SEMICONDUCTOR MEMORY TO STORE DIGITAL INFORMATION FOR USE IN COMPUTERS, COMMUNICATION DEVICES AND ELECTRONIC CONSUMER PRODUCTS; MEMORY CONTROLLERS, NAMELY, INTEGRATED CIRCUITS USED IN MEMORY CARDS FOR CONTROLLING WRITE IN/READ OUT DATA FROM THE MEMORY CARDS THAT ARE APPLIED TO COMPUTERS, TELECOMMUNICATION PRODUCTS AND ELECTRONIC CONSUMER PRODUCTS (U.S. CLS. 21, 23, 26, 36 AND 38).

CLASS 42—SCIENTIFIC, COMPUTER AND LEGAL SERVICES

FOR DESIGN AND TESTING OF INTEGRATED CIRCUITS FOR OTHERS; TESTING AND ANALYSIS OF INTEGRATED CIRCUITS FOR THE PURPOSE OF CERTIFICATION; DESIGN AND TESTING OF SEMICONDUCTOR CHIPS AND INTEGRATED CIRCUITS FOR OTHERS; SEMICONDUCTOR INTEGRATED CIRCUIT DESIGN AND CONSULTATION; INTEGRATED CIRCUIT DESIGN CONSULTATION; TECHNICAL CONSULTATION IN THE FIELDS OF INTEGRATED CIRCUIT DESIGN, AND DATA TRANSFORMATION AND FABRICATING PROCEDURES WITH RESPECT TO INTEGRATED CIRCUITS (U.S. CLS. 100 AND 101).

SN 78-190,463. BOEING MANAGEMENT COMPANY, SEAL BEACH, CA. FILED 12-2-2002.

F-15 STRIKE EAGLE

OWNER OF U.S. REG. NO. 2,707,382.

CLASS 9—ELECTRICAL AND SCIENTIFIC APPARATUS

FOR COMPUTER GAME PROGRAMS; COMPUTER SOFTWARE PROGRAMS FOR USE IN FLIGHT SIMULATION; MOUSEPADS (U.S. CLS. 21, 23, 26, 36 AND 38).

CLASS 14—JEWELRY

FOR CLOCKS AND WATCHES. (U.S. CLS. 2, 27, 28 AND 50).

SN 78-190,487. BOEING MANAGEMENT COMPANY, SEAL BEACH, CA. FILED 12-2-2002.

SONIC CRUISER**CLASS 14—JEWELRY**

FOR CLOCKS AND WATCHES. (U.S. CLS. 2, 27, 28 AND 50).

CLASS 18—LEATHER GOODS

FOR LUGGAGE (U.S. CLS. 1, 2, 3, 22 AND 41).

SN 78-190,960. BÖLLHOFF GMBH, BIELEFELD, FED REP GERMANY, FILED 12-4-2002.

FLEXAX

PRIORITY CLAIMED UNDER SEC. 44(D) ON FED REP GERMANY APPLICATION NO. 30227994.6, FILED 6-6-2002, REG. NO. 30227994, DATED 10-4-2002, EXPIRES 6-30-2012.

CLASS 6—METAL GOODS

FOR METAL CONNECTORS AND FASTENERS, NAMELY SCREWS, BOLTS, NUTS, WASHERS, AND COMPENSATING BUSHINGS; METAL CONNECTORS AND FASTENERS, NAMELY SCREWS, BOLTS, NUTS, WASHERS, AND COMPENSATING BUSHINGS; METAL CONNECTORS AND FASTENERS, NAMELY SCREWS, BOLTS, NUTS, WASHERS, AND COMPENSATING BUSHINGS (U.S. CLS. 2, 12, 13, 14, 23, 25 AND 50).

CLASS 20—FURNITURE AND ARTICLES NOT OTHERWISE CLASSIFIED

FOR NON-METAL CONNECTORS AND FASTENERS, NAMELY, PLASTIC SCREWS, PLASTIC BOLTS, PLASTIC NUTS, PLASTIC WASHERS, AND PLASTIC COMPENSATING BUSHINGS, AND CONNECTORS AND FASTENERS, NAMELY SCREWS, BOLTS, NUTS, WASHERS, AND COMPENSATING BUSHINGS, MADE OF A COMBINATION OF METAL AND PLASTIC; NON-METAL CONNECTORS AND FASTENERS, NAMELY, PLASTIC SCREWS, PLASTIC BOLTS, PLASTIC NUTS, PLASTIC WASHERS, AND PLASTIC COMPENSATING BUSHINGS, AND CONNECTORS AND FASTENERS, NAMELY SCREWS, BOLTS, NUTS, WASHERS, AND COMPENSATING BUSHINGS, MADE OF A COMBINATION OF METAL AND PLASTIC; NON-METAL CONNECTORS AND FASTENERS, NAMELY, PLASTIC SCREWS, PLASTIC BOLTS, PLASTIC NUTS, PLASTIC WASHERS, AND PLASTIC COMPENSATING BUSHINGS, AND CONNECTORS AND FASTENERS, NAMELY SCREWS, BOLTS, NUTS, WASHERS, AND COMPENSATING BUSHINGS, MADE OF A COMBINATION OF METAL AND PLASTIC (U.S. CLS. 2, 13, 22, 25, 32 AND 50).

SN 78-190,987. FORD MOTOR COMPANY, DEARBORN, MI. FILED 12-4-2002.

MONTCLAIR**CLASS 12—VEHICLES**

FOR MOTOR VEHICLES, NAMELY, AUTOMOBILES, TRUCKS, VANS, SPORT-UTILITY VEHICLES AND THEIR STRUCTURAL PARTS AND ENGINES (U.S. CLS. 19, 21, 23, 31, 35 AND 44).

CLASS 37—CONSTRUCTION AND REPAIR

FOR AUTOMOTIVE REPAIR AND MAINTENANCE SERVICES (U.S. CLS. 100, 103 AND 106).

SN 78-190,990. FORD MOTOR COMPANY, DEARBORN, MI. FILED 12-4-2002.

MOMENTUM**CLASS 12—VEHICLES**

FOR MOTOR VEHICLES, NAMELY, AUTOMOBILES, TRUCKS, VANS, SPORT-UTILITY VEHICLES AND THEIR STRUCTURAL PARTS AND ENGINES (U.S. CLS. 19, 21, 23, 31, 35 AND 44).

CLASS 37—CONSTRUCTION AND REPAIR

FOR AUTOMOTIVE REPAIR AND MAINTENANCE SERVICES (U.S. CLS. 100, 103 AND 106).

SN 78-190,994. FORD MOTOR COMPANY, DEARBORN, MI.
FILED 12-4-2002.

SN 78-193,892. VILLEROY & BOCH AG, METTLACH, FED
REP GERMANY, FILED 12-12-2002.

MARINER

CLASS 12—VEHICLES

FOR MOTOR VEHICLES, NAMELY, AUTOMOBILES, TRUCKS, VANS, SPORT-UTILITY VEHICLES AND THEIR STRUCTURAL PARTS AND ENGINES (U.S. CLS. 19, 21, 23, 31, 35 AND 44).

CLASS 37—CONSTRUCTION AND REPAIR

FOR AUTOMOTIVE REPAIR AND MAINTENANCE SERVICES (U.S. CLS. 100, 103 AND 106).

SN 78-191,024. FORD MOTOR COMPANY, DEARBORN, MI.
FILED 12-4-2002.

MONTAGE

CLASS 12—VEHICLES

FOR MOTOR VEHICLES, NAMELY, AUTOMOBILES, TRUCKS, VANS, SPORT-UTILITY VEHICLES AND THEIR STRUCTURAL PARTS AND ENGINES (U.S. CLS. 19, 21, 23, 31, 35 AND 44).

CLASS 37—CONSTRUCTION AND REPAIR

FOR AUTOMOTIVE REPAIR AND MAINTENANCE SERVICES (U.S. CLS. 100, 103 AND 106).

SN 78-191,094. JOHN RICH AND SONS INVESTMENT HOLDING COMPANY, WILMINGTON, DE. FILED 12-4-2002.

INSPIRED BY THE OUTDOORS

CLASS 20—FURNITURE AND ARTICLES NOT OTHERWISE CLASSIFIED

FOR PILLOWS (U.S. CLS. 2, 13, 22, 25, 32 AND 50).
FIRST USE 9-8-2002; IN COMMERCE 9-8-2002.

CLASS 24—FABRICS

FOR BLANKETS, COMFORTERS, DUST RUFFLES, PILLOW CASES, QUILTS, SHAMS, SHEETS, AND TROWS (U.S. CLS. 42 AND 50).
FIRST USE 9-8-2002; IN COMMERCE 9-8-2002.

CLASS 27—FLOOR COVERINGS

FOR DOORMATS AND RUGS (U.S. CLS. 19, 20, 37, 42 AND 50).
FIRST USE 9-8-2002; IN COMMERCE 9-8-2002.

HYPE

PRIORITY CLAIMED UNDER SEC. 44(D) ON FED REP GERMANY APPLICATION NO. 30229143.1/1, FILED 6-12-2002, REG. NO. 30229143, DATED 12-5-2002, EXPIRES 6-30-2012.

CLASS 11—ENVIRONMENTAL CONTROL APPARATUS

FOR LAMPS, WALL LIGHT FIXTURES, AND ELECTRIC LIGHT APPLIANCES, NAMELY, TRACK LIGHTING UNITS, FLUORESCENT LIGHTING TUBES, SCONCES AND SOCKETS; SANITARY EQUIPMENT ITEMS, NAMELY BATH TUBS, SHOWER TUBS, WHIRLPOOL TUBS AND STEAM BATHS, LAVATORIES, TOILET TANKS, TOILET SEATS, STRUCTURAL COVERS FOR URINALS, BIDETS AND URINALS; BATHROOM FITTING FOR CONNECTION, MIXING AND DISTRIBUTION OF WATER, NAMELY, BIBBS, COCKS, TRAPS AND VALVES; PLUMBING FITTINGS, NAMELY COUPLINGS, TAPS, VALVES, TRAPS, BIBBS, COCKS, CONTROL FITTINGS, NAMELY AERATORS, REDUCERS AND DIVERTERS; WALL UNITS, NAMELY, SHOWER WALL PARTITIONS AND SINKS; SHOWERS; SHOWER FITTINGS, NAMELY COUPLINGS, TAPS, VALVES, TRAPS, BIBBS AND CONTROL FITTINGS, NAMELY AERATORS, REDUCERS AND DIVERTERS; SHOWER ENCLOSURES, SHOWER TUBS AND SHOWER TRAYS FOR BATHROOMS AND PUBLIC BATHS; BATHTUB FEET; PLUMBING FITTINGS FOR WASH BASINS, SINKS, BATHTUBS AND SHOWERS NAMELY, FAUCETS, TAPS, SHOWER HEADS AND SHOWER VALVES, TUB FILLERS; PLUMBING FITTINGS, NAMELY, PLUMBING VALVES FOR MIXING SANITARY WATER SUPPLY; STRUCTURAL AND REPLACEMENT PARTS AND COMPONENTS FOR THE AFOREMENTIONED GOODS (U.S. CLS. 13, 21, 23, 31 AND 34).

CLASS 20—FURNITURE AND ARTICLES NOT OTHERWISE CLASSIFIED

FOR PICTURE FRAMES, MIRROR FRAMES, MIRRORS, MIRRORED BATHROOM CABINETS; FURNITURE FOR BATHROOMS, NAMELY VANITIES, SHELVES, CABINETS, RACKS, TABLES, AND CHAIRS (U.S. CLS. 2, 13, 22, 25, 32 AND 50).

CLASS 21—HOUSEWARES AND GLASS

FOR HOUSEHOLD CONTAINERS AND ARTICLES OF GLASS, CERAMIC AND PORCELAIN, NAMELY DECORATIVE BOWLS, PLATES AND PLATTERS, FIGURINES, SCULPTURES, CENTERPIECES, TEAPOTS, CANDLESTICKS AND CANDLE HOLDERS, VASES, POTS FOR PLANTS; DINNERWARE, NAMELY PLATES, CUPS, GLASSES, BOWLS, PLATTERS, PITCHERS, CASEROLE DISHES; KITCHEN CONTAINERS, NAMELY PITCHERS, VASES, BOWLS, TRAYS, PLATTERS, DISHES FOR COOKING AND BAKING; CERAMIC BATH ACCESSORIES, NAMELY TOILET PAPER HOLDERS, TOILET BRUSH HOLDERS, TOWEL HOLDERS, TOWEL RACKS, BATH UTENSIL HOLDERS, TOOTHBRUSH HOLDERS, BATHROOM CUPS AND WASH BASINS; BASKETS OF WICKER, STRAW AND WOOD (U.S. CLS. 2, 13, 23, 29, 30, 33, 40 AND 50).

SN 78-194,507. INTERNATIONAL TRUCK INTELLECTUAL PROPERTY COMPANY, LLC, WARRENVILLE, IL. FILED 12-13-2002.

SN 78-194,746. CORPORATE SUITES, LLC, NEW YORK, NY. FILED 12-16-2002.

PERFORMANCE A/C

OWNER OF U.S. REG. NO. 2,666,519.
NO CLAIM IS MADE TO THE EXCLUSIVE RIGHT TO USE "A/C", APART FROM THE MARK AS SHOWN.

CLASS 37—CONSTRUCTION AND REPAIR

FOR REPAIR AND MAINTENANCE OF AIR CONDITIONING SYSTEMS OF TRUCKS, BUSES AND PARTS THEREFORE (U.S. CLS. 100, 103 AND 106).
FIRST USE 4-0-2002; IN COMMERCE 4-0-2002.

CLASS 41—EDUCATION AND ENTERTAINMENT

FOR TRAINING SERVICES IN THE FIELD OF REPAIR AND MAINTENANCE OF AIR CONDITIONING SYSTEMS OF TRUCKS, BUSES AND PARTS THEREFORE (U.S. CLS. 100, 101 AND 107).
FIRST USE 4-0-2002; IN COMMERCE 4-0-2002.

SN 78-194,589. ORNSTEIN, NOAH, JEFFREY, NEW YORK, NY. FILED 12-14-2002.



THE MARK CONSISTS OF A STYLIZED DUCK.

CLASS 16—PAPER GOODS AND PRINTED MATTER

FOR BOOKS IN THE FIELD OF FIANCE AND LAW; FINANCIAL PRIMER BOOKS AND CALCULATORS SOLD AS IN A UNIT (U.S. CLS. 2, 5, 22, 23, 29, 37, 38 AND 50).

CLASS 36—INSURANCE AND FINANCIAL

FOR FINANCIAL PLANNING AND PROVIDING FINANCIAL INFORMATION (U.S. CLS. 100, 101 AND 102).

CLASS 42—SCIENTIFIC, COMPUTER AND LEGAL SERVICES

FOR LEGAL SERVICES (U.S. CLS. 100 AND 101).

CORPORATE SUITES

NO CLAIM IS MADE TO THE EXCLUSIVE RIGHT TO USE "SUITES", APART FROM THE MARK AS SHOWN.

CLASS 35—ADVERTISING AND BUSINESS

FOR TELEPHONE ANSWERING SERVICES AND MAIL SORTING, HANDLING AND RECEIVING SERVICES (U.S. CLS. 100, 101 AND 102).
FIRST USE 9-1-1997; IN COMMERCE 9-1-1997.

CLASS 36—INSURANCE AND FINANCIAL

FOR RENTAL AND LEASING OF OFFICE SPACE, EXECUTIVE OFFICE SUITES, AND CONFERENCE ROOMS (U.S. CLS. 100, 101 AND 102).
FIRST USE 9-1-1997; IN COMMERCE 9-1-1997.

SN 78-197,700. PPG INDUSTRIES OHIO, INC., CLEVELAND, OH. FILED 12-24-2002.

ENVIROSAGE

CLASS 2—PAINTS

FOR COATING COMPOSITIONS IN THE NATURE OF PAINT FOR AUTOMOTIVE AND INDUSTRIAL APPLICATIONS. (U.S. CLS. 6, 11 AND 16).

CLASS 42—SCIENTIFIC, COMPUTER AND LEGAL SERVICES

FOR ENGINEERING AND CONSULTING SERVICES IN THE FIELD OF THE SELECTION, FORMULATION AND APPLICATION OF COATINGS AND PAINTS. (U.S. CLS. 100 AND 101).

SN 78-198,299. EXPEDITORS INTERNATIONAL OF WASHINGTON INC., SEATTLE, WA. FILED 12-27-2002.

TRADE FLOW

CLASS 35—ADVERTISING AND BUSINESS

FOR BUSINESS CONSULTATION IN THE FIELD OF FREIGHT MANAGEMENT, IMPORTING AND EXPORTING, AND CONSOLIDATION (U.S. CLS. 100, 101 AND 102).

CLASS 39—TRANSPORTATION AND STORAGE

FOR INTERNATIONAL FREIGHT FORWARDING, IMPORTING AND EXPORTING, AND CONSOLIDATION (U.S. CLS. 100 AND 105).

CLASS 42—SCIENTIFIC, COMPUTER AND LEGAL SERVICES

FOR PROVIDING TEMPORARY USE OF ON-LINE NON-DOWNLOADABLE SOFTWARE FOR USE IN MANAGEMENT OF FREIGHT FORWARDING, IMPORTING AND EXPORTING, AND CONSOLIDATION (U.S. CLS. 100 AND 101).

SN 78-225,044. THE DOW CHEMICAL COMPANY, MIDLAND, MI. FILED 3-13-2003.

EXO

CLASS 9—ELECTRICAL AND SCIENTIFIC APPARATUS

FOR OUTER AND ACCESSORY ENCLOSURES, NONE BEING SOFTWARE OR ELECTRONIC HARDWARE, FOR CONSUMER ELECTRONIC AND INFORMATION TECHNOLOGY EQUIPMENT AND DEVICES (U.S. CLS. 21, 23, 26, 36 AND 38).

CLASS 40—MATERIAL TREATMENT

FOR CUSTOM MANUFACTURING OF OUTER AND ACCESSORY ENCLOSURES, NONE BEING SOFTWARE OR ELECTRONIC HARDWARE, FOR CONSUMER ELECTRONIC AND INFORMATION TECHNOLOGY EQUIPMENT AND DEVICES (U.S. CLS. 100, 103 AND 106).

CLASS 42—SCIENTIFIC, COMPUTER AND LEGAL SERVICES

FOR CUSTOM DESIGN AND ENGINEERING OF OUTER AND ACCESSORY ENCLOSURES, NONE BEING SOFTWARE OR ELECTRONIC HARDWARE, FOR CONSUMER ELECTRONIC AND INFORMATION TECHNOLOGY EQUIPMENT AND DEVICES (U.S. CLS. 100 AND 101).

* * * * *

SECTION 2.— INTERNATIONAL CLASSIFICATION

The short titles associated below with the international class numbers are terms designed merely for quick identification and are not an official part of the international classification. The full names of international classes are given in section 6.1 of the trademark rules of practice.

The designation "U.S. Cl." appearing in this section refers to the U.S. class in effect prior to Sep. 1, 1973 rather than the international class which applies to applications filed on or after that date. For adoption of international classification see notice in the OFFICIAL GAZETTE of Jun. 26, 1973 (911 O.G. TM 210).

Application in one class

CLASS 1—CHEMICALS

SN 75-541,316. S.N.F., S.A., 42000 SAINT-ETIENNE, FRANCE, FILED 8-24-1998.

FLOCARE

OWNER OF FRANCE REG. NO. 95572433, DATED 5-16-1995, EXPIRES 5-16-2005.

FOR CHEMICALS AND POLYMERS FOR USE IN THE MANUFACTURE OF COSMETICS EXCLUDING FLOCCULANT AGENTS AND COSMETIC BASES (U.S. CLS. 1, 5, 6, 10, 26 AND 46).

SN 75-731,702. VICTORIAN CHEMICALS INTERNATIONAL PTY LTD, RICHMOND 3121, VICTORIA, AUSTRALIA, FILED 6-18-1999.

HOT-UP

FOR CHEMICALS NAMELY ADJUVANTS THAT ARE USED WITH AGROCHEMICALS SUCH AS HERBICIDES, INSECTICIDES, PESTICIDES, CROP DESICCANTS, DEFOLIANTS AND PLANT HORMONES TO IMPROVE THE EFFICACY THEREOF FOR USE IN AGRICULTURE, HORTICULTURE AND FORESTRY (U.S. CLS. 1, 5, 6, 10, 26 AND 46).

SN 76-181,954. PREMIER TECH LTD., RIVIERE-DU-LOUP, QUEBEC G5R 4C9, CANADA, FILED 12-15-2000.

MYKE

PRIORITY CLAIMED UNDER SEC. 44(D) ON CANADA APPLICATION NO. 1075180, FILED 9-15-2000.

FOR MICROSCOPIC FUNGUS USED AS A BIOLOGICAL GROWING STIMULANT FOR PLANTS (U.S. CLS. 1, 5, 6, 10, 26 AND 46).

FIRST USE 3-0-2001; IN COMMERCE 2-0-2003.

CLASS 1—(Continued).

SN 76-319,131. DDB CORPORATION, HIALEAH, FL. FILED 9-28-2001.



NO CLAIM IS MADE TO THE EXCLUSIVE RIGHT TO USE "SWEET AMERICA", APART FROM THE MARK AS SHOWN.

FOR ARTIFICIAL SWEETENERS, NAMELY, A LOW CALORIE SUGAR SUBSTITUTE (U.S. CLS. 1, 5, 6, 10, 26 AND 46).

SN 76-369,477. GENECHOICE, INC., FREDERICK, MD. FILED 2-12-2002.

GENECHOICE

FOR FULL LINE OF MOLECULAR BIOLOGY KITS AND REAGENTS FOR GENETIC RESEARCH INCLUDING, DNA POLYMERASE; DNA POLYMERASE REACTION BUFFERS IN THE NATURE OF BUFFERS USED FOR AMPLIFICATION OF DNA; REACTION MIXES FOR RUNNING POLYMERASE CHAIN REACTIONS COMPRISING DNA POLYMERASE, DNTP AND RED DYE; DNA POLYMERASE, NAMELY, ENZYMES WITH DNA POLYMERASE AND PROOF-READING EXONNUCLEASE ACTIVITIES; BUFFER OPTIMIZATION KITS COMPRISING STANDARD BUFFERS, AMMONIUM BUFFERS AND COMBINATION BUFFERS USED FOR FINDING OPTIMAL SOLUTIONS FOR POLYMERASE CHAIN REACTIONS; ENHANCER OPTIMIZATION KITS FOR SELECTING ADDITIVES FOR TEMPLATES COMPRISING REACTIONS OF ENHANCER SOLUTIONS FOR TESTING TO DETERMINE IMPROVEMENTS IN POLYMERASE CHAIN REACTIONS; NUCLEOTIDES; DNTP MIXES; DNTP SOLUTIONS FOR USE IN DNA POLYMERIZATION REACTIONS, DNA-LABELLING AND SEQUENCING PROCESSES; DNA LADDERS; RAPID LIGATION KITS FOR CLONING OR SPLICING DNA COMPRISING LIGASE, ATP, AND BUFFERS; CELLS, RESTRICTION ENZYMES USED FOR CUTTING DNA; RESTRICTION ENDONUCLEASES USED FOR CUTTING DNA; RNA FROM SPECIFIC TISSUE; DIETHYL PYROCARBONATE TREATED WATER; THERMOSTABLE REVERSE TRANSCRIPTASE FOR MAKING CDNA; RIBONUCLEASE INHIBITORS FOR PREVENTING PROTEINS FROM DEGRADING RNA; REVERSE TRANSCRIPTASE KITS FOR PURIFYING

CLASS 1—(Continued).

CDNA COMPRISING BUFFERS, REVERSE TRANSCRIPTASE AND PRIMERS FOR ALLOWING COPYING OF RNA INTO DNA; MODIFYING ENZYMES FOR MODIFYING DNA; DNA LABELLING KITS COMPRISING DNA POLYMERASE, RANDOM HEXAMERS, NUCLEOTIDE MIXES AND REACTION BUFFERS FOR ALLOWING DOWNSTREAM IDENTIFICATION OF DNA; PLASMID PURIFICATION SPIN KITS FOR PURIFYING PLASMA DNA COMPRISING RESINS, CENTRIFUGE TUBES OR CONTAINERS, AND BUFFERS FOR ALLOWING ISOLATION OF PLASMA DNA FROM BACTERIA; GENOMIC DNA SPIN KITS COMPRISING RESINS, CENTRIFUGE TUBES OR CONTAINERS, AND BUFFERS FOR ALLOWING ISOLATION OF DNA FROM CELLS; DNA BLOOD SPIN KITS COMPRISING RESINS, CENTRIFUGE TUBES OR CONTAINERS, AND BUFFERS FOR ALLOWING ISOLATION OF DNA FROM BLOOD; DNA OR RNA ISOLATION KITS FOR EXTRACTING GENOMIC DNA OR RNA FROM WHOLE BLOOD, BLOOD LYMPHOCYTES, CULTURED CELLS OR TISSUES, COMPRISING RESINS, COLUMNS AND BUFFERS FOR ALLOWING ISOLATION OF DNA OR RNA FROM CELLS OR TISSUE; KITS FOR RECOVERING DNA FRAGMENTS FROM GELS OR SOLUTIONS COMPRISING RESINS AND BUFFERS FOR ISOLATING DNA FROM AGROSE GEL; KITS FOR PURIFICATION OF PCR PRODUCTS OR DNA COMPRISING PCR ASSAY, BUFFERS AND SPIN FILTERS FOR ISOLATING DNA FROM POLYMERASE CHAIN REACTIONS; SPIN COLUMNS FOR ISOLATING DNA OR RNA; KITS FOR ISOLATING RNA FREE OF GENOMIC DNA COMPRISING RESINS, COLUMNS AND BUFFERS FOR ALLOWING ISOLATION OF RNA FROM CELLS OR TISSUE; KITS FOR ISOLATING RNA FROM A VARIETY OF SAMPLES COMPRISING RESINS, COLUMNS AND BUFFERS FOR ALLOWING ISOLATION OF RNA FROM CELLS OR TISSUE; KITS FOR ISOLATING RNA FROM PLANT MATERIAL COMPRISING RESINS, COLUMNS, AND BUFFERS FOR ALLOWING ISOLATION OF RNA FROM PLANT TISSUE; AND REAGENTS (U.S. CLS. 1, 5, 6, 10, 26 AND 46).

FIRST USE 9-0-2000; IN COMMERCE 9-0-2000.

SN 76-399,902. LYNAS CORPORATION LTD., SYDNEY 2000 NEW SOUTH WALES, AUSTRALIA, FILED 4-24-2002.



PRIORITY CLAIMED UNDER SEC. 44(D) ON AUSTRALIA APPLICATION NO. 894082, FILED 11-6-2001, REG. NO. 894082, DATED 11-6-2001, EXPIRES 11-6-2011.

FOR LANTHANIDE AND ACTINIDE RARE EARTH ELEMENTS AND RARE EARTH METALS OF THE PERIODIC TABLE IN THEIR RAW FORM AND OXIDES OF THE AFOREMENTIONED, ALL USED FOR A WIDE VARIETY OF APPLICATIONS; CHEMICALS USED FOR A WIDE VARIETY OF APPLICATIONS IN INDUSTRY, SCIENCE AND PHOTOGRAPHY (U.S. CLS. 1, 5, 6, 10, 26 AND 46).

CLASS 1—(Continued).

SN 76-427,994. ADVANCED CHEMICALS CORPORATION, CASA GRANDE, AZ. FILED 7-8-2002.

INSTANT STOP 0042

FOR WATERPROOF CHEMICAL COMPOSITION FOR ARTICLES OF MASONRY, WOOD AND CONCRETE AND OTHER CONSTRUCTION SURFACES (U.S. CLS. 1, 5, 6, 10, 26 AND 46).

SN 76-474,192. GILLESPIE, MARK E., LOUISVILLE, OH. FILED 12-12-2002.



THE LINING IS A FEATURE OF THE MARK AND DOES NOT INDICATE COLOR.

FOR WATERPROOFING CHEMICAL COMPOSITIONS FOR USE ON WOOD AND WOOD PRODUCTS (U.S. CLS. 1, 5, 6, 10, 26 AND 46).

SN 78-056,296. EDEN BIOSCIENCE CORPORATION, BOTHELL, WA. FILED 4-2-2001.

MESSENGER

OWNER OF U.S. REG. NOS. 2,291,557 AND 2,291,558. FOR PLANT FOOD; GENES FOR USE IN THE PRODUCTION OF AGRICULTURAL SEED; GENES FOR USE IN THE MANUFACTURE OF AGRICULTURAL SEED; GENETICALLY ENGINEERED PROTEINS FOR PLANTS; CHEMICALS USED IN AGRICULTURE, HORTICULTURE AND FORESTRY, NAMELY, CHEMICALS USED AS PLANT FROST PROTECTANTS, CHEMICALS USED AS PLANT STRESS RELIEVERS AND CHEMICALS USED AS PLANT BIO-STIMULANTS; CHEMICALS USED FOR THE ENHANCEMENT OF SEED PERFORMANCE; CHEMICAL SUBSTANCES FOR PRESERVING FOODSTUFFS, PLANTS, AND FLOWERS; PRESERVATIVES FOR AGRICULTURAL, HORTICULTURAL AND FORESTRY USE; SURFACTANTS USED AS ADJUVANTS FOR PLANT GROWTH REGULATORS; CHEMICAL SUBSTANCES FOR ENHANCEMENT OF FLOWER SIZE, EXPANSION OF PETALS, BLOOM RETENTION AND INHIBITOR OF DESICCATION OF CUTTINGS FROM ORNAMENTAL PLANTS; AND SURFACTANTS FOR USE IN CONNECTION WITH AGRICULTURAL PESTICIDES (U.S. CLS. 1, 5, 6, 10, 26 AND 46).

CLASS 1—(Continued).

SN 78-142,515. COOTS, MICHEAL, DEXTER, MO. FILED 7-10-2002.



NO CLAIM IS MADE TO THE EXCLUSIVE RIGHT TO USE "CARBON CATALYST", APART FROM THE MARK AS SHOWN.

FOR LIQUID HUMAS FERTILIZER FOR AGRICULTURAL USE (U.S. CLS. 1, 5, 6, 10, 26 AND 46).

SN 78-143,100. POLYVAL PLC, LONDON, UNITED KINGDOM, FILED 7-11-2002.

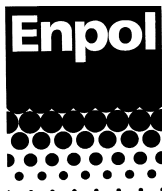

it's a wrap

OWNER OF U.S. REG. NO. 2,473,857.
FOR POLYMERS AND PLASTICS, UNPROCESSED PLASTICS IN THE NATURE OF FILTERING MATERIALS AND POLYMERS FOR USE IN MANUFACTURING CHEMICAL MIXING SACHETS, DETERGENT SACHETS, COTTON WOOL BUD STICKS, LAUNDRY BAGS, FISHING BAIT BAGS, DIAPERS, FEMININE HYGIENE PRODUCTS, HOSPITAL GLOVES AND GOWNS, REFUSE SACKS, CARRIER BAGS, PALLET WRAP, DISPOSABLE GLOVES, AGRICULTURAL FILMS, SEEDLING TRAYS, BEVERAGE CAN HOLDERS, BOTTLE LABELS, SEMICONDUCTOR PACKAGING, DISPOSABLE PLATES, CUPS, CUTLERY, LOOSE FILL PACKAGING, MOLDED PACKAGING, HEAT INSULATION MATERIAL, SEAT CUSHIONS, CIGARETTE FILTERS, AND FIRE RETARDANT MATERIALS; AND ADHESIVES FOR GENERAL BONDING AND REPAIR PURPOSES. (U.S. CLS. 1, 5, 6, 10, 26 AND 46).

CLASS 1—(Continued).

SN 78-149,308. ROHM AND HAAS COMPANY, PHILADELPHIA, PA. FILED 7-31-2002.

TSET

FOR CHEMICALS, CHEMICAL COMPOUNDS AND BINDERS USED TO ENHANCE PERFORMANCE, INCREASE STRENGTH, DURABILITY, STABILITY, ADHESION, HAND, HEAT, FLAME, FIRE AND SOLVENT RESISTANCE, AND PREVENT DEGRADATION AND DISCOLORATION FOR NATURAL, SYNTHETIC, AND MINERAL FIBERS AND SUBSTRATES BY THE NON-WOVEN, TEXTILE AND BUILDING PRODUCTS INDUSTRIES (U.S. CLS. 1, 5, 6, 10, 26 AND 46).

SN 78-165,830. BONIDE PRODUCTS, INC., ORISKANY, NY. FILED 9-19-2002.

EZ

FOR PESTICIDES FOR AGRICULTURAL AND DOMESTIC USE; INSECTICIDES FOR AGRICULTURAL AND DOMESTIC USE; HERBICIDES FOR AGRICULTURAL AND DOMESTIC USE; FUNGICIDES FOR AGRICULTURAL AND DOMESTIC USE (U.S. CLS. 1, 5, 6, 10, 26 AND 46).
FIRST USE 6-11-2002; IN COMMERCE 6-11-2002.

SN 78-173,389. HALLIBURTON ENERGY SERVICES, INC., CARROLLTON, TX. FILED 10-11-2002.

CRYSTAL-DRIL

FOR CHEMICAL ADDITIVES FOR USE IN A WATER-BASED, INHIBITIVE DRILLING FLUID USED TO MAXIMIZE DRILLING RATES OF PENETRATION IN OIL AND GAS WELL DRILLING (U.S. CLS. 1, 5, 6, 10, 26 AND 46).

SN 78-180,088. ROCKLAND CORPORATION, WEST CALDWELL, NJ. FILED 10-30-2002.

WINTER SHIELD

NO CLAIM IS MADE TO THE EXCLUSIVE RIGHT TO USE "WINTER", APART FROM THE MARK AS SHOWN.
FOR ANTI-TRANSPIRANTS AND ANTIDESSICANTS FOR TREES, SHRUBS, ORNAMENTAL PLANTS AND TURF, TO BE USED BOTH DOMESTICALLY AND COMMERCIALY (U.S. CLS. 1, 5, 6, 10, 26 AND 46).
FIRST USE 11-1-1985; IN COMMERCE 11-1-1985.

CLASS 1—(Continued).

SN 78-241,027. THE DOW CHEMICAL COMPANY, MIDLAND, MI. FILED 4-23-2003.

AGILITY

FOR POLYURETHANE DISPERSIONS FOR USE IN THE MANUFACTURE OF SYNTHETIC LEATHER (U.S. CLS. 1, 5, 6, 10, 26 AND 46).

SN 78-241,059. THE DOW CHEMICAL COMPANY, MIDLAND, MI. FILED 4-23-2003.

PHYSIQUE

FOR POLYURETHANE DISPERSIONS FOR USE IN THE MANUFACTURE OF SYNTHETIC LEATHER (U.S. CLS. 1, 5, 6, 10, 26 AND 46).

SN 78-241,077. THE DOW CHEMICAL COMPANY, MIDLAND, MI. FILED 4-23-2003.

ENDURANCE

FOR POLYURETHANE DISPERSIONS FOR USE IN THE MANUFACTURE OF SYNTHETIC LEATHER (U.S. CLS. 1, 5, 6, 10, 26 AND 46).

CLASS 2—PAINTS

SN 76-214,756. AKZO NOBEL COATINGS INTERNATIONAL BV, 2171 AJ SASSENHEIM, NETHERLANDS, FILED 2-22-2001.

ODYSSEY

PRIORITY CLAIMED UNDER SEC. 44(D) ON BENELUX APPLICATION NO. 0975886, FILED 10-20-2000, REG. NO. 0677227, DATED 10-20-2000, EXPIRES 10-20-2010.
FOR ANTIPOULING PAINTS FOR COMMERCIAL MARINE USE (U.S. CLS. 6, 11 AND 16).

CLASS 2—(Continued).

SN 76-417,587. TRIANGLE COATINGS, INC., SAN LEANDRO, CA. FILED 6-5-2002.

TRIANGLE DIGITAL

NO CLAIM IS MADE TO THE EXCLUSIVE RIGHT TO USE "DIGITAL", APART FROM THE MARK AS SHOWN.

FOR INKJET INKS FOR DROP-ON-DEMAND AND CONTINUOUS INKJET PRINTERS FOR WIDE AND SUPER-WIDE FORMAT AND OTHER PRINTERS USED TO PRINT INDOOR AND OUTDOOR ADVERTISING, FINE ART, AND PACKAGING MATERIALS ON PAPER, VINYL, WOOD, PLASTIC AND METAL SUBSTRATES, FOR USE IN PRINTING, PACKAGING AND CONVERTING INDUSTRIES; CLEAR COATINGS AND LIQUID LAMINATES IN THE NATURE OF PAINT FOR THE PROTECTION OF INK LAYERS ON ADVERTISING AND OTHER PRINTED MATERIALS SUCH AS PRINTS, LABELS, SIGNAGE, TRUCKS AND BUSES (U.S. CLS. 6, 11 AND 16).

FIRST USE 9-30-2000; IN COMMERCE 9-30-2000.

SN 76-458,302. TNEMEC COMPANY, INC., KANSAS CITY, MO. FILED 10-15-2002.

ULTRA-TREAD

FOR CEMENTATIOUS URETHANE COATING FOR REPAIR AND RESURFACING OF CONCRETE FLOORS (U.S. CLS. 6, 11 AND 16).

SN 78-045,549. SHERWIN-WILLIAMS COMPANY, THE, CLEVELAND, OH. FILED 1-30-2001.

KEM FLOOR

NO CLAIM IS MADE TO THE EXCLUSIVE RIGHT TO USE "FLOOR", APART FROM THE MARK AS SHOWN.

FOR PROTECTIVE AND DECORATIVE COATINGS USED IN THE NATURE OF PAINT FOR FLOORS (U.S. CLS. 6, 11 AND 16).

SN 78-128,065. ZHUHAI NINESTAR TECHNOLOGY CO., LTD., NANPING, ZHUHAI, CHINA, FILED 5-12-2002.

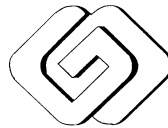

G&G

FOR INK CARTRIDGES AND INK REFILL KITS FOR COMPUTER PRINTERS, TONER AND TONER CARTRIDGES FOR COPIERS AND LASER PRINTERS (U.S. CLS. 6, 11 AND 16).

FIRST USE 1-8-2001; IN COMMERCE 1-8-2001.

CLASS 2—(Continued).

SN 78-161,945. THE SHERWIN-WILLIAMS COMPANY, CLEVELAND, OH. FILED 9-9-2002.

FUSION FOR PLASTIC

NO CLAIM IS MADE TO THE EXCLUSIVE RIGHT TO USE "PLASTIC", APART FROM THE MARK AS SHOWN. FOR DECORATIVE SPRAY COATINGS THAT HAVE PROTECTIVE QUALITIES (U.S. CLS. 6, 11 AND 16). FIRST USE 12-2-2002; IN COMMERCE 12-2-2002.

SN 78-197,695. PPG INDUSTRIES OHIO, INC., CLEVELAND, OH. FILED 12-24-2002.

STRATABASE

FOR COATING COMPOSITIONS IN THE NATURE OF PAINT FOR AUTOMOTIVE AND INDUSTRIAL APPLICATIONS. (U.S. CLS. 6, 11 AND 16).

SN 78-198,123. SATIS VACUUM OF AMERICA, INC., GROVEPORT, OH. FILED 12-27-2002.

MIRROR_X

The Next Generation of Color For Prescription Lenses

NO CLAIM IS MADE TO THE EXCLUSIVE RIGHT TO USE "PRESCRIPTION LENSES", APART FROM THE MARK AS SHOWN.

FOR OPHTHALMIC THIN FILM COATING, APPLIED TO PRESCRIPTION GLASS, POLYCARBONATE AND PLASTIC SUNGLASS LENSES (U.S. CLS. 6, 11 AND 16).

CLASS 3—COSMETICS AND CLEANING PREPARATIONS

SN 75-719,173. BASIC BEAUTY LLC, LOS ANGELES, CA. FILED 6-1-1999.

SEXY LIPS

NO CLAIM IS MADE TO THE EXCLUSIVE RIGHT TO USE "LIPS", APART FROM THE MARK AS SHOWN.

FOR COSMETICS AND BEAUTY PRODUCTS FOR LIPS, NAMELY LIPSTICKS, LIP PENCILS, LIP LINERS, LIP GLOSS, LIP CREAMS, LIP COLOR, LIP SEALANT, LIP CONDITIONERS, LIP MOISTURIZERS AND NON-MEDICATED LIP BALMS (U.S. CLS. 1, 4, 6, 50, 51 AND 52).

CLASS 3—(Continued).

SN 75-841,047. WELLA AG, 64274 DARMSTADT, FED REP GERMANY, FILED 11-4-1999.

WELLNESS

OWNER OF U.S. REG. NOS. 378,026, 1,702,745 AND OTHERS.

FOR HAIR CARE PREPARATIONS, NAMELY, SHAMPOO, CONDITIONERS AND FOR HAIR STYLING PREPARATIONS, NAMELY, SPRAYS, LOTIONS, GELS, MOUSSES AND POMADES (U.S. CLS. 1, 4, 6, 50, 51 AND 52).

SN 76-056,830. ART PROFESSIONAL COSMETIC GMBH, 85757 KARLSFELD, FED REP GERMANY, FILED 5-25-2000.

ARABESQUE

OWNER OF FED REP GERMANY REG. NO. 1088919, DATED 3-11-1986, EXPIRES 8-24-2004.

FOR PERSONAL AND BEAUTY CARE PRODUCTS, NAMELY DEODORANTS, TALCUM POWDER, SOAPS, ESSENTIAL OILS; HAIR CARE PRODUCTS, NAMELY HAIR SHAMPOOS, HAIR CONDITIONERS, HAIR WAX, HAIR STYLING MOUSSE, HAIR COLORANTS, HAIR DYES, HAIR DETANGLERS, HAIR SPRAYS AND HAIR BALMS; SUN PROTECTION PRODUCTS, NAMELY, SUN CREAMS, SUN TAN LOTIONS, SUN TAN OILS AND NON-MEDICATED LIPSTICKS; AND FOOT CARE PRODUCTS, NAMELY CREAMS, GELS, LOTIONS AND NON-MEDICATED CORN REMOVING PREPARATIONS (U.S. CLS. 1, 4, 6, 50, 51 AND 52).

SN 76-064,268. PLAYTEX PRODUCTS, INC., WESTPORT, CT. FILED 6-6-2000.

FOR THAT JUST BATHED CLEAN

FOR BABY WIPES, BABY BATH PRODUCTS, NAMELY HAIR SHAMPOO, BODY WASH, POWDERS, LOTIONS AND OILS (U.S. CLS. 1, 4, 6, 50, 51 AND 52). FIRST USE 9-30-2000; IN COMMERCE 9-30-2000.

SN 76-095,231. THE TV SHOPPING SOURCE, INC., NEW CANAAN, CT. FILED 7-24-2000.

SCENT OF A MAN

NO CLAIM IS MADE TO THE EXCLUSIVE RIGHT TO USE "SCENT", APART FROM THE MARK AS SHOWN.

FOR COLOGNE, PERFUME AND A FULL LINE OF TOILETRIES (U.S. CLS. 1, 4, 6, 50, 51 AND 52).

CLASS 3—(Continued).

SN 76-153,560. ALTERNA, INC., LOS ANGELES, CA. FILED 10-25-2000.

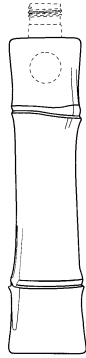

THE MARK CONSISTS OF A BOTTLE IN THE FORM OF A PIECE OF BAMBOO WITH TWO PROTRUDING GROWTH RINGS, AND DOTTED LINES INDICATE PORTIONS OF THE CONTAINER THAT ARE NOT FEATURES OF THE MARK.

FOR HAIR SHAMPOO (U.S. CLS. 1, 4, 6, 50, 51 AND 52).
FIRST USE 8-8-2000; IN COMMERCE 8-8-2000.



SN 76-153,561. ALTERNA, INC., LOS ANGELES, CA. FILED 10-25-2000.

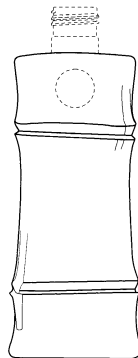

THE MARK CONSISTS OF A BOTTLE IN THE FORM OF A PIECE OF BAMBOO WITH TWO PROTRUDING GROWTH RINGS, AND DOTTED LINES INDICATE PORTIONS OF THE CONTAINER THAT ARE NOT FEATURES OF THE MARK.

FOR HAIR CONDITIONER (U.S. CLS. 1, 4, 6, 50, 51 AND 52).
FIRST USE 8-8-2000; IN COMMERCE 8-8-2000.

CLASS 3—(Continued).

SN 76-362,205. CAMPBELL, JOHN W., STARKSVILLE, MA. FILED 1-23-2002.



FOR NON-MEDICATED SKIN CARE PREPARATIONS (U.S. CLS. 1, 4, 6, 50, 51 AND 52).
FIRST USE 11-17-2000; IN COMMERCE 11-17-2000.



SN 76-386,556. CARDIN, PIERRE, 75008 PARIS, FRANCE, FILED 3-25-2002.

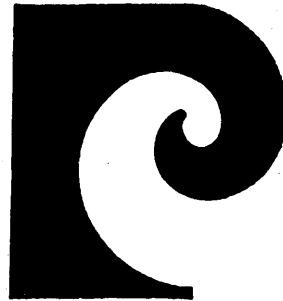

OWNER OF FRANCE REG. NO. 1,734,281, DATED 12-6-1989, EXPIRES 11-4-2009.

THE MARK CONSISTS OF THE STYLIZED LETTERS "PC".
FOR GENERAL PURPOSE CLEANING, POLISHING AND ABRASIVE LIQUIDS AND POWDERS; BODY SOAPS; PERFUMES; ESSENTIAL OILS FOR PERSONAL USE; COSMETICS; HAIR LOTIONS AND TOOTHPASTE (U.S. CLS. 1, 4, 6, 50, 51 AND 52).



SN 76-404,520. L'OREAL, PARIS, FRANCE, FILED 5-7-2002.

FORCINTENSE

OWNER OF FRANCE REG. NO. 99809684, DATED 8-27-1999, EXPIRES 8-27-2009.

FOR HAIR CARE PRODUCTS, NAMELY, SHAMPOOS AND HAIR COLOR (U.S. CLS. 1, 4, 6, 50, 51 AND 52).

CLASS 3—(Continued).

SN 76-404,887. L'OREAL, PARIS, FRANCE, FILED 5-9-2002.

RICHESSSE

THE ENGLISH TRANSLATION OF "RICHESSSE" IS "WEALTH".

FOR HAIR COLOR (U.S. CLS. 1, 4, 6, 50, 51 AND 52).
FIRST USE 9-0-2000; IN COMMERCE 9-0-2000.

SN 76-407,830. JCL COMPANIES, INC., NEW YORK, NY.
FILED 5-8-2002.

PURITY

FOR ESSENTIAL OILS FOR SKIN, HAIR AND SCALP
(U.S. CLS. 1, 4, 6, 50, 51 AND 52).

SN 76-410,160. LEPADATU, ADRIANA, LA JOLLA, CA.
FILED 5-21-2002.

**ADRIANA LEPADATU
ORGANIC EUROPEAN SKIN
CARE-NATURE'S BEAUTY
GIFT**

NO CLAIM IS MADE TO THE EXCLUSIVE RIGHT TO
USE "ORGANIC EUROPEAN SKIN CARE", APART FROM
THE MARK AS SHOWN.

FOR FACE MASQUES, FACE CREAMS, FACE EYE
CREAMS, FACE TONERS, FACE LOTIONS, HANDS
CREAMS, BODY JELLYS, BODY SPRAYS (U.S. CLS. 1,
4, 6, 50, 51 AND 52).

SN 76-411,291. PARK, DONG-SUNG, KANGNAM-GU,
SEOUL, REPUBLIC OF KOREA, FILED 5-30-2002.

GREENOX

FOR ALL PURPOSE CLEANSER FOR USE IN KITCHENS,
HOSPITALS, RESTAURANT, CAFETERIA AND
CATERING FACILITIES; AND CARPET CLEANERS
FOR USE IN KITCHENS, HOSPITALS, RESTAURANT,
CAFETERIA AND CATERING FACILITIES; DETERGENT
SOAP FOR USE IN KITCHENS, HOSPITALS,
RESTAURANT, CAFETERIA AND CATERING FACILITIES;
AND DISHWASHING DETERGENT FOR USE IN
KITCHENS, HOSPITALS, RESTAURANT, CAFETERIA
AND CATERING FACILITIES; SKIN SOAP; FACIAL
CLEANSERS; SKIN CLEANSING CREAM AND LOTION;
AND CLEANING PREPARATIONS FOR USE ON AND
IN TOILETS (U.S. CLS. 1, 4, 6, 50, 51 AND 52).

CLASS 3—(Continued).

SN 76-414,790. MYKYTYN ENTERPRISES, INC., HOUSTON, TX. FILED 5-30-2002.

ONE MINUTE FACIAL

OWNER OF U.S. REG. NO. 2,500,082.

NO CLAIM IS MADE TO THE EXCLUSIVE RIGHT TO
USE "FACIAL", APART FROM THE MARK AS SHOWN.

FOR HAND CREME, BODY SKIN SOAP; RESTORATION
BODY OIL, AND FACE CREME (U.S. CLS. 1, 4, 6,
50, 51 AND 52).

SN 76-422,854. FLINN, GEORGE, MEMPHIS, TN. FILED 6-
19-2002.

PERSONAL SKIN TRAINER

NO CLAIM IS MADE TO THE EXCLUSIVE RIGHT TO
USE "SKIN", APART FROM THE MARK AS SHOWN.

FOR COSMETIC CREAM FOR APPLICATION TO
SKIN (U.S. CLS. 1, 4, 6, 50, 51 AND 52).

SN 76-422,916. CHANEL, INC., NEW YORK, NY. FILED 6-19-
2002.

INITIATEUR HYDRATATION

NO CLAIM IS MADE TO THE EXCLUSIVE RIGHT TO
USE "HYDRATATION", APART FROM THE MARK AS
SHOWN.

THE ENGLISH TRANSLATION OF "INITIATEUR HY-
DRATATION" IS "INITIATOR HYDRATION".

FOR NON-MEDICATED SKIN CARE PREPARATIONS
(U.S. CLS. 1, 4, 6, 50, 51 AND 52).

SN 76-425,956. TRASK ENTERPRISES, INC., ORANGE, CA.
FILED 6-28-2002.

BODY BOUQUET

NO CLAIM IS MADE TO THE EXCLUSIVE RIGHT TO
USE "BODY", APART FROM THE MARK AS SHOWN.

FOR COSMETICS, NAMELY, SKIN SOAPS, PER-
FUMES, BODY OILS, SKIN LOTIONS, SKIN CREAMS,
SKIN EXFOLIATES, HAIR CONDITIONERS AND
SHAMPOOS, LIP COLORING, FACIAL TREATMENTS,
AND NAIL CARE PREPARATIONS (U.S. CLS. 1, 4, 6, 50,
51 AND 52).

CLASS 3—(Continued).

SN 76-425,958. TRASK ENTERPRISES, INC., ORANGE, CA.
FILED 6-28-2002.

BABY BOUQUET

NO CLAIM IS MADE TO THE EXCLUSIVE RIGHT TO USE "BABY", APART FROM THE MARK AS SHOWN.

FOR COSMETICS, NAMELY, SKIN SOAPS, PERFUMES, BODY OILS, SKIN LOTIONS, SKIN CREAMS, SKIN EXFOLIATES, HAIR CONDITIONERS AND SHAMPOOS, LIP COLORING, FACIAL TREATMENTS, AND NAIL CARE PREPARATIONS (U.S. CLS. 1, 4, 6, 50, 51 AND 52).

SN 76-453,670. LAYFF KOSMETIC LTDA, UBERABA - MG,
BRAZIL, FILED 9-23-2002.



FOR HAIR AND SCALP CARE PRODUCTS AND PREPARATIONS, NAMELY, HAIR SHAMPOOS, HAIR CONDITIONERS, HAIR MOISTURIZERS, HAIR RELAXERS AND HAIR RELAXING PREPARATIONS, HAIR STRAIGHTENING PREPARATIONS, HAIR RINSES, HAIR LOTIONS, HAIR CLEANING PREPARATIONS, HAIR STYLING PREPARATIONS (U.S. CLS. 1, 4, 6, 50, 51 AND 52).

SN 76-461,558. DE CASTRO, BLANCA CARRIERE, MENDOZA, ARGENTINA, FILED 10-24-2002.



THE ENGLISH TRANSLATION OF "TIERRAS DEL VOLCAN" IS "LAND OF THE VOLCANO".

FOR NON-MEDICATED NATURAL SKIN CARE PREPARATIONS AND CREAMS, NAMELY MUD TREATMENTS, FIRING CREAMS, CLEANSING CREAMS; BATH AND SHOWER GELS, SOAPS, THERMAL WATER SPRAY, HAIR SHAMPOOS AND CONDITIONERS (U.S. CLS. 1, 4, 6, 50, 51 AND 52).

CLASS 3—(Continued).

SN 76-465,182. ANDERSON, PAMELA, BEVERLY HILLS, CA.
FILED 11-7-2002.

PAMELA ANDERSON

THE MARK IDENTIFIES A LIVING INDIVIDUAL WHOSE CONSENT IS OF RECORD.

FOR COSMETICS, COSMETIC REMOVERS, BEAUTY MASKS, BODY MASKS, FACIAL CLEANSERS, FACIAL MASKS, SHAVING GEL, SKIN CLEANSERS, SKIN MOISTURIZING MASKS, PERSONAL FRAGRANCES, NAMELY COLOGNE, EAU DE TOILETTE, PERFUME AND ESSENTIAL OILS FOR PERSONAL USE, BATH POWDER, BODY POWDER, PERSONAL CARE PREPARATIONS, NAMELY BATH, HAND AND BODY LOTIONS (U.S. CLS. 1, 4, 6, 50, 51 AND 52).

SN 76-466,928. NEUTROGENA CORPORATION, LOS ANGELES, CA. FILED 11-5-2002.

NEUTROGENA HYDRATING FACIAL

OWNER OF U.S. REG. NOS. 590,385, 2,019,977 AND OTHERS.

NO CLAIM IS MADE TO THE EXCLUSIVE RIGHT TO USE "HYDRATING FACIAL", APART FROM THE MARK AS SHOWN.

FOR FACIAL SKIN CARE PRODUCTS, NAMELY, FACIAL CLEANSER, FACIAL WIPES AND FACIAL STRIPS, EYE CREAM, EYE GEL, EYE LOTION, FACIAL TREATMENT CREAM, FACIAL TREATMENT GEL, FACIAL TREATMENT LOTION, ANTI-AGING CREAM, ANTI-AGING GEL, ANTI-AGING LOTION, MOISTURIZER CREAM, MOISTURIZER GEL, MOISTURIZER LOTION, FACIAL MASKS; COSMETICS, NAMELY, FOUNDATION, MAKE-UP, LOOSE FACIAL POWDER, PRESSED FACIAL POWDER, CONCEALER, EYE SHADOW AND LIP COLOR; BODY CARE PRODUCTS, NAMELY, BODY LOTION, BODY CREAM, BODY WASH, BODY SHAVE GEL, ANTI-PERSPIRANT, HAND CREAM AND HAND LOTION (U.S. CLS. 1, 4, 6, 50, 51 AND 52).

CLASS 3—(Continued).

SN 76-467,839. BEIERSDORF AKTIENGESELLSCHAFT, 20245 HAMBURG, FED REP GERMANY, FILED 11-18-2002.



OWNER OF FED REP GERMANY REG. NO. 30214366, DATED 6-10-2002, EXPIRES 3-31-2012.

OWNER OF U.S. REG. NO. 2,340,170 AND OTHERS.

NO CLAIM IS MADE TO THE EXCLUSIVE RIGHT TO USE "LIP CARE", APART FROM THE MARK AS SHOWN.

THE MARK CONSISTS OF THE WORDS "NIVEA LIP CARE" WHICH APPEAR IN WHITE STYLIZED LETTERING AGAINST A DARK BLUE OVAL DESIGN. A CRESCENT DESIGN APPEARS IN THE LOWER RIGHT OF THE OVAL; THE LEFT SIDE OF THE CRESCENT IS WHITE; THE RIGHT A BLEND OF WHITE, SILVER AND GRAY. THE OVAL IS SURROUNDED BY A THIN BORDER WHICH IS A BLEND OF WHITE, SILVER AND GRAY. THE COLORS DARK BLUE, SILVER AND GRAY ARE CLAIMED AS FEATURES OF THE MARK.

FOR PREPARATIONS FOR BODY AND BEAUTY CARE, NAMELY NON-MEDICATED LIP BALM AND NON-MEDICATED SUN SCREEN PROTECTION PREPARATIONS FOR LIP CARE (U.S. CLS. 1, 4, 6, 50, 51 AND 52).

SN 76-468,019. GERMAINE DE CAPUCCINI, S.A., 03800 ALCOY (ALICANTE), SPAIN, FILED 11-12-2002.

**HYDRASOIN**

OWNER OF U.S. REG. NOS. 1,434,420 AND 1,839,815. FOR FACIAL CREAMS; FACIAL EMULSIONS; SKIN LIGHTENERS; FACIAL LOTIONS; SKIN MOISTURIZERS (U.S. CLS. 1, 4, 6, 50, 51 AND 52).

FIRST USE 9-13-2001; IN COMMERCE 12-19-2001.

SN 76-469,507. SPIRIT EARTH, L.L.C., BRICK, NJ. FILED 11-14-2002.



FOR COSMETICS; SOAPS, CLEANSERS, TONERS AND EXFOLIATES FOR THE SKIN; MOISTURIZING LOTIONS, CREAMS AND ESSENTIAL OILS FOR THE SKIN (U.S. CLS. 1, 4, 6, 50, 51 AND 52).

CLASS 3—(Continued).

SN 76-470,469. CHESEBROUGH-POND'S INC., WILMINGTON, DE. FILED 11-27-2002.



FOR BODY WASH (U.S. CLS. 1, 4, 6, 50, 51 AND 52).

SN 76-471,745. A.G. PROFESSIONAL HAIR CARE PRODUCTS, LTD., BURNABY, BRITISH COLUMBIA, CANADA, FILED 10-17-2002.

SPRAY FIXX

OWNER OF CANADA REG. NO. TMA493,037, DATED 4-16-1998, EXPIRES 4-16-2013.

NO CLAIM IS MADE TO THE EXCLUSIVE RIGHT TO USE "SPRAY", APART FROM THE MARK AS SHOWN.

FOR HAIR CARE PRODUCTS, NAMELY, SHAPING AND STYLING PREPARATIONS FOR HAIR (U.S. CLS. 1, 4, 6, 50, 51 AND 52).

SN 76-473,330. BROWN, FORREST C., DALLAS, TX. FILED 12-10-2002.

LATIN ORCHID

FOR COSMETICS (U.S. CLS. 1, 4, 6, 50, 51 AND 52).

SN 76-477,265. AUSTRALIAN GOLD, INC., INDIANAPOLIS, IN. FILED 12-20-2002.

DA' BOMB BRONZER

NO CLAIM IS MADE TO THE EXCLUSIVE RIGHT TO USE "BRONZER", APART FROM THE MARK AS SHOWN. FOR SUNTANNING PREPARATIONS (U.S. CLS. 1, 4, 6, 50, 51 AND 52).

CLASS 3—(Continued).

SN 76-477,531. CHESEBROUGH-POND'S INC., WILMINGTON, DE. FILED 12-20-2002.

LEVER 2000 MOISTURE FRESH

OWNER OF U.S. REG. NOS. 1,842,235, 2,326,537 AND 2,544,611.
FOR BODY WASH (U.S. CLS. 1, 4, 6, 50, 51 AND 52).

SN 76-477,752. L'OREAL, PARIS, FRANCE, FILED 12-24-2002.

MAKE YOUR SKIN SING WITH HAPPINESS

FOR COSMETICS, NAMELY, CREAMS, MILKS, LOTIONS, GELS AND POWDERS FOR THE FACE, BODY AND THE HANDS; COSMETIC SUN CARE PREPARATIONS (U.S. CLS. 1, 4, 6, 50, 51 AND 52).

SN 76-478,404. ACUITY BRANDS, INC., ATLANTA, GA. FILED 12-20-2002.

DRAINTAINER

FOR DRAIN CLEANERS AND OPENERS (U.S. CLS. 1, 4, 6, 50, 51 AND 52).
FIRST USE 10-31-2002; IN COMMERCE 10-31-2002.

SN 76-478,710. FOREVER NEW INTERNATIONAL, INC., SIOUX FALLS, SD. FILED 12-27-2002.

OVACIÓN

APPLICANT FURTHER STATES THAT "OVACION" IS THE SPANISH WORD FOR "OVATION".
FOR CLEANING PREPARATIONS FOR FABRIC (U.S. CLS. 1, 4, 6, 50, 51 AND 52).
FIRST USE 4-22-1998; IN COMMERCE 4-22-1998.

SN 76-478,740. INTERNATIONAL LABORATORY TECHNOLOGY CORP., MIAMI, FL. FILED 12-13-2002.

TRAVEL GUARD

FOR ANTIBACTERIAL HAND LOTION (U.S. CLS. 1, 4, 6, 50, 51 AND 52).

CLASS 3—(Continued).

SN 76-479,733. TREVCO, INC., TROY, MI. FILED 12-30-2002.

ZEN MOMENT

FOR POTPOURRI, AROMATHERAPY OILS, AND SCENTED OILS USED TO PRODUCE AROMAS WHEN HEATED (U.S. CLS. 1, 4, 6, 50, 51 AND 52).

SN 76-485,304. PRL USA HOLDINGS, INC., WILMINGTON, DE. FILED 1-27-2003.

POLO SPORT COOL RALPH LAUREN

OWNER OF U.S. REG. NOS. 1,222,278, 2,338,949 AND OTHERS.

THE NAME "RALPH LAUREN" IDENTIFIES A LIVING INDIVIDUAL WHOSE CONSENT IS OF RECORD.

FOR EAU DE TOILETTE, FACE AND BODY MOISTURIZERS, CREAMS AND LOTIONS, FACE AND BODY CLEANSERS AND TONERS, FACE WASH, SHAVING CREAM, SHAVING GEL, AFTER SHAVE, EYE GELS, EYE CREAMS, NON-MEDICATED SKIN CREAMS AND SKIN LOTIONS FOR RELIEVING RAZOR BURNS, BATH AND SHOWER GEL, AND SOAPS (U.S. CLS. 1, 4, 6, 50, 51 AND 52).

SN 76-492,344. POLI GLOW PRODUCTS, INC., FORT PIERCE, FL. FILED 2-26-2003.

POLI GLOW

FOR POLYMER SEALANT FOR CLEANING, SHINING AND PROTECTING FIBERGLASS (U.S. CLS. 1, 4, 6, 50, 51 AND 52).

FIRST USE 7-0-1993; IN COMMERCE 7-0-1993.

SN 78-025,346. VAZQUEZ, MAXIMINO, NEW YORK, NY. FILED 9-11-2000.

FEVER

FOR PERFUMES, EAUX DE COLOGNE, TOILET SOAPS, TOILET WATER, ESSENTIAL OILS FOR PERSONAL USE, MILKS FOR THE FACE AND BODY, SKIN SOAP, SKIN LOTIONS, BODY EMULSIONS, BODY MOISTURIZER, GELS FOR FACE AND BODY, AFTER-SHAVE LOTION, AFTERSHAVE GEL, SHAVING CREAM, SHAVING LOTION, DUSTING POWDER, TALCUM POWDER, PERFUMED BATH POWDER, DEODORANTS FOR PERSONAL USE, BODY CREAMS, NON-MEDICATED BATH GELS, NON-MEDICATED BATH OILS, NON-MEDICATED BATH SALTS, LIPSTICKS, LIPGLOSS STICKS, NAIL ENAMEL, FOUNDATION MAKEUP COLORED SKIN CREAMS, MAKE-UP REMOVING MILKS, MAKE-UP REMOVING CREAMS, MAKE-UP REMOVING GELS, MASCARA, EYE SHADOW, ROUGE, PENCILS FOR COSMETIC USE, FACIAL POWDERS, NON-MEDICATED HAIR PREPARATIONS, NAMELY, HAIR SPRAY, HAIR GEL, HAIR CREAMS, HAIR BALMS, HAIR FOAMS, HAIR SHAMPOOS (U.S. CLS. 1, 4, 6, 50, 51 AND 52).

CLASS 3—(Continued).

SN 78-130,204. PHILOSOPHY, INC., PHOENIX, AZ. FILED 5-21-2002.

BABY GRACE

NO CLAIM IS MADE TO THE EXCLUSIVE RIGHT TO USE "BABY", APART FROM THE MARK AS SHOWN.

FOR MAKE-UP KITS COMPRISED OF LIPSTICK, LIP GLOSS, LIP LINER, LIP BALM, BLUSH, FOUNDATION, EYE SHADOW, EYE LINER, MASCARA, CONCEALER, COSMETIC PENCILS, AND FACIAL POWDER; COSMETICS, NAMELY, LIPSTICK, LIP GLOSS, LIP LINER, LIP BALM, BLUSH, FOUNDATION, EYE SHADOW, EYE LINER, MASCARA, CONCEALER, COSMETIC PENCILS, AND FACIAL POWDER; FRAGRANCES, NAMELY, PERFUME, COLOGNE, AND AFTER-SHAVE; NON-MEDICATED SKIN CARE PRODUCTS, NAMELY, SOAP, SCRUBS, TONER, CONDITIONER, EXFOLIATORS, SKIN CLARIFIER, WRINKLE REMOVING SKIN CARE PREPARATIONS, AND MOISTURIZER; FACE AND BODY LOTION, CREAM, OIL, GEL AND SPRAY; SUN SCREEN PREPARATIONS, NAMELY, LOTION, CREAM, GEL, AND SPRAY; NON-MEDICATED FACE AND BODY SKIN LIGHTENER; HAIR CARE PRODUCTS, NAMELY, SHAMPOO, CONDITIONER, RINSE, GEL, MOUSSE, SPRAY AND TONIC; BATH CARE PRODUCTS, NAMELY, SOAP, SALTS, CRYSTALS, BEADS, GEL, OIL, POWDER, AND BUBBLE BATH; SCENTED HEAD-TO-TOE BODY WASH; NAIL CARE PREPARATIONS, NAMELY, CUTICLE CREAM, CUTICLE REMOVING PREPARATIONS, NAIL ENAMEL, NAIL POLISH, NAIL POLISH REMOVER, NAIL POLISH BASE COAT, NAIL POLISH TOP COAT, AND NAIL STRENGTHENERS; PERSONAL DEODORANT; NON-MEDICATED BABY CARE PRODUCTS, NAMELY LOTIONS, CREAMS, OINTMENTS, BATH SOAPS, POWDERS, AND SHAMPOOS. (U.S. CLS. 1, 4, 6, 50, 51 AND 52).

SN 78-131,867. ICEBOX-SCOOPS, INC., NEW YORK, NY. FILED 5-29-2002.

ICED PLATINUM

FOR COSMETICS, NON-MEDICATED SKIN CARE PREPARATIONS, HAIR CARE PREPARATIONS, LIP GLOSS, LIPSTICK, LIP PENCIL, LIP BALM, NAIL POLISH, MASCARA, EYE SHADOW, BLUSH, EYE PENCIL, FOUNDATION, FOUNDATION CREAM, COSMETIC POWDER, BATH AND BODY LOTION, SHOWER GEL, HAIR SHAMPOO, AND CONDITIONERS (U.S. CLS. 1, 4, 6, 50, 51 AND 52).

SN 78-132,473. LOW, ARTHUR, MIAMI, FL. FILED 5-31-2002.

SEA THERAPEUTICS

NO CLAIM IS MADE TO THE EXCLUSIVE RIGHT TO USE "THERAPEUTICS", APART FROM THE MARK AS SHOWN.

FOR COSMETICS, NAMELY, SOAPS, BATH SALTS, AND BODY SPRAYS (U.S. CLS. 1, 4, 6, 50, 51 AND 52).

CLASS 3—(Continued).

SN 78-138,076. HENKEL KGAA, DUESSELDORF, FED REP GERMANY, FILED 6-24-2002.

RE-NATURE

OWNER OF FED REP GERMANY REG. NO. 39739687, DATED 3-2-2001, EXPIRES 8-31-2007.

FOR NON-MEDICATED HAIR CARE PREPARATIONS, NAMELY HAIR COLOR RESTORING CREAM, SHAMPOO (U.S. CLS. 1, 4, 6, 50, 51 AND 52).

SN 78-144,539. TUDRYN, KRISTY, SANTA BARBARA, CA. FILED 7-17-2002.

THE BATH BAKERY

NO CLAIM IS MADE TO THE EXCLUSIVE RIGHT TO USE "BATH", APART FROM THE MARK AS SHOWN.

FOR SOAPS, SHAMPOOS; COSMETICS, NAMELY, SKIN MOISTURIZERS AND NON-MEDICATED LIP BALMS; ABRASIVES FOR PERSONAL USE, NAMELY, FACIAL SCRUB, FACIAL CLEANSERS, FACIAL SOAP, BODY SCRUB, SKIN MOISTURIZING CREAM, HAND MOISTURIZING LOTION AND MOISTURIZING BODY LOTION; NON-MEDICATED MASSAGE OILS, LOTION STICKS, AND LOTIONS; BATH ADDITIVES, NAMELY, BATH OILS, BATH TEAS, BATH BEADS, MILK BATH, BODY SHAMPOOS, SHOWER GELS, BATH SALTS AND BUBBLE BATH, ALL NOT FOR MEDICAL PURPOSES; SHAVING CREAM, SHAVING LOTION, SHAVING BALM, SHAVING GEL, AFTER-SHAVE LOTION AND GEL; ESSENTIAL OILS FOR PERSONAL USE, CLEANSING AND MOISTURIZING FACIAL PACKS, FACIAL MASKS AND PUMICE STONES FOR PERSONAL USE (U.S. CLS. 1, 4, 6, 50, 51 AND 52).

SN 78-145,566. REVLON CONSUMER PRODUCTS CORPORATION, NEW YORK, NY. FILED 7-19-2002.

COLOR ILLUSION REVLON

OWNER OF U.S. REG. NOS. 647,222, 1,983,525 AND OTHERS.

NO CLAIM IS MADE TO THE EXCLUSIVE RIGHT TO USE "COLOR", APART FROM THE MARK AS SHOWN.

FOR NAIL ENAMEL (U.S. CLS. 1, 4, 6, 50, 51 AND 52). FIRST USE 8-30-2002; IN COMMERCE 8-30-2002.

SN 78-152,852. PACIFIC WORLD CORPORATION, LAKE FOREST, CA. FILED 8-9-2002.

NAIL PERFECT

NO CLAIM IS MADE TO THE EXCLUSIVE RIGHT TO USE "NAIL", APART FROM THE MARK AS SHOWN.

FOR ARTIFICIAL NAILS (U.S. CLS. 1, 4, 6, 50, 51 AND 52).

CLASS 3—(Continued).

SN 78-154,726. CLARINS S.A., NEUILLY-SUR-SEINE, FRANCE, FILED 8-15-2002.

PAR AMOUR

PRIORITY CLAIMED UNDER SEC. 44(D) ON BENELUX APPLICATION NO. 1006063, FILED 2-25-2002, REG. NO. 0707142, DATED 2-25-2002, EXPIRES 2-25-2012.

THE MARK TRANSLATES TO THE ENGLISH WORDING "WITH LOVE" OR "THROUGH LOVE".

FOR PERFUME, PERFUME WATER, EAU DE TOILETTE, EAU DE COLOGNE, COSMETIC PREPARATIONS FOR BATH AND DOUCHE, COSMETIC CREAMS, PERFUMED BODY LOTIONS AND BODY MILKS FOR COSMETIC USE, TALCUM POWDER, PERFUMED SOAP, DEODORANTS FOR PERSONAL USE, PERFUMED OIL FOR COSMETIC USE (U.S. CLS. 1, 4, 6, 50, 51 AND 52).

SN 78-161,562. NIOXIN RESEARCH LABORATORIES, INC., ATLANTA, GA. FILED 9-6-2002.

**CYTONUTRIENT ACTIVES
TREATMENT**

NO CLAIM IS MADE TO THE EXCLUSIVE RIGHT TO USE "TREATMENT", APART FROM THE MARK AS SHOWN.

FOR HAIR CARE PREPARATIONS (U.S. CLS. 1, 4, 6, 50, 51 AND 52).

FIRST USE 6-10-2002; IN COMMERCE 6-10-2002.

SN 78-171,135. PRODUCTION CHEMICAL MANUFACTURING, INC., STOCKTON, CA. FILED 10-4-2002.

ANTEE WEB WAX

OWNER OF U.S. REG. NO. 2,157,923.

NO CLAIM IS MADE TO THE EXCLUSIVE RIGHT TO USE "WEB WAX", APART FROM THE MARK AS SHOWN.

FOR AUTOMOBILE WAX, NAMELY, A PROTECTIVE COATING FOR REMOVING SPIDERWEBS AND POLISHING AND PROTECTING THE SURFACE OF AUTOMOBILES APPLIED IN THE MANNER OF A POLISH OR SIMILAR PREPARATION (U.S. CLS. 1, 4, 6, 50, 51 AND 52).

FIRST USE 9-2-1997; IN COMMERCE 9-2-1997.

SN 78-175,657. PACIFIC WORLD CORPORATION, LAKE FOREST, CA. FILED 10-17-2002.

EXPRESS NAIL REMOVER

NO CLAIM IS MADE TO THE EXCLUSIVE RIGHT TO USE "NAIL REMOVER", APART FROM THE MARK AS SHOWN.

FOR NAIL TREATMENTS, NAMELY ARTIFICIAL FINGERNAIL ADHESIVE REMOVERS (U.S. CLS. 1, 4, 6, 50, 51 AND 52).

CLASS 3—(Continued).

SN 78-177,814. NA'ALE NAOT (1994) LTD., UPPER GALILEE, ISRAEL, FILED 10-24-2002.

DEAD SEA TREASURES

NO CLAIM IS MADE TO THE EXCLUSIVE RIGHT TO USE "DEAD SEA", APART FROM THE MARK AS SHOWN, FOR BATH CRYSTALS, FOOT CREAM, HAND CREAM AND BODY LOTION (U.S. CLS. 1, 4, 6, 50, 51 AND 52).

FIRST USE 11-6-2000; IN COMMERCE 11-6-2000.

SN 78-179,258. SATO PHARMACEUTICAL CO., LTD., TOKYO, JAPAN, FILED 10-28-2002.

LARYNGOAL

OWNER OF U.S. REG. NO. 1,625,581.

FOR BREATH FRESHENERS (U.S. CLS. 1, 4, 6, 50, 51 AND 52).

SN 78-180,355. BLAINE LABS, INC., SANTA FE SPRINGS, CA. FILED 10-31-2002.

LIGHT TOUCH

FOR LIQUID SKIN BLEACH FOR BLEACHING DARK SKIN BLEMISHES. (U.S. CLS. 1, 4, 6, 50, 51 AND 52).

SN 78-180,434. NOON IN CHINA, LLC, NEW YORK, NY. FILED 10-31-2002.

ENVIRONMENTAL RESCUE

FOR FACIAL MAKE-UP, FOUNDATION, FACE POWDER, BLUSH, GLITTER, HAIR COLOR, HAIR DYES, HAIR LIGHTENERS, HAIR RINSES, LIPSTICK, LIP BALM, LIP LINERS, LIP PENCILS, ASTRINGENTS FOR COSMETIC PURPOSES, BEAUTY MASKS, CONCEALERS FOR SKIN AND FACE, COSMETIC PENCILS, MASCARA, EYE MAKEUP, EYE LINER, EYE SHADOW, EYE PENCILS, EYE MAKEUP REMOVER, NAIL STRENGTHENERS, NAIL ENAMEL, NAIL POLISH, NAIL POLISH REMOVER, CUTICLE CONDITIONERS, CUTICLE REMOVING PREPARATIONS, OTHER COSMETICS; ARTIFICIAL FINGERNAILS, ARTIFICIAL EYELASHES (U.S. CLS. 1, 4, 6, 50, 51 AND 52).

FIRST USE 12-1-1998; IN COMMERCE 12-1-1998.

CLASS 3—(Continued).

SN 78-187,997. THE PROCTER & GAMBLE COMPANY, CINCINNATI, OH. FILED 11-22-2002.



THE MARK CONSISTS OF AN ABSTRACT DESIGN OF A MAN, WOMAN, AND CHILD HOLDING HANDS WITHIN A SHIELD DESIGN.

FOR PERSONAL CLEANSING PRODUCTS, NAMELY, BAR SOAP (U.S. CLS. 1, 4, 6, 50, 51 AND 52).

SN 78-189,009. S. C. JOHNSON & SON, INC., RACINE, WI. FILED 11-26-2002.

POWER BEADS

NO CLAIM IS MADE TO THE EXCLUSIVE RIGHT TO USE "BEADS", APART FROM THE MARK AS SHOWN. FOR TOILET BOWL CLEANERS. (U.S. CLS. 1, 4, 6, 50, 51 AND 52).

SN 78-189,361. SMITHKLINE BEECHAM CORPORATION, PHILADELPHIA, PA. FILED 11-27-2002.

AQUAFRESH LIMITED EDITION

OWNER OF U.S. REG. NOS. 1,006,820, 2,343,517 AND OTHERS. FOR TOOTHPASTE (U.S. CLS. 1, 4, 6, 50, 51 AND 52).

SN 78-189,428. KEYSTONE SCENT COMPANY, INC., BALTIMORE, MD. FILED 11-27-2002.

STONEDESIGNS

OWNER OF U.S. REG. NOS. 983,113, 2,088,313 AND OTHERS. FOR AIR FRESHENER (U.S. CLS. 1, 4, 6, 50, 51 AND 52). FIRST USE 2-1-2000; IN COMMERCE 2-1-2000.

CLASS 3—(Continued).

SN 78-189,820. HANDY APPLICATIONS, INC., ATLANTA, GA. FILED 11-29-2002.

HANDYAPPS

FOR TOPICAL SKIN CARE PRODUCT APPLICATORS (U.S. CLS. 1, 4, 6, 50, 51 AND 52).

SN 78-190,488. WILK, BRIAN L., CHALFONT, PA. FILED 12-2-2002.

ENLIGHTEN

FOR COSMETIC TOOTH WHITENER (U.S. CLS. 1, 4, 6, 50, 51 AND 52).

SN 78-190,855. PHILOSOPHY, INC., PHOENIX, AZ. FILED 12-3-2002.

TIME IN A BOTTLE

FOR MAKE-UP KITS COMPRISED OF LIPSTICK, LIP GLOSS, LIP LINER, LIP BALM, BLUSH, FOUNDATION, EYE SHADOW, EYE LINER, MASCARA, CONCEALER, COSMETIC PENCILS, AND FACIAL POWDER; COSMETICS, NAMELY, LIPSTICK, LIP GLOSS, LIP LINER, LIP BALM, BLUSH, FOUNDATION, EYE SHADOW, EYE LINER, MASCARA, CONCEALER, COSMETIC PENCILS, AND FACIAL POWDER; FRAGRANCES, NAMELY, PERFUME, COLOGNE, AND AFTER-SHAVE; NON-MEDICATED SKIN CARE PRODUCTS, NAMELY, SOAP, SCRUBS, TONER, CONDITIONER, EXFOLIATORS, SKIN CLARIFIER, WRINKLE REMOVING SKIN CARE PREPARATIONS, AND MOISTURIZER; FACE AND BODY LOTION, CREAM, OIL, GEL AND SPRAY; SUN SCREEN PREPARATIONS, NAMELY, LOTION, CREAM, GEL, AND SPRAY; NON-MEDICATED FACE AND BODY SKIN LIGHTENER; HAIR CARE PRODUCTS, NAMELY, SHAMPOO, CONDITIONER, RINSE, GEL, MOUSSE, SPRAY AND TONIC; BATH CARE PRODUCTS, NAMELY, SOAP, SALTS, CRYSTALS, BEADS, GEL, OIL, POWDER, AND BUBBLE BATH; SCENTED HEAD-TO-TOE BODY WASH; NAIL CARE PREPARATIONS, NAMELY, CUTICLE CREAM, CUTICLE REMOVING PREPARATIONS, NAIL ENAMEL, NAIL POLISH, NAIL POLISH REMOVER, NAIL POLISH BASE COAT, NAIL POLISH TOP COAT, AND NAIL STRENGTHENERS; PERSONAL DEODORANT. (U.S. CLS. 1, 4, 6, 50, 51 AND 52).

SN 78-190,995. L'OREAL USA CREATIVE, INC., NEW YORK, NY. FILED 12-4-2002.

ULTRA-LINER

FOR COSMETICS, NAMELY, EYE LINER (U.S. CLS. 1, 4, 6, 50, 51 AND 52). FIRST USE 0-0-1990; IN COMMERCE 0-0-1990.

CLASS 3—(Continued).

SN 78-194,938. NOXELL CORPORATION, HUNT VALLEY, MD. FILED 12-16-2002.

COLOUR ADAPT PARTICLES

FOR COSMETICS, NAMELY, FOUNDATION (U.S. CLS. 1, 4, 6, 50, 51 AND 52).

SN 78-197,106. STOECKER, MARK A., FLOWER MOUND, TX. FILED 12-21-2002.

REGENOVATE

FOR COSMETICS (U.S. CLS. 1, 4, 6, 50, 51 AND 52).

SN 78-197,806. DOCTOR BRONZE SOLAR POTIONS INC., ELMONT, NY. FILED 12-26-2002.

GEL E ROLL

FOR AFTER-SHAVE LOTIONS; AFTER-SUN LOTIONS; ANTI-AGING AND ANTI-WRINKLE CREAMS; ANTI-BACTERIAL, DEODORANT, SADDLE, AND TOILET SOAPS; LIQUID SOAPS FOR HAND, FACE AND BODY; DEODORANTS AND ANTIPERSPIRANTS; AROMATHERAPY OILS; BABY SHAMPOOS, LOTIONS, OILS AND POWDERS; BATH BEADS, CRYSTALS, FOAMS, GELS, OILS, PEARLS, AND POWDERS; NON-MEDICATED BATH SALTS; BEAUTY MASKS; SHOWER GELS; BODY CREAMS, EMULSIONS, OILS, POWDERS, AND SCRUBS; BODY MASKS; BUBBLE BATH; SKIN CLEANSING CREAMS AND LOTIONS; COCOA BUTTER FOR COSMETIC PURPOSES; COLD CREAMS; COLOGNE; COMPACTS CONTAINING MAKEUP; CONCEALERS; HAIR CARE AND HAIR CLEANING PREPARATIONS; HAIR CONDITIONERS, SHAMPOOS, SCULPTING GELS, STYLING GELS, LOTIONS, LIGHTENERS, MOUSSE, POMADES, RELAXERS, RINSES, AND SPRAYS; HAIR MASCARAS; SKIN CONDITIONERS; COTTON, COTTON BALLS, COTTON STICKS, AND COTTON SWABS ALL FOR COSMETIC PURPOSES; COSMETIC PENCILS; ALL-PURPOSE COTTON SWABS FOR PERSONAL USE; EYE CREAMS AND GELS; HAIR REMOVING CREAMS; HAND CREAMS; NIGHT CREAMS; SHAVING BALMS, CREAMS, FOAMS, LOTIONS, AND GELS; VANISHING CREAMS; CREAMS FOR CELLULITE REDUCTION; CUTICLE CREAMS AND CONDITIONERS; CUTICLE REMOVING PREPARATIONS; DEPILATORIES; DEPILATORY CREAMS; DISPOSABLE WIPES IMPREGNATED WITH CHEMICALS OR COMPOUNDS FOR PERSONAL HYGIENE; HAIR COLORS AND DYES; HAIR COLOR REMOVERS; EAU DE PARFUM; EAU DE TOILETTE; PERFUME; TOILET WATER; EMERY BOARDS; EYE MAKEUP AND EYE MAKEUP REMOVER; EYE AND EYEBROW PENCILS; EYE SHADOWS; EYE LINERS; FACE CREAMS AND POWDERS; SKIN AND FACIAL CLEANSERS, CREAMS, EMULSIONS, MASKS, AND SCRUBS; NON-MEDICATED FOOT POWDERS AND FOOT DEODORANT SPRAYS; FOUNDATION MAKEUP; SHOWER GELS; TOOTH GELS, PASTES, POLISHES, AND POWDERS; NON-MEDICATED LIP BALM; LIP GLOSS; LIP CREAMS; LIPSTICK; LIP LINERS; HAIR DRESSING FOR MEN; HAIR STRENGTHENING PREPARATIONS; HAIR WAVING LOTIONS; MAKEUP; MAKEUP REMOVERS; MASCARA; MASSAGE OILS; SKIN MOISTURIZERS; MUSTACHE WAX; NAIL CARE PREPARATIONS; NAIL CREAMS, ENAMELS, GLITTER, HARDENERS, AND POLISH; NAIL POLISH REMOVERS; NON-MEDICATED BODY SOAKS; ESSENTIAL OILS FOR PERSONAL USE; PATCHES CONTAINING

CLASS 3—(Continued).

SUN SCREEN AND SUN BLOCK FOR USE ON THE SKIN; PERFUME OILS; PETROLEUM JELLY FOR COSMETIC PURPOSES; TALCUM POWDERS; PRE-MOISTENED COSMETIC TISSUES, TOWELETTS, AND WIPES; PUMICE STONES FOR PERSONAL USE; ROUGE; SCENTED BODY SPRAYS; SELF-TANNING LOTIONS; SHAVING SOAP; SKIN ABRASIVE PREPARATIONS; SKIN CLARIFIERS, CLEANSERS, EMOLLIENTS, LIGHTENERS, TEXTURIZERS, TONERS, AND LOTIONS; SKIN GELS FOR ACCELERATING, ENHANCING OR EXTENDING TANS; SKIN SOAPS; SKIN WHITENING CREAMS; SUN BLOCK AND SUN SCREEN PREPARATIONS; SUNTANNING PREPARATIONS, NAMELY, CREAMS, GELS, LOTIONS, AND OILS; AND WRINKLE REMOVING SKIN CARE PREPARATIONS (U.S. CLS. 1, 4, 6, 50, 51 AND 52).

SN 78-199,389. MAKE-UP ART COSMETICS INC., NEW YORK, NY. FILED 1-2-2003.

CHROMACAKE

FOR COSMETICS (U.S. CLS. 1, 4, 6, 50, 51 AND 52).

SN 78-213,416. SMITHKLINE BEECHAM CORPORATION, PHILADELPHIA, PA. FILED 2-11-2003.

AQUAFRESH FAST & FLEXIBLE

OWNER OF U.S. REG. NOS. 1,006,820, 1,906,569 AND OTHERS.

NO CLAIM IS MADE TO THE EXCLUSIVE RIGHT TO USE "FAST", APART FROM THE MARK AS SHOWN.

FOR TOOTH WHITENING PREPARATIONS (U.S. CLS. 1, 4, 6, 50, 51 AND 52).

SN 78-213,421. SMITHKLINE BEECHAM CORPORATION, PHILADELPHIA, PA. FILED 2-11-2003.

AQUAFRESH FAST FLEX

OWNER OF U.S. REG. NOS. 1,006,820, 1,906,569 AND OTHERS.

NO CLAIM IS MADE TO THE EXCLUSIVE RIGHT TO USE "FAST", APART FROM THE MARK AS SHOWN.

FOR TOOTH WHITENING PREPARATIONS (U.S. CLS. 1, 4, 6, 50, 51 AND 52).

SN 78-225,004. SMITHKLINE BEECHAM CORPORATION, PHILADELPHIA, PA. FILED 3-13-2003.

CINNAMON SPLASH

NO CLAIM IS MADE TO THE EXCLUSIVE RIGHT TO USE "CINNAMON", APART FROM THE MARK AS SHOWN.

FOR TOOTHPASTE (U.S. CLS. 1, 4, 6, 50, 51 AND 52).

CLASS 3—(Continued).

SN 78-233,891. ROSE, JOHN R., PHOENIX, AZ. FILED 4-4-2003.

GLIMRA

FOR ALL NATURAL INDOOR TANNING CREME. (U.S. CLS. 1, 4, 6, 50, 51 AND 52).

CLASS 5—PHARMACEUTICALS

SN 75-771,087. BOEHRINGER INGELHEIM INTERNATIONAL GMBH, D-55216 INGELHEIM AM RHEIN, FED REP GERMANY, FILED 8-9-1999.

MIRAZE

OWNER OF FED REP GERMANY REG. NO. 39907654, DATED 6-3-1999, EXPIRES 2-11-2009.

FOR PHARMACEUTICAL PREPARATIONS, NAMELY FOR THE TREATMENT OF DISEASES OF THE CARDIOVASCULAR SYSTEM, THE RESPIRATORY TRACT, THE CENTRAL NERVOUS SYSTEM, THE MUSCULAR-SKELETAL SYSTEM, AND THE IMMUNOLOGICAL SYSTEM (U.S. CLS. 6, 18, 44, 46, 51 AND 52).

CLASS 4—LUBRICANTS AND FUELS

SN 78-136,185. FORKAS, LISA M., DBA ADIRONDACK LIGHTS, SCHENECTADY, NY. FILED 6-17-2002.

ADIRONDACK LIGHTS

NO CLAIM IS MADE TO THE EXCLUSIVE RIGHT TO USE "LIGHTS", APART FROM THE MARK AS SHOWN. FOR CANDLES (U.S. CLS. 1, 6 AND 15). FIRST USE 9-1-1996; IN COMMERCE 9-1-1996.

SN 75-915,420. ASN INTERNATIONAL, INC., HOOD RIVER, OR. FILED 2-2-2000.



FOR NUTRITIONAL AND DIETARY SUPPLEMENTS (U.S. CLS. 6, 18, 44, 46, 51 AND 52). FIRST USE 9-11-1998; IN COMMERCE 9-11-1998.

SN 78-192,857. IDEAL INDUSTRIES, INC., SYCAMORE, IL. FILED 12-10-2002.

CLEARGLIDE

FOR WIRE PULLING LUBRICANT (U.S. CLS. 1, 6 AND 15). FIRST USE 5-31-1999; IN COMMERCE 5-31-1999.

SN 76-222,848. ADHEREX TECHNOLOGIES INC., OTTAWA, ONTARIO, CANADA, FILED 3-8-2001.



SN 78-200,559. MIRACLE CANDLE COMPANY, LAREDO, TX. FILED 1-7-2003.

GATEWAY CANDLES

NO CLAIM IS MADE TO THE EXCLUSIVE RIGHT TO USE "CANDLES", APART FROM THE MARK AS SHOWN. FOR CANDLES (U.S. CLS. 1, 6 AND 15).

FOR PHARMACEUTICAL PREPARATIONS, NAMELY, CELL ADHESION MODULATING AGENTS FOR USE IN THE TREATMENT OF CANCER, ENDOMETRIOSIS, MACULAR DEGENERATION AND OTHER ANGIOGENESIS-DEPENDENT CONDITIONS, MULTIPLE SCLEROSIS AND OTHER DEMYELINATING DISEASES, SPINAL CORD INJURY, OBESITY, AND HAIR LOSS; THERAPEUTIC PREPARATIONS, NAMELY, CELL ADHESION MODULATING AGENTS FOR USE IN DRUG DELIVERY SYSTEMS FOR FACILITATING THE TRANSMISSION OF AGENTS THROUGH HUMAN TISSUE; AND DIAGNOSTIC PREPARATIONS, NAMELY, CELL ADHESION MODULATING AGENTS FOR USE IN MEDICAL DIAGNOSTIC REAGENTS (U.S. CLS. 6, 18, 44, 46, 51 AND 52).

CLASS 5—(Continued).

SN 76-272,319. NEWAYS, INC., SALEM, UT. FILED 6-14-2001.

SILENCE

FOR NUTRITIONAL SUPPLEMENT (U.S. CLS. 6, 18, 44, 46, 51 AND 52).

SN 76-331,424. FOREFRONT DIAGNOSTIC, INC., LAKE FOREST, CA. FILED 10-30-2001.

INSTASCREEN

OWNER OF U.S. REG. NOS. 2,251,052, 2,566,709 AND 2,603,851.

FOR DRUG SCREENING KIT COMPRISING REAGENT STRIPS FOR TESTING FOR DRUGS IN URINE (U.S. CLS. 6, 18, 44, 46, 51 AND 52).

FIRST USE 4-30-2001; IN COMMERCE 4-30-2001.

SN 76-333,327. CHEMCOLOUR INDUSTRIES (NZ) LTD, GLENFIELD, AUCKLAND, NEW ZEALAND, FILED 11-1-2001.

TREET

PRIORITY CLAIMED UNDER SEC. 44(D) ON NEW ZEALAND APPLICATION NO. 614376, FILED 12-5-2000, REG. NO. 614376, DATED 12-17-2001, EXPIRES 5-12-2007.

FOR FUNGICIDES AND HERBICIDES FOR DOMESTIC AND AGRICULTURAL USE; CHEMICAL PREPARATIONS IN THE NATURE OF FUNGICIDES FOR THE TREATMENT OF TRUNK DISEASES (U.S. CLS. 6, 18, 44, 46, 51 AND 52).

SN 76-337,843. MAKHTESHIM CHEMICAL WORKS LTD., BEER SHEVA, ISRAEL, FILED 11-15-2001.

COTNION

OWNER OF ISRAEL REG. NO. 16,221, DATED 6-5-1958, RENEWED AS REG. NO. 16221, DATED 7-30-1992, EXPIRES 7-30-2006.

FOR AGRICULTURAL INSECTICIDE (U.S. CLS. 6, 18, 44, 46, 51 AND 52).

SN 76-368,568. COLLATERAL THERAPEUTICS, INC., SAN DIEGO, CA. FILED 2-8-2002.

GENEREX

FOR PHARMACEUTICALS FOR USE IN THE TREATMENT OF CARDIOVASCULAR DISORDERS, FOR STIMULATION OF BLOOD VESSEL GROWTH AND FOR GENE THERAPY (U.S. CLS. 6, 18, 44, 46, 51 AND 52).

CLASS 5—(Continued).

SN 76-371,371. MEDENTECH LIMITED, WEXFORD, IRELAND, FILED 2-15-2002.

INOVOTABS

PRIORITY CLAIMED UNDER SEC. 44(D) ON IRELAND APPLICATION NO. 2001/03578, FILED 11-27-2001, REG. NO. 223621, DATED 11-27-2001, EXPIRES 11-27-2012.

FOR STERILIZING PREPARATIONS, SANITIZING PREPARATIONS, AND DISINFECTANTS, ALL FOR USE IN THE POULTRY INDUSTRY, ESPECIALLY FOR NEEDLES THAT VACCINATE EMBRYOS IN THE EGG PRIOR TO HATCHING (U.S. CLS. 6, 18, 44, 46, 51 AND 52).

SN 76-383,261. NEW VISION USA, TEMPE, AZ. FILED 3-18-2002.

THE DESERT DIET

NO CLAIM IS MADE TO THE EXCLUSIVE RIGHT TO USE "DIET", APART FROM THE MARK AS SHOWN.

FOR DIETARY AND NUTRITIONAL SUPPLEMENT (U.S. CLS. 6, 18, 44, 46, 51 AND 52).

SN 76-392,265. FANCL CORPORATION, SAKAE-KU, YOKOHAMA-SHI, KANAGAWA, JAPAN, FILED 4-8-2002.

**Evanté
エヴァンテ**

PRIORITY CLAIMED UNDER SEC. 44(D) ON JAPAN APPLICATION NO. 2001-92154, FILED 10-15-2001, REG. NO. 4603808, DATED 9-13-2002, EXPIRES 9-13-2012.

THE ENGLISH TRANSLITERATION OF ALL FOREIGN CHARACTERS IN THE MARK IS "EVANTE".

FOR NUTRITIONAL SUPPLEMENTS USING WEED EXTRACTS FOR FOOD AS THE MAIN INGREDIENT AND TAKING THE FORM OF TABLETS, CAPSULES, GRANULES, LIQUID OR POWDER; NUTRITIONAL SUPPLEMENTS USING A VITAMIN AS THE MAIN INGREDIENT AND TAKING THE FORM OF TABLETS, CAPSULES, GRANULES, LIQUID OR POWDER; NUTRITIONAL SUPPLEMENTS USING MINERAL AS THE MAIN INGREDIENT AND TAKING THE FORM OF TABLETS, CAPSULES, GRANULES, LIQUID OR POWDER; NUTRITIONAL SUPPLEMENTS USING FOOD FIBERS AS THE MAIN INGREDIENT AND TAKING THE FORM OF TABLETS, CAPSULES, GRANULES, LIQUID OR POWDER; NUTRITIONAL SUPPLEMENTS USING AMINO ACIDS AS THE MAIN INGREDIENT AND TAKING THE FORM OF TABLETS, CAPSULES, GRANULES, LIQUID OR POWDER; NUTRITIONAL SUPPLEMENTS USING FUNGI AS THE MAIN INGREDIENT AND TAKING THE FORM OF TABLETS, CAPSULES, GRANULES, LIQUID OR POWDER; NUTRITIONAL SUPPLEMENTS USING VEGETABLES AS THE MAIN INGREDIENT AND TAKING THE FORM OF TABLETS, CAPSULES, GRANULES, LIQUID OR POWDER;

CLASS 5—(Continued).

NUTRITIONAL SUPPLEMENTS USING PROPOLIS FOR HUMAN CONSUMPTION AS THE MAIN INGREDIENT AND TAKING THE FORM OF TABLETS, CAPSULES, GRANULES, LIQUID OR POWDER; NUTRITIONAL SUPPLEMENTS USING FISH OILS AS THE MAIN INGREDIENT AND TAKING THE FORM OF TABLETS, CAPSULES, GRANULES, LIQUID OR POWDER; NUTRITIONAL SUPPLEMENTS USING OLIGOSACCHARIDE AS THE MAIN INGREDIENT AND TAKING THE FORM OF TABLETS, CAPSULES, GRANULES, LIQUID OR POWDER; NUTRITIONAL SUPPLEMENTS USING TEA AS THE MAIN INGREDIENT AND TAKING THE FORM OF TABLETS, CAPSULES, GRANULES, LIQUID OR POWDER; NUTRITIONAL SUPPLEMENTS USING VEGETABLE AS THE MAIN INGREDIENT AND TAKING THE FORM OF TABLETS, CAPSULES, GRANULES, LIQUID OR POWDER; NUTRITIONAL SUPPLEMENTS USING FRUITS AS THE MAIN INGREDIENT AND TAKING THE FORM OF TABLETS, CAPSULES, GRANULES, LIQUID OR POWDER (U.S. CLS. 6, 18, 44, 46, 51 AND 52).

SN 76-407,634. FLEX-POWER, INC., BERKELEY, CA. FILED 5-14-2002.

FLEX-POWER

FOR TOPICAL CREAM FOR RELIEF FROM PAIN AND ARTHRITIS; TOPICAL ANTI-INFLAMMATORY CREAM (U.S. CLS. 6, 18, 44, 46, 51 AND 52).
FIRST USE 2-12-2002; IN COMMERCE 2-12-2002.

SN 76-427,243. MENICON CO., LTD., NAGOYA-SHI, AICHIKEN, JAPAN, FILED 7-3-2002.

MENICON PROGENT

OWNER OF U.S. REG. NOS. 1,110,441, 2,548,640 AND OTHERS.
FOR CONTACT LENS CARE PRODUCTS, NAMELY CLEANING SOLUTION FOR CONTACT LENS, PRESERVATIVE SOLUTION FOR CONTACT LENS, STERILIZING SOLUTION FOR CONTACT LENS, AND EYE DROPS (U.S. CLS. 6, 18, 44, 46, 51 AND 52).

SN 76-432,447. ONO PHARMACEUTICAL CO., LTD., OSAKA, JAPAN, FILED 7-17-2002.

URIDAS

FOR PHARMACEUTICAL PREPARATIONS FOR THE TREATMENT OF GENITOURINARY DISORDERS (U.S. CLS. 6, 18, 44, 46, 51 AND 52).

CLASS 5—(Continued).

SN 76-432,448. ONO PHARMACEUTICAL CO., LTD., OSAKA, JAPAN, FILED 7-17-2002.

VIGOTTE

FOR PHARMACEUTICAL PREPARATIONS FOR THE TREATMENT OF GENITOURINARY DISORDERS (U.S. CLS. 6, 18, 44, 46, 51 AND 52).

SN 76-441,331. SPORTPHARMA USA, INC., CONCORD, CA. FILED 8-19-2002.

SLIM AGAIN

FOR NUTRITIONAL SUPPLEMENTS (U.S. CLS. 6, 18, 44, 46, 51 AND 52).

SN 76-461,249. SISFIELD TECHNOLOGIES, INC., ATLANTA, GA. FILED 10-21-2002.

SIS AM 500

NO CLAIM IS MADE TO THE EXCLUSIVE RIGHT TO USE "AM500", APART FROM THE MARK AS SHOWN.
FOR ANTIMICROBIAL PRODUCT USED TO INHIBIT THE GROWTH OF MICROORGANISMS AND TO PROTECT AGAINST BACTERIA, MOLD, MILDEW, ALGAE AND VIRUS (U.S. CLS. 6, 18, 44, 46, 51 AND 52).

SN 76-465,880. BIO-BOTANICA, INC., HAUPPAUGE, NY. FILED 10-31-2002.

HAWTHORNPlex

FOR BOTANICAL ESSENCES AND DIETARY FOOD SUPPLEMENTS CONTAINING HAWTHORN (U.S. CLS. 6, 18, 44, 46, 51 AND 52).

SN 76-485,889. ALTANA PHARMA AG, 78467 KONSTANZ, FED REP GERMANY, FILED 1-24-2003.

AQOY

PRIORITY CLAIMED UNDER SEC. 44(D) ON FED REP GERMANY APPLICATION NO. 30246904.4/0, FILED 9-23-2002, REG. NO. 30246904, DATED 10-17-2002, EXPIRES 9-30-2012.

FOR PHARMACEUTICAL PREPARATIONS FOR THE TREATMENT OF GASTROINTESTINAL DISEASES AND CONDITIONS (U.S. CLS. 6, 18, 44, 46, 51 AND 52).

CLASS 5—(Continued).

SN 76-485,891. ALTANA PHARMA AG, 78467 KONSTANZ, FED REP GERMANY, FILED 1-24-2003.

BURNEX

PRIORITY CLAIMED UNDER SEC. 44(D) ON FED REP GERMANY APPLICATION NO. 30246906.0/0, FILED 9-23-2002, REG. NO. 30246906, DATED 10-16-2002, EXPIRES 10-16-2012.

FOR PHARMACEUTICAL PREPARATIONS FOR THE TREATMENT OF GASTROINTESTINAL DISEASES AND CONDITIONS (U.S. CLS. 6, 18, 44, 46, 51 AND 52).

SN 76-485,894. ALTANA PHARMA AG, 78467 KONSTANZ, FED REP GERMANY, FILED 1-24-2003.

FORPIAN

PRIORITY CLAIMED UNDER SEC. 44(D) ON FED REP GERMANY APPLICATION NO. 30246908.705, FILED 9-23-2002, REG. NO. 30246908, DATED 10-16-2002, EXPIRES 9-30-2012.

FOR PHARMACEUTICAL PREPARATIONS FOR THE TREATMENT OF GASTROINTESTINAL DISEASES AND CONDITIONS (U.S. CLS. 6, 18, 44, 46, 51 AND 52).

SN 76-490,960. PARK, KINAM, WEST LAFAYETTE, IN. FILED 2-24-2003.

FROSTA

FOR CHEMICALS FOR ENHANCING THE DISSOLUTION RATE OF PHARMACEUTICAL COMPOSITIONS IN TABLET FORM, SOLD AS AN INTEGRAL COMPONENT OF PHARMACEUTICALS (U.S. CLS. 6, 18, 44, 46, 51 AND 52).

FIRST USE 2-12-2003; IN COMMERCE 2-12-2003.

SN 78-082,535. SHELDON MARKETING LLC, PRESCOTT VALLEY, AZ. FILED 9-4-2001.



FOR WEIGHT LOSS PRODUCT, NAMELY, NUTRITIONAL SUPPLEMENTS FOR WEIGHT LOSS (U.S. CLS. 6, 18, 44, 46, 51 AND 52).

CLASS 5—(Continued).

SN 78-118,137. WESTERN HOLDINGS, L.L.C., CASPER, WY. FILED 3-28-2002.

OXYPILLS

FOR DIETARY SUPPLEMENTS MAINLY USED FOR WEIGHT LOSS AND SPECIFICALLY EXCLUDING ACNE PREPARATIONS AND SKIN CARE PREPARATIONS (U.S. CLS. 6, 18, 44, 46, 51 AND 52).

SN 78-131,515. YANKEE CANDLE COMPANY INC., THE, SOUTH DEERFIELD, MA. FILED 5-28-2002.

A LA MODE

FOR AIR FRESHENERS AND ROOM DEODORANTS NOT SOLD IN PROFESSIONAL BEAUTY SALONS OR SPAS (U.S. CLS. 6, 18, 44, 46, 51 AND 52).

SN 78-133,408. SARAMAR, L.L.C., CHICAGO, IL. FILED 6-5-2002.

FRUITS OF PARADISE

NO CLAIM IS MADE TO THE EXCLUSIVE RIGHT TO USE "FRUITS", APART FROM THE MARK AS SHOWN. FOR AIR FRESHENERS AND ROOM DEODORIZERS (U.S. CLS. 6, 18, 44, 46, 51 AND 52). FIRST USE 10-9-2002; IN COMMERCE 10-9-2002.

SN 78-136,573. PEPGEN CORPORATION, ALAMEDA, CA. FILED 6-18-2002.

TAUFERON

FOR BIOPHARMACEUTICALS FOR USE IN THE DIAGNOSIS, PREVENTION, AND TREATMENT OF HUMAN AND ANIMAL DISEASES, NAMELY CANCER, VIRAL INFECTIONS, MICROBIAL INFECTIONS, AUTOIMMUNE DISEASES, ALLERGIES, IMMUNOLOGICAL DYSFUNCTIONS, NEUROLOGICAL DISORDERS, BLOOD DISORDERS, AND INFLAMMATORY DISEASES (U.S. CLS. 6, 18, 44, 46, 51 AND 52).

SN 78-138,970. TRIANGLE PHARMACEUTICALS, INC., DURHAM, NC. FILED 6-26-2002.

COPREVIR

FOR ANTIVIRAL PREPARATIONS (U.S. CLS. 6, 18, 44, 46, 51 AND 52).

CLASS 5—(Continued).

SN 78-140,413. WILBUR-ELLIS COMPANY, SAN FRANCISCO, CA. FILED 7-1-2002.

DESPERADO

FOR AGRICULTURAL PESTICIDES (U.S. CLS. 6, 18, 44, 46, 51 AND 52).

SN 78-140,441. DEER, RICHARD A., INDIANAPOLIS, IN. FILED 7-1-2002.

DYNAFED E.X.

OWNER OF U.S. REG. NOS. 1,749,788 AND 2,260,831. FOR OVER-THE-COUNTER PHARMACEUTICALS, NAMELY, PHARMACEUTICAL PREPARATIONS FOR THE TREATMENT OF PAIN, FEVER AND PAIN AND FEVER (U.S. CLS. 6, 18, 44, 46, 51 AND 52). FIRST USE 12-31-1994; IN COMMERCE 12-31-1994.

SN 78-142,106. BAYER CORPORATION, PITTSBURGH, PA. FILED 7-9-2002.

ONE A DAY DIET ESSENTIALS

OWNER OF U.S. REG. NOS. 1,248,113, 2,586,687 AND OTHERS. NO CLAIM IS MADE TO THE EXCLUSIVE RIGHT TO USE "DIET ESSENTIALS", APART FROM THE MARK AS SHOWN. SEC. 2(F) AS TO "ONE A DAY". FOR NUTRITIONAL SUPPLEMENTS (U.S. CLS. 6, 18, 44, 46, 51 AND 52).

SN 78-145,533. SMITHKLINE BEECHAM CORPORATION, PHILADELPHIA, PA. FILED 7-19-2002.

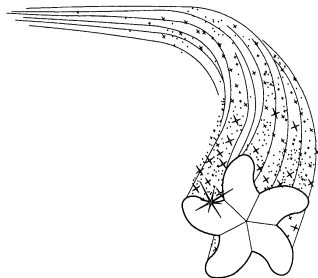

FOR VACCINES FOR HUMAN USE (U.S. CLS. 6, 18, 44, 46, 51 AND 52).

CLASS 5—(Continued).

SN 78-145,540. SMITHKLINE BEECHAM CORPORATION, PHILADELPHIA, PA. FILED 7-19-2002.

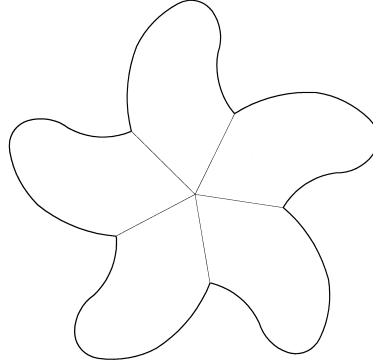

THE MARK CONSISTS OF A STYLISTIC REPRESENTATION OF A FIVE-POINTED STAR WITH ROUNDED POINTS SEGMENTED INTO FIVE EQUAL SECTIONS. FOR VACCINES FOR HUMAN USE. (U.S. CLS. 6, 18, 44, 46, 51 AND 52).

SN 78-147,753. PROMOTIA INTERNATIONAL, INC., DENVER, NJ. FILED 7-26-2002.

NET EFFECT

FOR INSECT REPELLENT (U.S. CLS. 6, 18, 44, 46, 51 AND 52).

SN 78-156,106. MICROHEART, INC., MOUNTAIN VIEW, CA. FILED 8-20-2002.

MICROHEART

FOR PHARMACEUTICAL PREPARATIONS FOR TREATMENT OF CARDIOVASCULAR DISEASES (U.S. CLS. 6, 18, 44, 46, 51 AND 52).

SN 78-163,751. N.V. ORGANON, 5349 AB OSS, NETHERLANDS, FILED 9-13-2002.

LIVIFEM

PRIORITY CLAIMED UNDER SEC. 44(D) ON BENELUX APPLICATION NO. 1008288, FILED 3-28-2002, REG. NO. 0711992, DATED 3-28-2002, EXPIRES 3-28-2012. FOR MEDICINES AND PHARMACEUTICAL PREPARATIONS FOR THE TREATMENT OF MENOPAUSAL COMPLAINTS AND FOR PREVENTION OF OSTEOPOROSIS (U.S. CLS. 6, 18, 44, 46, 51 AND 52).

CLASS 5—(Continued).

SN 78-172,110. NUTRANEX LLC, LOUGHTON, UNITED KINGDOM, FILED 10-8-2002.

KIZZ-ME

FOR NUTRITIONALLY FORTIFIED BEVERAGES, NAMELY HERBAL HEALTH BEVERAGES (U.S. CLS. 6, 18, 44, 46, 51 AND 52).

SN 78-173,077. KLAPPER, PETER, B, SAN FRANCISCO, CA. FILED 10-10-2002.

HEMORRHOIDS NO MORE

NO CLAIM IS MADE TO THE EXCLUSIVE RIGHT TO USE "HEMORRHOIDS", APART FROM THE MARK AS SHOWN.

FOR MEDICATED SKIN CARE PREPARATIONS FOR THE TREATMENT OF HEMORRHOIDS (U.S. CLS. 6, 18, 44, 46, 51 AND 52).

FIRST USE 9-1-2000; IN COMMERCE 9-1-2000.

SN 78-173,455. SMITHKLINE BEECHAM CORPORATION, PHILADELPHIA, PA. FILED 10-11-2002.

OXY PAD LIFTER

OWNER OF U.S. REG. NOS. 1,293,829 AND 2,007,981. NO CLAIM IS MADE TO THE EXCLUSIVE RIGHT TO USE "PAD", APART FROM THE MARK AS SHOWN.

FOR MEDICATED SKIN CARE PREPARATIONS FOR THE TREATMENT OF ACNE, NAMELY, PRE-MOISTENED MEDICATED SKIN WIPES. (U.S. CLS. 6, 18, 44, 46, 51 AND 52).

SN 78-175,830. AVENTIS PHARMA S.A., ANTONY CEDEX, FRANCE, FILED 10-18-2002.

XEMERA

OWNER OF FRANCE REG. NO. 95-951444, DATED 10-6-1995, EXPIRES 10-6-2005.

OWNER OF U.S. REG. NO. 2,095,396. FOR PHARMACEUTICAL PREPARATIONS USED IN HORMONE REPLACEMENT THERAPY FOR POSTMENOPAUSAL WOMEN (U.S. CLS. 6, 18, 44, 46, 51 AND 52).

CLASS 5—(Continued).

SN 78-175,831. HEALTH FOREVER PRODUCTS, LTD., IKEJA, NIGERIA, AND AXON BIOPHARM, INC., SILVER SPRING, MD. FILED 10-18-2002.



FOR VITAMINS, MINERALS, DIETARY AND NUTRITIONAL SUPPLEMENTS, ALL CONTAINING HERBS AND HERBAL EXTRACTS (U.S. CLS. 6, 18, 44, 46, 51 AND 52).

FIRST USE 1-15-2002; IN COMMERCE 9-15-2002.

SN 78-181,930. CENTENNIAL HEALTH, INC., BOCA RATON, FL. FILED 11-5-2002.

ERECTOL

FOR FOOD SUPPLEMENTS, VITAMIN AND MINERAL SUPPLEMENTS, AND NUTRITIONAL AND DIETARY SUPPLEMENTS (U.S. CLS. 6, 18, 44, 46, 51 AND 52).

SN 78-186,820. S. C. JOHNSON & SON, INC., RACINE, WI. FILED 11-20-2002.

FLORAL ESCAPE

NO CLAIM IS MADE TO THE EXCLUSIVE RIGHT TO USE "FLORAL", APART FROM THE MARK AS SHOWN.

FOR AIR FRESHENERS (U.S. CLS. 6, 18, 44, 46, 51 AND 52).

SN 78-189,217. BLUE SEAL FEEDS, INC., LONDONDERRY, NH. FILED 11-26-2002.

E-Z HOOF

NO CLAIM IS MADE TO THE EXCLUSIVE RIGHT TO USE "HOOF", APART FROM THE MARK AS SHOWN.

FOR HORSE FEED SUPPLEMENTS (U.S. CLS. 6, 18, 44, 46, 51 AND 52).

SN 78-190,570. HI-TECH PHARMACAL CO INC., AMITYVILLE, NY. FILED 12-3-2002.

DIABETIMEAL

FOR PACKAGED MEAL REPLACEMENT FOR DIABETICS (U.S. CLS. 6, 18, 44, 46, 51 AND 52).

CLASS 5—(Continued).

SN 78-190,843. E.M. MATSON, JR. CO., INC., NORTH BEND, WA. FILED 12-3-2002.

SNARE

FOR PESTICIDE FOR DOMESTIC AND AGRICULTURAL USE, NAMELY, SLUG AND SNAIL BAIT (U.S. CLS. 6, 18, 44, 46, 51 AND 52).

FIRST USE 11-5-2002; IN COMMERCE 11-5-2002.

SN 78-190,911. SAMSON DISTRIBUTING INC., LAKE WORTH, FL. FILED 12-3-2002.

CYCLE

FOR NUTRITIONAL SUPPLEMENTS (U.S. CLS. 6, 18, 44, 46, 51 AND 52).

SN 78-190,912. FIZOGEN PRECISION TECHNOLOGIES, WELLINGTON, FL. FILED 12-3-2002.

FUSION

FOR NUTRITIONAL SUPPLEMENTS (U.S. CLS. 6, 18, 44, 46, 51 AND 52).

SN 78-191,049. LIFENET, VIRGINIA BEACH, VA. FILED 12-4-2002.

READIGRAFT

FOR HUMAN CADAVERIC TISSUE ALLOGRAFT FOR IMPLANTATION IN A PATIENT (U.S. CLS. 6, 18, 44, 46, 51 AND 52).

SN 78-191,803. WELLESLEY INTERNATIONAL LLC, EDISON, NJ. FILED 12-5-2002.

GO HERBAL TODAY

NO CLAIM IS MADE TO THE EXCLUSIVE RIGHT TO USE "HERBAL", APART FROM THE MARK AS SHOWN. FOR NUTRICEUTICALS FOR USE AS A DIETARY SUPPLEMENT, NAMELY HERBAL DIETARY SUPPLEMENTS IN PILL AND CAPSULE FORM. (U.S. CLS. 6, 18, 44, 46, 51 AND 52).

CLASS 5—(Continued).

SN 78-193,161. WELLQUEST INTERNATIONAL, INC., NEW YORK, NY. FILED 12-10-2002.

TRIMAZENE

FOR DIETARY SUPPLEMENTS (U.S. CLS. 6, 18, 44, 46, 51 AND 52).

SN 78-193,205. ALTANA INC., MELVILLE, NY. FILED 12-11-2002.

ZETAZOLE

FOR PHARMACEUTICAL PREPARATIONS, NAMELY A TOPICAL ANTIFUNGAL PREPARATION FOR THE TREATMENT OF FUNGAL INFECTIONS (U.S. CLS. 6, 18, 44, 46, 51 AND 52).

SN 78-193,287. NPS PHARMACEUTICALS, INC., SALT LAKE CITY, UT. FILED 12-11-2002.

PROCALCIN

FOR PHARMACEUTICAL PREPARATIONS FOR THE TREATMENT OF HYPERCALCAEMIC-RELATED DISEASES AND HYPERPARATHYROID-RELATED DISEASES (U.S. CLS. 6, 18, 44, 46, 51 AND 52).

SN 78-193,302. NPS PHARMACEUTICALS, INC., SALT LAKE CITY, UT. FILED 12-11-2002.

NORCALCIN

FOR PHARMACEUTICAL PREPARATIONS FOR TREATMENT OF HYPERCALCAEMIC-RELATED AND HYPERPARATHYROID-RELATED DISEASES (U.S. CLS. 6, 18, 44, 46, 51 AND 52).

SN 78-196,839. MEDICAL NUTRITION, INC., ENGLEWOOD, NJ. FILED 12-20-2002.

CRAVENDER

FOR NUTRITIONAL APPETITE CONTROL SUPPLEMENTS (U.S. CLS. 6, 18, 44, 46, 51 AND 52).

CLASS 5—(Continued).

SN 78-197,587. MAX-RX, LLC, CARROLLTON, TX. FILED 12-23-2002.

MAX-RX

FOR DIETARY HERBAL SUPPLEMENT (U.S. CLS. 6, 18, 44, 46, 51 AND 52).
FIRST USE 11-1-2002; IN COMMERCE 11-1-2002.

SN 78-208,422. MEDICAL NUTRITION, INC., ENGLEWOOD, NJ. FILED 1-29-2003.

CRAVE ENDER

FOR NUTRITIONAL APPETITE CONTROL SUPPLEMENTS (U.S. CLS. 6, 18, 44, 46, 51 AND 52).

SN 78-234,284. ROSE, JOHN R., PHOENIX, AZ. FILED 4-4-2003.

ACUSAN

FOR NATURAL ACNE THERAPY CREAM. (U.S. CLS. 6, 18, 44, 46, 51 AND 52).

SN 78-238,314. FARNAM COMPANIES, INC., PHOENIX, AZ. FILED 4-16-2003.

MOSQUITO HALT

OWNER OF U.S. REG. NO. 2,687,485.
NO CLAIM IS MADE TO THE EXCLUSIVE RIGHT TO USE "MOSQUITO", APART FROM THE MARK AS SHOWN.
FOR MOSQUITO AND INSECT REPELLENT PRODUCT FOR USE ON SMALL AND LARGE COMPANION ANIMALS (U.S. CLS. 6, 18, 44, 46, 51 AND 52).
FIRST USE 4-9-2003; IN COMMERCE 4-9-2003.

CLASS 6—METAL GOODS

SN 76-149,989. MOBILE MINI, INC., TEMPE, AZ. FILED 10-19-2000.

TRI-CAM LOCKING SYSTEM

NO CLAIM IS MADE TO THE EXCLUSIVE RIGHT TO USE "LOCKING SYSTEM", APART FROM THE MARK AS SHOWN.

SEC. 2(F).
FOR METAL LOCKS, METAL PADLOCKS AND METAL LOCKING SYSTEMS CONSISTING PRIMARILY OF CAMS AND LOCKING BARS, ALL SOLD AS A COMPONENT FEATURE OF CONTAINERS FOR THE STORAGE AND TRANSPORTATION OF GOODS (U.S. CLS. 2, 12, 13, 14, 23, 25 AND 50).
FIRST USE 1-0-1991; IN COMMERCE 1-0-1991.

SN 76-222,966. FORMS AND SURFACES COMPANY, LLC, CARPINTERIA, CA. FILED 3-12-2001.

AERO

FOR FORMED ALUMINUM SHEETS FOR USE IN CLADDING SURFACES, CREATING ARCHITECTURAL ACCENTS AND INCORPORATING INTO DISPLAYS (U.S. CLS. 2, 12, 13, 14, 23, 25 AND 50).

SN 76-354,641. PORCELEN LIMITED CT LLC, HAMDEN, CT. FILED 1-3-2002.

SPECURITY

FOR METAL CANTILEVER GATES (U.S. CLS. 2, 12, 13, 14, 23, 25 AND 50).

SN 76-389,724. NU-AIR MANUFACTURING CO., TAMPA, FL. FILED 3-28-2002.

NUVIEW

FOR METAL WINDOWS (U.S. CLS. 2, 12, 13, 14, 23, 25 AND 50).
FIRST USE 11-9-1981; IN COMMERCE 11-9-1981.

SN 76-419,426. OETLINGER TOOL ENGINEERING CO., INC., GRAFTON, WI. FILED 6-11-2002.

FLUSHPRESSER

FOR PRIMARILY METAL CLAMP USED TO ENGAGE AND HOLD CARTON BLANKING SCRAP PRIOR TO THE PUNCHING AND REMOVAL OF THE CARTON BLANK (U.S. CLS. 2, 12, 13, 14, 23, 25 AND 50).

CLASS 6—(Continued).

SN 76-458,313. COPELAND-GIBSON PRODUCTS, CORP., TROY, MI. FILED 10-15-2002.

NYC EXPRESSIONS

NO CLAIM IS MADE TO THE EXCLUSIVE RIGHT TO USE "NYC", APART FROM THE MARK AS SHOWN.

FOR SCENES CUT OUT OF NON-PRECIOUS METAL SUITABLE FOR FREE STANDING DISPLAY OR ATTACHING TO WALLS AND SURFACES (U.S. CLS. 2, 12, 13, 14, 23, 25 AND 50).

SN 76-459,570. INGENIUM PACKAGING, LLC, CANTON, OH. FILED 10-21-2002.

INGENIUM

FOR THIN-WALLED CANS FOR PACKAGING FOOD PRODUCTS (U.S. CLS. 2, 12, 13, 14, 23, 25 AND 50).

SN 76-469,146. GLADNEY, GENE, VERONA, MO. FILED 11-22-2002.

TRAIL-N-STOR

FOR PORTABLE METAL STORAGE STRUCTURES (U.S. CLS. 2, 12, 13, 14, 23, 25 AND 50).

SN 76-473,447. NEW BUFFALO CORPORATION, SAINT LOUIS, MO. FILED 11-29-2002.

ROLL & FOLD

FOR METAL SCAFFOLDING (U.S. CLS. 2, 12, 13, 14, 23, 25 AND 50).
FIRST USE 11-1-2002; IN COMMERCE 11-1-2002.

SN 78-114,286. ENVENTURE GLOBAL TECHNOLOGY, L.L.C., HOUSTON, TX. FILED 3-12-2002.

VERSAFLEX

FOR OIL AND GAS WELL DOWNHOLE METAL GOODS, NAMELY, EXPANDABLE LINER HANGERS (U.S. CLS. 2, 12, 13, 14, 23, 25 AND 50).

CLASS 6—(Continued).

SN 78-144,494. OPEN HOUSE SYSTEMS AB, LANDSKRONA, SWEDEN, FILED 7-16-2002.



NO CLAIM IS MADE TO THE EXCLUSIVE RIGHT TO USE "BUILDING SYSTEM", APART FROM THE MARK AS SHOWN.

FOR PREFABRICATED METAL BUILDINGS. (U.S. CLS. 2, 12, 13, 14, 23, 25 AND 50).

SN 78-145,681. SHOWALTER, GREGORY, SEATTLE, WA. FILED 7-19-2002.

SUR-STOP

FOR METAL SNOW GUARDS AND SNOW STOPS FOR METAL ROOFS TO KEEP SNOW FROM SLIDING OFF THE ROOF. (U.S. CLS. 2, 12, 13, 14, 23, 25 AND 50).

SN 78-148,371. TM WINDOW & DOOR LLC, POMPANO BEACH, FL. FILED 7-29-2002.



NO CLAIM IS MADE TO THE EXCLUSIVE RIGHT TO USE "AMERICA'S BEST", APART FROM THE MARK AS SHOWN.

FOR ALUMINUM WINDOWS AND DOORS (U.S. CLS. 2, 12, 13, 14, 23, 25 AND 50).

SN 78-152,076. HADRIAN, WILLIAM, VISTA, CA. AND HADRIAN, ROD, VISTA, CA. FILED 8-7-2002.

TRIDIPANEL

FOR BUILDING WALL PANELS OF METAL USED IN THE CONSTRUCTION, FABRICATED WITH AN INSULATED CORE MATERIAL SANDWICHED BETWEEN TWO ENGINEERED SHEETS OF WELDED WIRE FABRIC MESH (U.S. CLS. 2, 12, 13, 14, 23, 25 AND 50).
FIRST USE 1-9-1999; IN COMMERCE 1-1-2000.

CLASS 6—(Continued).

SN 78-190,274. KABUSHIKI KAISHA KOBE SEIKO SHO, TA KOBE STEEL, LTD., HYOGO, JAPAN, FILED 12-2-2002.

ECOMEL

FOR IRON POWDER (U.S. CLS. 2, 12, 13, 14, 23, 25 AND 50).

SN 78-193,512. GEORGIA-PACIFIC CORPORATION, ATLANTA, GA. FILED 12-11-2002.

REDI-FIT

OWNER OF U.S. REG. NO. 1,583,663.
FOR METAL BRACKET FOR MOUNTING DISPENSERS (U.S. CLS. 2, 12, 13, 14, 23, 25 AND 50).

SN 78-197,812. OHIO STEEL INDUSTRIES, INC., COLUMBUS, OH. FILED 12-26-2002.

HANDI-DECK

FOR PREFABRICATED METAL PLATFORMS ATTACHABLE TO VEHICLES FOR HAULING CARGO (U.S. CLS. 2, 12, 13, 14, 23, 25 AND 50).
FIRST USE 9-18-2002; IN COMMERCE 9-18-2002.

CLASS 7—MACHINERY

SN 75-857,582. BIESSE S.P.A, PESARO, ITALY, FILED 11-26-1999.

COMIL

OWNER OF ITALY REG. NO. 744474, DATED 3-30-1998, EXPIRES 3-30-2018.

FOR MACHINES FOR USE IN THE FURNITURE, DOOR AND WINDOW INDUSTRIES, NAMELY, MACHINES FOR BORING AND INSERTING PARTS OR PANELS MADE OF WOOD AND WOOD DERIVATIVES, PLASTIC, GLASS, MARBLE AND METAL, AND FOR ASSEMBLING AND PACKAGING FURNITURE, DOOR FRAMES AND WINDOW FRAMES (U.S. CLS. 13, 19, 21, 23, 31, 34 AND 35).

CLASS 7—(Continued).

SN 76-064,729. UNITED STATES GEAR CORPORATION, CHICAGO, IL. FILED 6-7-2000.



OWNER OF U.S. REG. NO. 1,786,671.
NO CLAIM IS MADE TO THE EXCLUSIVE RIGHT TO USE "US GEAR" AND "POWER FAN", APART FROM THE MARK AS SHOWN.

THE MARK IS LINED FOR THE COLORS RED AND BLUE. THE STARS IN THE SHIELD ARE LINED FOR THE COLOR BLUE.

FOR ROTARY FAN WITH TEMPERATURE-ACTUATED ELECTROMAGNETIC CLUTCH FOR LAND VEHICLE ENGINES (U.S. CLS. 13, 19, 21, 23, 31, 34 AND 35).

SN 76-068,048. SMS MEER GMBH, FED REP GERMANY, BY ASSIGNMENT SMS DEMAG AKTIENGESELLSCHAFT, FED REP GERMANY, FILED 6-12-2000.

CBP

PRIORITY CLAIMED UNDER SEC. 44(D) ON FED REP GERMANY APPLICATION NO. 39978572.8/0, FILED 12-11-1999, REG. NO. 39978572, DATED 1-27-2000, EXPIRES 12-31-2009.

FOR MACHINES, NAMELY, ROLLING MACHINES, PRESSING MACHINES, FORGING PRESSES, CASTING MACHINES AND MACHINE PARTS THEREOF NAMELY, CYLINDERS, NOZZLES, SEALS, AND VALVES; PARTS OF MACHINE TOOLS, NAMELY, GEARS, BEARINGS AND PUMPS; MOTORS AND ENGINES FOR MACHINES; MACHINE COUPLING AND TRANSMISSION COMPONENTS, NAMELY ROLLING MILL COUPLINGS (U.S. CLS. 13, 19, 21, 23, 31, 34 AND 35).

SN 76-085,092. SOUTHER, RICK, TABER, ALBERTA, CANADA, FILED 7-6-2000.



NO CLAIM IS MADE TO THE EXCLUSIVE RIGHT TO USE "DIAMOND", APART FROM THE MARK AS SHOWN.

FOR POWER OPERATED INDUSTRIAL DRILL BITS, HAVING POLYCRYSTALLINE DIAMOND COMPACTS AS A CUTTING SURFACE, FOR USE IN THE MINING, OIL AND GAS INDUSTRIES (U.S. CLS. 13, 19, 21, 23, 31, 34 AND 35).

FIRST USE 4-1-1999; IN COMMERCE 9-1-1999.

CLASS 7—(Continued).

SN 76-191,841. DELTA/DUCON COMPONENTS GROUP COMPANY, MALVERN, PA. FILED 1-10-2001.

DUCON

FOR PNEUMATIC CONVEYING SYSTEMS, AND COMPONENTS THEREFORE, NAMELY, PRESSURE POTS, PNEUMATIC TUBES, TERMINAL HOUSINGS, CARRIERS, PNEUMATIC BLOWERS, PNEUMATIC PUMPS, AND CONVEYORS (U.S. CLS. 13, 19, 21, 23, 31, 34 AND 35).

FIRST USE 0-0-1964; IN COMMERCE 0-0-1964.

SN 76-198,730. DE'LONGHI S.P.A., 31100 TREVISO, ITALY, FILED 1-24-2001.



PRIORITY CLAIMED UNDER SEC. 44(D) ON ITALY APPLICATION NO. M12000C01162, FILED 10-23-2000, REG. NO. 833980, DATED 6-24-2001, EXPIRES 10-23-2010.

FOR VACUUM CLEANERS; SOLID AND LIQUID ASPIRATORS FOR INDUSTRIAL USE (U.S. CLS. 13, 19, 21, 23, 31, 34 AND 35).

SN 76-205,526. ALLTRADE INC., LONG BEACH, CA. FILED 2-6-2001.

GARAGE IN A BOX

NO CLAIM IS MADE TO THE EXCLUSIVE RIGHT TO USE "IN A BOX", APART FROM THE MARK AS SHOWN.

FOR KIT CONSISTING PRIMARILY OF A HYDRAULIC JACK, JACK STANDS FOR USE THEREWITH, AND A MECHANICS' CREEPER FOR USE IN AUTOMOTIVE REPAIR (U.S. CLS. 13, 19, 21, 23, 31, 34 AND 35).

FIRST USE 7-1-2000; IN COMMERCE 7-1-2000.

SN 76-236,853. ROBERT BOSCH GMBH, D-70839 GERLINGEN, FED REP GERMANY, FILED 4-9-2001.

ECOFLOW

PRIORITY CLAIMED UNDER SEC. 44(D) ON FED REP GERMANY APPLICATION NO. 30074926.0, FILED 10-10-2000, REG. NO. 30074926, DATED 3-2-2001, EXPIRES 10-31-2010.

FOR CONVEYOR BELTS, NAMELY, CONVEYOR ROLLS, METAL PROFILES, ROLLER CONVEYORS, AND CASTER-ROLLER RUNS TO CONVERT WORK-STATIONS (U.S. CLS. 13, 19, 21, 23, 31, 34 AND 35).

CLASS 7—(Continued).

SN 76-269,693. JEWELRY SPA, INC., NYACK, NY. FILED 6-8-2001.

JEWELMAN JEWELRY SPA

NO CLAIM IS MADE TO THE EXCLUSIVE RIGHT TO USE "JEWELRY", APART FROM THE MARK AS SHOWN.

FOR ELECTRONIC APPARATUS USED TO CLEAN JEWELRY, GEMS, DENTAL WORK AND OTHER CONDUCTIVE METALS (U.S. CLS. 13, 19, 21, 23, 31, 34 AND 35).

FIRST USE 3-1-2001; IN COMMERCE 3-1-2001.

SN 76-294,952. EARTH (CANADA) CORPORATION, MONTREAL, QUEBEC, CANADA, FILED 8-6-2001.

TORR

PRIORITY CLAIMED UNDER SEC. 44(D) ON CANADA APPLICATION NO. 1091544, FILED 2-5-2001, REG. NO. TMA572.510, DATED 12-18-2002, EXPIRES 12-18-2017.

FOR MACHINE USED FOR ENVIRONMENTAL, COMMERCIAL AND INDUSTRIAL CLEANUP TO RECOVER NON-AQUEOUS SUBSTANCES MIXED WITH AN AQUEOUS LIQUID (U.S. CLS. 13, 19, 21, 23, 31, 34 AND 35).

SN 76-330,280. KIESSNER, LAURA, SALT LAKE CITY, UT. FILED 10-29-2001.

EMSIZE SIZED PACKAGING WHEN NEEDED

FOR MACHINES FOR PRODUCING CORRECTLY SIZED CORRUGATED CONTAINERS OUT OF FAN-FOLD CORRUGATED BOARD AT MOMENT WHEN NEEDED (U.S. CLS. 13, 19, 21, 23, 31, 34 AND 35).

FIRST USE 0-0-1998; IN COMMERCE 0-0-2000.

SN 76-403,614. KALKHOVEN, ALLEN, B., TROUTDALE, OR. AND KALKHOVEN, JUNE, L., TROUTDALE, OR. FILED 5-3-2002.

HOLD YOUR GROUND

FOR TRENCH SHORING CONSULTATION SERVICES (U.S. CLS. 13, 19, 21, 23, 31, 34 AND 35).

CLASS 7—(Continued).

SN 76-404,107. S. MORANTZ INC., PHILADELPHIA, PA.
FILED 5-6-2002.



FOR MACHINES FOR CLEANING AND RESTORING
ITEMS DAMAGED BY SOOT AND SMOKE (U.S. CLS. 13,
19, 21, 23, 31, 34 AND 35).
FIRST USE 1-0-1990; IN COMMERCE 5-0-1990.

SN 76-416,485. H.T. MOULD INC., ST. LAURENT, QUEBEC,
CANADA, FILED 5-31-2002.

SANDBOSS

FOR PNEUMATIC DRUM SANDERS FOR USE WITH
POWER OPERATED DRILLS (U.S. CLS. 13, 19, 21, 23, 31,
34 AND 35).
FIRST USE 5-0-1990; IN COMMERCE 9-0-1990.

SN 76-416,888. UNITED STATES FILTER CORPORATION,
PALM DESERT, CA. FILED 6-4-2002.

TARGET-TRAK

FOR BLAST WHEEL PARTS, NAMELY, EXTERNAL
CONTROL CAGE FOR ROTATION AND POSITIONING
USED IN AIRLESS SURFACE PREPARATION EQUIP-
MENT (U.S. CLS. 13, 19, 21, 23, 31, 34 AND 35).

SN 76-417,083. OLDHAM SAW CO., INC., WEST JEFFERSON,
NC. FILED 6-5-2002.

FOR SAW BLADES FOR USE WITH PORTABLE AND
STATIONARY POWER TOOLS (U.S. CLS. 13, 19, 21, 23,
31, 34 AND 35).

CLASS 7—(Continued).

SN 76-417,687. AIRSCOOTER CORPORATION, HENDER-
SON, NV. FILED 6-7-2002.



FOR MOTORS FOR AIRCRAFT AND WATERCRAFTS,
NAMELY BOATS, AND STRUCTURAL PARTS THERE-
FOR (U.S. CLS. 13, 19, 21, 23, 31, 34 AND 35).

SN 76-434,198. HARBISON-FISCHER, INC, CROWLEY, TX.
FILED 7-25-2002.

PRO-ALIGN

FOR OIL AND GAS WELLHEAD TOOLS AND EQUIP-
MENT; NAMELY, POLISHED ROD ALIGNMENT
TOOLS. USED TO ALIGN POLISHED RODS WITH
WELL BORES (U.S. CLS. 13, 19, 21, 23, 31, 34 AND 35).

SN 76-439,194. MARTIN SPROCKET & GEAR, INC., AR-
LINGTON, TX. FILED 8-12-2002.

PowerCat HTS

OWNER OF U.S. REG. NO. 1,815,334.
FOR MACHINE PARTS, NAMELY HIGH CAPACITY
SYNCHRONOUS BELT DRIVEN SPROCKET/PULLEY
(U.S. CLS. 13, 19, 21, 23, 31, 34 AND 35).

SN 76-458,354. DITEQ, INC., ANAHEIM, CA. FILED 10-8-
2002.

DITEQ

FOR POWER-OPERATED DIAMOND TOOLS AND
EQUIPMENTS, NAMELY, SAW BLADES, CORE BITS,
TILE SAWS, CONCRETE SAWS AND MASONRY SAWS
(U.S. CLS. 13, 19, 21, 23, 31, 34 AND 35).

CLASS 7—(Continued).

SN 76-460,812. ACASI MACHINERY, INC., MIAMI, FL. FILED 10-21-2002.



FOR BOTTLING AND PACKAGING EQUIPMENT, NAMELY, CAPPING, LABELING AND FILLING MACHINERY (U.S. CLS. 13, 19, 21, 23, 31, 34 AND 35). FIRST USE 1-0-2000; IN COMMERCE 1-0-2000.

SN 76-465,154. SHANNON CHASTAIN ENTERPRISES, INC., EATONTON, GA. FILED 11-1-2002.

BASIC

FOR CONSTRUCTION EQUIPMENT NAMELY, ASPHALT ROLLERS, MOTOR GRADERS AND STRUCTURAL PARTS THEREFOR (U.S. CLS. 13, 19, 21, 23, 31, 34 AND 35). FIRST USE 1-1-2001; IN COMMERCE 1-1-2001.

SN 76-466,693. RICH PALM ENTERPRISE CORP. LTD., TAIPEI, TAIWAN, FILED 11-4-2002.

RICH PALM GEAR

NO CLAIM IS MADE TO THE EXCLUSIVE RIGHT TO USE "GEAR", APART FROM THE MARK AS SHOWN. FOR MACHINE PARTS, NAMELY, ROLLER CHAINS; ENGINES NOT FOR LAND VEHICLES; PULLEYS BEING PARTS OF MACHINES; HYDRAULIC DOOR OPENERS; ELECTRIC PUMPS; METAL CLAMPS USED FOR HOLDING PIECE PARTS ON MACHINE TOOL TABLES; HYDRAULIC CLAMPS; HYDRAULIC PUMPS; VACUUM PUMPS; BEARINGS FOR TRANSMISSION SHAFTS, BEING PARTS OF MACHINES; ENGINE BEARINGS; MACHINE PARTS, NAMELY, BEARINGS AND BUSHINGS; MACHINE PARTS, NAMELY, ROLLER BEARINGS; SHAFT BEARINGS FOR VACUUM PUMPS; WORM GEAR REDUCERS AND GEAR REDUCERS FOR MACHINES; ELECTRIC MOTORS FOR MACHINES; GEAR BOXES FOR MACHINES; CONVEYER CHAINS FOR MACHINES; POWER-OPERATED CHAIN SAWS; WOOD WORKING MACHINES, NAMELY, BAND SAWING MACHINES, CROSS-CUT CIRCULAR SAWS, SAW BLAZING CLAMPS USED FOR HOLDING PIECE PARTS ON MACHINE TOOL TABLES, POWER-OPERATED STRAIGHT SAW SHARPENERS, VENEER REELING AND UNREELING MACHINES, POWER-OPERATED VENEER CLIPPERS, POWER-OP-

CLASS 7—(Continued).

ERATED DOUBLE SIZERS, ELECTRIC SANDERS FOR PLYWOOD, POWER-OPERATED LUMBER CORE COMPOSERS, INDUSTRIAL COLD PRESSES, DEHUMIDIFICATION WOOD DRYERS, POWER-OPERATED BAND SCROLL SAWS, CIRCULAR SAW BENCHES, POWER-OPERATED TRIMMING SAWS, PANEL SIZING CIRCULAR SAWS, HAND OPERATED TRIMMING MACHINES, DOUBLE SAWS, GANG RIP SAWS, RADIAL ARM SAWS, MULTI-BLADE CIRCULAR SAWS FOR PANEL SIZING, JIG SAWS, DOUBLE END SAWS FOR ROUND BAR, PLANERS, MILLING MACHINES, POWER-OPERATED SINGLE-HEAD WOOD BORERS, WOOD LATHE MACHINES, AUTOMATIC WOOD LATHES, WOOD COPYING LATHES, ROUND BAR MAKING MACHINES, DOWEL MAKING MACHINES, DOWEL CUTTING MACHINES, POLISHING MACHINES FOR USE IN GRINDING AND POLISHING WOOD, MECHANICAL GLUE SPREADERS, POWER-OPERATED HOT PRESS LUMBER COMPOSERS, EDGE BANDING MACHINES, DRILLING AND TAPPING MACHINES (U.S. CLS. 13, 19, 21, 23, 31, 34 AND 35).

SN 76-468,453. 3M COMPANY, ST. PAUL, MN. FILED 11-12-2002.

PPS

FOR SPRAY GUNS COMPRISING CUPS AND LINERS FOR MIXING AND DISPENSING LIQUIDS (U.S. CLS. 13, 19, 21, 23, 31, 34 AND 35).

SN 76-468,956. NIKOTA USA, WHITTIER, CA. FILED 11-13-2002.



Into the future...now

THE MARK CONSISTS IN PART OF THE STYLIZED LETTERS "FS".

FOR POWER TOOLS, NAMELY, HEAVY DUTY CORDLESS DRILL, ELECTRIC SANDERS, IMPACT WRENCH, POLISHER, JIG SAW, ELECTRIC RANDOM ORBIT SANDER, ELECTRIC DETAIL SANDER, ELECTRIC BELT SANDER, ELECTRIC HEAVY DUTY ANGLE SANDER, TILE SAW, CHOP SAW, GROUT SAW, ELECTRIC STAPLER, POWER OPERATED GRASS/WEED TRIMMER, POWER BLOWER FOR LAWN DEBRIS, VACUUM CLEANERS, ELECTRIC CHAIN SAW IMPACT DRILL, ELECTRIC RECIPROCATING SAW, PILE DRIVER, ROUTERS AND MITER SAW, CORDLESS SCREWDRIVERS, CORDLESS CIRCULAR SAW, CORDLESS DRILL/DRIVER COMBO, ELECTRIC ROTARY HAMMER, VACUUM LEANER HOSES, AND VACUUM PUMPS FOR MACHINES (U.S. CLS. 13, 19, 21, 23, 31, 34 AND 35).

FIRST USE 8-1-2002; IN COMMERCE 8-1-2002.

CLASS 7—(Continued).

SN 76-470,384. ATLAS COPCO WAGNER INC., PORTLAND, OR. FILED 11-29-2002.

THE RATEL

FOR MINING EQUIPMENT, NAMELY, LOW-PROFILE MINING LOADERS (U.S. CLS. 13, 19, 21, 23, 31, 34 AND 35).

FIRST USE 3-0-2001; IN COMMERCE 3-0-2001.

SN 76-471,860. ADHESIVE TECHNOLOGIES, INC., HAMPTON, NH. FILED 11-15-2002.

DETAILER

FOR ELECTRIC GLUE HEATER AND APPLICATOR (U.S. CLS. 13, 19, 21, 23, 31, 34 AND 35).

FIRST USE 4-0-2002; IN COMMERCE 4-0-2002.

SN 76-472,153. SNAPPER PRODUCTS, INC., FORT WASHINGTON, WI. BY ASSIGNMENT SNAPPER, INC., MCDONOUGH, GA. FILED 11-13-2002.

POWERGLIDE

FOR LAWN AND GARDEN EQUIPMENT; NAMELY RIDING AND WALK-BEHIND LAWN MOWERS (U.S. CLS. 13, 19, 21, 23, 31, 34 AND 35).

SN 76-474,357. CHIU TING MACHINERY CO., LTD., TAI-CHUNG, TAIWAN, FILED 12-3-2002.



FOR LATHES; MILLING MACHINES; GRINDING MACHINES; DRILLING MACHINES AND MACHINING CENTER (U.S. CLS. 13, 19, 21, 23, 31, 34 AND 35).

SN 76-475,495. JOY MM DELAWARE, INC., WILMINGTON, DE. FILED 12-13-2002.

BROADBAND

FOR CONVEYOR CHAINS (U.S. CLS. 13, 19, 21, 23, 31, 34 AND 35).

CLASS 7—(Continued).

SN 78-043,264. PORTA S.P.A., BRESCIA, ITALY, FILED 1-16-2001.



OWNER OF ITALY REG. NO. 703384, DATED 5-8-2001, EXPIRES 2-4-2007.

THE ENGLISH TRANSLATION OF "PORTA" IS "PORT" OR "PORTHOLE", "TO CARRY", "DOOR", "DOORWAY", "GATE", OR "GATE", "ENTRANCE".

FOR MACHINES, MACHINES FOR THE MANUFACTURE OF TOOLS, AND MACHINE TOOLS AND THEIR PARTS, NAMELY, MECHANICAL CONVEYORS, PNEUMATIC AND HYDRAULIC CONVEYORS, TRANSFERS, LIFTS, PROGRAMMABLE PART PROCESSORS, TOOL PROCESSORS, ELECTRO-HYDRAULICALLY OPERATED MACHINES, THREADING UNITS, ROBOT AND AUTOMATIC LOADING/UNLOADING MACHINES FOR MACHINE TOOLS, DRAW-BENCH MACHINES, MECHANICAL PRESSES, HYDRAULIC AND OLEODYNAMIC MACHINES, CONVEYORS, COUPLERS, CLAMPERS AND TRANSFERS FOR WORKING SHEET METAL AND METAL DIE-CUT ITEMS (U.S. CLS. 13, 19, 21, 23, 31, 34 AND 35).

SN 78-112,361. HUSKEY, MICHAEL L., MAKANDA, IL. FILED 3-4-2002.

SORT-A-BOUT

FOR RECYCLING EQUIPMENT, NAMELY CONVEYORS, AND SORTING APPARATUS, NAMELY BLOWERS, MAGNETS, AND EDDY-CURRENT SORTERS (U.S. CLS. 13, 19, 21, 23, 31, 34 AND 35).

FIRST USE 9-10-2001; IN COMMERCE 9-10-2001.

SN 78-135,643. DIAMOND TANK RENTALS, INC., MORGAN CITY, LA. FILED 6-13-2002.

POLYSHEAR

FOR MACHINE USED TO BLEND DRILLING FLUIDS FOR USE IN DRILLING OIL AND GAS WELLS (U.S. CLS. 13, 19, 21, 23, 31, 34 AND 35).

SN 78-161,407. WOOD-MIZER PRODUCTS, INC., INDIANAPOLIS, IN. FILED 9-6-2002.

DOUBLEHARD

FOR SAWMILL BLADES (U.S. CLS. 13, 19, 21, 23, 31, 34 AND 35).

FIRST USE 7-1-2000; IN COMMERCE 7-1-2000.

CLASS 7—(Continued).

SN 78-164,356. SUNG KWANG ELECTRONIC CO., LTD., YANGSAN, REPUBLIC OF KOREA, FILED 9-16-2002.

LIHOT

FOR VACUUM CLEANERS (U.S. CLS. 13, 19, 21, 23, 31, 34 AND 35).

SN 78-177,812. SEA S.R.L., 64020 TERAMO, ITALY, FILED 10-24-2002.



THE LINING IN THE DRAWING IS A FEATURE OF THE MARK AND DOES NOT INDICATE COLOR.

FOR HYDRAULIC OPERATIONAL CONTROL MECHANISMS FOR RESIDENTIAL GATES, FOR SINGLE OR DOUBLE SWING GATES, FOR DOUBLE FOLDING GATES, FOR GARAGE DOORS; MOTORS WITH GEARED REDUCTION UNITS IN OIL-BATH FOR OPENING GARAGE DOORS, COMMERCIAL AND RESIDENTIAL SLIDING GATES, WINDOW SHUTTERS AND SECURITY BARS; AUTOMATIC HYDRAULIC BARRIER GATE MOTOR UNITS TO REGULATE GARAGE ENTRANCES AND EXITS (U.S. CLS. 13, 19, 21, 23, 31, 34 AND 35).

FIRST USE 7-13-1990; IN COMMERCE 7-23-1998.

SN 78-181,396. ILLINOIS TOOL WORKS INC., GLENVIEW, IL. FILED 11-4-2002.

COBRA

FOR STRETCH FILM WRAPPING MACHINES (U.S. CLS. 13, 19, 21, 23, 31, 34 AND 35).

FIRST USE 5-31-1984; IN COMMERCE 5-31-1984.

SN 78-185,815. TOWNSEND INTERNATIONAL BOP'S, INC., ODESSA, TX. FILED 11-16-2002.

ANNURAM

FOR OIL WELL DRILLING, GAS WELL DRILLING AND WORK OVER EQUIPMENT, NAMELY, BLOWOUT PREVENTERS (U.S. CLS. 13, 19, 21, 23, 31, 34 AND 35).

FIRST USE 2-24-2002; IN COMMERCE 10-1-2002.

CLASS 7—(Continued).

SN 78-190,273. HYDRO TEK SYSTEMS, INC, REDLANDS, CA. FILED 12-2-2002.

HOT2GO

FOR MACHINES-NAMELY HOT WATER PORTABLE, ELECTRIC POWERED HIGH PRESSURE WASHERS (U.S. CLS. 13, 19, 21, 23, 31, 34 AND 35).

FIRST USE 4-16-1997; IN COMMERCE 6-1-1997.

SN 78-190,584. HARBISON-WALKER REFRACTORIES COMPANY, MOON TOWNSHIP, PA. FILED 12-3-2002.

TRI-FIRE

FOR REFRACTORY CRUCIBLES (U.S. CLS. 13, 19, 21, 23, 31, 34 AND 35).

FIRST USE 10-25-2002; IN COMMERCE 10-25-2002.

SN 78-193,829. BOART LONGYEAR INTERNATIONAL HOLDINGS INC., SALT LAKE CITY, UT. FILED 12-12-2002.

ALPHA BIT

NO CLAIM IS MADE TO THE EXCLUSIVE RIGHT TO USE "BIT", APART FROM THE MARK AS SHOWN.

FOR DRILL BITS FOR EARTH DRILLING EQUIPMENT (U.S. CLS. 13, 19, 21, 23, 31, 34 AND 35).

CLASS 8—HAND TOOLS

SN 76-223,472. JANN YEI INDUSTRY CO., LTD., TAI-CHUNG CITY, TAIWAN, FILED 3-13-2001.

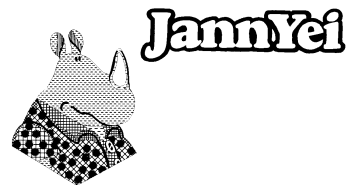

THE LINING SHOWN IN THE DRAWINGS IS A FEATURE OF THE MARK AND NOT INTENDED TO INDICATE COLOR. THE STIPPLING IN THE DRAWING IS FOR SHADING PURPOSES ONLY.

FOR HAND OPERATED STAPLE GUNS (U.S. CLS. 23, 28 AND 44).

FIRST USE 3-1-2000; IN COMMERCE 3-1-2000.

CLASS 8—(Continued).

SN 76-257,947. BUD K & WORLDWIDE, INC., MOULTRIE, GA. FILED 5-17-2001.

RIDGERUNNER

OWNER OF U.S. REG. NO. 2,150,312.
FOR POCKET KNIVES (U.S. CLS. 23, 28 AND 44).
FIRST USE 9-1-1996; IN COMMERCE 9-1-1996.

SN 76-419,821. STACHOWSKI, BARBARA C., ORINDA, CA.
FILED 6-12-2002.

FLAX

FOR MANUALLY OPERATED HAND-HELD HAIR
REMOVAL APPLIANCE (U.S. CLS. 23, 28 AND 44).

SN 76-458,427. RARE STAR INCORPORATION, TAI PING
CITY, TAICHUNG HSIEN, TAIWAN, FILED 10-8-2002.

72T + MULTIGEAR

FOR HAND TOOLS, NAMELY, SCREWDRIVERS AND
WRENCHES (U.S. CLS. 23, 28 AND 44).
FIRST USE 6-2-2002; IN COMMERCE 6-2-2002.

SN 76-459,647. SANTORO, ANTHONY, ORLANDO, FL.
FILED 10-21-2002.

THE PASTOR'S SWORD

NO CLAIM IS MADE TO THE EXCLUSIVE RIGHT TO
USE "SWORD", APART FROM THE MARK AS SHOWN.
FOR SWORDS (U.S. CLS. 23, 28 AND 44).
FIRST USE 8-7-2002; IN COMMERCE 8-7-2002.

SN 76-469,834. TACTICAL & SURVIVAL SPECIALTIES, INC.,
HARRISONBURG, VA. FILED 11-25-2002.



NO CLAIM IS MADE TO THE EXCLUSIVE RIGHT TO
USE "TACOPS", APART FROM THE MARK AS SHOWN.
FOR MULTI-FUNCTIONAL RESCUE HAND TOOLS
COMPRISED OF KNIVES, SCREWDRIVER, PRYING
LEVER, GLASS SAWS, SERRATED KNIVES FOR CUT-
TING SEAT BELTS, CORDS, ROPES (U.S. CLS. 23, 28
AND 44).
FIRST USE 1-1-2002; IN COMMERCE 1-1-2002.

CLASS 8—(Continued).

SN 78-161,506. KÖMHOFF, FRANCISCUS, HENRICUS WIL-
HELMUS, OUD-TURNHOUT, BELGIUM, FILED 9-6-2002.

FRUITMATE

PRIORITY CLAIMED UNDER SEC. 44(D) ON BENELUX
APPLICATION NO. 1006989, FILED 3-12-2002, REG. NO.
0710028, DATED 3-15-2002, EXPIRES 3-15-2012.

FOR CUTLERY, NAMELY KNIVES, FORKS AND
SPOONS.; CUTLERY, NAMELY KNIVES, FORKS AND
SPOONS. (U.S. CLS. 23, 28 AND 44).

SN 78-190,095. BUCCELLATI HOLDING AMERICA, INC.,
NEW YORK, NY. FILED 12-2-2002.

TAHITI

FOR STERLING SILVER FLATWARE, NAMELY,
FORKS, KNIVES, AND SPOONS (U.S. CLS. 23, 28 AND
44).

FIRST USE 12-31-1966; IN COMMERCE 12-31-1966.

SN 78-190,100. BUCCELLATI HOLDING AMERICA, INC.,
NEW YORK, NY. FILED 12-2-2002.

TIBER

FOR STERLING SILVER FLATWARE, NAMELY,
FORKS, KNIVES, AND SPOONS (U.S. CLS. 23, 28 AND
44).

FIRST USE 12-31-1966; IN COMMERCE 12-31-1966.

SN 78-193,950. FEDERATED DEPARTMENT STORES, INC.,
NEW YORK, NY. FILED 12-12-2002.

SHARP FOR LIFE

NO CLAIM IS MADE TO THE EXCLUSIVE RIGHT TO
USE "SHARP", APART FROM THE MARK AS SHOWN.
FOR SERRATED KNIVES (U.S. CLS. 23, 28 AND 44).

SN 78-199,997. ERRERA, RICHARD, B., RONKONKOMA,
NY. FILED 1-3-2003.

TASTY SMILES

FOR HAND-OPERATED FOOD EMBOSsing TOOL
(U.S. CLS. 23, 28 AND 44).

**CLASS 9—ELECTRICAL AND SCIENTIFIC
APPARATUS**

CLASS 9—(Continued).

SN 75-139,313. BUTTERFLIES, LOS ANGELES, CA. FILED 7-24-1996.

BUTTERFLIES

FOR SERIES OF MUSICAL SOUND RECORDINGS AND PRERECORDED VIDEOTAPES AND VIDEODISCS FEATURING MUSIC (U.S. CLS. 21, 23, 26, 36 AND 38).

SN 75-427,237. PAYLINX CORPORATION, ST. LOUIS, MS. BY MERGER PAYLINX CORPORATION, ST. LOUIS, MO. FILED 2-2-1998.

PAYLINX

OWNER OF U.S. REG. NO. 2,144,171.
FOR COMPUTER PROGRAMS FOR USE IN INTERACTIVE CREDIT CARD PROCESSING (U.S. CLS. 21, 23, 26, 36 AND 38).
FIRST USE 4-26-1996; IN COMMERCE 4-26-1996.

SN 75-452,084. SAND TECHNOLOGY INC., WESTMOUNT, QUEBEC, CANADA, BY CHANGE OF NAME SAND TECHNOLOGY SYSTEMS INTERNATIONAL, INC., WESTMOUNT, QUEBEC, CANADA, FILED 3-18-1998.

**NUCLEUS EXPLORATION
DATA WAREHOUSE**

OWNER OF U.S. REG. NO. 1,503,735.
NO CLAIM IS MADE TO THE EXCLUSIVE RIGHT TO USE "DATA WAREHOUSE", APART FROM THE MARK AS SHOWN.
FOR COMPUTER PROGRAMS FOR USE IN DATABASE MANAGEMENT (U.S. CLS. 21, 23, 26, 36 AND 38).

SN 75-452,085. SAND TECHNOLOGY INC., WESTMOUNT, QUEBEC, CANADA, BY CHANGE OF NAME SAND TECHNOLOGY SYSTEMS INTERNATIONAL, INC., WESTMOUNT, QUEBEC, CANADA, FILED 3-18-1998.

**NUCLEUS EXPLORATION
DATA MART**

OWNER OF U.S. REG. NO. 1,503,735.
NO CLAIM IS MADE TO THE EXCLUSIVE RIGHT TO USE "DATA MART", APART FROM THE MARK AS SHOWN.
FOR COMPUTER PROGRAMS FOR USE IN DATABASE MANAGEMENT (U.S. CLS. 21, 23, 26, 36 AND 38).

CLASS 9—(Continued).

SN 75-452,086. SAND TECHNOLOGY INC., WESTMOUNT, QUEBEC, CANADA, BY CHANGE OF NAME SAND TECHNOLOGY SYSTEMS INTERNATIONAL, INC., WESTMOUNT, QUEBEC, CANADA, FILED 3-18-1998.

**NUCLEUS EXPLORATION
WAREHOUSE**

OWNER OF U.S. REG. NO. 1,503,735.
NO CLAIM IS MADE TO THE EXCLUSIVE RIGHT TO USE "WAREHOUSE", APART FROM THE MARK AS SHOWN.
FOR COMPUTER PROGRAMS FOR USE IN DATABASE MANAGEMENT (U.S. CLS. 21, 23, 26, 36 AND 38).

SN 75-607,499. DRUNK BUSTERS OF AMERICA, L.L.C., FOND DU LAC, WI. FILED 12-21-1998.



THE MARK IS LINED FOR THE COLOR RED.
FOR OPTICAL IMPAIRMENT SIMULATOR GOGGLES USED IN ALCOHOL AND IMPAIRED DRIVING AWARENESS AND PREVENTION PROGRAMS (U.S. CLS. 21, 23, 26, 36 AND 38).
FIRST USE 10-28-1998; IN COMMERCE 10-29-1998.

SN 75-687,714. CANADIAN IMPERIAL BANK OF COMMERCE, AS ADMINISTRATIVE AGENT, NEW YORK, NY, BY CHANGE OF NAME CORIOLIS GROUP, LLC, THE, SCOTTSDALE, AZ. FILED 4-21-1999.

CORIOLISOPEN

FOR MULTIMEDIA SOFTWARE RECORDED ON CD-ROM, DISKETTES AND MAGNETIC TAPES FEATURING INFORMATION FOR USE BY NETWORKING PROFESSIONALS AND OTHER PERSONS SEEKING CERTIFICATION, TRAINING AND/OR INFORMATION IN THE FIELD OF COMPUTER HARDWARE AND/OR SOFTWARE (U.S. CLS. 21, 23, 26, 36 AND 38).

CLASS 9—(Continued).

SN 75-720,576. CALIFORNIA MICRO UTILITY, INC., OAKLAND, CA. FILED 6-30-1999.

E ENERGY

NO CLAIM IS MADE TO THE EXCLUSIVE RIGHT TO USE "ENERGY", APART FROM THE MARK AS SHOWN. FOR ELECTRIC POWER MEASURING DEVICES, NAMELY, WATTMETERS (U.S. CLS. 21, 23, 26, 36 AND 38).

FIRST USE 0-0-1997; IN COMMERCE 6-15-1999.

SN 75-749,011. CBC (AMERICA) CORP., COMMACK, NY. FILED 6-15-1999.



OWNER OF U.S. REG. NO. 2,155,602. THE MARK IS COMPRISED OF A HIGHLY STYLIZED REPRESENTATION OF THE LETTERS CBC.

FOR CLOSED CIRCUIT TELEVISION (CCTV) EQUIPMENT, NAMELY, TELEVISION CAMERAS, MONITORS, VCRS AND MULTIPLEXERS, ALL FOR USE IN THE FIELDS OF SECURITY AND SURVEILLANCE, AND MACHINE VISION (U.S. CLS. 21, 23, 26, 36 AND 38).

SN 75-788,163. AQUACY.COM CORPORATION, BUFFALO GROVE, IL. FILED 8-30-1999.

AQRIT

NO CLAIM IS MADE TO THE EXCLUSIVE RIGHT TO USE "ACCURATE", APART FROM THE MARK AS SHOWN. FOR REMITTANCE PROCESSING SYSTEM FOR BANK NOTES, SUCH AS CHECKS, CONSISTING PRIMARILY OF OPTICAL SCANNERS, SORTING MACHINES, AND COMPUTER SOFTWARE FOR OPERATING OPTICAL SCANNERS AND SORTING MACHINES (U.S. CLS. 21, 23, 26, 36 AND 38).

FIRST USE 1-5-1999; IN COMMERCE 1-5-1999.

SN 75-826,796. OPTEC JAPAN KABUSHIKI-KAISHA, SA-BAE-SHI, FUKUI-KEN, JAPAN, FILED 10-19-1999.

LLOYDHOUSE

OWNER OF JAPAN REG. NO. 1836413, DATED 1-24-1986, EXPIRES 1-24-2006.

FOR EYEGLASSES, EYEGLASS PARTS, CONTACT LENSES, SUNGLASSES, PINCE-NEZ AND RELATED ACCESSORIES, NAMELY, EYEGLASS CASES, EYEGLASS CHAINS, PINCE-NEZ CHAINS, PINCE-NEZ CASES, PINCE-NEZ MOUNTINGS AND CONTAINERS FOR CONTACT LENSES (U.S. CLS. 21, 23, 26, 36 AND 38).

CLASS 9—(Continued).

SN 75-829,228. UNION PACIFIC CORPORATION, OMAHA, NE. FILED 10-22-1999.

TERMINALMASTER

FOR COMPUTER SOFTWARE FOR USE IN TRACKING THE LOCATION, STATUS AND DESTINATION OF RAIL CARS AND LOCOMOTIVES IN AND FOR USE IN TRACKING AND COMMUNICATING THE STATUS OF RAIL TRACKS, TRAINS AND SWITCH WORK ORDERS (U.S. CLS. 21, 23, 26, 36 AND 38).

SN 75-896,417. SOUND CONTROL TECHNOLOGIES, INC., NORWALK, CT. FILED 1-7-2000.

AVT 24

FOR TELECONFERENCING SYSTEMS; AUDIO TELECONFERENCING SYSTEMS PROVIDING IMPROVED SYSTEM OPERATIONS THROUGH THE USE OF AN ACOUSTIC MODEL OF THE TELECONFERENCING SPACE TO CANCEL ECHOES; TELECONFERENCING INTERFACES; AUDIO/VIDEO TELECONFERENCING INTERFACES; TELECONFERENCING INTERFACES SPECIFICALLY DESIGNED FOR INTEGRATION INTO HIGHER LEVEL AUDIO AND VIDEO TELECONFERENCING SYSTEMS; AUDIO AND VIDEO LINKS BETWEEN TWO OR MORE SITES FOR PROVIDING AN AUDIO INTERFACE IN AUDIO SYSTEMS (U.S. CLS. 21, 23, 26, 36 AND 38).

FIRST USE 1-0-1993; IN COMMERCE 1-0-1993.

SN 75-911,203. LUN DATA, INC., MILLTON, PA. FILED 2-7-2000.



NO CLAIM IS MADE TO THE EXCLUSIVE RIGHT TO USE "ATM ALLIANCE", APART FROM THE MARK AS SHOWN.

FOR AUTOMATIC TELLER MACHINE (U.S. CLS. 21, 23, 26, 36 AND 38).

FIRST USE 7-12-1999; IN COMMERCE 7-12-1999.

CLASS 9—(Continued).

SN 75-922,676. APPLERA CORPORATION, FOSTER CITY, CA. BY CHANGE OF NAME; BY ASSIGNMENT PERKIN-ELMER CORPORATION, THE, FOSTER CITY, CA. FILED 2-18-2000.

SQL*LIMS

NO CLAIM IS MADE TO THE EXCLUSIVE RIGHT TO USE "LIMS", APART FROM THE MARK AS SHOWN. SEC. 2(F).

FOR COMPUTER UTILITY AND OPERATING SYSTEMS SOFTWARE; COMPUTER SOFTWARE USED FOR TRACKING LABORATORY SAMPLES; COMPUTER SOFTWARE USED FOR COLLECTION, STORAGE, ORGANIZATION, ANALYSIS, INTEGRATION AND COMMUNICATION OF INFORMATION; COMPUTER SOFTWARE USED TO GENERATE COST REPORTS; COMPUTER SOFTWARE USED FOR COMMUNICATIONS BETWEEN AND AMONG GLOBAL AND LOCAL COMPUTER COMMUNICATIONS NETWORKS (U.S. CLS. 21, 23, 26, 36 AND 38).

FIRST USE 9-26-1990; IN COMMERCE 9-26-1990.

SN 76-051,115. HAFELE GMBH & CO., D-72202 NAGOLD, FED REP GERMANY, FILED 5-18-2000.

DIALOCK

OWNER OF FED REP GERMANY REG. NO. 39843566, DATED 10-22-1998, EXPIRES 8-31-2008.

FOR DATA PROCESSING DEVICES, NAMELY, DATA PROCESSORS, COMPUTERS, DATA TRANSMISSION DEVICES, NAMELY, APPARATUS FOR TRANSMITTING DATA TO A COMPUTER VIA WIRELESS, INFRARED OR WIRE TRANSMISSION; COMPUTER SOFTWARE FOR USE IN THE FIELD OF MONITORING ROOMS REGARDING TEMPERATURE, ILLUMINATION, AIR PURITY, CURRENT ENERGY CONSUMPTION; ELECTRONIC CONTROL AND READING MODULES, NAMELY, APPARATUS FOR READING MAGNETICALLY ENCODED CARDS, ELECTRIC SWITCHES, ELECTRONIC MOTION SWITCHES AND ELECTRONIC TOUCH SENSITIVE SWITCHES (U.S. CLS. 21, 23, 26, 36 AND 38).

SN 76-058,501. ANYSTREAM, INC., STERLING, VA. FILED 5-30-2000.

AGILITY ENCODER

OWNER OF U.S. REG. NO. 2,497,208.
NO CLAIM IS MADE TO THE EXCLUSIVE RIGHT TO USE "ENCODER", APART FROM THE MARK AS SHOWN.
FOR COMPUTER SOFTWARE, NAMELY, STREAMING AUDIO AND VIDEO PLAYERS FOR USE OVER A GLOBAL COMPUTER NETWORK (U.S. CLS. 21, 23, 26, 36 AND 38).

CLASS 9—(Continued).

SN 76-088,762. ANYSTREAM, INC., STERLING, VA. FILED 7-14-2000.

AGILITY EDGE

OWNER OF U.S. REG. NO. 2,497,208.
NO CLAIM IS MADE TO THE EXCLUSIVE RIGHT TO USE "EDGE", APART FROM THE MARK AS SHOWN.
FOR COMPUTER SOFTWARE, NAMELY, STREAMING AUDIO AND VIDEO PLAYERS FOR USE OVER A GLOBAL COMPUTER NETWORK (U.S. CLS. 21, 23, 26, 36 AND 38).

SN 76-109,014. ANYSTREAM, INC., STERLING, VA. FILED 8-15-2000.

AGILITY ENTERPRISE

OWNER OF U.S. REG. NO. 2,497,208.
NO CLAIM IS MADE TO THE EXCLUSIVE RIGHT TO USE "ENTERPRISE", APART FROM THE MARK AS SHOWN.
FOR COMPUTER SOFTWARE, NAMELY STREAMING AUDIO AND VIDEO PLAYERS FOR USE OVER A GLOBAL COMPUTER NETWORK (U.S. CLS. 21, 23, 26, 36 AND 38).

SN 76-112,643. NORTHERN TRUST CORPORATION, CHICAGO, IL. FILED 8-18-2000.

PASSPORT

OWNER OF U.S. REG. NO. 2,125,051.
FOR COMPUTER DATABASE MANAGEMENT SOFTWARE IN THE FIELDS OF BANKING, FINANCE, AND INVESTMENTS FOR USE IN MANAGEMENT INFORMATION REPORTING AND FUNDS MOVEMENT; AND COMPUTER MANUALS DISTRIBUTED THEREWITH (U.S. CLS. 21, 23, 26, 36 AND 38).

SN 76-120,314. KING SHOW GAMES, MINNETONKA, MN. FILED 8-31-2000.

WALL STREET

FOR GAMING MACHINES, NAMELY SLOT MACHINES AND GAMING DEVICES, NAMELY INTERACTIVE VIDEO GAMES OF VIRTUAL REALITY COMPRISED OF COMPUTER HARDWARE AND SOFTWARE; COMPUTER SOFTWARE FOR USE IN GAMBLING AND GAMING MACHINES, VIDEO DISPLAY SERVERS (U.S. CLS. 21, 23, 26, 36 AND 38).

CLASS 9—(Continued).

SN 76-137,620. INNOVATIVE SOLUTIONS & SUPPORT, INC., MALVERN, PA. FILED 9-29-2000.

PILOT'S/IP

FOR INTEGRATED AVIONICS INSTRUMENTATION DISPLAY SYSTEMS, COMPRISED PRIMARILY OF A DISPLAY AND A RENDERING COMPUTER SYSTEM FOR RECEIVING INPUT DATA AND FOR PROCESSING THE INPUT DATA FOR GRAPHICALLY DISPLAYING INFORMATION ON THE DISPLAY, FOR THE DISPLAY OF AIRCRAFT, FLIGHT AND NAVIGATIONAL INFORMATION TO THE AIRCRAFT FLIGHT CREW (U.S. CLS. 21, 23, 26, 36 AND 38).

SN 76-142,059. ANYSTREAM, INC., STERLING, VA. FILED 10-6-2000.

AGILITY WORKGROUP

OWNER OF U.S. REG. NO. 2,497,208.
NO CLAIM IS MADE TO THE EXCLUSIVE RIGHT TO USE "WORKGROUP", APART FROM THE MARK AS SHOWN.

FOR COMPUTER SOFTWARE, NAMELY, STREAMING AUDIO AND VIDEO PLAYERS FOR USE OVER A GLOBAL COMPUTER NETWORK (U.S. CLS. 21, 23, 26, 36 AND 38).

SN 76-143,890. DETEWE-DEUTSCHE TELEPHONWERKE AG & CO., 10997 BERLIN, FED REP GERMANY, FILED 10-9-2000.

OpenDimension

PRIORITY CLAIMED UNDER SEC. 44(D) ON FED REP GERMANY APPLICATION NO. 30036675.2/0, FILED 5-15-2000, REG. NO. 30036675, DATED 5-15-2000, EXPIRES 5-31-2010.

FOR ELECTRIC AND ELECTRONIC, OPTO-ELECTRONIC, ANALOG, DIGITAL, WIRE-BASED AND WIRELESS COMMUNICATION SYSTEMS AND APPARATUS, NAMELY, PRIVATE BRANCH EXCHANGES; TELEPHONES, AND TELEPHONE SYSTEMS, COMPRISED OF SYSTEM TELEPHONES AND OPERATOR TERMINAL; APPARATUS FOR ACQUISITION, COMPUTING, BROADCASTING, TRANSMITTING, EXCHANGING, STORING, RECEIVING AND OUTPUTTING OF SPEECH, TEXT AND DATA, NAMELY, TELEPHONE CONNECTION COMPUTER HARDWARE ROUTERS AND SWITCHING DEVICES; TELECOMMUNICATION DEVICES, NAMELY, MODEMS, ANALOG TO DIGITAL, AND DIGITAL TO ANALOG, AND OTHER CONVERTERS; DATA OUTPUT PRINTERS AND PLOTTERS, PRINTED CIRCUIT BOARDS AND CASSETTE DRIVE ASSEMBLIES FOR HARD-DISCS, COMPUTER TAPES, FLOPPY DISCS AND; COMPUTER PROGRAMS FOR PROCESSING, CONTROLLING, MONITORING AND TRANSMITTING OF DATA IN THE FIELD OF TELECOMMUNICATIONS (U.S. CLS. 21, 23, 26, 36 AND 38).

CLASS 9—(Continued).

SN 76-155,843. IBRITE, INC., RESTON, VA. FILED 10-30-2000.

IZOOM

FOR COMPUTER SOFTWARE FOR AUTHORIZING, ORGANIZING, AND DISPLAYING ELECTRONIC INFORMATION, NAMELY TEXT AND MULTIMEDIA CONTENT, ON PORTABLE COMPUTER DEVICES; COMPUTER SOFTWARE FOR DELIVERING ELECTRONIC INFORMATION, NAMELY TEXT AND MULTIMEDIA CONTENT, FROM PERSONAL COMPUTERS AND COMPUTER NETWORKS TO PORTABLE COMPUTER DEVICES (U.S. CLS. 21, 23, 26, 36 AND 38).

SN 76-157,101. PARKER DAVIS CO., INC., CHARLOTTE, NC. FILED 10-31-2000.

QUIK STAKE

FOR MARKERS FOR USE IN SURVEYING (U.S. CLS. 21, 23, 26, 36 AND 38).
FIRST USE 3-23-2001; IN COMMERCE 3-23-2001.

SN 76-159,424. KOWA CO., LTD., NAGOYA-SHI, AICHI 460-0003, JAPAN, FILED 11-3-2000.

STEGANOSIGN

OWNER OF JAPAN REG. NO. 4300392, DATED 7-30-1999, EXPIRES 7-30-2009.

FOR ELECTRONIC CIRCUITS, BLANK MAGNETIC DISKS, BLANK MAGNETIC TAPES, OPTICAL DISKS, AND OPTICAL MAGNETIC DISKS USED WITH COMPUTER SOFTWARE; MAGNETIC DISKS AND MAGNETIC TAPES CONTAINING COMPUTER PROGRAMS, IN THE FIELD OF SECURITY, ACCESS CONTROL, AND ENCRYPTION; ELECTRONIC CIRCUITS, BLANK MAGNETIC DISKS, BLANK MAGNETIC TAPES, OPTICAL DISKS, AND OPTICAL MAGNETIC DISKS; AND COMPUTER HARDWARE (U.S. CLS. 21, 23, 26, 36 AND 38).

SN 76-169,509. ICAREPLACE, INC., BANGOR, ME. FILED 11-20-2000.

ICAREPLACE

FOR COMPUTER DATABASE MANAGEMENT PROGRAMS FOR USE IN COMPREHENSIVE MANAGEMENT OF CLIENT INFORMATION IN THE FIELD OF HEALTHCARE, INCLUDING MENTAL HEALTH CARE AND BEHAVIORAL HEALTH CARE; SOCIAL SERVICES AND CHILD WELFARE; AND EDUCATION, INCLUDING ELEMENTARY, SECONDARY, AND SPECIAL NEEDS; COMPUTER DATABASE MANAGEMENT SOFTWARE FOR USE IN COMPREHENSIVE MANAGEMENT OF CLIENT INFORMATION IN THE FIELDS OF HEALTHCARE, INCLUDING MENTAL HEALTH CARE AND BEHAVIORAL HEALTH CARE; SOCIAL SERVICES AND CHILD WELFARE; AND EDUCATION, INCLUDING ELEMENTARY, SECONDARY, AND SPECIAL NEEDS (U.S. CLS. 21, 23, 26, 36 AND 38).

CLASS 9—(Continued).

SN 76-186,477. KABUSHIKI KAISHA TOKUMA SHOTEN, MINATO-KU, TOKYO, JAPAN, FILED 12-27-2000.

INCREDIBLE CRISIS!

FOR COMPUTER VIDEO GAME PROGRAMS, COMPUTER VIDEO GAME SOFTWARE STORED ON CARTRIDGES, CASSETTES, CARDS AND DISCS (U.S. CLS. 21, 23, 26, 36 AND 38).

FIRST USE 11-23-2000; IN COMMERCE 11-23-2000.

SN 76-189,590. CALYPSO MEDICAL TECHNOLOGIES INC., SEATTLE, WA. FILED 1-4-2001.

BEACON

FOR COMPUTER HARDWARE IN THE NATURE OF TRANSCEIVERS AND TRANSPONDERS (U.S. CLS. 21, 23, 26, 36 AND 38).

SN 76-190,533. ASCENTIAL SOFTWARE, INC., MENLO PARK, CA. BY CHANGE OF NAME INFORMIX BUSINESS SOLUTIONS, INC., MENLO PARK, CA. FILED 1-5-2001.

ASCENTIAL

FOR COMPUTER PROGRAMS, NAMELY DATA WAREHOUSING AND DATA INTEGRATION SOFTWARE FOR THE MANAGEMENT, ANALYSIS AND INTEGRATION OF DATA, AND THE TRANSFER OF DATA FROM ONE COMPUTER, SOFTWARE APPLICATION OR DATABASE TO ANOTHER (U.S. CLS. 21, 23, 26, 36 AND 38).

SN 76-200,691. CIRQUE CORPORATION, SALT LAKE CITY, UT. FILED 1-26-2001.

MICRO GLIDEPOINT

OWNER OF U.S. REG. NOS. 1,754,454 AND 1,917,722. FOR INPUT DEVICES, NAMELY KEYBOARDS, TOUCHPADS, TOUCHPAD KEYBOARDS, AND STYLUSES FOR USE WITH PORTABLE ELECTRONIC APPLIANCES SUCH AS COMPUTERS, PERSONAL DIGITAL ASSISTANTS, AND CELL PHONES (U.S. CLS. 21, 23, 26, 36 AND 38).

CLASS 9—(Continued).

SN 76-212,012. GROWMARK, INC., BLOOMINGTON, IL. FILED 2-20-2001.



OWNER OF U.S. REG. NO. 1,642,619. NO CLAIM IS MADE TO THE EXCLUSIVE RIGHT TO USE "IMS", APART FROM THE MARK AS SHOWN. FOR COMPUTER BUSINESS SOFTWARE, NAMELY, REPORTING PROFITABILITY MEASUREMENTS FOR PETROLEUM AND AGRICULTURAL DISTRIBUTION (U.S. CLS. 21, 23, 26, 36 AND 38).

FIRST USE 6-15-1998; IN COMMERCE 6-15-1998.

SN 76-216,168. ADAC LABORATORIES, MILPITAS, CA. FILED 2-27-2001.

INSYNC

FOR COMPUTER SOFTWARE FOR MEDICAL IMAGING USED TO OPERATE MEDICAL IMAGING EQUIPMENT, COMPUTER SOFTWARE USED TO DIAGNOSE AILMENTS FROM MEDICAL IMAGES (U.S. CLS. 21, 23, 26, 36 AND 38).

SN 76-216,279. DE LA RUE INTERNATIONAL LIMITED, HAMPSHIRE RG22 4BS, ENGLAND, FILED 2-27-2001.

COBRA

PRIORITY CLAIMED UNDER SEC. 44(D) ON ERPNCMNTY TM OFC APPLICATION NO. 002105427, FILED 2-26-2001, REG. NO. 2105427, DATED 4-12-2002, EXPIRES 4-13-2012.

FOR APPARATUS MACHINES FOR DISPENSING, DEPOSITING, COUNTING AND RECYCLING CURRENCY; AUTOMATED BANKNOTE DISPENSERS, COUNTERS, SORTERS, DEPOSITORS AND RECYCLERS; AUTOMATED TELLER AND CASH DISPENSERS FOR PAPER DOCUMENTS AND CASH; PARTS AND FITTINGS FOR ALL THE AFORESAID GOODS (U.S. CLS. 21, 23, 26, 36 AND 38).

FIRST USE 5-13-2002; IN COMMERCE 5-13-2002.

SN 76-238,727. CLIFF WEIL, INC., MECHANICSVILLE, VA. FILED 4-10-2001.

ACTIONEYZ

FOR EYEWEAR, NAMELY, SUNGLASSES (U.S. CLS. 21, 23, 26, 36 AND 38).

FIRST USE 1-1-2002; IN COMMERCE 1-1-2002.

CLASS 9—(Continued).

SN 76-239,353. MICROBAR, INC., SUNNYVALE, CA. FILED 4-10-2001.

SCANMATE

FOR BAR CODING SYSTEMS COMPRISED OF BAR CODE LOCATOR AND IDENTIFIED LABELS AND BAR CODE READING DEVICE FOR IDENTIFYING AND LOCATING CHEMICALS USED IN INTEGRATED CIRCUIT AND SEMICONDUCTOR MANUFACTURING (U.S. CLS. 21, 23, 26, 36 AND 38).

SN 76-243,473. GK INDUSTRIES, INCORPORATED, NORTHBROOK, IL. FILED 4-20-2001.

**DIGITALVDO
FRAMEMASTER**

NO CLAIM IS MADE TO THE EXCLUSIVE RIGHT TO USE "DIGITAL", APART FROM THE MARK AS SHOWN. FOR DIGITAL VIDEO RECORDER (U.S. CLS. 21, 23, 26, 36 AND 38).
FIRST USE 12-31-2000; IN COMMERCE 12-31-2000.

SN 76-255,064. IOBION INFORMATICS, L.L.C., LA JOLLA, CA. BY ASSIGNMENT BIOCREST HOLDINGS, L.L.C., LA JOLLA, CA. FILED 5-10-2001.

IOBION

FOR COMPUTER HARDWARE; COMPUTER SOFTWARE FOR BIOINFORMATICS APPLICATIONS, NAMELY DATA ANALYSIS, DATA RETRIEVAL AND DATABASE MANAGEMENT IN THE FIELD OF LIFE SCIENCES RESEARCH (U.S. CLS. 21, 23, 26, 36 AND 38).

SN 76-258,359. HOYA CORPORATION, SHINJUKU-KU TOKYO, JAPAN, FILED 5-17-2001.

HOYALUX SUMMIT PRO

PRIORITY CLAIMED UNDER SEC. 44(D) ON ERPNTY TM OFC APPLICATION NO. 2075414, FILED 2-8-2001, REG. NO. 002075414, DATED 1-23-2003, EXPIRES 2-8-2011.

FOR LENSES FOR EYEGLASSES (U.S. CLS. 21, 23, 26, 36 AND 38).

CLASS 9—(Continued).

SN 76-263,512. AUDIO PRODUCTS INTERNATIONAL CORP., SCARBOROUGH, ONTARIO, CANADA, FILED 5-29-2001.

ENERGY

OWNER OF CANADA REG. NO. TMA395924, DATED 3-20-1992, EXPIRES 3-20-2007.

OWNER OF U.S. REG. NOS. 1,201,814 AND 1,807,139. FOR LOUDSPEAKERS, SOUND AMPLIFIERS, RADIO AND STEREO RECEIVERS, TURNTABLES, AUDIO TAPE RECORDERS, AUDIO TAPE PLAYERS, STEREO TUNERS, GRAPHIC EQUALIZERS, ELECTRONIC NOISE REDUCTION UNITS, AND ELECTRONIC SIGNAL MODIFICATION UNITS FOR LOUD SPEAKERS (U.S. CLS. 21, 23, 26, 36 AND 38).

SN 76-265,635. COPPOLA FAMILY TRUST, THE, SAN FRANCISCO, CA. FILED 6-4-2001.

APOCALYPSE NOW

FOR PRERECORDED VIDEO CASSETTES, DIGITAL VIDEO DISCS, COMPACT DISCS AND AUDIO CASSETTES FEATURING ACTION AND DRAMATIC FILMS (U.S. CLS. 21, 23, 26, 36 AND 38).

SN 76-284,873. OY CYBERSOFT AB, 33200 TAMPERE, FINLAND, FILED 7-13-2001.

NEURODESIGNER

PRIORITY CLAIMED UNDER SEC. 44(D) ON FINLAND APPLICATION NO. T200100798, FILED 3-6-2001, REG. NO. 223281, DATED 3-15-2002, EXPIRES 3-15-2012.

FOR COMPUTER SOFTWARE FOR USE IN MODELING, TEACHING, VISUALIZING, TESTING, EMBEDDING AND USING NEURAL NETWORKS (U.S. CLS. 21, 23, 26, 36 AND 38).

SN 76-289,782. RBN, INC., COLUMBIA, MD. FILED 7-25-2001.

**BRINGING THE LONG HAUL
HOME**

FOR BROADBAND PHOTONIC NETWORKING SYSTEMS COMPRISING COMPUTER HARDWARE, COMPUTER NETWORK HUBS, SWITCHES AND ROUTERS, AND COMMUNICATIONS SOFTWARE FOR CONNECTING COMPUTER NETWORK USERS AND GLOBAL COMPUTER NETWORKS (U.S. CLS. 21, 23, 26, 36 AND 38).

CLASS 9—(Continued).

SN 76-289,885. DATAPAQ, INC., WILMINGTON, MA. FILED 7-25-2001.

MULTI TRACKER

NO CLAIM IS MADE TO THE EXCLUSIVE RIGHT TO USE "TRACKER", APART FROM THE MARK AS SHOWN. FOR TEMPERATURE PROFILING SYSTEM COMPRISED OF THERMOCOUPLES AND COMPUTER SOFTWARE FOR USE TO ANALYZE TEMPERATURES AND LOG DATA IN THE FIELD OF FOOD PROCESORS (U.S. CLS. 21, 23, 26, 36 AND 38).
FIRST USE 10-0-1993; IN COMMERCE 10-0-1993.

SN 76-292,115. AQUA-MUSIQUE FRANCE, LASSEURE, FRANCE, FILED 7-30-2001.

OWNER OF ERPN CMNTY TM OFC REG. NO. 000549105, DATED 8-16-1999, EXPIRES 8-16-2009.

THE MARK CONTAINS PORTIONS AS INDICATED THAT ARE BLUE.

THE TERM "AQUA" IS DERIVED FROM LATIN AND MEANS "WATER". THE TERM "MUSIQUE" IS THE FRENCH WORD FOR "MUSIC".

FOR SOUND ALARMS, NAMELY, PERSONAL SECURITY ALARMS; MAGNETIC TAPE RECORDERS, AUDIO AND VIDEO HEAD CLEANING TAPES; BLANK MAGNETIC TAPES, BLANK VIDEO TAPES, BRANCH BOXES, CABINETS FOR LOUDSPEAKERS, VIDEO CAMERAS, CD-ROM DRIVERS AND WRITERS; ACOUSTIC COUPLERS, MAGNETIC DISCS, NAMELY, BLANK VIDEO DISCS AND BLANK OPTICAL DISCS, OPTICAL DISCS, NAMELY, BLANK OPTICAL DISCS TELEPHONE RECEIVERS, VIDEO SCREENS, TELECOMMUNICATIONS TRANSMITTERS, ELECTRONIC SIGNAL TRANSMITTERS, LOUDSPEAKERS, WATER LEVEL INDICATORS, TEMPERATURE INDICATORS, OPTICAL GOODS, NAMELY, OPTICAL FILTERS, OPTICAL FRAMES; SPECTACLES, MICROPHONES, MODEMS, MONITORS, NAMELY, COMPUTER MONITORS AND VIDEO MONITORS, MUSICAL JUKE BOXES, COMPUTER PERIPHERAL JUKE BOXES, PUBLIC ADDRESS EQUIPMENT, NAMELY, HORNS FOR USE WITH LOUDSPEAKERS; AUDIO RECEIVERS, VIDEO RECEIVERS, SOUND REPRODUCTION EQUIPMENT, NAMELY, AMPLIFIERS, SOUNDS MIXING DESKS; SCANNERS, AUDIO DISC AND AUDIO CASSETTE READERS, SOUND AMPLIFIERS, GRAPHIC EQUALIZERS (U.S. CLS. 21, 23, 26, 36 AND 38).

CLASS 9—(Continued).

SN 76-300,599. I-DATA INTERNATIONAL A/S, DK-2880 BAGSVAERD, DENMARK, FILED 8-15-2001.

SAFECOM

OWNER OF DENMARK REG. NO. VR199902764, DATED 7-30-1999, EXPIRES 7-30-2009.

FOR COMPUTER SOFTWARE, NAMELY, COMPUTER PROGRAMS FOR MANAGING, ACCOUNTING, ENCRYPTING, STORING, RELEASING AND SECURING CONFIDENTIAL PRINT-JOBS (U.S. CLS. 21, 23, 26, 36 AND 38).

SN 76-305,057. PHOTONETICS, 78160 MARLY LE ROI, FRANCE, FILED 8-27-2001.

OSICS

PRIORITY CLAIMED UNDER SEC. 44(D) ON ERPN CMNTY TM OFC APPLICATION NO. 002231330, FILED 5-11-2001.

FOR MATERIAL TESTING AND REGULATING APPLIANCES AND INSTRUMENTS NAMELY OPTICAL FIBER TESTING AND REGULATING APPLIANCES AND INSTRUMENTS USED IN TELECOMMUNICATION, NETWORKS AND IN FIBER OPTIC NETWORKS; OPTICAL SPECTRUM ANALYZERS AND SPECTRUM ANALYZERS FOR FIBER-OPTIC NETWORKS, WAVELENGTH-DIVISION OPTICAL MULTIPLEXERS AND DEMULTIPLEXERS; OPTICAL SPECTRUM ANALYZERS AND SPECTRUM ANALYZERS FOR FIBER-OPTIC NETWORKS; OPTICAL REFLECTOMETERS AND POLARIMETERS MODAL DISTORTION IN A LIGHT BEAM MEASURING APPLIANCES; MULTI-WAVELENGTH LASER SOURCE APPLIANCES AND INSTRUMENTS (U.S. CLS. 21, 23, 26, 36 AND 38).
FIRST USE 2-0-1999; IN COMMERCE 3-1-1999.

SN 76-307,196. E.GADS, LLC, LAS VEGAS, NV. FILED 8-30-2001.

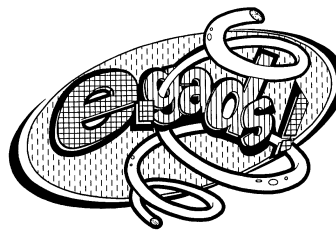

THE OVAL BACKGROUND IS LINED FOR THE COLOR VIOLET, THE SMALL LETTER "E", THE PERIOD AND THE EXCLAMATION MARK ARE LINED FOR THE COLOR GOLD, THE LETTERS "GADS" ARE LINED FOR THE COLOR RED.

FOR ELECTRONIC, MAGNETIC, COMPUTERIZED OR OPTICAL SIGNS AND DISPLAYS EMPLOYING LIGHT EMITTING DIODES, LAMPS OR FLUID CRYSTAL DISPLAYS FOR THE OUTPUT OF ELECTRONIC, MAGNETIC OR OPTICAL TEXT, GRAPHIC, VIDEO OR AUDIO CONTENT; SOFTWARE USED IN CONNECTION WITH COMPUTERIZED ELECTRIC SIGNAGE AND DISPLAYS (U.S. CLS. 21, 23, 26, 36 AND 38).

FIRST USE 6-1-2000; IN COMMERCE 6-1-2000.

CLASS 9—(Continued).

SN 76-314,818. ORON, RAM, REHOVOT 76469, ISRAEL, AND NEVO, DORON, RA'ANANA 43563, ISRAEL, FILED 9-18-2001.

KiloLambda

PRIORITY CLAIMED UNDER SEC. 44(D) ON ISRAEL APPLICATION NO. 148762, FILED 4-23-2001, REG. NO. 148762, DATED 5-3-2002, EXPIRES 4-23-2008.

FOR COMMUNICATIONS, TELECOMMUNICATIONS AND OPTICAL APPARATUS AND INSTRUMENTS, NAMELY, OPTICAL SOURCES; OPTICAL TRANSMITTERS; RECEIVERS AND AMPLIFIERS; OPTICAL TESTERS; OPTICAL APPARATUS FOR PROTECTION AND OPERATION OF OPTICAL NETWORKS, NAMELY, OPTICAL SWITCHES, LIMITERS, ATTENUATORS, FILTERS AND TERMINATORS; OPTICAL PULSE GENERATORS (U.S. CLS. 21, 23, 26, 36 AND 38).

CLASS 9—(Continued).

SN 76-330,867. UCONN TECHNOLOGY INC., HSINCHU TAIWAN, CHINA, FILED 10-29-2001.



PRIORITY CLAIMED UNDER SEC. 44(D) ON CHINA APPLICATION NO. 90037427, FILED 9-7-2001, REG. NO. 01029965, DATED 1-16-2003, EXPIRES 5-31-2007.

FOR OPTICAL FIBER COMPONENTS, NAMELY, OPTICAL CONNECTOR; OPTICAL ADAPTOR; OPTIC FIBER PATCHCORD; OPTICAL ATTENUATOR; OPTICAL COUPLER; OPTICAL WAVELENGTH DIVISION MULTIPLEXER; OPTICAL COLLIMATOR; OPTICAL ISOLATOR; OPTICAL AMPLIFIER; FIBER BRAGG GRATING (U.S. CLS. 21, 23, 26, 36 AND 38).

SN 76-335,733. DUAL-LITE INC., CHESHIRE, CT. FILED 11-8-2001.

EVERGARD

SN 76-324,892. NEVADA LEARNING SERIES INC., TORONTO, M4K 1M0, ONTARIO, CANADA, BY ASSIGNMENT STONYLAKE SOLUTIONS INC., TORONTO, ONTARIO, FILED 10-12-2001.

FOR EMERGENCY LIGHTING UNITS AND ILLUMINATED EXIT SIGNS (U.S. CLS. 21, 23, 26, 36 AND 38).

SN 76-338,309. TENENZ, INC., BLOOMINGTON, MN. FILED 11-16-2001.

INSIDEOUT FIREWALL REPORTER

PRIORITY CLAIMED UNDER SEC. 44(D) ON CANADA APPLICATION NO. 1,102,722, FILED 5-10-2001.

NO CLAIM IS MADE TO THE EXCLUSIVE RIGHT TO USE "FIREWALL REPORTER", APART FROM THE MARK AS SHOWN.

FOR FIREWALL USAGE REPORTING SOFTWARE (U.S. CLS. 21, 23, 26, 36 AND 38).

FIRST USE 8-0-2001; IN COMMERCE 8-0-2001.

Tax-Aid
Eagle View Software 

NO CLAIM IS MADE TO THE EXCLUSIVE RIGHT TO USE "SOFTWARE", APART FROM THE MARK AS SHOWN. SEC. 2(F) AS TO "TAX-AID".

FOR TAX PREPARATION SOFTWARE FOR FILING FEDERAL AND STATE TAX RETURNS FOR INDIVIDUALS AND BUSINESSES SOLD TO PROFESSIONAL TAX PREPARERS (U.S. CLS. 21, 23, 26, 36 AND 38).

CLASS 9—(Continued).

SN 76-340,263. VODAVI COMMUNICATIONS SYSTEMS, INC., SCOTTSDALE, AZ. FILED 11-20-2001.



FOR COMPUTER TELEPHONY SYSTEMS NAMELY, COMPUTERS, TELEPHONES, AUTOMATED DIALERS, HARDWARE AND SOFTWARE USED IN CONNECTION WITH INTERACTIVE, DIGITIZED, SYNTHESIZED AND AUDIO RECOGNITION TECHNOLOGY FOR USE IN DELIVERING AND RECEIVING DATA, MESSAGES AND PROGRAMMING COMMANDS (U.S. CLS. 21, 23, 26, 36 AND 38).

SN 76-340,549. SAMSUNG ELECTRONICS CO., LTD., SUWON-CITY KYUNGKI-DO, REPUBLIC OF KOREA, FILED 11-23-2001.

PROPICTURE

PRIORITY CLAIMED UNDER SEC. 44(D) ON REPUBLIC OF KOREA APPLICATION NO. 2001-0045134, FILED 10-15-2001, REG. NO. 0543548, DATED 3-20-2003, EXPIRES 3-20-2013.

FOR TELEVISIONS (U.S. CLS. 21, 23, 26, 36 AND 38).

SN 76-341,705. NANOWORLD AG, CH-20007 NEUCHATEL, SWITZERLAND, FILED 11-27-2001.

NANOWORLD

PRIORITY CLAIMED UNDER SEC. 44(D) ON ERPN CMNTY TM OFC APPLICATION NO. 2,389,500, FILED 9-26-2001, REG. NO. 2389500, DATED 12-16-2002, EXPIRES 9-26-2010.

FOR SCIENTIFIC, SURVEYING, ELECTRIC, OPTICAL, AND MEASURING APPARATUS AND INSTRUMENTS, NAMELY, SCANNING PROBE MICROSCOPES, SCANNING ELECTRON MICROSCOPES AND ATOMIC FORCE MICROSCOPES; ELECTRIC AND ELECTRONIC AND MICRO-MECHANICAL AND MICRO-ELECTROMECHANICAL SENSORS AND PROBES FOR NON-OPTICAL MICROSCOPES AND OPTICAL NEAR FIELD MICROSCOPES; ELECTRIC AND ELECTRONIC AND MICRO-MECHANICAL AND MICRO-ELECTROMECHANICAL SENSORS FOR DETECTION OF PRESSURE, GASES, TEMPERATURE, INTENSITY OF LIGHT, FORCES, ACCELERATION, VIBRATIONS, NICK ANGLE, HUMIDITY, DISTANCES, SPEED, ROUGHNESS, THICKNESS, ACOUSTIC WAVES, AND MOLECULES, FOR MEASURING SURFACE TOPOGRAPHY, HEIGHT, ELECTRICAL AND MAGNETICAL SURFACE PROPERTIES, POTENTIALS AND CURRENTS; ELECTRIC AND ELECTRONIC AND MICRO-MECHANICAL AND MICRO-ELECTROMECHANICAL SENSORS AND PROBES FOR ATOMIC FORCE MICROSCOPY, FOR SCANNING PROBE MICROSCOPY, AND FOR SCANNING ELECTRON MICROSCOPY; ELECTRIC AND ELECTRONIC AND MICRO-MECHANICAL AND MICRO-ELECTROMECHANICAL SENSORS COMPRISED OF MICRO-MECHANICAL CANTILEVERS AND MEMBRANES (U.S. CLS. 21, 23, 26, 36 AND 38).

CLASS 9—(Continued).

SN 76-342,599. SONY KABUSHIKI KAISHA, TA SONY CORPORATION, TOKYO, JAPAN, FILED 11-28-2001.



NO CLAIM IS MADE TO THE EXCLUSIVE RIGHT TO USE "VIEW", APART FROM THE MARK AS SHOWN. FOR VIDEO CAMERAS FOR SURVEILLANCE PURPOSES (U.S. CLS. 21, 23, 26, 36 AND 38).

SN 76-344,771. INTERNATIONAL ELECTRONICS, INC., CANTON, MA. FILED 12-5-2001.

HUB MANAGER

NO CLAIM IS MADE TO THE EXCLUSIVE RIGHT TO USE "HUB", APART FROM THE MARK AS SHOWN.

FOR COMPUTER BASED ACCESS CONTROL SYSTEMS COMPRISING COMPUTER HARDWARE AND SOFTWARE FOR USE IN CONTROLLING ACCESS BY INDIVIDUALS TO ENTRY WAYS AND DEVICES (U.S. CLS. 21, 23, 26, 36 AND 38).

FIRST USE 8-15-2001; IN COMMERCE 8-15-2001.

SN 76-348,070. VIDEOJET TECHNOLOGIES, INC., WOOD DALE, IL. BY CHANGE OF NAME MARCONI DATA SYSTEMS INC., WOOD DALE, IL. FILED 12-12-2001.

SNOWFLAKE ENCODED

OWNER OF U.S. REG. NO. 2,341,607.

NO CLAIM IS MADE TO THE EXCLUSIVE RIGHT TO USE "ENCODED", APART FROM THE MARK AS SHOWN. FOR COMPUTER SOFTWARE, FIRMWARE, AND HARDWARE FOR ENCODING, DECODING, OR FORMING MACHINE READABLE SYMBOLS; DEVICES CONTAINING COMPUTER SOFTWARE, FIRMWARE, OR HARDWARE FOR ENCODING, DECODING, OR FORMING MACHINE READABLE SYMBOLS, NAMELY SCANNERS, READERS, AND IMAGE PROCESSORS; COMPUTER PERIPHERAL DEVICES, NAMELY SCANNERS, READERS AND IMAGE PROCESSORS; DOT MATRIX CHARACTER READERS, NAMELY SCANNERS AND IMAGE PROCESSORS (U.S. CLS. 21, 23, 26, 36 AND 38).

FIRST USE 10-0-2000; IN COMMERCE 10-0-2000.

CLASS 9—(Continued).

SN 76-348,255. TECMO KABUSHIKI KAISHA, TOKYO 102-8230, JAPAN, FILED 12-12-2001.

NINJA GAIDEN

OWNER OF U.S. REG. NO. 1,571,115.
THE ENGLISH TRANSLATION OF THE WORD "GAIDEN" IS "ANOTHER STORY".

FOR VIDEO GAME PROGRAMS FOR USE WITH VIDEO GAME MACHINES ADAPTED FOR USE WITH TELEVISIONS; VIDEO GAME PROGRAMS FOR USE WITH COIN-OPERATED ELECTRONIC GAME EQUIPMENT; VIDEO GAME PROGRAMS FOR USE WITH CELLULAR TELEPHONES; COMPUTERS; DOWNLOADABLE COMPUTER GAME SOFTWARE; DOWNLOADABLE MUSICAL SOUND RECORDINGS; DOWNLOADABLE VIDEO RECORDINGS FEATURING MUSIC, GAMES, SELF-IMPROVEMENT TECHNIQUES; DOWNLOADABLE ELECTRONIC PUBLICATIONS IN THE NATURE OF PAMPHLETS, BOOKS, USER MANUALS IN THE FIELD OF GAME PLAYING TACTICS AND PRACTICES AND RELATED GAME PLAYING INFORMATION; COMPUTER GAME PROGRAMS; COMPUTER GAME SOFTWARE VIDEO GAME SOFTWARE; MICRO-COMPUTERS ADAPTED FOR PLAYING GAMES; VIDEO GAME JOY STICKS; COMPUTER MOUSE; COMPUTER TRACK BALL; ELECTRONIC GAMES PROGRAMS, NAMELY, VIDEO GAMES, ADAPTED FOR USE WITH TELEVISIONS; VIDEO GAME MACHINES ADAPTED FOR USE WITH TELEVISION RECEIVERS (U.S. CLS. 21, 23, 26, 36 AND 38).

SN 76-350,000. CERNER CORPORATION, KANSAS CITY, MO. FILED 12-18-2001.

CARENET

OWNER OF U.S. REG. NO. 1,850,225.
FOR COMPUTER SOFTWARE FOR USE IN THE HEALTHCARE FIELD, NAMELY SOFTWARE FOR MANAGING, STORING, ANALYZING, MAINTAINING, PROCESSING, STRUCTURING, REVIEWING, BUILDING, EDITING, DISTRIBUTING, COMMUNICATING, ORGANIZING, SHARING, REFERENCING, MONITORING AND INTEGRATING PATIENT INFORMATION; COMPUTER SOFTWARE FOR AUTOMATING CLINICAL AND ADMINISTRATIVE HEALTHCARE PROCESSES, NAMELY SOFTWARE FOR AUTOMATING PATIENT REGISTRATION, ADMISSION, TRANSFER AND DISCHARGE, CHARGE SUBMISSION, CARE COORDINATION, ORDERING, AND DOCUMENTATION; COMPUTER SOFTWARE FOR USE IN THE HEALTHCARE FIELD, NAMELY SOFTWARE FOR AUTOMATING SCHEDULING AND PROCESSING SCHEDULING INFORMATION (U.S. CLS. 21, 23, 26, 36 AND 38).
FIRST USE 3-0-1987; IN COMMERCE 3-0-1987.

CLASS 9—(Continued).

SN 76-352,246. STUDIOCANAL IMAGE, BOULOGNE-BILLANCOURT, FRANCE, BY MERGER CANAL + D.A., BOULOGNE BILLANCOURT, FRANCE, FILED 12-21-2001.

ESCAPE FROM NEW YORK

NO CLAIM IS MADE TO THE EXCLUSIVE RIGHT TO USE "NEW YORK", APART FROM THE MARK AS SHOWN.
FOR COMPUTER GAME SOFTWARE, COMPUTER GAME DISKS, COMPUTER GAME PROGRAMS, COMPUTER GAME CASSETTES AND TAPES, COMPUTER GAME CARTRIDGES, MULTIMEDIA SOFTWARE RECORDED ON A CD-ROM FEATURING COMPUTER GAMES, COMPUTER GAME SOFTWARE THAT IS DOWNLOADABLE FROM A GLOBAL COMPUTER NETWORK, COMPUTERS, COMPUTER HARDWARE, COMPUTER GAME FIRMWARE, COMPUTER MOUSE PADS, VIDEO GAME MACHINES FOR USE WITH TELEVISIONS, VIDEO GAME CARTRIDGES, VIDEO GAME CASSETTES, PRE-RECORDED VIDEO TAPES FEATURING COMPUTER GAMES AND CHARACTERS, COMPUTER GAME PROGRAMS AND VIDEO GAME MACHINES FOR USE WITH TELEVISION SETS, AND MOTION PICTURE FILMS FEATURING THE ACTION AND ADVENTURE GENRE (U.S. CLS. 21, 23, 26, 36 AND 38).

SN 76-353,217. HYPER THERM AUTOMATION, WEST LEBANON, NH. FILED 12-19-2001.

HYPERNET

FOR COMMUNICATION SOFTWARE FOR COMPUTER CONTROLLED PLASMA ARC CUTTING OR WELDING SYSTEMS THAT ALLOW USERS TO PROGRAM CUTTING PROFILES OR SHAPES (U.S. CLS. 21, 23, 26, 36 AND 38).
FIRST USE 7-0-2001; IN COMMERCE 7-0-2001.

CLASS 9—(Continued).

SN 76-360,260. RADIOSCAPE LIMITED, LONDON NW1 4DS, UNITED KINGDOM, FILED 1-15-2002.



PRIORITY CLAIMED UNDER SEC. 44(D) ON UNITED KINGDOM APPLICATION NO. 2,262,437, FILED 2-27-2001, REG. NO. 2262437, DATED 8-3-2001, EXPIRES 2-27-2011.

THE STIPPLING SHOWN IN THE DRAWING IS A FEATURE OF THE TRADEMARK AND NOT INTENDED TO INDICATE COLOR.

FOR SOFTWARE FOR USE IN CONNECTION WITH TELECOMMUNICATIONS, DIGITAL BROADCASTING AND COMMUNICATIONS TECHNOLOGY AND RECEIVERS, NAMELY, SOFTWARE FOR MULTIPLEXING AUDIO AND DATA STREAMS FOR BROADCASTING OVER DIGITAL RADIO NETWORKS AND WIRELESS TELECOMMUNICATIONS NETWORKS; COMPUTER SOFTWARE FOR USE IN MANAGING, DESIGNING AND DEVELOPING COMMUNICATIONS SYSTEMS; SOFTWARE AND SIGNAL PROCESSING APPLICATIONS FOR SEMICONDUCTORS AND SEMICONDUCTOR ARCHITECTURES; COMPUTER SOFTWARE FOR USE IN MANAGING, DESIGNING AND DEVELOPING WIRELESS ELECTRONIC SYSTEMS; COMPUTER HARDWARE FOR USE IN CONNECTION WITH TELECOMMUNICATIONS, DIGITAL BROADCASTING AND COMMUNICATIONS TECHNOLOGY AND RECEIVERS, NAMELY, COMPUTER HARDWARE FOR MANAGING, DESIGNING, DEVELOPING AND TESTING TELECOMMUNICATIONS APPARATUS; COMPUTER SOFTWARE AND HARDWARE FOR TESTING AND MODELING TELECOMMUNICATIONS PROTOCOLS, PROTOCOL STACKS, SYSTEMS AND EQUIPMENT; TELECOMMUNICATIONS APPARATUS AND INSTRUMENTS, NAMELY, PERSONAL COMPUTERS AND PROPRIETARY BASE STATION HARDWARE DEVICES; TRANSMISSION, TRANSMITTER AND RECEIVER TESTING EQUIPMENT, NAMELY, EQUIPMENT FOR MEASURING SYSTEM EFFICIENCY OF WIRELESS DIGITAL SIGNAL PROCESSING; DIGITAL TELECOMMUNICATIONS APPARATUS AND INSTRUMENTS, NAMELY, BASE STATIONS AND TRANSMISSION EQUIPMENT; DIGITAL RADIO PRODUCTS, NAMELY, TERRESTRIAL DIGITAL RADIO AND SATELLITE DIGITAL RADIO CONSUMER DEVICES FOR PORTABLE RADIOS, TELEMATICS AND STEREO RECEIVERS AND ASSOCIATED HARDWARE AND SOFTWARE APPLICATIONS AND EQUIPMENT FOR PROCESSING AND BROADCASTING DIGITAL RADIO SIGNALS; RADIO RECEIVERS; RADIO TRANSMITTERS; DIGITAL SIGNAL PROCESSORS; SOFTWARE DEFINED RADIO PRODUCTS, NAMELY, PRODUCTS INVOLVED WITH ADAPTIVE AND RECONFIGURABLE RADIO TECHNOLOGY; SEMICONDUCTORS; APPARATUS AND INSTRUMENTS FOR USE IN THE TRANSMISSION OF INFORMATION OVER AIRWAVES, NAMELY, WIRELESS BASEBAND ARCHITECTURE INCLUDING DIGITAL SIGNAL PROCESSORS (DSPS), APPLICATION SPECIFIC INTEGRATED CIRCUITS (ASICS) AND FIELD PROGRAMMABLE GATE ARRAYS (FPGAS); DIGITAL AUDIO BROADCAST PRODUCTS, NAMELY, SOFTWARE MUSICAMS, MULTIMEDIA OBJECT TRANSFER (MOT) SERVERS, PROGRAM ASSOCIATED DATA (PAD) MULTIPLEXES, PACKET MULTIPLEXES (NPAD), ENSEMBLE MULTIPLEXERS (EMUX), ENSEMBLE TRANSPORT INTERFACE MONITORS (ETI), BROADCAST REMOTE/LOCAL TEST RECEIVERS, ELECTRONIC PROGRAM GUIDES; MOBILE TELEPHONES; CELLULAR TELEPHONES; AND PARTS AND FITTINGS FOR ALL THE AFORESAID GOODS (U.S. CLS. 21, 23, 26, 36 AND 38).

CLASS 9—(Continued).

SN 76-361,919. WITCHOUSE, INC., LOS ANGELES, CA, FILED 1-23-2002.

DEADSY

FOR POSTERS, TOUR BOOKS, CALENDARS, SONG BOOKS, PENS, PENCILS, GREETING CARDS, CHRISTMAS CARDS, AUTOGRAPH BOOKS, POSTER BOOKS, PHOTO ALBUMS, ADDRESS BOOKS, APPOINTMENT BOOKS, PAPER PLACE MATS, PAPER COASTERS, DECALS, STICKERS, NOTEBOOKS, BOOK COVERS, BINDERS, BANK CHECKS, CHECK BOOKS, BUMPER STICKERS, PEN CASES, PENCIL CASES, FAN CLUB MAGAZINES, MAGNETIC BOARDS, SHEET MUSIC, NOTE PADS, GIFT WRAPPING PAPER, PAPER BANNERS, UNMOUNTED PHOTOGRAPHS, MOUNTED PHOTOGRAPHS, PRINTED MUSIC BOOKS, POSTCARDS, STATIONERY, TRADING CARDS AND LITHOGRAPHS (U.S. CLS. 21, 23, 26, 36 AND 38).

SN 76-367,523. KB ELECTRONICS, INC., CORAL SPRINGS, FL, FILED 2-6-2002.

GENESIS

FOR VARIABLE FREQUENCY AC INVERTERS USED FOR SPEED CONTROL OF 3-PHASE AC INDUCTION MOTORS; PROGRAMMABLE RELAYS USED TO INTERCONNECT AND CONTROL ELECTRO AND ELECTRO-MECHANICAL DEVICES, NAMELY, MANUFACTURING MACHINERY, HVAC SYSTEMS, AGRICULTURAL MACHINERY, CONVEYORS, PUMPS, PRINTING MACHINERY AND PACKAGING MACHINERY; PROGRAMMABLE LOGIC CONTROLLERS (PLCS) USED TO INTERCONNECT AND CONTROL ELECTRO AND ELECTRO-MECHANICAL DEVICES, NAMELY, MANUFACTURING MACHINERY, HVAC SYSTEMS, AGRICULTURAL MACHINERY, CONVEYORS, PUMPS, PRINTING MACHINERY AND PACKAGING MACHINERY; AND HUMAN MACHINE INTERFACES (HMI), NAMELY, ELECTRONIC TOUCH SCREENS USED TO CONTROL PROGRAMMABLE RELAYS, PROGRAMMABLE LOGIC CONTROLLERS AND INVERTERS USED IN MANUFACTURING MACHINERY, HVAC SYSTEMS, AGRICULTURAL MACHINERY, CONVEYORS, PUMPS, PRINTING MACHINERY AND PACKAGING MACHINERY (U.S. CLS. 21, 23, 26, 36 AND 38).

SN 76-368,923. ONMOBILE SYSTEMS, INC., LOS ALTOS, CA, FILED 2-11-2002.

OnMobile
TRUE MOBILITY

FOR COMPUTER SOFTWARE IN THE FIELD OF TELECOMMUNICATIONS, NAMELY, SOFTWARE WHICH DELIVERS MULTI-MODAL VOICE AND DATA APPLICATIONS TO CARRIERS, SERVICE PROVIDERS AND ENTERPRISES WORLDWIDE (U.S. CLS. 21, 23, 26, 36 AND 38).

FIRST USE 8-0-2001; IN COMMERCE 8-0-2001.

CLASS 9—(Continued).

SN 76-371,827. FUSIONVR, INC., AURORA, CO. FILED 2-19-2002.



THE MARK CONSISTS OF THE WORD "FUSIONVR" WITH AN ACCOMPANYING MARK COMPRISED OF TWO TOUCHING SPHERES MELDING TOGETHER AT A 45 DEGREE ANGLE.

FOR VIRTUAL REALITY INTERACTIVE COMPUTER SOFTWARE FOR USE IN CREATING FULLY INTERACTIVE OBJECTS WITHIN AN E-COMMERCE WEB SITE TO ALLOW A USER TO ROTATE THE ANGLE OF SAID OBJECTS (U.S. CLS. 21, 23, 26, 36 AND 38).
FIRST USE 12-10-2001; IN COMMERCE 12-10-2001.

SN 76-373,664. SOFTOV ADVANCED SYSTEMS, LTD., EDISON, NJ. FILED 2-21-2002.

AUTOLIMS

FOR COMPUTER PROGRAMS AND SOFTWARE FOR LABORATORY INFORMATION AND MANAGEMENT SYSTEMS, NAMELY, COMPUTER PROGRAMS AND SOFTWARE FOR RECORDING AND TRACKING THE COLLECTION OF PATIENT SPECIMENS AND SAMPLES, ASSOCIATED TEST RESULTS AND COMMENTS MADE BY PROFESSIONALS, FOR ALLOWING AND FACILITATING DATA ENTRY, FOR ASSESSING AND ASSURING QUALITY SAMPLES, RESULTS AND PROCEDURES, FOR ANALYSIS OF QUALITY CONTROL, SCHEDULING OF SAMPLES, GENERATING REPORTS, CREATION AND MANAGEMENT OF AUDIT TRAILS, TRACKING CHAIN OF CUSTODY, MANAGEMENT OF SAMPLES AND RESULTS, AND MAINTENANCE AND MONITORING OF SAMPLES, FOR CONTROLLING ACCESS TO LABORATORY SYSTEMS, FOR HANDLING OF PATIENT SPECIMENS, AND FOR ANALYSIS, RECORDING AND REPORTING OF LABORATORY INFORMATION AND TESTING RESULTS, AND INSTRUCTION MANUALS SOLD THEREWITH (U.S. CLS. 21, 23, 26, 36 AND 38).

FIRST USE 6-15-1996; IN COMMERCE 2-12-2001.

SN 76-374,750. THOMSON MULTIMEDIA INC., INDIANAPOLIS, IN. FILED 2-22-2002.

VPORT

FOR CONNECTOR JACK SOLD AS A COMPONENT OF TELEVISION RECEIVERS FOR CONNECTING A VIDEO GAME CONSOLE THERETO, AND ELECTRICAL CABLES FOR USE THEREWITH (U.S. CLS. 21, 23, 26, 36 AND 38).

FIRST USE 5-31-2002; IN COMMERCE 5-31-2002.

CLASS 9—(Continued).

SN 76-382,418. MOLDFLOW IRELAND, LTD., DUBLIN 2, IRELAND, FILED 3-13-2002.

**MOLDFLOW
MANUFACTURING
SOLUTIONS**

OWNER OF U.S. REG. NOS. 1,916,037, 2,619,336 AND OTHERS.

NO CLAIM IS MADE TO THE EXCLUSIVE RIGHT TO USE "MANUFACTURING SOLUTIONS", APART FROM THE MARK AS SHOWN.

FOR COMPUTER HARDWARE AND SOFTWARE FOR USE IN PRODUCTION AND PROCESS CONTROL MANUFACTURING SYSTEMS AND FOR USE IN PLASTIC INJECTION MOLDING APPLICATIONS (U.S. CLS. 21, 23, 26, 36 AND 38).

SN 76-383,722. NEXTEL COMMUNICATIONS, INC., RESTON, VA. FILED 3-19-2002.



OWNER OF U.S. REG. NOS. 1,637,139, 2,435,925 AND OTHERS.

NO CLAIM IS MADE TO THE EXCLUSIVE RIGHT TO USE "COMPATIBLE PRODUCT", APART FROM THE MARK AS SHOWN.

FOR EQUIPMENT USED IN PROVIDING TELECOMMUNICATIONS SERVICES, NAMELY, MOBILE RADIOS, TWO-WAY RADIOS, CELLULAR TELEPHONES, DIGITAL CELLULAR TELEPHONES, MOBILE TELEPHONES, PAGERS AND MOBILE DATA TRANSCIVERS; WIRELESS TELECOMMUNICATIONS DEVICES, NAMELY, TELEPHONES FEATURING INSTANT CONFERENCING, DIGITAL CELLULAR, VOICE MAIL AND TEXT/NUMERIC MESSAGING; DIGITAL CELLULAR DEVICES AND WIRELESS HANDHELD COMMUNICATIONS DEVICES, NAMELY MOBILE RADIOS, TWO-WAY RADIOS, CELLULAR TELEPHONES, DIGITAL CELLULAR TELEPHONES, MOBILE TELEPHONES, PAGERS, PERSONAL DIGITAL ASSISTANTS AND TRANSCIVERS USED IN PROVIDING TELECOMMUNICATIONS SERVICES, ALL USED TO TRANSMIT, RECEIVE AND OTHERWISE ACCESS COMMUNICATIONS NETWORKS AND ACCESSORIES THEREFORE; WIRELESS TELEPHONES, WIRELESS TELEPHONE ACCESSORIES AND EQUIPMENT, NAMELY, MOBILE AND PORTABLE DISPATCH UNITS, BATTERIES AND BATTERY ACCESSORIES; MOBILE WIRED AND WIRELESS MODEMS; HAND HELD COMPUTERS, PERSONAL DIGITAL ASSISTANTS, ELECTRONIC ORGANIZERS, ELECTRONIC NOTEPADS, TELEPHONES, MICROPROCESSORS, COMPUTER MEMORIES, ELECTRICAL CIRCUIT BOARDS, PRINTED CIRCUIT BOARDS, MEMORY CARDS, MONITORS, LIQUID CRYSTAL DISPLAYS, COMPUTER KEYBOARDS, COMPUTER CABLES, MODEMS, COMPUTER PRINTERS, VIDEOPHONES, COMPUTER DISC DRIVES, AND PHOTOGRAPHIC AND VIDEO CAMERAS; A DIRECTORY OF INFORMATION AND SITES, AVAILABLE ON COMPUTER NETWORKS; COMPUTER SOFTWARE FOR PROVIDING MULTIPLE-USER ACCESS TO COMPUTER NETWORKS, SUCH SOFTWARE BEING DOWNLOADABLE AND COMPATIBLE WITH CELLULAR TELEPHONES, DIGITAL CELLULAR TELEPHONES, MOBILE TELEPHONES, PAGERS AND MOBILE DATA TRANSCIVERS; COMPUTER SOFTWARE FOR CONNECTING, ACCESSING OR INTEGRATING LOCAL AND WIDE AREA COMPUTER

CLASS 9—(Continued).

NETWORKS, WIRELESS COMMUNICATION NETWORKS, INTRANET, EXTRANET AND OUTERNET NETWORKS AND THE GLOBAL COMPUTER INFORMATION NETWORK TO HARDWIRED ELECTRONIC DEVICES OR WIRELESS ELECTRONIC DEVICES, SUCH SOFTWARE BEING DOWNLOADABLE AND COMPATIBLE WITH CELLULAR TELEPHONES, DIGITAL CELLULAR TELEPHONES, MOBILE TELEPHONES, PAGERS AND MOBILE DATA TRANSCEIVERS; COMPUTER SOFTWARE, NAMELY, PERSONAL INFORMATION MANAGEMENT SOFTWARE, DATABASE MANAGEMENT SOFTWARE, CHARACTER RECOGNITION SOFTWARE, TELEPHONY MANAGEMENT SOFTWARE, ELECTRONIC MAIL AND MESSAGING SOFTWARE, PAGING SOFTWARE, DATABASE SYNCHRONIZATION SOFTWARE, SOFTWARE FOR SEARCHING AND RETRIEVING INFORMATION AND SITES ON COMPUTER NETWORKS, ACCOUNTING SOFTWARE, CUSTOMER RELATIONSHIP MANAGEMENT SOFTWARE, FLEET MANAGEMENT SOFTWARE, FIELD SALES/FIELDS SERVICE SOFTWARE, GRAPHICS SOFTWARE, WORD PROCESSING SOFTWARE, OPERATING SYSTEM SOFTWARE, ANTI-VIRUS PROTECTION SOFTWARE, GAMING SOFTWARE, FILE COMPRESSIONS SOFTWARE, FILE TRANSFER SOFTWARE, AUDIO RECORDING AND PLAYBACK SOFTWARE, INTERNET BROWSER SOFTWARE, APPLICATION DEVELOPMENT SOFTWARE, AND COMPUTER PROGRAMS FOR ACCESSING, BROWSING AND SEARCHING ONLINE DATABASES; ALL SUCH SOFTWARE BEING DOWNLOADABLE AND COMPATIBLE WITH CELLULAR TELEPHONES, DIGITAL CELLULAR TELEPHONES, MOBILE TELEPHONES, PAGERS AND MOBILE DATA TRANSCEIVERS (U.S. CLS. 21, 23, 26, 36 AND 38).

SN 76-385,198. BITFONE CORPORATION, MOUNTAIN VIEW, CA. FILED 3-20-2002.

MPROVE

FOR SOFTWARE, OPERATING SYSTEMS, FIRMWARE AND RELATED NETWORKING SOFTWARE FOR SENDING, SWITCHING, ROUTING, TRANSMITTING, MULTICASTING, RECEIVING, STORING, AND MANAGING SOFTWARE AND DATA VIA PRIVATE AND PUBLIC NETWORKS, FOR THE INSTALLATION, INTEGRATION, MONITORING, UPDATING AND MANAGEMENT OF SOFTWARE AND FIRMWARE IN MOBILE WIRELESS DEVICES (U.S. CLS. 21, 23, 26, 36 AND 38).

SN 76-389,646. ALTERA CORPORATION, SAN JOSE, CA. FILED 3-29-2002.

AVALON

FOR EMBEDDED COMPUTER BUS AND EMBEDDED COMPUTER SOFTWARE FACILITATING THE COMMUNICATION TO AND AMONG MICROPROCESSORS, AND SLAVE PERIPHERALS FOR IMPROVING PERFORMANCE AND DATA FLOW (U.S. CLS. 21, 23, 26, 36 AND 38).

FIRST USE 2-0-2001; IN COMMERCE 2-0-2001.

CLASS 9—(Continued).

SN 76-389,660. CARDINTELL EXPLOITATION SA, 2000 NEUCHATEL, SWITZERLAND, FILED 4-1-2002.



OWNER OF SWITZERLAND REG. NO. 429894, DATED 8-23-1996, EXPIRES 3-22-2005.

FOR COMPUTER PROGRAMS, NAMELY, SOFTWARE USED IN CRYPTOGRAPHIC APPLICATIONS FOR DIGITAL DATA ENCRYPTION; COMPUTERS; MAGNETIC CODED CARDS; BLANK ELECTRONIC CHIP CARDS; BLANK INTEGRATED CIRCUIT CARDS; BLANK OPTICAL CARDS; COMPUTER HARDWARE, NAMELY, MEMORY CARDS, MICROPROCESSORS, COMPUTER MEMORIES, MAGNETIC AND OPTICAL CARD READERS; SMART CARD READERS; BLANK COMPUTER DISKS, BLANK FLOPPY COMPUTER DISKS; BLANK OPTICAL DISKS (U.S. CLS. 21, 23, 26, 36 AND 38).

SN 76-389,718. AFFYMETRIX, INC., SANTA CLARA, CA. FILED 3-28-2002.

CUSTOMEXPRESS

FOR MICROARRAYS (U.S. CLS. 21, 23, 26, 36 AND 38). FIRST USE 3-4-2002; IN COMMERCE 3-4-2002.

SN 76-391,000. EGAN, BRIAN A., LOVELAND, CO. FILED 4-3-2002.

SMART TREAD BOOT COVERS

NO CLAIM IS MADE TO THE EXCLUSIVE RIGHT TO USE "TREAD BOOT COVERS", APART FROM THE MARK AS SHOWN.

FOR SLIP PROOF SHOE PROTECTORS, NAMELY, PROTECTIVE SHOE COVERS FOR INDUSTRIAL USE (U.S. CLS. 21, 23, 26, 36 AND 38).

CLASS 9—(Continued).

SN 76-391,114. ACRODYNE INDUSTRIES, INC., COCKEYSVILLE, MD. FILED 4-2-2002.

AI

FOR TELEVISION BROADCAST TRANSMITTERS (U.S. CLS. 21, 23, 26, 36 AND 38).
FIRST USE 3-22-2002; IN COMMERCE 3-22-2002.

SN 76-391,311. NATIONAL DATACOMM CORPORATION, HSINCHU, TAIWAN, FILED 4-5-2002.

InstantWave

FOR WIRELESS NETWORKING SYSTEM, COMPRISING INTEGRATED HARDWARE NAMELY, ADAPTERS, ACCESS POINTS, WIDE AREA NETWORK CIRCUIT BOARDS, RADIO FREQUENCY MODULES, PRINTER SHARING CIRCUIT BOARDS, A COMMUNICATION GATEWAY, SERVERS, ANTENNA, AND SOFTWARE, NAMELY, DRIVERS AND INSTALLATION, CONFIGURATION AND DIAGNOSTIC PROGRAMS (U.S. CLS. 21, 23, 26, 36 AND 38).

SN 76-392,002. BROADMAX TECHNOLOGIES, INC., CITY OF INDUSTRY, CA. FILED 4-5-2002.

LinkM@x

THE LINING IN THE MARK IS FOR SHADING PURPOSES ONLY.

FOR TELECOMMUNICATION EQUIPMENT, NAMELY, MODEMS, COMPUTER NETWORK ROUTERS AND HOME HUBS, TELEPHONES WITH INTERNET ACCESS, GATEWAYS, NAMELY, BROADBAND INTERNET DSL MODEMS; COMPUTER HARDWARE (U.S. CLS. 21, 23, 26, 36 AND 38).

FIRST USE 1-8-2002; IN COMMERCE 1-8-2002.

CLASS 9—(Continued).

SN 76-392,285. TEAM PRODUCTS INTERNATIONAL, PAR-SIPPANY, NJ. FILED 4-5-2002.

SMART PAD

NO CLAIM IS MADE TO THE EXCLUSIVE RIGHT TO USE "SMART", APART FROM THE MARK AS SHOWN.

FOR MULTI-FUNCTION CONTROL UNIT SOLD AS A COMPONENT PART OF VARIOUS BATTERY OPERATED ELECTRONIC CONSUMER GOODS, NAMELY, SPOTLIGHTS, EMERGENCY LIGHTS, FLASHLIGHTS, RECHARGEABLE VACUUM CLEANERS, RECHARGEABLE COMPRESSORS, AND JUMPSTART SYSTEMS COMPRISED OF BOOSTER CABLES, RECHARGEABLE BATTERIES, BATTERY METERS, FLUORESCENT LIGHT, COMPRESSOR, AC AND DC CHARGING CORDS, DC POWER PORT AND CARRYING CASE (U.S. CLS. 21, 23, 26, 36 AND 38).

FIRST USE 1-12-2002; IN COMMERCE 1-12-2002.

SN 76-392,575. HMS TRADING, INC., WILMINGTON, DE. FILED 4-5-2002.



The logo for HERLEY features a stylized, three-dimensional 'E' symbol on the left, composed of three curved, overlapping bands. To the right of this symbol, the word 'HERLEY' is written in a bold, uppercase, sans-serif font.

FOR FLIGHT COMMAND AND CONTROL PRODUCTS, NAMELY FREQUENCY TRANSLATORS, PHASE SHIFTERS, OSCILLATORS, ATTENUATORS, MODULATORS, RADAR ALTIMETERS, FLIGHT TERMINATION RECEIVERS AND DECODERS, AND RELATED COMMAND AND CONTROL COMPONENTS, NAMELY TRANSPONDERS AND RELAYS; MICROWAVE NAVIGATION AND PRECISION TRACKING DEVICES, NAMELY C-BAND RADAR TRANSPONDERS, X-BAND RADAR TRANSPONDERS, AND RELATED MICROWAVE COMPONENTS, NAMELY ANTENNAS, POWER DIVIDERS, TRANSPONDERS AND RELAYS; NUCLEAR MAGNETIC RESONANCE COMPONENTS, NAMELY POWER AMPLIFIERS AND CONVERTERS; AND NUCLEAR RESONANCE IMAGING COMPONENTS, NAMELY POWER AMPLIFIERS AND CONVERTERS (U.S. CLS. 21, 23, 26, 36 AND 38).

FIRST USE 10-1-2000; IN COMMERCE 10-1-2000.

CLASS 9—(Continued).

SN 76-393,782. LIGHTSCAPE NETWORKS LTD., PETACH TIKVA 49517, ISRAEL, FILED 4-11-2002.

CLASS 9—(Continued).

SN 76-395,455. FROMSOFTWARE, INC., TOKYO, 151-0073, JAPAN, FILED 4-12-2002.

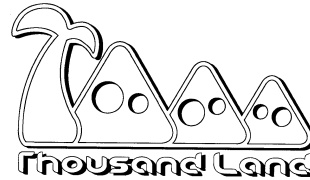
**BUILD AS YOU GROW**

PRIORITY CLAIMED UNDER SEC. 44(D) ON ISRAEL APPLICATION NO. 153887, FILED 12-12-2001, REG. NO. 153887, DATED 12-31-2002, EXPIRES 12-31-2008.

FOR TELECOMMUNICATION EQUIPMENT, NAMELY, SPLITTERS, COMBINERS, FILTERS, OPTICAL AND ELECTRICAL MULTIPLEXERS, TRANSMITTERS, TRANSCEIVERS, RECEIVERS, TRANSPONDERS, REPEATERS, AMPLIFIERS, CONTROLLERS, DIGITAL PROCESSORS, ROUTERS, BRIDGES, HUBS, STARS, SWITCHES, CROSS-CONNECTS; TRANSMISSION EQUIPMENT, NAMELY, OPTICAL AND ELECTRICAL MULTIPLEXERS, CROSS-CONNECTS, FIBERS, DISPERSION FIBERS, COMPENSATION FIBERS; TRANSMITTERS, TRANSCEIVERS, RECEIVERS, TRANSPONDERS, REPEATERS; POWER SUPPLIERS; CONNECTORS; VOICE, VIDEO AND DATA TRANSMISSION SYSTEMS, NAMELY, SIGNAL HANDLING HARDWARE AND SOFTWARE FOR TRANSMITTING, RECEIVING AND DELIVERING VOICE, VIDEO AND DATA COMMUNICATIONS OVER TRANSMISSION MEDIA, NAMELY FIBER OPTIC, COPPER TRANSMISSION LINES, COAX TRANSMISSION LINES, WIRELESS, POWER TRANSMISSION LINES OR SATELLITES; VOCODERS; VIDEO COMPRESSORS; VIDEO AND AUDIO EDITORS; NETWORK MANAGEMENT SYSTEMS, NAMELY COMPUTER HARDWARE AND SOFTWARE FOR PLANNING, MANAGING AND CONTROLLING VOICE, VIDEO AND DATA COMMUNICATION OVER TRANSMISSION MEDIA, NAMELY, FIBER OPTIC, COPPER TRANSMISSION LINES, COAX TRANSMISSION LINES, WIRELESS, POWER TRANSMISSION LINES OR SATELLITES; NETWORK ANALYSIS HARDWARE AND SOFTWARE FOR MONITORING COMMUNICATIONS BETWEEN NETWORK ELEMENTS; NETWORK PLANNING SOFTWARE TO DESIGN OR REDESIGN COMMUNICATIONS NETWORKS; HARDWARE AND SOFTWARE FOR INTELLIGENT OPTICAL NETWORKING, FIBER OPTIC TRANSPORT EQUIPMENT FOR BROADBAND CONNECTIVITY USING WAVE DIVISION MULTIPLEXING, NAMELY, OPTICAL NETWORK INTERFACES, PROGRAMMABLE TRANSPORT TERMINALS, CROSS-CONNECTS AND FIBER OPTIC DATA LINKS; AND SOFTWARE FOR THE OPERATION OF ALL THE AFORESAID GOODS (U.S. CLS. 21, 23, 26, 36 AND 38).

FOR ELECTRONIC COMPUTERS; TV GAME HOME USE APPARATUS, NAMELY, VIDEO GAME MACHINES FOR USE WITH TELEVISIONS, AND FOR USE WITH TELEVISIONS AND COMMUNICATION NETWORKS; TV GAME COMMERCIAL USE APPARATUS, NAMELY, VIDEO GAME MACHINES FOR USE WITH TELEVISIONS, AND FOR USE WITH TELEVISIONS AND COMMUNICATION NETWORKS; PROGRAM STORING ELECTRONIC CIRCUITS, NAMELY, COMPUTER GAME-PROGRAM STORING INTEGRATED CIRCUITS; PROGRAM STORING DISCS, NAMELY COMPUTER GAME-PROGRAM STORING FLOPPY DISKS, CD-ROMS AND DVDS; PRERECORDED MAGNETIC TAPES, NAMELY, COMPUTER GAME-PROGRAM STORING VIDEO CASSETTE TAPES; SOUND RECORDED MAGNETIC TAPES AND DISCS, NAMELY, PRERECORDED AUDIO CASSETTE TAPES AND COMPACT DISCS FEATURING MUSIC AND SPECIAL SOUND EFFECTS; MOVING PICTURE RECORDED MAGNETIC TAPES AND DISCS, NAMELY PRERECORDED VIDEO TAPES AND DVDS WITH MOTION PICTURE FILMS FEATURING STORIES BASED UPON GAMES (U.S. CLS. 21, 23, 26, 36 AND 38).

SN 76-398,680. SIEMENS MEDICAL SOLUTIONS HEALTH SERVICES CORPORATION, MALVERN, PA. FILED 4-22-2002.

PDAccess

FOR COMPUTER SOFTWARE FOR THE HEALTH INDUSTRY, NAMELY, COMPUTER SOFTWARE FOR USE IN HAND-HELD ELECTRONIC DEVICES THAT TRANSPORTS DATA ELEMENTS FROM ELECTRONIC PATIENT CHARTS TO AND FROM HAND-HELD DEVICES SUCH AS A PERSONAL DIGITAL ASSISTANT FOR USE BY PHYSICIANS AND OTHER CLINICIANS TO ASSIST IN REVIEWING AND ENTERING CLINICAL INFORMATION ABOUT THEIR PATIENTS (U.S. CLS. 21, 23, 26, 36 AND 38).

CLASS 9—(Continued).

SN 76-400,801. IBSEN PHOTONICS A/S, 3520 FARUM, DENMARK, FILED 4-24-2002.

D-MON

PRIORITY CLAIMED UNDER SEC. 44(D) ON DENMARK APPLICATION NO. VA200104176, FILED 11-2-2001, REG. NO. VR200200098, DATED 1-9-2002, EXPIRES 1-9-2012.

FOR TELECOMMUNICATIONS EQUIPMENT, NAMELY DENSE WAVELENGTH DIVISION MULTIPLEXING (DWDM)-POWER MONITORS, DWDM-CHANNEL POWER MONITORS, DWDM-PERFORMANCE MONITORS AND DWDM-WAVELENGTH MONITORS AND PARTS THEREOF (U.S. CLS. 21, 23, 26, 36 AND 38).

SN 76-401,482. INFORUM SOLUTIONS, INC., TOPSFIELD, MA. FILED 4-29-2002.

INFORUM

OWNER OF U.S. REG. NOS. 1,795,646, 2,361,309 AND 2,401,272.

FOR COMPUTER SOFTWARE USED TO MANAGE BUSINESS AND PROJECT INFORMATION SHARING WITHIN ENTERPRISE-WIDE COLLABORATIVE APPLICATIONS AND PLATFORMS VIA A GLOBAL COMPUTER NETWORK; COMPUTER SOFTWARE AND COMPUTER PROGRAMS TO FACILITATE AND IMPROVE THE SHARING OF INFORMATION BY USERS OF ENTERPRISE-WIDE COLLABORATIVE APPLICATIONS AND PROGRAMS; COMPUTER SOFTWARE, NAMELY, COLLABORATIVE SOFTWARE USED TO CREATE CUSTOM, SECURE, FULLY FUNCTIONAL WEB PAGES AND WEB SITES THAT ALLOW USERS TO INTEGRATE COMMUNICATION, DATA COLLECTION AND EVALUATION, KNOWLEDGE MANAGEMENT, OFFICE MANAGEMENT, PROJECT MANAGEMENT AND PROJECT WORKFLOW, AND PLANNING TOOLS IN A SINGLE WEB-BASED SYSTEM; AND RELATED INSTRUCTION MANUALS SOLD TOGETHER THEREWITH AS A UNIT (U.S. CLS. 21, 23, 26, 36 AND 38).

FIRST USE 4-15-1991; IN COMMERCE 5-20-1998.

SN 76-403,771. TAMARACK SOFTWARE, INC., FRANKFORT, MI. FILED 4-29-2002.

TESTGEN

FOR TESTGEN IS A SOFTWARE PROGRAM THAT PRODUCES AND ORGANIZES QUESTIONS AND ANSWERS TO GENERATE TESTS FOR DISTRIBUTION IN VARIOUS FORMATS (U.S. CLS. 21, 23, 26, 36 AND 38).

FIRST USE 8-0-1995; IN COMMERCE 8-0-1995.

SN 76-408,129. TAKE-TWO INTERACTIVE SOFTWARE, INC., NEW YORK, NY. FILED 5-14-2002.

GOTHAM GAMES

FOR COMPUTER GAME SOFTWARE AND VIDEO GAME PROGRAMS (U.S. CLS. 21, 23, 26, 36 AND 38).

CLASS 9—(Continued).

SN 76-409,364. CARTER HOLT HARVEY LIMITED, AUCKLAND, NEW ZEALAND, FILED 5-20-2002.

STRAIGHTEDGE

PRIORITY CLAIMED UNDER SEC. 44(D) ON NEW ZEALAND APPLICATION NO. 650744, FILED 1-7-2002, REG. NO. 650744, DATED 7-8-2002, EXPIRES 1-3-2009.

FOR COMPUTER SOFTWARE NAMELY, ENGINEERING AND ARCHITECTURAL SOFTWARE PROGRAMS, MANUFACTURING PROCESS AND MANUFACTURING OPTIMIZATION SOFTWARE FOR USE TO DESIGN COMMERCIAL AND RESIDENTIAL BUILDING PROJECTS AND TO PROVIDE ESTIMATES FOR COSTS, MATERIALS, AND SUPPLIES FOR COMMERCIAL AND RESIDENTIAL BUILDING PROJECTS (U.S. CLS. 21, 23, 26, 36 AND 38).

SN 76-410,163. PERKINS, CHARLES A., PLANT CITY, FL. FILED 5-21-2002.

WHITE CHOCOLATE

FOR VIDEO TAPES, DISCS, AND MOTION PICTURES FEATURING ADULT SUBJECT MATTER OF VARIOUS FEMALE FLASHING ACTIVITIES (U.S. CLS. 21, 23, 26, 36 AND 38).

FIRST USE 12-0-1991; IN COMMERCE 4-22-2001.

SN 76-411,699. DIAPHONICS INC., HALIFAX, NOVA SCOTIA, CANADA, FILED 5-22-2002.



NO CLAIM IS MADE TO THE EXCLUSIVE RIGHT TO USE "SERVER", APART FROM THE MARK AS SHOWN.

FOR COMPUTER HARDWARE AND SOFTWARE PROVIDING BIOMETRIC SECURITY OVER WIRELESS OR WIRE LINE TELEPHONES, COMPUTER NETWORKS AND INTERNET (U.S. CLS. 21, 23, 26, 36 AND 38).

SN 76-411,944. FUJITSU LIMITED, KANAGAWA-KEN, JAPAN, FILED 5-17-2002.

POCKET LOOX

PRIORITY CLAIMED UNDER SEC. 44(D) ON JAPAN APPLICATION NO. 2002-005545, FILED 1-28-2002, REG. NO. 4644243, DATED 2-14-2003, EXPIRES 2-14-2013.

NO CLAIM IS MADE TO THE EXCLUSIVE RIGHT TO USE "POCKET", APART FROM THE MARK AS SHOWN.

FOR PERSONAL DIGITAL ASSISTANTS (PDAS), PERSONAL COMPUTERS AND COMPUTER PERIPHERALS (U.S. CLS. 21, 23, 26, 36 AND 38).

CLASS 9—(Continued).

SN 76-413,933. INOVONICS CORPORATION, LOUISVILLE, CO. FILED 5-23-2002.

ECHOSTREAM

FOR WIRELESS SYSTEMS, NAMELY, MULTIPLE POINT NETWORKS CONSISTING OF ON-SITE CENTRAL CONTROLLERS AND A PLURALITY OF REMOTE TRANSMITTERS, RECEIVERS AND/OR TRANSCEIVERS IN COMMUNICATION WITH THE CENTRAL CONTROLLER (U.S. CLS. 21, 23, 26, 36 AND 38).

SN 76-415,902. 20/10 PERFECT VISION OPTISCHE GERAETE GMBH, D-69123 HEIDELBERG, FED REP GERMANY, FILED 6-4-2002.



OWNER OF U.S. REG. NOS. 2,541,502, 2,541,503 AND 2,557,052.

NO CLAIM IS MADE TO THE EXCLUSIVE RIGHT TO USE "PERFECT VISION", APART FROM THE MARK AS SHOWN.

FOR EYEGLASSES AND CONTACT LENSES FOR VISION CORRECTION/ENHANCEMENT (U.S. CLS. 21, 23, 26, 36 AND 38).

SN 76-415,993. ENVENERGY, INC., CARPINTERIA, CA. FILED 6-6-2002.

MEDIATOR 1200

FOR IMBEDDED COMPUTER SERVER AND OPTIMIZED COMPUTER SOFTWARE THAT GATHERS DATA FROM GAS, ELECTRIC AND WATER UTILITY REVENUE METERS, AND FROM FACILITY DEVICES, IN THE NATURE OF HVAC EQUIPMENT, DISTRIBUTED ELECTRICAL GENERATION EQUIPMENT, BUILDING CONTROL SYSTEMS, LIGHTING CONTROL SYSTEMS AND SECURITY SYSTEMS, AND THAT COMMUNICATES THIS DATA OVER COMPUTER NETWORKS (U.S. CLS. 21, 23, 26, 36 AND 38).

FIRST USE 4-8-2002; IN COMMERCE 4-8-2002.

SN 76-417,766. XDIMENSIONAL TECHNOLOGIES, INC., BREA, CA. FILED 6-5-2002.

NEXSURE

FOR COMPUTER SOFTWARE FOR USE BY INSURANCE AGENCIES TO MANAGE CUSTOMER INFORMATION AND TO FACILITATE MAKING CUSTOMER INFORMATION AVAILABLE TO CUSTOMERS OVER GLOBAL COMPUTER NETWORKS (U.S. CLS. 21, 23, 26, 36 AND 38).

CLASS 9—(Continued).

SN 76-417,805. NUEVA-VILLA, INCORPORATED, DBA NUEVA VILLA INC., OCEANSIDE, CA. FILED 6-3-2002.

B2G

FOR ANIMAL TRAINING EQUIPMENT, NAMELY, WHISTLES, WARNING BELLS, HAND-HELD NOISE-MAKING COMPRESSED GAS EMITTERS; AND PRERECORDED VIDEOS FEATURING ANIMAL TRAINING (U.S. CLS. 21, 23, 26, 36 AND 38).

SN 76-418,591. UNIVERSAL ELECTRONICS INC., CYPRESS, CA. FILED 6-5-2002.

NEVOGUIDE

FOR APPLICATION SOFTWARE FOR HAND-HELD DEVICES; AND ELECTRONIC TELEVISION GUIDES FOR USE IN CONNECTION WITH APPLICATION SOFTWARE FOR HAND-HELD DEVICES (U.S. CLS. 21, 23, 26, 36 AND 38).

SN 76-419,452. JOWOOD PRODUCTIONS SOFTWARE AG, 4802 EBENSEE, AUSTRIA, FILED 6-11-2002.



NO CLAIM IS MADE TO THE EXCLUSIVE RIGHT TO USE "HOTEL", APART FROM THE MARK AS SHOWN.

FOR ELECTRICAL APPARATUS FOR RECORDING, TRANSMISSION AND REPRODUCTION OF SOUND AND IMAGES, NAMELY, BLANK VIDEO CASSETTES, VIDEO TAPE RECORDERS, AND VIDEO AND VIDEO OUTPUT GAME MACHINES FOR USE WITH TELEVISIONS; VIDEO GAME MACHINES FOR USE WITH TELEVISION; DATA CARRIERS, NAMELY, BLANK CD ROM'S, FLOPPY DISCS AND MAGNETIC TAPES; DATA CARRIERS, NAMELY, PRE-RECORDED CD ROM'S FLOPPY DISCS AND MAGNETIC TAPES FEATURING COMPUTER GAME SOFTWARE; COMPUTER MEMORY CHIPS, NAMELY, DIGITAL MEMORY MODULES; COMPUTER GAME SOFTWARE (U.S. CLS. 21, 23, 26, 36 AND 38).

SN 76-419,793. GLOBESPANVIRATA, INC., RED BANK, NJ. FILED 6-12-2002.

HELIUM

FOR COMMUNICATIONS PROCESSOR THAT ENABLES HIGH-SPEED INTERNET ACCESS CAPABILITY FOR SINGLE- AND MULTIPLE-USER ENDPOINT DEVICES, SUCH AS USB MODEMS, HOME GATEWAY DEVICES AND SMALL OFFICE/HOME OFFICE ROUTERS (U.S. CLS. 21, 23, 26, 36 AND 38).

FIRST USE 1-0-2000; IN COMMERCE 1-0-2000.

CLASS 9—(Continued).

SN 76-420,091. PERFUSION PARTNERS & ASSOCIATES, INC., FORT MYERS, FL. FILED 6-13-2002.

SEQUINE

OWNER OF U.S. REG. NO. 2,644,328.
FOR LABORATORY CENTRIFUGE TUBES FOR VETERINARY USE (U.S. CLS. 21, 23, 26, 36 AND 38).

SN 76-420,238. ANGELBABIES, LLC, LOS ANGELES, CA. FILED 5-24-2002.

ANGEL BABIES

FOR PHOTOGRAPHIC AND VIDEO CAMERAS AND CASES; COMPUTER PROGRAMS FEATURING SCREENSAVERS AND MANUALS SOLD IN CONNECTION THEREWITH; INTERACTIVE VIDEO GAME PROGRAMS AND VIDEO GAME SOFTWARE; INTERACTIVE VIDEO GAME PROGRAMS AND VIDEO GAME SOFTWARE DOWNLOADABLE FROM A GLOBAL COMPUTER NETWORK; PRERECORDED COMPACT DISCS, VINYL RECORDS, AUDIO-CASSETTES, MOTION PICTURE FILM, VIDEO TAPES AND DISCS FEATURING ACTION-ADVENTURE, ANIMATION, MUSIC, COMEDY, SPORTS, EXERCISE; EYEGLASSES, SUNGLASSES, AND CASES FOR ABOVE GOODS; TELEPHONES; PRE-PAID MAGNETICALLY ENCODED TELEPHONE CALLING CARDS; COMPUTER MOUSE PADS; REFRIGERATOR MAGNETS, SPORTS HELMETS FOR USE IN ALL MANNER OF SPORTING ACTIVITIES, PROTECTIVE HELMETS (U.S. CLS. 21, 23, 26, 36 AND 38).

SN 76-420,295. TMS ENTERTAINMENT LTD., TOKYO BRANCH, NAKANO-KU, TOKYO 164-0002, JAPAN, FILED 5-22-2002.

LUPIN THE 3RD

FOR PRE-RECORDED VIDEOCASSETTES, LASER DISKS, VIDEO COMPACT DISCS, DIGITAL VIDEO DISCS; RECORDABLE COMPACT DISKS, DVD-ROMS, DVD-RAMS, VIDEO DISKS CONTAINING ANIMATED CARTOON PROGRAMS (U.S. CLS. 21, 23, 26, 36 AND 38).
FIRST USE 4-30-2002; IN COMMERCE 4-30-2002.

CLASS 9—(Continued).

SN 76-420,520. INSTALLATION SOFTWARE TECHNOLOGIES, INC., DBA INSTALLSHIELD SOFTWARE CORPORATION, SCHAUMBURG, IL. FILED 6-13-2002.

INSTALLSHIELD DEVELOPER

OWNER OF U.S. REG. NOS. 1,844,225, 2,085,577 AND OTHERS.

NO CLAIM IS MADE TO THE EXCLUSIVE RIGHT TO USE "DEVELOPER", APART FROM THE MARK AS SHOWN.

FOR COMPUTER SOFTWARE, TRAINING MATERIALS AND MANUALS PACKAGED AS A UNIT FOR USE BY APPLICATIONS DEVELOPERS TO CREATE INSTALLATION PROGRAMS AND INTELLIGENT FILE HANDLING APPLICATIONS (U.S. CLS. 21, 23, 26, 36 AND 38).
FIRST USE 7-0-2001; IN COMMERCE 8-0-2001.

SN 76-421,204. ONE WORLD NETWORKS INTEGRATED TECHNOLOGIES, INC., LOS ANGELES, CA. FILED 6-22-2002.

AGELESS WOMAN

NO CLAIM IS MADE TO THE EXCLUSIVE RIGHT TO USE "WOMAN", APART FROM THE MARK AS SHOWN.

FOR PRE-RECORDED AUDIO AND VIDEO RECORDINGS FEATURING ADVICE AND INNOVATIVE INSTRUCTION ON HOW TO GAIN PERSONAL GROWTH ON STAYING YOUNG IN MIND, BODY AND SPIRIT (U.S. CLS. 21, 23, 26, 36 AND 38).

SN 76-421,785. ORBOGRAPH LTD., 81102, YAVNE, ISRAEL, FILED 6-17-2002.

ACCURA

FOR COMPUTER SYSTEMS COMPRISING COMPUTER HARDWARE, COMPUTER SOFTWARE AND OPTICAL SCANNERS IN THE FIELDS OF BANKING, CLEARING CHECKS, DATA ENTRY, FORMS PROCESSING AND DATA PROCESSING; COMPUTER SOFTWARE IN THE FIELDS OF BANKING, CLEARING CHECKS, DATA ENTRY, FORMS PROCESSING AND DATA PROCESSING (U.S. CLS. 21, 23, 26, 36 AND 38).
FIRST USE 2-4-2002; IN COMMERCE 2-4-2002.

SN 76-422,091. SOFTPRO SOFTWARE PROFESSIONAL GMBH & CO. KG, 71034 BOEBLINGEN, FED REP GERMANY, FILED 6-19-2002.

SIGNSECURE

FOR COMPUTER SOFTWARE FOR EMBEDDING SIGNATURES IN FILES AND ELECTRONIC DOCUMENTS AND FOR AUTHENTICATION OF FILES AND ELECTRONIC DOCUMENTS USING HANDWRITTEN SIGNATURES (U.S. CLS. 21, 23, 26, 36 AND 38).

CLASS 9—(Continued).

SN 76-422,092. SOFTPRO SOFTWARE PROFESSIONAL GMBH & CO. KG, 71034 BOEBLINGEN, FED REP GERMANY, FILED 6-19-2002.

SIGNCHIP

FOR COMPUTER SOFTWARE FOR ELECTRONIC STORING, COMPARING, RECOGNIZING, VISUALIZING AND PROCESSING OF HANDWRITTEN SIGNATURES IN CONNECTION WITH CHIP CARDS OR SMART CARDS (U.S. CLS. 21, 23, 26, 36 AND 38).

SN 76-423,006. SINETEC TECHNOLOGY CO., LTD., CHUNG HO, TAIPEI, TAIWAN, FILED 6-17-2002.



NO CLAIM IS MADE TO THE EXCLUSIVE RIGHT TO USE "STORAGE", APART FROM THE MARK AS SHOWN. FOR COMPUTER; COMPUTER DISKS; DVDS; RAMS; DATA STORAGE MACHINE, NAMELY, CD-R; CENTRAL PROCESSING UNITS; VIDEO CASSETTE RECORDERS; VIDEO TAPE PLAYERS; COMPUTER MONITORS; TELEVISIONS; ELECTRICAL TRANSFORMERS; STORAGE BATTERIES; COMPUTER LINKS, NAMELY, COMPUTER BUS LINES; BLANK VIDEO DISKS; COMPACT VIDEO; BLANK COMPACT DISKS; NETWORK CARDS AND CIRCUIT BOARDS (U.S. CLS. 21, 23, 26, 36 AND 38).

FIRST USE 4-25-2002; IN COMMERCE 5-1-2002.

SN 76-423,778. ROBERT BOSCH GMBH, 70839, GERLINGEN, FED REP GERMANY, FILED 6-24-2002.

DENOXTRONIC

PRIORITY CLAIMED UNDER SEC. 44(D) ON FED REP GERMANY APPLICATION NO. 30219733.8, FILED 4-17-2002, REG. NO. 30219733, DATED 6-7-2002, EXPIRES 4-30-2012.

FOR ELECTRIC AND ELECTRONIC SENSORS FOR ANALYZING EXHAUST GAS FROM ENGINES (U.S. CLS. 21, 23, 26, 36 AND 38).

SN 76-424,211. BUNTING, JOHN E., NEW BOSTON, NH, FILED 6-24-2002.

QUICKREAD

FOR DIAGNOSTIC AND ROUTINE MAINTENANCE MONITORS THAT READ INFORMATION FROM DATA PORTS OF HVAC OIL AND GAS BURNERS FOR COMMERCIAL, DOMESTIC AND INDUSTRIAL USE (U.S. CLS. 21, 23, 26, 36 AND 38).

CLASS 9—(Continued).

SN 76-427,382. PHAT FASHIONS LLC., NEW YORK, NY, FILED 7-1-2002.



OWNER OF U.S. REG. NOS. 1,809,325, 2,487,976 AND 2,552,152.

FOR TELEPHONES; CORDLESS, WIRELESS AND SATELLITE TELEPHONES; CELLULAR TELEPHONES; PREPAID CELLULAR TELEPHONES USED IN CONNECTION WITH PREPAID AIRTIME CELLULAR TELEPHONE COMMUNICATION SERVICES; RADIO TELEPHONES, PAGERS, TWO-WAY RADIOS, RADIO TRANSMITTERS, RADIO RECEIVERS, RADIO TRANSCIEVERS, RADIO BASE STATIONS, MODEMS, GLOBAL POSITIONING UNITS, BATTERIES, AND BATTERY CHARGERS; CAR KITS FOR THE ADAPTATION OF PORTABLE COMMUNICATION APPARATUS AND INSTRUMENTS FOR VEHICULAR USE PRINCIPALLY COMPOSED OF MOUNT, CRADLE, HEADSET, AUDIO SPEAKERS, MICROPHONES, EXTENSION CORDS, POWER CABLES, EXTERNAL ANTENNA CONNECTORS, BATTERY, BATTERY CHARGER AND CARRYING CASE MARKETED AS A UNIT; COMPUTERS, COMPUTER DISC DRIVES, COMPUTER PERIPHERALS; ELECTRONIC ORGANIZERS, HAND HELD COMPUTERS AND ORGANIZERS, PERSONAL DIGITAL ASSISTANTS, COMPUTER SOFTWARE, NAMELY, PRERECORDED COMPUTER PROGRAMS FOR PERSONAL INFORMATION MANAGEMENT, DATABASE MANAGEMENT SOFTWARE, CHARACTER RECOGNITION SOFTWARE, TELEPHONY MANAGEMENT SOFTWARE, ELECTRONIC MAIL AND MESSAGING SOFTWARE, PAGING SOFTWARE, AND DATABASE SYNCHRONIZATION SOFTWARE; TELEVISIONS, VIDEOPHONES, PHOTOGRAPHIC AND VIDEO CAMERAS, VIDEO COMPUTER AND GLOBAL COMPUTER NETWORK TERMINAL MONITORS, VIDEO TAPE RECORDERS, AND SATELLITE RECEIVERS; WEB BROWSER SOFTWARE FOR USE IN CONNECTION WITH E-COMMERCE BUSINESS TRANSACTIONS; ENCRYPTION SOFTWARE FOR USE IN CONNECTION WITH E-COMMERCE BUSINESS TRANSACTIONS; COMMUNICATIONS SOFTWARE FOR LINKING COMPUTERS AND TELECOMMUNICATIONS DEVICES TO THE INTERNET FOR THE PURPOSE OF PERFORMING E-COMMERCE BUSINESS TRANSACTIONS; CARRYING CASES FOR THE FOREGOING GOODS AND REPLACEMENT PARTS FOR THE FOREGOING GOODS; INSTRUCTION MANUALS DISTRIBUTED WITH THE FOREGOING; PREPAID MAGNETICALLY ENCODED TELEPHONE CALLING CARDS; MAGNETICALLY ENCODED CREDIT CARDS (U.S. CLS. 21, 23, 26, 36 AND 38).

SN 76-427,487. TDC SOLUTIONS, INC., LOUISVILLE, KY, FILED 7-5-2002.



THE MARK CONSISTS OF TWO ARROWHEADS AND "SYNERGYSC".

FOR COMPUTER SOFTWARE FOR PLANNING, SCHEDULING, AND MANAGING INVENTORY THROUGHOUT THE ENTIRE SUPPLY CHAIN (U.S. CLS. 21, 23, 26, 36 AND 38).

CLASS 9—(Continued).

SN 76-427,817. POINT BLANK BODY ARMOR, INC., OAKLAND PARK, FL. FILED 6-28-2002.

T-1

FOR PROTECTIVE BODY ARMOR, NAMELY BALLISTIC, BULLET, SLASH, AND STAB RESISTANT BODY ARMOR AND PROTECTIVE CLOTHING (U.S. CLS. 21, 23, 26, 36 AND 38).

FIRST USE 10-0-1999; IN COMMERCE 10-0-1999.

SN 76-428,011. FOOTWEAR SPECIALTIES INTERNATIONAL, LLC, PORTLAND, OR. FILED 7-8-2002.

SLIPBUSTER

FOR PROTECTIVE FOOTWEAR, NAMELY SHOES AND BOOTS FOR USE IN INDUSTRIAL, PUBLIC SAFETY, HOSPITALITY, AND NURSING SERVICES (U.S. CLS. 21, 23, 26, 36 AND 38).

SN 76-428,062. ICOP DIGITAL, INC., OLATHE, KS. FILED 7-8-2002.



NO CLAIM IS MADE TO THE EXCLUSIVE RIGHT TO USE "DIGITAL", APART FROM THE MARK AS SHOWN.

FOR ELECTRONIC DEVICES FOR USE BY LAW ENFORCEMENT AND RELATED ENTITIES, NAMELY DIGITAL CAMERAS, DIGITAL VIDEO RECORDERS, GLOBAL POSITIONING SYSTEMS CONSISTING OF COMPUTERS, COMPUTER SOFTWARE, TRANSMITTERS, RECEIVERS, AND NETWORK INTERFACE DEVICES; RADAR DEVICES (U.S. CLS. 21, 23, 26, 36 AND 38).

SN 76-428,063. ICOP DIGITAL, INC., OLATHE, KS. FILED 7-8-2002.

ICOP DIGITAL

NO CLAIM IS MADE TO THE EXCLUSIVE RIGHT TO USE "DIGITAL", APART FROM THE MARK AS SHOWN.

FOR ELECTRONIC DEVICES FOR USE BY LAW ENFORCEMENT AND RELATED ENTITIES, NAMELY DIGITAL CAMERAS, DIGITAL VIDEO RECORDERS, GLOBAL POSITIONING SYSTEMS CONSISTING OF COMPUTERS, COMPUTER SOFTWARE, TRANSMITTERS, RECEIVERS, AND NETWORK INTERFACE DEVICES; RADAR DEVICES (U.S. CLS. 21, 23, 26, 36 AND 38).

CLASS 9—(Continued).

SN 76-428,064. ICOP DIGITAL, INC., OLATHE, KS. FILED 7-8-2002.

ICOP

FOR ELECTRONIC DEVICES FOR USE BY LAW ENFORCEMENT AND RELATED ENTITIES, NAMELY DIGITAL CAMERAS, DIGITAL VIDEO RECORDERS, GLOBAL POSITIONING SYSTEMS CONSISTING OF COMPUTERS, COMPUTER SOFTWARE, TRANSMITTERS, RECEIVERS, AND NETWORK INTERFACE DEVICES; RADAR DEVICES (U.S. CLS. 21, 23, 26, 36 AND 38).

SN 76-428,261. PRESIDIO COMPONENTS INC., SAN DIEGO, CA. FILED 7-1-2002.

PRESIDIO COMPONENTS INC.

NO CLAIM IS MADE TO THE EXCLUSIVE RIGHT TO USE "COMPONENTS INC.", APART FROM THE MARK AS SHOWN.

FOR ELECTRONIC COMPONENTS, NAMELY, CAPACITORS (U.S. CLS. 21, 23, 26, 36 AND 38).

FIRST USE 2-19-1980; IN COMMERCE 5-19-1980.

SN 76-429,610. PHTV INC, AVON LAKE, OH. FILED 7-11-2002.

URBAN CANCER PROJECT

NO CLAIM IS MADE TO THE EXCLUSIVE RIGHT TO USE "CANCER PROJECT", APART FROM THE MARK AS SHOWN.

FOR VIDEOTAPES FEATURING A SERIES OF SYNCHRONIZED NEWS AND INFORMATIONAL SEGMENTS ABOUT CANCER (U.S. CLS. 21, 23, 26, 36 AND 38).

FIRST USE 2-1-2002; IN COMMERCE 2-1-2002.

SN 76-429,935. DIMS! ORGANIZING PRINT, INC., LISLE, IL. FILED 7-11-2002.

DIMS!

FOR SOFTWARE IN THE FIELD OF THE PRINTING INDUSTRY, NAMELY, MANAGEMENT, INFORMATION AND OPERATIONAL SOFTWARE (U.S. CLS. 21, 23, 26, 36 AND 38).

FIRST USE 10-0-2000; IN COMMERCE 10-0-2000.

CLASS 9—(Continued).

SN 76-430,654. MATSUSHITA ELECTRIC INDUSTRIAL CO., LTD., KADOMA-SHI, OSAKA-FU, JAPAN, FILED 7-12-2002.

Design Selection

NO CLAIM IS MADE TO THE EXCLUSIVE RIGHT TO USE "DESIGN", APART FROM THE MARK AS SHOWN. THE DOT FOR THE LETTER "I" IN DESIGN IS RED. FOR BLANK VIDEO CASSETTE TAPES (U.S. CLS. 21, 23, 26, 36 AND 38).

SN 76-432,456. DECISION TECHNOLOGY, INC., PRINCETON, NJ. FILED 7-19-2002.

DECISION ANALYZER

SEC. 2(F).
FOR COMPUTER SOFTWARE FOR ACCESSING AND RETRIEVING DATA STORED ON LARGE MAINFRAME COMPUTERS AND PROCESSING SAID DATA TO BE VIEWED, PRINTED, FORMATTED AND TRANSFERRED BY AN END USER AT A REMOTE COMPUTER LOCATION (U.S. CLS. 21, 23, 26, 36 AND 38).
FIRST USE 10-5-1987; IN COMMERCE 10-5-1987.

SN 76-433,496. SKYHAWKE TECHNOLOGIES, LLC, RIDGE-LAND, MS. FILED 7-18-2002.

SKYCADDIE

FOR ELECTRONIC SATELLITE TRACKING AND INFORMATION SYSTEM COMPRISING COMPUTER HARDWARE AND COMPUTER SOFTWARE USED TO DETERMINE DISTANCES ON GOLF COURSES AND FOR ACCESSING RELEVANT DATA AND STATISTICS PERTINENT THERETO (U.S. CLS. 21, 23, 26, 36 AND 38).

SN 76-435,855. PRIMA MUSIC, L.L.C., ISLAND HEIGHTS, NJ. FILED 7-31-2002.

MAGNAGROOVE RECORDS

NO CLAIM IS MADE TO THE EXCLUSIVE RIGHT TO USE "RECORDS", APART FROM THE MARK AS SHOWN. FOR MUSICAL SOUND RECORDINGS, NAMELY COMPACT DISKS AND CASSETTE TAPES WHICH FEATURE MUSIC (U.S. CLS. 21, 23, 26, 36 AND 38).

CLASS 9—(Continued).

SN 76-435,953. SPOKEN WORD, INC., THE, SIMI VALLEY, CA. FILED 7-31-2002.

LOS HERALDOS DEL REY

THE FOREIGN WORDING IN THE MARK TRANSLATES INTO ENGLISH AS "THE KING'S HERALDS".
FOR SERIES OF PRE-RECORDED COMPACT DISKS, CASSETTES AND VIDEO DISKS FEATURING MUSIC (U.S. CLS. 21, 23, 26, 36 AND 38).
FIRST USE 1-1-1943; IN COMMERCE 1-1-1943.

SN 76-435,955. SPOKEN WORD, INC., THE, SIMI VALLEY, CA. FILED 7-31-2002.

KING'S HERALDS

FOR SERIES OF PRE-RECORDED COMPACT DISKS, CASSETTES AND VIDEO DISKS FEATURING MUSIC (U.S. CLS. 21, 23, 26, 36 AND 38).
FIRST USE 1-1-1937; IN COMMERCE 1-1-1937.

SN 76-436,915. INTELLIGENT AUTOMATION DESIGN, LLC, YARDLEY, PA. FILED 8-1-2002.



NO CLAIM IS MADE TO THE EXCLUSIVE RIGHT TO USE "SMARTHEAD", APART FROM THE MARK AS SHOWN.

FOR SERVO AND STEPPER CONTROLLED PICK AND PLACE MECHANISMS (U.S. CLS. 21, 23, 26, 36 AND 38).
FIRST USE 3-31-2000; IN COMMERCE 1-1-2002.

SN 76-438,472. METRA ELECTRONICS CORPORATION, HOLLY HILL, FL. FILED 8-5-2002.



OWNER OF U.S. REG. NOS. 2,706,529, 2,708,813 AND 2,708,865.

FOR HOME THEATER CONNECTING PRODUCTS, NAMELY, AUDIO AND VIDEO CABLES AND SPEAKER WIRES (U.S. CLS. 21, 23, 26, 36 AND 38).

CLASS 9—(Continued).

SN 76-440,131. CYBERLINK CORP., TAIPEI HSIEN, TAIWAN, FILED 8-2-2002.

Medi@Show

FOR COMPUTER SOFTWARE FOR AUDIO AND VIDEO EDITING FOR PRODUCING EDITED VIDEO AND AUDIO EFFECTS ON A COMPUTER; COMPACT AND FLOPPY DISCS RECORDED WITH COMPUTER PROGRAMS FOR AUDIO AND VIDEO EDITING OF DATA (U.S. CLS. 21, 23, 26, 36 AND 38).

FIRST USE 7-1-1999; IN COMMERCE 8-5-1999.

SN 76-440,670. ELKIND + SWEET COMMUNICATIONS, INC., SAN FRANCISCO, CA. FILED 8-15-2002.

POPCORN PARK

FOR PRE-RECORDED VIDEOTAPES FEATURING EDUCATIONAL MATERIAL FOR YOUTHS, AND INSTRUCTIONAL BOOKLETS SOLD AS A UNIT; COMPUTER SOFTWARE, NAMELY, SOFTWARE FEATURING EDUCATIONAL MATERIAL FOR YOUTHS, AND INSTRUCTIONAL BOOKLETS SOLD AS A UNIT (U.S. CLS. 21, 23, 26, 36 AND 38).

SN 76-441,134. GREENE, TWEED OF DELAWARE, INC., WILMINGTON, DE. FILED 8-12-2002.

ENVIROTIGHT

FOR FIBER OPTIC CONNECTORS (U.S. CLS. 21, 23, 26, 36 AND 38).

FIRST USE 1-1-2002; IN COMMERCE 1-1-2002.

SN 76-442,386. DIRECT TECHNOLOGIES, LLC, POMPANO BEACH, FL. FILED 8-21-2002.

SWIPE N' GO

NO CLAIM IS MADE TO THE EXCLUSIVE RIGHT TO USE "SWIPE", APART FROM THE MARK AS SHOWN.

FOR ELECTRONIC MAGNETIC CARD READING DEVICES, NAMELY, ELECTRONIC PORTABLE POINT-OF-SALE TERMINALS, UTILIZED IN CONNECTION WITH TRANSACTION AND CREDIT CARD PROCESSING (U.S. CLS. 21, 23, 26, 36 AND 38).

FIRST USE 8-21-2001; IN COMMERCE 8-21-2001.

CLASS 9—(Continued).

SN 76-448,195. BANDWIZ, INC., WALTHAM, MA. FILED 9-9-2002.

MULTIREACH

FOR COMPUTER SOFTWARE PROGRAMS FOR THE DELIVERY OF CRITICAL DIGITAL ASSETS OVER A NETWORK AND COMPUTING INFRASTRUCTURE BY DEPLOYING APPLICATION LAYER MULTICAST AND MEDIATED PEER-TO-PEER TRANSPORT LAYERS (U.S. CLS. 21, 23, 26, 36 AND 38).

SN 76-449,802. NEUROSMITH, L.L.C., LONG BEACH, CA. FILED 9-16-2002.

MAGIC SENSOR

NO CLAIM IS MADE TO THE EXCLUSIVE RIGHT TO USE "SENSOR", APART FROM THE MARK AS SHOWN.

FOR ELECTRONIC SENSORS, BEING INTEGRAL COMPONENTS OF MUSICAL TOYS, FOR SENSING VIBRATIONS, SOUNDS OR MOTIONS AND CONVERTING THEM INTO SOUND OR MUSIC PATTERNS (U.S. CLS. 21, 23, 26, 36 AND 38).

SN 76-452,446. SHOKAN INTERNATIONAL CO., LTD., YUNG KANG CITY, TAINAN SHIEN, TAIWAN, FILED 9-17-2002.



THE MARK CONSIST OF THE LETTERS "AFX" STYLIZED.

FOR BICYCLE HELMETS, MOTORCYCLE HELMETS, PROTECTIVE HELMETS AND SAFETY HELMETS (U.S. CLS. 21, 23, 26, 36 AND 38).

FIRST USE 7-5-2001; IN COMMERCE 7-5-2001.

SN 76-453,324. BANKER'S TOOLBOX, INC., LOS ANGELES, CA. FILED 9-26-2002.



NO CLAIM IS MADE TO THE EXCLUSIVE RIGHT TO USE "BSA MANAGER", APART FROM THE MARK AS SHOWN.

FOR COMPUTER SOFTWARE FOR BANK SECRECY ACT/CASH TRANSACTION REPORT/SUSPICIOUS ACTIVITY REPORT/US PATRIOT ACT COMPLIANCE (U.S. CLS. 21, 23, 26, 36 AND 38).

FIRST USE 7-1-2001; IN COMMERCE 7-1-2001.

CLASS 9—(Continued).

SN 76-453,912. CENTAGE CORPORATION, HOUSTON, TX. FILED 9-30-2002.

BUDGETNOW

FOR COMPUTER SOFTWARE FOR USE IN FINANCIAL BUDGETING, FINANCIAL FORECASTING, AND FINANCIAL REPORTING IN THE FIELD OF BUSINESS FINANCE (U.S. CLS. 21, 23, 26, 36 AND 38).
FIRST USE 8-16-2002; IN COMMERCE 8-16-2002.

SN 76-456,475. JACKSON NATIONAL LIFE INSURANCE COMPANY, LANSING, MI. FILED 10-7-2002.



NO CLAIM IS MADE TO THE EXCLUSIVE RIGHT TO USE "FP SUITE", APART FROM THE MARK AS SHOWN.

FOR PROPRIETARY COMPUTER SOFTWARE FOR USE IN DATABASE MANAGEMENT, SPECIFICALLY IN THE FIELD OF FINANCIAL PLANNING (U.S. CLS. 21, 23, 26, 36 AND 38).

FIRST USE 6-20-2002; IN COMMERCE 6-20-2002.

SN 76-458,040. AMERICAN ESCAPE SYSTEMS, INC., ROCHESTER HILLS, MI. FILED 10-15-2002.

LIFECENDER

FOR SAFETY EQUIPMENT KITS COMPRISED OF BELT AND HARNESS RESTRAINTS, ROPE, DESCENDER DEVICES AND DEVICE ANCHORS, ALL FOR LOWERING PEOPLE TO SAFETY (U.S. CLS. 21, 23, 26, 36 AND 38).

SN 76-458,114. QED TECHNOLOGIES, INC., ROCHESTER, NY. FILED 10-15-2002.

QED TECHNOLOGIES

NO CLAIM IS MADE TO THE EXCLUSIVE RIGHT TO USE "TECHNOLOGIES", APART FROM THE MARK AS SHOWN.

FOR MACHINES FOR POLISHING AND MEASURING HIGH PRECISION SURFACES IN THE FIELDS OF OPTICS AND MICROELECTRONIC SUBSTRATES (U.S. CLS. 21, 23, 26, 36 AND 38).

FIRST USE 12-0-1998; IN COMMERCE 12-0-1998.

CLASS 9—(Continued).

SN 76-458,115. QED TECHNOLOGIES, INC., ROCHESTER, NY. FILED 10-15-2002.

MR JET

THE MARK DOES NOT IDENTIFY A PARTICULAR LIVING INDIVIDUAL.

FOR MACHINES FOR POLISHING PRECISION SURFACES IN THE FIELD OF OPTICS AND FOR FINISHING OF MOLD, OPHTHALMIC OR MICROELECTRONIC SUBSTRATES (U.S. CLS. 21, 23, 26, 36 AND 38).

SN 76-458,213. ALAN M. HYATT, DBA PMI AUDIO GROUP, TORRANCE, CA. FILED 10-15-2002.

JOEMEEK

FOR MICROPHONES, MICROPHONE PREAMPLIFIERS, STUDIO MONITOR SPEAKERS, EQUALIZERS, OPTICAL COMPRESSORS, AUDIO CABLES, AND ACCESSORIES, NAMELY, CABLES, CONNECTORS, PLUGS, ADAPTORS, WINDSCREEN FILTERS, RACK TRAYS, AUDIO STANDS RELATED TO AUDIO, LIMITERS, OPTICAL COMPRESSORS, AND POWER AMPLIFIERS (U.S. CLS. 21, 23, 26, 36 AND 38).

SN 76-460,720. GLOBAL RESOURCE ENTERPRISES, LLC, HAYMARKET, VA. FILED 10-23-2002.



MARK CONSISTS OF A GLOBE MARKED BY MERIDIANS AND PARALLEL LINES, IMPOSED UNDER A HUMAN HAND AND SERIES OF SQUARES, IN CONJUNCTION WITH THE WORD "S@FECHILDNET".

FOR SOFTWARE FOR USE ON INDIVIDUAL COMPUTERS TO PROTECT CHILDREN AND BLOCK OBJECTIONABLE MATERIAL AND DATA OBTAINED VIA UNAUTHORIZED SITES FROM A GLOBAL COMPUTER NETWORK (U.S. CLS. 21, 23, 26, 36 AND 38).

FIRST USE 2-6-2002; IN COMMERCE 3-11-2002.

CLASS 9—(Continued).

SN 76-461,705. FESTIVAL ATTRACTIONS, INC., NEW YORK, NY. FILED 10-21-2002.

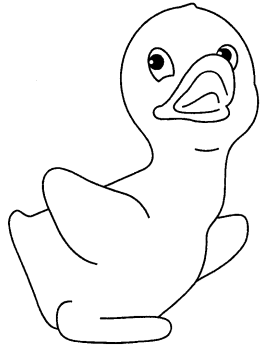

FOR COMPUTER GAME SOFTWARE, ELECTRONIC GAME PROGRAMS, VIDEO GAME SOFTWARE, COMPUTER GAME PROGRAMS THAT ARE DOWNLOADABLE FROM A GLOBAL COMPUTER NETWORK AND INSTRUCTIONAL MANUAL SOLD THEREWITH; PRE-RECORDED AUDIO CASSETTES, AUDIO TAPES, DIGITAL AUDIO TAPES, RECORDS, AND COMPACT DISCS FEATURING MUSIC AND SPOKEN WORD; VIDEO DISCS, PRE-RECORDED VIDEO CASSETTES, VIDEO RECORDINGS, AND DVDS FEATURING MOVIES, ANIMATED FILMS, AND MUSIC; PRE-RECORDED AUDIO CASSETTES, FEATURING SPOKEN LANGUAGE AND SONG, AND CHILDREN'S BOOKS SOLD AS A SET; PRE-RECORDED COMPACT DISCS, FEATURING SPOKEN LANGUAGE AND SONG, AND CHILDREN'S BOOKS SOLD AS A SET; INTERACTIVE COMPUTER GAMES AND INSTRUCTION MANUALS SOLD THEREWITH; COMPUTER GAME DISKETTES AND CARTRIDGES AND INSTRUCTION MANUALS SOLD THEREWITH; VIDEO GAME INTERACTIVE HAND HELD REMOTE CONTROLS FOR PLAYING ELECTRONIC GAMES; DOWNLOADABLE ELECTRONIC PUBLICATION IN THE NATURE OF A DAILY NEWSPAPER FOR CHILDREN FEATURING EDUCATIONAL MATERIALS AND GAMES IN A VARIETY OF SUBJECTS; KALEIDOSCOPIES; SUNGLASSES (U.S. CLS. 21, 23, 26, 36 AND 38).

SN 76-462,064. AMERIVON LLC, AGOURA HILLS, CA. FILED 10-28-2002.

AMERIVOICE CONNECTOR

NO CLAIM IS MADE TO THE EXCLUSIVE RIGHT TO USE "CONNECTOR", APART FROM THE MARK AS SHOWN.

FOR TELECOMMUNICATIONS EQUIPMENT, NAMELY TELEPHONE DIALERS (U.S. CLS. 21, 23, 26, 36 AND 38).

FIRST USE 9-30-2002; IN COMMERCE 9-30-2002.

CLASS 9—(Continued).

SN 76-462,651. LEON, EDUARDO, SHERMAN OAKS, CA. FILED 10-29-2002.

MARIACHI LOBO

NO CLAIM IS MADE TO THE EXCLUSIVE RIGHT TO USE "MARIACHI", APART FROM THE MARK AS SHOWN. THE FOREIGN WORDING IN THE MARK TRANSLATES INTO ENGLISH AS "MARIACHI WOLF".

FOR SERIES OF PRE-RECORDED PHONOGRAPH RECORDS, AUDIO CASSETTES, VIDEO CASSETTES, AND COMPACT DISCS FEATURING MUSIC (U.S. CLS. 21, 23, 26, 36 AND 38).

SN 76-463,035. SNELL MEDICAL COMMUNICATION INC., MONTREAL QUEBEC, CANADA, FILED 10-24-2002.

**INTERVENTIONAL
CARDIOLOGY ROUNDS**

OWNER OF U.S. REG. NOS. 2,282,192, 2,557,887 AND 2,559,082.

NO CLAIM IS MADE TO THE EXCLUSIVE RIGHT TO USE "INTERVENTIONAL CARDIOLOGY", APART FROM THE MARK AS SHOWN.

FOR ELECTRONIC PUBLICATIONS, NAMELY A MEDICAL NEWSLETTER, RECORDED ON A CD-ROM (U.S. CLS. 21, 23, 26, 36 AND 38).

SN 76-463,405. MARTIN, CRAIG, PORTER RANCH, CA. FILED 10-31-2002.

KIDZ 'N POWER

NO CLAIM IS MADE TO THE EXCLUSIVE RIGHT TO USE "KIDS", APART FROM THE MARK AS SHOWN.

FOR PRE-RECORDED INSTRUCTIONAL SAFETY VIDEO FOR CHILD ABDUCTION PREVENTION; CHILD SELF-DEFENSE AND SAFETY AND WRITTEN INSTRUCTIONAL MATERIALS THEREWITH (U.S. CLS. 21, 23, 26, 36 AND 38).

SN 76-463,671. IMPRIVATA, INC., LEXINGTON, MA. FILED 11-1-2002.

ONESIGN

FOR COMPUTER SOFTWARE AND HARDWARE FOR USE IN AUTHENTICATION, AUTHORIZATION, ADMINISTRATION AND MANAGEMENT OF USER IDENTITY, APPLICATIONS, INFORMATION AND/OR TRANSACTIONS OVER GLOBAL COMPUTER NETWORKS; COMPUTER SECURITY SOFTWARE FOR USE IN ENSURING THE SECURITY AND PRIVACY OF INDIVIDUALS, TRANSACTIONS, AND DATA; COMMUNICATIONS COMPUTER SOFTWARE FOR CONNECTING COMPUTER USERS TO LOGONS, APPLICATIONS AND OTHER SOFTWARE (U.S. CLS. 21, 23, 26, 36 AND 38).

FIRST USE 9-0-2002; IN COMMERCE 9-0-2002.

CLASS 9—(Continued).

SN 76-464,767. GSE SYSTEMS, INC., COLUMBIA, MD.
FILED 11-6-2002.

SIMSUITE PRO

NO CLAIM IS MADE TO THE EXCLUSIVE RIGHT TO USE "SIMSUITE", APART FROM THE MARK AS SHOWN. FOR COMPUTER SOFTWARE FOR PROCESS ENGINEERING SIMULATION, NAMELY, AN INTEGRATED SOFTWARE SUITE TO BUILD, TEST, AND RUN SIMULATION MODELS DYNAMICALLY AND IN REAL-TIME (U.S. CLS. 21, 23, 26, 36 AND 38).

FIRST USE 2-0-1996; IN COMMERCE 11-0-1996.

CLASS 9—(Continued).

SN 76-469,443. MINITAB INC., STATE COLLEGE, PA. FILED 11-14-2002.

**MINITAB QUALITY
TRAINER**

OWNER OF U.S. REG. NOS. 2,251,375 AND 2,624,053.
NO CLAIM IS MADE TO THE EXCLUSIVE RIGHT TO USE "QUALITY TRAINER", APART FROM THE MARK AS SHOWN.

FOR COMPUTER SOFTWARE FOR USE IN TRAINING OF STATISTICS AND STATISTICAL SOFTWARE (U.S. CLS. 21, 23, 26, 36 AND 38).

SN 76-466,060. DMD AMERICA, INC., EAST SYRACUSE, NY. FILED 11-4-2002.

Analy\$ource

FOR DATABASE MANAGEMENT SOFTWARE USED TO TRACK AND ANALYZE DRUG PRODUCTS AND PRICING (U.S. CLS. 21, 23, 26, 36 AND 38).

FIRST USE 7-1-1996; IN COMMERCE 7-1-1996.

SN 76-469,950. INDUMART, INC., RICHMOND HILL, ONTARIO L4B 1H6, CANADA, FILED 11-25-2002.

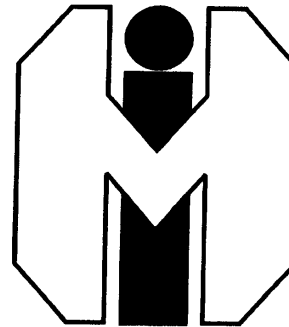

SN 76-467,830. COVARO NETWORKS, INC., RICHARDSON, TX. FILED 11-18-2002.

ETHERJACK

FOR COMPUTER HARDWARE AND SOFTWARE FOR USE IN CONNECTING, MANAGING AND OPERATING NETWORK COMMUNICATIONS SERVICES (U.S. CLS. 21, 23, 26, 36 AND 38).

FOR MECHANICAL AND ELECTRONIC PROCESS CONTROL AND INSTRUMENTATION PRODUCTS, NAMELY, TEMPERATURE GAUGES, PRESSURE GAUGES, SIGNAL CONDITIONERS, RECORDERS, CALIBRATORS, VALVES, INDICATORS, SWITCHES, CONTROLLERS, AND TRANSMITTERS USED TO MEASURE AND MONITOR TEMPERATURE, FLOW VOLUME, PRESSURE, HUMIDITY, AND LIQUID LEVELS (U.S. CLS. 21, 23, 26, 36 AND 38).

FIRST USE 8-18-1989; IN COMMERCE 8-18-1989.

SN 76-469,342. THE HOEFLER TYPE FOUNDRY, INC., NEW YORK, NY. FILED 11-22-2002.

CHAMPION GOTHIC

NO CLAIM IS MADE TO THE EXCLUSIVE RIGHT TO USE "GOTHIC", APART FROM THE MARK AS SHOWN.

FOR TYPE FACE FONTS RECORDED ON MAGNETIC AND OPTICAL MEDIA (U.S. CLS. 21, 23, 26, 36 AND 38).

FIRST USE 6-1-1991; IN COMMERCE 6-1-1991.

SN 76-471,192. XYRON CORPORATION, VANCOUVER, WA. FILED 11-29-2002.

XYRONIUM

FOR COMPUTER HARDWARE, MICROPROCESSORS, SEMICONDUCTORS, FIELD PROGRAMMABLE GATE ARRAYS (FPGAS), DEVELOPMENT BOARDS, INTEGRATED CIRCUITS, MICROPROCESSOR DESIGNS, NAMELY, CUSTOMIZED MICROCHIPS, MASK WORKS, INTEGRATED CIRCUITS, PRINTED CIRCUIT BOARDS, AND USER MANUALS FOR USE WITH, AND SOLD AS A UNIT WITH, ALL THE AFORESAID GOODS (U.S. CLS. 21, 23, 26, 36 AND 38).

FIRST USE 3-18-2002; IN COMMERCE 3-18-2002.

CLASS 9—(Continued).

SN 76-471,315. WILSON ELECTRONICS, INC., SAINT GEORGE, UT. FILED 11-22-2002.

CELLULAR TRUCKER

NO CLAIM IS MADE TO THE EXCLUSIVE RIGHT TO USE "CELLULAR", APART FROM THE MARK AS SHOWN. FOR ANTENNAS (U.S. CLS. 21, 23, 26, 36 AND 38). FIRST USE 1-1-2000; IN COMMERCE 1-1-2000.

SN 76-472,763. MICROEDA CORPORATION, ROCKLIN, CA. FILED 12-9-2002.

MICROMASK

FOR INTEGRATED CIRCUIT DATA VERIFICATION AND CONVERSION SOFTWARE (U.S. CLS. 21, 23, 26, 36 AND 38). FIRST USE 10-29-2002; IN COMMERCE 10-29-2002.

SN 76-472,783. TKO SOFTWARE, INC., SANTA CRUZ, CA. FILED 12-9-2002.

KNUCKLE UP!

FOR COMPUTER SOFTWARE FOR VIDEO GAMES AND COMPUTER GAMES; COMPUTER SOFTWARE TO ENHANCE THE AUDIO-VISUAL CAPABILITIES OF MULTIMEDIA APPLICATIONS, NAMELY, FOR THE INTEGRATION OF TEXT, AUDIO, GRAPHICS, STILL IMAGES AND MOVING PICTURES IN THE FIELD OF DIGITAL ENTERTAINMENT (U.S. CLS. 21, 23, 26, 36 AND 38).

SN 76-472,819. L.F.P., INC., BEVERLY HILLS, CA. FILED 12-6-2002.

BUSTY BEAUTIES

OWNER OF U.S. REG. NOS. 2,067,942 AND 2,137,503. FOR PRE-RECORDED VIDEO TAPES AND DIGITAL VIDEO DISCS (DVDS) IN THE FIELD OF ADULT ENTERTAINMENT (U.S. CLS. 21, 23, 26, 36 AND 38). FIRST USE 11-26-2002; IN COMMERCE 11-26-2002.

SN 76-473,443. WEATHERDATA, INC., WICHITA, KS. FILED 11-20-2002.

STORM HAWK

NO CLAIM IS MADE TO THE EXCLUSIVE RIGHT TO USE "STORM", APART FROM THE MARK AS SHOWN. FOR GPS BASED COMPUTER SOFTWARE FOR PROCESSING AND DISPLAYING WEATHER AND MAPPING INFORMATION (U.S. CLS. 21, 23, 26, 36 AND 38).

CLASS 9—(Continued).

SN 76-473,525. SONY ELECTRONICS INC., PARK RIDGE, NJ. FILED 12-4-2002.



FOR COMPUTER HARDWARE AND SOFTWARE FOR ENCRYPTING DIGITAL TELEVISION SIGNALS (U.S. CLS. 21, 23, 26, 36 AND 38).

SN 76-473,654. SEISMIC MICRO-TECHNOLOGY, INC., HOUSTON, TX. FILED 12-6-2002.

AVOPAK

FOR COMPUTER SOFTWARE AND ACCOMPANYING PRINTED MATERIALS FOR USE WITH EXPLORATION AND PRODUCTION TECHNOLOGY IN THE OIL AND GAS ENVIRONMENTAL INDUSTRIES AND GEOPHYSICAL AND GEOLOGICAL APPLICATIONS, APPLIED AS AN ANALYTICAL AND VISUALIZATION TOOL IN COMPUTER SOFTWARE FOR EVALUATING FLUID CONTENT AND ROCK PROPERTIES IN SUBSURFACE DATA (U.S. CLS. 21, 23, 26, 36 AND 38).

SN 76-473,670. WEINBRENNER SHOE COMPANY, INC., MERRILL, WI. FILED 12-6-2002.

HELL FIRE

FOR PROTECTIVE FIRE RETARDANT FOOTWEAR (U.S. CLS. 21, 23, 26, 36 AND 38).

SN 76-473,918. KABUSHIKI KAISHA SEGA, DBA SEGA CORPORATION, TOKYO, JAPAN, FILED 12-6-2002.

SEGA ARCADE GALLERY

OWNER OF U.S. REG. NOS. 2,106,258, 2,555,187 AND OTHERS.

NO CLAIM IS MADE TO THE EXCLUSIVE RIGHT TO USE "ARCADE", APART FROM THE MARK AS SHOWN.

FOR VIDEO GAME SOFTWARE; COMPUTER GAME PROGRAMS; COMPUTER GAME DISCS; VIDEO COMPUTER GAME PROGRAMS; HOME VIDEO COMPUTER GAME DISCS; GAME DISCS, CARTRIDGES AND CIRCUIT BOARDS CONTAINING GAME PROGRAMS FOR USE WITH HAND-HELD OR ARCADE VIDEO GAME MACHINES WITH BUILT-IN SCREENS (U.S. CLS. 21, 23, 26, 36 AND 38).

CLASS 9—(Continued).

SN 76-474,014. KABUSHIKI KAISHA TOSHIBA, TA TOSHIBA CORPORATION, TOKYO 105-8001, JAPAN, FILED 12-10-2002.

TRIPLO

FOR COMPUTER SOFTWARE, NAMELY, DATA ENCRYPTION PROGRAMS (U.S. CLS. 21, 23, 26, 36 AND 38).

SN 76-474,107. PHOTAGS, INC., GARDEN CITY, NY. FILED 12-5-2002.

JMS

FOR COMPUTER SOFTWARE FOR APPENDING TEXTUAL MATERIAL TO JPEG FILES (U.S. CLS. 21, 23, 26, 36 AND 38).

SN 76-474,257. LUMBERG, INC., MIDLOTHIAN, VA. FILED 12-9-2002.

ETHERMATE

FOR DATA TRANSMISSION AND COMMUNICATIONS EQUIPMENT, NAMELY CABLES, CABLE CONNECTORS, ELECTRICAL INPUT/OUTPUT DISTRIBUTION AND COUPLING MODULES (U.S. CLS. 21, 23, 26, 36 AND 38).
FIRST USE 11-20-2000; IN COMMERCE 1-25-2001.

SN 76-474,276. CABINET VISION, INC., TUSCALOOSA, AL. FILED 12-6-2002.

Manage IT!

FOR COMPUTER PROGRAMS, NAMELY, SOFTWARE DESIGNED TO CREATE A CUSTOM DATABASE OF CUSTOMER INFORMATION (U.S. CLS. 21, 23, 26, 36 AND 38).
FIRST USE 4-1-2001; IN COMMERCE 4-1-2001.

CLASS 9—(Continued).

SN 76-474,277. CABINET VISION, INC., TUSCALOOSA, AL. FILED 12-6-2002.

Solid Design

FOR COMPUTER PROGRAMS, NAMELY, SOFTWARE DESIGNED TO DEVELOP AND PLAN CUSTOM CABINETS OR ARCHITECTURAL CASEWORK (U.S. CLS. 21, 23, 26, 36 AND 38).
FIRST USE 4-1-1997; IN COMMERCE 4-1-1997.

SN 76-474,279. CABINET VISION, INC., TUSCALOOSA, AL. FILED 12-6-2002.

PHOTOVISION

FOR COMPUTER PROGRAMS, NAMELY, SOFTWARE DESIGNED TO ARCHITECTURALLY SIMULATE AND RENDER DESIGNS OF CUSTOM CABINETS OR ARCHITECTURAL CASEWORK IN A COMPUTER GRAPHIC FORMAT (U.S. CLS. 21, 23, 26, 36 AND 38).
FIRST USE 4-1-1989; IN COMMERCE 4-1-1989.

SN 76-474,546. VENDESIGN MANUFACTURING, INC., COTTONWOOD, CA. FILED 12-6-2002.

VENDESIGN

FOR AUTOMATED MERCHANDISE DISPENSER (U.S. CLS. 21, 23, 26, 36 AND 38).
FIRST USE 2-0-1987; IN COMMERCE 0-0-1988.

SN 76-476,165. SOFTMED SYSTEMS, INC., SILVER SPRING, MD. FILED 12-9-2002.

SOFTMED

FOR COMPUTER SOFTWARE FOR MEDICAL RECORDS MANAGEMENT (U.S. CLS. 21, 23, 26, 36 AND 38).
FIRST USE 12-7-1983; IN COMMERCE 12-7-1983.

CLASS 9—(Continued).

SN 76-476,167. ARTISAN ENTERTAINMENT INC., SANTA MONICA, CA. FILED 12-9-2002.

POWER ZONE

FOR PRE-RECORDED VIDEO CASSETTES AND DVDS IN THE FIELD OF EXERCISE AND FITNESS (U.S. CLS. 21, 23, 26, 36 AND 38).

SN 76-477,208. V SHAPE MIND GENERAL PARTNERSHIP, MIDDLETON, WI. FILED 12-20-2002.

V SHAPE MIND

FOR SERIES OF PRE-RECORDED PHONOGRAPH RECORDS, AUDIO CASSETTES, COMPACT DISCS, PRE-RECORDED VIDEO CASSETTES, LASER DISCS AND DIGITAL VIDEO DISCS, ALL FEATURING MUSICAL SOUND RECORDINGS AND PERFORMANCE (U.S. CLS. 21, 23, 26, 36 AND 38).

FIRST USE 9-1-1995; IN COMMERCE 9-1-1995.

SN 76-477,770. MACK INFORMATION SYSTEMS, INC., WYNCOTE, PA. FILED 12-24-2002.

PLEXIUM

THE TWO "X"S IN THE MARK ARE RED, AND THE REMAINING LETTERS ARE PURPLE. THE COLORS RED AND PURPLE ARE CLAIMED AS FEATURES OF THE MARK.

FOR INSTRUMENTATION FOR USE WITH CRITICAL LABORATORY PROCESSES, NAMELY, A MONITORING, RECORDING AND ALARM SYSTEM COMPRISED OF SENSORS, COMPUTER HARDWARE, COMPUTER SOFTWARE AND NETWORKING EQUIPMENT, TO MONITOR ENVIRONMENTAL CONDITIONS IN LABORATORIES AND STORAGE FACILITIES SUCH AS FOOD AND DRUG ADMINISTRATION (FDA) REGULATED FACILITIES AND GENERAL LIFE SCIENCE LABORATORIES (U.S. CLS. 21, 23, 26, 36 AND 38).

SN 76-488,230. ARISTOCRAT TECHNOLOGIES AUSTRALIA PTY LTD, LANE COVE, 2066, NSW, AUSTRALIA, FILED 2-6-2003.

POPCORN

FOR GAMING DEVICES, NAMELY GAMING MACHINES AND COMPUTER SOFTWARE USED THEREWITH TO ENABLE THE GAMING MACHINES TO RUN (U.S. CLS. 21, 23, 26, 36 AND 38).

CLASS 9—(Continued).

SN 78-031,284. ONSPEC ELECTRONIC, INC., SANTA CLARA, CA. FILED 10-18-2000.

OMNIFLASH

FOR FLASH MEMORY CARD READERS; FIXED SOLID STATE MEMORY DRIVES (U.S. CLS. 21, 23, 26, 36 AND 38).

SN 78-049,551. UNI/CARE SYSTEMS, INC., SARASOTA, FL. FILED 2-21-2001.



NO CLAIM IS MADE TO THE EXCLUSIVE RIGHT TO USE "PROFILER", APART FROM THE MARK AS SHOWN. THE STIPLING IS A FEATURE OF THE MARK AND DOES NOT INDICATE COLOR.

THE ORIGINAL MARK TO BE USED IN A BLUE AND WHITE RECTANGLE WITH HALF A GLOBE AT THE LEFT SIDE WITH THE WORD "PRO-FILER" (AERIAL BLACK, ITALICIZED) WRITTEN ACROSS. THE MARK INCLUDES GRADIENT COLORS AND DROP SHADOWS WHICH CANNOT BE PROPERLY DEMONSTRATED IN THE BLACK AND WHITE IMAGE DISPLAYED BELOW.

FOR COMPUTER SOFTWARE ASSISTING HEALTH AND HUMAN SERVICE AGENCIES IN IMPROVING CRITICAL PROCESSES IN EVERY ASPECT OF THEIR BUSINESS FUNCTIONS, NAMELY, DATA COLLECTION AND MANAGEMENT FOR SERVICES PLANNING TO SERVICE DELIVERY, COMPLIANCE MONITORING, OUTCOME MEASURING AND BILLING AND CASH APPLICATIONS (U.S. CLS. 21, 23, 26, 36 AND 38).

FIRST USE 2-20-2001; IN COMMERCE 2-20-2001.

SN 78-055,107. WOJU AMERICA CORP., DBA ABL CORP., SANTA FE SPRINGS, CA. FILED 3-26-2001.

ABL.COM

FOR CLOSED CIRCUIT TELEVISIONS (U.S. CLS. 21, 23, 26, 36 AND 38).

FIRST USE 3-26-2001; IN COMMERCE 3-26-2001.

CLASS 9—(Continued).

SN 78-066,098. WINPAT HOLDINGS LTD., DELTA, BRITISH COLUMBIA, FILED 5-29-2001.

QRMS QUEST RECORDS MANAGEMENT SYSTEM

NO CLAIM IS MADE TO THE EXCLUSIVE RIGHT TO USE "RECORDS MANAGEMENT SYSTEM", APART FROM THE MARK AS SHOWN.

FOR COMPUTER SOFTWARE FOR USE IN DATA-BASE MANAGEMENT (U.S. CLS. 21, 23, 26, 36 AND 38).
FIRST USE 11-1-2002; IN COMMERCE 12-1-2002.

SN 78-066,142. CREATIVENGINE, INC., SANTA MONICA, CA. FILED 5-29-2001.

s i t e e n g i n e

FOR COMPUTER SOFTWARE FOR MANAGING AND EDITING A WEBSITE'S CONTENT (U.S. CLS. 21, 23, 26, 36 AND 38).

FIRST USE 12-1-1997; IN COMMERCE 12-1-1997.

SN 78-074,324. WARREN MILLER ENTERTAINMENT, INC., NEW YORK, NY. BY ASSIGNMENT INTERNATIONAL ENTERTAINMENT GROUP, INC., BOULDER, CO. FILED 7-17-2001.

ADVENTURES
of
ZIMMO

FOR PRE-RECORDED VIDEOCASSETTES FEATURING ENTERTAINMENT AND INFORMATION OF GENERAL INTEREST TO PARENTS AND CHILDREN (U.S. CLS. 21, 23, 26, 36 AND 38).

FIRST USE 2-15-2000; IN COMMERCE 2-15-2000.

SN 78-082,951. BAKER HUGHES INCORPORATED, HOUSTON, TX. FILED 9-6-2001.

ONTRAK

FOR MODULAR MEASUREMENT-WHILE-DRILLING BOTTOM HOLE ASSEMBLY, CONSISTING PRIMARILY OF A BI-DIRECTIONAL COMMUNICATION AND POWER MODULE AND AN ELECTRONIC SENSOR MODULE GENERALLY HAVING A CENTRAL PROCESSOR, DATA MEMORY AND A PLURALITY OF SENSORS FOR MAKING DIRECTIONAL, DRILLING AND FORMATION MEASUREMENTS, NAMELY, DIRECTION, TEMPERATURE, BORE AND ANNULAR PRESSURE, FORMATION DENSITY, POROSITY, RESISTIVITY, VIBRATION, STICK/SLIP, GAMMA RAY AND OTHER DRILLING SYSTEM OR FORMATION EVALUATION MEASUREMENTS, THAT IS USED FOR DIRECTIONAL DRILLING AND FORMATION EVALUATION IN SUBTERRANEAN OIL, GAS, WATER, MINERAL AND GEOTHERMAL CELL FORMATIONS (U.S. CLS. 21, 23, 26, 36 AND 38).

CLASS 9—(Continued).

SN 78-089,527. ROMAGNOLE PRODUTOS ELETRICOS LTDA., PARANA, BRAZIL, FILED 10-22-2001.

ROMAGNOLE

SEC. 2(F).
FOR ELECTRICAL TRANSFORMERS (U.S. CLS. 21, 23, 26, 36 AND 38).

FIRST USE 1-18-1991; IN COMMERCE 1-18-1991.

SN 78-110,227. TOSOH QUARTZ, INC., PORTLAND, OR. FILED 2-21-2002.

EFA

FOR SURFACE FINISH PUT ON GLASS, METAL AND CERAMIC SEMICONDUCTOR EQUIPMENT BY ETCHING ACID AND MECHANICAL PROCESSING THAT ALLOWS PROCESS FILMS TO ADHERE BETTER TO THE EQUIPMENT DURING THE MANUFACTURE OF SEMICONDUCTORS, SOLD AS A COMPONENT OF SEMICONDUCTOR EQUIPMENT (U.S. CLS. 21, 23, 26, 36 AND 38).

FIRST USE 8-7-1998; IN COMMERCE 4-27-1999.

SN 78-110,847. IMPOSSIBLE, INC., SANTA BARBARA, CA. FILED 2-25-2002.

COMPOUND ENVIRONMENT

FOR SOFTWARE FOR MANAGING AND PROCESSING DIGITAL IMAGES (U.S. CLS. 21, 23, 26, 36 AND 38).

SN 78-115,802. HOYA CORPORATION, TOKYO, JAPAN, FILED 3-19-2002.

ADDPower

PRIORITY CLAIMED UNDER SEC. 44(D) ON JAPAN APPLICATION NO. 2002-015349, FILED 2-28-2002, REG. NO. 4638868, DATED 1-24-2003, EXPIRES 1-24-2013.

FOR OPHTHALMIC READING LENSES AND CONTACT LENSES (U.S. CLS. 21, 23, 26, 36 AND 38).

CLASS 9—(Continued).

SN 78-120,773. SHIH, WENJENQ, CHINO HILLS, CA. FILED 4-10-2002.



THE LINING IS A FEATURE OF THE MARK AND DOES NOT INDICATE COLOR.

FOR COMPUTER PERIPHERALS AND ACCESSORIES, NAMELY, PC MOUSE AND PC KEYBOARD (U.S. CLS. 21, 23, 26, 36 AND 38).

FIRST USE 3-21-2002; IN COMMERCE 3-21-2002.

SN 78-123,780. 20/10 PERFECT VISION OPTISCHE GERAETE GMBH, D-69123 HEIDELBERG, FED REP GERMANY, FILED 4-24-2002.

20/10 PERFECT VISION

OWNER OF U.S. REG. NO. 2,557,052.

NO CLAIM IS MADE TO THE EXCLUSIVE RIGHT TO USE "PERFECT VISION", APART FROM THE MARK AS SHOWN.

FOR EYEGLASSES AND CONTACT LENSES FOR VISION CORRECTION/ENHANCEMENT. (U.S. CLS. 21, 23, 26, 36 AND 38).

SN 78-126,640. CIDEX COMPUTER SYSTEMS, INCORPORATED, HOBOKEN, NJ. FILED 5-6-2002.

SITE IQ

NO CLAIM IS MADE TO THE EXCLUSIVE RIGHT TO USE "SITE", APART FROM THE MARK AS SHOWN.

FOR COMPUTER PROGRAM FOR ANALYSIS OF WEB SITE SERVER LOGS BASED ON WEB SITE SPECIFIC DATA, STRUCTURE AND LAYOUT (U.S. CLS. 21, 23, 26, 36 AND 38).

SN 78-127,250. WEST CORPORATION, OMAHA, NE. FILED 5-8-2002.

WEB OPS

NO CLAIM IS MADE TO THE EXCLUSIVE RIGHT TO USE "WEB", APART FROM THE MARK AS SHOWN.

FOR COMPUTER SOFTWARE AND COMPUTER SOFTWARE PLATFORMS FOR ANALYZING PRODUCTIVITY OF TELESERVICES AGENTS, NAMELY MONITORING TIME WORKED BY SAID AGENTS AND COMPUTING VARIOUS EFFICIENCY PARAMETERS ASSOCIATED WITH AGENTS (U.S. CLS. 21, 23, 26, 36 AND 38).

CLASS 9—(Continued).

SN 78-127,252. MEDTRONIC PHYSIO-CONTROL CORP., REDMOND, WA. FILED 5-8-2002.

ADAPTIDOSE

FOR FEATURE OF COMPUTER SOFTWARE WHICH ADAPTS SHOCK WAVEFORM TO THE NEEDS OF THE PATIENT DURING EXTERNAL DEFIBRILLATION (U.S. CLS. 21, 23, 26, 36 AND 38).

SN 78-128,079. MAISON D'OPTIQUE, STUDIO CITY, CA. AND MARKET OPTOMETRIX, DOCTORS OF OPTOMETRY, INC., LOS ANGELES, CA. FILED 5-12-2002.

LUXURIATOR

FOR EYEGLASS FRAMES (U.S. CLS. 21, 23, 26, 36 AND 38).

FIRST USE 10-1-2001; IN COMMERCE 10-1-2001.

SN 78-130,888. ABIDIN, ALBERT R., LONG BEACH, CA. FILED 5-23-2002.



THE MARK CONSISTS OF AN OUTER CIRCLE AND AN INNER CIRCLE WITH A PYRAMID IN THE MIDDLE OF THE INNER CIRCLE, COVERED BY A LIGHTNING BOLT AND A SWORD. THE LETTERS "F=MA" APPEAR IN THE LOWER RIGHT CORNER OF THE PYRAMID. "CUTTING EDGE" APPEARS ABOVE THE TOP OF THE INNER CIRCLE AND "COMBAT" APPEARS BELOW THE BOTTOM EDGE OF THE INNER CIRCLE.

FOR PRE-RECORDED VIDEOS FEATURING SELF-DEFENSE INSTRUCTION (U.S. CLS. 21, 23, 26, 36 AND 38).

CLASS 9—(Continued).

SN 78-131,178. TWENTIETH CENTURY FOX FILM CORPORATION, LOS ANGELES, CA. FILED 5-24-2002.

FOXSTORE.COM

OWNER OF U.S. REG. NO. 1,841,687.
FOR MOTION PICTURE FILMS FEATURING MULTI-SUBJECT ACTION, ADVENTURE, DRAMA, COMEDIC, DOCUMENTARY, SPORTS AND CHILDREN'S THEMES AND INFORMATION REFERENCE SUBJECTS; PRE-RECORDED AUDIO TAPES, PRE-RECORDED VIDEO TAPES, PRE-RECORDED AUDIO CASSETTES, PRE-RECORDED VIDEO CASSETTES; PRE-RECORDED AUDIO DISCS, PRE-RECORDED VIDEO DISCS, PRE-RECORDED DVDS, PRE-RECORDED VIDEO COMPACT DISCS, PRE-RECORDED HIGH DEFINITION DVDS, ALL OF THE FOREGOING FEATURING MULTI-SUBJECT ACTION, ADVENTURE, DRAMA, COMEDIC, DOCUMENTARY, SPORTS AND CHILDREN'S THEMES AND MUSICAL PERFORMANCES; COMPUTER GAME SOFTWARE; VIDEO GAME SOFTWARE; COMPUTER GAME CASSETTES, COMPUTER GAME CARTRIDGES, COMPUTER GAME DISCS AND COMPUTER GAME CD-ROMS; VIDEO GAME CASSETTES, VIDEO GAME CARTRIDGES, VIDEO GAME DISCS AND VIDEO GAME CD-ROMS; MOUSE PADS, COMPUTER SCREEN SAVER SOFTWARE; SPECIALTY HOLSTERS FOR CARRYING MOBILE PHONES; COMPUTER AND VIDEO GAME JOYSTICKS (U.S. CLS. 21, 23, 26, 36 AND 38).

SN 78-131,191. TWENTIETH CENTURY FOX FILM CORPORATION, LOS ANGELES, CA. FILED 5-24-2002.

FOXVIDEO.COM

OWNER OF U.S. REG. NOS. 1,783,915, 1,888,345 AND OTHERS.

FOR MOTION PICTURE FILMS FEATURING MULTI-SUBJECT ACTION, ADVENTURE, DRAMA, COMEDIC, DOCUMENTARY, SPORTS AND CHILDREN'S THEMES AND INFORMATION REFERENCE SUBJECTS; PRE-RECORDED AUDIO TAPES, PRE-RECORDED VIDEO TAPES, PRE-RECORDED AUDIO CASSETTES, PRE-RECORDED VIDEO CASSETTES; PRE-RECORDED AUDIO DISCS, PRE-RECORDED VIDEO DISCS, PRE-RECORDED DVDS, PRE-RECORDED VIDEO COMPACT DISCS, PRE-RECORDED HIGH DEFINITION DVDS, ALL OF THE FOREGOING FEATURING MULTI-SUBJECT ACTION, ADVENTURE, DRAMA, COMEDIC, DOCUMENTARY, SPORTS AND CHILDREN'S THEMES AND MUSICAL PERFORMANCES; COMPUTER GAME SOFTWARE; VIDEO GAME SOFTWARE; COMPUTER GAME CASSETTES, COMPUTER GAME CARTRIDGES, COMPUTER GAME DISCS AND COMPUTER GAME CD-ROMS; VIDEO GAME CASSETTES, VIDEO GAME CARTRIDGES, VIDEO GAME DISCS AND VIDEO GAME CD-ROMS; MOUSE PADS, COMPUTER SCREEN SAVER SOFTWARE; SPECIALTY HOLSTERS FOR CARRYING MOBILE PHONES; COMPUTER AND VIDEO GAME JOYSTICKS (U.S. CLS. 21, 23, 26, 36 AND 38).

SN 78-135,974. CRESPO, CYNTHIA, LAS VEGAS, NV. FILED 6-14-2002.

ROCK THE SLOT

NO CLAIM IS MADE TO THE EXCLUSIVE RIGHT TO USE "SLOT", APART FROM THE MARK AS SHOWN.
FOR SLOT MACHINES FOR HOTELS AND CASINOS (U.S. CLS. 21, 23, 26, 36 AND 38).

CLASS 9—(Continued).

SN 78-136,462. WHIRLPOOL PROPERTIES, INC., ST. JOSEPH, MI. FILED 6-18-2002.

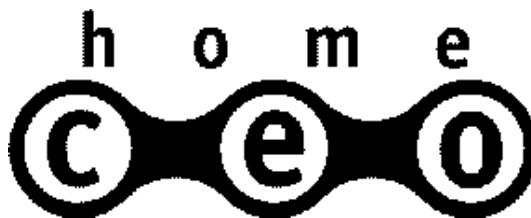

NO CLAIM IS MADE TO THE EXCLUSIVE RIGHT TO USE "HOME", APART FROM THE MARK AS SHOWN.

FOR PERSONAL AND HANDHELD COMPUTERS; COMPUTER PRINTERS; COMPUTER MONITORS; COMPUTER PERIPHERALS; HOME AUTOMATION CONTROLS, NAMELY, A WEB PAD FOR CONTROLLING AND OPERATING HOME APPLIANCES, SMALL ELECTRIC APPLIANCES, LIGHTING, HOME ENTERTAINMENT AND CONTROL SYSTEMS, SECURITY SYSTEMS AND COMMUNICATION DEVICES VIA THE INTERNET; CENTRAL HOME COMMUNICATION GATEWAY HARDWARE FOR FACILITATING THE INTEGRATION OF MULTIPLE COMMUNICATIONS MEDIUMS INTO A SINGLE COMMUNICATIONS GATEWAY; AND BROADBAND INTERNET MODEMS (U.S. CLS. 21, 23, 26, 36 AND 38).

SN 78-137,459. SPACE UPDATE, INC., HOUSTON, TX. FILED 6-20-2002.



NO CLAIM IS MADE TO THE EXCLUSIVE RIGHT TO USE "SPACE UPDATE", APART FROM THE MARK AS SHOWN.

FOR EDUCATIONAL SOFTWARE FEATURING PHOTOS, MOVIES, IMAGES, GAMES, LESSONS AND ACTIVITIES IN THE SPACE SCIENCES, NAMELY, ASTRONOMY, SOLAR SYSTEM, SPACE WEATHER, SUN, STAR CHARTS, AND PLANETARIUMS, FOR USE IN MUSEUMS, SCHOOLS, PLANETARIUMS, AND BY THE PUBLIC (U.S. CLS. 21, 23, 26, 36 AND 38).

FIRST USE 5-1-1994; IN COMMERCE 5-8-2002.

CLASS 9—(Continued).

SN 78-137,530. GENERAL ELECTRIC COMPANY, SCHE-
NECTADY, NY. FILED 6-21-2002.

VIDEO IQ

NO CLAIM IS MADE TO THE EXCLUSIVE RIGHT TO
USE "VIDEO", APART FROM THE MARK AS SHOWN.

FOR SECURITY AND SURVEILLANCE EQUIPMENT,
NAMELY, VIDEO CAMERAS, VIDEO OBJECT RECOG-
NIZERS, VIDEO OBJECT TRACKERS, VIDEO MOTION
DETECTORS, VIDEO LICENSE PLATE READERS, VIDE-
O ALARM VERIFIERS, VIDEO FACE RECOGNIZ-
ERS, VIDEO VEHICLE RECOGNIZERS, VIDEO
TRAFFIC DETECTORS, VIDEO ACCESS DOOR CON-
TROLLERS, VIDEO INTRUSION DETECTORS; PROCES-
SING HARDWARE AND SOFTWARE THAT ANALYZES
DIGITAL VIDEO IMAGES TO AUTOMATICALLY EX-
TRACT, RECORD AND REPORT INTELLIGENCE IN-
FORMATION (U.S. CLS. 21, 23, 26, 36 AND 38).

SN 78-138,773. VERBATIM CORPORATION, CHARLOTTE,
NC. FILED 6-25-2002.



NO CLAIM IS MADE TO THE EXCLUSIVE RIGHT TO
USE "SUPERIOR PERFORMANCE & DURABILITY",
APART FROM THE MARK AS SHOWN.

FOR REMOVABLE MAGNETIC AND OPTICAL MEDIA
PRODUCTS USED FOR RECORDING AND STOR-
AGE OF DATA, SOUND AND VIDEO, NAMELY,
HIGH CAPACITY BLANK AND PERFORMATTED
FLOPPY DISKS AND BLANK AND PREFORMATTED
OPTICAL DISKS, BLANK CD AND DVD-ROM AND
BLANK RECORDABLE AND REWRITABLE CDS AND
DVD DISKS (U.S. CLS. 21, 23, 26, 36 AND 38).

SN 78-139,011. KUNDURU MUSIC, INC., NEW YORK, NY.
FILED 6-26-2002.

LIVING THEATER

FOR PRE-RECORDED RECORDS, TAPES AND DISCS
FEATURING MUSIC (U.S. CLS. 21, 23, 26, 36 AND 38).
FIRST USE 0-0-2000; IN COMMERCE 7-0-2001.

CLASS 9—(Continued).

SN 78-141,028. LEMO USA, INC., ROHNERT PARK, CA.
FILED 7-3-2002.

PIQE PERFORMANCE

FOR ELECTRONIC CONNECTORS AND PARTS
THEREOF, ELECTRICAL CONNECTORS AND PARTS
THEREOF, FLUIDIC ELECTRONIC CONNECTORS AND
PARTS THEREOF, FLUIDIC ELECTRICAL CONNec-
TORS AND PARTS THEREOF, FIBER OPTIC CONNec-
TORS AND PARTS THEREOF, THERMOCOUPLE
ELECTRONIC CONNECTORS AND PARTS THEREOF,
THERMOCOUPLE ELECTRICAL CONNECTORS AND
PARTS THEREOF, DISPOSABLE ELECTRONIC CONNec-
TORS AND PARTS THEREOF, DISPOSABLE ELEC-
TRICAL CONNECTORS AND PARTS THEREOF,
WATERTIGHT ELECTRONIC CONNECTORS AND
PARTS THEREOF, WATERTIGHT ELECTRICAL CONNec-
TORS AND PARTS THEREOF, HYBRID ELECTRONIC
CONNECTORS AND PARTS THEREOF, HYBRID
ELECTRICAL CONNECTORS AND PARTS THEREOF,
MULTIPIN AND MIXED ELECTRONIC CONNECTORS
AND PARTS THEREOF, MULTIPIN AND MIXED ELEC-
TRICAL CONNECTORS AND PARTS THEREOF, PLAS-
TIC ELECTRONIC CONNECTORS AND PARTS
THEREOF, PLASTIC ELECTRICAL CONNECTORS
AND PARTS THEREOF, ELECTRICAL PLUGS/ELEC-
TRICAL RECEPTACLES AND PARTS THEREOF (U.S.
CLS. 21, 23, 26, 36 AND 38).

SN 78-141,117. KULICKE & SOFFA INVESTMENTS INC.,
WILMINGTON, DE. FILED 7-3-2002.

POWER WLP

FOR SEMICONDUCTOR PACKAGING FOR MANU-
FACTURERS OF SEMICONDUCTORS AND DEVICES
UTILIZING SEMICONDUCTORS, NAMELY, UNDER
BUMP METALIZATION, POLYMER THIN FILM
LAYERS AND SOLDER BUMPS CONSTRUCTED ON
SEMICONDUCTOR WAFER TO PROTECT THE INTEG-
RATED CIRCUIT FROM CONTAMINANTS AND
MOISTURE AND TO MAKE AN ELECTRICAL CONNec-
TION BETWEEN THE INTEGRATED CIRCUIT
CHIP AND PRINTED CIRCUIT BOARD OR OTHER
SUBSTRATES (U.S. CLS. 21, 23, 26, 36 AND 38).

SN 78-141,444. INNOVATIVE ELECTRONIC DESIGNS, INC.,
LOUISVILLE, KY. FILED 7-5-2002.

LANCOM

FOR PUBLIC-ADDRESS SYSTEMS COMPRISED OF
MICROPHONES, LOGIC CIRCUITS, AMPLIFIERS,
AUDIO PROCESSORS, AUDIO SWITCHERS, AUDIO
ROUTERS, DIGITAL AUDIO PROCESSORS, DIGITAL
ATTENUATORS, MICROCOMPUTERS, AND AUTO-
MATIC INTEGRITY TESTING EQUIPMENT; AND IN-
STRUCTIONAL MANUALS SOLD AS A UNIT (U.S. CLS.
21, 23, 26, 36 AND 38).

CLASS 9—(Continued).

SN 78-141,931. MAYLIN GRAPHICS, L.L.C., PORT CHARLOTTE, FL. FILED 7-8-2002.

SITE-SWIPE

FOR CARDS HAVING A MAGNETIC STRIP FOR CONVEYING INFORMATION AND COMPUTER SYSTEMS COMPRISING HARDWARE AND SOFTWARE FOR READING MAGNETIC CODED CARDS (U.S. CLS. 21, 23, 26, 36 AND 38).

SN 78-142,234. J.R. NEUMILLER, GREENSBORO, NC. FILED 7-9-2002.

RIPVAN100

FOR BATTERIES (U.S. CLS. 21, 23, 26, 36 AND 38). FIRST USE 5-31-2000; IN COMMERCE 5-31-2000.

SN 78-144,265. RADIUS RECORDS, LLC, SANFORD, FL. FILED 7-16-2002.

3AE

FOR MUSICAL SOUND RECORDINGS AND DOWNLOADABLE MUSICAL SOUND RECORDINGS; AUDIOVISUAL RECORDINGS AND DOWNLOADABLE AUDIOVISUAL RECORDINGS IN THE FIELDS OF MUSIC; COMPACT DISCS FEATURING MUSIC; CD-ROMS FEATURING MUSIC, MUSIC VIDEOS AND RELATED MUSICAL ENTERTAINMENT; PRE-RECORDED AUDIO TAPES FEATURING MUSIC; PRE-RECORDED DIGITAL AUDIO AND AUDIOVISUAL TAPES FEATURING MUSIC, MUSIC VIDEOS AND RELATED MUSICAL ENTERTAINMENT; PHONOGRAPH RECORDS FEATURING MUSIC; PRE-RECORDED VIDEO TAPES FEATURING MUSIC, MUSIC VIDEOS AND RELATED MUSICAL ENTERTAINMENT; PRE-RECORDED VIDEO DISCS AND DVDS FEATURING MUSIC, MUSIC VIDEOS AND RELATED MUSICAL ENTERTAINMENT (U.S. CLS. 21, 23, 26, 36 AND 38).

SN 78-144,881. SPIELO MANUFACTURING INCORPORATED, MONCTON, NEW BRUNSWICK, CANADA, FILED 7-17-2002.

BONUS-LINK

FOR GAMING MANAGEMENT SOFTWARE USED TO MANAGE A PROGRESSIVE JACKPOT FOR CASINOS AND LOTTERIES (U.S. CLS. 21, 23, 26, 36 AND 38).

CLASS 9—(Continued).

SN 78-144,974. MPC COMPUTERS, LLC, NAMPA, ID. BY CHANGE OF NAME MICRONPC, LLC, NAMPA, ID. FILED 7-17-2002.

MPC

OWNER OF U.S. REG. NOS. 2,022,731, 2,048,539 AND OTHERS.

FOR COMPUTER CABLES, COMPUTER HARDWARE, COMPUTER INTERFACE BOARDS, COMPUTER KEYBOARDS, COMPUTER MONITORS, COMPUTER PERIPHERALS, COMPUTER TERMINALS, COMPUTER SERVERS, LAPTOP COMPUTERS, DESKTOP COMPUTERS (U.S. CLS. 21, 23, 26, 36 AND 38).

SN 78-148,886. HAMMETT, PHILIP, T., RAYMOND, ME. AND FREYRE, RAUL, RAYMOND, ME. FILED 7-30-2002.

SWEET ABYSS

FOR MUSICAL SOUND RECORDINGS, COMPACT DISCS FEATURING MUSIC, AUDIO TAPES FEATURING MUSIC, DIGITAL AUDIO TAPES FEATURING MUSIC, DOWNLOADABLE AUDIO RECORDINGS FEATURING MUSIC, DIGITAL CHIPS FEATURING MUSIC, VIDEOTAPES FEATURING MUSIC, VIDEO DISCS FEATURING MUSIC, DOWNLOADABLE VIDEO RECORDINGS FEATURING MUSIC VIDEOS, MULTIMEDIA SOFTWARE RECORDED ON CD-ROM FEATURING MUSIC (U.S. CLS. 21, 23, 26, 36 AND 38).

SN 78-149,054. MORPHEUS SOFTWARE, LLC, LARCHMONT, NY. FILED 7-30-2002.

MORPHEUS

FOR ANIMATION SOFTWARE PROGRAM THAT MORPHS TWO OR MORE IMAGES; DOWNLOADABLE ANIMATION SOFTWARE PROGRAM THAT MORPHS TWO OR MORE IMAGES (U.S. CLS. 21, 23, 26, 36 AND 38).

FIRST USE 2-1-2002; IN COMMERCE 2-1-2002.

SN 78-150,266. MCKESSON CORPORATION, SAN FRANCISCO, CA. FILED 8-2-2002.

BAKER CASSETTE

NO CLAIM IS MADE TO THE EXCLUSIVE RIGHT TO USE "CASSETTE", APART FROM THE MARK AS SHOWN.

FOR AUTOMATED STORAGE AND RETRIEVAL SYSTEMS FOR STORING AND DISPENSING MEDICINE, NAMELY, AUTOMATED DISPENSERS FOR PILLS OR CAPSULES SOLD EMPTY AND CABINETS TO HOLD THE DISPENSERS, COUNTING HEADS IN THE NATURE OF A MECHANICAL DEVICE THAT RELEASES PILLS AND CAPSULES FROM THE DISPENSER INTO A CHUTE, AND COMPUTER HARDWARE AND SOFTWARE TO OPERATE THE DISPENSERS, ALL OF THE FOREGOING SOLD TOGETHER AS A UNIT (U.S. CLS. 21, 23, 26, 36 AND 38).

FIRST USE 12-31-1988; IN COMMERCE 12-31-1988.

CLASS 9—(Continued).

SN 78-150,405. PNY TECHNOLOGIES, INC., PARSIPPANY, NJ. FILED 8-2-2002.

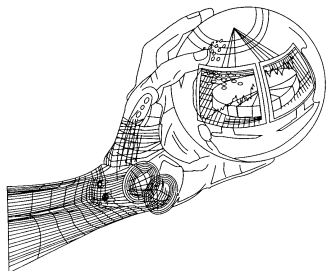

THE LINING IS A FEATURE OF THE MARK AND DOES NOT INDICATE COLOR.

FOR COMPUTER GRAPHIC CARDS USED TO ENHANCE THE PERFORMANCE OF COMPUTER GAMES, PERSONAL AND DESKTOP COMPUTERS, AND COMPUTER WORKSTATIONS (U.S. CLS. 21, 23, 26, 36 AND 38).

FIRST USE 6-21-2002; IN COMMERCE 6-21-2002.

SN 78-154,990. VIGLO HOLDINGS PTY LTD., MELBOURNE, AUSTRALIA, FILED 8-16-2002.

MAPPAD

FOR COMPUTER SOFTWARE, NAMELY, SOFTWARE FOR PROVIDING DATABASE ACCESS, MAPPING, GLOBAL INFORMATION SYSTEM AND GLOBAL POSITIONING SYSTEM INTEGRATION VIA HANDHELD AND MOBILE DEVICES (U.S. CLS. 21, 23, 26, 36 AND 38).

FIRST USE 9-0-1997; IN COMMERCE 9-0-1997.

SN 78-155,352. NCIPHER CORPORATION LIMITED, CAMBRIDGE, UNITED KINGDOM, FILED 8-19-2002.

PAYSHIELD

PRIORITY CLAIMED UNDER SEC. 44(D) ON UNITED KINGDOM APPLICATION NO. 2307206, FILED 8-5-2002, REG. NO. 2307206, DATED 1-3-2003, EXPIRES 8-5-2012.

FOR COMPUTER PERIPHERAL DEVICES, NAMELY, ACCELERATORS AND ENCRYPTOGRAPHIC ACCELERATORS FOR DATA SECURITY; COMPUTER SOFTWARE, NAMELY, ENCODED COMPUTER PROGRAMS AND FIRMWARE FOR ENCRYPTION, DECRYPTION, SIGNING, AND VERIFICATION OF DIGITAL SIGNATURES FOR USE WITH THE ABOVE-NAMED DEVICES (U.S. CLS. 21, 23, 26, 36 AND 38).

SN 78-159,841. KLEINDIENST CORPORATION, HOUSTON, TX. FILED 8-30-2002.

KLEINDIENST SC35H

FOR COMPUTER HARDWARE (U.S. CLS. 21, 23, 26, 36 AND 38).

CLASS 9—(Continued).

SN 78-162,429. IBAK HELMUT HUNGER GMBH & CO. KG, D-24148 KIEL, FED REP GERMANY, FILED 9-10-2002.

MIDI

FOR SEWER INSPECTION TELEVISION SYSTEMS, COMPRISING CLOSED CIRCUIT TELEVISION, CAMERAS, CAMERA CABLES, CAMERA CARRIAGES AND SKID DEVICES, CAMERA WINCHES (U.S. CLS. 21, 23, 26, 36 AND 38).

SN 78-163,459. CHEMGUARD, INC., MANSFIELD, TX. FILED 9-12-2002.

MIST-A-FOAM

FOR FIRE SUPPRESSION APPARATUS, NAMELY DEVICES FOR DISPENSING FOAM-BASED FIRE EXTINGUISHING AGENTS (U.S. CLS. 21, 23, 26, 36 AND 38).

SN 78-164,464. COMMERCESTREAM CORP., SANTA MONICA, CA. FILED 9-16-2002.

PCDETECTIVE

FOR COMPUTER SOFTWARE FOR ACCESSING INFORMATION ON, AND INVESTIGATING, PEOPLE, ORGANIZATIONS, OR COMPUTER SYSTEMS AND NETWORKS, INCLUDING LOCATION, PHONE NUMBERS, BACKGROUND CHECKS, ASSET SEARCHES, CRIMINAL/COURT/MOTOR VEHICLE AND OTHER PUBLIC RECORDS, CREDIT AND SECURITY RISK ASSESSMENT, AND OTHER INFORMATION PERTAINING TO INDIVIDUALS, GROUPS, ORGANIZATIONS, AND THEIR COMPUTER SYSTEMS, NETWORKS, ACTIVITIES, AND PREFERENCES, FOR BUSINESS OR PERSONAL PURPOSES (U.S. CLS. 21, 23, 26, 36 AND 38).

SN 78-164,488. COMMERCESTREAM CORP., SANTA MONICA, CA. FILED 9-16-2002.

PCANTISPY

FOR COMPUTER SOFTWARE AND SERVICE THAT DETECTS, EXPOSES, AND PREVENTS ATTEMPTS BY SOFTWARE, VIRUSES, HARDWARE DEVICES, TROJAN HORSES, HACKS, OR OTHER MEANS, TO STORE, REVEAL, OR TRANSMIT PRIVATE DATA OR ACTIVITY LOGS, OR TO RECORD OR REMOTELY CONTROL DATA OR ACTIVITIES, AND TO DISCLOSE THEM TO UNAUTHORIZED USERS (U.S. CLS. 21, 23, 26, 36 AND 38).

CLASS 9—(Continued).

SN 78-165,031. ADVION BIOSCIENCES, INC., ITHACA, NY. FILED 9-17-2002.

NANOMATE

FOR FULLY AUTOMATED NANO-ELECTROSPRAY INSTRUMENT FOR CHEMICAL AND BIOLOGICAL SAMPLE ANALYSIS THAT IS MOUNTED ON A MASS SPECTROMETER FOR CONVERTING A SAMPLE IN SOLUTION TO GAS-PHASE IONS THAT CAN BE MEASURED (U.S. CLS. 21, 23, 26, 36 AND 38).

FIRST USE 6-3-2002; IN COMMERCE 8-1-2002.

SN 78-165,857. ATS DENVER, INC., HIGHLANDS RANCH, CO. FILED 9-19-2002.

FOCUS-GMS

FOR COMPUTER SOFTWARE USED IN CONJUNCTION WITH THE INTERNET FOR USE IN COLLECTING AND INTEGRATING SPATIAL INFORMATION, DATA, VIDEO, AND GRAPHICAL INFORMATION, INTERRELATING THESE VARIOUS FORMS OF INFORMATION IN A FORMAT THAT ALLOWS THEM TO BE VIEWED AND ANALYZED TOGETHER FOR PLANNING, LOGISTICS, OPERATIONS, MANAGEMENT, AND FINANCE PURPOSES (U.S. CLS. 21, 23, 26, 36 AND 38).

SN 78-171,132. ACCENT GRAPHICS, INC., MELBOURNE, FL. FILED 10-4-2002.



FOR COMPUTER PROGRAMS, NAMELY DATA BASE MANAGEMENT SOFTWARE, FOR THE MANAGEMENT, ARRANGEMENT, DISTRIBUTION AND RETRIEVAL OF DIGITAL DOCUMENTS, MEDIA, OR PRESENTATIONS (U.S. CLS. 21, 23, 26, 36 AND 38).

SN 78-178,336. THYSSEN ELEVATOR CAPITAL CORPORATION, TROY, MI. FILED 10-25-2002.

VISTA

FOR ELEVATOR PERFORMANCE MONITORING SYSTEM, NAMELY EMBEDDED SOFTWARE IN CONTROLLERS FOR MONITORING ELEVATOR FUNCTIONS (U.S. CLS. 21, 23, 26, 36 AND 38).

CLASS 9—(Continued).

SN 78-178,892. RUCKSTUHL, MICHAEL L., WINTER GARDEN, FL. FILED 10-28-2002.

UNIGUEST

FOR COMPUTER OPERATING SYSTEM FOR DELIVERING VIDEO-ON-DEMAND AND INTERNET SERVICES TO MULTIPLE DWELLINGS UNITS (U.S. CLS. 21, 23, 26, 36 AND 38).

SN 78-179,387. THALES AVIONICS IN-FLIGHT SYSTEMS, LLC, IRVINE, CA. FILED 10-29-2002.

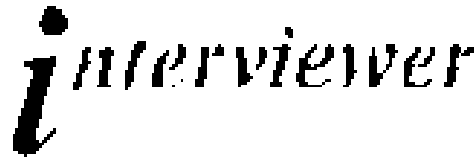

FOR COMPUTER SOFTWARE FOR IN-FLIGHT PASSENGER ENTERTAINMENT, PROVIDING AUDIO AND VIDEO ENTERTAINMENT PROGRAMMING AND INTERACTIVE GAMES (U.S. CLS. 21, 23, 26, 36 AND 38).

SN 78-181,026. CREATIVE TECHNOLOGY LTD., SINGAPORE, SINGAPORE, FILED 11-1-2002.

BROADBAND BLASTER

NO CLAIM IS MADE TO THE EXCLUSIVE RIGHT TO USE "BROADBAND", APART FROM THE MARK AS SHOWN.

FOR COMPUTER HARDWARE; COMPUTER PERIPHERALS; MODEMS; COMPUTER INTERFACE CABLES; MICROPROCESSORS; TELECOMMUNICATIONS EQUIPMENT NAMELY, ROUTERS, BRIDGES, SWITCHES, SPLITTERS, HUBS, ENCODERS, ADAPTERS, MEDIA CONVERTERS, TRANSCEIVERS, REPEATERS, CABLES, CONNECTORS AND INTEGRATED CIRCUITS; COMPUTER SOFTWARE FOR THE TRANSMISSION, DISTRIBUTION, MANIPULATION AND RETRIEVAL OF DATA, IMAGES, VIDEO, AND SOUND OVER COMPUTER NETWORKS; COMPUTER SOFTWARE FOR CONNECTING, MANAGING AND OPERATING COMPUTER NETWORKS; COMPUTER SOFTWARE FOR WIRELESS NETWORK COMMUNICATIONS; COMPUTER OPERATING SYSTEM SOFTWARE; COMPUTER SOFTWARE FOR PROVIDING SINGLE COMPUTER OR COMPUTER NETWORK SECURITY AND PROTECTION FROM UNAUTHORIZED ELECTRONIC INTRUSION; COMPUTER SOFTWARE FOR REMOTE ACCESS AND CONFIGURATION OF COMPUTER HARDWARE AND INSTRUCTIONAL MANUALS DISTRIBUTED THEREWITH (U.S. CLS. 21, 23, 26, 36 AND 38).

CLASS 9—(Continued).

SN 78-182,410. BENELOGIC, LLC, TIMONIUM, MD. FILED 11-6-2002.

COMPLIANCE CONNECTION

NO CLAIM IS MADE TO THE EXCLUSIVE RIGHT TO USE "COMPLIANCE", APART FROM THE MARK AS SHOWN.

FOR DOWNLOADABLE ELECTRONIC PUBLICATIONS IN THE NATURE OF NEWSLETTERS DELIVERED BY ELECTRONIC MAIL OR ACCESSIBLE ON A WEB SITE, CONTAINING INFORMATION REGARDING NEWS, EVENTS, TRENDS, REGULATIONS, TECHNOLOGY AND OPERATIONAL ACTIVITIES INFORMATION IN THE FIELD OF GROUP HEALTH/BENEFITS (U.S. CLS. 21, 23, 26, 36 AND 38).

FIRST USE 9-17-2002; IN COMMERCE 9-17-2002.

SN 78-186,876. IMPERIAL TECHNOLOGY INC., EL SEGUNDO, CA. FILED 11-20-2002.

VALUMATION

FOR COMPUTER SOFTWARE FOR ESTABLISHING THE VALUE OF SPECIFIC DATA ELEMENTS IN BOTH STRUCTURED AND UNSTRUCTURED DATA FOR THE PURPOSE OF PRIORITIZING THE PROCESSING OF THAT DATA FOR BUSINESS BENEFIT (U.S. CLS. 21, 23, 26, 36 AND 38).

SN 78-186,890. IMPERIAL TECHNOLOGY INC., EL SEGUNDO, CA. FILED 11-20-2002.

VALUMATION SOFTWARE

NO CLAIM IS MADE TO THE EXCLUSIVE RIGHT TO USE "SOFTWARE", APART FROM THE MARK AS SHOWN.

FOR COMPUTER SOFTWARE FOR ESTABLISHING THE VALUE OF SPECIFIC DATA ELEMENTS IN BOTH STRUCTURED AND UNSTRUCTURED DATA FOR THE PURPOSE OF PRIORITIZING THE PROCESSING OF THAT DATA FOR BUSINESS BENEFIT (U.S. CLS. 21, 23, 26, 36 AND 38).

SN 78-189,267. MERRICK & COMPANY, AURORA, CO. FILED 11-26-2002.

MARS

FOR COMPUTER SOFTWARE USED TO MANAGE AND CHECK THE QUALITY OF LIGHT IMAGING AND RANGING DATA, AIRBORNE LIGHT IMAGING AND RANGING DATA AND DIGITAL IMAGING SYSTEMS (U.S. CLS. 21, 23, 26, 36 AND 38).

CLASS 9—(Continued).

SN 78-189,421. EN TECHNOLOGY CORPORATION, NEWPORT, NH. FILED 11-27-2002.

ENEXPRESS

FOR ELECTRONIC EQUIPMENT FOR VIDEO AND AUDIO RECORDING AND BROADCASTING, NAMELY DIGITAL TO ANALOG AUDIO AND VIDEO CONVERTERS, AND ANALOG TO DIGITAL AUDIO AND VIDEO CONVERTERS (U.S. CLS. 21, 23, 26, 36 AND 38).

SN 78-189,655. DIACHEMIX LLC, MILWAUKEE, WI. FILED 11-27-2002.

DIACHEMIX

FOR DIAGNOSTIC TESTS FOR IDENTIFYING PATHOGENS, ANTIBODIES, TOXINS, ANALYTES, CHEMICAL RESIDUES, FOOD INGREDIENTS, AND DNA SEQUENCES (U.S. CLS. 21, 23, 26, 36 AND 38).

FIRST USE 10-21-1996; IN COMMERCE 10-21-1996.

SN 78-189,755. IDEAZON, INC., CARLSBAD, CA. FILED 11-27-2002.

ZBOARD

FOR COMPUTER HARDWARE, NAMELY, KEYBOARDS AND OTHER INPUT DEVICES AND PARTS THEREOF, AND COMPUTER SOFTWARE FOR CONTROLLING KEYBOARDS AND OTHER INPUT DEVICES (U.S. CLS. 21, 23, 26, 36 AND 38).

SN 78-190,223. SUE, STEVEN JOHN, OAKLAND, CA. FILED 12-2-2002.

STORYMANAGER

FOR BUSINESS MANAGEMENT, MARKETING, BRANDING AND COMMUNICATIONS SOFTWARE IN THE FIELD OF CREATING AND MAINTAINING ENTERPRISE, NON-PROFIT AND INDIVIDUALS' BRAND IDENTITIES (U.S. CLS. 21, 23, 26, 36 AND 38).

FIRST USE 8-18-2001; IN COMMERCE 8-18-2001.

CLASS 9—(Continued).

SN 78-190,523. LIPMAN U.S.A., INC., SYOSSET, NY. FILED 12-3-2002.

IMAGEPAK

FOR POINT OF SALE TERMINAL SYSTEM CONSISTING OF TOUCH SENSITIVE PADS AND A MICROCOMPUTER FOR ONLINE AND OFF-LINE PROCESSING OF FINANCIAL TRANSACTIONS INVOLVING THE USE OF CREDIT CARDS, BANK CARDS, CHARGE CARDS, DEBIT CARDS, STORED VALUE CARDS, AND SMART CARDS, ALL INTEGRATED WITH AN ELECTRONIC DEVICE MANUFACTURED BY A THIRD PARTY THAT READS AND IMAGES CHECKS, AND USED FOR PROCESSING AND VERIFICATION OF RELATED FINANCIAL TRANSACTIONS, AND FOR ONLINE AND OFFLINE ELECTRONIC CAPTURE, STORAGE, AND RETRIEVAL OF SIGNATURES, RECEIPTS, TRANSACTION HISTORIES, AND CHECK IMAGES (U.S. CLS. 21, 23, 26, 36 AND 38).

SN 78-190,555. SPARKS EXHIBITS & ENVIRONMENTS, PHILADELPHIA, PA. FILED 12-3-2002.

SPARKSTRACK

FOR WEB BASED INVENTORY TRACKING SERVICE (U.S. CLS. 21, 23, 26, 36 AND 38).
FIRST USE 5-31-2002; IN COMMERCE 5-31-2002.

SN 78-190,997. ACCENT GRAPHICS, INC., MELBOURNE, FL. FILED 12-4-2002.

CAN'T FIND IT. CAN'T USE IT.

FOR COMPUTER PROGRAMS FOR THE MANAGEMENT, ARRANGEMENT, DISTRIBUTION, OR RETRIEVAL OF DIGITAL DOCUMENTS, MEDIA, OR PRESENTATIONS (U.S. CLS. 21, 23, 26, 36 AND 38).
FIRST USE 10-1-2002; IN COMMERCE 10-1-2002.

SN 78-191,030. NOVAR CONTROLS CORPORATION, COPLEY, OH. FILED 12-4-2002.

EPIRELAY

FOR RELAY PANELS FOR USE IN BUILDING CONTROL SYSTEMS FOR CONTROLLING HEATING, VENTILATION, AIR CONDITIONING, LIGHTING AND SECURITY SYSTEMS (U.S. CLS. 21, 23, 26, 36 AND 38).

CLASS 9—(Continued).

SN 78-191,870. INTERNATIONAL RESOURCE MANAGEMENT, INC., CENTERBROOK, CT. FILED 12-6-2002.

PRISMATIC

FOR COMPUTER SOFTWARE FOR USE IN EVALUATING ECOMMERCE RISK ASSESSMENT (U.S. CLS. 21, 23, 26, 36 AND 38).

SN 78-192,133. STANDARD MICROSYSTEMS CORPORATION, HAUPPAUGE, NY. FILED 12-6-2002.

RFCONNECT

FOR INTEGRATED CIRCUITS AND COMPUTER HARDWARE, NAMELY, TRANSCIEVERS, TRANSMITTERS, RECEIVERS, REPEATERS, CONTROLLERS, AND BASE STATIONS, FOR USE IN FACILITATING WIRELESS DATA COMMUNICATION AND EXCHANGE; COMPUTER SOFTWARE, NAMELY, SOFTWARE FOR USE IN FACILITATING WIRELESS DATA COMMUNICATION AND EXCHANGE (U.S. CLS. 21, 23, 26, 36 AND 38).

SN 78-193,196. MARVEL CHARACTERS, INC., LOS ANGELES, CA. FILED 12-11-2002.

BROTHER VOODOO

FOR PRERECORDED VIDEO, AUDIO AND AUDIO-VISUAL TAPES, DISCS, AND CASSETTES FEATURING MUSIC AND/OR LIVE ACTION PROGRAMS OR MOTION PICTURES OR ANIMATED CARTOONS; SUNGLASSES; VIDEO GAME SOFTWARE FOR HAND-HELD GAME UNITS, VIDEO GAME CARTRIDGES FOR HAND-HELD GAME UNITS; VIDEO GAME CARTRIDGES; VIDEO GAME DISCS; VIDEO GAME SOFTWARE PROGRAMS; INTERACTIVE VIDEO GAME PROGRAMS; VIRTUAL REALITY GAME SOFTWARE; COMPUTER GAME PROGRAMS; MOTION PICTURE, VIDEO, AND PHOTOGRAPHIC CAMERAS; BICYCLE HELMETS. (U.S. CLS. 21, 23, 26, 36 AND 38).

SN 78-193,198. MARVEL CHARACTERS, INC., LOS ANGELES, CA. FILED 12-11-2002.

1,000 DAYS

FOR PRERECORDED VIDEO, AUDIO AND AUDIO-VISUAL TAPES, DISCS, AND CASSETTES FEATURING MUSIC AND/OR LIVE ACTION PROGRAMS OR MOTION PICTURES OR ANIMATED CARTOONS; SUNGLASSES; VIDEO GAME SOFTWARE FOR HAND-HELD GAME UNITS, VIDEO GAME CARTRIDGES FOR HAND-HELD GAME UNITS; VIDEO GAME CARTRIDGES; VIDEO GAME DISCS; VIDEO GAME SOFTWARE PROGRAMS; INTERACTIVE VIDEO GAME PROGRAMS; VIRTUAL REALITY GAME SOFTWARE; COMPUTER GAME PROGRAMS; MOTION PICTURE, VIDEO, AND PHOTOGRAPHIC CAMERAS; BICYCLE HELMETS. (U.S. CLS. 21, 23, 26, 36 AND 38).

CLASS 9—(Continued).

SN 78-193,639. SYNESIOU, JOHN, SAN DIEGO, CA. FILED 12-11-2002.

NUCEM

FOR COMPUTER SOFTWARE FOR THE PURPOSE OF PREVENTING SPAM BY ACTUALLY TRACKING DOWN THE TRUE IDENTITY OF SPAMMERS, AND GIVING THEM NOTICE THAT THEY MUST CEASE AND DESIST SPAMMING, AND ALSO INFORMING THEIR INTERNET SERVICE PROVIDER THAT THEIR CLIENT IS PROBABLY VIOLATING THEIR ACCEPTABLE USE POLICY (U.S. CLS. 21, 23, 26, 36 AND 38).

FIRST USE 4-29-2002; IN COMMERCE 4-29-2002.

SN 78-194,088. BANDAI ENTERTAINMENT INC., CYPRESS, CA. FILED 12-12-2002.

STAND ALONE COMPLEX

FOR VIDEO GAME CARTRIDGES, CASSETTES AND DISKS, PRE-RECORDED VIDEO CASSETTES AND DVDS FEATURING AN ANIMATED SERIES (U.S. CLS. 21, 23, 26, 36 AND 38).

SN 78-194,653. MARLOW, CHERI L, MIDLAND, MI. FILED 12-15-2002.

THE ARTIST'S SECRET

FOR SERIES OF VIDEO TAPES AND VIDEO DISCS FEATURING ART INSTRUCTION (U.S. CLS. 21, 23, 26, 36 AND 38).

SN 78-194,735. SLEEK SOFTWARE CORPORATION, AUSTIN, TX. FILED 12-16-2002.



OWNER OF U.S. REG. NO. 2,297,883.
NO CLAIM IS MADE TO THE EXCLUSIVE RIGHT TO USE "SOFTWARE", APART FROM THE MARK AS SHOWN.
FOR COMPUTER SOFTWARE TO BE USED BY TEACHERS FOR THE PURPOSE OF TUTORING STUDENTS AND COMPILING, MANAGING, AND ANALYZING STUDENT TUTORIAL DATA AT THE ELEMENTARY THROUGH COLLEGE LEVEL (U.S. CLS. 21, 23, 26, 36 AND 38).

FIRST USE 7-15-2002; IN COMMERCE 8-1-2002.

CLASS 9—(Continued).

SN 78-194,995. THE CARTOON NETWORK LP, LLLP, ATLANTA, GA. FILED 12-16-2002.

AQUA TEEN HUNGER FORCE

FOR MOTION PICTURE FILMS FEATURING COMEDY, DRAMA, ACTION, ADVENTURE AND/OR ANIMATION, AND MOTION PICTURE FILMS FOR BROADCAST ON TELEVISION FEATURING COMEDY, DRAMA, ACTION, ADVENTURE AND/OR ANIMATION; PRERECORDED VINYL RECORDS, AUDIO TAPES, AUDIO-VIDEO TAPES, AUDIO-VIDEO CASSETTES, AUDIO-VIDEO DISCS, AND DIGITAL VERSATILE DISCS FEATURING MUSIC, COMEDY, DRAMA, ACTION, ADVENTURE, AND/OR ANIMATION; STEREO HEADPHONES; BATTERIES; CORDLESS TELEPHONES; HAND-HELD CALCULATORS; AUDIO CASSETTE AND CD PLAYERS; CD ROM GAMES; HAND-HELD KARAOKE PLAYERS, TELEPHONE AND/OR RADIO PAGERS; SHORT MOTION PICTURE FILM CASSETTES FEATURING COMEDY, DRAMA, ACTION, ADVENTURE AND/OR ANIMATION TO BE USED WITH HAND-HELD VIEWERS OR PROJECTORS; VIDEO CASSETTE RECORDERS AND PLAYERS, COMPACT DISC PLAYERS, DIGITAL AUDIO TAPE RECORDERS AND PLAYERS, ELECTRONIC DIARIES; RADIOS; MOUSE PADS; EYEGLASSES, SUNGLASSES AND CASES THEREFOR; AUDIO TAPES AND BOOKLETS SOLD TOGETHER AS A UNIT; COMPUTER PROGRAMS, NAMELY, SOFTWARE LINKING DIGITIZED VIDEO AND AUDIO MEDIA TO A GLOBAL COMPUTER INFORMATION NETWORK; GAME EQUIPMENT SOLD AS A UNIT FOR PLAYING A PARLOR-TYPE COMPUTER GAME; VIDEO AND COMPUTER GAME PROGRAMS; VIDEO GAME CARTRIDGES AND CASSETTES; ENCODED MAGNETIC CARDS, NAMELY, KEY CARDS, PHONE CARDS, CREDIT CARDS, DEBIT CARDS AND CASH CARDS; DECORATIVE MAGNETS (U.S. CLS. 21, 23, 26, 36 AND 38).

SN 78-196,815. ESPEED, INC., NEW YORK, NY. FILED 12-20-2002.

STREETSWEeper

FOR COMPUTER SOFTWARE FOR USE IN THE FIELD OF FINANCIAL TRADING FOR FACILITATING THE PURCHASE AND SALE OF STOCKS, BONDS, FUTURES, OPTIONS, AND MUTUAL FUNDS (U.S. CLS. 21, 23, 26, 36 AND 38).

SN 78-197,103. HELMER LABS, INC., NOBLESVILLE, IN. FILED 12-21-2002.

QUICKSPIN

FOR CENTRIFUGE USED FOR RAPID BLOOD SAMPLE SEPARATIONS FOR USE IN HOSPITAL LABORATORIES (U.S. CLS. 21, 23, 26, 36 AND 38).

FIRST USE 10-7-2002; IN COMMERCE 10-7-2002.

CLASS 9—(Continued).

SN 78-197,149. AURAVISION LLC, SAN JUAN CAPISTRANO, CA. FILED 12-21-2002.

AURAVISION

FOR COMPUTER KEYBOARDS (U.S. CLS. 21, 23, 26, 36 AND 38).
FIRST USE 11-21-2002; IN COMMERCE 11-21-2002.

SN 78-197,150. AURAVISION LLC, SAN JUAN CAPISTRANO, CA. FILED 12-21-2002.

ELUMINX

FOR COMPUTER KEYBOARDS (U.S. CLS. 21, 23, 26, 36 AND 38).
FIRST USE 11-21-2002; IN COMMERCE 11-21-2002.

SN 78-197,159. INNOVATIVE BUSINESS SOLUTIONS INC., GLEN ALLEN, VA. FILED 12-22-2002.

EFAACT

FOR COMPUTER SOFTWARE TOOL FOR USE IN THE ORGANIZING AND MANAGEMENT OF GOVERNMENT CONTRACTS (U.S. CLS. 21, 23, 26, 36 AND 38).
FIRST USE 6-15-2001; IN COMMERCE 6-15-2001.

SN 78-197,724. KONAMI GAMING, INC., LAS VEGAS, NV. FILED 12-24-2002.

GOLDEN THEATER

FOR GAMING EQUIPMENT, NAMELY, SLOT MACHINES, GAMING MACHINES AND GAME SOFTWARE USED THEREWITH (U.S. CLS. 21, 23, 26, 36 AND 38).

SN 78-198,251. BALLY GAMING INTERNATIONAL, INC., LAS VEGAS, NV. FILED 12-27-2002.

CASTLE OF CASH

NO CLAIM IS MADE TO THE EXCLUSIVE RIGHT TO USE "CASH", APART FROM THE MARK AS SHOWN.
FOR GAMING DEVICES, NAMELY SLOT MACHINES, WITH OR WITHOUT VIDEO OUTPUT (U.S. CLS. 21, 23, 26, 36 AND 38).

CLASS 9—(Continued).

SN 78-198,720. CHAMBERS, KHIA, ATLANTA, GA. FILED 12-30-2002.

KHIA

FOR SERIES OF MUSICAL SOUND RECORDINGS AND AUDIOVISUAL RECORDINGS (U.S. CLS. 21, 23, 26, 36 AND 38).

SN 78-198,730. INTEGRATED DECISION SYSTEMS, INC., LOS ANGELES, CA. FILED 12-30-2002.

GIM

OWNER OF U.S. REG. NOS. 2,158,351 AND 2,509,732.
FOR COMPUTER SOFTWARE FOR USE IN PORTFOLIO ADMINISTRATION AND ACCOUNTING (U.S. CLS. 21, 23, 26, 36 AND 38).

SN 78-198,732. CHAMBERS, KHIA, ATLANTA, GA. FILED 12-30-2002.

MY NECK, MY BACK

FOR MUSICAL SOUND AND VIDEO RECORDINGS (U.S. CLS. 21, 23, 26, 36 AND 38).

SN 78-198,746. SANSHIN ELECTRONICS CO., LTD., IRVINE, CA. FILED 12-30-2002.

GSHARK

FOR ELECTRONIC HARDWARE, SPECIFICALLY, TWO DIMENSION AND THREE DIMENSION GRAPHICS PROCESSOR (U.S. CLS. 21, 23, 26, 36 AND 38).
FIRST USE 12-27-2002; IN COMMERCE 12-27-2002.

SN 78-198,749. PANGEA SOFTWARE, INC., AUSTIN, TX. FILED 12-30-2002.

BILLY FRONTIER

FOR COMPUTER VIDEO GAME ENTERTAINMENT SOFTWARE (U.S. CLS. 21, 23, 26, 36 AND 38).

CLASS 9—(Continued).

SN 78-198,764. TRANSPARENT PRODUCTS, INC., VALENCIA, CA. FILED 12-30-2002.

RELIATOUCH

FOR COMPUTER TOUCHSCREENS (U.S. CLS. 21, 23, 26, 36 AND 38).
FIRST USE 12-6-1994; IN COMMERCE 12-6-1994.

SN 78-199,360. KING, MELODY, JOY, OAKLAND, MD.
FILED 1-2-2003.

KETATS

FOR SOFTWARE USED TO DOCUMENT AND ORGANIZE TRAVEL RELATED INFORMATION. (U.S. CLS. 21, 23, 26, 36 AND 38).

SN 78-199,989. ITM SOFTWARE CORPORATION, MOUNTAIN VIEW, CA. FILED 1-3-2003.

7 PILLARS OF IT KNOWLEDGE

FOR COMPUTER SOFTWARE FOR BUSINESS MANAGEMENT OF INFORMATION TECHNOLOGY ORGANIZATIONS (U.S. CLS. 21, 23, 26, 36 AND 38).

SN 78-200,546. CAMPBELL, CRAIG, SOUTH SAN FRANCISCO, CA. FILED 1-7-2003.

SMARTSOLAR

FOR APPRATUS FOR CONVERTING ELECTRONIC RADIATION TO ELECTRICAL ENERGY, NAMELY PHOTOVOLTAIC SOLAR MODULES, SOLAR COLLECTORS, SOLAR-THERMAL HYBIRD MODULES (U.S. CLS. 21, 23, 26, 36 AND 38).

SN 78-232,686. BOEING MANAGEMENT COMPANY, SEAL BEACH, CA. FILED 4-1-2003.

F-4 PHANTOM II

OWNER OF U.S. REG. NO. 2,466,357.
FOR COMPUTER GAME PROGRAMS; COMPUTER SOFTWARE PROGRAMS FOR USE IN FLIGHT SIMULATION; MOUSEPADS (U.S. CLS. 21, 23, 26, 36 AND 38).

CLASS 10—MEDICAL APPARATUS

SN 76-145,196. CTI PET SYSTEMS, INC., KNOXVILLE, TN. FILED 10-12-2000.

ECAT REVEAL

OWNER OF U.S. REG. NO. 1,092,712.
FOR MEDICAL APPARATUS, NAMELY, POSITION EMISSION TOPOGRAPHY MACHINE FOR LOOKING AT AND REVIEWING THE ORGANS OF THE BODY (U.S. CLS. 26, 39 AND 44).

SN 76-186,497. HOME DIAGNOSTICS, INC., FT. LAUDERDALE, FL. FILED 12-27-2000.

PRESTIGE LX

FOR MEDICAL APPARATUS, NAMELY BLOOD GLUCOSE METERS, BLOOD GLUCOSE TEST STRIPS, BLOOD GLUCOSE CONTROL SOLUTIONS, AND LANCING DEVICES SOLD SEPARATELY AND AS PART OF A BLOOD GLUCOSE DIAGNOSTIC TEST KIT (U.S. CLS. 26, 39 AND 44).
FIRST USE 8-19-1999; IN COMMERCE 12-20-1999.

SN 76-229,053. CYPRUS PERSONAL CARE PRODUCTS, INC., SAN FRANCISCO, CA. FILED 3-21-2001.



FOR LATEX CONDOMS AND THE CARRYING CASES FOR THE CONDOMS SOLD TOGETHER (U.S. CLS. 26, 39 AND 44).
FIRST USE 10-15-1997; IN COMMERCE 10-15-1997.

SN 76-231,256. OTKRYTOE AKTSIONERNOE OBSHCHESTVO YAROSLAVSKY MEZHOTRASLEVOI NAUCHNO-TEKH-NICHESKY TSENTR "YARTEK", RU -150000 YAROSLAVL, RUSSIAN FEDERATIO, FILED 3-27-2001.

YAMIK

OWNER OF RUSSIAN FEDERATIO REG. NO. 104804, DATED 3-25-2001, EXPIRES 3-25-2011.
FOR CATHETERS (U.S. CLS. 26, 39 AND 44).

CLASS 10—(Continued).

SN 76-234,648. KABUSHIKI KAISHA HITACHI SEISAKUSHO, DBA HITACHI, LTD., CHIYODA-KU, TOKYO 101-8010, JAPAN, FILED 4-3-2001.

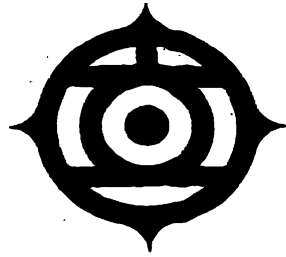

OWNER OF JAPAN REG. NO. 0302541, DATED 6-19-1998, EXPIRES 6-19-2008.

OWNER OF U.S. REG. NOS. 701,265, 2,246,932 AND OTHERS.

FOR MEDICAL APPARATUS AND INSTRUMENTS, NAMELY, DIAGNOSTIC OPTICAL TOPOGRAPHY APPARATUS, MRI APPARATUS, X-RAY DIAGNOSTIC APPARATUS, MOUNTS FOR MEDICAL X-RAY NEGATIVES, X-RAY PHOTOGRAPHS FOR MEDICAL PURPOSES, ULTRASOUND DIAGNOSTIC APPARATUS, RADIOLOGICAL APPARATUS FOR MEDICAL PURPOSES, POSITRON EMISSION TOMOGRAPHY (PET) DIAGNOSTIC IMAGING APPARATUS AND COMPONENTS THEREFOR SOLD TOGETHER AS A UNIT; TRIANGULAR COMPRESSION AND ELASTIC BANDAGES; ORTHOPEDIC SUPPORT BANDAGES; SURGICAL CATGUTS; CUPS ADAPTED FOR FEEDING BABIES AND CHILDREN; MEDICAL SYRINGES, NAMELY, BULB SYRINGES; MEDICAL ICE PACKS AND SUSPENDERS THEREFOR; BABY NURSING APPLIANCES, NAMELY, NURSING PADS, BABY NURERS, BREAST PUMPS, BABY BOTTLES, AND BABY BOTTLE NIPPLES; FEEDING BOTTLES; INTRAVENOUS FEEDING TUBES; VACUUM SEALED FEEDING BOTTLES; PROTECTIVE FINGER GUARDS FOR MEDICAL PURPOSES; CONTRACEPTIVES, NAMELY, CONDOMS; EAR IMPLANTS, NAMELY, ARTIFICIAL TYMPANIC MEMBRANES; PROSTHESES, NAMELY, ARTIFICIAL LIMBS, ARTIFICIAL BREASTS, ARTIFICIAL EYES, ARTIFICIAL SKIN FOR SURGICAL PURPOSES, BONE IMPLANTS COMPOSED OF ARTIFICIAL MATERIALS NOT FOR DENTAL USE AND SURGICAL IMPLANTS COMPOSED OF ARTIFICIAL MATERIALS NOT FOR DENTAL USE; EAR PLUGS FOR MEDICAL PURPOSES; GLOVES FOR MEDICAL PURPOSES; ELECTRIC MASSAGE APPARATUS FOR HOUSEHOLD USE; URINALS FOR MEDICAL PURPOSES; BED PANS; EAR PICKS (U.S. CLS. 26, 39 AND 44).

CLASS 10—(Continued).

SN 76-273,546. BERCHTOLD HOLDING AG, SCHAFFHAUSEN, SWITZERLAND, BY ASSIGNMENT BERCHTOLD HOLDING GMBH, 78532 TUTTLINGEN, FED REP GERMANY, FILED 6-18-2001.

ELEKTROTOM HITT

PRIORITY CLAIMED UNDER SEC. 44(D) ON FED REP GERMANY APPLICATION NO. 30094310.5/1, FILED 12-28-2000, REG. NO. 30094310, DATED 12-28-2000, EXPIRES 12-31-2010.

OWNER OF U.S. REG. NO. 1,268,563.

FOR ELECTRO-SURGICAL APPARATUS FOR USE IN THE TREATMENT OF TISSUE OF THE HUMAN OR ANIMAL BODY, NAMELY HIGH FREQUENCY GENERATORS, ELECTRODES, NEEDLE ELECTRODES AND INJECTION PUMPS (U.S. CLS. 26, 39 AND 44).

SN 76-352,544. ZOE MEDICAL, INC., TOPSFIELD, MA. FILED 12-26-2001.

NIGHTINGALE

FOR ELECTRICAL APPARATUS, NAMELY MEDICAL PATIENT MONITORING SYSTEMS COMPRISED OF PATIENT MONITORS, NAMELY ECG (ELECTRO CARDIOGRAM) LEADS ATTACHED TO THE PATIENT WHICH ACQUIRE PHYSIOLOGICAL WAVEFORMS AND PARAMETERS, CONNECTED TO A CENTRAL MONITORING STATION BY A MULTI-SERIAL PORT HUB (U.S. CLS. 26, 39 AND 44).

FIRST USE 11-15-2001; IN COMMERCE 11-15-2001.

SN 76-357,591. KCI LICENSING, SAN ANTONIO, TX. FILED 1-14-2002.

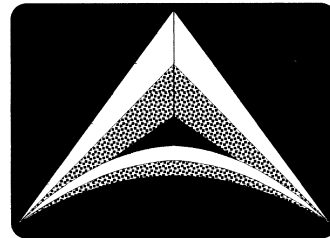

THE DOTS ON THE DRAWING PAGE ARE INTENDED TO INDICATE THAT THIS AREA IS THE COLOR PINK.

FOR PATIENT SUPPORT SYSTEMS COMPRISED OF THERAPEUTIC MATTRESSES, AND SPECIALIZED HOSPITAL BED FRAMES, PARTICULARLY TO PROVIDE PULMONARY AND SKIN THERAPIES FOR THE CRITICALLY ILL AND IMMOBILIZED PATIENT AND TO PROVIDE THERAPIES FOR TREATING ACUTE PULMONARY CONDITIONS (U.S. CLS. 26, 39 AND 44).

CLASS 10—(Continued).

SN 76-404,808. STRYKER CORPORATION, KALAMAZOO, MI. FILED 5-9-2002.

MX-PRO

FOR WHEELED MEDICAL TRANSPORT APPARATUS, NAMELY, COTS, STRETCHERS AND GURNEYS FOR USE IN AMBULANCES OR AERO MEDICAL AIRCRAFTS AND PARTS THEREFOR (U.S. CLS. 26, 39 AND 44).

FIRST USE 4-29-1997; IN COMMERCE 4-29-1997.

SN 76-414,216. ADVANCED MEDICAL APPLICATIONS, INC., DBA CELLERATION, EDEN PRAIRIE, MN. FILED 6-3-2002.

CELLERATION

FOR ULTRASOUND DEVICE USED TO TREAT WOUNDS (U.S. CLS. 26, 39 AND 44).

FIRST USE 12-1-2000; IN COMMERCE 3-1-2001.

SN 76-439,651. C. R. BARD, INC., MURRAY HILL, NJ. FILED 8-8-2002.

APOLLO AC

OWNER OF U.S. REG. NO. 2,107,505.
FOR MEDICAL DEVICES NAMELY, PAPILOTOMES AND CANNULAS (U.S. CLS. 26, 39 AND 44).

SN 76-441,256. SUNSTAR INC., OSAKA, JAPAN, FILED 8-19-2002.

GUIDOR

FOR DENTAL DEVICES, NAMELY, DENTAL IMPLANTS, ARTIFICIAL TOOTH, ARTIFICIAL GUM TISSUE, ARTIFICIAL GUM MUCOUS; ODONTOLOGICAL APPARATUS, NAMELY, DENTAL BAR, DENTAL MIRROR, SURGICAL EQUIPMENT, GLOVES FOR MEDICAL USE, MATRIX BARRIERS FOR DENTAL PROPOSE (U.S. CLS. 26, 39 AND 44).

SN 76-447,052. INSOUND MEDICAL, INC., NEWARK, CA. FILED 9-3-2002.

INSOUND XT

OWNER OF U.S. REG. NO. 2,493,443.
FOR INSERTABLE AND IMPLANTABLE MEDICAL DEVICES, NAMELY, HEARING DEVICES, HEARING-AIDS, WEARABLE TRANSDUCERS FOR CONVERTING AUDIO SIGNALS TO AUDIBLE VIBRATIONS TO ENHANCE HEARING OF THE WEARER, EXTENDED WEAR AND SEMI-PERMANENT HEARING DEVICES, IN-THE-CANAL AND COMPLETELY-IN-THE-CANAL HEARING DEVICES (U.S. CLS. 26, 39 AND 44).

CLASS 10—(Continued).

SN 76-448,349. PISHARODI, MADHAVAN, BROWNSVILLE, TX. FILED 9-10-2002.

UNIMAX

FOR MEDICAL DEVICES, SPECIFICALLY SPINAL FIXATION DEVICES (U.S. CLS. 26, 39 AND 44).

SN 76-472,165. CONMED CORPORATION, UTICA, NY. FILED 11-13-2002.

KOROT CUFF

NO CLAIM IS MADE TO THE EXCLUSIVE RIGHT TO USE CUFF, APART FROM THE MARK AS SHOWN.

FOR MEDICAL APPARATUS, NAMELY BLOOD PRESSURE CUFFS (U.S. CLS. 26, 39 AND 44).

SN 76-481,335. STRYKER CORPORATION, KALAMAZOO, MI. FILED 1-9-2003.

VIZIOHD

FOR MEDICAL IMAGING SYSTEMS COMPRISED OF CAMERAS, VIDEO MONITORS, IMAGE CAPTURING SYSTEMS, AUDIO AND VIDEO CONTROL INTERFACES AND OPERATING SOFTWARE, SOLD AS A UNIT (U.S. CLS. 26, 39 AND 44).

SN 78-097,487. GENERAL ELECTRIC COMPANY, SCHE-NECTADY, NY. FILED 12-10-2001.

ADVENT

FOR MEDICAL DIAGNOSTIC IMAGING EQUIPMENT NAMELY, MRI DIAGNOSTIC APPARATUS AND PARTS THEREFOR (U.S. CLS. 26, 39 AND 44).

SN 78-131,783. VELOCIMED, INC., MAPLE GROVE, MN. FILED 5-29-2002.

**IMPROVING LIVES
THROUGH INNOVATION**

FOR MEDICAL DEVICES FOR USE BY INTERVENTIONAL CARDIOLOGIST, NAMELY, DEVICES TO OPEN OCCLUDED ARTERIES AND DEVICES TO PROTECT PATIENTS FROM EMBOLIC EVENTS (U.S. CLS. 26, 39 AND 44).

CLASS 10—(Continued).

SN 78-134,518. MEDICAL DATA ELECTRONICS; A SUBSIDIARY OF VIASYS HEALTHCARE, ARLETA, CA. FILED 6-10-2002.

ANGEL TELEMETRY

NO CLAIM IS MADE TO THE EXCLUSIVE RIGHT TO USE "TELEMETRY", APART FROM THE MARK AS SHOWN.

FOR MEDICAL EQUIPMENT IN THE NATURE OF SINGLE PATIENT USE ELECTROCARDIOGRAPHIC APPARATUS, NAMELY, A TRANSMITTER UNIT FOR ACQUIRING AND TRANSMITTING ELECTROCARDIOGRAPHIC DATA FROM AN AMBULATORY PATIENT (U.S. CLS. 26, 39 AND 44).

SN 78-134,523. MEDICAL DATA ELECTRONICS; A SUBSIDIARY OF VIASYS HEALTHCARE, ARLETA, CA. FILED 6-10-2002.

ANGEL BABY TELEMETRY

NO CLAIM IS MADE TO THE EXCLUSIVE RIGHT TO USE "TELEMETRY", APART FROM THE MARK AS SHOWN.

FOR MEDICAL EQUIPMENT IN THE NATURE OF SINGLE PATIENT USE ELECTROCARDIOGRAPHIC APPARATUS, NAMELY, A TRANSMITTER UNIT FOR ACQUIRING AND TRANSMITTING ELECTROCARDIOGRAPHIC DATA FROM AN AMBULATORY PATIENT (U.S. CLS. 26, 39 AND 44).

SN 78-134,528. MEDICAL DATA ELECTRONICS; A SUBSIDIARY OF VIASYS HEALTHCARE, ARLETA, CA. FILED 6-10-2002.

GUARDIAN ANGEL TELEMETRY

NO CLAIM IS MADE TO THE EXCLUSIVE RIGHT TO USE "TELEMETRY", APART FROM THE MARK AS SHOWN.

FOR MEDICAL ELECTROCARDIOGRAPHIC AND PHYSIOLOGIC APPARATUS, NAMELY, A TRANSMITTER UNIT FOR ACQUIRING AND TRANSMITTING ELECTROCARDIOGRAPHIC AND OTHER PHYSIOLOGIC DATA FROM AN AMBULATORY PATIENT (U.S. CLS. 26, 39 AND 44).

CLASS 10—(Continued).

SN 78-134,532. MEDICAL DATA ELECTRONICS; A SUBSIDIARY OF VIASYS HEALTHCARE, ARLETA, CA. FILED 6-10-2002.

GUARDIAN ANGEL BABY TELEMETRY

NO CLAIM IS MADE TO THE EXCLUSIVE RIGHT TO USE "TELEMETRY", APART FROM THE MARK AS SHOWN.

FOR MEDICAL ELECTROCARDIOGRAPHIC AND PHYSIOLOGIC APPARATUS, NAMELY, A TRANSMITTER UNIT FOR ACQUIRING AND TRANSMITTING ELECTROCARDIOGRAPHIC AND OTHER PHYSIOLOGIC DATA FROM AN AMBULATORY PATIENT (U.S. CLS. 26, 39 AND 44).

SN 78-137,783. LAZARE, MARC, JERICHO, NY. FILED 6-21-2002.

VENEER STYX

NO CLAIM IS MADE TO THE EXCLUSIVE RIGHT TO USE "VENEER", APART FROM THE MARK AS SHOWN.

FOR DENTAL APPLIANCE FOR FIXATION OF A SURFACE COVERING ON A TOOTH DURING BONDING (U.S. CLS. 26, 39 AND 44).

SN 78-149,419. ADVANCED MEDICAL GROUP, INC., SANTA ANA, CA. FILED 7-31-2002.

DIGITECH EMS

FOR MEDICAL DEVICE, NAMELY A DIGITAL, PROGRAMMABLE, MICROPROCESSOR FOR USE IN RELAXATION OF MUSCLE SPASMS, PREVENTION OR RETARDATION OF DISUSE ATROPHY, INCREASING LOCAL BLOOD CIRCULATION, MUSCLE REEDUCATION, MAINTAINING OR INCREASING RANGE OF MOTION AND IMMEDIATE POSTSURGICAL STIMULATION OF CALF MUSCLES TO PREVENT VENOUS THROMBOSIS (U.S. CLS. 26, 39 AND 44).

FIRST USE 5-1-2002; IN COMMERCE 5-1-2002.

SN 78-159,792. CLEAR SIGHT, INC., CHICAGO, IL. FILED 8-30-2002.

EZPREPAK

FOR MEDICAL DEVICES, NAMELY, OPHTHALMIC CLIPS AND INSTRUMENTS FOR APPLYING THE SAME PACKAGED TOGETHER (U.S. CLS. 26, 39 AND 44).

CLASS 10—(Continued).

SN 78-166,800. ARTHREX, INC., NAPLES, FL. FILED 9-23-2002.

SUTUREDOKK

FOR MEDICAL DEVICES, NAMELY SUTURE PASSES (U.S. CLS. 26, 39 AND 44).

SN 78-171,839. REYNOLDS, ROBERT F., ESSEX, CT. FILED 10-7-2002.

GOOD VIBRATIONS

FOR REMOTELY AND MANUALLY ACTUABLE DEVICE FOR STIMULATING THE HUMAN BODY, NAMELY, AN ELECTRICAL VIBRATOR AND ASSOCIATED COUNTER FOR THE PURPOSE OF MODIFYING SELF-REGULATIVE BEHAVIOR OF HUMANS (U.S. CLS. 26, 39 AND 44).

SN 78-184,446. SHERWOOD SERVICES AG, SCHAFFHAUSEN, SWITZERLAND, FILED 11-13-2002.

THE SILICONE SOLUTION

NO CLAIM IS MADE TO THE EXCLUSIVE RIGHT TO USE "SILICONE", APART FROM THE MARK AS SHOWN. FOR UROLOGICAL CATHETERS AND CATHETER TRAYS (U.S. CLS. 26, 39 AND 44).

SN 78-185,703. HESKA CORPORATION, FT. COLLINS, CO. FILED 11-15-2002.

E. R. D. - HEALTH SCREEN

OWNER OF U.S. REG. NO. 2,691,606.
FOR TESTING APPARATUS FOR THE DETECTION OF MICROALBUMINURIA IN ANIMALS; ANIMAL SPECIMEN COLLECTION APPARATUS, NAMELY, URINE COLLECTION SPONGES (U.S. CLS. 26, 39 AND 44).

SN 78-186,515. NOVIACE, PARAMUS, NJ. FILED 11-19-2002.

NOVIACE

FOR MEDICAL DEVICES, NAMELY ORTHOPADICS JOINT IMPLANTS FOR USE IN BONE RECONSTRUCTION (U.S. CLS. 26, 39 AND 44).

CLASS 10—(Continued).

SN 78-189,149. MEDTRONIC, INC., MINNEAPOLIS, MN. FILED 11-26-2002.

**Medtronic**

OWNER OF U.S. REG. NOS. 1,833,626 AND 2,520,725.
FOR SURGICAL AND MEDICAL APPARATUS, APPLIANCES AND INSTRUMENTS, NAMELY CARDIAC RHYTHM MANAGEMENT APPARATUS; IMPLANTABLE NEUROLOGICAL PAIN, TREMOR, INCONTINENCE AND SPASTICITY MANAGEMENT APPARATUS; PROSTHETIC AND BIOPROSTHETIC HEART VALVES; CATHETERS FOR ANGIOPLASTY; MEDICAL STENTS; IMPLANTABLE DRUG ADMINISTRATION SYSTEMS; HYDROCEPHALIC SHUNTS; SURGICAL INSTRUMENTS AND ACCESSORIES, NAMELY SCALPELS, BLADES, STAPLERS, ANASTOMOTIC COUPLERS AND CARDIAC STABILIZERS; AUTOTRANSFUSION EQUIPMENT AND DISPOSABLE DEVICES FOR HANDLING AND MONITORING BLOOD (U.S. CLS. 26, 39 AND 44).
FIRST USE 6-1-2000; IN COMMERCE 6-1-2000.

SN 78-189,836. MAGNA FORTIS CORPORATION, KIRKLAND, WA. FILED 11-29-2002.

METASCOPE

FOR STETHOSCOPES. (U.S. CLS. 26, 39 AND 44).

SN 78-190,559. SCIMED LIFE SYSTEMS, INC., MAPLE GROVE, MN. FILED 12-3-2002.

POWERBALL

FOR ELECTROSURGICAL ELECTRODES (U.S. CLS. 26, 39 AND 44).

SN 78-193,317. MERIT MEDICAL SYSTEMS, INC., SOUTH JORDAN, UT. FILED 12-11-2002.

ASK FOR SAFETY

FOR MEDICAL DEVICES, NAMELY SAFETY NEEDLES AND SAFETY NEEDLE KITS (U.S. CLS. 26, 39 AND 44).

CLASS 10—(Continued).

SN 78-193,322. MEDTRONIC, INC., MINNEAPOLIS, MN. FILED 12-11-2002.

STABLEMAPR

FOR DIAGNOSTIC ELECTROPHYSIOLOGY CATETER (U.S. CLS. 26, 39 AND 44).
FIRST USE 5-13-2002; IN COMMERCE 5-13-2002.

SN 78-196,487. DEL CASTILLO, GIL, KATY, TX. FILED 12-19-2002.

SNAIL NAIL

FOR SURGICAL AND MEDICAL INSTRUMENTS, NAMELY, INTRAVENOUS CATHETERS WITH RE-TRACTABLE NEEDLES (U.S. CLS. 26, 39 AND 44).

SN 78-199,365. MEDTRONIC, INC., MINNEAPOLIS, MN. FILED 1-2-2003.

SLIMLINE

FOR PH ESOPHOGEAL CATHETER (U.S. CLS. 26, 39 AND 44).

CLASS 11—ENVIRONMENTAL CONTROL APPARATUS

SN 75-599,626. KONINKLIJKE PHILIPS ELECTRONICS N.V., EINDHOVEN, NETHERLANDS, FILED 12-4-1998.

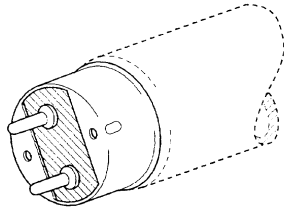

OWNER OF BENELUX REG. NO. 614001, DATED 7-23-1997, EXPIRES 7-23-2007.

OWNER OF U.S. REG. NO. 2,113,481.

NO CLAIM IS MADE TO THE EXCLUSIVE RIGHT TO USE THE REPRESENTATION OF THE CONFIGURATION OF THE FLORESCENT LAMP, APART FROM THE MARK AS SHOWN.

THE COLOR LINING IN THE DRAWING IS FOR GREEN, WHICH IS CLAIMED AS THE MARK, AND THE DOTTED LINES IN THE DRAWING ARE PORTIONS OF THE GOODS NOT CLAIMED.

THE MARK CONSISTS OF THE COLOR GREEN APPLIED TO THE INSULATOR OF THE GOODS.

SEC. 2(F).

FOR FLUORESCENT LAMPS (U.S. CLS. 13, 21, 23, 31 AND 34).

CLASS 11—(Continued).

SN 76-336,232. PAPER MAGIC GROUP, INC., THE, WILMINGTON, DE. FILED 11-9-2001.

PHANTOM FLAME

FOR DECORATIVE NOVELTY ITEMS COMPRISING AN ELECTRIC FAN, ELECTRIC LIGHT AND RIBBON TO SIMULATE FLAME (U.S. CLS. 13, 21, 23, 31 AND 34).

SN 76-413,310. MARSHALL OUTDOOR PRODUCTS, LLC, BATON ROUGE, LA. FILED 5-29-2002.

BUCKHEAD

FOR CEILING FANS, CEILING FAN PARTS, AND CEILING FAN ACCESSORIES; NAMELY, PULL CHAINS, BLADE ARMS, BLADES, FLY WHEELS, BALL CANOPIES, FAN BRACES, ELECTRICAL PANS, BALL HANGER BRACKETS, HANGER BALLS, LIGHT SOCKETS, LIGHT FIXTURES, WALL PLATES, FINIALS, DOWN RODS, CEILING FAN BRUSHES, AND SPEED CONTROLS (U.S. CLS. 13, 21, 23, 31 AND 34).

SN 76-417,357. MARSHALL OUTDOOR PRODUCTS, LLC, BATON ROUGE, LA. FILED 5-31-2002.



FOR CEILING FANS, CEILING FAN PARTS, AND CEILING FAN ACCESSORIES; NAMELY, PULL CHAINS, BLADE ARMS, BLADES, FLY WHEELS, BALL CANOPIES, FAN BRACES, ELECTRICAL PANS, BALL HANGER BRACKETS, HANGER BALLS, LIGHT SOCKETS, LIGHT FIXTURES, WALL PLATES, FINIALS, DOWN RODS, CEILING FAN BRUSHES, AND SPEED CONTROLS (U.S. CLS. 13, 21, 23, 31 AND 34).

SN 76-442,905. FUORISERIE IMPORTS, INC., BROOKLYN, NY. FILED 8-19-2002.

ECCO

OWNER OF U.S. REG. NO. 2,355,864.

THE ENGLISH TRANSLATION OF THE WORD "ECCO" IN THE MARK IS "BEHOLD" OR "LOOK".

FOR LAMPS AND TABLE FANS (U.S. CLS. 13, 21, 23, 31 AND 34).

FIRST USE 1-0-1988; IN COMMERCE 1-0-1988.

CLASS 11—(Continued).

SN 76-443,707. RADIANT ENERGY SYSTEM, WIXOM, MI. FILED 8-26-2002.

EURO-ROLLER U.S.A.

NO CLAIM IS MADE TO THE EXCLUSIVE RIGHT TO USE "U.S.A.", APART FROM THE MARK AS SHOWN.

FOR EXHAUST VENTING SYSTEM COMPRISED OF VENTING UNITS AND A HIGH TEMPERATURE HOSE THAT ATTACHES TO THE VEHICLE EXHAUST WHICH ALLOWS THE VEHICLES EXHAUST TO BE VENTED OUTDOORS WHILE THE VEHICLE IS RUNNING, FOR USE IN A VEHICLES REPAIR FACILITY OR A MUNICIPAL/PUBLIC BUILDING THAT HOUSES EMERGENCY VEHICLES (U.S. CLS. 13, 21, 23, 31 AND 34).

SN 76-445,168. ENFIOMUSI, GIUSEPPE, MATAWAN, NJ. FILED 8-29-2002.

EXIT

FOR HAND HELD HAIR DRYER (U.S. CLS. 13, 21, 23, 31 AND 34).
FIRST USE 3-28-2002; IN COMMERCE 3-28-2002.

SN 76-447,055. LAUNEY, KURT C., TERRYTOWN, LA. FILED 8-21-2002.

LITE IDEAS

NO CLAIM IS MADE TO THE EXCLUSIVE RIGHT TO USE "LITE", APART FROM THE MARK AS SHOWN.

FOR LIGHT KITS, CONSISTING OF ILLUMINATION CIRCUIT AND PAPER SHEETS FOR CREATING ILLUMINATING DISPLAY ON PAPER GOODS, SUCH AS BOOKS, SCRAPBOOKS, GREETING CARDS (U.S. CLS. 13, 21, 23, 31 AND 34).

SN 76-449,636. WEBER-STEPHEN PRODUCTS CO., PALATINE, IL. FILED 9-16-2002.



FOR BARBECUE GRILLS (U.S. CLS. 13, 21, 23, 31 AND 34).

CLASS 11—(Continued).

SN 76-452,030. CRYOSTOP INTERNATIONAL, INC., WILMINGTON, NC. FILED 9-23-2002.

CRYO-LATOR

FOR PIPE FREEZING EQUIPMENT, NAMELY, A KIT COMPOSED OF A METALLIC INSULATING JACKET, HOSE, NITROGEN CYLINDERS, AND PIPE SEAL ASSEMBLY FOR USE IN PLUMBING REPAIRS (U.S. CLS. 13, 21, 23, 31 AND 34).

SN 76-455,136. RAIN BIRD CORPORATION, GLENDORA, CA. FILED 9-25-2002.

INSTALL CONFIDENCE

FOR SPRINKLERS AND IRRIGATION SYSTEMS COMPRISED OF IRRIGATION PIPE, SPRINKLERS, VALVES, FILTERS, CONTROLLERS, AND PARTS THEREFOR; IMPACT AND IMPULSE DRIVE SPRINKLERS; POP-UP SPRINKLERS; BALL DRIVE SPRINKLERS; TURBINE DRIVE SPRINKLERS; REACTION DRIVE SPRINKLERS; OSCILLATORS; SPRAY HEADS; BUBBLERS; SPRINKLER NOZZLES; SPRINKLER SUPPORTS AND BASES; DRIPPERS; SPRINKLER EMITTERS; SOAKERS; SPINNER SEPARATORS; SPRINKLER SYSTEM FILTERS AND FILTER SCREENS; ELECTRIC OUTDOOR LIGHTS; AND FAUCET ADAPTERS (U.S. CLS. 13, 21, 23, 31 AND 34).
FIRST USE 5-20-2002; IN COMMERCE 5-20-2002.

SN 76-462,218. URUS INDUSTRIAL CORPORATION, DBA KOOLATRON, BRANTFORD ONTARIO, CANADA, FILED 10-28-2002.

FLAVOR JET

FOR INFRARED OVENS FOR COOKING (U.S. CLS. 13, 21, 23, 31 AND 34).

SN 76-463,776. FEELUX CO., LTD., KYONGGI-DO, REPUBLIC OF KOREA, FILED 11-4-2002.

DIMSLIM

FOR LIGHTING APPARATUS, NAMELY, ELECTRIC LAMPS, FLUORESCENT LAMPS, COMPACT FLUORESCENT LAMPS, FREE STANDING ELECTRIC LAMPS, DECORATIVE LAMPS, ELECTRIC LIGHTING FIXTURES AND FLUORESCENT LAMP TUBES (U.S. CLS. 13, 21, 23, 31 AND 34).

CLASS 11—(Continued).

SN 76-463,785. HEALTHYHOME.COM, INC., SAINT PETERSBURG, FL. FILED 11-4-2002.

AQUATURA

FOR WATER FILTRATION UNITS (U.S. CLS. 13, 21, 23, 31 AND 34).
FIRST USE 4-12-2002; IN COMMERCE 4-12-2002.

SN 76-463,870. FEELUX CO., LTD., KYONGGI-DO, REPUBLIC OF KOREA, FILED 11-4-2002.

SLIMFIX

FOR LIGHTING APPARATUS, NAMELY, ELECTRIC LAMPS, FLUORESCENT LAMPS, COMPACT FLUORESCENT LAMPS, FREE STANDING ELECTRIC LAMPS, DECORATIVE LAMPS, ELECTRIC LIGHTING FIXTURES AND FLUORESCENT LAMP TUBES (U.S. CLS. 13, 21, 23, 31 AND 34).

SN 76-469,061. ENVIRONMENTAL LIGHTING CONCEPTS, INC., TAMPA, FL. FILED 11-21-2002.



OTT-LITE
TECHNOLOGY
The Science of Natural Light

OWNER OF U.S. REG. NOS. 2,573,318, 2,592,054 AND OTHERS.

NO CLAIM IS MADE TO THE EXCLUSIVE RIGHT TO USE "TECHNOLOGY", APART FROM THE MARK AS SHOWN.

THE MARK CONSISTS, IN PART, OF THE STYLIZED REPRESENTATION OF THE LETTER "O".

FOR FLUORESCENT LIGHTING FIXTURES AND LIGHT BULBS (U.S. CLS. 13, 21, 23, 31 AND 34).

FIRST USE 10-20-2002; IN COMMERCE 10-20-2002.

SN 76-469,638. HON TECHNOLOGY INC., MUSCATINE, IA. FILED 11-25-2002.

FIREBRICK

FOR FIREPLACES (U.S. CLS. 13, 21, 23, 31 AND 34).
FIRST USE 9-0-2001; IN COMMERCE 9-0-2001.

CLASS 11—(Continued).

SN 76-469,678. BACHMAN ENTERPRISES INC., GARDNERVILLE, NV. FILED 11-25-2002.

TURBOKOOL

FOR EVAPORATIVE AIR COOLING UNITS (U.S. CLS. 13, 21, 23, 31 AND 34).
FIRST USE 10-1-2002; IN COMMERCE 10-1-2002.

SN 76-470,607. BUNN-O-MATIC CORPORATION, SPRINGFIELD, IL. FILED 11-29-2002.

DBC

FOR ELECTRIC COFFEE, TEA AND HOT WATER PREPARATION APPARATUS (U.S. CLS. 13, 21, 23, 31 AND 34).
FIRST USE 11-2-1992; IN COMMERCE 4-0-1996.

SN 76-471,230. ILCAR, 06510 CARROS, FRANCE, FILED 11-18-2002.

ILCAR

FOR ELECTRIC LIGHTING FIXTURES, LAMPS, STREET LAMPS (U.S. CLS. 13, 21, 23, 31 AND 34).

SN 76-471,775. KONINKLIJKE PHILIPS ELECTRONICS N.V., EINDHOVEN, NETHERLANDS, FILED 11-7-2002.

CRYSTAL VISION

FOR ELECTRIC LAMPS, LIGHTING FIXTURES AND LIGHTING INSTALLATIONS, NAMELY FOR AUTOMOTIVE LIGHTING (U.S. CLS. 13, 21, 23, 31 AND 34).

SN 76-472,673. TRIANGLE ENGINEERING OF ARKANSAS, INC., JACKSONVILLE, AR. FILED 11-29-2002.

QB-2

FOR INDUSTRIAL VENTILATION FANS (U.S. CLS. 13, 21, 23, 31 AND 34).
FIRST USE 10-1-2001; IN COMMERCE 10-1-2001.

CLASS 11—(Continued).

SN 76-473,405. FEIG, MARVIN, NORTHBROOK, IL. FILED 12-4-2002.

GOOD EARTH LIGHTING

OWNER OF U.S. REG. NO. 1,798,609.
NO CLAIM IS MADE TO THE EXCLUSIVE RIGHT TO USE "LIGHTING", APART FROM THE MARK AS SHOWN.
FOR ELECTRIC LIGHTING FIXTURES (U.S. CLS. 13, 21, 23, 31 AND 34).
FIRST USE 9-29-1992; IN COMMERCE 9-29-1992.

SN 78-109,996. FOOD EQUIPMENT TECHNOLOGIES COMPANY, INC., LINCOLNSHIRE, IL. FILED 2-20-2002.



THE MARK CONSISTS OF THE WORDS "THE EXTRACTOR" ON TOP OF AN IMAGE OF A STYLIZED BAG WITH A WINDOW SHOWING COFFEE BEANS INSIDE THE BAG.
FOR ELECTRIC COMMERCIAL COFFEE BREWERS, ELECTRIC ICED TEA BREWERS AND ELECTRIC HOT TEA BREWERS FOR COMMERCIAL USE; AND INSULATED DISPENSERS SOLD THEREWITH SPECIALLY ADAPTED TO FIT TOGETHER WITH THE BREWERS FOR DIRECT RECEIPT OF FRESHLY BREWED BEVERAGE FROM THE ASSOCIATED BREWER (U.S. CLS. 13, 21, 23, 31 AND 34).

SN 78-130,446. LEER LIMITED PARTNERSHIP, NEW LISBON, WI. FILED 5-22-2002.

Q.B. COOL

THE NAME IN THE MARK DOES NOT IDENTIFY A LIVING INDIVIDUAL.
FOR ICE FREEZERS (U.S. CLS. 13, 21, 23, 31 AND 34).

SN 78-132,391. WINNER INTERNATIONAL ROYALTY LLC, SHARON, PA. FILED 5-31-2002.

HIP 1887

NO CLAIM IS MADE TO THE EXCLUSIVE RIGHT TO USE "1887", APART FROM THE MARK AS SHOWN.
FOR FLASHLIGHTS AND ELECTRIC LANTERNS (U.S. CLS. 13, 21, 23, 31 AND 34).

CLASS 11—(Continued).

SN 78-138,565. BIC CORPORATION, MILFORD, CT. FILED 6-25-2002.

LIGHT SMART

NO CLAIM IS MADE TO THE EXCLUSIVE RIGHT TO USE "LIGHT", APART FROM THE MARK AS SHOWN.
FOR LIGHTERS, PRIMARILY FOR LIGHTING GRILLS, FIREPLACES AND CANDLES (U.S. CLS. 13, 21, 23, 31 AND 34).

SN 78-140,575. GENLYTE THOMAS GROUP LLC, LOUISVILLE, KY. FILED 7-2-2002.

MATRIX

FOR ELECTRICAL LIGHTING FIXTURES (U.S. CLS. 13, 21, 23, 31 AND 34).
FIRST USE 12-1-1993; IN COMMERCE 12-1-1993.

SN 78-162,993. LEDALITE ARCHITECTURAL PRODUCTS, LANGLEY, BRITISH COLUMBIA, CANADA. FILED 9-11-2002.

CACHET

FOR ELECTRICAL LIGHTING FIXTURES (U.S. CLS. 13, 21, 23, 31 AND 34).

SN 78-173,500. PDG HIGHTOWER INC., SAN DIEGO, CA. FILED 10-11-2002.

BREWRIGHT

FOR AUTOMATED HOME BEER BREWING MACHINE WITH HEATING ELEMENT (U.S. CLS. 13, 21, 23, 31 AND 34).

SN 78-174,156. CRAFTMADE INTERNATIONAL INC., COPPELL, TX. FILED 10-14-2002.

TWIN AIR

NO CLAIM IS MADE TO THE EXCLUSIVE RIGHT TO USE "AIR", APART FROM THE MARK AS SHOWN.
FOR CEILING FANS (U.S. CLS. 13, 21, 23, 31 AND 34).

CLASS 11—(Continued).

SN 78-180,428. D M INDUSTRIES LIMITED, OPA LOCKA, FL. FILED 10-31-2002.

VITA SPA

NO CLAIM IS MADE TO THE EXCLUSIVE RIGHT TO USE "SPA", APART FROM THE MARK AS SHOWN. THE ENGLISH TRANSLATION OF THE WORD "VITA" IN THE MARK IS "LIFE".

FOR NON-METAL LARGE BATHING TUBS, HOT TUBS, SPAS, SMALL WHIRLPOOLS, ABOVE-GROUND AND PORTABLE OR IN GROUND HYDROTHERAPY TUBS, HEATED OR COLD WHIRLPOOL TUBS FOR IN HOME OR OUTSIDE USE AND HEATERS, DRAINS, PIPING, INLETS, RETURNS, FILTERS, PUMPS, LIGHTS, MOTORS AND PUMPS SOLD IN COMBINATION FOR USE WITH THE FOREGOING (U.S. CLS. 13, 21, 23, 31 AND 34).
FIRST USE 8-15-1984; IN COMMERCE 8-15-1984.

SN 78-190,538. WHIRLPOOL PROPERTIES, INC., ST. JOSEPH, MI. FILED 12-3-2002.

CLEANRELEASE

FOR NON-STICK COATING SOLD AS AN INTEGRAL PART OF MICROWAVE OVENS. (U.S. CLS. 13, 21, 23, 31 AND 34).

SN 78-198,184. HOMER TLC, INC., CLAYMONT, DE. FILED 12-27-2002.

BURLINGTON

FOR ELECTRIC LIGHTING FIXTURES (U.S. CLS. 13, 21, 23, 31 AND 34).

CLASS 12—VEHICLES

SN 76-260,406. JONES, KIRK ANTHONY, CONCORD, CA. FILED 5-22-2001.

BILLETPROOF EQUIPPED

FOR AUTOMOBILE INTERIOR TRIM (U.S. CLS. 19, 21, 23, 31, 35 AND 44).
FIRST USE 9-1-1997; IN COMMERCE 9-1-1997.

CLASS 12—(Continued).

SN 76-347,024. SAVANT MANUFACTURING INC., KINDER, LA. FILED 12-7-2001.

STICK STOPPERS

NO CLAIM IS MADE TO THE EXCLUSIVE RIGHT TO USE "STICK", APART FROM THE MARK AS SHOWN.

FOR PROTECTIVE PLATES AND GUARDS FOR ALL TERRAIN VEHICLES, NAMELY AXIAL GUARDS IN THE NATURE OF DEBRIS GUARDS (U.S. CLS. 19, 21, 23, 31, 35 AND 44).
FIRST USE 3-16-1993; IN COMMERCE 9-9-1993.

SN 76-355,846. FITZGERALD, KEVIN R., JR., LONG BEACH, CA. AND HALE, ARTHUR D., III, LONG BEACH, CA. FILED 1-4-2002.

CACHÉ

THE WORD "CACHE" TRANSLATES FROM FRENCH INTO ENGLISH AS "HIDDEN", "SECRET", OR "CONCEALED".

FOR MOTOR VEHICLE WHEELS AND STRUCTURAL PARTS THEREOF (U.S. CLS. 19, 21, 23, 31, 35 AND 44).

SN 76-371,916. TG SQUARED, INC., CASTLE HAYNE, NC. FILED 2-15-2002.



FOR RACING VEHICLE COMPONENTS FOR GO-KARTS, NAMELY, GEAR HUB ASSEMBLIES, GEARS, MOTOR MOUNTS, TANK BRACES, THROTTLE BRACKETS, AND CHAIN GUARDS (U.S. CLS. 19, 21, 23, 31, 35 AND 44).
FIRST USE 1-25-2002; IN COMMERCE 1-25-2002.

CLASS 12—(Continued).

SN 76-385,086. ATTIVA, LLC, DBA EUROPEAN BOAT WORKS, SEATTLE, WA. FILED 3-18-2002.

ARMADORA

"ARMADORA" IS A DUTCH WORD DEFINING A PIECE OF WOOD WHICH HOLDS SEVERAL PEGS TO WHICH ROPES ARE EITHER TIED OR SOMETIMES COILED AND WHICH WAS A STANDARD FEATURE OF THE RIGGING OF 18TH AND 19TH CENTURY SAILING SHIPS.

FOR BOATS AND STRUCTURAL PARTS THEREFOR (U.S. CLS. 19, 21, 23, 31, 35 AND 44).

SN 76-400,872. BOSTROM SEATING, INC., PIEDMONT, AL. FILED 4-25-2002.

AIR-715

OWNER OF U.S. REG. NOS. 1,174,104, 1,189,928 AND OTHERS.

FOR SEATS AND PARTS THEREOF FOR LAND VEHICLES (U.S. CLS. 19, 21, 23, 31, 35 AND 44).

SN 76-407,588. NISSAN NORTH AMERICA, INC., GARDENA, CA. FILED 5-14-2002.

ADVENTURES IN ON-ROADING

FOR MOTOR VEHICLES, NAMELY AUTOMOBILES AND SPORT UTILITY VEHICLES (U.S. CLS. 19, 21, 23, 31, 35 AND 44).

FIRST USE 11-14-2002; IN COMMERCE 11-14-2002.

SN 76-414,655. DRAGON POWERBOATS, INC., AVENTURA, FL. FILED 6-3-2002.

THE DRAGON

FOR POWERBOATS (U.S. CLS. 19, 21, 23, 31, 35 AND 44).

FIRST USE 6-3-2002; IN COMMERCE 6-3-2002.

CLASS 12—(Continued).

SN 76-426,244. JAWAUNION, S.R.O., 257 41 TYNEC NAD SAZAVOU, CZECH REPUBLIC, FILED 6-26-2002.



OWNER OF CZECH REPUBLIC REG. NO. 151683, DATED 11-25-1954, EXPIRES 10-23-2004.

FOR LAND MOTOR VEHICLES, NAMELY, MOTORCYCLES AND THEIR COMPONENT PARTS (U.S. CLS. 19, 21, 23, 31, 35 AND 44).

SN 76-445,445. C & B TRAILER SALES INC., PITTSBURGH, PA. FILED 8-30-2002.

PIONEER

FOR ENCLOSED CARGO TRAILERS (U.S. CLS. 19, 21, 23, 31, 35 AND 44).

FIRST USE 4-10-1998; IN COMMERCE 6-24-1998.

SN 76-459,897. DJ PRODUCTS INC., PLYMOUTH, MN. FILED 10-15-2002.

PARTSCADDY

FOR BATTERY POWERED, MANUALLY CONTROLLED MOTORIZED CARTS USED TO PUSH, PULL OR LIFT HEAVY EQUIPMENT AND MATERIALS (U.S. CLS. 19, 21, 23, 31, 35 AND 44).

FIRST USE 3-6-1999; IN COMMERCE 3-13-1999.

SN 76-461,275. NATIONAL RV HOLDINGS, INC., PERRIS, CA. FILED 10-24-2002.

UNI-CAGE

FOR SIDEWALLS AND ROOFS OF MOTOR HOMES AND TRAVEL TRAILERS (U.S. CLS. 19, 21, 23, 31, 35 AND 44).

SN 76-462,023. RALLY MANUFACTURING, INC., MIAMI, FL. FILED 10-24-2002.

EVER CLEAR

FOR WINDSHIELD WIPER ASSEMBLIES, NAMELY, WIPER ARMS, WIPER BLADES, WIPER REFILLS, AND WIPER CONNECTORS FOR CONNECTING WIPER ASSEMBLIES TO WIPER ARMS (U.S. CLS. 19, 21, 23, 31, 35 AND 44).

CLASS 12—(Continued).

SN 76-463,164. MT RACING INCORPORATED, TAICHUNG, TAIWAN, FILED 10-25-2002.



The logo for "Learn2Ride" features the text in a stylized, rounded font. The "2" is significantly larger and more prominent than the other characters, and the entire text is slanted upwards from left to right.

FOR BICYCLES; TRICYCLES; BICYCLE PARTS, NAMELY, BRAKES, HEAD TUBES, FRONT FORKS, HUBS, CRANKS, QUICK-RELEASE LEVERS, AUXILIARY WHEELS, TIRES, INNER TUBES AND PATCHES FOR RETREADING TIRES; SHOPPING CARTS; WHEEL CHAIRS (U.S. CLS. 19, 21, 23, 31, 35 AND 44).

CLASS 12—(Continued).

SN 76-475,419. BOZE ALLOYS, INC., FOUNTAIN VALLEY, CA. FILED 11-29-2002.



The logo for "BOZE" consists of the word in a bold, sans-serif font, enclosed within a thick, black, horizontally-oriented oval border.

FOR AUTOMOTIVE VEHICLE WHEELS AND RIMS (U.S. CLS. 19, 21, 23, 31, 35 AND 44).
FIRST USE 2-7-2001; IN COMMERCE 2-7-2001.

SN 76-470,436. HILSENBECK, PETE K., ARVADA, CO. FILED 11-25-2002.

REVOLUTIONIZING THE WAY YOU FLY

FOR AIRLINE SEAT PARACHUTES (U.S. CLS. 19, 21, 23, 31, 35 AND 44).

SN 76-471,307. HOPE TECHNOLOGY USA INC., CHERRY VALLEY, CA. FILED 11-22-2002.



The logo for "HOPE" features the word in a bold, sans-serif font, enclosed within a thick, black, horizontally-oriented oval border.

FOR BICYCLE PARTS, NAMELY, HUBS AND REPLACEMENT PARTS THEREFOR, SKEWERS, BRAKES AND REPLACEMENT PARTS THEREFOR, BOTTOM BRACKETS AND REPLACEMENT PARTS THEREFOR (U.S. CLS. 19, 21, 23, 31, 35 AND 44).
FIRST USE 5-1-1999; IN COMMERCE 5-1-1999.

SN 76-474,810. WESTINGHOUSE AIR BRAKE TECHNOLOGIES CORPORATION, WILMERDING, PA. FILED 11-29-2002.

FASTBRAKE

FOR RAILWAY LOCOMOTIVE BRAKE EQUIPMENT COMPRISING AIR VALVES AND ELECTRICAL CONTROLS (U.S. CLS. 19, 21, 23, 31, 35 AND 44).

SN 78-130,903. UNITED WHEEL CORPORATION, WHITTIER, CA. FILED 5-23-2002.

RAZOR ALLOYS

NO CLAIM IS MADE TO THE EXCLUSIVE RIGHT TO USE "ALLOYS", APART FROM THE MARK AS SHOWN.
FOR AUTOMOTIVE WHEELS AND WHEEL ACCESSORIES, NAMELY, LUG NUTS, VALVE STEMS, WHEEL LOCKS AND CENTER CAPS (U.S. CLS. 19, 21, 23, 31, 35 AND 44).
FIRST USE 7-1-2001; IN COMMERCE 7-1-2001.

SN 78-135,560. POLARIS INDUSTRIES INC., MEDINA, MN. FILED 6-13-2002.

POLARIS PROFESSIONAL SERIES

NO CLAIM IS MADE TO THE EXCLUSIVE RIGHT TO USE "PROFESSIONAL SERIES", APART FROM THE MARK AS SHOWN.
FOR OFF ROAD GENERAL PURPOSE UTILITY VEHICLES (U.S. CLS. 19, 21, 23, 31, 35 AND 44).
FIRST USE 1-31-2001; IN COMMERCE 1-31-2001.

SN 78-146,539. UNITED DYNETICS, LLC, GRAND BLANC, MI. BY ASSIGNMENT UNITED DYNETICS, INC., GRAND BLANC, MI. FILED 7-23-2002.

UNITED DYNETICS

FOR VEHICLES, NAMELY, CABS AND TRUCKS FOR MILITARY AND NON-MILITARY USE (U.S. CLS. 19, 21, 23, 31, 35 AND 44).

CLASS 12—(Continued).

SN 78-149,333. SPICER TECHNOLOGY, INC., FT. WAYNE, IN. FILED 7-31-2002.

HYDRA-LOK

FOR VEHICLE AXLE (U.S. CLS. 19, 21, 23, 31, 35 AND 44).

SN 78-153,373. KORHUMEL, INC., ELK GROVE VILLAGE, IL. FILED 8-12-2002.



NO CLAIM IS MADE TO THE EXCLUSIVE RIGHT TO USE THE GLOBE DESIGN, APART FROM THE MARK AS SHOWN.

THE STIPPLING IS FOR SHADING PURPOSES.
FOR FARM EQUIPMENT, NAMELY, RUNNING GEAR FOR WAGONS, WAGONS, WAGON BODIES AND GRAVITY BOXES AND BODIES FOR HAULING GRAIN ADAPTABLE FOR MOUNTING ON TRAILERS, RUNNING GEAR, TANDEM GEAR AND WAGONS (U.S. CLS. 19, 21, 23, 31, 35 AND 44).
FIRST USE 2-2-1978; IN COMMERCE 2-2-1978.

SN 78-153,594. L.V. INTERNATIONAL, INC., MIAMI, FL. FILED 8-13-2002.



THE LINING IS A FEATURE OF THE MARK AND DOES NOT INDICATE COLOR.
FOR TIRES (U.S. CLS. 19, 21, 23, 31, 35 AND 44).

SN 78-155,806. BRIDGESTONE CORPORATION, TOKYO, JAPAN, FILED 8-20-2002.

HP50

OWNER OF U.S. REG. NO. 1,759,145.
FOR TIRES (U.S. CLS. 19, 21, 23, 31, 35 AND 44).

CLASS 12—(Continued).

SN 78-160,261. HASTY, DOUGLAS S., IRVING, TX. FILED 9-3-2002.

GT500E

FOR AUTOMOBILES (U.S. CLS. 19, 21, 23, 31, 35 AND 44).
FIRST USE 8-1-2002; IN COMMERCE 8-1-2002.

SN 78-162,388. FIAT AUTO S.P.A., TORINO, ITALY, FILED 9-10-2002.

ALFA ROMEO

OWNER OF ITALY REG. NO. 792360, DATED 10-25-1999, RENEWED AS REG. NO. 507577, DATED 11-12-2002, EXPIRES 11-12-2012.

OWNER OF U.S. REG. NOS. 228,220, 1,278,461 AND OTHERS.

FOR MOTOR VEHICLES, NAMELY, AUTOMOBILES, AND STRUCTURAL PARTS THEREOF (U.S. CLS. 19, 21, 23, 31, 35 AND 44).

SN 78-175,310. FORD MOTOR COMPANY, DEARBORN, MI. FILED 10-17-2002.

MESSENGER

FOR MOTOR VEHICLES, NAMELY AUTOMOBILES, TRUCKS, VANS, SPORT-UTILITY VEHICLES, AND THEIR STRUCTURAL PARTS AND ENGINES (U.S. CLS. 19, 21, 23, 31, 35 AND 44).

SN 78-183,235. ONTV, INC., ROCHESTER, NY. FILED 11-8-2002.

TREADLE DON'T PEDAL

FOR FOOT-POWERED CONVEYANCE IN THE NATURE OF A SCOOTER (U.S. CLS. 19, 21, 23, 31, 35 AND 44).

FIRST USE 10-12-2002; IN COMMERCE 10-12-2002.

CLASS 12—(Continued).

SN 78-185,717. KING, KALVIN, TACOMA, WA. FILED 11-15-2002.

DINGMAT

FOR LAND VEHICLE AND BOAT PARTS AND ACCESSORIES, NAMELY, MUD GUARDS, SEAT CUSHIONS, BUMPERS AND FITTED LINERS FOR THE CARGO AREA OF VEHICLES; PROTECTIVE PADS FOR ATTACHMENT TO A VEHICLE, NAMELY, BUMPER GUARDS, BUMPER PADS, HOOD SHIELDS AND DOOR GUARDS; VEHICLE SUN VISORS; VEHICLE FOOD AND DRINK HOLDERS; VEHICLE LITTER BAGS, BASKETS AND HOLDERS; REMOVABLE VEHICLE STORAGE CONTAINERS (U.S. CLS. 19, 21, 23, 31, 35 AND 44).

SN 78-189,436. MICHELIN RECHERCHE ET TECHNIQUE S.A., 1763 GRANGES-PACCOT, SWITZERLAND, FILED 11-27-2002.

SNOWPRO

FOR PNEUMATIC TIRES AND INNER TUBES FOR VEHICLE WHEELS; TREADS FOR RETREADING TIRES. (U.S. CLS. 19, 21, 23, 31, 35 AND 44).

SN 78-191,354. ICE MARINE, HAMPTON ALDERSHOT, UNITED KINGDOM, FILED 12-5-2002.

BLADERUNNER

FOR RECREATIONAL BOATS, COMMERCIAL BOATS AND SHIPS AND PATROL BOATS (U.S. CLS. 19, 21, 23, 31, 35 AND 44).
FIRST USE 0-0-1996; IN COMMERCE 0-0-1997.

SN 78-195,273. GENERAL MOTORS CORPORATION, DETROIT, MI. FILED 12-17-2002.

UPLANDER

FOR MOTOR LAND VEHICLES, NAMELY, AUTOMOBILES, SPORT UTILITY VEHICLES, TRUCKS, VANS, ENGINES THEREFOR AND STRUCTURAL PARTS THEREOF. (U.S. CLS. 19, 21, 23, 31, 35 AND 44).

SN 78-196,843. MIDWEST MOTORCYCLE SUPPLY DISTRIBUTORS CORP., ARNOLD, MO. FILED 12-20-2002.

LETHAL WEAPON

FOR WHEELS FOR MOTORCYCLES (U.S. CLS. 19, 21, 23, 31, 35 AND 44).

CLASS 12—(Continued).

SN 78-196,846. MIDWEST MOTORCYCLE SUPPLY DISTRIBUTORS CORP., ARNOLD, MO. FILED 12-20-2002.

BAYONET II

FOR WHEELS FOR MOTORCYCLES (U.S. CLS. 19, 21, 23, 31, 35 AND 44).

SN 78-198,525. MORSE INDUSTRIES INC., KENT, WA. FILED 12-30-2002.

VIRGINRAIL

FOR RUBBER BUMPERS FOR MARINE VESSELS OF ALL TYPES (U.S. CLS. 19, 21, 23, 31, 35 AND 44).

CLASS 13—FIREARMS

SN 76-438,593. NEW COLT HOLDING CORPORATION, HARTFORD, CT. FILED 8-7-2002.

SINGLE ACTION ARMY

NO CLAIM IS MADE TO THE EXCLUSIVE RIGHT TO USE "SINGLE ACTION", APART FROM THE MARK AS SHOWN.

FOR REVOLVERS (U.S. CLS. 2 AND 9).
FIRST USE 0-0-1873; IN COMMERCE 0-0-1873.

CLASS 14—JEWELRY

SN 76-263,420. NANASI ENTERPRISES OF NEW JERSEY INC., HACKENSACK, NJ. FILED 5-25-2001.

DIAMOND SOLUTIONS

NO CLAIM IS MADE TO THE EXCLUSIVE RIGHT TO USE "DIAMOND," APART FROM THE MARK AS SHOWN, APART FROM THE MARK AS SHOWN.

FOR DIAMONDS, DIAMOND RINGS, DIAMOND EARRINGS, DIAMOND BRACELETS, AND DIAMOND PENDANTS (U.S. CLS. 2, 27, 28 AND 50).

FIRST USE 9-0-1996; IN COMMERCE 9-0-1996.

CLASS 14—(Continued).

SN 76-360,236. NUGAN, CHARLOTTE LEE, NORTH PALM BEACH, FL. FILED 1-18-2002.

LOVE FEAR

FOR JEWELRY, NAMELY, INDIVIDUALLY DESIGNED AND HAND-CRAFTED BRACELETS, EARRINGS, NECKLACES AND RINGS (U.S. CLS. 2, 27, 28 AND 50).

FIRST USE 10-15-2001; IN COMMERCE 11-21-2001.

SN 76-404,552. MOVADO LLC, WILMINGTON, DE. FILED 5-7-2002.

BRIGADOON

FOR WATCHES (U.S. CLS. 2, 27, 28 AND 50).

SN 76-461,367. TXDC, L.P., IRVING, TX. FILED 10-23-2002.

**CAPTURE THE BRILLIANCE
CAPTURE HER HEART**

FOR JEWELRY (U.S. CLS. 2, 27, 28 AND 50).

SN 76-467,709. KWIAT, INC., NEW YORK, NY. FILED 11-15-2002.



FOR DIAMONDS AND JEWELRY CONTAINING DIAMONDS (U.S. CLS. 2, 27, 28 AND 50).
FIRST USE 5-0-2001; IN COMMERCE 5-0-2001.

SN 76-470,443. SAHARA CLUB, LLC, NEW YORK, NY. FILED 11-25-2002.

**SAHARA CLUB THE ART OF
WEEKEND LIVING**

OWNER OF U.S. REG. NOS. 1,294,472, 1,717,118 AND 2,400,761.
FOR WATCHES, CLOCKS, JEWELRY (U.S. CLS. 2, 27, 28 AND 50).

CLASS 14—(Continued).

SN 76-474,216. ROMAN COMPANY, ST. LOUIS, MO. FILED 12-12-2002.

STELLA MOON

FOR STERLING SILVER JEWELRY (U.S. CLS. 2, 27, 28 AND 50).

SN 76-474,266. RITANI LLC, NEW YORK, NY. FILED 12-4-2002.

**PERFECT PROPORTIONS
MEAN ULTRA BRILLIANCE**

FOR DIAMONDS (U.S. CLS. 2, 27, 28 AND 50).

SN 76-475,407. RAINBOW GEM, INC., NEW YORK, NY. FILED 11-29-2002.

RBGI

FOR GOLD AND PLATINUM JEWELRY (U.S. CLS. 2, 27, 28 AND 50).
FIRST USE 11-1-2002; IN COMMERCE 11-1-2002.

SN 78-148,454. LORENZ S.P.A., MILAN, ITALY, FILED 7-29-2002.

FENS

FOR PRECIOUS METALS AND THEIR ALLOYS; JEWELRY, PRECIOUS STONES; HOROLOGICAL AND CHRONOMETRIC INSTRUMENTS, NAMELY, CHRONOMETERS, CHRONOGRAPHS, WATCHES, WRIST-WATCHES, POCKET-WATCHES, STOP-WATCHES, CLOCKS, TABLE CLOCKS, PENDULUM CLOCKS, WALL CLOCKS, AND ALARM CLOCKS (U.S. CLS. 2, 27, 28 AND 50).

SN 78-159,703. RUDA OVERSEAS INC, LONG ISLAND CITY, NY. FILED 8-30-2002.



FOR WALL CLOCKS AND DESK CLOCKS (U.S. CLS. 2, 27, 28 AND 50).
FIRST USE 7-13-1999; IN COMMERCE 4-1-2001.

CLASS 14—(Continued).

SN 78-189,404. QVC, INC., WEST CHESTER, PA. FILED 11-27-2002.

SUSPICION

FOR JEWELRY (U.S. CLS. 2, 27, 28 AND 50).

SN 78-190,464. BOEING MANAGEMENT COMPANY, SEAL BEACH, CA. FILED 12-2-2002.

F/A-18 SUPER HORNET

FOR CLOCKS AND WATCHES. (U.S. CLS. 2, 27, 28 AND 50).

SN 78-191,039. MCRAE'S, INC., BIRMINGHAM, AL. FILED 12-4-2002.

MISS ATTITUDE

FOR ANKLE BRACELETS; JEWELRY BRACELETS; CHARMS; JEWELRY CHAINS; EARRINGS; JEWELRY; COSTUME JEWELRY; LAPEL PINS; NECKLACES; PINS; RINGS BEING JEWELRY; WATCHES; WATCH STRAPS. (U.S. CLS. 2, 27, 28 AND 50).

SN 78-194,058. PREMIER BRANDS L.L.C., OAKLAND PARK, IL. FILED 12-12-2002.

FINE JEWELRY EXPRESS

NO CLAIM IS MADE TO THE EXCLUSIVE RIGHT TO USE "FINE JEWELRY", APART FROM THE MARK AS SHOWN.

FOR JEWELRY (U.S. CLS. 2, 27, 28 AND 50).

SN 78-200,129. KUKUWICH, WENDEE ELLEN, HONOLULU, HI. FILED 1-5-2003.

WENDEE ELLEN

FOR JEWELRY, NECKLACES AND EARRINGS (U.S. CLS. 2, 27, 28 AND 50).

CLASS 15—MUSICAL INSTRUMENTS

CLASS 15—(Continued).

SN 76-327,810. SAVAREZ, 69004 LYON, FRANCE, FILED 10-19-2001.

ARGENTINE

THE MARK CONSISTS, IN PART, OF THE STYLIZED DEPICTION OF A GAUCHO.
SEC. 2(F) AS TO "ARGENTINE".
FOR STRINGS FOR MUSICAL INSTRUMENTS (U.S. CLS. 2, 21 AND 36).
FIRST USE 11-24-1994; IN COMMERCE 11-24-1994.

SN 76-468,306. DEERING, JANET L., SPRING VALLEY, CA. FILED 11-12-2002.

COLE

FOR BANJOS, STRINGED INSTRUMENTS AND CARRYING CASES FOR MUSICAL INSTRUMENTS (U.S. CLS. 2, 21 AND 36).
FIRST USE 12-29-1998; IN COMMERCE 12-29-1998.

SN 76-471,138. YAMAHA CORPORATION, SHIZUOKA, JAPAN, FILED 11-19-2002.

ENTERTAINMENT STATION

FOR ELECTRONIC MUSICAL KEYBOARDS, PARTS THEREFOR (U.S. CLS. 2, 21 AND 36).

SN 76-471,296. YAMAHA CORPORATION, HAMAMATSU-SHI, SHIZUOKA, JAPAN, FILED 11-18-2002.

SILENT

OWNER OF U.S. REG. NOS. 2,091,883, 2,560,115 AND OTHERS.

FOR MUSICAL INSTRUMENTS, NAMELY, MUTES FOR BRASS MUSICAL INSTRUMENTS; ELECTRIC OR ELECTRONIC PERCUSSION OR DRUM SETS, DRUM TRIGGER MODULES, GENERALLY, DRUM MODULES AND PERCUSSION MODULES; ELECTRIC AND ELECTRONIC STRING INSTRUMENTS, NAMELY, VIOLINS, CELLOS, BASSES, VIOLAS, GUITARS, CONTROL UNITS AND SIGNAL PROCESSORS SOLD AS COMPONENT PARTS THEREFOR (U.S. CLS. 2, 21 AND 36).

FIRST USE 9-26-1995; IN COMMERCE 9-26-1995.

CLASS 15—(Continued).

SN 78-197,684. J. D'ADDARIO & CO., INC., FARMINGDALE, NY. FILED 12-24-2002.

THE SQUID

FOR ACCESSORIES FOR MUSICAL INSTRUMENTS, NAMELY, SHOULDER PAD FOR MUSICAL INSTRUMENT STRAP (U.S. CLS. 2, 21 AND 36).

CLASS 16—PAPER GOODS AND PRINTED MATTER

SN 75-776,044. FLOMO PLASTICS INDUSTRIAL CO., LTD, TAINAN, TAIWAN, FILED 8-13-1999.

Unlimited

OWNER OF TAIWAN REG. NO. 831172, DATED 12-16-1998, EXPIRES 12-15-2008.

OWNER OF U.S. REG. NO. 2,294,211.
FOR COLORING PAPER; WRAPPING PAPER; TISSUE PAPER; PAPER NAPKINS; PAPER TOWELS; PAPER HANDKERCHIEFS; STICKERS; GREETING CARDS; ENVELOPES; WRITING PAPER; LETTER SETS COMPRISED OF LETTER PADS AND ENVELOPES; BOOK MARKERS; SCRATCH PAPER; MEMO PADS; DAILY RECORD BOOKS; ORGANIZERS FOR STATIONERY USE; DRAWING BOOKS; PHOTO ALBUMS; BUSINESS CARD BOOKS; NOTEBOOKS; DIARIES; BOOK MARKER COLLECTING BOOKS; TELEPHONE BOOKS; ADDRESS BOOKS; PAPER BAGS; PAPER BOXES; PENCIL AND PEN HOLDERS; ADHESIVE TAPE FOR STATIONERY USE; GLUE FOR STATIONERY OR HOUSEHOLD USE; PEN HOLDERS; THUMB TACKS; SLIPCASES; BOOK CLIPS; FILE HOLDERS; FILE FOLDERS; LOOSE-LEAF FILES; PAPER STAPLERS; PAPER CLIPS; LAP AND/OR COUNTER READING STANDS; MEMO PAD HOLDERS; LETTER OPENERS; CORRECTING TAPE; STATIONERY CLIPS; FILE CLIPS; PAPER CLIP HOLDERS; ADHESIVE TAPE DISPENSERS FOR HOUSEHOLD OR STATIONERY USE; CORRECTING PENS; DESK TOP DOCUMENT STANDS; PENCIL SHARPENERS; PENCIL SHARPENING KNIVES; STATIONERY BOARD CLIPS; BUSINESS CARD CASES; STATIONERY BOXES; PENCILS; CRAYONS; PENCIL LEAD; PENS; COLORED PENS; FLUORESCENT MARKERS; MARKERS; BALL-POINT PENS; MECHANICAL PENCILS; PEN BOXES; PEN BAGS; INK PADS; WRITING MATS; ERASERS; WATERCOLOR CASES; WATERCOLOR PALETTES; PENCIL CASES; PLAYING CARDS; BINDERS; WRITE-ON MESSAGE BOARDS; CALENDARS; AUTOGRAPH BOOKS; STATIONERY SETS AND/OR STUDY KITS COMPRISED OF PENS, PENCILS, MEMO PADS, GLUE, DRAWING RULERS; ART AND CRAFT PAINT KITS COMPRISED OF COLORED PENCILS, WATER COLOR PAINTS, CRAYONS, BRUSHES, STENCILS, PALETTES; RUBBER STAMP SETS COMPRISED OF RUBBER STAMPS AND INK PADS; STICKER BOOKS; PAPER GIFT BAGS; NYLON BOOK STRAPS; ERASABLE MARKERS; STENCILS AND BOOK ENDS (U.S. CLS. 2, 5, 22, 23, 29, 37, 38 AND 50).

CLASS 16—(Continued).

SN 75-918,638. POTEAT, MICHELLE D., SUMTER, SC. FILED 2-14-2000.

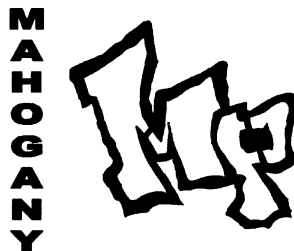
**PRODUCTIONS**

NO CLAIM IS MADE TO THE EXCLUSIVE RIGHT TO USE "PRODUCTIONS", APART FROM THE MARK AS SHOWN.

FOR SERIES OF BOOKS ABOUT LOVE, COOKING, FRATERNITIES/SORORITIES, AND BUSINESSES OWNED/OPERATED BY AFRICAN AMERICANS (U.S. CLS. 2, 5, 22, 23, 29, 37, 38 AND 50).

SN 76-000,596. DAVID B. CODLING AND JANET E. SMITH PARTNERSHIP, THE, DBA HOTEL COMPANION, COURTICE, ONTARIO, CANADA, FILED 3-15-2000.

HOTEL COMPANION

PRIORITY CLAIMED UNDER SEC. 44(D) ON CANADA APPLICATION NO. 1029477, FILED 9-20-1999, REG. NO. TMA574073, DATED 1-20-2003, EXPIRES 1-20-2018.

NO CLAIM IS MADE TO THE EXCLUSIVE RIGHT TO USE "HOTEL", APART FROM THE MARK AS SHOWN.

FOR PUBLICATIONS, NAMELY, LEAFLETS, FLYERS, BOOKLETS AND DIRECTORIES FEATURING INFORMATION AND ADVERTISING ON HOTELS, THE LOCATION AND SAFETY AND EMERGENCY FACILITIES WITHIN AND NEAR THOSE HOTELS, INFORMATION ABOUT SERVICES AVAILABLE TO GUESTS OF HOTELS (U.S. CLS. 2, 5, 22, 23, 29, 37, 38 AND 50).

SN 76-012,945. REALTIME DRAMA, INC., SAN RAMON, CA. BY CHANGE OF NAME MAIA ENTERTAINMENT, INC. SAN RAMON, CA. FILED 3-29-2000.

REALTIME DRAMA

FOR PRINTED MATERIALS, NAMELY, POSTCARDS, CALENDARS, COMIC BOOKS, BULLETINS, POSTERS, STATIONERY, PLAYING CARDS, BOOKMARKS, AND BLANK NOTEBOOKS; MAGAZINES BOOKS, PAMPHLETS, NEWSLETTERS, AND BROCHURES AND JOURNALS, FEATURING INFORMATION ABOUT ONLINE GAMES, VIRTUAL WORLDS, STORIES CREATED AND DEVELOPED ON-LINE IN VIRTUAL REALITY GAMES, AND FEATURING FICTIONAL AND/OR ANIMATED ACTION ADVENTURE, COMEDY, AND/OR DRAMA CHARACTERS, EVENTS, AND LOCATIONS (U.S. CLS. 2, 5, 22, 23, 29, 37, 38 AND 50).

CLASS 16—(Continued).

SN 76-168,816. DALLAS BASKETBALL LIMITED, DALLAS, TX. FILED 11-14-2000.



OWNER OF U.S. REG. NOS. 1,235,458, 1,537,463 AND 1,831,415.

FOR PUBLICATIONS AND PRINTED MATTER, NAMELY BASKETBALL TRADING CARDS, DANCE TEAM TRADING CARDS, MASCOT TRADING CARDS, ENTERTAINMENT TRADING CARDS, STICKERS, DECALS, COMMEMORATIVE BASKETBALL STAMPS, COLLECTIBLE CARDBOARD TRADING DISCS, MEMO PADS, BALL POINT PENS, PENCILS, PEN AND PAPER HOLDERS, STANDING BOARDS, SCRAP BOOKS, RUBBER STAMPS, PAPER BANNERS AND FLAGS, BOOKMARKS, 3-RING BINDERS, STATIONERY FOLDERS, WIREBOUND NOTEBOOKS, PORTFOLIO NOTEBOOKS, UNMOUNTED AND MOUNTED PHOTOGRAPHS, POSTERS, CALENDARS, BUMPER STICKERS, BOOK COVERS, WRAPPING PAPER, CHILDREN'S ACTIVITY BOOKS, STATISTICAL BOOKS, GUIDE BOOKS AND REFERENCE BOOKS FOR BASKETBALL, MAGAZINES IN THE FIELD OF BASKETBALL, MAGAZINES IN THE FIELD OF BASKETBALL, COMMEMORATIVE GAME PROGRAMS, PAPER PENNANTS, STATIONERY, STATIONERY-TYPE PORTFOLIOS, AND STATISTICAL SHEETS FOR BASKETBALL TOPICS, NEWSLETTERS AND PAMPHLETS IN THE FIELD OF BASKETBALL (U.S. CLS. 2, 5, 22, 23, 29, 37, 38 AND 50).

SN 76-181,653. EADS LAUNCH VEHICLES, 75116 PARIS, FRANCE, BY CHANGE OF NAME AEROSPATIALE MATRA LANCEURS STRATEGIQUES ET SPATIAUX, 75116 PARIS, FRANCE, FILED 12-15-2000.

SPATIUM

OWNER OF FRANCE REG. NO. 99817224, DATED 10-13-1999, EXPIRES 10-13-2009.

FOR MAGAZINES AND PERIODICALS IN THE FIELD OF AVIATION, AERONAUTICS AND SPACE (U.S. CLS. 2, 5, 22, 23, 29, 37, 38 AND 50).

CLASS 16—(Continued).

SN 76-250,159. BARCHARTS, INC., BOCA RATON, FL. FILED 5-2-2001.

KNOW IT NOW

FOR PRINTED REFERENCE AND TEACHING GUIDES IN THE NATURE OF CONDENSED FACT SHEETS IN THE AREAS OF BUSINESS, MEDICAL, HEALTH, COMPUTER, HOME, SPORTS, PUBLIC SPEAKING, PHOTOGRAPHY, AND ACADEMICS, NAMELY, MATH, SCIENCE, HISTORY, LITERATURE, ENGLISH GRAMMAR, LANGUAGE, GEOGRAPHY, GOVERNMENT, AND SOCIOLOGY, SPECIFICALLY EXCLUDING CURRENT EVENTS (U.S. CLS. 2, 5, 22, 23, 29, 37, 38 AND 50).

FIRST USE 2-9-2001; IN COMMERCE 3-14-2001.

SN 76-288,897. UNITED STATES CONFERENCE OF CATHOLIC BISHOPS, THE, WASHINGTON, DC. FILED 7-23-2001.

PARENT POWER

FOR PERIODICAL NEWSLETTER FOR SCHOOL-PARENT ASSOCIATIONS (U.S. CLS. 2, 5, 22, 23, 29, 37, 38 AND 50).

FIRST USE 0-0-1994; IN COMMERCE 0-0-1994.

SN 76-290,964. PANLINE USA, INC., NORTHVALE, NJ. FILED 7-27-2001.

SPLASH N SPARKLE

FOR PAINT KITS COMPRISED OF UMBRELLAS WITH PREPRINTED LINE ART PANELS, SCREEN PRINTED PONCHOS, WATERPROOF GLITTER PAINTS AND BRUSHES (U.S. CLS. 2, 5, 22, 23, 29, 37, 38 AND 50).

FIRST USE 2-13-1999; IN COMMERCE 2-13-1999.

SN 76-346,307. SANDERS, ERIC, BEVERLY HILLS, CA. FILED 12-7-2001.

Ballin' Magazine

NO CLAIM IS MADE TO THE EXCLUSIVE RIGHT TO USE MAGAZINE, APART FROM THE MARK AS SHOWN.

FOR PERIODICAL PUBLICATIONS, NAMELY, MAGAZINES, JOURNALS AND NEWSLETTERS IN THE FIELD OF AUTOMOBILES, FASHION TRENDS, LUXURY GOODS, CULTURE, GEOGRAPHY, TRAVEL AND COLLECTIBLES (U.S. CLS. 2, 5, 22, 23, 29, 37, 38 AND 50).

CLASS 16—(Continued).

SN 76-361,372. INTERNATIONAL FRANCHISE ASSOCIATION, WASHINGTON, DC. FILED 1-22-2002.

FRANCHISE OPPORTUNITIES GUIDE

OWNER OF U.S. REG. NO. 1,670,919.
NO CLAIM IS MADE TO THE EXCLUSIVE RIGHT TO USE "GUIDE", APART FROM THE MARK AS SHOWN.
SEC. 2(F) AS TO "FRANCHISE OPPORTUNITIES GUIDE".
FOR NEWSLETTERS, GUIDES AND HANDBOOKS IN THE FIELD OF BUSINESS OPPORTUNITIES AND FRANCHISING (U.S. CLS. 2, 5, 22, 23, 29, 37, 38 AND 50).
FIRST USE 10-24-1990; IN COMMERCE 10-24-1990.

SN 76-362,239. O'DELL, ROBERT, JR., SEEKONK, MA. FILED 1-24-2002.

PAINTING ART BY MUSIC NOTATION

NO CLAIM IS MADE TO THE EXCLUSIVE RIGHT TO USE "PAINTING ART", APART FROM THE MARK AS SHOWN.
FOR COLORING BOOKS, PAINTING SETS AND ARTS AND CRAFT PAINT KITS (U.S. CLS. 2, 5, 22, 23, 29, 37, 38 AND 50).

SN 76-362,540. O'DELL, ROBERT, JR., SEEKONK, MA. FILED 1-24-2002.

COLORED PENCIL ART BY MUSIC NOTATION

NO CLAIM IS MADE TO THE EXCLUSIVE RIGHT TO USE "COLORED PENCIL ART", APART FROM THE MARK AS SHOWN.
FOR COLORING BOOKS AND COLORING KITS CONSISTING PRIMARILY OF PENS, PENCILS, MARKERS AND CRAYONS (U.S. CLS. 2, 5, 22, 23, 29, 37, 38 AND 50).

SN 76-366,624. PUTMAN MEDIA, INC., ITASCA, IL. FILED 2-4-2002.

SOLUTIONS FOR THE PROCESS INDUSTRIES

NO CLAIM IS MADE TO THE EXCLUSIVE RIGHT TO USE "PROCESS INDUSTRIES", APART FROM THE MARK AS SHOWN.
FOR MAGAZINE PUBLICATION PROVIDING INFORMATION ABOUT THE LATEST EQUIPMENT AND TECHNOLOGY IN THE CHEMICAL, FOOD, AND PHARMACEUTICAL INDUSTRIES (U.S. CLS. 2, 5, 22, 23, 29, 37, 38 AND 50).
FIRST USE 6-1-2001; IN COMMERCE 6-1-2001.

CLASS 16—(Continued).

SN 76-370,167. MAXSON CORPORATION, ELK GROVE VILLAGE, IL. FILED 2-11-2002.



NO CLAIM IS MADE TO THE EXCLUSIVE RIGHT TO USE "CORPORATION", APART FROM THE MARK AS SHOWN.
THE LINING IS A FEATURE OF THE MARK AND DOES NOT INDICATE COLOR.
FOR PLASTIC PACKAGING PRODUCTS, NAMELY, PLASTIC FILM, PLASTIC SLEEVES, AND PLASTIC TUBING FOR INDUSTRIAL AND COMMERCIAL PACKAGING USE (U.S. CLS. 2, 5, 22, 23, 29, 37, 38 AND 50).
FIRST USE 1-1-2000; IN COMMERCE 1-1-2000.

SN 76-370,250. PAXSON COMMUNICATIONS CORPORATION, WEST PALM BEACH, FL. FILED 2-13-2002.

PAX

OWNER OF U.S. REG. NOS. 2,365,862, 2,388,419 AND 2,466,354.
FOR PAPER GOODS AND PRINTED MATERIALS, NAMELY GIFT BAGS, STATIONERY WRITING PAPER, ENVELOPES, DESK CALENDARS, WALL CALENDARS, AND GREETING CARDS (U.S. CLS. 2, 5, 22, 23, 29, 37, 38 AND 50).
FIRST USE 6-7-1999; IN COMMERCE 6-7-1999.

SN 76-390,905. LADY NOAH LTD., ALLEN PARK, MI. FILED 4-1-2002.

PREDICT ME

FOR CARDS BASED ON ANIMAL IMAGES THROUGH WHICH PSYCHIC IMPRESSIONS AND FORTUNETELLING ARE INTERPRETED FOR ENTERTAINMENT (U.S. CLS. 2, 5, 22, 23, 29, 37, 38 AND 50).
FIRST USE 3-1-2001; IN COMMERCE 3-1-2001.

SN 76-399,177. CROSSGENERATION COMICS, INC., OLDSMAR, FL. FILED 4-12-2002.

SOLUS

FOR PRINTED MATERIALS AND PUBLICATIONS, NAMELY COMIC BOOKS AND COMIC MAGAZINES (U.S. CLS. 2, 5, 22, 23, 29, 37, 38 AND 50).
FIRST USE 8-1-2002; IN COMMERCE 3-0-2003.

CLASS 16—(Continued).

SN 76-402,093. BOOKS FOR A CAUSE, INC., WEST CHESTER, PA. FILED 5-1-2002.



Larkin's Little Readers

NO CLAIM IS MADE TO THE EXCLUSIVE RIGHT TO USE "READERS", APART FROM THE MARK AS SHOWN. FOR CHILDREN'S BOOKS (U.S. CLS. 2, 5, 22, 23, 29, 37, 38 AND 50).
FIRST USE 9-10-2001; IN COMMERCE 9-10-2001.

SN 76-403,973. NLP IP COMPANY, NEWARK, DE. FILED 5-3-2002.

HEALTH CARE FRAUD & ABUSE NEWSLETTER

NO CLAIM IS MADE TO THE EXCLUSIVE RIGHT TO USE "NEWSLETTER", APART FROM THE MARK AS SHOWN.
SEC. 2(F).
FOR LEGAL NEWSLETTERS (U.S. CLS. 2, 5, 22, 23, 29, 37, 38 AND 50).
FIRST USE 2-0-1998; IN COMMERCE 2-0-1998.

SN 76-405,935. JACKSON, LISA M., JACKSON, WY. FILED 5-10-2002.

SIMPLE DETAILS

FOR PHOTOGRAPHS AND GREETING CARDS (U.S. CLS. 2, 5, 22, 23, 29, 37, 38 AND 50).
FIRST USE 8-0-1999; IN COMMERCE 6-0-2002.

SN 76-407,038. HUBBARD MEDIA GROUP, LLC, ST. PAUL, MN. FILED 5-10-2002.

MOVIEWATCH TELEVISION

NO CLAIM IS MADE TO THE EXCLUSIVE RIGHT TO USE "TELEVISION", APART FROM THE MARK AS SHOWN.
FOR PERIODICAL PUBLICATIONS, NAMELY, MAGAZINES AND NEWSLETTERS IN THE FIELDS OF MOTION PICTURES AND THE MOTION PICTURE INDUSTRY (U.S. CLS. 2, 5, 22, 23, 29, 37, 38 AND 50).

CLASS 16—(Continued).

SN 76-407,040. HUBBARD MEDIA GROUP, LLC, ST. PAUL, MN. FILED 5-10-2002.

MOVIEWATCH TV

NO CLAIM IS MADE TO THE EXCLUSIVE RIGHT TO USE "TV", APART FROM THE MARK AS SHOWN.
FOR PERIODICAL PUBLICATIONS, NAMELY MAGAZINES AND NEWSLETTERS IN THE FIELDS OF MOTION PICTURES AND THE MOTION PICTURE INDUSTRY (U.S. CLS. 2, 5, 22, 23, 29, 37, 38 AND 50).

SN 76-408,736. STORA ENSO NORTH AMERICA CORP., WISCONSIN RAPIDS, WI. FILED 5-15-2002.



FOR EDUCATIONAL PERIODIC PUBLICATION, NAMELY A BOOKLET PUBLISHED THREE TIMES A YEAR, WHICH RELATES TO PRINTING TECHNOLOGY (U.S. CLS. 2, 5, 22, 23, 29, 37, 38 AND 50).
FIRST USE 3-20-2002; IN COMMERCE 3-20-2002.

SN 76-413,595. SMITH, ELIZABETH A., HOUSTON, TX. FILED 5-24-2002.

COMMUNITY OF COMPETENCE

FOR BOOKS IN THE FIELD OF PATIENT SAFETY QUALITY MANAGEMENT SOLUTIONS AND COST CONTAINMENT SOLUTIONS FOR HEALTH CARE PROVIDERS (U.S. CLS. 2, 5, 22, 23, 29, 37, 38 AND 50).

SN 76-417,032. BREWZER ENTERPRIZES, INC., NAVARRE, FL. FILED 6-4-2002.

THUMBWEAR

FOR PRINTED PAPER PRODUCTS - NAMELY, GREETING CARDS AND STATIONARY (U.S. CLS. 2, 5, 22, 23, 29, 37, 38 AND 50).
FIRST USE 10-30-2000; IN COMMERCE 10-30-2000.

CLASS 16—(Continued).

SN 76-420,095. SAN DIEGO CONVENTION & TOURIST BUREAU, DBA SAN DIEGO CONVENTION AND VISITORS BUREAU, SAN DIEGO, CA. FILED 6-13-2002.



CONVENTION &
VISITORS BUREAU

OWNER OF U.S. REG. NOS. 2,256,955 AND 2,348,568.
SEC. 2(F).

FOR PRINTED MATERIALS FOR TOURISM, NAMELY, BROCHURES, PAMPHLETS, POSTERS, MAPS, PAPER LABELS AND DECALS TO PROMOTE CONVENTION AND VISITOR ACTIVITIES FOR THE COMMUNITY AND GENERALLY DISTRIBUTED TO THE PUBLIC AT NO CHARGE (U.S. CLS. 2, 5, 22, 23, 29, 37, 38 AND 50).

FIRST USE 11-0-1996; IN COMMERCE 11-0-1996.

SN 76-421,380. IRVINE COMPANY, THE, NEWPORT BEACH, CA. FILED 6-14-2002.

**IRVINE RANCH LAND
RESERVE**

OWNER OF U.S. REG. NOS. 2,377,289 AND 2,432,996.
SEC. 2(F).

FOR TRAIL MAPS; INFORMATIONAL AND EDUCATIONAL NEWSLETTERS CONCERNING ACTIVITIES AND EVENTS; AND CONSERVATION TOPICS (U.S. CLS. 2, 5, 22, 23, 29, 37, 38 AND 50).

FIRST USE 11-28-2001; IN COMMERCE 11-28-2001.

SN 76-421,381. IRVINE COMPANY, THE, NEWPORT BEACH, CA. FILED 6-14-2002.



**IRVINE RANCH
LAND RESERVE**

OWNER OF U.S. REG. NO. 2,377,289.

NO CLAIM IS MADE TO THE EXCLUSIVE RIGHT TO USE "RANCH" OR "LAND RESERVE", APART FROM THE MARK AS SHOWN.

FOR TRAIL MAPS; INFORMATIONAL AND EDUCATIONAL NEWSLETTERS CONCERNING ACTIVITIES AND EVENTS; AND CONSERVATION TOPICS (U.S. CLS. 2, 5, 22, 23, 29, 37, 38 AND 50).

FIRST USE 11-28-2001; IN COMMERCE 11-28-2001.

CLASS 16—(Continued).

SN 76-421,393. SAKURA COLOR PRODUCTS OF AMERICA, INC., HAYWARD, CA. FILED 6-14-2002.

GEL-RACER

OWNER OF U.S. REG. NOS. 1,692,910, 2,497,750 AND OTHERS.

FOR WRITING INSTRUMENTS, NAMELY, PENCILS, BALL-POINT PENS, FOUNTAIN PENS, MARKERS, ROLLER BALL PENS, HIGHLIGHTING MARKERS AND PENS, DRAFTING PENS, CALLIGRAPHY PENS, ALL PACKAGED INDIVIDUALLY AND IN SETS, DRAWING MATERIALS, NAMELY, CRAYONS, PASTELS, DRAFTING INKS, ALL PACKAGED INDIVIDUALLY AND IN SETS, ERASABLE INKS (U.S. CLS. 2, 5, 22, 23, 29, 37, 38 AND 50).

SN 76-422,378. CRUISIN' STYLE MAGAZINE, INC., PALMETTO, FL. FILED 6-19-2002.

CRUISIN' TEXAS STYLE

OWNER OF U.S. REG. NO. 2,255,232.

NO CLAIM IS MADE TO THE EXCLUSIVE RIGHT TO USE "TEXAS", APART FROM THE MARK AS SHOWN.

FOR MAGAZINE IN THE FIELD OF CUSTOM CARS, HOTRODS, CLASSICS, AUTOMOTIVE NEWS, AUTOMOTIVE EVENTS AND CAR SHOWS (U.S. CLS. 2, 5, 22, 23, 29, 37, 38 AND 50).

FIRST USE 5-31-2000; IN COMMERCE 5-31-2000.

SN 76-422,875. MANU COMM ENTERPRISES, PITTSBURGH, PA. FILED 6-19-2002.

**COACHES' CHOICE
FUNDRAISING CARD**

NO CLAIM IS MADE TO THE EXCLUSIVE RIGHT TO USE "FUNDRAISING CARD", APART FROM THE MARK AS SHOWN.

FOR NON-MAGNETICALLY CODED RIGID CARDS WITH ADVERTISING AND COUPONS FOR MERCHANTS AND RESTAURANTS AND INFORMATION ABOUT FUNDRAISING ORGANIZATIONS (U.S. CLS. 2, 5, 22, 23, 29, 37, 38 AND 50).

CLASS 16—(Continued).

SN 76-423,337. ALLO SYSTEMS GMBH, D-35390 GIESSEN, FED REP GERMANY, FILED 6-19-2002.



PRIORITY CLAIMED UNDER SEC. 44(D) ON FED REP GERMANY APPLICATION NO. 30225578.8, FILED 5-22-2002, REG. NO. 30225578, DATED 12-12-2002, EXPIRES 5-31-2012.

NO CLAIM IS MADE TO THE EXCLUSIVE RIGHT TO USE "JOURNAL", APART FROM THE MARK AS SHOWN. THE ENGLISH TRANSLATION OF "BG-BESPLATNAJA GASETA" IS "GRATIS JOURNAL".

FOR NEWSPAPERS, MAGAZINES AND BOOKS IN THE FIELD OF CURRENT EVENTS, NEWS AND TOPICS OF GENERAL INTEREST; BOOKBINDINGS; BOOKBINDING TAPE; BOOKBINDING WIRE (U.S. CLS. 2, 5, 22, 23, 29, 37, 38 AND 50).

SN 76-426,100. INTERMUNE, INC., BRISBANE, CA. FILED 6-28-2002.



THE MARK CONSISTS OF IRREGULARLY SHAPED GEOMETRIC FIGURES AROUND A LOOP.

FOR PRINTED MATTER AND EDUCATIONAL MATERIALS RELATING TO PHARMACEUTICALS, NAMELY BOOKLETS, BOOKS, PAMPHLETS, AND BROCHURES (U.S. CLS. 2, 5, 22, 23, 29, 37, 38 AND 50).

CLASS 16—(Continued).

SN 76-435,022. WAXMAN CONSUMER PRODUCTS GROUP INC., BEDFORD HEIGHTS, OH. FILED 7-26-2002.

EZ MOUNT

NO CLAIM IS MADE TO THE EXCLUSIVE RIGHT TO USE "MOUNT", APART FROM THE MARK AS SHOWN.

FOR ADHESIVE FABRIC WITH A DRY ERASE WRITING SURFACE FOR MOUNTING ON A SURFACE FOR HOUSEHOLD, EDUCATIONAL AND OFFICE USE; DOUBLE-SIDED ADHESIVE FABRIC FOR HANGING PICTURES, PAPER AND OTHER OBJECTS, NAMELY, PHOTOS, GREETING CARDS, BUSINESS CARDS, PAPER DECORATIONS, AND PAPER NOTES, TO A SURFACE FOR HOUSEHOLD, EDUCATIONAL AND OFFICE USE; DOUBLE-SIDED ADHESIVE FABRIC CUT INTO DECORATIVE SHAPES, FOR ADHERING TO A SURFACE, ON WHICH PICTURE, PAPER, AND OTHER OBJECTS, NAMELY, PHOTOS, GREETING CARDS, BUSINESS CARDS, PAPER DECORATIONS, AND PAPER NOTES, MAY BE MOUNTED FOR HOUSEHOLD, EDUCATIONAL AND OFFICE USE (U.S. CLS. 2, 5, 22, 23, 29, 37, 38 AND 50).

SN 76-438,802. TURNER ENTERTAINMENT CO., BURBANK, CA. BY MERGER TURNER ENTERTAINMENT CO., BURBANK, CA. FILED 8-7-2002.



THE NAMES THAT COMPOSE THE MARK ARE NOT THE NAMES OF LIVING INDIVIDUALS.

FOR PRINTED MATTER AND PAPER GOODS—NAMELY, BOOKS FEATURING CHARACTERS FROM ANIMATED, ACTION ADVENTURE, COMEDY AND/OR DRAMA FEATURES, COMIC BOOKS, CHILDREN'S BOOKS, MAGAZINES FEATURING CHARACTERS FROM ANIMATED, ACTION ADVENTURE, COMEDY AND/OR DRAMA FEATURES, COLORING BOOKS, CHILDREN'S ACTIVITY BOOKS; STATIONERY, WRITING PAPER, ENVELOPES, NOTEBOOKS, DIARIES, NOTE CARDS, GREETING CARDS, BANK CHECKS, TRADING CARDS; LITHOGRAPHS; PENS, PENCILS, CASES THEREFOR, ERASERS, CRAYONS, MARKERS, COLORED PENCILS, PAINTING SETS, CHALK AND CHALKBOARDS; DECALS, SELF-STICKING LABELS, HEAT TRANSFERS; POSTERS; MOUNTED AND/OR UNMOUNTED PHOTOGRAPHS; BOOK COVERS, BOOK MARKS, CALENDARS, GIFT WRAPPING PAPER; PAPER PARTY FAVORS AND PAPER PARTY DECORATIONS—NAMELY, PAPER NAPKINS, PAPER DOILIES, PAPER PLACE MATS, CREPE PAPER, PAPER HATS, INVITATIONS, PAPER TABLE CLOTHS, PAPER CAKE DECORATIONS; PRINTED DECALS FOR EMBROIDERY AND FABRIC APPLIQUES; PRINTED PATTERNS FOR COSTUMES, PAJAMAS, SWEATSHIRTS AND T-SHIRTS (U.S. CLS. 2, 5, 22, 23, 29, 37, 38 AND 50).

FIRST USE 12-30-1995; IN COMMERCE 12-30-1995.

CLASS 16—(Continued).

SN 76-440,514. HANLEY-WOOD, LLC, WASHINGTON, DC. FILED 8-14-2002.

SYSTEMS BUILDER

FOR PUBLICATIONS, NAMELY PERIODIC MAGAZINES IN THE FIELD OF CONSTRUCTION (U.S. CLS. 2, 5, 22, 23, 29, 37, 38 AND 50).

SN 76-443,923. JACKSON, HAL, NEW YORK, NY. FILED 8-21-2002.

THE HOUSE THAT JACK BUILT

FOR SERIES OF NON-FICTION BOOKS IN THE FIELD OF HISTORY AND ENTERTAINMENT FEATURING THE HISTORY OF RADIO PROGRAMMING AND THE RADIO ENTERTAINMENT INDUSTRY (U.S. CLS. 2, 5, 22, 23, 29, 37, 38 AND 50).

SN 76-445,692. CAPTAIN SEGULL'S NAUTICAL CHARTS INC., PORTSMOUTH, RI. FILED 8-30-2002.



**Captain Segull's
Sportfishing Chart**

NO CLAIM IS MADE TO THE EXCLUSIVE RIGHT TO USE "SPORTFISHING CHART", APART FROM THE MARK AS SHOWN.

FOR SPORTS FISHING MAPS AND CHARTS, NAMELY, MAPS AND MARINE NAVIGATION CHARTS CONTAINING INFORMATION OF INTEREST TO THE SPORTS FISHING INDUSTRY (U.S. CLS. 2, 5, 22, 23, 29, 37, 38 AND 50).

FIRST USE 0-0-1985; IN COMMERCE 0-0-1985.

SN 76-449,285. SULLIVAN, NANCY Z., ROCHESTER, NH. FILED 9-13-2002.

NANCY ZIESKE

OWNER OF U.S. REG. NOS. 2,424,974 AND 2,426,662. THE NAME COMPOSING THE MARK IS ANOTHER NAME UNDER WHICH THE APPLICANT DOES BUSINESS. FOR ORIGINAL ARTWORK PAINTINGS (U.S. CLS. 2, 5, 22, 23, 29, 37, 38 AND 50).

FIRST USE 7-1-1998; IN COMMERCE 7-14-1998.

CLASS 16—(Continued).

SN 76-449,816. CABIN CREEK, LTD., PLEASANT GROVE, UT. FILED 9-12-2002.

**TOUCHING HEARTS,
CHANGING LIVES**

FOR MAGAZINES, CATALOGS, AND IDEA BOOKS RELATING TO SCRAPBOOKS, JOURNALS, RUBBER STAMPS, GREETING CARDS, AND ARTS AND CRAFTS, AND TO COMPONENTS, TECHNIQUES, AND METHODOLOGY FOR ASSEMBLING, CREATING, OR USING THE SAME (U.S. CLS. 2, 5, 22, 23, 29, 37, 38 AND 50).

FIRST USE 6-0-2000; IN COMMERCE 6-0-2000.

SN 76-452,384. LOCKERMATE CORPORATION, MINNEAPOLIS, MN. FILED 9-23-2002.

ROOMMATE

FOR HOLDERS FOR PAPER AND OFFICE SUPPLIES, NAMELY, LETTERS, PENS, PENCILS, PAPER CLIPS, POSTAGE STAMPS, SCISSORS, LETTER OPENERS, PICTURES, PAPER NOTES, PAPER, POST CARDS, GLUE STICKS, AND ADHESIVE TAPE (U.S. CLS. 2, 5, 22, 23, 29, 37, 38 AND 50).

SN 76-456,067. GUIDRY ASSOCIATES, INC., WINCHESTER, VA. FILED 10-4-2002.

WHO'S WHO IN SPORTS

OWNER OF U.S. REG. NOS. 1,676,428 AND 1,687,391. NO CLAIM IS MADE TO THE EXCLUSIVE RIGHT TO USE "WHO'S WHO", APART FROM THE MARK AS SHOWN.

SEC. 2(F).

FOR PRINTED MATTER, NAMELY BIOGRAPHICAL DIRECTORY BOOKS ON ATHLETES AND AWARD CERTIFICATES OF ACHIEVEMENT (U.S. CLS. 2, 5, 22, 23, 29, 37, 38 AND 50).

FIRST USE 1-17-1990; IN COMMERCE 1-17-1990.

SN 76-457,071. BB QUILTWORKS, LLC, BUFFALO GROVE, IL. BY ASSIGNMENT BB QUILTWORKS, BUFFALO GROVE, IL. FILED 10-7-2002.

BB QUILTWORKS

NO CLAIM IS MADE TO THE EXCLUSIVE RIGHT TO USE "QUILTWORKS", APART FROM THE MARK AS SHOWN.

FOR QUILT PATTERNS (U.S. CLS. 2, 5, 22, 23, 29, 37, 38 AND 50).

CLASS 16—(Continued).

SN 76-461,985. VEENTUREONE CORPORATION, SAN FRANCISCO, CA. FILED 10-28-2002.

THE VENTURE CAPITAL ANALYST

NO CLAIM IS MADE TO THE EXCLUSIVE RIGHT TO USE "VENTURE CAPITAL", APART FROM THE MARK AS SHOWN.

FOR NEWSPAPERS, MAGAZINES, JOURNALS, BROCHURES, DIRECTORIES AND NEWSLETTERS PROVIDING FINANCIAL AND INVESTMENT INFORMATION IN THE FIELDS OF TECHNOLOGY AND HEALTH CARE (U.S. CLS. 2, 5, 22, 23, 29, 37, 38 AND 50).

FIRST USE 3-1-2002; IN COMMERCE 3-1-2002.

SN 76-462,574. TIME WARNER ENTERTAINMENT COMPANY, L.P., NEW YORK, NY. FILED 10-28-2002.



OWNER OF U.S. REG. NOS. 2,434,173, 2,550,436 AND OTHERS.

NO CLAIM IS MADE TO THE EXCLUSIVE RIGHT TO USE "RESTAURANT" AND "LAS VEGAS", APART FROM THE MARK AS SHOWN.

FOR PRINTED MATTER AND PAPER GOODS—NAMESLY, BOOKS FEATURING CHARACTERS FROM ANIMATED, ACTION ADVENTURE, COMEDY AND/OR DRAMA FEATURES, COMIC BOOKS, CHILDREN'S BOOKS, MAGAZINES FEATURING CHARACTERS FROM ANIMATED, ACTION ADVENTURE, COMEDY AND/OR DRAMA FEATURES, COLORING BOOKS, CHILDREN'S ACTIVITY BOOKS; STATIONERY, WRITING PAPER, ENVELOPES, NOTEBOOKS, DIARIES, NOTE CARDS, GREETING CARDS, TRADING CARDS; LITHOGRAPHS; PENS, PENCILS, CASES THEREFOR, ERASERS, CRAYONS, MARKERS, COLORED PENCILS, PAINTING SETS, CHALK AND CHALKBOARDS; DECALS, HEAT TRANSFERS; POSTERS; MOUNTED AND/OR UNMOUNTED PHOTOGRAPHS; BOOK COVERS, BOOK MARKS, CALENDARS, GIFT WRAPPING PAPER; PAPER PARTY FAVORS AND PAPER PARTY DECORATIONS—NAMESLY, PAPER NAPKINS, PAPER DOILIES, PAPER PLACE MATS, CREPE PAPER, PAPER HATS, INVITATIONS, PAPER TABLE CLOTHS, PAPER CAKE DECORATIONS; PRINTED TRANSFERS FOR EMBROIDERY OR FABRIC APPLIQUES; PRINTED PATTERNS FOR COSTUMES, PAJAMAS, SWEATSHIRTS AND T-SHIRTS (U.S. CLS. 2, 5, 22, 23, 29, 37, 38 AND 50).

FIRST USE 2-5-2000; IN COMMERCE 2-5-2000.

CLASS 16—(Continued).

SN 76-465,253. HODGES BADGE COMPANY, INC., PORTSMOUTH, RI. FILED 11-7-2002.

HORSE SHOW IN A BOX

FOR HORSE SHOW KITS FOR CONDUCTING HORSE SHOWS COMPRISED OF PADS, BLANK PRESS RELEASES, BLANK WINNERS RESULTS FORMS, POSTERS, TAPE ROLLS, PENS, MARKERS, PUSH PINS, CLIPBOARDS, POSTERBOARDS, RIBBONS, AWARDS, MEDALS, TRAYS, PRIZES, RIDERS' NUMBERS, STRINGS, IDENTIFICATION BUTTONS, AND INSTRUCTION MANUALS SOLD THEREWITH (U.S. CLS. 2, 5, 22, 23, 29, 37, 38 AND 50).

SN 76-467,638. LGE PERFORMANCE SYSTEMS, INC., ORLANDO, FL. FILED 11-18-2002.

FULL ENGAGEMENT

FOR PUBLICATIONS, NAMESLY, SERIES OF BOOKS, BOOKLETS, WORKBOOKS, AND MANUALS; PAPER AND PLASTIC OVERHEAD TRANSPARENCIES; CHARTS, TABLES; HANDOUTS, NAMESLY, INSTRUCTION AND INFORMATION SHEETS; AND PAMPHLETS, ALL IN THE FIELDS OF IMPROVING PERSONAL AND BUSINESS SKILLS, ABILITIES AND PERFORMANCE (U.S. CLS. 2, 5, 22, 23, 29, 37, 38 AND 50).

SN 76-468,102. PLEASANT COMPANY, MIDDLETON, WI. FILED 11-19-2002.



FOR STATIONERY SETS, CONTAINING KEEPSAKE BOX, STATIONERY, ENVELOPES, STICKERS, RUBBER STAMPS, INK PAD, STENCILS, ERASERS, PENCIL SHARPENER, PENCILS, PAPER CLIPS; BIRTHDAY PARTY KITS, CONTAINING PRINTED INVITATIONS AND THANK YOU CARDS, PRINTED PAPER PARTY GUIDE, PHOTO ALBUM, PAPER DECORATIONS, EG, CAKE DECORATIONS, TISSUE PAPER, PLACE CARDS, WALL DECORATIONS AND GAMES, CREPE PAPER STREAMERS, AND CONFETTI; PARTY FAVOR BAGS, RUBBER STAMPS AND STAMP PADS, CRAFT BOOK; AND STICKERS (U.S. CLS. 2, 5, 22, 23, 29, 37, 38 AND 50).

FIRST USE 9-29-2002; IN COMMERCE 9-29-2002.

CLASS 16—(Continued).

SN 76-470,377. BIRTH TO THREE, EUGENE, OR. FILED 11-29-2002.

WORDS TO LOVE BY

FOR DECK OF 52 CARDS AND 4 ADDITIONAL CARDS, BROKEN INTO 4 SUITS AND CONTAINING PARENTING AFFIRMATIONS AND INSIGHTFUL QUOTES USED FOR ENCOURAGEMENT, BUT NOT AS PLAYING CARDS (U.S. CLS. 2, 5, 22, 23, 29, 37, 38 AND 50).

SN 76-470,914. ABBOTT, MARK WENTWORTH, LYNDHURST, NJ. FILED 11-25-2002.

I'M ON A JOY-RIDE WITH JESUS!!! BECAUSE HE STOLE THE DEVIL'S KEYS!!!

FOR BUMPER STICKERS (U.S. CLS. 2, 5, 22, 23, 29, 37, 38 AND 50).

SN 76-470,915. ABBOTT, MARK WENTWORTH, LYNDHURST, NJ. FILED 11-25-2002.

JESUS AND JERSEY PERFECT TOGETHER!

FOR BUMPER STICKERS (U.S. CLS. 2, 5, 22, 23, 29, 37, 38 AND 50).

SN 76-471,391. AMERICAN CITY BUSINESS JOURNALS, INC., CHARLOTTE, NC. FILED 11-18-2002.

TRIANGLE BUSINESS JOURNAL

OWNER OF U.S. REG. NO. 2,365,448.
NO CLAIM IS MADE TO THE EXCLUSIVE RIGHT TO USE "BUSINESS JOURNAL", APART FROM THE MARK AS SHOWN.

FOR NEWSPAPERS AND MAGAZINES IN THE FIELD OF BUSINESS (U.S. CLS. 2, 5, 22, 23, 29, 37, 38 AND 50).

CLASS 16—(Continued).

SN 76-471,423. LGE PERFORMANCE SYSTEMS, INC., ORLANDO, FL. FILED 11-18-2002.

THE POWER OF FULL ENGAGEMENT

FOR PUBLICATIONS, NAMELY, BOOKS, BOOKLETS, WORKBOOKS, MANUALS, OVERHEADS, CHARTS, TABLES, HANDOUTS AND PAMPHLETS, ALL IN THE FIELDS OF IMPROVING PERSONAL AND BUSINESS SKILLS, ABILITIES AND PERFORMANCE (U.S. CLS. 2, 5, 22, 23, 29, 37, 38 AND 50).

FIRST USE 6-0-2002; IN COMMERCE 6-0-2002.

SN 76-474,151. STECK-VAUGHN COMPANY, AUSTIN, TX. FILED 12-10-2002.

STRENGTH IN NUMBERS

FOR PRINTED MATERIALS, NAMELY, A SERIES OF EDUCATIONAL BOOKS, STUDY GUIDES, WORKSHEETS AND TEACHING MANUALS FOR ELEMENTARY AND SECONDARY STUDENTS IN THE FIELD OF MATHEMATICS (U.S. CLS. 2, 5, 22, 23, 29, 37, 38 AND 50).

FIRST USE 7-0-2002; IN COMMERCE 7-0-2002.

SN 76-476,056. LIEBERMAN, ANNETTE R., NEW YORK, NY. FILED 12-17-2002.

VISUAL KOANS

FOR PHOTOGRAPHS USED FOR STATIONERY GOODS INCLUDING GREETING CARDS, NOTE CARDS, CALENDARS, APPOINTMENT BOOKS, POSTERS (U.S. CLS. 2, 5, 22, 23, 29, 37, 38 AND 50).

SN 76-477,179. VILLAGE R.V., INC., ROSEVILLE, CA. FILED 12-20-2002.

LIVE BIG

FOR PRINTED MATERIAL, NAMELY A NEWSLETTER CONCERNING TRAVEL, RVS AND RV MAINTENANCE (U.S. CLS. 2, 5, 22, 23, 29, 37, 38 AND 50).

FIRST USE 8-0-2001; IN COMMERCE 8-0-2001.

SN 76-477,612. LUBKA, S. RUTH, HIGHLAND PARK, NJ. FILED 12-20-2002.

PUPNIKS

FOR STORY BOOK AND ILLUSTRATIONS (U.S. CLS. 2, 5, 22, 23, 29, 37, 38 AND 50).

CLASS 16—(Continued).

SN 76-477,901. DIAL BRANDS, INC., SCOTTSDALE, AZ. FILED 12-23-2002.



FOR NEWSLETTERS DEALING WITH HEALTH, HYGIENE, AND CARE OF THE SKIN (U.S. CLS. 2, 5, 22, 23, 29, 37, 38 AND 50).

SN 76-477,968. MERIDIAN INCORPORATED, TROY, MI. FILED 12-2-2002.

EARTH CITY

FOR PERIODIC PUBLICATIONS, NAMELY CONSUMER MAGAZINES TARGETED TOWARD MULTICULTURAL, URBAN AUDIENCES IN THE CATEGORY OF GENERAL INTEREST (U.S. CLS. 2, 5, 22, 23, 29, 37, 38 AND 50).

SN 76-478,888. ADVANCE MAGAZINE PUBLISHERS INC., NEW YORK, NY. FILED 12-20-2002.

EASY ELEGANCE

FOR PUBLICATIONS NAMELY MAGAZINES, MAGAZINE COLUMNS, MAGAZINE SECTIONS IN THE FIELD OF INTERIOR DECORATION (U.S. CLS. 2, 5, 22, 23, 29, 37, 38 AND 50).

SN 76-479,625. BARSHAY, DEBORAH LYNDA, PROVIDENCE, RI. AND BARSHAY, BEATRICE C., PROVIDENCE, RI. FILED 12-31-2002.

THE UGLY LOVEABLES

OWNER OF U.S. REG. NO. 950,390.
FOR CARTOONS PUBLISHED IN NEWSPAPER, BOOK AND INDIVIDUAL FORM (U.S. CLS. 2, 5, 22, 23, 29, 37, 38 AND 50).
FIRST USE 9-15-1971; IN COMMERCE 10-31-1971.

CLASS 16—(Continued).

SN 78-062,251. CHANG, VIVIAN, ROSELYN, NEW YORK, NY. FILED 5-7-2001.

VIVID CHANGE

FOR GRAPHIC DESIGN PRODUCTS, NAMELY BOOKMARKS, GREETING CARDS, WRAPPING PAPER AND PRINTED INVITATIONS (U.S. CLS. 2, 5, 22, 23, 29, 37, 38 AND 50).

SN 78-108,961. NEUFELD, ADINA KALISH, NEW YORK, NY. FILED 2-15-2002.

GOIN' SOLO

FOR SERIES OF BOOKS IN THE FIELD OF SELF HELP FOR PERSONS AT VARIOUS LIFESTAGES (U.S. CLS. 2, 5, 22, 23, 29, 37, 38 AND 50).

SN 78-117,273. SMITHKLINE BEECHAM CORPORATION, PHILADELPHIA, PA. FILED 3-25-2002.

THE POWER OF BALANCE

FOR PRINTED MATERIALS, NAMELY, PAMPHLETS IN THE FIELD OF THE TREATMENT AND DIAGNOSIS OF DEPRESSION AND OTHER CENTRAL NERVOUS SYSTEM DISORDERS (U.S. CLS. 2, 5, 22, 23, 29, 37, 38 AND 50).

SN 78-122,018. MAUS, WARREN, KANSAS CITY, MO. FILED 4-16-2002.

VIRTU

FOR MAGAZINE FEATURING WOMEN'S FASHION, HOME DECORATING, ENTERTAINING AND GARDENING (U.S. CLS. 2, 5, 22, 23, 29, 37, 38 AND 50).

SN 78-123,283. CLEAR POND TECHNOLOGIES, INC., NEEDHAM, MA. FILED 4-22-2002.

EVERYONE'S GUIDEBOOK

NO CLAIM IS MADE TO THE EXCLUSIVE RIGHT TO USE "GUIDEBOOK", APART FROM THE MARK AS SHOWN.

FOR BOOKS, CATALOGS, BROCHURES, GUIDES, MANUALS IN THE FIELD OF COMPUTERS, COMPUTING, AND INFORMATION SERVICES. (U.S. CLS. 2, 5, 22, 23, 29, 37, 38 AND 50).

CLASS 16—(Continued).

SN 78-130,595. APPLIED WAVE RESEARCH, INC., EL SEGUNDO, CA. FILED 5-22-2002.



FOR PUBLICATIONS, NAMELY, USER MANUALS, INSTRUCTION GUIDES, REFERENCE GUIDES, NEWSLETTERS, MAGAZINES, AND BOOKS ABOUT ELECTRONIC-DESIGN-AUTOMATION TOOLS (U.S. CLS. 2, 5, 22, 23, 29, 37, 38 AND 50).

FIRST USE 6-30-1997; IN COMMERCE 6-30-1997.

SN 78-138,386. EASY TELECOMMUNICATIONS, PHOENIX, AZ. FILED 6-24-2002.

LA GUADALUPANA

THE ENGLISH TRANSLATION OF THE SPANISH WORDING IN THE MARK IS "THE VIRGIN OF GUADALUPE" OR "OUR LADY OF GUADALUPE".

FOR PREPAID TELEPHONE CALLING CARDS NOT MAGNETICALLY ENCODED (U.S. CLS. 2, 5, 22, 23, 29, 37, 38 AND 50).

FIRST USE 11-1-1997; IN COMMERCE 11-1-1997.

SN 78-143,317. PAPALUCA, VINCENT, GLEN IRIS VICTORIA, AUSTRALIA, FILED 7-12-2002.

LIQUITAINER

OWNER OF AUSTRALIA REG. NO. 883401, DATED 7-23-2001, EXPIRES 7-23-2008.

FOR BAGS OF PLASTIC FOR PACKAGING BEING BLADDERS FOR CONTAINING LIQUID (U.S. CLS. 2, 5, 22, 23, 29, 37, 38 AND 50).

CLASS 16—(Continued).

SN 78-148,156. HYMAN, WALTER ROBERT, BRENTWOOD, CA. FILED 7-26-2002.



NO CLAIM IS MADE TO THE EXCLUSIVE RIGHT TO USE "EVENTS", APART FROM THE MARK AS SHOWN.

ANY STIPPLING(S) IF INDICATED WOULD BE A FEATURE OF THE MARK.

FOR EVENT AND OCCASION KITS CONSISTING OF REUSABLE PAPER FOAM BOARD LETTERS, NUMBERS, WORDS AND DATES INSERTED IN A REUSABLE HOLDER FOR SPECIAL OCCASION DISPLAY PURPOSES WHICH CAN BE PHOTOGRAPHED FOR FUTURE MEMORIES (U.S. CLS. 2, 5, 22, 23, 29, 37, 38 AND 50).

SN 78-162,342. VISION MINDER CORPORATION, AJAX ONTARIO, CANADA, FILED 9-10-2002.

VISION MINDER

NO CLAIM IS MADE TO THE EXCLUSIVE RIGHT TO USE "VISION", APART FROM THE MARK AS SHOWN.

FOR VISUALLY BASED FUNCTIONAL PRINTED MARKETING MATERIALS, NAMELY ERASABLE AND NONERASABLE POSTERS (U.S. CLS. 2, 5, 22, 23, 29, 37, 38 AND 50).

SN 78-167,024. BUNDLE BAND INDUSTRIES, INC., YONKERS, NY. FILED 9-23-2002.



FOR TWO RUBBER BANDS JOINED TOGETHER BY A METAL RING TO MAKE ONE BAND THAT WRAPS AROUND FILES VERTICALLY AND HORIZONTALLY (U.S. CLS. 2, 5, 22, 23, 29, 37, 38 AND 50).

FIRST USE 6-1-1997; IN COMMERCE 6-1-1997.

CLASS 16—(Continued).

SN 78-168,276. GOD'S HOUSE OF PRAYER, INC., SOUTH-LAKE, TX. FILED 9-26-2002.

EDWIN LOUIS COLE

THE NAME "EDWIN LOUIS COLE" DOES NOT IDENTIFY A LIVING INDIVIDUAL.
FOR RELIGIOUS BOOKS (U.S. CLS. 2, 5, 22, 23, 29, 37, 38 AND 50).

SN 78-169,344. EISENBERG, MITCHELL, FAIRFIELD, CT. FILED 9-30-2002.

SPORTYGIRLS

FOR PRINTED MATTER IN THE NATURE OF PRINTED PUBLICATIONS, NAMELY, SERIES OF FICTION, SERIES OF NON-FICTION AND ACTIVITY BOOKS, NAMELY, COLORING BOOKS RELATED TO SPORTS, PERIODICALS RELATING TO SPORTS, NEWSLETTERS RELATING TO SPORTS, MAGAZINES RELATING TO SPORTS, CARDBOARD AND GOODS MADE FROM THESE MATERIALS, NAMELY TRADING CARDS, BOARD GAMES, POSTERS AND NOTEBOOKS (U.S. CLS. 2, 5, 22, 23, 29, 37, 38 AND 50).

SN 78-172,150. OUTSOURCING TODAY, LLC, FAIRFIELD, NJ. FILED 10-8-2002.

**HUMAN RESOURCES
OUTSOURCING TODAY**

NO CLAIM IS MADE TO THE EXCLUSIVE RIGHT TO USE "HUMAN RESOURCES OUTSOURCING", APART FROM THE MARK AS SHOWN.

FOR MAGAZINE ON THE TOPIC OF HUMAN RESOURCES (U.S. CLS. 2, 5, 22, 23, 29, 37, 38 AND 50).
FIRST USE 7-0-2002; IN COMMERCE 10-0-2002.

SN 78-173,690. FOX RIVER PAPER COMPANY LLC, APPLETON, WI. FILED 10-11-2002.

THE WORKHORSE

FOR PAPER, NAMELY PRINTING, TEXT, AND COVER PAPER (U.S. CLS. 2, 5, 22, 23, 29, 37, 38 AND 50).
FIRST USE 6-30-2001; IN COMMERCE 6-30-2001.

CLASS 16—(Continued).

SN 78-175,364. PERFORMING ARTS CENTER AUTHORITY, THE, FT. LAUDERDALE, FL. FILED 10-17-2002.

R I V E R W A L K

FOR ENTERTAINMENT GUIDE MAGAZINE (U.S. CLS. 2, 5, 22, 23, 29, 37, 38 AND 50).
FIRST USE 10-5-2001; IN COMMERCE 10-5-2001.

SN 78-181,087. BANDAI AMERICA INCORPORATED, CYPRESS, CA. FILED 11-1-2002.

B STYLIN'

FOR ARTISTS' MATERIALS, NAMELY, PENCILS, PENS, PAINTS, BRUSHES, PAINTING SETS, STENCILS, CRAYONS, CHALK AND MARKERS; PRINTED PAINTING SETS; RUB DOWN TRANSFERS; SKETCHBOOKS; STICKERS; STICKER BOOKS; STICKER KITS; TEMPORARY TATTOOS; WRITING PENS; PAINTBRUSHES; SLATES FOR WRITING; BLACKBOARDS; CHALKBOARDS FOR SCHOOL, OFFICE AND HOME USE; WIPE OFF BOARDS AND ERASERS; CHALK ERASERS; CORK BULLETIN BOARDS; FLASH CARDS; WRITING PENS; MARKERS; FELT-TIPPED PENS; PENCILS; PENS; POSTER PEN SETS CONSISTING OF MARKERS, POSTER PENS, ERASERS, STAMPERS, BLACK AND WHITE POSTERS, AND MESSAGE BOARD CLEANER SOLD AS A UNIT; COLORED PENCILS; COLORING BOOKS; COLOR BY NUMBER KITS CONSISTING OF PRE-PRINTED PANELS, CRAYONS, PENCILS, PAINTS, AND PAINT BRUSHES, SOLD AS A UNIT; PAINT SETS INCLUDING WATERCOLOR AND WATER-BASED PAINTS AND PAINT BRUSHES; DECORATIVE RUBBER STAMPS; STENCILS; STICKERS; STICKER BOOKS; STICKER KITS; CONSTRUCTION PAPER; CHILDREN'S ART EASEL WITH A DESK FEATURE; MODELING COMPOUNDS, NAMELY PUTTY, DOUGH AND CLAY AND MODELING COMPOUND AND RELATED ACCESSORIES, NAMELY MODELING TOOLS, PLAY MATS, EXTRUDERS, COOKIE CUTTER SHAPES, PLASTIC MOLDS, AND PLASTIC PIECES SUCH AS GEOMETRIC SHAPES, RULERS, HATS, EYEGLASSES, AND FACIAL COMPONENTS, SOLD AS A UNIT THEREWITH; POSTER PAINTS; WATERCOLOR AND WATER-BASED PAINTS AND PAINT BRUSHES; FINGER PAINTS; ARTS AND CRAFTS PAINT KITS; CASES FOR PENS AND PENCILS; CHILDREN'S ACTIVITY BOOKS; CONSTRUCTION PAPER; CRAFT PAPER; STATIONERY GLITTER GLUE; GLUE FOR STATIONERY OR HOUSEHOLD USE; PENCIL SHARPENERS; STAMPERS USED TO MAKE GEOMETRIC SHAPES, LETTERS, NUMBERS, AND ANIMAL FIGURES; AND STAMPER MARKER AND ARTS AND CRAFTS ACTIVITY KITS COMPRISED OF ONE OR MORE OF THE ABOVE GOODS (U.S. CLS. 2, 5, 22, 23, 29, 37, 38 AND 50).

CLASS 16—(Continued).

SN 78-182,589. STRATTON, THOMAS K, LEXINGTON, KY. FILED 11-7-2002.

HIT THE JACKPOT AT HOME

FOR BOOKS, WORKBOOKS, CD'S, AND/OR VCR TAPES FOR GUIDING SOMEONE THROUGH THE BUYING AND BUILDING OF A SUCCESSFUL INTERNET WEBSITE FROM THEIR HOME (U.S. CLS. 2, 5, 22, 23, 29, 37, 38 AND 50).

SN 78-184,131. KRAFT FOODS HOLDINGS, INC., NORTHFIELD, IL. FILED 11-12-2002.

KRAFT SALAD DAYS

NO CLAIM IS MADE TO THE EXCLUSIVE RIGHT TO USE "SALAD", APART FROM THE MARK AS SHOWN.

FOR PRINTED RECIPES SOLD AS A COMPONENT OF FOOD PACKAGING; RECIPE BOOKLETS (U.S. CLS. 2, 5, 22, 23, 29, 37, 38 AND 50).

SN 78-188,940. RPM COMMUNICATIONS, LLC, ROYAL OAK, MI. FILED 11-26-2002.

SPEED, STYLE, & SOUND

FOR MAGAZINE IN THE FIELD OF TWO OR FOUR WHEELED VEHICLES PUBLISHED MONTHLY OR AT OTHER INTERVALS (U.S. CLS. 2, 5, 22, 23, 29, 37, 38 AND 50).

SN 78-189,139. MOSHER, DONNA, WOODLANDS, TX. FILED 11-26-2002.

AUTHENTIC LIVING

FOR PRINTED PUBLICATIONS, NAMELY MAGAZINES, JOURNALS, NEWSLETTERS, ELECTRONIC PUBLICATIONS ABOUT PERSONAL, PROFESSIONAL AND SPIRITUAL GROWTH (U.S. CLS. 2, 5, 22, 23, 29, 37, 38 AND 50).

SN 78-191,036. MCRAE'S, INC., BIRMINGHAM, AL. FILED 12-4-2002.

MISS ATTITUDE

FOR PHOTOGRAPH ALBUMS; SCRAPBOOKS ALBUMS; AUTOGRAPH BOOKS; PAPER PARTY BAGS; BOOKMARKS; ADDRESS BOOKS; CALENDARS; PEN CASES; PENCIL CASES; DIARIES; NOTE CARDS; NOTE STATIONERY; STICKERS. (U.S. CLS. 2, 5, 22, 23, 29, 37, 38 AND 50).

CLASS 16—(Continued).

SN 78-192,321. RICKEL, VALERIE, LOS ANGELES, CA. FILED 12-9-2002.

SOULFUL LIVING

FOR PRINTED INSTRUCTIONAL, EDUCATIONAL, AND TEACHING MATERIALS, FICTION AND NON-FICTION BOOKS, TEXTBOOKS, WORKBOOKS, GIFT BOOKS, COOK BOOKS, STORY BOOKS, NEWSPAPERS, NEWSPAPER SUPPLEMENTS, SYNDICATED NEWSPAPER COLUMNS, JOURNALS, PERIODICALS, MAGAZINES, MAGAZINE SECTIONS, MAGAZINE DEPARTMENTS, MAGAZINE COLUMNS, NEWSLETTERS, BOOKLETS, BROCHURES, LEAFLETS, AND PRINTED COURSE MATERIALS, LESSONS, STUDY GUIDES, AND LECTURES; PAPER GOODS AND PRINTED MATTER, NAMELY DATE BOOKS, CALENDARS, DESK CALENDARS, DESKTOP PLANNERS, PERSONAL DIARIES, BLANK BOOKS FOR WRITING, PHOTO ALBUMS, ADDRESS BOOKS, STATIONERY, WRITING PAPERS, ENVELOPES, STATIONERY BOXES, STATIONERY-TYPE PORTFOLIOS, INVITATIONS, POSTCARDS, NOTE CARDS, GREETING CARDS, OCCASION CARDS, GIFT CARDS, PAPER GIFT WRAP AND BOXES, NOTEBOOKS, NOTEPADS, WRITING TABLETS, FLASH CARDS, CONTEMPLATIVE AND MOTIVATIONAL CARDS, TAROT CARDS, PHOTOGRAPHS, PHOTOGRAPHIC PRINTS, ART PRINTS, PRINTED ART REPRODUCTIONS, ART PICTURES, ART ETCHINGS, POSTERS, DECORATIVE AND MULTI-DIMENSIONAL PAPER MOBILES AND CENTERPIECES, STICKERS AND DECALS; ARTS AND CRAFTS MATERIALS, NAMELY ARTS AND CRAFTS PAINT KITS, RUBBER STAMPS, STAMP PADS, STAMP PAD INKS, MODELING CLAY, PAINTBRUSHES, ART PADS, DRAWING PAPER, CRAFT PAPER, ARTISTS' PENS, PENCILS, AND PASTELS; OFFICE SUPPLIES; NAMELY PENS, PENCILS, PAPERWEIGHTS, CARD FILES, DESK STANDS, DESK SETS, AND DESKTOP ORGANIZERS; ALL FEATURING PERSONAL DEVELOPMENT, SELF-HELP, SELF-ACTUALIZATION, SELF-FULFILLMENT, SELF-ANALYSIS, SELF-TRANSFORMATION, SPIRITUALITY, INSPIRATIONAL, MOTIVATIONAL, ART, CREATIVITY, WOMEN'S STUDIES, CULTURAL TRADITIONS AND CUSTOMS, LIFESTYLE, QUALITY OF LIFE, WELLNESS, HEALTH, HEALING, ECOLOGICAL, ENVIRONMENTAL, INTERIOR DECORATING, CONSCIOUS LIVING, WHOLE LIFE AND HOLISTIC LIVING TOPICS. (U.S. CLS. 2, 5, 22, 23, 29, 37, 38 AND 50).

SN 78-194,709. SOCIETE BIC, CLICHY, FRANCE, FILED 12-16-2002.

NOUVEAU

FOR WRITING INSTRUMENTS NAMELY, PENS, PENCILS, MARKERS AND HIGHLIGHTING MARKERS (U.S. CLS. 2, 5, 22, 23, 29, 37, 38 AND 50).

CLASS 16—(Continued).

SN 78-194,996. THE CARTOON NETWORK LP, LLLP, ATLANTA, GA. FILED 12-16-2002.

AQUA TEEN HUNGER FORCE

FOR PRINTED MATTER AND PAPER GOODS NAMELY, BOOKS FEATURING CHARACTERS FROM ANIMATED, ACTION ADVENTURE, COMEDY AND/OR DRAMA FEATURES, COMIC BOOKS, CHILDREN'S BOOKS, MAGAZINES FEATURING CHARACTERS FROM ANIMATED, ACTION ADVENTURE, COMEDY AND/OR DRAMA FEATURES, COLORING BOOKS, CHILDREN'S ACTIVITY BOOKS; STATIONERY, WRITING PAPER, ENVELOPES, NOTEBOOKS, DIARIES, NOTE CARDS, GREETING CARDS, TRADING CARDS; LITHOGRAPHS AND ANIMATION CELLS; PENS, PENCILS, CASES THEREFOR, ERASERS, CRAYONS, MARKERS, COLORED PENCILS, PAINTING SETS, CHALK AND CHALKBOARDS; DECALS, HEAT TRANSFERS; POSTERS; MOUNTED AND/OR UNMOUNTED PHOTOGRAPHS; BOOK COVERS, BOOK MARKS, CALENDARS, GIFT WRAPPING PAPER; PAPER PARTY FAVORS AND PAPER PARTY DECORATIONS - NAMELY, PAPER NAPKINS, PAPER DOILIES, PAPER PLACE MATS, CREPE PAPER, PAPER HATS, INVITATIONS, PAPER TABLE CLOTHS, PAPER CAKE DECORATIONS; PRINTED TRANSFERS FOR EMBROIDERY OR FABRIC APPLIQUES; PRINTED PATTERNS FOR COSTUMES, PAJAMAS, SWEATSHIRTS AND T-SHIRTS; PAPER PHOTO FRAMES (U.S. CLS. 2, 5, 22, 23, 29, 37, 38 AND 50).

SN 78-198,724. CHAMBERS, KHIA, ATLANTA, GA. FILED 12-30-2002.

KHIA

FOR PAPER GOODS AND PRINTED MATTER, NAMELY, SOUVENIR PROGRAMS FEATURING A MUSICAL RECORDING ARTIST; SONG BOOKS; SHEET MUSIC BOOKS; PICTURE BOOKS; LITHOGRAPHS; POSTERS; STICKERS AND DECALS; CALENDARS; AND FAN CLUB NEWSLETTERS (U.S. CLS. 2, 5, 22, 23, 29, 37, 38 AND 50).

SN 78-198,735. CHAMBERS, KHIA, ATLANTA, GA. FILED 12-30-2002.

MY NECK, MY BACK

FOR SOUVENIR PROGRAMS CONCERNING A MUSICAL ARTIST; SONG BOOKS; PRINTED SHEET MUSIC BOOKS; LITHOGRAPHS; POSTERS; CALENDARS; DECALS; STICKERS; FAN CLUB NEWSLETTERS (U.S. CLS. 2, 5, 22, 23, 29, 37, 38 AND 50).

CLASS 16—(Continued).

SN 78-200,010. DOWRICK, PETER W., KANEHOE, HI. FILED 1-3-2003.

CREATING FUTURES

FOR PRINTED EDUCATIONAL MATERIALS, NAMELY BOOKS, MANUALS, AND FORMS, IN THE FIELD OF REMEDIAL SERVICES TO CHILDREN AND THEIR FAMILIES WITH DISABILITIES OR OTHER DISADVANTAGES. (U.S. CLS. 2, 5, 22, 23, 29, 37, 38 AND 50).

SN 78-200,558. LEFFERT JAY & POLGLAZE, P.A., MINNEAPOLIS, MN. FILED 1-7-2003.

INTELLECTUAL PROPERTY LAW NEWSLINK

NO CLAIM IS MADE TO THE EXCLUSIVE RIGHT TO USE "INTELLECTUAL PROPERTY LAW", APART FROM THE MARK AS SHOWN.

FOR NEWSLETTER FOR LEGAL SERVICES AND RELATED TOPICS IN THE AREA OF INTELLECTUAL PROPERTY LAW (U.S. CLS. 2, 5, 22, 23, 29, 37, 38 AND 50).

FIRST USE 12-31-2002; IN COMMERCE 12-31-2002.

CLASS 17—RUBBER GOODS

SN 76-236,020. IPEX INC., DON MILLS, CANADA, FILED 4-6-2001.

ENVIRO-TITE

PRIORITY CLAIMED UNDER SEC. 44(D) ON CANADA APPLICATION NO. 1096030, FILED 3-14-2001, REG. NO. TMA576293, DATED 2-25-2003, EXPIRES 2-25-2018.

FOR PLASTIC PIPES FOR SEWER PURPOSES (U.S. CLS. 1, 5, 12, 13, 35 AND 50).

CLASS 17—(Continued).

SN 76-278,614. VULCANA, INC., ALEXANDRIA, VA. FILED 6-29-2001.

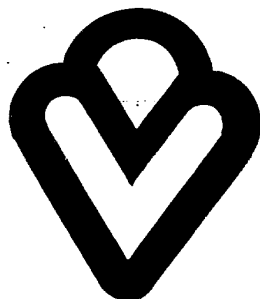

FOR SHEET RUBBER FOR USE IN THE MANUFACTURE OF HANDBAGS, ATTACHE CASES, BACKPACKS, BAGS, NAMELY, ALL-PURPOSE SPORT, ATHLETIC, BEACH, BOOK, CLUTCH, DIAPER, DUFFEL, GYM, OVERNIGHT, SCHOOL, SHOULDER, TOTE, TRAVEL, TRAVELING AND TOOL BAGS, FEED BAGS FOR ANIMALS, GARMENT BAGS FOR TRAVEL, BILL-FOLDS, HAT BOXES FOR TRAVEL, BRIEFCASES, CASES, NAMELY, DOCUMENT, BUSINESS CARD, BUSINESS, CALLING CARD, KEY, COSMETIC, TOILETRY, VANITY AND CREDIT CARD, DOG CLOTHING, DOG COLLARS, DOG LEASHES, FANNY PACKS, LUGGAGE, LUGGAGE TAGS, STRAPS FOR LUGGAGE, WAIST PACKS, POCKETBOOKS, ART PORTFOLIO CASES, BRIEFCASE-TYPE PORTFOLIOS, PURSES, NAMELY, CHANGE, CLUTCH AND COIN, RUCKSACKS, SHAVING BAGS, SUITCASES, TRUNKS FOR TRAVELING, VALISES, WALLETS, BINDERS, LOOSE LEAF BINDERS, BOOK BINDINGS, BLOTTERS, BOOKS, NAMELY, ACCOUNTING, ADDRESS, APPOINTMENT, AUTOGRAPH, BUSINESS, RECORD, CHECK, DATA, DATE, EXPENSE, TELEPHONE NUMBER AND WIRE BOUND, BOXES, NAMELY, PENCIL, PAPER AND STATIONERY; CALENDAR DESK PADS; POCKET CALENDARS, CHECKBOOK COVERS, CHECKBOOK HOLDERS, DAILY PLANNERS, DESK PADS, GUEST BOOKS, PEN OR PENCIL HOLDERS, PHOTOGRAPH ALBUMS, PLANNERS, NAMELY, DAILY, DESK TOP AND PERSONAL, STATIONERY-TYPE PORTFOLIOS, CHAIRS, DECK CHAIRS, FURNITURE, FURNITURE PARTS, NAMELY, MATERIAL TO COVER SEAT FRAMES, SEAT CUSHIONS, CD CASES, PICTURE FRAMES, DECORATIVE BOXES, MESSENGER BAGS, SATCHELS, YOGA MATS, PET CARRIERS, TENNIS RACKET COVERS, PADDLE TENNIS RACKET COVERS, SQUASH RACKET COVERS, GRILL COVERS, MATERIAL TO COVER CHAISE LOUNGES, AUTOMOBILE COVERS, BOTTLE AND JAR OPENERS, ROOFING MATERIAL AND CONSTRUCTION MATERIAL (U.S. CLS. 1, 5, 12, 13, 35 AND 50).

FIRST USE 6-27-2001; IN COMMERCE 6-27-2001.

SN 76-414,623. CAL-TEX PROTECTIVE COATINGS, INCORPORATED, SCHERTZ, TX. FILED 5-31-2002.

PROTECTALL

FOR VEHICULAR CARE AND VEHICULAR SAFETY PRODUCTS, NAMELY SHEETS OF FILM MATERIAL THAT PROTECT THE APPEARANCE OF VEHICLE AND/OR ENHANCE THE VISIBILITY OF VEHICLES (U.S. CLS. 1, 5, 12, 13, 35 AND 50).

CLASS 17—(Continued).

SN 76-419,468. ADCHEM CORPORATION, RIVERHEAD, NY. FILED 6-11-2002.

ADCHEM

FOR ADHESIVE TAPES, PRESSURE SENSITIVE ADHESIVE TAPES, DOUBLE-COATED ADHESIVE TAPES, SINGLE-COATED ADHESIVE TAPES, UNSUPPORTED ADHESIVE FILMS FOR INDUSTRIAL OR COMMERCIAL USE (U.S. CLS. 1, 5, 12, 13, 35 AND 50).
FIRST USE 12-15-1966; IN COMMERCE 12-15-1966.

SN 76-430,889. CHEM POLYMER CORPORATION, FORT MYERS, FL. FILED 7-11-2002.

RECYCLON

FOR ARTIFICIAL RESINS AND THERMOPLASTIC COMPOUNDS, ALL IN PELLET FORM FOR USE IN INJECTION MOLDING AND EXTRUSION APPLICATIONS (U.S. CLS. 1, 5, 12, 13, 35 AND 50).

SN 78-135,093. MCP INDUSTRIES, INC., CORONA, CA. FILED 6-12-2002.



FOR SILICONE RUBBER HOSES USED IN CONNECTION WITH AUTOMOTIVE AND MARINE VEHICLES (U.S. CLS. 1, 5, 12, 13, 35 AND 50).
FIRST USE 6-27-1990; IN COMMERCE 6-27-1990.

SN 78-175,304. POLYPHEN INTERNATIONAL PTY LTD, POINT LONSDALE, AUSTRALIA, FILED 10-17-2002.

POLYPHEN

OWNER OF AUSTRALIA REG. NO. 890449, DATED 9-27-2001, EXPIRES 9-27-2011.

FOR INSULATING MATERIALS, NAMELY FOAMED PLASTIC INSULATING MATERIALS BEING FOR USE IN MANUFACTURE OF CONSTRUCTION PANELS (U.S. CLS. 1, 5, 12, 13, 35 AND 50).

CLASS 17—(Continued).

SN 78-189,140. GOODYEAR TIRE & RUBBER COMPANY, THE, AKRON, OH. FILED 11-26-2002.

PLICORD DIVERSIFLEX

OWNER OF U.S. REG. NO. 386,361.
FOR NONMETALLIC HOSE FOR USE PRINCIPALLY IN THE CEMENT, CHEMICAL, FERTILIZER AND SALT INDUSTRIES (U.S. CLS. 1, 5, 12, 13, 35 AND 50).
FIRST USE 10-0-1987; IN COMMERCE 10-0-1987.

SN 78-190,935. TYCO PLASTICS SERVICES AG, SCHAFFHAUSEN, SWITZERLAND, FILED 12-4-2002.

MARVELGUARD

FOR BUILDING MATERIAL IN THE FORM OF AN INSULATING OR VAPOR BARRIER FOR HOMES (U.S. CLS. 1, 5, 12, 13, 35 AND 50).

SN 78-194,505. AVANT, LLC, CONCORD, CA. FILED 12-13-2002.

WINDOW ARMOR

NO CLAIM IS MADE TO THE EXCLUSIVE RIGHT TO USE "WINDOW", APART FROM THE MARK AS SHOWN.
FOR LAMINATED FILM FOR VEHICLE WINDOWS (U.S. CLS. 1, 5, 12, 13, 35 AND 50).

SN 78-195,731. SHERWIN-WILLIAMS COMPANY, THE, CLEVELAND, OH. FILED 12-18-2002.

STORM BLASTER

FOR CAULKS AND ADHESIVE SEALANTS FOR GENERAL USE (U.S. CLS. 1, 5, 12, 13, 35 AND 50).
FIRST USE 2-25-2003; IN COMMERCE 2-25-2003.

CLASS 18—LEATHER GOODS**CLASS 18—(Continued).**

SN 76-307,182. DUARTE, HENRY, LOS ANGELES, CA. FILED 8-30-2001.

HENRY DUARTE

OWNER OF U.S. REG. NO. 2,288,801.
"HENRY DUARTE" IS A LIVING INDIVIDUAL WHO BY HIS SIGNATURE BELOW CONSENTS TO THE REGISTRATION OF HIS NAME.

FOR PURSES, CLUTCHES IN THE NATURE OF PURSES, SHOULDER BAGS, COSMETIC BAGS SOLD EMPTY, TOTE BAGS, LUGGAGE, BACKPACKS, GYM BAGS, DUFFLE BAGS, TRAVEL BAGS, ROLL BAGS, BEACH BAGS, SUIT BAGS, TIE CASES, SATCHELS, GARMENT BAGS FOR TRAVEL, COIN PURSES, DRAW-STRING POUCHES, OVERNIGHT BAGS, WALLETS, UMBRELLAS, VANITY CASES SOLD EMPTY, KEY CASES; LEATHER GOODS, NAMELY, WALLETS, PURSES, LUGGAGE, SATCHELS, BACKPACKS, SHAVING BAGS SOLD EMPTY (U.S. CLS. 1, 2, 3, 22 AND 41).

SN 76-314,247. TRI-COASTAL DESIGN GROUP, INC., BRIDGEWATER, NJ. FILED 9-18-2001.

PARCEL

FOR HANDBAGS, PURSES, WALLETS, AND COSMETIC BAGS SOLD EMPTY (U.S. CLS. 1, 2, 3, 22 AND 41).

FIRST USE 12-22-2000; IN COMMERCE 12-22-2000.

SN 76-322,614. SEDONA GOLF PRODUCTS COMPANY, LLC, TEMPE, AZ. FILED 10-5-2001.

SEDONA

FOR LUGGAGE, NAMELY DUFFEL BAGS, BACK PACKS, TRAVEL BAGS, SHOE BAGS FOR TRAVEL, GARMENT BAGS FOR TRAVEL, SUIT CASES, UMBRELLAS (U.S. CLS. 1, 2, 3, 22 AND 41).

FIRST USE 6-0-1994; IN COMMERCE 11-0-1994.

SN 76-366,301. ZARR MEN L.A., INC., LOS ANGELES, CA. FILED 2-1-2002.

LORDS

OWNER OF U.S. REG. NO. 2,567,268.
FOR LEATHER GOODS, NAMELY, DUFFEL BAGS, BACK PACKS, GARMENT BAGS FOR TRAVEL, FANNY PACKS, PURSES, HANDBAGS, CARRY-ON BAGS, SHOE BAGS FOR TRAVEL AND WALLETS; LEATHER ACCESSORIES, NAMELY, LEATHER KEY CHAINS, LUGGAGE TAGS, UMBRELLA COVERS, WALKING STICK HANDLES, LIPSTICK HOLDERS, AND KEY CASES (U.S. CLS. 1, 2, 3, 22 AND 41).

CLASS 18—(Continued).

SN 76-428,408. NEW WEATHERVANE RETAIL CORPORATION, NEW BRITAIN, CT. FILED 7-9-2002.

WEATHERVANE

FOR BAGS, NAMELY BACKPACKS AND PURSES (U.S. CLS. 1, 2, 3, 22 AND 41).

SN 76-430,462. GERDAN SACS, S.L., 08006, BARCELONA, SPAIN, FILED 7-11-2002.

GO GURU

FOR HANDBAGS, TRAVEL BAGS, GARMENT BAGS FOR TRAVEL, SUITCASES, KNAPSACKS, BACKPACKS, PURSES, TOTE BAGS, BRIEFCASES, COSMETIC BAGS SOLD EMPTY, TOILETRY CASES SOLD EMPTY; SHOE BAGS FOR TRAVEL, WALLETS, BILLFOLDS, BRIEF-CASE-TYPE PORTFOLIOS (U.S. CLS. 1, 2, 3, 22 AND 41).

SN 76-470,490. DEWIED INTERNATIONAL, INC., SAN ANTONIO, TX. FILED 11-14-2002.

PRO-RING

FOR CASINGS FOR SAUSAGES AND FORMED MEAT PRODUCTS (U.S. CLS. 1, 2, 3, 22 AND 41).

SN 76-470,493. DEWIED INTERNATIONAL, INC., SAN ANTONIO, TX. FILED 11-14-2002.

PRO-FRESH

FOR CASINGS FOR SAUSAGES AND FORMED MEAT PRODUCTS (U.S. CLS. 1, 2, 3, 22 AND 41).

SN 76-471,896. MAPAC GROUP, LTD., WATFORD, HERTZ WD24UY, UNITED KINGDOM, FILED 11-7-2002.

MAPAC

FOR SCHOOL BAGS, ART BRIEFCASE TYPE PORTFOLIOS, LEATHER SHOPPING BAGS, MESH SHOPPING BAGS, AND TEXTILE SHOPPING BAGS, TRAVEL BAGS, DUFFEL BAGS, UMBRELLAS, AND BRIEFCASES (U.S. CLS. 1, 2, 3, 22 AND 41).

FIRST USE 6-1-1999; IN COMMERCE 6-1-1999.

CLASS 18—(Continued).

SN 76-474,292. KERNKAMP, ANNE, TEMECULA, CA. FILED 12-6-2002.

THE HIPPIE

FOR INFANT CARRIER HAVING A CANTILEVERED SUPPORT BAR HELD BY A SUPPORT BAND ENCIRCLING A USER'S WAIST (U.S. CLS. 1, 2, 3, 22 AND 41).

SN 76-476,269. COWTAN AND TOUT, INC., NEW YORK, NY. FILED 12-16-2002.



FOR LEATHERS; NAMELY, ANIMAL SKINS USED IN UPHOLSTERY (U.S. CLS. 1, 2, 3, 22 AND 41).

SN 78-151,086. DADA CORPORATION, SEOUL, REPUBLIC OF KOREA, FILED 8-5-2002.

GELOSIA

THE ENGLISH TRANSLATION OF THE ITALIAN WORD "GELOSIA" IN THE MARK IS "JEALOUSY".

FOR SUIT BAGS, BRIEFCASES, WALLETS, TRAVEL BAGS, SPORTS BAGS, SHOPPING BAGS NAMELY, -LEATHER SHOPPING BAGS, MESH SHOPPING BAGS, -SHOPPING BAGS WITH WHEELS ATTACHED, TEXTILE SHOPPING BAGS, SCHOOL BAGS, HANDBAGS, BOSTON BAGS, BEACH BAGS (U.S. CLS. 1, 2, 3, 22 AND 41).

SN 78-190,917. HARDCORE ENTERPRISES PTY. LTD., ABBOTSFORD VIC 3067, AUSTRALIA, FILED 12-3-2002.



FOR BAGS, BACKPACKS, TRAVEL BAGS, GARMENT BAGS, WALLETS, PURSES AND DUFFEL BAGS (U.S. CLS. 1, 2, 3, 22 AND 41).

FIRST USE 6-30-2002; IN COMMERCE 6-30-2002.

CLASS 19—NON-METALLIC BUILDING MATERIALS

CLASS 19—(Continued).

SN 76-000,226. CONGOLEUM CORPORATION, MERCERVILLE, NJ. FILED 3-14-2000.

ULTIMA

FOR PLASTIC FLOOR COVERING HAVING A WATER RESISTANT, SMOOTH OR EMBOSSED SURFACE IN ROLLS OR TILES (U.S. CLS. 1, 12, 33 AND 50).
FIRST USE 7-0-2000; IN COMMERCE 7-0-2000.

SN 76-414,426. TAPCO INTERNATIONAL CORPORATION, PLYMOUTH, MI. FILED 5-28-2002.



OWNER OF U.S. REG. NO. 1,687,752.
NO CLAIM IS MADE TO THE EXCLUSIVE RIGHT TO USE "BUILDING PRODUCTS", APART FROM THE MARK AS SHOWN.
THE STIPPLING IS A FEATURE OF THE MARK.
FOR WINDOW SHUTTERS COMPOSED PRIMARILY OF FIBERGLASS OR PLASTIC (U.S. CLS. 1, 12, 33 AND 50).

SN 76-414,972. TAPCO INTERNATIONAL CORPORATION, PLYMOUTH, MI. FILED 5-28-2002.

THE HOME OF OPPORTUNITY

FOR WINDOW SHUTTERS COMPOSED PRIMARILY OF FIBERGLASS OR PLASTIC (U.S. CLS. 1, 12, 33 AND 50).

SN 76-444,167. MULTI-REACH, INC., LONDON, ONTARIO, CANADA, FILED 8-23-2002.

SHADE IN A BAG

NO CLAIM IS MADE TO THE EXCLUSIVE RIGHT TO USE "SHADE", APART FROM THE MARK AS SHOWN.
FOR NON-METAL EXTERIOR WINDOW BLINDS (U.S. CLS. 1, 12, 33 AND 50).

CLASS 19—(Continued).

SN 76-453,303. VANTAGE PRODUCTS CORPORATION, CONYERS, GA. FILED 9-23-2002.



NO CLAIM IS MADE TO THE EXCLUSIVE RIGHT TO USE "ADVANCED INTERMENT SYSTEMS", APART FROM THE MARK AS SHOWN.

FOR BURIAL VAULTS, GRAVE LINERS, URN VAULTS AND LAWN CRYPTS, ALL BEING NOT OF METAL (U.S. CLS. 1, 12, 33 AND 50).

SN 76-453,305. VANTAGE PRODUCTS CORPORATION, CONYERS, GA. FILED 9-23-2002.



FOR BURIAL VAULTS, GRAVE LINERS, URN VAULTS AND LAWN CRYPTS, ALL BEING NOT OF METAL (U.S. CLS. 1, 12, 33 AND 50).

SN 76-455,650. MITTEN VINYL INC., PARIS ONTARIO, CANADA, FILED 10-3-2002.

ACT

PRIORITY CLAIMED UNDER SEC. 44(D) ON CANADA APPLICATION NO. 1153633, FILED 9-20-2002.
FOR VINYL SIDING PROFILES (U.S. CLS. 1, 12, 33 AND 50).

CLASS 19—(Continued).

SN 76-463,099. RTR GROUP, INC., FAYETTEVILLE, TN. FILED 10-31-2002.

TRILOGY POOLS

NO CLAIM IS MADE TO THE EXCLUSIVE RIGHT TO USE "POOLS", APART FROM THE MARK AS SHOWN. FOR FIBERGLASS SWIMMING POOLS AND SWIM-IN-PLACE POOLS (U.S. CLS. 1, 12, 33 AND 50).

SN 76-466,998. CRAFTMASTER MANUFACTURING, INC., CHICAGO, IL. FILED 11-15-2002.

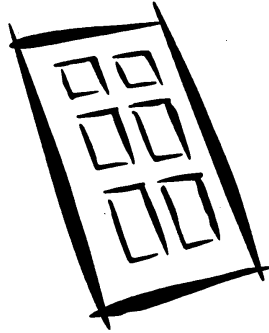

FOR NON-METAL MOLDED DOOR FACINGS; NON-METAL DOORSKINS; DOOR PRODUCTS, NAMELY, DOOR CASINGS NOT OF METAL, NON-METALLIC DOOR FRAMES, NON-METALLIC DOOR PANELS (U.S. CLS. 1, 12, 33 AND 50). FIRST USE 0-0-1990; IN COMMERCE 0-0-1990.

SN 76-469,756. MW MANUFACTURERS, INC., ROCKY MOUNT, VA. FILED 11-26-2002.

FREEDOM

OWNER OF U.S. REG. NO. 1,548,316. FOR NONMETAL WINDOWS AND NONMETAL PATIO DOORS (U.S. CLS. 1, 12, 33 AND 50). FIRST USE 9-18-1989; IN COMMERCE 9-18-1989.

SN 76-471,147. COOLEY GROUP HOLDINGS, INC., PAW-TUCKET, RI. FILED 11-21-2002.

COOLGRIP

FOR THERMOPLASTIC ROOFTOP WALKWAY PADS (U.S. CLS. 1, 12, 33 AND 50).

CLASS 19—(Continued).

SN 76-477,181. IMPERIAL POOLS, INC., LATHAM, NY. FILED 12-20-2002.

MATRIX

FOR SWIMMING POOLS MADE PRIMARILY OF NON-METAL (U.S. CLS. 1, 12, 33 AND 50).

SN 78-131,070. KERTAM CORPORATION, PARADISE VALLEY, AZ. FILED 5-24-2002.

E-Z GRIP

NO CLAIM IS MADE TO THE EXCLUSIVE RIGHT TO USE "GRIP", APART FROM THE MARK AS SHOWN. FOR NON-METAL BUILDING MATERIALS, NAMELY FIBERGLASS MESH (U.S. CLS. 1, 12, 33 AND 50). FIRST USE 5-7-2002; IN COMMERCE 5-7-2002.

SN 78-148,122. ASC PROFILES, INC., WEST SACRAMENTO, CA. FILED 7-26-2002.

BOLDLINE

OWNER OF U.S. REG. NO. 1,193,191. FOR METAL ROOFING AND SIDING PANELS (U.S. CLS. 1, 12, 33 AND 50). FIRST USE 1-5-1978; IN COMMERCE 1-15-1978.

SN 78-151,502. CRANE PRODUCTS LTD., COLUMBUS, OH. FILED 8-6-2002.



FOR NON-METALLIC BUILDING MATERIALS, NAMELY, DRAINAGE SYSTEM FOR DECKS COMPRISED OF NON-METALLIC PANELS AND FASTENING CLIPS (U.S. CLS. 1, 12, 33 AND 50). FIRST USE 7-31-2000; IN COMMERCE 7-31-2000.

CLASS 19—(Continued).

SN 78-166,365. APOLLO HARDWOODS COMPANY, COR-
AOPOLIS, PA. FILED 9-20-2002.

APOLLO HARDWOODS

NO CLAIM IS MADE TO THE EXCLUSIVE RIGHT TO
USE "HARDWOODS", APART FROM THE MARK AS
SHOWN.

FOR DECORATIVE HARDWOOD PLYWOOD SOLD
TO MANUFACTURERS FOR USE IN FURNITURE,
CABINETS, STORE FIXTURES AND DOORS (U.S. CLS.
1, 12, 33 AND 50).

SN 78-181,055. AVANTI MATERIAL SALES, LTD., WEB-
STER, TX. FILED 11-1-2002.

AV-202

NO CLAIM IS MADE TO THE EXCLUSIVE RIGHT TO
USE "202", APART FROM THE MARK AS SHOWN.
FOR GROUT (U.S. CLS. 1, 12, 33 AND 50).
FIRST USE 2-1-1986; IN COMMERCE 2-1-1986.

SN 78-189,073. VARIFORM, INC., KEARNEY, MO. FILED 11-
26-2002.

PERMAHUE

FOR DECORATIVE POLYPROPYLENE SHAKE AND
SCALLOP SIDING PANELS, VINYL SIDING PANELS,
VINYL SOFFIT, VINYL SKIRTING AND VINYL ACCES-
SORIES THEREFOR, NAMELY WIDE CROWN MOLD-
ING, FLUTED CORNER POSTS, WINDOW AND DOOR
SURROUND FOR EXTERIOR SURFACES OF RESIDEN-
TIAL AND COMMERCIAL BUILDINGS (U.S. CLS. 1, 12,
33 AND 50).

SN 78-195,750. OLDCASTLE PRECAST, INC., AUBURN, WA.
FILED 12-18-2002.

CASTLE ARCH

NO CLAIM IS MADE TO THE EXCLUSIVE RIGHT TO
USE "ARCH", APART FROM THE MARK AS SHOWN.
FOR PRECAST CONCRETE ARCH BRIDGES (U.S.
CLS. 1, 12, 33 AND 50).

**CLASS 20—FURNITURE AND ARTICLES NOT
OTHERWISE CLASSIFIED**

SN 75-850,769. WURIAN, HANS, DBA DESIGN SALT, RED-
WAY, CA. AND STURM, JOSEF, DBA DESIGN SALT,
REDWAY, CA. FILED 11-16-1999.

COCOON

FOR SLEEPING BAGS AND SLEEPING BAG LINERS
(U.S. CLS. 2, 13, 22, 25, 32 AND 50).

SN 76-211,966. SERROT INTERNATIONAL, INC., HENDER-
SON, NV. FILED 2-16-2001.

EZDRAIN

FOR PLASTIC INSERTS FOR USE AS PLANT CON-
TAINER LINERS (U.S. CLS. 2, 13, 22, 25, 32 AND 50).
FIRST USE 11-22-2001; IN COMMERCE 11-22-2001.

SN 76-339,717. BROYHILL FURNITURE INDUSTRIES, INC.,
LENOIR, NC. FILED 11-19-2001.

ATTIC HEIRLOOMS

FOR BEDROOM, DINING ROOM, LIVING ROOM,
GREAT ROOM, AND ENTERTAINMENT ROOM FUR-
NITURE (U.S. CLS. 2, 13, 22, 25, 32 AND 50).
FIRST USE 1-18-2002; IN COMMERCE 1-18-2002.

SN 76-380,506. LOCKERMATE CORPORATION, MINNEA-
POLIS, MN. FILED 3-11-2002.

classic mate

FOR CONTAINERS OF PLASTIC FOR PERSONAL
ITEMS; NON-METAL CLIPS FOR ATTACHING TO
WALLS FOR HOLDING PAPER, AND FURNITURE,
NAMELY, MIRRORS AND FRAMED MIRRORS,
PHOTOGRAPH FRAMES AND PLAQUES (U.S. CLS. 2,
13, 22, 25, 32 AND 50).

SN 76-415,569. BROYHILL FURNITURE INDUSTRIES, INC.,
LENOIR, NC. FILED 6-4-2002.

BIG COUNTRY

FOR FURNITURE (U.S. CLS. 2, 13, 22, 25, 32 AND 50).
FIRST USE 5-2-2002; IN COMMERCE 5-2-2002.

CLASS 20—(Continued).

SN 76-422,909. MANU COMM ENTERPRISES, PITTSBURGH, PA. FILED 6-19-2002.

CHOICE TAG

NO CLAIM IS MADE TO THE EXCLUSIVE RIGHT TO USE "TAG", APART FROM THE MARK AS SHOWN.

FOR PLASTIC KEY TAG THAT CAN BE ATTACHED TO KEY CHAINS, WITH ADVERTISING AND COUPONS FOR MERCHANTS AND RESTAURANTS AND INFORMATION ABOUT FUNDRAISING ORGANIZATIONS (U.S. CLS. 2, 13, 22, 25, 32 AND 50).

SN 76-440,357. REXAM MEDICAL PACKAGING INC., CHARLOTTE, NC. FILED 8-12-2002.

DISPENSE-A-SEAL

FOR NON-METAL REMOVABLE CLOSURES FOR USE WITH BOTTLES AND CONTAINERS (U.S. CLS. 2, 13, 22, 25, 32 AND 50).

SN 76-452,950. VITRA PATENTE AG, CH-4132 MUTTENZ, SWITZERLAND, FILED 9-20-2002.

FOLLOW ME

PRIORITY CLAIMED UNDER SEC. 44(D) ON SWITZERLAND APPLICATION NO. 01600/2002, FILED 4-5-2002, REG. NO. 498956, DATED 5-5-2002, EXPIRES 4-5-2012.

FOR OFFICE FURNITURE, NAMELY, NON-METAL CONTAINERS FOR COMMERCIAL USE, LOCKERS, NON-METAL BINS, SHELVES, CHAIRS AND TABLES (U.S. CLS. 2, 13, 22, 25, 32 AND 50).

SN 76-457,678. PRECISION DYNAMICS CORPORATION, SAN FERNANDO, CA. FILED 10-7-2002.

MOSAIC

FOR NON-METALLIC IDENTIFICATION WRISTBANDS FOR USE IN CROWD CONTROL, SCREENING AND ADMISSIONS (U.S. CLS. 2, 13, 22, 25, 32 AND 50).
FIRST USE 4-0-2002; IN COMMERCE 5-0-2002.

SN 76-457,684. PRECISION DYNAMICS CORPORATION, SAN FERNANDO, CA. FILED 10-7-2002.

MOON DUST

FOR NON-METALLIC IDENTIFICATION WRISTBANDS FOR USE IN CROWD CONTROL, SCREENING AND ADMISSIONS (U.S. CLS. 2, 13, 22, 25, 32 AND 50).
FIRST USE 4-0-2002; IN COMMERCE 5-0-2002.

CLASS 20—(Continued).

SN 76-459,551. KEARNEY-NATIONAL INC., NEW YORK, NY. FILED 10-21-2002.

AMERICAN SPIRIT

FOR RESIDENTIAL FLAGPOLE CONSISTING OF ALUMINUM TUBING, BALL AND TRUCK HALYARD FOR RAISING AND LOWERING FLAG (U.S. CLS. 2, 13, 22, 25, 32 AND 50).

SN 76-459,552. KEARNEY-NATIONAL INC., NEW YORK, NY. FILED 10-21-2002.

AMERICAN TRADITION

FOR RESIDENTIAL FLAGPOLE CONSISTING OF ALUMINUM TUBING, BALL AND TRUCK HALYARD FOR RAISING AND LOWERING FLAG (U.S. CLS. 2, 13, 22, 25, 32 AND 50).

SN 76-471,967. MACNEIL AUTOMOTIVE PRODUCTS LIMITED, DOWNERS GROVE, IL. FILED 11-15-2002.

CLICK AND STAY

FOR PLASTIC SCREW CAPS FOR LICENSE PLATE COVERS (U.S. CLS. 2, 13, 22, 25, 32 AND 50).
FIRST USE 11-5-2002; IN COMMERCE 11-5-2002.

SN 76-473,664. KIM PARKER INC., NEW YORK, NY. FILED 12-6-2002.

KIM PARKER

THE NAME "KIM PARKER" IDENTIFIES A LIVING INDIVIDUAL WHOSE CONSENT IS OF RECORD.
FOR PILLOWS (U.S. CLS. 2, 13, 22, 25, 32 AND 50).

SN 76-474,036. SCHEETZ, WILLIAM, EMMAUS, PA. FILED 12-4-2002.

FAN FANNY

FOR SEAT CUSHION (U.S. CLS. 2, 13, 22, 25, 32 AND 50).

CLASS 20—(Continued).

SN 78-096,448. GENERAL MOTORS CORPORATION, DETROIT, MI. FILED 12-4-2001.

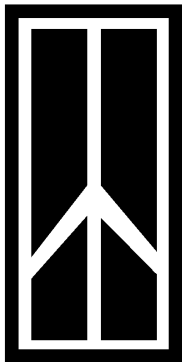

OWNER OF U.S. REG. NOS. 1,034,465, 1,822,801 AND OTHERS.

FOR CLEAR PLASTIC HOLDERS FOR BADGES; BEDS; CHAIRS; NON-METAL CLAMPS; DESK ORNAMENTS MADE OF PLASTIC AND WOOD; JEWELRY BOXES NOT OF METAL; NON-METAL KEY CHAINS; NON-METAL KEY FOBBS; NON-METAL KEY HOLDERS; NON-METAL KEY CHAINS; NON-METAL KEY TAGS; NON-METAL LICENSE PLATES; MIRRORS; NON-METAL KEY RINGS; NON-METAL NAMEPLATES; PICTURES FRAMES; PILLOWS; PLAQUES; PLASTIC FLATS; PLASTIC STORAGE BINS; SEAT CUSHIONS, STOOLS (U.S. CLS. 2, 13, 22, 25, 32 AND 50).

FIRST USE 1-1-1977; IN COMMERCE 1-1-1977.

SN 78-134,360. LIGHT STRING MINDER, LLC, BOISE, ID. FILED 6-10-2002.

LIGHT MINDER

NO CLAIM IS MADE TO THE EXCLUSIVE RIGHT TO USE "LIGHT", APART FROM THE MARK AS SHOWN.

FOR PLASTIC CONTAINERS FOR STORING AND DISPENSING ELECTRIC WIRE CORDS CARRYING ELECTRIC LIGHTS, FOR EXAMPLE CHRISTMAS LIGHT STRINGS (U.S. CLS. 2, 13, 22, 25, 32 AND 50).

SN 78-176,596. LASKO HOLDINGS, INC., WILMINGTON, DE. FILED 10-21-2002.

TASK ORGANIZER

NO CLAIM IS MADE TO THE EXCLUSIVE RIGHT TO USE "ORGANIZER", APART FROM THE MARK AS SHOWN.

FOR NON-METAL MULTI-PURPOSE UTILITY BOXES (U.S. CLS. 2, 13, 22, 25, 32 AND 50).

FIRST USE 1-16-2002; IN COMMERCE 1-16-2002.

CLASS 20—(Continued).

SN 78-178,131. SUNWISE PRODUCTS, LLC, RICHARDSON, TX. BY ASSIGNMENT SUNSATIONAL PRODUCTS, LLC, RICHARDSON, TX. FILED 10-24-2002.

TOTE'L TOWEL

NO CLAIM IS MADE TO THE EXCLUSIVE RIGHT TO USE "TOWEL", APART FROM THE MARK AS SHOWN.

FOR COMBINATION FITTED FABRIC FURNITURE COVER AND TOTE BAG FOR INDOOR/OUTDOOR FURNITURE, SUCH AS LOUNGE CHAIR (U.S. CLS. 2, 13, 22, 25, 32 AND 50).

FIRST USE 4-11-2000; IN COMMERCE 10-0-2000.

SN 78-190,528. BUCKHORN, INC., MILFORD, OH. FILED 12-3-2002.

CITADEL

FOR NON-METAL CONTAINERS FOR COMMERCIAL USE (U.S. CLS. 2, 13, 22, 25, 32 AND 50).

SN 78-191,032. MCRAE'S, INC., BIRMINGHAM, AL. FILED 12-4-2002.

MISS ATTITUDE

FOR PICTURE FRAMES; HAND HELD MIRRORS; PILLOWS; SLEEPING BAGS (U.S. CLS. 2, 13, 22, 25, 32 AND 50).

CLASS 21—HOUSEWARES AND GLASS

SN 75-302,316. GODINGER SILVER ART CO., LTD., NEW YORK, NY. FILED 6-3-1997.

CRYSTAL DIAMONDS

NO CLAIM IS MADE TO THE EXCLUSIVE RIGHT TO USE "CRYSTAL", APART FROM THE MARK AS SHOWN.

FOR CRYSTAL GIFTWARE NAMELY, BOXES, BOWLS, CANDLESTICKS, BEVERAGEWARE AND FIGURINES (U.S. CLS. 2, 13, 23, 29, 30, 33, 40 AND 50).

SN 76-174,146. LIBERTY HARDWARE MFG. CORP., BOCA RATON, FL. FILED 12-4-2000.

AUCKLAND

FOR BATHROOM ACCESSORIES NAMELY TOWEL BARS, TOWEL RINGS, TOILET TISSUE HOLDERS, SOAP DISHES TUMBLER HOLDERS AND TOOTHBRUSH HOLDERS (U.S. CLS. 2, 13, 23, 29, 30, 33, 40 AND 50).

CLASS 21—(Continued).

SN 76-233,059. CHAVEZ, JANE, SANTA FE, NM. FILED 3-29-2001.

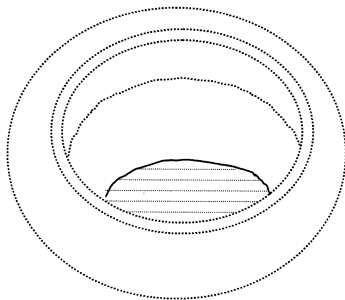

NO CLAIM IS MADE TO THE EXCLUSIVE RIGHT TO USE THE REPRESENTATION OF THE MATTER SHOWN BY THE DOTTED LINES, APART FROM THE MARK AS SHOWN.

THE MARK IS A BASKET DESIGN CONSISTING OF A COMBINATION OF A WOVEN BASKET WEAVE UPPER PORTION AND METAL BADGE OR BASE HAVING A SILVER COLORATION AND A PATTERN. THE BASKET BASE PLATE IS THE COLOR SILVER AND THIS COLOR IS A PART OF THE MARK. THE BROKEN LINES ON THE BASKET ARE INTENDED TO REPRESENT ANY BASKET CONFIGURATION. LIKEWISE, THE BROKEN LINES ON THE PERIMETER OF THE BASE ARE INTENDED TO REPRESENT ANY BASE CONFIGURATION.

SEC. 2(F).

FOR DECORATIVE BASKETS MADE PRIMARILY OF HORSEHAIR, AND ALSO CONSISTING OF SILVER AND PEWTER (U.S. CLS. 2, 13, 23, 29, 30, 33, 40 AND 50).

FIRST USE 6-0-1993; IN COMMERCE 6-0-1993.

SN 76-294,295. KENTUCKY BOURBON FESTIVAL, INCORPORATED, THE, BARDSTOWN, KY. FILED 8-2-2001.

BOURBON CAPITAL OF THE WORLD

FOR GLASSWARE, NAMELY, CUPS, MUGS, AND BEVERAGE GLASSES, SHOT GLASSES, COCKTAIL GLASSES, TUMBLERS, GOBLETS (U.S. CLS. 2, 13, 23, 29, 30, 33, 40 AND 50).

FIRST USE 3-20-2003; IN COMMERCE 3-20-2003.

CLASS 21—(Continued).

SN 76-422,585. WAECHTERSbacher KERAMIK OTTO F. FURST ZU YSENBURG AND BUDINGEN GMBH & CO. KG, 63636 BRACHTTAL, FED REP GERMANY, FILED 6-18-2002.



NO CLAIM IS MADE TO THE EXCLUSIVE RIGHT TO USE "SINCE 1832", APART FROM THE MARK AS SHOWN.

FOR CANDELABRAS MADE OF GLASS, PORCELAIN OR CERAMICS; GOODS MADE OF GLASS, PORCELAIN AND CERAMICS FOR HOUSEHOLD AND KITCHEN USE, NAMELY, CUPS, MUGS, SAUCERS, PLATES, MILK JUGS, SUGAR BOWLS, SALT AND PEPPER SHAKERS AND CASTERS, BOWLS, DRINKING VESSELS, DISHES, BUTTER DISHES, MARMALADE DISHES, BREAD BASKETS, BREAD BINS, COOKIE JARS, GOBLETS, JUGS, POTS, PITCHERS, AND NAPKIN RINGS; PORCELAIN OR CERAMIC PET FEEDING DISHES; BASTING SPOONS FOR KITCHEN USE; TEA INFUSERS AND STRAINERS NOT MADE OF PRECIOUS METAL; CAKE MOLDS; AND KITCHEN CONTAINERS NOT FORMED OF PRECIOUS METAL (U.S. CLS. 2, 13, 23, 29, 30, 33, 40 AND 50).

FIRST USE 0-0-1995; IN COMMERCE 0-0-1995.

SN 76-423,948. LOOCK, C.J., BURBANK, CA. FILED 6-18-2002.

RALPH-THE LITTLE STOWAWAY

FOR PLASTIC PAILS FOR HOUSEHOLD USE (U.S. CLS. 2, 13, 23, 29, 30, 33, 40 AND 50).

FIRST USE 4-26-2002; IN COMMERCE 4-26-2002.

SN 76-428,660. PREMIER RESEARCH LABORATORIES, LP, ROUND ROCK, TX. FILED 7-2-2002.

VIOLITE

FOR BOTTLES SOLD EMPTY (U.S. CLS. 2, 13, 23, 29, 30, 33, 40 AND 50).

SN 76-434,338. FU YUAN INTERNATIONAL, INC., LOS ANGELES, CA. FILED 7-22-2002.

FF FISHERMEN'S FORTUNE

FOR CERAMIC AND PORCELAIN GIFTWARE AND HOUSEWARE, NAMELY, CERAMIC AND PORCELAIN POTS, VASES, JARS, DECORATIVE PLATES, DECORATIVE BOWLS, DECORATIVE SAUCERS; CERAMIC AND PORCELAIN FIGURINES (U.S. CLS. 2, 13, 23, 29, 30, 33, 40 AND 50).

CLASS 21—(Continued).

SN 76-445,675. KENNEDY, KAREN, LOS ANGELES, CA.
FILED 8-30-2002.

**KAREN KENNEDY
PERSONALIZED CHALK
BOXES**

NO CLAIM IS MADE TO THE EXCLUSIVE RIGHT TO USE "PERSONALIZED CHALK BOXES", APART FROM THE MARK AS SHOWN.

FOR NON-METAL HAND-PAINTED DECORATIVE CHALK BOXES PERSONALIZED FOR CHILDREN FOR ID PURPOSES (U.S. CLS. 2, 13, 23, 29, 30, 33, 40 AND 50).
FIRST USE 3-0-1996; IN COMMERCE 3-0-1996.

SN 76-446,870. CANNON, JACQUELINE, IRVING, TX.
FILED 8-5-2002.

**WOMEN ARE GEMS...
PRECIOUS, PRICELESS,
IRREPLACEABLE**

FOR MUGS (U.S. CLS. 2, 13, 23, 29, 30, 33, 40 AND 50).

SN 76-453,586. JOHN R. LYMAN COMPANY, CHICOPEE, MA. FILED 9-19-2002.

Purity Wipes

Manufactured By

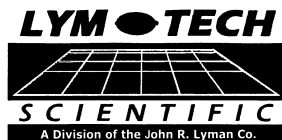

NO CLAIM IS MADE TO THE EXCLUSIVE RIGHT TO USE "WIPES" AND "MANUFACTURED BY LYM TECH SCIENTIFIC A DIVISION OF THE JOHN R. LYMAN CO.", APART FROM THE MARK AS SHOWN.

FOR CLEANROOM WIPES MADE OF POLYESTER FIBER (U.S. CLS. 2, 13, 23, 29, 30, 33, 40 AND 50).
FIRST USE 10-1-1982; IN COMMERCE 10-1-1982.

CLASS 21—(Continued).

SN 76-460,955. HANA COBI CO., LTD., NAMDONG-KU, INCHEON, REPUBLIC OF KOREA, FILED 10-15-2002.

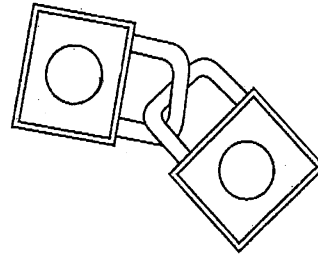

FOR HOUSEHOLD UTENSILS NOT OF PRECIOUS METAL, NAMELY, SOAP BOXES, TRASH CANS, COOKING POTS AND FRYING PANS, BOWLS, DISHES, PLASTIC CUPS, CRUETS, KITCHEN LADLES, NON-ELECTRIC KITCHEN CONTAINERS, SERVING TRAYS, BUCKETS, ICE BUCKETS, BASINS, DRINKING VESSELS (U.S. CLS. 2, 13, 23, 29, 30, 33, 40 AND 50).
FIRST USE 4-27-2000; IN COMMERCE 4-27-2000.

SN 76-478,474. SPORNETTE INTERNATIONAL, INC., HOMEWOOD, IL. FILED 12-20-2002.

SUPER STROKES

OWNER OF U.S. REG. NO. 2,518,105.
FOR HAIRBRUSHES (U.S. CLS. 2, 13, 23, 29, 30, 33, 40 AND 50).
FIRST USE 3-11-2002; IN COMMERCE 3-11-2002.

SN 78-015,861. NEAL, LINCOLN, L., COOKEVILLE, TN.
FILED 7-7-2000.

FRUIT SWIPES

NO CLAIM IS MADE TO THE EXCLUSIVE RIGHT TO USE "FRUIT", APART FROM THE MARK AS SHOWN.

FOR PRE-MOISTENED TOWELETTES FOR CLEANING AND DISINFECTING FRESH FRUIT AND VEGETABLES (U.S. CLS. 2, 13, 23, 29, 30, 33, 40 AND 50).

CLASS 21—(Continued).

SN 78-114,749. OBENITEC INC., SANTA CRUZ, CA. FILED 3-14-2002.

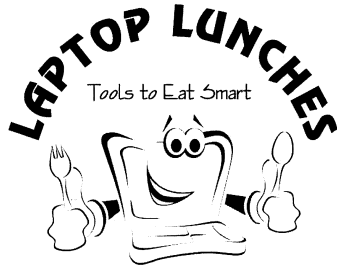

FOR PLASTIC FOOD CONTAINER (U.S. CLS. 2, 13, 23, 29, 30, 33, 40 AND 50).

CLASS 21—(Continued).

SN 78-147,676. CATALINA PRODUCTS, L.L.C., TUCSON, AZ. FILED 7-25-2002.

MY BEER. MY WAY.

NO CLAIM IS MADE TO THE EXCLUSIVE RIGHT TO USE "BEER", APART FROM THE MARK AS SHOWN.
 FOR KITS COMPOSED OF A KEG, PACKET OF BEER MIX, CLEANSER, REUSABLE BEER BOTTLES AND BREWING GUIDE FOR THE BREWING OF ALCOHOLIC BEVERAGES (U.S. CLS. 2, 13, 23, 29, 30, 33, 40 AND 50).
 FIRST USE 7-16-2002; IN COMMERCE 7-16-2002.

SN 78-164,877. MCDONALD, GERALD, ANDREW, GLOUCESTER, MA. FILED 9-17-2002.

DIRT BALL

NO CLAIM IS MADE TO THE EXCLUSIVE RIGHT TO USE "DIRT", APART FROM THE MARK AS SHOWN.
 FOR MOPS, HAND HELD HOUSEHOLD CLEANING DEVICES, NAMELY, SCRUB SPONGES, CLEANING CLOTHS, CLEANING SPONGES (U.S. CLS. 2, 13, 23, 29, 30, 33, 40 AND 50).

SN 78-138,959. FULL COURT PRESS, INC., ATLANTA, GA. FILED 6-26-2002.

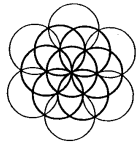

The Scoop

NO CLAIM IS MADE TO THE EXCLUSIVE RIGHT TO USE "SCOOP", APART FROM THE MARK AS SHOWN.
 FOR KITCHEN AND COOKING UTENSILS, NAMELY, A SCOOP UTENSIL; MULTI-FUNCTION CAMPSITE TOOL, NAMELY, A SCOOP UTENSIL; MULTI-FUNCTION CLEANUP AND TRANSPORT UTENSIL IN THE NATURE OF A SCOOP UTENSIL (U.S. CLS. 2, 13, 23, 29, 30, 33, 40 AND 50).
 FIRST USE 12-11-2002; IN COMMERCE 12-11-2002.

SN 78-173,240. CASCARINO'S PIZZA EXPRESS, LTD., COLLEGE POINT, NY. FILED 10-10-2002.



OWNER OF U.S. REG. NO. 2,461,377.
 NO CLAIM IS MADE TO THE EXCLUSIVE RIGHT TO USE "PIZZA EXPRESS", APART FROM THE MARK AS SHOWN.
 FOR PLASTIC AND PAPER GOODS, NAMELY, PLATES AND CUPS (U.S. CLS. 2, 13, 23, 29, 30, 33, 40 AND 50).

SN 78-146,836. TERRY, BRIAN, L., CORONADO, CA. AND STEIN, NICHOLAS, PAUL, NORTHRIDGE, CA. FILED 7-23-2002.

DISHWIZ

FOR CLEANING DEVICE FOR CLEANING TABLEWARE, DISHES, PLATES, CUTLERY, COOKING UTENSILS, POTS AND PANS, CUPS, GLASSES AND BOTTLES WITH BRUSHES, SPONGES, SCRAPERS, SCOURERS (U.S. CLS. 2, 13, 23, 29, 30, 33, 40 AND 50).

SN 78-176,018. ADAMS, KATHLEEN A., SAN DIEGO, CA. FILED 10-18-2002.

SNAP SAVER

FOR ALL PURPOSE PORTABLE STORAGE CONTAINERS FOR HOUSEHOLD USE (U.S. CLS. 2, 13, 23, 29, 30, 33, 40 AND 50).

CLASS 21—(Continued).

SN 78-182,257. GOOD IDEAS INTERNATIONAL, LLC, SARASOTA, FL. FILED 11-6-2002.

FOAMAIR

FOR DISPENSERS FOR LIQUID SOAP (U.S. CLS. 2, 13, 23, 29, 30, 33, 40 AND 50).
FIRST USE 9-14-2002; IN COMMERCE 9-14-2002.

SN 78-188,368. SANEK, LAWRENCE F. SR., HIGHLAND, IN. FILED 11-24-2002.

WHICH FOOD?? WHICH WINE?? RED, WHITE, PINK OR BUBBLY

FOR BEVERAGE GLASSWARE, BEVERAGE GLASSES, BOTTLE OPENERS, BOTTLE STANDS, COASTERS, DRINKING GLASSES, RECIPE BOXES, WINE BOTTLE CRADLES, WINE BUCKETS (U.S. CLS. 2, 13, 23, 29, 30, 33, 40 AND 50).

SN 78-189,870. SMITHKLINE BEECHAM CORPORATION, PHILADELPHIA, PA. FILED 11-29-2002.

AQUAFRESH BRILLIANT

OWNER OF U.S. REG. NOS. 1,662,981, 2,392,260 AND OTHERS.
FOR TOOTHBRUSHES (U.S. CLS. 2, 13, 23, 29, 30, 33, 40 AND 50).

SN 78-191,075. MEADE, RICK D., CLEVELAND, OH. FILED 12-4-2002.

POUNDERS

FOR DRINKING GLASSES AND BEER MUGS (U.S. CLS. 2, 13, 23, 29, 30, 33, 40 AND 50).

SN 78-193,272. PALUMBO, FRANK T., YARDLEY, PA. FILED 12-11-2002.

BRUSH-RIGHT

FOR TOOTHBRUSHES (U.S. CLS. 2, 13, 23, 29, 30, 33, 40 AND 50).

CLASS 21—(Continued).

SN 78-194,888. PET ZONE PRODUCTS LTD., CLEVELAND, OH. FILED 12-16-2002.

PIK-UP-BAGS

FOR PLASTIC PET WASTE CONTAINERS (U.S. CLS. 2, 13, 23, 29, 30, 33, 40 AND 50).

SN 78-200,585. GILLETTE CANADA COMPANY, DBA ORAL-B LABORATORIES, MISSISSAUGA, ONTARIO, CANADA, FILED 1-7-2003.

ARTICA

FOR TOOTHBRUSHES (U.S. CLS. 2, 13, 23, 29, 30, 33, 40 AND 50).

CLASS 22—CORDAGE AND FIBERS

SN 75-928,744. UNIFI, INC., GREENSBORO, NC. FILED 2-25-2000.

SORBTEK

FOR SYNTHETIC FIBER FOR POLYESTER BASED FABRIC (U.S. CLS. 1, 2, 7, 19, 22, 42 AND 50).
FIRST USE 1-19-2000; IN COMMERCE 1-19-2000.

SN 76-337,595. PAN TECHNOLOGIES, SANTA BARBARA, CA. FILED 11-15-2001.

GIRAFFIA

FOR RAW MATERIAL RAFFIA FIBERS, NATURAL AND DYED (U.S. CLS. 1, 2, 7, 19, 22, 42 AND 50).
FIRST USE 4-1-2000; IN COMMERCE 4-1-2000.

SN 76-340,924. MULTI-REACH, INC, LONDON, ONTARIO, CANADA, FILED 11-23-2001.

AWNINGS IN A BOX

SEC. 2(F).
FOR DO-IT-YOURSELF, PRE-FABRICATED AWNING KITS FOR FABRIC AWNINGS (U.S. CLS. 1, 2, 7, 19, 22, 42 AND 50).
FIRST USE 11-15-1996; IN COMMERCE 11-15-1996.

CLASS 22—(Continued).

SN 76-469,763. ACTIVA AWNING SYSTEMS, LLC, LOS ANGELES, CA. FILED 11-26-2002.

SHADING THE WORLD

FOR AWNINGS MADE OF FIBERGLASS OR FABRIC COVERED WITH RUBBER, FIBERGLASS OR PLASTIC (U.S. CLS. 1, 2, 7, 19, 22, 42 AND 50).

SN 78-186,902. CUNNINGHAM RESEARCH CORP., OSPREY, FL. FILED 11-20-2002.

COOL CANOPY

NO CLAIM IS MADE TO THE EXCLUSIVE RIGHT TO USE "CANOPY", APART FROM THE MARK AS SHOWN.

FOR CANOPY MADE FROM POLYETHYLENE KNITTED FABRIC DESIGNED TO LET THE AIR PASS THROUGH WHILE BLOCKING 90% OF THE ULTRA VIOLET RADIATION FOR OUTDOOR USE (U.S. CLS. 1, 2, 7, 19, 22, 42 AND 50).

CLASS 24—FABRICS

SN 76-461,250. NURSERY PAL, INC., MIDWEST CITY, OK. FILED 10-24-2002.

NURSERY PAL

NO CLAIM IS MADE TO THE EXCLUSIVE RIGHT TO USE NURSERY, APART FROM THE MARK AS SHOWN. FOR BEDDING, NAMELY SHEETS (U.S. CLS. 42 AND 50).

FIRST USE 11-15-1997; IN COMMERCE 11-15-1997.

SN 76-473,836. HILL FLORAL PRODUCTS, INC., RICHMOND, IN. FILED 12-11-2002.

AFGHAN EXPRESSIONS

NO CLAIM IS MADE TO THE EXCLUSIVE RIGHT TO USE "AFGHAN", APART FROM THE MARK AS SHOWN. FOR AFGHANS (U.S. CLS. 42 AND 50). FIRST USE 4-18-2000; IN COMMERCE 4-18-2000.

CLASS 24—(Continued).

SN 78-139,074. LEVI STRAUSS & CO., SAN FRANCISCO, CA. FILED 6-26-2002.



THE MARK CONSISTS OF A STYLIZED WING AND ANCHOR.

FOR BED SHEETS; BEDDING ENSEMBLES CONSISTING OF SHEETS, PILLOWCASES, COMFORTERS, DUVETS, SHAMS, DUSTRUFFLES; COMFORTERS, DUVETS, TOWELS, QUILTS AND SHOWER CURTAINS (U.S. CLS. 42 AND 50).

SN 78-150,684. SAYRE ENTERPRISES, INC., BUENA VISTA, VA. FILED 8-5-2002.

FLAG TALES

NO CLAIM IS MADE TO THE EXCLUSIVE RIGHT TO USE "FLAG", APART FROM THE MARK AS SHOWN.

FOR CLOTH FLAGS AND BANNERS, TABLE LINEN, NAMELY, NAPKINS, PLACE MATS AND TABLE-CLOTHS, TOWELS, GOLF TOWELS (U.S. CLS. 42 AND 50).

SN 78-152,175. DONGHIA FURNITURE/TEXTILES, LTD., NEW YORK, NY. FILED 8-8-2002.

& VICE VERSA

FOR TEXTILE FABRICS FOR THE MANUFACTURE OF UPHOLSTERY, CUSHIONS, DECORATIVE PILLOWS, UMBRELLAS, AWNINGS, WINDOW TREATMENTS AND DRAPERIES AND HAMMOCKS (U.S. CLS. 42 AND 50).

SN 78-160,068. WEAVEXX CORPORATION, WAKE FOREST, NC. FILED 9-3-2002.

AXXIAL

FOR PAPERMAKING FABRIC FOR USE IN PAPERMAKING MACHINES (U.S. CLS. 42 AND 50).

CLASS 24—(Continued).

SN 78-163,870. BERKSHIRE BLANKET, INC., WARE, MA.
FILED 9-13-2002.



FOR LAP THROWS AND BLANKETS FOR USE ON
BEDS (U.S. CLS. 42 AND 50).
FIRST USE 10-0-1997; IN COMMERCE 6-0-2000.

CLASS 24—(Continued).

SN 78-193,992. SHOGAKUKAN PRODUCTION CO., LTD.,
TOYKO, JAPAN, FILED 12-12-2002.



FOR BED LINEN, BED SHEETS, BED SKIRTS, BED
SPREADS, BED CANOPIES, BED BLANKETS, COMFOR-
TERS, WINDOW DRAPES, DUST RUFFLES, DUVET
COVERS, PILLOW CASES, PILLOW SHAMS, FABRIC
VALANCES, WINDOW CURTAINS, AND QUILTS (U.S.
CLS. 42 AND 50).

SN 78-167,341. QST INDUSTRIES, INC., CHICAGO, IL.
FILED 9-24-2002.

Polyastro

NO CLAIM IS MADE TO THE EXCLUSIVE RIGHT TO
USE "POLY", APART FROM THE MARK AS SHOWN.
FOR NON-WOVEN TEXTILE FABRICS (U.S. CLS. 42
AND 50).
FIRST USE 10-19-1973; IN COMMERCE 10-19-1973.

CLASS 25—CLOTHING

SN 75-482,638. CRL, INC., DBA MARBLE ARMS, GLAD-
STONE, MI. FILED 5-11-1998.

MARBLE'S

FOR CAPS, T-SHIRTS, SWEATSHIRTS, COATS AND
JACKETS (U.S. CLS. 22 AND 39).
FIRST USE 11-28-1995; IN COMMERCE 11-28-1995.

SN 78-178,435. LIFESYSTEMS LIMITED, ALDERMASTON,
UNITED KINGDOM, FILED 10-25-2002.

TREK TOWEL

NO CLAIM IS MADE TO THE EXCLUSIVE RIGHT TO
USE "TOWEL", APART FROM THE MARK AS SHOWN.
FOR TOWELS OF TEXTILE (U.S. CLS. 42 AND 50).

SN 75-591,685. MAZZA GRAZIANO, MONTEGRANARO
(ASCOLI PICENO), ITALY, FILED 11-10-1998.

PR-1

FOR FOOTWEAR AND BELTS (U.S. CLS. 22 AND 39).
FIRST USE 7-5-1999; IN COMMERCE 7-5-1999.

CLASS 25—(Continued).

SN 75-842,161. P. GOPALDAS LIMITED, KOWLOON, HONG KONG, FILED 11-5-1999.



THE NAME IN THE MARK "JOYCE JONES" DOES NOT IDENTIFY A PARTICULAR LIVING INDIVIDUAL. FOR CLOTHING, NAMELY, UNDERWEAR, BRASIERES, SKIRTS AND PANTIES (U.S. CLS. 22 AND 39). FIRST USE 4-16-2000; IN COMMERCE 4-16-2000.

SN 76-026,649. VIABLE PRODUCTS L.C., TAMPA, FL. FILED 4-7-2000.



NO CLAIM IS MADE TO THE EXCLUSIVE RIGHT TO USE "SOCK", APART FROM THE MARK AS SHOWN. FOR HOSIERY (U.S. CLS. 22 AND 39). FIRST USE 2-28-1999; IN COMMERCE 3-15-1999.

SN 76-154,419. RUBIE'S COSTUME, CO., RICHMOND HILL, NY. FILED 10-26-2000.

BUBBLE GUM GIRLS

NO CLAIM IS MADE TO THE EXCLUSIVE RIGHT TO USE "GIRLS", APART FROM THE MARK AS SHOWN. FOR HALLOWEEN AND MASQUERADE COSTUMES (U.S. CLS. 22 AND 39). FIRST USE 2-0-2001; IN COMMERCE 5-0-2001.

SN 76-166,813. POWER SPORT INDUSTRIES, INC., OLEY, PA. FILED 11-16-2000.

ALL BALLS RACING

FOR CLOTHING, NAMELY, SHIRTS, SKIRTS, SHORTS, PANTS, DRESSES, BUTTON DOWN SHIRTS, GOLF SHIRTS, SWEATERS, TANK TOPS, T SHIRTS, SWEAT SHIRTS, SWEAT PANTS, JACKETS, UNDER GARMENTS, SOCKS, PAJAMAS, HATS AND CAPS FOR MEN, WOMAN AND CHILDREN (U.S. CLS. 22 AND 39).

CLASS 25—(Continued).

SN 76-195,653. SMASH, INC., LOS ANGELES, CA. FILED 1-18-2001.

INTENSO

FOR CLOTHING, NAMELY, SHIRTS, PANTS, JACKETS, SUITS, SWEATERS, VESTS, COATS, UNDERWEAR, PAJAMAS, SOCKS, SHOES, HATS, T-SHIRTS, SKIRTS, BLOUSES, LINGERIE, AND HOSIERY (U.S. CLS. 22 AND 39).

SN 76-226,175. ANDERSON, DEMOYNE, BRONX, NY. FILED 3-19-2001.



FOR UNISEX CASUAL WEAR ATHLETIC WEAR AND CLOTHING, NAMELY, SHIRTS SWEATERS, PANTS, SLEEPWEAR, PAJAMAS, RAINWEAR, JACKETS JEANS, SHORTS, SLACKS, VESTS, HOSIERY, UNDERWEAR, SPORTS BRAS AND TIGHTS, SOCKS, SCARVES, GLOVES, WRISTBANDS, SWEATERS, SWEATSHIRTS, SWEATSUITS, BELTS FOR CLOTHING, SWIMWEAR, TANK TOPS, DRESSES, SKIRTS, BLOUSES; HEADWEAR, NAMELY, HEADBANDS, BANDANAS, CAPS AND HATS, BEANIE CAPS; FOOTWEAR, NAMELY, SHOES, SANDALS, SNEAKERS AND BOOTS (U.S. CLS. 22 AND 39).

SN 76-258,290. VIRTUOUS DESIGNS & VIRTUOUS WOMAN, MILWAUKEE, WI. FILED 5-18-2001.



NO CLAIM IS MADE TO THE EXCLUSIVE RIGHT TO USE "WOMAN", APART FROM THE MARK AS SHOWN. FOR CLOTHING, NAMELY, HATS, CAPS, SHIRTS, PANTS, HEAD WRAPS, SCARVES, SOCKS, DRESSES, PANT SUITS, LINGERIE, PAJAMAS, EVENING GOWNS, SKIRTS, AND DRESSES (U.S. CLS. 22 AND 39). FIRST USE 8-1-2000; IN COMMERCE 8-1-2000.

CLASS 25—(Continued).

SN 76-279,105. QVC, INC., WEST CHESTER, PA. FILED 7-2-2001.

CWS

FOR APPAREL, NAMELY BLOUSES, SHIRTS AND PANTS (U.S. CLS. 22 AND 39).
FIRST USE 4-7-1996; IN COMMERCE 4-7-1996.

CLASS 25—(Continued).

SN 76-297,271. OBSHCHESTVO S OGRANICHENNOY OTVETSTVENNOSTYU "RAZU MIKHINA", TA RAZU MIKHINA LTD., MOSCOW 109240, RUSSIAN FEDERATIO, FILED 8-8-2001.

SN 76-279,106. QVC, INC, WEST CHESTER, PA. FILED 7-2-2001.

FOR APPAREL, NAMELY BLOUSES, SHIRTS AND PANTS (U.S. CLS. 22 AND 39).
FIRST USE 4-7-1996; IN COMMERCE 4-7-1996.

PRIORITY CLAIMED UNDER SEC. 44(D) ON RUSSIAN FEDERATIO APPLICATION NO. 2001710413, FILED 4-10-2001, REG. NO. 222623, DATED 4-10-2001. EXPIRES 4-10-2011.
THE NAME "RAZU MIKHINA" IDENTIFIES A LIVING INDIVIDUAL WHOSE CONSENT IS OF RECORD.

FOR CLOTHING FOR MEN, WOMEN AND CHILDREN, NAMELY COATS, RAINCOATS, BELTS, WAISTCOAT, BLOUSES AND PULLOVERS, JACKETS, TROUSERS, SKIRTS, DRESSES, SUITS, SHIRTS AND CHEMISES, T-SHIRTS, SWEATERS, UNDERWEAR, SOCKS AND STOCKINGS, GLOVES, TIES, SCARVES, HATS AND CAPS, BOOTS, SHOES AND SLIPPERS (U.S. CLS. 22 AND 39).

SN 76-292,491. CAROL ANDERSON, INC., RANCHO DOMINGUEZ, CA. FILED 7-30-2001.



NO CLAIM IS MADE TO THE EXCLUSIVE RIGHT TO USE "RESORT GOODS ORIGINAL TRADEMARK" AND "MAUI BRAND", APART FROM THE MARK AS SHOWN.

FOR CLOTHING, NAMELY JACKETS, SWEATERS, VESTS, SWEAT SHIRTS, SWEAT PANTS, TOPS, BLOUSES, PANTS, SHORTS, SKIRTS, SKORTS, DRESSES, HATS, SHOES AND SWIMWEAR (U.S. CLS. 22 AND 39).
FIRST USE 2-28-2000; IN COMMERCE 2-28-2000.

SN 76-314,638. NATIONAL FASHION IMPORTS INC., BROOKLYN, NY. FILED 9-19-2001.

NO CLAIM IS MADE TO THE EXCLUSIVE RIGHT TO USE "JR.", APART FROM THE MARK AS SHOWN.

THE STIPPLING IN THE MARK IS FOR SHADING PURPOSES ONLY.

THE COLORS RED, GREEN AND BLUE ARE CLAIMED AS A FEATURE OF THE MARK.

FOR FOOTWEAR (U.S. CLS. 22 AND 39).
FIRST USE 7-0-2000; IN COMMERCE 7-0-2000.

CLASS 25—(Continued).

SN 76-327,569. TWIN TOWERS FUND, NEW YORK, NY. BY ASSIGNMENT NEW YORK CITY PUBLIC PRIVATE INITIATIVES, INC., NEW YORK, NY. FILED 10-19-2001.

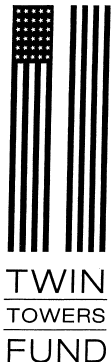

NO CLAIM IS MADE TO THE EXCLUSIVE RIGHT TO USE "FUND", APART FROM THE MARK AS SHOWN. FOR CLOTHING, NAMELY T-SHIRTS, SWEAT-SHIRTS, GOLF OR POLO SHIRTS (U.S. CLS. 22 AND 39).

SN 76-337,332. SOFTSPIKES, INC., GAITHERSBURG, MD. FILED 11-14-2001.

SOFTSPIKES

OWNER OF U.S. REG. NOS. 1,773,925 AND 2,278,540. FOR CLOTHING, NAMELY TROUSERS, SHORTS AND SOCKS (U.S. CLS. 22 AND 39).

SN 76-357,605. ERCAN GIYIM SANAYII A.S., KURTULUS, ISTANBUL, TURKEY, FILED 1-10-2002.

FREDDINI

OWNER OF U.S. REG. NO. 2,378,693. FOR WOMEN'S CLOTHING, NAMELY, LINGERIE (U.S. CLS. 22 AND 39). FIRST USE 7-31-1996; IN COMMERCE 7-31-1996.

SN 76-374,218. OCWEN LTD., GUERNSEY, CHANNEL ISLANDS, FILED 2-21-2002.



THE ENGLISH TRANSLATION OF "BALDORIA" IS "MERRYMAKING, REVELRY".

FOR CLOTHING, NAMELY, SHIRTS, SKIRTS, AND TOPS; CLOTHING ACCESSORIES, NAMELY, TIES, SCARVES, BOWTIES, FOULARDS, PAREOS, CAFTANS, AND BANDANAS (U.S. CLS. 22 AND 39).

FIRST USE 11-0-1999; IN COMMERCE 11-0-1999.

CLASS 25—(Continued).

SN 76-383,618. KUSHELOWITZ, BARRY, NEW YORK, NY. FILED 3-13-2002.

MODEL MALL

FOR CLOTHING, NAMELY, SHIRTS, PANTS, HATS AND JACKETS, BATHING SUITS, BATHING TRUNKS, BATHROBES, BELTS, BIKINIS, BLAZERS, BLOUSES, BODY SUITS, BOXER BRIEFS, BOXER SHORTS, BRAS, BRIEFS, BUSTIERS, SWEATERS, COATS, COVERALLS, DRESSES, FOUNDATION GARMENTS, GLOVES, GOWNS, GYM SHORTS, GYM SUITS, HALTER TOPS, HOSIERY, JEANS, JOGGING SUITS, JUMPERS, JUMPSUITS, KIMONOS, LAB COATS, LEG WARMERS, LEGGINGS, LEOTARDS, LINGERIE, LOUNGE WEAR, MINISKIRTS, MITTENS, NECKERCHIEFS, NECKTIES, NEGLIGEEES, NIGHT GOWNS, OVERALLS, PANAMAS, PANTIES, PANTYHOSE, VESTS, ROBES, SARONGS, SASHES, SCARVES, SHAWLS, SHORTS, SKIRTS, SKORTS, SLACKS, SLEEPWEAR, SMOCKS, SNOW SUITS, SOCKS, SPORT COATS, STOCKINGS, SUITS, SURF WEAR, SWIMSUITS, T-SHIRTS, TIES, TIGHTS, TOGAS, TROUSERS, TUNICS, TUXEDOS, UNDERWEAR, AND WARM UP SUITS (U.S. CLS. 22 AND 39).

SN 76-383,619. KUSHELOWITZ, BARRY, NEW YORK, NY. FILED 3-13-2002.

MODEL BEHAVIOR

FOR CLOTHING, NAMELY, SHIRTS, PANTS, HATS AND JACKETS, BATHING SUITS, BATHING TRUNKS, BATHROBES, BELTS, BIKINIS, BLAZERS, BLOUSES, BODY SUITS, BOXER BRIEFS, BOXER SHORTS, BRAS, BRIEFS, BUSTIERS, SWEATERS, COATS, COVERALLS, DRESSES, FOUNDATION GARMENTS, GLOVES, GOWNS, GYM SHORTS, GYM SUITS, HALTER TOPS, HOSIERY, JEANS, JOGGING SUITS, JUMPERS, JUMPSUITS, KIMONOS, LAB COATS, LEG WARMERS, LEGGINGS, LEOTARDS, LINGERIE, LOUNGE WEAR, MINISKIRTS, MITTENS, NECKERCHIEFS, NECKTIES, NEGLIGEEES, NIGHT GOWNS, OVERALLS, PANAMAS, PANTIES, PANTYHOSE, VESTS, ROBES, SARONGS, SASHES, SCARVES, SHAWLS, SHORTS, SKIRTS, SKORTS, SLACKS, SLEEPWEAR, SMOCKS, SNOW SUITS, SOCKS, SPORT COATS, STOCKINGS, SUITS, SURF WEAR, SWIMSUITS, T-SHIRTS, TIES, TIGHTS, TOGAS, TROUSERS, TUNICS, TUXEDOS, UNDERWEAR, AND WARM UP SUITS (U.S. CLS. 22 AND 39).

SN 76-392,286. LONG, WILLIAM IVEY, NEW YORK, NY. FILED 4-5-2002.

WILLIAM IVEY LONG

FOR CLOTHING, NAMELY, DRESSES, GOWNS, COATS, JACKETS, SUITS, PANTS, TOPS, BLOUSES, LINGERIE AND SLEEPWEAR (U.S. CLS. 22 AND 39).

CLASS 25—(Continued).

SN 76-394,265. CROWN FANCY GOODS, CO., LTD., TOKYO, JAPAN, FILED 4-8-2002.

FIFTY-FIVE POSSIBLE

FOR CLOTHING, NAMELY COATS, SWEATERS, T-SHIRTS, PAJAMAS, UNDERWEAR, SWIM WEAR, APRONS, MUFFLERS, SOCKS, SCARFS, NECKTIES, EARMUFFS, CAPS, SUSPENDERS, BELTS, SPORTS WEAR, NAMELY SPORTS SHIRTS AND SPORT COATS, AND SHOES (U.S. CLS. 22 AND 39).

SN 76-401,607. CLOTHING INTERNATIONAL, INC., CHULA VISTA, CA. FILED 4-29-2002.

SD CLASSICK

NO CLAIM IS MADE TO THE EXCLUSIVE RIGHT TO USE "CLASSICK", APART FROM THE MARK AS SHOWN.

FOR CLOTHING, NAMELY MEN'S, WOMEN'S AND CHILDREN'S SLACKS, JEANS, T-SHIRTS, SWEATERS, SWEATSHIRTS, JACKETS, SHORTS, SOCKS, CAPS, HATS, SHOES, BELTS AND UNDERWEAR (U.S. CLS. 22 AND 39).

SN 76-417,078. TRAN, FRANCIS TUAN PHUONG, WESTMINSTER, CA. AND PASCUAL, ALFRED SANTOS, WESTMINSTER, CA. AND KAO, VINCENT WEN-CHIEN, WESTMINSTER, CA. FILED 6-5-2002.

HOOP JUNKIES

FOR CLOTHING, NAMELY, T-SHIRTS, SHIRTS, PANTS, SHORTS, CUTOFFS, JERSEYS, SHIRTS, HATS, CAPS, BEANIES, SOCKS, SHOES, SANDALS, SWEATERS, JACKETS, UNDERWEAR, SWEAT BANDS, BANDANAS (U.S. CLS. 22 AND 39).

SN 76-420,285. HOLLIS, KEITH W, ATLANTIC CITY, NJ. FILED 5-22-2002.

POCCIT

FOR MEN'S, WOMEN'S AND CHILDREN'S CLOTHING, NAMELY, SHIRTS, SWEATERS, JACKETS, PANTS, SHORTS, SKIRTS, DRESSES, HATS, UNDERWEAR AND SHOES (U.S. CLS. 22 AND 39).

SN 76-420,659. TIME WARNER ENTERTAINMENT COMPANY, L.P., NEW YORK, NY. FILED 6-14-2002.

BOXING AFTER DARK

OWNER OF U.S. REG. NO. 2,704,327.
FOR CLOTHING, NAMELY, HATS AND T-SHIRTS (U.S. CLS. 22 AND 39).
FIRST USE 2-3-1996; IN COMMERCE 2-3-1996.

CLASS 25—(Continued).

SN 76-420,692. ZHEJIANG SILK USA, INC., NEW YORK, NY. FILED 6-14-2002.

NICOLE TAYLOR

THE NAME "NICOLE TAYLOR" DOES NOT IDENTIFY A LIVING INDIVIDUAL.

FOR LADIES, MEN, AND CHILDREN'S CLOTHING, NAMELY, SPORTSWEAR, BLOUSES, PANTS, SKIRTS, JACKETS, DRESSES, KNIT AND WOVEN SHIRTS (U.S. CLS. 22 AND 39).

FIRST USE 8-0-2000; IN COMMERCE 8-0-2000.

SN 76-421,551. BECTON, WENDELL WALTON, FORSYTH, IL. FILED 6-14-2002.

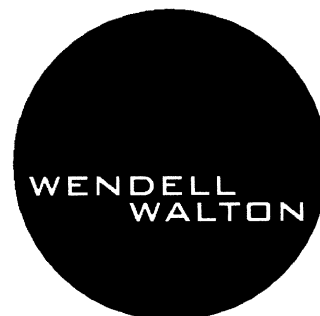

FOR CLOTHING (U.S. CLS. 22 AND 39).

SN 76-435,202. OFFICIAL BUGLE BOY, LLC, COLUMBUS, OH. FILED 7-29-2002.

RISK EVERYTHING

OWNER OF U.S. REG. NO. 2,044,043.
FOR WEARING APPAREL, NAMELY PANTS, SHORTS, JEANS, T-SHIRTS, SWEATSHIRTS, SWEAT-PANTS, SWEATERS, VESTS, JACKETS, BLOUSES, DRESSES, BLAZERS, COATS, BASEBALL CAPS AND VISORS (U.S. CLS. 22 AND 39).

SN 76-435,970. FITZBRADSHAWRACING, L.L.C., WESTLAKE, TX. FILED 7-31-2002.

FITZBRADSHAWRACING

FOR CLOTHING, NAMELY CAPS, HATS, SHIRTS, T-SHIRTS, POLO SHIRTS, WINDSHIRTS, PULLOVERS AND JACKETS (U.S. CLS. 22 AND 39).
FIRST USE 12-1-2001; IN COMMERCE 12-1-2001.

CLASS 25—(Continued).

SN 76-443,108. AUSTIN REED LTD., NORTH YORKSHIRE YO7 1QH, ENGLAND, FILED 8-19-2002.

WRIGHT & PEEL

OWNER OF UNITED KINGDOM REG. NO. 1451760, DATED 5-22-1992, EXPIRES 1-3-2008.

FOR CLOTHING, NAMELY, COATS, JACKETS, JUMPERS, PULLOVERS, LEGGINGS; BEACH CLOTHES, NAMELY BATHING SUITS, BATHING TRUNKS, BATHING CAPS; PAJAMAS, BATH ROBES, UNDERGARMENTS, DRESSING GOWNS, DRESSES, SKIRTS, SHIRTS, TROUSERS, SUITS, WAISTCOATS, TEE-SHIRTS, GLOVES; FOOTWEAR, NAMELY, SANDALS, SLIPPERS, BOOTS, SHOES, SNEAKERS, BEACH SHOES; HEADGEAR, NAMELY, CAPS, BERETS, BANDANNAS, TOP HATS; SCARVES, BELTS, TIES; SPORTSWEAR, NAMELY, SPORTS JERSEYS, SPORTS TEE-SHIRTS, TRACK SUITS, SPORTS SOCKS, SPORTS JACKETS, SPORTS COATS (U.S. CLS. 22 AND 39).

SN 76-443,388. CINTAS CORPORATION NO. 3, SPARKS, NV. FILED 8-23-2002.

NOVATION

FOR CLEANROOM SUPPLIES FOR MANUFACTURING GOODS IN CONTROLLED ENVIRONMENTS, NAMELY, GLOVES, CAPS, AND GARMENTS (U.S. CLS. 22 AND 39).

SN 76-447,263. LONG, KIP, MESA, AZ. FILED 9-6-2002.



NO CLAIM IS MADE TO THE EXCLUSIVE RIGHT TO USE "ATHLETIC WEAR", APART FROM THE MARK AS SHOWN.

FOR ATHLETIC UNIFORMS, WRIST BANDS, GOLF SHIRTS, GYM SHORTS, GYM SUITS, WIND RESISTANT JACKETS, JOGGING SUITS, PARKAS, POLO SHIRTS, SWEAT SHIRTS, SWEAT PANTS, SOCKS, SWIM WEAR, SWIM TRUNKS, T-SHIRTS, TANK TOPS, TRACKSUITS AND UNITARDS (U.S. CLS. 22 AND 39).

SN 76-451,996. J.G. JOHNSON CORPORATION, JUPITER, FL. FILED 9-23-2002.

JOSET WALKER

THE NAME "JOSET WALKER" DOES NOT IDENTIFY A LIVING INDIVIDUAL.

FOR CLOTHING, NAMELY BLOUSES, DRESSES, SKIRTS, SHIRTS, PANTS, JEANS, SHORTS (U.S. CLS. 22 AND 39).

CLASS 25—(Continued).

SN 76-457,587. E! ENTERTAINMENT TELEVISION, INC., LOS ANGELES, CA. FILED 10-8-2002.

WILD ON

OWNER OF U.S. REG. NO. 2,449,201.

FOR CLOTHING; NAMELY SHIRTS, T-SHIRTS, TANK TOPS, SWEATSHIRTS, HATS, CAPS, BANDANAS, ROBES, AND JACKETS (U.S. CLS. 22 AND 39).
FIRST USE 8-1-2000; IN COMMERCE 8-1-2000.

SN 76-466,392. RENAL, INC., ENGLEWOOD CLIFFS, NJ. FILED 11-13-2002.

WRAP CAP

NO CLAIM IS MADE TO THE EXCLUSIVE RIGHT TO USE "CAP", APART FROM THE MARK AS SHOWN.
FOR CAPS (U.S. CLS. 22 AND 39).

SN 76-466,799. JAMES, JESSE, LONG BEACH, CA. FILED 11-14-2002.

LONG BEACH LOW RIDER REPAIR

NO CLAIM IS MADE TO THE EXCLUSIVE RIGHT TO USE "LONG BEACH", APART FROM THE MARK AS SHOWN.

FOR CLOTHING, NAMELY, SHIRTS, T-SHIRTS, JACKETS, PANTS, SWEAT SHIRTS, SWEAT PANTS; HEADWEAR, NAMELY, HATS, CAPS, HEADBANDS (U.S. CLS. 22 AND 39).

SN 76-466,956. NEW BALANCE ATHLETIC SHOE, INC., BOSTON, MA. FILED 11-7-2002.

N-ERGY

FOR FOOTWEAR (U.S. CLS. 22 AND 39).
FIRST USE 4-15-1998; IN COMMERCE 4-15-1998.

SN 76-467,018. SCOPE IMPORTS, INC., HOUSTON, TX. FILED 11-5-2002.

BURNSIDE ACTIVE

FOR PANTS, JACKETS, TOPS, BOTTOMS, SWIMWEAR, SHORTS, AND SWEATERS (U.S. CLS. 22 AND 39).

FIRST USE 8-0-2001; IN COMMERCE 8-0-2001.

CLASS 25—(Continued).

SN 76-467,587. AT LAST SPORTSWEAR INC., SECAUCUS, NJ. FILED 11-15-2002.

SABYASACHI

FOR LADIES, MEN'S AND CHILDREN'S WEARING APPAREL, NAMELY, TOPS, PANTS, BLOUSES, SHORTS, SHIRTS, SWEATERS, PLAYSUITS, JACKETS, COATS, AND SLEEPWEAR (U.S. CLS. 22 AND 39).
FIRST USE 5-13-2002; IN COMMERCE 5-13-2002.

SN 76-467,845. BARBARA K. ENTERPRISES, INC., NEW YORK, NY. FILED 11-18-2002.



FOR WOMEN'S WORK-WEAR CLOTHING FOR USE IN HOME IMPROVEMENT ACTIVITIES, NAMELY, SMOCK TOPS, SHIRTS AND GLOVES (U.S. CLS. 22 AND 39).

SN 76-467,902. PLEASANT COMPANY, MIDDLETON, WI. FILED 11-19-2002.

DRESS LIKE YOUR DOLL

FOR CHILDREN'S CLOTHING, NAMELY, BLOUSES, SHIRTS, SKIRTS, LEOTARDS, SWEATERS, TANK TOPS, TEE SHIRTS, TURTLENECKS AND MOCK TURTLENECKS, DRESSES, JUMPERS, PANTS, JEANS, SHORTS, VESTS, SWEATSHIRTS, SWEATSUITS, SWEAT PANTS, BELTS, COATS, JACKETS, HATS, CAPS, MITTENS, HEAD BANDS AND HEAD WREATHS, TIGHTS, SCARVES, KERCHIEFS, SLEEPWEAR, PAJAMAS, NIGHTGOWNS, ROBES, SLIPPERS, AND HALLOWEEN COSTUMES (U.S. CLS. 22 AND 39).
FIRST USE 12-30-1996; IN COMMERCE 12-30-1996.

SN 76-468,254. CAPITAL MERCURY APPAREL, LTD., NEW YORK, NY. FILED 11-12-2002.

NO STRESS NO PRESS

FOR SHIRTS, SWEATERS, SLACKS, SHORTS, COATS AND JACKETS (U.S. CLS. 22 AND 39).

CLASS 25—(Continued).

SN 76-468,332. JACOB ASH COMPANY, INC., MCKEES ROCKS, PA. FILED 11-20-2002.

HYDRA SHIELD

FOR CLOTHING, NAMELY, GLOVES THAT CONTAIN A WATERPROOF, BREATHABLE, WINDPROOF MEMBRANE (U.S. CLS. 22 AND 39).

SN 76-468,363. HUDSON, SARAH, SAN ANTONIO, TX. FILED 11-18-2002.

NORSAH

FOR CLOTHING, NAMELY, JACKETS, BLAZERS, COATS, PARKAS, RAINWEAR, HEADWEAR, HATS, SCARVES, SHIRTS, BLOUSES, SWEATERS, DRESSES, SKIRTS, JUMPERS, PANTS, JEANS, SHORTS, JOGGING SUITS, ROBES, SLEEPWEAR, UNDERCLOTHES, BODY SUITS, SWIMWEAR AND BEACHWEAR (U.S. CLS. 22 AND 39).

SN 76-468,454. CAPITAL MERCURY APPAREL, LTD., NEW YORK, NY. FILED 11-12-2002.

NO PRESS NO STRESS

FOR SHIRTS, SWEATERS, SLACKS, SHORTS, COATS AND JACKETS (U.S. CLS. 22 AND 39).

SN 76-468,482. PROMEX INTERNATIONAL, INC., NEW YORK, NY. FILED 11-20-2002.

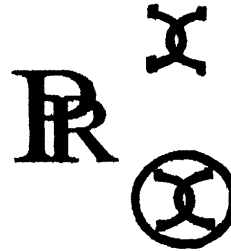

FOR FOOTWEAR, NAMELY, SHOES AND CLOTHING, NAMELY, SHIRTS, SUITS, PANTS, SKIRTS, JACKETS, SWEATERS, COSTUMES, PAJAMAS, NIGHT SHIRTS, AND HATS (U.S. CLS. 22 AND 39).

CLASS 25—(Continued).

SN 76-468,483. L&W FASHION, INC., SCARSDALE, NY.
FILED 11-20-2002.

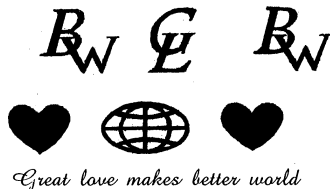

FOR FOOTWEAR, NAMELY, SHOES AND CLOTHING, NAMELY, SHIRTS, SUITS, PANTS, SKIRTS, JACKETS, SWEATERS, COSTUMES, PAJAMAS, NIGHTS SHIRTS, AND HATS (U.S. CLS. 22 AND 39).

SN 76-469,843. COLUMBIA INSURANCE COMPANY, OMAHA, NE. FILED 11-26-2002.

AIRSHAFT

FOR FOOTWEAR (U.S. CLS. 22 AND 39).

SN 76-469,846. COLUMBIA INSURANCE COMPANY, OMAHA, NE. FILED 11-26-2002.

MONOSHOX

FOR FOOTWEAR (U.S. CLS. 22 AND 39).

SN 76-469,847. COLUMBIA INSURANCE COMPANY, OMAHA, NE. FILED 11-26-2002.

AIRWORKS

FOR FOOTWEAR (U.S. CLS. 22 AND 39).

SN 76-471,335. T-RIX ENTERPRISES, RENO, NV. FILED 12-2-2002.



FOR CYCLING APPAREL, NAMELY, HATS, CAPS, T-SHIRTS, SHIRTS, SHORTS, PANTS, SWEATSHIRTS AND GLOVES (U.S. CLS. 22 AND 39).

CLASS 25—(Continued).

SN 76-471,710. SINGH, GURCHARAN, GUTTENBERG, NJ.
FILED 11-12-2002.

DENIM DEGREE

NO CLAIM IS MADE TO THE EXCLUSIVE RIGHT TO USE "DENIM", APART FROM THE MARK AS SHOWN.
FOR LADIES AND MEN'S GARMENTS, NAMELY—PANTS, SHIRTS, SKIRTS, BLOUSES, GOWNS AND SHORTS (U.S. CLS. 22 AND 39).
FIRST USE 1-1-2002; IN COMMERCE 1-1-2002.

SN 76-471,742. RAJCO INTERNATIONAL INC., NEW YORK, NY. FILED 10-15-2002.

FROM THE HOUSE, TO THE PATIO AND BEYOND

FOR WOMEN'S, MEN'S, AND CHILDREN'S APPAREL NAMELY; SHIRTS, JACKETS, PANTS DRESSES, AND BLOUSES (U.S. CLS. 22 AND 39).

SN 76-474,275. TURTLE FUR COMPANY, MORRISVILLE, VT. FILED 12-6-2002.

HELMET UNDIES

FOR HOODS WITH NECKWARMERS, HATS, HOOD AND HAT LINERS (U.S. CLS. 22 AND 39).
FIRST USE 7-2-2002; IN COMMERCE 7-2-2002.

SN 76-474,300. CHAPMAN, STEVEN, DEXTER, ME. FILED 11-29-2002.

I-ROC

FOR SPECIAL SHOES, HEELESS FOR WALKING (U.S. CLS. 22 AND 39).

SN 76-474,737. GROOP DESIGN, LLC, ATHENS, GA. FILED 12-13-2002.

GROOP

FOR T-SHIRTS AND BABY DOLL STYLE SHIRTS (U.S. CLS. 22 AND 39).
FIRST USE 9-1-1999; IN COMMERCE 11-1-1999.

CLASS 25—(Continued).

SN 76-474,990. GFSI, INC., LENEXA, KS. FILED 12-10-2002.

LUXE TOUCH

FOR APPAREL, NAMELY, SWEATSHIRTS, T-SHIRTS, SHORTS, COATS, JACKETS, POLO SHIRTS, KNIT TOPS, WARM-UP SUITS, SWEATERS, CAPS, PANTS AND SOCKS (U.S. CLS. 22 AND 39).

SN 76-475,306. WORKING CLASS INDUSTRIES, INC., WALL, NJ. FILED 12-11-2002.



FOR CLOTHING, NAMELY, WOOL HATS, KNIT HATS, BASEBALL CAPS, WORK JACKETS, LONG-SLEEVE AND SHORT-SLEEVE T-SHIRTS, SWEATSHIRTS, SHORTS, PANTS, DENIM JEANS (U.S. CLS. 22 AND 39).

FIRST USE 2-2-2002; IN COMMERCE 2-2-2002.

SN 76-475,341. GFSI, INC., LENEXA, KS. FILED 12-13-2002.

GFS.GEAR

FOR APPAREL, NAMELY, SWEATSHIRTS, T-SHIRTS, SHORTS, COATS, JACKETS, POLO SHIRTS, KNIT TOPS, WARM-UP SUITS, SWEATERS, CAPS, PANTS AND SOCKS (U.S. CLS. 22 AND 39).

SN 76-475,443. SCULPTED FOOTWEAR, DBA DINOSHOES, TOPANGA CANYON, CA. FILED 12-16-2002.

DINOSHOES

FOR APPAREL, NAMELY, SHIRTS, BLOUSES, T-SHIRTS, PANTS, SHORTS, OVERALLS, SHORTALLS, CREEPERS, SWEATSHIRTS, SWEATPANTS, JOGGING SUITS, JACKETS, COATS, SKIRTS, DRESSES, JUMPSUITS, JUMPERS, TOPS, SWEATERS, VESTS, MITTENS, OUTERWEAR, RAINCOATS, UNDERWEAR, NIGHT GOWNS, PAJAMAS, ROBES, BOXER SHORTS, UNDERSHIRTS, NECKTIES, SWIM WEAR, BEACH WEAR, BEACH COVER UPS; GLOVES, SCARVES, SUSPENDERS, BELTS; LEOTARDS, SOCKS, LEGGINGS, BOOTIES AND FOOTWEAR (U.S. CLS. 22 AND 39).

CLASS 25—(Continued).

SN 78-011,130. KEITH SCHEINBERG, NEWPORT BEACH, CA. AND DEREK JEAGER, IRVINE, CA. FILED 6-4-2000.

PIMPIT

FOR SHOES, SOCKS, HATS, BELTS, PANTS, SOCKS, UNDERWEAR FOR GUYS AND GIRLS, BRAS, JACKETS, SWEATERS, SWEATSHIRTS, BEANIES, TANK TOPS, SHIRTS, UNDERWEAR FOR GUYS AND GIRLS (U.S. CLS. 22 AND 39).

FIRST USE 2-1-1998; IN COMMERCE 2-1-1998.

SN 78-054,111. YZY DESIGNS, LLC, SAN FRANCISCO, CA. FILED 3-20-2001.

YZY

FOR MEN'S, WOMEN'S AND CHILDREN'S CLOTHING, NAMELY, T-SHIRTS; FOOTWEAR AND HEADWEAR (U.S. CLS. 22 AND 39).

SN 78-058,072. JUST DUCKY ENTERPRISES INC., FRANKLIN LAKES, NJ. FILED 4-12-2001.

SQUEAKY SNEAKS

NO CLAIM IS MADE TO THE EXCLUSIVE RIGHT TO USE "SNEAKS", APART FROM THE MARK AS SHOWN.

FOR SNEAKERS (U.S. CLS. 22 AND 39).

FIRST USE 4-1-2001; IN COMMERCE 4-1-2001.

SN 78-077,313. BURKE, PATRICK J., CEDAR RAPIDS, IA. FILED 8-3-2001.

URBAN SOLE

NO CLAIM IS MADE TO THE EXCLUSIVE RIGHT TO USE "URBAN", APART FROM THE MARK AS SHOWN.

FOR CLOTHING, NAMELY, SWEATSHIRTS, JACKETS AND T-SHIRTS; FOOTWEAR (U.S. CLS. 22 AND 39).

SN 78-078,653. MARBLE SPORTSWEAR, INC., BEVERLY HILLS, CA. FILED 8-10-2001.

PANACH'

FOR BATHING SUITS, BLAZERS, BLOUSES, BOOTS, BRAS, BRIEFS, CAMISOLES, CAPS, COATS, DRESSES, GLOVES, HATS, JACKETS, JEANS, JUMPSUITS, LEOTARDS, NECKTIES, NIGHTGOWNS, OVERALLS, PAJAMAS, PANTS, PANTYHOSE, RAINCOATS, ROBES, SANDALS, SHIRTS, SHOES, SHORTALLS, SHORTS, SKIRTS, SLIPPERS, SLIPS, SOCKS, STOCKINGS, SUITS, SWEATERS, SWEATPANTS, SWEATSHIRTS, T-SHIRTS, TIGHTS, TUXEDOS, VESTS, WARM-UP SUITS (U.S. CLS. 22 AND 39).

CLASS 25—(Continued).

SN 78-093,948. BOW DOWN, SANTA MONICA, CA. FILED 11-17-2001.

WHITEBOY

FOR SHIRTS, HATS, AND PANTS (U.S. CLS. 22 AND 39).

SN 78-097,885. VERANDAH DEVELOPMENT LLC, BONITA SPRINGS, FL. FILED 12-12-2001.

VERANDAH

FOR MEN'S, WOMEN'S AND CHILDREN'S CLOTHING, NAMELY BATHING SUITS, BATHROBES, BEACH WEAR, BLAZERS, BOXER SHORTS, COATS, GOLF SHIRTS, GOLF SHOES, GYM SHORTS, HATS, JACKETS, JOGGING SUITS, POLO SHIRTS, SHIRTS, SHOES, SHORTS, SLACKS, SWEAT SHIRTS, SWEATERS, TENNIS WEAR AND T-SHIRTS. (U.S. CLS. 22 AND 39).

SN 78-125,784. THE WILDLIFE EXPERIENCE, INC., GREENWOOD VILLAGE, CO. FILED 5-2-2002.



FOR CLOTHING, NAMELY, SHIRTS, T-SHIRT, SWEATSHIRTS, HATS, CAPS, AND JACKETS (U.S. CLS. 22 AND 39).

SN 78-125,787. THE WILDLIFE EXPERIENCE, INC., GREENWOOD VILLAGE, CO. FILED 5-2-2002.

TWE

FOR CLOTHING, NAMELY, SHIRTS, T-SHIRTS, SWEATSHIRTS, HATS, CAPS AND JACKETS (U.S. CLS. 22 AND 39).

CLASS 25—(Continued).

SN 78-128,289. BALLARD, DANIEL, NATHAN, MCLEAN, VA. FILED 5-13-2002.

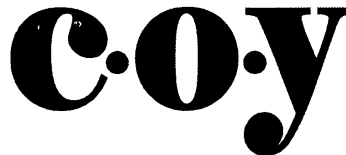

FOR FEMALE GRAPHIC T-SHIRTS (U.S. CLS. 22 AND 39).

SN 78-128,401. VARASTEHE, STEVE, TUCSON, AZ. AND BABIARZ, DAVID, TUCSON, AZ. FILED 5-13-2002.

QUACK ATTACK

FOR CLOTHING NAMELY TOPS AND BOTTOMS, T-SHIRTS, SHIRTS, TANK TOPS, PANTS, SHORTS, SWEATSHIRTS, SWEATPANTS, WARM-UP SUITS, UNDERWEAR, SLEEPWEAR, SWIMSUITS, RAIN COATS, SHOES, SOCKS, HATS, BANDANAS, SWEATBANDS, TIES, SUSPENDERS, BELTS (U.S. CLS. 22 AND 39). FIRST USE 11-21-1999; IN COMMERCE 11-21-1999.

SN 78-131,770. CROATIA SPORTSWEAR INCORPORATED, CAMBRIDGE, ONTARIO, N3H-5G7, CANADA, FILED 5-29-2002.

PLAY HARD, BE RECOGNIZED.

FOR CLOTHING, NAMELY, T-SHIRTS, SWEATSHIRTS, SWEATERS, GOLF AND POLO SHIRTS, SHORTS, SPORT SHIRTS, JERSEYS, WOVEN SHIRTS, BUTTON DOWN SHIRTS; FLEECE APPAREL NAMELY, HOODED AND NON-HOODED PULLOVERS AND VESTS, SWEATSHIRTS, AND JACKETS; HEADWEAR, NAMELY, HATS, VISORS AND CAPS; AND WINDSHIRTS (U.S. CLS. 22 AND 39).

SN 78-132,640. MANKOVITZ, ROY, CALABASAS, CA. FILED 6-2-2002.

HEALTHBRA

FOR BREAST-SUPPORTING GARMENTS, NAMELY, BRASSIERES, SHIRTS THAT CONTAIN BUILT-IN BRASSIERES, BATHING SUITS THAT CONTAIN BUILT-IN BRASSIERES, AND FOUNDATION GARMENTS, NAMELY, CORSETS (U.S. CLS. 22 AND 39).

CLASS 25—(Continued).

SN 78-133,304. LI, NING, BEIJING, CHINA, FILED 6-5-2002.



THE ENGLISH TRANSLATION OF "SUERTE" IS "LUCK". FOR CLOTHING, HEADWEAR AND FOOTWEAR, JACKETS, SPORTSWEAR NAMELY WARM UP SUITS CONSISTING OF JACKETS AND PANTS, SHORTS AND PANTS, SHIRTS, T-SHIRTS, SWEATSHIRTS, SOCKS, SHOES, CAPS (U.S. CLS. 22 AND 39).
FIRST USE 5-1-2002; IN COMMERCE 5-1-2002.

SN 78-140,418. RUFF RYDERS ENTERTAINMENT, INC., NEW YORK, NY. FILED 7-1-2002.



OWNER OF U.S. REG. NOS. 2,355,392 AND 2,565,726.
NO CLAIM IS MADE TO THE EXCLUSIVE RIGHT TO USE "DIRTY DENIM", APART FROM THE MARK AS SHOWN.
FOR CLOTHING AND ACCESSORIES, NAMELY COATS, JACKETS, VESTS, SHIRTS, PANTS, JEANS, DRESSES, SKIRTS, SWEATERS, JERSEYS, T-SHIRTS, TANKS, SHORTS, OVERALLS, SWEAT SUITS, JOGGING SUITS, UNDERWEAR, SOCKS, FOOTWEAR, GLOVES, HATS AND BANDANAS (U.S. CLS. 22 AND 39).

SN 78-140,937. EAST WEST CONNECTIONS, INC., BASALT, CO. FILED 7-2-2002.

SITARA

THE ENGLISH TRANSLATION OF "SITARA" FROM HINDI IS "MORNING STAR".
FOR LADIES APPAREL, NAMELY, DRESSES, SKIRTS, BLOUSES PANTS AND JACKETS (U.S. CLS. 22 AND 39).

CLASS 25—(Continued).

SN 78-144,490. TRAYLOR, GARY, HOUSTON, TX. FILED 7-16-2002.

**FISHER OF MEN I CATCH
'EM GOD CLEANS 'EM**

FOR SPORTS CLOTHING NAMELY T-SHIRTS AND HATS (U.S. CLS. 22 AND 39).

SN 78-145,195. UNITED STATES OLYMPIC COMMITTEE, COLORADO SPRINGS, CO. FILED 7-18-2002.

OLYMPIC

OWNER OF U.S. REG. NOS. 968,566, 2,311,493 AND OTHERS.
FOR CLOTHING, NAMELY T-SHIRTS, SWEATSHIRTS, CAPS AND HATS (U.S. CLS. 22 AND 39).
FIRST USE 5-15-2002; IN COMMERCE 5-15-2002.

SN 78-149,980. MARBLE SPORTSWEAR, INC., BEVERLY HILLS, CA. FILED 8-1-2002.

VINTAGE PARADISE

NO CLAIM IS MADE TO THE EXCLUSIVE RIGHT TO USE "VINTAGE", APART FROM THE MARK AS SHOWN.
FOR BATHING SUITS, BLAZERS, BLOUSES, BOOTS, BRAS, BRIEFS, CAMISOLES, CAPS, COATS, DRESSES, GLOVES, HATS, JACKETS, JEANS, JUMPSUITS, LEOTARDS, NECKTIES, NIGHTGOWNS, OVERALLS, PAJAMAS, PANTS, PANTYHOSE, RAINCOATS, ROBES, SANDALS, SHIRTS, SHOES, SHORTALLS, SHORTS, SKIRTS, SLIPPERS, SLIPS, SOCKS, STOCKINGS, SUITS, SWEATERS, SWEATPANTS, SWEATSHIRTS, T-SHIRTS, TIGHTS, TUXEDOS, VESTS AND WARM-UP SUITS. (U.S. CLS. 22 AND 39).

SN 78-154,920. LEBA, CHRIS, BROOKLYN, NY. FILED 8-16-2002.

OXEN

FOR CLOTHING; NAMELY, JEANS, TEE SHIRTS, SWEAT SHIRTS, SHIRTS, SHORTS AND JACKETS (U.S. CLS. 22 AND 39).

SN 78-159,877. BRAND EXPERIENCE, LLC, THE, MIAMI BEACH, FL. FILED 8-30-2002.

BE SUNSAFE

FOR SUN PROTECTIVE APPAREL AND ACCESSORIES, NAMELY, SWIMWEAR, HATS, SHIRTS, SHORTS, PANTS AND SHOES (U.S. CLS. 22 AND 39).

CLASS 25—(Continued).

SN 78-159,880. BRAND EXPERIENCE, LLC, THE, MIAMI BEACH, FL. FILED 8-30-2002.

PRACTICAL SOLUTIONS FOR SUN PROTECTION

NO CLAIM IS MADE TO THE EXCLUSIVE RIGHT TO USE "SUN PROTECTION", APART FROM THE MARK AS SHOWN.

FOR SUN PROTECTIVE APPAREL AND ACCESSORIES, NAMELY, SWIMWEAR, HATS, SHIRTS, SHORTS, PANTS AND SHOES (U.S. CLS. 22 AND 39).
FIRST USE 4-15-2002; IN COMMERCE 5-30-2002.

SN 78-163,619. NEW LINE PRODUCTIONS, INC., NEW YORK, NY. FILED 9-12-2002.

DUMB AND DUMBER

OWNER OF U.S. REG. NOS. 2,111,100, 2,144,964 AND 2,222,095.

FOR CLOTHING FOR MEN, WOMEN AND CHILDREN - NAMELY, SHIRTS, T-SHIRTS, SWEATSHIRTS, JOGGING SUITS, TROUSERS, PANTS, SHORTS, TANK TOPS, RAINWEAR, CLOTHS BABY BIBS AND BIB OVERALLS, SKIRTS, BLOUSES, DRESSES, SUSPENDERS, SWEATERS, JACKETS, COATS, RAINCOATS, SNOW SUITS, TIES, ROBES, HATS, CAPS, SUNVISORS, BELTS, SCARVES, SLEEPWEAR, PAJAMAS, LINGERIE, UNDERWEAR, BOOTS, SHOES, SNEAKERS, SANDALS, BOOTIES, SLIPPER SOCKS, SWIMWEAR AND MASQUERADE AND HALLOWEEN COSTUMES AND MASKS SOLD IN CONNECTION THEREWITH (U.S. CLS. 22 AND 39).

SN 78-165,976. BMC PLAYERS, INC., WILMINGTON, DE. FILED 9-19-2002.

CHOSEN ONE

FOR CLOTHING, NAMELY, T-SHIRTS, SWEATSHIRTS, TANK TOPS, POLO SHIRTS, JERSEYS, SPORT SHIRTS, JACKETS, WARM-UP SUITS, PANTS, SHORTS, SWEAT PANTS, CAPS, HATS, SWEAT BANDS AND SOCKS; FOOTWEAR (U.S. CLS. 22 AND 39).

SN 78-166,243. DEACON, DANE T., GILROY, CA. FILED 9-20-2002.

RUBBER

FOR HATS, SHIRTS, PANTS, JACKETS AND UNDERGARMENTS (U.S. CLS. 22 AND 39).

CLASS 25—(Continued).

SN 78-170,482. HUNAN TEXTILES IMP. & EXP. CORP., CHANG SHA, CHINA, FILED 10-3-2002.



FOR CLOTHING, NAMELY, SHIRTS, TROUSERS, SUITS, OVERCOATS AND T-SHIRTS; UNDERWEAR; PANTS; BRASSIERES; SLEEP SHIRTS; FUR COATS; CLOTHING FOR KIDS, NAMELY KNITWEAR, SKIRTS, AND TROUSERS; LEATHER COATS; SINGLET; LAYETTES; INFANT DIAPER COVERS; SWIM WEAR; CLOTHING FOR GYMNASTICS, NAMELY, GYM SUITS, GYM SHORTS; WATERPROOF CLOTHING, NAMELY RAIN COATS, RAIN JACKETS, RAIN SUITS; MASQUERADE COSTUMES; HATS; HOSIERY; STOCKINGS; SOCKS; GLOVES; SCARFS; BOW TIES; NECKTIES; WEDDING GOWNS (U.S. CLS. 22 AND 39).

SN 78-173,197. CASCARINO'S PIZZA EXPRESS, LTD, COLLEGE POINT, NY. FILED 10-10-2002.



OWNER OF U.S. REG. NO. 2,461,377.
FOR CLOTHING, NAMELY, T-SHIRTS, SWEATSHIRTS, BLOUSES, BUTTON-DOWN SHIRTS, APRONS, CAPS, JACKETS AND HATS (U.S. CLS. 22 AND 39).

SN 78-173,687. TAO, MARGARET, NEW YORK, NY. FILED 10-11-2002.

MAGGIE TAO

FOR WOMEN'S WEAR, NAMELY, JACKETS, TOPS, BOTTOMS, SWEATERS, AND CLOTHING ACCESSORIES, NAMELY, HATS, CAPS, BELTS AND SHOES (U.S. CLS. 22 AND 39).

SN 78-174,111. INNOVATIVE FASHION GROUP CORP., NEW YORK, NY. FILED 10-14-2002.

LAYER 8

FOR CLOTHING, NAMELY SHIRTS, SHORTS AND PANTS (U.S. CLS. 22 AND 39).

CLASS 25—(Continued).

SN 78-180,169. MAGASCHONI APPAREL GROUP, INC.,
NEW YORK, NY. FILED 10-30-2002.

MAGGIE BY MAGASCHONI

OWNER OF U.S. REG. NO. 2,187,617.
FOR WEARING APPAREL, NAMELY, JACKETS,
SKIRTS, PANTS, CAMISOLES, VESTS, DRESSES, TANK
TOPS, BLAZERS, TOPS, SHORTS, SHIRTS, SWEATERS
AND T-SHIRTS (U.S. CLS. 22 AND 39).

SN 78-180,382. SAUCONY, INC., PEABODY, MA. FILED 10-
31-2002.

GRID VISION

OWNER OF U.S. REG. NO. 1,678,640.
FOR FOOTWEAR (U.S. CLS. 22 AND 39).

SN 78-184,521. SANTIAGO PONS QUINTANA S.A., ALAYOR
(MENORCA), SPAIN, FILED 11-13-2002.

PQ PONS QUINTANA

"PON QUINTANA" DOES NOT IDENTIFY A PARTICULAR
LIVING INDIVIDUAL.
FOR FOOTWEAR (U.S. CLS. 22 AND 39).
FIRST USE 12-31-1980; IN COMMERCE 7-13-1993.

SN 78-185,274. ACREE, PATRICK, J, FARMINGTON, MI.
FILED 11-14-2002.

PHAT ASS JEAN CO.

NO CLAIM IS MADE TO THE EXCLUSIVE RIGHT TO
USE "JEAN CO.", APART FROM THE MARK AS SHOWN.
FOR CLOTHING, NAMELY, JEANS, JACKETS, HATS,
AND SHIRTS (U.S. CLS. 22 AND 39).

SN 78-185,294. KOLANTHIA, INCORPORATED, RALEIGH,
NC. FILED 11-14-2002.

**RACISM MAY BE ALIVE BUT
IT'S DEFINITELY DYING.**

FOR CLOTHING, NAMELY- T-SHIRTS, SWEAT-
SHIRTS, HATS (U.S. CLS. 22 AND 39).

CLASS 25—(Continued).

SN 78-185,433. RHE HATCO, INC., GARLAND, TX. FILED
11-15-2002.



OWNER OF U.S. REG. NO. 2,058,519.
NO CLAIM IS MADE TO THE EXCLUSIVE RIGHT TO
USE "HAT" AND "CO.", APART FROM THE MARK AS
SHOWN.

THE MARK CONSISTS OF THE STYLIZED LETTER "C"
IN THE SHAPE OF A HORSE SHOE, SURROUNDED BY A
CIRCULAR ROPE DESIGN, TOGETHER WITH THE
WORDS, "CHARLIE 1 HORSE" AND "HAT CO." IN SCRIPT.
FOR CLOTHING; NAMELY, HATS, CAPS, T-SHIRTS,
SWEATSHIRTS AND JACKETS (U.S. CLS. 22 AND 39).

FIRST USE 10-4-1996. THE MARK WAS FIRST USED
ANYWHERE IN A DIFFERENT FORM OTHER THAN
THAT SOUGHT TO BE REGISTERED ON 00/00/1980; IN
COMMERCE 10-4-1996. THE MARK WAS FIRST USED IN
COMMERCE IN A DIFFERENT FORM OTHER THAN
THAT SOUGHT TO BE REGISTERED ON 00/00/1980.

SN 78-187,956. TOTES ISOTONER CORPORATION, CINCIN-
NATI, OH. FILED 11-22-2002.

**IMPRESSIONS FROM
ISOTONER**

OWNER OF U.S. REG. NOS. 885,094, 2,335,015 AND
OTHERS.
FOR GLOVES (U.S. CLS. 22 AND 39).

SN 78-187,989. TOTES ISOTONER CORPORATION, CINCIN-
NATI, OH. FILED 11-22-2002.

**SENSATIONS FROM
ISOTONER**

OWNER OF U.S. REG. NOS. 885,094, 2,335,015 AND
OTHERS.
FOR SLIPPERS (U.S. CLS. 22 AND 39).

CLASS 25—(Continued).

SN 78-188,298. MICAH C, CAMERON, NY, NY. FILED 11-23-2002.

DINERO GEAR

NO CLAIM IS MADE TO THE EXCLUSIVE RIGHT TO USE "GEAR", APART FROM THE MARK AS SHOWN.

THE ENGLISH TRANSLATION OF "DINERO" IS "MONEY".

FOR CLOTHING, NAMELY, T-SHIRTS, SHIRTS, SWEAT SHIRTS, SWEAT SUITS, PANTS, SKIRTS, DRESSES, HATS, JACKETS, UNDERWEAR (U.S. CLS. 22 AND 39).

SN 78-188,339. L.C. LICENSING, INC., NEW YORK, NY. FILED 11-24-2002.

CAREFREE LIZ CLAIBORNE

OWNER OF U.S. REG. NOS. 1,167,434, 2,010,455 AND OTHERS.

THE NAME "LIZ CLAIBORNE" IDENTIFIES A LIVING INDIVIDUAL WHOSE CONSENT IS OF RECORD.

FOR CLOTHING, NAMELY, PANTS, SKIRTS, SHIRTS, BLOUSES, JACKETS, VESTS, SWEATERS, DRESSES, SHORTS, JEANS, SCARVES, HOSIERY, COATS, HATS, CAPS, HOODS, GLOVES, MITTENS; SWIMWEAR, RAINWEAR AND SLEEPWEAR (U.S. CLS. 22 AND 39).

SN 78-188,448. GOODY'S FAMILY CLOTHING, INC., KNOXVILLE, TN. FILED 11-25-2002.

GOOD KIDZ

OWNER OF U.S. REG. NO. 2,073,536.

NO CLAIM IS MADE TO THE EXCLUSIVE RIGHT TO USE "KIDZ", APART FROM THE MARK AS SHOWN.

FOR CHILDREN'S CLOTHING, NAMELY, SHIRTS, TOPS, SHORTS, PANTS, DRESSES, SKIRTS, STOCKINGS, TIES, HATS, AND CAPS (U.S. CLS. 22 AND 39).

FIRST USE 5-1-2002, THE MARK WAS FIRST USED ANYWHERE IN A DIFFERENT FORM OTHER THAN THAT SOUGHT TO BE REGISTERED ON 09/01/1995 ; IN COMMERCE 5-1-2002, THE MARK WAS FIRST USED IN COMMERCE IN A DIFFERENT FORM OTHER THAN THAT SOUGHT TO BE REGISTERED ON 09/01/1995.

SN 78-189,001. BLALOCK, JACOB, NEWPORT BEACH, CA. FILED 11-26-2002.



FOR SHIRTS, SHORTS, PANTS, COATS, HATS, SURF TRUNKS, SHIRTS MADE OF STRETCH MATERIAL FOR USE IN WATER, WETSUITS, SWEATSHIRTS, SWEATPANTS, JACKETS, SWIMSUITS, WRISTBANDS (U.S. CLS. 22 AND 39).

CLASS 25—(Continued).

SN 78-189,154. BOEING MANAGEMENT COMPANY, SEAL BEACH, CA. FILED 11-26-2002.

MCDONNELL DOUGLAS

FOR SHIRTS, HEADWEAR AND FOOTWEAR, JACKETS, SWEATSHIRTS. (U.S. CLS. 22 AND 39).

SN 78-189,265. GUESS?, INC., LOS ANGELES, CA. FILED 11-26-2002.

GUESS USA

OWNER OF U.S. REG. NO. 1,765,883.

NO CLAIM IS MADE TO THE EXCLUSIVE RIGHT TO USE USA, APART FROM THE MARK AS SHOWN.

FOR APPAREL, NAMELY BLAZERS, BLOUSES, BODYSUITS, CAMISOLES, CARDIGANS, SPORT COATS, DRESSES, HALTER TOPS, JEANS, JUMPSUITS, KNIT SHIRTS, MINISKIRTS, OVERALLS, PANTS, PANTSUITS, POLO SHIRTS, PULL-OVERS, SPORT SHIRTS, SWEATSHIRTS, SHORTS, SKIRTS, SLACKS, SWEATPANTS, SWEATSHORTS, SWEATSUITS, SWEATERS, T-SHIRTS, TANK TOPS, TOPS, TROUSERS AND VESTS (U.S. CLS. 22 AND 39).

FIRST USE 0-0-1991; IN COMMERCE 0-0-1991.

SN 78-189,776. MIGUEL DELAFUENTE, MIAMI, FL. FILED 11-28-2002.

LIFE IS BEAUTIFUL

FOR WEARING APPAREL, NAMELY, SHIRTS, T-SHIRTS, SHORTS, PANTS, SWEATSHIRTS, SWEATPANTS, HATS, SHOES, BELTS (U.S. CLS. 22 AND 39).

SN 78-189,834. GEAR, EDWARD T., JR., MALDEN, MA. FILED 11-29-2002.

ALWAYS AGGRESSIVE

FOR ATHLETIC AND SPORTING APPAREL, NAMELY, T-SHIRTS, SWEATSHIRTS, HATS, SHORTS (U.S. CLS. 22 AND 39).

SN 78-190,394. BOEING MANAGEMENT COMPANY, SEAL BEACH, CA. FILED 12-2-2002.

B-25 MITCHELL

FOR SHIRTS, HEADWEAR AND FOOTWEAR, JACKETS, SWEATSHIRTS. (U.S. CLS. 22 AND 39).

CLASS 25—(Continued).

SN 78-190,430. POLEN GIYIM SANAYI VE TICARET LIMITED SIRKETI, ISTANBUL, TURKEY, FILED 12-2-2002.

FOR CLOTHING, NAMELY, SHORTS, SHIRTS, T-SHIRTS, SWIMSUITS, BLOUSES, SKIRTS, SCARVES, GLOVES, PANTS, SWEATERS, JERSEYS, SOCKS, JACKETS, SUITS, TRAINING SUITS, VESTS, NECKTIES, BELTS, SUSPENDERS, DRESSES, COATS, RAINCOATS, OVERCOATS, SMOCKS, UNDERWEAR, PAJAMAS, BRASSIERES, CORSETS, SLIPS, LINGERIE; HEADWEAR, NAMELY, HATS, CAPS AND BERETS; FOOTWEAR, NAMELY, BOOTS, SANDALS, SHOES AND SLIPPERS (U.S. CLS. 22 AND 39).

SN 78-190,436. BOEING MANAGEMENT COMPANY, SEAL BEACH, CA. FILED 12-2-2002.

DC-3

FOR SHIRTS, HEADWEAR AND FOOTWEAR, JACKETS, SWEATSHIRTS. (U.S. CLS. 22 AND 39).

SN 78-190,461. BOEING MANAGEMENT COMPANY, SEAL BEACH, CA. FILED 12-2-2002.

F-4 PHANTOM II

OWNER OF U.S. REG. NO. 2,466,357.
FOR SHIRTS, HEADWEAR AND FOOTWEAR, JACKETS, SWEATSHIRTS. (U.S. CLS. 22 AND 39).

SN 78-190,481. BOEING MANAGEMENT COMPANY, SEAL BEACH, CA. FILED 12-2-2002.

PT-17 KAYDET

FOR SHIRTS, HEADWEAR AND FOOTWEAR, JACKETS, SWEATSHIRTS. (U.S. CLS. 22 AND 39).

CLASS 25—(Continued).

SN 78-190,916. HARDCORE ENTERPRISES PTY. LTD., ABBOTSFORD VIC 3067, AUSTRALIA, FILED 12-3-2002.



FOR CLOTHING, NAMELY SHIRTS, TEE SHIRTS, TANK TOPS, SWEAT SHIRTS, PANTS, SHORTS, HATS, FOOTWEAR, SWIMWEAR, BLOUSES, SKIRTS, UNDERWEAR, JACKETS, VESTS, BANDANAS, SOCKS AND SWEAT PANTS (U.S. CLS. 22 AND 39).
FIRST USE 8-30-2002; IN COMMERCE 8-30-2002.

SN 78-191,028. MCRAE'S, INC., BIRMINGHAM, AL. FILED 12-4-2002.

MISS ATTITUDE

FOR HEAD BANDS; BATHING SUITS; BATHROBES; BEACH COVERUPS; BEACHWEAR; CLOTHING BELTS; BLOUSES; BOOTS; CAMISOLES; CARDIGANS; CLOGS; COATS; DRESSES; EAR MUFFS; FOOTWEAR; GLOVES; GOWNS; NIGHT GOWNS; GYM SHORTS; HOSIERY; JACKETS; JEANS; JUMPERS; LEGGINGS; LEOTARDS; MITTENS; MUFFS; PAJAMAS; PANTIES; PANTS; PANTYHOSE; PETTICOATS; PULLOVERS; RAIN COATS; ROBES; SANDALS; SHIRTS; SHOES; SHORTS; SKIRTS; SLACKS; SLEEPWEAR; SLIPPERS; SLIPS; SNEAKERS; SOCKS; STOCKINGS; SWEAT SHIRTS; SWEAT PANTS; SWEAT SUITS; SWEATERS; SWIMSUITS; T-SHIRTS; TIGHTS; TURTLENECKS; UNDERPANTS; UNDERSHIRTS; UNDERWEAR; VESTS; WIND RESISTANT JACKETS. (U.S. CLS. 22 AND 39).

SN 78-192,261. DEPARTMENT OF THE ARMY, ARLINGTON, VA. FILED 12-8-2002.

BASIC TRAINING

FOR MEN'S, WOMEN'S, AND CHILDREN'S CLOTHING, NAMELY, BELTS, SHIRTS, SPORT SHIRTS, KNIT SHIRTS, GOLF SHIRTS, TANK TOPS, T-SHIRTS, SWEAT SHIRTS AND SWEAT PANTS, JOGGING SUITS, PANTS, JEANS AND OVERALLS, SWEATERS, SHORTS, FLEECE PULLOVERS, COATS AND JACKETS, BATHING SUITS AND SWIM WEAR, HATS AND CAPS, VISORS, BANDANAS, WRIST BANDS, SOCKS, PAJAMAS AND UNDERGARMENTS, ATHLETIC SHOES, DRESS SHOES, BOOTS, INFANT WARE AND TODDLER WARE CONSISTING OF SHIRTS, PANTS, JACKETS, AND BABY SHOES (U.S. CLS. 22 AND 39).

CLASS 25—(Continued).

SN 78-192,950. BELLUM HOUSE, LLC, NEW YORK, NY.
FILED 12-10-2002.

BELLUM

THE FOREIGN WORDING IN THE MARK TRANSLATES INTO ENGLISH AS "PRETTY".

FOR CLOTHING, NAMELY, SWEATERS, KNIT TOPS, BLOUSES, PANTS, SHORTS, SKIRTS, DRESSES, COATS, JACKETS, AND HATS (U.S. CLS. 22 AND 39).

FIRST USE 9-9-2002; IN COMMERCE 9-25-2002.

SN 78-193,643. KEAGLE IV, CHARLES L., SAN FRANCISCO, CA. FILED 12-11-2002.

FLUFFBALLS

FOR SHIRTS, SWEATSHIRTS, AND BABY CLOTHES, NAMELY, PANTS, SHIRTS, SOCKS, PAJAMAS, DRESSES, SHOES, BABY BIBS NOT OF PAPER, AND BABY CREEPERS (U.S. CLS. 22 AND 39).

FIRST USE 11-15-2002; IN COMMERCE 11-15-2002.

SN 78-194,572. WEST, MICHAEL, A, SAN PEDRO, CA. FILED 12-13-2002.

SEPIA

FOR CLOTHING, NAMELY COTTON, POLY AND NYLON PANTS, SHIRTS, JACKETS AND VESTS, FLEECE WEAR, NAMELY HOODED SWEATSHIRTS, T-SHIRTS, AND SWEATPANTS, ACCESSORIES, NAMELY KNIT HATS, HEADWEAR, AND BELTS, FOOTWEAR, NAMELY CASUAL, SPORT AND SKATEBOARD SHOES (U.S. CLS. 22 AND 39).

FIRST USE 6-12-2002; IN COMMERCE 11-13-2002.

SN 78-195,017. BECKERMAN, BRAD, NEW YORK, NY. FILED 12-16-2002.

REHASH

FOR MENS' AND WOMEN'S CLOTHING; NAMELY, JACKETS, PANTS, SHIRTS, JEANS, COATS, VESTS, DRESSES, BATHING SUITS, SKIRTS, SOCKS, UNDERWEAR, BELTS, SWEATERS, HATS AND FOOTWEAR (U.S. CLS. 22 AND 39).

CLASS 25—(Continued).

SN 78-196,412. CAVE SPRINGS, INC., WILMINGTON, DE.
FILED 12-19-2002.

**EVERY DAY IS MOTHERS
DAY AT MOTHERHOOD**

OWNER OF U.S. REG. NOS. 1,898,334, 2,606,719 AND OTHERS.

FOR MATERNITY, INFANT'S AND CHILDREN'S CLOTHING, NAMELY, SHIRTS, SOCKS, SLEEPWEAR, SWIMWEAR, FLEECE SETS COMPRISING TOPS AND BOTTOMS, SUNSUITS, JUMPSUITS, PANT SETS, DRESSES, SWEATER SETS, CREEPERS, PRAM SUITS, BLANKET SLEEPERS, CLOTH BABY BIBS, KNITWEAR, NAMELY, SPORTSHIRTS, TOPS, PULLOVERS, JACKETS, SLACKS, PANTS, BLOUSES, DRESSES, SWEATERS AND SCARVES (U.S. CLS. 22 AND 39).

SN 78-198,737. CHAMBERS, KHIA, ATLANTA, GA. FILED 12-30-2002.

MY NECK, MY BACK

FOR BANDANAS; BEACH AND SWIM WEAR; UNDERWEAR; LINGERIE; LOUNGEWEAR; SLEEPWEAR; ROBES; JOGGING AND WARM UP SUITS; SUITS; TUXEDOS; SHIRTS; JERSEYS; SWEATERS; SKIRTS; BLOUSES; SHORTS; DRESSES; GOWNS; OVERALLS; JUMPERS; JUMPSUITS; PANTS; JEANS; LEGGINGS; HOSIERY; SOCKS; SCARVES; GLOVES; HATS; CAPS; SUN VISORS; NECKTIES; COATS; JACKETS; VESTS; PONCHOS; PULLOVERS; FOOTWEAR (U.S. CLS. 22 AND 39).

SN 78-199,347. BARCO UNIFORMS, INC., GARDENA, CA. FILED 1-2-2003.

**WE UNDERSTAND THE
VALUE OF YOUR BRAND**

FOR UNIFORMS, SMOCKS, SHIRTS, AND DRESSES FOR PROFESSIONAL WOMEN SUCH AS NURSES, RESEARCH WORKERS, PHARMACISTS, COSMETOLOGISTS, MEDICAL ASSISTANTS; AND SHIRT COATS, LAB COATS AND JACKETS FOR PROFESSIONAL MEN SUCH AS MEDICAL DOCTORS, INTERNS, RESEARCH WORKERS, MEDICAL ASSISTANTS, PHARMACISTS AND NON-PROFESSIONALS SUCH AS BARBERS (U.S. CLS. 22 AND 39).

FIRST USE 12-0-2002; IN COMMERCE 12-0-2002.

CLASS 25—(Continued).

SN 78-200,027. PONCE, MOISES, SAN PEDRO, CA. FILED 1-4-2003.



FOR SHIRTS, T-SHIRTS, CAMISOLES, JACKETS, SWEATSHIRTS, AND HATS (U.S. CLS. 22 AND 39).

SN 78-200,072. MILLER, CHARLES, A, FORT BENNING, GA. FILED 1-4-2003.

**CHILDREN BORN
UNDERGROUND/ C.B.U.**

FOR HATS, SWEATSHIRTS, T-SHIRTS (U.S. CLS. 22 AND 39).

CLASS 26—FANCY GOODS

SN 76-334,986. DUARTE, HENRY, LOS ANGELES, CA. FILED 11-2-2001.

HENRY DUARTE

OWNER OF U.S. REG. NO. 2,288,801.
THE NAME "HENRY DUARTE" IDENTIFIES A LIVING INDIVIDUAL WHOSE CONSENT IS OF RECORD.
FOR HAIR PINS, HAIR ORNAMENTS, HAIR BANDS, AND HAIR RIBBONS; BELT BUCKLES NOT OF PRECIOUS METAL FOR CLOTHING; BUCKLES FOR SHOES; EYELETS, CLOTHING HOOKS, FASTENERS, BUTTONS, CLASPS; AND ORNAMENTAL NOVELTY PINS (U.S. CLS. 37, 39, 40, 42 AND 50).

CLASS 26—(Continued).

SN 76-385,486. SILKIES, INC., VISTA, CA. FILED 3-18-2002.



NO CLAIM IS MADE TO THE EXCLUSIVE RIGHT TO USE "REPLICA PLANTS" AND "INC.", APART FROM THE MARK AS SHOWN.

SEC. 2(F) AS TO "SILKIES".
FOR ARTIFICIAL FLORAL ARRANGEMENTS, PLANTS, AND TREES (U.S. CLS. 37, 39, 40, 42 AND 50).
FIRST USE 1-1-1995; IN COMMERCE 1-1-1995.

SN 76-474,297. UNIZIP, INC., GARDENA, CA. FILED 12-6-2002.

UNI

FOR ZIPPERS AND SLIDE FASTENERS (U.S. CLS. 37, 39, 40, 42 AND 50).

SN 78-175,161. ALLSTATE FLORAL & CRAFT, INC., CERRITOS, CA. FILED 10-16-2002.

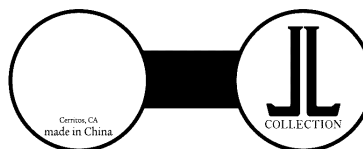

NO CLAIM IS MADE TO THE EXCLUSIVE RIGHT TO USE "CERRITOS, CA MADE IN CHINA", APART FROM THE MARK AS SHOWN.

FOR ARTIFICIAL FLOWERS (U.S. CLS. 37, 39, 40, 42 AND 50).
FIRST USE 5-30-2001; IN COMMERCE 6-20-2002.

SN 78-191,026. MCRAE'S, INC., BIRMINGHAM, AL. FILED 12-4-2002.

MISS ATTITUDE

FOR HAIR BANDS; BARRETTES; HAIR BOWS; HAIR ORNAMENTS; HAIR PINS; HAIR RIBBONS; PONYTAIL HOLDERS. (U.S. CLS. 37, 39, 40, 42 AND 50).

CLASS 27—FLOOR COVERINGS

CLASS 27—(Continued).

SN 76-426,177. THE PEACE RUG COMPANY, INC., DALTON, GA. FILED 6-28-2002.

THE PEACE RUG

OWNER OF U.S. REG. NOS. 2,610,459 AND 2,632,737. NO CLAIM IS MADE TO THE EXCLUSIVE RIGHT TO USE "RUG", APART FROM THE MARK AS SHOWN. FOR FLOOR COVERINGS, NAMELY, CARPETS AND RUGS (U.S. CLS. 19, 20, 37, 42 AND 50). FIRST USE 6-0-2000; IN COMMERCE 11-11-2001.

SN 76-469,633. GEORGIA CARPET FINISHERS, INC., CHATSWORTH, GA. FILED 11-25-2002.

BESTBAC

FOR CARPET BACKING (U.S. CLS. 19, 20, 37, 42 AND 50).

SN 76-469,636. GEORGIA CARPET FINISHERS, INC., CHATSWORTH, GA. FILED 11-25-2002.

BESTBAC PLUS

FOR CARPET BACKING (U.S. CLS. 19, 20, 37, 42 AND 50).

SN 76-470,817. TURFSTORE.COM INC., CALHOUN, GA. FILED 11-27-2002.

TURFSTORE

FOR ATHLETIC AND RECREATIONAL SURFACING PRODUCTS, NAMELY, ARTIFICIAL AND SYNTHETIC TURF (U.S. CLS. 19, 20, 37, 42 AND 50). FIRST USE 11-3-2000; IN COMMERCE 11-3-2000.

SN 78-181,617. POOLE, WILLIAM E., WILMINGTON, NC. FILED 11-5-2002.

WILLIAM E. POOLE

THE NAME "WILLIAM E. POOLE" IDENTIFIES A LIVING INDIVIDUAL WHOSE CONSENT IS OF RECORD. FOR RUGS (U.S. CLS. 19, 20, 37, 42 AND 50).

CLASS 28—TOYS AND SPORTING GOODS

SN 75-221,942. 1141477 ONTARIO INC, DBA MILLENNIUM PROMOTIONS, CHELMSFORD, ONTARIO, CANADA, FILED 1-2-1997.

TRIKTRUNK

PRIORITY CLAIMED UNDER SEC. 44(D) ON CANADA APPLICATION NO. 817027, FILED 7-4-1996, REG. NO. TMA567095, DATED 9-10-2002, EXPIRES 9-10-2017. FOR MANIPULATIVE PUZZLES (U.S. CLS. 22, 23, 38 AND 50).

SN 76-012,946. REALTIME DRAMA, INC., SAN RAMON, CA. BY CHANGE OF NAME MAIA ENTERTAINMENT, INC., SAN RAMON, CA. FILED 3-29-2000.

REALTIME DRAMA

FOR ELECTRONIC GAMES, NAMELY, HANDHELD UNIT FOR PLAYING VIDEO GAMES; CARD GAMES; BOARD GAMES; STAND ALONE VIDEO OUTPUT GAME MACHINES; ACTION SKILL GAMES; MECHANICAL ACTION TOYS; ACTION- TYPE TARGET GAMES; ADULTS' AND CHILDREN'S PARTY GAMES; AERODYNAMIC DISK FOR USE IN PLAYING CATCHING GAMES; BABY MULTIPLE ACTIVITY TOYS; PADDLE BALL GAMES; BATH TOYS; MUSIC BOX TOYS; COIN-OPERATED VIDEO GAMES; CONSTRUCTION TOYS; CHILDREN'S ACTIVITY TABLES CONTAINING MANIPULATIVE TOYS WHICH CONVERT TO EASELS; ELECTRONIC DART GAMES; ELECTRONIC ACTION TOYS; DISC TOSS TOYS, DRAWING TOYS; FANTASY CHARACTER TOYS, PARTY FAVORS; MANIPULATIVE GAMES; PINBALL GAMES; PET TOYS; PLUSH TOYS; PRINTING TOYS; PULL TOYS; PUNCHING TOYS; PUSH TOYS; RIDE-ON TOYS; RING GAMES; ROLE PLAYING GAMES; SANDBOX TOYS; SKETCHING TOYS; SQUEEZE TOYS; STUFFED TOYS; TALKING TOYS; WATER SQUIRTING TOYS; WIND-UP TOYS; TRANSFORMING ROBOTIC TOYS; WEARABLE TOY DEVICES FOR PLAYING GAMES; DICE GAMES (U.S. CLS. 22, 23, 38 AND 50).

SN 76-228,498. ANTONIOUS, ANTHONY J., SARASOTA, FL. FILED 3-22-2001.

AWSM

OWNER OF U.S. REG. NO. 1,589,125. FOR GOLF GLOVES AND GOLF BALLS (U.S. CLS. 22, 23, 38 AND 50).

SN 76-252,936. K-FLY, INC., BOISE, ID. FILED 5-8-2001.

K-FLY

FOR FISHING FLIES AND LURES AND MATERIAL FOR MAKING FISHING FLIES AND LURES, NAMELY FEATHERS, STRING, BEADS, FOAMS, HAIR, MAN-MADE FIBERS, AND OTHER TRADITIONAL FLY AND LURE MAKING MATERIALS (U.S. CLS. 22, 23, 38 AND 50). FIRST USE 12-1-1992; IN COMMERCE 12-1-1992.

CLASS 28—(Continued).

SN 76-319,737. SHERWOOD-DROLET CORPORATION LTD., SHERBROOKE, PROVINCE OF QUEBEC, CANADA, FILED 10-2-2001.

AXION BLADE

PRIORITY CLAIMED UNDER SEC. 44(D) ON CANADA APPLICATION NO. 1114338, FILED 8-30-2001.

NO CLAIM IS MADE TO THE EXCLUSIVE RIGHT TO USE "BLADE", APART FROM THE MARK AS SHOWN.

FOR HOCKEY STICKS AND HOCKEY STICK BLADES (U.S. CLS. 22, 23, 38 AND 50).

FIRST USE 11-7-2002; IN COMMERCE 11-7-2002.

SN 76-352,247. STUDIOCANAL IMAGE, BOULOGNE-BILLANCOURT, FRANCE, BY MERGER CANAL + D.A., BOULOGNE BILLANCOURT, FRANCE, FILED 12-21-2001.

ESCAPE FROM NEW YORK

NO CLAIM IS MADE TO THE EXCLUSIVE RIGHT TO USE "NEW YORK", APART FROM THE MARK AS SHOWN.

FOR STAND ALONE AND COIN-OPERATED VIDEO GAME MACHINES; HANDHELD UNITS FOR PLAYING ELECTRONIC GAMES (U.S. CLS. 22, 23, 38 AND 50).

SN 76-382,005. CARTOON NETWORK LP, LLLP, THE, ATLANTA, GA. FILED 3-14-2002.

WHATEVER HAPPENED TO ROBOT JONES?

FOR TOYS AND SPORTING GOODS IN THE NATURE OF GAMES AND PLAYTHINGS, NAMELY, ACTION FIGURES AND ACCESSORIES THEREFOR, PLUSH TOYS, BALLOONS, BATHTUB TOYS, RIDE-ON TOYS, TOY VEHICLES, DOLLS, FLYING DISCS, HAND HELD UNIT FOR PLAYING ELECTRONIC GAMES, BOARD GAMES, CARD GAMES, MANIPULATIVE GAMES, PARLOR GAMES, COMPUTERIZED PARLOR-TYPE GAMES, ACTION-TYPE TARGET GAMES, STAND ALONE VIDEO OUTPUT GAME MACHINES, JIGSAW AND MANIPULATIVE PUZZLES, PAPER FACE MASKS, SKATEBOARDS, ICE SKATES, WATER SQUIRTING TOYS, BALLS, NAMELY, PLAYGROUND BALLS, SOCCER BALLS, SPORT BALLS, BASEBALLS, BASKETBALLS, BASEBALL GLOVES, SWIMMING FLOATS FOR RECREATIONAL USE, KICKBOARD FLOTATION DEVICES FOR RECREATIONAL USE, SURFBOARDS, SWIM BOARDS FOR RECREATIONAL USE, SWIM FINS, TOY BAKEWARE AND TOY COOKWARE, TOY BANKS AND CHRISTMAS TREE ORNAMENTS (U.S. CLS. 22, 23, 38 AND 50).

CLASS 28—(Continued).

SN 76-394,575. OLIVINE INTERNATIONAL TRADING LIMITED, HENDERSON, NV. FILED 4-11-2002.

BIG ROCK DINOSAURS

NO CLAIM IS MADE TO THE EXCLUSIVE RIGHT TO USE "DINOSAURS", APART FROM THE MARK AS SHOWN.

FOR PLUSH TOYS AND PLASTIC TOYS CONSISTING OF ANIMALS (U.S. CLS. 22, 23, 38 AND 50).

FIRST USE 12-1-2001; IN COMMERCE 12-1-2001.

SN 76-401,766. REARDEN STUDIOS, INC., SAN FRANCISCO, CA. FILED 4-26-2002.

REARDEN STUDIOS

FOR GAMES AND TOYS, NAMELY, BATTERY OPERATED ACTION TOYS AND ACTION FIGURES AND PLUSH TOYS (U.S. CLS. 22, 23, 38 AND 50).

SN 76-406,090. TIME4 MEDIA, INC., NEW YORK, NY. FILED 5-10-2002.

GOLF MAGAZINE

OWNER OF U.S. REG. NOS. 1,521,775, 2,429,568 AND OTHERS.

SEC. 2(F).

FOR SPORTING GOOD ITEMS FOR THE PURPOSE OF ENHANCING GOLF GAME PERFORMANCE, NAMELY, PUTTING CUPS AND GREENS, PRACTICE NETS, MATS, WEIGHTS, GRIPS, BAGS, GOLF CLUBS, GOLF BALL DISPENSERS, ELASTIC SWING TRAINERS, GOLF CLUB SWING AIDS, NAMELY, BALANCING AND POSITIONING DEVICES (U.S. CLS. 22, 23, 38 AND 50).

FIRST USE 11-15-2002; IN COMMERCE 11-15-2002.

SN 76-410,009. 2008337 ONTARIO INC., TORONTO, ONTARIO, CANADA, FILED 5-17-2002.

COUNTDOWN

PRIORITY CLAIMED UNDER SEC. 44(D) ON CANADA APPLICATION NO. 1138783, FILED 4-25-2002.

FOR GAME EQUIPMENT SOLD AS A UNIT FOR PLAYING A MATH GAME INCLUDING DICE AND A BOARD WITH A WALLED DICE-ROLLING AREA ON WHICH THE DICE CAN BE ROLLED AND NUMBER INDICATORS TO INDICATE WHICH INDIVIDUAL NUMBERS HAVE OR HAVE NOT BEEN SELECTED (U.S. CLS. 22, 23, 38 AND 50).

CLASS 28—(Continued).

SN 76-420,819. TOMY CORPORATION, NEWPORT BEACH, CA. FILED 6-4-2002.

MICRO PETS

FOR TOYS AND GAMES, NAMELY, INTERACTIVE PLASTIC TOYS, INCLUDING ANIMALS AND MONSTERS WHICH MAY BE PROVIDED WITH VOICE RECOGNITION CAPABILITIES (U.S. CLS. 22, 23, 38 AND 50).

FIRST USE 5-16-2002; IN COMMERCE 5-16-2002.

SN 76-423,975. WOODGUARD, INC., SAN BERNARDINO, CA. FILED 6-18-2002.

CONGO

FOR PLAYGROUND EQUIPMENT, NAMELY, PLAY STRUCTURES COMPRISED OF CLIMBING UNITS, PLATFORMS, SAND BOXES, SWING SETS, JUNGLE GYMS, PLAYHOUSES, GYMNASTICS APPARATUS AND SLIDES (U.S. CLS. 22, 23, 38 AND 50).

FIRST USE 12-1-2000; IN COMMERCE 12-1-2000.

SN 76-424,614. ICEE OF AMERICA, INC., ONTARIO, CA. FILED 6-24-2002.

ICEE MAKER

NO CLAIM IS MADE TO THE EXCLUSIVE RIGHT TO USE "MAKER", APART FROM THE MARK AS SHOWN.

FOR MANUALLY OPERATED TOY THAT MIXES ICE CUBES AND SODA OR FRUIT PUNCH (U.S. CLS. 22, 23, 38 AND 50).

SN 76-425,345. HOUSEMASTER OF AMERICA, INC., BOUND BROOK, NJ. FILED 6-25-2002.

THE MILLION DOLLAR SELLER

FOR CARD GAME (U.S. CLS. 22, 23, 38 AND 50). FIRST USE 8-17-1984; IN COMMERCE 8-17-1984.

CLASS 28—(Continued).

SN 76-428,533. IMPEX, INC., CITY OF INDUSTRY, CA. FILED 7-9-2002.

MARCY

OWNER OF U.S. REG. NO. 1,502,915.

FOR GYMNASIUM-TYPE BODYBUILDING EXERCISE EQUIPMENT, NAMELY, STATIONARY BIKES, WEIGHT LIFTING MACHINES, EXERCISE BENCHES, WEIGHT LIFTING BENCHES AND BENCH ACCESSORIES, DUMBBELL SETS, FITNESS WEIGHTED BALLS, WEIGHT PLATES, BARBELLS, DUMBELLS, AND DUMBBELL HANDLES (U.S. CLS. 22, 23, 38 AND 50).

FIRST USE 2-4-1980; IN COMMERCE 2-4-1980.

SN 76-446,151. SYSTEME CREATION PRATIQUE, 69150 DECINES CHARPIEU, FRANCE, FILED 9-4-2002.

ERGOMIA

PRIORITY CLAIMED UNDER SEC. 44(D) ON FRANCE APPLICATION NO. 023151630, FILED 3-5-2002, REG. NO. 023151630, DATED 3-5-2002, EXPIRES 3-5-2012.

FOR PLAYING CARDS (U.S. CLS. 22, 23, 38 AND 50).

SN 76-446,417. BARFIELD, JAMES D., MARIETTA, GA. FILED 9-3-2002.

Restin' Ready

FOR FISHING EQUIPMENT, NAMELY FISHING ROD HOLDERS, FISHING POLE HOLDERS AND SPORTSMAN'S FISHING BAGS AND CASES THEREFORE (U.S. CLS. 22, 23, 38 AND 50).

SN 76-448,852. BRINE, INC., MILFORD, MA. FILED 9-12-2002.

CONTROL-X

FOR LACROSSE STICKS, LACROSSE STICK HEADS AND PARTS THEREOF (U.S. CLS. 22, 23, 38 AND 50).

CLASS 28—(Continued).

SN 76-449,114. CENTURY INCORPORATED, MIDWEST CITY, OK. FILED 9-13-2002.

C THE POWER

FOR EXERCISE EQUIPMENT, NAMELY, WEIGHT-LIFTING BENCHES, WEIGHT LIFTING MACHINES, LOWER BODY STRETCHING MACHINES, SLANT BOARDS, DUMBBELL RACKS, WEIGHT LIFTING PLATE TREES, WEIGHT LIFTING GLOVES, FITNESS BALLS, AND CHIN-UP/SIT-UP BARS; AND BOXING AND MARTIAL ARTS GEAR, NAMELY, JUMP ROPES, MEDICINE BALLS, BOXING BAGS, BOXING TARGET MITTS, BOXING GLOVES, BODY SHIELDS, HEAD GUARDS FOR BOXING, HEAD GUARDS FOR MARTIAL ARTS, KICK BOARDS, HANDWRAPS, SHIN GUARDS, FOREARM GUARDS, RIB GUARDS, FOOT GUARDS, MOUTHGUARDS, ATHLETIC SUPPORTERS, ATHLETIC CUPS, AND FEMALE GROIN PADS (U.S. CLS. 22, 23, 38 AND 50).

SN 76-459,467. BINNEY & SMITH INC., EASTON, PA. FILED 10-21-2002.

IMAGIO

FOR HANDHELD DRAWING TOYS (U.S. CLS. 22, 23, 38 AND 50).

SN 76-460,097. J.S. ENGLISH CO., CHAGRIN FALLS, OH. FILED 10-15-2002.

LONE REINDEER

NO CLAIM IS MADE TO THE EXCLUSIVE RIGHT TO USE "REINDEER", APART FROM THE MARK AS SHOWN. FOR TOY FIGURES (U.S. CLS. 22, 23, 38 AND 50).

SN 76-460,632. LANDSCAPE STRUCTURES INC., DELANO, MN. FILED 10-22-2002.

TEKTRAK

FOR SURFACE MATERIALS SOLD AS A COMPONENT PART OF SKATEBOARDING, BIKING, ROLLER-SKATING AND IN-LINE SKATING OBSTACLES AND RAMPS (U.S. CLS. 22, 23, 38 AND 50).

CLASS 28—(Continued).

SN 76-461,703. FESTIVAL ATTRACTIONS, INC., NEW YORK, NY. FILED 10-21-2002.

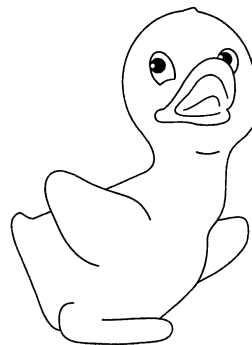

FOR RUBBER ACTION BALLS; ACTION FIGURES AND ACCESSORIES THEREFOR; ACTION SKILL GAMES; MECHANICAL ACTION TOYS; ELECTRIC ACTION TOYS; ACTION-TYPE TARGET GAMES; AMUSEMENT PARK RIDES; CARNIVAL AMUSEMENT RIDES; STUFFED TOYS; STUFFED TOY ANIMALS; BABY MULTIPLE ACTIVITY TOYS; BALLOONS; TOY BANKS; BASEBALL GLOVES; BASEBALL MITTS; BASEBALLS; BATH TOYS; BEAN BAGS; TOY BUILDING BLOCKS; BOARD GAMES; ROLE PLAYING EQUIPMENT IN THE NATURE OF A GAME AND MANUALS SOLD THEREWITH; BODY BOARDS; VENTRILOQUIST'S DUMMIES; DOLLS; DOLL ACCESSORIES; PAPER FACE MASKS; PARTY FAVORS IN THE NATURE OF SMALL TOYS; MUSICAL BOX TOYS; MUSICAL TOYS; TOY BOXES; CARD GAMES; CASES FOR ACTION FIGURES, PLAY ACCESSORIES, TOY STRUCTURES, TOY VEHICLES; CONSTRUCTION BLOCKS; ACTION FIGURE AND PLAY FIGURE CLOTHING; ELECTRONIC GAME EQUIPMENT WITH A WATCH FUNCTION; HAND HELD UNITS FOR PLAYING ELECTRONIC GAMES; HAND HELD UNITS FOR PLAYING VIDEO GAMES; FLYING DISCS; FOOTBALLS; CHESS AND CHECKER SETS; JIGSAW PUZZLES; KICK BOARD FLOATATION DEVICES FOR RECREATIONAL USE; KITES; TOY MOBILES; MODEL VEHICLES AND RELATED ACCESSORIES; ELECTRONICALLY OPERATED TOY MOTOR VEHICLES; PINBALL MACHINES; PLAYGROUND BALLS; PORCELAIN DOLLS; PUPPETS; THREE DIMENSIONAL PUZZLES; RAG DOLLS; RIDE-ON TOYS; NON-MOTORIZED TOY SCOOTERS; SKATEBOARDS; SNOW SLEDS FOR RECREATIONAL USE; SOCCER BALLS; PLUSH TOYS; SOFTBALL MITTS AND GLOVES; SPORT BALLS; SURFBOARDS; SURF FINS; SURFBOARD FINS; SURFBOARD LEASHES; SURFBOARD WAX; SWIM FINS; SWIM FLOATS FOR RECREATIONAL USE; SWIMMING AIDS, NAMELY, POOL RINGS AND ARM FLOATS FOR RECREATIONAL USE; INFLATABLE SWIMMING POOLS; PLAY SWIMMING POOLS; PLAYGROUND EQUIPMENT, NAMELY, CLIMBING UNITS, SAND BOXES, SWING SETS, AND SLIDES; GAME TABLES; BILLIARD TABLES; TENNIS RACKETS, BALLS, AND RACKET COVERS; TABLE TENNIS PADDLES, BALLS, AND PADDLE COVERS; TETHER BALLS; TOY VEHICLES; SOFT SCULPTURE TOYS; WATER SQUIRTING TOYS; WIND-UP TOYS; TOY MODEL TRAIN SETS; MAGIC TRICKS; WATER SKIS; SKIS; YO-YOS; CHRISTMAS TREE DECORATIONS, GARLANDS AND ORNAMENTS (U.S. CLS. 22, 23, 38 AND 50).

CLASS 28—(Continued).

SN 76-462,508. TECHNOGYM S.P.A., 47035 GAMBETTOLA (FO), ITALY, FILED 10-22-2002.

WELLNESS IN MOTION

OWNER OF ERPN CMNTY TM OFC REG. NO. 1559897, DATED 5-23-2001, EXPIRES 3-16-2010.

OWNER OF U.S. REG. NO. 2,575,179.

NO CLAIM IS MADE TO THE EXCLUSIVE RIGHT TO USE "WELLNESS", APART FROM THE MARK AS SHOWN.

FOR MACHINES AND EQUIPMENT FOR PHYSICAL AND GYMNASIAC EXERCISES, FOR MUSCLE TRAINING AND REHABILITATION, AND FOR AEROBIC AND CARDIOVASCULAR EXERCISE, NAMELY, TREADMILLS, STEP SIMULATORS, ROWING MACHINES, CYCLE SIMULATORS, BARBELLS, DUMBBELLS AND EXERCISE WEIGHTS (U.S. CLS. 22, 23, 38 AND 50).

SN 76-462,659. CHOOSE GAMES INC., TORONTO, ONTARIO, CANADA, FILED 10-29-2002.

**IF YOU HAD TO CHOOSE...?
A FANTASY GAME ABOUT
PRIORITIES**

FOR BOARD GAMES (U.S. CLS. 22, 23, 38 AND 50).

SN 76-466,689. RPS SPECIALITY PRODUCTS, INC., LEBA-
NON, IL. FILED 10-7-2002.



NO CLAIM IS MADE TO THE EXCLUSIVE RIGHT TO USE "ULTIMATE CORE TRAINING", APART FROM THE MARK AS SHOWN.

THE STIPPLING IN THE DRAWING INDICATES SHAD-
ING.

FOR EXERCISE EQUIPMENT, NAMELY, ABDOM-
INAL EXERCISERS, EXERCISE CHAIRS, AND PERSONAL ABDOMINAL EXERCISE MATS (U.S. CLS. 22, 23, 38 AND 50).

FIRST USE 6-0-2002; IN COMMERCE 6-0-2002.

SN 76-467,658. HINES, WILLIAM J., VERNON, NJ. FILED 11-
15-2002.

XCERSOLE

FOR TRAINING DEVICES, NAMELY WEIGHTED
INSERTS FOR FOOTWEAR (U.S. CLS. 22, 23, 38 AND 50).

CLASS 28—(Continued).

SN 76-470,099. HASBRO, INC., PAWTUCKET, RI. FILED 11-
26-2002.

PINK SUNSPARKLE

NO CLAIM IS MADE TO THE EXCLUSIVE RIGHT TO
USE "PINK", APART FROM THE MARK AS SHOWN.

FOR TOY PONIES AND ACCESSORIES FOR USE
THEREWITH (U.S. CLS. 22, 23, 38 AND 50).

SN 76-470,112. HASBRO, INC., PAWTUCKET, RI. FILED 11-
26-2002.

V TRAINERS

NO CLAIM IS MADE TO THE EXCLUSIVE RIGHT TO
USE "TRAINERS", APART FROM THE MARK AS SHOWN.

FOR HAND HELD UNIT FOR PLAYING ELECTRO-
NIC GAMES AND TOY ACTION FIGURES AND AC-
CESSORIES FOR USE THEREWITH (U.S. CLS. 22, 23, 38
AND 50).

FIRST USE 8-5-2002; IN COMMERCE 8-5-2002.

SN 76-470,116. HASBRO, INC., PAWTUCKET, RI. FILED 11-
26-2002.

CELEBRATION CASTLE

NO CLAIM IS MADE TO THE EXCLUSIVE RIGHT TO
USE "CASTLE", APART FROM THE MARK AS SHOWN.

FOR PLAYSETS COMPRISING A TOY PONY AND
ACCESSORIES FOR USE THEREWITH (U.S. CLS. 22, 23,
38 AND 50).

SN 76-470,120. BUZIL, STEVE, CHICAGO, IL. FILED 11-26-
2002.

DOT-IT

FOR MARKER FOR GOLF COURSE GREENS (U.S.
CLS. 22, 23, 38 AND 50).

SN 76-470,194. FONTANA, WILLIAM R, SAN PEDRO, CA.
FILED 11-26-2002.

LIKE-CHESS

FOR BOARD GAMES (U.S. CLS. 22, 23, 38 AND 50).

CLASS 28—(Continued).

SN 76-471,160. CASSADY, JILL, SHERMAN OAKS, CA. FILED 12-2-2002.

PILATES FOOTCORRECTOR

NO CLAIM IS MADE TO THE EXCLUSIVE RIGHT TO USE "PILATES", APART FROM THE MARK AS SHOWN.
FOR EXERCISE EQUIPMENT, NAMELY A MANUALLY OPERATED APPARATUS PROVIDING RESISTANCE INTENDED TO EXERCISE AND STRETCH THE MUSCLES OF THE FOOT, ANKLE AND CALF (U.S. CLS. 22, 23, 38 AND 50).

SN 76-471,545. BATTAT INCORPORATED, PLATTSBURGH, NY. FILED 11-18-2002.

TOOT SWEET

FOR TOYS, NAMELY, INFANT HAND MANIPULATIVES, NAMELY, INFANT DEVELOPMENT TOYS; BABY RATTLES INCORPORATING TEETHING RINGS; BABY RATTLES, MUSICAL TOYS; BABY MULTIPLE ACTIVITY TOYS THAT ALSO CONSIST IN PART OF AN ATTACHED BLANKET AND RATTLE (U.S. CLS. 22, 23, 38 AND 50).

SN 76-473,909. ALEXANDER DOLL COMPANY, NEW YORK, NY. FILED 12-5-2002.

CHAOS THE BEAR

NO CLAIM IS MADE TO THE EXCLUSIVE RIGHT TO USE "BEAR", APART FROM THE MARK AS SHOWN.
FOR PLUSH STUFFED TOY ANIMALS IN A VARIETY OF COLORS AND SIZES (U.S. CLS. 22, 23, 38 AND 50).

SN 76-473,910. ALEXANDER DOLL COMPANY, NEW YORK, NY. FILED 12-5-2002.

MISCHIEF THE CAT

NO CLAIM IS MADE TO THE EXCLUSIVE RIGHT TO USE "CAT", APART FROM THE MARK AS SHOWN.
FOR PLUSH STUFFED TOY ANIMALS IN A VARIETY OF COLORS AND SIZES (U.S. CLS. 22, 23, 38 AND 50).

SN 76-473,911. ALEXANDER DOLL COMPANY, NEW YORK, NY. FILED 12-5-2002.

DANGER THE DOG

NO CLAIM IS MADE TO THE EXCLUSIVE RIGHT TO USE "DOG", APART FROM THE MARK AS SHOWN.
FOR PLUSH STUFFED TOY ANIMALS IN A VARIETY OF COLORS AND SIZES (U.S. CLS. 22, 23, 38 AND 50).

CLASS 28—(Continued).

SN 76-475,123. LEE MIDDLETON ORIGINAL DOLLS, INC., WESTERVILLE, OH. FILED 12-13-2002.

NEWBORN NURSERY

FOR DOLLS, DOLL CLOTHING AND DOLL ACCESSORIES (U.S. CLS. 22, 23, 38 AND 50).
FIRST USE 1-0-2001; IN COMMERCE 1-0-2001.

SN 76-475,149. BOWLING, MICHAEL, TUCSON, AZ. FILED 12-16-2002.

BATTLE HIVE

FOR CARRYING CASES FOR ITEMS USED IN PLAYING TABLE TOP ROLE-PLAYING GAMES (U.S. CLS. 22, 23, 38 AND 50).

SN 76-476,171. DAIWA SEIKO, INC., HIGASHIKURUMECITY, TOKYO, JAPAN, FILED 12-9-2002.

MINICAST

FOR FISHING REELS, FISHING RODS, FISHING LURES, FISHING SINKERS, FISHING FLOATS, FISHING TACKLE BOXES AND FISHING LINES (U.S. CLS. 22, 23, 38 AND 50).

FIRST USE 11-0-2002; IN COMMERCE 11-0-2002.

SN 76-476,814. HALLOCK, JOSEPH A., WAYNE, NJ. FILED 12-19-2002.



NO CLAIM IS MADE TO THE EXCLUSIVE RIGHT TO USE "MARK THE SPOT", APART FROM THE MARK AS SHOWN.

THE LINING IS A FEATURE OF THE MARK AND DOES NOT INDICATE COLOR.

FOR GOLF BALL MARKERS, NAMELY, BRIGHTLY COLORED WATER REPELLANT PIECE OF FABRIC WITH A POCKET FOR HOLDING A GOLF BALL OR OTHER WEIGHT, AND USED TO INDICATE THE LOCATION OF A PLAYED GOLF BALL HIT INTO AND LYING IN THE ROUGH AFTER IT HAS BEEN FOUND (U.S. CLS. 22, 23, 38 AND 50).

CLASS 28—(Continued).

SN 76-477,228. YOMEGA CORP., FALL RIVER, MA. FILED 12-16-2002.

TOPPLEOPOLIS

FOR TUMBLING PLANKS GAME (U.S. CLS. 22, 23, 38 AND 50).

SN 76-477,322. INNOVATIVE CREATIVE PRODUCTS, LTD., RALEIGH, NC. FILED 12-19-2002.

VIPO

FOR PLUSH TOYS (U.S. CLS. 22, 23, 38 AND 50).

SN 76-477,323. INNOVATIVE CREATIVE PRODUCTS, LTD., RALEIGH, NC. FILED 12-19-2002.

VIPSEE

FOR PLUSH TOYS (U.S. CLS. 22, 23, 38 AND 50).

SN 76-477,324. INNOVATIVE CREATIVE PRODUCTS, LTD., RALEIGH, NC. FILED 12-19-2002.

VIPEE

FOR PLUSH TOYS (U.S. CLS. 22, 23, 38 AND 50).

SN 76-477,487. HASBRO, INC., PAWTUCKET, RI. FILED 12-23-2002.

THE CAT AND THE FIDDLE

FOR BOARD GAMES (U.S. CLS. 22, 23, 38 AND 50).

SN 76-477,488. HASBRO, INC., PAWTUCKET, RI. FILED 12-23-2002.

BLACK HARTS

FOR BOARD GAMES (U.S. CLS. 22, 23, 38 AND 50).

CLASS 28—(Continued).

SN 76-477,637. BLACK BEAUTY CUSTOM STICKS, L.L.C., BIRMINGHAM, MI. FILED 12-20-2002.



NO CLAIM IS MADE TO THE EXCLUSIVE RIGHT TO USE "CUSTOM MADE BLADES & SHAFTS", APART FROM THE MARK AS SHOWN.

FOR SPORTING GOODS AND ATHLETIC EQUIPMENT; NAMELY, HOCKEY STICKS AND BLADES FOR HOCKEY STICKS (U.S. CLS. 22, 23, 38 AND 50). FIRST USE 10-0-2002; IN COMMERCE 10-0-2002.

SN 76-478,052. BODY MASTERS SPORTS INDUSTRIES, INC., RAYNE, LA. FILED 12-23-2002.

**B A S I X**

FOR MANUALLY OPERATED EXERCISE EQUIPMENT (U.S. CLS. 22, 23, 38 AND 50). FIRST USE 10-5-2002; IN COMMERCE 12-15-2002.

SN 76-478,083. HORSE SENSE, INC., DELRAY BEACH, FL. FILED 12-24-2002.

INTUITION

FOR CARD GAME OF CHANCE SOLD AND USED EXCLUSIVELY IN CASINOS AND OTHER GAMING ENVIRONMENTS (U.S. CLS. 22, 23, 38 AND 50).

SN 76-478,669. STILETTO TOOLS, INC., ATWATER, CA. FILED 12-27-2002.

STILETTO

OWNER OF U.S. REG. NOS. 1,984,702 AND 2,361,797. FOR SPORTING GOODS, NAMELY SURFBOARDS, WAKEBOARDS, SNOWBOARDS AND SKATEBOARDS (U.S. CLS. 22, 23, 38 AND 50).

CLASS 28—(Continued).

SN 76-480,166. JCC ASSOCIATION OF NORTH AMERICA, NEW YORK CITY, NY. FILED 12-20-2002.

DAFNA

FOR SOFT SCULPTURE DOLLS, BEAN BAG DOLLS, PAPER DOLLS, PLASTIC DOLLS, VINYL DOLLS AND ACCESSORIES THEREFOR (U.S. CLS. 22, 23, 38 AND 50).

SN 76-482,431. SPORTS DESIGN AND DEVELOPMENT, INC., ALEXANDRIA, LA. FILED 1-15-2003.

BLEEDING SHAD

OWNER OF U.S. REG. NO. 1,878,727. NO CLAIM IS MADE TO THE EXCLUSIVE RIGHT TO USE "SHAD", APART FROM THE MARK AS SHOWN. FOR FISHING LURES (U.S. CLS. 22, 23, 38 AND 50). FIRST USE 7-0-2002; IN COMMERCE 7-0-2002.

SN 78-043,854. TRAKFX L.L.C., PRAIRIEVILLE, LA. FILED 1-18-2001.



FOR TOY MODEL VEHICLES AND RELATED ACCESSORIES SOLD AS UNITS (U.S. CLS. 22, 23, 38 AND 50).

SN 78-099,526. CALLAWAY GOLF COMPANY, CARLSBAD, CA. FILED 12-20-2001.

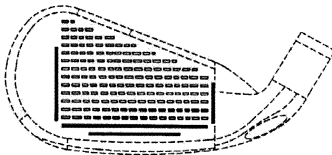

THE MARK CONSISTS OF AN IRON GOLF CLUB HEAD

CLASS 28—(Continued).

WHEREIN TWO LINES ARE LOCATED VERTICALLY ON THE GOLF CLUB FACE, THE LINE NEAR THE HEEL END BEING SUBSTANTIALLY SHORTER THAN THE LINES ON THE TOE END, AND THE TWO HORIZONTAL LINES NEAREST THE SOLE, THE LOWEST ONE THE SMALLEST IN LENGTH. THE APPLICANT CLAIMS THE COLOR WHITE IN THE FOUR LINES AS PART OF THE MARK. THE DOTTED LINES DO NOT FORM PART OF THE MARK BUT ARE RATHER FOR ILLUSTRATIVE PURPOSES ONLY.

SEC. 2(F).
FOR IRON GOLF CLUBS AND IRON GOLF CLUB HEADS (U.S. CLS. 22, 23, 38 AND 50).
FIRST USE 1-1-1996; IN COMMERCE 1-1-1996.

SN 78-114,526. U-WEAR, INC, HUNTINGTON PARK, CA. FILED 3-13-2002.

DIGI-LAYOUT

FOR GAMING EQUIPMENT, NAMELY, A TABLE COVER WITH A GAMING LAYOUT PRINTED ON IT (U.S. CLS. 22, 23, 38 AND 50).

SN 78-128,919. MATTEL, INC., EL SEGUNDO, CA. FILED 5-15-2002.

EMOTIONAL INTELLIGENCE

FOR TOYS, GAMES AND PLAYTHINGS, NAMELY, DOLLS, DOLL CLOTHING AND DOLL ACCESSORIES; TOY FIGURES AND ACCESSORIES THEREFOR; STUFFED TOYS; TOY AIRPLANES; BALLOONS; TOY BAKEWARE AND COOKWARE; SPORT BALLS; TOY BANKS; BATH TOYS; BEAN BAGS; TOY BUILDING BLOCKS; PLAY WANDS; MUSIC BOX TOYS; BUBBLE-MAKING WANDS AND SOLUTION SETS; CARD GAMES; CHILDREN'S PLAY COSMETICS; TOY MOBILES; FLYING DISCS; PORCELAIN DOLLS; PAPER DOLLS; JIGSAW PUZZLES; MUSICAL TOYS; PLUSH TOYS; PUPPETS; RIDE-ON TOYS; MANIPULATIVE PUZZLES; COLLECTIBLE TOY FIGURES; DOLL HOUSES; DRAWING TOYS; PLAY HOUSES; RADIO-CONTROLLED TOY VEHICLES; SAND TOYS; SAND BOX TOYS; TALKING TOYS; SLIDE PUZZLES; PADDLE BALL GAMES; BOARD GAMES; PARLOR GAMES; ROLE-PLAYING GAMES; TOY VEHICLES AND ACCESSORIES; TOY FURNITURE, SPECIFICALLY BEDS, WARDROBES, VANITIES AND CHESTS; DOLL CASES; COMPACT CASES CONTAINING PLAY ENVIRONMENTS SOLD WITH MINIATURE DOLLS; CRIB MOBILES; CONSTRUCTION TOYS; AND MECHANICAL TOYS (U.S. CLS. 22, 23, 38 AND 50).

CLASS 28—(Continued).

SN 78-132,546. LISA FRANK, INC., TUCSON, AZ. FILED 5-31-2002.

VALERIE

FOR TOYS, GAMES, AND PLAYTHINGS, NAMELY DOLLS, DOLL CLOTHING AND DOLL ACCESSORIES, MAGNETIC DOLL PLAYSETS, HOBBY CRAFT KITS FOR THE PURPOSE OF MAKING DOLLS, HOBBY CRAFT KITS FOR THE PURPOSE OF MAKING JEWELRY, HOBBY CRAFT KITS FOR THE PURPOSE OF MAKING AND DECORATING ROOM ACCESSORIES, AND STUFFED TOY FIGURES (U.S. CLS. 22, 23, 38 AND 50).

SN 78-135,063. MATTEL, INC., EL SEGUNDO, CA. FILED 6-12-2002.

LIL' GENTLEMAN

FOR TOYS, GAMES AND PLAYTHINGS, NAMELY, DOLLS, DOLL CLOTHING AND DOLL ACCESSORIES (U.S. CLS. 22, 23, 38 AND 50).

SN 78-135,067. MATTEL, INC., EL SEGUNDO, CA. FILED 6-12-2002.

LIL' BRIDE

NO CLAIM IS MADE TO THE EXCLUSIVE RIGHT TO USE "BRIDE", APART FROM THE MARK AS SHOWN.

FOR TOYS, GAMES AND PLAYTHINGS, NAMELY, DOLLS, DOLL CLOTHING AND DOLL ACCESSORIES (U.S. CLS. 22, 23, 38 AND 50).

SN 78-135,069. MATTEL, INC., EL SEGUNDO, CA. FILED 6-12-2002.

ALL GROWN UP

FOR TOYS, GAMES AND PLAYTHINGS, NAMELY, DOLLS, DOLL CLOTHING AND DOLL ACCESSORIES (U.S. CLS. 22, 23, 38 AND 50).

SN 78-135,098. MATTEL, INC., EL SEGUNDO, CA. FILED 6-12-2002.

SUPER-BLAST HELICOPTER

NO CLAIM IS MADE TO THE EXCLUSIVE RIGHT TO USE "HELICOPTER", APART FROM THE MARK AS SHOWN.

FOR TOYS, GAMES AND PLAYTHINGS, NAMELY, A TOY HELICOPTER (U.S. CLS. 22, 23, 38 AND 50).

CLASS 28—(Continued).

SN 78-140,338. RAZOR CAPS, INC., MERCERVILLE, NJ. FILED 7-1-2002.

RAZORCAPS

FOR ARROWHEADS FOR ARCHERY EQUIPMENT, NAMELY, BLADE UNITS, FERRULES, AND BROAD-HEADS (U.S. CLS. 22, 23, 38 AND 50).

SN 78-145,470. PERFORMANCE MATERIALS CORPORATION, CAMARILLO, CA. FILED 7-18-2002.

PLAY HARDER

FOR HOCKEY EQUIPMENT, NAMELY, HOCKEY STICKS AND HOCKEY STICK BLADES (U.S. CLS. 22, 23, 38 AND 50).

SN 78-149,972. REMICK, GLORIA JEAN, FORISTELL, MO. FILED 8-1-2002.

**VORTEX ELECTRONIC
STEEL TIP DART MACHINE**

NO CLAIM IS MADE TO THE EXCLUSIVE RIGHT TO USE "ELECTRONIC STEEL TIP DART MACHINE", APART FROM THE MARK AS SHOWN.

FOR ELECTRONIC BRISTLE BOARD COIN-OPERATED STEEL TIP DART GAME (U.S. CLS. 22, 23, 38 AND 50).

SN 78-166,835. MAC GOLF INTERNATIONAL, INC., SANTA CLARITA, CA. FILED 9-23-2002.



FOR GOLF CLUBS AND COMPONENT PARTS THEREOF, NAMELY, HEADS, SHAFTS AND GRIPS (U.S. CLS. 22, 23, 38 AND 50).

CLASS 28—(Continued).

SN 78-172,433. FARNAM COMPANIES, INC., PHOENIX, AZ.
FILED 10-9-2002.

MAGIC CAT HAT

NO CLAIM IS MADE TO THE EXCLUSIVE RIGHT TO
USE "CAT HAT", APART FROM THE MARK AS SHOWN.
FOR PET TOYS (U.S. CLS. 22, 23, 38 AND 50).

SN 78-173,808. JAS. D. EASTON, INC., VAN NUYS, CA.
FILED 10-11-2002.

TRIPLE 7

FOR SPORTING GOODS, NAMELY, SOFTBALL BATS
AND BASEBALL BATS. (U.S. CLS. 22, 23, 38 AND 50).
FIRST USE 4-1-2001; IN COMMERCE 4-1-2001.

SN 78-178,752. NEW GENERATION INNOVATIONS, L.L.C.,
LITTLETON, CO. FILED 10-26-2002.

Squeezie

FOR SPORT, LEISURE, AND ACTIVITY TOYS FOR
CATS AND DOGS. (U.S. CLS. 22, 23, 38 AND 50).

CLASS 28—(Continued).

SN 78-185,354. MAYACAMA GOLF CLUB LLC, SANTA
ROSA, CA. FILED 11-14-2002.

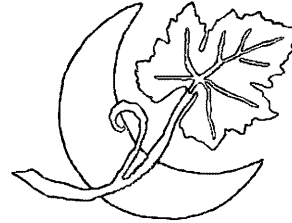

THE MARK CONSISTS OF THE DESIGN OF A SINGLE
GRAPE LEAF WITH AN ATTACHED VINE IN FRONT OF A
CRESCENT MOON.

FOR GOLF BAGS; GOLF BAG COVERS; GOLF BAG
PEGS; GOLF BAG TAGS; GOLF BALL MARKERS; GOLF
BALL RETRIEVERS; GOLF BALL SLEEVES; GOLF
BALLS; GOLF CLUB HEADS; GOLF CLUB INSERTS;
GOLF CLUB SHAFTS; GOLF CLUBS; GOLF FLAGS;
GOLF GLOVES; GOLF IRONS; GOLF PUTTER COVERS;
GOLF PUTTERS; GOLF TEE MARKERS; GOLF TEES;
GOLF TOWEL CLIPS FOR ATTACHMENT TO GOLF
BAGS; GOLF ACCESSORY POUCHES; GRIP TAPES FOR
GOLF CLUBS; HAND GRIPS FOR GOLF CLUBS; HEAD
COVERS FOR GOLF CLUBS; DIVOT REPAIR TOOLS;
AND MODULAR FOAM PREFABRICATED MINIATURE
GOLF COURSES AND PUTTING SURFACES (U.S. CLS.
22, 23, 38 AND 50).

FIRST USE 3-1-2001; IN COMMERCE 8-1-2001.

SN 78-185,960. GORRELL, MARCY, OAK PARK, IL. FILED
11-18-2002.

FLAT SAM

FOR EDUCATIONAL GAME, NAMELY, A MAP
BOARD GAME (U.S. CLS. 22, 23, 38 AND 50).

SN 78-188,350. LIFETIME PRODUCTS, INC., CLEARFIELD,
UT. FILED 11-24-2002.

POWER SHOCK

FOR BASKETBALL EQUIPMENT, NAMELY, RIMS,
BACKBOARDS, POLES, GOALS, NETS, FIXED BASKET-
BALL STANDARDS, IN-GROUND BASKETBALL STAND-
ARDS, PORTABLE BASKETBALL STANDARDS,
WEIGHT-BEARING BALLAST BASE FOR PORTABLE
BASKETBALL STANDARDS, BASKETBALL GOAL
HEIGHT ADJUSTMENT MECHANISMS, ARCADE-TYPE
BASKETBALL GAMES AND RETURN MECHANISMS
FOR RETURNING A BASKETBALL TO A USER. (U.S.
CLS. 22, 23, 38 AND 50).

CLASS 28—(Continued).

SN 78-188,925. WINSTON PROPERTIES, INC., ORADELL, NJ. FILED 11-26-2002.

THE FUTURE OF RADIO CONTROL

NO CLAIM IS MADE TO THE EXCLUSIVE RIGHT TO USE "RADIO CONTROL", APART FROM THE MARK AS SHOWN.

FOR TOY RADIO CONTROL AIRPLANES, CARS, TRUCKS AND PARTS AND ACCESSORIES THEREFOR (U.S. CLS. 22, 23, 38 AND 50).

SN 78-189,142. AFTER HOURS ADVERTISING, INC., PHOENIX, AZ. FILED 11-26-2002.

RADVERBS

FOR BOARD GAMES. (U.S. CLS. 22, 23, 38 AND 50).

SN 78-189,778. SOUTHWORTH, JILL, DALLAS, TX. FILED 11-28-2002.

MONSTER REPELLENT

FOR CHILDRENS TOYS NAMELY PLUSH MONSTER DOLLS AND SIMULATED SPRAY REPELLENT FOR MONSTERS (U.S. CLS. 22, 23, 38 AND 50).

SN 78-190,264. EFFANBEE DOLL COMPANY, INC., HURLEY, NY. FILED 12-2-2002.

DOLLS THAT TOUCH YOUR HEART

FOR TOYS, NAMELY, DOLLS (U.S. CLS. 22, 23, 38 AND 50).

SN 78-190,268. EAT YOUR LUNCH LLC, LA GRANGE, IL. FILED 12-2-2002.

BZOTS

FOR TOYS, NAMELY, PLUSH TOYS, PULL TOYS, CRIB TOYS, ELECTRONIC ACTION TOYS, ACTION FIGURES, STUFFED FIGURES, MECHANICAL ACTION TOYS, BOARD GAMES, ELECTRONIC BOARD GAMES, HAND-HELD ELECTRONIC GAMES, ROLE-PLAYING GAMES, ACTION SKILL GAMES; SPORTING ARTICLES, NAMELY, BALLS OF ALL KIND; TOY AND MODEL VEHICLES; MASKS, NAMELY, COSTUME MASKS; PUPPETS; BALLOONS; NOVELTIES FOR PARTIES, NAMELY, PARTY FAVORS IN THE NATURE OF SMALL TOYS (U.S. CLS. 22, 23, 38 AND 50).

CLASS 28—(Continued).

SN 78-190,949. NELSON TECHNOLOGIES, INC., KINGSFORD, MI. FILED 12-4-2002.

HOTSPOT

FOR PAINTBALLS (U.S. CLS. 22, 23, 38 AND 50). FIRST USE 11-1-1999; IN COMMERCE 11-1-1999.

SN 78-191,021. MCRAE'S, INC., BIRMINGHAM, AL. FILED 12-4-2002.

MISS ATTITUDE

FOR STUFFED TOY ANIMALS; BATHTUB TOYS; BOARD GAMES; CARD GAMES; DOLL CASES; CHRISTMAS TREE DECORATIONS; CHILDREN'S PLAY COSMETICS; DOLLS; PLAYSETS FOR DOLLS; PLUSH TOYS. (U.S. CLS. 22, 23, 38 AND 50).

SN 78-191,408. OUTDOOR INNOVATIONS, L.L.C., TULSA, OK. FILED 12-5-2002.

SNAPBACK SUPER PLASTICS

OWNER OF U.S. REG. NO. 2,157,757. NO CLAIM IS MADE TO THE EXCLUSIVE RIGHT TO USE "SUPER PLASTICS", APART FROM THE MARK AS SHOWN.

FOR FISHING EQUIPMENT, NAMELY, LURES, FISHING RODS, FISHING TERMINAL TACKLE AND FISHING REELS (U.S. CLS. 22, 23, 38 AND 50).

FIRST USE 1-0-2002; IN COMMERCE 1-0-2002.

SN 78-193,200. TRUE TEMPER SPORTS, INC., MEMPHIS, TN. FILED 12-11-2002.

TCI

FOR GOLF SHAFTS (U.S. CLS. 22, 23, 38 AND 50).

CLASS 28—(Continued).

SN 78-194,117. HANNA-BARBERA PRODUCTIONS, INC., SHERMAN OAKS, CA. FILED 12-12-2002.

INCH HIGH PRIVATE EYE

FOR TOYS AND SPORTING GOODS, NAMELY, GAMES AND PLAYTHINGS, NAMELY, ACTION FIGURES AND ACCESSORIES THEREFOR; PLUSH TOYS; BALLOONS; BATHTUB TOYS; RIDE-ON TOYS; EQUIPMENT SOLD AS A UNIT FOR PLAYING CARD GAMES; TOY VEHICLES; DOLLS; FLYING DISCS; ELECTRONIC HAND-HELD GAME UNIT; GAME EQUIPMENT SOLD AS A UNIT FOR PLAYING A BOARD GAME, A CARD GAME, A MANIPULATIVE GAME, A PARLOR GAME AND AN ACTION TYPE TARGET GAME; STAND ALONE VIDEO OUTPUT GAME MACHINES; JIGSAW AND MANIPULATIVE PUZZLES; PAPER FACE MASKS; SKATEBOARDS; ICE SKATES; WATER SQUIRTING TOYS; BALLS, NAMELY, PLAYGROUND BALLS, SOCCER BALLS, BASEBALL, BASKETBALLS; BASEBALL GLOVES; SWIMMING FLOATS FOR RECREATIONAL USE; SWIM FINS; TOY BAKEWARE AND TOY COOKWARE; TOY BANKS; TOY SNOW GLOBES; AND CHRISTMAS TREE ORNAMENTS, NAMELY, BELLS (U.S. CLS. 22, 23, 38 AND 50).

SN 78-194,900. SECOND NATURE DESIGN, INC., TEMPE, AZ. FILED 12-16-2002.

QUARRY CRITTERS

OWNER OF U.S. REG. NOS. 2,477,461 AND 2,622,126. NO CLAIM IS MADE TO THE EXCLUSIVE RIGHT TO USE "CRITTERS", APART FROM THE MARK AS SHOWN. FOR PLUSH TOYS, NAMELY, SOFT SCULPTURE FIGURES (U.S. CLS. 22, 23, 38 AND 50).

SN 78-197,039. WIZKIDS, LLC, BELLEVUE, WA. FILED 12-20-2002.

TSURO

THE ENGLISH TRANSLATION OF "TSURO" IS "CRANE" OR "CRANES".

FOR BOARD GAME WITH RULES, GUIDE BOOKS, AND GAME PIECES SOLD AS A UNIT (U.S. CLS. 22, 23, 38 AND 50).

SN 78-198,339. TAYLOR MADE GOLF COMPANY, INC., CARLSBAD, CA. FILED 12-28-2002.

M3

FOR GOLF EQUIPMENT, NAMELY GOLF CLUBS, GOLF GRIPS, WEDGES, PUTTERS, SHAFTS, GOLF BALLS, GOLF GLOVES, GOLF TEES, GOLF CLUB COVERS AND GOLF BAGS (U.S. CLS. 22, 23, 38 AND 50).

CLASS 28—(Continued).

SN 78-198,722. THE VICTORY GROUP, INC., SALEM, OR. FILED 12-30-2002.

QUESTION OF EMPIRE

FOR WAR BOARD GAME (U.S. CLS. 22, 23, 38 AND 50).

SN 78-221,375. VIACOM INTERNATIONAL INC., NEW YORK, NY. FILED 3-4-2003.

NICKTIVITIES GOOOZE TOONS

OWNER OF U.S. REG. NO. 2,383,096.

FOR TOYS AND PLAYTHINGS, NAMELY A VISCOUS SUBSTANCE USED FOR AMUSEMENT; GAMES AND PLAYTHINGS, NAMELY, CARD GAMES, DARTS, DOLLS; ACTION FIGURES AND ACCESSORIES THEREOF; STAND ALONE VIDEO GAME MACHINES UTILIZING CD ROM'S, STAND ALONE VIDEO GAME MACHINES, STAND ALONE AUDIO OUTPUT GAME MACHINES, AND BOARD GAMES; SPORTING ARTICLES, NAMELY, GOLF CLUBS, BASEBALLS, FOOTBALLS, PADDLE BALLS, BASEBALL BATS; CHRISTMAS TREES ORNAMENTS (U.S. CLS. 22, 23, 38 AND 50).

SN 78-221,384. VIACOM INTERNATIONAL INC., NEW YORK, NY. FILED 3-4-2003.

NICKTIVITIES GOOOZE ITS

OWNER OF U.S. REG. NO. 2,383,096.

FOR TOYS AND PLAYTHINGS, NAMELY A VISCOUS SUBSTANCE USED FOR AMUSEMENT; GAMES AND PLAYTHINGS, NAMELY, CARD GAMES, DARTS, DOLLS; ACTION FIGURES AND ACCESSORIES THEREOF; STAND ALONE VIDEO GAME MACHINES UTILIZING CD ROM'S, STAND ALONE VIDEO GAME MACHINES, STAND ALONE AUDIO OUTPUT GAME MACHINES, AND BOARD GAMES; SPORTING ARTICLES, NAMELY, GOLF CLUBS, BASEBALLS, FOOTBALLS, PADDLE BALLS, BASEBALL BATS; CHRISTMAS TREES ORNAMENTS (U.S. CLS. 22, 23, 38 AND 50).

CLASS 29—MEATS AND PROCESSED FOODS

SN 75-169,117. SUNFRESH FOODS, INC., SEATTLE, WA. FILED 9-20-1996.



FOR PROCESSED FRUITS, NAMELY, FREEZER JAMS (U.S. CL. 46).
FIRST USE 10-0-1988; IN COMMERCE 10-0-1988.

SN 75-667,526. CADOS, DIMITRI, ORINDA, CA. FILED 3-25-1999.

BERKELEY BISTRO TO GO

NO CLAIM IS MADE TO THE EXCLUSIVE RIGHT TO USE "BERKELEY", APART FROM THE MARK AS SHOWN. FOR PREPACKAGED MEALS CONTAINING PROCESSED VEGETABLES, FRUITS, AND DAIRY PRODUCTS (U.S. CL. 46).
FIRST USE 3-25-1999; IN COMMERCE 3-25-1999.

SN 76-018,025. BEE-LOR, INC., BRUNSVILLE, IA. FILED 3-31-2000.



FOR PORK SOLD IN RETAIL CHANNELS OF TRADE (U.S. CL. 46).
FIRST USE 9-24-1999; IN COMMERCE 9-24-1999.

CLASS 29—(Continued).

SN 76-022,240. ALFRESH FOODS, INC., FT. LAUDERDALE, FL. BY ASSIGNMENT TNFB, HOUSTON, TX. FILED 4-10-2000.



NO CLAIM IS MADE TO THE EXCLUSIVE RIGHT TO USE "SPANISH", "CHEF" AND "BRAND", APART FROM THE MARK AS SHOWN.

FOR FOOD PRODUCTS, NAMELY, PREPARED MEALS CONSISTING PRIMARILY OF BEEF, SHREDDED PORK, POULTRY AND VEGETABLES (U.S. CL. 46).

FIRST USE 12-1-1999; IN COMMERCE 12-1-1999.

SN 76-232,340. PANAGO PIZZA INC., ABBOTSFORD, BRITISH COLUMBIA, CANADA, FILED 3-27-2001.



FOR PREPARED CHICKEN (U.S. CL. 46).
FIRST USE 3-27-2001; IN COMMERCE 3-27-2001.

SN 76-355,033. AUSTRALIAN LAMB COMPANY, INC., THE, WILTON, CT. FILED 12-31-2001.

OPAL VALLEY

FOR FRESH, FROZEN AND PROCESSED LAMB (U.S. CL. 46).
FIRST USE 5-3-1999; IN COMMERCE 5-3-1999.

SN 76-395,070. CONAGRA FOODS REFRIGERATED, DOWNERS GROVE, IL. BY CHANGE OF NAME SWIFT-ECKRICH, INC., DOWNERS GROVE, IL. FILED 4-8-2002.

SANDWICH STARTERS

FOR CHICKEN BREAST FILLETS AND TURKEY BREAST FILLETS (U.S. CL. 46).

CLASS 29—(Continued).

SN 76-426,341. DEVAULT PACKAGING CO., DEVAULT, PA.
FILED 6-28-2002.

MRS. DI FILLIPPO'S

OWNER OF U.S. REG. NO. 1,720,504.
THE NAME SHOWN IN THE MARK DOES NOT IDENTIFY
A LIVING INDIVIDUAL.
FOR COOKED PORK (U.S. CL. 46).
FIRST USE 4-1-2002; IN COMMERCE 4-1-2002.

SN 76-426,425. M & I SEAFOOD MANUFACTURING, INC.,
BALTIMORE, MD. FILED 6-28-2002.

**CHESAPEAKE BAY
GOURMET**

OWNER OF U.S. REG. NO. 1,725,990.
SEC. 2(F).
FOR SEAFOOD AND PRE-PACKAGED DINNERS
CONSISTING PRIMARILY OF SEAFOOD (U.S. CL. 46).
FIRST USE 0-0-1994; IN COMMERCE 0-0-1994.

SN 76-433,459. DEB-EL FOODS CORP., ELIZABETH, NJ.
FILED 7-22-2002.

DEB-EL FOODS

NO CLAIM IS MADE TO THE EXCLUSIVE RIGHT TO
USE "FOODS", APART FROM THE MARK AS SHOWN.
FOR DRIED EGG WHITES (U.S. CL. 46).
FIRST USE 1-0-1985; IN COMMERCE 1-0-1985.

SN 76-434,878. RAISING CANE'S USA, L.L.C., BATON
ROUGE, LA. FILED 7-26-2002.

CANIAC

FOR PREPARED MEALS CONSISTING PRIMARILY
OF CHICKEN (U.S. CL. 46).
FIRST USE 10-1-2000; IN COMMERCE 10-1-2000.

SN 76-437,887. EMPIRE KOSHER POULTRY, INC., MIF-
FLINTOWN, PA. FILED 8-5-2002.

HADAS KOSHER POULTRY

OWNER OF U.S. REG. NO. 1,767,057.
NO CLAIM IS MADE TO THE EXCLUSIVE RIGHT TO
USE "KOSHER POULTRY", APART FROM THE MARK AS
SHOWN.
THE ENGLISH TRANSLATION OF THE HEBREW WORD
"HADAS" IS "THE LAW".
FOR POULTRY, NAMELY CHICKENS AND TUR-
KEYS, WHOLE AND IN PARTS (U.S. CL. 46).
FIRST USE 7-13-1992; IN COMMERCE 7-13-1992.

CLASS 29—(Continued).

SN 76-448,153. EURO FOODS, INC., DBA CITTERIO U.S.A.,
LONG ISLAND, NY. FILED 9-4-2002.

PERFETTE

FOR PROCESSED MEATS, NAMELY DELI MEATS
AND CHEESE (U.S. CL. 46).
FIRST USE 8-31-2002; IN COMMERCE 8-31-2002.

SN 76-467,545. THE DANNON COMPANY, INC., TARRY-
TOWN, NY. FILED 11-18-2002.

TOTALLY VANILLA

NO CLAIM IS MADE TO THE EXCLUSIVE RIGHT TO
USE "VANILLA", APART FROM THE MARK AS SHOWN.
FOR YOGURT (U.S. CL. 46).
FIRST USE 9-1-2002; IN COMMERCE 9-1-2002.

SN 76-467,974. PRIORITY TRADEMARKS, INC., MIAMI, FL.
FILED 11-18-2002.



NO CLAIM IS MADE TO THE EXCLUSIVE RIGHT TO
USE "PIKANTE SALADS", APART FROM THE MARK AS
SHOWN.

"PIKANTE" MEANS: PREPARED IN SUCH A WAY AS TO
THE SPICY; HAVING A SAUCE TYPICALLY CONTAINING
TOMATOES, ONIONS, PEPPERS, VINEGAR, AND OTHER
CONDIMENTS. "PIKANTE" IS A DIFFERENT SPELLING
OF THE WORD "PICANTE".

THE TRANSLITERATION OF THE NON-ENGLISH
WORD IN THE MARK IS "ETNKIP".

FOR PACKAGED VEGETABLE SALADS AND FISH
SALADS (U.S. CL. 46).

SN 76-472,917. TRANS FAMILY, INC., SAN GABRIEL, CA.
FILED 12-9-2002.

DIAMOND ELEPHANT

FOR CANNED MILK (U.S. CL. 46).

CLASS 29—(Continued).

SN 76-475,624. CAGLE'S, INC., ATLANTA, GA. FILED 12-16-2002.

DOUGLAS COUNTY FARMS

NO CLAIM IS MADE TO THE EXCLUSIVE RIGHT TO USE "FARMS", APART FROM THE MARK AS SHOWN. FOR POULTRY FOR CONSUMPTION ON OR OFF THE PREMISES (U.S. CL. 46).
FIRST USE 3-1-1994; IN COMMERCE 3-1-1994.

CLASS 29—(Continued).

SN 78-050,555. KENDALL, SADIE, ATASCADERO, CA. FILED 2-28-2001.

Crème Fraîche
Pasteurized Cultured Cream



**Kendall
Farms**

NO CLAIM IS MADE TO THE EXCLUSIVE RIGHT TO USE "CREME FRAICHE" AND "PASTEURIZED CULTURED CREAM", APART FROM THE MARK AS SHOWN. THE ENGLISH TRANSLATION OF "CREME FRAICHE" IS "FRESH CREAM".
SEC. 2(F) AS TO "FARMS".
FOR DAIRY CREAM (U.S. CL. 46).
FIRST USE 6-23-1988; IN COMMERCE 8-23-1988.

SN 76-479,180. GRAND VALLEY FOODS, INC., GRAND JUNCTION, CO. FILED 12-23-2002.

SN 78-185,817. DEGENFELDER, JOSEPH R., CLEVELAND, OH. FILED 11-16-2002.

LIFECHEESE

FOR CHEESE CONTAINING ENHANCED AMOUNTS OF CONJUGATED LINOLEIC ACID (U.S. CL. 46).

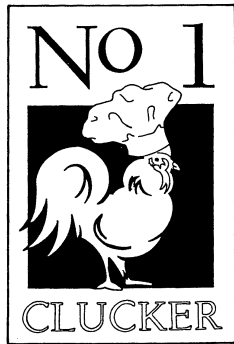

SN 78-189,448. DEAN INTELLECTUAL PROPERTY SERVICES II, L.P., DALLAS, TX. FILED 11-27-2002.

TLC

FOR MILK (U.S. CL. 46).
FIRST USE 1-0-1989; IN COMMERCE 1-0-1989.

NO CLAIM IS MADE TO THE EXCLUSIVE RIGHT TO USE "NO. 1 CLUCKER", APART FROM THE MARK AS SHOWN.

THE MARK CONSISTS OF A YELLOW CHICKEN WEARING A WHITE HAT SHOWN AGAINST A BLACK BACKGROUND. THE WORDS "NO 1 CLUCKER" IS IN BLACKLETTERING AGAINST A RED BACKGROUND.
FOR PREPACKAGED, CUT CHICKEN PIECES (U.S. CL. 46).

SN 78-191,624. BEANIUS, LLC, BROOKLYN, NY. FILED 12-5-2002.

S'OLIEVE

FOR SOY AND OLIVE-BASED SPREAD OR PASTE (U.S. CL. 46).

CLASS 29—(Continued).

SN 78-194,864. CARGILL, INCORPORATED, WAYZATA, MN. FILED 12-16-2002.

SKILLET OMELETS

OWNER OF U.S. REG. NO. 1,760,832.
NO CLAIM IS MADE TO THE EXCLUSIVE RIGHT TO USE "OMELETS", APART FROM THE MARK AS SHOWN. SEC. 2(F).
FOR OMELETS (U.S. CL. 46).
FIRST USE 1-17-1992; IN COMMERCE 1-17-1992.

SN 78-196,089. TARGET SALES MANAGEMENT, INC., TRUMBULL, CT. FILED 12-19-2002.

EUROHARVEST

FOR CANNED, COOKED OR OTHERWISE PROCESSED FOODS, NAMELY, FRUITS, VEGETABLES, BEANS, ARTICHOKE, TOMATOES, OLIVES, EGG-PLANT, GRAPE LEAVES, GREEN AND RED PEPPERS, MUSHROOMS, LEGUMES, FISH, CAVIAR, CARP, COD FISH, OCTOPUS, SARDINES, ANCHOVIES, SQUID, CHEESES, EDIBLE OILS, OLIVE OIL, VEGETABLE OIL, SESAME SEED OIL, PICKLES, PICKLED ONIONS, FRUIT JAMS AND FRUIT PRESERVES (U.S. CL. 46).
FIRST USE 7-18-2001; IN COMMERCE 9-5-2001.

SN 78-196,498. PROTESIA CORPORATION, WOODLAND HILLS, CA. FILED 12-19-2002.

PROTESIA

FOR SOY PROTEIN FOR USE AS FOOD ADDITIVES (U.S. CL. 46).

SN 78-200,003. PEARSALL, MATTHEW J., MORETOWN, VT. FILED 1-3-2003.

HEY JERKY

NO CLAIM IS MADE TO THE EXCLUSIVE RIGHT TO USE "JERKY", APART FROM THE MARK AS SHOWN. FOR BEEF JERKY AND JERKY (U.S. CL. 46).

CLASS 30—STAPLE FOODS

SN 75-342,206. PATSY'S BRAND, INC., NEW YORK, NY. FILED 8-18-1997.

PATSY'S

OWNER OF U.S. REG. NO. 1,874,789.
FOR SAUCES (U.S. CL. 46).
FIRST USE 2-15-1994; IN COMMERCE 2-15-1994.

SN 75-839,801. COST PLUS MARKETING SERVICES, INC., OAKLAND, CA. BY ASSIGNMENT COST PLUS, INC., OAKLAND, CA. FILED 11-3-1999.

CROSSROADS

FOR COFFEE, BARBECUE SAUCE, HOT SAUCE, MARINADE, SALSA, CORN CHIPS, CANDY, CANDIED FRUIT AND NUTS, BISCOTTI, PASTA AND PASTA PRODUCTS, COCOA, CHOCOLATE, FLAVORED COCOA MIXES, TEA, COFFEE SUBSTITUTES, SPICES AND HERBS IN ALL FORMS, BAKERY GOODS AND PRODUCTS, HERBAL AND GRAIN-BASED FOOD BEVERAGES, CEREALS, GRAINS, BREAD MIXES, CAKE AND PIE MIXES, FILLINGS AND EDIBLE CAKE DECORATIONS, CONDIMENTS, CAPERS, CARAMEL POPCORN, CATSUP, CHEESE SAUCE, POTATO AND CORN CHIPS, DRIED CHILI PEPPERS, CHUTNEY, CHOW CHOW, PASTA, COOKIES, CRACKERS, EXTRACTS USED AS FLAVORING, SYRUPS, FLOUR, READY-TO-EAT CEREAL DERIVED FOOD BARS, FROSTINGS AND FROSTING MIXES, GRAVIES AND GRAVY MIXES, CHEWING GUM, HONEY, MAYONNAISE, MUSTARD, NOODLES, SNACK MIX CONSISTING PRIMARILY OF CRACKERS, PRETZELS, CANDIED NUTS AND/OR POPPED POPCORN, CHOCOLATE COVERED NUTS, OATMEAL, PICKLE RELISH, PANCAKE MIXES, POPPED POPCORN, PRETZELS, PUDDINGS AND PUDDING MIXES, RICE AND RICE PRODUCTS, SAUCES, NATURAL SWEETENERS, VINEGAR, FLAVORED VINEGARS, AND YEAST (U.S. CL. 46).

SN 76-061,761. FLEET NATIONAL BANK, BOSTON, MA. BY ASSIGNMENT FRIENDLY ICE CREAM CORPORATION, WILBRAHAM, MA. FILED 6-2-2000.

ORANGE CRÈME ROLL

THE ENGLISH TRANSLATION OF "CREME" IS "CREAM".
SEC. 2(F).
FOR FROZEN DESSERT, NAMELY ICE CREAM FOR CONSUMPTION ON OR OFF THE PREMISES (U.S. CL. 46).
FIRST USE 5-0-1992; IN COMMERCE 5-0-1992.

CLASS 30—(Continued).

SN 76-099,987. SEAFORTH CREAMERY INC., SEAFORTH, ONTARIO, CANADA, FILED 8-1-2000.

TUSCAN GARDEN

FOR SPOONABLE AND PORTABLE SALAD DRESSINGS (U.S. CL. 46).

SN 76-187,878. DON SATUR S.R.L., PROVINCE OF BUENOS AIRES, ARGENTINA, FILED 12-29-2000.



PRIORITY CLAIMED UNDER SEC. 44(D) ON ARGENTINA APPLICATION NO. 2.315.528, FILED 11-10-2000, REG. NO. 1872423, DATED 5-22-2002, EXPIRES 5-22-2012.

NO CLAIM IS MADE TO THE EXCLUSIVE RIGHT TO USE "FUNDADO EN 1967", APART FROM THE MARK AS SHOWN.

THE LINING AROUND THE PORTRAIT IN THE DRAWING IS A FEATURE OF THE MARK.

THE NAME "DON SATUR", "DON SATURNINO MARTINEZ" AND THE PORTRAIT OF A GENTLEMAN IN THE MARK IDENTIFIES A PARTICULAR LIVING INDIVIDUAL, WHOSE CONSENT IS OF RECORD.

THE HORIZONTAL LINES ARE A FEATURE OF THE MARK AND DO NOT INTEND TO INDICATE COLOR. THE UPPERMOST AND THE LOWERMOST HORIZONTAL STRIPES ARE IN THE COLOR YELLOW. THE WORDING "DON SATUR" AND "DON SATURNINO MARTINEZ" IS AGAINST A RED BACKGROUND.

THE ENGLISH TRANSLATION OF THE WORDING IS "DON SATUR", "FUNDADO EN 1967" AND "DON SATURNINO MARTINEZ" ARE "MR. SATUR, FOUNDED IN 1967" AND "MR. SATURNINO MARTINEZ".

FOR BAKERY PRODUCTS, NAMELY, PASTRY, BISCUITS, CEREAL-BASED SNACK FOOD, RICE-BASED SNACK FOOD (U.S. CL. 46).

SN 76-302,185. RAYMOND HADLEY CORP., SPENCER, NY, FILED 8-20-2001.



SEC. 2(F).

FOR FINE YELLOW CORN MEAL, PROCESSED YELLOW CORN, PROCESSED WHOLE YELLOW CORN, MILO MEAL, UN-ENRICHED PROCESSED WHEAT, SUGAR, PLANTAIN FLOUR, YELLOW CORN FLOUR, PROCESSED YELLOW CRACKED CORN (U.S. CL. 46).

FIRST USE 1-2-1981; IN COMMERCE 1-2-1981.

CLASS 30—(Continued).

SN 76-349,938. O.B. MACARONI COMPANY, FORT WORTH, TX, FILED 12-4-2001.

LANERI

SEC. 2(F).

FOR PASTA (U.S. CL. 46).

FIRST USE 0-0-1997; IN COMMERCE 0-0-1997.

SN 76-381,456. BAKER'S BREAKFAST COOKIE, INC., BELLINGHAM, WA, FILED 3-12-2002.

FUEL IN A COOKIE

FOR BAKED GOODS, NAMELY COOKIES (U.S. CL. 46).

SN 76-402,768. HANNA-BARBERA PRODUCTIONS, INC., SHERMAN OAKS, CA, FILED 4-22-2002.

SCOOBY-DOO

FOR COOKIES; BASES FOR MAKING MILKSHAKES, BREAKFAST CEREAL, BUBBLE GUM, CAKE DECORATIONS MADE OF CANDY, CHEWING GUM, FROZEN CONFECTIONS, CRACKERS, FROZEN YOGURT, ICE CREAM, PRETZELS, PEANUT BUTTER CONFECTIONERY CHIPS, MALT FOR FOOD; SOYBEAN MALT; MALT BISCUITS; SUGAR CONFECTIONERY; EDIBLE DECORATIONS FOR CAKE; RICE CAKES; PASTILLES; PASTRIES; BISCUITS AND BREAD; COFFEE BEVERAGES WITH MILK; COCOA BEVERAGES WITH MILK, CHOCOLATE-BASED BEVERAGES, COFFEE AND COFFEE-BASED BEVERAGES, COCOA AND COCOA-BASED BEVERAGES; TEA, NAMELY, GINSENG TEA, BLACK TEA, OOLONG TEA, BARLEY AND BARLEY-LEAF TEA; MEAT TENDERIZERS FOR HOUSEHOLD PURPOSES; BINDING AGENTS FOR ICE-CREAM (U.S. CL. 46).

FIRST USE 7-31-1999; IN COMMERCE 7-31-1999.

SN 76-413,129. AN THAI CO., LTD., DAK LAK PROVINCE, VIETNAM, FILED 5-29-2002.



OWNER OF VIETNAM REG. NO. 39487, DATED 12-28-2001, EXPIRES 8-24-2010.

FOR COFFEE, AND COFFEE-BASED BEVERAGES CONTAINING MILK (U.S. CL. 46).

CLASS 30—(Continued).

SN 76-416,982. TIKTAK B.V., NETHERLANDS, FILED 6-5-2002.

TIKTAK

FOR COFFEE, TEA (U.S. CL. 46).
FIRST USE 2-0-2001; IN COMMERCE 2-0-2001.

SN 76-419,951. PERFETTI VAN MELLE S.P.A., MILAN, ITALY, FILED 6-13-2002.

RESET

FOR CONFECTIONERY, NAMELY, BUBBLE GUM, CHEWING GUM, CHEW CANDIES, CANDY MINTS, CANDY DROPS, GUM DROPS, FLAVORED AND SWEETENED GELATIN CANDIES, LOLLIPOPS, TOFFEE, LICORICE, CANDIES; CHOCOLATE, TEA, FLAVORED ICES, PASTRY, AND SUGAR (U.S. CL. 46).

SN 76-422,163. LA TORTILLA FACTORY INC., SANTA ROSA, CA. FILED 6-17-2002.

SOY BUENO

THE ENGLISH TRANSLATION OF "SOY BUENO" IS "I AM GOOD".
FOR TORTILLAS (U.S. CL. 46).

SN 76-422,512. PERRY'S ICE CREAM COMPANY, INC., AKRON, NY. FILED 6-12-2002.

PANDA PAWS

FOR ICE CREAM (U.S. CL. 46).
FIRST USE 4-1-1999; IN COMMERCE 4-1-1999.

SN 76-428,721. JIMMY'S GIFT SHOP, INC., DAYTONA BEACH, FL. FILED 7-9-2002.

FRESH ORANGE

SEC. 2(F).
FOR BUBBLE GUM (U.S. CL. 46).
FIRST USE 9-26-1990; IN COMMERCE 9-26-1990.

CLASS 30—(Continued).

SN 76-429,293. AIRBOSS FEATURES, LTD., SAN ANTONIO, TX. FILED 7-11-2002.



FOR RESTAURANT FOODS, NAMELY, HAMBURGERS AND TACOS (U.S. CL. 46).

SN 76-432,648. NUVEX INGREDIENTS, INC., BLUE EARTH, MN. FILED 7-22-2002.

PROTI-OATS

FOR FLAKED FOOD MATERIAL, NAMELY FLAKES OF CEREAL GRAIN BASED FLOUR CONTAINING PROTEIN MADE FOR INCORPORATION INTO BARS AND BREAKFAST CEREALS FOR HUMAN CONSUMPTION (U.S. CL. 46).

SN 76-436,035. S & S FOOD BROKERS AND DISTRIBUTORS, INC., CHERRY HILL, NJ. FILED 7-29-2002.



NO CLAIM IS MADE TO THE EXCLUSIVE RIGHT TO USE "CANADIAN NATURELLE", AND "LEMON ICED TEA", APART FROM THE MARK AS SHOWN.

THE STIPPLING AND LINING IN THE DRAWING IS FOR SHADING PURPOSES ONLY.

THE ENGLISH TRANSLATION OF "NATURELLE" IS "NATURAL".

FOR ICED TEA (U.S. CL. 46).
FIRST USE 6-0-2001; IN COMMERCE 6-0-2001.

CLASS 30—(Continued).

SN 76-444,112. CENTRAL IMPULSORA, S.A. DE C.V.,
DELEGACION ALVARO OBREGON 01210 D.F. MEXICO,
FILED 8-27-2002.

EL PODER DEL TRIGO

NO CLAIM IS MADE TO THE EXCLUSIVE RIGHT TO
USE "TRIGO", APART FROM THE MARK AS SHOWN.

THE ENGLISH TRANSLATION OF THE PHRASE "EL
PODER DEL TRIGO" IS "THE POWER OF WHEAT".

FOR TORTILLA CHIPS, TORTILLAS, BAKERY PRO-
DUCTS, NAMELY BREAD, BUNS, ROLLS, SWEET
GOODS, PASTRIES AND COOKIES (U.S. CL. 46).

FIRST USE 6-0-2001; IN COMMERCE 6-0-2001.

CLASS 30—(Continued).

SN 76-457,524. TRIXIECAKES, INC., NEW YORK, NY.
FILED 10-10-2002.



THE APPLICANT HEREBY ASSERTS THAT THE MARK
IS A COLOR MARK. THE APPLICANT HEREBY IDENTI-
FIES THE HAIR OF THE LOGO AS ORANGE, THE CAKE
OF THE LOGO AS YELLOW, THE PLATE, SHOES AND LIPS
OF THE LOGO AS RED, THE APRON AND HAT OF THE
LOGO AS WHITE, THE DRESS OF THE LOGO AS LIGHT
PURPLE, THE FACE, ARMS, NECK AND LEGS OF THE
LOGO AS PINK, AND THE BRACELETS OF THE LOGO AS
YELLOW, RED AND LIGHT PURPLE.

FOR CAKES (U.S. CL. 46).

SN 76-451,414. BREZELKONIG GMBH & CO. KG, 55129
MAINZ, FED REP GERMANY, FILED 9-20-2002.

BREZELKÖNIG

OWNER OF U.S. REG. NO. 2,142,292.
THE ENGLISH TRANSLATION OF "BREZELKONIG" IS
"PRETZEL KING".

FOR BAKED GOODS, NAMELY, COOKIES AND
CAKES; BREAD; PRETZELS; PASTRIES; PIZZAS (U.S.
CL. 46).

SN 76-462,591. J&J SNACK FOODS CORP., PENNSAUKEN,
NJ. FILED 10-29-2002.

BELLY BEARS

NO CLAIM IS MADE TO THE EXCLUSIVE RIGHT TO
USE "BEARS", APART FROM THE MARK AS SHOWN.

FOR COOKIES (U.S. CL. 46).

FIRST USE 1-0-2003; IN COMMERCE 1-0-2003.

SN 76-455,619. DJR HOLDINGS, LLC, NEW YORK, NY.
FILED 10-1-2002.

DEF JAM WRESTLING

OWNER OF U.S. REG. NOS. 1,790,206, 2,361,626 AND
OTHERS.

FOR CANDY; BUBBLE GUM; COOKIES; CANDY
CAKE DECORATIONS; CHEWING GUM; EDIBLE CAKE
DECORATIONS; FROZEN YOGURT; FRUIT ICE; ICE
CREAM; PRE-COOKED PASTA; SNACKS WITH VAR-
IOUS FILLINGS AND/OR TOPPINGS, NAMELY, CER-
EAL BASED SNACK FOODS, CHEESE FLAVORED
PUFFED CORN SNACKS, CHEESE FLAVORED
SNACKS, NAMELY, CHEESE CURLS AND CHEESE
BALLS, PUFFED CORN SNACKS, RICE BASED SNACK
FOODS, SNACK MIXES CONSISTING PRIMARILY OF
CRACKERS, PRETZELS, CANDIED NUTS AND/OR
POPPED POPCORN, AND WHEAT BASED SNACK
FOODS; CHOCOLATE AND GRANOLA FOOD BARS,
PRETZELS, POPPED CORN, CRACKERS (U.S. CL. 46).

SN 76-464,347. DANCING SANDWICH ENTERPRISES, INC.,
ANN ARBOR, MI. FILED 11-4-2002.

UNIVERSE O'TEA

FOR TEA (U.S. CL. 46).

FIRST USE 1-1-1995; IN COMMERCE 1-1-1995.

CLASS 30—(Continued).

SN 76-467,415. DREAMFIELD FARM LLC, STOCKTON, NJ. FILED 11-15-2002.



FOR BARBEQUE SAUCES, SALSA SAUCES, CONDIMENTS, NAMELY, SPICE MIXES AND RUBS (U.S. CL. 46).

FIRST USE 8-21-2002; IN COMMERCE 8-21-2002.

SN 76-470,549. PAULHUS, PAMELA, SOMERS, NY. FILED 11-29-2002.

FORTUNE CONES

NO CLAIM IS MADE TO THE EXCLUSIVE RIGHT TO USE "CONES", APART FROM THE MARK AS SHOWN.

FOR EDIBLE CONES ADAPTED TO BE FILLED WITH A FOOD ITEM, SUCH AS ICE CREAM (U.S. CL. 46).

SN 76-474,702. KENNEDY, CAROLYN C., FOSTER CITY, CA. FILED 12-12-2002.

VIA CALABRIA FINE DESSERTS

NO CLAIM IS MADE TO THE EXCLUSIVE RIGHT TO USE "FINE DESSERTS", APART FROM THE MARK AS SHOWN.

FOR WHOLESALE ICE CREAMS AND PIES (U.S. CL. 46).

SN 76-477,454. KRAFT FOODS HOLDINGS, INC., NORTHFIELD, IL. FILED 12-23-2002.

KICKERS

FOR HANDMADE CARAMEL PRALINE CANDY (U.S. CL. 46).

FIRST USE 9-1-1999; IN COMMERCE 9-1-1999.

CLASS 30—(Continued).

SN 76-477,658. SPECIALTY CHEESE COMPANY, INC., LOWELL, WI. FILED 12-23-2002.

BHARATMA

THE ENGLISH TRANSLATION OF "BHARATMA" IS "MOTHER INDIA".

FOR CHEESE (U.S. CL. 46).

SN 76-481,127. CALDERONE, MICHAEL, LAS VEGAS, NV. FILED 1-9-2003.

SMILES COFFEE

NO CLAIM IS MADE TO THE EXCLUSIVE RIGHT TO USE "COFFEE", APART FROM THE MARK AS SHOWN.

FOR PARTIALLY ROASTED AND PACKAGED COFFEE BEANS FOR SALE TO CONSUMERS (U.S. CL. 46).

FIRST USE 9-30-2000; IN COMMERCE 9-27-2002.

SN 76-490,947. JACOBSENS BAKERY LTD. A/S, DK-8722 HEDENSTED, DENMARK, FILED 2-13-2003.

RED ROSE

FOR PASTRIES, CRACKERS, BISCUITS, AND COOKIES (U.S. CL. 46).

FIRST USE 0-0-1993; IN COMMERCE 0-0-1993.

SN 78-108,093. FARMER DIRECT FOODS, INC., ATCHISON, KS. BY CHANGE OF NAME AMERICAN WHITE WHEAT PRODUCERS ASSOCIATION, ATCHISON, KS. FILED 2-11-2002.

HANDCRAFTERS

FOR PROCESSED MILLED AND WHOLE GRAINS FOR HUMAN CONSUMPTION; FLOUR AND GRAIN-BASED INGREDIENTS FOR BAKED GOODS, PASTA, NOODLES, FOOD BARS, CEREAL, AND BEVERAGES (U.S. CL. 46).

CLASS 30—(Continued).

SN 78-134,329. ANGEL IBARRA Y COMPANIA SA DE CV, GUADALAJARA, JALISCO, MEXICO, FILED 6-10-2002.

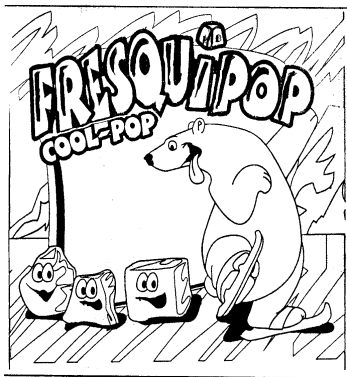

FOR CANDIES AND LOLLIPOPS (U.S. CL. 46).

SN 78-137,390. EURALIM S.A., BUENOS AIRES, ARGENTINA, FILED 6-20-2002.

CUCINA BUONA

OWNER OF ARGENTINA REG. NO. 1779374, DATED 11-30-1989, EXPIRES 3-17-2010.

NO CLAIM IS MADE TO THE EXCLUSIVE RIGHT TO USE "CUCINA", APART FROM THE MARK AS SHOWN.

THE FOREIGN WORDING IN THE MARK TRANSLATES INTO ENGLISH AS "GOOD KITCHEN".

FOR ALIMENTARY PASTES, BAKERY DESSERTS, CAKES, CANNELLONE, CALZONES, CREPES, EMPANADAS, FROZEN, PREPARED OR PACKAGED ENTREES CONSISTING PRIMARILY OF PASTA OR RICE, FROZEN CONFECTIONS, GNOCCHI, LASAGNA, FROZEN, PREPARED OR PACKAGED MEALS CONSISTING PRIMARILY OF PASTA OR RICE, NOODLES, PANCAKES, PASTA, PIES, PIZZA, PIZZA CRUSTS, QUICHE, RAVIOLI, ROLLS, STUFFED ROLLS (U.S. CL. 46).

SN 78-138,248. LJT MANAGEMENT SERVICES INC., DBA "PLANTATION STATION COFFEE ROASTERS", SAN DIEGO, CA. FILED 6-24-2002.



NO CLAIM IS MADE TO THE EXCLUSIVE RIGHT TO USE "COFFEE ROASTERS", APART FROM THE MARK AS SHOWN.

FOR COFFEE (U.S. CL. 46).

CLASS 30—(Continued).

SN 78-144,679. COCOA PETE'S CHOCOLATE ADVENTURES COMPANY, CAMPBELL, CA. FILED 7-17-2002.

BERRY BERRY DANGEROUS

FOR CANDIES, CHOCOLATE AND CONFECTIONS, NAMELY, CANDIES AND CHOCOLATE (U.S. CL. 46).

SN 78-169,959. TAUSKY, EDWARD CURT, NASHUA, NH. FILED 10-1-2002.

MARTIANMALLOW

FOR MARSHMALLOW-BASED CANDY, CEREAL THAT CONTAINS MARSHMALLOW-BASED CANDY, COOKIES THAT CONTAIN MARSHMALLOW-BASED CANDY, ICE CREAM THAT CONTAINS MARSHMALLOW-BASED CANDY, CUPCAKES THAT CONTAIN MARSHMALLOW-BASED CANDY, HOT CHOCOLATE THAT CONTAINS MARSHMALLOW-BASED CANDY, FROZEN CONFECTIONS THAT CONTAIN MARSHMALLOW-BASED CANDY, PUDDING THAT CONTAINS MARSHMALLOW-BASED CANDY, SNACK FOODS THAT CONTAIN MARSHMALLOW-BASED CANDY, AND MARSHMALLOW-BASED SYRUP (U.S. CL. 46).

SN 78-176,333. SANTA BARBARA GOURMET, LLC, BUELLTON, CA. FILED 10-20-2002.



NO CLAIM IS MADE TO THE EXCLUSIVE RIGHT TO USE CALIFORNIA COLLECTION, APART FROM THE MARK AS SHOWN.

FOR PASTA SAUCE, SALSA, SALAD DRESSINGS (U.S. CL. 46).

FIRST USE 9-15-2001; IN COMMERCE 9-15-2001.

SN 78-177,033. ALANIS, CARLOS ENRIQUE, MONTERREY NL, MEXICO, FILED 10-22-2002.

ISLA DEL SOL

THE ENGLISH TRANSLATION OF "ISLA DEL SOL" IS "SUN'S ISLAND".

FOR FLAVORED AND SWEETENED GELATINS, CORN SOPE, TORTILLAS, TORTILLA CHIPS, TOSTADAS, NACHO CHIPS (U.S. CL. 46).

CLASS 30—(Continued).

SN 78-179,810. QUINN, ROBERT, CATHEDRAL CITY, CA. AND QUINN, DEBORAH, CATHEDRAL CITY, CA. FILED 10-29-2002.

SANDTRAP

FOR PACKAGED BAKERY GOODS, NAMELY PASTRIES, CRACKERS AND COOKIES SOLD THROUGH GOLF SHOPS AND OTHER GOLF-RELATED BUSINESSES (U.S. CL. 46).

SN 78-182,574. EXPERENTIS LTD, LONDON, UNITED KINGDOM, FILED 11-7-2002.

GOCO

FOR CHOCOLATE AND CONFECTIONERY PRODUCTS, NAMELY, ENERGY CHOCOLATE, CHOCOLATE CONTAINING GUARANA, ICE CREAM AND CHOCOLATE DRINKS, NAMELY HOT CHOCOLATE AND CHOCOLATE FOOD BEVERAGES NOT DAIRY OR VEGETABLE BASED (U.S. CL. 46).

SN 78-184,150. ANGEL IBARRA Y COMPANIA SA DE CV, GUADALAJARA, JALISCO, MEXICO, FILED 11-12-2002.

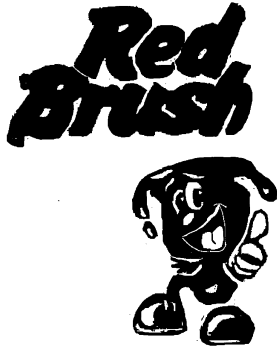

FOR CANDIES, SUCKERS AND LOLLIPOPS (U.S. CL. 46).

SN 78-184,890. DELEON, FEDERICO, WAPATO, WA. FILED 11-13-2002.

CHILASO

FOR RED CHILI PEPPER POWDER FOR USE AS AN INGREDIENT IN THE MANUFACTURE OF HOT SAUCE (U.S. CL. 46).

CLASS 30—(Continued).

SN 78-188,195. ARGENTINE PRODUCTS, LLC, BAINBRIDGE ISLAND, WA. FILED 11-22-2002.

DE LA ESTANCIA

THE FOREIGN WORDING IN THE MARK TRANSLATES INTO ENGLISH AS "OF THE ESTATE".
FOR PACKAGED CORNMEAL AND PACKAGED POLENTA (U.S. CL. 46).

SN 78-188,431. CHEN, KING CHUNG, MARKHAM, CANADA, FILED 11-25-2002.

RICEGHETTI

PRIORITY CLAIMED UNDER SEC. 44(D) ON CANADA APPLICATION NO. 1145357, FILED 7-4-2002.
FOR PASTA, NOODLES, PASTA SAUCE AND PASTA SALAD (U.S. CL. 46).

SN 78-188,616. CELESTIAL SEASONINGS, INC., BOULDER, CO. FILED 11-25-2002.

LEMON ZINGER

OWNER OF U.S. REG. NOS. 1,390,142, 1,515,651 AND OTHERS.
NO CLAIM IS MADE TO THE EXCLUSIVE RIGHT TO USE "LEMON", APART FROM THE MARK AS SHOWN.
FOR TEAS; READY TO DRINK TEAS. (U.S. CL. 46).

SN 78-189,151. BETTER BAKED FOODS, INC., NORTH EAST, PA. FILED 11-26-2002.

NOW THAT'S FAST FOOD

FOR PIZZA AND BAKERY GOODS TOPPED WITH CHEESE AND/OR EGGS AND/OR MEAT AND/OR FRUIT (U.S. CL. 46).

CLASS 30—(Continued).

SN 78-189,167. VIACOM INTERNATIONAL INC., NEW YORK, NY. FILED 11-26-2002.

NICKELODEON NICK CANDY

OWNER OF U.S. REG. NOS. 2,070,866, 2,507,291 AND OTHERS.

NO CLAIM IS MADE TO THE EXCLUSIVE RIGHT TO USE "CANDY", APART FROM THE MARK AS SHOWN.

FOR BREAD, BREAD STICKS, BUBBLE GUM, CANDY CAKE DECORATIONS, EDIBLE CAKE DECORATIONS, CAKE MIXES, CAKES, CHOCOLATE BASED FILLINGS FOR PIES AND CAKES, CANDY, CANDY COATED POPCORN, CARAMEL POPCORN, CARAMELS, CEREAL BASED SNACK FOOD, CHEESE FLAVORED CORN PUFFED SNACKS, CHEWING GUM, CHOCOLATE CHIPS, CORN CHIPS, FLOUR BASED CHIPS, CHOCOLATE, CHOCOLATE COVERED NUTS, CHOCOLATE POWDER, CHOCOLATE SYRUP, CHOCOLATE TOPPING, COCOA MIXES, CONES FOR ICE CREAMS, COOKIES, CORN CURLS, CRACKER AND CHEESE COMBINATIONS, CRACKERS, READY TO EAT CEREAL DERIVED FOOD BARS, FROSTING, FRUIT PIES, FLAVORED AND SWEETENED GELATINS, GRANOLA BASED SNACK BARS, HOT CHOCOLATE, POPPED POPCORN, PRETZELS, PUDDINGS, WAFFLES; ICE CREAM, ICE MILK, FLAVORED ICES, FROZEN CONFECTIONS, FROZEN YOGURT, FROZEN CUSTARD (U.S. CL. 46).

SN 78-189,221. G & H FOODS, INC., KNOXVILLE, TN. FILED 11-26-2002.



NO CLAIM IS MADE TO THE EXCLUSIVE RIGHT TO USE "GOURMET" AND "SALSA", APART FROM THE MARK AS SHOWN.

FOR SALSA (U.S. CL. 46).
FIRST USE 5-16-2002; IN COMMERCE 5-16-2002.

SN 78-190,561. CHOVANA CHOCOLATIER, LLC., DBA CHOVANA CHOCOLATIER, MALVERN, PA. FILED 12-3-2002.

CHOVANA

FOR CHOCOLATE AND CANDY (U.S. CL. 46).
FIRST USE 10-31-2002; IN COMMERCE 11-25-2002.

CLASS 30—(Continued).

SN 78-191,018. BASKIN-ROBBINS INCORPORATED, GLENDALE, CA. FILED 12-4-2002.

TANGANILLA

FOR CANDY (U.S. CL. 46).
FIRST USE 6-30-1999; IN COMMERCE 6-30-1999.

SN 78-191,086. GOURMET KITCHENS, INC., CHICAGO, IL. FILED 12-4-2002.

LAST MINUTE GOURMET

NO CLAIM IS MADE TO THE EXCLUSIVE RIGHT TO USE "GOURMET", APART FROM THE MARK AS SHOWN.

FOR ENTREES CONSISTING PRIMARILY OF PREPARED MEAT, FISH, POULTRY OR VEGETABLES; SALADS CONSISTING PRIMARILY OF MEAT, FISH, POULTRY, POTATOES, TOFU OR PRE-CUT VEGETABLES; COMBINATION MEALS CONSISTING OF PREPARED MEAT OR POULTRY PACKAGED WITH COOKIES AND PRE-CUT VEGETABLE SALAD OR PREPARED PASTA (U.S. CL. 46).

FIRST USE 11-8-2002; IN COMMERCE 11-8-2002.

SN 78-193,158. KMG GROUP, INC., SEATTLE, WA. FILED 12-10-2002.

KUBLAZ

FOR SAUCES AND SEASONINGS; MIX FOR SAUCES FOR MAKING NOODLE-BASED GRILLED DISHES; SOY SAUCE; HOT SAUCE; BARBECUE SAUCE; TERIYAKI SAUCE; MONGOLIAN SAUCE; CAJUN PLUM SAUCE; YAKISOBA SAUCE; CHINESE SAUCE; SPICY PEANUT SAUCE; MUSHROOM SAUCE (U.S. CL. 46).

SN 78-197,659. CADBURY TREBOR ALLAN INC., TORONTO, ONTARIO, CANADA, FILED 12-24-2002.

KISSCOOL

FOR CONFECTIONERY, NAMELY GUM, MINTS AND CANDY (U.S. CL. 46).

SN 78-198,344. SOKOLOFF, MARTIN, NEW YORK, NY. FILED 12-28-2002.

RICE N SIMPLE

FOR RICE, NAMELY, MEALS, ENTREES, PRE-COOKED, PACKAGED, IN CANS, POUCHES AND TRAYS; RICE CAKES, RICE SALAD AND RICE BASED SNACK FOODS (U.S. CL. 46).

CLASS 30—(Continued).

SN 78-209,172. THE JEL SERT CO., WEST CHICAGO, IL.
FILED 1-30-2003.

COMIC PUDDING

NO CLAIM IS MADE TO THE EXCLUSIVE RIGHT TO USE "PUDDING", APART FROM THE MARK AS SHOWN.

FOR READY TO EAT PUDDING, POWDER AND MIXES FOR MAKING FLAVORED PUDDING (U.S. CL. 46).

SN 78-215,156. VIACOM INTERNATIONAL INC., NEW YORK, NY. FILED 2-14-2003.

NICK CANDY

NO CLAIM IS MADE TO THE EXCLUSIVE RIGHT TO USE "CANDY", APART FROM THE MARK AS SHOWN.

FOR BREAD, BREAD STICKS, BUBBLE GUM, CANDY CAKE DECORATIONS, EDIBLE CAKE DECORATIONS, CAKE MIXES, CAKES, CHOCOLATE BASED FILLINGS FOR PIES AND CAKES, CANDY, CANDY COATED POPCORN, CARAMEL POPCORN, CARAMELS, CEREAL BASED SNACK FOOD, CHEESE FLAVORED CORN PUFFED SNACKS, CHEWING GUM, CHOCOLATE CHIPS, CORN CHIPS, FLOUR BASED CHIPS, CHOCOLATE, CHOCOLATE COVERED NUTS, CHOCOLATE POWDER, CHOCOLATE SYRUP, CHOCOLATE TOPPING, COCOA MIXES, CONES FOR ICE CREAM, COOKIES, CORN CURLS, CRACKER AND CHEESE COMBINATIONS, CRACKERS, READY TO EAT CEREAL DERIVED FOOD BARS, FROSTING, FRUIT PIES, FLAVORED AND SWEETENED GELATINS, GRANOLA BASED SNACK BARS, HOT CHOCOLATE, POPPED POPCORN, PRETZELS, PUDDINGS, WAFFLES; ICE CREAM, ICE MILK, FLAVORED ICES, FROZEN CONFECTIONS, FROZEN YOGURT, FROZEN CUSTARD (U.S. CL. 46).

CLASS 31—NATURAL AGRICULTURAL PRODUCTS

SN 75-689,802. CERVECERIA MODELO, S.A. DE C.V., 11320 MEXICO, D.F, MEXICO, FILED 4-23-1999.

CORONA

OWNER OF U.S. REG. NOS. 662,347, 1,761,605 AND OTHERS.

THE ENGLISH TRANSLATION OF THE WORD "CORONA" IS "CROWN."

FOR FRESH FRUIT, NAMELY LEMONS AND LIMES (U.S. CLS. 1 AND 46).

CLASS 31—(Continued).

SN 76-015,869. GILFENBAIN, STEVEN L., BEVERLY HILLS, CA. FILED 4-3-2000.



NO CLAIM IS MADE TO THE EXCLUSIVE RIGHT TO USE "SUPER GRAPE", APART FROM THE MARK AS SHOWN.

FOR FRESH GRAPES (U.S. CLS. 1 AND 46).
FIRST USE 8-0-2000; IN COMMERCE 8-0-2000.

SN 76-114,456. ITO PACKING CO., REEDLEY, CA. FILED 8-14-2000.



NO CLAIM IS MADE TO THE EXCLUSIVE RIGHT TO USE "MANGO", APART FROM THE MARK AS SHOWN.

FOR FRESH FRUIT, NAMELY NECTARINES (U.S. CLS. 1 AND 46).

SN 76-302,186. RAYMOND HADLEY CORP., SPENCER, NY. FILED 8-20-2001.

Saint Marc
Haiti

SEC. 2(F).

FOR UNPROCESSED BEANS NAMELY, LIGHT RED KIDNEY BEANS, PIGEON PEAS, BLACK BEANS, SMALL RED BEANS, PINTO BEANS (U.S. CLS. 1 AND 46).

FIRST USE 5-1-1991; IN COMMERCE 5-1-1991.

CLASS 31—(Continued).

SN 76-381,683. SUIDAE TECHNOLOGY, INC., BATESVILLE, IN. FILED 3-6-2002.



NO CLAIM IS MADE TO THE EXCLUSIVE RIGHT TO USE "LINE", APART FROM THE MARK AS SHOWN. FOR ANIMAL FEED, NAMELY ANIMAL FEED FOR LIVESTOCK (U.S. CLS. 1 AND 46).

SN 76-417,249. SENORITA FRUIT CORPORATION, BAY-SIDE, NY. FILED 5-1-2002.



THE MARK CONSISTS THE WORK "SENORITA" IN THE COLOR RED AND OUTLINED IN THE COLOR GREEN. THE DEPICTION OF THE SUN IS THE COLOR YELLOW. THE OUTLINE TRIM OF THE SUN IS THE COLOR RED. THE CIRCLE IN THE INTERIOR IS THE COLOR WHITE. FOR FRESH ORGANIC BANANAS (U.S. CLS. 1 AND 46).

SN 76-432,185. BIOCHEM ZUSATZSTOFFE HANDELS- UND PRODUKTIONSGESELLSCHAFT MBH, LOHNE, FED REP GERMANY, FILED 7-19-2002.

RESCUE KIT

OWNER OF FED REP GERMANY REG. NO. 30111140, DATED 5-7-2001, EXPIRES 2-28-2011. FOR NON-MEDICATED ADDITIVES FOR ANIMAL FEED (U.S. CLS. 1 AND 46). FIRST USE 12-31-2000; IN COMMERCE 12-31-2000.

CLASS 31—(Continued).

SN 76-446,854. WAL-MART STORES, INC., BENTONVILLE, AR. FILED 8-20-2002.

SCENT EXPRESS

THE MARK CONSISTS OF THE WORDS SCENT EXPRESS FOR LIVE AND CUT FLOWERS (U.S. CLS. 1 AND 46). FIRST USE 4-25-2002; IN COMMERCE 4-25-2002.

SN 76-453,296. CCR ENTERPRISES, INC., OLD CHATHAM, NY. FILED 9-20-2002.

WILDFLOWER HORSE TREATS

NO CLAIM IS MADE TO THE EXCLUSIVE RIGHT TO USE "HORSE TREATS", APART FROM THE MARK AS SHOWN. FOR TREATS FOR HORSES (U.S. CLS. 1 AND 46).

SN 76-458,571. CORN PRODUCTS INTERNATIONAL, INC., WESTCHESTER, IL. FILED 10-16-2002.

PROGERM

FOR ANIMAL FEED, NAMELY WET FEED AND WET GERM (U.S. CLS. 1 AND 46).

SN 76-460,402. GIMBORN PET SPECIALTIES, LLC, ATLANTA, GA. FILED 10-15-2002.

CATNIP PLUS

OWNER OF U.S. REG. NO. 1,881,570. NO CLAIM IS MADE TO THE EXCLUSIVE RIGHT TO USE "CATNIP", APART FROM THE MARK AS SHOWN. FOR KITS FOR GROWING CATNIP FOR CATS - NAMELY, CATNIP SEED AND A CONTAINER WITH GROWING MEDIUM (U.S. CLS. 1 AND 46). FIRST USE 10-7-2002; IN COMMERCE 10-7-2002.

SN 76-477,721. SYMPHONY ORCHIDS, RIVERSIDE, CA. FILED 12-23-2002.

SYMPHONY ORCHIDS

NO CLAIM IS MADE TO THE EXCLUSIVE RIGHT TO USE "ORCHIDS", APART FROM THE MARK AS SHOWN. FOR LIVING ORCHID PLANTS AND ORCHID FLOWERS (U.S. CLS. 1 AND 46). FIRST USE 11-8-1999; IN COMMERCE 11-8-1999.

CLASS 31—(Continued).

SN 76-479,536. YOON, DONNA, BAKERSFIELD, CA. FILED 12-27-2002.

SUNTAC

FOR UNPROCESSED ORANGES, GRAPEFRUITS, LEMONS, KIWIS AND MANDARIN ORANGES (U.S. CLS. 1 AND 46).

SN 76-481,122. EDEN ENTERPRISE, INC., ADEL, IA. FILED 1-9-2003.



FOR HYBRID SEEDS, NAMELY CORN AND SOY-BEANS (U.S. CLS. 1 AND 46).

SN 76-481,123. EDEN ENTERPRISE, INC., ADEL, IA. FILED 1-9-2003.

TRI-VALLEY

FOR HYBRID SEEDS, NAMELY CORN AND SOY-BEANS (U.S. CLS. 1 AND 46).

SN 76-483,648. TRINIDAD HOLDINGS, LLC, LOS ANGELES, CA. FILED 1-21-2003.

**CHUBBY & TUBBY
CHRISTMAS TREES**

NO CLAIM IS MADE TO THE EXCLUSIVE RIGHT TO USE "CHRISTMAS TREES", APART FROM THE MARK AS SHOWN.
FOR LIVE CHRISTMAS TREES (U.S. CLS. 1 AND 46).

CLASS 31—(Continued).

SN 76-492,481. PETSPOUR USA, INC., PITTSBURG, CA. FILED 2-26-2003.



THE LINING IS A FEATURE OF THE MARK AND DOES NOT INDICATE COLOR.
FOR PET FOODS (U.S. CLS. 1 AND 46).

SN 78-133,688. VAN WELL NURSERY, INC., EAST WENATCHEE, WA. FILED 6-6-2002.

ADAMS APPLE

NO CLAIM IS MADE TO THE EXCLUSIVE RIGHT TO USE "APPLE", APART FROM THE MARK AS SHOWN.
FOR LIVE FRUIT TREES, NAMELY, APPLE TREES FOR COMMERCIAL ORCHARDS (U.S. CLS. 1 AND 46).

SN 78-138,501. CHIANOVA RESEARCH INC., TORONTO, ONTARIO, CANADA, FILED 6-25-2002.

SALBA

FOR NUTRIENT DENSE UNPROCESSED EDIBLE SEEDS RICH IN OMEGA3 (U.S. CLS. 1 AND 46).

SN 78-146,361. RAMIREZ, EDWARD M., CORONA, CA. FILED 7-22-2002.

BIOPLANKTON

FOR FISH FOOD (U.S. CLS. 1 AND 46).
FIRST USE 4-1-1999; IN COMMERCE 5-1-2000.

CLASS 31—(Continued).

SN 78-153,754. KAL KAN FOODS, INC., VERNON, CA.
FILED 8-13-2002.

WINERGY VENTIL-ATE

OWNER OF U.S. REG. NO. 2,451,772.
FOR FOOD FOR HORSES (U.S. CLS. 1 AND 46).

SN 78-153,755. KAL KAN FOODS, INC., VERNON, CA.
FILED 8-13-2002.

OPTIM-ATE

FOR FOOD FOR HORSES. (U.S. CLS. 1 AND 46).

SN 78-153,758. KAL KAN FOODS, INC., VERNON, CA.
FILED 8-13-2002.

WINERGY OPTIM-ATE

OWNER OF U.S. REG. NO. 2,451,772.
FOR FOOD FOR HORSES. (U.S. CLS. 1 AND 46).

SN 78-155,507. BATIZ GREENHOUSES INC., SAN DIEGO,
CA. FILED 8-19-2002.

**DISCOVER THE ROYAL
TASTE**

FOR FRESH FRUITS AND VEGETABLES NAMELY
TOMATOES, CHILE PEPPERS, SQUASHES, PUMPKIN,
PEPPERS, MELONS, WATERMELONS; SEEDS AND
PLANTS FOR FRESH FRUITS AND VEGETABLES;
FLOWERING PLANTS (U.S. CLS. 1 AND 46).

SN 78-161,803. BONIFACE, JENNIFER, TEMPLE HILLS, MD.
FILED 9-8-2002.



NO CLAIM IS MADE TO THE EXCLUSIVE RIGHT TO
USE "ALL-NATURAL PET FOOD", APART FROM THE
MARK AS SHOWN.

FOR HOMEMADE, FROZEN, RAW, COMPLETE AND
BALANCED PET FOOD FOR DOGS, CATS, AND FER-
RETS (U.S. CLS. 1 AND 46).

FIRST USE 4-1-1999; IN COMMERCE 4-17-1999.

CLASS 31—(Continued).

SN 78-175,769. CALIFORNIA OLIVE GROWERS, MADERA,
CA. FILED 10-17-2002.

PIZZA RINGS

FOR EXTRUDED OLIVE SLICES USED ON PIZZAS
AND IN FOOD PRODUCTS (U.S. CLS. 1 AND 46).
FIRST USE 10-17-2002; IN COMMERCE 10-17-2002.

SN 78-187,392. DLM FOODS L.L.C., PITTSBURH, PA. BY
MERGER; BY ASSIGNMENT PROMARK INTERNA-
TIONAL, INC., BOISE, ID. FILED 11-21-2002.

CHEW-LOTTA

FOR PET FOOD AND PET SNACKS (U.S. CLS. 1 AND
46).

SN 78-191,115. ADVANTA USA, INC., SLATER, IA. FILED 12-
4-2002.

FOR AGRICULTURAL SEEDS (U.S. CLS. 1 AND 46).

CLASS 32—LIGHT BEVERAGES

SN 75-197,352. CERVECERIA MODELO, S.A. DE C.V., 11320
MEXICO, D.F., MEXICO, FILED 11-13-1996.

LIGHT MODELO ESPECIAL

OWNER OF MEXICO REG. NO. 471783, DATED 10-10-
1994, EXPIRES 5-30-2004.

OWNER OF U.S. REG. NOS. 1,022,817, 1,055,321 AND
1,217,760.

NO CLAIM IS MADE TO THE EXCLUSIVE RIGHT TO
USE "LIGHT" AND "ESPECIAL", APART FROM THE
MARK AS SHOWN.

THE ENGLISH TRANSLATION OF "MODELO ESPE-
CIAL" IS "SPECIAL MODEL".

FOR BEER (U.S. CLS. 45, 46 AND 48).

CLASS 32—(Continued).

SN 75-888,962. CREAMERY CORPORATION, THE, ANCHORAGE, AR. FILED 1-6-2000.

CLEARLY ALASKAN

NO CLAIM IS MADE TO THE EXCLUSIVE RIGHT TO USE "ALASKAN", APART FROM THE MARK AS SHOWN.
FOR BOTTLED DRINKING WATER (U.S. CLS. 45, 46 AND 48).

SN 76-212,812. TACO BUENO RESTAURANTS, INC., ANAHEIM, CA. FILED 2-20-2001.

BUENO CHILLERS

OWNER OF U.S. REG. NO. 1,842,523.
NO CLAIM IS MADE TO THE EXCLUSIVE RIGHT TO USE "BUENO", APART FROM THE MARK AS SHOWN.
THE ENGLISH TRANSLATION OF "BUENO" IS "GOOD, KIND, SIMPLE, FINE, RIGHT, SOUND, FUNNY, AMUSING, SURPRISING OR AMAZING".
FOR FROZEN BEVERAGES, NAMELY, NON-ALCOHOLIC FRUIT FLAVORED DRINKS SOLD ONLY THROUGH APPLICANT'S AUTHORIZED RESTAURANTS (U.S. CLS. 45, 46 AND 48).
FIRST USE 4-18-2000; IN COMMERCE 4-18-2000.

SN 76-434,424. BRASSERIES ALKEN-MAES N.V., KONTICH 2550, BELGIUM, FILED 7-24-2002.

SUDDEN DEATH

FOR BEER, ALE, LAGER, STOUT, PORTER, BITTER TYPE BEER, SHANDY, MINERAL WATER, AERATED WATER, SOFT DRINKS, FRUIT FLAVORED DRINKS, FRUIT JUICES, VEGETABLE FLAVORED DRINKS, VEGETABLE JUICES, MIXTURES CONTAINING ANY OF THE AFORESAID, PREPARATIONS FOR MAKING ANY OF THE AFORESAID (U.S. CLS. 45, 46 AND 48).

SN 76-448,948. FLORIDA ICE AND FARM COMPANY, S.A., SAN JOSE, COSTA RICA, FILED 9-10-2002.

PILSEN FROM COSTA RICA

NO CLAIM IS MADE TO THE EXCLUSIVE RIGHT TO USE "FROM COSTA RICA", APART FROM THE MARK AS SHOWN.
FOR BEVERAGES, NAMELY, MINERAL AND AERATED WATER; NON-ALCOHOLIC DRINKS, NAMELY, FRUIT DRINKS AND FRUIT JUICES; SYRUPS USED IN THE PREPARATION OF SOFT DRINKS; BEER; MALT BEVERAGES, NAMELY, NON-ALCOHOLIC MALT BEVERAGE AND NON-ALCOHOLIC MALT COOLERS; PREPARATIONS FOR MAKING FRUIT BEVERAGES (U.S. CLS. 45, 46 AND 48).

CLASS 32—(Continued).

SN 76-476,664. WAL-MART STORES, INC., BENTONVILLE, AR. FILED 12-17-2002.

BOP! POP

NO CLAIM IS MADE TO THE EXCLUSIVE RIGHT TO USE "POP", APART FROM THE MARK AS SHOWN.
FOR SOFT DRINKS, BOTTLED DRINKING WATERS AND FRUIT JUICES (U.S. CLS. 45, 46 AND 48).

SN 76-492,002. PUSSEY'S (2001) LTD., CHARLESTOWN, ST. CHRIST-NEVIS, FILED 2-24-2003.

PAINKILLER COCKTAIL MIX

NO CLAIM IS MADE TO THE EXCLUSIVE RIGHT TO USE "COCKTAIL MIX", APART FROM THE MARK AS SHOWN.
FOR NON-ALCOHOLIC MIXED FRUIT JUICES (U.S. CLS. 45, 46 AND 48).
FIRST USE 9-0-1981; IN COMMERCE 9-0-1994.

SN 76-492,143. PATZ, HOWARD G., POUND, WI. FILED 2-24-2003.

ATHIRST

FOR BOTTLED DRINKING WATER (U.S. CLS. 45, 46 AND 48).
FIRST USE 7-11-2002; IN COMMERCE 7-11-2002.

SN 78-122,969. TRU INDUSTRIES LLC, EL CAJON, CA. FILED 4-19-2002.

SIMPLY WATER

NO CLAIM IS MADE TO THE EXCLUSIVE RIGHT TO USE "WATER", APART FROM THE MARK AS SHOWN.
FOR DRINKING WATER, BOTTLED DRINKING WATER (U.S. CLS. 45, 46 AND 48).
FIRST USE 5-1-2002; IN COMMERCE 5-1-2002.

CLASS 32—(Continued).

SN 78-123,519. VARA FOOD & DRINK CO., LTD., BANGKOK, THAILAND, FILED 4-23-2002.

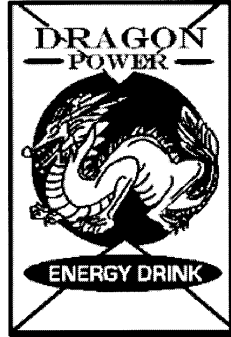

NO CLAIM IS MADE TO THE EXCLUSIVE RIGHT TO USE "ENERGY DRINK", APART FROM THE MARK AS SHOWN.

FOR NON-ALCOHOLIC BEVERAGES, NAMELY, ENERGY DRINKS; DRINK MIXES, NAMELY, SYRUPS, ESSENCES AND OTHER PREPARATIONS FOR MAKING ENERGY DRINKS (U.S. CLS. 45, 46 AND 48).

SN 78-141,346. SAMBA, INC, DANA POINT, CA. FILED 7-3-2002.



NO CLAIM IS MADE TO THE EXCLUSIVE RIGHT TO USE "AÇAÍ", APART FROM THE MARK AS SHOWN.
FOR NON-ALCOHOLIC FRUIT BASED BEVERAGES AND FRUIT SMOOTHIES (U.S. CLS. 45, 46 AND 48).

SN 78-145,473. THE BABY PALACE OF MIAMI, INC., MIAMI, FL. FILED 7-18-2002.

FRESS

FOR BEVERAGES, NAMELY, POP (U.S. CLS. 45, 46 AND 48).

CLASS 32—(Continued).

SN 78-164,182. INTERBREW S.A., 1000 BRUSSELS, BELGIUM, FILED 9-14-2002.

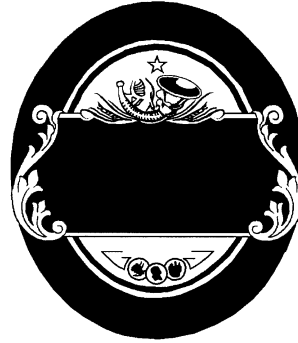

PRIORITY CLAIMED UNDER SEC. 44(D) ON BENELUX APPLICATION NO. 1007538, FILED 3-19-2002, REG. NO. 1007538, DATED 3-19-2002, EXPIRES 3-19-2012.

THE MARK CONSISTS OF A LABEL WITH A GOLD BORDER, A GOLD HORN, GOLD LEAVES WITH A STAR IN RED AND THE MIDDLE IN RED.

FOR BEER (U.S. CLS. 45, 46 AND 48).
FIRST USE 4-26-1996; IN COMMERCE 4-26-1996.

SN 78-175,692. THE TRUSTEES OF AMERICA'S DRIVE-IN TRUST, RENO, NV. FILED 10-17-2002.

SONIC

OWNER OF U.S. REG. NOS. 776,766, 2,553,330 AND OTHERS.
FOR SOFT DRINKS (U.S. CLS. 45, 46 AND 48).
FIRST USE 7-9-1959; IN COMMERCE 3-1-1961.

SN 78-178,765. SHORTROUND CORPORATION, SEATTLE, WA. FILED 10-26-2002.



NO CLAIM IS MADE TO THE EXCLUSIVE RIGHT TO USE "BREWED AND PACKED BY", "BREWING COMPANY" AND "SEATTLE, WA 2002", APART FROM THE MARK AS SHOWN.

FOR BEER (U.S. CLS. 45, 46 AND 48).

CLASS 32—(Continued).

SN 78-179,789. THE SWEETWATER COMPANY, INC., CULVER, OR. FILED 10-29-2002.

SUMWADDA

FOR BOTTLED DRINKING WATER (U.S. CLS. 45, 46 AND 48).

SN 78-190,068. SCOTT, ALISON, NEW ORLEANS, LA. FILED 12-2-2002.

**PHARMACY IN A BOTTLE
(AS IN 'LIKE A PHARMACY
IN A BOTTLE' AND 'MY
PHARMACY IN A BOTTLE')**

FOR HEALTH JUICE MADE FROM ALL-NATURAL FRUIT JUICES (U.S. CLS. 45, 46 AND 48).

SN 78-190,921. LIQUID SALVATION, TAHOE CITY, CA. FILED 12-3-2002.

**PURE WATER FOR AN
IMPURE WORLD**

FOR BOTTLED WATER FOR CONSUMER SALES (U.S. CLS. 45, 46 AND 48).

SN 78-194,981. DR PEPPER/SEVEN UP, INC., PLANO, TX. FILED 12-16-2002.

TROPICAL VIBE

FOR FRUIT FLAVORED DRINK CONTAINING WATER (U.S. CLS. 45, 46 AND 48).

SN 78-199,371. PEPSICO, INC., PURCHASE, NY. FILED 1-2-2003.

DRINK IN THE GAME

FOR SOFT DRINKS, AND SYRUPS AND CONCENTRATES FOR MAKING THE SAME (U.S. CLS. 45, 46 AND 48).

CLASS 32—(Continued).

SN 78-210,562. MILLER BREWING COMPANY, MILWAUKEE, WI. FILED 2-4-2003.



OWNER OF U.S. REG. NOS. 1,275,437, 2,505,043 AND OTHERS.

NO CLAIM IS MADE TO THE EXCLUSIVE RIGHT TO USE "LITE" OR "PILSNER BEER", APART FROM THE MARK AS SHOWN.

FOR BEER (U.S. CLS. 45, 46 AND 48).

FIRST USE 12-1-2002; IN COMMERCE 12-1-1999.

CLASS 33—WINES AND SPIRITS

SN 75-881,843. BULMERS LIMITED, DUBLIN 10, IRELAND, BY CHANGE OF NAME SHOWERINGS (IRELAND) LIMITED, DUBLIN 10, IRELAND, FILED 12-28-1999.



NO CLAIM IS MADE TO THE EXCLUSIVE RIGHT TO USE "ORIGINAL", "VINTAGE CIDER", "AUTHENTICITAS" AND "IRISH CIDER", APART FROM THE MARK AS SHOWN.

THE MARK CONSISTS OF AN EMBLEM CONTAINING THE WORDING, "MAGNERS IRISH CIDER" APPEARING IN THE CENTER, "MAGNERS ORIGINAL VINTAGE CIDER" APPEARING ON THE BORDER, WITH THE TERM "AUTHENTICITAS" APPEARING ON A BANNER THAT IS LOCATED BELOW A REPRESENTATION OF THREE STYLIZED CIDER VATS WITH THE TERM "ORIGINAL" APPEARING BELOW "IRISH CIDER".

THE ENGLISH TRANSLATION OF "AUTHENTICITAS" IS "AUTHENTIC".

FOR HARD CIDER (U.S. CLS. 47 AND 49).

CLASS 33—(Continued).

SN 76-204,275. AVERYS OF BRISTOL LIMITED, NAILSEA, BRISTOL BS48 1JN, UNITED KINGDOM, FILED 2-2-2001.

CLASS 33—(Continued).

SN 76-396,856. CARIBBEAN DISTILLERS CORPORATION INTERNATIONAL LIMITED, ROAD BAY, ANGUILLA, FILED 4-17-2002.

OPAL RIDGE

FOR ALCOHOLIC BEVERAGES, NAMELY, WINES (U.S. CLS. 47 AND 49).



SN 76-341,847. S. SMITH & SON, PTY, LTD., SOUTH AUSTRALIA, AUSTRALIA, FILED 11-27-2001.



NAUTILUS

FOR WINES (U.S. CLS. 47 AND 49).
FIRST USE 7-22-1987; IN COMMERCE 7-22-1987.



SN 76-343,101. KLEIN FOODS, INC., DBA RODNEY STRONG VINEYARDS, HEALDSBURG, CA. FILED 11-30-2001.

THE MARK CONSISTS OF A CONFIGURATION OF A VODKA BOTTLE. THE MAIN PART OF THE BOTTLE HAS A RECTANGULAR VERTICAL SHAPE. THE TOP AND BOTTOM OF THE MAIN PART OF THE BOTTLE ARE NOT PERPENDICULAR TO THE SIDES OF THE BOTTLE, BUT ARE SLIGHTLY SLOPED. THE CORNERS OF THE BOTTLE AND CAP ARE TAPERED. THE CAP AND BASE OF THE BOTTLE ARE PARTIALLY ROTATED HORIZONTALLY FROM BEING IN LINE WITH THE MAIN PART OF THE BOTTLE CONFIGURATION.
FOR VODKA (U.S. CLS. 47 AND 49).

ALEXANDER'S CROWN



FOR WINES (U.S. CLS. 47 AND 49).

SN 76-398,308. BODEGA MUSTIGUILLO SA, REQUENA, VALENCIA, SPAIN, FILED 4-19-2002.



SN 76-361,712. RED HEAD, INC., DBA CABO WABO ENTERPRISES, NOVATO, CA. FILED 1-23-2002.

FINCA TERRERAZO

CABO WABORITA

THE ENGLISH TRANSLATION OF THE WORD "CABO" IS "CAPE".
FOR TEQUILA; DISTILLED SPIRITS; PREPARED ALCOHOLIC COCKTAILS (U.S. CLS. 47 AND 49).

NO CLAIM IS MADE TO THE EXCLUSIVE RIGHT TO USE "FINCA", APART FROM THE MARK AS SHOWN.
"FINCA" IS THE SPANISH EQUIVALENT FOR TERMINOLOGY RELATING TO REAL PROPERTY ON WHICH VINEYARDS ARE CULTIVATED.
FOR WINES (U.S. CLS. 47 AND 49).

CLASS 33—(Continued).

SN 76-408,489. BLACK & RED, INC., DBA CHATEAU DE LEELANAU VINEYARD & WINERY, TRAVERSE CITY, MI. FILED 5-15-2002.



NO CLAIM IS MADE TO THE EXCLUSIVE RIGHT TO USE "LEELANAU" AND "VINEYARD & WINERY", APART FROM THE MARK AS SHOWN.

THE MARK CONSISTS OF ENCIRCLED LEAF WITH GRAPE CLUSTER AND THE NAME.

FOR WINES, NAMELY, RED, WHITE, AND SPARKLING WINES OF ALL VARIETIES, APERITIF WINES, COOKING WINES, FRUIT WINES, WINE COCKTAILS, WINE COOLERS, AND WINE PUNCHES (U.S. CLS. 47 AND 49).

FIRST USE 4-17-2000; IN COMMERCE 5-4-2000.

SN 76-413,567. LUZHOU LAOJIAO STOCK CORPORATION, LIMITED, LUZHOU CITY, SICHUAN PROVINCE, CHINA, FILED 5-29-2002.

百年老窖

OWNER OF U.S. REG. NO. 2,151,675.

NO CLAIM IS MADE TO THE EXCLUSIVE RIGHT TO USE THE NON-LATIN CHARACTERS THAT TRANSLATE AND TRANSLITERATE TO THE WORD "CELLAR", APART FROM THE MARK AS SHOWN.

THE NON-LATIN CHARACTER(S) IN THE MARK TRANSLITERATES INTO "BAI NIAN LAO JIAO", AND THIS MEANS "ONE-HUNDRED YEAR OLD CELLAR" IN ENGLISH.

FOR WINES, BRANDY SPIRITS, POTABLE SPIRITS, AND DISTILLED SPIRITS OF RICE, CORN AND BARLEY (U.S. CLS. 47 AND 49).

SN 76-448,567. MARTIN & HOBBS, LLC, SAN LUIS OBISPO, CA. FILED 9-11-2002.

FOSSIL CREEK

FOR WINE (U.S. CLS. 47 AND 49).
FIRST USE 11-19-1999; IN COMMERCE 11-19-1999.

CLASS 33—(Continued).

SN 76-453,430. VEGA DE TORO, S.L., LA RIOJA, SPAIN, FILED 9-27-2002.

TERMANTIA

OWNER OF SPAIN REG. NO. 2427927, DATED 3-5-2002, EXPIRES 3-5-2012.

"TERMANTIA" REFERS TO A CITY LOCATED IN THE PROVINCE OF SORIA IN SPAIN.

FOR WINE (U.S. CLS. 47 AND 49).

SN 76-454,073. ZUCCARDI, JOSE ALBERTO, MAIPU, PROVINCIA DE MENDOZA, ARGENTINA, FILED 9-30-2002.



THE STIPLING IN THE MARK IS A FEATURE OF THE MARK AND DOES NOT INTENDED TO INDICATE COLOR.

THE RECTANGULAR BACKGROUND OF THE MARK IS IN THE COLOR PANTONE 436C.

THE ENGLISH TRANSLATION OF THE WORD "VIDA ORGANICA" IN THE MARK IS "ORGANIC LIFE".

FOR WINES (U.S. CLS. 47 AND 49).

SN 76-456,566. PACIFIC INTERNATIONAL LIQUOR, INC., LOS ANGELES, CA. FILED 10-1-2002.

KABUKI

FOR WINES AND OTHER ALCOHOLIC BEVERAGES, NAMELY, RUM, VODKA, RYE WHISKEY, SCOTCH WHISKEY, GIN, BOURBON (U.S. CLS. 47 AND 49).

SN 76-460,771. GOLDEN DOME IMPORTS, INC., DALLAS, TX. FILED 10-16-2002.

ARÔME

THE ENGLISH TRANSLATION OF THE WORD "ARÔME" IN THE MARK IS "AROMA".

FOR BRANDY (U.S. CLS. 47 AND 49).

CLASS 33—(Continued).

SN 76-460,774. GOLDEN DOME IMPORTS, INC., DALLAS, TX. FILED 10-16-2002.

DOME D'OR

FOR BRANDY (U.S. CLS. 47 AND 49).

SN 76-460,776. GOLDEN DOME IMPORTS, INC., DALLAS, TX. FILED 10-16-2002.

DOME DOR

FOR BRANDY (U.S. CLS. 47 AND 49).

SN 76-468,316. BACARDI & COMPANY LIMITED, NASSAU, NEW PROVIDENCE, BAHAMAS, FILED 11-12-2002.

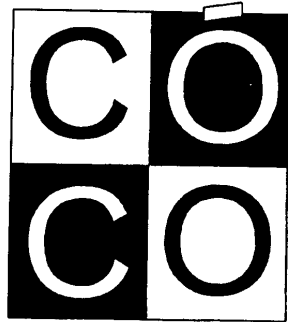

FOR SPIRITS AND LIQUEURS, NAMELY, RUM AND RUM-BASED ALCOHOLIC BEVERAGES (U.S. CLS. 47 AND 49).

SN 76-468,317. BACARDI & COMPANY LIMITED, NASSAU, NEW PROVIDENCE, BAHAMAS, FILED 11-12-2002.

BACARDI

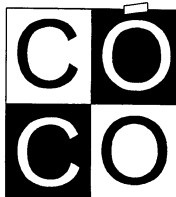

FOR SPIRITS AND LIQUEURS, NAMELY, RUM AND RUM-BASED ALCOHOLIC BEVERAGES (U.S. CLS. 47 AND 49).



CLASS 33—(Continued).

SN 76-472,366. PHEASANT HOLLOW WINERY INC., WHITTINGTON, IL. FILED 12-5-2002.

BLACK & BLUE

FOR WINE (U.S. CLS. 47 AND 49).
FIRST USE 7-4-1999; IN COMMERCE 10-16-1999.

SN 76-473,818. C3 BRANDS, INC., NEW YORK, NY. FILED 12-11-2002.

CAFÉ DE NUIT

NO CLAIM IS MADE TO THE EXCLUSIVE RIGHT TO USE "CAFE", APART FROM THE MARK AS SHOWN.

THE TERM "CAFE DE NUIT" TRANSLATES INTO ENGLISH AS "COFFEE OF THE NIGHT".

FOR COFFEE FLAVORED LIQUEUR (U.S. CLS. 47 AND 49).

SN 78-047,390. ALLIED LOMAR, INC., BURLINGAME, CA. FILED 2-8-2001.

COWBOY LITTLE BARREL

FOR BOURBON WHISKEY (U.S. CLS. 47 AND 49).
FIRST USE 8-31-1995; IN COMMERCE 8-31-1995.

SN 78-139,653. PFENDLER, PETER G., PETALUMA, CA. FILED 6-27-2002.

COPELAND CREEK

FOR WINE (U.S. CLS. 47 AND 49).

SN 78-142,517. BK- TRADING SCANDINAVIA AB, ARJANG, SWEDEN, AND BENT KARLSEN TRADING SCANDINAVIA AB, ARJANG, SWEDEN, FILED 7-10-2002.

ROYAL EDINBURGH

OWNER OF SWEDEN REG. NO. 349517, DATED 10-19-2001, EXPIRES 10-19-2011.

NO CLAIM IS MADE TO THE EXCLUSIVE RIGHT TO USE "EDINBURGH", APART FROM THE MARK AS SHOWN.

FOR ALCOHOLIC BEVERAGES, NAMELY, SCOTCH WHISKY. (U.S. CLS. 47 AND 49).

CLASS 33—(Continued).

SN 78-146,513. REMY FINANCE B.V., EM'S-GRAVENHAGE, NETHERLANDS, FILED 7-23-2002.



OWNER OF U.S. REG. NOS. 682,296, 2,259,748 AND OTHERS.

NO CLAIM IS MADE TO THE EXCLUSIVE RIGHT TO USE "1896", APART FROM THE MARK AS SHOWN.

THE MARK CONSISTS OF THE WORD "GALLIANO", WITH THE LETTER "G" APPEARING WITH A LEAF; THE LETTER "G" APPEARING IN A CIRCLE WITH A LEAF; FLOWERS WITHIN A LABEL.

FOR LIQUEURS (U.S. CLS. 47 AND 49).

FIRST USE 12-31-1998; IN COMMERCE 12-31-1998.

SN 78-147,782. D'ANDREA FAMILY LIMITED PARTNERSHIP, PITTSBURGH, PA. FILED 7-26-2002.

VILLA SORONO

NO CLAIM IS MADE TO THE EXCLUSIVE RIGHT TO USE "VILLA", APART FROM THE MARK AS SHOWN.

THE FOREIGN WORDING IN THE MARK TRANSLATES INTO ENGLISH AS "VILLA" TRANSLATES TO "HOUSE".

FOR WINE (U.S. CLS. 47 AND 49).

SN 78-169,603. JASMINE WINES PTY LTD, MILDURA, AUSTRALIA, FILED 10-1-2002.



PRIORITY CLAIMED UNDER SEC. 44(D) ON AUSTRALIA APPLICATION NO. 912503, FILED 5-13-2002, REG. NO. 912503, DATED 5-13-2002, EXPIRES 5-13-2009.

FOR WINE (U.S. CLS. 47 AND 49).

CLASS 33—(Continued).

SN 78-171,893. CANANDAIGUA WINE COMPANY, INC., CANANDAIGUA, NY. FILED 10-7-2002.

AMBIENTE

THE FOREIGN WORDING IN THE MARK TRANSLATES INTO ENGLISH AS "AMBIENT", "ATMOSPHERE", "ENVIRONMENT", "SETTING".

FOR ALCOHOLIC BEVERAGES, NAMELY WINES, SPARKLING WINES, CHAMPAGNES, FLAVORED WINES, AND WINE-BASED BEVERAGES (U.S. CLS. 47 AND 49).

SN 78-172,483. CANTINE LEONARDO DA VINCI SOC.COOP.A.R.L., 50059 VINCI, FIRENZE, ITALY, FILED 10-9-2002.

SAN ZIO

THE FOREIGN WORDING IN THE MARK TRANSLATES INTO ENGLISH AS "HOLY UNCLE" OR "SAINT UNCLE".

FOR WINES (U.S. CLS. 47 AND 49).

FIRST USE 1-0-1998; IN COMMERCE 7-0-2000.

SN 78-179,092. PERNA, WILLIAM, SOUTH FREEPORT, ME. FILED 10-28-2002.

SPARHAWK

FOR ALCOHOLIC BEVERAGES, NAMELY ALCOHOLIC BEVERAGES PRODUCED FROM A BREWED MALT BASE WITH NATURAL FLAVORS (U.S. CLS. 47 AND 49).

SN 78-180,370. MATUA VALLEY WINES LIMITED, AUKLAND, NEW ZEALAND, FILED 10-31-2002.

NORTHBANK

FOR BEVERAGES, NAMELY, WINES, DISTILLED SPIRITS AND LIQUEURS (U.S. CLS. 47 AND 49).

SN 78-185,085. TEQUILA CUERVO LA ROJENA, S.A. DE C.V., ZAPOPAN JALISCO, MEXICO, FILED 11-14-2002.

1800 ANTIGUO

OWNER OF U.S. REG. NOS. 2,151,166, 2,523,278 AND OTHERS.

THE WORD "ANTIGUO" MAY BE TRANSLATED INTO ENGLISH AS "OLD".

FOR ALCOHOLIC BEVERAGES, NAMELY TEQUILA (U.S. CLS. 47 AND 49).

CLASS 33—(Continued).

SN 78-189,564. SCHRADER CELLARS, LLC, CALISTOGA, CA. AND MIDSUMMER CELLARS, LLC, ST. HELENA, CA. FILED 11-27-2002.

DOUBLE DIAMOND

FOR WINE AND DISTILLED SPIRITS (U.S. CLS. 47 AND 49).

SN 78-190,578. TARGET BRANDS, INC., MINNEAPOLIS, MN. FILED 12-3-2002.

VIVID

FOR SPARKLING WINE (U.S. CLS. 47 AND 49).

SN 78-196,492. CORTE GIARA S.R.L., 37022 FUMANE (VR), ITALY, FILED 12-19-2002.

GROLETTA

FOR WINES, GRAPPA (U.S. CLS. 47 AND 49).

SN 78-196,496. FINE ESTATES FROM SPAIN, INC., DEDHAM, MA. FILED 12-19-2002.

WRONGO DONGO

FOR WINE FROM SPAIN (U.S. CLS. 47 AND 49).

SN 78-196,768. BACARDI & COMPANY LIMITED, NEW PROVIDENCE, BAHAMAS, FILED 12-20-2002.

BRILLIG

FOR ALCOHOLIC BEVERAGES, NAMELY DISTILLED SPIRITS (U.S. CLS. 47 AND 49).

SN 78-219,102. HOLT'S COMPANY, PHILADELPHIA, PA. FILED 2-26-2003.

ASHTON

OWNER OF U.S. REG. NOS. 1,376,628, 2,639,893 AND OTHERS.
SEC. 2(F).
FOR BOURBON, BRANDY, GIN, RUM, SCOTCH, TEQUILA, VODKA, WHISKEY AND WINE (U.S. CLS. 47 AND 49).

CLASS 34—SMOKERS' ARTICLES

SN 76-191,084. SARATOGA DESIGN, INC., KEY WEST, FL. FILED 1-9-2001.

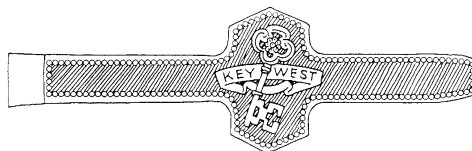

NO CLAIM IS MADE TO THE EXCLUSIVE RIGHT TO USE "KEY WEST", APART FROM THE MARK AS SHOWN. THE LINING IN THE DRAWING IS A FEATURE OF THE MARK AND IS NOT INTENDED TO INDICATE COLOR. FOR CIGARS (U.S. CLS. 2, 8, 9 AND 17).
FIRST USE 6-20-2000; IN COMMERCE 6-20-2000.

SN 76-213,361. 3327612 CANADA INC., OTTAWA, ONTARIO K1N 5T5, CANADA, FILED 2-21-2001.

BOOTIEZ

PRIORITY CLAIMED UNDER SEC. 44(D) ON CANADA APPLICATION NO. 1080217, FILED 10-26-2000, REG. NO. TMA569092, DATED 10-18-2002, EXPIRES 10-18-2017.
FOR CIGARETTE ACCESSORIES NOT MADE OF PRECIOUS METAL, NAMELY, DECORATIVE COVERS FOR CIGARETTE BOXES (U.S. CLS. 2, 8, 9 AND 17).

SN 76-299,246. GPS WORLDWIDE, APARTADO 951 PANAMA 1, PANAMA, FILED 8-15-2001.

**RUMBA**

FOR CIGARETTES, CIGARS, TOBACCO, SMOKELESS TOBACCO, CIGAR BANDS, CIGAR TUBES, CIGARETTE CASES AND CIGARETTE LIGHTERS NOT OF PRECIOUS METALS (U.S. CLS. 2, 8, 9 AND 17).
FIRST USE 11-0-1999; IN COMMERCE 11-0-1999.

CLASS 34—(Continued).

SN 78-182,198. CROSS BRIDGE, LLC, MIAMI, FL. FILED 11-6-2002.

SPRINGFIELD CIGARETTES

NO CLAIM IS MADE TO THE EXCLUSIVE RIGHT TO USE "CIGARETTES", APART FROM THE MARK AS SHOWN.

FOR SMOKING TOBACCO (U.S. CLS. 2, 8, 9 AND 17).

SN 78-197,196. HBI INTERNATIONAL, PHOENIX, AZ. FILED 12-22-2002.

BROWN SUGAR

FOR TOBACCO AND TOBACCO ACCESSORIES, NAMELY ROLLING PAPERS, ROLLING MACHINES, CIGARETTES, CIGARS, MATCHES, PIPES (U.S. CLS. 2, 8, 9 AND 17).

FIRST USE 6-6-1996; IN COMMERCE 6-6-1996.

SERVICE MARKS**CLASS 35—ADVERTISING AND BUSINESS**

SN 75-324,813. SUREFIRE DISTRIBUTION, INC., BOSTON, MA. FILED 7-15-1997.

SUREFIRE

OWNER OF U.S. REG. NO. 2,691,233.
FOR DISTRIBUTORSHIPS IN THE FIELDS OF MUSICAL SOUND RECORDINGS AND PRERECORDED COMPACT DISCS (U.S. CLS. 100, 101 AND 102).

FIRST USE 12-3-1993; IN COMMERCE 12-28-1993.

SN 75-477,157. SCRIPPS NETWORKS, INC., KNOXVILLE, TN. BY CHANGE OF NAME SCRIPPS HOWARD BROADCASTING COMPANY, DBA HOME & GARDEN TELEVISION, KNOXVILLE, TN. FILED 4-30-1998.

**HGTV DREAM HOME
GIVEAWAY**

OWNER OF U.S. REG. NOS. 1,890,679, 2,145,008 AND OTHERS.

NO CLAIM IS MADE TO THE EXCLUSIVE RIGHT TO USE "GIVEAWAY", APART FROM THE MARK AS SHOWN.
FOR PROMOTING CABLE TELEVISION BROADCASTING SERVICES THROUGH SWEEPSTAKES AND CONTESTS (U.S. CLS. 100, 101 AND 102).

FIRST USE 2-1-1997; IN COMMERCE 2-1-1997.

CLASS 35—(Continued).

SN 75-516,408. ROCKET U.S.A. INC., OAK PARK, IL. FILED 7-9-1998.

UNIVERSAL FUN

FOR RETAIL STORE SERVICES, AVAILABLE THROUGH COMPUTER COMMUNICATION NETWORKS FEATURING TOYS, NAMELY TIN TOYS, ROCKET TOYS, MECHANICAL ACTION TOYS, AND MECHANICAL ROBOT TOYS OF TIN AND OTHER MATERIAL (U.S. CLS. 100, 101 AND 102).

SN 75-676,085. KNOWITALL, LP, AUSTIN, TX. FILED 4-5-1999.

KNOWITALL.COM

FOR EXPERT REFERRALS IN VARIOUS FIELDS OF EXPERTISE, NAMELY TECHNICAL SUPPORT, CUSTOMER SERVICE, SALES SUPPORT AND ACADEMIA (U.S. CLS. 100, 101 AND 102).

SN 75-725,093. JULIE ANN TURNER & COMPANY, PLANO, TX. FILED 7-1-1999.

TEAM MVP

FOR COOPERATIVE ADVERTISING AND MARKETING (U.S. CLS. 100, 101 AND 102).

SN 75-727,051. USNET.NET INC., WESTLAKE VILLAGE, CA. FILED 6-11-1999.

NEED2SELL.COM

FOR PROVIDING A WEBSITE OVER ELECTRONIC COMMUNICATION NETWORKS FOR BUSINESS PRODUCTS AND SERVICES FOR BUYERS AND SELLERS, NAMELY PROVIDING A VIRTUAL MARKETPLACE WHERE BUSINESSES CAN RESEARCH, BUY AND SELL PRODUCTS AND SERVICES, PUT THEIR NEEDS FOR PRODUCTS AND SERVICES OUT FOR BID, GET MATCHED WITH APPROPRIATE VENDORS, RECEIVE QUOTES FROM VENDORS, AND CAN ELECT TO COMPLETE SALES TRANSACTIONS EITHER ON-LINE OR OFF-LINE (U.S. CLS. 100, 101 AND 102).

CLASS 35—(Continued).

SN 75-863,704. SUPERVISION CCTV SYSTEMS, INC., TAMPA, FL. FILED 12-6-1999.



SUPERVISION

THE LINING SHOWN IN THE DRAWING IS NOT INTENDED TO INDICATE COLOR.

FOR RETAIL SERVICES BY DIRECT SOLICITATION BY SALES AGENTS IN THE FIELD OF SURVEILLANCE SYSTEMS (U.S. CLS. 100, 101 AND 102).

FIRST USE 8-1-1996; IN COMMERCE 8-1-1996.

SN 75-896,777. REDIRECTORY SERVICES INC., EDMONTON, ALBERTA, T5J 2W4, CANADA, FILED 1-14-2000.

RECONNECT WITH REDIRECT

PRIORITY CLAIMED UNDER SEC. 44(D) ON CANADA APPLICATION NO. 1,022,552, FILED 7-15-1999, REG. NO. TMA565173, DATED 7-24-2002, EXPIRES 7-24-2017.

FOR TELEPHONE COMMUNICATION SERVICES IN THE NATURE OF TELEPHONE DIRECTORY INFORMATION SERVICES REGARDING DISCONTINUED TELEPHONE NUMBERS, FAX NUMBERS AND CELLULAR TELEPHONE NUMBERS (U.S. CLS. 100, 101 AND 102).

SN 75-934,635. FRITZ GIFTS & COLLECTIBLES, INC., MONROE, MI. FILED 3-3-2000.

FRITZGIFTS.COM

FOR ON-LINE RETAILSERVICES FEATURING GIFTWARE AND COLLECTIBLE ITEMS (U.S. CLS. 100, 101 AND 102).

FIRST USE 1-0-1997; IN COMMERCE 1-0-1997.

SN 76-028,852. CLICKFINGER.COM, INC., NEW YORK, NY. FILED 4-19-2000.

CLICK AND SAVE

FOR PROMOTING THE GOODS AND SERVICES OF OTHERS BY PREPARING AND PLACING ADVERTISEMENTS IN A WEB SITE ACCESSED THROUGH A GLOBAL COMPUTER NETWORK THAT ALLOWS A WEB USER TO SAVE WEB SITE ADVERTISEMENTS FOR REVIEW AT A LATER TIME. PRINT COUPONS RELATED TO THE ADVERTISEMENTS, AND TRANSMIT THE ADVERTISEMENTS BY ELECTRONIC MAIL (U.S. CLS. 100, 101 AND 102).

CLASS 35—(Continued).

SN 76-028,853. CLICKFINGER.COM, INC., NEW YORK, NY. FILED 4-19-2000.

CLICK N SAVE

FOR PROMOTING THE GOODS AND SERVICES OF OTHERS BY PREPARING AND PLACING ADVERTISEMENTS IN A WEB SITE ACCESSED THROUGH A GLOBAL COMPUTER NETWORK THAT ALLOWS A WEB USER TO SAVE WEB SITE ADVERTISEMENTS FOR REVIEW AT A LATER TIME. PRINT COUPONS RELATED TO THE ADVERTISEMENTS, AND TRANSMIT THE ADVERTISEMENTS BY ELECTRONIC MAIL (U.S. CLS. 100, 101 AND 102).

SN 76-084,467. THE SAVVY TRAVELLER, INC., CHICAGO, IL. FILED 7-7-2000.



NO CLAIM IS MADE TO THE EXCLUSIVE RIGHT TO USE "TRAVELLER", APART FROM THE MARK AS SHOWN.

FOR RETAIL STORE AND ONLINE STORE SERVICES FEATURING TRAVEL BOOKS, LUGGAGE, MAPS, TRAVEL-RELATED SOFTWARE AND TRAVEL-RELATED ACCESSORIES (U.S. CLS. 100, 101 AND 102).

FIRST USE 9-5-1996; IN COMMERCE 9-5-1996.

SN 76-092,544. ICOM INFORMATION & COMMUNICATIONS, INC., TORONTO, ONTARIO, CANADA, FILED 7-20-2000.

VARIPAQ

FOR DIRECT MAIL PROMOTION, NAMELY, DIRECT MAIL INSERTING SERVICES AND VARIABLE SELECTIVE DIRECT MAIL INSERTION SERVICES (U.S. CLS. 100, 101 AND 102).

FIRST USE 10-0-1999; IN COMMERCE 10-0-1999.

CLASS 35—(Continued).

SN 76-092,617. CERTUS INTERNATIONAL S.A., LUXEMBOURG, FILED 7-20-2000.



PRIORITY CLAIMED UNDER SEC. 44(D) ON BENELUX APPLICATION NO. 969652, FILED 7-20-2000, REG. NO. 0684441, DATED 7-20-2000, EXPIRES 7-20-2010.

FOR PROVIDING INFORMATION ABOUT WEBSITES AND THE PRODUCTS AND SERVICES OF OTHERS IN THE FIELD OF ELECTRONIC COMMERCE ON GLOBAL COMPUTER NETWORKS TO PROTECT CONSUMERS FROM CONFUSION AND TO ASSIST INTELLECTUAL PROPERTY OWNERS (U.S. CLS. 100, 101 AND 102).

SN 76-094,735. IHELLO.COM INC., MOUNTAIN VIEW, CA. FILED 7-20-2000.

IHELLO

FOR MARKETING AND ADVERTISING SERVICES, NAMELY CONSULTING, DESIGNING, AND IMPLEMENTING ADVERTISEMENTS AND PROMOTIONAL DISPLAYS FOR OTHERS WHICH USE SOUND AND SPEECH CONTENT AND OTHER FORMS OF MULTIMEDIA ON A GLOBAL COMPUTER NETWORK; TRACKING RESPONSES TO ADVERTISEMENTS AND PROMOTIONAL DISPLAYS OF OTHERS WHICH USE SOUND AND SPEECH CONTENT AND OTHER FORMS OF MULTIMEDIA DISSEMINATED ON A GLOBAL COMPUTER NETWORK (U.S. CLS. 100, 101 AND 102).

FIRST USE 5-18-2000; IN COMMERCE 5-18-2000.

SN 76-104,556. DEAN INTELLECTUAL PROPERTY SERVICES II, L.P., DALLAS, TX. BY ASSIGNMENT DTMIC, INC., FRANKLIN PARK, IL. FILED 8-7-2000.

THE DEAN ADVANTAGE

FOR CATEGORY MANAGEMENT SERVICES, NAMELY PROVIDING CUSTOMER MARKET TRENDS, CUSTOMER DEMOGRAPHICS, CUSTOMER INFORMATION, INFORMATION CONCERNING CONSUMER GOODS, SHELF SPACE MANAGEMENT FOR CONSUMER GOODS, AND PROVIDING CONSUMER PRODUCT INFORMATION VIA THE INTERNET (U.S. CLS. 100, 101 AND 102).

FIRST USE 11-0-1996; IN COMMERCE 11-0-1996.

CLASS 35—(Continued).

SN 76-125,864. PEREZ, NICOLAS, SAN JUAN, PUERTO RICO, FILED 9-12-2000.

**CONDOM
WORLD**

Protegiendo el Planeta

NO CLAIM IS MADE TO THE EXCLUSIVE RIGHT TO USE "CONDOM", APART FROM THE MARK AS SHOWN.

THE LINING SHOWN IN THE DRAWING IS NOT INTENDED TO INDICATE COLOR, IT JUST REPRESENTS SHADING.

THE ENGLISH TRANSLATION OF "PROTEGIENDO EL PLANETA" IS "PROTECTING THE PLANET".

FOR RETAIL, WHOLESALE, MAIL ORDER, AND ONLINE RETAIL STORE SERVICES FEATURING EDUCATIONAL VIDEOS, BOOKS, MAGAZINES, GIFT PACKAGES, PROPHYLACTICS, NOVELTIES, APPAREL, T-SHIRTS, CAPS, HANDBAGS, LOTIONS, AND PERSONAL LUBRICANTS, AND GELS (U.S. CLS. 100, 101 AND 102).

FIRST USE 7-0-1996; IN COMMERCE 7-0-1996.

SN 76-131,636. ADVP MANAGEMENT, LP, IRVING, TX. BY CHANGE OF NAME; BY ASSIGNMENT ADVANCE PARADIGM, INC., IRVING, TX. FILED 9-20-2000.



OWNER OF U.S. REG. NOS. 1,814,033, 1,912,020 AND 2,202,188.

FOR RETAIL PHARMACY AND DRUGSTORE SERVICES PROVIDED BY MEANS OF MAIL ORDER, TELEPHONE, AND ONLINE VIA A GLOBAL COMPUTER NETWORK (U.S. CLS. 100, 101 AND 102).

FIRST USE 7-0-1999; IN COMMERCE 7-0-1999.

CLASS 35—(Continued).

SN 76-164,787. MOREY MAHONEY ADVERTISING, INC., DENVER, CO. FILED 11-14-2000.

TRACTION

FOR CREATIVE AND ADVERTISING SERVICES, NAMELY, CREATING CORPORATE AND BRAND IDENTITY FOR OTHERS IN THE NATURE OF PLANNING, POSITIONING AND THE STRATEGIC PLANNING OF BRANDS; ARRANGING FOR THE DISSEMINATION OF ADVERTISING VIA THE INTERNET, PRINT AND BROADCAST MEDIA, AND PUBLIC RELATIONS DIRECTED TO BUSINESS INVESTORS AND CUSTOMERS (U.S. CLS. 100, 101 AND 102).

SN 76-187,870. WESCO EQUITY CORP., LAS VEGAS, NV. FILED 12-29-2000.

WESCO

FOR WHOLESALE DISTRIBUTORSHIP OF ELECTRICAL APPARATUS AND SUPPLIES NOT FOR USE IN THE AERONAUTICAL OR AIRCRAFT INDUSTRY (U.S. CLS. 100, 101 AND 102).
FIRST USE 12-30-1990; IN COMMERCE 1-5-1991.

SN 76-194,750. ABS COMPUTER TECHNOLOGY, WHITTIER, CA. FILED 1-16-2001.



FOR ONLINE RETAIL STORE FEATURING COMPUTER HARDWARE PRODUCTS (U.S. CLS. 100, 101 AND 102).
FIRST USE 7-26-2000; IN COMMERCE 7-26-2000.

SN 76-227,753. STEEL HORSE AUTOMOTIVE ACCESSORIES, INC., COMPTON, CA. FILED 3-21-2001.

ACME

FOR MAIL ORDER SERVICES FOR PARTS, COMPONENTS AND ACCESSORIES FOR TRUCKS AND SPORT UTILITY VEHICLES WHICH ARE OBTAINED BY A CUSTOMER PERFORMING THE STEPS OF SELECTING A SPECIFIC TYPE OF TRUCK OR SPORT UTILITY VEHICLE AND SELECTING A SPECIFIC PART, COMPONENT OR ACCESSORY SUITED FOR A SPECIFIC TYPE OF TRUCK OR SPORT UTILITY VEHICLE (U.S. CLS. 100, 101 AND 102).
FIRST USE 0-0-1953; IN COMMERCE 0-0-1953.

CLASS 35—(Continued).

SN 76-227,935. MCCLATCHY NEWSPAPERS, INC., SACRAMENTO, CA. FILED 3-20-2001.

**CENTRALVALLEY
JOBQUEST**

NO CLAIM IS MADE TO THE EXCLUSIVE RIGHT TO USE "CENTRAL VALLEY", APART FROM THE MARK AS SHOWN.

FOR COMPUTER SERVICES, CONSISTING OF ONLINE EMPLOYMENT SERVICES NAMELY CLASSIFIED ADVERTISING SEARCHES, RESUME POSTING AND JOB MATCHING (U.S. CLS. 100, 101 AND 102).
FIRST USE 3-9-2001; IN COMMERCE 3-9-2001.

SN 76-233,826. INGRAM, DAVID, VIENNA, VA. FILED 3-31-2001.

CAPITAL TECHSEARCH

NO CLAIM IS MADE TO THE EXCLUSIVE RIGHT TO USE "TECHSEARCH", APART FROM THE MARK AS SHOWN.

FOR EXECUTIVE RECRUITING AND PLACEMENT SERVICES (U.S. CLS. 100, 101 AND 102).

SN 76-255,408. NELROD COMPANY, THE, FORT WORTH, TX. FILED 5-11-2001.



NO CLAIM IS MADE TO THE EXCLUSIVE RIGHT TO USE "THE" AND "COMPANY", APART FROM THE MARK AS SHOWN.

FOR BUSINESS MANAGEMENT CONSULTATION (U.S. CLS. 100, 101 AND 102).

SN 76-267,919. HARKINS REEL DEALS, LLC, SCOTTSDALE, AZ. FILED 6-6-2001.

REEL DEALS

FOR MOVIE THEATER CONCESSIONS FEATURING FOOD AND DRINKS THAT HAVE BEEN PROMOTED THROUGH THE USE OF PROMOTIONAL MERCHANDISE AND TICKET DISCOUNT PACKAGES (U.S. CLS. 100, 101 AND 102).

FIRST USE 1-1-1996; IN COMMERCE 6-0-2001.

CLASS 35—(Continued).

SN 76-283,095. VISION WEST, INC., OCEANSIDE, CA. FILED 7-11-2001.

OPTICENTER

FOR BUYING GROUP SERVICES IN THE FIELD OF OPHTHALMIC AND OPTOMETRIC PRACTICE MANAGEMENT; BUSINESS MANAGEMENT CONSULTATION IN THE FIELD OF OPHTHALMIC AND OPTOMETRIC PRACTICE MANAGEMENT (U.S. CLS. 100, 101 AND 102).

FIRST USE 5-0-2000; IN COMMERCE 5-0-2000.

SN 76-302,600. DUARTE, HENRY, LOS ANGELES, CA. FILED 8-20-2001.

HENRY DUARTE

OWNER OF U.S. REG. NO. 2,288,801.
THE NAME "HENRY DUARTE" IDENTIFIES A LIVING INDIVIDUAL WHOSE CONSENT IS OF RECORD.

FOR RETAIL STORE SERVICES AND ON-LINE RETAIL STORE SERVICES, FEATURING, CLOTHING, JEWELRY, FASHION ACCESSORIES, PURSES, LEATHER GOODS, LUGGAGE, HANDBAGS, COSMETICS, HOUSEWARES, NOVELTY ITEMS, AND HAIR ACCESSORIES (U.S. CLS. 100, 101 AND 102).

SN 76-318,931. SOUTHERN ILLINOIS PAIN MANAGEMENT, S.C., MARION, IL. FILED 9-26-2001.

S.I. Pain Management, S.C.

NO CLAIM IS MADE TO THE EXCLUSIVE RIGHT TO USE "PAIN MANAGEMENT" AND "S.C.", APART FROM THE MARK AS SHOWN.

FOR BUSINESS CONSULTATION IN THE FIELD OF MEDICAL REHABILITATION SERVICES (U.S. CLS. 100, 101 AND 102).

SN 76-323,662. LANGLEY, HEATHER, PORTLAND, OR. AND LANGLEY, AMBER, PORTLAND, OR. FILED 10-9-2001.

THE PORCELAIN DOLLZ

FOR ENTERTAINMENT SERVICES, NAMELY, MODELING FOR ADVERTISING AND SALES PROMOTION, LIVE AND FILMED THEATRICAL AND MUSICAL PERFORMANCES (U.S. CLS. 100, 101 AND 102).

FIRST USE 10-4-2001; IN COMMERCE 10-4-2001.

CLASS 35—(Continued).

SN 76-335,764. U.S. LOYALTY CORP., GAHANNA, OH. FILED 11-8-2001.

JAZ FEST

FOR PROVIDING CUSTOMER INCENTIVE AWARD PROGRAMS IN THE NATURE OF LOYALTY PROGRAMS, WHICH INVOLVES THE CREDITING OF AWARD POINTS TO THE PURCHASERS OF THE GOODS OR SERVICES OF PARTICIPATING MERCHANTS AND, IN TURN, THE EXCHANGE OF THOSE AWARD POINTS FOR THE GOODS OR SERVICES OF THE PARTICIPATING MERCHANTS; AND ADVERTISING AND PROMOTING THE GOODS AND SERVICES OF OTHERS BY AWARDED POINTS TO PURCHASERS OF THE GOODS AND SERVICES OF OTHERS, AND BY DISTRIBUTING PROMOTIONAL MATERIALS VIA PRINTED PUBLICATIONS, THE INTERNET, TELEVISION AND RADIO (U.S. CLS. 100, 101 AND 102).

SN 76-346,327. HIBBLE, BRETT SEAN, THE GAP, QLD 4061, AUSTRALIA, AND SYKES, DOUGLAS KANE, THE GAP, QLD 4061, AUSTRALIA, FILED 12-6-2001.

DEMO-STATION

PRIORITY CLAIMED UNDER SEC. 44(D) ON AUSTRALIA APPLICATION NO. 883174, FILED 7-20-2001, REG. NO. 883174, DATED 7-20-2001, EXPIRES 7-20-2011.

FOR PERSONNEL PLACEMENT AND RECRUITMENT IN THE MUSICAL AND ENTERTAINMENT INDUSTRY; ADVERTISING SERVICES, NAMELY, PROMOTING THE SERVICES OF MUSICIANS, TECHNICIANS AND OTHERS FOR RECRUITMENT BY THE MUSICAL AND ENTERTAINMENT INDUSTRY, THE DISSEMINATION OF ADVERTISING FOR OTHERS VIA THE GLOBAL COMPUTER NETWORK, PREPARATION OF CUSTOM ADVERTISEMENTS AND CUSTOM PROMOTIONAL PRODUCTS FOR OTHERS, PREPARING AND PLACING ADVERTISEMENTS FOR OTHERS; BUSINESS MANAGEMENT, BUSINESS ADMINISTRATION, NAMELY, SECRETARIAL AND CLERICAL SERVICES, DISTRIBUTION OF BROCHURES, BUSINESS CONSULTANCY, AND TIME AND ATTENDANCE RECORD KEEPING, AND OFFICE FUNCTIONS NECESSARY FOR THE PROVISION OF A WEB SITE WHICH FEATURES ADVERTISEMENTS FOR THE SERVICES OF OTHERS ON A GLOBAL COMPUTER NETWORK, PROMOTING THE SERVICES OF OTHERS BY PREPARING AND PLACING ADVERTISEMENTS IN AN ELECTRONIC MAGAZINE ACCESS THROUGH A GLOBAL COMPUTER NETWORK AND RENTAL OF ADVERTISING SPACE (U.S. CLS. 100, 101 AND 102).

CLASS 35—(Continued).

SN 76-360,609. CARE COMMUNICATIONS, INC., CHICAGO, IL. FILED 1-18-2002.

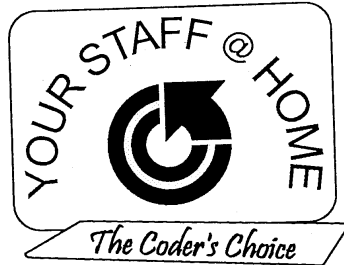

NO CLAIM IS MADE TO THE EXCLUSIVE RIGHT TO USE "CODER'S CHOICE", APART FROM THE MARK AS SHOWN.

FOR CONSULTING SERVICES RELATING TO A TELECOMMUTING PROGRAM FOR CODERS THAT WILL IMPROVE CODER RETENTION RATES, PRODUCTIVITY AND CODER SATISFACTION (U.S. CLS. 100, 101 AND 102).

FIRST USE 6-0-2001; IN COMMERCE 6-0-2001.

SN 76-363,419. HEARTLIGHT FOUNDATION, INC., THE, DURHAM, NC. FILED 1-28-2002.



NO CLAIM IS MADE TO THE EXCLUSIVE RIGHT TO USE "MAY 5, 2002 AT 5:00 PM EST" AND THE GEOGRAPHICAL DESIGN OF THE CONTINENT OF NORTH AMERICA, APART FROM THE MARK AS SHOWN.

THE DRAWING HAS LINES THAT MAY APPEAR TO BE BROKEN, BUT THE LINES, AS DEPICTED, ARE A FEATURE OF THE MARK.

FOR PROMOTING PUBLIC AWARENESS OF THE NEED FOR LOVE AND PEACE THROUGH SEMINARS, PUBLICIZING PROJECTS AND PUBLICATIONS (U.S. CLS. 100, 101 AND 102).

FIRST USE 11-1-2001; IN COMMERCE 11-1-2001.

CLASS 35—(Continued).

SN 76-363,420. HEARTLIGHT FOUNDATION, INC., THE, DURHAM, NC. FILED 1-28-2002.



The HeartLight Foundation
PLANTING THE SEEDS OF LOVE AND PEACE

NO CLAIM IS MADE TO THE EXCLUSIVE RIGHT TO USE "FOUNDATION" AND THE GEOGRAPHICAL DESIGN OF THE CONTINENT OF NORTH AMERICA, APART FROM THE MARK AS SHOWN.

FOR PROMOTING PUBLIC AWARENESS OF THE NEED FOR LOVE AND PEACE THROUGH FOUNDATION SERVICES OF A NON-DENOMINATIONAL CHURCH (U.S. CLS. 100, 101 AND 102).

FIRST USE 11-1-2001; IN COMMERCE 11-1-2001.

SN 76-366,914. EGR INTERNATIONAL INC., NEW YORK, NY. FILED 2-5-2002.

EGR

FOR BUSINESS SERVICES, NAMELY, CREATING, IMPLEMENTING, MANAGING, AND ADMINISTERING MEETINGS DESIGNED TO RECOGNIZE OR IMPROVE THE PERFORMANCE OF A CLIENT'S EMPLOYEES AND/OR THIRD PARTY PROVIDERS; AND CREATING, IMPLEMENTING, MANAGING, AND ADMINISTERING INCENTIVE AND PERFORMANCE AWARD PROGRAMS DESIGNED TO RECOGNIZE OR IMPROVE THE PERFORMANCE OF A CLIENT'S EMPLOYEES AND/OR THIRD PARTY PROVIDERS (U.S. CLS. 100, 101 AND 102).

FIRST USE 4-1-1970; IN COMMERCE 4-1-1970.

SN 76-371,642. OCWEN LTD., GUERNSEY, CHANNEL ISLANDS, FILED 2-14-2002.



THE ENGLISH TRANSLATION OF "BALDORIA" IS "MERRYMAKING, REVELRY".

FOR ONLINE RETAIL STORE SERVICES FEATURING CLOTHING AND CLOTHING ACCESSORIES (U.S. CLS. 100, 101 AND 102).

FIRST USE 11-0-1999; IN COMMERCE 11-0-1999.

CLASS 35—(Continued).

SN 76-372,522. SANCHEZ, JULIE ANN, MIAMI SHORES, FL. FILED 2-19-2002.



FOR TRANSPORTATION LOGISTICS SERVICES, NAMELY, ARRANGING THE TRANSPORTATION OF GOODS FOR OTHERS (U.S. CLS. 100, 101 AND 102). FIRST USE 10-18-2001; IN COMMERCE 10-18-2001.

SN 76-373,028. HUGHES, MARK E., SWARTHMORE, PA. FILED 2-20-2002.

BUZZMARKETING

FOR PROMOTING AND SECURING FOR OTHERS ADVERTISING SPACE ON GOODS USED IN THE RESTAURANT INDUSTRY, NAMELY ADVERTISING ON FORTUNE COOKIE INSERTS, DRINKING STRAW WRAPPERS, NAPKINS, TOWELS, PLACE MATS, TOILET PAPER, PIZZA BOXES, CARRY OUT CONTAINERS, BAGS, AND SALES RECEIPTS (U.S. CLS. 100, 101 AND 102).

SN 76-386,014. FOLLETT CORPORATION, DBA FOLLETT HIGHER EDUCATION GROUP, OAK BROOK, IL. FILED 3-22-2002.

EPARTNER

FOR PROVIDING AFFILIATE PROGRAM SERVICES TO COLLEGE AND UNIVERSITY BOOKSTORES, NAMELY, OFFERING TECHNICAL ASSISTANCE IN THE ESTABLISHMENT AND OPERATION OF ONLINE BOOKSTORES (U.S. CLS. 100, 101 AND 102). FIRST USE 3-22-2000; IN COMMERCE 3-30-2000.

SN 76-386,769. BETTER SOLUTIONS, INC., PITTSBURGH, PA. FILED 3-25-2002.

\$2.00 EMPLOYEE

NO CLAIM IS MADE TO THE EXCLUSIVE RIGHT TO USE "EMPLOYEE", APART FROM THE MARK AS SHOWN. FOR TEMPORARY EMPLOYMENT AGENCY WHEREBY A CANDIDATE FOR PLACEMENT REMAINS ON APPLICANT'S PAYROLL WHEN PLACED IN A TEMPORARY POSITION (U.S. CLS. 100, 101 AND 102).

CLASS 35—(Continued).

SN 76-387,590. R. WALKER, INCORPORATED, CLEARWATER, FL. FILED 3-25-2002.



NO CLAIM IS MADE TO THE EXCLUSIVE RIGHT TO USE "CHILD CARE STAFFING", APART FROM THE MARK AS SHOWN.

THE THREE HANDPRINTS IN THE MARK ARE RED, GREEN AND BLUE, AND THE LETTERS "C" ARE BLUE, RED AND GREEN.

THE MARK CONSISTS OF THE WORDS "CHILD CARE STAFFING" AND THREE HAND PRINTS THE FIRST HAND PRINT IS GREEN, THE SECOND IS BLUE, THE THIRD IS RED. COLOR IS A FEATURE OF THE MARK.

FOR EMPLOYMENT STAFFING (U.S. CLS. 100, 101 AND 102).

SN 76-389,676. ACE HARDWARE CORPORATION, OAK BROOK, IL. FILED 3-29-2002.



NO CLAIM IS MADE TO THE EXCLUSIVE RIGHT TO USE "NATIONAL SUPPLY NETWORK", APART FROM THE MARK AS SHOWN.

FOR WHOLESALE STORE SERVICES; NAMELY, PROVIDING WHOLESALE INDUSTRIAL SUPPLIES AND EQUIPMENT TO COMMERCIAL AND INDUSTRIAL CUSTOMERS (U.S. CLS. 100, 101 AND 102).

SN 76-393,822. LINCOLN HEALTHCARE INFORMATION COMPANY, NORWALK, CT. FILED 4-9-2002.

HOME HEALTH 100

NO CLAIM IS MADE TO THE EXCLUSIVE RIGHT TO USE "HOME HEALTH", APART FROM THE MARK AS SHOWN.

FOR CONDUCTING TRADE SHOWS IN THE HEALTH CARE FIELD (U.S. CLS. 100, 101 AND 102).

CLASS 35—(Continued).

SN 76-400,004. AMERICAN WATER RESOURCES ASSOCIATION, MIDDLEBURG, VA. FILED 4-25-2002.



NO CLAIM IS MADE TO THE EXCLUSIVE RIGHT TO USE "AMERICAN WATER RESOURCES ASSOCIATION", APART FROM THE MARK AS SHOWN.

FOR ASSOCIATION SERVICES - NAMELY, PROMOTING THE ADVANCEMENT OF WATER RESOURCES RESEARCH, PLANNING, DEVELOPMENT, MANAGEMENT, AND EDUCATION (U.S. CLS. 100, 101 AND 102). FIRST USE 1-0-2002; IN COMMERCE 1-0-2002.



SN 76-400,381. SJS HOLDINGS, LLC, DALLAS, TX. FILED 4-25-2002.

CORPORATE CLIPPER

NO CLAIM IS MADE TO THE EXCLUSIVE RIGHT TO USE "CORPORATE", APART FROM THE MARK AS SHOWN.

FOR BUSINESS MARKETING AND BUSINESS MANAGEMENT SERVICES FOR FRACTIONAL AIRLINE SERVICES, AIRPLANE CHARTER SERVICES AND OTHER BUSINESS JET SERVICES (U.S. CLS. 100, 101 AND 102).



SN 76-401,501. ARCHER-DANIELS-MIDLAND COMPANY, DECATUR, IL. FILED 4-29-2002.

ADM SOY

FOR PROVIDING CONSUMER INFORMATION IN THE FIELD OF HEALTH, HEALTH CONDITIONS AND SOY VIA A GLOBAL COMPUTER INFORMATION NETWORK; PROVIDING CONSUMER PRODUCT INFORMATION ON THE HEALTH BENEFITS OF FOODSTUFFS AND OTHER PRODUCTS CONTAINING SOY AND SOY DERIVATIVES VIA A GLOBAL COMPUTER INFORMATION NETWORK; AND PUBLIC OPINION POLLING SERVICES (U.S. CLS. 100, 101 AND 102).

CLASS 35—(Continued).

SN 76-404,056. S. MORANTZ INC., PHILADELPHIA, PA. FILED 5-6-2002.



FOR ADVERTISING SLOGAN AND ARTISTIC CHARACTER LICENSING FOR OTHERS (U.S. CLS. 100, 101 AND 102).

FIRST USE 1-0-1990; IN COMMERCE 5-0-1990.



SN 76-405,168. TBAC INVESTMENT TRUST, ARLINGTON, TX. FILED 5-9-2002.

ROLFS

OWNER OF U.S. REG. NOS. 604,067, 2,032,901 AND OTHERS.

FOR ON-LINE STORE SERVICES FEATURING CLOTHING, LUGGAGE AND ACCESSORIES (U.S. CLS. 100, 101 AND 102).

FIRST USE 10-19-1999; IN COMMERCE 10-19-1999.



SN 76-405,920. TBAC INVESTMENT TRUST, ARLINGTON, TX. FILED 5-10-2002.

ROLFS

OWNER OF U.S. REG. NOS. 604,067, 2,032,901 AND OTHERS.

FOR RETAIL STORE SERVICES FEATURING CLOTHING, LUGGAGE AND ACCESSORIES (U.S. CLS. 100, 101 AND 102).

CLASS 35—(Continued).

SN 76-406,117. CAMERA DI CORNMERCIO INDUSTRIA ARTIGIANATO E AGRICOLTURA DI UDINE, UDINE 33100, ITALY, FILED 5-6-2002.

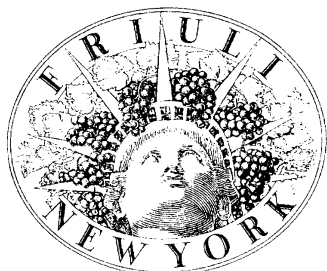

NO CLAIM IS MADE TO THE EXCLUSIVE RIGHT TO USE "FRIULI" AND "NEW YORK", APART FROM THE MARK AS SHOWN.

THE STIPPLING SHOWN IN THE DRAWING IS A FEATURE OF THE MARK AND NOT INTENDED TO INDICATE COLOR. THE LINING IN THE MARK IS MERELY TO INDICATE SHADING.

FOR CHAMBER OF COMMERCE SERVICES, NAMELY, PROMOTING THE AGRICULTURAL AND INDUSTRIAL PRODUCTS OF THE FRIULI REGION OF ITALY IN NEW YORK (U.S. CLS. 100, 101 AND 102).
FIRST USE 3-5-2002; IN COMMERCE 3-5-2002.

SN 76-407,836. DUFFIELD WARING STUDIOS, INC., RALEIGH, NC. FILED 5-14-2002.

TRAILBLAZER STUDIOS

NO CLAIM IS MADE TO THE EXCLUSIVE RIGHT TO USE "STUDIOS", APART FROM THE MARK AS SHOWN.

FOR PRODUCTION AND DISTRIBUTION OF RADIO COMMERCIALS, TELEVISION COMMERCIALS, AND AUDIO AND VIDEO INFOMERCIALS; PREPARATION OF AUDIO-VISUAL PRESENTATIONS FOR USE IN ADVERTISING; PROMOTING THE GOODS AND SERVICES OF OTHERS BY PREPARING AND PLACING ADVERTISEMENTS IN A FORMAT ACCESSIBLE THROUGH A GLOBAL COMPUTER NETWORK (U.S. CLS. 100, 101 AND 102).

FIRST USE 5-3-2002; IN COMMERCE 5-3-2002.

SN 76-409,794. SCHOTTENSTEIN ZOX & DUNN CO., L.P.A., COLUMBUS, OH. FILED 5-17-2002.

MED MAPPER

NO CLAIM IS MADE TO THE EXCLUSIVE RIGHT TO USE "MED", APART FROM THE MARK AS SHOWN.

FOR STRATEGIC BUSINESS PLANNING SERVICES FOR HOSPITALS (U.S. CLS. 100, 101 AND 102).

FIRST USE 5-17-2002; IN COMMERCE 5-17-2002.

CLASS 35—(Continued).

SN 76-410,515. SOIN INTERNATIONAL, LLC, DAYTON, OH. FILED 5-21-2002.

SOIN INTERNATIONAL

NO CLAIM IS MADE TO THE EXCLUSIVE RIGHT TO USE "INTERNATIONAL", APART FROM THE MARK AS SHOWN.

FOR HOLDING COMPANY SERVICES, NAMELY, PROVIDING BUSINESS MANAGEMENT AND BUSINESS MANAGEMENT CONSULTATION SERVICES TO SUBSIDIARIES AND AFFILIATES (U.S. CLS. 100, 101 AND 102).

FIRST USE 3-15-2002; IN COMMERCE 4-25-2002.

SN 76-412,051. INCHORD COMMUNICATIONS, INC., WESTERVILLE, OH. FILED 5-24-2002.

**THE MERIT PROCESS
MARKETING EXCELLENCE
READINESS: INSIGHTS AND
TACTICS**

FOR DIRECT MARKETING ADVERTISING FOR OTHERS; ADVERTISING AGENCY SERVICES; BUSINESS MARKETING CONSULTING TO THE PHARMACEUTICAL AND BIOTECH INDUSTRIES; BRANDING CONSULTING, NAMELY, PROVIDING INFORMATION IN THE FIELDS OF BRAND IDENTITY AND CORPORATE IDENTITY TO THE PHARMACEUTICAL AND BIOTECH INDUSTRIES (U.S. CLS. 100, 101 AND 102).

SN 76-415,176. HANLEY-WOOD LLC, WASHINGTON, DC. FILED 5-30-2002.

PROSALES FORCE

OWNER OF U.S. REG. NO. 2,043,491.

FOR PROMOTION OF MOBILE OFFICE VEHICLES OF OTHERS FOR BUILDING MATERIALS DEALERS IN PUBLICATIONS AND AT TRADE SHOWS (U.S. CLS. 100, 101 AND 102).

SN 76-417,758. MARS ADVERTISING COMPANY, INC., SOUTHFIELD, MI. FILED 6-5-2002.

RE-SPEC YOURSELF

FOR RETAIL STORE SERVICES FEATURING EYEGLASSES AND SUNGLASSES (U.S. CLS. 100, 101 AND 102).

CLASS 35—(Continued).

SN 76-420,726. TRANSZAP, INC., DENVER, CO. FILED 6-12-2002.

JIB CONNECT

NO CLAIM IS MADE TO THE EXCLUSIVE RIGHT TO USE "JIB", APART FROM THE MARK AS SHOWN.

FOR COMPUTER SERVICES, NAMELY, PROVIDING A WEB SITE AND DATABASE THAT AUTOMATES BUSINESS MANAGEMENT BY MONITORING, COMPILING AND DELIVERING BUSINESS, STATISTICAL AND ADMINISTRATION DATA, AND THAT AUTOMATES ACCOUNTING AND ELECTRIC INVOICING IN THE OIL AND GAS INDUSTRY (U.S. CLS. 100, 101 AND 102).

FIRST USE 10-5-2001; IN COMMERCE 10-5-2001.

SN 76-420,727. TRANSZAP, INC., DENVER, CO. FILED 6-12-2002.

CHECKSTUB CONNECT

NO CLAIM IS MADE TO THE EXCLUSIVE RIGHT TO USE "CHECKSTUB", APART FROM THE MARK AS SHOWN.

FOR COMPUTER SERVICES, NAMELY, PROVIDING A WEB SITE AND DATABASE THAT AUTOMATES BUSINESS MANAGEMENT BY MONITORING, COMPILING AND DELIVERING BUSINESS, STATISTICAL AND ADMINISTRATION DATA, AND THAT AUTOMATES ACCOUNTING AND ELECTRIC INVOICING IN THE OIL AND GAS INDUSTRY (U.S. CLS. 100, 101 AND 102).

FIRST USE 12-15-2000; IN COMMERCE 12-15-2000.

SN 76-421,904. SOYVENTURES, INC, LAKE MILLS, IA. FILED 6-17-2002.

SOYVENTURES,INC.

NO CLAIM IS MADE TO THE EXCLUSIVE RIGHT TO USE "INC.", APART FROM THE MARK AS SHOWN.

FOR ONLINE AND RETAIL STORE SERVICES FEATURING SOYBEAN PRODUCTS, PRIMARILY SOYBEAN WAX CANDLES (U.S. CLS. 100, 101 AND 102).

FIRST USE 12-18-2001; IN COMMERCE 12-18-2001.

SN 76-423,873. HIT 55, INC., TAMPA, FL. FILED 6-24-2002.

HIT 55, INC.

NO CLAIM IS MADE TO THE EXCLUSIVE RIGHT TO USE "INC.", APART FROM THE MARK AS SHOWN.

FOR PROMOTING THE SALE OF GOODS AND SERVICES OF OTHERS THROUGH THE DISTRIBUTION OF PRINTED MATERIAL AND PROMOTIONAL CONTESTS (U.S. CLS. 100, 101 AND 102).

FIRST USE 4-0-1999; IN COMMERCE 4-0-1999.

CLASS 35—(Continued).

SN 76-424,327. HEALTH CLUB, INC., ISLIP TERRACE, NY. FILED 6-24-2002.



**TOTAL HEALTH
EXPERIENCE**

NO CLAIM IS MADE TO THE EXCLUSIVE RIGHT TO USE "HEALTH CLUB" AND "HEALTH", APART FROM THE MARK AS SHOWN.

THE MARK CONSISTS OF THE WORDS "T.H.E. HEALTH CLUB TOTAL HEALTH EXPERIENCE" IN BROWN LETTERING AND THE LEAF DESIGN IN GREEN.

FOR RETAIL PHARMACY SERVICES; RETAIL SPORTING GOODS STORES; RETAIL HEALTH FOOD STORES; RETAIL ORGANIC FOOD STORES; RETAIL DRUG STORES; RETAIL GIFT SHOPS (U.S. CLS. 100, 101 AND 102).

SN 76-425,212. ALFRED ANGELO, INC., HORSHAM, PA. FILED 6-27-2002.

**ALFRED ANGELO BRIDE'S
TO GO**

OWNER OF U.S. REG. NOS. 1,365,681, 2,558,174 AND OTHERS.

NO CLAIM IS MADE TO THE EXCLUSIVE RIGHT TO USE "BRIDE'S", APART FROM THE MARK AS SHOWN.

THE NAME "ALFRED ANGELO" DOES NOT IDENTIFY A LIVING INDIVIDUAL.

FOR RETAIL CLOTHING STORE SERVICES (U.S. CLS. 100, 101 AND 102).

CLASS 35—(Continued).

SN 76-426,503. KETERA TECHNOLOGIES LLC, MOUNTAIN VIEW, CA. BY CHANGE OF NAME MARKETMILE LLC, MOUNTAIN VIEW, CA. FILED 7-1-2002.

KETERA

FOR PROVIDING BUSINESS INFORMATION, NAMELY ACCOUNTS PAYABLE DATA, PURCHASING CARD DATA, GENERAL LEDGER DATA, PURCHASE ORDER DATA AND SUPPLIER ORDER DATA OVER A GLOBAL COMPUTER INFORMATION NETWORK; CREATING, MAINTAINING AND PROVIDING AN ON-LINE CATALOGUE OF GOODS AND SERVICES OFFERED TO BUSINESSES BY SUPPLIERS; BUSINESS CONSULTATION IN THE FIELD OF E-COMMERCE AND PROCUREMENT ANALYSIS; PROVIDING A WEBSITE USED TO PLACE ONLINE ORDERS AND PROVIDING ORDER FULFILLMENT SERVICES; PROMOTING THE SALE OF THE GOODS AND SERVICES OF OTHERS THROUGH ONLINE ORDERING AND CATALOGUING OF THOSE GOODS AND SERVICES (U.S. CLS. 100, 101 AND 102).

SN 76-428,424. NEW WEATHERVANE RETAIL CORPORATION, NEW BRITAIN, CT. FILED 7-9-2002.



FOR ON-LINE RETAIL STORE SERVICES FEATURING WOMEN'S CLOTHING (U.S. CLS. 100, 101 AND 102). FIRST USE 0-0-1998; IN COMMERCE 0-0-1998.

SN 76-434,730. BPLOGIC, INC., NEWPORT, RI. FILED 7-26-2002.



NO CLAIM IS MADE TO THE EXCLUSIVE RIGHT TO USE "BUSINESS PROCESS LOGIC", APART FROM THE MARK AS SHOWN.

FOR BUSINESS PROCESS OUTSOURCING SERVICES; CONSULTING SERVICES IN THE FIELD OF BUSINESS PROCESS OUTSOURCING; BUSINESS MANAGEMENT SERVICES IN THE FIELD OF BACK-OFFICE OPERATIONS (U.S. CLS. 100, 101 AND 102).

FIRST USE 12-0-2000; IN COMMERCE 12-0-2000.

CLASS 35—(Continued).

SN 76-437,752. FRED MARTIN MOTOR COMPANY, BARTON, OH. FILED 8-5-2002.

DASH FOR THE CASH

FOR AUTOMOBILE DEALERSHIPS IN THE FIELD OF NEW AND USED VEHICLES (U.S. CLS. 100, 101 AND 102).

FIRST USE 8-1-2002; IN COMMERCE 8-1-2002.

SN 76-439,863. MARKETING RESEARCH SERVICES INC., CINCINNATI, OH. FILED 8-12-2002.



NO CLAIM IS MADE TO THE EXCLUSIVE RIGHT TO USE "MARKETING RESEARCH SERVICES, INC.", APART FROM THE MARK AS SHOWN.

FOR MARKET RESEARCH SERVICES (U.S. CLS. 100, 101 AND 102).

FIRST USE 9-0-1991; IN COMMERCE 9-0-1991.

SN 76-440,600. MEGA FORCE STAFFING GROUP, INC., THE, FAYETTEVILLE, NC. FILED 8-12-2002.

MEGA FORCE

OWNER OF U.S. REG. NO. 1,450,001. FOR EMPLOYMENT AGENCY SERVICES (U.S. CLS. 100, 101 AND 102).

FIRST USE 9-0-1982; IN COMMERCE 9-0-1982.

SN 76-440,983. SHARERX LLC, ARLINGTON HEIGHTS, IL. FILED 8-16-2002.

ShareRx

FOR INDEPENDENT SALES REPRESENTATIVES IN THE FIELD OF PHARMACEUTICALS AND PHARMACY SERVICES, BUSINESS MARKETING CONSULTING SERVICES IN THE FIELD OF PHARMACEUTICALS AND PHARMACY SERVICES AND DIRECT MARKETING ADVERTISING SERVICES FOR OTHERS IN THE FIELD OF PHARMACEUTICALS AND PHARMACY SERVICES (U.S. CLS. 100, 101 AND 102).

FIRST USE 8-15-2002; IN COMMERCE 8-15-2002.

CLASS 35—(Continued).

SN 76-441,216. GOLANA TECHNOLOGY CORP., TAIPEI HSIEN, TAIWAN, FILED 8-13-2002.

GOLANA

FOR IMPORT AND EXPORT AGENCY SERVICES (U.S. CLS. 100, 101 AND 102).

SN 76-442,026. R.J. REYNOLDS TOBACCO COMPANY, WINSTON-SALEM, NC. FILED 8-21-2002.

CAMEL CONCIERGE

FOR ADMINISTRATION OF CUSTOMER LOYALTY PROGRAM FEATURING THE DISSEMINATION OF ADVERTISING MATERIALS, SPECIAL EVENT INFORMATION, SPECIAL EVENT OFFERS, PRODUCT OFFERS, SWEEPSTAKES INFORMATION, AND CONTEST INFORMATION VIA DIRECT MAIL COMMUNICATION, ELECTRONIC MAIL COMMUNICATIONS, AND PERSON-TO-PERSON COMMUNICATION AT EVENTS; PROOFS OF PURCHASE ACCUMULATION AND REDEMPTION FOR GOODS AND SERVICES, AND DISCOUNT PURCHASE OFFERS, DESIGNED TO INCREASE CUSTOMER LOYALTY AND INCREASE THE NUMBER OF CUSTOMERS (U.S. CLS. 100, 101 AND 102).

SN 76-446,561. ESSENTIAL GEAR, INC., GREENFIELD, MA. FILED 9-3-2002.

ESSENTIAL GEAR HIGH-TECH SURVIVAL TOOLS

FOR TELEPHONE ORDERING AND COMPUTER ON LINE ORDERING SERVICES IN THE FIELD OF BUTANE LIGHTERS, FLASHLIGHTS AND HEADLAMPS (U.S. CLS. 100, 101 AND 102).
FIRST USE 7-1-1995; IN COMMERCE 7-1-1995.

SN 76-451,775. SOIN INTERNATIONAL, LLC, DAYTON, OH. FILED 9-18-2002.

SOIN

FOR HOLDING COMPANY SERVICES, NAMELY, PROVIDING BUSINESS MANAGEMENT AND BUSINESS MANAGEMENT CONSULTATION SERVICES TO SUBSIDIARIES AND AFFILIATES (U.S. CLS. 100, 101 AND 102).
FIRST USE 4-19-2002; IN COMMERCE 4-19-2002.

CLASS 35—(Continued).

SN 76-452,633. MAXIM HEALTHCARE SERVICES, INC., COLUMBIA, MD. FILED 9-23-2002.



OWNER OF U.S. REG. NOS. 2,019,182, 2,571,110 AND OTHERS.

NO CLAIM IS MADE TO THE EXCLUSIVE RIGHT TO USE "HEALTHCARE SERVICES", APART FROM THE MARK AS SHOWN.

FOR EMPLOYMENT AGENCY AND CONSULTING SERVICES RELATING TO THE TEMPORARY AND PERMANENT PLACEMENT OF HEALTH CARE PERSONNEL (U.S. CLS. 100, 101 AND 102).

FIRST USE 1-1-1993; IN COMMERCE 1-1-1993.

SN 76-454,420. ROCK-TENN COMPANY, NORCROSS, GA. FILED 9-23-2002.

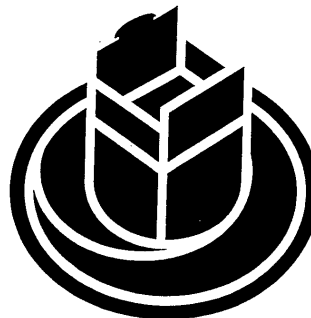

THE MARK CONSIST OF THREE-DIMENSIONAL, OPEN BOX THAT APPEARS TO BE SITTING AND SWIRLING ON A DISC.

FOR CONSULTATION SERVICES PROVIDED IN CONNECTION WITH CUSTOMER SERVICES IN THE FIELD OF PACKAGING (U.S. CLS. 100, 101 AND 102).

SN 76-457,458. EMPLAN, INC., MENDHAM, NJ. FILED 10-10-2002.

EMPLAN

FOR BUSINESS MANAGEMENT CONSULTING SERVICES FOR OTHERS (U.S. CLS. 100, 101 AND 102).
FIRST USE 9-5-2002; IN COMMERCE 9-5-2002.

CLASS 35—(Continued).

SN 76-458,561. POINTSMITH POINT-OF-PURCHASE MANAGEMENT SERVICES, LP, HOUSTON, TX. FILED 10-16-2002.

POINT VISION

FOR ADVERTISING SERVICES, NAMELY CREATION AND PLACEMENT OF POINT OF PURCHASE DISPLAYS FOR GOODS OF OTHERS AND MAINTENANCE OF POINT OF PURCHASE DISPLAYS FOR GOODS OF OTHERS (U.S. CLS. 100, 101 AND 102).

SN 76-459,026. E & S VOLE ENTERPRISES, INC., VERNON HILLS, IL. FILED 10-15-2002.

ERNIE'S C-STORE

NO CLAIM IS MADE TO THE EXCLUSIVE RIGHT TO USE "C-STORE", APART FROM THE MARK AS SHOWN. FOR RETAIL STORE SERVICES FEATURING CONVENIENCE STORE ITEMS (U.S. CLS. 100, 101 AND 102). FIRST USE 2-1-1997; IN COMMERCE 9-18-1998.

SN 76-459,161. GRANT, WAYNE, BROOKLYN, NY. FILED 10-15-2002.

MAXSTAGE

FOR ON-LINE ORDERING AND RETAIL STORE SERVICES FEATURING FILMS, CINEMA FILMS, MOTION PICTURES, VIDEO CASSETTES, VIDEO DISCS, VIDEO GAMES, VIDEO GAME PLAYERS, CD-ROMS, VIDEO COMPACT DISKS, DIGITAL VIDEO DISKS, RECORDABLE COMPACT DISKS, DVD-ROMS, DVD-RAMS AND RELATED HOME ENTERTAINMENT PRODUCTS (U.S. CLS. 100, 101 AND 102).

SN 76-459,430. SCULPTURE SUPPLY, INC., EAGAN, MN. FILED 10-21-2002.



NO CLAIM IS MADE TO THE EXCLUSIVE RIGHT TO USE "SCULPTURE SUPPLY", APART FROM THE MARK AS SHOWN.

THE NAME "BRAD OREN" IDENTIFIES A LIVING INDIVIDUAL WHOSE CONSENT IS OF RECORD.

FOR WHOLESALE AND RETAIL DISTRIBUTORSHIP FEATURING SCULPTURE MATERIALS, MACHINES, TOOLS, WOOD, CLAY, ABRASIVES, CHISELS, HAMMERS, FILES, GRINDERS, RASPS, BURRS, SANDERS, GLUES, FILLERS, STONE POLISH, STONE SEALERS, BUFFS, AND SANDPAPER, CARVING STONE, WOOD, CLAY, AND ABRASIVES AND TOOLS, MACHINES AND SUPPLIES FOR SCULPTURING AND BASES AND PEDESTALS USED TO DISPLAY SCULPTURES (U.S. CLS. 100, 101 AND 102).

FIRST USE 3-1-1995; IN COMMERCE 3-1-1995.

CLASS 35—(Continued).

SN 76-461,236. SCHNEIDER, DAVID L., SAN DIEGO, CA. FILED 10-21-2002.

ADVERTISINGTRACKER

OWNER OF U.S. REG. NOS. 2,621,281, 2,692,607 AND OTHERS.

FOR ADVERTISING AGENCY SERVICES; ADVERTISING SERVICES, NAMELY, PROVIDING ONLINE MARKETING SERVICES IN THE NATURE OF BANNER ADVERTISING, DISPLAY ADVERTISING, LINK EXCHANGES AND SEARCH ENGINE PLACEMENT SERVICES FOR OTHERS; DISSEMINATION OF ADVERTISING FOR OTHERS VIA THE INTERNET; ONLINE REFERRAL SERVICES IN THE ADVERTISING INDUSTRY; PROVIDING A SEARCHABLE DIRECTORY OF ADVERTISING INDUSTRY RELATED INFORMATION VIA THE INTERNET (U.S. CLS. 100, 101 AND 102). FIRST USE 10-21-2002; IN COMMERCE 10-21-2002.

SN 76-463,158. TOTAL BUILDING SOLUTIONS, INC., WASHINGTON, DC. FILED 10-25-2002.



THE LINING IN THE MARK IS A FEATURE THEREOF, AND DOES NOT REPRESENT COLOR.

FOR DISTRIBUTORSHIP SERVICES IN THE FIELD OF AIR FILTERS AND OTHER HVAC EQUIPMENT AND PARTS (U.S. CLS. 100, 101 AND 102).

SN 76-463,769. GEORGIA PROFESSIONAL STANDARDS COMMISSION, ATLANTA, GA. FILED 11-4-2002.

USE YOUR HEAD. FOLLOW YOUR HEART.

FOR TEACHER RECRUITING SERVICES (U.S. CLS. 100, 101 AND 102).

FIRST USE 6-0-2002; IN COMMERCE 6-0-2002.

CLASS 35—(Continued).

SN 76-463,876. OYUKI CORP., COCONUT GROVE, FL. FILED 10-28-2002.

OYUKI

THE ENGLISH TRANSLATION OF "OYUKI" IS "GREAT SNOW FALL".

FOR RETAIL STORE SERVICES FEATURING WOMEN'S BAGS, BELTS, SHOES, CLOTHING AND COSTUME AND FASHION JEWELRY (U.S. CLS. 100, 101 AND 102).

SN 76-467,068. TALENT SPRINGS, LLC, WEST CHESTER, OH. FILED 11-12-2002.



FOR PERSONNEL MANAGEMENT CONSULTING (U.S. CLS. 100, 101 AND 102).

CLASS 35—(Continued).

SN 76-468,100. PLEASANT COMPANY, MIDDLETON, WI. FILED 11-19-2002.



FOR RETAIL STORE, MAIL ORDER CATALOG SERVICES, AND ON-LINE RETAIL STORE SERVICES, EACH FEATURING ALL OF THE FOLLOWING GOODS, NAMELY, CHILDREN'S PUBLICATIONS, INCLUDING BOOKS AND BOOKLETS FEATURING A FICTIONAL DOG CHARACTER AND FICTIONAL AND NON-FICTIONAL STORIES ABOUT FRIENDSHIP AND ANIMALS AND OTHER TOPICS, CALENDARS, POSTCARDS, POSTERS, PAPER DOLLS, BOOKMARKS, TRADING CARDS, COOK BOOKS, CRAFT BOOKS, STICKERS, STATIONERY SETS COMPRISED OF KEEPSAKE BOX, STATIONERY, ENVELOPES, STICKERS, RUBBER STAMPS, INK PAD, STENCILS, ERASERS, PENCIL SHARPENER, PENCILS, AND PAPERCLIPS; BIRTHDAY PARTY KITS COMPRISED OF PRINTED INVITATIONS AND THANK YOU CARDS, PRINTED PARTY GUIDE, PHOTO ALBUM, PAPER DECORATIONS, PARTY FAVOR BAGS, RUBBER STAMPS AND STAMP PADS, MAGNETIC PICTURE FRAME, CRAFT BOOK, PAPER PLATES, PAPER NAPKINS, PAPER CUPS, PLACE CARDS, DRINKING STRAWS, PLASTIC CUTLERY, CANDLES, CAKE STANDS, GAMES, AND PARTY FAVORS; PURSES, BACKPACKS, TOTE BAGS, CHILDREN'S CLOTHING, NAMELY, T-SHIRTS, AND TOY DOGS AND CLOTHING AND ACCESSORIES FOR TOY DOGS; STUFFED TOYS AND CLOTHING AND ACCESSORIES FOR STUFFED TOYS, AND BALLOONS (U.S. CLS. 100, 101 AND 102).

SN 76-468,276. WAL-MART STORES, INC., BENTONVILLE, AR. FILED 11-12-2002.

IN BUSINESS FOR SMALL BUSINESS

FOR RETAIL AND WHOLESALE DEPARTMENT STORE SERVICES (U.S. CLS. 100, 101 AND 102).

SN 76-468,277. WAL-MART STORES, INC., BENTONVILLE, AR. FILED 11-12-2002.

IN BUSINESS FOR YOUR BUSINESS

FOR RETAIL AND WHOLESALE DEPARTMENT STORE SERVICES (U.S. CLS. 100, 101 AND 102).

CLASS 35—(Continued).

SN 76-468,321. WAL-MART STORES, INC., BENTONVILLE, AR. FILED 11-12-2002.

IN BUSINESS TO SERVE SMALL BUSINESS

FOR RETAIL AND WHOLESALE DEPARTMENT STORE SERVICES (U.S. CLS. 100, 101 AND 102).

SN 76-468,322. WAL-MART STORES, INC., BENTONVILLE, AR. FILED 11-12-2002.

WE ARE IN BUSINESS TO SERVE SMALL BUSINESS

FOR RETAIL AND WHOLESALE DEPARTMENT STORE SERVICES (U.S. CLS. 100, 101 AND 102).

SN 76-468,323. WAL-MART STORES, INC., BENTONVILLE, AR. FILED 11-12-2002.

WE ARE IN BUSINESS FOR SMALL BUSINESS

FOR RETAIL AND WHOLESALE DEPARTMENT STORE SERVICES (U.S. CLS. 100, 101 AND 102).
FIRST USE 11-21-2002; IN COMMERCE 11-21-2002.

SN 76-468,324. WAL-MART STORES, INC., BENTONVILLE, AR. FILED 11-12-2002.

WE ARE IN BUSINESS FOR YOUR BUSINESS

FOR RETAIL AND WHOLESALE DEPARTMENT STORE SERVICES (U.S. CLS. 100, 101 AND 102).

SN 76-468,515. DYNADIRECT.COM, INC., NEWPORT NEWS, VA. FILED 11-8-2002.

DYNADIRECT.COM STOP SEARCHING. START SAVING.

OWNER OF U.S. REG. NO. 2,515,407.
FOR ON-LINE RETAIL STORE SERVICES FEATURING GENERAL MERCHANDISE (U.S. CLS. 100, 101 AND 102).
FIRST USE 1-0-1999; IN COMMERCE 1-0-1999.

CLASS 35—(Continued).

SN 76-469,572. DILLARD'S, INC., LITTLE ROCK, AR. FILED 11-14-2002.

ROCK-A-BYE-BABY

FOR BABY REGISTRY SERVICES VIA RETAIL DEPARTMENT STORES AND/OR A GLOBAL COMPUTER NETWORK (U.S. CLS. 100, 101 AND 102).

SN 76-469,583. PHOENIX INTANGIBLES HOLDING COMPANY, GREENVILLE, DE. FILED 11-25-2002.

GIANT EAGLE GETGO

FOR CONVENIENCE STORE SERVICES INCLUDING FUEL (U.S. CLS. 100, 101 AND 102).

SN 76-470,405. LILLIS, MARTY, BOSTON, MA. FILED 11-25-2002.

WE CREATE SELL- THROUGH

FOR CONSULTING SERVICES, NAMELY MARKETING AND SALES CONSULTING SERVICES TO RETAILERS OF SPORTING GOODS AND RECREATIONAL EQUIPMENT (U.S. CLS. 100, 101 AND 102).
FIRST USE 10-1-2000; IN COMMERCE 10-1-2000.

SN 76-470,820. LEBOW COMPANY, INC., BELLEVUE, WA. FILED 11-27-2002.

WORKPLACE WELLNESS STUDY

NO CLAIM IS MADE TO THE EXCLUSIVE RIGHT TO USE "STUDY", APART FROM THE MARK AS SHOWN.
FOR BUSINESS MANAGEMENT CONSULTATION IN THE FIELD OF ORGANIZATIONAL DEVELOPMENT (U.S. CLS. 100, 101 AND 102).

SN 76-471,243. THE STRATHFORD GROUP, LLC, DBA SCRAPBOOK BUZZ, CEDAR CITY, UT. FILED 11-25-2002.

SCRAPBOOK BUZZ

NO CLAIM IS MADE TO THE EXCLUSIVE RIGHT TO USE "SCRAPBOOK", APART FROM THE MARK AS SHOWN.
FOR COMPUTERIZED ON-LINE RETAIL STORE SERVICES FEATURING SCRAPBOOK PRODUCTS (U.S. CLS. 100, 101 AND 102).
FIRST USE 11-27-2001; IN COMMERCE 2-25-2002.

CLASS 35—(Continued).

SN 76-472,405. THE MAY DEPARTMENT STORES COMPANY, ST. LOUIS, MO. FILED 12-3-2002.

CHATEAU ORLEANS

FOR RETAIL DEPARTMENT STORE SERVICES IN THE HOME AREA, NAMELY, FOR BEDROOM FURNITURE (U.S. CLS. 100, 101 AND 102).

SN 76-472,455. THE FIRM, INC., BEVERLY HILLS, CA. FILED 12-5-2002.

MADISON & WILSHIRE

FOR MARKETING AND CONSULTATION SERVICES, NAMELY PROVIDING STRATEGIC MARKETING CONSULTATION SERVICES; CONDUCTING BUSINESS AND MARKET RESEARCH; PROVIDING BUSINESS AND MARKET APPRAISAL SERVICES; DEVELOPING MARKETING CAMPAIGNS FOR BUSINESSES; BRAND REPRESENTATION AND BRAND MANAGEMENT SERVICES, NAMELY MANAGEMENT AND ADMINISTRATION OF LICENSING, MERCHANDISING AND MARKETING PROGRAMS FOR THE BRANDS OF OTHERS (U.S. CLS. 100, 101 AND 102).

SN 76-474,102. SHOW TENDERS, INC., ORLANDO, FL. FILED 12-5-2002.

**SHOWTENDERS HOME
BARTENDERS
ASSOCIATION**

OWNER OF U.S. REG. NO. 1,779,859.
NO CLAIM IS MADE TO THE EXCLUSIVE RIGHT TO USE "HOME BARTENDERS ASSOCIATION", APART FROM THE MARK AS SHOWN.
FOR ASSOCIATION SERVICES, NAMELY PROMOTING THE INTERESTS OF PERSONS INTERESTED IN MIXING AND SERVING DRINKS (U.S. CLS. 100, 101 AND 102).

SN 76-474,293. KALLENBACH, STEVE, ANAHEIM, CA. FILED 12-6-2002.

WE BRING YOUR BRAND TO LIFE!

FOR BUSINESS MARKETING CONSULTANT SERVICES (U.S. CLS. 100, 101 AND 102).
FIRST USE 12-1-2001; IN COMMERCE 12-1-2001.

CLASS 35—(Continued).

SN 76-474,374. AMERICAN LEGACY FOUNDATION, WASHINGTON, DC. FILED 12-3-2002.

CIRCLE OF FRIENDS

FOR PROMOTING PUBLIC AWARENESS OF THE NEED TO PREVENT DISEASE ASSOCIATED WITH THE USE OF TOBACCO PRODUCTS, AND TO REDUCE TOBACCO USE AND SUBSTANCE ABUSE (U.S. CLS. 100, 101 AND 102).
FIRST USE 2-1-2003; IN COMMERCE 2-1-2003.

SN 76-475,167. THE SETON FUND, AUSTIN, TX. FILED 11-29-2002.

GREAT HABITS

FOR RETAIL STORE SERVICES IN THE NATURE OF HOSPITAL GIFT SHOPS (U.S. CLS. 100, 101 AND 102).
FIRST USE 5-1-1999; IN COMMERCE 5-1-1999.

SN 76-475,168. THE SETON FUND, AUSTIN, TX. FILED 11-29-2002.

SWEET CHARITY

FOR RETAIL STORE SERVICES IN THE NATURE OF GIFT SHOPS (U.S. CLS. 100, 101 AND 102).
FIRST USE 8-6-1998; IN COMMERCE 8-6-1998.

SN 76-477,527. SCHNEIDER, DAVID L., SAN DIEGO, CA. FILED 12-20-2002.

MONEYSPY

FOR MARKETING SERVICES, NAMELY, PROVIDING QUALIFIED SALES LEADS FOR OTHERS IN THE BANKING AND MORTGAGE INDUSTRY; ONLINE REFERRAL SERVICES IN THE BANKING AND MORTGAGE INDUSTRY; PROVIDING A SEARCHABLE DIRECTORY OF BANKING AND MORTGAGE RELATED INFORMATION FOR OBTAINING DATA AND INFORMATION FROM OTHERS VIA THE INTERNET; ADVERTISING SERVICES, NAMELY, PROVIDING ONLINE MARKETING SERVICES IN THE NATURE OF BANNER ADVERTISING, DISPLAY ADVERTISING, LINK EXCHANGES AND SEARCH ENGINE PLACEMENT SERVICES FOR THE BANKING AND MORTGAGE INDUSTRY (U.S. CLS. 100, 101 AND 102).
FIRST USE 12-17-2002; IN COMMERCE 12-17-2002.

CLASS 35—(Continued).

SN 76-477,728. STARBOARD MEDIA FOUNDATION, INC., GREEN BAY, WI. FILED 12-23-2002.

LPFMHELP

FOR BUSINESS MANAGEMENT CONSULTATION, NAMELY ASSISTING OTHERS IN THE DEVELOPMENT, MARKETING, PROCESS, PROCEDURES, AND INFORMATION SYSTEMS RELATING TO THE START-UP AND MANAGEMENT OF A RADIO STATION (U.S. CLS. 100, 101 AND 102).

FIRST USE 10-15-2002; IN COMMERCE 10-15-2002.

SN 76-479,431. BARRISTER'S FINE CHOCOLATES & ICE CREAM SHOPPE, INC., CORAL SPRINGS, FL. FILED 12-31-2002.

**BARRISTER'S FINE
CHOCOLATES & ICE CREAM
SHOPPE**

NO CLAIM IS MADE TO THE EXCLUSIVE RIGHT TO USE "FINE CHOCOLATES AND ICE CREAM SHOP", APART FROM THE MARK AS SHOWN.

FOR RETAIL STORE SERVICES FEATURING FINE CHOCOLATES AND ICE CREAM AND OTHER RELATED CONFECTIONERY (U.S. CLS. 100, 101 AND 102).

SN 76-480,730. MUSHARBASH, WILLIAM, POMONA, CA. FILED 1-6-2003.

MILES

FOR RETAIL STORE SERVICES FEATURING CONVENIENCE STORE ITEMS AND GASOLINE AND DIESEL FUEL (U.S. CLS. 100, 101 AND 102).

SN 76-483,705. CUSTOM-PAK, INC., IMMOKALEE, FL. FILED 1-22-2003.

CUSTOM PAK

OWNER OF U.S. REG. NO. 2,005,605.
FOR WHOLESALE DISTRIBUTORSHIPS FEATURING PRODUCE (U.S. CLS. 100, 101 AND 102).
FIRST USE 10-15-1994; IN COMMERCE 10-15-1994.

CLASS 35—(Continued).

SN 76-485,553. INSIGNIA SYSTEMS, INC., PLYMOUTH, MN. FILED 1-28-2003.

ULTRA COLOR

FOR RENTAL OF IN-STORE SIGNAGE FOR ADVERTISING PURPOSES; REPORTING OF SALES RESULTS BY VOLUME OF UNITS BASED ON THE UNIVERSAL PRODUCT CODE FOR OTHERS (U.S. CLS. 100, 101 AND 102).

SN 76-501,603. PHOENIX INTANGIBLES HOLDING COMPANY, GREENVILLE, DE. FILED 3-28-2003.

GETGO FROM GIANT EAGLE

FOR CONVENIENCE STORE SERVICES INCLUDING FUEL (U.S. CLS. 100, 101 AND 102).

SN 76-975,369. TIMBERLAND COMPANY, THE, STRATHAM, NH. FILED 3-11-2002.

SEEK OUT

FOR RETAIL STORES, AND COMPUTERIZED ONLINE RETAIL SERVICES, IN THE FIELD OF FOOTWEAR, APPAREL, HEADWEAR, LEATHER GOODS, LEATHER AND SHOE CARE PRODUCTS, LUGGAGE, PACKS, TRAVEL AND HIKING GEAR, PERSONAL ACCESSORIES, EYEWEAR AND WATCHES (U.S. CLS. 100, 101 AND 102).

FIRST USE 3-0-2002; IN COMMERCE 3-0-2002.

SN 78-055,584. AXIS TECHNOLOGIES LLC, SEATTLE, WA. FILED 3-28-2001.

VALET

FOR PROVIDING A SITE ON A COMPUTER NETWORK, NAMELY AN INTERNAL COMPUTER NETWORK NOT AVAILABLE ON THE WORLD-WIDE-WEB (INTRANET) AND AN EXTERNAL COMPUTER NETWORK NOT AVAILABLE ON THE WORLD-WIDE-WEB (EXTRANET) WHEREBY POTENTIAL BUYERS OF GOODS OR SERVICES LOCATE AND RECEIVE INFORMATION FROM MULTIPLE PARTICIPATING VENDORS AND WHEREBY PARTICIPATING VENDORS TO THE INTRANET AND EXTRANET PROVIDE INFORMATION ABOUT THE GOODS AND SERVICES TO THE POTENTIAL BUYERS, AND PROMOTING THE GOODS AND SERVICES OF OTHERS THROUGH ONLINE ORDERING OF THOSE GOODS AND SERVICES; OPERATION OF A BUSINESS FOR OTHERS IN THE NATURE OF AN E-MAIL MESSAGE CENTER THAT SENDS, RECEIVES, AND MANAGES ELECTRONIC CORRESPONDENCE TO AND FROM THE EXTRANET OR INTRANET USERS WITHIN THE EXTRANET OR INTRANET (U.S. CLS. 100, 101 AND 102).

CLASS 35—(Continued).

SN 78-076,859. WATCH MART, HOLLYWOOD, FL. FILED 8-1-2001.



NO CLAIM IS MADE TO THE EXCLUSIVE RIGHT TO USE "BRAND NAME WATCHES FOR LESS", APART FROM THE MARK AS SHOWN.

FOR RETAIL STORE SERVICES FEATURING WATCHES, JEWELRY, AND OTHER GIFT ITEMS (U.S. CLS. 100, 101 AND 102).

SN 78-093,367. UPROAR COMMUNICATIONS LTD., ANN ARBOR, MI. FILED 11-14-2001.

OCTAGON MODEL

NO CLAIM IS MADE TO THE EXCLUSIVE RIGHT TO USE "MODEL", APART FROM THE MARK AS SHOWN.

FOR BUSINESS ORGANIZATIONAL CONSULTATION MODEL USED IN CONNECTION WITH BUSINESS CONSULTATION, BUSINESS PLANNING, AND SALES AND MARKETING PLANNING (U.S. CLS. 100, 101 AND 102).

FIRST USE 10-1-2001; IN COMMERCE 11-1-2001.

SN 78-098,346. INTERNATIONAL DATA GROUP, INC., FRAMINGHAM, MA. FILED 12-14-2001.

EXPERTROI

FOR RESEARCH AND CONSULTATION SERVICES RELATING TO COST/BENEFIT ANALYSIS FOR PURCHASING DECISIONS (U.S. CLS. 100, 101 AND 102).

FIRST USE 1-31-2002; IN COMMERCE 1-31-2002.

SN 78-099,547. FITZPATRICK, GABRIELLE, LOS ANGELES, CA. AND ZARIF, NEBIL, LOS ANGELES, CA. FILED 12-20-2001.

FUCHSIA

FOR RETAIL STORES SERVICES FEATURING IMPORTED GOODS; NAMELY, WINE; BODY AND HAND CREAMS AND OILS; BEAUTY PRODUCTS, NAMELY, LOTIONS; SHAMPOOS AND FURNITURE (U.S. CLS. 100, 101 AND 102).

CLASS 35—(Continued).

SN 78-111,814. CRAWFORD, GRANT B., ALBUQUERQUE, NM. FILED 2-28-2002.

SALT OF THE EARTH

FOR WHOLESALE DISTRIBUTORSHIPS FEATURING SALT, PEPPER, SPICES, AND SEASONINGS (U.S. CLS. 100, 101 AND 102).

FIRST USE 1-14-1999; IN COMMERCE 1-14-1999.

SN 78-116,628. NEOLA, INC., COSHOCTON, OH. FILED 3-21-2002.

NEOLA, INC.

NO CLAIM IS MADE TO THE EXCLUSIVE RIGHT TO USE "INC.", APART FROM THE MARK AS SHOWN.

FOR BUSINESS CONSULTATION, NAMELY, DEVELOPING AND UPDATING BOARD POLICIES, ADMINISTRATIVE GUIDELINES, AND FORMS IN PRINTED AND ELECTRONIC FORMAT (U.S. CLS. 100, 101 AND 102).

FIRST USE 6-1-1981; IN COMMERCE 6-1-1981.

SN 78-116,646. NEOLA, INC., COSHOCTON, OH. FILED 3-21-2002.

NEOLA

FOR BUSINESS CONSULTATION, NAMELY, DEVELOPING AND UPDATING BOARD POLICIES, ADMINISTRATIVE GUIDELINES, AND FORMS IN PRINTED AND ELECTRONIC FORMAT (U.S. CLS. 100, 101 AND 102).

SN 78-121,340. LONGFELLOW, SHANAN L., DURANGO, CO. FILED 4-12-2002.

SORREL SKY GALLERY

NO CLAIM IS MADE TO THE EXCLUSIVE RIGHT TO USE "GALLERY", APART FROM THE MARK AS SHOWN.

FOR ART GALLERY SERVICES (U.S. CLS. 100, 101 AND 102).

FIRST USE 3-1-2002; IN COMMERCE 3-1-2002.

CLASS 35—(Continued).

SN 78-125,887. PROTECH CORPORATE ENTERPRISES, INC., NEW YORK, NY. FILED 5-2-2002.

PHARMHIRES

FOR RECRUITMENT AND PLACEMENT OF EXECUTIVE, PROFESSIONAL, COLLEGE GRADUATE AND TECHNICAL PERSONNEL; CONSULTING SERVICES IN THE FIELD OF EMPLOYEE RECRUITING AND RETENTION; CONSULTING SERVICES IN THE FIELD OF EMPLOYEE TRAINING, NAMELY, CONSULTATION REGARDING TESTING TO DETERMINE EMPLOYMENT SKILLS AND QUALIFICATIONS; PROVIDING INFORMATION IN THE FIELDS OF RECRUITMENT, EMPLOYMENT, ADVERTISING, CAREERS, AND RESUME CREATION; PROVIDING RESUME TRANSMITTAL SERVICES, NAMELY, PROVIDING POTENTIAL EMPLOYERS WITH RESUMES OF CANDIDATES AND NOTIFYING PROSPECTIVE EMPLOYEES OF THE RESPONSES THERETO; RESUME MATCHING SERVICES; PROVIDING EMPLOYEE RELOCATION INFORMATION, NAMELY, PROVIDING INFORMATION PERTAINING TO LIFESTYLES IN VARIOUS GEOGRAPHIC REGIONS; RECRUITMENT AND PLACEMENT OF EXECUTIVE, PROFESSIONAL, COLLEGE GRADUATE AND TECHNICAL PERSONNEL VIA THE INTERNET; CONSULTING SERVICES IN THE FIELD OF EMPLOYEE RECRUITING AND RETENTION VIA THE INTERNET; CONSULTING SERVICES IN THE FIELD OF EMPLOYEE TRAINING VIA THE INTERNET, NAMELY, CONSULTATION REGARDING TESTING TO DETERMINE EMPLOYMENT SKILLS AND QUALIFICATIONS; PROVIDING INFORMATION IN THE FIELDS OF RECRUITMENT, EMPLOYMENT, ADVERTISING, CAREERS, AND RESUME CREATION VIA THE INTERNET; PROVIDING RESUME TRANSMITTAL SERVICES, NAMELY, PROVIDING POTENTIAL EMPLOYERS WITH RESUMES OF CANDIDATES AND NOTIFYING PROSPECTIVE EMPLOYEES OF THE RESPONSES THERETO VIA THE INTERNET; RESUME MATCHING SERVICES VIA THE INTERNET; PROVIDING EMPLOYEE RELOCATION INFORMATION, NAMELY, PROVIDING INFORMATION PERTAINING TO LIFESTYLES IN VARIOUS GEOGRAPHIC REGIONS VIA THE INTERNET (U.S. CLS. 100, 101 AND 102).

SN 78-130,171. PROTECH CORPORATE ENTERPRISES, INC., NEW YORK, NY. FILED 5-21-2002.

PharmHires.com
The Automated Job Exchange

NO CLAIM IS MADE TO THE EXCLUSIVE RIGHT TO USE "AUTOMATED JOB EXCHANGE", APART FROM THE MARK AS SHOWN.

FOR RECRUITMENT AND PLACEMENT OF EXECUTIVE, PROFESSIONAL, COLLEGE GRADUATE AND TECHNICAL PERSONNEL; CONSULTING SERVICES IN THE FIELD OF EMPLOYEE RECRUITING AND RETENTION; CONSULTING SERVICES IN THE FIELD OF EMPLOYEE TRAINING, NAMELY, CONSULTATION REGARDING TESTING TO DETERMINE EMPLOYMENT SKILLS AND QUALIFICATIONS; PROVIDING INFORMATION IN THE FIELDS OF RECRUITMENT, EMPLOYMENT, ADVERTISING, CAREERS, AND RESUME CREATION; PROVIDING RESUME TRANSMITTAL SERVICES, NAMELY, PROVIDING POTENTIAL EMPLOYERS WITH RESUMES OF CANDIDATES AND NOTIFYING PROSPECTIVE EMPLOYEES OF THE RESPONSES THERETO; RESUME MATCHING SERVICES; PROVIDING EMPLOYEE RELOCATION INFORMATION, NAMELY, PROVIDING INFORMATION PERTAINING TO LIFESTYLES IN VARIOUS GEOGRAPHIC

CLASS 35—(Continued).

REGIONS; RECRUITMENT AND PLACEMENT OF EXECUTIVE, PROFESSIONAL, COLLEGE GRADUATE AND TECHNICAL PERSONNEL VIA THE INTERNET; CONSULTING SERVICES IN THE FIELD OF EMPLOYEE RECRUITING AND RETENTION VIA THE INTERNET; CONSULTING SERVICES IN THE FIELD OF EMPLOYEE TRAINING VIA THE INTERNET, NAMELY, CONSULTATION REGARDING TESTING TO DETERMINE EMPLOYMENT SKILLS AND QUALIFICATIONS; PROVIDING INFORMATION IN THE FIELDS OF RECRUITMENT, EMPLOYMENT, ADVERTISING, CAREERS, AND RESUME CREATION VIA THE INTERNET; PROVIDING RESUME TRANSMITTAL SERVICES, NAMELY, PROVIDING POTENTIAL EMPLOYERS WITH RESUMES OF CANDIDATES AND NOTIFYING PROSPECTIVE EMPLOYEES OF THE RESPONSES THERETO VIA THE INTERNET; RESUME MATCHING SERVICES VIA THE INTERNET; PROVIDING EMPLOYEE RELOCATION INFORMATION, NAMELY, PROVIDING INFORMATION PERTAINING TO LIFESTYLES IN VARIOUS GEOGRAPHIC REGIONS VIA THE INTERNET (U.S. CLS. 100, 101 AND 102).

SN 78-131,513. NAVITAIRE INC., MINNEAPOLIS, MN. FILED 5-28-2002.

DIRECTNET

FOR ON-LINE BUSINESS INFORMATION MANAGEMENT SERVICES IN THE FIELDS OF AIRLINE RESERVATIONS, CUSTOMER INFORMATION, AND FLIGHT SCHEDULES PROVIDED TO TRAVEL DISTRIBUTORS, NAMELY AIRLINES, TOUR OPERATORS AND TRAVEL AGENCIES (U.S. CLS. 100, 101 AND 102).
FIRST USE 3-0-2002; IN COMMERCE 3-0-2002.

SN 78-131,810. DYNAMIC CIRCUIT CORPORATION, MONTEREY PARK, CA. FILED 5-29-2002.

美國華商資訊
Centralyp.com 

NO CLAIM IS MADE TO THE EXCLUSIVE RIGHT TO USE THE REPRESENTATION OF THE WALKING FINGER DESIGN, OR TO THE NON-LATIN CHARACTERS IN THE MARK, APART FROM THE MARK AS SHOWN.

THE MARK CONSISTS OF THE WORD "CENTRALYP.COM", SIX CHINESE CHARACTERS, AND THE WALKING FINGERS ON THE LETTER "E" WITH SLANTED LINES LINKED TO EACH OTHER IN THE BACKGROUND.

THE NON-LATIN CHARACTER(S) IN THE MARK TRANSLITERATES INTO "U.S.A.", "CHINESE", "COMMERCE", "RESOURCES" AND "INFORMATION", AND THIS MEANS "AMERICAN CHINESE BUSINESS INFORMATION" IN ENGLISH.

FOR PROVIDING ON-LINE DIRECTORY INFORMATION SERVICES ALSO FEATURING HYPERLINKS TO OTHER WEB SITES, PROVIDING ONLINE BUSINESS GUIDES; PROMOTING THE GOODS AND SERVICES OF OTHERS BY PREPARING AND PLACING ADVERTISEMENTS AND PROMOTIONAL DISPLAYS ON A WEBSITE; PROVIDING RETAIL STORE INFORMATION AND BUSINESS LISTINGS BY ELECTRONIC MEANS (U.S. CLS. 100, 101 AND 102).

FIRST USE 3-0-2002; IN COMMERCE 3-0-2002.

CLASS 35—(Continued).

SN 78-132,234. R. N. GOSS GAS PRODUCTS CO., RENO, PA.
FILED 5-30-2002.



NO CLAIM IS MADE TO THE EXCLUSIVE RIGHT TO USE "INC", APART FROM THE MARK AS SHOWN.
FOR RETAIL STORE SERVICES FEATURING PROPANE GAS (U.S. CLS. 100, 101 AND 102).
FIRST USE 5-1-2002; IN COMMERCE 5-1-2002.

SN 78-133,004. GUERRERO BUSINESS SOLUTIONS, INC.,
LAKE WORTH, FL. FILED 6-4-2002.

W.A.R.P.

FOR PROMOTING THE INTERNET RELATED GOODS AND SERVICES OF OTHERS BY MEANS OF REFERRING SUBSCRIBING MEMBERS TO PREFERRED SERVICE PROVIDERS VIA AN ONLINE GLOBAL COMPUTER NETWORK (U.S. CLS. 100, 101 AND 102).

SN 78-136,666. MILLER, JACK, HENDERSON, NV. FILED 6-18-2002.

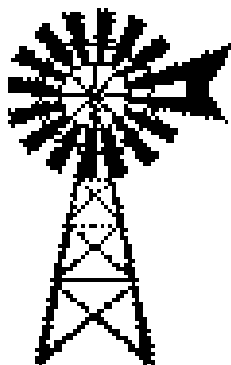

FOR OPERATING ON-LINE MARKETPLACES FOR SELLERS OF GOODS AND OR SERVICES (U.S. CLS. 100, 101 AND 102).
FIRST USE 3-21-2002; IN COMMERCE 7-1-2002.

CLASS 35—(Continued).

SN 78-137,827. XETA TECHNOLOGIES, INC., BROKEN ARROW, OK. FILED 6-21-2002.

XTRAMILE PARTNERSHIP

NO CLAIM IS MADE TO THE EXCLUSIVE RIGHT TO USE "PARTNERSHIP", APART FROM THE MARK AS SHOWN.

FOR CUSTOMER SERVICES IN THE FIELD OF COMMERCIAL TELECOMMUNICATIONS EQUIPMENT SYSTEMS (U.S. CLS. 100, 101 AND 102).
FIRST USE 10-0-2001; IN COMMERCE 10-0-2001.

SN 78-143,005. BRISTOL-MYERS SQUIBB COMPANY, NEW YORK, NY. FILED 7-11-2002.

TOGETHER WE WIN

FOR CORPORATE AND BUSINESS DEVELOPMENT SERVICES IN THE FIELD OF PHARMACEUTICALS; BUSINESS MARKETING CONSULTING SERVICES, NAMELY, DESIGNING AND IMPLEMENTING CUSTOMIZED MARKETING STRATEGIES FOR HEALTHCARE ORGANIZATIONS AND BUSINESSES THROUGH THE DISTRIBUTION OF PRINTED PROMOTIONAL MATERIALS, ORGANIZING PROGRAMS AND BY RENDERING SALES PROMOTION ADVICE (U.S. CLS. 100, 101 AND 102).

SN 78-144,229. THE THINKING BOX LTD, LONDON, UNITED KINGDOM, FILED 7-16-2002.

THE THINKING BOX

PRIORITY CLAIMED UNDER SEC. 44(D) ON UNITED KINGDOM APPLICATION NO. 2304141, FILED 7-1-2002, REG. NO. 2304141, DATED 7-1-2002, EXPIRES 7-1-2012.
FOR BUSINESS CONSULTATION (U.S. CLS. 100, 101 AND 102).

CLASS 35—(Continued).

SN 78-144,434. HENRY GROUP LTD., THE, WESTLAKE, OH. FILED 7-16-2002.

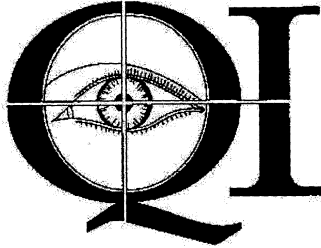

FOR MARKET RESEARCH; RESEARCH, NAMELY CONDUCTING SURVEYS VIA PANELS OF CONSUMERS OR BUSINESS OWNERS; ANALYTICAL SERVICES, NAMELY, MARKET DATA ANALYSIS; BUSINESS, DEMOGRAPHIC, BUSINESS MARKETING, AND DIRECT MAIL CONSULTING SERVICES; MARKETING OUTSOURCING SERVICES; AND DIRECT MARKETING ADVERTISING FOR OTHERS (U.S. CLS. 100, 101 AND 102).

SN 78-148,494. ONCE UPON A TOY, INC., EDWARDSVILLE, IL. FILED 7-29-2002.

ONCE UPON A TOY

NO CLAIM IS MADE TO THE EXCLUSIVE RIGHT TO USE "TOY", APART FROM THE MARK AS SHOWN.

FOR RETAIL STORE SERVICES FEATURING TOYS, GAMES, AND ARTS AND CRAFTS SUPPLIES (U.S. CLS. 100, 101 AND 102).

FIRST USE 10-0-1987; IN COMMERCE 10-0-1987.

SN 78-148,638. MANUCY, POLLY P, PALATKA, FL. FILED 7-30-2002.

COTTONCANDYINAJAR

FOR RETAIL STORE SERVICES FEATURING CANDY (U.S. CLS. 100, 101 AND 102).

SN 78-149,046. DASTMALCHI ENTERPRISES, INC., COSTA MESA, CA. FILED 7-30-2002.

MI DOCTOR

NO CLAIM IS MADE TO THE EXCLUSIVE RIGHT TO USE "DOCTOR", APART FROM THE MARK AS SHOWN.

THE FOREIGN WORDING IN THE MARK TRANSLATES INTO ENGLISH AS MY DOCTOR.

FOR DIRECT RESPONSE ADVERTISING IN THE FIELD OF MEDICAL SERVICES (U.S. CLS. 100, 101 AND 102).

FIRST USE 5-7-2002; IN COMMERCE 6-13-2002.

CLASS 35—(Continued).

SN 78-155,194. THE SPANISH ACTION COMMITTEE OF CHICAGO, CHICAGO, IL. FILED 8-16-2002.

SACC

FOR PROVIDING REFERRALS TO SOCIAL WORKERS; PROMOTING PUBLIC AWARENESS OF THE NEED TO REGISTER TO VOTE AND PROMOTING THE INTERESTS OF PUERTO RICAN ORGANIZATIONS (U.S. CLS. 100, 101 AND 102).

FIRST USE 6-12-1966; IN COMMERCE 6-12-1966.

SN 78-157,131. HOMER TLC, INC., CLAYMONT, DE. FILED 8-23-2002.

OUR JOB'S NOT DONE UNTIL YOURS IS

FOR RETAIL STORE SERVICES, MAIL ORDER CATALOG SERVICES, COMPUTERIZED ON-LINE RETAIL SERVICES AND ELECTRONIC CATALOG SERVICES ALL FEATURING GARDEN SUPPLIES AND TOOLS, LANDSCAPING SUPPLIES, LAWNMOWERS, PATIO FURNITURE AND HOME IMPROVEMENT ITEMS (U.S. CLS. 100, 101 AND 102).

FIRST USE 8-1-2002; IN COMMERCE 8-1-2002.

SN 78-158,694. THE CHOSEN ONE, PHILADELPHIA, PA. FILED 8-28-2002.

CHOSEN ONE

FOR MAIL ORDER SERVICES AND ONLINE RETAIL STORE SERVICES FEATURING AMULETS, CHARMS TALISMANS, JEWELRY, FIGURINES AND HERBAL REMEDIES (U.S. CLS. 100, 101 AND 102).

FIRST USE 4-1-2002; IN COMMERCE 4-1-2002.

SN 78-162,612. GAMEHOUSE, INC., SEATTLE, WA. FILED 9-10-2002.

COLLAPSE!

FOR LICENSING ELECTRONIC GAME SOFTWARE FOR PLAYING GAMES OVER COMPUTER NETWORKS (U.S. CLS. 100, 101 AND 102).

FIRST USE 11-0-2000; IN COMMERCE 11-0-2000.

CLASS 35—(Continued).

SN 78-163,256. PROENERGY SERVICES, LLC, SEDALIA, MO. FILED 9-12-2002.

PROVIDING THE PRO'S FOR THE ENERGY INDUSTRIES

NO CLAIM IS MADE TO THE EXCLUSIVE RIGHT TO USE ENERGY INDUSTRIES, APART FROM THE MARK AS SHOWN.

FOR BUSINESS MANAGEMENT SERVICES, NAMELY, MANAGING THE BUSINESS PROJECTS OF OTHERS IN THE ELECTRICAL GENERATION INDUSTRY (U.S. CLS. 100, 101 AND 102).
FIRST USE 5-21-2002; IN COMMERCE 5-21-2002.

SN 78-163,686. HARVEST MOON INTERNATIONAL, LLC, RALEIGH, NC. FILED 9-13-2002.



NO CLAIM IS MADE TO THE EXCLUSIVE RIGHT TO USE "AG CLASSIFIEDS ON-LINE", APART FROM THE MARK AS SHOWN.

FOR DISSEMINATION OF CLASSIFIED ADVERTISING FOR OTHERS VIA THE INTERNET; PROVIDING AN ON-LINE COMPUTERIZED SEARCHABLE DATABASE FEATURING THE CLASSIFIED ADVERTISEMENTS OF OTHERS (U.S. CLS. 100, 101 AND 102).

SN 78-167,264. INTERWEAVE CORPORATION, TAMPA, FL. FILED 9-24-2002.

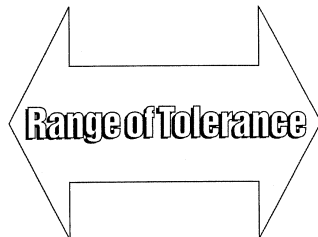

NO CLAIM IS MADE TO THE EXCLUSIVE RIGHT TO USE "RANGE OF TOLERANCE", APART FROM THE MARK AS SHOWN.

FOR PERFORMANCE MANAGEMENT BUSINESS CONSULTING (U.S. CLS. 100, 101 AND 102).
FIRST USE 9-10-2002; IN COMMERCE 9-10-2002.

CLASS 35—(Continued).

SN 78-168,241. ENGSTROM, INC., TWO RIVERS, WI. FILED 9-26-2002.

**YOUR TEAM + OUR TEAM -

----- = RESULTS**

FOR EMPLOYMENT AGENCY (U.S. CLS. 100, 101 AND 102).

SN 78-168,414. PERFUMBAY.COM, INC., LOS ANGELES, CA. FILED 9-26-2002.

PERFUME BAY

NO CLAIM IS MADE TO THE EXCLUSIVE RIGHT TO USE "PERFUME", APART FROM THE MARK AS SHOWN.

FOR INTERACTIVE RETAIL STORE SERVICES, RENDERED BY MEANS OF A GLOBAL COMPUTER INFORMATION NETWORK, FEATURING PERFUMES, TOILETRIES, BEAUTY CARE PRODUCTS, COSMETICS, PERSONAL CARE PRODUCTS, AND GIFT ITEMS, NOT INCLUDING PRODUCTS IN THE TELECOMMUNICATIONS FIELD (U.S. CLS. 100, 101 AND 102).
FIRST USE 10-30-1999; IN COMMERCE 10-30-1999.

SN 78-169,436. NICHEDIRECTORIES, LLC, BOCA RATON, FL. FILED 9-30-2002.

VENUESTAFF.COM

FOR PROVIDING ONLINE INFORMATION AND DIRECTORIES DIRECTED TO THE HOSPITALITY INDUSTRY IN THE FIELDS OF EMPLOYMENT, RECRUITMENT, JOB LISTINGS AND RESUMES, AND RESUME MATCHING SERVICES (U.S. CLS. 100, 101 AND 102).
FIRST USE 4-0-2002; IN COMMERCE 4-0-2002.

SN 78-171,103. BEBE STUDIO, INC., LOS ANGELES, CA. FILED 10-4-2002.

BEBESPORT.COM

FOR ON-LINE RETAIL STORE SERVICES FEATURING CLOTHING (U.S. CLS. 100, 101 AND 102).

CLASS 35—(Continued).

SN 78-178,348. COLEMAN METAL PRODUCTS COMPANY,
FORT WORTH, TX. FILED 10-25-2002.

SPA EXPO

NO CLAIM IS MADE TO THE EXCLUSIVE RIGHT TO
USE "SPA", APART FROM THE MARK AS SHOWN.

FOR RETAIL STORE SERVICES FEATURING SPAS
AND SPA ACCESSORIES AND SUPPLIES (U.S. CLS. 100,
101 AND 102).

SN 78-180,970. DOMINET, INC., HOUSTON, TX. FILED 11-1-
2002.

PROCUREAGENT

FOR MANAGING PROCESSES FOR PURCHASING,
FULFILLING AND MANAGING GOODS AND SER-
VICES OF OTHERS VIA A GLOBAL COMPUTER IN-
FORMATION NETWORK (U.S. CLS. 100, 101 AND 102).
FIRST USE 11-0-2001; IN COMMERCE 11-0-2001.

SN 78-181,785. SCHUYLER CENTER FOR ANALYSIS AND
ADVOCACY, INC., ALBANY, NY. FILED 11-5-2002.



NO CLAIM IS MADE TO THE EXCLUSIVE RIGHT TO
USE "NY", APART FROM THE MARK AS SHOWN.

FOR PROMOTING PUBLIC AWARENESS ABOUT THE
NEED FOR PUBLIC FUNDING OF EARLY CARE AND
EDUCATION OF CHILDREN BY INFORMING THE
PUBLIC AND LEGISLATURE ABOUT EARLY CARE
AND EDUCATION OF CHILDREN, AND ADVOCATING
FOR PUBLIC FUNDING OF EARLY CARE AND EDU-
CATION OF CHILDREN (U.S. CLS. 100, 101 AND 102).

FIRST USE 9-12-2002; IN COMMERCE 10-23-2002.

SN 78-182,010. CINEMANOW, INC., MARINA DEL REY, CA.
FILED 11-5-2002.

PATCHBAY

FOR LICENSING OF INTERNET PROTOCOL (IP)
BASED AUDIO, VIDEO, TEXT, IMAGE, MOVIE AND
MUSIC CONTENT DISTRIBUTION SYSTEMS (U.S. CLS.
100, 101 AND 102).

FIRST USE 3-0-2001; IN COMMERCE 3-0-2001.

CLASS 35—(Continued).

SN 78-183,764. FIRST CALL MEDICAL, INC., TULSA, OK.
FILED 11-11-2002.

YOUR STAFFING SOURCE

NO CLAIM IS MADE TO THE EXCLUSIVE RIGHT TO
USE "STAFFING SOURCE", APART FROM THE MARK AS
SHOWN.

FOR MEDICAL STAFFING SERVICES (U.S. CLS. 100,
101 AND 102).

SN 78-183,816. GROWMARK, INC., BLOOMINGTON, IL.
FILED 11-11-2002.

GROWMARK

OWNER OF U.S. REG. NOS. 1,206,667 AND 2,094,313.
FOR AGRICULTURAL COOPERATIVE SERVICES,
NAMELY, COOPERATIVE ADVERTISING AND MAR-
KETING SERVICES AND WHOLESALE AND RETAIL
DISTRIBUTORSHIPS OF AGRICULTURAL PRODUCTS
(U.S. CLS. 100, 101 AND 102).

FIRST USE 5-31-1981; IN COMMERCE 5-31-1981.

SN 78-184,392. INTERNATIONAL DX ASSOCIATION, CAT-
AWBA, SC. FILED 11-12-2002.

**INDEXA**

NO CLAIM IS MADE TO THE EXCLUSIVE RIGHT TO
USE "DX ASSOCIATION", "WORLD RADIO AMATEURS",
"DX", AND "FELLOWSHIP", APART FROM THE MARK AS
SHOWN.

SEC. 2(F) AS TO "INTERNATIONAL".
FOR ASSOCIATION SERVICES—NAMELY, PROMOT-
ING THE INTERESTS OF AMATEUR RADIO OPERA-
TORS (U.S. CLS. 100, 101 AND 102).

FIRST USE 6-1-1976; IN COMMERCE 6-1-1976.

CLASS 35—(Continued).

SN 78-184,508. RECOUPIT, INC., MECHANICSBURG, PA. FILED 11-13-2002.

recoupIT

FOR ON-LINE RETAIL STORE SERVICES FEATURING USED PERSONAL COMPUTERS AND USED EQUIPMENT RELATING TO PERSONAL COMPUTERS, NAMELY, COMPUTER MONITORS (U.S. CLS. 100, 101 AND 102).

FIRST USE 1-1-2002; IN COMMERCE 1-1-2002.

SN 78-184,520. CHRISTUS HEALTH, HOUSTON, TX. FILED 11-13-2002.

HEAVENLY CAREERS

NO CLAIM IS MADE TO THE EXCLUSIVE RIGHT TO USE "CAREERS", APART FROM THE MARK AS SHOWN.

FOR EMPLOYMENT COUNSELING AND RECRUITING; PERSONNEL RECRUITMENT, PLACEMENT, AND RELOCATION; EMPLOYMENT INFORMATION, NAMELY, EMPLOYEE RELATIONS INFORMATION SERVICES (U.S. CLS. 100, 101 AND 102).

FIRST USE 4-0-2002; IN COMMERCE 4-0-2002.

SN 78-185,710. SOUTHERN STRATEGY GROUP, INC., TALLAHASSEE, FL. FILED 11-15-2002.

SOUTHERN STRATEGY GROUP

NO CLAIM IS MADE TO THE EXCLUSIVE RIGHT TO USE "STRATEGY GROUP", APART FROM THE MARK AS SHOWN.

FOR PUBLIC RELATIONS CONSULTING SERVICES AND BUSINESS CONSULTING SERVICES IN THE FIELDS OF BUSINESS STRATEGIES, CORPORATE POSITIONING, LEGISLATIVE AFFAIRS, PUBLIC AFFAIRS, COMMUNITY AFFAIRS, MEDIA RELATIONS; AND GOVERNMENT RELATIONS SERVICES FOR OTHERS, NAMELY, PROVIDING LOBBYING SERVICES (U.S. CLS. 100, 101 AND 102).

FIRST USE 6-21-1999; IN COMMERCE 6-21-1999.

CLASS 35—(Continued).

SN 78-186,553. DISABILITY EMPOWERMENT GROUP, LLC, BONITA SPRINGS, FL. FILED 11-19-2002.

VIP DIRECTORY

NO CLAIM IS MADE TO THE EXCLUSIVE RIGHT TO USE "DIRECTORY", APART FROM THE MARK AS SHOWN.

FOR PROMOTING THE GOODS AND SERVICES OF BUSINESSES TO THE VISUALLY IMPAIRED, NAMELY PROVIDING TELEPHONE NUMBER LISTINGS AND ADVERTISING SERVICES TO BUSINESS SUBSCRIBERS THAT ALLOWS VISUALLY IMPAIRED PERSONS TO HEAR A BUSINESS PHONE NUMBER AND ADVERTISING INFORMATION BY CONTACTING THE SERVICE, AND REQUESTING THE PHONE NUMBER FOR A PARTICULAR TYPE OF BUSINESS RATHER THAN LOOKING UP PHONE NUMBERS IN A PRINTED DIRECTORY. (U.S. CLS. 100, 101 AND 102).

SN 78-186,591. A. VASTI, ELIZABETH, TAMPA, FL. FILED 11-19-2002.

THE MANAGER'S COACH

FOR BUSINESS CONSULTATION IN THE FIELDS OF PERSONAL DEVELOPMENT OR SELF-AWARENESS, AND MANAGEMENT EFFECTIVENESS (U.S. CLS. 100, 101 AND 102).

SN 78-186,755. CALIFORNIA STRAWBERRY COMMISSION, WATSONVILLE, CA. FILED 11-19-2002.

THE RED EDGE

FOR PROMOTING THE CALIFORNIA-GROWN STRAWBERRIES OF OTHERS THROUGH THE DISTRIBUTION OF PRINTED AND AUDIO PROMOTIONAL MATERIALS; ASSOCIATION SERVICES, NAMELY, PROMOTING THE INTEREST OF CALIFORNIA STRAWBERRY PRODUCERS THROUGH ADVERTISING AND PUBLIC AWARENESS CAMPAIGNS (U.S. CLS. 100, 101 AND 102).

SN 78-187,717. CASA DEL VINO LLC, TIJERAS, NM. FILED 11-21-2002.

CASA DEL VINO

NO CLAIM IS MADE TO THE EXCLUSIVE RIGHT TO USE "VINO", APART FROM THE MARK AS SHOWN.

THE ENGLISH TRANSLATION OF "CASA DEL VINO" IS "HOUSE OF THE WINE".

FOR MAIL ORDER SERVICES IN THE FIELD OF WINE ON A GLOBAL COMPUTER NETWORK (U.S. CLS. 100, 101 AND 102).

CLASS 35—(Continued).

SN 78-188,432. THE BRAINY BABY COMPANY, LLC, ALPHARETTA, GA. FILED 11-25-2002.

BRAINY KIDS

OWNER OF U.S. REG. NO. 2,315,020.
NO CLAIM IS MADE TO THE EXCLUSIVE RIGHT TO USE "KIDS", APART FROM THE MARK AS SHOWN.
FOR RETAIL SERVICES BY CATALOG, DIRECT SOLICITATION, THE INTERNET, AND BY RETAIL STANDS AND SHOPS FEATURING VIDEO TAPES, AUDIO CASSETTES, COMPACT DISCS, DIGITAL VIDEO DISCS, BOOKS, PAPER GOODS, GAMES, TOYS, AND CLOTHING FOR INFANTS AND CHILDREN (U.S. CLS. 100, 101 AND 102).

SN 78-190,535. GINN REAL ESTATE COMPANY, LLC, CELEBRATION, FL. FILED 12-3-2002.

DREAMSAMPLER

FOR REAL ESTATE MARKETING SERVICES, NAMELY, ADVERTISING AND PROMOTING THE SALES OF RESORT PROPERTIES THROUGH INCENTIVE VACATION PACKAGES TO ENTICE POTENTIAL PURCHASERS TO VISIT THE RESORT PROPERTIES (U.S. CLS. 100, 101 AND 102).
FIRST USE 8-1-2002; IN COMMERCE 9-9-2002.

SN 78-190,941. DETROIT REGIONAL CHAMBER, DETROIT, MI. FILED 12-4-2002.

DIGITAL DRIVE

FOR PROMOTING ECONOMIC DEVELOPMENT IN THE STATE OF MICHIGAN (U.S. CLS. 100, 101 AND 102).

SN 78-190,968. TECHNICAL AID CORPORATION, DEDHAM, MA. FILED 12-4-2002.

TECHNICALLY, THE BEST

FOR PROVIDING TEMPORARY CONTRACT WORKERS FOR EMPLOYMENT IN THE BUSINESSES OF OTHERS (U.S. CLS. 100, 101 AND 102).

SN 78-191,864. FRESH LOOK ADVERTISING OF ARIZONA CORPORATION, GLENDALE, AZ. FILED 12-6-2002.

SUPERCAN

FOR ADVERTISING AGENCY SERVICES, NAMELY, PROVIDING ADVERTISING SPACE ON TRASH RECEPTACLES (U.S. CLS. 100, 101 AND 102).
FIRST USE 12-2-2002; IN COMMERCE 12-2-2002.

CLASS 35—(Continued).

SN 78-193,154. KMG GROUP, INC., SEATTLE, WA. FILED 12-10-2002.

KUBLAZ

FOR RESTAURANT FRANCHISING (U.S. CLS. 100, 101 AND 102).
FIRST USE 10-12-2002; IN COMMERCE 10-12-2002.

SN 78-193,203. BIAS, INC., PHILADELPHIA, PA. FILED 12-11-2002.

BIAS

FOR RETAIL STORE SERVICES FEATURING CLOTHING AND HANDBAGS (U.S. CLS. 100, 101 AND 102).

SN 78-193,294. ON ASSIGNMENT, INC., CALABASAS, CA. FILED 12-11-2002.

PERX

FOR TEMPORARY EMPLOYMENT AGENCY SERVICES (U.S. CLS. 100, 101 AND 102).
FIRST USE 11-20-2002; IN COMMERCE 11-20-2002.

SN 78-193,399. PIGTAILS & CREWCUTS, LLC, ATLANTA, GA. FILED 12-11-2002.

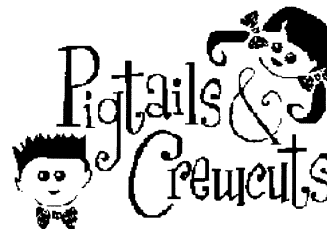

NO CLAIM IS MADE TO THE EXCLUSIVE RIGHT TO USE "PIGTALES & CREWCUTS" IN RELATION TO THE FRANCHISING SERVICES, NAMELY, PROVIDING TECHNICAL ASSISTANCE IN THE ESTABLISHMENT AND/OR OPERATION OF BUSINESSES THAT PROVIDE CHILDREN'S HAIR CARE, CUTTING AND STYLING SERVICES, APART FROM THE MARK AS SHOWN.

THE STIPPLING IS A FEATURE OF THE MARK AND IS NOT USED TO INDICATE COLORING.

FOR FRANCHISING SERVICES, NAMELY, PROVIDING TECHNICAL ASSISTANCE IN THE ESTABLISHMENT AND/OR OPERATION OF BUSINESSES THAT PROVIDE CHILDREN'S HAIR CARE, CUTTING, AND STYLING SERVICES AND CHILDREN'S PARTIES AND ENTERTAINMENT EVENTS; BUSINESS MANAGEMENT CONSULTATION (U.S. CLS. 100, 101 AND 102).

CLASS 35—(Continued).

SN 78-194,050. JD FINE & COMPANY, CONCORD, CA. FILED 12-12-2002.

THE PAJAMA FACTORY

NO CLAIM IS MADE TO THE EXCLUSIVE RIGHT TO USE "PAJAMA", APART FROM THE MARK AS SHOWN.
FOR WOMEN'S SLEEPWEAR RETAIL STORE (U.S. CLS. 100, 101 AND 102).
FIRST USE 11-7-2002; IN COMMERCE 11-7-2002.

SN 78-194,581. MARKLEY, KARIN, CHATSWORTH, CA. FILED 12-14-2002.

HIRING AMERICA'S HEROES

NO CLAIM IS MADE TO THE EXCLUSIVE RIGHT TO USE "HIRING", APART FROM THE MARK AS SHOWN.
FOR EMPLOYMENT OPPORTUNITY SERVICES, NAMELY PROVIDING A WEBSITE THAT FEATURE A DATABASE FOR DISCHARGED MILITARY PERSONNEL AND THEIR FAMILIES (U.S. CLS. 100, 101 AND 102).

SN 78-194,889. TELLEEN-LAWTON, DAVID, E., SANTA BARBARA, CA. FILED 12-16-2002.

DON'T SETTLE FOR GUESS

FOR BUSINESS CONSULTATION, NAMELY, CONSULTING SERVICES TO IMPROVE CLIENTS' UNDERSTANDING OF WHAT THE DEMAND IS FOR THEIR PRODUCT, EXISTING OR UNDER DEVELOPMENT, AND WHAT ACTIONS TO TAKE TO EFFECTIVELY DEVELOP A PROFITABLE BUSINESS MEETING THIS DEMAND (U.S. CLS. 100, 101 AND 102).
FIRST USE 3-1-2002; IN COMMERCE 3-1-2002.

SN 78-195,426. OVERGAAUW, JACE, L., NEWBURY PARK, CA. FILED 12-17-2002.

PASSAGE CONSULTING GROUP

NO CLAIM IS MADE TO THE EXCLUSIVE RIGHT TO USE "CONSULTING GROUP", APART FROM THE MARK AS SHOWN.
FOR BUSINESS MANAGEMENT CONSULTATION (U.S. CLS. 100, 101 AND 102).

CLASS 35—(Continued).

SN 78-196,493. NATIONAL HOT ROD ASSOCIATION, GLEN-DORA, CA. FILED 12-19-2002.

NITROMALL

FOR RETAIL STORE SERVICES AND ON-LINE RETAIL STORE SERVICES FEATURING APPAREL, ACCESSORIES, NOVELTIES RELATED TO AUTO RACING, DECALS, LOGOS, EMBLEMS, TOYS, BOOKS, GAMES, AND MODEL CARS (U.S. CLS. 100, 101 AND 102).
FIRST USE 2-1-2001; IN COMMERCE 2-1-2001.

CLASS 36—INSURANCE AND FINANCIAL

SN 75-277,277. CITIGROUP GLOBAL MARKETS INC., NEW YORK, NY. BY CHANGE OF NAME; BY MERGER; BY CHANGE OF NAME SMITH BARNABY INC., NEW YORK, NY. FILED 4-18-1997.

SMITH BARNEY CAPITAL ACCESS

OWNER OF U.S. REG. NOS. 1,986,596, 2,051,277 AND OTHERS.

NO CLAIM IS MADE TO THE EXCLUSIVE RIGHT TO USE "CAPITAL ACCESS", APART FROM THE MARK AS SHOWN.

FOR ON-LINE COMPUTER FINANCIAL AND INVESTMENT SERVICES, NAMELY, PROVIDING INFORMATION CONCERNING INVESTMENT BANKING, ASSET MANAGEMENT, CAPITAL MARKETS AND SECURITIES SALES AND TRADING (U.S. CLS. 100, 101 AND 102).

SN 75-770,653. NATIONAL COUNCIL ON COMPENSATION INSURANCE, INC., BOCA RATON, FL. FILED 8-6-1999.

DATA COMPANION

FOR PROVIDING AN ON-LINE COMPUTER DATABASE IN THE FIELD OF WORKERS COMPENSATION AND THE ABILITY TO MAKE, PROVIDE AND OBTAIN INFORMATION REGARDING, AND RECEIVE CUSTOMER SUPPORT REGARDING, AND RECEIVE CUSTOMER SUPPORT REGARDING WORKERS COMPENSATION INSURANCE CLAIMS VIA A GLOBAL COMPUTER INFORMATION NETWORK (U.S. CLS. 100, 101 AND 102).
FIRST USE 3-13-2000; IN COMMERCE 3-13-2000.

SN 75-776,930. MCG GLOBAL, LLC, WESTPORT, CT. FILED 8-16-1999.

MCG GLOBAL, LLC

NO CLAIM IS MADE TO THE EXCLUSIVE RIGHT TO USE "GLOBAL, LLC", APART FROM THE MARK AS SHOWN.

FOR PRIVATE MERCHANT BANKING SERVICES, NAMELY MANAGEMENT OF INVESTMENTS (U.S. CLS. 100, 101 AND 102).

CLASS 36—(Continued).

SN 75-815,863. HOSPITAL SERVICE ASSOCIATION OF NORTHEASTERN PENNSYLVANIA, DBA BLUE CROSS OF NORTHEASTERN PENNSYLVANIA, WILKES-BARRE, PA. FILED 10-5-1999.

FIRST POINT

FOR UNDERWRITING INSURANCE FOR PREPAID HEALTH CARE (U.S. CLS. 100, 101 AND 102).

SN 76-016,777. FEDERAL AGRICULTURAL MORTGAGE CORPORATION, WASHINGTON, DC. FILED 4-4-2000.

PART-TIME FARM

NO CLAIM IS MADE TO THE EXCLUSIVE RIGHT TO USE "FARM", APART FROM THE MARK AS SHOWN. SEC. 2(F).

FOR LOAN SERVICES, NAMELY AGRICULTURAL LOAN SERVICES (U.S. CLS. 100, 101 AND 102). FIRST USE 2-0-1998; IN COMMERCE 2-0-1998.

SN 76-065,103. CANADIAN IMPERIAL BANK OF COMMERCE, TORONTO, ONTARIO, CANADA, FILED 6-7-2000.

AMICUS CORP.

NO CLAIM IS MADE TO THE EXCLUSIVE RIGHT TO USE "CORP.", APART FROM THE MARK AS SHOWN.

FOR BANKING SERVICES PROVIDED AT AND THROUGH BANK LOCATIONS SITUATED IN RETAIL STORES, NAMELY CHECKING ACCOUNTS, SAVINGS ACCOUNTS, SALES AND REDEMPTIONS OF CERTIFICATES OF DEPOSIT, CREDIT CARD SERVICES, DEBIT CARD SERVICES, ATM SERVICES, HOME MORTGAGE LOANS, HOME EQUITY LOANS, AND AUTOMOBILE LOANS (U.S. CLS. 100, 101 AND 102).

CLASS 36—(Continued).

SN 76-154,058. NIPPONKOA SONGAI HOKEN KABUSHIKI KAISHA, TOKYO, JAPAN, BY CHANGE OF NAME NIHON KASAI KAIJO HOKEN KABUSHIKI KAISHA, CHUO-KU, TOKYO, JAPAN, FILED 10-25-2000.

日本興亜
NIPPONKOA

PRIORITY CLAIMED UNDER SEC. 44(D) ON JAPAN APPLICATION NO. 2000-74382, FILED 7-4-2000, REG. NO. 4511778, DATED 10-5-2001, EXPIRES 10-5-2011.

THE NON-LATIN CHARACTERS IN THE MARK MEANS "NIPPONKOA" IN ENGLISH.

FOR FINANCIAL SERVICES; NAMELY, LOAN FINANCING, TEMPORARY LOANS, MORTGAGE BANKING, MORTGAGE LENDING, MORTGAGE BROKERAGE; SECURITY SERVICES, NAMELY, GUARANTEED MONEY LOANS, BILL PAYMENT SERVICES; FINANCIAL SERVICES, NAMELY, LENDING MONEY AGAINST SECURITIES, SAFETY DEPOSIT BOX SERVICES FOR KEEPING SHARE AND STOCK CERTIFICATES, BONDS AND OTHER SECURITIES, PRECIOUS METALS AND OTHER ARTICLES; MONETARY EXCHANGE SERVICES; TRUST SERVICES, NAMELY, INVESTMENT AND TRUST COMPANY SERVICES; ESTATE TRUST MANAGEMENT; TRUSTEESHIP REPRESENTATIVES; AGENCIES IN THE FIELD OF BONDS; FOREIGN CURRENCY EXCHANGE SERVICES; LEASE PURCHASE FINANCING; LOAN FINANCING; COLLECTING AND PROCESSING BILL PAYMENTS ON BEHALF OF OTHERS, NAMELY, UTILITY BILLS SUCH AS GAS AND ELECTRICITY; BANKING SERVICES, NAMELY, SECURITIES TRADING FOR OTHERS; STOCK EXCHANGE PRICE QUOTATIONS; COMMODITIES EXCHANGE SERVICES; INSURANCE ADMINISTRATION; INSURANCE UNDERWRITING FOR ALL TYPES OF INSURANCE; ELECTRONIC PROCESSING OF INSURANCE CLAIMS AND PAYMENT DATA; INSURANCE AGENCY SERVICES; INSURANCE CONSULTATION; ACTUARIAL SERVICES; REAL ESTATE MANAGEMENT; LEASING OF REAL ESTATE; LEASING OF BUILDINGS, NAMELY, APARTMENTS, OFFICE SPACE, AND SHOPPING MALL SPACE; REAL ESTATE LISTING; REAL ESTATE ACQUISITION SERVICES; REAL ESTATE PROCUREMENT FOR OTHERS; REAL ESTATE TRUSTEE SERVICES; MARKETING LAND FOR OTHERS; REAL ESTATE APPRAISAL; LEASING OF REAL ESTATE; APPRAISAL OF ANTIQUES, WORKS OF ART AND JEWELRY; CREDIT RATING SERVICES; TAX PAYMENT PROCESSING SERVICES; CHARITABLE FUND RAISING SERVICES; AND FINANCIAL ANALYSIS AND CONSULTATION (U.S. CLS. 100, 101 AND 102).

SN 76-190,874. GENESYS CAPITAL PARTNERS INC., TORONTO, ONTARIO M5J 1S9, CANADA, FILED 1-8-2001.

GENESYS

OWNER OF CANADA REG. NO. 571417, DATED 11-28-2002, EXPIRES 11-28-2017.

FOR FINANCIAL INVESTMENT IN THE FIELD OF VENTURE CAPITAL, NAMELY, HIGH TECHNOLOGY AND BIOTECHNOLOGY COMPANIES (U.S. CLS. 100, 101 AND 102).

FIRST USE 5-13-2000; IN COMMERCE 6-0-2000.

CLASS 36—(Continued).

SN 76-316,697. INTERNATIONAL MEDICAL GROUP, INC.,
INDIANAPOLIS, IN. FILED 9-25-2001.

PATRIOT EXECUTIVE

NO CLAIM IS MADE TO THE EXCLUSIVE RIGHT TO
USE "EXECUTIVE", APART FROM THE MARK AS
SHOWN.

FOR DEVELOPING AND ADMINISTERING MEDI-
CAL AND TRAVEL INSURANCE PLANS THAT ARE
DIRECTED TOWARD INDIVIDUALS, FAMILIES AND
GROUPS LIVING AND TRAVELING INTERNATION-
ALLY (U.S. CLS. 100, 101 AND 102).

FIRST USE 1-0-1998; IN COMMERCE 1-0-1998.

SN 76-353,489. A SPECIAL WISH FOUNDATION, INC.,
DAYTON, OH. FILED 12-31-2001.



A SPECIAL WISH FOUNDATION, INC.

OWNER OF U.S. REG. NO. 1,462,214.

NO CLAIM IS MADE TO THE EXCLUSIVE RIGHT TO
USE "FOUNDATION, INC.", APART FROM THE MARK AS
SHOWN.

FOR CHARITABLE FUND RAISING TO GRANT THE
SPECIAL WISH OF A CHILD/ADOLESCENT, BIRTH
THROUGH 20 YEARS, WHO HAS BEEN DIAGNOSED
BY A PHYSICIAN WITH A LIFE THREATENING DIS-
ORDER (U.S. CLS. 100, 101 AND 102).

FIRST USE 1-15-2001; IN COMMERCE 1-15-2001.

SN 76-358,338. PROVIDENCE EQUITY PARTNERS INC.,
PROVIDENCE, RI. FILED 1-14-2002.

PROVIDENCEEQUITY

FOR FINANCIAL SERVICES, NAMELY SERVICES IN
THE FIELDS OF LEVERAGED BUYOUTS AND VEN-
TURE CAPITAL INVESTMENTS, PRIVATE INVEST-
MENT SERVICES, EQUITY CAPITAL MANAGEMENT,
FINANCIAL MANAGEMENT AND ADVISORY SER-
VICES AND FINANCIAL CONSULTANCY SERVICES
RELATED TO THE FOREGOING (U.S. CLS. 100, 101
AND 102).

FIRST USE 2-29-1996; IN COMMERCE 2-29-1996.

CLASS 36—(Continued).

SN 76-362,104. UNITED STUDENT AID FUNDS, INC.,
INDIANAPOLIS, IN. FILED 1-23-2002.

**USA FUNDS ACCESS TO
EDUCATION
SCHOLARSHIPS**

OWNER OF U.S. REG. NOS. 1,362,413 AND 2,023,878.

NO CLAIM IS MADE TO THE EXCLUSIVE RIGHT TO
USE "FUNDS ACCESS TO EDUCATION SCHOLARSHIPS",
APART FROM THE MARK AS SHOWN.

SEC. 2(F) AS TO "USA FUNDS".

FOR PROVIDING EDUCATIONAL SCHOLARSHIPS
(U.S. CLS. 100, 101 AND 102).

FIRST USE 1-2-2002; IN COMMERCE 1-2-2002.

SN 76-364,849. SUNTRUST BANKS, INC., ORLANDO, FL.
FILED 1-31-2002.

YOUCENTRIC

FOR FINANCIAL SERVICES, NAMELY FINANCIAL
CONSULTATION AND INVESTMENT ACCOUNT PLAN-
NING (U.S. CLS. 100, 101 AND 102).

FIRST USE 12-0-2001; IN COMMERCE 12-0-2001.

SN 76-371,278. NATIONWIDE MUTUAL INSURANCE COM-
PANY, COLUMBUS, OH. FILED 2-15-2002.

**NATIONWIDE FAMILY TRU
TRUST**

OWNER OF U.S. REG. NOS. 854,888, 2,371,088 AND
OTHERS.

NO CLAIM IS MADE TO THE EXCLUSIVE RIGHT TO
USE "FAMILY" AND "TRUST", APART FROM THE MARK
AS SHOWN.

FOR TRUST SERVICES, NAMELY, ESTATE TRUST
MANAGEMENT AND CONSULTATION OF INVEST-
MENT FOR TOTAL RETURN UNITRUSTS FOR AD-
DRESSING FAMILY WEALTH TRANSFER ISSUES (U.S.
CLS. 100, 101 AND 102).

FIRST USE 1-15-2002; IN COMMERCE 1-15-2002.

CLASS 36—(Continued).

SN 76-388,256. DEPARTMENT OF INSURANCE, COMMONWEALTH OF PENNSYLVANIA, HARRISBURG, PA. FILED 3-27-2002.



NO CLAIM IS MADE TO THE EXCLUSIVE RIGHT TO USE "ADULTBASIC" AND "HEALTH INSURANCE FOR ADULT PENNSYLVANIANS", APART FROM THE MARK AS SHOWN.

FOR OFFERING OF HEALTH CARE INSURANCE THROUGH PRIVATE COMPANIES FOR LOW INCOME ADULTS (U.S. CLS. 100, 101 AND 102).

CLASS 36—(Continued).

SN 76-405,596. WEALTH ADVISORY GROUP LLC, NEW YORK, NY. FILED 4-30-2002.



NO CLAIM IS MADE TO THE EXCLUSIVE RIGHT TO USE "WEALTH ADVISORY GROUP LLC", APART FROM THE MARK AS SHOWN.

FOR FINANCIAL PLANNING SERVICES, NAMELY, INSURANCE, ESTATE, RETIREMENT AND BUSINESS CONTINUITY PLANNING (U.S. CLS. 100, 101 AND 102). FIRST USE 12-15-2000; IN COMMERCE 12-15-2000.

SN 76-394,628. HILLSBOROUGH RIVER REALTY CORPORATION, CHICAGO, IL. FILED 4-12-2002.

HRRC

OWNER OF U.S. REG. NO. 2,525,549. FOR LEASING OF COMMERCIAL AND RETAIL REAL ESTATE (U.S. CLS. 100, 101 AND 102). FIRST USE 5-0-1999; IN COMMERCE 5-0-1999.

SN 76-402,532. GARTMORE INVESTMENT MANAGEMENT PLC, LONDON, ENGLAND, UNITED KINGDOM, FILED 5-1-2002.

ALPHAGEN CAELUM

OWNER OF UNITED KINGDOM REG. NO. 2292187, DATED 2-8-2002, EXPIRES 2-8-2009.

FOR FINANCIAL SERVICES, NAMELY, HEDGE FUND MANAGEMENT AND INVESTMENT SERVICES AND INVESTMENT MANAGEMENT (U.S. CLS. 100, 101 AND 102).

FIRST USE 2-8-2002; IN COMMERCE 2-8-2002.

SN 76-403,931. AXSYS NATIONAL BANK, SIOUX FALLS, SD. FILED 5-3-2002.

AXSYS CREDIT ADVANTAGE

OWNER OF U.S. REG. NOS. 2,488,447 AND 2,488,557. NO CLAIM IS MADE TO THE EXCLUSIVE RIGHT TO USE "CREDIT", APART FROM THE MARK AS SHOWN. FOR BANKING SERVICES AND CREDIT CARD SERVICES (U.S. CLS. 100, 101 AND 102). FIRST USE 5-14-1999; IN COMMERCE 5-14-1999.

SN 76-411,488. NATIONWIDE MUTUAL INSURANCE COMPANY, COLUMBUS, OH. FILED 5-20-2002.

NATIONWIDE PORTRAIT SERIES

OWNER OF U.S. REG. NOS. 854,888, 2,371,088 AND OTHERS.

FOR FINANCIAL SERVICES, NAMELY, LIFE INSURANCE AND ANNUITY UNDERWRITING, INVESTMENT MANAGEMENT AND DISTRIBUTION (U.S. CLS. 100, 101 AND 102).

FIRST USE 5-15-2002; IN COMMERCE 5-15-2002.

SN 76-412,632. MERCER MUTUAL INSURANCE COMPANY, PENNINGTON, NJ. FILED 5-22-2002.



NO CLAIM IS MADE TO THE EXCLUSIVE RIGHT TO USE "INSURANCE COMPANY", APART FROM THE MARK AS SHOWN.

THE NAME AND LIKENESS IN THE MARK DOES NOT IDENTIFY A LIVING INDIVIDUAL.

FOR INSURANCE UNDERWRITING AND ADMINISTRATION SERVICES FOR ALL TYPES OF INSURANCE; INSURANCE BROKERAGE; AND INSURANCE CLAIMS ADMINISTRATION (U.S. CLS. 100, 101 AND 102).

CLASS 36—(Continued).

SN 76-413,783. JUSTCHEX LLC, PORT HUENEME, CA. FILED 5-31-2002.

PUSH THE BUTTON

FOR FINANCIAL SERVICES, NAMELY, RE-PRESENTING AND COLLECTING NSF CHECKS RETURNED TO PAYEES, THE NSF FEE AND NSF BANK CHARGE FOR PAYEES BY OPERATING A WEBSITE TO ENTER THE NSF CHECK AND TO PROVIDE ON-LINE COLLECTION STATUS OF THE NSF CHECKS (U.S. CLS. 100, 101 AND 102).

SN 76-416,341. CASH PLUS, INC., TUSTIN, CA. FILED 6-3-2002.

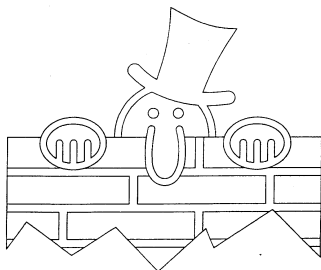

FOR CHECK CASHING SERVICES (U.S. CLS. 100, 101 AND 102).
FIRST USE 5-15-2002; IN COMMERCE 5-15-2002.

SN 76-419,844. WORD & BROWN INSURANCE ADMINISTRATORS, INC., ORANGE, CA. FILED 6-12-2002.

COBRAPRO

SEC. 2(F).
FOR ADMINISTRATION OF EMPLOYEE BENEFIT PLANS (U.S. CLS. 100, 101 AND 102).
FIRST USE 11-1-1995; IN COMMERCE 11-1-1995.

SN 76-424,396. NEW CENTURY FINANCIAL, INC., HOUSTON, TX. FILED 6-19-2002.

JUST IN TIME CASH

FOR PROVISION OF WORKING CAPITAL TO SMALL BUSINESSES MAINLY THROUGH ACCOUNTS RECEIVABLE FINANCING AND OTHER TYPES OF LOANS (U.S. CLS. 100, 101 AND 102).
FIRST USE 6-4-2002; IN COMMERCE 6-12-2002.

CLASS 36—(Continued).

SN 76-425,083. LIBERTY PROPERTY LIMITED PARTNERSHIP, MALVERN, PA. FILED 6-27-2002.

ONE PENNSYLVANIA PLAZA

FOR REAL ESTATE SERVICES, NAMELY, THE MANAGEMENT AND LEASING OF COMMERCIAL REAL ESTATE (U.S. CLS. 100, 101 AND 102).
FIRST USE 5-16-2001; IN COMMERCE 5-16-2001.

SN 76-425,624. RADIAN GROUP INC., PHILADELPHIA, PA. FILED 6-25-2002.

RADIAN LIEN PROTECTION

OWNER OF U.S. REG. NOS. 2,445,568, 2,513,095 AND 2,601,532.
NO CLAIM IS MADE TO THE EXCLUSIVE RIGHT TO USE "LIEN PROTECTION", APART FROM THE MARK AS SHOWN.
FOR MORTGAGE INSURANCE UNDERWRITING AND ADMINISTRATION (U.S. CLS. 100, 101 AND 102).
FIRST USE 10-0-2001; IN COMMERCE 10-0-2001.

SN 76-427,076. ASSOCIATES FIRST CAPITAL CORPORATION, IRVING, TX. FILED 7-2-2002.

ARCADIA FINANCIAL LTD.

NO CLAIM IS MADE TO THE EXCLUSIVE RIGHT TO USE "FINANCIAL LTD.", APART FROM THE MARK AS SHOWN.
FOR FINANCIAL SERVICES, NAMELY, CONSUMER LENDING SERVICES AND SERVICING LOANS AND EXTENSIONS OF CREDIT (U.S. CLS. 100, 101 AND 102).
FIRST USE 3-0-1990; IN COMMERCE 3-0-1990.

SN 76-427,522. TITLEVEST AGENCY, INC., NEW YORK, NY. FILED 7-5-2002.

TITLEVEST

FOR TITLE INSURANCE AGENCY OFFERING TITLE SERVICES TO ATTORNEYS AND REAL ESTATE PROFESSIONALS, INCLUDING VIA THE INTERNET (U.S. CLS. 100, 101 AND 102).
FIRST USE 11-0-2000; IN COMMERCE 11-0-2000.

SN 76-429,219. AMERICAN COMMUNITY MUTUAL INSURANCE COMPANY, LIVONIA, MI. FILED 7-11-2002.

AAGP

FOR INSURANCE UNDERWRITING SERVICES IN THE FIELD OF HEALTH CARE (U.S. CLS. 100, 101 AND 102).

CLASS 36—(Continued).

SN 76-432,209. GLOBE LIFE AND ACCIDENT INSURANCE COMPANY, OKLAHOMA CITY, OK. FILED 7-19-2002.

YOUNG AMERICAN PLAN

NO CLAIM IS MADE TO THE EXCLUSIVE RIGHT TO USE "PLAN", APART FROM THE MARK AS SHOWN.
SEC. 2(F).
FOR INSURANCE UNDERWRITING IN THE FIELD OF LIFE (U.S. CLS. 100, 101 AND 102).
FIRST USE 0-0-1973; IN COMMERCE 0-0-1973.

SN 76-434,032. ARGONAUT GROUP, INC., MENLO PARK, CA. FILED 7-25-2002.

ArgoVantage

FOR INSURANCE SERVICES, NAMELY, WORKERS' COMPENSATION INSURANCE FOR SMALL BUSINESSES AND PROVIDING ANCILLARY SERVICES THERETO; NAMELY, INSURANCE ADMINISTRATION (U.S. CLS. 100, 101 AND 102).

SN 76-434,199. ARGONAUT GROUP, INC., MENLO PARK, CA. FILED 7-25-2002.

ARGO VANTAGE

FOR INSURANCE SERVICES, NAMELY, WORKERS' COMPENSATION INSURANCE FOR SMALL BUSINESSES AND PROVIDING ANCILLARY SERVICES THERETO; NAMELY, INSURANCE ADMINISTRATION (U.S. CLS. 100, 101 AND 102).

SN 76-434,220. ARGONAUT GROUP, INC., MENLO PARK, CA. FILED 7-25-2002.

**ArgoVantage
ArgoVantage
ArgoVantage**

FOR INSURANCE SERVICES, NAMELY, WORKERS' COMPENSATION INSURANCE FOR SMALL BUSINESSES AND PROVIDING ANCILLARY SERVICES THERETO; NAMELY, INSURANCE ADMINISTRATION (U.S. CLS. 100, 101 AND 102).

CLASS 36—(Continued).

SN 76-434,453. KEARNS, JOHN F. III, WEST HARTFORD, CT. FILED 7-26-2002.

FINANCIAL SELF DEFENCE

NO CLAIM IS MADE TO THE EXCLUSIVE RIGHT TO USE "FINANCIAL", APART FROM THE MARK AS SHOWN.

FOR FINANCIAL ANALYSIS AND CONSULTATION FOR FINANCIAL PREPARATION FOR LONG TERM CARE OR CATASTROPHIC ILLNESS TO FAMILIES WITH AGING RELATIVES; ESTATE PLANNING (U.S. CLS. 100, 101 AND 102).
FIRST USE 1-0-2002; IN COMMERCE 1-0-2002.

SN 76-434,650. CAISSE DE DEPOT ET PLACEMENT DU QUEBEC, MONTREAL, QUEBEC H3A 3C7, CANADA, FILED 7-26-2002.

CDP CAPITAL-PRIVATE EQUITY

PRIORITY CLAIMED UNDER SEC. 44(D) ON CANADA APPLICATION NO. 1138476, FILED 4-23-2002.

NO CLAIM IS MADE TO THE EXCLUSIVE RIGHT TO USE "EQUITY", APART FROM THE MARK AS SHOWN.

FOR COUNSELLING SERVICES FOR PENSION FUNDS MANAGEMENT; PRIVATE PLACEMENT AND VENTURE CAPITAL INVESTMENT SERVICES; FINANCIAL MANAGEMENT SERVICES; REAL ESTATE INVESTMENT SERVICES; MORTGAGE LOANS AND FINANCING SERVICES; SECURIZATION SERVICES; MANAGEMENT SERVICES FOR REAL ESTATE INVESTMENT; FINANCING SERVICES FOR SPONSORED BUSINESSES WITHIN THE FIELD OF TECHNOLOGICAL INNOVATION; DEVELOPMENT OF INVESTMENT PORTFOLIO IN TECHNOLOGICAL INNOVATION BUSINESSES; INVESTMENT PORTFOLIO SERVICE; FINANCIAL ADVISES; INVESTMENT, SUPPORT AND FINANCING SERVICES FOR BUSINESSES; VENTURE CAPITAL AND VENTURE CAPITAL MANAGEMENT SERVICES; FINANCIAL CONSULTATION SERVICES; INVESTMENT SERVICES WITHIN THE CONTEXT OF AN ACCESS PROGRAM FOR FAMILY BUSINESSES; FINANCIAL SERVICES FOR BUSINESSES ESPECIALLY LOAN SERVICES, FINANCIAL COUNSELING, MONEY MARKET INVESTMENT SERVICES (U.S. CLS. 100, 101 AND 102).

CLASS 36—(Continued).

SN 76-434,655. CAISSE DE DEPOT ET PLACEMENT DU QUEBEC, MONTREAL, QUEBEC H3A 3C7, CANADA, FILED 7-26-2002.

CDP CAPITAL-REAL ESTATE GROUP

PRIORITY CLAIMED UNDER SEC. 44(D) ON CANADA APPLICATION NO. 1138463, FILED 4-23-2002.

NO CLAIM IS MADE TO THE EXCLUSIVE RIGHT TO USE "REAL ESTATE GROUP", APART FROM THE MARK AS SHOWN.

FOR COUNSELLING SERVICES FOR PENSION FUNDS MANAGEMENT; PRIVATE PLACEMENT AND VENTURE CAPITAL INVESTMENT SERVICES; FINANCIAL MANAGEMENT SERVICES; REAL ESTATE INVESTMENT SERVICES; MORTGAGE LOANS AND FINANCING SERVICES; SECURIZATION SERVICES; MANAGEMENT SERVICES FOR REAL ESTATE INVESTMENT; INVESTMENT PORTFOLIO SERVICE; FINANCIAL ADVISES; INVESTMENT, SUPPORT AND FINANCING SERVICES FOR BUSINESSES; VENTURE CAPITAL AND VENTURE CAPITAL MANAGEMENT SERVICES; FINANCIAL CONSULTATION SERVICES; INVESTMENT SERVICES WITHIN THE CONTEXT OF AN ACCESS PROGRAM FOR FAMILY BUSINESSES; FINANCIAL SERVICES FOR BUSINESSES ESPECIALLY LOAN SERVICES, FINANCIAL COUNSELING, MONEY MARKET INVESTMENT SERVICES (U.S. CLS. 100, 101 AND 102).

SN 76-434,659. CAISSE DE DEPOT ET PLACEMENT DU QUEBEC, MONTREAL, QUEBEC H3A 3C7, CANADA, FILED 7-26-2002.

CDP CAPITAL - ENTERTAINMENT

PRIORITY CLAIMED UNDER SEC. 44(D) ON CANADA APPLICATION NO. 1138470, FILED 4-23-2002.

FOR COUNSELLING SERVICES FOR PENSION FUNDS MANAGEMENT; PRIVATE PLACEMENT AND VENTURE CAPITAL INVESTMENT SERVICES; FINANCIAL MANAGEMENT SERVICES; REAL ESTATE INVESTMENT SERVICES; MORTGAGE LOANS AND FINANCING SERVICES; SECURIZATION SERVICES; MANAGEMENT SERVICES FOR REAL ESTATE INVESTMENT; FINANCING SERVICES FOR SPONSORED BUSINESSES WITHIN THE FIELD OF TECHNOLOGICAL INNOVATION; DEVELOPMENT OF INVESTMENT PORTFOLIO IN TECHNOLOGICAL INNOVATION BUSINESSES; INVESTMENT PORTFOLIO SERVICE; FINANCIAL ADVISES; INVESTMENT, SUPPORT AND FINANCING SERVICES FOR BUSINESSES; VENTURE CAPITAL AND VENTURE CAPITAL MANAGEMENT SERVICES; FINANCIAL CONSULTATION SERVICES; INVESTMENT SERVICES WITHIN THE CONTEXT OF AN ACCESS PROGRAM FOR FAMILY BUSINESSES; FINANCIAL SERVICES FOR BUSINESSES ESPECIALLY LOAN SERVICES, FINANCIAL COUNSELING, MONEY MARKET INVESTMENT SERVICES (U.S. CLS. 100, 101 AND 102).

CLASS 36—(Continued).

SN 76-434,677. CAISSE DE DEPOT ET PLACEMENT DU QUEBEC, MONTREAL, QC H3A 3C7, CANADA, FILED 7-26-2002.

CDP CAPITAL - COMMUNICATIONS

PRIORITY CLAIMED UNDER SEC. 44(D) ON CANADA APPLICATION NO. 1138460, FILED 4-23-2002.

FOR COUNSELLING SERVICES FOR PENSION FUNDS MANAGEMENT; PRIVATE PLACEMENT AND VENTURE CAPITAL INVESTMENT SERVICES; FINANCIAL MANAGEMENT SERVICES; REAL ESTATE INVESTMENT SERVICES; MORTGAGE LOANS AND FINANCING SERVICES; SECURIZATION SERVICES; MANAGEMENT SERVICES FOR REAL ESTATE INVESTMENT; FINANCING SERVICES FOR SPONSORED BUSINESSES WITHIN THE FIELD OF TECHNOLOGICAL INNOVATION; DEVELOPMENT OF INVESTMENT PORTFOLIO IN TECHNOLOGICAL INNOVATION BUSINESSES; INVESTMENT PORTFOLIO SERVICE; FINANCIAL ADVISES; INVESTMENT, SUPPORT AND FINANCING SERVICES FOR BUSINESSES; VENTURE CAPITAL AND VENTURE CAPITAL MANAGEMENT SERVICES; FINANCIAL CONSULTATION SERVICES; INVESTMENT SERVICES WITHIN THE CONTEXT OF AN ACCESS PROGRAM FOR FAMILY BUSINESSES; FINANCIAL SERVICES FOR BUSINESSES ESPECIALLY LOAN SERVICES, FINANCIAL COUNSELLING, MONEY MARKET INVESTMENT SERVICES (U.S. CLS. 100, 101 AND 102).

SN 76-440,460. NETWORK LIQUIDITY ACCEPTANCE COMPANY, LLC, OVERLAND PARK, KS. FILED 8-14-2002.

NLAC

FOR FINANCIAL SERVICES, NAMELY PURCHASING OF LOANS FROM CREDIT UNIONS, SECURITIZING LOANS, AND SALES OF LOAN PORTFOLIOS (U.S. CLS. 100, 101 AND 102).

FIRST USE 6-9-1998; IN COMMERCE 6-9-1998.

SN 76-442,555. LIPSCHITZ, BEN, DBA ELITE FINANCIAL SOLUTIONS, NEW YORK, NY. FILED 8-22-2002.

ELITE FINANCIAL SOLUTIONS

NO CLAIM IS MADE TO THE EXCLUSIVE RIGHT TO USE "FINANCIAL SOLUTIONS", APART FROM THE MARK AS SHOWN.

FOR FINANCIAL AND INSURANCE SERVICES, NAMELY, INVESTMENT AND INSURANCE PLANNING, PERSONAL FAMILY FINANCIAL PLANNING, STRATEGIC FINANCIAL PLANNING FOR BUSINESSES, ESTATE PRESERVATION PLANNING, ANNUITY BROKERAGE SERVICES, AND INSURANCE BROKERAGE SERVICES OF LIFE AND LONG TERM CARE INSURANCE FOR THE MATURE MARKET (U.S. CLS. 100, 101 AND 102).

FIRST USE 7-0-2002; IN COMMERCE 7-0-2002.

CLASS 36—(Continued).

SN 76-444,523. COMMERCE BANCSHARES, INC., KANSAS CITY, MO. FILED 8-28-2002.

COMMERCE CONNECTIONS

OWNER OF U.S. REG. NOS. 1,867,202, 2,651,328 AND OTHERS.

FOR BANKING SERVICES, NAMELY, ONLINE BANKING, PROVIDING ONLINE ACCOUNT INFORMATION, CASH MANAGEMENT, ELECTRONIC FUNDS TRANSFER AND WIRE TRANSFER OF FUNDS (U.S. CLS. 100, 101 AND 102).

FIRST USE 0-0-1988; IN COMMERCE 0-0-1988.

SN 76-444,843. XCOIN.COM LIMITED, SHEUNG WAN, HONG KONG, FILED 8-26-2002.

*How
Business
Pays*

FOR ELECTRONIC CASH TRANSACTION SERVICES RELATING TO FINANCIAL SERVICES- ELECTRONIC FUND-TRANSFER SERVICES; ELECTRONIC PAYMENT SETTLEMENT SERVICES NAMELY, ELECTRONIC PROCESSING AND TRANSMISSION OF BILL PAYMENT DATA; ELECTRONIC CREDIT CARD TRANSACTIONS; PROVISION OF ONLINE ELECTRONIC DATABASE IN THE FIELD OF PAYMENTS AND PAYMENT ADMINISTRATION; FINANCIAL SERVICES IN PROVIDING ACCOUNT MANAGEMENT SERVICES; PROVISION OF FINANCIAL INFORMATION, FINANCIAL PLANNING, FINANCIAL MANAGEMENT AND FINANCIAL REPORTS VIA GLOBAL COMPUTER SYSTEMS; CONSULTANCY AND ADVISORY SERVICES RELATING TO FINANCIAL SERVICES (U.S. CLS. 100, 101 AND 102).

SN 76-445,028. WELLS FARGO & COMPANY, MINNEAPOLIS, MN. FILED 8-29-2002.

EQUITYLINE WITH FLEXABILITY

OWNER OF U.S. REG. NOS. 1,265,252 AND 2,571,073. SEC. 2(F) AS TO "EQUITYLINE".
FOR BANKING SERVICES; MORTGAGE BANKING AND LENDING SERVICES (U.S. CLS. 100, 101 AND 102).

CLASS 36—(Continued).

SN 76-446,492. APARTMENT INVESTMENT AND MANAGEMENT COMPANY, DENVER, CO. FILED 9-4-2002.

AMERICA COMES HOME TO AIMCO

FOR MANAGEMENT OF RESIDENTIAL APARTMENT PROPERTIES AND OTHER PROPERTIES INCIDENTAL TO THE FOREGOING (U.S. CLS. 100, 101 AND 102).

SN 76-447,053. NORTHLAND SECURITIES, INC., MINNEAPOLIS, MN. FILED 9-3-2002.

NORTHLAND SECURITIES

NO CLAIM IS MADE TO THE EXCLUSIVE RIGHT TO USE "SECURITIES", APART FROM THE MARK AS SHOWN.

FOR FULL SERVICE SECURITIES BROKERAGE, NAMELY, BROKERAGE OF STOCKS, BONDS, MUTUAL FUNDS, AND OTHER SECURITIES; UNDERWRITING OF STOCKS AND BONDS; AND INVESTMENT BROKERAGE, CONSULTATION AND MANAGEMENT (U.S. CLS. 100, 101 AND 102).
FIRST USE 10-2-2002; IN COMMERCE 10-2-2002.

SN 76-447,735. EDUCATORS PERSONAL INSURANCE CENTER AGENCY, INC., APPLE VALLEY, MN. FILED 9-9-2002.

EDUCATORS PERSONAL INSURANCE CENTER

OWNER OF U.S. REG. NO. 2,074,763.
NO CLAIM IS MADE TO THE EXCLUSIVE RIGHT TO USE "PERSONAL INSURANCE CENTER", APART FROM THE MARK AS SHOWN.

SEC. 2(F).
FOR PROPERTY, CASUALTY, HOMEOWNER AND AUTOMOBILE INSURANCE AGENCY AND BROKERAGE SERVICES AND CLAIMS ADMINISTRATION (U.S. CLS. 100, 101 AND 102).
FIRST USE 6-4-1993; IN COMMERCE 6-4-1993.

SN 76-448,561. DOLEX DOLLAR EXPRESS, INC., ARLINGTON, TX. FILED 9-11-2002.

MERCADO EXPRESS

NO CLAIM IS MADE TO THE EXCLUSIVE RIGHT TO USE "EXPRESS", APART FROM THE MARK AS SHOWN.
THE ENGLISH TRANSLATION OF THE WORD "MERCADO" IN THE MARK IS "MARKET".

FOR FINANCIAL SERVICES, NAMELY, MONEY TRANSFER AND BANKING SERVICES AND DEBIT, CREDIT, CHECK AND PREPAID CARD SERVICES (U.S. CLS. 100, 101 AND 102).

CLASS 36—(Continued).

SN 76-448,562. DOLEX DOLLAR EXPRESS, INC., ARLINGTON, TX. FILED 9-11-2002.

CARTERA EXPRESS

NO CLAIM IS MADE TO THE EXCLUSIVE RIGHT TO USE "EXPRESS", APART FROM THE MARK AS SHOWN.

THE ENGLISH TRANSLATION OF THE WORD "CARTERA" IN THE MARK IS "PORTFOLIO".

FOR FINANCIAL SERVICES, NAMELY, MONEY TRANSFER AND BANKING SERVICES AND DEBIT, CREDIT, CHECK AND PREPAID CARD SERVICES (U.S. CLS. 100, 101 AND 102).

SN 76-455,714. SIMMONS, DANNY G., ARLINGTON, TX. FILED 10-3-2002.

FINANCIAL WOR_x

NO CLAIM IS MADE TO THE EXCLUSIVE RIGHT TO USE "FINANCIAL", APART FROM THE MARK AS SHOWN.

FOR FINANCIAL PLANNING SERVICES (U.S. CLS. 100, 101 AND 102).

SN 76-455,751. EPS SETTLEMENTS GROUP, INC., GREENWOOD VILLAGE, CO. FILED 9-30-2002.



FOR STRUCTURED SETTLEMENT SERVICES, NAMELY, DESIGNING AND BROKERING SETTLEMENTS OF LEGAL CLAIMS (U.S. CLS. 100, 101 AND 102).

FIRST USE 8-15-2002; IN COMMERCE 8-15-2002.

CLASS 36—(Continued).

SN 76-459,230. TAYLOR, BEAN & WHITAKER MORTGAGE CORPORATION, OCALA, FL. FILED 10-18-2002.



NO CLAIM IS MADE TO THE EXCLUSIVE RIGHT TO USE "COMMUNITY BANKS ONLINE", APART FROM THE MARK AS SHOWN.

FOR INTERNET BASED MORTGAGE LOAN ORIGINATION FOR COMMUNITY BANKS (U.S. CLS. 100, 101 AND 102).

FIRST USE 2-9-2001; IN COMMERCE 2-9-2001.

SN 76-460,123. PALOMINO CAPITAL MANAGEMENT, LLC, PITTSBURGH, PA. FILED 10-17-2002.

PALOMINO CAPITAL MANAGEMENT

NO CLAIM IS MADE TO THE EXCLUSIVE RIGHT TO USE "CAPITAL MANAGEMENT", APART FROM THE MARK AS SHOWN.

FOR FINANCIAL SERVICES, NAMELY, INVESTMENT ADVISORY SERVICES (U.S. CLS. 100, 101 AND 102).

SN 76-460,341. CHRISTIAN COMMUNITY CREDIT UNION, COVINA, CA. FILED 10-17-2002.

THE CARD THAT GIVES TO MISSIONS

FOR FINANCIAL SERVICES, NAMELY, CREDIT CARD AND DEBT CARD SERVICES AND CHARITABLE DONATION SERVICES, NAMELY, PHILANTHROPIC SERVICES CONCERNING MONETARY DONATIONS (U.S. CLS. 100, 101 AND 102).

FIRST USE 0-0-1993; IN COMMERCE 0-0-1993.

SN 76-460,355. MACDILL FEDERAL CREDIT UNION, TAMPA, FL. FILED 10-21-2002.



NO CLAIM IS MADE TO THE EXCLUSIVE RIGHT TO USE "FEDERAL CREDIT UNION", APART FROM THE MARK AS SHOWN.

FOR BANKING SERVICES; FINANCIAL SERVICES, NAMELY, MORTGAGE LENDING, CREDIT CARD SERVICES AND INSURANCE AGENCY SERVICES (U.S. CLS. 100, 101 AND 102).

FIRST USE 4-1-2000; IN COMMERCE 4-1-2000.

CLASS 36—(Continued).

SN 76-460,614. THE TRUSTEES OF THE RETAIL PROPERTY TRUST, A MASSACHUSETTS BUSINESS TRUST, THE TRUSTEES COMPRISING MELVIN SIMON, HERBERT SIMON, DAVID SIMON, RICHARD S. SOKOLOV, AND STEPHEN E. STERRETT, ALL U.S. CITIZENS, INDIANAPOLIS, IN. FILED 10-22-2002.

WALT WHITMAN MALL

OWNER OF U.S. REG. NO. 1,213,441.
NO CLAIM IS MADE TO THE EXCLUSIVE RIGHT TO USE "MALL", APART FROM THE MARK AS SHOWN.
FOR LEASING OF SPACE IN A SHOPPING CENTER AND SHOPPING CENTER SERVICES (U.S. CLS. 100, 101 AND 102).
FIRST USE 1-1-1962; IN COMMERCE 1-1-1962.

SN 76-461,453. LINCOLN FINANCIAL ADVISORS CORPORATION, HARTFORD, CT. FILED 10-17-2002.



OWNER OF U.S. REG. NO. 2,191,355.
NO CLAIM IS MADE TO THE EXCLUSIVE RIGHT TO USE "FINANCIAL ADVISORS", APART FROM THE MARK AS SHOWN.
FOR FINANCIAL SERVICES, NAMELY, FINANCIAL PLANNING SERVICES PROVIDED TO THIRD PARTIES THROUGH BANKS, CREDIT UNIONS, ACCOUNTANTS, ATTORNEYS AND ASSOCIATIONS (U.S. CLS. 100, 101 AND 102).
FIRST USE 10-4-2002; IN COMMERCE 10-4-2002.

SN 76-462,217. TRABON SOLUTIONS, L.L.C., KANSAS CITY, MO. FILED 10-28-2002.

DATA ASSOCIATES DIRECT

FOR CREDIT MANAGEMENT SERVICES, NAMELY, PROVIDING ON-LINE RETRIEVAL AND REVIEW OF CREDIT INFORMATION (U.S. CLS. 100, 101 AND 102).

SN 76-462,428. SUMITOMO MITSUI BANKING CORPORATION, NEW YORK, NY. FILED 10-23-2002.

E-MONEYGER TAX

OWNER OF U.S. REG. NO. 2,602,535.
NO CLAIM IS MADE TO THE EXCLUSIVE RIGHT TO USE "TAX", APART FROM THE MARK AS SHOWN.
FOR TAX PAYMENT PROCESSING SERVICES (U.S. CLS. 100, 101 AND 102).

CLASS 36—(Continued).

SN 76-462,488. NORTHLAND SECURITIES, INC., MINNEAPOLIS, MN. FILED 10-23-2002.



NO CLAIM IS MADE TO THE EXCLUSIVE RIGHT TO USE "SECURITIES", APART FROM THE MARK AS SHOWN.

FOR FULL SERVICE SECURITIES BROKERAGE, NAMELY, BROKERAGE OF STOCKS, BONDS, MUTUAL FUNDS, AND OTHER SECURITIES; UNDERWRITING OF STOCKS AND BONDS; AND INVESTMENT BROKERAGE, CONSULTATION AND MANAGEMENT (U.S. CLS. 100, 101 AND 102).
FIRST USE 10-2-2002; IN COMMERCE 10-2-2002.

SN 76-463,093. THE ROBERT WOOD JOHNSON FOUNDATION, PRINCETON, NJ. FILED 10-31-2002.

PATHS TO RECOVERY

FOR PROVIDING GRANTS TO SUBSTANCE ABUSE TREATMENT PROVIDERS (U.S. CLS. 100, 101 AND 102).

SN 76-467,549. K&K CONSULTING SERVICES, L.L.C., SEATTLE, WA. FILED 11-18-2002.

BETA

FOR INSURANCE BROKERAGE IN THE FIELD OF EDUCATIONAL TRAVEL (U.S. CLS. 100, 101 AND 102).
FIRST USE 10-15-2002; IN COMMERCE 10-15-2002.

SN 76-468,498. APPLIED UNDERWRITERS, INC., SAN FRANCISCO, CA. FILED 11-20-2002.



NO CLAIM IS MADE TO THE EXCLUSIVE RIGHT TO USE "UNDERWRITERS", APART FROM THE MARK AS SHOWN.

FOR FINANCIAL SERVICES FOR BUSINESS, NAMELY ADMINISTRATION OF INSURANCE AND EMPLOYEE BENEFIT PLANS FOR BUSINESS ORGANIZATIONS (U.S. CLS. 100, 101 AND 102).
FIRST USE 10-15-2002; IN COMMERCE 10-15-2002.

CLASS 36—(Continued).

SN 76-468,499. APPLIED UNDERWRITERS, INC., SAN FRANCISCO, CA. FILED 11-20-2002.

Equity
Comp

FOR FINANCIAL SERVICES FOR BUSINESS, NAMELY ADMINISTRATION OF INSURANCE AND EMPLOYEE BENEFIT PLANS FOR BUSINESS ORGANIZATIONS (U.S. CLS. 100, 101 AND 102).

FIRST USE 10-15-2002; IN COMMERCE 10-15-2002.

SN 76-470,050. FIRST TEAM REAL ESTATE - ORANGE COUNTY, COSTA MESA, CA. FILED 11-25-2002.

HOME BAZAAR

NO CLAIM IS MADE TO THE EXCLUSIVE RIGHT TO USE "HOME", APART FROM THE MARK AS SHOWN.

FOR REAL ESTATE BROKERAGE SERVICES AND REAL ESTATE LISTINGS; REAL ESTATE BROKERAGE SERVICES AND REAL ESTATE LISTINGS BY MEANS OF A GLOBAL COMPUTER NETWORK (U.S. CLS. 100, 101 AND 102).

SN 76-470,150. APPLIED UNDERWRITERS, INC., SAN FRANCISCO, CA. FILED 11-25-2002.

**APPLIED
EXPERIENCE.APPLIED
INTELLIGENCE**

FOR FINANCIAL SERVICES FOR BUSINESS, NAMELY ADMINISTRATION OF INSURANCE AND EMPLOYEE BENEFIT PLANS FOR BUSINESS ORGANIZATIONS (U.S. CLS. 100, 101 AND 102).

FIRST USE 10-15-2002; IN COMMERCE 10-15-2002.

SN 76-470,213. THE CREDIT PEOPLE COMPANY, HERNON, VA. FILED 11-26-2002.

**HIGH INTEREST IN PEOPLE,
LOW INTEREST ON LOANS**

FOR FINANCIAL SERVICES, NAMELY, CONSUMER LENDING AND MORTGAGE BROKERAGE (U.S. CLS. 100, 101 AND 102).

FIRST USE 10-28-2002; IN COMMERCE 10-28-2002.

CLASS 36—(Continued).

SN 76-470,474. FIRSTMERIT CORPORATION, AKRON, OH. FILED 11-27-2002.

**FIRSTMERIT MORTGAGE
CHECKING**

OWNER OF U.S. REG. NOS. 1,877,966, 2,404,243 AND OTHERS.

NO CLAIM IS MADE TO THE EXCLUSIVE RIGHT TO USE "MORTGAGE CHECKING", APART FROM THE MARK AS SHOWN.

FOR BANKING SERVICES (U.S. CLS. 100, 101 AND 102).

SN 76-470,653. THE RENT MAN, LLC, MCDONOUGH, GA. FILED 11-27-2002.

THE RENT MAN

FOR REAL ESTATE MANAGEMENT SERVICES, REAL ESTATE BROKERAGE SERVICES, REAL ESTATE LEASING SERVICES AND REAL PROPERTY LEASING SERVICES (U.S. CLS. 100, 101 AND 102).

SN 76-470,738. THE NEMOURS FOUNDATION, JACKSONVILLE, FL. FILED 11-27-2002.

NEMOURS

FOR CHARITABLE FUNDRAISING IN THE FIELDS OF HEALTH, MEDICAL, AND HOSPITAL CARE FOR INFANTS, CHILDREN, ADOLESCENTS, THE ELDERLY, AND THEIR FAMILIES, AND FOR EDUCATION AND RESEARCH IN SUCH FIELDS; FINANCIAL SPONSORSHIP OF EDUCATIONAL CONFERENCES IN THE FIELDS OF HEALTH CARE, MEDICINE, AND HUMAN WELFARE (U.S. CLS. 100, 101 AND 102).

FIRST USE 0-0-1949; IN COMMERCE 0-0-1949.

SN 76-470,845. FUN-RAISERS USA, LLC., ATLANTA, GA. FILED 11-21-2002.

**COMMON-THREADS
FUNDRAISING**

NO CLAIM IS MADE TO THE EXCLUSIVE RIGHT TO USE "FUNDRAISING", APART FROM THE MARK AS SHOWN.

FOR FUND RAISING SERVICES IN THE NATURE OF PROVIDING GOODS AND ORGANIZATIONAL STRUCTURE FOR ORGANIZATIONS TO SELL IN ORDER TO RAISE MONEY (U.S. CLS. 100, 101 AND 102).

FIRST USE 9-1-2000; IN COMMERCE 9-1-2000.

CLASS 36—(Continued).

SN 76-471,032. SECURITY BENEFIT LIFE INSURANCE COMPANY, TOPEKA, KS. FILED 11-29-2002.

**SECURITY ALPHA
OPPORTUNITY FUND**

OWNER OF U.S. REG. NOS. 1,505,125, 2,149,414 AND OTHERS.

NO CLAIM IS MADE TO THE EXCLUSIVE RIGHT TO USE "FUND", APART FROM THE MARK AS SHOWN.

FOR MUTUAL FUND INVESTMENT SERVICES (U.S. CLS. 100, 101 AND 102).

CLASS 36—(Continued).

SN 76-474,973. THE HUMANITIES FOUNDATION, INC., CHARLESTON, SC. FILED 12-3-2002.

SHELTERNET

FOR CHARITABLE FINANCIAL SERVICES, NAMELY, PROVIDING SHORT-TERM FINANCIAL ASSISTANCE TO LOW AND VERY LOW-INCOME INDIVIDUALS AND FAMILIES IN RESPECT OF MORTGAGE PAYMENTS, RENT, AND/OR UTILITIES (U.S. CLS. 100, 101 AND 102).

FIRST USE 1-1-1995; IN COMMERCE 1-1-1995.

SN 76-471,575. ALLEGIANCE REALTY, INC., GLENDALE, AZ. FILED 12-2-2002.

ALLEGIANCE REALTY

NO CLAIM IS MADE TO THE EXCLUSIVE RIGHT TO USE "REALTY", APART FROM THE MARK AS SHOWN.

FOR REAL ESTATE BROKERAGE, MANAGEMENT AND CONSULTING SERVICES (U.S. CLS. 100, 101 AND 102).

FIRST USE 4-1-1999; IN COMMERCE 4-1-1999.

SN 76-475,374. STRUCTURED PRODUCTS SYNDICATE, INC., NEW YORK, NY. FILED 12-13-2002.

**SPS STRUCTURED
PRODUCTS SYNDICATE**

NO CLAIM IS MADE TO THE EXCLUSIVE RIGHT TO USE "STRUCTURED PRODUCTS SYNDICATE", APART FROM THE MARK AS SHOWN.

FOR INSURANCE BROKERAGE, INSURANCE UNDERWRITING, NAMELY, FINANCIAL GUARANTEE AND SURETY AND INSURANCE CONSULTING SERVICES (U.S. CLS. 100, 101 AND 102).

SN 76-472,179. GREENWAY CENTER, L.L.C., KANSAS CITY, MO. FILED 12-3-2002.

GREENWAY STATION

FOR SHOPPING CENTER SERVICES, INCLUDING THE LEASING AND MANAGEMENT OF MALL SPACE TO DEPARTMENT STORES, SPECIALITY STORES, RETAILERS, RESTAURANTS, THEATERS, PARTIES PROVIDING SERVICES TO OTHERS AND MAIL DROP BOXES (U.S. CLS. 100, 101 AND 102).

SN 76-475,877. ON YOUR SIDE INC, DBA ON YOUR SIDE INC. FINANCIAL PLANNING GROUP, EL SEGUNDO, CA. FILED 12-17-2002.

SN 76-472,385. GLOBAL REMITTANCE NETWORK INC., TORONTO, ONTARIO, CANADA, FILED 12-4-2002.

GLOBALPETTYCASHBOX

FOR PETTY CASH PAYMENT SERVICE APPLICATION THAT USES STORED VALUE CARDS AND PROVIDES DETAILED EXPENDITURE REPORTS ON A REAL TIME OR PERIOD BASIS AS REQUESTED BY THE PAYOR (U.S. CLS. 100, 101 AND 102).

NO CLAIM IS MADE TO THE EXCLUSIVE RIGHT TO USE "INC." AND "FINANCIAL PLANNING GROUP", APART FROM THE MARK AS SHOWN.

THE STIPPLING IN THE DRAWING IS FOR SHADING PURPOSES ONLY.

FOR INVESTMENT CONSULTATION AND FINANCIAL PLANNING (U.S. CLS. 100, 101 AND 102).

FIRST USE 3-1-2002; IN COMMERCE 3-1-2002.



CLASS 36—(Continued).

SN 76-476,336. PUBLIC EMPLOYEES RETIREMENT SYSTEM OF OHIO, COLUMBUS, OH. FILED 12-18-2002.



FOR ADMINISTRATION OF EMPLOYEE BENEFIT PLANS (U.S. CLS. 100, 101 AND 102).

SN 76-479,755. NATIONWIDE LIFE INSURANCE COMPANY, COLUMBUS, OH. FILED 1-2-2003.

**PROTECTION,
PERFORMANCE AND
CHOICE**

FOR INSURANCE UNDERWRITING SERVICES IN THE FIELDS OF LIFE, ANNUITIES AND PENSIONS AND MUTUAL FUND BROKERAGE SERVICES (U.S. CLS. 100, 101 AND 102).

SN 76-479,760. NATIONWIDE MUTUAL INSURANCE COMPANY, COLUMBUS, OH. FILED 1-2-2003.

**NATIONWIDE LEGACY
PROVIDER UNIVERSAL LIFE**

OWNER OF U.S. REG. NO. 2,017,147.
NO CLAIM IS MADE TO THE EXCLUSIVE RIGHT TO USE "UNIVERSAL LIFE", APART FROM THE MARK AS SHOWN.

FOR FINANCIAL SERVICES NAMELY UNDERWRITING, DISTRIBUTION AND BROKERAGE OF LIFE INSURANCE AND ANNUITIES AND THE DISTRIBUTION AND BROKERAGE OF MUTUAL FUNDS (U.S. CLS. 100, 101 AND 102).

SN 76-481,096. METROPOLITAN NATIONAL BANK, NEW YORK, NY. FILED 1-9-2003.

METBANK

OWNER OF U.S. REG. NO. 2,617,141.
FOR BANKING SERVICES (U.S. CLS. 100, 101 AND 102).
FIRST USE 5-12-1998; IN COMMERCE 6-22-1999.

CLASS 36—(Continued).

SN 76-482,455. EVANGELICAL FREE CHURCH OF AMERICA, BLOOMINGTON, MN. FILED 1-15-2003.

EFCA

FOR CHARITABLE FUND RAISING SERVICES (U.S. CLS. 100, 101 AND 102).
FIRST USE 1-9-1973; IN COMMERCE 1-9-1973.

SN 76-492,416. ROESENER, REGINA, DENVER, CO. AND PETRELLI, ANTHONY B., DENVER, CO. FILED 2-14-2003.

POETRI

FOR INVESTMENT BANKING SERVICES (U.S. CLS. 100, 101 AND 102).

SN 76-504,346. NORTH SOUND CAPITAL LLC, OLD GREENWICH, CT. FILED 4-8-2003.

NORTH SOUND

FOR FINANCIAL AND INVESTMENT ADVISORY SERVICES AND INVESTMENT FUND SERVICES (U.S. CLS. 100, 101 AND 102).
FIRST USE 3-18-2003; IN COMMERCE 4-1-2003.

SN 76-975,013. GENERAL RE CORPORATION, STAMFORD, CT. FILED 1-10-2001.

**Gen Re
Securities**

OWNER OF U.S. REG. NOS. 1,219,926, 2,064,414 AND OTHERS.

NO CLAIM IS MADE TO THE EXCLUSIVE RIGHT TO USE "SECURITIES", APART FROM THE MARK AS SHOWN.

FOR FINANCIAL RISK MANAGEMENT SERVICES, NAMELY, RISK MANAGEMENT IN THE FIELDS OF INTEREST RATES, CURRENCY, EQUITY, AND CREDIT; FINANCIAL ANALYSIS SERVICES; INVESTMENT ADVICE, ANALYSIS AND MANAGEMENT; CAPITAL MANAGEMENT; ASSET AND LIABILITY MANAGEMENT; SECURITIES AND DERIVATIVES BROKERAGE SERVICES; FINANCIAL PLANNING AND INVESTMENT SERVICES; PROVIDING INFORMATION VIA THE INTERNET IN THE FIELD OF FINANCIAL INVESTMENTS (U.S. CLS. 100, 101 AND 102).
FIRST USE 12-30-2000; IN COMMERCE 12-30-2000.

CLASS 36—(Continued).

SN 78-059,894. UNIPAC SERVICE CORPORATION, AURORA, CO. FILED 4-23-2001.

KWIKPAY

OWNER OF U.S. REG. NO. 1,927,626.
FOR ELECTRONIC PAYMENT, NAMELY, ELECTRONIC PROCESSING AND TRANSMISSION OF STUDENT LOAN DATA (U.S. CLS. 100, 101 AND 102).
FIRST USE 6-28-1994; IN COMMERCE 6-28-1994.

SN 78-127,937. MIDCOUNTRY FINANCIAL CORP., MACKON, GA. FILED 5-10-2002.

MIDCOUNTRY MORTGAGE

NO CLAIM IS MADE TO THE EXCLUSIVE RIGHT TO USE "MORTGAGE", APART FROM THE MARK AS SHOWN.

FOR MORTGAGE SERVICES, NAMELY, MORTGAGE BANKING SERVICES, MORTGAGE BROKERAGE SERVICES, MORTGAGE LENDER SERVICES, MORTGAGE PROCUREMENT FOR OTHERS, MAINTAINING MORTGAGE ESCROW ACCOUNTS, FINANCIAL ANALYSIS AND CONSULTATION, FINANCIAL INFORMATION IN THE NATURE OF RATES OF EXCHANGE, FINANCIAL INFORMATION PROCESSING, FINANCIAL MANAGEMENT, FINANCIAL PLANNING, FINANCIAL PORTFOLIO MANAGEMENT, FINANCIAL RESEARCH, FINANCIAL SERVICES IN THE NATURE OF AN INVESTMENT SECURITY, MONEY LENDING, INVESTMENT FUND TRANSFER AND TRANSACTION SERVICES AND FINANCIAL VALUATION OF PERSONAL PROPERTY AND REAL ESTATE (U.S. CLS. 100, 101 AND 102).

SN 78-127,940. MIDCOUNTRY FINANCIAL CORP., MACKON, GA. FILED 5-10-2002.

MIDCOUNTRY INVESTMENTS

NO CLAIM IS MADE TO THE EXCLUSIVE RIGHT TO USE "INVESTMENTS", APART FROM THE MARK AS SHOWN.

FOR INVESTMENT SERVICES, NAMELY, INVESTMENT MANAGEMENT, INVESTMENT CONSULTATION, INVESTMENT ADVICE, INVESTMENT OF FUNDS FOR OTHERS, DISTRIBUTION OF ANNUITIES, INVESTMENT FUND TRANSFER AND TRANSACTION SERVICES, INVESTMENT BROKERAGE AND INVESTMENT CLUB SERVICES, FINANCIAL SERVICES IN THE NATURE OF AN INVESTMENT SECURITY, TRUST SERVICES, NAMELY, INVESTMENT AND TRUST COMPANY SERVICES, FINANCIAL ANALYSIS AND CONSULTATION, FINANCIAL INFORMATION IN THE NATURE OF RATES OF EXCHANGE, FINANCIAL INFORMATION PROCESSING, FINANCIAL MANAGEMENT, FINANCIAL PLANNING, FINANCIAL PORTFOLIO MANAGEMENT, FINANCIAL RESEARCH, FINANCIAL SERVICES IN THE NATURE OF AN INVESTMENT SECURITY, MONEY LENDING, INVESTMENT FUND TRANSFER AND TRANSACTION SERVICES AND FINANCIAL VALUATION OF PERSONAL PROPERTY AND REAL ESTATE (U.S. CLS. 100, 101 AND 102).

CLASS 36—(Continued).

SN 78-130,971. RADIOLOGICAL SOCIETY OF NORTH AMERICA, INC., OAK BROOK, IL. FILED 5-24-2002.

FUNDING RADIOLOGY'S FUTURE

FOR CHARITABLE SERVICES, NAMELY, RAISING FUNDS FOR THE AWARDING OF RESEARCH AND EDUCATIONAL GRANTS AND AWARDS IN THE FIELD OF RADIOLOGY (U.S. CLS. 100, 101 AND 102).

SN 78-136,087. MARKETWATCH.COM, INC., SAN FRANCISCO, CA. FILED 6-15-2002.

MARKETWATCH.COM

FOR PROVIDING INFORMATION IN THE FIELD OF INVESTMENT AND FINANCE VIA THE INTERNET, COMPUTER NETWORKS AND GLOBAL COMMUNICATION NETWORKS; PROVIDING AN ON-LINE COMPUTER DATABASE IN THE FIELD OF INVESTMENT AND FINANCE (U.S. CLS. 100, 101 AND 102).

SN 78-136,092. MARKETWATCH.COM, INC., SAN FRANCISCO, CA. FILED 6-15-2002.

MARKETWATCH

FOR PROVIDING INFORMATION IN THE FIELD OF INVESTMENT AND FINANCE VIA THE INTERNET, COMPUTER NETWORKS AND GLOBAL COMMUNICATION NETWORKS; PROVIDING AN ON-LINE COMPUTER DATABASE IN THE FIELD OF INVESTMENT AND FINANCE (U.S. CLS. 100, 101 AND 102).

SN 78-141,872. MIROMAR DEVELOPMENT CORPORATION, BONITA SPRINGS, FL. FILED 7-8-2002.

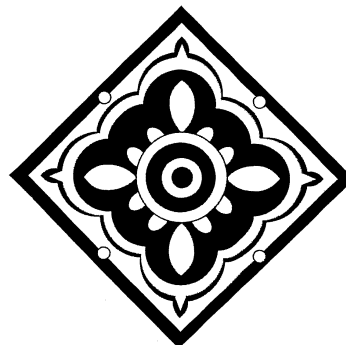

FOR SHOPPING CENTER SERVICES AND LEASING OF SHOPPING MALL SPACE (U.S. CLS. 100, 101 AND 102).

FIRST USE 8-0-1998; IN COMMERCE 8-0-1998.

CLASS 36—(Continued).

SN 78-141,904. FINANCIAL FOUNDRY LLC, PENNINGTON, NJ. FILED 7-8-2002.

BIDFUNDS

FOR PROVIDING ONLINE FINANCIAL INVESTMENT SERVICES IN THE FIELD OF SECURITIES (U.S. CLS. 100, 101 AND 102).

SN 78-143,501. F.N.B. CORPORATION, HERMITAGE, PA. FILED 7-12-2002.

INFITECH

FOR BANKING SERVICES; FINANCIAL SERVICES IN THE NATURE OF AN INVESTMENT SECURITY; FINANCIAL INFORMATION IN THE NATURE OF RATES OF EXCHANGE, FINANCIAL EXCHANGE, FINANCIAL FORECASTING AND FINANCIAL GUARANTEE AND SURETY; FINANCIAL INFORMATION PROVIDED BY ELECTRONIC MEANS; FINANCIAL MANAGEMENT; FINANCIAL PLANNING; FINANCIAL PORTFOLIO MANAGEMENT; FINANCIAL RESEARCH; FINANCIAL VALUATION OF PERSONAL PROPERTY AND REAL ESTATE; LOAN FINANCING; LEASE-PURCHASE FINANCING; FINANCING SERVICES; INVESTMENT SERVICES, NAMELY INVESTMENT BROKERAGE; CAPITAL INVESTMENT CONSULTATION; COMMODITY INVESTMENT ADVICE; FUND INVESTMENT CONSULTATION; INVESTMENT CONSULTATION; FINANCIAL INVESTMENT IN THE FIELD OF SECURITIES; FUNDS INVESTMENT; MUTUAL FUNDS INVESTMENT; REAL ESTATE INVESTMENT; COMMODITY INVESTMENT ADVICE; INVESTMENT ADVICE INVESTMENT BROKERAGE; INVESTMENT CLUBS; CAPITAL INVESTMENT CONSULTATION; INVESTMENT MANAGEMENT; MAINTAINING ESCROW ACCOUNTS FOR INVESTMENTS; INVESTMENT OF FUNDS FOR OTHERS; INSURANCE SERVICES, NAMELY INSURANCE UNDERWRITING, BROKERAGE AND EXTENDED WARRANTY CONTRACTS IN THE FIELDS OF LIFE, HEALTH, ACCIDENT, FIRE, MARINE, MEDICAL AND PRE-PAID HEALTH CARE AND LEGAL SERVICES; INSURANCE ADMINISTRATION IN THE FIELD OF LIFE, HEALTH, ACCIDENT, FIRE, MARINE, MEDICAL AND PRE-PAID HEALTH CARE AND LEGAL SERVICES; INSURANCE AGENCIES IN THE FIELDS OF LIFE, HEALTH, ACCIDENT, FIRE, MARINE, MEDICAL AND PRE-PAID HEALTH CARE AND LEGAL SERVICES; APPRAISALS FOR INSURANCE CLAIMS OF PERSONAL PROPERTY AND REAL ESTATE; INSURANCE BROKERAGE, CONSULTATION, SUBROGATION AND ACTUARIAL SERVICES IN THE FIELDS OF LIFE, HEALTH, ACCIDENT, FIRE, MARINE, MEDICAL AND PRE-PAID HEALTH CARE AND LEGAL SERVICES; AND PROVIDING FINANCIAL, INVESTMENT AND INSURANCE INFORMATION SERVICES PROVIDED VIA A GLOBAL COMPUTER NETWORK (U.S. CLS. 100, 101 AND 102).

SN 78-158,877. BRAZOS HIGHER EDUCATION SERVICE CORP., AUSTIN, TX. FILED 8-28-2002.

AFFORDIAN

FOR EDUCATIONAL LOANS SERVICES (U.S. CLS. 100, 101 AND 102).

CLASS 36—(Continued).

SN 78-163,493. BANCASA INTERNATIONAL CORPORATION, PEMBROKE PINES, FL. FILED 9-12-2002.

FOR APPRAISAL FOR INSURANCE CLAIMS OF REAL ESTATE; FINANCIAL VALUATION OF PERSONAL PROPERTY AND REAL ESTATE, LEASING OF REAL ESTATE, REAL ESTATE AGENCIES, REAL ESTATE APPRAISALS, LAND ACQUISITION, NAMELY, REAL ESTATE BROKERAGE, REAL ESTATE EQUITY SHARING, NAMELY, MANAGING AND ARRANGING FOR CO-OWNERSHIP OF REAL ESTATE, REAL ESTATE ESCROW SERVICES, REAL ESTATE INVESTMENT, REAL ESTATE LISTING, REAL ESTATE MANAGEMENT, REAL ESTATE SYNDICATION, REAL ESTATE TIME-SHARING, VACATION REAL ESTATE TIME-SHARING, REAL ESTATE TRUSTEE SERVICES (U.S. CLS. 100, 101 AND 102).

FIRST USE 10-1-1997; IN COMMERCE 10-1-1997.

SN 78-167,012. K-GROUP HOLDINGS INC., MIAMI, FL. FILED 9-23-2002.

METROPICA REALTY

NO CLAIM IS MADE TO THE EXCLUSIVE RIGHT TO USE "REALTY", APART FROM THE MARK AS SHOWN.

FOR REAL ESTATE BROKERAGE (U.S. CLS. 100, 101 AND 102).

SN 78-169,562. TRUDENTAL, COWAN HEIGHTS, CA. FILED 10-1-2002.

DENTAL BENEFITS WITH A NEW DIRECTION.

FOR DENTAL BENEFITS IN THE NATURE OF DENTAL HEALTH INSURANCE UNDERWRITING AND ADMINISTRATION RELATED TO DENTAL HEALTH CARE (U.S. CLS. 100, 101 AND 102).

CLASS 36—(Continued).

SN 78-173,467. NAUTILUS INSURANCE COMPANY, SCOTTSDALE, AZ. FILED 10-11-2002.

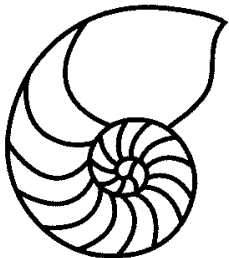
**Nautilus Insurance Company**

OWNER OF U.S. REG. NOS. 1,997,152, 2,028,532 AND 2,029,895.

NO CLAIM IS MADE TO THE EXCLUSIVE RIGHT TO USE "INSURANCE COMPANY ", APART FROM THE MARK AS SHOWN.

FOR INSURANCE ADMINISTRATION, INSURANCE CLAIMS ADMINISTRATION, INSURANCE CLAIMS PROCESSING, INSURANCE UNDERWRITING IN THE FIELDS OF LIFE INSURANCE AND ANNUITIES, PROPERTY AND CASUALTY, REINSURANCE, COMMERCIAL, EXCESS AND SURPLUS LINES (U.S. CLS. 100, 101 AND 102).

FIRST USE 10-0-2001; IN COMMERCE 10-0-2001.

SN 78-174,561. SWEENEY, ROSALINA, LYNNFIELD, MA. FILED 10-15-2002.



NO CLAIM IS MADE TO THE EXCLUSIVE RIGHT TO USE "REAL ESTATE", APART FROM THE MARK AS SHOWN.

FOR REAL ESTATE AGENCY (U.S. CLS. 100, 101 AND 102).

FIRST USE 3-27-2002; IN COMMERCE 4-30-2002.

SN 78-175,796. WACHOVIA CORPORATION, CHARLOTTE, NC. FILED 10-18-2002.

**EXPRESS ACCESS
CHECKING**

NO CLAIM IS MADE TO THE EXCLUSIVE RIGHT TO USE "CHECKING", APART FROM THE MARK AS SHOWN.

FOR BANKING SERVICES, NAMELY- CHECKING ACCOUNTS (U.S. CLS. 100, 101 AND 102).

CLASS 36—(Continued).

SN 78-182,177. BANK OF AMERICA CORPORATION, CHARLOTTE, NC. FILED 11-6-2002.

INDEX EAGLES

OWNER OF U.S. REG. NOS. 1,464,844, 2,378,630 AND OTHERS.

NO CLAIM IS MADE TO THE EXCLUSIVE RIGHT TO USE "INDEX", APART FROM THE MARK AS SHOWN.

FOR FINANCIAL AND INVESTMENT SERVICES, NAMELY, ISSUING, BROKERING AND UNDERWRITING UNSECURED SENIOR DEBT SECURITIES AND EQUITY DERIVATIVE SECURITIES (U.S. CLS. 100, 101 AND 102).

SN 78-184,736. PACE, NATALIE, W, SANTA MONICA, CA. FILED 11-13-2002.

MEMBER MOSAIC

NO CLAIM IS MADE TO THE EXCLUSIVE RIGHT TO USE "MEMBER", APART FROM THE MARK AS SHOWN.

FOR PROVIDING FINANCIAL INVESTMENT INFORMATION TO INTERNET WEBSITE MEMBERS (U.S. CLS. 100, 101 AND 102).

SN 78-189,133. CCC INFORMATION SERVICES INC., CHICAGO, IL. FILED 11-26-2002.

CCC VALUESCOPE

OWNER OF U.S. REG. NOS. 1,637,820 AND 2,013,714.
FOR TOTAL LOSS CLAIMS SETTLEMENT SERVICES OFFERED DIRECTLY AND OVER THE INTERNET TO THE AUTOMOTIVE CLAIMS INDUSTRY, NAMELY, PROVIDING VALUATION OF VEHICLES THAT ARE BEYOND REPAIR (U.S. CLS. 100, 101 AND 102).

SN 78-189,487. THE FOUNDATION FIGHTING BLINDNESS, INC., OWINGS MILLS, MD. FILED 11-27-2002.

**SEND A CARD ... FIND A
CURE**

FOR CHARITABLE FUND RAISING (U.S. CLS. 100, 101 AND 102).

CLASS 36—(Continued).

SN 78-189,531. ADOPT-A-STORMDRAIN, LLC, MANHATTAN BEACH, CA. FILED 11-27-2002.

CLEANER CITIES CLEANER RIVERS

FOR RAISING FUNDS FOR CLEANING AND MAINTAINING STORMDRAIN SYSTEMS AND ABOVE AND BELOW GROUND WATER SHEDS THROUGH CHARITABLE CONTRIBUTIONS OR OTHERWISE. (U.S. CLS. 100, 101 AND 102).

SN 78-190,226. MANNING & NAPIER ADVISORS, INC., ROCHESTER, NY. FILED 12-2-2002.

PRO-BLEND

FOR FINANCIAL SERVICES, NAMELY, OPERATION AND MANAGEMENT OF MUTUAL FUNDS; INVESTMENT ADVISORY SERVICES (U.S. CLS. 100, 101 AND 102).

SN 78-190,857. MASON WELLS, INC., MILWAUKEE, WI. FILED 12-3-2002.

FUNDING THE FUTURE

FOR PRIVATE EQUITY INVESTMENT SERVICES (U.S. CLS. 100, 101 AND 102).

SN 78-190,943. CHARTER ONE FINANCIAL, INC., CLEVELAND, OH. FILED 12-4-2002.



FOR BANKING SERVICES (U.S. CLS. 100, 101 AND 102).
FIRST USE 11-1-2002; IN COMMERCE 11-1-2002.

SN 78-190,989. INSIGHT INSURANCE SERVICES, INC., GENEVA, IL. FILED 12-4-2002.

WE MAKE IT EASY FOR YOU

FOR INSURANCE UNDERWRITING, BROKERAGE AND PROGRAM ADMINISTRATION IN THE FIELD OF PROFESSIONAL LIABILITY INSURANCE. (U.S. CLS. 100, 101 AND 102).

CLASS 36—(Continued).

SN 78-190,991. MORTGAGES ON MAIN, INC., SAUK CENTRE, MN. FILED 12-4-2002.

M.O.M.

FOR PROVIDING MORTGAGE BROKERAGE AND LENDING SERVICES (U.S. CLS. 100, 101 AND 102).
FIRST USE 8-24-1998; IN COMMERCE 8-24-1998.

SN 78-193,193. HARTFORD FIRE INSURANCE COMPANY, HARTFORD, CT. FILED 12-11-2002.

WORLDWIDE TRANSPORTATION POLICY

OWNER OF U.S. REG. NO. 2,029,369.
NO CLAIM IS MADE TO THE EXCLUSIVE RIGHT TO USE "POLICY", APART FROM THE MARK AS SHOWN, SEC. 2(F) AS TO "WORLDWIDE TRANSPORTATION POLICY".
FOR PROPERTY AND CASUALTY INSURANCE UNDERWRITING SERVICES (U.S. CLS. 100, 101 AND 102).
FIRST USE 2-0-1995; IN COMMERCE 2-0-1995.

SN 78-194,495. NORTH AMERICAN COMPANY FOR LIFE AND HEALTH INSURANCE, CHICAGO, IL. FILED 12-13-2002.

MARKET CHOICE III PLUS

OWNER OF U.S. REG. NO. 2,271,771.
FOR LIFE INSURANCE AND ANNUITY UNDERWRITING SERVICES (U.S. CLS. 100, 101 AND 102).
FIRST USE 11-15-2002; IN COMMERCE 11-15-2002.

SN 78-194,798. ROSENBLATT SECURITIES INC., NEW YORK, NY. FILED 12-16-2002.

RSI

FOR SECURITIES BROKERAGE SERVICES (U.S. CLS. 100, 101 AND 102).
FIRST USE 10-24-2002; IN COMMERCE 10-24-2002.

SN 78-194,883. CONOCO INC., HOUSTON, TX. FILED 12-16-2002.

CONOCO

OWNER OF U.S. REG. NOS. 521,617, 1,911,016 AND 2,525,929.
FOR PREPAID/PRESTORED POINT OF SALE PURCHASE CARD SERVICES, CREDIT CARD AND DEBIT CARD SERVICES, AND TELEPHONE CALLING CARD SERVICES (U.S. CLS. 100, 101 AND 102).
FIRST USE 12-1-2000; IN COMMERCE 12-1-2000.

CLASS 36—(Continued).

SN 78-196,450. SALOMON SMITH BARNEY INC., NEW YORK, NY. FILED 12-19-2002.

LOCAL DEPTH, GLOBAL REACH

FOR FINANCIAL AND INVESTMENT SERVICES, NAMELY INVESTING FUNDS OF OTHERS IN SUCH VEHICLES AS STOCKS, BONDS, FIXED INCOME VEHICLES, SECURITIES AND THE LIKE (U.S. CLS. 100, 101 AND 102).

FIRST USE 10-31-2000; IN COMMERCE 10-31-2000.

SN 78-198,129. GEORGETOWN INVESTMENT COMPANY, WASHINGTON, DC. FILED 12-27-2002.

GEORGETOWN Investment Co.

Managing Wealth For A Certain Few Families

NO CLAIM IS MADE TO THE EXCLUSIVE RIGHT TO USE "GEORGETOWN INVESTMENT CO.", APART FROM THE MARK AS SHOWN.

FOR FINANCIAL PLANNING, INVESTMENT MANAGEMENT, INVESTMENT CONSULTATION, MUTUAL FUND DISTRIBUTION, MUTUAL FUND INVESTMENT, INVESTMENT MANAGEMENT OF AND DISTRIBUTION OF VARIABLE ANNUITIES (U.S. CLS. 100, 101 AND 102).

SN 78-198,690. LIBERTY BANKERS LIFE INSURANCE COMPANY, INC., WEST DES MOINES, IA. FILED 12-30-2002.

LIBERTY SECURE

FOR ANNUITY SERVICES, NAMELY, UNDERWRITING AND ADMINISTERING INDIVIDUAL ANNUITY CONTRACTS (U.S. CLS. 100, 101 AND 102).

FIRST USE 9-30-2000; IN COMMERCE 9-30-2000.

SN 78-200,068. HALPERN, MICHAEL, A., WILMINGTON, NC. FILED 1-4-2003.

"SEE THE LIGHT"

FOR REAL ESTATE BROKERAGE AND PROPERTY MANAGEMENT SERVICES (U.S. CLS. 100, 101 AND 102).

CLASS 37—CONSTRUCTION AND REPAIR

CLASS 37—(Continued).

SN 76-392,586. REGISTER'S AUTO GLASS OF RALEIGH, INC., RALEIGH, NC. FILED 4-5-2002.



NO CLAIM IS MADE TO THE EXCLUSIVE RIGHT TO USE "AUTO GLASS" AND "GLASS SPECIALIST", APART FROM THE MARK AS SHOWN.

FOR INSTALLATION, REPAIR, AND REPLACEMENT OF GLASS FOR AUTOMOBILES (U.S. CLS. 100, 103 AND 106).

SN 76-400,942. TELMARK LLC, SYRACUSE, NY. BY ASSIGNMENT AGWAY INC., SYRACUSE, NY. FILED 4-29-2002.

TELMARK EXPRESS

OWNER OF U.S. REG. NOS. 1,487,757 AND 2,287,901.

NO CLAIM IS MADE TO THE EXCLUSIVE RIGHT TO USE "EXPRESS", APART FROM THE MARK AS SHOWN.

FOR LEASING EQUIPMENT AND MACHINERY FOR AGRICULTURAL AND COMMERCIAL USE (U.S. CLS. 100, 103 AND 106).

FIRST USE 7-0-1997; IN COMMERCE 7-0-1997.

SN 76-437,516. ROSENWACH TANK COMPANY, INC., LONG ISLAND CITY, NY. FILED 8-2-2002.



FOR CONSTRUCTION, BUILDING, MAINTENANCE AND REPAIR OF ROOFTOP WATER TANKS; PLUMBING SERVICES (U.S. CLS. 100, 103 AND 106).

FIRST USE 3-1-2002; IN COMMERCE 3-1-2002.

CLASS 37—(Continued).

SN 76-448,172. SERVICE EXPERTS INC., A LENNOX INTERNATIONAL COMPANY, RICHARDSON, TX. FILED 9-4-2002.

WE'RE THERE WHEN YOU NEED US THERE

FOR MAINTENANCE, REPAIR AND INSTALLATION SERVICES FOR HOME HEATING, AIR CONDITIONING, PLUMBING AND INDOOR AIR QUALITY EQUIPMENT (U.S. CLS. 100, 103 AND 106).

SN 76-448,937. HENRY COMPANY, HUNTINGTON PARK, CA. FILED 9-10-2002.

CLICK-N-SPEC

FOR PROVIDING A SEARCHABLE ON-LINE COMPUTER DATABASE IN THE FIELD OF ROOFING AND INSULATION SYSTEMS (U.S. CLS. 100, 103 AND 106).

SN 76-460,129. AHC INC., ARLINGTON, VA. FILED 10-16-2002.

AHC INC.

NO CLAIM IS MADE TO THE EXCLUSIVE RIGHT TO USE "INC.", APART FROM THE MARK AS SHOWN.

FOR RESIDENTIAL BUILDING CONSTRUCTION AND REAL ESTATE DEVELOPMENT, NAMELY DEVELOPING LOW AND MODERATE INCOME RESIDENTIAL PROPERTIES AND IMPROVEMENTS THEREON (U.S. CLS. 100, 103 AND 106).

FIRST USE 10-9-1998; IN COMMERCE 10-9-1998.

SN 76-468,073. ACTION ANIMAL TRAPPERS, INC., APOKA, FL. FILED 11-19-2002.

ACTION ANIMAL TRAPPERS, INC.

NO CLAIM IS MADE TO THE EXCLUSIVE RIGHT TO USE "ANIMAL TRAPPER, INC.", APART FROM THE MARK AS SHOWN.

FOR NUISANCE ANIMAL TRAPPING AND REMOVAL (U.S. CLS. 100, 103 AND 106).

FIRST USE 10-17-2002; IN COMMERCE 10-17-2002.

CLASS 37—(Continued).

SN 78-130,447. CAR WASH PARTNERS, INC., TUCSON, AZ. FILED 5-22-2002.

MCW AUTO GLASS

NO CLAIM IS MADE TO THE EXCLUSIVE RIGHT TO USE "AUTO GLASS", APART FROM THE MARK AS SHOWN.

FOR VEHICLE GLASS INSTALLATION, REPLACEMENT AND REPAIR (U.S. CLS. 100, 103 AND 106).

SN 78-133,638. INTEGREG VENTURES, LLC, TOLEDO, OH. FILED 6-6-2002.

HOME FITNESS

FOR BUILDING CONSTRUCTION AND REPAIR SERVICES; REPAIR AND FINISHING SERVICES FOR BUILDING INTERIORS AND EXTERIORS (U.S. CLS. 100, 103 AND 106).

SN 78-133,642. INTEGREG VENTURES, LLC, TOLEDO, OH. FILED 6-6-2002.

HOMEFIT

FOR BUILDING CONSTRUCTION AND REPAIR SERVICES; REPAIR AND FINISHING SERVICES FOR BUILDING INTERIORS AND EXTERIORS (U.S. CLS. 100, 103 AND 106).

SN 78-151,796. PICERNE MILITARY HOUSING, WARWICK, RI. FILED 8-7-2002.

FAMILIES FIRST

FOR REAL ESTATE DEVELOPMENT SPECIALIZING IN MILITARY HOUSING (U.S. CLS. 100, 103 AND 106).

SN 78-165,078. PROMETHEUS ENERGY SERVICES, LLC, LOS ANGELES, CA. FILED 9-17-2002.

PROMETHEUS ENERGY SERVICES

NO CLAIM IS MADE TO THE EXCLUSIVE RIGHT TO USE "ENERGY SERVICES", APART FROM THE MARK AS SHOWN.

FOR CONSTRUCTION SERVICES, NAMELY, DEVELOPMENT OF ELECTRICAL ENERGY GENERATION FACILITIES (U.S. CLS. 100, 103 AND 106).

FIRST USE 2-10-2001; IN COMMERCE 2-10-2001.

CLASS 37—(Continued).

SN 78-170,880. THE FITZPATRICK COMPANY, MILL VALLEY, CA. FILED 10-3-2002.

A FAMILY CLASSIC SINCE 1963

NO CLAIM IS MADE TO THE EXCLUSIVE RIGHT TO USE "SINCE 1963", APART FROM THE MARK AS SHOWN.

FOR REAL ESTATE DEVELOPMENT SERVICE; CONSTRUCTION SERVICES, NAMELY, PLANNING, LAYING OUT AND CUSTOM CONSTRUCTION OF RESIDENTIAL COMMUNITIES; RESIDENTIAL AND BUILDING CONSTRUCTION, NAMELY, SINGLE FAMILY HOMES, MULTI-FAMILY HOMES, AND CONDOMINIUM HOMES. (U.S. CLS. 100, 103 AND 106).

SN 78-175,085. HERITAGE-LONDON CROFT, L.P., FURLONG, PA. FILED 10-16-2002.



FOR CONSTRUCTION SERVICES, NAMELY, PLANNING AND LAYING OUT AND CUSTOM CONSTRUCTION OF RESIDENTIAL AND COMMERCIAL COMMUNITIES (U.S. CLS. 100, 103 AND 106).
FIRST USE 4-22-2002; IN COMMERCE 8-9-2002.

SN 78-177,796. REMEDICS RESTORATION INC., PLAIN CITY, OH. FILED 10-24-2002.



NO CLAIM IS MADE TO THE EXCLUSIVE RIGHT TO USE "RESTORATION FIRE WATER & MOLD SPECIALISTS", APART FROM THE MARK AS SHOWN.

FOR RESTORATION AND CLEANING OF BUILDING STRUCTURES AND CONTENTS; CONTENTS REMOVAL AND CLEANING; WATER EXTRACTION, DRYING AND DEHUMIDIFYING OF BUILDING STRUCTURES AND CONTENTS; MOLD REMEDIATION; REPAIR AND REPLACEMENT OF WINDOWS AND GARAGE DOORS (U.S. CLS. 100, 103 AND 106).
FIRST USE 2-25-2002; IN COMMERCE 2-25-2002.

CLASS 37—(Continued).

SN 78-181,163. KAY, LAWRENCE, PHILLIP, WHITESTONE, NY. FILED 11-2-2002.

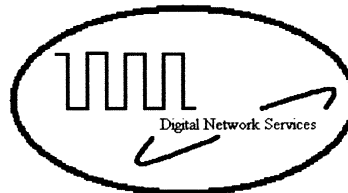

NO CLAIM IS MADE TO THE EXCLUSIVE RIGHT TO USE "DIGITAL NETWORK SERVICES", APART FROM THE MARK AS SHOWN.

THE MARK CONSISTS OF A SIX CYCLE DIGITAL WAVE FORM SYMBOL LOCATED ABOVE THE WORDS "DIGITAL NETWORK SERVICES". A SYMBOL DEPICTING A BROKEN SINE WAVE HAS THE UPPER HALF OF THE SINE WAVE SYMBOL LOCATED ABOVE THE WORDS "DIGITAL NETWORK SERVICES" AND THE LOWER HALF OF THE SINE WAVE SYMBOL LOCATED BELOW THE WORDS "DIGITAL NETWORK SERVICES". THE WORDS "DIGITAL NETWORK SERVICES" ARE PRINTED USING TIMES NEW ROMAN FONT STYLE. BOTH DIGITAL WAVE AND SINE WAVE SYMBOLS AND THE WORDS "DIGITAL NETWORK SERVICES" ARE ENCLOSED IN A 3-3/4 X 2-1-4 INCH OVAL OUTLINE. SINE WAVE SYMBOL COLOR IS ALWAYS ROYAL BLUE. DIGITAL WAVE FORM SYMBOL COLOR IS WHITE WHEN PRINTED ON A BLACK BACKGROUND AND IS BLACK WHEN PRINTED ON A WHITE OR GREY BACKGROUND. THE WORDS "DIGITAL NETWORK SERVICES" COLOR OF LETTERING IS ALWAYS RED. OVAL OUTLINE COLOR IS WHITE WHEN PRINTED ON A BLACK BACKGROUND AND IS BLACK WHEN PRINTED ON A WHITE OR GREY BACKGROUND.

FOR MAINTENANCE AND REPAIR OF COMPUTER NETWORKS (U.S. CLS. 100, 103 AND 106).
FIRST USE 9-1-2002; IN COMMERCE 10-1-2002.

SN 78-184,081. GENERAL CABLE TECHNOLOGIES CORPORATION, HIGHLAND HEIGHTS, KY. FILED 11-12-2002.

NEXTGEN CABLE SYSTEMS

NO CLAIM IS MADE TO THE EXCLUSIVE RIGHT TO USE "CABLE SYSTEMS", APART FROM THE MARK AS SHOWN.

FOR INSTALLATION, MAINTENANCE, AND REPAIR OF FIBER OPTIC CABLES AND FIBER OPTIC NETWORKS (U.S. CLS. 100, 103 AND 106).

SN 78-190,864. MICROSOFT CORPORATION, REDMOND, WA. FILED 12-3-2002.

MICROSOFT

OWNER OF U.S. REG. NOS. 1,200,236, 1,256,083 AND 1,259,874.

FOR INSTALLATION, MAINTENANCE AND REPAIR OF COMPUTER NETWORKS AND COMPUTER SYSTEMS CONSISTING OF COMPUTER HARDWARE, SOFTWARE AND PERIPHERALS (U.S. CLS. 100, 103 AND 106).

CLASS 37—(Continued).

SN 78-196,084. LIEVAN, RANDY, CHULA VISTA, CA. FILED 12-19-2002.

DRYCLEAN EXPO

OWNER OF U.S. REG. NO. 2,472,497.
 NO CLAIM IS MADE TO THE EXCLUSIVE RIGHT TO USE "DRYCLEAN", APART FROM THE MARK AS SHOWN.
 FOR DRY CLEANING SERVICES (U.S. CLS. 100, 103 AND 106).

CLASS 38—(Continued).

SN 76-293,927. XEROX CORPORATION, STAMFORD, CT. FILED 8-3-2001.

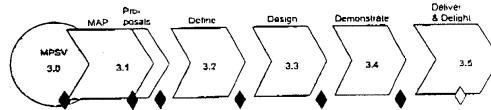

CLASS 38—COMMUNICATION

SN 76-043,401. BRAITHWAITE, JOHN J., NAVEMURN, SYDNEY, AUSTRALIA, FILED 5-8-2000.

INFORMATION INTERCHANGE

NO CLAIM IS MADE TO THE EXCLUSIVE RIGHT TO USE "MAP", "PROPOSALS", "DEFINE", "DESIGN" AND "DEMONSTRATE", APART FROM THE MARK AS SHOWN.
 FOR ELECTRONIC TRANSMISSION OF DATA AND DOCUMENTS VIA COMPUTER TERMINALS FOR INTERACTIVE DATA AND DOCUMENT MANAGEMENT AND CONTROL FOR USE IN PRODUCT DESIGN AND DEVELOPMENT (U.S. CLS. 100, 101 AND 104).

FOR TELECOMMUNICATIONS SERVICES, TELEPHONE COMMUNICATION SERVICES AND COMPUTER SERVICES, NAMELY, PROVIDING ELECTRONIC MAIL SERVICES, RESPONSE SERVICES, AUTOMATED RESPONSE AND FORWARDING SERVICES, INSTANT MESSAGING, PERSONAL COMMUNICATION SERVICES, PAGING SERVICES, VOICE MAIL SERVICES, ELECTRONIC MESSAGING SERVICES, WIRELESS DIGITAL MESSAGING SERVICES, ELECTRONIC TRANSMISSION OF DATA, VOICE, MESSAGES, VIDEO, AUDIO AND DOCUMENTS BY COMPUTER NETWORKS AND TELEPHONES; ELECTRONIC MESSAGING, NAMELY THE RECORDING, STORAGE, SUBSEQUENT TRANSMISSION OF MESSAGES BY TELEPHONE, WIRELESS TELEPHONE AND COMPUTER NETWORKS; PROVIDING MULTIPLE USER ACCESS TO A GLOBAL COMPUTER NETWORK (U.S. CLS. 100, 101 AND 104).

SN 76-335,905. ORBITEL S.A. E.S.P., MEDELLIN, COLOMBIA, FILED 11-8-2001.

CINCO

SN 76-150,533. RAYCOM MEDIA, INC., MONTGOMERY, AL. FILED 10-18-2000.

KWWL

FOR TELEVISION BROADCASTING SERVICES (U.S. CLS. 100, 101 AND 104).
 FIRST USE 11-26-1953; IN COMMERCE 11-26-1953.

IN THE SPANISH LANGUAGE, "CINCO" MEANS "FIVE".
 FOR COMMUNICATION SERVICES, NAMELY, TELEPHONE COMMUNICATION SERVICES, RADIO BROADCASTING SERVICES, TELEVISION BROADCASTING SERVICES, PAGING SERVICES, SATELLITE TRANSMISSION OF TELECOPIES, MESSAGES, SOUNDS AND IMAGES, AND MODEM TRANSMISSION OF TELECOPIES, MESSAGES, SOUNDS AND IMAGES (U.S. CLS. 100, 101 AND 104).

CLASS 38—(Continued).

SN 76-353,279. AT&T WIRELESS SERVICES, INC., REDMOND, WA. BY MERGER ALPHIE, INC., SEATTLE, WA. FILED 12-28-2001.

MZONE

FOR TELECOMMUNICATIONS SERVICES, NAMELY THE ELECTRONIC AND DIGITAL TRANSMISSION OF VOICE, DATA, IMAGE, AUDIO, AND VIDEO VIA TELEPHONE, SATELLITE AND GLOBAL COMPUTER NETWORKS; PROVIDING INFORMATION IN THE FIELD OF TELEPHONY; WIRELESS PAGING SERVICES; CELLULAR TELEPHONE SERVICES; TEXT MESSAGING SERVICES; FACSIMILE TRANSMISSION SERVICES; TELEPHONE VOICE MESSAGING SERVICES; ELECTRONIC VOICE MESSAGING, NAMELY, THE RECORDING AND SUBSEQUENT TRANSMISSION OF VOICE MESSAGES BY TELEPHONE; ELECTRONIC STORE-AND FORWARD MESSAGING; PAGING SERVICES; ELECTRONIC MAIL SERVICES; WIRELESS ROAMING SERVICES; INTERNET SERVICE PROVIDER SERVICES, NAMELY, PROVIDING MULTIPLE USER ACCESS TO A GLOBAL COMPUTER INFORMATION NETWORK; TELECOMMUNICATIONS SERVICES, NAMELY, PROVIDING TELECOMMUNICATIONS CONNECTIONS AND THE ELECTRONIC TRANSMISSION OF ORDERS, BILLING, PAYMENT AND ACCOUNT INFORMATION THAT ALLOW USERS TO PERFORM ELECTRONIC BUSINESS TRANSACTIONS VIA WIRELESS TELEPHONES, PERSONAL DIGITAL ASSISTANTS, HANDHELD COMPUTERS, AND MOBILE DATA RECEIVERS AND VIA A GLOBAL COMPUTER INFORMATION NETWORK, THE INTERNET AND PRIVATE COMPUTER INFORMATION NETWORKS; CELLULAR, WIRELESS, DIGITAL, MOBILE AND SATELLITE TELEPHONE SERVICES; INTERNET AND PRIVATE NETWORK BROADCASTING SERVICES; TELECOMMUNICATIONS CONSULTATION; ONLINE SERVICES NAMELY, PROVIDING MULTIPLE USER ACCESS TO THE INTERNET AND PRIVATE COMMUNICATIONS NETWORKS (U.S. CLS. 100, 101 AND 104).

SN 76-362,286. SOUTHERN COMBINED DISPATCH AND COMMUNICATION SYSTEM, THE, MATTESON, IL. FILED 1-24-2002.

SOUTHCOM

FOR COMMUNICATION SERVICES, NAMELY, SAFETY COMMUNICATION AND DISPATCH SERVICES AND ELECTRONIC COMMUNICATION SYSTEMS TO FACILITATE ACCESS TO AND USE OF EMERGENCY INFORMATION BY EMERGENCY ADMINISTRATIVE PERSONNEL AND PUBLIC SERVICE ACCESS PROVIDERS, FOR RECEIVING AND TRANSFERRING 911 EMERGENCY CALLS AND DISPATCHING OF 911 EMERGENCY CALLS FOR POLICE, FIRE AND SERGEANCY MEDICAL SERVICES (U.S. CLS. 100, 101 AND 104).

FIRST USE 10-0-1999; IN COMMERCE 10-0-1999.

SN 76-365,488. GEMSTAR DEVELOPMENT CORPORATION, PASADENA, CA. FILED 1-31-2002.

G LITE

FOR BROADCASTING SERVICES, NAMELY, BROADCASTING TELEVISION SCHEDULING INFORMATION. (U.S. CLS. 100, 101 AND 104).

CLASS 38—(Continued).

SN 76-407,835. DUFFIELD WARING STUDIOS, INC., RALEIGH, NC. FILED 5-14-2002.

TRAILBLAZER STUDIOS

NO CLAIM IS MADE TO THE EXCLUSIVE RIGHT TO USE "STUDIOS", APART FROM THE MARK AS SHOWN.

FOR MULTIMEDIA SERVICES, NAMELY LIVE SATELLITE BROADCASTING AND VIDEO BROADCASTING; STREAMLINING OF VIDEO MATERIAL AND AUDIO MATERIAL ON THE INTERNET; AND PROVIDING FACILITIES AND EQUIPMENT FOR VIDEO CONFERENCING AND TELECONFERENCING (U.S. CLS. 100, 101 AND 104).

FIRST USE 5-3-2002; IN COMMERCE 5-3-2002.

SN 76-419,632. LEADER TECHNOLOGIES, LLC, WESTERVILLE, OH. FILED 6-13-2002.

LEADER PORTAL

NO CLAIM IS MADE TO THE EXCLUSIVE RIGHT TO USE "PORTAL", APART FROM THE MARK AS SHOWN.

FOR TELECOMMUNICATIONS SERVICES, NAMELY ELECTRONIC TRANSMISSION OF VOICE, DATA, INFORMATION AND IMAGES (U.S. CLS. 100, 101 AND 104).

SN 76-420,034. LEADER TECHNOLOGIES, LLC, WESTERVILLE, OH. FILED 6-13-2002.

LEADER SMART CAMERA

NO CLAIM IS MADE TO THE EXCLUSIVE RIGHT TO USE "SMART CAMERA", APART FROM THE MARK AS SHOWN.

FOR TELECOMMUNICATIONS SERVICES, NAMELY ELECTRONIC TRANSMISSION OF VOICE, DATA, INFORMATION AND IMAGES (U.S. CLS. 100, 101 AND 104).

SN 76-420,039. LEADER TECHNOLOGIES, LLC, WESTERVILLE, OH. FILED 6-13-2002.

LEADERSHIP PORTAL

NO CLAIM IS MADE TO THE EXCLUSIVE RIGHT TO USE "PORTAL", APART FROM THE MARK AS SHOWN.

FOR TELECOMMUNICATIONS SERVICES, NAMELY ELECTRONIC TRANSMISSION OF VOICE, DATA, INFORMATION AND IMAGES (U.S. CLS. 100, 101 AND 104).

CLASS 38—(Continued).

SN 76-420,041. LEADER TECHNOLOGIES, LLC, WESTERVILLE, OH. FILED 6-13-2002.

LEADERSHIP ONLINE

NO CLAIM IS MADE TO THE EXCLUSIVE RIGHT TO USE "ONLINE", APART FROM THE MARK AS SHOWN. FOR TELECOMMUNICATIONS SERVICES, NAMELY ELECTRONIC TRANSMISSION OF VOICE, DATA, INFORMATION AND IMAGES (U.S. CLS. 100, 101 AND 104).

SN 76-420,643. LEADER TECHNOLOGIES, LLC, WESTERVILLE, OH. FILED 6-13-2002.

LEADERSHIP STORAGE

NO CLAIM IS MADE TO THE EXCLUSIVE RIGHT TO USE "STORAGE", APART FROM THE MARK AS SHOWN. FOR TELECOMMUNICATIONS SERVICES, NAMELY ELECTRONIC TRANSMISSION OF VOICE, DATA, INFORMATION AND IMAGES (U.S. CLS. 100, 101 AND 104).

SN 76-420,766. LEADER TECHNOLOGIES, LLC, WESTERVILLE, OH. FILED 6-13-2002.

LEADERSHIP PHONE

NO CLAIM IS MADE TO THE EXCLUSIVE RIGHT TO USE "PHONE", APART FROM THE MARK AS SHOWN. FOR TELECOMMUNICATIONS SERVICES, NAMELY ELECTRONIC TRANSMISSION OF VOICE, DATA, INFORMATION AND IMAGES (U.S. CLS. 100, 101 AND 104).

SN 76-423,542. AMERICA ONLINE, INC., DULLES, VA. FILED 6-20-2002.

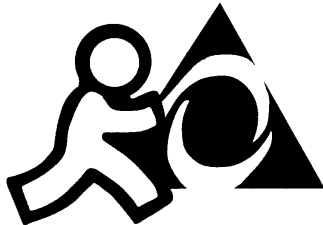

FOR COMPUTER SERVICES, NAMELY, PROVIDING MULTIPLE-USER ACCESS TO COMPUTER NETWORKS; ELECTRONIC TRANSMISSION OF DATA, IMAGES, AND DOCUMENTS VIA COMPUTER NETWORKS; PROVIDING ON-LINE CHAT ROOMS AND ELECTRONIC BULLETIN BOARDS FOR TRANSMISSION OF MESSAGES AMONG COMPUTER USERS CONCERNING A WIDE VARIETY OF TOPICS; ELECTRONIC MAIL SERVICES; PROVIDING ONLINE COMPUTER NETWORK FACILITIES FOR REAL-TIME INTERACTION AND COMMUNICATION WITH OTHER COMPUTER USERS (U.S. CLS. 100, 101 AND 104).

FIRST USE 4-0-2000; IN COMMERCE 4-0-2000.

CLASS 38—(Continued).

SN 76-428,407. NEW WEATHERVANE RETAIL CORPORATION, NEW BRITAIN, CT. FILED 7-9-2002.

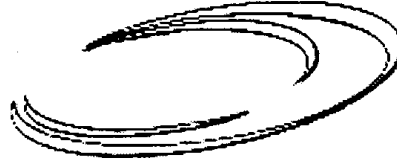

FOR PROVIDING ON-LINE ELECTRONIC BULLETIN BOARDS FOR TRANSMISSION OF MESSAGES AMONG COMPUTER USERS CONCERNING TOPICS OF INTEREST TO ADOLESCENT GIRLS, NAMELY, ENTERTAINMENT, HOROSCOPES AND POETRY (U.S. CLS. 100, 101 AND 104).

SN 76-439,967. ENTRAVISION COMMUNICATIONS CORPORATION, SANTA MONICA, CA. FILED 8-12-2002.



OWNER OF U.S. REG. NOS. 1,824,629 AND 2,550,045. THE ENGLISH TRANSLATION OF THE WORD "ESTRELLA" IS "STAR". FOR RADIO BROADCASTING SERVICES (U.S. CLS. 100, 101 AND 104).

FIRST USE 9-21-1999; IN COMMERCE 9-21-1999.

SN 76-457,730. BRODIE, SIMON, MIAMI, FL. FILED 10-11-2002.

XIFI

FOR PROVIDING MULTIPLE USER ACCESS TO THE INTERNET; PROVIDING WIRELESS BROADBAND INTERNET ACCESS SERVICES (U.S. CLS. 100, 101 AND 104).

FIRST USE 10-1-2002; IN COMMERCE 10-1-2002.

SN 78-089,947. SAFEDOCS, INC., WALNUT CREEK, CA. FILED 10-24-2001.

SAFEDOCS, INC., DIGITAL PACKAGING SERVICE

NO CLAIM IS MADE TO THE EXCLUSIVE RIGHT TO USE "INC., DIGITAL PACKAGING SERVICE", APART FROM THE MARK AS SHOWN.

FOR SECURE ONLINE DIGITAL DOCUMENT DELIVERY VIA GLOBAL COMPUTER NETWORK FOR THE MORTGAGE INDUSTRY (U.S. CLS. 100, 101 AND 104).

CLASS 38—(Continued).

SN 78-147,896. QWEST COMMUNICATIONS INTERNATIONAL INC., DENVER, CO. FILED 7-26-2002.

RIDE THE LIGHT

OWNER OF U.S. REG. NOS. 2,216,984 AND 2,289,880. FOR HOUSEMARK FOR A FULL LINE OF TELECOMMUNICATIONS SERVICES (U.S. CLS. 100, 101 AND 104).

FIRST USE 10-6-1997; IN COMMERCE 10-6-1997.

SN 78-156,815. LIBERATION MANAGEMENT LLC, RANCHO SANTA FE, CA. FILED 8-22-2002.

TEXTAMERICA

FOR TELECOMMUNICATIONS SERVICES, NAMELY, ELECTRONIC TRANSMISSION OF TEXT MESSAGES (U.S. CLS. 100, 101 AND 104).

FIRST USE 8-12-2002; IN COMMERCE 8-12-2002.

SN 78-161,852. SWITCH & DATA FACILITIES COMPANY LLC, TAMPA, FL. FILED 9-9-2002.

SINGLECNXT

FOR PROVIDING COLLOCATION SERVICES FOR VOICE, VIDEO AND DATA COMMUNICATIONS APPLICATIONS, NAMELY, PROVIDING A SINGLE INTERFACE TO SOURCE BANDWIDTH CONNECTIVITY FROM MULTIPLE PROVIDERS FOR TELECOMMUNICATIONS PURPOSES (U.S. CLS. 100, 101 AND 104).

FIRST USE 8-15-2002; IN COMMERCE 9-17-2002.

SN 78-179,206. MDHUB LLC, AVON, CT. FILED 10-28-2002.



FOR ELECTRONIC TRANSMISSION OF DATA, DOCUMENTS AND MESSAGES BETWEEN PHYSICIANS AND PATIENTS (U.S. CLS. 100, 101 AND 104).

FIRST USE 6-15-2000; IN COMMERCE 6-15-2000.

SN 78-189,114. ALLTEL COMMUNICATIONS, INC., LITTLE ROCK, AR. FILED 11-26-2002.

REGIONAL FREEDOM

FOR WIRELESS TELECOMMUNICATION SERVICES, NAMELY, TRANSMISSION OF VOICE AND DATA BY ELECTRONIC MEANS (U.S. CLS. 100, 101 AND 104).

FIRST USE 6-1-2000; IN COMMERCE 6-1-2000.

CLASS 38—(Continued).

SN 78-192,307. BRIGGS JEFFREY W., LOS ANGELES, CA. FILED 12-8-2002.

PINGPAL

FOR ELECTRONIC VOICE MESSAGING, NAMELY, THE RECORDING AND SUBSEQUENT TRANSMISSION OF VOICE MESSAGES BY TELEPHONE (U.S. CLS. 100, 101 AND 104).

SN 78-195,708. VERIZON TRADEMARK SERVICES LLC, ARLINGTON, VA. FILED 12-18-2002.

1-800-USE THE "VZ"

FOR TELECOMMUNICATION SERVICES, NAMELY TELEPHONE COMMUNICATION SERVICES (U.S. CLS. 100, 101 AND 104).

SN 78-197,129. INSPIRED LIFE DEVELOPMENT, LLC, ORLANDO, FL. FILED 12-21-2002.

LIFESTREAMS

FOR SUBSCRIPTION SERVICES FOR DIGITAL STREAMING OF SELF IMPROVEMENT MEDIA (U.S. CLS. 100, 101 AND 104).

FIRST USE 11-5-2002; IN COMMERCE 11-5-2002.

SN 78-198,127. M&C VENTURES, L.L.C., MARION, IA. FILED 12-27-2002.

RUNHOT

FOR PROVIDING TELECOMMUNICATIONS CONNECTIONS TO A GLOBAL COMPUTER NETWORK (U.S. CLS. 100, 101 AND 104).

CLASS 39—TRANSPORTATION AND STORAGE

SN 76-417,504. FEDERAL EXPRESS CORPORATION, MEMPHIS, TN. FILED 5-30-2002.

FEDEX FREIGHT NEXT DAY PLUS

OWNER OF U.S. REG. NOS. 1,311,503, 1,732,185 AND 1,998,790.

NO CLAIM IS MADE TO THE EXCLUSIVE RIGHT TO USE "FREIGHT NEXT DAY", APART FROM THE MARK AS SHOWN.

FOR PICK-UP, STORAGE, TRANSPORTATION AND DELIVERY OF FREIGHT AND CARGO BY LAND (U.S. CLS. 100 AND 105).

CLASS 39—(Continued).

SN 76-463,267. TRX INC., MINNEAPOLIS, MN. FILED 10-31-2002.

TRX INC.

NO CLAIM IS MADE TO THE EXCLUSIVE RIGHT TO USE "INC.", APART FROM THE MARK AS SHOWN.
FOR TRANSPORTATION OF GOODS BY TRUCK (U.S. CLS. 100 AND 105).

SN 76-470,646. THE SOLID TEAM, LLC, CLAREMONT, CA. FILED 11-29-2002.

SOLIDTEAM AIR CARGO

NO CLAIM IS MADE TO THE EXCLUSIVE RIGHT TO USE "AIR CARGO", APART FROM THE MARK AS SHOWN.

FOR TRANSPORTATION SERVICES, NAMELY TRANSPORTATION OF INTERMODAL CONTAINERS AND OVERSIZE CARGO BY AIRCRAFT (U.S. CLS. 100 AND 105).

FIRST USE 10-7-2002; IN COMMERCE 10-7-2002.

SN 78-180,720. SITONIT OFFICE SEATING, INC., CYPRESS, CA. FILED 10-31-2002.

SULTANS OF SPEED

FOR TRANSPORTATION AND DELIVERY OF FURNITURE FOR OTHERS VIA TRUCKS (U.S. CLS. 100 AND 105).

FIRST USE 6-0-2000; IN COMMERCE 6-0-2000.

SN 78-187,055. TRANSFLO CORPORATION, JACKSONVILLE, FL. FILED 11-20-2002.

BTU RAIL DIRECT

NO CLAIM IS MADE TO THE EXCLUSIVE RIGHT TO USE "BTU RAIL", APART FROM THE MARK AS SHOWN.

FOR LIQUID PETROLEUM GAS STORAGE, TRANSPORTATION AND HANDLING, NAMELY THE TRANSFER TO AND FROM TRANSPORTATION VEHICLES (U.S. CLS. 100 AND 105).

FIRST USE 8-1-2002; IN COMMERCE 8-1-2002.

SN 78-188,985. TROST, ALAN, WEST WILDWOOD, NJ. FILED 11-26-2002.

THINK PINK

FOR HIRED CAR AND TAXI SERVICES (U.S. CLS. 100 AND 105).

FIRST USE 4-0-2001; IN COMMERCE 4-0-2001.

CLASS 39—(Continued).

SN 78-190,241. REXIS CORPORATION, MESQUITE, TX. FILED 12-2-2002.



FOR LOADING AND UNLOADING OF FREIGHT ONTO TRUCKS; TRANSPORTATION OF FREIGHT BY TRUCK; LOADING AND UNLOADING OF FREIGHT BETWEEN TRUCKS AND RAILROAD CARS (U.S. CLS. 100 AND 105).

FIRST USE 2-0-1999; IN COMMERCE 2-0-1999.

SN 78-190,294. MIRANT CORPORATION, ATLANTA, GA. FILED 12-2-2002.

MIRANT MINDSET

OWNER OF U.S. REG. NOS. 2,561,777, 2,636,699 AND 2,642,217.

FOR TRANSMISSION AND DISTRIBUTION OF ENERGY TO RETAIL AND WHOLESALE CUSTOMERS (U.S. CLS. 100 AND 105).

FIRST USE 1-19-2001; IN COMMERCE 1-19-2001.

SN 78-193,167. DELIVERY ZONE, LLC, THE, LOS ANGELES, CA. FILED 12-10-2002.

SUNFARE

FOR DELIVERY OF PREPARED MEALS TO CUSTOMERS' HOMES OR PLACES OF WORK. (U.S. CLS. 100 AND 105).

SN 78-193,168. DELIVERY ZONE, LLC, THE, LOS ANGELES, CA. FILED 12-10-2002.

TODAY'S WAY TO EAT

FOR DELIVERY OF PREPARED MEALS TO CUSTOMERS' HOMES OR PLACES OF WORK. (U.S. CLS. 100 AND 105).

SN 78-193,613. CGEN RESEARCH CORPORATION, SEATTLE, WA. FILED 12-11-2002.

CGEN DISCOVERY, INC.

NO CLAIM IS MADE TO THE EXCLUSIVE RIGHT TO USE "INC.", APART FROM THE MARK AS SHOWN.

FOR BIOMEDICAL SERVICES, NAMELY, THE STORAGE OF HUMAN CELLS FOR MEDICAL USE (U.S. CLS. 100 AND 105).

CLASS 40—MATERIAL TREATMENT

SN 76-347,492. ROM SQUARED, INC., MILWAUKEE, WI. FILED 12-12-2001.



NO CLAIM IS MADE TO THE EXCLUSIVE RIGHT TO USE "INCORPORATED", APART FROM THE MARK AS SHOWN.

FOR DUPLICATION OF CDS, CD BUSINESS CARDS, VHS VIDEOTAPES, AND AUDIO CASSETTES; DIGITAL COMPRESSION OF VIDEOS (U.S. CLS. 100, 103 AND 106).

FIRST USE 1-7-2000; IN COMMERCE 1-7-2000.

SN 76-422,364. FIRST WAVE MARINE, INC., HOUSTON, TX. FILED 6-18-2002.



OWNER OF U.S. REG. NOS. 2,296,668, 2,352,371 AND OTHERS.

NO CLAIM IS MADE TO THE EXCLUSIVE RIGHT TO USE "ENVIRONMENTAL SERVICES", APART FROM THE MARK AS SHOWN.

FOR WASTE TREATMENT SERVICES (U.S. CLS. 100, 103 AND 106).

FIRST USE 6-17-2002; IN COMMERCE 6-17-2002.

CLASS 40—(Continued).

SN 76-427,269. PIEZOTECH, LLC, INDIANAPOLIS, IN. FILED 7-3-2002.



NO CLAIM IS MADE TO THE EXCLUSIVE RIGHT TO USE "PIEZO TECHNOLOGIES", APART FROM THE MARK AS SHOWN.

FOR CUSTOM MANUFACTURE OF PIEZOELECTRIC ULTRASOUND TRANSDUCERS AND CERAMIC CRYSTALS FOR APPLICATIONS SUCH AS VIBRATION MONITORING, IMAGING ARRAYS, WEATHER RADAR PROBES AND INDUSTRIAL AND PROCESS CONTROLS, AND INDUSTRIES SUCH AS BIOTECH, PHARMACEUTICAL, AUTOMOTIVE, MARINE, AEROSPACE AND CONSUMER (U.S. CLS. 100, 103 AND 106). FIRST USE 5-14-2002; IN COMMERCE 5-14-2002.

SN 76-438,442. A & A PERFORMANCE, INC., PALM BAY, FL. FILED 8-7-2002.



NO CLAIM IS MADE TO THE EXCLUSIVE RIGHT TO USE "MOTOR WORKS", APART FROM THE MARK AS SHOWN.

FOR MANUFACTURE OF CUSTOM MOTORCYCLES TO THE ORDER AND SPECIFICATION OF OTHERS (U.S. CLS. 100, 103 AND 106).

SN 76-440,187. KESTREL CORPORATION, ALBUQUERQUE, NM. FILED 8-14-2002.



NO CLAIM IS MADE TO THE EXCLUSIVE RIGHT TO USE "CORPORATION", APART FROM THE MARK AS SHOWN.

FOR REMOTE SENSING DIGITAL AND ANALOG IMAGING SERVICES SUITABLE FOR SURVEYING, MAPPING, AND ENVIRONMENTAL MISSIONS, NAMELY PERFORMING MULTISPECTRAL IMAGE DATA COLLECTION AND ANALYSIS OF PROCESSED IMAGE DATA TO IDENTIFY AND QUANTIFY STATIC AND DYNAMIC IMAGE COMPONENTS (U.S. CLS. 100, 103 AND 106).

FIRST USE 8-23-1993; IN COMMERCE 9-15-1993.

CLASS 40—(Continued).

SN 76-461,434. CANUS CORPORATION, LAKE FOREST, CA. FILED 10-15-2002.



THE LINING SHOWN IN THE DRAWING IS A FEATURE OF THE MARK AND NOT INTENDED TO INDICATE COLOR.

FOR CONSULTATION SERVICES RELATING TO NUCLEAR AND ELECTRICAL POWER GENERATION (U.S. CLS. 100, 103 AND 106).

SN 76-465,141. COMMAND PACKAGING, LOS ANGELES, CA. FILED 11-7-2002.

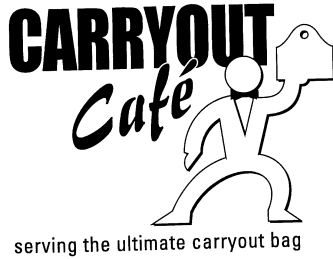

NO CLAIM IS MADE TO THE EXCLUSIVE RIGHT TO USE "CARRYOUT", APART FROM THE MARK AS SHOWN.

FOR MANUFACTURE OF PLASTIC RESTAURANT CARRYOUT BAGS TO THE ORDER AND SPECIFICATION OF OTHERS (U.S. CLS. 100, 103 AND 106). FIRST USE 6-1-2002; IN COMMERCE 6-5-2002.

SN 76-468,085. WINSTON PRINTING COMPANY, WINSTON-SALEM, NC. FILED 11-18-2002.

CUSTOM COLOR...TO GO!

NO CLAIM IS MADE TO THE EXCLUSIVE RIGHT TO USE "CUSTOM COLOR", APART FROM THE MARK AS SHOWN.

FOR DIGITAL PRINTING SERVICES (U.S. CLS. 100, 103 AND 106). FIRST USE 1-21-2002; IN COMMERCE 1-21-2002.

CLASS 40—(Continued).

SN 76-470,813. TURFSTORE.COM INC., CALHOUN, GA. FILED 11-27-2002.

I.C.E. CUTTING

FOR CUSTOM MANUFACTURE OF INLAYS, SUCH AS FIELD MARKINGS, ADVERTISING, LOGOS, SPONSOR PANELS, AND OTHER DESIGNS, FOR ATHLETIC AND RECREATIONAL SURFACING PRODUCTS, SUCH AS ARTIFICIAL AND SYNTHETIC TURF, CARPETING, RUBBER MATTING AND FLOORING (U.S. CLS. 100, 103 AND 106).

FIRST USE 9-27-2002; IN COMMERCE 9-27-2002.

SN 76-476,688. CERILLIANT CORPORATION, ROUND ROCK, TX. FILED 12-17-2002.

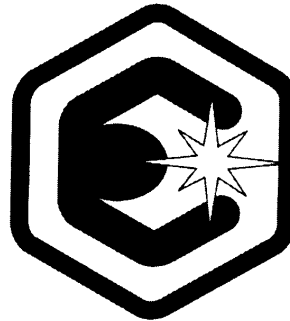

OWNER OF U.S. REG. NO. 2,592,711. FOR CUSTOM MANUFACTURE OF CHEMICAL PRODUCTS (U.S. CLS. 100, 103 AND 106). FIRST USE 10-0-2000; IN COMMERCE 10-0-2000.

SN 78-173,302. Q-TRACK CORPORATION, THE, BROWNSBORO, AL. FILED 10-10-2002.



THE MARK CONSISTS OF IN PART OF THE LETTER "Q" REPRESENTED BY A MAGNIFYING GLASS.

FOR CUSTOM MANUFACTURE OF RADIO DISTANCE MEASUREMENT DEVICES FOR LOCATING PEOPLE AND THINGS (U.S. CLS. 100, 103 AND 106). FIRST USE 10-8-2002; IN COMMERCE 10-10-2002.

CLASS 40—(Continued).

SN 78-175,646. USF CONSUMER & COMMERCIAL WATER-GROUP, INC., NORTHBROOK, IL. FILED 10-17-2002.



OWNER OF U.S. REG. NOS. 522,527 AND 1,147,115. NO CLAIM IS MADE TO THE EXCLUSIVE RIGHT TO USE "FILTERED BY", APART FROM THE MARK AS SHOWN.

FOR WATER TREATMENT AND WATER PURIFICATION SERVICES (U.S. CLS. 100, 103 AND 106). FIRST USE 5-19-2001; IN COMMERCE 5-19-2001.

SN 78-187,337. HALLIBURTON ENERGY SERVICES, INC., CARROLLTON, TX. FILED 11-21-2002.

COBRAJET FRAC

NO CLAIM IS MADE TO THE EXCLUSIVE RIGHT TO USE "FRAC" APART FROM THE MARK AS SHOWN, APART FROM THE MARK AS SHOWN.

FOR OIL AND GAS WELL FRACTURING SERVICES USING COILED TUBING. (U.S. CLS. 100, 103 AND 106).

CLASS 41—EDUCATION AND ENTERTAINMENT

SN 74-437,914. LUCIA, DUANE, BOSTON, MA. FILED 9-20-1993.

BOSS IN-LINE

NO CLAIM IS MADE TO THE EXCLUSIVE RIGHT TO USE "IN-LINE", APART FROM THE MARK AS SHOWN.

FOR EDUCATIONAL SERVICES, NAMELY PROVIDING INSTRUCTION IN THE FIELD OF IN-LINE SKATING; ENTERTAINMENT SERVICES, NAMELY, ARRANGING AND CONDUCTING IN-LINE SKATING COMPETITIONS (U.S. CLS. 100, 101 AND 107).

FIRST USE 8-1-1992; IN COMMERCE 8-1-1992.

CLASS 41—(Continued).

SN 75-038,482. ELECTRIC RANGE, RINDGE, NH. FILED 12-29-1995.

ELECTRIC RANGE

FOR ENTERTAINMENT SERVICES, NAMELY, MUSICAL ENTERTAINMENT SERVICES RENDERED BY A MUSICAL PERFORMING AND RECORDING GROUP (U.S. CLS. 100, 101 AND 107).

SN 75-328,721. IDEA CENTER, INC., LAS VEGAS, NV. FILED 7-22-1997.

SHOW ME THE MONEY

FOR ENTERTAINMENT SERVICES, NAMELY, AMUSEMENT ARCADES, CASINOS, AND AMUSEMENT CENTERS; PROVIDING AN ON-LINE COMPUTER GAME; PROVIDING A COMPUTER GAME THAT MAY BE ACCESSED NETWORK-WIDE BY NETWORK USERS (U.S. CLS. 100, 101 AND 107).

FIRST USE 6-0-1997; IN COMMERCE 6-0-1997.

SN 75-787,927. SCHULTZ SAV-0 STORES, INC., SHEBOYGAN, WI. FILED 8-30-1999.

BIG BANG

FOR ENTERTAINMENT SERVICES NAMELY FIREWORKS AND LIGHT SHOWS (U.S. CLS. 100, 101 AND 107).

SN 75-860,009. LYON, VERNON FREDERIC JR., WINTER PARK, FL. FILED 12-12-1999.

CORUNTHIANS

FOR PHYSICAL FITNESS INSTRUCTION, NAMELY, PROVIDING AND CONDUCTING A PHYSICAL FITNESS RUNNING AND WALKING PROGRAM FOR CHRISTIANS (U.S. CLS. 100, 101 AND 107).

FIRST USE 8-1-1998; IN COMMERCE 9-10-1998.

CLASS 41—(Continued).

SN 76-078,579. GLOBAL ICONS, LLC, LOS ANGELES, CA. FILED 6-27-2000.



NO CLAIM IS MADE TO THE EXCLUSIVE RIGHT TO USE "GLOBAL ICONS ENTERTAINMENT LICENSING", APART FROM THE MARK AS SHOWN.

FOR ENTERTAINMENT SERVICES, NAMELY, PERSONAL APPEARANCES BY CELEBRITIES INCLUDING MOVIE AND SPORTS STARS, PROVIDING A TELEVISION PROGRAM IN THE AREA OF HISTORICAL DATA ON CELEBRITIES INCLUDING MOVIE AND SPORTS STARS VIA A GLOBAL COMPUTER NETWORK, CONDUCTING PARTIES FOR CELEBRITIES INCLUDING MOVIE AND SPORTS STARS, AND MULTIMEDIA ENTERTAINMENT SOFTWARE PRODUCTION (U.S. CLS. 100, 101 AND 107).

FIRST USE 4-1-1997; IN COMMERCE 4-1-1997.

SN 76-096,941. EPISCOPAL HOME FOR CHILDREN, ST. LOUIS, MO. FILED 7-26-2000.

AAH2

FOR EDUCATIONAL SERVICES, NAMELY ORGANIZING AND CONDUCTING LECTURES, WORKSHOPS, SEMINARS, CLASSES, INDIVIDUAL INSTRUCTION, AND OTHER PROGRAMS IN THE FIELDS OF PSYCHOLOGY, SPIRITUAL AWARENESS, SELF-IMPROVEMENT, PERSONAL DEVELOPMENT, RELIGIOUS TEACHINGS, AND RELATED INSPIRATIONAL SUBJECTS, AND DISTRIBUTING COURSE MATERIAL, LITERATURE, AND PUBLICATIONS IN CONNECTION THEREWITH (U.S. CLS. 100, 101 AND 107).

SN 76-102,020. BRINSIGHTS LLC, NEW YORK, NY. FILED 8-3-2000.

BRIN'S BRAND THERAPY

NO CLAIM IS MADE TO THE EXCLUSIVE RIGHT TO USE "BRAND", APART FROM THE MARK AS SHOWN.

THE NAME "BRIN" IDENTIFIES A LIVING INDIVIDUAL WHOSE CONSENT IS OF RECORD.

FOR CONDUCTING MARKETING SEMINARS AND WORKSHOPS IN THE FIELD OF BRAND NAMES AND PRODUCTS (U.S. CLS. 100, 101 AND 107).

FIRST USE 9-1-2000; IN COMMERCE 9-1-2000.

CLASS 41—(Continued).

SN 76-140,100. DALLYDOO INC, GRANADA HILLS, CA. FILED 10-4-2000.

HOUSTON

THE NAME "HOUSTON" IDENTIFIES A LIVING INDIVIDUAL WHOSE CONSENT IS OF RECORD.

FOR ENTERTAINMENT SERVICES, NAMELY, ADULT ENTERTAINMENT SERVICES IN THE NATURE OF LIVE EROTIC DANCING BY A FEMALE INDIVIDUAL; ENTERTAINMENT SERVICES, NAMELY, AN ADULT ENTERTAINMENT WEB SITE FEATURING A FEMALE INDIVIDUAL WITH TEXT, MOVIES, VIDEOS, STORIES AND PHOTOGRAPHS (U.S. CLS. 100, 101 AND 107).

FIRST USE 0-0-1994; IN COMMERCE 0-0-1997.

SN 76-184,987. INSIDETRACK LEARNING, LLC, SAN FRANCISCO, CA. FILED 12-20-2000.

SPARKPOINT

FOR PROVIDING A WEB SITE ON INTERNET FEATURING INFORMATION ON A BROAD RANGE OF TOPICS RELATED TO COLLEGIATE COURSES OF INSTRUCTION; EDUCATIONAL SERVICES, NAMELY PROVIDING COURSES OF INSTRUCTION AND INDIVIDUAL TUTORIALS, COUNSELING AND INSTRUCTION AT THE COLLEGIATE LEVEL IN THE FIELD OF CAREER AND PERSONAL EFFECTIVENESS, AND DISTRIBUTING COURSE MATERIALS IN CONNECTION THEREWITH; PROVIDING INFORMATION IN THE FIELD OF CAREER EFFECTIVENESS AND PERSONAL EFFECTIVENESS DIRECTED TOWARDS CAREER DEVELOPMENT, VIA THE INTERNET (U.S. CLS. 100, 101 AND 107).

SN 76-201,272. FIRST.ORG, INC., MOUNTAIN VIEW, CA. FILED 1-29-2001.

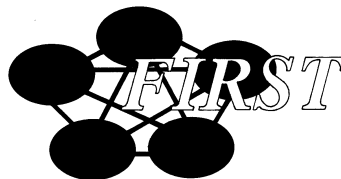

THE MARK CONTAINS FIVE GLOBES WITH THEIR INTERCONNECTING NETWORKED LINES THAT ARE IN THE COLOR BLUE, AND THE TERM "FIRST" IS IN THE COLOR PINK.

FOR PROVIDING CONFERENCES AND SEMINARS CONCERNING COMPUTER AND NETWORK SECURITY, NAMELY, THE PREVENTION, HANDLING AND REPORTING OF COMPUTER AND NETWORK SECURITY-RELATED INCIDENTS (U.S. CLS. 100, 101 AND 107).

FIRST USE 9-11-1992; IN COMMERCE 9-11-1992.

CLASS 41—(Continued).

SN 76-212,180. COUSTEAU SOCIETY, INC. THE, CHESAPEAKE, VA. FILED 2-15-2001.

THE COUSTEAU CHANNEL THE WATER CHANNEL

OWNER OF U.S. REG. NOS. 1,630,009 AND 1,631,392.

NO CLAIM IS MADE TO THE EXCLUSIVE RIGHT TO USE "CHANNEL THE WATER CHANNEL", APART FROM THE MARK AS SHOWN.

FOR ENTERTAINMENT SERVICES, NAMELY, PRODUCTION OF TELEVISION SHOWS FEATURING PROGRAMS ON ENVIRONMENTAL AND AQUATIC RELATED TOPICS (U.S. CLS. 100, 101 AND 107).

SN 76-279,283. CIEERE-LACHMAN, JULIET G., LOS ANGELES, CA. FILED 7-2-2001.

. . .in good voice. .

FOR TEACHING IN THE FIELD OF MUSIC FOR SPEECH IMPROVEMENT AND FOR SINGING IMPROVEMENT (U.S. CLS. 100, 101 AND 107).

SN 76-282,801. VELOCITY DEVELOPMENT COMPANY, INC., MARIETTA, GA. FILED 7-10-2001.

VELOCITY SPORTS PERFORMANCE

NO CLAIM IS MADE TO THE EXCLUSIVE RIGHT TO USE "SPORTS PERFORMANCE", APART FROM THE MARK AS SHOWN.

FOR PHYSICAL FITNESS TRAINING FOR ATHLETES (U.S. CLS. 100, 101 AND 107).

FIRST USE 1-1-1999; IN COMMERCE 1-1-1999.

SN 76-303,186. SECOND DISTRICT DENTAL SOCIETY OF THE STATE OF NEW YORK, BROOKLYN, NY. FILED 8-22-2001.

GREATER NEW YORK DENTAL MEETING

NO CLAIM IS MADE TO THE EXCLUSIVE RIGHT TO USE "MEETING", APART FROM THE MARK AS SHOWN. SEC. 2(F).

FOR EDUCATIONAL SERVICES, NAMELY, CONDUCTING SEMINARS AND CONFERENCES IN THE FIELD OF DENTISTRY (U.S. CLS. 100, 101 AND 107).

FIRST USE 0-0-1956; IN COMMERCE 0-0-1956.

CLASS 41—(Continued).

SN 76-312,387. BLACK ENTERTAINMENT TELEVISION, INC., WASHINGTON, DC. FILED 9-14-2001.

BET: BLUEPRINT

OWNER OF U.S. REG. NOS. 1,511,259, 2,075,972 AND OTHERS.

FOR ENTERTAINMENT SERVICES IN THE NATURE OF ON-GOING TELEVISION PROGRAMMING IN THE FIELD OF MUSIC, ENTERTAINMENT, NEWS AND GENERAL INTEREST TOPICS (U.S. CLS. 100, 101 AND 107).

SN 76-312,751. ABC INVESTMENT CORP., WILMINGTON, DE. FILED 9-17-2001.



RADIO SUPER HEROES

NO CLAIM IS MADE TO THE EXCLUSIVE RIGHT TO USE "RADIO SUPER HEROES", APART FROM THE MARK AS SHOWN.

FOR ENTERTAINMENT SERVICES, NAMELY PRODUCTION AND DISTRIBUTION OF OLD TIME RADIO SHOWS, SYNDICATIONS OF OLD TIME RADIO SHOWS (U.S. CLS. 100, 101 AND 107).

SN 76-325,884. JZK, INC., YELM, WA. FILED 10-15-2001.

C & E

FOR EDUCATIONAL SERVICES, NAMELY, CONDUCTING CLASSES, SEMINARS, CONFERENCES, WORKSHOPS AND FIELD EXERCISES IN THE FIELD OF SPIRITUAL DEVELOPMENT AND SPIRITUAL DISCIPLINES (U.S. CLS. 100, 101 AND 107).

FIRST USE 5-22-1998; IN COMMERCE 5-22-1998.

SN 76-327,144. POFFO, RANDY M., AKA RANDY SAVAGE, TREASURE ISLAND, FL. FILED 10-17-2001.

RANDY SAVAGE

THE NAME "RANDY SAVAGE" IDENTIFIES A LIVING INDIVIDUAL WHOSE CONSENT IS OF RECORD.

FOR ENTERTAINMENT SERVICES, NAMELY, LIVE, TELEVISED AND MOVIE APPEARANCES BY A PROFESSIONAL ENTERTAINER AND WRESTLER (U.S. CLS. 100, 101 AND 107).

FIRST USE 12-0-1977; IN COMMERCE 12-0-1977.

CLASS 41—(Continued).

SN 76-339,020. WCI COMMUNITIES, INC., BONITA SPRINGS, FL. FILED 11-16-2001.

TIBURON

THE ENGLISH TRANSLATION OF "TIBURON" IS "SHARK".

FOR COUNTRY CLUB SERVICES PROVIDING RECREATIONAL FACILITIES, NAMELY, GOLF COURSES, TENNIS COURTS, SWIMMING POOLS, ATHLETIC AND HEALTH CLUB FACILITIES (U.S. CLS. 100, 101 AND 107).

SN 76-341,455. FRAZIER-LYDE, JACQUELYN, PHILADELPHIA, PA. FILED 11-26-2001.

SISTER SMOKE

FOR ENTERTAINMENT IN THE NATURE OF BOXING CONTESTS (U.S. CLS. 100, 101 AND 107).
FIRST USE 2-6-2000; IN COMMERCE 2-6-2000.

SN 76-358,792. CUNNINGHAM, MAUREEN MALA, CHARLOTTESVILLE, VA. FILED 1-16-2002.

POSITIVE HEALTH SOLUTIONS

NO CLAIM IS MADE TO THE EXCLUSIVE RIGHT TO USE "HEALTH SOLUTIONS", APART FROM THE MARK AS SHOWN.

FOR EDUCATIONAL SERVICES, NAMELY, CONDUCTING CLASSES AND INDIVIDUAL INSTRUCTION CONCERNING STRESS MANAGEMENT, MEDITATION, PERSONAL AND SPIRITUAL GROWTH; DISTRIBUTING COURSE MATERIALS THEREWITH; PHYSICAL FITNESS AND EXERCISE INSTRUCTION AND CONDUCTING CLASSES, SEMINARS AND WORKSHOPS IN THE FIELD OF FITNESS AND DISTRIBUTING COURSE MATERIALS THEREWITH; ENTERTAINMENT IN THE NATURE OF AN ON-GOING TELEVISION AND RADIO PROGRAM IN THE FIELD OF FITNESS AND VARIETY ENTERTAINMENT (U.S. CLS. 100, 101 AND 107).
FIRST USE 8-20-1999; IN COMMERCE 8-20-1999.

CLASS 41—(Continued).

SN 76-399,717. UNITED STATES AMATEUR CONFEDERATION OF ROLLER SKATING, DBA USA ROLLER SPORTS, LINCOLN, NE. FILED 4-23-2002.



OWNER OF U.S. REG. NOS. 1,799,703 AND 2,260,389.
NO CLAIM IS MADE TO THE EXCLUSIVE RIGHT TO USE "USA ROLLER SPORTS", APART FROM THE MARK AS SHOWN.

FOR ENTERTAINMENT SERVICES, NAMELY, ORGANIZING AMATEUR ROLLER SPORTS EVENTS (U.S. CLS. 100, 101 AND 107).

SN 76-403,806. GREATER CINCINNATI CHAMBER OF COMMERCE, CINCINNATI, OH. FILED 5-6-2002.



OWNER OF U.S. REG. NO. 1,672,838.
FOR EDUCATIONAL SERVICES, NAMELY, MEETINGS, CONFERENCES AND FIELD TRIPS RELATED TO THE EXPANSION OF NETWORKS, REVIEW OF VITAL COMMUNITY ISSUES, AND EXPANSION OF OPPORTUNITIES FOR ASSUMING POSITIONS OF CIVIC RESPONSIBILITY (U.S. CLS. 100, 101 AND 107).
FIRST USE 12-31-1977; IN COMMERCE 12-31-1977.

SN 76-404,534. SCRIPTURE UNION, WAYNE, PA. FILED 5-2-2002.

PRIMETIME

FOR EDUCATIONAL SERVICES, NAMELY, PROVIDING CHRISTIAN RELIGIOUS INSTRUCTION IN AFTER-SCHOOL AND SUMMER PROGRAMS FOR CHILDREN AND YOUTH, AND DISTRIBUTION OF PRINTED MATERIALS THEREWITH; PROVIDING TRAINING AND INFORMATION IN CHRISTIAN RELIGIOUS INSTRUCTION AND THE USE OF EDUCATIONAL MATERIALS TO CHURCHES, GROUPS, AND INDIVIDUALS FOR THE PURPOSE OF PROMOTING THE STUDY OF THE BIBLE AND OTHER RELIGIOUS MATERIALS AND THE DEVELOPMENT OF CHRISTIAN CHARACTER (U.S. CLS. 100, 101 AND 107).

CLASS 41—(Continued).

SN 76-405,495. BROWN & WILLIAMSON TOBACCO CORPORATION, LOUISVILLE, KY. FILED 5-10-2002.

SPADES SLAM

NO CLAIM IS MADE TO THE EXCLUSIVE RIGHT TO USE "SPADES", APART FROM THE MARK AS SHOWN.

FOR ENTERTAINMENT IN THE NATURE OF PLAYING CARD TOURNAMENTS (U.S. CLS. 100, 101 AND 107).

SN 76-406,594. GRESHAM, TOM, NATCHITOCHES, LA. FILED 5-9-2002.

GUN TALK

NO CLAIM IS MADE TO THE EXCLUSIVE RIGHT TO USE "TALK", APART FROM THE MARK AS SHOWN. SEC. 2(F).

FOR ENTERTAINMENT SERVICES IN THE NATURE OF CONTINUING RADIO TALK SHOW PROGRAMS REGARDING TOPICS PERTAINING TO SOCIAL AND TECHNICAL ISSUES OF FIREARMS AND THEIR USES (U.S. CLS. 100, 101 AND 107).

FIRST USE 3-5-1995; IN COMMERCE 3-5-1995.

SN 76-406,650. THRON, RAJINDER M., RINGWOOD, NJ. FILED 5-6-2002.

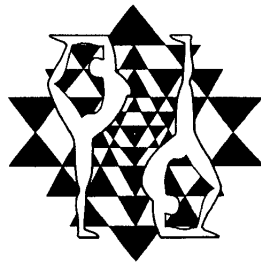

Yoga Synthesis
Raji Thron

NO CLAIM IS MADE TO THE EXCLUSIVE RIGHT TO USE "YOGA", APART FROM THE MARK AS SHOWN.

FOR EDUCATIONAL SERVICES, NAMELY, CONDUCTING PRIVATE AND PUBLIC HATHA YOGA CLASSES, RETREATS, AND WORKSHOPS; TEACHER TRAINING SERVICES IN THE FIELD OF HATHA YOGA; AND DISTRIBUTING COURSE MATERIALS IN CONNECTION THEREWITH (U.S. CLS. 100, 101 AND 107).

FIRST USE 0-0-1996; IN COMMERCE 9-0-1997.

CLASS 41—(Continued).

SN 76-412,972. CITY OF ATLANTA RECREATIONAL AUTHORITY, ATLANTA, GA. FILED 5-21-2002.

FANPLEX

FOR ENTERTAINMENT SERVICES, NAMELY OPERATION OF FAMILY ENTERTAINMENT AND RECREATIONAL FACILITY (U.S. CLS. 100, 101 AND 107).

SN 76-416,362. CONNECTIONS ACADEMY, INC., BALTIMORE, MD. FILED 6-3-2002.

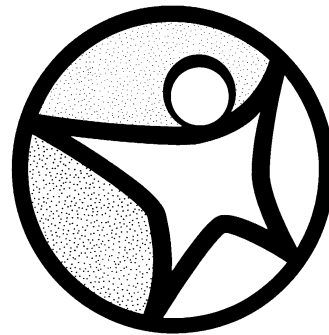

THE STIPPLING IN THE DRAWING IS FOR SHADING PURPOSES AND DOES NOT REPRESENT COLOR.

FOR CHARTER SCHOOL SERVICES; EDUCATIONAL SERVICES, NAMELY PROVIDING COURSES OF INSTRUCTION AT THE K-12 LEVELS; EDUCATIONAL SERVICES, NAMELY PROVIDING INTERNET AND PRINT-BASED COURSES OF INSTRUCTION AT THE K-12 LEVELS; EDUCATIONAL SERVICES, NAMELY PROVIDING TEACHING, LEARNING MANAGEMENT, TECHNOLOGY, REPORTING AND ALL OTHER ASPECTS OF OPERATING A CHARTER SCHOOL; EDUCATIONAL SERVICES, NAMELY PROVIDING CONSULTING SERVICES IN THE FIELD OF ESTABLISHING AND OPERATING CHARTER SCHOOLS (U.S. CLS. 100, 101 AND 107).

SN 76-420,974. LEE COUNTY BOARD OF COUNTY COMMISSIONERS, FORT MYERS, FL. FILED 6-14-2002.



NO CLAIM IS MADE TO THE EXCLUSIVE RIGHT TO USE "AWARDS", APART FROM THE MARK AS SHOWN.

THE MARK CONSISTS OF A STYLIZED STAR AND A STYLIZED LETTER "E".

FOR PROVIDING RECOGNITION AND INCENTIVES BY WAY OF AWARDS FOR PERSONS EMPLOYED IN THE HOSPITALITY AND TOURISM INDUSTRIES AND RELATED BUSINESSES THERETO (U.S. CLS. 100, 101 AND 107).

FIRST USE 5-0-2001; IN COMMERCE 5-0-2001.

CLASS 41—(Continued).

SN 76-421,431. MAJOR LEAGUE SOCCER L.L.C., NEW YORK, NY. FILED 6-14-2002.

DRIBBLE, PASS AND SCORE

OWNER OF U.S. REG. NO. 2,315,043.
FOR ORGANIZING AND CONDUCTING CHILDREN'S SOCCER TRAINING SESSIONS AND COMPETITIONS (U.S. CLS. 100, 101 AND 107).
FIRST USE 3-0-2002; IN COMMERCE 3-0-2002.

SN 76-423,228. ASOCIACION FONOGRAFICA Y VIDEOGRAFICA ESPANOLA (AFYVE), 28020 MADRID, SPAIN, FILED 6-19-2002.

PREMIOS AMIGO

OWNER OF SPAIN REG. NO. 2398738, DATED 11-11-2001, EXPIRES 5-8-2011.

NO CLAIM IS MADE TO THE EXCLUSIVE RIGHT TO USE "PREMIOS", APART FROM THE MARK AS SHOWN.
THE ENGLISH TRANSLATION OF "PREMIOS AMIGO" IS "FRIEND AWARDS".

FOR PROVIDING RECOGNITION AND INCENTIVES BY WAY OF AWARDS TO DEMONSTRATE EXCELLENCE IN THE FIELD OF MUSIC ENTERTAINMENT (U.S. CLS. 100, 101 AND 107).

SN 76-424,330. HEALTH CLUB, INC., ISLIP TERRACE, NY. FILED 6-24-2002.

**TOTAL HEALTH EXPERIENCE**

NO CLAIM IS MADE TO THE EXCLUSIVE RIGHT TO USE "HEALTH CLUB" AND "CLUB", APART FROM THE MARK AS SHOWN.

THE MARK CONSISTS OF THE WORDS "T.H.E. HEALTH CLUB TOTAL HEALTH EXPERIENCE" IN BROWN LETTERING AND THE LEAF DESIGN IN GREEN.

FOR EDUCATIONAL SERVICES, NAMELY, CONDUCTING CLASSES, SEMINARS, CONFERENCES AND WORKSHOPS IN THE FIELDS OF HEALTH, NUTRITION AND MEDICINE AND DISTRIBUTING COURSE MATERIALS IN CONNECTION THEREWITH; PROVIDING FITNESS AND EXERCISE FACILITIES (U.S. CLS. 100, 101 AND 107).

CLASS 41—(Continued).

SN 76-425,733. NELSON, SCOTT ALLAN, LOS ANGELES, CA. FILED 6-28-2002.

HOGWASH

FOR ENTERTAINMENT SERVICES FEATURING WOMEN THAT ARE SCANTILY DRESSED WASHING AND CLEANING MOTORCYCLES INSIDE A BAR, SALOON, CASINO, HOTEL, NIGHTCLUB OR OUTSIDE (U.S. CLS. 100, 101 AND 107).

SN 76-425,907. PEIRCE COLLEGE, PHILADELPHIA, PA. FILED 6-27-2002.

PEIRCE COLLEGE

NO CLAIM IS MADE TO THE EXCLUSIVE RIGHT TO USE "COLLEGE", APART FROM THE MARK AS SHOWN. SEC. 2(F).

FOR EDUCATIONAL SERVICES, NAMELY, PROVIDING COURSES OF INSTRUCTION AT THE COLLEGE AND UNIVERSITY LEVEL (U.S. CLS. 100, 101 AND 107).
FIRST USE 0-0-1881; IN COMMERCE 0-0-1881.

SN 76-427,568. BURKE, H. ELIZABETH, MOUNTAIN CENTER, CA. FILED 7-3-2002.

TE

FOR EDUCATIONAL SERVICES NAMELY, CONDUCTING PROFESSIONAL TRAININGS, WORKSHOPS, LECTURES, CLASSES AND INDIVIDUAL INSTRUCTION IN THE FIELDS OF TRANSPERSONAL, SOMATIC AND CONTEMPLATIVE PSYCHOLOGY, TRANSFORMATIONAL THERAPY, MIND-BODY HEALING, CONSCIOUSNESS STUDIES, AND INTUITIVE PRACTICES (U.S. CLS. 100, 101 AND 107).

FIRST USE 8-10-1999; IN COMMERCE 9-1-1999.

SN 76-429,408. MARTELLO, JEANNETTE, SOUTH PASADENA, CA. FILED 7-1-2002.

SKIN DEEP

FOR ENTERTAINMENT SERVICES, NAMELY, PROVIDING A RADIO PROGRAM IN THE FIELDS OF MEDICINE, SURGERY, HEALTH, HEALTH CARE, BEAUTY, SKIN CARE, COSMETIC SURGERY AND PLASTIC SURGERY (U.S. CLS. 100, 101 AND 107).

FIRST USE 4-13-2002; IN COMMERCE 4-20-2002.

CLASS 41—(Continued).

SN 76-432,109. INTERNATIONAL BUSINESS MACHINES CORPORATION, ARMONK, NY. FILED 7-18-2002.

SECUREWORLD

FOR EDUCATIONAL SERVICES, NAMELY, CONDUCTING CLASSES, SEMINARS, CONFERENCES, AND WORKSHOPS IN THE FIELD OF COMPUTER SECURITY, COMPUTER SOFTWARE SECURITY, COMPUTER APPLICATION SECURITY, COMPUTER SERVER SECURITY, COMPUTER SERVER PLATFORM SECURITY, INTERNET SECURITY, INTRANET SECURITY, ELECTRONIC BUSINESS SECURITY, NETWORK SECURITY, DISASTER RECOVERY OF DATA, AND THE DISTRIBUTION OF COURSE MATERIALS IN CONNECTION THEREWITH (U.S. CLS. 100, 101 AND 107).

FIRST USE 1-0-2000; IN COMMERCE 1-0-2000.

SN 76-433,437. WEINRICH, ROBERT SCOTT, BROOKVILLE, MD. FILED 7-23-2002.



FOR ENTERTAINMENT SERVICES; NAMELY, LIVE MUSICAL PERFORMANCES BY A BAND (U.S. CLS. 100, 101 AND 107).

FIRST USE 0-0-1979; IN COMMERCE 0-0-1980.

SN 76-434,189. COMPUTER MOTION, INC, SANTA BARBARA, CA. FILED 7-25-2002.

PARTNERSHIP FOR SURGICAL INNOVATION

FOR EDUCATIONAL SERVICES, NAMELY CONDUCTING CUSTOMIZED PROGRAMS IN THE FIELD OF ROBOTICALLY ASSISTED MINIMALLY INVASIVE SURGERY TO ASSIST ROBOTIC CENTERS (U.S. CLS. 100, 101 AND 107).

SN 76-434,735. MILLS, JOYCE C., SCOTTSDALE, AZ. FILED 7-26-2002.

STORYPLAY

FOR EDUCATIONAL SERVICES IN THE NATURE OF WORKSHOPS, RETREATS AND SEMINARS IN THE FIELDS OF PERSONAL GROWTH, PROFESSIONAL DEVELOPMENT, HEALING AND PROBLEM SOLVING FOR OTHERS; COUNSELING SERVICES FOR OTHERS IN THE FIELD OF PERSONAL GROWTH, PROFESSIONAL DEVELOPMENT, HEALING AND PROBLEM SOLVING (U.S. CLS. 100, 101 AND 107).

FIRST USE 6-29-2002; IN COMMERCE 6-29-2002.

CLASS 41—(Continued).

SN 76-435,881. MORAN, MALAIKA L., BROOKLYN, NY. FILED 7-30-2002.

SOCIALSTEP.COM

FOR ENTERTAINMENT SERVICES, NAMELY, CONDUCTING, HOSTING AND PRODUCING CULTURAL, PRIVATE AND SOCIAL EVENTS; PROVIDING INFORMATION IN THE AREAS OF CULTURAL, PRIVATE AND SOCIAL EVENTS (U.S. CLS. 100, 101 AND 107).

FIRST USE 5-1-1996; IN COMMERCE 5-1-1996.

SN 76-438,189. METROPOLITAN TRANSPORTATION AUTHORITY, NEW YORK, NY. FILED 8-6-2002.

THE NEW YORK SUBWAY - A CENTURY OF PROGRESS

SEC. 2(F) AS TO "NEW YORK SUBWAY".

FOR ORGANIZING AND CONDUCTING A CENTENIAL CELEBRATION FOR THE NEW YORK CITY SUBWAY NAMELY, ORGANIZING AND CONDUCTING CULTURAL EVENTS, ART AND PHOTOGRAPHY EXHIBITS, ENTERTAINMENT, NAMELY FIREWORKS DISPLAYS, MUSICAL PERFORMANCES, COMMUNITY EVENTS, LECTURES, FILM SERIES, HISTORICAL EXHIBITIONS, SUBWAY SYSTEM EXCURSIONS AND NEW YORK CITY NEIGHBORHOOD TOURS, AND EDUCATIONAL WORKSHOPS IN THE FIELD OF THE HISTORY OR PUBLIC TRANSPORTATION IN THE NEW YORK CITY REGION, IN PARTICULAR, THE NEW YORK CITY SUBWAY (U.S. CLS. 100, 101 AND 107).

FIRST USE 5-31-2002; IN COMMERCE 5-31-2002.

SN 76-438,329. MARTELLO, JEANNETTE, SOUTH PASADENA, CA. FILED 8-7-2002.

SKIN DEEP

FOR ENTERTAINMENT IN THE NATURE OF ONGOING TELEVISION PROGRAMS IN THE FIELDS OF MEDICINE, SURGERY, HEALTH, HEALTH CARE, BEAUTY, SKIN CARE, COSMETIC SURGERY AND PLASTIC SURGERY (U.S. CLS. 100, 101 AND 107).

SN 76-438,339. MARTELLO, JEANNETTE, SOUTH PASADENA, CA. FILED 8-7-2002.

SKIN DEEP

FOR PUBLICATION OF BOOKS (U.S. CLS. 100, 101 AND 107).

CLASS 41—(Continued).

SN 76-438,340. MARTELLO, JEANNETTE, SOUTH PASADENA, CA. FILED 8-7-2002.

SKIN DEEP

FOR PUBLICATION OF MAGAZINES (U.S. CLS. 100, 101 AND 107).

SN 76-438,559. HARRIS, WAYNE, DBA DB DRAG RACING, POST FALLS, ID. FILED 8-7-2002.

DEATHMATCH

FOR CONDUCTING COMPETITIONS IN THE FIELD OF AUTOMOTIVE AUDIO SYSTEMS (U.S. CLS. 100, 101 AND 107).

FIRST USE 10-0-1999; IN COMMERCE 10-0-1999.

SN 76-440,682. BAILEY, KIRK, RENO, NV. FILED 8-15-2002.

COGNITO

FOR PUBLICATION OF MAGAZINES IN THE FIELD OF COMMERCIAL AND RESIDENTIAL REAL ESTATE (U.S. CLS. 100, 101 AND 107).

SN 76-442,929. NEW FRONTIER MEDIA, INC., BOULDER, CO. FILED 8-22-2002.

XCLIPS

FOR ENTERTAINMENT SERVICES IN THE NATURE OF A SERIES OF TELEVISION, CABLE TELEVISION AND SATELLITE TELEVISION PROGRAMS FEATURING ADULT CONTENT (U.S. CLS. 100, 101 AND 107).

CLASS 41—(Continued).

SN 76-442,963. FLORIDA SOUTHERN COLLEGE, LAKE-LAND, FL. FILED 8-19-2002.

**FLORIDA
SOUTHERN
COLLEGE**

NO CLAIM IS MADE TO THE EXCLUSIVE RIGHT TO USE "COLLEGE", APART FROM THE MARK AS SHOWN. SEC. 2(F).

FOR EDUCATIONAL SERVICES, NAMELY, PROVIDING COURSES OF INSTRUCTION AT THE COLLEGE LEVEL; EDUCATIONAL SERVICES, NAMELY, CONDUCTING LECTURES IN THE FIELDS OF ART, ECONOMICS, HISTORY, MATHEMATICS, MUSIC AND SCIENCE; ENTERTAINMENT SERVICES, NAMELY, LIVE MUSIC CONCERTS; ENTERTAINMENT SERVICES, NAMELY, ENTERTAINMENT IN THE NATURE OF SPORTING EVENTS, SPECIFICALLY, INTERCOLLEGIATE BASEBALL GAMES, INTERCOLLEGIATE BASKETBALL GAMES, INTERCOLLEGIATE CROSS COUNTRY MEETS, INTERCOLLEGIATE GOLF MATCHES, INTERCOLLEGIATE SOCCER MATCHES, INTERCOLLEGIATE SOFTBALL GAMES, INTERCOLLEGIATE TENNIS MATCHES AND INTERCOLLEGIATE VOLLEYBALL GAMES; ORGANIZING EXHIBITIONS FOR ART, HISTORY, MUSIC AND SCIENCE (U.S. CLS. 100, 101 AND 107).

FIRST USE 9-0-2001; IN COMMERCE 9-0-2001.

SN 76-445,502. MULTINATIONAL BUSINESS SERVICES, INC., WASHINGTON, DC. FILED 8-29-2002.

WATCHDOG WATCH

NO CLAIM IS MADE TO THE EXCLUSIVE RIGHT TO USE "WATCHDOG", APART FROM THE MARK AS SHOWN.

FOR NEWS ANALYSIS REGARDING REGULATORY ORGANIZATIONS (U.S. CLS. 100, 101 AND 107).

FIRST USE 8-22-2002; IN COMMERCE 8-22-2002.

SN 76-456,644. EXPRESSCO, INC., WILMINGTON, DE. FILED 10-1-2002.

INSIDE EXPRESS

OWNER OF U.S. REG. NOS. 1,120,073, 2,607,818 AND OTHERS.

FOR PROVIDING NEWSLETTERS IN THE FIELD OF FASHION VIA E-MAIL (U.S. CLS. 100, 101 AND 107).

FIRST USE 7-7-2002; IN COMMERCE 7-7-2002.

SN 76-457,638. SEA PINES COMPANY, HILTON HEAD ISLAND, SC. FILED 10-11-2002.

HARBOUR TOWN

FOR GOLF COURSE AND GOLF CLUB SERVICES (U.S. CLS. 100, 101 AND 107).

FIRST USE 0-0-1970; IN COMMERCE 0-0-1970.

CLASS 41—(Continued).

SN 76-458,220. THE PULITZER FOUNDATION FOR THE ARTS, ST. LOUIS, MO. FILED 10-15-2002.

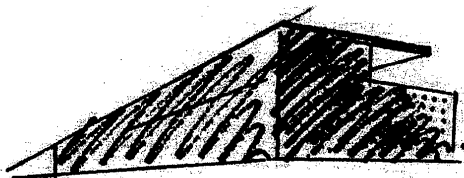

THE LINING AND STIPPLING ARE FEATURES OF THE MARK AND ARE NOT INTENDED TO INDICATE COLOR. THE MARK CONSISTS OF A STYLIZED DRAWING OF A BUILDING.

FOR ART MUSEUM SERVICES, NAMELY, PREPARING, ARRANGING, ORGANIZING AND DISPLAYING WORKS OF ART AND ARCHITECTURE; EDUCATIONAL SERVICES, NAMELY, CONDUCTING CLASSES, WORKSHOPS, CONFERENCES, LECTURES, AND SEMINARS ALL RELATED TO THE ARTS AND ARCHITECTURE (U.S. CLS. 100, 101 AND 107).

FIRST USE 9-0-1997; IN COMMERCE 9-0-2001.

SN 76-461,368. THE ARIZONA SPORTS FOUNDATION, TEMPE, AZ. FILED 10-23-2002.

ONLY NO.1 AND NO.2 ARE INVITED TO THIS FIESTA!

FOR ENTERTAINMENT SERVICES, NAMELY ORGANIZING, CONDUCTING AND STAGING COMMUNITY ACTIVITIES, NAMELY PARADES, SPORTING EVENTS INCLUDING INTERCOLLEGIATE FOOTBALL GAMES, AND FESTIVALS (U.S. CLS. 100, 101 AND 107).

FIRST USE 8-2-2002; IN COMMERCE 9-4-2002.

SN 76-461,983. AMAY, ANTOINE, WEST ORANGE, NJ. FILED 10-28-2002.

OVERBITE

FOR ENTERTAINMENT SERVICES IN THE NATURE OF LIVE PERFORMANCES BY A MUSICAL ARTIST (U.S. CLS. 100, 101 AND 107).

FIRST USE 10-15-1997; IN COMMERCE 10-15-1997.

CLASS 41—(Continued).

SN 76-462,031. THE PROMOTION CO., INC., INDIANAPOLIS, IN. FILED 10-25-2002.



NO CLAIM IS MADE TO THE EXCLUSIVE RIGHT TO USE "SUPERCROSS NATIONALS", APART FROM THE MARK AS SHOWN.

FOR ENTERTAINMENT SERVICES IN THE NATURE OF CONDUCTING COMPETITIVE EVENTS FOR MOTORCYCLE SPORTS ENTHUSIASTS (U.S. CLS. 100, 101 AND 107).

FIRST USE 10-12-2002; IN COMMERCE 10-12-2002.

SN 76-462,110. DUKE UNIVERSITY, DURHAM, NC. FILED 10-28-2002.

PSYCHCME

FOR EDUCATION SERVICES-NAMELY CONDUCTING PROGRAMS TO PROVIDE CONTINUING MEDICAL EDUCATION TO PHYSICIANS AND OTHER HEALTH PROFESSIONALS INCLUDING NURSES, PHARMACISTS, PSYCHOLOGISTS, PHYSICIANS ASSISTANTS, SOCIAL WORKERS AND ALLIED HEALTH PROFESSIONALS THROUGH LIVE SYMPOSIA, LIVE SATELLITE BROADCAST, AUDIO CONFERENCES, TELECONFERENCES, AND INTERNET EDUCATION (U.S. CLS. 100, 101 AND 107).

FIRST USE 11-1-2001; IN COMMERCE 11-1-2001.

SN 76-462,496. THE BROOKE JACKMAN FOUNDATION, INC., MILL NECK, NY. FILED 10-23-2002.

BROOKE'S BOOKS

NO CLAIM IS MADE TO THE EXCLUSIVE RIGHT TO USE "BOOKS", APART FROM THE MARK AS SHOWN.

FOR CHARITABLE SERVICES, NAMELY, PROVIDING BOOKS AND MENTORING OF SCHOOL AGE CHILDREN TO PROMOTE LITERACY, CHILDREN AND READING (U.S. CLS. 100, 101 AND 107).

FIRST USE 2-28-2002; IN COMMERCE 4-30-2002.

CLASS 41—(Continued).

SN 76-463,593. PRACTICAL SOLUTIONS UNLIMITED, INC., GRIFFIN, GA. FILED 11-1-2002.

C.E. MAGIC!

NO CLAIM IS MADE TO THE EXCLUSIVE RIGHT TO USE "C.E.", APART FROM THE MARK AS SHOWN.

FOR PROVIDING CONTINUING DENTAL, MEDICAL, AND VETERINARY EDUCATION COURSES AND SEMINARS AND DISTRIBUTING COURSE MATERIALS IN CONNECTION THEREWITH (U.S. CLS. 100, 101 AND 107).

SN 76-465,623. FURMAN UNIVERSITY, GREENVILLE, SC. FILED 11-8-2002.

FURMAN

SEC. 2(F).

FOR EDUCATIONAL SERVICES IN THE NATURE OF COURSES AT THE UNIVERSITY LEVEL; AND ENTERTAINMENT SERVICES IN THE NATURE OF FOOTBALL, BASEBALL, BASKETBALL, TENNIS, GOLF, SOCCER AND SWIMMING GAMES (U.S. CLS. 100, 101 AND 107).

FIRST USE 0-0-1850; IN COMMERCE 0-0-1850.

SN 76-466,475. DANCE NANNY PRODUCTIONS, INC., NEW YORK, NY. FILED 11-13-2002.

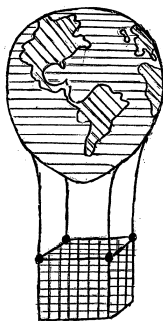
The Traveling Balloon

THE HORIZONTAL LINING ON THE GLOBE INDICATES THE COLOR BLUE, THE LINING ON THE SHAPES ON THE GLOBE INDICATES THE COLOR GREEN, AND THE LINING ON THE BASKET INDICATES THE COLOR BROWN.

FOR ONGOING CHILDREN'S PROGRAM DISTRIBUTED VIA TELEVISION, SATELLITE, CABLE AND RADIO (U.S. CLS. 100, 101 AND 107).

CLASS 41—(Continued).

SN 76-466,757. SILCORD U.S. PRODUCTIONS, LOS ANGELES, CA. FILED 11-14-2002.



THE MARK CONSISTS OF THE WORD "AEVA". FOR ENTERTAINMENT SERVICES, NAMELY, PROVIDING LIVE AND PRERECORDED MUSICAL AND MUSICO-DRAMATIC PERFORMANCES (U.S. CLS. 100, 101 AND 107).

SN 76-467,564. THE COACHES TRAINING INSTITUTE, SAN RAFAEL, CA. FILED 11-18-2002.

CONTINUING EDGE

FOR EDUCATIONAL SERVICES, NAMELY, PROFESSIONAL COACHING SEMINARS AND PROFESSIONAL COACHING COURSES OF INSTRUCTION (U.S. CLS. 100, 101 AND 107).

FIRST USE 10-1-2002; IN COMMERCE 10-1-2002.

SN 76-467,718. ICEPORT, LLC, CUDAHY, WI. FILED 11-15-2002.

ICEPORT

FOR PROVIDING SPORTS FACILITIES FOR ICE SKATING, ICE HOCKEY, AND ROLLER HOCKEY; PROVIDING CLASSES OF INSTRUCTION IN ICE HOCKEY, FIGURE SKATING, AND ROLLER HOCKEY (U.S. CLS. 100, 101 AND 107).

SN 76-469,020. THE WORKS AT WYOMISSING, BIRDSBORO, PA. FILED 11-21-2002.

GEARED FOR FUN

FOR ENTERTAINMENT SERVICES IN THE NATURE OF AN INDOOR AMUSEMENT COMPLEX (U.S. CLS. 100, 101 AND 107).

CLASS 41—(Continued).

SN 76-469,040. TRANSITIONS COACHING LLC, WAUWATOSA, WI. FILED 11-21-2002.

PROGRESSIVE LIFE

FOR CAREER COUNSELING AND VOCATIONAL GUIDANCE SERVICES; CAREER MANAGEMENT COUNSELING; CONSULTING WITH INDIVIDUALS REGARDING CAREER AND LEADERSHIP DEVELOPMENT, CAREER PLANNING, PERFORMANCE IMPROVEMENTS AND OVERCOMING SKILL DEFICIENCIES, AND CAREER TRANSITIONS AND JOB HUNTING SKILLS (U.S. CLS. 100, 101 AND 107).

SN 76-469,267. LEFTY PAW PRINT, LLC, NEW YORK, NY. FILED 11-21-2002.

GIRLS CAN DO IT TOO

NO CLAIM IS MADE TO THE EXCLUSIVE RIGHT TO USE "GIRLS", APART FROM THE MARK AS SHOWN.

FOR CONDUCTING AND ORGANIZING ENTERTAINMENT EXHIBITIONS IN THE NATURE OF SKATEBOARD COMPETITIONS, TOURNAMENTS AND GAMES; ARRANGING AND CONDUCTING ATHLETIC COMPETITIONS; ENTERTAINMENT IN THE NATURE OF ATHLETIC COMPETITIONS, TOURNAMENTS AND GAMES; RECORD PRODUCTION; MUSIC PRODUCTION; AUDIO RECORDING AND PRODUCTION; VIDEOTAPE PRODUCTION; MOTION PICTURE SONG PRODUCTION; PRODUCTION OF VIDEO DISCS FOR OTHERS; RECORDING STUDIOS; ENTERTAINMENT SERVICES, NAMELY, PRODUCING AND DISTRIBUTING MUSICAL AUDIO AND VIDEO RECORDINGS; MUSIC COMPOSITION AND TRANSCRIPTION FOR OTHERS; SONG WRITING SERVICES; MUSIC PUBLISHING SERVICES; ENTERTAINMENT IN THE NATURE OF A LIVE MUSICAL PERFORMER AND MUSICAL BAND; ENTERTAINMENT IN THE NATURE OF LIVE PERFORMANCES BY A MUSICAL ARTIST AND MUSICAL BAND; ENTERTAINMENT IN THE NATURE OF VISUAL AND AUDIO PERFORMANCES BY A MUSICAL ARTIST AND MUSICAL BAND; ENTERTAINMENT, NAMELY, LIVE MUSIC CONCERTS; ENTERTAINMENT, NAMELY, PERSONAL APPEARANCES BY A MUSICIAN AND MUSICAL BAND; ENTERTAINMENT SERVICES, NAMELY, PROVIDING A WEB SITE FEATURING MUSICAL PERFORMANCES, MUSICAL VIDEOS, RELATED FILM CLIPS, PHOTOGRAPHS, AND OTHER MULTIMEDIA MATERIALS; ENTERTAINMENT SERVICES, NAMELY, PROVIDING PRERECORDED MUSIC, INFORMATION IN THE FIELD OF MUSIC, COMMENTARY AND ARTICLES ABOUT MUSIC, ALL ONLINE VIA A GLOBAL COMPUTER NETWORK; TELEVISION AND RADIO PRODUCTION; RADIO ENTERTAINMENT PRODUCTION; ENTERTAINMENT IN THE NATURE OF ON-GOING TELEVISION AND RADIO PROGRAMS FEATURING MUSICAL PERFORMANCES (U.S. CLS. 100, 101 AND 107).

SN 76-470,380. BARNES, MISTI, SOUTH PASADENA, CA. FILED 11-29-2002.

SHEDANCE

FOR CONDUCTING ENTERTAINMENT EXHIBITIONS IN THE NATURE OF FILM FESTIVALS FOR ORIGINAL MOTION PICTURES BY AND/OR SHOWCASING WOMEN (U.S. CLS. 100, 101 AND 107).

CLASS 41—(Continued).

SN 76-470,735. THE NEMOURS FOUNDATION, JACKSONVILLE, FL. FILED 11-27-2002.

NEMOURS

FOR EDUCATIONAL SERVICES, NAMELY, ARRANGING AND CONDUCTING EDUCATIONAL CONFERENCES, CLASSES, SEMINARS, WORKSHOPS, AND INDIVIDUALIZED INSTRUCTION IN THE FIELDS OF HEALTH CARE, MEDICINE, AND HUMAN WELFARE; DEVELOPMENT AND DISSEMINATION OF EDUCATIONAL MATERIALS IN THE FIELDS OF HEALTH CARE, MEDICINE, AND HUMAN WELFARE (U.S. CLS. 100, 101 AND 107).

FIRST USE 0-0-1949; IN COMMERCE 0-0-1949.

SN 76-471,286. AARP, WASHINGTON, DC. FILED 11-18-2002.

NRTA LIVE & LEARN

OWNER OF U.S. REG. NOS. 743,468 AND 1,319,302.

FOR ON-LINE PUBLICATION OF NEWSPAPERS, NEWSLETTERS, PERIODICALS, BROCHURES, BOOKS AND BULLETINS IN THE FIELDS OF RETIRED EDUCATORS, MATURE INDIVIDUALS, RETIREMENT, MATURE OR RETIRED LIFESTYLES, AGING AND FAMILY RELATIONSHIPS (U.S. CLS. 100, 101 AND 107).

SN 76-471,386. LGE PERFORMANCE SYSTEMS, INC., ORLANDO, FL. FILED 11-18-2002.

FULL ENGAGEMENT

FOR EDUCATIONAL SERVICES, INCLUDING SEMINARS, WORKSHOPS, CONFERENCES, SPEECHES, TRAINING AND PERSONAL COACHING, ALL IN THE FIELDS OF IMPROVING PERSONAL AND BUSINESS SKILLS, ABILITIES AND PERFORMANCE (U.S. CLS. 100, 101 AND 107).

FIRST USE 3-0-2002; IN COMMERCE 3-0-2002.

SN 76-471,888. DEL TORO, BENICIO, BEVERLY HILLS, CA. FILED 11-15-2002.

KAPOW PRODUCTIONS

NO CLAIM IS MADE TO THE EXCLUSIVE RIGHT TO USE "PRODUCTIONS", APART FROM THE MARK AS SHOWN.

FOR PRODUCTION AND DISTRIBUTION OF MOTION PICTURES AND TELEVISION PROGRAMS (U.S. CLS. 100, 101 AND 107).

CLASS 41—(Continued).

SN 76-472,781. ELLIS, EUGENE, SAN DIEGO, CA. FILED 12-9-2002.

CONTROVERSIAL NEWS NETWORK

NO CLAIM IS MADE TO THE EXCLUSIVE RIGHT TO USE "NEWS NETWORK", APART FROM THE MARK AS SHOWN.

FOR PROVIDING A WEBSITE CONTAINING ARTICLES, BOOKS, AND PAMPHLETS FEATURING NEWS AND COMMENTARY ON NOTEWORTHY CURRENT EVENTS (U.S. CLS. 100, 101 AND 107).

SN 76-472,837. MACQUE CORPORATION, NAPERVILLE, IL. FILED 12-6-2002.

AMERICAN NGENUTY

FOR ENTERTAINMENT IN THE NATURE OF A VARIETY GAME SHOW DISTRIBUTED OVER TELEVISION (U.S. CLS. 100, 101 AND 107).

SN 76-473,947. AARON, HUGH E., RICHMOND, VA. FILED 12-10-2002.

MEDICARE BOOT CAMP

NO CLAIM IS MADE TO THE EXCLUSIVE RIGHT TO USE "MEDICARE", APART FROM THE MARK AS SHOWN.

FOR EDUCATIONAL SERVICES, NAMELY CONDUCTING COURSES IN THE FIELD OF MEDICARE MEDICAL BILLING, FOCUSING ON MEDICARE COVERAGE, CODING, BILLING AND PAYMENT RULES, AND DISTRIBUTING COURSE MATERIALS IN CONNECTION THEREWITH (U.S. CLS. 100, 101 AND 107).
FIRST USE 6-17-2002; IN COMMERCE 6-17-2002.

SN 76-474,918. GOTM, LLC, PITTSBURGH, PA. FILED 12-3-2002.

GOTM

FOR ENTERTAINMENT SERVICES, NAMELY PROVIDING ON-LINE GAMES BY MEANS OF THE INTERNET (U.S. CLS. 100, 101 AND 107).

SN 76-474,920. GOTM, LLC, PITTSBURGH, PA. FILED 12-3-2002.

FIT

FOR ENTERTAINMENT SERVICES, NAMELY PROVIDING ON-LINE GAMES BY MEANS OF THE INTERNET (U.S. CLS. 100, 101 AND 107).

CLASS 41—(Continued).

SN 76-475,753. BLUE STAR SOCCER SCHOOL, LLC, COSTA MESA, CA. FILED 12-16-2002.

BLUE STAR SOCCER

NO CLAIM IS MADE TO THE EXCLUSIVE RIGHT TO USE "SOCCER", APART FROM THE MARK AS SHOWN.
FOR SOCCER CAMPS AND SOCCER INSTRUCTION (U.S. CLS. 100, 101 AND 107).

SN 76-475,773. GIRLS PREPARATORY SCHOOL, CHATTANOOGA, TN. FILED 12-17-2002.

GPS

FOR EDUCATIONAL SERVICES, NAMELY, PROVIDING COURSES OF INSTRUCTION AT THE MIDDLE SCHOOL, HIGH SCHOOL AND COLLEGE PREPARATORY LEVELS AND DISTRIBUTING COURSE MATERIALS IN CONJUNCTION THEREWITH; RECREATION, SPORT AND SUMMER CAMPS; ENTERTAINMENT SERVICES, NAMELY, PROVIDING LIVE MUSICAL AND THEATRICAL PERFORMANCES, AND ARRANGING AND CONDUCTING ATHLETIC COMPETITIONS; AND INFORMATION SERVICES FOR ALL OF THE FOREGOING PROVIDED BY A GLOBAL COMPUTER NETWORK (U.S. CLS. 100, 101 AND 107).
FIRST USE 0-0-1906; IN COMMERCE 0-0-1906.

SN 76-476,299. PEGGY KNIGHT SOLUTIONS, INC., SAUSALITO, CA. FILED 12-16-2002.

THE NEXT PLANE

FOR EDUCATIONAL SERVICES, NAMELY, CONDUCTING CLASSES, SEMINARS, CONFERENCES, AND WORKSHOPS IN THE FIELD OF ENTREPRENEURSHIP (U.S. CLS. 100, 101 AND 107).
FIRST USE 12-6-2002; IN COMMERCE 12-6-2002.

SN 76-477,068. FARNETI, JOHN, JR., HOUSTON, TX. FILED 12-19-2002.

GOSPEL SOCKHOP - THERE IS NO CONSTITUTIONAL SEPARATION OF CHURCH AND BOOGIE

NO CLAIM IS MADE TO THE EXCLUSIVE RIGHT TO USE "GOSPEL SOCKHOP", APART FROM THE MARK AS SHOWN.

FOR ENTERTAINMENT SERVICES, NAMELY, PROVIDING A RADIO PROGRAM IN THE FIELD OF GOSPEL MUSIC AND CHRISTIAN PROGRAMMING (U.S. CLS. 100, 101 AND 107).

CLASS 41—(Continued).

SN 76-477,703. FREE AGENCY, INC., NEW YORK, NY. FILED 12-23-2002.

GAIA GIRL

NO CLAIM IS MADE TO THE EXCLUSIVE RIGHT TO USE "GAIA", APART FROM THE MARK AS SHOWN. "GAIA" IS THE NAME OF THE GREEK GODDESS OF THE EARTH.

FOR EDUCATIONAL SERVICES, NAMELY, PROVIDING WORKSHOPS, DISCUSSIONS, AND PERFORMANCES FEATURING A FICTIONAL CHARACTER TO ADDRESS ENVIRONMENTAL ISSUES (U.S. CLS. 100, 101 AND 107).

SN 78-015,489. THOMAS, ROBERT ALAN, MILPITAS, CA. FILED 7-5-2000.

AMATEUR ACTION

FOR ENTERTAINMENT SERVICES, NAMELY, PROVIDING ADULT PHOTOGRAPHS AND VIDEOS VIA A GLOBAL COMPUTER NETWORK (U.S. CLS. 100, 101 AND 107).

FIRST USE 2-10-1991; IN COMMERCE 2-10-1991.

SN 78-024,272. LEFF, LAURA, PIEDMONT, CA. FILED 9-2-2000.

INTERNATIONAL JACK BENNY FAN CLUB

NO CLAIM IS MADE TO THE EXCLUSIVE RIGHT TO USE "FAN CLUB", APART FROM THE MARK AS SHOWN. SEC. 2(F).

FOR FAN CLUB FOR JACK BENNY; TAPE LIBRARY SERVICES, NAMELY, PROVIDING AUDIO AND VIDEOTAPES FEATURING JACK BENNY APPEARANCES, TRIBUTES, OR THOSE OF HIS ASSOCIATES; AND PROVIDING ENTERTAINMENT INFORMATION SERVICES FEATURING JACK BENNY AND HIS ASSOCIATES (U.S. CLS. 100, 101 AND 107).

FIRST USE 1-1-1980; IN COMMERCE 3-1-1987.

SN 78-078,558. PUBLIC RADIO INTERNATIONAL, INC., MINNEAPOLIS, MN. FILED 8-9-2001.

AMERICAN PUBLIC RADIO

OWNER OF U.S. REG. NO. 1,882,559.

NO CLAIM IS MADE TO THE EXCLUSIVE RIGHT TO USE "PUBLIC RADIO", APART FROM THE MARK AS SHOWN.

SEC. 2(F).

FOR RADIO PROGRAMMING AND DISTRIBUTION OF RADIO PROGRAMMING FOR OTHERS (U.S. CLS. 100, 101 AND 107).

CLASS 41—(Continued).

SN 78-095,870. INTERNATIONAL UNION OF OPERATING ENGINEERS, WASHINGTON, DC. FILED 11-30-2001.

IUOE

OWNER OF U.S. REG. NO. 347,276.

FOR PROVIDING ON-LINE MAGAZINES IN THE FIELD OF INFORMATION PROMOTING THE INTERESTS OF OPERATING ENGINEERS (U.S. CLS. 100, 101 AND 107).

FIRST USE 5-31-2000; IN COMMERCE 5-31-2000.

SN 78-112,546. IFRA CENTRE FOR ADVANCED NEWS OPERATIONS, DBA IFRA NEWSOPS CENTRE, CAMDEN, SC. FILED 3-5-2002.

NEWSPLEX

FOR PROVIDING EDUCATIONAL SERVICES AND TRAINING FACILITIES, IN THE NATURE OF A COMBINED NEWSPAPER, TELEVISION AND ONLINE NEWSROOM AND STUDIO, IN THE FIELD OF NEWSROOM TECHNOLOGY AND JOURNALISM (U.S. CLS. 100, 101 AND 107).

FIRST USE 3-9-2001; IN COMMERCE 3-9-2001.

SN 78-131,797. MURPHY, DON, ATLANTA, GA. FILED 5-29-2002.

ETERNAL WARRIORS

FOR MUSIC PRODUCTION SERVICES; PRODUCTION OF VIDEOCASSETTES; ENTERTAINMENT, NAMELY LIVE PERFORMANCES BY A MUSICAL ARTIST (U.S. CLS. 100, 101 AND 107).

SN 78-134,969. HEALTH INTERNATIONAL CORPORATION, ST. PETERSBURG, FL. FILED 6-12-2002.

ASK YOUR PERSONAL TRAINER

NO CLAIM IS MADE TO THE EXCLUSIVE RIGHT TO USE "PERSONAL TRAINER", APART FROM THE MARK AS SHOWN.

FOR EDUCATIONAL AND ENTERTAINMENT SERVICES, NAMELY, PHYSICAL FITNESS, EXERCISE AND BODYBUILDING INSTRUCTION AND TRAINING; AND PHYSICAL EDUCATION SERVICES VIA A GLOBAL COMPUTER NETWORK, NAMELY, PHYSICAL FITNESS, EXERCISE AND BODYBUILDING INSTRUCTION AND TRAINING; PROVIDING A TELEVISION PROGRAM IN THE FIELD OF PHYSICAL FITNESS INSTRUCTION, EXERCISE AND BODYBUILDING INSTRUCTION AND TRAINING AND PHYSICAL EDUCATION (U.S. CLS. 100, 101 AND 107).

CLASS 41—(Continued).

SN 78-135,365. PARADE COMPANY, THE, DETROIT, MI. FILED 6-13-2002.

HEROES DAY

NO CLAIM IS MADE TO THE EXCLUSIVE RIGHT TO USE "DAY", APART FROM THE MARK AS SHOWN.

FOR ORGANIZING AND CONDUCTING CIVIC EVENTS IN THE NATURE OF COMMUNITY FESTIVALS (U.S. CLS. 100, 101 AND 107).

SN 78-136,089. MARKETWATCH.COM, INC., SAN FRANCISCO, CA. FILED 6-15-2002.

MARKETWATCH.COM

FOR ENTERTAINMENT SERVICES, NAMELY PRODUCTION OF RADIO AND TELEVISION PROGRAMS AND ONLINE VIDEO SEGMENTS DELIVERED VIA A GLOBAL COMPUTER NETWORK IN THE FIELDS OF NEWS, BUSINESS, FINANCE, AND CURRENT EVENTS (U.S. CLS. 100, 101 AND 107).

SN 78-136,093. MARKETWATCH.COM, INC., SAN FRANCISCO, CA. FILED 6-15-2002.

MARKETWATCH

FOR ENTERTAINMENT SERVICES, NAMELY PRODUCTION OF RADIO AND TELEVISION PROGRAMS AND ONLINE VIDEO SEGMENTS DELIVERED VIA A GLOBAL COMPUTER NETWORK IN THE FIELDS OF NEWS, BUSINESS, FINANCE, AND CURRENT EVENTS (U.S. CLS. 100, 101 AND 107).

SN 78-137,401. UNCLE NINO PRODUCTIONS, LLC, CHICAGO, IL. FILED 6-20-2002.

UNCLE NINO PRODUCTIONS

NO CLAIM IS MADE TO THE EXCLUSIVE RIGHT TO USE "PRODUCTIONS", APART FROM THE MARK AS SHOWN.

THE NAME(S), PORTRAIT(S), AND/OR SIGNATURE(S) SHOWN IN THE MARK DOES NOT IDENTIFY A PARTICULAR LIVING INDIVIDUAL.

FOR MOTION PICTURE FILM PRODUCTION SERVICES (U.S. CLS. 100, 101 AND 107).

CLASS 41—(Continued).

SN 78-141,434. FOWLER, ANTHONY BARCELO, GLENDALE, CA. FILED 7-5-2002.



NO CLAIM IS MADE TO THE EXCLUSIVE RIGHT TO USE "STUDIOS", APART FROM THE MARK AS SHOWN.

THE MARK CONSISTS OF A GOTHIC CATHEDRAL WITH A SUNBURST HALO BEHIND THE BUILDING WITH THE WORDING "WHISPERWORKS STUDIOS" DIRECTLY BELOW THE BUILDING. THE HALO BEHIND THE BUILDING IS COLORED VARIOUS SHADES OF BLUE WITH BLUE HIGHLIGHTING OF THE BUILDING AND WORDING.

FOR MULTIMEDIA ENTERTAINMENT SOFTWARE PRODUCTION SERVICES; PHOTOGRAPHY, VIDEOGRAPHY, AND CINEMATOGRAPHY SERVICES; ENTERTAINMENT NAMELY, PREPARATION OF SPECIAL EFFECTS; SPECIAL EFFECTS ANIMATION SERVICES FOR FILM AND VIDEO; DIRECTING MOTION PICTURE FILMS, TELEVISION AND RADIO PROGRAMS FOR OTHERS (U.S. CLS. 100, 101 AND 107). FIRST USE 7-22-1996; IN COMMERCE 10-29-1999.

SN 78-144,453. DUBIN, LESLIE, CELEBRATION, FL. FILED 7-16-2002.

LEARNER CENTERED STUDY SOLUTIONS

NO CLAIM IS MADE TO THE EXCLUSIVE RIGHT TO USE "LEARNER CENTERED STUDY", APART FROM THE MARK AS SHOWN.

FOR EDUCATION SERVICES, NAMELY, PROVIDING COURSES OF INSTRUCTION AT THE PRIMARY AND SECONDARY LEVELS (U.S. CLS. 100, 101 AND 107).

CLASS 41—(Continued).

SN 78-148,622. **FOODBOYZ.COM**, LOUISVILLE, KY. FILED 7-29-2002.



NO CLAIM IS MADE TO THE EXCLUSIVE RIGHT TO USE ".COM", APART FROM THE MARK AS SHOWN.

FOR ENTERTAINMENT SERVICES, NAMELY, PROVIDING RESTAURANT/CULINARY FOOD WINE AND NIGHT CLUB REVIEWS (U.S. CLS. 100, 101 AND 107).

SN 78-148,850. NATIONAL EDUCATION SEMINARS, INC., DBA HONDROS COLLEGE, WESTERVILLE, OH. FILED 7-30-2002.

Effective Career Education...Anytime, Anywhere

FAST CLASS.com

FOR EDUCATIONAL SERVICES, NAMELY, CONDUCTING COURSES IN THE FIELD OF REAL ESTATE AND FINANCE VIA THE GLOBAL COMMUNICATIONS NETWORK AND DISTRIBUTING COURSE MATERIALS IN CONNECTION THEREWITH (U.S. CLS. 100, 101 AND 107).

FIRST USE 7-1-2002; IN COMMERCE 7-1-2002.

SN 78-150,240. JOHNSON, R. SCOTT, DBA THE DREAM POLICE, SOUTH ELGIN, IL. FILED 8-2-2002.

THE

Dream Police
Dream Police

FOR ENTERTAINMENT NAMELY, LIVE PERFORMANCES BY A MUSICAL BAND (U.S. CLS. 100, 101 AND 107).

SN 78-158,145. CENTERED ON SUCCESS, INC., COLORADO SPRINGS, CO. FILED 8-27-2002.

COMMUNICARE

FOR EDUCATIONAL AND CONSULTING SERVICES, NAMELY PROVIDING COURSES OF INSTRUCTION, SEMINARS, EXECUTIVE COACHING SESSIONS, ADVISORY GUIDANCE, LEADERSHIP TRAINING, PUBLIC SPEAKING PRESENTATIONS, AND CUSTOM WORK PRODUCTS, NAMELY IN THE FIELDS OF ORGANIZATIONAL AND LEADERSHIP DEVELOPMENT, AT HUMAN SERVICE ORGANIZATIONS, NAMELY HEALTH CARE PROVIDERS, HOSPICES, SOCIAL SERVICES AGENCIES, AND NON-PROFIT ORGANIZATIONS (U.S. CLS. 100, 101 AND 107).

CLASS 41—(Continued).

SN 78-158,171. THE EVANGELISM INSTITUTE, RICHMOND, VA. FILED 8-27-2002.

UN-EVANGELISM

FOR EDUCATION SERVICES IN THE FIELD OF RELIGIOUS TRAINING AND OUTREACH, FOCUSED ON EVANGELISM, AND CONDUCTED THROUGH CLASSES, CONFERENCES, SEMINARS, AND WORKSHOPS, WHICH INCLUDES THE DISTRIBUTION OF COURSE MATERIALS (U.S. CLS. 100, 101 AND 107).

FIRST USE 1-9-2002; IN COMMERCE 1-9-2002.

SN 78-162,082. DAVIS DAIRY, INCORPORATED, STERLING, MA. FILED 9-9-2002.

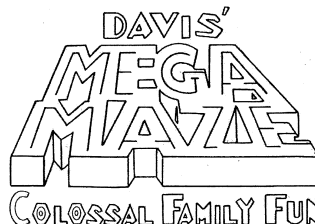

OWNER OF U.S. REG. NOS. 2,048,994 AND 2,064,821.

NO CLAIM IS MADE TO THE EXCLUSIVE RIGHT TO USE "MAZE", APART FROM THE MARK AS SHOWN.

FOR ENTERTAINMENT AND EDUCATIONAL SERVICES IN THE NATURE OF A FIELD MAZE (U.S. CLS. 100, 101 AND 107).

FIRST USE 6-30-1999; IN COMMERCE 6-30-1999.

SN 78-171,336. PASTORE, CARA, MIAMI BEACH, FL. FILED 10-4-2002.

F22 STUDIO

NO CLAIM IS MADE TO THE EXCLUSIVE RIGHT TO USE "STUDIO", APART FROM THE MARK AS SHOWN.

FOR PHOTOGRAPHY SERVICES, NAMELY PORTRAITURE, PUBLICITY PHOTOS, AND PUBLICATION OF PHOTOGRAPHS, BOOKS, MAGAZINES, BROCHURES, AND FLYERS IN BOTH COLOR AND BLACK AND WHITE (U.S. CLS. 100, 101 AND 107).

FIRST USE 12-4-2000; IN COMMERCE 12-4-2000.

SN 78-172,305. LEADERSHIP I2I, LLC, GREENSBORO, NC. FILED 10-8-2002.

LEADERSHIPi2i

NO CLAIM IS MADE TO THE EXCLUSIVE RIGHT TO USE "LEADERSHIP", APART FROM THE MARK AS SHOWN.

FOR CONSULTING SERVICES IN THE FIELD OF LEADERSHIP TRAINING (U.S. CLS. 100, 101 AND 107).

CLASS 41—(Continued).

SN 78-174,274. HORSELAND LLC, ROCHESTER, NY. FILED 10-14-2002.

HORSELAND

FOR ENTERTAINMENT SERVICES, NAMELY, PROVIDING ENTERTAINMENT IN THE FIELD OF INTERACTIVE GAMES BY MEANS OF A GLOBAL COMPUTER NETWORK (U.S. CLS. 100, 101 AND 107).

FIRST USE 8-1-1996; IN COMMERCE 8-1-1996.

SN 78-177,676. COLD TRUTH, LA VERGNE, TN. FILED 10-23-2002.

COLD TRUTH

FOR ENTERTAINMENT, NAMELY, LIVE PERFORMANCES BY A MUSICAL BAND (U.S. CLS. 100, 101 AND 107).

SN 78-178,352. KICK ASTHMA, LLC, SEATTLE, WA. FILED 10-25-2002.

KICK ASTHMA

FOR EDUCATIONAL SERVICES, NAMELY, PROVIDING SEMINARS IN THE FIELD OF BREATHING EXERCISES FOR ALLEVIATING STRESS AND HYPERVENTILATION, AND DISTRIBUTING MATERIALS RELATED THERETO (U.S. CLS. 100, 101 AND 107).

FIRST USE 3-0-2001; IN COMMERCE 10-18-2002.

SN 78-179,782. KENDALL, NANJI, L, VENICE, CA. FILED 10-29-2002.

BODHI BUILDING

THE ENGLISH TRANSLATION OF THE SANSKRIT WORD "BODHI" IN THE MARK IS "AWAKENED".

FOR PERSONAL TRAINING SERVICES, NAMELY, STRENGTH AND CONDITIONING TRAINING (U.S. CLS. 100, 101 AND 107).

SN 78-180,327. STAGE ONE PRODUCTIONS, INC., DENVER, CO. FILED 10-30-2002.

**WHERE IMAGINATION
MINGLES WITH MATTER**

FOR ENTERTAINMENT SERVICES, NAMELY, PRODUCTION AND DISTRIBUTION OF MOTION PICTURES; PRODUCTION OF VIDEO CASSETTES (U.S. CLS. 100, 101 AND 107).

FIRST USE 0-0-1977; IN COMMERCE 0-0-1978.

CLASS 41—(Continued).

SN 78-180,951. FIRST FLIGHT PRODUCTIONS, LLC, HARRISONBURG, VA. FILED 11-1-2002.

ACROSS GENERATIONS

NO CLAIM IS MADE TO THE EXCLUSIVE RIGHT TO USE "GENERATIONS", APART FROM THE MARK AS SHOWN.

FOR ENTERTAINMENT, NAMELY A CONTINUING VARIETY SHOW BROADCAST OVER TELEVISION, SATELLITE, AUDIO, AND VIDEO MEDIA FOCUSING ON FAMILY HISTORIES, HISTORICAL FIGURES AND EVENTS, AND GENEALOGY (U.S. CLS. 100, 101 AND 107).

FIRST USE 5-24-2002; IN COMMERCE 6-1-2002.

SN 78-185,791. MAYACAMA GOLF CLUB LLC, SANTA ROSA, CA. FILED 11-15-2002.

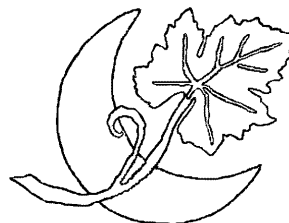

THE MARK CONSISTS OF THE DESIGN OF A SINGLE GRAPE LEAF WITH AN ATTACHED VINE IN FRONT OF A CRESCENT MOON.

FOR GOLF COURSES, GOLF CLUB SERVICES, GOLF CADDIE SERVICES, RECREATIONAL SERVICES IN THE NATURE OF GOLF COURSE FACILITIES, FITTING OF GOLF CLUBS TO INDIVIDUAL USERS, EDUCATIONAL DEMONSTRATION FOR INSTRUCTORS AND OTHERS IN THE FIELD OF GOLF; EDUCATIONAL SERVICES, NAMELY, CONDUCTING CLASSES, SEMINARS, CONFERENCES, AND WORKSHOPS IN THE FIELD OF GOLF FOR PROFESSIONAL INSTRUCTORS AND OTHERS, AND DISTRIBUTING COURSE MATERIALS IN CONNECTION THEREWITH; AND PROVIDING SPORTS FACILITIES, SPECIFICALLY, FOR GOLF AND TENNIS (U.S. CLS. 100, 101 AND 107).

FIRST USE 3-1-2001; IN COMMERCE 8-1-2001.

SN 78-187,330. NUTRAMERICA CORPORATION, CEDAR KNOLLS, NJ. FILED 11-21-2002.

DREAM BODY AWARD

NO CLAIM IS MADE TO THE EXCLUSIVE RIGHT TO USE "BODY AWARD", APART FROM THE MARK AS SHOWN.

FOR ENTERTAINMENT SERVICES IN THE NATURE OF PHYSICAL WELLNESS CONTESTS (U.S. CLS. 100, 101 AND 107).

CLASS 41—(Continued).

SN 78-188,739. WATCHMARK CORP., BELLEVUE, WA.
FILED 11-25-2002.

WATCHMARK

OWNER OF U.S. REG. NOS. 2,243,488, 2,250,248 AND OTHERS.

FOR EDUCATIONAL SERVICES, NAMELY, TRAINING, TEACHING, AND CONDUCTING WORKSHOPS AND SEMINARS IN THE FIELDS OF TELECOMMUNICATIONS, WIRELESS COMMUNICATIONS, TELECOMMUNICATIONS NETWORKS, WIRELESS AND INTERNET NETWORKS, BROADBAND AND WIRELESS APPLICATIONS, TELECOMMUNICATIONS NETWORK SECURITY, WIRELESS AND INTERNET NETWORK SECURITY, AND COMPUTER SOFTWARE INTEGRATION AND MAINTENANCE; ARRANGING AND CONDUCTING EDUCATIONAL CONFERENCES; COMPUTER EDUCATION TRAINING; DEVELOPING EDUCATIONAL MANUALS FOR OTHERS IN THE FIELDS OF TELECOMMUNICATIONS, WIRELESS COMMUNICATIONS, TELECOMMUNICATIONS NETWORKS, WIRELESS AND INTERNET NETWORKS, BROADBAND AND WIRELESS APPLICATIONS, TELECOMMUNICATIONS NETWORK SECURITY, WIRELESS AND INTERNET NETWORK SECURITY, AND COMPUTER SOFTWARE INTEGRATION AND MAINTENANCE; DEVELOPMENT AND DISSEMINATION OF EDUCATIONAL MATERIALS FOR OTHERS IN THE FIELDS OF TELECOMMUNICATIONS, WIRELESS COMMUNICATIONS, TELECOMMUNICATIONS NETWORKS, WIRELESS AND INTERNET NETWORKS, BROADBAND AND WIRELESS APPLICATIONS, TELECOMMUNICATIONS NETWORK SECURITY, WIRELESS AND INTERNET NETWORK SECURITY, AND COMPUTER SOFTWARE INTEGRATION AND MAINTENANCE; ON-LINE PUBLICATIONS, NAMELY, BOOKS, BROCHURES, JOURNALS, ARTICLES, LEAFLETS, MAGAZINES, MANUALS, AND TEXT BOOKS REGARDING TELECOMMUNICATIONS, WIRELESS COMMUNICATIONS, TELECOMMUNICATIONS NETWORKS, WIRELESS AND INTERNET NETWORKS, BROADBAND AND WIRELESS APPLICATIONS, TELECOMMUNICATIONS NETWORK SECURITY, WIRELESS AND INTERNET NETWORK SECURITY, AND COMPUTER SOFTWARE INTEGRATION AND MAINTENANCE; PUBLICATION OF BOOKS, BROCHURES, JOURNALS, LEAFLETS, MAGAZINES, MANUALS, TEXT BOOKS; SPECIAL EVENT PLANNING (U.S. CLS. 100, 101 AND 107).

SN 78-189,418. VIACOM INTERNATIONAL INC., NEW YORK, NY. FILED 11-27-2002.

MY LIFE AS A TEENAGE ROBOT

FOR ENTERTAINMENT SERVICES IN THE NATURE OF AN ON-GOING TELEVISION SERIES FEATURING ANIMATION; PROVIDING INFORMATION IN THE FIELD OF ENTERTAINMENT BY MEANS OF A GLOBAL COMPUTER NETWORK (U.S. CLS. 100, 101 AND 107).

SN 78-189,937. BURLESON ENTERPRISES INC., DBA BURLESON PRESS, KITTRELL, NC. FILED 12-1-2002.

ORACLE IN-FOCUS

FOR BOOK PUBLISHING (U.S. CLS. 100, 101 AND 107).

CLASS 41—(Continued).

SN 78-190,169. GLOBAL EDUTAINMENT INC., MIAMI, FL.
FILED 12-2-2002.

BINAR-E-WORLD

FOR EDUCATIONAL ENTERTAINMENT SERVICES, NAMELY, AN INTERACTIVE AMUSEMENT RIDE UTILIZING SPECIAL EFFECTS IN FEATURING INFORMATION RELATED TO COMPUTERS, GLOBAL COMPUTER NETWORKING, AND DIGITAL PROCESSING OF DATA (U.S. CLS. 100, 101 AND 107).

SN 78-190,398. BARTHOLOMEW, MEL, EDEN, UT. FILED 12-2-2002.

SQUARE METER GARDENING

NO CLAIM IS MADE TO THE EXCLUSIVE RIGHT TO USE "GARDENING", APART FROM THE MARK AS SHOWN.

FOR CONDUCTING LECTURES AND CLASSES IN THE FIELD OF GARDENING (U.S. CLS. 100, 101 AND 107).

SN 78-190,454. SINCLAIR OIL CORPORATION, SALT LAKE CITY, UT. FILED 12-2-2002.

GRETCHEN'S GOLD

FOR ENTERTAINMENT SERVICES IN THE NATURE OF A SKI RUN. (U.S. CLS. 100, 101 AND 107).

SN 78-190,467. COLLEGE OF FOOD, THE, WALNUT, CA.
FILED 12-2-2002.



The College of Food

NO CLAIM IS MADE TO THE EXCLUSIVE RIGHT TO USE "THE COLLEGE OF FOOD", APART FROM THE MARK AS SHOWN.

FOR EDUCATIONAL SERVICES, NAMELY, CONDUCTING CLASSES IN THE FIELD OF CULINARY ARTS (U.S. CLS. 100, 101 AND 107).

CLASS 41—(Continued).

SN 78-190,907. SOUND MIND ENTERTAINMENT, CAMERON PARK, CA. FILED 12-3-2002.



FOR PRODUCTION OF MUSICAL RECORDINGS, CD'S, VIDEOTAPES, AUDIO CASSETTES, PHONOGRAPHIC RECORDS, AND MUSIC VIDEOS (U.S. CLS. 100, 101 AND 107).

SN 78-190,958. REED, VINCENT N., SEVERN, MD. FILED 12-4-2002.

ALL ABOUT PHOTOGRAPHY

NO CLAIM IS MADE TO THE EXCLUSIVE RIGHT TO USE "PHOTOGRAPHY", APART FROM THE MARK AS SHOWN.

FOR PHOTOGRAPHY (U.S. CLS. 100, 101 AND 107).
FIRST USE 1-1-2001; IN COMMERCE 3-1-2001.

SN 78-193,199. MARVEL CHARACTERS, INC., LOS ANGELES, CA. FILED 12-11-2002.

1,000 DAYS

FOR ENTERTAINMENT AND EDUCATION SERVICES, NAMELY, STAGING RECREATIONAL GAMES AND CONTESTS FOR EXHIBITION OR PARTICIPATION BY ATTENDEES, LIVE PERFORMANCE GAMES AND EXHIBITIONS OF COSTUMED CHARACTERS FOR PARTIES, CONVENTIONS, EDUCATIONAL AND PROMOTIONAL PURPOSES AND SPECIAL EVENTS; LIVE PERFORMANCE THEATRICAL EXHIBITIONS FEATURING COSTUMED CHARACTERS; SERIES OF TELEVISION PROGRAMS FEATURING ANIMATED CARTOONS AND/OR LIVE ACTION ADVENTURE; TELEVISION PROGRAMMING FEATURING EXHIBITION OF FILMS AND VIDEO TAPES; MOVIE THEATRE SERVICES, NAMELY, THE EXHIBITION OF FILMS AND VIDEO TAPES IN THEATRES; EDUCATIONAL SERVICES, NAMELY CONDUCTING WORKSHOPS AND SEMINARS IN THE FIELDS OF WRITING, STORYTELLING AND ART FOR AND IN RELATION TO THE COMIC BOOK AND ANIMATION INDUSTRIES AND IN THE FIELD OF INTERACTIVE AND CONFIDENCE GAMES, AND CONDUCTING WORKSHOPS AND GAMES USED FOR TEACHING TEAMWORK, COMMUNICATION AND CONFLICT RESOLUTION. (U.S. CLS. 100, 101 AND 107).

CLASS 41—(Continued).

SN 78-193,201. MARVEL CHARACTERS, INC., LOS ANGELES, CA. FILED 12-11-2002.

BROTHER VOODOO

FOR ENTERTAINMENT AND EDUCATION SERVICES, NAMELY, STAGING RECREATIONAL GAMES AND CONTESTS FOR EXHIBITION OR PARTICIPATION BY ATTENDEES, LIVE PERFORMANCE GAMES AND EXHIBITIONS OF COSTUMED CHARACTERS FOR PARTIES, CONVENTIONS, EDUCATIONAL AND PROMOTIONAL PURPOSES AND SPECIAL EVENTS; LIVE PERFORMANCE THEATRICAL EXHIBITIONS FEATURING COSTUMED CHARACTERS; SERIES OF TELEVISION PROGRAMS FEATURING ANIMATED CARTOONS AND/OR LIVE ACTION ADVENTURE; TELEVISION PROGRAMMING FEATURING EXHIBITION OF FILMS AND VIDEO TAPES; MOVIE THEATRE SERVICES, NAMELY, THE EXHIBITION OF FILMS AND VIDEO TAPES IN THEATRES; EDUCATIONAL SERVICES, NAMELY CONDUCTING WORKSHOPS AND SEMINARS IN THE FIELDS OF WRITING, STORYTELLING AND ART FOR AND IN RELATION TO THE COMIC BOOK AND ANIMATION INDUSTRIES AND IN THE FIELD OF INTERACTIVE AND CONFIDENCE GAMES, AND CONDUCTING WORKSHOPS AND GAMES USED FOR TEACHING TEAMWORK, COMMUNICATION AND CONFLICT RESOLUTION. (U.S. CLS. 100, 101 AND 107).

SN 78-193,202. MARVEL CHARACTERS, INC., LOS ANGELES, CA. FILED 12-11-2002.

NIGHT THRASHER

FOR ENTERTAINMENT AND EDUCATION SERVICES, NAMELY, STAGING RECREATIONAL GAMES AND CONTESTS FOR EXHIBITION OR PARTICIPATION BY ATTENDEES, LIVE PERFORMANCE GAMES AND EXHIBITIONS OF COSTUMED CHARACTERS FOR PARTIES, CONVENTIONS, EDUCATIONAL AND PROMOTIONAL PURPOSES AND SPECIAL EVENTS; LIVE PERFORMANCE THEATRICAL EXHIBITIONS FEATURING COSTUMED CHARACTERS; SERIES OF TELEVISION PROGRAMS FEATURING ANIMATED CARTOONS AND/OR LIVE ACTION ADVENTURE; TELEVISION PROGRAMMING FEATURING EXHIBITION OF FILMS AND VIDEO TAPES; MOVIE THEATRE SERVICES, NAMELY, THE EXHIBITION OF FILMS AND VIDEO TAPES IN THEATRES; EDUCATIONAL SERVICES, NAMELY CONDUCTING WORKSHOPS AND SEMINARS IN THE FIELDS OF WRITING, STORYTELLING AND ART FOR AND IN RELATION TO THE COMIC BOOK AND ANIMATION INDUSTRIES AND IN THE FIELD OF INTERACTIVE AND CONFIDENCE GAMES, AND CONDUCTING WORKSHOPS AND GAMES USED FOR TEACHING TEAMWORK, COMMUNICATION AND CONFLICT RESOLUTION. (U.S. CLS. 100, 101 AND 107).

SN 78-194,890. LE CHATEAU ENTERPRISES GROUP, INC., FORT MYERS, FL. FILED 12-16-2002.

LETSPEAK.COM

FOR LANGUAGE TRANSLATION AND INTERPRETATION SERVICES (U.S. CLS. 100, 101 AND 107).
FIRST USE 1-4-1999; IN COMMERCE 1-4-1999.

CLASS 41—(Continued).

SN 78-194,899. INTERNATIONAL SOAP BOX DERBY, INC., AKRON, OH. FILED 12-16-2002.

AMERICAN SOAP BOX DERBY

OWNER OF U.S. REG. NOS. 1,057,229, 1,084,300 AND OTHERS.

NO CLAIM IS MADE TO THE EXCLUSIVE RIGHT TO USE "AMERICAN", APART FROM THE MARK AS SHOWN.

FOR DEVELOPING AND SUPERVISING PROGRAMS OF CONSTRUCTION OF GRAVITY RACING CARS AND CONDUCTING AMATEUR COMPETITIVE RACING EVENTS FOR THE PURPOSE OF DEVELOPING SPORTSMANSHIP, CHARACTER, CRAFTSMANSHIP AND INGENUITY IN YOUTH (U.S. CLS. 100, 101 AND 107).

SN 78-196,435. VERIZON TRADEMARK SERVICES LLC, ARLINGTON, VA. FILED 12-19-2002.

VZTV

FOR PROVIDING ONLINE INFORMATION IN THE FIELD OF ENTERTAINMENT AND ENTERTAINMENT IN THE NATURE OF A TELEVISION SHOW (U.S. CLS. 100, 101 AND 107).

SN 78-196,447. VERIZON TRADEMARK SERVICES LLC, ARLINGTON, VA. FILED 12-19-2002.

VZWTW

FOR PROVIDING ONLINE INFORMATION IN THE FIELD OF ENTERTAINMENT AND ENTERTAINMENT IN THE NATURE OF A TELEVISION SHOW (U.S. CLS. 100, 101 AND 107).

SN 78-196,767. KING WORLD PRODUCTIONS, INC., LOS ANGELES, CA. FILED 12-20-2002.

LIVING IT UP! WITH ALI & JACK

FOR ENTERTAINMENT SERVICES RENDERED THROUGH THE MEDIUM OF TELEVISION IN THE NATURE OF AN INTERVIEW AND VARIETY DAYTIME TALK SHOW SERIES; AND PROVIDING INFORMATION IN THE FIELD OF ENTERTAINMENT FEATURING A TELEVISION TALK SHOW SERIES BY MEANS OF A GLOBAL COMPUTER NETWORK. (U.S. CLS. 100, 101 AND 107).

CLASS 41—(Continued).

SN 78-197,808. TOWNSEND, RAMON D., PHILADELPHIA, PA. FILED 12-26-2002.

WHEN A CHILD MAKES ART, THE ART MAKES THE CHILD.

FOR INSTRUCTION IN ARTS AND CRAFTS (U.S. CLS. 100, 101 AND 107).

SN 78-197,810. TOWNSEND, RAMON D., PHILADELPHIA, PA. FILED 12-26-2002.

WE BELIEVE IN THE GIFT OF BOOKS

FOR INSTRUCTION IN ARTS AND CRAFTS (U.S. CLS. 100, 101 AND 107).

SN 78-198,247. MANSOR, FRANCISCO JOSE, BOHEMIA, NY. FILED 12-27-2002.

KIOTO BRAZILIAN JIU- JITSU

NO CLAIM IS MADE TO THE EXCLUSIVE RIGHT TO USE "BRAZILIAN JIU-JITSU", APART FROM THE MARK AS SHOWN.

FOR ENTERTAINMENT AND EDUCATION IN THE NATURE OF BRAZILIAN JIU-JITSU TECHNIQUES AND TOURNAMENTS (U.S. CLS. 100, 101 AND 107).

FIRST USE 9-1-1999; IN COMMERCE 9-1-1999.

SN 78-198,250. JIMMIE K. MURRAY, RICHARD T. BLACKWOOD, SHERMAN ANDRUS, AND HOVIE WALKER, GALLATIN, TN. FILED 12-27-2002.

THE NEW IMPERIALS QUARTET

NO CLAIM IS MADE TO THE EXCLUSIVE RIGHT TO USE "QUARTET", APART FROM THE MARK AS SHOWN.

FOR ENTERTAINMENT SERVICES, NAMELY, PERSONAL APPEARANCES BY A CHRISTIAN SINGING GROUP (U.S. CLS. 100, 101 AND 107).

CLASS 41—(Continued).

SN 78-198,695. WORLD WRESTLING ENTERTAINMENT, INC., STAMFORD, CT. FILED 12-30-2002.

REY MYSTERIO

FOR ENTERTAINMENT SERVICES, NAMELY WRESTLING EXHIBITIONS AND PERFORMANCES BY A PROFESSIONAL WRESTLER AND ENTERTAINER; PROVIDING WRESTLING NEWS AND INFORMATION VIA A GLOBAL COMPUTER NETWORK. (U.S. CLS. 100, 101 AND 107).

SN 78-198,729. CHAMBERS, KHIA, ATLANTA, GA. FILED 12-30-2002.

KHIA

FOR ENTERTAINMENT IN THE NATURE OF MUSICAL AND VOCAL PERFORMANCES BY A SOLO ARTIST; ENTERTAINMENT SERVICES, NAMELY, PROVIDING INFORMATION VIA THE INTERNET CONCERNING A SOLO MUSICAL ARTIST; FAN CLUB SERVICES (U.S. CLS. 100, 101 AND 107).

SN 78-215,079. VIACOM INTERNATIONAL INC., NEW YORK, NY. FILED 2-14-2003.

MTV ADVANCE WARNING

OWNER OF U.S. REG. NOS. 1,580,650, 2,540,212 AND OTHERS.

FOR ENTERTAINMENT SERVICES IN THE NATURE OF AN ON-GOING TELEVISION PROGRAM FEATURING MUSIC AND VIDEOS; PROVIDING INFORMATION IN THE FIELD OF ENTERTAINMENT FEATURING MUSIC AND VIDEOS RENDERED VIA COMPUTER BY MEANS OF A GLOBAL COMPUTER NETWORK; ENTERTAINMENT SERVICES IN THE NATURE OF PRODUCING LIVE TOUR EVENTS FEATURING MUSIC AND PERFORMERS (U.S. CLS. 100, 101 AND 107).

SN 78-222,370. VIACOM INTERNATIONAL INC., NEW YORK, NY. FILED 3-6-2003.

MTV ONE BAD TRIP

OWNER OF U.S. REG. NOS. 1,580,650, 2,540,212 AND OTHERS.

FOR ENTERTAINMENT SERVICES IN THE NATURE OF AN ON-GOING REALITY BASED TELEVISION PROGRAM FEATURING LIVE ACTION; PROVIDING INFORMATION IN THE FIELD OF ENTERTAINMENT RELATING TO AN ON-GOING REALITY BASED TELEVISION PROGRAM FEATURING LIVE ACTION RENDERED VIA COMPUTER BY MEANS OF A GLOBAL COMPUTER NETWORK (U.S. CLS. 100, 101 AND 107).

CLASS 41—(Continued).

SN 78-229,591. KARSTEN MANUFACTURING CORPORATION, PHOENIX, AZ. FILED 3-25-2003.

PING JUNIOR SOLHEIM CUP

OWNER OF U.S. REG. NOS. 704,552, 2,455,518 AND OTHERS.

NO CLAIM IS MADE TO THE EXCLUSIVE RIGHT TO USE "JUNIOR" AND "CUP", APART FROM THE MARK AS SHOWN.

FOR ORGANIZING AND CONDUCTING GOLF TOURNAMENTS (U.S. CLS. 100, 101 AND 107).

CLASS 42—SCIENTIFIC, COMPUTER AND LEGAL SERVICES

SN 74-529,875. TEAM LAW, INC., RAHWAY, NJ. BY ASSIGNMENT RAVICH, KOSTER, TOBIN, OLECKNA, REITMAN & GREENSTEIN, RAHWAY, NJ. FILED 5-26-1994.

TEAM-LAW

FOR LEGAL SERVICES (U.S. CLS. 100 AND 101). FIRST USE 10-1-1987; IN COMMERCE 10-22-1987.

SN 75-087,242. HORIZON BAY SENIORCARE, INC., WARWICK, RI. FILED 4-12-1996.

HORIZON BAY SENIORCARE

NO CLAIM IS MADE TO THE EXCLUSIVE RIGHT TO USE "SENIORCARE", APART FROM THE MARK AS SHOWN.

FOR PROVIDING NURSING HOME CARE, RESIDENTIAL RETIREMENT CARE AND PERSONAL AND HEALTH CARE IN ASSISTED LIVING FACILITIES AND IN HOMES IN THE COMMUNITY (U.S. CLS. 100 AND 101).

FIRST USE 8-31-1995; IN COMMERCE 8-31-1995.

SN 75-306,624. JERRY'S FAMOUS DELI, INC., STUDIO CITY, CA. BY ASSIGNMENT WOLFIE'S RESTAURANT, INC., MIAMI BEACH, FL. FILED 6-2-1997.

FOR DELICATESSEN SERVICES (U.S. CLS. 100 AND 101). FIRST USE 0-0-1947; IN COMMERCE 0-0-1947.

CLASS 42—(Continued).

SN 75-567,835. JOSEPH BAVONESE, PH.D., P.C., ROYAL OAK, MI. FILED 9-29-1998.

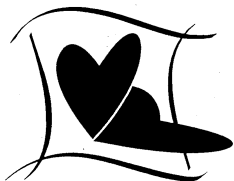

relationship institute

teaching the world to love ... one person at a time

NO CLAIM IS MADE TO THE EXCLUSIVE RIGHT TO USE "RELATIONSHIP INSTITUTE", APART FROM THE MARK AS SHOWN.

FOR PSYCHOLOGICAL SERVICES AND COUNSELING (U.S. CLS. 100 AND 101).

FIRST USE 5-5-1998; IN COMMERCE 5-5-1998.

SN 75-799,099. DEBEVOISE & PLIMPTON, NEW YORK, NY. FILED 9-14-1999.

DEBEVOISE

"DEBEVOISE" DOES NOT IDENTIFY A LIVING INDIVIDUAL.

SEC. 2(F).

FOR LEGAL SERVICES (U.S. CLS. 100 AND 101).

FIRST USE 10-1-1931; IN COMMERCE 10-1-1931.

SN 75-905,528. DIGIMARC CORPORATION, TUALATIN, OR. FILED 1-25-2000.

MEDIABRIDGE

SEC. 2(F).

FOR PRE-PRESS SERVICES, NAMELY, GRAPHIC ART DESIGN AND CONSULTING IN THE FIELD OF STEGANOGRAPHICALLY ENCODING MEDIA, FOR GRAPHIC ARTISTS, PUBLISHERS AND ADVERTISERS (U.S. CLS. 100 AND 101).

FIRST USE 5-0-2000; IN COMMERCE 5-0-2000.

CLASS 42—(Continued).

SN 75-937,969. SURFWAX, INC., MENLO PARK, CA. BY ASSIGNMENT VORT CORPORATION, PALO ALTO, CA. FILED 3-1-2000.

InfoCubby

FOR PROVIDING TEMPORARY USE OF ONLINE, NON-DOWNLOADABLE SOFTWARE NAMELY A USER-SCALABLE, SHRED-KNOWLEDGE OBJECT WITH A CUSTOMIZABLE DATA STRUCTURE THAT ALLOWS A USER TO ORGANIZE, RETAIN, AND REPACKAGE EXTRACTED INFORMATION FROM URL OR DOCUMENT ON THE INTERNET, INTRANETS, OR A CORPUS, AND WHICH ACTS AS A PERSONAL AGENT, WHICH CAN BE SHARED VIA EMAIL OR THROUGH SITE MEMBERSHIP LINKS TO USERS IN RELATED COMMUNITIES (U.S. CLS. 100 AND 101).

FIRST USE 3-31-2000; IN COMMERCE 6-6-2001.

SN 76-080,556. CRIMINOLOGICAL ASSOCIATES, INC., DAVIDSON, NC. FILED 6-29-2000.

DELINQUENCY ALERT

NO CLAIM IS MADE TO THE EXCLUSIVE RIGHT TO USE "DELINQUENCY", APART FROM THE MARK AS SHOWN.

FOR CRIMINOLOGICAL AND SOCIOLOGICAL CONSULTATION SERVICES, NAMELY, OFFER ADVICE CONCERNING TRAITS ASSOCIATED WITH CRIMINAL OR DELINQUENT BEHAVIOR; PRIVATE INVESTIGATION SERVICES; CRIMINOLOGICAL TESTING AND ASSESSMENTS AND CRIMINOLOGICAL RESEARCH REGARDING CRIMINAL AND DELINQUENT BEHAVIOR AND THE ORGANIZATIONS AND STRUCTURES DEALING WITH CRIMINAL AND DELINQUENT BEHAVIOR (U.S. CLS. 100 AND 101).

FIRST USE 6-15-2000; IN COMMERCE 6-15-2000.

SN 76-083,028. DAVID J. SULTANOV D.M.D., P.C., PITTSBURGH, PA. FILED 7-5-2000.

EXQUISITRY COSMETIC DENTAL PROCESS

NO CLAIM IS MADE TO THE EXCLUSIVE RIGHT TO USE "COSMETIC DENTAL PROCESS", APART FROM THE MARK AS SHOWN.

FOR COSMETIC DENTISTRY (U.S. CLS. 100 AND 101).

CLASS 42—(Continued).

SN 76-150,021. TRUGREEN LIMITED PARTNERSHIP, MEMPHIS, TN. FILED S.R. 10-19-2000; AM. P.R. 8-5-2002.

AMERICA'S AUTHORITY ON LAWN AND LANDSCAPE SERVICES

OWNER OF U.S. REG. NOS. 2,188,849, 2,204,869 AND 2,352,859.

NO CLAIM IS MADE TO THE EXCLUSIVE RIGHT TO USE "LAWN AND LANDSCAPE SERVICES", APART FROM THE MARK AS SHOWN.

FOR LAWN CARE, NAMELY, LAWN, TREE, AND SHRUB MAINTENANCE (U.S. CLS. 100 AND 101).

FIRST USE 4-0-2000; IN COMMERCE 4-0-2000.

SN 76-151,724. PLASTIC ENGINEERING & TECHNICAL SERVICES, INC., AUBURN HILLS, MI. FILED 10-23-2000.



**Plastic Engineering &
Technical Services, Inc.**

NO CLAIM IS MADE TO THE EXCLUSIVE RIGHT TO USE "PLASTIC ENGINEERING & TECHNICAL SERVICES, INC.", APART FROM THE MARK AS SHOWN.

FOR ENGINEERING AND CONSULTING SERVICES, NAMELY DESIGN AND DEVELOPMENT OF HOT MANIFOLD SYSTEMS FOR USE IN INJECTION MOLDING AND TECHNICAL SUPPORT THEREOF (U.S. CLS. 100 AND 101).

FIRST USE 4-0-2000; IN COMMERCE 4-0-2000.

SN 76-247,879. TURBOMANAGE CORPORATION, CEDAR RAPIDS, IA. FILED 4-26-2001.

TURBO MANAGE

NO CLAIM IS MADE TO THE EXCLUSIVE RIGHT TO USE "MANAGE", APART FROM THE MARK AS SHOWN.

FOR APPLICATION SERVICE PROVIDER (ASP) FEATURING SOFTWARE FOR USE IN IMPROVING EMPLOYEE PRODUCTIVITY BY MANAGING ELECTRONIC DOCUMENTS AND COMPUTER FILES, EMAIL COMMUNICATIONS, TASK LISTS AND REPORTS, AND OTHER TYPES OF INFORMATION STORED AND COMMUNICATED OVER LOCAL AREA NETWORKS AND OVER A GLOBAL COMPUTER INFORMATION NETWORK (U.S. CLS. 100 AND 101).

FIRST USE 4-5-2001; IN COMMERCE 4-5-2001.

CLASS 42—(Continued).

SN 76-251,626. AMICI'S MT, INC., SAN MATEO, CA. FILED 5-4-2001.



NO CLAIM IS MADE TO THE EXCLUSIVE RIGHT TO USE "PIZZERIA", APART FROM THE MARK AS SHOWN.

THE MARK CONSISTS OF THE PHRASE "AMICI'S EAST COAST PIZZERIA" AND A BRICK OVEN WITH FLAMES. A SECOND LINE ABOVE THE BRICK OVEN TRACES THE OUTLINE OF THE BRICK OVEN, FORMING AN ARCH. CIRCUMSCRIBED WITHIN THE ARCH IS THE PHRASE "A TASTE OF NEW YORK". THE MARK INCLUDES COLORS AS FOLLOWS: THE OUTER LINE ABOVE THE BRICK OVEN IS GREEN (PMS 343), AS IS THE LOWER RECTANGLE CONTAINING THE PHRASE "EAST COAST PIZZERIA;" THE ARCH IS BEIGE (PMS 4545); THE HEARTH IS RED BRICK (PMS 484); AND THE LARGE RECTANGLE CONTAINING THE WORD "AMICI'S" IS BLACK.

"AMICI" MEANS "FRIENDS" IN ITALIAN".
FOR RESTAURANT SERVICES (U.S. CLS. 100 AND 101).

FIRST USE 12-27-1995; IN COMMERCE 12-27-1995.

SN 76-258,225. MAGELLAN HEALTH SERVICES, INC., COLUMBIA, MD. FILED 5-17-2001.

LIVING HEALTHY WORKING WELL

FOR MANAGED MENTAL HEALTH CARE AND SUBSTANCE ABUSE TREATMENT AND EVALUATION SERVICES; DEVELOPMENT OF BEHAVIORAL HEALTH CARE PRODUCTS FOR OTHERS; PROVIDING EMPLOYEE ASSISTANCE PROGRAMS, NAMELY, SYSTEMATIC PROGRAMS TO HELP EMPLOYEES AND THEIR FAMILY MEMBERS RESOLVE PERSONAL PROBLEMS IN THE FIELDS OF FAMILY CONFLICT, DRUG AND ALCOHOL ABUSE, STRESS, MARITAL DISCORD AND PERSONAL FINANCES (U.S. CLS. 100 AND 101).

FIRST USE 7-0-1991; IN COMMERCE 7-0-1991.

SN 76-269,568. GLOBAL MARKET RESEARCH, INC., PLAINFIELD, VT. FILED 6-11-2001.

YOUR DAILY MAP OF THE MARKET

NO CLAIM IS MADE TO THE EXCLUSIVE RIGHT TO USE "MARKET", APART FROM THE MARK AS SHOWN.

FOR COMPUTER SERVICES, NAMELY, PROVIDING AN ONLINE NEWSLETTER IN THE FIELD OF STOCKS AND FINANCIAL MARKETS (U.S. CLS. 100 AND 101).

FIRST USE 5-21-1998; IN COMMERCE 9-10-1998.

CLASS 42—(Continued).

SN 76-273,972. RETAIL EXPERT, INC., WOBURN, MA.
FILED 6-21-2001.

NAVISTOR

FOR COMPUTER CONSULTATION SERVICES TO ASSIST IN THE MANAGEMENT OF BUSINESS (U.S. CLS. 100 AND 101).

FIRST USE 2-0-1999; IN COMMERCE 2-0-1999.

SN 76-301,614. DYNAMIX GROUP INC., ROSWELL, GA.
FILED 8-20-2001.

dynämixgroup

NO CLAIM IS MADE TO THE EXCLUSIVE RIGHT TO USE "GROUP", APART FROM THE MARK AS SHOWN.

FOR COMPUTER SERVICES, NAMELY, PROVIDING CONSULTING AND TECHNICAL ASSISTANCE RELATED TO THE INSTALLATION AND MAINTENANCE OF COMPUTER HARDWARE AND SOFTWARE PRODUCTS (U.S. CLS. 100 AND 101).

FIRST USE 4-1-2000; IN COMMERCE 11-1-2000.

SN 76-350,968. OHIO HIGH SCHOOL VOLLEYBALL COACHES ASSOCIATION, INC., ELYRIA, OH. FILED 12-20-2001.

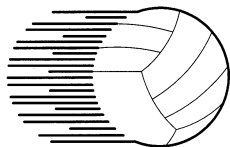
**OHSVCA**

THE OHIO HIGH SCHOOL
VOLLEYBALL COACHES ASSOCIATION

NO CLAIM IS MADE TO THE EXCLUSIVE RIGHT TO USE "OHIO HIGH SCHOOL VOLLEYBALL COACHES ASSOCIATION", APART FROM THE MARK AS SHOWN.

FOR ASSOCIATION SERVICES, NAMELY PROMOTING THE INTERESTS OF OHIO HIGH SCHOOL VOLLEYBALL, OHIO HIGH SCHOOL COACHES, AND OTHERS ENGAGED IN THE SPORT OF VOLLEYBALL (U.S. CLS. 100 AND 101).

SN 76-354,549. HARVEST TECHNOLOGY CORPORATION, WOOD-RIDGE, NJ. FILED 12-27-2001.

HARVEST TECHNOLOGY

NO CLAIM IS MADE TO THE EXCLUSIVE RIGHT TO USE "TECHNOLOGY", APART FROM THE MARK AS SHOWN.

FOR COMPUTER SITE AND APPLICATION DESIGN, WEBSITE DEVELOPMENT AND CONSULTATION RELATING THERETO FOR THE FINANCIAL SERVICES INDUSTRY (U.S. CLS. 100 AND 101).

FIRST USE 6-0-2000; IN COMMERCE 6-0-2000.

CLASS 42—(Continued).

SN 76-372,717. PROSOCIAL FRIENDS, INC., BOULDER, CO.
FILED 2-21-2002.



FOR PROVIDING THE SERVICES OF TEMPORARY USE OF AN ON-LINE NON-DOWNLOADABLE COMPUTERIZED SOFTWARE PROGRAM ACCESSIBLE THROUGH THE INTERNET TO FACILITATE BEHAVIOR MANAGEMENT BY NATURAL OR PROFESSIONAL CAREGIVERS TO PERSONS IN NEED OF SUPERVISION AND TO PERMIT NATURAL AND PROFESSIONAL CAREGIVERS TO COOPERATE THROUGH THE COMPUTERIZED PROGRAM TO EXPEDITE THE TREATMENT OF PERSONS IN NEED OF SUPERVISION (U.S. CLS. 100 AND 101).

SN 76-384,788. FUJI XEROX KABUSHIKI KAISHA, DBA FUJI XEROX CO., LTD., TOKYO, JAPAN, FILED 3-20-2002.



OWNER OF U.S. REG. NO. 2,159,208.

NO CLAIM IS MADE TO THE EXCLUSIVE RIGHT TO USE "PALO ALTO LABORATORY", APART FROM THE MARK AS SHOWN.

FOR RESEARCH AND DEVELOPMENT SERVICES ALL RELATING TO COMPUTERS, COMPUTER SOFTWARE AND COMPUTER SYSTEMS, NAMELY, RESEARCH AND DEVELOPMENT OF MULTIMEDIA AND NETWORK SYSTEMS FOR OTHERS; RESEARCH AND DEVELOPMENT OF DISTRIBUTION AND WORK FLOW OF ELECTRONIC DOCUMENTS FOR OTHERS; RESEARCH AND DEVELOPMENT OF PERSONAL INFORMATION TOOLS FOR OTHERS; RESEARCH AND DEVELOPMENT OF COLOR IMAGING AND SYSTEMS TECHNOLOGY FOR OTHERS; DOCUMENT IMAGE ANALYSIS FOR OTHERS (U.S. CLS. 100 AND 101).

FIRST USE 3-10-2001; IN COMMERCE 3-10-2001.

SN 76-390,457. H3 PHARMA INC., MONTREAL, QUEBEC, CANADA, FILED 4-3-2002.

H3 PHARMA

PRIORITY CLAIMED UNDER SEC. 44(D) ON CANADA APPLICATION NO. 1127169, FILED 1-8-2002.

FOR DEVELOPMENT OF PHARMACEUTICAL PRODUCTS AND MEDICAL DEVICES FOR OTHERS (U.S. CLS. 100 AND 101).

FIRST USE 1-15-2002; IN COMMERCE 1-15-2002.

CLASS 42—(Continued).

SN 76-399,663. TARGEEN, INC., SAN DIEGO, CA. FILED 4-22-2002.

TARGEEN

FOR MEDICAL, BIOMEDICAL, CHEMICAL AND PHARMACEUTICAL RESEARCH; DISCOVERY, DEVELOPMENT AND DESIGN OF PHARMACEUTICAL AND THERAPEUTIC PREPARATIONS (U.S. CLS. 100 AND 101).

SN 76-405,814. THE GCRH CORPORATION, MIDLAND, MI. FILED 5-10-2002.

RIGHTANSWER

FOR INTERNET BASED SERVICES FOR PROVIDING TEMPORARY USE OF ON-LINE NON-DOWNLOADABLE SOFTWARE FOR CREATING, IMAGING, ARCHIVING, RETRIEVING, PRINTING, AND MANAGING DOCUMENTS (U.S. CLS. 100 AND 101).
FIRST USE 2-13-2002; IN COMMERCE 2-13-2002.

SN 76-411,743. GRYPHON LABS LLC, INCLINE VILLAGE, NV. FILED 5-23-2002.

GRYPHON LABS

NO CLAIM IS MADE TO THE EXCLUSIVE RIGHT TO USE "LABS", APART FROM THE MARK AS SHOWN.
FOR COMPUTER SOFTWARE DESIGN, DEVELOPMENT AND CONSULTATION FOR OTHERS (U.S. CLS. 100 AND 101).
FIRST USE 10-1-2001; IN COMMERCE 10-1-2001.

SN 76-411,844. NEWMONT MINING CORPORATION, DENVER, CO. FILED 5-23-2002.



FOR TECHNICAL CONSULTATION IN THE FIELDS OF MINING AND MINERAL PROCESSING; MINERAL EXPLORATION SERVICES; GEOPHYSICAL INFORMATION ANALYSIS SERVICES (U.S. CLS. 100 AND 101).

CLASS 42—(Continued).

SN 76-411,845. NEWMONT MINING CORPORATION, DENVER, CO. FILED 5-23-2002.



FOR TECHNICAL CONSULTATION IN THE FIELDS OF MINING AND MINERAL PROCESSING; MINERAL EXPLORATION SERVICES; GEOPHYSICAL INFORMATION ANALYSIS SERVICES (U.S. CLS. 100 AND 101).

SN 76-411,857. NEWMONT MINING CORPORATION, DENVER, CO. FILED 5-23-2002.



FOR TECHNICAL CONSULTATION IN THE FIELDS OF MINING AND MINERAL PROCESSING; MINERAL EXPLORATION SERVICES; GEOPHYSICAL INFORMATION ANALYSIS SERVICES (U.S. CLS. 100 AND 101).

SN 76-411,858. NEWMONT MINING CORPORATION, DENVER, CO. FILED 5-23-2002.



FOR TECHNICAL CONSULTATION IN THE FIELDS OF MINING AND MINERAL PROCESSING; MINERAL EXPLORATION SERVICES; GEOPHYSICAL INFORMATION ANALYSIS SERVICES (U.S. CLS. 100 AND 101).

SN 76-411,867. NEWMONT MINING CORPORATION, DENVER, CO. FILED 5-23-2002.

NEWMONT

FOR TECHNICAL CONSULTATION IN THE FIELDS OF MINING AND MINERAL PROCESSING; MINERAL EXPLORATION SERVICES; GEOPHYSICAL INFORMATION ANALYSIS SERVICES (U.S. CLS. 100 AND 101).

CLASS 42—(Continued).

SN 76-412,428. MENESES, JAVIER A., SANTA ANA, CA. FILED 5-24-2002.

LATINO AMERICAN SERVICES CAPILLA LAS ROSAS WEDDING CHAPEL

NO CLAIM IS MADE TO THE EXCLUSIVE RIGHT TO USE "LATINO AMERICAN SERVICES", "CAPILLA" AND "WEDDING CHAPEL", APART FROM THE MARK AS SHOWN.

THE FOREIGN WORDING IN THE MARK TRANSLATES INTO ENGLISH AS "WEDDING CHAPEL THE ROSES".

FOR PERFORMING CIVIL MARRIAGE CEREMONIES (U.S. CLS. 100 AND 101).

FIRST USE 11-24-1992; IN COMMERCE 11-24-1992.

SN 76-417,096. ACUCORP, INC., SAN DIEGO, CA. FILED 6-5-2002.

THE NEW FACE OF COBOL

FOR CONSULTING SERVICES IN THE FIELD OF DESIGN, SELECTION, IMPLEMENTATION AND USE OF COMPUTER SOFTWARE SYSTEMS FOR OTHERS (U.S. CLS. 100 AND 101).

FIRST USE 3-1-2000; IN COMMERCE 3-1-2000.

SN 76-432,611. DIGITAL PAPER CORPORATION, ALEXANDRIA, VA. FILED 7-18-2002.

DIRECTSIGHT

FOR PROVIDING TEMPORARY USE OF ONLINE, NON-DOWNLOADABLE SOFTWARE USED FOR VIEWING DOCUMENT IMAGES BY MEANS OF COMPUTER NETWORKS, REGARDLESS OF THE SIZE COMPLEXITY OF THE DOCUMENT FOR THE PURPOSE OF PROVIDING WIDE ACCESS TO AND COLLABORATION ON LARGE AND/OR COMPLEX TECHNICAL DOCUMENTS (U.S. CLS. 100 AND 101).

FIRST USE 3-7-1997; IN COMMERCE 3-7-1997.

CLASS 42—(Continued).

SN 76-435,374. GLOBAL VISA SOLUTIONS, NEWPORT BEACH, CA. FILED 7-29-2002.

GLOBAL VISA SOLUTIONS

NO CLAIM IS MADE TO THE EXCLUSIVE RIGHT TO USE "GLOBAL VISA", APART FROM THE MARK AS SHOWN.

FOR LEGAL SERVICES, NAMELY, INTERNATIONAL IMMIGRATION MANAGEMENT SERVICES; ASSISTANCE REGARDING, AND CONSULTING AND LEGAL SERVICES FOR OBTAINING AND MANAGING ENTRY VISAS, AND RESIDENCE, WORK, AND DEPENDENT PERMITS; ASSISTANCE REGARDING, AND CONSULTING AND LEGAL SERVICES FOR OBTAINING DOCUMENT APOSTILLES, NOTARIZATIONS, CERTIFICATIONS, AND LEGALIZATIONS; CONSULAR DOCUMENT MANAGEMENT SERVICES, NAMELY, ASSISTANCE AND CONSULTATION REGARDING, AND PREPARATION AND SUBMISSION OF CONSULAR LEGAL DOCUMENTS (U.S. CLS. 100 AND 101).

FIRST USE 7-30-2001; IN COMMERCE 10-25-2001.

SN 76-445,162. APRISO CORPORATION, LONG BEACH, CA. FILED 8-29-2002.

FLEXCARE

FOR MAINTENANCE OF COMPUTER SOFTWARE AND TECHNICAL SUPPORT SERVICES, NAMELY, TROUBLESHOOTING OF COMPUTER SOFTWARE PROBLEMS (U.S. CLS. 100 AND 101).

SN 76-445,633. CRISIS TECHNOLOGIES, INC., MIDDLETOWN, NJ. FILED 8-30-2002.

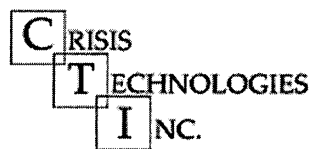

NO CLAIM IS MADE TO THE EXCLUSIVE RIGHT TO USE "INC.", APART FROM THE MARK AS SHOWN.

FOR TECHNICAL CONSULTATION AND RESEARCH IN THE FIELD OF EMERGENCY PLANNING AND MANAGEMENT OF A FACILITY (U.S. CLS. 100 AND 101).

FIRST USE 3-0-2001; IN COMMERCE 5-13-2002.

SN 76-448,270. MERSOFT CORPORATION, OVERLAND PARK, KS. FILED 9-10-2002.

MERSOFT

FOR COMMERCIAL SOFTWARE DEVELOPMENT (U.S. CLS. 100 AND 101).

FIRST USE 2-1-1996; IN COMMERCE 2-1-1996.

CLASS 42—(Continued).

SN 76-451,398. MANAGEDSTORAGE INTERNATIONAL, INC., BOULDER, CO. FILED 9-20-2002.



NO CLAIM IS MADE TO THE EXCLUSIVE RIGHT TO USE "MANAGEDSTORAGE", APART FROM THE MARK AS SHOWN.

FOR MONITORING THE COMPUTER SYSTEMS OF OTHERS FOR TECHNICAL PURPOSES AND PROVIDING BACK-UP COMPUTER SYSTEMS AND FACILITIES (U.S. CLS. 100 AND 101).

FIRST USE 4-15-2002; IN COMMERCE 4-15-2002.

SN 76-459,784. BRANCHLINQ CORPORATION, NORTHVILLE, MI. FILED 10-15-2002.

BRANCHLINQ

FOR APPLICATION SERVICE PROVIDER, NAMELY, HOSTING COMPUTER SOFTWARE SERVICES OVER THE INTERNET FOR THE MORTGAGE INDUSTRY (U.S. CLS. 100 AND 101).

SN 76-463,494. RADIATIVE SOLUTIONS LLC, LOS ALAMOS, NM. FILED 11-1-2002.

RADION

FOR COMPUTER PROGRAMMING AND ENGINEERING RELATING TO THE DEVELOPMENT, APPLICATION AND SUPPORT OF SOFTWARE FOR COMPUTER AIDED ENGINEERING ANALYSIS (U.S. CLS. 100 AND 101).

FIRST USE 10-15-2002; IN COMMERCE 10-16-2002.

CLASS 42—(Continued).

SN 76-466,415. ONDEO NALCO COMPANY, NAPERVILLE, FL. FILED 11-12-2002.

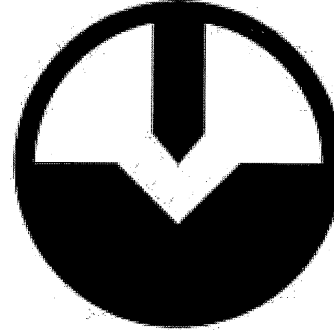

FOR TECHNICAL CONSULTATION IN THE FIELD OF METALWORKING (U.S. CLS. 100 AND 101).

FIRST USE 2-2-2002; IN COMMERCE 2-2-2002.

SN 76-470,734. THE NEMOURS FOUNDATION, JACKSONVILLE, FL. FILED 11-27-2002.

NEMOURS

FOR CONDUCTING MEDICAL AND SCIENTIFIC RESEARCH (U.S. CLS. 100 AND 101).

FIRST USE 10-0-1940; IN COMMERCE 10-0-1940.

SN 76-471,515. LAW OFFICES OF SAM BERNSTEIN, FARMINGTON HILLS, MI. FILED 11-29-2002.

HELP IS JUST A CLICK AWAY

OWNER OF U.S. REG. NOS. 1,548,696 AND 2,048,818. FOR LEGAL SERVICES (U.S. CLS. 100 AND 101).

SN 76-473,595. TELECOM COMPLIANCE SERVICES, INC., ALPHARETTA, GA. FILED 12-3-2002.

RECAP

FOR PROVIDING REGULATORY COMPLIANCE MANAGEMENT SERVICES VIA AN ONLINE PORTAL, NAMELY, DOCUMENT AND WORK FLOW MANAGEMENT OF BUSINESSES' STATE AND FEDERAL REGULATORY REPORTING AND COMPLIANCE (U.S. CLS. 100 AND 101).

FIRST USE 3-31-2001; IN COMMERCE 3-31-2001.

CLASS 42—(Continued).

SN 76-473,933. APPLIED GEOGRAPHICS, INC., BOSTON, MA. FILED 12-10-2002.

MARK-THE-SPOT

FOR APPLICATION SERVICE PROVIDER FEATURING SOFTWARE THAT CREATES AND STORES GEOGRAPHIC INFORMATION OR IMAGE COORDINATES AND THE LINKING OF SPATIAL LOCATION WITH DESCRIPTIVE DATA FOR LATER VIEWING AND ANALYSIS (U.S. CLS. 100 AND 101).

SN 76-474,211. KVAERNER OILFIELD PRODUCTS, INC., HOUSTON, TX. FILED 12-12-2002.

K-SAT

FOR SCIENTIFIC AND TECHNOLOGICAL SERVICES, NAMELY QUALITY ASSURANCE SERVICES CONNECTED TO THE PROVISION OF PRODUCTS AND SYSTEMS TO THE OFFSHORE PRODUCTION OF OIL AND GAS (U.S. CLS. 100 AND 101).
FIRST USE 11-9-2002; IN COMMERCE 11-9-2002.

SN 76-474,215. KVAERNER OILFIELD PRODUCTS, INC., HOUSTON, TX. FILED 12-12-2002.



FOR SCIENTIFIC AND TECHNOLOGICAL SERVICES, NAMELY QUALITY ASSURANCE SERVICES CONNECTED TO THE PROVISION OF PRODUCTS AND SYSTEMS TO THE OFFSHORE PRODUCTION OF OIL AND GAS (U.S. CLS. 100 AND 101).
FIRST USE 11-9-2002; IN COMMERCE 11-9-2002.

SN 76-474,752. JURLNNOV LTD., WESTLAKE, OH. FILED 12-13-2002.

JURINNOV

FOR PROVIDING TECHNICAL CONSULTING SERVICES FOR THE LEGAL INDUSTRY (U.S. CLS. 100 AND 101).
FIRST USE 10-0-2000; IN COMMERCE 10-0-2000.

CLASS 42—(Continued).

SN 76-476,686. CERILLIANT CORPORATION, ROUND ROCK, TX. FILED 12-17-2002.

CERILLIANT

OWNER OF U.S. REG. NOS. 2,592,708 AND 2,592,709.
FOR RESEARCH AND DEVELOPMENT OF NEW CHEMICAL PRODUCTS FOR OTHERS (U.S. CLS. 100 AND 101).
FIRST USE 10-0-2000; IN COMMERCE 10-0-2000.

SN 76-478,987. HALL, PHOEBE P., MIDLOTHIAN, VA. FILED 12-24-2002.

ZSMART

FOR LEGAL SERVICES AND MEDIATION (U.S. CLS. 100 AND 101).

SN 76-482,510. UNIFORM CODE COUNCIL, INC., LAWRENCEVILLE, NJ. FILED 1-15-2003.

EBUSINESSREADY

FOR TESTING, ANALYSIS AND EVALUATION OF THE COMPUTER GOODS AND SERVICES OF OTHERS FOR THE PURPOSE OF CERTIFICATION REGARDING COMPLIANCE WITH UNIFORM CODE COUNCIL'S STANDARDS ON E-COMMERCE AND XML (U.S. CLS. 100 AND 101).

SN 78-002,694. AUTOMATION CONSULTANTS, INC., BALTIMORE, MD. FILED 4-5-2000.

THE ACI GROUP

NO CLAIM IS MADE TO THE EXCLUSIVE RIGHT TO USE "GROUP", APART FROM THE MARK AS SHOWN.
FOR COMPUTER WEB SITE DESIGN AND DEVELOPMENT FOR OTHERS (U.S. CLS. 100 AND 101).

SN 78-012,145. JUSTSHOPONLINE.COM, INC., BLUE SPRINGS, MO. FILED 6-12-2000.

JUSTSHOPONLINE

FOR COMPUTER SERVICES, NAMELY, CREATING AND MAINTAINING AN ON-LINE DATABASE WITH LINKS AND DESCRIPTIONS TO E-COMMERCE SITES VIA A GLOBAL COMPUTER NETWORK (U.S. CLS. 100 AND 101).
FIRST USE 4-9-2000; IN COMMERCE 4-9-2000.

CLASS 42—(Continued).

SN 78-049,439. CLARIANT AG, MUTTENZ, SWITZERLAND, FILED 2-21-2001.

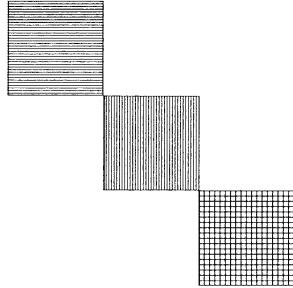

THE MARK IS LINED FOR THE COLORS BLUE, RED AND YELLOW.

FOR TECHNICAL CONSULTATION SERVICES IN THE AREA OF COLOR MATCHING TEXTILE FABRICS TO STANDARDS (U.S. CLS. 100 AND 101).

FIRST USE 11-1-2000; IN COMMERCE 11-1-2000.

SN 78-095,191. DANCE & JUMP SOFTWARE, INC., TAIPEI, TAIWAN, FILED 11-27-2001.



FOR DESIGN, CREATE AND MAINTAIN WEB SITES FOR OTHERS; RE-DESIGN EXISTING WEB SITE FOR OTHERS; AND DISPLAY THE WEB SITES AND IMAGES OF OTHERS ON A COMPUTER SERVER (U.S. CLS. 100 AND 101).

SN 78-099,502. PLANALYTICS, INC., WAYNE, PA. FILED 12-20-2001.

POWERPLANNER

FOR PROVIDING TEMPORARY USE OF NON-DOWNLOADABLE SOFTWARE VIA THE INTERNET FOR USE PERTAINING TO THE EFFECTS OF WEATHER ON RISK ANALYSIS, OPERATIONAL AND FINANCIAL MANAGEMENT OF ELECTRIC LOAD DEMAND AND THE SUBSEQUENT CONSEQUENCES (U.S. CLS. 100 AND 101).

SN 78-102,793. VAN WINKLE*BATEN*RIMSTIDT DISPUTE RESOLUTION, INDIANAPOLIS, IN. FILED 1-15-2002.

SERIOUS ALTERNATIVES FOR SERIOUS DISPUTES

FOR ALTERNATIVE DISPUTE RESOLUTION SERVICES (U.S. CLS. 100 AND 101).

CLASS 42—(Continued).

SN 78-117,829. IOWA STATE BAR ASSOCIATION, THE, DES MOINES, IA. FILED 3-27-2002.

IOWA CITE

NO CLAIM IS MADE TO THE EXCLUSIVE RIGHT TO USE "IOWA", APART FROM THE MARK AS SHOWN.

FOR ONLINE LEGAL RESEARCH SERVICES (U.S. CLS. 100 AND 101).

SN 78-119,420. FARBER COHEN VENTURES, MAPLE SHADE, NJ. FILED 4-3-2002.

INTERVIEWDIRECT

FOR DATA COLLECTION SERVICES, NAMELY, COLLECTING DATA THROUGH USE OF AUTOMATED TELEPHONE AND VIDEO INTERVIEWS SELECTED BY CUSTOMERS WHICH ALLOWS CUSTOMERS TO REVIEW THE RESULTS OF INTERVIEWS TAKEN UPON THEIR COMPLETION THROUGH USE OF A COMPUTER BASED GRAPHICAL POINT AND CLICK INTERFACE ACCESSIBLE VIA THE INTERNET (U.S. CLS. 100 AND 101).

SN 78-128,845. INTUII LLC, SAN DIEGO, CA. FILED 5-15-2002.

IDEA STOCK

NO CLAIM IS MADE TO THE EXCLUSIVE RIGHT TO USE "STOCK", APART FROM THE MARK AS SHOWN.

FOR PROVIDING AN ELECTRONIC DATABASE OF CERTIFICATES IN THE FIELD OF TRADABLE RIGHTS, NAMELY, PROPERTY RIGHTS, CONTRACTUAL RIGHTS, CONTINGENT CONTRACTUAL RIGHTS, INCHOATE RIGHTS, SHARES OF PORTFOLIOS OF CONTRACTUAL RIGHTS, SHARES OF PORTFOLIO OF PROPERTY RIGHTS, SHARES OF PORTFOLIO OF CONTINGENT CONTRACTUAL RIGHTS, SHARES OF PORTFOLIO OF INCHOATE RIGHTS, AND SHARES OF PORTFOLIO OF STOCK (U.S. CLS. 100 AND 101).

SN 78-128,873. INTUII LLC, SAN DIEGO, CA. FILED 5-15-2002.

IDEA

FOR PROVIDING AN ELECTRONIC DATABASE OF CERTIFICATES IN THE FIELD OF TRADABLE RIGHTS, NAMELY, PROPERTY RIGHTS, CONTRACTUAL RIGHTS, CONTINGENT CONTRACTUAL RIGHTS, INCHOATE RIGHTS, SHARES OF PORTFOLIOS OF CONTRACTUAL RIGHTS, SHARES OF PORTFOLIO OF PROPERTY RIGHTS, SHARES OF PORTFOLIO OF CONTINGENT CONTRACTUAL RIGHTS, SHARES OF PORTFOLIO OF INCHOATE RIGHTS, AND SHARES OF PORTFOLIO OF STOCK (U.S. CLS. 100 AND 101).

CLASS 42—(Continued).

SN 78-129,361. STRATABASE, ABBOTSFORD, BRITISH COLUMBIA, FILED 5-16-2002.

STRATABASE

FOR WEB SITE HOSTING SERVICES; WEB SITE DESIGNING, DEVELOPING, SUPPORTING AND MAINTAINING SERVICES (U.S. CLS. 100 AND 101).

SN 78-148,578. DIGITAL CHEETAH, L.L.C., AUSTIN, TX. FILED 7-29-2002.

DIGITAL CHEETAH

NO CLAIM IS MADE TO THE EXCLUSIVE RIGHT TO USE "DIGITAL", APART FROM THE MARK AS SHOWN. FOR WEB SITE DEVELOPMENT SERVICES (U.S. CLS. 100 AND 101).
FIRST USE 8-31-2001; IN COMMERCE 8-31-2001.

SN 78-152,711. VIAGEN, INC., AUSTIN, TX. FILED 8-9-2002.

VIAGEN

FOR RESEARCH AND DEVELOPMENT IN THE FIELDS OF GENETICS AND BIOTECHNOLOGY TO THE ORDER AND SPECIFICATION OF OTHERS; GENETIC TESTING, DIAGNOSTICS AND RESEARCH IN CONNECTION WITH THE SELECTION, MANAGEMENT AND GENETIC BRANDING OF ANIMALS (U.S. CLS. 100 AND 101).

SN 78-153,877. PAT CHEM LABORATORIES, MOORPARK, CA. FILED 8-13-2002.



NO CLAIM IS MADE TO THE EXCLUSIVE RIGHT TO USE "LABORATORIES", APART FROM THE MARK AS SHOWN.
SEC. 2(F).
FOR CHEMICAL ANALYSIS (U.S. CLS. 100 AND 101).
FIRST USE 1-8-1988; IN COMMERCE 1-8-1988.

CLASS 42—(Continued).

SN 78-158,991. NEXTIDE, INC., TOKYO, JAPAN, FILED 8-28-2002.

NEXTIDE

FOR INFORMATION TECHNOLOGY CONSULTING SERVICES; INTEGRATION OF COMPUTER SYSTEMS AND NETWORKS; COMPUTER SOFTWARE INSTALLATION SERVICES FOR OTHERS; TECHNICAL SUPPORT SERVICES, NAMELY, TROUBLESHOOTING OF COMPUTER HARDWARE AND SOFTWARE PROBLEMS; CONSULTING, DEVELOPMENT AND DESIGN SERVICES FOR COMPUTER HARDWARE AND SOFTWARE FOR OTHERS; ONLINE TECHNICAL SUPPORT SERVICES, NAMELY, TROUBLESHOOTING OF COMPUTER HARDWARE AND SOFTWARE PROBLEMS FOR OTHERS (U.S. CLS. 100 AND 101).

SN 78-159,299. NEOHAPSIS, INC., CHICAGO, IL. FILED 8-29-2002.

OSEC

FOR COMPUTER NETWORK SECURITY PRODUCT TESTING AND VALIDATION SERVICES (U.S. CLS. 100 AND 101).
FIRST USE 3-1-2001; IN COMMERCE 3-1-2001.

SN 78-174,481. FOOTSTAR CORPORATION, WEST NYACK, NY. FILED 10-15-2002.

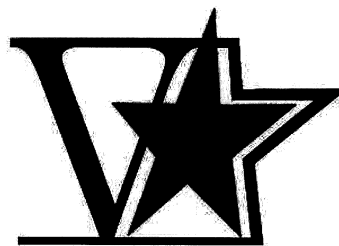

FOR LABORATORY QUALITY-TESTING FOR OTHERS OF PRODUCTS, NAMELY, FOOTWEAR (U.S. CLS. 100 AND 101).

SN 78-175,797. GOLFERPHILES, INC., BROOKLYN, NY. FILED 10-18-2002.

GOLFFINITY

FOR PROVIDING TEMPORARY USE OF ON-LINE NON DOWNLOADABLE SOFTWARE FOR USE IN DATA PROCESSING OF GOLF PERFORMANCE TRACKING AND ANALYSIS (U.S. CLS. 100 AND 101).
FIRST USE 5-29-2002; IN COMMERCE 5-29-2002.

CLASS 42—(Continued).

SN 78-180,250. XTL BIOPHARMACEUTICALS LIMITED, REHOVOT, 76100, ISRAEL, FILED 10-30-2002.

XTL

OWNER OF U.S. REG. NOS. 2,468,085 AND 2,471,826. FOR PHARMACEUTICAL, CHEMICAL AND BIOLOGICAL PRODUCT RESEARCH AND DEVELOPMENT SERVICES; SCREENING OF PHARMACEUTICALS FOR THERAPEUTIC EFFICACY; PHARMACEUTICAL, CHEMICAL AND BIOLOGICAL PRODUCT DEVELOPMENT CONSULTATION SERVICES (U.S. CLS. 100 AND 101). FIRST USE 9-14-1995; IN COMMERCE 9-14-1995.

SN 78-190,089. FUJISAWA HEALTHCARE, INC., DEERFIELD, IL. FILED 12-2-2002.

APPLES

FOR MEDICAL AND SCIENTIFIC RESEARCH, NAMELY CONDUCTING CLINICAL TRIALS (U.S. CLS. 100 AND 101).

SN 78-190,504. MPAQ AUTOMATION INC., MISSISSAUGA, ONTARIO, FILED 12-2-2002.

MPAQ

FOR CONSULTING SERVICES IN THE FIELD OF AUTOMATION SOLUTIONS FOR INDUSTRIAL PLANTS; CONSULTING SERVICES IN THE FIELD OF DESIGN, SELECTION, IMPLEMENTATION AND USE OF COMPUTER HARDWARE AND SOFTWARE SYSTEMS FOR OTHERS; CONSULTING SERVICES IN THE FIELD OF COMPUTERIZED BATCHING SYSTEMS; CONSULTING SERVICES IN THE FIELD OF COMPUTERIZED DISPATCH SYSTEMS (U.S. CLS. 100 AND 101). FIRST USE 4-29-1989; IN COMMERCE 12-1-1990.

SN 78-194,587. VOGEL, MARK, A., WILLOWBROOK, IL. FILED 12-14-2002.

aSITEobehold

FOR COMPUTER SERVICES, NAMELY CREATING AND MAINTAINING WEBSITES FOR OTHERS (U.S. CLS. 100 AND 101).

CLASS 42—(Continued).

SN 78-194,629. BLUE, JOHN L., INDIANAPOLIS, IN. FILED 12-15-2002.

**INFORMATION IS AT THE
HEART OF YOUR
BUSINESS... IS IT TIME FOR
A CHECK-UP?**

FOR INFORMATION AND COMPUTER CONSULTING SERVICES, NAMELY PROVIDING TECHNOLOGY AND INFORMATION ASSESSMENTS AND OPERATIONS OPTIMIZATION FOR CLIENTS (U.S. CLS. 100 AND 101).

SN 78-195,239. MASTERCARD INTERNATIONAL INCORPORATED, PURCHASE, NY. FILED 12-17-2002.

MASTERCARD WORKING

OWNER OF U.S. REG. NOS. 1,257,853, 2,607,150 AND OTHERS.

FOR CONCIERGE SERVICES, NAMELY, MEETING PLANNING SERVICES, EVENT REMINDER SERVICES, PROVISION OF DINING INFORMATION AND RESERVATIONS, PROVISION OF LODGING AND AIRLINE INFORMATION RESERVATIONS, PROVISION OF CAR AND LIMOUSINE INFORMATION AND RENTALS, PROVISION OF BUSINESS PROTOCOL AND ETIQUETTE INFORMATION, MEET AND GREET SERVICES, PROVISION OF THEATER, CONCERT, AND SPECIAL EVENT RESERVATIONS, PROVISION OF GOLF COURSE INFORMATION AND RESERVATIONS, AND PROVISION OF CUSTOMIZED GIFT AND INCENTIVE IDEAS FOR EMPLOYEES, COLLEAGUES AND CUSTOMERS; COMPUTER VIRUS PROTECT IN AND DATA RECOVERY SERVICES; SPENDING DATA COLLECTION, ORGANIZATION, CONSOLIDATION, ANALYSIS, MANAGEMENT, VIEWING AND REPORT GENERATION SERVICES; ROADSIDE ASSISTANCE SERVICES; EXTENDED WARRANTY SERVICES; TRAVEL ASSISTANCE SERVICES, NAMELY PROVISION OF EMERGENCY CASH, REPLACEMENT OF LOST TICKETS AND DOCUMENTS, LOST LUGGAGE ASSISTANCE, AND PROVISION OF INFORMATION ON REQUIRED TRAVEL DOCUMENTS, IMMUNIZATION AND CURRENCY RATES FOR FOREIGN COUNTRIES; LEGAL REFERRAL SERVICES; LIABILITY PROTECTION SERVICES; ADMINISTRATION AND PROVISION OF A POINTS-BASED LOYALTY PROGRAM; ADMINISTRATION AND PROVISION OF OF A DISCOUNT PAYMENT PROGRAM FOR THE WARES AND SERVICES OF OTHERS; AND FOREIGN TAX REIMBURSEMENTS SERVICES (U.S. CLS. 100 AND 101).

CLASS 42—(Continued).

SN 78-196,191. NEVUM SOLUTIONS CORP., MIAMI, FL.
FILED 12-19-2002.



NO CLAIM IS MADE TO THE EXCLUSIVE RIGHT TO USE "IMPLEMENTATION METHODOLOGY", APART FROM THE MARK AS SHOWN.
FOR COMPUTER SYSTEM ANALYSIS FOR THE IMPLEMENTATION OF COMPUTER SYSTEMS (U.S. CLS. 100 AND 101).

SN 78-198,198. DEUTSCH CONSULTING & MARKETING, INC., HOLLYWOOD, FL. FILED 12-27-2002.

TRAFFIC TICKET DEPOT

NO CLAIM IS MADE TO THE EXCLUSIVE RIGHT TO USE "TRAFFIC TICKET", APART FROM THE MARK AS SHOWN.
FOR LEGAL SERVICES AND PARALEGAL SERVICES (U.S. CLS. 100 AND 101).

CLASS 43—HOTEL AND RESTAURANT SERVICES

SN 76-346,298. WESTIN LICENSE COMPANY, WHITE PLAINS, NY. FILED 12-6-2001.

HP

FOR RESTAURANT, CATERING AND BAR SERVICES (U.S. CLS. 100 AND 101).
FIRST USE 1-29-2002; IN COMMERCE 1-29-2002.

SN 76-372,972. USA HOLDINGS, LLC, NEWPORT BEACH, CA. FILED 2-20-2002.

SPEEDY BANDITO

THE ENGLISH TRANSLATION OF THE WORD "BANDITO" IN THE MARK IS THE SPANISH WORD MEANING "BANDIT" OR "OUTLAW".
FOR RESTAURANT SERVICES (U.S. CLS. 100 AND 101).

CLASS 43—(Continued).

SN 76-377,673. Q-TASTE INTERNATIONAL, SAN JOSE, CA.
FILED 3-4-2002.

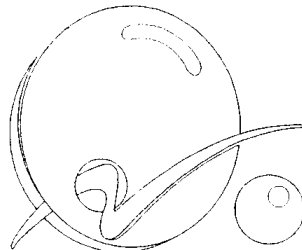

FOR RESTAURANTS AND CAFES (U.S. CLS. 100 AND 101).
FIRST USE 9-9-2001; IN COMMERCE 9-9-2001.

SN 76-379,789. QUAIL CREEK PLANTATION, INC., FORT LAUDERDALE, FL. FILED 3-7-2002.

QUAIL CREEK PLANTATION

FOR HUNTING AND RESORT LODGING SERVICES (U.S. CLS. 100 AND 101).
FIRST USE 1-0-2002; IN COMMERCE 1-0-2002.

SN 76-408,740. MCDONALD'S CORPORATION, OAK BROOK, IL. FILED 5-15-2002.

**BOSTON MARKET
ROTISSERIE**

OWNER OF U.S. REG. NOS. 1,517,660, 2,551,400 AND OTHERS.
NO CLAIM IS MADE TO THE EXCLUSIVE RIGHT TO USE "ROTISSERIE", APART FROM THE MARK AS SHOWN.
SEC. 2(F) IN PART, AS TO "BOSTON".
FOR RESTAURANT SERVICES (U.S. CLS. 100 AND 101).

SN 76-425,109. ORIGINAL MAXWELL STREET, INC., THE, CHICAGO, IL. FILED 6-24-2002.

MAXWELL ST.YLE

NO CLAIM IS MADE TO THE EXCLUSIVE RIGHT TO USE "ST.YLE", APART FROM THE MARK AS SHOWN.
THE NAME(S), PORTRAIT(S), AND/OR SIGNATURE(S) SHOWN IN THE MARK DOES NOT IDENTIFY A PARTICULAR LIVING INDIVIDUAL.
FOR RESTAURANT SERVICES (U.S. CLS. 100 AND 101).

CLASS 43—(Continued).

SN 76-425,111. ORIGINAL MAXWELL STREET, INC., THE, CHICAGO, IL. FILED 6-24-2002.

MAXWELL STYLE

NO CLAIM IS MADE TO THE EXCLUSIVE RIGHT TO USE "STYLE", APART FROM THE MARK AS SHOWN. THE NAME(S), PORTRAIT(S), AND/OR SIGNATURE(S) SHOWN IN THE MARK DOES NOT IDENTIFY A PARTICULAR LIVING INDIVIDUAL.

FOR RESTAURANT SERVICES (U.S. CLS. 100 AND 101).

SN 76-429,292. AIRBOSS FEATURES, LTD., SAN ANTONIO, TX. FILED 7-11-2002.



FOR RESTAURANT SERVICES (U.S. CLS. 100 AND 101).

SN 76-437,760. IRELAND, WILLIAM J., WINSTON-SALEM, NC. FILED 8-5-2002.

JUICE JUNKIES

NO CLAIM IS MADE TO THE EXCLUSIVE RIGHT TO USE "JUICE", APART FROM THE MARK AS SHOWN. FOR RESTAURANT AND JUICE BAR SERVICES (U.S. CLS. 100 AND 101).

SN 76-445,857. PALMS THAI INC, LOS ANGELES, CA. FILED 9-3-2002.

PALMS THAI

NO CLAIM IS MADE TO THE EXCLUSIVE RIGHT TO USE "THAI", APART FROM THE MARK AS SHOWN. FOR RESTAURANT SERVICES (U.S. CLS. 100 AND 101). FIRST USE 1-1-1992; IN COMMERCE 1-1-1992.

CLASS 43—(Continued).

SN 76-454,368. EDISON HOLDING CORP., LAS VEGAS, NV. FILED 10-1-2002.

**PRIME Resort**

NO CLAIM IS MADE TO THE EXCLUSIVE RIGHT TO USE RESORT, APART FROM THE MARK AS SHOWN. FOR HOTEL, RESORT HOTELS AND RESTAURANT SERVICES (U.S. CLS. 100 AND 101).

SN 76-461,680. SAVOY ENTERPRISES, INC., DBA HAMMOND'S B-B-Q, GLEN ROSE, TX. FILED 10-25-2002.

HAMMOND'S B-B-Q

NO CLAIM IS MADE TO THE EXCLUSIVE RIGHT TO USE "B-B-Q", APART FROM THE MARK AS SHOWN. SEC. 2(F). FOR RESTAURANT SERVICES (U.S. CLS. 100 AND 101). FIRST USE 2-5-1997; IN COMMERCE 2-5-1997.

SN 76-467,913. LANDRY'S TRADEMARK, INC., WILMINGTON, DE. FILED 11-19-2002.

SHRIMP MANIA!

NO CLAIM IS MADE TO THE EXCLUSIVE RIGHT TO USE "SHRIMP", APART FROM THE MARK AS SHOWN. FOR RESTAURANT AND BAR SERVICES (U.S. CLS. 100 AND 101). FIRST USE 9-2-2002; IN COMMERCE 9-2-2002.

SN 76-470,426. LEGACY ACADEMY, INC., BUFORD, GA. FILED 11-25-2002.

**THE PERFECT BEGINNING
FOR YOUR LEGACY**

FOR CHILD CARE SERVICES (U.S. CLS. 100 AND 101). FIRST USE 5-5-1997; IN COMMERCE 5-5-1997.

CLASS 43—(Continued).

SN 76-470,784. HILLERICH & BRADSBY CO., LOUISVILLE, KY. FILED 11-29-2002.



OWNER OF U.S. REG. NOS. 379,405, 2,598,944 AND OTHERS.

NO CLAIM IS MADE TO THE EXCLUSIVE RIGHT TO USE "SPORTS TAVERN & GRILLE" AND "FLOYD & MARKET", APART FROM THE MARK AS SHOWN.

FOR RESTAURANT AND BAR SERVICES (U.S. CLS. 100 AND 101).

CLASS 43—(Continued).

SN 76-472,647. GREENEBOOK LTD., OCEAN CITY, MD. FILED 12-4-2002.

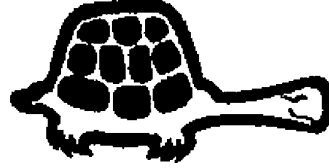

FOR RESTAURANT AND BAR SERVICES (U.S. CLS. 100 AND 101).

FIRST USE 0-0-1976; IN COMMERCE 0-0-1976.

SN 76-471,623. LENJ, LLC, MINNEAPOLIS, MN. FILED 12-2-2002.

UNCLE FRANKY'S

FOR RESTAURANT/DELI (U.S. CLS. 100 AND 101).
FIRST USE 6-1-2002; IN COMMERCE 6-1-2002.

SN 76-473,043. TURONI'S PIZZA, INC., EVANSVILLE, IN. FILED 11-25-2002.



NO CLAIM IS MADE TO THE EXCLUSIVE RIGHT TO USE "PIZZERIA & BREWERY", APART FROM THE MARK AS SHOWN.

FOR RESTAURANT SERVICES (U.S. CLS. 100 AND 101).

FIRST USE 1-1-1975; IN COMMERCE 1-1-1975.

SN 76-472,642. GREENEBOOK LTD., OCEAN CITY, MD. FILED 12-4-2002.

THE GREENE TURTLE

FOR RESTAURANT AND BAR SERVICES (U.S. CLS. 100 AND 101).
FIRST USE 0-0-1976; IN COMMERCE 0-0-1976.

SN 76-473,044. TURONI'S PIZZA, INC., EVANSVILLE, IN. FILED 11-25-2002.

TURONI'S

FOR RESTAURANT SERVICES (U.S. CLS. 100 AND 101).

FIRST USE 1-1-1970; IN COMMERCE 1-1-1970.

SN 76-472,646. GREENEBOOK LTD., OCEAN CITY, MD. FILED 12-4-2002.



SN 76-475,709. GONZO'S ENTERPRISES, INC., CHICAGO, IL. FILED 11-29-2002.

GONZO'S JUICE JUNGLE

FOR RESTAURANT SERVICES (U.S. CLS. 100 AND 101).

FIRST USE 10-0-1986; IN COMMERCE 10-0-1986.

NO CLAIM IS MADE TO THE EXCLUSIVE RIGHT TO USE "JUICE", APART FROM THE MARK AS SHOWN.

FOR RESTAURANT SERVICES (U.S. CLS. 100 AND 101).

CLASS 43—(Continued).

SN 76-475,764. NEWPORT NEWS HOSPITALITY ASSOCIATION, NEWPORT NEWS, VA. FILED 12-16-2002.



FOR HOTELS (U.S. CLS. 100 AND 101).
FIRST USE 5-7-2001; IN COMMERCE 5-7-2001.

SN 76-477,526. SEAFOOD RESTAURANTS NORTHWEST, LLC, SEATAC, WA. FILED 12-20-2002.

EAT MORE FISH

FOR RESTAURANT SERVICES (U.S. CLS. 100 AND 101).
FIRST USE 6-0-2002; IN COMMERCE 6-0-2002.

SN 76-478,086. BOULEVARD INN LIMITED LIABILITY COMPANY, COLUMBUS, OH. FILED 12-24-2002.

THE LOFTS A HOTEL WITH STYLE

NO CLAIM IS MADE TO THE EXCLUSIVE RIGHT TO USE "HOTEL", APART FROM THE MARK AS SHOWN.
FOR HOTEL AND LODGING SERVICES (U.S. CLS. 100 AND 101).
FIRST USE 11-1-1997; IN COMMERCE 11-1-1997.

SN 76-484,446. BOULEVARD INN LIMITED LIABILITY COMPANY, COLUMBUS, OH. FILED 1-21-2003.

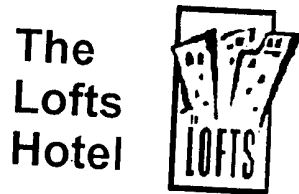

NO CLAIM IS MADE TO THE EXCLUSIVE RIGHT TO USE "HOTEL", APART FROM THE MARK AS SHOWN.
FOR HOTEL AND LODGING SERVICES (U.S. CLS. 100 AND 101).
FIRST USE 11-1-1997; IN COMMERCE 11-1-1997.

CLASS 43—(Continued).

SN 78-087,982. HOT 'N NOW, L.L.C., HOLT, MI. FILED 10-11-2001.



THE ENGLISH TRANSLATION OF THE WORD "EL TORO'S" IN THE MARK IS "THE BULLS".
FOR RESTAURANT SERVICES (U.S. CLS. 100 AND 101).

SN 78-134,315. GINSBURG ENTERPRISES INCORPORATED, FORT LAUDERDALE, FL. FILED 6-10-2002.



OWNER OF U.S. REG. NOS. 1,339,606, 2,242,559 AND OTHERS.
NO CLAIM IS MADE TO THE EXCLUSIVE RIGHT TO USE "KITCHEN CAFE", APART FROM THE MARK AS SHOWN.
FOR RESTAURANT AND BAR SERVICES (U.S. CLS. 100 AND 101).

SN 78-134,928. DOG TOWN, L.L.C., ADA, MI. FILED 6-12-2002.



NO CLAIM IS MADE TO THE EXCLUSIVE RIGHT TO USE "DOG", APART FROM THE MARK AS SHOWN.
FOR RESTAURANT SERVICES (U.S. CLS. 100 AND 101).
FIRST USE 5-25-2002; IN COMMERCE 5-25-2002.

CLASS 43—(Continued).

SN 78-145,027. RUEZ LLC, PHOENIX, AZ. FILED 7-17-2002.

ZOOM ESPRESSO

NO CLAIM IS MADE TO THE EXCLUSIVE RIGHT TO USE "ESPRESSO", APART FROM THE MARK AS SHOWN. FOR CAFES FEATURING COFFEE DRINKS AND ESPRESSO (U.S. CLS. 100 AND 101).

SN 78-185,802. HEALTHY DRIVE, LLC, HONOLULU, HI. FILED 11-16-2002.

HEALTHY DRIVE

NO CLAIM IS MADE TO THE EXCLUSIVE RIGHT TO USE "HEALTHY", APART FROM THE MARK AS SHOWN. FOR "RESTAURANT SERVICES" (U.S. CLS. 100 AND 101).

SN 78-189,243. COMIDA CORPORATION, MESA, AZ. FILED 11-26-2002.

PAPIZ PASTA & PIZZA

NO CLAIM IS MADE TO THE EXCLUSIVE RIGHT TO USE PASTA & PIZZA, APART FROM THE MARK AS SHOWN.

FOR S 043 M 1/1/02 RESTAURANTS SERVING ITALIAN FOOD, PASTA, PIZZA, SANDWICHES, SALADS (U.S. CLS. 100 AND 101).

SN 78-191,005. SIX CONTINENTS HOTELS, INC., ATLANTA, GA. FILED 12-4-2002.

BOOK WITH CONFIDENCE

FOR HOTEL RESERVATION SERVICES USING THE INTERNET. (U.S. CLS. 100 AND 101).

SN 78-192,920. MCDONALD'S CORPORATION, OAK BROOK, IL. FILED 12-10-2002.

NOTHING BUT NET

OWNER OF U.S. REG. NOS. 2,012,982 AND 2,167,799. FOR RESTAURANT SERVICES (U.S. CLS. 100 AND 101).

CLASS 43—(Continued).

SN 78-198,436. WHISTLIN' DIXIE, INC., LUBBOCK, TX. FILED 12-29-2002.

STOCKMEN'S WOOD FIRED GRILL

NO CLAIM IS MADE TO THE EXCLUSIVE RIGHT TO USE "WOOD FIRED GRILL", APART FROM THE MARK AS SHOWN.

FOR RESTAURANT (U.S. CLS. 100 AND 101).

CLASS 44—MEDICAL, BEAUTY AND AGRICULTURAL SERVICES

SN 76-383,783. Y-BEAM TECHNOLOGIES, INC., LAKE FOREST, CA. FILED 3-15-2002.

VIRTUAL NEEDLE

NO CLAIM IS MADE TO THE EXCLUSIVE RIGHT TO USE "NEEDLE", APART FROM THE MARK AS SHOWN.

FOR SKIN CARE SALONS FEATURING TREATMENT OF ACNE, SCARRING, AND PHOTO DAMAGE, SKIN PORE MINIMIZING AND REFINING, SKIN STRENGTHENING, FIRING AND TIGHTENING; THE REMOVAL OF WRINKLES, CAPILLARIES, RED SPOTS, BROWN SPOTS, AGE SPOTS, TATTOOS, SPIDER VEINS, FACIAL AND BODY HAIR. PROCEDURES FOR STIMULATING COLLAGEN PRODUCTION, EVENING SKIN TONE AND SKIN RESURFACING, AND CONSULTATION RENDERED IN CONNECTION THEREWITH, THE PREVENTION OF ACNE, TREATMENT OF ACTIVE ACNE, CORRECTION OF SKIN PIGMENTATION PROBLEMS, CORRECTIONS OF VASCULAR PROBLEMS, AND CONSULTATION RENDERED IN CONNECTION THEREWITH (U.S. CLS. 100 AND 101).

FIRST USE 2-23-2002; IN COMMERCE 2-23-2002.

SN 76-412,013. ROBERT L. LEVINE, D.M.D., SAN DIEGO, CA. FILED 5-24-2002.



NO CLAIM IS MADE TO THE EXCLUSIVE RIGHT TO USE "FLOSS", APART FROM THE MARK AS SHOWN. FOR DENTIST SERVICES (U.S. CLS. 100 AND 101). FIRST USE 9-1-1995; IN COMMERCE 4-26-1999.

CLASS 44—(Continued).

SN 76-455,652. WENTWORTH-DOUGLASS HOSPITAL, DOVER, NH. FILED 10-3-2002.

**WENTWORTH-DOUGLASS
HOSPITAL THE SEACOAST'S
LEADING MEDICAL CENTER**

NO CLAIM IS MADE TO THE EXCLUSIVE RIGHT TO USE "HOSPITAL" AND "THE SEACOAST'S LEADING MEDICAL CENTER", APART FROM THE MARK AS SHOWN. FOR MEDICAL SERVICES - PROVIDING HEALTH AND HOSPITAL CARE (U.S. CLS. 100 AND 101). FIRST USE 7-15-2002; IN COMMERCE 7-15-2002.

SN 76-464,028. JABOUR, BRADLEY A., SANTA MONICA, CA. FILED 10-28-2002.

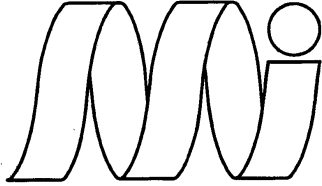

THE MARK CONSISTS OF THE LETTERS "MI" IN A STYLIZED DESIGN. FOR MEDICAL IMAGING AND RADIOLOGY SERVICES (U.S. CLS. 100 AND 101). FIRST USE 0-0-1989; IN COMMERCE 0-0-1989.

SN 76-464,811. NEILL CORPORATION, HAMMOND, LA. FILED 10-29-2002.

LUMIDERM

FOR BEAUTY AND SKIN CARE SALON SERVICES (U.S. CLS. 100 AND 101). FIRST USE 5-1-2002; IN COMMERCE 5-1-2002.

CLASS 44—(Continued).

SN 76-466,457. ADVANCED RESEARCH AND TECHNOLOGY INSTITUTE, INC., BLOOMINGTON, IN. FILED 11-13-2002.



OWNER OF U.S. REG. NO. 2,578,630. THE MARK COMPRISES THE LETTERS "MPRI" WITH A SQUARE DESIGN. THE SQUARE CONTAINS MULTI-COLORED GEOMETRIC SHAPES. FOR MEDICAL SERVICES, NAMELY, PROVIDING RADIATION THERAPY SERVICES (U.S. CLS. 100 AND 101). FIRST USE 8-1-2002; IN COMMERCE 8-1-2002.

SN 76-468,395. PRENATT, FRANCINE M., ORMOND BY THE SEA, FL. FILED 11-18-2002.

SALUBRIUM

FOR SKIN CARE SALON SERVICES; AROMATHERAPY SERVICES; MASSAGES; HEALTH SPA SERVICES, NAMELY COSMETIC BODY CARE SERVICES FEATURING FACIALS, SEAWEED BODY TREATMENTS, MUD BODY TREATMENTS, AROMATHERAPY OIL BODY TREATMENTS, SALT RUBS, AND EAR CANDLING (U.S. CLS. 100 AND 101). FIRST USE 12-6-1998; IN COMMERCE 12-6-1998.

SN 76-470,737. THE NEMOURS FOUNDATION, JACKSONVILLE, FL. FILED 11-27-2002.

NEMOURS

FOR MEDICAL SERVICES; HEALTH CARE SERVICES; HOSPITAL SERVICES; OPERATION OF MEDICAL CLINICS; MEDICAL TRAUMA CENTER SERVICES (U.S. CLS. 100 AND 101). FIRST USE 7-0-1940; IN COMMERCE 7-0-1940.

SN 76-475,099. WHOLE WORLD PET, INC., SANTA MONICA, CA. FILED 12-13-2002.

WHOLE WORLD PET

NO CLAIM IS MADE TO THE EXCLUSIVE RIGHT TO USE "PET", APART FROM THE MARK AS SHOWN. FOR VETERINARY SERVICES (U.S. CLS. 100 AND 101). FIRST USE 10-1-2002; IN COMMERCE 10-1-2002.

CLASS 44—(Continued).

SN 76-475,564. TEXAS HEALTH RESOURCES, ARLINGTON, TX. FILED 12-16-2002.



FOR PHYSICAL THERAPY SERVICES (U.S. CLS. 100 AND 101).
FIRST USE 11-1-2002; IN COMMERCE 11-1-2002.

SN 76-476,105. DIEKEMPER, LAURA, ST. PETERS, MO. FILED 12-11-2002.

THE HAIRY ELEPHANT

FOR HAIR SALON FOR KIDS (U.S. CLS. 100 AND 101).

SN 76-476,543. SPATACULAR, INC., PRIOR LAKE, MN. FILED 12-10-2002.

SPATACULAR

FOR HEALTH SPA SERVICES, NAMELY, COSMETIC BODY CARE SERVICES; BEAUTY SALON SERVICES, SKIN CARE SALON SERVICES, AND MASSAGE SERVICES (U.S. CLS. 100 AND 101).

CLASS 44—(Continued).

SN 78-112,860. SASSAN HASSASSIAN, SOUTH RIDING, VA. FILED 3-5-2002.



Freedom From Pain

NO CLAIM IS MADE TO THE EXCLUSIVE RIGHT TO USE "PAIN MANAGEMENT CENTER" AND "PAIN" AND THE REPRESENTATION OF THE CADUCEUS, APART FROM THE MARK AS SHOWN.

THE MARK CONSISTS OF THE WORDING "METROPOLITAN PAIN MANAGEMENT CENTER" IN A CIRCLE SURROUNDING THE DESIGN OF A CADUCEUS, WITH THE WORDING "FREEDOM FROM PAIN" BELOW "METROPOLITAN PAIN MANAGEMENT CENTER" AND THE CIRCULAR DESIGN JUST DESCRIBED.

FOR MEDICAL SERVICES, NAMELY PAIN MANAGEMENT SERVICES, INCLUDING THE MEDICAL MANAGEMENT OF PAIN (U.S. CLS. 100 AND 101).

SN 78-147,860. TD'S CARIBBEAN TAN LLC, WAUWATOSA, WI. FILED 7-26-2002.



NO CLAIM IS MADE TO THE EXCLUSIVE RIGHT TO USE "CARIBBEAN TAN", APART FROM THE MARK AS SHOWN.

FOR TANNING SALON (U.S. CLS. 100 AND 101).

SN 78-175,786. JACOBSEN, CHRIS J., WASHOE VALLEY, NV. FILED 10-18-2002.

**SIERRA TAHOE
PONDEROSA**

NO CLAIM IS MADE TO THE EXCLUSIVE RIGHT TO USE "SIERRA TAHOE", APART FROM THE MARK AS SHOWN.

FOR HEALTH AND MEDICAL CARE SERVICES, NAMELY PROVIDING TESTING, ASSESSMENT, COUNSELING, TREATMENT, AND REHABILITATIVE SERVICES FOR PERSONS SUFFERING FROM ALCOHOLISM, CHEMICAL DEPENDENCY, OCCUPATIONAL STRESS AND ANXIETY, CODEPENDENCY, EATING DISORDERS, AND PSYCHIATRIC AND PSYCHOLOGICAL DISORDERS (U.S. CLS. 100 AND 101).

CLASS 44—(Continued).

SN 78-179,155. OCCUPATIONAL & HAND THERAPY, LTD., ORLAND PARK, IL. FILED 10-28-2002.



FOR PROVIDING PHYSICAL REHABILITATION SERVICES (U.S. CLS. 100 AND 101).
FIRST USE 12-1-1986; IN COMMERCE 12-1-1986.

SN 78-180,282. WAGNER, ROBERT, R., HUNTINGTON, NY. FILED 10-30-2002.

ROCKABILLY BARBERS

NO CLAIM IS MADE TO THE EXCLUSIVE RIGHT TO USE "BARBERS", APART FROM THE MARK AS SHOWN.
FOR HAIRCUTTING HAIRSTYLING HAIRDRESSING SERVICES (U.S. CLS. 100 AND 101).
FIRST USE 8-0-1997; IN COMMERCE 8-0-1997.

SN 78-181,556. KOBREN, SPENCER, WOODLAND HILLS, CA. FILED 11-4-2002.

THE BALD TRUTH

FOR PROVIDING INFORMATION IN THE FIELD OF HAIR LOSS PREVENTION AND TREATMENT AND RELATED HAIR LOSS ISSUES (U.S. CLS. 100 AND 101).
FIRST USE 3-30-1998; IN COMMERCE 3-30-1998.

SN 78-194,543. NAILPORT, INC., WILMINGTON, DE. FILED 12-13-2002.

NAILPORT EXPRESS

OWNER OF U.S. REG. NO. 2,402,693.
NO CLAIM IS MADE TO THE EXCLUSIVE RIGHT TO USE "EXPRESS", APART FROM THE MARK AS SHOWN.
FOR NAIL CARE SERVICES, NAMELY, MANICURES, PEDICURES, NAIL EXTENSIONS, NAIL FILL-INS, NAIL SILK WRAPS, NAIL DESIGNS OFFERED AT AIRPORTS, TRANSPORTATION TERMINALS, HOTELS, PROFESSIONAL BUILDINGS, MALLS, AND SHOPPING CENTERS (U.S. CLS. 100 AND 101).
FIRST USE 10-12-2000; IN COMMERCE 10-12-2000.

CLASS 44—(Continued).

SN 78-197,565. ON CALL INTERNATIONAL, LLC, SALEM, NH. FILED 12-23-2002.

IT COULD HAPPEN TO YOU!

FOR EMERGENCY MEDICAL ASSISTANCE (U.S. CLS. 100 AND 101).

SN 78-198,343. TANNER EHMKE, MARIAH D, LAFAYETTE, IN. FILED 12-28-2002.

AGRISAGE

FOR AGRICULTURAL CONSULTING (U.S. CLS. 100 AND 101).

CLASS 45—PERSONAL SERVICES

SN 76-465,734. STORK NEWS OF AMERICA, INC., FAYETTEVILLE, NC. FILED 11-12-2002.

STORK NEWS

OWNER OF U.S. REG. NO. 1,382,781.
NO CLAIM IS MADE TO THE EXCLUSIVE RIGHT TO USE "NEWS", APART FROM THE MARK AS SHOWN.
FOR BABY ANNOUNCEMENT SERVICES (U.S. CLS. 100 AND 101).
FIRST USE 1-16-1984; IN COMMERCE 1-16-1984.

SN 76-470,070. OLDEMARK LLC, BURLINGTON, VT. FILED 11-25-2002.



**DAVE THOMAS
FOUNDATION
FOR ADOPTION**

NO CLAIM IS MADE TO THE EXCLUSIVE RIGHT TO USE "FOUNDATION FOR ADOPTION", APART FROM THE MARK AS SHOWN.
THE NAME "DAVE THOMAS" DOES NOT IDENTIFY A LIVING INDIVIDUAL.
FOR ADOPTION AND CHILD PLACEMENT SERVICES (U.S. CLS. 100 AND 101).
FIRST USE 8-1-1992; IN COMMERCE 8-1-1992.

AUGUST 5, 2003

U.S. PATENT AND TRADEMARK OFFICE

TM 391

CLASS 45—(Continued).

SN 78-200,119. HANUS-DUSSMAN, PATRICIA M., HAZEL
CREST, IL. FILED 1-5-2003.

ASTRO-VISION

FOR ASTROLOGICAL FORECASTING AND AS-
TROLOGY CONSULTATION (U.S. CLS. 100 AND 101).
FIRST USE 0-0-1973; IN COMMERCE 0-0-1975.

* * * * *

SECTION 4.—PRIOR UNITED STATES CLASSIFICATION

APPLICATION IN ONE CLASS

COLLECTIVE MEMBERSHIP MARKS

SN 76-388,793. STATE HISTORICAL SOCIETY OF WISCONSIN, MADISON, WI. FILED 3-29-2002.

CLASS 200—COLLECTIVE MEMBERSHIP

SN 76-359,312. MOBEWARE, INC., CHICAGO, IL. FILED 1-13-2002.



FOR MEMBERSHIP IN A COLLECTIVE OF INDEPENDENTLY EMPLOYED PERSONS, NAMELY, ENTREPRENEURS, FREELANCERS, BUSINESS OWNERS, SELF-EMPLOYED PERSONS, INDEPENDENT CONTRACTORS, INDEPENDENT SALESPeOPLE, AND INDEPENDENT CONSULTANTS.



NO CLAIM IS MADE TO THE EXCLUSIVE RIGHT TO USE "WISCONSIN", APART FROM THE MARK AS SHOWN. THE MARK CONSISTS OF THE WORD "WISCONSIN" ABOVE A SQUARE CONTAINING "HI" WITH "STORY" BENEATH THE SQUARE.

FOR INDICATING MEMBERSHIP IN AN HISTORICAL SOCIETY.

FIRST USE 11-15-2001; IN COMMERCE 11-15-2001.

CERTIFICATION MARKS

CLASS A—GOODS

SN 76-482,509. UNIFORM CODE COUNCIL, INC., LAWRENCEVILLE, NJ. FILED 1-15-2003.

SN 76-363,369. ORDER OF QUETZALCOATL, THE, TUCSON, AZ. FILED 1-28-2002.



FOR INDICATING MEMBERSHIP IN A FRATERNAL ORGANIZATION.

FIRST USE 0-0-1945; IN COMMERCE 0-0-1948.



NO CLAIM IS MADE TO THE EXCLUSIVE RIGHT TO USE "INTEROPERABILITY TESTED", APART FROM THE MARK AS SHOWN.

THE CERTIFICATION MARK IS INTENDED TO BE USED BY AUTHORIZED ENTITIES OR PERSONS AND IS INTENDED TO CERTIFY THAT A SOFTWARE CONFORMS TO STANDARDS DESIGNATED BY THE UNIFORM CODE COUNCIL.

FOR COMPUTER SOFTWARE.

CLASS B—SERVICES

SN 76-195,247. DRUG & ALCOHOL TESTING INDUSTRY ASSOCIATION, INC., ALEXANDRIA, VA. FILED 1-17-2001.

SN 76-195,249. DRUG & ALCOHOL TESTING INDUSTRY ASSOCIATION, INC., ALEXANDRIA, VA. FILED 1-17-2001.

CERTIFIED PROFESSIONAL COLLECTOR

CERTIFIED PROFESSIONAL COLLECTOR TRAINER

NO CLAIM IS MADE TO THE EXCLUSIVE RIGHT TO USE "CERTIFIED", APART FROM THE MARK AS SHOWN. THE CERTIFICATION MARK, AS USED BY PERSONS AUTHORIZED BY APPLICANT, CERTIFIES THAT THE URINE SPECIMEN COLLECTION SERVICES IN THE FIELD OF DRUG AND ALCOHOL TESTING ARE PERFORMED BY PERSONS TRAINED, ACCREDITED AND CERTIFIED BY APPLICANT.

NO CLAIM IS MADE TO THE EXCLUSIVE RIGHT TO USE "CERTIFIED", APART FROM THE MARK AS SHOWN. THE CERTIFICATION MARK, AS USED BY PERSONS AUTHORIZED BY APPLICANT, CERTIFIES THAT THE URINE SPECIMEN COLLECTION SERVICES IN THE FIELD OF DRUG AND ALCOHOL TESTING ARE PERFORMED BY PERSONS TRAINED, ACCREDITED AND CERTIFIED BY APPLICANT.

FOR URINE SPECIMEN COLLECTION SERVICES IN THE FIELD OF DRUG AND ALCOHOL TESTING. FIRST USE 6-10-1999; IN COMMERCE 6-10-1999.

SEC. 2(F). FOR URINE SPECIMEN COLLECTION SERVICES IN THE FIELD OF DRUG AND ALCOHOL TESTING. FIRST USE 6-10-1999; IN COMMERCE 6-10-1999.

* * * * *

TRADEMARK REGISTRATIONS ISSUED

PRINCIPAL REGISTER

SECTION 1.— INTERNATIONAL CLASSIFICATION

The short titles associated below with the international class numbers are terms designed merely for quick identification and are not an official part of the international classification. The full names of international classes are given in section 6.1 of the trademark rules of practice.

The designation "U.S. Cl." appearing in this section refers to the U.S. class in effect prior to Sep. 1, 1973 rather than the international class which applies to applications filed on or after that date. For adoption of international classification see notice in the OFFICIAL GAZETTE of Jun. 26, 1973 (911 O.G. TM 210).

CLASS 1—CHEMICALS

- 2,745,455. **PROCHROM**. PROCHROM, MULTIPLE CLASS, (INT. CLS. 1, 9, 40 AND 42), (U.S. CLS. 1, 5, 6, 10, 21, 23, 26, 36, 38, 46, 100, 101, 103 AND 106). SN 75-496,892. PUB. 6-18-2002. FILED 6-5-1998.
- 2,745,475. **ESPOR**. PORTEC AG, MULTIPLE CLASS, (INT. CLS. 1 AND 7), (U.S. CLS. 1, 5, 6, 10, 13, 19, 21, 23, 26, 31, 34, 35 AND 46). SN 75-573,125. PUB. 12-18-2001. FILED 10-19-1998.
- 2,745,530. **BIOLEADS (STYLIZED)**. BIOLEADS GMBH, MULTIPLE CLASS, (INT. CLS. 1, 5 AND 42), (U.S. CLS. 1, 5, 6, 10, 18, 26, 44, 46, 51, 52, 100 AND 101). SN 75-749,553. PUB. 11-6-2001. FILED 7-13-1999.
- 2,745,535. **INGENIUM**. INGENIUM PHARMACEUTICALS AG, MULTIPLE CLASS, (INT. CLS. 1, 5 AND 42), (U.S. CLS. 1, 5, 6, 10, 18, 26, 44, 46, 51, 52, 100 AND 101). SN 75-759,276. PUB. 1-15-2002. FILED 7-23-1999.
- 2,745,560. **RHEOPHIL**. MEDOS MEDIZINTECHNIK GMBH, MULTIPLE CLASS, (INT. CLS. 1, 5 AND 40), (U.S. CLS. 1, 5, 6, 10, 18, 26, 44, 46, 51, 52, 100, 103 AND 106). SN 75-822,438. PUB. 12-11-2001. FILED 10-14-1999.
- 2,745,606. **EPICHIP**. EPIGENOMICS GMBH, MULTIPLE CLASS, (INT. CLS. 1, 5, 9, 38 AND 42), (U.S. CLS. 1, 5, 6, 10, 18, 21, 23, 26, 36, 38, 44, 46, 51, 52, 100, 101 AND 104). SN 75-908,863. PUB. 7-30-2002. FILED 2-2-2000.
- 2,745,617. **M-PHASYS**. M-PHASYS GMBH, MULTIPLE CLASS, (INT. CLS. 1, 5 AND 42), (U.S. CLS. 1, 5, 6, 10, 18, 26, 44, 46, 51, 52, 100 AND 101). SN 75-931,154. PUB. 10-23-2001. FILED 2-29-2000.
- 2,745,674. **SHOES24**. KEUTER, STEFAN, (U.S. CLS. 1, 5, 6, 10, 26 AND 46). SN 76-046,401. PUB. 10-29-2002. FILED 5-10-2000.
- 2,745,693. **MISCELLANEOUS DESIGN**. FERRANIA S.P.A., MULTIPLE CLASS, (INT. CLS. 1 AND 9), (U.S. CLS. 1, 5, 6, 10, 21, 23, 26, 36, 38 AND 46). SN 76-060,394. PUB. 5-13-2003. FILED 5-31-2000.
- 2,745,696. **KERMEL PERFORMANCE IS OUR PROFESSION AND DESIGN**. KERMEL, MULTIPLE CLASS, (INT. CLS. 1, 6, 9, 16, 17, 22, 23 AND 24), (U.S. CLS. 1, 2, 5, 6, 7, 10, 12, 13, 14, 19, 21, 22, 23, 25, 26, 29, 35, 36, 37, 38, 42, 43, 46 AND 50). SN 76-062,649. PUB. 4-23-2002. FILED 6-1-2000.
- 2,745,720. **ULTRASEAL**. ENVIRO-COATINGS CANADA LTD., (U.S. CLS. 1, 5, 6, 10, 26 AND 46). SN 76-083,348. PUB. 5-13-2003. FILED 7-5-2000.
- 2,745,730. **THIOLIN**. DE PAOLI AMBROSI GIANFRANCO, MULTIPLE CLASS, (INT. CLS. 1, 3 AND 5), (U.S. CLS. 1, 4, 5, 6, 10, 18, 26, 44, 46, 50, 51 AND 52). SN 76-096,018. PUB. 5-13-2003. FILED 7-25-2000.
- 2,745,740. **MICROPAN**. RIM - TECH A.S., MULTIPLE CLASS, (INT. CLS. 1 AND 3), (U.S. CLS. 1, 4, 5, 6, 10, 26, 46, 50, 51 AND 52). SN 76-102,908. PUB. 5-13-2003. FILED 7-31-2000.
- 2,745,746. **PRENAGNOST (STYLIZED)**. ADNAGEN GMBH, MULTIPLE CLASS, (INT. CLS. 1 AND 5), (U.S. CLS. 1, 5, 6, 10, 18, 26, 44, 46, 51 AND 52). SN 76-106,370. PUB. 9-11-2001. FILED 8-8-2000.
- 2,745,747. **CHITO-GREEN**. INTERNATIONAL CHITIN PRODUCTION INC., (U.S. CLS. 1, 5, 6, 10, 26 AND 46). SN 76-109,301. PUB. 12-3-2002. FILED 8-15-2000.
- 2,745,811. **URENCO**. URENCO LIMITED, MULTIPLE CLASS, (INT. CLS. 1, 35, 37, 39, 40 AND 42), (U.S. CLS. 1, 5, 6, 10, 26, 46, 100, 101, 102, 103, 105 AND 106). SN 76-166,082. PUB. 5-13-2003. FILED 11-15-2000.
- 2,745,846. **NUKLEOPORATION**. AMAXA GMBH, MULTIPLE CLASS, (INT. CLS. 1, 5 AND 9), (U.S. CLS. 1, 5, 6, 10, 18, 21, 23, 26, 36, 38, 44, 46, 51 AND 52). SN 76-192,951. PUB. 10-8-2002. FILED 1-11-2001.
- 2,745,854. **PYROSYN (STYLIZED)**. HERAEUS QUARZGLAS GMBH & CO. KG, MULTIPLE CLASS, (INT. CLS. 1, 9 AND 19), (U.S. CLS. 1, 5, 6, 10, 12, 21, 23, 26, 33, 36, 38, 46 AND 50). SN 76-196,168. PUB. 10-29-2002. FILED 1-19-2001.
- 2,745,868. **VIVENTIA**. VIVENTIA BIOTECH INC., MULTIPLE CLASS, (INT. CLS. 1, 5 AND 42), (U.S. CLS. 1, 5, 6, 10, 18, 26, 44, 46, 51, 52, 100 AND 101). SN 76-205,555. PUB. 9-17-2002. FILED 2-5-2001.
- 2,745,973. **UNIEXCEL CHEMICAL SOLUTIONS LLC 1 AND DESIGN**. UNIEXCEL CHEMICAL SOLUTIONS, L.L.C., (U.S. CLS. 1, 5, 6, 10, 26 AND 46). SN 76-263,777. PUB. 5-13-2003. FILED 5-30-2001.
- 2,745,979. **PDP**. SYN X PHARMA, INC., MULTIPLE CLASS, (INT. CLS. 1, 5 AND 42), (U.S. CLS. 1, 5, 6, 10, 18, 26, 44, 46, 51, 52, 100 AND 101). SN 76-266,423. PUB. 5-13-2003. FILED 6-4-2001.
- 2,745,983. **PHOENIX**. SIMPLOT TURF AND HORTICULTURE, A DIVISION OF J.R. SIMPLOT COMPANY, BY ASSIGNMENT ECO SOIL SYSTEMS, INC., (U.S. CLS. 1, 5, 6, 10, 26 AND 46). SN 76-266,883. PUB. 12-10-2002. FILED 6-5-2001.
- 2,746,002. **SUNTORY WATER GROUP**. SUNTORY WATER GROUP, INC., MULTIPLE CLASS, (INT. CLS. 1, 21 AND 32), (U.S. CLS. 1, 2, 5, 6, 10, 13, 23, 26, 29, 30, 33, 40, 45, 46, 48 AND 50). SN 76-274,926. PUB. 11-5-2002. FILED 6-21-2001.
- 2,746,042. **MAGAPURE**. CORTEX BIOCHEM, INC., MULTIPLE CLASS, (INT. CLS. 1 AND 5), (U.S. CLS. 1, 5, 6, 10, 18, 26, 44, 46, 51 AND 52). SN 76-289,333. PUB. 1-14-2003. FILED 7-24-2001.
- 2,746,075. **BEST YET AND DESIGN**. FLEMING COMPANIES, INC., MULTIPLE CLASS, (INT. CLS. 1, 3, 5, 8, 9, 10, 11, 16, 17, 21, 25 AND 34), (U.S. CLS. 1, 2, 4, 5, 6, 8, 9, 10, 12, 13, 17, 18, 21, 22, 23, 26, 28, 29, 30, 31, 33, 34, 35, 36, 37, 38, 39, 40, 44, 46, 50, 51 AND 52). SN 76-300,427. PUB. 1-14-2003. FILED 8-16-2001.
- 2,746,079. **LIPO AND DESIGN**. LIPO CHEMICALS, INC., MULTIPLE CLASS, (INT. CLS. 1, 3 AND 5), (U.S. CLS. 1, 4, 5, 6, 10, 18, 26, 44, 46, 50, 51 AND 52). SN 76-302,970. PUB. 5-13-2003. FILED 8-17-2001.
- 2,746,162. **A APPLAUD AND DESIGN**. NICHINO AMERICA, INC., MULTIPLE CLASS, (INT. CLS. 1 AND 5), (U.S. CLS. 1, 5, 6, 10, 18, 26, 44, 46, 51 AND 52). SN 76-331,803. PUB. 5-13-2003. FILED 10-30-2001.
- 2,746,164. **RIFFIX**. DURAND TECHNOLOGY LIMITED, MULTIPLE CLASS, (INT. CLS. 1, 9 AND 17), (U.S. CLS. 1, 5, 6, 10, 12, 13, 21, 23, 26, 35, 36, 38, 46 AND 50). SN 76-331,894. PUB. 12-17-2002. FILED 10-30-2001.
- 2,746,234. **PUROX**. DSM N.V., MULTIPLE CLASS, (INT. CLS. 1 AND 31), (U.S. CLS. 1, 5, 6, 10, 26 AND 46). SN 76-350,053. PUB. 5-13-2003. FILED 12-19-2001.
- 2,746,276. **MIDAS**. UNITED STATES FILTER CORPORATION, (U.S. CLS. 1, 5, 6, 10, 26 AND 46). SN 76-363,493. PUB.

- 6-25-2002. FILED 1-28-2002.
- 2,746,357. **OS. HONEYWELL INTERNATIONAL INC.**, (U.S. CLS. 1, 5, 6, 10, 26 AND 46). SN 76-380,932. PUB. 5-13-2003. FILED 3-11-2002.
- 2,746,470. **FIRETECT. AMERICAN FLAMECOAT OF SOUTHERN CALIFORNIA, INC., DBA FIRETECT**, MULTIPLE CLASS, (INT. CLS. 1, 35 AND 40), (U.S. CLS. 1, 5, 6, 10, 26, 46, 100, 101, 102, 103 AND 106). SN 76-399,030. PUB. 5-13-2003. FILED 4-22-2002.
- 2,746,524. **RIBBON FLOW. UNIROYAL CHEMICAL COMPANY, INC.**, (U.S. CLS. 1, 5, 6, 10, 26 AND 46). SN 76-406,331. PUB. 5-13-2003. FILED 5-13-2002.
- 2,746,603. **RX-ACID SCAVENGER (STYLIZED). NUCALGON WHOLESALE, INC.**, (U.S. CLS. 1, 5, 6, 10, 26 AND 46). SN 76-420,083. PUB. 5-13-2003. FILED 5-31-2002.
- 2,746,812. **PUR-BOND. THIN FILM TECHNOLOGY, INC.**, (U.S. CLS. 1, 5, 6, 10, 26 AND 46). SN 76-450,400. PUB. 5-13-2003. FILED 9-13-2002.
- 2,747,031. **CRAB-EX. UNITED INDUSTRIES CORPORATION, MULTIPLE CLASS, (INT. CLS. 1 AND 5), (U.S. CLS. 1, 5, 6, 10, 18, 26, 44, 46, 51 AND 52)**. SN 76-464,485. PUB. 5-13-2003. FILED 10-29-2002.
- 2,747,043. **FIBER-TAC. CORRUGATED CHEMICALS, INC.**, (U.S. CLS. 1, 5, 6, 10, 26 AND 46). SN 76-469,178. PUB. 5-13-2003. FILED 11-22-2002.
- 2,747,046. **ONESHOT. MILLER CHEMICAL & FERTILIZER CORPORATION, (U.S. CLS. 1, 5, 6, 10, 26 AND 46)**. SN 76-470,085. PUB. 5-13-2003. FILED 11-26-2002.
- 2,747,048. **ALBROM. ALBEMARLE CORPORATION, MULTIPLE CLASS, (INT. CLS. 1 AND 5), (U.S. CLS. 1, 5, 6, 10, 18, 26, 44, 46, 51 AND 52)**. SN 76-471,042. PUB. 5-13-2003. FILED 11-27-2002.
- 2,747,049. **ACCUBLACK. THE CHROMALINE CORPORATION, (U.S. CLS. 1, 5, 6, 10, 26 AND 46)**. SN 76-472,726. PUB. 5-13-2003. FILED 12-9-2002.
- 2,747,050. **ACCUART. THE CHROMALINE CORPORATION, (U.S. CLS. 1, 5, 6, 10, 26 AND 46)**. SN 76-472,752. PUB. 5-13-2003. FILED 12-9-2002.
- 2,747,088. **PHYSALG. COMPAGNIE FINANCIERE ET DE PARTICIPATIONS ROULLIER, (U.S. CLS. 1, 5, 6, 10, 26 AND 46)**. SN 78-073,882. PUB. 4-30-2002. FILED 7-13-2001.
- 2,747,093. **CUEVA. W. NEUDORFF GMBH KG, MULTIPLE CLASS, (INT. CLS. 1 AND 5), (U.S. CLS. 1, 5, 6, 10, 18, 26, 44, 46, 51 AND 52)**. SN 78-081,962. PUB. 10-15-2002. FILED 8-30-2001.
- 2,747,235. **BASSMEDICS. COUVILLION, ALLEN J., AND BURTON, RICHARD E.**, (U.S. CLS. 1, 5, 6, 10, 26 AND 46). SN 78-145,003. PUB. 5-13-2003. FILED 7-17-2002.
- 2,747,243. **ACTIFIRM. ACTIVE ORGANICS, INC.**, (U.S. CLS. 1, 5, 6, 10, 26 AND 46). SN 78-147,311. PUB. 5-13-2003. FILED 7-25-2002.
- 2,747,287. **MOTOTECH. KROGER CO. OF MICHIGAN, THE, MULTIPLE CLASS, (INT. CLS. 1, 3, 7, 9 AND 21), (U.S. CLS. 1, 2, 4, 5, 6, 10, 13, 19, 21, 23, 26, 29, 30, 31, 33, 34, 35, 36, 38, 40, 46, 50, 51 AND 52)**. SN 78-153,587. PUB. 5-13-2003. FILED 8-13-2002.
- 2,747,299. **IQ. PIERCE BIOTECHNOLOGY, INC.**, (U.S. CLS. 1, 5, 6, 10, 26 AND 46). SN 78-155,331. PUB. 5-13-2003. FILED 8-19-2002.
- 2,747,339. **TITANIUM5. ILLINOIS TOOL WORKS INC.**, (U.S. CLS. 1, 5, 6, 10, 26 AND 46). SN 78-163,803. PUB. 5-13-2003. FILED 9-13-2002.
- 2,747,352. **SOILPAM. EARTH CHEM, INC.**, (U.S. CLS. 1, 5, 6, 10, 26 AND 46). SN 78-165,468. PUB. 5-13-2003. FILED 9-18-2002.

CLASS 2—PAINTS

- 2,745,567. **Z VOC (STYLIZED). UV COATINGS LIMITED, MULTIPLE CLASS, (INT. CLS. 2 AND 19), (U.S. CLS. 1, 6, 11, 12, 16, 33 AND 50)**. SN 75-839,759. PUB. 12-3-2002. FILED 11-4-1999.
- 2,745,583. **DURON (STYLIZED). DURON, INC.**, MULTIPLE CLASS, (INT. CLS. 2, 16, 17 AND 35), (U.S. CLS. 1, 2, 5, 6, 11, 12, 13, 16, 22, 23, 29, 35, 37, 38, 50, 100, 101 AND 102). SN 75-872,799. PUB. 5-21-2002. FILED 12-16-1999.

- 2,745,614. **DEBEER CAR-REFINISHES AND DESIGN. DE BEER LAKFABRIEKEN B.V.**, MULTIPLE CLASS, (INT. CLS. 2 AND 3), (U.S. CLS. 1, 4, 6, 11, 16, 50, 51 AND 52). SN 75-927,499. PUB. 7-23-2002. FILED 2-25-2000.
- 2,745,679. **AUTHENTICARE AND DESIGN. BUNDESDRUCKEREI GMBH, MULTIPLE CLASS, (INT. CLS. 2, 9, 16 AND 42), (U.S. CLS. 2, 5, 6, 11, 16, 21, 22, 23, 26, 29, 36, 37, 38, 50, 100 AND 101)**. SN 76-047,829. PUB. 9-17-2002. FILED 5-11-2000.
- 2,745,765. **SUNQWIK MILLENNIUM. SUN CHEMICAL CORPORATION, (U.S. CLS. 6, 11 AND 16)**. SN 76-122,927. PUB. 12-10-2002. FILED 9-7-2000.
- 2,746,379. **SEAL MASTER PROFESSIONAL GRADE AND DESIGN. SEALMASTER INDUSTRIES, INC.**, MULTIPLE CLASS, (INT. CLS. 2 AND 17), (U.S. CLS. 1, 5, 6, 11, 12, 13, 16, 35 AND 50). SN 76-385,192. PUB. 5-13-2003. FILED 3-21-2002.
- 2,746,380. **ALACAR. AKZO NOBEL COATINGS INTERNATIONAL B.V.**, MULTIPLE CLASS, (INT. CLS. 2, 9, 35, 36, 37, 39 AND 40), (U.S. CLS. 6, 11, 16, 21, 23, 26, 36, 38, 100, 101, 102, 103, 105 AND 106). SN 76-385,264. PUB. 5-13-2003. FILED 3-21-2002.
- 2,746,580. **ARMOR. EASYWARE HOUSEHOLD CORP.**, (U.S. CLS. 6, 11 AND 16). SN 76-416,039. PUB. 5-13-2003. FILED 6-6-2002.
- 2,746,941. **SCOTT PAINT AND DESIGN. SCOTT PAINT COMPANY, (U.S. CLS. 6, 11 AND 16)**. SN 76-458,021. PUB. 5-13-2003. FILED 10-15-2002.
- 2,746,994. **SUPERGOLD. ECKART AMERICA L.P.**, (U.S. CLS. 6, 11 AND 16). SN 76-461,224. PUB. 5-13-2003. FILED 10-24-2002.

CLASS 3—COSMETICS AND CLEANING PREPARATIONS

- 2,745,431. **DEESSE (STYLIZED). DEESSE AG, (U.S. CLS. 1, 4, 6, 50, 51 AND 52)**. SN 75-312,079. PUB. 5-13-2003. FILED 6-20-1997.
- 2,745,457. **O OUI! (STYLIZED). LANCOME PARFUMS ET BEAUTE & CIE, (U.S. CLS. 1, 4, 6, 50, 51 AND 52)**. SN 75-506,804. PUB. 6-22-1999. FILED 6-22-1998.
- 2,745,466. **4 SHOT. S. C. JOHNSON COMMERCIAL MARKETS, INC.**, MULTIPLE CLASS, (INT. CLS. 3, 5 AND 21), (U.S. CLS. 1, 2, 4, 6, 13, 18, 23, 29, 30, 33, 40, 44, 46, 50, 51 AND 52). SN 75-536,771. PUB. 11-26-2002. FILED 8-17-1998.
- 2,745,469. **TWISTER. CHAMPION CHEMICAL CO., INC.**, (U.S. CLS. 1, 4, 6, 50, 51 AND 52). SN 75-555,901. PUB. 11-19-2002. FILED 9-21-1998.
- 2,745,493. **TREAT ME RIGHT. MANA PRODUCTS, INC.**, (U.S. CLS. 1, 4, 6, 50, 51 AND 52). SN 75-634,485. PUB. 10-29-2002. FILED 2-5-1999.
- 2,745,500. **CUSH. DOLPHIN ACQUISITION CORPORATION, (U.S. CLS. 1, 4, 6, 50, 51 AND 52)**. SN 75-656,434. PUB. 12-24-2002. FILED 3-9-1999.
- 2,745,550. **DIESELSTYLELAB. DIESEL S.P.A.**, MULTIPLE CLASS, (INT. CLS. 3, 9, 14, 18, 25 AND 35), (U.S. CLS. 1, 2, 3, 4, 6, 21, 22, 23, 26, 27, 28, 36, 38, 39, 41, 50, 51, 52, 100, 101 AND 102). SN 75-803,090. PUB. 10-8-2002. FILED 9-16-1999.
- 2,745,558. **MARY READ AND DESIGN. SPENGOLD LIMITED, MULTIPLE CLASS, (INT. CLS. 3, 9, 18 AND 25), (U.S. CLS. 1, 2, 3, 4, 6, 21, 22, 23, 26, 36, 38, 39, 41, 50, 51 AND 52)**. SN 75-818,619. PUB. 2-5-2002. FILED 10-8-1999.
- 2,745,569. **W LISE WATIER AND DESIGN. LISE WATIER COSMETIQUES INC.**, MULTIPLE CLASS, (INT. CLS. 3, 18 AND 21), (U.S. CLS. 1, 2, 3, 4, 6, 13, 22, 23, 29, 30, 33, 40, 41, 50, 51 AND 52). SN 75-845,711. PUB. 12-24-2002. FILED 11-9-1999.
- 2,745,582. **EZZOO.COM. FORTUNEGLOBE GMBH, BY ASSIGNMENT HOELLGER, THORSTEN, MULTIPLE CLASS, (INT. CLS. 3, 14, 18 AND 25), (U.S. CLS. 1, 2, 3, 4, 6, 22, 27, 28, 39, 41, 50, 51 AND 52)**. SN 75-870,374. PUB. 10-15-2002. FILED 12-23-1999.
- 2,745,590. **LEATHER MATE. TASK CANADA INC.**, (U.S. CLS. 1, 4, 6, 50, 51 AND 52). SN 75-890,822. PUB. 5-13-2003. FILED 1-7-2000.
- 2,745,593. **N NATURE'S GIFT AROMATHERAPY PRODUCTS**

- AND DESIGN.** CLARK, MARGARET G., (U.S. CLS. 1, 4, 6, 50, 51 AND 52). SN 75-895,394. PUB. 11-5-2002. FILED 1-13-2000.
- 2,745,614 (*See Class 2 for this trademark.*).
- 2,745,636. **RAGDOLL.** RAGDOLL LIMITED, MULTIPLE CLASS, (INT. CLS. 3, 9, 16, 18, 21 AND 41), (U.S. CLS. 1, 2, 3, 4, 5, 6, 13, 21, 22, 23, 26, 29, 30, 33, 36, 37, 38, 40, 41, 50, 51, 52, 100, 101 AND 107). SN 75-983,068. PUB. 5-13-2003. FILED 12-20-2001.
- 2,745,680. **MISCELLANEOUS DESIGN.** SENNHEISER ELECTRONIC GMBH & CO. KG, MULTIPLE CLASS, (INT. CLS. 3, 9, 18, 21, 25, 28 AND 42), (U.S. CLS. 1, 2, 3, 4, 6, 13, 21, 22, 23, 26, 29, 30, 33, 36, 38, 39, 40, 41, 50, 51, 52, 100 AND 101). SN 76-049,262. PUB. 10-8-2002. FILED 5-16-2000.
- 2,745,683. **ALAIN FIGARET.** FIGARET, ALAIN, MULTIPLE CLASS, (INT. CLS. 3, 9, 14, 18 AND 25), (U.S. CLS. 1, 2, 3, 4, 6, 21, 22, 23, 26, 27, 28, 36, 38, 39, 41, 50, 51 AND 52). SN 76-051,311. PUB. 6-11-2002. FILED 5-18-2000.
- 2,745,684. **S AND DESIGN.** SEPHORA, BY CHANGE OF NAME SEPHORA HOLDING, MULTIPLE CLASS, (INT. CLS. 3 AND 26), (U.S. CLS. 1, 4, 6, 37, 39, 40, 42, 50, 51 AND 52). SN 76-052,505. PUB. 11-5-2002. FILED 5-19-2000.
- 2,745,729. **CC TWENTY-FOUR 7 (STYLIZED).** CHANNOINE COSMETICS AG, MULTIPLE CLASS, (INT. CLS. 3, 14 AND 18), (U.S. CLS. 1, 2, 3, 4, 6, 22, 27, 28, 41, 50, 51 AND 52). SN 76-095,224. PUB. 5-13-2003. FILED 7-24-2000.
- 2,745,730 (*See Class 1 for this trademark.*).
- 2,745,740 (*See Class 1 for this trademark.*).
- 2,745,793. **BLUSH FONDANT.** LA ROCHE-POSAY LABORATOIRE PHARMACEUTIQUE, (U.S. CLS. 1, 4, 6, 50, 51 AND 52). SN 76-150,265. PUB. 5-13-2003. FILED 10-19-2000.
- 2,745,819. **BENNY GOODMAN COLLECTION THE FINEST QUALITY (STYLIZED).** JACKSON INTERNATIONAL TRADING COMPANY KURT D. BRUHL GMBH & CO. KG, MULTIPLE CLASS, (INT. CLS. 3, 18 AND 25), (U.S. CLS. 1, 2, 3, 4, 6, 22, 39, 41, 50, 51 AND 52). SN 76-172,958. PUB. 4-23-2002. FILED 11-29-2000.
- 2,745,820. **PARFUMS DE FAMILLE.** BRUNET, PIERRE, (U.S. CLS. 1, 4, 6, 50, 51 AND 52). SN 76-173,907. PUB. 4-16-2002. FILED 12-1-2000.
- 2,745,835. **MOONBEAM SOAP WWW.MOONBEAMSOAP.COM AND DESIGN.** KRAMER, NOELLE, (U.S. CLS. 1, 4, 6, 50, 51 AND 52). SN 76-188,190. PUB. 8-20-2002. FILED 12-29-2000.
- 2,745,843. **LISS CONTROL +.** L'OREAL, (U.S. CLS. 1, 4, 6, 50, 51 AND 52). SN 76-190,660. PUB. 5-13-2003. FILED 1-5-2001.
- 2,745,890. **KELUAL.** PIERRE FABRE DERMO-COSMETIQUE, MULTIPLE CLASS, (INT. CLS. 3 AND 5), (U.S. CLS. 1, 4, 6, 18, 44, 46, 50, 51 AND 52). SN 76-217,660. PUB. 5-13-2003. FILED 2-28-2001.
- 2,745,974. **GARNIER 100% COLOR.** LABORATOIRE GARNIER & CIE, (U.S. CLS. 1, 4, 6, 50, 51 AND 52). SN 76-263,833. PUB. 2-4-2003. FILED 5-29-2001.
- 2,746,003. **GLOSS STIXX.** BOGGI INTERNATIONAL, INC., (U.S. CLS. 1, 4, 6, 50, 51 AND 52). SN 76-275,257. PUB. 5-13-2003. FILED 6-19-2001.
- 2,746,027. **LIXELIA.** BIOMERIEUX PIERRE FABRE, MULTIPLE CLASS, (INT. CLS. 3 AND 5), (U.S. CLS. 1, 4, 6, 18, 44, 46, 50, 51 AND 52). SN 76-286,215. PUB. 5-13-2003. FILED 7-17-2001.
- 2,746,075 (*See Class 1 for this trademark.*).
- 2,746,079 (*See Class 1 for this trademark.*).
- 2,746,087. **MAXIM.** ROBERTS, KEITH A., (U.S. CLS. 1, 4, 6, 50, 51 AND 52). SN 76-306,419. PUB. 12-24-2002. FILED 8-29-2001.
- 2,746,098. **CIRCLE CLEAR.** CAT MEDIA PTY LIMITED, (U.S. CLS. 1, 4, 6, 50, 51 AND 52). SN 76-311,422. PUB. 5-13-2003. FILED 9-13-2001.
- 2,746,105. **100% COLOR.** LABORATOIRE GARNIER & CIE, (U.S. CLS. 1, 4, 6, 50, 51 AND 52). SN 76-312,748. PUB. 1-21-2003. FILED 9-14-2001.
- 2,746,119. **DONNA'S DIVERSIONS.** CALDWELL-SMOLDT, DONNA, (U.S. CLS. 1, 4, 6, 50, 51 AND 52). SN 76-318,408. PUB. 5-13-2003. FILED 9-28-2001.
- 2,746,127. **BE UP WOMEN MEN AND DESIGN.** LABORATOIRES LIERAC S.A., (U.S. CLS. 1, 4, 6, 50, 51 AND 52). SN 76-321,318. PUB. 5-13-2003. FILED 10-4-2001.
- 2,746,141. **LITTLE KISSES.** FLEMING COMPANIES, INC., MULTIPLE CLASS, (INT. CLS. 3 AND 5), (U.S. CLS. 1, 4, 6, 18, 44, 46, 50, 51 AND 52). SN 76-325,768. PUB. 10-8-2002. FILED 10-16-2001.
- 2,746,161. **THE FRUIT OF OUR LABOR.** SULLIVAN, MARY ELLEN, AND BERNHARDY, B. PAUL, (U.S. CLS. 1, 4, 6, 50, 51 AND 52). SN 76-331,800. PUB. 10-8-2002. FILED 10-30-2001.
- 2,746,179. **TOUCH'N GO.** NGUYEN, JOHN, (U.S. CLS. 1, 4, 6, 50, 51 AND 52). SN 76-336,433. PUB. 11-19-2002. FILED 11-13-2001.
- 2,746,213. **MICHEL GERMAIN.** BAILEY, STEVEN, MULTIPLE CLASS, (INT. CLS. 3 AND 25), (U.S. CLS. 1, 4, 6, 22, 39, 50, 51 AND 52). SN 76-343,157. PUB. 5-13-2003. FILED 11-30-2001.
- 2,746,255. **SOIR DE PARIS.** BOURJOIS, (U.S. CLS. 1, 4, 6, 50, 51 AND 52). SN 76-356,794. PUB. 5-13-2003. FILED 1-9-2002.
- 2,746,271. **MIPOX.** NIHON MICRO COATING KABUSHIKI KAISHA, MULTIPLE CLASS, (INT. CLS. 3 AND 7), (U.S. CLS. 1, 4, 6, 13, 19, 21, 23, 31, 34, 35, 50, 51 AND 52). SN 76-361,845. PUB. 5-13-2003. FILED 1-23-2002.
- 2,746,281. **MISCELLANEOUS DESIGN.** ZOYA COMPANY, (U.S. CLS. 1, 4, 6, 50, 51 AND 52). SN 76-365,099. PUB. 5-13-2003. FILED 1-30-2002.
- 2,746,291. **INSTANT MANICURE.** LAVENIR, LLC, (U.S. CLS. 1, 4, 6, 50, 51 AND 52). SN 76-368,657. PUB. 11-26-2002. FILED 2-5-2002.
- 2,746,315. **TOTAL SPORT.** CHURCH & DWIGHT COMPANY, (U.S. CLS. 1, 4, 6, 50, 51 AND 52). SN 76-373,264. PUB. 12-10-2002. FILED 2-20-2002.
- 2,746,317. **MINT ASURE.** HEALTH ASURE, INC., (U.S. CLS. 1, 4, 6, 50, 51 AND 52). SN 76-373,715. PUB. 5-13-2003. FILED 2-21-2002.
- 2,746,351. **SELF-SCENTERED.** DIDIMARS, INC., (U.S. CLS. 1, 4, 6, 50, 51 AND 52). SN 76-379,815. PUB. 5-13-2003. FILED 3-7-2002.
- 2,746,370. **VIVECLAT (STYLIZED).** LANCOME PARFUMS ET BEAUTE & CIE, (U.S. CLS. 1, 4, 6, 50, 51 AND 52). SN 76-383,866. PUB. 5-13-2003. FILED 3-14-2002.
- 2,746,389. **PIERRE CARDIN.** CARDIN, PIERRE, (U.S. CLS. 1, 4, 6, 50, 51 AND 52). SN 76-386,555. PUB. 5-13-2003. FILED 3-25-2002.
- 2,746,407. **FROM FARMS TO FORMULATIONS.** DESERT WHALE JOJOBA COMPANY, (U.S. CLS. 1, 4, 6, 50, 51 AND 52). SN 76-389,894. PUB. 5-13-2003. FILED 4-2-2002.
- 2,746,409. **CHUTZSPA.** MELVCO, INC., DBA HAKEN RAIN COUNTRY, (U.S. CLS. 1, 4, 6, 50, 51 AND 52). SN 76-390,335. PUB. 5-13-2003. FILED 4-2-2002.
- 2,746,426. **CUCUMBER ROSE.** AQUA VITAE, INC, (U.S. CLS. 1, 4, 6, 50, 51 AND 52). SN 76-393,145. PUB. 5-13-2003. FILED 4-8-2002.
- 2,746,456. **HYDRACHROMATIC.** GUERLAIN S.A., (U.S. CLS. 1, 4, 6, 50, 51 AND 52). SN 76-396,317. PUB. 5-13-2003. FILED 4-15-2002.
- 2,746,460. **OR-PHA-LEE KLEEN.** HARRIS, ORPHA LEE, DBA L&R CONCEPTS, (U.S. CLS. 1, 4, 6, 50, 51 AND 52). SN 76-397,358. PUB. 5-13-2003. FILED 4-15-2002.
- 2,746,464. **DESIGNER FRENCH TIPS.** VOUVAKIS, JAMES M., AND TAKAHASHI, YUMI, (U.S. CLS. 1, 4, 6, 50, 51 AND 52). SN 76-397,849. PUB. 5-13-2003. FILED 4-20-2002.
- 2,746,481. **THE FRAGRANCE OF A NEW ERA.** PACO RABANNE PARFUMS, (U.S. CLS. 1, 4, 6, 50, 51 AND 52). SN 76-400,996. PUB. 5-13-2003. FILED 4-26-2002.
- 2,746,484. **ECOWET.** KWH MIRKA LTD., (U.S. CLS. 1, 4, 6, 50, 51 AND 52). SN 76-401,054. PUB. 5-13-2003. FILED 4-26-2002.
- 2,746,488. **TAN MISSION.** LANCOME PARFUMS ET BEAUTE & CIE, (U.S. CLS. 1, 4, 6, 50, 51 AND 52). SN 76-402,199. PUB. 5-13-2003. FILED 5-1-2002.
- 2,746,508. **ANGEL SCHLESSER.** OVEJERO, ANGEL FERNANDEZ, (U.S. CLS. 1, 4, 6, 50, 51 AND 52). SN 76-404,459. PUB. 5-13-2003. FILED 5-7-2002.
- 2,746,592. **NOW THERE IS ALWAYS A DOCTOR IN YOUR HOUSE.** RODAN & FIELDS, LLC, MULTIPLE CLASS, (INT. CLS. 3 AND 5), (U.S. CLS. 1, 4, 6, 18, 44, 46, 50, 51 AND 52). SN 76-418,289. PUB. 5-13-2003. FILED 6-7-2002.
- 2,746,595. **LANCIANE.** PIERRE FABRE DERMO-COSMETIQUE, (U.S. CLS. 1, 4, 6, 50, 51 AND 52). SN 76-419,084. PUB. 5-13-2003. FILED 6-10-2002.
- 2,746,618. **LUCKY TOUCH AND DESIGN.** LUCKY TOUCH

ENTERPRISES, LLC, (U.S. CLS. 1, 4, 6, 50, 51 AND 52). SN 76-422,184. PUB. 5-13-2003. FILED 6-17-2002.

2,746,620. **PARA ME (STYLIZED)**. PARA ME COSMETICS, LLC, (U.S. CLS. 1, 4, 6, 50, 51 AND 52). SN 76-422,516. PUB. 5-13-2003. FILED 6-17-2002.

2,746,666. **HAUTE TENUE**. YVES SAINT LAURENT PARFUMS, (U.S. CLS. 1, 4, 6, 50, 51 AND 52). SN 76-433,694. PUB. 5-13-2003. FILED 7-19-2002.

2,746,727. **METASOL**. INTERNATIONAL BEAUTY EXCHANGE, (U.S. CLS. 1, 4, 6, 50, 51 AND 52). SN 76-443,042. PUB. 5-13-2003. FILED 8-22-2002.

2,746,832. **FP AND DESIGN**. THE FACE PLACE, MULTIPLE CLASS, (INT. CLS. 3 AND 44), (U.S. CLS. 1, 4, 6, 50, 51, 52, 100 AND 101). SN 76-452,171. PUB. 5-13-2003. FILED 9-18-2002.

2,746,853. **SAMY**. SAMY MARK, INC., MULTIPLE CLASS, (INT. CLS. 3 AND 21), (U.S. CLS. 1, 2, 4, 6, 13, 23, 29, 30, 33, 40, 50, 51 AND 52). SN 76-453,162. PUB. 5-13-2003. FILED 9-26-2002.

2,746,868. **LUV2U**. DE LOS SANTOS, FEDERICO E., (U.S. CLS. 1, 4, 6, 50, 51 AND 52). SN 76-453,785. PUB. 5-13-2003. FILED 9-30-2002.

2,746,879. **TRANQUIL MOMENTS**. AVON PRODUCTS, INC., (U.S. CLS. 1, 4, 6, 50, 51 AND 52). SN 76-454,308. PUB. 5-13-2003. FILED 10-1-2002.

2,746,892. **VITABATH ESSENTIALS**. BELAE BRANDS, INC., (U.S. CLS. 1, 4, 6, 50, 51 AND 52). SN 76-455,187. PUB. 5-13-2003. FILED 9-27-2002.

2,746,898. **DYNA-MIGHT**. C-TECH ENTERPRISES, INC., (U.S. CLS. 1, 4, 6, 50, 51 AND 52). SN 76-455,314. PUB. 5-13-2003. FILED 10-1-2002.

2,746,914. **ICEFX**. CREATIVE MARKETING AND DESIGN, INC., (U.S. CLS. 1, 4, 6, 50, 51 AND 52). SN 76-456,153. PUB. 5-13-2003. FILED 10-7-2002.

2,746,932. **VASELINE**. CHESEBROUGH-POND'S INC., (U.S. CLS. 1, 4, 6, 50, 51 AND 52). SN 76-457,132. PUB. 5-13-2003. FILED 10-9-2002.

2,747,037. **PULL-UPS**. KIMBERLY-CLARK CORPORATION, (U.S. CLS. 1, 4, 6, 50, 51 AND 52). SN 76-465,844. PUB. 5-13-2003. FILED 11-12-2002.

2,747,064. **BLACK BY DESIGN**. VISAGE INTERNATIONAL LIMITED, (U.S. CLS. 1, 4, 6, 50, 51 AND 52). SN 78-032,048. PUB. 11-5-2002. FILED 10-24-2000.

2,747,113. **EYE LUSTER**. FRESH INC, (U.S. CLS. 1, 4, 6, 50, 51 AND 52). SN 78-098,719. PUB. 7-2-2002. FILED 12-17-2001.

2,747,182. **COLGATE SIMPLY WHITE**. COLGATE-PALMOLIVE COMPANY, (U.S. CLS. 1, 4, 6, 50, 51 AND 52). SN 78-121,948. PUB. 5-13-2003. FILED 4-16-2002.

2,747,197. **A CRYSTAL APPLIQUE NAIL DECORATING KIT CRYSTALICIOUS AND DESIGN**. MILLER, THERESA C., (U.S. CLS. 1, 4, 6, 50, 51 AND 52). SN 78-126,725. PUB. 5-13-2003. FILED 5-7-2002.

2,747,210. **THE FRAGRANCE PEOPLE AND DESIGN**. DELTA EXPORTS (I), (U.S. CLS. 1, 4, 6, 50, 51 AND 52). SN 78-131,404. PUB. 5-13-2003. FILED 5-28-2002.

2,747,224. **CORNROW MAGIC**. SPARTAN BRANDS INCORPORATED, (U.S. CLS. 1, 4, 6, 50, 51 AND 52). SN 78-140,792. PUB. 5-13-2003. FILED 7-2-2002.

2,747,287 (*See Class 1 for this trademark*).

2,747,295. **ORGANITECH**. ORGANITECH CLEANERS, INC., (U.S. CLS. 1, 4, 6, 50, 51 AND 52). SN 78-154,151. PUB. 5-13-2003. FILED 8-14-2002.

2,747,306. **PUMOUSE**. BK PUMICE PRODUCTS, INC., (U.S. CLS. 1, 4, 6, 50, 51 AND 52). SN 78-156,671. PUB. 5-13-2003. FILED 8-22-2002.

2,747,329. **SPLAT**. DEVELOPLUS, INC., (U.S. CLS. 1, 4, 6, 50, 51 AND 52). SN 78-162,890. PUB. 5-13-2003. FILED 9-11-2002.

2,747,362. **BINGO**. ECOLAB INC., (U.S. CLS. 1, 4, 6, 50, 51 AND 52). SN 78-166,834. PUB. 5-13-2003. FILED 9-23-2002.

2,747,389. **TESTROXIN**. WESTERN HOLDINGS, L.L.C., (U.S. CLS. 1, 4, 6, 50, 51 AND 52). SN 78-169,229. PUB. 5-13-2003. FILED 9-30-2002.

2,747,424. **SPOOKY SPIRITS SPRAY**. LAURIA, KELLY M., (U.S. CLS. 1, 4, 6, 50, 51 AND 52). SN 78-171,805. PUB. 5-13-2003. FILED 10-7-2002.

CLASS 4—LUBRICANTS AND FUELS

2,745,513. **ROADKOTE 2000**. MARYN INTERNATIONAL, LTD., (U.S. CLS. 1, 6 AND 15). SN 75-687,408. PUB. 10-15-2002. FILED 4-20-1999.

2,745,656. **FUEGO**. GROUPE CASA FUEGO INC., MULTIPLE CLASS, (INT. CLS. 4, 5, 21 AND 35), (U.S. CLS. 1, 2, 6, 13, 15, 18, 23, 29, 30, 33, 40, 44, 46, 50, 51, 52, 100, 101 AND 102). SN 76-020,865. PUB. 9-17-2002. FILED 4-7-2000.

2,745,787. **RACING AND DESIGN**. VOLKSWAGEN AKTIENGESELLSCHAFT, MULTIPLE CLASS, (INT. CLS. 4, 7, 12, 25, 28, 37 AND 41), (U.S. CLS. 1, 6, 13, 15, 19, 21, 22, 23, 31, 34, 35, 38, 39, 44, 50, 100, 101, 103, 106 AND 107). SN 76-141,898. PUB. 1-14-2003. FILED 10-5-2000.

2,746,118. **COILHOSE PNEUMATICS**. COILHOSE PNEUMATICS, INC., MULTIPLE CLASS, (INT. CLS. 4, 6, 9 AND 17), (U.S. CLS. 1, 2, 5, 6, 12, 13, 14, 15, 21, 23, 25, 26, 35, 36, 38 AND 50). SN 76-318,370. PUB. 9-10-2002. FILED 9-27-2001.

2,747,300. **ASSURON**. CASTROL LIMITED, (U.S. CLS. 1, 6 AND 15). SN 78-155,344. PUB. 5-13-2003. FILED 8-19-2002.

CLASS 5—PHARMACEUTICALS

2,745,427. **HERBA**. E. EXCEL INTERNATIONAL, INC., (U.S. CLS. 6, 18, 44, 46, 51 AND 52). SN 75-266,041. PUB. 12-3-2002. FILED 3-28-1997.

2,745,432. **BIO-ENERGY SYSTEMS**. BIO-ENERGY SYSTEMS, INC., MULTIPLE CLASS, (INT. CLS. 5 AND 40), (U.S. CLS. 6, 18, 44, 46, 51, 52, 100, 103 AND 106). SN 75-323,140. PUB. 5-13-2003. FILED 7-11-1997.

2,745,445. **VELOGENE**. ID BIOMEDICAL CORPORATION, (U.S. CLS. 6, 18, 44, 46, 51 AND 52). SN 75-434,874. PUB. 11-27-2001. FILED 2-17-1998.

2,745,466 (*See Class 3 for this trademark*).

2,745,480. **APURNA**. COMPAGNIE GERVAIS DANONE, SOCIETE ANONYME, MULTIPLE CLASS, (INT. CLS. 5, 29, 30, 31 AND 32), (U.S. CLS. 1, 6, 18, 44, 45, 46, 48, 51 AND 52). SN 75-597,339. PUB. 1-15-2002. FILED 11-27-1998.

2,745,482. **BENEO AND DESIGN**. RAFFINERIE TIRLEMONTOISE S.A., EN NEERLANDAIS TIENSE SUIKERRAFFINADERIJ N.V., MULTIPLE CLASS, (INT. CLS. 5, 29, 30 AND 31), (U.S. CLS. 1, 6, 18, 44, 46, 51 AND 52). SN 75-602,185. PUB. 1-21-2003. FILED 12-9-1998.

2,745,490. **ADEPT**. M L LABORATORIES PLC, (U.S. CLS. 6, 18, 44, 46, 51 AND 52). SN 75-618,784. PUB. 10-15-2002. FILED 1-11-1999.

2,745,514. **ORGANIC BY NATURE, QUALITY BY HOLISTA**. HOLISTA HEALTH CORPORATION, (U.S. CLS. 6, 18, 44, 46, 51 AND 52). SN 75-694,299. PUB. 11-13-2001. FILED 4-29-1999.

2,745,517. **VISANNE**. SCHERING AKTIENGESELLSCHAFT, (U.S. CLS. 6, 18, 44, 46, 51 AND 52). SN 75-698,443. PUB. 1-11-2000. FILED 5-5-1999.

2,745,530 (*See Class 1 for this trademark*).

2,745,533. **ENERCOR**. RATH, MATTHIAS, MULTIPLE CLASS, (INT. CLS. 5, 16 AND 41), (U.S. CLS. 2, 5, 6, 18, 22, 23, 29, 37, 38, 44, 46, 50, 51, 52, 100, 101 AND 107). SN 75-753,599. PUB. 8-22-2000. FILED 7-19-1999.

2,745,535 (*See Class 1 for this trademark*).

2,745,539. **YULIN AND DESIGN**. GUANGXI YU LIN PHARMACEUTICAL FACTORY, DBA YU LIN PHARMACEUTICAL FACTORY, (U.S. CLS. 6, 18, 44, 46, 51 AND 52). SN 75-769,058. PUB. 11-26-2002. FILED 8-6-1999.

2,745,549. **INNUVAIR**. BAYER AKTIENGESELLSCHAFT, (U.S. CLS. 6, 18, 44, 46, 51 AND 52). SN 75-802,105. PUB. 12-19-2000. FILED 9-17-1999.

2,745,560 (*See Class 1 for this trademark*).

2,745,578. **YOU CAN**. RATH, MATTHIAS, MULTIPLE CLASS, (INT. CLS. 5, 16, 31, 41 AND 42), (U.S. CLS. 1, 2, 5, 6, 18, 22, 23, 29, 37, 38, 44, 46, 50, 51, 52, 100, 101 AND 107). SN 75-861,707. PUB. 12-3-2002. FILED 12-1-1999.

2,745,603. **TRUTINA DULCEM**. NUTRILAB CORPORATION, (U.S. CLS. 6, 18, 44, 46, 51 AND 52). SN 75-904,583. PUB. 5-13-2003. FILED 1-24-2000.

2,745,606 (*See Class 1 for this trademark*).

- 2,745,617 (*See Class 1 for this trademark.*)
- 2,745,627. **NEXAVAR**. BAYER AKTIENGESSELLSCHAFT, (U.S. CLS. 6, 18, 44, 46, 51 AND 52). SN 75-943,985. PUB. 4-10-2001. FILED 3-14-2000.
- 2,745,642. **CEROVITE**. WATSON PHARMACEUTICALS, INC., (U.S. CLS. 6, 18, 44, 46, 51 AND 52). SN 76-006,872. PUB. 9-24-2002. FILED 3-22-2000.
- 2,745,656 (*See Class 4 for this trademark.*)
- 2,745,682. **MISCELLANEOUS DESIGN**. BLOCH, ARMIN, AND GOPPERT, MANFRED, MULTIPLE CLASS, (INT. CLS. 5, 14, 16, 25, 28, 35, 41 AND 42), (U.S. CLS. 2, 5, 6, 18, 22, 23, 27, 28, 29, 37, 38, 39, 44, 46, 50, 51, 52, 100, 101, 102 AND 107). SN 76-051,254. PUB. 5-13-2003. FILED 5-18-2000.
- 2,745,730 (*See Class 1 for this trademark.*)
- 2,745,746 (*See Class 1 for this trademark.*)
- 2,745,779. **CSF DYNAMICS**. CSF DYNAMICS APS, MULTIPLE CLASS, (INT. CLS. 5, 10 AND 42), (U.S. CLS. 6, 18, 26, 39, 44, 46, 51, 52, 100 AND 101). SN 76-138,805. PUB. 10-1-2002. FILED 9-29-2000.
- 2,745,786. **DRAGER DRUGTEST (STYLIZED)**. DRAGER SAFETY AG & CO. KGAA, BY CHANGE OF NAME; BY CHANGE OF NAME DRAGER SICHERHEITSTECHNIK GMBH, MULTIPLE CLASS, (INT. CLS. 5 AND 10), (U.S. CLS. 6, 18, 26, 39, 44, 46, 51 AND 52). SN 76-141,883. PUB. 10-29-2002. FILED 10-5-2000.
- 2,745,801. **MESTREL (STYLIZED)**. SCHERING AKTIENGESSELLSCHAFT, (U.S. CLS. 6, 18, 44, 46, 51 AND 52). SN 76-158,901. PUB. 10-8-2002. FILED 11-3-2000.
- 2,745,802. **SPORT CAPS**. SUNRIDER CORPORATION, THE, DBA SUNRIDER INTERNATIONAL, (U.S. CLS. 6, 18, 44, 46, 51 AND 52). SN 76-158,985. PUB. 5-13-2003. FILED 11-2-2000.
- 2,745,825. **MENO-AID**. KENNEDY, GEORGINA E., (U.S. CLS. 6, 18, 44, 46, 51 AND 52). SN 76-177,402. PUB. 5-13-2003. FILED 12-8-2000.
- 2,745,827. **MISCELLANEOUS DESIGN**. RSR LIMITED, MULTIPLE CLASS, (INT. CLS. 5 AND 10), (U.S. CLS. 6, 18, 26, 39, 44, 46, 51 AND 52). SN 76-180,983. PUB. 11-12-2002. FILED 12-14-2000.
- 2,745,846 (*See Class 1 for this trademark.*)
- 2,745,860. **ADNAGEN**. WASCHUTZA, STEFANIE, (U.S. CLS. 6, 18, 44, 46, 51 AND 52). SN 76-199,330. PUB. 9-4-2001. FILED 1-19-2001.
- 2,745,868 (*See Class 1 for this trademark.*)
- 2,745,890 (*See Class 3 for this trademark.*)
- 2,745,899. **URETEX**. SOFRADIM PRODUCTION, MULTIPLE CLASS, (INT. CLS. 5 AND 10), (U.S. CLS. 6, 18, 26, 39, 44, 46, 51 AND 52). SN 76-226,702. PUB. 5-13-2003. FILED 3-19-2001.
- 2,745,900. **VERITA**. AVENTIS CROPSCIENCE SA, (U.S. CLS. 6, 18, 44, 46, 51 AND 52). SN 76-226,977. PUB. 3-4-2003. FILED 3-16-2001.
- 2,745,913. **STAMINA-RX**. WHEAT, JARED R., (U.S. CLS. 6, 18, 44, 46, 51 AND 52). SN 76-232,497. PUB. 11-12-2002. FILED 3-29-2001.
- 2,745,942. **DIARSANYL**. CEVA SANTE ANIMALE, (U.S. CLS. 6, 18, 44, 46, 51 AND 52). SN 76-246,048. PUB. 6-25-2002. FILED 4-25-2001.
- 2,745,979 (*See Class 1 for this trademark.*)
- 2,745,991. **LUNDBECK AND DESIGN**. H. LUNDBECK A/S, MULTIPLE CLASS, (INT. CLS. 5, 9, 16, 41 AND 42), (U.S. CLS. 2, 5, 6, 18, 21, 22, 23, 26, 29, 36, 37, 38, 44, 46, 50, 51, 52, 100, 101 AND 107). SN 76-268,931. PUB. 9-17-2002. FILED 6-10-2001.
- 2,745,993. **ANGIOPEPTINE**. SOCIETE DE CONSEILS DE RECHERCHES ET D'APPLICATIONS SCIENTIFIQUES (S.C.R.A.S.), (U.S. CLS. 6, 18, 44, 46, 51 AND 52). SN 76-270,807. PUB. 12-3-2002. FILED 6-13-2001.
- 2,746,027 (*See Class 3 for this trademark.*)
- 2,746,042 (*See Class 1 for this trademark.*)
- 2,746,051. **GENETICS TECH AND DESIGN**. MARTEX NUTRITION, INC., (U.S. CLS. 6, 18, 44, 46, 51 AND 52). SN 76-292,714. PUB. 5-13-2003. FILED 7-31-2001.
- 2,746,075 (*See Class 1 for this trademark.*)
- 2,746,079 (*See Class 1 for this trademark.*)
- 2,746,104. **YELLOW THUNDER**. REV-UP, INC., (U.S. CLS. 6, 18, 44, 46, 51 AND 52). SN 76-312,521. PUB. 5-13-2003. FILED 9-14-2001.
- 2,746,129. **ACCENTUA**. ACCENTUA PHARMA AG, MULTIPLE CLASS, (INT. CLS. 5 AND 42), (U.S. CLS. 6, 18, 44, 46, 51, 52, 100 AND 101). SN 76-321,370. PUB. 5-13-2003. FILED 10-3-2001.
- 2,746,141 (*See Class 3 for this trademark.*)
- 2,746,145. **SINUTUSS**. WE PHARMACEUTICALS, INC., (U.S. CLS. 6, 18, 44, 46, 51 AND 52). SN 76-326,468. PUB. 10-22-2002. FILED 10-18-2001.
- 2,746,162 (*See Class 1 for this trademark.*)
- 2,746,314. **ISOCELL**. VIX, FRANCOIS, (U.S. CLS. 6, 18, 44, 46, 51 AND 52). SN 76-373,220. PUB. 5-13-2003. FILED 2-21-2002.
- 2,746,331. **THE FOODS THAT MAKE YOUR VITAMINS WORK**. BIOSAN LABORATORIES, INC., (U.S. CLS. 6, 18, 44, 46, 51 AND 52). SN 76-376,070. PUB. 10-1-2002. FILED 2-13-2002.
- 2,746,429. **TELSOVA**. ASTRAZENECA AB, (U.S. CLS. 6, 18, 44, 46, 51 AND 52). SN 76-393,397. PUB. 5-13-2003. FILED 4-9-2002.
- 2,746,536. **ERWINASE**. MICROBIOLOGICAL RESEARCH AUTHORITY, (U.S. CLS. 6, 18, 44, 46, 51 AND 52). SN 76-407,468. PUB. 5-13-2003. FILED 5-2-2002.
- 2,746,578. **SWIMMER'S AID (STYLIZED)**. PRODUCT QUEST MANUFACTURING, INC., (U.S. CLS. 6, 18, 44, 46, 51 AND 52). SN 76-415,889. PUB. 5-13-2003. FILED 6-5-2002.
- 2,746,585. **GRACIL**. DR. PEITHNER KG NUNMEHR GMBH & CO, (U.S. CLS. 6, 18, 44, 46, 51 AND 52). SN 76-417,372. PUB. 5-13-2003. FILED 6-3-2002.
- 2,746,592 (*See Class 3 for this trademark.*)
- 2,746,636. **SANDRENA**. ORION CORPORATION, (U.S. CLS. 6, 18, 44, 46, 51 AND 52). SN 76-424,635. PUB. 5-13-2003. FILED 6-21-2002.
- 2,746,637. **ZIMINO**. ORION CORPORATION, (U.S. CLS. 6, 18, 44, 46, 51 AND 52). SN 76-424,636. PUB. 5-13-2003. FILED 6-21-2002.
- 2,746,683. **PSORA-CREME**. HOLISTIC NATUROPATHIC CENTER, LLC, (U.S. CLS. 6, 18, 44, 46, 51 AND 52). SN 76-436,376. PUB. 5-13-2003. FILED 7-31-2002.
- 2,746,770. **HRC BECOMP-C**. CENCI, HERMAN R., (U.S. CLS. 6, 18, 44, 46, 51 AND 52). SN 76-447,527. PUB. 5-13-2003. FILED 9-4-2002.
- 2,746,788. **MISCELLANEOUS DESIGN**. WAKAMOTO PHARMACEUTICAL COMPANY LIMITED, (U.S. CLS. 6, 18, 44, 46, 51 AND 52). SN 76-448,906. PUB. 5-13-2003. FILED 9-9-2002.
- 2,746,913. **CHRISTIAN HEALTH PRODUCTS**. GRAHAM & BUFFETT, LTD., MULTIPLE CLASS, (INT. CLS. 5 AND 32), (U.S. CLS. 6, 18, 44, 45, 46, 48, 51 AND 52). SN 76-456,105. PUB. 5-13-2003. FILED 9-30-2002.
- 2,746,926. **SNUFF IT OUT AND DESIGN**. THE LEATHER FACTORY, INC., (U.S. CLS. 6, 18, 44, 46, 51 AND 52). SN 76-456,713. PUB. 5-13-2003. FILED 10-3-2002.
- 2,747,018. **STERO PRO**. 206 MACOPIN CORP., (U.S. CLS. 6, 18, 44, 46, 51 AND 52). SN 76-463,299. PUB. 5-13-2003. FILED 10-30-2002.
- 2,747,030. **SKINSATIONS**. UNITED INDUSTRIES CORPORATION, (U.S. CLS. 6, 18, 44, 46, 51 AND 52). SN 76-464,482. PUB. 5-13-2003. FILED 10-29-2002.
- 2,747,031 (*See Class 1 for this trademark.*)
- 2,747,039. **THIN II HERBAL CHEWS**. BIO-GENICS, INC., DBA E'OLA INTERNATIONAL, (U.S. CLS. 6, 18, 44, 46, 51 AND 52). SN 76-467,297. PUB. 5-13-2003. FILED 11-15-2002.
- 2,747,040. **THERMO AMP HERBAL CHEWS**. BIO-GENICS, INC., DBA E'OLA INTERNATIONAL, (U.S. CLS. 6, 18, 44, 46, 51 AND 52). SN 76-467,299. PUB. 5-13-2003. FILED 11-15-2002.
- 2,747,041. **NATURE'S MAGIC**. GAO, ZHEN SHEN, (U.S. CLS. 6, 18, 44, 46, 51 AND 52). SN 76-468,062. PUB. 5-13-2003. FILED 11-19-2002.
- 2,747,044. **REBETOL AND DESIGN**. SCHERING CORPORATION, (U.S. CLS. 6, 18, 44, 46, 51 AND 52). SN 76-469,995. PUB. 5-13-2003. FILED 11-25-2002.
- 2,747,045. **REBETRON AND DESIGN**. SCHERING CORPORATION, (U.S. CLS. 6, 18, 44, 46, 51 AND 52). SN 76-470,042. PUB. 5-13-2003. FILED 11-25-2002.
- 2,747,048 (*See Class 1 for this trademark.*)
- 2,747,063. **FUSITAB**. OXFORD BIOMEDICA PLC, MULTIPLE CLASS, (INT. CLS. 5, 10 AND 42), (U.S. CLS. 6, 18, 26, 39, 44, 46, 51, 52, 100 AND 101). SN 78-030,862. PUB. 7-2-2002. FILED 10-16-2000.

- 2,747,093 (*See Class 1 for this trademark*).
 2,747,099. **ILEUSTIM**. GENEMEDIX PLC, (U.S. CLS. 6, 18, 44, 46, 51 AND 52). SN 78-087,138. PUB. 5-7-2002. FILED 10-5-2001.
 2,747,139. **OSTULAR**. NOVARTIS AG, (U.S. CLS. 6, 18, 44, 46, 51 AND 52). SN 78-111,003. PUB. 5-13-2003. FILED 2-26-2002.
 2,747,185. **ALYMPIA**. SMITHKLINE BEECHAM BIOLOGICALS S.A., (U.S. CLS. 6, 18, 44, 46, 51 AND 52). SN 78-122,586. PUB. 5-13-2003. FILED 4-18-2002.
 2,747,192. **PROS HEAL**. EDEN SPRING HERBS, (U.S. CLS. 6, 18, 44, 46, 51 AND 52). SN 78-124,511. PUB. 5-13-2003. FILED 4-26-2002.
 2,747,205. **FIGUEROLA**. FIGUEROLA LABORATORIES, (U.S. CLS. 6, 18, 44, 46, 51 AND 52). SN 78-129,653. PUB. 5-13-2003. FILED 5-17-2002.
 2,747,214. **SALONAS GEL-PATCH**. HISAMITSU PHARMACEUTICAL CO., INC., (U.S. CLS. 6, 18, 44, 46, 51 AND 52). SN 78-133,841. PUB. 5-13-2003. FILED 6-6-2002.
 2,747,330. **PARENTCHECK**. SCITECK, INC., (U.S. CLS. 6, 18, 44, 46, 51 AND 52). SN 78-162,992. PUB. 5-13-2003. FILED 9-11-2002.
 2,747,365. **HEXADENE**. VIRBAC AH, INC., (U.S. CLS. 6, 18, 44, 46, 51 AND 52). SN 78-166,928. PUB. 5-13-2003. FILED 9-23-2002.
 2,747,382. **TRANSORB AND DESIGN**. MONSANTO TECHNOLOGY LLC, (U.S. CLS. 6, 18, 44, 46, 51 AND 52). SN 78-168,747. PUB. 5-13-2003. FILED 9-27-2002.
 2,747,418. **PROBIOTIC NIBBLERS**. ADVOCARE INTERNATIONAL, L.L.C., (U.S. CLS. 6, 18, 44, 46, 51 AND 52). SN 78-171,623. PUB. 5-13-2003. FILED 10-7-2002.
 2,747,442. **BECAUSE REAL WEIGHT LOSS STARTS WITH YOUR BRAIN...NOT YOUR STOMACH**. M.D. NATURALS, LTD., (U.S. CLS. 6, 18, 44, 46, 51 AND 52). SN 78-174,533. PUB. 5-13-2003. FILED 10-15-2002.
 2,747,443. **GLUCORELL R**. FERGUSON, JEREL SCOTT, (U.S. CLS. 6, 18, 44, 46, 51 AND 52). SN 78-174,602. PUB. 5-13-2003. FILED 10-15-2002.

CLASS 6—METAL GOODS

- 2,745,420. **MISCELLANEOUS DESIGN**. WACO INTERNATIONAL CORPORATION, (U.S. CLS. 2, 12, 13, 14, 23, 25 AND 50). SN 75-085,806. PUB. 1-21-2003. FILED 4-9-1996.
 2,745,436. **MG & DESIGN AND DESIGN**. ROVER GROUP LIMITED, MULTIPLE CLASS, (INT. CLS. 6, 14, 18 AND 25), (U.S. CLS. 1, 2, 3, 12, 13, 14, 22, 23, 25, 27, 28, 39, 41 AND 50). SN 75-367,761. PUB. 10-1-2002. FILED 10-3-1997.
 2,745,440. **MISCELLANEOUS DESIGN**. ACERALIA CORPORATION SIDERURGICA, S.A., MULTIPLE CLASS, (INT. CLS. 6, 16, 39, 40 AND 42), (U.S. CLS. 2, 5, 12, 13, 14, 22, 23, 25, 29, 37, 38, 50, 100, 101, 103, 105 AND 106). SN 75-393,567. PUB. 5-13-2003. FILED 11-20-1997.
 2,745,488. **TRADITIONS**. COSTCO WHOLESALE CORPORATION, (U.S. CLS. 2, 12, 13, 14, 23, 25 AND 50). SN 75-615,111. PUB. 12-17-2002. FILED 1-4-1999.
 2,745,506. **S. SCHNEIDER SA**, MULTIPLE CLASS, (INT. CLS. 6, 9, 11, 36, 37, 39 AND 42), (U.S. CLS. 2, 12, 13, 14, 21, 23, 25, 26, 31, 34, 36, 38, 50, 100, 101, 102, 103, 105 AND 106). SN 75-666,217. PUB. 1-16-2001. FILED 3-23-1999.
 2,745,515. **TYCON AND DESIGN**. R & M ITALIA S.P.A., MULTIPLE CLASS, (INT. CLS. 6 AND 11), (U.S. CLS. 2, 12, 13, 14, 21, 23, 25, 31, 34 AND 50). SN 75-695,614. PUB. 10-15-2002. FILED 4-30-1999.
 2,745,602. **MKJ3**. MINEBEA CO., LTD., (U.S. CLS. 2, 12, 13, 14, 23, 25 AND 50). SN 75-903,544. PUB. 10-15-2002. FILED 1-26-2000.
 2,745,696 (*See Class 1 for this trademark*).
 2,745,724. **VERIPACK.COM AND DESIGN**. VERIPACK.COM, INC., MULTIPLE CLASS, (INT. CLS. 6, 16, 17, 22 AND 35), (U.S. CLS. 1, 2, 5, 7, 12, 13, 14, 19, 22, 23, 25, 29, 35, 37, 38, 42, 50, 100, 101 AND 102). SN 76-091,708. PUB. 5-13-2003. FILED 7-19-2000.
 2,745,882. **A AND DESIGN**. THE BOARD OF TRUSTEES OF THE UNIVERSITY OF ALABAMA, MULTIPLE CLASS, (INT. CLS. 6, 14, 16, 20, 21, 25, 28 AND 41), (U.S. CLS. 2, 5, 12, 13, 14, 22, 23, 25, 27, 28, 29, 30, 32, 33, 37, 38, 39, 40, 50, 100, 101 AND 107). SN 76-212,791. PUB. 12-3-2002. FILED 2-20-2001.
 2,745,898. **JAC MONT BLANC**. JAC PRODUCTS, INC., MULTIPLE CLASS, (INT. CLS. 6 AND 12), (U.S. CLS. 2, 12, 13, 14, 19, 21, 23, 25, 31, 35, 44 AND 50). SN 76-226,545. PUB. 12-3-2002. FILED 3-19-2001.
 2,745,907. **T AND DESIGN**. TORCA PRODUCTS, INC., (U.S. CLS. 2, 12, 13, 14, 23, 25 AND 50). SN 76-231,242. PUB. 5-13-2003. FILED 3-28-2001.
 2,745,918. **KINGDREAM AND DESIGN**. KINGDREAM PUBLIC LIMITED COMPANY, MULTIPLE CLASS, (INT. CLS. 6 AND 7), (U.S. CLS. 2, 12, 13, 14, 19, 21, 23, 25, 31, 34, 35 AND 50). SN 76-235,107. PUB. 6-11-2002. FILED 4-4-2001.
 2,745,930. **STAFSJO (STYLIZED)**. AB STAFSJO BRUK, MULTIPLE CLASS, (INT. CLS. 6, 7 AND 9), (U.S. CLS. 2, 12, 13, 14, 19, 21, 23, 25, 26, 31, 34, 35, 36, 38 AND 50). SN 76-240,209. PUB. 5-13-2003. FILED 4-12-2001.
 2,745,954. **LOCKHEED AND DESIGN**. LOCKHEED WINDOW CORP., MULTIPLE CLASS, (INT. CLS. 6, 19 AND 37), (U.S. CLS. 1, 2, 12, 13, 14, 23, 25, 33, 50, 100, 103 AND 106). SN 76-250,034. PUB. 5-14-2002. FILED 5-2-2001.
 2,746,066. **THE HIP SITE AND DESIGN**. BENETTON GROUP S.P.A., MULTIPLE CLASS, (INT. CLS. 6 AND 26), (U.S. CLS. 2, 12, 13, 14, 23, 25, 37, 39, 40, 42 AND 50). SN 76-295,049. PUB. 5-13-2003. FILED 8-6-2001.
 2,746,100. **MISCELLANEOUS DESIGN**. KEENELAND ASSOCIATION, INC., MULTIPLE CLASS, (INT. CLS. 6, 14, 16, 18, 20, 25, 33 AND 35), (U.S. CLS. 1, 2, 3, 5, 12, 13, 14, 22, 23, 25, 27, 28, 29, 32, 37, 38, 39, 41, 47, 49, 50, 100, 101 AND 102). SN 76-311,767. PUB. 10-29-2002. FILED 9-13-2001.
 2,746,118 (*See Class 4 for this trademark*).
 2,746,132. **PSI AND DESIGN**. WIELAND-WERKE AG, (U.S. CLS. 2, 12, 13, 14, 23, 25 AND 50). SN 76-323,245. PUB. 5-13-2003. FILED 10-10-2001.
 2,746,249. **ASP**. HUCK INTERNATIONAL, INC., (U.S. CLS. 2, 12, 13, 14, 23, 25 AND 50). SN 76-355,177. PUB. 11-26-2002. FILED 1-7-2002.
 2,746,284. **MAGNUM PIERING**. MAGNUM PIERING, INC., (U.S. CLS. 2, 12, 13, 14, 23, 25 AND 50). SN 76-366,375. PUB. 9-24-2002. FILED 2-4-2002.
 2,746,322. **LAMOR**. LAMOR CORPORATION AB, (U.S. CLS. 2, 12, 13, 14, 23, 25 AND 50). SN 76-374,907. PUB. 5-13-2003. FILED 2-25-2002.
 2,746,420. **BOSTLAN**. BOSTLAN, S.A., (U.S. CLS. 2, 12, 13, 14, 23, 25 AND 50). SN 76-392,347. PUB. 5-13-2003. FILED 4-3-2002.
 2,746,483. **THE STABILIZER**. MITEK INDUSTRIES, INC., (U.S. CLS. 2, 12, 13, 14, 23, 25 AND 50). SN 76-401,014. PUB. 2-25-2003. FILED 4-26-2002.
 2,746,512. **HOPPE**. HOPPE NORTH AMERICA INC., BY CHANGE OF NAME; BY CHANGE OF NAME HARDWARE TECHNOLOGIES, LTD., MULTIPLE CLASS, (INT. CLS. 6 AND 20), (U.S. CLS. 2, 12, 13, 14, 22, 23, 25, 32 AND 50). SN 76-404,850. PUB. 5-13-2003. FILED 5-6-2002.
 2,746,588. **SILLARIAN AND DESIGN**. KYONGSANGBUKDO, MULTIPLE CLASS, (INT. CLS. 6 AND 24), (U.S. CLS. 2, 12, 13, 14, 23, 25, 42 AND 50). SN 76-417,844. PUB. 5-13-2003. FILED 6-6-2002.
 2,746,668. **RHEINZINK**. RHEINZINK GMBH & CO. KG, (U.S. CLS. 2, 12, 13, 14, 23, 25 AND 50). SN 76-433,885. PUB. 5-13-2003. FILED 7-24-2002.
 2,746,682. **DECK ONE AND DESIGN**. ALCHEMY NOMINEES PTY LTD, (U.S. CLS. 2, 12, 13, 14, 23, 25 AND 50). SN 76-436,127. PUB. 5-13-2003. FILED 7-31-2002.
 2,746,762. **SCR**. SOUTHWIRE COMPANY, MULTIPLE CLASS, (INT. CLS. 6 AND 7), (U.S. CLS. 2, 12, 13, 14, 19, 21, 23, 25, 31, 34, 35 AND 50). SN 76-446,412. PUB. 5-13-2003. FILED 9-3-2002.
 2,747,068. **BEST**. INTERSTATE STEEL CORPORATION, (U.S. CLS. 2, 12, 13, 14, 23, 25 AND 50). SN 78-039,262. PUB. 5-13-2003. FILED 12-14-2000.
 2,747,127. **LAMOT**. LAMOT CORPORATION, (U.S. CLS. 2, 12, 13, 14, 23, 25 AND 50). SN 78-106,324. PUB. 4-8-2003. FILED 2-1-2002.
 2,747,135. **EQUAL SYSTEM**. SMITH, ROBERT D., (U.S. CLS. 2, 12, 13, 14, 23, 25 AND 50). SN 78-107,910. PUB. 5-13-2003. FILED 2-11-2002.
 2,747,341. **ACRES**. CLICK BOND, INC., (U.S. CLS. 2, 12, 13, 14, 23, 25 AND 50). SN 78-164,847. PUB. 5-13-2003. FILED 9-17-

2002.

CLASS 7—MACHINERY

- 2,745,422. **ENVIROPAD**. SIMONSON, ROGER, (U.S. CLS. 13, 19, 21, 23, 31, 34 AND 35). SN 75-131,645. PUB. 5-13-2003. FILED 7-9-1996.
- 2,745,437. **TWINCUT TECHNOLOGY AND DESIGN**. TWINER AKTIEBOLAG, MULTIPLE CLASS, (INT. CLS. 7 AND 16), (U.S. CLS. 2, 5, 13, 19, 21, 22, 23, 29, 31, 34, 35, 37, 38 AND 50). SN 75-391,589. PUB. 9-5-2000. FILED 11-14-1997. 2,745,475 (*See Class 1 for this trademark*).
- 2,745,523. **COREHEATER**. KVAERNER PANEL SYSTEMS GMBH MASCHINEN-UND ANLAGENBAU, (U.S. CLS. 13, 19, 21, 23, 31, 34 AND 35). SN 75-711,960. PUB. 5-13-2003. FILED 5-21-1999.
- 2,745,542. **CONFUCIUS**. ZHIHONG, XU, AND JIANLUN, FEI, MULTIPLE CLASS, (INT. CLS. 7, 11, 16, 18, 24 AND 25), (U.S. CLS. 1, 2, 3, 5, 13, 19, 21, 22, 23, 29, 31, 34, 35, 37, 38, 39, 41, 42 AND 50). SN 75-789,259. PUB. 1-14-2003. FILED 8-31-1999.
- 2,745,601. **MAGNUM**. GRACO INC., (U.S. CLS. 13, 19, 21, 23, 31, 34 AND 35). SN 75-902,952. PUB. 3-4-2003. FILED 4-26-1999.
- 2,745,622. **PERMASEAL**. ALPHA TECHNOLOGIES U.S., L.P., (U.S. CLS. 13, 19, 21, 23, 31, 34 AND 35). SN 75-942,818. PUB. 12-10-2002. FILED 3-13-2000.
- 2,745,634. **XCELLSIS**. DAIMLERCHRYSLER AG, MULTIPLE CLASS, (INT. CLS. 7, 9, 12, 37 AND 42), (U.S. CLS. 13, 19, 21, 23, 26, 31, 34, 35, 36, 38, 44, 100, 101, 103 AND 106). SN 75-982,930. PUB. 5-13-2003. FILED 7-10-2000.
- 2,745,641. **WHEN QUALITY COUNTS**. DIEBOLD GOLDRING TOOLING LLC, (U.S. CLS. 13, 19, 21, 23, 31, 34 AND 35). SN 76-005,054. PUB. 5-14-2002. FILED 3-20-2000.
- 2,745,666. **NUOVO PIGNONE GLOBAL SERVICES AND DESIGN**. NUOVO PIGNONE HOLDING S.P.A., MULTIPLE CLASS, (INT. CLS. 7, 9, 11, 37 AND 42), (U.S. CLS. 13, 19, 21, 23, 26, 31, 34, 35, 36, 38, 100, 101, 103 AND 106). SN 76-039,398. PUB. 7-16-2002. FILED 5-2-2000.
- 2,745,669. **TOOL STORAGE CONCEPT TSC**. SEB, MULTIPLE CLASS, (INT. CLS. 7, 8 AND 21), (U.S. CLS. 2, 13, 19, 21, 23, 28, 29, 30, 31, 33, 34, 35, 40, 44 AND 50). SN 76-042,792. PUB. 10-9-2001. FILED 5-8-2000.
- 2,745,672. **FINN-POWER LASER AND DESIGN**. LILLBACKA OY, MULTIPLE CLASS, (INT. CLS. 7 AND 9), (U.S. CLS. 13, 19, 21, 23, 26, 31, 34, 35, 36 AND 38). SN 76-045,341. PUB. 12-11-2001. FILED 5-10-2000.
- 2,745,673. **FINN-POWER LASER AND DESIGN**. LILLBACKA OY, MULTIPLE CLASS, (INT. CLS. 7 AND 9), (U.S. CLS. 13, 19, 21, 23, 26, 31, 34, 35, 36 AND 38). SN 76-045,343. PUB. 1-15-2002. FILED 5-10-2000.
- 2,745,728. **FANUC**. FANUC LTD., MULTIPLE CLASS, (INT. CLS. 7, 9, 37 AND 42), (U.S. CLS. 13, 19, 21, 23, 26, 31, 34, 35, 36, 38, 100, 101, 103 AND 106). SN 76-094,813. PUB. 11-5-2002. FILED 7-21-2000.
- 2,745,736. **KJRO AND DESIGN**. MINEBEA CO., LTD., (U.S. CLS. 13, 19, 21, 23, 31, 34 AND 35). SN 76-101,893. PUB. 1-28-2003. FILED 8-2-2000.
- 2,745,737. **KJRI AND DESIGN**. MINEBEA CO., LTD., (U.S. CLS. 13, 19, 21, 23, 31, 34 AND 35). SN 76-101,895. PUB. 12-24-2002. FILED 8-2-2000.
- 2,745,738. **KJL AND DESIGN**. MINEBEA CO., LTD., (U.S. CLS. 13, 19, 21, 23, 31, 34 AND 35). SN 76-101,896. PUB. 12-24-2002. FILED 8-2-2000.
- 2,745,762. **TIMBERLINE**. AMANA TOOL COMPANY, (U.S. CLS. 13, 19, 21, 23, 31, 34 AND 35). SN 76-118,462. PUB. 5-13-2003. FILED 8-29-2000.
- 2,745,766. **KWS**. KWS SAAT AG, MULTIPLE CLASS, (INT. CLS. 7, 31 AND 42), (U.S. CLS. 1, 13, 19, 21, 23, 31, 34, 35, 46, 100 AND 101). SN 76-123,993. PUB. 10-22-2002. FILED 9-7-2000.
- 2,745,787 (*See Class 4 for this trademark*).
- 2,745,810. **PETPACK**. ATLAS COPCO CREPELLE S.A., MULTIPLE CLASS, (INT. CLS. 7 AND 42), (U.S. CLS. 13, 19, 21, 23, 31, 34, 35, 100 AND 101). SN 76-165,820. PUB. 6-11-2002. FILED 11-14-2000.
- 2,745,823. **MISCELLANEOUS DESIGN**. HAAS BURSTEN-FABRIK GMBH, MULTIPLE CLASS, (INT. CLS. 7 AND 21), (U.S. CLS. 2, 13, 19, 21, 23, 29, 30, 31, 33, 34, 35, 40 AND 50). SN 76-176,017. PUB. 7-16-2002. FILED 12-5-2000.
- 2,745,901. **ANTI-VIBE**. S & W MANUFACTURING COMPANY, INC., MULTIPLE CLASS, (INT. CLS. 7 AND 17), (U.S. CLS. 1, 5, 12, 13, 19, 21, 23, 31, 34, 35 AND 50). SN 76-227,473. PUB. 5-13-2003. FILED 3-20-2001.
- 2,745,918 (*See Class 6 for this trademark*).
- 2,745,930 (*See Class 6 for this trademark*).
- 2,746,000. **SAND PRO**. TROYER, LLOYD, (U.S. CLS. 13, 19, 21, 23, 31, 34 AND 35). SN 76-274,368. PUB. 6-11-2002. FILED 6-19-2001.
- 2,746,123. **S SCAND TECH AND DESIGN**. SCAND TECH USA, L.L.C., (U.S. CLS. 13, 19, 21, 23, 31, 34 AND 35). SN 76-319,726. PUB. 5-13-2003. FILED 10-1-2001.
- 2,746,133. **ROTOVAC**. ROTOVAC CORPORATION, (U.S. CLS. 13, 19, 21, 23, 31, 34 AND 35). SN 76-323,313. PUB. 10-8-2002. FILED 10-11-2001.
- 2,746,135. **REWDALE**. REWDALE PRECISION TOOLS PRIVATE LIMITED, (U.S. CLS. 13, 19, 21, 23, 31, 34 AND 35). SN 76-323,808. PUB. 5-13-2003. FILED 10-11-2001.
- 2,746,156. **OXYGEN INFUSOR**. KEEPALIVE, INC., MULTIPLE CLASS, (INT. CLS. 7, 11 AND 21), (U.S. CLS. 2, 13, 19, 21, 23, 29, 30, 31, 33, 34, 35, 40 AND 50). SN 76-329,733. PUB. 5-13-2003. FILED 10-25-2001.
- 2,746,159. **ADVICS AND DESIGN**. KABUSHIKI KAISHA ADVICS, AKA ADVICS CO., LTD., MULTIPLE CLASS, (INT. CLS. 7 AND 12), (U.S. CLS. 13, 19, 21, 23, 31, 34, 35 AND 44). SN 76-331,609. PUB. 5-13-2003. FILED 10-30-2001.
- 2,746,169. **SONIX IV AND DESIGN**. SONIX IV CORPORATION, (U.S. CLS. 13, 19, 21, 23, 31, 34 AND 35). SN 76-333,714. PUB. 5-13-2003. FILED 11-2-2001.
- 2,746,201. **PROTOOL AND DESIGN**. TTS TOOLTECHNIC SYSTEMS AG & CO. KG, MULTIPLE CLASS, (INT. CLS. 7, 8, 9 AND 20), (U.S. CLS. 2, 13, 19, 21, 22, 23, 25, 26, 28, 31, 32, 34, 35, 36, 38, 44 AND 50). SN 76-341,279. PUB. 11-19-2002. FILED 11-21-2001.
- 2,746,271 (*See Class 3 for this trademark*).
- 2,746,312. **TRILO AND DESIGN**. VAN LOEN TECHNIEK B.V., (U.S. CLS. 13, 19, 21, 23, 31, 34 AND 35). SN 76-373,115. PUB. 12-10-2002. FILED 2-20-2002.
- 2,746,372. **M-FORM MANNER-GROUP AND DESIGN**. OTTO MANNER HEISSKANALSYSTEME GMBH & CO. KG, (U.S. CLS. 13, 19, 21, 23, 31, 34 AND 35). SN 76-384,378. PUB. 5-13-2003. FILED 3-18-2002.
- 2,746,373. **HURRICANE**. INDUSTRIAL VACUUM EQUIPMENT CORPORATION, (U.S. CLS. 13, 19, 21, 23, 31, 34 AND 35). SN 76-384,542. PUB. 5-13-2003. FILED 3-12-2002.
- 2,746,434. **GT GENERAL TRANSMISSIONS**. SOCIETE COMMERCIALE ET D'ENGINEERING - S C E, MULTIPLE CLASS, (INT. CLS. 7 AND 12), (U.S. CLS. 13, 19, 21, 23, 31, 34, 35 AND 44). SN 76-393,668. PUB. 5-13-2003. FILED 4-10-2002.
- 2,746,449. **POSI-TRAC**. DOCK PRODUCTS CANADA INC., (U.S. CLS. 13, 19, 21, 23, 31, 34 AND 35). SN 76-395,514. PUB. 5-13-2003. FILED 4-12-2002.
- 2,746,450. **CLEAN FRAME**. DOCK PRODUCTS CANADA INC., (U.S. CLS. 13, 19, 21, 23, 31, 34 AND 35). SN 76-395,515. PUB. 5-13-2003. FILED 4-12-2002.
- 2,746,457. **BUNDLE BREAKER**. ALLIANCE MACHINE SYSTEMS INTERNATIONAL, LLC, (U.S. CLS. 13, 19, 21, 23, 31, 34 AND 35). SN 76-396,362. PUB. 5-13-2003. FILED 4-16-2002.
- 2,746,569. **MAINSTRIP**. MAIN MANAGEMENT INSPIRATION AG, (U.S. CLS. 13, 19, 21, 23, 31, 34 AND 35). SN 76-411,936. PUB. 5-13-2003. FILED 5-17-2002.
- 2,746,589. **DEMAK**. DEMAK S.R.L., (U.S. CLS. 13, 19, 21, 23, 31, 34 AND 35). SN 76-418,031. PUB. 5-13-2003. FILED 6-7-2002.
- 2,746,602. **TURBO CHUCK**. OLYMPIA GROUP, INC., (U.S. CLS. 13, 19, 21, 23, 31, 34 AND 35). SN 76-419,727. PUB. 5-13-2003. FILED 6-12-2002.
- 2,746,703. **TORQLOC**. SEW-EURODRIVE, INC., (U.S. CLS. 13, 19, 21, 23, 31, 34 AND 35). SN 76-440,692. PUB. 5-13-2003. FILED 8-15-2002.
- 2,746,719. **WRAPPER AND DESIGN**. FUJI MACHINERY CO., LTD., (U.S. CLS. 13, 19, 21, 23, 31, 34 AND 35). SN 76-442,166. PUB. 5-13-2003. FILED 8-15-2002.

2,746,762 (*See Class 6 for this trademark*).
 2,746,792. **VORTEX**. HAND TOOL DESIGN CORPORATION, (U.S. CLS. 13, 19, 21, 23, 31, 34 AND 35). SN 76-449,306. PUB. 5-13-2003. FILED 9-9-2002.
 2,746,805. **SPEEDBAR**. SDC INNOVATIONS, INC., (U.S. CLS. 13, 19, 21, 23, 31, 34 AND 35). SN 76-450,116. PUB. 5-13-2003. FILED 9-16-2002.
 2,747,096. **WE AND DESIGN**. WAUPACA ELEVATOR COMPANY, INC., (U.S. CLS. 13, 19, 21, 23, 31, 34 AND 35). SN 78-083,914. PUB. 5-13-2003. FILED 9-14-2001.
 2,747,231. **ORBITER SKYTRAK**. S.N.M. MANUFACTURING, INC., (U.S. CLS. 13, 19, 21, 23, 31, 34 AND 35). SN 78-144,196. PUB. 5-13-2003. FILED 7-16-2002.
 2,747,234. **CLEANLINER**. BALDWIN GERMANY GMBH, (U.S. CLS. 13, 19, 21, 23, 31, 34 AND 35). SN 78-144,841. PUB. 5-13-2003. FILED 7-17-2002.
 2,747,278. **DAYTON**. DAYTON PROGRESS CORPORATION, (U.S. CLS. 13, 19, 21, 23, 31, 34 AND 35). SN 78-152,874. PUB. 5-13-2003. FILED 8-9-2002.
 2,747,284. **MIGHTY PRO**. RUG DOCTOR, L.P., (U.S. CLS. 13, 19, 21, 23, 31, 34 AND 35). SN 78-153,277. PUB. 5-13-2003. FILED 8-12-2002.
 2,747,287 (*See Class 1 for this trademark*).
 2,747,374. **MISSING LINK**. SYNAPSE ENGINEERING INCORPORATED, (U.S. CLS. 13, 19, 21, 23, 31, 34 AND 35). SN 78-168,032. PUB. 5-13-2003. FILED 9-26-2002.
 2,747,392. **TORQFLO**. COMPRESSORWORKS, INC., (U.S. CLS. 13, 19, 21, 23, 31, 34 AND 35). SN 78-169,312. PUB. 5-13-2003. FILED 9-30-2002.
 2,747,419. **SPRINTER**. CENTRAL TANK OF OKLAHOMA, (U.S. CLS. 13, 19, 21, 23, 31, 34 AND 35). SN 78-171,674. PUB. 5-13-2003. FILED 10-7-2002.

CLASS 8—HAND TOOLS

2,745,669 (*See Class 7 for this trademark*).
 2,745,799. **CALDERONI ROCCA**. ROCCA S.P.A., MULTIPLE CLASS, (INT. CLS. 8 AND 14), (U.S. CLS. 2, 23, 27, 28, 44 AND 50). SN 76-158,610. PUB. 5-13-2003. FILED 11-2-2000.
 2,745,915. **EPILAST**. EPILAST SAS, MULTIPLE CLASS, (INT. CLS. 8, 10 AND 42), (U.S. CLS. 23, 26, 28, 39, 44, 100 AND 101). SN 76-234,225. PUB. 4-30-2002. FILED 4-2-2001.
 2,746,028. **TRADESMEN**. J-DAN, INC., (U.S. CLS. 23, 28 AND 44). SN 76-286,362. PUB. 12-17-2002. FILED 7-17-2001.
 2,746,075 (*See Class 1 for this trademark*).
 2,746,201 (*See Class 7 for this trademark*).
 2,746,359. **MINI-SPAT**. DRIPLESS, INC., (U.S. CLS. 23, 28 AND 44). SN 76-381,297. PUB. 5-13-2003. FILED 3-12-2002.
 2,746,448. **X.POWER NAIL FILE MACHINE 2001**. TRU-FORM INTERNET, INC., (U.S. CLS. 23, 28 AND 44). SN 76-395,322. PUB. 5-13-2003. FILED 4-15-2002.
 2,746,500. **DIAMONDBACK**. BUCK KNIVES, INC., (U.S. CLS. 23, 28 AND 44). SN 76-403,580. PUB. 5-13-2003. FILED 5-2-2002.
 2,746,579. **CAMPFLAME**. VICTORINOX AG, MULTIPLE CLASS, (INT. CLS. 8, 11 AND 34), (U.S. CLS. 2, 8, 9, 13, 17, 21, 23, 28, 31, 34 AND 44). SN 76-415,905. PUB. 5-13-2003. FILED 6-4-2002.
 2,746,611. **CELLDYNE**. TESCO COMMUNICATIONS INCORPORATED, (U.S. CLS. 23, 28 AND 44). SN 76-420,471. PUB. 5-13-2003. FILED 6-19-2002.
 2,746,680. **STRIPWRAP AND DESIGN**. LEON J. BOOLE & L.J. BOOLE, INC., (U.S. CLS. 23, 28 AND 44). SN 76-435,824. PUB. 5-13-2003. FILED 7-30-2002.
 2,747,414. **NIG**. NICEGOOD U.S.A. LTD., (U.S. CLS. 23, 28 AND 44). SN 78-171,486. PUB. 5-13-2003. FILED 10-6-2002.

CLASS 9—ELECTRICAL AND SCIENTIFIC APPARATUS

2,745,418. **T NET AND DESIGN**. DEUTSCHE TELEKOM AG, MULTIPLE CLASS, (INT. CLS. 9, 14, 16, 18, 25, 28, 36, 37, 38, 41 AND 42), (U.S. CLS. 1, 2, 3, 5, 21, 22, 23, 26, 27, 28, 29, 36,

37, 38, 39, 41, 50, 100, 101, 102, 103, 104, 106 AND 107). SN 74-720,623. PUB. 7-17-2001. FILED 8-24-1995.
 2,745,424. **PAPERGATE**. STORA KOPPARBERGS BERG-SLAGS AB, MULTIPLE CLASS, (INT. CLS. 9 AND 42), (U.S. CLS. 21, 23, 26, 36, 38, 100 AND 101). SN 75-230,459. PUB. 10-29-2002. FILED 1-24-1997.
 2,745,426. **VRTUAL DECOR AND DESIGN**. SOEXPORTA-SOCIEDADE EXPORTADORA PORTUGUESA, LDA, MULTIPLE CLASS, (INT. CLS. 9 AND 42), (U.S. CLS. 21, 23, 26, 36, 38, 100 AND 101). SN 75-262,322. PUB. 7-24-2001. FILED 3-21-1997.
 2,745,430. **MOBILO**. DAIMLERCHRYSLER AG, BY MERGER; BY MERGER MERCEDES-BENZ AKTIENGESELLSCHAFT, MULTIPLE CLASS, (INT. CLS. 9, 35, 36, 37, 38 AND 39), (U.S. CLS. 21, 23, 26, 36, 38, 100, 101, 102, 103, 104, 105 AND 106). SN 75-296,300. PUB. 12-10-2002. FILED 5-22-1997.
 2,745,434. **TORSANA**. TORSANA A/S, MULTIPLE CLASS, (INT. CLS. 9 AND 10), (U.S. CLS. 21, 23, 26, 36, 38, 39 AND 44). SN 75-347,460. PUB. 8-1-2000. FILED 8-26-1997.
 2,745,435. **CONTESSA DA VINCI AND DESIGN**. CONTESSA DA VINCI S.R.L., MULTIPLE CLASS, (INT. CLS. 9, 14, 18 AND 25), (U.S. CLS. 1, 2, 3, 21, 22, 23, 26, 27, 28, 36, 38, 39, 41 AND 50). SN 75-356,594. PUB. 11-6-2001. FILED 9-15-1997.
 2,745,439. **WINGSPAN**. MPL COMMUNICATIONS LIMITED, MULTIPLE CLASS, (INT. CLS. 9, 16, 25 AND 41), (U.S. CLS. 2, 5, 21, 22, 23, 26, 29, 36, 37, 38, 39, 50, 100, 101 AND 107). SN 75-392,843. PUB. 10-29-2002. FILED 11-19-1997.
 2,745,444. **CITYLITE**. CITY OPTICAL INC., (U.S. CLS. 21, 23, 26, 36 AND 38). SN 75-432,907. PUB. 5-8-2001. FILED 2-12-1998.
 2,745,447. **SITECO**. SITECO BELEUCHTUNGSTECHNIK GMBH, MULTIPLE CLASS, (INT. CLS. 9, 11 AND 42), (U.S. CLS. 13, 21, 23, 26, 31, 34, 36, 38, 100 AND 101). SN 75-453,073. PUB. 4-23-2002. FILED 3-19-1998.
 2,745,448. **AKKUFIT**. AKKUMULATOREN AUFARBEITUNGS FRANCHISE GMBH, MULTIPLE CLASS, (INT. CLS. 9 AND 37), (U.S. CLS. 21, 23, 26, 36, 38, 100, 103 AND 106). SN 75-453,180. PUB. 2-8-2000. FILED 3-19-1998.
 2,745,449. **GOODBYE LINES**. CITY OPTICAL INC., (U.S. CLS. 21, 23, 26, 36 AND 38). SN 75-461,196. PUB. 4-10-2001. FILED 4-2-1998.
 2,745,454. **ATLWORKS (STYLIZED)**. ADVANTEST CORPORATION, (U.S. CLS. 21, 23, 26, 36 AND 38). SN 75-489,184. PUB. 10-23-2001. FILED 5-21-1998.
 2,745,455 (*See Class 1 for this trademark*).
 2,745,463. **SM@RTCAFE AND DESIGN**. GIESECKE & DEVRIENT GMBH, MULTIPLE CLASS, (INT. CLS. 9, 37 AND 42), (U.S. CLS. 21, 23, 26, 36, 38, 100, 101, 103 AND 106). SN 75-529,590. PUB. 6-25-2002. FILED 8-3-1998.
 2,745,467. **CASMIR AND DESIGN**. CHOPARD HOLDING S.A., MULTIPLE CLASS, (INT. CLS. 9 AND 16), (U.S. CLS. 2, 5, 21, 22, 23, 26, 29, 36, 37, 38 AND 50). SN 75-546,571. PUB. 4-11-2000. FILED 9-1-1998.
 2,745,470. **MILLENNIA WIRELESS**. MMWAVE SYSTEMS INC., BY ASSIGNMENT MMWAVE TECHNOLOGIES INC., (U.S. CLS. 21, 23, 26, 36 AND 38). SN 75-559,081. PUB. 12-4-2001. FILED 9-24-1998.
 2,745,474. **WORLD CLASS**. BUSHNELL PERFORMANCE OPTICS, BY CHANGE OF NAME; BY ASSIGNMENT; BY ASSIGNMENT TASCO SALES, INC., (U.S. CLS. 21, 23, 26, 36 AND 38). SN 75-572,456. PUB. 5-13-2003. FILED 10-19-1998.
 2,745,489. **LEAP FROG PONDS**. LEAPFROG ENTERPRISES, INC., BY ASSIGNMENT AB OVO, (U.S. CLS. 21, 23, 26, 36 AND 38). SN 75-618,414. PUB. 12-31-2002. FILED 1-11-1999.
 2,745,491. **MISCELLANEOUS DESIGN**. PHOENIX SYSTEMS, INC., (U.S. CLS. 21, 23, 26, 36 AND 38). SN 75-626,797. PUB. 11-5-2002. FILED 1-24-1999.
 2,745,496. **QUEST SOFTWARE**. QUEST SOFTWARE, INC., (U.S. CLS. 21, 23, 26, 36 AND 38). SN 75-644,260. PUB. 11-26-2002. FILED 2-19-1999.
 2,745,503. **MOBILO LIFE**. DAIMLERCHRYSLER AG, MULTIPLE CLASS, (INT. CLS. 9, 35, 36, 37, 38 AND 39), (U.S. CLS. 21, 23, 26, 36, 38, 100, 101, 102, 103, 104, 105 AND 106). SN 75-659,939. PUB. 12-10-2002. FILED 3-15-1999.
 2,745,506 (*See Class 6 for this trademark*).
 2,745,507. **AEGIS**. HOME SYSTEMS PLUS, LLC, (U.S. CLS. 21,

- 23, 26, 36 AND 38). SN 75-666,654. PUB. 10-8-2002. FILED 3-24-1999.
- 2,745,510. **PCFORYOU**. LESSARD, RANDY, (U.S. CLS. 21, 23, 26, 36 AND 38). SN 75-675,172. PUB. 5-13-2003. FILED 4-23-1999.
- 2,745,511. **STARFLEX**. ZUMTOBEL STAFF GMBH, MULTIPLE CLASS, (INT. CLS. 9, 11 AND 42), (U.S. CLS. 13, 21, 23, 26, 31, 34, 36, 38, 100 AND 101). SN 75-680,723. PUB. 5-13-2003. FILED 4-12-1999.
- 2,745,518. **FLOMOTION**. SNELL & WILCOX LTD., (U.S. CLS. 21, 23, 26, 36 AND 38). SN 75-700,923. PUB. 5-13-2003. FILED 5-7-1999.
- 2,745,522. **MONGOOSE**. TK "VIST-SERVICE" LIMITED, MULTIPLE CLASS, (INT. CLS. 9 AND 12), (U.S. CLS. 19, 21, 23, 26, 31, 35, 36, 38 AND 44). SN 75-709,755. PUB. 8-13-2002. FILED 5-20-1999.
- 2,745,524. **TRAX**. PERMOBIL AB, MULTIPLE CLASS, (INT. CLS. 9, 10 AND 12), (U.S. CLS. 19, 21, 23, 26, 31, 35, 36, 38, 39 AND 44). SN 75-711,997. PUB. 7-3-2001. FILED 5-21-1999.
- 2,745,525. **CHAIRMAN**. PERMOBIL AB, MULTIPLE CLASS, (INT. CLS. 9 AND 10), (U.S. CLS. 21, 23, 26, 36, 38, 39 AND 44). SN 75-712,051. PUB. 7-17-2001. FILED 5-21-1999.
- 2,745,528. **EMAP**. EMAP PLC., MULTIPLE CLASS, (INT. CLS. 9, 35, 38, 41 AND 42), (U.S. CLS. 21, 23, 26, 36, 38, 100, 101, 102, 104 AND 107). SN 75-743,898. PUB. 5-21-2002. FILED 7-6-1999.
- 2,745,536. **KLUGER DAUMEN**. SCHNITZLBAUMER, HANS, MULTIPLE CLASS, (INT. CLS. 9 AND 16), (U.S. CLS. 2, 5, 21, 22, 23, 26, 29, 36, 37, 38 AND 50). SN 75-764,678. PUB. 12-4-2001. FILED 7-30-1999.
- 2,745,537. **AXIS**. DIGITAL INSIGHT CORPORATION, (U.S. CLS. 21, 23, 26, 36 AND 38). SN 75-766,721. PUB. 12-17-2002. FILED 8-3-1999.
- 2,745,540. **ARIUS3D**. ARIUS3D INC., MULTIPLE CLASS, (INT. CLS. 9, 35 AND 40), (U.S. CLS. 21, 23, 26, 36, 38, 100, 101, 102, 103 AND 106). SN 75-769,308. PUB. 8-6-2002. FILED 8-5-1999.
- 2,745,541. **VIACODE**. VIACODE LIMITED, BY ASSIGNMENT POST OFFICE, THE, MULTIPLE CLASS, (INT. CLS. 9, 16, 35, 38, 40 AND 42), (U.S. CLS. 2, 5, 21, 22, 23, 26, 29, 36, 37, 38, 50, 100, 101, 102, 103, 104 AND 106). SN 75-772,314. PUB. 8-27-2002. FILED 8-10-1999.
- 2,745,547. **VIVID**. NATIONAL AUSTRALIA BANK LIMITED, MULTIPLE CLASS, (INT. CLS. 9 AND 36), (U.S. CLS. 21, 23, 26, 36, 38, 100, 101 AND 102). SN 75-797,140. PUB. 5-13-2003. FILED 9-9-1999.
- 2,745,550 (*See Class 3 for this trademark*).
- 2,745,553. **SIPLANT**. SIEMENS AKTIENGESELLSCHAFT, MULTIPLE CLASS, (INT. CLS. 9, 35, 37, 39, 41 AND 42), (U.S. CLS. 21, 23, 26, 36, 38, 100, 101, 102, 103, 105, 106 AND 107). SN 75-809,345. PUB. 12-17-2002. FILED 9-27-1999.
- 2,745,554. **ELLIPS AND DESIGN**. SOCIETA' PER I SERVIZI BANCARI - SSB S.P.A., MULTIPLE CLASS, (INT. CLS. 9, 35, 36, 38 AND 42), (U.S. CLS. 21, 23, 26, 36, 38, 100, 101, 102 AND 104). SN 75-811,272. PUB. 7-16-2002. FILED 9-29-1999.
- 2,745,557. **SAFETY EXPRESS AND DESIGN**. SAFETY EXPRESS LTD., (U.S. CLS. 21, 23, 26, 36 AND 38). SN 75-817,082. PUB. 10-8-2002. FILED 10-7-1999.
- 2,745,558 (*See Class 3 for this trademark*).
- 2,745,570. **LANDIS & GYR CONVERGE (STYLIZED)**. SIEMENS METERING AG, MULTIPLE CLASS, (INT. CLS. 9, 35, 37 AND 42), (U.S. CLS. 21, 23, 26, 36, 38, 100, 101, 102, 103 AND 106). SN 75-851,101. PUB. 7-16-2002. FILED 11-17-1999.
- 2,745,571. **SOS STAY ORGANIZED SYSTEM AND DESIGN**. DJ CONSULTANTS, INC., MULTIPLE CLASS, (INT. CLS. 9 AND 18), (U.S. CLS. 1, 2, 3, 21, 22, 23, 26, 36, 38 AND 41). SN 75-857,368. PUB. 9-24-2002. FILED 11-24-1999.
- 2,745,572. **MAMMA.COM THE MOTHER OF ALL SEARCH ENGINES**. MAMMA.COM INC., MULTIPLE CLASS, (INT. CLS. 9, 35 AND 42), (U.S. CLS. 21, 23, 26, 36, 38, 100, 101 AND 102). SN 75-859,194. PUB. 12-3-2002. FILED 11-29-1999.
- 2,745,573. **MAMMA.COM**. MAMMA.COM INC., MULTIPLE CLASS, (INT. CLS. 9, 35 AND 42), (U.S. CLS. 21, 23, 26, 36, 38, 100, 101 AND 102). SN 75-859,195. PUB. 12-3-2002. FILED 11-29-1999.
- 2,745,574. **SYMBIAN**. SYMBIAN LIMITED, MULTIPLE CLASS, (INT. CLS. 9, 16, 35, 37, 38 AND 42), (U.S. CLS. 2, 5, 21, 22, 23, 26, 29, 36, 37, 38, 50, 100, 101, 102, 103, 104 AND 106). SN 75-859,197. PUB. 8-13-2002. FILED 11-29-1999.
- 2,745,579. **WEBCLARITY**. SEA CHANGE CORPORATION, (U.S. CLS. 21, 23, 26, 36 AND 38). SN 75-862,235. PUB. 5-13-2003. FILED 12-2-1999.
- 2,745,584. **COOLMOS AND DESIGN**. INFINEON TECHNOLOGIES AG, (U.S. CLS. 21, 23, 26, 36 AND 38). SN 75-879,844. PUB. 11-7-2000. FILED 12-24-1999.
- 2,745,592. **E-HEALTH.COMMUNITY**. GMD - GESELLSCHAFT FUR MEDIZINISCHE DATENVERARBEITUNG MBH, MULTIPLE CLASS, (INT. CLS. 9, 35 AND 42), (U.S. CLS. 21, 23, 26, 36, 38, 100, 101 AND 102). SN 75-894,496. PUB. 5-13-2003. FILED 1-12-2000.
- 2,745,594. **STAR PLUG+ AND DESIGN**. KONINKLIJKE PHILIPS ELECTRONICS N.V., (U.S. CLS. 21, 23, 26, 36 AND 38). SN 75-895,648. PUB. 11-13-2001. FILED 1-12-2000.
- 2,745,596. **E*TAG (STYLIZED)**. SOUNDSCRAFT, INC., DBA SECURA KEY, (U.S. CLS. 21, 23, 26, 36 AND 38). SN 75-897,549. PUB. 8-20-2002. FILED 1-15-2000.
- 2,745,597. **CONTROL-LINK**. MUSCO CORPORATION, MULTIPLE CLASS, (INT. CLS. 9, 35, 37, 41 AND 42), (U.S. CLS. 21, 23, 26, 36, 38, 100, 101, 102, 103, 106 AND 107). SN 75-898,215. PUB. 5-13-2003. FILED 1-17-2000.
- 2,745,600. **GEMSTAR**. GEMINI, INC., MULTIPLE CLASS, (INT. CLS. 9, 10 AND 28), (U.S. CLS. 21, 22, 23, 26, 36, 38, 39, 44 AND 50). SN 75-902,805. PUB. 10-22-2002. FILED 1-25-2000.
- 2,745,606 (*See Class 1 for this trademark*).
- 2,745,613. **POWERWARE BUSINESS MANAGEMENT SYSTEMS (STYLIZED)**. MIC SYSTEMS & SOFTWARE, INC., (U.S. CLS. 21, 23, 26, 36 AND 38). SN 75-926,641. PUB. 12-3-2002. FILED 2-24-2000.
- 2,745,615. **PACTWARE AND DESIGN**. PEPPERL + FUCHS GMBH, MULTIPLE CLASS, (INT. CLS. 9, 16 AND 42), (U.S. CLS. 2, 5, 21, 22, 23, 26, 29, 36, 37, 38, 50, 100 AND 101). SN 75-927,686. PUB. 11-12-2002. FILED 2-25-2000.
- 2,745,629. **ENDERMO**. LPG SYSTEMS, MULTIPLE CLASS, (INT. CLS. 9 AND 10), (U.S. CLS. 21, 23, 26, 36, 38, 39 AND 44). SN 75-980,397. PUB. 8-28-2001. FILED 8-20-1998.
- 2,745,634 (*See Class 7 for this trademark*).
- 2,745,636 (*See Class 3 for this trademark*).
- 2,745,638. **XCOMMERCE**. SILVERSTREAM SOFTWARE, INC., (U.S. CLS. 21, 23, 26, 36 AND 38). SN 76-000,572. PUB. 4-2-2002. FILED 3-15-2000.
- 2,745,644. **GENTECH AND DESIGN**. GENTECH, MULTIPLE CLASS, (INT. CLS. 9, 31 AND 42), (U.S. CLS. 1, 21, 23, 26, 36, 38, 46, 100 AND 101). SN 76-009,438. PUB. 9-24-2002. FILED 3-24-2000.
- 2,745,645. **DIRXMETAHUB (STYLIZED)**. SIEMENS AKTIENGESELLSCHAFT, (U.S. CLS. 21, 23, 26, 36 AND 38). SN 76-011,153. PUB. 11-19-2002. FILED 3-28-2000.
- 2,745,648. **ERAM NOTES (STYLIZED)**. DRM TECHNOLOGIES, INC., MULTIPLE CLASS, (INT. CLS. 9 AND 42), (U.S. CLS. 21, 23, 26, 36, 38, 100 AND 101). SN 76-014,201. PUB. 9-17-2002. FILED 3-31-2000.
- 2,745,649. **INTERNATIONAL INSTITUTE FOR TRANSFORMATION**. HELLIWELL, TANIS, MULTIPLE CLASS, (INT. CLS. 9, 16 AND 41), (U.S. CLS. 2, 5, 21, 22, 23, 26, 29, 36, 37, 38, 50, 100, 101 AND 107). SN 76-014,385. PUB. 11-19-2002. FILED 3-31-2000.
- 2,745,654. **FIPSPY**. ALSTOM, (U.S. CLS. 21, 23, 26, 36 AND 38). SN 76-019,715. PUB. 5-14-2002. FILED 4-6-2000.
- 2,745,660. **BOMBAY DREAMS**. REALLY USEFUL GROUP LIMITED, THE, MULTIPLE CLASS, (INT. CLS. 9, 16, 25 AND 41), (U.S. CLS. 2, 5, 21, 22, 23, 26, 29, 36, 37, 38, 39, 50, 100, 101 AND 107). SN 76-023,488. PUB. 8-27-2002. FILED 4-11-2000.
- 2,745,664. **ROAD WARRIOR**. ARI ACQUISITION CORP., BY MERGER; BY MERGER IGO CORPORATION, MULTIPLE CLASS, (INT. CLS. 9 AND 42), (U.S. CLS. 21, 23, 26, 36, 38, 100 AND 101). SN 76-037,214. PUB. 12-10-2002. FILED 4-28-2000.
- 2,745,665. **WEBELEC (STYLIZED)**. CDME WORLD TRADE, MULTIPLE CLASS, (INT. CLS. 9, 11 AND 16), (U.S. CLS. 2, 5, 13, 21, 22, 23, 26, 29, 31, 34, 36, 37, 38 AND 50). SN 76-038,889. PUB. 9-24-2002. FILED 5-1-2000.
- 2,745,666 (*See Class 7 for this trademark*).
- 2,745,671. **LOST BOYS**. TEAM LOST BOYS B.V., MULTIPLE CLASS, (INT. CLS. 9, 35, 38, 41 AND 42), (U.S. CLS. 21, 23,

- 26, 36, 38, 100, 101, 102, 104 AND 107). SN 76-044,527. PUB. 11-12-2002. FILED 5-9-2000.
- 2,745,672 (*See Class 7 for this trademark*).
- 2,745,673 (*See Class 7 for this trademark*).
- 2,745,678. **SYSTOLIX**. SYSTOLIX LIMITED, (U.S. CLS. 21, 23, 26, 36 AND 38). SN 76-046,886. PUB. 4-9-2002. FILED 5-12-2000.
- 2,745,679 (*See Class 2 for this trademark*).
- 2,745,680 (*See Class 3 for this trademark*).
- 2,745,683 (*See Class 3 for this trademark*).
- 2,745,692. **POPWORLD AND DESIGN**. POPWORLD LIMITED, MULTIPLE CLASS, (INT. CLS. 9, 16, 25, 28, 35, 36, 38 AND 41), (U.S. CLS. 2, 5, 21, 22, 23, 26, 29, 36, 37, 38, 39, 50, 100, 101, 102, 104 AND 107). SN 76-058,752. PUB. 1-21-2003. FILED 5-30-2000.
- 2,745,693 (*See Class 1 for this trademark*).
- 2,745,696 (*See Class 1 for this trademark*).
- 2,745,701. **STACKWARE**. FORCE COMPUTERS GMBH, MULTIPLE CLASS, (INT. CLS. 9, 38 AND 42), (U.S. CLS. 21, 23, 26, 36, 38, 100, 101 AND 104). SN 76-068,272. PUB. 5-13-2003. FILED 6-12-2000.
- 2,745,704. **MISCELLANEOUS DESIGN**. ATOSS SOFTWARE AG, MULTIPLE CLASS, (INT. CLS. 9, 16, 35, 37 AND 42), (U.S. CLS. 2, 5, 21, 22, 23, 26, 29, 36, 37, 38, 50, 100, 101, 102, 103 AND 106). SN 76-073,367. PUB. 6-11-2002. FILED 6-19-2000.
- 2,745,705. **ATOSS**. ATOSS SOFTWARE AG, MULTIPLE CLASS, (INT. CLS. 9, 16, 35, 37 AND 42), (U.S. CLS. 2, 5, 21, 22, 23, 26, 29, 36, 37, 38, 50, 100, 101, 102, 103 AND 106). SN 76-073,509. PUB. 4-23-2002. FILED 6-19-2000.
- 2,745,715. **FRENCH CONNECTION**. FRENCH CONNECTION LIMITED, MULTIPLE CLASS, (INT. CLS. 9 AND 14), (U.S. CLS. 2, 21, 23, 26, 27, 28, 36, 38 AND 50). SN 76-079,373. PUB. 5-21-2002. FILED 6-28-2000.
- 2,745,721. **SAMONAS**. STEINBACH, INGO, (U.S. CLS. 21, 23, 26, 36 AND 38). SN 76-083,629. PUB. 5-13-2003. FILED 7-5-2000.
- 2,745,726. **CERAMUS**. HIRSCHMANN LABORGERATE GMBH & CO. KG, (U.S. CLS. 21, 23, 26, 36 AND 38). SN 76-092,444. PUB. 10-15-2002. FILED 7-20-2000.
- 2,745,728 (*See Class 7 for this trademark*).
- 2,745,731. **DATAMAIL**. TELEFONICA, S.A., (U.S. CLS. 21, 23, 26, 36 AND 38). SN 76-097,524. PUB. 11-5-2002. FILED 7-27-2000.
- 2,745,745. **POWERMAX**. VISONIC LTD., (U.S. CLS. 21, 23, 26, 36 AND 38). SN 76-106,011. PUB. 5-13-2003. FILED 8-9-2000.
- 2,745,749. **KRYPTOGRAFICS**. KRYPTOGRAFICS GMBH, (U.S. CLS. 21, 23, 26, 36 AND 38). SN 76-110,439. PUB. 1-21-2003. FILED 8-16-2000.
- 2,745,758. **SIMAX SIEMENS POINT OPERATING SYSTEMS AND DESIGN**. SIEMENS AKTIENGESELLSCHAFT, (U.S. CLS. 21, 23, 26, 36 AND 38). SN 76-116,514. PUB. 12-24-2002. FILED 8-24-2000.
- 2,745,759. **IETS (STYLIZED)**. EUROPEAN INSTALLATION BUS ASSOCIATION, MULTIPLE CLASS, (INT. CLS. 9, 16 AND 42), (U.S. CLS. 2, 5, 21, 22, 23, 26, 29, 36, 37, 38, 50, 100 AND 101). SN 76-117,269. PUB. 10-15-2002. FILED 8-25-2000.
- 2,745,760. **SOFTWORX**. APPLIED PRECISION HOLDINGS, LLC, BY ASSIGNMENT APPLIED PRECISION, INC., (U.S. CLS. 21, 23, 26, 36 AND 38). SN 76-117,602. PUB. 5-13-2003. FILED 8-28-2000.
- 2,745,770. **NFORCE (STYLIZED)**. NCIPHER CORPORATION LIMITED, (U.S. CLS. 21, 23, 26, 36 AND 38). SN 76-128,848. PUB. 9-24-2002. FILED 9-14-2000.
- 2,745,771. **60**. TRUCK-LITE CO., INC., MULTIPLE CLASS, (INT. CLS. 9 AND 11), (U.S. CLS. 13, 21, 23, 26, 31, 34, 36 AND 38). SN 76-130,447. PUB. 11-5-2002. FILED 9-16-2000.
- 2,745,776. **VRMASS (STYLIZED)**. OVAL CORPORATION, (U.S. CLS. 21, 23, 26, 36 AND 38). SN 76-135,360. PUB. 9-24-2002. FILED 9-26-2000.
- 2,745,777. **MET OFFICE AND DESIGN**. SECRETARY OF STATE FOR DEFENCE IN HER BRITANNIC MAJESTY'S GOVERNMENT OF THE UNITED KINGDOM OF GREAT BRITAIN AND NORTHERN IRELAND, THE, MULTIPLE CLASS, (INT. CLS. 9, 16, 25, 28, 35, 38, 41 AND 42), (U.S. CLS. 2, 5, 21, 22, 23, 26, 29, 36, 37, 38, 39, 50, 100, 101, 102, 104 AND 107). SN 76-135,711. PUB. 12-17-2002. FILED 9-26-2000.
- 2,745,780. **VENTURE CAPITAL INSTITUTE AND DESIGN**. NATIONAL ASSOCIATION OF SMALL BUSINESS INVESTMENT COMPANIES, MULTIPLE CLASS, (INT. CLS. 9, 16 AND 41), (U.S. CLS. 2, 5, 21, 22, 23, 26, 29, 36, 37, 38, 50, 100, 101 AND 107). SN 76-139,202. PUB. 5-13-2003. FILED 9-29-2000.
- 2,745,783. **ARCORDIA**. ARCORDIA SOLUTIONS LIMITED, MULTIPLE CLASS, (INT. CLS. 9, 16, 35, 36 AND 42), (U.S. CLS. 2, 5, 21, 22, 23, 26, 29, 36, 37, 38, 50, 100, 101 AND 102). SN 76-140,684. PUB. 5-13-2003. FILED 10-4-2000.
- 2,745,788. **E P W A R E (STYLIZED)**. KONICA CORPORATION, (U.S. CLS. 21, 23, 26, 36 AND 38). SN 76-144,328. PUB. 11-5-2002. FILED 10-11-2000.
- 2,745,803. **Z-WAVE**. ZENSYS A/S, MULTIPLE CLASS, (INT. CLS. 9, 16 AND 42), (U.S. CLS. 2, 5, 21, 22, 23, 26, 29, 36, 37, 38, 50, 100 AND 101). SN 76-161,494. PUB. 12-10-2002. FILED 11-7-2000.
- 2,745,808. **LADOT**. KALEXER BVBA, MULTIPLE CLASS, (INT. CLS. 9, 35, 36, 38, 41 AND 42), (U.S. CLS. 21, 23, 26, 36, 38, 100, 101, 102, 104 AND 107). SN 76-164,474. PUB. 5-13-2003. FILED 11-13-2000.
- 2,745,809. **NUVATIME**. N.V. ORGANON, (U.S. CLS. 21, 23, 26, 36 AND 38). SN 76-164,526. PUB. 7-16-2002. FILED 11-13-2000.
- 2,745,816. **EXCOSOFT AND DESIGN**. EXCOSOFT AB, MULTIPLE CLASS, (INT. CLS. 9, 38 AND 42), (U.S. CLS. 21, 23, 26, 36, 38, 100, 101 AND 104). SN 76-172,168. PUB. 5-13-2003. FILED 11-27-2000.
- 2,745,817. **CLVAO**. SCREENY MEDIA S.A., MULTIPLE CLASS, (INT. CLS. 9, 16, 28, 35, 38, 41 AND 42), (U.S. CLS. 2, 5, 21, 22, 23, 26, 29, 36, 37, 38, 50, 100, 101, 102, 104 AND 107). SN 76-172,400. PUB. 10-29-2002. FILED 11-29-2000.
- 2,745,818. **SCREENY**. SCREENY MEDIA S.A., MULTIPLE CLASS, (INT. CLS. 9, 16, 28, 35, 38, 41 AND 42), (U.S. CLS. 2, 5, 21, 22, 23, 26, 29, 36, 37, 38, 50, 100, 101, 102, 104 AND 107). SN 76-172,402. PUB. 11-5-2002. FILED 11-29-2000.
- 2,745,821. **HERAEUS QUARTZTECH (STYLIZED)**. HERAEUS HOLDING GMBH, (U.S. CLS. 21, 23, 26, 36 AND 38). SN 76-174,634. PUB. 2-18-2003. FILED 11-29-2000.
- 2,745,824. **WORKDYNAMICS TECHNOLOGIES**. WORKDYNAMICS TECHNOLOGIES, INC., MULTIPLE CLASS, (INT. CLS. 9, 41 AND 42), (U.S. CLS. 21, 23, 26, 36, 38, 100, 101 AND 107). SN 76-176,470. PUB. 5-13-2003. FILED 12-5-2000.
- 2,745,828. **BINARYCLOUD**. TURING STUDIO, THE, MULTIPLE CLASS, (INT. CLS. 9 AND 42), (U.S. CLS. 21, 23, 26, 36, 38, 100 AND 101). SN 76-182,400. PUB. 5-13-2003. FILED 12-18-2000.
- 2,745,831. **EDAPTER**. EDAPTING SOLUTIONS, L.L.C., (U.S. CLS. 21, 23, 26, 36 AND 38). SN 76-185,369. PUB. 9-11-2001. FILED 12-20-2000.
- 2,745,837. **SERVIS**. FUJITSU TAKAMIZAWA COMPONENT LIMITED, (U.S. CLS. 21, 23, 26, 36 AND 38). SN 76-189,394. PUB. 5-13-2003. FILED 1-3-2001.
- 2,745,838. **LAMBDA CROSSING AND DESIGN**. LAMBDA CROSSING LTD., (U.S. CLS. 21, 23, 26, 36 AND 38). SN 76-189,564. PUB. 8-13-2002. FILED 1-4-2001.
- 2,745,839. **LAMBDA CROSSING**. LAMBDA CROSSING LTD., (U.S. CLS. 21, 23, 26, 36 AND 38). SN 76-189,566. PUB. 8-13-2002. FILED 1-4-2001.
- 2,745,840. **LET A HOSTAGE NEGOTIATOR RING YOUR BELLS**. RESCUE PHONE, INC., (U.S. CLS. 21, 23, 26, 36 AND 38). SN 76-189,581. PUB. 10-29-2002. FILED 1-4-2001.
- 2,745,846 (*See Class 1 for this trademark*).
- 2,745,849. **COLIBRIA**. COLIBRIA AS, MULTIPLE CLASS, (INT. CLS. 9, 38 AND 42), (U.S. CLS. 21, 23, 26, 36, 38, 100, 101 AND 104). SN 76-194,328. PUB. 10-1-2002. FILED 1-16-2001.
- 2,745,853. **XOS AND DESIGN**. MEMETRICS INC., MULTIPLE CLASS, (INT. CLS. 9, 35 AND 42), (U.S. CLS. 21, 23, 26, 36, 38, 100, 101 AND 102). SN 76-195,612. PUB. 10-8-2002. FILED 1-16-2001.
- 2,745,854 (*See Class 1 for this trademark*).
- 2,745,855. **DESKTOP STAYING POWER**. BLISS, GARETH, MULTIPLE CLASS, (INT. CLS. 9, 38 AND 42), (U.S. CLS. 21, 23, 26, 36, 38, 100, 101 AND 104). SN 76-196,337. PUB. 1-7-2003. FILED 1-17-2001.
- 2,745,857. **PRIMION**. PRIMION TECHNOLOGY AG, MULTIPLE CLASS, (INT. CLS. 9, 37 AND 42), (U.S. CLS. 21, 23, 26,

- 36, 38, 100, 101, 103 AND 106). SN 76-198,029. PUB. 10-22-2002. FILED 1-23-2001.
- 2,745,861. **SCALA AND DESIGN**. SCALA BUSINESS SOLUTIONS N.V., MULTIPLE CLASS, (INT. CLS. 9 AND 16), (U.S. CLS. 2, 5, 21, 22, 23, 26, 29, 36, 37, 38 AND 50). SN 76-200,178. PUB. 5-13-2003. FILED 1-25-2001.
- 2,745,867. **METAPACK**. GECKO ELECTRONIQUE, INC., (U.S. CLS. 21, 23, 26, 36 AND 38). SN 76-204,922. PUB. 5-13-2003. FILED 2-5-2001.
- 2,745,876. **APPIANVISTA**. APPIAN COMMUNICATIONS, INC., (U.S. CLS. 21, 23, 26, 36 AND 38). SN 76-208,855. PUB. 5-13-2003. FILED 2-12-2001.
- 2,745,877. **APPIAN**. APPIAN COMMUNICATIONS, INC., (U.S. CLS. 21, 23, 26, 36 AND 38). SN 76-209,255. PUB. 5-13-2003. FILED 2-12-2001.
- 2,745,883. **A & W**. ADVANCED & WISE TECHNOLOGY CORP., (U.S. CLS. 21, 23, 26, 36 AND 38). SN 76-214,824. PUB. 1-7-2003. FILED 2-23-2001.
- 2,745,894. **DESIGN RAY CONTROL**. ESSILOR INTERNATIONAL (COMPAGNIE GENERALE D'OPTIQUE), (U.S. CLS. 21, 23, 26, 36 AND 38). SN 76-220,304. PUB. 12-11-2001. FILED 3-5-2001.
- 2,745,920. **SITRAM**. SIEMENS AKTIENGESELLSCHAFT, (U.S. CLS. 21, 23, 26, 36 AND 38). SN 76-235,580. PUB. 11-12-2002. FILED 4-3-2001.
- 2,745,926. **MISCELLANEOUS DESIGN**. METZELER AUTOMOTIVE PROFILE SYSTEMS GMBH, BY CHANGE OF NAME METZELER AUTOMOTIVE PROFILES GMBH, MULTIPLE CLASS, (INT. CLS. 9, 12, 17 AND 27), (U.S. CLS. 1, 5, 12, 13, 19, 20, 21, 23, 26, 31, 35, 36, 37, 38, 42, 44 AND 50). SN 76-238,831. PUB. 10-22-2002. FILED 4-10-2001.
- 2,745,930 (*See Class 6 for this trademark*).
- 2,745,934. **SPOTLIGHT AND DESIGN**. SPOTLIGHT SOLUTIONS, INC., MULTIPLE CLASS, (INT. CLS. 9 AND 42), (U.S. CLS. 21, 23, 26, 36, 38, 100 AND 101). SN 76-242,283. PUB. 10-29-2002. FILED 4-17-2001.
- 2,745,936. **4GHI**. TELEFONAKTIEBOLAGET LM ERICSSON, MULTIPLE CLASS, (INT. CLS. 9, 38 AND 42), (U.S. CLS. 21, 23, 26, 36, 38, 100, 101 AND 104). SN 76-243,235. PUB. 5-13-2003. FILED 4-19-2001.
- 2,745,938. **CREDIT LYONNAIS**. CREDIT LYONNAIS, MULTIPLE CLASS, (INT. CLS. 9, 35, 36 AND 38), (U.S. CLS. 21, 23, 26, 36, 38, 100, 101, 102 AND 104). SN 76-244,052. PUB. 5-13-2003. FILED 4-20-2001.
- 2,745,946. **THE STANDARD FOR BENCHMARKING**. CARTER, PAUL, MULTIPLE CLASS, (INT. CLS. 9 AND 42), (U.S. CLS. 21, 23, 26, 36, 38, 100 AND 101). SN 76-247,434. PUB. 5-13-2003. FILED 4-27-2001.
- 2,745,947. **ZOOMTOWN CINCINNATI**. ZOOMTOWN.COM INC., MULTIPLE CLASS, (INT. CLS. 9, 36, 38 AND 41), (U.S. CLS. 21, 23, 26, 36, 38, 100, 101, 102, 104 AND 107). SN 76-248,318. PUB. 5-13-2003. FILED 4-30-2001.
- 2,745,948. **ZOOMTOWN CINCINNATI AND DESIGN**. ZOOMTOWN.COM INC., MULTIPLE CLASS, (INT. CLS. 9, 36, 38 AND 41), (U.S. CLS. 21, 23, 26, 36, 38, 100, 101, 102, 104 AND 107). SN 76-248,319. PUB. 5-13-2003. FILED 4-30-2001.
- 2,745,949. **MARINER**. VOLANTIS SYSTEMS LIMITED, MULTIPLE CLASS, (INT. CLS. 9 AND 42), (U.S. CLS. 21, 23, 26, 36, 38, 100 AND 101). SN 76-248,334. PUB. 12-10-2002. FILED 4-30-2001.
- 2,745,952. **ALYS**. LECTRA SYSTEMES, (U.S. CLS. 21, 23, 26, 36 AND 38). SN 76-249,214. PUB. 6-18-2002. FILED 5-1-2001.
- 2,745,956. **ETREX LEGEND**. GARMIN LTD., (U.S. CLS. 21, 23, 26, 36 AND 38). SN 76-252,299. PUB. 5-14-2002. FILED 5-4-2001.
- 2,745,969. **PHINS**. IXSEA, (U.S. CLS. 21, 23, 26, 36 AND 38). SN 76-260,918. PUB. 5-13-2003. FILED 5-23-2001.
- 2,745,970. **CMS**. MEDIS MEDICAL IMAGING SYSTEMS, B.V., (U.S. CLS. 21, 23, 26, 36 AND 38). SN 76-261,475. PUB. 12-10-2002. FILED 5-22-2001.
- 2,745,977. **MAPTEL AND DESIGN**. TERRA NETWORKS, S.A., MULTIPLE CLASS, (INT. CLS. 9, 16, 38 AND 42), (U.S. CLS. 2, 5, 21, 22, 23, 26, 29, 36, 37, 38, 50, 100, 101 AND 104). SN 76-264,494. PUB. 3-18-2003. FILED 5-30-2001.
- 2,745,978. **NCX**. NEXANS FRANCE, (U.S. CLS. 21, 23, 26, 36 AND 38). SN 76-265,503. PUB. 5-13-2003. FILED 6-1-2001.
- 2,745,980. **PETER GROSS**. LINDTNER, MONIKA, (U.S. CLS. 21, 23, 26, 36 AND 38). SN 76-266,661. PUB. 5-13-2003. FILED 6-4-2001.
- 2,745,984. **GLUCONLINE**. DISETRONIC LICENSING AG, MULTIPLE CLASS, (INT. CLS. 9, 10 AND 42), (U.S. CLS. 21, 23, 26, 36, 38, 39, 44, 100 AND 101). SN 76-267,213. PUB. 6-18-2002. FILED 6-5-2001.
- 2,745,990. **EPIGRAPH XCELLERANT AND DESIGN**. EPIGRAPH GROUP, INC., (U.S. CLS. 21, 23, 26, 36 AND 38). SN 76-268,827. PUB. 12-17-2002. FILED 6-8-2001.
- 2,745,991 (*See Class 5 for this trademark*).
- 2,745,994. **INTERPRETER**. KPMG INTERNATIONAL, MULTIPLE CLASS, (INT. CLS. 9, 16, 35, 36 AND 42), (U.S. CLS. 2, 5, 21, 22, 23, 26, 29, 36, 37, 38, 50, 100, 101 AND 102). SN 76-271,392. PUB. 5-13-2003. FILED 6-14-2001.
- 2,745,995. **SMART SWITCH**. INALFA SUNROOFS USA, LLC, (U.S. CLS. 21, 23, 26, 36 AND 38). SN 76-271,458. PUB. 5-13-2003. FILED 6-13-2001.
- 2,745,999. **DCRS AND DESIGN**. NUVO TECHNOLOGIES, INC., DBA PLP DIGITAL SYSTEMS, INC., (U.S. CLS. 21, 23, 26, 36 AND 38). SN 76-273,991. PUB. 4-15-2003. FILED 6-20-2001.
- 2,746,005. **PC SUPPLIES (STYLIZED)**. EMCO, INC., (U.S. CLS. 21, 23, 26, 36 AND 38). SN 76-276,454. PUB. 5-13-2003. FILED 6-26-2001.
- 2,746,008. **PROGENESIS**. NONLINEAR DYNAMICS LIMITED, MULTIPLE CLASS, (INT. CLS. 9 AND 42), (U.S. CLS. 21, 23, 26, 36, 38, 100 AND 101). SN 76-277,368. PUB. 1-7-2003. FILED 6-27-2001.
- 2,746,012. **ROMY**. MIRA ENTERPRISES, INC., (U.S. CLS. 21, 23, 26, 36 AND 38). SN 76-278,358. PUB. 5-13-2003. FILED 6-20-2001.
- 2,746,024. **RETRO**. HUNZA HOLDINGS LIMITED, (U.S. CLS. 21, 23, 26, 36 AND 38). SN 76-285,584. PUB. 5-13-2003. FILED 7-16-2001.
- 2,746,055. **FASTLEADER**. SAMSUNG ELECTRONICS CO., LTD., (U.S. CLS. 21, 23, 26, 36 AND 38). SN 76-293,119. PUB. 5-13-2003. FILED 8-2-2001.
- 2,746,057. **MISCELLANEOUS DESIGN**. "DJ HONDA" RECORDINGS CO. LTD. JAPAN, (U.S. CLS. 21, 23, 26, 36 AND 38). SN 76-293,653. PUB. 5-13-2003. FILED 8-1-2001.
- 2,746,065. **HI-TEK**. HI-TEK PRODUCTIONS, INC., (U.S. CLS. 21, 23, 26, 36 AND 38). SN 76-294,882. PUB. 5-13-2003. FILED 8-7-2001.
- 2,746,067. **BROADBEAM**. SOUND TUBE ENTERTAINMENT, INC., (U.S. CLS. 21, 23, 26, 36 AND 38). SN 76-296,208. PUB. 5-13-2003. FILED 7-31-2001.
- 2,746,074. **INTERNATIONAL JUSTICE MISSION**. INTERNATIONAL JUSTICE MISSION, THE, (U.S. CLS. 21, 23, 26, 36 AND 38). SN 76-300,385. PUB. 5-13-2003. FILED 8-16-2001.
- 2,746,075 (*See Class 1 for this trademark*).
- 2,746,080. **RAILCOM**. LENZ ELEKTRONIK GMBH, (U.S. CLS. 21, 23, 26, 36 AND 38). SN 76-303,014. PUB. 10-8-2002. FILED 8-22-2001.
- 2,746,086. **DARTMAIL**. DOUBLECLICK INC., (U.S. CLS. 21, 23, 26, 36 AND 38). SN 76-305,993. PUB. 5-13-2003. FILED 8-28-2001.
- 2,746,088. **KAMESAN**. SIGMA SYSTEMS ENGINEERING CO., LTD., (U.S. CLS. 21, 23, 26, 36 AND 38). SN 76-306,422. PUB. 5-13-2003. FILED 8-29-2001.
- 2,746,093. **HARD WORKING LAW**. GOODMAN AND CARR LLP, MULTIPLE CLASS, (INT. CLS. 9, 14, 16, 18, 21, 24, 25, 28 AND 42), (U.S. CLS. 1, 2, 3, 5, 13, 21, 22, 23, 26, 27, 28, 29, 30, 33, 36, 37, 38, 39, 40, 41, 42, 50, 100 AND 101). SN 76-307,728. PUB. 5-13-2003. FILED 8-30-2001.
- 2,746,101. **PARACLETE**. PARACLETE ARMOR & EQUIPMENT, INC., MULTIPLE CLASS, (INT. CLS. 9, 10 AND 18), (U.S. CLS. 1, 2, 3, 21, 22, 23, 26, 36, 38, 39, 41 AND 44). SN 76-311,862. PUB. 5-13-2003. FILED 9-12-2001.
- 2,746,109. **FLOWMATRIX AND DESIGN**. FLOWMATRIX, INC., (U.S. CLS. 21, 23, 26, 36 AND 38). SN 76-314,808. PUB. 12-10-2002. FILED 9-18-2001.
- 2,746,110. **FLOWMATRIX**. FLOWMATRIX, INC., (U.S. CLS. 21, 23, 26, 36 AND 38). SN 76-314,814. PUB. 12-24-2002. FILED 9-18-2001.
- 2,746,115. **POWERMATTE**. REFLEC PLC, BY ASSIGNMENT VIEWERCOM LIMITED, MULTIPLE CLASS, (INT. CLS. 9 AND 24), (U.S. CLS. 21, 23, 26, 36, 38, 42 AND 50). SN 76-316,974. PUB. 5-13-2003. FILED 9-26-2001.
- 2,746,116. **FAST CASH WITH QUICK TURN REAL ESTATE**.

- SDI LEGRAND PUBLISHING, INC., MULTIPLE CLASS, (INT. CLS. 9 AND 36), (U.S. CLS. 21, 23, 26, 36, 38, 100, 101 AND 102). SN 76-317,308. PUB. 5-13-2003. FILED 9-26-2001. 2,746,118 (*See Class 4 for this trademark*).
- 2,746,125. **SWX PLATFORM**. SWX SWISS EXCHANGE, BY CHANGE OF NAME SCHWEIZERISCHE EFFEKTENBORSE (BOURSE SUISSE DE VALEURS MOBILIERES) (SWISS STOCK EXCHANGE) (BORSA VALORI SVIZZERA, MULTIPLE CLASS, (INT. CLS. 9, 16, 35, 36, 38, 41 AND 42), (U.S. CLS. 2, 5, 21, 22, 23, 26, 29, 36, 37, 38, 50, 100, 101, 102, 104 AND 107). SN 76-320,532. PUB. 5-13-2003. FILED 10-2-2001.
- 2,746,130. **NAVISION (STYLIZED)**. NAVISION A/S, MULTIPLE CLASS, (INT. CLS. 9 AND 42), (U.S. CLS. 21, 23, 26, 36, 38, 100 AND 101). SN 76-321,419. PUB. 10-8-2002. FILED 10-4-2001.
- 2,746,149. **FIELD2LAB**. MB DYNAMICS INC., (U.S. CLS. 21, 23, 26, 36 AND 38). SN 76-327,364. PUB. 11-12-2002. FILED 10-19-2001.
- 2,746,150. **RIGHTNOW**. PRIORITY ONE INTERNATIONAL, INC., MULTIPLE CLASS, (INT. CLS. 9, 16, 41 AND 45), (U.S. CLS. 2, 5, 21, 22, 23, 26, 29, 36, 37, 38, 50, 100, 101 AND 107). SN 76-327,591. PUB. 10-8-2002. FILED 10-18-2001.
- 2,746,152. **OCTRON**. LIDL STIFTUNG & CO. KG, (U.S. CLS. 21, 23, 26, 36 AND 38). SN 76-328,131. PUB. 5-13-2003. FILED 10-19-2001.
- 2,746,164 (*See Class 1 for this trademark*).
- 2,746,177. **SURE-SEAL**. FORESTRY SUPPLIERS, INC., (U.S. CLS. 21, 23, 26, 36 AND 38). SN 76-336,030. PUB. 5-13-2003. FILED 11-9-2001.
- 2,746,180. **SIMDESK**. INTERNET ACCESS TECHNOLOGIES, INC., MULTIPLE CLASS, (INT. CLS. 9 AND 42), (U.S. CLS. 21, 23, 26, 36, 38, 100 AND 101). SN 76-336,532. PUB. 12-10-2002. FILED 11-9-2001.
- 2,746,186. **MISCELLANEOUS DESIGN**. ALTRA TECHNOLOGIES, INC., (U.S. CLS. 21, 23, 26, 36 AND 38). SN 76-337,512. PUB. 10-15-2002. FILED 11-13-2001.
- 2,746,191. **KANEST (STYLIZED)**. KASYS, MULTIPLE CLASS, (INT. CLS. 9, 41 AND 42), (U.S. CLS. 21, 23, 26, 36, 38, 100, 101 AND 107). SN 76-339,042. PUB. 12-24-2002. FILED 11-16-2001.
- 2,746,192. **STRATATRAK**. STRATA DECISION TECHNOLOGY, LLC, (U.S. CLS. 21, 23, 26, 36 AND 38). SN 76-339,119. PUB. 5-7-2002. FILED 11-16-2001.
- 2,746,197. **FIREFLY**. SPECTROS CORPORATION, MULTIPLE CLASS, (INT. CLS. 9 AND 10), (U.S. CLS. 21, 23, 26, 36, 38, 39 AND 44). SN 76-340,772. PUB. 11-19-2002. FILED 11-20-2001.
- 2,746,201 (*See Class 7 for this trademark*).
- 2,746,203. **BLUEGRID**. NTT SOFTWARE KABUSHIKI KAISHA, DBA NTT SOFTWARE CORPORATION, (U.S. CLS. 21, 23, 26, 36 AND 38). SN 76-341,645. PUB. 5-13-2003. FILED 11-27-2001.
- 2,746,212. **BARUFFA**. ZEGNA BARUFFA LANE BORGOSIA S.P.A., MULTIPLE CLASS, (INT. CLS. 9 AND 14), (U.S. CLS. 2, 21, 23, 26, 27, 28, 36, 38 AND 50). SN 76-343,135. PUB. 10-15-2002. FILED 11-30-2001.
- 2,746,220. **CYCLOCKS**. CYPRESS SEMICONDUCTOR CORPORATION, (U.S. CLS. 21, 23, 26, 36 AND 38). SN 76-345,743. PUB. 5-13-2003. FILED 12-7-2001.
- 2,746,221. **GENOPRO**. MORIN, DANIEL, (U.S. CLS. 21, 23, 26, 36 AND 38). SN 76-345,937. PUB. 5-13-2003. FILED 12-7-2001.
- 2,746,224. **INNOVETA (STYLIZED)**. INNOVETA TECHNOLOGIES, INC., (U.S. CLS. 21, 23, 26, 36 AND 38). SN 76-346,447. PUB. 5-13-2003. FILED 12-7-2001.
- 2,746,230. **MANAGE PATH AND DESIGN**. FISCHER SOLUTIONS, INC., DBA MANAGEPATH, (U.S. CLS. 21, 23, 26, 36 AND 38). SN 76-348,628. PUB. 5-13-2003. FILED 12-13-2001.
- 2,746,231. **MISCELLANEOUS DESIGN**. HOODMAN CORPORATION, (U.S. CLS. 21, 23, 26, 36 AND 38). SN 76-349,628. PUB. 5-13-2003. FILED 12-18-2001.
- 2,746,232. **MISCELLANEOUS DESIGN**. S. TOUS, S.L., (U.S. CLS. 21, 23, 26, 36 AND 38). SN 76-349,826. PUB. 9-24-2002. FILED 12-19-2001.
- 2,746,238. **HUNZA**. HUNZA HOLDINGS LTD, MULTIPLE CLASS, (INT. CLS. 9 AND 11), (U.S. CLS. 13, 21, 23, 26, 31, 34, 36 AND 38). SN 76-352,326. PUB. 5-13-2003. FILED 12-26-2001.
- 2,746,241. **UNIVISIUM 1:2 AND DESIGN**. STORARO, FABRIZIO, AND STORARO, VITTORIO, MULTIPLE CLASS, (INT. CLS. 9 AND 40), (U.S. CLS. 21, 23, 26, 36, 38, 100, 103 AND 106). SN 76-354,051. PUB. 5-13-2003. FILED 12-28-2001.
- 2,746,244. **VINEYARD MUSIC**. VINEYARD MUSIC GROUP, INC., (U.S. CLS. 21, 23, 26, 36 AND 38). SN 76-354,486. PUB. 5-13-2003. FILED 1-2-2002.
- 2,746,248. **VINEYARD MUSIC V AND DESIGN**. VINEYARD MUSIC GROUP, INC., (U.S. CLS. 21, 23, 26, 36 AND 38). SN 76-354,840. PUB. 5-13-2003. FILED 1-2-2002.
- 2,746,256. **MINIMATE**. PRISM VISUAL SOFTWARE, INC., (U.S. CLS. 21, 23, 26, 36 AND 38). SN 76-357,106. PUB. 10-29-2002. FILED 1-10-2002.
- 2,746,261. **THIN-QUERY**. INFORMATION SYSTEMS ENGINEERING, INC., (U.S. CLS. 21, 23, 26, 36 AND 38). SN 76-358,986. PUB. 5-13-2003. FILED 1-15-2002.
- 2,746,278. **VINEYARD WORSHIP**. VINEYARD MUSIC GROUP, INC., (U.S. CLS. 21, 23, 26, 36 AND 38). SN 76-364,005. PUB. 5-13-2003. FILED 1-29-2002.
- 2,746,301. **VISUAL INSTRUCTOR**. LILLY SOFTWARE ASSOCIATES, INC., (U.S. CLS. 21, 23, 26, 36 AND 38). SN 76-371,251. PUB. 5-13-2003. FILED 2-14-2002.
- 2,746,305. **VITS**. BRITISH AEROSPACE PUBLIC LIMITED COMPANY, (U.S. CLS. 21, 23, 26, 36 AND 38). SN 76-372,245. PUB. 5-13-2003. FILED 2-20-2002.
- 2,746,308. **ANNE FRANK**. ANNE FRANK STICHTING, (U.S. CLS. 21, 23, 26, 36 AND 38). SN 76-372,784. PUB. 5-13-2003. FILED 2-20-2002.
- 2,746,309. **MISCELLANEOUS DESIGN**. ANNE FRANK STICHTING, (U.S. CLS. 21, 23, 26, 36 AND 38). SN 76-372,785. PUB. 5-13-2003. FILED 2-20-2002.
- 2,746,319. **TRU BLU AND DESIGN**. HOME ENTERTAINMENT SUPPLIERS PTY LTD, MULTIPLE CLASS, (INT. CLS. 9 AND 35), (U.S. CLS. 21, 23, 26, 36, 38, 100, 101 AND 102). SN 76-374,062. PUB. 5-13-2003. FILED 2-22-2002.
- 2,746,327. **SIDOR**. MAIHAK AG, MULTIPLE CLASS, (INT. CLS. 9 AND 41), (U.S. CLS. 21, 23, 26, 36, 38, 100, 101 AND 107). SN 76-375,146. PUB. 5-13-2003. FILED 2-25-2002.
- 2,746,333. **STEINER**. STEINER-OPTIK GMBH, (U.S. CLS. 21, 23, 26, 36 AND 38). SN 76-376,925. PUB. 5-13-2003. FILED 2-28-2002.
- 2,746,345. **VIDEODISCOVERY**. VIDEODISCOVERY, INC., (U.S. CLS. 21, 23, 26, 36 AND 38). SN 76-378,881. PUB. 9-24-2002. FILED 3-6-2002.
- 2,746,355. **COLLECT WHAT'S REAL**. VICTORY COLLECTIBLES, LTD., (U.S. CLS. 21, 23, 26, 36 AND 38). SN 76-380,635. PUB. 5-13-2003. FILED 3-11-2002.
- 2,746,361. **TIRESAFE**. ALGONQUIN SCIENTIFIC, LLC, (U.S. CLS. 21, 23, 26, 36 AND 38). SN 76-381,688. PUB. 5-13-2003. FILED 3-5-2002.
- 2,746,364. **CROSSPOINT**. INTERSECT SOFTWARE CORPORATION, (U.S. CLS. 21, 23, 26, 36 AND 38). SN 76-382,786. PUB. 5-13-2003. FILED 3-13-2002.
- 2,746,380 (*See Class 2 for this trademark*).
- 2,746,390. **MIO**. MIO MECHANICAL CORPORATION, (U.S. CLS. 21, 23, 26, 36 AND 38). SN 76-386,743. PUB. 5-13-2003. FILED 3-25-2002.
- 2,746,392. **MARKTRACK**. LEXMARK INTERNATIONAL, INC., (U.S. CLS. 21, 23, 26, 36 AND 38). SN 76-386,856. PUB. 5-13-2003. FILED 3-22-2002.
- 2,746,393. **EDUTECH LTD.**. EDUTECH LTD., MULTIPLE CLASS, (INT. CLS. 9, 16 AND 41), (U.S. CLS. 2, 5, 21, 22, 23, 26, 29, 36, 37, 38, 50, 100, 101 AND 107). SN 76-386,895. PUB. 5-13-2003. FILED 3-25-2002.
- 2,746,394. **TEK-CHAIN**. TEK CHAIN DEVELOPMENT INC., (U.S. CLS. 21, 23, 26, 36 AND 38). SN 76-386,933. PUB. 5-13-2003. FILED 3-27-2002.
- 2,746,396. **SSA GLOBAL TECHNOLOGIES AND DESIGN**. SSA GLOBAL TECHNOLOGIES, INC., (U.S. CLS. 21, 23, 26, 36 AND 38). SN 76-387,245. PUB. 5-13-2003. FILED 3-25-2002.
- 2,746,399. **VALU-RIP**. MICHAEL WEINIG, INC., (U.S. CLS. 21, 23, 26, 36 AND 38). SN 76-387,631. PUB. 5-13-2003. FILED 3-27-2002.
- 2,746,400. **OPTIMAL ROBOTICS**. OPTIMAL ROBOTICS CORP., (U.S. CLS. 21, 23, 26, 36 AND 38). SN 76-387,891. PUB. 5-13-2003. FILED 3-26-2002.
- 2,746,404. **PRESSPLAY**. DUET G.P., (U.S. CLS. 21, 23, 26, 36 AND 38). SN 76-388,998. PUB. 5-13-2003. FILED 4-1-2002.

- 2,746,425. **I AM YOUR IDEA.** ACCENTURE GLOBAL SERVICES GMBH, MULTIPLE CLASS, (INT. CLS. 9, 16, 35, 36, 37, 41 AND 42), (U.S. CLS. 2, 5, 21, 22, 23, 26, 29, 36, 37, 38, 50, 100, 101, 102, 103, 106 AND 107). SN 76-393,070. PUB. 5-13-2003. FILED 4-1-2002.
- 2,746,431. **PHOENIX RISING CHI-GONG AND DESIGN.** THE TRUSTEES OF THE EDUCATIONAL ENTERPRISES, AN ARIZONA TRUST, THE TRUSTEES COMPRISING J.C. CHISUM AND JOHN WILDE, BOTH U.S. CITIZENS, (U.S. CLS. 21, 23, 26, 36 AND 38). SN 76-393,511. PUB. 5-13-2003. FILED 4-9-2002.
- 2,746,432. **NEON SPORTS AND DESIGN.** NEON SPORTS, LLC, (U.S. CLS. 21, 23, 26, 36 AND 38). SN 76-393,604. PUB. 5-13-2003. FILED 4-8-2002.
- 2,746,440. **TRACE.** XANTREX INTERNATIONAL, (U.S. CLS. 21, 23, 26, 36 AND 38). SN 76-394,533. PUB. 5-13-2003. FILED 4-11-2002.
- 2,746,444. **MATA HARI.** IGT, (U.S. CLS. 21, 23, 26, 36 AND 38). SN 76-394,920. PUB. 11-19-2002. FILED 4-12-2002.
- 2,746,454. **HERMES.** HERMES INTERNATIONAL, (U.S. CLS. 21, 23, 26, 36 AND 38). SN 76-396,081. PUB. 5-13-2003. FILED 4-16-2002.
- 2,746,458. **PRINCE 2 AND DESIGN.** THE LORDS COMMISSIONERS OF HER MAJESTY'S TREASURY ACTING THROUGH THE OFFICE OF GOVERNMENT COMMERCE, MULTIPLE CLASS, (INT. CLS. 9, 16, 35 AND 41), (U.S. CLS. 2, 5, 21, 22, 23, 26, 29, 36, 37, 38, 50, 100, 101, 102 AND 107). SN 76-396,374. PUB. 5-13-2003. FILED 4-16-2002.
- 2,746,461. **RICOS.** WIELAND ELECTRIC GMBH, (U.S. CLS. 21, 23, 26, 36 AND 38). SN 76-397,503. PUB. 5-13-2003. FILED 4-19-2002.
- 2,746,462. **ARTSIGN.** ZUMTOBEL STAFF GMBH, MULTIPLE CLASS, (INT. CLS. 9, 11 AND 42), (U.S. CLS. 13, 21, 23, 26, 31, 34, 36, 38, 100 AND 101). SN 76-397,625. PUB. 5-13-2003. FILED 4-17-2002.
- 2,746,463. **COMSIGN.** ZUMTOBEL STAFF GMBH, MULTIPLE CLASS, (INT. CLS. 9, 11 AND 42), (U.S. CLS. 13, 21, 23, 26, 31, 34, 36, 38, 100 AND 101). SN 76-397,626. PUB. 5-13-2003. FILED 4-17-2002.
- 2,746,469. **ARRAYFORT.** KABUSHIKI KAISHA TOSHIBA, TA TOSHIBA CORPORATION, (U.S. CLS. 21, 23, 26, 36 AND 38). SN 76-398,893. PUB. 5-13-2003. FILED 4-22-2002.
- 2,746,471. **THE PARENT INSTITUTE.** NIS, INC., DBA THE PARENT INSTITUTE, MULTIPLE CLASS, (INT. CLS. 9, 16 AND 42), (U.S. CLS. 2, 5, 21, 22, 23, 26, 29, 36, 37, 38, 50, 100 AND 101). SN 76-399,095. PUB. 5-13-2003. FILED 4-25-2002.
- 2,746,480. **IVEND.** INLAND FINANCE COMPANY, (U.S. CLS. 21, 23, 26, 36 AND 38). SN 76-400,915. PUB. 5-13-2003. FILED 4-29-2002.
- 2,746,487. **GEMS - GLOBAL ENTERPRISE MARKETING SYSTEM.** INTEGRATED MARKETING TECHNOLOGY, INC., (U.S. CLS. 21, 23, 26, 36 AND 38). SN 76-401,521. PUB. 5-13-2003. FILED 4-29-2002.
- 2,746,507. **EG ESCHER GROUP AND DESIGN.** ESCHER GROUP LTD., (U.S. CLS. 21, 23, 26, 36 AND 38). SN 76-404,435. PUB. 5-13-2003. FILED 5-7-2002.
- 2,746,510. **H HOMESPUN AND DESIGN.** HOMESPUN TAPES, LTD., (U.S. CLS. 21, 23, 26, 36 AND 38). SN 76-404,624. PUB. 5-13-2003. FILED 5-8-2002.
- 2,746,517. **THE FAMILY PRACTICE AND DESIGN.** FAMILY PRACTICE, INC., THE, (U.S. CLS. 21, 23, 26, 36 AND 38). SN 76-405,189. PUB. 5-13-2003. FILED 5-7-2002.
- 2,746,520. **JOBS JCMB'S OPEN BUSINESS SYSTEM AND DESIGN.** JCMB TECHNOLOGY INC., (U.S. CLS. 21, 23, 26, 36 AND 38). SN 76-405,949. PUB. 5-13-2003. FILED 5-10-2002.
- 2,746,527. **SEISMIC ACTIVITY.** PEAVEY ELECTRONICS CORPORATION, (U.S. CLS. 21, 23, 26, 36 AND 38). SN 76-406,569. PUB. 5-13-2003. FILED 5-6-2002.
- 2,746,540. **INTEGRAL ENTERPRISE DATA ACCESS SERIES.** DECISION RESOURCES, INC., (U.S. CLS. 21, 23, 26, 36 AND 38). SN 76-407,972. PUB. 5-13-2003. FILED 5-14-2002.
- 2,746,549. **LINK5.** NOKIA CORPORATION, MULTIPLE CLASS, (INT. CLS. 9, 28 AND 41), (U.S. CLS. 21, 22, 23, 26, 36, 38, 50, 100, 101 AND 107). SN 76-409,006. PUB. 5-13-2003. FILED 5-16-2002.
- 2,746,566. **OKAYA.** OKAYA ELECTRIC INDUSTRIES CO., LTD., (U.S. CLS. 21, 23, 26, 36 AND 38). SN 76-411,651. PUB. 5-13-2003. FILED 5-22-2002.
- 2,746,567. **OKAYA ELECTRIC INDUSTRIES CO., LTD..** OKAYA ELECTRIC INDUSTRIES CO., LTD., (U.S. CLS. 21, 23, 26, 36 AND 38). SN 76-411,652. PUB. 5-13-2003. FILED 5-22-2002.
- 2,746,573. **PAC CHECK.** MOCON, INC., (U.S. CLS. 21, 23, 26, 36 AND 38). SN 76-412,848. PUB. 5-13-2003. FILED 5-22-2002.
- 2,746,591. **MINISCU.** SCI SYSTEMS, INC., (U.S. CLS. 21, 23, 26, 36 AND 38). SN 76-418,225. PUB. 5-13-2003. FILED 5-17-2002.
- 2,746,597. **DYG-DIALOG.** DYG HOLDINGS, INC., MULTIPLE CLASS, (INT. CLS. 9 AND 16), (U.S. CLS. 2, 5, 21, 22, 23, 26, 29, 36, 37, 38 AND 50). SN 76-419,221. PUB. 5-13-2003. FILED 6-10-2002.
- 2,746,601. **OE PLUS PERFORMANCE.** STANDARD MOTOR PRODUCTS, INC., (U.S. CLS. 21, 23, 26, 36 AND 38). SN 76-419,706. PUB. 5-13-2003. FILED 6-12-2002.
- 2,746,609. **CERAMIC HOT TOOLS.** HELEN OF TROY LIMITED (BARBADOS), (U.S. CLS. 21, 23, 26, 36 AND 38). SN 76-420,279. PUB. 5-13-2003. FILED 6-14-2002.
- 2,746,612. **SITEBOTS AND DESIGN.** MEDIATROPE LLC, (U.S. CLS. 21, 23, 26, 36 AND 38). SN 76-420,665. PUB. 5-13-2003. FILED 6-14-2002.
- 2,746,614. **STORSTATION.** SONY KABUSHIKI KAISHA, TA SONY CORPORATION, (U.S. CLS. 21, 23, 26, 36 AND 38). SN 76-421,008. PUB. 5-13-2003. FILED 6-13-2002.
- 2,746,617. **STAFFALERT.** EDWARDS SYSTEMS TECHNOLOGY, INC., (U.S. CLS. 21, 23, 26, 36 AND 38). SN 76-422,107. PUB. 5-13-2003. FILED 6-12-2002.
- 2,746,622. **AS/SET.** SSA GLOBAL TECHNOLOGIES, INC., (U.S. CLS. 21, 23, 26, 36 AND 38). SN 76-422,833. PUB. 5-13-2003. FILED 6-19-2002.
- 2,746,624. **THE EMBEDDED VIDEO SOLUTIONS COMPANY.** NEOPARADIGM LABS, INC., DBA VIVODA COMMUNICATIONS, (U.S. CLS. 21, 23, 26, 36 AND 38). SN 76-422,954. PUB. 5-13-2003. FILED 6-19-2002.
- 2,746,630. **ENFOG.** ENCON SAFETY PRODUCTS, INC., (U.S. CLS. 21, 23, 26, 36 AND 38). SN 76-423,366. PUB. 5-13-2003. FILED 6-20-2002.
- 2,746,631. **IMI INFORMATION MAPPING (STYLIZED).** INFORMATION MAPPING, INC., (U.S. CLS. 21, 23, 26, 36 AND 38). SN 76-423,491. PUB. 5-13-2003. FILED 6-18-2002.
- 2,746,633. **TUFF-SPEC.** ENCON SAFETY PRODUCTS, INC., (U.S. CLS. 21, 23, 26, 36 AND 38). SN 76-423,584. PUB. 5-13-2003. FILED 6-20-2002.
- 2,746,635. **VIDEOBANNER.** CLARITY VISUAL SYSTEMS, INC., (U.S. CLS. 21, 23, 26, 36 AND 38). SN 76-424,283. PUB. 5-13-2003. FILED 6-24-2002.
- 2,746,639. **TOTOKU.** TOKYO TOKUSHU DENSEN KABUSHIKI KAISHA, TA TOTOKU ELECTRIC CO., LTD., (U.S. CLS. 21, 23, 26, 36 AND 38). SN 76-425,416. PUB. 5-13-2003. FILED 6-26-2002.
- 2,746,647. **THE BIG AHA.** SKYSHAPERS FITNESS FOUNDATION, INC., MULTIPLE CLASS, (INT. CLS. 9, 16 AND 41), (U.S. CLS. 2, 5, 21, 22, 23, 26, 29, 36, 37, 38, 50, 100, 101 AND 107). SN 76-427,003. PUB. 5-13-2003. FILED 7-2-2002.
- 2,746,672. **WINSIGHT.** C/S SOLUTIONS, INC., (U.S. CLS. 21, 23, 26, 36 AND 38). SN 76-434,711. PUB. 5-13-2003. FILED 7-25-2002.
- 2,746,692. **REQUIEM.** HOEFLER TYPE FOUNDRY, INC., THE, (U.S. CLS. 21, 23, 26, 36 AND 38). SN 76-438,725. PUB. 5-13-2003. FILED 8-8-2002.
- 2,746,693. **WHITNEY.** HOEFLER TYPE FOUNDRY, INC., THE, (U.S. CLS. 21, 23, 26, 36 AND 38). SN 76-438,726. PUB. 5-13-2003. FILED 8-8-2002.
- 2,746,700. **FRM.** YOKOGAWA ELECTRIC CORPORATION, (U.S. CLS. 21, 23, 26, 36 AND 38). SN 76-440,191. PUB. 5-13-2003. FILED 8-14-2002.
- 2,746,722. **SIGNA.** UNIVERSAL LIGHTING TECHNOLOGIES, INC., (U.S. CLS. 21, 23, 26, 36 AND 38). SN 76-442,370. PUB. 5-13-2003. FILED 8-22-2002.
- 2,746,726. **GOPP'S GALAXY.** INFLEXION, INC., (U.S. CLS. 21, 23, 26, 36 AND 38). SN 76-442,826. PUB. 5-13-2003. FILED 8-16-2002.
- 2,746,731. **DINOTOPIA.** BDSP, INC., (U.S. CLS. 21, 23, 26, 36 AND 38). SN 76-443,821. PUB. 5-13-2003. FILED 8-26-2002.
- 2,746,736. **BILSTEIN B9.** KRUPP BILSTEIN GMBH, MULTIPLE CLASS, (INT. CLS. 9 AND 12), (U.S. CLS. 19, 21, 23, 26,

- 31, 35, 36, 38 AND 44). SN 76-444,717. PUB. 5-13-2003. FILED 8-19-2002.
- 2,746,737. **BILSTEIN B8**. KRUPP BILSTEIN GMBH, MULTIPLE CLASS, (INT. CLS. 9 AND 12), (U.S. CLS. 19, 21, 23, 26, 31, 35, 36, 38 AND 44). SN 76-444,719. PUB. 5-13-2003. FILED 8-19-2002.
- 2,746,738. **BILSTEIN B17**. KRUPP BILSTEIN GMBH, MULTIPLE CLASS, (INT. CLS. 9 AND 12), (U.S. CLS. 19, 21, 23, 26, 31, 35, 36, 38 AND 44). SN 76-444,720. PUB. 5-13-2003. FILED 8-19-2002.
- 2,746,739. **BILSTEIN B11**. KRUPP BILSTEIN GMBH, MULTIPLE CLASS, (INT. CLS. 9 AND 12), (U.S. CLS. 19, 21, 23, 26, 31, 35, 36, 38 AND 44). SN 76-444,723. PUB. 5-13-2003. FILED 8-19-2002.
- 2,746,740. **BILSTEIN B12**. KRUPP BILSTEIN GMBH, MULTIPLE CLASS, (INT. CLS. 9 AND 12), (U.S. CLS. 19, 21, 23, 26, 31, 35, 36, 38 AND 44). SN 76-444,724. PUB. 5-13-2003. FILED 8-19-2002.
- 2,746,742. **BILSTEIN B20**. KRUPP BILSTEIN GMBH, MULTIPLE CLASS, (INT. CLS. 9 AND 12), (U.S. CLS. 19, 21, 23, 26, 31, 35, 36, 38 AND 44). SN 76-444,907. PUB. 5-13-2003. FILED 8-19-2002.
- 2,746,743. **BILSTEIN B15**. KRUPP BILSTEIN GMBH, MULTIPLE CLASS, (INT. CLS. 9 AND 12), (U.S. CLS. 19, 21, 23, 26, 31, 35, 36, 38 AND 44). SN 76-444,909. PUB. 5-13-2003. FILED 8-19-2002.
- 2,746,744. **BILSTEIN B18**. KRUPP BILSTEIN GMBH, MULTIPLE CLASS, (INT. CLS. 9 AND 12), (U.S. CLS. 19, 21, 23, 26, 31, 35, 36, 38 AND 44). SN 76-444,910. PUB. 5-13-2003. FILED 8-19-2002.
- 2,746,745. **BILSTEIN B2**. KRUPP BILSTEIN GMBH, MULTIPLE CLASS, (INT. CLS. 9 AND 12), (U.S. CLS. 19, 21, 23, 26, 31, 35, 36, 38 AND 44). SN 76-444,912. PUB. 5-13-2003. FILED 8-19-2002.
- 2,746,746. **BILSTEIN B5**. KRUPP BILSTEIN GMBH, MULTIPLE CLASS, (INT. CLS. 9 AND 12), (U.S. CLS. 19, 21, 23, 26, 31, 35, 36, 38 AND 44). SN 76-444,916. PUB. 5-13-2003. FILED 8-19-2002.
- 2,746,764. **FULLRIVER AND DESIGN**. FULLRIVER BATTERY MANUFACTURE CO., LTD., (U.S. CLS. 21, 23, 26, 36 AND 38). SN 76-446,785. PUB. 5-13-2003. FILED 9-3-2002.
- 2,746,783. **MISCELLANEOUS DESIGN**. SUNDANCE PUBLISHING LLC, (U.S. CLS. 21, 23, 26, 36 AND 38). SN 76-448,558. PUB. 5-13-2003. FILED 9-11-2002.
- 2,746,803. **INFOTYME (STYLIZED)**. CITY DIRECTORIES, INC., (U.S. CLS. 21, 23, 26, 36 AND 38). SN 76-450,014. PUB. 5-13-2003. FILED 9-16-2002.
- 2,746,813. **BVS**. BVS, INC., DBA BVS PERFORMANCE SYSTEMS, MULTIPLE CLASS, (INT. CLS. 9 AND 16), (U.S. CLS. 2, 5, 21, 22, 23, 26, 29, 36, 37, 38 AND 50). SN 76-450,427. PUB. 5-13-2003. FILED 9-17-2002.
- 2,746,824. **WORLD CLASS CUISINE**. DISCOVERY COMMUNICATIONS, INC., MULTIPLE CLASS, (INT. CLS. 9 AND 41), (U.S. CLS. 21, 23, 26, 36, 38, 100, 101 AND 107). SN 76-451,789. PUB. 5-13-2003. FILED 9-18-2002.
- 2,746,835. **KEEP AMERICA SEWING**. VSM GROUP AB, (U.S. CLS. 21, 23, 26, 36 AND 38). SN 76-452,246. PUB. 5-13-2003. FILED 9-23-2002.
- 2,746,837. **APPASSURE**. ALIGNMENT SOFTWARE INC., (U.S. CLS. 21, 23, 26, 36 AND 38). SN 76-452,374. PUB. 5-13-2003. FILED 9-24-2002.
- 2,746,840. **MAKING CANCER HISTORY**. BOARD OF REGENTS, THE UNIVERSITY OF TEXAS SYSTEM, MULTIPLE CLASS, (INT. CLS. 9, 12, 14, 16, 18, 20, 21, 25 AND 28), (U.S. CLS. 1, 2, 3, 5, 13, 19, 21, 22, 23, 25, 26, 27, 28, 29, 30, 31, 32, 33, 35, 36, 37, 38, 39, 40, 41, 44 AND 50). SN 76-452,546. PUB. 5-13-2003. FILED 9-25-2002.
- 2,746,864. **ALLEGRA**. BECKMAN COULTER, INC., (U.S. CLS. 21, 23, 26, 36 AND 38). SN 76-453,678. PUB. 5-13-2003. FILED 9-30-2002.
- 2,746,880. **SERVICES AND MATERIALS**. FLEX-O-LITE, INC., (U.S. CLS. 21, 23, 26, 36 AND 38). SN 76-454,380. PUB. 5-13-2003. FILED 9-25-2002.
- 2,746,890. **K-S**. STI LICENSING CORPORATION, (U.S. CLS. 21, 23, 26, 36 AND 38). SN 76-454,995. PUB. 5-13-2003. FILED 10-2-2002.
- 2,746,904. **MISCELLANEOUS DESIGN**. XEROX CORPORATION, (U.S. CLS. 21, 23, 26, 36 AND 38). SN 76-455,575. PUB. 5-13-2003. FILED 10-2-2002.
- 2,746,905. **P.T.O.**. KOEI CO., LTD., (U.S. CLS. 21, 23, 26, 36 AND 38). SN 76-455,667. PUB. 5-13-2003. FILED 10-3-2002.
- 2,746,920. **A-2000**. LEVITON MANUFACTURING CO., INC., (U.S. CLS. 21, 23, 26, 36 AND 38). SN 76-456,327. PUB. 5-13-2003. FILED 9-27-2002.
- 2,746,933. **ZEEBAR**. HOMAC MFG. COMPANY, (U.S. CLS. 21, 23, 26, 36 AND 38). SN 76-457,148. PUB. 5-13-2003. FILED 10-9-2002.
- 2,746,939. **SOLUTION SELLING**. SOLUTION SELLING, INC., (U.S. CLS. 21, 23, 26, 36 AND 38). SN 76-457,567. PUB. 5-13-2003. FILED 9-30-2002.
- 2,746,946. **AIR PAW**. ERGOAIR, INC., (U.S. CLS. 21, 23, 26, 36 AND 38). SN 76-458,758. PUB. 5-13-2003. FILED 10-17-2002.
- 2,746,947. **AMERICAN HERITAGE**. LION APPAREL, INC., (U.S. CLS. 21, 23, 26, 36 AND 38). SN 76-458,763. PUB. 5-13-2003. FILED 10-17-2002.
- 2,746,948. **RIP TIDE**. NORTHERN SAFETY CO., INC., (U.S. CLS. 21, 23, 26, 36 AND 38). SN 76-458,800. PUB. 5-13-2003. FILED 10-9-2002.
- 2,746,949. **TOUR RALLY**. NORTHERN SAFETY CO., INC., (U.S. CLS. 21, 23, 26, 36 AND 38). SN 76-458,803. PUB. 5-13-2003. FILED 10-9-2002.
- 2,746,951. **EZREAD**. GARNER INDUSTRIES, INC., (U.S. CLS. 21, 23, 26, 36 AND 38). SN 76-458,875. PUB. 5-13-2003. FILED 10-17-2002.
- 2,746,952. **E-SEARCH & VIEW**. MOBIUS MANAGEMENT SYSTEMS, INC., (U.S. CLS. 21, 23, 26, 36 AND 38). SN 76-458,889. PUB. 5-13-2003. FILED 10-17-2002.
- 2,746,956. **PENSIONPARTNER**. SEGAL COMPANY (EASTERN STATES), INC., THE, (U.S. CLS. 21, 23, 26, 36 AND 38). SN 76-458,993. PUB. 5-13-2003. FILED 10-17-2002.
- 2,746,967. **EXPRESSOMATIC**. PROPARK, INC., (U.S. CLS. 21, 23, 26, 36 AND 38). SN 76-459,320. PUB. 5-13-2003. FILED 10-18-2002.
- 2,746,969. **AIRPAY BY AUTHORIZE.NET**. INFOSPACE, INC., MULTIPLE CLASS, (INT. CLS. 9 AND 36), (U.S. CLS. 21, 23, 26, 36, 38, 100, 101 AND 102). SN 76-459,466. PUB. 5-13-2003. FILED 10-21-2002.
- 2,746,975. **BRAINIAC! AND DESIGN**. FRICK, GLEN S., (U.S. CLS. 21, 23, 26, 36 AND 38). SN 76-459,980. PUB. 5-13-2003. FILED 10-21-2002.
- 2,746,979. **HOSTALERT**. JTECH COMMUNICATIONS, INC., (U.S. CLS. 21, 23, 26, 36 AND 38). SN 76-460,222. PUB. 5-13-2003. FILED 10-11-2002.
- 2,746,980. **T-REX ONE**. TECHRX INCORPORATED, (U.S. CLS. 21, 23, 26, 36 AND 38). SN 76-460,223. PUB. 5-13-2003. FILED 10-11-2002.
- 2,746,988. **CHEMKIN**. REACTION DESIGN, (U.S. CLS. 21, 23, 26, 36 AND 38). SN 76-460,913. PUB. 5-13-2003. FILED 10-22-2002.
- 2,746,991. **IQTROLLER**. METROLOGIC INSTRUMENTS, INC., (U.S. CLS. 21, 23, 26, 36 AND 38). SN 76-461,002. PUB. 5-13-2003. FILED 10-18-2002.
- 2,746,992. **VINLOGIC**. INSIGHT NETWORK LOGISTICS, (U.S. CLS. 21, 23, 26, 36 AND 38). SN 76-461,038. PUB. 5-13-2003. FILED 10-24-2002.
- 2,746,998. **BUILD A FORM**. THE MORF CORPORATION, (U.S. CLS. 21, 23, 26, 36 AND 38). SN 76-461,685. PUB. 5-13-2003. FILED 10-25-2002.
- 2,747,002. **EPIC**. U.I. LAPP GMBH, (U.S. CLS. 21, 23, 26, 36 AND 38). SN 76-461,874. PUB. 5-13-2003. FILED 10-28-2002.
- 2,747,003. **SAL**. SECURITY APPLICATIONS, INC., (U.S. CLS. 21, 23, 26, 36 AND 38). SN 76-461,884. PUB. 5-13-2003. FILED 10-28-2002.
- 2,747,004. **PAPERLESS**. MASTER CONTROL SYSTEMS, INC., (U.S. CLS. 21, 23, 26, 36 AND 38). SN 76-461,947. PUB. 5-13-2003. FILED 10-25-2002.
- 2,747,007. **MERANT COLLAGE**. MERANT INC., (U.S. CLS. 21, 23, 26, 36 AND 38). SN 76-462,076. PUB. 5-13-2003. FILED 10-28-2002.
- 2,747,024. **CUBECAST**. OVERLAND, ARVE, (U.S. CLS. 21, 23, 26, 36 AND 38). SN 76-463,918. PUB. 5-13-2003. FILED 11-4-2002.
- 2,747,027. **ZENOBI**. FONT BUREAU, INC., THE, (U.S. CLS. 21, 23, 26, 36 AND 38). SN 76-464,079. PUB. 5-13-2003. FILED 11-4-2002.
- 2,747,028. **TRUTH**. FONT BUREAU, INC., THE, (U.S. CLS. 21,

- 23, 26, 36 AND 38). SN 76-464,080. PUB. 5-13-2003. FILED 11-4-2002.
- 2,747,033. **GENELCO**. LIBERTY INSURANCE SERVICES CORPORATION, (U.S. CLS. 21, 23, 26, 36 AND 38). SN 76-465,050. PUB. 5-13-2003. FILED 11-7-2002.
- 2,747,034. **GENELCO REINSURANCE+**. LIBERTY INSURANCE SERVICES CORPORATION, (U.S. CLS. 21, 23, 26, 36 AND 38). SN 76-465,051. PUB. 5-13-2003. FILED 11-7-2002.
- 2,747,035. **GENELCO GROUPWEB**. LIBERTY INSURANCE SERVICES CORPORATION, (U.S. CLS. 21, 23, 26, 36 AND 38). SN 76-465,055. PUB. 5-13-2003. FILED 11-7-2002.
- 2,747,056. **ADLIZARD AND DESIGN**. LIZARD RESEARCH PTY LTD, MULTIPLE CLASS, (INT. CLS. 9 AND 42), (U.S. CLS. 21, 23, 26, 36, 38, 100 AND 101). SN 78-015,324. PUB. 5-13-2003. FILED 7-3-2000.
- 2,747,057. **PROXIMION**. PROXIMION FIBER OPTICS AB, (U.S. CLS. 21, 23, 26, 36 AND 38). SN 78-015,625. PUB. 5-13-2003. FILED 7-6-2000.
- 2,747,058. **INDUSTRIAL TECHNOLOGIES AND DESIGN**. IRAD NV, (U.S. CLS. 21, 23, 26, 36 AND 38). SN 78-022,781. PUB. 5-13-2003. FILED 8-24-2000.
- 2,747,059. **FOGEX**. INVENTION TECHNOLOGIES PTY LTD, (U.S. CLS. 21, 23, 26, 36 AND 38). SN 78-025,597. PUB. 2-5-2002. FILED 9-12-2000.
- 2,747,062. **EELE ENHANCED AND DESIGN**. EELE LABORATORIES, LLC, (U.S. CLS. 21, 23, 26, 36 AND 38). SN 78-030,130. PUB. 5-13-2003. FILED 10-11-2000.
- 2,747,071. **MISCELLANEOUS DESIGN**. SANDSTORM ENTERPRISES, INC., (U.S. CLS. 21, 23, 26, 36 AND 38). SN 78-042,594. PUB. 5-13-2003. FILED 1-10-2001.
- 2,747,072. **VIASCOPE**. SCOPE INC., (U.S. CLS. 21, 23, 26, 36 AND 38). SN 78-042,993. PUB. 10-22-2002. FILED 1-12-2001.
- 2,747,077. **ROLE MINER**. SYSTOR GMBH & CO. KG, MULTIPLE CLASS, (INT. CLS. 9 AND 42), (U.S. CLS. 21, 23, 26, 36, 38, 100 AND 101). SN 78-057,038. PUB. 10-8-2002. FILED 4-5-2001.
- 2,747,080. **ARTS4ALL**. ARTS4ALL, LTD., MULTIPLE CLASS, (INT. CLS. 9, 38, 41 AND 42), (U.S. CLS. 21, 23, 26, 36, 38, 100, 101, 104 AND 107). SN 78-061,090. PUB. 5-13-2003. FILED 4-30-2001.
- 2,747,081. **BLUWIN (STYLIZED)**. BLUEWIN AG, MULTIPLE CLASS, (INT. CLS. 9, 16, 35, 38 AND 42), (U.S. CLS. 2, 5, 21, 22, 23, 26, 29, 36, 37, 38, 50, 100, 101, 102 AND 104). SN 78-066,740. PUB. 5-13-2003. FILED 5-31-2001.
- 2,747,083. **MECOM AND DESIGN**. MOORE, GREGORY, (U.S. CLS. 21, 23, 26, 36 AND 38). SN 78-071,112. PUB. 5-13-2003. FILED 6-26-2001.
- 2,747,085. **ASSETHOUSE**. ASSETHOUSE TECHNOLOGY LIMITED, MULTIPLE CLASS, (INT. CLS. 9, 38 AND 42), (U.S. CLS. 21, 23, 26, 36, 38, 100, 101 AND 104). SN 78-072,033. PUB. 5-13-2003. FILED 7-2-2001.
- 2,747,089. **POSLITE AND DESIGN**. JIANGSU DONGHAI OPTICAL GLASSES CO., LTD., (U.S. CLS. 21, 23, 26, 36 AND 38). SN 78-075,836. PUB. 11-5-2002. FILED 7-26-2001.
- 2,747,091. **XCLEF**. MULTICHANNEL LABS CO., LTD., (U.S. CLS. 21, 23, 26, 36 AND 38). SN 78-080,381. PUB. 1-28-2003. FILED 8-21-2001.
- 2,747,108. **MISCELLANEOUS DESIGN**. CEYLONSOFT TECHNOLOGIES INC., (U.S. CLS. 21, 23, 26, 36 AND 38). SN 78-095,973. PUB. 5-13-2003. FILED 11-30-2001.
- 2,747,120. **PACS MMS MIS SMS DST AND DESIGN**. HARPAK, INC., (U.S. CLS. 21, 23, 26, 36 AND 38). SN 78-103,599. PUB. 5-13-2003. FILED 1-18-2002.
- 2,747,121. **KLEANZ AND DESIGN**. NEXCOR TECHNOLOGIES, INC., (U.S. CLS. 21, 23, 26, 36 AND 38). SN 78-104,049. PUB. 5-13-2003. FILED 1-22-2002.
- 2,747,123. **SAGESTAR**. LEGEND TECHNOLOGY CO., LTD., MULTIPLE CLASS, (INT. CLS. 9 AND 28), (U.S. CLS. 21, 22, 23, 26, 36, 38 AND 50). SN 78-104,758. PUB. 5-13-2003. FILED 1-25-2002.
- 2,747,131. **DATACORE**. DATACORE SOFTWARE CORPORATION, (U.S. CLS. 21, 23, 26, 36 AND 38). SN 78-106,986. PUB. 5-13-2003. FILED 2-5-2002.
- 2,747,134. **IT GLOBALSECURE, INC. AND DESIGN**. IT GLOBALSECURE, INC., MULTIPLE CLASS, (INT. CLS. 9 AND 42), (U.S. CLS. 21, 23, 26, 36, 38, 100 AND 101). SN 78-107,476. PUB. 5-13-2003. FILED 2-7-2002.
- 2,747,137. **BRAINSELECT**. MINDSET BIOPHARMACEUTICALS (USA) INC., MULTIPLE CLASS, (INT. CLS. 9, 42 AND 44), (U.S. CLS. 21, 23, 26, 36, 38, 100 AND 101). SN 78-109,037. PUB. 5-13-2003. FILED 2-15-2002.
- 2,747,140. **MISCELLANEOUS DESIGN**. SPOTWAVE WIRELESS INC., (U.S. CLS. 21, 23, 26, 36 AND 38). SN 78-111,155. PUB. 5-13-2003. FILED 2-26-2002.
- 2,747,141. **SHOUTING THOMAS**. THOMAS, STEPHEN, AND THOMAS, MYRNA, (U.S. CLS. 21, 23, 26, 36 AND 38). SN 78-111,179. PUB. 5-13-2003. FILED 2-26-2002.
- 2,747,150. **QUICKSET**. QUICKSET INTERNATIONAL, INC., (U.S. CLS. 21, 23, 26, 36 AND 38). SN 78-113,335. PUB. 5-13-2003. FILED 3-7-2002.
- 2,747,160. **SMASHER**. NEAL, KENNETH W., (U.S. CLS. 21, 23, 26, 36 AND 38). SN 78-117,708. PUB. 5-13-2003. FILED 3-27-2002.
- 2,747,173. **WIRELESSWALL**. CRANITE SYSTEMS, INC., (U.S. CLS. 21, 23, 26, 36 AND 38). SN 78-120,015. PUB. 5-13-2003. FILED 4-6-2002.
- 2,747,175. **CONSPAN**. LEAP SOFTWARE, INC., (U.S. CLS. 21, 23, 26, 36 AND 38). SN 78-120,128. PUB. 5-13-2003. FILED 4-8-2002.
- 2,747,177. **ACCUTECH AND DESIGN**. RACING PRODUCTS GROUP, INC., (U.S. CLS. 21, 23, 26, 36 AND 38). SN 78-120,486. PUB. 5-13-2003. FILED 4-9-2002.
- 2,747,179. **SYMPHONIA**. ORION SYSTEMS NEW ZEALAND LIMITED, (U.S. CLS. 21, 23, 26, 36 AND 38). SN 78-121,620. PUB. 5-13-2003. FILED 4-14-2002.
- 2,747,181. **CALYTRIX SIMPLICITY**. CALYTRIX TECHNOLOGIES PTY LTD., (U.S. CLS. 21, 23, 26, 36 AND 38). SN 78-121,701. PUB. 5-13-2003. FILED 4-15-2002.
- 2,747,191. **AUTOBANKER**. DIEBOLD, INCORPORATED, (U.S. CLS. 21, 23, 26, 36 AND 38). SN 78-124,314. PUB. 5-13-2003. FILED 4-26-2002.
- 2,747,193. **JOY STORIES**. FROST, JOY, (U.S. CLS. 21, 23, 26, 36 AND 38). SN 78-124,522. PUB. 5-13-2003. FILED 4-26-2002.
- 2,747,207. **KNOWLEDGE POST**. KNOWLEDGE ANALYSIS TECHNOLOGIES, LLC, (U.S. CLS. 21, 23, 26, 36 AND 38). SN 78-130,399. PUB. 5-13-2003. FILED 5-22-2002.
- 2,747,213. **MERCHANT MAGIC**. CERVELLE SOFTWARE INCORPORATED, (U.S. CLS. 21, 23, 26, 36 AND 38). SN 78-133,329. PUB. 5-13-2003. FILED 6-5-2002.
- 2,747,215. **BAULIN-TUBE**. WISEMAN, BRIAN, M., (U.S. CLS. 21, 23, 26, 36 AND 38). SN 78-135,101. PUB. 5-13-2003. FILED 6-12-2002.
- 2,747,240. **SERVOCAM AND DESIGN**. AMT MACHINE SYSTEMS LTD., (U.S. CLS. 21, 23, 26, 36 AND 38). SN 78-146,915. PUB. 5-13-2003. FILED 7-24-2002.
- 2,747,250. **IXATTACK**. IXIA, (U.S. CLS. 21, 23, 26, 36 AND 38). SN 78-148,363. PUB. 5-13-2003. FILED 7-29-2002.
- 2,747,252. **QUEUE (STYLIZED)**. GAMEKITCHEN LLC, (U.S. CLS. 21, 23, 26, 36 AND 38). SN 78-149,108. PUB. 5-13-2003. FILED 7-31-2002.
- 2,747,271. **CYBERLINK POWERDIRECTOR**. CYBERLINK CORP., (U.S. CLS. 21, 23, 26, 36 AND 38). SN 78-152,126. PUB. 5-13-2003. FILED 8-8-2002.
- 2,747,274. **TOUCHFOCUS**. TOSHIBA AMERICA CONSUMER PRODUCTS, INC., (U.S. CLS. 21, 23, 26, 36 AND 38). SN 78-152,595. PUB. 5-13-2003. FILED 8-9-2002.
- 2,747,287 (See Class 1 for this trademark).
- 2,747,289. **DEEP SIX**. ENERGY SAVERS UNLIMITED, INC., (U.S. CLS. 21, 23, 26, 36 AND 38). SN 78-153,629. PUB. 5-13-2003. FILED 8-13-2002.
- 2,747,297. **TAKECHARGE (STYLIZED)**. SMART MEDICAL SOFTWARE, (U.S. CLS. 21, 23, 26, 36 AND 38). SN 78-154,705. PUB. 5-13-2003. FILED 8-15-2002.
- 2,747,298. **THIRST AND DESIGN**. HEINEKEN BROUWERIJEN B.V., MULTIPLE CLASS, (INT. CLS. 9 AND 41), (U.S. CLS. 21, 23, 26, 36, 38, 100, 101 AND 107). SN 78-154,884. PUB. 5-13-2003. FILED 8-16-2002.
- 2,747,303. **REGI AND DESIGN**. ATTRONICA COMPUTERS, INC., (U.S. CLS. 21, 23, 26, 36 AND 38). SN 78-155,866. PUB. 5-13-2003. FILED 8-20-2002.
- 2,747,314. **CRT**. VANDYKE SOFTWARE, INC., (U.S. CLS. 21, 23, 26, 36 AND 38). SN 78-159,090. PUB. 4-8-2003. FILED 8-29-2002.
- 2,747,320. **VAPOR PRO FX**. ARIZONA INSTRUMENT, LLC, (U.S. CLS. 21, 23, 26, 36 AND 38). SN 78-160,311. PUB. 5-13-2003. FILED 9-3-2002.

- 2,747,321. **DARWIN TECHNOLOGIES SOFTWARE**. RESEARCH INSTITUTE, (U.S. CLS. 21, 23, 26, 36 AND 38). SN 78-160,529. PUB. 5-13-2003. FILED 9-4-2002.
- 2,747,325. **FABGEN**. SYSMARK INFORMATION SYSTEMS, INC., (U.S. CLS. 21, 23, 26, 36 AND 38). SN 78-161,796. PUB. 5-13-2003. FILED 9-8-2002.
- 2,747,327. **MARKETRON**. MARKETRON INTERNATIONAL, INC., BY MERGER BUYMEDIA, INC., (U.S. CLS. 21, 23, 26, 36 AND 38). SN 78-162,832. PUB. 5-13-2003. FILED 9-11-2002.
- 2,747,336. **SLEEPING AT LAST**. RYAN CURTIS O'NEAL, (U.S. CLS. 21, 23, 26, 36 AND 38). SN 78-163,532. PUB. 5-13-2003. FILED 9-12-2002.
- 2,747,356. **TRAVEL AGENCY IN A BOX**. GLOBAL TRAVEL INTERNATIONAL, INC., MULTIPLE CLASS, (INT. CLS. 9 AND 35), (U.S. CLS. 21, 23, 26, 36, 38, 100, 101 AND 102). SN 78-165,849. PUB. 5-13-2003. FILED 9-19-2002.
- 2,747,375. **FLAT SCREEN AND DESIGN**. SANYO MANUFACTURING CORPORATION, (U.S. CLS. 21, 23, 26, 36 AND 38). SN 78-168,072. PUB. 5-13-2003. FILED 9-26-2002.
- 2,747,383. **3SI SECURITY SYSTEMS AND DESIGN**. 3SI SECURITY SYSTEMS, (U.S. CLS. 21, 23, 26, 36 AND 38). SN 78-168,901. PUB. 5-13-2003. FILED 9-27-2002.
- 2,747,401. **POINTMERGE**. MEDTRONIC, INC., (U.S. CLS. 21, 23, 26, 36 AND 38). SN 78-170,257. PUB. 5-13-2003. FILED 10-2-2002.
- 2,747,402. **SURFACEMERGE**. MEDTRONIC, INC., (U.S. CLS. 21, 23, 26, 36 AND 38). SN 78-170,259. PUB. 5-13-2003. FILED 10-2-2002.
- 2,747,421. **TRAK-POLE**. POLE/ZERO CORPORATION, (U.S. CLS. 21, 23, 26, 36 AND 38). SN 78-171,684. PUB. 5-13-2003. FILED 10-7-2002.
- 2,747,422. **WRENCHHEAD PRO MANAGER**. WRENCHHEAD-COM, INC., (U.S. CLS. 21, 23, 26, 36 AND 38). SN 78-171,757. PUB. 5-13-2003. FILED 10-7-2002.
- 2,747,428. **ACROBAT RECORDS**. NATHANSON, MATT, (U.S. CLS. 21, 23, 26, 36 AND 38). SN 78-171,944. PUB. 5-13-2003. FILED 10-7-2002.
- 2,747,429. **HOT POINT FITNESS**. ZIMELMAN, STEVEN T, (U.S. CLS. 21, 23, 26, 36 AND 38). SN 78-171,950. PUB. 5-13-2003. FILED 10-7-2002.
- 2,747,434. **TENNIS IN A CAN**. BOLLETTIERI, INC., MULTIPLE CLASS, (INT. CLS. 9 AND 16), (U.S. CLS. 2, 5, 21, 22, 23, 26, 29, 36, 37, 38 AND 50). SN 78-172,360. PUB. 5-13-2003. FILED 10-8-2002.
- 2,747,438. **MYOTAPE (STYLIZED)**. ACCUFITNESS, LLC, (U.S. CLS. 21, 23, 26, 36 AND 38). SN 78-173,594. PUB. 5-13-2003. FILED 10-11-2002.
- 2,747,448. **TWIN TURBINE**. MICHELI, DON, DBA CONSUMER ELECTRONICS UNLIMITED, (U.S. CLS. 21, 23, 26, 36 AND 38). SN 78-178,617. PUB. 5-13-2003. FILED 10-25-2002.
- 2,747,454. **POWERED BY MINT**. BALDOR ELECTRIC COMPANY, (U.S. CLS. 21, 23, 26, 36 AND 38). SN 78-182,236. PUB. 5-13-2003. FILED 11-6-2002.
- 2,747,455. **KEEMUX**. NETWORK TECHNOLOGIES, INC., (U.S. CLS. 21, 23, 26, 36 AND 38). SN 78-185,617. PUB. 5-13-2003. FILED 11-15-2002.
- 2,745,814. **SNAPFLAP**. FISHER & PAYKEL HEALTHCARE LIMITED, (U.S. CLS. 26, 39 AND 44). SN 76-171,596. PUB. 2-19-2002. FILED 11-27-2000.
- 2,745,827 (*See Class 5 for this trademark*).
- 2,745,884. **RSWT RADIAL SHOCK WAVE THERAPY**. EMS MEDICAL VERTRIEBS-UND FORSCHUNGSGESELLSCHAFT MBH, (U.S. CLS. 26, 39 AND 44). SN 76-215,489. PUB. 5-13-2003. FILED 2-22-2001.
- 2,745,899 (*See Class 5 for this trademark*).
- 2,745,902. **VISUALIZATION TECHNOLOGY AND DESIGN**. VISUALIZATION TECHNOLOGY, INC., (U.S. CLS. 26, 39 AND 44). SN 76-228,059. PUB. 10-8-2002. FILED 3-21-2001.
- 2,745,908. **MISCELLANEOUS DESIGN**. PORTEX, INC., BY CHANGE OF NAME SIMS PORTEX INC., (U.S. CLS. 26, 39 AND 44). SN 76-231,649. PUB. 5-13-2003. FILED 3-28-2001.
- 2,745,912. **ESHELL (STYLIZED)**. PHONAK HOLDING AG, (U.S. CLS. 26, 39 AND 44). SN 76-232,324. PUB. 11-19-2002. FILED 3-29-2001.
- 2,745,915 (*See Class 8 for this trademark*).
- 2,745,984 (*See Class 9 for this trademark*).
- 2,746,010. **MEDSOURCE TECHNOLOGIES**. MEDSOURCE TECHNOLOGIES, INC., MULTIPLE CLASS, (INT. CLS. 10 AND 35), (U.S. CLS. 26, 39, 44, 100, 101 AND 102). SN 76-277,592. PUB. 5-13-2003. FILED 6-27-2001.
- 2,746,011. **MEDSOURCE TECHNOLOGIES AND DESIGN**. MEDSOURCE TECHNOLOGIES, INC., MULTIPLE CLASS, (INT. CLS. 10 AND 35), (U.S. CLS. 26, 39, 44, 100, 101 AND 102). SN 76-277,625. PUB. 5-13-2003. FILED 6-27-2001.
- 2,746,017. **GOLDEN-RULE**. PBN MEDICALS DENMARK A/S, (U.S. CLS. 26, 39 AND 44). SN 76-281,474. PUB. 5-13-2003. FILED 7-6-2001.
- 2,746,075 (*See Class 1 for this trademark*).
- 2,746,096. **GEL-E DONUT**. RESPIRONICS NOVAMETRIX, INC., BY MERGER NOVAMETRIX MEDICAL SYSTEMS INC., (U.S. CLS. 26, 39 AND 44). SN 76-309,667. PUB. 5-13-2003. FILED 9-6-2001.
- 2,746,101 (*See Class 9 for this trademark*).
- 2,746,185. **SKY SOCK**. UNIVERSITY COLLEGE LONDON, MULTIPLE CLASS, (INT. CLS. 10 AND 25), (U.S. CLS. 22, 26, 39 AND 44). SN 76-337,451. PUB. 5-13-2003. FILED 11-14-2001.
- 2,746,197 (*See Class 9 for this trademark*).
- 2,746,207. **ACTIGAIT**. NEURODAN A/S, (U.S. CLS. 26, 39 AND 44). SN 76-342,211. PUB. 5-13-2003. FILED 11-27-2001.
- 2,746,289. **ALLFLEX AND DESIGN**. ALLFLEX USA, INC., (U.S. CLS. 26, 39 AND 44). SN 76-368,338. PUB. 10-22-2002. FILED 2-8-2002.
- 2,746,324. **HERO APICAL**. MICRO MEGA, S.A., (U.S. CLS. 26, 39 AND 44). SN 76-375,011. PUB. 4-15-2003. FILED 2-26-2002.
- 2,746,325. **HERO SHAPER**. MICRO MEGA, S.A., (U.S. CLS. 26, 39 AND 44). SN 76-375,012. PUB. 4-15-2003. FILED 2-26-2002.
- 2,746,326. **ENDOF LARE**. MICRO MEGA, S.A., (U.S. CLS. 26, 39 AND 44). SN 76-375,013. PUB. 5-13-2003. FILED 2-26-2002.
- 2,746,437. **BIOWARM AND DESIGN**. LIN, KU-SHEN, (U.S. CLS. 26, 39 AND 44). SN 76-394,322. PUB. 5-13-2003. FILED 4-12-2002.
- 2,746,498. **T.E.A.R. TECH 2000**. VISIONQUEST INDUSTRIES, INC., DBA VQ ORTHOCARE, (U.S. CLS. 26, 39 AND 44). SN 76-402,920. PUB. 5-13-2003. FILED 5-2-2002.
- 2,746,760. **SPORTSRAC**. SPORTSTRAC SYSTEMS, INC., (U.S. CLS. 26, 39 AND 44). SN 76-446,246. PUB. 5-13-2003. FILED 8-30-2002.
- 2,746,806. **JEWETT**. FLORIDA BRACE CORPORATION, (U.S. CLS. 26, 39 AND 44). SN 76-450,118. PUB. 5-13-2003. FILED 9-16-2002.
- 2,747,023. **HEARTSINE**. HEARTSINE TECHNOLOGIES, INC., (U.S. CLS. 26, 39 AND 44). SN 76-463,917. PUB. 5-13-2003. FILED 11-4-2002.
- 2,747,029. **FOILER**. ALPHA SCIENTIFIC CORPORATION, (U.S. CLS. 26, 39 AND 44). SN 76-464,218. PUB. 5-13-2003. FILED 11-5-2002.
- 2,747,063 (*See Class 5 for this trademark*).
- 2,747,074. **OSTEOFORM MESH**. OSTEOMED L.P., BY ASSIGNMENT OSTEOMED CORPORATION, (U.S. CLS. 26, 39 AND 44). SN 78-045,316. PUB. 5-13-2003. FILED 1-28-2001.
- 2,747,103. **PROACT**. NTERO SURGICAL, (U.S. CLS. 26, 39 AND 44). SN 78-093,417. PUB. 5-13-2003. FILED 11-14-2001.

CLASS 10—MEDICAL APPARATUS

- 2,745,434 (*See Class 9 for this trademark*).
- 2,745,459. **AMNIOMAT**. KARL STORZ GMBH & CO. KG., BY ASSIGNMENT KARL STORZ GMBH, & CO., (U.S. CLS. 26, 39 AND 44). SN 75-513,902. PUB. 9-17-2002. FILED 7-3-1998.
- 2,745,524 (*See Class 9 for this trademark*).
- 2,745,525 (*See Class 9 for this trademark*).
- 2,745,600 (*See Class 9 for this trademark*).
- 2,745,629 (*See Class 9 for this trademark*).
- 2,745,695. **N R J ETICS**. INTERNATIONAL DELTON FABRICS LTD., MULTIPLE CLASS, (INT. CLS. 10, 11, 24, 25 AND 27), (U.S. CLS. 13, 19, 20, 21, 22, 23, 26, 31, 34, 37, 39, 42, 44 AND 50). SN 76-061,142. PUB. 10-8-2002. FILED 6-1-2000.
- 2,745,779 (*See Class 5 for this trademark*).
- 2,745,786 (*See Class 5 for this trademark*).
- 2,745,791. **ACCUSAGE**. TACTICA INTERNATIONAL, INC., (U.S. CLS. 26, 39 AND 44). SN 76-146,616. PUB. 5-13-2003. FILED 10-16-2000.

2,747,153. **NEUFLEX**. DEPUY, INC., (U.S. CLS. 26, 39 AND 44). SN 78-115,206. PUB. 5-13-2003. FILED 3-15-2002.
 2,747,247. **EZCOVER**. LITTLE RAPIDS CORPORATION, (U.S. CLS. 26, 39 AND 44). SN 78-147,748. PUB. 5-13-2003. FILED 7-26-2002.
 2,747,344. **EMSI-4250**. ELECTROSTIM MEDICAL SERVICES, INC., DBA EMSI CORPORATION, (U.S. CLS. 26, 39 AND 44). SN 78-164,954. PUB. 5-13-2003. FILED 9-17-2002.

CLASS 11—ENVIRONMENTAL CONTROL APPARATUS

2,745,447 (*See Class 9 for this trademark*).
 2,745,460. **MISCELLANEOUS DESIGN**. MAG INSTRUMENT, INC., (U.S. CLS. 13, 21, 23, 31 AND 34). SN 75-520,395. PUB. 4-2-2002. FILED 7-16-1998.
 2,745,504. **EO3T ENVIROZONE TECHNOLOGIES INC. AND DESIGN**. ENVIROZONE TECHNOLOGIES, INC., MULTIPLE CLASS, (INT. CLS. 11, 37, 40 AND 42), (U.S. CLS. 13, 21, 23, 31, 34, 100, 101, 103 AND 106). SN 75-663,764. PUB. 5-13-2003. FILED 3-19-1999.
 2,745,506 (*See Class 6 for this trademark*).
 2,745,511 (*See Class 9 for this trademark*).
 2,745,515 (*See Class 6 for this trademark*).
 2,745,542 (*See Class 7 for this trademark*).
 2,745,546. **VALORSTAT**. VALOR LIMITED, (U.S. CLS. 13, 21, 23, 31 AND 34). SN 75-792,811. PUB. 5-13-2003. FILED 9-2-1999.
 2,745,548. **BTA**. BTA BIOTECHNISCHE ABFALLVERWERTUNG GMBH & CO. KG, MULTIPLE CLASS, (INT. CLS. 11, 40 AND 42), (U.S. CLS. 13, 21, 23, 31, 34, 100, 101, 103 AND 106). SN 75-799,684. PUB. 12-4-2001. FILED 9-14-1999.
 2,745,665 (*See Class 9 for this trademark*).
 2,745,666 (*See Class 7 for this trademark*).
 2,745,695 (*See Class 10 for this trademark*).
 2,745,771 (*See Class 9 for this trademark*).
 2,745,813. **OPTIMA AND DESIGN**. HAMON THERMAL EUROPE S.A., (U.S. CLS. 13, 21, 23, 31 AND 34). SN 76-170,682. PUB. 5-13-2003. FILED 11-24-2000.
 2,745,826. **SOFTPLASMA (STYLIZED)**. NKT RESEARCH A/S, MULTIPLE CLASS, (INT. CLS. 11, 40 AND 42), (U.S. CLS. 13, 21, 23, 31, 34, 100, 101, 103 AND 106). SN 76-179,457. PUB. 5-13-2003. FILED 12-12-2000.
 2,745,972. **MOORCROFT**. W. MOORCROFT P.L.C., MULTIPLE CLASS, (INT. CLS. 11, 14, 16, 19, 21 AND 24), (U.S. CLS. 1, 2, 5, 12, 13, 21, 22, 23, 27, 28, 29, 30, 31, 33, 34, 37, 38, 40, 42 AND 50). SN 76-262,164. PUB. 5-13-2003. FILED 5-23-2001.
 2,746,025. **ULTISEP**. POROUS MEDIA CORPORATION, (U.S. CLS. 13, 21, 23, 31 AND 34). SN 76-285,940. PUB. 10-22-2002. FILED 7-9-2001.
 2,746,069. **MELTEMI**. NEMO S.P.A., BY CHANGE OF NAME NEMO S.R.L., (U.S. CLS. 13, 21, 23, 31 AND 34). SN 76-296,882. PUB. 5-13-2003. FILED 8-7-2001.
 2,746,075 (*See Class 1 for this trademark*).
 2,746,082. **STEFANI AND DESIGN**. CERAMICA STEFANI S.A., (U.S. CLS. 13, 21, 23, 31 AND 34). SN 76-305,088. PUB. 5-13-2003. FILED 8-27-2001.
 2,746,156 (*See Class 7 for this trademark*).
 2,746,238 (*See Class 9 for this trademark*).
 2,746,279. **DUALAIRE**. ERIC COURT INDUSTRIES INC., DBA EVOLVE CORPORATION, (U.S. CLS. 13, 21, 23, 31 AND 34). SN 76-364,288. PUB. 5-13-2003. FILED 1-29-2002.
 2,746,384. **VERWATER ENVIRONMENTAL, LLC AND DESIGN**. VERWATER ENVIRONMENTAL, LLC, (U.S. CLS. 13, 21, 23, 31 AND 34). SN 76-385,870. PUB. 5-13-2003. FILED 3-21-2002.
 2,746,452. **ULTRAVATION**. ULTRAVATION, INC., (U.S. CLS. 13, 21, 23, 31 AND 34). SN 76-395,752. PUB. 5-13-2003. FILED 4-15-2002.
 2,746,462 (*See Class 9 for this trademark*).
 2,746,463 (*See Class 9 for this trademark*).
 2,746,522. **CLEAR MIRROR AND DESIGN**. NEWHOME BATH AND MIRROR, INC., (U.S. CLS. 13, 21, 23, 31 AND 34). SN 76-406,209. PUB. 5-13-2003. FILED 5-9-2002.
 2,746,579 (*See Class 8 for this trademark*).
 2,746,721. **WALRAD**. HAMWORTHY COMBUSTION ENGI-

NEERING LTD., (U.S. CLS. 13, 21, 23, 31 AND 34). SN 76-442,223. PUB. 5-13-2003. FILED 8-21-2002.
 2,746,723. **BREEZAIR**. FF SEELEY NOMINEES PTY LTD, (U.S. CLS. 13, 21, 23, 31 AND 34). SN 76-442,582. PUB. 5-13-2003. FILED 8-16-2002.
 2,746,787. **COLORCHECK AND DESIGN**. THE HOLMES GROUP, INC., (U.S. CLS. 13, 21, 23, 31 AND 34). SN 76-448,715. PUB. 5-13-2003. FILED 9-12-2002.
 2,746,802. **AIRQC**. AIRQC CORPORATION, FORMERLY BREATHE EASY, INC., (U.S. CLS. 13, 21, 23, 31 AND 34). SN 76-449,876. PUB. 5-13-2003. FILED 9-6-2002.
 2,746,888. **SOFTCELL (STYLIZED)**. METRY COMPANIES, LLC, (U.S. CLS. 13, 21, 23, 31 AND 34). SN 76-454,743. PUB. 5-13-2003. FILED 10-2-2002.
 2,747,100. **MISCELLANEOUS DESIGN**. INNOVATIVE LIGHTING, INC., (U.S. CLS. 13, 21, 23, 31 AND 34). SN 78-090,014. PUB. 5-13-2003. FILED 10-24-2001.
 2,747,238. **BRILLIANT AND DESIGN**. PRODUCTWORKS LLC, (U.S. CLS. 13, 21, 23, 31 AND 34). SN 78-146,495. PUB. 5-13-2003. FILED 7-23-2002.
 2,747,255. **QUIET PARTNER**. WHIRLPOOL PROPERTIES, INC., (U.S. CLS. 13, 21, 23, 31 AND 34). SN 78-149,625. PUB. 5-13-2003. FILED 8-1-2002.
 2,747,313. **VITIPORE**. MILLIPORE CORPORATION, (U.S. CLS. 13, 21, 23, 31 AND 34). SN 78-159,059. PUB. 5-13-2003. FILED 8-29-2002.
 2,747,337. **PINNACLE**. IMI CORNELIUS INC., (U.S. CLS. 13, 21, 23, 31 AND 34). SN 78-163,534. PUB. 5-13-2003. FILED 9-12-2002.
 2,747,396. **KLEERWATER**. KLEERWATER TECHNOLOGIES, (U.S. CLS. 13, 21, 23, 31 AND 34). SN 78-169,966. PUB. 5-13-2003. FILED 10-1-2002.
 2,747,397. **MISCELLANEOUS DESIGN**. KLEERWATER TECHNOLOGIES, (U.S. CLS. 13, 21, 23, 31 AND 34). SN 78-169,972. PUB. 5-13-2003. FILED 10-1-2002.
 2,747,398. **SOLARMAX**. SYNERGOS HOLDINGS CORPORATION, (U.S. CLS. 13, 21, 23, 31 AND 34). SN 78-169,974. PUB. 5-13-2003. FILED 10-1-2002.
 2,747,415. **NIG**. NICEGOOD U.S.A. LTD., (U.S. CLS. 13, 21, 23, 31 AND 34). SN 78-171,488. PUB. 5-13-2003. FILED 10-6-2002.
 2,747,435. **CONCENTRA**. HUNTER FAN COMPANY, (U.S. CLS. 13, 21, 23, 31 AND 34). SN 78-172,443. PUB. 5-13-2003. FILED 10-9-2002.
 2,747,436. **COMMODORE VANDERBILT**. HUNTER FAN COMPANY, (U.S. CLS. 13, 21, 23, 31 AND 34). SN 78-172,445. PUB. 5-13-2003. FILED 10-9-2002.

CLASS 12—VEHICLES

2,745,522 (*See Class 9 for this trademark*).
 2,745,524 (*See Class 9 for this trademark*).
 2,745,556. **NOTHING OUTWORKS A WORKHORSE**. WORKHORSE CUSTOM CHASSIS, LLC, (U.S. CLS. 19, 21, 23, 31, 35 AND 44). SN 75-815,976. PUB. 9-12-2000. FILED 10-5-1999.
 2,745,634 (*See Class 7 for this trademark*).
 2,745,707. **NORTHERN LITE**. NORTHERN LITE MFG. LTD., (U.S. CLS. 19, 21, 23, 31, 35 AND 44). SN 76-074,257. PUB. 5-13-2003. FILED 6-20-2000.
 2,745,753. **HI-PLY**. BCATCO ARL, (U.S. CLS. 19, 21, 23, 31, 35 AND 44). SN 76-113,875. PUB. 5-13-2003. FILED 8-22-2000.
 2,745,754. **MUD'R HI-TRAK**. BCATCO ARL, (U.S. CLS. 19, 21, 23, 31, 35 AND 44). SN 76-113,882. PUB. 5-13-2003. FILED 8-22-2000.
 2,745,768. **SPEEDGLASS RACING WINDSHIELDS AND DESIGN**. PERCY'S HIGH PERFORMANCE, INC., (U.S. CLS. 19, 21, 23, 31, 35 AND 44). SN 76-127,141. PUB. 10-8-2002. FILED 9-14-2000.
 2,745,772. **ESCORT**. THOR TECH, INC., (U.S. CLS. 19, 21, 23, 31, 35 AND 44). SN 76-130,849. PUB. 10-23-2001. FILED 9-19-2000.
 2,745,774. **WORKBOSS**. AIRBOSS OF AMERICA CORP., (U.S. CLS. 19, 21, 23, 31, 35 AND 44). SN 76-132,119. PUB. 12-31-2002. FILED 9-20-2000.
 2,745,784. **ROLL-TOP-COVER**. PACE-EDWARDS CO., (U.S. CLS. 19, 21, 23, 31, 35 AND 44). SN 76-140,979. PUB. 5-13-2003. FILED 10-3-2000.

2,745,787 (*See Class 4 for this trademark*).
 2,745,834. **CHALLENGER OFFSHORE**. MARINE HOLDINGS, INC., (U.S. CLS. 19, 21, 23, 31, 35 AND 44). SN 76-187,338. PUB. 8-6-2002. FILED 12-28-2000.
 2,745,898 (*See Class 6 for this trademark*).
 2,745,911. **AISLE-MASTER AND DESIGN**. AISLE MASTER LTD., (U.S. CLS. 19, 21, 23, 31, 35 AND 44). SN 76-231,969. PUB. 5-13-2003. FILED 3-28-2001.
 2,745,926 (*See Class 9 for this trademark*).
 2,745,929. **CERATO**. KIA MOTORS CORPORATION, (U.S. CLS. 19, 21, 23, 31, 35 AND 44). SN 76-239,922. PUB. 9-4-2001. FILED 4-12-2001.
 2,746,058. **NATURE WHEEL**. AUSTRIA ALU-GUSS GESELLSCHAFT M.B.H., (U.S. CLS. 19, 21, 23, 31, 35 AND 44). SN 76-293,801. PUB. 7-16-2002. FILED 8-1-2001.
 2,746,059. **JAG CART PULLER**. COLUMBIA PARCAR CORP., (U.S. CLS. 19, 21, 23, 31, 35 AND 44). SN 76-293,817. PUB. 7-30-2002. FILED 8-2-2001.
 2,746,060. **R 580**. DAIMLERCHRYSLER AG, (U.S. CLS. 19, 21, 23, 31, 35 AND 44). SN 76-294,734. PUB. 9-10-2002. FILED 8-2-2001.
 2,746,061. **R 550**. DAIMLERCHRYSLER AG, (U.S. CLS. 19, 21, 23, 31, 35 AND 44). SN 76-294,735. PUB. 9-10-2002. FILED 8-2-2001.
 2,746,062. **R 500**. DAIMLERCHRYSLER AG, (U.S. CLS. 19, 21, 23, 31, 35 AND 44). SN 76-294,736. PUB. 9-10-2002. FILED 8-2-2001.
 2,746,063. **R 520**. DAIMLERCHRYSLER AG, (U.S. CLS. 19, 21, 23, 31, 35 AND 44). SN 76-294,737. PUB. 10-8-2002. FILED 8-2-2001.
 2,746,064. **R 280**. DAIMLERCHRYSLER AG, (U.S. CLS. 19, 21, 23, 31, 35 AND 44). SN 76-294,742. PUB. 9-10-2002. FILED 8-2-2001.
 2,746,102. **KLEEN**. KAWASAKI JUKOGYO KABUSHIKI KAISHA, DBA KAWASAKI HEAVY INDUSTRIES, LTD., (U.S. CLS. 19, 21, 23, 31, 35 AND 44). SN 76-311,873. PUB. 5-13-2003. FILED 9-12-2001.
 2,746,106. **PRO-THERM**. FRANTSCHACH COATING BELGIUM N.V., (U.S. CLS. 19, 21, 23, 31, 35 AND 44). SN 76-313,096. PUB. 5-13-2003. FILED 9-17-2001.
 2,746,128. **SIGUS 2000**. KEIPER GMBH & CO., (U.S. CLS. 19, 21, 23, 31, 35 AND 44). SN 76-321,327. PUB. 10-29-2002. FILED 10-4-2001.
 2,746,144. **X-30**. MASTERCRAFT BOAT COMPANY, INC., (U.S. CLS. 19, 21, 23, 31, 35 AND 44). SN 76-326,230. PUB. 3-26-2002. FILED 10-17-2001.
 2,746,159 (*See Class 7 for this trademark*).
 2,746,262. **SL 550**. DAIMLERCHRYSLER AG, MULTIPLE CLASS, (INT. CLS. 12, 28 AND 37), (U.S. CLS. 19, 21, 22, 23, 31, 35, 38, 44, 50, 100, 103 AND 106). SN 76-359,644. PUB. 5-13-2003. FILED 1-16-2002.
 2,746,266. **DECORSA AND DESIGN**. KANEI INC., (U.S. CLS. 19, 21, 23, 31, 35 AND 44). SN 76-361,088. PUB. 5-13-2003. FILED 1-23-2002.
 2,746,341. **O AND DESIGN**. OXYGEN S.P.A., (U.S. CLS. 19, 21, 23, 31, 35 AND 44). SN 76-377,912. PUB. 5-13-2003. FILED 3-1-2002.
 2,746,434 (*See Class 7 for this trademark*).
 2,746,570. **MINI**. BAYERISCHE MOTOREN WERKE AKTIENGESELLSCHAFT, (U.S. CLS. 19, 21, 23, 31, 35 AND 44). SN 76-412,371. PUB. 5-13-2003. FILED 5-14-2002.
 2,746,652. **FLEE**. MINIBIKEWORLD.COM LLC, (U.S. CLS. 19, 21, 23, 31, 35 AND 44). SN 76-427,437. PUB. 5-13-2003. FILED 7-3-2002.
 2,746,736 (*See Class 9 for this trademark*).
 2,746,737 (*See Class 9 for this trademark*).
 2,746,738 (*See Class 9 for this trademark*).
 2,746,739 (*See Class 9 for this trademark*).
 2,746,740 (*See Class 9 for this trademark*).
 2,746,742 (*See Class 9 for this trademark*).
 2,746,743 (*See Class 9 for this trademark*).
 2,746,744 (*See Class 9 for this trademark*).
 2,746,745 (*See Class 9 for this trademark*).
 2,746,746 (*See Class 9 for this trademark*).
 2,746,758. **P4 CARBON**. P4 GROUP, LLC, (U.S. CLS. 19, 21, 23, 31, 35 AND 44). SN 76-445,963. PUB. 5-13-2003. FILED 8-30-2002.
 2,746,780. **ESSENTIAL**. INVACARE CORPORATION, (U.S.

CLS. 19, 21, 23, 31, 35 AND 44). SN 76-448,323. PUB. 5-13-2003. FILED 9-10-2002.
 2,746,791. **RIVIERA**. RIVIERA MARINE (MFG.) PTY. LTD., (U.S. CLS. 19, 21, 23, 31, 35 AND 44). SN 76-449,253. PUB. 5-13-2003. FILED 9-13-2002.
 2,746,840 (*See Class 9 for this trademark*).
 2,747,444. **BESTREST AND DESIGN**. BESTREST PRODUCTS, L.L.C., (U.S. CLS. 19, 21, 23, 31, 35 AND 44). SN 78-176,138. PUB. 5-13-2003. FILED 10-18-2002.

CLASS 13—FIREARMS

2,745,764. **TERMINATOR**. NORTH CENTRAL INDUSTRIES, INC., (U.S. CLS. 2 AND 9). SN 76-118,825. PUB. 10-16-2001. FILED 6-5-2000.
 2,746,338. **I-RDX**. SNPE, (U.S. CLS. 2 AND 9). SN 76-377,372. PUB. 5-13-2003. FILED 3-1-2002.
 2,746,365. **GECO AND DESIGN**. DYNAMIT NOBEL GMBH EXPLOSIVSTOFF-UND SYSTEMTECHNIK, (U.S. CLS. 2 AND 9). SN 76-382,789. PUB. 5-13-2003. FILED 3-13-2002.
 2,746,367. **H MANTEL AND DESIGN**. DYNAMIT NOBEL GMBH EXPLOSIVSTOFF-UND SYSTEMTECHNIK, (U.S. CLS. 2 AND 9). SN 76-383,110. PUB. 5-13-2003. FILED 3-13-2002.
 2,746,490. **V VIHTAVUORI AND DESIGN**. NEXPLO VIHTAVUORI OY, (U.S. CLS. 2 AND 9). SN 76-402,563. PUB. 5-13-2003. FILED 4-30-2002.

CLASS 14—JEWELRY

2,745,418 (*See Class 9 for this trademark*).
 2,745,435 (*See Class 9 for this trademark*).
 2,745,436 (*See Class 6 for this trademark*).
 2,745,487. **CHLOE**. CHLOE SOCIETE ANONYME, (U.S. CLS. 2, 27, 28 AND 50). SN 75-611,908. PUB. 4-8-2003. FILED 12-24-1998.
 2,745,550 (*See Class 3 for this trademark*).
 2,745,580. **PHILIPPE MORALY AND DESIGN**. AWARTANI, NASER MUNIER A/R, (U.S. CLS. 2, 27, 28 AND 50). SN 75-862,782. PUB. 5-13-2003. FILED 12-2-1999.
 2,745,582 (*See Class 3 for this trademark*).
 2,745,682 (*See Class 5 for this trademark*).
 2,745,683 (*See Class 3 for this trademark*).
 2,745,715 (*See Class 9 for this trademark*).
 2,745,729 (*See Class 3 for this trademark*).
 2,745,743. **FENDISSIME**. FENDI ADELE S.R.L., (U.S. CLS. 2, 27, 28 AND 50). SN 76-105,862. PUB. 5-13-2003. FILED 8-9-2000.
 2,745,799 (*See Class 8 for this trademark*).
 2,745,822. **PIERRES SAUVAGES**. CARTIER INTERNATIONAL B.V., (U.S. CLS. 2, 27, 28 AND 50). SN 76-174,804. PUB. 5-13-2003. FILED 12-4-2000.
 2,745,829. **B AND DESIGN**. WILLY BOGNER GMBH & CO. KOMMANDITGESELLSCHAFT AUF AKTIEN, (U.S. CLS. 2, 27, 28 AND 50). SN 76-184,016. PUB. 11-19-2002. FILED 12-20-2000.
 2,745,882 (*See Class 6 for this trademark*).
 2,745,972 (*See Class 11 for this trademark*).
 2,746,034. **VERONESE COLLECTION AND DESIGN**. QVC, INC., (U.S. CLS. 2, 27, 28 AND 50). SN 76-287,574. PUB. 5-13-2003. FILED 7-19-2001.
 2,746,085. **LENOX**. NORFOLK INVESTMENTS, INC., (U.S. CLS. 2, 27, 28 AND 50). SN 76-305,958. PUB. 11-5-2002. FILED 8-28-2001.
 2,746,093 (*See Class 9 for this trademark*).
 2,746,100 (*See Class 6 for this trademark*).
 2,746,148. **MISCELLANEOUS DESIGN**. FEDERATION FRANCAISE DE FOOTBALL, MULTIPLE CLASS, (INT. CLS. 14, 16, 18, 25, 28, 38 AND 41), (U.S. CLS. 1, 2, 3, 5, 22, 23, 27, 28, 29, 37, 38, 39, 41, 50, 100, 101, 104 AND 107). SN 76-326,737. PUB. 11-19-2002. FILED 10-18-2001.
 2,746,212 (*See Class 9 for this trademark*).
 2,746,405. **BALFOUR PREMIUM SILVER WITH PLATINUM**

- AND DESIGN.** COMMEMORATIVE BRANDS, INC., (U.S. CLS. 2, 27, 28 AND 50). SN 76-389,563. PUB. 5-13-2003. FILED 3-29-2002.
- 2,746,423. **ECCOMI (STYLIZED),** MARO JEWELRY CO., LTD., MULTIPLE CLASS, (INT. CLS. 14, 26 AND 35), (U.S. CLS. 2, 27, 28, 37, 39, 40, 42, 50, 100, 101 AND 102). SN 76-392,836. PUB. 5-13-2003. FILED 4-9-2002.
- 2,746,445. **STULLER.** STULLER, INC., MULTIPLE CLASS, (INT. CLS. 14 AND 35), (U.S. CLS. 2, 27, 28, 50, 100, 101 AND 102). SN 76-394,997. PUB. 5-13-2003. FILED 4-12-2002.
- 2,746,475. **MY HEART'S MISSING LINK AND DESIGN.** KILBURG, CHERYL, (U.S. CLS. 2, 27, 28 AND 50). SN 76-399,833. PUB. 5-13-2003. FILED 4-23-2002.
- 2,746,563. **NRG EXCITING ITALIAN DESIGN.** ROBERTO TRAVISIO, SAS, (U.S. CLS. 2, 27, 28 AND 50). SN 76-411,275. PUB. 5-13-2003. FILED 5-28-2002.
- 2,746,564. **MENEGATTI.** MENEGATTI FRATELLI SPA., (U.S. CLS. 2, 27, 28 AND 50). SN 76-411,276. PUB. 5-13-2003. FILED 5-28-2002.
- 2,746,840 (*See Class 9 for this trademark*).
- 2,746,878. **SPRINGCUT.** KANNER, AMI, (U.S. CLS. 2, 27, 28 AND 50). SN 76-454,242. PUB. 5-13-2003. FILED 10-1-2002.
- 2,746,882. **PERFECTLY ENGAGING.,** HEARTS ON FIRE COMPANY, (U.S. CLS. 2, 27, 28 AND 50). SN 76-454,437. PUB. 5-13-2003. FILED 9-23-2002.
- 2,747,149. **OMEGA AND DESIGN.** OMEGA SA (OMEGA AG) (OMEGA LTD.), (U.S. CLS. 2, 27, 28 AND 50). SN 78-113,326. PUB. 5-13-2003. FILED 3-7-2002.
- 2,747,166. **W AND DESIGN.** KURACINA, THOMAS C., MULTIPLE CLASS, (INT. CLS. 14 AND 16), (U.S. CLS. 2, 5, 22, 23, 27, 28, 29, 37, 38 AND 50). SN 78-118,831. PUB. 5-13-2003. FILED 4-1-2002.
- 2,747,169. **TWO BLONDE LIZZARDS "STELLAR SUPERFLUTITIES" (ADJ. AWE-INSPIRING N. TRINKETS) AND DESIGN.** TWO BLONDE LIZZARDS, LLC., MULTIPLE CLASS, (INT. CLS. 14 AND 25), (U.S. CLS. 2, 22, 27, 28, 39 AND 50). SN 78-119,579. PUB. 5-13-2003. FILED 4-4-2002.
- 2,747,171. **ASTROBAND.** ASHBROOK, DANIEL W., (U.S. CLS. 2, 27, 28 AND 50). SN 78-119,871. PUB. 5-13-2003. FILED 4-5-2002.
- 2,747,226. **SIDIO.** STANFORD INTERNATIONAL HOLDING CORPORATION, (U.S. CLS. 2, 27, 28 AND 50). SN 78-142,450. PUB. 5-13-2003. FILED 7-9-2002.
- 2,747,333. **DISCOVERY COVE AND DESIGN.** SEA WORLD, INC., (U.S. CLS. 2, 27, 28 AND 50). SN 78-163,460. PUB. 5-13-2003. FILED 9-12-2002.
- 2,747,348. **MARC LAZAR.** MARC LAZAR INC., (U.S. CLS. 2, 27, 28 AND 50). SN 78-165,243. PUB. 5-13-2003. FILED 9-18-2002.
- 2,745,446. **OPTIMA.** ATLANTIC PACKAGING PRODUCTS LTD., (U.S. CLS. 2, 5, 22, 23, 29, 37, 38 AND 50). SN 75-445,881. PUB. 1-22-2002. FILED 3-6-1998.
- 2,745,464. **STORK CLUB AND DESIGN.** LEISURE TIME SERVICES, INC., MULTIPLE CLASS, (INT. CLS. 16, 21, 29 AND 35), (U.S. CLS. 2, 5, 13, 22, 23, 29, 30, 33, 37, 38, 40, 46, 50, 100, 101 AND 102). SN 75-535,236. PUB. 9-19-2000. FILED 8-12-1998.
- 2,745,467 (*See Class 9 for this trademark*).
- 2,745,521. **KO-REC-IT.** BAROUH EATON ALLEN CORPORATION, (U.S. CLS. 2, 5, 22, 23, 29, 37, 38 AND 50). SN 75-709,350. PUB. 6-11-2002. FILED 5-17-1999.
- 2,745,533 (*See Class 5 for this trademark*).
- 2,745,534. **ECOACH.** SENN-DELANEY LEADERSHIP CONSULTING GROUP, INC., MULTIPLE CLASS, (INT. CLS. 16 AND 42), (U.S. CLS. 2, 5, 22, 23, 29, 37, 38, 50, 100 AND 101). SN 75-756,280. PUB. 12-31-2002. FILED 7-19-1999.
- 2,745,536 (*See Class 9 for this trademark*).
- 2,745,541 (*See Class 9 for this trademark*).
- 2,745,542 (*See Class 7 for this trademark*).
- 2,745,574 (*See Class 9 for this trademark*).
- 2,745,576. **YANKEE PAPER CO.,** RODNEY LOOMIS, DBA LOOMCO INTERNATIONAL, (U.S. CLS. 2, 5, 22, 23, 29, 37, 38 AND 50). SN 75-860,925. PUB. 8-29-2000. FILED 11-29-1999.
- 2,745,578 (*See Class 5 for this trademark*).
- 2,745,583 (*See Class 2 for this trademark*).
- 2,745,595. **H.E. HARRIS & CO.,** TREAT ENTERTAINMENT, INC., MULTIPLE CLASS, (INT. CLS. 16 AND 35), (U.S. CLS. 2, 5, 22, 23, 29, 37, 38, 50, 100, 101 AND 102). SN 75-896,910. PUB. 5-13-2003. FILED 1-14-2000.
- 2,745,608. **VALUE SOFT.** POTLATCH CORPORATION, (U.S. CLS. 2, 5, 22, 23, 29, 37, 38 AND 50). SN 75-914,452. PUB. 5-13-2003. FILED 2-8-2000.
- 2,745,615 (*See Class 9 for this trademark*).
- 2,745,631. **WOW.** THOMAS AND KING, INC., (U.S. CLS. 2, 5, 22, 23, 29, 37, 38 AND 50). SN 75-982,402. PUB. 7-16-2002. FILED 4-19-2001.
- 2,745,635. **MARYLAND'S TOP 100 WOMEN AND DESIGN.** DOLAN MEDIA COMPANY, (U.S. CLS. 2, 5, 22, 23, 29, 37, 38 AND 50). SN 75-983,020. PUB. 5-13-2003. FILED 10-29-2001.
- 2,745,636 (*See Class 3 for this trademark*).
- 2,745,643. **SCOTIAFX.** BANK OF NOVA SCOTIA, THE, MULTIPLE CLASS, (INT. CLS. 16 AND 36), (U.S. CLS. 2, 5, 22, 23, 29, 37, 38, 50, 100, 101 AND 102). SN 76-007,144. PUB. 7-2-2002. FILED 3-22-2000.
- 2,745,649 (*See Class 9 for this trademark*).
- 2,745,660 (*See Class 9 for this trademark*).
- 2,745,662. **WACKO'S.** SAN CARLO GRUPPO ALIMENTARE S.P.A., MULTIPLE CLASS, (INT. CLS. 16, 25, 28, 29, 30, 32, 35, 41 AND 42), (U.S. CLS. 2, 5, 22, 23, 29, 37, 38, 39, 45, 46, 48, 50, 100, 101, 102 AND 107). SN 76-026,372. PUB. 11-12-2002. FILED 4-14-2000.
- 2,745,665 (*See Class 9 for this trademark*).
- 2,745,679 (*See Class 2 for this trademark*).
- 2,745,682 (*See Class 5 for this trademark*).
- 2,745,692 (*See Class 9 for this trademark*).
- 2,745,696 (*See Class 1 for this trademark*).
- 2,745,704 (*See Class 9 for this trademark*).
- 2,745,705 (*See Class 9 for this trademark*).
- 2,745,708. **NATURERITER.** MERANGUE INTERNATIONAL LIMITED, (U.S. CLS. 2, 5, 22, 23, 29, 37, 38 AND 50). SN 76-074,373. PUB. 5-13-2003. FILED 6-21-2000.
- 2,745,714. **SIZZLECARDS.** SUCCESS PRODUCTS, INC., (U.S. CLS. 2, 5, 22, 23, 29, 37, 38 AND 50). SN 76-078,452. PUB. 5-13-2003. FILED 6-27-2000.
- 2,745,718. **IMMUNOCLIN.** IMMUNOCLIN LABORATORIES LIMITED, (U.S. CLS. 2, 5, 22, 23, 29, 37, 38 AND 50). SN 76-080,100. PUB. 5-13-2003. FILED 6-29-2000.
- 2,745,724 (*See Class 6 for this trademark*).
- 2,745,759 (*See Class 9 for this trademark*).
- 2,745,777 (*See Class 9 for this trademark*).
- 2,745,780 (*See Class 9 for this trademark*).
- 2,745,783 (*See Class 9 for this trademark*).
- 2,745,803 (*See Class 9 for this trademark*).
- 2,745,817 (*See Class 9 for this trademark*).
- 2,745,818 (*See Class 9 for this trademark*).

CLASS 15—MUSICAL INSTRUMENTS

- 2,746,091. **GRUNHAINCHENER ANGELS (STYLIZED).** WENDT & KUEHN KG, MULTIPLE CLASS, (INT. CLS. 15, 20 AND 28), (U.S. CLS. 2, 13, 21, 22, 23, 25, 32, 36, 38 AND 50). SN 76-306,675. PUB. 5-13-2003. FILED 8-29-2001.
- 2,746,794. **CHICAGO JAZZ SERIES.** BARRINGTON MUSIC PRODUCTS, INC., (U.S. CLS. 2, 21 AND 36). SN 76-449,350. PUB. 5-13-2003. FILED 9-13-2002.
- 2,747,258. **MISCELLANEOUS DESIGN.** UNITED SALES ASSOCIATES INC., (U.S. CLS. 2, 21 AND 36). SN 78-150,781. PUB. 5-13-2003. FILED 8-5-2002.
- 2,747,340. **BOURGEOIS (STYLIZED).** BOURGEOIS, DANA, (U.S. CLS. 2, 21 AND 36). SN 78-164,756. PUB. 5-13-2003. FILED 9-17-2002.

CLASS 16—PAPER GOODS AND PRINTED MATTER

- 2,745,418 (*See Class 9 for this trademark*).
- 2,745,437 (*See Class 7 for this trademark*).
- 2,745,439 (*See Class 9 for this trademark*).
- 2,745,440 (*See Class 6 for this trademark*).

- 2,745,842. **LION TALK**. DREYFUS SERVICE CORPORATION, MULTIPLE CLASS, (INT. CLS. 16 AND 36), (U.S. CLS. 2, 5, 22, 23, 29, 37, 38, 50, 100, 101 AND 102). SN 76-189,689. PUB. 12-3-2002. FILED 1-4-2001.
- 2,745,848. **TRI-LITE**. GENERAL BINDING CORPORATION, (U.S. CLS. 2, 5, 22, 23, 29, 37, 38 AND 50). SN 76-194,035. PUB. 1-21-2003. FILED 1-16-2001.
- 2,745,859. **THE BLUEBOOK OF CLEANING, RECONSTRUCTION AND REPAIR COSTS AND DESIGN**. JOSIPOVICH, DOROTHY, AND JOSIPOVICH, DANIEL E., AND JOSIPOVICH, DANIEL T., AND JOSIPOVICH, MARK, AND JOSIPOVICH, MICHELA, MULTIPLE CLASS, (INT. CLS. 16 AND 42), (U.S. CLS. 2, 5, 22, 23, 29, 37, 38, 50, 100 AND 101). SN 76-198,769. PUB. 12-24-2002. FILED 1-23-2001.
- 2,745,861 (*See Class 9 for this trademark*).
- 2,745,864. **LEARNING MONSTER**. HALL, ANTHONY ROBERT, MULTIPLE CLASS, (INT. CLS. 16 AND 28), (U.S. CLS. 2, 5, 22, 23, 29, 37, 38 AND 50). SN 76-202,696. PUB. 10-15-2002. FILED 1-31-2001.
- 2,745,872. **MELISSA**. PCM LIMITED, (U.S. CLS. 2, 5, 22, 23, 29, 37, 38 AND 50). SN 76-206,470. PUB. 5-13-2003. FILED 2-8-2001.
- 2,745,882 (*See Class 6 for this trademark*).
- 2,745,897. **BECK SCALE FOR SUICIDE IDEATION**. PSYCHOLOGICAL CORPORATION, THE, (U.S. CLS. 2, 5, 22, 23, 29, 37, 38 AND 50). SN 76-226,394. PUB. 5-13-2003. FILED 3-19-2001.
- 2,745,917. **HTT HYDRO THERMAL THERAPY AND DESIGN**. JELKS, GEORGE W., (U.S. CLS. 2, 5, 22, 23, 29, 37, 38 AND 50). SN 76-234,957. PUB. 5-13-2003. FILED 4-4-2001.
- 2,745,940. **RENAISSANCE**. ALBUM X CORPORATION, (U.S. CLS. 2, 5, 22, 23, 29, 37, 38 AND 50). SN 76-244,548. PUB. 9-18-2001. FILED 4-20-2001.
- 2,745,950. **ARIEL BOOKS**. EISEN, ARMAND, DBA ARIEL BOOKS, (U.S. CLS. 2, 5, 22, 23, 29, 37, 38 AND 50). SN 76-248,748. PUB. 5-13-2003. FILED 4-30-2001.
- 2,745,951. **GOODLOT**. NOVAMEDIA B.V., MULTIPLE CLASS, (INT. CLS. 16 AND 41), (U.S. CLS. 2, 5, 22, 23, 29, 37, 38, 50, 100, 101 AND 107). SN 76-248,855. PUB. 2-25-2003. FILED 4-30-2001.
- 2,745,965. **SWEETSAR**. SWEETSAR, INC., BY ASSIGNMENT BARBARA REGER AND CHRISTINE BOUCHER, DBA SWEETSAR, (U.S. CLS. 2, 5, 22, 23, 29, 37, 38 AND 50). SN 76-259,438. PUB. 5-13-2003. FILED 5-18-2001.
- 2,745,966. **REACHING THE HARD TO TEACH**. WOOD, JUDY, MULTIPLE CLASS, (INT. CLS. 16 AND 42), (U.S. CLS. 2, 5, 22, 23, 29, 37, 38, 50, 100 AND 101). SN 76-259,624. PUB. 3-12-2002. FILED 5-21-2001.
- 2,745,967. **FAIRVIEW AND DESIGN**. FAIRVIEW HEALTH SERVICES, (U.S. CLS. 2, 5, 22, 23, 29, 37, 38 AND 50). SN 76-260,195. PUB. 10-29-2002. FILED 5-21-2001.
- 2,745,968. **PHANTOMS TORONTO AND DESIGN**. ARENA FOOTBALL LEAGUE LLC, MULTIPLE CLASS, (INT. CLS. 16, 25 AND 41), (U.S. CLS. 2, 5, 22, 23, 29, 37, 38, 39, 50, 100, 101 AND 107). SN 76-260,635. PUB. 11-5-2002. FILED 5-17-2001.
- 2,745,972 (*See Class 11 for this trademark*).
- 2,745,977 (*See Class 9 for this trademark*).
- 2,745,991 (*See Class 5 for this trademark*).
- 2,745,994 (*See Class 9 for this trademark*).
- 2,746,029. **MISCELLANEOUS DESIGN**. PHARMACYCLICS, INC., (U.S. CLS. 2, 5, 22, 23, 29, 37, 38 AND 50). SN 76-286,374. PUB. 5-13-2003. FILED 7-17-2001.
- 2,746,038. **MILAN (STYLIZED)**. TARRES, SANTIAGO MARCO, (U.S. CLS. 2, 5, 22, 23, 29, 37, 38 AND 50). SN 76-288,548. PUB. 10-29-2002. FILED 7-20-2001.
- 2,746,047. **ULTIMA HORA (STYLIZED)**. EDITORA ULTIMA HORA, C. POR A., (U.S. CLS. 2, 5, 22, 23, 29, 37, 38 AND 50). SN 76-291,572. PUB. 5-13-2003. FILED 7-27-2001.
- 2,746,049. **A ABITARE AND DESIGN**. EDITRICE ABITARE SEGESTA S.P.A., (U.S. CLS. 2, 5, 22, 23, 29, 37, 38 AND 50). SN 76-291,948. PUB. 5-13-2003. FILED 7-30-2001.
- 2,746,075 (*See Class 1 for this trademark*).
- 2,746,076. **VICTORY**. VICTORY PACKAGING, INC., MULTIPLE CLASS, (INT. CLS. 16, 17, 35 AND 40), (U.S. CLS. 1, 2, 5, 12, 13, 22, 23, 29, 35, 37, 38, 50, 100, 101, 102, 103 AND 106). SN 76-300,717. PUB. 5-13-2003. FILED 8-16-2001.
- 2,746,093 (*See Class 9 for this trademark*).
- 2,746,100 (*See Class 6 for this trademark*).
- 2,746,111. **ART IN ACTION IMAGINATION MOVES THE MIND AND DESIGN**. CALIFORNIA ART-IN-ACTION FOUNDATION, (U.S. CLS. 2, 5, 22, 23, 29, 37, 38 AND 50). SN 76-315,536. PUB. 5-13-2003. FILED 9-21-2001.
- 2,746,114. **(ISC)2 (STYLIZED)**. INTERNATIONAL INFORMATION SYSTEMS SECURITY CERTIFICATION CONSORTIUM, INC., MULTIPLE CLASS, (INT. CLS. 16, 41 AND 42), (U.S. CLS. 2, 5, 22, 23, 29, 37, 38, 50, 100, 101 AND 107). SN 76-316,029. PUB. 10-29-2002. FILED 9-21-2001.
- 2,746,124. **NEWSINFO LINKS**. LION TECHNOLOGY INC., MULTIPLE CLASS, (INT. CLS. 16 AND 41), (U.S. CLS. 2, 5, 22, 23, 29, 37, 38, 50, 100, 101 AND 107). SN 76-319,744. PUB. 5-13-2003. FILED 9-26-2001.
- 2,746,125 (*See Class 9 for this trademark*).
- 2,746,140. **PHARMACEUTICAL APPROVALS MONTHLY**. F-D-C REPORTS, INC., (U.S. CLS. 2, 5, 22, 23, 29, 37, 38 AND 50). SN 76-325,624. PUB. 5-13-2003. FILED 10-15-2001.
- 2,746,143. **PHYSICS OF PLASMAS**. AMERICAN INSTITUTE OF PHYSICS INCORPORATED, AKA AIP, (U.S. CLS. 2, 5, 22, 23, 29, 37, 38 AND 50). SN 76-326,202. PUB. 5-13-2003. FILED 10-18-2001.
- 2,746,148 (*See Class 14 for this trademark*).
- 2,746,150 (*See Class 9 for this trademark*).
- 2,746,157. **HOME FASHION AND FURNITURE TRENDS**. TALCOTT PUBLISHING CORPORATION, (U.S. CLS. 2, 5, 22, 23, 29, 37, 38 AND 50). SN 76-331,144. PUB. 11-26-2002. FILED 10-29-2001.
- 2,746,163. **FOX PACKAGING**. KENNETH FOX SUPPLY CO., MULTIPLE CLASS, (INT. CLS. 16, 40 AND 42), (U.S. CLS. 2, 5, 22, 23, 29, 37, 38, 50, 100, 101, 103 AND 106). SN 76-331,826. PUB. 5-13-2003. FILED 10-29-2001.
- 2,746,195. **WASHINGTON COLLEGE OF LAW**. AMERICAN UNIVERSITY, MULTIPLE CLASS, (INT. CLS. 16, 21, 25, 28 AND 41), (U.S. CLS. 2, 5, 13, 22, 23, 29, 30, 33, 37, 38, 39, 40, 50, 100, 101 AND 107). SN 76-340,191. PUB. 2-4-2003. FILED 11-21-2001.
- 2,746,200. **IE (STYLIZED)**. S.D. WARREN SERVICES COMPANY, MULTIPLE CLASS, (INT. CLS. 16 AND 42), (U.S. CLS. 2, 5, 22, 23, 29, 37, 38, 50, 100 AND 101). SN 76-340,868. PUB. 5-13-2003. FILED 11-21-2001.
- 2,746,226. **CEMAT (STYLIZED)**. DEUTSCHE MESSE AG, (U.S. CLS. 2, 5, 22, 23, 29, 37, 38 AND 50). SN 76-346,990. PUB. 5-13-2003. FILED 12-11-2001.
- 2,746,236. **REFLEX**. PAPER AUSTRALIA PTY LTD., (U.S. CLS. 2, 5, 22, 23, 29, 37, 38 AND 50). SN 76-350,926. PUB. 5-13-2003. FILED 12-19-2001.
- 2,746,237. **ALOGA (STYLIZED)**. STILGENBAUER, INGRID, MULTIPLE CLASS, (INT. CLS. 16 AND 18), (U.S. CLS. 1, 2, 3, 5, 22, 23, 29, 37, 38, 41 AND 50). SN 76-351,635. PUB. 5-13-2003. FILED 12-21-2001.
- 2,746,257. **ALCA ASSOCIATED LANDSCAPE CONTRACTORS OF AMERICA (STYLIZED)**. ASSOCIATED LANDSCAPE CONTRACTORS OF AMERICA, INC., MULTIPLE CLASS, (INT. CLS. 16, 35 AND 41), (U.S. CLS. 2, 5, 22, 23, 29, 37, 38, 50, 100, 101, 102 AND 107). SN 76-357,145. PUB. 5-13-2003. FILED 1-11-2002.
- 2,746,330. **COMBITRANS**. WIPAK WALSRODE GMBH & CO. KG, MULTIPLE CLASS, (INT. CLS. 16 AND 17), (U.S. CLS. 1, 2, 5, 12, 13, 22, 23, 29, 35, 37, 38 AND 50). SN 76-375,727. PUB. 5-13-2003. FILED 2-25-2002.
- 2,746,337. **HOTLINE SCOOP**. NATIONAL JOURNAL GROUP, INC., MULTIPLE CLASS, (INT. CLS. 16 AND 41), (U.S. CLS. 2, 5, 22, 23, 29, 37, 38, 50, 100, 101 AND 107). SN 76-377,305. PUB. 5-13-2003. FILED 3-1-2002.
- 2,746,339. **THE ULTIMATE SCOREBOOK AND DESIGN**. ULTIMATE SCOREBOOKS INC., THE, (U.S. CLS. 2, 5, 22, 23, 29, 37, 38 AND 50). SN 76-377,552. PUB. 5-13-2003. FILED 3-4-2002.
- 2,746,350. **RABBIT'S FOOT PRESS**. SPS STUDIOS, INC., (U.S. CLS. 2, 5, 22, 23, 29, 37, 38 AND 50). SN 76-379,493. PUB. 5-13-2003. FILED 3-6-2002.
- 2,746,381. **PUERTAS AL SOL**. SANTILLANA USA PUBLISHING COMPANY, INC., (U.S. CLS. 2, 5, 22, 23, 29, 37, 38 AND 50). SN 76-385,303. PUB. 5-13-2003. FILED 3-18-2002.
- 2,746,382. **RICHMOND**. SANTILLANA USA PUBLISHING COMPANY, INC., (U.S. CLS. 2, 5, 22, 23, 29, 37, 38 AND 50). SN 76-385,305. PUB. 5-13-2003. FILED 3-18-2002.

- 2,746,393 (*See Class 9 for this trademark*).
- 2,746,397. **L AND DESIGN.** MARYLAND STATE LOTTERY AGENCY, MULTIPLE CLASS, (INT. CLS. 16, 28 AND 41), (U.S. CLS. 2, 5, 22, 23, 29, 37, 38, 50, 100, 101 AND 107). SN 76-387,368. PUB. 10-22-2002. FILED 3-25-2002.
- 2,746,413. **THE MANSION ON TURTLE CREEK.** MOTC, L.P., MULTIPLE CLASS, (INT. CLS. 16, 29 AND 30), (U.S. CLS. 2, 5, 22, 23, 29, 37, 38, 46 AND 50). SN 76-390,937. PUB. 5-13-2003. FILED 4-4-2002.
- 2,746,421. **MISCELLANEOUS DESIGN.** SANDHILLS PUBLISHING COMPANY, MULTIPLE CLASS, (INT. CLS. 16 AND 41), (U.S. CLS. 2, 5, 22, 23, 29, 37, 38, 50, 100, 101 AND 107). SN 76-392,717. PUB. 5-13-2003. FILED 3-19-2002.
- 2,746,425 (*See Class 9 for this trademark*).
- 2,746,458 (*See Class 9 for this trademark*).
- 2,746,471 (*See Class 9 for this trademark*).
- 2,746,505. **LAW FIRM PARTNERSHIP & BENEFITS REPORT.** NLP IP COMPANY, (U.S. CLS. 2, 5, 22, 23, 29, 37, 38 AND 50). SN 76-404,219. PUB. 5-13-2003. FILED 4-30-2002.
- 2,746,506. **DR. CUPP READERS.** CUPP PUBLISHERS, INC., (U.S. CLS. 2, 5, 22, 23, 29, 37, 38 AND 50). SN 76-404,338. PUB. 5-13-2003. FILED 5-7-2002.
- 2,746,526. **HBR ONPOINT.** PRESIDENT AND FELLOWS OF HARVARD COLLEGE, (U.S. CLS. 2, 5, 22, 23, 29, 37, 38 AND 50). SN 76-406,536. PUB. 5-13-2003. FILED 5-13-2002.
- 2,746,529. **EMCOMAT.** BROWNVILLE SPECIALTY PAPER PRODUCTS, INC., (U.S. CLS. 2, 5, 22, 23, 29, 37, 38 AND 50). SN 76-406,804. PUB. 5-13-2003. FILED 5-2-2002.
- 2,746,532. **HEARTS AFIRE AND DESIGN.** ARMSTRONG, YVONNE C., (U.S. CLS. 2, 5, 22, 23, 29, 37, 38 AND 50). SN 76-407,016. PUB. 5-13-2003. FILED 5-10-2002.
- 2,746,542. **FRACOTE.** FRASER PAPERS INC., (U.S. CLS. 2, 5, 22, 23, 29, 37, 38 AND 50). SN 76-408,296. PUB. 5-13-2003. FILED 5-13-2002.
- 2,746,554. **THE AMERICAN GIRLS COLLECTION AND DESIGN.** PLEASANT COMPANY, (U.S. CLS. 2, 5, 22, 23, 29, 37, 38 AND 50). SN 76-409,667. PUB. 5-13-2003. FILED 5-17-2002.
- 2,746,568. **LA PALABRA ENTRE NOSOTROS AND DESIGN.** THE WORD AMONG US, INC., (U.S. CLS. 2, 5, 22, 23, 29, 37, 38 AND 50). SN 76-411,810. PUB. 5-13-2003. FILED 5-23-2002.
- 2,746,597 (*See Class 9 for this trademark*).
- 2,746,604. **KOUGRA.** NEOPETS, INC., (U.S. CLS. 2, 5, 22, 23, 29, 37, 38 AND 50). SN 76-420,264. PUB. 5-13-2003. FILED 6-11-2002.
- 2,746,605. **QUIGGLE.** NEOPETS, INC., (U.S. CLS. 2, 5, 22, 23, 29, 37, 38 AND 50). SN 76-420,271. PUB. 5-13-2003. FILED 6-11-2002.
- 2,746,606. **USUL.** NEOPETS, INC., (U.S. CLS. 2, 5, 22, 23, 29, 37, 38 AND 50). SN 76-420,272. PUB. 5-13-2003. FILED 6-11-2002.
- 2,746,607. **KACHEEK.** NEOPETS, INC., (U.S. CLS. 2, 5, 22, 23, 29, 37, 38 AND 50). SN 76-420,273. PUB. 5-13-2003. FILED 6-11-2002.
- 2,746,608. **AISHA.** NEOPETS, INC., (U.S. CLS. 2, 5, 22, 23, 29, 37, 38 AND 50). SN 76-420,274. PUB. 5-13-2003. FILED 6-11-2002.
- 2,746,621. **SCREW MACHINE WORLD.** SCREW MACHINE WORLD, INC., MULTIPLE CLASS, (INT. CLS. 16 AND 41), (U.S. CLS. 2, 5, 22, 23, 29, 37, 38, 50, 100, 101 AND 107). SN 76-422,791. PUB. 5-13-2003. FILED 6-19-2002.
- 2,746,647 (*See Class 9 for this trademark*).
- 2,746,648. **MYREPORTLINKS.** ENSLOW PUBLISHERS, INC., MULTIPLE CLASS, (INT. CLS. 16 AND 41), (U.S. CLS. 2, 5, 22, 23, 29, 37, 38, 50, 100, 101 AND 107). SN 76-427,006. PUB. 5-13-2003. FILED 7-2-2002.
- 2,746,677. **VOICE OF THE MID-COLUMBIA.** MCCLATCHY MANAGEMENT SERVICES, INC., (U.S. CLS. 2, 5, 22, 23, 29, 37, 38 AND 50). SN 76-435,203. PUB. 5-13-2003. FILED 7-29-2002.
- 2,746,724. **FLORACULTURE INTERNATIONAL.** BALL HORTICULTURAL COMPANY, (U.S. CLS. 2, 5, 22, 23, 29, 37, 38 AND 50). SN 76-442,796. PUB. 5-13-2003. FILED 8-22-2002.
- 2,746,747. **POWER PENCIL.** LO, DAVID, (U.S. CLS. 2, 5, 22, 23, 29, 37, 38 AND 50). SN 76-444,928. PUB. 5-13-2003. FILED 8-29-2002.
- 2,746,748. **HRAMIEC HOFFMAN.** MARK J. HOFFMAN AND MARY HRAMIEC HOFFMAN PARTNERSHIP, THE, (U.S. CLS. 2, 5, 22, 23, 29, 37, 38 AND 50). SN 76-444,954. PUB. 5-13-2003. FILED 8-12-2002.
- 2,746,753. **THE WHITETAIL FANATIC! AND DESIGN.** FANATIC ENTERPRISES, LLC, (U.S. CLS. 2, 5, 22, 23, 29, 37, 38 AND 50). SN 76-445,702. PUB. 5-13-2003. FILED 8-30-2002.
- 2,746,766. **FLIP-IT.** LIZZIE*KATE, INC., (U.S. CLS. 2, 5, 22, 23, 29, 37, 38 AND 50). SN 76-446,951. PUB. 5-13-2003. FILED 9-5-2002.
- 2,746,767. **BOXERS.** LIZZIE*KATE, INC., (U.S. CLS. 2, 5, 22, 23, 29, 37, 38 AND 50). SN 76-446,952. PUB. 5-13-2003. FILED 9-5-2002.
- 2,746,772. **MISCELLANEOUS DESIGN.** PLEASANT COMPANY, (U.S. CLS. 2, 5, 22, 23, 29, 37, 38 AND 50). SN 76-447,596. PUB. 5-13-2003. FILED 9-5-2002.
- 2,746,773. **1866 AND DESIGN.** HARCOURT, INC., (U.S. CLS. 2, 5, 22, 23, 29, 37, 38 AND 50). SN 76-447,646. PUB. 5-13-2003. FILED 9-6-2002.
- 2,746,797. **THE NEW YORKER.** ADVANCE MAGAZINE PUBLISHERS INC., (U.S. CLS. 2, 5, 22, 23, 29, 37, 38 AND 50). SN 76-449,476. PUB. 5-13-2003. FILED 9-9-2002.
- 2,746,813 (*See Class 9 for this trademark*).
- 2,746,822. **ROVER.** FORAN, MICHAEL, (U.S. CLS. 2, 5, 22, 23, 29, 37, 38 AND 50). SN 76-451,316. PUB. 5-13-2003. FILED 9-16-2002.
- 2,746,840 (*See Class 9 for this trademark*).
- 2,746,871. **VIGNETTES.** CIZZI, LTD., (U.S. CLS. 2, 5, 22, 23, 29, 37, 38 AND 50). SN 76-453,951. PUB. 5-13-2003. FILED 9-30-2002.
- 2,746,907. **95 EAST.** ALVAREZ, MIRABEL, (U.S. CLS. 2, 5, 22, 23, 29, 37, 38 AND 50). SN 76-455,845. PUB. 5-13-2003. FILED 10-4-2002.
- 2,746,912. **POSITIVE ACTION.** GERBER-ALLRED, CAROL, (U.S. CLS. 2, 5, 22, 23, 29, 37, 38 AND 50). SN 76-456,070. PUB. 5-13-2003. FILED 10-4-2002.
- 2,746,915. **EXCELLENCE AT WORK.** NEWYORK-PRESBYTERIAN HOSPITAL, MULTIPLE CLASS, (INT. CLS. 16 AND 35), (U.S. CLS. 2, 5, 22, 23, 29, 37, 38, 50, 100, 101 AND 102). SN 76-456,155. PUB. 5-13-2003. FILED 10-7-2002.
- 2,746,916. **CYCLER.** WASTE MANAGEMENT, INC., (U.S. CLS. 2, 5, 22, 23, 29, 37, 38 AND 50). SN 76-456,156. PUB. 5-13-2003. FILED 10-7-2002.
- 2,746,918. **PROVIEW.** THE UPPER DECK COMPANY, LLC, (U.S. CLS. 2, 5, 22, 23, 29, 37, 38 AND 50). SN 76-456,182. PUB. 5-13-2003. FILED 10-7-2002.
- 2,746,934. **SOMETHING EXTRA.** RALEY'S TM, INC., (U.S. CLS. 2, 5, 22, 23, 29, 37, 38 AND 50). SN 76-457,228. PUB. 5-13-2003. FILED 10-9-2002.
- 2,746,970. **A LITTLE ROMANCE.** AGC, INC., (U.S. CLS. 2, 5, 22, 23, 29, 37, 38 AND 50). SN 76-459,542. PUB. 5-13-2003. FILED 10-21-2002.
- 2,746,971. **WILD WOMEN ON WINE.** MARTIN, SHANIN MARIE, AND WOLK-NELSON, CATHY E., MULTIPLE CLASS, (INT. CLS. 16, 21 AND 25), (U.S. CLS. 2, 5, 13, 22, 23, 29, 30, 33, 37, 38, 39, 40 AND 50). SN 76-459,621. PUB. 5-13-2003. FILED 10-18-2002.
- 2,746,974. **PREPARE THE WORD.** TRUEQUEST COMMUNICATIONS, LLC, (U.S. CLS. 2, 5, 22, 23, 29, 37, 38 AND 50). SN 76-459,801. PUB. 5-13-2003. FILED 10-11-2002.
- 2,746,993. **AGA TODAY.** ASSOCIATION OF GOVERNMENT ACCOUNTANTS, (U.S. CLS. 2, 5, 22, 23, 29, 37, 38 AND 50). SN 76-461,167. PUB. 5-13-2003. FILED 10-18-2002.
- 2,747,008. **OBSERVER-DISPATCH.** MEDIA WEST - GSI, INC., (U.S. CLS. 2, 5, 22, 23, 29, 37, 38 AND 50). SN 76-462,400. PUB. 5-13-2003. FILED 10-22-2002.
- 2,747,009. **THE LITTLE ENGINE THAT COULD.** PENGUIN PUTNAM INC., MULTIPLE CLASS, (INT. CLS. 16, 20 AND 28), (U.S. CLS. 2, 5, 13, 22, 23, 25, 29, 32, 37, 38 AND 50). SN 76-462,454. PUB. 5-13-2003. FILED 10-23-2002.
- 2,747,015. **DANGER MEN PLAYING AND DESIGN.** ANDE ROONEY INC., (U.S. CLS. 2, 5, 22, 23, 29, 37, 38 AND 50). SN 76-463,125. PUB. 5-13-2003. FILED 10-25-2002.
- 2,747,016. **DANGER MEN PLAYING.** ANDE ROONEY INC., (U.S. CLS. 2, 5, 22, 23, 29, 37, 38 AND 50). SN 76-463,126. PUB. 5-13-2003. FILED 10-25-2002.
- 2,747,036. **HUGGIES PULL-UPS BRAND TRAINING PANTS AND DESIGN.** KIMBERLY-CLARK CORPORATION, (U.S. CLS. 2, 5, 22, 23, 29, 37, 38 AND 50). SN 76-465,574. PUB. 5-13-2003. FILED 11-8-2002.
- 2,747,060. **STICK-N-STITCH.** FILLMER, SCOTT L., DBA PIECES OF THE PAST, (U.S. CLS. 2, 5, 22, 23, 29, 37, 38 AND 50). SN 78-026,742. PUB. 5-13-2003. FILED 9-20-2000.

2,747,070. **SILVER SUN PHOTOGRAPHY AND DESIGN.** STADTHERR, MELODY, A., (U.S. CLS. 2, 5, 22, 23, 29, 37, 38 AND 50). SN 78-041,186. PUB. 5-13-2003. FILED 12-31-2000.

2,747,075. **TRANSLUCENT IMAGERY.** JONES, D., (U.S. CLS. 2, 5, 22, 23, 29, 37, 38 AND 50). SN 78-048,556. PUB. 5-13-2003. FILED 2-15-2001.

2,747,081 (*See Class 9 for this trademark.*).

2,747,098. **KNICKS CITY DANCERS AND DESIGN.** MADISON SQUARE GARDEN, L.P., (U.S. CLS. 2, 5, 22, 23, 29, 37, 38 AND 50). SN 78-087,019. PUB. 5-13-2003. FILED 10-4-2001.

2,747,102. **TRIAMINIC PARENTS CLUB.** NOVARTIS AG, (U.S. CLS. 2, 5, 22, 23, 29, 37, 38 AND 50). SN 78-092,302. PUB. 5-13-2003. FILED 11-8-2001.

2,747,119. **GIFTS TO GO.** COLORBOK, INC., (U.S. CLS. 2, 5, 22, 23, 29, 37, 38 AND 50). SN 78-102,958. PUB. 5-13-2003. FILED 1-16-2002.

2,747,128. **FRANKLIN SMALL PRESS PRICING BOOK AND DESIGN.** FRANKLIN ESTIMATING SYSTEMS, INC., (U.S. CLS. 2, 5, 22, 23, 29, 37, 38 AND 50). SN 78-106,743. PUB. 5-13-2003. FILED 2-4-2002.

2,747,129. **FRANKLIN QUICK PRINT PRICING BOOK AND DESIGN.** FRANKLIN ESTIMATING SYSTEMS, INC., (U.S. CLS. 2, 5, 22, 23, 29, 37, 38 AND 50). SN 78-106,744. PUB. 5-13-2003. FILED 2-4-2002.

2,747,130. **FRANKLIN OFFSET PRESS PRICING BOOK AND DESIGN.** FRANKLIN ESTIMATING SYSTEMS, INC., (U.S. CLS. 2, 5, 22, 23, 29, 37, 38 AND 50). SN 78-106,747. PUB. 5-13-2003. FILED 2-4-2002.

2,747,154. **GRABBOOTIE (STYLIZED).** BOOTIE BREWING COMPANY, MULTIPLE CLASS, (INT. CLS. 16 AND 32), (U.S. CLS. 2, 5, 22, 23, 29, 37, 38, 45, 46, 48 AND 50). SN 78-116,686. PUB. 5-13-2003. FILED 3-21-2002.

2,747,159. **CURRENT REVIEWS FOR NURSE ANESTHETISTS.** CURRENT REVIEWS FOR NURSE ANESTHETISTS, INC., (U.S. CLS. 2, 5, 22, 23, 29, 37, 38 AND 50). SN 78-117,508. PUB. 5-13-2003. FILED 3-26-2002.

2,747,166 (*See Class 14 for this trademark.*).

2,747,167. **CIO 20/20 VISION AWARDS.** INTERNATIONAL DATA GROUP, INC., MULTIPLE CLASS, (INT. CLS. 16, 41 AND 42), (U.S. CLS. 2, 5, 22, 23, 29, 37, 38, 50, 100, 101 AND 107). SN 78-119,168. PUB. 5-13-2003. FILED 4-3-2002.

2,747,168. **C - LOCK (STYLIZED).** CONSTANTINE, THEO A., (U.S. CLS. 2, 5, 22, 23, 29, 37, 38 AND 50). SN 78-119,375. PUB. 5-13-2003. FILED 4-3-2002.

2,747,172. **SHE MAGAZINE AND DESIGN.** BERRY, MELIA, (U.S. CLS. 2, 5, 22, 23, 29, 37, 38 AND 50). SN 78-119,881. PUB. 5-13-2003. FILED 4-5-2002.

2,747,209. **POWER PAGES.** ME & MY BIG IDEAS, INC., (U.S. CLS. 2, 5, 22, 23, 29, 37, 38 AND 50). SN 78-131,146. PUB. 5-13-2003. FILED 5-24-2002.

2,747,227. **FLORAL & NURSERY TIMES AND DESIGN.** XXX PUBLISHING ENTERPRISES, LTD., (U.S. CLS. 2, 5, 22, 23, 29, 37, 38 AND 50). SN 78-142,461. PUB. 5-13-2003. FILED 7-10-2002.

2,747,254. **NETWORKING TIMES.** GABRIEL MEDIA GROUP, INC., (U.S. CLS. 2, 5, 22, 23, 29, 37, 38 AND 50). SN 78-149,535. PUB. 5-13-2003. FILED 7-31-2002.

2,747,257. **POLLY DOODLES.** PITZER, KAREN A, (U.S. CLS. 2, 5, 22, 23, 29, 37, 38 AND 50). SN 78-150,561. PUB. 5-13-2003. FILED 8-3-2002.

2,747,261. **MOJAVE.** MOJAVE FOODS CORPORATION, MULTIPLE CLASS, (INT. CLS. 16 AND 29), (U.S. CLS. 2, 5, 22, 23, 29, 37, 38, 46 AND 50). SN 78-150,996. PUB. 5-13-2003. FILED 8-5-2002.

2,747,267. **MISCELLANEOUS DESIGN.** CLEARSNAP, INC., (U.S. CLS. 2, 5, 22, 23, 29, 37, 38 AND 50). SN 78-151,993. PUB. 5-13-2003. FILED 8-7-2002.

2,747,276. **HUNT CLUB DIGEST.** EBSCO INDUSTRIES, INC., (U.S. CLS. 2, 5, 22, 23, 29, 37, 38 AND 50). SN 78-152,740. PUB. 5-13-2003. FILED 8-9-2002.

2,747,294. **WASI.** PSYCHOLOGICAL CORPORATION, THE, (U.S. CLS. 2, 5, 22, 23, 29, 37, 38 AND 50). SN 78-153,776. PUB. 5-13-2003. FILED 8-13-2002.

2,747,338. **GIRLS FOR GOD.** THE ZONDERVAN CORPORATION, (U.S. CLS. 2, 5, 22, 23, 29, 37, 38 AND 50). SN 78-163,790. PUB. 5-13-2003. FILED 9-13-2002.

2,747,363. **YOUR DAILY GUIDE TO MIRACLES.** ORAL

ROBERTS UNIVERSITY, (U.S. CLS. 2, 5, 22, 23, 29, 37, 38 AND 50). SN 78-166,857. PUB. 5-13-2003. FILED 9-23-2002.

2,747,391. **THERMOLON.** DIZOGIO, FRANK P., III, MULTIPLE CLASS, (INT. CLS. 16 AND 21), (U.S. CLS. 2, 5, 13, 22, 23, 29, 30, 33, 37, 38, 40 AND 50). SN 78-169,309. PUB. 5-13-2003. FILED 9-30-2002.

2,747,408. **THE TWELVE TEAS.** THE HAWKIN'S CHILDREN'S LLC, (U.S. CLS. 2, 5, 22, 23, 29, 37, 38 AND 50). SN 78-171,079. PUB. 5-13-2003. FILED 10-4-2002.

2,747,417. **MOTHERMORPHOSIS.** DE BINDER, CAROLINE BRANDT, (U.S. CLS. 2, 5, 22, 23, 29, 37, 38 AND 50). SN 78-171,603. PUB. 5-13-2003. FILED 10-7-2002.

2,747,420. **IBD WATCH AND DESIGN.** MDG DEVELOPMENT GROUP, INC., DBA MARKET DEVELOPMENT GROUP, (U.S. CLS. 2, 5, 22, 23, 29, 37, 38 AND 50). SN 78-171,675. PUB. 5-13-2003. FILED 10-7-2002.

2,747,434 (*See Class 9 for this trademark.*).

CLASS 17—RUBBER GOODS

2,745,473. **MIKRON.** MIKRON PRODUCTS, INC., (U.S. CLS. 1, 5, 12, 13, 35 AND 50). SN 75-565,719. PUB. 5-15-2001. FILED 10-7-1998.

2,745,568. **HARVEL.** HARVEL PLASTICS, INC., (U.S. CLS. 1, 5, 12, 13, 35 AND 50). SN 75-841,478. PUB. 5-13-2003. FILED 11-5-1999.

2,745,583 (*See Class 2 for this trademark.*).

2,745,696 (*See Class 1 for this trademark.*).

2,745,700. **MARINEWRAP.** ADVANCED THERMAL PRODUCTS INC., (U.S. CLS. 1, 5, 12, 13, 35 AND 50). SN 76-066,476. PUB. 5-13-2003. FILED 6-9-2000.

2,745,724 (*See Class 6 for this trademark.*).

2,745,896. **FLEXAPHARM.** FLEXAFILMS S.P.A., (U.S. CLS. 1, 5, 12, 13, 35 AND 50). SN 76-224,517. PUB. 5-13-2003. FILED 3-14-2001.

2,745,901 (*See Class 7 for this trademark.*).

2,745,926 (*See Class 9 for this trademark.*).

2,745,975. **ROYAL.** ROYAL GROUP TECHNOLOGIES LIMITED, MULTIPLE CLASS, (INT. CLS. 17 AND 19), (U.S. CLS. 1, 5, 12, 13, 33, 35 AND 50). SN 76-263,978. PUB. 6-11-2002. FILED 5-29-2001.

2,746,007. **SNAP BACK HOSE.** LUBECKI TECHNICAL HOLDINGS INC., (U.S. CLS. 1, 5, 12, 13, 35 AND 50). SN 76-276,980. PUB. 5-13-2003. FILED 6-27-2001.

2,746,043. **RIKAPOR.** RIKA INTERNATIONAL LIMITED, (U.S. CLS. 1, 5, 12, 13, 35 AND 50). SN 76-291,089. PUB. 5-13-2003. FILED 7-24-2001.

2,746,075 (*See Class 1 for this trademark.*).

2,746,076 (*See Class 16 for this trademark.*).

2,746,118 (*See Class 4 for this trademark.*).

2,746,137. **MISCELLANEOUS DESIGN.** INA ACQUISITION CORP., (U.S. CLS. 1, 5, 12, 13, 35 AND 50). SN 76-324,237. PUB. 12-24-2002. FILED 10-10-2001.

2,746,164 (*See Class 1 for this trademark.*).

2,746,188. **EXPANFLEX.** INTERDELTA GLOBAL CORPORATION, (U.S. CLS. 1, 5, 12, 13, 35 AND 50). SN 76-337,867. PUB. 5-13-2003. FILED 11-13-2001.

2,746,209. **NITREX (STYLIZED).** EVA-GLORY INDUSTRIAL CO., LTD., MULTIPLE CLASS, (INT. CLS. 17, 25 AND 28), (U.S. CLS. 1, 5, 12, 13, 22, 23, 35, 38, 39 AND 50). SN 76-342,338. PUB. 2-18-2003. FILED 11-27-2001.

2,746,275. **THE BETTER INSULATION.** ROXUL INC., (U.S. CLS. 1, 5, 12, 13, 35 AND 50). SN 76-363,249. PUB. 11-19-2002. FILED 1-29-2002.

2,746,283. **SUPERSTICK.** D&K INTERNATIONAL, INC., (U.S. CLS. 1, 5, 12, 13, 35 AND 50). SN 76-366,306. PUB. 5-13-2003. FILED 2-1-2002.

2,746,323. **LAMOR.** LAMOR CORPORATION AB, (U.S. CLS. 1, 5, 12, 13, 35 AND 50). SN 76-374,908. PUB. 5-13-2003. FILED 2-25-2002.

2,746,330 (*See Class 16 for this trademark.*).

2,746,352. **COUNTERMATE.** COLOR CAULK INC., (U.S. CLS. 1, 5, 12, 13, 35 AND 50). SN 76-379,974. PUB. 5-13-2003. FILED 3-8-2002.

2,746,379 (*See Class 2 for this trademark.*).

2,746,697. **CLEARBRAID.** ACCUFLEX INDUSTRIAL HOSE

LTD., (U.S. CLS. 1, 5, 12, 13, 35 AND 50). SN 76-439,743. PUB. 5-13-2003. FILED 8-13-2002.
 2,746,735. **VAKTAPE**. FILTRONA UNITED KINGDOM LIMITED, (U.S. CLS. 1, 5, 12, 13, 35 AND 50). SN 76-444,444. PUB. 5-13-2003. FILED 8-28-2002.
 2,747,164. **COILHOSE**. COILHOSE PNEUMATICS, INC., (U.S. CLS. 1, 5, 12, 13, 35 AND 50). SN 78-118,273. PUB. 10-22-2002. FILED 3-28-2002.
 2,747,376. **NATUREEDGE**. REHAU INCORPORATED, (U.S. CLS. 1, 5, 12, 13, 35 AND 50). SN 78-168,095. PUB. 5-13-2003. FILED 9-26-2002.
 2,747,377. **FLEXEDGE**. REHAU INCORPORATED, (U.S. CLS. 1, 5, 12, 13, 35 AND 50). SN 78-168,104. PUB. 5-13-2003. FILED 9-26-2002.

INC., (U.S. CLS. 1, 2, 3, 22 AND 41). SN 76-377,047. PUB. 5-13-2003. FILED 3-1-2002.
 2,746,362. **HUNTERPET**. LEATHER BROTHERS, INC., (U.S. CLS. 1, 2, 3, 22 AND 41). SN 76-381,784. PUB. 5-13-2003. FILED 3-14-2002.
 2,746,583. **HUNTER SPORTS AND DESIGN**. KENNEX GARMENT MFG. CO., LTD., (U.S. CLS. 1, 2, 3, 22 AND 41). SN 76-416,951. PUB. 5-13-2003. FILED 6-5-2002.
 2,746,840 (*See Class 9 for this trademark*).
 2,746,870. **WALK-N-LEAD**. FOSTER & SMITH, INC., (U.S. CLS. 1, 2, 3, 22 AND 41). SN 76-453,936. PUB. 5-13-2003. FILED 9-30-2002.
 2,747,190. **COURTENEY AND DESIGN**. COURTENEY BOOT COMPANY, THE, MULTIPLE CLASS, (INT. CLS. 18 AND 25), (U.S. CLS. 1, 2, 3, 22, 39 AND 41). SN 78-124,119. PUB. 5-13-2003. FILED 4-25-2002.

CLASS 18—LEATHER GOODS

2,745,418 (*See Class 9 for this trademark*).
 2,745,435 (*See Class 9 for this trademark*).
 2,745,436 (*See Class 6 for this trademark*).
 2,745,478. **JUNIOR GIRL LE CHATEAU AND DESIGN**. LE CHATEAU INC., BY CHANGE OF NAME CHATEAU STORES OF CANADA LTD., MULTIPLE CLASS, (INT. CLS. 18, 25 AND 35), (U.S. CLS. 1, 2, 3, 22, 39, 41, 100, 101 AND 102). SN 75-593,867. PUB. 11-12-2002. FILED 11-23-1998.
 2,745,542 (*See Class 7 for this trademark*).
 2,745,543. **SINA FLORA**. ZHIHONG, XU, AND JIANLUN, FEI, MULTIPLE CLASS, (INT. CLS. 18, 24 AND 25), (U.S. CLS. 1, 2, 3, 22, 39, 41, 42 AND 50). SN 75-789,309. PUB. 10-8-2002. FILED 8-31-1999.
 2,745,550 (*See Class 3 for this trademark*).
 2,745,558 (*See Class 3 for this trademark*).
 2,745,569 (*See Class 3 for this trademark*).
 2,745,571 (*See Class 9 for this trademark*).
 2,745,582 (*See Class 3 for this trademark*).
 2,745,616. **NATIVE GEAR AND DESIGN**. PACIFIC ISLE IMPORTS, INC., MULTIPLE CLASS, (INT. CLS. 18 AND 25), (U.S. CLS. 1, 2, 3, 22, 39 AND 41). SN 75-927,774. PUB. 12-24-2002. FILED 2-28-2000.
 2,745,636 (*See Class 3 for this trademark*).
 2,745,680 (*See Class 3 for this trademark*).
 2,745,683 (*See Class 3 for this trademark*).
 2,745,685. **CLOUD NINE SHEEPSKIN AND DESIGN**. CLOUD NINE SHEEPSKIN, INC., (U.S. CLS. 1, 2, 3, 22 AND 41). SN 76-054,371. PUB. 10-15-2002. FILED 5-23-2000.
 2,745,729 (*See Class 3 for this trademark*).
 2,745,742. **LAMTEC**. TRIMARK ATHLETIC SUPPLIES INC., (U.S. CLS. 1, 2, 3, 22 AND 41). SN 76-104,291. PUB. 5-13-2003. FILED 8-7-2000.
 2,745,796. **URBANBOARD URBANBOARD.COM AND DESIGN**. MONTEBLANCO LIMITED, MULTIPLE CLASS, (INT. CLS. 18, 25 AND 28), (U.S. CLS. 1, 2, 3, 22, 23, 38, 39, 41 AND 50). SN 76-155,376. PUB. 5-13-2003. FILED 10-30-2000.
 2,745,819 (*See Class 3 for this trademark*).
 2,746,013. **MARTHA STEWART EVERYDAY GARDEN**. MARTHA STEWART LIVING OMNIMEDIA, INC., BY ASSIGNMENT MSO IP HOLDINGS, INC., MULTIPLE CLASS, (INT. CLS. 18, 20 AND 22), (U.S. CLS. 1, 2, 3, 7, 13, 19, 22, 25, 32, 41, 42 AND 50). SN 76-278,433. PUB. 5-13-2003. FILED 6-26-2001.
 2,746,093 (*See Class 9 for this trademark*).
 2,746,100 (*See Class 6 for this trademark*).
 2,746,101 (*See Class 9 for this trademark*).
 2,746,148 (*See Class 14 for this trademark*).
 2,746,237 (*See Class 16 for this trademark*).
 2,746,313. **MISCELLANEOUS DESIGN**. MOUNT VINTAGE INTERNATIONAL CHAMPIONSHIP, INC., MULTIPLE CLASS, (INT. CLS. 18, 25 AND 41), (U.S. CLS. 1, 2, 3, 22, 39, 41, 100, 101 AND 107). SN 76-373,213. PUB. 5-13-2003. FILED 2-21-2002.
 2,746,334. **PONY AND DESIGN**. PONY INTERNATIONAL, INC., (U.S. CLS. 1, 2, 3, 22 AND 41). SN 76-376,984. PUB. 5-13-2003. FILED 3-1-2002.
 2,746,335. **PONY AND DESIGN**. PONY INTERNATIONAL,

CLASS 19—NON-METALLIC BUILDING MATERIALS

2,745,561. **DOLFY AND DESIGN**. ESPACE PRODUCTION INTERNATIONALE AYANT POUR SIGLE "EPI", MULTIPLE CLASS, (INT. CLS. 19 AND 27), (U.S. CLS. 1, 12, 19, 20, 33, 37, 42 AND 50). SN 75-823,904. PUB. 11-20-2001. FILED 10-18-1999.
 2,745,567 (*See Class 2 for this trademark*).
 2,745,604. **SECURTORCH**. CASCADES INC., (U.S. CLS. 1, 12, 33 AND 50). SN 75-904,661. PUB. 12-24-2002. FILED 1-28-2000.
 2,745,620. **AMERICAN RUSTICS**. MANNINGTON MILLS, INC, (U.S. CLS. 1, 12, 33 AND 50). SN 75-934,028. PUB. 1-7-2003. FILED 3-3-2000.
 2,745,833. **SETSTONE**. URBANSTONE PTY LTD., (U.S. CLS. 1, 12, 33 AND 50). SN 76-187,171. PUB. 11-5-2002. FILED 12-28-2000.
 2,745,854 (*See Class 1 for this trademark*).
 2,745,869. **INTRODUCE MOTHER NATURE TO FATHER TIME**. EPOCH COMPOSITE PRODUCTS, INC., (U.S. CLS. 1, 12, 33 AND 50). SN 76-205,717. PUB. 10-15-2002. FILED 2-6-2001.
 2,745,891. **EZ SPAN AND DESIGN**. JACKPINE ENGINEERED WOOD PRODUCTS INC., (U.S. CLS. 1, 12, 33 AND 50). SN 76-218,129. PUB. 5-13-2003. FILED 3-1-2001.
 2,745,954 (*See Class 6 for this trademark*).
 2,745,972 (*See Class 11 for this trademark*).
 2,745,975 (*See Class 17 for this trademark*).
 2,746,190. **AMANDARI**. WALKER & ZANGER, INC., (U.S. CLS. 1, 12, 33 AND 50). SN 76-338,938. PUB. 11-19-2002. FILED 11-16-2001.
 2,746,210. **DRAINTRAK**. BASEMENT SYSTEMS, INC., (U.S. CLS. 1, 12, 33 AND 50). SN 76-342,462. PUB. 10-29-2002. FILED 11-26-2001.
 2,746,378. **FLORADRAIN**. ZINK, RAINER, MULTIPLE CLASS, (INT. CLS. 19 AND 31), (U.S. CLS. 1, 12, 33, 46 AND 50). SN 76-385,119. PUB. 5-13-2003. FILED 3-20-2002.
 2,746,433. **PRESTIGE HOMES**. MMH PRESTIGE HOMES INC., MULTIPLE CLASS, (INT. CLS. 19, 35 AND 37), (U.S. CLS. 1, 12, 33, 50, 100, 101, 102, 103 AND 106). SN 76-393,619. PUB. 5-13-2003. FILED 4-8-2002.
 2,746,670. **H JH AND DESIGN**. JAMES HARDIE RESEARCH PTY LIMITED, (U.S. CLS. 1, 12, 33 AND 50). SN 76-434,190. PUB. 5-13-2003. FILED 7-25-2002.
 2,746,720. **PILKINGTON FLEMISH**. PILKINGTON PLC, (U.S. CLS. 1, 12, 33 AND 50). SN 76-442,172. PUB. 5-13-2003. FILED 8-15-2002.
 2,746,790. **WOOD REFLECTIONS**. WITEX USA, INC., MULTIPLE CLASS, (INT. CLS. 19 AND 27), (U.S. CLS. 1, 12, 19, 20, 33, 37, 42 AND 50). SN 76-449,045. PUB. 5-13-2003. FILED 9-13-2002.
 2,747,260. **PRODEMA AND DESIGN**. PRODEMA, S.A., (U.S. CLS. 1, 12, 33 AND 50). SN 78-150,923. PUB. 5-13-2003. FILED 8-5-2002.
 2,747,416. **GREEN MOUNTAIN**. PANTIM WOOD PRODUCTS, INC., (U.S. CLS. 1, 12, 33 AND 50). SN 78-171,505. PUB. 5-13-2003. FILED 10-7-2002.

CLASS 20—FURNITURE AND ARTICLES NOT OTHERWISE CLASSIFIED

- 2,745,433. **HA HERITAGE ARTISTS THE COLLECTOR'S CHOICE AND DESIGN.** 3831558 CANADA INC., BY ASSIGNMENT HERITAGE DECOYS LTD., (U.S. CLS. 2, 13, 22, 25, 32 AND 50). SN 75-331,211. PUB. 5-13-2003. FILED 7-28-1997.
- 2,745,462. **GOSLING.** WESTEX INTERNATIONAL (CANADA) LTD., MULTIPLE CLASS, (INT. CLS. 20 AND 24), (U.S. CLS. 2, 13, 22, 25, 32, 42 AND 50). SN 75-525,979. PUB. 5-13-2003. FILED 7-27-1998.
- 2,745,486. **TRADITIONS.** COSTCO WHOLESALE CORPORATION, (U.S. CLS. 2, 13, 22, 25, 32 AND 50). SN 75-608,883. PUB. 12-17-2002. FILED 12-18-1998.
- 2,745,498. **SPIRALOK.** RESTONIC CORPORATION, (U.S. CLS. 2, 13, 22, 25, 32 AND 50). SN 75-653,557. PUB. 11-5-2002. FILED 3-4-1999.
- 2,745,512. **DUET.** LEIF JACOBSEN HOLDINGS LIMITED, (U.S. CLS. 2, 13, 22, 25, 32 AND 50). SN 75-686,007. PUB. 8-13-2002. FILED 4-19-1999.
- 2,745,527. **MELGRATI.** MELGRATI, ROBERTO, (U.S. CLS. 2, 13, 22, 25, 32 AND 50). SN 75-733,692. PUB. 9-17-2002. FILED 6-22-1999.
- 2,745,544. **STINNES LOGISTICS AND DESIGN.** STINNES AG, (U.S. CLS. 2, 13, 22, 25, 32 AND 50). SN 75-791,369. PUB. 4-23-2002. FILED 9-2-1999.
- 2,745,577. **SEDUS.** SEDUS STOLL AG, (U.S. CLS. 2, 13, 22, 25, 32 AND 50). SN 75-861,065. PUB. 10-1-2002. FILED 12-1-1999.
- 2,745,690. **TP AND DESIGN.** TUBEPACK LIMITED, MULTIPLE CLASS, (INT. CLS. 20 AND 40), (U.S. CLS. 2, 13, 22, 25, 32, 50, 100, 103 AND 106). SN 76-058,494. PUB. 11-12-2002. FILED 5-30-2000.
- 2,745,691. **TUBEPACK AND DESIGN.** TUBEPACK LIMITED, MULTIPLE CLASS, (INT. CLS. 20 AND 40), (U.S. CLS. 2, 13, 22, 25, 32, 50, 100, 103 AND 106). SN 76-058,496. PUB. 11-12-2002. FILED 5-30-2000.
- 2,745,723. **Z BLINDS COMPANY WE'VE GOT YOU COVERED. AND DESIGN.** ZEKIAN, LEVON, (U.S. CLS. 2, 13, 22, 25, 32 AND 50). SN 76-089,510. PUB. 5-13-2003. FILED 7-17-2000.
- 2,745,761. **VANGUARD.** MAUSER-WERKE GMBH & CO. KG, BY CHANGE OF NAME MAUSER-WERKE GMBH, MULTIPLE CLASS, (INT. CLS. 20 AND 37), (U.S. CLS. 2, 13, 22, 25, 32, 50, 100, 103 AND 106). SN 76-117,915. PUB. 11-5-2002. FILED 8-28-2000.
- 2,745,882 (*See Class 6 for this trademark.*)
- 2,745,957. **ONE ROOM LIVING.** INNOVATION RANDERS A/S, (U.S. CLS. 2, 13, 22, 25, 32 AND 50). SN 76-253,914. PUB. 10-15-2002. FILED 5-9-2001.
- 2,746,013 (*See Class 18 for this trademark.*)
- 2,746,091 (*See Class 15 for this trademark.*)
- 2,746,100 (*See Class 6 for this trademark.*)
- 2,746,201 (*See Class 7 for this trademark.*)
- 2,746,205. **PACIFIC CREST.** WORLDWIDE DISTRIBUTORS, INC., (U.S. CLS. 2, 13, 22, 25, 32 AND 50). SN 76-341,821. PUB. 10-29-2002. FILED 11-26-2001.
- 2,746,222. **FABRI-TRAK.** FABRI TRAK SYSTEMS, INC., (U.S. CLS. 2, 13, 22, 25, 32 AND 50). SN 76-346,008. PUB. 5-13-2003. FILED 12-5-2001.
- 2,746,265. **HOME ENVIRONMENTS.** ASHLEY FURNITURE INDUSTRIES, INC., (U.S. CLS. 2, 13, 22, 25, 32 AND 50). SN 76-360,525. PUB. 5-13-2003. FILED 1-22-2002.
- 2,746,321. **TENDA DORICA AND DESIGN.** TENDA DORICA - S.R.L., MULTIPLE CLASS, (INT. CLS. 20 AND 21), (U.S. CLS. 2, 13, 22, 23, 25, 29, 30, 32, 33, 40 AND 50). SN 76-374,756. PUB. 5-13-2003. FILED 2-25-2002.
- 2,746,376. **LZB.** LZB PROPERTIES, INC., (U.S. CLS. 2, 13, 22, 25, 32 AND 50). SN 76-384,735. PUB. 5-13-2003. FILED 3-8-2002.
- 2,746,446. **LEMOYNE SLEEPER COMPANY INC. AND DESIGN.** LEMOYNE SLEEPER CO., INC., (U.S. CLS. 2, 13, 22, 25, 32 AND 50). SN 76-395,185. PUB. 5-13-2003. FILED 4-12-2002.
- 2,746,467. **ELECTRO.** MECHOSHAD SYSTEMS, INC., (U.S. CLS. 2, 13, 22, 25, 32 AND 50). SN 76-398,557. PUB. 5-13-2003. FILED 4-22-2002.
- 2,746,512 (*See Class 6 for this trademark.*)
- 2,746,565. **BOOK NOMAD.** LEVINGER COMPANY, (U.S.

- CLS. 2, 13, 22, 25, 32 AND 50). SN 76-411,320. PUB. 5-13-2003. FILED 5-21-2002.
- 2,746,663. **NEOPOLITAN BLUE.** BATESVILLE SERVICES, INC., (U.S. CLS. 2, 13, 22, 25, 32 AND 50). SN 76-431,719. PUB. 5-13-2003. FILED 7-18-2002.
- 2,746,755. **BRING THE FUN INSIDE.** CORTZ, INC., MULTIPLE CLASS, (INT. CLS. 20 AND 28), (U.S. CLS. 2, 13, 22, 23, 25, 32, 38 AND 50). SN 76-445,784. PUB. 5-13-2003. FILED 8-29-2002.
- 2,746,840 (*See Class 9 for this trademark.*)
- 2,746,965. **ARCONAS.** ARCONAS CORPORATION, (U.S. CLS. 2, 13, 22, 25, 32 AND 50). SN 76-459,211. PUB. 5-13-2003. FILED 10-10-2002.
- 2,746,986. **PRINTEX.** PRINTEX PACKAGING CORPORATION, MULTIPLE CLASS, (INT. CLS. 20, 40 AND 42), (U.S. CLS. 2, 13, 22, 25, 32, 50, 100, 101, 103 AND 106). SN 76-460,818. PUB. 5-13-2003. FILED 10-21-2002.
- 2,746,999. **FLIPWORKS AND DESIGN.** SPECTRUM CONCEPTS, INC., (U.S. CLS. 2, 13, 22, 25, 32 AND 50). SN 76-461,709. PUB. 5-13-2003. FILED 10-21-2002.
- 2,747,009 (*See Class 16 for this trademark.*)
- 2,747,012. **BETTER SLEEP FOR THE TWO OF YOU.** DREAMWELL, LTD., (U.S. CLS. 2, 13, 22, 25, 32 AND 50). SN 76-462,686. PUB. 5-13-2003. FILED 10-29-2002.
- 2,747,025. **RESTFUL NIGHTS.** PACIFIC COAST FEATHER COMPANY, MULTIPLE CLASS, (INT. CLS. 20 AND 24), (U.S. CLS. 2, 13, 22, 25, 32, 42 AND 50). SN 76-463,983. PUB. 5-13-2003. FILED 11-4-2002.
- 2,747,092. **FIX KITS.** CANNON RUBBER LIMITED, (U.S. CLS. 2, 13, 22, 25, 32 AND 50). SN 78-081,662. PUB. 6-18-2002. FILED 8-29-2001.
- 2,747,155. **POWERSPAN.** SEALY TECHNOLOGY LLC, (U.S. CLS. 2, 13, 22, 25, 32 AND 50). SN 78-116,922. PUB. 5-13-2003. FILED 3-22-2002.
- 2,747,280. **CASA FIORA.** CASA FIORA, L.L.C., MULTIPLE CLASS, (INT. CLS. 20 AND 24), (U.S. CLS. 2, 13, 22, 25, 32, 42 AND 50). SN 78-153,151. PUB. 5-13-2003. FILED 8-12-2002.
- 2,747,307. **SLEEP PARADISE.** DYNASTY CONSOLIDATED INDUSTRIES, INC., (U.S. CLS. 2, 13, 22, 25, 32 AND 50). SN 78-156,841. PUB. 5-13-2003. FILED 8-22-2002.
- 2,747,347. **EQUITAINER.** HAMILTON RESEARCH, INC., (U.S. CLS. 2, 13, 22, 25, 32 AND 50). SN 78-165,213. PUB. 5-13-2003. FILED 9-18-2002.
- 2,747,349. **IN YOUR DREAMS.** BRITANNICA HOME FASHIONS, INC., MULTIPLE CLASS, (INT. CLS. 20 AND 24), (U.S. CLS. 2, 13, 22, 25, 32, 42 AND 50). SN 78-165,280. PUB. 5-13-2003. FILED 9-18-2002.
- 2,747,403. **ERGO-SMART.** INTERNATIONAL RETAIL SERVICES GROUP, LLC, (U.S. CLS. 2, 13, 22, 25, 32 AND 50). SN 78-170,265. PUB. 5-13-2003. FILED 10-2-2002.
- 2,747,425. **DREAMWOODS.** AVENO INC., (U.S. CLS. 2, 13, 22, 25, 32 AND 50). SN 78-171,890. PUB. 5-13-2003. FILED 10-7-2002.
- 2,747,426. **THERMOWOOD.** AVENO INC., (U.S. CLS. 2, 13, 22, 25, 32 AND 50). SN 78-171,891. PUB. 5-13-2003. FILED 10-7-2002.

CLASS 21—HOUSEWARES AND GLASS

- 2,745,438. **SERENDIPITEA.** SERENDIPITEA LIFE INC., DBA SERENDIPITEA, MULTIPLE CLASS, (INT. CLS. 21 AND 30), (U.S. CLS. 2, 13, 23, 29, 30, 33, 40, 46 AND 50). SN 75-391,619. PUB. 5-8-2001. FILED 10-31-1997.
- 2,745,464 (*See Class 16 for this trademark.*)
- 2,745,466 (*See Class 3 for this trademark.*)
- 2,745,485. **TRADITIONS.** COSTCO WHOLESALE CORPORATION, (U.S. CLS. 2, 13, 23, 29, 30, 33, 40 AND 50). SN 75-607,988. PUB. 12-17-2002. FILED 12-18-1998.
- 2,745,569 (*See Class 3 for this trademark.*)
- 2,745,636 (*See Class 3 for this trademark.*)
- 2,745,656 (*See Class 4 for this trademark.*)
- 2,745,663. **MISCELLANEOUS DESIGN.** SMITHKLINE BEECHAM CORPORATION, (U.S. CLS. 2, 13, 23, 29, 30, 33, 40 AND 50). SN 76-035,010. PUB. 1-8-2002. FILED 4-21-2000.
- 2,745,669 (*See Class 7 for this trademark.*)
- 2,745,680 (*See Class 3 for this trademark.*)

2,745,711. **DB DIAMOND BEAR BREWING COMPANY AND DESIGN.** DIAMOND BEAR BREWING COMPANY, MULTIPLE CLASS, (INT. CLS. 21, 25 AND 32), (U.S. CLS. 2, 13, 22, 23, 29, 30, 33, 39, 40, 45, 46, 48 AND 50). SN 76-076,204. PUB. 5-13-2003. FILED 6-23-2000.

2,745,823 (*See Class 7 for this trademark.*)

2,745,882 (*See Class 6 for this trademark.*)

2,745,904. **MISCELLANEOUS DESIGN.** AMCO HOUSEWARE, LLC, BY ASSIGNMENT L&P PROPERTY MANAGEMENT COMPANY, (U.S. CLS. 2, 13, 23, 29, 30, 33, 40 AND 50). SN 76-230,249. PUB. 5-13-2003. FILED 3-26-2001.

2,745,972 (*See Class 11 for this trademark.*)

2,746,002 (*See Class 1 for this trademark.*)

2,746,018. **EXCELLE ELITE.** WILTON INDUSTRIES, INC., (U.S. CLS. 2, 13, 23, 29, 30, 33, 40 AND 50). SN 76-281,513. PUB. 4-30-2002. FILED 6-29-2001.

2,746,022. **BARBECUE GRILL CLUB AND DESIGN.** HIGH BRANDON INCORPORATED, (U.S. CLS. 2, 13, 23, 29, 30, 33, 40 AND 50). SN 76-284,059. PUB. 5-13-2003. FILED 7-12-2001.

2,746,075 (*See Class 1 for this trademark.*)

2,746,093 (*See Class 9 for this trademark.*)

2,746,156 (*See Class 7 for this trademark.*)

2,746,195 (*See Class 16 for this trademark.*)

2,746,321 (*See Class 20 for this trademark.*)

2,746,360. **KROSNO AND DESIGN.** KROSIENSKIE HUTY SZKLA "KROSNO" SA, (U.S. CLS. 2, 13, 23, 29, 30, 33, 40 AND 50). SN 76-381,466. PUB. 5-13-2003. FILED 3-12-2002.

2,746,410. **SPLAK.** IBI, (U.S. CLS. 2, 13, 23, 29, 30, 33, 40 AND 50). SN 76-390,389. PUB. 5-13-2003. FILED 4-3-2002.

2,746,561. **KALLE.** KALLE GMBH & CO. KG, (U.S. CLS. 2, 13, 23, 29, 30, 33, 40 AND 50). SN 76-411,225. PUB. 5-13-2003. FILED 5-20-2002.

2,746,641. **WILLIAM JAMES.** CHAN, WILLIAM W.K., (U.S. CLS. 2, 13, 23, 29, 30, 33, 40 AND 50). SN 76-426,355. PUB. 5-13-2003. FILED 7-1-2002.

2,746,840 (*See Class 9 for this trademark.*)

2,746,853 (*See Class 3 for this trademark.*)

2,746,893. **BESSIE PEASE GUTMANN.** BALLIOL CORPORATION, THE, DBA THE BALLIOL CORPORATION, (U.S. CLS. 2, 13, 23, 29, 30, 33, 40 AND 50). SN 76-455,231. PUB. 5-13-2003. FILED 10-3-2002.

2,746,971 (*See Class 16 for this trademark.*)

2,747,013. **BB.** BLACKBOARD INC., (U.S. CLS. 2, 13, 23, 29, 30, 33, 40 AND 50). SN 76-462,785. PUB. 5-13-2003. FILED 10-25-2002.

2,747,014. **BLACKBOARD.** BLACKBOARD INC., (U.S. CLS. 2, 13, 23, 29, 30, 33, 40 AND 50). SN 76-462,798. PUB. 5-13-2003. FILED 10-25-2002.

2,747,054. **CIRCULON.** MEYER MANUFACTURING COMPANY LIMITED, (U.S. CLS. 2, 13, 23, 29, 30, 33, 40 AND 50). SN 76-975,353. PUB. 10-9-2001. FILED 8-16-2000.

2,747,162. **H AND DESIGN.** HAWKINS CHILDREN'S LLC, (U.S. CLS. 2, 13, 23, 29, 30, 33, 40 AND 50). SN 78-118,235. PUB. 5-13-2003. FILED 3-28-2002.

2,747,287 (*See Class 1 for this trademark.*)

2,747,390. **GOLD STANDARD.** CLAD HOLDINGS CORP., (U.S. CLS. 2, 13, 23, 29, 30, 33, 40 AND 50). SN 78-169,262. PUB. 5-13-2003. FILED 9-30-2002.

2,747,391 (*See Class 16 for this trademark.*)

CLASS 22—CORDAGE AND FIBERS

2,745,696 (*See Class 1 for this trademark.*)

2,745,724 (*See Class 6 for this trademark.*)

2,745,921. **LOVE BAG.** FIRST HAND FOUNDATION, (U.S. CLS. 1, 2, 7, 19, 22, 42 AND 50). SN 76-236,431. PUB. 5-13-2003. FILED 4-9-2001.

2,746,013 (*See Class 18 for this trademark.*)

2,746,196. **PACIFIC CREST.** WORLDWIDE DISTRIBUTORS, INC., (U.S. CLS. 1, 2, 7, 19, 22, 42 AND 50). SN 76-340,235. PUB. 10-22-2002. FILED 11-20-2001.

2,746,422. **SO.CAP.** (STYLIZED). SO.CAP.S.R.L., MULTIPLE CLASS, (INT. CLS. 22 AND 26), (U.S. CLS. 1, 2, 7, 19, 22, 37, 39, 40, 42 AND 50). SN 76-392,818. PUB. 5-13-2003. FILED 4-8-2002.

2,747,412. **LINEON.** ORCON CORPORATION, (U.S. CLS. 1, 2, 7, 19, 22, 42 AND 50). SN 78-171,346. PUB. 5-13-2003. FILED 10-4-2002.

CLASS 23—YARNS AND THREADS

2,745,696 (*See Class 1 for this trademark.*)

CLASS 24—FABRICS

2,745,462 (*See Class 20 for this trademark.*)

2,745,542 (*See Class 7 for this trademark.*)

2,745,543 (*See Class 18 for this trademark.*)

2,745,695 (*See Class 10 for this trademark.*)

2,745,696 (*See Class 1 for this trademark.*)

2,745,928. **SETAMARINA (STYLIZED).** RATTI S.P.A., MULTIPLE CLASS, (INT. CLS. 24 AND 25), (U.S. CLS. 22, 39, 42 AND 50). SN 76-239,775. PUB. 5-13-2003. FILED 4-12-2001.

2,745,972 (*See Class 11 for this trademark.*)

2,746,093 (*See Class 9 for this trademark.*)

2,746,115 (*See Class 9 for this trademark.*)

2,746,398. **X Y Z ETC. AND DESIGN.** TRION, INC., DBA THE CRATE, (U.S. CLS. 42 AND 50). SN 76-387,595. PUB. 5-13-2003. FILED 3-25-2002.

2,746,494. **MER ET SOLEIL.** BEL AIR INDUSTRIES, (U.S. CLS. 42 AND 50). SN 76-402,701. PUB. 5-13-2003. FILED 5-1-2002.

2,746,588 (*See Class 6 for this trademark.*)

2,747,025 (*See Class 20 for this trademark.*)

2,747,069. **A TOUCH OF ELEGANCE.** SETHI & SETHI INC., (U.S. CLS. 42 AND 50). SN 78-040,676. PUB. 5-13-2003. FILED 12-27-2000.

2,747,218. **THE BEEBOP.** PICADILLY KIDS, INC., (U.S. CLS. 42 AND 50). SN 78-138,263. PUB. 5-13-2003. FILED 6-24-2002.

2,747,246. **COMFORTCASE.** LITTLE RAPIDS CORPORATION, (U.S. CLS. 42 AND 50). SN 78-147,741. PUB. 5-13-2003. FILED 7-26-2002.

2,747,264. **DANCING FOUNTAIN DESIGNS.** NAHINU, PATSY W., (U.S. CLS. 42 AND 50). SN 78-151,754. PUB. 5-13-2003. FILED 8-7-2002.

2,747,277. **CHARMEUSE SATIN BY SCENT-SATION.** SCENT-SATION, INC., (U.S. CLS. 42 AND 50). SN 78-152,755. PUB. 5-13-2003. FILED 8-9-2002.

2,747,280 (*See Class 20 for this trademark.*)

2,747,349 (*See Class 20 for this trademark.*)

CLASS 25—CLOTHING

2,745,418 (*See Class 9 for this trademark.*)

2,745,435 (*See Class 9 for this trademark.*)

2,745,436 (*See Class 6 for this trademark.*)

2,745,439 (*See Class 9 for this trademark.*)

2,745,442. **TREK.** TREK BICYCLE CORPORATION, MULTIPLE CLASS, (INT. CLS. 25 AND 28), (U.S. CLS. 22, 23, 38, 39 AND 50). SN 75-414,082. PUB. 5-13-2003. FILED 1-5-1998.

2,745,456. **SPORTS STAR.** COLLEGEWARE U.S.A., INC., (U.S. CLS. 22 AND 39). SN 75-505,815. PUB. 12-3-2002. FILED 6-19-1998.

2,745,471. **ADDICTION.** EXQUISITE APPAREL CORP., (U.S. CLS. 22 AND 39). SN 75-563,581. PUB. 5-13-2003. FILED 10-2-1998.

2,745,472. **ADDICTION.** EXQUISITE APPAREL CORP., (U.S. CLS. 22 AND 39). SN 75-563,582. PUB. 5-13-2003. FILED 10-2-1998.

2,745,478 (*See Class 18 for this trademark.*)

2,745,492. **CAMPER AND DESIGN.** CAMPER, S.L., (U.S. CLS. 22 AND 39). SN 75-628,268. PUB. 12-24-2002. FILED 1-26-1999.

2,745,495. **XS.** INTERNATIONAL APPAREL GROUP LLC, BY ASSIGNMENT CARMICHAEL, CHRIS, AND CARMICHAEL, ALBERT R., DBA INTERNATIONAL APPAREL

- GROUP LLC, (U.S. CLS. 22 AND 39), SN 75-643,944. PUB. 4-8-2003. FILED 2-19-1999.
- 2,745,531. **I MATTER AND DESIGN**. GRIFFIN, ANNE, (U.S. CLS. 22 AND 39), SN 75-751,957. PUB. 1-14-2003. FILED 7-12-1999.
- 2,745,542 (*See Class 7 for this trademark*).
- 2,745,543 (*See Class 18 for this trademark*).
- 2,745,550 (*See Class 3 for this trademark*).
- 2,745,558 (*See Class 3 for this trademark*).
- 2,745,563. **LIQUID CURVES**. MAIDENFORM, INC., (U.S. CLS. 22 AND 39), SN 75-829,052. PUB. 5-13-2003. FILED 10-22-1999.
- 2,745,582 (*See Class 3 for this trademark*).
- 2,745,599. **FASHIONISTA AND DESIGN**. THE DREW PHILIPS CORP., (U.S. CLS. 22 AND 39), SN 75-901,707. PUB. 5-13-2003. FILED 1-21-2000.
- 2,745,609. **TAYGEE**. TAYLOR, AARON MICHAEL, (U.S. CLS. 22 AND 39), SN 75-917,636. PUB. 5-13-2003. FILED 2-12-2000.
- 2,745,616 (*See Class 18 for this trademark*).
- 2,745,660 (*See Class 9 for this trademark*).
- 2,745,662 (*See Class 16 for this trademark*).
- 2,745,680 (*See Class 3 for this trademark*).
- 2,745,682 (*See Class 5 for this trademark*).
- 2,745,683 (*See Class 3 for this trademark*).
- 2,745,687. **RE-DESIGNED . PRE-SHRUNK WASHED & READY BIG COTTON AND DESIGN**. GFSI, INC., (U.S. CLS. 22 AND 39), SN 76-054,731. PUB. 2-12-2002. FILED 5-22-2000.
- 2,745,689. **G GRACE AND DESIGN**. REPUBLIC CLOTHING CORPORATION, (U.S. CLS. 22 AND 39), SN 76-056,392. PUB. 11-26-2002. FILED 5-25-2000.
- 2,745,692 (*See Class 9 for this trademark*).
- 2,745,695 (*See Class 10 for this trademark*).
- 2,745,711 (*See Class 21 for this trademark*).
- 2,745,739. **BABY BUNS INC.**, BABY BUNS, INC., (U.S. CLS. 22 AND 39), SN 76-102,641. PUB. 3-26-2002. FILED 8-3-2000.
- 2,745,751. **DRAMBUIE AND DESIGN**. THE DRAMBUIE LIQUEUR COMPANY LIMITED, MULTIPLE CLASS, (INT. CLS. 25, 30 AND 33), (U.S. CLS. 22, 39, 46, 47 AND 49), SN 76-111,782. PUB. 5-13-2003. FILED 8-17-2000.
- 2,745,777 (*See Class 9 for this trademark*).
- 2,745,778. **NW SPORTS APPAREL**. NATIONWIDE LLC, (U.S. CLS. 22 AND 39), SN 76-136,868. PUB. 11-12-2002. FILED 9-26-2000.
- 2,745,787 (*See Class 4 for this trademark*).
- 2,745,794. **A AND DESIGN**. AVIREX LTD., (U.S. CLS. 22 AND 39), SN 76-151,366. PUB. 1-7-2003. FILED 10-20-2000.
- 2,745,795. **MOVER**. MOVER SPORTSWEAR AB, (U.S. CLS. 22 AND 39), SN 76-154,742. PUB. 5-13-2003. FILED 10-26-2000.
- 2,745,796 (*See Class 18 for this trademark*).
- 2,745,819 (*See Class 3 for this trademark*).
- 2,745,830. **MISCELLANEOUS DESIGN**. ART THANG, INC., (U.S. CLS. 22 AND 39), SN 76-184,958. PUB. 11-12-2002. FILED 12-22-2000.
- 2,745,858. **PRECIOUS (STYLIZED)**. GIORGIO GRATI S.P.A., (U.S. CLS. 22 AND 39), SN 76-198,399. PUB. 5-13-2003. FILED 1-23-2001.
- 2,745,882 (*See Class 6 for this trademark*).
- 2,745,888. **CABOTINE**. INDUSTRIAL Y COMERCIAL NICOLAS, S.L., (U.S. CLS. 22 AND 39), SN 76-216,291. PUB. 5-13-2003. FILED 2-27-2001.
- 2,745,928 (*See Class 24 for this trademark*).
- 2,745,955. **D-WOLVES AND DESIGN**. FUJIAN SEPTWOLVES GROUP CORP., (U.S. CLS. 22 AND 39), SN 76-251,080. PUB. 8-20-2002. FILED 5-3-2001.
- 2,745,968 (*See Class 16 for this trademark*).
- 2,746,009. **VANDERBILT AND DESIGN**. VANDERBILT UNIVERSITY, (U.S. CLS. 22 AND 39), SN 76-277,436. PUB. 5-13-2003. FILED 6-25-2001.
- 2,746,021. **SUNLIGHT MOUNTAIN RESORT AND DESIGN**. SUNLIGHT, INC., MULTIPLE CLASS, (INT. CLS. 25 AND 41), (U.S. CLS. 22, 39, 100, 101 AND 107), SN 76-283,479. PUB. 10-29-2002. FILED 7-10-2001.
- 2,746,075 (*See Class 1 for this trademark*).
- 2,746,093 (*See Class 9 for this trademark*).
- 2,746,094. **GOCARR GEAR**. GOODMAN AND CARR LLP, (U.S. CLS. 22 AND 39), SN 76-307,730. PUB. 5-13-2003. FILED 8-30-2001.
- 2,746,099. **ROGER MARTIN**. ZENTO INTERNATIONAL LTD., (U.S. CLS. 22 AND 39), SN 76-311,615. PUB. 12-17-2002. FILED 9-10-2001.
- 2,746,100 (*See Class 6 for this trademark*).
- 2,746,131. **MISCELLANEOUS DESIGN**. SHA SHA FINE SHOES, INC., (U.S. CLS. 22 AND 39), SN 76-321,717. PUB. 8-27-2002. FILED 10-9-2001.
- 2,746,148 (*See Class 14 for this trademark*).
- 2,746,158. **L (STYLIZED)**. JACK SCHWARTZ SHOES, INC., (U.S. CLS. 22 AND 39), SN 76-331,549. PUB. 11-5-2002. FILED 10-26-2001.
- 2,746,167. **KB & COMPANY**. FRED MEYER STORES, INC., (U.S. CLS. 22 AND 39), SN 76-333,008. PUB. 11-5-2002. FILED 11-1-2001.
- 2,746,173. **COW PONY**. BELL, MICHELLE BEAUCLAIR, (U.S. CLS. 22 AND 39), SN 76-335,019. PUB. 10-29-2002. FILED 11-7-2001.
- 2,746,178. **WARM SPIRIT**. WARM SPIRIT, INC., (U.S. CLS. 22 AND 39), SN 76-336,179. PUB. 5-13-2003. FILED 11-10-2001.
- 2,746,181. **MATRIX OUTWEAR AND DESIGN**. MATRIX GROUP LIMITED, INC., (U.S. CLS. 22 AND 39), SN 76-336,707. PUB. 6-25-2002. FILED 11-13-2001.
- 2,746,185 (*See Class 10 for this trademark*).
- 2,746,193. **PACIFIC CREST**. WORLDWIDE DISTRIBUTORS, INC., (U.S. CLS. 22 AND 39), SN 76-339,354. PUB. 10-29-2002. FILED 11-16-2001.
- 2,746,195 (*See Class 16 for this trademark*).
- 2,746,209 (*See Class 17 for this trademark*).
- 2,746,213 (*See Class 3 for this trademark*).
- 2,746,240. **HAROLD HUNTER**. AARON LACANFORA, DBA ALL SURFACE ENTERTAINMENT, INC., (U.S. CLS. 22 AND 39), SN 76-353,804. PUB. 11-12-2002. FILED 1-2-2002.
- 2,746,270. **DEADSY**. WITHOUSE, INC., (U.S. CLS. 22 AND 39), SN 76-361,827. PUB. 5-13-2003. FILED 1-23-2002.
- 2,746,274. **NAUGHTY COMPANY**. HOME BOY CLOTHING (PTY) LTD., (U.S. CLS. 22 AND 39), SN 76-363,232. PUB. 5-13-2003. FILED 1-29-2002.
- 2,746,298. **CURTIS LIPSCOMB AND DESIGN**. LIPSCOMB, CURTIS ALEXANDER, (U.S. CLS. 22 AND 39), SN 76-370,615. PUB. 5-13-2003. FILED 2-14-2002.
- 2,746,313 (*See Class 18 for this trademark*).
- 2,746,427. **MISCELLANEOUS DESIGN**. HOFF, DAVID M., (U.S. CLS. 22 AND 39), SN 76-393,378. PUB. 5-13-2003. FILED 4-9-2002.
- 2,746,438. **THE SURREAL GOURMET**. BLUMER, ROBERT, (U.S. CLS. 22 AND 39), SN 76-394,341. PUB. 5-13-2003. FILED 4-11-2002.
- 2,746,447. **COOL CLOTHING**. MUHAMMAD, KAMAL, (U.S. CLS. 22 AND 39), SN 76-395,222. PUB. 5-13-2003. FILED 4-11-2002.
- 2,746,473. **TRY THE FIT HELP THE CAUSE**. KEYSTONE INDUSTRIES (1970) LTD/LTEE, (U.S. CLS. 22 AND 39), SN 76-399,571. PUB. 5-13-2003. FILED 4-24-2002.
- 2,746,477. **SWORD**. KABUSHIKI KAISHA UMEDA SHOKAI, MULTIPLE CLASS, (INT. CLS. 25 AND 28), (U.S. CLS. 22, 23, 38, 39 AND 50), SN 76-400,065. PUB. 5-13-2003. FILED 4-25-2002.
- 2,746,486. **DEMOCRATA AND DESIGN**. DEMOCRATA CALCADOS E ARTEFATOS DE COURO LTDA., (U.S. CLS. 22 AND 39), SN 76-401,493. PUB. 5-13-2003. FILED 4-29-2002.
- 2,746,518. **SARAH SPENCER**. TJX COMPANIES, INC., THE, (U.S. CLS. 22 AND 39), SN 76-405,743. PUB. 5-13-2003. FILED 5-10-2002.
- 2,746,523. **WOLFORD'S BODYWORKS**. WOLFORD AKTIENGESELLSCHAFT, (U.S. CLS. 22 AND 39), SN 76-406,326. PUB. 5-13-2003. FILED 5-13-2002.
- 2,746,546. **PRICK**. PRICK APPAREL L.L.C., (U.S. CLS. 22 AND 39), SN 76-408,822. PUB. 5-13-2003. FILED 5-16-2002.
- 2,746,572. **E.VIL AS DECREED BY THE QUEEN OF E.VIL (STYLIZED)**. SOLEIMANZADEH, AIMEE, (U.S. CLS. 22 AND 39), SN 76-412,845. PUB. 5-13-2003. FILED 5-22-2002.
- 2,746,584. **CRIME WEAR AND DESIGN**. SENKIR, DAMIEN, (U.S. CLS. 22 AND 39), SN 76-416,998. PUB. 5-13-2003. FILED 6-4-2002.
- 2,746,686. **MIKASI DE COUTIER**. CHASE, STEPHEN, (U.S. CLS. 22 AND 39), SN 76-436,817. PUB. 5-13-2003. FILED 8-2-2002.
- 2,746,688. **ORIALI**. LEVEL GROUP S.R.L., (U.S. CLS. 22 AND

39). SN 76-437,236. PUB. 5-13-2003. FILED 7-31-2002.
 2,746,694. **JANTE AND DESIGN**. C.S. ASSOCIATES INC., (U.S. CLS. 22 AND 39). SN 76-438,779. PUB. 5-13-2003. FILED 8-6-2002.
 2,746,711. **MISCELLANEOUS DESIGN**. PARKER, EDWIN C., (U.S. CLS. 22 AND 39). SN 76-441,575. PUB. 5-13-2003. FILED 5-2-2002.
 2,746,716. **DO THE HULA**. M R S ENTERPRISES LLC, (U.S. CLS. 22 AND 39). SN 76-441,794. PUB. 5-13-2003. FILED 8-19-2002.
 2,746,763. **BIG DOGS KIDS**. BIG DOG HOLDINGS, INC., (U.S. CLS. 22 AND 39). SN 76-446,456. PUB. 5-13-2003. FILED 9-3-2002.
 2,746,768. **GEL-FREEDOM**. ASICS CORPORATION, (U.S. CLS. 22 AND 39). SN 76-447,063. PUB. 5-13-2003. FILED 9-3-2002.
 2,746,774. **BLU HEAVEN**. ALLIANCE APPAREL, INC., (U.S. CLS. 22 AND 39). SN 76-447,719. PUB. 5-13-2003. FILED 9-6-2002.
 2,746,801. **GREAT NORTHWEST**. FRED MEYER STORES, INC., (U.S. CLS. 22 AND 39). SN 76-449,862. PUB. 5-13-2003. FILED 9-16-2002.
 2,746,804. **SPORTELE**. SPORT-ELLE, INC., (U.S. CLS. 22 AND 39). SN 76-450,056. PUB. 5-13-2003. FILED 9-16-2002.
 2,746,836. **ASICS DUO TECH AND DESIGN**. ASICS CORPORATION, (U.S. CLS. 22 AND 39). SN 76-452,249. PUB. 5-13-2003. FILED 9-23-2002.
 2,746,839. **MUC'S**. PIERRE FASHIONS, INC., (U.S. CLS. 22 AND 39). SN 76-452,476. PUB. 5-13-2003. FILED 9-19-2002.
 2,746,840 (*See Class 9 for this trademark*).
 2,746,847. **FX FISHING EXPEDITIONS AND DESIGN**. FISHING EXPEDITIONS OUTDOOR APPAREL, (U.S. CLS. 22 AND 39). SN 76-452,987. PUB. 5-13-2003. FILED 9-26-2002.
 2,746,848. **SIQ**. GALLOWAY, JAY D., (U.S. CLS. 22 AND 39). SN 76-453,000. PUB. 5-13-2003. FILED 9-25-2002.
 2,746,854. **WOMPAS**. GENTRY, COREY S., (U.S. CLS. 22 AND 39). SN 76-453,166. PUB. 5-13-2003. FILED 9-26-2002.
 2,746,863. **GRACE**. ALDI INC., (U.S. CLS. 22 AND 39). SN 76-453,580. PUB. 5-13-2003. FILED 9-23-2002.
 2,746,869. **EZZA**. MICHAEL HOBAN, INC., (U.S. CLS. 22 AND 39). SN 76-453,838. PUB. 5-13-2003. FILED 9-30-2002.
 2,746,872. **STEPHANNA'S CURVES**. STEPHANNA'S CURVES, (U.S. CLS. 22 AND 39). SN 76-453,979. PUB. 5-13-2003. FILED 9-30-2002.
 2,746,875. **SKATE ONE**. SKATE ONE CORP., MULTIPLE CLASS, (INT. CLS. 25, 28 AND 35), (U.S. CLS. 22, 23, 38, 39, 50, 100, 101 AND 102). SN 76-454,097. PUB. 5-13-2003. FILED 10-1-2002.
 2,746,877. **GPG**. HALE, GARY A., (U.S. CLS. 22 AND 39). SN 76-454,187. PUB. 5-13-2003. FILED 10-1-2002.
 2,746,891. **FITELLE**. SSB ENTERPRISES OF MIAMI, INC., MULTIPLE CLASS, (INT. CLS. 25 AND 35), (U.S. CLS. 22, 39, 100, 101 AND 102). SN 76-455,153. PUB. 5-13-2003. FILED 9-30-2002.
 2,746,903. **WASHOES**. ZANIN, KRISTINA M., (U.S. CLS. 22 AND 39). SN 76-455,565. PUB. 5-13-2003. FILED 10-3-2002.
 2,746,971 (*See Class 16 for this trademark*).
 2,747,019. **THE MYSTERY MACHINE**. HANNA-BARBERA PRODUCTIONS, INC., (U.S. CLS. 22 AND 39). SN 76-463,336. PUB. 5-13-2003. FILED 10-31-2002.
 2,747,076. **RED ROCK**. RED ROCK CLOTHING COMPANY, LTD., (U.S. CLS. 22 AND 39). SN 78-054,731. PUB. 5-13-2003. FILED 3-23-2001.
 2,747,079. **SWISSHANDMADE.COM AND DESIGN**. ALLEN-SPACH, NATALIE F., (U.S. CLS. 22 AND 39). SN 78-060,997. PUB. 5-13-2003. FILED 4-29-2001.
 2,747,115. **GOOSE GEAR EST. 1946 AND DESIGN**. MUSI, RICHARD ALEXANDER, (U.S. CLS. 22 AND 39). SN 78-099,026. PUB. 5-13-2003. FILED 12-18-2001.
 2,747,125. **J. KEYDGE**. JEAN CLAUDE FRANCOIS-FERDINAND BERNARD AND PATRICK CHAMBOREDON PARTNERSHIP, THE, (U.S. CLS. 22 AND 39). SN 78-105,119. PUB. 5-13-2003. FILED 1-27-2002.
 2,747,148. **INTL IN ORBIT INC.**, (U.S. CLS. 22 AND 39). SN 78-113,268. PUB. 5-13-2003. FILED 3-7-2002.
 2,747,169 (*See Class 14 for this trademark*).
 2,747,183. **MISCELLANEOUS DESIGN**. MARINER INTERNATIONAL TRAVEL, INC., (U.S. CLS. 22 AND 39). SN 78-

122,060. PUB. 5-13-2003. FILED 4-16-2002.
 2,747,186. **PACAWOOL**. MERELINDA FARM LLC, DBA ALPACA.COM LLC, (U.S. CLS. 22 AND 39). SN 78-123,018. PUB. 5-13-2003. FILED 4-20-2002.
 2,747,187. **PACAPIMA**. MERELINDA FARM LLC, DBA ALPACA.COM LLC, (U.S. CLS. 22 AND 39). SN 78-123,019. PUB. 5-13-2003. FILED 4-20-2002.
 2,747,190 (*See Class 18 for this trademark*).
 2,747,217. **PLAY SAFE THONG AND DESIGN**. HME CORPORATION, (U.S. CLS. 22 AND 39). SN 78-137,469. PUB. 5-13-2003. FILED 6-20-2002.
 2,747,236. **OSSIRA (STYLIZED)**. STERLICCHIO, LUIS ALBERTO, AND STERLICCHIO DE ELIZALDE, ANA MARÍA, MULTIPLE CLASS, (INT. CLS. 25 AND 35), (U.S. CLS. 22, 39, 100, 101 AND 102). SN 78-145,111. PUB. 5-13-2003. FILED 7-18-2002.
 2,747,263. **JESSIE DELLA FEMINA**. DELLA FEMINA ENTERPRISES, INC., (U.S. CLS. 22 AND 39). SN 78-151,523. PUB. 5-13-2003. FILED 8-6-2002.
 2,747,302. **EASY SPIRIT**. NINE WEST DEVELOPMENT CORPORATION, (U.S. CLS. 22 AND 39). SN 78-155,451. PUB. 5-13-2003. FILED 8-19-2002.
 2,747,310. **LPJ AND DESIGN**. INTERNATIONAL DENIM INC., (U.S. CLS. 22 AND 39). SN 78-158,658. PUB. 5-13-2003. FILED 8-28-2002.
 2,747,447. **B AND DESIGN**. BACCI, LLC, (U.S. CLS. 22 AND 39). SN 78-178,430. PUB. 5-13-2003. FILED 10-25-2002.
 2,747,449. **USW**. URBAN STREET WEAR, INC., (U.S. CLS. 22 AND 39). SN 78-178,636. PUB. 5-13-2003. FILED 10-25-2002.

CLASS 26—FANCY GOODS

2,745,494. **YPP**. YKK CORPORATION, BY ASSIGNMENT JUNGWOO ZIPPER CO., LTD., (U.S. CLS. 37, 39, 40, 42 AND 50). SN 75-643,359. PUB. 11-16-1999. FILED 2-17-1999.
 2,745,684 (*See Class 3 for this trademark*).
 2,745,893. **AQUABLOC**. YKK CORPORATION, (U.S. CLS. 37, 39, 40, 42 AND 50). SN 76-219,742. PUB. 5-13-2003. FILED 3-5-2001.
 2,745,932. **HI Q**. HAIR COLLECTION INC., (U.S. CLS. 37, 39, 40, 42 AND 50). SN 76-241,612. PUB. 5-13-2003. FILED 4-16-2001.
 2,746,066 (*See Class 6 for this trademark*).
 2,746,422 (*See Class 22 for this trademark*).
 2,746,423 (*See Class 14 for this trademark*).
 2,747,178. **DR. MARTENS**. "DR. MARTENS" INTERNATIONAL TRADING GMBH, (U.S. CLS. 37, 39, 40, 42 AND 50). SN 78-120,930. PUB. 5-13-2003. FILED 4-10-2002.

CLASS 27—FLOOR COVERINGS

2,745,561 (*See Class 19 for this trademark*).
 2,745,564. **SNAP BY KAINDL AND DESIGN**. M. KAINDL, (U.S. CLS. 19, 20, 37, 42 AND 50). SN 75-833,646. PUB. 7-30-2002. FILED 10-27-1999.
 2,745,695 (*See Class 10 for this trademark*).
 2,745,841. **SPIETH AND DESIGN**. SPIETH GYMNASIUM GMBH, MULTIPLE CLASS, (INT. CLS. 27 AND 28), (U.S. CLS. 19, 20, 22, 23, 37, 38, 42 AND 50). SN 76-189,625. PUB. 12-10-2002. FILED 1-4-2001.
 2,745,926 (*See Class 9 for this trademark*).
 2,746,242. **SPORTSTILE**. WATERFORD, GARY WAYNE, MULTIPLE CLASS, (INT. CLS. 27 AND 37), (U.S. CLS. 19, 20, 37, 42, 50, 100, 103 AND 106). SN 76-354,270. PUB. 5-13-2003. FILED 12-19-2001.
 2,746,790 (*See Class 19 for this trademark*).
 2,746,817. **BAREFOOT**. BEAGLE 1, INC., (U.S. CLS. 19, 20, 37, 42 AND 50). SN 76-450,801. PUB. 5-13-2003. FILED 9-12-2002.
 2,746,945. **CUSHION-LOK**. MSM INDUSTRIES, (U.S. CLS. 19, 20, 37, 42 AND 50). SN 76-458,537. PUB. 5-13-2003. FILED 10-8-2002.

CLASS 28—TOYS AND SPORTING GOODS

- 2,745,416. **TIGER**. HASBRO, INC., BY MERGER TIGER ELECTRONICS, INC., (U.S. CLS. 22, 23, 38 AND 50). SN 74-560,235. PUB. 6-6-1995. FILED 8-8-1994.
- 2,745,418 (See Class 9 for this trademark).
- 2,745,419. **COLUMBIA GAMES**. COLUMBIA GAMES, INC., (U.S. CLS. 22, 23, 38 AND 50). SN 75-029,053. PUB. 10-8-1996. FILED 12-7-1995.
- 2,745,442 (See Class 25 for this trademark).
- 2,745,545. **IL CAPO**. SUMARA, FRANK, AND SANTI, DANIEL DELLI, (U.S. CLS. 22, 23, 38 AND 50). SN 75-792,469. PUB. 12-10-2002. FILED 8-30-1999.
- 2,745,551. **JP AUSTRALIA AND DESIGN**. POLAKOW, JASON NICHOLAS, (U.S. CLS. 22, 23, 38 AND 50). SN 75-806,466. PUB. 5-13-2003. FILED 9-22-1999.
- 2,745,588. **COSMIC UFO**. BUKUR, THOMAS J., (U.S. CLS. 22, 23, 38 AND 50). SN 75-887,668. PUB. 5-13-2003. FILED 1-5-2000.
- 2,745,600 (See Class 9 for this trademark).
- 2,745,630. **BLACK LABEL (STYLIZED)**. BL FLAME, INC., (U.S. CLS. 22, 23, 38 AND 50). SN 75-981,307. PUB. 11-12-2002. FILED 6-29-2000.
- 2,745,662 (See Class 16 for this trademark).
- 2,745,676. **PRIMEVAL PREDATORS**. ROYAL ONTARIO MUSEUM, THE, (U.S. CLS. 22, 23, 38 AND 50). SN 76-046,498. PUB. 5-13-2003. FILED 5-10-2000.
- 2,745,680 (See Class 3 for this trademark).
- 2,745,682 (See Class 5 for this trademark).
- 2,745,692 (See Class 9 for this trademark).
- 2,745,712. **DIBBLER**. SCHIMMEL GROUP, INC., THE, (U.S. CLS. 22, 23, 38 AND 50). SN 76-077,345. PUB. 9-17-2002. FILED 6-26-2000.
- 2,745,735. **PASSWORD**. PEARSON TELEVISION OPERATIONS B.V., (U.S. CLS. 22, 23, 38 AND 50). SN 76-101,693. PUB. 12-18-2001. FILED 8-1-2000.
- 2,745,777 (See Class 9 for this trademark).
- 2,745,787 (See Class 4 for this trademark).
- 2,745,796 (See Class 18 for this trademark).
- 2,745,817 (See Class 9 for this trademark).
- 2,745,818 (See Class 9 for this trademark).
- 2,745,841 (See Class 27 for this trademark).
- 2,745,851. **GEPPETTO'S PUPPETS AND DESIGN**. HAMMOND, JACQUELINE E, (U.S. CLS. 22, 23, 38 AND 50). SN 76-195,262. PUB. 10-8-2002. FILED 1-18-2001.
- 2,745,864 (See Class 16 for this trademark).
- 2,745,882 (See Class 6 for this trademark).
- 2,745,906. **AIR GYM (STYLIZED)**. WEBER, ALBERT, (U.S. CLS. 22, 23, 38 AND 50). SN 76-230,812. PUB. 5-13-2003. FILED 3-27-2001.
- 2,745,944. **CLIFFORD THE BIG RED DOG**. BRIDWELL, NORMAN, (U.S. CLS. 22, 23, 38 AND 50). SN 76-246,128. PUB. 5-13-2003. FILED 4-25-2001.
- 2,745,996. **EXO-SKIN**. L.A. PROMOTION DEVELOPMENT, INC., (U.S. CLS. 22, 23, 38 AND 50). SN 76-271,793. PUB. 5-13-2003. FILED 6-15-2001.
- 2,746,006. **AB TRAINER**. PRECISE EXERCISE EQUIPMENT, INC., (U.S. CLS. 22, 23, 38 AND 50). SN 76-276,655. PUB. 5-13-2003. FILED 6-26-2001.
- 2,746,052. **APEX**. J. DEBEER & SONS, INC., (U.S. CLS. 22, 23, 38 AND 50). SN 76-292,805. PUB. 5-13-2003. FILED 7-31-2001.
- 2,746,073. **BODYTONE**. F.F. ACQUISITION CORP., (U.S. CLS. 22, 23, 38 AND 50). SN 76-299,043. PUB. 5-13-2003. FILED 8-13-2001.
- 2,746,091 (See Class 15 for this trademark).
- 2,746,093 (See Class 9 for this trademark).
- 2,746,136. **YAMAMOTO HULA GRUB**. YAMAMOTO, GARY, BY ASSIGNMENT GARY YAMAMOTO CUSTOM BAITS, INC., (U.S. CLS. 22, 23, 38 AND 50). SN 76-323,825. PUB. 5-13-2003. FILED 10-11-2001.
- 2,746,148 (See Class 14 for this trademark).
- 2,746,195 (See Class 16 for this trademark).
- 2,746,209 (See Class 17 for this trademark).
- 2,746,243. **LUNATIC LURE**. SO SLO LURES, INC., (U.S. CLS. 22, 23, 38 AND 50). SN 76-354,361. PUB. 5-13-2003. FILED 1-3-2002.
- 2,746,262 (See Class 12 for this trademark).
- 2,746,264. **EVERLOCK**. SPIRALOCK CORPORATION, (U.S. CLS. 22, 23, 38 AND 50). SN 76-360,470. PUB. 5-13-2003. FILED 1-8-2002.
- 2,746,280. **KI-ENERGIZER**. FIT-RITE, INC., (U.S. CLS. 22, 23, 38 AND 50). SN 76-364,970. PUB. 11-12-2002. FILED 1-30-2002.
- 2,746,293. **HOOSIER HOOPS**. HOOSIER HOOPS BASKETBALL SYSTEMS, INC., (U.S. CLS. 22, 23, 38 AND 50). SN 76-369,046. PUB. 5-13-2003. FILED S.R. 2-11-2002; AM. P.R. 2-6-2003.
- 2,746,294. **TWA AN AMERICAN AIRLINES COMPANY AND DESIGN**. AMR CORPORATION, (U.S. CLS. 22, 23, 38 AND 50). SN 76-369,137. PUB. 5-13-2003. FILED 2-8-2002.
- 2,746,353. **CORSAIR**. NORTHROP GRUMMAN CORPORATION, (U.S. CLS. 22, 23, 38 AND 50). SN 76-380,025. PUB. 5-13-2003. FILED 3-8-2002.
- 2,746,356. **MAD TRIAD CHALLENGE AND DESIGN**. DAH YANG TOY INDUSTRIAL CO., LTD., (U.S. CLS. 22, 23, 38 AND 50). SN 76-380,677. PUB. 5-13-2003. FILED 3-8-2002.
- 2,746,397 (See Class 16 for this trademark).
- 2,746,406. **WILD FORCE DELUXE BLACK SAVAGE BATTLE POWER RANGER**. BVS ENTERTAINMENT, INC., (U.S. CLS. 22, 23, 38 AND 50). SN 76-389,757. PUB. 5-13-2003. FILED 4-2-2002.
- 2,746,477 (See Class 25 for this trademark).
- 2,746,489. **"HANDY" MAD TRIAD (STYLIZED)**. DAH YANG TOY INDUSTRIAL CO., LTD., (U.S. CLS. 22, 23, 38 AND 50). SN 76-402,296. PUB. 5-13-2003. FILED 4-30-2002.
- 2,746,492. **PARIS WILLIAMS**. ALEXANDER DOLL COMPANY, INC., (U.S. CLS. 22, 23, 38 AND 50). SN 76-402,668. PUB. 5-13-2003. FILED 5-2-2002.
- 2,746,549 (See Class 9 for this trademark).
- 2,746,552. **CHESS TECH AND DESIGN**. KIDS ONLY, (U.S. CLS. 22, 23, 38 AND 50). SN 76-409,616. PUB. 5-13-2003. FILED 5-16-2002.
- 2,746,590. **BASIC BROWN BEAR FACTORY**. BASIC BROWN BEARS, INC., MULTIPLE CLASS, (INT. CLS. 28, 35 AND 41), (U.S. CLS. 22, 23, 38, 50, 100, 101, 102 AND 107). SN 76-418,166. PUB. 5-13-2003. FILED 6-10-2002.
- 2,746,610. **NEXT RAMP**. EMSCO INC., (U.S. CLS. 22, 23, 38 AND 50). SN 76-420,317. PUB. 5-13-2003. FILED 5-29-2002.
- 2,746,613. **READYTOFLYFUN**. TOYTRONIX LLC, (U.S. CLS. 22, 23, 38 AND 50). SN 76-420,731. PUB. 5-13-2003. FILED 6-2-2002.
- 2,746,654. **"K" WACKY HOOKS**. FALCON LURES, LLC, (U.S. CLS. 22, 23, 38 AND 50). SN 76-428,138. PUB. 5-13-2003. FILED 7-3-2002.
- 2,746,674. **JR (STYLIZED)**. HORIZON HOBBY, INC., (U.S. CLS. 22, 23, 38 AND 50). SN 76-434,792. PUB. 5-13-2003. FILED 7-26-2002.
- 2,746,675. **JR**. HORIZON HOBBY, INC., (U.S. CLS. 22, 23, 38 AND 50). SN 76-434,793. PUB. 5-13-2003. FILED 7-26-2002.
- 2,746,725. **UFS UNIVERSAL FRAME SYSTEM AND DESIGN**. SALOMON S.A., (U.S. CLS. 22, 23, 38 AND 50). SN 76-442,813. PUB. 5-13-2003. FILED 8-21-2002.
- 2,746,733. **FADE BLADE AND DESIGN**. BOBO, DALTON, (U.S. CLS. 22, 23, 38 AND 50). SN 76-444,211. PUB. 5-13-2003. FILED 8-23-2002.
- 2,746,749. **BUTT WIPE**. BARTON, JACK H., (U.S. CLS. 22, 23, 38 AND 50). SN 76-445,098. PUB. 5-13-2003. FILED 8-26-2002.
- 2,746,755 (See Class 20 for this trademark).
- 2,746,808. **POWER CURVE**. GOLDEN BEAR INTERNATIONAL, INC., (U.S. CLS. 22, 23, 38 AND 50). SN 76-450,277. PUB. 5-13-2003. FILED 9-17-2002.
- 2,746,810. **GIGA MOTTA AND DESIGN**. GIGATOY INC, (U.S. CLS. 22, 23, 38 AND 50). SN 76-450,312. PUB. 5-13-2003. FILED 9-17-2002.
- 2,746,811. **WINGWALL**. BREWER'S LEDGE INC., (U.S. CLS. 22, 23, 38 AND 50). SN 76-450,317. PUB. 5-13-2003. FILED 9-17-2002.
- 2,746,840 (See Class 9 for this trademark).
- 2,746,841. **DIDORY**. BEAR STUDIO CO. LTD., (U.S. CLS. 22, 23, 38 AND 50). SN 76-452,599. PUB. 5-13-2003. FILED 9-19-2002.
- 2,746,843. **CAT-OPOLY**. LATE FOR THE SKY PRODUCTIONS, INC., (U.S. CLS. 22, 23, 38 AND 50). SN 76-452,696. PUB. 5-13-2003. FILED 9-25-2002.
- 2,746,844. **DOG-OPOLY**. LATE FOR THE SKY PRODUCTIONS, INC., (U.S. CLS. 22, 23, 38 AND 50). SN 76-452,697. PUB. 5-13-2003. FILED 9-25-2002.

- 2,746,855. **PRO JAM.** HOOSIER HOOPS BASKETBALL SYSTEMS, INC., TA HOOSIER HOOPS, INC., (U.S. CLS. 22, 23, 38 AND 50). SN 76-453,214. PUB. 5-13-2003. FILED 9-26-2002.
- 2,746,856. **DANCIN' RAIDER.** BUCHER, JOE, (U.S. CLS. 22, 23, 38 AND 50). SN 76-453,282. PUB. 5-13-2003. FILED 9-20-2002.
- 2,746,857. **DEPTHAIDER.** BUCHER, JOE, (U.S. CLS. 22, 23, 38 AND 50). SN 76-453,283. PUB. 5-13-2003. FILED 9-20-2002.
- 2,746,862. **AVALON HILL.** HASBRO, INC., (U.S. CLS. 22, 23, 38 AND 50). SN 76-453,402. PUB. 5-13-2003. FILED 9-27-2002.
- 2,746,867. **J-BANDS.** JAEGER, ALAN, DBA JAEGER SPORTS ACADEMY, (U.S. CLS. 22, 23, 38 AND 50). SN 76-453,758. PUB. 5-13-2003. FILED 9-30-2002.
- 2,746,875 (*See Class 25 for this trademark.*)
- 2,746,894. **LOCOMOTION.** DIGITRAX, INC., (U.S. CLS. 22, 23, 38 AND 50). SN 76-455,239. PUB. 5-13-2003. FILED 10-3-2002.
- 2,746,917. **MISCELLANEOUS DESIGN.** CHETAT PLAYING CARDS SDN BHD, (U.S. CLS. 22, 23, 38 AND 50). SN 76-456,176. PUB. 5-13-2003. FILED 10-7-2002.
- 2,746,995. **DANGER MEN PLAYING.** ANDE ROONEY INC., (U.S. CLS. 22, 23, 38 AND 50). SN 76-461,232. PUB. 5-13-2003. FILED 10-22-2002.
- 2,746,996. **DANGER MEN COOKING.** ANDE ROONEY INC., (U.S. CLS. 22, 23, 38 AND 50). SN 76-461,239. PUB. 5-13-2003. FILED 10-23-2002.
- 2,746,997. **DANGER MEN COOKING AND DESIGN.** ANDE ROONEY INC., (U.S. CLS. 22, 23, 38 AND 50). SN 76-461,240. PUB. 5-13-2003. FILED 10-23-2002.
- 2,747,009 (*See Class 16 for this trademark.*)
- 2,747,123 (*See Class 9 for this trademark.*)
- 2,747,269. **AEROBOUNCE AND DESIGN.** AEROBOUNCE, INC., (U.S. CLS. 22, 23, 38 AND 50). SN 78-152,060. PUB. 5-13-2003. FILED 8-7-2002.
- 2,747,288. **SWAP!** PATCH PRODUCTS, INC., (U.S. CLS. 22, 23, 38 AND 50). SN 78-153,626. PUB. 5-13-2003. FILED 8-13-2002.
- 2,747,291. **SYNERGY.** JAS. D. EASTON, INC., (U.S. CLS. 22, 23, 38 AND 50). SN 78-153,665. PUB. 5-13-2003. FILED 8-13-2002.
- 2,747,296. **JOCFAIN AND DESIGN.** SIMON, GUDRUN RIA, (U.S. CLS. 22, 23, 38 AND 50). SN 78-154,619. PUB. 5-13-2003. FILED 8-15-2002.
- 2,747,317. **HILLBILLY.** KING CYCLES, INC., (U.S. CLS. 22, 23, 38 AND 50). SN 78-159,551. PUB. 5-13-2003. FILED 8-30-2002.
- 2,747,319. **BEARY SWEET.** MY FAVORITE COMPANY, INC., (U.S. CLS. 22, 23, 38 AND 50). SN 78-160,264. PUB. 5-13-2003. FILED 9-3-2002.
- 2,747,357. **MARKMASTER.** GOLFING INNOVATIONS, LLC, (U.S. CLS. 22, 23, 38 AND 50). SN 78-165,942. PUB. 5-13-2003. FILED 9-19-2002.
- CLS. 29 AND 30), (U.S. CL. 46). SN 76-158,821. PUB. 5-13-2003. FILED 11-3-2000.
- 2,745,850. **BALANCE.** BALANCE BAR COMPANY, (U.S. CL. 46). SN 76-194,400. PUB. 11-5-2002. FILED 1-16-2001.
- 2,745,937. **SWF SAM WYLDE FLOUR CO., INC. AND DESIGN.** PURATOS BAKERY SUPPLY, INC., BY ASSIGNMENT FISHER MILLS, INC., (U.S. CL. 46). SN 76-243,252. PUB. 10-15-2002. FILED 4-17-2001.
- 2,745,964. **FIVESON'S FOODS.** FIVESON'S FOODS, INC., (U.S. CL. 46). SN 76-258,322. PUB. 5-13-2003. FILED 5-17-2001.
- 2,745,976. **THE SCIENCE OF WELLBEING.** EBRO PULEVA, S.A., (U.S. CL. 46). SN 76-264,003. PUB. 5-13-2003. FILED 5-29-2001.
- 2,746,070. **TOLEDO AND DESIGN.** EMPACADORA TOLEDO, S.A., (U.S. CL. 46). SN 76-297,001. PUB. 1-21-2003. FILED 8-9-2001.
- 2,746,134. **SMART MEALS.** SMART MEALS, INC., (U.S. CL. 46). SN 76-323,363. PUB. 7-2-2002. FILED 10-10-2001.
- 2,746,139. **NUEGRA.** KUN WHA PHARMACEUTICAL COMPANY LTD., (U.S. CL. 46). SN 76-324,878. PUB. 5-13-2003. FILED 10-12-2001.
- 2,746,151. **JUMBO JUMBOS.** BAR-S FOODS CO., (U.S. CL. 46). SN 76-327,904. PUB. 11-5-2002. FILED 10-19-2001.
- 2,746,202. **LYNTON MANOR AND DESIGN.** LIDL STIFTUNG & CO. KG, (U.S. CL. 46). SN 76-341,591. PUB. 5-13-2003. FILED 11-26-2001.
- 2,746,251. **ASPEN VALLEY LAMB.** SWISSLAND PACKING COMPANY, (U.S. CL. 46). SN 76-356,473. PUB. 5-13-2003. FILED 1-8-2002.
- 2,746,282. **LONGFENG AND DESIGN.** SHANTOU LONGFENG FOODSTUFF CO., LTD, (U.S. CL. 46). SN 76-365,314. PUB. 5-13-2003. FILED 1-30-2002.
- 2,746,340. **DARN GOOD CHEESE.** HELUVA GOOD, LLC, (U.S. CL. 46). SN 76-377,729. PUB. 11-26-2002. FILED 3-5-2002.
- 2,746,413 (*See Class 16 for this trademark.*)
- 2,746,443. **CLAMSTERS.** HERB'S SEAFOOD, INC., (U.S. CL. 46). SN 76-394,701. PUB. 5-13-2003. FILED 4-12-2002.
- 2,746,479. **NAPPA VALLEY GERHARD'S SAUSAGE AND DESIGN.** GNVS ACQUISITION, LLC, BY ASSIGNMENT TWELE, GERHARD, DBA GERHARD'S NAPA VALLEY SAUSAGE, (U.S. CL. 46). SN 76-400,727. PUB. 4-1-2003. FILED 4-24-2002.
- 2,746,501. **CARNIVAL CAJUN CLASSICS.** CARNIVAL BRANDS, INC., (U.S. CL. 46). SN 76-403,780. PUB. 5-13-2003. FILED 4-29-2002.
- 2,746,665. **KEENAN FARMS CALIFORNIA.** KEENAN FARMS, INC., (U.S. CL. 46). SN 76-433,406. PUB. 5-13-2003. FILED 7-16-2002.
- 2,746,899. **YOLA.** MORENO, S.A., (U.S. CL. 46). SN 76-455,380. PUB. 5-13-2003. FILED 10-3-2002.
- 2,746,962. **GARIMARK FOODS.** GARIMARK FOODS, INC., (U.S. CL. 46). SN 76-459,030. PUB. 5-13-2003. FILED 10-15-2002.
- 2,747,086. **FROMALP XL AND DESIGN.** FROMALP AG, MULTIPLE CLASS, (INT. CLS. 29, 30 AND 31), (U.S. CLS. 1 AND 46). SN 78-072,479. PUB. 10-15-2002. FILED 7-5-2001.
- 2,747,233. **CHILI OLE.** BLIMPIE INTERNATIONAL, INC., (U.S. CL. 46). SN 78-144,593. PUB. 5-13-2003. FILED 7-17-2002.
- 2,747,242. **TIGER THAI RT FOODS, INC.,** (U.S. CL. 46). SN 78-147,269. PUB. 5-13-2003. FILED 7-24-2002.
- 2,747,261 (*See Class 16 for this trademark.*)
- 2,747,301. **SOUP AT HAND (STYLIZED).** CSC BRANDS LP, (U.S. CL. 46). SN 78-155,405. PUB. 5-13-2003. FILED 8-19-2002.
- 2,747,315. **ALOUETTE BABY BRIE.** BC-USA, INC., (U.S. CL. 46). SN 78-159,101. PUB. 5-13-2003. FILED 8-29-2002.
- 2,747,405. **BLACK HILLS GOLD.** PEANOTZ, INC., (U.S. CL. 46). SN 78-170,666. PUB. 5-13-2003. FILED 10-3-2002.

CLASS 29—MEATS AND PROCESSED FOODS

- 2,745,464 (*See Class 16 for this trademark.*)
- 2,745,480 (*See Class 5 for this trademark.*)
- 2,745,482 (*See Class 5 for this trademark.*)
- 2,745,526. **SOYACCINO.** AUSTRALASIAN CONFERENCE ASSOCIATED LIMITED, MULTIPLE CLASS, (INT. CLS. 29 AND 32), (U.S. CLS. 45, 46 AND 48). SN 75-722,507. PUB. 3-12-2002. FILED 6-9-1999.
- 2,745,640. **SHEZAN AND DESIGN.** INTERSHEZ CORP., MULTIPLE CLASS, (INT. CLS. 29, 30 AND 32), (U.S. CLS. 45, 46 AND 48). SN 76-004,635. PUB. 5-13-2003. FILED 3-20-2000.
- 2,745,646. **IL MADONNINO OLIO EXTRA VERGINE DI OLIVA AND DESIGN.** COLLEGIO TOSCANO DEGLI OLIVICOLTORI OL.MA. S.C.R.L., (U.S. CL. 46). SN 76-013,550. PUB. 5-13-2003. FILED 3-30-2000.
- 2,745,662 (*See Class 16 for this trademark.*)
- 2,745,702. **EL VENTERO.** QUESOS FORLASA, S.A., (U.S. CL. 46). SN 76-068,907. PUB. 4-30-2002. FILED 6-12-2000.
- 2,745,800. **OZARK MOUNTAIN FAMILY.** OZARK MOUNTAIN SMOKE HOUSE, INC., MULTIPLE CLASS, (INT.

CLASS 30—STAPLE FOODS

- 2,745,438 (*See Class 21 for this trademark.*)
- 2,745,468. **MACKINAC ISLAND FUDGE.** DENALI FLAVORS,

- L.L.C., (U.S. CL. 46). SN 75-546,631. PUB. 9-24-2002. FILED 9-1-1998.
- 2,745,480 (*See Class 5 for this trademark.*)
- 2,745,482 (*See Class 5 for this trademark.*)
- 2,745,508. **BALBOA BAY**. TONE PRODUCTS, INC., MULTIPLE CLASS, (INT. CLS. 30 AND 32), (U.S. CLS. 45, 46 AND 48). SN 75-667,928. PUB. 11-23-1999. FILED 3-25-1999.
- 2,745,516. **THE BOMB**. DON MIGUEL MEXICAN FOODS, INC., (U.S. CL. 46). SN 75-696,745. PUB. 8-29-2000. FILED 5-3-1999.
- 2,745,529. **NOI L'ESPRESSO**. LA TAZZA D'ORO S.R.L., (U.S. CL. 46). SN 75-745,927. PUB. 8-14-2001. FILED 7-9-1999.
- 2,745,639. **FARMHOUSE AND DESIGN**. INTERNATIONAL MULTIFOODS CORPORATION, BY ASSIGNMENT GENERAL MILLS, INC., (U.S. CL. 46). SN 76-003,115. PUB. 12-10-2002. FILED 3-17-2000.
- 2,745,640 (*See Class 29 for this trademark.*)
- 2,745,662 (*See Class 16 for this trademark.*)
- 2,745,694. **ZAVIDA**. ZAVIDA COFFEE COMPANY INC., BY CHANGE OF NAME FLAVORCOFFEE CO. INC., MULTIPLE CLASS, (INT. CLS. 30, 35 AND 42), (U.S. CLS. 46, 100, 101 AND 102). SN 76-060,735. PUB. 11-19-2002. FILED 5-30-2000.
- 2,745,699. **EVERYDAY**. WHOLE FOODS MARKET SERVICES, INC., (U.S. CL. 46). SN 76-066,126. PUB. 3-26-2002. FILED 6-8-2000.
- 2,745,751 (*See Class 25 for this trademark.*)
- 2,745,781. **A (STYLIZED)**. KRAFT FOODS HOLDINGS, INC., (U.S. CL. 46). SN 76-139,399. PUB. 12-31-2002. FILED 9-29-2000.
- 2,745,792. **TUNDRA TRADING, INC.**. TUNDRA TRADING, INC., (U.S. CL. 46). SN 76-147,020. PUB. 11-5-2002. FILED 10-16-2000.
- 2,745,798. **OPEN KETTLE DUMPLINGS**. HOM/ADE FOODS, INC., (U.S. CL. 46). SN 76-158,309. PUB. 12-10-2002. FILED 11-2-2000.
- 2,745,800 (*See Class 29 for this trademark.*)
- 2,745,844. **MISCELLANEOUS DESIGN**. CANDYTREE U.S.A., INC., (U.S. CL. 46). SN 76-191,583. PUB. 5-13-2003. FILED 1-8-2001.
- 2,745,875. **LUCINI**. LUCINI ITALIA COMPANY, (U.S. CL. 46). SN 76-208,378. PUB. 5-13-2003. FILED 2-8-2001.
- 2,745,885. **MARTHA GOOCH**. GOOCH FOODS, INC., BY ASSIGNMENT ARCHER DANIELS MIDLAND COMPANY, (U.S. CL. 46). SN 76-215,503. PUB. 5-13-2003. FILED 2-23-2001.
- 2,745,903. **MOZART TWISTS**. PAUL REBER GMBH & CO. KG, (U.S. CL. 46). SN 76-228,923. PUB. 5-13-2003. FILED 3-21-2001.
- 2,745,909. **PEANUT PORRIDGE MIX THE ENERGIZER AND DESIGN**. CARIBBEAN CHRISTIAN BROADCASTING NETWORK, INC., (U.S. CL. 46). SN 76-231,901. PUB. 7-30-2002. FILED 3-16-2001.
- 2,745,924. **FRUTSTIX AND DESIGN**. TLC TRADEMARK COMPANY, (U.S. CL. 46). SN 76-238,175. PUB. 5-13-2003. FILED 4-9-2001.
- 2,745,933. **NOVA**. BATOOK CHEWING GUM IND., LTD., (U.S. CL. 46). SN 76-242,004. PUB. 12-3-2002. FILED 4-17-2001.
- 2,746,117. **"GUAYMALLEN" AND DESIGN**. ALEXVIAN S.A.C.I.F.I.A., (U.S. CL. 46). SN 76-318,205. PUB. 11-5-2002. FILED 9-26-2001.
- 2,746,120. **CAFE DON PEDRO (STYLIZED)**. ENERGUS INTERNATIONAL, INC., (U.S. CL. 46). SN 76-318,496. PUB. 12-3-2002. FILED 9-27-2001.
- 2,746,174. **PICA RICO CHAMOY VK LA SABROZA AND DESIGN**. ALIMENTOS NATURALES SABROZA, S.A. DE C.V., (U.S. CL. 46). SN 76-335,331. PUB. 1-21-2003. FILED 11-7-2001.
- 2,746,187. **ASHRAFI**. IMPERIAL NOUGAT, CO., (U.S. CL. 46). SN 76-337,675. PUB. 12-3-2002. FILED 11-15-2001.
- 2,746,189. **KOHINOOR BASMATI RICE & SPICE**. SATNAM OVERSEAS LIMITED, (U.S. CL. 46). SN 76-338,500. PUB. 5-13-2003. FILED 11-16-2001.
- 2,746,263. **EGG'WICH**. BURGER KING BRANDS, INC., (U.S. CL. 46). SN 76-359,931. PUB. 5-13-2003. FILED 1-18-2002.
- 2,746,268. **MINI MINI**. QUAKER HILL FARMS, INC., (U.S. CL. 46). SN 76-361,400. PUB. 10-29-2002. FILED 1-22-2002.
- 2,746,316. **SEVIGNY'S (STYLIZED)**. F.B. WASHBURN CANDY CORPORATION, (U.S. CL. 46). SN 76-373,645. PUB. 5-13-2003. FILED 2-25-2002.
- 2,746,413 (*See Class 16 for this trademark.*)
- 2,746,476. **MOCHASIPPI**. COMMUNITY COFFEE COMPANY, LLC, DBA CC'S COFFEE HOUSE, (U.S. CL. 46). SN 76-400,029. PUB. 5-13-2003. FILED 4-23-2002.
- 2,746,478. **GAMESA LONCHERA**. CORPORATIVO INTERNACIONAL MEXICANO, S. DE R.L. DE C.V., (U.S. CL. 46). SN 76-400,289. PUB. 5-13-2003. FILED 4-24-2002.
- 2,746,519. **HUDSON'S**. DRUG HOUSES OF AUSTRALIA (OVERSEAS) LTD., (U.S. CL. 46). SN 76-405,821. PUB. 5-13-2003. FILED 5-10-2002.
- 2,746,537. **ORVILLE REDENBACHER'S**. CONAGRA BRANDS, INC., (U.S. CL. 46). SN 76-407,755. PUB. 5-13-2003. FILED 5-14-2002.
- 2,746,576. **DALMATINO**. NIM IMPORT & EXPORTGESELLSCHAFT MBH FUR NATUR-, GENUB- AND INDUSTRIE-ERZEUGNISSE, MULTIPLE CLASS, (INT. CLS. 30 AND 33), (U.S. CLS. 46, 47 AND 49). SN 76-413,954. PUB. 5-13-2003. FILED 5-24-2002.
- 2,746,650. **ALL-AMERICAN PIE**. HORIZON SNACK FOODS, INC., (U.S. CL. 46). SN 76-427,179. PUB. 5-13-2003. FILED 7-3-2002.
- 2,746,929. **DOLLAR CHOICES**. MAIZORO, S.A. DE C.V., (U.S. CL. 46). SN 76-456,764. PUB. 5-13-2003. FILED 10-3-2002.
- 2,746,930. **CHOOSE YOUR OWN AND DESIGN**. FAIRYTALE BROWNIES, INC., (U.S. CL. 46). SN 76-456,988. PUB. 5-13-2003. FILED 10-7-2002.
- 2,746,972. **COWBOY PETE'S**. ANDE ROONEY INC., (U.S. CL. 46). SN 76-459,708. PUB. 5-13-2003. FILED 10-16-2002.
- 2,747,086 (*See Class 29 for this trademark.*)
- 2,747,097. **241 PIZZA AND DESIGN**. 241 PIZZA (1997) INC., MULTIPLE CLASS, (INT. CLS. 30 AND 42), (U.S. CLS. 46, 100 AND 101). SN 78-085,369. PUB. 5-13-2003. FILED 9-25-2001.
- 2,747,107. **SANTA CRUZ**. COLLEEN CROSBY AND BRONSON BAKER, DBA THE SANTA CRUZ COFFEE ROASTING COMPANY, (U.S. CL. 46). SN 78-095,940. PUB. 5-13-2003. FILED 11-30-2001.
- 2,747,110. **EMME (STYLIZED)**. LIONSING FOOD GROUP CO., LTD., (U.S. CL. 46). SN 78-096,661. PUB. 5-13-2003. FILED 12-5-2001.
- 2,747,117. **CROCK & COOK**. ANGOSTURA INTERNATIONAL LIMITED, (U.S. CL. 46). SN 78-099,961. PUB. 5-13-2003. FILED 12-26-2001.
- 2,747,118. **MAGICODE**. SOREMARTEC S.A., (U.S. CL. 46). SN 78-102,826. PUB. 1-28-2003. FILED 1-15-2002.
- 2,747,251. **MATIZ**. POWER-SELLES IMPORTS, INC., (U.S. CL. 46). SN 78-148,969. PUB. 5-13-2003. FILED 7-30-2002.
- 2,747,253. **YOLK FREE**. AMERICAN ITALIAN PASTA COMPANY, (U.S. CL. 46). SN 78-149,448. PUB. 5-13-2003. FILED 7-31-2002.
- 2,747,275. **A SOLID COLD CHILLIN' TREAT**. PLANET ICE CREAM, INC., (U.S. CL. 46). SN 78-152,608. PUB. 5-13-2003. FILED 8-9-2002.
- 2,747,305. **VIVIL CREME HIGHLIGHTS**. VIVIL A. MUELLER GMBH & CO. KG, (U.S. CL. 46). SN 78-156,215. PUB. 5-13-2003. FILED 8-21-2002.
- 2,747,324. **CUTIE PIE AND DESIGN**. HORIZON SNACK FOODS, INC., (U.S. CL. 46). SN 78-161,646. PUB. 5-13-2003. FILED 9-6-2002.
- 2,747,355. **MISCELLANEOUS DESIGN**. ANHING CORPORATION, (U.S. CL. 46). SN 78-165,594. PUB. 5-13-2003. FILED 9-18-2002.
- 2,747,359. **JUST THE NUTS!**. LINCOLN SNACKS COMPANY, (U.S. CL. 46). SN 78-166,308. PUB. 5-13-2003. FILED 9-20-2002.
- 2,747,360. **IT'S THE NUTTIEST] AND DESIGN**. LINCOLN SNACKS COMPANY, (U.S. CL. 46). SN 78-166,344. PUB. 5-13-2003. FILED 9-20-2002.
- 2,747,378. **THE GREAT ONE**. DUNKIN' DONUTS USA, INC., (U.S. CL. 46). SN 78-168,229. PUB. 5-13-2003. FILED 9-26-2002.
- 2,747,387. **MIRACLE MUFFINS**. MAKAR, RAMSEY, R., (U.S. CL. 46). SN 78-169,196. PUB. 5-13-2003. FILED 9-30-2002.
- 2,747,409. **DINORONIRUS**. VALRICO FOODS, INC., (U.S. CL. 46). SN 78-171,120. PUB. 5-13-2003. FILED 10-4-2002.

- 2,747,411. **PRINCE OF PEACE**. PRINCE OF PEACE ENTERPRISES, INC., (U.S. CL. 46). SN 78-171,340. PUB. 5-13-2003. FILED 10-4-2002.
 2,747,440. **RAIN OR SHINE IT'S BBQ TIME**. D&K ENTERPRISES, INC., (U.S. CL. 46). SN 78-174,098. PUB. 5-13-2003. FILED 10-14-2002.

CLASS 31—NATURAL AGRICULTURAL PRODUCTS

- 2,745,480 (*See Class 5 for this trademark*).
 2,745,482 (*See Class 5 for this trademark*).
 2,745,578 (*See Class 5 for this trademark*).
 2,745,644 (*See Class 9 for this trademark*).
 2,745,766 (*See Class 7 for this trademark*).
 2,746,234 (*See Class 1 for this trademark*).
 2,746,378 (*See Class 19 for this trademark*).
 2,746,459. **CRAIN OF CALIFORNIA**. CRAIN WALNUT SHELLING, INC., (U.S. CLS. 1 AND 46). SN 76-396,599. PUB. 5-13-2003. FILED 4-16-2002.
 2,746,656. **DIGESTOR BROILER**. CITREX, INC., (U.S. CLS. 1 AND 46). SN 76-428,857. PUB. 5-13-2003. FILED 7-5-2002.
 2,746,657. **DIGESTOR PIG**. CITREX, INC., (U.S. CLS. 1 AND 46). SN 76-428,859. PUB. 5-13-2003. FILED 7-5-2002.
 2,746,671. **OAK GROVE VINEYARDS**. LODI WINE GRAPES LLC, (U.S. CLS. 1 AND 46). SN 76-434,381. PUB. 5-13-2003. FILED 7-23-2002.
 2,746,715. **HIGGINS**. THE HIGGINS GROUP CORP., (U.S. CLS. 1 AND 46). SN 76-441,757. PUB. 5-13-2003. FILED 8-20-2002.
 2,746,900. **BUNING THE FLORIST (STYLIZED)**. BUNING EXOTIC GARDENS, L.L.C., (U.S. CLS. 1 AND 46). SN 76-455,450. PUB. 5-13-2003. FILED 9-30-2002.
 2,746,922. **MILLIKEN CREEK VINEYARD**. UCC VINEYARDS GROUP, INC., (U.S. CLS. 1 AND 46). SN 76-456,634. PUB. 5-13-2003. FILED 10-1-2002.
 2,747,000. **MOTHER'S FINEST**. OLD MOTHER HUBBARD DOG FOOD CO., INC., (U.S. CLS. 1 AND 46). SN 76-461,732. PUB. 5-13-2003. FILED 10-25-2002.
 2,747,086 (*See Class 29 for this trademark*).
 2,747,216. **THREE CHEERS RAW! RAW! RAW!**. KLAPAC, JANET W., (U.S. CLS. 1 AND 46). SN 78-136,144. PUB. 5-13-2003. FILED 6-17-2002.
 2,747,244. **MABEL LABEL**. EARL'S ORGANIC PRODUCE, INC., (U.S. CLS. 1 AND 46). SN 78-147,317. PUB. 5-13-2003. FILED 7-25-2002.
 2,747,342. **ROUND UP**. SALIX CORPORATION, (U.S. CLS. 1 AND 46). SN 78-164,849. PUB. 5-13-2003. FILED 9-17-2002.
 2,747,433. **LOOK FOR THE FOOT**. UNDER A FOOT PLANT COMPANY, (U.S. CLS. 1 AND 46). SN 78-172,325. PUB. 5-13-2003. FILED 10-8-2002.

CLASS 32—LIGHT BEVERAGES

- 2,745,480 (*See Class 5 for this trademark*).
 2,745,484. **RICA**. PASTEURIZADORA RICA, C. X A., (U.S. CLS. 45, 46 AND 48). SN 75-605,947. PUB. 10-8-2002. FILED 12-15-1998.
 2,745,508 (*See Class 30 for this trademark*).
 2,745,526 (*See Class 29 for this trademark*).
 2,745,640 (*See Class 29 for this trademark*).
 2,745,657. **BIG APPLE**. APOLLINARIS BRUNNEN AG, (U.S. CLS. 45, 46 AND 48). SN 76-021,821. PUB. 11-26-2002. FILED 4-7-2000.
 2,745,662 (*See Class 16 for this trademark*).
 2,745,711 (*See Class 21 for this trademark*).
 2,745,744. **DAFRUTA (STYLIZED)**. LIBERTY IMPORTS USA, INC., (U.S. CLS. 45, 46 AND 48). SN 76-105,954. PUB. 5-13-2003. FILED 8-10-2000.
 2,745,939. **MAUI FRUIT BLENDS "CATCH THE WAVE" AND DESIGN**. PEGASUS MARKETING GROUP, INC., (U.S. CLS. 45, 46 AND 48). SN 76-244,076. PUB. 6-18-2002. FILED 4-20-2001.

- 2,746,002 (*See Class 1 for this trademark*).
 2,746,015. **ORANGE MARS AND DESIGN**. PAN AMERICAN GRAIN MFG. CO., INC., (U.S. CLS. 45, 46 AND 48). SN 76-281,417. PUB. 8-6-2002. FILED 7-6-2001.
 2,746,016. **ORANGE MARS (STYLIZED)**. PAN AMERICAN GRAIN MFG. CO., INC., (U.S. CLS. 45, 46 AND 48). SN 76-281,418. PUB. 8-6-2002. FILED 7-6-2001.
 2,746,035. **WARSTEINER DUNKEL DIE KONIGIN UNTER DEN BIEREN AND DESIGN**. WARSTEINER BRAUEREI HAUS CRAMER KG, (U.S. CLS. 45, 46 AND 48). SN 76-287,820. PUB. 5-13-2003. FILED 7-19-2001.
 2,746,040. **DIE KONIGIN UNTER DEN BIEREN WARSTEINERPREMIUM VERUM AND DESIGN**. WARSTEINER BRAUEREI HAUS CRAMER KG, MULTIPLE CLASS, (INT. CLS. 32 AND 43), (U.S. CLS. 45, 46, 48, 100 AND 101). SN 76-288,881. PUB. 10-1-2002. FILED 7-23-2001.
 2,746,246. **KEY WEST LAGER AND DESIGN**. YBOR CITY BREWING COMPANY, BY ASSIGNMENT KEY WEST BREWERY, INC., (U.S. CLS. 45, 46 AND 48). SN 76-354,725. PUB. 5-13-2003. FILED 1-3-2002.
 2,746,272. **JUMEX LIGHT**. FRUGOSA, S.A. DE C. V., (U.S. CLS. 45, 46 AND 48). SN 76-362,507. PUB. 5-13-2003. FILED 1-24-2002.
 2,746,288. **BEAT THE HEAT SUMMER WHEAT**. AVADO BRANDS INC., (U.S. CLS. 45, 46 AND 48). SN 76-367,916. PUB. 5-13-2003. FILED 2-7-2002.
 2,746,491. **KIRIN ICHIBAN**. KIRIN BEER KABUSHIKI KAISHA, TA KIRIN BREWERY CO., LTD., (U.S. CLS. 45, 46 AND 48). SN 76-402,564. PUB. 5-13-2003. FILED 4-30-2002.
 2,746,598. **CORSENDONK**. BROUWERIJ CORSENDONK, (U.S. CLS. 45, 46 AND 48). SN 76-419,530. PUB. 5-13-2003. FILED 6-12-2002.
 2,746,634. **TART IS SMART**. TPG ENTERPRISES, INC., (U.S. CLS. 45, 46 AND 48). SN 76-424,252. PUB. 5-13-2003. FILED 6-24-2002.
 2,746,913 (*See Class 5 for this trademark*).
 2,747,065. **SHLOER**. MERRYDOWN PLC, (U.S. CLS. 45, 46 AND 48). SN 78-034,175. PUB. 11-19-2002. FILED 11-7-2000.
 2,747,154 (*See Class 16 for this trademark*).
 2,747,293. **CRYSTALS**. CRYSTALS INTERNATIONAL INC., (U.S. CLS. 45, 46 AND 48). SN 78-153,775. PUB. 5-13-2003. FILED 8-13-2002.
 2,747,370. **FRUITFORCE**. TROPICANA PRODUCTS, INC., (U.S. CLS. 45, 46 AND 48). SN 78-167,792. PUB. 5-13-2003. FILED 9-25-2002.

CLASS 33—WINES AND SPIRITS

- 2,745,465. **SPIER AND DESIGN**. SPIER PROPERTIES (PTY) LIMITED, (U.S. CLS. 47 AND 49). SN 75-536,592. PUB. 5-13-2003. FILED 8-12-1998.
 2,745,552. **CALITERRA...GOOD PEOPLE, GOOD WINE**. VINA CALITERRA S.A., (U.S. CLS. 47 AND 49). SN 75-806,976. PUB. 5-13-2003. FILED 9-23-1999.
 2,745,575. **DREAMS**. JOSEF FRIEDERICH WEINGUTERWEINKELLEREIEN GMBH & CO. KG, (U.S. CLS. 47 AND 49). SN 75-860,838. PUB. 12-11-2001. FILED 11-30-1999.
 2,745,733. **DITA AND DESIGN**. RICARD, PERNOD, (U.S. CLS. 47 AND 49). SN 76-099,184. PUB. 5-13-2003. FILED 7-28-2000.
 2,745,751 (*See Class 25 for this trademark*).
 2,745,773. **TAVOLA ROTONDA**. CAVIT CANTINA VITICOLTORI CONSORZIO CANTINE SOCIALI DEL TRENTINO SOC. COOP. A R.L., (U.S. CLS. 47 AND 49). SN 76-131,265. PUB. 10-8-2002. FILED 9-19-2000.
 2,745,943. **REDWOOD VINEYARDS**. HOUSE OF DANIELS, INC., DBA HOUSE OF DANIELS AND DBA REDWOOD VINTNERS FINE WINE & SPIRITS, (U.S. CLS. 47 AND 49). SN 76-246,094. PUB. 5-13-2003. FILED 4-24-2001.
 2,745,981. **OUDE MEESTER AND DESIGN**. DISTILLERS CORPORATION LIMITED, (U.S. CLS. 47 AND 49). SN 76-266,826. PUB. 2-4-2003. FILED 6-5-2001.
 2,745,982. **DROSTDY-HOF (STYLIZED)**. DROSTDY WINES LIMITED, (U.S. CLS. 47 AND 49). SN 76-266,827. PUB. 2-18-2003. FILED 6-5-2001.
 2,745,998. **MAJUANG CHARDONNAY CALIFORNIA TASTE THE SUNSHINE AND DESIGN**. DOOSAN CORPORA-

- TION, (U.S. CLS. 47 AND 49). SN 76-273,316. PUB. 1-14-2003. FILED 6-18-2001.
- 2,746,036. **TIERRUCA**. VINEDOS ERRAZURIZ OVALLE S.A., (U.S. CLS. 47 AND 49). SN 76-288,327. PUB. 10-22-2002. FILED 7-20-2001.
- 2,746,037. **RIOJA SOLARCE CALIFICADA DENOMINACION ORIGEN CONSEJO REGULADOR AND DESIGN**. GIL, ALICIA ROJAS, (U.S. CLS. 47 AND 49). SN 76-288,359. PUB. 5-13-2003. FILED 7-20-2001.
- 2,746,056. **IL (STYLIZED)**. MIONETTO S.P.A., (U.S. CLS. 47 AND 49). SN 76-293,434. PUB. 10-8-2002. FILED 8-1-2001.
- 2,746,100 (*See Class 6 for this trademark*).
- 2,746,103. **RUSSIAN DIAMONDS**. KALUZHSKOE OTKRYTOE AKTSIONERNOE OBSHCHESTVO KRISTALL, (U.S. CLS. 47 AND 49). SN 76-312,296. PUB. 3-12-2002. FILED 9-14-2001.
- 2,746,227. **VILLABELLA (STYLIZED)**. VILLABELLA AZ. AGR.DI DELIBORI T. E CRISTOFORETTI G. S.S., (U.S. CLS. 47 AND 49). SN 76-347,433. PUB. 5-13-2003. FILED 12-12-2001.
- 2,746,267. **MISCELLANEOUS DESIGN**. PLANTAGENET WINES PTY LTD., (U.S. CLS. 47 AND 49). SN 76-361,227. PUB. 5-13-2003. FILED 1-23-2002.
- 2,746,290. **EARLY HARVEST**. DE LOACH VINEYARDS, INC., (U.S. CLS. 47 AND 49). SN 76-368,519. PUB. 7-30-2002. FILED 2-4-2002.
- 2,746,295. **ESPIRITU DEL ECUADOR (STYLIZED)**. ESPIRITU DEL ECUADOR SA, (U.S. CLS. 47 AND 49). SN 76-369,353. PUB. 5-13-2003. FILED 2-8-2002.
- 2,746,303. **TEN MINUTES BY TRACTOR**. TEN MINUTES BY TRACTOR PTY LTD, (U.S. CLS. 47 AND 49). SN 76-372,010. PUB. 5-13-2003. FILED 2-15-2002.
- 2,746,304. **10 MINUTES X TRACTOR**. TEN MINUTES BY TRACTOR PTY LTD, (U.S. CLS. 47 AND 49). SN 76-372,011. PUB. 5-13-2003. FILED 2-15-2002.
- 2,746,329. **ANTEA MARQUES DE CACERES AND DESIGN**. UNION VITI-VINICOLA, S.A. VINEDOS EN CENICERO, (U.S. CLS. 47 AND 49). SN 76-375,390. PUB. 5-13-2003. FILED 2-26-2002.
- 2,746,391. **CHATEAU BEAUREGARD AND DESIGN**. SCEA DU CHATEAU DE BEAUREGARD, (U.S. CLS. 47 AND 49). SN 76-386,826. PUB. 5-13-2003. FILED 3-25-2002.
- 2,746,556. **HVE (STYLIZED)**. HUNTER WINE AUSTRALIA PTY LIMITED, (U.S. CLS. 47 AND 49). SN 76-410,446. PUB. 5-13-2003. FILED 5-21-2002.
- 2,746,557. **HVE HUNTER VALLEY ELEMENTS (STYLIZED)**. HUNTER WINE AUSTRALIA PTY LIMITED, (U.S. CLS. 47 AND 49). SN 76-410,447. PUB. 5-13-2003. FILED 5-21-2002.
- 2,746,576 (*See Class 30 for this trademark*).
- 2,746,615. **VIDAL ESTATE AND DESIGN**. VILLA MARIA ESTATE LIMITED, (U.S. CLS. 47 AND 49). SN 76-421,508. PUB. 5-13-2003. FILED 6-14-2002.
- 2,746,649. **MISCELLANEOUS DESIGN**. PERNOD RICARD, (U.S. CLS. 47 AND 49). SN 76-427,161. PUB. 5-13-2003. FILED 7-3-2002.
- 2,746,714. **DEATH BY CHOCOLATE MARTINI**. S&A RESTAURANT CORP., (U.S. CLS. 47 AND 49). SN 76-441,744. PUB. 5-13-2003. FILED 8-20-2002.
- 2,746,925. **WORK VINEYARD WORK AND DESIGN**. WORK WINE COMPANY, LLC, (U.S. CLS. 47 AND 49). SN 76-456,697. PUB. 5-13-2003. FILED 10-3-2002.
- 2,746,950. **CHATEAU LAURENT**. CHATEAU LAURENT, (U.S. CLS. 47 AND 49). SN 76-458,839. PUB. 5-13-2003. FILED 10-15-2002.
- 2,746,982. **THE BARBARIAN**. NIGHT MOON, INCORPORATED, (U.S. CLS. 47 AND 49). SN 76-460,365. PUB. 5-13-2003. FILED 10-21-2002.
- 2,746,985. **SASSETTO**. SANTINI FINE WINES, INC., (U.S. CLS. 47 AND 49). SN 76-460,690. PUB. 5-13-2003. FILED 10-21-2002.
- 2,747,022. **MON AMI**. MANTEY-MON AMI-LONZ WINERIES, INC., (U.S. CLS. 47 AND 49). SN 76-463,663. PUB. 5-13-2003. FILED 11-1-2002.
- 2,747,399. **STONE COTE**. HARTFORD-JACKSON, LLC, (U.S. CLS. 47 AND 49). SN 78-170,167. PUB. 5-13-2003. FILED 10-2-2002.

CLASS 34—SMOKERS' ARTICLES

- 2,745,953. **COTAIS**. CITA TOBACCO INTERNATIONAL, S.L., (U.S. CLS. 2, 8, 9 AND 17). SN 76-249,899. PUB. 10-29-2002. FILED 5-2-2001.
- 2,746,075 (*See Class 1 for this trademark*).
- 2,746,579 (*See Class 8 for this trademark*).
- 2,746,779. **HUMI-SYSTEM**. J.C. NEWMAN CIGAR COMPANY, INC., (U.S. CLS. 2, 8, 9 AND 17). SN 76-448,163. PUB. 5-13-2003. FILED 9-4-2002.
- 2,746,896. **PATRIARCH**. GIZEH RAUCHERBEDARF GMBH, (U.S. CLS. 2, 8, 9 AND 17). SN 76-455,302. PUB. 5-13-2003. FILED 10-1-2002.
- 2,747,051. **DOMINICAN DELIGHTS**. SOUTHERN SMOKE LLC, (U.S. CLS. 2, 8, 9 AND 17). SN 76-478,467. PUB. 5-13-2003. FILED 12-23-2002.
- 2,747,273. **BATTLEGROUND**. CONNECTICUT VALLEY TOBACCONIST, LLC, (U.S. CLS. 2, 8, 9 AND 17). SN 78-152,583. PUB. 5-13-2003. FILED 8-9-2002.
- 2,747,281. **BIGGER. BOLDER. MOISTER..** PINKERTON TOBACCO CO. LP, (U.S. CLS. 2, 8, 9 AND 17). SN 78-153,161. PUB. 5-13-2003. FILED 8-12-2002.
- 2,747,335. **HEAVENLY CIGAR COMPANY**. HEAVENLY CIGAR COMPANY, (U.S. CLS. 2, 8, 9 AND 17). SN 78-163,514. PUB. 5-13-2003. FILED 9-12-2002.

SERVICE MARKS**CLASS 35—ADVERTISING AND BUSINESS**

- 2,745,415. **FUTURECARE AFFILIATES, INC.**. FUTURECARE AFFILIATES, INC., (U.S. CLS. 100, 101 AND 102). SN 74-471,210. PUB. 5-13-2003. FILED 12-20-1993.
- 2,745,423. **BOARD ZONE**. RIORDAN SPORTS WAREHOUSE OUTLETS INC., (U.S. CLS. 100, 101 AND 102). SN 75-225,790. PUB. 5-13-2003. FILED 1-14-1997.
- 2,745,425. **LEAPFROG**. LEAPFROG ENTERPRISES, INC., ASSIGNEE OF; ASSIGNEE OF; BY CHANGE OF NAME LEAPFROG, L.L.C., (U.S. CLS. 100, 101 AND 102). SN 75-239,546. PUB. 12-17-2002. FILED 2-10-1997.
- 2,745,428. **CITY OPTICAL**. CITY OPTICAL INC., (U.S. CLS. 100, 101 AND 102). SN 75-270,813. PUB. 10-24-2000. FILED 4-4-1997.
- 2,745,430 (*See Class 9 for this trademark*).
- 2,745,441. **TOZ**. BAKERS FOOTWEAR GROUP, INC., BY CHANGE OF NAME WEISS & NEUMAN SHOE COMPANY, (U.S. CLS. 100, 101 AND 102). SN 75-408,616. PUB. 5-13-2003. FILED 12-19-1997.
- 2,745,450. **LSTECH**. UNIVERSITY OF GUELPH, LABORATORY SERVICES DIVISION, MULTIPLE CLASS, (INT. CLS. 35 AND 42), (U.S. CLS. 100, 101 AND 102). SN 75-471,911. PUB. 4-30-2002. FILED 4-22-1998.
- 2,745,452. **GALAXY SYSTEMS**. GALAXY SYSTEMS, INC., MULTIPLE CLASS, (INT. CLS. 35 AND 42), (U.S. CLS. 100, 101 AND 102). SN 75-483,926. PUB. 5-13-2003. FILED 5-12-1998.
- 2,745,453. **VEDIOR**. VEDIOR INTERNATIONAL CONTRACTS B.V., BY CHANGE OF NAME VEDIOR INTERNATIONAL B.V., MULTIPLE CLASS, (INT. CLS. 35, 41 AND 42), (U.S. CLS. 100, 101, 102 AND 107). SN 75-487,654. PUB. 8-24-1999. FILED 5-19-1998.
- 2,745,464 (*See Class 16 for this trademark*).
- 2,745,478 (*See Class 18 for this trademark*).
- 2,745,479. **BYOB WATER STORE AND DESIGN**. BYOB* WATER STORES, INC., (U.S. CLS. 100, 101 AND 102). SN 75-596,847. PUB. 12-31-2002. FILED 11-30-1998.
- 2,745,497. **THE BRAND RANCH (STYLIZED)**. HULL, WILLIAM RANDALL, MULTIPLE CLASS, (INT. CLS. 35 AND 42), (U.S. CLS. 100, 101 AND 102). SN 75-651,474. PUB. 5-13-2003. FILED 3-10-1999.
- 2,745,499. **JET CONNECTION**. JET CONNECTION BUSINESSFLIGHT AG, MULTIPLE CLASS, (INT. CLS. 35, 36, 39 AND 42), (U.S. CLS. 100, 101, 102 AND 105). SN 75-654,099. PUB. 1-29-2002. FILED 3-8-1999.
- 2,745,503 (*See Class 9 for this trademark*).

- 2,745,505. **(MINACS) WORLDWIDE**. MINACS WORLDWIDE, INC., BY CHANGE OF NAME; BY ASSIGNMENT MINACS GROUP INC., THE, MULTIPLE CLASS, (INT. CLS. 35, 38 AND 41), (U.S. CLS. 100, 101, 102, 104 AND 107). SN 75-664,486. PUB. 9-24-2002. FILED 3-19-1999.
- 2,745,528 (*See Class 9 for this trademark*).
- 2,745,540 (*See Class 9 for this trademark*).
- 2,745,541 (*See Class 9 for this trademark*).
- 2,745,550 (*See Class 3 for this trademark*).
- 2,745,553 (*See Class 9 for this trademark*).
- 2,745,554 (*See Class 9 for this trademark*).
- 2,745,570 (*See Class 9 for this trademark*).
- 2,745,572 (*See Class 9 for this trademark*).
- 2,745,573 (*See Class 9 for this trademark*).
- 2,745,574 (*See Class 9 for this trademark*).
- 2,745,583 (*See Class 2 for this trademark*).
- 2,745,586. **ECCO SELECT**. ELITE COMPUTER CONSULTANTS CORP., (U.S. CLS. 100, 101 AND 102). SN 75-883,911. PUB. 10-8-2002. FILED 1-3-2000.
- 2,745,587. **ABSOLUTE VICTORY**. ROBERT PINO CENTER FOR GROWTH B.V., MULTIPLE CLASS, (INT. CLS. 35 AND 41), (U.S. CLS. 100, 101, 102 AND 107). SN 75-884,003. PUB. 5-13-2003. FILED 12-30-1999.
- 2,745,591. **MOTORCARE AND DESIGN**. MOTORCARE SERVICES INTERNATIONAL B.V., (U.S. CLS. 100, 101 AND 102). SN 75-892,674. PUB. 7-3-2001. FILED 1-7-2000.
- 2,745,592 (*See Class 9 for this trademark*).
- 2,745,595 (*See Class 16 for this trademark*).
- 2,745,597 (*See Class 9 for this trademark*).
- 2,745,610. **NEEDHAM EMERGING GROWTH PARTNERS, L.P.**, NEEDHAM & COMPANY, INC., MULTIPLE CLASS, (INT. CLS. 35 AND 36), (U.S. CLS. 100, 101 AND 102). SN 75-920,860. PUB. 5-13-2003. FILED 2-16-2000.
- 2,745,621. **STATER AND DESIGN**. STATER N.V., BY CHANGE OF NAME STATER B.V., MULTIPLE CLASS, (INT. CLS. 35, 36 AND 42), (U.S. CLS. 100, 101 AND 102). SN 75-938,612. PUB. 5-13-2003. FILED 3-8-2000.
- 2,745,628. **CORTECHS INC SOFTWARE EXCELLENCE AND DESIGN**. CORTECHS, INC., (U.S. CLS. 100, 101 AND 102). SN 75-960,275. PUB. 4-30-2002. FILED 3-15-2000.
- 2,745,652. **ACCESS NURSE**. TEAM HEALTH, INC., MULTIPLE CLASS, (INT. CLS. 35 AND 42), (U.S. CLS. 100, 101 AND 102). SN 76-016,938. PUB. 12-31-2002. FILED 4-4-2000.
- 2,745,656 (*See Class 4 for this trademark*).
- 2,745,658. **REACHHOME.COM**. REACHHOME.COM INC., MULTIPLE CLASS, (INT. CLS. 35 AND 42), (U.S. CLS. 100, 101 AND 102). SN 76-021,975. PUB. 10-15-2002. FILED 4-7-2000.
- 2,745,662 (*See Class 16 for this trademark*).
- 2,745,671 (*See Class 9 for this trademark*).
- 2,745,677. **SYLOG**. SYLOG CONSULTING S.A., MULTIPLE CLASS, (INT. CLS. 35, 37, 41 AND 42), (U.S. CLS. 100, 101, 102, 103, 106 AND 107). SN 76-046,860. PUB. 2-19-2002. FILED 5-12-2000.
- 2,745,682 (*See Class 5 for this trademark*).
- 2,745,686. **SHIPVISION**. CHRONOPOST, MULTIPLE CLASS, (INT. CLS. 35, 36, 38, 39 AND 42), (U.S. CLS. 100, 101, 102, 104 AND 105). SN 76-054,634. PUB. 5-13-2003. FILED 5-19-2000.
- 2,745,692 (*See Class 9 for this trademark*).
- 2,745,694 (*See Class 30 for this trademark*).
- 2,745,698. **NETSOURCE**. MANAGEMENT REPORTS INTERNATIONAL, (U.S. CLS. 100, 101 AND 102). SN 76-064,515. PUB. 12-10-2002. FILED 6-7-2000.
- 2,745,704 (*See Class 9 for this trademark*).
- 2,745,705 (*See Class 9 for this trademark*).
- 2,745,706. **VERTICALSCOPE**. VERTICALSCOPE INC., BY CHANGE OF NAME TOPHOSTS INTERNATIONAL.COM LIMITED, (U.S. CLS. 100, 101 AND 102). SN 76-073,592. PUB. 3-4-2003. FILED 6-19-2000.
- 2,745,713. **NETSOURCE AND DESIGN**. MANAGEMENT REPORTS INTERNATIONAL, (U.S. CLS. 100, 101 AND 102). SN 76-077,570. PUB. 12-10-2002. FILED 6-23-2000.
- 2,745,719. **SUN LLC**. SUN LLC, (U.S. CLS. 100, 101 AND 102). SN 76-080,163. PUB. 12-31-2002. FILED 6-28-2000.
- 2,745,724 (*See Class 6 for this trademark*).
- 2,745,727. **ANGLERS ROOST AND DESIGN**. WYE-YOSHI HOLDING CORPORATION, (U.S. CLS. 100, 101 AND 102). SN 76-092,494. PUB. 9-17-2002. FILED 7-19-2000.
- 2,745,741. **BLUE VIDEO AND DESIGN**. BLUE VIDEO, INC., (U.S. CLS. 100, 101 AND 102). SN 76-103,854. PUB. 12-10-2002. FILED 8-7-2000.
- 2,745,750. **MRI AND DESIGN**. MOORES ROWLAND INTERNATIONAL LIMITED, (U.S. CLS. 100, 101 AND 102). SN 76-111,184. PUB. 7-30-2002. FILED 8-17-2000.
- 2,745,755. **CONTEXT MARKETING**. CONTEXT MARKETING, (U.S. CLS. 100, 101 AND 102). SN 76-115,156. PUB. 12-31-2002. FILED 8-18-2000.
- 2,745,756. **ARTGUARDIAN.COM (STYLIZED)**. ARTGUARDIAN.COM.AG, MULTIPLE CLASS, (INT. CLS. 35, 36, 38 AND 42), (U.S. CLS. 100, 101, 102 AND 104). SN 76-115,180. PUB. 11-19-2002. FILED 8-23-2000.
- 2,745,763. **WWW.RTNIELSON.COM**. R.T. NIELSON COMPANY, MULTIPLE CLASS, (INT. CLS. 35 AND 42), (U.S. CLS. 100, 101 AND 102). SN 76-118,814. PUB. 2-19-2002. FILED 8-28-2000.
- 2,745,767. **ARIZONA HEALTH FOODS SINCE 1968 AND DESIGN**. ARIZONA HEALTH FOODS, INC., (U.S. CLS. 100, 101 AND 102). SN 76-125,695. PUB. 4-30-2002. FILED 9-11-2000.
- 2,745,777 (*See Class 9 for this trademark*).
- 2,745,783 (*See Class 9 for this trademark*).
- 2,745,785. **ASCENTRA NEW MEDIA**. KELMSCOTT COMMUNICATIONS, LLC, MULTIPLE CLASS, (INT. CLS. 35, 39, 41 AND 42), (U.S. CLS. 100, 101, 102, 105 AND 107). SN 76-141,085. PUB. 9-24-2002. FILED 10-4-2000.
- 2,745,789. **NEWSGRADE**. NEWSGRADE.COM, INC., MULTIPLE CLASS, (INT. CLS. 35 AND 36), (U.S. CLS. 100, 101 AND 102). SN 76-144,793. PUB. 5-13-2003. FILED 10-11-2000.
- 2,745,790. **EC@LINE AND DESIGN**. BOLLHOFF GMBH, (U.S. CLS. 100, 101 AND 102). SN 76-145,108. PUB. 5-13-2003. FILED 10-11-2000.
- 2,745,797. **ADQUIRA AND DESIGN**. TELEFONICA, S.A., (U.S. CLS. 100, 101 AND 102). SN 76-157,291. PUB. 5-13-2003. FILED 11-1-2000.
- 2,745,804. **CREATIVE FILMWORKS**. CIAVATTA, ANTHONY, MULTIPLE CLASS, (INT. CLS. 35 AND 41), (U.S. CLS. 100, 101, 102 AND 107). SN 76-162,936. PUB. 5-13-2003. FILED 11-13-2000.
- 2,745,805. **PREMIER SEARCH**. PREMIER SEARCH, INC., (U.S. CLS. 100, 101 AND 102). SN 76-162,951. PUB. 5-13-2003. FILED 11-9-2000.
- 2,745,808 (*See Class 9 for this trademark*).
- 2,745,811 (*See Class 1 for this trademark*).
- 2,745,817 (*See Class 9 for this trademark*).
- 2,745,818 (*See Class 9 for this trademark*).
- 2,745,836. **WE KNOW OUR STUFF**. ENDURANCE SPORTS, INC., (U.S. CLS. 100, 101 AND 102). SN 76-188,988. PUB. 5-13-2003. FILED 12-26-2000.
- 2,745,845. **SOCCERCRAZY & MORE**. SOCCER CRAZY & MORE!! INC., (U.S. CLS. 100, 101 AND 102). SN 76-191,750. PUB. 5-13-2003. FILED 1-9-2001.
- 2,745,852. **EDGE PARK AND DESIGN**. RGH ENTERPRISES, INC., (U.S. CLS. 100, 101 AND 102). SN 76-195,269. PUB. 4-2-2002. FILED 1-18-2001.
- 2,745,853 (*See Class 9 for this trademark*).
- 2,745,862. **DISCON & DEAD SEMICONDUCTOR**. JAPAN UMIX CO., LTD., (U.S. CLS. 100, 101 AND 102). SN 76-201,794. PUB. 5-13-2003. FILED 1-30-2001.
- 2,745,863. **SNPMAP**. SNPCHIP, L.L.C., (U.S. CLS. 100, 101 AND 102). SN 76-201,833. PUB. 5-13-2003. FILED 1-30-2001.
- 2,745,865. **GOLFDEPOT.COM**. GEORGE, CAMILLE J., (U.S. CLS. 100, 101 AND 102). SN 76-203,866. PUB. 5-13-2003. FILED 2-2-2001.
- 2,745,871. **UGSMEDICARE**. UNITED GOVERNMENT SERVICES, LLC., MULTIPLE CLASS, (INT. CLS. 35 AND 45), (U.S. CLS. 100, 101 AND 102). SN 76-206,126. PUB. 5-13-2003. FILED 1-29-2001.
- 2,745,874. **TVI MEDIA**. CONUS COMMUNICATIONS COMPANY LIMITED PARTNERSHIP, (U.S. CLS. 100, 101 AND 102). SN 76-207,866. PUB. 5-13-2003. FILED 2-9-2001.
- 2,745,878. **EBAN AND DESIGN**. EBAN HOLDINGS (HONG KONG) LIMITED, (U.S. CLS. 100, 101 AND 102). SN 76-210,182. PUB. 5-13-2003. FILED 2-14-2001.
- 2,745,889. **HEALTHCARE BUSINESS RESOURCES, INC.**, HEALTHCARE BUSINESS RESOURCES, INC., MULTI-

- PLE CLASS, (INT. CLS. 35, 36 AND 41), (U.S. CLS. 100, 101, 102 AND 107). SN 76-217,254. PUB. 10-8-2002. FILED 2-28-2001.
- 2,745,916. **THE POSTCARD PEOPLE**. RSVP DEVELOPMENT CORP., (U.S. CLS. 100, 101 AND 102). SN 76-234,659. PUB. 5-13-2003. FILED 4-3-2001.
- 2,745,938 (*See Class 9 for this trademark*).
- 2,745,963. **OUR FIRST FOCUS IS YOU**. FIRST DATA MERCHANT SERVICES CORPORATION, (U.S. CLS. 100, 101 AND 102). SN 76-256,282. PUB. 10-23-2001. FILED 5-14-2001.
- 2,745,971. **AVENTOR (STYLIZED)**. AVENTOR, LLC, BY ASSIGNMENT BAKER & DANIELS, MULTIPLE CLASS, (INT. CLS. 35 AND 42), (U.S. CLS. 100, 101 AND 102). SN 76-262,104. PUB. 12-10-2002. FILED 5-24-2001.
- 2,745,985. **WOMYNS' WARE INC. AND DESIGN**. WOMYNS' WARE INC., (U.S. CLS. 100, 101 AND 102). SN 76-267,614. PUB. 5-13-2003. FILED 6-7-2001.
- 2,745,994 (*See Class 9 for this trademark*).
- 2,745,997. **AUTO U.S.A. AND DESIGN**. MORRISSEY MOTORS, INC., (U.S. CLS. 100, 101 AND 102). SN 76-273,034. PUB. 10-15-2002. FILED 6-18-2001.
- 2,746,004. **.BIZ AND DESIGN**. NEULEVEL, INC., MULTIPLE CLASS, (INT. CLS. 35 AND 42), (U.S. CLS. 100, 101 AND 102). SN 76-276,055. PUB. 5-13-2003. FILED 6-25-2001.
- 2,746,010 (*See Class 10 for this trademark*).
- 2,746,011 (*See Class 10 for this trademark*).
- 2,746,019. **EAGLE NETWORK**. SIMMERMAN, SCOTT J., DBA PERFORMANCE MANAGEMENT CO., (U.S. CLS. 100, 101 AND 102). SN 76-281,924. PUB. 10-1-2002. FILED 7-9-2001.
- 2,746,023. **REFERBACK AND DESIGN**. REFERBACK LIMITED, (U.S. CLS. 100, 101 AND 102). SN 76-285,577. PUB. 5-13-2003. FILED 7-16-2001.
- 2,746,026. **RV UNIVERSITY**. STAG-PARKWAY, INC., (U.S. CLS. 100, 101 AND 102). SN 76-285,952. PUB. 5-13-2003. FILED 7-17-2001.
- 2,746,032. **VALORIS**. VALORIS (SOCIETE ANONYME), MULTIPLE CLASS, (INT. CLS. 35 AND 42), (U.S. CLS. 100, 101 AND 102). SN 76-287,094. PUB. 2-11-2003. FILED 7-18-2001.
- 2,746,039. **KEYMRO (STYLIZED)**. KEYMRO, MULTIPLE CLASS, (INT. CLS. 35, 36, 38 AND 42), (U.S. CLS. 100, 101, 102 AND 104). SN 76-288,850. PUB. 1-14-2003. FILED 7-23-2001.
- 2,746,041. **LEASE PLAN AND DESIGN**. ABN AMRO LEASE HOLDING N.V., MULTIPLE CLASS, (INT. CLS. 35, 36 AND 39), (U.S. CLS. 100, 101, 102 AND 105). SN 76-288,895. PUB. 5-13-2003. FILED 7-23-2001.
- 2,746,050. **SOLARA MEDICAL SUPPLIES**. SOLARA MEDICAL SUPPLIES, (U.S. CLS. 100, 101 AND 102). SN 76-292,526. PUB. 5-13-2003. FILED 7-30-2001.
- 2,746,053. **CROSS COUNTRY**. CFRC, INC., BY ASSIGNMENT CROSS COUNTRY, INC., (U.S. CLS. 100, 101 AND 102). SN 76-292,888. PUB. 9-24-2002. FILED 7-31-2001.
- 2,746,071. **GUNS MAGAZINE**. PUBLISHER'S DEVELOPMENT CORPORATION, MULTIPLE CLASS, (INT. CLS. 35 AND 42), (U.S. CLS. 100, 101 AND 102). SN 76-297,592. PUB. 12-10-2002. FILED 8-9-2001.
- 2,746,072. **LES TISSUS COLBERT**. HANLEY, ALAN, (U.S. CLS. 100, 101 AND 102). SN 76-298,285. PUB. 5-13-2003. FILED 8-14-2001.
- 2,746,076 (*See Class 16 for this trademark*).
- 2,746,077. **AT THE SPEED OF NEED**. SONIC CHAIN LLC, (U.S. CLS. 100, 101 AND 102). SN 76-301,893. PUB. 5-13-2003. FILED 8-20-2001.
- 2,746,078. **STUDEBAKER AND DESIGN**. STUDEBAKER NATIONAL MUSEUM, INC., MULTIPLE CLASS, (INT. CLS. 35 AND 41), (U.S. CLS. 100, 101, 102 AND 107). SN 76-302,517. PUB. 6-25-2002. FILED 8-21-2001.
- 2,746,100 (*See Class 6 for this trademark*).
- 2,746,108. **WINNING IN THE CASH FLOW BUSINESS**. AMERICA'S NOTE NETWORK, MULTIPLE CLASS, (INT. CLS. 35 AND 41), (U.S. CLS. 100, 101, 102 AND 107). SN 76-313,615. PUB. 2-4-2003. FILED 9-12-2001.
- 2,746,112. **ASPEN DATA SERVICES**. NEWS AMERICA MARKETING PROPERTIES, INC., MULTIPLE CLASS, (INT. CLS. 35 AND 42), (U.S. CLS. 100, 101 AND 102). SN 76-315,714. PUB. 10-22-2002. FILED 9-21-2001.
- 2,746,121. **BIDDLE & ASSOCIATES, INC.**. BIDDLE & ASSOCIATES, INC., (U.S. CLS. 100, 101 AND 102). SN 76-318,950. PUB. 5-13-2003. FILED 9-27-2001.
- 2,746,122. **DIVINESEARCH.COM**. O'SHEA, DIVINE AND COMPANY, INC., (U.S. CLS. 100, 101 AND 102). SN 76-319,226. PUB. 5-13-2003. FILED 9-28-2001.
- 2,746,125 (*See Class 9 for this trademark*).
- 2,746,126. **MISCELLANEOUS DESIGN**. POINTSTREAK.COM INC., (U.S. CLS. 100, 101 AND 102). SN 76-321,268. PUB. 7-23-2002. FILED 10-4-2001.
- 2,746,138. **PACIFICO**. PACIFICO, INC., (U.S. CLS. 100, 101 AND 102). SN 76-324,541. PUB. 9-24-2002. FILED 10-11-2001.
- 2,746,153. **ALDER ASSOCIATES**. ALDER ASSOCIATES, LLC, (U.S. CLS. 100, 101 AND 102). SN 76-328,563. PUB. 10-29-2002. FILED 9-14-2001.
- 2,746,154. **E ENTERPRISE EVENTS GROUP AND DESIGN**. ENTERPRISE EVENTS GROUP, INC., (U.S. CLS. 100, 101 AND 102). SN 76-329,172. PUB. 5-13-2003. FILED 10-24-2001.
- 2,746,160. **RETURN ON IMAGINATION**. BATES WORLDWIDE, INC., (U.S. CLS. 100, 101 AND 102). SN 76-331,755. PUB. 12-10-2002. FILED 10-30-2001.
- 2,746,165. **EXTENSURE**. AVNET, INC., MULTIPLE CLASS, (INT. CLS. 35 AND 42), (U.S. CLS. 100, 101 AND 102). SN 76-332,087. PUB. 5-13-2003. FILED 10-30-2001.
- 2,746,172. **ARRC AUTO RENTAL RESOURCE CENTER AND DESIGN**. U-SAVE AUTO RENTAL OF AMERICA, INC., MULTIPLE CLASS, (INT. CLS. 35 AND 36), (U.S. CLS. 100, 101 AND 102). SN 76-334,120. PUB. 5-13-2003. FILED 11-6-2001.
- 2,746,175. **NAPA PARTS PRO AND DESIGN**. NATIONAL AUTOMOTIVE PARTS ASSOCIATION, (U.S. CLS. 100, 101 AND 102). SN 76-335,731. PUB. 1-7-2003. FILED 11-8-2001.
- 2,746,194. **AG XPRESS AND DESIGN**. ALABAMA GRAPHICS & ENGINEERING SUPPLY, INC., MULTIPLE CLASS, (INT. CLS. 35 AND 40), (U.S. CLS. 100, 101, 102, 103 AND 106). SN 76-339,608. PUB. 12-24-2002. FILED 11-20-2001.
- 2,746,199. **SPECTRUM**. SPECTRUM INVESTMENT COMPANY, LLC, (U.S. CLS. 100, 101 AND 102). SN 76-340,847. PUB. 11-19-2002. FILED 11-21-2001.
- 2,746,204. **SOLTRIS**. SOLTRIS, INC., MULTIPLE CLASS, (INT. CLS. 35 AND 42), (U.S. CLS. 100, 101 AND 102). SN 76-341,749. PUB. 2-4-2003. FILED 11-26-2001.
- 2,746,206. **JOANNE HUDSON ASSOCIATES, LTD.**. JOANNE HUDSON ASSOCIATES, LTD., MULTIPLE CLASS, (INT. CLS. 35 AND 42), (U.S. CLS. 100, 101 AND 102). SN 76-342,174. PUB. 4-1-2003. FILED 11-27-2001.
- 2,746,208. **VIRTU**. VIRTU, LLC, (U.S. CLS. 100, 101 AND 102). SN 76-342,327. PUB. 5-13-2003. FILED 11-27-2001.
- 2,746,211. **THE HUN'S YELLOW PAGES**. TER WEE, PATRICK, MULTIPLE CLASS, (INT. CLS. 35, 36, 38 AND 41), (U.S. CLS. 100, 101, 102, 104 AND 107). SN 76-342,866. PUB. 5-13-2003. FILED 11-29-2001.
- 2,746,219. **HUGO HUGO BOSS**. HUGO BOSS AG, (U.S. CLS. 100, 101 AND 102). SN 76-344,981. PUB. 5-13-2003. FILED 12-4-2001.
- 2,746,223. **THE BRAND VELOCITY SYSTEM FOR SUSTAINABLE PERFORMANCE**. BRAND VELOCITY, INC., (U.S. CLS. 100, 101 AND 102). SN 76-346,316. PUB. 5-13-2003. FILED 12-6-2001.
- 2,746,239. **4 ELBOWS**. 4 ELBOWS, LLC, (U.S. CLS. 100, 101 AND 102). SN 76-353,611. PUB. 5-13-2003. FILED 12-28-2001.
- 2,746,247. **KEY WEST BREWERY AND DESIGN**. YBOR CITY BREWING COMPANY, BY ASSIGNMENT KEY WEST BREWERY, INC., (U.S. CLS. 100, 101 AND 102). SN 76-354,788. PUB. 5-13-2003. FILED 1-3-2002.
- 2,746,257 (*See Class 16 for this trademark*).
- 2,746,260. **M AND DESIGN**. BIG M, INC., (U.S. CLS. 100, 101 AND 102). SN 76-358,201. PUB. 10-8-2002. FILED 1-3-2002.
- 2,746,273. **LISTENUPS WE FIND BUYERS (STYLIZED)**. SMITH, ROBERT W., (U.S. CLS. 100, 101 AND 102). SN 76-362,721. PUB. 10-15-2002. FILED 1-25-2002.
- 2,746,285. **AMERICAN COLLEGE OF PHYSICIANS**. AMERICAN COLLEGE OF PHYSICIANS - AMERICAN SOCIETY OF INTERNAL MEDICINE, MULTIPLE CLASS, (INT. CLS. 35 AND 41), (U.S. CLS. 100, 101, 102 AND 107). SN 76-366,805. PUB. 5-13-2003. FILED 2-4-2002.
- 2,746,296. **HERITAGE**. HERITAGE CAPITAL CORPORATION, (U.S. CLS. 100, 101 AND 102). SN 76-369,910. PUB.

- 5-13-2003. FILED 2-12-2002.
- 2,746,300. **TESDANE NANNY SERVICES**. TESDANE NANNY SERVICES, INC., (U.S. CLS. 100, 101 AND 102). SN 76-370,767. PUB. 5-13-2003. FILED 2-15-2002.
- 2,746,306. **MEADOWBROOK GOLF AND DESIGN**. MEADOWBROOK GOLF GROUP, INC., MULTIPLE CLASS, (INT. CLS. 35, 37 AND 44), (U.S. CLS. 100, 101, 102, 103 AND 106). SN 76-372,410. PUB. 5-13-2003. FILED 2-20-2002.
- 2,746,319 (*See Class 9 for this trademark*).
- 2,746,336. **AGILQUEST**. AGILQUEST CORPORATION, BY CHANGE OF NAME V TECHNOLOGIES INTERNATIONAL CORPORATION, MULTIPLE CLASS, (INT. CLS. 35 AND 42), (U.S. CLS. 100, 101 AND 102). SN 76-377,140. PUB. 9-24-2002. FILED 2-28-2002.
- 2,746,343. **JOHN HOLTZ BRINGS YOU THE WORLD**. HOLTZ HOUSE OF VEHICLES INC., (U.S. CLS. 100, 101 AND 102). SN 76-378,256. PUB. 5-13-2003. FILED 3-4-2002.
- 2,746,354. **TRAVEL ANALYTICS**. TRAVEL ANALYTICS, INC., (U.S. CLS. 100, 101 AND 102). SN 76-380,603. PUB. 5-13-2003. FILED 3-8-2002.
- 2,746,363. **AMERICAN INDIAN COLLEGE FUND EDUCATION IS STRENGTH AND DESIGN**. AMERICAN INDIAN COLLEGE FUND, MULTIPLE CLASS, (INT. CLS. 35 AND 36), (U.S. CLS. 100, 101 AND 102). SN 76-382,563. PUB. 5-13-2003. FILED 3-14-2002.
- 2,746,371. **SOUNDSMITH**. SOUNDSMITH PRODUCTIONS, INC., MULTIPLE CLASS, (INT. CLS. 35 AND 41), (U.S. CLS. 100, 101, 102 AND 107). SN 76-384,333. PUB. 5-13-2003. FILED 3-12-2002.
- 2,746,380 (*See Class 2 for this trademark*).
- 2,746,388. **COLLEGEXIT**. TCW/CRESCENT MEZZANE MANAGEMENT III, L.L.C. AS COLLATERAL AGENT, BY ASSIGNMENT COLLEGIATE FUNDING SERVICES, LLC, MULTIPLE CLASS, (INT. CLS. 35 AND 36), (U.S. CLS. 100, 101 AND 102). SN 76-386,430. PUB. 5-13-2003. FILED 3-22-2002.
- 2,746,395. **GET NOTICED, GET PLAYING**. PLAY LIKE THE PROS, LLC, (U.S. CLS. 100, 101 AND 102). SN 76-386,941. PUB. 5-13-2003. FILED 3-22-2002.
- 2,746,408. **PYRAMID PLUS**. GRIZZARD ADVERTISING, INC., (U.S. CLS. 100, 101 AND 102). SN 76-390,208. PUB. 5-13-2003. FILED 4-2-2002.
- 2,746,416. **VALUE PLUS PROGRAM**. HAGEMEYER NORTH AMERICA, INC., (U.S. CLS. 100, 101 AND 102). SN 76-391,815. PUB. 5-13-2003. FILED 4-3-2002.
- 2,746,423 (*See Class 14 for this trademark*).
- 2,746,425 (*See Class 9 for this trademark*).
- 2,746,428. **THE SUPPLY EXPERTS**. MOORE MEDICAL CORP., (U.S. CLS. 100, 101 AND 102). SN 76-393,379. PUB. 5-13-2003. FILED 4-9-2002.
- 2,746,433 (*See Class 19 for this trademark*).
- 2,746,445 (*See Class 14 for this trademark*).
- 2,746,455. **M&J BUTTONS AND DESIGN**. M&J TRIMMING CO., INC., (U.S. CLS. 100, 101 AND 102). SN 76-396,197. PUB. 5-13-2003. FILED 4-15-2002.
- 2,746,458 (*See Class 9 for this trademark*).
- 2,746,466. **WS I AND DESIGN**. WEB SERVICES-INTEROPERABILITY ORGANIZATION, INC., DBA D/B/A WEB SERVICES-INTEROPERABILITY ORGANIZATION, (U.S. CLS. 100, 101 AND 102). SN 76-398,105. PUB. 5-13-2003. FILED 4-19-2002.
- 2,746,468. **JOBS-SOCAL.COM AND DESIGN**. EMMERON, INC., (U.S. CLS. 100, 101 AND 102). SN 76-398,674. PUB. 5-13-2003. FILED 4-22-2002.
- 2,746,470 (*See Class 1 for this trademark*).
- 2,746,493. **MARTOPIA AND DESIGN**. MARTOPIA, (U.S. CLS. 100, 101 AND 102). SN 76-402,669. PUB. 5-13-2003. FILED 5-2-2002.
- 2,746,496. **GAMEFLY**. GAMEFLY, INC., BY ASSIGNMENT SPECTOR, SEAN, MULTIPLE CLASS, (INT. CLS. 35 AND 41), (U.S. CLS. 100, 101, 102 AND 107). SN 76-402,871. PUB. 5-13-2003. FILED 4-30-2002.
- 2,746,502. **THE ESSENCE OF HOME**. GABBERTS INC., (U.S. CLS. 100, 101 AND 102). SN 76-404,142. PUB. 5-13-2003. FILED 5-6-2002.
- 2,746,503. **GABBERTS (STYLIZED)**. GABBERTS INC., (U.S. CLS. 100, 101 AND 102). SN 76-404,144. PUB. 5-13-2003. FILED 5-6-2002.
- 2,746,504. **GABBERTS**. GABBERTS INC., (U.S. CLS. 100, 101 AND 102). SN 76-404,146. PUB. 5-13-2003. FILED 5-6-2002.
- 2,746,511. **INTERNATIONAL MUNICIPAL SIGNAL ASSOCIATION**. INTERNATIONAL MUNICIPAL SIGNAL ASSOCIATION, (U.S. CLS. 100, 101 AND 102). SN 76-404,796. PUB. 5-13-2003. FILED 4-30-2002.
- 2,746,515. **VACATIONPORT**. PASSPORT ONLINE, INC., (U.S. CLS. 100, 101 AND 102). SN 76-405,049. PUB. 5-13-2003. FILED 5-6-2002.
- 2,746,528. **BOARDROOM**. T.N.T. VENTURES LTD., MULTIPLE CLASS, (INT. CLS. 35 AND 40), (U.S. CLS. 100, 101, 102, 103 AND 106). SN 76-406,734. PUB. 5-13-2003. FILED 5-8-2002.
- 2,746,530. **THE MOST COMFORTABLE STORE IN THE WORLD!**. MATTRESS WAREHOUSE INC., (U.S. CLS. 100, 101 AND 102). SN 76-406,905. PUB. 5-13-2003. FILED 5-7-2002.
- 2,746,531. **MATTRESS KIDS AND DESIGN**. MATTRESS WAREHOUSE INC., (U.S. CLS. 100, 101 AND 102). SN 76-406,908. PUB. 5-13-2003. FILED 5-7-2002.
- 2,746,558. **AIRPORT SEND OFF**. INTERNATIONAL HOLIDAYS, INC., (U.S. CLS. 100, 101 AND 102). SN 76-410,728. PUB. 5-13-2003. FILED 5-22-2002.
- 2,746,574. **K AND DESIGN**. CIRCLE K STORES INC., (U.S. CLS. 100, 101 AND 102). SN 76-413,555. PUB. 5-13-2003. FILED 5-29-2002.
- 2,746,575. **ELTP**. NATIONAL ASSOCIATION OF BOARDS OF PHARMACY, (U.S. CLS. 100, 101 AND 102). SN 76-413,815. PUB. 5-13-2003. FILED 5-28-2002.
- 2,746,582. **HOUSE OF BLUES AND DESIGN**. HOUSE OF BLUES BRANDS CORP., (U.S. CLS. 100, 101 AND 102). SN 76-416,770. PUB. 5-13-2003. FILED 6-4-2002.
- 2,746,590 (*See Class 28 for this trademark*).
- 2,746,599. **CLUB GEM**. SU, JE GEM, (U.S. CLS. 100, 101 AND 102). SN 76-419,644. PUB. 5-13-2003. FILED 6-10-2002.
- 2,746,600. **CLUBGEM.COM**. SU, JE GEM, (U.S. CLS. 100, 101 AND 102). SN 76-419,645. PUB. 5-13-2003. FILED 6-10-2002.
- 2,746,616. **SALISHAN**. YCP SALISHAN OPERATOR, INC., MULTIPLE CLASS, (INT. CLS. 35, 41 AND 43), (U.S. CLS. 100, 101, 102 AND 107). SN 76-421,622. PUB. 5-13-2003. FILED 6-17-2002.
- 2,746,623. **FLYNN'S**. URRA CO., INC., (U.S. CLS. 100, 101 AND 102). SN 76-422,945. PUB. 5-13-2003. FILED 6-19-2002.
- 2,746,642. **MUSICAL KIDS CLOTHES AND MORE!**. MUSICAL KIDS CLOTHES BY HI-D-ZINES, LLC, (U.S. CLS. 100, 101 AND 102). SN 76-426,717. PUB. 5-13-2003. FILED 7-1-2002.
- 2,746,643. **THE WORLD'S MOST UNUSUAL KIDS STORE**. MUSICAL KIDS CLOTHES BY HI-D-ZINES, LLC, (U.S. CLS. 100, 101 AND 102). SN 76-426,719. PUB. 5-13-2003. FILED 7-1-2002.
- 2,746,645. **SLIM AND TONE**. SHAPES 30 MINUTE WORKOUT FOR WOMEN LIMITED LIABILITY COMPANY, (U.S. CLS. 100, 101 AND 102). SN 76-426,830. PUB. 5-13-2003. FILED 7-1-2002.
- 2,746,653. **FROM GRAPE TO GLASS**. CONNOISSEUR ENCOUNTERS, DBA SHERMER SPECIALTIES, (U.S. CLS. 100, 101 AND 102). SN 76-427,689. PUB. 5-13-2003. FILED 7-2-2002.
- 2,746,664. **SNACKTORY FOODS**. BROWN, BRUCE, (U.S. CLS. 100, 101 AND 102). SN 76-432,193. PUB. 5-13-2003. FILED 7-19-2002.
- 2,746,669. **H AND DESIGN**. HOMEVESTORS OF AMERICA, INC., (U.S. CLS. 100, 101 AND 102). SN 76-433,904. PUB. 5-13-2003. FILED 7-22-2002.
- 2,746,673. **THE TOOLS. THE KNOWLEDGE. THE SOURCE.** LF, LLC, (U.S. CLS. 100, 101 AND 102). SN 76-434,747. PUB. 5-13-2003. FILED 7-29-2002.
- 2,746,676. **BANKERS' COMPLIANCE GROUP (STYLIZED)**. BANKERS' COMPLIANCE GROUP, INC., (U.S. CLS. 100, 101 AND 102). SN 76-435,039. PUB. 5-13-2003. FILED 7-29-2002.
- 2,746,684. **SUPER S.W.O.T.**. EMMERLING COMMUNICATIONS LLC, (U.S. CLS. 100, 101 AND 102). SN 76-436,397. PUB. 5-13-2003. FILED 7-31-2002.
- 2,746,685. **BIOSECTOR2 ENERGY + INNOVATION AND DESIGN**. BIOSECTOR 2, L.L.C., (U.S. CLS. 100, 101 AND 102). SN 76-436,777. PUB. 5-13-2003. FILED 8-2-2002.

- 2,746,687. **TAXML**. VERTEX INC., (U.S. CLS. 100, 101 AND 102). SN 76-437,173. PUB. 5-13-2003. FILED 8-2-2002.
- 2,746,691. **MISCELLANEOUS DESIGN**. DAZZLE DONUTS. INC., (U.S. CLS. 100, 101 AND 102). SN 76-438,109. PUB. 5-13-2003. FILED 7-8-2002.
- 2,746,696. **ORDER OF AHEPA AND DESIGN**. THE AMERICAN-HELLENIC EDUCATIONAL PROGRESSIVE ASSOCIATION, AND AHEPA MOTHER LODGE CHAPER #1, (U.S. CLS. 100, 101 AND 102). SN 76-439,401. PUB. 5-13-2003. FILED 8-12-2002.
- 2,746,701. **SCHAFFEN INTERNATIONAL AND DESIGN**. SCHAFFEN INTERNATIONAL, INC., (U.S. CLS. 100, 101 AND 102). SN 76-440,317. PUB. 5-13-2003. FILED 8-7-2002.
- 2,746,705. **MIDNIGHT EXPRESS**. SHAH, SURENDRA, (U.S. CLS. 100, 101 AND 102). SN 76-440,921. PUB. 5-13-2003. FILED 8-16-2002.
- 2,746,706. **NELL HILL'S**. NELL HILL'S CORPORATION, (U.S. CLS. 100, 101 AND 102). SN 76-441,037. PUB. 5-13-2003. FILED 8-14-2002.
- 2,746,707. **GDL INTERNATIONAL**. DELANEY, MAURICE, (U.S. CLS. 100, 101 AND 102). SN 76-441,122. PUB. 5-13-2003. FILED 8-16-2002.
- 2,746,712. **FCA AND DESIGN**. SAN DIEGO FORENSIC CONSULTANTS ASSOCIATION, (U.S. CLS. 100, 101 AND 102). SN 76-441,615. PUB. 5-13-2003. FILED 8-19-2002.
- 2,746,713. **MANAGING THE BUSINESS OF MEDICINE**. IBX TECHNOLOGIES INC, MULTIPLE CLASS, (INT. CLS. 35 AND 36), (U.S. CLS. 100, 101 AND 102). SN 76-441,670. PUB. 5-13-2003. FILED 8-20-2002.
- 2,746,750. **H2 HOMEOWNER HOMEWORK (STYLIZED)**. KUDLA ENTERPRISES, INC., (U.S. CLS. 100, 101 AND 102). SN 76-445,149. PUB. 5-13-2003. FILED 8-20-2002.
- 2,746,782. **TOWN FAIR TIRE AND DESIGN**. TOWN FAIR TIRE CENTERS, INC., (U.S. CLS. 100, 101 AND 102). SN 76-448,528. PUB. 5-13-2003. FILED 9-11-2002.
- 2,746,786. **A WHOLE NEW WAY TO LOOK AT THINGS!**. DISTRIBUTORCENTRAL L.L.C., (U.S. CLS. 100, 101 AND 102). SN 76-448,611. PUB. 5-13-2003. FILED 9-6-2002.
- 2,746,821. **QUOTEMARKET**. SCHNEIDER, DAVID L., (U.S. CLS. 100, 101 AND 102). SN 76-451,298. PUB. 5-13-2003. FILED 9-19-2002.
- 2,746,829. **RESTAURANT TIPS**. QUESTAR DATA SYSTEMS, INC., (U.S. CLS. 100, 101 AND 102). SN 76-452,044. PUB. 5-13-2003. FILED 9-23-2002.
- 2,746,833. **WEBAVA**. WALTER V. CLARKE ASSOCIATES, INCORPORATED, (U.S. CLS. 100, 101 AND 102). SN 76-452,184. PUB. 5-13-2003. FILED 9-18-2002.
- 2,746,838. **COMMAND AND DESIGN**. COMMAND SOFTWARE SYSTEMS, INC., MULTIPLE CLASS, (INT. CLS. 35 AND 42), (U.S. CLS. 100, 101 AND 102). SN 76-452,455. PUB. 5-13-2003. FILED 9-25-2002.
- 2,746,846. **THE JOY OF GARDENING**. FRED MEYER STORES, INC., (U.S. CLS. 100, 101 AND 102). SN 76-452,807. PUB. 5-13-2003. FILED 9-25-2002.
- 2,746,865. **CREATIVE DISPLAYS. POWERFUL RESULTS..** DISPLAY INDUSTRIES, LLC., (U.S. CLS. 100, 101 AND 102). SN 76-453,691. PUB. 5-13-2003. FILED 9-30-2002.
- 2,746,875 (*See Class 25 for this trademark*).
- 2,746,887. **MOMENTUM THE STRATEGIC PLAN MOOSE INTERNATIONAL AND DESIGN**. MOOSE INTERNATIONAL, INC., (U.S. CLS. 100, 101 AND 102). SN 76-454,728. PUB. 5-13-2003. FILED 10-2-2002.
- 2,746,889. **RESULTWARE**. RESULTWARE LIMITED, (U.S. CLS. 100, 101 AND 102). SN 76-454,993. PUB. 5-13-2003. FILED 10-2-2002.
- 2,746,891 (*See Class 25 for this trademark*).
- 2,746,897. **KIDZONE**. SPEEDBAR, INC., (U.S. CLS. 100, 101 AND 102). SN 76-455,311. PUB. 5-13-2003. FILED 10-1-2002.
- 2,746,909. **BUILDING TRIAGE**. REALWINWIN, INC., (U.S. CLS. 100, 101 AND 102). SN 76-455,903. PUB. 5-13-2003. FILED 10-4-2002.
- 2,746,910. **NOI BUILDER**. REALWINWIN, INC., (U.S. CLS. 100, 101 AND 102). SN 76-455,926. PUB. 5-13-2003. FILED 10-4-2002.
- 2,746,915 (*See Class 16 for this trademark*).
- 2,746,923. **ON THE RIM & OUT THE DOOR**. MR. TIRE, INC., (U.S. CLS. 100, 101 AND 102). SN 76-456,670. PUB. 5-13-2003. FILED 10-8-2002.
- 2,746,943. **OLD FASHIONED MONEY**. OLD FASHIONED MONEY, LIMITED PARTNERSHIP, (U.S. CLS. 100, 101 AND 102). SN 76-458,284. PUB. 5-13-2003. FILED 10-15-2002.
- 2,746,944. **IMRA**. INTERNATIONAL MASS RETAIL ASSOCIATION, INC., MULTIPLE CLASS, (INT. CLS. 35 AND 41), (U.S. CLS. 100, 101, 102 AND 107). SN 76-458,366. PUB. 5-13-2003. FILED 10-7-2002.
- 2,746,953. **INTERVALS**. NEW LEAF ENTERPRISES, LLC, (U.S. CLS. 100, 101 AND 102). SN 76-458,917. PUB. 5-13-2003. FILED 10-17-2002.
- 2,746,957. **AEEG**. NATIONAL VENTURE CAPITAL ASSOCIATION, (U.S. CLS. 100, 101 AND 102). SN 76-459,000. PUB. 5-13-2003. FILED 10-9-2002.
- 2,746,958. **AMERICAN ENTREPRENEURS FOR ECONOMIC GROWTH**. NATIONAL VENTURE CAPITAL ASSOCIATION, (U.S. CLS. 100, 101 AND 102). SN 76-459,007. PUB. 5-13-2003. FILED 10-9-2002.
- 2,746,960. **SOUTHERN XPOSURE SILVER**. CLINE MEDIA GROUP LLC, (U.S. CLS. 100, 101 AND 102). SN 76-459,016. PUB. 5-13-2003. FILED 10-9-2002.
- 2,746,961. **SOUTHERN XPOSURE GOLD**. CLINE MEDIA GROUP LLC, (U.S. CLS. 100, 101 AND 102). SN 76-459,017. PUB. 5-13-2003. FILED 10-9-2002.
- 2,746,966. **UNITE AND DESIGN**. UNITE, INC., (U.S. CLS. 100, 101 AND 102). SN 76-459,305. PUB. 5-13-2003. FILED 10-18-2002.
- 2,746,968. **YALSA**. AMERICAN LIBRARY ASSOCIATION, (U.S. CLS. 100, 101 AND 102). SN 76-459,456. PUB. 5-13-2003. FILED 10-21-2002.
- 2,746,976. **LOOK FOR THE HEART CHECK MARK**. AMERICAN HEART ASSOCIATION, INC., (U.S. CLS. 100, 101 AND 102). SN 76-460,060. PUB. 5-13-2003. FILED 10-11-2002.
- 2,746,977. **SHOP SMART. LIVE WELL..** AMERICAN HEART ASSOCIATION, INC., (U.S. CLS. 100, 101 AND 102). SN 76-460,061. PUB. 5-13-2003. FILED 10-11-2002.
- 2,746,983. **FCSI**. FOODSERVICE CONSULTANTS SOCIETY INTERNATIONAL, (U.S. CLS. 100, 101 AND 102). SN 76-460,371. PUB. 5-13-2003. FILED 10-21-2002.
- 2,747,005. **ACCUMALL**. ACCU-WEATHER, INC., (U.S. CLS. 100, 101 AND 102). SN 76-462,011. PUB. 5-13-2003. FILED 10-24-2002.
- 2,747,047. **ACCUCLIP**. CYBERALERT, INC., (U.S. CLS. 100, 101 AND 102). SN 76-470,280. PUB. 5-13-2003. FILED 11-26-2002.
- 2,747,053. **WIRESTONE AND DESIGN**. WIRESTONE, LLC, BY ASSIGNMENT; BY CHANGE OF NAME KARL, ALLAN F., MULTIPLE CLASS, (INT. CLS. 35, 41 AND 42), (U.S. CLS. 100, 101, 102 AND 107). SN 76-975,177. PUB. 5-13-2003. FILED 10-16-2000.
- 2,747,067. **ALECTA AND DESIGN**. ALECTA PENSIONSFORSAKRING, OMSESIDIGT, BY ASSIGNMENT ESSEN INTERNATIONAL AB, MULTIPLE CLASS, (INT. CLS. 35, 36 AND 42), (U.S. CLS. 100, 101 AND 102). SN 78-037,055. PUB. 5-13-2003. FILED 11-29-2000.
- 2,747,081 (*See Class 9 for this trademark*).
- 2,747,090. **ENGINEERED-LAB**. ARGENT, (U.S. CLS. 100, 101 AND 102). SN 78-077,072. PUB. 5-13-2003. FILED 8-2-2001.
- 2,747,095. **PLANETEDU (STYLIZED)**. CULTURAL EXPERIENCES ABROAD, INC., (U.S. CLS. 100, 101 AND 102). SN 78-083,773. PUB. 5-13-2003. FILED 9-13-2001.
- 2,747,104. **ZAPPOS.COM THE WEB'S MOST POPULAR SHOE STORE! AND DESIGN**. ZAPPOS.COM, INC., (U.S. CLS. 100, 101 AND 102). SN 78-094,381. PUB. 5-13-2003. FILED 11-20-2001.
- 2,747,114. **FORESTEXPRESS**. FORESTEXPRESS LLC, (U.S. CLS. 100, 101 AND 102). SN 78-098,890. PUB. 5-13-2003. FILED 12-18-2001.
- 2,747,126. **XDL**. XDL CAPITAL CORPORATION, MULTIPLE CLASS, (INT. CLS. 35 AND 36), (U.S. CLS. 100, 101 AND 102). SN 78-105,626. PUB. 5-13-2003. FILED 1-30-2002.
- 2,747,143. **THE CONSULTING EXCHANGE**. THE CONSULTING EXCHANGE, INC., (U.S. CLS. 100, 101 AND 102). SN 78-111,922. PUB. 5-13-2003. FILED 3-1-2002.
- 2,747,151. **AOT**. AMERICAN OVERSEAS TRANSPORT LTD., (U.S. CLS. 100, 101 AND 102). SN 78-113,470. PUB. 5-13-2003. FILED 3-8-2002.
- 2,747,152. **CCENERGY**. RAGSDALE, SCOTT D., (U.S. CLS. 100, 101 AND 102). SN 78-114,685. PUB. 5-13-2003. FILED 3-

- 13-2002.
- 2,747,157. **INTEGRITY REWARDS**. INTEGRITY INCORPORATED, (U.S. CLS. 100, 101 AND 102). SN 78-117,207. PUB. 5-13-2003. FILED 3-25-2002.
- 2,747,176. **PERKS PLUS AND DESIGN**. EXCLUSIVE PRODUCERS NETWORK, INC., (U.S. CLS. 100, 101 AND 102). SN 78-120,181. PUB. 5-13-2003. FILED 4-8-2002.
- 2,747,180. **QUACKPACK**. GREAT AMERICAN DUCK RACES, INC., DBA GAME: GREAT AMERICAN MERCHANDISE AND EVENTS, (U.S. CLS. 100, 101 AND 102). SN 78-121,692. PUB. 5-13-2003. FILED 4-15-2002.
- 2,747,184. **SOUTH POLE SMOOTHIES AND DESIGN**. SOUTH POLE SMOOTHIES FRANCHISE SYSTEMS, INC., MULTIPLE CLASS, (INT. CLS. 35 AND 43), (U.S. CLS. 100, 101 AND 102). SN 78-122,466. PUB. 5-13-2003. FILED 4-17-2002.
- 2,747,196. **TIMCO-COMPUTERS.COM**. TIMCO, LANCE A., (U.S. CLS. 100, 101 AND 102). SN 78-126,477. PUB. 5-13-2003. FILED 5-6-2002.
- 2,747,198. **MODEL RESOURCE GROUP (MRG) ...FOR TRUTH IN MODELING**. LEE, LINDA, (U.S. CLS. 100, 101 AND 102). SN 78-127,379. PUB. 5-13-2003. FILED 5-8-2002.
- 2,747,212. **RE/MAX AND DESIGN**. RE/MAX INTERNATIONAL, INC., (U.S. CLS. 100, 101 AND 102). SN 78-132,014. PUB. 5-13-2003. FILED 5-30-2002.
- 2,747,220. **Z GALLERIE**. Z GALLERIE, INC., (U.S. CLS. 100, 101 AND 102). SN 78-138,774. PUB. 5-13-2003. FILED 6-25-2002.
- 2,747,232. **THE PHONE LADY**. TELECOMMUNICATIONS EXPORT COMPANY LTD., (U.S. CLS. 100, 101 AND 102). SN 78-144,301. PUB. 5-13-2003. FILED 7-16-2002.
- 2,747,236 (*See Class 25 for this trademark*).
- 2,747,239. **SHOWCASE OF DISTINCTIVE HOMES**. BUILDING INDUSTRY ASSOCIATION OF SOUTHEASTERN MICHIGAN, (U.S. CLS. 100, 101 AND 102). SN 78-146,675. PUB. 5-13-2003. FILED 7-23-2002.
- 2,747,248. **INSPIRED BY INNOVATION, PROVEN BY PERFORMANCE**. LITTLE RAPIDS CORPORATION, (U.S. CLS. 100, 101 AND 102). SN 78-147,757. PUB. 5-13-2003. FILED 7-26-2002.
- 2,747,256. **Q AND DESIGN**. BUSTIN & CO., INC., (U.S. CLS. 100, 101 AND 102). SN 78-149,821. PUB. 5-13-2003. FILED 8-1-2002.
- 2,747,259. **UBERBRAND**. BIZWORD LLC, (U.S. CLS. 100, 101 AND 102). SN 78-150,815. PUB. 5-13-2003. FILED 8-5-2002.
- 2,747,265. **C CHADWICK'S REWARDS (STYLIZED)**. CHADWICK'S OF BOSTON, INC., (U.S. CLS. 100, 101 AND 102). SN 78-151,769. PUB. 5-13-2003. FILED 8-7-2002.
- 2,747,268. **MEDICORP, INC.**. MEDICORP, INC., (U.S. CLS. 100, 101 AND 102). SN 78-152,054. PUB. 5-13-2003. FILED 8-7-2002.
- 2,747,270. **PROFILES**. MEDICORP, INC., (U.S. CLS. 100, 101 AND 102). SN 78-152,069. PUB. 5-13-2003. FILED 8-7-2002.
- 2,747,279. **MOTOPSYCHO**. MOTOPSYCHO LLC, (U.S. CLS. 100, 101 AND 102). SN 78-153,048. PUB. 5-13-2003. FILED 8-10-2002.
- 2,747,286. **ICBA: THE NATION'S LEADING VOICE FOR COMMUNITY BANKS**. INDEPENDENT COMMUNITY BANKERS OF AMERICA, (U.S. CLS. 100, 101 AND 102). SN 78-153,283. PUB. 5-13-2003. FILED 8-12-2002.
- 2,747,290. **GEEZER GASSERS**. HIX, DANIEL H., MULTIPLE CLASS, (INT. CLS. 35 AND 41), (U.S. CLS. 100, 101, 102 AND 107). SN 78-153,645. PUB. 5-13-2003. FILED 8-13-2002.
- 2,747,311. **SHOE CARNIVAL (STYLIZED)**. SCLC, INC., (U.S. CLS. 100, 101 AND 102). SN 78-158,842. PUB. 5-13-2003. FILED 8-28-2002.
- 2,747,316. **YOUR NEIGHBORHOOD CPAS**. WILLIS, THERESA ANNE, AND BAUER, PATRICIA ANN, (U.S. CLS. 100, 101 AND 102). SN 78-159,143. PUB. 5-13-2003. FILED 8-29-2002.
- 2,747,322. **HOUSTON WORLD TRADE ASSOCIATION**. GREATER HOUSTON PARTNERSHIP, INC., (U.S. CLS. 100, 101 AND 102). SN 78-161,289. PUB. 5-13-2003. FILED 9-6-2002.
- 2,747,323. **LIK SANG**. LIK SANG INTERNATIONAL LIMITED, (U.S. CLS. 100, 101 AND 102). SN 78-161,301. PUB. 5-13-2003. FILED 9-6-2002.
- 2,747,328. **ADVERTHINKING**. PERICH + PARTNERS, INC, (U.S. CLS. 100, 101 AND 102). SN 78-162,860. PUB. 5-13-2003. FILED 9-11-2002.
- 2,747,354. **GCS GLASS CLAIMS SERVICES AND DESIGN**. ALLIANCE GLASS NETWORK, INC., (U.S. CLS. 100, 101 AND 102). SN 78-165,498. PUB. 5-13-2003. FILED 9-18-2002.
- 2,747,356 (*See Class 9 for this trademark*).
- 2,747,364. **BARTER BING**. ROSENBERG, WILBERT S., (U.S. CLS. 100, 101 AND 102). SN 78-166,860. PUB. 5-13-2003. FILED 9-23-2002.
- 2,747,384. **E ELEGANCE AND DESIGN**. ELEGANCE CORPORATION, (U.S. CLS. 100, 101 AND 102). SN 78-169,028. PUB. 5-13-2003. FILED 9-29-2002.
- 2,747,385. **HELPING TO STRENGTHEN HEARTS, MINDS & SOULS**. FAMILY CHRISTIAN STORES, INC., (U.S. CLS. 100, 101 AND 102). SN 78-169,184. PUB. 5-13-2003. FILED 9-30-2002.
- 2,747,393. **SERVICE EMPLOYEES INTERNATIONAL UNION**. SERVICE EMPLOYEES INTERNATIONAL UNION, (U.S. CLS. 100, 101 AND 102). SN 78-169,633. PUB. 5-13-2003. FILED 10-1-2002.
- 2,747,394. **THE BEAR PROMISE**. BUILD-A-BEAR WORKSHOP, INC., (U.S. CLS. 100, 101 AND 102). SN 78-169,807. PUB. 5-13-2003. FILED 10-1-2002.
- 2,747,407. **CONNECTION VISION**. GOVERNMENT EMPLOYEES HOSPITAL ASSOCIATION, INC., (U.S. CLS. 100, 101 AND 102). SN 78-170,962. PUB. 5-13-2003. FILED 10-4-2002.
- 2,747,431. **SUPPLYLINEWEB**. OWEN HEALTHCARE INC., (U.S. CLS. 100, 101 AND 102). SN 78-172,140. PUB. 5-13-2003. FILED 10-8-2002.
- 2,747,432. **FLIGHTWORKS AND DESIGN**. AVIOR TECHNOLOGIES OPERATIONS, INC., DBA FLIGHTWORKS, MULTIPLE CLASS, (INT. CLS. 35, 37 AND 39), (U.S. CLS. 100, 101, 102, 103, 105 AND 106). SN 78-172,295. PUB. 5-13-2003. FILED 10-8-2002.
- 2,747,441. **MLEGAL**. MLEGAL CONSULTING, INC., (U.S. CLS. 100, 101 AND 102). SN 78-174,246. PUB. 5-13-2003. FILED 10-14-2002.

CLASS 36—INSURANCE AND FINANCIAL

- 2,745,417. **ONLINE USA**. USA FEDERAL CREDIT UNION, (U.S. CLS. 100, 101 AND 102). SN 74-711,381. PUB. 9-24-2002. FILED 8-4-1995.
- 2,745,418 (*See Class 9 for this trademark*).
- 2,745,430 (*See Class 9 for this trademark*).
- 2,745,481. **MORGAN STANLEY DEAN WITTER CHOICE**. MORGAN STANLEY DEAN WITTER & CO., BY CHANGE OF NAME MORGAN STANLEY DEAN WITTER & CO., (U.S. CLS. 100, 101 AND 102). SN 75-598,545. PUB. 12-28-1999. FILED 12-3-1998.
- 2,745,483. **SWORD**. LONDON METAL EXCHANGE LIMITED, THE, MULTIPLE CLASS, (INT. CLS. 36, 38 AND 39), (U.S. CLS. 100, 101, 102, 104 AND 105). SN 75-603,107. PUB. 11-27-2001. FILED 12-10-1998.
- 2,745,499 (*See Class 35 for this trademark*).
- 2,745,501. **CSCONNECTION AND DESIGN**. PAINWEBBER INCORPORATED, (U.S. CLS. 100, 101 AND 102). SN 75-658,209. PUB. 12-31-2002. FILED 3-11-1999.
- 2,745,502. **CSC IN-TOUCH AND DESIGN**. PAINWEBBER INCORPORATED, (U.S. CLS. 100, 101 AND 102). SN 75-658,210. PUB. 12-3-2002. FILED 3-11-1999.
- 2,745,503 (*See Class 9 for this trademark*).
- 2,745,506 (*See Class 6 for this trademark*).
- 2,745,547 (*See Class 9 for this trademark*).
- 2,745,554 (*See Class 9 for this trademark*).
- 2,745,585. **EUROPAWEB**. GROUPE ARNAULT SA, (U.S. CLS. 100, 101 AND 102). SN 75-883,655. PUB. 5-15-2001. FILED 12-28-1999.
- 2,745,598. **CHOICEGUARD**. CHOICE ONE COMMUNICATIONS INC., (U.S. CLS. 100, 101 AND 102). SN 75-899,656. PUB. 9-24-2002. FILED 1-20-2000.
- 2,745,607. **HEALTHWRAP**. AMERICAN MEDICAL SECURITY GROUP, INC., (U.S. CLS. 100, 101 AND 102). SN 75-911,651. PUB. 1-21-2003. FILED 2-7-2000.
- 2,745,610 (*See Class 35 for this trademark*).

- 2,745,612. **NYSE INSTITUTIONAL INSIGHT**. NEW YORK STOCK EXCHANGE, INC., (U.S. CLS. 100, 101 AND 102). SN 75-926,640. PUB. 10-29-2002. FILED 2-24-2000.
- 2,745,621 (*See Class 35 for this trademark*).
- 2,745,626. **MISCELLANEOUS DESIGN**. ELVETIA ENGINEERING S.P.A., MULTIPLE CLASS, (INT. CLS. 36, 37, 39 AND 42), (U.S. CLS. 100, 101, 102, 103, 105 AND 106). SN 75-943,721. PUB. 7-16-2002. FILED 3-14-2000.
- 2,745,632. **ISG AND DESIGN**. INTERNATIONAL SERVICE GROUP, INC., (U.S. CLS. 100, 101 AND 102). SN 75-982,866. PUB. 5-13-2003. FILED 11-16-2001.
- 2,745,643 (*See Class 16 for this trademark*).
- 2,745,650. **PERFORMALINK (STYLIZED)**. SUPERIOR TELECOMMUNICATIONS, INC., (U.S. CLS. 100, 101 AND 102). SN 76-015,462. PUB. 5-13-2003. FILED 4-3-2000.
- 2,745,659. **QUANTUM**. MBNA AMERICA BANK, NATIONAL ASSOCIATION, (U.S. CLS. 100, 101 AND 102). SN 76-023,352. PUB. 5-13-2003. FILED 4-11-2000.
- 2,745,668. **IGS**. INTERSTATE GAS SUPPLY, INC., (U.S. CLS. 100, 101 AND 102). SN 76-042,338. PUB. 5-13-2003. FILED 5-5-2000.
- 2,745,686 (*See Class 35 for this trademark*).
- 2,745,692 (*See Class 9 for this trademark*).
- 2,745,748. **SECURING YOUR FUTURE AND DESIGN**. MASSACHUSETTS FINANCIAL SERVICES COMPANY, (U.S. CLS. 100, 101 AND 102). SN 76-110,370. PUB. 11-5-2002. FILED 8-16-2000.
- 2,745,756 (*See Class 35 for this trademark*).
- 2,745,775. **EDERIVATIVE.COM AND DESIGN**. EDERIVATIVE.COM, INC., (U.S. CLS. 100, 101 AND 102). SN 76-132,825. PUB. 10-22-2002. FILED 9-21-2000.
- 2,745,783 (*See Class 9 for this trademark*).
- 2,745,789 (*See Class 35 for this trademark*).
- 2,745,808 (*See Class 9 for this trademark*).
- 2,745,815. **SMARTCLAIM**. STRATEGIC CLAIM SERVICES, INC., (U.S. CLS. 100, 101 AND 102). SN 76-171,770. PUB. 5-13-2003. FILED 11-28-2000.
- 2,745,832. **CSC**. PAINWEBBER INCORPORATED, (U.S. CLS. 100, 101 AND 102). SN 76-186,132. PUB. 11-26-2002. FILED 12-22-2000.
- 2,745,842 (*See Class 16 for this trademark*).
- 2,745,866. **EBIDS FROM THE HEART**. MACERICH PARTNERSHIP, L.P., (U.S. CLS. 100, 101 AND 102). SN 76-204,355. PUB. 5-13-2003. FILED 2-2-2001.
- 2,745,879. **H HOLDUN INVESTMENT MANAGEMENT INC. ACORNS INTO OAKS AND DESIGN**. HOLDUN INVESTMENT MANAGEMENT, INC., (U.S. CLS. 100, 101 AND 102). SN 76-210,255. PUB. 12-24-2002. FILED 2-14-2001.
- 2,745,880. **ACORNS INTO OAKS AND DESIGN**. HOLDUN INVESTMENT MANAGEMENT, INC., (U.S. CLS. 100, 101 AND 102). SN 76-212,693. PUB. 11-12-2002. FILED 2-12-2001.
- 2,745,881. **ACORNS INTO OAKS**. HOLDUN INVESTMENT MANAGEMENT, INC., (U.S. CLS. 100, 101 AND 102). SN 76-212,696. PUB. 11-12-2002. FILED 2-12-2001.
- 2,745,889 (*See Class 35 for this trademark*).
- 2,745,892. **UBS PAINWEBBER THANK YOU**. UBS AG, MULTIPLE CLASS, (INT. CLS. 36, 38 AND 41), (U.S. CLS. 100, 101, 102, 104 AND 107). SN 76-219,538. PUB. 5-13-2003. FILED 3-5-2001.
- 2,745,931. **LAWPRO PLUS AND DESIGN**. PLUS COMPANIES, INC., THE, (U.S. CLS. 100, 101 AND 102). SN 76-240,219. PUB. 7-16-2002. FILED 4-12-2001.
- 2,745,935. **INSTANTVPN**. SERVLET INC., MULTIPLE CLASS, (INT. CLS. 36 AND 38), (U.S. CLS. 100, 101, 102 AND 104). SN 76-242,896. PUB. 10-8-2002. FILED 4-19-2001.
- 2,745,938 (*See Class 9 for this trademark*).
- 2,745,945. **AMERICREDITONLINE (STYLIZED)**. AMERICREDIT CORP., (U.S. CLS. 100, 101 AND 102). SN 76-247,144. PUB. 12-11-2001. FILED 4-26-2001.
- 2,745,947 (*See Class 9 for this trademark*).
- 2,745,948 (*See Class 9 for this trademark*).
- 2,745,987. **FOOD ALLERGY INITIATIVE AND DESIGN**. FOOD ALLERGY INITIATIVE, MULTIPLE CLASS, (INT. CLS. 36, 41 AND 42), (U.S. CLS. 100, 101, 102 AND 107). SN 76-267,804. PUB. 6-11-2002. FILED 6-5-2001.
- 2,745,989. **GROCERS INSURANCE AND DESIGN**. ROYAL & SUNALLIANCE USA, INC., (U.S. CLS. 100, 101 AND 102). SN 76-268,646. PUB. 5-13-2003. FILED 6-8-2001.
- 2,745,994 (*See Class 9 for this trademark*).
- 2,746,033. **THE DYNAMIC PORTFOLIO EXPERIENCE**. GIOKAS FINANCIAL SERVICES, INC., (U.S. CLS. 100, 101 AND 102). SN 76-287,219. PUB. 5-14-2002. FILED 7-18-2001.
- 2,746,039 (*See Class 35 for this trademark*).
- 2,746,041 (*See Class 35 for this trademark*).
- 2,746,081. **YMCA AND DESIGN**. NATIONAL COUNCIL OF YOUNG MEN'S CHRISTIAN ASSOCIATIONS OF THE UNITED STATES OF AMERICA, THE, MULTIPLE CLASS, (INT. CLS. 36 AND 41), (U.S. CLS. 100, 101, 102 AND 107). SN 76-303,717. PUB. 5-13-2003. FILED 8-22-2001.
- 2,746,090. **SAXO BANK**. SAXO BANK A/S, (U.S. CLS. 100, 101 AND 102). SN 76-306,545. PUB. 5-13-2003. FILED 8-28-2001.
- 2,746,095. **THE CFO'S CHOICE**. EYGN LIMITED, BY ASSIGNMENT ERNST & YOUNG U.S. LLP, (U.S. CLS. 100, 101 AND 102). SN 76-308,779. PUB. 10-29-2002. FILED 9-4-2001.
- 2,746,107. **CA AND DESIGN**. COMMUNICATING FOR AMERICA, INC., (U.S. CLS. 100, 101 AND 102). SN 76-313,289. PUB. 11-12-2002. FILED 9-18-2001.
- 2,746,116 (*See Class 9 for this trademark*).
- 2,746,125 (*See Class 9 for this trademark*).
- 2,746,168. **THE TEMPLE BAR SCHOLARSHIPS**. AMERICAN INNS OF COURT FOUNDATION, (U.S. CLS. 100, 101 AND 102). SN 76-333,676. PUB. 11-19-2002. FILED 11-5-2001.
- 2,746,170. **TEMPLE BAR SCHOLARS**. AMERICAN INNS OF COURT FOUNDATION, (U.S. CLS. 100, 101 AND 102). SN 76-334,083. PUB. 11-19-2002. FILED 11-6-2001.
- 2,746,172 (*See Class 35 for this trademark*).
- 2,746,211 (*See Class 35 for this trademark*).
- 2,746,214. **WEALTH NOW GROUP AND DESIGN**. VENVEST, INC., (U.S. CLS. 100, 101 AND 102). SN 76-343,304. PUB. 8-20-2002. FILED 11-21-2001.
- 2,746,254. **KABRIK TRADING LLC**. KABRIK TRADING, LLC, (U.S. CLS. 100, 101 AND 102). SN 76-356,670. PUB. 5-13-2003. FILED 1-9-2002.
- 2,746,307. **HORTICA BROKERAGE & FINANCIAL SERVICES**. FLORISTS' MUTUAL INSURANCE COMPANY, (U.S. CLS. 100, 101 AND 102). SN 76-372,530. PUB. 5-13-2003. FILED 2-19-2002.
- 2,746,310. **OPENING EYES**. SPECIAL OLYMPICS, INC., MULTIPLE CLASS, (INT. CLS. 36 AND 44), (U.S. CLS. 100, 101 AND 102). SN 76-373,096. PUB. 5-13-2003. FILED 2-20-2002.
- 2,746,311. **SPECIAL SMILES**. SPECIAL OLYMPICS, INC., MULTIPLE CLASS, (INT. CLS. 36 AND 44), (U.S. CLS. 100, 101 AND 102). SN 76-373,098. PUB. 5-13-2003. FILED 2-20-2002.
- 2,746,358. **MAIER SIEBEL BABER**. UNITED STATES TRUST COMPANY OF NEW YORK, (U.S. CLS. 100, 101 AND 102). SN 76-381,017. PUB. 5-13-2003. FILED 3-12-2002.
- 2,746,363 (*See Class 35 for this trademark*).
- 2,746,375. **S&P 1000**. MCGRAW-HILL COMPANIES, INC., THE, (U.S. CLS. 100, 101 AND 102). SN 76-384,631. PUB. 5-13-2003. FILED 3-19-2002.
- 2,746,380 (*See Class 2 for this trademark*).
- 2,746,388 (*See Class 35 for this trademark*).
- 2,746,402. **FRANKLIN COLLECTION SERVICE INC. FRANKLIN PROFESSIONAL DEBT COLLECTION SINCE 1980 AND DESIGN**. FRANKLIN COLLECTION SERVICE, INC., (U.S. CLS. 100, 101 AND 102). SN 76-388,082. PUB. 5-13-2003. FILED 3-25-2002.
- 2,746,411. **BUY A PIECE OF AMERICA**. ARNOLD, FONTAINE F., (U.S. CLS. 100, 101 AND 102). SN 76-390,717. PUB. 5-13-2003. FILED 4-1-2002.
- 2,746,417. **SECTORAL ASSET MANAGEMENT**. SECTORAL ASSET MANAGEMENT INC., (U.S. CLS. 100, 101 AND 102). SN 76-391,832. PUB. 5-13-2003. FILED 4-5-2002.
- 2,746,425 (*See Class 9 for this trademark*).
- 2,746,472. **PURSUING PERFECTION**. ROBERT WOOD JOHNSON FOUNDATION, THE, (U.S. CLS. 100, 101 AND 102). SN 76-399,437. PUB. 5-13-2003. FILED 4-23-2002.
- 2,746,509. **HALF MOON BAY CHARITY GOLF CLASSIC**. SETON MEDICAL CENTER, MULTIPLE CLASS, (INT. CLS. 36 AND 41), (U.S. CLS. 100, 101, 102 AND 107). SN 76-404,586. PUB. 5-13-2003. FILED 5-2-2002.
- 2,746,521. **HEALTH CARE ABROAD AND DESIGN**. WAL-LACH & COMPANY, INC., (U.S. CLS. 100, 101 AND 102).

- SN 76-406,149. PUB. 5-13-2003. FILED 5-3-2002.
- 2,746,547. **SAXOTRADER**. SAXO BANK A/S, (U.S. CLS. 100, 101 AND 102). SN 76-408,914. PUB. 5-13-2003. FILED 5-16-2002.
- 2,746,560. **HEARING FEE PLAN AND DESIGN**. ELITE PHYSICIAN SERVICES, LLC, (U.S. CLS. 100, 101 AND 102). SN 76-411,185. PUB. 5-13-2003. FILED 5-20-2002.
- 2,746,619. **KM AND DESIGN**. KOONTZ/MCCOMBS LLC, MULTIPLE CLASS, (INT. CLS. 36 AND 37), (U.S. CLS. 100, 101, 102, 103 AND 106). SN 76-422,221. PUB. 5-13-2003. FILED 6-18-2002.
- 2,746,625. **GLOBAL EXPRESS AND DESIGN**. GLOBAL EXPRESS MONEY ORDERS, INC., (U.S. CLS. 100, 101 AND 102). SN 76-423,007. PUB. 5-13-2003. FILED 6-17-2002.
- 2,746,627. **SUNOVA OFFSHORE**. SUNOVA CAPITAL, L.P., (U.S. CLS. 100, 101 AND 102). SN 76-423,303. PUB. 5-13-2003. FILED 6-17-2002.
- 2,746,628. **SUNOVA CAPITAL AND DESIGN**. SUNOVA CAPITAL, L.P., (U.S. CLS. 100, 101 AND 102). SN 76-423,304. PUB. 5-13-2003. FILED 6-17-2002.
- 2,746,629. **SUNOVA PARTNERS**. SUNOVA CAPITAL, L.P., (U.S. CLS. 100, 101 AND 102). SN 76-423,306. PUB. 5-13-2003. FILED 6-17-2002.
- 2,746,646. **CRITICALASSISTANCE SELECT**. TRANSAMERICA ASSURANCE COMPANY, (U.S. CLS. 100, 101 AND 102). SN 76-426,873. PUB. 11-5-2002. FILED 7-2-2002.
- 2,746,655. **RED CLOUD FILMS**. RED CLOUD FILMS, LLC, (U.S. CLS. 100, 101 AND 102). SN 76-428,207. PUB. 5-13-2003. FILED 7-5-2002.
- 2,746,702. **AFMAXX**. AMERICAN FIDELITY ASSURANCE COMPANY, (U.S. CLS. 100, 101 AND 102). SN 76-440,523. PUB. 5-13-2003. FILED 8-14-2002.
- 2,746,709. **C AND DESIGN**. CHURCHILL CASUALTY LTD., (U.S. CLS. 100, 101 AND 102). SN 76-441,197. PUB. 5-13-2003. FILED 8-13-2002.
- 2,746,713 (*See Class 35 for this trademark*).
- 2,746,754. **AMERICA'S JUNIOR MISS**. AMERICA'S JUNIOR MISS PAGEANT, INC., MULTIPLE CLASS, (INT. CLS. 36 AND 41), (U.S. CLS. 100, 101, 102 AND 107). SN 76-445,745. PUB. 5-13-2003. FILED 8-29-2002.
- 2,746,771. **GMAC MORTGAGE**. GMAC MORTGAGE CORPORATION, (U.S. CLS. 100, 101 AND 102). SN 76-447,562. PUB. 5-13-2003. FILED 9-6-2002.
- 2,746,819. **MERCHANT IBA**. PAYSYSTEMS CORPORATION, (U.S. CLS. 100, 101 AND 102). SN 76-451,206. PUB. 5-13-2003. FILED 9-17-2002.
- 2,746,820. **MERCHANT IMA**. PAYSYSTEMS CORPORATION, (U.S. CLS. 100, 101 AND 102). SN 76-451,207. PUB. 5-13-2003. FILED 9-17-2002.
- 2,746,831. **CAMP HAZE**. SCOTT HAZELCORN MEMORIAL CHILDREN'S FOUNDATION, MULTIPLE CLASS, (INT. CLS. 36 AND 41), (U.S. CLS. 100, 101, 102 AND 107). SN 76-452,136. PUB. 5-13-2003. FILED 9-24-2002.
- 2,746,849. **ANGELMAN SYNDROME FOUNDATION, INC. AND DESIGN**. ANGELMAN SYNDROME FOUNDATION, INC., MULTIPLE CLASS, (INT. CLS. 36 AND 41), (U.S. CLS. 100, 101, 102 AND 107). SN 76-453,029. PUB. 5-13-2003. FILED 9-17-2002.
- 2,746,906. **MERCHANT SERVICES NETWORK 3061 7020 AND DESIGN**. MSN MERCHANT MARKETING, INC., (U.S. CLS. 100, 101 AND 102). SN 76-455,762. PUB. 5-13-2003. FILED 9-30-2002.
- 2,746,927. **NATIONS FUNDS AND DESIGN**. BANK OF AMERICA CORPORATION, (U.S. CLS. 100, 101 AND 102). SN 76-456,743. PUB. 5-13-2003. FILED 10-7-2002.
- 2,746,928. **NATIONS FUNDS**. BANK OF AMERICA CORPORATION, (U.S. CLS. 100, 101 AND 102). SN 76-456,744. PUB. 5-13-2003. FILED 10-7-2002.
- 2,746,942. **THE ARC FAMILY BUILDING PROGRAM**. ADVANCED REPRODUCTIVE CARE, INC., (U.S. CLS. 100, 101 AND 102). SN 76-458,247. PUB. 5-13-2003. FILED 10-7-2002.
- 2,746,954. **MISCELLANEOUS DESIGN**. UNITED JEWISH APPEAL - FEDERATION OF JEWISH PHILANTHROPIES OF NEW YORK, INC., (U.S. CLS. 100, 101 AND 102). SN 76-458,952. PUB. 5-13-2003. FILED 10-17-2002.
- 2,746,955. **THE WALL STREET DINNER**. UNITED JEWISH APPEAL - FEDERATION OF JEWISH PHILANTHROPIES OF NEW YORK, INC., (U.S. CLS. 100, 101 AND 102). SN 76-458,953. PUB. 5-13-2003. FILED 10-17-2002.
- 2,746,959. **HCSB**. HALE COUNTY STATE BANK, (U.S. CLS. 100, 101 AND 102). SN 76-459,010. PUB. 5-13-2003. FILED 10-9-2002.
- 2,746,969 (*See Class 9 for this trademark*).
- 2,746,973. **EXPRESS LANE**. NORTH AMERICAN COMPANY FOR LIFE AND HEALTH INSURANCE, (U.S. CLS. 100, 101 AND 102). SN 76-459,785. PUB. 5-13-2003. FILED 10-15-2002.
- 2,746,978. **AHC INC., GOOD HOUSING GOOD NEIGHBORS**. AHC INC., (U.S. CLS. 100, 101 AND 102). SN 76-460,128. PUB. 5-13-2003. FILED 10-16-2002.
- 2,747,020. **CHANGING THE NATURE OF RISK**. RADIAN GROUP INC., (U.S. CLS. 100, 101 AND 102). SN 76-463,349. PUB. 5-13-2003. FILED 10-31-2002.
- 2,747,067 (*See Class 35 for this trademark*).
- 2,747,082. **VISMA AND DESIGN**. VISMA ASA, (U.S. CLS. 100, 101 AND 102). SN 78-069,618. PUB. 11-5-2002. FILED 6-18-2001.
- 2,747,084. **SAGE**. INSURANCE REFERENCE SYSTEMS, INC., (U.S. CLS. 100, 101 AND 102). SN 78-071,715. PUB. 11-5-2002. FILED 6-29-2001.
- 2,747,101. **ARIZONA STUDENT HOUSING CONNECTION WWW.AZSTUDENTHOUSING.COM AND DESIGN**. EASTERN WAY, LTD, THE, (U.S. CLS. 100, 101 AND 102). SN 78-091,272. PUB. 5-13-2003. FILED 11-1-2001.
- 2,747,124. **COUNT ON EMC (STYLIZED)**. EMPLOYERS MUTUAL CASUALTY COMPANY, (U.S. CLS. 100, 101 AND 102). SN 78-104,788. PUB. 5-13-2003. FILED 1-25-2002.
- 2,747,126 (*See Class 35 for this trademark*).
- 2,747,132. **SIGNATURE**. PRUDENTIAL INSURANCE COMPANY OF AMERICA, THE, MULTIPLE CLASS, (INT. CLS. 36 AND 41), (U.S. CLS. 100, 101, 102 AND 107). SN 78-107,006. PUB. 8-13-2002. FILED 2-5-2002.
- 2,747,142. **COMMUNICARE AND DESIGN**. COMMUNICARE, INC., (U.S. CLS. 100, 101 AND 102). SN 78-111,181. PUB. 5-13-2003. FILED 2-26-2002.
- 2,747,161. **EBC EMPLOYEE BENEFITS CORPORATION AND DESIGN**. EMPLOYEE BENEFITS CORPORATION, (U.S. CLS. 100, 101 AND 102). SN 78-117,806. PUB. 10-22-2002. FILED 3-27-2002.
- 2,747,163. **NORDSTROM PACESETTER**. NIHC, INC., (U.S. CLS. 100, 101 AND 102). SN 78-118,249. PUB. 5-13-2003. FILED 3-28-2002.
- 2,747,170. **PREMIUMSELECT AND DESIGN**. PREMIUMSELECT INSURANCE & FINANCIAL SERVICES BROKERAGE, INC., (U.S. CLS. 100, 101 AND 102). SN 78-119,858. PUB. 5-13-2003. FILED 4-5-2002.
- 2,747,203. **MAJESTIC INSURANCE AND DESIGN**. MAJESTIC INSURANCE COMPANY, (U.S. CLS. 100, 101 AND 102). SN 78-127,815. PUB. 5-13-2003. FILED 5-10-2002.
- 2,747,223. **FEDBEN**. AMERICAN EXPRESS COMPANY, (U.S. CLS. 100, 101 AND 102). SN 78-140,734. PUB. 5-13-2003. FILED 7-2-2002.
- 2,747,285. **HEARTLAND PAYDAY AND DESIGN**. HEARTLAND PAYMENT SYSTEMS, INC., (U.S. CLS. 100, 101 AND 102). SN 78-153,278. PUB. 5-13-2003. FILED 8-12-2002.
- 2,747,343. **\$ WOW! AND DESIGN**. WOW! TECHNOLOGIES, INC., (U.S. CLS. 100, 101 AND 102). SN 78-164,850. PUB. 5-13-2003. FILED 9-17-2002.
- 2,747,361. **ROSE ASSOCIATES, INC.**. ROSE ASSOCIATES, INC., MULTIPLE CLASS, (INT. CLS. 36 AND 37), (U.S. CLS. 100, 101, 102, 103 AND 106). SN 78-166,736. PUB. 5-13-2003. FILED 9-23-2002.
- 2,747,371. **LEE R. GOLDSTEIN SELLING THE MOST IMPORTANT HOUSE IN THE WORLD...YOURS! AND DESIGN**. GOLDSTEIN, LEE R., (U.S. CLS. 100, 101 AND 102). SN 78-167,833. PUB. 5-13-2003. FILED 9-25-2002.
- 2,747,372. **MCDONALD FINANCIAL GROUP**. KEYCORP, (U.S. CLS. 100, 101 AND 102). SN 78-167,879. PUB. 5-13-2003. FILED 9-25-2002.
- 2,747,410. **CHAPS**. CENTEX CORPORATION, (U.S. CLS. 100, 101 AND 102). SN 78-171,253. PUB. 5-13-2003. FILED 10-4-2002.
- 2,747,427. **ACTIVEGIVING**. THE ACTIVE NETWORK, INC., (U.S. CLS. 100, 101 AND 102). SN 78-171,914. PUB. 5-13-2003. FILED 10-7-2002.
- 2,747,439. **HENDERSON BROTHERS**. HENDERSON BROTH-

ERS, INC., (U.S. CLS. 100, 101 AND 102). SN 78-174,077. PUB. 5-13-2003. FILED 10-14-2002.

2,747,445. **PROTECTING THE REWARDS OF LIFE**. TRANS-AMERICA OCCIDENTAL LIFE INSURANCE COMPANY, (U.S. CLS. 100, 101 AND 102). SN 78-176,200. PUB. 5-13-2003. FILED 10-18-2002.

2,747,450. **EARLY WARNING PROTECTING YOU**. PRIMARY PAYMENT SYSTEMS, INC., (U.S. CLS. 100, 101 AND 102). SN 78-178,667. PUB. 5-13-2003. FILED 10-25-2002.

2,747,451. **EARLY WARNING PROTECTING YOU AND DESIGN**. PRIMARY PAYMENT SYSTEMS, INC., (U.S. CLS. 100, 101 AND 102). SN 78-178,670. PUB. 5-13-2003. FILED 10-25-2002.

2,747,452. **EARLY WARNING AND DESIGN**. PRIMARY PAYMENT SYSTEMS, INC., (U.S. CLS. 100, 101 AND 102). SN 78-178,671. PUB. 5-13-2003. FILED 10-25-2002.

2,747,453. **EARLY WARNING**. PRIMARY PAYMENT SYSTEMS, INC., (U.S. CLS. 100, 101 AND 102). SN 78-178,672. PUB. 5-13-2003. FILED 10-25-2002.

CLASS 37—CONSTRUCTION AND REPAIR

2,745,418 (*See Class 9 for this trademark*).

2,745,430 (*See Class 9 for this trademark*).

2,745,448 (*See Class 9 for this trademark*).

2,745,463 (*See Class 9 for this trademark*).

2,745,503 (*See Class 9 for this trademark*).

2,745,504 (*See Class 11 for this trademark*).

2,745,506 (*See Class 6 for this trademark*).

2,745,509. **INTEGRATED COMMERCIAL MANAGEMENT BY SIEMENS ICM AND DESIGN**. SIEMENS AKTIENGESELLSCHAFT, MULTIPLE CLASS, (INT. CLS. 37 AND 42), (U.S. CLS. 100, 101, 103 AND 106). SN 75-669,018. PUB. 10-15-2002. FILED 3-26-1999.

2,745,553 (*See Class 9 for this trademark*).

2,745,570 (*See Class 9 for this trademark*).

2,745,574 (*See Class 9 for this trademark*).

2,745,597 (*See Class 9 for this trademark*).

2,745,618. **HOME SOLUTIONS**. IVERNESS GROUP, INC., THE, (U.S. CLS. 100, 103 AND 106). SN 75-932,458. PUB. 2-4-2003. FILED 3-1-2000.

2,745,626 (*See Class 36 for this trademark*).

2,745,634 (*See Class 7 for this trademark*).

2,745,661. **INFRACARE**. FUJITSU LIMITED, MULTIPLE CLASS, (INT. CLS. 37, 38 AND 42), (U.S. CLS. 100, 101, 103, 104 AND 106). SN 76-025,059. PUB. 4-30-2002. FILED 4-12-2000.

2,745,666 (*See Class 7 for this trademark*).

2,745,677 (*See Class 35 for this trademark*).

2,745,681. **SIGMA AND DESIGN**. AIR INTERNATIONAL TRANSIT, INC., MULTIPLE CLASS, (INT. CLS. 37 AND 40), (U.S. CLS. 100, 103 AND 106). SN 76-049,888. PUB. 9-24-2002. FILED 5-15-2000.

2,745,697. **AMERICAN PIPE & TANK LINING CO**. AMERICAN PIPE & TANK LINING CO., INC., (U.S. CLS. 100, 103 AND 106). SN 76-063,200. PUB. 5-13-2003. FILED 6-5-2000.

2,745,704 (*See Class 9 for this trademark*).

2,745,705 (*See Class 9 for this trademark*).

2,745,728 (*See Class 7 for this trademark*).

2,745,761 (*See Class 20 for this trademark*).

2,745,782. **PANEL TEC**. MARINO BUILDING SYSTEMS CORP., MULTIPLE CLASS, (INT. CLS. 37 AND 42), (U.S. CLS. 100, 101, 103 AND 106). SN 76-139,409. PUB. 1-14-2003. FILED 10-4-2000.

2,745,787 (*See Class 4 for this trademark*).

2,745,811 (*See Class 1 for this trademark*).

2,745,857 (*See Class 9 for this trademark*).

2,745,925. **BRAVOBUILD**. BRAVOSOLUTION S.P.A., BY CHANGE OF NAME NEWCO.COM S.P.A., MULTIPLE CLASS, (INT. CLS. 37, 38 AND 42), (U.S. CLS. 100, 101, 103, 104 AND 106). SN 76-238,742. PUB. 10-8-2002. FILED 4-10-2001.

2,745,954 (*See Class 6 for this trademark*).

2,745,988. **SCR ELECTRIC, INC. AND DESIGN**. SCR ELECTRIC, INC., (U.S. CLS. 100, 103 AND 106). SN 76-268,608. PUB. 5-13-2003. FILED 6-11-2001.

2,746,045. **AIR STREAM AND DESIGN**. AIR STREAM AIR CONDITIONING CORP., MULTIPLE CLASS, (INT. CLS. 37 AND 42), (U.S. CLS. 100, 101, 103 AND 106). SN 76-291,338. PUB. 9-17-2002. FILED 7-26-2001.

2,746,225. **VILLAGE OF FIVE PARKS**. VILLAGE HOMES OF COLORADO, INC., (U.S. CLS. 100, 103 AND 106). SN 76-346,979. PUB. 5-13-2003. FILED 12-5-2001.

2,746,242 (*See Class 27 for this trademark*).

2,746,259. **A SOLID SOLUTION**. KANSAS CITY MASTER COMPANIES, (U.S. CLS. 100, 103 AND 106). SN 76-358,073. PUB. 9-24-2002. FILED 1-11-2002.

2,746,262 (*See Class 12 for this trademark*).

2,746,269. **NMC AND DESIGN**. NATIONAL MOTOR CLUB OF AMERICA, INC., MULTIPLE CLASS, (INT. CLS. 37 AND 39), (U.S. CLS. 100, 103, 105 AND 106). SN 76-361,544. PUB. 5-13-2003. FILED 1-22-2002.

2,746,297. **HSS**. HSS HIRE SERVICE GROUP PLC, (U.S. CLS. 100, 103 AND 106). SN 76-370,487. PUB. 10-15-2002. FILED 2-11-2002.

2,746,306 (*See Class 35 for this trademark*).

2,746,380 (*See Class 2 for this trademark*).

2,746,425 (*See Class 9 for this trademark*).

2,746,433 (*See Class 19 for this trademark*).

2,746,439. **LHI AND DESIGN**. LGI DEVELOPMENT CORP., (U.S. CLS. 100, 103 AND 106). SN 76-394,393. PUB. 5-13-2003. FILED 4-10-2002.

2,746,453. **BOB SUMEREL**. BOB SUMEREL TIRE CO., INC., (U.S. CLS. 100, 103 AND 106). SN 76-395,869. PUB. 5-13-2003. FILED 4-15-2002.

2,746,482. **SCAPES**. SCAPES, LLC, MULTIPLE CLASS, (INT. CLS. 37, 42 AND 44), (U.S. CLS. 100, 101, 103 AND 106). SN 76-401,002. PUB. 5-13-2003. FILED 4-26-2002.

2,746,513. **MISCELLANEOUS DESIGN**. HENRICKSEN & COMPANY, INC., MULTIPLE CLASS, (INT. CLS. 37 AND 42), (U.S. CLS. 100, 101, 103 AND 106). SN 76-404,863. PUB. 5-13-2003. FILED 5-6-2002.

2,746,534. **RAFT**. RAFT, INC., MULTIPLE CLASS, (INT. CLS. 37 AND 41), (U.S. CLS. 100, 101, 103, 106 AND 107). SN 76-407,360. PUB. 5-13-2003. FILED 5-14-2002.

2,746,535. **RAFT AND DESIGN**. RAFT, INC., MULTIPLE CLASS, (INT. CLS. 37 AND 41), (U.S. CLS. 100, 101, 103, 106 AND 107). SN 76-407,368. PUB. 5-13-2003. FILED 5-14-2002.

2,746,538. **BD ELECTRICAL, INC. AND DESIGN**. BD ELECTRICAL, INC., (U.S. CLS. 100, 103 AND 106). SN 76-407,782. PUB. 5-13-2003. FILED 5-14-2002.

2,746,619 (*See Class 36 for this trademark*).

2,746,638. **SUNGLO TECHNOLOGIES AND DESIGN**. SUNGLO TECHNOLOGIES, INC., MULTIPLE CLASS, (INT. CLS. 37 AND 42), (U.S. CLS. 100, 101, 103 AND 106). SN 76-425,325. PUB. 5-13-2003. FILED 6-25-2002.

2,746,659. **IS YOUR SIGN UP YET?**. PROTECTION ONE ALARM MONITORING, INC., MULTIPLE CLASS, (INT. CLS. 37 AND 45), (U.S. CLS. 100, 101, 103 AND 106). SN 76-431,466. PUB. 5-13-2003. FILED 7-17-2002.

2,746,660. **BECAUSE YOUR WORLD IS WORTH PROTECTING**. PROTECTION ONE ALARM MONITORING, INC., MULTIPLE CLASS, (INT. CLS. 37 AND 45), (U.S. CLS. 100, 101, 103 AND 106). SN 76-431,469. PUB. 5-13-2003. FILED 7-17-2002.

2,746,661. **SWOOP**. STRONG WOMEN ORGANIZING OUTRAGEOUS PROJECTS, (U.S. CLS. 100, 103 AND 106). SN 76-431,483. PUB. 5-13-2003. FILED 7-17-2002.

2,746,695. **PYRAMID ELECTRIC SERVICE INC ELECTRICAL CONTRACTORS 1963 LICENSED INSURED AND DESIGN**. PYRAMID ELECTRIC SERVICE INC., (U.S. CLS. 100, 103 AND 106). SN 76-439,138. PUB. 5-13-2003. FILED 8-9-2002.

2,746,730. **PROTECTING YOUR BUSINESS IS OUR BUSINESS**. PROTECTION ONE ALARM MONITORING, INC., MULTIPLE CLASS, (INT. CLS. 37 AND 45), (U.S. CLS. 100, 101, 103 AND 106). SN 76-443,732. PUB. 5-13-2003. FILED 8-26-2002.

2,746,741. **SHAMROCK**. SHAMROCK DENTAL CO., INC., (U.S. CLS. 100, 103 AND 106). SN 76-444,736. PUB. 5-13-2003. FILED 8-26-2002.

2,746,761. **SERCOMP INC. AND DESIGN**. SERCOMP INC., (U.S. CLS. 100, 103 AND 106). SN 76-446,338. PUB. 5-13-2003. FILED 9-3-2002.

- 2,746,876. **LET GO. CATCH LIFE.**, WCI COMMUNITIES, INC., (U.S. CLS. 100, 103 AND 106). SN 76-454,159. PUB. 5-13-2003. FILED 10-1-2002.
- 2,746,990. **RESISERV.** SAWYER'S PEST CONTROL OF IDAHO, INC., (U.S. CLS. 100, 103 AND 106). SN 76-460,959. PUB. 5-13-2003. FILED 10-15-2002.
- 2,747,017. **NPL (STYLIZED).** NORTHERN PIPELINE CONSTRUCTION CO., (U.S. CLS. 100, 103 AND 106). SN 76-463,276. PUB. 5-13-2003. FILED 10-30-2002.
- 2,747,052. **COGUN AND DESIGN.** COGUN, INC., (U.S. CLS. 100, 103 AND 106). SN 76-481,093. PUB. 5-13-2003. FILED 1-9-2003.
- 2,747,156. **Z-PRIDE.** POWERS AND SONS CONSTRUCTION COMPANY, INCORPORATED, (U.S. CLS. 100, 103 AND 106). SN 78-117,013. PUB. 5-13-2003. FILED 3-22-2002.
- 2,747,174. **MOBILE MAIDS BONDED AND INSURED AND DESIGN.** ROCKWOOD, CLIFF H., (U.S. CLS. 100, 103 AND 106). SN 78-120,101. PUB. 5-13-2003. FILED 4-8-2002.
- 2,747,225. **B AND DESIGN.** BEST SIDING CORPORATION, (U.S. CLS. 100, 103 AND 106). SN 78-141,127. PUB. 5-13-2003. FILED 7-3-2002.
- 2,747,292. **YOUR CLOTHES WILL LOVE US.** SUDSIES, INC., (U.S. CLS. 100, 103 AND 106). SN 78-153,700. PUB. 5-13-2003. FILED 8-13-2002.
- 2,747,318. **MISCELLANEOUS DESIGN.** JAYNES CORPORATION, (U.S. CLS. 100, 103 AND 106). SN 78-159,895. PUB. 5-13-2003. FILED 8-31-2002.
- 2,747,346. **WE RESTORE "COME HAIL OR HIGH WATER".** DR. RESTORATION, LLC, (U.S. CLS. 100, 103 AND 106). SN 78-164,975. PUB. 5-13-2003. FILED 9-17-2002.
- 2,747,361 (*See Class 36 for this trademark.*).
- 2,747,404. **HEAVYQUIP.** CRAWLER PARTS, INC., (U.S. CLS. 100, 103 AND 106). SN 78-170,641. PUB. 5-13-2003. FILED 10-3-2002.
- 2,747,413. **TOP WRENCH.** CAPPELLO, JOHN, (U.S. CLS. 100, 103 AND 106). SN 78-171,407. PUB. 5-13-2003. FILED 10-5-2002.
- 2,747,432 (*See Class 35 for this trademark.*).

CLASS 38—COMMUNICATION

- 2,745,418 (*See Class 9 for this trademark.*).
- 2,745,430 (*See Class 9 for this trademark.*).
- 2,745,483 (*See Class 36 for this trademark.*).
- 2,745,503 (*See Class 9 for this trademark.*).
- 2,745,505 (*See Class 35 for this trademark.*).
- 2,745,528 (*See Class 9 for this trademark.*).
- 2,745,541 (*See Class 9 for this trademark.*).
- 2,745,554 (*See Class 9 for this trademark.*).
- 2,745,574 (*See Class 9 for this trademark.*).
- 2,745,606 (*See Class 1 for this trademark.*).
- 2,745,619. **WIDEOPEN (STYLIZED).** WIDOPENWEST NETWORKS, LLC, (U.S. CLS. 100, 101 AND 104). SN 75-932,817. PUB. 5-14-2002. FILED 2-25-2000.
- 2,745,647. **HOLLYWOOD SATELLITE TV (STYLIZED).** HOLLYWOOD SYSTEMS, INC., (U.S. CLS. 100, 101 AND 104). SN 76-013,752. PUB. 2-27-2001. FILED 3-30-2000.
- 2,745,651. **COMTECH21.** COMTECH21, (U.S. CLS. 100, 101 AND 104). SN 76-015,953. PUB. 5-13-2003. FILED 4-3-2000.
- 2,745,655. **TE BUSCO.** PRIMERA RED INTERACTIVA DE MEDIOS ARGENTINOS (PRIMA) S.A., MULTIPLE CLASS, (INT. CLS. 38 AND 42), (U.S. CLS. 100, 101 AND 104). SN 76-019,904. PUB. 5-13-2003. FILED 4-3-2000.
- 2,745,661 (*See Class 37 for this trademark.*).
- 2,745,671 (*See Class 9 for this trademark.*).
- 2,745,686 (*See Class 35 for this trademark.*).
- 2,745,692 (*See Class 9 for this trademark.*).
- 2,745,701 (*See Class 9 for this trademark.*).
- 2,745,717. **102.5 HIT CHANNEL AND DESIGN.** RTL 102.500 HIT RADIO S.R.L., MULTIPLE CLASS, (INT. CLS. 38 AND 41), (U.S. CLS. 100, 101, 104 AND 107). SN 76-079,900. PUB. 7-16-2002. FILED 6-29-2000.
- 2,745,732. **ZAIRMAIL EXPRESS DIRECT.** ZAIRMAIL, INC., (U.S. CLS. 100, 101 AND 104). SN 76-098,278. PUB. 5-13-2003. FILED 7-31-2000.
- 2,745,734. **AQUA BROWSER.** MEDIALAB B.V., MULTIPLE CLASS, (INT. CLS. 38 AND 42), (U.S. CLS. 100, 101 AND 104). SN 76-100,215. PUB. 11-19-2002. FILED 7-31-2000.
- 2,745,756 (*See Class 35 for this trademark.*).
- 2,745,777 (*See Class 9 for this trademark.*).
- 2,745,808 (*See Class 9 for this trademark.*).
- 2,745,816 (*See Class 9 for this trademark.*).
- 2,745,817 (*See Class 9 for this trademark.*).
- 2,745,818 (*See Class 9 for this trademark.*).
- 2,745,849 (*See Class 9 for this trademark.*).
- 2,745,855 (*See Class 9 for this trademark.*).
- 2,745,892 (*See Class 36 for this trademark.*).
- 2,745,925 (*See Class 37 for this trademark.*).
- 2,745,935 (*See Class 36 for this trademark.*).
- 2,745,936 (*See Class 9 for this trademark.*).
- 2,745,938 (*See Class 9 for this trademark.*).
- 2,745,947 (*See Class 9 for this trademark.*).
- 2,745,948 (*See Class 9 for this trademark.*).
- 2,745,961. **FAMILY RADIO.** FAMILY STATIONS, INC., MULTIPLE CLASS, (INT. CLS. 38 AND 41), (U.S. CLS. 100, 101, 104 AND 107). SN 76-256,050. PUB. 11-5-2002. FILED 5-14-2001.
- 2,745,962. **FAMILY RADIO NETWORK.** FAMILY STATIONS, INC., MULTIPLE CLASS, (INT. CLS. 38 AND 41), (U.S. CLS. 100, 101, 104 AND 107). SN 76-256,054. PUB. 11-5-2002. FILED 5-14-2001.
- 2,745,977 (*See Class 9 for this trademark.*).
- 2,746,014. **INSTITUTO DE EMPRESA AND DESIGN.** INSTITUTO DE EMPRESA, S.L., MULTIPLE CLASS, (INT. CLS. 38 AND 41), (U.S. CLS. 100, 101, 104 AND 107). SN 76-281,275. PUB. 5-13-2003. FILED 7-6-2001.
- 2,746,039 (*See Class 35 for this trademark.*).
- 2,746,113. **ASPEN DATA SERVICES AND DESIGN.** NEWS AMERICA MARKETING PROPERTIES, INC., (U.S. CLS. 100, 101 AND 104). SN 76-315,804. PUB. 10-15-2002. FILED 9-21-2001.
- 2,746,125 (*See Class 9 for this trademark.*).
- 2,746,142. **SPARK INTERACTIVE CORPORATION AND DESIGN.** SPARK INTERACTIVE CORPORATION, MULTIPLE CLASS, (INT. CLS. 38 AND 41), (U.S. CLS. 100, 101, 104 AND 107). SN 76-326,079. PUB. 10-8-2002. FILED 10-16-2001.
- 2,746,148 (*See Class 14 for this trademark.*).
- 2,746,211 (*See Class 35 for this trademark.*).
- 2,746,253. **AMERICA'S CHOICE AND DESIGN.** CELLCO PARTNERSHIP, DBA VERIZON WIRELESS, (U.S. CLS. 100, 101 AND 104). SN 76-356,565. PUB. 11-12-2002. FILED 1-9-2002.
- 2,746,581. **THE HANDS ON MARATHON.** CUMULUS BROADCASTING, INC., (U.S. CLS. 100, 101 AND 104). SN 76-416,125. PUB. 5-13-2003. FILED 5-31-2002.
- 2,746,662. **MKECARDS MKECARDS (STYLIZED).** MARY KAY INC., (U.S. CLS. 100, 101 AND 104). SN 76-431,587. PUB. 3-18-2003. FILED 7-17-2002.
- 2,746,830. **YELLOW PAGES I.M.A.-ELITE.** YELLOW PAGES INTEGRATED MEDIA ASSOCIATION, (U.S. CLS. 100, 101 AND 104). SN 76-452,082. PUB. 5-13-2003. FILED 9-24-2002.
- 2,747,080 (*See Class 9 for this trademark.*).
- 2,747,081 (*See Class 9 for this trademark.*).
- 2,747,085 (*See Class 9 for this trademark.*).
- 2,747,386. **MAZINGO THE MOBILE ENTERTAINMENT NETWORK AND DESIGN.** MAZINGO NETWORK, INC., (U.S. CLS. 100, 101 AND 104). SN 78-169,194. PUB. 5-13-2003. FILED 9-30-2002.

CLASS 39—TRANSPORTATION AND STORAGE

- 2,745,430 (*See Class 9 for this trademark.*).
- 2,745,440 (*See Class 6 for this trademark.*).
- 2,745,483 (*See Class 36 for this trademark.*).
- 2,745,499 (*See Class 35 for this trademark.*).
- 2,745,503 (*See Class 9 for this trademark.*).
- 2,745,506 (*See Class 6 for this trademark.*).
- 2,745,553 (*See Class 9 for this trademark.*).
- 2,745,559. **FASTBREAKS (STYLIZED).** PASSAGEWAYS TRAVEL, MULTIPLE CLASS, (INT. CLS. 39 AND 42), (U.S. CLS. 100, 101 AND 105). SN 75-820,582. PUB. 9-4-2001. FILED 11-

3-1999.
 2,745,581. **PORT OF MIAMI AND DESIGN.** MIAMI-DADE COUNTY, SEAPORT DEPARTMENT, (U.S. CLS. 100 AND 105). SN 75-868,088. PUB. 5-13-2003. FILED 12-10-1999.
 2,745,626 (*See Class 36 for this trademark.*)
 2,745,686 (*See Class 35 for this trademark.*)
 2,745,752. **PARIS IN THE PALM OF YOUR HAND.** BRAUNHUON, STARR, (U.S. CLS. 100 AND 105). SN 76-113,197. PUB. 5-13-2003. FILED 8-18-2000.
 2,745,785 (*See Class 35 for this trademark.*)
 2,745,811 (*See Class 1 for this trademark.*)
 2,745,958. **SMACK ON TIME.** SMACK ON TIME PTY LIMITED, (U.S. CLS. 100 AND 105). SN 76-254,018. PUB. 5-13-2003. FILED 5-8-2001.
 2,745,959. **MAERSK SEALAND.** DAMPSKIBSSELSKABET AF 1912, AKTIESELSKAB, AND AKTIESELSKABET DAMPSKIBSSELSKABET SVENDBORG, (U.S. CLS. 100 AND 105). SN 76-254,474. PUB. 5-13-2003. FILED 5-9-2001.
 2,745,960. **TRAVITALIA TOURS AND DESIGN.** INTERCONTINENTAL TRAVEL COMPANY S.R.L., (U.S. CLS. 100 AND 105). SN 76-255,422. PUB. 5-13-2003. FILED 5-9-2001.
 2,746,001. **TRANSPO-TRUCK.** EURO-LOG TELEKOMMUNIKATIONSMEHRWERTDIENSTE GMBH, (U.S. CLS. 100 AND 105). SN 76-274,769. PUB. 5-21-2002. FILED 6-20-2001.
 2,746,041 (*See Class 35 for this trademark.*)
 2,746,250. **HIDDEN LINKS.** HIDDEN LINKS, INC., (U.S. CLS. 100 AND 105). SN 76-355,569. PUB. 9-17-2002. FILED 1-4-2002.
 2,746,252. **GET THE CAR YOU WANT WITH COMPASS-RIGHT LEASE!** COMPASS BANCSHARES, INC., (U.S. CLS. 100 AND 105). SN 76-356,488. PUB. 5-13-2003. FILED 1-8-2002.
 2,746,269 (*See Class 37 for this trademark.*)
 2,746,287. **B AND DESIGN.** BERMUDA LIMOUSINE INTERNATIONAL, INC., (U.S. CLS. 100 AND 105). SN 76-367,897. PUB. 5-13-2003. FILED 2-6-2002.
 2,746,344. **IRON MOUNTAIN.** IRON MOUNTAIN INCORPORATED, MULTIPLE CLASS, (INT. CLS. 39 AND 42), (U.S. CLS. 100, 101 AND 105). SN 76-378,498. PUB. 5-13-2003. FILED 3-5-2002.
 2,746,380 (*See Class 2 for this trademark.*)
 2,746,386. **ABSOLUTE ASIA ABSOLUTE AFRICA ABSOLUTE SOUTH PACIFIC AND DESIGN.** SANUK ENTERPRISES, INC., MULTIPLE CLASS, (INT. CLS. 39 AND 43), (U.S. CLS. 100, 101 AND 105). SN 76-385,993. PUB. 5-13-2003. FILED 3-21-2002.
 2,746,387. **ABSOLUTE SOUTH PACIFIC AND DESIGN.** SANUK ENTERPRISES, INC., MULTIPLE CLASS, (INT. CLS. 39 AND 43), (U.S. CLS. 100, 101 AND 105). SN 76-385,995. PUB. 5-13-2003. FILED 3-21-2002.
 2,746,497. **TRE AND DESIGN.** DALLAS AREA RAPID TRANSIT, AND FORT WORTH TRANSPORTATION AUTHORITY, (U.S. CLS. 100 AND 105). SN 76-402,903. PUB. 5-13-2003. FILED 5-2-2002.
 2,746,545. **CONDOMINIUM CONNECTION.** CONDOMINIUM CONNECTION, MULTIPLE CLASS, (INT. CLS. 39 AND 43), (U.S. CLS. 100, 101 AND 105). SN 76-408,761. PUB. 5-13-2003. FILED 5-16-2002.
 2,746,798. **RX ON WHEELS AND DESIGN.** RX ON WHEELS, (U.S. CLS. 100 AND 105). SN 76-449,656. PUB. 5-13-2003. FILED 9-11-2002.
 2,746,815. **ANTIQUES ABROAD LTD. AND DESIGN.** ANTIQUES ABROAD, LTD, (U.S. CLS. 100 AND 105). SN 76-450,663. PUB. 5-13-2003. FILED 9-18-2002.
 2,746,921. **PARK CLOSER. SHOP LONGER..** SIMON PROPERTY GROUP, L.P., (U.S. CLS. 100 AND 105). SN 76-456,579. PUB. 5-13-2003. FILED 10-8-2002.
 2,746,984. **RIDE CONNECTION AND DESIGN.** RIDE CONNECTION, INC., (U.S. CLS. 100 AND 105). SN 76-460,379. PUB. 5-13-2003. FILED 10-22-2002.
 2,747,010. **JOURNEYZING.** HERRING, VICTORIA L., (U.S. CLS. 100 AND 105). SN 76-462,654. PUB. 5-13-2003. FILED 10-29-2002.
 2,747,032. **MISCELLANEOUS DESIGN.** CESSNA AIRCRAFT COMPANY, (U.S. CLS. 100 AND 105). SN 76-464,669. PUB. 5-13-2003. FILED 11-5-2002.
 2,747,202. **QUICK CITY GUIDE AND DESIGN.** IMPAX MARKETING COMMUNICATIONS, INC., (U.S. CLS. 100

AND 105). SN 78-127,755. PUB. 5-13-2003. FILED 5-10-2002.
 2,747,230. **ARE YOU READY? MENOPAUSAL TOURS WHERE DO YOU WANT TO GO? AND DESIGN.** MENOPAUSAL TOURS LLC, (U.S. CLS. 100 AND 105). SN 78-144,101. PUB. 5-13-2003. FILED 7-15-2002.
 2,747,432 (*See Class 35 for this trademark.*)

CLASS 40—MATERIAL TREATMENT

2,745,432 (*See Class 5 for this trademark.*)
 2,745,440 (*See Class 6 for this trademark.*)
 2,745,451. **GORHAM.** YORK BRONZE COMPANY, BY MERGER; BY MERGER COLONIAL GUILD, LTD., (U.S. CLS. 100, 103 AND 106). SN 75-477,919. PUB. 10-23-2001. FILED 5-1-1998.
 2,745,455 (*See Class 1 for this trademark.*)
 2,745,504 (*See Class 11 for this trademark.*)
 2,745,540 (*See Class 9 for this trademark.*)
 2,745,541 (*See Class 9 for this trademark.*)
 2,745,548 (*See Class 11 for this trademark.*)
 2,745,560 (*See Class 1 for this trademark.*)
 2,745,675. **SHOES24.** KEUTER, STEFAN, (U.S. CLS. 100, 103 AND 106). SN 76-046,413. PUB. 7-30-2002. FILED 5-10-2000.
 2,745,681 (*See Class 37 for this trademark.*)
 2,745,690 (*See Class 20 for this trademark.*)
 2,745,691 (*See Class 20 for this trademark.*)
 2,745,811 (*See Class 1 for this trademark.*)
 2,745,826 (*See Class 11 for this trademark.*)
 2,746,076 (*See Class 16 for this trademark.*)
 2,746,084. **MPO SYSTEMS.** MPO SYSTEMS, INC., (U.S. CLS. 100, 103 AND 106). SN 76-305,763. PUB. 5-13-2003. FILED 8-28-2001.
 2,746,163 (*See Class 16 for this trademark.*)
 2,746,194 (*See Class 35 for this trademark.*)
 2,746,218. **ACCON.** A. T. WALL COMPANY, (U.S. CLS. 100, 103 AND 106). SN 76-344,943. PUB. 5-13-2003. FILED 12-4-2001.
 2,746,241 (*See Class 9 for this trademark.*)
 2,746,292. **CLEANAWAY AND DESIGN.** BRAMBLES AUSTRALIA LIMITED, (U.S. CLS. 100, 103 AND 106). SN 76-368,996. PUB. 5-13-2003. FILED 2-8-2002.
 2,746,380 (*See Class 2 for this trademark.*)
 2,746,470 (*See Class 1 for this trademark.*)
 2,746,528 (*See Class 35 for this trademark.*)
 2,746,539. **MISCELLANEOUS DESIGN.** MICHIGAN WIND ENERGY LLC, (U.S. CLS. 100, 103 AND 106). SN 76-407,821. PUB. 5-13-2003. FILED 5-8-2002.
 2,746,559. **COPPERMINE.** ASM INTERNATIONAL N.V., (U.S. CLS. 100, 103 AND 106). SN 76-410,866. PUB. 5-13-2003. FILED 5-15-2002.
 2,746,704. **GIANT GUARD.** MATTRESS GIANT CORPORATION, (U.S. CLS. 100, 103 AND 106). SN 76-440,859. PUB. 5-13-2003. FILED 8-15-2002.
 2,746,732. **TEMS AND DESIGN.** TEMS, LLC, (U.S. CLS. 100, 103 AND 106). SN 76-443,989. PUB. 5-13-2003. FILED 8-26-2002.
 2,746,799. **P H DREW, INC. FABRICATION SERVICE AND DESIGN.** P H DREW, INC., (U.S. CLS. 100, 103 AND 106). SN 76-449,725. PUB. 5-13-2003. FILED 9-6-2002.
 2,746,800. **P H DREW INC..** P H DREW, INC., (U.S. CLS. 100, 103 AND 106). SN 76-449,739. PUB. 5-13-2003. FILED 9-6-2002.
 2,746,807. **MAKE IT L.A.S.T..** THOMSON INFORMATION LICENSING CORPORATION, (U.S. CLS. 100, 103 AND 106). SN 76-450,246. PUB. 5-13-2003. FILED 9-17-2002.
 2,746,873. **SIGNCHEF FAST TO GOURMET AND DESIGN.** SIGNCHEF, INC., (U.S. CLS. 100, 103 AND 106). SN 76-454,002. PUB. 5-13-2003. FILED 9-30-2002.
 2,746,986 (*See Class 20 for this trademark.*)
 2,747,158. **BLACK SUN.** BLACK, MICHAEL A., MULTIPLE CLASS, (INT. CLS. 40, 41 AND 42), (U.S. CLS. 100, 101, 103, 106 AND 107). SN 78-117,295. PUB. 5-13-2003. FILED 3-25-2002.
 2,747,266. **A NEAT CARD.** PAS-CO INTERCORP, INC., (U.S. CLS. 100, 103 AND 106). SN 78-151,894. PUB. 5-13-2003. FILED 8-7-2002.

2,747,350. **ALL SAFE. ALL SAFE DOCUMENT DESTRUCTION SERVICE, INC.**, (U.S. CLS. 100, 103 AND 106). SN 78-165,301. PUB. 5-13-2003. FILED 9-18-2002.

CLASS 41—EDUCATION AND ENTERTAINMENT

2,745,418 (See Class 9 for this trademark).

2,745,421. **SMAART. PROFIT ENHANCEMENT GROUP, INC., THE**, (U.S. CLS. 100, 101 AND 107). SN 75-105,949. PUB. 9-24-2002. FILED 5-17-1996.

2,745,439 (See Class 9 for this trademark).

2,745,443. **HEROES OF THE HEART. HEART OF AMERICA FOUNDATION, THE**, (U.S. CLS. 100, 101 AND 107). SN 75-417,251. PUB. 12-3-2002. FILED 1-13-1998.

2,745,453 (See Class 35 for this trademark).

2,745,458. **THE LOCKEROOM AND DESIGN. LOCKEROOM PRODUCTIONS, L.L.C.** (U.S. CLS. 100, 101 AND 107). SN 75-512,026. PUB. 5-1-2001. FILED 7-21-1999.

2,745,476. **AMERISCHOOLS ACADEMY. BARR, REGINALD E., AND BARR, SANDRA E.**, (U.S. CLS. 100, 101 AND 107). SN 75-576,460. PUB. 12-7-1999. FILED 10-27-1998.

2,745,477. **VINOPOLIS CITY OF WINE AND DESIGN. WINE-WORLD LONDON PLC**, (U.S. CLS. 100, 101 AND 107). SN 75-589,724. PUB. 5-13-2003. FILED 11-16-1998.

2,745,505 (See Class 35 for this trademark).

2,745,520. **MISCELLANEOUS DESIGN. FORT HAYS STATE UNIVERSITY**, (U.S. CLS. 100, 101 AND 107). SN 75-705,532. PUB. 5-13-2003. FILED 6-10-1999.

2,745,528 (See Class 9 for this trademark).

2,745,533 (See Class 5 for this trademark).

2,745,553 (See Class 9 for this trademark).

2,745,555. **MENTE AND DESIGN. TORRENCE, DANA STEVEN**, (U.S. CLS. 100, 101 AND 107). SN 75-813,538. PUB. 6-5-2001. FILED 10-4-1999.

2,745,578 (See Class 5 for this trademark).

2,745,587 (See Class 35 for this trademark).

2,745,589. **BLUE SMOKE. TRIMARCO, WILLIAM A., DBA BILL TURNER**, (U.S. CLS. 100, 101 AND 107). SN 75-888,879. PUB. 5-13-2003. FILED 1-6-2000.

2,745,597 (See Class 9 for this trademark).

2,745,611. **PERSONAL ENERGY MANAGEMENT AND DESIGN. WUCHTERL, JOSEPH E.**, (U.S. CLS. 100, 101 AND 107). SN 75-926,175. PUB. 11-26-2002. FILED 2-24-2000.

2,745,636 (See Class 3 for this trademark).

2,745,649 (See Class 9 for this trademark).

2,745,653. **TOUCH AND WIN. JVL CORPORATION**, (U.S. CLS. 100, 101 AND 107). SN 76-018,206. PUB. 10-29-2002. FILED 4-6-2000.

2,745,660 (See Class 9 for this trademark).

2,745,662 (See Class 16 for this trademark).

2,745,671 (See Class 9 for this trademark).

2,745,677 (See Class 35 for this trademark).

2,745,682 (See Class 5 for this trademark).

2,745,692 (See Class 9 for this trademark).

2,745,703. **MARZ. HUKIC, ZLATKO, AKA BOBBY HUKIC**, (U.S. CLS. 100, 101 AND 107). SN 76-072,732. PUB. 3-13-2001. FILED 6-19-2000.

2,745,710. **IQUICK STUDY. CISCO TECHNOLOGY, INC.**, (U.S. CLS. 100, 101 AND 107). SN 76-076,062. PUB. 5-13-2003. FILED 6-22-2000.

2,745,717 (See Class 38 for this trademark).

2,745,725. **RECREATION GALAXY. UMBERSHOOT**, (U.S. CLS. 100, 101 AND 107). SN 76-092,115. PUB. 7-2-2002. FILED 7-20-2000.

2,745,769. **MAJOR LEAGUE BASEBALL PLAYERS ALUMNI LEGENDS FOR YOUTH AND DESIGN. MAJOR LEAGUE BASEBALL PLAYERS ALUMNI ASSOCIATION**, (U.S. CLS. 100, 101 AND 107). SN 76-127,616. PUB. 12-18-2001. FILED 9-12-2000.

2,745,777 (See Class 9 for this trademark).

2,745,780 (See Class 9 for this trademark).

2,745,785 (See Class 35 for this trademark).

2,745,787 (See Class 4 for this trademark).

2,745,804 (See Class 35 for this trademark).

2,745,808 (See Class 9 for this trademark).

2,745,817 (See Class 9 for this trademark).

2,745,818 (See Class 9 for this trademark).

2,745,824 (See Class 9 for this trademark).

2,745,847. **SOULBUSINESS.COM. VUCOLO, JAMES S.**, (U.S. CLS. 100, 101 AND 107). SN 76-193,205. PUB. 5-13-2003. FILED 1-16-2001.

2,745,882 (See Class 6 for this trademark).

2,745,889 (See Class 35 for this trademark).

2,745,892 (See Class 36 for this trademark).

2,745,895. **DYNAMIC NETWORKS USA. DYNAMIC NETWORKS USA, INC.**, (U.S. CLS. 100, 101 AND 107). SN 76-221,470. PUB. 5-13-2003. FILED 3-9-2001.

2,745,922. **PAGE 2. ESPN, INC.**, (U.S. CLS. 100, 101 AND 107). SN 76-236,911. PUB. 5-13-2003. FILED 4-6-2001.

2,745,923. **RESTON ASSOCIATION AND DESIGN. RESTON HOMEOWNER'S ASSOCIATION, DBA RESTON ASSOCIATION, MULTIPLE CLASS, (INT. CLS. 41 AND 42)**, (U.S. CLS. 100, 101 AND 107). SN 76-237,277. PUB. 5-13-2003. FILED 4-9-2001.

2,745,947 (See Class 9 for this trademark).

2,745,948 (See Class 9 for this trademark).

2,745,951 (See Class 16 for this trademark).

2,745,961 (See Class 38 for this trademark).

2,745,962 (See Class 38 for this trademark).

2,745,968 (See Class 16 for this trademark).

2,745,986. **INNOVATIVE MARBLE. INNOVATIVE MARBLE & TILE INC.**, (U.S. CLS. 100, 101 AND 107). SN 76-267,686. PUB. 5-13-2003. FILED 6-7-2001.

2,745,987 (See Class 36 for this trademark).

2,745,991 (See Class 5 for this trademark).

2,746,014 (See Class 38 for this trademark).

2,746,020. **WIREDRAWING 101. ROGER N. WRIGHT, INC.**, (U.S. CLS. 100, 101 AND 107). SN 76-282,293. PUB. 5-13-2003. FILED 7-9-2001.

2,746,021 (See Class 25 for this trademark).

2,746,030. **VS VIRTUAL SCHOOL LEARNING FOR THE MILLENIUM HOUSTON INDEPENDENT SCHOOL DISTRICT AND DESIGN. HOUSTON INDEPENDENT SCHOOL DISTRICT**, (U.S. CLS. 100, 101 AND 107). SN 76-286,612. PUB. 5-13-2003. FILED 7-18-2001.

2,746,031. **GEETO TIGER. SCHIFFER, ERIC M.**, (U.S. CLS. 100, 101 AND 107). SN 76-286,772. PUB. 5-13-2003. FILED 7-17-2001.

2,746,044. **LOST & FOUND AND DESIGN. FRIENDS COMMUNITY CHURCH**, (U.S. CLS. 100, 101 AND 107). SN 76-291,213. PUB. 5-13-2003. FILED 7-26-2001.

2,746,048. **PI-LAH-TEEZ ZONE THE PILATES METHOD STUDIO PILATES ZONE AND DESIGN. PI-LAH-TEEZ ZONE INC.**, (U.S. CLS. 100, 101 AND 107). SN 76-291,793. PUB. 10-8-2002. FILED 7-27-2001.

2,746,054. **WILD WISE AND DESIGN. WOODLAND PARK ZOOLOGICAL SOCIETY**, (U.S. CLS. 100, 101 AND 107). SN 76-293,010. PUB. 5-13-2003. FILED 8-2-2001.

2,746,068. **GAME STRUCTURE. FRAG UNLIMITED, INC.**, (U.S. CLS. 100, 101 AND 107). SN 76-296,858. PUB. 5-13-2003. FILED 8-9-2001.

2,746,078 (See Class 35 for this trademark).

2,746,081 (See Class 36 for this trademark).

2,746,089. **FUNFEST. MID AMERICA DIRECT, INC.**, (U.S. CLS. 100, 101 AND 107). SN 76-306,502. PUB. 5-13-2003. FILED 8-29-2001.

2,746,092. **E EXTASY AND DESIGN. COLORADO SATELLITE BROADCASTING, INC.**, (U.S. CLS. 100, 101 AND 107). SN 76-307,309. PUB. 5-13-2003. FILED 9-4-2001.

2,746,108 (See Class 35 for this trademark).

2,746,114 (See Class 16 for this trademark).

2,746,124 (See Class 16 for this trademark).

2,746,125 (See Class 9 for this trademark).

2,746,142 (See Class 38 for this trademark).

2,746,147. **HEAD EAST. BRYANT, THOMAS R., AND SOMERVILLE, MICHAEL**, (U.S. CLS. 100, 101 AND 107). SN 76-326,692. PUB. 5-13-2003. FILED 10-17-2001.

2,746,148 (See Class 14 for this trademark).

2,746,150 (See Class 9 for this trademark).

2,746,155. **PATRIOTS EXPERIENCE AND DESIGN. NEW ENGLAND PATRIOTS L.P.**, (U.S. CLS. 100, 101 AND 107). SN 76-329,685. PUB. 12-24-2002. FILED 10-24-2001.

2,746,166. **MELODY RANCH. VELUZAT, RENAUD**, (U.S.

- CLS. 100, 101 AND 107). SN 76-332,910. PUB. 5-13-2003. FILED 11-5-2001.
- 2,746,171. **MISCELLANEOUS DESIGN**. UNIFIED SCHOOL DISTRICT NO. 259, SEDGWICK COUNTY, KANSAS, (U.S. CLS. 100, 101 AND 107). SN 76-334,106. PUB. 12-24-2002. FILED 11-6-2001.
- 2,746,191 (*See Class 9 for this trademark*).
- 2,746,195 (*See Class 16 for this trademark*).
- 2,746,211 (*See Class 35 for this trademark*).
- 2,746,217. **CHP UNIVERSITY ENRICHING OUR PRESENT CREATING OUR FUTURE AND DESIGN**. CATHOLIC HEALTHCARE PARTNERS, (U.S. CLS. 100, 101 AND 107). SN 76-344,680. PUB. 10-8-2002. FILED 12-4-2001.
- 2,746,229. **EXCELLENCE IN EXECUTION**. JOHNSON & JOHNSON, (U.S. CLS. 100, 101 AND 107). SN 76-348,380. PUB. 5-13-2003. FILED 12-14-2001.
- 2,746,245. **VINEYARD MUSIC AND DESIGN**. VINEYARD MUSIC GROUP, INC., (U.S. CLS. 100, 101 AND 107). SN 76-354,491. PUB. 5-13-2003. FILED 1-2-2002.
- 2,746,257 (*See Class 16 for this trademark*).
- 2,746,277. **THE JIMMY DORSEY ORCHESTRA**. KNORR-MILLER, (U.S. CLS. 100, 101 AND 107). SN 76-363,511. PUB. 5-13-2003. FILED 1-28-2002.
- 2,746,285 (*See Class 35 for this trademark*).
- 2,746,286. **24 HOUR FITNESS TEAMSPORTS AND DESIGN**. 24 HOUR FITNESS USA, INC., (U.S. CLS. 100, 101 AND 107). SN 76-367,884. PUB. 5-13-2003. FILED 2-5-2002.
- 2,746,302. **THE KAIROS JOURNAL**. EMMANUEL FOUNDATION, (U.S. CLS. 100, 101 AND 107). SN 76-371,311. PUB. 5-13-2003. FILED 2-15-2002.
- 2,746,313 (*See Class 18 for this trademark*).
- 2,746,318. **CAPE COD INSTITUTE**. PROFESSIONAL LEARNING NETWORK, LLC, (U.S. CLS. 100, 101 AND 107). SN 76-373,731. PUB. 5-13-2003. FILED 2-20-2002.
- 2,746,320. **HARVEST FOUNDATION**. HARVEST FOUNDATION, (U.S. CLS. 100, 101 AND 107). SN 76-374,347. PUB. 5-13-2003. FILED 2-22-2002.
- 2,746,327 (*See Class 9 for this trademark*).
- 2,746,337 (*See Class 16 for this trademark*).
- 2,746,342. **BETTER INVESTING**. NATIONAL ASSOCIATION OF INVESTORS CORPORATION, (U.S. CLS. 100, 101 AND 107). SN 76-378,082. PUB. 5-13-2003. FILED 3-4-2002.
- 2,746,346. **BIKRAM YOGA**. CHOUDHURY, BIKRAM, (U.S. CLS. 100, 101 AND 107). SN 76-378,915. PUB. 10-8-2002. FILED 3-6-2002.
- 2,746,366. **DEJOPE**. HO-CHUNK NATION, (U.S. CLS. 100, 101 AND 107). SN 76-383,077. PUB. 5-13-2003. FILED 3-18-2002.
- 2,746,368. **FOOTBALL FRENZY**. STATION CASINOS, INC., (U.S. CLS. 100, 101 AND 107). SN 76-383,763. PUB. 5-13-2003. FILED 3-14-2002.
- 2,746,371 (*See Class 35 for this trademark*).
- 2,746,385. **HARVEST AND DESIGN**. HARVEST FOUNDATION, (U.S. CLS. 100, 101 AND 107). SN 76-385,957. PUB. 5-13-2003. FILED 3-21-2002.
- 2,746,393 (*See Class 9 for this trademark*).
- 2,746,397 (*See Class 16 for this trademark*).
- 2,746,401. **MULTIMEDIA - PLUS AND DESIGN**. MULTIMEDIA PLUS, INC., (U.S. CLS. 100, 101 AND 107). SN 76-388,023. PUB. 5-13-2003. FILED 3-26-2002.
- 2,746,414. **TRI-STATE SOCCER**. SHEARER, MARK, (U.S. CLS. 100, 101 AND 107). SN 76-390,988. PUB. 5-13-2003. FILED 3-27-2002.
- 2,746,418. **POWER PHONE TALK AND DESIGN**. VENVEST, INC., (U.S. CLS. 100, 101 AND 107). SN 76-391,995. PUB. 5-13-2003. FILED 4-8-2002.
- 2,746,421 (*See Class 16 for this trademark*).
- 2,746,424. **THE ACADEMY COUTINUUA EMENDATIO AND DESIGN**. ACADEMY OF SOUTH FLORIDA, INC., THE, (U.S. CLS. 100, 101 AND 107). SN 76-392,883. PUB. 5-13-2003. FILED 4-9-2002.
- 2,746,425 (*See Class 9 for this trademark*).
- 2,746,430. **EAT DRINK PLAY**. JILLIAN'S ENTERTAINMENT CORPORATION, MULTIPLE CLASS, (INT. CLS. 41 AND 43), (U.S. CLS. 100, 101 AND 107). SN 76-393,484. PUB. 5-13-2003. FILED 4-9-2002.
- 2,746,436. **HIGHLIGHTSKIDS.COM**. HIGHLIGHTS FOR CHILDREN, INC., (U.S. CLS. 100, 101 AND 107). SN 76-394,318. PUB. 5-13-2003. FILED 4-12-2002.
- 2,746,441. **SHIPPENSBURG UNIVERSITY OF PENNSYLVANIA FOUNDED IN 1871 VIRTUE LIBERTY AND INDEPENDENCE AND DESIGN**. SHIPPENSBURG UNIVERSITY OF PENNSYLVANIA, (U.S. CLS. 100, 101 AND 107). SN 76-394,669. PUB. 5-13-2003. FILED 4-11-2002.
- 2,746,442. **SHIPPENSBURG UNIVERSITY AND DESIGN**. SHIPPENSBURG UNIVERSITY OF PENNSYLVANIA, (U.S. CLS. 100, 101 AND 107). SN 76-394,670. PUB. 5-13-2003. FILED 4-11-2002.
- 2,746,458 (*See Class 9 for this trademark*).
- 2,746,465. **FLORIDA'S PERFECT GOLF DESTINATION**. PELICAN LANDING GOLF RESORT VENTURES, (U.S. CLS. 100, 101 AND 107). SN 76-397,861. PUB. 5-13-2003. FILED 4-18-2002.
- 2,746,485. **GLASSWEEKEND**. WHEATON VILLAGE, INC., (U.S. CLS. 100, 101 AND 107). SN 76-401,445. PUB. 5-13-2003. FILED 4-26-2002.
- 2,746,495. **MISCELLANEOUS DESIGN**. PUMPERNICKEL ASSOCIATES, LLC, (U.S. CLS. 100, 101 AND 107). SN 76-402,832. PUB. 5-13-2003. FILED 5-2-2002.
- 2,746,496 (*See Class 35 for this trademark*).
- 2,746,509 (*See Class 36 for this trademark*).
- 2,746,514. **HOUSTON FILM COMMISSION AND DESIGN**. GREATER HOUSTON CONVENTION AND VISITORS BUREAU, (U.S. CLS. 100, 101 AND 107). SN 76-404,973. PUB. 5-13-2003. FILED 5-9-2002.
- 2,746,516. **THE FAMILY PRACTICE AND DESIGN**. FAMILY PRACTICE, INC., THE, (U.S. CLS. 100, 101 AND 107). SN 76-405,188. PUB. 5-13-2003. FILED 5-7-2002.
- 2,746,533. **CHUY'S RACING**. BAJA CHUY'S MESQUITE BROILER, INC., (U.S. CLS. 100, 101 AND 107). SN 76-407,219. PUB. 5-13-2003. FILED 5-10-2002.
- 2,746,534 (*See Class 37 for this trademark*).
- 2,746,535 (*See Class 37 for this trademark*).
- 2,746,541. **NEOPEDIA**. NEOPETS, INC., (U.S. CLS. 100, 101 AND 107). SN 76-408,049. PUB. 5-13-2003. FILED 5-14-2002.
- 2,746,549 (*See Class 9 for this trademark*).
- 2,746,550. **MINNESOTA SHOWCASE HOCKEY**. SHOWCASE ENTERPRISES, INC., (U.S. CLS. 100, 101 AND 107). SN 76-409,356. PUB. 5-13-2003. FILED 5-20-2002.
- 2,746,551. **MINNESOTA SHOWCASE HOCKEY AND DESIGN**. SHOWCASE ENTERPRISES, INC., (U.S. CLS. 100, 101 AND 107). SN 76-409,358. PUB. 5-13-2003. FILED 5-20-2002.
- 2,746,553. **J.D. BUCK SAVAGE**. SMITH, DAVE, (U.S. CLS. 100, 101 AND 107). SN 76-409,622. PUB. 5-13-2003. FILED 5-16-2002.
- 2,746,555. **MINNESOTA HOCKEY LEAGUE AAA AND DESIGN**. SHOWCASE ENTERPRISES, INC., (U.S. CLS. 100, 101 AND 107). SN 76-410,220. PUB. 5-13-2003. FILED 5-21-2002.
- 2,746,562. **HBO LATINO**. TIME WARNER ENTERTAINMENT COMPANY, L.P., (U.S. CLS. 100, 101 AND 107). SN 76-411,246. PUB. 5-13-2003. FILED 5-20-2002.
- 2,746,577. **VIVA TV! AND DESIGN**. VENTANA PRODUCTIONS, (U.S. CLS. 100, 101 AND 107). SN 76-414,347. PUB. 5-13-2003. FILED 5-28-2002.
- 2,746,587. **"THE AFTER SCHOOL ALTERNATIVE" (STYLIZED)**. BERGENFIELD ASSEMBLY OF GOD CHURCH, INC, (U.S. CLS. 100, 101 AND 107). SN 76-417,622. PUB. 5-13-2003. FILED 5-31-2002.
- 2,746,590 (*See Class 28 for this trademark*).
- 2,746,593. **INSTITUTE FOR INTERESTING PEOPLE AND DESIGN**. FEARON, REGEN H., (U.S. CLS. 100, 101 AND 107). SN 76-418,344. PUB. 5-13-2003. FILED 6-3-2002.
- 2,746,596. **MABEL MABEL**. MABEL MABEL, (U.S. CLS. 100, 101 AND 107). SN 76-419,193. PUB. 5-13-2003. FILED 6-10-2002.
- 2,746,616 (*See Class 35 for this trademark*).
- 2,746,621 (*See Class 16 for this trademark*).
- 2,746,632. **CZARS 400 YEARS OF IMPERIAL GRANDEUR AND DESIGN**. WONDERS: THE MEMPHIS INTERNATIONAL CULTURAL SERIES, (U.S. CLS. 100, 101 AND 107). SN 76-423,541. PUB. 5-13-2003. FILED 6-20-2002.
- 2,746,644. **MULTIPLE PERSPECTIVES, ONE MISSION**. AMERICAN INSTITUTE FOR MANAGING DIVERSITY, INC., (U.S. CLS. 100, 101 AND 107). SN 76-426,755. PUB. 5-13-2003. FILED 7-1-2002.

- 2,746,647 (*See Class 9 for this trademark*).
 2,746,648 (*See Class 16 for this trademark*).
 2,746,651. **PLANETA ROCK**. PERFECT IMAGE FILM & VIDEO PRODUCTION, INC., (U.S. CLS. 100, 101 AND 107). SN 76-427,318. PUB. 5-13-2003. FILED 7-3-2002.
 2,746,658. **NTRA GREAT STATE CHALLENGE AND DESIGN**. NATIONAL THOROUGHbred RACING ASSOCIATION, INC., (U.S. CLS. 100, 101 AND 107). SN 76-430,257. PUB. 5-13-2003. FILED 7-12-2002.
 2,746,667. **MISCELLANEOUS DESIGN**. WIZARD PUBLICATIONS, INC., (U.S. CLS. 100, 101 AND 107). SN 76-433,830. PUB. 5-13-2003. FILED 7-22-2002.
 2,746,678. **B.L.I. HOLY BIBLE AND DESIGN**. BIBLICAL LIFE INSTITUTE, (U.S. CLS. 100, 101 AND 107). SN 76-435,294. PUB. 5-13-2003. FILED 7-29-2002.
 2,746,679. **CROSS REFERENCE AND DESIGN**. VON ALMEN, GARY, AND VON ALMEN, SANDRA, (U.S. CLS. 100, 101 AND 107). SN 76-435,427. PUB. 5-13-2003. FILED 7-29-2002.
 2,746,681. **VIRTU@L CAMPUS**. FRANKLIN UNIVERSITY, (U.S. CLS. 100, 101 AND 107). SN 76-435,917. PUB. 5-13-2003. FILED 7-31-2002.
 2,746,690. **DEFENSIVE LIVING**. LANDAU, JEROME ALAN, (U.S. CLS. 100, 101 AND 107). SN 76-438,085. PUB. 5-13-2003. FILED 8-5-2002.
 2,746,699. **WAYNE FOSTER**. STENZLER, JACQUELINE, (U.S. CLS. 100, 101 AND 107). SN 76-440,122. PUB. 5-13-2003. FILED 8-8-2002.
 2,746,708. **THE WAY OF STORY**. JONES, CATHRINE ANN, (U.S. CLS. 100, 101 AND 107). SN 76-441,188. PUB. 5-13-2003. FILED 8-14-2002.
 2,746,728. **WHITE PRIEST (PAI SENG-SHIH)**. SIMON PARTNERSHIP, (U.S. CLS. 100, 101 AND 107). SN 76-443,540. PUB. 5-13-2003. FILED 8-26-2002.
 2,746,729. **WHITE TIGER (PAI HU SHIH)**. SIMON PARTNERSHIP, (U.S. CLS. 100, 101 AND 107). SN 76-443,541. PUB. 5-13-2003. FILED 8-26-2002.
 2,746,752. **GREEN HIGHWAY AND DESIGN**. GET RIGHT, INC., (U.S. CLS. 100, 101 AND 107). SN 76-445,470. PUB. 5-13-2003. FILED 8-30-2002.
 2,746,754 (*See Class 36 for this trademark*).
 2,746,757. **EVERYBODY FITS**. EVERYBODY FITS, LP, (U.S. CLS. 100, 101 AND 107). SN 76-445,954. PUB. 5-13-2003. FILED 8-30-2002.
 2,746,776. **THE ENERGY ADDICT**. GORDON, JON, (U.S. CLS. 100, 101 AND 107). SN 76-448,024. PUB. 5-13-2003. FILED 9-9-2002.
 2,746,781. **MISCELLANEOUS DESIGN**. LAKE FOREST GRADUATE SCHOOL OF MANAGEMENT, (U.S. CLS. 100, 101 AND 107). SN 76-448,430. PUB. 5-13-2003. FILED 9-11-2002.
 2,746,784. **W4L**. LESLIE ALLEN FOUNDATION, INC., (U.S. CLS. 100, 101 AND 107). SN 76-448,559. PUB. 5-13-2003. FILED 9-11-2002.
 2,746,785. **WIN 4 LIFE**. LESLIE ALLEN FOUNDATION, INC., (U.S. CLS. 100, 101 AND 107). SN 76-448,560. PUB. 5-13-2003. FILED 9-11-2002.
 2,746,795. **ENRICHING LIVES**. LA GRANGE PARK PUBLIC LIBRARY DISTRICT, (U.S. CLS. 100, 101 AND 107). SN 76-449,351. PUB. 5-13-2003. FILED 9-13-2002.
 2,746,796. **VOLCAN NORTENO (STYLIZED)**. OLIVA, CARLOS, AND GONZALEZ, MODESTO, (U.S. CLS. 100, 101 AND 107). SN 76-449,352. PUB. 5-13-2003. FILED 9-13-2002.
 2,746,816. **IRON BARTENDER**. THE WINE GROUP LLC, (U.S. CLS. 100, 101 AND 107). SN 76-450,754. PUB. 5-13-2003. FILED 9-16-2002.
 2,746,823. **POSITIVE IMAGE**. POSITIVE IMAGE PERSONAL TRAINING, INC., (U.S. CLS. 100, 101 AND 107). SN 76-451,498. PUB. 5-13-2003. FILED 9-20-2002.
 2,746,824 (*See Class 9 for this trademark*).
 2,746,825. **READING EXCELLENCE AND DISCOVERY FOUNDATION**. READING EXCELLENT AND DISCOVERY FOUNDATION, INC., (U.S. CLS. 100, 101 AND 107). SN 76-451,888. PUB. 5-13-2003. FILED 9-23-2002.
 2,746,827. **RAINING REWARDS**. STATION CASINOS, INC., (U.S. CLS. 100, 101 AND 107). SN 76-452,031. PUB. 5-13-2003. FILED 9-23-2002.
 2,746,828. **BOUNCE BACK BONUS!**. STATION CASINOS, INC., (U.S. CLS. 100, 101 AND 107). SN 76-452,032. PUB. 5-13-2003. FILED 9-23-2002.
 2,746,831 (*See Class 36 for this trademark*).
 2,746,834. **BLAST FITNESS AND DESIGN**. BRASNER, MICHAEL, (U.S. CLS. 100, 101 AND 107). SN 76-452,191. PUB. 5-13-2003. FILED 9-18-2002.
 2,746,842. **EDUCATION COUNTS**. BOARD OF REGENTS, THE UNIVERSITY OF TEXAS SYSTEM, (U.S. CLS. 100, 101 AND 107). SN 76-452,675. PUB. 5-13-2003. FILED 9-25-2002.
 2,746,845. **BROADWAY YOUR WAY**. BARKLEY KALPAK ASSOCIATES, (U.S. CLS. 100, 101 AND 107). SN 76-452,702. PUB. 5-13-2003. FILED 9-25-2002.
 2,746,849 (*See Class 36 for this trademark*).
 2,746,850. **GUYS WHO LOVE GOD**. GUYS WHO LOVE GOD, LLC, (U.S. CLS. 100, 101 AND 107). SN 76-453,073. PUB. 5-13-2003. FILED 9-26-2002.
 2,746,859. **DIAMONDMAN**. SEMMEL, NEIL S., (U.S. CLS. 100, 101 AND 107). SN 76-453,329. PUB. 5-13-2003. FILED 9-27-2002.
 2,746,860. **NATURALLY WOMEN**. NATURALLY WOMEN FITNESS CENTERS, (U.S. CLS. 100, 101 AND 107). SN 76-453,362. PUB. 5-13-2003. FILED 9-27-2002.
 2,746,886. **"TRUNKS & TWIGS" AND DESIGN**. SUGAR CREEK PUBLISHING, INC., (U.S. CLS. 100, 101 AND 107). SN 76-454,617. PUB. 5-13-2003. FILED 10-2-2002.
 2,746,895. **THE BIGGEST CHILDREN'S BOOK IN THE WORLD**. SCHOLASTIC INC., (U.S. CLS. 100, 101 AND 107). SN 76-455,247. PUB. 5-13-2003. FILED 10-3-2002.
 2,746,911. **CONNECTEDU AND DESIGN**. CONNECTEDU, INC., (U.S. CLS. 100, 101 AND 107). SN 76-455,948. PUB. 5-13-2003. FILED 10-4-2002.
 2,746,919. **THE FENIMORE ART MUSEUM**. NEW YORK STATE HISTORICAL ASSOCIATION, (U.S. CLS. 100, 101 AND 107). SN 76-456,237. PUB. 5-13-2003. FILED 10-7-2002.
 2,746,924. **RACHEL ASHWELL**. SHABBY CHIC, INC., (U.S. CLS. 100, 101 AND 107). SN 76-456,683. PUB. 5-13-2003. FILED 10-3-2002.
 2,746,931. **DOUBLEHEADER**. AMERICAN CORPORATE COUNSEL ASSOCIATION, (U.S. CLS. 100, 101 AND 107). SN 76-457,127. PUB. 5-13-2003. FILED 10-9-2002.
 2,746,937. **ROCK N RACQUETS**. SFX SPORTS GROUP, INC., (U.S. CLS. 100, 101 AND 107). SN 76-457,467. PUB. 5-13-2003. FILED 10-10-2002.
 2,746,938. **FINDING STELLA**. MOLLENAUER, MARTHA A., (U.S. CLS. 100, 101 AND 107). SN 76-457,489. PUB. 5-13-2003. FILED 10-10-2002.
 2,746,944 (*See Class 35 for this trademark*).
 2,746,963. **FLIP YOUR LID**. FLIP YOUR LID, INC., (U.S. CLS. 100, 101 AND 107). SN 76-459,091. PUB. 5-13-2003. FILED 10-4-2002.
 2,746,964. **HIGHLAND MERCENARIES**. MCLELLAND, MITCHELL, AND ARNESEN, LISA, (U.S. CLS. 100, 101 AND 107). SN 76-459,182. PUB. 5-13-2003. FILED 10-11-2002.
 2,746,981. **THE PROGRESSIVE CONSERVATIVE**. COX, JOHN H., (U.S. CLS. 100, 101 AND 107). SN 76-460,235. PUB. 5-13-2003. FILED 10-16-2002.
 2,747,021. **JAMFEST**. BLUE SKY KENTUCKY, INC., (U.S. CLS. 100, 101 AND 107). SN 76-463,529. PUB. 5-13-2003. FILED 11-1-2002.
 2,747,026. **GREAT OGEECHEE SEAFOOD FESTIVAL**. RICHMOND HILL-BRYAN COUNTY CHAMBER OF COMMERCE, (U.S. CLS. 100, 101 AND 107). SN 76-464,047. PUB. 5-13-2003. FILED 11-4-2002.
 2,747,042. **IDEA SAVER**. IN2BOOKS, INC., (U.S. CLS. 100, 101 AND 107). SN 76-468,185. PUB. 5-13-2003. FILED 11-13-2002.
 2,747,053 (*See Class 35 for this trademark*).
 2,747,080 (*See Class 9 for this trademark*).
 2,747,094. **GREEN GUERRILLAS**. GREEN GUERRILLAS, MULTIPLE CLASS, (INT. CLS. 41 AND 42), (U.S. CLS. 100, 101 AND 107). SN 78-082,166. PUB. 5-13-2003. FILED 8-31-2001.
 2,747,109. **WRITERS IN THE SCHOOLS AND DESIGN**. WRITERS IN THE SCHOOLS, (U.S. CLS. 100, 101 AND 107). SN 78-096,241. PUB. 5-13-2003. FILED 12-3-2001.
 2,747,116. **MISCELLANEOUS DESIGN**. DATAFLUX CORPORATION, (U.S. CLS. 100, 101 AND 107). SN 78-099,250. PUB. 5-13-2003. FILED 12-19-2001.
 2,747,132 (*See Class 36 for this trademark*).
 2,747,133. **VADHA**. WYKA, MICHAEL H., AND MCCRAVE, JOHN J., AND MCCRAVE, JOHN V., (U.S. CLS. 100, 101

AND 107). SN 78-107,278. PUB. 5-13-2003. FILED 2-6-2002.

2,747,144. **SENIOR CITIZENS AND CHILDREN MAKING A DIFFERENCE.** MARIA-MADELINE PROJECT, INC., (U.S. CLS. 100, 101 AND 107). SN 78-112,338. PUB. 5-13-2003. FILED 3-4-2002.

2,747,147. **ANIME.TV ANIME TV FOR YOU AND ME AND DESIGN.** CENTRAL PARK MEDIA CORPORATION, (U.S. CLS. 100, 101 AND 107). SN 78-113,172. PUB. 5-13-2003. FILED 3-7-2002.

2,747,158 (*See Class 40 for this trademark.*).

2,747,167 (*See Class 16 for this trademark.*).

2,747,195. **TRINITYFEST.** TRINITY RIVER COMMISSION FOUNDATION, INC., DBA TRINITY COMMONS FOUNDATION, (U.S. CLS. 100, 101 AND 107). SN 78-126,208. PUB. 5-13-2003. FILED 5-3-2002.

2,747,200. **PARALAB.** ENGINEERED INTELLIGENCE CORPORATION, (U.S. CLS. 100, 101 AND 107). SN 78-127,551. PUB. 4-29-2003. FILED 5-9-2002.

2,747,201. **AM IN THE PM.** CRADDOCK, JOHN A., (U.S. CLS. 100, 101 AND 107). SN 78-127,579. PUB. 5-13-2003. FILED 5-9-2002.

2,747,206. **SOUL GRASS AND DESIGN.** HEAVERS, DEBRA L., AND FOSTER, DAVID G., (U.S. CLS. 100, 101 AND 107). SN 78-129,803. PUB. 5-13-2003. FILED 5-19-2002.

2,747,208. **THE OIL & GAS CONFERENCE AND DESIGN.** ENERCOM, INC., (U.S. CLS. 100, 101 AND 107). SN 78-130,586. PUB. 5-13-2003. FILED 5-22-2002.

2,747,211. **TASTE OF SUCCESS.** BOSTON BEER CORPORATION, (U.S. CLS. 100, 101 AND 107). SN 78-131,570. PUB. 5-13-2003. FILED 5-28-2002.

2,747,222. **PRIME TIME THEATRE PRODUCTIONS AND DESIGN.** MONNOT, SUSAN, PRICE, (U.S. CLS. 100, 101 AND 107). SN 78-140,168. PUB. 5-13-2003. FILED 6-30-2002.

2,747,237. **BOB JEFFREYS CLINICS PARTNERSHIP TRAINING FOR HORSE & RIDER AND DESIGN.** JEFFCREST, INC., (U.S. CLS. 100, 101 AND 107). SN 78-145,112. PUB. 5-13-2003. FILED 7-18-2002.

2,747,249. **YELLOW BALL TENNIS CAMP AND DESIGN.** HERRICK, MARY, (U.S. CLS. 100, 101 AND 107). SN 78-147,964. PUB. 5-13-2003. FILED 7-26-2002.

2,747,262. **TEX IN THE CITY AND DESIGN.** TEX IN THE CITY LLC, (U.S. CLS. 100, 101 AND 107). SN 78-151,472. PUB. 5-13-2003. FILED 8-6-2002.

2,747,272. **TAP THE ACHIEVEMENT PROJECT.** JEFFERSON, NICOLA TOLLETT, (U.S. CLS. 100, 101 AND 107). SN 78-152,218. PUB. 5-13-2003. FILED 8-8-2002.

2,747,282. **JOT.** NEIGHBORHOOD WRITING ALLIANCE, (U.S. CLS. 100, 101 AND 107). SN 78-153,182. PUB. 5-13-2003. FILED 8-12-2002.

2,747,283. **JOURNAL OF ORDINARY THOUGHT.** NEIGHBORHOOD WRITING ALLIANCE, (U.S. CLS. 100, 101 AND 107). SN 78-153,187. PUB. 5-13-2003. FILED 8-12-2002.

2,747,290 (*See Class 35 for this trademark.*).

2,747,298 (*See Class 9 for this trademark.*).

2,747,309. **MARINA AND DESIGN.** MARYLAND STATE DEPARTMENT OF EDUCATION-DIVISION OF LIBRARY DEVELOPMENT SERVICES, (U.S. CLS. 100, 101 AND 107). SN 78-158,061. PUB. 5-13-2003. FILED 8-27-2002.

2,747,326. **SUGARLAND.** NETTLES, JENNIFER, AND HALL, KRISTEN A., AND BUSH, KRISTIAN, (U.S. CLS. 100, 101 AND 107). SN 78-162,167. PUB. 5-13-2003. FILED 9-9-2002.

2,747,345. **SOUL SALAD.** DUBY, DEBRA, MULTIPLE CLASS, (INT. CLS. 41 AND 44), (U.S. CLS. 100, 101 AND 107). SN 78-164,960. PUB. 5-13-2003. FILED 9-17-2002.

2,747,351. **KAFI.** KALAMAZOO VALLEY COMMUNITY COLLEGE, (U.S. CLS. 100, 101 AND 107). SN 78-165,438. PUB. 5-13-2003. FILED 9-18-2002.

2,747,353. **MANORAIL AND DESIGN.** MANORAIL CORPORATION, AND MANORAIL CORPORATION, (U.S. CLS. 100, 101 AND 107). SN 78-165,492. PUB. 5-13-2003. FILED 9-18-2002.

2,747,358. **LA COCINA ALEGRE.** AUSTIN COMMUNITY GARDENS DBA SUSTAINABLE FOOD CENTER, (U.S. CLS. 100, 101 AND 107). SN 78-166,271. PUB. 5-13-2003. FILED 9-20-2002.

2,747,366. **2BU. (STYLIZED).** THE UNIVERSITY OF SOUTH DAKOTA, (U.S. CLS. 100, 101 AND 107). SN 78-167,040. PUB. 5-13-2003. FILED 9-23-2002.

2,747,379. **BLAST BY THE BAY.** CHAMPIONSHIP AUTO RACING TEAMS, INC., (U.S. CLS. 100, 101 AND 107). SN 78-168,313. PUB. 5-13-2003. FILED 9-26-2002.

2,747,388. **THE TRUTH TO A GREATER DEGREE.** CORNERSTONE UNIVERSITY, (U.S. CLS. 100, 101 AND 107). SN 78-169,212. PUB. 5-13-2003. FILED 9-30-2002.

2,747,400. **DARK SOUND ENTERTAINMENT.** CHRISTMAS, EYON NEAL, (U.S. CLS. 100, 101 AND 107). SN 78-170,198. PUB. 5-13-2003. FILED 10-2-2002.

2,747,423. **GALIDOR.** KIRKBI A/S, (U.S. CLS. 100, 101 AND 107). SN 78-171,782. PUB. 5-13-2003. FILED 10-7-2002.

2,747,446. **MASTER THE NIGHT.** BELL HELICOPTER TEXTRON INC., (U.S. CLS. 100, 101 AND 107). SN 78-176,661. PUB. 5-13-2003. FILED 10-21-2002.

CLASS 42—SCIENTIFIC, COMPUTER AND LEGAL SERVICES

2,745,418 (*See Class 9 for this trademark.*).

2,745,424 (*See Class 9 for this trademark.*).

2,745,426 (*See Class 9 for this trademark.*).

2,745,429. **REEL TO REAL.** FANTLE, DAVID A., (U.S. CLS. 100 AND 101). SN 75-292,610. PUB. 5-13-2003. FILED 5-14-1997.

2,745,440 (*See Class 6 for this trademark.*).

2,745,447 (*See Class 9 for this trademark.*).

2,745,450 (*See Class 35 for this trademark.*).

2,745,452 (*See Class 35 for this trademark.*).

2,745,453 (*See Class 35 for this trademark.*).

2,745,455 (*See Class 1 for this trademark.*).

2,745,461. **EINSTEIN MEDICAL.** EINSTEIN MEDICAL, INC., (U.S. CLS. 100 AND 101). SN 75-524,586. PUB. 12-25-2001. FILED 7-23-1998.

2,745,463 (*See Class 9 for this trademark.*).

2,745,497 (*See Class 35 for this trademark.*).

2,745,499 (*See Class 35 for this trademark.*).

2,745,504 (*See Class 11 for this trademark.*).

2,745,506 (*See Class 6 for this trademark.*).

2,745,509 (*See Class 37 for this trademark.*).

2,745,511 (*See Class 9 for this trademark.*).

2,745,519. **X AND DESIGN.** XWAVE SOLUTIONS INC., (U.S. CLS. 100 AND 101). SN 75-704,314. PUB. 5-13-2003. FILED 5-13-1999.

2,745,528 (*See Class 9 for this trademark.*).

2,745,530 (*See Class 1 for this trademark.*).

2,745,532. **COGNIA.** COGNIA CORPORATION, (U.S. CLS. 100 AND 101). SN 75-752,364. PUB. 5-1-2001. FILED 7-15-1999.

2,745,534 (*See Class 16 for this trademark.*).

2,745,535 (*See Class 1 for this trademark.*).

2,745,538. **ORTHOPAEDIC SPECIALITY CENTER MARYLAND'S ORTHOPAEDIC TEAM AND DESIGN.** ORTHOPAEDIC SPECIALITY CENTER OF BALTIMORE, P. A., (U.S. CLS. 100 AND 101). SN 75-766,732. PUB. 5-13-2003. FILED 8-3-1999.

2,745,541 (*See Class 9 for this trademark.*).

2,745,548 (*See Class 11 for this trademark.*).

2,745,553 (*See Class 9 for this trademark.*).

2,745,554 (*See Class 9 for this trademark.*).

2,745,559 (*See Class 39 for this trademark.*).

2,745,562. **ARMS.** EQUIPNET, INC., (U.S. CLS. 100 AND 101). SN 75-824,953. PUB. 10-15-2002. FILED 10-18-1999.

2,745,565. **E ONLINE ENGLISH AND DESIGN.** ONLINE ENGLISH PTY LTD, (U.S. CLS. 100 AND 101). SN 75-834,972. PUB. 12-3-2002. FILED 10-30-1999.

2,745,566. **AAA AAA LEGAL SERVICES AND DESIGN.** JASON, MARIUS J., (U.S. CLS. 100 AND 101). SN 75-835,327. PUB. 5-13-2003. FILED 11-17-1999.

2,745,570 (*See Class 9 for this trademark.*).

2,745,572 (*See Class 9 for this trademark.*).

2,745,573 (*See Class 9 for this trademark.*).

2,745,574 (*See Class 9 for this trademark.*).

2,745,578 (*See Class 5 for this trademark.*).

2,745,592 (*See Class 9 for this trademark.*).

2,745,597 (*See Class 9 for this trademark.*).

2,745,605. **EACTIVE.** WEST PALM BEACH TECHNOLOGIES, INC., (U.S. CLS. 100 AND 101). SN 75-908,180. PUB. 10-1-

2002. FILED 2-2-2000.
 2,745,606 (*See Class 1 for this trademark.*)
 2,745,615 (*See Class 9 for this trademark.*)
 2,745,617 (*See Class 1 for this trademark.*)
 2,745,621 (*See Class 35 for this trademark.*)
 2,745,623. **YOU CAN RUN, BUT YOU CAN'T HIDE FROM ME - GOD.** GODSPEAKS, INC., (U.S. CLS. 100 AND 101). SN 75-943,300. PUB. 5-13-2003. FILED 3-15-2000.
 2,745,624. **"FEELIN' YANKED IN THE WRONG DIRECTION? TAKE-MY HAND-GOD.** GODSPEAKS, INC., (U.S. CLS. 100 AND 101). SN 75-943,312. PUB. 5-13-2003. FILED 3-15-2000.
 2,745,625. **SEARCHING FOR THE ULTIMATE HIGH? I'M UP HERE - GOD.** GODSPEAKS, INC., (U.S. CLS. 100 AND 101). SN 75-943,318. PUB. 5-13-2003. FILED 3-15-2000.
 2,745,626 (*See Class 36 for this trademark.*)
 2,745,633. **CR SAFETY ASSESSMENT.** CONSUMERS UNION OF UNITED STATES, INC., (U.S. CLS. 100 AND 101). SN 75-982,914. PUB. 5-13-2003. FILED 11-2-2001.
 2,745,634 (*See Class 7 for this trademark.*)
 2,745,637. **VESPA.** SIEMENS AKTIENGESELLSCHAFT, (U.S. CLS. 100 AND 101). SN 76-000,280. PUB. 12-4-2001. FILED 3-15-2000.
 2,745,644 (*See Class 9 for this trademark.*)
 2,745,648 (*See Class 9 for this trademark.*)
 2,745,652 (*See Class 35 for this trademark.*)
 2,745,655 (*See Class 38 for this trademark.*)
 2,745,658 (*See Class 35 for this trademark.*)
 2,745,661 (*See Class 37 for this trademark.*)
 2,745,662 (*See Class 16 for this trademark.*)
 2,745,664 (*See Class 9 for this trademark.*)
 2,745,666 (*See Class 7 for this trademark.*)
 2,745,667. **CONCURRENT TECHNOLOGIES CORPORATION.** CONCURRENT TECHNOLOGIES CORPORATION, (U.S. CLS. 100 AND 101). SN 76-040,447. PUB. 5-13-2003. FILED 5-4-2000.
 2,745,670. **ATRUS.** AGAMA LIMITED, BY ASSIGNMENT AGAMA INC., (U.S. CLS. 100 AND 101). SN 76-043,257. PUB. 12-18-2001. FILED 5-8-2000.
 2,745,671 (*See Class 9 for this trademark.*)
 2,745,677 (*See Class 35 for this trademark.*)
 2,745,679 (*See Class 2 for this trademark.*)
 2,745,680 (*See Class 3 for this trademark.*)
 2,745,682 (*See Class 5 for this trademark.*)
 2,745,686 (*See Class 35 for this trademark.*)
 2,745,688. **CORELAB.** CORE LABORATORIES GLOBAL N.V., (U.S. CLS. 100 AND 101). SN 76-056,301. PUB. 5-13-2003. FILED 5-24-2000.
 2,745,694 (*See Class 30 for this trademark.*)
 2,745,701 (*See Class 9 for this trademark.*)
 2,745,704 (*See Class 9 for this trademark.*)
 2,745,705 (*See Class 9 for this trademark.*)
 2,745,709. **YANKEE PIER.** DELLAR, MICHAEL D., AND OGDEN, BRADLEY M., (U.S. CLS. 100 AND 101). SN 76-074,963. PUB. 1-22-2002. FILED 6-21-2000.
 2,745,716. **LEO LINDY'S.** TRADEMARK HOLDING, INC., BY ASSIGNMENT NATIONAL RESTAURANTS MANAGEMENT, INC., (U.S. CLS. 100 AND 101). SN 76-079,396. PUB. 7-31-2001. FILED 6-28-2000.
 2,745,722. **E TESTING LABS AND DESIGN.** ZIFF DAVIS PUBLISHING HOLDINGS INC., (U.S. CLS. 100 AND 101). SN 76-083,703. PUB. 5-13-2003. FILED 7-6-2000.
 2,745,728 (*See Class 7 for this trademark.*)
 2,745,734 (*See Class 38 for this trademark.*)
 2,745,756 (*See Class 35 for this trademark.*)
 2,745,757. **CELEBRATE A LIFE.** FOREST LAWN MORTUARY, (U.S. CLS. 100 AND 101). SN 76-115,270. PUB. 9-24-2002. FILED 8-23-2000.
 2,745,759 (*See Class 9 for this trademark.*)
 2,745,763 (*See Class 35 for this trademark.*)
 2,745,766 (*See Class 7 for this trademark.*)
 2,745,777 (*See Class 9 for this trademark.*)
 2,745,779 (*See Class 5 for this trademark.*)
 2,745,782 (*See Class 37 for this trademark.*)
 2,745,783 (*See Class 9 for this trademark.*)
 2,745,785 (*See Class 35 for this trademark.*)
 2,745,803 (*See Class 9 for this trademark.*)
 2,745,806. **EACH PATIENT'S CANCER IS AS UNIQUE AS THE HUMAN FINGERPRINT.** ONCOTECH, INC., (U.S. CLS. 100 AND 101). SN 76-163,251. PUB. 5-13-2003. FILED 11-10-2000.
 2,745,807. **ONCOPROFILE.** ONCOTECH, INC., (U.S. CLS. 100 AND 101). SN 76-163,593. PUB. 5-13-2003. FILED 11-10-2000.
 2,745,808 (*See Class 9 for this trademark.*)
 2,745,810 (*See Class 7 for this trademark.*)
 2,745,811 (*See Class 1 for this trademark.*)
 2,745,812. **INVOSCREEN.** GENETICS COMPANY INC, THE, (U.S. CLS. 100 AND 101). SN 76-167,972. PUB. 5-13-2003. FILED 11-20-2000.
 2,745,816 (*See Class 9 for this trademark.*)
 2,745,817 (*See Class 9 for this trademark.*)
 2,745,818 (*See Class 9 for this trademark.*)
 2,745,824 (*See Class 9 for this trademark.*)
 2,745,826 (*See Class 11 for this trademark.*)
 2,745,828 (*See Class 9 for this trademark.*)
 2,745,849 (*See Class 9 for this trademark.*)
 2,745,853 (*See Class 9 for this trademark.*)
 2,745,855 (*See Class 9 for this trademark.*)
 2,745,857 (*See Class 9 for this trademark.*)
 2,745,859 (*See Class 16 for this trademark.*)
 2,745,868 (*See Class 1 for this trademark.*)
 2,745,870. **LOCATIONNET AND DESIGN.** LOCATIONNET SYSTEMS 2000 LTD., (U.S. CLS. 100 AND 101). SN 76-205,945. PUB. 5-13-2003. FILED 2-7-2001.
 2,745,873. **ROADMAP.** RANDOM WALK COMPUTING, INC., (U.S. CLS. 100 AND 101). SN 76-207,184. PUB. 11-5-2002. FILED 2-8-2001.
 2,745,905. **AMPAP.** GLOBAL VALIDATORS INC., (U.S. CLS. 100 AND 101). SN 76-230,720. PUB. 12-10-2002. FILED 3-27-2001.
 2,745,910. **ECRMGUIDE.** JUPITERMEDIA CORPORATION, BY CHANGE OF NAME INTERNET.COM CORPORATION, (U.S. CLS. 100 AND 101). SN 76-231,949. PUB. 2-11-2003. FILED 3-28-2001.
 2,745,914. **IMAGINARY PLANET.** IMAGINARYPLANET.COM LLC, (U.S. CLS. 100 AND 101). SN 76-232,561. PUB. 5-13-2003. FILED 3-29-2001.
 2,745,915 (*See Class 8 for this trademark.*)
 2,745,919. **MEGA DOPPLER NETWORK 12.** KSLA, LLC., (U.S. CLS. 100 AND 101). SN 76-235,405. PUB. 12-3-2002. FILED 4-4-2001.
 2,745,923 (*See Class 41 for this trademark.*)
 2,745,925 (*See Class 37 for this trademark.*)
 2,745,927. **THE MET.** PALMER LUCK LIMITED, (U.S. CLS. 100 AND 101). SN 76-239,222. PUB. 11-19-2002. FILED 4-11-2001.
 2,745,934 (*See Class 9 for this trademark.*)
 2,745,936 (*See Class 9 for this trademark.*)
 2,745,941. **SPARKMATCH.** SPARKNOTES LLC, (U.S. CLS. 100 AND 101). SN 76-245,031. PUB. 10-15-2002. FILED 4-23-2001.
 2,745,946 (*See Class 9 for this trademark.*)
 2,745,949 (*See Class 9 for this trademark.*)
 2,745,966 (*See Class 16 for this trademark.*)
 2,745,971 (*See Class 35 for this trademark.*)
 2,745,977 (*See Class 9 for this trademark.*)
 2,745,979 (*See Class 1 for this trademark.*)
 2,745,984 (*See Class 9 for this trademark.*)
 2,745,987 (*See Class 36 for this trademark.*)
 2,745,991 (*See Class 5 for this trademark.*)
 2,745,992. **PORONUI RANCH.** PORONUI RANCH LIMITED, (U.S. CLS. 100 AND 101). SN 76-270,292. PUB. 5-13-2003. FILED 6-12-2001.
 2,745,994 (*See Class 9 for this trademark.*)
 2,746,004 (*See Class 35 for this trademark.*)
 2,746,008 (*See Class 9 for this trademark.*)
 2,746,032 (*See Class 35 for this trademark.*)
 2,746,039 (*See Class 35 for this trademark.*)
 2,746,045 (*See Class 37 for this trademark.*)
 2,746,046. **JACKSON HOLE HOME OF THE 7 OZ. BURGER AND DESIGN.** JOINT VENTURE TRADEMARK CORPORATION, (U.S. CLS. 100 AND 101). SN 76-291,405. PUB. 5-13-2003. FILED 7-27-2001.
 2,746,071 (*See Class 35 for this trademark.*)
 2,746,083. **EDEN FOUNDATION FOR THE PEOPLE WITH DISABILITIES AND DESIGN.** EDEN FOUNDATION, (U.S. CLS. 100 AND 101). SN 76-305,325. PUB. 5-13-2003. FILED 8-28-2001.

- 2,746,093 (*See Class 9 for this trademark*).
 2,746,097. **ELDERWATCH**. HENSON, THOMAS, (U.S. CLS. 100 AND 101). SN 76-310,166. PUB. 5-13-2003. FILED 9-7-2001.
 2,746,112 (*See Class 35 for this trademark*).
 2,746,114 (*See Class 16 for this trademark*).
 2,746,125 (*See Class 9 for this trademark*).
 2,746,129 (*See Class 5 for this trademark*).
 2,746,130 (*See Class 9 for this trademark*).
 2,746,146. **LIFECYCLE**. FEI BEHAVIORAL HEALTH, INC., (U.S. CLS. 100 AND 101). SN 76-326,619. PUB. 11-5-2002. FILED 10-17-2001.
 2,746,163 (*See Class 16 for this trademark*).
 2,746,165 (*See Class 35 for this trademark*).
 2,746,176. **MISCELLANEOUS DESIGN**. VARIETY CHILDREN'S LIFELINE, (U.S. CLS. 100 AND 101). SN 76-335,945. PUB. 5-13-2003. FILED 11-9-2001.
 2,746,180 (*See Class 9 for this trademark*).
 2,746,182. **SPM-I**. MATERIALS MANAGEMENT MICROSYSTEMS, (U.S. CLS. 100 AND 101). SN 76-337,254. PUB. 11-26-2002. FILED 11-14-2001.
 2,746,183. **SPM**. MATERIALS MANAGEMENT MICROSYSTEMS, (U.S. CLS. 100 AND 101). SN 76-337,255. PUB. 11-26-2002. FILED 11-14-2001.
 2,746,191 (*See Class 9 for this trademark*).
 2,746,198. **SCRIPTCHECK (STYLIZED)**. LABONE, INC., (U.S. CLS. 100 AND 101). SN 76-340,796. PUB. 5-13-2003. FILED 11-23-2001.
 2,746,200 (*See Class 16 for this trademark*).
 2,746,204 (*See Class 35 for this trademark*).
 2,746,206 (*See Class 35 for this trademark*).
 2,746,215. **CLOSING THE COMMUNICATIONS LOOP**. DIALOGIC COMMUNICATIONS CORPORATION, (U.S. CLS. 100 AND 101). SN 76-343,821. PUB. 5-13-2003. FILED 11-30-2001.
 2,746,216. **KINACE (STYLIZED)**. KERYX BIOPHARMACEUTICALS, INC., (U.S. CLS. 100 AND 101). SN 76-344,427. PUB. 5-13-2003. FILED 12-4-2001.
 2,746,228. **CODE VALLEY**. CODE VALLEY CORP PTY LTD, (U.S. CLS. 100 AND 101). SN 76-347,709. PUB. 5-13-2003. FILED 12-12-2001.
 2,746,235. **SYSTEMATIC COLOR CONTROL**. SUN CHEMICAL CORPORATION, (U.S. CLS. 100 AND 101). SN 76-350,091. PUB. 5-13-2003. FILED 12-19-2001.
 2,746,299. **THE ENGINEERING APPROACH**. ONDEO NALCO COMPANY, (U.S. CLS. 100 AND 101). SN 76-370,645. PUB. 5-13-2003. FILED 2-14-2002.
 2,746,328. **CPR AND DESIGN**. CREATIVE PRESENTATION RESOURCES LLC, (U.S. CLS. 100 AND 101). SN 76-375,190. PUB. 5-13-2003. FILED 2-26-2002.
 2,746,336 (*See Class 35 for this trademark*).
 2,746,344 (*See Class 39 for this trademark*).
 2,746,347. **METAVERA (STYLIZED)**. JOHNSON, PETER, AND FERRARINI, DANTE, (U.S. CLS. 100 AND 101). SN 76-378,974. PUB. 5-13-2003. FILED 3-6-2002.
 2,746,348. **MISCELLANEOUS DESIGN**. JOHNSON, PETER, AND FERRARINI, DANTE, (U.S. CLS. 100 AND 101). SN 76-379,120. PUB. 5-13-2003. FILED 3-6-2002.
 2,746,349. **METAVERA AND DESIGN**. JOHNSON, PETER, AND FERRARINI, DANTE, (U.S. CLS. 100 AND 101). SN 76-379,122. PUB. 5-13-2003. FILED 3-6-2002.
 2,746,374. **MISCELLANEOUS DESIGN**. ERGO WORKS INC., (U.S. CLS. 100 AND 101). SN 76-384,555. PUB. 5-13-2003. FILED 3-20-2002.
 2,746,383. **WR TOOLKIT**. WEEKLY READER CORPORATION, (U.S. CLS. 100 AND 101). SN 76-385,375. PUB. 5-13-2003. FILED 3-21-2002.
 2,746,415. **MCART**. ADVANCED INTERNET TECHNOLOGIES, INC., (U.S. CLS. 100 AND 101). SN 76-391,513. PUB. 5-13-2003. FILED 4-4-2002.
 2,746,425 (*See Class 9 for this trademark*).
 2,746,435. **MCART PRO**. ADVANCED INTERNET TECHNOLOGIES, INC., (U.S. CLS. 100 AND 101). SN 76-394,019. PUB. 5-13-2003. FILED 4-10-2002.
 2,746,462 (*See Class 9 for this trademark*).
 2,746,463 (*See Class 9 for this trademark*).
 2,746,471 (*See Class 9 for this trademark*).
 2,746,474. **IT'S ALL ABOUT THE BOTTOM LINE.** NETCAR-RIER, INC., (U.S. CLS. 100 AND 101). SN 76-399,700. PUB. 5-13-2003. FILED 4-23-2002.
 2,746,482 (*See Class 37 for this trademark*).
 2,746,499. **TRIANGLE PLASTICS**. WILBERT, INC., (U.S. CLS. 100 AND 101). SN 76-402,970. PUB. 5-13-2003. FILED 5-2-2002.
 2,746,513 (*See Class 37 for this trademark*).
 2,746,543. **MISCELLANEOUS DESIGN**. ACCURATE LOCATING, INC., (U.S. CLS. 100 AND 101). SN 76-408,596. PUB. 5-13-2003. FILED 5-15-2002.
 2,746,544. **MISCELLANEOUS DESIGN**. ACCURATE LOCATING, INC., (U.S. CLS. 100 AND 101). SN 76-408,597. PUB. 5-13-2003. FILED 5-15-2002.
 2,746,586. **COMMAND TOWER**. COMMAND TOWER LLC, (U.S. CLS. 100 AND 101). SN 76-417,553. PUB. 5-13-2003. FILED 6-6-2002.
 2,746,626. **TENGO INTERNET AND DESIGN**. TENGO INTERNET, INC., (U.S. CLS. 100 AND 101). SN 76-423,271. PUB. 5-13-2003. FILED 6-20-2002.
 2,746,638 (*See Class 37 for this trademark*).
 2,746,717. **MISCELLANEOUS DESIGN**. DOMINION SURVEYORS, INC., (U.S. CLS. 100 AND 101). SN 76-441,829. PUB. 5-13-2003. FILED 8-14-2002.
 2,746,756. **TECHNOLOGY SERVICE CORPORATION**. TECHNOLOGY SERVICE CORPORATION, (U.S. CLS. 100 AND 101). SN 76-445,902. PUB. 5-13-2003. FILED 8-29-2002.
 2,746,765. **ENSS AND DESIGN**. THE OHIO STATE UNIVERSITY, (U.S. CLS. 100 AND 101). SN 76-446,932. PUB. 5-13-2003. FILED 9-5-2002.
 2,746,769. **S&C SOIL & ENVIRONMENTAL CONSULTANTS, PA AND DESIGN**. SOIL & ENVIRONMENTAL CONSULTANTS, PA, (U.S. CLS. 100 AND 101). SN 76-447,080. PUB. 5-13-2003. FILED 9-4-2002.
 2,746,777. **MISCELLANEOUS DESIGN**. THE POLARIS GROUP, (U.S. CLS. 100 AND 101). SN 76-448,105. PUB. 5-13-2003. FILED 9-9-2002.
 2,746,793. **OSR ONLINE**. OSR OPEN SYSTEM RESOURCES, INC., (U.S. CLS. 100 AND 101). SN 76-449,346. PUB. 5-13-2003. FILED 9-12-2002.
 2,746,814. **LEAGUEMINDER**. SIMPLIFIED ATHLETIC TECHNOLOGIES, LLC, (U.S. CLS. 100 AND 101). SN 76-450,569. PUB. 5-13-2003. FILED 9-12-2002.
 2,746,838 (*See Class 35 for this trademark*).
 2,746,874. **OCSI**. WEATHER RESEARCH CENTER, (U.S. CLS. 100 AND 101). SN 76-454,023. PUB. 5-13-2003. FILED 9-30-2002.
 2,746,884. **GOOD TO GROW**. MONSANTO TECHNOLOGY LLC, (U.S. CLS. 100 AND 101). SN 76-454,544. PUB. 5-13-2003. FILED 9-27-2002.
 2,746,885. **LIFE INTEGRATION COACHING: BEYOND BALANCE TO LIFE INTEGRATION**. ANDERSON, JUDITH A., DBA BUSINESS GOLF UNLIMITED, (U.S. CLS. 100 AND 101). SN 76-454,545. PUB. 5-13-2003. FILED 9-25-2002.
 2,746,935. **NPORATA (STYLIZED)**. NPORATA, INC., (U.S. CLS. 100 AND 101). SN 76-457,330. PUB. 5-13-2003. FILED 10-10-2002.
 2,746,936. **MISCELLANEOUS DESIGN**. NPORATA, INC., (U.S. CLS. 100 AND 101). SN 76-457,331. PUB. 5-13-2003. FILED 10-10-2002.
 2,746,940. **TACTICAL OFFICE**. APPLIED DATA TRENDS, INC., (U.S. CLS. 100 AND 101). SN 76-457,930. PUB. 5-13-2003. FILED 10-8-2002.
 2,746,986 (*See Class 20 for this trademark*).
 2,747,053 (*See Class 35 for this trademark*).
 2,747,055. **MISCELLANEOUS DESIGN**. POWERSURGE TECHNOLOGIES, INC., (U.S. CLS. 100 AND 101). SN 76-975,512. PUB. 7-16-2002. FILED 7-19-2000.
 2,747,056 (*See Class 9 for this trademark*).
 2,747,061. **STARWISE ASTROLOGICAL SERVICES AND DESIGN**. BYERS, STEPHEN T., (U.S. CLS. 100 AND 101). SN 78-028,864. PUB. 3-12-2002. FILED 10-3-2000.
 2,747,063 (*See Class 5 for this trademark*).
 2,747,066. **S.A.F.E.-T.2 (STYLIZED)**. CALDERIN, DIEGO F., (U.S. CLS. 100 AND 101). SN 78-035,667. PUB. 5-13-2003. FILED 11-16-2000.
 2,747,067 (*See Class 35 for this trademark*).
 2,747,073. **VDS VOCATIONAL DATA SUPPORT AND DESIGN**. RAINIER CASE MANAGEMENT, INC., (U.S. CLS.

- 100 AND 101), SN 78-043,319. PUB. 2-26-2002. FILED 1-16-2001.
- 2,747,077 (*See Class 9 for this trademark*).
- 2,747,078. **FILOMED AND DESIGN**. FILONET CORPORATION, (U.S. CLS. 100 AND 101). SN 78-060,727. PUB. 5-13-2003. FILED 4-26-2001.
- 2,747,080 (*See Class 9 for this trademark*).
- 2,747,081 (*See Class 9 for this trademark*).
- 2,747,085 (*See Class 9 for this trademark*).
- 2,747,087. **HOTEL SOURCE, INC.**, MARX, STEVEN J., (U.S. CLS. 100 AND 101). SN 78-073,466. PUB. 10-22-2002. FILED 7-11-2001.
- 2,747,094 (*See Class 41 for this trademark*).
- 2,747,097 (*See Class 30 for this trademark*).
- 2,747,105. **SPRUCE AND DESIGN**. RACHEL SIEGEL AND NATALIA REICHER PARTNERSHIP, THE, DBA SPRUCE, (U.S. CLS. 100 AND 101). SN 78-095,199. PUB. 5-13-2003. FILED 11-27-2001.
- 2,747,106. **TIDELINE DESIGNS AND DESIGN**. CHAVE, WILLIAM E., (U.S. CLS. 100 AND 101). SN 78-095,542. PUB. 5-13-2003. FILED 11-28-2001.
- 2,747,111. **ADVOCACY ANIMATION**. GIBSON, THOMAS, (U.S. CLS. 100 AND 101). SN 78-096,943. PUB. 5-13-2003. FILED 12-6-2001.
- 2,747,112. **TKE AND DESIGN**. TAU KAPPA EPSILON FRATERNITY, INC., (U.S. CLS. 100 AND 101). SN 78-098,162. PUB. 5-13-2003. FILED 12-13-2001.
- 2,747,134 (*See Class 9 for this trademark*).
- 2,747,136. **ACTIVEHEAD AND DESIGN**. ACTIVEHEAD, LLC, (U.S. CLS. 100 AND 101). SN 78-108,669. PUB. 5-13-2003. FILED 2-13-2002.
- 2,747,137 (*See Class 9 for this trademark*).
- 2,747,138. **DOCUMENT IMAGING IS FOR WORK PAPER IS FOR PLAY**. INTEGRATED DOCUMENT TECHNOLOGIES, INC., (U.S. CLS. 100 AND 101). SN 78-109,066. PUB. 5-13-2003. FILED 2-15-2002.
- 2,747,145. **LP LEGAL PEOPLE AND DESIGN**. WAY2SMART, INC., (U.S. CLS. 100 AND 101). SN 78-112,775. PUB. 5-13-2003. FILED 3-5-2002.
- 2,747,146. **SEA HORSE DESIGNS AND DESIGN**. WILLIAMS, CHRISTABEL M., (U.S. CLS. 100 AND 101). SN 78-112,853. PUB. 5-13-2003. FILED 3-5-2002.
- 2,747,158 (*See Class 40 for this trademark*).
- 2,747,167 (*See Class 16 for this trademark*).
- 2,747,188. **ENTERPRISESITE**. PRINTCAFE IP MANAGEMENT, INC., (U.S. CLS. 100 AND 101). SN 78-123,456. PUB. 5-13-2003. FILED 4-23-2002.
- 2,747,189. **SCLS**. BURKE, JEFF, (U.S. CLS. 100 AND 101). SN 78-123,650. PUB. 5-13-2003. FILED 4-24-2002.
- 2,747,219. **FINANCIAL TECHNOLOGY PARTNERS**. FINANCIAL TECHNOLOGY PARTNERS, INC., (U.S. CLS. 100 AND 101). SN 78-138,609. PUB. 5-13-2003. FILED 6-25-2002.
- 2,747,221. **LOGICIAN**. DECISION ANALYST, INC., (U.S. CLS. 100 AND 101). SN 78-139,762. PUB. 5-13-2003. FILED 6-28-2002.
- 2,747,228. **NET-INSPECT**. NET-INSPECT, LLC, (U.S. CLS. 100 AND 101). SN 78-142,813. PUB. 5-13-2003. FILED 7-10-2002.
- 2,747,308. **COMPUTER ADVOCATE**. COMPUTER ADVOCATE, INC., (U.S. CLS. 100 AND 101). SN 78-157,087. PUB. 5-13-2003. FILED 8-23-2002.
- 2,747,331. **VISUALAG**. VISUALAG, L.C., (U.S. CLS. 100 AND 101). SN 78-163,091. PUB. 5-13-2003. FILED 9-11-2002.
- 2,747,334. **ZELUS**. COMPASS GROUP USA, INC., (U.S. CLS. 100 AND 101). SN 78-163,492. PUB. 5-13-2003. FILED 9-12-2002.
- 2,747,367. **YOU'VE WORKED HARD TO BUILD YOUR NEST EGG. WE CAN HELP YOU KEEP IT ALL IN THE FAMILY.** SUELTHAUS & WALSH, P.C., (U.S. CLS. 100 AND 101). SN 78-167,459. PUB. 5-13-2003. FILED 9-24-2002.
- 2,747,368. **YOU'VE WORKED HARD TO BUILD YOUR NEST EGG. WE CAN HELP YOU PRESERVE IT.** SUELTHAUS & WALSH, P.C., (U.S. CLS. 100 AND 101). SN 78-167,472. PUB. 5-13-2003. FILED 9-24-2002.
- 2,747,369. **YOU'VE WORKED HARD TO BUILD YOUR NEST EGG. WE CAN HELP YOU PASS IT ON.** SUELTHAUS & WALSH, P.C., (U.S. CLS. 100 AND 101). SN 78-167,477. PUB. 5-13-2003. FILED 9-24-2002.
- 2,747,381. **LOANVIEW**. LEND LEASE REAL ESTATE INVESTMENTS, INC., (U.S. CLS. 100 AND 101). SN 78-168,505. PUB. 5-13-2003. FILED 9-27-2002.
- 2,747,395. **PIXEL MOUNTAIN**. ROBBINS, RACHEL, M., (U.S. CLS. 100 AND 101). SN 78-169,965. PUB. 5-13-2003. FILED 10-1-2002.
- 2,747,406. **MAKING NETWORKS WORK**. MELSERNET, INC., (U.S. CLS. 100 AND 101). SN 78-170,669. PUB. 5-13-2003. FILED 10-3-2002.
- 2,747,430. **EVERYTHING IT TAKES**. FRY, INC., (U.S. CLS. 100 AND 101). SN 78-172,100. PUB. 5-13-2003. FILED 10-8-2002.
- 2,747,437. **MEDIATE BEFORE YOU LITIGATE**. HUGHES, JOHN W., (U.S. CLS. 100 AND 101). SN 78-172,490. PUB. 5-13-2003. FILED 10-9-2002.

CLASS 43—HOTEL AND RESTAURANT SERVICES

- 2,746,040 (*See Class 32 for this trademark*).
- 2,746,233. **WILD WILLY'S BURGERS**. WILD WILLY'S BURGERS, INC., (U.S. CLS. 100 AND 101). SN 76-349,930. PUB. 5-13-2003. FILED 12-7-2001.
- 2,746,258. **ESTUDIO GIGANTE**. RESTORAN ESTUDIO GIGANTE S.A., (U.S. CLS. 100 AND 101). SN 76-357,744. PUB. 4-22-2003. FILED 1-10-2002.
- 2,746,332. **SUMMERWOOD AND DESIGN**. EXCEL WORLD, INC., (U.S. CLS. 100 AND 101). SN 76-376,260. PUB. 10-8-2002. FILED 2-28-2002.
- 2,746,386 (*See Class 39 for this trademark*).
- 2,746,387 (*See Class 39 for this trademark*).
- 2,746,412. **CATFISH COVE**. CATFISH COVE OF FORT SMITH, INC., (U.S. CLS. 100 AND 101). SN 76-390,726. PUB. 5-13-2003. FILED 4-1-2002.
- 2,746,430 (*See Class 41 for this trademark*).
- 2,746,451. **ORPHAN GRAIN TRAIN**. ORPHAN GRAIN TRAIN, INC., MULTIPLE CLASS, (INT. CLS. 43, 44 AND 45), (U.S. CLS. 100 AND 101). SN 76-395,671. PUB. 5-13-2003. FILED 4-15-2002.
- 2,746,545 (*See Class 39 for this trademark*).
- 2,746,548. **FANTASY MARKET BUFFET ALL YOU CAN EAT! AND DESIGN**. FIESTA PALMS, LLC, (U.S. CLS. 100 AND 101). SN 76-408,999. PUB. 5-13-2003. FILED 5-16-2002.
- 2,746,594. **TERRA GRILLE AND DESIGN**. ENVIRONMENTAL FOOD GROUP, INC., (U.S. CLS. 100 AND 101). SN 76-418,356. PUB. 5-13-2003. FILED 6-7-2002.
- 2,746,616 (*See Class 35 for this trademark*).
- 2,746,640. **WAWONA AND DESIGN**. YOSEMITE CONCESSION SERVICES CORPORATION, (U.S. CLS. 100 AND 101). SN 76-425,976. PUB. 5-13-2003. FILED 6-28-2002.
- 2,746,698. **FIND YOUR SWEET SPOT**. STARWOOD HOTELS & RESORTS WORLDWIDE, INC., (U.S. CLS. 100 AND 101). SN 76-439,884. PUB. 5-13-2003. FILED 8-13-2002.
- 2,746,734. **AMERICAN GIRL CAFE**. PLEASANT COMPANY, (U.S. CLS. 100 AND 101). SN 76-444,318. PUB. 5-13-2003. FILED 8-23-2002.
- 2,746,775. **GH GUESTHOUSE INTERNATIONAL AND DESIGN**. GUESTHOUSE INTERNATIONAL FRANCHISE SYSTEMS, INC., (U.S. CLS. 100 AND 101). SN 76-447,955. PUB. 5-13-2003. FILED 9-9-2002.
- 2,746,778. **MADRAS PALACE AND DESIGN**. KUNCHI, SAHADEVAN, (U.S. CLS. 100 AND 101). SN 76-448,107. PUB. 5-13-2003. FILED 9-9-2002.
- 2,746,789. **KIT'S BIRTHDAY TEA**. PLEASANT COMPANY, (U.S. CLS. 100 AND 101). SN 76-449,027. PUB. 5-13-2003. FILED 9-13-2002.
- 2,746,818. **CLICK 6 AND DESIGN**. SOCIETE DE PARTICIPATIONS ET D'INVESTISSEMENTS DE MOTELS, (U.S. CLS. 100 AND 101). SN 76-451,130. PUB. 5-13-2003. FILED 9-19-2002.
- 2,746,866. **FIRST SLICE**. DIAZ, MARY ELLEN, (U.S. CLS. 100 AND 101). SN 76-453,694. PUB. 5-13-2003. FILED 9-30-2002.
- 2,747,006. **BANNA STROW'S**. BANNASTROW'S LLC, (U.S. CLS. 100 AND 101). SN 76-462,017. PUB. 5-13-2003. FILED 10-24-2002.
- 2,747,011. **COMPASS GROUP**. COMPASS GROUP PLC, (U.S. CLS. 100 AND 101). SN 76-462,685. PUB. 5-13-2003. FILED 10-29-2002.

2,747,184 (*See Class 35 for this trademark*).
 2,747,194. **TASTES LIKE MAMA'S**. WOLFE, SCOTT, AND WOLFE, JANE, (U.S. CLS. 100 AND 101). SN 78-126,197. PUB. 5-13-2003. FILED 5-3-2002.
 2,747,229. **INNO**. HOLLY, CATHERINE LOCKE, (U.S. CLS. 100 AND 101). SN 78-143,764. PUB. 5-13-2003. FILED 7-15-2002.
 2,747,241. **THE PIZZA RANCH HOME OF THE PIZZA LOVER'S PIZZA AND DESIGN**. PIZZA RANCH, INC., (U.S. CLS. 100 AND 101). SN 78-146,942. PUB. 5-13-2003. FILED 7-24-2002.
 2,747,245. **NO PIZZA BEATS PETE'S PIZZA**. PETE'S PIZZA, INC., (U.S. CLS. 100 AND 101). SN 78-147,644. PUB. 5-13-2003. FILED 7-25-2002.
 2,747,304. **MISCELLANEOUS DESIGN**. CHIPOTLE MEXICAN GRILL, INC., (U.S. CLS. 100 AND 101). SN 78-155,928. PUB. 5-13-2003. FILED 8-20-2002.
 2,747,332. **BROILERMAKERS**. FAST FEEDERS, INC., (U.S. CLS. 100 AND 101). SN 78-163,366. PUB. 5-13-2003. FILED 9-12-2002.
 2,747,373. **ROOM AND DESIGN**. GOLDSTEIN, JEFFREY, (U.S. CLS. 100 AND 101). SN 78-167,980. PUB. 5-13-2003. FILED 9-25-2002.
 2,747,380. **KEUNGAMA KOREAN RESTAURANT**. JAE IL CO., DBA KEUNGAMA KOREAN RESTAURANT, (U.S. CLS. 100 AND 101). SN 78-168,378. PUB. 5-13-2003. FILED 9-26-2002.

CLASS 44—MEDICAL, BEAUTY AND AGRICULTURAL SERVICES

2,745,856. **THE INSTITUTE FOR COUNSELING ADVANCEMENT AND PERSONAL GROWTH AND DESIGN**. AMOS-WILLIAMS, JEAN, (U.S. CLS. 100 AND 101). SN 76-197,572. PUB. 5-13-2003. FILED 1-23-2001.
 2,746,184. **MEDIFAX PC+**. MEDIFAX-EDI, INC., (U.S. CLS. 100 AND 101). SN 76-337,383. PUB. 12-10-2002. FILED 11-13-2001.
 2,746,306 (*See Class 35 for this trademark*).
 2,746,310 (*See Class 36 for this trademark*).
 2,746,311 (*See Class 36 for this trademark*).
 2,746,369. **AGE-E.R.A.S.E.**. Y-BEAM TECHNOLOGIES, INC., (U.S. CLS. 100 AND 101). SN 76-383,780. PUB. 5-13-2003. FILED 3-15-2002.
 2,746,451 (*See Class 43 for this trademark*).
 2,746,482 (*See Class 37 for this trademark*).
 2,746,571. **ORGANICS PLUS**. NUTRILAWN INC., (U.S. CLS. 100 AND 101). SN 76-412,562. PUB. 5-13-2003. FILED 5-24-2002.
 2,746,689. **BACK ON COURSE**. ONSLOW COUNTY HOSPITAL AUTHORITY, (U.S. CLS. 100 AND 101). SN 76-437,610. PUB. 5-13-2003. FILED 8-5-2002.
 2,746,710. **WINGS AND DESIGN**. BJC HEALTH CARE, (U.S. CLS. 100 AND 101). SN 76-441,330. PUB. 5-13-2003. FILED 8-19-2002.
 2,746,751. **DESIGNING EDEN**. SCHIPUL, RICHARD WAKEMAN, (U.S. CLS. 100 AND 101). SN 76-445,190. PUB. 5-13-2003. FILED 8-29-2002.
 2,746,832 (*See Class 3 for this trademark*).
 2,746,851. **SAMY**. SAMY MARK, INC., (U.S. CLS. 100 AND 101). SN 76-453,082. PUB. 5-13-2003. FILED 9-26-2002.
 2,746,852. **SMOOTHKIN AND DESIGN**. SMOOTHKIN, INC., (U.S. CLS. 100 AND 101). SN 76-453,151. PUB. 5-13-2003. FILED 9-26-2002.
 2,746,858. **HEAVENLY HOUNDS**. PERKINS, NORALEE A., DBA HEAVENLY HOUNDS, (U.S. CLS. 100 AND 101). SN 76-453,321. PUB. 5-13-2003. FILED 9-26-2002.
 2,746,861. **TEAMSTAR RX**. UNITED AMERICAN INSURANCE COMPANY, (U.S. CLS. 100 AND 101). SN 76-453,399. PUB. 5-13-2003. FILED 9-27-2002.
 2,746,883. **PLAISIR DES SENS**. MUTALER, INC., (U.S. CLS. 100 AND 101). SN 76-454,458. PUB. 5-13-2003. FILED 9-26-2002.
 2,746,902. **BARBARA MINKOWITZ, MD, PC PEDIATRIC ORTHOPAEDIC SURGEON BY APPOINTMENT ONLY 1800 CLOVE ROAD STATEN ISLAND, NY 10304 TEL.718-**

815-0011 FAX.718-815-0010 AND DESIGN. MINKOWITZ, BARBARA, (U.S. CLS. 100 AND 101). SN 76-455,550. PUB. 5-13-2003. FILED 10-3-2002.
 2,746,908. **YOUR PARTNER IN THERAPY**. HEALTHCARE THERAPY SERVICES, INC., (U.S. CLS. 100 AND 101). SN 76-455,859. PUB. 5-13-2003. FILED 10-4-2002.
 2,746,987. **MISCELLANEOUS DESIGN**. ALEMIS, ALEXANDER G., (U.S. CLS. 100 AND 101). SN 76-460,847. PUB. 5-13-2003. FILED 10-22-2002.
 2,746,989. **MISCELLANEOUS DESIGN**. BAYRON, HARRY, AND BAYRON, SARA, (U.S. CLS. 100 AND 101). SN 76-460,938. PUB. 5-13-2003. FILED 10-21-2002.
 2,747,001. **GOLDEN PROPORTION DENTISTRY**. ODOMO, WATARU, (U.S. CLS. 100 AND 101). SN 76-461,858. PUB. 5-13-2003. FILED 10-28-2002.
 2,747,038. **ARBORSCAPES**. CATES, JASON, (U.S. CLS. 100 AND 101). SN 76-466,147. PUB. 5-13-2003. FILED 11-12-2002.
 2,747,122. **CALIFORNIA ORTHOPEDIC AND SPORTS THERAPY**. CALIFORNIA ORTHOPEDIC AND SPORTS THERAPY REHABILITATION SERVICES, INC., (U.S. CLS. 100 AND 101). SN 78-104,461. PUB. 5-13-2003. FILED 1-24-2002.
 2,747,137 (*See Class 9 for this trademark*).
 2,747,165. **I'M AMAZING!**. CARESTAF OF OKLAHOMA, INC., (U.S. CLS. 100 AND 101). SN 78-118,352. PUB. 5-13-2003. FILED 3-29-2002.
 2,747,204. **SBMC AND DESIGN**. LONGEVITY RESEARCH, INC., (U.S. CLS. 100 AND 101). SN 78-129,187. PUB. 5-13-2003. FILED 5-16-2002.
 2,747,312. **ACROCARE INITIATIVE**. NOVARTIS AG, (U.S. CLS. 100 AND 101). SN 78-159,032. PUB. 5-13-2003. FILED 8-29-2002.
 2,747,345 (*See Class 41 for this trademark*).

CLASS 45—PERSONAL SERVICES

2,745,871 (*See Class 35 for this trademark*).
 2,746,150 (*See Class 9 for this trademark*).
 2,746,377. **APA**. APA OF MADISON, INC., (U.S. CLS. 100 AND 101). SN 76-385,092. PUB. 5-13-2003. FILED 3-21-2002.
 2,746,403. **QUALYSGUARD**. QUALYS, INC., (U.S. CLS. 100 AND 101). SN 76-388,733. PUB. 5-13-2003. FILED 3-29-2002.
 2,746,419. **LIFE COPING INC.**. LIFE COPING, INC., (U.S. CLS. 100 AND 101). SN 76-392,095. PUB. 5-13-2003. FILED 4-8-2002.
 2,746,451 (*See Class 43 for this trademark*).
 2,746,525. **SINGLES IN AGRICULTURE**. SINGLES IN AGRICULTURE, INC., (U.S. CLS. 100 AND 101). SN 76-406,441. PUB. 5-13-2003. FILED 5-13-2002.
 2,746,659 (*See Class 37 for this trademark*).
 2,746,660 (*See Class 37 for this trademark*).
 2,746,730 (*See Class 37 for this trademark*).
 2,746,809. **TOGETHER**. TOGETHER MANAGEMENT GROUP, INC., (U.S. CLS. 100 AND 101). SN 76-450,307. PUB. 5-13-2003. FILED 9-17-2002.
 2,746,826. **SHIELD CLICKCARE**. SHIELD-CALIFORNIA HEALTH CARE CENTER, INC., (U.S. CLS. 100 AND 101). SN 76-451,894. PUB. 5-13-2003. FILED 9-23-2002.
 2,746,881. **RISE UP AMERICA FROM TRAGEDY TO TRIUMPH**. SCARLET CIRCLE MINISTRIES, (U.S. CLS. 100 AND 101). SN 76-454,413. PUB. 5-13-2003. FILED 9-23-2002.
 2,746,901. **MISCELLANEOUS DESIGN**. NOBLE GRACE LLC, (U.S. CLS. 100 AND 101). SN 76-455,526. PUB. 5-13-2003. FILED 9-30-2002.
 2,747,199. **THE ORGANIZING JEANNIE AND DESIGN**. CLEARY, JEANNIE, M., (U.S. CLS. 100 AND 101). SN 78-127,415. PUB. 5-13-2003. FILED 5-9-2002.

* * * * *

SECTION 2.—PRIOR UNITED STATES CLASSIFICATION

COLLECTIVE MEMBERSHIP MARKS

CLASS 200—COLLECTIVE MEMBERSHIP

2,745,887. **U.S. SNOWBOARD TEAM.** UNITED STATES SKI ASSOCIATION, DBA UNITED STATES SKI & SNOWBOARD ASSOCIATION, SN 76-216,177. PUB. 5-13-2003. FILED 2-26-2001.

2,746,718. **LATINO PEACE OFFICERS ASSOCIATION.** NATIONAL LATINO PEACE OFFICERS ASSOCIATION, SN 76-441,891. PUB. 5-13-2003. FILED 8-14-2002.

2,746,759. **SIGMA ALPHA IOTA.** SIGMA ALPHA IOTA -

INTERNATIONAL MUSIC FRATERNITY, SN 76-446,194. PUB. 5-13-2003. FILED 8-30-2002.

CERTIFICATION MARKS

CLASS A—GOODS

2,745,886. **HALLMARK.** WINDOW & DOOR MANUFACTURERS ASSOCIATION, SN 76-215,956. PUB. 5-13-2003. FILED 2-23-2001.

* * * * *

TRADEMARK REGISTRATIONS ISSUED UNDER SECTION 1(d)

The following marks have registered on the Principal Register pursuant to the intent-to-use provisions of Section 1(d) of the Trademark Act of 1946, as amended.

SECTION 1.— INTERNATIONAL CLASSIFICATION

The short titles associated below with the international class numbers are terms designed merely for quick identification and are not an official part of the international classification. The full names of international classes are given in section 6.1 of the trademark rules of practice.

The designation "U.S. Cl." appearing in this section refers to the U.S. class in effect prior to Sep. 1, 1973 rather than the international class which applies to applications filed on or after that date. For adoption of international classification see notice in the OFFICIAL GAZETTE of Jun. 26, 1973 (911 O.G. TM 210).

Application in more than one class

2,747,458. CAMOUFLAGE ASSOCIATES, NEW YORK, NY.
SN 75-041,812. PUB. 8-1-2000, FILED 1-11-1996.

2,747,475. CURL CORPORATION, CAMBRIDGE, MA. SN 75-
487,363. PUB. 12-21-1999, FILED 5-18-1998.

SPIN

OWNER OF U.S. REG. NO. 1,351,650.

CLASS 9—ELECTRICAL AND SCIENTIFIC APPARATUS

FOR CD-ROMS FEATURING MUSIC, ENTERTAINMENT, AND DOCUMENTARIES; MUSICAL SOUND RECORDINGS; VIDEO RECORDINGS FEATURING MUSIC AND ENTERTAINMENT (U.S. CLS. 21, 23, 26, 36 AND 38).

FIRST USE 11-0-2001; IN COMMERCE 11-0-2001.

CLASS 41—EDUCATION AND ENTERTAINMENT

FOR TELEVISION AND RADIO PROGRAMMING SERVICES; ON-LINE INFORMATION SERVICES, NAMELY, PROVIDING INFORMATION BY MEANS OF A GLOBAL COMPUTER NETWORK IN THE FIELDS OF MUSIC AND ENTERTAINMENT; PROVIDING ACCESS TO SOUND FILES BY MEANS OF A GLOBAL COMPUTER NETWORK (U.S. CLS. 100, 101 AND 107).

FIRST USE 12-0-1994; IN COMMERCE 12-0-1994.

CLASS 42—SCIENTIFIC, COMPUTER AND LEGAL SERVICES

FOR ON-LINE INFORMATION SERVICES, NAMELY, PROVIDING INFORMATION BY MEANS OF A GLOBAL COMPUTER NETWORK ON GENERAL INTEREST TOPICS (U.S. CLS. 100 AND 101).

FIRST USE 12-0-1994; IN COMMERCE 12-0-1994.

CURL

CLASS 9—ELECTRICAL AND SCIENTIFIC APPARATUS

FOR COMPUTER SOFTWARE FOR SOFTWARE DEVELOPMENT, FOR DEVELOPING, COMPILING OR DEBUGGING OTHER SOFTWARE, FOR THE DEPLOYMENT OR UTILIZATION OF ELECTRONIC COMMUNICATIONS NETWORKS, OR FOR DELIVERY OF CONTENT BY MEANS OF ELECTRONIC COMMUNICATIONS NETWORKS; COMPUTER HARDWARE (U.S. CLS. 21, 23, 26, 36 AND 38).

FIRST USE 12-29-1999; IN COMMERCE 12-29-1999.

CLASS 42—SCIENTIFIC, COMPUTER AND LEGAL SERVICES

FOR COMPUTER SOFTWARE DESIGN AND DEVELOPMENT SERVICES (U.S. CLS. 100 AND 101).

FIRST USE 5-31-2002; IN COMMERCE 7-15-2002.

2,747,479. BARR SYSTEMS, INC., GAINESVILLE, FL. SN 75-
500,538. PUB. 12-21-1999, FILED 6-11-1998.

BARR ENTERPRISE MODEL

OWNER OF U.S. REG. NO. 1,780,103.

NO CLAIM IS MADE TO THE EXCLUSIVE RIGHT TO USE "ENTERPRISE MODEL", APART FROM THE MARK AS SHOWN.

SEC. 2(F) AS TO "BARR".

CLASS 9—ELECTRICAL AND SCIENTIFIC APPARATUS

FOR DOCUMENT MANAGEMENT SYSTEM SOFTWARE (U.S. CLS. 21, 23, 26, 36 AND 38).

FIRST USE 3-11-2002; IN COMMERCE 6-3-2002.

CLASS 16—PAPER GOODS AND PRINTED MATTER

FOR PUBLICATIONS RELATING TO DOCUMENT MANAGEMENT SYSTEMS (U.S. CLS. 2, 5, 22, 23, 29, 37, 38 AND 50).

FIRST USE 3-11-2002; IN COMMERCE 6-3-2002.

2,747,480. AGAINST THE GRAIN PRODUCTIONS, INC., WESTPORT, CT. SN 75-501,201. PUB. 6-8-1999, FILED 6-12-1998.

Against The Grain Productions

NO CLAIM IS MADE TO THE EXCLUSIVE RIGHT TO USE "PRODUCTIONS", APART FROM THE MARK AS SHOWN.

CLASS 9—ELECTRICAL AND SCIENTIFIC APPARATUS

FOR AUDIO RECORDINGS CONTAINING MUSIC (U.S. CLS. 21, 23, 26, 36 AND 38).

FIRST USE 7-0-2001; IN COMMERCE 7-0-2001.

CLASS 41—EDUCATION AND ENTERTAINMENT

FOR PRODUCTION SERVICES, NAMELY, PRODUCING AUDIO RECORDINGS OF LIVE PERFORMANCES, FEATURING, CONCERTS AND DRAMATIC READINGS CONTAINING MUSIC, AND PRODUCING LIVE CONCERTS AND DRAMATIC READINGS CONTAINING MUSIC (U.S. CLS. 100, 101 AND 107).

FIRST USE 9-22-2001; IN COMMERCE 9-22-2001.

2,747,490. INTERNATIONAL DATA GROUP, INC., FRAMINGHAM, MA. SN 75-522,539. PUB. 12-28-1999, FILED 7-20-1998.

JOBWORLD**CLASS 16—PAPER GOODS AND PRINTED MATTER**

FOR PRINTED PUBLICATIONS, NAMELY, NEWSLETTERS, MAGAZINES AND SUPPLEMENTS THERE-TO, JOURNALS, NEWSPAPERS AND BOOKS IN THE FIELD OF COMPUTERS, COMPUTER SOFTWARE, HIGH TECHNOLOGY, COMMUNICATIONS, INFORMATION TECHNOLOGY AND INFORMATION SERVICES (U.S. CLS. 2, 5, 22, 23, 29, 37, 38 AND 50).

FIRST USE 5-0-2000; IN COMMERCE 5-0-2000.

CLASS 42—SCIENTIFIC, COMPUTER AND LEGAL SERVICES

FOR PROVIDING WEBSITES OF INFORMATION IN THE FIELD OF COMPUTERS, COMPUTER SOFTWARE, HIGH TECHNOLOGY, COMMUNICATIONS, INFORMATION TECHNOLOGY AND INFORMATION SERVICES; AND COMPUTER ONLINE PUBLICATIONS, NAMELY NEWSLETTERS, MAGAZINES JOURNALS, NEWSPAPERS AND BOOKS IN THE FIELD OF COMPUTERS, COMPUTER SOFTWARE, HIGH TECHNOLOGY, COMMUNICATIONS, INFORMATION TECHNOLOGY AND INFORMATION SERVICES (U.S. CLS. 100 AND 101).

FIRST USE 11-30-2001; IN COMMERCE 11-30-2001.

2,747,521. STUDY GROUP INTERNATIONAL LIMITED, EAST SUSSEX, UNITED KINGDOM, BY ASSIGNMENT CENTER FOR ENGLISH STUDIES, INC., THE FORT LAUDERDALE, FL. SN 75-610,651. PUB. 5-29-2001, FILED 12-22-1998.

EMBASSY CES**CLASS 41—EDUCATION AND ENTERTAINMENT**

FOR EDUCATIONAL SERVICES IN THE NATURE OF COURSES TEACHING ENGLISH AS A SECOND LANGUAGE (U.S. CLS. 100, 101 AND 107).

FIRST USE 8-3-1998; IN COMMERCE 1-1-1999.

CLASS 42—SCIENTIFIC, COMPUTER AND LEGAL SERVICES

FOR ARRANGING FOR TEMPORARY HOUSING ACCOMMODATION FOR STUDENTS (U.S. CLS. 100 AND 101).

FIRST USE 8-3-1998; IN COMMERCE 1-1-1999.

2,747,526. UNO DOS TRES.COM INC., COCONUT GROVE, FL. SN 75-624,018. PUB. 6-26-2001, FILED 1-21-1999.

UNODOSTRES.COM

THE ENGLISH EQUIVALENT OF THE MARK "UNODOSTRES.COM" IS "ONETWOTHREE.COM"

CLASS 35—ADVERTISING AND BUSINESS

FOR PROVIDING SELECT DIRECTORY LISTINGS OF OTHER ELECTRONIC INFORMATION PROVIDERS CATERING TO THE HISPANIC COMMUNITY (U.S. CLS. 100, 101 AND 102).

FIRST USE 8-14-1999; IN COMMERCE 8-14-1999.

CLASS 42—SCIENTIFIC, COMPUTER AND LEGAL SERVICES

FOR ON-LINE ELECTRONIC INFORMATION SERVICE PROVIDED BY MEANS OF A GLOBAL COMPUTER INFORMATION NETWORK FOR THE HISPANIC COMMUNITY FEATURING INTERACTIVE NEWS, WEATHER, SPORTS, ENTERTAINMENT, FASHION, SHOPPING, TRAVEL, COMMUNITY AND FAMILY AFFAIRS AND LIFESTYLES (U.S. CLS. 100 AND 101).

FIRST USE 8-14-1999; IN COMMERCE 8-14-1999.

2,747,528. COGNIS DEUTSCHLAND GMBH, D-40191 DUESSELDORF, FED REP GERMANY, BY ASSIGNMENT HENKEL KOMMANDITGESELLSCHAFT AUF AKTIEN, D-40191 DUESSELDORF, FED REP GERMANY. SN 75-635,363. PUB. 9-12-2000, FILED 2-5-1999.

COGNIS

OWNER OF U.S. REG. NOS. 1,753,044 AND 1,966,934.

CLASS 1—CHEMICALS

FOR HOUSEMARK FOR A FULL LINE OF CHEMICALS FOR USE IN A VARIETY OF INDUSTRIES, INCLUDING BUT NOT LIMITED TO, THE DETERGENT, CLEANER, COSMETIC, PERSONAL CARE, PHARMACEUTICAL, NUTRITION AND HEALTH, TEXTILE, PAINTS, COATINGS, PLASTICS, LUBRICANTS AND AGRICULTURAL INDUSTRIES (U.S. CLS. 1, 5, 6, 10, 26 AND 46).

FIRST USE 1-1-2000; IN COMMERCE 1-1-2000.

CLASS 4—LUBRICANTS AND FUELS

FOR HOUSEMARK FOR A FULL LINE OF LUBRICANTS FOR USE IN VEHICLES, ENGINES, TRANSMISSIONS, INDUSTRIAL MACHINERY AND EQUIPMENT, REFRIGERATION AND AIR CONDITIONING SYSTEMS, AND FOR GENERAL INDUSTRIAL LUBRICANTS (U.S. CLS. 1, 6 AND 15).

FIRST USE 1-1-2000; IN COMMERCE 1-1-2000.

CLASS 5—PHARMACEUTICALS

FOR VITAMINS AND NUTRITIONAL SUPPLEMENTS (U.S. CLS. 6, 18, 44, 46, 51 AND 52).

FIRST USE 12-31-1998; IN COMMERCE 12-31-1998.

CLASS 42—SCIENTIFIC, COMPUTER AND LEGAL SERVICES

FOR TECHNICAL CONSULTING, PRODUCT RESEARCH AND DEVELOPMENT AND PROVIDING INFORMATION FOR THE CHEMICALS INDUSTRY, ALL IN THE FIELD OF DETERGENTS, CLEANERS, COSMETICS, PERSONAL CARE, PHARMACEUTICALS, NUTRITION AND HEALTH, TEXTILES, PAINTS, COATINGS, PLASTICS, LUBRICANTS AND AGRICULTURE (U.S. CLS. 100 AND 101).

FIRST USE 12-31-2001; IN COMMERCE 12-31-2001.

2,747,530. BARBARA BRENNAN, INC., EAST HAMPTON, NY. SN 75-636,507. PUB. 11-23-1999, FILED 2-8-1999.

HEYOAN

CLASS 9—ELECTRICAL AND SCIENTIFIC APPARATUS

FOR SOUND RECORDINGS OF LECTURES IN THE FIELDS OF HEALTH, SPIRITUALISM, PHILOSOPHY, AND HUMAN POTENTIAL (U.S. CLS. 21, 23, 26, 36 AND 38).

FIRST USE 12-4-2002; IN COMMERCE 12-4-2002.

CLASS 16—PAPER GOODS AND PRINTED MATTER

FOR SERIES OF BOOKS OF POETRY AND NON-FICTION WRITINGS ON HEALTH, SPIRITUALISM, PHILOSOPHY, AND HUMAN POTENTIAL (U.S. CLS. 2, 5, 22, 23, 29, 37, 38 AND 50).

FIRST USE 12-4-2002; IN COMMERCE 12-4-2002.

2,747,533. IMAGEID LTD., TEL-AVIV 64078, ISRAEL. SN 75-642,856. PUB. 11-7-2000, FILED 2-17-1999.

IMAGEID

CLASS 38—COMMUNICATION

FOR ELECTRONIC TRANSMISSION OF PHOTOGRAPHIC DATA; PROVIDING PHOTOGRAPHS BY MEANS OF ELECTRONIC TRANSMISSION WHICH CAN THEN BE DOWNLOADED BY RECEIVING USERS (U.S. CLS. 100, 101 AND 104).

FIRST USE 7-0-1998; IN COMMERCE 7-0-1998.

CLASS 40—MATERIAL TREATMENT

FOR ELECTRONIC SCANNING AND DIGITIZING OF PHOTOGRAPHIC IMAGES (U.S. CLS. 100, 103 AND 106).

FIRST USE 7-0-1998; IN COMMERCE 7-0-1998.

2,747,576. AERO PRODUCTS INTERNATIONAL, INC., WAUCONDA, IL, BY ASSIGNMENT IMAGINAIR, INC., WAUCONDA, IL. SN 75-722,046. PUB. 1-25-2000, FILED 6-4-1999.

**A WHOLE NEW WAY TO
THINK ABOUT AIR**

CLASS 20—FURNITURE AND ARTICLES NOT OTHERWISE CLASSIFIED

FOR INFLATABLE BEDDING, MATTRESSES, PADS AND CUSHIONS; INFLATABLE FURNITURE (U.S. CLS. 2, 13, 22, 25, 32 AND 50).

FIRST USE 8-0-2000; IN COMMERCE 8-0-2000.

CLASS 28—TOYS AND SPORTING GOODS

FOR INFLATABLE MATTRESSES, PADS, AND FLOAT MATTRESSES FOR RECREATIONAL USE; INFLATABLE SWIMMING POOLS; INFLATABLE POOLS FOR RECREATIONAL USE; INFLATABLE PLAY SWIMMING POOLS; INFLATABLE PLAY TENTS; INFLATABLE PLAY HOUSES; INFLATABLE PLAY PENS; INFLATABLE SNOW SLEDS FOR RECREATIONAL USE; INFLATABLE TOYS, BOATING TOYS, SNOW TOYS, BEACH TOYS AND RIDE-ON TOYS; INFLATABLE SUN UMBRELLAS (U.S. CLS. 22, 23, 38 AND 50).

FIRST USE 8-0-2000; IN COMMERCE 8-0-2000.

2,747,582. EDLIFE HOLDINGS LTD., HAMILTON, BERMUDA, BY ASSIGNMENT EDLIFE, INC., STUDIO CITY, CA. SN 75-733,519. PUB. 1-11-2000, FILED 6-21-1999.

EDLIFE

CLASS 36—INSURANCE AND FINANCIAL

FOR FINANCIAL PLANNING AND FINANCIAL MANAGEMENT SERVICES DESIGNED TO PLAN FOR AND FUND THE COST OF HIGHER EDUCATION FOR CHILDREN (U.S. CLS. 100, 101 AND 102).

FIRST USE 3-7-2003; IN COMMERCE 3-7-2003.

CLASS 42—SCIENTIFIC, COMPUTER AND LEGAL SERVICES

FOR EDUCATIONAL COUNSELING SERVICES (U.S. CLS. 100 AND 101).
FIRST USE 3-7-2003; IN COMMERCE 3-7-2003.

2,747,586. LEGAL COMPUTER SOLUTIONS, INC., BOSTON, MA. SN 75-750,426. PUB. 4-3-2001, FILED 8-9-1999.

LEXTRANET**CLASS 35—ADVERTISING AND BUSINESS**

FOR NETWORK-BASED DATA PROCESSING SERVICES FOR LAW FIRMS, LEGAL DEPARTMENTS AND THEIR CLIENTS (U.S. CLS. 100, 101 AND 102).
FIRST USE 1-0-2003; IN COMMERCE 1-0-2003.

2,747,584. POLYMER TECHNOLOGY GROUP INC, THE, BERKELEY, CA. SN 75-737,138. PUB. 4-16-2002, FILED 6-25-1999.

CARBOSIL**CLASS 1—CHEMICALS**

FOR SYNTHETIC RESINS IN LIQUID OR CRUMB FORM FOR USE IN THE MANUFACTURE OF A WIDE VARIETY OF EXTRUDED, MOLDED, COATED, OR DIPPED CONFIGURED INDUSTRIAL AND MEDICAL EQUIPMENT AND PRODUCTS CONTAINING PLASTICS (U.S. CLS. 1, 5, 6, 10, 26 AND 46).
FIRST USE 10-7-1999; IN COMMERCE 10-7-1999.

CLASS 42—SCIENTIFIC, COMPUTER AND LEGAL SERVICES

FOR CONSULTING SERVICES IN THE FIELD OF LAW OFFICE AND LEGAL DEPARTMENT AUTOMATION (U.S. CLS. 100 AND 101).
FIRST USE 1-0-2003; IN COMMERCE 1-0-2003.

CLASS 17—RUBBER GOODS

FOR RESINS IN SOLID PELLET FORM FOR USE IN THE MANUFACTURE OF A WIDE VARIETY OF EXTRUDED, MOLDED, COATED, OR DIPPED, CONFIGURED INDUSTRIAL AND MEDICAL EQUIPMENT AND PRODUCTS CONTAINING PLASTICS (U.S. CLS. 1, 5, 12, 13, 35 AND 50).
FIRST USE 10-7-1999; IN COMMERCE 10-7-1999.

2,747,591. BCD HOLDINGS N.V., CURACAO, NETHERLD ANTILLES. SN 75-759,924. PUB. 7-3-2001, FILED 7-26-1999.

2,747,585. FPS FOOD PROCESSING SYSTEMS B.V., 2631 RE NOOTDORP, NETHERLANDS. SN 75-745,772. PUB. 6-20-2000, FILED 7-8-1999.

OMNIA

PRIORITY CLAIMED UNDER SEC. 44(D) ON BENELUX APPLICATION NO. 930136, FILED 1-8-1999, REG. NO. 0642345, DATED 1-8-1999, EXPIRES 1-8-2009.

CLASS 7—MACHINERY

FOR EGG SORTING MACHINES AND PARTS THEREOF (U.S. CLS. 13, 19, 21, 23, 31, 34 AND 35).
FIRST USE 7-1-1993; IN COMMERCE 6-30-1994.

OWNER OF BENELUX REG. NO. 633393, DATED 7-3-1998, EXPIRES 7-3-2008.
OWNER OF U.S. REG. NO. 1,485,472.

CLASS 9—ELECTRICAL AND SCIENTIFIC APPARATUS

FOR DEVICES FOR DETECTION OF CRACKS AND IMPURITIES IN AND ON EGGS, NAMELY, AN OPTICAL DETECTION AND SOUND UNIT CONSISTING OF COMPUTER HARDWARE, NAMELY A SORTING COMPUTER, AND SOFTWARE AND INSTRUCTIONAL MANUALS PROVIDED AS A UNIT USED TO PROCESS DATA AND DETERMINE ANY IMPURITIES AND IMPERFECTIONS IN EGGS; WEIGHTING APPARATUS, NAMELY LOAD CELL UNITS PASSED BY THE EGGS (U.S. CLS. 21, 23, 26, 36 AND 38).
FIRST USE 3-31-1995; IN COMMERCE 8-0-1995.

CLASS 16—PAPER GOODS AND PRINTED MATTER

FOR (BASED ON 44(E)) PAPER, CARDBOARD AND GOODS MADE FROM THESE MATERIALS, NAMELY, PAPER BOARDS, DRAWING PAPER BOARDS, BOND PAPER, PAPER BOXES, BUNTING PAPER, CARBON PAPER, DECORATIVE PAPER CENTERPIECES, PAPER TABLE CLOTHS, PAPER CLOTH FOR POLISHING AND CLEANING, CONSTRUCTION PAPER, PAPER CONTAINERS, COPY PAPER, CORRUGATED PAPER; PRINTED MATTER, NAMELY, GENERAL FEATURE MAGAZINES AND BOOKS, NAMELY, APPOINTMENT BOOKS, AUTOGRAPH BOOKS, BOOKKEEPING BOOKS, BUSINESS RECORD BOOKS; AND BOOKBINDING MATERIALS, NAMELY, BOOKBINDING TAPE, WIRE, AND CLOTH (U.S. CLS. 2, 5, 22, 23, 29, 37, 38 AND 50).



CLASS 36—INSURANCE AND FINANCIAL

FOR INSURANCE AND FINANCIAL AFFAIRS, NAMELY, ACCIDENT INSURANCE UNDERWRITING, INSURANCE ACTUARIAL SERVICES, INSURANCE ADMINISTRATION IN THE FIELD OF HOME, ACCIDENT, AUTOMOBILE, FIRE, FLOOD; INSURANCE AGENCIES IN THE FIELD OF HOME, ACCIDENT, AUTOMOBILE, FIRE, FLOOD; FINANCIAL SERVICES, NAMELY, FINANCIAL ANALYSIS AND CONSULTATION, FINANCIAL CLEARING HOUSES, FINANCIAL EXCHANGE, FINANCIAL FORECASTING, AND FINANCIAL GUARANTEE AND SURETY; FUNDING, NAMELY FINANCING SERVICES, AND FINANCING REAL ESTATE PROJECTS IN THE NATURE OF LAND ACQUISITION, NAMELY, REAL ESTATE BROKERAGE, REAL ESTATE INVESTMENT AND REAL ESTATE DEVELOPMENT; REAL ESTATE MANAGEMENT; REAL ESTATE APPRAISAL AND BUSINESS APPRAISAL IN THE FIELD OF MORTGAGE BANKING BROKERAGE BANKING; BROKERAGE IN THE FIELD OF BUYING AND SELLING STOCKS IN INVESTMENT FUNDS; MANAGEMENT OF INVESTMENT FUNDS (U.S. CLS. 100, 101 AND 102).

FIRST USE 0-0-1975; IN COMMERCE 0-0-1975.

CLASS 39—TRANSPORTATION AND STORAGE

FOR (BASED ON 44(E)) TRANSPORT OF GOODS AND PASSENGERS BY FERRY, BOAT, RAIL, TRUCK, BUS AND AIR; TRANSPORT OF TRAVELERS BY FERRY, BOAT, RAIL, CAR, BUS AND AIR; TRAVEL AGENCY SERVICES, NAMELY, MAKING RESERVATIONS AND BOOKINGS FOR TRANSPORTATION; ARRANGING OF TOURS AND SIGHTSEEING; VEHICLE RENTAL; AND PROVIDING INFORMATION WITH REGARD TO THE AFOREMENTIONED SERVICES (U.S. CLS. 100 AND 105).

2,747,597. GLOBAL LOGISTICS TECHNOLOGIES, INC., SHELTON, CT. SN 75-768,361. PUB. 6-20-2000, FILED 8-3-1999.

G LOG**CLASS 9—ELECTRICAL AND SCIENTIFIC APPARATUS**

FOR COMPUTER SOFTWARE FOR USE IN THE MANAGEMENT OF GLOBAL LOGISTICS AND FREIGHT TRANSPORTATION IN THE SUPPLY CHAIN (U.S. CLS. 21, 23, 26, 36 AND 38).

FIRST USE 1-26-2000; IN COMMERCE 1-26-2000.

CLASS 35—ADVERTISING AND BUSINESS

FOR BUSINESS MANAGEMENT, NAMELY MANAGING GLOBAL LOGISTICS AND MANAGING FREIGHT TRANSPORTATION IN THE SUPPLY CHAIN FOR OTHERS (U.S. CLS. 100, 101 AND 102).

FIRST USE 1-26-2000; IN COMMERCE 1-26-2000.

2,747,601. ISOLUX AMERICA CORPORATION, NAPLES, FL. SN 75-776,517. PUB. 1-9-2001, FILED 8-12-1999.

ISOLUX**CLASS 10—MEDICAL APPARATUS**

FOR MEDICAL EQUIPMENT, NAMELY, FIBER OPTIC SILICONE STERILIZABLE CABLES FOR ENDOSCOPIC USE, FIBER OPTIC SURGICAL AND DIAGNOSTIC HEADLIGHT ILLUMINATION SCOPES, FIBER OPTIC SURGICAL HEADLIGHT ILLUMINATION VIDEO/DISPLAY AND RECORDING APPARATUS, FIBER OPTIC SCOPE RETRACTOR; FIBER OPTIC SPECIALTY MEDICAL INSTRUMENTS, NAMELY, FIBER OPTIC ILLUMINATED VIDEO ASSIST RECORDING DEVICES FOR ENDOSCOPIC SURGICAL USE, LOUPES FOR MICROSURGERY AND DENTISTRY, CARDIOVASCULAR AND SAPHEOUS VEIN HARVESTING APPARATUS (U.S. CLS. 26, 39 AND 44).

FIRST USE 11-15-1998; IN COMMERCE 11-15-1998.

CLASS 11—ENVIRONMENTAL CONTROL APPARATUS

FOR FIBER OPTICAL ILLUMINATING LAMPS FEATURING HALOGEN ILLUMINATOR, XENO ILLUMINATOR AND METHOLHALIDE ILLUMINATOR (U.S. CLS. 13, 21, 23, 31 AND 34).

FIRST USE 11-15-1998; IN COMMERCE 11-15-1998.

2,747,607. UNLIMITED HOLDINGS, INC., DBA ADDED EXTRAS, INC., NEW YORK, NY. SN 75-799,839. PUB. 5-2-2000, FILED 9-15-1999.

GIRL 2 GIRL**CLASS 3—COSMETICS AND CLEANING PREPARATIONS**

FOR PERSONAL CARE PRODUCTS, NAMELY, , NAIL STENCILS, , NAIL KITS COMPRISED OF LACQUER, GLUE, GLITTER, ENAMEL AND STENCILS, SHOWER GEL, BUBBLE BATH, FRAGRANT BODY SPLASH, BODY LOTION, HAIR STYLING GEL, , PERFUME, BODY GLITTER, MASCARA, BLUSH, EYE SHADOW, LIP STICK, LIP GLOSS, , EYE CREAM, HAND, BODY AND FACE CREAM, , BATH OIL, BATH BEADS, , BODY POWDER, FACE POWDER, I, INCENSE, SACHETS, SCENTED BATH (U.S. CLS. 1, 4, 6, 50, 51 AND 52).

FIRST USE 1-31-2002; IN COMMERCE 1-31-2002.

CLASS 26—FANCY GOODS

FOR HAIR ACCESSORIES, NAMELY, ORNAMENTS, PINS, CLIPS, RIBBONS, BOWS AND PONYTAIL HOLDERS, ORNAMENTAL NOVELTY PINS, AND SHOE ORNAMENTS NOT OF PRECIOUS METAL (U.S. CLS. 37, 39, 40, 42 AND 50).

FIRST USE 1-31-2002; IN COMMERCE 1-31-2002.

2,747,610. FRIED, FRANK, HARRIS, SHRIVER & JACOBSON, WASHINGTON, DC. SN 75-804,350. PUB. 3-12-2002, FILED 9-21-1999.

21st CENTURY MONEY, BANKING & COMMERCE ALERT

OWNER OF U.S. REG. NO. 2,085,532.

NO CLAIM IS MADE TO THE EXCLUSIVE RIGHT TO

USE "MONEY, BANKING & COMMERCE", APART FROM THE MARK AS SHOWN.

2,747,641. PANDUIT CORP., TINLEY PARK, IL. SN 75-839,577. PUB. 1-8-2002, FILED 11-3-1999.

CLASS 35—ADVERTISING AND BUSINESS

FOR COMPUTER SERVICES NAMELY PROVIDING INFORMATION BY MEANS OF A GLOBAL COMPUTER NETWORK IN THE FIELD OF DEVELOPMENTS AND TRENDS IN ELECTRONIC COMMERCE AND TECHNOLOGICAL ADVANCES WITHIN THE COMMERCE FIELD (U.S. CLS. 100, 101 AND 102).

FIRST USE 11-0-1999; IN COMMERCE 11-0-1999.

CLASS 36—INSURANCE AND FINANCIAL

FOR COMPUTER SERVICES NAMELY PROVIDING INFORMATION BY MEANS OF A GLOBAL COMPUTER NETWORK IN THE FIELD OF DEVELOPMENTS AND TRENDS IN ELECTRONIC BANKING, ELECTRONIC FINANCIAL SERVICES, AND TECHNOLOGICAL ADVANCES WITHIN THE BANKING AND FINANCIAL SERVICES FIELDS (U.S. CLS. 100, 101 AND 102).

FIRST USE 11-0-1999; IN COMMERCE 11-0-1999.

CLASS 42—SCIENTIFIC, COMPUTER AND LEGAL SERVICES

FOR ON-LINE PUBLICATIONS, NAMELY PROVIDING NEWSLETTERS AND OTHER DOCUMENTS IN THE FIELDS OF DEVELOPMENTS AND TRENDS IN ELECTRONIC BANKING, ELECTRONIC FINANCIAL SERVICES, ELECTRONIC COMMERCE AND TECHNOLOGICAL ADVANCES WITHIN THE BANKING, FINANCIAL SERVICES AND COMMERCE FIELDS (U.S. CLS. 100 AND 101).

FIRST USE 11-0-1999; IN COMMERCE 11-0-1999.

2,747,628. SCAPA GROUP PLC, BLACKBURN, LANCA-SHIRE, BB2 6AY, UNITED KINGDOM. SN 75-821,946. PUB. 1-9-2001, FILED 10-13-1999.

SYBERTEX

CLASS 7—MACHINERY

FOR FILTERS BEING PARTS OF FILTRATION MACHINES, AND FILTER CLOTHS AND BELT FILTERS FOR USE IN MACHINES; FILTER PRESSES FOR EXAMPLE PLATE AND FRAME, RECESSED PLATE, MEMBRANE, MIXED PACK AND PRESSURE DISC FILTER PRESSES; BELT FILTERS SUCH AS MULTI-ROLL BELT PRESSES, GRAVITY BELT FILTERS; PRESSURE LEAF FILTERS, HORIZONTAL LEAF FILTERS, CIRCULAR LEAF FILTERS; ROTARY VACUUM DRUM FILTERS, ROTARY PRESSURE FILTERS, VACUUM DRUM FILTERS; PAN FILTERS, DISC FILTERS, VACUUM DISC FILTERS; POLISHING FILTERS; CANDLE FILTERS; TUBULAR FILTERS (U.S. CLS. 13, 19, 21, 23, 31, 34 AND 35).

FIRST USE 2-14-2000; IN COMMERCE 2-14-2000.

CLASS 24—FABRICS

FOR FABRIC FOR USE IN THE MANUFACTURE OF FILTER CLOTHS (U.S. CLS. 42 AND 50).

FIRST USE 2-14-2000; IN COMMERCE 2-14-2000.

PAN-CODE

OWNER OF U.S. REG. NO. 2,303,295.

CLASS 16—PAPER GOODS AND PRINTED MATTER

FOR LABEL PRINTING MACHINES; LABEL PRINTING MACHINE RIBBONS; PRINTED LABELS; BLANK OR PARTIALLY PRINTED LABELS; HEAT SHRINK LABELING KITS COMPRISED OF PRINTED LABELS; MARKER BOOKS; MARKER CARDS; PRE-TITLED WRITE-ON PAPER MARKERS USED FOR INDUSTRIAL AND ELECTRICAL APPLICATIONS; SLIP-ON PAPER MARKERS USED FOR IDENTIFICATION OF WIRES; AND CLIP-ON PAPER MARKERS USED FOR IDENTIFICATION OF WIRES (U.S. CLS. 2, 5, 22, 23, 29, 37, 38 AND 50).

FIRST USE 12-31-1998; IN COMMERCE 12-31-1998.

CLASS 20—FURNITURE AND ARTICLES NOT OTHERWISE CLASSIFIED

FOR PLASTIC LABELS; HEAT SHRINK LABELING KITS COMPRISED OF PLASTIC LABELS; PRE-TITLED WRITE-ON PLASTIC MARKERS USED FOR INDUSTRIAL AND ELECTRICAL APPLICATIONS; SLIP-ON PLASTIC MARKERS FOR IDENTIFICATION OF WIRES; AND CLIP-ON PLASTIC MARKERS USED FOR IDENTIFICATION OF WIRES (U.S. CLS. 2, 13, 22, 25, 32 AND 50).

FIRST USE 12-31-1998; IN COMMERCE 12-31-1998.

2,747,647. KABUSHIKI KAISHA SEGA, DBA SEGA CORPORATION, TOKYO 144-0043, JAPAN, BY CHANGE OF NAME KABUSHIKI KAISHA SEGA ENTERPRISES, DBA SEGA ENTERPRISES, LTD., TOKYO 144-0043, JAPAN. SN 75-843,489. PUB. 6-18-2002, FILED 11-8-1999.

AIR TRIX

PRIORITY CLAIMED UNDER SEC. 44(D) ON JAPAN APPLICATION NO. 11-83900, FILED 9-16-1999, REG. NO. 4418755, DATED 9-22-2000, EXPIRES 9-22-2010.

CLASS 9—ELECTRICAL AND SCIENTIFIC APPARATUS

FOR VIDEO GAME SOFTWARE; COMPUTER GAME PROGRAMS; COMPUTER GAME CARTRIDGES, DISCS AND CASSETTES; VIDEO COMPUTER GAME PROGRAMS; HOME VIDEO COMPUTER GAME CARTRIDGES, DISCS AND CASSETTES; GAME CARTRIDGES, DISCS, CASSETTES AND CIRCUIT BOARDS CONTAINING GAME PROGRAMS FOR USE WITH HAND-HELD OR ARCADE VIDEO GAME MACHINES WITH BUILT-IN SCREENS (U.S. CLS. 21, 23, 26, 36 AND 38).

FIRST USE 12-0-2000; IN COMMERCE 2-0-2001.

CLASS 28—TOYS AND SPORTING GOODS

FOR STAND ALONE VIDEO GAME MACHINES; ARCADE VIDEO GAME MACHINES WITH BUILT-IN SCREENS (U.S. CLS. 22, 23, 38 AND 50).

FIRST USE 12-0-2000; IN COMMERCE 2-0-2001.

2,747,652. RAMPART CAPITAL CORPORATION, HOUSTON, TX. SN 75-854,920. PUB. 9-3-2002, FILED 11-22-1999.



THE MARK CONSISTS OF A STYLIZED "R" CONTAINING A CASTLE OUTLINE..

CLASS 35—ADVERTISING AND BUSINESS

FOR PROVIDING FACILITIES FOR BUSINESS MEETINGS, MEETINGS, NAMELY, PROVIDE FOR OTHERS RENTAL OF MEETING ROOMS AND AUDIO EQUIPMENT USED THEREWITH FOR CONFERENCES (U.S. CLS. 100, 101 AND 102).

FIRST USE 9-20-1999; IN COMMERCE 4-10-2003.

CLASS 36—INSURANCE AND FINANCIAL

FOR FINANCIAL SERVICES, NAMELY, MEZZANINE FINANCING FOR COMPLEX REAL ESTATE PROJECTS AND RESOLUTION OF DISTRESSED DEBT INSTRUMENTS, FOR OTHERS (U.S. CLS. 100, 101 AND 102).

FIRST USE 9-20-1999; IN COMMERCE 9-20-1999.

CLASS 41—EDUCATION AND ENTERTAINMENT

FOR PROVIDE SPORTS AND ENTERTAINMENT SERVICES FOR OTHERS, NAMELY, PUBLIC GOLF COURSE FACILITY (U.S. CLS. 100, 101 AND 107).

FIRST USE 9-20-1999; IN COMMERCE 4-10-2003.

CLASS 42—SCIENTIFIC, COMPUTER AND LEGAL SERVICES

FOR RESTAURANT SERVICES, NAMELY, PROVIDE FOR OTHERS CATERING SERVICES WITH RENTAL OF MEETING AND EVENT ROOMS, SNACK BAR AND GRILL SERVICES (U.S. CLS. 100 AND 101).

FIRST USE 9-20-1999; IN COMMERCE 4-10-2003.

2,747,659. LDR INDUSTRIES, INC., CHICAGO, IL. SN 75-863,193. PUB. 6-27-2000, FILED 12-3-1999.

PERMASHINE

CLASS 11—ENVIRONMENTAL CONTROL APPARATUS

FOR PLUMBING HARDWARE AND FITTINGS NAMELY, FAUCET SETS FOR KITCHEN SINKS, LAVATORY SINKS, BATHTUBS, SHOWERS, DRINKING FOUNTAINS, AND BIDETS, SHOWER HEADS; TUB SPOUTS; SPRAY HEADS; PERSONAL SHOWERS; SHOWER ARMS; TOILET FLUSH ARMS; SINK STRAINERS; DRAINS; WATER SUPPLY LINES; FAUCET POPUPS FOR SINKS; AERATORS FOR USE WITH FAUCETS; AND VALVES ALL MADE OF PLASTIC OR OF METAL, INCLUDING BRASS WITH A PARTICULAR FINISH (U.S. CLS. 13, 21, 23, 31 AND 34).

FIRST USE 12-1-2000; IN COMMERCE 12-1-2000.

CLASS 21—HOUSEWARES AND GLASS

FOR BRASS BATHROOM ACCESSORIES WITH A PARTICULAR FINISH, NAMELY TOWEL BARS; TOWEL RINGS; TOILET PAPER HOLDERS; TISSUE PAPER DISPENSING HOLDERS; SOAP DISPENSERS; SOAP DISHES; TUMBLER HOLDERS; AND SHOWER CADDIES; STOPPERS FOR SINKS AND DRAINS; FAUCET HOLD COVERS, AND AIR GAP COVERS (U.S. CLS. 2, 13, 23, 29, 30, 33, 40 AND 50).

FIRST USE 5-23-2001; IN COMMERCE 5-23-2001.

2,747,661. WEDDINGCHANNEL.COM, INC., LOS ANGELES, CA, BY MERGER, BY CHANGE OF NAME WEDCOM, INC., LOS ANGELES, CA. SN 75-864,720. PUB. 10-23-2001, FILED 12-6-1999.

RAPID REGISTRY

NO CLAIM IS MADE TO THE EXCLUSIVE RIGHT TO USE "REGISTRY", APART FROM THE MARK AS SHOWN.

CLASS 35—ADVERTISING AND BUSINESS

FOR ONLINE GIFT REGISTRY SERVICES (U.S. CLS. 100, 101 AND 102).

FIRST USE 2-11-2000; IN COMMERCE 2-11-2000.

CLASS 42—SCIENTIFIC, COMPUTER AND LEGAL SERVICES

FOR PROVIDING INFORMATION IN THE FIELD OF WEDDING PLANNING VIA THE INTERNET (U.S. CLS. 100 AND 101).

FIRST USE 2-11-2000; IN COMMERCE 2-11-2000.

2,747,662. KEY LIME, INC., SMYRNA, GA. SN 75-866,572. PUB. 9-25-2001, FILED 12-9-1999.

KENNY'S

OWNER OF U.S. REG. NO. 1,861,873.

CLASS 29—MEATS AND PROCESSED FOODS

FOR JELLY (U.S. CL. 46).

FIRST USE 5-7-2002; IN COMMERCE 5-7-2002.

CLASS 30—STAPLE FOODS

FOR BAKERY ITEMS AND SORBET (U.S. CL. 46).

FIRST USE 8-30-1989; IN COMMERCE 1-25-1992.

2,747,663. ISU CHEMICAL CO., LTD., SEOCHO-GU, SEOUL, REPUBLIC OF KOREA. SN 75-869,422. PUB. 5-28-2002, FILED 12-9-1999.



CLASS 1—CHEMICALS

FOR ANTIFREEZE FOR USE WITH FUEL; BRANCHED ALKYL BENZENE FOR USE AS BASE OIL FOR INDUSTRIAL LUBRICANTS; HEAVY LINEAR ALKYL BENZENE FOR USE AS BASE OIL FOR SPECIALTY LUBRICANTS; NORMAL PARAFFIN FOR USE AS A CHEMICAL INTERMEDIATE FOR OILS, HYDRO-CARBON COMPOSITIONS AND BENZENE (U.S. CLS. 1, 5, 6, 10, 26 AND 46).

FIRST USE 4-2-1996; IN COMMERCE 8-10-2001.

CLASS 4—LUBRICANTS AND FUELS

FOR LUBRICANTS, NAMELY INDUSTRIAL LUBRICANTS AND INDUSTRIAL OILS, MOTORS OILS, FUEL OILS, ALL PURPOSE PENETRATING OILS, CUTTING OILS FOR METAL WORKING; INDUSTRIAL PARAFFIN OILS; GASOLINE FUEL, DIESEL FUEL, GREASES FOR MACHINES; AUTOMOBILE GREASES, GENERAL PURPOSE GREASES; GASOLINE FOR INDUSTRIAL PURPOSES; AND NON-CHEMICAL GASOLINE ADDITIVES (U.S. CLS. 1, 6 AND 15).

FIRST USE 4-2-1996; IN COMMERCE 8-10-2001.

CLASS 9—ELECTRICAL AND SCIENTIFIC APPARATUS

FOR ELECTRICAL AND ELECTRONIC APPARATUS, NAMELY, PRINTED CIRCUIT BOARD, VOLTAGE REGULATORS, ELECTRICAL TRANSFORMER, CHIP CONDENSERS; AND SOFT FERRITE CORES FOR USE IN ELECTRICAL, TRANSFORMERS AND IN ELECTRONIC EQUIPMENT (U.S. CLS. 21, 23, 26, 36 AND 38).

FIRST USE 4-1-1997; IN COMMERCE 8-10-2001.

2,747,665. BENEV COMPANY INC., LAKE FOREST, CA. BY ASSIGNMENT J.K.S.W.A. INTERNATIONAL SYSTEM, INC., COSTA MESA, CA. SN 75-871,562. PUB. 3-6-2001, FILED 12-14-1999.



CLASS 3—COSMETICS AND CLEANING PREPARATIONS

FOR SKIN MOISTURIZERS; SKIN CLEANING PREPARATIONS; AND SUN SCREEN PREPARATIONS (U.S. CLS. 1, 4, 6, 50, 51 AND 52).

FIRST USE 10-17-2001; IN COMMERCE 10-17-2001.

CLASS 5—PHARMACEUTICALS

FOR DIETARY SUPPLEMENTS (U.S. CLS. 6, 18, 44, 46, 51 AND 52).

FIRST USE 5-19-2000; IN COMMERCE 5-19-2000.

2,747,679. TEAMON.COM, INC., ISSAQUAH, WA. SN 75-890,625. PUB. 5-14-2002, FILED 1-6-2000.



CLASS 9—ELECTRICAL AND SCIENTIFIC APPARATUS

FOR COMPUTER SOFTWARE FOR ONLINE OFFICING ACTIVITIES, NAMELY, COMPUTER SOFTWARE THAT FACILITATES VIDEO CONFERENCES AND ONLINE CONFERENCES, COMPUTER SOFTWARE FOR PROVIDING ELECTRONIC MAIL AND SCHEDULING CAPABILITIES, COMPUTER SOFTWARE FOR MANAGING, VIEWING, AND EDITING FILES, DOCUMENTS, ELECTRONIC MAIL MESSAGES AND PRIVATE NETWORK AND GLOBAL COMPUTER NETWORK COMMUNICATIONS; COMPUTER SOFTWARE FOR MEETING AND EVENT SCHEDULING, MANAGING GROUP CALENDARS, TASK DELEGATION AND REPORTING, RECORDING NOTES, TRANSFERRING DATA TO AND FROM DATABASES AND TO AND FROM COMPUTER PROGRAMS AND COMPUTER FILES; ADDRESS BOOK PROGRAMS, TELEPHONE DIALING PROGRAMS, PROGRAMS FOR TALLYING VOTING RESPONSES; COMPUTER SOFTWARE THAT ALLOWS USERS TO PERFORM ELECTRONIC BUSINESS TRANSACTIONS VIA A GLOBAL COMPUTER NETWORK; COMPUTER SOFTWARE FOR CONFIRMING AUTHORIZATION TO PURCHASE GOODS AND SERVICES; COMPUTER SOFTWARE FOR MANAGEMENT OF PRODUCT INVENTORY AND SERVICE CAPABILITY; AND INSTRUCTION MANUALS THEREFOR SOLD AS A UNIT (U.S. CLS. 21, 23, 26, 36 AND 38).

FIRST USE 1-17-2000; IN COMMERCE 1-17-2000.

CLASS 38—COMMUNICATION

FOR ELECTRONIC MAIL SERVICES (U.S. CLS. 100, 101 AND 104).

FIRST USE 1-17-2000; IN COMMERCE 1-17-2000.

CLASS 42—SCIENTIFIC, COMPUTER AND LEGAL SERVICES

FOR APPLICATION SERVICE PROVIDER SERVICES FEATURING SOFTWARE FOR THE PURPOSE OF FACILITATING ELECTRONIC MAIL SERVICES; SCHEDULING TASKS; VIDEO AND ONLINE CONFERENCES; MANAGING, VIEWING, AND EDITING FILES, DOCUMENTS, AND PRIVATE NETWORK AND GLOBAL COMPUTER NETWORK COMMUNICATIONS; TASK DELEGATION AND REPORTING; MANAGING GROUP CALENDARS; MEETING AND EVENT SCHEDULING; RECORDING NOTES; TRANSFERRING DATA TO AND FROM DATABASES AND TO AND FROM COMPUTER PROGRAMS AND COMPUTER FILES; MANAGEMENT OF PRODUCT INVENTORY AND SERVICE CAPABILITY; AND WEB-BASED COMPUTER APPLICATION HOSTING FOR OTHERS VIA A GLOBAL INFORMATION NETWORK (U.S. CLS. 100 AND 101).

FIRST USE 1-17-2000; IN COMMERCE 1-17-2000.

2,747,686. SOUTHERN DREAM FOODS, INC., LOUISVILLE, KY. BY ASSIGNMENT INCLAN ENTERPRISES, INC., DBA BOURBON COUNTRY, INC., LOUISVILLE, KY. SN 75-903,026. PUB. 4-16-2002, FILED 1-26-2000.



CLASS 29—MEATS AND PROCESSED FOODS

FOR JELLIES, JAMS, FRUIT-BASED SPREADS, FRUIT PRESERVES, APPLE BUTTER, PUMPKIN BUTTER, MARMALADE, , YOGURT, PICKLES (U.S. CL. 46).

FIRST USE 2-1-2002; IN COMMERCE 2-1-2002.

CLASS 30—STAPLE FOODS

FOR SAUCES, CORN RELISH, PEPPER RELISH, CINNAMON, PANCAKE SYRUP, MUSTARD, PICKLE RELISH, MOLASSES, CHOW-CHOW RELISH, BARBECUE SAUCES, LIQUOR FLAVORED BARBECUE SAUCES (U.S. CL. 46).

FIRST USE 1-1-2001; IN COMMERCE 1-1-2001.

2,747,692. OREGON CORRECTIONS ENTERPRISES, SALEM, OR. SN 75-909,322. PUB. 6-12-2001, FILED 2-3-2000.

MADE ON THE INSIDE TO BE WORN ON THE OUTSIDE

CLASS 16—PAPER GOODS AND PRINTED MATTER

FOR BUMPER STICKERS AND STICKERS (U.S. CLS. 2, 5, 22, 23, 29, 37, 38 AND 50).

FIRST USE 5-0-1999; IN COMMERCE 5-0-1999.

CLASS 18—LEATHER GOODS

FOR BAGS, NAMELY, BOOK BAGS, DUFFEL BAGS, AND OTHER CARRYING BAGS (U.S. CLS. 1, 2, 3, 22 AND 41).

FIRST USE 5-0-1999; IN COMMERCE 5-0-1999.

CLASS 25—CLOTHING

FOR CLOTHING, NAMELY, CAPS, SHIRTS, SHORTS, JEANS, SWEATSHIRTS, T-SHIRTS, JACKETS, COATS, COVERALLS, OVERALLS, AND APRONS (U.S. CLS. 22 AND 39).

FIRST USE 5-0-2001; IN COMMERCE 5-0-2001.

2,747,702. HYPOGUARD LIMITED, WOODBRIDGE, SUFFOLK, IP12 1PE, UNITED KINGDOM. SN 75-933,038. PUB. 8-7-2001, FILED 3-2-2000.

HYPOGUARD ADVANCE

CLASS 5—PHARMACEUTICALS

FOR MEDICAL REAGENTS AND TEST STRIPS FOR USE IN MEASURING BLOOD GLUCOSE LEVELS (U.S. CLS. 6, 18, 44, 46, 51 AND 52).

FIRST USE 11-22-2002; IN COMMERCE 12-31-2002.

CLASS 10—MEDICAL APPARATUS

FOR MEDICAL DEVICES, NAMELY, DIAGNOSTIC TESTING APPARATUS FOR MEASURING BLOOD GLUCOSE LEVELS; LANCING DEVICES; LANCETS; AND PARTS AND FITTINGS FOR ALL THE AFORESAID GOODS (U.S. CLS. 26, 39 AND 44).

FIRST USE 11-22-2002; IN COMMERCE 12-31-2002.

2,747,709. LOUISVILLE LADDER GROUP LLC, LOUISVILLE, KY. SN 75-940,840. PUB. 6-4-2002, FILED 3-10-2000.

QUICKLATCH

CLASS 6—METAL GOODS

FOR METAL LADDERS AND PARTS THEREFORE, NAMELY, RUNG LOCKS, AND REPLACEMENT PARTS THEREFOR NAMELY, RUNG LOCK (U.S. CLS. 2, 12, 13, 14, 23, 25 AND 50).

FIRST USE 3-1-1999; IN COMMERCE 3-1-1999.

CLASS 20—FURNITURE AND ARTICLES NOT OTHERWISE CLASSIFIED

FOR NON-METAL LADDERS AND PARTS THEREFORE, NAMELY, RUNG LOCKS, AND REPLACEMENT PARTS THEREFORE NAMELY, RUNG LOCKS (U.S. CLS. 2, 13, 22, 25, 32 AND 50).

FIRST USE 3-1-1999; IN COMMERCE 3-1-1999.

2,747,713. ECOSMART TECHNOLOGIES, INC., FRANKLIN, TN. SN 75-981,556. PUB. 8-20-2002, FILED 8-29-2000.

BIOGANIC

CLASS 1—CHEMICALS

FOR FERTILIZERS FOR DOMESTIC AND AGRICULTURAL USE; FOOD FOR PLANTS, FLOWERS, FRUITS AND VEGETABLES; AND FERTILIZER IN THE NATURE OF A ROOT DEVELOPER FOR PLANTS AND TREES FOR DOMESTIC AND AGRICULTURAL USE (U.S. CLS. 1, 5, 6, 10, 26 AND 46).

FIRST USE 6-0-1999; IN COMMERCE 6-0-1999.

CLASS 5—PHARMACEUTICALS

FOR PESTICIDES, INSECTICIDES, HERBICIDES, AND FUNGICIDES, ALL FOR DOMESTIC AND AGRICULTURAL USE; INSECT AND PEST REPELLANTS; CHEMICAL PREPARATIONS USED TO KILL INSECTS AND EXTERNAL PARASITES FOR DOMESTIC USE; PREPARATIONS USED FOR DESTROYING VERMIN; AND INSECT AND PEST REPELLANTS IN THE NATURE OF OILS, LOTIONS AND SPRAYS (U.S. CLS. 6, 18, 44, 46, 51 AND 52).

FIRST USE 6-0-1999; IN COMMERCE 6-0-1999.

2,747,714. ECOSMART TECHNOLOGIES, INC., FRANKLIN, TN. SN 75-982,196. PUB. 8-20-2002, FILED 11-29-2000.



OWNER OF U.S. REG. NOS. 2,216,458 AND 2,362,741.
NO CLAIM IS MADE TO THE EXCLUSIVE RIGHT TO USE "SAFETY BRANDS", APART FROM THE MARK AS

SHOWN.

CLASS 1—CHEMICALS

FOR FERTILIZERS FOR DOMESTIC AND AGRICULTURAL USE; FOOD FOR PLANTS, FLOWERS, FRUITS AND VEGETABLES; AND FERTILIZER IN THE NATURE OF A ROOT DEVELOPER FOR PLANTS AND TREES FOR DOMESTIC AND AGRICULTURAL USE (U.S. CLS. 1, 5, 6, 10, 26 AND 46).

FIRST USE 6-0-2000; IN COMMERCE 6-0-2000.

CLASS 5—PHARMACEUTICALS

FOR PESTICIDES, INSECTICIDES, HERBICIDES, AND FUNGICIDES, ALL FOR DOMESTIC AND AGRICULTURAL USE; INSECT AND PEST REPELLANTS; CHEMICAL PREPARATIONS USED TO KILL INSECTS AND EXTERNAL PARASITES FOR DOMESTIC USE; PREPARATIONS USED FOR DESTROYING VERMIN; AND INSECT AND PEST REPELLANTS IN THE NATURE OF OILS, LOTIONS AND SPRAYS (U.S. CLS. 6, 18, 44, 46, 51 AND 52).

FIRST USE 6-0-2000; IN COMMERCE 6-0-2000.

CLASS 42—SCIENTIFIC, COMPUTER AND LEGAL SERVICES

FOR PROVIDING INFORMATION IN THE FIELDS OF FERTILIZER, PESTICIDES, PESTS, HERBICIDES AND AGRICULTURE; PROVIDING AN ONLINE MAGAZINE IN THE FIELDS OF FERTILIZER, PESTICIDES, PESTS, HERBICIDES AND AGRICULTURE; RESEARCH, DEVELOPMENT AND TESTING SERVICES IN THE FIELDS OF FERTILIZER, PESTICIDES, PESTS AND HERBICIDES; PROMOTING PUBLIC AWARENESS OF THE NEED FOR SAFE USE AND APPLICATION OF FERTILIZER, PESTICIDES, REPELLANTS AND HERBICIDES; AND CONSULTING IN THE FIELD OF FERTILIZER, PESTICIDES, PESTS, HERBICIDES AND AGRICULTURE (U.S. CLS. 100 AND 101).

FIRST USE 6-0-2000; IN COMMERCE 6-0-0200.

2,747,715. METZNER, JAMES G., YORKTOWN HEIGHTS, NY. SN 75-982,785. PUB. 10-23-2001, FILED 3-6-2001.

PULSE OF THE PLANET

OWNER OF U.S. REG. NO. 1,643,172.

CLASS 9—ELECTRICAL AND SCIENTIFIC APPARATUS

FOR SERIES OF COMPACT DISCS, DVDS, VIDEO TAPES, CASSETTES AND CD-ROMS FEATURING SCIENTIFIC, CULTURAL AND ENVIRONMENTAL SUBJECTS (U.S. CLS. 21, 23, 26, 36 AND 38).

FIRST USE 2-21-2002; IN COMMERCE 2-21-2002.

CLASS 16—PAPER GOODS AND PRINTED MATTER

FOR POSTERS, POSTCARDS, CALENDARS, A SERIES OF BOOKS, BOOK/CD PACKAGES AND A NEWSPAPER COLUMN FEATURING SCIENTIFIC, CULTURAL AND ENVIRONMENTAL SUBJECTS (U.S. CLS. 2, 5, 22, 23, 29, 37, 38 AND 50).

FIRST USE 10-0-1994; IN COMMERCE 10-0-1994.

CLASS 41—EDUCATION AND ENTERTAINMENT

FOR ENTERTAINMENT AND EDUCATIONAL SERVICES, NAMELY A TELEVISION SERIES AND A SERIES OF TELEVISION FEATURES OR MODULES FEATURING SCIENTIFIC, CULTURAL AND ENVIRONMENTAL ISSUES; PROVIDING EDUCATIONAL, ENVIRONMENTAL, CULTURAL AND SCIENTIFIC MATERIALS AND CONTENT VIA THE INTERNET (U.S. CLS. 100, 101 AND 107).

FIRST USE 4-13-1990; IN COMMERCE 4-13-1990.

2,747,718. LENDINGTREE, INC., CHARLOTTE, NC. SN 76-000,195. PUB. 3-6-2001, FILED 3-15-2000.

LEND-X**CLASS 9—ELECTRICAL AND SCIENTIFIC APPARATUS**

FOR COMPUTER SOFTWARE FOR USE IN THE FIELD OF MORTGAGE, CONSUMER AND BUSINESS LENDING, NAMELY COMPUTER SOFTWARE FOR USE BY LENDERS TO COLLECT AND TRANSMIT INFORMATION FROM POTENTIAL BORROWERS, SCREEN AND FILTER OUT BORROWERS WHO WOULD NOT FIT SPECIFIED CRITERIA TO OBTAIN LOANS, DECIDE WHICH BORROWERS WOULD BE ELIGIBLE TO OBTAIN LOANS AND FACILITATE THE PROCESSING OF THIS INFORMATION SO THAT BORROWERS AND LENDERS ARE MATCHED (U.S. CLS. 21, 23, 26, 36 AND 38).

FIRST USE 1-24-2000; IN COMMERCE 1-24-2000.

CLASS 36—INSURANCE AND FINANCIAL

FOR FINANCIAL SERVICES FOR LENDERS IN THE FIELD OF MORTGAGE, CONSUMER AND BUSINESS LENDING, NAMELY, COUNSELING LENDERS ON COLLECTING LENDING-RELATED INFORMATION FROM BORROWERS, SCREENING BORROWERS WHO WOULD NOT FIT CRITERIA TO OBTAIN LOANS, AND COMPLETING SUCCESSFUL TRANSACTIONS WITH BORROWERS ELIGIBLE TO OBTAIN LOANS (U.S. CLS. 100, 101 AND 102).

FIRST USE 1-24-2000; IN COMMERCE 1-24-2000.

CLASS 42—SCIENTIFIC, COMPUTER AND LEGAL SERVICES

FOR COMPUTER SERVICES FOR LENDERS IN THE FIELD OF MORTGAGE, CONSUMER AND BUSINESS LENDING, NAMELY COUNSELING LENDERS ON SELECTING, INSTALLING AND OPERATING COMPUTER SOFTWARE AND HARDWARE FOR ON-LINE LENDING SYSTEMS AND DESIGNING, CREATING, HOSTING AND MAINTAINING WEB SITES FOR ON-LINE LENDING (U.S. CLS. 100 AND 101).

FIRST USE 1-24-2000; IN COMMERCE 1-24-2000.

2,747,726. STORYDOG, INC., CHICAGO, IL. SN 76-008,101. PUB. 8-27-2002, FILED 3-23-2000.

STORYDOG**CLASS 16—PAPER GOODS AND PRINTED MATTER**

FOR PRINTED MATERIAL, NAMELY ILLUSTRATED CHILDREN'S BOOKS AND STICKERS (U.S. CLS. 2, 5, 22, 23, 29, 37, 38 AND 50).

FIRST USE 4-5-2003; IN COMMERCE 4-5-2003.

CLASS 28—TOYS AND SPORTING GOODS

FOR CHILDREN'S TOYS, NAMELY PLUSH TOYS; AND CHILDREN'S GAMES, NAMELY WORD GAMES AND SKILL GAMES (U.S. CLS. 22, 23, 38 AND 50).
FIRST USE 8-5-2001; IN COMMERCE 8-5-2001.

2,747,729. THREE DIMENSION SYSTEMS, INC., PITTSBURGH, PA. SN 76-015,427. PUB. 7-30-2002, FILED 4-3-2000.

GENTLE STEP**CLASS 10—MEDICAL APPARATUS**

FOR ORTHOPEDIC DEVICES FOR THE FOOT, NAMELY ORTHOPEDIC SOLES AND HEEL INSERTS (U.S. CLS. 26, 39 AND 44).
FIRST USE 3-10-2003; IN COMMERCE 3-10-2003.

CLASS 25—CLOTHING

FOR FOOTWEAR, NAMELY, NON-ORTHOPEDIC, CUSTOM-MADE INSOLES (U.S. CLS. 22 AND 39).
FIRST USE 5-1-2002; IN COMMERCE 5-1-2002.

2,747,738. CNET NETWORKS, INC., SAN FRANCISCO, CA. SN 76-025,638. PUB. 7-9-2002, FILED 4-14-2000.

CNET

OWNER OF U.S. REG. NOS. 1,888,794, 2,254,659, AND OTHERS.

CLASS 9—ELECTRICAL AND SCIENTIFIC APPARATUS

FOR COMPUTER HARDWARE; COMPUTER SOFTWARE, AND MANUALS SOLD AS A UNIT, FOR FACILITATING ELECTRONIC SHOPPING OR PURCHASING BY MEANS OF ELECTRONIC COMMUNICATIONS NETWORKS; COMPUTER SOFTWARE PROVIDING DATABASES OF PRODUCT OR SERVICE INFORMATION IN THE FIELDS OF COMPUTERS, COMPUTING, COMPUTER SOFTWARE, ELECTRONIC GAMING, WEBSITE DESIGN AND HOSTING, SOFTWARE APPLICATION HOSTING, HIGH TECHNOLOGY, ELECTRONIC COMMUNICATIONS, ELECTRONIC COMMERCE, CONSUMER ELECTRONICS, FINANCE OR DIGITAL TECHNOLOGIES; COMPUTER SOFTWARE FOR FACILITATING THE TRANSMISSION OF TEXT, AUDIO, VIDEO, IMAGES, COMPUTER SOFTWARE OR MULTIMEDIA DATA OVER ELECTRONIC COMMUNICATIONS NETWORKS; COMPUTER SOFTWARE FOR DESIGNING AND MANAGING COMMUNICATIONS NETWORKS (U.S. CLS. 21, 23, 26, 36 AND 38).
FIRST USE 11-24-1997; IN COMMERCE 11-24-1997.

CLASS 35—ADVERTISING AND BUSINESS

FOR BUSINESS SERVICES, NAMELY, THE PROVISION OF ONLINE TRADING, AUCTIONS, AND RETAIL AND COMPARISON SHOPPING SERVICES IN THE FIELDS OF COMPUTERS, COMPUTING, COMPUTER SOFTWARE, ELECTRONIC GAMING, HIGH TECHNOLOGY, ELECTRONIC COMMUNICATIONS, ELECTRONIC COMMERCE, CONSUMER ELECTRONICS, OR DIGITAL TECHNOLOGIES, ALL BY MEANS OF ELECTRONIC COMMUNICATIONS NETWORKS; PROVIDING CONSUMER PRODUCT AND CONSUMER SERVICE INFORMATION FOR BUSINESSES AND FOR INDIVIDUALS IN THE FIELDS OF COMPUTERS, COMPUTING, COMPUTER SOFTWARE, ELECTRONIC GAMING, WEBSITE DESIGN AND HOSTING, SOFTWARE APPLICATION HOSTING, HIGH TECHNOLOGY, CONSUMER ELECTRONICS, ELECTRONIC COMMERCE, ELECTRONIC COMMUNICATIONS OR DIGITAL TECHNOLOGIES, ALL BY MEANS OF ELECTRONIC COMMUNICATIONS NETWORKS; BUSINESS INFORMATION SERVICES IN THE FIELD OF RECENT BUSINESS DEVELOPMENTS IN MARKETING, INFORMATION TECHNOLOGY, OFFICE EQUIPMENT, CONSUMER ELECTRONICS PRODUCTS, COMPUTING, AND CORPORATE ORGANIZATION, MANAGEMENT, MERGERS AND ACQUISITIONS (U.S. CLS. 100, 101 AND 102).
FIRST USE 11-24-1997; IN COMMERCE 11-24-1997.

CLASS 36—INSURANCE AND FINANCIAL

FOR FINANCIAL INFORMATION AND RELATED SERVICES, NAMELY, PROVISION OF STOCK QUOTES, FINANCIAL ANALYSIS, FINANCIAL NEWS, FINANCIAL RESEARCH, FINANCIAL COMMENTARY, AND INTERACTIVE MESSAGE SERVICES, ALL IN THE FIELD OF FINANCE AND VIA ELECTRONIC COMMUNICATIONS NETWORKS (U.S. CLS. 100, 101 AND 102).
FIRST USE 8-2-1999; IN COMMERCE 8-2-1999.

CLASS 38—COMMUNICATION

FOR TELECOMMUNICATIONS SERVICES, NAMELY, ELECTRONIC TRANSMISSION OF TEXT, AUDIO, VIDEO, IMAGES, COMPUTER SOFTWARE AND MULTIMEDIA DATA VIA ELECTRONIC COMMUNICATIONS NETWORKS; CHAT ROOM SERVICES IN THE FIELDS OF COMPUTERS, COMPUTING, COMPUTER SOFTWARE, ELECTRONIC GAMING, WEBSITE DESIGN AND HOSTING, SOFTWARE APPLICATION HOSTING, HIGH TECHNOLOGY, ELECTRONIC COMMUNICATIONS, ELECTRONIC COMMERCE, CONSUMER ELECTRONICS, FINANCE OR DIGITAL TECHNOLOGIES (U.S. CLS. 100, 101 AND 104).
FIRST USE 6-24-1995; IN COMMERCE 6-24-1995.

CLASS 41—EDUCATION AND ENTERTAINMENT

FOR EDUCATIONAL AND ENTERTAINMENT SERVICES, NAMELY, PROVIDING RADIO AND TELEVISION PROGRAMMING, AND PROGRAMMING DELIVERED VIA ELECTRONIC COMMUNICATIONS NETWORKS, ALL IN THE FIELDS OF COMPUTERS, COMPUTING, COMPUTER SOFTWARE, ELECTRONIC GAMING, WEBSITE DESIGN AND HOSTING, SOFTWARE APPLICATION HOSTING, HIGH TECHNOLOGY, ELECTRONIC COMMUNICATIONS, ELECTRONIC COMMERCE, CONSUMER ELECTRONICS, FINANCE OR DIGITAL TECHNOLOGIES (U.S. CLS. 100, 101 AND 107).
FIRST USE 4-1-1995; IN COMMERCE 4-1-1995.

CLASS 42—SCIENTIFIC, COMPUTER AND LEGAL SERVICES

FOR PROVIDING A WIDE RANGE OF NEWS, INFORMATION, REVIEWS, COMMENTARY, COMMUNICATIONS, ENTERTAINMENT AND EDUCATIONAL CONTENT IN THE FIELDS OF COMPUTERS, COMPUTING, COMPUTER SOFTWARE, ELECTRONIC GAMING, WEBSITE DESIGN AND HOSTING, SOFTWARE APPLICATION HOSTING, HIGH TECHNOLOGY, ELECTRONIC COMMUNICATIONS, ELECTRONIC COMMERCE, CONSUMER ELECTRONICS, OR DIGITAL TECHNOLOGIES, ALL VIA ELECTRONIC COMMUNICATIONS NETWORKS; COMPUTER SERVICES, NAMELY, MAINTAINING A WEBSITE FOR THE DISSEMINATION OF DOWNLOADABLE SOFTWARE OF OTHERS IN A WIDE VARIETY OF FIELDS; COMPUTER SERVICES NAMELY PROVIDING A SEARCH ENGINE FOR USE ON ELECTRONIC COMMUNICATIONS NETWORKS (U.S. CLS. 100 AND 101).

FIRST USE 6-24-1995; IN COMMERCE 6-24-1995.

2,747,743. ENTERTAINMENT DECISIONS, INC., EVANSTON, IL. SN 76-030,914. PUB. 2-19-2002, FILED 4-19-2000.

GUIDING YOU TO GREAT CHOICES

CLASS 9—ELECTRICAL AND SCIENTIFIC APPARATUS

FOR COMPUTER HARDWARE AND SOFTWARE, NAMELY, ARTIFICIAL INTELLIGENCE PROGRAMS FOR TRANSMITTING USER-APPROPRIATE INFORMATION, TO ALLOW USERS TO CONDUCT ELECTRONIC E-COMMERCE BUSINESS TRANSACTIONS VIA A GLOBAL COMPUTER NETWORK IN THE FIELD OF CONSUMER ENTERTAINMENT, MUSIC, LITERATURE, PERIODICALS, FOOD, TRAVEL AND ART (U.S. CLS. 21, 23, 26, 36 AND 38).

FIRST USE 5-16-2002; IN COMMERCE 5-16-2002.

CLASS 41—EDUCATION AND ENTERTAINMENT

FOR ONLINE INTERACTIVE DATABASE SERVICES IN THE NATURE OF COMPILING AND PROVIDING INFORMATION FOR CONSUMERS ON CONSUMER DECISIONS IN THE FIELDS OF ENTERTAINMENT, MUSIC, LITERATURE, PERIODICALS, FOOD, TRAVEL AND ART (U.S. CLS. 100, 101 AND 107).

FIRST USE 5-16-2002; IN COMMERCE 5-16-2002.

2,747,744. PACIFIC MEDIA CENTER, INC., SANTA CLARA, CA. SN 76-031,451. PUB. 5-15-2001, FILED 4-20-2000.

AHLIFE

CLASS 9—ELECTRICAL AND SCIENTIFIC APPARATUS

FOR PRERECORDED AUDIO AND VIDEO TAPES, CD-ROM AND DVD FEATURING EDUCATIONAL, HEALTH AND LIFESTYLE SUBJECT MATTER, AND WORKBOOKS SOLD AS UNIT (U.S. CLS. 21, 23, 26, 36 AND 38).

FIRST USE 3-16-2000; IN COMMERCE 3-16-2000.

CLASS 38—COMMUNICATION

FOR AUDIO, VIDEO AND RICH MEDIA BROADCASTING VIA A GLOBAL COMPUTER NETWORK; ON-DEMAND VIDEO TRANSMISSION SERVICES (U.S. CLS. 100, 101 AND 104).

FIRST USE 3-29-2000; IN COMMERCE 3-29-2000.

CLASS 41—EDUCATION AND ENTERTAINMENT

FOR EDUCATIONAL SERVICES, NAMELY, ON-LINE WORKSHOPS IN THE FIELD OF AUDIO, VIDEO AND RICH MEDIA BROADCASTING VIA A GLOBAL COMPUTER NETWORK AND CONDUCTING WORKSHOPS AND SEMINARS IN THE FIELD OF MULTIMEDIA COMMUNICATIONS, AND THE DISTRIBUTION OF COURSE MATERIALS IN CONNECTION THEREWITH; VIDEO AND MULTIMEDIA PRODUCTION SERVICES (U.S. CLS. 100, 101 AND 107).

FIRST USE 3-28-2000; IN COMMERCE 3-28-2000.

2,747,751. AETHER SYSTEMS, INC., OWINGS MILLS, MD. SN 76-036,185. PUB. 9-3-2002, FILED 4-26-2000.

AETHER

CLASS 9—ELECTRICAL AND SCIENTIFIC APPARATUS

FOR COMPUTER AND COMMUNICATIONS SOFTWARE AND HARDWARE FOR CONNECTING WIRELESSLY MULTIPLE USERS TO PUBLIC AND PRIVATE COMPUTER INFORMATION NETWORKS FOR THE TRANSMISSION OF REAL-TIME DATA TO AND FROM SUCH NETWORKS AND WIRELESS DEVICES, NAMELY HANDHELD COMPUTERS, PERSONAL DIGITAL ASSISTANTS, MOBILE TELEPHONES, LAPTOP COMPUTERS, PAGERS; COMPUTER SOFTWARE DEVELOPMENT TOOLS (U.S. CLS. 21, 23, 26, 36 AND 38).

FIRST USE 10-15-1999; IN COMMERCE 10-15-1999.

CLASS 38—COMMUNICATION

FOR TELECOMMUNICATIONS AND WIRELESS COMMUNICATIONS SERVICES, NAMELY, PROVIDING MULTIPLE-USER WIRELESS TELECOMMUNICATIONS CONNECTIONS TO PUBLIC AND PRIVATE COMPUTER INFORMATION NETWORKS FOR THE TRANSMISSION OF REAL-TIME DATA TO AND FROM SUCH NETWORKS AND WIRELESS DEVICES, NAMELY HANDHELD COMPUTERS, PERSONAL DIGITAL ASSISTANTS, MOBILE TELEPHONES, LAPTOP COMPUTERS, PAGERS (U.S. CLS. 100, 101 AND 104).

FIRST USE 10-15-1999; IN COMMERCE 10-15-1999.

CLASS 42—SCIENTIFIC, COMPUTER AND LEGAL SERVICES

FOR ENGINEERING CONSULTING SERVICES IN THE FIELD OF COMPUTER SOFTWARE, HARDWARE AND TELECOMMUNICATIONS; CUSTOM DESIGN OF COMPUTER SOFTWARE, MIDDLEWARE AND WIRELESS DATA TRANSMISSION SOFTWARE AND SYSTEMS FOR OTHERS; CUSTOM DESIGN, DEVELOPMENT AND INTEGRATION OF WIRELESS DATA NETWORK SYSTEMS; TECHNICAL SUPPORT SERVICES, NAMELY, TROUBLESHOOTING OF WIRELESS DATA AND COMMUNICATIONS SOFTWARE AND HARDWARE PROBLEMS VIA TELEPHONE, E-MAIL, IN PERSON (U.S. CLS. 100 AND 101).

FIRST USE 10-15-1999; IN COMMERCE 10-15-1999.

2,747,755. BIO-REFERENCE LABORATORIES, INC., ELMWOOD PARK, NJ. SN 76-039,328. PUB. 6-18-2002, FILED 5-1-2000.

2,747,756. METRO ONE TELECOMMUNICATIONS, INC., BEAVERTON, OR. SN 76-040,220. PUB. 10-22-2002, FILED 5-1-2000.

CAREEVOLVE



CLASS 35—ADVERTISING AND BUSINESS

FOR BUSINESS MANAGEMENT AND CONSULTATION SERVICES FOR THE HEALTH CARE AND HEALTH CARE INSURANCE INDUSTRIES, IN THE NATURE OF TECHNICAL ASSISTANCE IN THE ESTABLISHMENT AND/OR OPERATION OF HEALTH CARE INSURANCE COMPANIES, HEALTH MAINTENANCE ORGANIZATIONS, AND HEALTH CARE PROVIDERS, HEALTH CARE UTILIZATION AND REVIEW SERVICES, MEDICAL EMPLOYMENT STAFFING SERVICES, AND ONLINE STORE SERVICES FEATURING COMPUTER EQUIPMENT, OFFICE SUPPLIES, USED MEDICAL EQUIPMENT, MEDICAL SUPPLIES, AND SOFTWARE; ARRANGING FOR DELIVERY OF GOODS AND SOFTWARE BY COMMON CARRIER TO HEALTH CARE PROVIDERS (U.S. CLS. 100, 101 AND 102).
FIRST USE 9-19-2000; IN COMMERCE 9-19-2000.

CLASS 38—COMMUNICATION

FOR BUSINESS OPERATIONAL SERVICES FOR HEALTH CARE PROVIDERS IN THE FORM OF TELECOMMUNICATIONS SERVICES, NAMELY WEBSITES FEATURING WEB MESSAGING SERVICES BETWEEN PHYSICIANS AND PATIENTS, LABORATORIES, OTHER PHYSICIANS, PAYERS AND PHARMACIES; ELECTRONIC MAIL SERVICES; ELECTRONIC DELIVERY SERVICES, NAMELY ELECTRONIC DELIVERY OF IMAGES AND PHOTOGRAPHS VIA A GLOBAL COMPUTER NETWORK AND ELECTRONIC TRANSMISSION OF DATA AND DOCUMENTS ALL IN THE NATURE OF LABORATORY TEST RESULTS, CLAIMS ELIGIBILITY DOCUMENTS, CLAIMS PROCESSING DOCUMENTS AND MEDICAL DATA (U.S. CLS. 100, 101 AND 104).
FIRST USE 9-19-2000; IN COMMERCE 9-19-2000.

CLASS 42—SCIENTIFIC, COMPUTER AND LEGAL SERVICES

FOR MANAGEMENT SERVICES FOR THE HEALTH CARE AND HEALTH CARE INSURANCE INDUSTRY IN THE NATURE OF IMMUNIZATION RECORD-KEEPING, NAMELY MAINTAINING PERSONAL IMMUNIZATION MEDICAL HISTORY, PROVIDING MEDICAL INFORMATION IN THE NATURE OF PATIENT CARE RECORDS FOR THE HEALTH CARE AND HEALTH CARE INSURANCE INDUSTRIES, PROVIDING ELECTRONIC APPOINTMENT SCHEDULER SERVICES, NAMELY, REMINDER SERVICES IN THE AREA OF UPCOMING IMPORTANT DATES AND EVENTS FOR THE HEALTH CARE AND HEALTH CARE INSURANCE INDUSTRIES (U.S. CLS. 100 AND 101).
FIRST USE 9-19-2000; IN COMMERCE 9-19-2000.

CLASS 35—ADVERTISING AND BUSINESS

FOR ORDERING SERVICES IN THE FIELD OF FLOWERS, GIFT ITEMS, AND TICKETS TO SPORTS AND ENTERTAINMENT EVENTS; BUSINESS SERVICES, NAMELY, MEETING ARRANGEMENT AND PLANNING SERVICES; AND PROVIDING TELEPHONE DIRECTORY INFORMATION (U.S. CLS. 100, 101 AND 102).

FIRST USE 8-13-2001; IN COMMERCE 8-13-2001.

CLASS 42—SCIENTIFIC, COMPUTER AND LEGAL SERVICES

FOR PROVIDING INFORMATION IN THE FIELD OF WEATHER, TOURIST ATTRACTIONS, AMUSEMENT PARKS, RESTAURANTS, HOTELS, CAMPGROUNDS, STORES, GOVERNMENTAL AGENCIES, MEDICAL SERVICES, RECREATIONAL ACTIVITIES, GOLF, SPORTS EVENTS, MOVIES, SHOWS, AND OTHER ENTERTAINMENT EVENTS; CONCIERGE SERVICES, NAMELY, MAKING ARRANGEMENTS FOR PERSONAL SERVICES SUCH AS AUTOMOBILE SERVICES, LAUNDRY SERVICES, DRY CLEANING, ALTERATIONS, SHOE SHINING, MAID SERVICE, HOUSE SITTING, CARPET CLEANING, HOUSEHOLD REPAIR AND IMPROVEMENTS, LAWN CARE, LANDSCAPING, PEST CONTROL, AND POOL MAINTENANCE, AND MAKING RESERVATIONS FOR RESTAURANTS, TEMPORARY LODGING, GOLF TEE TIMES, AND SPORTS AND ENTERTAINMENT EVENTS; AND PROVIDING SPECIAL DATE REMINDERS (U.S. CLS. 100 AND 101).
FIRST USE 8-13-2001; IN COMMERCE 8-13-2001.

2,747,757. ACELLION, INC., SAN JOSE, CA, BY ASSIGNMENT SPACEDISK PTE LTD., SINGAPORE, SINGAPORE. SN 76-042,295. PUB. 1-8-2002, FILED 5-5-2000.

GO TO THE EDGE

CLASS 38—COMMUNICATION

FOR PROVIDING MULTIPLE USER ACCESS TO A GLOBAL COMPUTER NETWORK; ELECTRONIC AND DIGITAL TRANSMISSION OF DATA, DOCUMENTS, INFORMATION, IMAGES, MESSAGES AND APPLICATIONS IN THE FORM OF TEXT (U.S. CLS. 100, 101 AND 104).
FIRST USE 1-0-2000; IN COMMERCE 1-0-2000.

CLASS 39—TRANSPORTATION AND STORAGE

FOR ELECTRONIC STORAGE OF DIGITAL DATA, DOCUMENTS, INFORMATION, IMAGES, MESSAGES AND APPLICATIONS IN THE FORM OF TEXT (U.S. CLS. 100 AND 105).
FIRST USE 1-0-2000; IN COMMERCE 1-0-2000.

CLASS 42—SCIENTIFIC, COMPUTER AND LEGAL SERVICES

FOR COMPUTER SERVICES, NAMELY, COMPUTER SYSTEMS ANALYSIS SERVICES FOR OTHERS, COMPUTER SYSTEM INTEGRATION SERVICES, CREATING COMPUTER PROGRAMS FOR OTHERS FOR DATA PROCESSING, CREATING COMPUTER PROGRAMS FOR OTHERS FOR CONVERSION OF DATA, COMPUTER APPLICATIONS HOSTING FOR OTHERS (U.S. CLS. 100 AND 101).

FIRST USE 1-0-2000; IN COMMERCE 1-0-2000.

CLASS 42—SCIENTIFIC, COMPUTER AND LEGAL SERVICES

FOR DESIGN AND DEVELOPMENT OF COMPUTER SOFTWARE FOR OTHERS; PROFESSIONAL AND TECHNICAL CONSULTING SERVICES IN RELATION TO COMPUTERS, COMPUTER SOFTWARE, DATABASES AND DATABASE MANAGEMENT, NETWORKING, PROGRAMMING AND APPLICATION DEVELOPMENT, USER INTERFACES, CLIENT/SERVER AND REMOTE COMPUTING APPLICATIONS, COMPUTER SYSTEMS OPERATIONS TOOLS AND UTILITIES, GLOBAL COMPUTER INFORMATION NETWORK, ENTERPRISE, WIDE AREA AND LOCAL AREA NETWORK ACCESS, OPERATIONS AND SYSTEMS MANAGEMENT, DEVELOPMENT TOOLS AND UTILITIES, AND MONITORING, CONTROL AND MANAGEMENT OF COMPUTER SYSTEMS; MAINTENANCE AND SUPPORT SERVICES FOR COMPUTER SOFTWARE, NAMELY TELEPHONE CONSULTATION, DEBUGGING COMPUTER SOFTWARE, UPDATING COMPUTER SOFTWARE, PROVIDING ELECTRONIC AND ON-LINE BULLETIN BOARDS AND REFERENCE INFORMATION, AND WEBSITES, ALL IN THE FIELDS OF COMPUTERS, COMPUTER SOFTWARE AND COMPUTER SYSTEMS; COMPUTER SYSTEMS AND COMPUTER SOFTWARE DEVELOPMENT CONSULTING SERVICES (U.S. CLS. 100 AND 101).

FIRST USE 9-28-1999; IN COMMERCE 3-7-1999.

2,747,762. BORLAND SOFTWARE CORPORATION, SCOTTS VALLEY, CA. SN 76-047,538. PUB. 8-27-2002, FILED 5-12-2000.

KYLIX**CLASS 9—ELECTRICAL AND SCIENTIFIC APPARATUS**

FOR COMPUTER PROGRAMS, NAMELY, COMPILERS AND ASSEMBLERS; VISUAL DEVELOPMENT SOFTWARE FOR USE IN CREATING APPLICATIONS AND OTHER PROGRAMS AND FOR DEVELOPING GRAPHICAL USER INTERFACES; E-COMMERCE PROGRAMS IN THE NATURE OF SOFTWARE FOR FACILITATING ON-LINE SHOPPING AND BUSINESS TRANSACTIONS, ORDER FULFILLMENT, CREDIT CARD AND CHARGE PROCESSING AND FINANCIAL SERVICES APPLICATIONS; GLOBAL COMPUTER NETWORK AND WEB-BASED COMPUTER PROGRAMS, APPLICATIONS COMPUTER PROGRAMS AND APPLICATION DEVELOPMENT SOFTWARE FOR USE IN DESIGNING, DEVELOPING, WRITING AND IMPLEMENTING USER-SPECIFIC APPLICATIONS AND GENERAL PURPOSE APPLICATION PROGRAMS; OBJECT-ORIENTED AND CLIENT/SERVER PROGRAMMING DEVELOPMENT SOFTWARE, TOOLS AND UTILITIES; DATABASE, DATABASE SERVER AND DATABASE MANAGEMENT SOFTWARE FOR GENERAL USE; OBJECT REQUEST BROKER (ORB) PROGRAM DEVELOPMENT SOFTWARE, TOOLS AND UTILITIES FOR USE IN WRITING AND IMPLEMENTING COMPUTER PROGRAMS USING ORB TECHNOLOGY; DEVELOPMENT SOFTWARE, TOOLS AND UTILITIES FOR USE IN DESIGNING AND IMPLEMENTING PROGRAMS FOR ACCESS TO AND FOR USE IN CONNECTION WITH LOCAL AREA NETWORKS, WIDE AREA NETWORKS, ENTERPRISE NETWORKS, LOCAL COMPUTER NETWORKS, EXTRA NETS, CORPORATE INFORMATION NETWORKS, WIDE AREA NETWORKS AND GLOBALLY INTERCONNECTED COMPUTER NETWORKS LINKED BY COMMON OR DIVERSE PROTOCOLS; PROGRAMMING SOFTWARE TOOLS FOR USE IN DEVELOPING, MAINTAINING, ENHANCING AND OPERATING COMPUTER PROGRAMS AND COMPUTER SYSTEMS; COMPUTER UTILITY PROGRAMS, AND USER MANUALS SOLD THEREWITH AS A UNIT (U.S. CLS. 21, 23, 26, 36 AND 38).

FIRST USE 9-28-1999; IN COMMERCE 3-7-2001.

2,747,764. TEAMTECHNIK MASCHINEN UND ANLAGEN GMBH, D-71691 FREIBERG, FED REP GERMANY. SN 76-050,108. PUB. 10-1-2002, FILED 5-16-2000.



PRIORITY CLAIMED UNDER SEC. 44(D) ON FED REP GERMANY APPLICATION NO. 39971838, FILED 11-16-1999, REG. NO. 39971838, DATED 1-13-2000, EXPIRES 11-30-2009.

CLASS 7—MACHINERY

FOR OIL FILLING MACHINES, SUCTION MACHINES FOR INDUSTRIAL PURPOSES; DRIVING MOTORS EXCEPT FOR LAND VEHICLES; AIR CUSHION CONVEYORS FOR MOVING LOADS; BENDING MACHINES, COMPRESSED AIR MACHINES, PACKAGING MACHINES, ELECTROMECHANICAL MACHINES FOR CHEMICAL INDUSTRY, LABELING MACHINES, MOLDING MACHINES, GUIDES FOR MACHINES, BOTTLE FILLING MACHINES; GAS VALVE HANDLING MACHINES, AUTOMATIC MANIPULATORS FOR USE IN INDUSTRIAL SETTINGS; STANDS FOR MACHINES, TABLES FOR MACHINES, AXLES FOR MACHINES, DIE-STAMPING MACHINES, MACHINE TOOLS, NAMELY, ELECTRIC POWER TOOLS, NAMELY, ELECTRIC HAMMER DRILLS, ROBOTIC MACHINES FOR INDUSTRIAL USE, CHUCKS FOR MACHINES; BELTS FOR CONVEYORS, PACKING MACHINES; MACHINES FOR ASSEMBLING WORKPIECES; FORCE-TRANSFER COUPLINGS AND ELEMENTS, NAMELY, BRAKES, NOT FOR LAND VEHICLES; ASSEMBLING DEVICES, NAMELY, ASSEMBLY SYSTEMS FOR THE ASSEMBLY OF GAS METERS; BRAKES AND BRAKE COMPONENTS, NOT FOR LAND VEHICLES; WATER PUMPS, OIL PUMPS, HYDRAULIC PUMPS, TRANSMISSION COMPONENTS, NOT FOR LAND VEHICLES, NAMELY ACTUATORS, BEARINGS AND BELTS; ELECTRIC POWER TOOLS, NAMELY HAMMER DRILLS, HOUSEHOLD APPLIANCES AND COMPONENTS, NAMELY DISH WASHERS AND CIRCULATING PUMPS FOR DISHWASHERS, VALVES AND POWER STEERING COMPONENTS, NAMELY, POWER STEERING PUMPS AND POWER STEERING GEARS; PRODUCTION, ASSEMBLY AND TESTING MACHINES IN THE AUTOMOTIVE AND AUTOMOTIVE SUPPLIER INDUSTRY, ELECTRICAL ENGINEERING INDUSTRY, MANUFACTURERS OF CONSUMER PRODUCTS INDUSTRY, FLUID TECHNOLOGY INDUSTRY, HOUSEHOLD COMPONENTS AND APPLIANCES TECHNOLOGY INDUSTRY AND MEDICAL PRODUCTS INDUSTRY; TRANSPORTING DEVICES IN THE NATURE OF CONVEYOR BELTS; VIBRATING TABLES; DRIVE MECHANISMS FOR THE CIRCULATING PATH COMMANDS FOR PALLETS, WHICH IN ADDITION CAN BE COMBINED WITH ELECTRICAL OR ELECTRONIC DEVICES; AND MACHINES FOR PROCESSING AND ASSEMBLING MECHANICAL PARTS IN MULTITUDE WORK FUNCTIONS OR AT MULTIPLE WORK STATIONS, AND APPARATUS, NAMELY, MODULAR ASSEMBLY SYSTEM, CONTAINING MODULAR TRANSPORT DEVICES WHICH CHANGE WORK STATIONS, WHEREIN THE PROCESSING OR ASSEMBLY FUNCTION IS PERFORMED IN AN AUTOMATIC OR MANUAL MANNER; AND DIAPHRAGM PUMP (U.S. CLS. 13, 19, 21, 23, 31, 34 AND 35).

FIRST USE 12-31-1978; IN COMMERCE 1-31-1998.

CLASS 9—ELECTRICAL AND SCIENTIFIC APPARATUS

FOR COMPUTERS; COMPUTER PROGRAMS FOR THE PURPOSE OF EVALUATING AUTOMATED TESTING FOR MACHINERY, RECORDED PROGRAMS FOR THE PURPOSE OF PRODUCT TRAINING; COMPUTER SOFTWARE FOR THE PURPOSE OF PERFORMING FUNCTIONAL TESTING OF MACHINERY, DATA PROCESSING APPARATUS, NAMELY, DATA PROCESSOR, MEASURING APPARATUS, NAMELY, GAS METER AND WATER METER, ELECTRICAL MEASURING APPARATUS, NAMELY, VOLTMETER, PRESSURE MEASURING APPARATUS, NAMELY, PRESSURE GAUGE, AND ELECTRICAL WELDING APPARATUS, NAMELY, ARC WELDER; HYDRAULIC CONTROLS FOR MACHINES, MOTORS AND ENGINES; PNEUMATIC CONTROLS FOR MACHINES, MOTORS AND ENGINES; CONTROL MECHANISMS FOR MACHINES, ENGINES OR MOTORS; ELECTRICAL, OPTICAL AND OTHER APPARATUSES, NAMELY, SCALES, FOR MEASURING, WEIGHING, SIGNALING, SUPERVISING AND EXAMINING; APPARATUSES, NAMELY, FUNCTIONAL AND DIMENSIONAL TEST BOOTHS, FOR INFORMATION PROCESSING AND INFORMATION MANAGEMENT; ELECTRICAL COMPONENTS, NAMELY, ELECTRIC MOTORS AND ELECTRIC GENERATORS, NOT FOR LAND VEHICLES (U.S. CLS. 21, 23, 26, 36 AND 38).

FIRST USE 12-31-1978; IN COMMERCE 1-31-1998.

CLASS 20—FURNITURE AND ARTICLES NOT OTHERWISE CLASSIFIED

FOR NON-METAL PALLETS FOR SUPPORTING WORKPIECES (U.S. CLS. 2, 13, 22, 25, 32 AND 50).

FIRST USE 12-31-1978; IN COMMERCE 1-31-1998.

CLASS 42—SCIENTIFIC, COMPUTER AND LEGAL SERVICES

FOR UPDATING COMPUTER SOFTWARE FOR OTHERS, MAINTAINING COMPUTER SOFTWARE FOR OTHERS, COMPUTER PROGRAMMING FOR OTHERS, CALIBRATING AND MEASURING PRESSURE AND TEMPERATURE, TECHNICAL RESEARCH, MECHANICAL RESEARCH, RESEARCH IN THE FIELD OF MECHANICAL ENGINEERING; CONSTRUCTION DRAFTING, CONDUCTING TECHNICAL PROJECT STUDIES IN THE FIELD OF AUTOMOTIVES AND AUTOMOTIVE SUPPLIERS, ELECTRICAL ENGINEERING, MANUFACTURERS OF CONSUMER PRODUCTS, FLUID TECHNOLOGY, HOUSEHOLD COMPONENTS AND APPLIANCES TECHNOLOGY AND MEDICAL PRODUCTS; AND QUALITY CONTROL SERVICES FOR OTHERS (U.S. CLS. 100 AND 101).

FIRST USE 12-31-1978; IN COMMERCE 1-31-1998.

2,747,766. ELIZABETH ARDEN SALON HOLDINGS, INC., PHOENIX, AZ. SN 76-050,686. PUB. 2-13-2001, FILED 5-17-2000.

SPA 7/52 LIVE IT. ANY DAY. EVERYDAY.

NO CLAIM IS MADE TO THE EXCLUSIVE RIGHT TO USE "SPA", APART FROM THE MARK AS SHOWN.

CLASS 3—COSMETICS AND CLEANING PREPARATIONS

FOR POTPOURRI, SKINCARE AND BODY MOISTURIZING LOTIONS, SKINCARE AND BODY MOISTURIZING CREAMS SKIN SOAP, SKIN CLEANSERS, SKIN TONERS, SKIN SCRUBS, BEAUTY MASKS, NON-MEDICATED SKIN SERUMS, NAIL POLISH HAIR SHAMPOO, HAIR CONDITIONERS, HAIR GEL, HAIR MOUSSE, HAIR GLAZE, HAIR SPRAY, HAIR POMADE, HAIR CREAM, BATH GELS AND OILS (U.S. CLS. 1, 4, 6, 50, 51 AND 52).

FIRST USE 9-0-2000; IN COMMERCE 9-0-2000.

CLASS 4—LUBRICANTS AND FUELS

FOR CANDLES (U.S. CLS. 1, 6 AND 15).

FIRST USE 9-0-2000; IN COMMERCE 9-0-2000.

2,747,767. FEDERAL EXPRESS CORPORATION, MEMPHIS, TN. SN 76-050,946. PUB. 8-20-2002, FILED 5-18-2000.

FEDEX SHIP MANAGER

OWNER OF U.S. REG. NOS. 1,311,503 AND 1,984,646.

NO CLAIM IS MADE TO THE EXCLUSIVE RIGHT TO USE "SHIP MANAGER", APART FROM THE MARK AS SHOWN.

CLASS 9—ELECTRICAL AND SCIENTIFIC APPARATUS

FOR AUTOMATED COMPUTER SOFTWARE AND HARDWARE USED TO PROCESS SHIPPING TRANSACTIONS FOR DOCUMENTS, PACKAGES AND FREIGHT (U.S. CLS. 21, 23, 26, 36 AND 38).

FIRST USE 8-31-2000; IN COMMERCE 8-31-2000.

CLASS 42—SCIENTIFIC, COMPUTER AND LEGAL SERVICES

FOR PROVIDING USE OF DOWNLOADABLE SOFTWARE USED TO PROCESS SHIPPING TRANSACTIONS FOR DOCUMENTS, PACKAGES AND FREIGHT (U.S. CLS. 100 AND 101).

FIRST USE 8-31-2000; IN COMMERCE 8-31-2000.

2,747,776. GLOBAL EXECUTIVE TRAVEL SELECTIONS, INC., NEW YORK, NY. SN 76-057,678. PUB. 4-9-2002, FILED 5-26-2000.



2,747,772. E-TRAFFIC, INC., MOUNTAIN VIEW, CA. SN 76-052,626. PUB. 2-12-2002, FILED 5-19-2000.

TOPMOXIE**CLASS 9—ELECTRICAL AND SCIENTIFIC APPARATUS**

FOR COMPUTER PROGRAMS, DOWNLOADED THROUGH A GLOBAL COMPUTER NETWORK, ENABLING ONLINE MERCHANTS TO PROVIDE PROMOTIONS AND OTHER PRODUCT INFORMATION, NAMELY, INFORMATION ABOUT THE PRICE AND CHARACTERISTICS OF PRODUCTS, TO CUSTOMERS (U.S. CLS. 21, 23, 26, 36 AND 38).

FIRST USE 5-4-2002; IN COMMERCE 5-4-2002.

CLASS 42—SCIENTIFIC, COMPUTER AND LEGAL SERVICES

FOR PROVIDING TEMPORARY USE OF ON-LINE NON-DOWNLOADABLE SOFTWARE FOR ENABLING ON-LINE BUSINESSES TO PROVIDE PROMOTIONS AND MESSAGES RELATING TO ON-LINE PRODUCT AND SERVICE OFFERINGS (U.S. CLS. 100 AND 101).

FIRST USE 5-4-2000; IN COMMERCE 5-4-2000.

CLASS 39—TRANSPORTATION AND STORAGE

FOR TRAVEL SERVICES, NAMELY, MAKING TRANSPORTATION ARRANGEMENTS BY OFFERING BUSINESS CLASS AIR TICKETS AT DISCOUNTED PRICES AND VOUCHERS FOR CAR RENTALS, LIMOUSINE TRANSFERS AND AIRLINE TICKETS (U.S. CLS. 100 AND 105).

FIRST USE 12-31-2000; IN COMMERCE 12-31-2000.

CLASS 42—SCIENTIFIC, COMPUTER AND LEGAL SERVICES

FOR TRAVEL SERVICES, NAMELY, MAKING ARRANGEMENTS FOR LODGING BY PROVIDING VOUCHERS FOR LODGING AT HOTELS (U.S. CLS. 100 AND 101).

FIRST USE 12-31-2000; IN COMMERCE 12-31-2000.

2,747,779. TABLET, INC., NEW YORK, NY. SN 76-059,715. PUB. 7-23-2002, FILED 5-31-2000.

TABLET**CLASS 35—ADVERTISING AND BUSINESS**

FOR ONLINE RETAIL SERVICES FEATURING A WIDE VARIETY OF CONSUMER GOODS OF OTHERS (U.S. CLS. 100, 101 AND 102).

FIRST USE 9-0-2001; IN COMMERCE 9-0-2001.

CLASS 42—SCIENTIFIC, COMPUTER AND LEGAL SERVICES

FOR COMPUTER SERVICES, NAMELY, DESIGNING AND IMPLEMENTING WEB SITES AND DESIGNING RELATED SOFTWARE FOR OTHERS, AND APPLICATION SERVICE PROVIDER SERVICES FEATURING SOFTWARE IN THE FIELDS OF TEMPORARY LODGING RESERVATION MANAGEMENT (U.S. CLS. 100 AND 101).

FIRST USE 3-0-2000; IN COMMERCE 3-0-2000.

CLASS 43—HOTEL AND RESTAURANT SERVICES

FOR ONLINE TRAVEL AGENCY SERVICES, NAMELY, TEMPORARY LODGING RESERVATION SERVICES (U.S. CLS. 100 AND 101).

FIRST USE 10-0-2000; IN COMMERCE 10-0-2000.

2,747,773. HUCK INTERNATIONAL, INC., TUCSON, AZ. SN 76-055,932. PUB. 3-6-2001, FILED 5-18-2000.

U-SPIN**CLASS 6—METAL GOODS**

FOR METAL FASTENING DEVICES, NAMELY, LOCKBOLTS AND THREADED FASTENERS (U.S. CLS. 2, 12, 13, 14, 23, 25 AND 50).

FIRST USE 3-1-2002; IN COMMERCE 3-1-2002.

CLASS 7—MACHINERY

FOR POWER TOOLS FOR INSTALLING FASTENERS, NAMELY, LOCKBOLTS AND THREADED FASTENERS (U.S. CLS. 13, 19, 21, 23, 31, 34 AND 35).

FIRST USE 3-1-2002; IN COMMERCE 3-1-2002.

2,747,780. ALERUS FINANCIAL CORPORATION, GRAND FORKS, ND, BY CHANGE OF NAME FIRST NATIONAL CORPORATION NORTH DAKOTA, GRAND FORKS, ND. SN 76-059,884. PUB. 4-16-2002, FILED 5-31-2000.



CLASS 36—INSURANCE AND FINANCIAL

FOR BANKING SERVICES; TRUST AND ASSET MANAGEMENT SERVICES; MORTGAGE BANKING AND LENDING SERVICES; INVESTMENT ADVISORY, BROKERAGE AND MANAGEMENT SERVICES; INSURANCE AGENCY AND ADMINISTRATION SERVICES; PROPERTY APPRAISAL SERVICES; AND FINANCIAL SERVICES RELATED TO THE ABOVE-MENTIONED SERVICES (U.S. CLS. 100, 101 AND 102).

FIRST USE 11-13-2000; IN COMMERCE 11-13-2000.

CLASS 41—EDUCATION AND ENTERTAINMENT

FOR PROVIDING CONVENTION FACILITIES FOR SPORTS TOURNAMENTS AND ENTERTAINMENT EVENTS (U.S. CLS. 100, 101 AND 107).

FIRST USE 11-13-2000; IN COMMERCE 11-13-2000.

2,747,786. WAVE2WAVE COMMUNICATIONS, INC., HACKENSACK, NJ. SN 76-062,668. PUB. 5-22-2001, FILED 6-5-2000.



CLASS 9—ELECTRICAL AND SCIENTIFIC APPARATUS

FOR COMPUTER SOFTWARE FOR PROVIDING ACCESS TO THE GLOBAL COMPUTER INFORMATION NETWORK; TELECOMMUNICATION COMPONENTS FOR WIRELESS ACCESS TO THE GLOBAL COMPUTER INFORMATION NETWORK, NAMELY ANTENNAS, TRANSCEIVERS, SUBSCRIBER BOXES AND COMPUTER INTERFACE CARDS (U.S. CLS. 21, 23, 26, 36 AND 38).

FIRST USE 6-0-2000; IN COMMERCE 6-0-2000.

CLASS 38—COMMUNICATION

FOR TELECOMMUNICATION SERVICES, NAMELY ELECTRONIC TRANSMISSION OF DATA, IMAGES, AND DOCUMENTS OVER THE GLOBAL COMPUTER INFORMATION NETWORK VIA COMPUTER TERMINALS; ELECTRONIC MAIL SERVICES; PROVIDING MULTIPLE USER ACCESS TO THE GLOBAL COMPUTER INFORMATION NETWORK (U.S. CLS. 100, 101 AND 104).

FIRST USE 6-0-2000; IN COMMERCE 6-0-2000.

CLASS 39—TRANSPORTATION AND STORAGE

FOR ELECTRONIC STORAGE OF DATA AND DOCUMENTS (U.S. CLS. 100 AND 105).

FIRST USE 6-0-2000; IN COMMERCE 6-0-2000.

CLASS 42—SCIENTIFIC, COMPUTER AND LEGAL SERVICES

FOR HOSTING OF WEB SITES FOR OTHERS ON A COMPUTER SERVER FOR THE GLOBAL COMPUTER INFORMATION NETWORK (U.S. CLS. 100 AND 101).

FIRST USE 6-0-2000; IN COMMERCE 6-0-2000.

2,747,787. ARCHIPELAGO HOLDINGS, LLC, CHICAGO, IL. SN 76-064,048. PUB. 12-11-2001, FILED 6-6-2000.

ALL ST

CLASS 16—PAPER GOODS AND PRINTED MATTER

FOR NEWSLETTERS, BROCHURES, PAMPHLETS, BOOKLETS, LEAFLETS, AND FLYERS IN THE FIELDS OF SECURITIES, BONDS AND OTHER FINANCIAL INSTRUMENTS (U.S. CLS. 2, 5, 22, 23, 29, 37, 38 AND 50).

FIRST USE 6-0-2000; IN COMMERCE 6-0-2000.

CLASS 36—INSURANCE AND FINANCIAL

FOR BROKER-DEALER SERVICES IN THE FIELD OF SECURITIES, BONDS, OPTIONS, AND OTHER FINANCIAL INSTRUMENTS; FINANCIAL SECURITY EXCHANGE SERVICES, ORDER, ENTRY; AND EXECUTION SERVICES IN THE FIELD OF SECURITIES (U.S. CLS. 100, 101 AND 102).

FIRST USE 6-0-2000; IN COMMERCE 6-0-2000.

CLASS 38—COMMUNICATION

FOR ELECTRONIC TRANSMISSION OF DATA PERTAINING TO TRADING EQUITIES, FUTURES, OPTIONS, AND OTHER FINANCIAL INSTRUMENTS (U.S. CLS. 100, 101 AND 104).

FIRST USE 6-0-2000; IN COMMERCE 6-0-2000.

2,747,796. MARKETBRIDGE CORP., BETHESDA, MD, BY CHANGE OF NAME OXFORD ASSOCIATES, INC., BETHESDA, MD. SN 76-071,071. PUB. 11-13-2001, FILED 6-15-2000.

MARKETBRIDGE

CLASS 35—ADVERTISING AND BUSINESS

FOR BUSINESS CONSULTATION AND RESEARCH; CONDUCTING BUSINESS AND MARKETPLACE SURVEYS; MARKETPLACE STATISTICAL ANALYSIS (U.S. CLS. 100, 101 AND 102).

FIRST USE 9-18-2000; IN COMMERCE 9-18-2000.

CLASS 36—INSURANCE AND FINANCIAL

FOR FINANCIAL FORECASTING (U.S. CLS. 100, 101 AND 102).

FIRST USE 9-18-2000; IN COMMERCE 9-18-2000.

CLASS 42—SCIENTIFIC, COMPUTER AND LEGAL SERVICES

FOR DESIGNING COMPUTER HARDWARE AND SOFTWARE FOR OTHERS AND IMPLEMENTING COMPUTER SOFTWARE FOR OTHERS (U.S. CLS. 100 AND 101).

FIRST USE 9-18-2000; IN COMMERCE 9-18-2000.

2,747,806. GS DEVELOPMENT AB, S-21375 MALMO, SWEDEN. SN 76-078,654. PUB. 7-30-2002, FILED 6-22-2000.



OWNER OF SWEDEN REG. NO. 302082, DATED 5-26-1995, EXPIRES 5-26-2005.

2,747,797. INTERNATIONAL BRIQUETTE HOLDING, CARACAS, VENEZUELA. SN 76-073,586. PUB. 4-24-2001, FILED 6-19-2000.



NO CLAIM IS MADE TO THE EXCLUSIVE RIGHT TO USE "INTERNATIONAL BRIQUETTE", APART FROM THE MARK AS SHOWN.

CLASS 6—METAL GOODS

FOR IRON ORE PRODUCED BY IRON ORE REDUCTION PROCESS FOR USE IN STEEL MAKING (U.S. CLS. 2, 12, 13, 14, 23, 25 AND 50).

FIRST USE 12-31-2000; IN COMMERCE 12-31-2000.

CLASS 5—PHARMACEUTICALS

FOR LIPID BASED DELIVERY PREPARATIONS SOLD AS INTEGRAL COMPONENTS OF VARIOUS ACTIVE DRUGS, NAMELY, TABLETS, PATCHES, CAPSULES, INTRAVENOUS, ORAL SOLUTIONS, PARENTERAL SOLUTIONS, SUPPOSITORIES FOR HUMAN AND VETERINARY USE; NUTRITIONAL SUPPLEMENTS; BABY FOOD, MEDICAL PLASTERS; SURGICAL AND WOUND DRESSINGS; FILLINGS FOR TEETH; DENTAL WAX; PESTICIDES, FUNGICIDES AND HERBICIDES, ALL FOR DOMESTIC AND AGRICULTURAL USE (U.S. CLS. 6, 18, 44, 46, 51 AND 52).

FIRST USE 4-11-1996; IN COMMERCE 4-11-1996.

CLASS 42—SCIENTIFIC, COMPUTER AND LEGAL SERVICES

FOR CHEMICAL LABORATORY SERVICES, NAMELY, CHEMICAL RESEARCH AND ANALYSIS, TECHNICAL CONSULTING AND MEDICAL AND SCIENTIFIC RESEARCH IN PHARMACEUTICAL, FOODSTUFF, COSMETIC AND BIOTECHNICAL FIELDS; LICENSING OF INTELLECTUAL PROPERTY (U.S. CLS. 100 AND 101).

FIRST USE 8-27-1997; IN COMMERCE 8-27-1997.

CLASS 40—MATERIAL TREATMENT

FOR INDUSTRIAL PLANT SERVICES FOR THE REDUCTION OF IRON ORE (U.S. CLS. 100, 103 AND 106).

FIRST USE 12-31-2000; IN COMMERCE 12-31-2000.

2,747,807. RISK MANAGEMENT SOLUTIONS, INC., MENLO PARK, CA. SN 76-078,856. PUB. 10-16-2001, FILED 6-28-2000.

CLIMETRIX

2,747,798. SHOPKO STORES, INC., GREEN BAY, WI. SN 76-073,788. PUB. 10-8-2002, FILED 6-20-2000.

TOTAL TEAM EYE CARE

NO CLAIM IS MADE TO THE EXCLUSIVE RIGHT TO USE "EYE CARE", APART FROM THE MARK AS SHOWN.

CLASS 35—ADVERTISING AND BUSINESS

FOR RETAIL OPTICAL STORE SERVICES (U.S. CLS. 100, 101 AND 102).

FIRST USE 2-4-2001; IN COMMERCE 2-4-2001.

CLASS 35—ADVERTISING AND BUSINESS

FOR OPERATING AN ONLINE MARKETPLACE FOR THE TRANSACTION BY OTHERS OF FINANCIAL CONTRACTS REGARDING WEATHER-RELATED RISKS VIA A GLOBAL COMPUTER NETWORK (U.S. CLS. 100, 101 AND 102).

FIRST USE 9-1-2000; IN COMMERCE 9-1-2000.

CLASS 36—INSURANCE AND FINANCIAL

FOR CONSULTING, ADVISORY AND ANALYSIS SERVICES IN THE FIELDS OF INSURANCE, REINSURANCE, RISK MANAGEMENT, RISK ASSESSMENT AND PORTFOLIO RISK (U.S. CLS. 100, 101 AND 102).

FIRST USE 9-1-2000; IN COMMERCE 9-1-2000.

CLASS 42—SCIENTIFIC, COMPUTER AND LEGAL SERVICES

FOR OPTICIAN AND OPTOMETRY SERVICES (U.S. CLS. 100 AND 101).

FIRST USE 2-4-2001; IN COMMERCE 2-4-2001.

CLASS 42—SCIENTIFIC, COMPUTER AND LEGAL SERVICES

FOR PROVIDING NEWS AND INFORMATION IN THE FIELD OF WEATHER-RELATED RISKS VIA A GLOBAL COMPUTER NETWORK (U.S. CLS. 100 AND 101).

FIRST USE 9-1-2000; IN COMMERCE 9-1-2000.

2,747,809. M.C. DEAN, INC., CHANTILLY, VA. SN 76-079,687. PUB. 11-27-2001, FILED 6-28-2000.

SMART NEIGHBORHOOD

NO CLAIM IS MADE TO THE EXCLUSIVE RIGHT TO USE "SMART", APART FROM THE MARK AS SHOWN.

CLASS 37—CONSTRUCTION AND REPAIR

FOR CUSTOM DESIGN, CONSTRUCTION AND BUILDING OF ENERGY SYSTEMS, NAMELY, POWER AND LIGHTING SYSTEMS, TELECOMMUNICATION SYSTEMS, HOME AUTOMATION SYSTEMS, NAMELY, INDUSTRIAL AND BUILDING CONTROL AND MONITORING SYSTEMS, CABLE AND GLOBAL NETWORK OF INTERCONNECTED COMPUTERS ACCESS SYSTEMS, AND/OR ELECTRONIC AND PHYSICAL SECURITY SYSTEMS; MAINTENANCE AND REPAIR OF ENERGY SYSTEMS, NAMELY, POWER AND LIGHTING SYSTEMS, TELECOMMUNICATION SYSTEMS, HOME AUTOMATION SYSTEMS, NAMELY, INDUSTRIAL AND BUILDING CONTROL AND MONITORING SYSTEMS, CABLE AND GLOBAL NETWORK OF INTERCONNECTED COMPUTERS ACCESS SYSTEMS, AND/OR ELECTRONIC AND PHYSICAL SECURITY SYSTEMS (U.S. CLS. 100, 103 AND 106).

FIRST USE 9-4-2001; IN COMMERCE 9-4-2001.

CLASS 42—SCIENTIFIC, COMPUTER AND LEGAL SERVICES

FOR ENGINEERING SERVICES RELATING TO ENERGY SYSTEMS, NAMELY, POWER AND LIGHTING SYSTEMS, TELECOMMUNICATION SYSTEMS, HOME AUTOMATION SYSTEMS, NAMELY, INDUSTRIAL AND BUILDING CONTROL AND MONITORING SYSTEMS, CABLE AND GLOBAL NETWORK OF INTERCONNECTED COMPUTERS ACCESS SYSTEMS, AND OR ELECTRONIC AND PHYSICAL SECURITY SYSTEMS (U.S. CLS. 100 AND 101).

FIRST USE 9-4-2001; IN COMMERCE 9-4-2001.

2,747,819. LAW OF THE JUNGLE PTY LIMITED, EVE-LEIGH, NEW SOUTH WALES, AUSTRALIA. SN 76-084,753. PUB. 1-22-2002, FILED 7-7-2000.

LAW OF THE JUNGLE

CLASS 9—ELECTRICAL AND SCIENTIFIC APPARATUS

FOR COMPUTER SOFTWARE FOR BUSINESS PROCESS MANAGEMENT, DATABASE MANAGEMENT, WORK FLOW MANAGEMENT, REGULATORY AND LEGAL COMPLIANCE, BUSINESS POLICY AND PROCEDURE MANAGEMENT, RISK MANAGEMENT, INFORMATION DELIVERY, TRAINING AND KNOWLEDGE MANAGEMENT FOR USE IN THE LEGAL, BUSINESS AND EDUCATIONAL FIELDS; AUDIO-VISUAL DEVICES BEING PRE-RECORDED CASSETTE TAPES, CD-ROMS, VIDEO TAPES AND DVDS RELATING TO LAW, BUSINESS AND EDUCATION (U.S. CLS. 21, 23, 26, 36 AND 38).

FIRST USE 9-17-2002; IN COMMERCE 9-17-2002.

CLASS 16—PAPER GOODS AND PRINTED MATTER

FOR PRINTED INSTRUCTIONAL, EDUCATIONAL, AND TEACHING MATERIALS RELATING TO BUSINESS PROCESS MANAGEMENT, DATABASE MANAGEMENT, WORK FLOW MANAGEMENT, REGULATORY AND LEGAL COMPLIANCE, BUSINESS POLICY AND PROCEDURE MANAGEMENT, RISK MANAGEMENT, INFORMATION DELIVERY, TRAINING AND KNOWLEDGE MANAGEMENT FOR USE IN THE LEGAL, BUSINESS AND EDUCATIONAL FIELDS; AND COMPUTER MANUALS FOR SOFTWARE FOR BUSINESS PROCESS MANAGEMENT, DATABASE MANAGEMENT, WORK FLOW MANAGEMENT, REGULATORY AND LEGAL COMPLIANCE, RISK MANAGEMENT, INFORMATION DELIVERY AND KNOWLEDGE MANAGEMENT FOR USE IN THE LEGAL, BUSINESS AND EDUCATIONAL FIELDS (U.S. CLS. 2, 5, 22, 23, 29, 37, 38 AND 50).

FIRST USE 9-17-2002; IN COMMERCE 9-17-2002.

CLASS 38—COMMUNICATION

FOR VIDEO AND AUDIO TELE-CONFERENCING; PROVIDING ON-LINE CHAT ROOMS FOR TRANSMISSION OF MESSAGES AMONG COMPUTER USERS CONCERNING BUSINESS PROCESS MANAGEMENT, DATABASE MANAGEMENT, WORK FLOW MANAGEMENT, REGULATORY AND LEGAL COMPLIANCE, BUSINESS POLICY AND PROCEDURE MANAGEMENT, RISK MANAGEMENT, INFORMATION DELIVERY, TRAINING AND KNOWLEDGE MANAGEMENT IN THE LEGAL, BUSINESS AND EDUCATIONAL FIELDS; PROVIDING ON-LINE ELECTRONIC BULLETIN BOARDS FOR TRANSMISSION OF MESSAGES AMONG COMPUTER USERS CONCERNING BUSINESS PROCESS MANAGEMENT, DATABASE MANAGEMENT, WORK FLOW MANAGEMENT, REGULATORY AND LEGAL COMPLIANCE, RISK MANAGEMENT, INFORMATION DELIVERY AND KNOWLEDGE MANAGEMENT IN THE LEGAL, BUSINESS AND EDUCATIONAL (U.S. CLS. 100, 101 AND 104).

FIRST USE 9-17-2002; IN COMMERCE 9-17-2002.

CLASS 41—EDUCATION AND ENTERTAINMENT

FOR COMPUTER BASED EDUCATION AND TRAINING SERVICES IN THE FIELDS OF LAW AND BUSINESS; LIBRARY SERVICES INCLUDING ON-LINE LIBRARIES; AUDIO AND VIDEOTAPE RECORDING AND PRODUCTION; PUBLICATION OF BOOKS; ORGANIZING EXHIBITIONS RELATING TO BUSINESS PROCESS MANAGEMENT, DATABASE MANAGEMENT, WORK FLOW MANAGEMENT, REGULATORY AND LEGAL COMPLIANCE, RISK MANAGEMENT, INFORMATION DELIVERY AND KNOWLEDGE MANAGEMENT IN THE LEGAL, BUSINESS AND EDUCATIONAL FIELDS (U.S. CLS. 100, 101 AND 107).

FIRST USE 9-17-2002; IN COMMERCE 9-17-2002.

CLASS 42—SCIENTIFIC, COMPUTER AND LEGAL SERVICES

FOR UPDATING OF COMPUTER SOFTWARE; COMPUTER SOFTWARE DESIGN FOR OTHERS; COMPUTER PROGRAMMING FOR OTHERS, COMPUTER CONSULTATION; COMPUTER SERVICES NAMELY, SEARCH ENGINES FOR OBTAINING DATA ON A GLOBAL NETWORK; PROVIDING TEMPORARY USE OF ON-LINE NON-DOWNLOADABLE SOFTWARE FOR BUSINESS PROCESS MANAGEMENT, DATABASE MANAGEMENT, WORK FLOW MANAGEMENT, REGULATORY AND LEGAL COMPLIANCE, BUSINESS POLICY AND PROCEDURE MANAGEMENT, RISK MANAGEMENT, INFORMATION DELIVERY, TRAINING AND KNOWLEDGE MANAGEMENT IN THE LEGAL, BUSINESS AND EDUCATIONAL FIELDS; COMPUTER TIME-SHARING SERVICES; PROVIDING QUALITY ASSURANCE SERVICES AND QUALITY CONTROL IN THE FIELDS OF LEGAL PRACTICE, BUSINESS MANAGEMENT AND COMPUTER SOFTWARE APPLICATIONS; AND LEGAL SERVICES (U.S. CLS. 100 AND 101).

FIRST USE 9-17-2002; IN COMMERCE 9-17-2002.

2,747,822. IND. E COM. DE PRODUTOS ALIMENTICIOS CEPERA LTDA, SAO PAULO - SP, BRAZIL. SN 76-089,135. PUB. 8-6-2002, FILED 7-14-2000.

CEPERA

CLASS 29—MEATS AND PROCESSED FOODS

FOR CANNED PEPPERS, NAMELY, BAHIA PEPPERS, COMARI PEPPERS, SPANISH PEPPERS, MALAGUETA PEPPERS, RED PEPPERS AND; EDIBLE OIL NAMELY, BAHIA DENDE OIL (U.S. CL. 46).

FIRST USE 6-28-1985; IN COMMERCE 5-8-2000.

CLASS 30—STAPLE FOODS

FOR SAUCES AND CONDIMENTS, NAMELY, GARLIC SAUCE; ENGLISH EXTRA SAUCE; CALABRIA PEPPER SAUCE; RED PEPPER SAUCE; GREEN PEPPER SAUCE; SHOYU JAPANESE SAUCE; YELLOW MOSTARD; DUTCH TYPE DARK MOSTARD; TOMATO EXTRACT; KETCHUP; PICUANT KETCHUP; GARLIC DOUGH; AND SALT (U.S. CL. 46).

FIRST USE 9-12-1997; IN COMMERCE 5-8-2000.

2,747,824. ADVISORTECH CORPORATION, BOSTON, MA. SN 76-092,888. PUB. 4-23-2002, FILED 7-19-2000.



CLASS 9—ELECTRICAL AND SCIENTIFIC APPARATUS

FOR COMPUTER SOFTWARE FOR CONDUCTING CREDIT SEARCHES AND ASSESSING STOCKS; COMPUTER SOFTWARE FOR USE IN EXECUTING TRADES OF INVESTMENT FUNDS, SECURITIES AND BONDS; COMPUTER SOFTWARE FOR USE IN GENERATING INVESTMENT ACCOUNT REPORTS; COMPUTER SOFTWARE FOR THE MONITORING AND MANAGEMENT OF INVESTMENT PORTFOLIOS; COMPUTER SOFTWARE FOR MANAGING, STORING AND REPORTING FINANCIAL INFORMATION TO OTHERS VIA ELECTRONIC COMMUNICATIONS AND COMPUTER NETWORKS (U.S. CLS. 21, 23, 26, 36 AND 38).

FIRST USE 4-15-2000; IN COMMERCE 4-15-2000.

CLASS 36—INSURANCE AND FINANCIAL

FOR FINANCIAL SERVICES, NAMELY, PROVIDING CURRENT AND HISTORICAL INFORMATION REGARDING FINANCIAL MARKETS, INVESTMENT OPPORTUNITIES, STOCKS, OPTIONS, FUTURES, COMMODITIES, BONDS, MUTUAL FUNDS VIA ELECTRONIC COMMUNICATIONS AND COMPUTER NETWORKS; PROVIDING FINANCIAL INFORMATION REGARDING PUBLICLY TRADED COMPANIES VIA ELECTRONIC COMMUNICATIONS AND COMPUTER NETWORKS; MUTUAL FUND BROKERAGE SERVICES; SECURITIES BROKERAGE SERVICES; INVESTMENT ACCOUNT MANAGEMENT SERVICES; ELECTRONIC FUNDS TRANSFER SERVICES; FINANCIAL INVESTMENT AND FINANCIAL PORTFOLIO MANAGEMENT SERVICES PROVIDED VIA ELECTRONIC COMMUNICATIONS AND COMPUTER NETWORKS; PROVIDING INFORMATION IN THE FIELDS OF FINANCE, INVESTMENT AND ECONOMICS; PROVIDING QUESTIONNAIRES VIA ELECTRONIC COMMUNICATIONS AND COMPUTER NETWORKS FOR DETERMINING THE INVESTOR PROFILE OF CUSTOMERS; PROVIDING ACCOUNT INFORMATION; MANAGING AND STORING FINANCIAL INFORMATION FOR OTHERS; REPORTING FINANCIAL INFORMATION TO CUSTOMERS (U.S. CLS. 100, 101 AND 102).

FIRST USE 4-15-2000; IN COMMERCE 4-15-2000.

2,747,825. KABUSHIKI KAISHA SEGA ENTERPRISES, DBA SEGA ENTERPRISES, LTD., TOKYO 144-0043, JAPAN. SN 76-093,329. PUB. 1-8-2002, FILED 7-20-2000.

SEGA SPORTS

OWNER OF U.S. REG. NOS. 1,050,573, 1,935,745, AND 2,106,258.

NO CLAIM IS MADE TO THE EXCLUSIVE RIGHT TO USE "SPORTS", APART FROM THE MARK AS SHOWN.

CLASS 16—PAPER GOODS AND PRINTED MATTER

FOR PRINTED MATTER AND PUBLICATIONS, NAMELY, MAGAZINES AND NEWSLETTERS FEATURING INFORMATION ON VIDEO GAMES, ONLINE COMPUTER GAMES AND ARCADE GAMES, ADDRESS BOOKS, BOOK COVERS, BOOK MARKS, CALENDARS, COMIC BOOKS, MEMO BOARDS, MEMO PADS, NOTE PADS, NOTEBOOKS, PAPER BANNERS, AND MOUNTABLE PAPER PARTY DECORATIONS; CRAYONS; DRAWING RULERS; ERASERS; FELT-TIP MARKERS; IRON-ON TRANSFERS; ERASEABLE MAGNETIC SLATES FOR WRITING AND DRAWING; ART AND CRAFTS PAINT KITS CONTAINING WASHABLE PAINT, PAINT BRUSHES, INSTRUCTION BOOKS, NUMBER AND PICTURE STENCILS, MARKERS, CRAYONS AND DRAWING PAPER; INK PENS; MECHANICAL BINDER SET COMPRISED OF RINGS, DIVIDERS AND FOLDERS; AND FOLDERS (U.S. CLS. 2, 5, 22, 23, 29, 37, 38 AND 50).

FIRST USE 1-0-2000; IN COMMERCE 1-0-2000.

CLASS 18—LEATHER GOODS

FOR ATHLETIC BAGS; BACKPACKS; BEACH BAGS; BOOK BAGS; OVERNIGHT BAGS; DUFFEL BAGS; SCHOOL BAGS; SHOULDER BAGS; TOTE BAGS; FANNY PACKS; WAIST PACKS; WALLETS; SATCHELS; AND UMBRELLAS (U.S. CLS. 1, 2, 3, 22 AND 41).

FIRST USE 9-0-2001; IN COMMERCE 9-0-2001.

CLASS 21—HOUSEWARES AND GLASS

FOR LUNCH BOXES; PORTABLE BEVERAGE COOLERS; BEVERAGE GLASSWARE; COFFEE CUPS; CANDY AND CONFECTIONERY CONTAINERS; AND BOTTLES, SOLD EMPTY, FOR HOLDING AND CONSUMING WATER OR OTHER BEVERAGES (U.S. CLS. 2, 13, 23, 29, 30, 33, 40 AND 50).

FIRST USE 3-0-2000; IN COMMERCE 3-0-2000.

CLASS 28—TOYS AND SPORTING GOODS

FOR PLUSH TOYS; ACTION FIGURES; COLLECTIBLE TOY FIGURES; AND ACCESSORIES THEREFOR (U.S. CLS. 22, 23, 38 AND 50).

FIRST USE 5-21-2002; IN COMMERCE 5-21-2002.

CLASS 41—EDUCATION AND ENTERTAINMENT

FOR ENTERTAINMENT SERVICES, NAMELY, PROVIDING ON-LINE COMPUTER GAMES (U.S. CLS. 100, 101 AND 107).

FIRST USE 1-0-2000; IN COMMERCE 1-0-2000.

2,747,828. JMP HOLDING COMPANY, INC., GAITHERSBURG, MD. SN 76-094,500. PUB. 12-3-2002, FILED 7-19-2000.



THE MARK CONSISTS OF THREE CIRCLES REPRESENTING HUMAN FACES BEARING DIFFERENT EXPRESSIONS, EACH CIRCLE CONTAINING A GEOMETRIC ELEMENT REPRESENTING A MOUTH.

CLASS 35—ADVERTISING AND BUSINESS

FOR ARRANGING AND CONDUCTING TRADE SHOW EXHIBITIONS IN A WIDE VARIETY OF FIELDS (U.S. CLS. 100, 101 AND 102).

FIRST USE 5-0-2002; IN COMMERCE 5-0-2002.

CLASS 41—EDUCATION AND ENTERTAINMENT

FOR ARRANGING ENTERTAINMENT EXHIBITIONS IN THE NATURE OF LIVE PERFORMANCES BY MUSICAL BANDS, SINGERS, DANCERS, COMEDY ROUTINES, CELEBRITY SPEAKERS FOR BUSINESS CONFERENCES, NAMELY BUSINESS MEETINGS, BUSINESS SEMINARS AND BUSINESS CONVENTIONS; ARRANGING AND CONDUCTING EDUCATIONAL DEMONSTRATIONS FOR BUSINESS CONFERENCES, NAMELY BUSINESS MEETINGS, BUSINESS SEMINARS, BUSINESS CONVENTIONS, AND THEMED EXHIBITIONS (U.S. CLS. 100, 101 AND 107).

FIRST USE 5-0-2002; IN COMMERCE 5-0-2002.

CLASS 42—SCIENTIFIC, COMPUTER AND LEGAL SERVICES

FOR DESIGN AND DEVELOPMENT OF WEB SITES FOR OTHERS; AND, DESIGN AND DEVELOPMENT OF INTERACTIVE COMPUTER HARDWARE IN THE FORM OF STAND-ALONE KIOSKS (U.S. CLS. 100 AND 101).

FIRST USE 5-0-2002; IN COMMERCE 5-0-2002.

2,747,829. JMP HOLDING COMPANY, INC., GAITHERSBURG, MD. SN 76-094,501. PUB. 9-17-2002, FILED 7-19-2000.

THE EXPERIENCE TO INSPIRE**CLASS 35—ADVERTISING AND BUSINESS**

FOR ARRANGING AND CONDUCTING TRADE SHOW EXHIBITIONS IN A WIDE VARIETY OF FIELDS (U.S. CLS. 100, 101 AND 102).

FIRST USE 5-0-2002; IN COMMERCE 5-0-2002.

CLASS 41—EDUCATION AND ENTERTAINMENT

FOR ARRANGING ENTERTAINMENT EXHIBITIONS IN THE NATURE OF LIVE PERFORMANCES BY MUSICAL BANDS, SINGERS, DANCERS, COMEDY ROUTINES, CELEBRITY SPEAKERS FOR BUSINESS CONFERENCES, NAMELY BUSINESS MEETINGS, BUSINESS SEMINARS AND BUSINESS CONVENTIONS; ARRANGING AND CONDUCTING EDUCATIONAL DEMONSTRATIONS FOR BUSINESS CONFERENCES, NAMELY BUSINESS MEETINGS, BUSINESS SEMINARS, BUSINESS CONVENTIONS, AND THEMED EXHIBITIONS (U.S. CLS. 100, 101 AND 107).

FIRST USE 5-0-2002; IN COMMERCE 5-0-2002.

CLASS 42—SCIENTIFIC, COMPUTER AND LEGAL SERVICES

FOR DESIGN AND DEVELOPMENT OF WEB SITES FOR OTHERS; AND, DESIGN AND DEVELOPMENT OF INTERACTIVE COMPUTER HARDWARE IN THE FORM OF STAND-ALONE KIOSKS (U.S. CLS. 100 AND 101).

FIRST USE 5-0-2002; IN COMMERCE 5-0-2002.

2,747,830. AIRIA LIMITED, LONDON EC1Y 1AX, UNITED KINGDOM. SN 76-095,237. PUB. 6-25-2002, FILED 7-24-2000.

AIRIA

CLASS 38—COMMUNICATION

FOR PROVISION OF BROADCASTING SERVICES TO MOBILE USERS; PROVISION OF TELECOMMUNICATIONS CONNECTIONS TO THE INTERNET (U.S. CLS. 100, 101 AND 104).

FIRST USE 8-0-2001; IN COMMERCE 8-0-2001.

CLASS 41—EDUCATION AND ENTERTAINMENT

FOR ENTERTAINMENT SERVICES, NAMELY, PROVIDING TELEVISION PROGRAMMING AND STREAMING VIDEO CONTENT IN THE FIELDS OF SPORTS, NEWS, TRAVEL, HISTORY, GEOGRAPHY, FOOD, WEATHER, COMEDY, BUT SPECIFICALLY EXCLUDING LIVE AND PRE-RECORDED MUSICAL PERFORMANCES (U.S. CLS. 100, 101 AND 107).

FIRST USE 8-0-2001; IN COMMERCE 8-0-2001.

2,747,834. GOOD EARTH CORPORATION, THE, SANTA CRUZ, CA. SN 76-100,537. PUB. 5-22-2001, FILED 8-2-2000.

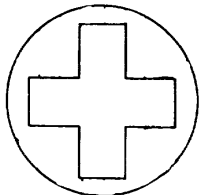

THE MARK CONSISTS OF A WHITE CROSS WITHIN A BLACK CIRCLE.

CLASS 5—PHARMACEUTICALS

FOR DIETARY SUPPLEMENTS, NAMELY, A FULL LINE OF VITAMIN, MINERAL, HERBAL AND OTHER NUTRITIONAL PRODUCTS FOR HUMAN USE; PHARMACEUTICAL PREPARATIONS FOR LAXATIVES AND WEIGHT LOSS AND FOR TREATMENT OF COLD, FLU, INSOMNIA, TENSION, AND INDIGESTION (U.S. CLS. 6, 18, 44, 46, 51 AND 52).

FIRST USE 8-0-2000; IN COMMERCE 8-0-2000.

CLASS 30—STAPLE FOODS

FOR TEA (U.S. CL. 46).

FIRST USE 8-0-2000; IN COMMERCE 8-0-2000.

2,747,840. KILLERLINK, LLC, CORONA DEL MAR, CA. SN 76-106,487. PUB. 2-5-2002, FILED 8-7-2000.

TRAVELSIZE

CLASS 35—ADVERTISING AND BUSINESS

FOR RETAIL STORES SERVICES FEATURING BOOKS, MAPS, CLOCKS, WATCHES, FLASHLIGHTS, POWER ADAPTERS, TOILETRIES, FIRST AID KITS, TRAVEL COMFORT ITEMS, HEAD RESTS, BLANKETS, PILLOWS, CLOTHING, COATS, WALLETS, LUGGAGE, ANIMAL CARRIERS, BRIEF CASES, COMPUTER CARRIERS, DIVING EQUIPMENT, SKIING EQUIPMENT, HIKING EQUIPMENT, AND CAMPING EQUIPMENT, VIA AN ON-LINE ELECTRONIC COMMUNICATIONS NETWORK AND VIA MAIL ORDER (U.S. CLS. 100, 101 AND 102).

FIRST USE 4-1-2003; IN COMMERCE 4-1-2003.

CLASS 39—TRANSPORTATION AND STORAGE

FOR TRAVEL AGENCY SERVICES, NAMELY, MAKING RESERVATIONS AND BOOKINGS FOR TRANSPORTATION (U.S. CLS. 100 AND 105).

FIRST USE 4-1-2003; IN COMMERCE 4-1-2003.

CLASS 42—SCIENTIFIC, COMPUTER AND LEGAL SERVICES

FOR TRAVEL AGENCY SERVICES, NAMELY, MAKING RESERVATIONS AND BOOKING FOR TEMPORARY LODGING (U.S. CLS. 100 AND 101).

FIRST USE 4-1-2003; IN COMMERCE 4-1-2003.

2,747,849. NEES COMMUNICATIONS, INC., WESTBOROUGH, MA. SN 76-112,632. PUB. 1-8-2002, FILED 8-18-2000.



CLASS 36—INSURANCE AND FINANCIAL

FOR LEASING AND LICENSING BUILDING SPACE FOR USE BY TELECOMMUNICATIONS COMPANIES (U.S. CLS. 100, 101 AND 102).

FIRST USE 4-1-2000; IN COMMERCE 10-1-2001.

CLASS 38—COMMUNICATION

FOR LEASING UNLIT FIBER OPTIC CABLE (U.S. CLS. 100, 101 AND 104).

FIRST USE 7-1-2000; IN COMMERCE 7-1-2000.

2,747,854. BILLINGZONE, LP, PITTSBURGH, PA, BY CHANGE OF NAME BILLINGZONE, LLC, PITTSBURGH, PA. SN 76-118,766. PUB. 7-16-2002, FILED 8-29-2000.



CLASS 35—ADVERTISING AND BUSINESS

FOR BUSINESS CONSULTING SERVICES (U.S. CLS. 100, 101 AND 102).

FIRST USE 9-27-2000; IN COMMERCE 9-27-2000.

CLASS 36—INSURANCE AND FINANCIAL

FOR AUTOMATED PAYMENT AND BILL PRESENTMENT SERVICES TO AID BUSINESSES AND USERS IN THE CONDUCT OF COMMERCIAL TRANSACTIONS OVER A GLOBAL NETWORK, WIDE AREA NETWORK, OR LOCAL AREA NETWORK; CONSULTATION REGARDING COMPUTERIZED BILL PAYMENT AND COMPUTERIZED BILL PRESENTMENT (U.S. CLS. 100, 101 AND 102).

FIRST USE 9-27-2000; IN COMMERCE 9-27-2000.

CLASS 42—SCIENTIFIC, COMPUTER AND LEGAL SERVICES

FOR COMPUTER SERVICES, NAMELY, DESIGN, DEVELOPMENT, INTEGRATION, AND IMPLEMENTATION OF COMPUTERS AND COMPUTER NETWORKS FOR OTHERS; COMPUTER SOFTWARE DEVELOPMENT AND IMPLEMENTATION FOR OTHERS; PROVIDING ON-LINE CORPORATE PUBLICATIONS, NAMELY, NEWSLETTERS IN THE FIELD OF BUSINESS CONSULTING AND BUSINESS MANAGEMENT, ELECTRONIC COMMERCE, COMPUTERS, AND RELATED INFORMATION TECHNOLOGY (U.S. CLS. 100 AND 101).

FIRST USE 9-27-2000; IN COMMERCE 9-27-2000.

2,747,855. LINDEN CORPORATION, WILMINGTON, DE.
SN 76-119,111. PUB. 6-12-2001, FILED 8-29-2000.

POWERONS

CLASS 3—COSMETICS AND CLEANING PREPARATIONS

FOR GENERAL-PURPOSE CLEANER WITH DISINFECTING PROPERTIES (U.S. CLS. 1, 4, 6, 50, 51 AND 52).
FIRST USE 12-19-2002; IN COMMERCE 12-19-2002.

CLASS 5—PHARMACEUTICALS

FOR GENERAL-PURPOSE DISINFECTANT WITH CLEANING PROPERTIES (U.S. CLS. 6, 18, 44, 46, 51 AND 52).
FIRST USE 12-19-2002; IN COMMERCE 12-19-2002.

2,747,856. ELIZABETH GRADY FACE FIRST, INC., MEDFORD, MA. SN 76-119,164. PUB. 11-27-2001, FILED 8-31-2000.

ELIZABETH GRADY

OWNER OF U.S. REG. NOS. 1,451,643, 2,002,906, AND OTHERS.

THE NAME "ELIZABETH GRADY" IDENTIFIES A LIVING INDIVIDUAL WHOSE CONSENT IS OF RECORD.

CLASS 10—MEDICAL APPARATUS

FOR MEDICAL APPARATUS, NAMELY, HIGH FREQUENCY SKIN TREATMENT MACHINES FOR TREATING THE SKIN; AND MEDICAL APPARATUS, NAMELY, MACHINES USED FOR PERFORMING MICRODERMABRASION FOR TREATMENT OF SKIN (U.S. CLS. 26, 39 AND 44).

FIRST USE 9-0-2000; IN COMMERCE 9-0-2000.

CLASS 11—ENVIRONMENTAL CONTROL APPARATUS

FOR FACIAL SAUNAS, NAMELY, STEAM TREATMENT APPARATUS FOR THE SKIN, HIGH FREQUENCY SKIN TREATMENT APPARATUS, MICRODERMABRASION SKIN TREATMENT APPARATUS, AND DISINFECTING SKIN TREATMENT APPARATUS AND COMPONENTS THEREOF (U.S. CLS. 13, 21, 23, 31 AND 34).

FIRST USE 9-0-2000; IN COMMERCE 9-0-2000.

2,747,858. GE INTERLOGIX, INC., TUALATIN, OR, BY MERGER INTERLOGIX, INC., BOCA RATON, FL. SN 76-119,381. PUB. 11-20-2001, FILED 8-28-2000.

CASI-RUSCO

OWNER OF U.S. REG. NO. 1,363,808.

CLASS 9—ELECTRICAL AND SCIENTIFIC APPARATUS

FOR COMPUTER HARDWARE AND SOFTWARE FOR USE IN CONFIGURING, MONITORING AND MANAGING SECURITY ACCESS SYSTEMS (U.S. CLS. 21, 23, 26, 36 AND 38).

FIRST USE 9-28-1987; IN COMMERCE 9-28-1987.

CLASS 37—CONSTRUCTION AND REPAIR

FOR INSTALLATION AND MAINTENANCE OF SECURITY ACCESS SYSTEMS (U.S. CLS. 100, 103 AND 106).

FIRST USE 9-28-1987; IN COMMERCE 9-28-1987.

CLASS 42—SCIENTIFIC, COMPUTER AND LEGAL SERVICES

FOR PROVIDING CUSTOM INSTALLATION AND MAINTENANCE OF SOFTWARE AND CUSTOM DESIGN AND MONITORING OF SECURITY ACCESS SYSTEMS (U.S. CLS. 100 AND 101).

FIRST USE 9-28-1987; IN COMMERCE 9-28-1987.

2,747,860. ECOSMART TECHNOLOGIES, INC., FRANKLIN, TN. SN 76-119,943. PUB. 8-27-2002, FILED 8-29-2000.

BIOGANIC SAFETY BRANDS

OWNER OF U.S. REG. NO. 2,216,458.

NO CLAIM IS MADE TO THE EXCLUSIVE RIGHT TO USE "SAFETY BRANDS", APART FROM THE MARK AS SHOWN.

CLASS 1—CHEMICALS

FOR FERTILIZERS FOR DOMESTIC AND AGRICULTURAL USE; FOOD FOR PLANTS, FLOWERS, FRUITS AND VEGETABLES; AND FERTILIZER IN THE NATURE OF A ROOT DEVELOPER FOR PLANTS AND TREES FOR DOMESTIC AND AGRICULTURAL USE (U.S. CLS. 1, 5, 6, 10, 26 AND 46).

FIRST USE 6-0-2000; IN COMMERCE 6-0-2000.

CLASS 5—PHARMACEUTICALS

FOR PESTICIDES, INSECTICIDES, HERBICIDES, AND FUNGICIDES, ALL FOR DOMESTIC AND AGRICULTURAL USE; INSECT AND PEST REPELLENTS; CHEMICAL PREPARATIONS USED TO KILL INSECTS AND EXTERNAL PARASITES FOR DOMESTIC USE; PREPARATIONS USED FOR DESTROYING VERMIN; AND INSECT AND PEST REPELLANTS IN THE NATURE OF OILS, LOTIONS AND SPRAYS (U.S. CLS. 6, 18, 44, 46, 51 AND 52).

FIRST USE 6-0-2000; IN COMMERCE 6-0-2000.

CLASS 42—SCIENTIFIC, COMPUTER AND LEGAL SERVICES

FOR PROVIDING INFORMATION IN THE FIELDS OF FERTILIZER, PESTICIDES, PESTS, HERBICIDES AND AGRICULTURE; PROVIDING AN ONLINE MAGAZINE IN THE FIELDS OF FERTILIZER, PESTICIDES, PESTS, HERBICIDES AND AGRICULTURE; RESEARCH, DEVELOPMENT AND TESTING SERVICES IN THE FIELDS OF FERTILIZER, PESTICIDES, PESTS AND HERBICIDES; PROMOTING PUBLIC AWARENESS OF THE NEED FOR SAFE USE AND APPLICATION OF FERTILIZER, PESTICIDES, REPELLANTS AND HERBICIDES; AND CONSULTING IN THE FIELD OF FERTILIZER, PESTICIDES, PESTS, HERBICIDES AND AGRICULTURE (U.S. CLS. 100 AND 101).

FIRST USE 6-0-2000; IN COMMERCE 6-0-2000.

2,747,863. 2ND C A/S, 3450 ALLEROD, DENMARK. SN 76-120,631. PUB. 3-5-2002, FILED 8-31-2000.

2,747,872. RANDOM HOUSE, INC., NEW YORK, NY. SN 76-128,590. PUB. 9-17-2002, FILED 9-14-2000.

DocuWise

CLASS 9—ELECTRICAL AND SCIENTIFIC APPARATUS

FOR COMPUTER SOFTWARE USED FOR INFORMATION MANAGEMENT; AND DATA PROCESSORS (U.S. CLS. 21, 23, 26, 36 AND 38).
FIRST USE 6-0-2002; IN COMMERCE 6-0-2002.

CLASS 42—SCIENTIFIC, COMPUTER AND LEGAL SERVICES

FOR COMPUTER SOFTWARE DESIGN FOR OTHERS; COMPUTER CONSULTATION IN THE FIELD OF HARDWARE AND SOFTWARE (U.S. CLS. 100 AND 101).
FIRST USE 6-0-2002; IN COMMERCE 6-0-2002.

2,747,866. VENDARIA, INC., FORMERLY BROADCAST-ZONE, INC., SEATTLE, WA. SN 76-125,072. PUB. 1-1-2002, FILED 9-8-2000.

MOVING PICTURES. MOVING PRODUCTS.

CLASS 35—ADVERTISING AND BUSINESS

FOR ADVERTISING AGENCY SERVICES PROVIDED VIA A GLOBAL NETWORK AND TELECOMMUNICATION NETWORK; PROMOTING THE GOODS AND SERVICES OF OTHERS BY PREPARING AND PLACING ADVERTISEMENTS IN AN ELECTRONIC MAGAZINE ACCESSED THROUGH A GLOBAL COMPUTER AND TELECOMMUNICATIONS NETWORK (U.S. CLS. 100, 101 AND 102).
FIRST USE 9-20-2000; IN COMMERCE 9-20-2000.

CLASS 41—EDUCATION AND ENTERTAINMENT

FOR MULTIMEDIA PRODUCTION SERVICES, NAMELY, PRODUCING CONTENT FILLED WEBSITES FEATURING DIGITAL MEDIA, NAMELY, MOVING IMAGES, STILL IMAGES, GRAPHICS, AUDIO, TEXT AND DATA, FOR USE IN THE FIELDS OF ADVERTISING, BUSINESS, ENTERTAINMENT, AND EDUCATION VIA A GLOBAL COMPUTER AND TELECOMMUNICATIONS NETWORK (U.S. CLS. 100, 101 AND 107).
FIRST USE 9-20-2000; IN COMMERCE 9-20-2000.

CLASS 42—SCIENTIFIC, COMPUTER AND LEGAL SERVICES

FOR COMPUTER SERVICES, NAMELY, PROVIDING TEMPORARY USE OF ON-LINE NON-DOWNLOADABLE SOFTWARE FOR EXCHANGE, TRANSMISSION AND RECEPTION BETWEEN COMPUTERS OF DIGITAL MEDIA, NAMELY, MOVING IMAGES, STILL IMAGES, GRAPHICS, AUDIO, TEXT, DATA AND VIDEO FOR USE IN THE FIELDS OF ADVERTISING, BUSINESS, PRESENTATION AND EDUCATION; COMPUTER CONSULTATION; COMPUTER PROGRAMMING FOR OTHERS (U.S. CLS. 100 AND 101).
FIRST USE 9-20-2000; IN COMMERCE 9-20-2000.

HARLEM MOON

CLASS 9—ELECTRICAL AND SCIENTIFIC APPARATUS

FOR SERIES OF ELECTRONIC BOOKS IN THE FIELD OF AFRICAN-AMERICAN AUTHORS AND SUBJECTS, DOWNLOADABLE BY MEANS OF THE INTERNET, AND SOUND RECORDINGS IN THE NATURE OF AUDIO BOOKS (U.S. CLS. 21, 23, 26, 36 AND 38).
FIRST USE 9-24-2002; IN COMMERCE 9-24-2002.

CLASS 16—PAPER GOODS AND PRINTED MATTER

FOR SERIES OF BOOKS IN THE FIELD OF AFRICAN-AMERICAN AUTHORS AND SUBJECTS (U.S. CLS. 2, 5, 22, 23, 29, 37, 38 AND 50).
FIRST USE 9-24-2002; IN COMMERCE 9-24-2002.

CLASS 41—EDUCATION AND ENTERTAINMENT

FOR PROVIDING INFORMATION PERTAINING TO BOOKS, LITERARY WORKS, AND PUBLISHING IN THE FIELD OF AFRICAN-AMERICAN AUTHORS AND SUBJECTS BY MEANS OF THE INTERNET (U.S. CLS. 100, 101 AND 107).
FIRST USE 9-24-2002; IN COMMERCE 9-24-2002.

2,747,883. BOC LIMITED, WINDLESHAM SURREY, ENGLAND. SN 76-138,696. PUB. 8-27-2002, FILED 10-2-2000.

FABSUITE

CLASS 9—ELECTRICAL AND SCIENTIFIC APPARATUS

FOR COMPUTER SOFTWARE RELATING TO THE MANUFACTURE OF SEMICONDUCTORS AND SIMILAR DEVICES (U.S. CLS. 21, 23, 26, 36 AND 38).
FIRST USE 1-31-2002; IN COMMERCE 1-31-2002.

CLASS 40—MATERIAL TREATMENT

FOR CUSTOM MANUFACTURE OF SEMICONDUCTORS AND RELATED GOODS THROUGH THE USE OF DIAGNOSTIC COMPUTER SOFTWARE PACKAGES (U.S. CLS. 100, 103 AND 106).
FIRST USE 1-31-2002; IN COMMERCE 1-31-2002.

2,747,885. ACCRETIVE SOLUTIONS, INC., HAUPPAUGE, NY, BY CHANGE OF NAME ACCOUNTEC, INC., HAUPPAUGE, NY. SN 76-139,909. PUB. 6-25-2002, FILED 10-2-2000.

ACCRETIVE SOLUTIONS

NO CLAIM IS MADE TO THE EXCLUSIVE RIGHT TO USE "SOLUTIONS", APART FROM THE MARK AS SHOWN.

CLASS 35—ADVERTISING AND BUSINESS

FOR ACCOUNTING CONSULTING SERVICES; EMPLOYMENT AGENCY SERVICES, NAMELY, TEMPORARY EMPLOYMENT STAFFING, RECRUITMENT AND SEARCH SERVICES; OUTSOURCING SERVICES FOR OTHERS IN THE FIELDS OF ACCOUNTING, INFORMATION TECHNOLOGY AND FINANCE; BUSINESS CONSULTING SERVICES (U.S. CLS. 100, 101 AND 102).
FIRST USE 12-0-2000; IN COMMERCE 12-0-2000.

CLASS 36—INSURANCE AND FINANCIAL

FOR FINANCIAL CONSULTATION SERVICES (U.S. CLS. 100, 101 AND 102).
FIRST USE 12-0-2000; IN COMMERCE 12-0-2000.

CLASS 42—SCIENTIFIC, COMPUTER AND LEGAL SERVICES

FOR INFORMATION TECHNOLOGY CONSULTING (U.S. CLS. 100 AND 101).
FIRST USE 12-0-2000; IN COMMERCE 12-0-2000.

2,747,902. PACIFIC COAST FEATHER COMPANY, SEATTLE, WA. SN 76-151,535. PUB. 5-7-2002, FILED 10-23-2000.

MAXILOFT**CLASS 20—FURNITURE AND ARTICLES NOT OTHERWISE CLASSIFIED**

FOR SYNTHETIC FIBERS SOLD AS A COMPONENT OF PILLOWS (U.S. CLS. 2, 13, 22, 25, 32 AND 50).
FIRST USE 10-7-1998; IN COMMERCE 10-7-1998.

CLASS 24—FABRICS

FOR SYNTHETIC FIBERS SOLD AS A COMPONENT OF COMFORTERS (U.S. CLS. 42 AND 50).
FIRST USE 9-0-2002; IN COMMERCE 9-0-2002.

2,747,892. AERO PRODUCTS INTERNATIONAL, INC., WAUCONDA, IL, BY ASSIGNMENT IMAGINAIR, INC., WAUCONDA, IL. SN 76-143,502. PUB. 1-1-2002, FILED 10-10-2000.

INSTASLEEP**CLASS 20—FURNITURE AND ARTICLES NOT OTHERWISE CLASSIFIED**

FOR INFLATABLE MATTRESSES FOR INDOOR AND OUTDOOR USE (U.S. CLS. 2, 13, 22, 25, 32 AND 50).
FIRST USE 9-30-2002; IN COMMERCE 9-30-2002.

CLASS 28—TOYS AND SPORTING GOODS

FOR INFLATABLE MATTRESSES FOR RECREATIONAL USE (U.S. CLS. 22, 23, 38 AND 50).
FIRST USE 9-30-2002; IN COMMERCE 9-30-2002.

2,747,894. FENDER MUSEUM OF THE ARTS FOUNDATION, CORONA, CA. SN 76-146,680. PUB. 7-3-2001, FILED 10-12-2000.

KIDS ROCK FREE**CLASS 16—PAPER GOODS AND PRINTED MATTER**

FOR WRITING INSTRUMENTS NAMELY PENS AND PENCILS; DECALS, BUMPER STICKERS AND STICKERS (U.S. CLS. 2, 5, 22, 23, 29, 37, 38 AND 50).
FIRST USE 11-1-2002; IN COMMERCE 11-1-2002.

CLASS 18—LEATHER GOODS

FOR BACKPACKS (U.S. CLS. 1, 2, 3, 22 AND 41).
FIRST USE 3-12-2003; IN COMMERCE 3-12-2003.

CLASS 20—FURNITURE AND ARTICLES NOT OTHERWISE CLASSIFIED

FOR NON-METAL KEY CHAINS (U.S. CLS. 2, 13, 22, 25, 32 AND 50).
FIRST USE 3-7-2003; IN COMMERCE 3-7-2003.

2,747,907. ROLAND CORPORATION, OSAKA, JAPAN. SN 76-158,624. PUB. 3-12-2002, FILED 11-2-2000.



OWNER OF U.S. REG. NOS. 1,055,073, 2,252,094, AND OTHERS.

NO CLAIM IS MADE TO THE EXCLUSIVE RIGHT TO USE "MUSIC TUTOR INTERACTIVE", APART FROM THE MARK AS SHOWN.

CLASS 9—ELECTRICAL AND SCIENTIFIC APPARATUS

FOR COMPUTER SOFTWARE FOR USE IN MUSIC EDUCATION, INSTRUCTION, AND PERFORMANCE, FEATURING PRE-RECORDED MUSICAL SOUNDS AND TONE DATA AND INSTRUCTIONAL MANUALS AND SERIAL CABLES SOLD AS A UNIT; PRE-RECORDED CD-ROMS FEATURING MUSIC AND SONG FILES; PRE-RECORDED VIDEO TAPES FEATURING DEMONSTRATIONS AND INSTRUCTIONS FOR USING MUSIC SOFTWARE AND MUSIC KEYBOARDS (U.S. CLS. 21, 23, 26, 36 AND 38).
FIRST USE 1-0-2001; IN COMMERCE 1-0-2001.

CLASS 16—PAPER GOODS AND PRINTED MATTER

FOR PRINTED MATTER, NAMELY, MUSIC BOOKS, DEMONSTRATION MANUALS FEATURING MUSIC, MUSIC SCORES, AND SHEET MUSIC (U.S. CLS. 2, 5, 22, 23, 29, 37, 38 AND 50).
FIRST USE 1-0-2001; IN COMMERCE 1-0-2001.

2,747,910. DEMARAY, LINDA, ARVADA, CO. SN 76-159,987.
PUB. 8-27-2002, FILED 11-6-2000.

WHEELS OF GENESIS

CLASS 16—PAPER GOODS AND PRINTED MATTER

FOR BOOKS, PAMPHLETS AND EDUCATION AND TRAINING MATERIALS IN THE FIELD OF SPIRITUAL HEALING (U.S. CLS. 2, 5, 22, 23, 29, 37, 38 AND 50).
FIRST USE 8-20-1999; IN COMMERCE 9-28-1999.

CLASS 21—HOUSEWARES AND GLASS

FOR SEMIWORKED UNWROUGHT GLASS PRODUCTS, NAMELY, GLASS SHAPES AND FIGURINES (U.S. CLS. 2, 13, 23, 29, 30, 33, 40 AND 50).
FIRST USE 8-20-1999; IN COMMERCE 9-28-1999.

CLASS 35—ADVERTISING AND BUSINESS

FOR RETAIL AND WHOLESALE DISTRIBUTORSHIP SERVICES FEATURING BOOKS, UNWROUGHT GLASS PRODUCTS, WOOD CARVINGS, AND METAL PRODUCTS; ONLINE RETAIL AND WHOLESALE DISTRIBUTORSHIP SERVICES FEATURING BOOKS, UNWROUGHT GLASS PRODUCTS, WOOD CARVINGS AND METAL PRODUCTS ON THE GLOBAL COMPUTER NETWORK (U.S. CLS. 100, 101 AND 102).
FIRST USE 8-20-1999; IN COMMERCE 9-28-1999.

CLASS 41—EDUCATION AND ENTERTAINMENT

FOR EDUCATIONAL SERVICES, NAMELY, CONDUCTING TRAINING SEMINARS, LECTURES, AND COURSES IN THE FIELD OF SPIRITUAL HEALING, AND DISTRIBUTING EDUCATIONAL AND TRAINING MATERIALS THEREWITH (U.S. CLS. 100, 101 AND 107).
FIRST USE 8-20-1999; IN COMMERCE 9-28-1999.

2,747,911. DEMARAY, LINDA, ARVADA, CO. SN 76-160,174.
PUB. 11-26-2002, FILED 11-6-2000.

BIOOSCILLATOR

CLASS 16—PAPER GOODS AND PRINTED MATTER

FOR BOOKS, PAMPHLETS AND EDUCATION AND TRAINING MATERIALS IN THE FIELD OF SPIRITUAL HEALING (U.S. CLS. 2, 5, 22, 23, 29, 37, 38 AND 50).
FIRST USE 6-24-2000; IN COMMERCE 6-24-2000.

CLASS 21—HOUSEWARES AND GLASS

FOR SEMIWORKED UNWROUGHT GLASS PRODUCTS, NAMELY, GLASS SHAPES AND FIGURINES (U.S. CLS. 2, 13, 23, 29, 30, 33, 40 AND 50).
FIRST USE 6-24-2000; IN COMMERCE 6-24-2000.

CLASS 35—ADVERTISING AND BUSINESS

FOR RETAIL AND WHOLESALE DISTRIBUTORSHIP SERVICES FEATURING BOOKS, UNWROUGHT GLASS PRODUCTS, WOOD CARVINGS, AND METAL PRODUCTS; ONLINE RETAIL AND WHOLESALE DISTRIBUTORSHIP SERVICES FEATURING BOOKS, UNWROUGHT GLASS PRODUCTS, WOOD CARVINGS AND METAL PRODUCTS ON THE GLOBAL COMPUTER NETWORK (U.S. CLS. 100, 101 AND 102).
FIRST USE 6-24-2000; IN COMMERCE 6-24-2000.

CLASS 41—EDUCATION AND ENTERTAINMENT

FOR EDUCATIONAL SERVICES NAMELY, CONDUCTING TRAINING SEMINARS, LECTURES AND COURSES IN THE FIELD OF SPIRITUAL HEALING, AND DISTRIBUTING EDUCATIONAL AND TRAINING MATERIALS THEREWITH (U.S. CLS. 100, 101 AND 107).
FIRST USE 6-24-2000; IN COMMERCE 6-24-2000.

2,747,919. TRUPER HERRAMIENTAS, S.A. DE C.V., JILOTEPEC ESTADO DE MEXICO, MEXICO. SN 76-165,280.
PUB. 4-9-2002, FILED 11-15-2000.

PRETUL

CLASS 7—MACHINERY

FOR ELECTRIC AND HOT MELT GLUE GUNS; TILE CUTTING MACHINES (U.S. CLS. 13, 19, 21, 23, 31, 34 AND 35).
FIRST USE 1-31-2002; IN COMMERCE 1-31-2002.

CLASS 8—HAND TOOLS

FOR HAND, CARPENTRY AND GARDEN TOOLS, NAMELY, HACKSAW FRAMES AND BLADES, DRILL BITS, CARPENTRY PLANES, COLD CHISELS, TUBING CUTTERS, FLARING TOOLS, BRICK/POINTING TROWELS, TILE CUTTERS, SCREWDRIVERS, SQUARES, PUTTY KNIVES, CHISELS, ADJUSTABLE WRENCHES, COMBINATION WRENCHES, OPEN END WRENCHES, UNIVERSAL WRENCHES, FOUR WAY LUG WRENCHES, HEX AND TORQ KEYS AND KEY SETS, PIPE WRENCHES, SHOVELS AND REPLACEMENT HANDLES FOR SHOVELS, HAMMERS, UTILITY KNIVES, SNAP-OFF KNIVES, PLIERS, LOCKING PLIERS, RIVETERS, SOCKET PUNCHES, HANDSAWS AND SCISSORS; DRIVE SOCKET SETS COMPRISED OF WRENCHES, RATCHETS, SOCKETS, HEX AND TORQ KEYS (U.S. CLS. 23, 28 AND 44).
FIRST USE 1-31-2002; IN COMMERCE 1-31-2002.

CLASS 9—ELECTRICAL AND SCIENTIFIC APPARATUS

FOR TAPE MEASURES AND MEASURING INSTRUMENTS, NAMELY, NON-ELECTRIC GRADUATED TAPE RULES; SURVEYOR'S SPIRIT LEVELS; CARPENTRY LEVELS (U.S. CLS. 21, 23, 26, 36 AND 38).
FIRST USE 1-31-2002; IN COMMERCE 1-31-2002.

2,747,925. GART BROS. SPORTING GOODS COMPANY, ENGLEWOOD, CO. BY ASSIGNMENT DNS SPORTS LIMITED LIABILITY COMPANY, LONGMONT, CO. SN 76-169,092. PUB. 4-30-2002, FILED 11-21-2000.

ALPINE DESIGN

OWNER OF U.S. REG. NO. 946,381.
NO CLAIM IS MADE TO THE EXCLUSIVE RIGHT TO USE "DESIGN", APART FROM THE MARK AS SHOWN.

CLASS 18—LEATHER GOODS

FOR BACKPACKS (U.S. CLS. 1, 2, 3, 22 AND 41).
FIRST USE 4-0-2002; IN COMMERCE 4-0-2002.

CLASS 20—FURNITURE AND ARTICLES NOT OTHERWISE CLASSIFIED

FOR SLEEPING BAGS (U.S. CLS. 2, 13, 22, 25, 32 AND 50).
FIRST USE 4-0-2002; IN COMMERCE 4-0-2002.

CLASS 22—CORDAGE AND FIBERS

FOR TENTS (U.S. CLS. 1, 2, 7, 19, 22, 42 AND 50).
FIRST USE 4-0-2002; IN COMMERCE 4-0-2002.

CLASS 39—TRANSPORTATION AND STORAGE

FOR ELECTRONIC DATA STORAGE OF CUMULATIVE SKI INFORMATION FOR LOCAL DISPLAY AND FOR DISPLAY VIA THE INTERNET (U.S. CLS. 100 AND 105).
FIRST USE 2-0-2001; IN COMMERCE 2-0-2001.

2,747,932. ARIEL RESEARCH CORPORATION, BETHESDA, MD. SN 76-170,703. PUB. 7-2-2002, FILED 11-22-2000.

ARIEL GLOBALVIEW**CLASS 9—ELECTRICAL AND SCIENTIFIC APPARATUS**

FOR PRE-RECORDED MEDIA, NAMELY, MAGNETIC TAPES, MAGNETIC CARTRIDGES, CD-ROMS, AND DVDS, CONTAINING A DATABASE OF WORLDWIDE CHEMICAL REGULATORY INFORMATION; SOFTWARE FOR ACCESSING, MANIPULATING, PROCESSING, AND DISPLAYING WORLDWIDE CHEMICAL REGULATORY INFORMATION (U.S. CLS. 21, 23, 26, 36 AND 38).
FIRST USE 6-30-2001; IN COMMERCE 6-30-2001.

CLASS 42—SCIENTIFIC, COMPUTER AND LEGAL SERVICES

FOR ON-LINE SUBSCRIPTION SERVICE PROVIDING ACCESS TO A DATABASE OF WORLDWIDE CHEMICAL REGULATORY INFORMATION VIA A GLOBAL COMPUTER NETWORK (U.S. CLS. 100 AND 101).
FIRST USE 6-30-2001; IN COMMERCE 6-30-2001.

2,747,935. IDMICRO, INC., TACOMA, WA. SN 76-174,391. PUB. 1-29-2002, FILED 12-1-2000.

VERTICAL ADVANTAGE**CLASS 9—ELECTRICAL AND SCIENTIFIC APPARATUS**

FOR ELECTRONIC SYSTEMS FOR DETERMINING AND STORING VERTICAL SKI INFORMATION FOR INDIVIDUALS FOR LOCAL DISPLAY AND FOR DISPLAY VIA THE INTERNET COMPRISING COMPUTERS, RF TRANSPONDERS, RF INTERROGATORS INCLUDING MOUNTING AND SUPPORT EQUIPMENT, RF NETWORKING COMPONENTS, NAMELY, ANTENNAS, COAXIAL CABLES AND MODEMS, VIDEO DISPLAYS, SOFTWARE FOR STORING AND UPDATING VERTICAL SKI INFORMATION AND PROVIDING REWARDS TO MEMBERS AND PARTS AND COMPONENTS THEREFOR (U.S. CLS. 21, 23, 26, 36 AND 38).
FIRST USE 1-1-2002; IN COMMERCE 1-1-2002.

CLASS 35—ADVERTISING AND BUSINESS

FOR DATA PROCESSING SERVICES, NAMELY, DATA COLLECTION AND PROCESSING OF CUMULATIVE SKI INFORMATION FOR LOCAL DISPLAY AND FOR DISPLAY VIA THE INTERNET (U.S. CLS. 100, 101 AND 102).
FIRST USE 2-0-2001; IN COMMERCE 2-1-2001.

2,747,936. ROASTY'S RESTAURANT HOLDINGS LLC, HEWLETT, NY. SN 76-175,629. PUB. 8-21-2001, FILED 12-6-2000.

ROASTY'S**CLASS 29—MEATS AND PROCESSED FOODS**

FOR ROAST BEEF (U.S. CL. 46).
FIRST USE 10-9-2002; IN COMMERCE 10-9-2002.

CLASS 42—SCIENTIFIC, COMPUTER AND LEGAL SERVICES

FOR RESTAURANT SERVICES (U.S. CLS. 100 AND 101).
FIRST USE 10-9-2002; IN COMMERCE 10-9-2002.

2,747,940. KOLON INDUSTRIES, INC., KWACHON-CITY, KYUNGGI-DO 427-040, REPUBLIC OF KOREA. SN 76-176,472. PUB. 6-25-2002, FILED 12-5-2000.

ROJEL**CLASS 23—YARNS AND THREADS**

FOR SYNTHETIC AND ELASTIC THREADS AND YARNS FOR TEXTILE USE; RAYON THREAD AND YARNS; SPUN THREAD AND YARN; SEWING THREAD AND YARN; MIXED SILK THREAD AND YARN (U.S. CL. 43).
FIRST USE 1-14-2001; IN COMMERCE 1-14-2001.

CLASS 24—FABRICS

FOR SYNTHETIC FIBER FABRICS, NAMELY POLYESTER, RAYON AND NYLON; COTTON AND SILK KNITTED FABRICS (U.S. CLS. 42 AND 50).
FIRST USE 1-14-2001; IN COMMERCE 1-14-2001.

CLASS 25—CLOTHING

FOR CLOTHING, NAMELY MEN'S SUITS, JUMPERS, JACKETS, UNDERWEAR, SWIMSUITS, STOCKINGS, ALOHA SHIRTS, AND WATERPROOF CLOTHING, NAMELY JACKETS (U.S. CLS. 22 AND 39).
FIRST USE 1-14-2001; IN COMMERCE 1-14-2001.

2,747,945. FOG CUTTER CAPITAL GROUP INC., PORTLAND, OR. SN 76-180,457. PUB. 7-2-2002, FILED 12-12-2000.

2,747,950. BORLAND SOFTWARE CORPORATION, SCOTT VALLEY, CA. SN 76-182,060. PUB. 6-4-2002, FILED 12-14-2000.

FOG CUTTER

CLX

CLASS 36—INSURANCE AND FINANCIAL

FOR REAL ESTATE BROKERAGE SERVICES; REAL ESTATE INVESTMENT SERVICES; REAL ESTATE APPRAISAL SERVICES; REAL ESTATE LISTING SERVICES; REAL ESTATE MANAGEMENT AND LEASING SERVICES; FINANCIAL INVESTMENT SERVICES IN THE FIELDS OF SECURITIES, COMMODITIES, MUTUAL FUNDS, AND REAL ESTATE; FINANCIAL MANAGEMENT SERVICES; AND CONSULTATION SERVICES IN THE FIELDS OF FINANCIAL AND REAL ESTATE INVESTMENT ADVICE, ANALYSIS AND MANAGEMENT (U.S. CLS. 100, 101 AND 102).

FIRST USE 1-25-2001; IN COMMERCE 1-25-2001.

CLASS 37—CONSTRUCTION AND REPAIR

FOR REAL ESTATE DEVELOPMENT SERVICES (U.S. CLS. 100, 103 AND 106).

FIRST USE 1-25-2001; IN COMMERCE 1-25-2001.

CLASS 9—ELECTRICAL AND SCIENTIFIC APPARATUS

FOR COMPUTER PROGRAMS, NAMELY, COMPILERS AND ASSEMBLERS; VISUAL DEVELOPMENT SOFTWARE FOR USE IN CREATING APPLICATIONS AND OTHER PROGRAMS AND FOR DEVELOPING GRAPHICAL USER INTERFACES; GLOBAL COMPUTER NETWORK AND WEB-BASED COMPUTER PROGRAMS, COMPUTER PROGRAMS AND APPLICATION DEVELOPMENT SOFTWARE FOR USE IN DESIGNING, DEVELOPING, WRITING AND IMPLEMENTING USER-SPECIFIC APPLICATIONS AND GENERAL PURPOSE APPLICATION PROGRAMS; OBJECT-ORIENTED AND CLIENT/SERVER PROGRAMMING DEVELOPMENT SOFTWARE, TOOLS AND UTILITIES; OBJECT REQUEST BROKER (ORB) PROGRAM DEVELOPMENT SOFTWARE, TOOLS AND UTILITIES FOR USE IN WRITING AND IMPLEMENTING COMPUTER PROGRAMS USING ORB TECHNOLOGY; DEVELOPMENT SOFTWARE, TOOLS AND UTILITIES FOR USE IN DESIGNING AND IMPLEMENTING PROGRAMS FOR ACCESS TO AND FOR USE IN CONNECTION WITH LOCAL AREA NETWORKS, ENTERPRISE NETWORKS, LOCAL COMPUTER NETWORKS, EXTRANETS, CORPORATE INFORMATION NETWORKS, WIDE AREA NETWORKS AND GLOBALLY INTERCONNECTED COMPUTER NETWORKS LINKED BY COMMON OR DIVERSE PROTOCOLS; PROGRAMMING SOFTWARE TOOLS FOR USE IN DEVELOPING, MAINTAINING, ENHANCING AND OPERATING COMPUTER PROGRAMS AND COMPUTER SYSTEMS; COMPUTER UTILITY PROGRAMS, AND USER MANUALS SOLD THEREWITH AS A UNIT (U.S. CLS. 21, 23, 26, 36 AND 38).

FIRST USE 3-7-2001; IN COMMERCE 3-7-2001.

CLASS 42—SCIENTIFIC, COMPUTER AND LEGAL SERVICES

FOR DESIGN AND DEVELOPMENT OF COMPUTER SOFTWARE FOR OTHERS; PROFESSIONAL AND TECHNICAL CONSULTING SERVICES IN RELATION TO COMPUTERS, COMPUTER SOFTWARE, DATABASES AND DATABASE MANAGEMENT, NETWORKING, PROGRAMMING AND APPLICATION DEVELOPMENT, USER INTERFACES, CLIENT/SERVER AND REMOTE COMPUTING APPLICATIONS, COMPUTER SYSTEMS OPERATION TOOLS AND UTILITIES, GLOBAL COMPUTER INFORMATION NETWORK, ENTERPRISE, WIDE AREA AND LOCAL AREA NETWORK ACCESS, OPERATIONS AND SYSTEMS MANAGEMENT, DEVELOPMENT TOOLS AND UTILITIES, AND MONITORING, CONTROL AND MANAGEMENT OF COMPUTER SYSTEMS; MAINTENANCE AND SUPPORT SERVICES FOR COMPUTER SOFTWARE, NAMELY TELEPHONE CONSULTATION, DEBUGGING COMPUTER SOFTWARE, UPDATING COMPUTER SOFTWARE, PROVIDING ELECTRONIC AND ON-LINE BULLETIN BOARDS AND REFERENCE INFORMATION, AND WEB SITES, ALL IN THE FIELDS OF COMPUTERS, COMPUTER SOFTWARE AND COMPUTER SYSTEMS; COMPUTER SYSTEMS AND COMPUTER SOFTWARE DEVELOPMENT CONSULTING SERVICES (U.S. CLS. 100 AND 101).

FIRST USE 3-7-2001; IN COMMERCE 3-7-2001.

2,747,946. WORLD WIDE WEB APPLICATIONS, LLC, INDIANAPOLIS, IN. SN 76-180,827. PUB. 7-16-2002, FILED 12-14-2000.

APPNUITY

CLASS 38—COMMUNICATION

FOR ELECTRONIC MAIL SERVICES (U.S. CLS. 100, 101 AND 104).

FIRST USE 1-1-2001; IN COMMERCE 1-1-2001.

CLASS 42—SCIENTIFIC, COMPUTER AND LEGAL SERVICES

FOR HOSTING THE WEB SITES OF OTHERS ON A COMPUTER SERVER FOR A GLOBAL COMPUTER NETWORK; INFORMATION TECHNOLOGY CONSULTING SERVICES, NAMELY, COMPUTER SOFTWARE SUPPORT AND MAINTENANCE (U.S. CLS. 100 AND 101).

FIRST USE 1-1-2001; IN COMMERCE 1-1-2001.

2,747,961. GOEKEN GROUP CORPORATION, NAPERVILLE, IL. SN 76-189,208. PUB. 7-2-2002, FILED 1-3-2001.

E-CAP

CLASS 38—COMMUNICATION

FOR TELECOMMUNICATION SERVICES, NAMELY, USING COMPUTER GENERATED MAPPING SYSTEMS, LOCATION SYSTEMS, AND DATABASES TO TRANSMIT MESSAGES AND DATA TO 911 PUBLIC SAFETY ANSWERING POINTS, HOSPITALS, AMBULANCE EMERGENCY MEDICAL SERVICES AND HEALTH CARE AGENCIES; TELECOMMUNICATION SERVICES, NAMELY, TRANSMITTING AND ROUTING WIRELESS HELP REQUESTS FOR APPROPRIATE MEDICAL, ROADSIDE OR POLICE ASSISTANCE (U.S. CLS. 100, 101 AND 104).

FIRST USE 1-30-2001; IN COMMERCE 1-30-2001.

CLASS 42—SCIENTIFIC, COMPUTER AND LEGAL SERVICES

FOR INFORMATION SERVICES, NAMELY, PROVIDING A COMPUTER DATABASE IN THE FIELD OF MEDICAL INFORMATION FOR USE BY MEDICAL PROVIDERS (U.S. CLS. 100 AND 101).

FIRST USE 1-30-2001; IN COMMERCE 1-30-2001.

2,747,969. HUBBARD & REVO-COHEN, INC., VIENNA, VA. SN 76-193,503. PUB. 9-4-2001, FILED 1-12-2001.

SCENDIS

CLASS 9—ELECTRICAL AND SCIENTIFIC APPARATUS

FOR COMPUTER SOFTWARE IN THE FIELD OF RISK MANAGEMENT FOR USE IN HELPING COMPANIES AND GOVERNMENTS BETTER MANAGE HIGH RISK HUMAN RESOURCES AND BUSINESS ISSUES SUCH AS SEXUAL HARASSMENT, DIVERSITY, CONFLICT RESOLUTION, EEO/AFFIRMATIVE ACTION AND DISCRIMINATION CLAIMS (U.S. CLS. 21, 23, 26, 36 AND 38).

FIRST USE 1-12-2001; IN COMMERCE 1-12-2001.

CLASS 35—ADVERTISING AND BUSINESS

FOR BUSINESS MANAGEMENT CONSULTING, HUMAN RESOURCE CONSULTING (U.S. CLS. 100, 101 AND 102).

FIRST USE 1-12-2001; IN COMMERCE 1-12-2001.

CLASS 41—EDUCATION AND ENTERTAINMENT

FOR PROVIDING SEMINARS, CLASSES AND TRAINING IN HUMAN RESOURCES AND HIGH RISK EMPLOYMENT ISSUES SUCH AS HARASSMENT AND DIVERSITY (U.S. CLS. 100, 101 AND 107).

FIRST USE 1-12-2001; IN COMMERCE 1-12-2001.

2,747,975. OSCAR III, INC., WILDWOOD, MO. SN 76-195,487. PUB. 8-20-2002, FILED 1-17-2001.

DAVID OSCARSON

THE NAME IN THE MARK IDENTIFIES A LIVING

INDIVIDUAL WHOSE CONSENT IS OF RECORD.

CLASS 14—JEWELRY

FOR JEWELRY (U.S. CLS. 2, 27, 28 AND 50).
FIRST USE 11-5-2001; IN COMMERCE 11-5-2001.

CLASS 16—PAPER GOODS AND PRINTED MATTER

FOR LETTER OPENERS, WRITING INSTRUMENTS (U.S. CLS. 2, 5, 22, 23, 29, 37, 38 AND 50).
FIRST USE 6-28-2000; IN COMMERCE 6-28-2000.

CLASS 20—FURNITURE AND ARTICLES NOT OTHERWISE CLASSIFIED

FOR PICTURE FRAMES (U.S. CLS. 2, 13, 22, 25, 32 AND 50).
FIRST USE 11-5-2001; IN COMMERCE 11-5-2001.

2,747,991. GEOBRA BRANDSTATTER GMBH & CO. KG, D-90513 ZIRNDORF, FED REP GERMANY. SN 76-203,236. PUB. 7-30-2002, FILED 2-1-2001.

CLASS 9—ELECTRICAL AND SCIENTIFIC APPARATUS

FOR SPECTACLES (U.S. CLS. 21, 23, 26, 36 AND 38).
FIRST USE 0-0-1998; IN COMMERCE 1-0-2001.

CLASS 21—HOUSEWARES AND GLASS

FOR CLOTH FOR CLEANING SPECTACLES (U.S. CLS. 2, 13, 23, 29, 30, 33, 40 AND 50).
FIRST USE 0-0-1988; IN COMMERCE 1-0-2001.

2,747,992. MSCL, INC., SANTA MONICA, CA. SN 76-204,296. PUB. 6-25-2002, FILED 2-2-2001.

FILMCORE

CLASS 39—TRANSPORTATION AND STORAGE

FOR AUDIO AND VIDEO DISK STORAGE; ELECTRONIC STORAGE OF VIDEO AND AUDIO DATA; WAREHOUSE STORAGE OF VIDEO AND AUDIO DATA (U.S. CLS. 100 AND 105).
FIRST USE 1-26-1984; IN COMMERCE 1-26-1984.

CLASS 40—MATERIAL TREATMENT

FOR AUDIO, VIDEO, AND FILM DUPLICATION (U.S. CLS. 100, 103 AND 106).
FIRST USE 1-26-1984; IN COMMERCE 1-26-1984.

CLASS 41—EDUCATION AND ENTERTAINMENT

FOR FILM POST-PRODUCTION (U.S. CLS. 100, 101 AND 107).

FIRST USE 1-26-1984; IN COMMERCE 1-26-1984.

2,748,010. MASONIC HOME, INC., THE, CHARLTON, MA. SN 76-211,122. PUB. 3-19-2002, FILED 2-15-2001.

2,748,003. CTA, LLC., FORT WAYNE, IN. SN 76-209,184. PUB. 7-9-2002, FILED 2-9-2001.

AMERIZON**CLASS 9—ELECTRICAL AND SCIENTIFIC APPARATUS**

FOR SUPERVISORY CONTROL AND DATA ACQUISITION (SC ADA) AND TELEMETRY EQUIPMENT AND DEVICES, NAMELY, SATELLITE DISHES, SATELLITE TELEPHONES, SATELLITE PROCESSORS, AND SATELLITE NAVIGATIONAL SYSTEMS IN THE NATURE OF A GLOBAL POSITIONING SYSTEM; WIRELESS VOICE AND DATA COMMUNICATION DEVICES, NAMELY, WIRELESS TELEPHONES, TWO-WAY RADIOS, AND PAGERS (U.S. CLS. 21, 23, 26, 36 AND 38).

FIRST USE 2-12-2001; IN COMMERCE 2-12-2001.

CLASS 37—CONSTRUCTION AND REPAIR

FOR INSTALLATION AND REPAIR OF SUPERVISORY CONTROL AND DATA ACQUISITION (SC ADA) AND TELEMETRY EQUIPMENT AND DEVICES AND WIRELESS VOICE AND DATA COMMUNICATION DEVICES (U.S. CLS. 100, 103 AND 106).

FIRST USE 2-12-2001; IN COMMERCE 2-12-2001.

2,748,004. KISSOON, KATHLEEN W., EDINA, MN. SN 76-209,527. PUB. 7-23-2002, FILED 2-10-2001.

OURFAMILYWIZARD**CLASS 38—COMMUNICATION**

FOR ELECTRONIC MAIL SERVICES FOR FAMILIES, BLENDED FAMILIES, AND SIMILAR GROUPS OF PERSONS SHARING A COMMON INTEREST IN COORDINATING SCHEDULES (U.S. CLS. 100, 101 AND 104).

FIRST USE 3-31-2001; IN COMMERCE 3-31-2001.

CLASS 39—TRANSPORTATION AND STORAGE

FOR ELECTRONIC STORAGE OF FAMILY DATA, NAMELY, CUSTODY ORDERS AND CHILD REARING INFORMATION (U.S. CLS. 100 AND 105).

FIRST USE 3-31-2001; IN COMMERCE 3-31-2001.

CLASS 42—SCIENTIFIC, COMPUTER AND LEGAL SERVICES

FOR PROVIDING A WEBSITE WHICH ENABLES DIVORCED PARENTS AND BLENDED FAMILIES TO COORDINATE CHILD VISITATION SCHEDULES (U.S. CLS. 100 AND 101).

FIRST USE 3-31-2001; IN COMMERCE 3-31-2001.

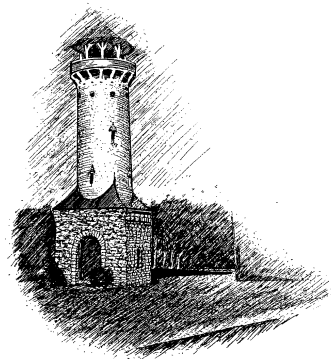

THE STIPPLING IS A FEATURE OF THE MARK AND DOES NOT INDICATE COLOR.

CLASS 35—ADVERTISING AND BUSINESS

FOR PROVIDING OPERATIONAL MANAGEMENT OF HEALTH CARE FACILITIES FOR OTHERS, NAMELY, NURSING HOME FACILITIES, RETIREMENT HOME FACILITIES, AND RESIDENTIAL LONG TERM HEALTH CARE FACILITIES (U.S. CLS. 100, 101 AND 102).

FIRST USE 2-1-2001; IN COMMERCE 2-15-2001.

CLASS 36—INSURANCE AND FINANCIAL

FOR PROVIDING PROPERTY MANAGEMENT SERVICES, NAMELY, LEASING OF REAL PROPERTY AND REAL ESTATE BROKERAGE SERVICES, AND PROVIDING ADMINISTRATION SERVICES FOR PRE-PAID HEALTH CARE PLANS, NAMELY, PROVIDING ON-PREMISES SKILLED NURSING CARE WITHIN A RETIREMENT COMMUNITY (U.S. CLS. 100, 101 AND 102).

FIRST USE 2-1-2001; IN COMMERCE 2-15-2001.

CLASS 42—SCIENTIFIC, COMPUTER AND LEGAL SERVICES

FOR PROVIDING HOUSING AND ACCOMMODATION SERVICES, NAMELY, RETIREMENT AND NURSING HOME SERVICES, HEALTH CARE SERVICES, AND ON-PREMISES ASSISTED LIVING AND SKILLED NURSING CARE SERVICES (U.S. CLS. 100 AND 101).

FIRST USE 2-1-2001; IN COMMERCE 2-15-2001.

2,748,016. CEMM THOME S.A., DONNEMARIE DONTILLY, FRANCE, BY MERGER THOME S.A., BOISSY SAIANT LEGER, FRANCE. SN 76-216,601. PUB. 6-25-2002, FILED 2-27-2001.

CEMM

OWNER OF U.S. REG. NO. 2,595,345.

CLASS 40—MATERIAL TREATMENT

FOR CUSTOM MANUFACTURE OF ELECTRICAL WIRING HARNESSSES, CONNECTORS AND SOCKETS (U.S. CLS. 100, 103 AND 106).

FIRST USE 0-0-1996; IN COMMERCE 0-0-1996.

CLASS 42—SCIENTIFIC, COMPUTER AND LEGAL SERVICES

FOR DESIGN AND DEVELOPMENT OF ELECTRICAL WIRING HARNESES, CONNECTORS AND SOCKETS (U.S. CLS. 100 AND 101).

FIRST USE 0-0-1996; IN COMMERCE 0-0-1996.

2,748,017. TUFTS ASSOCIATED HEALTH MAINTENANCE ORGANIZATION, INC., WALTHAM, MA. SN 76-217,117. PUB. 10-9-2001, FILED 2-27-2001.

NO ONE DOES MORE TO KEEP YOU HEALTHY

CLASS 16—PAPER GOODS AND PRINTED MATTER

FOR PERIODICALS, NEWSLETTERS AND BROCHURES RELATING TO HEALTH INSURANCE, HEALTH CARE, HEALTH MAINTENANCE AND MEDICAL INFORMATION (U.S. CLS. 2, 5, 22, 23, 29, 37, 38 AND 50).

FIRST USE 9-0-2002; IN COMMERCE 9-0-2002.

CLASS 36—INSURANCE AND FINANCIAL

FOR INSURANCE AND REINSURANCE UNDERWRITING AND BROKERAGE SERVICES IN THE FIELDS OF HEALTH CARE, DENTAL CARE, PRESCRIPTION DRUGS, MENTAL HEALTH CARE, PREPAID HEALTH CARE, HEALTH INDEMNITY INSURANCE, LIFE INSURANCE, DISABILITY INSURANCE, AND ACCIDENT INSURANCE; THIRD-PARTY INSURANCE ADMINISTRATION SERVICES IN THE FIELDS OF HEALTH CARE, DENTAL CARE, PRESCRIPTION DRUGS, MENTAL HEALTH CARE, PREPAID HEALTH CARE, HEALTH INDEMNITY INSURANCE, LIFE INSURANCE, DISABILITY INSURANCE, ACCIDENT INSURANCE, SELF-INSURANCE, EMPLOYEE BENEFITS AND CLAIMS PROCESSING; ELECTRONIC PROCESSING OF INSURANCE CLAIMS AND PAYMENT DATA, PROVIDING AN ON-LINE COMPUTER DATABASE FEATURING INFORMATION RELATING TO ADMINISTRATION OF HEALTH CARE, HEALTH INSURANCE, AND EMPLOYEE BENEFITS; PROVIDING HEALTH TESTING SERVICES (U.S. CLS. 100, 101 AND 102).

FIRST USE 6-0-1990; IN COMMERCE 6-0-1990.

CLASS 39—TRANSPORTATION AND STORAGE

FOR COMPUTER SERVICES, NAMELY, ELECTRONIC STORAGE AND RETRIEVAL OF INFORMATION IN THE FIELDS OF HEALTH CARE, HEALTH INSURANCE, AND EMPLOYEE BENEFITS ADMINISTRATION (U.S. CLS. 100 AND 105).

FIRST USE 5-0-1997; IN COMMERCE 5-0-1997.

CLASS 41—EDUCATION AND ENTERTAINMENT

FOR EDUCATIONAL SERVICES, NAMELY, CONDUCTING CLASSES, SEMINARS, CONFERENCES, WORKSHOPS AND LECTURES IN THE FIELD OF HEALTH INSURANCE, HEALTH CARE, HEALTH MAINTENANCE, MEDICAL INFORMATION, AND HOSPITAL ADMINISTRATION (U.S. CLS. 100, 101 AND 107).

FIRST USE 6-0-2002; IN COMMERCE 6-0-2002.

2,748,018. GETZOV, HARRY J., NEW YORK, NY. SN 76-217,327. PUB. 6-18-2002, FILED 2-28-2001.

ELDERCATION

CLASS 9—ELECTRICAL AND SCIENTIFIC APPARATUS

FOR PRE-RECORDED DVDS, VIDEOTAPES AND AUDIOTAPES CONCERNING HEALTHCARE AND LAW (U.S. CLS. 21, 23, 26, 36 AND 38).

FIRST USE 12-19-1999; IN COMMERCE 12-19-1999.

CLASS 41—EDUCATION AND ENTERTAINMENT

FOR EDUCATIONAL SERVICES, NAMELY, PROVIDING WORKSHOPS AND SEMINARS IN THE FIELDS OF HEALTHCARE AND LAW (U.S. CLS. 100, 101 AND 107).

FIRST USE 12-19-1999; IN COMMERCE 12-19-1999.

2,748,020. GOODRICH CORPORATION, CHARLOTTE, NC. SN 76-218,240. PUB. 6-4-2002, FILED 3-2-2001.

CLASS 8—HAND TOOLS

FOR MULTIPLE FUNCTION FOLDING POCKET TOOLS; POCKETKNIVES; MULTIPLE FUNCTION POCKET SIZE INSTRUMENTS CONSISTING OF VARIOUS IMPLEMENTS, NAMELY, NAIL FILE WITH SCREWDRIVER TIP, TOOTHPICK, STRAIGHT PIN, TWEEZERS, PEN, RULER, KNIFE BLADE AND SCISSORS (U.S. CLS. 23, 28 AND 44).

FIRST USE 6-1-2001; IN COMMERCE 6-1-2001.

CLASS 14—JEWELRY

FOR CLOCKS; WATCHES; CLOCKS INCORPORATING CALCULATORS (U.S. CLS. 2, 27, 28 AND 50).

FIRST USE 6-1-2001; IN COMMERCE 6-1-2001.

CLASS 16—PAPER GOODS AND PRINTED MATTER

FOR PENS; HIGHLIGHTING PENS; NOTE PADS; MEMO BOOKS; WRITING SETS CONSISTING PRIMARILY OF PENCILS, PENCIL SHARPENER, ERASER, AND DRAWING RULER; STATIONERY PORTFOLIOS; DOCUMENT HOLDERS; LUNCH BAGS (U.S. CLS. 2, 5, 22, 23, 29, 37, 38 AND 50).

FIRST USE 6-1-2001; IN COMMERCE 6-1-2001.

CLASS 18—LEATHER GOODS

FOR BUSINESS CARD CASES; UMBRELLAS; GOLF SHOE BAGS FOR TRAVEL; PLASTIC TRADE SHOW TOTE BAGS; SUITCASES; DUFFEL BAGS; GARMENT BAGS FOR TRAVEL; LUGGAGE TAGS; WALLETS; ALL-PURPOSE ATHLETIC BAGS (U.S. CLS. 1, 2, 3, 22 AND 41).

FIRST USE 6-1-2001; IN COMMERCE 6-1-2001.

CLASS 21—HOUSEWARES AND GLASS

FOR PORTABLE BEVERAGE COOLERS; PORTABLE COOLERS; MUGS; SPORTS BOTTLES SOLD EMPTY; VACUUM BOTTLES; INSULATING SLEEVE HOLDERS FOR BEVERAGE CANS (U.S. CLS. 2, 13, 23, 29, 30, 33, 40 AND 50).

FIRST USE 6-1-2001; IN COMMERCE 6-1-2001.

CLASS 24—FABRICS

FOR TOWELS; FABRIC FLAGS AND BANNERS (U.S. CLS. 42 AND 50).

FIRST USE 6-1-2001; IN COMMERCE 6-1-2001.

CLASS 25—CLOTHING

FOR CLOTHING, NAMELY, CAPS, SHIRTS, JACKETS, VESTS, SWEATERS, PANTS AND SKIRTS (U.S. CLS. 22 AND 39).

FIRST USE 6-1-2001; IN COMMERCE 6-1-2001.

CLASS 28—TOYS AND SPORTING GOODS

FOR SPORTING GOODS, NAMELY, GOLF BALLS, TENNIS BALLS, GOLF TEES, AND DIVOT FIXERS (U.S. CLS. 22, 23, 38 AND 50).

FIRST USE 6-1-2001; IN COMMERCE 6-1-2001.

2,748,025. VOLVO TRADEMARK HOLDING AB, 405 08 GÖTEBORG, SWEDEN. SN 76-221,308. PUB. 6-18-2002, FILED 3-8-2001.

VOLVO FOR LIFE**CLASS 35—ADVERTISING AND BUSINESS**

FOR PROMOTING THE SALE OF GOODS AND SERVICES OF OTHERS BY DISSEMINATION OF PROMOTIONAL MATERIAL THROUGH AN ONLINE GLOBAL COMPUTER NETWORK, THROUGH THE DISTRIBUTION OF PRINTED MATERIAL, AUDIO AND VIDEO TAPES, TELEVISION AND RADIO BROADCASTS, AND PROMOTIONAL CONTESTS, AND THROUGH THE ADMINISTRATION OF CUSTOMER LOYALTY PROGRAMS; DEALER EXCELLENCE RECOGNITION AWARDS; MOTOR VEHICLE DEALERSHIP SERVICES (U.S. CLS. 100, 101 AND 102).

FIRST USE 1-5-2001; IN COMMERCE 1-5-2001.

CLASS 36—INSURANCE AND FINANCIAL

FOR FINANCIAL SPONSORSHIP OF CULTURAL EVENTS, SPORTING EVENTS, CONTESTS AND PROMOTIONS (U.S. CLS. 100, 101 AND 102).

FIRST USE 3-1-1999; IN COMMERCE 3-1-1999.

2,748,034. CHANNEL NEWS NETWORK, INC., VIENNA, VA. SN 76-224,602. PUB. 7-30-2002, FILED 3-15-2001.

CHANNEL NEWS NETWORK

NO CLAIM IS MADE TO THE EXCLUSIVE RIGHT TO USE "NEWS NETWORK", APART FROM THE MARK AS SHOWN.

CLASS 9—ELECTRICAL AND SCIENTIFIC APPARATUS

FOR ELECTRONIC PUBLICATIONS, NAMELY ONLINE MAGAZINES FEATURING GENERAL NEWS, BUSINESS NEWS, FINANCIAL NEWS, POLITICS, STOCK MARKET TABLES AND CURRENCY EXCHANGE RATES (U.S. CLS. 21, 23, 26, 36 AND 38).

FIRST USE 11-21-2000; IN COMMERCE 11-21-2000.

CLASS 35—ADVERTISING AND BUSINESS

FOR PROMOTING THE GOODS AND SERVICES OF OTHERS BY PROVIDING HYPERTEXT LINKS TO THE WEB SITES OF OTHERS; COMPUTERIZED ON-LINE RETAIL SERVICES IN THE FIELD OF MALE AND FEMALE CLOTHING, BEAUTY ACCESSORIES, ELECTRONIC AND INTERNET COMPONENTS, JEWELRY, WATCHES, SPORTS CLOTHING, CHILDREN'S CLOTHING, CHILDREN'S TOYS, BOOKS, CARPETS, ANTIQUES, PERSONAL AND HOUSEHOLD GOODS AND SIMILAR PRODUCTS OR GOODS; DISSEMINATION OF ADVERTISING FOR OTHERS VIA THE INTERNET (U.S. CLS. 100, 101 AND 102).

FIRST USE 11-21-2000; IN COMMERCE 11-21-2000.

CLASS 41—EDUCATION AND ENTERTAINMENT

FOR NEWS ANALYSIS AND FEATURES DISTRIBUTION (U.S. CLS. 100, 101 AND 107).

FIRST USE 11-21-2000; IN COMMERCE 11-21-2000.

2,748,022. VIVOMETRICS, INC., VENTURA, CA. SN 76-218,280. PUB. 7-16-2002, FILED 3-1-2001.

VIVOLOGIC**CLASS 9—ELECTRICAL AND SCIENTIFIC APPARATUS**

FOR SOFTWARE THAT TRANSFORMS DATA GATHERED FROM MEDICAL MONITORING SYSTEMS INTO PHYSIOLOGICAL AND MEDICAL INDICATIONS (U.S. CLS. 21, 23, 26, 36 AND 38).

FIRST USE 4-0-2002; IN COMMERCE 4-0-2002.

CLASS 42—SCIENTIFIC, COMPUTER AND LEGAL SERVICES

FOR PROCESSING AND ORGANIZING MEDICAL DATA FOR OTHERS, WHICH IS GATHERED FROM MEDICAL MONITORING SYSTEMS AND TRANSFORMED INTO PHYSIOLOGICAL AND MEDICAL INDICATIONS (U.S. CLS. 100 AND 101).

FIRST USE 4-0-2002; IN COMMERCE 4-0-2002.

CLASS 42—SCIENTIFIC, COMPUTER AND LEGAL SERVICES

FOR COMPUTER SERVICES, NAMELY PROVIDING DATABASES FEATURING GENERAL, SPECIALIZED, AND LOCAL NEWS AND INFORMATION TO SPECIFIC GEOGRAPHICAL AREAS (U.S. CLS. 100 AND 101).
FIRST USE 11-21-2000; IN COMMERCE 11-21-2000.

2,748,041. FINN TAWIL VENTURES, LLC, HOLLYWOOD, CA. SN 76-227,378. PUB. 8-20-2002, FILED 3-21-2001.

TOPLIGHT**CLASS 11—ENVIRONMENTAL CONTROL APPARATUS**

FOR FOLDABLE MODULAR LIGHT DIFFUSION BOXES; AND FOLDABLE MODULAR LIGHT DIFFUSION FIXTURES WITH LIGHTS THEREIN (U.S. CLS. 13, 21, 23, 31 AND 34).
FIRST USE 4-16-2001; IN COMMERCE 4-16-2001.

CLASS 37—CONSTRUCTION AND REPAIR

FOR RENTAL OF LIGHT DIFFUSION BOXES AND FOLDABLE MODULAR LIGHT DIFFUSION FIXTURES WITH LIGHTS THEREIN (U.S. CLS. 100, 103 AND 106).
FIRST USE 4-16-2001; IN COMMERCE 4-16-2001.

2,748,049. NANOCHRON, LLC, ARLINGTON, VA. SN 76-231,361. PUB. 12-4-2001, FILED 3-27-2001.

NANOCHRON**CLASS 9—ELECTRICAL AND SCIENTIFIC APPARATUS**

FOR COMPUTERS; COMPUTER HARDWARE; AND COMPUTER SOFTWARE FOR RESEARCH, DEVELOPMENT, DESIGN AND SYNTHESIS OF OPTICAL AND QUANTUM COMPUTER TECHNOLOGY (U.S. CLS. 21, 23, 26, 36 AND 38).
FIRST USE 4-9-2003; IN COMMERCE 4-9-2003.

CLASS 42—SCIENTIFIC, COMPUTER AND LEGAL SERVICES

FOR CONSULTATION IN THE FIELD OF RESEARCH, DEVELOPMENT, DESIGN AND FABRICATION OF OPTICAL AND QUANTUM COMPUTER TECHNOLOGY (U.S. CLS. 100 AND 101).
FIRST USE 4-9-2003; IN COMMERCE 4-9-2003.

2,748,053. DAN-DEE INTERNATIONAL, LTD., JERSEY CITY, NJ. SN 76-233,661. PUB. 9-3-2002, FILED 3-30-2001.

RUSTIC GARDEN

NO CLAIM IS MADE TO THE EXCLUSIVE RIGHT TO USE "GARDEN", APART FROM THE MARK AS SHOWN.

CLASS 19—NON-METALLIC BUILDING MATERIALS

FOR STEPPING STONES, BIRD BATHS MADE OF CONCRETE OR WOOD AND STATUARY LANTERNS MADE OF CONCRETE (U.S. CLS. 1, 12, 33 AND 50).
FIRST USE 10-1-2001; IN COMMERCE 10-1-2001.

CLASS 21—HOUSEWARES AND GLASS

FOR LAWN ORNAMENTS, NAMELY, GAZING BALLS, BIRD CAGES AND BIRD FEEDERS (U.S. CLS. 2, 13, 23, 29, 30, 33, 40 AND 50).
FIRST USE 7-1-2001; IN COMMERCE 7-1-2001.

2,748,056. ARAMARK CORPORATION, PHILADELPHIA, PA. SN 76-234,795. PUB. 12-4-2001, FILED 4-2-2001.



The logo for Euro Baguette features the words "Euro Baguette" in a stylized, hand-drawn font. The letter "B" is particularly large and has a decorative flourish underneath it. The entire logo is rendered in a dark, textured style.

NO CLAIM IS MADE TO THE EXCLUSIVE RIGHT TO USE "BAGUETTE", APART FROM THE MARK AS SHOWN. THE STIPPLING IS A FEATURE OF THE MARK AND DOES NOT INDICATE COLOR.

CLASS 30—STAPLE FOODS

FOR SANDWICHES (U.S. CL. 46).
FIRST USE 2-13-2001; IN COMMERCE 2-13-2001.

CLASS 42—SCIENTIFIC, COMPUTER AND LEGAL SERVICES

FOR RESTAURANT SERVICES (U.S. CLS. 100 AND 101).
FIRST USE 2-13-2001; IN COMMERCE 2-13-2001.

2,748,058. DFREEDOMZONE, INC., SAN FRANCISCO, CA. SN 76-235,593. PUB. 10-2-2001, FILED 4-3-2001.



DfreedomZone

CLASS 9—ELECTRICAL AND SCIENTIFIC APPARATUS

FOR SOFTWARE USED TO GENERATE 3-DIMENSIONAL IMAGES FOR USE AND DISPLAY ON A GLOBAL COMPUTER NETWORK (U.S. CLS. 21, 23, 26, 36 AND 38).
FIRST USE 12-12-2002; IN COMMERCE 12-12-2002.

CLASS 42—SCIENTIFIC, COMPUTER AND LEGAL SERVICES

FOR DESIGN FOR OTHERS IN THE FIELD OF GLOBAL COMPUTER NETWORKS (U.S. CLS. 100 AND 101).
FIRST USE 11-1-2002; IN COMMERCE 11-1-2002.

2,748,060. ACE-IT GOLF, INC., EVANSTON, IL. SN 76-236,150. PUB. 7-23-2002, FILED 4-3-2001.

PERSONAL APPROACH DISTANCE

CLASS 41—EDUCATION AND ENTERTAINMENT

FOR EDUCATIONAL SERVICES, NAMELY, PROVIDING GOLF PERFORMANCE ANALYSIS SERVICES AND TRAINING SERVICES IN THE FIELD OF GOLF; PROVIDING AN ON-LINE COMPUTER DATABASE IN THE FIELD OF GOLF PERFORMANCE INFORMATION (U.S. CLS. 100, 101 AND 107).

FIRST USE 6-0-2001; IN COMMERCE 6-0-2001.

CLASS 42—SCIENTIFIC, COMPUTER AND LEGAL SERVICES

FOR PROVIDING TEMPORARY USE OF ON-LINE NON DOWNLOADABLE SOFTWARE FOR ANALYSIS OF GOLF SHOTS AND GOLF PERFORMANCE AND FOR INSTRUCTION IN THE FIELD OF GOLF (U.S. CLS. 100 AND 101).

FIRST USE 6-0-2001; IN COMMERCE 6-0-2001.

2,748,062. SRIQUI, VERONIQUE, DBA ARTISTIC FRAMES BY V.V., POTOMAC, MD. SN 76-237,366. PUB. 6-4-2002, FILED 4-9-2001.

CANDLEFOLIES

CLASS 4—LUBRICANTS AND FUELS

FOR CANDLES; AND SCENTED CANDLES (U.S. CLS. 1, 6 AND 15).

FIRST USE 1-0-2000; IN COMMERCE 1-0-2000.

CLASS 21—HOUSEWARES AND GLASS

FOR CANDLE HOLDERS NOT OF PRECIOUS METAL; CANDLE RINGS NOT OF PRECIOUS METAL; CANDLE SNUFFERS NOT OF PRECIOUS METAL; CANDLESTICKS NOT OF PRECIOUS METALS (U.S. CLS. 2, 13, 23, 29, 30, 33, 40 AND 50).

FIRST USE 1-0-2000; IN COMMERCE 1-0-2000.

CLASS 35—ADVERTISING AND BUSINESS

FOR RETAIL STORE SERVICES AND COMPUTERIZED ON-LINE RETAIL SERVICE FEATURING CANDLES, SCENTED CANDLES, CANDLE HOLDERS, CANDLE RINGS, CANDLE SNUFFERS, CANDLESTICKS, LANTERNS AND HOME DECORATING GIFTS (U.S. CLS. 100, 101 AND 102).

FIRST USE 1-0-2000; IN COMMERCE 1-0-2000.

2,748,065. PACIFIC CREST INDUSTRIES, LAKE ELSINOR, CA. SN 76-238,464. PUB. 6-11-2002, FILED 4-10-2001.



NO CLAIM IS MADE TO THE EXCLUSIVE RIGHT TO USE "METAL", APART FROM THE MARK AS SHOWN.

CLASS 6—METAL GOODS

FOR ARCHITECTURAL METAL WITH ORNATE DESIGNS ENGRAVED THEREON, NAMELY STEEL, ALUMINUM AND BRASS IN SHEET AND BILLET FORM (U.S. CLS. 2, 12, 13, 14, 23, 25 AND 50).

FIRST USE 4-30-2001; IN COMMERCE 4-30-2001.

CLASS 40—MATERIAL TREATMENT

FOR ENGRAVING SERVICES, NAMELY ENGRAVING ORNATE DESIGNS ONTO ARCHITECTURAL METALS, NAMELY STEEL, ALUMINUM AND BRASS (U.S. CLS. 100, 103 AND 106).

FIRST USE 4-16-2001; IN COMMERCE 4-16-2001.

2,748,066. OPERATION ROLE MODELS OF AMERICA, INC., NEW YORK, NY. SN 76-238,689. PUB. 7-30-2002, FILED 4-10-2001.

OPERATION ROLE MODELS OF AMERICA

CLASS 35—ADVERTISING AND BUSINESS

FOR LOCATING, RECRUITING AND BOOKING SPEAKERS FOR YOUTH AND ADULT AUDIENCES (U.S. CLS. 100, 101 AND 102).

FIRST USE 6-0-1992; IN COMMERCE 6-0-1992.

CLASS 41—EDUCATION AND ENTERTAINMENT

FOR EDUCATIONAL SERVICES, NAMELY ARRANGING AND CONDUCTING EDUCATIONAL ENRICHMENT WORKSHOPS FOR YOUTH AND ADULT AUDIENCES (U.S. CLS. 100, 101 AND 107).

FIRST USE 6-0-1992; IN COMMERCE 6-0-1992.

2,748,068. PREMIER ASSET MANAGEMENT, INC., INCLINE VILLAGE, NV. SN 76-239,080. PUB. 7-30-2002, FILED 4-11-2001.

JUNIPER SPRINGS

CLASS 36—INSURANCE AND FINANCIAL

FOR PROVIDING APARTMENT HOUSE MANAGEMENT SERVICES (U.S. CLS. 100, 101 AND 102).

FIRST USE 12-14-2000; IN COMMERCE 12-14-2000.

CLASS 37—CONSTRUCTION AND REPAIR

FOR PROVIDING LAUNDRY SERVICES, DRY CLEANINGS SERVICES, SHOE REPAIR AND CLEANING SERVICES, AND AUTOMOBILE WASHING AND VACUUMING SERVICES FOR APARTMENT HOUSE TENANTS (U.S. CLS. 100, 103 AND 106).

FIRST USE 12-14-2000; IN COMMERCE 12-14-2000.

CLASS 40—MATERIAL TREATMENT

FOR PROVIDING CLOTHING ALTERATIONS SERVICES (U.S. CLS. 100, 103 AND 106).

FIRST USE 12-14-2000; IN COMMERCE 12-14-2000.

CLASS 42—SCIENTIFIC, COMPUTER AND LEGAL SERVICES

FOR CONCIERGE SERVICES FOR OTHERS COMPRISING MAKING REQUESTED PERSONAL INDIVIDUAL NEED RENDERED TOGETHER IN AN APARTMENT COMPLEX, AND PERSONAL SHOPPING SERVICES FOR APARTMENT HOUSE TENANTS (U.S. CLS. 100 AND 101).

FIRST USE 12-14-2000; IN COMMERCE 12-14-2000.

2,748,071. SIMULEARN, INC., WILTON, CT. SN 76-239,464. PUB. 1-29-2002, FILED 4-11-2001.

SIMULEARN**CLASS 9—ELECTRICAL AND SCIENTIFIC APPARATUS**

FOR EDUCATIONAL SOFTWARE FEATURING INSTRUCTIONS IN CORPORATE MANAGEMENT (U.S. CLS. 21, 23, 26, 36 AND 38).

FIRST USE 7-0-2002; IN COMMERCE 7-0-2002.

CLASS 35—ADVERTISING AND BUSINESS

FOR BUSINESS CONSULTING SERVICES IN THE FIELD OF CORPORATE MANAGEMENT (U.S. CLS. 100, 101 AND 102).

FIRST USE 9-0-2002; IN COMMERCE 9-0-2002.

CLASS 41—EDUCATION AND ENTERTAINMENT

FOR EDUCATIONAL SERVICES, NAMELY, CONDUCTING CLASSES, SEMINARS AND WORKSHOPS IN THE FIELD OF CORPORATE MANAGEMENT (U.S. CLS. 100, 101 AND 107).

FIRST USE 9-0-2002; IN COMMERCE 9-0-2002.

2,748,089. WIGGANS, THOMAS G., ATHERTON, CA. SN 76-246,898. PUB. 7-16-2002, FILED 4-23-2001.

KUPHORIA**CLASS 16—PAPER GOODS AND PRINTED MATTER**

FOR BOOKS AND MAGAZINES IN THE FIELD OF SPORTS, STICKERS, POSTERS, WRITING TABLETS, NOTE PADS, PENS, PENCILS, STATIONERY, BINDERS, NOTEBOOKS, PLAYING CARDS, CALENDARS (U.S. CLS. 2, 5, 22, 23, 29, 37, 38 AND 50).

FIRST USE 3-24-2003; IN COMMERCE 4-4-2003.

CLASS 25—CLOTHING

FOR T-SHIRTS, SWEATSHIRTS, VESTS, GOLF SHIRTS, NYLON JACKETS, SWIMSUITS, SWIM TRUNKS, BIKINIS, HATS, BASEBALL CAPS, VISORS, TENNIS SHOES, ATHLETIC SHOES, SOCKS, PAJAMAS, SLIPPERS (U.S. CLS. 22 AND 39).

FIRST USE 3-24-2003; IN COMMERCE 4-4-2003.

2,748,091. CS VENTURES LLC, SOUTHPORT, CT. SN 76-247,540. PUB. 9-3-2002, FILED 4-30-2001.

EAT, DRINK AND BE MURRAY**CLASS 25—CLOTHING**

FOR CLOTHING IN THE NATURE OF T-SHIRTS, SWEATSHIRTS, SWEATPANTS, TANK TOPS, SWEATERS, SOCKS, CAPS, HATS, VISORS, GOLF SHIRTS, POLO SHIRTS, SPORT SHIRTS, UNDERWEAR, SHORTS, PANTS, JACKETS, WIND RESISTANT OUTERWEAR, NAMELY, JACKETS AND PANTS, RAINWEAR, HEAD BANDS, WRIST BANDS, TIES, NECKWEAR, SCARVES, GLOVES, PAJAMAS, BATHROBES, LOUNGEWEAR, FOOTWEAR, BATHING SUITS, BELTS, SUSPENDERS (U.S. CLS. 22 AND 39).

FIRST USE 6-10-2001; IN COMMERCE 6-30-2001.

CLASS 42—SCIENTIFIC, COMPUTER AND LEGAL SERVICES

FOR RESTAURANT, BAR, AND NIGHT CLUB SERVICES (U.S. CLS. 100 AND 101).

FIRST USE 6-10-2001; IN COMMERCE 7-31-2002.

2,748,095. MEDORDER, INC., SEATTLE, WA. SN 76-249,015. PUB. 12-4-2001, FILED 4-30-2001.

ANATOMIC NAVIGATOR**CLASS 9—ELECTRICAL AND SCIENTIFIC APPARATUS**

FOR COMPUTER SOFTWARE FOR PROVIDING ACCESS TO AN INTERACTIVE COMPUTER DATABASE IN THE FIELD OF HEALTHCARE, MANAGING PATIENT AND PAYOR INFORMATION IN THE FIELD OF HEALTHCARE, PROVIDING DIAGNOSTIC AND TREATMENT INFORMATION IN THE FIELD OF HEALTHCARE, ADMINISTERING SCHEDULING, BILLING AND PAYMENT OF HEALTHCARE SERVICES, PROVIDING MEDICAL DIAGNOSTIC AND TREATMENT INFORMATION AND PROVIDING MEDICAL HISTORY RECORDS AND FILES (U.S. CLS. 21, 23, 26, 36 AND 38).

FIRST USE 4-29-2002; IN COMMERCE 4-29-2002.

CLASS 42—SCIENTIFIC, COMPUTER AND LEGAL SERVICES

FOR ON-LINE COMPUTER SERVICES, NAMELY, PROVIDING AN INTERACTIVE COMPUTER DATABASE IN THE FIELD OF HEALTHCARE, MANAGING PATIENT AND PAYOR INFORMATION IN THE FIELD OF HEALTHCARE, ADMINISTERING SCHEDULING, BILLING AND PAYMENT OF HEALTHCARE SERVICES, PROVIDING MEDICAL DIAGNOSTIC AND TREATMENT INFORMATION, AND PROVIDING MEDICAL HISTORY RECORDS AND FILES (U.S. CLS. 100 AND 101).

FIRST USE 4-29-2002; IN COMMERCE 4-29-2002.

2,748,098. CARWASH CELL, INC., THE, PORT CHESTER, NY. SN 76-249,768. PUB. 9-24-2002, FILED 4-27-2001.

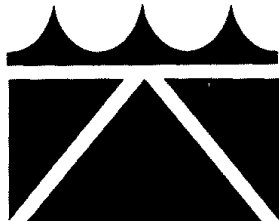

CLASS 7—MACHINERY

FOR SELF-CONTAINED VEHICLE WASHING UNITS COMPRISING VEHICLE WASHING MACHINES, VEHICLE DRYING MACHINES AND VEHICLE POLISHING MACHINES (U.S. CLS. 13, 19, 21, 23, 31, 34 AND 35).
FIRST USE 5-1-2001; IN COMMERCE 5-1-2001.

CLASS 35—ADVERTISING AND BUSINESS

FOR FRANCHISING, NAMELY, OFFERING TECHNICAL ASSISTANCE IN THE ESTABLISHMENT AND/OR OPERATION OF CARWASHES (U.S. CLS. 100, 101 AND 102).
FIRST USE 5-1-2001; IN COMMERCE 5-1-2001.

CLASS 37—CONSTRUCTION AND REPAIR

FOR VEHICLE WASHING AND DETAILING SERVICES (U.S. CLS. 100, 103 AND 106).
FIRST USE 5-1-2001; IN COMMERCE 5-1-2001.

2,748,114. GCS GROUP, INC., PITTSBURGH, PA. SN 76-258,704. PUB. 6-4-2002, FILED 5-17-2001.



CLASS 9—ELECTRICAL AND SCIENTIFIC APPARATUS

FOR COMPUTER SOFTWARE, NAMELY, COMPUTER SOFTWARE FOR USE IN THE HUMAN SERVICES FIELD WHICH PERFORMS THE FOLLOWING FUNCTIONS (I) BILLING AND FINANCIAL MANAGEMENT; (II) QUALITY ASSURANCE; AND (III) PROVIDING AND AIDING IN THE USE OF ELECTRONIC CLINICAL RECORDS (U.S. CLS. 21, 23, 26, 36 AND 38).
FIRST USE 1-14-2003; IN COMMERCE 1-14-2003.

CLASS 35—ADVERTISING AND BUSINESS

FOR BUSINESS CONSULTING SERVICES IN THE HUMAN SERVICES FIELD (U.S. CLS. 100, 101 AND 102).
FIRST USE 10-24-2002; IN COMMERCE 10-24-2002.

CLASS 42—SCIENTIFIC, COMPUTER AND LEGAL SERVICES

FOR INFORMATION TECHNOLOGY CONSULTING SERVICES IN THE HUMAN SERVICES FIELD (U.S. CLS. 100 AND 101).
FIRST USE 10-24-2002; IN COMMERCE 10-24-2002.

2,748,118. OCEAN PACIFIC APPAREL CORP., IRVINE, CA. SN 76-259,835. PUB. 7-2-2002, FILED 5-18-2001.

OP

OWNER OF U.S. REG. NOS. 1,639,594, 2,471,870, AND OTHERS.

CLASS 18—LEATHER GOODS

FOR BAGS, NAMELY, ATHLETIC BAGS, DIAPER BAGS, ALL PURPOSE ATHLETIC BAGS, BEACH BAGS, BOOK BAGS, CARRY-ON BAGS, CLUTCH BAGS, GYM BAGS, SCHOOL BOOK BAGS, SCHOOL BAGS, TRAVEL BAGS, PURSES, LUGGAGE, FANNY PACKS, RUCK-SACKS, SATCHELS (U.S. CLS. 1, 2, 3, 22 AND 41).
FIRST USE 3-0-1984; IN COMMERCE 3-0-1984.

CLASS 25—CLOTHING

FOR CLOTHING, NAMELY, LOUNGEWEAR, UNDERWEAR, PAJAMAS, ROBES, JUMPERS, SLEEPERS, JUMPSUITS, BOOTIES, SLIPPERS (U.S. CLS. 22 AND 39).
FIRST USE 6-0-1970; IN COMMERCE 6-0-1970.

CLASS 41—EDUCATION AND ENTERTAINMENT

FOR PROMOTIONAL EVENTS, NAMELY, ARRANGING AND CONDUCTING SPORTING EVENTS AND SURFING CONTESTS (U.S. CLS. 100, 101 AND 107).
FIRST USE 1-0-1983; IN COMMERCE 1-0-1983.

2,748,128. CWI, INC., BOWLING GREEN, KY. SN 76-261,888. PUB. 9-17-2002, FILED 5-24-2001.

ROADCARE CLASSIC

CLASS 36—INSURANCE AND FINANCIAL

FOR REIMBURSEMENT OF EMERGENCY TRAVEL EXPENSES (U.S. CLS. 100, 101 AND 102).
FIRST USE 7-16-2001; IN COMMERCE 7-16-2001.

CLASS 37—CONSTRUCTION AND REPAIR

FOR EMERGENCY ROADSIDE SERVICES (U.S. CLS. 100, 103 AND 106).
FIRST USE 7-16-2001; IN COMMERCE 7-16-2001.

CLASS 39—TRANSPORTATION AND STORAGE

FOR EMERGENCY TOWING OF AUTOMOBILES, TRUCKS, RECREATIONAL VEHICLES, TRAILERS, AND CAMPERS; FLUID DELIVERY SERVICES PROVIDING GASOLINE AND OIL TO STRANDED VEHICLES AND TRANSPORTATION RESERVATION SERVICES (U.S. CLS. 100 AND 105).

FIRST USE 7-16-2001; IN COMMERCE 7-16-2001.

CLASS 42—SCIENTIFIC, COMPUTER AND LEGAL SERVICES

FOR LOCKSMITH SERVICES; AND MAKING HOTEL RESERVATIONS FOR OTHERS (U.S. CLS. 100 AND 101).

FIRST USE 7-16-2001; IN COMMERCE 7-16-2001.

2,748,130. KEY BRIDGE CORPORATION, RESTON, VA. SN 76-262,412. PUB. 10-15-2002, FILED 5-25-2001.

**CLASS 35—ADVERTISING AND BUSINESS**

FOR MANAGEMENT OF COMPUTER DATA AND OPERATIONS CENTERS; TRAFFIC LOAD MANAGEMENT, NAMELY, COMPUTERIZED DATABASE MANAGEMENT (U.S. CLS. 100, 101 AND 102).

FIRST USE 5-0-2001; IN COMMERCE 5-0-2001.

CLASS 36—INSURANCE AND FINANCIAL

FOR REAL ESTATE AGENCY SERVICES, NAMELY, PROCURING, SELLING AND LEASING OF SPACE IN COMPUTER DATA AND OPERATIONS CENTERS (U.S. CLS. 100, 101 AND 102).

FIRST USE 5-0-2001; IN COMMERCE 5-0-2001.

CLASS 38—COMMUNICATION

FOR PROVIDING MULTIPLE USER ACCESS TO A VIRTUAL PRIVATE COMPUTER NETWORK; CONTENT DELIVERY NETWORK SERVICES; NAMELY, ELECTRONIC DELIVERY OF MESSAGES AND DATA (U.S. CLS. 100, 101 AND 104).

FIRST USE 5-0-2001; IN COMMERCE 5-0-2001.

CLASS 39—TRANSPORTATION AND STORAGE

FOR ELECTRONIC STORAGE OF FILES AND DOCUMENTS (U.S. CLS. 100 AND 105).

FIRST USE 5-0-2001; IN COMMERCE 5-0-2001.

CLASS 42—SCIENTIFIC, COMPUTER AND LEGAL SERVICES

FOR MANAGED INTERNET SERVICES, NAMELY, CONSTRUCTION OF COMPUTER DATA AND OPERATIONS CENTERS; HOSTING COMPUTER DATA AND OPERATIONS CENTERS; HOSTING OF DIGITAL CONTENT ON THE INTERNET; COMPUTER SECURITY SERVICES, NAMELY, FIREWALL AND FIREWALL VPN SERVICES, SECURITY GUARD SERVICES FOR PHYSICAL FACILITIES, AND MONITORING OF SECURITY SYSTEMS; AND DATA RECOVERY SERVICES (U.S. CLS. 100 AND 101).

FIRST USE 5-0-2001; IN COMMERCE 5-0-2001.

2,748,132. BAY WEST PAPER CORPORATION, HARRODSBURG, KY. SN 76-263,087. PUB. 5-14-2002, FILED 5-24-2001.

SILHOUETTE**CLASS 20—FURNITURE AND ARTICLES NOT OTHERWISE CLASSIFIED**

FOR COMMERCIAL, INDUSTRIAL AND INSTITUTIONAL PAPER TOWEL AND PAPER TISSUE DISPENSERS NOT OF METAL (U.S. CLS. 2, 13, 22, 25, 32 AND 50).

FIRST USE 2-20-2002; IN COMMERCE 2-20-2002.

CLASS 21—HOUSEWARES AND GLASS

FOR COMMERCIAL, INDUSTRIAL AND INSTITUTIONAL SOAP DISPENSERS (U.S. CLS. 2, 13, 23, 29, 30, 33, 40 AND 50).

FIRST USE 11-6-2002; IN COMMERCE 11-6-2002.

2,748,134. HEATHSOUTH, BIRMINGHAM, AL. SN 76-263,514. PUB. 8-20-2002, FILED 5-29-2001.

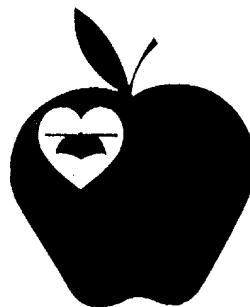
**CLASS 16—PAPER GOODS AND PRINTED MATTER**

FOR PRINT MATERIAL AND EDUCATIONAL TEXTS, NAMELY, NEWSLETTERS, MAGAZINES, PAMPHLETS AND BROCHURES PRESENTING INFORMATION IN THE FIELD OF HEART RISK ASSESSMENT, EVALUATION AND REMEDIATION (U.S. CLS. 2, 5, 22, 23, 29, 37, 38 AND 50).

FIRST USE 5-23-2001; IN COMMERCE 5-23-2001.

CLASS 25—CLOTHING

FOR MEN'S, WOMEN'S AND CHILDREN'S APPAREL, NAMELY, SHIRTS, T-SHIRTS, SWEAT SHIRTS, BLOUSES, PANTS, JACKETS AND POLO-SHIRTS (U.S. CLS. 22 AND 39).

FIRST USE 5-23-2001; IN COMMERCE 5-23-2001.

CLASS 41—EDUCATION AND ENTERTAINMENT

FOR EDUCATIONAL SERVICES, NAMELY, CONDUCTING CLASSES, CONFERENCES, SEMINARS, AND WORKSHOPS IN THE FIELD OF HEART RISK ASSESSMENT, EVALUATION AND REMEDIATION AND DISTRIBUTION OF COURSE MATERIALS IN CONNECTION THEREWITH (U.S. CLS. 100, 101 AND 107).

FIRST USE 5-23-2001; IN COMMERCE 5-23-2001.

CLASS 42—SCIENTIFIC, COMPUTER AND LEGAL SERVICES

FOR CONSULTING SERVICES IN THE FIELD OF HEART RISK ASSESSMENT, EVALUATION AND REMEDIATION (U.S. CLS. 100 AND 101).

FIRST USE 5-23-2001; IN COMMERCE 5-23-2001.

2,748,147. DUNKIN' DONUTS USA, INC., DETROIT, MI. SN 76-266,480. PUB. 8-20-2002, FILED 6-5-2001.

2,748,139. SERVICYS INC., BANNOCKBURN, IL. SN 76-264,081. PUB. 8-6-2002, FILED 5-30-2001.

ENSOURCE**CLASS 35—ADVERTISING AND BUSINESS**

FOR BUSINESS ANALYSIS, NAMELY, ASSISTING THIRD PARTIES BY CONDUCTING PRODUCTIVITY ANALYSIS; BUSINESS MANAGEMENT SERVICES, NAMELY, PROVIDING PROPOSED SCHEDULES FOR THE BUSINESS'S PERSONNEL (U.S. CLS. 100, 101 AND 102).

FIRST USE 7-1-2001; IN COMMERCE 7-1-2001.

CLASS 41—EDUCATION AND ENTERTAINMENT

FOR TRAINING OF PERSONNEL OF THIRD PARTIES IN THE USE OF CLEANING SUPPLIES AND EQUIPMENT (U.S. CLS. 100, 101 AND 107).

FIRST USE 7-1-2001; IN COMMERCE 7-1-2001.

2,748,145. WINKLEVOSS, HAROLD, GREENWICH, CT. AND WINKLEVOSS, CAROL, GREENWICH, CT. SN 76-265,287. PUB. 7-23-2002, FILED 5-31-2001.

ROWAMERICA**CLASS 41—EDUCATION AND ENTERTAINMENT**

FOR FITNESS AND HEALTH CLUB SERVICES, NAMELY PROVIDING FITNESS EXERCISE FACILITIES AND INSTRUCTION, AND ROWING FACILITIES AND INSTRUCTION, AND RECREATIONAL FACILITIES (U.S. CLS. 100, 101 AND 107).

FIRST USE 0-0-2000; IN COMMERCE 0-0-2001.

CLASS 42—SCIENTIFIC, COMPUTER AND LEGAL SERVICES

FOR PROMOTING PUBLIC INTEREST IN AND AWARENESS OF ROWING SPORTS (U.S. CLS. 100 AND 101).

FIRST USE 0-0-2000; IN COMMERCE 0-0-2001.



OWNER OF U.S. REG. NOS. 748,901, 1,159,354, AND OTHERS.

NO CLAIM IS MADE TO THE EXCLUSIVE RIGHT TO USE "DONUTS", APART FROM THE MARK AS SHOWN.

THE MARK CONSISTS OF THE DESIGN OF A CUP CONTAINING A HOT BEVERAGE. THE WORD "DUNKIN' DONUTS" IN DESIGN APPEAR ON THE FACE OF THE CUP.

CLASS 29—MEATS AND PROCESSED FOODS

FOR FRUIT-BASED FILLINGS FOR DOUGHNUTS, COOKIES, CAKES AND PIES; EDIBLE OILS AND FATS; FRUIT TOPPING; NUT TOPPING; SHORTENINGS (U.S. CL. 46).

FIRST USE 2-28-2002; IN COMMERCE 2-28-2002.

CLASS 30—STAPLE FOODS

FOR DOUGHNUTS AND BAKERY PRODUCTS; COFFEE; TEA; COCOA; SUGAR; COOKIES; CAKES; PIES; MUFFINS; PLAIN, GLAZED, COATED AND FILLED FRIED CAKES; BAGELS; CHOCOLATE-BASED FILLINGS FOR CAKES AND PIES; CUSTARD-BASED FILLINGS FOR CAKES AND PIES; CHOCOLATE-BASED TOPPING; FLOUR; FLAVORING EXTRACTS; CONFECTIONERY CHIPS FOR BAKING; HONEY; YEAST; BAKING-POWDER; HOT CHOCOLATE; HOT COCOA (U.S. CL. 46).

FIRST USE 5-8-2001; IN COMMERCE 5-8-2001.

CLASS 32—LIGHT BEVERAGES

FOR FRUIT DRINKS AND FRUIT JUICES; COFFEE-FLAVORED SOFT DRINKS; SYRUPS AND OTHER PREPARATIONS, CONCENTRATES AND POWDER, FOR MAKING SOFT DRINKS AND FRUIT DRINKS (U.S. CLS. 45, 46 AND 48).

FIRST USE 5-8-2001; IN COMMERCE 5-8-2001.

CLASS 43—HOTEL AND RESTAURANT SERVICES

FOR RESTAURANT AND CARRYOUT FOOD SERVICES (U.S. CLS. 100 AND 101).

FIRST USE 5-8-2001; IN COMMERCE 5-8-2001.

2,748,150. SAVISA (PTY) LTD, WINDEMEUL, SOUTH AFRICA. SN 76-267,196. PUB. 4-16-2002, FILED 6-7-2001.



CLASS 32—LIGHT BEVERAGES

FOR BEVERAGES, NAMELY BEERS, NONALCOHOLIC BEVERAGES, MINERAL AND AERATED WATERS, FRUIT DRINKS, AND JUICES; SYRUPS, ESSENCES, EXTRACTS, AND PREPARATIONS FOR MAKING BEERS, NONALCOHOLIC BEVERAGES, MINERAL AND AERATED WATERS, FRUIT DRINKS, AND JUICES (U.S. CLS. 45, 46 AND 48).

FIRST USE 12-0-2000; IN COMMERCE 10-0-2002.

CLASS 33—WINES AND SPIRITS

FOR ALCOHOLIC BEVERAGES, NAMELY WINES, DISTILLED SPIRITS, AND LIQUEURS (U.S. CLS. 47 AND 49).

FIRST USE 12-0-2000; IN COMMERCE 10-0-2002.

2,748,153. FRESH INTELLECTUAL PROPERTIES, INC., WILMINGTON, DE. SN 76-268,107. PUB. 10-1-2002, FILED 6-1-2001.

E-MMEDIATE GIFT

NO CLAIM IS MADE TO THE EXCLUSIVE RIGHT TO USE "GIFT", APART FROM THE MARK AS SHOWN.

CLASS 35—ADVERTISING AND BUSINESS

FOR ONLINE RETAIL STORE SERVICES FEATURING GIFTS (U.S. CLS. 100, 101 AND 102).

FIRST USE 2-12-2001; IN COMMERCE 2-12-2001.

CLASS 38—COMMUNICATION

FOR ELECTRONIC TRANSMISSION OF MESSAGES AND DATA, NAMELY, TRANSMISSION OF E-MAIL NOTIFICATION, MESSAGES, AND/OR PICTURES OF GIFTS TO BE DELIVERED TO INTENDED RECIPIENT (U.S. CLS. 100, 101 AND 104).

FIRST USE 2-12-2001; IN COMMERCE 2-12-2001.

2,748,157. KNUD NIELSEN COMPANY, INC., EVERGREEN, AL. SN 76-270,071. PUB. 8-6-2002, FILED 6-11-2001.

BATH ELEMENTS

NO CLAIM IS MADE TO THE EXCLUSIVE RIGHT TO

USE "BATH", APART FROM THE MARK AS SHOWN.

CLASS 3—COSMETICS AND CLEANING PREPARATIONS

FOR ANTIBACTERIAL SKIN SOAPS; BATH CRYSTALS AND BATH POWDER; COLOGNE; BATH GELS FOR PERSONAL USE; PERFUME OILS; POTPOURRI; ROOM FRAGRANCE; SKIN CLEANERS, SKIN CREAMS, AND SKIN LOTIONS; AND SKIN TEXTURIZERS (U.S. CLS. 1, 4, 6, 50, 51 AND 52).

FIRST USE 8-8-2001; IN COMMERCE 8-8-2001.

CLASS 5—PHARMACEUTICALS

FOR AIR FRESHENERS (U.S. CLS. 6, 18, 44, 46, 51 AND 52).

FIRST USE 1-23-2002; IN COMMERCE 1-23-2002.

CLASS 21—HOUSEWARES AND GLASS

FOR CANDLE HOLDERS NOT OF PRECIOUS METAL (U.S. CLS. 2, 13, 23, 29, 30, 33, 40 AND 50).

FIRST USE 4-24-2003; IN COMMERCE 4-24-2003.

2,748,160. ABATEMENT TECHNOLOGIES, INC., DULUTH, GA. SN 76-270,563. PUB. 10-1-2002, FILED 6-13-2001.

BIO-MIGHT

OWNER OF U.S. REG. NO. 1,805,044.

CLASS 2—PAINTS

FOR STAIN BLOCKING PRIMER (U.S. CLS. 6, 11 AND 16).

FIRST USE 7-18-2002; IN COMMERCE 7-18-2002.

CLASS 5—PHARMACEUTICALS

FOR SANITIZERS FOR COMMERCIAL USE; ALL PURPOSE DISINFECTANTS AND LONG-TERM MOLD INHIBITORS (U.S. CLS. 6, 18, 44, 46, 51 AND 52).

FIRST USE 7-17-2002; IN COMMERCE 7-17-2002.

2,748,169. R.J. RUDDEN ASSOCIATES, INC., HAUPPAUGE, NY. SN 76-274,799. PUB. 7-23-2002, FILED 6-21-2001.



NO CLAIM IS MADE TO THE EXCLUSIVE RIGHT TO USE "ASSOCIATES", APART FROM THE MARK AS SHOWN.

THE NAME RJ RUDDEN IDENTIFIES A LIVING INDIVIDUAL WHOSE CONSENT IS OF RECORD.

CLASS 35—ADVERTISING AND BUSINESS

FOR MANAGEMENT AND ECONOMIC CONSULTING SERVICES SPECIALIZING IN THE ENERGY AND UTILITY INDUSTRIES, STRATEGIC PLANNING SERVICES, CONSULTING SERVICES IN THE FIELD OF MERGERS AND ACQUISITIONS; MARKET ANALYSIS AND SALES FORECASTING AND ANALYSIS, AND PUBLIC RELATIONS PROGRAMS AND SERVICES; PRICING AND REGULATORY POLICY ANALYSIS; BUSINESS CONSULTATION SERVICES, NAMELY, DEVELOPING INTEGRATED MARKETING COMMUNICATION PROGRAMS FOR OTHERS; BUSINESS ORGANIZATIONAL CONSULTING SERVICES; CONSULTING AND SUPPORT SERVICES IN THE FIELD OF BUSINESS PLANNING (U.S. CLS. 100, 101 AND 102).
FIRST USE 5-20-2001; IN COMMERCE 5-20-2001.

CLASS 36—INSURANCE AND FINANCIAL

FOR ENERGY PROJECT MANAGEMENT, FINANCING AND ANALYSIS SERVICES; RISK MANAGEMENT, ORGANIZATIONAL STRUCTURE, AND INFORMATION SYSTEMS; FINANCIAL ORGANIZATIONAL CONSULTING SERVICES (U.S. CLS. 100, 101 AND 102).
FIRST USE 5-20-2001; IN COMMERCE 5-20-2001.

CLASS 39—TRANSPORTATION AND STORAGE

FOR ELECTRICITY TRANSMISSION PLANNING SERVICES, GAS SUPPLY AND TRANSPORTATION PLANNING SERVICES (U.S. CLS. 100 AND 105).
FIRST USE 5-20-2001; IN COMMERCE 5-20-2001.

CLASS 42—SCIENTIFIC, COMPUTER AND LEGAL SERVICES

FOR CONSULTING AND SUPPORT SERVICES IN THE FIELDS OF ENGINEERING, OPERATIONS, STAFF FUNCTIONS, GOVERNMENT REGULATION AND COMPLIANCE, FUELS AND ENERGY ACQUISITION AND RISK MANAGEMENT, ORGANIZATIONAL STRUCTURE, COMPUTERS, AND INFORMATION SYSTEMS; COMPUTER MODELING AND INFORMATION SYSTEMS DEVELOPMENT AND SUPPORT SERVICES; LITIGATION SUPPORT SERVICES (U.S. CLS. 100 AND 101).
FIRST USE 5-20-2001; IN COMMERCE 5-20-2001.

2,748,174. INTEGRATIVE AESTHETICS, LLC, BURNS, TN. SN 76-275,712. PUB. 10-30-2001, FILED 6-21-2001.

INTEGRATIVE AESTHETICS**CLASS 3—COSMETICS AND CLEANING PREPARATIONS**

FOR SKIN AND HAIR PREPARATIONS; NAMELY, SKIN MOISTURIZERS, TONERS, SOAPS, LOTIONS, GELS, CLEANSERS, CREAMS AND SHAMPOO (U.S. CLS. 1, 4, 6, 50, 51 AND 52).
FIRST USE 3-19-2003; IN COMMERCE 3-19-2003.

CLASS 5—PHARMACEUTICALS

FOR TOPICAL PREPARATIONS FOR MEDICAL AND THERAPEUTIC USE; NAMELY, GELS, LOTIONS, CREAMS, ASTRINGENTS, SHAMPOO; VITAMINS (U.S. CLS. 6, 18, 44, 46, 51 AND 52).
FIRST USE 3-19-2003; IN COMMERCE 3-19-2003.

2,748,177. SHANGHAI BESTWAY PLASTIC PRODUCTS CO., LTD., SHANGHAI, 201812, CHINA. SN 76-277,426. PUB. 7-23-2002, FILED 6-25-2001.

BESTWAY**CLASS 9—ELECTRICAL AND SCIENTIFIC APPARATUS**

FOR SCUBA GOGGLES, DIVING MASKS, SNORKELS AND FINS (U.S. CLS. 21, 23, 26, 36 AND 38).
FIRST USE 9-3-1994; IN COMMERCE 9-3-1994.

CLASS 12—VEHICLES

FOR RAFTS AND OARS (U.S. CLS. 19, 21, 23, 31, 35 AND 44).
FIRST USE 9-3-1994; IN COMMERCE 9-3-1994.

CLASS 20—FURNITURE AND ARTICLES NOT OTHERWISE CLASSIFIED

FOR AIR MATTRESSES FOR CAMPING (U.S. CLS. 2, 13, 22, 25, 32 AND 50).
FIRST USE 9-3-1994; IN COMMERCE 9-3-1994.

CLASS 28—TOYS AND SPORTING GOODS

FOR INFLATABLE FLOAT MATTRESSES AND PADS AND SWIM FLOATS FOR RECREATIONAL USE; INFLATABLE BALLS, ANIMALS, CARTOON CHARACTERS AND SIMILAR FIGURES, TREES, FISH, SNOW TUBES, CARS, PLANES, BOATS, SWIMMING POOLS AND PLAY CENTERS, SUCH AS CASTLES AND SPACE SHIPS ALL FOR RECREATIONAL USE (U.S. CLS. 22, 23, 38 AND 50).
FIRST USE 9-3-1994; IN COMMERCE 9-4-1994.

2,748,178. LEPRECAN, L.L.C., CHICAGO, IL. SN 76-277,949. PUB. 7-30-2002, FILED 6-29-2001.

LEPRECAN**CLASS 11—ENVIRONMENTAL CONTROL APPARATUS**

FOR PORTABLE TOILET FACILITIES AND PORTABLE TOILET SINKS (U.S. CLS. 13, 21, 23, 31 AND 34).
FIRST USE 6-13-2003; IN COMMERCE 6-13-2003.

CLASS 42—SCIENTIFIC, COMPUTER AND LEGAL SERVICES

FOR RENTAL OF PORTABLE TOILET FACILITIES AND PORTABLE SINKS (U.S. CLS. 100 AND 101).
FIRST USE 6-13-2003; IN COMMERCE 6-13-2003.

2,748,179. PIPELIFE INTERNATIONAL GMBH, WIENER NEUDORF A-2355, AUSTRIA. SN 76-278,050. PUB. 8-27-2002, FILED 6-27-2001.

PIPELIFE

CLASS 17—RUBBER GOODS

FOR PRODUCTS MADE WITH PLASTIC, NAMELY, PLUMBING PIPES, PIPES FOR CONVEYING NATURAL GAS AND FLEXIBLE PIPES; MATERIALS FOR FILLING INSULATING, NAMELY, BUILDING INSULATION, ELECTRICAL INSULATING TAPE AND FIBERGLASS FABRICS FOR BUILDING INSULATION; CONSTRUCTION MATERIALS, NAMELY, PLASTIC SHEETING USED IN THE CONSTRUCTION INDUSTRY AS A VAPOR BARRIER (U.S. CLS. 1, 5, 12, 13, 35 AND 50).
FIRST USE 6-30-2002; IN COMMERCE 6-30-2002.

CLASS 19—NON-METALLIC BUILDING MATERIALS

FOR RIGID PIPES, NOT OF METAL; NON-METAL DUCTS; SHEET MATERIAL AND SHEET MATERIAL FOR SHEATHING, NAMELY, SHEATHING BOARD; CONSTRUCTION MATERIALS, NAMELY, CEMENT POSTS AND BRICKS (U.S. CLS. 1, 12, 33 AND 50).
FIRST USE 6-30-2002; IN COMMERCE 6-30-2002.

CLASS 20—FURNITURE AND ARTICLES NOT OTHERWISE CLASSIFIED

FOR PRODUCTS MADE WITH PLASTIC, NAMELY, NON-METAL PIPE FITTINGS (U.S. CLS. 2, 13, 22, 25, 32 AND 50).
FIRST USE 6-30-2002; IN COMMERCE 6-30-2002.

2,748,185. ARADIANT CORPORATION, SAN DIEGO, CA, BY CHANGE OF NAME ARADIANT CORPORATION, SAN DIEGO, CA. SN 76-280,946. PUB. 7-16-2002, FILED 7-3-2001.

ARADIANT

CLASS 35—ADVERTISING AND BUSINESS

FOR CUSTOMER RELATIONSHIP MANAGEMENT SERVICES, NAMELY, CUSTOMER CARE AND CUSTOMER SUPPORT SERVICES, NAMELY, PROVIDING PRODUCT INFORMATION, ANSWERING CUSTOMER QUESTIONS AND INQUIRIES, AND ORDER PROCESSING, ALL VIA A GLOBAL COMPUTER NETWORK, TELEPHONE, FAX, E-MAIL, WEB CHAT, WEB CALLBACK, VOICE OVER INTERNET PROTOCOL, AND VIDEO OVER INTERNET PROTOCOL; OPERATION AND MANAGEMENT OF TELEPHONE CALL CENTERS FOR OTHERS; CUSTOMER ADMINISTRATIVE BACK OFFICE SUPPORT SERVICES, NAMELY, BUSINESS MANAGEMENT OF SALES AND MARKETING OPERATIONS OF OTHERS; ORDER TAKING AND ORDER FULFILLMENT SERVICES; AND BILLING SERVICES (U.S. CLS. 100, 101 AND 102).
FIRST USE 8-6-2001; IN COMMERCE 8-6-2001.

CLASS 36—INSURANCE AND FINANCIAL

FOR COLLECTION AGENCIES; TELEPHONE CALLING CARD SERVICES (U.S. CLS. 100, 101 AND 102).
FIRST USE 8-6-2001; IN COMMERCE 8-6-2001.

CLASS 38—COMMUNICATION

FOR TELECOMMUNICATIONS SERVICES, NAMELY, CONFERENCE CALL SERVICES, CALL FORWARDING SERVICES, TELEPHONE CALL BRIDGING, CALL ANNUNCIATION AND RE-DIAL WITH AUTOMATED VOICE-MAIL DELIVERY; WIRELESS MESSAGING SERVICES, NAMELY AUTOMATED DELIVERY OF WIRELESS E-MAIL VIA THE INTERNET, WEB SITES OR DIRECT DIAL MODEM, AUTOMATED INPUT AND CALL CENTER INPUT OF ELECTRONIC CALENDAR MESSAGES, SMS MESSAGES AND GROUP MESSAGES TO MULTIPLE SUBSCRIBERS VIA MULTIPLE NETWORKS; UNIFIED MESSAGING SERVICES, NAMELY, VOICE MAIL, NUMERIC PAGING, FACSIMILE STORE AND FORWARD, ALPHANUMERIC MESSAGING AND "LIVE CALL CONNECT" SERVICES; WIRELESS INFORMATION SERVICES; WIRELESS ELECTRONIC CALENDAR MESSAGING; REMOTE DEVICE WIRELESS COMMAND SERVICES; AND TRANSMISSION OF ELECTRONIC HEALTH INFORMATION TO HEALTH SERVICES PERSONNEL (U.S. CLS. 100, 101 AND 104).
FIRST USE 8-6-2001; IN COMMERCE 8-6-2001.

CLASS 42—SCIENTIFIC, COMPUTER AND LEGAL SERVICES

FOR ALTERNATIVE DISPUTE RESOLUTION SERVICES; TECHNICAL SUPPORT SERVICES, NAMELY, SYSTEM INTEGRATION, NETWORK MANAGEMENT AND COLLOCATION HOSTING OF WEB SITES; TECHNICAL "HELP DESK" SUPPORT, NAMELY, TROUBLESHOOTING OF COMPUTER HARDWARE AND SOFTWARE PROBLEMS VIA A GLOBAL COMPUTER NETWORK, TELEPHONE, FAX, E-MAIL, WEB CHAT, WEB CALLBACK, VOICE OVER INTERNET PROTOCOL, AND VIDEO OVER INTERNET PROTOCOL; WIRELESS MONITORING OF HEALTH SERVICES VIA WIRELESS DATA TRANSMISSION, VOICE TELECOMMUNICATIONS AND VOICE TELECONFERENCING (U.S. CLS. 100 AND 101).
FIRST USE 8-6-2001; IN COMMERCE 8-6-2001.

2,748,195. ATEECO, INC., SHENANDOAH, PA. SN 76-283,996. PUB. 2-26-2002, FILED 7-12-2001.

PIEROGYMAN

CLASS 25—CLOTHING

FOR CLOTHING, NAMELY, SHIRTS, HATS, JACKETS AND CLOTH BIBS (U.S. CLS. 22 AND 39).
FIRST USE 10-0-2001; IN COMMERCE 10-0-2001.

CLASS 30—STAPLE FOODS

FOR PIEROGIES (U.S. CL. 46).
FIRST USE 2-0-2003; IN COMMERCE 2-0-2003.

2,748,208. TRIBECA BEVERAGE COMPANY, LARGO, FL. SN 76-287,734. PUB. 7-16-2002, FILED 7-19-2001.

TRIBECA VIAQUA

CLASS 5—PHARMACEUTICALS

FOR NON-ALCOHOLIC DIETARY SUPPLEMENTS IN THE NATURE OF ENERGY BEVERAGES THAT ARE FORTIFIED WITH HERBS AND VITAMINS (U.S. CLS. 6, 18, 44, 46, 51 AND 52).
FIRST USE 10-30-2001; IN COMMERCE 10-30-2001.

CLASS 32—LIGHT BEVERAGES

FOR NON-ALCOHOLIC SOFT DRINKS (U.S. CLS. 45, 46 AND 48).
FIRST USE 10-30-2001; IN COMMERCE 10-30-2001.

2,748,209. NOVEON IP HOLDINGS CORP., BRECKSVILLE, OH. SN 76-289,005. PUB. 11-19-2002, FILED 7-20-2001.



SYSTEM COMPATIBLE

OWNER OF U.S. REG. NOS. 1,906,527 AND 2,168,321.
NO CLAIM IS MADE TO THE EXCLUSIVE RIGHT TO USE "SYSTEM COMPATIBLE", APART FROM THE MARK AS SHOWN.

THE DRAWING IS LINED FOR THE COLOR(S) GOLD.
THE MARK CONSISTS OF A DEPICTION OF A TAN PIPE WITH A GOLD STRIPE CONTAINING THE LETTERS "FGG" AND THE PHRASE "SYSTEM COMPATIBLE" BENEATH THE PIPE

CLASS 1—CHEMICALS

FOR CHEMICAL SOLUTION UTILIZED FOR DETECTING LEAKS IN PLUMBING SYSTEMS (U.S. CLS. 1, 5, 6, 10, 26 AND 46).
FIRST USE 1-2-2003; IN COMMERCE 1-2-2003.

CLASS 17—RUBBER GOODS

FOR MATERIALS USED IN THE INSTALLATION OF POTABLE HOT AND COLD WATER DISTRIBUTION SYSTEMS WHICH ARE CONSTITUTED OF CHLORINATED POLYVINYL CHLORIDE PIPE, NAMELY, PIPE JOINT SEALANTS, CAULKING, PIPE INSULATION, ADHESIVE SEALANTS, FIRESTOP SEALANTS, AND FOAM INSULATION FOR USE IN BUILDING AND CONSTRUCTION (U.S. CLS. 1, 5, 12, 13, 35 AND 50).
FIRST USE 1-2-2003; IN COMMERCE 1-2-2003.

2,748,216. TUM YETO, INC., SAN DIEGO, CA. SN 76-291,436. PUB. 10-8-2002, FILED 7-27-2001.

**HOLLYWOOD
SKATEBOARDS**

NO CLAIM IS MADE TO THE EXCLUSIVE RIGHT TO USE "SKATEBOARDS", APART FROM THE MARK AS SHOWN.

CLASS 25—CLOTHING

FOR CLOTHING, NAMELY, SHIRTS, SHORTS, PANTS, JACKETS, HATS, AND BELTS (U.S. CLS. 22 AND 39).
FIRST USE 5-0-2001; IN COMMERCE 9-0-2001.

CLASS 28—TOYS AND SPORTING GOODS

FOR SPORTING GOODS, NAMELY, SKATEBOARDS, SKATEBOARD TRUCKS, SKATEBOARD WHEELS; AND, SKATEBOARD ACCESSORIES, NAMELY, BEARINGS, HARDWARE, RISER PADS, AND GRIP TAPE (U.S. CLS. 22, 23, 38 AND 50).
FIRST USE 5-0-2001; IN COMMERCE 9-0-2001.

2,748,219. MULBERRY COMPANY (DESIGN) LIMITED, SOMERSET BA4 5NF, UNITED KINGDOM. SN 76-292,849. PUB. 4-23-2002, FILED 7-30-2001.



MULBERRY

OWNER OF U.S. REG. NOS. 1,123,282, 1,235,319, AND 2,031,468.

CLASS 16—PAPER GOODS AND PRINTED MATTER

FOR PRINTED MATERIALS, NAMELY, STATIONERY, CALENDARS, NOTE CARDS, NOTE PADS, BOOKMARKS, POSTCARDS AND GREETING CARDS (U.S. CLS. 2, 5, 22, 23, 29, 37, 38 AND 50).
FIRST USE 2-26-2001; IN COMMERCE 2-26-2001.

CLASS 18—LEATHER GOODS

FOR LEATHER, IMITATION LEATHER, SYNTHETIC AND FABRIC BAGS AND CASES, NAMELY, TRAVEL BAGS, SUITCASES, GRIPS, TOTE BAGS, TRUNK AND VALISES, HAND BAGS, SPORTS BAGS, SCHOOL BAGS, BACK PACKS, ATTACHE CASES, BRIEF CASES, SHOPPING BAGS, PURSES, POCKET CASES, POCKET WALLET, PERSONAL ORGANIZER LEATHER CASES AND PERSONAL ORGANIZER CASES; AND UMBRELLAS AND PARASOLS (U.S. CLS. 1, 2, 3, 22 AND 41).
FIRST USE 4-30-2001; IN COMMERCE 4-30-2001.

CLASS 25—CLOTHING

FOR CLOTHING, NAMELY, HATS, GLOVES, TIES, SCARVES, JACKETS, COATS, SHIRTS, SKIRTS, DRESSES, TROUSERS, MEN'S AND WOMEN'S SUITS, NIGHTWEAR, SOCKS, SHOES, FOOTWEAR AND BELTS (U.S. CLS. 22 AND 39).
FIRST USE 4-30-2001; IN COMMERCE 4-30-2001.

CLASS 35—ADVERTISING AND BUSINESS

FOR RETAIL STORE SERVICES AND ONLINE RETAIL STORE SERVICES FEATURING STATIONERY, SUNGLASSES, WATCHES, LEATHER, IMITATION LEATHER, SYNTHETIC AND FABRIC BAGS AND CASES, INTERIOR DESIGN, SHOES, FOOTWEAR AND CLOTHING (U.S. CLS. 100, 101 AND 102).
FIRST USE 4-30-2001; IN COMMERCE 4-30-2001.

2,748,224. BADER, CAROL, GRASS VALLEY, CA. AND BADER, WALTER, GRASS VALLEY, CA. SN 76-294,310. PUB. 7-2-2002, FILED 8-3-2001.

LIFEKIND

OWNER OF U.S. REG. NO. 2,358,556.

CLASS 20—FURNITURE AND ARTICLES NOT OTHERWISE CLASSIFIED

FOR MATTRESSES (U.S. CLS. 2, 13, 22, 25, 32 AND 50).
FIRST USE 10-1-1998; IN COMMERCE 10-1-1998.

CLASS 24—FABRICS

FOR BEDDING, NAMELY, BED LINENS, BED SPREADS, COMFORTERS, SHEETS, BLANKETS AND PILLOW COVERS (U.S. CLS. 42 AND 50).
FIRST USE 10-1-1998; IN COMMERCE 10-1-1998.

2,748,225. WOOLPERT DESIGN-BUILD, LLC, DAYTON, OH. SN 76-295,008. PUB. 10-8-2002, FILED 8-2-2001.



NO CLAIM IS MADE TO THE EXCLUSIVE RIGHT TO USE "A DESIGN-BUILD CO.", APART FROM THE MARK AS SHOWN.

THE MARK CONSISTS IN PART OF A STYLIZED DESIGN OF A CITY LANDSCAPE.

CLASS 37—CONSTRUCTION AND REPAIR

FOR BUILD SERVICES, NAMELY THE BUILDING OF COMMERCIAL, RESIDENTIAL AND INDUSTRIAL BUILDINGS; CONSTRUCTION SERVICES, NAMELY, PLANNING, LAYOUT AND CUSTOM CONSTRUCTION OF COMMERCIAL, RESIDENTIAL AND INDUSTRIAL BUILDINGS; CONSTRUCTION PLANNING, SUPERVISION AND MANAGEMENT SERVICES; CONSULTING SERVICES IN THE FIELDS OF CONSTRUCTION AND BUILDING SERVICES (U.S. CLS. 100, 103 AND 106).
FIRST USE 7-1-2001; IN COMMERCE 7-1-2001.

CLASS 42—SCIENTIFIC, COMPUTER AND LEGAL SERVICES

FOR ENGINEERING SERVICES, ARCHITECTURAL DESIGN SERVICES, AND CONSULTING SERVICES IN THE FIELDS OF ENGINEERING AND ARCHITECTURAL DESIGN (U.S. CLS. 100 AND 101).
FIRST USE 7-1-2001; IN COMMERCE 7-1-2001.

2,748,229. KNIPP, LILLIAN H., BALTIMORE, MD. SN 76-296,138. PUB. 10-29-2002, FILED 8-8-2001.

HUGHES KNIPP CONSULTING

NO CLAIM IS MADE TO THE EXCLUSIVE RIGHT TO USE "CONSULTING", APART FROM THE MARK AS SHOWN.

CLASS 35—ADVERTISING AND BUSINESS

FOR BUSINESS MANAGEMENT CONSULTING SERVICES, NAMELY, PROVIDING ADVICE WITH RESPECT TO BUSINESS STAKEHOLDER RELATIONS, COMMUNICATIONS STRATEGIES AND FUNCTIONAL PROCESSES; BUSINESS MANAGEMENT AND ORGANIZATION CONSULTING, NAMELY, PROFESSIONAL CONSULTING IN CONNECTION WITH THE REORGANIZATION AND RESTRUCTURING OF BUSINESS COMMUNICATIONS FUNCTIONS; BUSINESS MANAGEMENT SERVICES, NAMELY, MANAGING ANNUAL REPORT PRODUCTION FOR OTHERS; PUBLIC RELATIONS SERVICES; MARKET RESEARCH AND MARKET ANALYSIS SERVICES; BUSINESS MARKETING CONSULTING SERVICES, NAMELY CONSULTING ON CORPORATE COMMUNICATIONS, ADVERTISING AND PROMOTIONS; WRITING AND DESIGNING COLLATERAL MARKETING MATERIALS SUCH AS ADVERTISEMENTS, BROCHURES, MEDIA MATERIALS, AND NEWSLETTERS FOR OTHERS (U.S. CLS. 100, 101 AND 102).
FIRST USE 11-0-2001; IN COMMERCE 11-0-2001.

CLASS 42—SCIENTIFIC, COMPUTER AND LEGAL SERVICES

FOR WRITING NARRATIVE FOR ANNUAL REPORTS FOR OTHERS; HIGH LEVEL COMMUNICATIONS FOR OTHERS, NAMELY, SPEECHWRITING, EDITORIAL WRITING, WRITING POSITION PAPERS, WRITING PRESS RELEASES, WRITING AND PREPARING BUSINESS PRESENTATIONS, AND WRITING FEATURE STORIES; CONSULTANT TECHNIQUES CONSULTATION FOR THE COMMUNICATIONS SUPPORT STAFF OF OTHERS; MEDIA RELATIONS CONSULTATION SERVICES, INCLUDING ADVICE ON PUBLIC ISSUES, COURSES OF ACTION AND COMMUNICATIONS PROJECTS (U.S. CLS. 100 AND 101).
FIRST USE 11-0-2001; IN COMMERCE 11-0-2001.

2,748,233. ATEECO, INC., SHENANDOAH, PA. SN 76-297,294. PUB. 5-28-2002, FILED 8-9-2001.

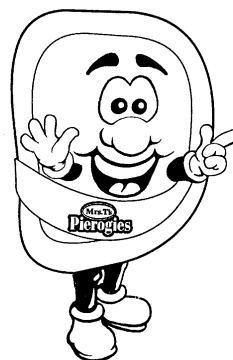

OWNER OF U.S. REG. NO. 728,072.

NO CLAIM IS MADE TO THE EXCLUSIVE RIGHT TO USE "PIEROGIES" FOR CLASS 030 GOODS ONLY, APART FROM THE MARK AS SHOWN.

CLASS 25—CLOTHING

FOR CLOTHING, NAMELY SHIRTS, HATS, JACKETS AND BIBS (U.S. CLS. 22 AND 39).
FIRST USE 10-0-2001; IN COMMERCE 10-0-2001.

CLASS 30—STAPLE FOODS

FOR PIEROGIES (U.S. CL. 46).
FIRST USE 2-0-2003; IN COMMERCE 2-0-2003.

2,748,241. SMEAD MANUFACTURING COMPANY, HASTINGS, MN. SN 76-299,196. PUB. 7-9-2002, FILED 8-10-2001.



KEEPING YOU ORGANIZED

OWNER OF U.S. REG. NOS. 1,241,113, 2,369,000, AND OTHERS.

THE LINING SHOWN IN THE DRAWING IS A FEATURE OF THE MARK AND NOT INTENDED TO INDICATE COLOR.

CLASS 9—ELECTRICAL AND SCIENTIFIC APPARATUS

FOR COMPUTER HARDWARE; COMPUTER SOFTWARE FOR DOCUMENT MANAGEMENT, NAMELY, DOCUMENT IMAGING, RETRIEVAL AND BAR-CODE TRACKING, AND PRINTERS AND SCANNERS THEREFOR; COMPUTER SOFTWARE USED FOR ELECTRONIC MAIL; ON-DEMAND COLOR CODE LABEL PRINTING SOFTWARE AND PRINTERS FOR DOCUMENT TRACKING, DATABASE MANAGEMENT SOFTWARE FOR DATA AND IMAGE MANAGEMENT, FACSIMILE MANAGEMENT SOFTWARE, COMPUTER LASER DISK SOFTWARE AND HARDWARE FOR DOCUMENT MANAGEMENT; SOFTWARE FOR ROUTING OF FAX AND DOCUMENT INFORMATION, DOCUMENT ARCHIVING SOFTWARE, AND MANUALS FOR ALL OF THE ABOVE (U.S. CLS. 21, 23, 26, 36 AND 38).

FIRST USE 10-21-2001; IN COMMERCE 10-21-2001.

CLASS 16—PAPER GOODS AND PRINTED MATTER

FOR OFFICE REQUISITES, NAMELY, STATIONERY TYPE PORTFOLIOS, PAPER FILES, FOLDERS, ENVELOPES, FILING INDEXES, LABELS, PAPER AND PLASTIC COVERS FOR PAPER IN SHEET FORM, GUIDES FOR LOCATING AND SEPARATING FILED MATERIAL, FASTENERS FOR FILING, INDEX CARDS, FILING TABS, FACE SHIELDS FOR FILING TABS, INSERTS FOR FILING TABS, BINDERS AND BINDER COVERS, HANGING FOLDER FRAMES, STEEL TRAYS FOR HANGING FOLDERS, HANGING AND BOX BOTTOM FOLDERS, FILING POCKETS, FILE JACKETS, FILE WALLETS, AND EXPANDING FILES (U.S. CLS. 2, 5, 22, 23, 29, 37, 38 AND 50).

FIRST USE 10-21-2001; IN COMMERCE 10-21-2001.

2,748,242. KABUSHIKI KAISHA BEACON INFORMATION TECHNOLOGY, AKA BEACON INFORMATION TECHNOLOGY INC., TOKYO, JAPAN. SN 76-299,576. PUB. 8-6-2002, FILED 8-14-2001.

SEGMENTIZER

CLASS 9—ELECTRICAL AND SCIENTIFIC APPARATUS

FOR COMPUTER SOFTWARE FOR MANAGING, IDENTIFYING AND ANALYZING INFORMATION FOR USE IN THE MARKETING FIELD UTILIZING CUSTOMER DATABASES AND DATA WAREHOUSES, AND INSTRUCTIONAL MATERIALS PROVIDED THEREWITH (U.S. CLS. 21, 23, 26, 36 AND 38).

FIRST USE 9-30-2001; IN COMMERCE 9-30-2001.

CLASS 16—PAPER GOODS AND PRINTED MATTER

FOR PRINTED INSTRUCTIONAL MATERIALS AND MANUALS FOR COMPUTER SOFTWARE (U.S. CLS. 2, 5, 22, 23, 29, 37, 38 AND 50).

FIRST USE 9-30-2001; IN COMMERCE 9-30-2001.

2,748,247. LEISURE STATION CO., LTD., TAICHUNG, TAIWAN. SN 76-300,709. PUB. 6-18-2002, FILED 8-15-2001.

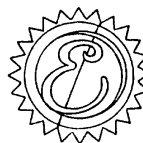

Leisure Station

CLASS 35—ADVERTISING AND BUSINESS

FOR FRANCHISING OF DINING CAR SERVICES (U.S. CLS. 100, 101 AND 102).

FIRST USE 7-31-2002; IN COMMERCE 7-31-2002.

CLASS 42—SCIENTIFIC, COMPUTER AND LEGAL SERVICES

FOR BAR SERVICES, SNACK BARS, CARRY-OUT RESTAURANTS, COCKTAIL LOUNGES, COCKTAIL LOUNGE BUFFETS, OFFICE COFFEE SUPPLY SERVICES, RENTAL OF FOOD SERVICE EQUIPMENT, RESTAURANTS, SELF-SERVICE RESTAURANTS, RESTAURANTS FEATURING HOME DELIVERY, SALAD BARS, CANTEEN SERVICES, CAFES, AND CAFETERIAS (U.S. CLS. 100 AND 101).

FIRST USE 7-31-2002; IN COMMERCE 7-31-2002.

2,748,254. ORBITEL S.A. E.S.P., MEDELLIN, COLOMBIA. SN 76-303,708. PUB. 3-19-2002, FILED 8-22-2001.

TARJETA CINCO

NO CLAIM IS MADE TO THE EXCLUSIVE RIGHT TO USE "TARJETA", APART FROM THE MARK AS SHOWN.

IN THE SPANISH LANGUAGE, "TARJETA" MEANS "CARD" AND "CINCO" MEANS "FIVE".

CLASS 16—PAPER GOODS AND PRINTED MATTER

FOR PREPAID TELEPHONE CALLING CARDS, NOT MAGNETICALLY ENCODED (U.S. CLS. 2, 5, 22, 23, 29, 37, 38 AND 50).

FIRST USE 11-27-2001; IN COMMERCE 11-27-2001.

CLASS 38—COMMUNICATION

FOR PREPAID TELEPHONE COMMUNICATION SERVICES (U.S. CLS. 100, 101 AND 104).

FIRST USE 11-27-2001; IN COMMERCE 11-27-2001.

2,748,263. EMERACHEM LLC, KNOXVILLE, TN. SN 76-307,747. PUB. 7-23-2002, FILED 8-30-2001.

THE POWER OF CATALYSIS

NO CLAIM IS MADE TO THE EXCLUSIVE RIGHT TO USE "CATALYSIS", APART FROM THE MARK AS SHOWN.

CLASS 1—CHEMICALS

FOR CATALYTIC SYSTEM COMPRISING CHEMICAL COMPOUNDS USED FOR THE REDUCTION AND REMOVAL OF NITROGEN OXIDES, CARBON MONOXIDE, AND VOLATILE ORGANIC COMPOUNDS, SULFUR AND PARTICULATE MATTER EMITTED FROM COMBUSTION SOURCES AS A RESULT OF BURNING FOSSIL FUELS (U.S. CLS. 1, 5, 6, 10, 26 AND 46).
FIRST USE 10-1-2001; IN COMMERCE 10-1-2001.

CLASS 7—MACHINERY

FOR MACHINES USED FOR THE REDUCTION AND REMOVAL OF NITROGEN OXIDES, CARBON MONOXIDE, AND VOLATILE ORGANIC COMPOUNDS, SULFUR AND PARTICULATE MATTER EMITTED FROM COMBUSTION SOURCES AS A RESULT OF BURNING FOSSIL FUELS (U.S. CLS. 13, 19, 21, 23, 31, 34 AND 35).
FIRST USE 10-1-2001; IN COMMERCE 10-1-2001.

CLASS 40—MATERIAL TREATMENT

FOR AIR PURIFICATION FOR OTHERS, NAMELY, THE REDUCTION AND REMOVAL OF NITROGEN OXIDES, CARBON MONOXIDE, AND VOLATILE ORGANIC COMPOUNDS, SULFUR AND PARTICULATE MATTER EMITTED FROM COMBUSTION SOURCES AS A RESULT OF BURNING FOSSIL FUELS (U.S. CLS. 100, 103 AND 106).
FIRST USE 10-1-2001; IN COMMERCE 10-1-2001.

2,748,268. HARPER, SANDRA, RIVERSIDE, CA. SN 76-310,306. PUB. 10-22-2002, FILED 9-7-2001.

TIMJAGARI AND FRIENDS

CLASS 16—PAPER GOODS AND PRINTED MATTER

FOR PAPER GOODS, NAMELY GREETING CARDS, STORY BOOKS, APPOINTMENT BOOKS, CHILDREN'S COLOR BOOKS, MESSAGE BOARDS, AND STATIONERY (U.S. CLS. 2, 5, 22, 23, 29, 37, 38 AND 50).
FIRST USE 4-6-2003; IN COMMERCE 4-6-2003.

CLASS 25—CLOTHING

FOR CLOTHING, NAMELY T-SHIRTS, SWEAT SHIRTS, PANTS, SKIRTS, JEANS, SHIRTS, GLOVES, SOCKS, AND HEADWEAR (U.S. CLS. 22 AND 39).
FIRST USE 4-6-2003; IN COMMERCE 4-6-2003.

2,748,281. SPECTRA SYSTEMS CORP., PROVIDENCE, RI. SN 76-315,738. PUB. 2-19-2002, FILED 9-21-2001.

ACTIVA

CLASS 2—PAINTS

FOR PLASTIC COATINGS WITH LIGHT, NAMELY FLUORESCENT UV OR IR, STIMULATED MATERIAL FORMING OPTICAL CODES (U.S. CLS. 6, 11 AND 16).
FIRST USE 10-11-2001; IN COMMERCE 12-10-2002.

CLASS 17—RUBBER GOODS

FOR PLASTIC FILM WITH LIGHT, NAMELY FLUORESCENT UV OR IR, STIMULATED MATERIAL FORMING OPTICAL CODES (U.S. CLS. 1, 5, 12, 13, 35 AND 50).
FIRST USE 10-11-2001; IN COMMERCE 12-10-2002.

2,748,303. KIM, CHOONG YUP, LOS ANGELES, CA. SN 76-322,412. PUB. 9-3-2002, FILED 10-9-2001.

SSAP

CLASS 2—PAINTS

FOR WATERPROOF COATINGS MADE OF URETHANE FOR APPLICATION TO STUCCO, CONCRETE, ASBESTOS, WOOD, GALVANIZED METAL, BRICK, MASONRY AND ROOFING SHINGLES (U.S. CLS. 6, 11 AND 16).
FIRST USE 4-1-1999; IN COMMERCE 10-1-1999.

CLASS 17—RUBBER GOODS

FOR WATERPROOF SHEETING MADE OF RUBBERIZED ASPHALT USED IN THE CONSTRUCTION INDUSTRY AS A VAPOR BARRIER (U.S. CLS. 1, 5, 12, 13, 35 AND 50).
FIRST USE 4-1-1999; IN COMMERCE 10-1-1999.

2,748,304. WISCONSIN ENERGY CORPORATION, MILWAUKEE, WI. SN 76-322,826. PUB. 10-29-2002, FILED 10-9-2001.

WE ENERGIES

NO CLAIM IS MADE TO THE EXCLUSIVE RIGHT TO USE "ENERGIES", APART FROM THE MARK AS SHOWN.

CLASS 36—INSURANCE AND FINANCIAL

FOR CUSTOMER SERVICES IN THE UTILITY SERVICE FIELD IN THE NATURE OF PAYMENT PLANS (U.S. CLS. 100, 101 AND 102).
FIRST USE 4-15-2002; IN COMMERCE 4-15-2002.

CLASS 39—TRANSPORTATION AND STORAGE

FOR UTILITY SERVICES, NAMELY, THE TRANSMISSION AND DISTRIBUTION OF ELECTRICITY, NATURAL GAS AND STEAM POWER; WATER UTILITY SERVICES; OUTDOOR LIGHTING SERVICES (U.S. CLS. 100 AND 105).
FIRST USE 4-15-2002; IN COMMERCE 4-15-2002.

CLASS 40—MATERIAL TREATMENT

FOR THE PRODUCTION OF ENERGY (U.S. CLS. 100, 103 AND 106).
FIRST USE 4-15-2002; IN COMMERCE 5-27-2002.

CLASS 42—SCIENTIFIC, COMPUTER AND LEGAL SERVICES

FOR ASSISTANCE AND COUNSELING SERVICES FOR CUSTOMERS WITH REGARD TO ENERGY USAGE, ENERGY SAFETY AND ENERGY CONSERVATION; AND THE PROVISION OF ENERGY GENERATOR SYSTEMS (U.S. CLS. 100 AND 101).
FIRST USE 4-15-2002; IN COMMERCE 4-15-2002.

2,748,311. LIPTON INVESTMENTS, INC., WILMINGTON, DE. SN 76-324,205. PUB. 7-16-2002, FILED 10-11-2001.

HONEY MUSTARD MADNESS

NO CLAIM IS MADE TO THE EXCLUSIVE RIGHT TO USE "HONEY MUSTARD", APART FROM THE MARK AS SHOWN.

CLASS 29—MEATS AND PROCESSED FOODS

FOR SNACK DIPS (U.S. CL. 46).
FIRST USE 1-1-2003; IN COMMERCE 1-1-2003.

CLASS 30—STAPLE FOODS

FOR SAUCES (U.S. CL. 46).
FIRST USE 1-1-2003; IN COMMERCE 1-1-2003.

2,748,325. NRZ, INC., MIAMI, FL. SN 76-328,547. PUB. 7-16-2002, FILED 10-22-2001.

BEACH ACCESS

CLASS 25—CLOTHING

FOR CLOTHING, NAMELY T-SHIRTS, WOVEN SHIRTS, KNIT SHIRTS, PANTS, SHORTS, SWIM WEAR, JACKETS, HATS AND VISORS; BEACHWEAR (U.S. CLS. 22 AND 39).
FIRST USE 2-6-2003; IN COMMERCE 2-6-2003.

CLASS 35—ADVERTISING AND BUSINESS

FOR RETAIL STORES FEATURING CLOTHING, NAMELY T-SHIRTS, WOVEN SHIRTS, KNIT SHIRTS, PANTS, SHORTS, SWIM WEAR, JACKETS, HATS AND VISORS; BEACH WEAR; BEACH ACCESSORIES; SUNGLASSES; TOYS; JEWELRY AND SOUVENIRS (U.S. CLS. 100, 101 AND 102).
FIRST USE 2-6-2003; IN COMMERCE 2-6-2003.

2,748,335. EASTMAN OUTDOORS, INC., FLUSHING, MI. SN 76-332,454. PUB. 7-23-2002, FILED 10-31-2001.

WOK KING

NO CLAIM IS MADE TO THE EXCLUSIVE RIGHT TO USE "WOK", APART FROM THE MARK AS SHOWN.

CLASS 8—HAND TOOLS

FOR CHOPSTICKS AND BAMBOO COOKING CHOPSTICKS (U.S. CLS. 23, 28 AND 44).
FIRST USE 12-0-2001; IN COMMERCE 12-0-2001.

CLASS 21—HOUSEWARES AND GLASS

FOR NON-ELECTRIC COOKING UTENSILS, NAMELY, BAMBOO TONGS, BAMBOO SPATULAS, BAMBOO RICE PADDLES, BAMBOO COOKING CHOPSTICKS, SERVING BOWLS, NON-ELECTRIC CHROME STEAMERS, AND NON-ELECTRIC WOKS (U.S. CLS. 2, 13, 23, 29, 30, 33, 40 AND 50).
FIRST USE 12-0-2001; IN COMMERCE 12-0-2001.

CLASS 30—STAPLE FOODS

FOR COOKING SAUCES (U.S. CL. 46).
FIRST USE 12-0-2001; IN COMMERCE 12-0-2001.

2,748,337. DEALTEK, LTD., SYRACUSE, NY. SN 76-332,928. PUB. 10-8-2002, FILED 11-1-2001.

DEALS DEVELOPMENT, EXPANSION AND LOCATION SOLUTIONS

OWNER OF U.S. REG. NO. 2,438,011.

NO CLAIM IS MADE TO THE EXCLUSIVE RIGHT TO USE "DEVELOPMENT, EXPANSION AND LOCATION SOLUTIONS", APART FROM THE MARK AS SHOWN.

CLASS 35—ADVERTISING AND BUSINESS

FOR PROVIDING AN ON-LINE COMPUTER DATABASE OF ECONOMIC, DEMOGRAPHIC, AND COMPANY-SPECIFIC DATA FOR MANAGEMENT USE IN STRATEGIC PROJECT DECISION MAKING REGARDING THE DEVELOPMENT, EXPANSION, CONSOLIDATION, LOCATION, AND RELOCATION OF BUSINESS OPERATIONS AND FACILITIES; PROVIDING ON-LINE BUSINESS CONSULTING SERVICES TO OPTIMIZE THE RESULTS OF STRATEGIC PROJECT DECISIONS REGARDING THE DEVELOPMENT, EXPANSION, CONSOLIDATION, LOCATION, AND RELOCATION OF BUSINESS OPERATIONS AND FACILITIES; PROVIDING AN INTERACTIVE ON-LINE COMPUTER DATABASE THAT PERMITS USERS TO TRACK NEGOTIATION PROCESSES AND PERMITS THE ANNOTATION OF DISCUSSIONS, NEGOTIATIONS AND DECISIONS RELATING TO FINANCIAL, ECONOMIC AND DEMOGRAPHIC DATA RELATING TO BUSINESS DEVELOPMENT, EXPANSION, CONSOLIDATION, LOCATION, RELOCATION AS WELL AS ECONOMIC DEVELOPMENT (U.S. CLS. 100, 101 AND 102).
FIRST USE 6-7-2000; IN COMMERCE 6-7-2000.

CLASS 42—SCIENTIFIC, COMPUTER AND LEGAL SERVICES

FOR PROVIDING TEMPORARY USE OF ON-LINE NON-DOWNLOADABLE SOFTWARE FOR ACCESSING, ASSEMBLING, TRACKING, UPDATING AND MODELING PRIVILEGED AND CONFIDENTIAL PROJECT MANAGEMENT INFORMATION USED TO FACILITATE THE DEVELOPMENT, EXPANSION, CONSOLIDATION, LOCATION AND RELOCATION OF BUSINESSES AND THEIR OPERATIONS AND FACILITIES; PROVIDING TEMPORARY USE OF ON-LINE NON-DOWNLOADABLE SOFTWARE FOR USE IN FINANCIAL MODELING, CALCULATIONS AND PROJECTIONS RELATING TO THE DEVELOPMENT, EXPANSION, CONSOLIDATION, LOCATION AND RELOCATION OF BUSINESSES AND THEIR OPERATIONS AND FACILITIES; PROVIDING TEMPORARY USE OF ON-LINE NON-DOWNLOADABLE SOFTWARE CONTAINING ONE OR MORE OF THE FOLLOWING BUSINESS AND ECONOMIC DECISION MAKING AND NEGOTIATING TOOLS, NAMELY, ELECTRONIC CONFERENCE ROOM CAPABILITIES, PROJECT QUESTIONNAIRES, DECISION MODELING PROCESSES, AND ECONOMIC, DEMOGRAPHIC, PROJECT AND FINANCIAL DATA, PROJECTIONS AND REQUIREMENTS; PROVIDING TEMPORARY USE OF ON-LINE NON-DOWNLOADABLE SOFTWARE FOR USE IN DATABASE MANAGEMENT AND PROJECT MANAGEMENT RELATING TO BUSINESS DEVELOPMENT, EXPANSION, CONSOLIDATION, LOCATION, RELOCATION AS WELL AS ECONOMIC DEVELOPMENT (U.S. CLS. 100 AND 101).

FIRST USE 6-7-2000; IN COMMERCE 6-7-2000.

2,748,367. SOFTLIFE CORPORATION, THE, NORTHBROOK, IL. SN 76-341,005. PUB. 6-4-2002, FILED 11-21-2001.

SOFTLIFE**CLASS 35—ADVERTISING AND BUSINESS**

FOR BUSINESS SERVICES, NAMELY, BUSINESS MANAGEMENT AND CONSULTATION (U.S. CLS. 100, 101 AND 102).

FIRST USE 1-1-2002; IN COMMERCE 1-1-2002.

CLASS 36—INSURANCE AND FINANCIAL

FOR INSURANCE SERVICES, NAMELY, INSURANCE ADMINISTRATION; INSURANCE ADMINISTRATION IN THE FIELD OF LIFE INSURANCE AND ANNUITIES; INSURANCE CLAIMS ADMINISTRATION; ELECTRONIC PROCESSING OF INSURANCE CLAIMS AND PAYMENT DATA; INSURANCE CONSULTATION; AND FINANCIAL SERVICES, NAMELY, FINANCIAL ANALYSIS AND CONSULTATION; FINANCIAL INFORMATION PROVIDED BY ELECTRONIC MEANS; AND FINANCIAL MANAGEMENT (U.S. CLS. 100, 101 AND 102).

FIRST USE 1-1-2002; IN COMMERCE 1-1-2002.

2,748,371. PLEASANT COMPANY, MIDDLETON, WI. SN 76-341,887. PUB. 11-12-2002, FILED 11-20-2001.

BITTY PIGGY

OWNER OF U.S. REG. NOS. 1,990,314, 2,395,813, AND OTHERS.

NO CLAIM IS MADE TO THE EXCLUSIVE RIGHT TO USE "PIGGY", APART FROM THE MARK AS SHOWN.

CLASS 16—PAPER GOODS AND PRINTED MATTER

FOR CHILDREN'S FICTION AND ACTIVITY BOOKS (U.S. CLS. 2, 5, 22, 23, 29, 37, 38 AND 50).

FIRST USE 9-2-2002; IN COMMERCE 9-2-2002.

CLASS 28—TOYS AND SPORTING GOODS

FOR STUFFED TOY ANIMALS AND ACCESSORIES FOR STUFFED TOY ANIMALS, TOY FURNITURE AND TOY DISHES TO ACCOMPANY STUFFED TOY ANIMALS (U.S. CLS. 22, 23, 38 AND 50).

FIRST USE 9-2-2002; IN COMMERCE 9-2-2002.

2,748,376. M & L ONLINE L.L.C., FARMINGTON HILLS, MI. SN 76-344,326. PUB. 6-18-2002, FILED 12-3-2001.

TALK TO THE MIRROR**CLASS 16—PAPER GOODS AND PRINTED MATTER**

FOR PENS, PAPER NOTEBOOK TABLETS AND BINDERS (U.S. CLS. 2, 5, 22, 23, 29, 37, 38 AND 50).

FIRST USE 1-31-2002; IN COMMERCE 1-31-2002.

CLASS 18—LEATHER GOODS

FOR HANDBAGS, TOTE BAGS, WAIST POUCHES AND POCKET PORTFOLIOS (U.S. CLS. 1, 2, 3, 22 AND 41).

FIRST USE 1-31-2002; IN COMMERCE 1-31-2002.

CLASS 20—FURNITURE AND ARTICLES NOT OTHERWISE CLASSIFIED

FOR HAND-HELD MIRRORS (U.S. CLS. 2, 13, 22, 25, 32 AND 50).

FIRST USE 1-31-2002; IN COMMERCE 1-31-2002.

CLASS 21—HOUSEWARES AND GLASS

FOR PLASTIC CUPS AND SPORTS BOTTLES, SOLD EMPTY (U.S. CLS. 2, 13, 23, 29, 30, 33, 40 AND 50).

FIRST USE 1-31-2002; IN COMMERCE 1-31-2002.

CLASS 25—CLOTHING

FOR CLOTHING, NAMELY, T-SHIRTS, CAPS, VISORS, JERSEYS, BODYSUITS, FITNESS TOPS, HEADBANDS, JACKETS, PANTS, SHORTS, SOCKS, TIGHTS, UNITARDS, WARM-UP SUITS AND WRISTBANDS (U.S. CLS. 22 AND 39).

FIRST USE 1-31-2002; IN COMMERCE 1-31-2002.

2,748,388. METEORLOGIX, LLC, BURNSVILLE, MN, BY CHANGE OF NAME DTN WEATHER SERVICES, LLC, BURNSVILLE, MN. SN 76-348,541. PUB. 7-9-2002, FILED 12-12-2001.

MXINSIGHT**CLASS 9—ELECTRICAL AND SCIENTIFIC APPARATUS**

FOR SOFTWARE FOR PROCESSING AND DISPLAYING WEATHER INFORMATION (U.S. CLS. 21, 23, 26, 36 AND 38).

FIRST USE 10-23-2001; IN COMMERCE 10-23-2001.

CLASS 42—SCIENTIFIC, COMPUTER AND LEGAL SERVICES

FOR WEATHER FORECASTING SERVICES, NAMELY DISTRIBUTION OF WEATHER INFORMATION (U.S. CLS. 100 AND 101).

FIRST USE 10-23-2001; IN COMMERCE 10-23-2001.

CLASS 43—HOTEL AND RESTAURANT SERVICES

FOR HOTEL, MOTEL AND RESTAURANT SERVICES; MAKING TEMPORARY LODGING RESERVATIONS FOR OTHERS (U.S. CLS. 100 AND 101).

FIRST USE 9-1-2002; IN COMMERCE 9-1-2002.

2,748,396. FRED MEYER STORES, INC., PORTLAND, OR. SN 76-350,444. PUB. 9-24-2002, FILED 12-18-2001.

PLAYVILLE**CLASS 28—TOYS AND SPORTING GOODS**

FOR TOYS, NAMELY, BABY MULTIPLE ACTIVITY TOYS, BATTERY OPERATED ACTION TOYS, BENDABLE TOYS, CHILDREN'S MULTIPLE ACTIVITY TOYS, CHILDREN'S WIRE CONSTRUCTION AND ART ACTIVITY TOYS, CONSTRUCTION TOYS, DRAWING TOYS, FANTASY CHARACTER TOYS, INFLATABLE TOYS SHOWING DECORATIVE PICTURES, MECHANICAL TOYS, MUSIC BOX TOYS, PARTY FAVORS IN THE NATURE OF SMALL TOYS, PLASTIC CHARACTER TOYS, PLUSH TOYS, POP UP TOYS, PRINTING TOYS, PULL TOYS, RUBBER CHARACTER TOYS, SAND TOYS, SANDBOX TOYS, SKETCHING TOYS, SQUEEZE TOYS, TALKING TOYS, TOSSING DISC TOYS, TRANSFORMING ROBOTIC TOYS, WATER SQUIRTING TOYS AND WIND-UP TOYS (U.S. CLS. 22, 23, 38 AND 50).

FIRST USE 8-0-2002; IN COMMERCE 8-0-2002.

CLASS 35—ADVERTISING AND BUSINESS

FOR RETAIL DEPARTMENT STORE SERVICES (U.S. CLS. 100, 101 AND 102).

FIRST USE 8-0-2002; IN COMMERCE 8-0-2002.

2,748,404. TM ACQUISITION CORP., PHOENIX, AZ. SN 76-351,774. PUB. 6-25-2002, FILED 12-20-2001.



OWNER OF U.S. REG. NOS. 2,037,694, 2,089,627, AND OTHERS.

NO CLAIM IS MADE TO THE EXCLUSIVE RIGHT TO USE "INN & SUITES", APART FROM THE MARK AS SHOWN.

CLASS 35—ADVERTISING AND BUSINESS

FOR FRANCHISING, NAMELY, RENDERING TECHNICAL ASSISTANCE IN THE ORGANIZATION AND ESTABLISHMENT OF MOTELS AND RESTAURANTS SERVICES (U.S. CLS. 100, 101 AND 102).

FIRST USE 9-1-2002; IN COMMERCE 9-1-2002.

2,748,411. ELLIPSIS COMMUNICATIONS, LLC, MOORESTOWN, NJ. SN 76-353,295. PUB. 7-16-2002, FILED 12-28-2001.

RED ELLIPSIS

OWNER OF U.S. REG. NOS. 2,464,631 AND 2,542,226.

CLASS 35—ADVERTISING AND BUSINESS

FOR PREPARING AND PLACING MAGAZINE, TELEVISION AND RADIO ADVERTISEMENTS FOR OTHERS, DIRECT MAIL ADVERTISING, MARKET RESEARCH SERVICES, TELEMARKETING, ARRANGING AND CONDUCTING BUSINESS CONFERENCES AND BUSINESS MEETINGS, BUSINESS MARKETING CONSULTATION, AND PUBLIC RELATIONS SERVICES (U.S. CLS. 100, 101 AND 102).

FIRST USE 12-17-2001; IN COMMERCE 1-30-2002.

CLASS 42—SCIENTIFIC, COMPUTER AND LEGAL SERVICES

FOR CUSTOM WRITING SERVICES, NAMELY WRITING SPEECHES FOR OTHERS; COMMERCIAL ART DESIGN; COMPUTER SERVICES, NAMELY DESIGNING AND DEVELOPING WEBSITES FOR OTHERS (U.S. CLS. 100 AND 101).

FIRST USE 12-17-2001; IN COMMERCE 1-30-2002.

2,748,424. NAMCO LTD., TOKYO, JAPAN. SN 76-357,224. PUB. 9-17-2002, FILED 1-9-2002.

NINJA ASSAULT**CLASS 9—ELECTRICAL AND SCIENTIFIC APPARATUS**

FOR VIDEO GAME CARTRIDGES; COMPUTER GAME PROGRAMS (U.S. CLS. 21, 23, 26, 36 AND 38).

FIRST USE 11-12-2002; IN COMMERCE 11-12-2002.

CLASS 28—TOYS AND SPORTING GOODS

FOR COIN-OPERATED AMUSEMENT GAME MACHINES (U.S. CLS. 22, 23, 38 AND 50).

FIRST USE 12-5-2000; IN COMMERCE 12-5-2000.

2,748,426. MTD PRODUCTS INC, CLEVELAND, OH. SN 76-358,316. PUB. 8-6-2002, FILED 1-4-2002.

SMART SPEED

NO CLAIM IS MADE TO THE EXCLUSIVE RIGHT TO USE "SMART", APART FROM THE MARK AS SHOWN.

CLASS 7—MACHINERY

FOR POWERED-OPERATED LAWN MACHINES, NAMELY, LAWN AND GARDEN VACUUMS AND PARTS THEREFOR; POWER OPERATED LAWN AND GARDEN STRING TRIMMERS; HAND MOWERS, POWER MOWERS, ROTARY MOWERS, GANG AND TRAILER MOWERS; FRONT-MOUNTED MOWER ATTACHMENTS FOR LAWN TRACTORS; POWER-OPERATED LAWN AND GARDEN EQUIPMENT, NAMELY, RIDING MOWERS, COMMERCIAL LAWN MOWERS, LEAF SHREDDERS, LAWN VACUUMS, WALK-BEHIND MOWERS, SELF-PROPELLED MOWERS, SIDE DISCHARGE MOWERS, CONVERTIBLE MOWERS, REAR DISCHARGE MOWERS, SIDE DISCHARGE HIGH WHEEL MOWERS, MULCHING MOWERS, ELECTRIC MOWERS, WALK-BEHIND ROTARY AND REEL MOWERS, CHIPPER/SHREDDERS, LIFTS, TILLERS, FRONT TINE TILLERS, REAR TINE TILLERS, SELF-PROPELLED TILLERS, POWER-OPERATED, TRACTOR-TOWED IMPELLERS, CULTIVATORS, PLOWS; POWER-OPERATED LAWN EDGERS, POWER-OPERATED LOG SPLITTER; SNOW THROWERS; TWO-STAGE SNOW THROWERS; TRACK DRIVE SNOW THROWERS; RIDING SULKIES AND SEATED SULKIES FOR LAWN MOWERS, LAWN MOWER ATTACHMENTS, NAMELY, BAGGER/MULCHERS AND ANTI-SCALP ROLLERS; RIDING MOWERS, POWER-OPERATED LAWN AND GARDEN TILLERS, BLOWERS FOR LAWN DEBRIS, LEAF BLOWERS, LEAF SHREDDERS, LAWN SWEEPERS, LAWN VACUUMS, ROLLER CONVEYORS; LAWN AND GARDEN ACCESSORIES FOR MOWERS AND TRACTORS, NAMELY GRASS CATCHERS, GRASS SWEEPERS, DOZER BLADES AND SNOW BLADES; SNOW-REMOVAL ATTACHMENTS FOR LAWN TRACTORS; POWER-OPERATED LAWN MOWER SERVICE TOOLS, NAMELY, REEL GRINDERS, CUTTER BAR GRINDERS, AND LAPPING STANDS; HAND LAWN MOWERS; MULTI-PURPOSE VACUUM CLEANERS; STRUCTURAL PARTS FOR ALL THE FOREGOING GOODS (U.S. CLS. 13, 19, 21, 23, 31, 34 AND 35).
FIRST USE 1-31-2001; IN COMMERCE 1-31-2001.

CLASS 12—VEHICLES

FOR LAWN AND GARDEN TRACTORS; TRACTORS; THREE-POINT TRAILER HITCHES (U.S. CLS. 19, 21, 23, 31, 35 AND 44).
FIRST USE 1-31-2001; IN COMMERCE 1-31-2001.

2,748,430. HEAD SPORT AG, A-6921 KENNELBACH, AUSTRIA. SN 76-359,816. PUB. 10-15-2002, FILED 1-18-2002.

INTELLIGENCE X**CLASS 18—LEATHER GOODS**

FOR SPORTS BAGS (U.S. CLS. 1, 2, 3, 22 AND 41).
FIRST USE 2-0-2002; IN COMMERCE 2-0-2002.

CLASS 28—TOYS AND SPORTING GOODS

FOR TENNIS, SQUASH, AND RACQUETBALL RACKETS AND COVERS THEREFOR (U.S. CLS. 22, 23, 38 AND 50).
FIRST USE 2-0-2002; IN COMMERCE 2-0-2002.

2,748,434. SHN, INC., PLYMOUTH, MN. SN 76-360,371. PUB. 12-24-2002, FILED 1-18-2002.



NO CLAIM IS MADE TO THE EXCLUSIVE RIGHT TO USE "SELLERS HOME NETWORK.COM", APART FROM THE MARK AS SHOWN.

CLASS 35—ADVERTISING AND BUSINESS

FOR FRANCHISING SERVICES, NAMELY, PROVIDING TECHNICAL ASSISTANCE IN THE ESTABLISHMENT AND OPERATION OF REAL ESTATE AGENCIES AND REAL ESTATE BROKERAGES (U.S. CLS. 100, 101 AND 102).
FIRST USE 10-26-1999; IN COMMERCE 10-26-1999.

CLASS 36—INSURANCE AND FINANCIAL

FOR REAL ESTATE AGENCY AND REAL ESTATE BROKERAGE SERVICES (U.S. CLS. 100, 101 AND 102).
FIRST USE 10-26-1999; IN COMMERCE 10-26-1999.

2,748,458. INSANITY HOUSE, INC., ALBUQUERQUE, NM. SN 76-366,824. PUB. 11-19-2002, FILED 2-5-2002.

RAISE THE NATION**CLASS 35—ADVERTISING AND BUSINESS**

FOR CONSULTING SERVICES IN THE FIELD OF MARKET RESEARCH RELATING TO SINGLE PARENT AND NONTRADITIONAL FAMILIES (U.S. CLS. 100, 101 AND 102).
FIRST USE 6-1-2002; IN COMMERCE 6-1-2002.

CLASS 45—PERSONAL SERVICES

FOR PROVIDING INFORMATION VIA WEBSITE AND TELEPHONE RELATING TO THE VARIOUS NEEDS OF SINGLE PARENT AND NONTRADITIONAL FAMILIES, NAMELY, PROVIDING INFORMATION ON THE SUBJECT OF PARENTING, SOCIAL SERVICES AND SOCIAL CLUBS (U.S. CLS. 100 AND 101).
FIRST USE 6-1-2002; IN COMMERCE 6-1-2002.

2,748,479. ADAPTIS INC., SEATTLE, WA. SN 76-375,406.
PUB. 11-12-2002, FILED 2-26-2002.



The logo for Adaptis features a stylized 'A' composed of three overlapping circles of varying sizes, followed by the word 'Adaptis' in a serif font.

CLASS 35—ADVERTISING AND BUSINESS

FOR BUSINESS INFORMATION MANAGEMENT OF HEALTH PLAN ADMINISTRATION AND FINANCIAL INFORMATION TECHNOLOGY SERVICES FOR HEALTHCARE PROGRAMS (U.S. CLS. 100, 101 AND 102).

FIRST USE 12-15-2001; IN COMMERCE 12-15-2001.

CLASS 36—INSURANCE AND FINANCIAL

FOR ADMINISTRATION OF HEALTHCARE PLANS FOR OTHERS AND PROCESSING OF INSURANCE AND PAYMENT DATA FOR HEALTH CARE PLANS AND PROGRAMS (U.S. CLS. 100, 101 AND 102).

FIRST USE 12-15-2001; IN COMMERCE 12-15-2001.

2,748,483. KOHL'S ILLINOIS, INC., AURORA, IL. SN 76-377,519. PUB. 11-12-2002, FILED 3-4-2002.

SUMMER LIVING

OWNER OF U.S. REG. NO. 1,795,415.

CLASS 18—LEATHER GOODS

FOR HANDBAGS (U.S. CLS. 1, 2, 3, 22 AND 41).
FIRST USE 1-0-2002; IN COMMERCE 1-0-2002.

CLASS 25—CLOTHING

FOR SHOES, SOCKS AND HOSIERY (U.S. CLS. 22 AND 39).

FIRST USE 1-0-2002; IN COMMERCE 1-0-2002.

2,748,504. ELECTROMED TECHNOLOGIES LLC, CHICAGO, IL, BY MERGER ELECTROMED TECHNOLOGIES, INC., CHICAGO, IL. SN 76-384,065. PUB. 12-3-2002, FILED 3-14-2002.

QUITTING TIME WATCH

NO CLAIM IS MADE TO THE EXCLUSIVE RIGHT TO USE "WATCH", APART FROM THE MARK AS SHOWN.

CLASS 14—JEWELRY

FOR WATCHES AND SMOKING CESSATION KIT COMPRISED OF A SPECIALLY PROGRAMMED WATCH AND INSTRUCTION BOOK (U.S. CLS. 2, 27, 28 AND 50).

FIRST USE 9-16-2002; IN COMMERCE 9-16-2002.

CLASS 16—PAPER GOODS AND PRINTED MATTER

FOR SMOKING CESSATION KIT COMPRISED OF AN INSTRUCTION BOOK AND SPECIALLY PROGRAMMED WATCH (U.S. CLS. 2, 5, 22, 23, 29, 37, 38 AND 50).

FIRST USE 9-16-2002; IN COMMERCE 9-16-2002.

2,748,534. TAYLOR CORPORATION, NORTH MANKATO, MN, BY ASSIGNMENT NOWDOCS, INC., ALISO VIEJO, CA. SN 76-396,328. PUB. 10-29-2002, FILED 4-17-2002.

NOWPRINT

CLASS 9—ELECTRICAL AND SCIENTIFIC APPARATUS

FOR COMPUTER SOFTWARE, NAMELY, SOFTWARE THAT ALLOWS SUBMISSION OF PRINT JOB ORDERS AND FULFILLMENT OF PRINT JOB ORDERS VIA THE INTERNET AND INTRANETS (U.S. CLS. 21, 23, 26, 36 AND 38).

FIRST USE 9-0-2001; IN COMMERCE 9-0-2001.

CLASS 42—SCIENTIFIC, COMPUTER AND LEGAL SERVICES

FOR PROVIDING TEMPORARY USE OF NON-DOWNLOADABLE COMPUTER SOFTWARE THAT ALLOWS SUBMISSION OF PRINT JOB ORDERS AND FULFILLMENT OF PRINT JOB ORDERS VIA THE INTERNET AND INTRANETS (U.S. CLS. 100 AND 101).

FIRST USE 10-31-2001; IN COMMERCE 10-31-2001.

2,748,537. ROBBINS INDUSTRIES, INC., FLORENCE, AL. SN 76-397,508. PUB. 10-29-2002, FILED 4-19-2002.

ELOS

THE ENGLISH TRANSLATION OF "ELOS" IS "LINK OR BOG".

CLASS 8—HAND TOOLS

FOR HOUSEHOLD UTENSILS SOLD INDIVIDUALLY AND AS A UNIT, NAMELY, A HANDLE WITH MULTIPLE IMPLEMENTS, NAMELY, NON-ELECTRIC FRUIT AND VEGETABLE PEELER, PARING KNIFE, PIZZA CUTTER, CITRUS ZESTER, CHEESE SLICER, NON-ELECTRIC CAN OPENER, AND APPLE CORER, EACH BEING EASILY ATTACHABLE TO AND DETACHABLE FROM THE HANDLE, AND A STORAGE UNIT THEREFOR (U.S. CLS. 23, 28 AND 44).

FIRST USE 4-20-2002; IN COMMERCE 4-20-2002.

CLASS 21—HOUSEWARES AND GLASS

FOR HOUSEHOLD UTENSILS SOLD INDIVIDUALLY AND AS A UNIT, NAMELY, A HANDLE WITH MULTIPLE IMPLEMENTS, NAMELY, A GRATER, NON-ELECTRIC JUICER, MELON BALLER, JAR OPENER, BOTTLE OPENER, AND GARLIC PRESS, EACH BEING EASILY ATTACHABLE TO AND DETACHABLE FROM THE HANDLE, AND A STORAGE UNIT THEREFOR (U.S. CLS. 2, 13, 23, 29, 30, 33, 40 AND 50).

FIRST USE 4-20-2002; IN COMMERCE 4-20-2002.

2,748,538. TUFTIN, LESLIE, PRINEVILLE, OR. SN 76-397,804. PUB. 10-29-2002, FILED 4-20-2002.

STOLEN HORSE

CLASS 9—ELECTRICAL AND SCIENTIFIC APPARATUS

FOR MUSICAL SOUND RECORDINGS, NAMELY PRE-RECORDED COMPACT DISCS AND AUDIO CASSETTES FEATURING VOCAL AND INSTRUMENTAL MUSIC (U.S. CLS. 21, 23, 26, 36 AND 38).

FIRST USE 5-1-2002; IN COMMERCE 5-1-2002.

CLASS 35—ADVERTISING AND BUSINESS

FOR ONLINE RETAIL STORES IN THE FIELD OF PRE-RECORDED AUDIO CASSETTES AND COMPACT DISCS FEATURING WORDS AND INSTRUMENTAL MUSIC (U.S. CLS. 100, 101 AND 102).

FIRST USE 5-1-2002; IN COMMERCE 5-1-2002.

2,748,545. KUCERA INTERNATIONAL INC., WILLOUGHBY, OH. SN 76-400,620. PUB. 11-12-2002, FILED 4-25-2002.

ORTHO-EXPRESS

CLASS 40—MATERIAL TREATMENT

FOR DIGITAL RADIOPHOTOGRAPH SERVICES, NAMELY, DIGITAL PROCESSING OF PHOTOGRAPHS TO PRODUCE RADIOPHOTOGRAPH IMAGES (U.S. CLS. 100, 103 AND 106).

FIRST USE 2-28-2002; IN COMMERCE 8-28-2002.

CLASS 41—EDUCATION AND ENTERTAINMENT

FOR DIGITAL RADIOPHOTOGRAPH SERVICES, NAMELY AERIAL PHOTOGRAPHY (U.S. CLS. 100, 101 AND 107).

FIRST USE 2-28-2002; IN COMMERCE 8-28-2002.

2,748,566. PACIFIC CONTINENTAL APPAREL, INC., RANCHO DOMINGUEZ, CA. SN 76-420,368. PUB. 12-3-2002, FILED 6-12-2002.

GASP

CLASS 18—LEATHER GOODS

FOR PURSES, TOTE BAGS AND BACKPACKS (U.S. CLS. 1, 2, 3, 22 AND 41).

FIRST USE 10-10-2002; IN COMMERCE 10-10-2002.

CLASS 25—CLOTHING

FOR CLOTHING, NAMELY, KNIT TOPS AND BOTTOMS, WOVEN TOPS AND BOTTOMS, DENIM TOPS AND BOTTOMS, PAJAMAS, SOCKS, OUTERWEAR, NAMELY DENIM JACKETS, AND FOOTWEAR, NAMELY SHOES, FOR WOMEN AND JUNIOR GIRLS (U.S. CLS. 22 AND 39).

FIRST USE 10-10-2002; IN COMMERCE 10-10-2002.

CLASS 26—FANCY GOODS

FOR HAIR ACCESSORIES, NAMELY HAIR BANDS, SCRUNCHIES, HAIR RIBBONS (U.S. CLS. 37, 39, 40, 42 AND 50).

FIRST USE 10-10-2002; IN COMMERCE 10-10-2002.

2,748,569. CROSSWORKS, INC., COOKEVILLE, TN. SN 76-975,128. PUB. 2-19-2002, FILED 8-15-2001.

X COMMANDMENTS

CLASS 25—CLOTHING

FOR T-SHIRTS AND CAPS (U.S. CLS. 22 AND 39).

FIRST USE 6-25-2001; IN COMMERCE 9-7-2001.

CLASS 28—TOYS AND SPORTING GOODS

FOR DOLLS (U.S. CLS. 22, 23, 38 AND 50).

FIRST USE 8-4-2001; IN COMMERCE 11-14-2001.

2,748,570. REMO, INC., VALENCIA, CA. SN 76-975,231. PUB. 2-19-2002, FILED 11-20-2000.

HEALTH RHYTHMS

CLASS 15—MUSICAL INSTRUMENTS

FOR DRUMS AND PERCUSSION INSTRUMENTS (U.S. CLS. 2, 21 AND 36).

FIRST USE 1-23-2002; IN COMMERCE 1-23-2002.

CLASS 41—EDUCATION AND ENTERTAINMENT

FOR PROVIDING INSTRUCTION AND TRAINING TO HEALTH CARE ADMINISTRATORS AND OTHER HEALTH PROFESSIONALS, HEALTH CARE ORGANIZATIONS AND INSTITUTIONS REGARDING A HEALTH RELATED PROTOCOL INVOLVING MUSICAL DRUMMING AS A MEANS TO EFFECT NEURO-IMMUNE SYSTEM CHANGES IN PATIENTS, INCLUDING PROGRAM MATERIALS DISTRIBUTED THEREWITH (U.S. CLS. 100, 101 AND 107).

FIRST USE 1-23-2002; IN COMMERCE 1-23-2002.

CLASS 42—SCIENTIFIC, COMPUTER AND LEGAL SERVICES

FOR PROVIDING HEALTH INFORMATION TO CONSUMERS, RETAILERS, MUSICAL THERAPISTS AND OTHERS IN THE MUSIC AND RELATED TRADES ABOUT THE HEALTH BENEFITS OF PERCUSSION, PARTICULARLY MUSICAL DRUMMING (U.S. CLS. 100 AND 101).

FIRST USE 1-23-2002; IN COMMERCE 1-23-2002.

2,748,574. DELONGHI AMERICA, INC., SADDLE BROOK, NJ. SN 76-975,390. PUB. 7-2-2002, FILED 3-9-2001.

LIVING INNOVATION

CLASS 7—MACHINERY

FOR HOUSE MARK FOR A FULL LINE OF HOUSEHOLD ELECTRIC APPLIANCES, NAMELY, FOOD PROCESSORS, JUICE EXTRACTORS, HAND-HELD MIXERS, BLENDERS, MINCING MACHINES AND REPLACEMENT PARTS THEREFOR; AND FLOOR CARE APPLIANCES, NAMELY, ELECTRIC SWEEPERS, EXTRACTOR CLEANERS, VACUUM CLEANERS, AND HAND HELD STEAM CLEANERS, AND REPLACEMENT PARTS THEREFOR (U.S. CLS. 13, 19, 21, 23, 31, 34 AND 35).

FIRST USE 3-1-2000; IN COMMERCE 3-1-2000.

CLASS 11—ENVIRONMENTAL CONTROL APPARATUS

FOR HOUSE MARK FOR A FULL LINE OF DOMESTIC HEATING APPLIANCES, NAMELY, FAN HEATERS, CONVECTORS, OIL FILLED ELECTRIC RADIATORS, WOOD AND COAL BURNING STOVES, KEROSENE HEATERS, CATALYTIC GAS HEATERS, NATURAL GAS HEATERS, INFRA-RED GAS HEATERS, AND INFRA-RED QUARTZ HEATERS, ELECTRIC CONTACT GRILLS, ELECTRIC BARBECUES, ELECTRIC DEEP FRYERS, ELECTRIC OVENS, MICROWAVE OVENS FOR COOKING, ELECTRIC TOASTER OVENS, ESPRESSO, CAPPUCCINO AND FILTER COFFEE MACHINES, ELECTRIC PERCOLATORS, ELECTRIC TOASTERS, HAND HELD ELECTRIC HAIR DRYERS, AND REPLACEMENT PARTS THEREFOR; ELECTRIC ICE CREAM MAKERS AND REPLACEMENT PARTS THEREFOR AND AIR TREATMENT APPLIANCES, NAMELY, HUMIDIFIERS, DEHUMIDIFIERS, AIR PURIFIERS, ELECTRIC FANS, AND AIR CONDITIONERS, AND REPLACEMENT PARTS THEREOF (U.S. CLS. 13, 21, 23, 31 AND 34).

FIRST USE 3-1-2000; IN COMMERCE 3-1-2000.

2,748,580. HALL, RICHARD, NEW YORK, NY. SN 76-975,453. PUB. 7-30-2002, FILED 6-2-2000.

MOBY

CLASS 9—ELECTRICAL AND SCIENTIFIC APPARATUS

FOR MOTION PICTURE FILMS, VIDEO RECORDINGS, PRE-RECORDED AUDIO AND VIDEO CASSETTES, PRE-RECORDED AUDIO AND VIDEO COMPACT DISCS, ALL FEATURING MUSICAL PERFORMANCES; PHONOGRAPH RECORDS FEATURING MUSICAL PERFORMANCES; LASER DISCS FEATURING MUSICAL PERFORMANCES; MUSICAL SOUND RECORDINGS; AND MUSICAL VIDEO RECORDINGS (U.S. CLS. 21, 23, 26, 36 AND 38).

FIRST USE 11-0-1990; IN COMMERCE 11-0-1990.

CLASS 16—PAPER GOODS AND PRINTED MATTER

FOR NON-FICTION BOOKS; CARTOON BOOKS, COMICS, TOUR PROGRAMS; STICKERS; POSTERS; AND PHOTOGRAPHIC PRINTS (U.S. CLS. 2, 5, 22, 23, 29, 37, 38 AND 50).

FIRST USE 11-0-1994; IN COMMERCE 11-0-1994.

CLASS 25—CLOTHING

FOR CLOTHING AND ACCESSORIES, NAMELY JACKETS, SWEATERS, T-SHIRTS, UNDERWEAR; HATS AND HEADWEAR (U.S. CLS. 22 AND 39).

FIRST USE 1-0-1992; IN COMMERCE 1-0-1992.

CLASS 41—EDUCATION AND ENTERTAINMENT

FOR MOTION PICTURE FILM PRODUCTION; PRESENTATION OF LIVE PERFORMANCES BY A MUSICAL ENTERTAINER; SOUND RECORDING STUDIO SERVICES; LIVE MUSIC CONCERTS; MUSIC PUBLISHING AND BOOK PUBLISHING (U.S. CLS. 100, 101 AND 107).

FIRST USE 11-0-1990; IN COMMERCE 11-0-1990.

2,748,581. GOLDEN BOY ENTERPRISES, LLC, LOS ANGELES, CA. SN 76-975,466. PUB. 5-14-2002, FILED 11-14-2000.

OSCARDELAHOYA.COM

OWNER OF U.S. REG. NOS. 2,210,496, 2,556,279, AND OTHERS.

THE NAME "OSCAR DE LA HOYA" IDENTIFIES A LIVING INDIVIDUAL WHOSE CONSENT IS OF RECORD.

CLASS 16—PAPER GOODS AND PRINTED MATTER

FOR ADDRESS BOOKS; BANNERS; BLANK CARDS; BOOK COVERS; CALENDARS; CHALK; COLORING BOOKS; CRAYONS; DECALS; ERASERS; GIFT WRAPPING PAPER; GREETING CARDS; MOUNTED AND UNMOUNTED PHOTOGRAPHS; NOTEBOOKS; NOTE CARDS; PAPER AND PAPER ARTICLES, NAMELY, MEMO, NOTE AND WRITING PAPER AND PADS; PAPER NAPKINS; PAPER PARTY BAGS; PAPER PARTY DECORATIONS; PAPER PARTY FAVORS; PAPER PARTY HATS; PENCILS; PENCIL CASES; PEN CASES; PENS; PHOTOGRAPH ALBUMS; PICTURES; PLACEMATS; PLAYING CARDS; POSTCARDS; POSTERS; PUBLICATIONS, NAMELY, BOOKS, BULLETINS, MAGAZINES AND NEWSLETTERS ABOUT SPORTS AND SPORTS FIGURES; RUBBER STAMPS; STATIONERY; TISSUE PAPER; AND TRADING CARDS (U.S. CLS. 2, 5, 22, 23, 29, 37, 38 AND 50).

FIRST USE 1-7-2000; IN COMMERCE 7-1-2001.

CLASS 24—FABRICS

FOR BED SHEETS; BEDSPREADS; CLOTH AND PLASTIC PENNANTS; COMFORTERS; CURTAINS; DRAPERIES; LINEN; PILLOW CASES; POTHOLDERS; QUILTS; SHAMS; TABLECLOTHS NOT OF PAPER; TEXTILE PLACEMATS; TEXTILE WALL HANGINGS; AND TOWELS (U.S. CLS. 42 AND 50).

FIRST USE 1-7-2000; IN COMMERCE 7-1-2001.

CLASS 25—CLOTHING

FOR CLOTHING, NAMELY, BELTS, BOXER SHORTS, GLOVES, JACKETS, JEANS, JERSEYS, MUSCLE SHIRTS, PANTS, SHIRTS, SHORTS, SPORTS SHIRTS, SWEATERS, SWEATPANTS, SWEATSHIRTS, SWIMWEAR, T-SHIRTS AND VESTS; FOOTWEAR, NAMELY, SHOES AND SOCKS; HEADGEAR, NAMELY, CAPS, HATS AND VISORS (U.S. CLS. 22 AND 39).

FIRST USE 1-7-2000; IN COMMERCE 7-1-2001.

2,748,582. CENTRE NATIONAL DE LA RECHERCHE SCIENTIFIQUE, 75794 PARIS CEDEX 16, FRANCE. SN 76-975,485. PUB. 7-9-2002, FILED 6-16-2000.

2,748,584. BLOCK, DANIEL W., DBA D. W. BLOCK, ASSOCIATES, PORTLAND, OR. SN 76-975,490. PUB. 6-25-2002, FILED 7-16-2001.

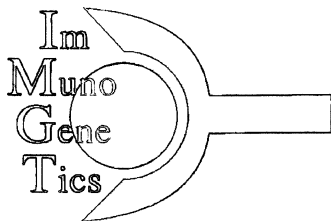

MEAT & POTATOES

PRIORITY CLAIMED UNDER SEC. 44(D) ON FRANCE APPLICATION NO. 003005152, FILED 2-3-2000, REG. NO. 003005152, DATED 2-3-2000, EXPIRES 2-3-2010.

NO CLAIM IS MADE TO THE EXCLUSIVE RIGHT TO USE "IMMUNOGENETICS", APART FROM THE MARK AS SHOWN.

CLASS 9—ELECTRICAL AND SCIENTIFIC APPARATUS

FOR COMPUTER SOFTWARE FOR USE IN ORGANIZING, ADMINISTERING AND MANAGING DNA SEQUENCES AND PROTEINS, PROTEIN SEQUENCES AND TRIDIMENSIONAL STRUCTURES, AND DATA ON EXPRESSION SPECIFICITY, FUNCTION AND POLYMORPHISMS AND ENGINEERING IN THE FIELD OF IMMUNOGENETICS; ELECTRONIC PUBLICATIONS, NAMELY BOOKS, MANUALS, MAGAZINES, FEATURING DNA SEQUENCES AND PROTEIN SEQUENCES AND TRIDIMENSIONAL STRUCTURES, AND DATA ON EXPRESSION SPECIFICITY, FUNCTION AND POLYMORPHISMS AND ENGINEERING IN THE FIELD OF IMMUNOGENETICS RECORDED ON CD-ROM, COMPUTER DISKETTES AND COMPUTER MEMORIES (U.S. CLS. 21, 23, 26, 36 AND 38).

FIRST USE 7-0-1995; IN COMMERCE 7-0-1995.

CLASS 42—SCIENTIFIC, COMPUTER AND LEGAL SERVICES

FOR PROVIDING AN ON-LINE COMPUTER DATABASE IN THE FIELD OF IMMUNOGENETICS; COMPUTER PROGRAMMING FOR OTHERS; DESIGNING AND DEVELOPING COMPUTER SOFTWARE AND DATA BASES FOR OTHERS; UPDATING OF COMPUTER SOFTWARE AND DATABASES FOR OTHERS IN THE FIELD OF IMMUNOGENETICS; PROVIDING INFORMATION AND CONSULTATION IN THE FIELD OF IMMUNOGENETICS; COMPUTER CONSULTATION; MAINTENANCE OF COMPUTERIZED DATABASES FOR OTHERS IN THE FIELD OF IMMUNOGENETICS; LEASING OF COMPUTER FACILITIES, NAMELY LEASING ACCESS TIME TO COMPUTER SERVERS CONTAINING A DATABASE IN THE FIELD OF IMMUNOGENETICS (U.S. CLS. 100 AND 101).

FIRST USE 7-0-1995; IN COMMERCE 7-0-1995.

CLASS 16—PAPER GOODS AND PRINTED MATTER

FOR NEWSLETTERS AND PERIODICALS IN THE FIELDS OF GENERAL BUSINESS, BUSINESS MANAGEMENT AND AGRICULTURAL BUSINESS, PERIODICALS, PRINTED INSTRUCTIONAL, EDUCATIONAL AND TEACHING MATERIALS IN THE FIELDS OF GENERAL BUSINESS, BUSINESS MANAGEMENT AND AGRICULTURAL BUSINESS (U.S. CLS. 2, 5, 22, 23, 29, 37, 38 AND 50).

FIRST USE 1-0-2003; IN COMMERCE 1-0-2003.

CLASS 35—ADVERTISING AND BUSINESS

FOR CONSULTING SERVICES IN THE FIELDS OF GENERAL BUSINESS, BUSINESS MANAGEMENT AND AGRICULTURAL BUSINESS; PROVIDING ON-LINE INFORMATION AND NEWS IN THE FIELDS OF GENERAL BUSINESS, BUSINESS MANAGEMENT AND AGRICULTURAL BUSINESS (U.S. CLS. 100, 101 AND 102).

FIRST USE 1-0-2003; IN COMMERCE 1-0-2003.

CLASS 41—EDUCATION AND ENTERTAINMENT

FOR EDUCATIONAL SERVICES, NAMELY, PROVIDING COURSES OF INSTRUCTION IN THE FIELDS OF GENERAL BUSINESS, BUSINESS MANAGEMENT AND AGRICULTURAL BUSINESS; CONDUCTING WORKSHOPS AND SEMINARS IN THE FIELDS OF GENERAL BUSINESS, BUSINESS MANAGEMENT AND AGRICULTURAL BUSINESS; PROVIDING ON-LINE INFORMATION AND NEWS IN THE FIELDS OF GENERAL BUSINESS, BUSINESS MANAGEMENT AND AGRICULTURAL BUSINESS (U.S. CLS. 100, 101 AND 107).

FIRST USE 1-0-2003; IN COMMERCE 1-0-2003.

2,748,586. NEW YORK ASSOCIATION FOR NEW AMERICANS, INC., THE, NEW YORK, NY. SN 76-975,528. PUB. 6-11-2002, FILED 5-11-2001.

2,748,589. SETI INSTITUTE, MOUNTAIN VIEW, CA. SN 76-975,590. PUB. 7-16-2002, FILED 11-2-2001.



SETI INSTITUTE

CLASS 35—ADVERTISING AND BUSINESS

FOR BUSINESS CONSULTING, ADVISORY, AND MARKETING SERVICES, NAMELY, CONSULTING WITH BUSINESSES REGARDING MARKET TRENDS RELATED TO HEALTH CARE NEEDS, HEALTH ISSUES, CONSUMER FINANCE ISSUES, CONSUMER PRODUCT ISSUES, CAREER AND EMPLOYMENT ISSUES, AND TECHNOLOGY ISSUES; CONDUCTING BUSINESS AND MARKET RESEARCH SURVEYS; MARKET RESEARCH; CONDUCTING TRADE SHOWS IN THE FIELDS OF PERSONAL, CONSUMER, AND BUSINESS ISSUES AND POLICIES THAT AFFECT THE IMMIGRANT POPULATION AND THEIR FAMILIES; PROMOTING THE GOODS AND SERVICES OF OTHERS THROUGH ARRANGING FOR MEMBER DISCOUNTS AT A WIDE VARIETY OF BUSINESSES AND THE DISTRIBUTION OF DISCOUNT CARDS IN CONNECTION WITH THE FOREGOING (U.S. CLS. 100, 101 AND 102).

FIRST USE 6-25-2001; IN COMMERCE 6-25-2001.

CLASS 36—INSURANCE AND FINANCIAL

FOR INSURANCE SERVICES, NAMELY, OFFERING HEALTH, LIFE, AND AUTOMOBILE INSURANCE; AND PROVIDING DISCOUNTS TO MEMBERS IN THE AREAS OF INSURANCE, BANKING, AND PERSONAL INVESTING (U.S. CLS. 100, 101 AND 102).

FIRST USE 6-25-2001; IN COMMERCE 6-25-2001.

CLASS 42—SCIENTIFIC, COMPUTER AND LEGAL SERVICES

FOR ASSOCIATION SERVICES, NAMELY, REPRESENTING AND SERVING THE IMMIGRANT POPULATION AND THEIR FAMILIES BY PROVIDING INFORMATION TO CONSUMERS, THE MEDIA, GOVERNMENT OFFICIALS, AND BUSINESSES IN CONNECTION WITH THE ISSUES, POLICIES, LEGISLATION, TRENDS, AND NEWS RELATED TO AND/OR OF INTEREST TO THE IMMIGRANT POPULATION AND THEIR FAMILIES; PROVIDING ONLINE LINKS TO VARIOUS WEB SITES THAT CONTAIN INFORMATION RELATED TO AND/OR OF INTEREST TO THE IMMIGRANT POPULATION THEIR FAMILIES; PROVIDING AND SPONSORING ADVOCACY AND LOBBYING SERVICES ON BEHALF OF THE IMMIGRANT POPULATION AND THEIR FAMILIES (U.S. CLS. 100 AND 101).

FIRST USE 6-25-2001; IN COMMERCE 6-25-2001.

OWNER OF U.S. REG. NO. 2,544,042.

NO CLAIM IS MADE TO THE EXCLUSIVE RIGHT TO USE "INSTITUTE" ONLY IN INTERNATIONAL CLASSES 41 AND 42, APART FROM THE MARK AS SHOWN.

THE MARK CONSISTS OF SHADED CIRCLES ARRANGED IN THE FORM OF A GLOBE AND THE UNIVERSE ABOVE THE WORDS "SETI INSTITUTE".

SEC. 2(F) AS TO "SETI INSTITUTE" ONLY IN INTERNATIONAL CLASSES 16,41AND 42.

CLASS 16—PAPER GOODS AND PRINTED MATTER

FOR EDUCATIONAL AND REFERENCE BOOKS IN THE AREAS OF SCIENCE AND EXTRATERRESTRIAL INTELLIGENCE; PAPERWEIGHTS; NOTEPAPER; PLASTIC TRANSPARENCIES; PENS; BOOKMARKS; STICKERS; DECALS; POSTCARDS; PENHOLDERS; PLAYING CARDS; FLASHCARDS; PENCILS; ERASERS; NOTE-PADS; STATIONERY; FELT-TIPPED MARKERS; PENCIL SHARPENERS; CALENDARS; GREETING CARDS; NOTE CARDS; POSTERS; AND TRADING CARDS (U.S. CLS. 2, 5, 22, 23, 29, 37, 38 AND 50).

FIRST USE 7-31-2002; IN COMMERCE 7-31-2002.

CLASS 25—CLOTHING

FOR T-SHIRTS; HATS; POLO SHIRTS; SWEATSHIRTS; JACKETS; SWEATERS; CAPS; SCARVES; TIES; VISORS; AND APRONS (U.S. CLS. 22 AND 39).

FIRST USE 1-30-2002; IN COMMERCE 1-30-2002.

CLASS 41—EDUCATION AND ENTERTAINMENT

FOR DEVELOPMENT AND DISSEMINATION OF CURRICULUM AND EDUCATIONAL MATERIALS FOR OTHERS FOR USE IN SCHOOLS AND BY THE GENERAL PUBLIC, IN THE FIELDS OF SCIENCE, EVOLUTION, AND LIFE IN THE UNIVERSE; EDUCATIONAL SERVICES, NAMELY, CONDUCTING SEMINARS, CONFERENCES, WORKSHOPS, AND LECTURES IN THE FIELD OF INTELLIGENT LIFE IN THE UNIVERSE (U.S. CLS. 100, 101 AND 107).

FIRST USE 11-3-2001; IN COMMERCE 11-3-2001.

CLASS 42—SCIENTIFIC, COMPUTER AND LEGAL SERVICES

FOR RESEARCH IN THE FIELDS OF SCIENCE RELATED TO THE SEARCH FOR INTELLIGENT LIFE IN THE UNIVERSE, NAMELY, SCIENCE AND TECHNOLOGY ASPECTS OF ASTRONOMY AND PLANETARY SCIENCES, CHEMICAL EVOLUTION, ORIGIN OF LIFE, BIOLOGICAL EVOLUTION, AND CULTURAL EVOLUTION; PROMOTING PUBLIC AWARENESS OF THE NEED TO STUDY LIFE IN THE UNIVERSE THROUGH THE FIELDS OF SCIENCE, TECHNOLOGY, ASTRONOMY, PLANETARY SCIENCES, CHEMICAL EVOLUTION, ORIGIN OF LIFE, BIOLOGICAL EVOLUTION, AND CULTURAL EVOLUTION; COMPUTER SERVICES, NAMELY, PROVIDING ON-LINE INSTRUCTIONAL, EDUCATIONAL AND TEACHING MATERIALS IN THE FIELDS OF SCIENCE AND EXTRATERRESTRIAL INTELLIGENCE (U.S. CLS. 100 AND 101).

FIRST USE 11-3-2001; IN COMMERCE 11-3-2001.

CLASS 35—ADVERTISING AND BUSINESS

FOR RETAIL STORE SERVICES, COMPUTERIZED ONLINE RETAIL STORE SERVICES, AND MAIL ORDER SERVICES ALL FEATURING AND IN THE FIELD OF OUTDOOR GOODS AND SERVICES, NAMELY FOR HUNTING, FISHING, CAMPING, HIKING, AND RELATED OUTDOOR GEAR, OUTDOOR EQUIPMENT, OUTDOOR CLOTHING AND HEAD GEAR, AND RELATED INFORMATION PERTAINING TO THESE OUTDOOR GOODS AND SERVICES (U.S. CLS. 100, 101 AND 102).

FIRST USE 3-1-2000; IN COMMERCE 6-15-2000.

2,748,603. CROWN DEVELOPMENT, INC., DALLAS, TX. SN 78-014,151. PUB. 1-8-2002, FILED 6-23-2000.

CROWN DEVELOPMENT, INC.

NO CLAIM IS MADE TO THE EXCLUSIVE RIGHT TO USE "DEVELOPMENT" AND "INC.", APART FROM THE MARK AS SHOWN.

CLASS 36—INSURANCE AND FINANCIAL

FOR REAL ESTATE INVESTMENT AND REAL ESTATE MANAGEMENT (U.S. CLS. 100, 101 AND 102).

FIRST USE 10-13-1964; IN COMMERCE 10-13-1964.

CLASS 37—CONSTRUCTION AND REPAIR

FOR REAL ESTATE DEVELOPMENT (U.S. CLS. 100, 103 AND 106).

FIRST USE 10-13-1964; IN COMMERCE 10-13-1964.

2,748,596. ST. PHILIP, FRANK E., COVINGTON, LA. SN 78-007,203. PUB. 9-11-2001, FILED 5-8-2000.

HOOK & SHOOT OUTDOORS

NO CLAIM IS MADE TO THE EXCLUSIVE RIGHT TO USE "OUTDOORS", APART FROM THE MARK AS SHOWN.

CLASS 25—CLOTHING

FOR CLOTHING FOR HUNTERS, FISHERMEN, AND OUTDOORSMAN, NAMELY SHIRTS, PANTS, COATS, CAPS, HATS, FOUL WEATHER GEAR, GLOVES, JACKETS, SHORTS, SWEATERS, VESTS, BELTS, BLOUSES, HEAD NETS, NAMELY VEILS, INSULATED COVERALLS AND UNINSULATED COVERALLS, OVERALLS, JEANS, UTILITY BELTS, GAME VESTS, SUSPENDERS, SPORT SHIRTS, FISHING VESTS, FISHING WADERS, HIP BOOTS, RAIN WEAR; FOOT WEAR NAMELY BOOTS, SHOES, AND BOOT COVERS CONSISTING OF BOOT AND SHOE COVERINGS (U.S. CLS. 22 AND 39).

FIRST USE 3-1-2000; IN COMMERCE 6-15-2000.

CLASS 28—TOYS AND SPORTING GOODS

FOR SPORTING GOODS AND EQUIPMENT FOR HUNTING, FISHING, AND OUTDOOR ACTIVITIES, NAMELY ARCHERY BOWS, HUNTING BOWS, ARCHERY EQUIPMENT, NAMELY, ARROW POINTS, BOW CASES, NON-TELESCOPIC BOW SIGHTS, BOW STRINGS, QUIVERS, FINGER TABS, BOW STRING RELEASES, AND ARCHERY TARGETS, TREE STANDS FOR HUNTING, HUNTING GAME CALLS, HUNTING GAME LURES, HUNTING GAME DECOYS, FISHING EQUIPMENT NAMELY RODS, REELS, HOOKS, PLUGS, SPINNERS, SINKERS, FISHING LINE, FISHING TACKLE, TACKLE BOXES, FISHING LURES, SNAPS, ROD HOLDERS, FISH STRINGERS, FLIES, HAND-HELD NETS FOR SPORTSMEN, BOBBERS, FISHING CORKS, AND FISHING GLOVES; FACE MASKS FOR HUNTING, FISHING, AND OTHER OUTDOORS ACTIVITIES (U.S. CLS. 22, 23, 38 AND 50).

FIRST USE 3-1-2000; IN COMMERCE 6-15-2000.

2,748,608. TEAM INDUSTRIES, INC., BAGLEY, MN. SN 78-016,409. PUB. 9-25-2001, FILED 7-12-2000.

TEAM

OWNER OF U.S. REG. NOS. 2,390,118 AND 2,398,200.

CLASS 35—ADVERTISING AND BUSINESS

FOR ON-LINE ORDERING SERVICES FEATURING POWER-TRAIN COMPONENTS (U.S. CLS. 100, 101 AND 102).

FIRST USE 12-0-2000; IN COMMERCE 12-0-2000.

CLASS 42—SCIENTIFIC, COMPUTER AND LEGAL SERVICES

FOR DESIGN OF POWER-TRAIN COMPONENTS FOR OTHERS AND ENGINEERING IN THE FIELD OF POWER-TRAIN COMPONENTS (U.S. CLS. 100 AND 101).

FIRST USE 2-1-2003; IN COMMERCE 2-1-2003.

2,748,610. GREEN TEA TERRACE, INC., IRVINE, CA. SN 78-017,882. PUB. 3-26-2002, FILED 7-21-2000.



NO CLAIM IS MADE TO THE EXCLUSIVE RIGHT TO USE THE NON-LATIN CHARACTER "CHA", APART FROM THE MARK AS SHOWN.

THE NON-LATIN CHARACTERS IN THE MARK TRANSLITERATE TO "CHA" AND THIS MEANS "TEA" IN ENGLISH.

CLASS 30—STAPLE FOODS

FOR TEA, ICE CREAM, SHERBET, SORBET, AND CONFECTIONERY ITEMS, NAMELY, CANDIES, COOKIES AND CHOCOLATES (U.S. CL. 46).
FIRST USE 9-25-2000; IN COMMERCE 9-25-2000.

CLASS 35—ADVERTISING AND BUSINESS

FOR WHOLESALE DISTRIBUTORSHIPS, RETAIL STORE, MAIL ORDER AND ONLINE STORE SERVICES FEATURING TEA, ICE CREAM, CANDIES AND OTHER CONFECTIONS, MUGS, CUPS, TEAPOTS, STORAGE CANISTERS, BOOKS, MUSICAL RECORDINGS, T-SHIRTS, CAPS, APRONS AND OTHER CLOTHING ITEMS (U.S. CLS. 100, 101 AND 102).
FIRST USE 11-17-1999; IN COMMERCE 11-17-1999.

CLASS 42—SCIENTIFIC, COMPUTER AND LEGAL SERVICES

FOR CAFE SERVICES FEATURING TEA, ICE CREAM AND PREPARED FOODS (U.S. CLS. 100 AND 101).
FIRST USE 11-17-1999; IN COMMERCE 11-17-1999.

2,748,612. MOREHANDS.COM, INC., AUSTIN, TX. SN 78-019,029. PUB. 6-12-2001, FILED 7-31-2000.

MORE HANDS.COM

CLASS 37—CONSTRUCTION AND REPAIR

FOR MAID SERVICES; CLEANING OF HOUSES, BUILDINGS AND VEHICLES (U.S. CLS. 100, 103 AND 106).
FIRST USE 6-1-2000; IN COMMERCE 6-1-2000.

CLASS 39—TRANSPORTATION AND STORAGE

FOR DELIVERY OF GOODS BY AUTOMOBILE; LOCAL FOOD DELIVERY (U.S. CLS. 100 AND 105).
FIRST USE 6-1-2000; IN COMMERCE 6-1-2000.

2,748,618. WEDDING WICKS, LLC, MARINA DEL REY, CA. SN 78-026,897. PUB. 3-5-2002, FILED 9-20-2000.

WEDDING WICKS

NO CLAIM IS MADE TO THE EXCLUSIVE RIGHT TO USE "WEDDING", APART FROM THE MARK AS SHOWN.

CLASS 4—LUBRICANTS AND FUELS

FOR CANDLES (U.S. CLS. 1, 6 AND 15).
FIRST USE 7-22-2000; IN COMMERCE 7-22-2000.

CLASS 21—HOUSEWARES AND GLASS

FOR CANDLE HOLDERS NOT OF PRECIOUS METAL AND CANDLE SNUFFERS NOT OF PRECIOUS METAL (U.S. CLS. 2, 13, 23, 29, 30, 33, 40 AND 50).
FIRST USE 7-22-2000; IN COMMERCE 7-22-2000.

2,748,626. LEE, KENNETH D., OGDEN, UT. SN 78-032,219. PUB. 10-29-2002, FILED 10-25-2000.

NEW LEGENDS ENTERTAINMENT

NO CLAIM IS MADE TO THE EXCLUSIVE RIGHT TO USE "ENTERTAINMENT", APART FROM THE MARK AS SHOWN.

CLASS 16—PAPER GOODS AND PRINTED MATTER

FOR POSTERS (U.S. CLS. 2, 5, 22, 23, 29, 37, 38 AND 50).
FIRST USE 9-9-2000; IN COMMERCE 10-21-2000.

CLASS 41—EDUCATION AND ENTERTAINMENT

FOR SCRIPT WRITING SERVICES FOR OTHERS, NAMELY, WRITING SCREENPLAYS; CUSTOM WRITING SERVICES FOR OTHERS, NAMELY, WRITING SHORT STORIES AND NOVELS (U.S. CLS. 100, 101 AND 107).
FIRST USE 9-9-2000; IN COMMERCE 3-29-2003.

2,748,627. HUGHES, LAURA B., KIRKWOOD, MO. SN 78-032,287. PUB. 4-23-2002, FILED 10-25-2000.

LIFE ADVISERS

NO CLAIM IS MADE TO THE EXCLUSIVE RIGHT TO USE "ADVISERS", APART FROM THE MARK AS SHOWN.

CLASS 35—ADVERTISING AND BUSINESS

FOR CONSULTATION SERVICES FOR INDIVIDUALS AND/OR COMPANIES AND THEIR EMPLOYEES, SEEKING HELP WITH BUSINESS-RELATED GOALS; INFORMATION REFERRAL SERVICES FOR INDIVIDUALS AND/OR COMPANIES AND THEIR EMPLOYEES, SEEKING HELP WITH BUSINESS-RELATED GOALS, STRESS MANAGEMENT, TIME MANAGEMENT, AND RELATED WORK/FAMILY ISSUES (U.S. CLS. 100, 101 AND 102).

FIRST USE 8-2-2000; IN COMMERCE 8-2-2000.

CLASS 42—SCIENTIFIC, COMPUTER AND LEGAL SERVICES

FOR CONSULTATION SERVICES FOR INDIVIDUALS AND/OR COMPANIES AND THEIR EMPLOYEES, SEEKING HELP WITH STRESS MANAGEMENT, TIME MANAGEMENT, AND RELATED WORK/FAMILY ISSUES (U.S. CLS. 100 AND 101).

FIRST USE 8-2-2000; IN COMMERCE 8-2-2000.

2,748,631. GENTEON, INC., SAN DIEGO, CA. SN 78-035,062. PUB. 11-5-2002, FILED 11-13-2000.

GENTEON

CLASS 1—CHEMICALS

FOR CHEMICALS, NAMELY, FLUORESCENT REAGENTS, CHEMICAL LABELS AND INTERCALATORS FOR MARKING BIOCHEMICALS, DNA, OR PROTEINS FOR DETECTION BY LASER-INDUCED FLUORESCENCE; ENZYMES FOR SCIENTIFIC OR MEDICAL RESEARCH, QUALITY CONTROL, MOLECULAR DIAGNOSTICS, FORENSICS, AND RELATED BIOLOGICAL, CHEMICAL AND BIOCHEMICAL APPLICATIONS AND USES; BUFFER SOLUTIONS NAMELY REACTION BUFFERS, LOADING BUFFERS FOR USE IN ELECTROPHORESIS, AND ELECTROPHORESIS BUFFERS FOR USE IN SEPARATION OF DNA, PROTEINS, OR BIOCHEMICALS BY ELECTROPHORESIS; OLIGONUCLEOTIDES; DISTILLED WATER; ELECTROPHORESIS GELS NAMELY AGAROSE AND ACRYLAMIDE GELS; AND SOLVENTS NAMELY ETHANOL, ACETONE, ISOPROPANOL FOR SCIENTIFIC OR MEDICAL RESEARCH, QUALITY CONTROL, MOLECULAR DIAGNOSTICS, FORENSICS, AND RELATED BIOLOGICAL, CHEMICAL AND BIOCHEMICAL APPLICATIONS AND USES; DIAGNOSTIC REAGENTS FOR SCIENTIFIC OR RESEARCH USE; REAGENTS FOR SCIENTIFIC OR MEDICAL RESEARCH USE; AND INSTRUCTIONAL MATERIAL PROVIDED WITH ALL OF THE ABOVE GOODS (U.S. CLS. 1, 5, 6, 10, 26 AND 46).

FIRST USE 10-11-2001; IN COMMERCE 10-11-2001.

CLASS 9—ELECTRICAL AND SCIENTIFIC APPARATUS

FOR INSTRUMENTS, SYSTEMS, APPARATUS, NAMELY, DNA SEQUENCERS, PROTEIN SEQUENCERS, GENETIC ANALYZERS, FRAGMENT ANALYZERS, PROTEIN AND CHEMICAL ANALYZERS FOR SCIENTIFIC OR MEDICAL RESEARCH OR QUALITY CONTROL, ELECTROPHORESIS MACHINES, CAPILLARY ELECTROPHORESIS ANALYZERS, LINKAGE ANALYZERS, GENETIC MAPPERS, THERMAL CYCLERS, CYTOMETERS, CHEMICAL REACTION MIXTURE CONTAINMENT APPARATUS AND PARTS THEREOF, PROTEIN AND PEPTIDE SYNTHESIZERS, NUCLEIC ACID SYNTHESIZERS, MASS SPECTROMETERS, PLASMA SPECTROMETERS AND ION PLASMA ANALYZERS, LIQUID CHROMATOGRAPHY ANALYZERS, HIGH-THROUGHPUT INSTRUMENTS FOR PREPARATION OF DNA AND RNA SAMPLES, NAMELY CENTRIFUGES, VORTEX MIXERS AND AGITATORS, SEPARATION AND PURIFICATION CARTRIDGES; LABORATORY SUPPLIES, NAMELY, VIALS AND REACTION TUBES, CENTRIFUGE TUBES, CAPS, SEPTA, NEEDLES, BOTTLES, FLASKS, CONTAINERS, FILTER TUBES, AND SEALS, AND PLASTIC, METAL, AND GLASS CONSUMABLES FOR LABORATORY USE, NAMELY CAPILLARY CARTRIDGES AND ARRAYS, PIPET TIPS, PIPETORS, REACTION AND SAMPLE PLATES, AND PLATE SEALANTS; COMPUTER HARDWARE FOR USE IN SCIENTIFIC OR MEDICAL RESEARCH AND RELATED RESEARCH APPLICATIONS, QUALITY CONTROL, INFORMATION MANAGEMENT, MOLECULAR DIAGNOSTICS, AND FORENSICS, AND INSTRUCTION AND USER MANUALS SOLD AS A UNIT THEREWITH; AND COMPUTER SOFTWARE FOR OPERATING SCIENTIFIC EQUIPMENT, COMPUTER SOFTWARE FOR DATABASE MANAGEMENT, COMPUTER SOFTWARE FOR ANALYSIS OF DATA, COMPUTER SOFTWARE FOR TRACKING OF SAMPLES AND PROCEDURES, COMPUTER SOFTWARE FOR DATA PROCESSING ALL IN THE FIELD OF SCIENTIFIC OR MEDICAL RESEARCH AND RELATED RESEARCH APPLICATIONS, QUALITY CONTROL, INFORMATION MANAGEMENT, MOLECULAR DIAGNOSTICS, AND FORENSICS, AND USER MANUALS SOLD AS A UNIT THEREWITH (U.S. CLS. 21, 23, 26, 36 AND 38).

FIRST USE 10-11-2001; IN COMMERCE 10-11-2001.

2,748,633. FMR CORPORATION, BOSTON, MA, BY MERGER FMR CORP., BOSTON, MA. SN 78-035,603. PUB. 9-4-2001, FILED 11-16-2000.

FIDELITY WORKPLACE SERVICES

OWNER OF U.S. REG. NOS. 1,543,851, 2,108,052, AND OTHERS.

NO CLAIM IS MADE TO THE EXCLUSIVE RIGHT TO USE "WORKPLACE SERVICES", APART FROM THE MARK AS SHOWN.

CLASS 35—ADVERTISING AND BUSINESS

FOR BUSINESS SERVICES IN THE FIELD OF HUMAN RESOURCES AND PAYROLL MANAGEMENT, NAMELY, MAINTAINING, UPDATING AND REPORTING INFORMATION ABOUT EMPLOYEE WORK SCHEDULES, PAYMENT SCHEDULES, SALARIES, CONTACT INFORMATION AND OTHER INFORMATION PERTAINING TO HUMAN RESOURCES AND PAYROLL MANAGEMENT; ALL BY MEANS OF A SITE ON A GLOBAL COMPUTER NETWORK TO WHICH EMPLOYERS AND/OR EMPLOYEES HAVE ACCESS FOR THE PURPOSE OF OBTAINING OR PROVIDING UPDATED INFORMATION; PAYROLL PREPARATION SERVICES; PROVIDING REPORTS OF PAYROLL-RELATED TAX INFORMATION TO GOVERNMENTAL AGENCIES AND TO EMPLOYERS (U.S. CLS. 100, 101 AND 102).

FIRST USE 9-23-2002; IN COMMERCE 9-23-2002.

CLASS 36—INSURANCE AND FINANCIAL

FOR ADMINISTERING EMPLOYEE PENSION PLANS; ADMINISTERING EMPLOYEE BENEFIT PLANS; INVESTMENT MANAGEMENT SERVICES; RETIREMENT FUND INVESTMENT SERVICES; PROVIDING FINANCIAL INFORMATION BY TELEPHONE; PROVIDING FINANCIAL INFORMATION BY MEANS OF AN INTERNET WEB SITE (U.S. CLS. 100, 101 AND 102).

FIRST USE 9-23-2002; IN COMMERCE 9-23-2002.

2,748,663. TM ACQUISITION CORPORATION, PHOENIX, AZ. SN 78-051,414. PUB. 7-2-2002, FILED 3-5-2001.

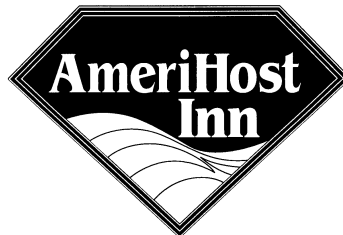

2,748,636. MOEN INCORPORATED, NORTH OLMSTED, OH. SN 78-039,356. PUB. 9-11-2001, FILED 12-14-2000.

ATWOOD

OWNER OF U.S. REG. NOS. 1,650,427 AND 1,953,194. NO CLAIM IS MADE TO THE EXCLUSIVE RIGHT TO USE "INN", APART FROM THE MARK AS SHOWN.

CLASS 6—METAL GOODS

FOR METAL ROBE HOOKS (U.S. CLS. 2, 12, 13, 14, 23, 25 AND 50).

FIRST USE 4-0-2001; IN COMMERCE 4-0-2001.

CLASS 35—ADVERTISING AND BUSINESS

FOR FRANCHISING, NAMELY, RENDERING TECHNICAL ASSISTANCE IN THE ORGANIZATION AND ESTABLISHMENT OF MOTEL AND RESTAURANT SERVICES (U.S. CLS. 100, 101 AND 102).

FIRST USE 3-30-2001; IN COMMERCE 3-30-2001.

CLASS 21—HOUSEWARES AND GLASS

FOR BATH ACCESSORIES, NAMELY, TOWEL BARS, TOWEL RINGS, TOOTHBRUSH HOLDERS, TOILET TISSUE HOLDERS, SOAP DISHES AND CUP HOLDERS (U.S. CLS. 2, 13, 23, 29, 30, 33, 40 AND 50).

FIRST USE 4-0-2001; IN COMMERCE 4-0-2001.

CLASS 42—SCIENTIFIC, COMPUTER AND LEGAL SERVICES

FOR HOTEL, MOTEL AND RESTAURANT SERVICES; MAKING TEMPORARY LODGING RESERVATIONS FOR OTHERS (U.S. CLS. 100 AND 101).

FIRST USE 3-30-2001; IN COMMERCE 3-30-2001.

2,748,647. BOARDVANTAGE, INC., MENLO PARK, CA. SN 78-044,574. PUB. 5-7-2002, FILED 1-23-2001.

BOARDVANTAGE

2,748,666. EUROKERA, SOCIETE EN NOM COLLECTIF, JOUARRE, FRANCE. SN 78-052,806. PUB. 6-11-2002, FILED 3-13-2001.

KERABISCUIT**CLASS 35—ADVERTISING AND BUSINESS**

FOR COMPUTERIZED DATABASE MANAGEMENT; PROVIDING AN ON-LINE COMPUTER DATABASE IN THE FIELD OF DOCUMENT, DATA, AND INFORMATION MANAGEMENT FOR BUSINESSES (U.S. CLS. 100, 101 AND 102).

FIRST USE 5-24-2001; IN COMMERCE 6-30-2001.

CLASS 11—ENVIRONMENTAL CONTROL APPARATUS

FOR ELECTRIC AND GAS COOKWARE, NAMELY, ELECTRIC AND GAS COOKING PLATES AND OVENS FOR DOMESTIC USE; ELECTRIC AND GAS GLASS-CERAMIC COOKING PLATES AND GLASS-CERAMIC OVENS FOR DOMESTIC USE, AND REPLACEMENT PARTS THEREFORE; FLAME PROTECTOR GLASS-CERAMIC SHEETS SOLD AS PARTS OF OVENS (U.S. CLS. 13, 21, 23, 31 AND 34).

FIRST USE 7-1-2001; IN COMMERCE 7-1-2001.

CLASS 42—SCIENTIFIC, COMPUTER AND LEGAL SERVICES

FOR PROVIDING RECURRENT USE OF ON-LINE NON-DOWNLOADABLE SOFTWARE FOR THE REAL-TIME INSTANT SIMULTANEOUS CONDUCT OF ON-LINE MEETINGS AND SHARING AND EXCHANGE OF INFORMATION AND DATA AMONG ALL USERS WITH FULL INTEGRATION OF TEXT, IMAGES, AUDIO, AND VIDEO (U.S. CLS. 100 AND 101).

FIRST USE 5-24-2001; IN COMMERCE 6-30-2001.

CLASS 21—HOUSEWARES AND GLASS

FOR FLAME PROTECTOR GLASS-CERAMIC SHEETS USED AS A COOKING UTENSIL AND FOR USE IN THE MANUFACTURE OF OVENS FOR DOMESTIC USE AND OF COOKING PLATES; UNWORKED AND SEMI-WORKED GLASS-CERAMIC FOR USE IN THE MANUFACTURE OF OVENS AND OF COOKING PLATES (U.S. CLS. 2, 13, 23, 29, 30, 33, 40 AND 50).

FIRST USE 7-1-2001; IN COMMERCE 7-1-2001.

2,748,669. LAI, CHING HUA, TAICHUNG, TAIWAN. SN 78-053,698. PUB. 8-28-2001, FILED 3-17-2001.

MIGHTY SEVEN

CLASS 7—MACHINERY

FOR POWER AND PNEUMATIC TOOLS, NAMELY, IMPACT SOCKETS, IMPACT WRENCHES, AND IMPACT DRIVERS (U.S. CLS. 13, 19, 21, 23, 31, 34 AND 35).
FIRST USE 11-16-2000; IN COMMERCE 10-6-2001.

CLASS 8—HAND TOOLS

FOR HAND TOOLS, NAMELY, SOCKET SETS, WRENCHES AND SCREWDRIVERS (U.S. CLS. 23, 28 AND 44).
FIRST USE 11-16-2000; IN COMMERCE 10-6-2001.

2,748,671. BAKER HUGHES INCORPORATED, HOUSTON, TX. SN 78-054,210. PUB. 6-4-2002, FILED 3-21-2001.

HORNET

CLASS 7—MACHINERY

FOR DOWNHOLE OIL FIELD EQUIPMENT, NAMELY PACKERS AND BRIDGE PLUGS, USED IN OIL AND GAS WELLS TO ISOLATE THE FLOW OF FLUIDS TO OR FROM GEOLOGIC FORMATIONS (U.S. CLS. 13, 19, 21, 23, 31, 34 AND 35).
FIRST USE 10-12-2001; IN COMMERCE 10-12-2001.

CLASS 9—ELECTRICAL AND SCIENTIFIC APPARATUS

FOR DOWNHOLE OIL FIELD EQUIPMENT, NAMELY FLOW REGULATORS USED IN OIL AND GAS WELLS (U.S. CLS. 21, 23, 26, 36 AND 38).
FIRST USE 10-12-2001; IN COMMERCE 10-12-2001.

2,748,676. EMWARE, INC., SALT LAKE CITY, UT. SN 78-055,357. PUB. 9-3-2002, FILED 3-27-2001.

POWERSAVE

CLASS 9—ELECTRICAL AND SCIENTIFIC APPARATUS

FOR COMPUTER HARDWARE, COMPUTER FIRMWARE AND COMPUTER SOFTWARE FOR USE IN THE FIELD OF REMOTE ENERGY USAGE MANAGEMENT FOR PROVIDING A COMMUNICATIONS INTERFACE FOR A HOUSEHOLD ELECTRONIC DEVICE SO THAT A REMOTELY LOCATED COMPUTER CAN COMMUNICATE WITH THE HOUSEHOLD ELECTRONIC DEVICE THROUGH USE OF THE COMMUNICATIONS INTERFACE VIA A GLOBAL COMPUTER NETWORK AND A TELECOMMUNICATIONS NETWORK (U.S. CLS. 21, 23, 26, 36 AND 38).
FIRST USE 11-29-2001; IN COMMERCE 11-29-2001.

CLASS 42—SCIENTIFIC, COMPUTER AND LEGAL SERVICES

FOR REMOTE ENERGY AUDITING SERVICES; REMOTE ENERGY USAGE MANAGEMENT (U.S. CLS. 100 AND 101).
FIRST USE 11-29-2001; IN COMMERCE 11-29-2001.

2,748,684. TITLEX.COM, INC., PALESTINE, TX. SN 78-058,235. PUB. 8-13-2002, FILED 4-12-2001.

TITLEX

CLASS 35—ADVERTISING AND BUSINESS

FOR COMPUTERIZED ON-LINE ORDERING SERVICES IN THE FIELD OF REAL PROPERTY HISTORY AND OWNERSHIP RECORDS AND COURT RECORDS WHICH RELATE TO REAL PROPERTY (U.S. CLS. 100, 101 AND 102).
FIRST USE 10-14-1999; IN COMMERCE 5-1-2000.

CLASS 42—SCIENTIFIC, COMPUTER AND LEGAL SERVICES

FOR PROVIDING A WEBSITE FEATURING INTERACTIVE REAL PROPERTY INFORMATION AND DATABASES IN THE FIELDS OF REAL PROPERTY TITLE SEARCH INFORMATION AND COURT RECORDS WHICH RELATE TO REAL PROPERTY VIA A GLOBAL COMPUTER NETWORK WITH COMPREHENSIVE RECORDS AS TO THE HISTORY AND OWNERSHIP OF REAL PROPERTY; AND PROVIDING A WEB SITE FEATURING INTERACTIVE REAL PROPERTY TITLE INFORMATION WHICH ALLOWS USERS TO CONDUCT ONLINE TITLE SEARCHES (U.S. CLS. 100 AND 101).
FIRST USE 5-1-2000; IN COMMERCE 5-1-2000.

2,748,688. ARLINGTON INDUSTRIES, INC., ARLINGTON, VT. SN 78-060,273. PUB. 11-26-2002, FILED 4-25-2001.



NO CLAIM IS MADE TO THE EXCLUSIVE RIGHT TO USE "TECH", APART FROM THE MARK AS SHOWN.

THE STIPPLING IS FOR SHADING PURPOSES ONLY.

THE MARK CONSISTS OF WORD "QUADRATEK" IN WHICH THE INSIDE OF THE LETTER "Q" IS DIVIDED INTO FOUR SECTORS CONTAINING DRAWINGS OF DIFFERENT PLASTIC PARTS.

CLASS 37—CONSTRUCTION AND REPAIR

FOR REPAIR AND MAINTENANCE OF CUSTOM INSERT MOLDING AND INJECTION MOLDING FOR THERMOS ET AND THERMOPLASTIC PARTS (U.S. CLS. 100, 103 AND 106).
FIRST USE 9-21-2001; IN COMMERCE 9-21-2001.

CLASS 40—MATERIAL TREATMENT

FOR CUSTOM INSERT MOLDING SERVICES, CUSTOM INJECTION MOLDING SERVICES FOR THERMOS ET AND THERMOPLASTIC PARTS AND CUSTOM MANUFACTURING OF MOLDS, TOOLS AND PARTS THEREFOR FOR USE IN INDUSTRY (U.S. CLS. 100, 103 AND 106).
FIRST USE 9-21-2001; IN COMMERCE 9-21-2001.

2,748,692. MILLIKEN & COMPANY, NEW YORK, NY. SN 78-064,932. PUB. 3-19-2002, FILED 5-22-2001.

LIFE CURTAIN

CLASS 12—VEHICLES

FOR SAFETY DEVICES FOR LAND, SEA AND AIR VEHICLES, NAMELY, PASSENGER RESTRAINT AIR BAGS AS PART OF VEHICLES (U.S. CLS. 19, 21, 23, 31, 35 AND 44).

FIRST USE 12-2-2002; IN COMMERCE 12-2-2002.

CLASS 24—FABRICS

FOR AIR BAG FABRIC (U.S. CLS. 42 AND 50).
FIRST USE 12-2-2002; IN COMMERCE 12-2-2002.

2,748,693. AUNTIE ANNE'S, INC., GAP, PA. SN 78-066,544. PUB. 10-8-2002, FILED 5-31-2001.



OWNER OF U.S. REG. NOS. 1,736,871, 2,130,367, AND OTHERS.

NO CLAIM IS MADE TO THE EXCLUSIVE RIGHT TO USE "CLASSIC CONES", APART FROM THE MARK AS SHOWN.

THE STIPPLING IS A FEATURE OF THE MARK.

CLASS 30—STAPLE FOODS

FOR FROZEN CUSTARD; FROZEN YOGURT; FRUIT ICE (U.S. CL. 46).

FIRST USE 10-11-2001; IN COMMERCE 10-11-2001.

CLASS 32—LIGHT BEVERAGES

FOR SMOOTHIES AND SLUSH-TYPE SOFT DRINKS (U.S. CLS. 45, 46 AND 48).

FIRST USE 10-11-2001; IN COMMERCE 10-11-2001.

CLASS 42—SCIENTIFIC, COMPUTER AND LEGAL SERVICES

FOR RESTAURANT SERVICES (U.S. CLS. 100 AND 101).

FIRST USE 10-11-2001; IN COMMERCE 10-11-2001.

2,748,708. LIGHTNER, LEE J., BALTIMORE, MD. SN 78-072,691. PUB. 9-17-2002, FILED 7-6-2001.

ABC RENTAL CENTER

NO CLAIM IS MADE TO THE EXCLUSIVE RIGHT TO

USE "RENTAL CENTER", APART FROM THE MARK AS SHOWN.

CLASS 37—CONSTRUCTION AND REPAIR

FOR RENTAL OF CONTRACTOR EQUIPMENT, NAMELY BACKHOES, LOADERS, PNEUMATIC TOOLS, AIR COMPRESSORS, PLUMBING AND PIPE TOOLS, SANDBLASTERS, SANDERS, GRINDERS, SAWS, SCAFOLDING, WELDING, METAL AND WOODWORKING TOOLS (U.S. CLS. 100, 103 AND 106).

FIRST USE 6-1-1972; IN COMMERCE 6-1-1972.

CLASS 42—SCIENTIFIC, COMPUTER AND LEGAL SERVICES

FOR RENTAL OF LAWN CARE AND PARTY RENTAL EQUIPMENT, NAMELY LAWNMOWERS, TILLERS, LADDERS, TENTS, TABLES, AND CHAIRS (U.S. CLS. 100 AND 101).

FIRST USE 6-1-1972; IN COMMERCE 6-1-1972.

2,748,713. FMR CORP., BOSTON, MA. SN 78-073,330. PUB. 7-23-2002, FILED 7-11-2001.

PRACTICEADVANTAGE

CLASS 35—ADVERTISING AND BUSINESS

FOR PROVIDING BUSINESS INFORMATION TO FINANCIAL SERVICE PROVIDERS BY MEANS OF AN INTERNET WEB SITE, IN THE FIELD OF BUSINESS MARKETING (U.S. CLS. 100, 101 AND 102).

FIRST USE 10-21-2002; IN COMMERCE 10-21-2002.

CLASS 41—EDUCATION AND ENTERTAINMENT

FOR PROVIDING BUSINESS INFORMATION TO FINANCIAL SERVICE PROVIDERS BY MEANS OF AN INTERNET WEB SITE, IN THE FIELD OF FINANCIAL EDUCATION (U.S. CLS. 100, 101 AND 107).

FIRST USE 10-21-2002; IN COMMERCE 10-21-2002.

CLASS 42—SCIENTIFIC, COMPUTER AND LEGAL SERVICES

FOR PROVIDING BUSINESS INFORMATION TO FINANCIAL SERVICE PROVIDERS BY MEANS OF AN INTERNET WEB SITE, IN THE FIELD OF FINANCIAL REGULATORY COMPLIANCE (U.S. CLS. 100 AND 101).

FIRST USE 10-21-2002; IN COMMERCE 10-21-2002.

2,748,725. UNIPRO FOODSERVICE, INC., ATLANTA, GA. SN 78-075,505. PUB. 5-14-2002, FILED 7-24-2001.

COMPANIONS

CLASS 8—HAND TOOLS

FOR PLASTIC FORKS, PLASTIC SPOONS, AND PLASTIC KNIVES (U.S. CLS. 23, 28 AND 44).

FIRST USE 11-1-2001; IN COMMERCE 11-1-2001.

CLASS 16—PAPER GOODS AND PRINTED MATTER

FOR PAPER PRODUCTS; NAMELY, NAPKINS, TOWELS, AND CARRY-OUT BOXES; AND PLACE MATS MADE OF PAPER OR PLASTIC (U.S. CLS. 2, 5, 22, 23, 29, 37, 38 AND 50).

FIRST USE 11-1-2001; IN COMMERCE 11-1-2001.

CLASS 21—HOUSEWARES AND GLASS

FOR PAPER PRODUCTS; NAMELY, PLATES AND BOWLS; CUPS MADE OF PAPER, FOAM, OR PLASTIC AND DRINKING STRAWS (U.S. CLS. 2, 13, 23, 29, 30, 33, 40 AND 50).

FIRST USE 11-1-2001; IN COMMERCE 11-1-2001.

2,748,741. BLUEGREEN CORPORATION, BOCA RATON, FL. SN 78-081,271. PUB. 7-30-2002, FILED 8-27-2001.

LEISUREPATH**CLASS 36—INSURANCE AND FINANCIAL**

FOR VACATION REAL ESTATE TIME-SHARING SERVICES (U.S. CLS. 100, 101 AND 102).

FIRST USE 3-7-2003; IN COMMERCE 3-7-2003.

CLASS 43—HOTEL AND RESTAURANT SERVICES

FOR TRAVEL AGENCY SERVICES, NAMELY, MAKING RESERVATIONS AND BOOKING FOR TEMPORARY LODGING (U.S. CLS. 100 AND 101).

FIRST USE 3-7-2003; IN COMMERCE 3-7-2003.

2,748,749. GOLDSTEIN, REID ALAN, GAVIOTA, CA. SN 78-082,861. PUB. 2-26-2002, FILED 9-6-2001.

FOREVER**CLASS 29—MEATS AND PROCESSED FOODS**

FOR FRUIT-BASED SNACK FOOD, DRIED FRUIT, AND DRIED FRUIT STICKS, JELLIES, JAMS, FRUIT SAUCES, COOKING OIL, MILK, BEEF JERKEY, FISH JERKEY, DRIED VEGETABLE STICKS, AND DRIED VEGETABLES (U.S. CL. 46).

FIRST USE 3-1-2002; IN COMMERCE 5-19-2003.

CLASS 30—STAPLE FOODS

FOR FROZEN CONFECTIONS, CANDY, CANDY BARS, ENERGY BARS, CEREAL-BASED SNACK FOOD AND SNACK BARS, PROCESSED CEREALS, READY TO EAT CEREAL BARS, BREAD, BAKERY GOODS, TABLE SYRUPS, HOT COCOA, COCOA MIX, CRACKERS, AND COOKIES (U.S. CL. 46).

FIRST USE 3-1-2002; IN COMMERCE 5-19-2003.

2,748,750. BADAB INC., FT LAUDERDALE, FL. SN 78-083,199. PUB. 10-1-2002, FILED 9-8-2001.

BADA BING A GENTLEMEN'S CLUB

NO CLAIM IS MADE TO THE EXCLUSIVE RIGHT TO USE "A GENTLEMEN'S CLUB", APART FROM THE MARK AS SHOWN.

CLASS 41—EDUCATION AND ENTERTAINMENT

FOR ENTERTAINMENT SERVICES, NAMELY, PROVIDING LIVE DANCE PERFORMANCES (U.S. CLS. 100, 101 AND 107).

FIRST USE 11-12-2001; IN COMMERCE 11-12-2001.

CLASS 42—SCIENTIFIC, COMPUTER AND LEGAL SERVICES

FOR BAR, RESTAURANT AND NIGHTCLUB SERVICES FEATURING LIVE DANCE PERFORMANCES AND REPLAYING VIDEO DANCE PERFORMANCES (U.S. CLS. 100 AND 101).

FIRST USE 11-12-2001; IN COMMERCE 11-12-2001.

2,748,759. FOOTSTAR CORPORATION, WEST NYACK, NY, BY CHANGE OF NAME APACHE MINNESOTA THOM MCAN, INC., WEST NYACK, NY. SN 78-084,255. PUB. 2-12-2002, FILED 9-17-2001.

PUSH OR GET PULLED**CLASS 25—CLOTHING**

FOR CLOTHING, NAMELY, SHIRTS, T-SHIRTS (U.S. CLS. 22 AND 39).

FIRST USE 4-21-2002; IN COMMERCE 4-21-2002.

CLASS 35—ADVERTISING AND BUSINESS

FOR RETAIL STORE SERVICES IN THE FIELD OF FOOTWEAR, CLOTHING, BAGS AND RELATED ACCESSORIES (U.S. CLS. 100, 101 AND 102).

FIRST USE 4-21-2002; IN COMMERCE 4-21-2002.

2,748,764. JAGER DESIGN, INC., DBA JAGER DIPAOLA KEMP DESIGN, BURLINGTON, VT. SN 78-085,638. PUB. 10-1-2002, FILED 9-26-2001.



OWNER OF U.S. REG. NO. 2,337,483.
NO CLAIM IS MADE TO THE EXCLUSIVE RIGHT TO USE "BRAND EVOLUTION", APART FROM THE MARK AS SHOWN.

CLASS 35—ADVERTISING AND BUSINESS

FOR ADVERTISING SERVICES, NAMELY CREATION OF ADVERTISING FOR OTHERS; MARKET RESEARCH SERVICES, NAMELY CONDUCTING MARKET SURVEYS, STUDIES AND ANALYSIS FOR OTHERS; CONSULTATION SERVICES, NAMELY PRODUCT, BRAND AND CORPORATE IDENTITY DEVELOPMENT FOR OTHERS (U.S. CLS. 100, 101 AND 102).

FIRST USE 3-1-2002; IN COMMERCE 3-1-2002.

CLASS 42—SCIENTIFIC, COMPUTER AND LEGAL SERVICES

FOR DESIGN SERVICES, NAMELY GRAPHIC ART, COMMERCIAL ART, PRODUCT, INDUSTRIAL AND PACKAGING DESIGN FOR OTHERS (U.S. CLS. 100 AND 101).

FIRST USE 3-1-2002; IN COMMERCE 3-1-2002.

2,748,794. ALLY, INC., SANTA CRUZ, CA. SN 78-093,350. PUB. 6-18-2002, FILED 11-14-2001.

ALLYCONTAINMENTCO

CLASS 18—LEATHER GOODS

FOR BACKPACKS, FANNY PACKS, ALL-PURPOSE SPORTS BAGS (U.S. CLS. 1, 2, 3, 22 AND 41).

FIRST USE 2-10-2001; IN COMMERCE 7-15-2001.

CLASS 25—CLOTHING

FOR T-SHIRTS, SWEATSHIRTS, SWEATERS, COATS, SHORTS, JEANS, CAPS, HATS (U.S. CLS. 22 AND 39).

FIRST USE 2-19-2001; IN COMMERCE 7-27-2001.

2,748,810. MEMOREX INTERNATIONAL INC., KWUN TONG, KOWLOON, HONG KONG, BY CHANGE OF NAME MEMTEK INTERNATIONAL, INC., KOWLOON, HONG KONG. SN 78-098,463. PUB. 9-24-2002, FILED 12-14-2001.

IS IT LIVE OR IS IT MEMOREX?

OWNER OF U.S. REG. NOS. 734,922, 2,548,308, AND OTHERS.

CLASS 9—ELECTRICAL AND SCIENTIFIC APPARATUS

FOR AUDIO AND VIDEO EQUIPMENT, NAMELY, BLANK AUDIO AND VIDEO TAPES; HEADPHONES; STEREO CABLES; CONNECTORS, NAMELY, AC ADAPTOR WALL TRANSFORMERS; AMPLIFIERS; REMOTE CONTROL UNITS; ANTENNAS; AUDIO SPEAKERS; CORDED AND CORDLESS TELEPHONES; MOBILE PHONES; ANSWERING MACHINES; RADIOS; 2-WAY RADIOS; RECEIVERS; ELECTRONIC CLOCKS; COMPACT DISC PLAYERS AND COMPACT DISC RECORDERS; AUDIO CASSETTE PLAYERS AND RECORDERS; DIGITAL VOICE RECORDERS; DIGITAL CAMERAS; DIGITAL DATA ORGANIZERS; DVD-PLAYERS AND RECORDERS; KARAOKE SYSTEMS, NAMELY, KARAOKE MACHINES, MICROPHONES, AND SOFTWARE, NAMELY COMPACT DISCS FEATURING MUSIC WITH ACCOMPANYING LYRICS AND GRAPHICS; BLANK OPTICAL RECORDING MEDIA, NAMELY, RECORDABLE AND REWRITEABLE COMPACT DISCS AND DVDS, RECORDABLE RANDOM ACCESS MEMORY RAM, AND DRIVES THEREFORE; MAGNETIC RECORDING MEDIA, NAMELY, BLANK MAGNETIC AUDIO AND VIDEO TAPES; TELEVISION SETS; VIDEO CASSETTE RECORDERS AND CAMCORDERS; VIDEO CASSETTE RECORDER CLEANING KITS COMPRISING A VIDEO CASSETTE CLEANING CARTRIDGE AND VIDEO CASSETTE RECORDER CLEANING SOLUTION; PORTABLE STEREO SYSTEMS COMPRISING AUDIO SPEAKERS AND ONE OR MORE OF THE FOLLOWING—AM-FM RADIO RECEIVER, AUDIO CASSETTE PLAYER/RECORDER, COMPACT DISC PLAYER; STEREO RACK SYSTEMS COMPRISING AUDIO SPEAKERS AND ONE OR MORE OF THE FOLLOWING—AM-FM RADIO RECEIVER, COMPACT DISC PLAYER, VIDEO CASSETTE PLAYER/RECORDER, AND PHONOGRAPH RECORD PLAYER; AUDIO AND VIDEO MEDIA STORAGE DEVICES, NAMELY, CARRYING CASES AND BOXES FOR COMPACT DISCS, AUDIO TAPES AND VIDEO TAPES; COMPUTER DISK DRIVES, OPTICAL DISC DRIVES; COMPUTER HARDWARE AND PERIPHERALS; COMPUTER MEMORY CARDS; COMPUTER CARD READERS; PCMCIA CARDS AND ADAPTERS (U.S. CLS. 21, 23, 26, 36 AND 38).

FIRST USE 1-31-1972; IN COMMERCE 1-31-1972.

CLASS 16—PAPER GOODS AND PRINTED MATTER

FOR PAPER SHREDDERS (U.S. CLS. 2, 5, 22, 23, 29, 37, 38 AND 50).

FIRST USE 2-28-2003; IN COMMERCE 2-28-2003.

2,748,834. SUNBEAM PRODUCTS, INC., BOCA RATON, FL. SN 78-102,557. PUB. 8-27-2002, FILED 1-14-2002.

2,748,853. CI ACQUISTION, INC., NEW YORK, NY, BY ASSIGNMENT CHF INDUSTRIES, INC., NEW YORK, NY. SN 78-104,137. PUB. 8-13-2002, FILED 1-22-2002.



OWNER OF U.S. REG. NOS. 2,175,929, 2,175,932, AND 2,253,874.
SEC. 2(F).

CLASS 10—MEDICAL APPARATUS

FOR MEDICAL APPARATUS, NAMELY, BLOOD PRESSURE MONITORS (U.S. CLS. 26, 39 AND 44).
FIRST USE 7-31-2002; IN COMMERCE 7-31-2002.

CLASS 11—ENVIRONMENTAL CONTROL APPARATUS

FOR HUMIDIFIERS; ELECTRIC VAPORIZERS; ELECTRICALLY ACTIVATED HEATING PADS AND BLANKETS NOT FOR MEDICAL PURPOSES; DEHUMIDIFIERS; CHEMICALLY ACTIVATED HEATING PADS AND HEATING CUSHIONS NOT FOR MEDICAL USE (U.S. CLS. 13, 21, 23, 31 AND 34).
FIRST USE 7-31-2002; IN COMMERCE 7-31-2002.

2,748,843. KOZIN, MICHELLE J., BOSTON, MA. SN 78-103,420. PUB. 10-1-2002, FILED 1-18-2002.

ORGANIC WEDDINGS

NO CLAIM IS MADE TO THE EXCLUSIVE RIGHT TO USE "WEDDINGS", APART FROM THE MARK AS SHOWN.

CLASS 16—PAPER GOODS AND PRINTED MATTER

FOR PUBLICATIONS, NAMELY, MAGAZINES, A SERIES OF BOOKS, AND NEWSLETTERS ON THE SUBJECT OF WEDDINGS AND WEDDING-RELATED TOPICS, LIFESTYLES, GARDENING, ORGANIC AND NATURAL PRODUCTS, HEALTH AND THE ENVIRONMENT (U.S. CLS. 2, 5, 22, 23, 29, 37, 38 AND 50).
FIRST USE 2-20-2002; IN COMMERCE 2-20-2002.

CLASS 41—EDUCATION AND ENTERTAINMENT

FOR COMPUTER SERVICES, NAMELY, PROVIDING ON-LINE MAGAZINES, A SERIES OF BOOKS, AND NEWSLETTERS ON THE SUBJECT OF WEDDINGS AND WEDDING-RELATED TOPICS, LIFESTYLES, GARDENING, ORGANIC AND NATURAL PRODUCTS, HEALTH AND THE ENVIRONMENT (U.S. CLS. 100, 101 AND 107).
FIRST USE 2-20-2002; IN COMMERCE 2-20-2002.

ON MY OWN

CLASS 20—FURNITURE AND ARTICLES NOT OTHERWISE CLASSIFIED

FOR PILLOWS, SLEEPING BAGS (U.S. CLS. 2, 13, 22, 25, 32 AND 50).
FIRST USE 4-0-2002; IN COMMERCE 4-0-2002.

CLASS 24—FABRICS

FOR TEXTILE GOODS, NAMELY, DUVETS, QUILTS, BEDSPREADS, PILLOW CASES, PILLOW SHAMS, BED SHEETS, BED BLANKETS AND BLANKET TROWS, COMFORTERS, DUST RUFFLES, TABLE CLOTHS NOT OF PAPER, CURTAINS, DRAPERIES, VALENCES, AND CURTAIN TIE BACKS (U.S. CLS. 42 AND 50).
FIRST USE 4-0-2002; IN COMMERCE 4-0-2002.

2,748,860. BELDEN TECHNOLOGIES, INC., RICHMOND, IN. SN 78-105,358. PUB. 10-15-2002, FILED 1-29-2002.

INSTALLABLE PERFORMANCE

CLASS 35—ADVERTISING AND BUSINESS

FOR MAIL ORDER CATALOG SERVICES FEATURING ELECTRICAL/ELECTRONIC AND FIBER OPTIC WIRES AND CABLES; ELECTRONIC RETAIL STORE SERVICES VIA TELEPHONE AND A GLOBAL COMPUTER NETWORK IN THE FIELD OF ELECTRICAL/ELECTRONIC AND FIBER OPTIC WIRES AND CABLES; PROVIDING CONSUMER PRODUCT INFORMATION SERVICES, NAMELY, PROVIDING SHOPPERS INFORMATION IN THE FIELD OF ELECTRICAL/ELECTRONIC AND FIBER OPTIC WIRES AND CABLES VIA TELEPHONE AND A GLOBAL COMPUTER NETWORK (U.S. CLS. 100, 101 AND 102).
FIRST USE 2-0-2002; IN COMMERCE 2-0-2002.

CLASS 42—SCIENTIFIC, COMPUTER AND LEGAL SERVICES

FOR PROVIDING TECHNICAL INFORMATION ON THE USE AND APPLICATION OF ELECTRICAL/ELECTRONIC AND FIBER OPTIC WIRES AND CABLES VIA TELEPHONE AND A GLOBAL COMPUTER NETWORK; PROVIDING ENGINEERING SERVICES IN THE FIELD OF ELECTRICAL/ELECTRONIC AND FIBER OPTIC WIRES AND CABLES (U.S. CLS. 100 AND 101).
FIRST USE 2-0-2002; IN COMMERCE 2-0-2002.

2,748,887. DIATOMIC STUDIOS CORPORATION, BREMER-TON, WA. SN 78-111,355. PUB. 9-3-2002, FILED 2-27-2002.

2,748,900. LIGHTNING2, LLC, WILLISTON, VT. SN 78-113,922. PUB. 12-17-2002, FILED 3-11-2002.



NO CLAIM IS MADE TO THE EXCLUSIVE RIGHT TO USE "HOST", APART FROM THE MARK AS SHOWN.

THE MARK CONSISTS OF A VORTEX OR NAUTILUS-LIKE SHAPE HAVING THE WORDS "IMMORTAL HOST" APPEARING DIRECTLY BELOW SO THAT THE INITIAL CAP IS CENTER-ALIGNED WITH THE INNER-MOST CIRCLE OF THE SHAPE. THE INITIAL CAPITAL "I" RISES HIGHER SO THAT IT, IN CONJUNCTION WITH THE SHAPE, APPEARS AS A PERSON.

CLASS 39—TRANSPORTATION AND STORAGE

FOR LONG TERM ELECTRONIC DIGITAL STORAGE FOR OTHERS; ELECTRONIC STORAGE OF DIGITAL MEDIA, NAMELY, IMAGES, TEXT, AUDIO AND VIDEO DATA; ELECTRONIC STORAGE OF CATALOGED INTERRELATIONS OF DIGITAL MEDIA AND INFORMATIONAL DATA (U.S. CLS. 100 AND 105).
FIRST USE 9-5-2002; IN COMMERCE 9-11-2002.

CLASS 40—MATERIAL TREATMENT

FOR DIGITIZING AND PROCESSING OF STILL AND TEMPORAL MEDIA FOR THE PURPOSES OF RESTORATION, PRESERVATION AND ON-LINE REFERENCE (U.S. CLS. 100, 103 AND 106).
FIRST USE 9-5-2002; IN COMMERCE 9-11-2002.

CLASS 41—EDUCATION AND ENTERTAINMENT

FOR CUSTOM WRITING AND MULTIMEDIA COMPOSITION FOR OTHERS; EDITORIAL CONSULTATION (U.S. CLS. 100, 101 AND 107).
FIRST USE 9-5-2002; IN COMMERCE 9-11-2002.

CLASS 42—SCIENTIFIC, COMPUTER AND LEGAL SERVICES

FOR HOSTING OF DIGITAL CONTENT ON THE INTERNET; PROVIDING TEMPORARY USE OF ON-LINE NON-DOWNLOADABLE SOFTWARE FOR THE PURPOSES OF VIEWING, UPLOADING, MANIPULATING AND CATALOGING OF MEDIA AND INFORMATION; CROSS-PLATFORM CONVERSION OF DIGITAL CONTENT INTO OTHER FORMS OF DIGITAL CONTENT; GENEALOGY RESEARCH (U.S. CLS. 100 AND 101).
FIRST USE 9-5-2002; IN COMMERCE 9-11-2002.

BELLISSE

CLASS 10—MEDICAL APPARATUS

FOR BRAS, CAMISOLES, GIRDLES, CORSETS, TORSO BINDERS, CHEST-BANDS, ARM-BANDS, LEG-BANDS AND STOCKINGS FOR THERAPEUTIC USE IN TREATMENT OF PRIMARY AND SECONDARY EDEMA AND LYMPHEDEMA (U.S. CLS. 26, 39 AND 44).
FIRST USE 8-28-2002; IN COMMERCE 8-28-2002.

CLASS 25—CLOTHING

FOR FOUNDATION GARMENTS, NAMELY, BRAS, CAMISOLES, GIRDLES AND CORSETS; STOCKINGS (U.S. CLS. 22 AND 39).
FIRST USE 8-28-2002; IN COMMERCE 8-28-2002.

2,748,902. CONAIR CIP, INC., STAMFORD, CT. SN 78-113,955. PUB. 9-17-2002, FILED 3-11-2002.

SIMPLY FLORAL

CLASS 9—ELECTRICAL AND SCIENTIFIC APPARATUS

FOR ELECTRIC CURLING BRUSHES, ELECTRIC CURLING IRONS, AND ELECTRIC HOT AIR BRUSHES (U.S. CLS. 21, 23, 26, 36 AND 38).
FIRST USE 6-14-2002; IN COMMERCE 6-14-2002.

CLASS 11—ENVIRONMENTAL CONTROL APPARATUS

FOR CONVENTIONAL HAND-HELD ELECTRIC HAIR DRYERS (U.S. CLS. 13, 21, 23, 31 AND 34).
FIRST USE 6-14-2002; IN COMMERCE 6-14-2002.

2,748,970. BAYER CORPORATION, PITTSBURGH, PA. SN 78-132,966. PUB. 12-3-2002, FILED 6-4-2002.



CLASS 5—PHARMACEUTICALS

FOR MEDICAL DIAGNOSTIC REAGENTS FOR THE ANALYSIS OF BODY FLUIDS (U.S. CLS. 6, 18, 44, 46, 51 AND 52).
FIRST USE 6-15-2002; IN COMMERCE 6-15-2002.

CLASS 10—MEDICAL APPARATUS

FOR MEDICAL DIAGNOSTIC INSTRUMENTS FOR THE ANALYSIS OF BODY FLUIDS, NAMELY, BLOOD GLUCOSE METERS (U.S. CLS. 26, 39 AND 44).
FIRST USE 6-15-2002; IN COMMERCE 6-15-2002.

SECTION 2.— INTERNATIONAL CLASSIFICATION

The short titles associated below with the international class numbers are terms designed merely for quick identification and are not an official part of the international classification. The full names of international classes are given in section 6.1 of the trademark rules of practice.

The designation "U.S. Cl." appearing in this section refers to the U.S. class in effect prior to Sep. 1, 1973 rather than the international class which applies to applications filed on or after that date. For adoption of international classification see notice in the OFFICIAL GAZETTE of Jun. 26, 1973 (911 O.G. TM 210).

Application in one class

CLASS 1—CHEMICALS

2,747,537. PIERCE & STEVENS CORPORATION, BUFFALO, NY. SN 75-657,623. PUB. 11-23-1999, FILED 3-10-1999.

CELLUBOND

FOR ADHESIVES, CEMENTS, AND GLUES USED IN PRODUCING COLLATED STAPLES AND NAILS (U.S. CLS. 1, 5, 6, 10, 26 AND 46).

FIRST USE 2-0-2002; IN COMMERCE 4-0-2002.

2,747,622. SHIPLEY COMPANY, L.L.C., MARLBOROUGH, MA. SN 75-814,967. PUB. 7-25-2000, FILED 10-5-1999.

SL

FOR CHEMICALS AND PHOTORESIST CHEMICALS FOR USE IN THE MANUFACTURE OF INTEGRATED CIRCUITS, SEMI-CONDUCTOR DEVICES AND OTHER ELECTRONIC DEVICES (U.S. CLS. 1, 5, 6, 10, 26 AND 46).

FIRST USE 8-15-2002; IN COMMERCE 8-15-2002.

2,747,792. MITSUBISHI CHEMICAL CORPORATION, CHIYODA-KU, TOKYO, JAPAN. SN 76-070,386. PUB. 3-26-2002, FILED 6-14-2000.

RABALON

FOR THERMOPLASTIC ELASTOMERS FOR USE IN MANUFACTURING MOLDED ARTICLES IN THE AUTOMOBILE, MOTORCYCLE, BICYCLE, ELECTRIC, ELECTRONIC, PHARMACEUTICAL, MEDICAL, FOOD, BEVERAGE, CONSTRUCTION, CABLE AND WIRE JACKETING, AND TOY INDUSTRIES (U.S. CLS. 1, 5, 6, 10, 26 AND 46).

FIRST USE 9-5-1989; IN COMMERCE 6-3-2001.

2,748,274. CHEM-X INTERNATIONAL, L.L.C., MCKINNEY, TX. SN 76-312,448. PUB. 8-20-2002, FILED 9-13-2001.

WASTE AWAY

CLASS 1—(Continued).

OWNER OF U.S. REG. NO. 2,463,502.
NO CLAIM IS MADE TO THE EXCLUSIVE RIGHT TO USE "WASTE", APART FROM THE MARK AS SHOWN.
FOR ENZYME PREPARATIONS USED FOR WASTE WATER TREATMENT, NAMELY, ENZYMES FOR TREATING SEPTIC SYSTEMS, MUNICIPAL WATER SYSTEMS, AND OTHER EFFLUENT WATER SYSTEMS (U.S. CLS. 1, 5, 6, 10, 26 AND 46).

FIRST USE 5-11-2001; IN COMMERCE 5-10-2001.

2,748,320. TEMBEC INDUSTRIES INC., TEMISCAMING, QUEBEC. SN 76-327,208. PUB. 9-17-2002, FILED 10-19-2001.

ARBO

FOR LIGNOSULFONATES FOR USE AS AN AGGLOMERATE, BINDER, DISPERSANT OR DEFLOCCULANT IN THE FOLLOWING INDUSTRIES AND PRODUCTS— CARBON BRIQUETTING, STEEL RECOVERY, TANNING DYESTUFF INDUSTRY, WATER TREATMENT PLANTS, SOIL STABILIZATION; FIBERGLASS, ACTIVATED CARBON, CORRUGATED CARDBOARD, CERAMICS, PESTICIDE AND FERTILIZERS, ANIMAL FEED, TILE AND BRICK CONCRETE ADMIXTURES, GYPSUM, WALLBOARD, CARBON BLACK, OIL WELL DRILLING SPECIALTY CHEMICALS, BATTERIES, INDUSTRIAL SOLVENTS, MOLECULAR SIEVES, MOLDED FINISHINGS, CEMENT, PHENOL FORMALDEHYDE OR UREA FORMALDEHYDE RESINS, AND MINERAL/ORE FLOTTATION EXTRACTION CHEMICALS (U.S. CLS. 1, 5, 6, 10, 26 AND 46).

FIRST USE 10-29-2001; IN COMMERCE 11-1-2001.

2,748,328. ACADIAN SEAPLANTS LIMITED, DARTMOUTH, NOVA SCOTIA, CANADA. SN 76-330,611. PUB. 3-26-2002, FILED 10-26-2001.

NUTRAMER

FOR MARINE PLANT BASED PREPARATIONS FOR FURTHER MANUFACTURE OF VITAMINS AND BEAUTY PRODUCTS (U.S. CLS. 1, 5, 6, 10, 26 AND 46).

FIRST USE 12-20-2002; IN COMMERCE 12-20-2002.

CLASS 1—(Continued).

2,748,356. HARDIGG INDUSTRIES, INC., SOUTH DEER-FIELD, MA. SN 76-336,752. PUB. 5-14-2002, FILED 11-13-2001.

HPX

FOR SYNTHETIC RESINS USED IN THE MANUFACTURE OF PLASTIC CASES (U.S. CLS. 1, 5, 6, 10, 26 AND 46).

FIRST USE 5-11-2001; IN COMMERCE 12-0-2001.

2,748,526. BAR'S PRODUCTS, INC., HOLLY, MI, BY CHANGE OF NAME FRE-BAR INC., HOLLY, MI. SN 76-392,213. PUB. 11-19-2002, FILED 4-8-2002.

SMOKE AWAY

FOR CHEMICAL ADDITIVE COMPOUND FOR MOTOR OIL (U.S. CLS. 1, 5, 6, 10, 26 AND 46).

FIRST USE 11-0-2002; IN COMMERCE 11-0-2002.

2,748,561. PENFORD PRODUCTS CO., CEDAR RAPIDS, IA. SN 76-415,018. PUB. 12-3-2002, FILED 5-30-2002.

PEN-TAPE

FOR MODIFIED INDUSTRIAL STARCH FOR USE IN THE MANUFACTURE OF PAPER TAPES (U.S. CLS. 1, 5, 6, 10, 26 AND 46).

FIRST USE 7-12-2002; IN COMMERCE 7-12-2002.

2,748,645. AGRILIANCE, LLC, ST. PAUL, MN. SN 78-044,420. PUB. 6-25-2002, FILED 1-23-2001.

CPX

FOR NON IONIC SPREADER STICKER FOR USE IN AGRICULTURE NAMELY, STICKING INGREDIENT TO HOLD PESTICIDES TO THE LEAF SURFACE AFTER THE SPREADER INGREDIENT HAS DISPERSED OVER THE PLANT SURFACE (U.S. CLS. 1, 5, 6, 10, 26 AND 46).

FIRST USE 2-20-2001; IN COMMERCE 2-20-2001.

2,748,648. MIRUS, INC., MADISON, WI. SN 78-045,325. PUB. 7-2-2002, FILED 1-28-2001.

HELA MONSTER

NO CLAIM IS MADE TO THE EXCLUSIVE RIGHT TO USE "HELA", APART FROM THE MARK AS SHOWN.

FOR HELA CELL TRANSFECTION REAGENT FOR SCIENTIFIC RESEARCH (U.S. CLS. 1, 5, 6, 10, 26 AND 46).

FIRST USE 8-15-2000; IN COMMERCE 3-15-2001.

CLASS 1—(Continued).

2,748,753. OBJET GEOMETRIES LTD., REHOVOT, ISRAEL. SN 78-083,689. PUB. 6-4-2002, FILED 9-13-2001.

FULLCURE

FOR CHEMICAL RESINS AND INDUSTRIAL AND SCIENTIFIC CHEMICALS USED TO BUILD THREE DIMENSIONAL MODELS AND PROTOTYPES; PHOTOGRAPHIC CHEMICALS (U.S. CLS. 1, 5, 6, 10, 26 AND 46).

FIRST USE 3-31-2001; IN COMMERCE 5-31-2001.

2,748,801. BAYER POLYMERS LLC, PITTSBURGH, PA, BY ASSIGNMENT BAYER CORPORATION, PITTSBURGH, PA. SN 78-096,292. PUB. 6-4-2002, FILED 12-3-2001.

CREMATT

FOR CHEMICAL ADDITIVES FOR USE IN THE MANUFACTURE OF POWDER COATINGS FOR THE AUTOMOTIVE AND INDUSTRIAL FINISHING INDUSTRIES (U.S. CLS. 1, 5, 6, 10, 26 AND 46).

FIRST USE 7-11-2002; IN COMMERCE 7-11-2002.

2,748,877. CJB INDUSTRIES, VALDOSTA, GA. SN 78-108,173. PUB. 9-10-2002, FILED 2-12-2002.

SCORCH

FOR ADJUVANT FOR HERBICIDES (U.S. CLS. 1, 5, 6, 10, 26 AND 46).

FIRST USE 2-22-2002; IN COMMERCE 4-1-2002.

2,748,936. GENERAL HYDROPONICS, INC., SEBASTOPOL, CA. SN 78-123,765. PUB. 12-17-2002, FILED 4-24-2002.

FLORALICIOUS

FOR PLANT NUTRIENTS (U.S. CLS. 1, 5, 6, 10, 26 AND 46).

FIRST USE 8-3-2002; IN COMMERCE 8-3-2002.

CLASS 2—PAINTS

CLASS 2—(Continued).

2,747,497. BRYNDANA INTERNATIONAL, LTD., HAVER-TOWN, PA. SN 75-537,325. PUB. 5-9-2000, FILED 8-17-1998.

MOLECUBOND

NO CLAIM IS MADE TO THE EXCLUSIVE RIGHT TO USE "COLOR", APART FROM THE MARK AS SHOWN.

FOR PAINTS FOR DOMESTIC AND COMMERCIAL USE, NAMELY, PAINTS FOR EXTERIOR USE, INTERIOR USE, USE AS HOUSE PAINT, USE ON AUTOMOBILES, USE ON FURNITURE, AND USE ON CLOTHING; VARNISHES FOR DOMESTIC AND COMMERCIAL USE (U.S. CLS. 6, 11 AND 16).

FIRST USE 8-30-1998; IN COMMERCE 8-30-1998.

2,747,836. TOTO U.S.A., INC., MORROW, GA. SN 76-102,679. PUB. 1-1-2002, FILED 8-3-2000.

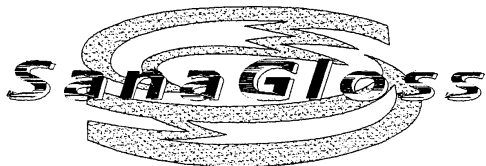

NO CLAIM IS MADE TO THE EXCLUSIVE RIGHT TO USE "GLOSS", APART FROM THE MARK AS SHOWN.

THE LINING AND STIPPLING IS A FEATURE OF THE MARK AND DOES NOT INDICATE COLOR.

FOR PAINTS AND LACQUERS, NAMELY, GLAZES AND FINISHES FOR TOILETS (U.S. CLS. 6, 11 AND 16).

FIRST USE 4-7-2000; IN COMMERCE 4-7-2000.

2,747,943. DAINICHISEIKA COLOR & CHEMICALS MFG. CO., LTD., TOKYO, JAPAN. SN 76-179,363. PUB. 6-25-2002, FILED 12-12-2000.

DAIPYROXIDE

OWNER OF JAPAN REG. NO. 1336020, DATED 7-21-1978, EXPIRES 7-21-2008.

FOR ORGANIC AND INORGANIC PIGMENTS USED IN PLASTICS, FIBERS, TEXTILES, PAPER, SYNTHETIC LEATHER, RUBBER, STATIONERY, PRINTING INKS AND PAINTS; MASTERBATCHES CONTAINING AS A MAIN INGREDIENT PIGMENTS AND AS DILUENT SYNTHETIC RESINS (U.S. CLS. 6, 11 AND 16).

FIRST USE 0-0-1979; IN COMMERCE 0-0-1979.

CLASS 3—COSMETICS AND CLEANING PREPARATIONS

2,747,599. DI AUGUSTINE, ANGELA, PHILADELPHIA, PA. SN 75-773,555. PUB. 2-22-2000, FILED 8-12-1999.

ACTIVE WEAR FOR SKIN**CLASS 3—(Continued).**

NO CLAIM IS MADE TO THE EXCLUSIVE RIGHT TO USE "FOR SKIN", APART FROM THE MARK AS SHOWN.

FOR SKIN CARE PREPARATIONS FOR THE FACE AND BODY, NAMELY, FACIAL MOISTURIZING CREAMS AND LOTIONS, FACIAL TONERS, FACIAL SCRUBS, FACIAL CLEANSING GEL, MILK AND LOTION, FACIAL BEAUTY MASKS, ANTI-WRINKLE CREAMS, SUN SCREENS, FOOT CREAM AND LOTION, ANTI-CELLULITE GEL; BATH PREPARATIONS, NAMELY, BATH OILS, SHOWER GELS, BATH OILS AND GELS, SKIN CREAMS, BATH SOAP, SKIN TONING CONDITIONER, HAIR REMOVER; HAIR CARE PREPARATIONS, NAMELY, SHAMPOOS AND CONDITIONERS (U.S. CLS. 1, 4, 6, 50, 51 AND 52).

FIRST USE 1-10-2003; IN COMMERCE 1-10-2003.

2,747,618. LOUFRANI, FRANKLIN, LONDON, UNITED KINGDOM. SN 75-810,328. PUB. 7-11-2000, FILED 10-20-1999.

SMILEY

FOR NON-MEDICATED COSMETIC PREPARATIONS FOR SLIMMING PURPOSES, NAMELY, SKIN CREAMS, SKIN LOTIONS, SKIN POMADES, RUST REMOVING PREPARATIONS, SUN-TANNING PREPARATIONS FOR COSMETIC PURPOSES, FABRIC SOFTENERS FOR LAUNDRY USE, SHAVING SOAP, COTTON STICKS FOR COSMETIC PURPOSES, SKIN WHITENING CREAMS, LAUNDRY BLEACH, SCENTED WOOD, FLOOR POLISH, HAIR COLOR, HAIR DYES, HAIR WAXING LOTIONS, ARTIFICIAL EYELASHES, SHOE CARE PRODUCTS, NAMELY, SHOE WAX, SHOE POLISH, AND SHOE CREAM, DEPILATORY WAX, PARQUET FLOOR WAX, POLISHING WAX FOR USE ON FURNITURE AND AUTOMOBILES, LEATHER PRESERVATIVES, NAMELY, POLISHING CREAMS AND WAXES, COSMETIC KITS COMPRISED OF EYELASH PENCILS, EYELID PENCILS, NAMELY, SHAMPOOS, DRAIN OPENERS, GENERAL PURPOSE SCOURING POWDERS, DECOLORANTS FOR COSMETIC PURPOSES, NAMELY, HAIR DECOLORANTS, DEGREASING PREPARATIONS NOT USED IN THE MANUFACTURING PROCESS FOR USE ON FLOORS, MAKE-UP REMOVING PREPARATIONS, DEPILATORY CREAMS, STAINS REMOVERS, PAINT REMOVERS, RUST AND MINERAL REMOVING CLEANING PREPARATIONS, LAUNDRY DETERGENTS, TOILET WATER, ANTI-STATIC DRYERS SHEETS, EMERY PAPER, EMERY CLOTH, EMERY BOARDS, POLISH FOR FURNITURE AND FLOORING, INCENSE, WIND-SCREEN CLEANING PREPARATIONS, ESSENTIALS OILS FOR PERSONAL USE, HAIR LACQUER, HAIR BLEACHING PREPARATIONS, SACHETS FOR PERFUMING LINEN, HAIR LOTIONS, FALSE NAILS, COTTON BALLS FOR COSMETIC PURPOSES, ABRASIVE PAPER FOR USE ON THE NAILS, WALLPAPER CLEANING PREPARATIONS, PAINT STRIPPER, PUMICE STONES FOR PERSONAL USE, ADHESIVES FOR COSMETIC USE, NAMELY, ADHESIVES FOR USE IN CONNECTION WITH ARTIFICIAL HAIR, SHAVING PREPARATIONS, VARNISH-REMOVING PREPARATIONS (U.S. CLS. 1, 4, 6, 50, 51 AND 52).

FIRST USE 2-26-2001; IN COMMERCE 2-26-2001.

CLASS 3—(Continued).

2,747,690. ORCHARD INTERNATIONAL INC., MISSISSAUGA, ONTARIO, CANADA. SN 75-906,848. PUB. 3-19-2002, FILED 2-1-2000.

SAL & JO'S DAIRY

FOR BATH PRODUCTS, NAMELY, BATH AND SHOWER GEL, BUBBLE BATH, FOAM BATH, SOAP, BATH SALTS, BODY LOTION, HAND LOTION, BODY CREAM AND BATH FIZZIES (U.S. CLS. 1, 4, 6, 50, 51 AND 52).

FIRST USE 9-1-1999; IN COMMERCE 9-1-1999.

2,747,694. EUROPEENNE DE PRODUITS DE BEAUTE, PARIS, FRANCE. SN 75-914,983. PUB. 5-14-2002, FILED 1-25-2000.

GATINEAU

FOR SKIN CARE PREPARATIONS; NAMELY, SKIN MOISTURIZERS, CREAMS, LOTIONS, SERUMS AND GELS, FACIAL MASKS, MAKEUP REMOVER, SKIN CLEANSING LOTIONS, GELS (U.S. CLS. 1, 4, 6, 50, 51 AND 52).

FIRST USE 6-21-2000; IN COMMERCE 6-21-2000.

2,747,740. OZKLEEN EURASIA LIMITED, EAST MALAYSIA, MALAYSIA. SN 76-027,443. PUB. 1-23-2001, FILED 4-17-2000.

BATH POWER

NO CLAIM IS MADE TO THE EXCLUSIVE RIGHT TO USE "BATH", APART FROM THE MARK AS SHOWN.

FOR CLEANING PREPARATIONS, NAMELY, PREPARATIONS FOR USE IN CLEANING BATHROOMS AND SHOWERS AND BATHROOM AND SHOWER FIXTURES AND FITTINGS (U.S. CLS. 1, 4, 6, 50, 51 AND 52).

FIRST USE 4-17-2003; IN COMMERCE 4-17-2003.

2,747,794. JAFRA COSMETICS INTERNATIONAL, INC., WESTLAKE VILLAGE, CA. SN 76-070,940. PUB. 2-27-2001, FILED 6-15-2000.

TENDER MOMENTS

FOR BABY CARE PRODUCTS; NAMELY, BABY HAIR AND BODY WASH, BABY MASSAGE CREAM, BABY BATH AND BODY OIL, BABY POWDER, AND BABY COLOGNE (U.S. CLS. 1, 4, 6, 50, 51 AND 52).

FIRST USE 12-15-2000; IN COMMERCE 12-15-2000.

CLASS 3—(Continued).

2,747,795. MEEKS, JOSEPH A., CORONA, CA. AND MEEKS, MARY GROSSMAN, CORONA, CA. SN 76-070,966. PUB. 5-28-2002, FILED 6-15-2000.

MEDI-TAR

FOR PET CARE PRODUCTS, NAMELY TAR AND SULPHUR SHAMPOO (U.S. CLS. 1, 4, 6, 50, 51 AND 52).

FIRST USE 6-0-2001; IN COMMERCE 6-0-2001.

2,747,799. FACEGAMES, INC., BAYSIDE, NY. SN 76-074,127. PUB. 5-14-2002, FILED 6-20-2000.

BEAUTYGAMES

FOR BEAUTY AND SKIN CARE PRODUCTS, NAMELY, FACE MOISTURIZERS, FACE CLEANSERS, FACE TONERS, FACE CREAMS, SKIN CREAMS, BODY LOTIONS, BODY MOISTURIZERS, BODY SCRUBS AND BODY EXFOLIANTS (U.S. CLS. 1, 4, 6, 50, 51 AND 52).

FIRST USE 6-19-1999; IN COMMERCE 1-0-2000.

2,747,852. SPORTSFRAGRANCE INC., SCOTTSDALE, AZ. SN 76-115,619. PUB. 6-5-2001, FILED 8-24-2000.

MERRY MATE

FOR PERFUMES, TOILET WATERS AND COLOGNES (U.S. CLS. 1, 4, 6, 50, 51 AND 52).

FIRST USE 8-0-2002; IN COMMERCE 8-0-2002.

2,747,865. ORIGINS NATURAL RESOURCES INC., NEW YORK, NY. SN 76-124,029. PUB. 1-22-2002, FILED 9-7-2000.

BALANCED DIET

FOR COSMETICS, NAMELY, SKIN CARE LOTION (U.S. CLS. 1, 4, 6, 50, 51 AND 52).

FIRST USE 3-31-2001; IN COMMERCE 3-31-2001.

2,747,917. PEGASUS INTERNATIONAL, INC., FORT WASHINGTON, PA. SN 76-164,021. PUB. 3-19-2002, FILED 11-13-2000.

SPA CORTINA

OWNER OF U.S. REG. NOS. 2,360,861 AND 2,451,235. NO CLAIM IS MADE TO THE EXCLUSIVE RIGHT TO USE "SPA", APART FROM THE MARK AS SHOWN. THE ENGLISH TRANSLATION OF "CORTINA" IS "CURTAIN".

FOR NON-MEDICATED HAIR AND SKIN CARE PRODUCTS, NAMELY, SCENTED BODY SPRAYS, SKIN LOTION, AND ESSENTIAL OILS FOR PERSONAL USE (U.S. CLS. 1, 4, 6, 50, 51 AND 52).

FIRST USE 10-0-2000; IN COMMERCE 11-0-2000.

CLASS 3—(Continued).

2,747,948. PARFUMS CHRISTIAN DIOR, S.A., 75008 PARIS, FRANCE. SN 76-181,720. PUB. 6-25-2002, FILED 12-14-2000.

DUOSTYL

FOR COSMETIC PENCILS, EYE MAKEUP, LIPSTICK (U.S. CLS. 1, 4, 6, 50, 51 AND 52).
FIRST USE 4-0-2001; IN COMMERCE 5-0-2001.

2,747,953. KOSE CORPORATION, CHUO-KU, TOKYO, JAPAN. SN 76-183,585. PUB. 10-8-2002, FILED 12-20-2000.

SERUM UN-SIGN

NO CLAIM IS MADE TO THE EXCLUSIVE RIGHT TO USE "SERUM", APART FROM THE MARK AS SHOWN.
FOR COSMETICS, PERFUMES, COSMETIC SOAPS AND HAIR LOTIONS (U.S. CLS. 1, 4, 6, 50, 51 AND 52).
FIRST USE 11-0-2000; IN COMMERCE 1-0-2002.

2,747,984. VICARIO, VICTORIANO MARTINEZ, 08185 LLICA DE VALL (BARCELONA), SPAIN. SN 76-200,194. PUB. 5-21-2002, FILED 1-25-2001.

Salerm
Pro•line

FOR ESSENTIAL OILS FOR PERSONAL USE; HAIR LOTIONS (U.S. CLS. 1, 4, 6, 50, 51 AND 52).
FIRST USE 9-27-2000; IN COMMERCE 9-27-2000.

2,748,012. GOLDMARK, FRANCES, NEW HOPE, PA. SN 76-211,798. PUB. 8-14-2001, FILED 2-20-2001.

DENIAL

FOR PERFUMES, COLOGNES, COSMETICS AND BODY LOTIONS (U.S. CLS. 1, 4, 6, 50, 51 AND 52).
FIRST USE 8-7-2001; IN COMMERCE 8-7-2001.

2,748,029. AUSTRALIAN GOLD, INC., INDIANAPOLIS, IN. SN 76-222,268. PUB. 9-18-2001, FILED 3-9-2001.

EMBER

FOR SUNTANNING PREPARATIONS (U.S. CLS. 1, 4, 6, 50, 51 AND 52).
FIRST USE 2-3-2002; IN COMMERCE 2-3-2002.

CLASS 3—(Continued).

2,748,036. L'OREAL USA CREATIVE, INC., NEW YORK, NY. SN 76-225,231. PUB. 3-26-2002, FILED 3-15-2001.

SUN MILK

FOR HAIR CARE PREPARATIONS, NAMELY, LEAVE-IN MOISTURIZER (U.S. CLS. 1, 4, 6, 50, 51 AND 52).
FIRST USE 2-0-2003; IN COMMERCE 2-0-2003.

2,748,074. L'OREAL, PARIS, FRANCE. SN 76-241,455. PUB. 9-18-2001, FILED 4-16-2001.

EXFOTONIC

FOR COSMETICS NAMELY GELS (U.S. CLS. 1, 4, 6, 50, 51 AND 52).
FIRST USE 1-2-2003; IN COMMERCE 1-2-2003.

2,748,086. CITRA-SOLV LLC, RIDGEFIELD, CT. SN 76-246,012. PUB. 9-24-2002, FILED 4-25-2001.

CITRA-WOOD

FOR POLISHES FOR WOOD, FURNITURE POLISH (U.S. CLS. 1, 4, 6, 50, 51 AND 52).
FIRST USE 1-17-2002; IN COMMERCE 1-17-2002.

2,748,102. HELENE CURTIS, INC., WILMINGTON, DE. SN 76-253,739. PUB. 10-9-2001, FILED 5-8-2001.

DEGREE COOL RUSH

OWNER OF U.S. REG. NOS. 1,574,203, 1,627,911, AND 1,775,676.
FOR ANTIPERSPIRANT AND DEODORANT (U.S. CLS. 1, 4, 6, 50, 51 AND 52).
FIRST USE 12-15-2001; IN COMMERCE 12-15-2001.

CLASS 3—(Continued).

2,748,197. E.T. BROWNE DRUG CO., INC., ENGLEWOOD CLIFFS, NJ. SN 76-284,196. PUB. 6-11-2002, FILED 7-12-2001.

BLACK & BEAUTIFUL

OWNER OF U.S. REG. NO. 927,471.

FOR PERSONAL CARE PRODUCTS FOR CARE OF THE SKIN, HAIR, LIPS AND/OR NAILS, NAMELY, AFTER-SHAVE LOTIONS, ANTI-PERSPIRANTS, ASTRINGENTS FOR COSMETICS PURPOSES, BABY OIL, BABY POWDER, BABY SHAMPOO, BATH GEL, BATH OIL, BATH POWDER, NON-MEDICATED BATH SALTS, BEAUTY MASKS, HAIR BLEACHING PREPARATIONS, BODY CREAMS AND LOTIONS, BODY OIL, BODY POWDER, BUBBLE BATH, SKIN CLEANSING CREAMS AND LOTIONS, COLD CREAM, EYE CREAM, HAIR CONDITIONERS, HAIR REMOVING CREAM, HAND CREAM AND LOTIONS, NIGHT CREAMS, SHAVING CREAM, SKIN CREAM AND LOTIONS, VANISHING CREAM, PERSONAL DEODORANTS, HAIR DYES, FACIAL SCRUBS, HAIR GEL, SHAVING GEL, SHOWER GEL, TOOTH GEL, NON-MEDICATED LIP BALM, MASSAGE OIL, ESSENTIALS OILS FOR PERSONAL USE, HAIR POMADES, HAIR SHAMPOO, SHAVING BALM, SHAVING LOTION, SKIN CLARIFIERS, SKIN CLEANSING CREAM, SKIN EMOLLIENTS, SKIN LIGHTENERS, SKIN MOISTURIZERS, SKIN SOAP, SKIN TONERS, DEODORANT SOAP, SADDLE SOAP, TOILET SOAP, LIQUID SOAPS FOR USE ON THE HANDS, FACE AND/OR BODY; SUN BLOCK, SUN SCREEN AND SUN TANNING PREPARATIONS; PRE-MOISTENED COSMETIC TOWELETTES; WRINKLE REMOVING SKIN CARE PREPARATIONS; COSMETICS, NAMELY, COMPACTS, COSMETIC PENCILS, EYE PENCILS, EYE MAKEUP, EYE MAKEUP REMOVER, EYE SHADOW, EYEBROW PENCILS, EYE LINERS, LIP GLOSS, LIPSTICK, MAKEUP, FACIAL MAKEUP, FOUNDATION MAKEUP, MASCARA, FACE POWDER; COLOGNE, PERFUME, TOILET WATER; PERSONAL CARE PRODUCTS FOR CARE OF THE NAILS AND NAIL COSMETICS, NAMELY, NAIL ENAMEL, NAIL HARDENERS, NAIL POLISH, NAIL POLISH BASE COAT, NAIL POLISH REMOVER, NAIL POLISH TOP COAT; NAIL STRENGTHENERS; NAIL GROOMING PRODUCTS, NAMELY, TIPS, GLUE, LACQUER AND GLITTER (U.S. CLS. 1, 4, 6, 50, 51 AND 52).

FIRST USE 0-0-1968; IN COMMERCE 0-0-1968.

2,748,251. SAINT CHARLES INTERNATIONAL, INC., INDIANAPOLIS, IN. SN 76-303,002. PUB. 6-25-2002, FILED 6-14-2001.



FOR NON-MEDICATED HAIR CARE PREPARATIONS (U.S. CLS. 1, 4, 6, 50, 51 AND 52).
FIRST USE 3-26-2003; IN COMMERCE 3-26-2003.

CLASS 3—(Continued).

2,748,262. SPA DE SOLEIL, INC., VAN NUYS, CA. SN 76-307,746. PUB. 4-30-2002, FILED 8-30-2001.



OWNER OF U.S. REG. NO. 2,510,149.

THE MARK CONSISTS OF THE LETTERS AND NUMBER "O2CH" IN THE STYLIZED LETTERS, AS SHOWN IN THE DRAWING.

FOR NON-MEDICATED SKIN CARE PRODUCTS AND FACIAL AND BODY TREATMENTS, NAMELY, SKIN CREAMS, FACIAL CREAMS, FACIAL MASKS, BODY CREAMS, BODY LOTIONS, BODY CLEANSERS, BODY MASKS, SHOWER GELS, HYDRATING BODY SCRUBS, ANTI CELLULITE ELIXIR, DRY OIL BODY SPRAY, STRETCH MARK CREAM, MASSAGE OILS, HAND CREAMS, FOOT CREAMS, BATH SALTS, GINKO SOAPS, SEAWEED SOAPS, AND WILD BERRY SOAPS (U.S. CLS. 1, 4, 6, 50, 51 AND 52).

FIRST USE 9-30-2001; IN COMMERCE 9-30-2001.

2,748,273. INTERNATIONAL FLAVORS & FRAGRANCES INC., NEW YORK, NY. SN 76-312,063. PUB. 10-29-2002, FILED 9-17-2001.

HEALING-FRAGRANCE

FOR ESSENTIAL OILS FOR USE IN THE MANUFACTURE OF COLOGNES; COSMETICS, NAMELY LIPSTICKS, LIP OIL, FACE POWDER, CAKE ROUGE, LIQUID ROUGE, MASCARA, CAKE MAKE-UP, EYEBROW PENCILS, EYE SHADOW AND NAIL CARE PREPARATIONS; COSMETIC SKIN CARE PRODUCTS, NAMELY, SHAVING CREAM, SHAVING GEL, AFTER SHAVE LOTION AND AFTER SHAVE MOISTURIZING GEL; SKIN CARE PRODUCTS, NAMELY LOTIONS, GELS, OILS, MOUSSES, SCENTED BODY SPRAYS, ANTIPERSPIRANTS, BATH FOAMS, MOISTURIZERS, CREAMS AND FACIAL MASQUES; SKIN TANNING PRODUCTS, NAMELY LOTIONS, SUNSCREENS, GELS, OILS, MOUSSES, SPRAYS, FOAMS AND CREAMS; HAIR CARE PRODUCTS, NAMELY SHAMPOOS, RINSES, GELS, FOAMS, CONDITIONERS AND SPRAYS; DETERGENTS, FABRIC SOFTENERS, ODORANTS, DEODORANTS, BLEACHES, LAUNDRY BRIGHTENERS (U.S. CLS. 1, 4, 6, 50, 51 AND 52).

FIRST USE 3-31-2003; IN COMMERCE 3-31-2003.

CLASS 3—(Continued).

2,748,295. STEPHAN CO., THE, FORT LAUDERDALE, FL. SN 76-319,877. PUB. 6-11-2002, FILED 10-1-2001.



NO CLAIM IS MADE TO THE EXCLUSIVE RIGHT TO USE "AMERICA", APART FROM THE MARK AS SHOWN. THE LINING IS A FEATURE OF THE MARK AND DOES NOT INDICATE COLOR.

FOR HAIR SHAMPOOS, HAIR SHAMPOO CONCENTRATES, HAIR STRENGTHENING TREATMENT LOTIONS, HAIR STYLING PREPARATIONS, HAIR THICKENERS, BODY SOAPS, TOILETTE WATERS AND COLOGNES (U.S. CLS. 1, 4, 6, 50, 51 AND 52). FIRST USE 12-3-2001; IN COMMERCE 12-3-2001.

2,748,316. KANEBO KABUSHIKI KAISHA (KANEBO, LTD.), SUMIDA-KU, TOKYO, JAPAN. SN 76-326,028. PUB. 3-19-2002, FILED 10-9-2001.

SIMPRO

FOR COSMETICS, NAMELY, FACE CREAM, SKIN CREAM, FACE PACKS, SKIN LOTION, MILKY FACE LOTION, LIP CREAM, MAKE-UP BASE, SKIN CLEANSING PREPARATIONS, SOAPS, SKIN WHITENING PREPARATIONS, FOUNDATION MAKE-UP, FACE POWDER, BATH POWDER, EYE MAKE-UP, EYE LINER, MASCARA, EYE BROW PENCILS, LIPSTICKS, CHEEK COLOR, NAIL CARE PREPARATIONS, NAMELY, NAIL COLOR AND CUTICLE COAT, COSMETIC PREPARATIONS FOR BATH, NAMELY, NON-MEDICATED BATH SALTS, BUBBLE BATH AND BATH OILS; HAIR CARE PREPARATIONS, NAMELY, SHAMPOO, RINSE, CONDITIONER, LOTION, HAIR CREAM, HAIR-DYE, SPRAY, GEL AND MOUSSE; PERFUMERY, NAMELY, PERFUME, EAU DE COLOGNE, EAU DE TOILETTE, COTTON BALLS FOR COSMETIC PURPOSES (U.S. CLS. 1, 4, 6, 50, 51 AND 52). FIRST USE 1-0-2002; IN COMMERCE 1-0-2003.

2,748,321. UN-DU PRODUCTS, INC., DALLAS, TX. SN 76-327,740. PUB. 5-21-2002, FILED 10-19-2001.

PHOTOCARE

FOR CLEANING PREPARATION FOR PHOTOGRAPHS (U.S. CLS. 1, 4, 6, 50, 51 AND 52). FIRST USE 2-1-2002; IN COMMERCE 2-1-2002.

CLASS 3—(Continued).

2,748,469. OPI PRODUCTS, INC., NORTH HOLLYWOOD, CA. SN 76-371,946. PUB. 9-3-2002, FILED 2-19-2002.

CHIP SKIP

FOR NAIL CARE PREPARATIONS, NAIL POLISH, NAIL LACQUER (U.S. CLS. 1, 4, 6, 50, 51 AND 52). FIRST USE 8-1-2002; IN COMMERCE 8-1-2002.

2,748,514. DON JAMES, INC., MARIETTA, GA. SN 76-389,695. PUB. 10-29-2002, FILED 3-29-2002.

LASAUNT SWEEPING LIGHTENER

FOR HAIR BLEACH (U.S. CLS. 1, 4, 6, 50, 51 AND 52). FIRST USE 3-1-2003; IN COMMERCE 3-1-2003.

2,748,601. SHELDON MARKETING LLC, PRESCOTT VALLEY, AZ. SN 78-011,788. PUB. 10-2-2001, FILED 6-8-2000.

ROYAL COMEONATURALS

NO CLAIM IS MADE TO THE EXCLUSIVE RIGHT TO USE "NATURALS", APART FROM THE MARK AS SHOWN. FOR ESSENTIAL OILS, NAMELY, ESSENTIAL OILS FOR PERSONAL USE (U.S. CLS. 1, 4, 6, 50, 51 AND 52). FIRST USE 7-25-2001; IN COMMERCE 7-25-2001.

2,748,654. AVON PRODUCTS, INC., NEW YORK, NY. SN 78-047,615. PUB. 6-25-2002, FILED 2-9-2001.

GET VITAL

FOR SKIN CARE PRODUCTS, NAMELY, FACIAL SKIN TONER (U.S. CLS. 1, 4, 6, 50, 51 AND 52). FIRST USE 3-0-2001; IN COMMERCE 3-0-2001.

2,748,694. BEAUTY HOLDING COMPANY, INC, HAMILTON HM12, BERMUDA. BY CHANGE OF NAME SALLY BEAUTY HOLDINGS, INC., HAMILTON, BERMUDA. SN 78-066,679. PUB. 9-3-2002, FILED 5-31-2001.

NAIL INSURANCE

NO CLAIM IS MADE TO THE EXCLUSIVE RIGHT TO USE NAIL, APART FROM THE MARK AS SHOWN. FOR NAIL TREATMENTS; NAMELY, HARDENERS, ENAMEL SEALERS, FINGERNAIL CREAMS AND FINGERNAIL OILS (U.S. CLS. 1, 4, 6, 50, 51 AND 52). FIRST USE 4-27-2003; IN COMMERCE 4-27-2003.

CLASS 3—(Continued).

2,748,703. MAVEN COSMETICS, LLC, CHICAGO, IL. SN 78-070,286. PUB. 10-8-2002, FILED 6-21-2001.



FOR COSMETICS; ESSENTIAL OILS FOR PERSONAL USE; HAIR CARE PREPARATIONS; PERFUMES (U.S. CLS. 1, 4, 6, 50, 51 AND 52).
FIRST USE 1-1-2001; IN COMMERCE 11-1-2001.

CLASS 3—(Continued).

2,748,782. STERN, PATRICIA, WOODBURY, NY. SN 78-090,638. PUB. 8-13-2002, FILED 10-29-2001.

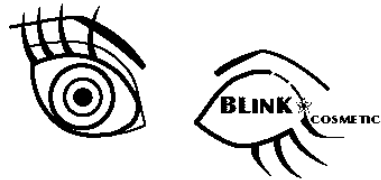

NO CLAIM IS MADE TO THE EXCLUSIVE RIGHT TO USE "COSMETICS", APART FROM THE MARK AS SHOWN.
FOR COSMETICS, NAMELY SHIMMER POWDER, GLITTER, EYE LINER, LIPSTICK, BODY GEL, MASCARA, LIP GLOSS, FOUNDATION POWDER, CONCEALER, EYE SHADOW, NAIL ENAMEL, EYE GLOSS, LIP PENCIL (U.S. CLS. 1, 4, 6, 50, 51 AND 52).
FIRST USE 1-30-2001; IN COMMERCE 4-9-2003.

2,748,722. JOHNSON & JOHNSON, NEW BRUNSWICK, NJ. SN 78-074,738. PUB. 7-23-2002, FILED 7-19-2001.

PROTIENT LIFT

FOR SKIN CARE PREPARATIONS, NAMELY SKIN FIRING MOISTURIZERS, CREAMS, AND LOTIONS, SKIN CLEANSERS AND EYE GELS (U.S. CLS. 1, 4, 6, 50, 51 AND 52).
FIRST USE 1-30-2002; IN COMMERCE 1-30-2002.

2,748,823. AVON PRODUCTS, INC., NEW YORK, NY. SN 78-100,176. PUB. 7-30-2002, FILED 12-28-2001.

NEAT NAILS

2,748,757. NOVARTIS AG, BASEL, SWITZERLAND. SN 78-084,137. PUB. 7-16-2002, FILED 9-17-2001.



FOR FACE MOISTURIZER AND A BODY MOISTURIZER FOR TODDLERS AND CHILDREN (U.S. CLS. 1, 4, 6, 50, 51 AND 52).
FIRST USE 12-0-2001; IN COMMERCE 12-0-2001.

NO CLAIM IS MADE TO THE EXCLUSIVE RIGHT TO USE "NAILS", APART FROM THE MARK AS SHOWN.
FOR CORRECTOR PENS CONTAINING NAIL POLISH REMOVER FOR REMOVING EXCESS NAIL POLISH (U.S. CLS. 1, 4, 6, 50, 51 AND 52).
FIRST USE 4-0-2002; IN COMMERCE 4-0-2002.

CLASS 3—(Continued).

2,748,846. PROCTER & GAMBLE COMPANY, THE, CINCINNATI, OH. SN 78-103,624. PUB. 9-24-2002, FILED 1-18-2002.



NO CLAIM IS MADE TO THE EXCLUSIVE RIGHT TO USE "QUICK DISSOLVING", APART FROM THE MARK AS SHOWN.

THE STIPPLING IS A FEATURE OF THE MARK.

THE MARK CONSISTS OF THE WORDS "QUICK DISSOLVING" CONTAINED WITHIN AN OVAL SHAPE AND TRAILING EFFERVESCENCE BEGINNING AT BOTTOM CENTER OF THE OVAL AND ENDING NEAR TOP CENTER ON THE LEFT AND BEGINNING AT THE TOP CENTER AND ENDING NEAR THE BOTTOM CENTER ON THE RIGHT. THE LETTERS ARE OUTLINED IN DARK BLUE AND WHITE ACCENT SHADING APPEARING IMMEDIATELY BELOW THE WORD "DISSOLVING". THE OVAL IS LINED FOR THE COLOR BLUE GRADUATING FROM A DARK BLUE TO AN AQUA BLUE IN THE CENTER AND TOP PORTION OF THE OVAL.

FOR LAUNDRY DETERGENT (U.S. CLS. 1, 4, 6, 50, 51 AND 52).

FIRST USE 5-13-2002; IN COMMERCE 5-13-2002.

2,748,847. PROCTER & GAMBLE COMPANY, THE, CINCINNATI, OH. SN 78-103,628. PUB. 9-24-2002, FILED 1-18-2002.



NO CLAIM IS MADE TO THE EXCLUSIVE RIGHT TO USE "DISSOLUTION RAPIDE", APART FROM THE MARK AS SHOWN.

THE STIPPLING IS A FEATURE OF THE MARK.

THE MARK CONSISTS OF THE WORDS "DISSOLUTION RAPIDE" CONTAINED WITHIN AN OVAL SHAPE AND TRAILING EFFERVESCENCE BEGINNING AT BOTTOM CENTER OF THE OVAL AND ENDING NEAR TOP CENTER ON THE LEFT AND BEGINNING AT THE TOP CENTER AND ENDING NEAR THE BOTTOM CENTER ON THE RIGHT. THE LETTERS ARE OUTLINED IN DARK BLUE AND WHITE ACCENT SHADING APPEARING IMMEDIATELY BELOW THE WORD "RAPIDE". THE OVAL IS LINED FOR THE COLOR BLUE GRADUATING FROM A DARK BLUE TO AN AQUA BLUE IN THE CENTER AND TOP PORTION OF THE OVAL.

FOR LAUNDRY DETERGENT (U.S. CLS. 1, 4, 6, 50, 51 AND 52).

FIRST USE 5-13-2002; IN COMMERCE 5-13-2002.

CLASS 3—(Continued).

2,748,854. NOXELL CORPORATION, HUNT VALLEY, MD. SN 78-104,305. PUB. 10-22-2002, FILED 1-23-2002.

NOXZEMA TRIPLE CLEAN

OWNER OF U.S. REG. NOS. 225,012, 690,350, AND 1,223,845.

NO CLAIM IS MADE TO THE EXCLUSIVE RIGHT TO USE "CLEAN", APART FROM THE MARK AS SHOWN.

FOR ANTIBACTERIAL FACIAL CLEANSER (U.S. CLS. 1, 4, 6, 50, 51 AND 52).

FIRST USE 7-1-2002; IN COMMERCE 7-1-2002.

2,748,862. KISS MY FACE, GARDINER, NY. SN 78-105,719. PUB. 10-15-2002, FILED 1-30-2002.

OBSESSIVELY ORGANIC

NO CLAIM IS MADE TO THE EXCLUSIVE RIGHT TO USE "ORGANIC", APART FROM THE MARK AS SHOWN.

FOR AFTERSHAVE LOTION, ASTRINGENTS FOR COSMETIC PURPOSES AND SKIN TONERS, BATH OILS AND SALTS, BODY AND FACIAL LOTIONS, HAIR SHAMPOO AND CONDITIONER, PERSONAL DEODORANT, FACIAL SCRUBS, FACIAL CLEANSERS, FACIAL CREAM, NON-MEDICATED FOOT CREAM, HAND CREAM, LIP BALMS, MAKE UP REMOVER, FACIAL MASKS, MOUTHWASH, NON-MEDICATED SKIN SERUM, SHOWER GELS AND BATH GELS, SKIN SOAPS, MOISTURIZING SOAPS (U.S. CLS. 1, 4, 6, 50, 51 AND 52).

FIRST USE 6-15-2002; IN COMMERCE 6-15-2002.

2,748,922. ICN PHARMACEUTICALS, INC., COSTA MESA, CA. SN 78-121,007. PUB. 10-22-2002, FILED 4-11-2002.

GLYQUIN XM

FOR SKIN BLEACHING MOISTURIZING CREAM (U.S. CLS. 1, 4, 6, 50, 51 AND 52).

FIRST USE 11-0-2002; IN COMMERCE 11-0-2002.

CLASS 3—(Continued).

2,748,930. ST. IVES LABORATORIES, INC., MELROSE PARK, IL. SN 78-122,283. PUB. 12-31-2002, FILED 4-17-2002.



OWNER OF U.S. REG. NOS. 1,393,684 AND 1,461,570. NO CLAIM IS MADE TO THE EXCLUSIVE RIGHT TO USE "SWISS FORMULA", APART FROM THE MARK AS SHOWN.

FOR HAIR CARE PREPARATIONS; NON-MEDICATED SKIN CARE PREPARATIONS (U.S. CLS. 1, 4, 6, 50, 51 AND 52).

FIRST USE 6-0-2002; IN COMMERCE 6-0-2002.

2,748,951. FORMACARE SOLUTIONS, INC. OAKLAND, CA. SN 78-128,630. PUB. 12-24-2002, FILED 5-14-2002.

WASA SOFT

FOR SOAP, NAMELY BODY AND HAND (U.S. CLS. 1, 4, 6, 50, 51 AND 52).

FIRST USE 12-25-2002; IN COMMERCE 12-25-2002.

2,748,954. DENTCO, INC., HUMACAO, PUERTO RICO. SN 78-129,437. PUB. 12-3-2002, FILED 5-17-2002.

FRESH IMPACT

FOR TOOTHPASTE (U.S. CLS. 1, 4, 6, 50, 51 AND 52).

FIRST USE 9-1-2002; IN COMMERCE 9-1-2002.

2,748,964. THE FULLER BRUSH COMPANY, GREAT BEND, KS. SN 78-132,878. PUB. 12-3-2002, FILED 6-3-2002.

TRUMIX

FOR CLEANING PREPARATIONS, NAMELY DISINFECTANTS, CARPET CLEANERS, FLOOR CLEANERS, HARD SURFACE CLEANERS AND INDUSTRIAL CLEANERS (U.S. CLS. 1, 4, 6, 50, 51 AND 52).

FIRST USE 5-22-2002; IN COMMERCE 5-22-2002.

CLASS 4—LUBRICANTS AND FUELS**CLASS 4—(Continued).**

2,747,721. LAMOUILLE, PIERRE, 38000 GRENOBLE, FRANCE. SN 76-002,840. PUB. 1-8-2002, FILED 3-17-2000.

HOLESHOT

PRIORITY CLAIMED UNDER SEC. 44(D) ON FRANCE APPLICATION NO. 99813930, FILED 9-20-1999, REG. NO. 99813930, DATED 9-20-1999, EXPIRES 9-20-2009.

FOR INDUSTRIAL OILS AND GREASES, NAMELY, GREASES FOR GENERAL PURPOSES, GREASES FOR MOTORIZED VEHICLES AND MOTORS; LUBRICANTS, NAMELY, INDUSTRIAL LUBRICANTS, ALL-PURPOSE LUBRICANTS, LUBRICANTS FOR MOTORIZED VEHICLES AND MOTORS; AND FUELS, NAMELY, FUEL OIL, DIESEL FUEL AND GASOLINE FUEL (U.S. CLS. 1, 6 AND 15).

FIRST USE 10-0-2002; IN COMMERCE 10-0-2002.

2,748,802. PAUL, STEPHEN, F., WEST ORANGE, NJ. SN 78-096,542. PUB. 7-30-2002, FILED 12-4-2001.

P-SERIES

FOR MOTOR FUEL FOR VEHICLES, NAMELY, VEHICLES WITH SPARK-IGNITED ENGINES (U.S. CLS. 1, 6 AND 15).

FIRST USE 1-10-1998; IN COMMERCE 4-10-2002.

2,748,818. BATH & BODY WORKS, INC., REYNOLDSBURG, OH. SN 78-099,404. PUB. 10-29-2002, FILED 12-20-2001.

ARRESTEK

FOR HOLDERS FOR WICKS, NAMELY, WICK CLIPS FOR HOLDING CANDLEWICKS (U.S. CLS. 1, 6 AND 15).

FIRST USE 2-9-2002; IN COMMERCE 2-9-2002.

2,748,882. DIAL BRANDS, INC., SCOTTSDALE, AZ. SN 78-110,773. PUB. 10-8-2002, FILED 2-25-2002.

WINTER VANILLA

OWNER OF U.S. REG. NOS. 2,080,132, 2,145,417, AND 2,159,632.

NO CLAIM IS MADE TO THE EXCLUSIVE RIGHT TO USE "VANILLA", APART FROM THE MARK AS SHOWN.

FOR CANDLES (U.S. CLS. 1, 6 AND 15).

FIRST USE 10-16-2002; IN COMMERCE 10-16-2002.

CLASS 4—(Continued).

2,748,883. DIAL BRANDS, INC., SCOTTSDALE, AZ. SN 78-110,774. PUB. 10-8-2002, FILED 2-25-2002.

HEAVENLY GINGERBREAD

NO CLAIM IS MADE TO THE EXCLUSIVE RIGHT TO USE "GINGERBREAD", APART FROM THE MARK AS SHOWN.

FOR CANDLES (U.S. CLS. 1, 6 AND 15).
FIRST USE 10-16-2002; IN COMMERCE 10-16-2002.

2,748,949. GREAT AMERICAN DUCK RACES, INC., DBA GAME: GREAT AMERICAN MERCHANDISE AND EVENTS, SCOTTSDALE, AZ. SN 78-128,510. PUB. 11-12-2002, FILED 5-14-2002.

FIRE QUACKER

FOR CANDLES (U.S. CLS. 1, 6 AND 15).
FIRST USE 9-27-2002; IN COMMERCE 9-27-2002.

CLASS 5—PHARMACEUTICALS

2,747,532. POLYPHENOLICS, INC., BURLINGAME, CA. SN 75-642,819. PUB. 6-4-2002, FILED 2-17-1999.

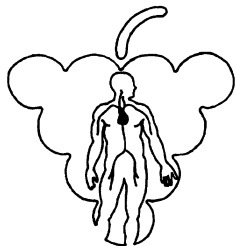

THE MARK CONSISTS OF A SILHOUETTE OF A BUNCH OF GRAPES AND A GROTESQUE HUMAN FIGURE.
FOR VITAMINS, FOOD SUPPLEMENTS, ANTIOXIDANTS, AND GRAPE SEED EXTRACTS USED AS A FOOD SUPPLEMENT (U.S. CLS. 6, 18, 44, 46, 51 AND 52).
FIRST USE 12-0-1998; IN COMMERCE 12-0-1998.

CLASS 5—(Continued).

2,747,535. PFIZER INC., NEW YORK, NY. SN 75-655,002. PUB. 11-9-1999, FILED 3-5-1999.



THE MARK IS LINED FOR THE COLORS BLUE AND GREEN.
FOR PHARMACEUTICAL COMPOUND USED IN THE TREATMENT OF MIGRAINES (U.S. CLS. 6, 18, 44, 46, 51 AND 52).
FIRST USE 8-30-2002; IN COMMERCE 8-30-2002.

2,747,554. PFIZER INC., NEW YORK, NY. SN 75-679,378. PUB. 12-21-1999, FILED 4-9-1999.

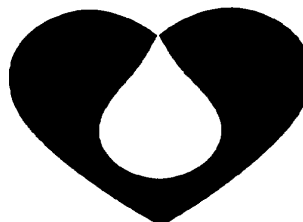

THE MARK CONSISTS OF A STYLIZED REPRESENTATION OF A HEART WITH A DROPLET CONTAINED INSIDE OF THE HEART.
FOR VETERINARY PHARMACEUTICAL PREPARATIONS APPLIED TO SMALL ANIMALS FOR THE TREATMENT OF INTERNAL AND EXTERNAL PARASITES (U.S. CLS. 6, 18, 44, 46, 51 AND 52).
FIRST USE 9-1-2002; IN COMMERCE 9-1-2002.

2,747,557. GUSTY WINDS CORPORATION, COSTA MESA, CA. SN 75-687,497. PUB. 7-18-2000, FILED 4-20-1999.

GO TO THE MAX

FOR DIETARY SUPPLEMENTS (U.S. CLS. 6, 18, 44, 46, 51 AND 52).
FIRST USE 11-1-2002; IN COMMERCE 11-1-2002.

CLASS 5—(Continued).

2,747,571. SANRIO COMPANY, LTD., TOKYO 141, JAPAN.
SN 75-714,746. PUB. 12-28-1999, FILED 6-3-1999.



OWNER OF U.S. REG. NOS. 1,289,682, 1,802,824, AND OTHERS.

THE MARK CONSISTS IN PART OF A HEART DESIGN, FOR ADHESIVE BANDAGES; FIRST AID KITS COMPRISED OF ADHESIVE BANDAGES, COTTON SWABS AND FIRST AID CREAM IN A CASE (U.S. CLS. 6, 18, 44, 46, 51 AND 52).

FIRST USE 1-1-2000; IN COMMERCE 1-1-2000.

2,747,581. MARTIN, HOWARD, SILVER SPRING, MD. SN 75-733,475. PUB. 12-28-1999, FILED 6-14-1999.

TGP

FOR ROOT CANAL FILLING MATERIALS MADE UP OF GUTTA PERCHA, ZINC OXIDE AND IODOFORM (U.S. CLS. 6, 18, 44, 46, 51 AND 52).

FIRST USE 2-27-2003; IN COMMERCE 2-27-2003.

2,747,589. RATH, MATTHIAS, NL-7609 KL ALMELO, NETHERLANDS. SN 75-753,331. PUB. 3-27-2001, FILED 7-19-1999.

METAVICOR

FOR NUTRITIONAL SUPPLEMENTS, DIETARY SUPPLEMENTS, VITAMIN AND MINERAL SUPPLEMENTS (U.S. CLS. 6, 18, 44, 46, 51 AND 52).

FIRST USE 2-0-2001; IN COMMERCE 2-0-2001.

2,747,620. NADIN COMPANY, DBA WHITEWING LABS, GLENDALE, CA. BY ASSIGNMENT WHITEWING LABS, INC., MISSION HILLS, CA. SN 75-812,965. PUB. 7-3-2001, FILED 9-24-1999.

JOINT AIDE

NO CLAIM IS MADE TO THE EXCLUSIVE RIGHT TO USE "JOINT", APART FROM THE MARK AS SHOWN.

FOR FOOD SUPPLEMENTS MADE OF NATURAL INGREDIENTS (U.S. CLS. 6, 18, 44, 46, 51 AND 52).

FIRST USE 10-28-1999; IN COMMERCE 10-28-1999.

CLASS 5—(Continued).

2,747,630. XTTRIUM LABORATORIES, INC., CHICAGO, IL. SN 75-826,842. PUB. 5-23-2000, FILED 10-19-1999.

WE' RE TOPS ON BOTTOMS

FOR MEDICATED SKIN CARE PREPARATIONS (U.S. CLS. 6, 18, 44, 46, 51 AND 52).

FIRST USE 12-0-2002; IN COMMERCE 12-0-2002.

2,747,643. NOVARTIS AG, BASEL, SWITZERLAND. SN 75-840,566. PUB. 6-20-2000, FILED 11-29-1999.

NUTRISHIELD

FOR FOOD FOR ENTERAL FEEDING (U.S. CLS. 6, 18, 44, 46, 51 AND 52).

FIRST USE 2-28-2000; IN COMMERCE 2-28-2000.

2,747,775. MERCK & CO., INC., WHITEHOUSE STATION, NJ. SN 76-057,522. PUB. 7-30-2002, FILED 5-26-2000.



OWNER OF U.S. REG. NOS. 1,710,682, 2,073,389, AND 2,438,692.

THE STIPLING IS FOR SHADING PURPOSES ONLY. FOR PHARMACEUTICAL PREPARATIONS FOR THE TREATMENT AND PREVENTION OF BONE DISEASES (U.S. CLS. 6, 18, 44, 46, 51 AND 52).

FIRST USE 11-13-2000; IN COMMERCE 11-13-2000.

2,747,784. PEDIAMED PHARMACEUTICAL, INC., DOWNTOWN, PA. SN 76-061,534. PUB. 3-27-2001, FILED 6-2-2000.

PEDIAMED

FOR LINE OF PEDIATRIC PHARMACEUTICALS, NAMELY, COUGH AND COLD REMEDIES AND HEAD LICE TREATMENT KITS (U.S. CLS. 6, 18, 44, 46, 51 AND 52).

FIRST USE 8-2-2001; IN COMMERCE 8-2-2001.

CLASS 5—(Continued).

2,747,810. NF DISTRIBUTION CANADA LTD., COQUITLAM, BC, CANADA, BY ASSIGNMENT NATURAL FACTORS NUTRITIONAL PRODUCTS LTD., COQUITLAM, BC, CANADA. SN 76-079,888. PUB. 10-8-2002, FILED 6-27-2000.

CLEARQ

FOR PROPRIETARY BLEND OF VITAMIN E, WITH COENZYME Q10 AND PHOSPHOIPIDS IN CAPSULE AND LIQUID FORM (U.S. CLS. 6, 18, 44, 46, 51 AND 52). FIRST USE 12-18-2000; IN COMMERCE 2-12-2001.

2,747,886. ECO-RIGHT, L.L.C., CAIRO, GA. SN 76-140,150. PUB. 2-19-2002, FILED 10-3-2000.

BIOPHOS

FOR FUNGICIDE CONTAINING AN AMOUNT OF PHOSPHONATE FOR AGRICULTURAL, HORTICULTURAL, COMMERCIAL AND RESIDENTIAL USE (U.S. CLS. 6, 18, 44, 46, 51 AND 52). FIRST USE 2-0-2003; IN COMMERCE 3-14-2003.

2,747,955. AAIPHARMA INC., WILMINGTON, NC. SN 76-184,850. PUB. 10-2-2001, FILED 12-20-2000.

AZASAN

FOR AZATHIOPRINE-BASED PHARMACEUTICALS USED AS IMMUNOSUPPRESSANTS AND ANTIRHEUMATIC DRUGS (U.S. CLS. 6, 18, 44, 46, 51 AND 52). FIRST USE 2-6-2003; IN COMMERCE 2-6-2003.

2,748,021. HANSEN BEVERAGE COMPANY, CORONA, CA. SN 76-218,267. PUB. 5-28-2002, FILED 3-1-2001.

**HANSEN'S NATURAL
ACTIVE NUTRITION**

NO CLAIM IS MADE TO THE EXCLUSIVE RIGHT TO USE "NUTRITION", APART FROM THE MARK AS SHOWN.
FOR NUTRITIONAL FOOD BARS (U.S. CLS. 6, 18, 44, 46, 51 AND 52). FIRST USE 4-20-2001; IN COMMERCE 4-20-2001.

CLASS 5—(Continued).

2,748,061. VITA CUBE SYSTEMS, INC., DENVER, CO. SN 76-236,482. PUB. 12-4-2001, FILED 3-26-2001.

CUBE UP

FOR NUTRITIONAL SUPPLEMENTS, NAMELY SOLID, LIQUID AND POWDERED DIETARY SUPPLEMENTS; DIETARY SUPPLEMENT NUTRITIONAL BARS CONTAINING PROTEINS, CARBOHYDRATES, VITAMINS AND MINERALS (U.S. CLS. 6, 18, 44, 46, 51 AND 52).

FIRST USE 4-9-2001; IN COMMERCE 1-11-2002.

2,748,088. BNG ENTERPRISES, INC., TEMPE, AZ. SN 76-246,739. PUB. 9-3-2002, FILED 4-25-2001.

TOTAL ECLIPSE

FOR DIETARY SUPPLEMENTS (U.S. CLS. 6, 18, 44, 46, 51 AND 52). FIRST USE 6-0-2001; IN COMMERCE 6-0-2001.

2,748,097. AGAN CHEMICAL MANUFACTURERS LTD., ASHDOD, ISRAEL. SN 76-249,674. PUB. 8-6-2002, FILED 5-2-2001.

SONORA

FOR INSECTICIDES, FUNGICIDES, AND HERBICIDES FOR USE IN INDUSTRIAL SITES, AREAS ADJACENT TO ROADS AND HIGHWAYS, PUBLIC AREAS AND FOR DOMESTIC USE (U.S. CLS. 6, 18, 44, 46, 51 AND 52).

FIRST USE 3-13-2001; IN COMMERCE 3-13-2001.

2,748,136. DYNAMIC LIFE, INC., LARGO, FL. SN 76-263,703. PUB. 10-22-2002, FILED 5-29-2001.

Vibrafem
♀

NO CLAIM IS MADE TO THE EXCLUSIVE RIGHT TO USE "THE FEMALE SYMBOL", APART FROM THE MARK AS SHOWN.

FOR TOPICAL GEL OR CREAM TO IMPROVE BLOOD FLOW TO THE VAGINAL AREA (U.S. CLS. 6, 18, 44, 46, 51 AND 52). FIRST USE 6-13-2001; IN COMMERCE 6-13-2001.

CLASS 5—(Continued).

2,748,167. BULLSONE CO., LTD., SEOCHO-GU, SEOUL, REPUBLIC OF KOREA. SN 76-274,714. PUB. 7-9-2002, FILED 6-20-2001.



FOR CAR DEODORIZERS, NAMELY, CAR STINK REMOVING AGENTS, AUTOMOBILE AIR-FRESHENERS AND CAR DEODORANT (U.S. CLS. 6, 18, 44, 46, 51 AND 52).
FIRST USE 3-19-2003; IN COMMERCE 3-19-2003.

2,748,207. AMERICAN MULTI-TRADE, INC., CANOGA PARK, CA. SN 76-287,237. PUB. 10-1-2002, FILED 7-18-2001.

ORGASMIX

FOR PERSONAL LUBRICATING GEL FOR USE IN ENHANCING SEXUAL INTERCOURSE AND RELATED ACTIVITIES (U.S. CLS. 6, 18, 44, 46, 51 AND 52).
FIRST USE 8-13-2001; IN COMMERCE 8-13-2001.

2,748,329. KING TECHNOLOGY, INC., HOPKINS, MN. SN 76-330,887. PUB. 9-3-2002, FILED 10-29-2001.

**AQUA SMARTE JUMP
START**

OWNER OF U.S. REG. NO. 2,175,334.
FOR SPA AND POOL PRODUCTS NAMELY ALGAE-CIDES AND BACTERICIDES (U.S. CLS. 6, 18, 44, 46, 51 AND 52).
FIRST USE 2-27-2002; IN COMMERCE 2-27-2002.

2,748,460. BIOBALANCE INTERNATIONAL, INC., PACIFIC PALISADES, CA. SN 76-367,825. PUB. 9-3-2002, FILED 2-7-2002.

NATURAL CHEMISTRY

NO CLAIM IS MADE TO THE EXCLUSIVE RIGHT TO USE "NATURAL", APART FROM THE MARK AS SHOWN, FOR VITAMIN AND NUTRITIONAL SUPPLEMENTS (U.S. CLS. 6, 18, 44, 46, 51 AND 52).
FIRST USE 3-25-2002; IN COMMERCE 3-25-2002.

CLASS 5—(Continued).

2,748,501. STIEFEL LABORATORIES, INC., CORAL GABLES, FL. SN 76-382,717. PUB. 10-22-2002, FILED 3-15-2002.

GLADASE

FOR TOPICAL DEBRIDEMENT PHARMACEUTICAL (U.S. CLS. 6, 18, 44, 46, 51 AND 52).
FIRST USE 1-7-2002; IN COMMERCE 1-7-2002.

2,748,661. ADVANTRX CORPORATION, CHANHASSEN, MN. SN 78-050,479. PUB. 8-27-2002, FILED 2-27-2001.



THE MARK CONSISTS OF THE TERMS "ADVANTRX FEEL THE ADVANTAGE" AND A LEAPING HUMAN FIGURE. THE "X" IN "ADVANTRX" IS FORMED FROM THE LEG OF THE "R". THE LEAPING HUMAN FIGURE TRANSITIONS THROUGH THE COLORS PURPLE, BLUE, GREEN, ORANGE, AND GOLD FROM TOP TO BOTTOM.
FOR DIETARY SUPPLEMENTS (U.S. CLS. 6, 18, 44, 46, 51 AND 52).
FIRST USE 10-10-2001; IN COMMERCE 2-20-2002.

2,748,664. NF DISTRIBUTION CANADA LTD., COQUITLAM, BRITISH COLUMBIA, CANADA, BY ASSIGNMENT NATURAL FACTORS NUTRITIONAL PRODUCTS LTD., COQUITLAM, BRITISH COLUMBIA, CANADA. SN 78-051,585. PUB. 11-12-2002, FILED 3-6-2001.

LIPCOM

PRIORITY CLAIMED UNDER SEC. 44(D) ON CANADA APPLICATION NO. 1093018, FILED 2-20-2001.
FOR NUTRITIONAL AND DIETARY SUPPLEMENTS CONTAINING PHOSPHOTIDYL CHOLINE, VITAMIN E AND COENZYME Q10 (U.S. CLS. 6, 18, 44, 46, 51 AND 52).
FIRST USE 12-18-2000; IN COMMERCE 2-12-2001.

CLASS 5—(Continued).

2,748,674. ALLERGAN, INC., IRVINE, CA. SN 78-054,981.
PUB. 4-30-2002, FILED 3-26-2001.



THE MARK CONSISTS OF A STYLIZED FIGURE IN SILHOUETTE. THE WORD "RESTASIS" APPEARS NEXT TO THE SILHOUETTE.

FOR TOPICAL OPHTHALMIC PHARMACEUTICAL PRODUCTS FOR THE TREATMENT OF DRYNESS OF THE EYE (U.S. CLS. 6, 18, 44, 46, 51 AND 52).

FIRST USE 10-29-1997; IN COMMERCE 4-1-2003.

CLASS 5—(Continued).

2,748,820. THE PROCTER & GAMBLE COMPANY, CINCINNATI, OH. SN 78-099,922. PUB. 1-21-2003, FILED 12-26-2001.



OWNER OF U.S. REG. NOS. 294,959, 2,396,429, AND OTHERS.

NO CLAIM IS MADE TO THE EXCLUSIVE RIGHT TO USE "PLASTIC", APART FROM THE MARK AS SHOWN. THE STIPPLING IS MEANT TO SHOW SHADING ONLY, AND IS NOT A FEATURE OF THE MARK.

THE MARK CONSISTS OF THE WORDS "TAMPAX PEARL PLASTIC" WITH A SWOOSH BEGINNING BELOW A PEARL SHAPE TO THE BOTTOM LEFT OF THE LETTER. FOR MANUFACTURED, DISPOSABLE TAMPONS (U.S. CLS. 6, 18, 44, 46, 51 AND 52).

FIRST USE 2-28-2002; IN COMMERCE 2-28-2002.

2,748,776. PITKOFF AND ASSOCIATES, INC., KENNEWICK, WA. SN 78-088,317. PUB. 10-8-2002, FILED 10-15-2001.

FARMER GIL'S

THE NAME FARMER GIL DOES NOT IDENTIFY A LIVING INDIVIDUAL.

FOR NATURAL MEDICATED HEALTH AND SKIN CARE PRODUCTS MADE FROM PLANT EXTRACTS AND VEGETABLE AGENTS THAT ARE TOPICALLY APPLIED TO THE SKIN, ALL FOR THE TREATMENT OF SKIN AILMENTS, NAMELY, ECZEMA AND ATHLETE'S FOOT, MOISTURIZERS FOR FACE AND SKIN AND CHEST RUBS FOR CONGESTION FROM COLDS AND FLU (U.S. CLS. 6, 18, 44, 46, 51 AND 52).

FIRST USE 10-31-2001; IN COMMERCE 10-31-2001.

2,748,821. THE PROCTER & GAMBLE COMPANY, CINCINNATI, OH. SN 78-099,924. PUB. 1-21-2003, FILED 12-26-2001.



THE STIPPLING IS MEANT TO SHOW SHADING ONLY, AND IS NOT A FEATURE OF THE MARK.

THE MARK CONSISTS OF THE WORD "PEARL" WITH A SWOOSH BEGINNING BELOW THE PEARL SHAPE TO THE BOTTOM LEFT OF THE THE LETTER "P" IN THE WORD "PEARL", MAKING UP PART OF THE LETTER "A" AND ENDING ABOVE THE LETTER "L".

FOR MANUFACTURED, DISPOSABLE TAMPONS (U.S. CLS. 6, 18, 44, 46, 51 AND 52).

FIRST USE 2-28-2002; IN COMMERCE 2-28-2002.

2,748,786. AGRILIANCE, LLC, ARDEN HILLS, MN. SN 78-092,092. PUB. 6-25-2002, FILED 11-7-2001.

AVALANCHE

FOR HERBICIDES, PESTICIDES, INSECTICIDES AND FUNGICIDES FOR AGRICULTURAL USE (U.S. CLS. 6, 18, 44, 46, 51 AND 52).

FIRST USE 4-30-2001; IN COMMERCE 4-30-2001.

2,748,833. HOUSTON TROPICARE, INC., THE WOODLANDS, TX. SN 78-102,521. PUB. 7-30-2002, FILED 1-14-2002.

NO-MO-SKEETO

FOR MOSQUITO AND INSECT KILLER AND REPELLENT (U.S. CLS. 6, 18, 44, 46, 51 AND 52).

FIRST USE 4-17-2003; IN COMMERCE 4-17-2003.

CLASS 5—(Continued).

2,748,844. AMGEN INC., THOUSAND OAKS, CA. SN 78-103,592. PUB. 7-30-2002, FILED 1-18-2002.

NEULASTA

FOR PHARMACEUTICAL PREPARATIONS, NAMELY, PHARMACEUTICALS USED FOR STIMULATING WHITE BLOOD CELL PRODUCTION (U.S. CLS. 6, 18, 44, 46, 51 AND 52).
FIRST USE 4-1-2002; IN COMMERCE 4-1-2002.

2,748,858. DENTSPLY INTERNATIONAL INC., YORK, PA. SN 78-104,850. PUB. 9-17-2002, FILED 1-25-2002.

ALLSOLUTIONS

FOR ORAL CARE PRODUCTS, NAMELY DENTAL RINSE (U.S. CLS. 6, 18, 44, 46, 51 AND 52).
FIRST USE 1-9-2003; IN COMMERCE 1-9-2003.

2,748,875. DENTSPLY INTERNATIONAL INC., YORK, PA. SN 78-107,995. PUB. 9-3-2002, FILED 2-11-2002.

TRIXA

FOR DENTAL COMPOUNDS, NAMELY, DENTAL PUTTY (U.S. CLS. 6, 18, 44, 46, 51 AND 52).
FIRST USE 5-9-2003; IN COMMERCE 5-9-2003.

2,748,876. NEOPHARMICA, INC., PORTOLA HILLS, CA. SN 78-108,015. PUB. 12-3-2002, FILED 2-11-2002.

VITA PHARMICA

FOR DIETARY SUPPLEMENTS (U.S. CLS. 6, 18, 44, 46, 51 AND 52).
FIRST USE 3-21-2002; IN COMMERCE 3-21-2002.

2,748,901. ARKOPHARMA LLC, BEDFORD, MA. SN 78-113,927. PUB. 9-17-2002, FILED 3-11-2002.

LEAN FOR LESS

FOR NUTRITIONAL DIETARY SUPPLEMENT TO ASSIST WITH WEIGHT LOSS (U.S. CLS. 6, 18, 44, 46, 51 AND 52).
FIRST USE 5-1-2002; IN COMMERCE 5-1-2002.

CLASS 5—(Continued).

2,748,912. HELENA CHEMICAL COMPANY, COLLIERVILLE, TN. SN 78-118,865. PUB. 11-26-2002, FILED 4-2-2002.

BAYONET

FOR HERBICIDES FOR AGRICULTURAL, COMMERCIAL AND DOMESTIC USE (U.S. CLS. 6, 18, 44, 46, 51 AND 52).
FIRST USE 11-22-2002; IN COMMERCE 11-22-2002.

2,748,919. GENERAL MARKS, INC., CLEARWATER, FL. SN 78-119,679. PUB. 10-29-2002, FILED 4-4-2002.

REFRESH EXPRESS

FOR DIETARY SUPPLEMENT (U.S. CLS. 6, 18, 44, 46, 51 AND 52).
FIRST USE 10-10-2002; IN COMMERCE 10-10-2002.

2,748,935. HUNTER'S SPECIALTIES, INC., CEDAR RAPIDS, IA. SN 78-123,138. PUB. 10-29-2002, FILED 4-22-2002.

VITA-RACK

FOR ANIMAL FEED ADDITIVE FOR USE AS A NUTRITIONAL SUPPLEMENT (U.S. CLS. 6, 18, 44, 46, 51 AND 52).
FIRST USE 4-11-2003; IN COMMERCE 4-11-2003.

2,748,943. ZYBER PHARMACEUTICALS, INC, GONZALES, LA. SN 78-126,667. PUB. 11-19-2002, FILED 5-6-2002.

ALDEX

FOR ALLERGY AND COLD RELIEF MEDICATION FOR ADULTS AND CHILDREN (U.S. CLS. 6, 18, 44, 46, 51 AND 52).
FIRST USE 6-13-2002; IN COMMERCE 8-13-2002.

2,748,944. JARROW FORMULAS, INC., LOS ANGELES, CA. SN 78-126,861. PUB. 10-29-2002, FILED 5-7-2002.

NEURODEFENSE

FOR DIETARY AND NUTRITIONAL SUPPLEMENTS (U.S. CLS. 6, 18, 44, 46, 51 AND 52).
FIRST USE 5-0-2002; IN COMMERCE 5-0-2002.

CLASS 5—(Continued).

2,748,952. PHARMANEX, LLC, PROVO, UT. SN 78-128,788.
PUB. 11-19-2002, FILED 5-15-2002.

FLEXCREME

FOR TOPICAL ANALGESIC PREPARATION (U.S. CLS. 6, 18, 44, 46, 51 AND 52).
FIRST USE 7-9-2002; IN COMMERCE 7-9-2002.

2,748,963. CHAY MEDICAL, LLC, CALISTOGA, CA. SN 78-132,660. PUB. 12-3-2002, FILED 6-2-2002.

EXCELSIOR

FOR MEDICAL APPARATUS, NAMELY BLOOD GLUCOSE TEST STRIPS (U.S. CLS. 6, 18, 44, 46, 51 AND 52).
FIRST USE 3-15-2003; IN COMMERCE 3-15-2003.

2,748,980. GNLD INTERNATIONAL, LLC, FREMONT, CA. SN 78-137,119. PUB. 12-17-2002, FILED 6-19-2002.

BETA-ZYME

FOR DIETARY AND NUTRITIONAL FOOD SUPPLEMENTS (U.S. CLS. 6, 18, 44, 46, 51 AND 52).
FIRST USE 10-31-2002; IN COMMERCE 10-31-2002.

CLASS 6—METAL GOODS

2,747,507. COLONIAL METAL PRODUCTS, INC., PETERSBURG, VA. SN 75-561,949. PUB. 11-23-1999, FILED 9-23-1998.

GUTTER GENIUS

NO CLAIM IS MADE TO THE EXCLUSIVE RIGHT TO USE "GUTTER", APART FROM THE MARK AS SHOWN.
FOR METAL RAIN GUTTER GUARDS AND METAL RAIN GUTTER GUARD INSTALLATION CLIPS (U.S. CLS. 2, 12, 13, 14, 23, 25 AND 50).
FIRST USE 1-30-2003; IN COMMERCE 1-30-2003.

2,747,583. FORD MOTOR COMPANY, DEARBORN, MI. SN 75-734,364. PUB. 1-4-2000, FILED 6-22-1999.

ESCAPE

FOR METAL GOODS, NAMELY, DECORATIVE BOXES, NON-LUMINOUS AND NON-MECHANICAL SIGNS, KEYS, KEY TABS, BANKS, KEY TAGS, KEY CHAINS, KEY FOBS, KEY RINGS, MONEY CLIPS, LICENSE PLATES, TOOL BOXES, TOOL RACKS AND ORNAMENTAL REPLICAS OF VEHICLES MADE OF PEWTER AND BRONZE (U.S. CLS. 2, 12, 13, 14, 23, 25 AND 50).
FIRST USE 12-31-2001; IN COMMERCE 12-31-2001.

CLASS 6—(Continued).

2,747,617. JENNMAR CORPORATION, PITTSBURGH, PA. SN 75-809,966. PUB. 4-25-2000, FILED 9-28-1999.

CABLEOX

FOR CABLE BOLTS (U.S. CLS. 2, 12, 13, 14, 23, 25 AND 50).
FIRST USE 7-0-2002; IN COMMERCE 7-0-2002.

2,747,653. AFFRUNTI, JOHN, BARTLETT, IL. SN 75-855,693. PUB. 5-15-2001, FILED 11-22-1999.



THE MARK CONSISTS OF THE WORDING "SPINE SAVER" WITH A DEPICTION OF A SPINAL CORD FORMING THE LETTER "S" IN EACH WORD.

FOR PREFABRICATED METAL PLATFORMS FOR USE IN CONJUNCTION WITH ROPES AND CABLES FOR HAULING OBJECTS ONTO ROOFS FROM BELOW (U.S. CLS. 2, 12, 13, 14, 23, 25 AND 50).
FIRST USE 2-4-2003; IN COMMERCE 2-4-2003.

2,747,693. SPECTRAMET, LLC, BEDFORD, MA. SN 75-913,274. PUB. 8-14-2001, FILED 2-8-2000.

SPECTRAMET

FOR METALS, NAMELY, OPTO-ELECTRONICALLY SORTED FERROUS AND NON-FERROUS METALS SOLD AS RAW MATERIAL OR SOLD FOR FURTHER PROCESSING (U.S. CLS. 2, 12, 13, 14, 23, 25 AND 50).
FIRST USE 4-0-1999; IN COMMERCE 12-0-2002.

2,748,214. BROADMARK, INC., THOUSAND OAKS, CA. SN 76-291,240. PUB. 9-17-2002, FILED 7-30-2001.

APPLE HINGE

NO CLAIM IS MADE TO THE EXCLUSIVE RIGHT TO USE "HINGE", APART FROM THE MARK AS SHOWN.
FOR METAL SELF-FASTENING EASEL HINGES FOR PHOTO FRAMES (U.S. CLS. 2, 12, 13, 14, 23, 25 AND 50).
FIRST USE 7-0-2001; IN COMMERCE 5-0-2002.

CLASS 6—(Continued).

2,748,360. BENECOR, INC., WICHITA, KS. SN 76-337,986. PUB. 5-21-2002, FILED 11-14-2001.

BENEFLANGE

FOR LIGHTWEIGHT STRUCTURAL MATERIALS MADE OF METAL OR METAL MATRIX COMPOSITES, NAMELY, PANELS, CORES, AND HONEYCOMBS FOR USE IN FURTHER MANUFACTURE OF CONSTRUCTION (U.S. CLS. 2, 12, 13, 14, 23, 25 AND 50).

FIRST USE 5-29-2001; IN COMMERCE 10-17-2001.

2,748,519. HOWARD, DON, WICHITA FALLS, TX. SN 76-390,800. PUB. 10-15-2002, FILED 4-1-2002.

STEELSAFE

FOR METAL STORM SHELTERS, NAMELY PREFABRICATED MODULAR STORM SHELTERS AND PARTS THEREOF (U.S. CLS. 2, 12, 13, 14, 23, 25 AND 50).

FIRST USE 4-28-2003; IN COMMERCE 4-28-2003.

2,748,851. PROLAMSA, INC., STAFFORD, TX. SN 78-103,865. PUB. 10-1-2002, FILED 1-21-2002.

COLORSHIELD

FOR STEEL TUBES USED MAINLY IN AGRICULTURAL IMPLEMENTS, CONSTRUCTION, TRUCKS AND TRAILERS, LIFTS, RACKS AND HOISTS, INDUSTRIAL EQUIPMENT AND ARCHITECTURAL AND ORNAMENTAL APPLICATIONS (U.S. CLS. 2, 12, 13, 14, 23, 25 AND 50).

FIRST USE 1-4-2002; IN COMMERCE 4-1-2003.

2,748,916. WIREWAY/HUSKY CORP., DENVER, NC. SN 78-119,162. PUB. 10-29-2002, FILED 4-3-2002.

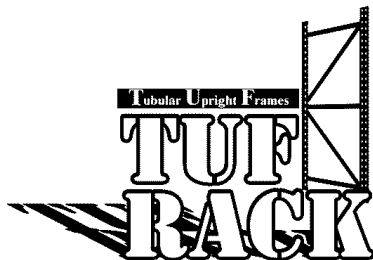

NO CLAIM IS MADE TO THE EXCLUSIVE RIGHT TO USE "TUBULAR UPRIGHT FRAMES" AND "RACK", APART FROM THE MARK AS SHOWN.

FOR METAL STORAGE RACKS FOR USE IN COMMERCIAL, INDUSTRIAL AND INSTITUTIONAL SETTINGS AND NOT FOR USE AS FURNITURE (U.S. CLS. 2, 12, 13, 14, 23, 25 AND 50).

FIRST USE 5-0-2002; IN COMMERCE 5-0-2002.

CLASS 7—MACHINERY

2,747,495. GEORG FISCHER ROHRLEITUNGSSYSTEME AG, CH-8201 SCHAFFHAUSEN, SWITZERLAND. SN 75-534,348. PUB. 6-22-1999, FILED 8-11-1998.

IR-225 PLUS

NO CLAIM IS MADE TO THE EXCLUSIVE RIGHT TO USE "IR-225", APART FROM THE MARK AS SHOWN.

FOR INFRARED ELECTROFUSION WELDING MACHINES FOR FUSION JOINING OF PLASTIC PIPES AND FITTINGS (U.S. CLS. 13, 19, 21, 23, 31, 34 AND 35).

FIRST USE 7-13-1998; IN COMMERCE 7-13-1998.

2,747,650. OTIS ELEVATOR COMPANY, FARMINGTON, CT. SN 75-852,652. PUB. 12-12-2000, FILED 11-18-1999.

FOR ELEVATORS AND REPLACEMENT MECHANICAL PARTS THEREFOR: ELEVATOR SYSTEMS COMPOSED OF ELEVATOR CARS, DOORS, MACHINES, DRIVES, BRAKES, RAILS, BELTS, BUTTONS, INDICATORS, SAFETIES, GOVERNORS AND DOOR OPERATORS (U.S. CLS. 13, 19, 21, 23, 31, 34 AND 35).

FIRST USE 3-20-2000; IN COMMERCE 3-20-2000.

2,747,710. STS BREITSTRECKWALZEN GMBH, RATINGEN, FED REP GERMANY. SN 75-945,080. PUB. 7-30-2002, FILED 2-23-2000.

STS SPREADER ROLLS

NO CLAIM IS MADE TO THE EXCLUSIVE RIGHT TO USE "SPREADER ROLLS", APART FROM THE MARK AS SHOWN.

FOR MACHINE PARTS, NAMELY SPREADER ROLLS FOR SPREADING WEBS PARTICULARLY COMPOSED OF PAPER, SYNTHETIC MATERIAL, TEXTILE OR METAL (U.S. CLS. 13, 19, 21, 23, 31, 34 AND 35).

FIRST USE 0-0-1996; IN COMMERCE 0-0-1999.

2,747,750. MONARCH INDUSTRIES LIMITED, WINNIPEG, MANITOBA, CANADA. SN 76-035,470. PUB. 10-16-2001, FILED 4-26-2000.

WATER HORSE

NO CLAIM IS MADE TO THE EXCLUSIVE RIGHT TO USE "WATER", APART FROM THE MARK AS SHOWN.

FOR WATER PUMPS, NAMELY SUMP PUMPS, WELL PUMPS, SUCTION PUMPS, BILGE PUMPS, CENTRIFUGAL PUMPS, AND ROTARY PUMPS (U.S. CLS. 13, 19, 21, 23, 31, 34 AND 35).

FIRST USE 11-30-2002; IN COMMERCE 11-30-2002.

CLASS 7—(Continued).

2,747,782. AKTIEBOLAGET ELECTROLUX (PUBL.), S-105-45 STOCKHOLM, SWEDEN. SN 76-060,970. PUB. 12-11-2001, FILED 6-1-2000.

ELECTROLUX

OWNER OF U.S. REG. NOS. 195,691, 248,774, AND OTHERS.

FOR DISHWASHING MACHINES (U.S. CLS. 13, 19, 21, 23, 31, 34 AND 35).

FIRST USE 10-17-2002; IN COMMERCE 10-17-2002.

2,747,891. WINKLER + DUNNEBIER AKTIENGESELLSCHAFT, 56562 NEUWIED, FED REP GERMANY. SN 76-142,870. PUB. 6-25-2002, FILED 10-5-2000.

ENVEPAC

FOR MACHINES FOR PACKING OBJECTS INCLUDING STACKED OBJECTS, IN PARTICULAR AUTOMATIC PACKAGING MACHINES; SPARE AND WEARING PARTS FOR THE AFOREMENTIONED MACHINES AND AUTOMATIC MACHINES (U.S. CLS. 13, 19, 21, 23, 31, 34 AND 35).

FIRST USE 12-0-1999; IN COMMERCE 10-0-2000.

2,748,057. PRIMESOURCE BUILDING PRODUCTS, INC., CARROLLTON, TX. SN 76-235,379. PUB. 5-14-2002, FILED 4-3-2001.



OWNER OF U.S. REG. NOS. 907,843, 2,448,100, AND OTHERS.

NO CLAIM IS MADE TO THE EXCLUSIVE RIGHT TO USE "TOOLS", APART FROM THE MARK AS SHOWN.

FOR PNEUMATIC AND ELECTRIC TOOLS FOR BLOWING AIR OR DRIVING NAILS, SCREWS, AND STAPLES (U.S. CLS. 13, 19, 21, 23, 31, 34 AND 35).

FIRST USE 10-29-2001; IN COMMERCE 10-29-2001.

2,748,144. JEFFREY SPECIALTY EQUIPMENT CORPORATION, WOODRUFF, SC. SN 76-265,236. PUB. 7-23-2002, FILED 5-31-2001.

ULTRALLOY

FOR MACHINE PARTS, NAMELY, HAMMERS FOR HAMMER MILLING MACHINES (U.S. CLS. 13, 19, 21, 23, 31, 34 AND 35).

FIRST USE 3-25-2003; IN COMMERCE 3-25-2003.

CLASS 7—(Continued).

2,748,148. JDV CONTROL VALVES CO., LTD., TAIPEI HSIEN, TAIWAN. SN 76-266,530. PUB. 7-2-2002, FILED 6-4-2001.

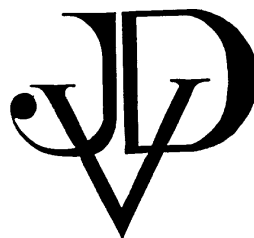

FOR MACHINE PARTS, NAMELY, CONTROL VALVES, SAFETY VALVES, PRESSURE REDUCING VALVES AND BALL VALVES FOR INDUSTRIAL AND RESIDENTIAL MACHINES (U.S. CLS. 13, 19, 21, 23, 31, 34 AND 35).

FIRST USE 3-16-1996; IN COMMERCE 11-30-2001.

2,748,161. MTD PRODUCTS INC, CLEVELAND, OH. SN 76-270,904. PUB. 4-9-2002, FILED 6-13-2001.

YARD RUNNER PLUS

NO CLAIM IS MADE TO THE EXCLUSIVE RIGHT TO USE "YARD" AND "PLUS", APART FROM THE MARK AS SHOWN.

FOR ELECTRIC AND GAS POWERED GARDEN TOOLS WITH MULTIPLE ATTACHMENTS, WHEREIN THE GARDEN TOOLS ARE NAMELY, GRASS TRIMMERS, VACUUMS, BLOWERS, CULTIVATORS, AND FOGGERS (U.S. CLS. 13, 19, 21, 23, 31, 34 AND 35).

FIRST USE 3-31-2002; IN COMMERCE 3-31-2003.

2,748,175. BELL & HOWELL MAIL & MESSAGING TECHNOLOGIES COMPANY, DURHAM, NC. SN 76-276,356. PUB. 11-13-2001, FILED 6-25-2001.

JETSTAR

FOR DOCUMENT SORTING MACHINES (U.S. CLS. 13, 19, 21, 23, 31, 34 AND 35).

FIRST USE 12-23-1988; IN COMMERCE 12-23-1988.

CLASS 7—(Continued).

2,748,196. JOHN CRANE UK LTD, TRAFFORD PARK, UNITED KINGDOM. SN 76-284,023. PUB. 6-18-2002, FILED 7-12-2001.

POWERSTREAM

FOR MACHINE PARTS, NAMELY GEARS, GEAR COUPLINGS AND FLEXIBLE POWER TRANSMISSION APPARATUS; PARTS AND FITTINGS FOR THE AFORESAID GOODS, NAMELY HUBS, HOLDING RINGS AND LOCKING SET SCREWS (U.S. CLS. 13, 19, 21, 23, 31, 34 AND 35).

FIRST USE 6-22-1993; IN COMMERCE 6-22-1993.

2,748,210. ENGINEERED FLUID, INC., CENTRALIA, IL. SN 76-290,187. PUB. 10-1-2002, FILED 7-25-2001.

CYCLE TAMER PLUS

NO CLAIM IS MADE TO THE EXCLUSIVE RIGHT TO USE "CYCLE", APART FROM THE MARK AS SHOWN.

FOR VALVING SYSTEMS FOR SUPPRESSING WATER HAMMER SURGING IN WATER DISTRIBUTION LINES COMPRISED OF HYDRAULIC CONTROL VALVES, PIPING AND PUMP CONTROL VALVES ALL SOLD TOGETHER AS A UNIT (U.S. CLS. 13, 19, 21, 23, 31, 34 AND 35).

FIRST USE 10-8-2001; IN COMMERCE 10-8-2001.

2,748,250. STAR MICRONICS CO., LTD., SHIZUOKA-SHI, SHIZUOKA 422-8654, JAPAN. SN 76-302,111. PUB. 9-10-2002, FILED 8-20-2001.

ECAS

FOR MACHINE TOOLS, NAMELY LATHES (U.S. CLS. 13, 19, 21, 23, 31, 34 AND 35).

FIRST USE 2-22-2002; IN COMMERCE 2-22-2002.

2,748,257. JLG INDUSTRIES, INC., MCCONNELLSBURG, PA. SN 76-305,586. PUB. 10-1-2002, FILED 8-28-2001.

AXXESSOR

FOR ELEVATING WORK PLATFORMS (U.S. CLS. 13, 19, 21, 23, 31, 34 AND 35).

FIRST USE 10-0-2001; IN COMMERCE 10-0-2001.

CLASS 7—(Continued).

2,748,296. PROGRESSIVE TOOL & INDUSTRIES CO., SOUTHFIELD, MI. SN 76-320,008. PUB. 9-17-2002, FILED 10-2-2001.

VERSAROLL

FOR ASSEMBLY LINE SYSTEMS, MACHINES, MACHINE TOOLS AND COMPONENT PARTS THEREFOR USED IN THE FABRICATION, MANUFACTURING AND ASSEMBLY OF AUTOMOBILES, AUTOMOBILE COMPONENTS AND VEHICLE BODIES, NAMELY, ASSEMBLY MACHINES FOR ASSEMBLING PARTS, WELDING MACHINE TOOLS, WORKPIECE CONVEYORS, LARGE WELDING UNITS COMPRISED OF WELDING GUNS, BELT CONVEYORS, INDUSTRIAL ROBOTS, CLAMPING MACHINES, WELDING MACHINES, NAMELY, WELDING RESHOT MACHINES, LASER WELDING MACHINES, ELECTRICAL MONORAIL CONVEYORS, TRANSFER CONVEYORS AND LOWERATORS (U.S. CLS. 13, 19, 21, 23, 31, 34 AND 35).

FIRST USE 6-0-2002; IN COMMERCE 6-0-2002.

2,748,423. ELLIOTT ENERGY SYSTEMS, INC., STUART, FL. SN 76-357,161. PUB. 7-23-2002, FILED 1-10-2002.

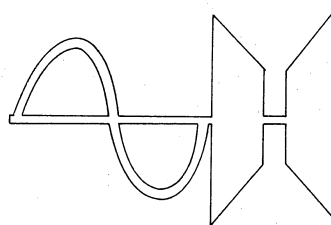

THE MARK CONSISTS OF A SINE WAVE, TWO TRAPEZOIDS AND A LINE THROUGH THE CENTER.

FOR COMPACT, HIGH CAPACITY FUEL COMBUSTION POWERED GENERATORS (U.S. CLS. 13, 19, 21, 23, 31, 34 AND 35).

FIRST USE 12-31-2002; IN COMMERCE 12-31-2002.

2,748,496. HYPRO CORPORATION, NEW BRIGHTON, MN. SN 76-380,825. PUB. 10-1-2002, FILED 3-8-2002.

CLEANLOAD

FOR CHEMICAL EDUCTORS FOR POWER OPERATED SPRAYERS, NAMELY FITTING AND NOZZLE PARTS DESIGNED TO DRAW OUTSIDE AIR INTO A CHEMICAL FLOW PATH TO PRODUCE LARGE, AIR-FILLED CHEMICAL DROPLETS WHICH ARE DELIVERED BY THE SPRAYER (U.S. CLS. 13, 19, 21, 23, 31, 34 AND 35).

FIRST USE 6-14-2002; IN COMMERCE 6-14-2002.

CLASS 7—(Continued).

2,748,542. RICH STAR PRECISION INDUSTRIAL CO., LTD., TAICHUNG, TAIWAN. SN 76-398,729. PUB. 11-26-2002, FILED 4-22-2002.



FOR SPRAYING MACHINES AND SPRAY GUNS FOR USE IN SPRAYING PAINTS; AIR COMPRESSORS FOR USE WITH POWER OPERATED TOOLS, NAMELY DRILL HAMMERS, GRINDERS, BUFFERS; ELECTRICALLY OPERATED HAND TOOLS, NAMELY ELECTRIC HAND-HELD DRILLS; HYDRAULICALLY OPERATED HAND TOOLS, NAMELY HYDRAULIC JACKS, LIFT TABLES, VALVE ACTUATORS; PNEUMATIC AND HYDRAULIC MACHINES FOR SPRAYING PAINT (U.S. CLS. 13, 19, 21, 23, 31, 34 AND 35).
FIRST USE 5-3-2002; IN COMMERCE 5-3-2002.

2,748,628. BARRY GRANT, INC., DAHLONEGIA, GA, BY CHANGE OF NAME GPT 300, INC., DAHLONEGA, GA. SN 78-033,357. PUB. 7-31-2001, FILED 11-1-2000.

KING ENDURO

FOR FUEL PUMPS FOR HIGH PERFORMANCE COMBUSTION ENGINES FOR VEHICLES (U.S. CLS. 13, 19, 21, 23, 31, 34 AND 35).
FIRST USE 10-0-2001; IN COMMERCE 1-0-2003.

2,748,699. SMITH INTERNATIONAL, INC., HOUSTON, TX. SN 78-069,081. PUB. 10-23-2001, FILED 6-14-2001.

RHINO

FOR WELL TOOLS, NAMELY UNDERREAMERS FOR USE IN THE OIL AND GAS INDUSTRY (U.S. CLS. 13, 19, 21, 23, 31, 34 AND 35).
FIRST USE 12-1-2002; IN COMMERCE 12-1-2002.

2,748,755. BAKER HUGHES INCORPORATED, HOUSTON, TX. SN 78-083,919. PUB. 8-20-2002, FILED 9-14-2001.

EXPRESS

FOR DOWNHOLE EQUIPMENT USED IN OIL, GAS, AND WATER WELLS, NAMELY FLUID FLOW REGULATORS, NAMELY SCREENS, FOR USE IN GRAVEL PACKING OPERATIONS DURING THE COMPLETION AND WORKOVER OF SUCH WELLS (U.S. CLS. 13, 19, 21, 23, 31, 34 AND 35).
FIRST USE 1-1-2000; IN COMMERCE 1-1-2000.

CLASS 7—(Continued).

2,748,766. GENERAL ELECTRIC COMPANY, SCHENECTADY, NY. SN 78-085,949. PUB. 2-12-2002, FILED 9-27-2001.

TRITON

FOR DISHWASHERS FOR DOMESTIC USE (U.S. CLS. 13, 19, 21, 23, 31, 34 AND 35).
FIRST USE 7-0-1999; IN COMMERCE 9-0-1999.

2,748,816. 3D SYSTEMS, INC., VALENCIA, CA. SN 78-099,357. PUB. 9-17-2002, FILED 12-20-2001.

OPTOFORM

FOR SYSTEM CONSISTING OF BUILD MATERIAL AND LASER, RECOATING, BUILD PLATFORM AND COMPUTER EQUIPMENT TO LAYER BY LAYER BUILD THREE DIMENSIONAL OBJECTS FROM COMPUTER DESIGN DATA FOR RAPID TOOLING AND DIRECT AND INDIRECT IN-LINE MANUFACTURING PROCESSES USING PASTE-LIKE MATERIAL (U.S. CLS. 13, 19, 21, 23, 31, 34 AND 35).
FIRST USE 12-26-2001; IN COMMERCE 12-26-2001.

2,748,931. PRECITECH, INC., KEENE, NH. SN 78-122,302. PUB. 10-22-2002, FILED 4-17-2002.

NANOTURN

FOR MACHINE TOOLS, NAMELY DIAMOND TURNING MACHINES, LATHES AND CONTOUR GRINDING MACHINES (U.S. CLS. 13, 19, 21, 23, 31, 34 AND 35).
FIRST USE 5-10-2002; IN COMMERCE 5-10-2002.

2,748,960. AEBTEC CORPORATION, HOLLYWOOD, FL. SN 78-131,683. PUB. 12-3-2002, FILED 5-29-2002.

PHANTOM

FOR ELECTRONICALLY CONTROLLED ENGINE EXHAUST MUFFLERS (U.S. CLS. 13, 19, 21, 23, 31, 34 AND 35).
FIRST USE 5-1-2002; IN COMMERCE 9-15-2002.

2,748,976. NILFISK-ADVANCE, INC., PLYMOUTH, MN. SN 78-135,788. PUB. 12-10-2002, FILED 6-14-2002.

RAZOR

FOR COMBINATION FLOOR CLEANING MACHINES, NAMELY, COMBINATION FLOOR SCRUBBERS AND VACUUM CLEANERS (U.S. CLS. 13, 19, 21, 23, 31, 34 AND 35).
FIRST USE 12-31-2002; IN COMMERCE 12-31-2002.

CLASS 8—HAND TOOLS

2,747,471. CTECH AG, LANDQUART, SWITZERLAND. SN 75-455,625. PUB. 12-7-1999, FILED 3-24-1998.

BUSINESS TOOL

OWNER OF U.S. REG. NO. 2,132,054.
NO CLAIM IS MADE TO THE EXCLUSIVE RIGHT TO USE "TOOL", APART FROM THE MARK AS SHOWN.
FOR A MULTIFUNCTIONAL POCKET KNIFE COMPRISING SOME OF THE FOLLOWING IMPLEMENTS—A KNIFE, A CUTTER KNIFE, SCISSORS, A PAPER KNIFE, A HOLE PUNCH, A STAPLER, PLIERS, A RULER, PINCERS, A STAPLE REMOVER, A MAGNIFIER, A SCREWDRIVER, AND A CASE ADAPTED FOR ALL OF THE AFOREMENTIONED (U.S. CLS. 23, 28 AND 44).
FIRST USE 12-20-2002; IN COMMERCE 12-20-2002.

2,747,561. STURM, RUGER & COMPANY, INC., SOUTHPORT, CT. SN 75-696,416. PUB. 1-4-2000, FILED 5-3-1999.

SINGLE SIX

OWNER OF U.S. REG. NO. 658,423.
FOR SPORTING KNIVES (U.S. CLS. 23, 28 AND 44).
FIRST USE 3-3-2003; IN COMMERCE 3-3-2003.

2,747,594. GODINGER SILVER ART CO., LTD., NEW YORK, NY. SN 75-765,695. PUB. 8-29-2000, FILED 8-2-1999.

CATCH OF THE DAY

FOR SILVERPLATE AND/OR STAINLESS FLATWARE, NAMELY, KNIVES, FORKS AND SPOONS, HAND TOOLS, NAMELY, SALAD TONGS (U.S. CLS. 23, 28 AND 44).
FIRST USE 9-30-2000; IN COMMERCE 9-30-2000.

2,747,861. T SQUARED, LLC, ROME, GA. SN 76-120,042. PUB. 5-22-2001, FILED 8-31-2000.



FOR MOVEABLE HANDTOOL FOR SHELVING, AND AS A STEP OR PLATFORM (U.S. CLS. 23, 28 AND 44).
FIRST USE 8-3-2000; IN COMMERCE 8-3-2000.

CLASS 8—(Continued).

2,748,054. FEDERATED DEPARTMENT STORES, INC., CINCINNATI, OH. SN 76-234,138. PUB. 9-3-2002, FILED 3-29-2001.

BUZZWORKS

FOR KITS OF HAND TOOLS AND CUTLERY FOR SPECIFIC PURPOSES ALL SOLD AS A UNIT, NAMELY, HAMMERS, PLIERS, WRENCHES, SCREW DRIVERS, LEVELS, BOX CUTTERS, TAPE MEASURES AND DRIVER BITS ASSEMBLED IN A HOUSEHOLD TOOL KIT; BARBECUE FORKS, SPATULAS, BASTING BRUSHES, SKEWERS, TONGS, AND GRILL CLEANING BRUSHES ASSEMBLED IN A BARBECUE SET; JUMPER CABLES, REFLECTIVE TRIANGLE SIGNS, AIR COMPRESSORS, FLASHLIGHTS, PONCHOS, FIRST AID KIT, FUEL SIPHONS AND HELP SIGN ASSEMBLED IN A ROAD-SIDE EMERGENCY KIT; AND TROWELS, SHOVELS, HAND CULTIVATORS, GARDEN TIES, DIBBLES, GARDEN SHEARS, AND GARDEN SAWS ASSEMBLED IN A GARDEN TOOL KIT (U.S. CLS. 23, 28 AND 44).
FIRST USE 6-1-2001; IN COMMERCE 6-1-2001.

2,748,082. AWI ACQUISITION COMPANY, SYLMAR, CA. SN 76-244,873. PUB. 12-3-2002, FILED 4-23-2001.

XLBLADE

FOR UTILITY KNIVES (U.S. CLS. 23, 28 AND 44).
FIRST USE 8-29-2001; IN COMMERCE 2-8-2002.

2,748,083. AWI ACQUISITION COMPANY, SYLMAR, CA. SN 76-244,874. PUB. 12-3-2002, FILED 4-23-2001.

XLDRIVER

FOR RATCHETING SCREWDRIVERS WITH MULTIPLE BITS (U.S. CLS. 23, 28 AND 44).
FIRST USE 8-29-2001; IN COMMERCE 10-5-2001.

2,748,269. QVC, INC., WEST CHESTER, PA. SN 76-310,367. PUB. 8-20-2002, FILED 9-7-2001.

FINLEY

FOR FLATWARE, NAMELY KNIVES, FORKS AND SPOONS (U.S. CLS. 23, 28 AND 44).
FIRST USE 10-19-2002; IN COMMERCE 10-19-2002.

2,748,488. OZAN, INC., MALIBU, CA. SN 76-379,865. PUB. 10-8-2002, FILED 3-7-2002.

SADDLE MATE

FOR TOOL BELTS AND TOOL HOLDERS (U.S. CLS. 23, 28 AND 44).
FIRST USE 10-15-2002; IN COMMERCE 10-15-2002.

CLASS 8—(Continued).

2,748,522. IMPERIAL SCHRADE CORP., ELLENVILLE, NY. SN 76-391,481. PUB. 10-1-2002, FILED 4-4-2002.



FOR KNIVES, NAMELY, HUNTING KNIVES, BUTCHER KNIVES, FISHING KNIVES, POCKET KNIVES AND SPORT KNIVES; AND MULTI-PURPOSE HAND TOOLS COMPRISED OF A KNIFE, SCISSORS, SAWS, SCREW-DRIVERS AND CAN OPENERS WITH SOME OR ALL OF THE FOLLOWING— PLIERS, CORKSCREW, WHISTLE, CIGARETTE LIGHTER, COMPASS, THERMOMETER, BAROMETER OR CLOCK (U.S. CLS. 23, 28 AND 44).
FIRST USE 7-0-2002; IN COMMERCE 7-0-2002.

2,748,568. HO CHENG GARDEN TOOLS CO., LTD., FU SHING HSIANG, CHANG HUA HSIEN, TAIWAN. SN 76-426,657. PUB. 11-19-2002, FILED 7-1-2002.

Wellkut

FOR FLOWER SCISSORS, TREE SCISSORS, SCISSORS FOR BRANCHES OF PLANTS, SHEATHES FOR KNIVES AND SCISSORS (U.S. CLS. 23, 28 AND 44).
FIRST USE 0-0-2002; IN COMMERCE 0-0-2002.

CLASS 9—ELECTRICAL AND SCIENTIFIC APPARATUS

2,747,463. JUNGLE VISION, FT. WALTON BEACH, FL. SN 75-353,167. PUB. 9-21-1999, FILED 9-8-1997.

DR. JENNY

"DR. JENNY" DOES NOT REPRESENT A LIVING INDIVIDUAL AND IT'S A FICTIONAL NAME.
FOR PRE-RECORDED VIDEOS FEATURING CHILDREN'S PROGRAMS; PRE-RECORDED CD ROMS FEATURING GAMES; AUDIO CASSETTES FEATURING MUSIC FOR CHILDREN (U.S. CLS. 21, 23, 26, 36 AND 38).
FIRST USE 11-25-1998; IN COMMERCE 11-25-1998.

CLASS 9—(Continued).

2,747,465. ROYAL CONSUMER INFORMATION PRODUCTS, INC., BRIDGEWATER, NJ, BY CHANGE OF NAME OLIVETTI OFFICE USA, INC., BRIDGEWATER, NJ. SN 75-358,024. PUB. 4-13-1999, FILED 9-15-1997.

ROYAL

OWNER OF U.S. REG. NOS. 930,005, 1,627,998, AND OTHERS.

FOR LASERS POINTERS, LIGHT POINTERS, WIRED MULTIMEDIA SPEAKERS, WIRELESS MULTIMEDIA SPEAKERS, WIRE HEADPHONES, WIRELESS HEADPHONES, PERSONAL COMPUTERS, NOTEBOOK COMPUTERS, COMPUTER MONITORS, MODEMS, COMPUTER CABLES, PERSONAL DIGITAL ASSISTANTS, TELEVISIONS, TELEVISION CAMERAS, VIDEO CASSETTE RECORDERS, CAMCORDERS, COMPACT DISK PLAYERS, DIGITAL VIDEO DISPLAY PLAYERS, TAPE RECORDERS, PORTABLE DIGITAL MEMO RECORDERS, PORTABLE TAPE PLAYERS, PORTABLE RADIOS, TELEVISION REMOTE CONTROLS, TELEVISION REMOTE CONTROLS INTEGRATED WITH TELEPHONES, TELEPHONE CALLER ID DECODERS, TELEPHONE SPEAKERPHONES, TELEPHONE ANSWERING MACHINES, INTEGRATED TELEPHONES AND TELEPHONE ANSWERING MACHINES, CAR STEREO, CAR STEREO SPEAKERS, CAR STEREO AMPLIFIERS, CAR STEREO HEADPHONES, PORTABLE GLOBAL POSITIONING SATELLITE RECEIVERS, CAR MOUNTED GLOBAL POSITIONING SATELLITE RECEIVERS, CREDIT CARD VERIFIERS, INTEGRATED CREDIT CARD VERIFIERS AND PRINTERS, INTEGRATED CREDIT CARD VERIFIERS AND CASH REGISTERS, CABINETS FOR COMPUTER MEDIA AND DISKETTES (U.S. CLS. 21, 23, 26, 36 AND 38).
FIRST USE 11-27-2000; IN COMMERCE 11-27-2000.

2,747,469. KNOWLES, SHERRY LEIGH, WINTER PARK, FL. SN 75-428,739. PUB. 12-29-1998, FILED 2-4-1998.

STUDY PRO

NO CLAIM IS MADE TO THE EXCLUSIVE RIGHT TO USE "STUDY", APART FROM THE MARK AS SHOWN.

FOR AUDIO TAPES AND COMPACT DISCS FEATURING EDUCATIONAL MATERIAL, NAMELY, INFORMATION USED TO PREPARE FOR NATIONAL PROFESSIONAL SPECIALTY EXAMINATIONS (U.S. CLS. 21, 23, 26, 36 AND 38).
FIRST USE 6-22-2001; IN COMMERCE 6-22-2001.

2,747,474. PRECISE SOFTWARE SOLUTIONS, INC., OR-YEHUDA, ISRAEL. SN 75-464,331. PUB. 7-9-2002, FILED 4-8-1998.

PRECISE/PULSE!

FOR COMPUTER SOFTWARE PROGRAM FOR MONITORING THE OPERATION AND PERFORMANCE OF OTHER COMPUTER SOFTWARE PROGRAMS (U.S. CLS. 21, 23, 26, 36 AND 38).
FIRST USE 4-15-1998; IN COMMERCE 7-28-1998.

CLASS 9—(Continued).

2,747,488. ARCOS, ARMANDO L., ALEXANDRIA, VA. SN 75-519,819. PUB. 6-8-1999, FILED 7-10-1998.

SOCCERLANDIA

FOR RADIOS (U.S. CLS. 21, 23, 26, 36 AND 38).
FIRST USE 8-16-2002; IN COMMERCE 8-16-2002.

2,747,496. CREATIVE TECHNOLOGY LTD., SINGAPORE.
SN 75-536,429. PUB. 7-23-2002, FILED 8-14-1998.

PLAYCENTER

FOR COMPUTER SOFTWARE FOR THE INTEGRATION OF TEXT, AUDIO, GRAPHICS, STILL IMAGES AND MOVING PICTURES INTO A COMPUTER-CONTROLLED AND INTERACTIVE AUDIO-VISUAL DELIVERY FOR USE WITH PERSONAL COMPUTERS FOR LOCAL MULTIMEDIA APPLICATIONS AND MULTIMEDIA APPLICATIONS RENDERED ON-LINE VIA A GLOBAL COMPUTER NETWORK AND MANUALS SOLD AS A UNIT (U.S. CLS. 21, 23, 26, 36 AND 38).
FIRST USE 8-0-1998; IN COMMERCE 8-0-1998.

2,747,498. FARO TECHNOLOGIES, INC., LAKE MARY, FL.
SN 75-537,405. PUB. 7-27-1999, FILED 8-14-1998.

FARO GAGE

FOR PORTABLE ARTICULATED MEASUREMENT ARM CAPABLE OF SCANNING AND MEASURING THREE-DIMENSIONAL SURFACES, EDGES, SPHERES, AND POINTS USED IN THE FIELD OF INDUSTRIAL DESIGN, REVERSE ENGINEERING, PRODUCTION, AND QUALITY CONTROL (U.S. CLS. 21, 23, 26, 36 AND 38).
FIRST USE 9-4-2002; IN COMMERCE 10-10-2002.

2,747,500. PARATEK MICROWAVE, INC., COLUMBIA, MD, BY MERGER PARATEK, INC., ABERDEEN, MD. SN 75-541,030. PUB. 3-21-2000, FILED 8-21-1998.

PARASCAN

FOR DIELECTRIC OXIDE CERAMIC MATERIALS SOLD AS A COMPONENT OF ANTENNAS, RESONATORS, VARISTORS, VARACTORS, TUNABLE FILTERS AND PHASE SHIFTERS (U.S. CLS. 21, 23, 26, 36 AND 38).
FIRST USE 8-15-2002; IN COMMERCE 8-15-2002.

CLASS 9—(Continued).

2,747,505. MEDIA FACTORY, INC., CHUO-KU, TOKYO, JAPAN. SN 75-557,180. PUB. 1-25-2000, FILED 9-21-1998.

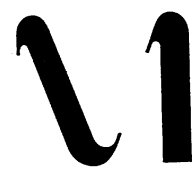
MEDIA

FACTORY

NO CLAIM IS MADE TO THE EXCLUSIVE RIGHT TO USE "MEDIA", APART FROM THE MARK AS SHOWN.
FOR PRERECORDED VIDEO DISKS AND PRERECORDED VIDEO TAPES FEATURING MUSIC, VOICE AND/OR IMAGES (U.S. CLS. 21, 23, 26, 36 AND 38).
FIRST USE 1-22-2002; IN COMMERCE 1-22-2002.

2,747,506. MEDIA FACTORY, INC., CHUO-KU, TOKYO, JAPAN. SN 75-557,191. PUB. 1-4-2000, FILED 9-21-1998.

MEDIA FACTORY

NO CLAIM IS MADE TO THE EXCLUSIVE RIGHT TO USE "MEDIA", APART FROM THE MARK AS SHOWN.
FOR PRERECORDED VIDEO DISKS AND PRERECORDED VIDEO TAPES FEATURING MUSIC, VOICE, AND/OR IMAGES (U.S. CLS. 21, 23, 26, 36 AND 38).
FIRST USE 1-22-2002; IN COMMERCE 1-22-2002.

2,747,511. PIPEBEACH AB, S-113 56 STOCKHOLM, SWEDEN.
SN 75-583,125. PUB. 1-4-2000, FILED 11-5-1998.

SPEECHWEB

FOR COMPUTER SOFTWARE FOR PROVIDING A SPEECH OR AUDIO INTERFACE WITH DIGITAL EQUIPMENT (U.S. CLS. 21, 23, 26, 36 AND 38).
FIRST USE 9-22-1998; IN COMMERCE 10-16-2000.

CLASS 9—(Continued).

2,747,513. SONY KABUSJIKI KAISHA, TA SONY CORPORATION, TOKYO 141, JAPAN. SN 75-594,886. PUB. 1-8-2002, FILED 11-24-1998.



OWNER OF U.S. REG. NOS. 1,841,228, 1,867,544, AND 1,885,838.

NO CLAIM IS MADE TO THE EXCLUSIVE RIGHT TO USE "DIGITAL DATA STORAGE", APART FROM THE MARK AS SHOWN.

FOR COMPUTER PERIPHERALS COMPRISED OF DIGITAL TAPE RECORDERS AND/OR PLAYERS WHICH STORE DATA, BLANK MAGNETIC TAPES FOR STORAGE OF COMPUTER DATA AND/OR SOUND DATA (U.S. CLS. 21, 23, 26, 36 AND 38).

FIRST USE 9-30-1999; IN COMMERCE 9-30-1999.

2,747,517. INTER-IKEA SYSTEMS B.V., 2616 LR DELFT, NETHERLANDS. SN 75-603,402. PUB. 1-18-2000, FILED 12-9-1998.

IKEA

OWNER OF U.S. REG. NOS. 1,118,706, 1,971,513, AND OTHERS.

FOR ARMRESTS FOR USE WITH COMPUTERS; LOUSPEAKER CABINETS; COMPUTER FURNITURE; COMPUTER PERIPHERALS; COMPUTER SOFTWARE FOR USE IN THE OPERATION AND MANAGEMENT OF RETAIL STORES; ELECTRICITY CONDUITS; ELECTRICAL CONNECTORS; ELECTRIC OUTLET COVERS; MAGNETS; MECHANICAL EGG TIMERS; ELECTRIC LIGHT DIMMERS; ELECTRIC LIGHT SWITCHES; SCALES (U.S. CLS. 21, 23, 26, 36 AND 38).

FIRST USE 5-0-1985; IN COMMERCE 5-0-1985.

2,747,522. MINITAB, INC., STATE COLLEGE, PA. SN 75-611,559. PUB. 7-24-2001, FILED 12-21-1998.

MINITAB

OWNER OF U.S. REG. NO. 2,251,375.
FOR CD-ROM, DISKETTES, OR DOWNLOADABLE SOFTWARE FROM A COMPUTER FILE SERVER FEATURING USER MANUALS FOR COMPUTER SOFTWARE IN THE FIELD OF STATISTICS (U.S. CLS. 21, 23, 26, 36 AND 38).

FIRST USE 11-0-1992; IN COMMERCE 11-0-1992.

CLASS 9—(Continued).

2,747,524. KAVLICO CORPORATION, MOORPARK, CA. SN 75-620,165. PUB. 1-4-2000, FILED 1-13-1999.

INCAP

FOR INDUSTRIAL MEASUREMENT INSTRUMENTATION, NAMELY, PRESSURE SENSORS, PRESSURE TRANSDUCERS, AND ELECTROMECHANICAL CONTROLS, NAMELY, ACCELEROMETERS (U.S. CLS. 21, 23, 26, 36 AND 38).

FIRST USE 0-0-1999; IN COMMERCE 0-0-1999.

2,747,536. DIVERSINET CORP., TORONTO, ONTARIO M2J 5C2, CANADA. SN 75-657,404. PUB. 8-20-2002, FILED 3-10-1999.



PRIORITY CLAIMED UNDER SEC. 44(D) ON CANADA APPLICATION NO. 1004720, FILED 2-9-1999.

FOR COMPUTER SOFTWARE FOR AUTHENTICATION AND AUTHORIZATION OF ACCESS CODES AND ACCOUNT INFORMATION FOR SECURING THE PRIVACY OF AND PROVIDING THE AUTHENTICATION OF INDIVIDUALS AND SERVERS USING DIGITAL CERTIFICATES OVER CORPORATE NETWORKS, TELECOMMUNICATIONS SYSTEMS, THE GLOBAL COMPUTER NETWORKS, THE LOCAL COMPUTER NETWORKS AND EXTRANET (U.S. CLS. 21, 23, 26, 36 AND 38).

FIRST USE 12-16-1999; IN COMMERCE 12-16-1999.

2,747,538. JAM TECHNOLOGIES, LLC, BOSTON, MA. SN 75-657,799. PUB. 12-21-1999, FILED 3-16-1999.

TRUE FIDELITY

NO CLAIM IS MADE TO THE EXCLUSIVE RIGHT TO USE "FIDELITY", APART FROM THE MARK AS SHOWN.
FOR DIGITAL AUDIO PROCESSING AMPLIFIERS (U.S. CLS. 21, 23, 26, 36 AND 38).

FIRST USE 3-27-2000; IN COMMERCE 1-31-2003.

CLASS 9—(Continued).

2,747,545. SARA LEE CORPORATION, WINSTON-SALEM, NC. SN 75-664,251. PUB. 5-30-2000, FILED 3-19-1999.



OWNER OF U.S. REG. NOS. 2,017,531, 2,111,307, AND OTHERS.

SEC. 2(F).

FOR MOUSE PADS THAT CAN BE DECORATED AND EMBELLISHED, COMPUTER HARDWARE AND COMPUTER SOFTWARE THAT PERMITS THE USER TO CREATE, DESIGN AND PRINT ARTWORK AND DESIGNS FOR APPLICATION TO APPAREL; COMPUTER SOFTWARE THAT ALLOWS DIRECT COMMUNICATION BETWEEN COMPANY AND CUSTOMER VIA THE GLOBAL COMPUTER NETWORK, ORDER ENTRY, AND INFORMATION RETRIEVAL BY THE CUSTOMER (U.S. CLS. 21, 23, 26, 36 AND 38).

FIRST USE 8-29-2002; IN COMMERCE 8-29-2002.

2,747,547. SUNGARD RECOVERY SERVICES L.P., WAYNE, PA. BY CHANGE OF NAME SUNGARD RECOVERY SERVICES INC., WAYNE, PA. SN 75-667,609. PUB. 8-6-2002, FILED 3-25-1999.

EPLANNER

FOR COMPUTER SOFTWARE WHICH ENABLES A WEB BROWSER TO BE USED AS AN INTERFACE WITH APPLICANT'S COMPUTER DISASTER RECOVERY PLANNING SOFTWARE (U.S. CLS. 21, 23, 26, 36 AND 38).

FIRST USE 9-0-1999; IN COMMERCE 9-0-1999.

2,747,548. MTI TECHNOLOGY CORPORATION, ANAHEIM, CA. SN 75-667,709. PUB. 11-30-1999, FILED 3-25-1999.

DATASENTRY

FOR COMPUTER SOFTWARE PROVIDING CONTINUOUS ACCESS TO DATA IN THE EVENT OF EQUIPMENT FAILURE OR DISASTER (U.S. CLS. 21, 23, 26, 36 AND 38).

FIRST USE 4-1-1992; IN COMMERCE 4-28-1992.

CLASS 9—(Continued).

2,747,549. MANHATTAN WIRELESS LLC, NEW YORK, NY. SN 75-671,128. PUB. 1-16-2001, FILED 3-30-1999.



FOR COMPUTER HARDWARE, ELECTRONIC TEXT AND DATA RECEIVERS, AND SOFTWARE, ALL FOR DELIVERING SECURITY AND OTHER FACILITY-RELATED INFORMATION IN RETAIL AND COMMERCIAL ENVIRONMENT (U.S. CLS. 21, 23, 26, 36 AND 38). FIRST USE 12-0-2002; IN COMMERCE 12-0-2002.

2,747,552. LMLM INC., CRYSTAL BEACH, FL. SN 75-675,547. PUB. 8-27-2002, FILED 4-29-1999.

BABY BUMBLEBEE

FOR AUDIO AND VIDEO MULTIMEDIA WORKS, NAMELY, PRERECORDED VIDEO CASSETTES CONTAINING IMAGES OF OBJECTS IN ASSOCIATION WITH THE LETTERED WORD REPRESENTING THE OBJECT AND THE SPOKEN AUDIO SOUND OF THE WORD, AND PRERECORDED AUDIO CASSETTES CONTAINING THE SPOKEN AUDIO SOUND OF THE WORDS (U.S. CLS. 21, 23, 26, 36 AND 38).

FIRST USE 9-1-1999; IN COMMERCE 9-1-1999.

2,747,563. THINKBOX MEDIA, INC., GLENDALE, CA. SN 75-697,081. PUB. 2-15-2000, FILED 4-30-1999.

KINDLE PARK

FOR PRE-RECORDED COMPACT DISCS FEATURING MUSIC, ACTIVITIES AND STORIES AND MULTI-MEDIA SOFTWARE RECORDED ON CD-ROMS IN THE FIELDS OF ENTERTAINMENT AND EDUCATION; COMPUTER PROGRAMS FOR USE IN THE FIELDS OF READING AND WRITING SKILLS, THINKING AND LEARNING SKILLS, LANGUAGES, ART, MUSIC, SOCIAL STUDIES, MATHEMATICS, SCIENCE AND THE HUMANITIES AND MANUALS SOLD AS A UNIT IN THE FIELDS OF ENTERTAINMENT AND EDUCATION (U.S. CLS. 21, 23, 26, 36 AND 38).

FIRST USE 11-30-1998; IN COMMERCE 9-2-2000.

CLASS 9—(Continued).

2,747,569. ZINC MATRIX POWER, INC., SANTA BARBARA, CA. SN 75-714,027. PUB. 12-28-1999, FILED 5-26-1999.

READY TO SHOOT

FOR CAMERA BATTERIES (U.S. CLS. 21, 23, 26, 36 AND 38).

FIRST USE 1-27-2003; IN COMMERCE 1-27-2003.

CLASS 9—(Continued).

2,747,609. SONY MUSIC ENTERTAINMENT INC., NEW YORK, NY. SN 75-802,110. PUB. 4-25-2000, FILED 9-17-1999.

LIVE BY REQUEST

FOR SERIES OF VIDEO AND SOUND RECORDINGS FEATURING MUSICAL ENTERTAINMENT FROM A TELEVISION SERIES FEATURING THE SAME (U.S. CLS. 21, 23, 26, 36 AND 38).

FIRST USE 12-14-2001; IN COMMERCE 12-14-2001.

2,747,573. QUALCOMM INCORPORATED, SAN DIEGO, CA. SN 75-721,254. PUB. 6-25-2002, FILED 6-4-1999.

MVPC

FOR MOBILE COMPUTER LOCATED ON A VEHICLE, USED IN THE FIELD OF WIRELESS COMMUNICATIONS (U.S. CLS. 21, 23, 26, 36 AND 38).

FIRST USE 12-15-1999; IN COMMERCE 12-15-1999.

2,747,611. POINTCROSS.COM, INC., FOSTER CITY, CA. SN 75-805,136. PUB. 5-1-2001, FILED 10-13-1999.

ORCHESTRA

FOR COMPUTER SOFTWARE FOR PROJECT MANAGEMENT, NAMELY, FOR GENERATING AND ANALYZING PROJECT REQUIREMENTS, DEFINITIONS, PRODUCT SPECIFICATIONS AND PROPOSALS EXCLUSIVE OF SOFTWARE FOR PAYROLL MANAGEMENT (U.S. CLS. 21, 23, 26, 36 AND 38).

FIRST USE 1-20-2000; IN COMMERCE 1-20-2001.

2,747,580. EMWARE, INC., SALT LAKE CITY, UT. SN 75-728,596. PUB. 3-5-2002, FILED 6-15-1999.

E-SMART

FOR FIRMWARE AND/OR COMPUTER SOFTWARE TO CONTROL AND/OR ACQUIRE DATA FOR CONSUMER AND/OR INDUSTRIAL APPLICATIONS FROM ELECTRONIC EQUIPMENT THROUGH LOCAL AND/OR GLOBAL COMPUTER NETWORKS AND INSTRUCTION MANUALS SOLD AS A UNIT THEREWITH EXCLUDING TELECOMMUNICATION AND COMMUNICATION PRODUCTS, EQUIPMENT, SOFTWARE, HARDWARE AND SERVICES THAT PROVIDE FOR OR ASSIST IN CONNECTIONS WITH DIGITAL CIRCUITS OR CONTROL OR MONITOR COMMUNICATION LINES (U.S. CLS. 21, 23, 26, 36 AND 38).

FIRST USE 11-11-1999; IN COMMERCE 11-11-1999.

2,747,613. CHANG, HERLIN, SHEN-KENG, TAIPEI, TAIWAN, CHINA. SN 75-807,428. PUB. 7-23-2002, FILED 9-22-1999.

EPOWER

FOR UNINTERRUPTED POWER SYSTEMS, NAMELY, ELECTRONIC CABLES, ELECTRONIC SWITCHES, VOLTAGE SURGE PROTECTORS, VOLTAGE SURGE SUPPRESSORS, CHARGERS AND CONVERTERS, AND POWER CABLES (U.S. CLS. 21, 23, 26, 36 AND 38).

FIRST USE 5-28-1999; IN COMMERCE 5-28-1999.

2,747,587. INFOGRAMS, INC., NEW YORK, NY, BY MERGER HUMONGOUS ENTERTAINMENT, INC., BOTHEL, WA. SN 75-753,029. PUB. 12-3-2002, FILED 7-15-1999.

BACKYARD FOOTBALL

NO CLAIM IS MADE TO THE EXCLUSIVE RIGHT TO USE "FOOTBALL", APART FROM THE MARK AS SHOWN.

FOR INTERACTIVE MULTIMEDIA SOFTWARE FEATURING FOOTBALL GAMES FOR USE ON PERSONAL COMPUTERS AND ELECTRONIC GAME-PLAYING UNITS (U.S. CLS. 21, 23, 26, 36 AND 38).

FIRST USE 10-1-1999; IN COMMERCE 10-1-1999.

2,747,615. ALARIS MEDICAL SYSTEMS, INC., SAN DIEGO, CA. SN 75-808,629. PUB. 7-3-2001, FILED 9-24-1999.

MEDLEY

FOR MEDICAL COMPUTER PROGRAMS TO CONTROL MEDICAL DEVICES FOR INFUSING MEDICAL FLUID INTO A PATIENT, NAMELY VOLUMETRIC INFUSION PUMPS, SYRINGE PUMPS, PATIENT-CONTROLLED ANALGESIA INSTRUMENTS, AND TO CONTROL PATIENT MONITORING DEVICES, NAMELY BLOOD PRESSURE MONITORS, THERMOMETERS, INVASIVE PRESSURE MONITORS, AND ELECTROCARDIOGRAM MONITORS; AND TO CONTROL MEDICATION MANAGEMENT SYSTEMS, NAMELY BAR CODE SCANNING, AND POINT OF CARE CLOSED LOOP THERAPY INSTRUMENTS (U.S. CLS. 21, 23, 26, 36 AND 38).

FIRST USE 5-18-2001; IN COMMERCE 5-18-2001.

CLASS 9—(Continued).

2,747,616. NIPPON SHEET GLASS CO., LTD., CHUO-KU, OSAKA, JAPAN. SN 75-809,398. PUB. 9-19-2000, FILED 9-27-1999.

SLA

FOR OPTICAL APPARATUS AND INSTRUMENTS, NAMELY, FIBER OPTICS; OPTICAL LENSES; OPTICAL LENS ARRAYS; LASERS NOT FOR MEDICAL PURPOSES; OPTICAL FIBERS, NAMELY, LIGHT CONDUCTING FILAMENTS; MICROSCOPES; OPTICAL CONDENSERS; OPTICAL CONNECTORS; ACTINOMETERS; DIFFRACTION GRATINGS FOR MICROSCOPY; MEASURING GLASSWARE; PHOTOMETERS; FIBER OPTIC CABLE; OPTICAL CHARACTER READERS; GLASS ROD LENSES AND LIGHT GUIDES WITH OR WITHOUT LIGHT FOCUSING CHARACTERISTICS FOR OPTICAL USE (U.S. CLS. 21, 23, 26, 36 AND 38).

FIRST USE 11-1-1976; IN COMMERCE 0-0-1980.

2,747,619. CORBIN RUSSWIN, INC., BERLIN, CT. SN 75-811,219. PUB. 6-6-2000, FILED 9-29-1999.



FOR LOCK, HARDWARE AND SECURITY PRODUCTS BEARING A LIFETIME DURABLE FINISH, NAMELY, COMBINED ELECTRONICALLY CONTROLLED DOOR HOLDER/CLOSER, ELECTROMAGNETIC DOOR RELEASES, ELECTROMAGNETIC LOCKS, ALARMS (NOT FOR VEHICLES), ELECTROMECHANICAL DOOR HOLDER/RELEASES, ELECTROMECHANICAL DOOR HOLDER/CLOSERS, ELECTROMECHANICAL DOOR LATCHES, CARD-OPERATED LOCKS, KEY PADS, KEY PAD-OPERATED LOCKS, SOLENOID-OPERATED LOCKS, ELECTROMECHANICAL EXIT DEVICES, LOCKS OPERATED BY INTERNAL COMPUTER; CODE OR KEYCARD ACTIVATED ELECTRIC OR MAGNETIC LOCKS; INFRA-RED OR MAGNETIC CONTACT DETECTORS, INFRA-RED KEYS, MAGNETIC CARD READERS, ELECTRIC STRIKES, AND PARTS AND FITTINGS FOR ALL THE AFORESAID GOODS (U.S. CLS. 21, 23, 26, 36 AND 38).

FIRST USE 10-31-1999; IN COMMERCE 10-31-1999.

CLASS 9—(Continued).

2,747,621. CORBIN RUSSWIN, INC., BERLIN, CT. SN 75-813,052. PUB. 6-6-2000, FILED 9-29-1999.

INFINI-T

FOR LOCK, HARDWARE AND SECURITY PRODUCTS BEARING A LIFETIME DURABLE FINISH, NAMELY, COMBINED ELECTRONICALLY CONTROLLED DOOR HOLDER/CLOSER, ELECTROMAGNETIC DOOR RELEASES, ELECTROMAGNETIC LOCKS, ALARMS (NOT FOR VEHICLES), ELECTROMECHANICAL DOOR HOLDER/RELEASES, ELECTROMECHANICAL DOOR HOLDER/CLOSERS, ELECTROMECHANICAL DOOR LATCHES, CARD-OPERATED LOCKS, KEY PADS, KEY PAD-OPERATED LOCKS, SOLENOID-OPERATED LOCKS, ELECTROMECHANICAL EXIT DEVICES, LOCKS OPERATED BY INTERNAL COMPUTER; CODE OR KEYCARD ACTIVATED ELECTRIC OR MAGNETIC LOCKS; INFRA-RED OR MAGNETIC CONTACT DETECTORS, INFRA-RED KEYS, MAGNETIC CARD READERS, ELECTRIC STRIKES, AND PARTS AND FITTINGS FOR ALL THE AFORESAID GOODS (U.S. CLS. 21, 23, 26, 36 AND 38).

FIRST USE 10-0-1999; IN COMMERCE 10-0-1999.

2,747,631. SHAKLEE CORPORATION, PLEASANTON, CA. SN 75-827,873. PUB. 7-2-2002, FILED 10-20-1999.

**SHAKLEE.NETWORK
BUILDER**

OWNER OF U.S. REG. NOS. 1,010,096, 2,181,796, AND OTHERS.

FOR COMPUTER SOFTWARE FOR THE BENEFIT OF AND FOR COMMUNICATION AMONG INDEPENDENT DISTRIBUTORS OF APPLICANT'S PRODUCTS, NAMELY, COMPUTER SOFTWARE FOR VIEWING SALES AND BONUS DATA ABOUT INDEPENDENT DOWNLINE DISTRIBUTORS, WORD PROCESSING, PERSONAL SCHEDULING, CREATING OF REPORTS, E-MAIL TECHNICAL SUPPORT, CATALOG VIEWING, E-MAIL, MAIL AND FACSIMILE CAPABILITIES FOR USE BY INDEPENDENT MULTI-LEVEL MARKETING DISTRIBUTORS IN THE FIELDS OF DIETARY AND NUTRITIONAL SUPPLEMENTS, HOUSEHOLD CLEANERS AND LAUNDRY PRODUCTS, PERSONAL CARE PRODUCTS, NAMELY, SKIN CARE, BEAUTY CARE AND HAIR CARE PREPARATIONS AND COSMETICS, WATER PURIFICATION UNITS FOR DOMESTIC USE, AIR FILTRATION UNITS FOR DOMESTIC USE AND OTHER HOUSEHOLD PRODUCTS (U.S. CLS. 21, 23, 26, 36 AND 38).

FIRST USE 2-1-2000; IN COMMERCE 2-1-2000.

CLASS 9—(Continued).

2,747,645. LANGUAGE LINE, LLC, MONTEREY, CA. SN 75-841,418. PUB. 4-23-2002, FILED 11-5-1999.



THE DRAWING OF THE MARKS REPRESENTS TWO STYLIZED PEOPLE DYNAMICALLY INTERACTING, DRAWN ENTIRELY IN RED.

FOR TELEPHONE APPARATUS, NAMELY TELEPHONE HEADSET, TELEPHONE CORD AND TELEPHONE HANDSET ADAPTER (U.S. CLS. 21, 23, 26, 36 AND 38).

FIRST USE 11-1-2000; IN COMMERCE 11-1-2000.

2,747,651. DEISSGROUP, ST. HELENA, CA. SN 75-854,743. PUB. 4-30-2002, FILED 11-22-1999.

EBOS

FOR BUSINESS MANAGEMENT SOFTWARE, NAMELY, KNOWLEDGE MANAGEMENT SOFTWARE ACCESSIBLE VIA A GLOBAL NETWORK ENABLING USERS TO IDENTIFY BUSINESS PERFORMANCE PROBLEMS AND SOLUTIONS TO THE PROBLEMS USING PROPRIETARY DIAGNOSTIC ENGINES, AND TO IMPLEMENT SOLUTIONS TO THE PROBLEMS (U.S. CLS. 21, 23, 26, 36 AND 38).

FIRST USE 1-0-2000; IN COMMERCE 1-0-2000.

2,747,654. KUCERA, JOHN THOMAS, PALO ALTO, CA. SN 75-860,331. PUB. 7-25-2000, FILED 12-14-1999.

ASPERON

FOR COMPUTER PROGRAMS FOR USE IN DEVELOPING OTHER COMPUTER PROGRAMS; COMPUTER SOFTWARE THAT ENABLES THE EXECUTION OF OTHER COMPUTER PROGRAMS OVER A LOCAL OR GLOBAL COMPUTER NETWORK (U.S. CLS. 21, 23, 26, 36 AND 38).

FIRST USE 3-2-2001; IN COMMERCE 1-8-2003.

CLASS 9—(Continued).

2,747,664. BURR, EVAN, BROOKLYN, NY. SN 75-870,403. PUB. 1-16-2001, FILED 12-24-1999.

LOUDMOUTH RECORDS

NO CLAIM IS MADE TO THE EXCLUSIVE RIGHT TO USE "RECORDS", APART FROM THE MARK AS SHOWN. FOR PRE-RECORDED PHONOGRAPH RECORDS, AUDIO CASSETTE TAPES, COMPACT DISCS, AND DIGITAL VIDEO DISCS FEATURING MUSIC AND PRERECORDED VIDEO TAPES FEATURING RECORDED PERFORMANCES OF A MUSICAL GROUP AND/OR ARTIST (U.S. CLS. 21, 23, 26, 36 AND 38). FIRST USE 7-14-1997; IN COMMERCE 9-21-1997.

2,747,680. KYOCERA CORPORATION, FUSHIMI-KU, KYOTO, 612-8501, JAPAN. SN 75-891,753. PUB. 12-25-2001, FILED 1-7-2000.

BTF

FOR HOUSING FOR ELECTRONIC COMPONENTS, NAMELY PACKAGES WITH OPTICAL FIBER CONNECTIONS FOR HOUSING SEMICONDUCTOR DEVICES, PHOTOSEMICONDUCTOR DEVICES OR OPTOELECTRONIC DEVICES (U.S. CLS. 21, 23, 26, 36 AND 38).

FIRST USE 1-21-2003; IN COMMERCE 1-21-2003.

2,747,681. KONINKLIJKE PHILIPS ELECTRONICS N.V., EINDHOVEN, NETHERLANDS. SN 75-895,647. PUB. 11-27-2001, FILED 1-12-2000.

EXPANIUM

PRIORITY CLAIMED UNDER SEC. 44(D) ON BENELUX APPLICATION NO. 0949944, FILED 11-10-1999, REG. NO. 0662754, DATED 11-10-1999, EXPIRES 11-10-2009.

FOR APPARATUS FOR RECORDING, REPRODUCING AND AMPLIFYING SOUND, NAMELY PORTABLE CD PLAYERS (U.S. CLS. 21, 23, 26, 36 AND 38).

FIRST USE 8-0-2000; IN COMMERCE 8-0-2000.

CLASS 9—(Continued).

2,747,682. EKLUND, G.W., BELLEVUE, WA. SN 75-896,165. PUB. 11-7-2000, FILED 1-13-2000.



THE DESIGN PORTION OF THE MARK INCLUDES A REPRESENTATION OF A SPLIT CD FORMING THE LETTERS "CD".

FOR COMPUTER SOFTWARE FOR USE IN THE FIELDS OF MEDICINE, MEDICAL EDUCATION, MEDICAL TEACHING, AND MEDICAL EDUCATIONAL PRESENTATIONS, AND FOR USE IN GENERAL EDUCATION AND DISTRIBUTION OF INFORMATION RELATED TO MEDICINE, MEDICAL EDUCATION, MEDICAL TEACHING AND MEDICAL PRESENTATIONS (U.S. CLS. 21, 23, 26, 36 AND 38).

FIRST USE 10-2-2002; IN COMMERCE 12-30-2002.

2,747,695. LISTENPOINT, INC., SAN RAMON, CA. SN 75-923,766. PUB. 12-5-2000, FILED 2-17-2000.

LISTENPOINT

FOR COMPUTER SOFTWARE FOR SOLICITING, COLLECTING, STORING AND REPORTING ON CUSTOMER FEEDBACK (U.S. CLS. 21, 23, 26, 36 AND 38).

FIRST USE 3-0-2001; IN COMMERCE 3-0-2001.

2,747,696. IPICOM, INC., CARLSBAD, CA. SN 75-925,600. PUB. 7-16-2002, FILED 2-16-2000.

IPICOM

FOR FIBER OPTIC DATA LINKS COMPRISING TRANSMITTERS, RECEIVERS, MULTIPLEXERS, DEMULTIPLEXERS AND ELECTRICAL INTERFACES FOR USE IN CONNECTING COMPUTERS FOR TRANSMITTING AND RECEIVING DATA; TRANSMISSION APPARATUS, NAMELY, OPTICAL TRANSMITTERS AND OPTICAL RECEIVERS; FIBER OPTIC COUPLERS; FIBER MANAGEMENT SYSTEMS CONSISTING OF COMPUTER HARDWARE AND SOFTWARE FOR MONITORING AND CONTROLLING DATA LINK PERFORMANCE (U.S. CLS. 21, 23, 26, 36 AND 38).

FIRST USE 9-0-2001; IN COMMERCE 9-18-2002.

CLASS 9—(Continued).

2,747,697. ELECTRONIC DATA SYSTEMS CORPORATION, PLANO, TX. SN 75-926,427. PUB. 7-10-2001, FILED 2-23-2000.



FOR DATA PROCESSING APPARATUS, NAMELY, DATA PROCESSORS; LOCAL AREA NETWORK AND WIDE AREA NETWORK COMPUTER HARDWARE AND SOFTWARE; COMPUTERS; COMPUTER NETWORKS CONSISTING OF HARDWARE AND SOFTWARE; SATELLITES; COMPUTER SOFTWARE FOR USE IN DATABASE MANAGEMENT FOR OTHERS, FOR USE AS A SPREADSHEET, FOR WORD PROCESSING, FOR MANAGEMENT OF COMPUTERS AND COMPUTER NETWORKS FOR OTHERS, TO ALLOW USERS TO PERFORM ELECTRONIC BUSINESS TRANSACTIONS VIA A GLOBAL COMPUTER NETWORK VIA A GLOBAL COMPUTER NETWORK, FOR DATA PROCESSING, FOR ELECTRONIC TRANSMISSION AND RECEPTION OF MAIL DOCUMENTS, NEWS, VIDEO, VOICE, AUDIO, FACSIMILE AND OTHER DATA, DOCUMENTS AND INFORMATION VIA COMPUTER, FOR ELECTRONIC DATA INTERCHANGE NETWORK SERVICES, ANALYZES DATA, FOR CREATING REPORTS, FOR CREATING WEB PAGES AND MANAGING WEB PAGES FOR OTHERS, AND FOR USE IN MANAGING AND SUPPORTING INFORMATION TECHNOLOGY FOR OTHERS (U.S. CLS. 21, 23, 26, 36 AND 38).

FIRST USE 1-1-2002; IN COMMERCE 1-1-2002.

2,747,705. CIENA CORPORATION, FREMONT, CA. BY ASSIGNMENT CYRAS SYSTEMS, INC., FREMONT, CA. SN 75-935,920. PUB. 12-11-2001, FILED 3-4-2000.

K2

FOR COMMUNICATIONS AND NETWORKING EQUIPMENT, NAMELY, TRANSMISSION AND SWITCHING EQUIPMENT, NAMELY, CROSS-CONNECT DEVICES, APPLICATION SPECIFIC INTEGRATED CIRCUITS, CHASSIS, BACKPLANES, INTERCHANGEABLE LINE AND TRUNK CARDS, DATA SWITCHES, MULTIPLEXERS, CIRCUITS, ROUTERS, AND HIGH SPEED ADD/DROP MULTIPLEXERS; COMPUTER SOFTWARE FOR USE BY TELECOMMUNICATIONS SERVICE PROVIDERS FOR TRANSMITTING, MANAGING AND OPTIMIZING VOICE, DATA, IMAGES AND INFORMATION OVER FIBER OPTIC CABLES IN THE FIELD OF TELECOMMUNICATIONS (U.S. CLS. 21, 23, 26, 36 AND 38).

FIRST USE 12-31-1999; IN COMMERCE 12-31-1999.

CLASS 9—(Continued).

2,747,707. INTERACTIVE VIDEO TECHNOLOGIES, INC., NEW YORK, NY, BY ASSIGNMENT DIGITAL LAVA, INC., MARINA DEL REY, CA. SN 75-936,607. PUB. 6-25-2002, FILED 3-6-2000.

HOTFOOT HOST

NO CLAIM IS MADE TO THE EXCLUSIVE RIGHT TO USE "HOST", APART FROM THE MARK AS SHOWN.

FOR COMPUTER SOFTWARE, NAMELY, SOFTWARE FOR USE IN VIDEO PUBLISHING, RICH MIXED MEDIA SOFTWARE AND STREAMING MEDIA DESKTOP APPLICATIONS, WHICH FUSES AUDIO AND VIDEO WITH DIGITALLY FORMATTED FILES INCLUDING, FOR EXAMPLE DOCUMENTS, SLIDES, IMAGES, TRANSCRIPTS, ANIMATIONS AND WEB PAGES (U.S. CLS. 21, 23, 26, 36 AND 38).

FIRST USE 9-22-2000; IN COMMERCE 9-22-2000.

2,747,712. SANTOON PRODUCTIONS INC., TARZANA, CA. SN 75-980,948. PUB. 8-6-2002, FILED 1-24-2000.



San King, Jr.

FOR MOTION PICTURE AND TELEVISION FILMS FEATURING ACTION, ADVENTURE, ANIMATION, COMEDY, DRAMA, OR MUSIC; PRERECORDED GOODS, NAMELY PRERECORDED RECORDS AND PRERECORDED AUDIO AND AUDIO-VIDEO TAPES, CASSETTES, DISCS FEATURING ACTION, ADVENTURE, ANIMATION, COMEDY, DRAMA, OR MUSIC; FILM CLIPS FEATURING ACTION, ADVENTURE, ANIMATION, COMEDY, DRAMA, OR MUSIC WITH CASSETTES USED WITH HAND-HELD VIEWERS OR PROJECTORS; AUDIO AND VIDEO CASSETTE PLAYERS AND RECORDERS (U.S. CLS. 21, 23, 26, 36 AND 38).

FIRST USE 1-1-2000; IN COMMERCE 1-1-2002.

CLASS 9—(Continued).

2,747,719. PHOTO RESEARCH, INC., CHATSWORTH, CA. SN 76-002,021. PUB. 6-11-2002, FILED 3-16-2000.

PHOTOWIN

OWNER OF U.S. REG. NOS. 2,219,258 AND 2,247,912.
FOR COMPUTER SOFTWARE FOR CONTROLLING AND COLLECTING, PROCESSING AND ANALYZING DATA FROM PHOTOMETERS, SPECTROPHOTOMETERS AND COLORIMETERS REGARDING AIRCRAFT INSTRUMENT DISPLAY PANELS; COMPUTER SOFTWARE FOR QUANTIFYING PHYSICAL CHARACTERISTICS, LUMINANCE, COLOR INFORMATION AND IMAGE QUALITY OF INFORMATION DISPLAYS, SPECIFICALLY, AIRCRAFT INSTRUMENT DISPLAY PANELS (U.S. CLS. 21, 23, 26, 36 AND 38).

FIRST USE 11-0-2002; IN COMMERCE 11-0-2002.

2,747,723. SUPERIOR COMMUNICATIONS PRODUCTS, INC., COVINA, CA. SN 76-004,961. PUB. 4-17-2001, FILED 3-20-2000.

DOCK 'N' TALK

FOR COMMUNICATIONS APPARATUS, NAMELY DIGITAL SPEAKER PHONE, VEHICLE BATTERY RAPID CHARGER, GENERAL BATTERY CHARGERS, HANDS-FREE KITS COMPRISED OF A SPEAKER, MICROPHONE, CRADLE DATA PORT, RADIO FREQUENCY (RF) PORT, HEADSET PORT AND ANTENNA (U.S. CLS. 21, 23, 26, 36 AND 38).

FIRST USE 9-1-1997; IN COMMERCE 9-1-1997.

2,747,731. IVL TECHNOLOGIES, LTD., VICTORIA, BRITISH COLUMBIA V8M 1Z6, CANADA. SN 76-016,832. PUB. 12-4-2001, FILED 4-4-2000.

HELICON

FOR ELECTRONIC AUDIO EQUIPMENT AND AUDIO EFFECTS PROCESSORS IN STANDALONE HARDWARE PRODUCTS, WHICH DO NOT REQUIRE COMPUTERS FOR THEM TO FUNCTION, AND SOFTWARE PROGRAMS, WHICH ARE USED EXCLUSIVELY ON AUDIO-CONFIGURED COMPUTER WORKSTATIONS, FOR USE WITH SOUND AMPLIFIERS AND SOUND RECORDING DEVICES FOR THE MODIFICATION, ENHANCEMENT OR TRANSFORMATION OF THE HUMAN VOICE IN ELECTRONIC AUDIO FORM, NAMELY, PITCH SHIFTING DEVICES, PITCH CORRECTORS, PITCH PROCESSORS, VOCAL FORMANTS, VOCAL RESYNTHESIZERS, LEAD-VOICE PROCESSORS, HARMONY PROCESSORS, FILTERS, COMPRESSOR/LIMITERS, AND MULTI-EFFECTS UNITS; AND INTEGRATED CIRCUIT BOARDS, CHIPS AND PARTS THEREFORE (U.S. CLS. 21, 23, 26, 36 AND 38).

FIRST USE 11-15-2000; IN COMMERCE 11-15-2000.

CLASS 9—(Continued).

2,747,733. HUMAN LIFE INTERNATIONAL, INC., FRONT ROYAL, VA. SN 76-019,296. PUB. 12-26-2000, FILED 4-7-2000.

HLI

FOR PRE-RECORDED AUDIO CASSETTES, PRE-RECORDED VIDEO CASSETTES, MULTIMEDIA CD-ROMS FEATURING EDUCATION, SPIRITUALITY, CATHOLIC CHURCH TEACHINGS, ALL IN THE FIELDS OF RELIGIOUS, SPIRITUAL, SOCIAL AND ETHICAL ISSUES (U.S. CLS. 21, 23, 26, 36 AND 38).

FIRST USE 12-0-1981; IN COMMERCE 0-0-1983.

2,747,746. VITALWORKS INC., RIDGEFIELD, CT, BY CHANGE OF NAME INFOCURE CORPORATION, ATLANTA, GA. SN 76-032,063. PUB. 7-31-2001, FILED 4-21-2000.



OWNER OF U.S. REG. NO. 2,132,665.
FOR COMPUTER SOFTWARE FOR MEDICAL PRACTICE MANAGEMENT (U.S. CLS. 21, 23, 26, 36 AND 38).
FIRST USE 6-0-2000; IN COMMERCE 6-0-2000.

2,747,758. PARICON TECHNOLOGIES CORPORATION, FALL RIVER, MA. SN 76-043,955. PUB. 1-23-2001, FILED 4-19-2000.

GIGAPOSER

FOR SOCKETS FOR ELECTRICAL CONNECTION OF TWO PARTS; SOCKETS FOR ELECTRICALLY INTERCONNECTING INTEGRATED CIRCUITS TO PRINTED CIRCUIT BOARDS (U.S. CLS. 21, 23, 26, 36 AND 38).

FIRST USE 4-11-2003; IN COMMERCE 4-11-2003.

2,747,759. AXIOHM TRANSACTION SOLUTIONS, INC., ITHACA, NY. SN 76-045,086. PUB. 9-25-2001, FILED 5-11-2000.

COLOR-POS

NO CLAIM IS MADE TO THE EXCLUSIVE RIGHT TO USE "COLOR", APART FROM THE MARK AS SHOWN.

FOR COMPUTER SOFTWARE AND COMPUTER FIRMWARE USED TO APPLY OPERATING INSTRUCTIONS AND OPERATIONAL COMMANDS TO A TWO-COLOR THERMAL PRINTING APPARATUS USED IN MONOCHROME THERMAL INTERFACES, TWO-COLOR IMPACT EMULATIONS, TWO-COLOR THERMAL PRINTING APPLICATIONS AND TWO-COLOR IMAGE PROCESSING (U.S. CLS. 21, 23, 26, 36 AND 38).

FIRST USE 6-25-2001; IN COMMERCE 6-25-2001.

CLASS 9—(Continued).

2,747,783. INNOVATIVE IT SOLUTIONS, INC., OKEMOS, MI. SN 76-061,254. PUB. 10-9-2001, FILED 6-1-2000.

SIRCON.DB

OWNER OF U.S. REG. NO. 2,397,588.

FOR DATABASE SOFTWARE IN THE FIELD OF INSURANCE REGULATORY COMPLIANCE MONITORING, FOR APPLICATION PROCESSING, INVESTIGATIONS, INSURANCE CODE ENFORCEMENT, REGULATORY EXAMINATIONS, RATE AND FORM FILINGS TRACKING AND REVENUE MANAGEMENT; DATABASE SOFTWARE IN THE FIELD OF INSURANCE REGULATORY COMPLIANCE MONITORING FOR APPLICATION PROCESSING, INVESTIGATIONS, INSURANCE COMPLIANCE MONITORING FOR APPLICATION PROCESSING, INVESTIGATIONS, INSURANCE CODE ENFORCEMENT, REGULATORY EXAMINATIONS, RATE AND FORM FILINGS TRACKING AND REVENUE MANAGEMENT THAT MAY BE DOWNLOADED FROM THE INTERNET (U.S. CLS. 21, 23, 26, 36 AND 38).

FIRST USE 10-0-2000; IN COMMERCE 9-0-2001.

2,747,785. AXERRA NETWORKS, INC., BOCA-RATON, FL. SN 76-062,158. PUB. 7-23-2002, FILED 6-2-2000.

CESoIP

FOR COMPUTER SOFTWARE FOR ENABLING LOCAL TELEPHONE AND DATA COMMUNICATIONS CARRIER SERVICE PROVIDERS TO OFFER MULTIPLE SERVICES, NAMELY LEASED LINE, FRAME RELAY, CIRCUIT SWITCHED VOICE, ATM (ASYNCHRONOUS TRANSFER MODE), AND INTERNET ACCESS, ALL OVER A UNIFIED IP-BASED NETWORK; COMPUTER HARDWARE (U.S. CLS. 21, 23, 26, 36 AND 38).

FIRST USE 12-31-2002; IN COMMERCE 12-31-2002.

CLASS 9—(Continued).

2,747,789. NOVALUX, INC., SUNNYVALE, CA. SN 76-066,353.
PUB. 1-22-2002, FILED 6-8-2000.



FOR LASER SYSTEMS, NAMELY SEMICONDUCTOR LASERS, SEMICONDUCTOR PUMP MODULES, OPTICAL AMPLIFIER PUMP MODULES, RAMAN AMPLIFIERS, SINGLE-MODE LASERS, SURFACE-EMITTING LASERS, SEMICONDUCTOR LASER PUMP SOURCES, AND OPTICAL COMPONENTS FOR USE WITH LASERS FOR COMMUNICATIONS, INDUSTRIAL, SCIENTIFIC, AND PROJECTION DISPLAY USES; FIBER OPTIC TELECOMMUNICATIONS DEVICES, NAMELY SEMICONDUCTOR LASERS, SURFACE-EMITTING LASERS, FIBER OPTICAL AMPLIFIERS, AND OPTICAL COMPONENTS FOR USE IN THE FIBER OPTIC TELECOMMUNICATIONS DEVICES, NAMELY, LASERS AND COMPONENTS FOR MODULATORS, TRANSMITTERS, AND SWITCHES FOR THE TELECOMMUNICATIONS INDUSTRY (U.S. CLS. 21, 23, 26, 36 AND 38).
FIRST USE 10-11-2002; IN COMMERCE 10-11-2002.

2,747,791. NOVALUX, INC., SUNNYVALE, CA. SN 76-067,172.
PUB. 1-22-2002, FILED 6-8-2000.

NOVALUX

FOR LASER SYSTEMS, NAMELY SEMICONDUCTOR LASERS, SEMICONDUCTOR PUMP MODULES, OPTICAL AMPLIFIER PUMP MODULES, RAMAN AMPLIFIERS, SINGLE-MODE LASERS, SURFACE-EMITTING LASERS, SEMICONDUCTOR LASER PUMP SOURCES, AND OPTICAL COMPONENTS FOR USE WITH LASERS FOR COMMUNICATIONS, INDUSTRIAL, SCIENTIFIC, AND PROJECTION DISPLAY USES; FIBER OPTIC TELECOMMUNICATIONS DEVICES, NAMELY SEMICONDUCTOR LASERS, SURFACE-EMITTING LASERS, FIBER OPTICAL AMPLIFIERS, AND OPTICAL COMPONENTS FOR USE IN THE FIBER OPTIC TELECOMMUNICATIONS DEVICES, NAMELY, LASERS AND COMPONENTS FOR MODULATORS, TRANSMITTERS, AND SWITCHES FOR THE TELECOMMUNICATIONS INDUSTRY (U.S. CLS. 21, 23, 26, 36 AND 38).
FIRST USE 10-11-2002; IN COMMERCE 10-11-2002.

2,747,793. CALABRO, JOHN L., BUFFALO, NY. SN 76-070,875. PUB. 3-6-2001, FILED 6-15-2000.

BINGO ARENA

NO CLAIM IS MADE TO THE EXCLUSIVE RIGHT TO USE "BINGO", APART FROM THE MARK AS SHOWN.
FOR VENDING MACHINES (U.S. CLS. 21, 23, 26, 36 AND 38).
FIRST USE 9-19-2000; IN COMMERCE 9-19-2000.

CLASS 9—(Continued).

2,747,800. ALPINE ELECTRONICS, INC., TOKYO 141-8501, JAPAN. SN 76-074,498. PUB. 4-23-2002, FILED 6-21-2000.

ALPINE#1STATUS

OWNER OF U.S. REG. NOS. 1,158,867, 1,667,505, AND OTHERS.

FOR AUDIO TAPE PLAYERS AND RECORDERS; DIGITAL AUDIO TAPE PLAYERS; VIDEO CASSETTE PLAYERS AND RECORDERS; COMPACT DISC PLAYERS AND RECORDERS; VIDEO DISC PLAYERS AND RECORDERS; MINI DISC PLAYERS AND RECORDERS; COMPACT DISC CHANGERS; MINI DISC CHANGERS; TELEVISION MONITORS, VIDEO MONITORS FOR AUTOMOBILE NAVIGATION SYSTEMS; RADIO RECEIVERS; AMPLIFIERS; EQUALIZERS; ELECTRONICS SIGNAL PROCESSORS, NAMELY, SOUND PROCESSORS, SURROUND-SOUND PROCESSORS, CHANNEL DIVIDERS, DIGITAL/ANALOG CONVERTERS AND FREQUENCY PROCESSORS FOR AUDIO AND VISUAL APPARATUS; AUDIO SPEAKERS; TELEVISION RECEIVERS; TELEPHONE ANTENNAS; CD-ROM DISC CONTAINING MAP INFORMATION FOR VEHICLE NAVIGATION SYSTEMS; DVD-ROM DISC CONTAINING MAP INFORMATION FOR VEHICLE NAVIGATION SYSTEMS; MEMORY CARDS CONTAINING COMPUTER PROGRAMS FOR MAP DATA; BLANK MEMORY CARDS; HARDWARE FOR MOUNTING AUDIO AND VIDEO EQUIPMENT IN VEHICLES SOLD AS A UNIT WITH THE AFOREMENTIONED AUDIO AND VIDEO EQUIPMENT FOR VEHICLES; REMOTE CONTROLS FOR CAR AUDIO APPARATUS OR NAVIGATION APPARATUS OR TELEVISION APPARATUS; ELECTRICAL EXTENSION CABLES; ELECTRICAL COMMUNICATION CABLES; NAVIGATION APPARATUS FOR DETERMINING OR SIGNALING THE AUTO LOCATION, THE LOCATION OF SITES, AND TRAVEL ROUTES, TIME, AND TRAFFIC CONDITIONS; MAGAZINES FOR HOLDING MULTIPLES DISCS FOR USE WITH COMPACT DISC CHANGERS OR MINI DISC CHANGERS; ELECTRICAL INTERCONNECTORS; BATTERIES AND BATTERY CHARGERS (U.S. CLS. 21, 23, 26, 36 AND 38).
FIRST USE 10-0-2001; IN COMMERCE 10-0-2001.

2,747,801. TELE-IP LIMITED, VICTORIA, 3149, AUSTRALIA.
SN 76-074,882. PUB. 2-19-2002, FILED 6-21-2000.

TELE-IP

FOR DIAGNOSTIC INSTRUMENTS AND ASSOCIATED APPARATUS FOR USE IN TELECOMMUNICATIONS SYSTEMS, NAMELY DIGITAL RADIO ANALYZERS USED TO ANALYZE RADIO AND MICROWAVE LINKS, TRANSMITTERS, MODULATORS, TRANSMISSION PATHS, RECEIVERS AND DEMODULATORS; NETWORK MANAGEMENT SYSTEMS AND APPARATUS, NAMELY, REMOTE MONITORS USED TO MANAGE DIGITAL NETWORKS AND DIGITAL RADIO AND MICROWAVE LINKS, AND EQUIPMENT TO RECORD AND TIME ALARMS AND EVENTS IN DIGITAL NETWORKS AS WELL AS TO PERFORM TIME-BASED ANALYSIS OF RECORDED ALARMS AND EVENTS (U.S. CLS. 21, 23, 26, 36 AND 38).
FIRST USE 4-0-2000; IN COMMERCE 9-0-2001.

CLASS 9—(Continued).

2,747,804. MICROSOFT CORPORATION, REDMOND, WA. SN 76-076,573. PUB. 7-2-2002, FILED 6-23-2000.

ULTIMATE TV

OWNER OF U.S. REG. NO. 2,229,930.
FOR COMPUTER HARDWARE AND COMPUTER SOFTWARE FOR USE IN CONNECTION WITH PERSONALIZED AND INTERACTIVE TELEVISION PROGRAMMING; COMPUTER PERIPHERALS FOR PERSONALIZED, INTERACTIVE TELEVISION PROGRAMMING; TELEVISIONS; TELEVISION AND CABLE AND SATELLITE SET-TOP BOXES; REMOTE CONTROL DEVICE FOR TELEVISIONS; CABLE AND SATELLITE TELEVISIONS AND EQUIPMENT THEREFOR; HOME ENTERTAINMENT ELECTRONIC EQUIPMENT, NAMELY, STEREO TUNERS, AMPLIFIERS AND RECEIVERS; VIDEO RECORDING AND PLAYBACK DEVICES, AND MONITORS AND DISPLAYS THEREFOR; VIDEO GAME MACHINES FOR USE WITH TELEVISIONS; VIDEO GAME INTERACTIVE REMOTE CONTROL UNITS; ELECTRONIC DEVICES FOR ACCESSING CABLE NETWORKS, WIRELESS NETWORKS, COMPUTER NETWORKS AND GLOBAL COMMUNICATION NETWORKS, NAMELY, INTERNET APPLIANCES, WIRELESS AND COMMUNICATION DEVICES, TELEPHONES, FACSIMILE MACHINES AND COMPUTERS; COMPUTER HARDWARE AND PERIPHERALS, NAMELY, KEYBOARDS, JOYSTICKS, AND COMPUTER MOUSE PRODUCTS; COMPUTER SOFTWARE FOR PLAYING COMPUTER GAMES AND VIDEO GAMES; ON-LINE DOWNLOADABLE COMPUTER GAME AND VIDEO GAME SOFTWARE THAT CAN BE ACCESSED AND PLAYED OVER CABLE AND SATELLITE NETWORKS, WIRELESS NETWORKS, COMPUTER NETWORKS AND GLOBAL COMMUNICATIONS NETWORKS; COMPUTER SOFTWARE FOR ACCESSING AND BROWSING CABLE NETWORKS, WIRELESS NETWORKS, COMPUTER NETWORKS AND GLOBAL COMMUNICATION NETWORKS; COMPUTER PROGRAMS FOR ACCESSING CABLE NETWORKS, WIRELESS NETWORKS, COMPUTER NETWORKS AND GLOBAL COMMUNICATION NETWORKS; COMPUTER GRAPHICAL UTILITIES PROGRAMS; COMPUTER SOFTWARE FOR COMPRESSING AND DECOMPRESSING DATA AND VIDEO IMAGES, COMPUTER SOFTWARE FOR WORD TEXT EDITING, AND E-MAIL; AND OPERATING SYSTEM SOFTWARE AND UTILITIES (U.S. CLS. 21, 23, 26, 36 AND 38).
FIRST USE 8-23-1996; IN COMMERCE 8-23-1996.

2,747,808. STANDARD HOLDINGS, LLC, NEW YORK, NY. SN 76-079,014. PUB. 11-5-2002, FILED 6-23-2000.

STANDARD SOUNDS

OWNER OF U.S. REG. NO. 1,258,321.
NO CLAIM IS MADE TO THE EXCLUSIVE RIGHT TO USE "SOUNDS", APART FROM THE MARK AS SHOWN.
FOR PHONOGRAPH RECORDS, COMPACT DISCS, AND PRE-RECORDED AUDIO AND VIDEO CASSETTES FEATURING MUSIC (U.S. CLS. 21, 23, 26, 36 AND 38).
FIRST USE 1-31-2001; IN COMMERCE 1-31-2001.

CLASS 9—(Continued).

2,747,811. RIVERDEEP INTERACTIVE LEARNING LIMITED, DUBLIN 2, IRELAND, BY ASSIGNMENT; BY ASSIGNMENT EDMARK CORPORATION, REDMOND, WA. SN 76-079,951. PUB. 6-5-2001, FILED 6-28-2000.

EDCONNECT

FOR CHILDREN'S EDUCATIONAL SOFTWARE; COMPUTER SOFTWARE FOR USE IN THE ADMINISTRATION AND MANAGEMENT OF SOFTWARE IN SCHOOLS (U.S. CLS. 21, 23, 26, 36 AND 38).
FIRST USE 6-1-2000; IN COMMERCE 6-1-2000.

2,747,820. CONITA TECHNOLOGIES, INC., COLUMBIA, SC. SN 76-087,310. PUB. 8-14-2001, FILED 7-12-2000.

PVASERVER

FOR COMPUTER SOFTWARE FOR COMMUNICATIONS MANAGEMENT IN A TELECOMMUNICATIONS NETWORK, AND INSTRUCTION MANUALS SUPPLIED AS A UNIT THEREWITH (U.S. CLS. 21, 23, 26, 36 AND 38).
FIRST USE 2-11-2000; IN COMMERCE 2-11-2000.

2,747,833. GENERAL ELECTRIC COMPANY, PLAINVILLE, CT. SN 76-099,257. PUB. 7-30-2002, FILED 7-31-2000.

PROSYS

FOR LIGHTING CONTROL SYSTEMS CONSISTING OF ELECTRIC LIGHT DIMMERS, ELECTRIC LIGHT SWITCHES, INTEGRATED CIRCUITS, COMPUTER HARDWARE, COMPUTER SOFTWARE AND A CLOCK FOR CONTROLLING THE ACTIVATION AND DEACTIVATION OF LIGHT DIMMERS AND SWITCHES (U.S. CLS. 21, 23, 26, 36 AND 38).
FIRST USE 11-0-2000; IN COMMERCE 11-0-2000.

2,747,837. FLARION TECHNOLOGIES, INC., BEDMINSTER, NJ. SN 76-104,742. PUB. 6-19-2001, FILED 8-3-2000.

EVERY BIT WIRELESS

NO CLAIM IS MADE TO THE EXCLUSIVE RIGHT TO USE "WIRELESS", APART FROM THE MARK AS SHOWN.
FOR TELECOMMUNICATIONS EQUIPMENT, NAMELY, BASE STATIONS, RADIOS, MODEMS, TERMINALS, COMMUNICATIONS CHIPSETS, APPLICATION SPECIFIC INTEGRATED CIRCUITS (ASICS), CELLULAR TELEPHONES, ROUTERS, WIRELESS LOCAL AREA NETWORK (LAN) CARDS, AND MODEMS USED IN WIRELESS DATA ACCESS NETWORKS (U.S. CLS. 21, 23, 26, 36 AND 38).
FIRST USE 8-0-2000; IN COMMERCE 1-0-2002.

CLASS 9—(Continued).

2,747,838. SPEEDWISE TECHNOLOGIES LTD., 43000 RA'ANANA, ISRAEL. SN 76-105,739. PUB. 5-15-2001, FILED 8-9-2000.

SPEEDWISE ISPOWER

FOR SOFTWARE WHICH ACCELERATES DATA TRANSFER ON THE GLOBAL COMMUNICATION NETWORK (U.S. CLS. 21, 23, 26, 36 AND 38).
FIRST USE 9-0-2000; IN COMMERCE 9-0-2000.

2,747,864. NEWSCANNER LTD, LLC, NEW YORK, NY. SN 76-121,617. PUB. 9-3-2002, FILED 8-31-2000.

NEWSCANNER

FOR ELECTRONIC SIGNS, NAMELY A VISUAL 360 DEGREE DISPLAY OF ELECTRONIC MESSAGES AND INFORMATION (U.S. CLS. 21, 23, 26, 36 AND 38).
FIRST USE 0-0-1985; IN COMMERCE 4-30-2001.

2,747,871. SANDVIK AB, SANDVIKEN, SWEDEN. SN 76-128,299. PUB. 6-4-2002, FILED 9-13-2000.

SANWELD

FOR COMPUTER SOFTWARE FOR USE IN DETERMINING WELD QUALITY, CONTROL OF ARC WELDING SYSTEMS AND SIMULATING WELDING PROCESSES AND MODELING WELD JOINTS (U.S. CLS. 21, 23, 26, 36 AND 38).
FIRST USE 0-0-1994; IN COMMERCE 0-0-1994.

2,747,874. MIRAL, NADINE A, NEW YORK, NY. SN 76-129,418. PUB. 10-29-2002, FILED 9-18-2000.

CELLBABIES

FOR TELEPHONE ACCESSORIES, NAMELY CELLULAR AND MOBILE TELEPHONE COVERS THAT LOOK LIKE CUTE LITTLE FUZZY STUFFED ANIMALS (U.S. CLS. 21, 23, 26, 36 AND 38).
FIRST USE 7-1-2000; IN COMMERCE 1-5-2001.

2,747,884. JAMIN' SUN SHAYDES, L.L.C., WIXOM, MI. SN 76-139,615. PUB. 6-4-2002, FILED 10-3-2000.

BRIMZ

FOR SUNGLASSES, SAFETY SHIELDS, NAMELY, FACE SHIELDS, AND SAFETY GLASSES (U.S. CLS. 21, 23, 26, 36 AND 38).
FIRST USE 9-0-1999; IN COMMERCE 9-0-1999.

CLASS 9—(Continued).

2,747,890. FROGPAD L.L.C., HOUSTON, TX. SN 76-142,206. PUB. 7-17-2001, FILED 10-10-2000.

FROGPAD

FOR COMPUTER KEYBOARDS, COMPUTER KEY-PADS (U.S. CLS. 21, 23, 26, 36 AND 38).
FIRST USE 3-15-2002; IN COMMERCE 3-15-2002.

2,747,897. DREAM STAGE ENTERTAINMENT, INC., TOKYO, JAPAN. SN 76-148,586. PUB. 5-28-2002, FILED 10-16-2000.

PRIDE FIGHTING CHAMPIONSHIPS

NO CLAIM IS MADE TO THE EXCLUSIVE RIGHT TO USE "FIGHTING CHAMPIONSHIPS", APART FROM THE MARK AS SHOWN.

FOR COMPACT DISCS FEATURING MIXED MARTIAL ARTS FIGHTING EVENTS AND DOCUMENTARIES; ELECTRONIC PUBLICATIONS IN THE NATURE OF ARTICLES, NEWSLETTERS, MAGAZINES, PAMPHLETS, BOOKS, MANUALS, AND INSTRUCTIONAL MATERIAL FEATURING THE FIELD OF MIXED MARTIAL ARTS FIGHTING EVENTS AND DOCUMENTARIES, AND FIGHTING-RELATED ISSUES RECORDED ON AUDIOTAPES, VIDEOTAPES, COMPACT DISCS, CD-ROMS, DVDS, COMPUTER DISCS, MAGNETIC MEDIA, AND OPTICAL MEDIA AND DOWNLOADABLE FROM A GLOBAL COMPUTER NETWORK; COMPUTER GAME SOFTWARE, PRE-RECORDED VIDEO TAPES FEATURING MIXED MARTIAL ARTS FIGHTING EVENTS AND DOCUMENTARIES, CELLULAR TELEPHONES, VIDEO GAME CARTRIDGES, PRE-RECORDED AUDIOVIDEO CD-ROMS, DISCS, AND CASSETTES FEATURING MIXED MARTIAL ARTS FIGHTING EVENTS AND DOCUMENTARIES; AND VIRTUAL REALITY GAME SOFTWARE (U.S. CLS. 21, 23, 26, 36 AND 38).

FIRST USE 4-29-1999; IN COMMERCE 4-29-1999.

2,747,898. COLOR KINETICS INCORPORATED, BOSTON, MA. SN 76-149,294. PUB. 8-6-2002, FILED 10-18-2000.

**SURROUND
|||||COLOR|||||**

NO CLAIM IS MADE TO THE EXCLUSIVE RIGHT TO USE "COLOR", APART FROM THE MARK AS SHOWN.

FOR COMPUTER HARDWARE, WHICH INTEGRATES LIGHTING SYSTEMS INTO ENTERTAINMENT AND COMPUTER DEVICES SUCH AS CONSUMER ELECTRONICS, PERSONAL COMPUTERS, TVS, DVDS, VIDEO PLAYERS, AUDIO EQUIPMENT, GAME PLAYERS, AND BROADBAND NETWORKS, AND COMPUTER SOFTWARE FOR OPERATING THE LIGHTING SYSTEM SOLD THEREWITH (U.S. CLS. 21, 23, 26, 36 AND 38).
FIRST USE 3-21-2001; IN COMMERCE 3-21-2001.

CLASS 9—(Continued).

2,747,904. APPLIED MATERIALS, INC., SANTA CLARA, CA. SN 76-154,698. PUB. 8-13-2002, FILED 10-25-2000.

EPICLEAN

FOR SEMICONDUCTOR WAFER PROCESSING EQUIPMENT FOR THE PROCESSING AND PRODUCTION OF SEMICONDUCTOR SUBSTRATES, THIN FILMS, SILICON DISCS AND WAFERS; NAMELY, EPITAXIAL REACTORS, CHEMICAL VAPOR DEPOSITION REACTORS, PHYSICAL VAPOR DEPOSITION REACTORS, PLASMA ETCHERS, ION IMPLANTERS, AND CHEMICAL MECHANICAL POLISHERS (U.S. CLS. 21, 23, 26, 36 AND 38).

FIRST USE 6-30-2002; IN COMMERCE 6-30-2002.

CLASS 9—(Continued).

2,747,918. CORRELANT COMMUNICATIONS, INC., SAN DIEGO, CA. SN 76-164,739. PUB. 7-2-2002, FILED 11-13-2000.

CORRELANT

FOR TRANSMITTERS, RECEIVERS, INTERFACES, MODEMS, SWITCHES AND NETWORKING HARDWARE AND SOFTWARE FOR BROADBAND CABLE, SATELLITE AND FIXED WIRELESS, AND INSTRUCTION MANUALS PROVIDED AS A UNIT THEREWITH (U.S. CLS. 21, 23, 26, 36 AND 38).

FIRST USE 10-1-2000; IN COMMERCE 1-22-2001.

2,747,909. M & M PROGRAMMING, INC., LEBANON, KY. SN 76-159,441. PUB. 10-1-2002, FILED 11-6-2000.

BOOK-TIME

FOR COMPUTER ACCOUNTING SOFTWARE (U.S. CLS. 21, 23, 26, 36 AND 38).

FIRST USE 2-1-2000; IN COMMERCE 1-1-2002.

2,747,915. VELQUEST CORPORATION, HOPKINTON, MA. SN 76-163,028. PUB. 7-9-2002, FILED 11-13-2000.

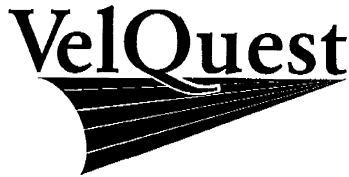

The logo for VelQuest features the word "VelQuest" in a bold, serif font. Below the text is a stylized graphic consisting of several curved lines that sweep upwards and to the right, resembling a wing or a signal beam.

FOR COMPUTER PROGRAMS FOR USE IN DATABASE MANAGEMENT, IN THE FIELD OF TESTING, EVALUATION AND APPROVAL OF MEDICAL, PHARMACEUTICAL, CHEMICAL AND BIOLOGICAL PRODUCTS (U.S. CLS. 21, 23, 26, 36 AND 38).

FIRST USE 8-4-2000; IN COMMERCE 8-4-2000.

2,747,916. CABLE DESIGN TECHNOLOGIES INC., DBA THERMAX/CDT, PITTSBURGH, PA. SN 76-163,555. PUB. 3-19-2002, FILED 11-13-2000.

WIRING THE WIRELESS WORLD

FOR WIRE AND CABLE PRODUCTS, NAMELY, COAXIAL CABLES, ELECTRICAL CABLES, HAND FORMABLE CABLES, HIGH-SPEED, LOW LOSS COAXIAL AND TWINAXIAL CABLES; ELECTRONIC CABLES AND FIBER-OPTIC CABLES (U.S. CLS. 21, 23, 26, 36 AND 38).

FIRST USE 9-0-2000; IN COMMERCE 9-0-2000.

2,747,921. OPENWAVE SYSTEMS INC., REDWOOD CITY, CA. SN 76-166,376. PUB. 3-26-2002, FILED 11-14-2000.



FOR COMPUTER SOFTWARE FOR USE BY COMMUNICATIONS SERVICE PROVIDERS TO ACCESS, CREATE, COLLECT, SORT, REMOVE, TRANSFER, DISSEMINATE, ORGANIZE OR OTHERWISE UTILIZE VOICE, TEXT, GRAPHICS OR OTHER DATA OVER A GLOBAL COMPUTER NETWORK AND OTHER NETWORKS, AND FOR USE BY COMMUNICATIONS DEVICE MANUFACTURERS TO ENABLE THEIR DEVICES TO ACCESS, CREATE, COLLECT, STORE, REMOVE, TRANSFER, DISSEMINATE, ORGANIZE OR OTHERWISE UTILIZE SUCH DATA OVER A GLOBAL COMPUTER NETWORK AND OTHER NETWORKS, AND USER MANUALS SOLD TOGETHER AS A UNIT; COMPUTER OPERATING SYSTEM, NAMELY, A CLIENT/SERVER PLATFORM CONSISTING OF HARDWARE AND SOFTWARE FOR LINKING WIRELESS APPLICATIONS WITH ENTERPRISE NETWORKS AND THE INTERNET; COMPUTER SOFTWARE FOR USE IN FACILITATING COMMUNICATIONS OVER COMPUTER NETWORKS, NAMELY, ELECTRONIC MESSAGING SOFTWARE; SERVER SOFTWARE FOR INTERFACING HAND-HELD DEVICES, SUCH AS PAGERS AND CELLULAR PHONES, TO HOST COMPUTERS, SERVERS AND THE GLOBAL COMPUTER NETWORK; NETWORK ADDRESS SOFTWARE FOR IDENTIFYING DIRECTORIES, DOMAIN NAMES AND NETWORK ADDRESSES TO TRANSMIT DATA TO A SPECIFIC ADDRESS VIA THE GLOBAL COMPUTER NETWORK; COMPUTER SOFTWARE, NAMELY, A MESSAGE TRANSPORT AGENT FOR DIRECTING ELECTRONIC MAIL ACROSS THE INTERNET BASED ON OPEN STANDARDS AND INCORPORATING HIGH SECURITY AND EASE OF USE; COMPUTER SOFTWARE FOR UPDATING AND INTEGRATION OF DATA, USER SPECIFICATIONS AND NETWORK SPECIFICATIONS OVER WIRELESS AND WIRELINE NETWORKS; COMPUTER SOFTWARE FOR SYNCHRONIZING CONTACT, CALENDAR, TASK LIST AND OTHER INFORMATION BETWEEN A PERSONAL COMPUTER AND A HAND-HELD DEVICE; COMPUTER SOFTWARE FOR DETERMINING LOCATION, PRESENCE OR AVAILABILITY OF A HAND-HELD DEVICE (U.S. CLS. 21, 23, 26, 36 AND 38).

FIRST USE 11-15-2002; IN COMMERCE 11-15-2002.

CLASS 9—(Continued).

2,747,927. MAPINFO CORPORATION, TROY, NY. SN 76-169,619. PUB. 8-20-2002, FILED 11-21-2000.

miAware

FOR COMPUTER APPLICATION SOFTWARE FOR CAPTURING, MANAGING, ACCESSING AND PRESENTING DEMOGRAPHIC DATA AND MAPPING INFORMATION, AND INSTRUCTION MANUALS THEREFOR SOLD AS A UNIT (U.S. CLS. 21, 23, 26, 36 AND 38).

FIRST USE 9-26-2001; IN COMMERCE 9-30-2002.

2,747,929. PONTIS ELECTRONIC GMBH, 92521 SCHWARZENFELD, FED REP GERMANY. SN 76-170,051. PUB. 9-24-2002, FILED 11-22-2000.

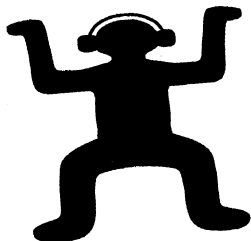

PRIORITY CLAIMED UNDER SEC. 44(D) ON FED REP GERMANY APPLICATION NO. 30039336.9, FILED 5-24-2000, REG. NO. 30039336, DATED 9-4-2000, EXPIRES 5-24-2010.

FOR DEVICES FOR RECORDING, TRANSMITTING, AND REPRODUCING SOUND AND IMAGE, NAMELY, AUDIO AND VIDEO CASSETTE RECORDERS, MP-3 PLAYERS, CD-PLAYER, AND MINI-DISC-PLAYER, RADIOS, CAMERAS, NAMELY PHOTOGRAPHIC CAMERAS, DISPLAYS, EARPHONES; COMPUTERS AND DATA PROCESSING INSTALLATIONS, NAMELY COMPUTER MONITORS, PRINTERS, KEYBOARDS, CD-SLOTS, DVDSLOTS, COMPUTER-INTERFACES, GAME CONSOLES, NAMELY HAND HELD JOY STICK UNITS FOR PLAYING COMPUTER GAMES, CARD STATIONS FOR MAGNETIC-COATED CARDS AND MEMORY CARDS; SIGNAL AND CONTROL DEVICES, NAMELY, DATA RADIO TRANSMITTERS AND RECEIVERS; CARRIERS OF RECORDED SOUNDS OR IMAGES, NAMELY, MAGNETIC AND OPTICAL DATA DISCS AS WELL AS MAGNETIC-COATED CARDS AND MEMORY CARDS; ELECTRICAL WEIGHTING, MEASURING, SIGNAL AND CONTROL DEVICES AND INSTRUMENTS, NAMELY, FIBER OPTICS, LASERS FOR MEASURING PURPOSES, MICROPHONES, CAMERA CONTROLLERS,

CLASS 9—(Continued).

DEVICES FOR MEASURING CURRENT VOLTAGE, RESISTANCE, CAPACITANCE, LIGHT INTENSITY, SOUND INTENSITY, TEMPERATURES, POSITIONS, DISTANCES, SAID DEVICES AND INSTRUMENTS CAPABLE OF BEING CONTROLLED BY A COMPUTER, NAMELY PERSONAL COMPUTERS, HAND-HELD COMPUTERS, AND PORTABLE COMPUTERS; SENSORS FOR THE DETERMINATION OF TEMPERATURES, POSITIONS, AND DISTANCES; ELECTRONIC COMPONENTS AND DEVICES, NAMELY, INTERFACES, NAMELY COMPUTER INTERFACES, AMPLIFIERS, INTEGRATED CIRCUITS, PROCESSORS, NAMELY MICRO-PROCESSORS, DATA PROCESSORS, DISPLAYS, NAMELY LIGHT EMITTING DIODE DISPLAYS, SPEAKERS, COMPUTER NETWORK SWITCHES, ELECTRIC SWITCHES, RESISTORS, CAPACITORS, LIGHT EMITTING DIODES, POWER SUPPLIES, AND DATA TRANSMISSION CABLES, AUTOMATED TEST BENCHES, NAMELY FOR MEASURING ELECTRICAL AND MECHANICAL PARAMETERS (U.S. CLS. 21, 23, 26, 36 AND 38).

FIRST USE 6-1-1999; IN COMMERCE 6-1-1999.

2,747,951. MEGASUN INC., ST LOUIS, MO. SN 76-182,429. PUB. 7-23-2002, FILED 12-18-2000.

SUNCLIPSE

FOR PROTECTIVE EYEWEAR GOGGLES USED FOR PROTECTING EYES AGAINST ULTRAVIOLET LIGHT (U.S. CLS. 21, 23, 26, 36 AND 38).

FIRST USE 4-15-1991; IN COMMERCE 9-1-1991.

2,747,957. DAVIS, RAYMOND E., GARLAND, TX. SN 76-186,149. PUB. 8-27-2002, FILED 12-26-2000.



NO CLAIM IS MADE TO THE EXCLUSIVE RIGHT TO USE "TEMP", APART FROM THE MARK AS SHOWN.

FOR THERMOMETERS NOT FOR MEDICAL PURPOSES THAT WILL INDICATE THE TEMPERATURE IN A WALK-IN COOLER VAULT (U.S. CLS. 21, 23, 26, 36 AND 38).

FIRST USE 6-7-2001; IN COMMERCE 4-4-2002.

CLASS 9—(Continued).

2,747,973. OPTICAL ACCESS OAL LTD., 20692 YOKNEAM, ISRAEL. SN 76-194,911. PUB. 5-14-2002, FILED 1-16-2001.

PRO-VISION

FOR COMPUTER SOFTWARE ENABLING VIEWING ON THE SCREEN ALL THE DEVICES, NAMELY SWITCHES, CONNECTIONS, ICONS, THAT ARE ON A NETWORK TO ENABLE CONTROL, REPAIR AND REPLACEMENT OF DEFECTIVE OR UNWANTED LINKS (U.S. CLS. 21, 23, 26, 36 AND 38).

FIRST USE 1-12-2001; IN COMMERCE 1-12-2001.

2,747,977. IVIVITY INC., ATLANTA, GA. SN 76-196,810. PUB. 9-4-2001, FILED 1-17-2001.

IVIVITY

FOR SOFTWARE AND RELATED HARDWARE FOR FACILITATING INTERNET DATA STORAGE AND FILE TRANSFER (U.S. CLS. 21, 23, 26, 36 AND 38).

FIRST USE 4-6-2003; IN COMMERCE 4-6-2003.

2,747,980. ALLOPTIC, INC., LIVERMORE, CA. SN 76-199,540. PUB. 7-2-2002, FILED 1-23-2001.

GIGAVU

FOR FIBER OPTIC NETWORK PRODUCTS, NAMELY, COMPUTER SOFTWARE FOR ACTIVATING, CONFIGURING AND MONITORING OF A FIBER OPTIC COMMUNICATIONS NETWORK SYSTEMS (U.S. CLS. 21, 23, 26, 36 AND 38).

FIRST USE 7-0-2000; IN COMMERCE 7-0-2000.

2,747,982. STARGEN, INC., MARLBOROUGH, MA, BY CHANGE OF NAME STARGEN, INC., MARLBOROUGH, MA. SN 76-199,947. PUB. 1-15-2002, FILED 1-25-2001.

STARFABRIC

FOR COMPUTER HARDWARE, NAMELY, INTERCONNECT SWITCHES FOR COMMUNICATIONS AND NETWORKING APPLICATIONS, AND OTHER GENERAL PURPOSE INPUT/OUTPUT INTERCONNECT APPLICATIONS (U.S. CLS. 21, 23, 26, 36 AND 38).

FIRST USE 1-22-2003; IN COMMERCE 1-22-2003.

CLASS 9—(Continued).

2,747,983. MAHR FEDERAL, INC., PROVIDENCE, RI. SN 76-199,959. PUB. 1-15-2002, FILED 1-25-2001.

MARTEST

FOR HIGH-PRECISION MEASURING INSTRUMENTS, NAMELY, HIGH-PRECISION TEST DIAL INDICATORS FOR USE IN THE METAL TOOLING INDUSTRY (U.S. CLS. 21, 23, 26, 36 AND 38).

FIRST USE 3-1-2003; IN COMMERCE 3-1-2003.

2,747,995. U B FOUNDATION ACTIVITIES, INC., BUFFALO, NY. SN 76-205,344. PUB. 6-25-2002, FILED 2-6-2001.

ALPHAFIM ANALYZER

NO CLAIM IS MADE TO THE EXCLUSIVE RIGHT TO USE "ANALYZER", APART FROM THE MARK AS SHOWN.

FOR COMPUTER SOFTWARE, NAMELY, COMPUTER PROGRAMS FOR THE RECORDING, COMPILING, STORING AND RETRIEVING OF EVALUATIONS AND MEASUREMENTS OF PATIENT SUITABILITY FOR MEDICAL REHABILITATION (U.S. CLS. 21, 23, 26, 36 AND 38).

FIRST USE 11-0-2001; IN COMMERCE 11-0-2001.

2,748,006. PRUFTECHNIK DIETER BUSCH AG, ISMANING, BAVARIA D 85737, FED REP GERMANY. SN 76-210,454. PUB. 11-27-2001, FILED 2-15-2001.

SMARTALIGN

OWNER OF U.S. REG. NOS. 2,193,646, 2,430,630, AND OTHERS.

FOR MEASURING, SUPERVISION AND TESTING APPARATUS AND INSTRUMENTS FOR TESTING THE ALIGNMENT OF ROTATING MACHINERY, OPTICAL AND LASER OPTICAL DEVICES FOR MEASURING AND TESTING THE STATUS OF ALIGNMENT OF ROLLS, COUPLED SHAFTS, COUPLED MACHINERY AND MECHANICAL STRUCTURES, COMPUTER HARDWARE AND SOFTWARE USED WITH SUCH APPARATUS, INSTRUMENTS AND DEVICES (U.S. CLS. 21, 23, 26, 36 AND 38).

FIRST USE 4-15-2002; IN COMMERCE 7-18-2002.

2,748,011. MAGIC EARTH, INC., HOUSTON, TX. SN 76-211,376. PUB. 11-27-2001, FILED 2-14-2001.

MAGICDESK

FOR COMPUTER WORKSTATIONS, COMPRISING COMPUTER HARDWARE AND COMPUTER SOFTWARE (U.S. CLS. 21, 23, 26, 36 AND 38).

FIRST USE 10-30-2002; IN COMMERCE 10-30-2002.

CLASS 9—(Continued).

2,748,023. HARRIS CORPORATION, MELBOURNE, FL. SN 76-219,401. PUB. 9-25-2001, FILED 3-2-2001.

PROCAST

FOR BROADCAST STUDIO EQUIPMENT NAMELY, AUDIO MIXERS (U.S. CLS. 21, 23, 26, 36 AND 38).
FIRST USE 4-27-2001; IN COMMERCE 4-27-2001.

2,748,024. SECURELOGIX CORPORATION, SAN ANTONIO, TX. SN 76-220,984. PUB. 7-30-2002, FILED 3-7-2001.

TELEIDS

FOR TELECOMMUNICATIONS HARDWARE AND SOFTWARE, NAMELY, ELECTRONIC SECURITY HARDWARE AND SOFTWARE FOR PROVIDING ENTERPRISE VISIBILITY AND CONTROL OF AN ORGANIZATION'S TELECOMMUNICATIONS INFRASTRUCTURE WITH RESPECT TO DETECTING PATTERNS OF INTEREST VIA THE CORRELATION OF CALL EVENTS AND CALL ATTRIBUTES, NAMELY, SOURCE, DESTINATION, TIME OF DAY, DURATION, CALL TYPE, ACROSS ONE OR MULTIPLE CALLS, THAT INDICATE POTENTIAL EVENTS SUCH AS WAR DIALING, TOLL FRAUD, MODEM HACKING, AND DUAL TONE MULTI-FREQUENCY (DTMF) ATTACKS ON PUBLIC BRANCH EXCHANGES (PBX'S) AND OTHER DUAL TONE MULTI-FREQUENCY CONTROLLED DEVICES AND VOICEMAIL SYSTEMS AND USER MANUALS SOLD AS A UNIT THEREWITH (U.S. CLS. 21, 23, 26, 36 AND 38).
FIRST USE 5-13-2001; IN COMMERCE 5-13-2001.

2,748,028. WEALTH PLANNING INSTITUTE, LLC, SCOTTSDALE, AZ. SN 76-222,198. PUB. 10-9-2001, FILED 3-9-2001.

DISCOVERING THE SIGNIFICANCE OF YOUR SUCCESS

FOR PRE-RECORDED MAGNETIC VIDEO TAPES AND AUDIO CASSETTES, COMPACT DISCS, DIGITAL FLOPPY DISKS, CD ROMS AND DIGITAL VIDEO DISCS (DVD), MINI-DISCS, VIDEO LASER DISCS, DIGITAL AUDIO TAPES (DAT), VIDEOGRAMS FEATURING INFORMATION FOR OTHERS IN THE FIELD OF PERSONAL FINANCES (U.S. CLS. 21, 23, 26, 36 AND 38).
FIRST USE 9-1-2001; IN COMMERCE 9-1-2001.

CLASS 9—(Continued).

2,748,030. LSI LOGIC CORPORATION, MILPITAS, CA. SN 76-222,881. PUB. 12-18-2001, FILED 3-12-2001.

STREAMPACK

FOR INTEGRATED CIRCUIT CORES, INTEGRATED CIRCUITS, SEMICONDUCTOR DEVICES, CHIP SETS, MULTI-PACKAGED DEVICES, NAMELY, MULTI-CHIPPED MODULES, CIRCUIT BOARDS, COMPUTER PERIPHERALS, COMPUTERS, COMPUTER HARDWARE AND SOFTWARE FOR USE IN THE TRANSMISSION, DISTRIBUTION, AND RETRIEVAL OF DATA IN THE FIELD OF NETWORKING AND COMMUNICATIONS TECHNOLOGIES, AND SPECIFICATION AND DATA SHEETS, DATA BOOKS, INSTRUCTION MANUALS AND REFERENCE MANUALS PROVIDED THEREWITH (U.S. CLS. 21, 23, 26, 36 AND 38).
FIRST USE 3-15-2000; IN COMMERCE 5-0-2000.

2,748,033. US CONEC LTD., HICKORY, NC. SN 76-223,875. PUB. 3-26-2002, FILED 3-13-2001.

MTP ELITE

OWNER OF U.S. REG. NO. 2,272,241.
FOR FIBER OPTIC CONNECTORS (U.S. CLS. 21, 23, 26, 36 AND 38).
FIRST USE 9-1-2002; IN COMMERCE 9-1-2002.

2,748,038. MASCOT METROPOLITAN INC., SOUTH SAN FRANCISCO, CA. SN 76-227,075. PUB. 6-11-2002, FILED 3-21-2001.

PDA SKINS

NO CLAIM IS MADE TO THE EXCLUSIVE RIGHT TO USE "PDA", APART FROM THE MARK AS SHOWN.
FOR CARRYING CASES FOR PERSONAL DIGITAL ASSISTANTS, TELEPHONE AND RADIO PAGERS (U.S. CLS. 21, 23, 26, 36 AND 38).
FIRST USE 11-10-2000; IN COMMERCE 1-10-2001.

2,748,042. EGENERA, INC., MARLBOROUGH, MA. SN 76-227,487. PUB. 10-16-2001, FILED 3-20-2001.

BLADEFRAME

FOR COMPUTER SOFTWARE AND HARDWARE FOR NETWORK, PROCESS AND RESOURCE MANAGEMENT FOR USE IN INTERNET DATA CENTERS (U.S. CLS. 21, 23, 26, 36 AND 38).
FIRST USE 9-11-2001; IN COMMERCE 9-11-2001.

CLASS 9—(Continued).

2,748,048. E4X, INC., 67060 TEL AVIV, ISRAEL. SN 76-230,123. PUB. 8-6-2002, FILED 3-26-2001.

E4X

FOR DOWNLOADABLE COMPUTER E-COMMERCE SOFTWARE, NAMELY, SOFTWARE WHICH INTEGRATES WITH AN E-SELLER'S WEBSITE ALLOWING THE E-SELLER TO DISPLAY FINAL PRICES IN FOREIGN CURRENCIES AND RECEIVE EXACT EXPECTED PAYMENT IN THE CURRENCY OF THE E-SELLER'S CHOICE (U.S. CLS. 21, 23, 26, 36 AND 38).
FIRST USE 6-0-2000; IN COMMERCE 6-0-2000.

2,748,050. SOUTHAMPTON PHOTONICS, INC., CUPERTINO, CA. SN 76-231,636. PUB. 12-18-2001, FILED 3-10-2001.



FOR OPTICAL FIBERS; OPTICAL FIBER COMPONENTS, NAMELY SIGNAL FILTERS, MULTIPLEXERS, DEMULTIPLEXERS, OPTICAL ADD DROP MULTIPLEXERS, OPTICAL INTERLEAVERS, DISPERSION COMPENSATORS, AND GAIN FLATTENED SIGNAL FILTERS; OPTICAL FIBER SUBSYSTEMS, NAMELY OPTICAL AMPLIFIERS, LASERS, LASER ARRAYS, SIGNAL TRANSMITTERS, AND SIGNAL RECEIVERS (U.S. CLS. 21, 23, 26, 36 AND 38).
FIRST USE 1-7-2003; IN COMMERCE 1-7-2003.

CLASS 9—(Continued).

2,748,064. SOUTHERN COMFORT PROPERTIES, INC., SAN RAFAEL, CA. SN 76-238,016. PUB. 9-3-2002, FILED 4-9-2001.

**SOUTHERN
COMFORT**

OWNER OF U.S. REG. NOS. 317,529, 1,522,030, AND OTHERS.

FOR SUNGLASSES AND CASES THEREFOR; CELLULAR PHONE COVERS; MAGNETICALLY ENCODED PRE-PAID TELEPHONE CALLING CARDS; DECORATIVE MAGNETS; ELECTRICAL SWITCH PLATE COVERS; RADIOS; AM/FM RADIOS; CLOCK RADIOS, NAMELY, RADIOS INCORPORATING CLOCKS; AM/FM RADIO CASSETTE PLAYER/RECORDER; CD PLAYERS; RECORD PLAYERS; BLANK AUDIO AND VIDEO CASSETTES; AUDIO AND VIDEO CASSETTES FEATURING MUSIC AND MOVIES; BLANK COMPACT DISKS (CD'S); COMPACT DISKS (CD'S) FEATURING MUSIC AND MOVIES; RECORDS FEATURING MUSIC; HEADPHONES; MICROPHONES; GOGGLES IN THE NATURE OF SAFETY GOGGLES AND MOTORCYCLE GOGGLES; EYEGASSES AND CASES THEREFOR; EYEGASS CHAINS (U.S. CLS. 21, 23, 26, 36 AND 38).
FIRST USE 9-30-2001; IN COMMERCE 9-30-2001.

2,748,067. CROSSPOINTE, INC., GULF BREEZE, FL. SN 76-238,888. PUB. 7-16-2002, FILED 4-11-2001.

**CROSSPOINTE SCHOOLS
ONLINE**

NO CLAIM IS MADE TO THE EXCLUSIVE RIGHT TO USE "SCHOOLS ONLINE", APART FROM THE MARK AS SHOWN.

FOR DOWNLOADABLE COMPUTER SOFTWARE IN THE FIELD OF SCHOOL DISTRICT ADMINISTRATION, NAMELY SOFTWARE FOR USE AS A DATABASE PROVIDING ACCESS TO ADMINISTRATORS, TEACHERS, PARENTS OR STUDENTS TO THOSE PORTIONS OF THE DATABASE THEY ARE ENTITLED TO ACCESS (U.S. CLS. 21, 23, 26, 36 AND 38).
FIRST USE 7-1-2001; IN COMMERCE 7-1-2001.

2,748,080. THOMSON, 92100 BOULOGNE-BILLANCOURT, FRANCE, BY ASSIGNMENT PHILIPS ELELCTRONICS NORTH AMERICA CORPORATION, NEW YORK, NY. SN 76-244,534. PUB. 12-4-2001, FILED 4-20-2001.

ACCUSWITCH

FOR DATA ROUTING CONTROL UNIT AND COMPUTER SOFTWARE FOR DATA ROUTING (U.S. CLS. 21, 23, 26, 36 AND 38).
FIRST USE 12-5-2000; IN COMMERCE 12-5-2000.

CLASS 9—(Continued).

2,748,081. KONAMI CORPORATION, MINATO-KU, TOKYO, JAPAN. SN 76-244,623. PUB. 7-2-2002, FILED 4-23-2001.

PARK BUILDER

FOR COMPUTER PRODUCTS, NAMELY COMPUTER GAME PROGRAMS; VIDEO GAME CARTRIDGES; VIDEO GAME CD-ROMS; COMPUTER GAME CD-ROMS; VIDEO GAME PROGRAMS; VIDEO GAME PROGRAMS FOR USE WITH TELEVISION SETS; AND VIDEO GAME MACHINES FOR USE WITH TELEVISION SETS; VIDEO GAME JOYSTICKS; DOWNLOADABLE ELECTRONIC AND COMPUTER GAME PROGRAMS, DOWNLOADABLE ELECTRONIC AND COMPUTER GAME PROGRAM UPDATES AND DOWNLOADABLE ELECTRONIC AND COMPUTER GAME SAMPLES (U.S. CLS. 21, 23, 26, 36 AND 38).

FIRST USE 6-5-2001; IN COMMERCE 6-5-2001.

2,748,105. PHORMION SALES TOOLS, INC., LINCROFT, NJ. SN 76-255,858. PUB. 7-30-2002, FILED 5-14-2001.

Phormion
Sales Tools, Inc



NO CLAIM IS MADE TO THE EXCLUSIVE RIGHT TO USE "SALES TOOLS, INC.", APART FROM THE MARK AS SHOWN.

THE MARK CONSISTS, IN PART, OF THE WORD "PHORMION SALES TOOLS, INC." APPEARING IMMEDIATELY ADJACENT AND TO THE LEFT OF A BLUE RECTANGLE CONTAINING THIN, VERTICAL, WHITE LINES AND A WHITE, STAR-LIKE OBJECT AT ITS CENTER THAT FADES INTO THE DESCRIBED BLUE BACKGROUND.

FOR COMPUTER COMMUNICATIONS SOFTWARE TO ALLOW SALES ORGANIZATIONS TO COMMUNICATE THEIR QUANTITATIVE VALUE PROPOSITIONS TO THEIR PROSPECTS (U.S. CLS. 21, 23, 26, 36 AND 38).

FIRST USE 6-27-2001; IN COMMERCE 6-27-2001.

2,748,117. FORUM NETWORKS, INC., SANDY, UT. SN 76-259,085. PUB. 9-17-2002, FILED 5-18-2001.

FORUM NETWORKS

NO CLAIM IS MADE TO THE EXCLUSIVE RIGHT TO USE "NETWORKS", APART FROM THE MARK AS SHOWN.

FOR COMPUTER HARDWARE FOR ENABLING CROSS-PLATFORM CONVERSION OF TRANSACTION BUSINESS INFORMATION AND OPERATING SOFTWARE THEREFOR (U.S. CLS. 21, 23, 26, 36 AND 38).

FIRST USE 4-22-2002; IN COMMERCE 4-22-2002.

CLASS 9—(Continued).

2,748,126. KOEI CO., LTD., YOKOHAMA 223-8503, JAPAN. SN 76-261,453. PUB. 5-14-2002, FILED 5-21-2001.

JOURNEY WEST

FOR COMPUTER GAME CASSETTES, COMPUTER GAME CARTRIDGES, COMPUTER GAME DISKS, COMPUTER GAME PROGRAMS, AND RELATED COMPUTER GAME SOFTWARE; DOWNLOADABLE VIDEO GAME SOFTWARE AND DOWNLOADABLE VIDEO GAME PROGRAMS; VIDEO OUTPUT GAME MACHINES FOR USE WITH TELEVISION SETS (U.S. CLS. 21, 23, 26, 36 AND 38).

FIRST USE 8-14-2001; IN COMMERCE 8-14-2001.

2,748,133. BROADVISION, INC., REDWOOD CITY, CA. SN 76-263,310. PUB. 7-2-2002, FILED 5-23-2001.

BROADVISION

OWNER OF U.S. REG. NOS. 2,053,081 AND 2,198,759.

FOR COMPUTER SOFTWARE FOR USE IN E-COMMERCE BUSINESS APPLICATIONS, NAMELY SOFTWARE FOR ESTABLISHING, ORGANIZING AND MANAGING RELATIONSHIPS WITH CUSTOMERS, SUPPLIERS, PARTNERS, AND EMPLOYEES VIA INTEGRATED EXTRANET, INTRANET, AND INTERNET SITES; SOFTWARE FOR USE IN INTEGRATING, AUTOMATING, PERSONALIZING, MARKETING AND PROMOTING COMPANIES' E-COMMERCE BUSINESS ACTIVITIES; SOFTWARE FOR USE IN BUILDING AND MANAGING APPLICATIONS FOR ORDER PROCESSING, CONTRACT ADMINISTRATION, BILL PROCESSING, FINANCIAL PLANNING, CUSTOMER SERVICE, MAINTENANCE AND REPAIR OPERATIONS; SOFTWARE FOR USE IN ESTABLISHING AND MANAGING ONLINE ENTERPRISE INFORMATION WEBSITES ENABLING BUSINESSES TO REACH CUSTOMERS, PARTNERS, SUPPLIERS AND EMPLOYEES; SOFTWARE FOR USE IN CREATING, PUBLISHING, UPDATING AND VERSIONING A COMPANY'S ELECTRONIC ASSETS; SOFTWARE FOR USE IN ONLINE TRAVEL TRANSACTIONS (U.S. CLS. 21, 23, 26, 36 AND 38).

FIRST USE 1-5-1996; IN COMMERCE 1-5-1996.

2,748,135. INFORMATICS, LTD., PLANO, TX. SN 76-263,518. PUB. 6-18-2002, FILED 5-29-2001.

APPFACTORY

FOR COMPUTER SOFTWARE FOR USE WITH HANDHELD PERSONAL COMPUTERS (U.S. CLS. 21, 23, 26, 36 AND 38).

FIRST USE 6-0-2002; IN COMMERCE 6-0-2002.

CLASS 9—(Continued).

2,748,140. NUCORE TECHNOLOGY INC., SANTA CLARA, CA. SN 76-264,374. PUB. 5-14-2002, FILED 5-29-2001.

CLASS 9—(Continued).

2,748,152. MAGNETEK, INC., LOS ANGELES, CA. SN 76-267,775. PUB. 8-13-2002, FILED 6-6-2001.

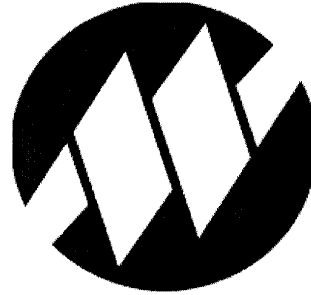
NDX TECHNOLOGY

NO CLAIM IS MADE TO THE EXCLUSIVE RIGHT TO USE "TECHNOLOGY", APART FROM THE MARK AS SHOWN.

FOR SEMICONDUCTOR MEMORIES; DIGITAL CAMERAS; AND DIGITAL VIDEO RECORDERS (U.S. CLS. 21, 23, 26, 36 AND 38).

FIRST USE 3-0-1998; IN COMMERCE 3-0-1998.

FOR INVERTERS AND POWER INVERTERS; UNINTERRUPTIBLE POWER SUPPLIES; POWER SUPPLIES; ANALOG POWER SUPPLIES; COMPACT PCI POWER SUPPLIES; MODULAR POWER SUPPLIES; FRONT-END POWER SUPPLIES; AC-DC POWER SUPPLIES; DC-DC POWER SUPPLIES; OEM POWER SUPPLIES; CUSTOM POWER SUPPLIES; DC-DC CONVERTERS; VOLTAGE REGULATOR MODULES FOR ELECTRIC POWER; POINT OF LOAD REGULATORS; ELECTRICAL POWER CONVERTERS; RECTIFIERS; DC POWER PLANT SYSTEM CONTROLLERS; POWER CONTROL UNITS; TELECOM POWER DISTRIBUTION PANELS; SUPPLEMENTAL POWER DISTRIBUTION BAYS; CIRCUIT BREAKER DISTRIBUTION FUSE BOARDS; ELECTRICAL POWER PANELS; BATTERY CHARGERS; POWER ELECTRONIC CONVERSION FOR CONSUMER PRODUCTS; POWER ELECTRONIC CONVERTERS FOR FUEL CELLS, PHOTO VOLTAIC, AND MICROTURBINES; VOLTAGE REGULATORS; CONTROLLERS; ELECTRONIC MOTOR DRIVE CONTROLS; ELEVATOR DRIVES; ELECTRONIC CRANE AND HOIST DRIVES; POWER CONDITIONERS; ELECTRONIC ADJUSTABLE SPEED DRIVES AND EDDY CURRENT COUPLINGS WHICH ADJUST AND CONTROL THE SPEED AND OUTPUT OF ELECTRIC MOTORS; POWER LINE CONDITIONERS; FAULT ISOLATION INDICATORS; 60 HZ TO 400 HZ POWER CONVERTERS; SOFTWARE FOR CONTROLLING AND OPERATING ELECTRONIC MOTOR DRIVES; ELECTRICAL AC MOTOR DRIVE CONTROLLERS; INDOOR AND OUTDOOR CABINETS AND ENCLOSURES FOR VOICE AND DATA COMMUNICATION EQUIPMENT (U.S. CLS. 21, 23, 26, 36 AND 38).

FIRST USE 6-0-2001; IN COMMERCE 10-0-2001.

2,748,141. KOMELON CORPORATION, SAHA-KU, PUSAN, REPUBLIC OF KOREA. SN 76-264,436. PUB. 6-18-2002, FILED 5-30-2001.

MAGRIP

2,748,156. C3BGROUP, INC., LAKEWOOD, CA, BY ASSIGNMENT 4GL SOLUTIONS, INC., LONG BEACH, CA. SN 76-269,605. PUB. 8-6-2002, FILED 6-12-2001.

TREEPILOT

FOR MEASURING DEVICES; NAMELY, TAPE MEASURES (U.S. CLS. 21, 23, 26, 36 AND 38).

FIRST USE 6-21-2001; IN COMMERCE 6-21-2001.

FOR COMPUTER SOFTWARE FOR USE IN INTERNET ENABLED DATABASE MANAGEMENT AND INTERNET PUBLISHING (U.S. CLS. 21, 23, 26, 36 AND 38).

FIRST USE 3-1-2000; IN COMMERCE 3-1-2000.

CLASS 9—(Continued).

2,748,159. SONIC FOUNDRY, INC., MADISON, WI. SN 76-270,417. PUB. 6-4-2002, FILED 6-12-2001.

TOONSTREAM

FOR COMPUTER SOFTWARE FOR CONVERTING AUDIOVISUAL ANIMATION DATA INTO A FORM SUITABLE FOR ELECTRONIC DISTRIBUTION ON A GLOBAL NETWORK (U.S. CLS. 21, 23, 26, 36 AND 38).
FIRST USE 1-0-2001; IN COMMERCE 1-0-2001.

2,748,176. SO, HO YUN, CARSON, CA. SN 76-276,386. PUB. 9-17-2002, FILED 6-25-2001.

E-LINEAR

FOR ANIMAL TRAINING DEVICES, NAMELY, ELECTRONIC ANIMAL COLLARS FOR ANIMAL TRAINING, ELECTRONIC REMOTE CONTROL SYSTEMS FOR ANIMAL TRAINING COMPRISED OF TRANSMITTERS, HAND HELD ULTRASONIC SOUND EMITTERS, AND RECEIVERS WORN BY ANIMALS TO ACTIVATE A METHOD OF STIMULATION OR CORRECTION, ELECTRONIC ANIMAL CONFINEMENT SYSTEMS, ELECTRIC ANIMAL PRODS FOR ADMINISTERING AN ELECTRIC SHOCK FOR USE IN ANIMAL TRAINING, AND DOG WHISTLES (U.S. CLS. 21, 23, 26, 36 AND 38).
FIRST USE 12-0-2001; IN COMMERCE 12-0-2001.

2,748,182. OSBOURNE, ARTON MARK MARTIN, STATEN ISLAND, NY. SN 76-280,328. PUB. 6-18-2002, FILED 7-5-2001.

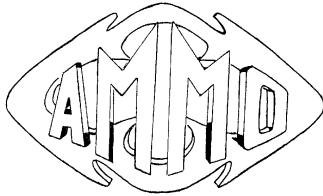

FOR COMPACT DISCS, AUDIO TAPES, RECORD ALBUMS, AND PHONOGRAPH RECORDS FEATURING MUSIC (U.S. CLS. 21, 23, 26, 36 AND 38).
FIRST USE 2-7-2003; IN COMMERCE 2-7-2003.

2,748,189. TECHNIWELD PRODUCTS CORPORATION, MISSISSAUGA, ONTARIO, CANADA. SN 76-282,241. PUB. 6-18-2002, FILED 7-10-2001.

POWERWELD

FOR WELDING TOOLS, NAMELY, WELDING ELECTRODE HOLDERS, GROUND CLAMPS, TUNGSTEN INERT GAS TORCHES AND METALLIC INERT GAS TORCHES (U.S. CLS. 21, 23, 26, 36 AND 38).
FIRST USE 7-31-2001; IN COMMERCE 7-31-2001.

CLASS 9—(Continued).

2,748,202. OPTEGON AG, CH-2563 IPSACH, SWITZERLAND. SN 76-285,836. PUB. 7-9-2002, FILED 7-16-2001.



FOR OPTICAL MEASURING DEVICES AND OPTOELECTRONIC EVALUATION DEVICES, NAMELY OPTICAL SPECTROMETERS, OPTICAL SPECTRAL ANALYZERS, OPTICAL THICKNESS ANALYZERS, INTERFEROMETRIC MEASUREMENT DEVICES, OPTICAL ENCODERS, HOLOGRAPHIC OPTICAL DATA STORAGE, OPTICAL RECEIVERS, OPTICAL CHEMOSENSORS, SPECTRAL SENSORS; COMPUTERS, NAMELY, MICROCONTROLLERS FOR OPTICAL DEVICES; COMPUTER SOFTWARE RECORDED ON MAGNETIC DATA CARRIERS FOR USE IN OPTICAL MEASUREMENT DATA PROCESSING (U.S. CLS. 21, 23, 26, 36 AND 38).
FIRST USE 6-15-2001; IN COMMERCE 6-15-2001.

2,748,211. SCHLUMBERGER TECHNOLOGY CORPORATION, HOUSTON, TX. SN 76-290,960. PUB. 11-13-2001, FILED 7-27-2001.

SIMCUBE

FOR COMPUTER SOFTWARE FOR OIL AND GAS EXPLORATION AND PRODUCTION, NAMELY, FOR TRANSFORMING GRIDS TO SEISMIC VOLUMES AND MANUALS DISTRIBUTED THEREWITH (U.S. CLS. 21, 23, 26, 36 AND 38).
FIRST USE 1-1-2003; IN COMMERCE 1-1-2003.

2,748,213. SATOR LASER GMBH, 22525 HAMBURG, FED REP GERMANY. SN 76-291,214. PUB. 9-3-2002, FILED 7-26-2001.



FOR LASER APPARATUS AND INSTRUMENTS, NAMELY, HIGH SPEED VECTOR LASERS FOR MARKING SYSTEMS AND LASER BASED FILL LEVEL SENSORS, ALL FOR NON-MEDICAL USE (U.S. CLS. 21, 23, 26, 36 AND 38).
FIRST USE 10-1-1996; IN COMMERCE 10-1-1996.

CLASS 9—(Continued).

2,748,217. INFINICON SYSTEMS, INC., KING OF PRUSSIA, PA. SN 76-292,369. PUB. 4-2-2002, FILED 8-1-2001.

INFININIC

FOR ETHERNET BASED I/O (INPUT/OUTPUT) HARDWARE, NAMELY I/O BOARDS, MEMORY BOARDS, IMAGE PROCESSORS AND DATA CONVERTERS (U.S. CLS. 21, 23, 26, 36 AND 38).

FIRST USE 6-0-2001; IN COMMERCE 8-0-2002.

2,748,218. MEDORDER, INC., SEATTLE, WA. SN 76-292,633. PUB. 12-11-2001, FILED 7-30-2001.

NAVRAD

FOR COMPUTER SOFTWARE FOR PROVIDING ACCESS TO AN INTERACTIVE COMPUTER DATABASE IN THE FIELD OF HEALTHCARE, MANAGING PATIENT AND PAYOR INFORMATION IN THE FIELD OF HEALTHCARE, PROVIDING DIAGNOSTIC AND TREATMENT INFORMATION IN THE FIELD OF HEALTHCARE, ADMINISTERING SCHEDULING, BILLING AND PAYMENT OF HEALTHCARE SERVICES, PROVIDING MEDICAL DIAGNOSTIC AND TREATMENT INFORMATION AND PROVIDING MEDICAL HISTORY RECORDS AND FILES (U.S. CLS. 21, 23, 26, 36 AND 38).

FIRST USE 7-31-2002; IN COMMERCE 7-31-2002.

2,748,232. NEPHROLOGY EDUCATIONAL SERVICES AND RESEARCH, INC., TARZANA, CA. SN 76-296,898. PUB. 1-29-2002, FILED 8-10-2001.

RENALTOUCH

FOR EDUCATIONAL SOFTWARE FOR DIALYSIS PATIENTS (U.S. CLS. 21, 23, 26, 36 AND 38).

FIRST USE 2-13-2002; IN COMMERCE 2-1-2002.

CLASS 9—(Continued).

2,748,238. KONAMI CORPORATION, MINATO-KU, TOKYO, JAPAN. SN 76-298,623. PUB. 9-17-2002, FILED 8-14-2001.



OWNER OF U.S. REG. NOS. 1,443,382, 2,487,288, AND 2,490,466.

FOR COMPUTER GAME PROGRAMS; VIDEO GAME CARTRIDGES; VIDEO GAME CD-ROMS; COMPUTER GAME CD-ROMS; VIDEO GAME PROGRAMS; VIDEO GAME MACHINES FOR USE WITH TELEVISIONS; VIDEO GAME PROGRAMS FOR USE WITH TELEVISIONS; VIDEO GAME JOYSTICKS; DOWNLOADABLE SOFTWARE FEATURING ELECTRONIC AND COMPUTER GAMES, ELECTRONIC AND COMPUTER GAME UPDATES, AND ELECTRONIC AND COMPUTER GAME SAMPLES (U.S. CLS. 21, 23, 26, 36 AND 38).

FIRST USE 9-11-2001; IN COMMERCE 9-11-2001.

2,748,249. MITSUBISHI ELECTRIC POWER PRODUCTS, WARRENDALE, PA, BY ASSIGNMENT MITSUBISHI ELECTRIC & ELECTRONICS USA, INC., CYPRESS, CA. SN 76-301,807. PUB. 4-30-2002, FILED 8-20-2001.

LEDERAD

OWNER OF U.S. REG. NO. 2,213,388.
FOR LIGHT EMITTING DIODE DISPLAYS FOR USE IN VISUAL ADVERTISING (U.S. CLS. 21, 23, 26, 36 AND 38).

FIRST USE 1-1-2000; IN COMMERCE 1-9-2003.

2,748,267. VODAVI COMMUNICATIONS SYSTEMS, INC., SCOTTSDALE, AZ. SN 76-310,088. PUB. 4-30-2002, FILED 9-6-2001.



NO CLAIM IS MADE TO THE EXCLUSIVE RIGHT TO USE "VOIP", APART FROM THE MARK AS SHOWN.

FOR GATEWAY INTERFACE CARD CONNECTING DATA NETWORKS WITH TELEPHONE NETWORKS (U.S. CLS. 21, 23, 26, 36 AND 38).

FIRST USE 3-6-2001; IN COMMERCE 3-6-2001.

CLASS 9—(Continued).

2,748,278. FINALLY DANCE INC., CARMEL, NY. SN 76-314,292. PUB. 6-25-2002, FILED 9-19-2001.

FINALLY DANCE!

NO CLAIM IS MADE TO THE EXCLUSIVE RIGHT TO USE "DANCE", APART FROM THE MARK AS SHOWN.
FOR PRE-RECORDED INSTRUCTIONAL VIDEOS, TAPES FEATURING DANCE INSTRUCTION AND PRINTED INSTRUCTIONAL MANUALS INCLUDED OR SOLD THEREWITH IN CONNECTION WITH DANCE INSTRUCTION (U.S. CLS. 21, 23, 26, 36 AND 38).
FIRST USE 12-0-2001; IN COMMERCE 12-0-2001.

2,748,280. COMMODITY GLOVE COMPANY, INC., WAYNE, PA. SN 76-314,626. PUB. 1-15-2002, FILED 9-19-2001.

TERMINATOR

FOR CUT-RESISTANT GLOVES FOR INDUSTRIAL USE (U.S. CLS. 21, 23, 26, 36 AND 38).
FIRST USE 6-27-2002; IN COMMERCE 6-27-2002.

2,748,308. VIAQUO CORPORATION, SAN JOSE, CA. SN 76-324,020. PUB. 3-19-2002, FILED 10-11-2001.

VIASEAL

FOR COMPUTER SOFTWARE TO SECURELY MANAGE ACCESS TO AND TO CONTROL ENTERPRISE-WIDE INFORMATION AND DIGITAL CONTENT (U.S. CLS. 21, 23, 26, 36 AND 38).
FIRST USE 11-0-2002; IN COMMERCE 11-0-2002.

2,748,309. VIAQUO CORPORATION, SAN JOSE, CA. SN 76-324,021. PUB. 3-19-2002, FILED 10-11-2001.

THE SAFETY SEAL FOR DIGITAL ASSETS

FOR COMPUTER SOFTWARE TO SECURELY MANAGE ACCESS TO AND TO CONTROL ENTERPRISE-WIDE INFORMATION AND DIGITAL CONTENT (U.S. CLS. 21, 23, 26, 36 AND 38).
FIRST USE 11-0-2002; IN COMMERCE 11-0-2002.

2,748,310. PEREGRINE SEMICONDUCTOR CORPORATION, SAN DIEGO, CA. SN 76-324,027. PUB. 4-30-2002, FILED 10-9-2001.

FOCUTSPAK

FOR INTEGRATED CIRCUITS (U.S. CLS. 21, 23, 26, 36 AND 38).
FIRST USE 1-17-2003; IN COMMERCE 1-17-2003.

CLASS 9—(Continued).

2,748,314. FEDERAL SIGNAL CORPORATION, OAK BROOK, IL. SN 76-325,180. PUB. 3-19-2002, FILED 10-16-2001.

ULTRAVOICE

FOR CONTROLLER AND AMPLIFIER FOR OUTDOOR ELECTRONIC SIRENS; COMPRISED OF A CONTROL BOARD, AMPLIFIERS AND POWER SUPPLY (U.S. CLS. 21, 23, 26, 36 AND 38).
FIRST USE 11-0-2001; IN COMMERCE 4-0-2002.

2,748,326. CABOT SAFETY INTERMEDIATE CORPORATION, NEWARK, DE. SN 76-328,698. PUB. 7-2-2002, FILED 10-19-2001.

METALIKS

FOR PROTECTIVE EYEWEAR (U.S. CLS. 21, 23, 26, 36 AND 38).
FIRST USE 3-0-2002; IN COMMERCE 3-0-2002.

2,748,332. PERTRONIX, INC., SAN DIMAS, CA. SN 76-331,654. PUB. 6-11-2002, FILED 10-29-2001.

SECOND STRIKE

FOR INTERNAL COMBUSTION ENGINE IGNITION SYSTEM COMPRISED OF A PRIMARY SPARK SENSOR, DC TO DC HIGH VOLTAGE CONVERTER, SPARK TIMER AND MICROCONTROLLER (U.S. CLS. 21, 23, 26, 36 AND 38).
FIRST USE 2-27-2003; IN COMMERCE 2-27-2003.

2,748,341. FUJI PHOTO FILM CO., LTD., ASHIGARA-SHI KANAGAWA, JAPAN. SN 76-334,579. PUB. 5-21-2002, FILED 11-5-2001.

CO-RES SCREENING

NO CLAIM IS MADE TO THE EXCLUSIVE RIGHT TO USE "SCREENING", APART FROM THE MARK AS SHOWN.
FOR COMPUTER SOFTWARE FOR PRODUCING SCREENING DATA TO BE USED FOR PRINTING (U.S. CLS. 21, 23, 26, 36 AND 38).
FIRST USE 9-0-2002; IN COMMERCE 9-0-2002.

CLASS 9—(Continued).

2,748,342. EVERMORE SOFTWARE, INC., ROWLAND HEIGHTS, CA. SN 76-334,648. PUB. 8-27-2002, FILED 11-6-2001.

EIO

FOR COMPUTER PROGRAMS, FOR USE AS A SPREADSHEET; FOR USE AS A CALCULATOR; FOR WORD PROCESSING; FOR DATABASE CREATION, DATA ENTRY, ACCESS, QUERY, ANALYSIS, COMPARISON, REPORTING, AND MANAGEMENT; FOR DATA AND VOICE COMMUNICATIONS, FOR TELEFAX, FOR ELECTRONIC MAIL, FOR ONLINE CONFERENCES, FOR ONLINE CHAT, FOR ELECTRONIC MESSAGING, OR TELEPHONE DIALING; FOR IMAGE EDITING, FOR GRAPHICS CREATION, EDITING AND GRAPHICS ALBUM MANAGEMENT; FOR AUDIO AND VIDEO RECORDING AND EDITING, AND THE STORAGE AND MANAGEMENT OF AUDIO AND VIDEO TRACKS; FOR MULTIMEDIA PRESENTATIONS, FOR MULTIMEDIA PRESENTATIONS USING MULTIPLE TYPES OF DATA OBJECTS, FOR SHARED EDITING OF TEXT AND MULTIMEDIA DOCUMENTS OVER PRIVATE AND PUBLIC NETWORKS; FOR TEXT AND MULTIMEDIA DOCUMENT AUTHORING, STORAGE, RETRIEVAL, CONTENTION CONTROL, VERSION HISTORY TRACKING, PROFILING, ACCESS CONTROL, AND SECURITY; FOR OPTICAL CHARACTER RECOGNITION; FOR VOICE RECOGNITION; FOR USE AS AN ELECTRONIC FILING CABINET OF MULTIMEDIA DATA IN A WIDE VARIETY OF DATA FORMATS; FOR PRODUCING CHARTS AND GRAPHS AND OTHER GRAPHICAL REPRESENTATION OF INFORMATION; FOR PRINTING; FOR USE AS A PERSONAL INFORMATION MANAGER; FOR DATA ENCRYPTION, SECURITY, AND DATA ACCESS CONTROL; FOR CONTROLLING USER ACCESS TO ELECTRONIC DATA; FOR CREATING, SERVING AND UPDATING WEB PAGES FOR USE ON INTRANETS AND THE GLOBAL COMPUTER NETWORK, AND ON OTHER PRIVATE AND PUBLIC NETWORKS; AND FOR COMPUTER NETWORKING; COMPUTER PROGRAMS FOR CALENDARING AND SCHEDULING, FOR DESKTOP PUBLISHING, FOR ACCOUNTING, FOR BUSINESS PLAN DEVELOPMENT, FOR FINANCIAL MANAGEMENT AND PLANNING, FOR USER TRAINING, FOR INVESTMENT ANALYSIS, FOR HUMAN RESOURCE MANAGEMENT, AND FOR PROJECT MANAGEMENT; INTEGRATED COMPUTER SOFTWARE CONSISTING OF ONE OR MORE OF THE FUNCTIONS STATED ABOVE; SUITE OF COMPUTER SOFTWARE CONSISTING OF ONE OR MORE OF THE ABOVE PROGRAMS; A COMPLETE LINE OF COMPUTER SOFTWARE CONSISTING OF ONE OR MORE OF THE ABOVE PROGRAMS; UTILITY PROGRAMS FOR ALL OF THE ABOVE; AND PRINTED MANUALS AND ELECTRONIC MEDIA FOR STORING THE SOFTWARE DISTRIBUTED AS A UNIT WITH ALL OF THE ABOVE; COMPUTER AND PARTS THEREFOR; NOTEBOOK COMPUTERS; ACCOUNTING COMPUTERS; COMPUTER PERIPHERALS; ELECTRONIC DICTIONARIES, ELECTRONIC DIARIES AND ADDRESS BOOKS; CALCULATORS; AND MICROPROCESSORS (U.S. CLS. 21, 23, 26, 36 AND 38).

FIRST USE 4-16-2002; IN COMMERCE 4-16-2002.

CLASS 9—(Continued).

2,748,345. BS&K HOLDING COMPANY, LLC, SYRACUSE, NY. SN 76-335,273. PUB. 9-17-2002, FILED 11-7-2001.



NO CLAIM IS MADE TO THE EXCLUSIVE RIGHT TO USE "COMPLIANCE", APART FROM THE MARK AS SHOWN.

FOR COMPUTER SOFTWARE FOR USE BY COLLEGES AND UNIVERSITIES IN COLLECTING, ANALYZING AND REPORTING INFORMATION REQUIRED BY THE REGULATIONS OF A COLLEGE ATHLETIC ASSOCIATION (U.S. CLS. 21, 23, 26, 36 AND 38).

FIRST USE 2-11-2002; IN COMMERCE 2-11-2002.

2,748,346. BS&K HOLDING COMPANY, LLC, SYRACUSE, NY. SN 76-335,274. PUB. 9-17-2002, FILED 11-7-2001.

**COMPLIANCE TOOLBOX**

BS&K COLLEGIATE SPORTS SERVICES, LLC

NO CLAIM IS MADE TO THE EXCLUSIVE RIGHT TO USE "COMPLIANCE" AND "COLLEGIATE SPORT SERVICES, LLC", APART FROM THE MARK AS SHOWN.

FOR COMPUTER SOFTWARE FOR USE BY COLLEGES AND UNIVERSITIES IN COLLECTING, ANALYZING AND REPORTING INFORMATION REQUIRED BY THE REGULATIONS OF A COLLEGE ATHLETIC ASSOCIATION (U.S. CLS. 21, 23, 26, 36 AND 38).

FIRST USE 2-11-2002; IN COMMERCE 2-11-2002.

2,748,348. DUAL-LITE INC., CHESHIRE, CT. SN 76-335,735. PUB. 4-9-2002, FILED 11-8-2001.

PHASOR

FOR INVERTERS FOR USE WITH EMERGENCY LIGHTING SYSTEMS (U.S. CLS. 21, 23, 26, 36 AND 38).

FIRST USE 8-31-2002; IN COMMERCE 8-31-2002.

CLASS 9—(Continued).

2,748,351. YORK INTERNATIONAL CORPORATION, YORK, PA. SN 76-336,339. PUB. 7-2-2002, FILED 11-13-2001.

SIMPLICITY

FOR ELECTRIC CONTROLLERS FOR USE WITH HEATING, VENTILATION, AIR CONDITIONING AND REFRIGERATION EQUIPMENT (U.S. CLS. 21, 23, 26, 36 AND 38).

FIRST USE 2-15-2002; IN COMMERCE 2-15-2002.

2,748,357. DATA RETRIEVAL CORPORATION, HOUSTON, TX. SN 76-337,038. PUB. 3-19-2002, FILED 11-13-2001.

SUBSEA SPIDR

OWNER OF U.S. REG. NO. 1,448,242.
FOR DATA ACQUISITION UNITS FOR UNDER-WATER USE, NAMELY, INSTRUMENTS FOR MEASURING AND STORING DATA FOR OIL AND GAS WELLS (U.S. CLS. 21, 23, 26, 36 AND 38).

FIRST USE 10-0-2002; IN COMMERCE 10-0-2002.

2,748,363. VIRAGE LOGIC CORPORATION, FREMONT, CA. SN 76-338,699. PUB. 10-1-2002, FILED 11-19-2001.

NOVEA

FOR ELECTRONIC MODULES FOR RECORDING, SENDING, ENCRYPTING, TRANSMITTING, SWITCHING AND STORING DATA; SEMICONDUCTOR MEMORY DEVICES PROVIDING NON-VOLATILE MEMORY ACCESS; AND COMPUTER OPERATING SOFTWARE FOR USE THEREWITH (U.S. CLS. 21, 23, 26, 36 AND 38).

FIRST USE 2-25-2002; IN COMMERCE 2-25-2002.

2,748,368. STUDIO ACOUSTICS, INC., WALNUT, CA. SN 76-341,256. PUB. 11-19-2002, FILED 11-26-2001.



FOR KARAOKE SETS COMPRISED OF MICROPHONES, VIDEO MONITORS AND CASSETTE AND DVD PLAYERS, SOLD TOGETHER AS A UNIT; TAPE RECORDER; GRAMOPHONE RECORDERS; STEREO LOUDSPEAKERS; STEREO AMPLIFIERS; NOISE AMPLIFIERS; MICROPHONE-MIXERS; CASES FOR STEREO LOUDSPEAKERS AND AUDIO CASSETTE PLAYERS; AND STEREO HOUSINGS (U.S. CLS. 21, 23, 26, 36 AND 38).

FIRST USE 10-9-2002; IN COMMERCE 10-9-2002.

CLASS 9—(Continued).

2,748,372. MEDIAMAP, INC., WATERTOWN, MA. SN 76-342,121. PUB. 5-21-2002, FILED 11-27-2001.

MEDIAMAPPERFORMA

FOR COMPUTER SOFTWARE FOR COMMUNICATIONS MANAGEMENT, NAMELY, SOFTWARE FOR MANAGING THE RELATIONSHIP, DISTRIBUTION, AND PERFORMANCE OF COMMUNICATIONS IN THE PROFESSIONAL COMMUNICATIONS INDUSTRY (U.S. CLS. 21, 23, 26, 36 AND 38).

FIRST USE 10-29-2001; IN COMMERCE 10-29-2001.

2,748,384. CHIP EXPRESS CORPORATION, SANTA CLARA, CA. SN 76-347,815. PUB. 7-9-2002, FILED 12-11-2001.



OWNER OF U.S. REG. NO. 1,673,300.
FOR SEMICONDUCTORS; INTEGRATED CIRCUITS; AND SEMICONDUCTOR AND INTEGRATED CIRCUIT LAYOUTS (U.S. CLS. 21, 23, 26, 36 AND 38).

FIRST USE 7-13-2001; IN COMMERCE 7-13-2001.

2,748,386. POSITION TECHNOLOGY INC./TECHNOLOGIE POSITION INC. QUEBEC J7R 5V3, CANADA. SN 76-348,290. PUB. 6-18-2002, FILED 12-14-2001.

XPLORER

FOR COMPUTERIZED BUILDING ALARM AND ACCESS CONTROL SYSTEMS COMPOSED OF SOFTWARE FOR INTERFACING WITH CONTROLLERS, READERS, CARDS AND RELATED SECURITY DEVICES, NAMELY CAMERAS, ENVIRONMENTAL SENSORS, MOTION SENSORS AND RELAYS (U.S. CLS. 21, 23, 26, 36 AND 38).

FIRST USE 8-5-2002; IN COMMERCE 10-30-2002.

CLASS 9—(Continued).

2,748,393. PADRES L.P., SAN DIEGO, CA. SN 76-349,924. PUB. 7-16-2002, FILED 12-18-2001.



NO CLAIM IS MADE TO THE EXCLUSIVE RIGHT TO USE "SAN DIEGO" AND "BASEBALL CLUB", APART FROM THE MARK AS SHOWN.

THE LINING IS A FEATURE OF THE MARK AND DOES NOT INDICATE COLOR.

FOR ELECTRICAL AND SCIENTIFIC APPARATUS, NAMELY, PRE-RECORDED VIDEOTAPES RELATING TO BASEBALL, PRE-RECORDED VIDEODISCS RELATING TO BASEBALL, DECORATIVE MAGNETS; PROTECTIVE HELMETS; CATCHERS HELMETS, COMPUTER ACCESSORIES, NAMELY MOUSE PADS; COMPUTER SOFTWARE, NAMELY SCREEN SAVERS; MONITOR FRAMES, VIDEO AND COMPUTER GAME CARTRIDGES, VIDEO AND COMPUTER GAME DISCS, VIDEO AND COMPUTER GAME CASSETTES, COMPUTER GAME PROGRAMS (U.S. CLS. 21, 23, 26, 36 AND 38).

FIRST USE 3-0-1997; IN COMMERCE 3-0-1997.

2,748,398. SYZGYST CORP., EAST GRAND RAPIDS, MI. SN 76-350,771. PUB. 7-2-2002, FILED 12-19-2001.

ARGUS

FOR COMPUTER SOFTWARE FOR USE IN ELECTRONIC ENTRY AND MANAGEMENT OF TIMEKEEPING AND EXPENSES FOR PROFESSIONAL SERVICES; COMPUTER SOFTWARE FOR SCHEDULING AND TASK MANAGEMENT FOR PROFESSIONAL SERVICES (U.S. CLS. 21, 23, 26, 36 AND 38).

FIRST USE 5-4-2002; IN COMMERCE 5-4-2002.

2,748,399. SYZGYST CORP., EAST GRAND RAPIDS, MI. SN 76-350,887. PUB. 7-2-2002, FILED 12-20-2001.



FOR COMPUTER SOFTWARE FOR USE IN ELECTRONIC ENTRY AND MANAGEMENT OF TIMEKEEPING AND EXPENSES FOR PROFESSIONAL SERVICES; COMPUTER SOFTWARE FOR SCHEDULING AND TASK MANAGEMENT FOR PROFESSIONAL SERVICES (U.S. CLS. 21, 23, 26, 36 AND 38).

FIRST USE 5-4-2002; IN COMMERCE 5-4-2002.

CLASS 9—(Continued).

2,748,402. EPIC SYSTEMS CORPORATION, MADISON, WI. SN 76-351,539. PUB. 7-23-2002, FILED 12-22-2001.

HYPERSPACE

FOR COMPUTER SOFTWARE IN THE HEALTH CARE FIELD, NAMELY SOFTWARE PROVIDING AN INTEGRATED USER INTERFACE FOR OTHER SOFTWARE APPLICATIONS (U.S. CLS. 21, 23, 26, 36 AND 38).

FIRST USE 12-6-2001; IN COMMERCE 3-29-2002.

2,748,406. JENSEN, ERNST A., DBA ELCO-ELEVATOR COMPONENTS CO., SAN RAFAEL, CA. SN 76-351,958. PUB. 6-25-2002, FILED 12-20-2001.

PROTEXUS 100 PLUS

FOR ELEVATOR SAFETY SYSTEM, NAMELY, A PROGRAMMABLE LIGHT CURTAIN SYSTEM FOR PREVENTING THE PREMATURE CLOSING OF ELEVATOR DOORS COMPRISING LIGHT TRANSMITTER STRIPS AND LIGHT RECEIVER STRIPS (U.S. CLS. 21, 23, 26, 36 AND 38).

FIRST USE 1-31-2002; IN COMMERCE 2-28-2002.

2,748,429. SALENTICA SYSTEMS INC., TORONTO, ONTARIO, CANADA. SN 76-359,624. PUB. 7-30-2002, FILED 1-17-2002.

SALENTICA

FOR COMPUTER SOFTWARE FOR COLLECTING, ORGANIZING, INTEGRATING AND ANALYZING DATA COLLECTED FROM A PLURALITY OF COMPUTER STATIONS NETWORKED IN RESPECT OF THE RUNNING OF A BUSINESS ORGANIZATION (U.S. CLS. 21, 23, 26, 36 AND 38).

FIRST USE 1-7-2002; IN COMMERCE 3-20-2003.

2,748,431. MEINEKE DISCOUNT MUFFLER SHOPS, INC., CHARLOTTE, NC. SN 76-359,910. PUB. 10-22-2002, FILED 1-16-2002.



NO CLAIM IS MADE TO THE EXCLUSIVE RIGHT TO USE "BUSINESS SYSTEM", APART FROM THE MARK AS SHOWN.

THE WORDS "M.KEY" ARE IN BLACK, THE KEY IS GOLD, AND THE WORDS "MEINEKE BUSINESS SYSTEM" ARE BLUE.

FOR COMPUTER SOFTWARE FOR USE IN THE OPERATION AND MANAGEMENT OF MOTOR VEHICLE MAINTENANCE AND REPAIR SHOPS (U.S. CLS. 21, 23, 26, 36 AND 38).

FIRST USE 2-4-2002; IN COMMERCE 2-4-2002.

CLASS 9—(Continued).

2,748,455. INFOGRAMS, INC., NEW YORK, NY. SN 76-366,125. PUB. 7-30-2002, FILED 1-31-2002.

BLENDER BROS.

FOR INTERACTIVE MULTIMEDIA GAME SOFTWARE FOR USE ON PERSONAL COMPUTERS AND ELECTRONIC GAME-PLAYING UNITS (U.S. CLS. 21, 23, 26, 36 AND 38).

FIRST USE 4-16-2002; IN COMMERCE 4-16-2002.

2,748,459. AIRMAGNET, INC., SUNNYVALE, CA. SN 76-367,788. PUB. 9-17-2002, FILED 2-5-2002.

AIRMAGNET

FOR SOFTWARE AND HARDWARE FOR SIGNAL AND PROTOCOL ANALYSIS OF DATA TRANSMITTED ACROSS A COMMUNICATION NETWORK (U.S. CLS. 21, 23, 26, 36 AND 38).

FIRST USE 5-11-2002; IN COMMERCE 5-11-2002.

2,748,461. SONY ELECTRONICS INC., PARK RIDGE, NJ. SN 76-368,293. PUB. 8-6-2002, FILED 2-6-2002.

REDEFINITION TELEVISION

NO CLAIM IS MADE TO THE EXCLUSIVE RIGHT TO USE "TELEVISION", APART FROM THE MARK AS SHOWN.

FOR TELEVISIONS (U.S. CLS. 21, 23, 26, 36 AND 38).
FIRST USE 12-31-2001; IN COMMERCE 12-31-2001.

2,748,463. SMITH DETECTION-EDGEWOOD INC., EDGEWOOD, MD, BY CHANGE OF NAME ENVIRONMENTAL TECHNOLOGIES GROUP, INC., BALTIMORE, MD. SN 76-369,349. PUB. 9-10-2002, FILED 2-8-2002.

BIO-SEEQ

FOR ELECTRONIC HAND-HELD DETECTOR FOR BIOLOGICAL MATERIALS (U.S. CLS. 21, 23, 26, 36 AND 38).

FIRST USE 12-12-2002; IN COMMERCE 12-12-2002.

2,748,467. COMPASS AI, INC., EL DORADO HILLS, CA. SN 76-371,516. PUB. 9-17-2002, FILED 2-15-2002.

INTELLIBOT

FOR COMPUTER SOFTWARE, NAMELY SOFTWARE TO PERFORM AUTOMATED APPLICATION INTEGRATION (U.S. CLS. 21, 23, 26, 36 AND 38).

FIRST USE 2-21-2002; IN COMMERCE 2-21-2002.

CLASS 9—(Continued).

2,748,473. ALTIUM LIMITED, FRENCHS FOREST NSW 2086, AUSTRALIA. SN 76-372,916. PUB. 9-17-2002, FILED 2-19-2002.

NVISAGE

FOR COMPUTER SOFTWARE USED AS A DEVELOPMENT TOOL FOR THE ELECTRONIC DESIGN OF COMPUTER HARDWARE, NAMELY, PRINTED CIRCUIT BOARDS AND OTHER ELECTRONIC SYSTEMS, AND RELATED USER MANUALS DISTRIBUTED THEREWITH (U.S. CLS. 21, 23, 26, 36 AND 38).

FIRST USE 12-13-2002; IN COMMERCE 12-13-2002.

2,748,484. ZENIMAX MEDIA INC., ROCKVILLE, MD. SN 76-377,689. PUB. 10-15-2002, FILED 3-1-2002.

MUD DUCK

FOR COMPUTER GAME PROGRAMS (U.S. CLS. 21, 23, 26, 36 AND 38).

FIRST USE 9-4-2002; IN COMMERCE 9-4-2002.

2,748,489. ADVANCED MICRO DEVICES, INC., SUNNYVALE, CA. SN 76-380,193. PUB. 11-5-2002, FILED 3-11-2002.

OPTERON

FOR COMPUTER HARDWARE; SEMICONDUCTOR DEVICES; MICROPROCESSOR MODULES; COMPUTER HARDWARE SUBSYSTEMS, NAMELY, INPUT UNITS, OUTPUT UNITS, CENTRAL PROCESSING UNITS, MEMORY CONTROLLERS, PERIPHERALS CONTROLLERS AND GRAPHICS CONTROLLERS; AND COMPUTER SOFTWARE, NAMELY, OPERATING SYSTEM SOFTWARE, GAMING SOFTWARE AND 3D GRAPHICS SOFTWARE (U.S. CLS. 21, 23, 26, 36 AND 38).

FIRST USE 1-0-2003; IN COMMERCE 4-0-2003.

2,748,499. SHEPHERD, COREY, ARVERN, NY. SN 76-382,177. PUB. 10-8-2002, FILED 3-15-2002.

LEDGEON

FOR MUSICAL SOUND RECORDINGS, CD'S PRE-RECORDED AUDIO AND VIDEO TAPES AND PHONOGRAPH RECORDS ALL CONTAINING MUSIC (U.S. CLS. 21, 23, 26, 36 AND 38).

FIRST USE 1-28-2002; IN COMMERCE 1-25-2003.

CLASS 9—(Continued).

2,748,510. BRUNTON COMPANY, INC., THE, RIVERTON, WY. SN 76-387,289. PUB. 10-22-2002, FILED 3-20-2002.

EPOCH

FOR BINOCULARS (U.S. CLS. 21, 23, 26, 36 AND 38). FIRST USE 8-1-2001; IN COMMERCE 2-1-2002.

2,748,515. RYLAND ORGANIZATION COMPANY, CALABASAS, CA. SN 76-389,869. PUB. 10-15-2002, FILED 4-2-2002.



NO CLAIM IS MADE TO THE EXCLUSIVE RIGHT TO USE "HOME SEARCH SOLUTION", APART FROM THE MARK AS SHOWN.

FOR COMPUTER DATABASE MANAGEMENT SOFTWARE FOR USE IN SEARCHING, ANALYZING, FORMATTING AND REPORTING DATA BASE INFORMATION REGARDING REAL ESTATE PROPERTIES, INCLUDING PROVIDING ON LINE SEARCHING OF LOCAL, REMOTE AND INTERNET-BASED REAL ESTATE DATA FILES, RESPONDING TO VOICE-ACTIVATED SEARCH REQUESTS FOR REAL ESTATE DATA, ANALYZING AND FORMATTING SELECTED REAL ESTATE DATA FOR USE INTERNALLY OR BY END CUSTOMERS OF REAL ESTATE PROPERTIES AND REPORTING FORMATTED REAL ESTATE DATA TO END CUSTOMERS (U.S. CLS. 21, 23, 26, 36 AND 38).

FIRST USE 1-25-2003; IN COMMERCE 1-25-2003.

2,748,517. UBI SOFT, INC., SAN FRANCISCO, CA. AND ENTERTAINMENT SOFTWARE PUBLISHING INC., TOKYO 151-0053, JAPAN. SN 76-390,409. PUB. 11-5-2002, FILED 4-1-2002.

EVOLUTION WORLDS

OWNER OF U.S. REG. NO. 2,452,055.

FOR SOFTWARE AND ELECTRONIC GAMES, NAMELY SOFTWARE GAMES RECORDED ON CD-ROM AND DIGITAL VIDEO DISCS FOR COMPUTERS; SOFTWARE GAMES RECORDED ON CD-ROMS, DIGITAL VIDEO DISCS, AND CARTRIDGES FOR CONSOLE AND INDIVIDUAL, PORTABLE GAMING SYSTEMS; COMPUTER SOFTWARE FOR ELECTRONIC GAMES THAT IS DOWNLOADABLE FROM A REMOTE COMPUTER SITE; AND COMPUTER GAME SOFTWARE FOR MOBILE PHONES AND PERSONAL DIGITAL ASSISTANTS (U.S. CLS. 21, 23, 26, 36 AND 38).

FIRST USE 12-3-2002; IN COMMERCE 12-3-2002.

CLASS 9—(Continued).

2,748,521. AIRMAGNET, INC., SUNNYVALE, CA. SN 76-391,415. PUB. 12-3-2002, FILED 4-4-2002.



FOR SOFTWARE AND HARDWARE FOR SIGNAL AND PROTOCOL ANALYSIS OF DATA TRANSMITTED ACROSS A COMMUNICATION NETWORK (U.S. CLS. 21, 23, 26, 36 AND 38).

FIRST USE 5-11-2002; IN COMMERCE 5-11-2002.

2,748,535. WILCOX INFORMATION SECURITY GROUP, INC., KALAMAZOO, MI. SN 76-397,032. PUB. 11-5-2002, FILED 4-16-2002.

HIPAA SAYS

NO CLAIM IS MADE TO THE EXCLUSIVE RIGHT TO USE "HIPAA", APART FROM THE MARK AS SHOWN.

FOR COMPUTER SOFTWARE PROGRAM DESIGNED TO ASSIST THE USER'S COMPLIANCE WITH THE REQUIREMENTS OF THE HEALTH INSURANCE PORTABILITY AND ACCOUNTABILITY ACT OF 1996 (HIPAA) (U.S. CLS. 21, 23, 26, 36 AND 38).

FIRST USE 12-20-2001; IN COMMERCE 4-2-2002.

2,748,539. THERMO CIDTEC INC., LIVERPOOL, NY. SN 76-398,003. PUB. 11-19-2002, FILED 4-18-2002.

SPECTRACAM

FOR SCIENTIFIC IMAGING CAMERAS WITH CHARGE INJECTION DEVICE (CID) PIXEL REGIONS (U.S. CLS. 21, 23, 26, 36 AND 38).

FIRST USE 9-20-2002; IN COMMERCE 9-20-2002.

2,748,543. UBI SOFT ENTERTAINMENT S.A., BOIS CEDEX, FRANCE. SN 76-399,309. PUB. 1-7-2003, FILED 4-24-2002.

SPLINTER CELL

FOR SOFTWARE AND ELECTRONIC GAMES, NAMELY SOFTWARE GAMES RECORDED ON CD-ROM AND DIGITAL VIDEO DISCS FOR COMPUTERS; SOFTWARE GAMES RECORDED ON CD-ROMS, DIGITAL VIDEO DISCS, AND CARTRIDGES FOR CONSOLE AND INDIVIDUAL, PORTABLE GAMING SYSTEMS; SOFTWARE GAMES THAT ARE DOWNLOADABLE FROM A REMOTE COMPUTER SITE; AND SOFTWARE GAMES FOR MOBILE PHONES, PERSONAL DIGITAL ASSISTANTS, AND HANDHELD COMPUTERS (U.S. CLS. 21, 23, 26, 36 AND 38).

FIRST USE 11-18-2002; IN COMMERCE 11-18-2002.

CLASS 9—(Continued).

2,748,557. FISHER HAMILTON LLC, TWO RIVERS, WI. SN 76-412,064. PUB. 12-3-2002, FILED 5-24-2002.

PRESTIGE

FOR CABINETRY FOR USE PRIMARILY IN LABORATORY ENVIRONMENTS (U.S. CLS. 21, 23, 26, 36 AND 38).

FIRST USE 9-0-2001; IN COMMERCE 9-0-2001.

2,748,591. TUNECASTER, INC., ST. JAMES, NY. SN 78-001,472. PUB. 9-11-2001, FILED 3-28-2000.

TUNE TIMELINE

NO CLAIM IS MADE TO THE EXCLUSIVE RIGHT TO USE "TUNE", APART FROM THE MARK AS SHOWN.

FOR COMPUTER SOFTWARE FOR USE IN THE FIELD OF MUSIC EDUCATION FOR PROVIDING INFORMATION ON MUSIC AND POPULAR SONGS (U.S. CLS. 21, 23, 26, 36 AND 38).

FIRST USE 3-27-2000; IN COMMERCE 11-8-2002.

2,748,592. TUNECASTER, INC., ST. JAMES, NY. SN 78-001,474. PUB. 9-11-2001, FILED 3-28-2000.

TUNECASTER

FOR COMPUTER SOFTWARE IN THE FIELD OF MUSIC EDUCATION FOR PROVIDING INFORMATION ON MUSIC AND POPULAR SONGS (U.S. CLS. 21, 23, 26, 36 AND 38).

FIRST USE 3-27-2000; IN COMMERCE 11-8-2002.

2,748,594. MATTEL, INC., EL SEGUNDO, CA. SN 78-004,174. PUB. 6-25-2002, FILED 4-14-2000.

EMERGENCY PATROL

FOR COMPUTER SOFTWARE FOR ENTERTAINMENT PURPOSES CONTAINED ON CD ROMS, COMPUTER GAME DISCS, AND COMPUTER GAME CARTRIDGES ALL FEATURING VIDEO GAMES AND CHILDREN'S ACTIVITIES (U.S. CLS. 21, 23, 26, 36 AND 38).

FIRST USE 10-0-2002; IN COMMERCE 10-0-2002.

CLASS 9—(Continued).

2,748,597. INTRINSITY, INC., AUSTIN, TX, BY CHANGE OF NAME EVSX, INC., AUSTIN, TX. SN 78-007,760. PUB. 3-13-2001, FILED 5-11-2000.



FOR SEMICONDUCTOR DEVICES (U.S. CLS. 21, 23, 26, 36 AND 38).

FIRST USE 12-23-2002; IN COMMERCE 12-23-2002.

2,748,615. WARREN I. BLUM PRODUCTIONS, LOS ANGELES, CA. SN 78-023,752. PUB. 9-17-2002, FILED 8-30-2000.

SMELOMANIA

OWNER OF U.S. REG. NOS. 75 AND 820,383.

FOR PRE RECORDED VIDEO TAPES, DVDS, AND MOTION PICTURE FILMS, ALL FEATURING AUDIO-VISUAL WORKS IN THE FIELD OF COMEDY AND SATIRE ENTERTAINMENT, DRAMATIC ENTERTAINMENT, MUSIC ENTERTAINMENT, AND DOCUMENTARIES; PRE-RECORDED CDS, AUDIO TAPES, AND DATS, ALL FEATURING MUSIC, SPOKEN WORDS, AND SOUND EFFECTS; MULTIMEDIA SOFTWARE RECORDED ON CD-ROMS FEATURING COMEDIC ENTERTAINMENT, SATIRICAL ENTERTAINMENT, DRAMATIC ENTERTAINMENT, GAMES, AND JOKES (U.S. CLS. 21, 23, 26, 36 AND 38).

FIRST USE 5-27-2003; IN COMMERCE 5-27-2003.

2,748,617. JOHNSON MANUFACTURING COMPANY, GRANDVILLE, MI. SN 78-024,584. PUB. 7-2-2002, FILED 9-6-2000.

GEARMASTER

FOR ELECTRONIC MONITORING SYSTEM, NAMELY GEAR AVAILABILITY AND SYNCHRONIZATION INDICATORS AND MONITORS FOR USE IN TRUCKS AND OTHER LAND VEHICLES FOR DISPLAYING AVAILABLE GEARS AND ENGINE SPEEDS REQUIRED FOR SYNCHRONOUS SHIFTING (U.S. CLS. 21, 23, 26, 36 AND 38).

FIRST USE 9-5-2002; IN COMMERCE 9-5-2002.

CLASS 9—(Continued).

2,748,620. CONEXANT SYSTEMS, INC., NEWPORT BEACH, CA. SN 78-027,381. PUB. 2-19-2002, FILED 9-23-2000.

SKYRAIL

FOR SEMICONDUCTOR DEVICES, NAMELY HIGH SPEED DATA TRANSCEIVERS (U.S. CLS. 21, 23, 26, 36 AND 38).

FIRST USE 9-18-2000; IN COMMERCE 6-1-2001.

2,748,623. QUALITY CARE SOLUTIONS INC., PHOENIX, AZ. SN 78-030,666. PUB. 8-6-2002, FILED 10-14-2000.

POWERED BY Q

FOR COMPUTER SOFTWARE IN THE FIELDS OF HEALTH CARE AND DENTAL CARE INSURANCE ADMINISTRATION, NAMELY, FOR RISK MANAGEMENT, CLAIMS PAYMENT, BENEFIT PLAN ADMINISTRATION, PROVIDER CONTRACTING, PREMIUM BILLING, DECISION SUPPORT AND REPORTING TOOLS (U.S. CLS. 21, 23, 26, 36 AND 38).

FIRST USE 12-1-2001; IN COMMERCE 12-1-2001.

2,748,630. KW INTERNATIONAL, LTD, LONDON, UNITED KINGDOM. SN 78-034,379. PUB. 9-17-2002, FILED 11-8-2000.

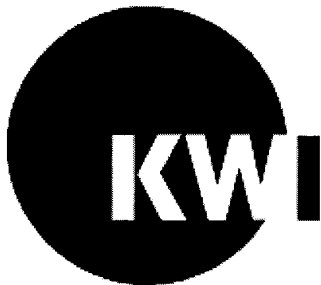

FOR COMPUTER SOFTWARE FOR USE IN TRADING, RISK MANAGEMENT SYSTEMS, SCHEDULING, AND SETTLEMENT FOR USE BY ENERGY ENTERPRISES (U.S. CLS. 21, 23, 26, 36 AND 38).

FIRST USE 8-0-1999; IN COMMERCE 8-0-1999.

2,748,632. GILES, SUSAN L., SAN MATEO, CA. SN 78-035,077. PUB. 3-12-2002, FILED 5-1-2001.

BENJIEBEE

FOR COMPUTER MOUSE FOR CHILDREN (U.S. CLS. 21, 23, 26, 36 AND 38).

FIRST USE 1-1-2001; IN COMMERCE 4-10-2001.

CLASS 9—(Continued).

2,748,634. JEFFREY V. HEININGER, BELLINGHAM, WA. SN 78-035,607. PUB. 3-5-2002, FILED 11-16-2000.

CELL CUP

NO CLAIM IS MADE TO THE EXCLUSIVE RIGHT TO USE "CELL", APART FROM THE MARK AS SHOWN.

FOR CELLULAR TELEPHONE CARRYING DEVICE, NAMELY, A CELLULAR TELEPHONE HOLDER THAT FITS IN A CUP HOLDER OF A CAR, TRUCK, BOAT, AIRPLANE, DESK, OR COUNTERTOP (U.S. CLS. 21, 23, 26, 36 AND 38).

FIRST USE 9-0-2000; IN COMMERCE 9-0-2000.

2,748,639. AZANDA NETWORK DEVICES, SUNNYVALE, CA. SN 78-041,779. PUB. 4-30-2002, FILED 1-4-2001.

AZANDA

FOR SEMICONDUCTOR DEVICES; COMMUNICATIONS PRODUCTS, NAMELY, LINECARDS, TRAFFIC MANAGERS AND SEMICONDUCTOR DEVICES, FOR OPTICAL NETWORKING, PROTOCOL INTERWORKING, DATA TRAFFIC MANAGEMENT, NETWORK MANAGEMENT, AND BANDWIDTH PROVISIONING (U.S. CLS. 21, 23, 26, 36 AND 38).

FIRST USE 6-14-2002; IN COMMERCE 6-14-2002.

2,748,640. GRONTMIJ GEO INFORMATIE B.V., NLX, NETHERLANDS, BY ASSIGNMENT GRONTMIJ GEOGROEP B.V., ROSENDAAL, NETHERLANDS. SN 78-042,382. PUB. 6-4-2002, FILED 1-9-2001.

MOVE3

OWNER OF BENELUX REG. NO. 614525, DATED 3-7-1997, EXPIRES 3-7-2007.

FOR COMPUTER SOFTWARE FOR DESIGN, ADJUSTMENT AND QUALITY CONTROL OF THREE DIMENSIONAL, TWO DIMENSIONAL AND ONE DIMENSIONAL GEODETIC NETWORKS (U.S. CLS. 21, 23, 26, 36 AND 38).

FIRST USE 3-10-1995; IN COMMERCE 3-10-1995.

CLASS 9—(Continued).

2,748,670. DRIVERMILL, LLC, ATLANTA, GA. SN 78-053,887. PUB. 7-9-2002, FILED 3-19-2001.



FOR DOWNLOADABLE COMPUTER SOFTWARE FOR PROJECT MANAGEMENT (U.S. CLS. 21, 23, 26, 36 AND 38).
FIRST USE 11-4-2001; IN COMMERCE 11-4-2001.

CLASS 9—(Continued).

2,748,687. SUPERB RECORDS, LTD., LOS ANGELES, CA. SN 78-059,397. PUB. 6-4-2002, FILED 4-19-2001.



NO CLAIM IS MADE TO THE EXCLUSIVE RIGHT TO USE "SUPERB RECORDS", APART FROM THE MARK AS SHOWN.

THE MARK CONTAINS A PICTORIAL REPRESENTATION OF A QUASAR.

FOR PHONOGRAPH RECORDS, PRERECORDED AUDIO TAPES, ENHANCED CDS, COMPACT DISCS, PRERECORDED VIDEO TAPES, PRERECORDED VIDEO CASSETTES, PRERECORDED AUDIO DIGITAL TAPES, DVDS AND LASER DISCS, ALL FEATURING MUSIC ENTERTAINMENT (U.S. CLS. 21, 23, 26, 36 AND 38).
FIRST USE 10-10-2001; IN COMMERCE 10-10-2001.

2,748,683. ENSOFTEC, INC., ROCKVILLE, MD. SN 78-057,320. PUB. 6-25-2002, FILED 4-7-2001.

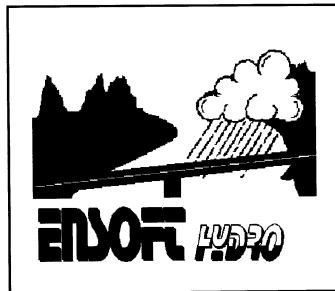

FOR COMPUTER SOFTWARE FOR USE IN DATABASE MANAGEMENT IN THE FIELD OF HYDRAULIC DESIGN (U.S. CLS. 21, 23, 26, 36 AND 38).
FIRST USE 6-5-2002; IN COMMERCE 6-5-2002.

2,748,714. LYNK SOFTWARE, INC., SCOTTSDALE, AZ. SN 78-073,437. PUB. 3-12-2002, FILED 7-11-2001.

**EVEREST CUSTOMER
FOCUSED QUALITY**

FOR COMPUTER SOFTWARE FOR CUSTOMER SERVICE AND QUALITY ASSURANCE PURPOSE, NAMELY CUSTOMER COMPLAINT TRACKING AND CORRECTIVE ACTION TRACKING SOFTWARE (U.S. CLS. 21, 23, 26, 36 AND 38).
FIRST USE 5-1-1999; IN COMMERCE 5-1-1999.

CLASS 9—(Continued).

2,748,724. CAMBRIDGE SILICON RADIO LTD., CAMBRIDGE, ENGLAND. SN 78-075,372. PUB. 7-2-2002, FILED 7-24-2001.

BlueSuite

FOR SEMICONDUCTORS, COMPUTER HARDWARE AND COMPUTER PERIPHERALS; CONTROL SOFTWARE, INTERFACE SOFTWARE, COMMUNICATIONS SOFTWARE FOR IMPLEMENTING THE PROTOCOL FOR USE IN CONNECTION WITH RADIO AND WIRELESS COMMUNICATION TRANSMITTERS, RECEIVERS AND SYNTHESIZERS; INTEGRATED CIRCUITS, SEMICONDUCTOR CHIPS, SEMICONDUCTOR CHIP SETS, AND CIRCUIT BOARD ASSEMBLIES (U.S. CLS. 21, 23, 26, 36 AND 38).

FIRST USE 5-19-2000; IN COMMERCE 5-19-2000.

2,748,727. FINAPLEX, INC., SAN FRANCISCO, CA. SN 78-076,022. PUB. 12-4-2001, FILED 7-27-2001.

FINAPLEX

FOR COMPUTER SOFTWARE USED FOR PERSONAL FINANCIAL MANAGEMENT (U.S. CLS. 21, 23, 26, 36 AND 38).

FIRST USE 9-1-2000; IN COMMERCE 2-19-2003.

2,748,728. CHOICE SYSTEMS, INC., RANCHO PALOS VERDES, CA. SN 78-077,404. PUB. 9-10-2002, FILED 8-3-2001.

RNET

FOR COMPUTER SOFTWARE FOR PROVIDING A MANAGEMENT SYSTEM FOR HEALTH CARE PROVIDERS, NAMELY, THE TRACKING, BILLING, INVOICING, COLLECTION AND MANAGEMENT OF FINANCIAL ASPECTS OF HOSPITALS, DOCTORS AND RELATED HEALTH CARE PROVIDERS AND THEIR PATIENTS (U.S. CLS. 21, 23, 26, 36 AND 38).

FIRST USE 8-1-2001; IN COMMERCE 11-15-2001.

CLASS 9—(Continued).

2,748,744. BARKSKY, STEVEN MARK, VENTURA, CA. SN 78-082,362. PUB. 1-7-2003, FILED 9-3-2001.



OWNER OF U.S. REG. NO. 2,483,296.

NO CLAIM IS MADE TO THE EXCLUSIVE RIGHT TO USE "VIDEO", APART FROM THE MARK AS SHOWN.

FOR PRERECORDED VIDEOS CASSETTES FEATURING SCUBA DIVING OR DEEP-SEA DIVING TOPICS (U.S. CLS. 21, 23, 26, 36 AND 38).

FIRST USE 12-30-2002; IN COMMERCE 5-20-2003.

2,748,747. WMS GAMING INC., WAUKEGAN, IL. SN 78-082,616. PUB. 4-2-2002, FILED 9-5-2001.

TOAST OF THE TOWN

FOR CURRENCY AND CREDIT OPERATED SLOT MACHINES AND GAMING DEVICES, NAMELY, GAMING MACHINES FOR USE IN GAMING ESTABLISHMENTS (U.S. CLS. 21, 23, 26, 36 AND 38).

FIRST USE 9-16-2002; IN COMMERCE 9-16-2002.

2,748,752. GIN, BRIAN R., SAN JOSE, CA. SN 78-083,623. PUB. 3-12-2002, FILED 9-12-2001.

BRIGHTENING MINDS

FOR VIDEO DISKS FEATURING MEDICAL AND EDUCATIONAL INFORMATION (U.S. CLS. 21, 23, 26, 36 AND 38).

FIRST USE 5-9-2003; IN COMMERCE 5-9-2003.

CLASS 9—(Continued).

2,748,761. AZIMUTH, INC., MORGANTOWN, WV. SN 78-084,945. PUB. 10-8-2002, FILED 9-21-2001.

TARGET MASTER

NO CLAIM IS MADE TO THE EXCLUSIVE RIGHT TO USE "TARGET", APART FROM THE MARK AS SHOWN.
FOR COMPUTER SOFTWARE FOR USE IN VISUALIZATION AND INFORMATION TRANSMISSION OF GEOSPATIAL ENVIRONMENTS AND PROCESSING IMAGERY INFORMATION, ALL IN THE FIELD OF IMAGERY ANALYSIS (U.S. CLS. 21, 23, 26, 36 AND 38).
FIRST USE 9-30-1998; IN COMMERCE 9-30-1998.

2,748,762. PDS ELECTRONICS, INC., AKRON, OH. SN 78-085,161. PUB. 3-5-2002, FILED 9-24-2001.

TELREX

FOR HIGH PERFORMANCE, LONG DISTANCE ANTENNAS USING HF, VHF OR UHF FREQUENCY BANDS TO OBTAIN OPTIMUM GAIN THROUGH CONTROL OF TAKE-OFF ANGLE, VOLTAGE STANDING WAVE RATIO AND ANTENNA PATTERN, INCLUDING BOTH PARASITIC AND ALL-DRIVEN ARRAYS AS WELL AS YAGI STACKING SYSTEMS AND VERTICAL ARRAY COMBINATIONS WHICH ALLOW INSTANT DIRECTIONAL SWITCHING AND SIMULTANEOUS COVERAGE OF TWO PATHS; YAGI PHASE BOXES, VERTICAL PHASE BOXES, SIDE MOUNT PHASE BOXES AND REMOTE COAXIAL SWITCHES (U.S. CLS. 21, 23, 26, 36 AND 38).
FIRST USE 5-6-2003; IN COMMERCE 5-6-2003.

2,748,767. TELECOMMUNICATION SYSTEMS, INC., ANNAPOLIS, MD. SN 78-086,671. PUB. 10-8-2002, FILED 10-3-2001.

SWIFT LINK

NO CLAIM IS MADE TO THE EXCLUSIVE RIGHT TO USE "LINK", APART FROM THE MARK AS SHOWN.
FOR PORTABLE COMMUNICATIONS TERMINAL COMPRISING COMPUTER HARDWARE AND SOFTWARE FOR USE IN CONNECTING TO THE INTERNET AND SATELLITES AND TRANSMITTING DATA, VOICE AND VIDEO OVER THE INTERNET AND SATELLITES (U.S. CLS. 21, 23, 26, 36 AND 38).
FIRST USE 12-0-2001; IN COMMERCE 1-0-2002.

CLASS 9—(Continued).

2,748,768. ELLIS ENTERPRISES, INC., OKLAHOMA CITY, OK. SN 78-086,721. PUB. 8-20-2002, FILED 10-3-2001.

MEGA BIBLE

NO CLAIM IS MADE TO THE EXCLUSIVE RIGHT TO USE "BIBLE", APART FROM THE MARK AS SHOWN.
FOR PRE-RECORDED MAGNETIC MEDIA IN THE NATURE OF CD ROMS FEATURING MULTIPLE BIBLE VERSIONS, A COLLECTION OF BIBLICAL RESEARCH AND REFERENCE WORKS, COMPUTER GAME PROGRAMS, PRE-RECORDED CLIP ART, MAPS, AND OTHER INFORMATION IN THE FIELD OF RELIGION, AND CONTAINING INTERACTIVE SEARCHING, ANNOTATION, AND NOTEPAD SOFTWARE (U.S. CLS. 21, 23, 26, 36 AND 38).
FIRST USE 10-24-2001; IN COMMERCE 10-24-2001.

2,748,769. GENERAL ELECTRIC COMPANY, SCHENECTADY, NY. SN 78-086,722. PUB. 9-17-2002, FILED 10-3-2001.

CENTRICITY

FOR COMPUTER MEDICAL SOFTWARE FOR USE IN INPATIENT AND OUTPATIENT CLINICAL CARE AREAS, RADIOLOGY DEPARTMENTS, AND RADIOLOGY DEPARTMENTS TO PROVIDE ELECTRONIC PATIENT RECORDS, AND INFORMATION AND MANAGEMENT (U.S. CLS. 21, 23, 26, 36 AND 38).
FIRST USE 11-0-2001; IN COMMERCE 11-0-2001.

2,748,770. ELLIS ENTERPRISES, INC., OKLAHOMA CITY, OK. SN 78-086,723. PUB. 9-17-2002, FILED 10-3-2001.

MICRO BIBLE

NO CLAIM IS MADE TO THE EXCLUSIVE RIGHT TO USE "BIBLE", APART FROM THE MARK AS SHOWN.
FOR PRE-RECORDED MAGNETIC MEDIA IN THE NATURE OF CD ROMS FEATURING MULTIPLE BIBLE VERSIONS, A COLLECTION OF BIBLICAL RESEARCH AND REFERENCE WORKS, COMPUTER GAME PROGRAMS, PRE-RECORDED CLIP ART, MAPS, AND OTHER INFORMATION IN THE FIELD OF RELIGION, AND CONTAINING INTERACTIVE SEARCHING, ANNOTATION, AND NOTEPAD SOFTWARE (U.S. CLS. 21, 23, 26, 36 AND 38).
FIRST USE 5-21-2002; IN COMMERCE 5-21-2002.

CLASS 9—(Continued).

2,748,771. ELLIS ENTERPRISES, INC., OKLAHOMA CITY, OK. SN 78-086,726. PUB. 10-8-2002, FILED S.R. 10-3-2001; AM. P.R. 6-17-2002.

MAXIMA BIBLE

NO CLAIM IS MADE TO THE EXCLUSIVE RIGHT TO USE "BIBLE", APART FROM THE MARK AS SHOWN.

FOR PRE-RECORDED MAGNETIC MEDIA IN THE NATURE OF CD ROM PACKAGES FEATURING MULTIPLE BIBLE VERSIONS, A COLLECTION OF BIBLICAL RESEARCH AND REFERENCE WORKS, AND CONTAINING COMPUTER GAME PROGRAMS, PRE-RECORDED SOFTWARE FEATURING CLIP ART AND MAPS IN THE FIELD OF RELIGION, AND CONTAINING INTERACTIVE SEARCHING, ANNOTATION, AND NOTEPAD SOFTWARE, ALL SOLD AS A UNIT (U.S. CLS. 21, 23, 26, 36 AND 38).

FIRST USE 10-24-2001; IN COMMERCE 10-24-2001.

2,748,784. NINE WEST DEVELOPMENT CORPORATION, WILMINGTON, DE. SN 78-091,015. PUB. 7-16-2002, FILED 10-31-2001.

NINE & COMPANY

OWNER OF U.S. REG. NOS. 1,724,670 AND 1,881,665.

NO CLAIM IS MADE TO THE EXCLUSIVE RIGHT TO USE "& COMPANY", APART FROM THE MARK AS SHOWN.

FOR SUNGLASSES, NON-PRESCRIPTION EYEGLASSES, READING GLASSES, CLIP-ON EYEGLOSS FRAMES AND EYEGLOSS FRAMES (U.S. CLS. 21, 23, 26, 36 AND 38).

FIRST USE 12-20-2001; IN COMMERCE 12-20-2001.

2,748,785. NDI TECHNOLOGIES LTD., WEST LOTHIAN, UNITED KINGDOM. SN 78-091,161. PUB. 8-20-2002, FILED 11-1-2001.

WINSUITE

FOR COMPUTER SOFTWARE FOR AUTHENTICATING USERS AND FOR CONTROLLING AND RESTRICTING ACCESS TO PROGRAMS, DOCUMENTS, AND OTHER COMPUTER FILES (U.S. CLS. 21, 23, 26, 36 AND 38).

FIRST USE 11-0-2001; IN COMMERCE 11-0-2001.

2,748,790. WMS GAMING INC., WAUKEGAN, IL. SN 78-092,683. PUB. 5-7-2002, FILED 11-9-2001.

ISLAND FORTUNE

FOR CURRENCY AND CREDIT OPERATED SLOT MACHINES AND GAMING DEVICES, NAMELY, GAMING MACHINES FOR USE IN GAMING ESTABLISHMENTS (U.S. CLS. 21, 23, 26, 36 AND 38).

FIRST USE 10-1-2001; IN COMMERCE 10-1-2001.

CLASS 9—(Continued).

2,748,797. CFS PRODUCTS, LLC, SANTA MARIA, CA. SN 78-094,808. PUB. 8-13-2002, FILED 11-23-2001.

SUSPENSION THEATER

NO CLAIM IS MADE TO THE EXCLUSIVE RIGHT TO USE "THEATER", APART FROM THE MARK AS SHOWN.

FOR CARRYING CASE FOR A PORTABLE DVD PLAYER, AND ITS ACCESSORIES, THAT CONVERT FROM A CARRYING CASE TO A MOUNTING PLATFORM ON WHICH A PORTABLE DVD PLAYER MAY BE POSITIONED FOR USE IN AN AUTOMOBILE OR LAND MOTOR VEHICLE (U.S. CLS. 21, 23, 26, 36 AND 38).

FIRST USE 12-15-2001; IN COMMERCE 12-15-2001.

2,748,799. LEADBYTE CORPORATION, BELLEVUE, WA. SN 78-095,385. PUB. 8-13-2002, FILED 11-28-2001.



NO CLAIM IS MADE TO THE EXCLUSIVE RIGHT TO USE "NETWORK SMART", APART FROM THE MARK AS SHOWN.

FOR COMPUTER SOFTWARE FOR MEASURING APPLICATION AND NETWORK PERFORMANCE (U.S. CLS. 21, 23, 26, 36 AND 38).

FIRST USE 9-1-1999; IN COMMERCE 12-1-1999.

2,748,800. METRO3D, INC., SAN JOSE, CA. SN 78-095,713. PUB. 7-16-2002, FILED 11-29-2001.

DUAL BLADES

FOR COMPUTER PROGRAMS, NAMELY, GAME SOFTWARE FOR USE ON COMPUTERS AND VIDEO GAME PLAYERS (U.S. CLS. 21, 23, 26, 36 AND 38).

FIRST USE 10-7-2002; IN COMMERCE 10-7-2002.

2,748,803. XEROX CORPORATION, STAMFORD, CT. SN 78-096,780. PUB. 6-25-2002, FILED 12-5-2001.

SILX

FOR COMPUTER SOFTWARE FOR OPTICAL CHARACTER RECOGNITION (OCR) SCANNING, FOR RECORDING COMPUTER DATA RECEIVED FROM SCANNING OR INPUT, FOR INDEXING OF DATA RECEIVED FROM SCANNING OR INPUT, FOR ENCRYPTION AND ACCESS CONTROL OF DATA (U.S. CLS. 21, 23, 26, 36 AND 38).

FIRST USE 12-6-2001; IN COMMERCE 12-6-2001.

CLASS 9—(Continued).

2,748,807. SVI SYSTEMS, INC., PEORIA, IL. SN 78-097,694.
PUB. 8-6-2002, FILED 12-11-2001.

MENU PLUS

NO CLAIM IS MADE TO THE EXCLUSIVE RIGHT TO USE "MENU", APART FROM THE MARK AS SHOWN.
FOR SOFTWARE FOR MANAGEMENT OF PATIENT FOOD SERVICE IN HOSPITALS AND HEALTH CARE FACILITIES (U.S. CLS. 21, 23, 26, 36 AND 38).
FIRST USE 7-0-2002; IN COMMERCE 7-0-2002.

2,748,832. MICROSOFT CORPORATION, REDMOND, WA.
SN 78-102,218. PUB. 8-6-2002, FILED 1-11-2002.

WHACKED!

FOR COMPUTER GAMES, NAMELY, GAME SOFTWARE FOR USE ON COMPUTERS AND VIDEO GAME PLAYERS (U.S. CLS. 21, 23, 26, 36 AND 38).
FIRST USE 10-8-2002; IN COMMERCE 10-8-2002.

2,748,836. OAKLEY, INC., FOOTHILL RANCH, CA. SN 78-102,600. PUB. 8-13-2002, FILED 1-14-2002.

O WIRE

OWNER OF U.S. REG. NOS. 1,952,458, 1,973,974, AND 2,339,802.

NO CLAIM IS MADE TO THE EXCLUSIVE RIGHT TO USE "WIRE", APART FROM THE MARK AS SHOWN.

FOR PROTECTIVE EYEWEAR, NAMELY, SPECTACLES, PRESCRIPTION EYEWEAR, ANTI-GLARE GLASSES AND SUNGLASSES AND THEIR PARTS AND ACCESSORIES, NAMELY, REPLACEMENT LENSES, FRAMES, EARSTEMS, AND NOSE PIECES; CASES SPECIALLY ADAPTED FOR SPECTACLES AND SUNGLASSES AND THEIR PARTS AND ACCESSORIES (U.S. CLS. 21, 23, 26, 36 AND 38).

FIRST USE 2-25-2002; IN COMMERCE 2-25-2002.

2,748,848. TUTORBOTS, INC., JENKINTOWN, PA. SN 78-103,696. PUB. 9-24-2002, FILED 1-18-2002.

EXPLORING CREATION

FOR EDUCATIONAL COMPUTER SOFTWARE FOR ELEMENTARY AND HIGH SCHOOL-LEVEL STUDENTS IN THE FIELD OF SCIENCE (U.S. CLS. 21, 23, 26, 36 AND 38).

FIRST USE 0-0-1998; IN COMMERCE 0-0-1998.

CLASS 9—(Continued).

2,748,849. OUT OF THE BOX PUBLISHING, INC., MADISON, WI. SN 78-103,755. PUB. 10-22-2002, FILED 1-20-2002.

MYCARD

FOR PERSONALIZED CARD GAME EXPANSION SYSTEM, CONSISTING OF SOFTWARE, WEBSITE TOOLS, PRINTABLE CARD STOCK AND ADDITIONAL CARD CREATION TOOLS AND GAME CONTENT (U.S. CLS. 21, 23, 26, 36 AND 38).

FIRST USE 3-28-2002; IN COMMERCE 12-13-2002.

2,748,850. INTELLIGENT DISTANCE LEARNING SYSTEMS, INC., CAMBRIDGE, MA. SN 78-103,817. PUB. 9-24-2002, FILED 1-21-2002.

IDESIGNER

FOR COMPUTER SOFTWARE TO CREATE AND DELIVER DISTANCE LEARNING COURSES (U.S. CLS. 21, 23, 26, 36 AND 38).

FIRST USE 2-0-2001; IN COMMERCE 2-0-2001.

2,748,859. ISCO, INC., LINCOLN, NE. SN 78-104,915. PUB. 10-15-2002, FILED 1-25-2002.

SWIFT

FOR LIQUID CHROMATOGRAPHY COLUMNS (U.S. CLS. 21, 23, 26, 36 AND 38).

FIRST USE 7-10-2002; IN COMMERCE 7-10-2002.

2,748,864. AVAYA INC., BASKING RIDGE, NJ. SN 78-105,839. PUB. 10-29-2002, FILED 1-30-2002.

AVAYA SOFTCONSOLE

FOR COMPUTER SOFTWARE APPLICATION FOR ACCEPTING AND MERGING INTERNET PROTOCOL OR DIGITAL TELEPHONE CALLS (U.S. CLS. 21, 23, 26, 36 AND 38).

FIRST USE 3-4-2002; IN COMMERCE 3-4-2002.

2,748,866. MARKETING INVESTORS CORPORATION, DALLAS, TX. SN 78-106,573. PUB. 9-24-2002, FILED 2-4-2002.

DURACOM

OWNER OF U.S. REG. NO. 1,830,231.
FOR DIGITAL VIDEO DISC PLAYERS (U.S. CLS. 21, 23, 26, 36 AND 38).

FIRST USE 4-4-2002; IN COMMERCE 4-4-2002.

CLASS 9—(Continued).

2,748,873. B AND L EQUIPMENT, INC., MIDLAND, TX. SN 78-107,795. PUB. 10-8-2002, FILED 2-9-2002.

DIGI-TALLY

FOR ELECTRONIC LASER MEASURING DEVICE FOR USE IN MEASURING AND RECORDING THE LENGTHS OF PIPE USED IN THE DRILLING AND COMPLETION OF OIL AND GAS WELLS (U.S. CLS. 21, 23, 26, 36 AND 38).

FIRST USE 1-22-2003; IN COMMERCE 1-22-2003.

2,748,878. FIORONI, RYAN, REMO, OAKLAND, CA. SN 78-108,241. PUB. 9-24-2002, FILED 2-12-2002.

REMO'CONSCIOUS

FOR COMPACT DISKS, CASSETTES, AND RECORDS FEATURING MUSIC (U.S. CLS. 21, 23, 26, 36 AND 38).

FIRST USE 11-1-2001; IN COMMERCE 2-1-2002.

2,748,880. LEGENDSOFT, INC., ALPHARETTA, GA. SN 78-109,536. PUB. 10-1-2002, FILED 2-18-2002.

SPOTS

FOR COMPUTER SOFTWARE FOR PROBLEM TRACKING, RESOLUTION, AND REPORTING, FOR THE CREATION, FULFILLMENT, AND REPORTING OF SERVICE ORDERS AND FOR TIME TRACKING, BILLING, REPORTING, AND ANALYSIS ALL FOR USE BY SOFTWARE DEVELOPERS AND ENTITIES WITH COMPUTER-RELATED HELP DESKS (U.S. CLS. 21, 23, 26, 36 AND 38).

FIRST USE 5-5-2003; IN COMMERCE 5-5-2003.

2,748,888. UNION SWITCH & SIGNAL, INC., PITTSBURGH, PA. SN 78-111,598. PUB. 12-3-2002, FILED 2-28-2002.

ECODE

FOR ELECTRONIC CIRCUITS AND PARTS THEREFORE FOR USE IN RAILWAY TRACKS (U.S. CLS. 21, 23, 26, 36 AND 38).

FIRST USE 11-0-2001; IN COMMERCE 11-0-2001.

2,748,889. UNION SWITCH & SIGNAL, INC., PITTSBURGH, PA. SN 78-111,603. PUB. 8-20-2002, FILED 2-28-2002.

I-LOK

FOR COMPUTER AND MICROPROCESSORS FOR USE IN AUTOMATED RAILWAY SIGNALING AND CONTROLLING (U.S. CLS. 21, 23, 26, 36 AND 38).

FIRST USE 3-0-2002; IN COMMERCE 3-0-2002.

CLASS 9—(Continued).

2,748,909. SCOTT, MURDOCK, DALLAS, TX. AND O'NEILL, SHAWN, LEWISVILLE, TX. SN 78-118,302. PUB. 11-5-2002, FILED 3-28-2002.

PAYNE'S GREY

FOR SOUND RECORDINGS FEATURING MUSIC (U.S. CLS. 21, 23, 26, 36 AND 38).

FIRST USE 11-1-1992; IN COMMERCE 3-1-2002.

2,748,911. AEGIS TECHNOLOGIES GROUP, INC., THE, HUNTSVILLE, AL. SN 78-118,790. PUB. 10-15-2002, FILED 4-1-2002.

ACSLXTREME

OWNER OF U.S. REG. NO. 2,087,062. FOR COMPUTER SOFTWARE FOR USE IN SIMULATING DYNAMIC SYSTEMS (U.S. CLS. 21, 23, 26, 36 AND 38).

FIRST USE 6-11-2002; IN COMMERCE 6-11-2002.

2,748,929. PROCESS & TECHNOLOGY CORPORATION, MIAMI, FL. SN 78-121,869. PUB. 11-5-2002, FILED 4-15-2002.



THE MARK CONSISTS OF A GRAY "2" BETWEEN TWO "E" LETTERS. THE RIGHT "E" IS ORANGE AND THE OTHER ONE IS BLUE. ALL THIS ELEMENTS ARE ABOVE THE WORD "WORKS".

FOR COMPUTER COMMUNICATIONS SOFTWARE TO ALLOW CUSTOMERS TO ACCESS BANK ACCOUNT INFORMATION AND TRANSACT BANK BUSINESS; COMPUTER SOFTWARE DEVELOPMENT TOOLS; FACTORY AUTOMATION SOFTWARE, NAMELY, SOFTWARE TO INTEGRATE MANUFACTURING MACHINE OPERATIONS, TRACK PROBLEMS AND GENERATE PRODUCTION REPORTS (U.S. CLS. 21, 23, 26, 36 AND 38).

FIRST USE 9-23-2001; IN COMMERCE 5-15-2002.

CLASS 9—(Continued).

2,748,958. TRS QUALITY, INC., WILMINGTON, DE. SN 78-131,096. PUB. 12-3-2002, FILED 5-24-2002.

FLATFOTO

FOR CREDIT CARD-SIZED, VEST POCKET DIGITAL CAMERA (U.S. CLS. 21, 23, 26, 36 AND 38).
FIRST USE 11-22-2002; IN COMMERCE 11-29-2002.

2,748,966. DEEPOUTDOORS, INC., POWAY, CA. SN 78-132,958. PUB. 12-3-2002, FILED 6-4-2002.

SERENITY

FOR BUOYANCY COMPENSATOR DEVICES FOR DIVERS (U.S. CLS. 21, 23, 26, 36 AND 38).
FIRST USE 6-1-2002; IN COMMERCE 6-1-2002.

2,748,967. DEEPOUTDOORS, INC., POWAY, CA. SN 78-132,959. PUB. 12-3-2002, FILED 6-4-2002.

TRANQUILITY

FOR BUOYANCY COMPENSATOR DEVICES FOR DIVERS (U.S. CLS. 21, 23, 26, 36 AND 38).
FIRST USE 6-1-2002; IN COMMERCE 6-1-2002.

2,748,968. DEEPOUTDOORS, INC., POWAY, CA. SN 78-132,960. PUB. 12-3-2002, FILED 6-4-2002.

UNITY

FOR BUOYANCY COMPENSATOR DEVICES FOR DIVERS (U.S. CLS. 21, 23, 26, 36 AND 38).
FIRST USE 6-1-2002; IN COMMERCE 6-1-2002.

2,748,969. DEEPOUTDOORS, INC., POWAY, CA. SN 78-132,961. PUB. 12-3-2002, FILED 6-4-2002.

INTEGRITY

FOR BUOYANCY COMPENSATOR DEVICES FOR DIVERS (U.S. CLS. 21, 23, 26, 36 AND 38).
FIRST USE 6-1-2002; IN COMMERCE 6-1-2002.

CLASS 9—(Continued).

2,748,975. ITCENTRIX, INC., FRAMINGHAM, MA. SN 78-134,591. PUB. 12-3-2002, FILED 6-11-2002.

VALUE ACCELERATOR

FOR COMPUTER SOFTWARE, NAMELY, DECISION SUPPORT SOFTWARE IN THE FIELD OF INFORMATION TECHNOLOGY (U.S. CLS. 21, 23, 26, 36 AND 38).
FIRST USE 5-0-2002; IN COMMERCE 6-0-2002.

2,748,977. CONVERSION TECHNOLOGY INC., NORCROSS, GA. SN 78-136,875. PUB. 1-21-2003, FILED 6-19-2002.



THE MARK CONSISTS OF BLUE COLORED "S" AND BLACK AND WHITE TEXT AND PICTURE.
FOR COMPUTER SOFTWARE FOR MANAGEMENT OF ENVIRONMENTAL, HEALTH AND SAFETY COMPLAINTS (U.S. CLS. 21, 23, 26, 36 AND 38).
FIRST USE 7-22-2000; IN COMMERCE 7-22-2000.

2,748,979. ROBERTS, KATHERINE, CAVE CREEK, AZ. SN 78-137,088. PUB. 12-17-2002, FILED 6-19-2002.

**YOGA FOR GOLFERS
BECAUSE YOUR BODY
DOESN'T GET A MULLIGAN**

FOR PRERECORDED VIDEOTAPES CONTAINING INSTRUCTION IN THE FIELD OF YOGA FOR GOLFERS (U.S. CLS. 21, 23, 26, 36 AND 38).
FIRST USE 12-0-2002; IN COMMERCE 12-0-2002.

CLASS 10—MEDICAL APPARATUS

2,747,499. MASIMO CORPORATION, IRVINE, CA. SN 75-540,527. PUB. 11-28-2000, FILED 8-21-1998.

DST

FOR MEDICAL APPARATUS, NAMELY, SENSORS FOR USE WITH COMPUTER HARDWARE AND COMPUTER SOFTWARE FOR MONITORING AND DETECTING PHYSIOLOGICAL DATA IN A PATIENT, SPECIFICALLY FOR BLOOD CONTENT MONITORING INCLUDING GLUCOSE AND OXYGEN, AND FOR HEMODYNAMIC MONITORING INCLUDING BLOOD PRESSURE AND ELECTROCARDIOGRAMS (U.S. CLS. 26, 39 AND 44).
FIRST USE 5-24-2000; IN COMMERCE 5-24-2002.

CLASS 10—(Continued).

2,747,600. MEDICAL DEPOT, INC., FARMINGDALE, NY, BY ASSIGNMENT; BY ASSIGNMENT MOBILITY USA, L.C., CAPE CORAL, FL. SN 75-773,636. PUB. 1-8-2002, FILED 8-12-1999.



NO CLAIM IS MADE TO THE EXCLUSIVE RIGHT TO USE "MOBILITY USA", APART FROM THE MARK AS SHOWN.

FOR MEDICAL EQUIPMENT, NAMELY, WALKERS, ROLLATORS IN THE NATURE OF WALKERS (U.S. CLS. 26, 39 AND 44).

FIRST USE 7-1-2002; IN COMMERCE 7-1-2002.

2,747,656. TELEFLEX INCORPORATED, LIMERICK, PA. SN 75-861,892. PUB. 7-18-2000, FILED 12-1-1999.

VIEWMAX

FOR LARYNGOSCOPES (U.S. CLS. 26, 39 AND 44).
FIRST USE 10-3-2002; IN COMMERCE 10-14-2002.

2,747,708. WALDEMAR LINK (GMBH & CO.), HAMBURG, FED REP GERMANY. SN 75-937,292. PUB. 10-1-2002, FILED 3-7-2000.



OWNER OF U.S. REG. NO. 1,266,231.
NO CLAIM IS MADE TO THE EXCLUSIVE RIGHT TO USE "SPINE GROUP INC.", APART FROM THE MARK AS SHOWN.

THE SHADING IS A FEATURE OF THE MARK AND DOES NOT INDICATE COLOR.

FOR SPINAL PROSTHETIC IMPLANTS FOR VERTEBRAL PROSTHESIS; AND SURGICAL INSTRUMENTS FOR INSERTING, FIXING, AND REMOVING OF VERTEBRAL PROSTHESIS FOR SPINAL PROSTHETIC IMPLANTATION THEREOF (U.S. CLS. 26, 39 AND 44).

FIRST USE 2-25-2000; IN COMMERCE 2-25-2000.

CLASS 10—(Continued).

2,747,867. GN RESOUND NORTH AMERICA CORPORATION, REDWOOD CITY, CA, BY CHANGE OF NAME GN RESOUND CORPORATION, REDWOOD CITY, CA. SN 76-125,526. PUB. 7-24-2001, FILED 9-11-2000.

CANTA

OWNER OF U.S. REG. NO. 798,604.
FOR HEARING AID DEVICES (U.S. CLS. 26, 39 AND 44).

FIRST USE 4-0-2001; IN COMMERCE 4-0-2001.

2,747,876. M.K. MEDITECH CO., LTD., TAOYUAN CITY, TAIWAN. SN 76-130,911. PUB. 10-8-2002, FILED 9-15-2000.

DuoProSS

FOR MEDICAL SYRINGES, NEEDLES FOR MEDICAL USE, BLOOD TRANSFUSION APPARATUS, PUNCTURE DEVICES FOR TAKING BLOOD SAMPLES, LANCETS, BLOOD DRAWING APPARATUS, INFANT NASAL ASPIRATORS, INTRAVENOUS INJECTION HYPODERMIC NEEDLES, ORAL CAVITY HYPODERMIC NEEDLES, OPERATING ROOM APPAREL, SURGICAL INSTRUMENT TRAY LINERS, CLAVICLE BRACES, CERVICAL COLLAR PILLOWS FOR MEDICAL USE (U.S. CLS. 26, 39 AND 44).

FIRST USE 8-29-2001; IN COMMERCE 12-6-2001.

2,748,040. VITA LICENSING, INC., WILMINGTON, DE, BY ASSIGNMENT ORTHOVITA, INC., MALVERN, PA. SN 76-227,353. PUB. 7-16-2002, FILED 3-20-2001.

IMBIBE

FOR ORTHOPEDIC AND SURGICAL MATERIALS, NAMELY, SYRINGES (U.S. CLS. 26, 39 AND 44).
FIRST USE 1-25-2002; IN COMMERCE 1-25-2002.

2,748,104. WESTERN MEDICAL INC., TENAFLY, NJ. SN 76-254,603. PUB. 10-15-2002, FILED 5-9-2001.

SYSTEM-FOUR

FOR BANDAGING KIT COMPRISING A PLURALITY OF COMPRESSION BANDAGES (U.S. CLS. 26, 39 AND 44).

FIRST USE 10-17-2001; IN COMMERCE 10-17-2001.

CLASS 10—(Continued).

2,748,116. VASCULAR ARCHITECTS, INC., SAN JOSE, CA. SN 76-258,843. PUB. 8-13-2002, FILED 5-16-2001.

PERISCOPE

FOR SURGICAL INSTRUMENT, NAMELY A DEBULKING ASSIST TOOL USED TO REMOVE MATERIAL FROM BLOOD VESSEL WALLS (U.S. CLS. 26, 39 AND 44).

FIRST USE 9-19-2001; IN COMMERCE 9-19-2001.

2,748,204. METRACOR TECHNOLOGIES, INC., SAN DIEGO, CA. SN 76-286,419. PUB. 8-13-2002, FILED 7-10-2001.

METRACOR

FOR MEDICAL SYSTEM COMPRISED OF A DISPOSABLE SENSOR AND DISPLAY MODULE ATTACHED TO EITHER A PATIENT'S ARTERIAL CATHETER OR INTRAVENOUS LINES, FOR MONITORING AND DISPLAYING PATIENT PHYSIOLOGICAL INFORMATION (U.S. CLS. 26, 39 AND 44).

FIRST USE 7-0-2001; IN COMMERCE 7-0-2001.

2,748,374. BIOMET, INC., WARSAW, IN. SN 76-343,270. PUB. 4-30-2002, FILED 11-14-2001.

SECOND ASSISTANT

FOR ORTHOPEDIC DEVICES, NAMELY, INTERNAL AND EXTERNAL INSTRUMENTS AND POSITIONERS FOR THE KNEE (U.S. CLS. 26, 39 AND 44).

FIRST USE 2-15-2002; IN COMMERCE 2-15-2002.

2,748,638. MEDTRONIC, INC., MINNEAPOLIS, MN. SN 78-041,463. PUB. 8-21-2001, FILED 1-3-2001.

BESTENT2

FOR IMPLANTABLE CORONARY STENT (U.S. CLS. 26, 39 AND 44).

FIRST USE 10-31-2000; IN COMMERCE 10-31-2000.

2,748,651. COLBAR R&D LTD., RAMAT HASHARON, ISRAEL. SN 78-046,990. PUB. 9-24-2002, FILED 2-7-2001.

OSSIX

FOR REGENERATIVE MEMBRANES FOR USE IN DENTISTRY (U.S. CLS. 26, 39 AND 44).

FIRST USE 6-0-2001; IN COMMERCE 6-0-2001.

CLASS 10—(Continued).

2,748,689. MEDTRONIC, INC., MINNEAPOLIS, MN. SN 78-061,779. PUB. 7-16-2002, FILED 5-3-2001.

SYNERGY VERSITREL

FOR IMPLANTABLE PULSE GENERATOR FOR PAIN (U.S. CLS. 26, 39 AND 44).

FIRST USE 1-31-2002; IN COMMERCE 1-31-2002.

2,748,839. GENESEE BIOMEDICAL, INC., DENVER, CO. SN 78-102,754. PUB. 8-6-2002, FILED 1-15-2002.

LOCNESS

FOR SURGICAL RETRACTORS (U.S. CLS. 26, 39 AND 44).

FIRST USE 11-21-2002; IN COMMERCE 11-21-2002.

2,748,840. NOVARTIS AG, BASEL, SWITZERLAND. SN 78-102,849. PUB. 9-24-2002, FILED 1-15-2002.

EZ SPIKE

NO CLAIM IS MADE TO THE EXCLUSIVE RIGHT TO USE "SPIKE", APART FROM THE MARK AS SHOWN.

FOR CONTAINER FOR USE WITH CLOSED SYSTEM ENTERAL TUBE FEEDING SYSTEM (U.S. CLS. 26, 39 AND 44).

FIRST USE 12-0-2001; IN COMMERCE 12-0-2001.

2,748,874. ALVEOLUS, INC, CHARLOTTE, NC. SN 78-107,823. PUB. 9-17-2002, FILED 2-9-2002.

ALVEOLUS

FOR MEDICAL APPARATUS, NAMELY, THERAPEUTIC STENT DEVICES FOR USE IN VARIOUS PARTS OF A PATIENT'S ANATOMY (U.S. CLS. 26, 39 AND 44).

FIRST USE 3-1-2003; IN COMMERCE 3-1-2003.

2,748,897. JORDAN NEUROSCIENCE, INC., SAN BERNARDINO, CA. SN 78-112,991. PUB. 9-10-2002, FILED 3-6-2002.

BRAINET

FOR MEDICAL EQUIPMENT, NAMELY, ELECTROENCEPHALOGRAPH HEADGEAR (U.S. CLS. 26, 39 AND 44).

FIRST USE 1-29-2003; IN COMMERCE 1-29-2003.

CLASS 10—(Continued).

2,748,965. EVERYTHING FOR LOVE, INCORPORATED, PINE MOUNTAIN, CA. SN 78-132,917. PUB. 11-26-2002, FILED 6-3-2002.

LOVE FINGERS

FOR MESSAGE APPARATUS (U.S. CLS. 26, 39 AND 44).
FIRST USE 2-15-2003; IN COMMERCE 2-15-2003.

CLASS 11—ENVIRONMENTAL CONTROL APPARATUS

2,747,459. VECTOR PRODUCTS, INC., MIAMI, FL. SN 75-127,331. PUB. 4-21-1998, FILED 6-28-1996.

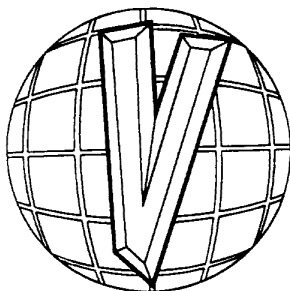

THE MARK CONSISTS OF A "V" AND A STYLIZED GLOBE.

FOR FLEX FANS AND AUTOMOTIVE AND MARINE PORTABLE BATTERY POWERED ELECTRIC FANS (U.S. CLS. 13, 21, 23, 31 AND 34).

FIRST USE 11-0-1996; IN COMMERCE 11-0-1996.

2,747,501. INTERNATIONAL DEVELOPMENT CORPORATION, IRVING, DALLAS, TX. SN 75-543,371. PUB. 4-25-2000, FILED 8-26-1998.

SAFE LITE

NO CLAIM IS MADE TO THE EXCLUSIVE RIGHT TO USE "LITE", APART FROM THE MARK AS SHOWN.

FOR TORCHIERE LAMP WITH HALOGEN BULB (U.S. CLS. 13, 21, 23, 31 AND 34).

FIRST USE 12-1-1998; IN COMMERCE 12-1-1998.

CLASS 11—(Continued).

2,747,603. ORION MACHINERY CO., LTD., SUZAKA-SHI, NAGANO-KEN 382-8502, JAPAN. SN 75-783,178. PUB. 6-12-2001, FILED 8-24-1999.

ORION

OWNER OF U.S. REG. NOS. 1,176,836 AND 1,625,632.
FOR REFRIGERATED WATER COOLERS; DESICCANT DRYING MACHINES FOR REMOVAL OF MOISTURE FOR INDUSTRIAL USE; AIR FILTERS FOR INDUSTRIAL INSTALLATIONS (U.S. CLS. 13, 21, 23, 31 AND 34).

FIRST USE 3-0-1990; IN COMMERCE 3-0-1990.

2,747,644. AAF-MCQUAY INC., LOUISVILLE, KY. SN 75-841,341. PUB. 11-5-2002, FILED 11-5-1999.

MEGACEL

FOR AIR FILTERS FOR INDUSTRIAL USE IN CLEAN ROOM APPLICATIONS (U.S. CLS. 13, 21, 23, 31 AND 34).
FIRST USE 7-30-1999; IN COMMERCE 7-30-1999.

2,747,868. HOLMES GROUP, INC., THE, MILFORD, MA. SN 76-125,968. PUB. 8-6-2002, FILED 9-11-2000.

1TOUCH

NO CLAIM IS MADE TO THE EXCLUSIVE RIGHT TO USE "TOUCH", APART FROM THE MARK AS SHOWN.

FOR ELECTRICAL FANS FOR DOMESTIC AND COMMERCIAL USE (U.S. CLS. 13, 21, 23, 31 AND 34).

FIRST USE 2-0-2001; IN COMMERCE 2-0-2001.

2,747,937. L.C.T. GLASS & LIGHTING COMPANY, LLC, THE, WEST HARTFORD, CT. SN 76-175,713. PUB. 7-3-2001, FILED 12-4-2000.

L.C.T.

FOR LAMPS; LAMPS SHADES (U.S. CLS. 13, 21, 23, 31 AND 34).

FIRST USE 6-30-2002; IN COMMERCE 6-30-2002.

CLASS 11—(Continued).

2,747,944. COLLINS INTERNATIONAL CO., LTD., FAIR LAWN, NJ. SN 76-180,406. PUB. 6-11-2002, FILED S.R. 12-14-2000; AM. P.R. 12-17-2001.

SUPER BRIGHT PLUS

NO CLAIM IS MADE TO THE EXCLUSIVE RIGHT TO USE "BRIGHT", APART FROM THE MARK AS SHOWN.

FOR ELECTRIC LIGHTS, NAMELY STRING LIGHTING COMPRISING LIGHT BULBS IN SOCKETS CONNECTED BY WIRING, AND LIGHTED DECORATIONS (U.S. CLS. 13, 21, 23, 31 AND 34).

FIRST USE 8-0-2001; IN COMMERCE 8-0-2001.

2,747,997. PORTAFIRE, INC., LITTLETON, CO. SN 76-206,377. PUB. 9-25-2001, FILED 2-7-2001.



NO CLAIM IS MADE TO THE EXCLUSIVE RIGHT TO USE "FIRE", APART FROM THE MARK AS SHOWN.

THE STIPPLING IS A FEATURE OF THE MARK AND DOES NOT INDICATE COLOR.

FOR ARTIFICIAL CAMPFIRE UNITS COMPRISED OF REFRACTORY LOGS AND A FIXED OR PORTABLE PRESSURIZED FUEL GAS SOURCE, WHICH CAN ALSO BE USED AS AN OUTDOOR COOKING UNIT (U.S. CLS. 13, 21, 23, 31 AND 34).

FIRST USE 7-15-2002; IN COMMERCE 7-15-2002.

CLASS 11—(Continued).

2,748,260. REIKER COMPANY, THE, SHALIMAR, FL. SN 76-307,688. PUB. 9-24-2002, FILED 8-31-2001.



NO CLAIM IS MADE TO THE EXCLUSIVE RIGHT TO USE "ROOM CONDITIONER", APART FROM THE MARK AS SHOWN.

THE MARK DEPICTS IN PART, A BALD EAGLE GRASPING A BROKEN LIGHTENING BOLT BETWEEN ITS TALONS.

FOR AIR RECIRCULATING AND HEATING DEVICES, NAMELY ELECTRIC CEILING FANS, ELECTRIC CEILING FANS IN COMBINATION WITH ELECTRIC HEATERS, ELECTRIC HEATERS IN COMBINATION WITH ELECTRIC FANS AND ELECTRIC SPACE HEATERS (U.S. CLS. 13, 21, 23, 31 AND 34).

FIRST USE 9-1-2002; IN COMMERCE 9-1-2002.

2,748,275. PURAFIL, INC., DORAVILLE, GA. SN 76-312,609. PUB. 10-8-2002, FILED 9-6-2001.

ALPHASORB

FOR SOLID GASEOUS FILTRATION MEDIA FOR REMOVING ODORS AND IMPURITIES FROM AIR IN COMMERCIAL AND INDUSTRIAL ENVIRONMENTS (U.S. CLS. 13, 21, 23, 31 AND 34).

FIRST USE 9-7-2001; IN COMMERCE 9-7-2001.

2,748,282. EVEREADY BATTERY COMPANY, INC., ST. LOUIS, MO. SN 76-316,325. PUB. 4-2-2002, FILED 9-21-2001.

WHEELIE

FOR LIGHTING PRODUCTS, NAMELY, FLASHLIGHTS AND BICYCLE LIGHTS (U.S. CLS. 13, 21, 23, 31 AND 34).

FIRST USE 6-6-2002; IN COMMERCE 6-6-2002.

CLASS 11—(Continued).

2,748,300. TARICCO CORPORATION, LONG BEACH, CA. SN 76-321,664. PUB. 7-9-2002, FILED 10-4-2001.

READY CLAVE

NO CLAIM IS MADE TO THE EXCLUSIVE RIGHT TO USE "CLAVE", APART FROM THE MARK AS SHOWN. FOR AUTOCLAVES (U.S. CLS. 13, 21, 23, 31 AND 34). FIRST USE 2-14-2003; IN COMMERCE 2-14-2003.

2,748,307. HELMAN GROUP, LTD., THE, OXNARD, CA. SN 76-323,952. PUB. 7-30-2002, FILED 10-10-2001.

OLD FASHIONED MOVIE TIME POPCORN MAKER

NO CLAIM IS MADE TO THE EXCLUSIVE RIGHT TO USE "POPCORN MAKER", APART FROM THE MARK AS SHOWN.

FOR ELECTRIC POPCORN APPLIANCE, NAMELY, POPCORN POPPING MACHINE (U.S. CLS. 13, 21, 23, 31 AND 34). FIRST USE 6-5-2001; IN COMMERCE 10-1-2001.

2,748,334. ALTMAN STAGE LIGHTING CO., INC., YONKERS, NY. SN 76-331,812. PUB. 9-3-2002, FILED 10-30-2001.

ECONO-CYC

FOR ELECTRIC LIGHTING FIXTURES, NAMELY, THEATRICAL AND ARCHITECTURAL LIGHTING FIXTURES (U.S. CLS. 13, 21, 23, 31 AND 34). FIRST USE 10-18-2001; IN COMMERCE 10-18-2001.

2,748,382. MARBLE-LITE CORPORATION, HIALEAH GARDENS, FL. SN 76-347,452. PUB. 8-6-2002, FILED 12-11-2001.

FIRENZE FIREPLACES

NO CLAIM IS MADE TO THE EXCLUSIVE RIGHT TO USE "FIREPLACES", APART FROM THE MARK AS SHOWN.

THE ENGLISH TRANSLATION OF "FIRENZE" IS "FLOR-ENCE".

FOR FIREPLACES (U.S. CLS. 13, 21, 23, 31 AND 34). FIRST USE 7-28-2002; IN COMMERCE 7-28-2002.

2,748,409. WATKINS MANUFACTURING CORPORATION, VISTA, CA. SN 76-352,599. PUB. 11-19-2002, FILED 12-21-2001.

SERENITY MADE SIMPLE

FOR SPAS IN THE NATURE OF HEATED WHIRLPOOLS (U.S. CLS. 13, 21, 23, 31 AND 34). FIRST USE 4-26-2000; IN COMMERCE 4-26-2000.

CLASS 11—(Continued).

2,748,446. LG ELECTRONICS INC., SEOUL, REPUBLIC OF KOREA. SN 76-363,943. PUB. 7-23-2002, FILED 1-30-2002.



FOR MICROWAVE OVENS FOR COOKING (U.S. CLS. 13, 21, 23, 31 AND 34). FIRST USE 8-0-2001; IN COMMERCE 8-0-2001.

2,748,449. BEERCOOLER COM LLC, BRIGANTINE, NJ. SN 76-365,076. PUB. 7-23-2002, FILED 1-31-2002.

SUDSBUDDY

FOR REFRIGERATED BEER KEG COOLERS (U.S. CLS. 13, 21, 23, 31 AND 34). FIRST USE 12-30-2002; IN COMMERCE 1-3-2003.

2,748,528. SQUEEZE BREEZE/CIRCULAIR, A DIVISION OF GLJ, LCC., ADDISON, IL. SN 76-392,645. PUB. 10-29-2002, FILED 4-8-2002.

SOFT TOUCH

FOR ELECTRIC FANS FOR HOME AND OFFICE USE (U.S. CLS. 13, 21, 23, 31 AND 34). FIRST USE 12-31-2001; IN COMMERCE 12-31-2001.

2,748,590. KRASON, JAN, DENVER, CO. SN 78-000,480. PUB. 9-25-2001, FILED 3-22-2000.

ZEOFILTER

FOR ENVIRONMENTAL CONTROL APPARATUS NAMELY, WATER PURIFICATOR COMPRISED OF NATURAL MINERALS, IN THE NATURE OF ZEOLITES, CRUSHED AND GRAINED, MODIFIED, FOR USE IN ENVIRONMENTAL APPLICATIONS IN THE NATURE OF WATER PURIFICATION AS WASTE AND WASTEWATER FILTER MEDIA (U.S. CLS. 13, 21, 23, 31 AND 34).

FIRST USE 10-15-1999; IN COMMERCE 12-17-1999.

CLASS 11—(Continued).

2,748,675. LIFETIME FILTER, INC., HOUSTON, TX. SN 78-055,251. PUB. 1-15-2002, FILED 3-27-2001.

FRESH AIRE

NO CLAIM IS MADE TO THE EXCLUSIVE RIGHT TO USE "AIR", APART FROM THE MARK AS SHOWN.

FOR DISPOSABLE, PLEATED AIR FILTERS FOR AIR CONDITIONING/HEATING SYSTEMS (U.S. CLS. 13, 21, 23, 31 AND 34).

FIRST USE 6-1-2002; IN COMMERCE 6-1-2002.

2,748,798. CONAIR CIP, INC., STAMFORD, CT, BY ASSIGNMENT CONAIR CIP, INC., STAMFORD, CT. SN 78-094,924. PUB. 8-6-2002, FILED 11-26-2001.

TITAN

FOR HAND-HELD ELECTRIC HAIR DRYERS (U.S. CLS. 13, 21, 23, 31 AND 34).

FIRST USE 9-6-2001; IN COMMERCE 9-6-2001.

2,748,827. SEARFOSS, ROBERT, ATLANTA, GA. SN 78-100,525. PUB. 7-23-2002, FILED 1-2-2002.

**SLEEP TONIGHT
SLUMBERLIGHT**

FOR TABLE, FLOOR, DESK, AND CLIP-ON LAMPS (U.S. CLS. 13, 21, 23, 31 AND 34).

FIRST USE 1-2-2002; IN COMMERCE 3-1-2002.

2,748,933. REVOLUTIONARY COOLING SYSTEMS, INC., SALT POINT, NY. SN 78-122,891. PUB. 12-3-2002, FILED 4-19-2002.

CHILL ON DEMAND

NO CLAIM IS MADE TO THE EXCLUSIVE RIGHT TO USE "CHILL", APART FROM THE MARK AS SHOWN.

FOR HOUSEHOLD ELECTRIC APPLIANCE IN THE NATURE OF A RAPID BEVERAGE CHILLING MACHINE THAT SPRAYS THE BEVERAGE WITH A COLD FLUID WHILE SIMULTANEOUSLY ROTATING THE BEVERAGE (U.S. CLS. 13, 21, 23, 31 AND 34).

FIRST USE 10-1-2002; IN COMMERCE 10-17-2002.

CLASS 11—(Continued).

2,748,985. AMERICA STANDARD INTERNATIONAL INC., NEW YORK, NY, BY ASSIGNMENT AMERICAN STANDARD INC., PISCATAWAY, NJ. SN 78-140,720. PUB. 12-3-2002, FILED 7-2-2002.

BOULEVARD

FOR PLUMBING FIXTURES, NAMELY SINKS (U.S. CLS. 13, 21, 23, 31 AND 34).

FIRST USE 11-1-2002; IN COMMERCE 11-1-2002.

CLASS 12—VEHICLES

2,747,481. HONDA GIKEN KOGYO KABUSHIKI KAISHA (HONDA MOTOR CO., LTD.), MINATO-KU, TOKYO 107, JAPAN. SN 75-501,404. PUB. 2-29-2000, FILED 6-11-1998.

MAGIC SEAT

NO CLAIM IS MADE TO THE EXCLUSIVE RIGHT TO USE "SEAT", APART FROM THE MARK AS SHOWN.

FOR PRE-INSTALLED CAR SEATS SOLD AS A COMPONENT PART OF APPLICANT'S AUTOMOBILES (U.S. CLS. 19, 21, 23, 31, 35 AND 44).

FIRST USE 7-0-1998; IN COMMERCE 7-0-1998.

2,747,492. MOSLER AUTO CARE CENTER, INC., RIVIERA BEACH, FL. SN 75-530,869. PUB. 7-30-2002, FILED 8-5-1998.

TWINSTAR

FOR SPECIALTY AUTOMOBILES MODIFIED TO HAVE TWO ENGINES AND SOLD ON ORDER DIRECTLY TO THE ULTIMATE CUSTOMERS (U.S. CLS. 19, 21, 23, 31, 35 AND 44).

FIRST USE 8-0-1998; IN COMMERCE 2-0-1999.

2,747,510. GLOBAL AEROSPACE CORPORATION, ALTA DENA, CA. SN 75-582,957. PUB. 10-26-1999, FILED 11-4-1998.

STRATOSAIL

FOR AERODYNAMIC TRAJECTORY CONTROL WING, FRAME, WINCH, AND TETHERS SOLD AS A UNIT FOR CONTROLLING THE FLIGHT DIRECTION OF LIGHTER-THAN-AIR SCIENTIFIC, RECREATIONAL AND SPORT BALLOONS (U.S. CLS. 19, 21, 23, 31, 35 AND 44).

FIRST USE 2-9-2000; IN COMMERCE 3-20-2002.

CLASS 12—(Continued).

2,747,553. MARTELLO, GILBERT A., WILLOUGHBY HILLS, OH. SN 75-676,949. PUB. 4-2-2002, FILED 4-7-1999.



FOR NAUTICAL SUPPLIES, NAMELY, ANCHOR AND DOCK LINE (U.S. CLS. 19, 21, 23, 31, 35 AND 44).
FIRST USE 2-28-1999; IN COMMERCE 2-28-1999.

2,747,626. ROSEN SUNVISOR SYSTEMS, INC., EUGENE, OR, BY ASSIGNMENT ROSEN PRODUCTS LLC, EUGENE, OR. SN 75-821,121. PUB. 9-5-2000, FILED 10-12-1999.

PROTECTOR

FOR VEHICLE VISORS (U.S. CLS. 19, 21, 23, 31, 35 AND 44).
FIRST USE 9-3-2002; IN COMMERCE 9-3-2002.

2,747,638. DETROIT STEEL PRODUCTS CO., INC., MORRISTOWN, IN. SN 75-835,732. PUB. 9-3-2002, FILED 10-28-1999.

STABIL - AIR

FOR VEHICLE PARTS, NAMELY, SUSPENSION SPRINGS, STABILIZER BARS, AND MOUNTING HARDWARE THEREFORE (U.S. CLS. 19, 21, 23, 31, 35 AND 44).
FIRST USE 9-0-2002; IN COMMERCE 9-0-2002.

2,747,753. S & S FIRESTONE, INC., LEXINGTON, KY. SN 76-037,338. PUB. 8-27-2002, FILED 5-1-2000.

XTREME ALLOYS

NO CLAIM IS MADE TO THE EXCLUSIVE RIGHT TO USE "ALLOYS", APART FROM THE MARK AS SHOWN.
FOR WHEEL RIMS [FOR VEHICLES] WHEELS [LAND VEHICLE PARTS, NAMELY] (U.S. CLS. 19, 21, 23, 31, 35 AND 44).
FIRST USE 8-15-2000; IN COMMERCE 8-15-2000.

2,747,805. FEDERAL-MOGUL WORLD WIDE, INC., SOUTHFIELD, MI. SN 76-078,017. PUB. 5-8-2001, FILED 6-26-2000.

HYDROCLEAR

FOR VEHICLE WINDSHIELD WIPER BLADES (U.S. CLS. 19, 21, 23, 31, 35 AND 44).
FIRST USE 10-6-2000; IN COMMERCE 10-6-2000.

CLASS 12—(Continued).

2,747,817. NEXEN TIRE CORPORATION, KYONGSANG-NAM-DO, REPUBLIC OF KOREA. SN 76-083,903. PUB. 4-2-2002, FILED 7-6-2000.

WINGUARD

FOR TIRES, INNER TUBES FOR VEHICLE TIRES, AND LAND VEHICLE PARTS, NAMELY MUD FLAPS (U.S. CLS. 19, 21, 23, 31, 35 AND 44).
FIRST USE 3-1-2003; IN COMMERCE 3-1-2003.

2,747,879. OAK LAWN HARLEY DAVIDSON, L.L.C., OAK LAWN, IL. SN 76-135,592. PUB. 6-5-2001, FILED 9-21-2000.

BAD GIRL

FOR MOTORCYCLES (U.S. CLS. 19, 21, 23, 31, 35 AND 44).
FIRST USE 2-24-2003; IN COMMERCE 2-24-2003.

2,747,896. DYNACRAFT INDUSTRIES, INC, SAN RAFAEL, CA. SN 76-147,688. PUB. 6-5-2001, FILED 10-16-2000.

MISFIT

FOR BICYCLES (U.S. CLS. 19, 21, 23, 31, 35 AND 44).
FIRST USE 2-10-2002; IN COMMERCE 2-10-2002.

2,747,920. SHERWOOD DASH, INC., ONTARIO, CANADA. SN 76-165,586. PUB. 11-27-2001, FILED 11-15-2000.

LIBERTY DASH

NO CLAIM IS MADE TO THE EXCLUSIVE RIGHT TO USE "DASH", APART FROM THE MARK AS SHOWN.
FOR MOTOR VEHICLE ACCESSORIES, NAMELY COVERS FOR DASH BOARDS (U.S. CLS. 19, 21, 23, 31, 35 AND 44).
FIRST USE 12-3-2002; IN COMMERCE 1-28-2003.

CLASS 12—(Continued).

2,748,172. PRIDE MOBILITY PRODUCTS CORPORATION, EXETER, PA. SN 76-275,320. PUB. 7-2-2002, FILED 6-22-2001.

MOVING AT THE SPEED OF LIFE

FOR ELECTRICALLY POWERED PERSONAL MOBILITY VEHICLES NAMELY, SCOOTERS, POWERED WHEEL CHAIRS AND POWER CHAIRS IN THE NATURE OF CENTER WHEEL DRIVE CHAIRS HAVING FORWARD ANTI-TIP WHEELS WHICH ARE GENERALLY OFF THE GROUND AND REAR WHEELS IN THE FORM OF IDLER WHEELS, FOR USE PRIMARILY BY ELDERLY, DISABLED AND INFIRM PERSONS (U.S. CLS. 19, 21, 23, 31, 35 AND 44).

FIRST USE 3-3-2003; IN COMMERCE 3-3-2003.

2,748,226. FEDERAL-MOGUL WORLD WIDE, INC., SOUTH-FIELD, MI. SN 76-295,026. PUB. 7-23-2002, FILED 8-6-2001.

AeroVantage

OWNER OF U.S. REG. NOS. 1,582,452 AND 1,764,378. FOR VEHICLE PARTS - NAMELY, WINDSHIELD WIPER BLADES AND REFILLS, WINDSHIELD WIPER ARMS AND PARTS THEREFOR, WINDSHIELD WASHER PUMPS AND KITS CONSISTING PRIMARILY OF REPLACEMENT SEALS FOR WINDSHIELD WASHER PUMPS (U.S. CLS. 19, 21, 23, 31, 35 AND 44).

FIRST USE 5-28-1997; IN COMMERCE 5-28-1997.

2,748,244. KINESIS USA, INC., PORTLAND, OR. SN 76-300,027. PUB. 12-11-2001, FILED 8-10-2001.



FOR MOTORCYCLE PARTS AND ACCESSORIES (U.S. CLS. 19, 21, 23, 31, 35 AND 44).

FIRST USE 11-1-2001; IN COMMERCE 11-1-2001.

CLASS 12—(Continued).

2,748,245. KATZKIN LEATHER INTERIORS INC., MONTEBELLO, CA. SN 76-300,134. PUB. 7-30-2002, FILED 8-14-2001.

SUEDEZKIN

FOR FITTED LEATHER COVERINGS FOR AUTOMOBILE INTERIOR SURFACES (U.S. CLS. 19, 21, 23, 31, 35 AND 44).

FIRST USE 11-0-2001; IN COMMERCE 11-0-2001.

2,748,353. GREG MOSER ENGINEERING, INC., PORTLAND, IN. SN 76-336,558. PUB. 10-15-2002, FILED 11-13-2001.

GET THERE FIRST!

FOR HIGH PERFORMANCE REAR END COMPONENTS FOR VEHICLES, NAMELY, ALUMINUM SPOOLS, AXLE BEARINGS, C-CLIP ELIMINATORS FOR REPLACING FACTORY C-CLIPS, 12 BOLT AXLE HOUSINGS FOR REPLACING FACTORY AXLE HOUSINGS, CIRCLE TRACK AXLES, WHEEL STUDS, NODULAR 9-INCH CENTER SECTIONS, ALUMINUM 9-INCH CENTER SECTIONS, CUSTOM ALLOY AXLES, BRAKES, DRIVE SHAFTS, POSI-UNITS, FULL FLOATING AXLES, FULL SPOOL, PROFESSIONAL SPOOLS, TITANIUM SPOOLS, EXTREME AXLES, PINION SUPPORTS, LIMITED SLIP DIFFERENTIALS, LOCKING DIFFERENTIALS, PINION COUPLERS, REAR END HOUSINGS, HOUSING ENDS, MINI-SPOOLS, STOCK AXLES, PERFORMANCE YOKES, REAR END COVERS, RING AND PINION GEARS, RETAINER PLATES, 8 3/4 STOCK AXLES, CUSTOM FRONT AXLES, ALUMINUM PERFORMANCE YOKES, TRANSMISSION YOKES, 5/8 INCH DRIVE STUDS, AND COMPLETE CENTER SECTIONS (U.S. CLS. 19, 21, 23, 31, 35 AND 44).

FIRST USE 12-0-2001; IN COMMERCE 12-0-2001.

2,748,354. GREG MOSER ENGINEERING, INC., PORTLAND, IN. SN 76-336,565. PUB. 10-8-2002, FILED 11-13-2001.

MOSER **ENGINEERING**

FOR HIGH PERFORMANCE REAR END COMPONENTS FOR VEHICLES, NAMELY, ALUMINUM SPOOLS, AXLE BEARINGS, C-CLIP ELIMINATORS FOR REPLACING FACTORY C-CLIPS, 12 BOLT AXLE HOUSINGS FOR REPLACING FACTORY AXLE HOUSINGS, CIRCLE TRACK AXLES, WHEEL STUDS, NODULAR 9-INCH CENTER SECTIONS, ALUMINUM 9-INCH CENTER SECTIONS, CUSTOM ALLOY AXLES, BRAKES, DRIVE SHAFTS, POSI-UNITS, FULL FLOATING AXLES, FULL SPOOLS, PROFESSIONAL SPOOLS, TITANIUM SPOOLS, EXTREME AXLES, PINION COUPLERS, REAR END HOUSINGS, HOUSING ENDS, MINI-SPOOLS, STOCK AXLES, PERFORMANCE YOKES, REAR END COVERS, RING AND PINION GEARS, RETAINER PLATES, 8 3/4 STOCK AXLES, CUSTOM FRONT AXLES, ALUMINUM PERFORMANCE YOKES, TRANSMISSION YOKES, 5/8 INCH DRIVE STUDS, AND COMPLETE CENTER SECTIONS (U.S. CLS. 19, 21, 23, 31, 35 AND 44).

FIRST USE 12-0-2001; IN COMMERCE 12-0-2001.

CLASS 12—(Continued).

2,748,355. GREG MOSER ENGINEERING, INC., PORTLAND, IN. SN 76-336,566. PUB. 10-15-2002, FILED 11-13-2001.

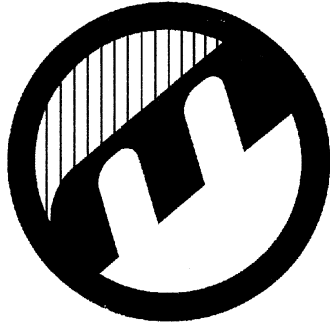

FOR HIGH PERFORMANCE REAR END COMPONENTS FOR VEHICLES, NAMELY, ALUMINUM SPOOLS, AXLE BEARINGS, C-CLIP ELIMINATORS FOR REPLACING FACTORY C-CLIPS, 12 BOLT AXLE HOUSINGS FOR REPLACING FACTORY AXLE HOUSINGS, CIRCLE TRACK AXLES, WHEEL STUDS, NODULAR 9-INCH CENTER SECTIONS, ALUMINUM 9-INCH CENTER SECTIONS, CUSTOM ALLOY AXLES, BRAKES, DRIVE SHAFTS, POSI-UNITS, FULL FLOATING AXLES, FULL SPOOLS, PROFESSIONAL SPOOLS, TITANIUM SPOOLS, EXTREME AXLES, PINION SUPPORTS, LIMITED SLIP DIFFERENTIALS, LOCKING DIFFERENTIALS, PINION COUPLERS, REAR END HOUSINGS, HOUSING ENDS, MINI-SPOOLS, STOCK AXLES, PERFORMANCE YOKES, REAR END COVERS, RING AND PINION GEARS, RETAINER PLATES, 83/4 STOCK AXLES, CUSTOM FRONT AXLES, ALUMINUM PERFORMANCE YOKES, TRANSMISSION YOKES, 5/8 INCH DRIVE STUDS, AND COMPLETE CENTER SECTIONS (U.S. CLS. 19, 21, 23, 31, 35 AND 44).
FIRST USE 12-0-2001; IN COMMERCE 12-0-2001.

2,748,383. GAUGE WORKS, LLC, GREAT FALLS, VA. SN 76-347,796. PUB. 7-16-2002, FILED 12-12-2001.

ROLL POD

FOR AUTOMOBILE GAUGE MOUNTS, AUTOMOBILE GAUGE MOUNT STRUCTURAL PARTS, AND GAUGE MOUNTING KITS SOLD AS A UNIT (U.S. CLS. 19, 21, 23, 31, 35 AND 44).
FIRST USE 11-0-2002; IN COMMERCE 11-0-2002.

2,748,437. H & R SPECIAL SPRINGS, L.P., BELLINGHAM, WA. SN 76-361,702. PUB. 8-6-2002, FILED 1-23-2002.

WIDER IS BETTER

FOR VEHICLE WHEEL SPACERS AND ADAPTERS (U.S. CLS. 19, 21, 23, 31, 35 AND 44).
FIRST USE 8-0-1997; IN COMMERCE 8-0-1997.

CLASS 12—(Continued).

2,748,438. H & R SPECIAL SPRINGS, L.P., BELLINGHAM, WA. SN 76-361,703. PUB. 8-6-2002, FILED 1-23-2002.

CHECK YOUR GAP

FOR VEHICLE WHEEL SPACERS AND ADAPTERS (U.S. CLS. 19, 21, 23, 31, 35 AND 44).
FIRST USE 8-0-1997; IN COMMERCE 8-0-1997.

2,748,447. COMPACT EQUIPMENT ATTACHMENTS, INC., MEQUON, WI. SN 76-364,069. PUB. 12-10-2002, FILED 1-29-2002.

EXTREMEDGE

FOR TIRES (U.S. CLS. 19, 21, 23, 31, 35 AND 44).
FIRST USE 4-22-2002; IN COMMERCE 4-22-2002.

2,748,464. FENA DESIGN, INC., PLYMOUTH, MN. SN 76-369,809. PUB. 11-12-2002, FILED 2-12-2002.

VERTRAN

FOR WHEEL CHAIRS (U.S. CLS. 19, 21, 23, 31, 35 AND 44).
FIRST USE 8-1-2002; IN COMMERCE 11-5-2002.

2,748,532. CCC GROUP, INC., SAN ANTONIO, TX. SN 76-395,624. PUB. 10-29-2002, FILED 4-15-2002.

RATV

FOR SPECIAL PURPOSE VEHICLE, NAMELY, A RESIDUE ALL-TERRAIN VEHICLE FOR USE IN MINES (U.S. CLS. 19, 21, 23, 31, 35 AND 44).
FIRST USE 12-19-2001; IN COMMERCE 12-19-2001.

2,748,730. CLUB CAR, INC., AGUSTA, GA. SN 78-077,881. PUB. 2-19-2002, FILED 8-7-2001.

PRECEDENT

FOR MOTORIZED GOLF CARTS, AND OFF ROAD UTILITY VEHICLES USED FOR PROPERTY MAINTENANCE, TRANSPORTATION OF PEOPLE AND GOODS, AND ENTERTAINMENT (U.S. CLS. 19, 21, 23, 31, 35 AND 44).
FIRST USE 4-23-2001; IN COMMERCE 1-28-2003.

CLASS 12—(Continued).

2,748,740. LAZANO, STEVEN L., NORCO, CA. AND LAZANO, KRISTINA L., NORCO, CA. SN 78-081,065. PUB. 1-15-2002, FILED 8-24-2001.

IT WILL TAKE YOU ALMOST ANYWHERE

FOR MOTOR VEHICLES; NAMELY AUTOMOBILES, TRUCKS, ENGINES THEREFOR AND STRUCTURAL PARTS THEREOF (U.S. CLS. 19, 21, 23, 31, 35 AND 44).
FIRST USE 10-1-2001; IN COMMERCE 10-1-2001.

2,748,777. DAIMLERCHRYSLER CORPORATION, AUBURN HILLS, MI. SN 78-089,274. PUB. 3-26-2002, FILED 10-19-2001.

LIBERTY

FOR VEHICLES, NAMELY INFANT AND TODDLER STROLLERS (U.S. CLS. 19, 21, 23, 31, 35 AND 44).
FIRST USE 1-27-2002; IN COMMERCE 1-27-2002.

2,748,778. YOUNG'S WELDING, INC., CHANUTE, KS. SN 78-089,508. PUB. 9-3-2002, FILED 10-22-2001.



NO CLAIM IS MADE TO THE EXCLUSIVE RIGHT TO USE "TRAILERS", APART FROM THE MARK AS SHOWN. THE MARK CONSISTS OF IN PART, OF THE DESIGN OF A LETTER CAPITAL "R" AND LOWER CASE "OLCO", WITH A LINE EXTENDING OFF THE LETTER "R" BENEATH THE LETTERS "OLCO" AND A HALF CIRCLE BENEATH THE LETTER "O", AND THE WORD "TRAILERS" IN SMALLER PRINT UNDER THE LETTERS "CO".
FOR VEHICLES, NAMELY BOAT AND UTILITY TRAILERS (U.S. CLS. 19, 21, 23, 31, 35 AND 44).
FIRST USE 12-1-2001; IN COMMERCE 12-1-2001.

2,748,779. KIA MOTORS CORPORATION, SEOUL, REPUBLIC OF KOREA. SN 78-090,243. PUB. 11-19-2002, FILED 10-25-2001.

SORENTO

FOR PASSENGER CARS, LORRIES, MINIVANS, VANS, BUSES, MINIBUSES (U.S. CLS. 19, 21, 23, 31, 35 AND 44).
FIRST USE 2-28-2002; IN COMMERCE 4-30-2002.

CLASS 12—(Continued).

2,748,783. MAZDA MOTOR OF AMERICA, INC., IRVINE, CA. SN 78-090,906. PUB. 4-23-2002, FILED 10-30-2001.

BODY OF A MINIVAN. SOUL OF A SPORTS CAR.

FOR AUTOMOBILES (U.S. CLS. 19, 21, 23, 31, 35 AND 44).
FIRST USE 2-0-2002; IN COMMERCE 2-0-2002.

2,748,788. ROBERT F. GROTTKAU, JR., NEW BERLIN, WI. SN 78-092,335. PUB. 9-17-2002, FILED 11-8-2001.

TUFF CHROME

NO CLAIM IS MADE TO THE EXCLUSIVE RIGHT TO USE "CHROME", APART FROM THE MARK AS SHOWN. FOR PARTS OF MOTORCYCLES, NAMELY, HEAD BOLT COVERS, BRAKE CABLES, HANDLE BARS, HANDLE BAR GRIPS, AND WHEELS (U.S. CLS. 19, 21, 23, 31, 35 AND 44).
FIRST USE 8-30-1998; IN COMMERCE 4-30-1999.

2,748,974. SUNRISE MEDICAL HHG INC., LONGMONT, CA. SN 78-134,437. PUB. 12-3-2002, FILED 6-10-2002.



THE MARK CONSISTS OF A STYLIZED LETTER "Q". FOR MANUAL AND ELECTRIC WHEELCHAIRS (U.S. CLS. 19, 21, 23, 31, 35 AND 44).
FIRST USE 12-31-2001; IN COMMERCE 6-30-2002.

2,748,984. HUFFY CORPORATION, MIAMISBURG, OH. SN 78-140,648. PUB. 11-26-2002, FILED 7-2-2002.

GREEN MACHINE

FOR THREE-WHEELED, NON-MOTORIZED, RIDE-ON TOY VEHICLE (U.S. CLS. 19, 21, 23, 31, 35 AND 44).
FIRST USE 12-9-2002; IN COMMERCE 12-9-2002.

CLASS 13—FIREARMS

CLASS 13—(Continued).

2,748,723. AMERICAN PROMOTIONAL EVENTS, INC., FLORENCE, AL. SN 78-074,965. PUB. 7-30-2002, FILED 7-20-2001.

TNT 500

OWNER OF U.S. REG. NO. 1,486,863.
FOR FIREWORKS (U.S. CLS. 2 AND 9).
FIRST USE 12-13-2001; IN COMMERCE 12-13-2001.

CLASS 14—(Continued).

2,747,670. PIANEGONDA S.R.L., 36043 CAMISANO VICENTINO VI, ITALY. SN 75-879,920. PUB. 4-23-2002, FILED 12-23-1999.

2213 VI**CLASS 14—JEWELRY**

2,747,460. MONTBLANC-SIMPLO GMBH, HAMBURG, FED REP GERMANY. SN 75-180,380. PUB. 4-2-2002, FILED 10-11-1996.

MEISTERSTÜCK

OWNER OF U.S. REG. NO. 1,324,392.
THE MARK IS THE GERMAN WORD FOR "MASTERPIECE".
FOR JEWELRY, CUFF-LINKS, TIE BARS, TIE PINS, TIE STUDS, AND PARTS FOR THE AFORESAID GOODS, WATCHES AND CLOCKS (U.S. CLS. 2, 27, 28 AND 50).
FIRST USE 0-0-1997; IN COMMERCE 0-0-1997.

2,747,520. MONTRES LEROY S.A., FL-9490 VADUZ, LIECHTENSTEIN. SN 75-605,708. PUB. 4-4-2000, FILED 12-15-1998.

LEROY

FOR WATCHES (U.S. CLS. 2, 27, 28 AND 50).
FIRST USE 0-0-2002; IN COMMERCE 0-0-2002.

2,747,559. SCINTO, GREGORY, SOUTH ORLEANS, MA. SN 75-690,082. PUB. 9-24-2002, FILED 5-17-1999.



FOR CLOCKS AND WATCHES (U.S. CLS. 2, 27, 28 AND 50).
FIRST USE 4-1-1999; IN COMMERCE 4-1-1999.

NO CLAIM IS MADE TO THE EXCLUSIVE RIGHT TO USE "VI", APART FROM THE MARK AS SHOWN.

FOR JEWELRY RINGS, SILVER PLATE, NAMELY, TEA POTS, DISHES, ASHTRAYS, SERVING TRAYS, AND FRAMES, SILVER ORNAMENTS, NAMELY, HAT ORNAMENTS, SHOE ORNAMENTS, AND SILVER BROOCHES AND SILVER BELTS, WORKS OF ART IN PRECIOUS METALS, NAMELY, ICONS AND CRUCIFIXES, TEA POTS OF PRECIOUS METALS, CHAIN MESH PURSES OF PRECIOUS METALS, JEWELRY BRACELETS, CANDLESTICKS OF PRECIOUS METALS, HOUSEHOLD CONTAINERS OF PRECIOUS METALS, HOUSEHOLD UTENSILS OF PRECIOUS METALS, WATCH CASES, JEWELRY CHAINS, NECKLACES, TIE PINS OF PRECIOUS METALS, TIE CLIPS OF PRECIOUS METALS, DIAMONDS, GEMS, JEWELRY, EARRINGS, WATCHES, PEARLS, DISHES OF PRECIOUS METALS, SEMIPRECIOUS GEMSTONES, PRECIOUS GEMSTONES, ASHTRAYS OF PRECIOUS METALS, FANCY KEY RINGS OF PRECIOUS METALS, SILVER PERFUME BOTTLE, CIGARETTE LIGHTERS OF PRECIOUS METALS, PENDANTS, NECKLACES FASTENERS, BANGLES, BELT BUCKLES OF PRECIOUS METALS FOR CLOTHING, BROOCHES, CHRONOGRAPHS FOR USE AS WATCHES, CHRONOMETERS, CIGARETTE CASES OF PRECIOUS METALS, NON MONETARY COINS OF PRECIOUS METALS, CRUETS OF PRECIOUS METALS, WATCH CHAINS, MEDALLIONS, NAPKIN RINGS OF PRECIOUS METALS, HAT ORNAMENTAL BROOCHES OF PRECIOUS METALS, SHOE ORNAMENTAL BROOCHES OF PRECIOUS METALS, SERVING TRAYS OF PRECIOUS METALS, AND WATCH STRAPS, PRECIOUS METALS AND THEIR ALLOYS SOLD IN BULK (U.S. CLS. 2, 27, 28 AND 50).
FIRST USE 12-31-1994; IN COMMERCE 12-31-1999.

2,747,939. INVERNESS CORPORATION, FAIR LAWN, NJ. SN 76-176,270. PUB. 12-3-2002, FILED 12-6-2000.

KLIKXX

FOR EARRINGS OF PRECIOUS METAL (U.S. CLS. 2, 27, 28 AND 50).
FIRST USE 4-3-2002; IN COMMERCE 10-14-2002.

CLASS 14—(Continued).

2,747,964. JEWELBUTTON & CO., CHONGRO-KU SEOUL, REPUBLIC OF KOREA. SN 76-191,253. PUB. 6-18-2002, FILED 1-9-2001.

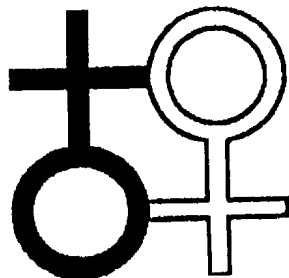

FOR EARRINGS; NECKLACES; RINGS; BROOCHES; BRACELETS; WATCHES; WORKS OF GOLD OR SILVER, NAMELY, KEY HOLDERS, BADGES, BUCKLES, ORNAMENTAL PINS, ORNAMENTAL PINS MADE OF JEWELRY, LAPEL PINS, LAPEL PINS MADE OF JEWELRY, HAIR PINS MADE OF JEWELRY, TIE CLIPS AND CUFF LINKS; DIAMONDS; AND PEARLS (U.S. CLS. 2, 27, 28 AND 50).

FIRST USE 6-0-2001; IN COMMERCE 1-0-2003.

2,748,092. AZAR JEWELERS, INC., LOS ANGELES, CA. SN 76-248,425. PUB. 1-15-2002, FILED 4-30-2001.

DINA'S

FOR JEWELRY (U.S. CLS. 2, 27, 28 AND 50).
FIRST USE 8-6-2001; IN COMMERCE 7-5-2002.

2,748,123. GOLD FORCE INTERNATIONAL, LTD., NEW YORK, NY. SN 76-261,396. PUB. 2-5-2002, FILED 5-23-2001.

22 Kt. Pt

NO CLAIM IS MADE TO THE EXCLUSIVE RIGHT TO USE "PT", APART FROM THE MARK AS SHOWN.
FOR JEWELRY MADE IN SIGNIFICANT PART OF PLATINUM AND ALLOYS CONTAINING PLATINUM (U.S. CLS. 2, 27, 28 AND 50).
FIRST USE 2-24-2003; IN COMMERCE 2-24-2003.

CLASS 14—(Continued).

2,748,124. GOLD FORCE INTERNATIONAL, LTD., NEW YORK, NY. SN 76-261,448. PUB. 4-2-2002, FILED 5-23-2001.

14 Kt. Pt

NO CLAIM IS MADE TO THE EXCLUSIVE RIGHT TO USE "PT", APART FROM THE MARK AS SHOWN.
FOR JEWELRY MADE IN SIGNIFICANT PART OF PLATINUM AND ALLOYS CONTAINING PLATINUM (U.S. CLS. 2, 27, 28 AND 50).
FIRST USE 2-24-2003; IN COMMERCE 2-24-2003.

2,748,125. GOLD FORCE INTERNATIONAL, LTD., NEW YORK, NY. SN 76-261,449. PUB. 2-5-2002, FILED 5-23-2001.

18 Kt. Pt

NO CLAIM IS MADE TO THE EXCLUSIVE RIGHT TO USE "PT", APART FROM THE MARK AS SHOWN.
FOR JEWELRY MADE IN SIGNIFICANT PART OF PLATINUM AND ALLOYS CONTAINING PLATINUM (U.S. CLS. 2, 27, 28 AND 50).
FIRST USE 2-24-2003; IN COMMERCE 2-24-2003.

CLASS 14—(Continued).

2,748,288. SINOHUI, ANDRES JR., BEAUMONT, CA. SN 76-318,244. PUB. 10-15-2002, FILED 9-27-2001.

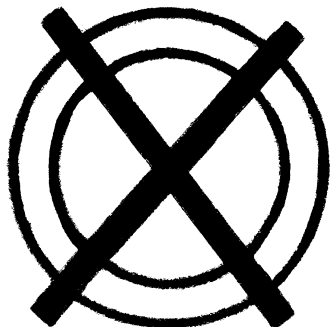

THE MARK CONSISTS OF TWO COMPLETE CIRCLES, ONE OUTER AND ONE INNER CIRCLE. THE LETTER "X" IS INSERTED WITHIN THE TWO CIRCLES. THE TOP HALF OF THE LETTER "X" OVERLAPS THE TOP OF THE TWO CIRCLES. THE BOTTOM HALF OF THE LETTER "X" UNDER LAPPS THE BOTTOM OF THE TWO CIRCLES.

FOR JEWELRY (U.S. CLS. 2, 27, 28 AND 50).
FIRST USE 8-1-2002; IN COMMERCE 8-1-2002.

2,748,331. SANDBERG & SIKORSKI DIAMOND CORPORATION, NEW YORK, NY. SN 76-331,454. PUB. 5-21-2002, FILED 10-30-2001.

A FLAWLESS DIAMOND FOR A PERFECT DAD

FOR JEWELRY, NAMELY EARRINGS, RINGS, BRACELETS, PENDANTS AND NECKLACES (U.S. CLS. 2, 27, 28 AND 50).
FIRST USE 1-21-2003; IN COMMERCE 1-21-2003.

CLASS 14—(Continued).

2,748,385. SCHURHAMMER MANUFACTURING, INC., WABASHA, MN. SN 76-348,006. PUB. 7-9-2002, FILED 12-13-2001.

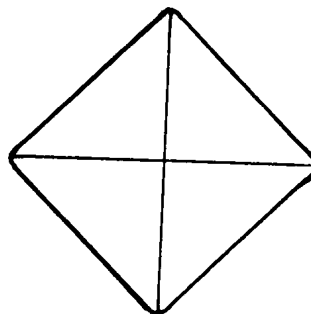

FOR DIAMONDS (U.S. CLS. 2, 27, 28 AND 50).
FIRST USE 2-1-2002; IN COMMERCE 2-1-2002.

2,748,420. QVC, INC., WEST CHESTER, PA. SN 76-355,953. PUB. 12-10-2002, FILED 1-7-2002.

EPIPHANY

FOR JEWELRY (U.S. CLS. 2, 27, 28 AND 50).
FIRST USE 4-11-2002; IN COMMERCE 4-11-2002.

2,748,444. DOTS, INC., SOLON, OH. SN 76-363,510. PUB. 6-18-2002, FILED 1-28-2002.

MKM

FOR JEWELRY (U.S. CLS. 2, 27, 28 AND 50).
FIRST USE 2-17-1997; IN COMMERCE 2-17-1997.

2,748,531. MIMI S. JEWELRY, INC., DBA MIMI SO, NEW YORK, NY. SN 76-395,481. PUB. 11-26-2002, FILED 4-15-2002.

SESI

FOR JEWELRY (U.S. CLS. 2, 27, 28 AND 50).
FIRST USE 3-0-2002; IN COMMERCE 3-0-2002.

CLASS 14—(Continued).

2,748,572. CAPRICE DE CHANTECLER S.N.C. DI APREA GABRIELE & C., 80133 NAPOLI, ITALY. SN 76-975,296. PUB. 4-30-2002, FILED 8-9-2000.



Chantecler

THE WORD MAY BE TRANSLATED INTO THE ENGLISH LANGUAGE AS "ROOSTER".

FOR PRECIOUS METALS AND THEIR ALLOYS SOLD IN BULK; JEWELRY, PRECIOUS GEMS AND STONES, PRODUCTS PLATED WITH SPECIAL METALS, NAMELY BRACELETS, NECKLACES, MEDALS, RINGS, EARRINGS, ANKLE BRACELETS AND PENDANTS; WATCHES, CLOCKS AND HOROLOGICAL AND CHRONOMETRIC INSTRUMENTS, NAMELY, SUN-DIALS, STOPWATCHES, WATCHES AND CLOCKS (U.S. CLS. 2, 27, 28 AND 50).

FIRST USE 0-0-1960; IN COMMERCE 0-0-1994.

2,748,579. VON STRUNCKEL, SHELLEY, LONDON SW1P-1QE, ENGLAND. SN 76-975,446. PUB. 5-28-2002, FILED 2-16-2001.

THE MARK CONSISTS OF THE NAME "SHELLEY VON STRUNCKEL" IN STYLIZED FORM.

FOR WATCHES (U.S. CLS. 2, 27, 28 AND 50).

FIRST USE 10-10-2002; IN COMMERCE 10-18-2002.

2,748,605. MGM JEWELRY MANUFACTURING, INC., LOS ANGELES, CA. SN 78-014,875. PUB. 8-14-2001, FILED 6-29-2000.

STARLIGHT DIAMOND

NO CLAIM IS MADE TO THE EXCLUSIVE RIGHT TO USE "DIAMOND", APART FROM THE MARK AS SHOWN, FOR SPECIAL CUT ROUND 10 SIDED DIAMONDS (U.S. CLS. 2, 27, 28 AND 50).

FIRST USE 10-0-2001; IN COMMERCE 10-0-2001.

CLASS 14—(Continued).

2,748,829. BROCK, HELENE M., DBA MOMS WITH A MISSION, LORTON, VA. SN 78-101,695. PUB. 8-13-2002, FILED 1-9-2002.

THE BAND OF HONOR

FOR JEWELRY, NAMELY BRACELETS (U.S. CLS. 2, 27, 28 AND 50).

FIRST USE 1-15-2002; IN COMMERCE 1-15-2002.

2,748,904. PREMIER GEM CORPORATION, NEW YORK, NY. SN 78-115,502. PUB. 10-15-2002, FILED 3-18-2002.

CROWN OF LIGHT

FOR JEWELRY (U.S. CLS. 2, 27, 28 AND 50).

FIRST USE 12-15-2002; IN COMMERCE 12-15-2002.

CLASS 15—MUSICAL INSTRUMENTS

2,747,924. REMO, INC., VALENCIA, CA. SN 76-168,718. PUB. 7-3-2001, FILED 11-20-2000.

NUSKYN

FOR DRUMHEADS (U.S. CLS. 2, 21 AND 36).

FIRST USE 1-31-2001; IN COMMERCE 1-31-2001.

2,748,215. MIDI MUSIC CENTER, INC., DBA LOWREY ORGAN COMPANY, LAGRANGE PARK, IL. SN 76-291,323. PUB. 8-27-2002, FILED 7-26-2001.

RHAPSODY

FOR ELECTRIC ORGANS (U.S. CLS. 2, 21 AND 36).

FIRST USE 1-1-2002; IN COMMERCE 3-1-2002.

2,748,548. HESTER, CHARLES, MEMPHIS, TN. SN 76-402,325. PUB. 11-5-2002, FILED 4-29-2002.

C-SHIRTZ

FOR PROTECTIVE COVERS FOR MUSICAL INSTRUMENTS (U.S. CLS. 2, 21 AND 36).

FIRST USE 7-18-2002; IN COMMERCE 7-18-2002.

CLASS 15—(Continued).

2,748,646. HUMAN BEAMS, KAILUA-KONA, HI. SN 78-044,458. PUB. 5-28-2002, FILED 1-23-2001.

HUMANBEAMS

FOR ELECTRONIC MUSICAL INSTRUMENTS UTILIZING A MULTIPLE ARRAY OF INFRARED AND LASER ENERGY STREAMS (U.S. CLS. 2, 21 AND 36).
FIRST USE 11-21-2002; IN COMMERCE 11-21-2002.

2,748,946. BIOPLASTICS COMPANY, N. RIDGEVILLE, OH. SN 78-127,855. PUB. 11-5-2002, FILED 5-10-2002.

KEPUR

FOR GUITAR STRAPS (U.S. CLS. 2, 21 AND 36).
FIRST USE 7-18-2002; IN COMMERCE 7-18-2002.

CLASS 16—PAPER GOODS AND PRINTED MATTER

2,747,509. CHICKS, INC., WOODSTOCK, NY. SN 75-577,546. PUB. 2-1-2000, FILED 10-27-1998.

**MAKE-UP
GIRLS**

NO CLAIM IS MADE TO THE EXCLUSIVE RIGHT TO USE "MAKE-UP", APART FROM THE MARK AS SHOWN.
FOR COLORING BOOKS (U.S. CLS. 2, 5, 22, 23, 29, 37, 38 AND 50).
FIRST USE 4-18-2003; IN COMMERCE 4-18-2003.

2,747,551. CERAMITEC INDUSTRIES, INC., CASA GRANDE, AZ. SN 75-673,366. PUB. 7-30-2002, FILED 4-2-1999.

TOOL SHADOW

NO CLAIM IS MADE TO THE EXCLUSIVE RIGHT TO USE "TOOL", APART FROM THE MARK AS SHOWN.
FOR DECALS FOR TOOL LOCATION (U.S. CLS. 2, 5, 22, 23, 29, 37, 38 AND 50).
FIRST USE 4-3-1999; IN COMMERCE 4-3-1999.

CLASS 16—(Continued).

2,747,575. FOX RACING, INC, MORGAN HILL, CA. SN 75-721,771. PUB. 7-2-2002, FILED 6-4-1999.

SHIFT

FOR DECALS, STICKERS, CALENDARS AND CATALOGS RELATING TO MOTOCROSS AND BICYCLING SPORTS CLOTHING, PROTECTIVE GEAR, FOOTWEAR AND ACCESSORIES (U.S. CLS. 2, 5, 22, 23, 29, 37, 38 AND 50).
FIRST USE 2-1-1997; IN COMMERCE 2-1-1997.

2,747,577. MISSION CITY PRESS, INC., SAN ANTONIO, TX. SN 75-722,963. PUB. 6-27-2000, FILED 6-7-1999.



THE MARK IS LINED FOR THE COLORS PURPLE/VIOLET, BUT COLOR DOES NOT FORM A PART OF THE MARK.

"ELSIE DINSMORE" IS THE NAME OF A FICTIONAL CHARACTER AND DOES NOT IDENTIFY A LIVING INDIVIDUAL.

FOR CHRISTIAN STUDY GUIDES; A SERIES OF EDUCATIONAL BOOKS ON THE SUBJECT OF ETIQUETTE; JOURNALS, AGENDAS, AND DIARIES WHICH CONTAIN CHRISTIAN AND SPIRITUAL MESSAGES OR THEMES; STATIONERY (U.S. CLS. 2, 5, 22, 23, 29, 37, 38 AND 50).

FIRST USE 3-12-2001; IN COMMERCE 3-12-2001.

2,747,579. VULCANA, INC., ALEXANDRIA, VA. SN 75-724,021. PUB. 1-11-2000, FILED 6-8-1999.



FOR BINDERS; LOOSE LEAF BINDERS; STATIONERY TYPE PORTFOLIOS (U.S. CLS. 2, 5, 22, 23, 29, 37, 38 AND 50).

FIRST USE 5-31-2001; IN COMMERCE 5-31-2001.

CLASS 16—(Continued).

2,747,595. SMART VISIONS, INC., PORTLAND, OR. SN 75-767,866. PUB. 8-6-2002, FILED 8-4-1999.

KID KIT

FOR INFORMATION ORGANIZER CONTAINING INDEX CARDS, PRINTED FORMS, SAFETY INSTRUCTIONS, EMERGENCY ACTION PLANS AND DATA COLLECTION MEDIA USED TO ORGANIZE INFORMATION USED TO TRACK, LOCATE, IDENTIFY, AND RECOVER MISSING PERSONS, PARTICULARLY CHILDREN, ELDERLY PERSONS, DISABLE PERSONS, AND MENTALLY IMPAIRED PERSONS (U.S. CLS. 2, 5, 22, 23, 29, 37, 38 AND 50).

FIRST USE 4-8-2002; IN COMMERCE 4-20-2002.

2,747,642. MERLINONE, INC., QUINCY, MA. SN 75-840,232. PUB. 11-26-2002, FILED 11-21-1999.



OWNER OF U.S. REG. NO. 1,947,199. FOR PHOTOGRAPHS (U.S. CLS. 2, 5, 22, 23, 29, 37, 38 AND 50).

FIRST USE 12-13-1999; IN COMMERCE 12-13-1999.

2,747,672. PLANET EARTH INC., LIMITED, 46 LYNDBURST TERRACE, CENTRAL, HONG KONG. SN 75-881,818. PUB. 12-18-2001, FILED 12-29-1999.

GROOVY PLANET

FOR TEACHING MATERIALS, NAMELY, BLACK BOARD, DRY ERASE WRITING BOARDS AND WRITING SURFACES, MEMO BOARD, CORK BOARD, MAGNETIC BULLETIN BOARD, BULLETIN BOARD, PUSH PINS, AND THUMB TACKS (U.S. CLS. 2, 5, 22, 23, 29, 37, 38 AND 50).

FIRST USE 1-0-2000; IN COMMERCE 1-0-2000.

CLASS 16—(Continued).

2,747,678. SAN FRANCISCO LESBIAN, GAY, BISEXUAL, TRANSGENDER PRIDE CELEBRATION COMMITTEE, INC., SAN FRANCISCO, CA. SN 75-889,438. PUB. 8-20-2002, FILED 1-5-2000.

OFFICIAL SAN FRANCISCO PRIDE GUIDE

NO CLAIM IS MADE TO THE EXCLUSIVE RIGHT TO USE "OFFICIAL SAN FRANCISCO" AND "GUIDE", APART FROM THE MARK AS SHOWN.

FOR PRINTED MATTER ON THE SUBJECT MATTER OF THE SAN FRANCISCO LESBIAN, GAY, BISEXUAL AND TRANSGENDER PRIDE CELEBRATION, NAMELY, GUIDEBOOKS, POSTCARDS, NEWSLETTERS, NEWSPAPERS, MAPS, DIRECTORIES, MAGAZINES AND POSTERS (U.S. CLS. 2, 5, 22, 23, 29, 37, 38 AND 50).

FIRST USE 2-1-1998; IN COMMERCE 6-1-2002.

2,747,698. KOKUYO KABUSHIKI KAISHA, TA KOKUYO CO., LTD., OSAKA-FU, JAPAN. SN 75-926,509. PUB. 9-26-2000, FILED 2-24-2000.

FITCURVE

FOR BALL POINT PENS, MECHANICAL PENCILS (U.S. CLS. 2, 5, 22, 23, 29, 37, 38 AND 50).

FIRST USE 8-0-2002; IN COMMERCE 8-0-2002.

2,747,716. CROSSGENERATION COMICS, INC., OLDSMAR, FL. SN 75-983,218. PUB. 5-21-2002, FILED 12-3-1999.

MERIDIAN

FOR PRINTED MATERIALS AND PUBLICATIONS, NAMELY, POSTERS, ACTION AND PICTURE STORIES CONTAINING MEMORABILIA RELATING TO FICTIONAL CHARACTERS, COMIC BOOKS AND PRINTED STORIES IN ILLUSTRATED FORM FEATURED IN BOOKS AND MAGAZINES (U.S. CLS. 2, 5, 22, 23, 29, 37, 38 AND 50).

FIRST USE 2-1-2000; IN COMMERCE 2-1-2000.

2,747,737. PROEIN SA, 28001, MADRID, SPAIN. SN 76-023,775. PUB. 2-5-2002, FILED 4-11-2000.

PRAETORIANS

FOR STATIONERY; ACTION AND ADVENTURE BOOKS; INSTRUCTION MANUALS; PERIODICAL PUBLICATIONS AND BROCHURES, ALL ABOUT ACTION AND ADVENTURE GAMES AND CHARACTERS; PACKING, NAMELY ENVELOPES, DECORATIVE BOXES AND WRAPPING PAPER MADE OF PAPER, CARDBOARD OR PLASTIC; POSTERS (U.S. CLS. 2, 5, 22, 23, 29, 37, 38 AND 50).

FIRST USE 3-0-2003; IN COMMERCE 3-0-2003.

CLASS 16—(Continued).

2,747,748. CHARTPAK, INC., LEEDS, MA. SN 76-033,030. PUB. 2-19-2002, FILED 4-24-2000.

PROPERTY GRAPHICS

NO CLAIM IS MADE TO THE EXCLUSIVE RIGHT TO USE "GRAPHICS", APART FROM THE MARK AS SHOWN, FOR RUB-ON ADHESIVE TRANSFERS FOR USE IN THE REAL ESTATE MARKET ON MAPS, SITE EXHIBITS AND PHOTOS (U.S. CLS. 2, 5, 22, 23, 29, 37, 38 AND 50).

FIRST USE 12-5-2001; IN COMMERCE 12-5-2001.

2,747,768. BUTTENPAPIERFABRIK GMUND GMBH & CO. KG, 83701 GMUND AM TEGERNSEE, FED REP GERMANY. SN 76-051,442. PUB. 3-5-2002, FILED 5-18-2000.

LAKEPAPER

NO CLAIM IS MADE TO THE EXCLUSIVE RIGHT TO USE "PAPER", APART FROM THE MARK AS SHOWN.

FOR PAPER, NAMELY, WRITING AND COVER PAPER, PRINTING PAPER, PACKAGING PAPER, GRAPH PAPER, STATIONERY PAPER, LABEL PAPER, PAPER FOR MOUNTING PHOTOGRAPHS AND ARTWORK, DECORATIVE PAPER FOR ARTS AND CRAFTS, DECORATIVE PAPER FOR SCRAPBOOKS, WRAPPING PAPER (U.S. CLS. 2, 5, 22, 23, 29, 37, 38 AND 50).

FIRST USE 1-0-2000; IN COMMERCE 4-0-2000.

2,747,816. POSEY PARK, LLC, CARROLLTON, TX. SN 76-083,045. PUB. 3-20-2001, FILED 7-5-2000.

POSEY PARK

FOR PRINTED MATTER, NAMELY, POETRY BOOKS; ART BOOKS; PRINTED PAPER SHEETS CONTAINING POETRY; ART PRINTS; PAINTINGS; BABY BOOKS; WEDDING BOOKS; GIFT BOOKS; GREETING CARDS; CALENDARS (U.S. CLS. 2, 5, 22, 23, 29, 37, 38 AND 50).

FIRST USE 7-1-2002; IN COMMERCE 7-1-2002.

2,747,832. PISTACHIO AUSTRALIA PTY. LTD., AUSTRALIAN CAPITAL TERRITORY, 2902, AUSTRALIA. SN 76-098,481. PUB. 6-25-2002, FILED 7-28-2000.

PISTACHIO

FOR ARTWORK, NAMELY ART ETCHINGS, ART PICTURES, ART PRINTS, PRINTED ART REPRODUCTIONS AND PHOTOGRAPHS; GRAPHIC ART REPRODUCTIONS AND PHOTOGRAPHS; ARTWORK MOUNTED IN FRAMES, NAMELY ART ETCHINGS, ART PICTURES, ART PRINTS, PRINTED ART REPRODUCTIONS, GRAPHIC ART REPRODUCTIONS, PHOTOGRAPHS AND DECORATIVE PAPER SCULPTURES ALL OF WHICH ARE MOUNTED IN FRAMES (U.S. CLS. 2, 5, 22, 23, 29, 37, 38 AND 50).

FIRST USE 0-0-1998; IN COMMERCE 8-0-2000.

CLASS 16—(Continued).

2,747,839. DAWN OF DAY CHILDRENS PUBLISHING CO., INC., LINDENHURST, NY. SN 76-106,047. PUB. 5-15-2001, FILED 8-9-2000.



THE STIPLING IS A FEATURE OF THE MARK AND DOES NOT SHOW SHADING.

FOR SERIES OF CHILDREN'S BOOKS (U.S. CLS. 2, 5, 22, 23, 29, 37, 38 AND 50).

FIRST USE 1-10-2001; IN COMMERCE 1-10-2001.

2,747,887. S.L.E. FOUNDATION, INC., THE, NEW YORK, NY. SN 76-140,462. PUB. 6-19-2001, FILED 10-4-2000.

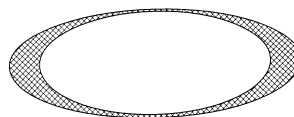

THE DRAWING IS LINED FOR THE COLOR ORANGE AND COLOR IS CLAIMED AS A FEATURE OF THE MARK.

FOR NOTEBOOKS, PENS, AND POSTERS (U.S. CLS. 2, 5, 22, 23, 29, 37, 38 AND 50).

FIRST USE 5-0-2000; IN COMMERCE 5-0-2000.

2,747,913. PORCELAIN PLUS, INC., VAN NUYS, CA. SN 76-161,388. PUB. 7-31-2001, FILED 11-7-2000.

SURFA-FIX

FOR KITS CONSISTING OF ADHESIVE AND APPLICATORS FOR REPAIR OF TILE, MARBLE, CERAMICS, PORCELAIN, METAL, FIBERGLASS, VINYL, BATH-TUBS, SINKS AND APPLIANCES (U.S. CLS. 2, 5, 22, 23, 29, 37, 38 AND 50).

FIRST USE 2-0-2000; IN COMMERCE 2-0-2000.

CLASS 16—(Continued).

2,747,914. KR U.S.A., INC., SAN JOSE, CA. SN 76-161,587. PUB. 7-2-2002, FILED 11-8-2000.

STREET MIAMI

NO CLAIM IS MADE TO THE EXCLUSIVE RIGHT TO USE "MIAMI", APART FROM THE MARK AS SHOWN. FOR NEWSPAPERS FOR GENERAL CIRCULATION, GENERAL FEATURE MAGAZINES, AND BOOKS CONTAINING INFORMATION REGARDING TO THE CITY OF MIAMI (U.S. CLS. 2, 5, 22, 23, 29, 37, 38 AND 50).

FIRST USE 11-17-2000; IN COMMERCE 11-17-2000.

2,747,949. UNIVERSAL CITY STUDIOS LLLP, UNIVERSITY CITY, CA. BY CHANGE OF NAME UNIVERSAL CITY STUDIOS, LP, UNIVERSAL CITY, CA. SN 76-181,895. PUB. 8-14-2001, FILED 12-18-2000.

UNIVERSAL'S ISLANDS OF ADVENTURE

FOR PHOTOGRAPH ALBUMS, PENS, POSTCARDS (U.S. CLS. 2, 5, 22, 23, 29, 37, 38 AND 50).

FIRST USE 8-0-2002; IN COMMERCE 8-0-2002.

2,747,981. AMPERSAND LABEL, INC., GARDEN GROVE, CA. SN 76-199,817. PUB. 7-16-2002, FILED 1-25-2001.

EASY TAB

FOR PRINTED LABELS, NAMELY MULTIPLE LAYER LABELS (U.S. CLS. 2, 5, 22, 23, 29, 37, 38 AND 50).

FIRST USE 5-0-2000; IN COMMERCE 5-0-2000.

2,747,994. ULTRA PRO LP, CITY OF COMMERCE, CA, BY ASSIGNMENT REMBRANDT PHOTO SERVICES, CITY OF COMMERCE, CA. SN 76-205,146. PUB. 3-12-2002, FILED 2-2-2001.

THE STANDARD IN SAFE STORAGE

OWNER OF U.S. REG. NOS. 1,766,700 AND 2,131,265. FOR PLASTIC HOLDERS, PLASTIC PROTECTIVE SLEEVES AND PLASTIC ALBUM PAGES FOR CONTAINING COLLECTIBLE CARDS, PHOTOGRAPHS AND COMIC BOOKS (U.S. CLS. 2, 5, 22, 23, 29, 37, 38 AND 50).

FIRST USE 2-0-2001; IN COMMERCE 2-0-2001.

CLASS 16—(Continued).

2,748,002. SCHWAN-STABILO SCHWANHAEUSSER GMBH & CO., D-90562 HEROLDSBERG, FED REP GERMANY. SN 76-208,049. PUB. 8-27-2002, FILED 2-9-2001.

COLORBALL

OWNER OF FED REP GERMANY REG. NO. 30049640, DATED 1-2-2001, EXPIRES 7-31-2010.

FOR PENCILS, PENCIL LEADS, AND PENCIL REFILLS; COLORED AND COPYING PENCILS, COLORED PENCIL LEADS AND COLORED PENCIL REFILLS, AND COPYING PENCIL LEADS AND COPYING PENCIL REFILLS; RETRACTABLE PENCILS, BALLPOINT PENS; REFILLS FOR BALLPOINT PENS; FELT AND FIBER PENS; REFILLS FOR FIBER PENS; FOUNTAIN PENS; MECHANICAL PENCILS; TEXT MARKERS AND HIGHLIGHTERS; POSTERS; OFFICE REQUISITES, NAMELY, PAPER CLIPS, NOTE PADS, STAPLERS, AND RUBBER BANDS (U.S. CLS. 2, 5, 22, 23, 29, 37, 38 AND 50).

FIRST USE 10-0-2000; IN COMMERCE 2-27-2003.

2,748,015. SIKKINK, TRACI, LOS ANGELES, CA. SN 76-214,479. PUB. 6-18-2002, FILED 2-22-2001.

MISS HEART

FOR LOOSE LEAF PAPER, LASER PRINTER PAPER AND BOND PAPER; CARDBOARD, CARDBOARD BOXES, CARDBOARD CONTAINERS AND CARDBOARD CARTONS; PRINTED MATTER, NAMELY, A SERIES OF BOOKS, MAGAZINES, GUIDEBOOKS, COLORING BOOKS AND NEWSLETTERS IN THE FIELD OF ORIGAMI INSTRUCTION; BOOKBINDINGS, BOOKBINDING TAPE AND BOOKBINDING WIRE; PHOTOGRAPHS; STATIONERY; ADHESIVES FOR STATIONERY AND HOUSEHOLD PURPOSES; ARTISTS' MATERIALS, NAMELY, PAINT BRUSHES, PAINT APPLICATORS, PAINT APPLICATOR ROLLERS, PAINT STIRRERS, PAINT TRAYS AND ARTS AND CRAFTS PAINT KITS; TYPEWRITERS, PAPER EMBOSSERS, PAPER SHREDDERS, PUNCHES, RUBBER BANDS AND STAPLERS; PLASTIC BAGS FOR MERCHANDISE PACKAGING; PLAYING CARDS; PRINTING TYPE AND PRINTING BLOCKS (U.S. CLS. 2, 5, 22, 23, 29, 37, 38 AND 50).

FIRST USE 3-1-2003; IN COMMERCE 3-1-2003.

2,748,026. SEARS, ROEBUCK AND CO., HOFFMAN ESTATES, IL. SN 76-221,592. PUB. 4-9-2002, FILED 3-8-2001.

SEARS CATALOG

OWNER OF U.S. REG. NOS. 1,529,006 AND 2,321,954. NO CLAIM IS MADE TO THE EXCLUSIVE RIGHT TO USE "CATALOG", APART FROM THE MARK AS SHOWN. SEC. 2(F).

FOR CATALOGS FEATURING CLOTHING, JEWELRY, FURNITURE, TOYS, FOOTWEAR, BEDDING, KITCHEN, BATH, AUTOMOTIVE, POWER AND HAND TOOLS, LAWN AND GARDEN, APPLIANCES, ELECTRONICS, AND RELATED ACCESSORIES FOR THE ABOVE-MENTIONED GOODS (U.S. CLS. 2, 5, 22, 23, 29, 37, 38 AND 50).

FIRST USE 7-0-2001; IN COMMERCE 7-0-2001.

CLASS 16—(Continued).

2,748,037. HUANG, ING-KAI, HSIN CHU, TAIWAN. SN 76-226,652. PUB. 6-11-2002, FILED 3-16-2001.



NO CLAIM IS MADE TO THE EXCLUSIVE RIGHT TO USE "CARD", APART FROM THE MARK AS SHOWN.

THE MARK CONSISTS OF THE WORD "CARD" TO THE LEFT OF A 5-POINTED STAR AND A CARICATURE OF A HUMAN HEAD.

FOR PAPER STAPLER; PAPER HOLE PUNCHES; AND PAPER CUTTERS (U.S. CLS. 2, 5, 22, 23, 29, 37, 38 AND 50).

FIRST USE 10-0-2001; IN COMMERCE 6-0-2002.

2,748,110. MACMILLAN PUBLISHERS (AUST.) PTY. LTD., VICTORIA 3141, AUSTRALIA. SN 76-258,008. PUB. 7-23-2002, FILED 5-16-2001.

FAST TRACK READING

NO CLAIM IS MADE TO THE EXCLUSIVE RIGHT TO USE "READING", APART FROM THE MARK AS SHOWN.

FOR PRINTED MATTER, NAMELY, BOOKS, MAGAZINES, NEWSLETTERS AND PRINTED AND INSTRUCTIONAL AND TEACHING MATERIALS IN THE FIELDS OF SCIENCE, SOCIAL STUDIES, READING DEVELOPMENT AND PERSONAL DEVELOPMENT (U.S. CLS. 2, 5, 22, 23, 29, 37, 38 AND 50).

FIRST USE 7-30-2001; IN COMMERCE 7-30-2001.

2,748,120. MILITARY OFFICERS ASSOCIATION OF AMERICA, ALEXANDRIA, VA, BY CHANGE OF NAME RETIRED OFFICERS ASSOCIATION, THE, ALEXANDRIA, VA. SN 76-260,150. PUB. 12-25-2001, FILED 5-22-2001.

TODAY'S OFFICER

NO CLAIM IS MADE TO THE EXCLUSIVE RIGHT TO USE "OFFICER", APART FROM THE MARK AS SHOWN.

FOR MONTHLY MAGAZINE IN THE FIELD OF ISSUES OF INTEREST TO RETIRED MILITARY OFFICERS (U.S. CLS. 2, 5, 22, 23, 29, 37, 38 AND 50).

FIRST USE 2-12-2003; IN COMMERCE 2-12-2003.

CLASS 16—(Continued).

2,748,146. S.A. DYERS, LTD., CHESTERFIELD, MO, BY ASSIGNMENT PLAID ENTERPRISES, INC., NORCROSS, GA. SN 76-265,300. PUB. 5-21-2002, FILED 5-30-2001.

MAGIC CANVAS

FOR PATTERNS FOR TRACING DESIGNS, PLASTIC TRACING SHEETS FOR TRANSPOSING ARTWORK AND DESIGNS, PAINT BRUSHES AND PRINTED INSTRUCTION SHEETS (U.S. CLS. 2, 5, 22, 23, 29, 37, 38 AND 50).

FIRST USE 7-5-2002; IN COMMERCE 7-5-2002.

2,748,294. EDWARD LOWE FOUNDATION, CASSOPOLIS, MI. SN 76-319,842. PUB. 10-1-2002, FILED 10-1-2001.

PEERSPECTIVES

FOR PUBLICATIONS ON THE SUBJECT OF BUSINESS PRACTICES AND TRENDS DIRECTED AT BUSINESS OWNERS, NAMELY, NEWSLETTERS, MAGAZINES, SPECIAL REPORTS, BOOKS, PRINTED EXECUTIVE TRAINING MATERIALS, AND PERIODICALS (U.S. CLS. 2, 5, 22, 23, 29, 37, 38 AND 50).

FIRST USE 5-20-2002; IN COMMERCE 5-20-2002.

2,748,312. EASTMAN, HAROLD S., BOISE, ID. SN 76-324,397. PUB. 7-2-2002, FILED 10-12-2001.

PEREGRINE IMAGES

OWNER OF U.S. REG. NO. 2,324,817.

NO CLAIM IS MADE TO THE EXCLUSIVE RIGHT TO USE "IMAGES", APART FROM THE MARK AS SHOWN.

FOR PHOTOGRAPHIC BOOKS; PRINTS; POSTERS; BLANK NOTE CARDS AND NOTE CARDS WITH MESSAGES; CALENDARS (U.S. CLS. 2, 5, 22, 23, 29, 37, 38 AND 50).

FIRST USE 11-8-2002; IN COMMERCE 11-8-2002.

2,748,421. MCLEARY, TIFFANIE, CHICAGO, IL. SN 76-356,386. PUB. 9-3-2002, FILED 1-7-2002.

MELANIN

FOR PRINTED PUBLICATIONS, NAMELY, MAGAZINE FEATURING ENTERTAINMENT, MUSIC, HEALTH AND BEAUTY, AND FASHION (U.S. CLS. 2, 5, 22, 23, 29, 37, 38 AND 50).

FIRST USE 9-0-2002; IN COMMERCE 9-0-2002.

CLASS 16—(Continued).

2,748,485. SCARY STORIES, INC., NEW YORK, NY. SN 76-378,366. PUB. 10-15-2002, FILED 3-4-2002.

NAUGHTY NAUGHTY PETS

FOR CHILDREN'S BOOKS (U.S. CLS. 2, 5, 22, 23, 29, 37, 38 AND 50).
FIRST USE 2-28-2002; IN COMMERCE 2-28-2002.

2,748,490. COUGHLAN COMPANIES, INC., MANKATO, MN. SN 76-380,223. PUB. 10-29-2002, FILED 3-8-2002.

PICTURE WINDOW BOOKS

NO CLAIM IS MADE TO THE EXCLUSIVE RIGHT TO USE "BOOKS", APART FROM THE MARK AS SHOWN.
FOR BOOKS FOR SCHOOL AGE CHILDREN (U.S. CLS. 2, 5, 22, 23, 29, 37, 38 AND 50).
FIRST USE 4-15-2002; IN COMMERCE 4-30-2002.

2,748,495. LASHMET, MICHAEL, INDIANAPOLIS, IN. SN 76-380,434. PUB. 10-15-2002, FILED 3-11-2002.

PADDLE TALK

FOR PLASTIC OR VINYL NOVELTY FLASH CARDS (U.S. CLS. 2, 5, 22, 23, 29, 37, 38 AND 50).
FIRST USE 10-10-2002; IN COMMERCE 3-20-2003.

2,748,540. LOFT, INC., THE, MINNEAPOLIS, MN. SN 76-398,139. PUB. 11-26-2002, FILED 4-19-2002.

SPEAKEASY

FOR LITERARY ARTS MAGAZINE (U.S. CLS. 2, 5, 22, 23, 29, 37, 38 AND 50).
FIRST USE 9-0-2002; IN COMMERCE 9-0-2002.

CLASS 16—(Continued).

2,748,571. FFPE, LLC, SAN DIEGO, CA. SN 76-975,258. PUB. 4-9-2002, FILED 6-30-2000.

PAT & OSCAR'S

FOR PAPER GOODS, NAMELY PAPER NAPKINS, PAPER CUPS, PAPER PLATES, PAPER BAGS, PAPER HATS, PAPER BOXES, PAPER TAKE-OUT CONTAINERS FOR FOOD, CARDBOARD CONTAINERS, COASTERS MADE OF PAPER, PAPER TRAY COVERS, PAPER BIBS, PAPER STREAMERS, PAPER TABLE CLOTHS, PAPER TABLE LINENS, PAPER PLACE MATS, PAPER PARTY FAVORS, PAPER BUNTING, STATIONERY, WRITING PAPER, NOTE CARDS, ADDRESS BOOKS, PHOTOGRAPH ALBUMS, BOOK COVERS, BOOKMARKS, BUMPER STICKERS, DECALS, CALENDARS, COLORING BOOKS, COOK BOOKS, COUPONS, PLAYING CARDS, NEWSLETTERS IN THE FIELD OF FOOD AND RESTAURANTS; PENS; PENCILS (U.S. CLS. 2, 5, 22, 23, 29, 37, 38 AND 50).
FIRST USE 4-0-2001; IN COMMERCE 4-0-2001.

2,748,637. ARIZONA BOARD OF REGENTS, FOR AND ON BEHALF OF ARIZONA STATE UNIVERSITY, TEMPE, AZ. SN 78-040,730. PUB. 8-21-2001, FILED 12-27-2000.

DIGI8

FOR NOTE CARDS, ENVELOPES, STICKERS, NOTE PAPER, BUSINESS CARDS, PAPER NAME BADGES, STATIONERY, NOTE PADS, PRINTED LABELS NOT OF TEXTILE, GIFT CARDS, ADDRESS LABELS, DIRECTORY PROVIDING DISCOUNT OPPORTUNITIES AND RELATED BENEFITS WITH RESPECT TO LODGING AND DINING, MAGAZINES AND PRINTED GUIDES CONTAINING INFORMATION ON TELEVISION PROGRAMMING, BLANK OR PARTIALLY PRINTED POSTCARDS, BOOKMARKS, CARDBOARD BOXES, PAPER BOXES, ANNOUNCEMENT CARDS, PAPER BANNERS, ORDER FORMS, PAPER IDENTIFICATION TAGS, PRINTED FORMS, MOTIVATIONAL CARDS AND BUSINESS FORMS (U.S. CLS. 2, 5, 22, 23, 29, 37, 38 AND 50).
FIRST USE 4-30-2003; IN COMMERCE 4-30-2003.

2,748,641. CHURCHILL, STEPHEN H., WOODBRIDGE, VA. SN 78-042,611. PUB. 3-12-2002, FILED 1-10-2001.

THE PEOPLE THAT YOU CAN TRUST!

FOR PERIODICAL, NAMELY, A BUSINESS DIRECTORY USED TO ADVERTISE LOCAL BUSINESSES AND SERVICES (U.S. CLS. 2, 5, 22, 23, 29, 37, 38 AND 50).
FIRST USE 6-1-2002; IN COMMERCE 9-15-2002.

CLASS 16—(Continued).

2,748,673. HAMMOND WORLD ATLAS CORPORATION, UNION, NJ. SN 78-054,343. PUB. 7-2-2002, FILED 3-21-2001.

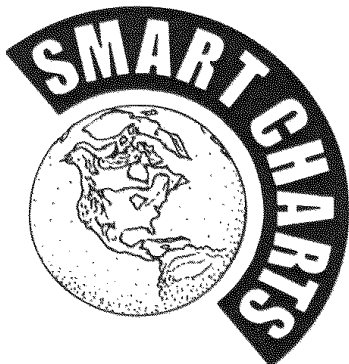

THE STIPPLING IS FOR SHADING PURPOSES ONLY. FOR WALL CHARTS (U.S. CLS. 2, 5, 22, 23, 29, 37, 38 AND 50).
FIRST USE 3-29-2001; IN COMMERCE 4-0-2001.

2,748,685. MARVEL CHARACTERS, INC., LOS ANGELES, CA. SN 78-058,318. PUB. 9-18-2001, FILED 4-13-2001.

EXILES

OWNER OF U.S. REG. NO. 1,877,157.
FOR PRINTED PUBLICATIONS, NAMELY COMIC BOOKS AND COMIC MAGAZINES AND STORIES IN ILLUSTRATED FORM (U.S. CLS. 2, 5, 22, 23, 29, 37, 38 AND 50).
FIRST USE 1-3-1992; IN COMMERCE 1-3-1992.

2,748,735. HACKNEY, MORGAN E., WHITTIER, CA. SN 78-079,542. PUB. 10-8-2002, FILED 8-16-2001.



THE MARK CONSISTS OF A PICTURE OF A MONKEY (HAIRY PRIMATE OF SOME SORT - GORILLA, ETC.) WARRIOR WITH ONE LEG UP AND A HAND SHADING THE EYES LOOKING INTO THE DISTANCE. THERE IS A WEAPON ON THE MONKEY'S BACK AND THE MONKEY

CLASS 16—(Continued).

IS WEARING CLOTHES. UNDER NEATH THE MONKEY IS THE MONKEY'S SHADOW SHOWING THAT THE SUN IS DIRECTLY OVER HEAD.

FOR COMIC STRIPS IN GENERAL AND IN MAGAZINES (U.S. CLS. 2, 5, 22, 23, 29, 37, 38 AND 50).
FIRST USE 7-1-2001; IN COMMERCE 7-1-2001.

2,748,738. RANPAK CORP., CONCORD TOWNSHIP, OH. SN 78-080,236. PUB. 12-11-2001, FILED 8-20-2001.

SMOOTHPAK

NO CLAIM IS MADE TO THE EXCLUSIVE RIGHT TO USE "PAK", APART FROM THE MARK AS SHOWN.

FOR PACKAGING MATERIALS, NAMELY PAPER DESIGNED FOR CONVERSION INTO A PACKING MATERIAL; AND CUSHIONING, PADDING AND/OR VOID FILLERS PRIMARILY MADE OF PAPER (U.S. CLS. 2, 5, 22, 23, 29, 37, 38 AND 50).
FIRST USE 1-21-2000; IN COMMERCE 1-21-2000.

2,748,796. DR. KENNETH J. MANGES & ASSOCIATES, INC., CINCINNATI, OH. SN 78-094,784. PUB. 7-9-2002, FILED 11-23-2001.

PSYCHOLOGICALLY SPEAKING

FOR BOOKS AND NEWSLETTERS IN THE FIELD OF CONTEMPORARY PSYCHOLOGY ISSUES AND COMMENTARY (U.S. CLS. 2, 5, 22, 23, 29, 37, 38 AND 50).
FIRST USE 12-0-2001; IN COMMERCE 12-0-2001.

2,748,808. MANGAN COMMUNICATIONS, INC., DAVENPORT, IA. SN 78-098,373. PUB. 11-12-2002, FILED 12-14-2001.

ASSISTIVE STYLE FORMATTING

FOR BOOKS, NAMELY, EDUCATIONAL BOOKS FEATURING INFORMATION ON OCCUPATIONAL SAFETY AND HEALTH AND GOVERNMENT REGULATIONS PERTAINING TO OCCUPATIONAL SAFETY AND HEALTH (U.S. CLS. 2, 5, 22, 23, 29, 37, 38 AND 50).
FIRST USE 5-1-2002; IN COMMERCE 5-12-2002.

CLASS 16—(Continued).

2,748,812. DESMOND CAGE, LYNNE, SANTA BARBARA, CA. SN 78-098,588. PUB. 9-3-2002, FILED 12-16-2001.

DIAPERS & DEADLINES

FOR PAPER GOODS AND PRINTED MATERIALS, NAMELY, NOTE CARDS RELATED TO WOMEN'S AND MOTHER'S ISSUES REGARDING BALANCING WORK AND HOME LIFE, BOOKS RELATED TO WOMEN'S AND MOTHER'S ISSUES REGARDING BALANCING WORK AND HOME LIFE, JOURNALS RELATED TO WOMEN'S AND MOTHER'S ISSUES REGARDING BALANCING WORK AND HOME LIFE, AND PRINTED INSTRUCTIONAL MATERIAL IN THE FIELD OF WOMEN'S AND MOTHER'S ISSUES REGARDING BALANCING WORK AND HOME LIFE; STATIONERY (U.S. CLS. 2, 5, 22, 23, 29, 37, 38 AND 50).

FIRST USE 2-1-2002; IN COMMERCE 2-1-2002.

2,748,838. MAXI SAVER GROUP, INC., NEW YORK, NY. SN 78-102,698. PUB. 8-13-2002, FILED 1-15-2002.

MAXI SAVER COUPONS

NO CLAIM IS MADE TO THE EXCLUSIVE RIGHT TO USE "COUPONS", APART FROM THE MARK AS SHOWN. FOR COUPONS FOR USE IN US MILITARY COMMISSARIES LOCATED ON MILITARY BASES WORLDWIDE (U.S. CLS. 2, 5, 22, 23, 29, 37, 38 AND 50).

FIRST USE 1-1-1988; IN COMMERCE 1-1-1988.

2,748,868. HEDSTROM CORPORATION, MOUNT PROSPECT, IL. SN 78-107,179. PUB. 7-30-2002, FILED 2-6-2002.

ROOM BUDDIES

FOR ADHESIVE DECALS (U.S. CLS. 2, 5, 22, 23, 29, 37, 38 AND 50).

FIRST USE 9-11-2002; IN COMMERCE 9-11-2002.

2,748,899. C-LINE PRODUCTS, INC., MT. PROSPECT, IL. SN 78-113,848. PUB. 9-17-2002, FILED 3-10-2002.

SECURITY GUARD

FOR OFFICE PRODUCTS, NAMELY SHEET PROTECTORS (U.S. CLS. 2, 5, 22, 23, 29, 37, 38 AND 50).

FIRST USE 7-2-2002; IN COMMERCE 7-2-2002.

CLASS 16—(Continued).

2,748,940. TRANSACTIONAL MARKETING PARTNERS, INC., SANTA MONICA, CA. SN 78-126,229. PUB. 1-21-2003, FILED 5-3-2002.

LIQUI STIC

FOR REUSABLE ADHESIVE FOR HOUSEHOLD OR STATIONERY USE (U.S. CLS. 2, 5, 22, 23, 29, 37, 38 AND 50).

FIRST USE 8-1-2002; IN COMMERCE 10-3-2002.

2,748,953. LISA FRANK, INC., TUCSON, AZ. SN 78-129,229. PUB. 12-3-2002, FILED 5-16-2002.

VALERIE

FOR PRINTED MATERIALS FOR CHILDREN, NAMELY, STICKERS, STICKER ALBUMS AND BOOKS, NOTEBOOKS, FOLDERS, BINDERS, ORGANIZERS FOR STATIONERY AND PERSONAL ORGANIZERS, STATIONERY-TYPE PORTFOLIOS, WRITING PADS, MEMO PADS, STATIONERY, PENCILS, PENCIL CASES, PENCIL SHARPENERS, PENS, MARKERS, CHALK, COLORING BOOKS, DIARIES, AND TRADING CARDS (U.S. CLS. 2, 5, 22, 23, 29, 37, 38 AND 50).

FIRST USE 5-17-2002; IN COMMERCE 5-17-2002.

CLASS 17—RUBBER GOODS

2,747,472. GENERAL ELECTRIC COMPANY, SCHENECTADY, NY, BY ASSIGNMENT ADVANCED CERAMICS CORPORATION, LAKEWOOD, OH. SN 75-457,180. PUB. 10-5-1999, FILED 3-25-1998.

TPG

FOR PARALYTIC GRAPHITE PRODUCT OF HIGH THERMAL CONDUCTIVITY FOR USE IN HEAT EXCHANGERS AND HEAT DISSIPATING EQUIPMENT SUCH AS, FOR EXAMPLE, ELECTRICAL CIRCUIT BOARDS AND THERMAL VIALS (U.S. CLS. 1, 5, 12, 13, 35 AND 50).

FIRST USE 3-25-1998; IN COMMERCE 3-25-1998.

2,747,491. MARINEGLO CORP., EDEN PRAIRIE, MN. SN 75-522,797. PUB. 1-4-2000, FILED 7-21-1998.

MARINEGLO

FOR MOORING PRODUCTS AND DOCK PRODUCTS, NAMELY, FENDERS, DOCK EDGING AND DOCK BUMPERS (U.S. CLS. 1, 5, 12, 13, 35 AND 50).

FIRST USE 6-5-2002; IN COMMERCE 6-5-2002.

CLASS 17—(Continued).

2,747,959. SAES GETTERS S.P.A., 20020 LAINATE, MILANO, ITALY. SN 76-187,722. PUB. 7-2-2002, FILED 12-28-2000.

INSULA

PRIORITY CLAIMED UNDER SEC. 44(D) ON ITALY APPLICATION NO. MI2000C01379, FILED 12-15-2000, REG. NO. 00834012, DATED 1-26-2001, EXPIRES 12-15-2010.

THE ENGLISH TRANSLATION OF THE WORD "INSULA" FROM LATIN IS "ISLAND".

FOR VACUUM THERMOINSULATION PANELS FOR REFRIGERATORS, FOR REFRIGERATION TRUCKS, FOR SHIPPING CONTAINERS, FOR VACUUM INSULATED BOTTLES, FOR PIPES, AND FOR BOILERS (U.S. CLS. 1, 5, 12, 13, 35 AND 50).

FIRST USE 9-20-2002; IN COMMERCE 9-20-2002.

CLASS 17—(Continued).

2,748,200. AFM CORPORATION, EXCELSIOR, MN. SN 76-284,606. PUB. 6-11-2002, FILED 7-2-2001.

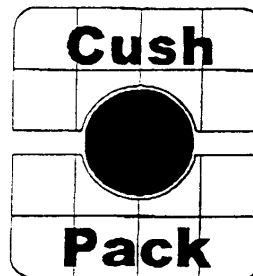

2,748,069. GENERAL ELECTRIC COMPANY, SCHENECTADY, NY. SN 76-239,119. PUB. 9-17-2002, FILED 4-9-2001.

ENYO

FOR SYNTHETIC POLYMERIC RESINS IN PELLET AND SHEET FORM THAT PROVIDE AESTHETIC QUALITIES IN THE FINISHED PRODUCTS OF OTHERS (U.S. CLS. 1, 5, 12, 13, 35 AND 50).

FIRST USE 9-0-2000; IN COMMERCE 9-0-2000.

NO CLAIM IS MADE TO THE EXCLUSIVE RIGHT TO USE "PACK", APART FROM THE MARK AS SHOWN.

THE LINING IS A FEATURE OF THE MARK AND DOES NOT INDICATE COLOR.

FOR PADDING MATERIAL OF PLASTIC FOAM FORMED TO FIT PACKAGED ARTICLES (U.S. CLS. 1, 5, 12, 13, 35 AND 50).

FIRST USE 3-6-2003; IN COMMERCE 3-6-2003.

2,748,085. UNISEAL, INC., EVANSVILLE, IN. SN 76-245,967. PUB. 7-2-2002, FILED 4-24-2001.

SOUNSECURE

FOR ADHESIVES AND SEALANTS FOR USE IN VIBRATION REDUCTION IN AUTOMOBILES (U.S. CLS. 1, 5, 12, 13, 35 AND 50).

FIRST USE 2-0-1999; IN COMMERCE 2-0-1999.

2,748,324. JAKQUMAR A.G., 6300 ZUG, SWITZERLAND. SN 76-328,234. PUB. 11-12-2002, FILED 10-23-2001.

FORMULA RS

NO CLAIM IS MADE TO THE EXCLUSIVE RIGHT TO USE "FORMULA", APART FROM THE MARK AS SHOWN.

FOR CAULKING, CAULKING COMPOUNDS, ADHESIVE SEALANTS FOR GENERAL USE AND FOR AUTOMOTIVE AND MARINE USE, AND SILICONE RUBBER SEALANTS FOR GENERAL USE AND FOR AUTOMOTIVE AND MARINE USE (U.S. CLS. 1, 5, 12, 13, 35 AND 50).

FIRST USE 5-23-2002; IN COMMERCE 5-23-2002.

2,748,199. AFM CORPORATION, EXCELSIOR, MN. SN 76-284,605. PUB. 7-16-2002, FILED 7-2-2001.

CUSHPACK

FOR PADDING MATERIAL OF PLASTIC FOAM FORMED TO FIT PACKAGED ARTICLES (U.S. CLS. 1, 5, 12, 13, 35 AND 50).

FIRST USE 3-6-2003; IN COMMERCE 3-6-2003.

2,748,400. BGF INDUSTRIES, INC., GREENSBORO, NC. SN 76-351,054. PUB. 11-19-2002, FILED 12-20-2001.

SILCOSOFT

FOR NON-WOVEN FIBERGLASS FABRIC FOR THERMAL INSULATION USED IN ENGINES TURBINES AND INDUSTRIAL FURNACES (U.S. CLS. 1, 5, 12, 13, 35 AND 50).

FIRST USE 11-27-2001; IN COMMERCE 11-27-2001.

CLASS 17—(Continued).

2,748,440. WYKO INDUSTRIAL SERVICES LIMITED, WEST MIDLANDS, B62 8WG, ENGLAND. SN 76-362,312. PUB. 11-5-2002, FILED 1-24-2002.

TRANSMOTION

FOR NON-METAL SEALS, GASKETS AND O-RINGS FOR USE IN ENGINES, MOTORS AND MACHINES (U.S. CLS. 1, 5, 12, 13, 35 AND 50).

FIRST USE 3-0-2002; IN COMMERCE 3-0-2002.

2,748,686. GENERAL ELECTRIC COMPANY, SCHENECTADY, NY. SN 78-059,347. PUB. 1-29-2002, FILED 4-19-2001.

HOME SOLUTIONS

NO CLAIM IS MADE TO THE EXCLUSIVE RIGHT TO USE "HOME", APART FROM THE MARK AS SHOWN.

FOR ADHESIVE SEALANTS FOR GENERAL USE; CAULKING AND CAULKING COMPOUND; GENERAL PURPOSE SILICONE RUBBER SEALANT; SEALANTS FOR BUILDINGS; RUBBER SEALANT FOR CAULKING AND ADHESIVE PURPOSES; GENERAL ADHESIVE FOR USE ON TILE, NAMELY, GROUT SUBSTITUTE (U.S. CLS. 1, 5, 12, 13, 35 AND 50).

FIRST USE 9-0-2000; IN COMMERCE 9-0-2000.

2,748,732. GENERAL ELECTRIC COMPANY, SCHENECTADY, NY. SN 78-078,659. PUB. 12-4-2001, FILED 8-10-2001.

FOAM HOME

FOR CAULKING AND CAULKING COMPOUND; GENERAL PURPOSE SILICONE RUBBER SEALANT; SEALANTS FOR BUILDINGS; RUBBER SEALANT FOR CAULKING AND ADHESIVE PURPOSES (U.S. CLS. 1, 5, 12, 13, 35 AND 50).

FIRST USE 8-9-2001; IN COMMERCE 8-9-2001.

2,748,890. 3M COMPANY, ST PAUL, MN, BY CHANGE OF NAME, BY MERGER MINNESOTA MINING AND MANUFACTURING COMPANY, ST. PAUL, MN. SN 78-111,870. PUB. 9-3-2002, FILED 3-1-2002.

SCOTCHGARD

OWNER OF U.S. REG. NOS. 630,698, 1,213,726, AND OTHERS.

FOR PLASTIC FILM FOR PROTECTING GRAPHICS AND SURFACES FROM DAMAGE OR ABUSE (U.S. CLS. 1, 5, 12, 13, 35 AND 50).

FIRST USE 3-5-2003; IN COMMERCE 3-5-2003.

CLASS 18—LEATHER GOODS**CLASS 18—(Continued).**

2,747,574. FOX RACING INC., MORGAN HILL, CA, BY CHANGE OF NAME FOX RACING USA, INC., MORGAN HILL, CA. SN 75-721,263. PUB. 9-3-2002, FILED 6-4-1999.

SHIFT

FOR GEAR BAGS FOR CARRYING MOTORCYCLING AND BICYCLING EQUIPMENT, SADDLE BAGS, TOOL PACKS SOLD EMPTY AND UMBRELLAS (U.S. CLS. 1, 2, 3, 22 AND 41).

FIRST USE 2-1-1997; IN COMMERCE 2-1-1997.

2,747,578. VULCANA, INC., ALEXANDRIA, VA. SN 75-724,019. PUB. 1-11-2000, FILED 6-8-1999.



FOR HANDBAGS; BACKPACKS; BAGS, NAMELY, ALL-PURPOSE SPORT, ATHLETIC, BEACH, BOOK, CLUTCH, OVERNIGHT, SCHOOL, SHOULDER, TOTE, TRAVEL; TOILETRY CASES SOLD EMPTY; POCKET-BOOKS; BRIEFCASE-TYPE PORTFOLIOS; PURSES, NAMELY, CLUTCH; RUCKSACKS; SHAVING BAGS SOLD EMPTY (U.S. CLS. 1, 2, 3, 22 AND 41).

FIRST USE 12-11-2000; IN COMMERCE 12-11-2000.

2,748,181. MAURIELLO, FRANK, PLEASANTVILLE, NJ. SN 76-279,071. PUB. 2-5-2002, FILED 7-2-2001.

ENELLE

FOR UMBRELLAS, WALLETS, PURSES, HANDBAGS, TRAVEL BAGS, BUSINESS CARD CASES, PASSPORT CASES, CLUTCH BAGS, KEY CASES, ATTACHE CASES, DUFFEL BAGS AND TOTE BAGS (U.S. CLS. 1, 2, 3, 22 AND 41).

FIRST USE 1-0-2003; IN COMMERCE 1-0-2003.

CLASS 18—(Continued).

2,748,315. PHOENIX LEATHER PRODUCTS, INC., CINCINNATI, OH. SN 76-325,908. PUB. 12-3-2002, FILED 10-16-2001.

BREEDERS

FOR PET COLLARS AND LEASHES (U.S. CLS. 1, 2, 3, 22 AND 41).
FIRST USE 12-0-2001; IN COMMERCE 12-0-2001.

2,748,344. BAGS INTERNATIONAL LLC, COMPTON, CA. SN 76-335,214. PUB. 8-20-2002, FILED 11-8-2001.

STAR SPORTS

NO CLAIM IS MADE TO THE EXCLUSIVE RIGHT TO USE "SPORTS", APART FROM THE MARK AS SHOWN.
FOR BACKPACKS, TOTE BAGS, BRIEFCASES, BRIEFCASE-TYPE PORTFOLIOS, LEATHER BACKPACKS, BEACH BAGS, AND LUGGAGE (U.S. CLS. 1, 2, 3, 22 AND 41).
FIRST USE 10-10-2002; IN COMMERCE 10-10-2002.

2,748,425. FIVE OF US, INC., THE, SAN FRANCISCO, CA. SN 76-357,641. PUB. 10-15-2002, FILED 1-11-2002.

LIL'ER PAL PACK

NO CLAIM IS MADE TO THE EXCLUSIVE RIGHT TO USE "PACK", APART FROM THE MARK AS SHOWN.
FOR FANCIFUL BACKPACKS (U.S. CLS. 1, 2, 3, 22 AND 41).
FIRST USE 2-0-2002; IN COMMERCE 2-0-2002.

2,748,442. DEMARCO, JOSEPH, NEW YORK, NY. SN 76-362,565. PUB. 9-17-2002, FILED 1-25-2002.

PORTA-BRELLA

FOR PATIO UMBRELLAS; BEACH UMBRELLAS (U.S. CLS. 1, 2, 3, 22 AND 41).
FIRST USE 11-1-2002; IN COMMERCE 11-1-2002.

CLASS 18—(Continued).

2,748,536. SEARS, ROEBUCK AND CO., HOFFMAN ESTATES, IL. SN 76-397,342. PUB. 11-5-2002, FILED 4-18-2002.

COVINGTON

OWNER OF U.S. REG. NO. 2,207,913.
FOR ACCESSORIES, NAMELY, HANDBAGS, PURSES, TOTE BAGS (U.S. CLS. 1, 2, 3, 22 AND 41).
FIRST USE 7-0-2002; IN COMMERCE 7-0-2002.

2,748,565. PEGULA, CHRIS J., SANTA MONICA, CA. SN 76-419,682. PUB. 12-3-2002, FILED 6-12-2002.

DIAPER DUDE

NO CLAIM IS MADE TO THE EXCLUSIVE RIGHT TO USE "DIAPER", APART FROM THE MARK AS SHOWN.
FOR DIAPER BAGS (U.S. CLS. 1, 2, 3, 22 AND 41).
FIRST USE 11-11-2002; IN COMMERCE 11-13-2002.

2,748,711. NBDL ENTERPRISES, LLC, SECAUCUS, NJ. SN 78-073,060. PUB. 7-23-2002, FILED 7-10-2001.



NO CLAIM IS MADE TO THE EXCLUSIVE RIGHT TO USE "MOBILE", APART FROM THE MARK AS SHOWN.
FOR ATHLETIC BAGS, SHOE BAGS FOR TRAVEL, OVERNIGHT BAGS, UMBRELLAS, BACKPACKS, BABY BACKPACKS, DUFFEL BAGS, TOTE BAGS, LUGGAGE, LUGGAGE TAGS, PATIO UMBRELLAS, VALISES, ATTACHE CASES, BILLFOLDS, WALLETS, BRIEFCASES, CANES, BUSINESS CARD CASES, BOOK BAGS, ALL PURPOSE SPORTS BAGS, GOLF UMBRELLAS, GYM BAGS, PURSES, COIN PURSES, FANNY PACKS, WAIST PACKS, COSMETIC CASES SOLD EMPTY, GARMENT BAGS FOR TRAVEL, HANDBAGS, KEY CASES, KNAPSACKS, SUITCASES, TOILETRY CASES SOLD EMPTY, TRUNKS FOR TRAVELING AND RUCKSACKS (U.S. CLS. 1, 2, 3, 22 AND 41).
FIRST USE 11-30-2001; IN COMMERCE 11-30-2001.

CLASS 18—(Continued).

2,748,819. TEEPAK PROPERTIES, LLC, LISLE, IL. SN 78-099,430. PUB. 8-13-2002, FILED 12-20-2001.

RTU

FOR CELLULOSE FOOD CASINGS AND PAPER-REINFORCED CELLULOSE FOOD CASINGS (U.S. CLS. 1, 2, 3, 22 AND 41).
FIRST USE 2-21-2003; IN COMMERCE 2-21-2003.

2,748,905. NICHOLS, ANNE, HEALDSBURG, CA. SN 78-116,393. PUB. 9-17-2002, FILED 3-20-2002.

ANNIE C.

FOR WOMEN'S PURSES (U.S. CLS. 1, 2, 3, 22 AND 41).
FIRST USE 10-21-2002; IN COMMERCE 10-25-2002.

CLASS 19—NON-METALLIC BUILDING MATERIALS

2,747,502. MI HOME PRODUCTS, INC., CLEARWATER, FL. SN 75-548,758. PUB. 10-19-1999, FILED 9-4-1998.

ADMIRE

FOR NON-METAL WINDOWS (U.S. CLS. 1, 12, 33 AND 50).
FIRST USE 10-31-2002; IN COMMERCE 10-31-2002.

2,747,689. RIDGLASS MANUFACTURING COMPANY, INC., FRESNO, CA. SN 75-906,392. PUB. 5-22-2001, FILED 1-31-2000.

KWIK SILVER

FOR BUILDING MATERIALS, NAMELY NON-METALLIC ROOFING (U.S. CLS. 1, 12, 33 AND 50).
FIRST USE 6-13-2000; IN COMMERCE 6-13-2000.

2,747,774. RAPID MAT S.A.R.L., CH1006 LAUSANNE, SWITZERLAND, BY ASSIGNMENT RAPID MAT, LLC, WASHINGTON, DC. SN 76-056,789. PUB. 5-7-2002, FILED 5-25-2000.

RAPID MAT

NO CLAIM IS MADE TO THE EXCLUSIVE RIGHT TO USE "MAT", APART FROM THE MARK AS SHOWN.
FOR HINGED FOLDED FIBERGLASS MATS FOR USE IN STABILIZING OUTDOOR SURFACES, NAMELY, RUNWAYS, HIGHWAYS, AND ROADS (U.S. CLS. 1, 12, 33 AND 50).
FIRST USE 11-30-2000; IN COMMERCE 11-30-2000.

CLASS 19—(Continued).

2,748,031. KIMBERLY-CLARK WORLDWIDE, INC., NEENAH, WI, BY ASSIGNMENT KIMBERLY-CLARK CORPORATION, NEENAH, WI. SN 76-223,505. PUB. 6-11-2002, FILED 3-12-2001.

HEIRLOOM

FOR UTILITY, DECORATIVE AND FURNITURE CONSTRUCTION MATERIALS, NAMELY, VENEER AND TAMBOUR BACKERS FOR DURABILITY FLEXIBILITY OF WOOD VENEER IN THE MANUFACTURE OF FURNITURE AND DECORATIVE PANELS (U.S. CLS. 1, 12, 33 AND 50).
FIRST USE 5-31-2002; IN COMMERCE 5-31-2002.

2,748,094. TAMKO ROOFING PRODUCTS, INC., JOPLIN, MO. SN 76-248,688. PUB. 7-2-2002, FILED 4-27-2001.

DECLARATION

FOR ASPHALT-BASED BUILDING MATERIALS, NAMELY, SHINGLES (U.S. CLS. 1, 12, 33 AND 50).
FIRST USE 1-22-2003; IN COMMERCE 1-22-2003.

2,748,099. HARRIS, TERRY L., MASCOT, TN. SN 76-249,980. PUB. 6-25-2002, FILED 5-2-2001.

HERCULES

FOR NON-METAL BUILDING MATERIALS, NAMELY CHAIRS IN THE NATURE OF PLASTIC BRACKETS FOR SUPPORTING REINFORCING RODS IN A FOUNDATION OR SLAB (U.S. CLS. 1, 12, 33 AND 50).
FIRST USE 2-20-2002; IN COMMERCE 11-14-2002.

2,748,163. HOME DYNAMIX, S. HACKENSACK, NJ. SN 76-271,518. PUB. 7-9-2002, FILED 6-14-2001.

FLOOR IT YOURSELF

FOR NON-METAL, NON-WOODEN SELF ADHESIVE FLOOR TILES (U.S. CLS. 1, 12, 33 AND 50).
FIRST USE 12-0-2002; IN COMMERCE 12-0-2002.

2,748,230. DURAMAX, INC., MIDDLEFIELD, OH. SN 76-296,319. PUB. 7-30-2002, FILED 8-7-2001.

MATERA

FOR VINYL FLOORING TILE (U.S. CLS. 1, 12, 33 AND 50).
FIRST USE 2-7-2003; IN COMMERCE 2-7-2003.

CLASS 19—(Continued).

2,748,559. DURO-LAST, INC., SAGINAW, MI. SN 76-413,274. PUB. 11-26-2002, FILED 5-23-2002.

DURO-SHIELD

FOR ROOFING ACCESSORIES; NAMELY, NON-ELECTRIC, STATIONARY VENTS, RIGID FACIA STRIPS, RIGID AND FLEXIBLE CORNERS, SCUPPERS, DRAINS, DRAIN CLAMPING EXPANSION RINGS, DRIP EDGE COVERING, DRAIN LEAF GRATES, GRAVEL STOPS, FLASHINGS, ROOFING MEMBRANE SHEETING, UNDERLAYMENT; NAMELY, FIBER-GLASS MAT AND PLASTIC FILM, TERMINATION BARS, ROOF MEMBRANE STRESS DISTRIBUTION PLATES, AND MOISTURE ABSORBERS IN THE NATURE OF GRANULATED BENTONITE CLAY SOLD IN BAGS (U.S. CLS. 1, 12, 33 AND 50).

FIRST USE 12-10-2002; IN COMMERCE 12-10-2002.

2,748,822. MOHAWK BRANDS, INC., WILMINGTON, DE. SN 78-100,060. PUB. 8-6-2002, FILED 12-27-2001.

SOUND INHIBITOR BY MOHAWK

OWNER OF U.S. REG. NO. 1,099,660. NO CLAIM IS MADE TO THE EXCLUSIVE RIGHT TO USE "SOUND INHIBITOR", APART FROM THE MARK AS SHOWN.

FOR BACKING FOR WOOD LAMINATE FLOORING (U.S. CLS. 1, 12, 33 AND 50).

FIRST USE 2-12-2002; IN COMMERCE 2-12-2002.

2,748,835. INTERNATIONAL AMERICAN CERAMICS, INC., TULSA, OK. SN 78-102,575. PUB. 8-13-2002, FILED 1-14-2002.

NEWCASTLE

FOR CERAMIC TILE (U.S. CLS. 1, 12, 33 AND 50). FIRST USE 1-6-2003; IN COMMERCE 1-6-2003.

2,748,871. W.R. GRACE & CO.-CONN., NEW YORK, NY. SN 78-107,582. PUB. 9-24-2002, FILED 2-8-2002.

FLOPRUFE

FOR NON-METALLIC BUILDING MATERIALS, NAMELY, PRE-FORMED WATERPROOFING FLOORING MEMBRANES IN SHEET AND STRIP FORM AND COMPRISED OF WATERPROOF ADHESIVE AND POLYMERIC CARRIER SUPPORT SOLD TOGETHER AS A UNIT (U.S. CLS. 1, 12, 33 AND 50).

FIRST USE 3-22-2002; IN COMMERCE 3-22-2002.

CLASS 19—(Continued).

2,748,879. PREMARK RWP HOLDINGS, INC., WILMINGTON, DE. SN 78-108,531. PUB. 9-17-2002, FILED 2-13-2002.

VELOCITY

FOR NON-METAL FLOORING PANELS (U.S. CLS. 1, 12, 33 AND 50).

FIRST USE 6-5-2002; IN COMMERCE 6-5-2002.

CLASS 20—FURNITURE AND ARTICLES NOT OTHERWISE CLASSIFIED

2,747,523. ERGONOMIC ACCESSORIES INTERNATIONAL CORPORATION, SCOTTSDALE, AZ, BY ASSIGNMENT SPECTRACOM TECHNOLOGIES CORPORATION, SCOTTSDALE, AZ. SN 75-616,445. PUB. 1-8-2002, FILED 1-6-1999.



NO CLAIM IS MADE TO THE EXCLUSIVE RIGHT TO USE "ERGONOMIC PRODUCTS", APART FROM THE MARK AS SHOWN.

FOR FURNITURE (U.S. CLS. 2, 13, 22, 25, 32 AND 50). FIRST USE 4-5-1998; IN COMMERCE 4-5-1998.

2,747,777. MEDPORT LLC, PROVIDENCE, RI, BY ASSIGNMENT MEDPORT INVERSTMENT INC., PROVIDENCE, RI. SN 76-059,038. PUB. 6-4-2002, FILED 5-30-2000.



FOR DISPENSERS FOR MEDICATIONS IN THE FORM OF PILLS, TABLETS, CAPLETS OR CAPSULES SOLD EMPTY, AND PLASTIC CONTAINERS, TRAYS AND HOLDERS THEREFOR, ALL FOR THE PURPOSE OF ORGANIZING MEDICATIONS AND FACILITATING MEDICATION REGIMEN COMPLIANCE (U.S. CLS. 2, 13, 22, 25, 32 AND 50).

FIRST USE 6-0-2000; IN COMMERCE 6-0-2000.

CLASS 20—(Continued).

2,747,905. EME HOLDING COMPANY, LLC, SALT LAKE CITY, UT. SN 76-155,330. PUB. 8-14-2001, FILED 10-27-2000.

EME

FOR SCULPTURES, STATUES STATUETTES AND FIGURINES MADE OF PLASTIC, PLASTER, OR RESIN (U.S. CLS. 2, 13, 22, 25, 32 AND 50).
FIRST USE 3-20-2002; IN COMMERCE 4-15-2002.

2,747,979. ELITE INTERNATIONAL, INC., BROOKLYN, NY. SN 76-199,174. PUB. 12-11-2001, FILED 1-22-2001.

BAM-A-BOO SHOOTS

NO CLAIM IS MADE TO THE EXCLUSIVE RIGHT TO USE "SHOOTS", APART FROM THE MARK AS SHOWN.
FOR CABINETS WITH WOODEN DOORS (U.S. CLS. 2, 13, 22, 25, 32 AND 50).
FIRST USE 3-5-2003; IN COMMERCE 3-5-2003.

2,747,996. CCN INTERNATIONAL, GENEVA, NY. SN 76-205,988. PUB. 1-8-2002, FILED 2-7-2001.

pöché

THE ENGLISH TRANSLATION OF THE FRENCH WORD "PÖCHE" IN THE MARK IS "POCKET".
FOR EXECUTIVE AND MANAGERIAL OFFICE FURNITURE (U.S. CLS. 2, 13, 22, 25, 32 AND 50).
FIRST USE 3-1-2003; IN COMMERCE 3-1-2003.

2,748,000. DREXEL HERITAGE FURNISHINGS INC., DREXEL, NC. SN 76-207,901. PUB. 4-9-2002, FILED 2-9-2001.

AMERICAN CHARTER

NO CLAIM IS MADE TO THE EXCLUSIVE RIGHT TO USE "AMERICAN", APART FROM THE MARK AS SHOWN.
FOR FURNITURE (U.S. CLS. 2, 13, 22, 25, 32 AND 50).
FIRST USE 11-30-2001; IN COMMERCE 11-30-2001.

2,748,032. ANTHRO CORPORATION, TUALATIN, OR. SN 76-223,789. PUB. 5-14-2002, FILED 3-12-2001.

FIT SYSTEM**CLASS 20—(Continued).**

NO CLAIM IS MADE TO THE EXCLUSIVE RIGHT TO USE "SYSTEM", APART FROM THE MARK AS SHOWN.

FOR OFFICE AND COMPUTER FURNITURE: WORKSTATIONS COMPRISING OF ONE OR MORE DESKS, WORK SURFACES, PANELS, CREDENZAS, CUPBOARDS, CABINETS, LOCKERS, PEDESTALS, CARTS, SHELVES, KEYBOARD TRAYS, COMPUTER MOUSE SHELVES, BASKETS, PAPER TRAYS, PRIVACY PANELS, AND CASTERS (U.S. CLS. 2, 13, 22, 25, 32 AND 50).

FIRST USE 6-1-2001; IN COMMERCE 6-1-2001.

2,748,084. CUSTOM DESIGNS & MANUFACTURING COMPANY, INC., POCONO SUMMIT, PA. SN 76-245,174. PUB. 5-14-2002, FILED 4-24-2001.



The logo for Quaker Maid Cabinetry features the brand name in a stylized, cursive script. Below the name, the word "CABINETRY" is written in a smaller, bold, sans-serif font.

OWNER OF U.S. REG. NO. 996,794.
NO CLAIM IS MADE TO THE EXCLUSIVE RIGHT TO USE "CABINETRY", APART FROM THE MARK AS SHOWN.

THE STIPLING IN THE DRAWING IS FOR SHADING PURPOSES ONLY.

FOR KITCHEN CABINETS (U.S. CLS. 2, 13, 22, 25, 32 AND 50).

FIRST USE 11-30-2001; IN COMMERCE 11-30-2001.

2,748,096. JOANNE'S BED & BACK STORES, INC., BELTSVILLE, MD. SN 76-249,531. PUB. 1-8-2002, FILED 5-2-2001.

BACK PRESERVER

OWNER OF U.S. REG. NO. 1,951,935.
FOR BEDS, MATTRESSES, CHAIRS, PILLOWS, AND FOOTSTOOLS (U.S. CLS. 2, 13, 22, 25, 32 AND 50).
FIRST USE 5-0-2001; IN COMMERCE 5-0-2001.

2,748,115. BOYDS COLLECTION, LTD, THE, MCSHERRYSTOWN, PA. SN 76-258,788. PUB. 7-9-2002, FILED 5-17-2001.

THE EDGEWATER SERIES

NO CLAIM IS MADE TO THE EXCLUSIVE RIGHT TO USE "SERIES", APART FROM THE MARK AS SHOWN.

FOR FIGURINES MADE PRIMARILY OF RESIN (U.S. CLS. 2, 13, 22, 25, 32 AND 50).

FIRST USE 6-30-2001; IN COMMERCE 6-30-2001.

CLASS 20—(Continued).

2,748,154. WOLF ORGANIZATION, INC., THE, YORK, PA.
SN 76-268,895. PUB. 7-16-2002, FILED 6-11-2001.

CHATHAM HILL CABINETRY

NO CLAIM IS MADE TO THE EXCLUSIVE RIGHT TO USE "CABINETRY", APART FROM THE MARK AS SHOWN.

FOR WOODEN FURNITURE, NAMELY CABINETS (U.S. CLS. 2, 13, 22, 25, 32 AND 50).

FIRST USE 8-29-2001; IN COMMERCE 10-1-2001.

CLASS 20—(Continued).

2,748,381. CONNECTICUT PACKAGING MATERIALS, INC., SOUTH WINDSOR, CT. SN 76-347,386. PUB. 1-21-2003, FILED 12-11-2001.

SCOUR GUARD

NO CLAIM IS MADE TO THE EXCLUSIVE RIGHT TO USE "GUARD", APART FROM THE MARK AS SHOWN.

FOR FITTED PLASTIC INSERTS FOR USE AS COOKING CONTAINER LINERS (U.S. CLS. 2, 13, 22, 25, 32 AND 50).

FIRST USE 5-13-2002; IN COMMERCE 5-13-2002.

2,748,220. WOLF ORGANIZATION, INC., THE, YORK, PA.
SN 76-292,866. PUB. 7-16-2002, FILED 7-31-2001.

2,748,391. LEISURE ARTS, INC., BIRMINGHAM, AL. SN 76-349,566. PUB. 9-24-2002, FILED 12-18-2001.

DOOR CREATURES



NO CLAIM IS MADE TO THE EXCLUSIVE RIGHT TO USE "CABINETRY", APART FROM THE MARK AS SHOWN.

FOR WOODEN FURNITURE, NAMELY CABINETS (U.S. CLS. 2, 13, 22, 25, 32 AND 50).

FIRST USE 8-29-2001; IN COMMERCE 10-1-2001.

NO CLAIM IS MADE TO THE EXCLUSIVE RIGHT TO USE "DOOR", APART FROM THE MARK AS SHOWN.

FOR HALLOWEEN DECORATIONS NAMELY, PRINTED VINYL WITH THREE DIMENSIONAL VACU-FORMED PVC FACES ON THEM IN THE IMAGES OF TYPICAL HALLOWEEN CHARACTERS MEANT TO BE DISPLAYED BY HANGING FROM A DOOR OR DOORFRAME (U.S. CLS. 2, 13, 22, 25, 32 AND 50).

FIRST USE 11-4-2002; IN COMMERCE 11-4-2002.

2,748,222. UNIVERSAL FURNITURE LIMITED, HIGH POINT, NC. SN 76-294,006. PUB. 2-19-2002, FILED 8-2-2001.

2,748,456. GABAY, DAVID, NEW ROCHELLE, NY. AND GABAY, FRAN, NEW ROCHELLE, NY. SN 76-366,163. PUB. 7-23-2002, FILED 1-31-2002.

I SPY MYSELF

FOR SHELVES (U.S. CLS. 2, 13, 22, 25, 32 AND 50).
FIRST USE 4-0-2003; IN COMMERCE 4-0-2003.

RECLINEABILITIES

FOR FURNITURE (U.S. CLS. 2, 13, 22, 25, 32 AND 50).
FIRST USE 8-31-2001; IN COMMERCE 8-31-2001.

2,748,491. LEISURE ARTS, INC., BIRMINGHAM, AL. SN 76-380,281. PUB. 10-8-2002, FILED 3-1-2002.

TOMBSTONE TRAIL

NO CLAIM IS MADE TO THE EXCLUSIVE RIGHT TO USE "TOMBSTONE", APART FROM THE MARK AS SHOWN.

FOR NOVELTY PLASTIC TOMBSTONES FOR DECORATIVE USE ALONGSIDE DRIVEWAYS AND SIDEWALKS (U.S. CLS. 2, 13, 22, 25, 32 AND 50).

FIRST USE 11-4-2002; IN COMMERCE 11-4-2002.

2,748,252. WARD-KRAFT, INC., FT. SCOTT, KS. SN 76-303,211. PUB. 5-14-2002, FILED 8-20-2001.

DURAGLOSS

FOR PLASTIC DECORATIVE LICENSE PLATES (U.S. CLS. 2, 13, 22, 25, 32 AND 50).
FIRST USE 8-0-2001; IN COMMERCE 2-13-2003.

CLASS 20—(Continued).

2,748,502. KRUEGER INTERNATIONAL, INC., GREEN BAY, WI. SN 76-382,931. PUB. 10-22-2002, FILED 3-12-2002.

COLOSSAL

FOR OFFICE AND INSTITUTIONAL FURNITURE (U.S. CLS. 2, 13, 22, 25, 32 AND 50).
FIRST USE 6-13-2002; IN COMMERCE 6-13-2002.

2,748,541. RESTONIC CORPORATION, ROSEMONT, IL. SN 76-398,165. PUB. 10-29-2002, FILED 4-18-2002.

SENSORA

FOR MATTRESSES AND FOUNDATIONS (U.S. CLS. 2, 13, 22, 25, 32 AND 50).
FIRST USE 7-29-2002; IN COMMERCE 7-29-2002.

2,748,544. GENERATION 2 WORLDWIDE LLC, DOTHAN, AL. SN 76-400,190. PUB. 11-5-2002, FILED 4-25-2002.

FREEHAND

FOR CRIBS HAVING A LATCH WHICH ALLOWS THE SIDE PANEL OF THE CRIB TO BE RAISED AND LOWERED WITH ONE HAND (U.S. CLS. 2, 13, 22, 25, 32 AND 50).
FIRST USE 6-0-2001; IN COMMERCE 9-0-2001.

2,748,560. SCHER, ROBERT, RANCHO PALOS VERDES, CA. SN 76-413,467. PUB. 12-3-2002, FILED 5-28-2002.

NAP-CAP

FOR HARNESS FOR HOLDING A PERSON'S HEAD STRAIGHT IN A CHAIR (U.S. CLS. 2, 13, 22, 25, 32 AND 50).
FIRST USE 11-10-2002; IN COMMERCE 11-10-2002.

2,748,563. THE SPRING AIR COMPANY, ELK GROVES VILLAGE, IL. SN 76-415,831. PUB. 12-10-2002, FILED 6-4-2002.

**THE HEATED MATTRESS
FOR JUST RIGHT NIGHTS**

OWNER OF U.S. REG. NOS. 2,357,639, 2,548,360, AND 2,624,171.
FOR MATTRESSES AND BOX SPRINGS (U.S. CLS. 2, 13, 22, 25, 32 AND 50).
FIRST USE 8-1-2002; IN COMMERCE 8-1-2002.

CLASS 20—(Continued).

2,748,564. STYLEX, INC., DELANCO, NJ. SN 76-419,585. PUB. 12-24-2002, FILED 5-28-2002.

TUNE

FOR OFFICE SEATING (U.S. CLS. 2, 13, 22, 25, 32 AND 50).
FIRST USE 7-5-2002; IN COMMERCE 7-5-2002.

2,748,621. SHERWIN-WILLIAMS COMPANY, THE, CLEVELAND, OH. SN 78-028,017. PUB. 2-26-2002, FILED 9-28-2000.



NO CLAIM IS MADE TO THE EXCLUSIVE RIGHT TO USE "COLOR", APART FROM THE MARK AS SHOWN.
FOR PLASTIC DISPLAY RACKS AND HOLDERS FOR USE WITH PAINT COLOR CARDS, FORMULA BOOKS AND ASSOCIATED FAN DECKS (U.S. CLS. 2, 13, 22, 25, 32 AND 50).
FIRST USE 4-1-2003; IN COMMERCE 4-1-2003.

2,748,691. PRODUCTS & VENTURES INTERNATIONAL, INC., SANTA BARBARA, CA. SN 78-064,712. PUB. 11-13-2001, FILED 5-21-2001.

CEDAR-LITE

FOR WOODEN SLATS USED FOR THE MANUFACTURE OF PENCILS (U.S. CLS. 2, 13, 22, 25, 32 AND 50).
FIRST USE 1-16-2003; IN COMMERCE 1-16-2003.

2,748,824. ALLIANCE HANGERS INC., HONG KONG, HONG KONG. SN 78-100,223. PUB. 12-3-2002, FILED 12-28-2001.

ALLIANCE HANGERS

PRIORITY CLAIMED UNDER SEC. 44(D) ON HONG KONG APPLICATION NO. 200120792, FILED 12-27-2001, REG. NO. 09398, DATED 12-27-2001, EXPIRES 12-27-2008.
NO CLAIM IS MADE TO THE EXCLUSIVE RIGHT TO USE "HANGERS", APART FROM THE MARK AS SHOWN.
FOR GARMENT HANGERS (U.S. CLS. 2, 13, 22, 25, 32 AND 50).
FIRST USE 8-2-2002; IN COMMERCE 8-2-2002.

CLASS 21—HOUSEWARES AND GLASS

2,747,605. OZONEX LIMITED, LONDON N14 5BP, UNITED KINGDOM. SN 75-789,818. PUB. 2-22-2000, FILED 9-1-1999.

OZONE

FOR TOOTHBRUSHES; PARTS AND FITTINGS FOR ALL THE AFORESAID GOODS (U.S. CLS. 2, 13, 23, 29, 30, 33, 40 AND 50).

FIRST USE 2-21-2003; IN COMMERCE 2-21-2003.

2,747,660. LE YUAN INDUSTRIAL CO. LTD, CHANG HUA HSIEN, TAIWAN. SN 75-863,913. PUB. 9-25-2001, FILED 12-3-1999.



NO CLAIM IS MADE TO THE EXCLUSIVE RIGHT TO USE "GARDEN", APART FROM THE MARK AS SHOWN.

THE STIPPLING IS FOR SHADING PURPOSES ONLY AND DOES NOT INDICATE COLOR. THE LINING CONTAINED IN THE WORDING GARDEN IS FOR SHADING PURPOSES ONLY AND DOES NOT INDICATE COLOR. THE FLOWER DESIGN IS LINED FOR THE COLOR YELLOW.

FOR LAWN AND GARDEN WATERING PRODUCTS, NAMELY, SPRINKLERS, WATERING GUN SPRAYERS, AND SPRINKLER HEADS (U.S. CLS. 2, 13, 23, 29, 30, 33, 40 AND 50).

FIRST USE 12-0-1999; IN COMMERCE 12-0-1999.

2,747,684. KOTOWSKI, ARNE, 52349 DUREN, FED REP GERMANY. SN 75-896,867. PUB. 7-16-2002, FILED 1-14-2000.

TEA-BOY

OWNER OF FED REP GERMANY REG. NO. 39803114, DATED 6-18-1998, EXPIRES 1-31-2008.

FOR APPLIANCES FOR THE PREPARATION AND SERVING OF TEA AND HOT BEVERAGES NAMELY, TEA SERVERS NOT OF PRECIOUS METAL, TEA KETTLES AND TEA POTS NOT OF PRECIOUS METAL; THERMAL INSULATED CONTAINERS FOR FOOD AND BEVERAGES; SERVING CONTAINER FOR HOUSEHOLD AND KITCHEN USE NOT OF PRECIOUS METAL; CONTAINERS FOR FOOD (U.S. CLS. 2, 13, 23, 29, 30, 33, 40 AND 50).

FIRST USE 2-15-1998; IN COMMERCE 4-28-1999.

CLASS 21—(Continued).

2,747,812. CARTNER, CURTIS C., THOMASVILLE, NC. SN 76-080,480. PUB. 7-16-2002, FILED 6-29-2000.

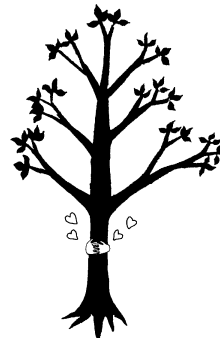

FOR GARDEN KIT CONSISTING OF A SOIL BOX AND CANOPY (U.S. CLS. 2, 13, 23, 29, 30, 33, 40 AND 50). FIRST USE 6-1-2001; IN COMMERCE 6-1-2001.

2,747,862. PERRIN MANUFACTURING COMPANY, CITY OF INDUSTRY, CA. SN 76-120,347. PUB. 6-25-2002, FILED 9-1-2000.

EASY TOUCH

FOR INSTITUTIONAL, NON-HOUSEHOLD PAPER TOWEL DISPENSERS EMPLOYED IN PUBLIC RESTROOMS AND HOLDING A PLURALITY OF PAPER TOWELS AND INCORPORATING AN AUTOMATIC TRANSFER MECHANISM WHICH AUTOMATICALLY PRESENTS THE LEAD END OF A RESERVE PAPER TOWEL ROLL AT A DISPENSING POSITION FOR GRASPING BY A USER UPON DEPLETION OF ANOTHER PAPER TOWEL ROLL (U.S. CLS. 2, 13, 23, 29, 30, 33, 40 AND 50).

FIRST USE 2-27-2003; IN COMMERCE 2-27-2003.

CLASS 21—(Continued).

2,747,942. FRANKE (HESHAN) KITCHEN EQUIPMENT CO. LTD., HESHAN GUANDONG, CHINA. SN 76-178,629. PUB. 7-23-2002, FILED 12-11-2000.



FOR PORCELAIN JARS FOR JAMS AND JELLIES; CAKE MOLDS; NON-ELECTRIC EGG BEATERS; COMMERCIAL COOKING UTENSILS, NOT OF PRECIOUS METAL, NAMELY, SPATULAS, SIEVES, STRAINERS, GRATERS AND TURNERS; NON-ELECTRIC DEEP FRYER PANS; NON-ELECTRIC PRESSURE COOKERS; DISHES, NOT OF PRECIOUS METAL; POTS; NON-ELECTRIC DOMESTIC COFFEE GRINDERS; NON-ELECTRIC BLENDERS FOR HOUSEHOLD PURPOSES; NON-ELECTRIC WHISKS FOR HOUSEHOLD PURPOSES; NON-ELECTRIC FRUIT PRESSES FOR HOUSEHOLD PURPOSES; CONTAINERS, NOT OF PRECIOUS METAL, FOR HOUSEHOLD KITCHEN USE; FOOD COOKING DEVICES, CONTAINING HEAT EXCHANGE FLUID FOR HOUSEHOLD PURPOSES; FRYING PANS; DUSTBINS; CLOTHES DRYING RACKS; HOUSEHOLD UTENSILS, NAMELY, SIEVES; NON-METAL BREAD BASKETS FOR DOMESTIC USE; BASINS; COOKERY MOLDS; COOKING POTS; PAILS; NON-ELECTRIC GRIDDLES; CROCKERY, NAMELY, EARTHENWARE MUGS; EARTHENWARE SAUCEPANS; PICNIC BASKETS; SAUCE DISPENSERS; CUP DISPENSERS (U.S. CLS. 2, 13, 23, 29, 30, 33, 40 AND 50).

FIRST USE 9-9-2001; IN COMMERCE 9-9-2001.

2,747,987. BATH UNLIMITED, INC., PASSAIC, NJ, BY CHANGE OF NAME MELARD MANUFACTURING CORP., PASSAIC, NJ. SN 76-200,746. PUB. 8-21-2001, FILED 1-29-2001.

BEAUMONT

FOR BATHROOM ACCESSORIES, NAMELY, TOWEL RINGS, TOWEL BARS, TISSUE HOLDERS AND TOOTHBRUSH-TUMBLER HOLDERS (U.S. CLS. 2, 13, 23, 29, 30, 33, 40 AND 50).

FIRST USE 10-0-2001; IN COMMERCE 10-0-2001.

2,748,119. BARDWELL & MCALISTER, INC., SUN VALLEY, CA. SN 76-259,881. PUB. 7-30-2002, FILED 5-22-2001.

C-3

FOR PLASTIC STRAW HOLDER FOR USE WITH AEROSOL CANS (U.S. CLS. 2, 13, 23, 29, 30, 33, 40 AND 50).

FIRST USE 1-0-2002; IN COMMERCE 1-0-2002.

CLASS 21—(Continued).

2,748,289. DV INTERNATIONAL, INC., ST. PAUL, MN. SN 76-318,739. PUB. 8-6-2002, FILED 9-28-2001.

MADESMART

FOR HOUSEHOLD PLASTIC STORAGE ORGANIZERS, NAMELY, CUTLERY TRAYS, SPICE RACKS, LAZY SUSANS, AND DRAWER ORGANIZERS (U.S. CLS. 2, 13, 23, 29, 30, 33, 40 AND 50).

FIRST USE 1-10-2002; IN COMMERCE 1-24-2002.

2,748,305. NATIONAL BASEBALL HALL OF FAME AND MUSEUM, INC., COOPERSTOWN, NY. SN 76-323,626. PUB. 11-12-2002, FILED 10-10-2001.

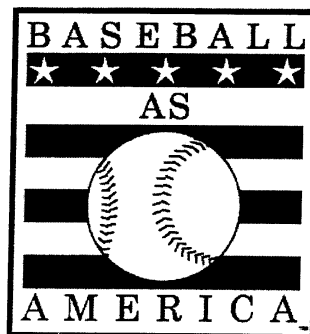

OWNER OF U.S. REG. NO. 2,191,138. FOR MUGS AND BEVERAGE GLASSWARE (U.S. CLS. 2, 13, 23, 29, 30, 33, 40 AND 50).

FIRST USE 11-8-2001; IN COMMERCE 3-12-2002.

2,748,336. KIDQUEST, INC., DBA WONDERWINGS.COM ENTERTAINMENT, DALLAS, TX. SN 76-332,771. PUB. 7-16-2002, FILED 11-2-2001.



OWNER OF U.S. REG. NOS. 1,927,865 AND 2,308,293. FOR PAPER TABLEWARE, NAMELY, PLATES, CUPS; PLASTIC CAKE DECORATIONS, NAMELY, CANDLE HOLDERS; LUNCH BOXES; THERMAL INSULATED TOTE BAGS FOR FOOD OR BEVERAGE; TOOTHBRUSHES (U.S. CLS. 2, 13, 23, 29, 30, 33, 40 AND 50).

FIRST USE 9-1-2002; IN COMMERCE 9-1-2002.

CLASS 21—(Continued).

2,748,369. WILTON INDUSTRIES, INC., WOODRIDGE, IL. SN 76-341,379. PUB. 7-16-2002, FILED 11-20-2001.

DESSERT DECORATOR MAX

NO CLAIM IS MADE TO THE EXCLUSIVE RIGHT TO USE "DESSERT DECORATOR", APART FROM THE MARK AS SHOWN.

FOR FOOD DISPENSERS (U.S. CLS. 2, 13, 23, 29, 30, 33, 40 AND 50).
FIRST USE 3-20-2003; IN COMMERCE 3-20-2003.

2,748,475. BLUEDESERT, LTD., KFAR MONASH 42875, ISRAEL, BY ASSIGNMENT BLUEDESERT LTD., BELGRADE, MT. SN 76-373,380. PUB. 7-30-2002, FILED 2-20-2002.

BLUEDESERT

FOR PORTABLE LIQUID STORAGE AND DRINKING DEVICES, PORTABLE WATER CARRIERS (U.S. CLS. 2, 13, 23, 29, 30, 33, 40 AND 50).
FIRST USE 5-0-2001; IN COMMERCE 5-0-2001.

2,748,656. HOLD EM, INC., WEST PALM BEACH, FL. SN 78-048,744. PUB. 5-7-2002, FILED 2-16-2001.



NO CLAIM IS MADE TO THE EXCLUSIVE RIGHT TO USE "ROOT TRAINER", APART FROM THE MARK AS SHOWN.

THE LINING IS A FEATURE OF THE MARK AND DOES NOT INDICATE COLOR.

THE MARK CONSISTS OF A DEPICTION OF A TREE WITH ROOTS UNDERNEATH, AND THE WORDING "ROOT" TO THE LEFT OF THE TREE, AND THE WORDING "TRAINER" TO THE RIGHT OF THE TREE, WITH THE TREE TRUNK FORMING THE STYLIZED LETTER "T" IN THE WORDING "TRAINER".

FOR CONTAINERS FOR PLANTS (U.S. CLS. 2, 13, 23, 29, 30, 33, 40 AND 50).
FIRST USE 7-23-2001; IN COMMERCE 7-23-2001.

CLASS 21—(Continued).

2,748,700. PRESTIGE DE MEXICO SA DE CV, TLAQUEPAQUE, JALISCO, MEXICO. SN 78-069,277. PUB. 12-3-2002, FILED 6-15-2001.



FOR WINDOW GLASS FOR VEHICLES (U.S. CLS. 2, 13, 23, 29, 30, 33, 40 AND 50).
FIRST USE 3-15-1996; IN COMMERCE 8-2-2001.

2,748,881. NEWFREY LLC, NEWARK, DE, BY CHANGE OF NAME EMHART LLC, NEWARK, DE. SN 78-109,684. PUB. 10-8-2002, FILED 2-19-2002.

GRAZIA

THE ENGLISH TRANSLATION OF "GRAZIA" IS "GRACE".

FOR BATHROOM ACCESSORIES IN THE NATURE OF TOWEL RINGS, TOWEL BARS AND TOILET PAPER HOLDERS (U.S. CLS. 2, 13, 23, 29, 30, 33, 40 AND 50).
FIRST USE 4-1-2002; IN COMMERCE 4-1-2002.

2,748,941. THEURER, HAROLD, JR., BROOKLYN, NY. SN 78-126,457. PUB. 11-26-2002, FILED 5-6-2002.

GOOD LUCK SPRAY!

OWNER OF U.S. REG. NO. 1,185,818.
NO CLAIM IS MADE TO THE EXCLUSIVE RIGHT TO USE "SPRAY", APART FROM THE MARK AS SHOWN.
FOR NOVELTY ITEM IN THE NATURE OF AN AEROSOL AIR FRESHENER, SPRAY CAN (U.S. CLS. 2, 13, 23, 29, 30, 33, 40 AND 50).
FIRST USE 10-10-2002; IN COMMERCE 10-10-2002.

2,748,948. ANHEUSER-BUSCH, INCORPORATED, ST. LOUIS, MO. SN 78-128,284. PUB. 11-5-2002, FILED 5-13-2002.

MICHELOB ULTRA

OWNER OF U.S. REG. NOS. 1,257,788, 1,354,391, AND OTHERS.

FOR DRINKING VESSELS (U.S. CLS. 2, 13, 23, 29, 30, 33, 40 AND 50).
FIRST USE 7-31-2002; IN COMMERCE 7-31-2002.

CLASS 22—CORDAGE AND FIBERS

CLASS 22—(Continued).

2,747,960. CARBON ASSOCIATES, INC., ANGLETON, TX. SN 76-189,045. PUB. 7-23-2002, FILED 1-3-2001.

NUSHIELD

FOR CARBONACEOUS AND CARBON FIBERS FOR TEXTILE USE, THAT PREVENT ELECTROMAGNETIC INTERFERENCES WITH ELECTRONIC SENSORS IN AUTOMOBILES (U.S. CLS. 1, 2, 7, 19, 22, 42 AND 50).
FIRST USE 12-0-2001; IN COMMERCE 12-0-2001.

CLASS 23—(Continued).

2,747,912. TEIJIN KABUSHIKI KAISHA (TEIJIN LIMITED), OSAKA, JAPAN. SN 76-160,986. PUB. 4-2-2002, FILED 11-7-2000.

TEIJIN MONOFILAMENT

NO CLAIM IS MADE TO THE EXCLUSIVE RIGHT TO USE "MONOFILAMENT", APART FROM THE MARK AS SHOWN.

FOR YARNS AND THREADS, FOR TEXTILE USE (U.S. CL. 43).
FIRST USE 4-1-2002; IN COMMERCE 4-1-2002.

2,748,234. SHAKESPEARE COMPANY, LLC, COLUMBIA, SC. SN 76-297,848. PUB. 11-20-2001, FILED 8-9-2001.

ISOTUFF

FOR ABRASION RESISTANT FIBERS, NAMELY, SYNTHETIC FIBERS (U.S. CLS. 1, 2, 7, 19, 22, 42 AND 50).
FIRST USE 2-8-2002; IN COMMERCE 2-8-2002.

2,748,576. MERIDIAN INDUSTRIES, INC., MILWAUKEE, WI. SN 76-975,411. PUB. 7-9-2002, FILED 6-20-2001.

HOLLYBEE

FOR YARN AND THREAD (U.S. CL. 43).
FIRST USE 5-25-2001; IN COMMERCE 5-25-2001.

2,748,805. YALE CORDAGE INC., BIDDEFORD, ME. SN 78-096,846. PUB. 5-21-2002, FILED 12-5-2001.

LOUP

FOR CORDAGE (U.S. CLS. 1, 2, 7, 19, 22, 42 AND 50).
FIRST USE 10-7-2001; IN COMMERCE 2-22-2002.

CLASS 24—FABRICS

2,747,588. FRANCO MANUFACTURING CO., INC., METUCHEN, NJ. SN 75-753,148. PUB. 1-25-2000, FILED 7-16-1999.

DREAMWEAR

FOR BEDDING, NAMELY, SHEETS, PILLOWCASES, PILLOW SHAMS, DUST RUFFLES, BLANKETS, BED SPREADS, COMFORTERS, DUVET COVERS AND BED LINEN (U.S. CLS. 42 AND 50).
FIRST USE 9-1-2002; IN COMMERCE 9-1-2002.

CLASS 23—YARNS AND THREADS

2,747,901. KABUSHIKIKAISHA BARUDAN, AICHI-KEN, JAPAN. SN 76-151,286. PUB. 7-16-2002, FILED 10-23-2000.

Barudan

PRIORITY CLAIMED UNDER SEC. 44(D) ON JAPAN APPLICATION NO. 2000-95339, FILED 8-30-2000, REG. NO. 4482833, DATED 6-15-2001, EXPIRES 6-15-2011.

FOR EMBROIDERY THREAD AND YARN; SEWING THREAD AND YARN THREAD, NAMELY, COTTON THREAD, BAST FIBER THREAD, SILK THREAD, WOOL THREAD, CHEMICAL AND SYNTHETIC FIBER THREAD, INORGANIC AND MINERAL FIBER THREAD, BLENDED THREAD, RUBBER AND ELASTOMER THREAD, PAPER THREAD, GOLD AND SILVER AND METAL THREAD (U.S. CL. 43).
FIRST USE 1-11-2003; IN COMMERCE 1-11-2003.

2,747,666. LOOMWORKS APPAREL, INC., IRVINE, CA. SN 75-871,948. PUB. 8-1-2000, FILED 12-16-1999.

P.J. SALVAGE

FOR BARBECUE MITTS, BATH LINEN, FABRIC BATH MATS, BED BLANKETS, BED CANOPIES, BED LINEN, BED PADS, BED SHEETS, BED SPREADS, BED BLANKETS, CRIB CANOPIES, PILLOW CASES, DISH CLOTHS, WASHCLOTHS, TABLE CLOTHS NOT OF PAPER, TABLE LINEN, NAMELY, COASTERS, NAPKINS AND PLACE MATS, DUVET COVERS, MATTRESS COVERS, UNFITTED FABRIC FURNITURE COVERS, CRIB BUMPERS, CURTAIN FABRIC, CURTAINS, NET CURTAINS, WINDOW CURTAINS, DRAPERIES, DUVETS, EIDERDOWNS, KITCHEN TOWELS, LINEN, HANDKERCHIEFS, HOUSEHOLD LINEN, FABRIC FOR BOOTS AND SHOES, OVEN MITTS, WASHING MITTS, RAGS FOR PAPER MAKING, PILLOW SHAMS, TEXTILE PLACE MATS, QUILTS, TABLE LINEN, TABLE MATS NOT OF PAPER, FABRIC TABLE RUNNERS, TEA TOWELS, TEXTILE BATH MATS, TEXTILE NAPKINS, TEXTILES PRINTERS' BLANKETS, TOWELS UPHOLSTERY FABRICS, TEXTILE WALL HANGINGS, WASHING MITTS, WOOLEN CLOTH, WOOLEN FABRIC, ZEPHYR FABRIC (U.S. CLS. 42 AND 50).
FIRST USE 3-19-2003; IN COMMERCE 3-25-2003.

CLASS 24—(Continued).

2,748,168. GFD FABRICS, INC., GREENSBORO, NC. SN 76-274,738. PUB. 5-7-2002, FILED 6-19-2001.

FRE-FLO PCT

NO CLAIM IS MADE TO THE EXCLUSIVE RIGHT TO USE "FREE-FLOW", APART FROM THE MARK AS SHOWN.

FOR WARP KNITTED TRICOT FABRIC FOR USE IN THE MANUFACTURE OF REVERSE OSMOSIS PRODUCTS (U.S. CLS. 42 AND 50).

FIRST USE 7-10-2001; IN COMMERCE 7-10-2001.

2,748,186. ZHENG ZHANG USA, INC., EDISON, NJ. SN 76-281,272. PUB. 9-17-2002, FILED 7-6-2001.

DISTINCTIVE HOME

FOR COMFORTERS, QUILTS, BED BLANKETS, BED SPREADS, BED COVERS, BED SHEETS, BED SKIRTS, DUST RUFFLES, PILLOW CASES, SHAMS, DUVETS, MOSQUITO NETS, BLANKET THROWS, FABRIC VALANCES, DRAPERIES, CURTAINS, TABLE CLOTHS NOT OF PAPER, TEXTILE NAPKINS, SHOWER CURTAINS, FABRIC BATH MATS, TOWELS, WASH CLOTHS (U.S. CLS. 42 AND 50).

FIRST USE 6-1-2002; IN COMMERCE 6-1-2002.

2,748,206. BI PROPERTIES I INC., GREENSBORO, NC. SN 76-286,668. PUB. 10-9-2001, FILED 7-17-2001.

FLEXSTYLE

FOR FABRIC FOR USE IN THE MANUFACTURE OF CLOTHING (U.S. CLS. 42 AND 50).

FIRST USE 8-31-2001; IN COMMERCE 8-31-2001.

2,748,277. NAS MANUFACTURING, INC., CLARKSVILLE, GA. SN 76-312,989. PUB. 8-13-2002, FILED 9-12-2001.



FOR BEDDING PRODUCTS; NAMELY PILLOW CASES, PILLOW SHAMS, MATTRESS COVERS, MATTRESS PADS, AND COMFORTERS (U.S. CLS. 42 AND 50).

FIRST USE 2-1-2002; IN COMMERCE 5-17-2002.

CLASS 24—(Continued).

2,748,301. TIAHJANA, ATJING, BANDUNG 40173, INDONESIA. SN 76-321,900. PUB. 7-30-2002, FILED 10-9-2001.

DRIWORKS

FOR FABRICS, NAMELY POLYESTER AND COTTON, FOR USE IN MAKING CLOTHING AND UPHOLSTERY (U.S. CLS. 42 AND 50).

FIRST USE 2-14-2003; IN COMMERCE 2-14-2003.

2,748,358. DISOP, S.A., 28108 ALCOBENDAS (MADRID), SPAIN. SN 76-337,207. PUB. 6-25-2002, FILED 11-14-2001.

OPTI-FIBER

FOR CLOTH FOR THE CLEANING OF GLASS LENSES (U.S. CLS. 42 AND 50).

FIRST USE 5-0-2002; IN COMMERCE 5-0-2002.

2,748,842. VALLEY, DIANE C., SALISBURY, NC. SN 78-103,414. PUB. 10-15-2002, FILED 1-17-2002.



THE NAME IN THE MARK DOES NOT IDENTIFY A LIVING INDIVIDUAL.

THE MARK CONSISTS OF A HEART WITH THE WORD "DE'TNIONA" HANDWRITTEN THROUGH IT.

THE ENGLISH TRANSLATION OF "DE'TNIONA" IS "DESHAWNA".

FOR CHEESE CLOTHS; LINENS FOR KITCHEN, NAMELY, TABLE LINEN; BATHROOM LINEN; BEDROOM LINEN; HANDKERCHIEFS; TOWELS; PILLOWCASES; BED SHEETS; DRAPERIES; AND POT HOLDERS (U.S. CLS. 42 AND 50).

FIRST USE 2-19-2002; IN COMMERCE 7-25-2002.

CLASS 24—(Continued).

2,748,957. MILLIKEN & COMPANY, NEW YORK, NY. SN 78-131,053. PUB. 11-19-2002, FILED 5-24-2002.

NOW GETTING THE ROAD OFF IS AS EASY AS GETTING OFF ROAD

FOR TEXTILE FABRICS MADE OF NATURAL AND/OR SYNTHETIC FIBERS AND COMBINATIONS THEREOF FOR USE IN AUTOMOTIVE UPHOLSTERY (U.S. CLS. 42 AND 50).

FIRST USE 8-1-2001; IN COMMERCE 8-1-2001.

CLASS 25—CLOTHING

2,747,456. TOM MORRIS LIMITED, SCOTLAND, UNITED KINGDOM. SN 74-559,650. PUB. 10-8-2002, FILED 8-9-1994.



OWNER OF UNITED KINGDOM REG. NO. 1560360, DATED 1-27-1994, RENEWED AS REG. NO. 1560360, DATED 1-27-2001, EXPIRES 1-27-2011.

NO CLAIM IS MADE TO THE EXCLUSIVE RIGHT TO USE "ST. ANDREWS", APART FROM THE MARK AS SHOWN.

FOR CLOTHING, NAMELY HEADWEAR, SWEATERS, SHIRTS, AND SWEAT SHIRTS (U.S. CLS. 22 AND 39).

FIRST USE 2-15-1982; IN COMMERCE 2-15-1982.

2,747,457. DJF ENTERPRISES, CULVER CITY, CA. SN 74-716,364. PUB. 5-12-1998, FILED 8-16-1995.

SMASH BOX

FOR CLOTHING, AND HEADWEAR, NAMELY, T-SHIRTS, SHIRTS, TANK TOPS, SWEAT SHIRTS, JACKETS, HATS, CAPS AND VISORS (U.S. CLS. 22 AND 39).

FIRST USE 0-0-1990; IN COMMERCE 0-0-1996.

CLASS 25—(Continued).

2,747,461. AIKAU, CLYDE, WAIMANALO, HI. SN 75-258,033. PUB. 8-6-2002, FILED 3-17-1997.



NO CLAIM IS MADE TO THE EXCLUSIVE RIGHT TO USE "HAWAIIAN", APART FROM THE MARK AS SHOWN. THE LINING ON THE DRAWING IS INTENDED TO INDICATE COLOR RED.

FOR CLOTHING FOR MEN, WOMEN, AND CHILDREN, NAMELY, SHIRTS, JACKETS, SWEATERS, PANTS, FOOTWEAR, BELTS, T-SHIRTS, SOCKS, COORDINATED SHIRTS, JACKETS AND SLACKS, TENNIS SHOES, SWEAT SHIRTS, JERSEYS, SHORTS, JOGGING SUITS, SWEAT PANTS, HATS/CAPS, SCARVES, GLOVES, HOSIERY, NECKTIES, RAINWEAR, PAJAMAS, ROBES, NIGHT SHIRTS, THERMAL UNDERWEAR, HEADBANDS, AND WRISTBANDS (U.S. CLS. 22 AND 39).

FIRST USE 7-15-1997; IN COMMERCE 7-15-1997.

2,747,462. SCHNARCH, DAVID, EVERGREEN, CO. SN 75-314,023. PUB. 8-24-1999, FILED 6-24-1997.

CRUCIBLE

FOR CLOTHING, NAMELY, T-SHIRTS, CAPS, HATS AND MASQUERADE COSTUMES (U.S. CLS. 22 AND 39).

FIRST USE 3-6-2002; IN COMMERCE 3-6-2002.

2,747,482. VANS, INC., SANTE FE SPRINGS, CA, BY ASSIGNMENT SWITCH MANUFACTURING, SANTE FE SPRINGS, CA. SN 75-505,839. PUB. 2-1-2000, FILED 6-19-1998.

ACTIVE CLOSURE SYSTEM

NO CLAIM IS MADE TO THE EXCLUSIVE RIGHT TO USE "CLOSURE SYSTEM", APART FROM THE MARK AS SHOWN.

FOR LATCHES FOR BINDINGS SOLD AS AN INTEGRAL COMPONENT OF SNOW BOARD BOOTS (U.S. CLS. 22 AND 39).

FIRST USE 12-0-2000; IN COMMERCE 12-0-2000.

CLASS 25—(Continued).

2,747,485. MIMRAN GROUP INC., TORONTO, ONTARIO, CANADA. SN 75-512,314. PUB. 6-15-1999, FILED 7-1-1998.

ALFRED SUNG

OWNER OF CANADA REG. NO. TMA416257, DATED 9-3-1993, EXPIRES 9-3-2008.

OWNER OF U.S. REG. NOS. 1,364,576, 1,932,572, AND OTHERS.

THE NAME IN THE MARK IDENTIFIES A LIVING INDIVIDUAL WHOSE CONSENT IS OF RECORD.

FOR MEN'S CLOTHING, NAMELY, COORDINATED SEPARATE SLACKS, DRESS AND SPORT SHIRTS, SWEATERS, POLO SHIRTS AND JACKETS (U.S. CLS. 22 AND 39).

FIRST USE 0-0-1990; IN COMMERCE 8-0-1999.

2,747,555. LCN APPAREL, INC., NEW YORK, NY. SN 75-682,586. PUB. 1-11-2000, FILED 4-14-1999.

ESCO NIÑO

NO CLAIM IS MADE TO THE EXCLUSIVE RIGHT TO USE "NINO", APART FROM THE MARK AS SHOWN.

THE ENGLISH TRANSLATION OF "NINO" IS "CHILD". FOR CHILDREN'S CLOTHING, NAMELY, SHIRTS, VESTS, SWEATERS, SHOES, CAPS, BANDANNAS, SHORTS, SWEAT SHIRTS, PANTS, BELTS FOR CLOTHING, SOCKS, SWIM WEAR, JACKETS, RAINWEAR, BLOUSES, DRESSES, FOOTWEAR, HOSIERY, SCARVES, HATS, HEAD BANDS, PAJAMAS AND SLEEP WEAR (U.S. CLS. 22 AND 39).

FIRST USE 6-14-1999; IN COMMERCE 6-14-1999.

2,747,558. TWENTIETH CENTURY FOX FILM CORPORATION, LOS ANGELES, CA. SN 75-688,604. PUB. 12-28-1999, FILED 4-21-1999.

PLANET OF THE APES

FOR PANTS; PAJAMAS; HALLOWEEN AND MASQUERADE COSTUMES AND MASKS SOLD IN CONNECTION THEREWITH (U.S. CLS. 22 AND 39).

FIRST USE 7-31-2001; IN COMMERCE 7-31-2001.

2,747,560. TROON GOLF, L.L.C., SCOTTSDALE, AZ. SN 75-695,995. PUB. 5-9-2000, FILED 5-3-1999.

TROON ATLANTIC

OWNER OF U.S. REG. NOS. 2,242,602 AND 2,242,603.

CLASS 25—(Continued).

NO CLAIM IS MADE TO THE EXCLUSIVE RIGHT TO USE "ATLANTIC", APART FROM THE MARK AS SHOWN.

FOR BUSINESS MANAGEMENT OF GOLF COURSES (U.S. CLS. 22 AND 39).

FIRST USE 3-1-2003; IN COMMERCE 3-1-2003.

2,747,590. P45 L.L.C., CHICAGO, IL. SN 75-757,473. PUB. 2-27-2001, FILED 7-7-1999.

P45

FOR CLOTHING, NAMELY, HATS, DRESSES, PANTS, SKIRTS, SHIRTS, TOPS, BLOUSES, UNDERWEAR, SWIM WEAR, COATS, SHAWLS, SWEATERS, T-SHIRTS, SOCKS, SHOES, SCARVES, JEANS, GLOVES AND BELTS (U.S. CLS. 22 AND 39).

FIRST USE 2-1-2003; IN COMMERCE 2-1-2003.

2,747,596. NINE GROUP, INC., THE, CHICAGO, IL. SN 75-767,884. PUB. 12-12-2000, FILED 8-4-1999.

GHOST BAR

FOR COMMEMORATIVE CLOTHING, NAMELY, T-SHIRTS, SWEATSHIRTS, POLO SHIRTS, SPORT SHIRTS, HATS, CAPS, SUN VISORS AND BOXER SHORTS, COMMEMORATING A RESTAURANT AND COCKTAIL LOUNGE OF THE SAME NAME (U.S. CLS. 22 AND 39).

FIRST USE 11-15-2001; IN COMMERCE 11-15-2001.

2,747,629. KABBALAH CENTRE INTERNATIONAL, INCORPORATED, LOS ANGELES, CA, BY ASSIGNMENT RESEARCH CENTRE OF KABBALAH, RICHMOND HILL, NY. SN 75-823,983. PUB. 7-4-2000, FILED 10-16-1999.



OWNER OF U.S. REG. NOS. 2,207,181, 2,216,217, AND 2,218,620.

THE LINING IS A FEATURE OF THE MARK AND DOES NOT INDICATE COLOR.

FOR SWEAT SHIRTS, BASEBALL CAPS, GOLF SHIRTS, HATS, JACKETS, KNIT SHIRTS, POLO SHIRTS, AND T-SHIRTS (U.S. CLS. 22 AND 39).

FIRST USE 6-0-1993; IN COMMERCE 9-0-1993.

CLASS 25—(Continued).

2,747,683. TOMORROW INTERNATIONAL, INC., TORTOLA, BR. VIRGIN ISLANDS. SN 75-896,555. PUB. 3-26-2002, FILED 1-14-2000.

THE X STORE TRACK & FIELD SPORTSWEAR

NO CLAIM IS MADE TO THE EXCLUSIVE RIGHT TO USE "STORE TRACK & FIELD SPORTSWEAR", APART FROM THE MARK AS SHOWN.

FOR ATHLETIC CLOTHING, NAMELY SHIRTS, JERSEYS, JACKETS, SWIMSUITS, T-SHIRTS, TIGHTS, PANTS, VESTS, TANKS, NAMELY TANK TOPS, AND TOPS (U.S. CLS. 22 AND 39).

FIRST USE 11-7-2002; IN COMMERCE 11-7-2002.

2,747,687. EASTWOOD, CLINT, TEHAMA, CA. SN 75-903,859. PUB. 3-26-2002, FILED 1-27-2000.



FOR WEARING APPAREL, NAMELY, SHIRTS, JACKETS, SWEATERS, SHELLS, PULLOVERS, SWEAT SHIRTS, T-SHIRTS, JERSEYS, ATHLETIC UNIFORMS, VESTS, SWEAT PANTS, PANTS, SHORTS, BLOUSES, SKIRTS, SKORTS, DRESSES, SOCKS, HATS, CAPS, GLOVES, SHOES, HEAD BANDS, SWEATBANDS, WRISTBANDS, BELTS, AND RAINWEAR, NAMELY, WATER-RESISTANT AND WATERPROOF SHIRTS, JACKETS, VESTS AND PANTS (U.S. CLS. 22 AND 39).

FIRST USE 1-0-1998; IN COMMERCE 10-0-1998.

CLASS 25—(Continued).

2,747,688. THE TRUSTEES OF COLUMBIA UNIVERSITY IN THE CITY OF NEW YORK, NEW YORK, NY. SN 75-905,950. PUB. 6-5-2001, FILED 1-28-2000.



FOR CLOTHING, NAMELY, T-SHIRTS, SWEATSHIRTS, POLO SHIRTS, FLEECE WEAR NAMELY, FLEECE JACKETS, JACKETS, RAIN AND WIND VESTS, TURTLENECK SHIRTS, SWEAT SHORTS AND PANTS, HATS, SWEATERS (U.S. CLS. 22 AND 39).

FIRST USE 11-0-2000; IN COMMERCE 11-0-2000.

2,747,725. E.S. ORIGINALS, INC., NEW YORK, NY. SN 76-007,903. PUB. 11-21-2000, FILED 3-23-2000.

SOLE TOUGH

NO CLAIM IS MADE TO THE EXCLUSIVE RIGHT TO USE "SOLE", APART FROM THE MARK AS SHOWN.

FOR FOOTWEAR (U.S. CLS. 22 AND 39).

FIRST USE 2-0-2002; IN COMMERCE 2-0-2002.

2,747,848. GADAMS, MARY K., RICHMOND, VA. SN 76-112,194. PUB. 6-12-2001, FILED 8-18-2000.

RACINGTHEPLANET

OWNER OF U.S. REG. NO. 2,707,562.

FOR SHIRTS, SHORTS, PANTS, VESTS, CAPS, AND HATS (U.S. CLS. 22 AND 39).

FIRST USE 8-0-2000; IN COMMERCE 8-0-2000.

CLASS 25—(Continued).

2,747,857. POLAKOW, JASON NICHOLAS, VICTORIA 3228, AUSTRALIA. SN 76-119,216. PUB. 1-29-2002, FILED 8-30-2000.



NO CLAIM IS MADE TO THE EXCLUSIVE RIGHT TO USE "AUSTRALIA", APART FROM THE MARK AS SHOWN.

FOR CLOTHING, NAMELY, SWEATERS, JACKETS, SHIRTS, T-SHIRTS, PANTS, SWEATSHIRTS, BEACH COVERUPS, AND HEADWEAR (U.S. CLS. 22 AND 39).
FIRST USE 8-0-1997; IN COMMERCE 8-0-1997.

2,747,869. VAZQUEZ, ESTELA MARIA, BUENOS AIRES, ARGENTINA. SN 76-127,201. PUB. 5-7-2002, FILED 9-12-2000.

MARIA VAZQUEZ

THE NAME "MARIA VAZQUEZ" IDENTIFIES A LIVING INDIVIDUAL WHOSE CONSENT IS OF RECORD.

THE MARK IS PRESENTED WITHOUT ANY CLAIM TO SPECIAL FORM.

FOR DRESSES, EVENING GOWNS, JEAN DRESSES, T-SHIRTS, SHIRTS, BATHING SUITS, COVERUPS, SHORTS, PULLOVERS, SWEATERS, COATS, OVERCOATS, JEANS (U.S. CLS. 22 AND 39).
FIRST USE 11-0-1993; IN COMMERCE 5-31-2001.

2,747,881. BENCHMARK BRANDS, INC., MEMPHIS, TN. SN 76-137,446. PUB. 7-24-2001, FILED 9-29-2000.

FOOTSMART

FOR SOCKS, HOSIERY, SHOES AND SLIPPERS (U.S. CLS. 22 AND 39).

FIRST USE 4-14-1997; IN COMMERCE 4-14-1997.

2,747,888. SUTTON CREATIONS, INC., NEW YORK, NY. SN 76-140,638. PUB. 7-16-2002, FILED 10-4-2000.

SAN MICHELLE BAY

FOR TOPS, SKIRTS, SHORTS, VESTS, PANTS, SWEATSHIRTS, SWEATPANTS, DRESSES, SWEATERS, FLEECE TOPS (U.S. CLS. 22 AND 39).

FIRST USE 7-0-2000; IN COMMERCE 7-0-2000.

CLASS 25—(Continued).

2,747,954. SPECIALTY BRANDS LIMITED, GREY LYNN AUCKLAND, NEW ZEALAND. SN 76-183,797. PUB. 9-24-2002, FILED 12-21-2000.



FOR CLOTHING, NAMELY, PANTS, SHIRTS, HATS, CAPS, NECKWEAR, JACKETS, RAINJACKETS, COATS, WATERPROOF LEGGINGS, PARKAS, VESTS, UNDERWEAR, SKIRTS, DRESSES, SPORTS SHIRTS, KNITTED SHIRTS, WOOLEN SHIRTS, T-SHIRTS, SINGLETTS, TRACKSUITS, SHORTS, SOCKS, SHOES, SANDALS, BOOTS, SLIPPERS, TIES, CRAVATS, SCARVES (U.S. CLS. 22 AND 39).
FIRST USE 0-0-1987; IN COMMERCE 4-12-1999.

2,747,956. SEMORE INC., LOS ANGELES, CA. SN 76-185,131. PUB. 6-25-2002, FILED 12-20-2000.

PASSEGIATE COUTURE

NO CLAIM IS MADE TO THE EXCLUSIVE RIGHT TO USE "COUTURE", APART FROM THE MARK AS SHOWN.

THE ENGLISH TRANSLATION OF THE FRENCH WORD "COUTURE" IS "SEWING OR DRESSMAKING". THE ENGLISH TRANSLATION OF THE ITALIAN WORD "PASSEGIATA" IS "WALK".

FOR CLOTHING AND SPORTSWEAR, NAMELY, JEANS, PANTS, T-SHIRTS, POLO SHIRTS, SHIRTS, SHORTS, JACKETS, SWEATERS, SOCKS, UNDERWEAR AND HATS (U.S. CLS. 22 AND 39).

FIRST USE 7-0-2002; IN COMMERCE 7-0-2002.

2,747,970. EDMONTON INVESTORS GROUP LIMITED PARTNERSHIP, EDMONTON, ALBERTA T5G 3H7, CANADA. SN 76-193,934. PUB. 3-19-2002, FILED 1-12-2001.

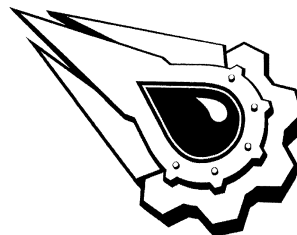

FOR CLOTHING, NAMELY, BOXER SHORTS, CAPS, HATS, HEADBANDS, JACKETS, JERSEYS, PAJAMAS, SHIRTS, SUN VISORS, SWEATERS, SWEATPANTS, SWEATSHIRTS, T-SHIRTS, UNDERWEAR, WARM-UP SUITS (U.S. CLS. 22 AND 39).

FIRST USE 10-0-2001; IN COMMERCE 10-0-2002.

CLASS 25—(Continued).

2,747,986. CANTON MOTORSPORTS & EXPO PARK, INC., CANTON, NC, BY ASSIGNMENT WESTMORELAND, STEPHEN C., DBA CANTON MOTORSPORTS PARK, CANTON, NC. SN 76-200,694. PUB. 7-16-2002, FILED 1-26-2001.

CANTON MOTORSPORTS PARK

NO CLAIM IS MADE TO THE EXCLUSIVE RIGHT TO USE "CANTON", APART FROM THE MARK AS SHOWN. FOR CLOTHING, NAMELY, HATS, SWEATSHIRTS, SHIRTS AND T-SHIRTS (U.S. CLS. 22 AND 39). FIRST USE 1-0-2001; IN COMMERCE 1-0-2001.

2,748,019. MAMIYE BROTHERS, INC., NEW YORK, NY. SN 76-217,649. PUB. 6-18-2002, FILED 2-28-2001.

OFFSPRING

FOR CLOTHING, NAMELY, INFANTS' AND TODDLERS' OVERALLS, KNIT SHIRTS, WOVEN SHIRTS, SHORTS AND TOPS, CREEPERS, SHORT PANTS, OVERALLS, DRESSES, JUMPERS, WARM-UP SUITS, STRETCH SUITS, SWIMWEAR, TIGHTS, SOCKS, HATS, JACKETS, SWEATERS, VESTS, SHORTS, PANTS AND SKIRTS (U.S. CLS. 22 AND 39). FIRST USE 7-0-2002; IN COMMERCE 7-0-2002.

2,748,059. SANSEGAL SPORTSWEAR, INC., SANDY, UT. SN 76-235,726. PUB. 9-10-2002, FILED 4-4-2001.

COLORMYSTUFF

FOR CLOTHING AND SPORTSWEAR, NAMELY JACKETS, SWEATERS, SWEAT SUITS, SHORTS, SWIM WEAR, SHIRTS, T-SHIRTS, SWEATSHIRTS, CAPS AND HATS, TANK TOPS, UNDERWEAR, JEANS, SHOES, BOOTS, PARKAS; FLEECE GOODS, NAMELY, FLEECE SHIRTS, FLEECE SHORTS, FLEECE PANTS, AND FLEECE JACKETS; DENIM CLOTHING, NAMELY, DENIM JEANS, DENIM PANTS, AND DENIM SHORTS (U.S. CLS. 22 AND 39). FIRST USE 4-1-2001; IN COMMERCE 4-30-2002.

CLASS 25—(Continued).

2,748,075. LIGHT FORCE S.R.L., CARPI (MODENA), ITALY. SN 76-241,923. PUB. 4-2-2002, FILED 4-17-2001.

TWIN-SET SIMONA BARBIERI

NO CLAIM IS MADE TO THE EXCLUSIVE RIGHT TO USE "TWIN-SET", APART FROM THE MARK AS SHOWN. THE NAME "SIMONA BARBIERI" IDENTIFIES A LIVING INDIVIDUAL WHOSE CONSENT IS OF RECORD.

FOR CLOTHING FOR MEN, WOMEN, AND CHILDREN IN ANY KIND OF FABRICS AND MATERIALS, NAMELY, SUITS, DRESSES, SKIRTS, TROUSERS, SHIRTS, BLOUSES, CARDIGANS, PULLOVERS, T-SHIRTS, VESTS, BRASSIERES, PANTS, KNICKERS, SUSPENDER BELTS, OVERALLS, OVERCOATS, GREAT COATS, JACKETS, BLAZERS, WIND RESISTANT JACKETS, RAINCOATS, STOCKINGS, SOCKS, HATS, SCARVES, GLOVES, TIES, BATHING SUITS, FOOTWEAR, BATHROBES, UNDERWEAR (U.S. CLS. 22 AND 39).

FIRST USE 9-17-2001; IN COMMERCE 11-21-2001.

2,748,078. GART BROS. SPORTING GOODS COMPANY, ENGLEWOOD, CO. SN 76-243,993. PUB. 8-6-2002, FILED 4-20-2001.

ALPINE DESIGN

OWNER OF U.S. REG. NO. 946,381. NO CLAIM IS MADE TO THE EXCLUSIVE RIGHT TO USE "DESIGN", APART FROM THE MARK AS SHOWN. FOR OUTERWEAR, NAMELY, JACKETS, PARKAS, VESTS, TROUSERS; SWEATERS, HATS, GLOVES, MITTENS, UNDERWEAR (U.S. CLS. 22 AND 39). FIRST USE 9-15-2002; IN COMMERCE 9-15-2002.

CLASS 25—(Continued).

2,748,093. NBA PROPERTIES, INC., NEW YORK, NY. SN 76-248,679. PUB. 9-3-2002, FILED 4-30-2001.



OWNER OF U.S. REG. NO. 2,001,707.
NO CLAIM IS MADE TO THE EXCLUSIVE RIGHT TO USE "OAKLAND", APART FROM THE MARK AS SHOWN.
FOR HOSIERY, FOOTWEAR, T-SHIRTS, SWEATERS, SWEATPANTS, PANTSTANK TOPS, JERSEYS, SHORTS, PAJAMAS, SPORT SHIRTS, BASKETBALL SHIRTS, BASKETBALL SHORTS, FOOTWEAR, RUGBY SHIRTS, SWEATERS, BELTS, TIES, NIGHTSHIRTS, HAT WARM-UP PANTS, WARM-UP TOPS, JACKETS, PULLOVER JACKETS, WIND-RESISTANT JACKETS, PARKAS, COATS, CLOTH BIBS, HEAD BANDS, WRIST BANDS, APRONS, BOXER SHORTS, SLACKS, CAPS, TOQUES, EAR MUFFS, GLOVES, MITTENS, SOCKS, WOVEN SHIRTS (U.S. CLS. 22 AND 39).
FIRST USE 3-1-1996; IN COMMERCE 3-1-1996.

CLASS 25—(Continued).

2,748,221. GAETANO, DRAKE, MANLIUS, NY. SN 76-293,272. PUB. 9-17-2002, FILED 8-2-2001.



NO CLAIM IS MADE TO THE EXCLUSIVE RIGHT TO USE "PRODUCT", APART FROM THE MARK AS SHOWN.
FOR CLOTHING, NAMELY, WOMEN'S T-SHIRTS, JACKETS, SWEATSHIRTS, AND BLOUSES (U.S. CLS. 22 AND 39).
FIRST USE 5-16-2002; IN COMMERCE 5-16-2002.

2,748,284. QVC, INC., WEST CHESTER, PA. SN 76-316,934. PUB. 7-23-2002, FILED 9-25-2001.

BELLE ISLE

2,748,198. GEDDES, ANNE, PARNELL, AUCKLAND, NEW ZEALAND. SN 76-284,310. PUB. 8-20-2002, FILED 7-13-2001.

THE ENGLISH TRANSLATION OF "BELLE" IS "BEAUTIFUL".
FOR WOMEN'S APPAREL; NAMELY SWEATERS, PANTS AND SKIRTS (U.S. CLS. 22 AND 39).
FIRST USE 2-23-2002; IN COMMERCE 2-23-2002.



2,748,285. GRAHAM, LADAN P., DUBLIN, OH. SN 76-317,829. PUB. 5-28-2002, FILED 9-27-2001.

GOD'S GUY

THE LINING/STIPPLING SHOWN IN THE MARK IS MERELY TO INDICATE SHADING.
FOR CLOTHING, NAMELY BANDANAS, COSTUMES, BIBS, BODYSUITS, BONNETS, BOOTIES, CAPS, DRESSES, GOWNS, JACKETS, HATS, ONE-PIECE OUTFITS, PANTALOONS, BUNTING, SHOES, SWEATERS, T-SHIRTS, PANTS (U.S. CLS. 22 AND 39).
FIRST USE 11-21-2001; IN COMMERCE 11-21-2001.

FOR CLOTHING AND WEARING APPAREL, NAMELY, SHIRTS, JACKETS, SWEATERS, COATS, HATS, GLOVES, SHOES, SOCKS, SLACKS, TEE-SHIRTS, AND UNDERWEAR (U.S. CLS. 22 AND 39).
FIRST USE 5-15-2002; IN COMMERCE 5-15-2002.

CLASS 25—(Continued).

2,748,306. OFFICIAL BUGLE BOY, LLC, COLUMBUS, OH. SN 76-323,675. PUB. 10-29-2002, FILED 10-11-2001.

BUGLE BOY JEAN CO.

OWNER OF U.S. REG. NOS. 1,214,082, 2,445,620, AND OTHERS.

NO CLAIM IS MADE TO THE EXCLUSIVE RIGHT TO USE "JEAN CO.", APART FROM THE MARK AS SHOWN.

FOR CLOTHING, NAMELY, JEANS, SHORTS, SHIRTS, TOPS, JACKETS, COATS, VESTS, PANTS, DRESSES, JUMPERS, ROMPERS, JUMPSUITS, PANTSUITS, SKIRTS, HALTER TOPS, OVERALLS, BASEBALL CAPS, BELTS, UNDERWEAR, SNOWBOARD PANTS, BOXER SHORTS, SWEATSHIRTS, T-SHIRTS, AND KNIT CAPS (U.S. CLS. 22 AND 39).

FIRST USE 6-0-2002; IN COMMERCE 6-0-2002.

2,748,317. PHILLIPS-VAN HEUSEN CORPORATION, NEW YORK, NY. SN 76-326,410. PUB. 7-23-2002, FILED 10-18-2001.

IZOD
BOXERS

OWNER OF U.S. REG. NOS. 655,860, 2,518,381, AND OTHERS.

NO CLAIM IS MADE TO THE EXCLUSIVE RIGHT TO USE "BOXERS", APART FROM THE MARK AS SHOWN.

FOR UNDERWEAR, LOUNGEWEAR AND PAJAMAS, INCLUDING BOXER SHORTS (U.S. CLS. 22 AND 39).

FIRST USE 3-0-2002; IN COMMERCE 3-0-2002.

2,748,343. MAGGY LONDON INTERNATIONAL, LTD., NEW YORK, NY. SN 76-335,114. PUB. 9-3-2002, FILED 11-7-2001.

ADDRESS MAGGY

FOR WOMEN'S APPAREL, NAMELY, PANTS, JACKETS, BLOUSES, DRESSES AND SKIRTS (U.S. CLS. 22 AND 39).

FIRST USE 2-1-2002; IN COMMERCE 2-1-2002.

2,748,359. ILKOVICS, VICTOR MIKLOS, AUSTIN, TX. SN 76-337,408. PUB. 5-21-2002, FILED 11-13-2001.

MARSOL

FOR SWIMSUITS FOR CHILDREN, MEN AND WOMEN; SWIMSUIT COVER-UPS AND BATHROBES (U.S. CLS. 22 AND 39).

FIRST USE 9-6-1956; IN COMMERCE 9-9-1956.

CLASS 25—(Continued).

2,748,392. QVC, INC., WEST CHESTER, PA. SN 76-349,746. PUB. 8-20-2002, FILED 12-18-2001.

MOMMY & CO.

FOR MATERNITY CLOTHING, NAMELY, DENIM CAMP SHIRTS, STRETCH DENIM LEGGINGS, SEER-SUCKER CAMP SHIRTS; LACE-UP TOPS; CROPPED PANTS; DENIM WRAP DRESSES, SLEEVELESS TOPS AND CROPPED PANTS WITH EMBROIDERY (U.S. CLS. 22 AND 39).

FIRST USE 8-21-2002; IN COMMERCE 8-21-2002.

2,748,403. HOT FUDGE VENTURE FUND, BURLINGTON, VT. SN 76-351,590. PUB. 6-25-2002, FILED 12-26-2001.



FOR CLOTHING, NAMELY, MEN AND WOMEN'S T-SHIRTS, TANK TOPS, CROP TOPS, POLO SHIRTS, SPORTS SHIRTS, SWEATSHIRTS, PANTS, CAPS (U.S. CLS. 22 AND 39).

FIRST USE 3-0-2002; IN COMMERCE 6-1-2002.

2,748,407. PIVOTAL PROMONTORY DEVELOPMENT, L.L.C., PHOENIX, AZ. SN 76-352,276. PUB. 7-16-2002, FILED 12-20-2001.

THE RANCH CLUB

FOR CLOTHING, NAMELY, SHIRTS, T-SHIRTS, KNIT SHIRTS, GOLF SHIRTS, JACKETS, CAPS, SHOES, SHORTS, HATS, VISORS, JOGGING SUITS, PULL-OVERS, SOCKS, HEAD BANDS, WRIST BANDS, SPORT SHIRTS, SWEAT SUITS, WARM-UP SUITS, SWEATERS, TIES, UNDERWEAR, TURTLENECKS, VESTS, SLACKS, JEANS, SKIRTS, BLOUSES, DRESSES, GLOVES, SCARVES, COATS, BOOTS, SKI BOOTS, SKI PANTS, SKI JACKETS, AND SKI GLOVES (U.S. CLS. 22 AND 39).

FIRST USE 3-1-2001; IN COMMERCE 3-1-2001.

CLASS 25—(Continued).

2,748,413. MIZUNO KABUSHIKI KAISHA (MIZUNO CORPORATION, CHUO-KU, OSAKA, JAPAN. SN 76-353,448. PUB. 9-17-2002, FILED 12-27-2001.

WAVE LEGEND

FOR CLOTHING; NAMELY BASEBALL UNIFORMS, BASEBALL STOCKINGS, BASEBALL UNDERSHIRTS, BASEBALL UNDER STOCKINGS, BASEBALL SLIDING PANTS, BADMINTON SHIRTS, BADMINTON PANTS AND SHORTS, BADMINTON SKIRTS, TENNIS JACKETS, TENNIS SHIRTS, TENNIS PANTS, TENNIS SHORTS AND SKIRTS, TABLE TENNIS JACKETS, TABLE TENNIS PANTS AND SHORTS, TABLE TENNIS SHIRTS, BASKETBALL SHIRTS, BASKETBALL PANTS, BASKETBALL JERSEYS, GOLF SHIRTS, GOLF VESTS, GOLF JACKETS, GOLF PANTS, GOLF SOCKS, GOLF RAINCOATS, GOLF RAIN JACKETS AND PANTS, GOLF SWEATERS, RUGBY SHIRTS, RUGBY PANTS, FOOTBALL JACKETS, FOOTBALL PANTS, FOOTBALL SHIRTS, FOOTBALL HOSE, FOOTBALL SOCKS, FOOTBALL STOCKINGS, VOLLEYBALL JACKETS, VOLLEYBALL WARM-UP SHIRTS, VOLLEYBALL WARM-UP PANTS, VOLLEYBALL SHIRTS, VOLLEYBALL PANTS, SKI JACKETS, SKI PANTS, SKI ANORAK COATS, SKI JUMP SUITS, SKI STOCKINGS AND SOCKS; SKATE SUITS, BOXING TRUNKS, BOXING SHIRTS, WRESTLING UNIFORMS, TRACK AND FIELD SHIRTS, TRACK AND FIELD PANTS, TRACK AND FIELD WARM-UP SHIRTS, TRACK AND FIELD WARM-UP PANTS, GYMNAS TIC SHIRTS, GYMNAS TIC PANTS, MOUNTAINEERING JACKETS, MOUNTAINEERING SHIRTS, MOUNTAINEERING PANTS, MOUNTAINEERING SOCKS, MOUNTAINEERING BREECHES, MOUNTAINEERING ANORAKS, BOWLING SHIRTS, JUDO UNIFORMS COMPOSED OF PANTS, COATS AND BELTS, WOMEN'S JUDO UNDERWEAR, KARATE UNIFORMS COMPOSED OF PANTS, COATS AND BELTS, WOMEN'S KARATE UNDERWEAR, KENDO UNIFORMS COMPOSED OF PANTS, COATS AND BELTS, SWIM PANTS, SWIM SUITS, HANDBALL SHIRTS, HANDBALL PANTS, SOCCER SHIRTS, SOCCER PANTS, WET SUITS, WATER SKI JACKETS; SUITS, COATS, JACKETS, SHIRTS, UNDERWEAR, T-SHIRTS, SHORTS, SWEAT SHIRTS, SWEAT PANTS, GLOVES, POLO SHIRTS, BLOUSONS, VESTS, CARDIGANS, TROUSERS, SLACKS, SHORT PANTS, SOCKS AND HOSE, RAINWEAR, SKIRTS, CULOTTES AND WIND PROTECTION JACKETS, BLOUSES; FOOTWEAR, NAMELY BASEBALL SHOES, SOFTBALL SHOES, BADMINTON SHOES, TENNIS SHOES, TABLE TENNIS SHOES, BASKETBALL SHOES, GOLF SHOES, FOOTBALL SHOES, VOLLEYBALL SHOES, HOCKEY SHOES, ARCHERY SHOES, HANDBALL SHOES, SKI BOOTS, AFTER SKI BOOTS, ICE SKATE BOOTS, WRESTLING SHOES, RUNNING SHOES, TRACK AND FIELD SHOES, WALKING AND CLIMBING FOOTWEAR, GYMNAS TIC SHOES, WEIGHT LIFTING SHOES, BOXING SHOES, SOCCER SHOES, RUGBY SHOES, CROSS TRAINING SHOES, RACKET BALL SHOES AND SQUASH SHOES; CAP AND HATS; NAMELY BASEBALL CAPS, TENNIS CAPS, GOLF CAPS, GOLF SUN VISORS, SKI CAPS, AND SWIM CAPS (U.S. CLS. 22 AND 39).

FIRST USE 11-30-2001; IN COMMERCE 11-30-2001.

2,748,414. E.S. ORIGINALS, INC., NEW YORK, NY. SN 76-354,472. PUB. 6-18-2002, FILED 1-2-2002.

QUICK-FIX

FOR FOOTWEAR (U.S. CLS. 22 AND 39).
FIRST USE 4-0-2002; IN COMMERCE 4-0-2002.

CLASS 25—(Continued).

2,748,415. COMET INTERCONTINENTAL, INC., NEW YORK, NY. SN 76-354,569. PUB. 7-16-2002, FILED 12-27-2001.

STATE PROPERTY

FOR CLOTHING; NAMELY, JEANS, TEE SHIRTS, SHIRTS, JACKETS, SHORTS, PANTS, COATS, SKIRTS, DRESSES, JOGGING SUITS, SWEAT PANTS, SWEATSHIRTS, HATS, UNDERGARMENTS AND FOOTWEAR (U.S. CLS. 22 AND 39).

FIRST USE 10-22-2002; IN COMMERCE 10-22-2002.

2,748,454. BE THE BALL, INC., SALT LAKE CITY, UT. SN 76-366,017. PUB. 12-31-2002, FILED 2-4-2002.



OWNER OF U.S. REG. NO. 2,055,941.
FOR CLOTHING, NAMELY, T-SHIRTS, SWEAT SHIRTS, WIND SHIRTS, COLLARED SHIRTS, HATS, CAPS (U.S. CLS. 22 AND 39).

FIRST USE 3-31-2002; IN COMMERCE 3-31-2002.

2,748,497. GEORGE SHOE CORP., HSINCHU HSIEN, TAIWAN. SN 76-381,144. PUB. 10-1-2002, FILED 3-8-2002.

GCI

FOR LADIES CLOTHING, NAMELY, LADIES DRESSES, SHOES, SANDALS, SLIPPERS, CLOTH SHOES, LEATHER SHOES, BOOTS, HIGH-HEELED SHOES, BELTS, COSTUMES FOR USE IN ROLE-PLAYING GAMES, MASQUERADE, COSTUMES, HALLOWEEN COSTUMES (U.S. CLS. 22 AND 39).

FIRST USE 3-8-2002; IN COMMERCE 3-8-2002.

2,748,500. SIMPLY FASHIONS STORE, LTD., BIRMINGHAM, AL. SN 76-382,645. PUB. 10-29-2002, FILED 3-14-2002.

B.F.Y. BOOTS FOR YOU

FOR FOOTWEAR (U.S. CLS. 22 AND 39).
FIRST USE 7-31-2002; IN COMMERCE 7-31-2002.

CLASS 25—(Continued).

2,748,506. TCPIP, INC., WILMINGTON, DE. SN 76-385,035.
PUB. 10-22-2002, FILED 3-20-2002.

PLC

FOR CHILDREN'S PANTS, TROUSERS, JEANS, SLACKS, JUMPSUITS, SHORTS, SHIRTS, SWEATERS, SWEATSHIRTS, SWEAT SHORTS, VESTS, JACKETS, BLAZERS, T-SHIRTS, OVERALLS, SWIMSUITS, HATS, SOCKS, UNDERWEAR, SCARVES, GLOVES AND FOOTWEAR (U.S. CLS. 22 AND 39).

FIRST USE 8-1-2002; IN COMMERCE 8-1-2002.

2,748,512. NINA FOOTWEAR CORP., NEW YORK, NY. SN 76-388,417. PUB. 10-22-2002, FILED 3-28-2002.

MAX SILVER

THE MARK IDENTIFIES A PARTICULAR LIVING INDIVIDUAL WHOSE CONSENT IS ATTACHED.
FOR CHILDREN'S FOOTWEAR (U.S. CLS. 22 AND 39).
FIRST USE 10-10-2002; IN COMMERCE 10-10-2002.

2,748,518. ULTAMA SWIMWEAR, LLC, JACKSONVILLE, FL, BY ASSIGNMENT JACKSON, LESTER M., JACKSONVILLE, FL. SN 76-390,692. PUB. 10-22-2002, FILED 4-2-2002.

ULTAMA

FOR SWIM WEAR (U.S. CLS. 22 AND 39).
FIRST USE 1-1-2003; IN COMMERCE 1-1-2003.

2,748,553. AMBITION, SOUTH SAN FRANCISCO, CA. SN 76-406,524. PUB. 11-19-2002, FILED 5-13-2002.

SASHIMI

FOR JACKETS, PANTS AND SHIRTS (U.S. CLS. 22 AND 39).
FIRST USE 7-29-2002; IN COMMERCE 7-29-2002.

CLASS 25—(Continued).

2,748,562. GEORGE SHOE CORP., HSINCHU HSIEN, TAIWAN. SN 76-415,810. PUB. 11-19-2002, FILED 5-30-2002.

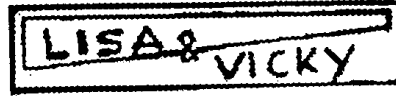

FOR LADIES CLOTHING, NAMELY, LADIES DRESSES, SHOES, SANDALS, SLIPPERS, CLOTH SHOES, LEATHER SHOES, BOOTS, HIGH-HEELED SHOES, BELTS, COSTUMES FOR USE IN ROLE-PLAYING GAMES, MASQUERADE COSTUMES, HALLOWEEN COSTUMES (U.S. CLS. 22 AND 39).
FIRST USE 4-23-2002; IN COMMERCE 4-23-2002.

2,748,577. MUDD, L.L.C., NEW YORK, NY. SN 76-975,440.
PUB. 5-21-2002, FILED 11-9-2001.

MUDD SPORT

NO CLAIM IS MADE TO THE EXCLUSIVE RIGHT TO USE "SPORT", APART FROM THE MARK AS SHOWN.
FOR SHOES, ATHLETIC SHOES, BOOTS, SANDALS, JEANS, PANTS, SHORTS, SHIRTS, T-SHIRTS, SWEATERS, TANK TOPS, SKIRTS, JACKETS, COATS, VESTS, HATS, CAMISOLES, BRAS, PANTIES (U.S. CLS. 22 AND 39).
FIRST USE 12-30-2002; IN COMMERCE 12-30-2002.

2,748,583. ATWOOD, BRIAN, MILAN, ITALY. SN 76-975,487.
PUB. 3-5-2002, FILED 4-24-2001.

BRIAN ATWOOD

FOR LEATHER SHOES (U.S. CLS. 22 AND 39).
FIRST USE 3-3-2001; IN COMMERCE 10-10-2001.

2,748,593. GOERTZ, JAMES L., UNIVERSITY PLACE, WA. SN 78-002,148. PUB. 7-16-2002, FILED 4-1-2000.

TIGER SKINS

FOR CLOTHING, NAMELY, HATS, CAPS, SHIRTS, JACKETS, SHOES, SOCKS, GLOVES, SHORTS, VESTS, SWEATERS, AND WIND RESISTANT JACKETS (U.S. CLS. 22 AND 39).
FIRST USE 6-24-2002; IN COMMERCE 2-17-2003.

CLASS 25—(Continued).

2,748,607. PETRONI, ERIK B., ATLANTIC BEACH, FL. AND PETRONI, KARINA B., ATLANTIC BEACH, FL. SN 78-016,354. PUB. 2-12-2002, FILED 7-12-2000.

SEA PRINCESS

FOR CLOTHING, NAMELY, BATHING TRUNKS, BELTS, BLOUSES, CHEMISETTES, COATS, DRESSING GOWNS, FLEECE PULLOVERS, FROCKS, GLOVES, HOODS, JACKETS, JUMPERS, LEATHER JACKETS, LEGGINGS, LEOTARDS, OVERALLS, OVERCOATS, PAJAMAS, PANTS, PARKAS, PULLOVERS, SCARVES, SHAWLS, SHIRTS, SINGLET, SKIRTS, SLIPS, SUSPENDERS, SWEATERS, SWEAT SHIRTS, TANK TOPS, TIGHTS, TOP COATS, TROUSERS, UNDERWEAR, BEACH SHOES, BOOTS, SANDALS, SHOES, BERETS, CAPS, HATS, AND VISORS (U.S. CLS. 22 AND 39).
FIRST USE 5-2-2000; IN COMMERCE 5-20-2000.

2,748,611. FERMAN/PANAMENO, MIGUEL A., LOS ANGELES, CA. AND GARAY, RICHARD E., LOS ANGELES, CA. SN 78-018,207. PUB. 1-29-2002, FILED 7-25-2000.



FOR MEN'S, WOMEN'S AND CHILDREN'S CLOTHING, NAMELY, SWEATSHIRTS, SHIRTS, T-SHIRTS, TANK-TOPS, JEANS, JACKETS, COATS, SHORTS, SWEATPANTS, SLACKS, SUITS, HATS, HEADBANDS, VISORS, CAPS, DRESSES, SHOES, SNEAKERS, AND BOOTS (U.S. CLS. 22 AND 39).
FIRST USE 1-5-1999; IN COMMERCE 1-5-1999.

2,748,614. STEPHEN MARKS (LONDON) LIMITED, LONDON, ENGLAND. SN 78-023,105. PUB. 11-13-2001, FILED 8-26-2000.

NICOLE FARHI INITIAL

OWNER OF U.S. REG. NOS. 1,483,879 AND 1,512,397. THE MARK "NICOLE FARHI" IDENTIFIES A LIVING INDIVIDUAL WHOSE CONSENT IS OF RECORD.

FOR CLOTHING, NAMELY, SKIRTS, BLOUSES, PANTS, JACKETS, VESTS, WAISTCOATS, SWEATERS, DRESSES, CULOTTES, SHORTS, BELTS, UNDERWEAR, NIGHTWEAR, SWIMWEAR, ROBES, COATS, OVERCOATS, GLOVES, SOCKS, STOCKINGS, TIGHTS, PANTYHOSE, HEADWEAR, HATS, CAPS, HOODS, RAINWEAR, FOOTWEAR, SHOES, SLIPPERS, SANDALS, BOOTS, T-SHIRTS, SWEATSHIRTS, SCARVES, SHAWLS, JEANS, VISORS, WRISTBANDS, NECKTIES, CRAVATS, BLAZERS, TROUSERS, JOGGING SUITS, WARM-UP SUITS (U.S. CLS. 22 AND 39).
FIRST USE 1-0-2001; IN COMMERCE 1-0-2001.

CLASS 25—(Continued).

2,748,653. PROLMAN, MICHAEL, NEEDHAM, MA. SN 78-047,565. PUB. 9-3-2002, FILED 2-9-2001.

SCHMUCK UNIVERSITY

FOR CLOTHING ITEMS, NAMELY, SHIRTS; T-SHIRTS; SWEAT SHIRTS; TANK TOPS; SHORTS; HEADWEAR, NAMELY, CAPS, HATS; AND JACKETS (U.S. CLS. 22 AND 39).

FIRST USE 5-23-2001; IN COMMERCE 11-13-2002.

2,748,736. SARA LEE CORPORATION, WINSTON-SALEM, NC. SN 78-079,818. PUB. 5-28-2002, FILED 8-17-2001.

**HANES HER WAY
STAYCLEAN**

OWNER OF U.S. REG. NOS. 1,407,771, 1,924,741, AND OTHERS.

FOR FOOTWEAR, NAMELY CANVAS AND LEATHER DRESS SHOES, CASUAL SHOES, BOOTS, SANDALS, BEACH SHOES, SNEAKERS AND SLIPPERS (U.S. CLS. 22 AND 39).

FIRST USE 12-31-2001; IN COMMERCE 12-31-2001.

2,748,739. XU, JIA MAN, GREENWOOD, AUSTRALIA. SN 78-080,472. PUB. 9-24-2002, FILED 8-22-2001.

AUSHOOW

THE ENGLISH TRANSLATION OF "AUSHOOW" IS "ELEGANCE FOR A PERSON OF TALENT".

FOR SUITS, PANTS, SHIRTS (U.S. CLS. 22 AND 39).
FIRST USE 5-14-1997; IN COMMERCE 5-14-1997.

2,748,772. MARBLE SPORTSWEAR, INC., BEVERLY HILLS, CA. SN 78-087,235. PUB. 6-25-2002, FILED 10-6-2001.

CAMP CALIFORNIA

NO CLAIM IS MADE TO THE EXCLUSIVE RIGHT TO USE "CALIFORNIA", APART FROM THE MARK AS SHOWN.

FOR BATHING SUITS, BLAZERS, BLOUSES, BOOTS, BRAS, BRIEFS, CAMISOLES, CAPS, COATS, DRESSES, GLOVES, HATS, JACKETS, JEANS, JUMPSUITS, LEOTARDS, NECKTIES, NIGHTGOWNS, OVERALLS, PAJAMAS, PANTS, PANTYHOSE, RAINCOATS, ROBES, SANDALS, SHIRTS, SHOES, SHORTALLS, SHORTS, SKIRTS, SLIPPERS, SLIPS, SOCKS, STOCKINGS, SUITS, SWEATERS, SWEATPANTS, SWEATSHIRTS, T-SHIRTS, TIGHTS, TUXEDOS, VESTS AND WARM-UP SUITS (U.S. CLS. 22 AND 39).

FIRST USE 7-1-2002; IN COMMERCE 7-1-2002.

CLASS 25—(Continued).

2,748,773. MARBLE SPORTSWEAR, INC., BEVERLY HILLS, CA. SN 78-087,236. PUB. 6-25-2002, FILED 10-6-2001.

CAMP USA

NO CLAIM IS MADE TO THE EXCLUSIVE RIGHT TO USE "USA", APART FROM THE MARK AS SHOWN.

FOR BATHING SUITS, BLAZERS, BLOUSES, BOOTS, BRAS, BRIEFS, CAMISOLES, CAPS, COATS, DRESSES, GLOVES, HATS, JACKETS, JEANS, JUMPSUITS, LEOTARDS, NECKTIES, NIGHTGOWNS, OVERALLS, PAJAMAS, PANTS, PANTYHOSE, RAINCOATS, ROBES, SANDALS, SHIRTS, SHOES, SHORTALLS, SHORTS, SKIRTS, SLIPPERS, SLIPS, SOCKS, STOCKINGS, SUITS, SWEATERS, SWEATPANTS, SWEATSHIRTS, T-SHIRTS, TIGHTS, TUXEDOS, VESTS AND WARM-UP SUITS (U.S. CLS. 22 AND 39).

FIRST USE 7-1-2002; IN COMMERCE 7-1-2002.

2,748,837. NBA PROPERTIES, INC., NEW YORK, NY. SN 78-102,618. PUB. 9-3-2002, FILED 1-14-2002.

LOVE IT LIVE

FOR CLOTHING, NAMELY HOSIERY, FOOTWEAR, BASKETBALL SHOES, BASKETBALL SNEAKERS, T-SHIRTS, SHIRTS, SWEATSHIRTS, SWEATPANTS, PANTS, TANK TOPS, JERSEYS, SHORTS, PAJAMAS, SPORT SHIRTS, RUGBY SHIRTS, SWEATERS, BELTS, TIES, NIGHTSHIRTS, HATS, WARM-UP SUITS, WARM-UP PANTS, WARM-UP TOPS, JACKETS, PARKAS, COATS, CLOTH BIBS, HEAD BANDS, WRIST BANDS, APRONS, BOXER SHORTS, SLACKS, CAPS, EAR MUFFS, GLOVES, MITTENS, WOVEN AND KNIT SHIRTS (U.S. CLS. 22 AND 39).

FIRST USE 5-6-2002; IN COMMERCE 5-6-2002.

2,748,857. NINE WEST DEVELOPMENT CORPORATION, WILMINGTON, DE. SN 78-104,634. PUB. 8-20-2002, FILED 1-24-2002.

TRUE SPIRIT BY EASY SPIRIT

FOR FOOTWEAR (U.S. CLS. 22 AND 39).
FIRST USE 5-8-2003; IN COMMERCE 5-8-2003.

2,748,893. WORKMAN, LARRY EDWARD, WEST HOLLYWOOD, CA. SN 78-112,354. PUB. 9-10-2002, FILED 3-4-2002.

LEWDESIGN

FOR CLOTHING, NAMELY, SHIRTS, PANTS AND SWEATERS (U.S. CLS. 22 AND 39).
FIRST USE 7-15-2002; IN COMMERCE 5-1-2003.

CLASS 25—(Continued).

2,748,898. WHEELS OF SOUL, PHILADELPHIA, PA. SN 78-113,839. PUB. 10-22-2002, FILED 3-10-2002.

WHEELS OF SOUL

FOR CLOTHING NAMELY JACKETS, SHIRTS, COATS, HATS (U.S. CLS. 22 AND 39).

FIRST USE 5-30-1967; IN COMMERCE 5-30-1967.

2,748,906. THE H.D. LEE COMPANY, INC., WILMINGTON, DE. SN 78-116,462. PUB. 12-3-2002, FILED 3-21-2002.

LEE SCHOOL

OWNER OF U.S. REG. NOS. 255,018, 2,421,222, AND OTHERS.

FOR BOY'S, GIRL'S AND YOUNG ADULT'S CLOTHING FOR SCHOOL NAMELY KNIT TOPS, WOVEN TOPS, SHIRTS, BLOUSES, PANTS, SLACKS, SHORTS, SWEATERS, PULLOVERS, CARDIGANS, JACKETS, VESTS, SOCKS, LEGGINGS, TIGHTS, HOSIERY, SKIRTS, SKORTS, JUMPERS, DRESSES; GYMWEAR NAMELY T-SHIRTS, JERSEYS, SHORTS, LONG PANTS, SWEATSHIRTS, SWEATPANTS, SWEATSHORTS, SWEAT JACKETS, SOCKS, AND SWEATBANDS; TIES OF ALL KINDS, NAMELY NECKTIES, BOWTIES AND CROSS TIES (U.S. CLS. 22 AND 39).

FIRST USE 2-28-2002; IN COMMERCE 2-28-2002.

2,748,908. JOCKEY INTERNATIONAL, INC., KENOSHA, WI. SN 78-116,934. PUB. 11-12-2002, FILED 3-22-2002.

SIMPLE COMFORT

FOR UNDERWEAR TOPS AND BOTTOMS FOR WOMEN (U.S. CLS. 22 AND 39).

FIRST USE 10-25-2002; IN COMMERCE 10-25-2002.

2,748,917. QUICK CHICK RACING, LLC., BROOMFIELD, CO. SN 78-119,428. PUB. 12-24-2002, FILED 4-3-2002.

QUICK CHICK RACING

FOR WOMEN'S WEARING APPAREL, NAMELY, HATS, CAPS, CAPRI PANTS, T-SHIRTS, LONG T-SHIRTS, HALTER TOPS, CAMISOLE TOPS, SWEATSHIRTS, SHORTS, JACKETS, AND SOCKS (U.S. CLS. 22 AND 39).

FIRST USE 10-25-2001; IN COMMERCE 3-28-2002.

CLASS 25—(Continued).

2,748,939. SMARTWOOL CORP., STEAMBOAT SPRINGS, CO. SN 78-124,966. PUB. 11-19-2002, FILED 4-29-2002.

SMART BY NATURE

FOR HOSIERY; SOCKS; THERMAL UNDERWEAR; UNDERGARMENTS; UNDERWEAR; PANTS; SHIRTS; JACKETS; SWEATERS; NECK GAITERS; TIGHTS; VESTS; SWEAT SHIRTS; LEG WARMERS; ARM WARMERS; HATS; GLOVES; AND MITTENS (U.S. CLS. 22 AND 39).

FIRST USE 9-15-2002; IN COMMERCE 9-15-2002.

2,748,947. FRENCH WEST, INC., LOS ANGELES, CA. SN 78-128,282. PUB. 11-5-2002, FILED 5-13-2002.

HALEBOB

FOR CLOTHING, NAMELY, PANTS, JEANS, DRESSES, SKIRTS, BLOUSES, SHOES, AND HATS (U.S. CLS. 22 AND 39).

FIRST USE 4-10-2003; IN COMMERCE 4-10-2003.

2,748,988. HAMMER LLC, CANNON BEACH, OR. SN 78-975,088. PUB. 8-13-2002, FILED 11-27-2001.

HAMMER SURF

FOR CLOTHING, NAMELY, T-SHIRTS, SWEAT-SHIRTS, JACKETS, PULLOVERS, HATS, SHORTS, BATHING SUITS (U.S. CLS. 22 AND 39).

FIRST USE 2-10-2003; IN COMMERCE 2-10-2003.

CLASS 26—FANCY GOODS

2,747,965. JEWELBUTTON & CO., CHONGRO-KU SEOUL, REPUBLIC OF KOREA. SN 76-191,257. PUB. 6-18-2002, FILED 1-9-2001.

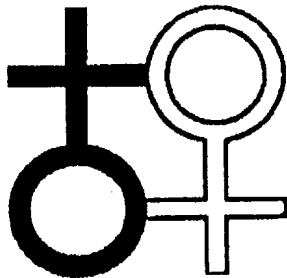

FOR WIGS; HAIR PINS; BELT ORNAMENTS; HAIR GRIPS; BUTTONS; BUCKLES FOR CLOTHING ACCESSORIES; BROOCHES FOR CLOTHING ACCESSORIES (U.S. CLS. 37, 39, 40, 42 AND 50).

FIRST USE 6-0-2001; IN COMMERCE 1-0-2003.

CLASS 26—(Continued).

2,748,478. BOY SCOUTS OF AMERICA, IRVING, TX. SN 76-375,076. PUB. 1-7-2003, FILED 2-26-2002.

TREK SAFELY

FOR CLOTH PATCHES FOR CLOTHING (U.S. CLS. 37, 39, 40, 42 AND 50).

FIRST USE 4-30-2002; IN COMMERCE 4-30-2002.

2,748,721. CONAIR CIP, INC., STAMFORD, CT. SN 78-074,699. PUB. 1-1-2002, FILED 7-19-2001.

SMART CLIP

NO CLAIM IS MADE TO THE EXCLUSIVE RIGHT TO USE "CLIP", APART FROM THE MARK AS SHOWN.

FOR HAIR CLIPS (U.S. CLS. 37, 39, 40, 42 AND 50).

FIRST USE 8-10-2002; IN COMMERCE 8-10-2002.

CLASS 27—FLOOR COVERINGS

2,747,899. JV CARBOX CARL BELLINGER GMBH & CO. KG, 28832 ACHIM, FED REP GERMANY. SN 76-151,157. PUB. 10-8-2002, FILED 10-20-2000.

CARBOX

FOR PLASTIC MATS, FOOT MATS, NON-SLIP MATS (U.S. CLS. 19, 20, 37, 42 AND 50).

FIRST USE 0-0-1974; IN COMMERCE 12-0-2002.

2,748,090. YORK WALLCOVERINGS, INC., YORK, PA. SN 76-247,498. PUB. 6-25-2002, FILED 4-27-2001.

COMPO BELLA

THE ENGLISH TRANSLATION OF "COMPO BELLA" IS "BEAUTIFUL VILLAGE".

FOR WALLPAPER (U.S. CLS. 19, 20, 37, 42 AND 50).

FIRST USE 3-26-2001; IN COMMERCE 5-14-2001.

2,748,235. YORK WALLCOVERINGS, INC., YORK, PA. SN 76-298,092. PUB. 8-6-2002, FILED 8-10-2001.

WILD WEST

FOR WALLPAPER (U.S. CLS. 19, 20, 37, 42 AND 50).

FIRST USE 10-29-2001; IN COMMERCE 12-10-2001.

CLASS 27—(Continued).

2,748,377. MAPLES INDUSTRIES, INC., SCOTTSBORO, AL. SN 76-345,229. PUB. 5-28-2002, FILED 12-5-2001.

COLORBOUND

FOR SCATTER RUGS (U.S. CLS. 19, 20, 37, 42 AND 50).
FIRST USE 2-18-2003; IN COMMERCE 2-18-2003.

2,748,397. FIELDTURF INC., TOWN OF MONT-ROYAL, QUEBEC, CANADA. SN 76-350,708. PUB. 7-9-2002, FILED 12-19-2001.

E-TURF

FOR SYNTHETIC SURFACING CONSISTING OF RIBBONS OF SYNTHETIC FIBERS WOVEN ON A BACKING AND PARTIALLY COVERED BY A PARTICULATE INFILL FOR THE PLAYING OF SOCCER, AMERICAN FOOTBALL, LACROSSE, FIELD HOCKEY, GOLF AND OTHER ATHLETIC ACTIVITIES (U.S. CLS. 19, 20, 37, 42 AND 50).

FIRST USE 6-0-2002; IN COMMERCE 6-0-2002.

2,748,419. SHAW INDUSTRIES, INC., DALTON, GA, BY CHANGE OF NAME SHAW INDUSTRIES, INC., DALTON, GA. SN 76-355,247. PUB. 7-23-2002, FILED 1-4-2002.

SHAW TEK

OWNER OF U.S. REG. NOS. 1,444,248, 2,547,524, AND OTHERS.

NO CLAIM IS MADE TO THE EXCLUSIVE RIGHT TO USE "TECH", APART FROM THE MARK AS SHOWN.

FOR CARPETING (U.S. CLS. 19, 20, 37, 42 AND 50).
FIRST USE 1-31-2002; IN COMMERCE 1-31-2002.

2,748,550. SUPERIOR MANUFACTURING GROUP, INC., CHICAGO, IL. SN 76-404,647. PUB. 11-5-2002, FILED 5-8-2002.

AQUA TRAX

FOR RUBBER BACKED TEXTILE FLOOR MATS FOR COMMERCIAL USE (U.S. CLS. 19, 20, 37, 42 AND 50).
FIRST USE 11-1-2002; IN COMMERCE 11-1-2002.

2,748,852. MOHAWK BRANDS, INC., WILMINGTON, DE. SN 78-104,097. PUB. 8-27-2002, FILED 1-22-2002.

WET LOCK BECAUSE SPILLS HAPPEN

FOR CARPET CUSHION (U.S. CLS. 19, 20, 37, 42 AND 50).
FIRST USE 6-12-2002; IN COMMERCE 6-12-2002.

CLASS 28—TOYS AND SPORTING GOODS

2,747,556. LECLAIR, ROBERT S., HUMBLE, TX. SN 75-683,334. PUB. 7-30-2002, FILED 4-15-1999.

BLESSING

FOR PLUSH TOYS (U.S. CLS. 22, 23, 38 AND 50).
FIRST USE 12-11-2000; IN COMMERCE 12-11-2000.

2,747,565. BENSON, SHAWN B., LENEXA, KS. SN 75-706,021. PUB. 3-21-2000, FILED 5-12-1999.

ACCU-LENGTH

FOR GOLF CLUBS (U.S. CLS. 22, 23, 38 AND 50).
FIRST USE 1-15-2003; IN COMMERCE 3-6-2003.

2,747,572. MATTEL, INC., EL SEGUNDO, CA. SN 75-715,337. PUB. 12-14-1999, FILED 6-22-1999.

HEAT FLEET

FOR TOY VEHICLES AND ACCESSORIES THEREFOR (U.S. CLS. 22, 23, 38 AND 50).
FIRST USE 1-0-2002; IN COMMERCE 1-0-2002.

2,747,625. FAO SCHWARZ, INC., KING OF PRUSSIA, PA, BY ASSIGNMENT; BY CHANGE OF NAME F.A.O. SCHWARZ, NEW YORK, NY. SN 75-817,753. PUB. 1-9-2001, FILED 10-7-1999.

KNUCKLES

FOR TOYS, NAMELY STUFFED PLUSH ANIMALS (U.S. CLS. 22, 23, 38 AND 50).
FIRST USE 12-1-1999; IN COMMERCE 12-1-1999.

CLASS 28—(Continued).

2,747,667. WNBA ENTERPRISES, LLC, SECAUCUS, NJ. SN 75-872,590. PUB. 7-2-2002, FILED 12-15-1999.



OWNER OF U.S. REG. NO. 2,003,595.
NO CLAIM IS MADE TO THE EXCLUSIVE RIGHT TO USE "SEATTLE", APART FROM THE MARK AS SHOWN.

THE MARK CONSISTS OF THE WORDS SEATTLE STORM IN STYLIZED LETTERING, AND THE DESIGNS OF A TOWER, CLOUDS, AND A BASKETBALL, IN AN OVAL LOGO.

FOR TOYS, GAMES AND SPORTING GOODS, NAMELY BASKETBALLS, GOLF BALLS, PLAYGROUND BALLS, SPORTS BALLS, RUBBER ACTION BALLS AND FOAM ACTION BALLS, BASKETBALL NETS, BASKETBALL BACKBOARDS, PUMPS FOR INFLATING BASKETBALLS, AND NEEDLES THEREFOR, GOLF CLUBS, GOLF BAGS, GOLF PUTTERS, GOLF BALL GIFT SETS WITH DIVOT REPAIR TOOLS, OR TEES OR BALL MARKERS, GOLF ACCESSORIES, NAMELY GOLF BAG COVERS, CLUB HEAD COVERS, GOLF GLOVES, GOLF BALL SLEEVES, BICYCLE TAGS, ELECTRONIC BASKETBALL TABLE TOP GAMES, BASKETBALL TABLE TOP GAMES, BASKETBALL BOARD GAMES, ELECTRONIC VIDEO ARCADE GAME MACHINES, BASKETBALL KIT COMPRISED OF A BASKETBALL NET AND WHISTLE, DOLLS, STUFFED TOYS, JIGSAW PUZZLES AND CHRISTMAS TREE ORNAMENTS (U.S. CLS. 22, 23, 38 AND 50).

FIRST USE 6-0-2000; IN COMMERCE 6-0-2000.

CLASS 28—(Continued).

2,747,749. COMPAGNIE INTERNATIONALE DES WAGONS-LITS ET DU TOURISME, BRUXELLES, BELGIUM. SN 76-033,428. PUB. 5-21-2002, FILED 4-25-2000.



OWNER OF U.S. REG. NOS. 2,124,935, 2,339,831, AND OTHERS.

THE TRANSLATION OF THE FOREIGN WORDING IN THE MARK IS "INTERNATIONAL COMPANY OF SLEEPING CARS AND GREAT EUROPEAN TRAINS".

FOR GAMES AND PLAYTHINGS, NAMELY, DOLLS AND ELECTRIC TRAINS; PUZZLES, NAMELY, THREE DIMENSIONAL POLYSTYRENE PUZZLES, TWO-DIMENSIONAL PUZZLES MADE OF CARDBOARD, PLASTICS AND WOOD; MODELS OF TRAIN CARS, NAMELY, SLEEPER CARS, DINING CARS, AND LOUNGE CARS; BUILDING GAMES, NAMELY, GAMES BUILDING TRAIN CARS, NAMELY, SLEEPER CARS, DINING CARS AND LOUNGE CARS; HAND HELD UNITS FOR PLAYING VIDEO GAMES (U.S. CLS. 22, 23, 38 AND 50).

FIRST USE 0-0-1995; IN COMMERCE 0-0-1999.

2,747,769. SPORTS AUTHORITY MICHIGAN, INC., THE, ROYAL OAK, MI. SN 76-051,626. PUB. 1-30-2001, FILED 5-18-2000.

TRU-FLIGHT

FOR DARTS, DARTBOARDS, DARTS AND DARTBOARDS SOLD AS A UNIT, DART TIPS AND FLIGHTS (U.S. CLS. 22, 23, 38 AND 50).

FIRST USE 10-0-2000; IN COMMERCE 10-0-2000.

2,747,846. ESTES-COX CORP., PENROSE, CO, BY ASSIGNMENT CENTURI CORPORATION, PENROSE, CO. SN 76-109,081. PUB. 5-14-2002, FILED 8-14-2000.

ESTES AIR

OWNER OF U.S. REG. NO. 921,049.
NO CLAIM IS MADE TO THE EXCLUSIVE RIGHT TO USE "AIR", APART FROM THE MARK AS SHOWN.

SEC. 2(F) AS TO "ESTES".

FOR AERIAL TOYS, NAMELY ROCKET SYSTEMS COMPRISING A ROCKET, A PUMP, A LAUNCHER, A LAUNCH CONTROL STATION AND INSTRUCTIONAL MATERIALS, ROCKETS, A LAUNCHER AND INSTRUCTIONAL MATERIALS; TOY MODELS OF AERIAL CRAFT, TOY MODEL HOBBY CRAFT KITS FOR MAKING TOY AIR CRAFT, AND ACCESSORIES FOR THE FOREGOING GOODS (U.S. CLS. 22, 23, 38 AND 50).

FIRST USE 6-28-2000; IN COMMERCE 2-16-2001.

CLASS 28—(Continued).

2,747,878. VIBEE VENTURES, CRESTON, BC, CANADA. SN 76-133,088. PUB. 4-30-2002, FILED 9-22-2000.

DON'T BE A BUTT-IN-SKI

FOR GAMES AND PLAYTHINGS, NAMELY, PARLOR GAMES (U.S. CLS. 22, 23, 38 AND 50).
FIRST USE 2-11-2001; IN COMMERCE 2-11-2001.

2,747,880. REGAN, LARA JO, LOS ANGELES, CA. SN 76-135,746. PUB. 7-10-2001, FILED 9-26-2000.

MR. WINKLE

FOR TOYS, NAMELY, STUFFED ANIMALS AND ACTION FIGURES (U.S. CLS. 22, 23, 38 AND 50).
FIRST USE 7-0-2002; IN COMMERCE 7-0-2002.

2,747,930. RICHMOND INTERNATIONAL RACEWAY, INC., RICHMOND, VA. SN 76-170,370. PUB. 9-25-2001, FILED 11-21-2000.



NO CLAIM IS MADE TO THE EXCLUSIVE RIGHT TO USE "RACEWAY", APART FROM THE MARK AS SHOWN. THE MARK FEATURES THE PHRASE "RICHMOND INTERNATIONAL RACEWAY" SUPERIMPOSED ON A STYLIZED OVAL SHAPED "R".

FOR GAMES AND TOYS; NAMELY, DIE CAST AND PLASTIC CARS, TRUCKS AND MOTORCYCLES AND OTHER VEHICLES, ELECTRONIC DRIVING AND ROAD RACING GAMES, COMPUTER VIDEO HANDHELD GAMES, COMPUTER VIDEO ARCADE GAMES, ELECTRONIC SLOT CARS, ADDITIONAL TRACK FOR RACING GAMES, BOARD GAMES, JIGSAW AND MANIPULATIVE PUZZLES, PLUSH STUFFED ANIMALS AND RADIO CONTROLLED CARS, TRUCKS AND OTHER VEHICLES; SPORTING EQUIPMENT, NAMELY GOLF BALLS, GOLF TEES, GOLF CLUBS, GOLF BAGS, GOLF CLUB COVERS, AND GOLF BALL MARKERS (U.S. CLS. 22, 23, 38 AND 50).
FIRST USE 3-1-2001; IN COMMERCE 3-1-2001.

2,747,938. ART HENRY GOLF SALES, INC., LOUISVILLE, KY. SN 76-176,162. PUB. 8-21-2001, FILED 12-5-2000.

LEAD HAND LOW

FOR SPORTING GOODS, NAMELY, GOLF CLUBS AND GOLF CLUB GRIPS (U.S. CLS. 22, 23, 38 AND 50).
FIRST USE 2-1-2002; IN COMMERCE 2-1-2002.

CLASS 28—(Continued).

2,747,947. NATURAL SCIENCE INDUSTRIES, LTD., WEST HEMPSTEAD, NY. SN 76-180,865. PUB. 7-2-2002, FILED 12-14-2000.

BLUE JEAN MACHINE

FOR HOBBY CRAFT SETS FOR DECORATING FABRIC AND APPAREL (U.S. CLS. 22, 23, 38 AND 50).
FIRST USE 12-13-2000; IN COMMERCE 12-13-2000.

2,747,958. CINDI REID CORPORATION, PONTE VEDRA, FL. SN 76-187,666. PUB. 3-12-2002, FILED 12-12-2000.



NO CLAIM IS MADE TO THE EXCLUSIVE RIGHT TO USE "GOLF", APART FROM THE MARK AS SHOWN.

THE NAME "CINDY REID" IDENTIFIES A LIVING INDIVIDUAL WHOSE CONSENT IS OF RECORD. FOR GOLF EQUIPMENT, NAMELY, GOLF CLUBS, GOLF BALLS, GOLF TEES, AND GOLF SWING TRAINING APPARATUS TO BE USED FOR IMPROVING AND CORRECTING A USER'S GOLF SWING PERFORMANCE (U.S. CLS. 22, 23, 38 AND 50).
FIRST USE 1-1-2003; IN COMMERCE 1-1-2003.

2,747,967. SWEET LIFE ENTERPRISE, INC., IRVINE, CA. SN 76-192,794. PUB. 11-12-2002, FILED 1-10-2001.

CHIPPY

FOR DOLLS (U.S. CLS. 22, 23, 38 AND 50).
FIRST USE 4-19-1999; IN COMMERCE 4-19-1999.

CLASS 28—(Continued).

2,747,998. BLUE BOX TOY FACTORY LIMITED, KOWLOON, HONG KONG. SN 76-207,724. PUB. 9-24-2002, FILED 2-7-2001.

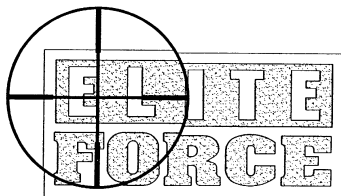

THE STIPPLING IN THE MARK IS FOR SHADING PURPOSES ONLY.

FOR TOYS AND GAMES, NAMELY, CASES FOR TOY VEHICLES, COLLECTABLE TOY FIGURES, MODELED PLASTIC TOY FIGURINES, POSITIONABLE TOY FIGURES, THREE DIMENSIONAL TOY MODELS FOR EDUCATIONAL PURPOSES, TOY ACTION FIGURES, TOY ACTION FIGURES AND ACCESSORIES THEREFOR, TOY AIRPLANES, TOY ARMOR, TOY FIGURES, TOY GUNS, TOY MODEL CARS, TOY MODEL HOBBY-CRAFT KITS, TOY MODEL KIT CARS, TOY MODEL VEHICLES AND RELATED ACCESSORIES SOLD AS UNITS, TOY VEHICLES, TOY VEHICLES AND ACCESSORIES THEREFOR, TOY WEAPONS, ELECTRICAL ACTION TOYS, MECHANICAL ACTION TOYS, TOY AIR PISTOLS, TOY AIR RIFLES, AIR SHOT OR PELLETS FOR TOY PISTOLS AND RIFLES, BENDABLE TOYS, CONSTRUCTION TOYS, FANTASY CHARACTER TOYS, TOY PISTOLS AND PARTS THEREOF, PLASTIC CHARACTER TOYS, PROMOTIONAL GAME CARDS, TOY FIGURINES AND ACCESSORIES THEREFOR (U.S. CLS. 22, 23, 38 AND 50).

FIRST USE 7-0-2000; IN COMMERCE 7-0-2000.

2,748,077. PRICE ADVANCED INNOVATIONS, INC., RENO, NV. SN 76-242,724. PUB. 6-11-2002, FILED 4-18-2001.

POWERSPIKE

FOR TRACTION-ENHANCING ATTACHMENT FOR USE ON GOLF SHOES (U.S. CLS. 22, 23, 38 AND 50).
FIRST USE 6-0-2001; IN COMMERCE 6-0-2001.

2,748,113. FORUM SNOWBOARDS, INC., SAN CLEMENTE, CA. SN 76-258,641. PUB. 9-24-2002, FILED 5-17-2001.

I-LOCK

FOR SNOWBOARD BINDINGS AND PARTS THEREFOR (U.S. CLS. 22, 23, 38 AND 50).
FIRST USE 12-0-2000; IN COMMERCE 1-0-2001.

CLASS 28—(Continued).

2,748,292. HELIOGENESIS, INC., ROCHESTER, NY. SN 76-319,249. PUB. 7-2-2002, FILED 9-28-2001.

SNOW BUBBLES

NO CLAIM IS MADE TO THE EXCLUSIVE RIGHT TO USE "BUBBLES", APART FROM THE MARK AS SHOWN.
FOR BUBBLE MAKING SOLUTIONS (U.S. CLS. 22, 23, 38 AND 50).

FIRST USE 10-15-2002; IN COMMERCE 10-15-2002.

2,748,293. KITE FACTORY, LIMITED, THE, TSIM SHA TSUI, KOWLOON, HONG KONG. SN 76-319,625. PUB. 3-19-2002, FILED 10-2-2001.

ROTO KITE

NO CLAIM IS MADE TO THE EXCLUSIVE RIGHT TO USE "KITE", APART FROM THE MARK AS SHOWN.

FOR KITES AND CONTAINERS THEREFOR, KITE HANDLES, KITE LINES AND KITE PARTS (U.S. CLS. 22, 23, 38 AND 50).

FIRST USE 9-0-2002; IN COMMERCE 9-0-2002.

2,748,302. BANOR ENTERPRISES, INC., BOURNE, MA. SN 76-322,344. PUB. 6-25-2002, FILED 10-10-2001.

SECOND EFFORT TECHNOLOGY

NO CLAIM IS MADE TO THE EXCLUSIVE RIGHT TO USE "TECHNOLOGY", APART FROM THE MARK AS SHOWN.

FOR GOLF BALLS (U.S. CLS. 22, 23, 38 AND 50).

FIRST USE 9-1-2001; IN COMMERCE 9-1-2001.

2,748,318. MELVCO, INC., SISTERS, OR. SN 76-326,841. PUB. 10-1-2002, FILED 10-16-2001.

GRAMPA'S TUB TOYS

NO CLAIM IS MADE TO THE EXCLUSIVE RIGHT TO USE "TUB TOYS", APART FROM THE MARK AS SHOWN.

FOR SQUEEZABLE TOYS DEPICTING ANIMALS FOR USE BY CHILDREN IN BATHTUBS AND OTHER BODIES OF WATER WHERE CHILDREN PLAY (U.S. CLS. 22, 23, 38 AND 50).

FIRST USE 1-0-2001; IN COMMERCE 1-0-2001.

CLASS 28—(Continued).

2,748,340. CONNECTOR SET LIMITED PARTNERSHIP, HATFIELD, PA. SN 76-334,576. PUB. 1-14-2003, FILED 11-5-2001.

CYBER SWARM

FOR CONSTRUCTION TOY SETS (U.S. CLS. 22, 23, 38 AND 50).
FIRST USE 6-25-2002; IN COMMERCE 6-25-2002.

2,748,390. HASBRO, INC., PAWTUCKET, RI. SN 76-349,417. PUB. 12-10-2002, FILED 12-17-2001.

AMERICAN PRIDE

FOR EQUIPMENT SOLD AS A UNIT FOR PLAYING A PARLOR GAME; AND JIGSAW PUZZLES (U.S. CLS. 22, 23, 38 AND 50).
FIRST USE 11-1-2001; IN COMMERCE 11-1-2001.

2,748,427. HASBRO, INC., PAWTUCKET, RI. SN 76-359,098. PUB. 8-6-2002, FILED 1-16-2002.

KNOCK OUT

OWNER OF U.S. REG. NO. 1,732,146.
FOR TOY ACTION FIGURES, TOY VEHICLES AND TOY ROBOTS CONVERTIBLE INTO OTHER VISUAL FORMS (U.S. CLS. 22, 23, 38 AND 50).
FIRST USE 2-12-2002; IN COMMERCE 2-12-2002.

2,748,439. JADA TOYS, INC., LOS ANGELES, CA. SN 76-361,814. PUB. 9-10-2002, FILED 1-23-2002.

BIG BALLERZ

FOR DIE CAST TOY CARS, TOY TRUCKS AND TOY VEHICLES, TOY FIGURINES (U.S. CLS. 22, 23, 38 AND 50).
FIRST USE 11-8-2002; IN COMMERCE 8-10-2002.

2,748,441. RADICA CHINA LTD., ROAD TOWN, TORTOLA, BR. VIRGIN ISLANDS. SN 76-362,365. PUB. 9-17-2002, FILED 1-24-2002.

FLOODLIGHT

FOR SCREEN ACCESSORY FOR USE IN PLAYING HAND HELD GAME UNITS (U.S. CLS. 22, 23, 38 AND 50).
FIRST USE 1-14-2002; IN COMMERCE 2-11-2002.

CLASS 28—(Continued).

2,748,457. INDIAN INDUSTRIES, INC., EVANSVILLE, IN. SN 76-366,330. PUB. 10-22-2002, FILED 2-4-2002.

CHATSWORTH

FOR POOL TABLES (U.S. CLS. 22, 23, 38 AND 50).
FIRST USE 5-1-2002; IN COMMERCE 6-1-2002.

2,748,480. ANDERSON, DAVID BRADLEY, LA JOLLA, CA. SN 76-375,709. PUB. 9-24-2002, FILED 2-27-2002.



FOR CUSTOM SKATEBOARDS (U.S. CLS. 22, 23, 38 AND 50).
FIRST USE 1-1-2001; IN COMMERCE 1-1-2001.

2,748,481. HASBRO, INC., PAWTUCKET, RI. SN 76-376,096. PUB. 10-8-2002, FILED 2-28-2002.

WEE LITTLE PIGGIES

FOR JIGSAW PUZZLES (U.S. CLS. 22, 23, 38 AND 50).
FIRST USE 11-1-2001; IN COMMERCE 11-1-2001.

2,748,503. HASBRO, INC., PAWTUCKET, RI. SN 76-383,540. PUB. 12-17-2002, FILED 3-13-2002.

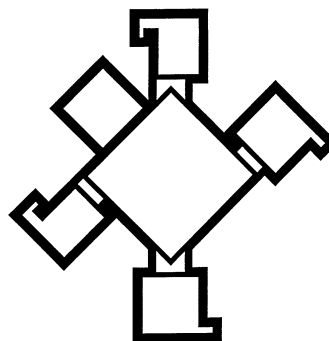

FOR TOY ACTION FIGURES AND ACCESSORIES FOR USE THEREWITH (U.S. CLS. 22, 23, 38 AND 50).
FIRST USE 11-1-2002; IN COMMERCE 11-1-2002.

CLASS 28—(Continued).

2,748,507. KZ GOLF, INC., STUDIO CITY, CA. SN 76-385,258.
PUB. 11-19-2002, FILED 3-21-2002.

CARLTON

FOR GOLF EQUIPMENT, NAMELY, GOLF BAGS; GOLF BALLS; GOLF CLUB HEADS; GOLF CLUB INSERTS; GOLF CLUB SHAFTS; GOLF CLUBS; GRIP TAPES FOR GOLF CLUBS; HAND GRIPS FOR GOLF CLUBS; GOLF GLOVES; GOLF ACCESSORY POUCHES; GOLF BAG COVERS; GOLF BAG TAGS; GOLF BALL MARKERS; GOLF IRONS; GOLF PUTTER COVERS; GOLF PUTTERS; GOLF TEE MARKERS; GOLF TEES (U.S. CLS. 22, 23, 38 AND 50).

FIRST USE 11-0-2002; IN COMMERCE 11-0-2002.

2,748,525. BRUNSWICK BOWLING & BILLIARDS CORPORATION, MUSKEGON, MI. SN 76-392,149. PUB. 11-5-2002, FILED 4-8-2002.

TRUSPEED

FOR BILLIARD TABLE CUSHIONS (U.S. CLS. 22, 23, 38 AND 50).
FIRST USE 8-0-2002; IN COMMERCE 8-0-2002.

2,748,529. DREAMWORKS L.L.C., UNIVERSAL CITY, CA. SN 76-393,800. PUB. 11-5-2002, FILED 4-9-2002.

LOOK FOR THE MARK

FOR ACTION FIGURES AND ACCESSORIES THEREFOR, BATHTUB TOYS, KITES, TOY BUILDING BLOCKS, BOARD GAMES, COSTUME MASKS, HANDHELD UNIT FOR PLAYING ELECTRONIC GAMES, DIE CAST MINIATURE TOY VEHICLES, DOLLS, DOLL ACCESSORIES, DOLL CLOTHING, BEAN BAG DOLLS, BENDABLE PLAY FIGURES, FLYING DISKS, INFLATABLE VINYL PLAY FIGURES, JIGSAW PUZZLES, MARBLES, PLUSH TOYS, PUPPETS, RIDE-ON TOYS, SKATEBOARDS, BALLOONS, ROLLERSKATES, TOY BANKS, WATER SQUIRTING TOYS, STUFFED TOYS, TOY VEHICLES, CHRISTMAS TREE ORNAMENTS; PINBALL MACHINES AND MODEL CRAFT KITS OF TOY FIGURES (U.S. CLS. 22, 23, 38 AND 50).

FIRST USE 4-1-2002; IN COMMERCE 4-1-2002.

2,748,558. PURPLE PEBBLE GAMES, L.L.C., MARBLEHEAD, MA. SN 76-412,461. PUB. 1-7-2003, FILED 5-24-2002.

NUMBERS COUNT

FOR GAMES, NAMELY, BOARD GAMES, CARD GAMES, PARLOR GAMES, AND MANIPULATIVE GAMES; PUZZLES, NAMELY JIGSAW PUZZLES AND MANIPULATIVE PUZZLES (U.S. CLS. 22, 23, 38 AND 50).
FIRST USE 1-30-2003; IN COMMERCE 1-30-2003.

CLASS 28—(Continued).

2,748,595. MATTEL, INC., EL SEGUNDO, CA. SN 78-006,780.
PUB. 10-2-2001, FILED 5-4-2000.

MINT CLASSIC

OWNER OF U.S. REG. NOS. 2,064,219, 2,317,243, AND OTHERS.

FOR DOLL CLOTHING AND DOLL ACCESSORIES (U.S. CLS. 22, 23, 38 AND 50).

FIRST USE 5-0-2000; IN COMMERCE 5-0-2000.

2,748,598. VIACOM INTERNATIONAL INC., NEW YORK, NY. SN 78-008,816. PUB. 2-27-2001, FILED 5-18-2000.

**NICKELODEON INVADER
ZIM**

OWNER OF U.S. REG. NOS. 1,217,864, 1,907,159, AND OTHERS.

FOR DOLLS; ACTION FIGURES AND ACCESSORIES THEREOF (U.S. CLS. 22, 23, 38 AND 50).

FIRST USE 11-1-2001; IN COMMERCE 11-1-2001.

2,748,624. MATTEL, INC., EL SEGUNDO, CA. SN 78-030,757.
PUB. 8-7-2001, FILED 10-16-2000.

ABOUT TOWN

FOR DOLLS, DOLL CLOTHING AND DOLL ACCESSORIES (U.S. CLS. 22, 23, 38 AND 50).

FIRST USE 8-30-2001; IN COMMERCE 8-30-2001.

2,748,649. MAKE YOUR MARK GOLF ACCESSORIES, INC., CAPE CORAL, FL. SN 78-045,771. PUB. 6-11-2002, FILED 1-30-2001.

MARKER MAGIC

NO CLAIM IS MADE TO THE EXCLUSIVE RIGHT TO USE "MARKER", APART FROM THE MARK AS SHOWN.

FOR GOLF BALL MARKERS (U.S. CLS. 22, 23, 38 AND 50).

FIRST USE 1-0-2001; IN COMMERCE 1-0-2001.

2,748,650. MATTEL, INC., EL SEGUNDO, CA. SN 78-046,709.
PUB. 8-7-2001, FILED 2-5-2001.

PERFECT PICNIC

OWNER OF U.S. REG. NOS. 1,760,737, 2,306,429, AND OTHERS.

FOR DOLLS, DOLL CLOTHING AND DOLL ACCESSORIES (U.S. CLS. 22, 23, 38 AND 50).

FIRST USE 6-26-2001; IN COMMERCE 6-26-2001.

CLASS 28—(Continued).

2,748,659. MATTEL, INC., EL SEGUNDO, CA. SN 78-049,991.
PUB. 1-15-2002, FILED 2-23-2001.

WE BRING YOU CLOSER TO THE CARS YOU LOVE

FOR TOY VEHICLES, TOY VEHICLE TRACK SETS,
TOY VEHICLE PLAYSETS AND ACCESSORIES FOR
ALL OF THE FOREGOING (U.S. CLS. 22, 23, 38 AND 50).
FIRST USE 1-0-2001; IN COMMERCE 1-0-2001.

2,748,668. TIME WARNER ENTERTAINMENT COMPANY,
L.P., NEW YORK, NY. SN 78-053,316. PUB. 9-11-2001,
FILED 3-15-2001.

TOM RIDDLE

THE NAME "TOM RIDDLE" DOES NOT IDENTIFY A
LIVING INDIVIDUAL.

FOR TOYS AND SPORTING GOODS, INCLUDING
GAMES AND PLAYTHINGS—NAMELY, ACTION FIG-
URES AND ACCESSORIES THEREFOR; PLUSH TOYS;
BALLOONS; BATHTUB TOYS; RIDE-ON TOYS; EQUIP-
MENT SOLD AS A UNIT FOR PLAYING CARD GAMES;
TOY VEHICLES; DOLLS; FLYING DISCS; ELECTRONIC
HAND-HELD GAME UNIT; GAME EQUIPMENT SOLD
AS A UNIT FOR PLAYING A BOARD GAME, A CARD
GAME, A MANIPULATIVE GAME, A PARLOR GAME
AND AN ACTION TYPE TARGET GAME; STAND
ALONE VIDEO OUTPUT GAME MACHINES; JIGSAW
AND MANIPULATIVE PUZZLES; PAPER FACE MASKS;
SKATEBOARDS; ICE SKATES; WATER SQUIRTING
TOYS; BALLS—NAMELY, PLAYGROUND BALLS,
SOCCER BALLS, BASEBALLS, BASKETBALLS; BASE-
BALL GLOVES; SWIMMING FLOATS FOR RECREA-
TIONAL USE; KICKBOARD FLOTATION DEVICES FOR
RECREATIONAL USE; SURFBOARDS; SWIM BOARDS
FOR RECREATIONAL USE; SWIM FINS; TOY BAKE-
WARE AND TOY COOKWARE; TOY BANKS; AND
CHRISTMAS TREE ORNAMENTS (U.S. CLS. 22, 23, 38
AND 50).

FIRST USE 1-1-2003; IN COMMERCE 1-1-2003.

2,748,677. MATTEL, INC., EL SEGUNDO, CA. SN 78-056,246.
PUB. 7-16-2002, FILED 4-2-2001.

FLYING SCHOOL

OWNER OF U.S. REG. NOS. 1,917,368, 2,469,327, AND
OTHERS.

FOR TOYS, NAMELY, MINIATURE DOLLS, MINIA-
TURE DOLL ACCESSORIES AND MINIATURE DOLL
PLAYSETS, SOLD TOGETHER AS A UNIT (U.S. CLS. 22,
23, 38 AND 50).

FIRST USE 10-16-2001; IN COMMERCE 10-16-2001.

CLASS 28—(Continued).

2,748,678. MATTEL, INC., EL SEGUNDO, CA. SN 78-056,260.
PUB. 8-6-2002, FILED 4-2-2001.

LONDON PREMIERE

FOR TOYS, GAMES, AND PLAYTHINGS, NAMELY,
DOLL CLOTHING AND DOLL ACCESSORIES (U.S. CLS.
22, 23, 38 AND 50).

FIRST USE 3-27-2001; IN COMMERCE 3-27-2001.

2,748,679. MATTEL, INC., EL SEGUNDO, CA. SN 78-056,262.
PUB. 8-6-2002, FILED 4-2-2001.

VINTAGE HOLLYWOOD

FOR TOYS, GAMES, AND PLAYTHINGS, NAMELY,
DOLL CLOTHING AND DOLL ACCESSORIES (U.S. CLS.
22, 23, 38 AND 50).

FIRST USE 3-27-2001; IN COMMERCE 3-27-2001.

2,748,680. MATTEL, INC., EL SEGUNDO, CA. SN 78-056,268.
PUB. 8-6-2002, FILED 4-2-2001.

CAMPUS COOL

FOR TOYS, GAMES AND PLAYTHINGS, NAMELY,
DOLL CLOTHING AND DOLL ACCESSORIES (U.S. CLS.
22, 23, 38 AND 50).

FIRST USE 3-27-2001; IN COMMERCE 3-27-2001.

2,748,681. MATTEL, INC., EL SEGUNDO, CA. SN 78-056,270.
PUB. 8-6-2002, FILED 4-2-2001.

POWER MOVE

FOR DOLLS, DOLL CLOTHING, AND ACCESSORIES
THEREFOR (U.S. CLS. 22, 23, 38 AND 50).

FIRST USE 3-27-2001; IN COMMERCE 3-27-2001.

2,748,696. MATTEL, INC., EL SEGUNDO, CA. SN 78-067,276.
PUB. 7-9-2002, FILED 6-4-2001.

MERMAID FUN

NO CLAIM IS MADE TO THE EXCLUSIVE RIGHT TO
USE "MERMAID", APART FROM THE MARK AS SHOWN.
FOR TOYS, NAMELY, DOLLS, DOLL CLOTHING
AND DOLL ACCESSORIES; DOLL PLAYSETS AND
ACCESSORIES THEREFOR (U.S. CLS. 22, 23, 38 AND 50).
FIRST USE 9-11-2001; IN COMMERCE 9-11-2001.

CLASS 28—(Continued).

2,748,712. NBDL ENTERPRISES, LLC, SECAUCUS, NJ. SN 78-073,068. PUB. 8-6-2002, FILED 7-10-2001.



NO CLAIM IS MADE TO THE EXCLUSIVE RIGHT TO USE "MOBILE", APART FROM THE MARK AS SHOWN.

FOR TOYS, GAMES AND SPORTING GOODS, NAMELY BASKETBALLS, GOLF BALLS, PLAYGROUND BALLS, SPORTS BALLS, RUBBER ACTION BALLS AND FOAM ACTION BALLS, PLUSH BALLS, BASKETBALL NETS, BASKETBALL BACKBOARDS, PUMPS FOR INFLATING BASKETBALLS, AND NEEDLES THEREFOR; GOLF CLUBS, GOLF BAGS, GOLF PUTTERS, GOLF BALL GIFT SETS WITH DIVOT REPAIR TOOLS, GOLF BALL GIFT SETS WITH TEES, AND GOLF BALL GIFT SETS WITH BALL MARKERS; GOLF ACCESSORIES, NAMELY GOLF BAG COVERS, CLUB HEAD COVERS, GOLF GLOVES, GOLF BALL SLEEVES; BICYCLE TAGS, ELECTRONIC BASKETBALL TABLE TOP GAMES, BASKETBALL TABLE TOP GAMES, BASKETBALL BOARD GAMES, ELECTRONIC VIDEO ARCADE GAME MACHINES, BASKETBALL KIT COMPRISED OF A BASKETBALL NET AND WHISTLE, DOLLS, TOY ACTION FIGURES, STUFFED TOYS, JIGSAW PUZZLES AND CHRISTMAS TREE ORNAMENTS (U.S. CLS. 22, 23, 38 AND 50).

FIRST USE 11-30-2001; IN COMMERCE 11-30-2001.

2,748,715. MATTEL, INC., EL SEGUNDO, CA. SN 78-073,571. PUB. 7-9-2002, FILED 7-12-2001.

MINA

FOR TOYS, NAMELY, PLUSH TOYS AND ACCESSORIES THEREFOR (U.S. CLS. 22, 23, 38 AND 50).
FIRST USE 9-0-2001; IN COMMERCE 9-0-2001.

2,748,718. MATTEL, INC., EL SEGUNDO, CA. SN 78-074,463. PUB. 7-16-2002, FILED 7-18-2001.

P7:LAZER BEAM'R

FOR TOYS, GAMES, AND PLAYTHINGS, NAMELY TOY VEHICLES THAT TRANSFORM INTO TOY ROBOTS AND ACCESSORIES THEREFOR (U.S. CLS. 22, 23, 38 AND 50).
FIRST USE 9-0-2001; IN COMMERCE 9-0-2001.

2,748,719. MATTEL, INC., EL SEGUNDO, CA. SN 78-074,466. PUB. 7-16-2002, FILED 7-18-2001.

P3:MOBILE MORTAR**CLASS 28—(Continued).**

NO CLAIM IS MADE TO THE EXCLUSIVE RIGHT TO USE "MORTAR", APART FROM THE MARK AS SHOWN.

FOR TOYS, GAMES AND PLAYTHINGS, NAMELY TOY VEHICLES THAT TRANSFORM INTO TOY ROBOTS AND ACCESSORIES THEREFOR (U.S. CLS. 22, 23, 38 AND 50).

FIRST USE 9-0-2001; IN COMMERCE 9-0-2001.

2,748,720. MATTEL, INC., EL SEGUNDO, CA. SN 78-074,468. PUB. 7-16-2002, FILED 7-18-2001.

P2:GATTLING GUNN'R

NO CLAIM IS MADE TO THE EXCLUSIVE RIGHT TO USE "GUNNER", APART FROM THE MARK AS SHOWN.

FOR TOYS, GAMES, AND PLAYTHINGS, NAMELY TOY VEHICLES THAT TRANSFORM INTO TOY ROBOTS AND ACCESSORIES THEREFOR (U.S. CLS. 22, 23, 38 AND 50).

FIRST USE 9-0-2001; IN COMMERCE 9-0-2001.

2,748,733. MATTEL, INC., EL SEGUNDO, CA. SN 78-078,989. PUB. 7-23-2002, FILED 8-13-2001.

HAYWIRED

FOR TOYS, GAMES AND PLAYTHINGS, NAMELY, MINIATURE TOY SKATEBOARDS AND ACCESSORIES THEREFOR (U.S. CLS. 22, 23, 38 AND 50).

FIRST USE 10-9-2001; IN COMMERCE 10-9-2001.

2,748,734. MATTEL, INC., EL SEGUNDO, CA. SN 78-078,993. PUB. 7-23-2002, FILED 8-13-2001.

DICERS

FOR TOYS, GAMES AND PLAYTHINGS, NAMELY, PARLOR GAMES AND BOARD GAMES (U.S. CLS. 22, 23, 38 AND 50).

FIRST USE 11-30-2001; IN COMMERCE 11-30-2001.

2,748,743. MATTEL, INC., EL SEGUNDO, CA. SN 78-081,909. PUB. 7-23-2002, FILED 8-30-2001.

FOURTH KIND

FOR TOYS, GAMES, AND PLAYTHINGS, NAMELY, TOY VEHICLES AND ACCESSORIES THEREFOR (U.S. CLS. 22, 23, 38 AND 50).

FIRST USE 10-0-2001; IN COMMERCE 10-0-2001.

CLASS 28—(Continued).

2,748,748. CONTROL ENGINEERING, INC., BANGOR, ME.
SN 78-082,617. PUB. 10-22-2002, FILED 9-5-2001.



NO CLAIM IS MADE TO THE EXCLUSIVE RIGHT TO USE "CONTROL ENGINEERING INC", APART FROM THE MARK AS SHOWN.

FOR ANALOG AND ELECTROMECHANICAL JOYSTICK USED IN MANEUVERING A BOAT IN THE DIRECTION THAT THE JOYSTICK IS POINTED (U.S. CLS. 22, 23, 38 AND 50).

FIRST USE 7-1-2001; IN COMMERCE 8-1-2001.

2,748,855. BUILD-A-BEAR WORKSHOP, INC., ST. LOUIS, MO. SN 78-104,494. PUB. 11-26-2002, FILED 1-24-2002.

PAWGO STICK

NO CLAIM IS MADE TO THE EXCLUSIVE RIGHT TO USE "STICK", APART FROM THE MARK AS SHOWN.

FOR TOY POGO STICKS (U.S. CLS. 22, 23, 38 AND 50).

FIRST USE 2-1-2002; IN COMMERCE 2-1-2002.

2,748,856. KEANE, TEAL ANN, STERLING, VA. SN 78-104,626. PUB. 9-24-2002, FILED 1-24-2002.

SPANKY THE SPIDER

NO CLAIM IS MADE TO THE EXCLUSIVE RIGHT TO USE "SPIDER", APART FROM THE MARK AS SHOWN.

FOR STUFFED TOYS, STUFFED TOY ANIMALS, DOLLS, PUPPETS, MARIONETTES, AND PLUSH TOYS (U.S. CLS. 22, 23, 38 AND 50).

FIRST USE 4-7-2003; IN COMMERCE 4-7-2003.

2,748,867. ZONAR, LLC, SOUTH MERIDEN, CT. SN 78-106,946. PUB. 7-30-2002, FILED 2-5-2002.

ZONAR

FOR BASKETBALL SHOOTING TEACHING AIDE AND INSTRUCTIONAL PRINTED MATERIALS AND INSTRUCTIONAL VIDEOS SOLD TOGETHER AS A UNIT (U.S. CLS. 22, 23, 38 AND 50).

FIRST USE 3-31-2002; IN COMMERCE 3-31-2002.

CLASS 28—(Continued).

2,748,886. R&R CONCEPTS, INC., NORTH PRAIRIE, WI. SN 78-111,031. PUB. 11-5-2002, FILED 2-26-2002.

HUNDRED KINGDOMS

FOR EQUIPMENT SOLD AS A UNIT FOR PLAYING HOBBY GAMES, WAR GAMES, SKIRMISH GAMES, ROLE PLAYING GAMES AND SCIENCE FICTION GAMES; MINIATURES AND MODELS FOR USE IN HOBBY GAMES, WAR GAMES, SKIRMISH GAMES, ROLE PLAYING GAMES AND SCIENCE FICTION GAMES; TOY HOBBYCRAFT KITS FOR CONSTRUCTING MODELS (U.S. CLS. 22, 23, 38 AND 50).

FIRST USE 7-15-2002; IN COMMERCE 7-15-2002.

2,748,913. RUNDLE, SCOTT, DBA ALL SOURCE, LAKE ARROWHEAD, CA. SN 78-119,131. PUB. 11-5-2002, FILED 4-3-2002.

BIG AIR

FOR TOY AIRPLANES AND GLIDERS (U.S. CLS. 22, 23, 38 AND 50).

FIRST USE 3-26-2003; IN COMMERCE 3-26-2003.

2,748,914. RUNDLE, SCOTT, DBA ALL SOURCE, LAKE ARROWHEAD, CA. SN 78-119,132. PUB. 10-22-2002, FILED 4-3-2002.

MAXAIR

FOR TOY AIRPLANES AND GLIDERS (U.S. CLS. 22, 23, 38 AND 50).

FIRST USE 3-26-2003; IN COMMERCE 3-26-2003.

2,748,920. JUMP CORDS INCORPORATED, LAFAYETTE HILL, PA. SN 78-120,382. PUB. 11-5-2002, FILED 4-9-2002.

TWIRL2

FOR EXERCISE MACHINE, NAMELY A JUMP ROPE SIMULATOR (U.S. CLS. 22, 23, 38 AND 50).

FIRST USE 4-9-2002; IN COMMERCE 1-1-2003.

2,748,950. WALKMILL, LLC., HATBORO, PA. SN 78-128,592. PUB. 12-3-2002, FILED 5-14-2002.

WALKMILL

FOR EXERCISE EQUIPMENT, NAMELY, TREADMILLS (U.S. CLS. 22, 23, 38 AND 50).

FIRST USE 1-1-2003; IN COMMERCE 1-1-2003.

CLASS 28—(Continued).

2,748,961. BANDAI AMERICA INCORPORATED, CYPRESS, CA. SN 78-131,742. PUB. 11-26-2002, FILED 5-29-2002.

D-TECTOR

FOR S; CARD GAMES AND PROMOTIONAL CARD GAMES; AND LCD GAME MACHINES (U.S. CLS. 22, 23, 38 AND 50).

FIRST USE 4-1-2002; IN COMMERCE 7-5-2002.

2,748,973. BRIDGESTONE SPORTS CO., LTD. TOKYO, 140, JAPAN. SN 78-134,311. PUB. 12-17-2002, FILED 6-10-2002.

U-TRI

FOR GOLF BALLS (U.S. CLS. 22, 23, 38 AND 50).

FIRST USE 9-2-2002; IN COMMERCE 9-2-2002.

2,748,987. JAS. D. EASTON, INC., LOS ANGELES, CA. SN 78-145,813. PUB. 1-28-2003, FILED 7-19-2002.

SYNERGY

FOR SPORTING GOODS, NAMELY, SOFTBALL AND BASEBALL BATS (U.S. CLS. 22, 23, 38 AND 50).

FIRST USE 2-1-2003; IN COMMERCE 2-1-2003.

CLASS 29—MEATS AND PROCESSED FOODS

2,747,539. INGREDIA, 62000 ARRAS, FRANCE. SN 75-658,504. PUB. 1-11-2000, FILED 3-11-1999.

PROCHOC

FOR DAIRY INGREDIENTS FOR PROCESS INDUSTRIES, NAMELY, PROTEIN FOR USE AS A FOOD ADDITIVE (U.S. CL. 46).

FIRST USE 0-0-1986; IN COMMERCE 3-13-2003.

2,747,540. INGREDIA, 62000 ARRAS, FRANCE. SN 75-658,506. PUB. 1-4-2000, FILED 3-11-1999.

PROCREAM

FOR DAIRY INGREDIENTS FOR PROCESS INDUSTRIES, NAMELY, PROTEIN FOR USE AS A FOOD ADDITIVE (U.S. CL. 46).

FIRST USE 0-0-1986; IN COMMERCE 3-13-2003.

CLASS 29—(Continued).

2,747,541. INGREDIA, 62000 ARRAS, FRANCE. SN 75-658,516. PUB. 1-4-2000, FILED 3-11-1999.

PROCHEF

FOR DAIRY INGREDIENTS FOR PROCESS INDUSTRIES, NAMELY, PROTEIN FOR USE AS A FOOD ADDITIVE (U.S. CL. 46).

FIRST USE 0-0-1986; IN COMMERCE 3-13-2003.

2,747,542. INGREDIA, 62000 ARRAS, FRANCE. SN 75-658,518. PUB. 1-11-2000, FILED 3-11-1999.

PROCAKE

FOR DAIRY INGREDIENTS FOR PROCESS INDUSTRIES, NAMELY, PROTEIN FOR USE AS A FOOD ADDITIVE (U.S. CL. 46).

FIRST USE 0-0-1986; IN COMMERCE 3-13-2003.

2,747,564. CHOYA YOSHU JOZO CO., LTD., OSAKA 583-0841, JAPAN. SN 75-699,498. PUB. 12-21-1999, FILED 5-7-1999.



THE MARK CONSISTS OF A STYLIZED DEPICTION OF A BUTTERFLY.

FOR PICKLED PLUMS (U.S. CL. 46).

FIRST USE 9-0-2000; IN COMMERCE 9-0-2000.

2,747,637. STRAUSS VEAL, INC., FRANKLIN, WI, BY CHANGE OF NAME; BY ASSIGNMENT RMCM L.L.C., CHICAGO, IL. SN 75-834,048. PUB. 8-22-2000, FILED 10-28-1999.

SILVERTON RIDGE

FOR MEAT PRODUCTS, NAMELY, RAW LAMB AND VEAL, PROCESSED LAMB AND VEAL (U.S. CL. 46).

FIRST USE 0-0-2000; IN COMMERCE 0-0-2000.

CLASS 29—(Continued).

2,747,727. ACEITUNAS SARASA, S.A., 31261 ANDOSILLA (NAVARRA), SPAIN. SN 76-012,768. PUB. 12-25-2001, FILED 3-29-2000.



THE ENGLISH TRANSLATION OF THE WORD "SARASA" IS "QUEER" OR "PANSY".
FOR PRESERVED OLIVES AND PICKLES (U.S. CL. 46).
FIRST USE 10-0-1968; IN COMMERCE 5-24-2002.

2,747,823. IND. E COM. DE PRODUTOS ALIMENTICIOS CEPERA LTDA, SAO PAULO - SP, BRAZIL. SN 76-089,180. PUB. 8-6-2002, FILED 7-14-2000.

CEPERA

FOR CANNED, BOTTLED AND PRESERVED FRUIT, NAMELY, STRAWBERRIES IN MARRASCH, CANNED FIGS, FIGS IN SYRUP, FIGS CANNED IN GUAVA POT, FIGS CANNED IN GUAVA LANNED, CANNED GUAVAS, CREAMY GUAVAS, CANNED PEACHES IN SYRUP (U.S. CL. 46).
FIRST USE 6-28-1995; IN COMMERCE 5-8-2000.

2,748,239. POLANER, INC., PARSIPPANY, NJ. SN 76-298,680. PUB. 4-16-2002, FILED 8-10-2001.

POLANER SPREADABLE

OWNER OF U.S. REG. NOS. 596,870, 1,650,259, AND OTHERS.
NO CLAIM IS MADE TO THE EXCLUSIVE RIGHT TO USE "SPREADABLE", APART FROM THE MARK AS SHOWN.
FOR FRUIT PRESERVES (U.S. CL. 46).
FIRST USE 11-0-2001; IN COMMERCE 11-0-2001.

2,748,253. SUPERVALU INC., MINNEAPOLIS, MN. SN 76-303,303. PUB. 3-12-2002, FILED 8-22-2001.

THIS IS NOT BUTTER, IT'S BUTTERIFFIC!

FOR VEGETABLE OIL BASED SPREAD USED AS A BUTTER OR MARGARINE SUBSTITUTE (U.S. CL. 46).
FIRST USE 8-29-2001; IN COMMERCE 8-29-2001.

CLASS 29—(Continued).

2,748,255. EXCEL CORPORATION, WICHITA, KS. SN 76-304,999. PUB. 5-7-2002, FILED 8-24-2001.

PREFERRED ANGUS

OWNER OF U.S. REG. NOS. 2,217,724 AND 2,345,284.
NO CLAIM IS MADE TO THE EXCLUSIVE RIGHT TO USE "ANGUS", APART FROM THE MARK AS SHOWN.
FOR BEEF (U.S. CL. 46).
FIRST USE 10-24-2001; IN COMMERCE 10-24-2001.

2,748,286. FISCALINI CHEESE COMPANY, LLC, MODESTO, CA. SN 76-318,107. PUB. 9-17-2002, FILED 9-27-2001.

SAN JOAQUIN GOLD

NO CLAIM IS MADE TO THE EXCLUSIVE RIGHT TO USE "SAN JOAQUIN", APART FROM THE MARK AS SHOWN.
FOR CHEESE AND CHEESE PRODUCTS, NAMELY, SPREADS, SUBSTITUTES, AND FONDUE (U.S. CL. 46).
FIRST USE 6-0-2001; IN COMMERCE 6-0-2001.

2,748,865. FRANKLIN FOODS, INC., ENOSBURG FALLS, VT. SN 78-105,992. PUB. 9-17-2002, FILED 1-31-2002.

NOT YOUR ORDINARY

FOR DAIRY PRODUCTS EXCLUDING ICE CREAM, ICE MILK AND FROZEN YOGURT (U.S. CL. 46).
FIRST USE 3-21-2003; IN COMMERCE 3-21-2003.

2,748,872. LINSEY FOODS LTD., MARKHAM, ONTARIO, CANADA. SN 78-107,609. PUB. 10-29-2002, FILED 2-8-2002.



NO CLAIM IS MADE TO THE EXCLUSIVE RIGHT TO USE "SIMPLY ADD VEGGIES", APART FROM THE MARK AS SHOWN.

FOR PACKAGED MEAL KITS CONSISTING PRIMARILY OF FORMED TEXTURED VEGETABLE PROTEIN, CHICKEN, SAUCES, SALSA, AND ALSO INCLUDING RICE AND TORTILLAS (U.S. CL. 46).
FIRST USE 6-10-2002; IN COMMERCE 6-10-2002.

CLASS 29—(Continued).

2,748,921. PROCESADORA LAGO MAR, C.A., MARACAIBO EDO., VENEZUELA. SN 78-121,000. PUB. 10-22-2002, FILED 4-11-2002.



FOR FROZEN FRESH SHRIMP AND CRAB (U.S. CL. 46).
FIRST USE 5-7-2002; IN COMMERCE 5-7-2002.

2,748,927. SPRUCE FOODS, INC., PRESCOTT, AZ. SN 78-121,820. PUB. 12-3-2002, FILED 4-15-2002.

VILLA FLOR

THE ENGLISH TRANSLATION OF THE SPANISH WORD "VILLA FLOR" IN THE MARK IS "VILLA FLOWER".
FOR FOOD PRODUCTS, NAMELY, CANNED BEANS, CANNED VEGETABLES, CANNED TOMATOES, EDIBLE OLIVE OILS (U.S. CL. 46).
FIRST USE 12-1-2002; IN COMMERCE 12-1-2002.

CLASS 30—STAPLE FOODS

2,747,484. ROSKAM BAKING COMPANY, GRAND RAPIDS, MI. SN 75-507,264. PUB. 8-29-2000, FILED 6-23-1998.

POPPY TOAST

NO CLAIM IS MADE TO THE EXCLUSIVE RIGHT TO USE "POPPY", APART FROM THE MARK AS SHOWN.
FOR SEASONED CROUTONS (U.S. CL. 46).
FIRST USE 9-17-1991; IN COMMERCE 9-17-1991.

2,747,519. LITTLE, ANTHONY, ST. PETERSBURG, FL. SN 75-604,944. PUB. 8-24-1999, FILED 12-14-1998.

GUILTLESS ENTREES

NO CLAIM IS MADE TO THE EXCLUSIVE RIGHT TO USE "ENTREES", APART FROM THE MARK AS SHOWN.
FOR PREPARED LOW FAT, LOW CALORIE MEALS CONSISTING PRIMARILY OF PASTA AND RICE (U.S. CL. 46).
FIRST USE 2-26-2003; IN COMMERCE 2-26-2003.

CLASS 30—(Continued).

2,747,550. GUEVREKIAN, JACK, MANHASSET, LONG ISLAND, NY. SN 75-672,567. PUB. 11-23-1999, FILED 3-31-1999.

MIZZA

FOR PASTRY PIE WITH VEGETABLES AND MEAT TOPPINGS (U.S. CL. 46).
FIRST USE 1-27-2001; IN COMMERCE 1-27-2001.

2,747,648. NUTS & SPICE CO., UNION CITY, CA. SN 75-846,238. PUB. 7-3-2001, FILED 11-10-1999.

CAPTAIN COOK

OWNER OF U.S. REG. NO. 2,329,994.
FOR FLOUR, SALT, SPICES, AND RICE (U.S. CL. 46).
FIRST USE 12-12-1999; IN COMMERCE 12-12-1999.

2,747,742. FIORI-BRUNA PASTA PRODUCTS, INC., MIAMI, FL. SN 76-029,579. PUB. 11-27-2001, FILED 4-20-2000.



NO CLAIM IS MADE TO THE EXCLUSIVE RIGHT TO USE "EGG NOODLE PRODUCT", APART FROM THE MARK AS SHOWN.
THE LINING IS FOR SHADING PURPOSES ONLY AND DOES NOT INDICATE COLOR.
THE ENGLISH TRANSLATION OF "CAMPO D' ORO" IS "FIELD OF GOLD".
FOR PASTA, NAMELY, PRE-PACKAGED PASTA; NOODLES, NAMELY, EGG NOODLES (U.S. CL. 46).
FIRST USE 5-0-2001; IN COMMERCE 5-0-2001.

2,747,926. DFS GROUP L.P., SAN FRANCISCO, CA. SN 76-169,281. PUB. 4-30-2002, FILED 11-21-2000.



NO CLAIM IS MADE TO THE EXCLUSIVE RIGHT TO USE "LAS VEGAS", APART FROM THE MARK AS SHOWN.
FOR CONFECTIONERY, NAMELY, CHOCOLATE, CANDY, COOKIES AND CHOCOLATE COVERED NUTS (U.S. CL. 46).
FIRST USE 12-0-2000; IN COMMERCE 12-0-2000.

CLASS 30—(Continued).

2,747,962. INSTAN, S.A. DE C.V., GRANJAS SAN ANTONIO C.P. 02760, MEXICO. SN 76-189,702. PUB. 7-23-2002, FILED 1-4-2001.

JATI

FOR COFFEE, GRAIN AND CHICORY BASED COFFEE SUBSTITUTES, TEA, RICE, PROCESSED CEREALS, BREAD, CHOCOLATE, MUSTARD, VINEGAR AND EDIBLE SALT (U.S. CL. 46).

FIRST USE 5-1-2001; IN COMMERCE 5-1-2001.

2,748,101. CIVELLI, MARCELO, ELMHURST, NY. SN 76-253,711. PUB. 6-25-2002, FILED 5-7-2001.

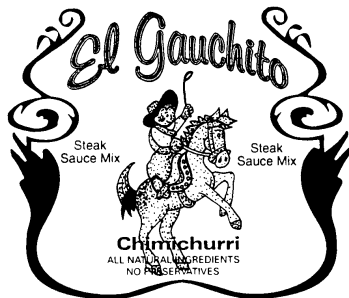

NO CLAIM IS MADE TO THE EXCLUSIVE RIGHT TO USE "STEAK SAUCE MIX", "STEAK SAUCE MIX", "CHIMICHURRI", "ALL NATURAL INGREDIENTS", AND "NO PRESERVATIVES", APART FROM THE MARK AS SHOWN.

THE STIPPLING SHOWN IN THE DRAWING IS A FEATURE OF THE MARK AND IS NOT INTENDED TO INDICATE COLOR.

THE ENGLISH TRANSLATION OF "EL GAUCHITO" IS "LITTLE COWBOY".

FOR CHIMICHURRI SAUCE (U.S. CL. 46).
FIRST USE 8-0-2001; IN COMMERCE 8-0-2001.

2,748,259. PERSONAL CARE GROUP, INC., WESTPORT, CT. SN 76-307,561. PUB. 3-12-2002, FILED 8-31-2001.

**FRESH BREATH IS JUST A
CLICK AWAY**

FOR BREATH MINTS (U.S. CL. 46).
FIRST USE 7-1-2001; IN COMMERCE 7-1-2001.

CLASS 30—(Continued).

2,748,297. ALIMENTOS GRANIX, B1604 CDH, FLORIDA, BUENOS AIRES, ARGENTINA. SN 76-320,073. PUB. 7-30-2002, FILED 10-2-2001.

SOUTHERN PRAIRIES

FOR CRACKERS AND CEREALS FOR BREAKFAST (U.S. CL. 46).

FIRST USE 10-0-2002; IN COMMERCE 10-0-2002.

2,748,362. CONAGRA GROCERY PRODUCTS COMPANY, IRVINE, CA. SN 76-338,373. PUB. 5-28-2002, FILED 11-16-2001.

DESSERT FAVORITES

NO CLAIM IS MADE TO THE EXCLUSIVE RIGHT TO USE "DESSERT", APART FROM THE MARK AS SHOWN.

FOR PUDDING (U.S. CL. 46).

FIRST USE 6-26-2002; IN COMMERCE 6-26-2002.

2,748,365. TOPPS COMPANY, INC., THE, NEW YORK, NY. SN 76-339,902. PUB. 7-16-2002, FILED 11-19-2001.

CANDY JUICE

NO CLAIM IS MADE TO THE EXCLUSIVE RIGHT TO USE "CANDY", APART FROM THE MARK AS SHOWN.

FOR CONFECTIONERY, NAMELY, CANDY AND LOLLIPOPS (U.S. CL. 46).

FIRST USE 12-0-2002; IN COMMERCE 12-0-2002.

2,748,505. UNILEVER N.V., 3013 AL ROTTERDAM, NETHERLANDS. SN 76-384,266. PUB. 10-29-2002, FILED 3-12-2002.

**BREYERS
Ice Cream Cake**

OWNER OF U.S. REG. NOS. 144,708, 2,421,382, AND OTHERS.

NO CLAIM IS MADE TO THE EXCLUSIVE RIGHT TO USE "ICE CREAM CAKE", APART FROM THE MARK AS SHOWN.

FOR ICE CREAM (U.S. CL. 46).

FIRST USE 2-1-2002; IN COMMERCE 2-1-2002.

CLASS 30—(Continued).

2,748,523. S&S BRANDS, INC., WILMINGTON, DE. SN 76-391,525. PUB. 11-19-2002, FILED 4-4-2002.

PEANUT BUTTER JUMBLE

NO CLAIM IS MADE TO THE EXCLUSIVE RIGHT TO USE "PEANUT BUTTER", APART FROM THE MARK AS SHOWN.

FOR ICE CREAM (U.S. CL. 46).
FIRST USE 9-11-2002; IN COMMERCE 10-1-2002.

CLASS 30—(Continued).

2,748,845. KRAFT FOODS HOLDINGS, INC., NORTHFIELD, IL. SN 78-103,611. PUB. 8-13-2002, FILED 1-18-2002.

TEDDY CHEDDY

OWNER OF U.S. REG. NOS. 1,508,468, 1,815,062, AND OTHERS.

FOR CRACKERS (U.S. CL. 46).
FIRST USE 7-0-2002; IN COMMERCE 7-0-2002.

2,748,527. CHECKERS DRIVE-IN RESTAURANTS, INC., TAMPA, FL. SN 76-392,563. PUB. 10-8-2002, FILED 4-9-2002.

SPOON BREAKER

FOR FROZEN CONFECTIONS CONSISTING PRIMARILY OF FROZEN CUSTARD COMBINED WITH ONE OR MORE OF THE FOLLOWING INGREDIENTS, NAMELY, CANDY, COOKIES, SYRUP, NUTS, AND FRUITS (U.S. CL. 46).

FIRST USE 6-30-2002; IN COMMERCE 6-30-2002.

2,748,861. KRAFT FOODS HOLDINGS, INC., NORTHFIELD, IL. SN 78-105,705. PUB. 9-24-2002, FILED 1-30-2002.

LIFE SAVERS FUSIONS

OWNER OF U.S. REG. NOS. 115,895, 1,130,067, AND OTHERS.

FOR CANDY (U.S. CL. 46).
FIRST USE 1-15-2003; IN COMMERCE 1-15-2003.

2,748,567. EMERALD HILLS COFFEE INC., MUKILTEO, WA. SN 76-425,492. PUB. 1-21-2003, FILED 6-25-2002.



NO CLAIM IS MADE TO THE EXCLUSIVE RIGHT TO USE "COFFEE", APART FROM THE MARK AS SHOWN. THE STIPPLING IN THE MARK IS FOR SHADING PURPOSES ONLY.

FOR COFFEE AND COFFEE BEANS (U.S. CL. 46).
FIRST USE 1-1-2003; IN COMMERCE 1-1-2003.

2,748,925. INDOPCO, INC., DBA NATIONAL STARCH & CHEMICAL COMPANY, BRIDGEWATER, NJ. SN 78-121,658. PUB. 10-22-2002, FILED 4-15-2002.

BINDTEX

FOR FOOD STARCH USED IN MEATS (U.S. CL. 46).
FIRST USE 3-6-2003; IN COMMERCE 3-6-2003.

2,748,938. MORNINGSTAR SERVICES, INC., WILMINGTON, DE. SN 78-124,410. PUB. 10-22-2002, FILED 4-26-2002.

WAKE UP THE REAL YOU

FOR COFFEE-BASED BEVERAGE CONTAINING MILK (U.S. CL. 46).
FIRST USE 1-1-2002; IN COMMERCE 1-1-2002.

2,748,758. GREAT BEAR ENTERPRISES, LLC, PHOENIX, AZ. SN 78-084,173. PUB. 3-12-2002, FILED 9-17-2001.

POLARIS

FOR TEAS (U.S. CL. 46).
FIRST USE 11-6-2001; IN COMMERCE 11-6-2001.

2,748,942. GOLDEN BAKE FOOD PRODUCTS, INC., ANAHEIM, CA. SN 78-126,619. PUB. 11-19-2002, FILED 5-6-2002.

MAMMOTH FREEZE

NO CLAIM IS MADE TO THE EXCLUSIVE RIGHT TO USE "FREEZE", APART FROM THE MARK AS SHOWN. FOR NON-CARBONATED, NON-ALCOHOLIC COFFEE BASED BEVERAGE (U.S. CL. 46).
FIRST USE 1-16-2003; IN COMMERCE 1-16-2003.

CLASS 30—(Continued).

2,748,955. KRAFT FOODS HOLDINGS, INC., NORTHFIELD, IL. SN 78-129,580. PUB. 11-12-2002, FILED 5-17-2002.

**SO MANY WAYS TO WOW
'EM**

FOR COOKIES (U.S. CL. 46).
FIRST USE 4-30-2002; IN COMMERCE 4-30-2002.

CLASS 31—(Continued).

2,747,765. HINES NURSERIES, INC., IRVINE, CA, BY ASSIGNMENT HINES HORTICULTURE, INC., IRVINE, CA. SN 76-050,279. PUB. 12-4-2001, FILED 5-17-2000.

HINES PERENNIALS

CLASS 31—NATURAL AGRICULTURAL PRODUCTS

2,747,527. MASTERSON, BONNIE, TULSA, OK. SN 75-624,356. PUB. 8-8-2000, FILED 1-21-1999.

PRINCESS CHARMING

FOR LIVE ROSES (U.S. CLS. 1 AND 46).
FIRST USE 11-0-2000; IN COMMERCE 11-0-2000.

OWNER OF U.S. REG. NOS. 1,551,517, 2,256,601, AND OTHERS.

NO CLAIM IS MADE TO THE EXCLUSIVE RIGHT TO USE "PERENNIALS", APART FROM THE MARK AS SHOWN.

SEC. 2(F).
FOR LIVE PLANTS (U.S. CLS. 1 AND 46).
FIRST USE 4-0-2001; IN COMMERCE 4-0-2001.

2,747,546. HORA, ROLAND, BARTELBERGERWEG 1, FED REP GERMANY. SN 75-665,889. PUB. 11-2-1999, FILED 3-22-1999.

DOGURT

FOR DOG FOOD CONTAINING YOGURT AND VITAMIN SUPPLEMENTS (U.S. CLS. 1 AND 46).
FIRST USE 1-25-2003; IN COMMERCE 1-25-2003.

2,747,889. WESTWAY TRADING CORPORATION, NEW ORLEANS, LA. SN 76-140,758. PUB. 4-16-2002, FILED 10-4-2000.

2,747,676. TECHNICO PTY. LIMITED, BOWRAL, NEW SOUTH WALES 2576, AUSTRALIA. SN 75-888,650. PUB. 4-30-2002, FILED 1-6-2000.



FOR POTATO TUBERS AND MINIATURE POTATO TUBERS (U.S. CLS. 1 AND 46).
FIRST USE 7-1-1999; IN COMMERCE 7-1-1999.

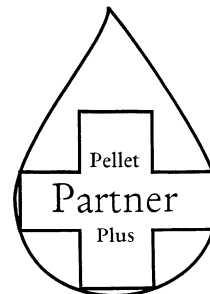

OWNER OF U.S. REG. NO. 1,796,479.
NO CLAIM IS MADE TO THE EXCLUSIVE RIGHT TO USE "PELLET" AND "PLUS", APART FROM THE MARK AS SHOWN.

THE MARK CONSISTS IN PART OF A CROSS DESIGN WITHIN A DROP DESIGN.
FOR NON-NUTRITIONAL FEED SUPPLEMENTS FOR LIVESTOCK (U.S. CLS. 1 AND 46).
FIRST USE 1-29-2001; IN COMMERCE 1-29-2001.

CLASS 31—(Continued).

2,747,928. BAY CITY FLOWER CO., INC., HALF MOON BAY, CA. SN 76-170,005. PUB. 6-25-2002, FILED 11-24-2000.



OWNER OF U.S. REG. NO. 2,437,320.
NO CLAIM IS MADE TO THE EXCLUSIVE RIGHT TO USE "BOUQUETS", APART FROM THE MARK AS SHOWN.
FOR FRESH FLOWERS; LIVE FLOWERING PLANTS; NATURAL DRIED FLOWERS; LIVE AND DRIED FLOWER ARRANGEMENTS (U.S. CLS. 1 AND 46).
FIRST USE 3-15-1999; IN COMMERCE 3-15-1999.

2,748,008. NUTRO PRODUCTS, INC., CITY OF INDUSTRY, CA. SN 76-210,674. PUB. 6-25-2002, FILED 2-13-2001.

NUTRO NATURAL CHOICE COMPLETE CARE

FOR PET FOOD (U.S. CLS. 1 AND 46).
FIRST USE 7-0-2001; IN COMMERCE 7-0-2001.

2,748,046. AMYCEL, INC., WATSONVILLE, CA. SN 76-228,593. PUB. 11-6-2001, FILED 3-19-2001.

BELLA

THE ENGLISH TRANSLATION OF "BELLA" IS "BEAUTIFUL".
FOR MUSHROOM SPAWN (U.S. CLS. 1 AND 46).
FIRST USE 5-30-2002; IN COMMERCE 5-30-2002.

2,748,051. STARK BRO'S NURSERIES & ORCHARDS CO., LOUISIANA, MO. SN 76-232,894. PUB. 7-2-2002, FILED 3-29-2001.

STARK KWIK KROP

OWNER OF U.S. REG. NOS. 663,618, 1,445,462, AND OTHERS.
NO CLAIM IS MADE TO THE EXCLUSIVE RIGHT TO USE "QUICK CROP", APART FROM THE MARK AS SHOWN.
FOR LIVE TREES AND PLANTS (U.S. CLS. 1 AND 46).
FIRST USE 12-28-2001; IN COMMERCE 12-28-2001.

CLASS 31—(Continued).

2,748,212. MALUEG-RAY, TERRI LYNN, ALPHARETTA, GA. SN 76-291,148. PUB. 8-6-2002, FILED 7-26-2001.

PET TASTIES

NO CLAIM IS MADE TO THE EXCLUSIVE RIGHT TO USE "PET", APART FROM THE MARK AS SHOWN.
FOR PET FOOD (U.S. CLS. 1 AND 46).
FIRST USE 11-1-2002; IN COMMERCE 4-1-2003.

2,748,373. CHIQUITA BRANDS, INC., CINCINNATI, OH. SN 76-343,212. PUB. 5-14-2002, FILED 11-29-2001.

THE PERFECT FAST FOOD

FOR FRESH FRUITS AND VEGETABLES (U.S. CLS. 1 AND 46).
FIRST USE 7-1-2002; IN COMMERCE 7-1-2002.

2,748,476. GOLDEN HARVEST SEEDS, INC., BLOOMINGTON, IL. SN 76-374,525. PUB. 8-27-2002, FILED 2-22-2002.

SEED TREATMENT SYSTEM

NO CLAIM IS MADE TO THE EXCLUSIVE RIGHT TO USE "SEED TREATMENT SYSTEM", APART FROM THE MARK AS SHOWN.
FOR AGRICULTURAL FIELD SEEDS TREATED WITH FUNGICIDES, HERBICIDES, PESTICIDES, INSECTICIDES OR NUTRIENTS (U.S. CLS. 1 AND 46).
FIRST USE 1-1-2003; IN COMMERCE 1-1-2003.

2,748,754. NESTLE PURINA PETCARE COMPANY, ST. LOUIS, MO, BY CHANGE OF NAME RALSTON PURINA COMPANY, ST. LOUIS, MO. SN 78-083,717. PUB. 2-26-2002, FILED 9-13-2001.

DOGWICHES

FOR DOG TREATS (U.S. CLS. 1 AND 46).
FIRST USE 1-13-2003; IN COMMERCE 1-13-2003.

CLASS 31—(Continued).

2,748,923. SYNGENTA PARTICIPATIONS AG, BASEL, SWITZERLAND. SN 78-121,010. PUB. 10-22-2002, FILED 4-11-2002.

PUREHEART

FOR SEEDS FOR AGRICULTURAL PURPOSES, NAMELY, MELONS AND WATERMELONS (U.S. CLS. 1 AND 46).

FIRST USE 10-1-2002; IN COMMERCE 10-1-2002.

2,748,962. ABNA LIMITED, LONDON, UNITED KINGDOM. SN 78-132,092. PUB. 11-26-2002, FILED 5-30-2002.

**THE HEART OF A GOOD
START**

FOR ANIMAL FOODSTUFFS (U.S. CLS. 1 AND 46).
FIRST USE 4-0-2002; IN COMMERCE 4-0-2002.

CLASS 32—LIGHT BEVERAGES

2,747,534. MAGIC HAT BREWING COMPANY & PERFORMING ARTS CENTER, INC., SOUTH BURLINGTON, VT. SN 75-652,604. PUB. 9-5-2000, FILED 3-3-1999.

CIRCUS BOY

FOR BEER AND ALE (U.S. CLS. 45, 46 AND 48).
FIRST USE 4-2-2003; IN COMMERCE 4-2-2003.

2,747,704. PATTI, JAMES J., BOCA RATON, FL. SN 75-935,855. PUB. 9-3-2002, FILED 3-6-2000.



GET IT BACK!

NO CLAIM IS MADE TO THE EXCLUSIVE RIGHT TO USE "THIRST QUENCHER", APART FROM THE MARK AS SHOWN.

FOR SOFT DRINK AND SPORTS DRINK (U.S. CLS. 45, 46 AND 48).

FIRST USE 10-1-1999; IN COMMERCE 10-1-1999.

CLASS 32—(Continued).

2,748,190. SMOOTHIE KING FRANCHISES, INC., KENNER, LA. SN 76-282,344. PUB. 11-6-2001, FILED 7-10-2001.

PINA COLADA ISLAND

NO CLAIM IS MADE TO THE EXCLUSIVE RIGHT TO USE "PINA COLADA", APART FROM THE MARK AS SHOWN.

FOR SMOOTHIES (U.S. CLS. 45, 46 AND 48).

FIRST USE 7-1-2001; IN COMMERCE 7-1-2001.

2,748,236. EZAKI GLICO KABUSHIKI KAISHI, DBA EZAKI GLICO COMPANY, LIMITED, NISHIYODOGAWA-KU, OSAKA, JAPAN. SN 76-298,130. PUB. 6-18-2002, FILED 8-11-2001.

POCKY

OWNER OF U.S. REG. NOS. 1,249,460, 2,393,716, AND 2,409,803.

FOR SOFT DRINKS; FRUIT AND VEGETABLE JUICES; NON-ALCOHOLIC BEVERAGES, NAMELY, PUNCH (U.S. CLS. 45, 46 AND 48).

FIRST USE 1-24-2003; IN COMMERCE 1-24-2003.

2,748,266. SHAW WALLACE & COMPANY LIMITED, WEST BENGAL, INDIA. SN 76-309,363. PUB. 9-3-2002, FILED 9-6-2001.

**KOHINOOR INDIAN
PREMIUM**

NO CLAIM IS MADE TO THE EXCLUSIVE RIGHT TO USE "INDIAN PREMIUM", APART FROM THE MARK AS SHOWN.

"KOHINOOR" IS A HINDI WORD THAT REFERS TO "A PRECIOUS GEM".

FOR BEER, ALE, PORTER (U.S. CLS. 45, 46 AND 48).

FIRST USE 9-0-2002; IN COMMERCE 9-0-2002.

2,748,279. MONIN, INC., CLEARWATER, FL. SN 76-314,451. PUB. 12-3-2002, FILED 9-20-2001.

MONIN O'FREE

FOR SUGAR-FREE FLAVORING SYRUPS FOR MAKING FRUIT DRINKS, ICE TEA, AND SOFT DRINKS; SUGAR-FREE CONCENTRATES, SYRUPS OR POWDERS USED IN THE PREPARATION OF FRUIT DRINKS, ICE TEA AND SOFT DRINKS; NON-ALCOHOLIC, SUGAR-FREE COCKTAIL MIXES (U.S. CLS. 45, 46 AND 48).

FIRST USE 1-6-2003; IN COMMERCE 1-6-2003.

CLASS 32—(Continued).

2,748,448. TALKING RAIN BEVERAGE CO. INC., PRESTON, WA. SN 76-364,102. PUB. 8-20-2002, FILED 1-28-2002.

VITARAIN

FOR CARBONATED AND NON-CARBONATED FLAVORED AND UNFLAVORED WATER (U.S. CLS. 45, 46 AND 48).

FIRST USE 2-0-2002; IN COMMERCE 2-0-2002.

2,748,575. SMOOTHIE KING FRANCHISES, INC., KENNER, LA. SN 76-975,410. PUB. 9-10-2002, FILED 10-31-2000.

SMOOTH2O

FOR DRINKING WATER (U.S. CLS. 45, 46 AND 48).

FIRST USE 6-0-2002; IN COMMERCE 6-0-2002.

2,748,672. THE TRUSTEES OF AMERICA'S DRIVE-IN TRUST, RENO, NV. SN 78-054,337. PUB. 8-6-2002, FILED 3-21-2001.

PINK FLAMINGO

FOR SOFT DRINKS, FRUIT FLAVORED, FOR CONSUMPTION ON OR OFF THE PREMISES (U.S. CLS. 45, 46 AND 48).

FIRST USE 9-1-2001; IN COMMERCE 9-1-2002.

2,748,707. LA CONSTANCIA, S.A., SAN SALVADOR, EL SALVADOR. SN 78-072,395. PUB. 7-23-2002, FILED 7-5-2001.

CERVEZA DEL MAR

NO CLAIM IS MADE TO THE EXCLUSIVE RIGHT TO USE "CERVEZA", APART FROM THE MARK AS SHOWN. THE ENGLISH TRANSLATION OF "CERVEZA DEL MAR" IS "BEER OF THE SEA".

FOR BEER (U.S. CLS. 45, 46 AND 48).

FIRST USE 7-26-2002; IN COMMERCE 7-26-2002.

2,748,760. TROPICANA PRODUCTS, INC., BRADENTON, FL. SN 78-084,729. PUB. 4-2-2002, FILED 9-20-2001.

KIWI GRAPE COMBUSTION

NO CLAIM IS MADE TO THE EXCLUSIVE RIGHT TO USE "KIWI GRAPE", APART FROM THE MARK AS SHOWN.

FOR FRUIT JUICE AND FRUIT JUICE DRINKS (U.S. CLS. 45, 46 AND 48).

FIRST USE 3-1-2002; IN COMMERCE 3-1-2002.

CLASS 32—(Continued).

2,748,896. WATER TIME, INC., PITTSBURGH, PA. SN 78-112,891. PUB. 9-17-2002, FILED 3-6-2002.

WATERTIME

FOR BOTTLED DRINKING WATER (U.S. CLS. 45, 46 AND 48).

FIRST USE 3-12-2002; IN COMMERCE 3-12-2002.

2,748,972. MAGIC HAT BREWING COMPANY & PERFORMING ARTS CENTER, INC., SOUTH BURLINGTON, VT. SN 78-133,795. PUB. 12-10-2002, FILED 6-6-2002.

HUMDINGER

FOR BEER AND ALE (U.S. CLS. 45, 46 AND 48).

FIRST USE 10-14-2002; IN COMMERCE 10-14-2002.

CLASS 33—WINES AND SPIRITS

2,747,657. BROADFIELDS WINE CELLARS, LLC, SOUTHOLD, NY. SN 75-862,517. PUB. 8-8-2000, FILED 11-5-1999.

BROADFIELDS

FOR WINE (U.S. CLS. 47 AND 49).

FIRST USE 6-15-2001; IN COMMERCE 8-30-2002.

2,747,671. TEQUILA DON JULIO, S.A. DE C.V., GUADALAJARA, JALISCO, MEXICO. SN 75-881,542. PUB. 1-16-2001, FILED 12-28-1999.

A LEGENDARY MAN. A LEGENDARY TEQUILA.

NO CLAIM IS MADE TO THE EXCLUSIVE RIGHT TO USE "TEQUILA", APART FROM THE MARK AS SHOWN. FOR TEQUILA AND TEQUILA-BASED COCKTAILS (U.S. CLS. 47 AND 49).

FIRST USE 12-28-2001; IN COMMERCE 12-28-2001.

CLASS 33—(Continued).

2,747,685. BERENTZEN BRENNEREIEN GMBH + CO. KG, D-49740 HASELUENNE, FED REP GERMANY. SN 75-897,939. PUB. 4-17-2001, FILED 1-18-2000.

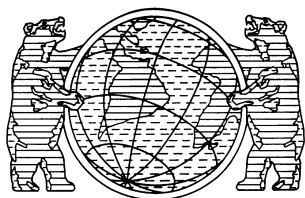

THE DRAWING IS LINED FOR THE COLORS BLUE AND GRAY.
FOR SPIRITS AND LIQUEURS (U.S. CLS. 47 AND 49).
FIRST USE 4-15-2000; IN COMMERCE 9-30-2000.

2,747,706. BECKSTOFFER VINEYARDS V, ST. HELENA, CA. SN 75-936,364. PUB. 9-11-2001, FILED 3-6-2000.

CARNEROS LAKE

NO CLAIM IS MADE TO THE EXCLUSIVE RIGHT TO USE "CARNEROS", APART FROM THE MARK AS SHOWN.
FOR WINES (U.S. CLS. 47 AND 49).
FIRST USE 9-0-2002; IN COMMERCE 9-0-2002.

2,747,966. JOHNSON, JAMES R., DBA JAMES JOHNSON VINEYARDS, ST. HELENA, CA. SN 76-191,433. PUB. 1-29-2002, FILED 1-8-2001.

BISOU

THE ENGLISH TRANSLATION OF "BISOU" IS "KISS".
FOR WINE AND SPIRITS (U.S. CLS. 47 AND 49).
FIRST USE 2-28-2003; IN COMMERCE 3-21-2003.

2,748,005. DECKER ESTATES CELLARS, LLC, SEDONA, AZ. SN 76-209,809. PUB. 7-2-2002, FILED 2-13-2001.

DECKER WINES

NO CLAIM IS MADE TO THE EXCLUSIVE RIGHT TO USE "WINES", APART FROM THE MARK AS SHOWN.
FOR WINES (U.S. CLS. 47 AND 49).
FIRST USE 8-0-2001; IN COMMERCE 8-0-2001.

2,748,039. AUSTIN ROBAIRE VINTNERS, WOODINVILLE, WA. SN 76-227,299. PUB. 4-2-2002, FILED 3-19-2001.

AUSTIN ROBAIRE**CLASS 33—(Continued).**

THE MARK DOES NOT IDENTIFY ANY PARTICULAR LIVING INDIVIDUAL.
FOR WINE (U.S. CLS. 47 AND 49).
FIRST USE 9-16-2001; IN COMMERCE 11-13-2001.

2,748,063. A.S.V. WINES, INC., DELANO, CA. SN 76-237,933. PUB. 8-21-2001, FILED 4-9-2001.

STORY RIDGE

FOR WINES (U.S. CLS. 47 AND 49).
FIRST USE 10-31-2002; IN COMMERCE 10-31-2002.

2,748,076. KRUPP BROTHERS WINERY LLC, NAPA, CA. SN 76-242,628. PUB. 8-6-2002, FILED 4-18-2001.

OVERLAND

FOR WINE (U.S. CLS. 47 AND 49).
FIRST USE 3-26-2003; IN COMMERCE 3-26-2003.

2,748,170. FIVE STAR FINE PRODUCTS, INC., PLAINVIEW, NY. SN 76-274,847. PUB. 7-23-2002, FILED 6-21-2001.

CARLIN WINE CELLAR

NO CLAIM IS MADE TO THE EXCLUSIVE RIGHT TO USE "WINE CELLAR", APART FROM THE MARK AS SHOWN.
FOR WINES (U.S. CLS. 47 AND 49).
FIRST USE 11-0-2001; IN COMMERCE 11-0-2001.

2,748,227. MITOLO WINES PTY LTD, PARKSIDE, SOUTH AUSTRALIA, AUSTRALIA. SN 76-295,374. PUB. 11-13-2001, FILED 8-6-2001.

SAVITAR

FOR WINES (U.S. CLS. 47 AND 49).
FIRST USE 10-30-2002; IN COMMERCE 12-6-2002.

2,748,471. BERINGER BLASS WINE ESTATES COMPANY, NAPA, CA. SN 76-372,587. PUB. 10-29-2002, FILED 2-15-2002.

MEDALINA

FOR WINE (U.S. CLS. 47 AND 49).
FIRST USE 7-12-2002; IN COMMERCE 7-31-2002.

CLASS 33—(Continued).

2,748,549. V. CIRACE & SON, INC., BOSTON, MA. SN 76-404,641. PUB. 12-31-2002, FILED 5-8-2002.

MANDARELLO

FOR MANDARIN-FLAVORED LIQUEUR (U.S. CLS. 47 AND 49).
FIRST USE 6-12-2002; IN COMMERCE 6-12-2002.

2,748,660. VINA FUNDACION DE MENDOZA S.A., BUENOS AIRES, ARGENTINA. SN 78-050,213. PUB. 4-30-2002, FILED 2-26-2001.

FUNDACION DE MENDOZA

THE ENGLISH TRANSLATION OF THE WORD "FOUNDATION DE MENDOZA" IN THE MARK IS FOUNDATION OF MENDOZA.
FOR WINES (U.S. CLS. 47 AND 49).
FIRST USE 9-28-2001; IN COMMERCE 9-28-2001.

2,748,662. FRANCISCAN VINEYARDS, INC., ST. HELENA, CA. SN 78-050,711. PUB. 7-30-2002, FILED 2-28-2001.

ESSENCE OF OAKVILLE

OWNER OF U.S. REG. NO. 2,106,185.
NO CLAIM IS MADE TO THE EXCLUSIVE RIGHT TO USE "OAKVILLE", APART FROM THE MARK AS SHOWN.
FOR ALCOHOLIC BEVERAGES, NAMELY, WINES (U.S. CLS. 47 AND 49).
FIRST USE 1-28-2001; IN COMMERCE 1-28-2001.

2,748,716. BODEGAS Y BEBIDAS, S.A., SAN SEBASTIAN, SPAIN. SN 78-074,025. PUB. 7-30-2002, FILED 7-16-2001.

QUINTA DE TARSUS

THE TERM "QUINTA" CAN BE TRANSLATED FROM SPANISH AS "COUNTRY HOUSE". THE WORD "DE" CAN BE TRANSLATED FROM SPANISH AS "OF"
FOR WINES (U.S. CLS. 47 AND 49).
FIRST USE 11-0-2000; IN COMMERCE 6-3-2002.

2,748,717. BODEGAS Y BEBIDAS, S.A., SAN SEBASTIAN, SPAIN. SN 78-074,040. PUB. 7-30-2002, FILED 7-16-2001.

VIÑA SELENTIA

THE TERM "VINA" CAN BE TRANSLATED FROM SPANISH AS "VINEYARD"
FOR WINES (U.S. CLS. 47 AND 49).
FIRST USE 12-0-2000; IN COMMERCE 10-29-2001.

CLASS 33—(Continued).

2,748,830. WHC, INC., KIRKLAND, WA. SN 78-102,162. PUB. 7-9-2002, FILED 1-11-2002.

SOLESCCE

FOR WINE (U.S. CLS. 47 AND 49).
FIRST USE 3-27-2003; IN COMMERCE 3-27-2003.

2,748,928. NATUREL WEST CORP., ONTARIO, CA. SN 78-121,850. PUB. 11-5-2002, FILED 4-15-2002.

PISTOLERO

THE ENGLISH TRANSLATION OF "PISTOLERO" IS "GUNMAN".
FOR ALCOHOLIC BEVERAGES, NAMELY DISTILLED SPIRITS, TEQUILA, WINE, LIQUEUR, AGARDIENTE, AND MEZCAL (U.S. CLS. 47 AND 49).
FIRST USE 11-5-2002; IN COMMERCE 11-5-2002.

2,748,932. NATUREL WEST CORP., ONTARIO, CA. SN 78-122,460. PUB. 11-5-2002, FILED 4-17-2002.

RAYO

"RAY"
FOR ALCOHOLIC BEVERAGE, LIQUEUR, DISTILLED SPIRITS, NAMELY MEZCAL, AGUARDIENTE, TEQUILA, AND WINE (U.S. CLS. 47 AND 49).
FIRST USE 11-5-2002; IN COMMERCE 11-5-2002.

CLASS 33—(Continued).

2,748,937. UNFILTERED NAPA LLC, NAPA, CA. SN 78-123,887. PUB. 12-3-2002, FILED 4-24-2002.



NO CLAIM IS MADE TO THE EXCLUSIVE RIGHT TO USE "CITRICO", APART FROM THE MARK AS SHOWN. THE MARK CONSISTS OF, IN PART, A STYLIZED HAND PRINT.

THE ENGLISH TRANSLATION OF THE WORDS "TOPO LOCO" IN THE MARK IS "CRAZY AWKWARD PERSON". THE ENGLISH TRANSLATION OF "CITRICO" IS "CITRUS".

FOR ALCOHOL BEVERAGE PRODUCED FROM MALT AND CONTAINING NATURAL FLAVORS (U.S. CLS. 47 AND 49).

FIRST USE 9-16-2002; IN COMMERCE 12-0-2002.

CLASS 34—SMOKERS' ARTICLES

2,748,166. PUJALS, EDUARDO FERNANDEZ, 28020 MADRID, SPAIN. SN 76-274,702. PUB. 9-10-2002, FILED 6-20-2001.

BUENA COSECHA

THE ENGLISH TRANSLATION OF THE WORD "BUENA COSECHA" IN THE MARK IS "GOOD HARVEST".

FOR TOBACCO, CIGARS, CIGARETTES AND CIGARILLOS; CIGARETTE HOLDERS NOT OF PRECIOUS METAL, PIPES FOR SMOKING, CIGAR CUTTERS, CIGAR CASES, TOBACCO TINS NOT OF PRECIOUS METAL, HUMIDORS FOR TOBACCO, LIGHTERS NOT OF PRECIOUS METAL, MATCHES (U.S. CLS. 2, 8, 9 AND 17).

FIRST USE 4-0-2003; IN COMMERCE 4-0-2003.

2,748,322. A. MAYER & COMPANY, L.L.C., WARREN, NJ. SN 76-327,930. PUB. 4-2-2002, FILED 10-19-2001.

ALFONS MAYER

FOR CIGARS (U.S. CLS. 2, 8, 9 AND 17).
FIRST USE 1-0-2003; IN COMMERCE 1-0-2003.

CLASS 34—(Continued).

2,748,394. ROBINSON, KEITH, PONTIAC, MI. SN 76-350,026. PUB. 11-19-2002, FILED 12-18-2001.

LIGHTER LEADER

NO CLAIM IS MADE TO THE EXCLUSIVE RIGHT TO USE "LIGHTER", APART FROM THE MARK AS SHOWN. FOR LIGHTER HOLDER (U.S. CLS. 2, 8, 9 AND 17).
FIRST USE 2-1-2002; IN COMMERCE 2-1-2002.

2,748,408. VECTOR TOBACCO LTD., HAMILTON, HMCX, BERMUDA. SN 76-352,487. PUB. 9-17-2002, FILED 12-21-2001.

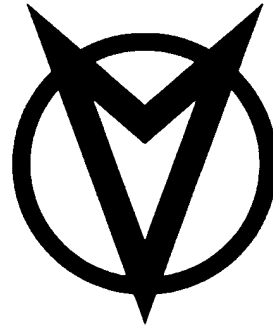

FOR CIGARETTES (U.S. CLS. 2, 8, 9 AND 17).
FIRST USE 7-0-2002; IN COMMERCE 9-9-2002.

2,748,432. U.S. CIGAR SALES INC., GREENWICH, CT. SN 76-359,943. PUB. 7-23-2002, FILED 1-17-2002.

HELIX

FOR CIGARS (U.S. CLS. 2, 8, 9 AND 17).
FIRST USE 5-31-2002; IN COMMERCE 5-31-2002.

2,748,729. BENGAL TOBACCO CORPORATION, DAVIE, FL. SN 78-077,501. PUB. 3-26-2002, FILED 8-4-2001.

KEYSTONE CIGARETTE

NO CLAIM IS MADE TO THE EXCLUSIVE RIGHT TO USE "CIGARETTE", APART FROM THE MARK AS SHOWN.

FOR CIGARETTES (U.S. CLS. 2, 8, 9 AND 17).
FIRST USE 11-10-2001; IN COMMERCE 11-10-2001.

CLASS 34—(Continued).

2,748,986. V.I.P. WORLD TRADE CONSULTING LLC, PORTLAND, OR. SN 78-145,481. PUB. 1-21-2003, FILED 7-18-2002.

MANCHESTER

FOR CIGARETTES (U.S. CLS. 2, 8, 9 AND 17).
FIRST USE 7-31-2002; IN COMMERCE 7-31-2002.

SERVICE MARKS**CLASS 35—ADVERTISING AND BUSINESS**

2,747,464. TRITON TIRE & BATTERY, LLC, MINNEAPOLIS, MN. SN 75-353,393. PUB. 7-6-1999, FILED 9-8-1997.

**TRITON TIRE & BATTERY
SPECIALISTS**

NO CLAIM IS MADE TO THE EXCLUSIVE RIGHT TO USE "TIRE & BATTERY SPECIALISTS", APART FROM THE MARK AS SHOWN.

FOR DISTRIBUTORSHIP SERVICES FOR TIRES AND BATTERIES (U.S. CLS. 100, 101 AND 102).
FIRST USE 11-1-2002; IN COMMERCE 12-1-2002.

2,747,468. URBAN BRANDS, INC., SECAUCUS, NJ. SN 75-413,469. PUB. 8-29-2000, FILED 12-31-1997.

URBAN BRANDS

NO CLAIM IS MADE TO THE EXCLUSIVE RIGHT TO USE "BRANDS", APART FROM THE MARK AS SHOWN.

FOR BUSINESS MANAGEMENT, CONSULTATION, PLANNING AND SUPERVISION SERVICES IN THE AREA OF RETAIL ESTABLISHMENTS (U.S. CLS. 100, 101 AND 102).

FIRST USE 12-0-1998; IN COMMERCE 12-0-1998.

2,747,478. JOURNEYS LIMITED, STAFFORDSHIRE, ST1 3BT, UNITED KINGDOM. SN 75-494,747. PUB. 6-20-2000, FILED 6-2-1998.

SOUL JOURNEYS

FOR COMPUTERIZED ON-LINE ORDERING SPECIALIZING IN BOOKS, MAGAZINES, INSTRUCTIONAL AND TEACHING MATERIALS, SOFTWARE, COMPUTER ACCESSORIES, JEWELRY, ARTWORK, GIFTS, TOYS, TABLEWARE, ORNAMENTS, AND PRE-RECORDED COMPACT DISCS AND AUDIOCASSETTES (U.S. CLS. 100, 101 AND 102).

FIRST USE 7-31-1998; IN COMMERCE 7-31-1998.

CLASS 35—(Continued).

2,747,493. WF ACQUISITION SUB, INC., IRVINE, CA, BY ASSIGNMENT; BY ASSIGNMENT; BY ASSIGNMENT PACIFIC ONLINE COMPUTERS, INC., DBA ONLINE CONNECTING POINT, IRVINE, CA. SN 75-531,941. PUB. 2-15-2000, FILED 8-6-1998.

OPSTRACK

FOR COMPUTERIZED DATABASE MANAGEMENT (U.S. CLS. 100, 101 AND 102).
FIRST USE 7-0-1997; IN COMMERCE 7-0-1997.

2,747,512. LINGUISTIQUE ET INTELLIGENCE ARTIFICIELLE, DBA LIDIA S.A, 45000 ORLEANS, FRANCE. SN 75-590,186. PUB. 5-2-2000, FILED 11-17-1998.

ANAGOGE

FOR BUSINESS CONSULTATION IN THE NATURE OF RESEARCH AND ANALYSIS OF THE SYNTAX OF WRITTEN AND VERBAL COMMUNICATIONS, WITH PARTICULAR REGARD TO THE RELATIONSHIP AND LINKAGE BETWEEN VARIOUS IDEAS AND CONCEPTS, IN ORDER TO DISCERN THE RELATIVE IMPORTANCE THEREOF TO THE BASIC PREMISE OF THE COMMUNICATION (U.S. CLS. 100, 101 AND 102).
FIRST USE 12-31-1986; IN COMMERCE 5-31-2001.

2,747,514. CENTROS COMERCIALES SORIANA, S.A. DE C.V., MONTERREY, N.L., MEXICO. SN 75-595,377. PUB. 1-4-2000, FILED 11-25-1998.

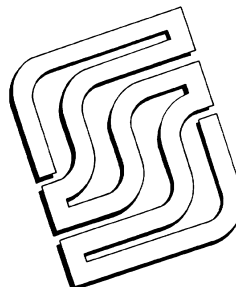

THE MARK CONSISTS OF A STYLIZED DESIGN OF THE LETTER "S".

FOR RETAIL STORE SERVICES, NAMELY, CONVENIENCE STORES (U.S. CLS. 100, 101 AND 102).
FIRST USE 0-0-1905; IN COMMERCE 0-0-1998.

CLASS 35—(Continued).

2,747,515. HEALTHAVENUE, INC., ASHEVILLE, NC. SN 75-598,988. PUB. 8-3-1999, FILED 11-30-1998.

HEALTHAVENUE

FOR RETAIL STORE SERVICES, AVAILABLE THROUGH COMPUTER COMMUNICATIONS, FEATURING HEALTH-RELATED PRODUCTS; AND WHOLESALE DISTRIBUTORSHIP FEATURING HEALTH-RELATED PRODUCTS (U.S. CLS. 100, 101 AND 102).

FIRST USE 4-10-2003; IN COMMERCE 4-10-2003.

2,747,525. RELIANT RESOURCES, INC., HOUSTON, TX, BY MERGER; BY CHANGE OF NAME; BY CHANGE OF NAME; BY ASSIGNMENT; BY ASSIGNMENT RELIANT ENERGY, INCORPORATED, HOUSTON, TX. SN 75-623,509. PUB. 6-18-2002, FILED 1-19-1999.



OWNER OF U.S. REG. NOS. 2,666,766 AND 2,681,501. NO CLAIM IS MADE TO THE EXCLUSIVE RIGHT TO USE "ENERGY", APART FROM THE MARK AS SHOWN.

FOR BUSINESS CONSULTATION SERVICES FOR THE ENERGY INDUSTRY; BILLING FOR ENERGY SUPPLIERS; BUSINESS MARKETING CONSULTING SERVICES IN THE ENERGY INDUSTRY; BUSINESS SUPPORT SERVICES FOR ENERGY SUPPLIERS, NAMELY, PROVIDING BILLING INFORMATION TO ENERGY CONSUMERS; OPERATION FOR OTHERS OF FACILITIES AND INFRASTRUCTURE FOR ENERGY GENERATION, GATHERING, TRANSMISSION, STORAGE AND DISTRIBUTION (U.S. CLS. 100, 101 AND 102).

FIRST USE 2-2-1999; IN COMMERCE 2-2-1999.

2,747,544. MARTHA STEWART LIVING OMNIMEDIA LLC, NEW YORK, NY. SN 75-659,121. PUB. 6-26-2001, FILED 3-12-1999.

HOMEKEEPING

FOR ONLINE RETAIL, MAIL ORDER AND CATALOG SERVICES IN THE FIELD OF LAUNDRY, CLOTHES, ORGANIZING, STORAGE, CLEANING AND MAINTAINING PRODUCTS (U.S. CLS. 100, 101 AND 102).

FIRST USE 3-0-2000; IN COMMERCE 3-0-2000.

CLASS 35—(Continued).

2,747,592. ZELBY INDUSTRIES, L.L.C., PROVIDENCE, RI. SN 75-765,175. PUB. 12-5-2000, FILED 8-24-1999.

ECASA

FOR PROMOTING THE GOODS AND SERVICES OF OTHERS BY PLACING ADVERTISEMENTS AND PROMOTIONAL DISPLAYS IN AN ELECTRONIC SITE ACCESSED THROUGH COMPUTER NETWORKS; ON-LINE COMPUTER SERVICES, NAMELY PROVIDING INFORMATION REGARDING THE GOODS AND SERVICES OF OTHERS IN THE NATURE OF A BUYER'S GUIDE; PROVIDING ON-LINE RETAILING AND ON-LINE ORDERING SERVICES IN THE FIELD OF GENERAL MERCHANDISE (U.S. CLS. 100, 101 AND 102).

FIRST USE 4-6-2000; IN COMMERCE 4-6-2000.

2,747,602. MEDIAOCEAN, INC., ATLANTA, GA, BY ASSIGNMENT MEDIAOCEAN PARTNERSHIP, THE, ATLANTA, GA. SN 75-780,511. PUB. 7-31-2001, FILED 9-16-1999.

MEDIAOCEAN

FOR ELECTRONIC COMMERCE SERVICES, NAMELY PROVIDING AN ONLINE WEB SITE FOR USE BY BUSINESSES AND INDIVIDUALS IN BUYING AND/OR SELLING PRINTED, TELEVISION, RADIO, AND ON-LINE MEDIA ADVERTISING (U.S. CLS. 100, 101 AND 102).

FIRST USE 11-15-2002; IN COMMERCE 11-15-2002.

2,747,606. AMERICAN MEDICAL VIRTUAL INTEGRATION, LLC., MEDINA, OH. SN 75-793,482. PUB. 11-20-2001, FILED 9-7-1999.

OHIOEYESITE

FOR PROMOTING THE VISION CARE GOODS AND SERVICES OF A SPONSOR AND OTHERS BY PROVIDING A WEB SITE AT WHICH USERS CAN LINK TO THE VISION CARE GOODS AND SERVICES WEB SITES OF SPONSOR AND OTHERS (U.S. CLS. 100, 101 AND 102).

FIRST USE 4-22-2002; IN COMMERCE 4-22-2002.

2,747,623. WILDOLPHIN, LTD., CHICAGO, IL, BY ASSIGNMENT MONACO, MARK S., CHICAGO, IL. SN 75-815,937. PUB. 2-13-2001, FILED 10-5-1999.

WILDOLPHIN

FOR CHANGE MANAGEMENT CONSULTATION AND BUSINESS STRATEGY CONSULTATION (U.S. CLS. 100, 101 AND 102).

FIRST USE 9-30-1999; IN COMMERCE 9-30-1999.

CLASS 35—(Continued).

2,747,632. SCHONFELD, MYRON, NEW YORK, NY. SN 75-830,955. PUB. 1-22-2002, FILED 10-23-1999.

COPY24

FOR COPYING, REPRODUCING AND COMPILING DOCUMENTS FOR OTHERS; COMPUTERIZED WORD PROCESSING AND TYPING FOR OTHERS; PRINTING SERVICES, NAMELY BINDING SERVICES (U.S. CLS. 100, 101 AND 102).

FIRST USE 6-0-2000; IN COMMERCE 6-0-2000.

2,747,635. BUILD-A-BEAR WORKSHOP, L.L.C., ST. LOUIS, MO. SN 75-831,936. PUB. 7-4-2000, FILED 10-27-1999.

**WHERE SPECIAL
MEMORIES ARE MADE**

FOR RETAIL STORE SERVICES, MAIL ORDER CATALOG SERVICES, AND RETAIL SERVICES VIA A GLOBAL COMPUTER NETWORK, ALL FEATURING STUFFED AND PLUSH TOY ANIMALS AND ACCESSORIES THEREFOR, DOLLS AND ACCESSORIES THEREFOR, ELECTRONIC MUSICAL DEVICES, SOUND RECORDINGS, COMPACT DISKS, JEWELRY, STATIONERY ITEMS, STICKERS, BOOKS, PUBLICATIONS, CLOTHING, BACKPACKS, TOTE BAGS, CARRYING CASES, PURSES, TOYS AND NOVELTY BUTTONS AND PINS (U.S. CLS. 100, 101 AND 102).

FIRST USE 4-7-2003; IN COMMERCE 4-7-2003.

2,747,668. PROTEC MANUFACTURING INC., CALGARY, ALBERTA, T2H 0T3, CANADA. SN 75-877,885. PUB. 6-25-2002, FILED 12-22-1999.



PRIORITY CLAIMED UNDER SEC. 44(D) ON CANADA APPLICATION NO. 1037081, FILED 11-23-1999, REG. NO. 553878, DATED 11-15-2001, EXPIRES 11-15-2016.

THE LINING SHOWN IN THE MARK IS MERELY TO INDICATE SHADING.

FOR WHOLESALE DISTRIBUTORSHIP FEATURING COMMERCIAL POPCORN MACHINES AND SUPPLIES FOR MAKING POPCORN, NAMELY OIL, TOPPING, UNPOPPED CORN, BAGS, CARTONS, AND HEATING LIGHTS (U.S. CLS. 100, 101 AND 102).

FIRST USE 9-30-2000; IN COMMERCE 9-30-2000.

CLASS 35—(Continued).

2,747,669. SOLID TEAM, LLC, THE, SANTA ANA, CA. SN 75-879,645. PUB. 11-27-2001, FILED 12-21-1999.

SOLID TEAM

FOR BUSINESS MANAGEMENT SERVICES, NAMELY CORPORATE TURNAROUND MANAGEMENT SERVICES (U.S. CLS. 100, 101 AND 102).

FIRST USE 8-24-2000; IN COMMERCE 1-16-2001.

2,747,703. SIGNAL HILL, INC., WINNETKA, IL. SN 75-935,383. PUB. 9-24-2002, FILED 2-17-2000.

SIGNAL HILL

FOR BUSINESS CONSULTATION SERVICES FOR THE VENTURE CAPITAL INVESTMENT INDUSTRY IN THE FIELDS OF STRATEGIC ANALYSIS AND ADVICE, ADVISORY BOARD CREATION, MONEY MANAGEMENT, INVESTING AND EXECUTIVE COUNSELING EXCLUDING THE UTILITY INDUSTRY (U.S. CLS. 100, 101 AND 102).

FIRST USE 7-5-2000; IN COMMERCE 4-1-2001.

2,747,717. RYOHIN KEIKAKU CO., LTD., TOKYO, JAPAN. SN 75-983,226. PUB. 11-6-2001, FILED 11-12-1999.

MUJI ONLINE

NO CLAIM IS MADE TO THE EXCLUSIVE RIGHT TO USE "ONLINE", APART FROM THE MARK AS SHOWN.

FOR ON-LINE RETAIL SERVICES AND MAIL ORDER SERVICES FEATURING CONSUMER GOODS, CLOTHING, HOUSEHOLD GOODS, OFFICE SUPPLIES, INDUSTRIAL SUPPLIES, BUSINESS EQUIPMENT (U.S. CLS. 100, 101 AND 102).

FIRST USE 9-1-1999; IN COMMERCE 9-1-1999.

2,747,722. PRESIDEO, INC., SEBASTIAN, FL, BY CHANGE OF NAME INTEGRATED VISIONS, INC., SEBASTIAN, FL. SN 76-003,975. PUB. 3-5-2002, FILED 3-20-2000.

TRUSTED SPACE

FOR BUSINESS CONSULTING SERVICES, FOR THE IMPLEMENTATION AND ADAPTATION OF COMPUTER SOFTWARE FOR CONTROLLED ACCESS TO CONFIDENTIAL INFORMATION, NAMELY, FINANCIAL INFORMATION, INSURANCE INFORMATION, HEALTH CARE BENEFITS INFORMATION, MEDICAL AND RELATED INFORMATION AND PERSONAL IDENTIFICATION INFORMATION OVER THE INTERNET (U.S. CLS. 100, 101 AND 102).

FIRST USE 4-30-2003; IN COMMERCE 4-30-2003.

CLASS 35—(Continued).

2,747,728. PHOENIX GROUP, INC., ATLANTA, GA. SN 76-013,806. PUB. 1-30-2001, FILED 3-30-2000.

LOGOBUY

FOR RETAIL STORE SERVICES FEATURING GENERAL MERCHANDISE; AND, ON-LINE STORE SERVICES FEATURING GENERAL MERCHANDISE (U.S. CLS. 100, 101 AND 102).

FIRST USE 4-0-2000; IN COMMERCE 4-0-2000.

2,747,741. MAGIC GREEN CORPORATION, SILEX, MO. SN 76-027,612. PUB. 2-27-2001, FILED 4-14-2000.

TURFHEALTH

FOR MAIL-ORDER CATALOG SERVICES AND ELECTRONIC ON-LINE CATALOG SERVICES PROVIDED THROUGH A GLOBAL COMPUTER NETWORK FEATURING FERTILIZERS, SOIL CONDITIONERS AND SOIL ADDITIVES FOR USE IN GROWING AND MAINTAINING TURF GRASS (U.S. CLS. 100, 101 AND 102).

FIRST USE 2-0-2003; IN COMMERCE 2-0-2003.

2,747,745. USBX, INC., SANTA MONICA, CA, BY ASSIGNMENT MAINEMARINAS, INC., SANTA MONICA, CA. SN 76-031,669. PUB. 5-15-2001, FILED 4-21-2000.

USBX

FOR BUSINESS CONSULTATION IN THE FIELD OF LOCATING, RESEARCHING, LISTING FOR SALE, BUYING, SELLING OR MERGING BUSINESSES VIA THE GLOBAL COMPUTER NETWORK (U.S. CLS. 100, 101 AND 102).

FIRST USE 4-3-2000; IN COMMERCE 6-5-2000.

2,747,747. DIGITAL ADCO, INC., NEW YORK, NY. SN 76-032,656. PUB. 10-8-2002, FILED 4-24-2000.

SPOT

FOR PROVIDING ADVERTISING SERVICES TO CABLE TELEVISION, BROADCAST TELEVISION, SATELLITE TELEVISION, OTHER TELEVISION COMPANIES AND OTHER DISTRIBUTORS OF TELEVISION PROGRAMMING, NAMELY, THE DISSEMINATION OF TARGETED COMMERCIAL ADVERTISING IN THE NATURE OF AUDIO AND VIDEO COMMERCIALS FOR OTHERS (U.S. CLS. 100, 101 AND 102).

FIRST USE 4-10-2000; IN COMMERCE 4-10-2000.

CLASS 35—(Continued).

2,747,770. TAPSCAN, INC., BIRMINGHAM, AL. SN 76-051,893. PUB. 6-11-2002, FILED 5-17-2000.

WEBAVAILS

OWNER OF U.S. REG. NOS. 1,430,916, 2,287,770, AND OTHERS.

FOR FACILITATING THE BUYING AND SELLING BY OTHERS OF TELEVISION AND CABLE ADVERTISING TIME VIA THE INTERNET AND ELECTRONIC MAIL; FACILITATING THE EXCHANGE OF INFORMATION REGARDING TELEVISION AND CABLE ADVERTISING TIME VIA THE INTERNET AND ELECTRONIC MAIL (U.S. CLS. 100, 101 AND 102).

FIRST USE 11-30-1999; IN COMMERCE 11-30-1999.

2,747,790. DEON RAE ERICKSON, O.D., INC., BOYNTON BEACH, FL. SN 76-066,732. PUB. 12-18-2001, FILED 6-9-2000.

ACCESSOREYES

FOR RETAIL STORE SERVICES FEATURING CONTACT LENSES AND EYEGLASSES (U.S. CLS. 100, 101 AND 102).

FIRST USE 6-0-2000; IN COMMERCE 8-0-2002.

2,747,835. CHILDBIRTH SOLUTIONS, INC., THE PLAINS, VA. SN 76-101,278. PUB. 10-15-2002, FILED 8-2-2000.

MATERNATOPIA

FOR ONLINE RETAIL STORE SERVICES FEATURING PRODUCTS AND SERVICES FOR PREGNANT WOMEN AND BABY PRODUCTS; INTERNET WEBSITE PROVIDING INFORMATION ABOUT PRODUCTS AND SERVICES FOR PREGNANT WOMEN AND BABY PRODUCTS (U.S. CLS. 100, 101 AND 102).

FIRST USE 8-0-2000; IN COMMERCE 8-0-2000.

2,747,843. SPONSORWISE, FREMONT, CA. SN 76-107,164. PUB. 7-23-2002, FILED 8-9-2000.

SPONSORWISE

FOR EXCHANGE SERVICES, NAMELY, BARTERING OF SPONSORSHIP SERVICES OF OTHERS; PROVIDING SPONSORSHIP INFORMATION; AND PROMOTING THE SPONSORSHIPS OF OTHERS VIA INTERNET-ENABLED SOFTWARE (U.S. CLS. 100, 101 AND 102).

FIRST USE 3-31-2001; IN COMMERCE 3-31-2001.

CLASS 35—(Continued).

2,747,844. BRANDJUICE CONSULTING, INC., DENVER, CO. SN 76-107,638. PUB. 10-1-2002, FILED 8-11-2000.

BRAND JUICE

OWNER OF U.S. REG. NO. 2,308,883.
NO CLAIM IS MADE TO THE EXCLUSIVE RIGHT TO USE "BRAND", APART FROM THE MARK AS SHOWN.

FOR BUSINESS MARKETING CONSULTING SERVICES; ADVERTISING SERVICES, NAMELY BRAND IMAGE DEVELOPMENT SERVICES, PRODUCT IMAGE DEVELOPMENT SERVICES, ADVERTISING AGENCY SERVICES; AND PUBLIC RELATIONS SERVICES (U.S. CLS. 100, 101 AND 102).

FIRST USE 0-0-1999; IN COMMERCE 0-0-1999.

2,747,850. INVINITY SYSTEMS CORPORATION, CALAVASAS, CA. SN 76-113,135. PUB. 5-22-2001, FILED 8-22-2000.

INVINITY

FOR PROVIDING INVENTORY CONTROL SERVICES VIA A GLOBAL COMPUTER NETWORK (U.S. CLS. 100, 101 AND 102).

FIRST USE 4-1-2001; IN COMMERCE 2-1-2002.

2,747,877. R.R.C.B. LLC, SAN DIEGO, CA. SN 76-131,236. PUB. 5-29-2001, FILED 9-19-2000.



FOR ON-LINE RETAIL STORE SERVICES FEATURING PET PRODUCTS (U.S. CLS. 100, 101 AND 102).
FIRST USE 2-1-2001; IN COMMERCE 2-1-2001.

2,747,882. UNITEDHEALTH GROUP INCORPORATED, MINNETONKA, MN. SN 76-137,985. PUB. 10-8-2002, FILED 9-29-2000.

OPTUM LIVE!

FOR EMPLOYEE ASSISTANCE SERVICES, NAMELY, PROVIDING ONLINE CONSULTATION, INFORMATION, ASSESSMENT, AND REFERRAL SERVICES FOR PHYSICAL AND MENTAL HEALTH, SUBSTANCE ABUSE, LEGAL AND FINANCIAL ISSUES, AND DAILY LIVING PROBLEMS (U.S. CLS. 100, 101 AND 102).

FIRST USE 12-0-2001; IN COMMERCE 12-0-2001.

CLASS 35—(Continued).

2,747,922. KINEXUS CORPORATION, NEW YORK, NY, BY CHANGE OF NAME WITAN GROUP, INC., THE, NEW YORK, NY. SN 76-167,003. PUB. 8-28-2001, FILED 11-17-2000.

KINEXUS

FOR PREPARING BUSINESS REPORTS; COMPUTER DATA BASE MANAGEMENT; DATA PROCESSING IN THE FIELD OF BUSINESS AND ACCOUNTING; AND ACCOUNTING SERVICES (U.S. CLS. 100, 101 AND 102).
FIRST USE 7-31-2001; IN COMMERCE 7-31-2001.

2,748,043. GRUNDMAN, TERESA LEE, SANTA CLARITA, CA. SN 76-227,534. PUB. 6-25-2002, FILED 3-17-2001.

HOMESPUN HEARTH

FOR COMPUTERIZED ON-LINE RETAIL AND WHOLESALE FABRIC STORE SERVICES FEATURING FABRICS, HOME SEWING, SERGING AND QUILTING ACCESSORIES, NOTIONS, PATTERNS, TRIMMINGS, AND CRAFTS, BY MEANS OF A GLOBAL COMPUTER NETWORK (U.S. CLS. 100, 101 AND 102).

FIRST USE 1-1-2001; IN COMMERCE 9-10-2001.

2,748,044. PENNWELL CORPORATION, TULSA, OK. SN 76-228,234. PUB. 6-18-2002, FILED 3-21-2001.

GLOBAL EQUIPMENT TRACE (GET!)

NO CLAIM IS MADE TO THE EXCLUSIVE RIGHT TO USE "GLOBAL EQUIPMENT TRACE", APART FROM THE MARK AS SHOWN.

FOR PROVIDING INFORMATION VIA A GLOBAL COMPUTER NETWORK IN THE FIELD OF EQUIPMENT USED IN THE ENERGY INDUSTRY; RESEARCH SERVICES, NAMELY RESEARCH INTO THE LOCATION AND AVAILABILITY OF EQUIPMENT USED IN THE ENERGY INDUSTRY (U.S. CLS. 100, 101 AND 102).

FIRST USE 3-0-2001; IN COMMERCE 3-0-2001.

2,748,070. ADVANCED MICRO DEVICES, INC., SUNNYVALE, CA. SN 76-239,384. PUB. 7-30-2002, FILED 4-12-2001.



NO CLAIM IS MADE TO THE EXCLUSIVE RIGHT TO USE "REWARDS PARTNER PROGRAM", APART FROM THE MARK AS SHOWN.

FOR COOPERATIVE ADVERTISING AND MARKETING (U.S. CLS. 100, 101 AND 102).

FIRST USE 6-0-2001; IN COMMERCE 6-0-2001.

CLASS 35—(Continued).

2,748,073. CAP GEMINI ERNST & YOUNG U.S. LLC, NEW YORK, NY. SN 76-239,974. PUB. 12-25-2001, FILED 4-9-2001.

CGEY.VELOCITY

FOR BUSINESS CONSULTING SERVICES IN THE FIELD OF SOFTWARE IMPLEMENTATION METHODOLOGY (U.S. CLS. 100, 101 AND 102).
FIRST USE 2-0-2000; IN COMMERCE 2-0-2000.

2,748,079. ANGEL ENGINEERS, INC., CONSHOHOCKEN, PA. SN 76-244,402. PUB. 7-9-2002, FILED 4-20-2001.

DOUBLE CHAIN

FOR BUSINESS MANAGEMENT CONSULTING SERVICES IN THE FIELD OF ELECTRONIC BUSINESS (U.S. CLS. 100, 101 AND 102).
FIRST USE 6-0-2001; IN COMMERCE 6-0-2001.

2,748,100. HIRERIGHT, INC., IRVINE, CA. SN 76-252,304. PUB. 8-6-2002, FILED 5-7-2001.

HIRERIGHT

OWNER OF U.S. REG. NOS. 1,942,442 AND 2,117,799.
FOR PRE-EMPLOYMENT SCREENING AND PERSONNEL ASSESSMENT SERVICES (U.S. CLS. 100, 101 AND 102).
FIRST USE 7-15-2001; IN COMMERCE 7-15-2001.

2,748,108. GULF SOUTH MEDICAL SUPPLY, INC., JACKSONVILLE, FL. SN 76-256,841. PUB. 7-30-2002, FILED 5-14-2001.

ANSWERS

FOR DISTRIBUTORSHIP SERVICES FEATURING A MEMBERSHIP BUYING PROGRAM IN THE FIELD OF MEDICAL SUPPLIES FOR NURSING HOMES (U.S. CLS. 100, 101 AND 102).
FIRST USE 5-31-2001; IN COMMERCE 5-31-2001.

2,748,142. MULTISALES, INC., CLEVELAND, GA. SN 76-264,806. PUB. 12-18-2001, FILED 5-31-2001.

FEATUREPRO

FOR PROMOTING FILMS, MOVIES, LIVE THEATER EVENTS, CONCERTS AND SPORTING EVENTS OF OTHERS THROUGH THE ADMINISTRATION OF AN ONLINE DIRECTORY PROGRAM (U.S. CLS. 100, 101 AND 102).
FIRST USE 3-11-2003; IN COMMERCE 3-11-2003.

CLASS 35—(Continued).

2,748,149. MCMILLIAN, ADRIAN, HERMOSA BEACH, CA. SN 76-267,189. PUB. 5-28-2002, FILED 6-6-2001.

ETAINIUM

FOR BUSINESS MANAGEMENT (U.S. CLS. 100, 101 AND 102).
FIRST USE 6-5-2002; IN COMMERCE 6-5-2002.

2,748,151. MOBILEVILLAGE LLC, PACIFICA, CA. SN 76-267,231. PUB. 7-23-2002, FILED 6-6-2001.



NO CLAIM IS MADE TO THE EXCLUSIVE RIGHT TO USE "MOBILE EXPO", APART FROM THE MARK AS SHOWN.

FOR ARRANGING AND CONDUCTING TRADE SHOWS, EXHIBITIONS AND CONFERENCES IN THE FIELD OF MOBILE AND WIRELESS TECHNOLOGY (U.S. CLS. 100, 101 AND 102).
FIRST USE 3-1-2001; IN COMMERCE 3-1-2001.

2,748,158. LE TOURNEAU, RONALD G., SOUTHFIELD, MI. SN 76-270,239. PUB. 7-9-2002, FILED 6-12-2001.

RGMD

FOR IMPORT AGENCY, DISTRIBUTORSHIP, AND WHOLESALE DISTRIBUTORSHIP SERVICES IN THE FIELD OF MEDICAL EQUIPMENT; BUSINESS CONSULTING SERVICES RELATING TO THE SALE AND DISTRIBUTION OF MEDICAL EQUIPMENT (U.S. CLS. 100, 101 AND 102).
FIRST USE 10-18-2002; IN COMMERCE 2-12-2003.

CLASS 35—(Continued).

2,748,162. PRIORITY FULFILLMENT SERVICES, INC., PLANO, TX. SN 76-271,304. PUB. 11-5-2002, FILED 6-14-2001.



OWNER OF U.S. REG. NO. 2,345,487.

NO CLAIM IS MADE TO THE EXCLUSIVE RIGHT TO USE "WEB", APART FROM THE MARK AS SHOWN.

FOR ORDER FULFILLMENT SERVICES, INTEGRATED TRACKING AND MANAGEMENT OF COMMERCIAL TRANSACTIONS, INVENTORY MANAGEMENT OF COMPUTER HARDWARE, SOFTWARE, PERIPHERALS AND SUPPLIES, CONSUMER ELECTRONICS, COSMETICS, APPAREL, NUMISMATICS, HOUSEWARES, BOOKS AND TELECOMMUNICATION EQUIPMENT, BILLING SERVICES, ON-LINE DISTRIBUTORSHIPS FEATURING COMPUTER HARDWARE, SOFTWARE, PERIPHERALS AND SUPPLIES, CONSUMER ELECTRONICS, COSMETICS, APPAREL, NUMISMATICS, HOUSEWARES, BOOKS, TELECOMMUNICATION EQUIPMENT (U.S. CLS. 100, 101 AND 102).

FIRST USE 3-6-2001; IN COMMERCE 3-6-2001.

2,748,165. MEDIMART PHARMACY, L.L.C., NORTH KANSAS CITY, MO. SN 76-273,832. PUB. 6-11-2002, FILED 6-20-2001.

STAR MEDICAL RX

NO CLAIM IS MADE TO THE EXCLUSIVE RIGHT TO USE "MEDICAL RX", APART FROM THE MARK AS SHOWN.

FOR MAIL ORDER SERVICES FEATURING PHARMACEUTICAL PRODUCTS, NAMELY RESPIRATORY MEDICATIONS AND OXYGEN EQUIPMENT (U.S. CLS. 100, 101 AND 102).

FIRST USE 8-0-2001; IN COMMERCE 8-0-2001.

2,748,183. GC INVESTMENT HOLDINGS, INC., STONE MOUNTAIN, GA. SN 76-280,677. PUB. 10-29-2002, FILED 7-5-2001.

GOODCENTS SOLUTIONS

OWNER OF U.S. REG. NOS. 1,111,117, 2,420,775, AND OTHERS.

FOR BUSINESS MARKETING CONSULTING SERVICES, NAMELY, PROVIDING MARKETING PROGRAMS IN THE FIELDS OF ENERGY EFFICIENCY AND ENERGY MANAGEMENT (U.S. CLS. 100, 101 AND 102).

FIRST USE 5-1-2001; IN COMMERCE 5-1-2001.

CLASS 35—(Continued).

2,748,191. MANNING & NAPIER INFORMATION SERVICES, LLC, ROCHESTER, NY. SN 76-283,084. PUB. 8-20-2002, FILED 7-11-2001.



THE STIPLING IS NOT A FEATURE OF THE MARK, BUT FOR SHADING PURPOSES ONLY.

FOR BUSINESS CONSULTATION IN THE INFORMATION TECHNOLOGY INDUSTRY (U.S. CLS. 100, 101 AND 102).

FIRST USE 3-31-2001; IN COMMERCE 3-0-2002.

2,748,338. HDN DEVELOPMENT CORPORATION, FLORINCE, KY. SN 76-333,056. PUB. 9-10-2002, FILED 11-1-2001.



OWNER OF U.S. REG. NOS. 939,106, 2,452,758, AND OTHERS.

FOR DOUGHNUT SHOP SERVICES (U.S. CLS. 100, 101 AND 102).

FIRST USE 5-0-2001; IN COMMERCE 5-0-2001.

2,748,347. NETKIN, ROBERT S., MOUNTAIN VIEW, CA. SN 76-335,429. PUB. 5-28-2002, FILED 11-8-2001.

THE MAGIC BASKET

FOR WHOLESALE AND RETAIL STORE SERVICES ALL FEATURING CD-ROMS, DVDS, VIDEOS, BOOKS AND DOLLS ALL FEATURING FICTIONAL CHARACTERS AND MATERIAL RELATED THERETO; ONLINE WHOLESALE AND ONLINE RETAIL STORE SERVICES ALL FEATURING CD-ROMS, DVDS, VIDEOS, BOOKS AND DOLLS ALL FEATURING FICTIONAL CHARACTERS AND MATERIAL RELATED THERETO (U.S. CLS. 100, 101 AND 102).

FIRST USE 5-8-2002; IN COMMERCE 5-8-2002.

CLASS 35—(Continued).

2,748,364. LUND'S, INC., EDINA, MN. SN 76-339,587. PUB. 8-6-2002, FILED 11-19-2001.



OWNER OF U.S. REG. NOS. 1,644,042, 1,685,461, AND OTHERS.

FOR RETAIL GROCERY STORES SERVICES; RETAIL STORE SERVICES FEATURING WINE, BEER AND SPIRITS (U.S. CLS. 100, 101 AND 102).

FIRST USE 1-1-1978; IN COMMERCE 1-1-1978.

2,748,370. MAXIM HEALTHCARE SERVICES, INC., CO-LUMBIA, MD. SN 76-341,654. PUB. 5-14-2002, FILED 11-27-2001.

TRAVELMAX MEDICAL PROFESSIONALS

NO CLAIM IS MADE TO THE EXCLUSIVE RIGHT TO USE "MEDICAL PROFESSIONALS", APART FROM THE MARK AS SHOWN.

FOR EMPLOYMENT AGENCY SERVICES RELATING TO THE TEMPORARY AND PERMANENT PLACEMENT OF PROFESSIONAL AND ADMINISTRATIVE MEDICAL PERSONNEL (U.S. CLS. 100, 101 AND 102).

FIRST USE 8-1-2002; IN COMMERCE 8-1-2002.

2,748,380. PACIFIC SALES KITCHEN AND BATH CENTERS, INC., TORRANCE, CA. SN 76-346,982. PUB. 12-3-2002, FILED 12-9-2001.

PACIFIC SALES

NO CLAIM IS MADE TO THE EXCLUSIVE RIGHT TO USE "SALES", APART FROM THE MARK AS SHOWN.

FOR RETAIL STORE SERVICES DIRECTED TO HOME CONSTRUCTION, FURNISHING, AND DECORATING PRODUCTS INCLUDING KITCHEN EQUIPMENT AND APPLIANCES; BATHROOM AND KITCHEN FIXTURES; BATHROOM AND KITCHEN PLUMBING FIXTURES, EQUIPMENT, AND HARDWARE; BATHROOM AND KITCHEN CABINETS HARDWARE; HOME ENTERTAINMENT PRODUCTS AND SYSTEMS INCLUDING TELEVISIONS, SPEAKERS, HOME THEATER AND AUDIO SYSTEMS, AND RELATED FURNITURE AND CABINETS; HOME FURNISHINGS INCLUDING FURNITURE; AND MATTRESSES (U.S. CLS. 100, 101 AND 102).

FIRST USE 0-0-1969; IN COMMERCE 0-0-1969.

CLASS 35—(Continued).

2,748,410. ADVANTIUM, INC., MACEDONIA, OH. SN 76-352,841. PUB. 7-23-2002, FILED 12-27-2001.

AUDITCARE

FOR BUSINESS CONSULTATION RELATED TO AUTOMATED AUDITING OF SUPPLY-CHAIN TRANSACTIONS AND BUSINESS PROCESS IMPROVEMENT SERVICES (U.S. CLS. 100, 101 AND 102).

FIRST USE 11-13-2001; IN COMMERCE 11-13-2001.

2,748,416. LYLE ANDERSON COMPANY, INC., THE, SCOTTSDALE, AZ. SN 76-354,695. PUB. 5-28-2002, FILED 1-3-2002.



FOR RETAIL STORE SERVICES AND MAIL ORDER SERVICES FEATURING CLOTHING FOR MEN, WOMEN AND CHILDREN, NAMELY, SHIRTS, SWEATSHIRTS AND SHORTS, PANTS, SHORTS, SWEATERS, JACKETS, ATHLETIC SHOES, SANDALS, UMBRELLAS, HATS, VISORS, SUNGLASSES, ALL PURPOSE ATHLETIC BAGS, TOTE BAGS; GOLF EQUIPMENT, NAMELY GOLF BALLS, GOLF BAGS, GOLF TEES; TENNIS EQUIPMENT, NAMELY, TENNIS RACKETS, AND TENNIS BALLS (U.S. CLS. 100, 101 AND 102).

FIRST USE 12-31-2000; IN COMMERCE 12-31-2000.

2,748,417. ETREBY COMPUTER COMPANY, INC., ANAHEIM, CA. SN 76-354,771. PUB. 9-3-2002, FILED 1-2-2002.

FLASHRX.COM

FOR ON-LINE RETAIL STORE SERVICES FEATURING PHARMACEUTICALS, OVER-THE-COUNTER DRUGS, PRESCRIPTION DRUGS, HEALTH SUPPLIES, AND BEAUTY SUPPLIES (U.S. CLS. 100, 101 AND 102).

FIRST USE 12-4-2001; IN COMMERCE 12-4-2001.

CLASS 35—(Continued).

2,748,435. COUNT ON ME, L.L.C., PASSAIC, NJ. SN 76-360,762. PUB. 10-15-2002, FILED 1-17-2002.

COUNT ON ME

FOR DATA COLLECTION AND PROCESSING SERVICES, NAMELY, THE COLLECTION AND COMPILATION OF DATA CONCERNING RETAIL PURCHASE AND SALES FOR USE IN CALCULATING REBATE AND INCENTIVE PAYMENTS TO BE MADE (U.S. CLS. 100, 101 AND 102).

FIRST USE 5-1-2002; IN COMMERCE 5-1-2002.

CLASS 35—(Continued).

2,748,453. ADVANCED INVENTORY TECHNOLOGIES, INC., KANSAS CITY, KS. SN 76-365,722. PUB. 8-6-2002, FILED 2-1-2002.

THERAWEAR

FOR ONLINE RETAIL STORE SERVICES AND MAIL ORDER SERVICES IN THE FIELD OF COMPRESSION PRODUCTS AND HOSIERY, SEAMLESS SOCKS, THERAPEUTIC SUPPORTS AND BRACES, HEEL AND ELBOW PADS FOR PROTECTIVE AND THERAPEUTIC PURPOSES, AND DIABETIC PRODUCTS (U.S. CLS. 100, 101 AND 102).

FIRST USE 4-1-2002; IN COMMERCE 4-1-2002.

2,748,436. MARKET DIRECTIONS, INC., KANSAS CITY, MO. SN 76-361,356. PUB. 10-8-2002, FILED 1-18-2002.

MAP

FOR CONSUMER RESEARCH SERVICES, NAMELY, USING A TESTING METHODOLOGY TO ESTIMATE THE SALES POTENTIAL OF A PRODUCT (U.S. CLS. 100, 101 AND 102).

FIRST USE 1-1-2003; IN COMMERCE 1-1-2003.

2,748,445. PRICEBARGAINS.COM, LLC, CHATHAM, NJ. SN 76-363,937. PUB. 7-23-2002, FILED 1-29-2002.

BARGAINGURU

FOR OPERATING ON-LINE MARKETPLACE FOR SELLERS OF GOODS AND SERVICES (U.S. CLS. 100, 101 AND 102).

FIRST USE 3-21-2002; IN COMMERCE 3-21-2002.

2,748,452. ITRAC OF OHIO, INC., COLUMBUS, OH, BY ASSIGNMENT PROFIT OR SAVINGS ENTERPRISE, INC., CLEVELAND, OH. SN 76-365,455. PUB. 8-20-2002, FILED 2-1-2002.

DON'T TRASH YOUR CASH!

FOR BUSINESS MANAGEMENT CONSULTATION SERVICES IN THE FIELD OF WASTE MANAGEMENT (U.S. CLS. 100, 101 AND 102).

FIRST USE 4-9-2002; IN COMMERCE 4-9-2002.

2,748,465. TROXELL, MICKEY K., HUNTINGTON BEACH, CA. SN 76-370,662. PUB. 10-29-2002, FILED 2-14-2002.

CERTIFIED THERAPY HORSE ASSOCIATION (CTHA)

NO CLAIM IS MADE TO THE EXCLUSIVE RIGHT TO USE "CERTIFIED THERAPY HORSE ASSOCIATION", APART FROM THE MARK AS SHOWN.

FOR ASSOCIATION SERVICES, NAMELY, PROMOTING THE INTERESTS OF HORSE THERAPY GIVERS AND HORSE CAREGIVERS (U.S. CLS. 100, 101 AND 102).

FIRST USE 2-0-2001; IN COMMERCE 2-0-2001.

2,748,466. ZENGIGI DESIGN, INC., BETHESDA, MD. SN 76-371,044. PUB. 7-23-2002, FILED 2-15-2002.



NO CLAIM IS MADE TO THE EXCLUSIVE RIGHT TO USE "DESIGN", APART FROM THE MARK AS SHOWN.

FOR ADVERTISING, MARKETING AND SALES PROMOTIONAL SERVICES FOR OTHERS, NAMELY, PROMOTING THE GOODS OR SERVICES OF OTHERS THROUGH THE DISTRIBUTION OF PRINTED, AUDIO, VIDEO AND ELECTRONIC PROMOTIONAL MATERIALS; THE CREATION OF CORPORATE LOGOS AND TRADEMARKS FOR OTHERS; IMPORT AGENCY SERVICES FEATURING FURNITURE AND HOUSEHOLD ITEMS; RETAIL STORE AND DISTRIBUTORSHIP SERVICES FEATURING FURNITURE AND HOUSEHOLD ITEMS (U.S. CLS. 100, 101 AND 102).

FIRST USE 4-1-2003; IN COMMERCE 4-1-2003.

CLASS 35—(Continued).

2,748,474. PREST-O-FIT MFG., INC., CHANDLER, AZ. SN 76-373,312. PUB. 11-12-2002, FILED 2-20-2002.

PRODUCTS RVERS RELY ON

FOR RETAIL STORE SERVICES, MAIL ORDER SERVICES AND ONLINE RETAIL STORE SERVICES IN THE FIELD OF EQUIPMENT, NAMELY, SEWER ELBOWS, PUSHOVER QUICK CONNECTORS, STRAIGHT HOSE COUPLERS, SEWER HOSE ADAPTERS, PUSHOVER TERMINATION CAPS, ELBOW STORAGE FITTINGS, SEWER HOSES, SEWER HOSE SUPPORTS AND PROTECTORS, HOSE COUPLER KITS, QUICK CONNECT SEWER KITS, SEWER KITS, TERMINATION KITS, STAINLESS CLAMPS, STEP RUGS, DOOR MATS, PATIO RUGS, RV INDOOR RUGS, BATHROOM MATS, KITCHEN MATS, HALL RUNNERS, WELCOME MATS AND SPRINGS, FOR USE WITH RECREATIONAL VEHICLES (U.S. CLS. 100, 101 AND 102).

FIRST USE 4-30-2002; IN COMMERCE 4-30-2002.

2,748,487. YELLOW PAGES INTEGRATED MEDIA ASSOCIATION, BERKELEY HTS, NJ. SN 76-379,682. PUB. 11-12-2002, FILED 3-7-2002.

YPIMA

FOR ASSOCIATION SERVICES, NAMELY PROMOTING THE INTEREST OF YELLOW PAGES PUBLISHERS ON BEHALF OF ASSOCIATION MEMBERS (U.S. CLS. 100, 101 AND 102).

FIRST USE 3-17-2002; IN COMMERCE 3-17-2002.

2,748,508. MILITARY OFFICERS ASSOCIATION OF AMERICA, ALEXANDRIA, VA, BY CHANGE OF NAME RETIRED OFFICERS ASSOCIATION, THE, ALEXANDRIA, VA. SN 76-385,315. PUB. 9-24-2002, FILED 3-18-2002.

MOAA

FOR ASSOCIATION SERVICES; NAMELY, PROMOTING THE INTERESTS OF MILITARY OFFICERS (U.S. CLS. 100, 101 AND 102).

FIRST USE 12-27-2002; IN COMMERCE 12-27-2002.

2,748,530. HEART OF AMERICA UNITED WAY, INC., KANSAS CITY, MO. SN 76-395,035. PUB. 12-24-2002, FILED 4-11-2002.

CARING CLUB

FOR ADMINISTRATION OF A PROGRAM THAT PERMITS HOLDERS OF DISCOUNT CARDS TO OBTAIN DISCOUNTS ON GOODS AND SERVICES FROM VARIOUS MERCHANTS (U.S. CLS. 100, 101 AND 102).

FIRST USE 5-1-2002; IN COMMERCE 5-1-2002.

CLASS 35—(Continued).

2,748,546. SMITH WEAVER SMITH, INC., INDIANAPOLIS, IN. SN 76-401,376. PUB. 12-10-2002, FILED 4-29-2002.

THE STRATEGY STUDIO

FOR BUSINESS SERVICES, NAMELY, THE PROVISION OF OFFICE SPACE AND FACILITIES FOR BUSINESS AND COMMUNITY GROUPS TO HOLD SESSIONS, CONFERENCES, AND MEETINGS TO IMPROVE AND ACCELERATE BUSINESSES DEVELOPMENT, ECONOMIC DEVELOPMENT, AND COMMUNITY DEVELOPMENT (U.S. CLS. 100, 101 AND 102).

FIRST USE 6-0-2002; IN COMMERCE 6-0-2002.

2,748,554. INTEGER GROUP, L.L.C., THE, GOLDEN, CO. SN 76-407,215. PUB. 11-12-2002, FILED 5-10-2002.

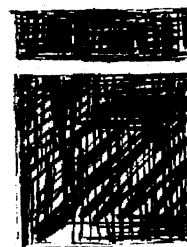

integer

FOR ADVERTISING AGENCY SERVICES; NAMELY, PROMOTING THE GOODS AND SERVICES OF OTHERS BY PREPARING AND PLANNING ADVERTISEMENTS AND DEVELOPING MARKETING PROGRAMS (U.S. CLS. 100, 101 AND 102).

FIRST USE 3-0-2002; IN COMMERCE 3-0-2002.

2,748,578. RATRIX ANALYTICS LLC, BEDMINSTER, NJ. SN 76-975,445. PUB. 5-28-2002, FILED 1-23-2001.

RATRIX

FOR MARKET RESEARCH; BUSINESS RESEARCH SERVICES ON INTANGIBLE CORPORATE ASSETS, CORPORATE IMAGE, CORPORATE MANAGEMENT, CORPORATE GOVERNANCE, BRAND EQUITY, HUMAN RESOURCES, CUSTOMER SERVICES, PRODUCT AND SERVICE DELIVERY AND INNOVATION, INVENTORY AND SUPPLY CHAIN, AND OTHER ASPECTS OF BUSINESSES; CUSTOMIZED BUSINESS RESEARCH FOR OTHERS; PROVIDING AN ONLINE DATABASE OF MARKET RESEARCH AND RATINGS OF INTANGIBLE CORPORATE ASSETS; PREPARING BUSINESS REPORTS AND PROVIDING REPORTS ON THE FOREGOING (U.S. CLS. 100, 101 AND 102).

FIRST USE 12-3-2002; IN COMMERCE 12-3-2002.

CLASS 35—(Continued).

2,748,609. INNOVEX L.P., PARSIPPANY, NJ. SN 78-017,851. PUB. 1-8-2002, FILED 7-21-2000.

MDUNITS

FOR PROMOTING THE WEBSITES, PRODUCTS, AND SERVICES OF OTHERS BY AWARDING PURCHASE POINTS TO CONSULTING PHYSICIANS IN EXCHANGE FOR PROVIDING ON-LINE EVALUATIONS OF THE PRODUCTS AND SERVICES OF OTHERS (U.S. CLS. 100, 101 AND 102).

FIRST USE 8-31-2001; IN COMMERCE 8-31-2001.

2,748,616. LOCATION INC GROUP CORPORATION, DBA LOCATION INC, WORCESTER, MA. SN 78-024,487. PUB. 1-7-2003, FILED 9-6-2000.

MOVINGSCOUT

FOR PROVIDING A WEBSITE ON A GLOBAL COMPUTER NETWORK FEATURING MAPS, DIRECTORIES AND INFORMATION REGARDING THE DEMOGRAPHICS, CHARACTER AND ECONOMIC CLIMATE IN A PARTICULAR CHOSEN GEOGRAPHIC AREA; PROVIDING A WEBSITE ON A GLOBAL COMPUTER NETWORK FOR OBTAINING USER PREFERENCES REGARDING GEOGRAPHIC LOCATIONS AND COMPARING THE DEMOGRAPHICS, CHARACTER AND ECONOMIC CLIMATE OF THOSE GEOGRAPHIC LOCATIONS TO DETERMINE SIMILARLY COMPATIBLE GEOGRAPHIC LOCATIONS; AND PROVIDING A WEBSITE FEATURING INFORMATION ABOUT AND ADVERTISEMENTS FOR THE GOODS AND SERVICES OF OTHERS IN GEOGRAPHIC LOCATIONS SELECTED BY THE USER (U.S. CLS. 100, 101 AND 102).

FIRST USE 6-9-2000; IN COMMERCE 5-1-2003.

2,748,619. HEWLETT-PACKARD COMPANY, PALO ALTO, CA. SN 78-026,899. PUB. 3-5-2002, FILED 9-20-2000.

KEYCHAIN

FOR BUSINESS MANAGEMENT CONSULTING, ECONOMIC FORECASTING, LOGISTICS PLANNING, INVENTORY MANAGEMENT, AND PROCUREMENT SERVICES, NAMELY, PURCHASING BUSINESS SUPPLIES FOR OTHERS (U.S. CLS. 100, 101 AND 102).

FIRST USE 8-0-2000; IN COMMERCE 8-0-2000.

2,748,625. GENERAL MILLS, INC., MINNEAPOLIS, MN. SN 78-031,918. PUB. 6-4-2002, FILED 10-23-2000.

QUICK CAT

FOR PROVIDING CUSTOM ANALYSIS OF RETAIL SALES TO FOOD RETAILERS TO AID THEM IN MANAGING THEIR RETAILING STRATEGIES (U.S. CLS. 100, 101 AND 102).

FIRST USE 11-30-2001; IN COMMERCE 11-30-2001.

CLASS 35—(Continued).

2,748,629. BRAUN, KATHRYN A., MONTGOMERY, AL. SN 78-033,921. PUB. 2-19-2002, FILED 11-5-2000.

MARKETING MEMORIES

NO CLAIM IS MADE TO THE EXCLUSIVE RIGHT TO USE "MARKETING", APART FROM THE MARK AS SHOWN.

FOR MARKET RESEARCH; BUSINESS CONSULTATION SERVICES (U.S. CLS. 100, 101 AND 102).

FIRST USE 11-0-2000; IN COMMERCE 11-0-2000.

2,748,642. MAILCODE, INC., LAFAYETTE, IN. SN 78-042,704. PUB. 9-18-2001, FILED 1-11-2001.

POSTBACKOFFICE.COM

FOR COMPUTERIZED TRACKING AND TRACING OF MAIL AND PACKAGES IN TRANSIT (U.S. CLS. 100, 101 AND 102).

FIRST USE 7-31-2001; IN COMMERCE 12-31-2002.

2,748,655. USBX, INC., SANTA MONICA, CA. SN 78-048,435. PUB. 3-19-2002, FILED 2-14-2001.



FOR BUSINESS ADMINISTRATION SERVICES, NAMELY PROVIDING A DATABASE FEATURING COMPUTERIZED TRACKING OF SMALL BUSINESS MERGERS AND ACQUISITIONS VIA A GLOBAL COMMUNICATIONS NETWORK (U.S. CLS. 100, 101 AND 102).

FIRST USE 12-1-2000; IN COMMERCE 6-1-2001.

2,748,658. PROMOSQUAD LLC, SARATOGA SPRINGS, NY. SN 78-049,677. PUB. 6-25-2002, FILED 2-22-2001.

PROMOSQUAD

FOR ON-LINE DIRECT MARKETING ADVERTISING FOR OTHERS IN THE FIELD OF MUSIC; ON-LINE COOPERATIVE ADVERTISING AND MARKETING SERVICES IN THE FIELD OF MUSIC (U.S. CLS. 100, 101 AND 102).

FIRST USE 7-0-2000; IN COMMERCE 7-0-2000.

CLASS 35—(Continued).

2,748,665. FMR CORP., BOSTON, MA. SN 78-051,822. PUB. 7-16-2002, FILED 3-7-2001.

FIDELITY ADVISORACCESS

OWNER OF U.S. REG. NOS. 1,277,373, 1,278,300, AND OTHERS.

FOR REFERRAL SERVICES IN THE FIELD OF INVESTMENT ADVICE AND FINANCIAL PLANNING (U.S. CLS. 100, 101 AND 102).

FIRST USE 12-31-2001; IN COMMERCE 12-31-2001.

2,748,695. CAMPBELL, WENDY W., OAKLAND, CA. SN 78-067,022. PUB. 7-30-2002, FILED 6-2-2001.

SAN FRANCISCO AND BEYOND

NO CLAIM IS MADE TO THE EXCLUSIVE RIGHT TO USE "SAN FRANCISCO", APART FROM THE MARK AS SHOWN.

FOR PROMOTING THE GOODS AND SERVICES OF OTHERS BY PROVIDING HYPERTEXT LINKS TO THE WEBSITES OF OTHERS; PROMOTING THE GOODS AND SERVICES OF OTHERS BY PREPARING AND PLACING ADVERTISEMENTS AND REVIEWS ON A GLOBAL NETWORK COMPUTER WEBSITE; PROVIDING A WEBSITE AT WHICH ADVERTISERS AND SPONSORS CAN OFFER GOODS FOR SALE AND SERVICES WHICH OTHERS CAN BUY VIA HYPERTEXT LINKS TO THE ADVERTISERS; PROVIDING A WEBSITE WHICH FEATURES ADVERTISEMENTS OF THE GOODS AND SERVICES OF OTHERS ON A GLOBAL COMPUTER NETWORK; PROVIDING SPACE AT A WEBSITE FOR THE ADVERTISEMENT OF THE GOODS AND SERVICES OF OTHERS (U.S. CLS. 100, 101 AND 102).

FIRST USE 10-31-2001; IN COMMERCE 10-31-2002.

2,748,698. TXU ENERGY SERVICES COMPANY, DALLAS, TX. SN 78-067,369. PUB. 8-27-2002, FILED 6-5-2001.

ASSURANCE ENERGY

NO CLAIM IS MADE TO THE EXCLUSIVE RIGHT TO USE "ENERGY", APART FROM THE MARK AS SHOWN.

FOR PROCUREMENT, NAMELY, PURCHASING ELECTRIC ENERGY GENERATED BY ANOTHER PARTY WHICH IS THEN PASSED ON TO CONSUMERS; MARKETING OF ELECTRIC ENERGY GENERATED BY OTHERS BY PROVIDING ADVERTISING MATERIALS VIA PRINT MEDIA AND WEBSITES (U.S. CLS. 100, 101 AND 102).

FIRST USE 1-1-2002; IN COMMERCE 1-1-2002.

CLASS 35—(Continued).

2,748,704. ONENECK IT SERVICES, CORPORATION, SCOTTSDALE, AZ. SN 78-070,624. PUB. 9-24-2002, FILED 6-22-2001.

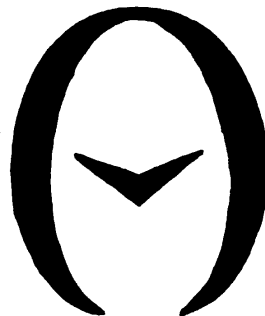

FOR OUTSOURCING SERVICES FOR OTHERS IN THE FIELD OF INFORMATION TECHNOLOGY (U.S. CLS. 100, 101 AND 102).

FIRST USE 6-1-2001; IN COMMERCE 6-1-2001.

2,748,706. MILANIAN, CYRUS, POMPANO BEACH, FL. SN 78-071,927. PUB. 1-8-2002, FILED 7-2-2001.

SPAIN, THE LAS VEGAS EXPERIENCE

FOR BUSINESS MANAGEMENT OF RESORT HOTELS, CASINOS AND THEME PARKS FOR OTHERS AND PRODUCTS MERCHANDISING SERVICES (U.S. CLS. 100, 101 AND 102).

FIRST USE 5-0-2000; IN COMMERCE 5-0-2000.

2,748,774. META GROUP, INC., STAMFORD, CT. SN 78-087,423. PUB. 10-8-2002, FILED 10-8-2001.

METASPECTRUM

FOR COMPUTERIZED EVALUATION SERVICES, NAMELY, EVALUATING THE MARKETPLACE FOR INFORMATION TECHNOLOGY AND SERVICE VENDORS THROUGH THE APPLICATION OF A METHODOLOGY EMBODIED OR DELIVERED VIA THE INTERNET (U.S. CLS. 100, 101 AND 102).

FIRST USE 9-30-2001; IN COMMERCE 9-30-2001.

CLASS 35—(Continued).

2,748,775. PICKERING & SIMMONS LLC, EDISON, NJ. SN 78-087,546. PUB. 2-12-2002, FILED 10-9-2001.

OLD DURHAM ROAD

FOR MAIL ORDER CATALOG SERVICES AND ON-LINE RETAIL STORE SERVICES FEATURING HOME PRODUCTS AND COLLECTIBLES (U.S. CLS. 100, 101 AND 102).

FIRST USE 9-25-2001; IN COMMERCE 9-25-2001.

2,748,781. TRANS/MID-AMERICA, INC., OMAHA, NE. SN 78-090,385. PUB. 1-7-2003, FILED 10-26-2001.



THE MARK CONSISTS OF AN ARBITRARY GEOMETRIC SHAPE DEPICTING NO KNOWN SUBJECT.

FOR OBTAINING TEMPORARY STATE TRUCKING PERMITS AND PROVIDING FOR THE PAYMENT OF FEES THEREFOR FOR HEAVY TRUCKING COMPANIES (U.S. CLS. 100, 101 AND 102).

FIRST USE 0-0-1989; IN COMMERCE 0-0-1989.

2,748,793. SASH MANAGEMENT L.L.C., DBA GIFT CHECK SOLUTIONS, BLUFFDALE, UT. SN 78-093,314. PUB. 11-19-2002, FILED 11-14-2001.

Franchise Friendly

NO CLAIM IS MADE TO THE EXCLUSIVE RIGHT TO USE "FRANCHISE", APART FROM THE MARK AS SHOWN.

FOR ISSUING GIFT CERTIFICATES WHICH MAY THEN BE REDEEMED FOR GOODS OR SERVICES (U.S. CLS. 100, 101 AND 102).

FIRST USE 1-0-2003; IN COMMERCE 1-0-2003.

CLASS 35—(Continued).

2,748,809. BEVERLY ENTERPRISES INC., FORT SMITH, AR. SN 78-098,386. PUB. 7-16-2002, FILED 12-14-2001.

CERES STRATEGIES

FOR PROCUREMENT, NAMELY, PURCHASING GOODS AND SERVICES FOR NURSING HOMES (U.S. CLS. 100, 101 AND 102).

FIRST USE 1-21-2002; IN COMMERCE 1-21-2002.

2,748,811. CD LISTENING BAR, INC., IRVINE, CA. SN 78-098,468. PUB. 7-23-2002, FILED 12-14-2001.

SUPERFILE

FOR COMPUTER SERVICES, NAMELY, PROVIDING DATABASES OF PUBLISHERS AND MANUFACTURERS (U.S. CLS. 100, 101 AND 102).

FIRST USE 8-10-2001; IN COMMERCE 10-10-2002.

2,748,825. SIGNHERE ONLINE, RIDGEFIELD, NJ. SN 78-100,463. PUB. 7-23-2002, FILED 12-31-2001.



FOR PROMOTING THE GOODS AND SERVICES OF OTHERS BY PREPARING AND PLACING ADVERTISEMENTS IN AN ELECTRONIC MAGAZINE ACCESSED THROUGH A GLOBAL COMPUTER NETWORK (U.S. CLS. 100, 101 AND 102).

FIRST USE 11-15-2000; IN COMMERCE 10-15-2002.

2,748,826. CROSBY GROUP, INC., THE, TULSA, OK. SN 78-100,497. PUB. 8-6-2002, FILED 1-2-2002.

CROSBY MARKET SEGMENTOR

OWNER OF U.S. REG. NOS. 623,420, 1,100,565, AND 1,139,374.

FOR ELECTRONIC CATALOG SERVICES, NAMELY CATALOGS ON CD ROM AND WEB-BASED CATALOGS FEATURING LIFTING PRODUCTS (U.S. CLS. 100, 101 AND 102).

FIRST USE 2-24-2002; IN COMMERCE 2-24-2002.

CLASS 35—(Continued).

2,748,828. PAZ, SONYA, SAN JOSE, CA. SN 78-101,045. PUB. 10-15-2002, FILED 1-4-2002.

SPAZ ART

NO CLAIM IS MADE TO THE EXCLUSIVE RIGHT TO USE "ART", APART FROM THE MARK AS SHOWN.

FOR RETAIL ART GALLERY SERVICES FEATURING ORIGINAL PAINTINGS, PRINTS, GREETING CARDS AND POSTCARDS; ON-LINE ART GALLERY SERVICES (U.S. CLS. 100, 101 AND 102).

FIRST USE 10-1-1999; IN COMMERCE 10-1-1999.

2,748,870. WEB SERVICE COMPANY, INC., REDONDO BEACH, CA. SN 78-107,534. PUB. 9-10-2002, FILED 2-7-2002.

PARTNERS OF DISTINCTION

FOR ADMINISTRATION OF A DISCOUNT AND INCENTIVE AWARD PROGRAM TO MEMBERS TO PROMOTE THE SALE OF PRODUCTS AND SERVICES OF OTHERS (U.S. CLS. 100, 101 AND 102).

FIRST USE 6-24-2002; IN COMMERCE 6-24-2002.

2,748,907. PLANNED PARENTHOOD FEDERATION OF AMERICA, INC., NEW YORK, NY. SN 78-116,913. PUB. 10-29-2002, FILED 3-22-2002.

REAL LIFE. REAL TALK.

FOR PROMOTING PUBLIC AWARENESS OF THE NEED FOR OPEN AND ACCURATE COMMUNICATION ABOUT HUMAN SEXUALITY (U.S. CLS. 100, 101 AND 102).

FIRST USE 12-0-2001; IN COMMERCE 12-0-2001.

2,748,918. MENASHA CORPORATION, NEENAH, WI. SN 78-119,496. PUB. 10-29-2002, FILED 4-4-2002.

RXEDGE

OWNER OF U.S. REG. NO. 2,350,424.
FOR PLACEMENT OF ADVERTISEMENTS FOR OTHERS, NAMELY THE PLACEMENT OF COUPONS, INFORMATIONAL MATERIAL, AND ADVERTISING DISPENSER BOXES IN STORES HAVING PHARMACIES (U.S. CLS. 100, 101 AND 102).

FIRST USE 4-19-2002; IN COMMERCE 4-19-2002.

CLASS 35—(Continued).

2,748,945. CITICASTERS CO., BURBANK, CA. SN 78-127,303. PUB. 11-5-2002, FILED 5-8-2002.

YEAH BABY!

FOR ARRANGING AND CONDUCTING TRADE SHOWS IN THE FIELD OF BABY PRODUCTS AND SERVICES (U.S. CLS. 100, 101 AND 102).

FIRST USE 3-31-2002; IN COMMERCE 3-31-2002.

2,748,956. XPAYS, INC., SAN FRANCISCO, CA. SN 78-130,901. PUB. 12-3-2002, FILED 5-23-2002.

DIALERCASH

FOR DISSEMINATION OF ADVERTISING OF THE GOODS AND SERVICES OF OTHERS VIA A GLOBAL COMPUTER NETWORK (U.S. CLS. 100, 101 AND 102).

FIRST USE 5-23-2002; IN COMMERCE 12-6-2002.

2,748,983. CITGO PETROLEUM CORPORATION, TULSA, OK. SN 78-139,496. PUB. 12-31-2002, FILED 6-27-2002.

BOUNCEBACK

FOR PROMOTING THE SALE OF GOODS AND SERVICES OF OTHERS BY AWARDING PURCHASE POINTS FOR CREDIT CARD USE (U.S. CLS. 100, 101 AND 102).

FIRST USE 9-0-2002; IN COMMERCE 9-0-2002.

CLASS 36—INSURANCE AND FINANCIAL

2,747,473. COOK INLET ENERGY SUPPLY L.L.C., LOS ANGELES, CA, BY CHANGE OF NAME; COOK INLET ENERGY SUPPLY LIMITED PARTNERSHIP, LOS ANGELES, CA. SN 75-461,069. PUB. 6-5-2001, FILED 4-2-1998.



NO CLAIM IS MADE TO THE EXCLUSIVE RIGHT TO USE "ENERGY", APART FROM THE MARK AS SHOWN.
FOR NATURAL GAS AND ELECTRICITY BROKERAGE (U.S. CLS. 100, 101 AND 102).

FIRST USE 5-0-1998; IN COMMERCE 5-0-1998.

CLASS 36—(Continued).

2,747,487. URBAN TELEVISION NETWORK, INC., MARINA DEL RAY, CA. SN 75-515,596. PUB. 2-15-2000, FILED 7-8-1998.

FREEDOM CARD INSURANCE

NO CLAIM IS MADE TO THE EXCLUSIVE RIGHT TO USE "CARD INSURANCE", APART FROM THE MARK AS SHOWN.

FOR LIFE INSURANCE UNDERWRITING; CASUALTY INSURANCE UNDERWRITING; AND HEALTH INSURANCE UNDERWRITING (U.S. CLS. 100, 101 AND 102).

FIRST USE 10-1-2002; IN COMMERCE 10-1-2002.

2,747,494. SOUTHERN HIGHLANDS, L.L.C., SCOTTSDALE, AZ. SN 75-534,331. PUB. 10-12-1999, FILED 8-11-1998.



THE MARK CONSISTS IN PART OF THE LETTERS "SH". FOR REAL ESTATE MANAGEMENT SERVICES FOR RESIDENTIAL COMMUNITIES AND GOLF COURSE FACILITIES (U.S. CLS. 100, 101 AND 102).
FIRST USE 1-31-1999; IN COMMERCE 1-31-1999.

2,747,508. FIRST TENNESSEE NATIONAL CORPORATION, MEMPHIS, TN. SN 75-574,960. PUB. 4-2-2002, FILED 10-22-1998.

FIRST HORIZON HOME LOANS

OWNER OF U.S. REG. NO. 1,362,420.
NO CLAIM IS MADE TO THE EXCLUSIVE RIGHT TO USE "HOME LOANS", APART FROM THE MARK AS SHOWN.
FOR MORTGAGE LENDING SERVICES (U.S. CLS. 100, 101 AND 102).
FIRST USE 3-4-2000; IN COMMERCE 3-4-2000.

2,747,529. LANNING, DOUGLAS D., RANDOLPH, NJ. SN 75-636,483. PUB. 12-21-1999, FILED 2-9-1999.

STARPOINT

FOR HOME MORTGAGE LENDING (U.S. CLS. 100, 101 AND 102).
FIRST USE 2-15-2003; IN COMMERCE 2-15-2003.

CLASS 36—(Continued).

2,747,567. DOMINI SOCIAL INVESTMENTS LLC, NEW YORK, NY. SN 75-711,759. PUB. 1-4-2000, FILED 5-21-1999.

DOMINI.COM

FOR PROVIDING INFORMATION RELATING TO FINANCIAL INVESTMENTS; INVESTMENT BROKERAGE SERVICES; FINANCIAL ADVISORY AND CONSULTATION SERVICES RELATING TO INVESTMENTS; MUTUAL FUND BROKERAGE, MANAGEMENT, INVESTMENT ADVISORY, AND DISTRIBUTION SERVICES; AND MONEY MARKET ACCOUNT SERVICES; EACH PROVIDED VIA A GLOBAL COMPUTER NETWORK (U.S. CLS. 100, 101 AND 102).

FIRST USE 3-25-2003; IN COMMERCE 3-25-2003.

2,747,598. PAN-AMERICAN LIFE INSURANCE COMPANY, NEW ORLEANS, LA. SN 75-769,305. PUB. 10-23-2001, FILED 8-5-1999.

BUILDER SERIES

NO CLAIM IS MADE TO THE EXCLUSIVE RIGHT TO USE "SERIES", APART FROM THE MARK AS SHOWN.
FOR INSURANCE UNDERWRITING IN THE FIELD OF LIFE (U.S. CLS. 100, 101 AND 102).

FIRST USE 9-0-1999; IN COMMERCE 9-0-1999.

2,747,624. JANUS INTERNATIONAL HOLDING LLC, RENO, NV, BY MERGER JANUS CAPITAL CORPORATION, DENVER, CO. SN 75-817,581. PUB. 12-17-2002, FILED 10-8-1999.

JANUS ADVISER SERIES

OWNER OF U.S. REG. NOS. 1,434,216, 2,272,511, AND OTHERS.

NO CLAIM IS MADE TO THE EXCLUSIVE RIGHT TO USE "ADVISER SERIES", APART FROM THE MARK AS SHOWN.

FOR INVESTING THE FUNDS OF OTHERS; MUTUAL FUND INVESTMENT (U.S. CLS. 100, 101 AND 102).
FIRST USE 3-24-2000; IN COMMERCE 8-1-2000.

2,747,636. GALAXYCARD INC., CALGARY, ALBERTA, CANADA. SN 75-832,605. PUB. 6-12-2001, FILED 10-27-1999.

GALAXYCARD

PRIORITY CLAIMED UNDER SEC. 44(D) ON CANADA APPLICATION NO. 1019692, FILED 6-18-1999.

FOR ISSUING CUSTOMER LOYALTY CARDS, NAMELY ISSUING STORED VALUE CARDS FOR USE BY CUSTOMERS AS PART OF AN INCENTIVE PROGRAM IN WHICH POINTS MAY BE ACCUMULATED AND TRANSLATED INTO CASH VALUE AND USED BY USED BY THE CUSTOMER TO PURCHASE GOODS OR SERVICES AT ANY PARTICIPATING LOCATION (U.S. CLS. 100, 101 AND 102).

FIRST USE 5-11-2001; IN COMMERCE 2-21-2003.

CLASS 36—(Continued).

2,747,724. RASKIN BENEFITS ADVISORS, LLC, ROCKVILLE CENTRE, NY. SN 76-005,477. PUB. 12-3-2002, FILED 3-20-2000.

EASY-TRIP

FOR ADMINISTRATION OF EMPLOYEE BENEFIT PLANS, NAMELY, RECORDKEEPING SERVICES FOR EMPLOYEE COMMUTER TRANSPORTATION REIMBURSEMENT BENEFIT PLANS (U.S. CLS. 100, 101 AND 102).

FIRST USE 6-1-2000; IN COMMERCE 6-1-2000.

2,747,735. COMERICA INCORPORATED, DETROIT, MI. SN 76-022,391. PUB. 6-11-2002, FILED 4-10-2000.

COMERICA MORTGAGE IN MINUTES

FOR BANKING SERVICES (U.S. CLS. 100, 101 AND 102).

FIRST USE 4-0-2000; IN COMMERCE 4-0-2000.

2,747,739. SOUTHEAST VENTURE PARTNERS, MORRISVILLE, NC. SN 76-025,680. PUB. 7-30-2002, FILED 4-14-2000.

SOUTHEAST INTERACTIVE TECHNOLOGY FUNDS

NO CLAIM IS MADE TO THE EXCLUSIVE RIGHT TO USE "INTERACTIVE TECHNOLOGY FUNDS", APART FROM THE MARK AS SHOWN.

FOR FINANCIAL SERVICES, NAMELY, VENTURE CAPITAL FUNDING, VENTURE CAPITAL INVESTMENT CONSULTATION SERVICES, INVESTMENT BANKING SERVICES, INVESTMENT BROKERAGE AND DEALER SERVICES IN SECURITIES, AND CONSULTING SERVICES, NAMELY, PROVIDING ADVISE AND CONSULTATION TO COMPANIES REGARDING VENTURE CAPITAL FINANCING AND GROWTH OPPORTUNITIES (U.S. CLS. 100, 101 AND 102).

FIRST USE 6-0-1995; IN COMMERCE 6-0-1995.

CLASS 36—(Continued).

2,747,754. FRANK RUSSELL COMPANY, TACOMA, WA. SN 76-037,924. PUB. 1-15-2002, FILED 4-28-2000.

RUSSELL INVESTMENT GROUP

OWNER OF U.S. REG. NOS. 1,576,348, 1,945,514, AND OTHERS.

NO CLAIM IS MADE TO THE EXCLUSIVE RIGHT TO USE "INVESTMENT GROUP", APART FROM THE MARK AS SHOWN.

FOR FINANCIAL CONSULTING SERVICES; REAL ESTATE INVESTMENT CONSULTING SERVICES; INVESTMENT PORTFOLIO MANAGER EVALUATION SERVICES; INVESTMENT PORTFOLIO MONITORING SERVICES; INVESTMENT PORTFOLIO PERFORMANCE ANALYSIS SERVICES; SECURITIES, COMMODITIES AND REAL ESTATE INVESTMENT RESEARCH SERVICES; TRUST AND INVESTMENT MANAGEMENT SERVICES; SECURITIES UNDERWRITING SERVICES; SECURITIES BROKERAGE SERVICES; MUTUAL FUND ADMINISTRATION SERVICES; INVESTMENT BANKING SERVICES; PROVIDING FINANCIAL INFORMATION BY ELECTRONIC MEANS; PROVIDING AND UPDATING AN INDEX OF SECURITIES VALUES FOR OTHERS AND PROVIDING RULES AS TO THE MAKEUP OF THE INDEX; AND FINANCIAL SERVICES IN THE NATURE OF AN INVESTMENT SECURITY (U.S. CLS. 100, 101 AND 102).

FIRST USE 3-1-2000; IN COMMERCE 3-1-2000.

2,747,761. BOARD OF TRADE CLEARING CORPORATION, CHICAGO, IL. SN 76-047,342. PUB. 12-25-2001, FILED 5-12-2000.

ACT

FOR FINANCIAL SERVICES, NAMELY, TRADE CLEARING AND SETTLEMENT SERVICES IN THE FIELD OF TRADING IN DERIVATIVES, COMMODITIES, OPTIONS, FUTURES AND RELATED INSTRUMENTS (U.S. CLS. 100, 101 AND 102).

FIRST USE 9-30-2001; IN COMMERCE 9-30-2001.

CLASS 36—(Continued).

2,747,763. ALERUS FINANCIAL CORPORATION, GRAND FORKS, ND, BY CHANGE OF NAME FIRST NATIONAL CORPORATION NORTH DAKOTA, GRAND FORKS, ND. SN 76-048,309. PUB. 3-26-2002, FILED 5-15-2000.



NO CLAIM IS MADE TO THE EXCLUSIVE RIGHT TO USE "FINANCIAL", APART FROM THE MARK AS SHOWN.

FOR BANKING SERVICES; TRUST AND ASSET MANAGEMENT SERVICES; MORTGAGE BANKING AND LENDING SERVICES; INVESTMENT ADVISORY, BROKERAGE AND MANAGEMENT SERVICES; INSURANCE AGENCY AND ADMINISTRATION SERVICES; AND FINANCIAL SERVICES RELATED TO THE ABOVE-MENTIONED SERVICES (U.S. CLS. 100, 101 AND 102).

FIRST USE 11-13-2000; IN COMMERCE 11-13-2000.

2,747,778. SAWIN COMPANY, NEW YORK, NY. SN 76-059,147. PUB. 8-13-2002, FILED 5-30-2000.

ADVISORAVENUE

FOR FINANCIAL INFORMATION SERVICES, NAMELY, COLLECTING, MAINTAINING AND DISSEMINATING INFORMATION ABOUT INVESTMENT ADVISORY SERVICE PROVIDERS, FINANCIAL INVESTMENT BUSINESSES AND INVESTMENT PROFESSIONALS; AND FINANCIAL MATCH-MAKING SERVICES, NAMELY, INTRODUCING, FACILITATING AND SERVICING BUSINESS RELATIONSHIPS BETWEEN INVESTMENT BUSINESSES AND PROFESSIONALS (U.S. CLS. 100, 101 AND 102).

FIRST USE 11-0-1999; IN COMMERCE 11-0-1999.

2,747,814. ALLMERICA FINANCIAL CORPORATION, WORCESTER, MA. SN 76-082,095. PUB. 7-31-2001, FILED 7-3-2000.

VERAVEST, INC.

NO CLAIM IS MADE TO THE EXCLUSIVE RIGHT TO USE "INC.", APART FROM THE MARK AS SHOWN.

FOR BROKERAGE SERVICES OFFERING SECURITIES PRODUCTS AND SERVICES IN THE FIELDS OF STOCKS, BONDS, MUTUAL FUNDS, AND RELATED SECURITIES TO RETAIL AND INSTITUTIONAL CLIENTS (U.S. CLS. 100, 101 AND 102).

FIRST USE 12-19-2002; IN COMMERCE 12-19-2002.

CLASS 36—(Continued).

2,747,845. FIRST UNION CORPORATION, CHARLOTTE, NC. AND WACHOVIA CORPORATION, CHARLOTTE, NC, BY CHANGE OF NAME, BY MERGER WACHOVIA CORPORATION, WINSTON-SALEM, NC. SN 76-108,007. PUB. 11-13-2001, FILED 8-11-2000.

WACHOVIA ALLIANCE SERVICES

OWNER OF U.S. REG. NOS. 883,529, 2,301,874, AND OTHERS.

NO CLAIM IS MADE TO THE EXCLUSIVE RIGHT TO USE "ALLIANCE SERVICES", APART FROM THE MARK AS SHOWN.

FOR BANKING AND RELATED FINANCIAL SERVICES; INVESTMENT SERVICES, NAMELY, INVESTMENT MANAGEMENT, INVESTMENT CONSULTATION, INVESTMENT BROKERAGE; FINANCIAL SERVICES, NAMELY, FINANCIAL ANALYSIS AND CONSULTATION, FINANCIAL MANAGEMENT, FINANCIAL PLANNING, FINANCIAL RESEARCH, AND FINANCIAL FORECASTING, AND INSURANCE SERVICES, NAMELY, PROVIDING INSURANCE ADMINISTRATION IN THE FIELDS OF LIFE, PROPERTY AND CASUALTY, ACCIDENT, HEALTH AND CREDIT INSURANCE; AND PROVIDING INSURANCE CONSULTATION SERVICES IN THE FIELDS OF LIFE, PROPERTY AND CASUALTY, ACCIDENT, HEALTH AND CREDIT INSURANCE; INSURANCE UNDERWRITING SERVICE (U.S. CLS. 100, 101 AND 102).

FIRST USE 1-1-2001; IN COMMERCE 1-1-2001.

2,747,859. FORD MOTOR COMPANY, DEARBORN, MI. SN 76-119,522. PUB. 9-11-2001, FILED 8-30-2000.



NO CLAIM IS MADE TO THE EXCLUSIVE RIGHT TO USE "CONSERVATION & ENVIRONMENTAL GRANTS", APART FROM THE MARK AS SHOWN.

FOR ADMINISTRATION OF AND PROVIDING GRANTS IN FIELDS OF ENVIRONMENTAL PROTECTION, CONSERVATION AND PRESERVATION (U.S. CLS. 100, 101 AND 102).

FIRST USE 8-31-2000; IN COMMERCE 8-31-2000.

CLASS 36—(Continued).

2,747,873. BANK ASSET MANAGEMENT AG, 6301 ZUG, SWITZERLAND. SN 76-128,675. PUB. 10-22-2002, FILED 9-15-2000.

BB MEDTECH

NO CLAIM IS MADE TO THE EXCLUSIVE RIGHT TO USE "MEDTECH", APART FROM THE MARK AS SHOWN. FOR "INVESTMENT MANAGEMENT" (U.S. CLS. 100, 101 AND 102).
FIRST USE 11-14-1995; IN COMMERCE 11-14-1995.

2,747,875. SUFFOLK UNIVERSITY, BOSTON, MA. SN 76-129,633. PUB. 6-18-2002, FILED 9-18-2000.



SUFFOLK UNIVERSITY
SUPERcard

NO CLAIM IS MADE TO THE EXCLUSIVE RIGHT TO USE "CARD", APART FROM THE MARK AS SHOWN. FOR CREDIT CARD SERVICES (U.S. CLS. 100, 101 AND 102).
FIRST USE 2-1-2000; IN COMMERCE 2-1-2000.

2,747,906. PNC FINANCIAL SERVICES GROUP, INC., THE, PITTSBURGH, PA. SN 76-157,262. PUB. 5-14-2002, FILED 11-1-2000.

WEALTH IS MONEY WITH A PLAN

FOR BANKING SERVICES; INVESTMENT MANAGEMENT; STOCK BROKERAGE, FIDUCIARY REPRESENTATIVE SERVICES, NAMELY, ACTING AS PERSONAL REPRESENTATIVES OF DECEDENT'S ESTATES AND AS TRUSTEES OF TRUSTS; CUSTODIAN SERVICES, NAMELY, HOLDING STOCKS, BONDS, SECURITIES AND OTHER FINANCIAL AND INVESTMENT INSTRUMENTS FOR OTHERS; FINANCIAL AND ESTATE PLANNING; FINANCIAL PLANNING SERVICES IN THE NATURE OF RETIREMENT, GIFT, AND DISTRIBUTION PLANNING; ANNUITIES AND LIFE INSURANCE UNDERWRITING; FINANCIAL MANAGEMENT OF ENDOWMENTS AND CHARITABLE AND PRIVATE FOUNDATIONS; ADMINISTRATION OF EMPLOYEE BENEFIT PLANS; MORTGAGE LENDING; FINANCIAL INVESTMENT SERVICES, NAMELY, OFFERING CERTIFICATES OF DEPOSIT, DEMAND DEPOSIT, AND TIME DEPOSIT PRODUCTS; LOAN FINANCING, INCLUDING, COMMERCIAL AND CONSUMER LENDING SERVICES (U.S. CLS. 100, 101 AND 102).
FIRST USE 10-26-2001; IN COMMERCE 10-26-2001.

CLASS 36—(Continued).

2,747,931. RYAN HOLDINGS LLC, NEW YORK, NY. SN 76-170,430. PUB. 8-28-2001, FILED 11-22-2000.

FITR

FOR FINANCIAL SERVICES, NAMELY, OFFERING AND ADMINISTERING OPEN-ENDED UNIT INVESTMENT TRUSTS (U.S. CLS. 100, 101 AND 102).
FIRST USE 11-1-2002; IN COMMERCE 11-1-2002.

2,747,934. MERRILL LYNCH & CO., INC., NEW YORK, NY. SN 76-174,106. PUB. 7-2-2002, FILED 12-1-2000.

**MERRILL LYNCH
FINANCIAL ADVISORY
CENTER**

OWNER OF U.S. REG. NOS. 1,272,653, 2,429,191, AND OTHERS.

NO CLAIM IS MADE TO THE EXCLUSIVE RIGHT TO USE "FINANCIAL ADVISORY CENTER", APART FROM THE MARK AS SHOWN.

FOR FINANCIAL SERVICES, NAMELY PROVIDING ONLINE AND TELEPHONIC PERSONALIZED AND EXPERT GUIDANCE FOR FINANCIAL INVESTMENT (U.S. CLS. 100, 101 AND 102).

FIRST USE 12-0-2000; IN COMMERCE 3-0-2001.

2,747,976. KINDER MORGAN, INC., HOUSTON, TX. SN 76-196,017. PUB. 6-18-2002, FILED 1-16-2001.

WINTER GUARD

FOR BILL PAYMENT PLAN SERVICES FOR CUSTOMERS REGARDING THEIR UTILITY AND ENERGY BILLS (U.S. CLS. 100, 101 AND 102).

FIRST USE 4-0-2001; IN COMMERCE 4-0-2001.

2,747,988. SIEMON COMPANY, THE, WATERTOWN, CT. SN 76-200,893. PUB. 7-16-2002, FILED 1-29-2001.

ULTRA 6

OWNER OF U.S. REG. NO. 2,352,737.
NO CLAIM IS MADE TO THE EXCLUSIVE RIGHT TO USE "6", APART FROM THE MARK AS SHOWN.

FOR PROVIDING EXTENDED WARRANTIES ON VOICE AND DATA CABLING HARDWARE AND CABLE (U.S. CLS. 100, 101 AND 102).

FIRST USE 8-0-2000; IN COMMERCE 8-0-2000.

CLASS 36—(Continued).

2,747,989. FIRSTMERIT CORPORATION, AKRON, OH. SN 76-201,010. PUB. 8-27-2002, FILED 1-29-2001.

FIRSTMERIT E-CONNECT

OWNER OF U.S. REG. NOS. 1,877,966, 2,404,243, AND OTHERS.

NO CLAIM IS MADE TO THE EXCLUSIVE RIGHT TO USE "E-CONNECT", APART FROM THE MARK AS SHOWN.

FOR BANKING SERVICES, NAMELY, PROVIDING ELECTRONIC BANK ACCOUNT INFORMATION AND ELECTRONIC FUND TRANSFER SERVICES FOR CORPORATE TREASURY MANAGEMENT VIA THE INTERNET (U.S. CLS. 100, 101 AND 102).

FIRST USE 6-6-2001; IN COMMERCE 6-6-2001.

2,748,001. ECS HOLDINGS, INC., WILMINGTON, DE. SN 76-208,033. PUB. 7-16-2002, FILED 2-9-2001.

XL ENVIRONMENTAL

NO CLAIM IS MADE TO THE EXCLUSIVE RIGHT TO USE "ENVIRONMENTAL", APART FROM THE MARK AS SHOWN.

FOR INSURANCE BROKERAGE SERVICES FOR OTHERS IN THE FIELD OF ENVIRONMENTAL INSURANCE; RISK MANAGEMENT SERVICES FOR OTHERS IN THE FIELD OF ENVIRONMENTAL INSURANCE (U.S. CLS. 100, 101 AND 102).

FIRST USE 4-2-2002; IN COMMERCE 4-2-2002.

2,748,007. MALLOY, J. MICHAEL, OREGON HOUSE, CA. SN 76-210,660. PUB. 8-6-2002, FILED 2-13-2001.



NO CLAIM IS MADE TO THE EXCLUSIVE RIGHT TO USE "INSURANCE SERVICES", "INSURANCE", "PRESERVE", "PROTECT", AND "GROW", APART FROM THE MARK AS SHOWN.

FOR INSURANCE CONSULTATION AND BROKERAGE INSURANCE IN THE FIELDS OF ACCIDENT, FIRE AND CASUALTY INSURANCE FOR BUSINESSES AND HOMES, AND HEALTH, DISABILITY AND LIFE INSURANCE; ESTATE PLANNING; FUNDS INVESTMENT CONSULTATION, NAMELY INVESTMENT IN VARIABLE ANNUITIES AND MUTUAL FUNDS (U.S. CLS. 100, 101 AND 102).

FIRST USE 12-0-1999; IN COMMERCE 12-0-1999.

CLASS 36—(Continued).

2,748,107. JUMA VENTURES, SAN FRANCISCO, CA. SN 76-256,316. PUB. 8-6-2002, FILED 5-9-2001.

FUTUREFUNDZ

FOR FINANCIAL SERVICES; NAMELY SAVINGS PROGRAMS FOR YOUTHS (U.S. CLS. 100, 101 AND 102). FIRST USE 7-26-2002; IN COMMERCE 7-26-2002.

2,748,121. LEWISVILLE LSF, L.P., ADDISON, TX. SN 76-261,201. PUB. 3-19-2002, FILED 5-22-2001.

CONVERGENCE OFFICE CENTER

NO CLAIM IS MADE TO THE EXCLUSIVE RIGHT TO USE "OFFICE CENTER", APART FROM THE MARK AS SHOWN.

FOR LEASING OF BUILDINGS, OFFICES AND OFFICE PARKS (U.S. CLS. 100, 101 AND 102).

FIRST USE 12-0-2000; IN COMMERCE 12-0-2000.

2,748,143. UCL FINANCIAL GROUP, LLC, MEMPHIS, TN. SN 76-265,223. PUB. 6-25-2002, FILED 5-31-2001.

FINANCIAL SOLUTIONS FROM THE BOARDROOM TO THE BREAKROOM

FOR FINANCIAL SERVICES, NAMELY, FINANCIAL PLANNING AND CONSULTING; INVESTMENT MANAGEMENT AND CONSULTING; RETIREMENT PLANNING; ESTATE PLANNING; BUSINESS SUCCESSION PLANNING; DESIGN AND ADMINISTRATION OF EMPLOYEE BENEFITS PLANS AND EMPLOYEE PENSION PLANS; EXECUTIVE BENEFITS AND COMPENSATION PLANNING; INSURANCE BROKERAGE SERVICES (U.S. CLS. 100, 101 AND 102).

FIRST USE 1-2-2002; IN COMMERCE 1-2-2002.

2,748,180. BAYERISCHE MOTOREN WERKE AKTIENGESELLSCHAFT, 80788 MUENCHEN, FED REP GERMANY. SN 76-278,424. PUB. 6-11-2002, FILED 6-27-2001.

ALPHERA

FOR FINANCIAL SERVICES, NAMELY, FINANCING VEHICLE LOANS AND LEASES (U.S. CLS. 100, 101 AND 102).

FIRST USE 9-0-2001; IN COMMERCE 9-0-2001.

CLASS 36—(Continued).

2,748,187. MBNA AMERICA BANK, NATIONAL ASSOCIATION, NEWARK, DE. SN 76-281,340. PUB. 7-2-2002, FILED 7-6-2001.

DISAPPEARING DEBT

NO CLAIM IS MADE TO THE EXCLUSIVE RIGHT TO USE "DEBT", APART FROM THE MARK AS SHOWN.

FOR BANKING AND DEBIT CARD SERVICES (U.S. CLS. 100, 101 AND 102).

FIRST USE 11-7-2002; IN COMMERCE 11-7-2002.

2,748,192. SCHULTZ, MARK, CLINTON, NJ. SN 76-283,680. PUB. 7-2-2002, FILED 7-12-2001.

TURNING LIVES INTO LEGACIES

FOR FINANCIAL SERVICES, NAMELY, FINANCIAL ANALYSIS AND CONSULTATION; FINANCIAL PLANNING; FINANCIAL MANAGEMENT; INSURANCE SERVICES, NAMELY, INSURANCE AGENCIES; INSURANCE BROKERAGE; AND ESTATE PLANNING (U.S. CLS. 100, 101 AND 102).

FIRST USE 12-30-2002; IN COMMERCE 12-30-2002.

2,748,193. SCHULTZ, MARK, CLINTON, NJ. SN 76-283,681. PUB. 10-8-2002, FILED 7-12-2001.

GENERATIONS TO COME

FOR FINANCIAL SERVICES, NAMELY, FINANCIAL ANALYSIS AND CONSULTATION; FINANCIAL PLANNING; FINANCIAL MANAGEMENT; INSURANCE SERVICES, NAMELY, INSURANCE AGENCIES; INSURANCE BROKERAGE; AND ESTATE PLANNING (U.S. CLS. 100, 101 AND 102).

FIRST USE 12-30-2002; IN COMMERCE 12-30-2002.

2,748,203. CHARTER ONE FINANCIAL, INC., CLEVELAND, OH. SN 76-285,873. PUB. 1-1-2002, FILED 7-16-2001.

TOTALLY e CHECKING

NO CLAIM IS MADE TO THE EXCLUSIVE RIGHT TO USE "E CHECKING", APART FROM THE MARK AS SHOWN.

FOR BANKING SERVICES (U.S. CLS. 100, 101 AND 102).

FIRST USE 1-0-2003; IN COMMERCE 1-0-2003.

CLASS 36—(Continued).

2,748,237. WELLS FARGO & COMPANY, MINNEAPOLIS, MN. SN 76-298,301. PUB. 11-26-2002, FILED 8-10-2001.

**WELLS FARGO
WORLDWIDE U.S. DOLLAR
RESERVE FUND**

OWNER OF U.S. REG. NOS. 791,983, 2,458,340, AND OTHERS.

NO CLAIM IS MADE TO THE EXCLUSIVE RIGHT TO USE "WORLDWIDE U.S. DOLLAR RESERVE FUND", APART FROM THE MARK AS SHOWN.

FOR FINANCIAL SERVICES, NAMELY, MUTUAL FUND INVESTMENT SERVICES (U.S. CLS. 100, 101 AND 102).

FIRST USE 1-2-2002; IN COMMERCE 1-2-2002.

2,748,240. UNIGARD INSURANCE COMPANY, BELLEVUE, WA. SN 76-299,016. PUB. 11-5-2002, FILED 8-10-2001.

UNLBOP

FOR INSURANCE SERVICES, NAMELY, UNDERWRITING IN THE FIELD OF PROPERTY, CASUALTY, WORKMEN'S COMPENSATION, SURETY, AUTOMOBILE AND MARINE INSURANCE (U.S. CLS. 100, 101 AND 102).

FIRST USE 9-0-2001; IN COMMERCE 9-0-2001.

2,748,246. OLD HARBOR CAPITAL MANAGEMENT, LLC, BOSTON, MA. SN 76-300,414. PUB. 7-16-2002, FILED 6-29-2001.



FOR FINANCIAL SERVICES, NAMELY, INVESTMENT MANAGEMENT, INVESTMENT ADVICE, INVESTMENT CONSULTATION AND INVESTMENT OF FUNDS FOR OTHERS (U.S. CLS. 100, 101 AND 102).

FIRST USE 4-23-2001; IN COMMERCE 4-23-2001.

CLASS 36—(Continued).

2,748,248. TRANS UNION L.L.C., CHICAGO, IL. SN 76-301,619. PUB. 6-11-2002, FILED 8-20-2001.

TOTAL ID

FOR FINANCIAL CREDIT VERIFICATION SERVICES IN THE NATURE OF PROVIDING FRAUD DETECTION SERVICES (U.S. CLS. 100, 101 AND 102).
FIRST USE 11-14-2002; IN COMMERCE 11-14-2002.

2,748,256. INSTITUTIONAL MARKETING SERVICES, LLC, LANHAM, MD. SN 76-305,404. PUB. 7-30-2002, FILED 8-27-2001.

IMS CASH PROGRAM

NO CLAIM IS MADE TO THE EXCLUSIVE RIGHT TO USE "CASH PROGRAM", APART FROM THE MARK AS SHOWN.

FOR FINANCIAL CONSULTATION SERVICES FOR THE MORTGAGE INDUSTRY IN CONJUNCTION WITH CONSUMER WEALTH ACCUMULATION PROGRAMS (U.S. CLS. 100, 101 AND 102).
FIRST USE 9-1-2001; IN COMMERCE 9-1-2001.

2,748,290. THE YORK CHILDREN'S FOUNDATION, HOUSTON, TX. SN 76-318,907. PUB. 10-1-2002, FILED 9-28-2001.

**YORK
CHILDREN'S
FOUNDATION**

OWNER OF U.S. REG. NO. 1,762,223.
NO CLAIM IS MADE TO THE EXCLUSIVE RIGHT TO USE "CHILDREN'S FOUNDATION", APART FROM THE MARK AS SHOWN.

FOR CHARITABLE FUND RAISING SERVICES, NAMELY, COLLECTION AND DISTRIBUTION OF CHARITABLE FUNDS TO CHILDREN'S ORGANIZATIONS ACROSS THE UNITED STATES (U.S. CLS. 100, 101 AND 102).
FIRST USE 10-10-2001; IN COMMERCE 10-10-2001.

CLASS 36—(Continued).

2,748,299. AMVESCAP PLC, ATLANTA, GA. SN 76-320,611. PUB. 9-10-2002, FILED 10-2-2001.

ATLANTIC TRUST

NO CLAIM IS MADE TO THE EXCLUSIVE RIGHT TO USE "TRUST", APART FROM THE MARK AS SHOWN.
FOR TRUST COMPANY SERVICES, INVESTMENT MANAGEMENT SERVICES AND PRIVATE BANKING SERVICES (U.S. CLS. 100, 101 AND 102).
FIRST USE 1-31-2002; IN COMMERCE 1-31-2002.

2,748,352. NASDAQ LIFFE MARKETS, LLC, NEW YORK, NY, BY CHANGE OF NAME NASDAQ LIFFE LLC, NEW YORK, NY. SN 76-336,454. PUB. 5-21-2002, FILED 11-9-2001.

NQLX

FOR FUTURES EXCHANGE SERVICES (U.S. CLS. 100, 101 AND 102).
FIRST USE 8-0-2001; IN COMMERCE 11-0-2001.

2,748,379. FOUNDATION FOR CHILDREN'S CARE, THE, DBA FAMILY LEGACY FUND, OAKLAND, CA. SN 76-346,972. PUB. 8-20-2002, FILED 12-7-2001.



FOR CHARITABLE FUNDRAISING AND GIFT PLANNING SERVICES, NAMELY, THE PROMOTION AND CREATION OF DONOR ADVISED FUNDS FOR THE PURPOSE OF SUPPORTING HEALTH, EDUCATIONAL, SCIENTIFIC AND CHILDREN'S HEALTHCARE, EDUCATION, SAFETY AND WELFARE AND OTHER CHARITABLE NEEDS (U.S. CLS. 100, 101 AND 102).
FIRST USE 9-24-2001; IN COMMERCE 9-24-2001.

2,748,443. SECURITY TECHNOLOGY VENTURES, LLC, SAN JOSE, CA. SN 76-362,605. PUB. 9-24-2002, FILED 1-23-2002.

STV

FOR VENTURE CAPITAL SERVICES (U.S. CLS. 100, 101 AND 102).
FIRST USE 11-15-2001; IN COMMERCE 11-15-2001.

CLASS 36—(Continued).

2,748,450. JACKSON NATIONAL LIFE INSURANCE COMPANY, LANSING, MI. SN 76-365,349. PUB. 7-30-2002, FILED 1-31-2002.

PERSPECTIVE FOCUS

OWNER OF U.S. REG. NOS. 2,041,380, 2,279,878, AND 2,474,133.

FOR FINANCIAL SERVICES, NAMELY, ANNUITY UNDERWRITING SERVICES (U.S. CLS. 100, 101 AND 102).

FIRST USE 4-1-2002; IN COMMERCE 4-1-2002.

2,748,451. ASSUREX GLOBAL CORP., COLUMBUS, OH. SN 76-365,390. PUB. 10-29-2002, FILED 1-31-2002.

ASSUREX GLOBAL

OWNER OF U.S. REG. NO. 965,287.
NO CLAIM IS MADE TO THE EXCLUSIVE RIGHT TO USE "GLOBAL", APART FROM THE MARK AS SHOWN.
FOR INSURANCE BROKERAGE SERVICES (U.S. CLS. 100, 101 AND 102).

FIRST USE 1-8-2002; IN COMMERCE 1-8-2002.

2,748,462. WELLPOINT HEALTH NETWORKS, INC., THOUSAND OAKS, CA. SN 76-369,043. PUB. 9-10-2002, FILED 2-11-2002.

MEMBERFLEX

FOR HEALTH INSURANCE UNDERWRITING (U.S. CLS. 100, 101 AND 102).

FIRST USE 7-1-2001; IN COMMERCE 7-1-2001.

2,748,472. MILA, INC., LYNNWOOD, WA. SN 76-372,656. PUB. 10-29-2002, FILED 2-19-2002.

MILA MORTGAGE INVESTMENT LENDING ASSOCIATES

NO CLAIM IS MADE TO THE EXCLUSIVE RIGHT TO USE "MORTGAGE INVESTMENT LENDING ASSOCIATES", APART FROM THE MARK AS SHOWN.

FOR MORTGAGE BANKING, MORTGAGE LENDING AND MORTGAGE PROCUREMENT FOR OTHERS (U.S. CLS. 100, 101 AND 102).

FIRST USE 6-1-1987; IN COMMERCE 6-1-1987.

CLASS 36—(Continued).

2,748,492. FIRST-CITIZENS BANK & TRUST COMPANY, RALEIGH, NC. SN 76-380,285. PUB. 10-8-2002, FILED 3-1-2002.

PARAMOUNT PLUS

FOR BANKING SERVICES, NAMELY, MANAGED ACCOUNT PROGRAMS (U.S. CLS. 100, 101 AND 102).
FIRST USE 7-3-2002; IN COMMERCE 7-11-2002.

2,748,493. FIRST-CITIZENS BANK & TRUST COMPANY, RALEIGH, NC. SN 76-380,286. PUB. 10-8-2002, FILED 3-1-2002.

PARAMOUNT CHOICE

FOR BANKING SERVICES, NAMELY, MANAGED ACCOUNT PROGRAMS (U.S. CLS. 100, 101 AND 102).
FIRST USE 7-3-2002; IN COMMERCE 7-11-2002.

2,748,494. FIRST-CITIZENS BANK & TRUST COMPANY, RALEIGH, NC. SN 76-380,287. PUB. 10-8-2002, FILED 3-1-2002.

PARAMOUNT

FOR BANKING SERVICES, NAMELY, MANAGED ACCOUNT PROGRAMS (U.S. CLS. 100, 101 AND 102).
FIRST USE 7-3-2002; IN COMMERCE 7-11-2002.

2,748,513. SEABURY & SMITH, INC., WASHINGTON, DC. SN 76-389,014. PUB. 11-12-2002, FILED 4-1-2002.

GATEWAY PLUS

OWNER OF U.S. REG. NOS. 1,760,769, 2,491,513, AND OTHERS.

FOR UNDERWRITING AND ADMINISTRATION OF PROPERTY AND LIABILITY INSURANCE FOR INDIVIDUALS ON FOREIGN ASSIGNMENT (U.S. CLS. 100, 101 AND 102).

FIRST USE 5-0-2002; IN COMMERCE 5-0-2002.

2,748,524. TODD, GROVER ELTON, JR., GREER, SC. SN 76-391,658. PUB. 10-1-2002, FILED 4-4-2002.

CREDIT CENTRAL

NO CLAIM IS MADE TO THE EXCLUSIVE RIGHT TO USE "CREDIT", APART FROM THE MARK AS SHOWN.

FOR PROVIDING FINANCIAL SERVICES FOR THE PRIVATE SECTOR, NAMELY, PROVIDING CONSUMER LOANS (U.S. CLS. 100, 101 AND 102).

FIRST USE 7-1-2002; IN COMMERCE 7-1-2002.

CLASS 36—(Continued).

2,748,547. ANNUITY INVESTORS LIFE INSURANCE COMPANY, CINCINNATI, OH. SN 76-401,751. PUB. 10-29-2002, FILED 4-29-2002.

COMMODORE HELMSMAN

FOR ANNUITY UNDERWRITING SERVICES (U.S. CLS. 100, 101 AND 102).
FIRST USE 8-1-2002; IN COMMERCE 8-1-2002.

2,748,551. KAYE, BARRY, BOCA RATON, FL. SN 76-404,749. PUB. 11-19-2002, FILED 5-6-2002.

THE WEALTH CREATION FOUNDATION

NO CLAIM IS MADE TO THE EXCLUSIVE RIGHT TO USE "FOUNDATION", APART FROM THE MARK AS SHOWN.

FOR ESTATE PLANNING AND PLANNED GIVING SERVICES FOR POTENTIAL DONORS TO DIRECT CHARITABLE MONETARY DONATIONS TO NON-PROFIT ORGANIZATIONS (U.S. CLS. 100, 101 AND 102).
FIRST USE 9-1-2002; IN COMMERCE 9-1-2002.

2,748,552. AMERICAN REPUBLIC INSURANCE COMPANY, DES MOINES, IA. SN 76-404,954. PUB. 1-14-2003, FILED 5-9-2002.

ULTRACOMP PREFERRED VALUE

OWNER OF U.S. REG. NO. 1,548,615.
NO CLAIM IS MADE TO THE EXCLUSIVE RIGHT TO USE "PREFERRED VALUE", APART FROM THE MARK AS SHOWN.

FOR UNDERWRITING AND ADMINISTRATION OF ACCIDENT AND HEALTH INSURANCE AND PREFERRED PROVIDER PLANS (U.S. CLS. 100, 101 AND 102).
FIRST USE 7-31-2001; IN COMMERCE 7-31-2001.

CLASS 36—(Continued).

2,748,573. AMERISERV FINANCIAL, INC., JOHNSTON, PA, BY CHANGE OF NAME USBANCORP, INC., JOHNSTOWN, PA. SN 76-975,345. PUB. 10-9-2001, FILED 4-24-2001.



NO CLAIM IS MADE TO THE EXCLUSIVE RIGHT TO USE "TRUST AND FINANCIAL SERVICES", APART FROM THE MARK AS SHOWN.

FOR CORPORATE, INSTITUTIONAL AND PERSONAL TRUST SERVICES; FINANCIAL PLANNING AND PORTFOLIO MANAGEMENT; AND ESTATE ADMINISTRATION SERVICES (U.S. CLS. 100, 101 AND 102).
FIRST USE 5-7-2001; IN COMMERCE 5-7-2001.

2,748,690. MCCLURE, JOHN M., MERIDIAN, ID. SN 78-063,614. PUB. 10-16-2001, FILED 5-15-2001.

PROFITSCORE

FOR INVESTMENT ADVICE AND CONSULTATION FOR OTHERS (U.S. CLS. 100, 101 AND 102).
FIRST USE 1-1-2000; IN COMMERCE 6-1-2000.

2,748,697. OCASH, INC., WHITE BEAR LAKE, MN, BY CHANGE OF NAME OCASH.COM, INC., WHITE BEAR LAKE, MN. SN 78-067,323. PUB. 2-12-2002, FILED 6-4-2001.

OCASH

FOR ELECTRONIC DEBIT TRANSACTION SERVICE FOR PURCHASING GOODS AND SERVICES (U.S. CLS. 100, 101 AND 102).
FIRST USE 8-11-2002; IN COMMERCE 8-11-2002.

2,748,710. SCHOOL-LINK TECHNOLOGIES, INC., SANTA MONICA, CA. SN 78-073,028. PUB. 6-18-2002, FILED 7-10-2001.

MYLUNCHMONEY.COM

FOR ONLINE BILL PAYMENT SERVICES FOR ALL TYPES OF SCHOOL ACTIVITIES; ELECTRONIC PAYMENT, NAMELY, ELECTRONIC PROCESSING AND TRANSMISSION OF BILL PAYMENT DATA FOR ALL TYPES OF SCHOOL ACTIVITIES (U.S. CLS. 100, 101 AND 102).

FIRST USE 12-11-2001; IN COMMERCE 12-11-2001.

CLASS 36—(Continued).

2,748,756. SACAL, ELIAS, MEXICO CITY, MEXICO. SN 78-083,986. PUB. 9-3-2002, FILED 9-14-2001.

PORTO FINO

THE ENGLISH TRANSLATION OF THE WORDING "PORTO FINO" IS "FINE PORTS".
FOR REAL ESTATE BROKERAGE SERVICES (U.S. CLS. 100, 101 AND 102).
FIRST USE 10-10-1996; IN COMMERCE 3-10-2001.

2,748,780. UPTON, JOHN K., MINNEAPOLIS, MN. SN 78-090,284. PUB. 10-29-2002, FILED 10-26-2001.



NO CLAIM IS MADE TO THE EXCLUSIVE RIGHT TO USE "REALTY", APART FROM THE MARK AS SHOWN.
FOR REAL ESTATE SERVICES IN THE NATURE OF REAL ESTATE BROKERAGE, MANAGEMENT, INVESTMENT SERVICES, REAL ESTATE LISTING, REAL ESTATE AGENCY SERVICES, REAL ESTATE PROCUREMENT SERVICES (U.S. CLS. 100, 101 AND 102).

FIRST USE 11-1-2001; IN COMMERCE 11-1-2001.

2,748,814. FMR CORP., BOSTON, MA. SN 78-099,151. PUB. 7-23-2002, FILED 12-19-2001.

THE CORPORATE PLAN FOR RETIREMENT EXECUTIVE PLAN

FOR FINANCIAL SERVICES, NAMELY, RETIREMENT FUND INVESTMENT SERVICES; PROVIDING FINANCIAL INFORMATION IN THE FIELD OF RETIREMENT PLANNING; RETIREMENT PLAN ADMINISTRATION SERVICES; INVESTMENT MANAGEMENT SERVICES; SECURITIES BROKERAGE SERVICES (U.S. CLS. 100, 101 AND 102).

FIRST USE 1-4-2002; IN COMMERCE 1-4-2002.

CLASS 36—(Continued).

2,748,815. BANKNORTH GROUP, INC., PORTLAND, ME. SN 78-099,160. PUB. 10-15-2002, FILED 12-19-2001.

It's **nice**
knowing

FOR BANKING SERVICES (U.S. CLS. 100, 101 AND 102).
FIRST USE 1-1-2002; IN COMMERCE 1-1-2002.

2,748,891. BBT&T CORPORATION, WINSTON-SALEM, NC, BY ASSIGNMENT SHEFFIELD FINANCIAL CORP., CLEMMONS, NC. SN 78-111,875. PUB. 9-10-2002, FILED 3-1-2002.

FINANCING YOUR DREAMS

FOR FINANCIAL SERVICES, NAMELY, POWER EQUIPMENT FINANCING FOR RETAIL PURCHASES (U.S. CLS. 100, 101 AND 102).
FIRST USE 3-15-2002; IN COMMERCE 3-15-2002.

2,748,910. METROPOLITAN LIFE INSURANCE COMPANY, NEW YORK, NY. SN 78-118,662. PUB. 12-3-2002, FILED 4-1-2002.

NLFS SELECT FUNDS

NO CLAIM IS MADE TO THE EXCLUSIVE RIGHT TO USE "SELECT FUNDS", APART FROM THE MARK AS SHOWN.

FOR FINANCIAL SERVICES, NAMELY THE ADMINISTRATION OF A MUTUAL FUNDS BASED RETIREMENT PROGRAM DESIGNED FOR SCHOOL EMPLOYEES (U.S. CLS. 100, 101 AND 102).
FIRST USE 4-1-2002; IN COMMERCE 4-1-2002.

2,748,971. FIRST FRANKLIN FINANCIAL CORPORATION, SAN JOSE, CA. SN 78-133,480. PUB. 11-19-2002, FILED 6-5-2002.

BETTER AND BETTER

FOR FINANCIAL SERVICES, NAMELY MORTGAGE BANKING AND MORTGAGE BROKERAGE SERVICES (U.S. CLS. 100, 101 AND 102).
FIRST USE 6-0-2002; IN COMMERCE 6-0-2002.

CLASS 36—(Continued).

2,748,981. RE/MAX INTERNATIONAL, INC., GREENWOOD VILLAGE, CO. SN 78-137,781. PUB. 12-17-2002, FILED 6-21-2002.

RE/MAX RACING FOR LIFE

OWNER OF U.S. REG. NOS. 1,139,014, 2,468,858, AND OTHERS.

FOR RAISING FUNDS FOR BREAST CANCER SCREENING AND TREATMENT, HEALTH EDUCATION PROJECTS, AND BREAST CANCER RESEARCH (U.S. CLS. 100, 101 AND 102).

FIRST USE 6-1-2002; IN COMMERCE 6-1-2002.

2,748,982. ROCCA ASSOCIATES, INC., PHILADELPHIA, PA. SN 78-139,419. PUB. 1-21-2003, FILED 6-27-2002.

A LEADING PROVIDER OF VALUATION SOLUTIONS

FOR PROFESSIONAL REAL ESTATE SERVICES, NAMELY, REAL ESTATE APPRAISAL AND CONSULTING SERVICES (U.S. CLS. 100, 101 AND 102).

FIRST USE 3-1-2002; IN COMMERCE 3-1-2002.

CLASS 37—CONSTRUCTION AND REPAIR

2,747,486. NTT COMMUNICATIONWARE KABUSHIKI KAISHA, DBA NTT COMMUNICATIONWARE CORPORATION, TOKYO, JAPAN. SN 75-512,586. PUB. 1-18-2000, FILED 7-2-1998.

NTT COMMUNICATIONWARE

FOR MAINTENANCE AND REPAIR OF PERSONAL COMPUTERS AND WORK STATIONS FOR COMPUTER SERVERS; MAINTENANCE AND REPAIR OF LARGE SCALE COMPUTER HARDWARE FOR MAINFRAME OF COMPUTER SYSTEMS; MAINTENANCE AND REPAIR OF COMPUTER SYSTEMS AND COMPUTER NETWORKS, INSTALLATION OF LOCAL AREA NETWORKS, AND WIDE AREA NETWORKS; INSTALLATION OF COMPUTER NETWORKS, GLOBAL COMPUTER INFORMATION NETWORK, INTRANET NETWORKS, AND EXTRANET NETWORKS; INSTALLATION OF DATA WAREHOUSE SYSTEMS; INSTALLATION OF COMPUTER NETWORKS FOR THE DISTRIBUTION OF INTEROFFICE INFORMATION (U.S. CLS. 100, 103 AND 106).

FIRST USE 10-1-1997; IN COMMERCE 11-14-2000.

CLASS 37—(Continued).

2,747,691. OPSWARE, INC., SUNNYVALE, CA, BY CHANGE OF NAME LOUDCLOUD, INC., SUNNYVALE, CA. SN 75-908,826. PUB. 10-9-2001, FILED 2-2-2000.

OPSWARE

FOR REPAIR AND INSTALLATION SERVICES FOR COMPUTER HARDWARE, WIRED AND WIRELESS TELECOMMUNICATIONS EQUIPMENT, TELECOMMUNICATIONS NETWORK EQUIPMENT, AND COMPUTER NETWORK EQUIPMENT USED FOR ONLINE COMMERCE (U.S. CLS. 100, 103 AND 106).

FIRST USE 2-0-2000; IN COMMERCE 2-0-2000.

2,747,903. BAHWAN CYBERTEK TECHNOLOGIES, INC., NATICK, MA. SN 76-152,479. PUB. 9-17-2002, FILED 10-24-2000.

EVOLVING YOUR BUSINESS

FOR COMPUTER NETWORK SYSTEM INSTALLATION AND MAINTENANCE (U.S. CLS. 100, 103 AND 106).

FIRST USE 10-11-1999; IN COMMERCE 10-11-1999.

2,747,941. KOCH PERFORMANCE ROADS, INC., WICHITA, KS. SN 76-177,556. PUB. 4-9-2002, FILED 12-7-2000.

KOCH PERFORMANCE

ROADS INC.

NO CLAIM IS MADE TO THE EXCLUSIVE RIGHT TO USE "ROADS, INC.", APART FROM THE MARK AS SHOWN.

FOR CONSTRUCTION AND REPAIR OF ROADS FOR OTHERS, FEATURING CONSTRUCTION PROJECT DEVELOPMENT, PAVEMENT DESIGN, CONSTRUCTION MANAGEMENT, AND MAINTENANCE SERVICES FOR ROADS (U.S. CLS. 100, 103 AND 106).

FIRST USE 12-18-2000; IN COMMERCE 12-18-2000.

2,747,963. TROUTT, KEVIN, DBA FIRST CHOICE AUTO GLASS, BOISE, ID. SN 76-190,185. PUB. 3-12-2002, FILED 1-3-2001.

THE WINDSHIELD GUY

NO CLAIM IS MADE TO THE EXCLUSIVE RIGHT TO USE "WINDSHIELD", APART FROM THE MARK AS SHOWN.

FOR VEHICLE WINDSHIELD REPAIR AND REPLACEMENT SERVICES (U.S. CLS. 100, 103 AND 106).

FIRST USE 8-1-2000; IN COMMERCE 8-1-2000.

CLASS 37—(Continued).

2,748,103. BEHR PAINTS IT!, INC., SANTA ANA, CA. SN 76-253,772. PUB. 7-23-2002, FILED 5-8-2001.

BEHR PAINTS IT!

FOR RESIDENTIAL PAINTING AND STAINING SERVICES (U.S. CLS. 100, 103 AND 106).
FIRST USE 6-25-2001; IN COMMERCE 6-25-2001.

2,748,164. RICHLAND CALABASAS, L.P., SANTA ANA, CA. SN 76-273,297. PUB. 7-9-2002, FILED 6-19-2001.

THE COUNTRY BY THE SEA

FOR REAL ESTATE DEVELOPMENT SERVICES (U.S. CLS. 100, 103 AND 106).
FIRST USE 8-23-2002; IN COMMERCE 8-23-2002.

2,748,258. MAGNUSON-HAWKINS, SHELBY, TUCSON, AZ. SN 76-306,178. PUB. 3-12-2002, FILED 8-27-2001.

ETT444

FOR TERMITE AND PEST CONTROL, NAMELY THE ABOVE-GROUND APPLICATION OF TERMITICIDE FORMULATIONS IN FOAM FORM (U.S. CLS. 100, 103 AND 106).
FIRST USE 10-31-2001; IN COMMERCE 10-31-2001.

2,748,265. JG NORTH RALEIGH, L.L.C., CLEVELAND, OH. SN 76-309,230. PUB. 3-5-2002, FILED 9-5-2001.

TRIANGLE TOWN

FOR REAL ESTATE DEVELOPMENT SERVICES (U.S. CLS. 100, 103 AND 106).
FIRST USE 11-1-2002; IN COMMERCE 11-1-2002.

2,748,330. METROBUILD ASSOCIATES, INC., NEW YORK, NY. SN 76-331,020. PUB. 5-28-2002, FILED 10-29-2001.

METROBUILD

FOR CUSTOM CONSTRUCTION AND BUILDING RENOVATION; CONSTRUCTION SERVICES, NAMELY, PLANNING, LAYING OUT AND CUSTOM CONSTRUCTION OF COMMERCIAL PROPERTIES AND CONSTRUCTION MANAGEMENT (U.S. CLS. 100, 103 AND 106).
FIRST USE 2-0-2002; IN COMMERCE 2-0-2002.

CLASS 37—(Continued).

2,748,387. AM GENERAL LLC, SOUTH BEND, IN, BY CHANGE OF NAME AM GENERAL CORPORATION, SOUTH BEND, IN. SN 76-348,470. PUB. 8-6-2002, FILED 12-13-2001.

AM GENERAL

FOR AUTOMOBILE REPAIR, MAINTENANCE AND SERVICING; REPAIR, REBUILDING, RECONDITIONING, REPLACEMENT AND SERVICING OF AUTOMOBILE ENGINES, PARTS THEREOF AND ACCESSORIES THERETO; INFORMATION SERVICES IN THE FIELD OF AUTOMOBILE CARE, SERVICE, MAINTENANCE AND REPAIR (U.S. CLS. 100, 103 AND 106).
FIRST USE 12-31-1994; IN COMMERCE 12-31-1994.

2,748,418. STEWART & STEVENSON SERVICES, INC., HOUSTON, TX. SN 76-355,132. PUB. 10-29-2002, FILED 1-4-2002.

STEWART & STEVENSON SOURCE1

OWNER OF U.S. REG. NOS. 2,437,847 AND 2,437,848.
FOR CONSTRUCTION AND REPAIR OF BUILDINGS; MAINTENANCE AND/OR REPAIR OF FACILITIES, NAMELY, HOSPITALS, OFFICE BUILDINGS, WAREHOUSE AND DISTRIBUTION CENTERS, SCHOOLS, INDUSTRIAL, CHEMICAL AND PETROLEUM REFINERY PLANTS, HEALTH CARE FACILITIES, MANUFACTURING FACILITIES, RETAIL STORES, COMMUNICATION FACILITIES, MILITARY FACILITIES, METAL AND PLASTIC FABRICATION FACILITIES, AND GOVERNMENT BUILDINGS; MAINTENANCE AND/OR REPAIR OF ELECTRICAL SYSTEMS, HVAC SYSTEMS, PLUMBING SYSTEMS, MATERIAL HANDLING SYSTEMS, FURNITURE, AND TOOLS (U.S. CLS. 100, 103 AND 106).
FIRST USE 12-1-2002; IN COMMERCE 12-1-2002.

2,748,468. KNOLL SYSTEMS CORP., CONCORD, CA. SN 76-371,834. PUB. 11-26-2002, FILED 2-19-2002.

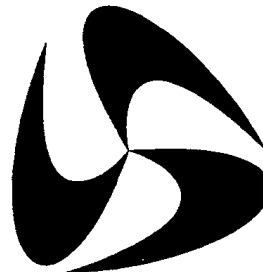

THE MARK CONSISTS OF A FANCIFUL FAN BLADE. FOR COOLING AND HEATING CONTRACTOR SERVICES (U.S. CLS. 100, 103 AND 106).
FIRST USE 11-1-2002; IN COMMERCE 11-1-2002.

CLASS 37—(Continued).

2,748,477. BROWN, DAVID L, DBA NEON DOC SIGNS, WHEATON, IL. SN 76-374,931. PUB. 10-1-2002, FILED 2-26-2002.

NEON DOC

NO CLAIM IS MADE TO THE EXCLUSIVE RIGHT TO USE "NEON", APART FROM THE MARK AS SHOWN.
FOR INSTALLATION AND REPAIR OF NEON SIGNS (U.S. CLS. 100, 103 AND 106).
FIRST USE 12-15-1994; IN COMMERCE 12-15-1994.

2,748,587. WESTERRA SOUTHLAKE, L.P., DALLAS, TX. SN 76-975,536. PUB. 10-16-2001, FILED 5-2-2000.

AVENTERRA

FOR PLANNING AND LAYING OUT OF COMMERCIAL COMMUNITIES; ONLINE INFORMATION SERVICES IN THE FIELD OF PLANNED COMMUNITIES (U.S. CLS. 100, 103 AND 106).
FIRST USE 1-15-2002; IN COMMERCE 1-15-2002.

2,748,613. ENCOMPASS SERVICES CORPORATION, HOUSTON, TX. SN 78-021,081. PUB. 10-2-2001, FILED 8-14-2000.

ENCOMPASS ELECTRICAL TECHNOLOGIES

NO CLAIM IS MADE TO THE EXCLUSIVE RIGHT TO USE "ELECTRICAL TECHNOLOGIES", APART FROM THE MARK AS SHOWN.
FOR REPAIR, REPLACEMENT, AND MAINTENANCE OF HEATING, VENTILATION AND AIR CONDITIONING EQUIPMENT AND SYSTEMS; BUILDING CONSTRUCTION, DESIGN, AND RENOVATION (U.S. CLS. 100, 103 AND 106).
FIRST USE 1-31-2001; IN COMMERCE 1-31-2001.

2,748,765. JIFFY LUBE INTERNATIONAL, INC., HOUSTON, TX. SN 78-085,942. PUB. 3-26-2002, FILED 9-27-2001.

THE WELL-OILED MACHINE

FOR VEHICLE LUBRICATING, MAINTENANCE, AND REPAIR SERVICES (U.S. CLS. 100, 103 AND 106).
FIRST USE 10-0-2001; IN COMMERCE 10-0-2001.

CLASS 37—(Continued).

2,748,806. SEARS, ROEBUCK AND CO., HOFFMAN ESTATES, IL. SN 78-097,160. PUB. 11-12-2002, FILED 12-7-2001.

A&E FACTORY SERVICE

NO CLAIM IS MADE TO THE EXCLUSIVE RIGHT TO USE "SERVICE", APART FROM THE MARK AS SHOWN.
FOR REPAIR SERVICES FOR APPLIANCES, ELECTRONICS, LAWN AND GARDEN EQUIPMENT, AND HEATING AND COOLING SYSTEMS (U.S. CLS. 100, 103 AND 106).
FIRST USE 12-1-2002; IN COMMERCE 12-1-2002.

2,748,892. OWENS-CORNING FIBERGLAS TECHNOLOGY INC., SUMMIT, IL. SN 78-112,306. PUB. 9-10-2002, FILED 3-4-2002.

BRINGING YOUR DREAMS HOME

FOR INSTALLATION OF BUILDING MATERIALS; BUILDING CONSTRUCTION AND REPAIR SERVICES, INCLUDING RESIDENTIAL REMODELING AND IMPROVEMENT (U.S. CLS. 100, 103 AND 106).
FIRST USE 11-30-2002; IN COMMERCE 11-30-2002.

2,748,924. LOOKOUT PARTNERS, L/P, HOUSTON, TX. SN 78-121,079. PUB. 10-29-2002, FILED 4-11-2002.

CRYSTAL FALLS

FOR REAL ESTATE DEVELOPMENT SERVICES (U.S. CLS. 100, 103 AND 106).
FIRST USE 9-24-1998; IN COMMERCE 1-1-1999.

CLASS 38—COMMUNICATION

2,747,466. WEBLINK WIRELESS, INC., DALLAS, TX. SN 75-366,587. PUB. 1-18-2000, FILED 10-1-1997.

PAGELAUNCHER

FOR DATA AND VOICE COMMUNICATION SERVICES, NAMELY, PROVIDING PAGING AND VOICE MESSAGING SERVICES (U.S. CLS. 100, 101 AND 104).
FIRST USE 4-25-2003; IN COMMERCE 4-25-2003.

CLASS 38—(Continued).

2,747,504. AMERICATEL CORPORATION, MIAMI, FL. SN 75-556,416. PUB. 7-18-2000, FILED 9-22-1998.

AMERICATEL, TELECOMUNICACIONES PARA TODO AMERICA

NO CLAIM IS MADE TO THE EXCLUSIVE RIGHT TO USE "TELECOMUNICACIONES" AND "AMERICA", APART FROM THE MARK AS SHOWN.

THE ENGLISH TRANSLATION OF "AMERICATEL", "TELECOMUNICACIONES", "PARA TODO AMERICA" IS "AMERICATEL, TELECOMMUNICATIONS FOR ALL OF AMERICA".

FOR TELECOMMUNICATIONS SERVICES, NAMELY, LONG DISTANCE, DATA TRANSMISSION AND VOICE TRANSMISSION COMMUNICATIONS SERVICES, RENDERED VIA LAND LINE AND SATELLITE, AND PROVIDING CONNECTIONS TO A GLOBAL COMMUNICATIONS NETWORK (U.S. CLS. 100, 101 AND 104).

FIRST USE 4-4-2003; IN COMMERCE 4-4-2003.

2,747,730. CITY OF THOMASVILLE, GEORGIA, THOMASVILLE, GA. SN 76-015,438. PUB. 6-4-2002, FILED 4-3-2000.

CNS COMMUNICATIONS

NO CLAIM IS MADE TO THE EXCLUSIVE RIGHT TO USE "COMMUNICATIONS", APART FROM THE MARK AS SHOWN.

FOR TELECOMMUNICATION SERVICES, NAMELY, PROVIDING VOICE AND DATA LINES AND TELECOMMUNICATION CONNECTIONS BETWEEN GEOGRAPHICALLY SEPARATED LOCATIONS (U.S. CLS. 100, 101 AND 104).

FIRST USE 1-1-2001; IN COMMERCE 1-1-2001.

2,747,752. J2 GLOBAL COMMUNICATIONS, INC., HOLLYWOOD, CA, BY CHANGE OF NAME JFAX.COM, INC., LOS ANGELES, CA. SN 76-036,546. PUB. 9-18-2001, FILED 4-28-2000.

J2

FOR COMMUNICATIONS SERVICES FOR ENABLING USERS TO SEND AND RECEIVE VOICE MESSAGES AND FACSIMILE TRANSMISSIONS USING AN E-MAIL ACCOUNT; COMMUNICATIONS SERVICES FOR ENABLING USERS TO ACCESS AND FORWARD EMAIL TRANSMISSIONS USING A TOUCH TONE TELEPHONE; COMMUNICATIONS SERVICES FOR TELECOMMUNICATIONS MANAGEMENT, NAMELY, TELEPHONE CALL HANDLING, NOTIFICATION, FORWARDING, CONNECTING AND/OR "FIND ME/FOLLOW ME" SERVICES CONSISTING DIRECTING CALLS TO VOICE MAIL BOXES, RECEIVING AND TRANSMITTAL OF FAXES TO EMAIL ACCOUNTS AND CONFERENCE CALL SERVICES THAT ARE INTEGRATED WITH SAID SERVICES AND WHICH ALLOW ACCESS TO ADDRESS BOOK AND COMMUNICATION DATABASE INFORMATION (U.S. CLS. 100, 101 AND 104).

FIRST USE 11-0-2000; IN COMMERCE 11-0-2000.

CLASS 38—(Continued).

2,747,803. ONESUITE CORPORATION, LOS ANGELES, CA, BY CHANGE OF NAME ONESUITE.COM CORPORATION, LOS ANGELES, CA. SN 76-076,149. PUB. 1-15-2002, FILED 6-22-2000.

ONESUITE.COM

FOR ELECTRONIC MAIL SERVICES, LONG DISTANCE TELEPHONE COMMUNICATION SERVICES, TELEPHONE VOICE MESSAGING SERVICES, FACSIMILE TRANSMISSION SERVICES (U.S. CLS. 100, 101 AND 104).

FIRST USE 9-1-2000; IN COMMERCE 9-1-2000.

2,748,013. BROADCLOUD COMMUNICATIONS, INC., AUSTIN, TX. SN 76-211,806. PUB. 12-10-2002, FILED 2-16-2001.

SURE·CONNECT

FOR PROVIDING MULTIPLE-USER ACCESS BY WIRELESS NETWORKS TO A GLOBAL COMPUTER INFORMATION NETWORK; TELECOMMUNICATION SERVICES, NAMELY, WIRELESS DATA SERVICES IN THE NATURE OF INTERNET AND NETWORK SERVICES (U.S. CLS. 100, 101 AND 104).

FIRST USE 6-1-2001; IN COMMERCE 6-1-2001.

2,748,112. ROYAL THOUGHTS, LLC, MINNEAPOLIS, MN. SN 76-258,568. PUB. 10-8-2002, FILED 5-17-2001.

eBridge

FOR ELECTRONIC TRANSMISSION OF MESSAGES AND DATA RELATED TO DEALERS, SUBSCRIBERS, AND EVENTS IN THE FIELD OF SECURITY MONITORING, MESSAGING AND DATA TRANSMISSION VIA MULTIPLE ELECTRONIC MEANS SUCH AS E-MAIL, INTERNET, WIRELESS DEVICES, FACSIMILE AND OTHER METHODS OF TRANSMITTING AND RECEIVING DATA (U.S. CLS. 100, 101 AND 104).

FIRST USE 3-5-2002; IN COMMERCE 3-5-2002.

CLASS 38—(Continued).

2,748,231. DISNEY ENTERPRISES, INC., BURBANK, CA. SN 76-296,488. PUB. 8-13-2002, FILED 8-8-2001.

ABC FAMILY

NO CLAIM IS MADE TO THE EXCLUSIVE RIGHT TO USE "FAMILY", APART FROM THE MARK AS SHOWN. FOR TELEVISION TRANSMISSION AND BROADCASTING SERVICES; RADIO COMMUNICATION SERVICES (U.S. CLS. 100, 101 AND 104). FIRST USE 11-10-2001; IN COMMERCE 11-10-2001.

2,748,264. M.C. DEAN, INC., CHANTILLY, VA. SN 76-308,743. PUB. 6-18-2002, FILED 8-31-2001.

GLASS MILE

FOR PROVIDING HIGH SPEED ACCESS TO AREA NETWORKS AND A GLOBAL COMPUTER INFORMATION NETWORK (U.S. CLS. 100, 101 AND 104). FIRST USE 9-4-2001; IN COMMERCE 9-4-2001.

2,748,401. LIGHTDIAL CORPORATION, IRVINE, CA. SN 76-351,330. PUB. 7-9-2002, FILED 12-19-2001.

LIGHTDIAL

FOR LOCAL AND LONG DISTANCE TELEPHONE SERVICES (U.S. CLS. 100, 101 AND 104). FIRST USE 6-0-2002; IN COMMERCE 6-0-2002.

2,748,486. PETROLEUM COMMUNICATIONS, INC., HARRISBURG, PA. SN 76-379,271. PUB. 9-24-2002, FILED 3-8-2002.



OWNER OF U.S. REG. NO. 1,931,188. FOR PROVIDING CELLULAR TELEPHONE COMMUNICATIONS SERVICES FOR THE OIL AND GAS INDUSTRY (U.S. CLS. 100, 101 AND 104). FIRST USE 0-0-2002; IN COMMERCE 0-0-2002.

CLASS 38—(Continued).

2,748,498. PETROLEUM COMMUNICATIONS, INC., HARRISBURG, PA. SN 76-381,435. PUB. 10-1-2002, FILED 3-13-2002.



OWNER OF U.S. REG. NO. 1,931,188. FOR PROVIDING CELLULAR TELEPHONE COMMUNICATIONS SERVICES FOR THE OIL AND GAS INDUSTRY (U.S. CLS. 100, 101 AND 104). FIRST USE 0-0-2002; IN COMMERCE 0-0-2002.

2,748,600. BAXTER, JOHN F., JR., MARCO ISLAND, FL. SN 78-010,776. PUB. 2-11-2003, FILED 6-1-2000.

VOICE IN MAIL

NO CLAIM IS MADE TO THE EXCLUSIVE RIGHT TO USE "VOICE" AND "MAIL", APART FROM THE MARK AS SHOWN. FOR DIGITAL AUDIO FILE TRANSMISSION SERVICES OVER A GLOBAL NETWORK (U.S. CLS. 100, 101 AND 104). FIRST USE 5-1-2000; IN COMMERCE 5-1-2000.

2,748,652. WORLDCOM, INC., JACKSON, MS. SN 78-047,457. PUB. 11-27-2001, FILED 2-9-2001.

MCI LOCAL COMPLETE

NO CLAIM IS MADE TO THE EXCLUSIVE RIGHT TO USE "LOCAL", APART FROM THE MARK AS SHOWN. FOR TELECOMMUNICATIONS SERVICES, NAMELY, A TELEPHONE CALLING RATE PLAN (U.S. CLS. 100, 101 AND 104). FIRST USE 5-11-2001; IN COMMERCE 9-30-2001.

CLASS 38—(Continued).

2,748,701. HAESTAD METHODS, INC., WATERBURY, CT. SN 78-069,317. PUB. 7-30-2002, FILED 6-15-2001.

WATERTALK

FOR PROVIDING AN ONLINE LIST SERVER, NAMELY, PROVIDING A SUBSCRIPTION TO AN ONLINE MAILING LIST AND DISTRIBUTING MESSAGES, NEWSLETTER, AND OTHER POSTINGS FROM THE LIST'S MEMBERS IN THE FIELD OF WATER DISTRIBUTION MODELING (U.S. CLS. 100, 101 AND 104).
FIRST USE 6-1-2001; IN COMMERCE 6-1-2001.

2,748,709. ILD TELECOMMUNICATIONS, INC., PONTE VEDRA BEACH, FL. SN 78-072,817. PUB. 8-6-2002, FILED 7-8-2001.

800-ROLL-CALL

OWNER OF U.S. REG. NO. 2,222,712.
FOR AUDIO TELECONFERENCING SERVICES, NAMELY A RESERVATION-FREE TELECONFERENCING SERVICE THAT ALLOWS THE CONFERENCE ORIGINATOR TO HOLD OR PLACE AN AUDIO CONFERENCE CALL AT ANY TIME OF THE DAY OR NIGHT (U.S. CLS. 100, 101 AND 104).
FIRST USE 9-0-2001; IN COMMERCE 9-0-2001.

CLASS 39—TRANSPORTATION AND STORAGE

2,747,477. EXELON VENTURES COMPANY, LLC, CHICAGO, IL, BY ASSIGNMENT PECO ENERGY COMPANY, PHILADELPHIA, PA. SN 75-494,120. PUB. 12-7-1999, FILED 6-1-1998.

EXELON

OWNER OF U.S. REG. NO. 2,153,101.
FOR PUBLIC UTILITY SERVICES IN THE NATURE OF NATURAL GAS DISTRIBUTION; INFORMATION SERVICES REGARDING ELECTRIC AND GAS PUBLIC UTILITY SERVICES PROVIDED THROUGH WEBSITES AND HOME PAGES, AND DISTRIBUTED VIA GLOBAL COMPUTER NETWORKS (U.S. CLS. 100 AND 105).
FIRST USE 10-20-2000; IN COMMERCE 10-20-2000.

CLASS 39—(Continued).

2,747,543. ALASKA AIRLINES, INC., SEATTLE, WA. SN 75-659,090. PUB. 6-20-2000, FILED 3-12-1999.

WWW.ALASKAAIR.COM

OWNER OF U.S. REG. NOS. 862,903, 1,684,001, AND OTHERS.

SEC. 2(F).
FOR AIR TRANSPORTATION SERVICES; AIRLINE PASSENGER SERVICES IN THE NATURE OF A FREQUENT FLYER PROGRAM; FREIGHT AND CARGO FORWARDING SERVICES; POSTAL SERVICES, NAMELY, PARCEL TRANSPORTATION, TRACKING, DELIVERY, AND PACKAGING ARTICLES FOR TRANSPORT; CAR RENTAL SERVICES; PROVIDING AN INTERACTIVE WEBSITE CONTAINING INFORMATION, SERVICES, RESERVATION AND CHECK-IN CAPABILITY PRIMARILY RELATING TO TRAVEL, CAR RENTAL, AND FREIGHT AND CARGO FORWARDING, NAMELY, AIRLINE FLIGHT SCHEDULES, AIRLINE FLIGHT RESERVATIONS, AIRLINE FLIGHT BOOKINGS, AIRLINE FLIGHT SEATING ASSIGNMENTS, AIRLINE FLIGHT MEALS, CAR RENTAL RESERVATIONS, TRAVEL AND TOUR PACKAGES, AND ARRANGEMENTS FOR FREIGHT AND CARGO SHIPMENTS (U.S. CLS. 100 AND 105).
FIRST USE 1-1-1996; IN COMMERCE 1-1-1996.

2,747,658. CUNARD LINE LIMITED, MIAMI, FL. SN 75-862,548. PUB. 1-1-2002, FILED 12-2-1999.

SEABOURN.COM

OWNER OF U.S. REG. NOS. 2,147,466 AND 2,167,162.
SEC. 2(F).
FOR CRUISE SHIP SERVICES; ARRANGING OF CRUISES; TRAVEL INFORMATION SERVICES PROVIDED VIA AN ON-LINE COMPUTER NETWORK (U.S. CLS. 100 AND 105).
FIRST USE 4-0-2002; IN COMMERCE 4-0-2002.

2,747,732. FISCHER, DANIEL, AVENTURA, FL. AND ZISMAN, SIMON, AVENTURA, FL. SN 76-017,755. PUB. 7-16-2002, FILED 4-5-2000.

DOUWANTIT.COM

FOR POSTAL SERVICES, NAMELY, PARCEL DELIVERY, PACKAGING ARTICLES FOR TRANSPORTATION, RENTAL OF MAILBOXES, FREIGHT TRANSPORTATION BY AIR FOR ON-LINE CUSTOMERS OF CONSUMER GOODS (U.S. CLS. 100 AND 105).
FIRST USE 1-20-2000; IN COMMERCE 1-20-2000.

CLASS 39—(Continued).

2,748,194. WORLDSPAN, L.P., ATLANTA, GA. SN 76-283,791. PUB. 7-23-2002, FILED 7-13-2001.

WORLDSPAN E-PRICING

OWNER OF U.S. REG. NOS. 182,550, 2,311,280, AND OTHERS.

NO CLAIM IS MADE TO THE EXCLUSIVE RIGHT TO USE "E-PRICING", APART FROM THE MARK AS SHOWN.

FOR PROVIDING ACCESS TIME TO A COMPUTER DATABASE IN THE TRAVEL INDUSTRY FOR THE PURPOSE OF OBTAINING MULTIPLE FARE AND ROUTE OPTIONS TO A BOOKED ITINERARY (U.S. CLS. 100 AND 105).

FIRST USE 4-15-2002; IN COMMERCE 4-15-2002.

2,748,327. MAILBOX 24 HR EXPRESS, INC., MARSHFIELD, MO. SN 76-329,053. PUB. 7-30-2002, FILED 10-23-2001.

Mailbox iT

NO CLAIM IS MADE TO THE EXCLUSIVE RIGHT TO USE "MAILBOX", APART FROM THE MARK AS SHOWN.

FOR POSTAL SERVICES, NAMELY, RENTAL OF MAIL BOXES, MAIL FORWARDING, PACKAGING ARTICLES FOR TRANSPORTATION, AND RECEIPT AND DELIVERY OF MAIL AND PARCELS FOR OTHERS (U.S. CLS. 100 AND 105).

FIRST USE 1-1-2003; IN COMMERCE 1-1-2003.

2,748,350. KEESEE, CHRISTIAN K., OKLAHOMA CITY, OK. SN 76-335,954. PUB. 7-23-2002, FILED 11-9-2001.

TIME LINES

NO CLAIM IS MADE TO THE EXCLUSIVE RIGHT TO USE "LINES", APART FROM THE MARK AS SHOWN.

FOR TRANSPORTATION OF PASSENGERS AND GOODS BY BUS (U.S. CLS. 100 AND 105).

FIRST USE 10-21-2002; IN COMMERCE 10-21-2002.

2,748,470. FIRST CHOICE POWER, INC., FORT WORTH, TX. SN 76-372,123. PUB. 10-29-2002, FILED 2-19-2002.

CERTAIN ENERGY

NO CLAIM IS MADE TO THE EXCLUSIVE RIGHT TO USE "ENERGY", APART FROM THE MARK AS SHOWN.

FOR PUBLIC UTILITY SERVICES (U.S. CLS. 100 AND 105).

FIRST USE 1-29-2002; IN COMMERCE 1-29-2002.

CLASS 39—(Continued).

2,748,831. NORTHRIDGE MOVING & STORAGE, INC., SIMI VALLEY, CA. SN 78-102,186. PUB. 10-29-2002, FILED 1-11-2002.

RELOCATION AT ITS BEST!

FOR STORAGE SERVICES IN THE FIELD OF HOUSEHOLD GOODS AND TRANSPORTATION OF HOUSEHOLD GOODS BY MOTOR VEHICLE (U.S. CLS. 100 AND 105).

FIRST USE 5-1-1986; IN COMMERCE 5-1-1986.

CLASS 40—MATERIAL TREATMENT

2,747,476. H&H ECO SYSTEMS, INC., NORTH BONNEVILLE, WA. SN 75-488,134. PUB. 9-7-1999, FILED 5-20-1998.

RADICAL OXIDATION

FOR MATERIAL TREATMENT SERVICES, NAMELY, SOLID AND LIQUID REMEDIATION SERVICES (U.S. CLS. 100, 103 AND 106).

FIRST USE 1-21-2003; IN COMMERCE 1-21-2003.

2,747,627. FLUID IMAGING TECHNOLOGIES, INC., EDGE-COMB, ME. SN 75-821,806. PUB. 3-26-2002, FILED 10-12-1999.

FlowCAM

FOR CUSTOM MANUFACTURE OF FLUID IMAGING DEVICES CONSISTING OF PERISTALTIC PUMPS WITH SPECIALIZED OPTICS, VIDEO CAMERAS, FLOW CYTOMETERS, MICROSCOPES, COMPUTER SOFTWARE, AND COMPUTER, WHICH ARE USED BY SCIENTISTS TO COUNT, IMAGE, MEASURE, PHOTOGRAPH AND DIGITALLY RECORD AND PRESERVE IMAGES OF INDIVIDUAL CELLS AND PARTICLES OF MICROPLANKTON (U.S. CLS. 100, 103 AND 106).

FIRST USE 10-15-2000; IN COMMERCE 10-15-2000.

CLASS 40—(Continued).

2,747,677. PIXEL MAGIC IMAGING, INC., SAN MARCOS, TX. SN 75-889,287. PUB. 5-7-2002, FILED 1-6-2000.

MYPHOTOLAB.COM

FOR ELECTRONIC IMAGING, SCANNING, DIGITIZING, ALTERATION, RETOUCHING AND RESTORATION OF PHOTOGRAPHIC IMAGES; PHOTOGRAPHIC PRINTING; MEDIA DUPLICATION OF DATA AND DIGITAL INFORMATION; PHOTOFINISHING SERVICES PROVIDED OVER AN ELECTRONIC COMPUTER NETWORK; FILM PROCESSING SERVICES WHICH ALLOW CUSTOMERS TO RECEIVE, VIEW, MANIPULATE, TRANSMIT AND STORE DIGITIZED PHOTOGRAPHS VIA A GLOBAL COMPUTER INFORMATION NETWORK (U.S. CLS. 100, 103 AND 106).
FIRST USE 9-0-1999; IN COMMERCE 2-0-2000.

2,747,990. BAIRD, LISA B., SPRINGFIELD, MO. SN 76-201,574. PUB. 9-17-2002, FILED 1-29-2001.

YODVD

FOR ELECTRONIC SCHOOL YEARBOOK SERVICES FOR OTHERS, NAMELY, ELECTRONIC IMAGING, SCANNING, DIGITIZING, ALTERATION AND/OR RETOUCHING OF STUDENT PHOTOGRAPHS, NAMELY, PHOTO-PERSONALIZATION TO DIGITAL VIDEO DISKS (DVDS); DIGITAL COMPRESSION AND DECOMPRESSION OF PRE-RECORDED DIGITAL IMAGES FROM REMOVABLE COMPUTER DEVICES; DIGITAL RESTORATION AND/OR ENHANCEMENT OF PHOTOGRAPHS FOR OTHERS (U.S. CLS. 100, 103 AND 106).
FIRST USE 1-31-2001; IN COMMERCE 1-31-2001.

2,747,999. DEXM CORPORATION, WAUKESHA, WI. SN 76-207,875. PUB. 6-4-2002, FILED 2-9-2001.

DEXM ENGINEERED PRODUCTS

OWNER OF U.S. REG. NO. 2,182,992.
NO CLAIM IS MADE TO THE EXCLUSIVE RIGHT TO USE "ENGINEERED PRODUCTS", APART FROM THE MARK AS SHOWN.
FOR CUSTOM MANUFACTURING, NAMELY, CUSTOM METAL STAMPING AND WIRE FORMED PRODUCTS FOR THE AUTOMOTIVE, AGRICULTURE, LAWN AND GARDEN, FLUID HANDLING, ELECTRICAL POWER AND DISTRIBUTION, MARINE, POINT-OF-PURCHASE DISPLAY, AND SPORTING GOODS INDUSTRIES (U.S. CLS. 100, 103 AND 106).
FIRST USE 0-0-2002; IN COMMERCE 0-0-2002.

CLASS 40—(Continued).

2,748,915. EASTMAN CHEMICAL COMPANY, KINGSPORT, TN. SN 78-119,138. PUB. 10-29-2002, FILED 4-3-2002.

YOUR VISION. OUR FOCUS

FOR CUSTOM MANUFACTURING OF CHEMICALS, PLASTICS AND FIBERS FOR GENERAL INDUSTRIAL USE (U.S. CLS. 100, 103 AND 106).
FIRST USE 4-1-2002; IN COMMERCE 4-1-2002.

CLASS 41—EDUCATION AND ENTERTAINMENT

2,747,503. LINDY PROMOTIONS, INC., BETHESDA, MD. SN 75-554,017. PUB. 7-30-2002, FILED 9-15-1998.

THE NATIONAL MILLENNIUM

NO CLAIM IS MADE TO THE EXCLUSIVE RIGHT TO USE "NATIONAL", APART FROM THE MARK AS SHOWN.
FOR ENTERTAINMENT IN THE NATURE OF COMMUNITY FESTIVALS FEATURING LIVE MUSIC CONCERTS, DANCE PERFORMANCES, FOOD AND DRINK (U.S. CLS. 100, 101 AND 107).
FIRST USE 12-0-1998; IN COMMERCE 12-0-1998.

2,747,516. AEROBICS AND FITNESS ASSOCIATION OF AMERICA, SHERMAN OAKS, CA. SN 75-599,354. PUB. 12-28-1999, FILED 12-3-1998.

NUTRITION GETS PERSONAL

NO CLAIM IS MADE TO THE EXCLUSIVE RIGHT TO USE "NUTRITION", APART FROM THE MARK AS SHOWN.
FOR EDUCATIONAL SERVICES, NAMELY, CONDUCTING SEMINARS AND CLASSES ON THE SUBJECTS OF NUTRITION AND HEALTH (U.S. CLS. 100, 101 AND 107).
FIRST USE 3-20-2003; IN COMMERCE 3-20-2003.

2,747,518. NATIONAL INSURANCE CRIME BUREAU, PALOS HILL, IL. SN 75-603,792. PUB. 7-9-2002, FILED 12-11-1998.

FRAUDSMART

FOR EDUCATIONAL AND TRAINING SERVICES, NAMELY, CONDUCTING CLASSES IN THE DETECTION OF FRAUD AND TECHNIQUES FOR THE PREVENTION OF FRAUD (U.S. CLS. 100, 101 AND 107).
FIRST USE 0-0-2000; IN COMMERCE 0-0-2000.

CLASS 41—(Continued).

2,747,562. THINKBOX INC., GLENDALE, CA, BY ASSIGNMENT THINKBOX MEDIA, LLC, HOLLYWOOD, CA. SN 75-697,078. PUB. 1-11-2000, FILED 4-30-1999.

KINDLE PARK

FOR ENTERTAINMENT SERVICES, NAMELY MOTION PICTURE FILM AND VIDEO PRODUCTION; ENTERTAINMENT IN THE NATURE OF AN ONGOING TELEVISION SERIES IN THE FIELD OF ANIMATED AND LIVE ACTION COMEDY-DRAMA, ACTION-ADVENTURE, AND EDUCATIONAL PROGRAMMING; MOTION PICTURE, RADIO PROGRAMMING AND TELEVISION PROGRAM DISTRIBUTION FOR OTHERS; PRODUCTION OF EDUCATIONAL AND ENTERTAINMENT VIDEO PROGRAMMING INTENDED FOR ONLINE DISTRIBUTION BY MEANS OF A GLOBAL COMPUTER NETWORK; PRODUCTION OF TELEVISION BROADCAST PROGRAMS AND INTERACTIVE TELEVISION PROGRAMS INTENDED FOR ONLINE DISTRIBUTION VIA A GLOBAL COMPUTER NETWORK AND FOR DISTRIBUTION VIA CABLE, SATELLITE, WIRELESS AND TRADITIONAL TELEVISION IN THE FIELDS OF EDUCATION AND ENTERTAINMENT FOR CHILDREN (U.S. CLS. 100, 101 AND 107).

FIRST USE 11-30-1998; IN COMMERCE 9-1-2000.

2,747,568. HILLTOP NEW MEDIA, INC., CULVER CITY, CA. SN 75-713,305. PUB. 3-21-2000, FILED 5-25-1999.

SOAP CITY

NO CLAIM IS MADE TO THE EXCLUSIVE RIGHT TO USE "SOAP", APART FROM THE MARK AS SHOWN.

FOR ENTERTAINMENT SERVICES, IN THE NATURE OF PROVIDING TELEVISION PROGRAMMING RELATED TO SOAP OPERAS (U.S. CLS. 100, 101 AND 107).

FIRST USE 2-26-2003; IN COMMERCE 2-26-2003.

2,747,633. PLATINUM STUDIOS LLC., BEVERLY HILLS, CA. SN 75-831,405. PUB. 8-20-2002, FILED 10-25-1999.



FOR MOTION PICTURE FILM AND VIDEO TAPE PRODUCTION; ENTERTAINMENT IN THE NATURE OF PRERECORDED AND CONTINUING LIVE-ACTION, ACTION ADVENTURE AND ANIMATED PROGRAMS DISTRIBUTED OVER TELEVISION, CABLE, SATELLITE, AUDIO, INTERACTIVE AND VIDEO MEDIA (U.S. CLS. 100, 101 AND 107).

FIRST USE 11-0-2000; IN COMMERCE 11-0-2000.

CLASS 41—(Continued).

2,747,634. PLATINUM STUDIOS LLC., BEVERLY HILLS, CA. SN 75-831,407. PUB. 8-27-2002, FILED 10-25-1999.

PLATINUM STUDIOS

NO CLAIM IS MADE TO THE EXCLUSIVE RIGHT TO USE "STUDIOS", APART FROM THE MARK AS SHOWN.

FOR MOTION PICTURE FILM PRODUCTION, NONE OF WHICH FEATURE EXERCISE PROGRAMS (U.S. CLS. 100, 101 AND 107).

FIRST USE 11-0-2000; IN COMMERCE 11-0-2000.

2,747,640. SPORTS CLUB COMPANY, INC., THE, LOS ANGELES, CA. SN 75-839,246. PUB. 6-25-2002, FILED 11-3-1999.

FITLAB

FOR FITNESS AND HEALTH CLUB SERVICES, NAMELY, PROVIDING FACILITIES FOR MAKING HEALTH AND FITNESS ASSESSMENTS AND SCREENINGS (U.S. CLS. 100, 101 AND 107).

FIRST USE 2-0-2000; IN COMMERCE 2-0-2000.

2,747,675. STAYWELL COMPANY, THE, SAN BRUNO, CA. SN 75-888,043. PUB. 2-19-2002, FILED 1-6-2000.

STAYWELL'S NEXTSTEPS

OWNER OF U.S. REG. NO. 1,189,585.

FOR EDUCATIONAL, TRAINING AND PERSONALIZED BEHAVIOR CHANGE PROGRAMS, NAMELY, CONDUCTING CONFERENCES BY PHONE OR MAIL CONCERNING HEALTH IMPROVEMENT IN THE FIELDS OF WEIGHT MANAGEMENT, EXERCISE, BLOOD PRESSURE MANAGEMENT, SMOKING CESSATION, CONGESTIVE HEART FAILURE, DIABETES (TYPE II), NUTRITION, STRESS MANAGEMENT, CHOLESTEROL MANAGEMENT, BACK CARE/ERGONOMICS, CORONARY ARTERY DISEASE AND ADULT ASTHMA (U.S. CLS. 100, 101 AND 107).

FIRST USE 3-1-2000; IN COMMERCE 3-1-2000.

CLASS 41—(Continued).

2,747,720. 1A DIRECTORS' CHAMPS PROGRAM, INC., SOUTHLAKE, TX. SN 76-002,764. PUB. 7-9-2002, FILED 3-17-2000.

CHAMPS PROGRAM OF EXCELLENCE

OWNER OF U.S. REG. NO. 1,938,667.
NO CLAIM IS MADE TO THE EXCLUSIVE RIGHT TO USE "PROGRAM OF EXCELLENCE", APART FROM THE MARK AS SHOWN.

FOR EDUCATIONAL SERVICES NAMELY, PROVIDING INCENTIVES TO SCHOOLS TO DEMONSTRATE EXCELLENCE IN THE EXECUTION OF A PROGRAM COMBINING TRAINING COUNSELING AND SUPPORT TO PROMOTE ACADEMIC AND ATHLETIC EXCELLENCE AND COMMUNITY LEADERSHIP THROUGH THE ISSUANCE OF AWARDS (U.S. CLS. 100, 101 AND 107).

FIRST USE 0-0-1997; IN COMMERCE 0-0-1997.

2,747,736. NORTHEASTERN UNIVERSITY, BOSTON, MA. SN 76-023,392. PUB. 7-24-2001, FILED 4-11-2000.



Northeastern
UNIVERSITY

NO CLAIM IS MADE TO THE EXCLUSIVE RIGHT TO USE "UNIVERSITY", APART FROM THE MARK AS SHOWN.

FOR EDUCATIONAL SERVICES, NAMELY PROVIDING INSTRUCTION, LECTURES AND SEMINARS AT THE POST-SECONDARY LEVEL; ARRANGING AND CONDUCTING EDUCATIONAL CONFERENCES; ENTERTAINMENT IN THE NATURE OF COLLEGIATE SPORTING EVENTS, DRAMATIC AND MUSICAL PRODUCTIONS, AND FILMS; PROVIDING FACILITIES FOR RECREATIONAL ACTIVITIES; MAGAZINE PUBLICATION; RADIO AND TELEVISION PROGRAM PRODUCTION (U.S. CLS. 100, 101 AND 107).

FIRST USE 10-0-1998; IN COMMERCE 10-0-1998.

CLASS 41—(Continued).

2,747,760. CARTOON NETWORK LP, LLLP, ATLANTA, GA. SN 76-046,031. PUB. 5-28-2002, FILED 5-11-2000.



OWNER OF U.S. REG. NO. 2,196,061.

FOR ENTERTAINMENT AND EDUCATION SERVICES IN THE NATURE OF A CONTINUING CARTOON PROGRAM SERIES AND MOTION PICTURE FILM PRODUCTION DIRECTED TOWARD CHILDREN AND YOUNG ADULTS, AND PROVIDED THROUGH CABLE TELEVISION, BROADCAST TELEVISION, BROADCAST RADIO AND THE GLOBAL COMPUTER INFORMATION NETWORK (U.S. CLS. 100, 101 AND 107).

FIRST USE 2-14-2003; IN COMMERCE 2-14-2003.

2,747,788. INTERVISTA INSTITUTE INC., JACKSONVILLE, FL. SN 76-066,350. PUB. 10-30-2001, FILED 6-8-2000.

INTERVISTA INSTITUTE

NO CLAIM IS MADE TO THE EXCLUSIVE RIGHT TO USE "INSTITUTE", APART FROM THE MARK AS SHOWN.

FOR EDUCATIONAL SERVICES, NAMELY, CONDUCTING SEMINARS, LECTURE AND CONFERENCE SESSIONS IN THE FIELD OF INFORMATION TECHNOLOGY FOR INFORMATION TECHNOLOGY EXECUTIVES AND CONSULTANTS (U.S. CLS. 100, 101 AND 107).

FIRST USE 2-0-2002; IN COMMERCE 2-0-2002.

2,747,802. PINNACLE ENTERTAINMENT, INC., GLENDALE, CA. SN 76-075,269. PUB. 12-25-2001, FILED 5-17-2000.

CHAMPIONS CLUB

NO CLAIM IS MADE TO THE EXCLUSIVE RIGHT TO USE "CLUB", APART FROM THE MARK AS SHOWN.

FOR CASINO SERVICES (U.S. CLS. 100, 101 AND 107).

FIRST USE 10-0-2000; IN COMMERCE 10-0-2000.

CLASS 41—(Continued).

2,747,813. GREAT AMERICAN INSURANCE COMPANY, CINCINNATI, OH. SN 76-081,250. PUB. 9-4-2001, FILED 6-30-2000.

GREAT AMERICAN BALL PARK

OWNER OF U.S. REG. NO. 2,088,045 AND OTHERS.
NO CLAIM IS MADE TO THE EXCLUSIVE RIGHT TO USE "AMERICAN BALL PARK", APART FROM THE MARK AS SHOWN.

FOR ENTERTAINMENT SERVICES, NAMELY HOSTING MAJOR LEAGUE SPORTING EVENTS AND OTHER ENTERTAINMENT AND SPORTING EVENTS IN A SPORTS AND ENTERTAINMENT FACILITY (U.S. CLS. 100, 101 AND 107).

FIRST USE 3-28-2003; IN COMMERCE 3-28-2003.

2,747,815. NEW WINE PRODUCTIONS, INC., JACKSON, MS. SN 76-082,330. PUB. 1-22-2002, FILED 7-3-2000.



NO CLAIM IS MADE TO THE EXCLUSIVE RIGHT TO USE "SPORTS REPORT", APART FROM THE MARK AS SHOWN.

STIPPLING IN THE DRAWING IS A FEATURE OF THE MARK AND DOES NOT SHOW SHADING.

THE NAME "STRAP WOODALL" DOES NOT IDENTIFY A LIVING INDIVIDUAL.

FOR ENTERTAINMENT IN THE NATURE OF A SERIES OF SHORT SPORTS REPORTS PROVIDED IN THE FORM OF A CARTOON FOR TELEVISION; ENTERTAINMENT IN THE NATURE OF A SERIES OF SHORT SPORTS REPORT PROVIDED IN THE FORM OF A CARTOON FOR ACCESS ON-LINE (U.S. CLS. 100, 101 AND 107).

FIRST USE 4-7-2003; IN COMMERCE 4-7-2003.

CLASS 41—(Continued).

2,747,851. GLOBAL SHARED SERVICES CONSULTING, SCOTTSDALE, AZ. SN 76-114,605. PUB. 3-19-2002, FILED 8-22-2000.

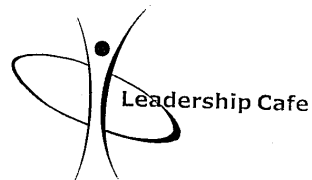

NO CLAIM IS MADE TO THE EXCLUSIVE RIGHT TO USE "LEADERSHIP", APART FROM THE MARK AS SHOWN.

THE MARK CONSISTS OF THE WORDS "LEADERSHIP CAFE" TO THE RIGHT OF A GEOMETRIC CONFIGURATION OF A PERSON STANDING IN FRONT OF A HORIZONTAL OVAL.

FOR TRAINING SERVICES, NAMELY CONDUCTING CLASSES FOR DESIGNING OF TRAINING MATERIALS, CONDUCTING WORKSHOPS, CLASSES AND CONFERENCES IN THE FIELD OF BUSINESS MANAGEMENT AND CONSULTING (U.S. CLS. 100, 101 AND 107).

FIRST USE 1-1-2001; IN COMMERCE 1-1-2001.

2,747,900. PARAMOUNT PICTURES CORPORATION, LOS ANGELES, CA. SN 76-151,220. PUB. 5-14-2002, FILED 10-20-2000.

FIRST MONDAY

FOR ENTERTAINMENT SERVICES IN THE NATURE OF A DRAMATIC TELEVISION SERIES (U.S. CLS. 100, 101 AND 107).

FIRST USE 1-15-2002; IN COMMERCE 1-15-2002.

2,747,933. MISNER, THOMAS, D-81737 MUNICH, FED REP GERMANY. SN 76-173,911. PUB. 5-28-2002, FILED 12-1-2000.



OWNER OF U.S. REG. NO. 2,407,606.
FOR EDUCATIONAL SERVICES, NAMELY EDUCATIONAL SEMINARS AND WORKSHOPS IN THE FIELD OF AUDIO ENGINEERING (U.S. CLS. 100, 101 AND 107).
FIRST USE 1-1-1997; IN COMMERCE 1-22-1998.

CLASS 41—(Continued).

2,747,952. ATOMSHOCKWAVE CORP., SAN FRANCISCO, CA. SN 76-182,670. PUB. 8-6-2002, FILED 12-19-2000.

DJ FU WAX ATTACK

FOR ENTERTAINMENT SERVICES; NAMELY PROVIDING ONLINE COMPUTER GAMES VIA A GLOBAL COMPUTER NETWORK (U.S. CLS. 100, 101 AND 107).
FIRST USE 5-22-2001; IN COMMERCE 5-22-2001.

2,747,971. US TUMBLERS, INC., VA BEACH, VA. SN 76-194,110. PUB. 3-12-2002, FILED 1-5-2001.

HARDCORE

FOR ORGANIZING AND CONDUCTING CHEERLEADING AND/OR GYMNASTICS COMPETITIONS; PROVIDING INSTRUCTION AND CONDUCTING CAMPS AND CLINICS IN THE FIELD OF GYMNASTICS AND/OR CHEERLEADING (U.S. CLS. 100, 101 AND 107).
FIRST USE 10-1-2000; IN COMMERCE 5-1-2001.

2,747,972. STATE PRESERVATION BOARD, AUSTIN, TX. SN 76-194,788. PUB. 8-20-2002, FILED 1-10-2001.

THE STORY OF TEXAS

NO CLAIM IS MADE TO THE EXCLUSIVE RIGHT TO USE "TEXAS", APART FROM THE MARK AS SHOWN.

FOR MUSEUM SERVICES, NAMELY, THE OPERATION OF A MUSEUM RELATED TO TEXAS HISTORY AND CULTURE; EDUCATIONAL SERVICES, NAMELY, PROVIDING COURSES OF INSTRUCTION, CLASSES, SEMINARS AND LECTURES IN THE FIELD OF HISTORY AND CULTURE; ARRANGING AND CONDUCTING EDUCATIONAL CONFERENCES; EDUCATIONAL RESEARCH; LIVE MUSIC CONCERTS; MOTION PICTURE THEATERS; DEVELOPMENT AND PRODUCTION OF LIVE PERFORMANCE EXHIBITIONS; DEVELOPMENT AND DISSEMINATION OF EDUCATIONAL AND CURRICULAR MATERIALS FOR OTHERS ALL RELATED TO TEXAS HISTORY AND CULTURE (U.S. CLS. 100, 101 AND 107).

FIRST USE 4-27-2001; IN COMMERCE 4-27-2001.

CLASS 41—(Continued).

2,747,974. HUMOR CONSULTANTS, INC., POWELL, OH. SN 76-195,100. PUB. 6-11-2002, FILED 1-16-2001.

**WORK SMART, HAVE FUN,
AND MAKE MONEY**

FOR ORGANIZING AND CONDUCTING KEYNOTE SPEECHES IN THE FIELD OF PROMOTING MENTAL, PHYSICAL AND SPIRITUAL WELL-BEING; MASTER OF CEREMONY SERVICES, PROVIDING SPEECHES IN THE FIELD OF PROMOTING MENTAL, PHYSICAL AND SPIRITUAL WELL-BEING; GROUP TRAINING SERVICES IN THE FIELD OF PROMOTING MENTAL, PHYSICAL AND SPIRITUAL WELL-BEING; AND CONDUCTING WORKSHOPS IN THE FIELD OF PROMOTING MENTAL, PHYSICAL AND SPIRITUAL WELL-BEING (U.S. CLS. 100, 101 AND 107).
FIRST USE 3-3-2003; IN COMMERCE 3-3-2003.

2,747,993. CARTOON NETWORK LP, LLLP, THE, ATLANTA, GA. SN 76-205,110. PUB. 7-24-2001, FILED 2-5-2001.



FOR ENTERTAINMENT AND EDUCATION SERVICES IN THE NATURE OF A CONTINUING PROGRAM SERIES AND MOTION PICTURE FILMS DIRECTED TOWARD CHILDREN AND YOUNG ADULTS, PROVIDED THROUGH CABLE TELEVISION, BROADCAST TELEVISION, BROADCAST RADIO AND THE GLOBAL COMPUTER INFORMATION NETWORK (U.S. CLS. 100, 101 AND 107).

FIRST USE 4-8-2003; IN COMMERCE 4-8-2003.

2,748,027. PHOENIX SOCIETY, INC., THE, DBA THE PHOENIX SOCIETY FOR BURN SURVIVORS, INC., EAST GRAND RAPIDS, MI. SN 76-222,164. PUB. 9-24-2002, FILED 3-9-2001.

SOAR

FOR EDUCATIONAL SERVICES, NAMELY, PROVIDING WORKSHOPS AND SEMINARS FOR TRAINEES OF BURN SURVIVORS TO ASSIST THEM IN PROVIDING PSYCHOLOGICAL GUIDANCE TO BURN SURVIVORS (U.S. CLS. 100, 101 AND 107).

FIRST USE 6-12-2001; IN COMMERCE 6-12-2001.

CLASS 41—(Continued).

2,748,045. BOYAR INVESTMENTS, L.L.C., DALLAS, TX. SN 76-228,430. PUB. 7-23-2002, FILED 3-21-2001.

MARBELLA HOUSE

NO CLAIM IS MADE TO THE EXCLUSIVE RIGHT TO USE "HOUSE", APART FROM THE MARK AS SHOWN.

FOR PRODUCTION AND PUBLICATION OF PRINTED MATERIALS AND MULTIMEDIA RECORDINGS, NAMELY, BOOKS; SOUND AND MUSIC RECORDED ON COMPACT DISCS; AUDIO AND VIDEO CASSETTES AND DVDS FEATURING A VARIETY OF TOPICS IN THE FIELDS OF EDUCATION AND GENERAL ENTERTAINMENT (U.S. CLS. 100, 101 AND 107).
FIRST USE 6-30-2001; IN COMMERCE 6-30-2001.

2,748,047. XM SATELLITE RADIO INC., WASHINGTON, DC. SN 76-228,703. PUB. 7-16-2002, FILED 3-22-2001.

THE POWER

FOR ENTERTAINMENT SERVICES, NAMELY, PROVIDING AUDIO PROGRAMS FEATURING MUSIC, SPORTS, TALK, NEWS AND DATA VIA SATELLITE AND VIA A GLOBAL COMMUNICATION NETWORK (U.S. CLS. 100, 101 AND 107).

FIRST USE 9-25-2001; IN COMMERCE 9-25-2001.

2,748,072. LASERSIGHT TECHNOLOGIES, INC., WINTER PARK, FL. SN 76-239,873. PUB. 7-2-2002, FILED 4-12-2001.

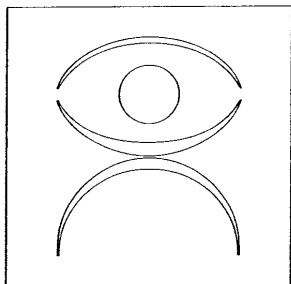

THE MARK CONSISTS OF A DEPICTION OF AN EYE ATOP A SEMI-CIRCLE, WHICH ALSO CAN BE VIEWED AS A DEPICTION OF A STYLIZED MAN WITH EXTENDED LEGS AND RAISED ARMS UNDER AN ARC, WITHIN A SQUARE.

FOR TRAINING IN THE USE AND OPERATION OF SURGICAL EQUIPMENT AND SURGICAL INSTRUMENTS IN THE FIELD OF OPHTHALMOLOGY (U.S. CLS. 100, 101 AND 107).

FIRST USE 8-15-2001; IN COMMERCE 8-15-2001.

CLASS 41—(Continued).

2,748,109. COMMONWEALTH OF KENTUCKY, FRANKFORT, KY. SN 76-257,488. PUB. 7-9-2002, FILED 5-16-2001.

KYVL

FOR COMPUTER ON-LINE LIBRARY SERVICES, NAMELY, PROVIDING REFERENCE DATABASES FEATURING RESEARCH AND EDUCATIONAL MATERIALS IN THE FIELDS OF THE ARTS, HUMANITIES, MATHEMATICS, SCIENCE, TECHNOLOGY, AND SOCIAL SCIENCES (U.S. CLS. 100, 101 AND 107).

FIRST USE 9-1-2001; IN COMMERCE 9-1-2001.

2,748,129. EUNIVERSE, INC., LOS ANGELES, CA. SN 76-262,274. PUB. 9-10-2002, FILED 5-24-2001.

CONTAGIOUS ENTERTAINMENT

NO CLAIM IS MADE TO THE EXCLUSIVE RIGHT TO USE "ENTERTAINMENT", APART FROM THE MARK AS SHOWN.

FOR ENTERTAINMENT SERVICES, NAMELY, PROVIDING WEB SITES FEATURING INFORMATION IN THE FIELD OF ANIMATED HUMOR, INSPIRATIONAL MESSAGES, MUSIC, MOVIES AND ENTERTAINMENT (U.S. CLS. 100, 101 AND 107).

FIRST USE 5-1-2001; IN COMMERCE 5-22-2001.

2,748,137. OLD PASADENA MANAGEMENT DISTRICT, PASADENA, CA. SN 76-263,737. PUB. 12-11-2001, FILED 5-29-2001.

THE PASADENA FOOD BOWL

NO CLAIM IS MADE TO THE EXCLUSIVE RIGHT TO USE "PASADENA FOOD", APART FROM THE MARK AS SHOWN.

FOR ENTERTAINMENT SERVICES, NAMELY CONDUCTING A FESTIVAL FEATURING FOOD, MUSIC, AND THE ARTS (U.S. CLS. 100, 101 AND 107).

FIRST USE 1-2-2002; IN COMMERCE 1-2-2002.

2,748,138. INTERNATIONAL BUSINESS MACHINES CORPORATION, ARMONK, NY. SN 76-264,046. PUB. 8-20-2002, FILED 5-30-2001.

MENTORPLACE

FOR EDUCATIONAL SERVICES, NAMELY, A VOLUNTEER PROGRAM FOR PROVIDING ONLINE COUNSELING AND TUTORING TO PARTICIPANTS (U.S. CLS. 100, 101 AND 107).

FIRST USE 11-0-2001; IN COMMERCE 11-0-2001.

CLASS 41—(Continued).

2,748,155. CMP MEDIA LLC, SAN FRANCISCO, CA. AND ATOMIC29, INC., LOS ALTOS, CA. SN 76-269,342. PUB. 7-9-2002, FILED 6-8-2001.

ATOMIC GIANTS

FOR ARRANGING AND CONDUCTING EDUCATIONAL CONFERENCES IN THE HIGH TECHNOLOGY INDUSTRY; AN AWARDS PROGRAM TO RECOGNIZE INDIVIDUALS AND ORGANIZATIONS FOR HIGH ACHIEVEMENT OR EXCELLENCE IN THE HIGH TECHNOLOGY INDUSTRY (U.S. CLS. 100, 101 AND 107).
FIRST USE 12-1-2000; IN COMMERCE 12-1-2000.

2,748,173. IMAGICA USA INC., LOS ANGELES, CA. SN 76-275,688. PUB. 8-27-2002, FILED 6-19-2001.

THE MAGIC LAB

FOR ENTERTAINMENT SERVICES, NAMELY, PRODUCTION OF OPTICAL AND DIGITAL SPECIAL EFFECTS FOR TELEVISION, MOTION PICTURES, DVDS, DIGITAL CINEMA AND VIDEO GAMES (U.S. CLS. 100, 101 AND 107).
FIRST USE 6-0-2000; IN COMMERCE 6-0-2000.

2,748,188. SYLVAN LEARNING SYSTEMS, INC., BALTIMORE, MD. SN 76-282,116. PUB. 9-3-2002, FILED 7-9-2001.

MATH ESSENTIALS

NO CLAIM IS MADE TO THE EXCLUSIVE RIGHT TO USE "MATH", APART FROM THE MARK AS SHOWN.

FOR EDUCATIONAL SERVICES, NAMELY, PROVIDING INTERACTIVE COURSES IN MATH AT THE PRIMARY, INTERMEDIATE AND SECONDARY EDUCATIONAL LEVELS VIA A GLOBAL COMMUNICATIONS NETWORK AND DISTRIBUTING CD-ROMS AND PRINTED MATERIALS IN CONNECTION THEREWITH; EDUCATIONAL SERVICES, NAMELY, PROVIDING COURSES OF INSTRUCTION AT THE PRIMARY, INTERMEDIATE, AND SECONDARY EDUCATIONAL LEVELS IN THE FIELD OF MATH; EDUCATIONAL TESTING AND SKILLS ASSESSMENT SERVICES IN THE FIELD OF MATH (U.S. CLS. 100, 101 AND 107).
FIRST USE 11-30-2001; IN COMMERCE 11-30-2001.

2,748,201. MINORITY CORPORATE COUNSEL ASSOCIATION, WASHINGTON, DC. SN 76-284,720. PUB. 7-23-2002, FILED 7-3-2001.

MCCA

FOR ARRANGING AND CONDUCTING ONLINE INTERACTIVE EDUCATIONAL CONFERENCES, PROGRAMS, SEMINARS, WORKSHOPS AND TRAINING SESSIONS FOR PROMOTING AND FOSTERING DIVERSITY IN THE WORK PLACE; PROVIDING ONLINE LEGAL EDUCATION AND RESOURCE INFORMATION SERVICES, AND PROVIDING ONLINE CONTINUING LEGAL EDUCATION PROGRAMS (U.S. CLS. 100, 101 AND 107).
FIRST USE 1-1-2000; IN COMMERCE 1-1-2000.

CLASS 41—(Continued).

2,748,223. GEI, INC., GREENWOOD, IN. SN 76-294,041. PUB. 7-30-2002, FILED 8-2-2001.

FAST

FOR TRAINING SERVICES IN THE AREA OF INDUSTRIAL EFFICIENCY IMPROVEMENT (U.S. CLS. 100, 101 AND 107).
FIRST USE 6-1-2001; IN COMMERCE 6-1-2001.

2,748,272. MOTORICITY, INC, LAMBERTVILLE, NJ. SN 76-311,728. PUB. 7-23-2002, FILED 9-10-2001.

MOTORICITY

FOR EDUCATIONAL SERVICES, NAMELY, CONDUCTING CLASSES, SEMINARS, CONFERENCES AND WORKSHOPS IN THE FIELD OF PHYSICAL FITNESS AND WEIGHT TRAINING; PHYSICAL FITNESS INSTRUCTION; PROVIDING FITNESS AND EXERCISE FACILITIES; TRAINING IN THE USE AND OPERATION OF EXERCISE EQUIPMENT AND INSTRUCTION IN THE FIELD OF PHYSICAL FITNESS (U.S. CLS. 100, 101 AND 107).
FIRST USE 8-1-2002; IN COMMERCE 8-1-2002.

2,748,323. LOE, TOM E., MAMMOTH LAKES, CA. AND LOE, MICHELE L., MAMMOTH LAKES, CA. SN 76-327,958. PUB. 10-15-2002, FILED 10-22-2001.



NO CLAIM IS MADE TO THE EXCLUSIVE RIGHT TO USE "SIERRA" AND "GUIDE SERVICE", APART FROM THE MARK AS SHOWN.

FOR FLY FISHING GUIDE SERVICE (U.S. CLS. 100, 101 AND 107).
FIRST USE 1-1-2000; IN COMMERCE 1-1-2000.

2,748,333. FLORIDA STATE UNIVERSITY, THE, TALLAHASSEE, FL. SN 76-331,661. PUB. 4-16-2002, FILED 10-25-2001.

NOT JUST ANOTHER.EDU

FOR EDUCATIONAL SERVICES NAMELY PROVIDING COURSES OF INSTRUCTION AT THE POST-SECONDARY LEVEL, IN LIBRARY AND INFORMATION SCIENCE (U.S. CLS. 100, 101 AND 107).
FIRST USE 9-30-2000; IN COMMERCE 12-31-2001.

CLASS 41—(Continued).

2,748,339. DISC MARKETING, INC., PASADENA, CA. SN 76-333,890. PUB. 9-17-2002, FILED 11-5-2001.

5 ALARM MUSIC

NO CLAIM IS MADE TO THE EXCLUSIVE RIGHT TO USE "MUSIC", APART FROM THE MARK AS SHOWN. FOR MUSIC PRODUCTION SERVICES (U.S. CLS. 100, 101 AND 107).
FIRST USE 4-23-2002; IN COMMERCE 4-23-2002.

2,748,361. PGA TOUR, INC., PONTE VEDRA BEACH, FL. SN 76-338,076. PUB. 4-16-2002, FILED 11-14-2001.

THE PLAYERS

OWNER OF U.S. REG. NOS. 1,241,244, 2,085,162, AND OTHERS. FOR ORGANIZING AND ARRANGING PROFESSIONAL GOLF TOURNAMENTS (U.S. CLS. 100, 101 AND 107).
FIRST USE 1-1-2003; IN COMMERCE 1-1-2003.

2,748,366. FEDERAL TRAINING ACADEMY, LLC, MCLEAN, VA. SN 76-339,984. PUB. 6-25-2002, FILED 11-20-2001.



NO CLAIM IS MADE TO THE EXCLUSIVE RIGHT TO USE "FEDERAL TRAINING ACADEMY", APART FROM THE MARK AS SHOWN. FOR CONDUCTING TRAINING WORKSHOPS AND SEMINARS FOR GOVERNMENT EMPLOYEES IN THE FIELDS OF HUMAN RESOURCES, PROFESSIONAL DEVELOPMENT, COMPUTER SKILLS, ADMINISTRATIVE SKILLS, WORKFORCE DIVERSITY ISSUES, COMMUNICATIONS AND COMPLIANCE WITH JOB PERFORMANCE AND EVALUATION CRITERIA (U.S. CLS. 100, 101 AND 107).
FIRST USE 12-0-2001; IN COMMERCE 1-0-2002.

CLASS 41—(Continued).

2,748,405. WOODROW WILSON SCHOOL, PRINCETON, NJ. SN 76-351,780. PUB. 7-16-2002, FILED 12-20-2001.

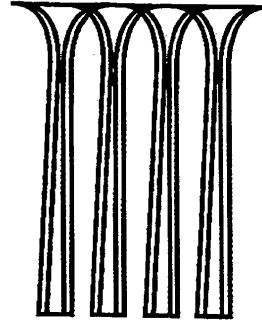

THE MARK DEPICTS COLUMNS. FOR EDUCATIONAL SERVICES, NAMELY, CLASSES AND COURSES IN PUBLIC AND INTERNATIONAL AFFAIRS AND POLICY (U.S. CLS. 100, 101 AND 107).
FIRST USE 1-31-2002; IN COMMERCE 1-31-2002.

2,748,412. BLANCHARD TRAINING AND DEVELOPMENT, INC., ESCONDIDO, CA. SN 76-353,419. PUB. 6-11-2002, FILED 12-31-2001.

WHALE DONE!

FOR EDUCATION SERVICES, NAMELY CONDUCTING SEMINARS AND CLASSES ON LEADERSHIP AND MANAGEMENT SKILLS (U.S. CLS. 100, 101 AND 107).
FIRST USE 4-19-2002; IN COMMERCE 12-2-2002.

2,748,428. BRENTON PRODUCTIONS, INC., SWANSEA, MA. SN 76-359,192. PUB. 7-2-2002, FILED 1-15-2002.

**Two Guys
GARAGE**

FOR TELEVISION SERIES FEATURING TOPICS OF INTEREST TO AUTOMOTIVE ENTHUSIASTS (U.S. CLS. 100, 101 AND 107).
FIRST USE 5-23-2002; IN COMMERCE 5-23-2002.

CLASS 41—(Continued).

2,748,433. AF2 ENTERPRISES LLC, CHICAGO, IL. SN 76-360,277. PUB. 9-24-2002, FILED 1-18-2002.

SAN DIEGO RIPTIDE

NO CLAIM IS MADE TO THE EXCLUSIVE RIGHT TO USE "SAN DIEGO", APART FROM THE MARK AS SHOWN. FOR ENTERTAINMENT SERVICES, NAMELY ORGANIZING AND PRESENTING FOOTBALL GAMES BEFORE LIVE AUDIENCES AND ON TELEVISION, RADIO, FOR GLOBAL COMPUTER NETWORK DISPLAY AND OTHER MEDIA (U.S. CLS. 100, 101 AND 107). FIRST USE 1-15-2002; IN COMMERCE 1-15-2002.

CLASS 41—(Continued).

2,748,585. EDUCATIONAL FUND TO STOP GUN VIOLENCE, THE, WASHINGTON, DC. SN 76-975,526. PUB. 5-28-2002, FILED 4-9-2001.



2,748,516. GOT IT PRODUCTIONS, LLC, ENCINAS, CA. SN 76-390,172. PUB. 11-19-2002, FILED 4-1-2002.

GOT IT PRODUCTIONS, LLC

NO CLAIM IS MADE TO THE EXCLUSIVE RIGHT TO USE "PRODUCTIONS, LLC", APART FROM THE MARK AS SHOWN. FOR MUSIC PRODUCTION SERVICES (U.S. CLS. 100, 101 AND 107). FIRST USE 12-17-2001; IN COMMERCE 12-17-2001.

NO CLAIM IS MADE TO THE EXCLUSIVE RIGHT TO USE "MEDIA", APART FROM THE MARK AS SHOWN. FOR EDUCATIONAL SERVICES, NAMELY, CONDUCTING WORKSHOPS AND TRAINING CLASSES DESIGNED TO FOSTER YOUTH DEVELOPMENT AND ENABLE YOUTH TO RESIST NEGATIVE INFLUENCES SUCH AS VIOLENCE; AND DISTRIBUTING COURSE MATERIALS IN CONNECTION THEREWITH (U.S. CLS. 100, 101 AND 107). FIRST USE 2-0-2001; IN COMMERCE 2-0-2001.

2,748,555. BURROUGHS & CHAPIN COMPANY, MYRTLE BEACH, SC. SN 76-408,337. PUB. 12-17-2002, FILED 5-16-2002.

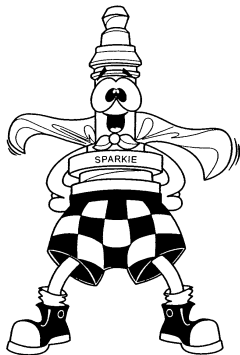

FOR ENTERTAINMENT SERVICES, NAMELY, PROVIDING GO-CART RACING FACILITIES AND GO-CART RACING (U.S. CLS. 100, 101 AND 107). FIRST USE 3-18-2003; IN COMMERCE 3-18-2003.

2,748,588. NGC NETWORK INTERNATIONAL LLC, WASHINGTON, DC. SN 76-975,554. PUB. 6-25-2002, FILED 9-27-2001.

NATIONAL GEO GENIUS

FOR TELEVISION PROGRAM SERIES FEATURING QUIZ SHOWS TO FIND THE PERSON WHO KNOWS THE MOST ABOUT OUR PLANET (U.S. CLS. 100, 101 AND 107). FIRST USE 10-14-2001; IN COMMERCE 10-14-2001.

2,748,606. REAGAN, PHIL, CAZENOVIA, NY. SN 78-015,307. PUB. 11-19-2002, FILED 7-3-2000.

CONGRUENCY MATRIX

FOR EDUCATIONAL SERVICES, NAMELY, CONDUCTING WORKSHOPS IN THE FIELD OF LEADERSHIP AND COACHING (U.S. CLS. 100, 101 AND 107). FIRST USE 1-0-2001; IN COMMERCE 1-0-2001.

CLASS 41—(Continued).

2,748,635. LOYOLA PRODUCTIONS, INC., LOS ANGELES, CA. SN 78-039,161. PUB. 11-26-2002, FILED 12-13-2000.



NO CLAIM IS MADE TO THE EXCLUSIVE RIGHT TO USE "PRODUCTIONS", APART FROM THE MARK AS SHOWN.

FOR FILM AND VIDEO PRODUCTION (U.S. CLS. 100, 101 AND 107).
FIRST USE 8-1-2000; IN COMMERCE 2-1-2001.

2,748,657. PATRICK, STEVE VANCE, WEST HOLLYWOOD, CA. SN 78-049,412. PUB. 4-23-2002, FILED 2-20-2001.

COMA

FOR ENTERTAINMENT SERVICES IN THE NATURE OF A LIVE MUSICAL GROUP; AUDIO RECORDING PRODUCTION; VIDEOTAPE PRODUCTION (U.S. CLS. 100, 101 AND 107).
FIRST USE 2-9-2000; IN COMMERCE 2-9-2000.

2,748,682. MONTEREY BAY AQUARIUM FOUNDATION, MONTEREY BAY, CA. SN 78-056,575. PUB. 11-19-2002, FILED 4-3-2001.



THE STIPPLING IS FOR SHADING PURPOSES ONLY. FOR MARINE ANIMAL EXHIBITION SERVICES (U.S. CLS. 100, 101 AND 107).
FIRST USE 5-19-2001; IN COMMERCE 5-19-2001.

2,748,726. SHANE, MICHAEL, DUNEDIN, FL. SN 78-075,828. PUB. 2-12-2002, FILED 7-26-2001.

MICHAEL SHANE

THE NAME "MICHAEL SHANE" IDENTIFIES A LIVING INDIVIDUAL WHOSE CONSENT IS OF RECORD. FOR ENTERTAINMENT IN THE NATURE OF WRESTLING CONTESTS (U.S. CLS. 100, 101 AND 107).
FIRST USE 11-1-1996; IN COMMERCE 11-1-1996.

CLASS 41—(Continued).

2,748,742. CINQUEMANI, ANTHONY M, STONE RIDGE, NY. SN 78-081,440. PUB. 8-20-2002, FILED 8-28-2001.



FOR ARRANGING FOR AMERICAN COLLEGE AND UNIVERSITY STUDENTS TO STUDY ABROAD AT UNIVERSITIES IN MADRID OR PARIS (U.S. CLS. 100, 101 AND 107).
FIRST USE 9-5-1967; IN COMMERCE 9-5-1967.

2,748,789. SHOWTIME NETWORKS INC., NEW YORK, NY. SN 78-092,655. PUB. 10-22-2002, FILED 11-9-2001.

SHOWTIME HAS THE BEST ORIGINAL FAMILY MOVIES ON TV!

OWNER OF U.S. REG. NOS. 2,496,206, 2,496,207, AND 2,496,208.

NO CLAIM IS MADE TO THE EXCLUSIVE RIGHT TO USE "BEST ORIGINAL FAMILY MOVIES ON TV", APART FROM THE MARK AS SHOWN.

FOR ENTERTAINMENT SERVICES, NAMELY, PRODUCTION AND DISTRIBUTION OF MOTION PICTURES, COMEDY, MUSICAL AND DRAMATIC SERIES, DOCUMENTARIES, SPORTING EVENTS BY MEANS OF AND FOR CABLE TELEVISION, SATELLITE-DELIVERED AND TELEVISION BROADCASTING; PROVIDING INFORMATION IN THE FIELD OF ENTERTAINMENT, NAMELY INFORMATION ABOUT THE APPLICANT'S TELEVISION PROGRAMMING VIA A GLOBAL COMPUTER NETWORK (U.S. CLS. 100, 101 AND 107).

FIRST USE 3-1-2002; IN COMMERCE 3-1-2002.

2,748,791. COUNTRY MUSIC TELEVISION, INC., NASHVILLE, TN. SN 78-092,997. PUB. 9-17-2002, FILED 11-13-2001.

FLAMEWORTHY

FOR ENTERTAINMENT SERVICES IN THE NATURE OF TELEVISION PROGRAMS FEATURING LIVE ACTION AND MUSIC; PROVIDING INFORMATION FEATURING LIVE ACTION AND MUSIC IN THE FIELD OF ENTERTAINMENT BY MEANS OF A GLOBAL COMPUTER NETWORK (U.S. CLS. 100, 101 AND 107).
FIRST USE 2-2-2002; IN COMMERCE 2-2-2002.

CLASS 41—(Continued).

2,748,795. COUNTRY MUSIC TELEVISION, INC., NASHVILLE, TN. SN 78-093,800. PUB. 10-8-2002, FILED 11-16-2001.

CMT INSIDE FAME

OWNER OF U.S. REG. NO. 1,698,119.
FOR ENTERTAINMENT SERVICES IN THE NATURE OF TELEVISION PROGRAM SERIES FEATURING LIVE-ACTION, INTERVIEWS, BIOGRAPHIES, AND MUSIC, AND PROVIDING INFORMATION IN THE FIELD OF ENTERTAINMENT BY MEANS OF A GLOBAL COMPUTER NETWORK (U.S. CLS. 100, 101 AND 107).
FIRST USE 5-28-2001; IN COMMERCE 5-28-2001.

2,748,804. GIRLS INCORPORATED, NEW YORK, NY. SN 78-096,783. PUB. 7-23-2002, FILED 12-5-2001.

GIRLS INC. ECONOMIC LITERACY

OWNER OF U.S. REG. NOS. 1,714,795, 2,222,115, AND OTHERS.

NO CLAIM IS MADE TO THE EXCLUSIVE RIGHT TO USE "ECONOMIC LITERACY", APART FROM THE MARK AS SHOWN.

SEC. 2(F) AS TO GIRLS INC..
FOR EDUCATIONAL SERVICES, NAMELY, DEVELOPING, ARRANGING, AND CONDUCTING EDUCATIONAL CONFERENCES AND PROGRAMS AND PROVIDING COURSES OF INSTRUCTION TO YOUTHS AND ADULTS WORKING WITH SUCH YOUTHS, ALL IN THE FIELDS OF ECONOMIC AND FINANCIAL LITERACY; FINANCIAL INDEPENDENCE AND ECONOMIC SELF-RELIANCE; CAREERS IN FINANCE AND ECONOMICS; BANKING, BUDGETING, INVESTING, SAVING, CREDIT CARDS, AND BORROWING; AND PRINTED MATERIALS DISTRIBUTED IN CONNECTION THEREWITH (U.S. CLS. 100, 101 AND 107).
FIRST USE 10-30-1999; IN COMMERCE 10-30-1999.

2,748,817. LEE, WILLIAM K., MCLEAN, VA. SN 78-099,362. PUB. 9-17-2002, FILED 12-20-2001.

HUMANROOM

FOR ENTERTAINMENT SERVICES IN THE NATURE OF LIVE PERFORMANCES BY A MUSICAL GROUP (U.S. CLS. 100, 101 AND 107).
FIRST USE 10-1-2000; IN COMMERCE 5-1-2001.

CLASS 41—(Continued).

2,748,885. WEATHER RESEARCH CENTER, HOUSTON, TX. SN 78-110,866. PUB. 11-5-2002, FILED 2-25-2002.

WEATHER WIZARD CORNER

NO CLAIM IS MADE TO THE EXCLUSIVE RIGHT TO USE "WEATHER", APART FROM THE MARK AS SHOWN.
FOR PROVIDING INTERACTIVE EXHIBITS AND DEMONSTRATIONS IN ASSOCIATION WITH A MUSEUM FOR EDUCATION AND ENTERTAINMENT IN THE FIELDS OF WEATHER AND METEOROLOGY (U.S. CLS. 100, 101 AND 107).
FIRST USE 3-1-2002; IN COMMERCE 3-1-2002.

2,748,894. MILIEFSKY, GARY, S, TYNGSBORO, MA. SN 78-112,467. PUB. 9-24-2002, FILED 3-4-2002.

TUNEZAP

FOR ENTERTAINMENT SERVICES, NAMELY, PROVIDING PRERECORDED MUSIC, INFORMATION IN THE FIELD OF MUSIC, AND COMMENTARY AND ARTICLES ABOUT MUSIC, ALL ONLINE VIA A GLOBAL COMPUTER NETWORK (U.S. CLS. 100, 101 AND 107).
FIRST USE 3-4-2002; IN COMMERCE 12-17-2002.

2,748,895. QUIKSILVER, INC., HUNTINGTON BEACH, CA. SN 78-112,673. PUB. 10-8-2002, FILED 3-5-2002.

MEN WHO RIDE MOUNTAINS

FOR ENTERTAINMENT IN THE NATURE OF BOARD RIDING COMPETITIONS AND EXHIBITIONS (U.S. CLS. 100, 101 AND 107).
FIRST USE 12-17-1988; IN COMMERCE 12-17-1988.

2,748,903. ROBERTS, MATTHEW A, BRIDGEWATER, NJ. SN 78-114,477. PUB. 11-5-2002, FILED 3-13-2002.

DESIGNER MEMORIES

FOR PRODUCTION OF VIDEOCASSETTES AND DISCS AND DVDS, FOR OTHERS (U.S. CLS. 100, 101 AND 107).
FIRST USE 3-21-2002; IN COMMERCE 1-20-2003.

CLASS 41—(Continued).

2,748,926. AMERICAN SOCIETY OF LAW ENFORCEMENT TRAINERS, FREDERICK, MD. SN 78-121,776. PUB. 11-5-2002, FILED 4-15-2002.



THE LINING IN THE DRAWING IS NOT INTENDED TO INDICATE COLOR.

"QUI DOCET, DISCET" TRANSLATES INTO "THOSE WHO TEACH, LEARN".

FOR LAW ENFORCEMENT TRAINING (U.S. CLS. 100, 101 AND 107).

FIRST USE 1-1-1990; IN COMMERCE 1-1-1990.

2,748,959. CANADIAN (21) STOOK LTD., RED DEER, ALBERTA, CANADA. SN 78-131,306. PUB. 12-17-2002, FILED 5-27-2002.

EXTREME 21

NO CLAIM IS MADE TO THE EXCLUSIVE RIGHT TO USE "21", APART FROM THE MARK AS SHOWN.

FOR ENTERTAINMENT SERVICES, NAMELY PROVIDING LIVE CASINO AND/OR GAMING ENVIRONMENT GAMES IN THE NATURE OF A GAME OF CHANCE PLAYED WITH PLAYING CARDS (U.S. CLS. 100, 101 AND 107).

FIRST USE 3-29-2002; IN COMMERCE 10-1-2002.

2,748,978. SAN ANTONIO SPURS, L.L.C., SAN ANTONIO, TX. SN 78-136,948. PUB. 12-31-2002, FILED 6-19-2002.

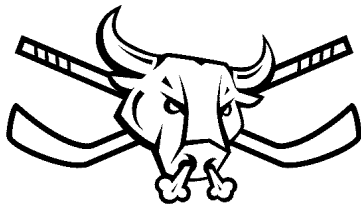

FOR ENTERTAINMENT IN THE NATURE OF PROFESSIONAL HOCKEY GAMES (U.S. CLS. 100, 101 AND 107).

FIRST USE 9-2-2002; IN COMMERCE 9-2-2002.

CLASS 42—SCIENTIFIC, COMPUTER AND LEGAL SERVICES

2,747,467. DEVLIN DESIGN GROUP, INC., SAN DIEGO, CA. SN 75-389,939. PUB. 7-30-2002, FILED 11-14-1997.

WEBCENTER

FOR DESIGN SERVICES FOR OTHERS IN THE FIELD OF TELEVISION NEWS AND ENTERTAINMENT SETS DISPLAYING AND HIGHLIGHTING GLOBAL COMPUTER NETWORKS AND GLOBAL COMPUTER NETWORK RELATED NEWS AND ENTERTAINMENT (U.S. CLS. 100 AND 101).

FIRST USE 4-17-2003; IN COMMERCE 4-17-2003.

2,747,470. DELAWARE LICENSING CORPORATION, CLAYMONT, DE, BY ASSIGNMENT; BY ASSIGNMENT THOMSON FINANCE SA, LUXEMBOURG, LUXEMBOURG. SN 75-445,759. PUB. 4-18-2000, FILED 3-6-1998.

ISI ALERTING SERVICE

OWNER OF U.S. REG. NOS. 734,569, 892,921, AND OTHERS.

NO CLAIM IS MADE TO THE EXCLUSIVE RIGHT TO USE "ALERTING SERVICE", APART FROM THE MARK AS SHOWN.

FOR COMPUTER SERVICES, NAMELY, PROVIDING CUSTOMERS WITH RESEARCH INFORMATION BASED ON JOURNAL TITLE LISTS AND PERSONAL PROFILES PROVIDED BY CUSTOMERS FROM A LINE OF TABLE OF CONTENTS AND PROFILE-BASED ALERTS DELIVERED VIA A GLOBAL COMPUTER NETWORK AND ELECTRONIC MAIL (U.S. CLS. 100 AND 101).

FIRST USE 12-0-1998; IN COMMERCE 12-0-1998.

2,747,483. EASTERN NATIONAL, CONSHOHOCKEN, PA. SN 75-506,883. PUB. 1-4-2000, FILED 6-22-1998.

IPI

FOR PROMOTING GREATER PUBLIC AWARENESS OF THE FOUNDING DOCUMENTS, HISTORY, GOVERNMENT, AND NATIONAL PARKS OF THE UNITED STATES (U.S. CLS. 100 AND 101).

FIRST USE 2-0-2001; IN COMMERCE 2-0-2001.

2,747,489. WEST JERSEY HEALTH SYSTEM, CAMDEN, NJ. SN 75-520,980. PUB. 1-25-2000, FILED 7-14-1998.

CHATT - COMMUNITY HEALTH ADVANCEMENT THROUGH TECHNOLOGY

FOR PROVIDING HEALTH RELATED INFORMATION TO PATIENTS AND THEIR FAMILIES (U.S. CLS. 100 AND 101).

FIRST USE 10-2-1998; IN COMMERCE 10-2-1998.

CLASS 42—(Continued).

2,747,531. EXODERMIC BRIDGE DECK, INC., LAKEVILLE, CT. SN 75-642,180. PUB. 12-21-1999, FILED 2-17-1999.

EXODERMIC

FOR CONSULTATION AND PROVIDING INFORMATION RELATED TO COMPOSITE BRIDGE DECKS COMPRISED OF UNFILLED GRID AND STRUCTURAL SLAB (U.S. CLS. 100 AND 101).

FIRST USE 12-31-2000; IN COMMERCE 12-31-2000.

2,747,566. BONDS, BOBBY DAREL, SAMMAMISH, WA. SN 75-710,269. PUB. 12-28-1999, FILED 6-14-1999.

XILYXIS

FOR COMPUTER SERVICES, NAMELY, DESIGNING, PROGRAMMING AND IMPLEMENTING WEB SITES FOR OTHERS AND DATABASE DEVELOPMENT SERVICES (U.S. CLS. 100 AND 101).

FIRST USE 8-12-1999; IN COMMERCE 1-6-2002.

2,747,570. ADT SERVICES AG, CH-8200 SCHAFFHAUSEN, SWITZERLAND. SN 75-714,582. PUB. 7-24-2001, FILED 5-27-1999.

SAFEWATCH CELLGUARD

OWNER OF U.S. REG. NOS. 1,446,049 AND 1,447,861. FOR CENTRAL STATION SECURITY MONITORING SERVICES (U.S. CLS. 100 AND 101).

FIRST USE 9-1-1999; IN COMMERCE 9-1-1999.

2,747,593. V STAR INC., SANTA BARBARA, CA. SN 75-765,664. PUB. 3-21-2000, FILED 8-2-1999.

V STAR

FOR MAINTAINING A GLOBAL COMPUTER NETWORK WEBSITE FOR OTHERS TO STORE AND TRANSMIT VOICE, MOTION, ANIMATION INSTRUCTIONS AND UPDATES THEREOF TO REGISTERED USERS (U.S. CLS. 100 AND 101).

FIRST USE 6-1-1998; IN COMMERCE 6-1-1998.

2,747,604. VIVADERM SKIN CARE LTD., IRVING, TX. SN 75-788,431. PUB. 8-6-2002, FILED 8-31-1999.

VIVA!DERM! SKIN CARE

NO CLAIM IS MADE TO THE EXCLUSIVE RIGHT TO USE "SKIN CARE", APART FROM THE MARK AS SHOWN. FOR SKIN CARE SALON (U.S. CLS. 100 AND 101).

FIRST USE 2-15-2000; IN COMMERCE 12-20-2002.

CLASS 42—(Continued).

2,747,608. MEADOWS, JOSEPH KEITH, KETTERING, OH. SN 75-800,133. PUB. 1-30-2001, FILED 10-6-1999.

HORROR-WOOD

FOR COMPUTER SERVICES, NAMELY, PROVIDING ON-LINE MAGAZINES IN THE FIELD OF HORROR MOVIES (U.S. CLS. 100 AND 101).

FIRST USE 10-31-1997; IN COMMERCE 10-31-1997.

2,747,612. WIZARD TECHNOLOGIES, INC., PURCHASE, NY. SN 75-807,203. PUB. 4-23-2002, FILED 9-23-1999.

WIZARDTECH

FOR PROVIDING TEMPORARY USE OF ON-LINE AND NON-DOWNLOADABLE SOFTWARE IN THE FIELD OF INVESTMENT ADVISOR ACCOUNT MANAGEMENT, NAMELY, PORTFOLIO MANAGEMENT TOOLS AND TRADING TOOLS; CUSTODIAN CONNECTION SOFTWARE, AND SOFTWARE FOR PROVIDING ELECTRONIC CONNECTIONS TO BROKERAGE FIRMS, FINANCIAL ANALYTICAL SOFTWARE AND FINANCIAL CONTACT MANAGEMENT TOOLS (U.S. CLS. 100 AND 101).

FIRST USE 12-0-1996; IN COMMERCE 12-0-1996.

2,747,614. OUTPOST OUTPOST, INC., PRINCETON, NJ. SN 75-808,621. PUB. 9-12-2000, FILED 9-28-1999.

TECHNOFOLK

FOR COMPUTER SERVICES, NAMELY, CREATING, DESIGNING, IMPLEMENTING AND MAINTAINING WEB SITES AND SOFTWARE FOR OTHERS (U.S. CLS. 100 AND 101).

FIRST USE 1-1-1997; IN COMMERCE 10-1-2002.

2,747,639. CARECORP, POTOMAC, MD. SN 75-836,615. PUB. 7-11-2000, FILED 11-1-1999.

CARESHIELD

FOR HEALTH CARE ADVISORY SERVICES (U.S. CLS. 100 AND 101).

FIRST USE 1-13-2003; IN COMMERCE 1-13-2003.

2,747,646. WILLIAMSON PRINTING CORPORATION, DALLAS, TX. SN 75-843,343. PUB. 7-24-2001, FILED 11-8-1999.

GLOKOTE

FOR PRINTING SERVICES (U.S. CLS. 100 AND 101).

FIRST USE 12-0-1999; IN COMMERCE 12-0-1999.

CLASS 42—(Continued).

2,747,649. YOMTAOBIAN ENTERPRISES INC, ENCINO, CA. SN 75-847,190. PUB. 11-26-2002, FILED 11-12-1999.

WWW.SEXMAGIC.COM

FOR REGISTRATION OF DOMAIN NAMES FOR IDENTIFICATION OF USERS ON A GLOBAL COMPUTER NETWORK (U.S. CLS. 100 AND 101).
FIRST USE 3-1-2001; IN COMMERCE 3-1-2001.

2,747,655. STRAUSS, CORINNE SOIKIN, WAINSCOTT, NY. SN 75-860,884. PUB. 10-24-2000, FILED 12-1-1999.

HAMPTON WEDDING

NO CLAIM IS MADE TO THE EXCLUSIVE RIGHT TO USE "WEDDING", APART FROM THE MARK AS SHOWN. FOR WEDDING CONSULTANT SERVICES (U.S. CLS. 100 AND 101).
FIRST USE 10-1-1998; IN COMMERCE 11-15-1999.

2,747,673. DECIPHER, INC., NORFOLK, VA. SN 75-885,487. PUB. 5-8-2001, FILED 1-7-2000.

BOY CRAZY!

FOR COMPUTER SERVICES, NAMELY, PROVIDING ON-LINE MAGAZINE DEVOTED TO THE INTERESTS OF YOUNG WOMEN AND GIRLS IN THE FIELD OF TOPICS OF GENERAL INTEREST (U.S. CLS. 100 AND 101).
FIRST USE 12-0-1999; IN COMMERCE 12-0-1999.

2,747,699. ABELOW, DANIEL, LONGWOOD, FL. SN 75-927,222. PUB. 7-16-2002, FILED 2-23-2000.

DIGITAL ABUNDANCE

NO CLAIM IS MADE TO THE EXCLUSIVE RIGHT TO USE "DIGITAL", APART FROM THE MARK AS SHOWN. FOR CONSULTING SERVICES THROUGH ON-SITE VISITS, TELECOMMUNICATIONS, PUBLISHED MATERIALS AND ONLINE INTERACTIVE EXCHANGES WITH BUSINESS, ACADEMIC, GOVERNMENT, CHARITABLE AND CONSUMER CLIENTS IN THE LICENSING, DEVELOPING AND CONFIGURING OF COMPUTER TECHNOLOGIES AND COMPUTER SOFTWARE EMBEDDED WITHIN OTHER PRODUCTS, ONLINE SITES FEATURING SERVICES AND WEB SITES TO PROVIDE TWO-WAY COMMUNICATIONS BETWEEN USERS AND VENDORS COMBINED WITH COMPUTER SOFTWARE TO SEARCH FOR, DOWNLOAD, ORGANIZE AND ASSEMBLE MULTIPLE SOURCES OF DIGITAL CONTENT INTO A COMPILATION FOR DISTRIBUTION TO THESE AND SUBSEQUENT USERS FOR USE AND CUSTOM MODIFICATION TO IMPROVE THE PERFORMANCE OF THE USERS (U.S. CLS. 100 AND 101).
FIRST USE 5-6-2001; IN COMMERCE 5-6-2001.

CLASS 42—(Continued).

2,747,700. FIRST PLAN OF MINNESOTA, INC., TWO HARBORS, MN. SN 75-932,259. PUB. 8-20-2002, FILED 3-1-2000.

SUPERIORHEALTH

FOR HEALTH CARE SERVICES, NAMELY, MEDICAL SERVICES PROVIDED BY BOARD-CERTIFIED HEALTH PROFESSIONALS THROUGH MEDICAL CLINICS, PHARMACIES AND HOSPITAL FACILITIES (U.S. CLS. 100 AND 101).
FIRST USE 2-23-2001; IN COMMERCE 2-23-2001.

2,747,701. JONES, GARY, IVINS, UT. SN 75-932,485. PUB. 8-13-2002, FILED 3-1-2000.

HEALTH FORCE ONE

NO CLAIM IS MADE TO THE EXCLUSIVE RIGHT TO USE "HEALTH", APART FROM THE MARK AS SHOWN. FOR PREVENTATIVE MEDICAL SCREENING SERVICES, NAMELY, MEDICAL DIAGNOSTICS PERFORMED BY BOARD-CERTIFIED SPECIALISTS IN CARDIOLOGY, ONCOLOGY, NEUROLOGY AND GASTROENTEROLOGY USING STATE-OF-THE-ART MEDICAL DIAGNOSTIC EQUIPMENT (U.S. CLS. 100 AND 101).
FIRST USE 2-17-2002; IN COMMERCE 7-19-2002.

2,747,711. SCHOCH, JUAN VICENTE, SOUTH DAYTONA, FL. SN 75-955,428. PUB. 3-26-2002, FILED 3-8-2000.

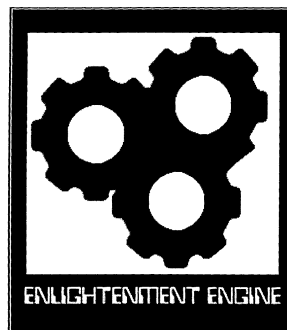

NO CLAIM IS MADE TO THE EXCLUSIVE RIGHT TO USE "ENGINE", APART FROM THE MARK AS SHOWN. THE MARK CONSISTS OF A SQUARE BORDER THAT ENCLOSES THREE GEARS THAT ARE FUSED TOGETHER INTO AN INDIVISIBLE PATTERN. THE BORDER CONTAINS THE WORDING "ENLIGHTENMENT ENGINE".
FOR PROVIDING A SEARCH ENGINE FOR OBTAINING DATA VIA A LOCAL/GLOBAL COMPUTER NETWORK (U.S. CLS. 100 AND 101).
FIRST USE 8-29-2000; IN COMMERCE 8-29-2000.

CLASS 42—(Continued).

2,747,734. TOBIAS, STEVEN, BELLAIRE, TX. SN 76-021,471. PUB. 12-4-2001, FILED 4-10-2000.

GEOPIPE

FOR GEOLOGICAL RESEARCH AND CONSULTING SERVICES, NAMELY ANALYZING, INTERPRETING AND MANIPULATING REMOTELY ACCESSED RAW GEOLOGICAL, GEOPHYSICAL, PETROPHYSICAL AND ENGINEERING DATA FOR THE PURPOSE OF RECOGNIZING, MEASURING AND EXPLOITING UNTAPPED GAS AND OIL RESERVES (U.S. CLS. 100 AND 101).
FIRST USE 1-0-2002; IN COMMERCE 1-0-2002.

2,747,771. ASSOCIATION OF PRIVATE PENSION AND WELFARE PLANS, WASHINGTON, DC. SN 76-052,182. PUB. 12-18-2001, FILED 5-19-2000.



AMERICAN BENEFITS
COUNCIL

NO CLAIM IS MADE TO THE EXCLUSIVE RIGHT TO USE "AMERICAN BENEFITS COUNCIL", APART FROM THE MARK AS SHOWN.

FOR ASSOCIATION SERVICES, NAMELY PROMOTING THE INTERESTS OF COMPANIES AND INDIVIDUALS CONCERNED ABOUT FEDERAL LEGISLATION AND REGULATION AFFECTING EMPLOYEE HEALTH AND RETIREMENT BENEFITS (U.S. CLS. 100 AND 101).
FIRST USE 9-21-2000; IN COMMERCE 9-21-2000.

2,747,781. M & L ONLINE L.L.C., FARMINGTON HILLS, MI. SN 76-060,502. PUB. 5-28-2002, FILED 5-31-2000.

FLORINE ONLINE

NO CLAIM IS MADE TO THE EXCLUSIVE RIGHT TO USE "ONLINE", APART FROM THE MARK AS SHOWN.

THE NAME "FLORINE" IDENTIFIES A LIVING INDIVIDUAL WHOSE CONSENT IS OF RECORD.

FOR PROVIDING HEALTH INFORMATION IN THE NATURE OF FACILITATING PERSONAL IMPROVEMENT FOR WELLNESS, HEALTHFUL LIVING, NUTRITION, DIET, FITNESS AND HEALTHY LIFESTYLES VIA THE GLOBAL COMPUTER NETWORK (U.S. CLS. 100 AND 101).

FIRST USE 7-11-2000; IN COMMERCE 7-11-2000.

CLASS 42—(Continued).

2,747,818. QUITA KILOS, S.A. DE C.V., MONTERREY, NUEVO LEON, MEXICO. SN 76-084,740. PUB. 6-11-2002, FILED 7-7-2000.



THE ENGLISH TRANSLATION OF "QUITAKILOS" IS "TAKE KILOS AWAY".
FOR FOOD NUTRITION CONSULTATION (U.S. CLS. 100 AND 101).

FIRST USE 3-7-2002; IN COMMERCE 3-7-2002.

2,747,821. THEORIS, INC., CARMEL, IN, BY CHANGE OF NAME SOFTWARE SYNERGY, INC., FISHERS, IN. SN 76-088,631. PUB. 5-28-2002, FILED 7-13-2000.



FOR PROVIDING COMPUTER CONSULTATION, COMPUTER SYSTEMS ANALYSIS, COMPUTER PROGRAMMING, AND COMPUTER SOFTWARE DESIGN SERVICES FOR OTHERS; AND PROVIDING WEB SITE DESIGN SERVICES FOR OTHERS, NAMELY, DESIGNING, CREATING, AND MAINTAINING WEB SITES; AND DESIGNING AND IMPLEMENTING WEB PAGES (U.S. CLS. 100 AND 101).

FIRST USE 8-1-2000; IN COMMERCE 8-1-2000.

2,747,826. PEREGRINE SYSTEMS, INC., SAN DIEGO, CA. SN 76-093,645. PUB. 12-11-2001, FILED 7-21-2000.

GET2CONNECT

FOR COMPUTER TECHNICAL CONSULTATION SERVICES NAMELY, ORGANIZING, EVALUATING, PLANNING AND IMPLEMENTING ELECTRONIC COMMERCE TECHNOLOGIES FOR OTHERS; TECHNICAL SUPERVISION IN THE FIELDS OF ELECTRONIC COMMERCE AND ELECTRONIC INTERCHANGE TECHNOLOGIES, MONITORING COMPUTER SYSTEMS OF OTHERS FOR ELECTRONIC COMMERCE AND ELECTRONIC INTERCHANGE TECHNOLOGIES AND PROVIDING BACKUP COMPUTER PROGRAMS AND FACILITIES AND SOFTWARE MANUFACTURING FACILITIES FOR OTHERS (U.S. CLS. 100 AND 101).

FIRST USE 8-0-2000; IN COMMERCE 8-0-2000.

CLASS 42—(Continued).

2,747,827. PEREGRINE SYSTEMS, INC., SAN DIEGO, CA. SN 76-093,646. PUB. 12-11-2001, FILED 7-21-2000.

GET2CONNECT.NET

FOR COMPUTER TECHNICAL CONSULTATION SERVICES NAMELY, ORGANIZING, EVALUATING, PLANNING AND IMPLEMENTING ELECTRONIC COMMERCE TECHNOLOGIES FOR OTHERS; TECHNICAL SUPERVISION IN THE FIELDS OF ELECTRONIC COMMERCE AND ELECTRONIC INTERCHANGE TECHNOLOGIES, MONITORING COMPUTER SYSTEMS OF OTHERS FOR ELECTRONIC COMMERCE AND ELECTRONIC INTERCHANGE TECHNOLOGIES AND PROVIDING BACKUP COMPUTER PROGRAMS AND FACILITIES AND SOFTWARE MANUFACTURING FACILITIES FOR OTHERS (U.S. CLS. 100 AND 101).

FIRST USE 8-0-2000; IN COMMERCE 8-0-2000.

2,747,831. MJ BIOWORKS, INC., SOUTH SAN FRANCISCO, CA. SN 76-098,441. PUB. 7-2-2002, FILED 7-27-2000.

MJ GENEWORKS

FOR GENOMIC AND BIOINFORMATIC RESEARCH AND CONSULTATION SERVICES (U.S. CLS. 100 AND 101).

FIRST USE 9-0-2000; IN COMMERCE 9-0-2000.

2,747,841. XDIMENSIONAL TECHNOLOGIES, INC., BREA, CA. SN 76-106,749. PUB. 7-16-2002, FILED 8-8-2000.

XDimensional
Technologies, Inc.

NO CLAIM IS MADE TO THE EXCLUSIVE RIGHT TO USE "TECHNOLOGIES INC.", APART FROM THE MARK AS SHOWN.

FOR COMPUTER SOFTWARE DESIGN FOR OTHERS; LEASING OF SOFTWARE OVER A GLOBAL COMPUTER NETWORK; COMPUTER HARDWARE AND SOFTWARE DESIGN; INSTALLATION, MAINTENANCE AND REPAIR OF COMPUTER SOFTWARE SYSTEMS; TECHNICAL SUPPORT OF INTERNET INFORMATION SERVERS VIA TELEPHONE, E-MAIL, POSTINGS ON GLOBAL COMPUTER NETWORKS, AND IN PERSON; TECHNICAL SUPPORT OF ACCESS TO INTRANET AND INTERNET NETWORKS VIA TELEPHONE, E-MAIL, AND IN PERSON (U.S. CLS. 100 AND 101).

FIRST USE 6-0-2000; IN COMMERCE 6-0-2000.

CLASS 42—(Continued).

2,747,842. XDIMENSIONAL TECHNOLOGIES, INC., BREA, CA. SN 76-106,751. PUB. 10-15-2002, FILED 8-8-2000.

XDIMENSIONAL TECHNOLOGIES

NO CLAIM IS MADE TO THE EXCLUSIVE RIGHT TO USE "TECHNOLOGIES", APART FROM THE MARK AS SHOWN.

FOR COMPUTER SOFTWARE DESIGN FOR OTHERS; CONSULTING SERVICES IN THE FIELDS OF COMPUTER HARDWARE, SOFTWARE, AUTOMATIONS, SYSTEM INTEGRATION, ANALYSIS OF WORKFLOW PROCEDURES, AND PLANNING, IMPLEMENTATION, AND MANAGEMENT OF AUTOMATION; LEASING OF SOFTWARE OVER A GLOBAL COMPUTER NETWORK; COMPUTER HARDWARE AND SOFTWARE DESIGN; INSTALLATION, MAINTENANCE AND REPAIR OF COMPUTER SOFTWARE SYSTEMS; SET-UP OF INTEGRATED E-MAIL SYSTEMS AS WELL AS TECHNICAL SUPPORT OF INTEGRATED E-MAIL SYSTEMS VIA TELEPHONE, POSTINGS ON GLOBAL COMPUTER NETWORKS, AND IN PERSON; TECHNICAL SUPPORT OF INTERNET INFORMATION SERVERS VIA TELEPHONE, E-MAIL, POSTINGS ON GLOBAL COMPUTER NETWORKS, AND IN PERSON; TECHNICAL SUPPORT OF ACCESS TO INTRANET AND INTERNET NETWORKS VIA TELEPHONE, E-MAIL, AND IN PERSON; INSTALLATION OF THIRD PARTY SOFTWARE AS WELL AS TECHNICAL SUPPORT, NAMELY, TROUBLESHOOTING OF THIRD PARTY SOFTWARE PROBLEMS VIA TELEPHONE, E-MAIL, POSTINGS ON GLOBAL COMPUTER NETWORKS, AND IN PERSON (U.S. CLS. 100 AND 101).

FIRST USE 6-0-2000; IN COMMERCE 6-0-2000.

2,747,847. PARK NICOLLET HEALTH SERVICES, ST. LOUIS PARK, MN, BY ASSIGNMENT INSTITUTE FOR RESEARCH AND EDUCATION, ST. LOUIS PARK, MN. SN 76-111,187. PUB. 2-12-2002, FILED 8-17-2000.

PARK NICOLLET HEALTH ADVISOR

OWNER OF U.S. REG. NOS. 1,397,997 AND 2,001,823.

NO CLAIM IS MADE TO THE EXCLUSIVE RIGHT TO USE "HEALTH", APART FROM THE MARK AS SHOWN.

FOR PROVIDING INFORMATION RELATING TO HEALTH THROUGH A GLOBAL COMPUTER NETWORK (U.S. CLS. 100 AND 101).

FIRST USE 11-6-2002; IN COMMERCE 11-6-2002.

2,747,853. DIETFIT, INC., ALEXANDRIA, VA, BY CHANGE OF NAME DIETDESIGN.COM, INC, ALEXANDRIA, VA. SN 76-118,167. PUB. 3-26-2002, FILED 8-25-2000.

DIETFIT

FOR WEIGHT REDUCTION DIET PLANNING AND SUPERVISION; NUTRITION COUNSELING (U.S. CLS. 100 AND 101).

FIRST USE 9-18-2000; IN COMMERCE 4-13-2002.

CLASS 42—(Continued).

2,747,870. CORPORATE MANAGEMENT GROUP, L.L.C., CANFIELD, OH. SN 76-127,994. PUB. 6-11-2002, FILED 9-14-2000.

PI-TRACK

FOR COORDINATING THE ACTIVITIES OF PRIVATE INVESTIGATORS FOR OTHERS (U.S. CLS. 100 AND 101).

FIRST USE 2-0-2000; IN COMMERCE 2-0-2000.

2,747,893. SENTIAT TECHNOLOGIES, INC., DALLAS, TX. SN 76-145,556. PUB. 4-30-2002, FILED 10-11-2000.

SENTIAT

FOR PROVIDING QUALITY ASSURANCE SERVICES IN THE FIELD OF COMPUTER SOFTWARE, NAMELY INTERNET APPLICATION FUNCTIONALITY AND PERFORMANCE MANAGEMENT AND MONITORING SERVICES (U.S. CLS. 100 AND 101).

FIRST USE 9-1-2000; IN COMMERCE 9-1-2000.

2,747,895. DAILYSHOPPER.COM, INC., SEATTLE, WA. SN 76-146,764. PUB. 7-9-2002, FILED 10-13-2000.

NETCIRCULAR

FOR APPLICATION SERVICE PROVIDER, NAMELY PROVIDING A WEBSITE ON A GLOBAL COMPUTER INFORMATION NETWORK FOR USE BY RETAILERS IN POSTING PROMOTIONAL DATA (U.S. CLS. 100 AND 101).

FIRST USE 11-0-1999; IN COMMERCE 11-0-1999.

2,747,908. WOODY INDUSTRIAL CORPORATION, TORRANCE, CA. SN 76-158,913. PUB. 7-24-2001, FILED 11-3-2000.

DIP N ROLL

FOR RESTAURANT SERVICES (U.S. CLS. 100 AND 101).

FIRST USE 4-10-2003; IN COMMERCE 4-10-2003.

CLASS 42—(Continued).

2,747,923. LUMENOS, INC., ALEXANDRIA, VA. SN 76-167,536. PUB. 7-2-2002, FILED 11-17-2000.

MY E-CHECKUP

NO CLAIM IS MADE TO THE EXCLUSIVE RIGHT TO USE "E-CHECKUP", APART FROM THE MARK AS SHOWN.

FOR PROVIDING HEALTH ASSESSMENT TOOLS AND SERVICES, NAMELY, EVALUATING AND ASSESSING AN INDIVIDUAL'S OVERALL HEALTH AND FITNESS AND PROVIDING RECOMMENDATIONS FOR IMPROVING HEALTH AND FITNESS, VIA THE INTERNET (U.S. CLS. 100 AND 101).

FIRST USE 6-1-2001; IN COMMERCE 6-1-2001.

2,747,968. PALADIN ENTERTAINMENT HOLDINGS, LLC, LAS VEGAS, NV, BY CHANGE OF NAME ADVENT COMMUNICATIONS & ENTERTAINMENT COMPANY, LLC, LAS VEGAS, NV. SN 76-193,171. PUB. 5-28-2002, FILED 1-12-2001.

NOCHE

THE ENGLISH TRANSLATION OF THE WORD "NOCHE" IS "NIGHT".

FOR RESTAURANT AND NIGHT CLUB SERVICES (U.S. CLS. 100 AND 101).

FIRST USE 6-5-2002; IN COMMERCE 6-5-2002.

2,747,978. TRUESPECTRA, INC., BURLINGAME, CA. SN 76-196,968. PUB. 4-9-2002, FILED 1-19-2001.



FOR PROVIDING TEMPORARY USE OF ON-LINE NON-DOWNLOADABLE SOFTWARE THAT ALLOWS THE USER TO SERVE AND RENDER IMAGES OVER A LOCAL OR GLOBAL COMPUTER INFORMATION NETWORK (U.S. CLS. 100 AND 101).

FIRST USE 11-1-2001; IN COMMERCE 11-1-2001.

CLASS 42—(Continued).

2,747,985. PULP AND PAPER RESEARCH INSTITUTE OF CANADA/INSTITUT CANADIEN DE RECHERCHES SUR LES PATES ET PAPIERS, QUEBEC, CANADA. SN 76-200,246. PUB. 7-23-2002, FILED 1-26-2001.

PAPRICANDIRECT

PRIORITY CLAIMED UNDER SEC. 44(D) ON CANADA APPLICATION NO. 1069445, FILED 7-27-2000.

OWNER OF U.S. REG. NO. 927,949.

FOR ASSOCIATION SERVICES, NAMELY PROMOTING THE INTERESTS OF THE PULP AND PAPER INDUSTRY; AND PROVIDING INFORMATION ON THE PULP AND PAPER INDUSTRY TO MEMBERS OF A PULP AND PAPER INDUSTRY ASSOCIATION VIA A WEBSITE AVAILABLE THROUGH THE INTERNET (U.S. CLS. 100 AND 101).

FIRST USE 1-29-2001; IN COMMERCE 1-29-2001.

2,748,009. AITEC HOLDINGS INC., OAKVILLE, ONTARIO, CANADA. SN 76-210,896. PUB. 10-1-2002, FILED 2-16-2001.

AITEC

FOR INSPECTION SERVICES, NAMELY, VISUAL, RADIOGRAPHY, LIQUID PENETRANT, MAGNETIC PARTICLE, ULTRASONICS, EDDY CURRENT, POSITIVE MATERIAL IDENTIFICATION AND MAGNETIC FLUX LEAKAGE INSPECTION; TESTING SERVICES, NAMELY, HARDNESS TESTING AND DESTRUCTIVE TESTING; CHEMICAL ANALYSIS AND FAILURE ANALYSIS; AND CONSULTING SERVICES IN THE FIELD OF INSPECTION, TESTING AND ANALYSIS (U.S. CLS. 100 AND 101).

FIRST USE 2-1-2001; IN COMMERCE 10-23-2001.

2,748,014. CLINICAL TRIALS NET, INC., CHARLESTON, SC. SN 76-212,108. PUB. 11-26-2002, FILED 2-20-2001.

PUT IT TO THE TEST

FOR PROVIDING CONTRACTUAL USE OF ONLINE NON-DOWNLOADABLE SOFTWARE FOR DESIGNING AND OPERATING CLINICAL TRIALS DATA MANAGEMENT DATABASES (U.S. CLS. 100 AND 101).

FIRST USE 6-1-2001; IN COMMERCE 6-1-2001.

2,748,035. PERFOREX, L.P., BELLINGHAM, WA. SN 76-224,753. PUB. 12-11-2001, FILED 3-15-2001.

PERFOREX SOLUTIONS

NO CLAIM IS MADE TO THE EXCLUSIVE RIGHT TO USE "SOLUTIONS", APART FROM THE MARK AS SHOWN.

FOR COMPUTER SERVICES, NAMELY, DESIGNING AND IMPLEMENTING COMPUTER HARDWARE AND SOFTWARE SYSTEMS FOR FOREST PRODUCTS COMPANIES TO HELP THEM IMPROVE THEIR PROFITABILITY (U.S. CLS. 100 AND 101).

FIRST USE 7-1-2001; IN COMMERCE 7-1-2001.

CLASS 42—(Continued).

2,748,052. NETCARRIER, INC., LANSDALE, PA. SN 76-233,207. PUB. 7-23-2002, FILED 3-30-2001.

**netcarrier**

NO CLAIM IS MADE TO THE EXCLUSIVE RIGHT TO USE "NETCARRIER", APART FROM THE MARK AS SHOWN.

FOR COMPUTER SERVICES, NAMELY, PROVIDING DATABASES FEATURING GENERAL AND LOCAL NEWS, AND INFORMATION OF INTEREST TO SPECIFIC GEOGRAPHIC AREAS; HOSTING THE WEB SITES OF OTHERS ON A COMPUTER SERVER FOR A GLOBAL COMPUTER NETWORK; COMPUTER NETWORK DESIGN FOR OTHERS; COMPUTER SERVICES, NAMELY, DESIGNING, MAINTAINING AND IMPLEMENTING NETWORK WEB SITES FOR OTHERS; COMPUTER SOFTWARE DESIGN FOR OTHERS; CONSULTING SERVICES IN THE FIELD OF DESIGN, SELECTION, IMPLEMENTATION AND USE OF COMPUTER HARDWARE AND SOFTWARE SYSTEMS FOR OTHERS; COMPUTER SERVICES, NAMELY, MANAGING WEB SITES FOR OTHERS; DISPLAYING THE WEB SITES AND IMAGES OF OTHERS ON A COMPUTER SERVER; TECHNICAL CONSULTATION IN THE FIELD OF ONLINE COMMERCE WEB SITES; DATABASE DEVELOPMENT SERVICES (U.S. CLS. 100 AND 101).

FIRST USE 5-7-2001; IN COMMERCE 5-7-2001.

2,748,055. YOMTOBIAN ENTERPRISES INC., MALIBU, CA. SN 76-234,493. PUB. 6-18-2002, FILED 4-3-2001.

WWW.MEMPHISEXPRESS.COM

FOR REGISTRATION OF DOMAIN NAMES FOR IDENTIFICATION OF USERS ON A GLOBAL COMPUTER NETWORK (U.S. CLS. 100 AND 101).

FIRST USE 8-1-2001; IN COMMERCE 8-1-2001.

2,748,087. ZYRAY WIRELESS INC., SAN DIEGO, CA. SN 76-246,348. PUB. 7-9-2002, FILED 4-24-2001.

ZYRAY

FOR DESIGN AND CONSULTATION SERVICES IN THE FIELD OF WIRELESS COMMUNICATIONS (U.S. CLS. 100 AND 101).

FIRST USE 11-0-2002; IN COMMERCE 11-0-2002.

CLASS 42—(Continued).

2,748,111. UNIVESSENCE DIGITAL STUDIOS (USA), INC., CULVER CITY, CA. SN 76-258,393. PUB. 7-23-2002, FILED 5-16-2001.

TEAMWEAVER

FOR APPLICATION SERVICE PROVIDER (ASP), NAMELY HOSTING COMPUTER SOFTWARE APPLICATIONS OF OTHERS AND/OR HOSTING OF DIGITAL CONTENT ON THE INTERNET; AND/OR HOSTING THE WEBSITES OF OTHERS ON A COMPUTER SERVER FOR A GLOBAL COMPUTER NETWORK; DESIGN, CREATION AND MAINTENANCE OF WEB SITES AND/OR COMPUTER SOFTWARE; LICENSING OF INTELLECTUAL PROPERTY; AND COMPUTER SERVICES NAMELY PROVIDING INTERNET AND NETWORK SECURITY SERVICES (U.S. CLS. 100 AND 101).
FIRST USE 2-6-2003; IN COMMERCE 2-6-2003.

2,748,122. AMERICAN SOCIETY FOR TRAINING & DEVELOPMENT, ALEXANDRIA, VA. SN 76-261,315. PUB. 7-2-2002, FILED 5-24-2001.

**ASTD CERTIFICATION
INSTITUTE**

OWNER OF U.S. REG. NOS. 1,195,442, 2,388,632, AND OTHERS.

NO CLAIM IS MADE TO THE EXCLUSIVE RIGHT TO USE "CERTIFICATION INSTITUTE", APART FROM THE MARK AS SHOWN.

FOR TESTING, ANALYSIS AND EVALUATION OF GOODS AND SERVICES OF OTHERS IN THE WORKPLACE LEARNING AND PERFORMANCE INDUSTRY FOR THE PURPOSE OF CERTIFICATION (U.S. CLS. 100 AND 101).

FIRST USE 1-0-2001; IN COMMERCE 1-0-2001.

2,748,127. PIVOTAL CENTURY PLAZA HOTEL, LLC, PHOENIX, AZ. SN 76-261,739. PUB. 2-26-2002, FILED 5-23-2001.

SPA MYSTIQUE

NO CLAIM IS MADE TO THE EXCLUSIVE RIGHT TO USE "SPA", APART FROM THE MARK AS SHOWN.

FOR FULL SERVICE HEALTH AND BEAUTY SPA SERVICES (U.S. CLS. 100 AND 101).

FIRST USE 4-15-2001; IN COMMERCE 5-15-2001.

2,748,131. AM I SAFE, INC., GREENVILLE, SC. SN 76-262,433. PUB. 6-25-2002, FILED 5-24-2001.

AMISAFE

FOR REPORTING SERVICES TO PROMOTE THE SAFE DRIVING HABITS OF TEENAGERS BY REPORTING DRIVERS' ACTIONS TO SUBSCRIBING MEMBERS (U.S. CLS. 100 AND 101).

FIRST USE 6-30-2001; IN COMMERCE 6-30-2001.

CLASS 42—(Continued).

2,748,184. REGENERON PHARMACEUTICALS, INC., TARRYTOWN, NY. SN 76-280,745. PUB. 10-23-2001, FILED 7-5-2001.

VELOCIGENE

FOR GENETIC ENGINEERING SERVICES, NAMELY, DELETION AND MODIFICATION OF GENES FOR OTHERS, AND PRODUCTION OF TRANSGENIC ANIMALS; GENETIC RESEARCH (U.S. CLS. 100 AND 101).
FIRST USE 12-23-2002; IN COMMERCE 12-23-2002.

2,748,205. GAL SERVICES, INC., EAST SYRACUSE, NY. SN 76-286,546. PUB. 7-23-2002, FILED 7-18-2001.

**Galson
NotiFive**
**Now that's
reassuring!**

FOR LABORATORY ANALYSIS OF AIR SAMPLES, FEATURING THE FURNISHING OF SAMPLE STATUS TO CUSTOMERS WITHIN 5 DAYS OF PLACEMENT OF ORDER (U.S. CLS. 100 AND 101).

FIRST USE 4-8-2003; IN COMMERCE 4-8-2003.

2,748,228. GRANITE SOLUTIONS INC., PORTAGE, MI. SN 76-295,837. PUB. 5-14-2002, FILED 8-6-2001.

BLUE GRANITE

FOR CUSTOM COMPUTER SOFTWARE DESIGN AND DEVELOPMENT SERVICES FOR OTHERS, AND WEBSITE DESIGN AND DEVELOPMENT SERVICES FOR OTHERS FOR USE IN THE FIELDS OF ELECTRONIC COMMERCE TRANSACTIONS, INTRA-CORPORATE COMMUNICATIONS, INVENTORY TRACKING AND ORDER MANAGEMENT, AND TRAINING MATERIAL ORGANIZATION (U.S. CLS. 100 AND 101).

FIRST USE 1-20-2003; IN COMMERCE 1-29-2003.

2,748,243. LARRY H. MILLER RESTAURANTS, INC., MURRAY, UT. SN 76-300,009. PUB. 10-8-2002, FILED 8-14-2001.

MAYAN EXPRESS

NO CLAIM IS MADE TO THE EXCLUSIVE RIGHT TO USE "EXPRESS", APART FROM THE MARK AS SHOWN.

FOR RESTAURANT SERVICES (U.S. CLS. 100 AND 101).

FIRST USE 2-5-2001; IN COMMERCE 2-5-2001.

CLASS 42—(Continued).

2,748,270. MUNGER, TOLLES & OLSON, LOS ANGELES, CA. SN 76-310,479. PUB. 8-13-2002, FILED 9-6-2001.

MTO

FOR LEGAL SERVICES (U.S. CLS. 100 AND 101).
FIRST USE 12-31-2002; IN COMMERCE 12-31-2002.

2,748,271. ORTIZ, LEROY, JR., SANTA FE, NM. SN 76-311,162. PUB. 7-2-2002, FILED 9-12-2001.

Cellular Evolution—The Tetros 7

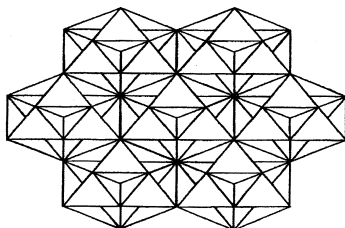

Cellular Geometry involves sacred patterns of genetic coding for expanding conscious beings.

NO CLAIM IS MADE TO THE EXCLUSIVE RIGHT TO USE "CELLULAR GEOMETRY INVOLVES SACRED PATTERNS OF GENETIC CODING FOR EXPANDING CONSCIOUS BEINGS", APART FROM THE MARK AS SHOWN.

FOR COUNSELING IN THE FIELD OF SPIRITUALITY NAMELY, PROVIDING HOLISTIC AND SPIRITUAL GUIDANCE, DEVELOPING HUMAN POTENTIAL, CONSCIOUS EXPANSION AND HEALING (U.S. CLS. 100 AND 101).

FIRST USE 1-1-2001; IN COMMERCE 1-1-2001.

2,748,276. ZOM OCEAN DRIVE, LTD., ORLANDO, FL. SN 76-312,823. PUB. 9-3-2002, FILED 9-13-2001.

THE VICTOR

FOR HOTELS, RESTAURANTS, AND RESORT HOTELS (U.S. CLS. 100 AND 101).
FIRST USE 11-6-2001; IN COMMERCE 11-6-2001.

CLASS 42—(Continued).

2,748,283. OLGA'S KITCHEN, INC., TROY, MI. SN 76-316,903. PUB. 10-22-2002, FILED 9-25-2001.

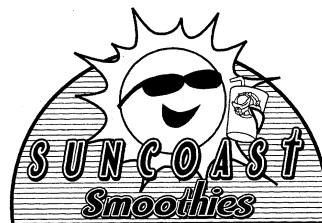

NO CLAIM IS MADE TO THE EXCLUSIVE RIGHT TO USE "SMOOTHIES", APART FROM THE MARK AS SHOWN.

THE LINING SHOWN IN THE DRAWING IS A FEATURE OF THE MARK AND IS NOT INTENDED TO INDICATE COLOR.

FOR RESTAURANT AND CARRY OUT RESTAURANT SERVICES FEATURING PRIMARILY BEVERAGES (U.S. CLS. 100 AND 101).

FIRST USE 10-0-2001; IN COMMERCE 10-0-2001.

2,748,287. MDL INFORMATION SYSTEMS, INC., SAN LEANDRO, CA. SN 76-318,220. PUB. 2-19-2002, FILED 9-26-2001.

DISCOVERYGATE

FOR PROVIDING INFORMATION VIA COMPUTER NETWORKS, PHONE AND ELECTRONIC MAIL FOR EDUCATION, RESEARCH AND DEVELOPMENT IN THE FIELDS OF LIFE SCIENCES, PHARMACEUTICALS, AGROCHEMISTRY, BIOTECHNOLOGY AND CHEMISTRY; COMPUTER SERVICES, NAMELY, A WEB SITE FOR THE COLLECTION, ANALYSIS, INTERPRETATION, MANAGEMENT, MANIPULATION, REGISTRATION, ORGANIZATION, REPORTING, FILTERING AND CLUSTERING OF SCIENTIFIC AND CHEMICAL DATA IN THE LIFE SCIENCES, PHARMACEUTICAL, AGROCHEMICAL, BIOTECHNOLOGY, AND CHEMISTRY INDUSTRIES; COMPUTER CONSULTING SERVICES FOR THE DEVELOPMENT AND IMPLEMENTATION OF SCIENTIFIC INFORMATION SYSTEMS (U.S. CLS. 100 AND 101).

FIRST USE 8-26-2002; IN COMMERCE 8-26-2002.

2,748,298. FUN-ONE INC., WESTERLY, RI. SN 76-320,216. PUB. 4-9-2002, FILED 10-2-2001.

FISH FACTORY

NO CLAIM IS MADE TO THE EXCLUSIVE RIGHT TO USE "FISH", APART FROM THE MARK AS SHOWN.

FOR RESTAURANT SERVICES (U.S. CLS. 100 AND 101).

FIRST USE 5-25-2002; IN COMMERCE 5-25-2002.

CLASS 42—(Continued).

2,748,313. SASA GROUP, LLC, SAN DIEGO, CA. SN 76-324,418. PUB. 8-6-2002, FILED 10-15-2001.

FUMARI

FOR GENERAL SNACK AND DESSERT BAR SERVICES; COFFEE BAR SERVICES; SMOKING LOUNGE SERVICES, NAMELY, PROVIDING A SMOKING ROOM FEATURING HOOKAHS, FLAVORED TOBACCO, CIGARS, AND SMOKING RELATED PRODUCTS (U.S. CLS. 100 AND 101).

FIRST USE 12-13-1997; IN COMMERCE 12-13-1997.

2,748,319. SOLIDSOURCE CORPORATION, COSTA MESA, CA. SN 76-327,176. PUB. 7-16-2002, FILED 10-19-2001.



THE MARK CONSISTS OF THE STYLIZED LETTER "S" FORMED AS TWO IDENTICAL "C" SHAPES AND ROTATED COUNTER CLOCKWISE ABOUT NINETY DEGREES.

FOR APPLICATION SERVICE PROVIDER (ASP) FEATURING SOFTWARE IN THE FIELD OF DATABASE MANAGEMENT FOR BUSINESS APPLICATIONS (U.S. CLS. 100 AND 101).

FIRST USE 5-25-1999; IN COMMERCE 5-25-1999.

2,748,349. 2028, INC., CAMBRIDGE, MA. SN 76-335,860. PUB. 7-2-2002, FILED 11-8-2001.

2028

FOR PROVIDING AS AN APPLICATION SERVICE PROVIDER (ASP), SOFTWARE FOR THE NAVIGATION AND ORGANIZATION OF INFORMATION AND DATA, INFORMATION AND DATA PROFILING, INDEXING AND SUMMARIZATION, AND INFORMATION AND DATA TREND ANALYSIS AND SURVEYS (U.S. CLS. 100 AND 101).

FIRST USE 1-0-1998; IN COMMERCE 5-0-2001.

CLASS 42—(Continued).

2,748,375. SZCZYPEK, RYSZARD, HAMDEN, CT. SN 76-343,951. PUB. 8-27-2002, FILED 11-30-2001.

PROJECTEFILES

FOR CONSULTATION IN THE FIELD OF WEBSITE DEVELOPMENT, AND COMPUTER SERVICES, NAMELY, DESIGNING AND IMPLEMENTING WEB SITES FOR OTHERS (U.S. CLS. 100 AND 101).

FIRST USE 5-8-2003; IN COMMERCE 5-8-2003.

2,748,378. WESTIN LICENSE COMPANY, WHITE PLAINS, NY. SN 76-346,297. PUB. 10-22-2002, FILED 12-6-2001.

HOLLYWOOD PRIME

NO CLAIM IS MADE TO THE EXCLUSIVE RIGHT TO USE "HOLLYWOOD", APART FROM THE MARK AS SHOWN.

FOR RESTAURANT, CATERING AND BAR SERVICES (U.S. CLS. 100 AND 101).

FIRST USE 1-29-2002; IN COMMERCE 1-29-2002.

2,748,389. METERLOGIX, LLC, BURNSVILLE, MN, BY CHANGE OF NAME DTN WEATHER SERVICES, LLC, BURNSVILLE, MN. SN 76-349,005. PUB. 5-21-2002, FILED 12-12-2001.

MXVISION

FOR WEATHER FORECASTING SERVICES, NAMELY DISTRIBUTION OF WEATHER INFORMATION (U.S. CLS. 100 AND 101).

FIRST USE 10-23-2001; IN COMMERCE 10-23-2001.

2,748,395. SLEEP DISORDERS LABORATORY, EAST BRUNSWICK, NJ. SN 76-350,139. PUB. 8-6-2002, FILED 12-18-2001.

**Central Jersey Sleep Disorders Center**

NO CLAIM IS MADE TO THE EXCLUSIVE RIGHT TO USE "CENTRAL JERSEY SLEEP DISORDERS CENTER", APART FROM THE MARK AS SHOWN.

FOR MEDICAL SERVICES IN THE FIELD OF SLEEP DISORDERS (U.S. CLS. 100 AND 101).

FIRST USE 9-10-2000; IN COMMERCE 9-10-2000.

CLASS 42—(Continued).

2,748,533. BAKER & TAYLOR, INC., CHARLOTTE, NC. SN 76-395,754. PUB. 10-22-2002, FILED 4-15-2002.

ED

FOR APPLICATION SERVICE PROVIDER FEATURING SOFTWARE THAT ENABLES LIBRARIES TO MANAGE A DIGITAL COLLECTION AND PROVIDE THEIR PATRONS WITH THE ABILITY TO SEARCH, BROWSE AND CHECK-OUT DIGITAL BOOKS, MOVIES OR MUSIC (U.S. CLS. 100 AND 101).
FIRST USE 1-0-2002; IN COMMERCE 1-0-2002.

2,748,599. GARITI, CHRISTOPHER, S., BLUFFTON, SC. SN 78-010,744. PUB. 11-12-2002, FILED 6-1-2000.



NO CLAIM IS MADE TO THE EXCLUSIVE RIGHT TO USE "HILTON HEAD GOLF VACATIONS INC.", APART FROM THE MARK AS SHOWN.

FOR TRAVEL AGENCY SERVICES, NAMELY, MAKING RESERVATIONS AND BOOKINGS FOR TEMPORARY LODGING FOR GOLF VACATIONS IN HILTON HEAD, SOUTH CAROLINA (U.S. CLS. 100 AND 101).
FIRST USE 6-0-2000; IN COMMERCE 6-0-2000.

2,748,602. HACKWORTH, SAMUEL R., LITTLE ROCK, AR. SN 78-011,909. PUB. 1-8-2002, FILED 6-8-2000.

**ASK A CHILD
PSYCHOLOGIST**

NO CLAIM IS MADE TO THE EXCLUSIVE RIGHT TO USE "CHILD PSYCHOLOGIST", APART FROM THE MARK AS SHOWN.

FOR PROVIDING INFORMATION IN THE FIELD OF CHILD PSYCHOLOGY VIA A WEBSITE ON GLOBAL COMPUTER NETWORKS (U.S. CLS. 100 AND 101).
FIRST USE 9-25-1999; IN COMMERCE 6-15-2001.

CLASS 42—(Continued).

2,748,604. HARRISON P. T. SERVICES, P. C., DENVER, CO. SN 78-014,185. PUB. 4-2-2002, FILED 6-24-2000.

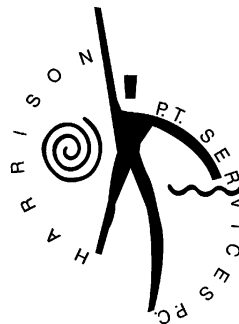

NO CLAIM IS MADE TO THE EXCLUSIVE RIGHT TO USE "P.T. SERVICES P.C.", APART FROM THE MARK AS SHOWN.

FOR PHYSICAL THERAPY SERVICES IN THE FIELDS OF NEUROLOGICAL TREATMENT, WHEELCHAIR AND SEATING EVALUATION AND TRAINING, AQUATIC PHYSICAL THERAPY, WARM WATER MASSAGE AND SHIATSU TECHNIQUES (U.S. CLS. 100 AND 101).
FIRST USE 6-0-2001; IN COMMERCE 6-0-2002.

2,748,622. PRECISION ENDOSCOPY OF AMERICA, INC., HUNT VALLEY, MD. SN 78-029,029. PUB. 9-17-2002, FILED 10-4-2000.

PRECISION TRAK

OWNER OF U.S. REG. NO. 2,013,843.

NO CLAIM IS MADE TO THE EXCLUSIVE RIGHT TO USE "TRAK", APART FROM THE MARK AS SHOWN.

FOR PROVIDING AN ON-LINE COMPUTER TRACKING SYSTEM THAT TRACKS PARTS AND TOOLING INVENTORY FROM THE TIME A PURCHASE ORDER IS CREATED UNTIL THE EXACT PART IS PLACED AN ENDOSCOPE UP UNTIL THE TIME IT IS USED AND FOR WHICH CUSTOMER IT IS DIRECTED THE TRACKING SYSTEM ENABLES THIRD PARTY USERS TO TRACK ALL SERVICE ORDERS AND STATUS OF SCOPE ORDERS OVER THE INTERNET (U.S. CLS. 100 AND 101).

FIRST USE 3-27-2003; IN COMMERCE 3-27-2003.

2,748,643. QUALCOMM INCORPORATED, SAN DIEGO, CA. SN 78-043,636. PUB. 10-2-2001, FILED 1-17-2001.

TRUE BREW

FOR PROVIDING COMPUTER SERVICES FOR OTHERS, NAMELY, COMPUTER APPLICATION SOFTWARE ADAPTATION FOR COMPATIBILITY WITH A COMPUTER OPERATING SYSTEM OR PLATFORM (U.S. CLS. 100 AND 101).

FIRST USE 7-1-2001; IN COMMERCE 7-1-2001.

CLASS 42—(Continued).

2,748,644. RATIONAL RECOVERY SYSTEMS, INC., LOTUS, CA. SN 78-044,073. PUB. 7-2-2002, FILED 1-19-2001.

BEAST

FOR ALCOHOL AND CHEMICAL ADDICTION RECOVERY AND REHABILITATION SERVICES (U.S. CLS. 100 AND 101).

FIRST USE 1-0-2003; IN COMMERCE 1-0-2003.

2,748,667. MCDONALD'S CORPORATION, OAK BROOK, IL. SN 78-053,084. PUB. 6-25-2002, FILED 3-14-2001.

DINER TO GO

FOR RESTAURANT SERVICES (U.S. CLS. 100 AND 101).

FIRST USE 3-19-2001; IN COMMERCE 3-19-2001.

2,748,702. DICAPO FOODS LLC, KANSAS CITY, MO. SN 78-070,252. PUB. 9-10-2002, FILED 6-21-2001.



NO CLAIM IS MADE TO THE EXCLUSIVE RIGHT TO USE "CHILI", APART FROM THE MARK AS SHOWN.

THE LIKENESS (OR, "PORTRAIT") IN THE MARK DOES NOT IDENTIFY A LIVING INDIVIDUAL.

FOR RESTAURANT (U.S. CLS. 100 AND 101).
FIRST USE 12-15-2000; IN COMMERCE 12-31-2001.

CLASS 42—(Continued).

2,748,705. NET VENTURES, INC., WEST BLOOMFIELD, MI. SN 78-070,732. PUB. 9-24-2002, FILED 6-24-2001.



OWNER OF U.S. REG. NO. 2,100,532.

NO CLAIM IS MADE TO THE EXCLUSIVE RIGHT TO USE "CANCER NEWS", APART FROM THE MARK AS SHOWN.

FOR PROVIDING INFORMATION ABOUT CANCER AND PROVIDING A NATIONAL CALENDAR OF CANCER-RELATED EVENTS FOR PATIENTS AND PHYSICIANS VIA A GLOBAL COMPUTER INFORMATION NETWORK; PROVIDING AN ON-LINE CO-BRANDED NEWSLETTER FEATURING CANCER-RELATED INFORMATION; PROVIDING AN ON-LINE DATABASE FEATURING CANCER-RELATED ARTICLES; PROVIDING AN ACTIVE CONTENT SHARING WEBSITE FEATURING CANCER-RELATED INFORMATION FOR OTHER CONTENT PROVIDERS TO USE AS CONTENT ON THEIR WEBSITES (U.S. CLS. 100 AND 101).

FIRST USE 6-4-2001; IN COMMERCE 7-1-2001.

2,748,731. RENEGADE THERAPEUTICS INC., NEW YORK, NY. SN 78-077,992. PUB. 1-22-2002, FILED 8-7-2001.

RENEGADE

FOR PHARMACEUTICAL AND BIOMEDICAL RESEARCH AND PRODUCT DEVELOPMENT, AND MOLECULAR GENETICS AND FUNCTIONAL GENOMICS RESEARCH (U.S. CLS. 100 AND 101).

FIRST USE 1-8-2003; IN COMMERCE 1-8-2003.

2,748,737. PATIENT COACH, INC., DOYLESTOWN, PA. SN 78-079,950. PUB. 7-23-2002, FILED 8-18-2001.

**patient
coach**

NO CLAIM IS MADE TO THE EXCLUSIVE RIGHT TO USE "PATIENT", APART FROM THE MARK AS SHOWN.

FOR COMPUTER SERVICES, NAMELY, DESIGNING AND IMPLEMENTING WEB SITES FOR OTHERS; PROVIDING MEDICAL PROCEDURE INFORMATION (U.S. CLS. 100 AND 101).

FIRST USE 6-1-2000; IN COMMERCE 4-1-2001.

CLASS 42—(Continued).

2,748,745. HAESTAD METHODS, INC., WATERBURY, CT. SN 78-082,429. PUB. 7-23-2002, FILED 9-4-2001.

CORPORATECARE

FOR OFFERING ENGINEERING AND TECHNICAL CONSULTATION BY TELEPHONE, ELECTRONIC MAIL AND IN-PERSON RELATING TO CIVIL ENGINEERING; PROVIDING INFORMATION RELATING TO CIVIL ENGINEERING, HYDROLOGY, HYDRAULICS AND TECHNICAL DEVELOPMENTS IN THE FIELD OF CIVIL ENGINEERING; COMPUTER SOFTWARE MAINTENANCE IN THE FIELD OF CIVIL ENGINEERING; UPDATING COMPUTER SOFTWARE IN THE FIELD OF CIVIL ENGINEERING FOR OTHERS; COMPUTER CONSULTATION SERVICES RELATING TO CIVIL ENGINEERING (U.S. CLS. 100 AND 101).
FIRST USE 9-6-2001; IN COMMERCE 9-6-2001.

2,748,746. POP WORLD MEDIA, LLC, BRUNSWICK, OH. SN 78-082,434. PUB. 7-2-2002, FILED 9-4-2001.

CLIQUESITE

FOR PROVIDING TEMPORARY ACCESS TO NON-DOWNLOADABLE COMPUTER SOFTWARE FOR USE IN CREATING WEB SITE (U.S. CLS. 100 AND 101).
FIRST USE 9-1-2002; IN COMMERCE 9-1-2002.

2,748,751. AMERICAN AUTOMOBILE ASSOCIATION, INC., HEATHROW, FL. SN 78-083,540. PUB. 7-2-2002, FILED 9-12-2001.

AAA EXCHANGE

OWNER OF U.S. REG. NOS. 1,685,564, 2,158,654, AND OTHERS.
NO CLAIM IS MADE TO THE EXCLUSIVE RIGHT TO USE "EXCHANGE", APART FROM THE MARK AS SHOWN.
FOR PROVIDING AN INTERACTIVE DATABASE CONTAINING PUBLIC AFFAIRS INFORMATION VIA A GLOBAL COMPUTER NETWORK (U.S. CLS. 100 AND 101).
FIRST USE 10-4-2002; IN COMMERCE 10-4-2002.

2,748,763. FISERV, INC., BROOKFIELD, WI. SN 78-085,362. PUB. 10-22-2002, FILED 9-25-2001.

WEB ID

FOR COMPUTER SERVICE, NAMELY, PROVIDING TEMPORARY USE OF ON-LINE NON-DOWNLOADABLE COMPUTER SOFTWARE FOR USE BY HEALTH-CARE CONSUMERS OR PROVIDERS TO VIEW INSURANCE IDENTIFICATION CARDS VIA THE INTERNET (U.S. CLS. 100 AND 101).
FIRST USE 8-31-2001; IN COMMERCE 8-31-2001.

CLASS 42—(Continued).

2,748,792. STENGER, BARBARA J., BRIMFIELD, IL. SN 78-093,303. PUB. 7-30-2002, FILED 11-14-2001.

JO'S JAVA AND ICE CREAM

NO CLAIM IS MADE TO THE EXCLUSIVE RIGHT TO USE "JAVA AND ICE CREAM", APART FROM THE MARK AS SHOWN.

FOR CARRY OUT RESTAURANT SERVICES (U.S. CLS. 100 AND 101).
FIRST USE 12-1-2001; IN COMMERCE 12-1-2001.

2,748,813. TELECOMMUNICATION SYSTEMS, INC., ANNAPOLIS, MD. SN 78-098,961. PUB. 7-30-2002, FILED 12-18-2001.

XLP

FOR COMPUTER SERVICES, NAMELY PROVIDING DATABASES FEATURING INFORMATION OF INTEREST TO SPECIFIC GEOGRAPHIC AREAS FOR MOBILE DEVICES (U.S. CLS. 100 AND 101).
FIRST USE 12-0-2001; IN COMMERCE 1-0-2002.

2,748,863. YEUNG, BAN, SAN JOSE, CA. SN 78-105,730. PUB. 10-29-2002, FILED 1-30-2002.

TRIWARE

FOR NETWORK SYSTEMS CONSULTING (U.S. CLS. 100 AND 101).
FIRST USE 3-1-2001; IN COMMERCE 3-1-2001.

2,748,934. THOMPSON, SHANE, M, SEATTLE, WA. SN 78-123,101. PUB. 11-26-2002, FILED 4-21-2002.

AFFORDABLE BRILLIANCE

NO CLAIM IS MADE TO THE EXCLUSIVE RIGHT TO USE "AFFORDABLE", APART FROM THE MARK AS SHOWN.
FOR GRAPHIC ART DESIGN (U.S. CLS. 100 AND 101).
FIRST USE 4-21-2002; IN COMMERCE 4-21-2002.

CLASS 43—HOTEL AND RESTAURANT SERVICES

CLASS 43—(Continued).

2,748,171. NO PLACE LIKE HOME COMMUNITIES, WAY-ZATA, MN. SN 76-274,968. PUB. 7-9-2002, FILED 6-21-2001.

NO PLACE LIKE HOME COMMUNITIES

NO CLAIM IS MADE TO THE EXCLUSIVE RIGHT TO USE "COMMUNITIES", APART FROM THE MARK AS SHOWN.

FOR PROVIDING ASSISTED LIVING FACILITIES (U.S. CLS. 100 AND 101).
FIRST USE 8-0-2001; IN COMMERCE 12-19-2002.

2,748,261. NO PLACE LIKE HOME COMMUNITIES, WAY-ZATA, MN. SN 76-307,737. PUB. 7-9-2002, FILED 8-30-2001.



NO CLAIM IS MADE TO THE EXCLUSIVE RIGHT TO USE "COMMUNITIES", APART FROM THE MARK AS SHOWN.

FOR PROVIDING ASSISTED LIVING FACILITIES (U.S. CLS. 100 AND 101).
FIRST USE 8-0-2001; IN COMMERCE 12-19-2002.

2,748,556. POTBELLY SANDWICH WORKS, LLC, CHICAGO, IL. SN 76-411,417. PUB. 11-19-2002, FILED 5-24-2002.

A SANDWICH A DAY KEEPS OUR LANDLORD AWAY

FOR RESTAURANT SERVICES (U.S. CLS. 100 AND 101).
FIRST USE 3-15-2003; IN COMMERCE 3-15-2003.

2,748,787. TARGET BRANDS, INC., MINNEAPOLIS, MN. SN 78-092,250. PUB. 8-20-2002, FILED 11-7-2001.

MARSHALL FIELD'S MARKETPLACE CAFE'

OWNER OF U.S. REG. NOS. 1,350,905, 1,474,607, AND OTHERS.

NO CLAIM IS MADE TO THE EXCLUSIVE RIGHT TO USE "CAFE'", APART FROM THE MARK AS SHOWN.

THE NAME "MARSHALL FIELD" DOES NOT IDENTIFY A LIVING INDIVIDUAL.

FOR RESTAURANT SERVICES (U.S. CLS. 100 AND 101).
FIRST USE 6-6-2002; IN COMMERCE 6-6-2002.

CLASS 43—(Continued).

2,748,841. AM RANCH COMPANY, LLC, SCOTTSDALE, AZ. SN 78-103,343. PUB. 8-6-2002, FILED 1-17-2002.

WIRED IN THE WOODS

FOR RESORT HOTEL AND LODGING SERVICES, RESTAURANT, BAR AND LOUNGE SERVICES (U.S. CLS. 100 AND 101).

FIRST USE 3-31-2003; IN COMMERCE 3-31-2003.

CLASS 44—MEDICAL, BEAUTY AND AGRICULTURAL SERVICES

2,748,482. ARZENO INSTITUTE, INC., THE, HILLSDALE, NJ. SN 76-376,374. PUB. 10-8-2002, FILED 2-27-2002.



FOR MASSAGE SERVICES (U.S. CLS. 100 AND 101).
FIRST USE 1-22-2002; IN COMMERCE 1-22-2002.

2,748,509. ST. JOHN HEALTH SYSTEM, DETROIT, MI. SN 76-385,842. PUB. 10-22-2002, FILED 3-22-2002.

TO HEAL, TO SERVE, TOGETHER

FOR HEALTHCARE AND HOSPITAL SERVICES (U.S. CLS. 100 AND 101).
FIRST USE 2-11-2002; IN COMMERCE 6-10-2002.

2,748,511. STORANDT PANN MARGOLIS & PARTNERS, LAGRANGE, IL. SN 76-388,387. PUB. 10-29-2002, FILED 3-27-2002.

HOW MEDICINE SHOULD BE

FOR HOSPITAL AND HEALTHCARE SERVICES (U.S. CLS. 100 AND 101).
FIRST USE 3-17-2002; IN COMMERCE 3-17-2002.

CLASS 45—(Continued).

2,748,520. SNEAK PEEK VIDEO, INC., LAS VEGAS, NV. SN 76-390,808. PUB. 10-29-2002, FILED 4-1-2002.

SNEAK PEEK VIDEO

FOR PROVIDING NON-MEDICAL ULTRA SOUND SERVICES TO PREGNANT WOMEN (U.S. CLS. 100 AND 101).

FIRST USE 3-1-2000; IN COMMERCE 4-1-2000.

2,748,869. MIDWEST RETINA, INC., COLUMBUS, OH. SN 78-107,381. PUB. 9-10-2002, FILED 2-7-2002.



NO CLAIM IS MADE TO THE EXCLUSIVE RIGHT TO USE "MIDWEST RETINA", APART FROM THE MARK AS SHOWN.

FOR OPHTHALMOLOGIC DIAGNOSTIC, TREATMENT, AND SURGICAL SERVICES (U.S. CLS. 100 AND 101).

FIRST USE 7-14-2002; IN COMMERCE 7-14-2002.

CLASS 45—PERSONAL SERVICES

CLASS 45—(Continued).

2,748,422. EXECUSHIELD, INC., SAN FRANCISCO, CA. SN 76-357,047. PUB. 7-23-2002, FILED 1-8-2002.

EXECUSHIELD

FOR CONSULTING SERVICES, NAMELY, SECURITY ASSESSMENT OF RISKS OR THREATS AGAINST PERSONS AND PROPERTY, ANALYSIS OF BUSINESS SECURITY AND SAFEGUARDS, PERFORMING PHYSICAL, INFORMATION AND NETWORK SECURITY AUDITS, PERFORMING SECURITY PLANNING AND DESIGN OF SECURITY SYSTEMS TO PROTECT THE PHYSICAL PROPERTY, INTELLECTUAL PROPERTY, PEOPLE AND INFORMATION SYSTEM OF INDIVIDUALS AND BUSINESS ENTERPRISES; SECURITY CRISIS MANAGEMENT, NAMELY, PLANNING AND IMPLEMENTING SECURITY RESPONSE TO WORK-PLACE VIOLENCE, PRODUCT TAMPERING, TERRORISM, KIDNAPPING AND POLITICAL UNREST; EXECUTIVE PROTECTION, NAMELY, PROVIDING RISK INFORMATION AS TO POTENTIAL SAFETY AND THREAT RISK AND TRAINED SECURITY PROFESSIONALS; INTELLECTUAL PROPERTY SECURITY SERVICES, NAMELY, PROVIDING ASSESSMENT AND PROTECTION SERVICES IN THE FIELD OF COUNTERFEITING, PRODUCT OVERRUNS, GRAY MARKET GOODS, TRADEMARK INFRINGEMENT, AND DIVERSION AND TRANSSHIPMENT OF GOODS; DUE DILIGENCE INVESTIGATION SERVICES, NAMELY, UNCOVERING INFORMATION ABOUT PEOPLE AND COMPANIES INVOLVED IN MERGERS, ACQUISITIONS, INVESTMENT TRANSACTIONS AND DISTRIBUTION OR LICENSING AGREEMENTS; PRE-EMPLOYMENT SCREENING SERVICES, NAMELY, BACKGROUND VERIFICATION AND INVESTIGATION, AND STRUCTURED INTERVIEWS; SECURITY GUARD SERVICES, SECURITY PATROL SERVICES, PERSONNEL PROTECTION, AND DETECTIVE INVESTIGATION SERVICES, NAMELY, SERVICE QUALITY INVESTIGATIONS, BACKGROUND INVESTIGATIONS, FINANCIAL CONDITION INVESTIGATIONS, FACT VERIFICATION INVESTIGATIONS, SURVEILLANCE AND UNDER COVER INVESTIGATIONS (U.S. CLS. 100 AND 101).

FIRST USE 7-1-2000; IN COMMERCE 7-1-2000.

2,748,884. VERITAS PARTNERS, LLC, OVERLAND PARK, KS. SN 78-110,790. PUB. 9-10-2002, FILED 2-25-2002.

FACILIDATE

FOR PERSONAL DATING SERVICES (U.S. CLS. 100 AND 101).

FIRST USE 4-17-2002; IN COMMERCE 4-17-2002.

* * * * *

PRIOR UNITED STATES CLASSIFICATION

APPLICATION IN ONE CLASS

COLLECTIVE MEMBERSHIP MARKS

2,748,291. BSE CERTIFICATION, INC., COLORADO SPRINGS, CO. SN 76-319,015. PUB. 10-29-2002, FILED 10-1-2001.

CLASS 200—COLLECTIVE MEMBERSHIP

2,748,106. SPENCE COMMUNICATIONS, INC., AUSTIN, TX. SN 76-256,224. PUB. 6-18-2002, FILED 5-10-2001.

STUDENTS OF THE WORLD

NO CLAIM IS MADE TO THE EXCLUSIVE RIGHT TO USE "STUDENTS", APART FROM THE MARK AS SHOWN. FOR INDICATING MEMBERSHIP IN AN ASSOCIATION OF STUDENTS AT A COLLEGE OR UNIVERSITY TO PROMOTE AWARENESS AND UNDERSTANDING OF THE CULTURES AND SOCIETIES OF THE UNITED STATES AND OTHER COUNTRIES (U.S. CL. 200). FIRST USE 11-16-2000; IN COMMERCE 11-16-2000.



CERTIFICATION MARKS

CLASS B—SERVICES
2,747,674. INTERNATIONAL ASSOCIATION OF ADMINISTRATIVE PROFESSIONALS, KANSAS CITY, MO. SN 75-887,535. PUB. 1-29-2002, FILED 1-5-2000.

CAP

THE CERTIFICATION MARK, AS INTENDED TO BE USED BY AUTHORIZED PERSONS, IS INTENDED TO CERTIFY THAT SUCH PERSONS MEET THE CERTIFIER'S STANDARDS AS TO QUALITY AND PROFICIENCY IN PROVIDING ADMINISTRATIVE SUPPORT, SECRETARIAL AND CLERICAL SERVICES AS REFLECTED BY THE SUCCESSFUL COMPLETION OF A WRITTEN EXAMINATION AND MEETING MINIMUM REQUIREMENTS OF EXPERIENCE IN PROVIDING THE ADMINISTRATIVE SUPPORT, SECRETARIAL AND CLERICAL SERVICES. FOR ADMINISTRATIVE SUPPORT, SECRETARIAL AND CLERICAL SERVICES (U.S. CL. B). FIRST USE 8-22-2001; IN COMMERCE 8-22-2001.

NO CLAIM IS MADE TO THE EXCLUSIVE RIGHT TO USE "BICYCLE STANDARD OF EXCELLENCE CERTIFICATION", APART FROM THE MARK AS SHOWN. THE CERTIFICATION MARK, AS USED BY PERSONS AUTHORIZED BY THE CERTIFIER, CERTIFIES THAT THE BICYCLE MECHANIC HAS PASSED A TEST OF MECHANICAL SKILL IN THE REPAIR OF BICYCLES. FOR CERTIFICATION OF BICYCLE MECHANICS (U.S. CL. B). FIRST USE 3-15-2003; IN COMMERCE 3-15-2003.

* * * * *

SUPPLEMENTAL REGISTER

These registrations are not subject to opposition.

SECTION 1.— INTERNATIONAL CLASSIFICATION

The short titles associated below with the international class numbers are terms designed merely for quick identification and are not an official part of the international classification. The full names of international classes are given in section 6.1 of the trademark rules of practice.

The designation "U.S. Cl." appearing in this section refers to the U.S. class in effect prior to Sep. 1, 1973 rather than the international class which applies to applications filed on or after that date. For adoption of international classification see notice in the OFFICIAL GAZETTE of Jun. 26, 1973 (911 O.G. TM 210).

Application in more than one class

2,748,991. AQUASCUTUM LIMITED, LONDON, ENGLAND.
SN 75-515,968. FILED P.R. 7-9-1998; AM. S.R. 3-27-2003.

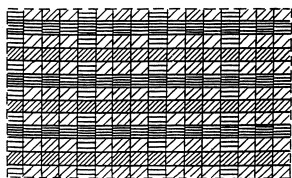

OWNER OF UNITED KINGDOM REG. NO. 2070822,
DATED 4-24-1998, EXPIRES 5-9-2006.

THE DRAWING IS LINED FOR THE COLORS BLUE,
BROWN AND BEIGE AND COLOR IS CLAIMED AS A
FEATURE OF THE MARK.

THE MARK CONSISTS OF A BLUE, BROWN AND BEIGE
CHECKERED REPEATING PATTERN WHICH IS USED ON
THE OUTSIDE OF THE GOODS IN CL. 18 AND ON THE
LINING OF THE GOODS IN CL.25.

CLASS 18—LEATHER GOODS

FOR LEATHER, IMITATION LEATHER, LEATHER
SKINS AND HIDES IN BULK; LUGGAGE, TRAVEL
BAGS, HANDBAGS, SUITCASES, ATTACHE CASES,
BRIEFCASES, WALLET, POCKET WALLET, POCKET
BOOKS, CREDIT CARD HOLDERS, KEY RING CASES,
PURSES, UMBRELLAS, PARASOLS, AND WALKING
STICKS (U.S. CLS. 1, 2, 3, 22 AND 41).

CLASS 25—CLOTHING

FOR WOOL COATS, RAINCOATS, JACKETS, TROU-
SERS, SHIRTS, SWEATERS, LEISURE WEAR JACKETS,
SCARVES, HATS, GLOVES, WAISTCOATS, DRESSES,
AND SKIRTS (U.S. CLS. 22 AND 39).

2,748,994. SHAKEN BABY ALLIANCE, THE, FORT WORTH,
TX. SN 75-783,700. FILED P.R. 8-24-1999; AM. S.R. 11-19-
2001.

THE SHAKEN BABY ALLIANCE

NO CLAIM IS MADE TO THE EXCLUSIVE RIGHT TO
USE "ALLIANCE", APART FROM THE MARK AS SHOWN.

CLASS 9—ELECTRICAL AND SCIENTIFIC APPARATUS

FOR EDUCATIONAL MATERIALS, NAMELY, PRE-
RECORDED VIDEO CASSETTES ON THE SUBJECT OF
SHAKEN BABY SYNDROME (U.S. CLS. 21, 23, 26, 36
AND 38).

FIRST USE 3-1-1998; IN COMMERCE 9-13-1998.

CLASS 16—PAPER GOODS AND PRINTED MATTER

FOR PRINTED EDUCATIONAL MATERIALS,
NAMELY, BOOKS AND PAMPHLETS ON THE SUBJECT
OF SHAKEN BABY SYNDROME (U.S. CLS. 2, 5, 22, 23,
29, 37, 38 AND 50).

FIRST USE 3-1-1998; IN COMMERCE 9-13-1998.

CLASS 41—EDUCATION AND ENTERTAIN- MENT

FOR EDUCATIONAL SERVICES, NAMELY, PROVID-
ING INFORMATION ON EDUCATIONAL OPPORTU-
NITIES FOR SHAKEN BABIES, THEIR PARENTS, AND
CAREGIVERS (U.S. CLS. 100, 101 AND 107).

FIRST USE 3-1-1998; IN COMMERCE 9-13-1998.

CLASS 42—SCIENTIFIC, COMPUTER AND LEGAL SERVICES

FOR SUPPORT SERVICES FOR PARENTS AND CARE-
GIVERS OF SHAKEN BABY SYNDROME VICTIMS,
BOTH SURVIVING AND DECEASED, NAMELY, ESTAB-
LISHING SELF-HELP SUPPORT GROUPS; PROMOTING
PUBLIC AWARENESS OF PROBLEMS FACED BY SHA-
KEN BABY SYNDROME VICTIMS, THEIR PARENTS,
AND CAREGIVERS; AND PROVIDING INFORMATION
REGARDING THE GRIEF PROCESS, MEDICAL CARE
FOR SURVIVORS, AND THE CRIMINAL JUSTICE
SYSTEM (U.S. CLS. 100 AND 101).

FIRST USE 3-1-1998; IN COMMERCE 9-13-1998.

2,748,997. WELLS FARGO & COMPANY, MINNEAPOLIS, MN. SN 76-008,390. FILED P.R. 3-22-2000; AM. S.R. 3-12-2001.

BUSINESS ADVISOR

CLASS 16—PAPER GOODS AND PRINTED MATTER

FOR PRINTED PUBLICATIONS, NAMELY MAGAZINES CONTAINING ARTICLES BASED UPON A VARIETY OF FINANCIAL AND BUSINESS RELATED TOPICS (U.S. CLS. 2, 5, 22, 23, 29, 37, 38 AND 50).

FIRST USE 1-3-2000; IN COMMERCE 1-3-2000.

CLASS 36—INSURANCE AND FINANCIAL

FOR PROVIDING FINANCIAL INFORMATION VIA A GLOBAL COMMUNICATIONS NETWORK (U.S. CLS. 100, 101 AND 102).

FIRST USE 1-3-2000; IN COMMERCE 1-3-2000.

2,749,009. DHARMA HOLDINGS LTD., DBA RAISING MORE MONEY, SEATTLE, WA. SN 76-266,766. FILED P.R. 6-5-2001; AM. S.R. 2-3-2003.

RAISING MORE MONEY E-NEWS

OWNER OF U.S. REG. NO. 2,242,227.

CLASS 9—ELECTRICAL AND SCIENTIFIC APPARATUS

FOR DOWNLOADABLE ELECTRONIC NEWSLETTERS AND BOOKS, NAMELY EDUCATIONAL, INSTRUCTIONAL, AND DOWNLOADABLE ELECTRONIC REFERENCE BOOKS AND NEWSLETTERS RELATED TO THE MANAGEMENT AND FUND DEVELOPMENT OF NON-PROFIT ORGANIZATIONS (U.S. CLS. 21, 23, 26, 36 AND 38).

FIRST USE 10-1-1998; IN COMMERCE 10-1-1998.

CLASS 16—PAPER GOODS AND PRINTED MATTER

FOR NEWSLETTERS AND BOOKS, NAMELY, EDUCATIONAL, INSTRUCTIONAL AND REFERENCE BOOKS AND NEWSLETTERS RELATED TO THE MANAGEMENT AND FUND DEVELOPMENT OF NON-PROFIT ORGANIZATIONS (U.S. CLS. 2, 5, 22, 23, 29, 37, 38 AND 50).

FIRST USE 10-1-1998; IN COMMERCE 10-1-1998.

2,749,010. CONNOLLY, JOSEPH, ORLANDO, FL. SN 76-286,869. FILED P.R. 7-17-2001; AM. S.R. 3-14-2002.

UNITED STATES YUDO ASSOCIATION

NO CLAIM IS MADE TO THE EXCLUSIVE RIGHT TO USE "YUDO ASSOCIATION", APART FROM THE MARK AS SHOWN.

CLASS 35—ADVERTISING AND BUSINESS

FOR ASSOCIATION SERVICES, NAMELY, PROMOTING THE INTEREST OF MARTIAL ARTS EDUCATORS AND INSTRUCTORS (U.S. CLS. 100, 101 AND 102).

FIRST USE 9-0-2000; IN COMMERCE 9-0-2000.

CLASS 41—EDUCATION AND ENTERTAINMENT

FOR EDUCATIONAL SERVICES, NAMELY, PROVIDING INSTRUCTION IN THE MARTIAL ARTS (U.S. CLS. 100, 101 AND 107).

FIRST USE 9-0-2000; IN COMMERCE 9-0-2000.

2,749,016. L'ALTRA MODA S.P.A. ROME, ITALY. SN 76-336,233. FILED P.R. 11-9-2001; AM. S.R. 4-7-2003.

COMPAGNIA ITALIANA

PRIORITY CLAIMED UNDER SEC. 44(D) ON ITALY APPLICATION NO. RM2001C00419, FILED 7-13-2001, REG. NO. 00854845, DATED 7-13-2001, EXPIRES 7-13-2011.

THE ENGLISH TRANSLATION OF "COMPAGNIA ITALIANA" IS "ITALIAN COMPANIONSHIP", "ITALIAN BAND", "ITALIAN CONFRATERNITY", OR "ITALIAN COMPANY".

CLASS 3—COSMETICS AND CLEANING PREPARATIONS

FOR PERFUMES; EAU DE PERFUMES, EAU DE TOILETTE, DEODORANT STICKS/ROLL ON, DEODORANT SPRAYS, AFTER SHAVE GELS AND LOTIONS, BODY LOTIONS, BODY MILKS, BODY SPRAYS, BODY PERFUMED CREAMS, PERFUMED POWDERS, BRONZING GELS, BODY OILS, REFRESHING CREAMS, AFTER SUN HYDRATING MILK, SOAPS, GELS FOR BATH, BATH AND SHOWER GELS, BATH PERFUMED GELS, BODY AND HAIR MILKY SHOWER GELS, NON-MEDICATED BODY SHAMPOOS, BATH PEARLS, PERFUMED BATH TABLETS, PERFUMED SACHETS FOR DOMESTIC USE; PERFUME BAGS, NAMELY, SACHETS, MOUTHWASHES, TOOTHPASTE, EAU DE COLOGNE, BATH SALTS, EYE SHADOWS, EYEBROW PENCILS, EYE LINERS, MASCARAS, EYE MAKE UP REMOVERS, CREAM FOUNDATIONS, CONCEALERS, FACE POWDERS, BLUSHES, LIPSTICKS, LIPGLOSSSES, LIP CONTOUR PENCILS, SKIN CLEANSERS, FACIAL COSMETIC LOTIONS, BEAUTY MASKS, NIGHT CREAMS, SKIN CLARIFIERS, SKIN CLEANSING CREAMS, SKIN EMOLLIENT CREAMS, SKIN LIGHTERS, SKIN MOISTURIZER, SKIN TONER, ANTI-WRINKLE NECK CREAMS, ANTI-WRINKLE FACE CREAMS, ANTI-WRINKLE EYE ZONE CREAMS, HAIR LOTIONS, HAIR DYES, NAIL VARNISH REMOVERS, COTTON WOOL BALLS FOR COSMETIC USE (U.S. CLS. 1, 4, 6, 50, 51 AND 52).

CLASS 18—LEATHER GOODS

FOR BRIEFCASES, HANDBAGS, OPERABAGS, KNAPSACKS, RUCKSACKS, WALLETS, KEYCASES, TRUNKS, TRAVAILING BAGS, POCKET BOOKS, POCKET BOOKS, CREDIT CARD CASES AND TOTE BAGS, ALL MADE OF LEATHER AND IMITATIONS OF LEATHER; ANIMAL HIDES; FURS SOLD IN BULK, UMBRELLAS, PARASOLS AND WALKING STICKS; WHIPS, HARNESS AND SADDLER (U.S. CLS. 1, 2, 3, 22 AND 41).

CLASS 25—CLOTHING

FOR CLOTHING, NAMELY, KNITWEAR, NAMELY, TROUSERS, PANTS, SHORTS, SKIRTS, SHIRTS, BODY-SHIRTS, SWEATSHIRTS, POLO SHIRTS, SUITS, EVENING DRESSES, TUNICS, ONE-PIECE DRESSES, TWO-PIECE DRESSES, SWEATERS, CARDIGAN JACKETS, VESTS, BLOUSES, JEANS, JACKETS, OVERCOATS, OUTERWEAR, NAMELY, SLIPS, SWIM SUITS, UNDERWEAR, SOCKS, STOCKINGS, TIGHTS, SCARVES, HATS AND CAPS, BELTS, BOOTS, SHOES, LEATHER SHOES, RUBBER SHOES, SANDALS AND SLIPPERS (U.S. CLS. 22 AND 39).

2,749,024. NIS, INC., DBA THE PARENT INSTITUTE, FAIRFAX, VA. SN 76-386,438. FILED P.R. 3-25-2002; AM. S.R. 4-3-2003.

**EDUCATORS' NOTEBOOK
ON FAMILY INVOLVEMENT**

NO CLAIM IS MADE TO THE EXCLUSIVE RIGHT TO USE "FAMILY INVOLVEMENT", APART FROM THE MARK AS SHOWN.

**CLASS 9—ELECTRICAL AND SCIENTIFIC
APPARATUS**

FOR DOWNLOADABLE ELECTRONIC PUBLICATIONS IN THE NATURE OF NEWSLETTERS CONTAINING PRACTICAL IDEAS FOR EDUCATORS TO USE TO STIMULATE INVOLVEMENT OF PARENTS IN THE EDUCATION OF THEIR CHILDREN (U.S. CLS. 21, 23, 26, 36 AND 38).

FIRST USE 8-12-1999; IN COMMERCE 8-12-1999.

**CLASS 16—PAPER GOODS AND PRINTED
MATTER**

FOR NEWSLETTERS ON THE SUBJECT OF WAYS EDUCATORS CAN ENCOURAGE PARENTAL INVOLVEMENT IN THE EDUCATION OF THEIR CHILDREN (U.S. CLS. 2, 5, 22, 23, 29, 37, 38 AND 50).

FIRST USE 8-12-1999; IN COMMERCE 8-12-1999.

2,749,037. GENENCOR INTERNATIONAL, INC., PALO ALTO, CA. SN 76-453,150. FILED P.R. 9-26-2002; AM. S.R. 4-15-2003.

MUTATORTECHNOLOGY**CLASS 40—MATERIAL TREATMENT**

FOR MANUFACTURE OF ENZYMES, BIO-CATALYSTS, PEPTIDES, PROTEINS, BIOPOLYMERS, CHEMICALS, BIOCHEMICALS, AND PARTICULATE, GRANULAR AND/OR LIQUID FORMULATIONS CONTAINING ONE OR MORE OF THE FOREGOING, NAMELY FOR THE BIOTECHNOLOGY, HEALTH CARE, AGRICULTURE, CLEANING, TEXTILE PROCESSING, GRAIN PROCESSING, FOOD, FEED, PERSONAL CARE, AND PHARMACEUTICAL INDUSTRIES; DIRECTED EVOLUTION SERVICES, NAMELY MANIPULATION OF GENES FOR THE BENEFIT OF OTHERS TO PRODUCE GENE SEQUENCES ENCODING PEPTIDES, PROTEINS AND/OR ENZYMES HAVING DESIRED CHARACTERISTICS, NAMELY FOR THE BIOTECHNOLOGY, HEALTH CARE, AGRICULTURE, INDUSTRIAL CHEMICALS, CLEANING PRODUCTS, TEXTILE PROCESSING, GRAIN PROCESSING, FOOD, FEED, PERSONAL CARE, AND PHARMACEUTICAL INDUSTRIES (U.S. CLS. 100, 103 AND 106).

FIRST USE 9-1-1999; IN COMMERCE 9-1-1999.

**CLASS 42—SCIENTIFIC, COMPUTER AND
LEGAL SERVICES**

FOR TECHNICAL CONSULTATION, RESEARCH AND DEVELOPMENT IN THE FIELDS OF GENE DISCOVERY, FUNCTIONAL GENOMICS, PROTEIN AND ENZYME PRODUCTION AND RECOVERY SYSTEMS, MOLECULAR EVOLUTION AND DESIGN, HUMAN IMMUNOLOGY, METABOLIC PATHWAY ENGINEERING, AND FORMULATION DELIVERY SYSTEMS, NAMELY FOR THE HEALTH CARE, AGRICULTURE, INDUSTRIAL CHEMICALS, CLEANING PRODUCTS, TEXTILE PROCESSING, GRAIN PROCESSING, FOOD, FEED, PERSONAL CARE, AND PHARMACEUTICAL INDUSTRIES; GENETIC AND PROTEIN ENGINEERING SERVICES; SCIENTIFIC RESEARCH SERVICES, DESIGN AND TESTING OF NEW BIOTECHNOLOGY, HEALTH CARE, AGRICULTURE AND INDUSTRIAL CHEMICAL PRODUCTS FOR OTHERS; IMMUNOBIOLOGICAL RESEARCH AND TESTING (U.S. CLS. 100 AND 101).

FIRST USE 9-1-1999; IN COMMERCE 9-1-1999.

* * * * *

SECTION 2.— INTERNATIONAL CLASSIFICATION

The short titles associated below with the international class numbers are terms designed merely for quick identification and are not an official part of the international classification. The full names of international classes are given in section 6.1 of the trademark rules of practice.

The designation "U.S. Cl." appearing in this section refers to the U.S. class in effect prior to Sep. 1, 1973 rather than the international class which applies to applications filed on or after that date. For adoption of international classification see notice in the OFFICIAL GAZETTE of Jun. 26, 1973 (911 O.G. TM 210).

Application in one class

CLASS 3—COSMETICS AND CLEANING PREPARATIONS

2,749,002. BNG ENTERPRISES, INC., TEMPE, AZ. SN 76-177,454. FILED P.R. 12-7-2000; AM. S.R. 4-11-2003.

HAIR DETOX

FOR HAIR CARE PRODUCT, NAMELY NON-MEDICATED HAIR SHAMPOO FOR REMOVING RESIDUES AND TOXINS FROM SKIN AND SCALP (U.S. CLS. 1, 4, 6, 50, 51 AND 52).
FIRST USE 1-31-2000; IN COMMERCE 1-31-2000.

2,749,015. GRAINGER, DAVID, WICHITA, KS. SN 76-330,925. FILED P.R. 10-29-2001; AM. S.R. 5-5-2003.

KNEES AND TOES

FOR LIQUID BODY CLEANSING GELS (U.S. CLS. 1, 4, 6, 50, 51 AND 52).
FIRST USE 4-25-2003; IN COMMERCE 4-25-2003.

2,749,039. NORSTAR CONSUMER PRODUCTS CO., INC., KENOSHA, WI. SN 76-456,282. FILED P.R. 10-2-2002; AM. S.R. 4-1-2003.

SALON TREATMENT

FOR SKIN EMOLLIENTS (U.S. CLS. 1, 4, 6, 50, 51 AND 52).
FIRST USE 11-2-2001; IN COMMERCE 11-2-2001.

CLASS 8—HAND TOOLS

CLASS 8—(Continued).

2,749,013. DESA INTERNATIONAL INC., BOWLING GREEN, KY. SN 76-318,789. FILED P.R. 9-27-2001; AM. S.R. 1-11-2002.

POWER HAMMER

FOR HAND TOOLS, NAMELY, POWDER-OPERATED FASTENING TOOLS USED TO DRIVE FASTENERS INTO CONCRETE AND OTHER MATERIALS (U.S. CLS. 23, 28 AND 44).
FIRST USE 0-0-1976; IN COMMERCE 0-0-1976.

CLASS 9—ELECTRICAL AND SCIENTIFIC APPARATUS

2,748,998. WINTHROP MEDIA GROUP LLC, NEW YORK, NY. SN 76-021,581. FILED P.R. 4-10-2000; AM. S.R. 1-25-2002.

WINTHROP RECORDS

NO CLAIM IS MADE TO THE EXCLUSIVE RIGHT TO USE "RECORDS", APART FROM THE MARK AS SHOWN. FOR RECORDS, COMPACT DISCS AND AUDIO AND VIDEO CASSETTES TAPES FEATURING MUSIC (U.S. CLS. 21, 23, 26, 36 AND 38).
FIRST USE 3-17-2000; IN COMMERCE 3-17-2000.

2,749,001. APPLIED PRECISION, LLC., ISSAQUAH, WA, BY ASSIGNMENT; BY ASSIGNMENT APPLIED PRECISION, INC., ISSAQUAH, WA. SN 76-146,933. FILED P.R. 10-12-2000; AM. S.R. 9-30-2002.

WAVETUNER

FOR HARDWARE DEVICE FOR ADJUSTING LASER FREQUENCY OF TUNABLE LASER SOURCES (U.S. CLS. 21, 23, 26, 36 AND 38).
FIRST USE 5-12-1999; IN COMMERCE 5-12-1999.

CLASS 9—(Continued).

2,749,012. SEIKO EPSON KABUSHIKI KAISHA, TA SEIKO EPSON CORPORATION, SHINJUKU-KU, TOKYO, JAPAN. SN 76-301,326. FILED P.R. 8-20-2001; AM. S.R. 5-5-2003.

PRINT IMAGE MATCHING

PRIORITY CLAIMED UNDER SEC. 44(D) ON JAPAN APPLICATION NO. 2001-060089, FILED 7-2-2001.

NO CLAIM IS MADE TO THE EXCLUSIVE RIGHT TO USE "IMAGE MATCHING", APART FROM THE MARK AS SHOWN.

FOR COMPUTER HARDWARE; COMPUTER PRINTERS; IMAGE SCANNERS; COMPUTER SOFTWARE FOR PROCESSING OF IMAGES; DIGITAL CAMERAS, BATTERIES AND BATTERY CHARGERS FOR DIGITAL CAMERAS; WORD PROCESSORS, COMPUTER KEYBOARDS, MODEMS, COMPUTER DISPLAYS, FLOPPY DISC DRIVES, MONITORS, CATHODE RAY TUBES, BLANK MAGNETIC TAPES, BLANK MAGNETIC DISCS, BLANK MAGNETIC CARDS, BLANK OPTICAL MEMORY CARDS, MAGNETIC DRUMS, MAGNET-OPTICAL DRIVES, LIQUID CRYSTAL PROJECTORS, LIQUID CRYSTAL DISPLAYS, DIGITAL DISPLAYS, OPTICAL SENSORS, IMAGE SENSORS, CD-ROM PLAYERS, CD BOOK PLAYERS, INTEGRATED CIRCUITS, LARGE SCALE INTEGRATED CIRCUITS, SEMICONDUCTOR MEMORIES, DIODES, QUARTZ RESONATORS, QUARTZ OSCILLATORS, CRYSTAL CONTROLLED TRANSMITTERS, OPTOELECTRONIC MEMORIES, TRANSISTORS, INTEGRATED CIRCUIT MEMORY CARDS, OPTICAL CARDS, RARE-EARTH MAGNETS; AUDIO-VISUAL APPARATUS AND APPARATUS FOR RECORDING, TRANSMITTING OR REPRODUCING SOUND OR IMAGES, NAMELY VIDEO CASSETTES RECORDERS, VIDEO CAMERAS, TELEVISION SETS, LIQUID CRYSTAL TELEVISIONS, TELEVISION CAMERAS, AUDIO TAPE RECORDERS, VIDEO TAPE RECORDERS, VIDEO DISC PLAYERS, VIDEO PROJECTORS, VIDEO PRINTERS, ANTENNAS, FACSIMILE MACHINES AND ELECTROSTATIC COPY MACHINES; AMMETERS, VOLTMETERS, FREQUENCY METERS, OSCILLOSCOPES, THERMOMETERS; AUTOMATED BILLING MACHINES AND AUTOMATED TELLER MACHINES; SPECTACLES, SPECTACLE LENSES, EYEGLOSS FRAMES AND CONTACT LENSES; PARTS OF ALL THE AFORESAID GOODS (U.S. CLS. 21, 23, 26, 36 AND 38).

FIRST USE 3-16-2001; IN COMMERCE 5-1-2001.

2,749,019. SYSTEMS MANUFACTURING CORPORATION, CONKLIN, NY. SN 76-343,405. FILED P.R. 11-30-2001; AM. S.R. 5-9-2003.

SMARTCABINET

FOR FURNITURE, NAMELY CABINETS FOR SECURELY ENCLOSING ELECTRONIC HARDWARE (U.S. CLS. 21, 23, 26, 36 AND 38).

FIRST USE 9-0-2000; IN COMMERCE 9-0-2000.

CLASS 9—(Continued).

2,749,028. SILENT WITNESS ENTERPRISES LTD., SURREY, BRITISH COLUMBIA V3S 4G5, CANADA. SN 76-405,150. FILED P.R. 5-6-2002; AM. S.R. 5-22-2003.

EXITVIEW

PRIORITY CLAIMED UNDER SEC. 44(D) ON CANADA APPLICATION NO. 1123088, FILED 11-23-2001.

FOR SECURITY, MONITORING AND SURVEILLANCE SYSTEMS FOR USE INSIDE AND OUTSIDE PREMISES COMPRISED OF VIDEO CAMERAS, VIDEO SURVEILLANCE CAMERAS, DIGITAL VIDEO CAMERAS, WIRELESS DIGITAL VIDEO CAMERAS, NETWORKED DIGITAL VIDEO CAMERAS, VIDEO CAMERA HOUSING ASSEMBLIES, VIDEO TAPE RECORDERS, DIGITAL VIDEO RECORDERS AND VIDEO MONITORS, AND PARTS AND ACCESSORIES THEREFOR, NAMELY, WIRING HARNESES AND MOUNTING HARDWARE SOLD TOGETHER THEREWITH; AND COMPONENTS FOR SECURITY, MONITORING AND SURVEILLANCE SYSTEMS, NAMELY, VIDEO CAMERAS, VIDEO SURVEILLANCE CAMERAS, DIGITAL VIDEO CAMERAS, WIRELESS DIGITAL VIDEO CAMERAS, NETWORKED DIGITAL VIDEO CAMERAS, VIDEO CAMERA HOUSING ASSEMBLIES, VIDEO TAPE RECORDERS, DIGITAL VIDEO RECORDERS AND VIDEO MONITORS, AND PARTS AND ACCESSORIES THEREFOR, NAMELY, WIRING HARNESES AND MOUNTING HARDWARE SOLD TOGETHER THEREWITH (U.S. CLS. 21, 23, 26, 36 AND 38).

FIRST USE 8-0-2001; IN COMMERCE 9-0-2001.

2,749,044. SMART INDUSTRIES CORPORATION, DES MOINES, IA. SN 78-047,294. FILED P.R. 2-8-2001; AM. S.R. 5-12-2003.

HOT BABES

FOR COIN OPERATED PHOTO BOOTHS (U.S. CLS. 21, 23, 26, 36 AND 38).

FIRST USE 12-6-2001; IN COMMERCE 12-6-2001.

2,749,052. INOVEC, INC., EUGENE, OR. SN 78-138,738. FILED P.R. 6-25-2002; AM. S.R. 5-16-2003.

CONTOURSCAN

FOR ELECTRICAL POSITION, MOTION AND PROCESS CONTROLS FOR USE IN SCANNING AND PARTS THEREFOR FOR USE IN THE WOOD PRODUCTS INDUSTRY (U.S. CLS. 21, 23, 26, 36 AND 38).

FIRST USE 6-28-2002; IN COMMERCE 6-28-2002.

CLASS 9—(Continued).

2,749,053. DATUM, INC., LEXINGTON, MA. SN 78-139,990. FILED P.R. 6-28-2002; AM. S.R. 5-16-2003.

STAMPSERVER

FOR COMPUTER HARDWARE AND SOFTWARE FOR PROVIDING SECURE AND AUDITABLE TIMING SYSTEMS FOR INFORMATION TECHNOLOGY APPLICATIONS, TRANSACTIONS AND LOGS (U.S. CLS. 21, 23, 26, 36 AND 38).
FIRST USE 9-30-2001; IN COMMERCE 9-30-2001.



CLASS 10—MEDICAL APPARATUS

2,749,034. PATTON MEDICAL CORPORATION, AUSTIN, TX. SN 76-420,742. FILED P.R. 6-12-2002; AM. S.R. 5-27-2003.

HOTBLADE

FOR SURGICAL INSTRUMENTS, NAMELY, DISSECTING, GRASPING, BIPOLAR CUTTING AND BIPOLAR COAGULATING INSTRUMENTS FOR LAPAROSCOPIC AND OPEN SURGERY (U.S. CLS. 26, 39 AND 44).
FIRST USE 7-18-2002; IN COMMERCE 7-18-2002.



CLASS 11—ENVIRONMENTAL CONTROL APPARATUS

2,749,003. LASKO METAL PRODUCTS, INC., WEST CHESTER, PA. SN 76-222,166. FILED P.R. 3-9-2001; AM. S.R. 4-14-2003.

QUICKMOUNT

FOR ELECTRIC FANS (U.S. CLS. 13, 21, 23, 31 AND 34).
FIRST USE 6-8-2001; IN COMMERCE 6-8-2001.



CLASS 15—MUSICAL INSTRUMENTS

CLASS 15—(Continued).

2,749,031. SAMICK MUSIC CORPORATION, CITY OF INDUSTRY, CA. SN 76-416,481. FILED P.R. 6-3-2002; AM. S.R. 4-11-2003.

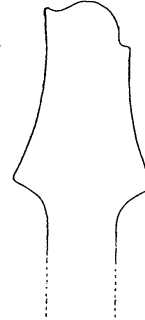

THE MARK CONSISTS OF THE SHAPE OR OUTLINE OF THE HEADSTOCK OF A GUITAR. THE PORTION OF THE DRAWING REPRESENTED IN BROKEN LINES IS NOT PART OF THE MARK.
FOR MUSICAL INSTRUMENTS, NAMELY, ELECTRIC GUITARS, ACOUSTIC GUITARS AND BASS GUITARS (U.S. CLS. 2, 21 AND 36).
FIRST USE 1-2-2000; IN COMMERCE 1-2-2000.



2,749,032. SAMICK MUSIC CORPORATION, CITY OF INDUSTRY, CA. SN 76-417,153. FILED P.R. 6-6-2002; AM. S.R. 4-11-2003.

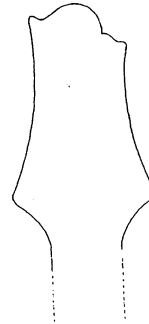

THE MARK CONSISTS OF THE SHAPE OR OUTLINE OF THE HEADSTOCK OF A GUITAR. THE PORTION OF THE DRAWING REPRESENTED IN BROKEN LINES IS NOT PART OF THE MARK.
FOR MUSICAL INSTRUMENTS, NAMELY, ELECTRIC GUITARS, ACOUSTIC GUITARS AND BASS GUITARS (U.S. CLS. 2, 21 AND 36).
FIRST USE 1-2-2000; IN COMMERCE 1-2-2000.



CLASS 16—PAPER GOODS AND PRINTED MATTER

CLASS 16—(Continued).

2,749,011. IFEX GLOBAL, INC., DBA RUSSIAN YELLOW PAGES, BENSLEM, PA. SN 76-300,675. FILED P.R. 8-17-2001; AM. S.R. 2-10-2003.

RUSSIAN YELLOW PAGES

NO CLAIM IS MADE TO THE EXCLUSIVE RIGHT TO USE "YELLOW PAGES", APART FROM THE MARK AS SHOWN.

FOR PUBLICATION NAMELY, A BILINGUAL ENGLISH AND RUSSIAN REFERENCE DIRECTORY (U.S. CLS. 2, 5, 22, 23, 29, 37, 38 AND 50).

FIRST USE 1-1-1999; IN COMMERCE 1-1-1999.

2,749,025. JACKSON, ERIC, LEESPORT, PA. SN 76-391,980. FILED P.R. 4-4-2002; AM. S.R. 5-28-2003.

SPRINGER'S HANDBOOK

NO CLAIM IS MADE TO THE EXCLUSIVE RIGHT TO USE "HANDBOOK", APART FROM THE MARK AS SHOWN.

FOR BOOKS, NAMELY CATALOGUES OF NON-POSTAGE STAMPS SUCH AS PROCESS BUTTER, MIXED FLOUR, OLEO MARGARINE, TOBACCO, HOTEL STAMPS, INDUSTRIAL STAMPS, MATCH STAMPS, MEDICINE STAMPS, NEWSPAPER STAMPS, TELEGRAPH STAMPS, TELEPHONE STAMPS, BEER STAMPS, FERMENTED FRUIT JUICE STAMPS, COTTON ORDERS, FOOD ORDERS, LICENSE AND ROYALTY STAMPS, NARCOTICS, DISTILLERY WAREHOUSE STAMPS, COLLEGE STAMPS, INDEPENDENT MAIL ROUTES, BREWER'S PERMITS, FERMENTED LIQUOR EXPORT STAMPS, GENERAL BONDED WAREHOUSE STAMPS, COMPLIMENTARY FRANK STAMPS, MONEY PACKAGE STAMPS, SPECIAL TAX STAMPS, LOCK SEALS, SNUFF SPECIMENS, BEER, FUEL STAMPS, TAX EXEMPT POTATOES, ADULTERATED BUTTER, FILLED CHEESE, ALLAN TAYLOR FORMS, IDENTIFYING LOCAL POSTS (U.S. CLS. 2, 5, 22, 23, 29, 37, 38 AND 50).

FIRST USE 3-8-1966; IN COMMERCE 3-8-1966.

2,749,026. WORLD SNOWMOBILE ASSOCIATION, MAPLE GROVE, MN. SN 76-396,708. FILED P.R. 4-16-2002; AM. S.R. 5-19-2003.

SNO-X

FOR MAGAZINE DEVOTED TO SNOWMOBILE RACING (U.S. CLS. 2, 5, 22, 23, 29, 37, 38 AND 50).
FIRST USE 9-30-2002; IN COMMERCE 9-30-2002.

CLASS 16—(Continued).

2,749,040. FRONTIERS UNLIMITED, INC., DBA MILLER PUBLISHING GROUP, SOUTHAMPTON, NY. SN 76-466,560. FILED P.R. 11-13-2002; AM. S.R. 4-21-2003.

MONTAUK LIVING

THE MAGAZINE
DEVOTED TO
LONG ISLAND'S
UNIQUE SEASIDE
RESORT COMMUNITY

NO CLAIM IS MADE TO THE EXCLUSIVE RIGHT TO USE "MAGAZINE", APART FROM THE MARK AS SHOWN.

FOR MAGAZINES CONTAINING EDITORIAL CONTENT, PHOTOGRAPHS, AND RELATED ADVERTISING REGARDING RESIDENTIAL HOMES LOCATED AND SITUATED IN THE HAMPTONS, EASTERN LONG ISLAND, NEW YORK, AND SURROUNDING COUNTIES (U.S. CLS. 2, 5, 22, 23, 29, 37, 38 AND 50).

FIRST USE 4-1-2002; IN COMMERCE 4-1-2002.

2,749,047. MANGAN COMMUNICATIONS, INC., DAVENPORT, IA. SN 78-110,349. FILED P.R. 2-22-2002; AM. S.R. 6-9-2003.

**THE ULTIMATE GREEN
BOOK**

NO CLAIM IS MADE TO THE EXCLUSIVE RIGHT TO USE "GREEN BOOK", APART FROM THE MARK AS SHOWN.

FOR BOOKS, NAMELY, A SERIES OF EDUCATION BOOKS IN THE FIELD OF GOVERNMENT OSHA REGULATIONS (U.S. CLS. 2, 5, 22, 23, 29, 37, 38 AND 50).

FIRST USE 11-11-2002; IN COMMERCE 11-18-2002.

2,749,056. DELABARTA, INC., WILMINGTON, DE. SN 78-162,403. FILED P.R. 9-10-2002; AM. S.R. 3-31-2003.

ORLANDO GOLF

OWNER OF U.S. REG. NO. 1,304,981.

FOR GOLF MAGAZINE CONTAINING— COURSE DESCRIPTIONS, PICTURES, AND LISTINGS; AND GOLF-ORIENTED FEATURE ARTICLES (U.S. CLS. 2, 5, 22, 23, 29, 37, 38 AND 50).

FIRST USE 12-31-2000; IN COMMERCE 12-31-2000.

CLASS 22—CORDAGE AND FIBERS

CLASS 22—(Continued).

2,749,021. DELAWARE CAPITAL FORMATION, INC., WILMINGTON, DE. SN 76-367,755. FILED P.R. 2-5-2002; AM. S.R. 11-26-2002.

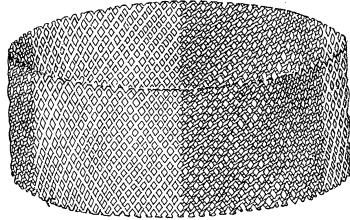

OWNER OF U.S. REG. NO. 1,944,841.
THE MARK CONSISTS OF A GREEN AND BLACK STRIPED DESIGN USED ON OR IN CONNECTION WITH MDPE OR POLYPROPYLENE NETTING. THE DARKER PORTION OF THE LINING SHOWN IN THE DRAWING INDICATES THE COLOR BLACK WITH THE LIGHTER PORTION INDICATING THE COLOR DARK GREEN.
FOR PLASTIC NETTING IN TUBULAR FORM FOR CONTAINMENT OF VARIOUS MATERIALS AND DEPLOYED AS CONTAINMENT BARRIERS (U.S. CLS. 1, 2, 7, 19, 22, 42 AND 50).
FIRST USE 6-0-2001; IN COMMERCE 6-0-2001.

CLASS 25—(Continued).

2,749,017. DUNGAREES U.S.A., INC., MONTREAL QUEBEC, CANADA. SN 76-343,179. FILED P.R. 11-29-2001; AM. S.R. 3-6-2003.

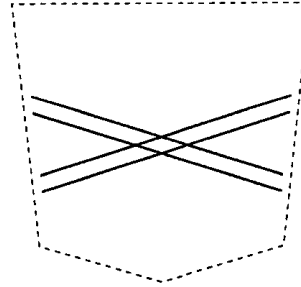

OWNER OF U.S. REG. NO. 2,147,027.
THE MARK CONSISTS OF STITCHING OF TWO PARALLEL DIAGONAL LINES FROM LEFT TO RIGHT AND TWO PARALLEL DIAGONAL LINES FROM RIGHT TO LEFT, FORMING AN X ON A POCKET FORMING PART OF THE GOODS. THE DOTTED LINES ARE NOT PART OF THE MARK; THEY REPRESENT THE POSITION ON THE GOODS, SUCH AS PANTS, WHERE THE MARK WILL BE ATTACHED.
FOR MEN'S AND WOMEN'S CLOTHING, NAMELY, PANTS, SHORTS, SKIRTS, SHIRTS, JACKETS, VESTS, AND OVERALLS (U.S. CLS. 22 AND 39).
FIRST USE 9-1-1992; IN COMMERCE 9-1-1992.

2,749,022. DELAWARE CAPITAL FORMATION, INC., WILMINGTON, DE. SN 76-372,198. FILED P.R. 2-5-2002; AM. S.R. 11-26-2002.

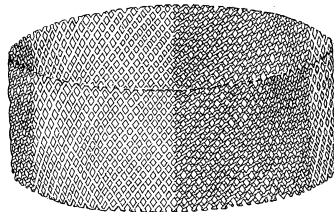

OWNER OF U.S. REG. NO. 1,944,841.
THE MARK CONSISTS OF AN ORANGE AND BLACK STRIPED DESIGN USED ON OR IN CONNECTION WITH MDPE OR POLYPROPYLENE NETTING. THE DARKER PORTION OF THE LINING SHOWN IN THE DRAWING INDICATES THE COLOR BLACK WITH THE LIGHTER PORTION INDICATING THE COLOR ORANGE.
FOR PLASTIC NETTING IN TUBULAR FORM FOR CONTAINMENT OF VARIOUS MATERIALS AND DEPLOYED AS CONTAINMENT BARRIERS (U.S. CLS. 1, 2, 7, 19, 22, 42 AND 50).
FIRST USE 6-0-2001; IN COMMERCE 6-0-2001.

2,749,018. DUNGAREES U.S.A., INC., MONTREAL QUEBEC, CANADA. SN 76-343,180. FILED P.R. 11-29-2001; AM. S.R. 3-6-2003.

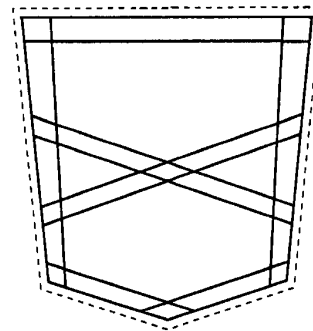

OWNER OF U.S. REG. NO. 2,147,027.
THE MARK CONSISTS OF STITCHING OF TWO PARALLEL DIAGONAL LINES FROM LEFT TO RIGHT AND TWO PARALLEL DIAGONAL LINES FROM RIGHT TO LEFT, FORMING AN X, AND TWO PARALLEL LINES ALONG THE TOP, BOTTOM, LEFT AND RIGHT SIDES OF A POCKET FORMING PART OF THE GOODS. THE DOTTED LINES ARE NOT PART OF THE MARK; THEY REPRESENT THE POSITION ON THE GOODS, SUCH AS PANTS, WHERE THE MARK WILL BE ATTACHED.
FOR MEN'S AND WOMEN'S CLOTHING, NAMELY, PANTS, SHORTS, SKIRTS, SHIRTS, JACKETS, VESTS, AND OVERALLS (U.S. CLS. 22 AND 39).
FIRST USE 9-1-1992; IN COMMERCE 9-1-1992.

CLASS 25—CLOTHING

CLASS 28—TOYS AND SPORTING GOODS

2,748,990. EBSCO INDUSTRIES, INC., LEEDS, AL. SN 74-323,440. FILED P.R. 10-19-1992; AM. S.R. 2-10-2003.

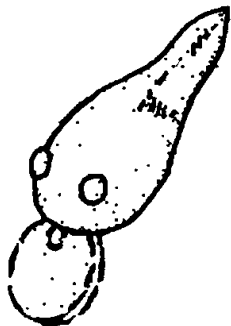

NO CLAIM IS MADE TO THE EXCLUSIVE RIGHT TO USE THE REPRESENTATION OF THE WEIGHT OR THE FISHING ATTACHMENT, APART FROM THE MARK AS SHOWN.

FOR FISHING LURES (U.S. CL. 22).
FIRST USE 9-15-1992; IN COMMERCE 9-15-1992.

CLASS 29—MEATS AND PROCESSED FOODS

2,749,033. WAL-MART STORES, INC., BENTONVILLE, AR. SN 76-417,460. FILED P.R. 6-13-2002; AM. S.R. 1-23-2003.

FRUIT SELECTIONS

NO CLAIM IS MADE TO THE EXCLUSIVE RIGHT TO USE "FRUIT", APART FROM THE MARK AS SHOWN.

FOR PROCESSED FRUITS (U.S. CL. 46).
FIRST USE 8-27-2002; IN COMMERCE 8-29-2002.

CLASS 30—STAPLE FOODS

2,748,989. FIORAVANTI, GUIDO, 20125 MILANO, ITALY. SN 73-437,531. FILED P.R. 8-2-1983; AM. S.R. 9-13-1984.

FIORAVANTI

FOR FRESH DRIED, PRESERVED, DEEP-FROZEN, READY -TO-USE ALIMENTARY PASTAS, BREAD, ITALIAN BREAD STICKS, CRACKERS, COOKIES, CAKES, BISCUITS, PASTRIES, TARTS, PIES, CANDY, CHOCOLATES, TOFFEES, CREAM PUFFS, ICE CREAMS, AND SEMIFREDDOS (U.S. CL. 46).

FIRST USE 0-0-1952; IN COMMERCE 5-25-1983.

CLASS 30—(Continued).

2,749,027. AMUROL CONFECTIONS COMPANY, YORKVILLE, IL. SN 76-402,186. FILED P.R. 5-1-2002; AM. S.R. 2-28-2003.

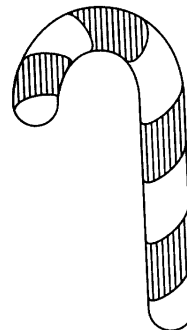

OWNER OF U.S. REG. NOS. 1,535,572, 2,063,940, AND OTHERS.

THE LINING IS FOR SHADING PURPOSES ONLY AND DOES NOT INDICATE COLOR.

THE MARK CONSISTS OF A CONFIGURATION OF CHEWING GUM IN THE SHAPE OF A DECORATIVE CANDY CANE.

FOR CONFECTIONERY, NAMELY, BUBBLE GUM (U.S. CL. 46).

FIRST USE 11-1-1995; IN COMMERCE 11-1-1995.

2,749,051. SOPRA, AURORA, IL. SN 78-133,415. FILED P.R. 6-5-2002; AM. S.R. 3-27-2003.

MILAZZO

FOR PASTA SAUCES; PASTA PRODUCTS, NAMELY, MACARONI; RICE; PIZZA; BREAD STICK; FROZEN PREPARED AND PACKAGED MEALS CONSISTING PRIMARILY OF PASTA OR RICE (U.S. CL. 46).

FIRST USE 8-13-2002; IN COMMERCE 12-17-2002.

CLASS 32—LIGHT BEVERAGES

2,749,045. G. K. SKAGGS, INC., ZEPHYR COVE, NV. SN 78-080,207. FILED P.R. 8-20-2001; AM. S.R. 1-13-2003.

MONTERREY

FOR BEER (U.S. CLS. 45, 46 AND 48).

FIRST USE 9-19-2001; IN COMMERCE 9-19-2001.

SERVICE MARKS**CLASS 35—ADVERTISING AND BUSINESS**

CLASS 35—(Continued).

2,749,014. AUTOMOBILE CLUB OF SOUTHERN CALIFORNIA, COSTA MESA, CA. SN 76-330,468. FILED P.R. 10-26-2001; AM. S.R. 4-24-2003.

AUTO CLUB

OWNER OF U.S. REG. NOS. 314,972, 2,472,022, AND OTHERS.

FOR PROMOTING THE GOODS AND SERVICES OF OTHERS BY NEGOTIATING DISCOUNTS FOR CLUB MEMBERS PERTAINING TO CELL PHONE AND WIRELESS COMMUNICATION SERVICES AND BY DEMONSTRATING THE FEATURES OF CELLULAR PHONES TO CLUB MEMBERS; PROMOTING THE GOODS AND SERVICES OF OTHERS BY NEGOTIATING DISCOUNTS FOR CLUB MEMBERS ON CELLULAR PHONES WHICH HAVE DIRECT ACCESS TO EMERGENCY ROADSIDE ASSISTANCE (U.S. CLS. 100, 101 AND 102).

FIRST USE 9-30-1989; IN COMMERCE 9-30-1989.

2,749,038. HERITAGE PRESERVATION CORPORATION, SPARTANBURG, SC. SN 76-455,286. FILED P.R. 10-3-2002; AM. S.R. 5-1-2003.

EDGAR NET.FILER

NO CLAIM IS MADE TO THE EXCLUSIVE RIGHT TO USE "EDGAR", APART FROM THE MARK AS SHOWN.

FOR PROVIDING A WEBSITE FEATURING ONLINE SERVICE APPLICATION TO ASSIST OTHERS IN SATISFYING FILING REQUIREMENTS PROMULGATED BY THE SECURITIES EXCHANGE COMMISSION (U.S. CLS. 100, 101 AND 102).

FIRST USE 8-28-2002; IN COMMERCE 8-28-2002.

2,749,049. PROMOTIONAL PRODUCTS ASSOCIATION INTERNATIONAL, IRVING, TX. SN 78-126,449. FILED P.R. 5-6-2002; AM. S.R. 5-27-2003.

VEGAS SHOW

NO CLAIM IS MADE TO THE EXCLUSIVE RIGHT TO USE "SHOW", APART FROM THE MARK AS SHOWN.

FOR PROMOTING AND CONDUCTING TRADE SHOWS IN THE PROMOTIONAL PRODUCTS INDUSTRY (U.S. CLS. 100, 101 AND 102).

FIRST USE 3-22-2002; IN COMMERCE 9-24-2002.

2,749,050. AMERICAN EDUCATIONAL MUSIC PUBLICATIONS, INC., DBA MUSICIANSMART.COM, FAIRFIELD, IA. SN 78-129,770. FILED P.R. 5-18-2002; AM. S.R. 6-6-2003.

MUSICIANSMART.COM

FOR MAIL ORDER CATALOG SERVICES AND COMPUTERIZED ON-LINE ORDERING SERVICES ALL IN THE FIELD OF EDUCATIONAL MUSIC PRODUCTS, NAMELY, INSTRUCTIONAL MUSIC BOOKS, MUSIC EDUCATION SOFTWARE, MUSIC INSTRUCTION AUDIO CDS, MUSIC INSTRUCTION VIDEOS, MUSIC INSTRUCTION DVDS, AND MUSIC INSTRUCTION AUDIOCASSETTES (U.S. CLS. 100, 101 AND 102).

FIRST USE 3-9-2001; IN COMMERCE 3-9-2001.

CLASS 35—(Continued).

2,749,054. BUSINESS RESOURCE GROUP, LOS ANGELES, CA. SN 78-143,605. FILED P.R. 7-12-2002; AM. S.R. 5-16-2003.

CAPITAL ACCESS

FOR ARRANGING AND CONDUCTING BUSINESS EXHIBITIONS AND MEETINGS IN THE NATURE OF PRESENTATIONS, LECTURES, AND FORUMS FOR PARTICIPANT INTERACTION IN THE FIELDS OF BUSINESS FINANCE AND BUSINESS MANAGEMENT (U.S. CLS. 100, 101 AND 102).

FIRST USE 11-0-2001; IN COMMERCE 11-0-2001.

2,749,055. J.M.H. TRADEMARK, INC., WILMINGTON, DE. SN 78-147,800. FILED P.R. 7-26-2002; AM. S.R. 4-28-2003.

SO CAL SWEEPSTAKES

FOR RETAIL STORE SERVICES FEATURING PERSONAL CARE ITEMS, CLOTHING AND CLOTHING ACCESSORIES AND FEATURING THE AWARD OF PRIZES FOR FREQUENT PURCHASERS (U.S. CLS. 100, 101 AND 102).

FIRST USE 7-13-2002; IN COMMERCE 7-13-2002.

2,749,057. KOBREN, SPENCER, WOODLAND HILLS, CA. SN 78-181,564. FILED P.R. 11-4-2002; AM. S.R. 5-29-2003.

THE INTERNATIONAL ALLIANCE OF HAIR RESTORATION SURGEONS

NO CLAIM IS MADE TO THE EXCLUSIVE RIGHT TO USE "ALLIANCE OF HAIR RESTORATION SURGEONS", APART FROM THE MARK AS SHOWN.

FOR ASSOCIATION SERVICES, NAMELY, THE PROMOTION OF THE INTERESTS OF THE MEMBERS OF AN ASSOCIATION OF DOCTORS (U.S. CLS. 100, 101 AND 102).

FIRST USE 3-30-1998; IN COMMERCE 3-30-1998.

CLASS 36—INSURANCE AND FINANCIAL

2,748,995. EMIGRANT MORTGAGE COMPANY INC., NEW YORK, NY. SN 75-854,752. FILED P.R. 11-19-1999; AM. S.R. 2-28-2003.

BROKERDIRECT

OWNER OF FRANCE REG. NO. 99/794.135, DATED 5-21-1999, EXPIRES 5-21-2009.

FOR MORTGAGE LENDING SERVICES, (U.S. CLS. 100, 101 AND 102).

FIRST USE 12-0-1998; IN COMMERCE 12-0-1998.

CLASS 36—(Continued).

2,748,999. ADVANCE PUBLICATIONS INC., NEW YORK, NY. SN 76-057,147. FILED 5-25-2000.

EASY PAY

FOR FINANCIAL SERVICES, NAMELY AUTOMATIC BILL PAYING SERVICES FOR NEWSPAPER SUBSCRIPTIONS (U.S. CLS. 100, 101 AND 102).
FIRST USE 5-15-1997; IN COMMERCE 5-15-1997.

2,749,029. THE JOHN AKRIDGE COMPANY, WASHINGTON, DC. SN 76-406,805. FILED P.R. 5-2-2002; AM. S.R. 3-3-2003.

REAL ESTATE AT THE HIGHEST GRADE

FOR REAL ESTATE ACQUISITION, LEASING AND MANAGEMENT (U.S. CLS. 100, 101 AND 102).
FIRST USE 9-20-2002; IN COMMERCE 9-20-2002.

2,749,036. CHECKFREE SERVICES CORPORATION, NORCROSS, GA. SN 76-440,471. FILED P.R. 8-14-2002; AM. S.R. 5-15-2003.

SMA FORUM

FOR PROVIDING AN ONLINE COMPUTER DATABASE OF FINANCIAL INFORMATION IN THE FIELD OF PRIVATE MONEY MANAGEMENT (U.S. CLS. 100, 101 AND 102).
FIRST USE 9-3-2002; IN COMMERCE 9-3-2002.

CLASS 41—EDUCATION AND ENTERTAINMENT

2,749,004. CLAY TARGET, SHOTGUN SPORTS, LLC, CINCINNATI, OH. SN 76-226,200. FILED P.R. 3-16-2001; AM. S.R. 11-29-2002.

U.S. AMATEUR SPORTING CLAYS CHAMPIONSHIP

NO CLAIM IS MADE TO THE EXCLUSIVE RIGHT TO USE "AMATEUR SPORTING CLAYS CHAMPIONSHIP", APART FROM THE MARK AS SHOWN.

FOR ORGANIZING AND STAGING AMATEUR SPORTING CLAYS AND CLAY TARGET ANNUAL SHOOTING CHAMPIONSHIP FOR ENTERTAINMENT PURPOSES (U.S. CLS. 100, 101 AND 107).
FIRST USE 3-0-1999; IN COMMERCE 3-0-1999.

CLASS 41—(Continued).

2,749,007. LITTLER MENDELSON, P.C., SAN FRANCISCO, CA. SN 76-254,026. FILED P.R. 5-7-2001; AM. S.R. 1-16-2002.

LEGAL LEARNING GROUP

NO CLAIM IS MADE TO THE EXCLUSIVE RIGHT TO USE "GROUP", APART FROM THE MARK AS SHOWN.

FOR EDUCATIONAL SERVICES, NAMELY CONDUCTING SEMINARS, CONFERENCES, WORKSHOPS AND CLASSES IN THE FIELD OF LABOR AND EMPLOYMENT LAW, HUMAN RESOURCES AND MANAGEMENT DEVELOPMENT (U.S. CLS. 100, 101 AND 107).
FIRST USE 5-15-2001; IN COMMERCE 5-15-2001.

2,749,008. POLARIS INDUSTRIES INC., MEDINA, MN. SN 76-256,148. FILED P.R. 5-11-2001; AM. S.R. 12-9-2002.

MASTER SERVICE DEALER

NO CLAIM IS MADE TO THE EXCLUSIVE RIGHT TO USE "SERVICE DEALER", APART FROM THE MARK AS SHOWN.

FOR EDUCATIONAL SERVICES, NAMELY PROVIDING TECHNICAL TRAINING COURSES REGARDING THE SERVICE AND REPAIR OF RECREATIONAL VEHICLES, AND CUSTOMER SERVICE TRAINING PROGRAMS FOR RECREATIONAL VEHICLE DEALERS (U.S. CLS. 100, 101 AND 107).
FIRST USE 6-0-2000; IN COMMERCE 6-0-2000.

2,749,020. DOVER DOWNS ENTERTAINMENT, INC., WILMINGTON, DE. SN 76-356,551. FILED P.R. 1-9-2002; AM. S.R. 4-28-2003.

GRAND PRIX OF ST. PETERSBURG

NO CLAIM IS MADE TO THE EXCLUSIVE RIGHT TO USE "GRAND PRIX", APART FROM THE MARK AS SHOWN.

FOR ENTERTAINMENT IN THE NATURE OF AUTOMOBILE RACES (U.S. CLS. 100, 101 AND 107).
FIRST USE 2-21-2003; IN COMMERCE 2-21-2003.

2,749,042. KAL KAN FOODS, INC., VERNON, CA. SN 76-975,492. FILED P.R. 12-20-2000; AM. S.R. 4-4-2003.

RACING TO FIND HOMES FOR PETS

FOR ENTERTAINMENT SERVICES IN THE NATURE OF AUTOMOBILE RACING (U.S. CLS. 100, 101 AND 107).

FIRST USE 2-0-2001; IN COMMERCE 2-0-2001.

CLASS 41—(Continued).

2,749,048. DONATI & STEIN PARTNERSHIP, SANTA BARBARA, CA. SN 78-122,135. FILED P.R. 4-16-2002; AM. S.R. 5-30-2003.

THE MONEY CAMP

FOR EDUCATIONAL SERVICES, NAMELY CONDUCTING CLASSES, SEMINARS, AND WORKSHOPS IN THE FIELDS OF FINANCE AND MONEY MANAGEMENT, FINANCIAL PRINCIPLES AND PHILOSOPHY, AND LIFE SKILLS, AND DISTRIBUTING COURSE MATERIALS IN CONNECTION THEREWITH (U.S. CLS. 100, 101 AND 107).

FIRST USE 4-4-2002; IN COMMERCE 4-28-2002.

CLASS 42—SCIENTIFIC, COMPUTER AND LEGAL SERVICES

2,748,992. NORTHEAST BLADDER RESEARCH GROUP, INC., HOLYOKE, MA. SN 75-651,158. FILED P.R. 3-1-1999; AM. S.R. 4-14-2003.

HealthProfiler

FOR PROVIDING A WEBSITE FEATURING INFORMATION IN THE MEDICAL FIELD (U.S. CLS. 100 AND 101).

FIRST USE 4-1-1998; IN COMMERCE 4-1-1998.

2,748,993. ONCOLOGY.COM, INC., NEW YORK, NY, BY CHANGE OF NAME MEDSPACE.COM, INC., NEW YORK, NY. SN 75-729,211. FILED P.R. 6-15-1999; AM. S.R. 8-2-2001.

ONCOLOGY.COM

FOR PROVIDING INFORMATION VIA A GLOBAL COMPUTER NETWORK IN THE FIELDS OF MEDICINE, HEALTH, HEALTH CARE, PHARMACEUTICALS (U.S. CLS. 100 AND 101).

FIRST USE 12-0-1999; IN COMMERCE 12-0-1999.

CLASS 42—(Continued).

2,748,996. MOON, RONALD T. Y., JR., BIRMINGHAM, AL. SN 75-867,029. FILED P.R. 12-9-1999; AM. S.R. 3-5-2003.

THE INDUSTRIAL ATHLETE

FOR PHYSICAL MEDICINE AND REHABILITATION SERVICES PRESENTED BY INTERDISCIPLINARY TEAM OF HEALTHCARE PROFESSIONALS DEDICATED TO HELPING INDIVIDUALS ACHIEVE AND MAINTAIN OPTIMAL HEALTH WHILE PREVENTING DISEASE THROUGH PROPER TREATMENT OF NUTRITION, EXERCISE AND GENERAL FITNESS AND SAFETY ISSUES, INDUSTRIALLY/OCCUPATIONALLY ORIENTED FUNCTIONAL RESTORATION SERVICES (U.S. CLS. 100 AND 101).

FIRST USE 7-1-1998; IN COMMERCE 7-1-1998.

2,749,000. KAUFMAN, HARLEY, NEW YORK, NY. SN 76-146,397. FILED P.R. 10-11-2000; AM. S.R. 4-2-2002.

LAWYERMD

FOR COMPUTER SERVICES, NAMELY, PROVIDING INFORMATION REGARDING LEGAL SERVICES, MEDICAL CARE SERVICES AND HEALTH CARE PRODUCTS AND SERVICES VIA GLOBAL COMPUTER NETWORK (U.S. CLS. 100 AND 101).

FIRST USE 2-1-2002; IN COMMERCE 2-1-2002.

2,749,005. ABELOW, DANIEL, LONGWOOD, FL. SN 76-232,280. FILED P.R. 3-29-2001; AM. S.R. 10-1-2002.

MOVABLE COMPILATIONS

FOR CONSULTING SERVICES THROUGH ON-SITE VISITS, TELECOMMUNICATIONS, PUBLISHED MATERIALS AND ONLINE INTERACTIVE EXCHANGES WITH BUSINESS, ACADEMIC, GOVERNMENT, CHARITABLE AND CONSUMER CLIENTS IN THE LICENSING, DEVELOPING AND CONFIGURING OF COMPUTER TECHNOLOGIES AND COMPUTER PROGRAMS; SPECIFICALLY INCLUDING COMPUTER SOFTWARE TO SEARCH FOR, DOWNLOAD, ORGANIZE AND ASSEMBLE MULTIPLE SOURCES OF DIGITAL CONTENT INTO ONE OR MORE COMPILATIONS FOR USE BY THESE AND SUBSEQUENT USERS WHO MAY DISTRIBUTE, USE AND MODIFY MULTIPLE GENERATIONS OF THESE COMPILATIONS (U.S. CLS. 100 AND 101).

FIRST USE 5-6-2001; IN COMMERCE 5-6-2001.

2,749,006. SIMON, DAVID F., GWYNEDD VALLEY, PA. SN 76-237,907. FILED P.R. 4-4-2001; AM. S.R. 6-4-2002.

HEALTH ADVOCATE

FOR ARRANGEMENT OF HEALTH CARE SERVICES; ADVICE REGARDING HEALTH CARE PROVIDERS; GUIDANCE REGARDING HEALTH RELATED ISSUES; COORDINATION OF OVERALL HEALTH CARE NEEDS; HEALTH ASSESSMENTS (U.S. CLS. 100 AND 101).

FIRST USE 2-19-2001; IN COMMERCE 3-17-2001.

CLASS 44—(Continued).

2,749,023. EUROPAEUS USA INC., PEEKSKILL, NY. SN 76-373,678. FILED P.R. 2-25-2002; AM. S.R. 9-3-2002.

EUROPAEUS

THE NAME "EUROPAEUS" IS A LATIN WORD MEANING "FROM EUROPE".

FOR WHOLESALE DISTRIBUTORSHIPS AND IMPORT SERVICES IN THE FIELD OF CERAMIC, PORCELAIN, TERRA COTTA, AND STAINLESS STEEL SERVE WARE TO THE RESTAURANT AND HOTEL TRADE (U.S. CLS. 100 AND 101).

FIRST USE 11-2-1992; IN COMMERCE 11-2-1992.

2,749,030. NAMEPROTECT INC., MADISON, WI. SN 76-415,586. FILED P.R. 6-3-2002; AM. S.R. 3-3-2003.

DIGITAL COMMON LAW

FOR RESEARCH AND CONSULTING SERVICES IN THE FIELD OF INTELLECTUAL PROPERTY; CONTENT PROVIDER OF INFORMATION IN THE FIELD OF INTELLECTUAL PROPERTY (U.S. CLS. 100 AND 101).

FIRST USE 4-1-2002; IN COMMERCE 5-1-2002.

2,749,043. PERKINS, ROBERT, BATON ROUGE, LA. SN 78-016,899. FILED P.R. 7-16-2000; AM. S.R. 6-5-2003.

DIGITALOILS

FOR DIGITAL IMAGING SERVICES, NAMELY, CONVERSION OF PHOTOGRAPHS AND IMAGES TO DIGITAL WORKS AND AGAIN TO OIL PAINTINGS ON CANVAS AND OTHER MATERIALS BY MEANS OF SPECIALIZED EQUIPMENTS AND PROPRIETARY METHODS (U.S. CLS. 100 AND 101).

FIRST USE 4-14-1999; IN COMMERCE 9-3-1999.

CLASS 43—HOTEL AND RESTAURANT SERVICES

2,749,035. ABRAXIS LTD., LAS VEGAS, NV. SN 76-438,660. FILED P.R. 8-7-2002; AM. S.R. 5-13-2003.

AMERICA DOG & CAT HOTEL

NO CLAIM IS MADE TO THE EXCLUSIVE RIGHT TO USE "DOG AND CAT HOTEL", APART FROM THE MARK AS SHOWN.

FOR DOG AND CAT DAY CARE, GROOMING AND KENNEL SERVICES (U.S. CLS. 100 AND 101).

FIRST USE 11-0-2002; IN COMMERCE 11-0-2002.

CLASS 44—MEDICAL, BEAUTY AND AGRICULTURAL SERVICES

2,749,058. LUCENTE, VINCENT, ALLENTOWN, PA. SN 78-198,225. FILED P.R. 12-27-2002; AM. S.R. 5-21-2003.

THE INSTITUTE FOR FEMALE PELVIC MEDICINE & RECONSTRUCTIVE SURGERY

FOR HEALTHCARE SERVICES, PROVIDING INFORMATION IN THE FIELDS OF HEALTHCARE AND WOMEN'S HEALTH ISSUES VIA THE INTERNET (U.S. CLS. 100 AND 101).

FIRST USE 7-31-2002; IN COMMERCE 7-31-2002.

* * * * *

PRIOR UNITED STATES CLASSIFICATION

APPLICATION IN ONE CLASS

CERTIFICATION MARKS

CLASS B—SERVICES

2,749,041. INTERNATIONAL BOARD OF LACTATION CONSULTANT EXAMINERS, FALLS CHURCH, VA. SN 76-474,711. FILED P.R. 12-12-2002; AM. S.R. 12-12-2002.

**REGISTERED LACTATION
CONSULTANT**

OWNER OF U.S. REG. NOS. 1,975,958, 1,975,983, AND 2,042,667.

THE MARK IS USED BY CERTIFIED PERSONS ON BUSINESS CARDS AND OTHER FORMS OF IDENTIFICATION OF THEIR CERTIFICATION

FOR THIS CERTIFICATION MARK, AS USED BY AUTHORIZED PERSONS, CERTIFIES THAT PERSONS PERFORMING LACTATION CONSULTING HAVE MET THE STANDARDS, QUALIFICATIONS, AND TESTING OF THE CERTIFIER (U.S. CL. B).

FIRST USE 10-4-1999; IN COMMERCE 10-4-1999.

* * * * *

TRADEMARK REGISTRATIONS RENEWED

The designation "U.S. Cl." appearing in this section refers to the U.S. class in effect prior to Sep. 1, 1973 rather than the international class which applies to applications filed on or after that date. For adoption of international classification see notice in the OFFICIAL GAZETTE of Jun. 26, 1973 (911 O.G. TM 210).

157,962.	GOLD SEAL. U.S. CL. 47. (INT. CL. 33). REG. 8-22-1922.	756,395.	MISCELLANEOUS DESIGN. U.S. CL. 26. (INT. CL. 9). REG. 9-10-1963.
158,423.	MISCELLANEOUS DESIGN. U.S. CL. 21. (INT. CL. 9). REG. 9-5-1922.	756,434.	UNIROYAL. U.S. CL. 35. (INT. CLS. 12 AND 17). REG. 9-10-1963.
164,714.	W AND DESIGN. U.S. CL. 28. (INT. CLS. 8 AND 14). REG. 2-27-1923.	756,690.	MULTIMET. U.S. CL. 14. (INT. CL. 6). REG. 9-17-1963.
166,026.	DURITE. INT. CL. 1. (U.S. CL. 1). REG. 3-27-1923.	758,281.	CORLIX. U.S. CL. 12. (INT. CL. 6). REG. 10-15-1963.
172,534.	E-Z AND DESIGN. U.S. CL. 46. (INT. CL. 30). REG. 9-4-1923.	759,213.	SYSTEMATIC (STYLIZED). U.S. CL. 32. (INT. CL. 20). REG. 10-29-1963.
176,507.	VALLEY KING. U.S. CL. 46. (INT. CL. 31). REG. 11-27-1923.	759,558.	DUPLEX. U.S. CL. 19. (INT. CL. 12). REG. 11-5-1963.
286,880.	TEKKO (STYLIZED). U.S. CL. 37. (INT. CL. 27). REG. 9-8-1931.	759,954.	BERG SWEDEN AND DESIGN. U.S. CL. 23. (INT. CL. 8). REG. 11-12-1963.
302,012.	MICRO-SET (STYLIZED). U.S. CL. 26. (INT. CL. 9). REG. 3-21-1933.	762,830.	NORTHRIDGE BREADS. U.S. CL. 46. (INT. CL. 30). REG. 1-7-1964.
306,772.	GAUTIER FRERES COGNAC ESTABLISHED 1755 AND DESIGN. U.S. CL. 49. (INT. CL. 33). REG. 9-26-1933.	930,102.	SNACKTIME (STYLIZED). U.S. CL. 46. (INT. CLS. 29 AND 30). REG. 2-28-1972.
401,420.	CHEVRON AND DESIGN. U.S. CL. 12. (INT. CL. 19). REG. 5-18-1943.	937,359.	FLOCULITE. U.S. CL. 6. (INT. CL. 1). REG. 7-11-1972.
403,520.	MISCELLANEOUS DESIGN. U.S. CL. 21. (INT. CL. 9). REG. 9-28-1943.	938,393.	PROQUEL. U.S. CL. 6. (INT. CLS. 1, 2, 3, 4 AND 5). REG. 7-25-1972.
553,247.	FRENCH LINE (STYLIZED). U.S. CL. 105. (INT. CL. 39). REG. 1-8-1952.	940,978.	EXHERE. U.S. CL. 37. (INT. CL. 16). REG. 8-15-1972.
562,926.	UNITED. U.S. CL. 23. (INT. CL. 7). REG. 8-19-1952.	943,205.	SURFTRAN. U.S. CL. 23. (INT. CL. 7). REG. 9-19-1972.
568,161.	JOHNSON&JOHNSON (STYLIZED). U.S. CL. 44. (INT. CLS. 5 AND 10). REG. 12-23-1952.	943,786.	BIG BROTHERS (STYLIZED). U.S. CL. 100. (INT. CL. 42). REG. 9-26-1972.
568,874.	SAKRETE. U.S. CL. 12. (INT. CL. 19). REG. 1-6-1953.	947,495.	CARPENTER MICRO-MELT. U.S. CL. 14. (INT. CL. 6). REG. 11-21-1972.
572,120.	LACTINEX (STYLIZED). U.S. CL. 18. (INT. CL. 5). REG. 3-17-1953.	948,503.	MUPPET. U.S. CL. 22. (INT. CL. 28). REG. 12-12-1972.
573,579.	SIGMA PHI EPSILON. U.S. CL. 100. (INT. CL. 42). REG. 4-21-1953.	949,894.	LINDSAY. U.S. CL. 46. (INT. CLS. 29 AND 30). REG. 1-2-1973.
575,223.	VACUAINER. U.S. CL. 44. (INT. CL. 10). REG. 6-2-1953.	950,855.	FITSALL. U.S. CL. 39. (INT. CL. 25). REG. 1-16-1973.
581,095.	"VIC". U.S. CL. 13. (INT. CL. 6). REG. 10-13-1953.	952,683.	BRIDGESTONE V-STEEL. U.S. CL. 35. (INT. CL. 12). REG. 2-6-1973.
698,137.	BROXODENT (STYLIZED). U.S. CL. 29. (INT. CL. 21). REG. 5-24-1960.	955,452.	PENKO AND DESIGN. U.S. CL. 101. (INT. CLS. 35 AND 42). REG. 3-13-1973.
735,264.	FULGHUM. U.S. CL. 23. (INT. CL. 7). REG. 7-31-1962.	956,548.	VIBRAM AND DESIGN. U.S. CL. 39. (INT. CL. 25). REG. 4-3-1973.
738,560.	PERM-A-PRINT (STYLIZED). U.S. CL. 23. (INT. CL. 7). REG. 10-2-1962.	956,751.	NATIONAL. U.S. CL. 36 ONLY. (INT. CL. 15). REG. 4-10-1973.
738,768.	FLAVOR FRY. U.S. CL. 46. (INT. CL. 29). REG. 10-2-1962.	956,767.	DURA-CUBE. U.S. CL. 6. (INT. CL. 1). REG. 4-10-1973.
739,221.	PARKSPAK O'GOLD. U.S. CL. 1. (INT. CL. 31). REG. 10-16-1962.	956,771.	STAR SPANGLED SALUTE. U.S. CL. 9. (INT. CL. 13). REG. 4-10-1973.
741,260.	FIREWIRE. U.S. CL. 26. (INT. CL. 9). REG. 11-27-1962.	956,887.	V.S.I. U.S. CL. 23. (INT. CL. 7). REG. 4-10-1973.
745,276.	MISCELLANEOUS DESIGN. U.S. CL. 7. (INT. CL. 6). REG. 2-19-1963.	957,547.	COROSEX. U.S. CL. 6. (INT. CL. 1). REG. 4-24-1973.
747,853.	MISCELLANEOUS DESIGN. U.S. CL. 27. (INT. CL. 14). REG. 4-9-1963.	957,550.	SKAT SHELL. U.S. CL. 9. (INT. CL. 13). REG. 4-24-1973.
747,979.	GEORGE KHOURY (STYLIZED). U.S. CL. A. REG. 4-9-1963.	957,614.	MEALS-ON-WHEELS. U.S. CL. 19. (INT. CL. 12). REG. 4-24-1973.
748,210.	CG (STYLIZED). U.S. CL. 102. (INT. CL. 36). REG. 4-16-1963.	957,725.	JO-PLUG. U.S. CL. 26. (INT. CL. 9). REG. 4-24-1973.
748,831.	LOU. U.S. CL. 39. (INT. CL. 25). REG. 4-30-1963.	957,786.	RESTORE COTE. U.S. CL. 37. (INT. CL. 16). REG. 4-24-1973.
749,139.	ATCO. U.S. CL. 36. (INT. CL. 9). REG. 5-7-1963.	957,929.	C & W. U.S. CL. 46. (INT. CLS. 29 AND 32). REG. 4-24-1973.
749,444.	ELSEVIER. U.S. CL. 38. (INT. CL. 16). REG. 5-14-1963.	958,061.	MTK. U.S. CL. 6. (INT. CL. 3). REG. 5-1-1973.
749,612.	GRAND PRIX. U.S. CL. 3. (INT. CL. 18). REG. 5-21-1963.	958,080.	ACA. U.S. CL. 10. (INT. CL. 1). REG. 5-1-1973.
749,681.	OWATROL. U.S. CL. 16. (INT. CL. 2). REG. 5-21-1963.	958,203.	TRAVERSE BAY. U.S. CL. 39. (INT. CL. 25). REG. 5-1-1973.
753,518.	TRU-LINE. INT. CL. 1. (U.S. CL. 1). REG. 7-30-1963.	958,255.	BERNSTEIN AND DESIGN. U.S. CL. 46. (INT. CLS. 29 AND 30). REG. 5-1-1973.
756,279.	BLU-SIL-CMC. INT. CL. 1. (U.S. CL. 1). REG. 9-10-1963.	958,596.	SONOMA. U.S. CL. 37. (INT. CL. 16). REG. 5-8-1973.

959,079.	BAIN'S CAFETERIA (STYLIZED). U.S. CL. 100. (INT. CL. 42). REG. 5-15-1973.	1,223,815.	STARGON. INT. CL. 1. (U.S. CLS. 6, 21, 23 AND 34). REG. 1-18-1983.
959,368.	STORE KRAFT. U.S. CL. 32. (INT. CL. 20). REG. 5-22-1973.	1,226,822.	WICKER'S (STYLIZED). INT. CL. 30. (U.S. CL. 46). REG. 2-8-1983.
959,819.	BESWICK. U.S. CLS. 30 AND 50. (INT. CL. 21). REG. 5-29-1973.	1,226,842.	MOUNT GAY. INT. CL. 33. (U.S. CL. 49). REG. 2-8-1983.
960,189.	CRESTLINE. U.S. CL. 3. (INT. CL. 18). REG. 6-5-1973.	1,227,867.	IDS AND DESIGN. INT. CL. 42. (U.S. CL. 100). REG. 2-15-1983.
960,982.	PISTON. U.S. CL. 42. (INT. CL. 24). REG. 6-12-1973.	1,228,599.	NORTHPORT NAILER. INT. CL. 28. (U.S. CL. 22). REG. 2-22-1983.
961,242.	IBDU. U.S. CL. 10. (INT. CL. 1). REG. 6-19-1973.	1,228,991.	7 AND DESIGN. INT. CL. 41. (U.S. CL. 107). REG. 3-1-1983.
961,433.	GRIPHOIST EASY PULL. U.S. CL. 23. (INT. CL. 7). REG. 6-19-1973.	1,230,855.	MISCELLANEOUS DESIGN. INT. CL. 21 ONLY. (U.S. CLS. 33 AND 34). REG. 3-15-1983.
962,040.	NNN (STYLIZED). U.S. CL. 34. (INT. CL. 11). REG. 6-26-1973.	1,232,093.	DONNYBROOK. INT. CLS. 30 AND 32. (U.S. CLS. 45 AND 46). REG. 3-22-1983.
963,319.	EMIT. U.S. CL. 6. (INT. CL. 1). REG. 7-10-1973.	1,232,370.	AMERICA'S HOMECOMING QUEEN. INT. CL. 41. (U.S. CL. 107). REG. 3-22-1983.
963,326.	CRABICIDE GREEN. U.S. CL. 6. (INT. CL. 1). REG. 7-10-1973.	1,232,620.	BOWSMITH. INT. CL. 11. (U.S. CL. 13). REG. 3-29-1983.
963,364.	USAV. U.S. CL. 13. (INT. CL. 7). REG. 7-10-1973.	1,232,640.	RAM-FLO. INT. CL. 12. (U.S. CL. 31). REG. 3-29-1983.
964,021.	AUREO S-P 250. U.S. CL. 18. (INT. CL. 5). REG. 7-17-1973.	1,232,708.	SYLLABLE SYNTHESIS. INT. CL. 16. (U.S. CLS. 38 AND 50). REG. 3-29-1983.
964,173.	CELLU-STACK. U.S. CL. 31. (INT. CL. 11). REG. 7-17-1973.	1,232,718.	ITC CENTURY. INT. CL. 16. (U.S. CLS. 14 AND 38). REG. 3-29-1983.
964,552.	DITROPAN. U.S. CL. 18. (INT. CL. 5). REG. 7-24-1973.	1,232,849.	Y'S FOR MEN (STYLIZED). INT. CL. 25. (U.S. CL. 39). REG. 3-29-1983.
965,262.	CAPT'N NEMO'S. U.S. CL. 100. (INT. CL. 42). REG. 7-31-1973.	1,233,099.	UOP (STYLIZED). INT. CL. 42. (U.S. CL. 100). REG. 3-29-1983.
968,496.	VIC-FLANGE. U.S. CL. 13. (INT. CL. 6). REG. 9-18-1973.	1,233,235.	Z AND DESIGN. INT. CL. 3. (U.S. CL. 51). REG. 4-5-1983.
970,198.	BECKETT. U.S. CL. 34. (INT. CL. 11). REG. 10-9-1973.	1,233,280.	SIGRAFLEX SIGRA FLEX. INT. CLS. 7, 9, 11 AND 17. (U.S. CLS. 1, 23, 26, 34 AND 35). REG. 4-5-1983.
970,300.	SEA-EST. U.S. CL. 46. (INT. CL. 29). REG. 10-9-1973.	1,233,372.	UMCOM. INT. CLS. 9, 16, 35 AND 41. (U.S. CLS. 21, 26, 38, 101 AND 107). REG. 4-5-1983.
974,268.	ZINC-IT. U.S. CL. 16. (INT. CL. 2). REG. 12-4-1973.	1,233,623.	WAMSUTTA. INT. CL. 24. (U.S. CL. 42). REG. 4-5-1983.
975,263.	PACTRA. U.S. CLS. 5 AND 16. (INT. CLS. 1 AND 2). REG. 12-25-1973.	1,233,794.	TACOS A LA NINFA (STYLIZED). INT. CL. 30. (U.S. CL. 46). REG. 4-5-1983.
982,104.	MISCELLANEOUS DESIGN. U.S. CL. 101. (INT. CL. 35). REG. 4-9-1974.	1,233,819.	TEXAS BURGER AND DESIGN. INT. CL. 30. (U.S. CL. 46). REG. 4-5-1983.
1,166,153.	GOETZE. INT. CL. 7. (U.S. CLS. 23 AND 35). REG. 8-25-1981.	1,233,898.	COMPUT-A-SEARCH. INT. CL. 36. (U.S. CL. 102). REG. 4-5-1983.
1,182,632.	OTIS. INT. CLS. 7 AND 9 ONLY. (U.S. CLS. 13, 21, 23 AND 26). REG. 12-22-1981.	1,234,215.	MISCELLANEOUS DESIGN. INT. CL. 3. (U.S. CLS. 4 AND 52). REG. 4-12-1983.
1,189,120.	OTC HYTEC (STYLIZED). INT. CL. 7. (U.S. CL. 23). REG. 2-9-1982.	1,234,236.	PASTURE GAINER. INT. CL. 5. (U.S. CLS. 18 AND 46). REG. 4-12-1983.
1,193,535.	RONAR. INT. CL. 9. (U.S. CL. 26). REG. 4-13-1982.	1,234,265.	W AND DESIGN. INT. CL. 6. (U.S. CL. 12). REG. 4-12-1983.
1,195,318.	MERMAID. INT. CL. 30. (U.S. CL. 46). REG. 5-11-1982.	1,234,338.	AUDIOVOX. INT. CL. 9. (U.S. CLS. 21 AND 36). REG. 4-12-1983.
1,196,797.	ENKASONIC. INT. CL. 17. (U.S. CL. 12). REG. 6-1-1982.	1,234,529.	X AND DESIGN. INT. CL. 13. (U.S. CL. 9). REG. 4-12-1983.
1,199,922.	YES (STYLIZED). INT. CL. 41. (U.S. CL. 107). REG. 6-29-1982.	1,234,581.	ITC BAUHAUS. INT. CL. 16. (U.S. CLS. 14 AND 38). REG. 4-12-1983.
1,201,978.	LOGLIFE AND DESIGN. INT. CL. 16. (U.S. CL. 37). REG. 7-20-1982.	1,234,678.	MISCELLANEOUS DESIGN. INT. CL. 23. (U.S. CL. 43). REG. 4-12-1983.
1,203,338.	FEMINIQUE. INT. CL. 5. (U.S. CL. 18). REG. 8-3-1982.	1,235,223.	CRUISEBASS. INT. CL. 15. (U.S. CL. 36). REG. 4-19-1983.
1,205,487.	MISCELLANEOUS DESIGN. INT. CL. 23. (U.S. CL. 43). REG. 8-17-1982.	1,235,584.	ODOR CONTROL CENTRAL, U.S.A.. INT. CL. 5. (U.S. CL. 6). REG. 4-26-1983.
1,209,713.	MINIGRIP. INT. CL. 17. (U.S. CL. 35). REG. 9-21-1982.	1,235,624.	DREITURM AND DESIGN. INT. CL. 8. (U.S. CL. 23). REG. 4-26-1983.
1,212,638.	ALTENMUNSTER BRAUER BIER (STYLIZED). INT. CL. 32. (U.S. CL. 48). REG. 10-12-1982.	1,235,714.	ITC KABEL. INT. CL. 16. (U.S. CLS. 37 AND 38). REG. 4-26-1983.
1,213,120.	PROMAC. INT. CL. 9. (U.S. CL. 26). REG. 10-19-1982.	1,235,814.	LIFETONE INTERNATIONAL. INT. CL. 35. (U.S. CL. 101). REG. 4-26-1983.
1,215,226.	INTERVEST. INT. CL. 36. (U.S. CL. 102). REG. 11-2-1982.	1,235,818.	OTTO BANKER AND DESIGN. INT. CL. 36. (U.S. CL. 102). REG. 4-26-1983.
1,216,139.	TR AND DESIGN. INT. CL. 41. (U.S. CL. 107). REG. 11-9-1982.	1,235,883.	FOX ACRES COUNTRY CLUB. INT. CLS. 41 AND 42. (U.S. CLS. 100, 101 AND 107). REG. 4-26-1983.
1,216,769.	BASSETTI. INT. CLS. 24 AND 25. (U.S. CLS. 39 AND 42). REG. 11-16-1982.	1,235,920.	DR OFFICE AND DESIGN. INT. CL. 42. (U.S. CL. 100). REG. 4-26-1983.
1,217,101.	MODIANO. INT. CL. 16. (U.S. CL. 22). REG. 11-16-1982.	1,235,968.	INDOFAST. INT. CL. 2. (U.S. CL. 6). REG. 5-3-1983.
1,217,889.	7 AND DESIGN. INT. CL. 41. (U.S. CL. 107). REG. 11-23-1982.	1,236,160.	HI-SHORE. INT. CL. 10. (U.S. CL. 44). REG. 5-3-1983.
1,218,137.	SHOGUN. INT. CL. 8. (U.S. CL. 23). REG. 11-30-1982.	1,236,958.	CREME OF NATURE. INT. CL. 3. (U.S. CL. 51). REG. 5-10-1983.
1,218,491.	STAR TREK. INT. CL. 28. (U.S. CLS. 22, 23, 38 AND 50). REG. 11-30-1982.	1,237,188.	TRACKER. INT. CL. 10. (U.S. CL. 44). REG. 5-10-1983.
1,219,172.	COVER LOFT AND DESIGN. INT. CL. 22. (U.S. CL. 50). REG. 12-7-1982.		
1,219,538.	EASY UP. INT. CL. 20. (U.S. CL. 32). REG. 12-7-1982.		
1,221,650.	TEMPERATURE DEVELOPMENTS. INT. CL. 16. (U.S. CL. 38). REG. 12-28-1982.		
1,223,355.	HARLEY-DAVIDSON. INT. CL. 14. (U.S. CL. 28). REG. 1-11-1983.		

- 1,237,325. GLASTHERM. INT. CL. 17. (U.S. CL. 12). REG. 5-10-1983.
- 1,237,506. FRANCESCO RINALDI. INT. CLS. 29 AND 30. (U.S. CL. 46). REG. 5-10-1983.
- 1,237,607. IFFA. INT. CL. 35. (U.S. CLS. 100 AND 101). REG. 5-10-1983.
- 1,237,608. ISH. INT. CL. 35. (U.S. CL. 101). REG. 5-10-1983.
- 1,237,609. AUTOMECHANIKA. INT. CL. 35. (U.S. CL. 101). REG. 5-10-1983.
- 1,237,714. UNITED STATES NATIONAL BALLROOM CHAMPIONSHIPS. INT. CL. 41. (U.S. CL. 107). REG. 5-10-1983.
- 1,237,844. AAO AND DESIGN. U.S. CL. 200. REG. 5-10-1983.
- 1,237,906. MASTERPIECE FRAGRANCES. INT. CL. 3. (U.S. CLS. 6 AND 51). REG. 5-17-1983.
- 1,237,922. ROEBIC. INT. CL. 3. (U.S. CLS. 6 AND 52). REG. 5-17-1983.
- 1,238,195. MULSANNE. INT. CL. 12. (U.S. CL. 19). REG. 5-17-1983.
- 1,238,526. HARBOUR CASUALS. INT. CL. 25. (U.S. CL. 39). REG. 5-17-1983.
- 1,238,606. PEACE. INT. CL. 28. (U.S. CLS. 22, 23, 38 AND 50). REG. 5-17-1983.
- 1,238,674. SPEEDY SWEETS. INT. CL. 31. (U.S. CL. 1). REG. 5-17-1983.
- 1,239,297. EURO T/A. INT. CL. 12. (U.S. CL. 35). REG. 5-24-1983.
- 1,239,374. HAI CONVENTION NEWS. INT. CL. 16. (U.S. CL. 38). REG. 5-24-1983.
- 1,239,396. TIDAL. INT. CL. 16. (U.S. CL. 37). REG. 5-24-1983.
- 1,239,624. SUPER MOIST (STYLIZED). INT. CL. 30. (U.S. CL. 46). REG. 5-24-1983.
- 1,239,813. HORIZON. INT. CL. 42. (U.S. CL. 100). REG. 5-24-1983.
- 1,239,892. OSMOSE SUNWOOD AND DESIGN. INT. CL. 2. (U.S. CL. 6). REG. 5-31-1983.
- 1,239,971. LPA. INT. CL. 9 ONLY. (U.S. CLS. 23 AND 26). REG. 5-31-1983.
- 1,240,179. THE EDGE. INT. CL. 12. (U.S. CL. 35). REG. 5-31-1983.
- 1,240,279. GREAT POSSIBILITIES. INT. CL. 16. (U.S. CL. 38). REG. 5-31-1983.
- 1,240,460. MISCELLANEOUS DESIGN. INT. CL. 26. (U.S. CL. 40). REG. 5-31-1983.
- 1,240,470. UNREAL LAMBSKIN. INT. CL. 27. (U.S. CL. 42). REG. 5-31-1983.
- 1,241,113. SMEAD AND DESIGN. INT. CL. 16. (U.S. CLS. 23, 32, 37 AND 38). REG. 6-7-1983.
- 1,241,491. UNIGLOBE. INT. CLS. 39 AND 41. (U.S. CLS. 105 AND 107). REG. 6-7-1983.
- 1,241,707. DEXOL. INT. CLS. 1 AND 5 ONLY. (U.S. CLS. 6 AND 10). REG. 6-14-1983.
- 1,241,718. SIVEX. INT. CL. 1. (U.S. CL. 6). REG. 6-14-1983.
- 1,242,413. ALPINE LOG HOMES. INT. CL. 42. (U.S. CLS. 100 AND 103). REG. 6-14-1983.
- 1,242,913. TRADER SPORTS AND DESIGN. INT. CL. 25. (U.S. CL. 39). REG. 6-21-1983.
- 1,243,427. SIMPSON AND DESIGN. INT. CLS. 9, 12 AND 18. (U.S. CLS. 3, 19, 26 AND 39). REG. 6-28-1983.
- 1,243,467. ADINA. INT. CL. 9. (U.S. CL. 38). REG. 6-28-1983.
- 1,243,709. MISCELLANEOUS DESIGN. INT. CL. 25. (U.S. CL. 39). REG. 6-28-1983.
- 1,243,863. VIEWFAX. INT. CL. 38. (U.S. CL. 104). REG. 6-28-1983.
- 1,243,880. THE UNIVERSITY OF TEXAS HEALTH SCIENCE CENTER AT SAN ANTONIO. INT. CL. 41. (U.S. CL. 107). REG. 6-28-1983.
- 1,243,881. THE UNIVERSITY OF TEXAS HEALTH SCIENCE CENTER AT SAN ANTONIO DISCIPLINA PRAESIDIUM CIVITATIS AND DESIGN. INT. CL. 41. (U.S. CL. 107). REG. 6-28-1983.
- 1,244,022. VERON. INT. CL. 1. (U.S. CLS. 6 AND 46). REG. 7-5-1983.
- 1,244,025. KOLORFINE. INT. CL. 1. (U.S. CL. 6). REG. 7-5-1983.
- 1,244,593. PIETRO TOLUCCI ROMA (STYLIZED). INT. CL. 25. (U.S. CL. 39). REG. 7-5-1983.
- 1,244,619. ZIP-FLAP (STYLIZED). INT. CL. 25. (U.S. CL. 39). REG. 7-5-1983.
- 1,244,929. SMA. INT. CL. 1. (U.S. CL. 6). REG. 7-12-1983.
- 1,246,616. FUN FACTORY. INT. CL. 41. (U.S. CL. 107). REG. 7-26-1983.
- 1,246,711. COR-TROL. INT. CL. 1. (U.S. CL. 6). REG. 8-2-1983.
- 1,247,063. GEMACO (STYLIZED). INT. CL. 16. (U.S. CLS. 22 AND 37). REG. 8-2-1983.
- 1,247,842. MISCELLANEOUS DESIGN. INT. CL. 31. (U.S. CL. 46). REG. 8-9-1983.
- 1,248,547. MON CHERI AND DESIGN. INT. CL. 30. (U.S. CL. 46). REG. 8-16-1983.
- 1,248,850. PACESETTER. INT. CL. 9. (U.S. CL. 21). REG. 8-23-1983.
- 1,249,171. MARRA BROS.. INT. CL. 29. (U.S. CL. 46). REG. 8-23-1983.
- 1,249,274. THE LOWELL CO-OPERATIVE BANK AND DESIGN. INT. CL. 36. (U.S. CL. 102). REG. 8-23-1983.
- 1,249,520. WORLD ENERGY ENGINEERING CONGRESS (STYLIZED). INT. CL. 35. (U.S. CL. 101). REG. 8-23-1983.
- 1,249,960. MISCELLANEOUS DESIGN. INT. CL. 29. (U.S. CL. 46). REG. 8-30-1983.
- 1,250,266. TRAC EDGE. INT. CL. 12. (U.S. CL. 35). REG. 9-6-1983.
- 1,251,031. DURA-FLEX. INT. CL. 9. (U.S. CL. 21). REG. 9-13-1983.
- 1,251,107. EMI (STYLIZED). INT. CL. 14. (U.S. CL. 28). REG. 9-13-1983.
- 1,252,513. THUNDER RIVER. INT. CL. 41. (U.S. CL. 107). REG. 9-27-1983.
- 1,252,567. POTEL ET CHABOT. INT. CL. 42. (U.S. CL. 100). REG. 9-27-1983.
- 1,253,895. TCHIBO. INT. CL. 30. (U.S. CL. 46). REG. 10-11-1983.
- 1,254,012. MISCELLANEOUS DESIGN. INT. CL. 42. (U.S. CL. 100). REG. 10-11-1983.
- 1,255,182. CORREVIT. INT. CL. 9. (U.S. CL. 26). REG. 10-25-1983.
- 1,259,033. LAUREN RALPH LAUREN AND DESIGN. INT. CL. 3. (U.S. CLS. 1, 4, 6, 50, 51 AND 52). REG. 11-29-1983.
- 1,259,606. WORLD ENERGY ENGINEERING CONGRESS WEEC AND DESIGN. INT. CL. 35. (U.S. CL. 101). REG. 11-29-1983.
- 1,260,191. G GLOBE LIFE AND DESIGN. INT. CL. 36. (U.S. CL. 102). REG. 12-6-1983.
- 1,260,960. BERNDES AND DESIGN. INT. CL. 21. (U.S. CLS. 2 AND 13). REG. 12-13-1983.
- 1,261,202. CHARLOTTE MOTOR SPEEDWAY. INT. CL. 41. (U.S. CL. 107). REG. 12-13-1983.
- 1,261,297. FASHION BUG PLUS. INT. CL. 42. (U.S. CL. 101). REG. 12-13-1983.
- 1,262,074. PK3 AND DESIGN. INT. CL. 1. (U.S. CL. 10). REG. 12-27-1983.
- 1,262,511. ALUMAGOAL. INT. CL. 28. (U.S. CL. 22). REG. 12-27-1983.
- 1,265,186. MAUNA KEA. INT. CL. 30. (U.S. CL. 46). REG. 1-24-1984.
- 1,267,534. DEFTOIL. INT. CL. 2. (U.S. CL. 16). REG. 2-21-1984.
- 1,268,241. RED RIVER REVEL. INT. CL. 41. (U.S. CL. 107). REG. 2-21-1984.
- 1,269,089. MISCELLANEOUS DESIGN. INT. CL. 11. (U.S. CL. 34). REG. 3-6-1984.
- 1,270,147. SUMBURGER. INT. CLS. 30 AND 42. (U.S. CLS. 46 AND 100). REG. 3-13-1984.
- 1,271,142. JOHNSON SCALE CO.. INT. CL. 42. (U.S. CL. 101). REG. 3-20-1984.
- 1,271,689. FIN-L-FILTER (STYLIZED). INT. CL. 11. (U.S. CLS. 31 AND 34). REG. 3-27-1984.
- 1,592,941. LE FRANCE (STYLIZED). INT. CL. 16 ONLY. (U.S. CLS. 2, 5, 22, 23, 29, 37, 38 AND 50). REG. 4-24-1990.
- 1,654,081. FRIEDLAND. INT. CLS. 9 AND 11. (U.S. CL. 21). REG. 8-13-1991.
- 1,660,078. REST ASSURED. INT. CL. 36. (U.S. CL. 102). REG. 10-8-1991.
- 1,668,141. HYDOSAN. INT. CL. 1. (U.S. CL. 6). REG. 12-17-1991.
- 1,672,258. REXNORD AND DESIGN. INT. CL. 42. (U.S. CL. 100). REG. 1-14-1992.
- 1,675,581. C (STYLIZED). INT. CL. 36. (U.S. CL. 102). REG. 2-11-1992.
- 1,677,488. MANHATTAN. INT. CL. 10. (U.S. CLS. 26, 39 AND 44). REG. 3-3-1992.
- 1,687,015. INVISIBLE BOUNDARY. INT. CL. 9. (U.S. CLS. 21 AND 26). REG. 5-12-1992.

- 1,691,168. M M (STYLIZED). INT. CLS. 7, 9, 37 AND 42. (U.S. CLS. 23, 26, 100 AND 103). REG. 6-9-1992.
- 1,694,457. FRESH-SAC. INT. CL. 22. (U.S. CL. 2). REG. 6-16-1992.
- 1,695,498. RICE*PRO. INT. CL. 30. (U.S. CL. 46). REG. 6-16-1992.
- 1,697,078. C CENTURA BANK (STYLIZED). INT. CL. 36. (U.S. CL. 102). REG. 6-23-1992.
- 1,701,629. HOLIDAY. INT. CL. 11. (U.S. CL. 31). REG. 7-21-1992.
- 1,702,482. GENEVEX. INT. CL. 14. (U.S. CL. 27). REG. 7-21-1992.
- 1,702,687. POLY D-TAC. INT. CL. 1. (U.S. CL. 6). REG. 7-28-1992.
- 1,704,405. COOL AIRE. INT. CL. 7. (U.S. CL. 23). REG. 7-28-1992.
- 1,704,794. AURAMO. INT. CL. 12. (U.S. CLS. 19 AND 23). REG. 8-4-1992.
- 1,705,301. OGGUN (STYLIZED). INT. CL. 33. (U.S. CL. 49). REG. 8-4-1992.
- 1,706,077. KEMPER-SYSTEM. INT. CLS. 1, 17 AND 37. (U.S. CLS. 1, 5, 6 AND 103). REG. 8-11-1992.
- 1,712,212. SOURCELOAN. INT. CL. 36. (U.S. CL. 102). REG. 9-1-1992.
- 1,712,354. SLICK WILLIE'S FAMILY POOL HALL. INT. CL. 41. (U.S. CL. 107). REG. 9-1-1992.
- 1,712,404. "NEVER SAY NEVER" AND DESIGN. INT. CL. 42. (U.S. CL. 100). REG. 9-1-1992.
- 1,715,190. LIVING HIS LIFE ABUNDANTLY. INT. CLS. 9 AND 16. (U.S. CLS. 21 AND 38). REG. 9-15-1992.
- 1,716,218. MISCELLANEOUS DESIGN. INT. CL. 30. (U.S. CL. 46). REG. 9-15-1992.
- 1,716,255. LA LANDSCAPE ALTERNATIVES, INC. (STYLIZED). INT. CL. 31. (U.S. CL. 1). REG. 9-15-1992.
- 1,718,212. EFC AND DESIGN. INT. CL. 21. (U.S. CL. 2). REG. 9-22-1992.
- 1,719,168. "AFFORDABLE EXCELLENCE". INT. CL. 42. (U.S. CLS. 100 AND 101). REG. 9-22-1992.
- 1,720,172. FUTURE-IZATION. INT. CL. 16. (U.S. CLS. 37 AND 38). REG. 9-29-1992.
- 1,720,781. LEARNING TO LEARN. INT. CL. 41. (U.S. CL. 107). REG. 9-29-1992.
- 1,720,904. THE SHACK. INT. CL. 42. (U.S. CL. 101). REG. 9-29-1992.
- 1,722,283. OLD MILWAUKEE. INT. CL. 32. (U.S. CL. 48). REG. 10-6-1992.
- 1,723,385. FIRETRAINER (STYLIZED). INT. CLS. 9 AND 37. (U.S. CLS. 38 AND 103). REG. 10-13-1992.
- 1,723,703. CRUSADERS. INT. CLS. 16 AND 25. (U.S. CLS. 2, 5, 22, 23, 29, 37, 38, 39 AND 50). REG. 10-13-1992.
- 1,724,613. TRIAD. INT. CL. 11. (U.S. CL. 31). REG. 10-13-1992.
- 1,724,645. GATE ONE AND DESIGN. INT. CL. 18. (U.S. CL. 3). REG. 10-13-1992.
- 1,724,864. MAGNELINE. INT. CL. 2. (U.S. CLS. 6 AND 16). REG. 10-20-1992.
- 1,724,985. MISCELLANEOUS DESIGN. INT. CL. 6. (U.S. CL. 13). REG. 10-20-1992.
- 1,725,002. COMBO COUPLER. INT. CL. 6. (U.S. CL. 13). REG. 10-20-1992.
- 1,725,044. ARGO ARGO-TECH AND DESIGN. INT. CL. 7. (U.S. CLS. 19 AND 23). REG. 10-20-1992.
- 1,725,074. WOOD SLICER. INT. CL. 8. (U.S. CL. 23). REG. 10-20-1992.
- 1,725,076. MISCELLANEOUS DESIGN. INT. CL. 8 ONLY. (U.S. CLS. 23, 28 AND 44). REG. 10-20-1992.
- 1,725,138. TRIM KNOB. INT. CL. 9. (U.S. CL. 44). REG. 10-20-1992.
- 1,725,435. STINGER. INT. CL. 12. (U.S. CL. 35). REG. 10-20-1992.
- 1,725,511. KEN DONE AND DESIGN. INT. CLS. 16, 18, 21 AND 24. (U.S. CLS. 2, 3, 38, 41 AND 42). REG. 10-20-1992.
- 1,725,695. MAGNELINE. INT. CL. 19. (U.S. CL. 12). REG. 10-20-1992.
- 1,726,308. MISCELLANEOUS DESIGN. INT. CL. 39. (U.S. CLS. 100 AND 105). REG. 10-20-1992.
- 1,726,480. LAMP. INT. CL. 42. (U.S. CL. 101). REG. 10-20-1992.
- 1,727,057. MISCELLANEOUS DESIGN. INT. CL. 7. (U.S. CL. 23). REG. 10-27-1992.
- 1,727,288. INTERGRAPH AND DESIGN. INT. CL. 9. (U.S. CLS. 21, 23, 26, 36 AND 38). REG. 10-27-1992.
- 1,727,771. DOUBLE-H HH AND DESIGN. INT. CL. 25. (U.S. CL. 39). REG. 10-27-1992.
- 1,727,905. NONNI'S (STYLIZED). INT. CL. 30. (U.S. CL. 46). REG. 10-27-1992.
- 1,728,238. NATIONAL CHILD SAFETY COUNCIL SAFETY THROUGH EDUCATION SAFETY FOR KIDS AND DESIGN. INT. CL. 41. (U.S. CL. 107). REG. 10-27-1992.
- 1,728,558. ENCORE. INT. CL. 10. (U.S. CL. 44). REG. 10-27-1992.
- 1,728,597. BEV-SEAL. INT. CL. 17. (U.S. CLS. 12 AND 35). REG. 10-27-1992.
- 1,728,961. ZETEX AND DESIGN. INT. CL. 9. (U.S. CLS. 21 AND 26). REG. 11-3-1992.
- 1,730,063. THE GOLDEN PEAR (STYLIZED). INT. CL. 42. (U.S. CL. 100). REG. 11-3-1992.
- 1,730,124. DON ROBERTO JEWELERS. INT. CL. 42. (U.S. CL. 101). REG. 11-3-1992.
- 1,730,338. PERFECT CHOICE SHUTTERS. INT. CL. 19. (U.S. CL. 12). REG. 11-3-1992.
- 1,730,462. AMPHIGEN. INT. CL. 1. (U.S. CLS. 6 AND 18). REG. 11-10-1992.
- 1,730,730. ONE TOUCH SYSTEMS. INT. CL. 9. (U.S. CLS. 21, 26 AND 38). REG. 11-10-1992.
- 1,731,357. EXPRESSNACKS. INT. CLS. 29 AND 30. (U.S. CL. 46). REG. 11-10-1992.
- 1,736,872. AUNTIE ANNE'S HAND-ROLLED SOFT PRETZELS AND DESIGN. INT. CLS. 30 AND 42. (U.S. CLS. 46 AND 100). REG. 12-1-1992.
- 1,737,030. BOWL FOR KIDS' SAKE. INT. CLS. 36 AND 41. (U.S. CLS. 102 AND 107). REG. 12-1-1992.
- 1,737,285. MISCELLANEOUS DESIGN. INT. CL. 42. (U.S. CL. 101). REG. 12-1-1992.
- 1,737,439. MICROLENE. INT. CL. 1. (U.S. CL. 6). REG. 12-1-1992.
- 1,738,714. CHILD SAFETY DAY. INT. CL. 41. (U.S. CL. 107). REG. 12-8-1992.
- 1,739,440. NEUTROSORB. INT. CL. 6. (U.S. CL. 14). REG. 12-15-1992.
- 1,740,593. QUIKRETE TUBESAND AND DESIGN. INT. CL. 19. (U.S. CLS. 1 AND 12). REG. 12-15-1992.
- 1,741,427. HOT TRAFFIC AND DESIGN. INT. CL. 25. (U.S. CL. 39). REG. 12-22-1992.
- 1,744,032. LEAKMODE. INT. CL. 37. (U.S. CL. 103). REG. 12-29-1992.
- 1,744,303. TAFELMUSIK. INT. CLS. 9 AND 41. (U.S. CLS. 21, 36 AND 107). REG. 1-5-1993.
- 1,744,318. TYLO. INT. CLS. 9 AND 11. (U.S. CLS. 13, 26 AND 34). REG. 1-5-1993.
- 1,745,502. KEATING KOUPLING. INT. CL. 6. (U.S. CL. 13). REG. 1-12-1993.
- 1,745,852. AWARE AND DESIGN. INT. CL. 25. (U.S. CL. 39). REG. 1-12-1993.
- 1,746,791. FYBRIL. INT. CL. 7. (U.S. CL. 31). REG. 1-19-1993.
- 1,748,512. ONYX. INT. CL. 19. (U.S. CL. 12). REG. 1-26-1993.
- 1,748,683. TYSON. INT. CLS. 29 AND 30. (U.S. CL. 46). REG. 1-26-1993.
- 1,749,556. FIDDLEHEAD. INT. CL. 33. (U.S. CL. 47). REG. 1-26-1993.
- 1,751,011. TITAN PRO-FINISH. INT. CL. 7. (U.S. CL. 23). REG. 2-9-1993.
- 1,751,244. INTERCEPTOR AND DESIGN. INT. CL. 16. (U.S. CL. 38). REG. 2-9-1993.
- 1,751,679. INSURASSIST. INT. CL. 42. (U.S. CLS. 100, 101 AND 105). REG. 2-9-1993.
- 1,751,775. NEORX. INT. CL. 5. (U.S. CL. 18). REG. 2-9-1993.
- 1,752,542. KOVER-ALL (STYLIZED). INT. CL. 16. (U.S. CL. 37). REG. 2-16-1993.
- 1,753,343. MISCELLANEOUS DESIGN. INT. CL. 30. (U.S. CL. 46). REG. 2-16-1993.
- 1,753,516. ELESPPONGE. INT. CL. 3. (U.S. CLS. 1, 4, 6, 50, 51 AND 52). REG. 2-23-1993.
- 1,753,837. MISCELLANEOUS DESIGN. INT. CLS. 14, 25 AND 42. (U.S. CLS. 28, 39 AND 101). REG. 2-23-1993.
- 1,754,550. RARE. INT. CL. 28. (U.S. CLS. 22, 23, 38 AND 50). REG. 2-23-1993.
- 1,754,765. PROSAT. INT. CL. 3. (U.S. CLS. 1, 4, 6, 50, 51 AND 52). REG. 3-2-1993.
- 1,755,339. MALIBU. INT. CL. 19. (U.S. CL. 12). REG. 3-2-1993.
- 1,755,398. THUNDERON. INT. CL. 22. (U.S. CL. 1). REG. 3-2-1993.
- 1,755,863. PARK MED. INT. CL. 42. (U.S. CL. 100). REG. 3-2-1993.

- 1,756,812. OXFORD PORTFILE (STYLIZED). INT. CL. 16. (U.S. CL. 2). REG. 3-9-1993.
- 1,758,963. BLUE BELL INN. INT. CL. 42. (U.S. CL. 100). REG. 3-16-1993.
- 1,759,320. VELSECURE. INT. CL. 1. (U.S. CL. 6). REG. 3-23-1993.
- 1,759,555. STOCKMASTER. INT. CL. 9. (U.S. CLS. 21, 23, 26, 36 AND 38). REG. 3-23-1993.
- 1,759,896. EMAUX DE BRIARE. INT. CL. 19. (U.S. CL. 12). REG. 3-23-1993.
- 1,759,963. UNGARO. INT. CL. 25. (U.S. CL. 39). REG. 3-23-1993.
- 1,760,103. GOLD COAST BLEND. INT. CL. 30. (U.S. CL. 46). REG. 3-23-1993.
- 1,760,494. P PARTS PLUS AUTOSTORE AND DESIGN. INT. CL. 42. (U.S. CL. 101). REG. 3-23-1993.
- 1,760,832. SKILLET OMELET AND DESIGN. INT. CL. 29. (U.S. CL. 46). REG. 3-23-1993.
- 1,760,887. JACKSONLEA AND DESIGN. INT. CLS. 2, 3 AND 7. (U.S. CLS. 4, 16, 23 AND 52). REG. 3-30-1993.
- 1,761,202. X-SCRIBE. INT. CL. 10. (U.S. CL. 44). REG. 3-30-1993.
- 1,761,239. UTILIMASTER AND DESIGN. INT. CL. 12. (U.S. CLS. 19, 21, 23, 31, 35 AND 44). REG. 3-30-1993.
- 1,761,698. DYNAMARK SECURITY CENTERS "WE PROTECT AMERICA" AND DESIGN. INT. CL. 37. (U.S. CL. 103). REG. 3-30-1993.
- 1,761,845. THE CORPORATE LINK. INT. CL. 42. (U.S. CLS. 100 AND 101). REG. 3-30-1993.
- 1,762,261. AQUA PLATE. INT. CL. 1. (U.S. CL. 6). REG. 4-6-1993.
- 1,762,406. RANGEMASTER. INT. CL. 6. (U.S. CL. 12). REG. 4-6-1993.
- 1,762,429. MISCELLANEOUS DESIGN. INT. CLS. 7 AND 9. (U.S. CLS. 23 AND 26). REG. 4-6-1993.
- 1,762,583. WESCOR. INT. CLS. 9 AND 10. (U.S. CLS. 26 AND 44). REG. 4-6-1993.
- 1,762,679. FERROLI AND DESIGN. INT. CL. 11. (U.S. CLS. 13 AND 34). REG. 4-6-1993.
- 1,762,778. POWERDESIGNER (STYLIZED). INT. CL. 16. (U.S. CL. 38). REG. 4-6-1993.
- 1,762,779. ELECTROETCH. INT. CL. 16. (U.S. CL. 38). REG. 4-6-1993.
- 1,762,789. CONNECTICUT POST. INT. CL. 16. (U.S. CL. 38). REG. 4-6-1993.
- 1,762,814. KOVER-UP. INT. CL. 16. (U.S. CL. 37). REG. 4-6-1993.
- 1,762,936. RAMPAGE. INT. CL. 25. (U.S. CL. 39). REG. 4-6-1993.
- 1,763,157. NOAH'S CALIFORNIA SPRING WATER FLOOD YOUR THIRST! AND DESIGN. INT. CL. 32. (U.S. CL. 45). REG. 4-6-1993.
- 1,763,162. TAJ MAHAL. INT. CL. 32. (U.S. CL. 48). REG. 4-6-1993.
- 1,763,251. PATHWAYS PLAN SERVICES (STYLIZED). INT. CL. 36. (U.S. CLS. 101 AND 102). REG. 4-6-1993.
- 1,763,361. JAM SESSION. INT. CL. 41. (U.S. CL. 107). REG. 4-6-1993.
- 1,763,495. S AND DESIGN. INT. CL. 42. (U.S. CL. 101). REG. 4-6-1993.
- 1,763,501. THE FLORIDA STORE. INT. CL. 42. (U.S. CL. 101). REG. 4-6-1993.
- 1,763,736. PLASTI-GOOP. INT. CL. 28. (U.S. CL. 22). REG. 4-6-1993.
- 1,763,902. KOOLIT. INT. CL. 1. (U.S. CL. 1). REG. 4-13-1993.
- 1,763,924. GHERARDINI. INT. CL. 25 ONLY. (U.S. CL. 39). REG. 4-13-1993.
- 1,763,989. OPTI-CAL. INT. CL. 5. (U.S. CL. 18). REG. 4-13-1993.
- 1,763,996. SUPER ALGI-GON. INT. CL. 5. (U.S. CL. 6). REG. 4-13-1993.
- 1,764,025. MSP. INT. CLS. 6, 7, 12 AND 42. (U.S. CLS. 13, 19, 23 AND 100). REG. 4-13-1993.
- 1,764,061. NILES. INT. CL. 7. (U.S. CL. 23). REG. 4-13-1993.
- 1,764,093. LUMINATOR. INT. CLS. 9 AND 11 ONLY. (U.S. CLS. 21, 26, 31, 34, 36 AND 50). REG. 4-13-1993.
- 1,764,150. STATIONMASTER. INT. CL. 9. (U.S. CL. 21). REG. 4-13-1993.
- 1,764,199. POWERPLUS. INT. CL. 9. (U.S. CL. 21). REG. 4-13-1993.
- 1,764,347. BIOTAC. INT. CL. 10. (U.S. CL. 44). REG. 4-13-1993.
- 1,764,368. PLANT-AIR. INT. CL. 11. (U.S. CLS. 21 AND 34). REG. 4-13-1993.
- 1,764,403. DURABIND. INT. CL. 16. (U.S. CLS. 2, 5, 22, 23, 29, 37, 38 AND 50). REG. 4-13-1993.
- 1,764,424. INSITE. INT. CL. 16. (U.S. CL. 38). REG. 4-13-1993.
- 1,764,454. TOYOBO AND DESIGN. INT. CL. 16. (U.S. CL. 50). REG. 4-13-1993.
- 1,764,661. HALLY CALLER. INT. CL. 28. (U.S. CL. 22). REG. 4-13-1993.
- 1,764,767. LITTLE NICKY. INT. CL. 31. (U.S. CL. 1). REG. 4-13-1993.
- 1,765,216. SF-ASIC. INT. CL. 9. (U.S. CL. 21). REG. 4-13-1993.
- 1,765,241. THE RETRIEVER. INT. CL. 10. (U.S. CL. 44). REG. 4-13-1993.
- 1,765,426. MISCELLANEOUS DESIGN. INT. CLS. 1 AND 19 ONLY. (U.S. CLS. 6, 10 AND 12). REG. 4-20-1993.
- 1,765,459. NATURE'S ALCHEMY. INT. CL. 3. (U.S. CLS. 51 AND 52). REG. 4-20-1993.
- 1,765,524. CAL-AID. INT. CL. 5. (U.S. CL. 18). REG. 4-20-1993.
- 1,765,557. FLEXOTECNICA. INT. CL. 7. (U.S. CL. 23). REG. 4-20-1993.
- 1,765,559. VINYL CYCLE. INT. CL. 7. (U.S. CL. 23). REG. 4-20-1993.
- 1,765,561. SERIES 90. INT. CL. 7. (U.S. CL. 23). REG. 4-20-1993.
- 1,765,631. + RED. INT. CL. 9. (U.S. CL. 26). REG. 4-20-1993.
- 1,765,683. "SET IT AND FORGET IT" (STYLIZED). INT. CL. 9. (U.S. CL. 38). REG. 4-20-1993.
- 1,765,689. ATUNAS (STYLIZED). INT. CL. 9. (U.S. CL. 26). REG. 4-20-1993.
- 1,765,723. INTEGRA. INT. CL. 10. (U.S. CL. 44). REG. 4-20-1993.
- 1,765,795. M.I. HUMMEL CLUB. INT. CLS. 16, 21, 39 AND 42. (U.S. CLS. 30, 37, 50, 100 AND 105). REG. 4-20-1993.
- 1,765,814. RANCHO SANTA MAGARITA NEWS. INT. CL. 16. (U.S. CL. 38). REG. 4-20-1993.
- 1,765,924. MICROFIRST (STYLIZED). INT. CL. 21. (U.S. CL. 29). REG. 4-20-1993.
- 1,765,946. SPYGLASS HILL. INT. CL. 25. (U.S. CLS. 22 AND 39). REG. 4-20-1993.
- 1,765,995. PLAYER'S EDGE. INT. CL. 28. (U.S. CLS. 22 AND 23). REG. 4-20-1993.
- 1,766,026. AMAZON ANNIE. INT. CL. 28. (U.S. CLS. 22 AND 38). REG. 4-20-1993.
- 1,766,108. HEAVYWEIGHT (STYLIZED). INT. CL. 31. (U.S. CL. 46). REG. 4-20-1993.
- 1,766,152. MISCELLANEOUS DESIGN. INT. CL. 35. (U.S. CLS. 100, 101 AND 102). REG. 4-20-1993.
- 1,766,182. AMERICAN AADVANTAGE FUNDS. INT. CL. 36. (U.S. CL. 102). REG. 4-20-1993.
- 1,766,208. WILLIAMS SCOTSMAN AND DESIGN. INT. CL. 36. (U.S. CLS. 100, 101 AND 102). REG. 4-20-1993.
- 1,766,217. LM (STYLIZED). INT. CL. 36. (U.S. CLS. 101 AND 102). REG. 4-20-1993.
- 1,766,234. DIGITREX. INT. CL. 38. (U.S. CL. 104). REG. 4-20-1993.
- 1,766,297. EAC. INT. CL. 41. (U.S. CL. 107). REG. 4-20-1993.
- 1,766,305. ALLIED STARS. INT. CL. 41. (U.S. CL. 107). REG. 4-20-1993.
- 1,766,378. TO LOVE A CHILD IS TO TOUCH TOMORROW. INT. CL. 42. (U.S. CL. 100). REG. 4-20-1993.
- 1,766,379. MISCELLANEOUS DESIGN. INT. CL. 42. (U.S. CL. 100). REG. 4-20-1993.
- 1,766,420. THE CRESCENT. INT. CL. 42. (U.S. CL. 100). REG. 4-20-1993.
- 1,766,498. TRIUMPH. INT. CL. 3. (U.S. CL. 51). REG. 4-20-1993.
- 1,766,646. CONSTANTCOLOR. INT. CL. 11. (U.S. CL. 21). REG. 4-20-1993.
- 1,766,655. SHIMANO XTR. INT. CL. 12. (U.S. CL. 19). REG. 4-20-1993.
- 1,766,660. DURASHELL. INT. CL. 12. (U.S. CL. 19). REG. 4-20-1993.
- 1,766,700. STOR SAFE. INT. CL. 16. (U.S. CL. 37). REG. 4-20-1993.
- 1,766,708. ENVIRO-CLEAN. INT. CL. 16. (U.S. CLS. 2 AND 37). REG. 4-20-1993.
- 1,766,724. CREATE-A-POND. INT. CL. 19. (U.S. CLS. 2, 12, 13, 23, 31 AND 34). REG. 4-20-1993.
- 1,766,806. STEALTH. INT. CL. 28. (U.S. CLS. 22, 23, 38 AND 50). REG. 4-20-1993.
- 1,766,817. MISCELLANEOUS DESIGN. INT. CL. 28. (U.S. CL. 22). REG. 4-20-1993.

- 1,766,847. KID RIDERS AND DESIGN. INT. CL. 28. (U.S. CL. 22). REG. 4-20-1993.
- 1,766,891. WORLD CLASSICS. INT. CL. 32. (U.S. CL. 45). REG. 4-20-1993.
- 1,766,902. STERLING DESIGN. INT. CL. 35. (U.S. CL. 101). REG. 4-20-1993.
- 1,766,904. MISCELLANEOUS DESIGN. INT. CL. 35. (U.S. CL. 101). REG. 4-20-1993.
- 1,766,994. PASTA JAY'S (STYLIZED). INT. CL. 42. (U.S. CL. 100). REG. 4-20-1993.
- 1,767,198. CON-O. INT. CL. 7. (U.S. CLS. 23 AND 34). REG. 4-27-1993.
- 1,767,209. PLEXUS. INT. CL. 7. (U.S. CL. 23). REG. 4-27-1993.
- 1,767,239. LIFEMAP. INT. CLS. 9 AND 41. (U.S. CLS. 38 AND 107). REG. 4-27-1993.
- 1,767,256. TANGENT STREAK. INT. CL. 9. (U.S. CL. 26). REG. 4-27-1993.
- 1,767,264. KIRBY MORGAN. INT. CLS. 9 AND 25. (U.S. CLS. 26, 39 AND 44). REG. 4-27-1993.
- 1,767,284. -LOGIC AND DESIGN. INT. CL. 9. (U.S. CL. 26). REG. 4-27-1993.
- 1,767,299. CONDAT. INT. CL. 9. (U.S. CL. 38). REG. 4-27-1993.
- 1,767,319. COLOR ENCORE. INT. CL. 9. (U.S. CL. 38). REG. 4-27-1993.
- 1,767,341. WELLNESS BY DESIGN. INT. CL. 10. (U.S. CL. 44). REG. 4-27-1993.
- 1,767,348. CHOLESTECH. INT. CL. 10. (U.S. CL. 44). REG. 4-27-1993.
- 1,767,382. XLT. INT. CL. 12. (U.S. CL. 19). REG. 4-27-1993.
- 1,767,602. COMPUTERXPPTS. INT. CL. 35. (U.S. CL. 101). REG. 4-27-1993.
- 1,767,815. M AND DESIGN. INT. CLS. 35, 41 AND 42. (U.S. CLS. 100, 101 AND 107). REG. 4-27-1993.
- 1,767,821. PENN-ORGANIC. INT. CLS. 1 AND 5. (U.S. CLS. 1, 6, 10 AND 18). REG. 4-27-1993.
- 1,767,897. PERATIVE. INT. CL. 5. (U.S. CLS. 18 AND 46). REG. 4-27-1993.
- 1,767,906. MV AND DESIGN. INT. CL. 6. (U.S. CL. 13). REG. 4-27-1993.
- 1,767,914. SIDEKICK (STYLIZED). INT. CL. 7. (U.S. CL. 23). REG. 4-27-1993.
- 1,767,944. SURESHOT. INT. CL. 9. (U.S. CLS. 21 AND 26). REG. 4-27-1993.
- 1,767,959. STAFF OPTIMIZER. INT. CL. 9. (U.S. CL. 38). REG. 4-27-1993.
- 1,767,986. DYNA-LOK. INT. CL. 10. (U.S. CL. 44). REG. 4-27-1993.
- 1,768,105. CACTUS LEAGUE. INT. CL. 25. (U.S. CL. 39). REG. 4-27-1993.
- 1,768,106. GRAPEFRUIT LEAGUE. INT. CL. 25. (U.S. CL. 39). REG. 4-27-1993.
- 1,768,270. WEIGHT-BUSTERS AND DESIGN. INT. CL. 42. (U.S. CL. 100). REG. 4-27-1993.
- 1,768,293. GLOBAL MUSIC PULSE. INT. CL. 16. (U.S. CL. 38). REG. 4-27-1993.
- 1,768,304. TITE LINER. INT. CL. 17. (U.S. CLS. 12 AND 13). REG. 4-27-1993.
- 1,768,401. DAIRYMAN'S EDGE. INT. CL. 5. (U.S. CL. 18). REG. 5-4-1993.
- 1,768,436. TRIAB AND DESIGN. INT. CL. 7. (U.S. CL. 23). REG. 5-4-1993.
- 1,768,442. MR. HORSEPOWER AND DESIGN. INT. CLS. 7 AND 12. (U.S. CL. 23). REG. 5-4-1993.
- 1,768,570. AEROSTAR. INT. CLS. 12 AND 37. (U.S. CLS. 19 AND 103). REG. 5-4-1993.
- 1,768,576. NDSU. INT. CLS. 14, 16, 25, 28 AND 41. (U.S. CLS. 2, 22, 28, 37, 38, 39, 50 AND 107). REG. 5-4-1993.
- 1,768,602. MISCELLANEOUS DESIGN. INT. CL. 16. (U.S. CL. 38). REG. 5-4-1993.
- 1,768,649. COVA. INT. CL. 17. (U.S. CLS. 12 AND 50). REG. 5-4-1993.
- 1,768,737. SIERRA RIDGE. INT. CL. 25. (U.S. CLS. 22 AND 39). REG. 5-4-1993.
- 1,768,758. HOT SAUCE AND DESIGN. INT. CL. 28. (U.S. CL. 22). REG. 5-4-1993.
- 1,768,902. MILKY WAY. INT. CL. 39. (U.S. CL. 105). REG. 5-4-1993.
- 1,768,912. OMCEO AND DESIGN. INT. CL. 41. (U.S. CL. 107). REG. 5-4-1993.
- 1,769,005. PIROD. INT. CL. 42. (U.S. CLS. 100 AND 101). REG. 5-4-1993.
- 1,769,161. SECURE 1000 (STYLIZED). INT. CL. 9. (U.S. CL. 26). REG. 5-4-1993.
- 1,769,187. CADCAT. INT. CL. 9. (U.S. CL. 38). REG. 5-4-1993.
- 1,769,447. IST SOURCE PARTNERSHIP PROGRAM. INT. CL. 36. (U.S. CL. 102). REG. 5-4-1993.
- 1,769,571. NAFTOSEAL. INT. CL. 1. (U.S. CL. 6). REG. 5-11-1993.
- 1,769,623. SUPER BEE (STYLIZED). INT. CL. 3. (U.S. CL. 52). REG. 5-11-1993.
- 1,769,632. STAR GAS AND DESIGN. INT. CL. 4. (U.S. CL. 15). REG. 5-11-1993.
- 1,769,697. MASTERCARVER. INT. CL. 7. (U.S. CL. 23). REG. 5-11-1993.
- 1,769,839. TRUETIME. INT. CL. 9. (U.S. CL. 21). REG. 5-11-1993.
- 1,769,853. MISCELLANEOUS DESIGN. INT. CL. 9. (U.S. CLS. 21, 23, 26, 36 AND 38). REG. 5-11-1993.
- 1,769,922. ARTHROFORCE. INT. CL. 10. (U.S. CL. 44). REG. 5-11-1993.
- 1,770,019. UNITED COUNTRY. INT. CL. 16. (U.S. CL. 38). REG. 5-11-1993.
- 1,770,275. BESS EATON AND DESIGN. INT. CL. 30. (U.S. CL. 46). REG. 5-11-1993.
- 1,770,451. ENGRAVE-A-CRETE. INT. CL. 37. (U.S. CL. 103). REG. 5-11-1993.
- 1,770,790. SPOTVIEW. INT. CL. 16. (U.S. CL. 38). REG. 5-11-1993.
- 1,770,814. CARABELLA COLLECTION. INT. CL. 25. (U.S. CL. 39). REG. 5-11-1993.
- 1,770,836. DIAMOND DUST BLADE. INT. CL. 28. (U.S. CL. 22). REG. 5-11-1993.
- 1,771,048. CRE-ACTIVE AND DESIGN. INT. CL. 5. (U.S. CLS. 6, 18, 44, 46, 51 AND 52). REG. 5-18-1993.
- 1,771,062. BACTIMICINA. INT. CL. 5. (U.S. CL. 18). REG. 5-18-1993.
- 1,771,239. ADVANCED. INT. CL. 9. (U.S. CL. 21). REG. 5-18-1993.
- 1,771,240. MISCELLANEOUS DESIGN. INT. CL. 9. (U.S. CL. 21). REG. 5-18-1993.
- 1,771,411. MR. HORSEPOWER AND DESIGN. INT. CL. 16. (U.S. CL. 38). REG. 5-18-1993.
- 1,771,474. WINDSOR. INT. CL. 19. (U.S. CL. 12). REG. 5-18-1993.
- 1,771,475. COUNTRY ESTATE. INT. CL. 19. (U.S. CL. 12). REG. 5-18-1993.
- 1,771,588. SCATCH AND DESIGN. INT. CL. 28. (U.S. CL. 22). REG. 5-18-1993.
- 1,771,755. MISCELLANEOUS DESIGN. INT. CL. 34. (U.S. CL. 17). REG. 5-18-1993.
- 1,771,902. AAA SELF STORAGE. INT. CL. 39. (U.S. CL. 105). REG. 5-18-1993.
- 1,771,978. COPELAND'S AND DESIGN. INT. CL. 42. (U.S. CL. 100). REG. 5-18-1993.
- 1,772,001. SPIKE'S JUNKYARD DOGS WORLD'S BEST HOTDOG MAYBE BETTER! AND DESIGN. INT. CL. 42. (U.S. CL. 100). REG. 5-18-1993.
- 1,772,041. O.A.S.I.S.. INT. CL. 42. (U.S. CL. 100). REG. 5-18-1993.
- 1,772,227. PLANTECH. INT. CL. 9. (U.S. CL. 38). REG. 5-18-1993.
- 1,772,257. WEATHERLINK. INT. CL. 9. (U.S. CLS. 26 AND 38). REG. 5-18-1993.
- 1,772,294. THERMOWELL. INT. CL. 9. (U.S. CL. 26). REG. 5-18-1993.
- 1,772,531. CITRUS VALLEY. INT. CL. 32. (U.S. CL. 46). REG. 5-18-1993.
- 1,772,692. DELI EGGS (STYLIZED). INT. CL. 29. (U.S. CL. 46). REG. 5-18-1993.
- 1,772,763. SILIFLAM. INT. CL. 5. (U.S. CLS. 6, 18, 44, 46, 51 AND 52). REG. 5-25-1993.
- 1,772,781. THE LOCKSMITH'S LOCK. INT. CL. 6. (U.S. CLS. 13 AND 25). REG. 5-25-1993.
- 1,772,896. FLEX H/A. INT. CL. 10. (U.S. CL. 44). REG. 5-25-1993.
- 1,772,926. CTS AND DESIGN. INT. CL. 14. (U.S. CL. 28). REG. 5-25-1993.
- 1,772,990. HINY HIDERS. INT. CL. 19. (U.S. CL. 12). REG. 5-25-1993.
- 1,773,010. DECOMIRROR BY HEADWEST, INC. AND DESIGN. INT. CL. 20. (U.S. CL. 32). REG. 5-25-1993.
- 1,773,020. FINE IDEA. INT. CL. 21. (U.S. CLS. 3 AND 29). REG. 5-25-1993.
- 1,773,201. JAWACDAH AND DESIGN. INT. CL. 41. (U.S. CLS. 100 AND 107). REG. 5-25-1993.
- 1,773,210. WHIFFENPOOFS AND DESIGN. INT. CL. 41. (U.S. CL. 107). REG. 5-25-1993.
- 1,773,241. THE REPUBLIC GROUP. INT. CL. 42. (U.S. CLS. 100 AND 101). REG. 5-25-1993.

- 1,773,246. FAMILY OF READERS (STYLIZED). INT. CL. 42. (U.S. CL. 100). REG. 5-25-1993.
- 1,773,296. CARE BEARS. INT. CLS. 16 AND 25. (U.S. CLS. 22, 38 AND 39). REG. 5-25-1993.
- 1,773,338. BUCKSKIN. INT. CL. 2. (U.S. CL. 16). REG. 5-25-1993.
- 1,773,400. SOLID AMERICAN. INT. CL. 6. (U.S. CLS. 13 AND 25). REG. 5-25-1993.
- 1,773,530. VAL-U-FIT. INT. CL. 10. (U.S. CL. 44). REG. 5-25-1993.
- 1,773,537. LASEREDGE AND DESIGN. INT. CL. 10. (U.S. CL. 44). REG. 5-25-1993.
- 1,773,570. NUMA JEANNIN. INT. CL. 14. (U.S. CL. 27). REG. 5-25-1993.
- 1,773,588. ORCHESTRA. INT. CL. 16. (U.S. CL. 50). REG. 5-25-1993.
- 1,773,599. RED MAGIC. INT. CL. 17. (U.S. CL. 35). REG. 5-25-1993.
- 1,773,600. BLUE MAGIC. INT. CL. 17. (U.S. CL. 35). REG. 5-25-1993.
- 1,773,601. YELLOW MAGIC. INT. CL. 17. (U.S. CL. 35). REG. 5-25-1993.
- 1,773,785. BAUMANN'S BEST. INT. CL. 30. (U.S. CL. 46). REG. 5-25-1993.
- 1,773,789. MOUNTAIN COLLECTION AND DESIGN. INT. CL. 30. (U.S. CL. 46). REG. 5-25-1993.
- 1,773,806. FRUITCAL. INT. CL. 32. (U.S. CL. 46). REG. 5-25-1993.
- 1,774,080. IDS (STYLIZED). INT. CL. 9. (U.S. CLS. 26 AND 38). REG. 6-1-1993.
- 1,774,081. INTERCAP (STYLIZED). INT. CL. 9. (U.S. CL. 26). REG. 6-1-1993.
- 1,774,108. CADENCE. INT. CL. 9. (U.S. CLS. 21 AND 36). REG. 6-1-1993.
- 1,774,157. NOAH (STYLIZED). INT. CL. 10. (U.S. CL. 44). REG. 6-1-1993.
- 1,774,181. LASER ATTACK. INT. CL. 13. (U.S. CL. 9). REG. 6-1-1993.
- 1,774,228. PC NOVICE AND DESIGN. INT. CL. 16. (U.S. CL. 38). REG. 6-1-1993.
- 1,774,325. CLASSIC TRIMS. INT. CL. 28. (U.S. CL. 50). REG. 6-1-1993.
- 1,774,392. PPS. INT. CL. 35. (U.S. CLS. 100 AND 101). REG. 6-1-1993.
- 1,774,531. TOM'S. INT. CL. 42. (U.S. CL. 100). REG. 6-1-1993.
- 1,774,633. VALIANT. INT. CL. 9. (U.S. CL. 26). REG. 6-1-1993.
- 1,774,676. TUFF POCKET AND DESIGN. INT. CL. 16. (U.S. CL. 37). REG. 6-1-1993.
- 1,774,745. THE CORRIDORS (STYLIZED). INT. CL. 36. (U.S. CLS. 101 AND 102). REG. 6-1-1993.
- 1,774,804. TURBO-SPOT. INT. CL. 1. (U.S. CL. 6). REG. 6-8-1993.
- 1,775,494. HEALTH-AIRE AND DESIGN. INT. CL. 37. (U.S. CL. 103). REG. 6-8-1993.
- 1,775,659. EURENOR. INT. CL. 1. (U.S. CL. 6). REG. 6-8-1993.
- 1,775,694. SCHERING-PLOUGH AND DESIGN. INT. CL. 5. (U.S. CLS. 18 AND 44). REG. 6-8-1993.
- 1,775,809. PROFILE. INT. CL. 10. (U.S. CL. 44). REG. 6-8-1993.
- 1,776,195. CUI AND DESIGN. INT. CL. 4. (U.S. CL. 15). REG. 6-15-1993.
- 1,776,258. KROSSGRINDING. INT. CL. 7. (U.S. CLS. 23 AND 26). REG. 6-15-1993.
- 1,776,461. MISCELLANEOUS DESIGN. INT. CL. 16. (U.S. CL. 38). REG. 6-15-1993.
- 1,776,548. ABOXABLOX. INT. CL. 19. (U.S. CL. 12). REG. 6-15-1993.
- 1,776,602. ASICS (STYLIZED). INT. CL. 25. (U.S. CL. 39). REG. 6-15-1993.
- 1,776,929. SIMMONDS HEALTHCARE. INT. CLS. 37 AND 42. (U.S. CLS. 100 AND 103). REG. 6-15-1993.
- 1,777,006. SP AND DESIGN. INT. CL. 5. (U.S. CLS. 18 AND 44). REG. 6-15-1993.
- 1,777,054. LAB TOP. INT. CL. 9. (U.S. CL. 21). REG. 6-15-1993.
- 1,777,192. ADVANCED PACKAGING. INT. CL. 16. (U.S. CL. 38). REG. 6-15-1993.
- 1,777,741. CDA. INT. CL. 9. (U.S. CL. 26). REG. 6-22-1993.
- 1,777,802. NEW ENGLAND FIREARMS. INT. CL. 13. (U.S. CL. 9). REG. 6-22-1993.
- 1,777,803. BULLSHOOTER. INT. CL. 13. (U.S. CL. 9). REG. 6-22-1993.
- 1,777,983. K'NEX. INT. CL. 28. (U.S. CL. 22). REG. 6-22-1993.
- 1,778,082. CAPITAL GROWTH MANAGEMENT. INT. CL. 36. (U.S. CLS. 101 AND 102). REG. 6-22-1993.
- 1,778,213. DILLY'S. INT. CL. 42. (U.S. CL. 100). REG. 6-22-1993.
- 1,778,265. MISCELLANEOUS DESIGN. INT. CL. 3. (U.S. CLS. 6 AND 52). REG. 6-22-1993.
- 1,778,381. STYLEMASTER. INT. CL. 21. (U.S. CL. 2). REG. 6-22-1993.
- 1,778,450. MEMPHI. INT. CL. 30. (U.S. CL. 46). REG. 6-22-1993.
- 1,778,684. STAR. INT. CL. 7. (U.S. CL. 23). REG. 6-29-1993.
- 1,778,823. OLD WORLD CHRISTMAS. INT. CLS. 11, 15, 20, 21 AND 28. (U.S. CLS. 21, 26, 30, 33 AND 50). REG. 6-29-1993.
- 1,778,944. COREBOARD. INT. CL. 17. (U.S. CL. 12). REG. 6-29-1993.
- 1,778,997. COLTECH. INT. CL. 25. (U.S. CL. 39). REG. 6-29-1993.
- 1,779,366. ELITE. INT. CL. 42. (U.S. CL. 100). REG. 6-29-1993.
- 1,780,075. I AM I CAN I WILL AND DESIGN. INT. CLS. 9 AND 16. (U.S. CLS. 21, 36 AND 38). REG. 7-6-1993.
- 1,780,177. AAT. INT. CL. 12. (U.S. CL. 35). REG. 7-6-1993.
- 1,780,178. AIR X. INT. CL. 12. (U.S. CL. 35). REG. 7-6-1993.
- 1,780,228. WEATHER GUIDE CALENDAR WITH PHENOMENAL WEATHER EVENTS. INT. CL. 16. (U.S. CLS. 37 AND 38). REG. 7-6-1993.
- 1,780,265. ARK-BRITE. INT. CL. 16. (U.S. CL. 37). REG. 7-6-1993.
- 1,780,275. WORLD WAR II. INT. CL. 16. (U.S. CL. 38). REG. 7-6-1993.
- 1,780,294. ASICS. INT. CL. 18. (U.S. CL. 3). REG. 7-6-1993.
- 1,780,372. CARYSMA. INT. CL. 25. (U.S. CL. 39). REG. 7-6-1993.
- 1,780,569. TRANS SERV. INT. CL. 36. (U.S. CLS. 102 AND 105). REG. 7-6-1993.
- 1,780,597. HSTN. INT. CL. 38. (U.S. CL. 104). REG. 7-6-1993.
- 1,780,666. OUTBACK STEAKHOUSE AND DESIGN. INT. CL. 42. (U.S. CLS. 100 AND 101). REG. 7-6-1993.
- 1,780,720. SU CASA. INT. CL. 42. (U.S. CL. 100). REG. 7-6-1993.
- 1,781,266. MI MICROTEK MEDICAL, INC AND DESIGN. INT. CL. 10. (U.S. CLS. 26, 39 AND 44). REG. 7-13-1993.
- 1,781,330. JB ROBINSON AND DESIGN. INT. CL. 14. (U.S. CLS. 27 AND 28). REG. 7-13-1993.
- 1,781,352. AUTOMOTIVE SATELLITE TELEVISION NETWORK. INT. CL. 16. (U.S. CL. 38). REG. 7-13-1993.
- 1,781,388. K AND DESIGN. INT. CL. 16. (U.S. CLS. 2 AND 37). REG. 7-13-1993.
- 1,781,429. HOUSE BLANKET. INT. CL. 17. (U.S. CL. 12). REG. 7-13-1993.
- 1,781,511. MISCELLANEOUS DESIGN. INT. CL. 25. (U.S. CL. 39). REG. 7-13-1993.
- 1,781,765. AUTOMOTIVE SATELLITE TELEVISION NETWORK. INT. CL. 38. (U.S. CL. 104). REG. 7-13-1993.
- 1,782,625. UNITED STATES PONY CLUBS AND DESIGN. INT. CL. 16. (U.S. CLS. 37 AND 38). REG. 7-20-1993.
- 1,782,725. BEAUVILLE AND DESIGN. INT. CL. 24. (U.S. CL. 42). REG. 7-20-1993.
- 1,783,039. WAL-MART. INT. CL. 42. (U.S. CL. 101). REG. 7-20-1993.
- 1,783,169. ACID-AWAY. INT. CL. 1. (U.S. CL. 6). REG. 7-20-1993.
- 1,783,185. LASH AMPLIFIER. INT. CL. 3. (U.S. CL. 51). REG. 7-20-1993.
- 1,783,248. D AND DESIGN. INT. CL. 9. (U.S. CLS. 21, 26 AND 50). REG. 7-20-1993.
- 1,783,529. SUN-BRITE. INT. CL. 28. (U.S. CL. 22). REG. 7-20-1993.
- 1,783,537. ENERGY BALLS. INT. CL. 29. (U.S. CL. 46). REG. 7-20-1993.
- 1,783,845. INTRUDER. INT. CL. 6. (U.S. CLS. 12, 13 AND 50). REG. 7-27-1993.
- 1,783,915. FOXVIDEO. INT. CL. 9. (U.S. CLS. 21 AND 36). REG. 7-27-1993.
- 1,784,015. THE HEAT SOLUTION. INT. CL. 10. (U.S. CL. 44). REG. 7-27-1993.
- 1,784,186. MISCELLANEOUS DESIGN. INT. CL. 24. (U.S. CL. 42). REG. 7-27-1993.
- 1,784,199. GOLD MEDAL. INT. CL. 25. (U.S. CL. 39). REG. 7-27-1993.

- 1,784,345. NORDIC. INT. CL. 32. (U.S. CL. 45). REG. 7-27-1993.
- 1,784,417. LIGHTS OF LOVE. INT. CL. 36. (U.S. CL. 102). REG. 7-27-1993.
- 1,784,544. CHIARO'S (STYLIZED). INT. CL. 42. (U.S. CL. 100). REG. 7-27-1993.
- 1,784,653. LAS VENTANAS. INT. CL. 42. (U.S. CL. 100). REG. 7-27-1993.
- 1,784,829. BOSS HOSS. INT. CL. 12. (U.S. CL. 19). REG. 7-27-1993.
- 1,784,836. E AND DESIGN. INT. CL. 16. (U.S. CL. 38). REG. 7-27-1993.
- 1,785,232. BRADEN AND DESIGN. INT. CL. 7. (U.S. CL. 23). REG. 8-3-1993.
- 1,785,247. DURALITE. INT. CL. 8. (U.S. CL. 23). REG. 8-3-1993.
- 1,785,400. MEDIGUARD AND DESIGN. INT. CL. 10. (U.S. CL. 44). REG. 8-3-1993.
- 1,785,602. KIMBERLY-CLARK. INT. CL. 21. (U.S. CL. 2). REG. 8-3-1993.
- 1,785,617. ELAINE POWERS AND DESIGN. INT. CL. 25. (U.S. CL. 39). REG. 8-3-1993.
- 1,785,621. IOWA STATE. INT. CL. 25. (U.S. CL. 39). REG. 8-3-1993.
- 1,785,704. TENNESSEE PRIDE JUST COOKED. INT. CL. 29. (U.S. CL. 46). REG. 8-3-1993.
- 1,786,122. THE ORIGINAL REBECCA GRAY DESIGNS BY KATHERINE AND DESIGN. INT. CL. 14. (U.S. CL. 28). REG. 8-3-1993.
- 1,786,167. SYNERGEX. INT. CL. 24. (U.S. CL. 42). REG. 8-3-1993.
- 1,786,367. 1-800-HOT-HOGS. INT. CLS. 1 AND 42. (U.S. CLS. 6 AND 101). REG. 8-10-1993.
- 1,786,495. COBRA. INT. CL. 7. (U.S. CL. 23). REG. 8-10-1993.
- 1,787,095. MISCELLANEOUS DESIGN. INT. CL. 40. (U.S. CLS. 100 AND 106). REG. 8-10-1993.
- 1,787,441. HEAROS. INT. CL. 10. (U.S. CL. 44). REG. 8-10-1993.
- 1,787,801. HEMOPET. INT. CL. 5. (U.S. CL. 18). REG. 8-17-1993.
- 1,788,462. PRELUDE. INT. CL. 36. (U.S. CL. 102). REG. 8-17-1993.
- 1,788,523. CHAMPIONSHIP WEEK. INT. CL. 41. (U.S. CL. 107). REG. 8-17-1993.
- 1,788,626. DECLARATIONS OF INDEPENDENCE. INT. CL. 42. (U.S. CL. 100). REG. 8-17-1993.
- 1,788,960. CASHBACK FROM ANPAC AND DESIGN. INT. CL. 36. (U.S. CL. 102). REG. 8-17-1993.
- 1,789,098. ORB. INT. CL. 5. (U.S. CL. 18). REG. 8-24-1993.
- 1,789,436. TRITON. INT. CL. 20. (U.S. CL. 32). REG. 8-24-1993.
- 1,789,461. IOWA STATE UNIVERSITY OF SCIENCE AND TECHNOLOGY SCIENCE WITH PRACTICE AND DESIGN. INT. CL. 25. (U.S. CL. 39). REG. 8-24-1993.
- 1,789,557. CHOCOLATE THUNDER FROM DOWN UNDER. INT. CL. 30. (U.S. CL. 46). REG. 8-24-1993.
- 1,789,590. SCT. INT. CLS. 35 AND 42. (U.S. CLS. 100 AND 101). REG. 8-24-1993.
- 1,789,809. MISCELLANEOUS DESIGN. INT. CL. 42. (U.S. CL. 100). REG. 8-24-1993.
- 1,791,037. MIGHTY MACHINES. INT. CL. 28. (U.S. CL. 22). REG. 8-31-1993.
- 1,791,284. DO HWI IT BEST AND DESIGN. INT. CL. 6. (U.S. CL. 13). REG. 9-7-1993.
- 1,791,413. AF/REMOTE. INT. CL. 9. (U.S. CL. 38). REG. 9-7-1993.
- 1,791,441. FIBRA. INT. CL. 9. (U.S. CL. 26). REG. 9-7-1993.
- 1,791,502. V AND DESIGN. INT. CL. 12. (U.S. CL. 35). REG. 9-7-1993.
- 1,791,789. C AND DESIGN. INT. CL. 30. (U.S. CL. 46). REG. 9-7-1993.
- 1,792,266. CHARGEPAC. INT. CL. 1. (U.S. CL. 6). REG. 9-14-1993.
- 1,792,271. MISCELLANEOUS DESIGN. INT. CL. 1. (U.S. CLS. 1 AND 6). REG. 9-14-1993.
- 1,793,017. JAWACDAH. INT. CL. 41. (U.S. CLS. 100 AND 107). REG. 9-14-1993.
- 1,793,019. PROFESSOR PUTTER AND HIS GADGETORIUM. INT. CL. 41. (U.S. CL. 107). REG. 9-14-1993.
- 1,793,077. ON 5IVE. INT. CL. 42. (U.S. CL. 101). REG. 9-14-1993.
- 1,793,124. HYATT VACATIONS AND DESIGN. INT. CL. 42. (U.S. CL. 100). REG. 9-14-1993.
- 1,793,472. DANTZ. INT. CL. 9. (U.S. CL. 38). REG. 9-21-1993.
- 1,793,501. SEXUAL HARASSMENT...SHADES OF GRAY. INT. CL. 9. (U.S. CLS. 21, 36 AND 38). REG. 9-21-1993.
- 1,793,928. NEW ENGLAND SPRING FLOWER SHOW. INT. CL. 41. (U.S. CL. 107). REG. 9-21-1993.
- 1,794,449. FRIGHT FEST. INT. CL. 41. (U.S. CL. 107). REG. 9-21-1993.
- 1,794,464. UP AND DESIGN. INT. CL. 42. (U.S. CLS. 100 AND 101). REG. 9-21-1993.
- 1,794,638. BOVI-LIFE. INT. CL. 5. (U.S. CLS. 18 AND 46). REG. 9-28-1993.
- 1,794,811. HOT OPTIX. INT. CL. 9. (U.S. CL. 26). REG. 9-28-1993.
- 1,795,158. BRO-TISSERIE. INT. CL. 29. (U.S. CL. 46). REG. 9-28-1993.
- 1,795,389. BRUNO AND DESIGN. INT. CL. 42. (U.S. CL. 100). REG. 9-28-1993.
- 1,795,477. HEALTH NET SENIORITY PLUS. INT. CLS. 36 AND 42. (U.S. CLS. 100, 101 AND 102). REG. 9-28-1993.
- 1,795,502. POLARSET. INT. CL. 1. (U.S. CL. 6). REG. 9-28-1993.
- 1,795,687. HYDRO-BLEND AND DESIGN. INT. CL. 9. (U.S. CL. 26). REG. 9-28-1993.
- 1,795,699. PREMIER POWER (STYLIZED). INT. CL. 9. (U.S. CL. 38). REG. 9-28-1993.
- 1,796,230. M-CLIP. INT. CL. 20 ONLY. (U.S. CL. 50). REG. 10-5-1993.
- 1,796,572. FUSES UNLIMITED. INT. CL. 42. (U.S. CL. 101). REG. 10-5-1993.
- 1,796,760. VERSATILE LOCK (STYLIZED). INT. CL. 7. (U.S. CL. 23). REG. 10-5-1993.
- 1,797,310. AI AMERICAN INDUSTRIAL MANUFACTURING SERVICES, INC. AND DESIGN. INT. CL. 40. (U.S. CLS. 103 AND 106). REG. 10-5-1993.
- 1,797,467. MISCELLANEOUS DESIGN. INT. CLS. 17 AND 19 ONLY. (U.S. CLS. 1, 12 AND 35). REG. 10-12-1993.
- 1,797,468. MISCELLANEOUS DESIGN. INT. CLS. 17 AND 19 ONLY. (U.S. CLS. 12 AND 35). REG. 10-12-1993.
- 1,797,550. SCRIPTPRO. INT. CL. 7. (U.S. CL. 23). REG. 10-12-1993.
- 1,798,484. OMNI-LITE. INT. CL. 7. (U.S. CLS. 23 AND 35). REG. 10-12-1993.
- 1,798,763. BURUKA. INT. CL. 25. (U.S. CL. 39). REG. 10-12-1993.
- 1,799,709. NAMCO (STYLIZED). INT. CL. 41. (U.S. CL. 107). REG. 10-19-1993.
- 1,799,749. THE PIRATES OF DARK WATER. INT. CL. 41. (U.S. CL. 107). REG. 10-19-1993.
- 1,800,112. TRITON BARRIER. INT. CL. 19. (U.S. CL. 12). REG. 10-19-1993.
- 1,800,755. THE GOOD BOOK. INT. CL. 16. (U.S. CL. 38). REG. 10-26-1993.
- 1,801,048. SHAW AND DESIGN. INT. CL. 35. (U.S. CL. 101). REG. 10-26-1993.
- 1,801,101. MISCELLANEOUS DESIGN. INT. CL. 37. (U.S. CL. 103). REG. 10-26-1993.
- 1,801,338. UN-CHAP. INT. CL. 3 ONLY. (U.S. CL. 51). REG. 10-26-1993.
- 1,801,702. ROOMS TO GO AND DESIGN. INT. CL. 42. (U.S. CL. 101). REG. 10-26-1993.
- 1,801,839. BLUE LABEL. INT. CL. 5. (U.S. CL. 6). REG. 11-2-1993.
- 1,802,456. KLONDIKE CAFE AND DESIGN. INT. CL. 42. (U.S. CL. 100). REG. 11-2-1993.
- 1,803,276. S (STYLIZED). INT. CL. 20. (U.S. CL. 32). REG. 11-9-1993.
- 1,803,732. ALPHA ZOO-LOVEABLES. INT. CL. 16. (U.S. CLS. 37 AND 39). REG. 11-9-1993.
- 1,803,775. WETTASK. INT. CL. 24. (U.S. CL. 42). REG. 11-9-1993.
- 1,804,998. READ RIGHT. INT. CLS. 9, 16 AND 41. (U.S. CLS. 36, 38 AND 107). REG. 11-16-1993.
- 1,805,318. BILL PAYMENT CENTER. INT. CL. 20. (U.S. CL. 2). REG. 11-16-1993.
- 1,806,167. TAMANET. INT. CL. 22. (U.S. CL. 7). REG. 11-23-1993.
- 1,806,398. WEAVER BROS. INSURANCE W AND DESIGN. INT. CL. 36. (U.S. CL. 102). REG. 11-23-1993.
- 1,806,641. DIAFORMER. INT. CL. 1. (U.S. CL. 6). REG. 11-23-1993.
- 1,807,015. LIQUID NEEDLE. INT. CL. 5. (U.S. CL. 18). REG. 11-30-1993.

- 1,807,041. MEGAFLANGE. INT. CL. 6. (U.S. CL. 13). REG. 11-30-1993.
- 1,807,863. TOWER AND DESIGN. INT. CL. 35. (U.S. CL. 101). REG. 11-30-1993.
- 1,808,736. LIVING MINT. INT. CLS. 3 AND 30. (U.S. CLS. 6, 17, 46 AND 51). REG. 12-7-1993.
- 1,809,154. AMERICAN RODDER. INT. CL. 16. (U.S. CL. 38). REG. 12-7-1993.
- 1,809,224. MISCELLANEOUS DESIGN. INT. CL. 21. (U.S. CL. 2). REG. 12-7-1993.
- 1,809,254. PRIMA SOFT. INT. CL. 25. (U.S. CL. 39). REG. 12-7-1993.
- 1,809,432. DIAMOND HEAD ESPRESSO. INT. CL. 30. (U.S. CL. 46). REG. 12-7-1993.
- 1,810,343. DREWTROL. INT. CL. 1. (U.S. CL. 6). REG. 12-14-1993.
- 1,810,631. ACUCISE. INT. CL. 10. (U.S. CL. 44). REG. 12-14-1993.
- 1,812,470. ORTHOBICIZE. INT. CL. 41. (U.S. CL. 107). REG. 12-21-1993.
- 1,812,634. ADVANTAGE PLUS. INT. CL. 1. (U.S. CL. 6). REG. 12-21-1993.
- 1,813,280. SANTOSOL. INT. CL. 1. (U.S. CL. 6). REG. 12-28-1993.
- 1,813,331. LIVING FRUIT. INT. CLS. 3 AND 30. (U.S. CLS. 6, 17, 46 AND 51). REG. 12-28-1993.
- 1,814,299. UNO. INT. CLS. 29 AND 30. (U.S. CL. 46). REG. 12-28-1993.
- 1,814,523. AMERICAN HEART WALK AND DESIGN. INT. CL. 36. (U.S. CL. 102). REG. 12-28-1993.
- 1,814,878. K-TAB. INT. CL. 16. (U.S. CL. 37). REG. 1-4-1994.
- 1,814,946. PERIMETER COIL. INT. CL. 20. (U.S. CL. 32). REG. 1-4-1994.
- 1,815,748. AMSIG. INT. CL. 9. (U.S. CLS. 21 AND 26). REG. 1-11-1994.
- 1,816,254. GOLD MEDAL WINE CLUB AND DESIGN. INT. CL. 42. (U.S. CL. 101). REG. 1-11-1994.
- 1,816,290. NORTHWEST FRESH AND DESIGN. INT. CL. 42. (U.S. CL. 101). REG. 1-11-1994.
- 1,816,320. FLEX-FLO. INT. CL. 1. (U.S. CLS. 1 AND 6). REG. 1-11-1994.
- 1,816,449. RUBY ANN'S. INT. CL. 30. (U.S. CL. 46). REG. 1-11-1994.
- 1,817,248. S SYNERGY (STYLIZED). INT. CL. 42. (U.S. CLS. 100 AND 101). REG. 1-18-1994.
- 1,817,340. NOVUS. INT. CL. 5. (U.S. CL. 18). REG. 1-18-1994.
- 1,817,848. TRANSFER-EASE. INT. CL. 10. (U.S. CL. 44). REG. 1-25-1994.
- 1,818,780. MCAFEE. INT. CL. 9. (U.S. CL. 38). REG. 2-1-1994.
- 1,819,018. DAYTONA INTERNATIONAL SPEEDWAY. INT. CLS. 25 AND 28 ONLY. (U.S. CLS. 22 AND 39). REG. 2-1-1994.
- 1,819,041. BUZZOOMS. INT. CL. 25. (U.S. CL. 39). REG. 2-1-1994.
- 1,819,276. REAL ITALIAN. REAL FAST. (STYLIZED). INT. CL. 42. (U.S. CL. 100). REG. 2-1-1994.
- 1,820,639. TRAXX (STYLIZED). INT. CL. 20. (U.S. CLS. 12 AND 32). REG. 2-8-1994.
- 1,822,561. SERIES 20000. INT. CL. 10. (U.S. CL. 44). REG. 2-22-1994.
- 1,822,849. DAYTONA USA. INT. CLS. 25 AND 41 ONLY. (U.S. CLS. 22, 39, 100, 101 AND 107). REG. 2-22-1994.
- 1,823,589. GEETECH AND DESIGN. INT. CL. 7. (U.S. CL. 23). REG. 2-22-1994.
- 1,823,925. MOBIUS STRIP. INT. CL. 41. (U.S. CL. 107). REG. 2-22-1994.
- 1,824,477. CHARLIE 1 HORSE. INT. CL. 25. (U.S. CL. 39). REG. 3-1-1994.
- 1,824,708. KEYSTONE AND DESIGN. INT. CL. 42. (U.S. CL. 101). REG. 3-1-1994.
- 1,826,428. LADY PLAYER. INT. CL. 25. (U.S. CL. 39). REG. 3-15-1994.
- 1,826,669. LESSONS PLUS. INT. CL. 41. (U.S. CL. 107). REG. 3-15-1994.
- 1,827,173. BOVA-PRO. INT. CL. 5. (U.S. CL. 18). REG. 3-22-1994.
- 1,830,163. FABRI-COMP. INT. CL. 7. (U.S. CL. 23). REG. 4-12-1994.

* * * * *

TRADEMARK REGISTRATIONS CANCELED

The designation "U.S. Cl." appearing in this section refers to the U.S. class in effect prior to Sep. 1, 1973 rather than the international class which applies to applications filed on or after that date. For adoption of international classification see notice in the OFFICIAL GAZETTE of Jun. 26, 1973 (911 O.G. TM 210).

SECTION 7(D)

795,903.	FOCUS. U.S. CL. 18. REG. 9-14-1965.	737,777.	UNION CARBIDE AND DESIGN. U.S. CL. 18. REG. 9-18-1962.
1,637,200.	PETCARE AND DESIGN. INT. CL. 42. REG. 3-5-1991.	737,786.	WIN. U.S. CL. 18. REG. 9-18-1962.
2,292,655.	BUBBLY CHUBBIES (STYLIZED). INT. CL. 28. REG. 11-16-1999.	737,791.	WIGRETTES. U.S. CL. 18. REG. 9-18-1962.
2,413,449.	LIFETIME. INT. CL. 8. REG. 12-19-2000.	737,800.	BONUS LINE. U.S. CL. 21. REG. 9-18-1962.
2,616,107.	INNOVENTIONS INC.. INT. CL. 9. REG. 9-10-2002.	737,802.	MAX-I-TRAN (STYLIZED). U.S. CL. 21. REG. 9-18-1962.

SECTION 8

158,917.	KIST (STYLIZED). U.S. CL. 45. REG. 9-19-1922.	737,813.	UDICO. U.S. CL. 21. REG. 9-18-1962.
158,923.	FLORIENT (STYLIZED). U.S. CL. 6. REG. 9-19-1922.	737,816.	SANDY-ANDY. U.S. CL. 22. REG. 9-18-1962.
159,030.	MAYFLOWER. U.S. CL. 42. REG. 9-19-1922.	737,818.	JIFFY-GYM (STYLIZED). U.S. CL. 22. REG. 9-18-1962.
159,045.	THE EXCHANGITE (STYLIZED). U.S. CL. 38. REG. 9-19-1922.	737,822.	PRO-POCKET. U.S. CL. 22. REG. 9-18-1962.
159,063.	CHEMCRAFT (STYLIZED). U.S. CL. 6. REG. 9-19-1922.	737,836.	AQUA-MAR. U.S. CL. 22. REG. 9-18-1962.
159,104.	RED JACKET AND DESIGN. U.S. CL. 39. REG. 9-19-1922.	737,842.	PAR AND DESIGN. U.S. CL. 23. REG. 9-18-1962.
159,110.	SO (STYLIZED). U.S. CL. 15. REG. 9-19-1922.	737,845.	SYNCHRO-MATIC (STYLIZED). U.S. CL. 23. REG. 9-18-1962.
159,149.	THE FARMER (STYLIZED). U.S. CL. 38. REG. 9-19-1922.	737,848.	CARTON KING. U.S. CL. 23. REG. 9-18-1962.
159,154.	WHITING & DAVIS CO MESH BAGS AND DESIGN. U.S. CL. 3. REG. 9-19-1922.	737,851.	BEAST. U.S. CL. 23. REG. 9-18-1962.
397,665.	REPUBLIC. U.S. CL. 26. REG. 9-15-1942.	737,856.	KAR-GARD (STYLIZED). U.S. CL. 23. REG. 9-18-1962.
397,698.	MY FRIEND (STYLIZED). U.S. CL. 40. REG. 9-15-1942.	737,857.	SEA KING. U.S. CL. 23. REG. 9-18-1962.
737,676.	NATIONAL BEAUTY. U.S. CL. 1. REG. 9-18-1962.	737,861.	DI-MATIC. U.S. CL. 26. REG. 9-18-1962.
737,685.	KHEOPS. U.S. CL. 1. REG. 9-18-1962.	737,865.	VIBROSEIS. U.S. CL. 26. REG. 9-18-1962.
737,694.	VISCO. U.S. CL. 6. REG. 9-18-1962.	737,872.	EXPEEDITER. U.S. CL. 26. REG. 9-18-1962.
737,695.	R-C. U.S. CL. 6. REG. 9-18-1962.	737,894.	OIL-FOAM (STYLIZED). U.S. CL. 31. REG. 9-18-1962.
737,698.	RESINEX. U.S. CL. 6. REG. 9-18-1962.	737,896.	SIMPLEX. U.S. CL. 32. REG. 9-18-1962.
737,705.	MAPROSYL. U.S. CL. 6. REG. 9-18-1962.	737,899.	CHARAK. U.S. CL. 32. REG. 9-18-1962.
737,715.	LONGHORN. U.S. CL. 9. REG. 9-18-1962.	737,900.	RIB-INFORCED CONSTRUCTION AND DESIGN. U.S. CL. 32. REG. 9-18-1962.
737,718.	STAPCO AND DESIGN. U.S. CL. 10. REG. 9-18-1962.	737,910.	ARMOR CLAD AND DESIGN. U.S. CL. 34. REG. 9-18-1962.
737,724.	FIREDIKE. U.S. CL. 12. REG. 9-18-1962.	737,915.	AUDITION. U.S. CL. 36. REG. 9-18-1962.
737,726.	TROLUMEN. U.S. CL. 12. REG. 9-18-1962.	737,924.	DUO-TANG. U.S. CL. 37. REG. 9-18-1962.
737,730.	SOLAR AND DESIGN. U.S. CL. 12. REG. 9-18-1962.	737,931.	BUILD-A-COURSE. U.S. CL. 38. REG. 9-18-1962.
737,731.	BONNELITE. U.S. CL. 12. REG. 9-18-1962.	737,937.	STRATOKOOL. U.S. CL. 39. REG. 9-18-1962.
737,733.	CORE HOUSE. U.S. CL. 12. REG. 9-18-1962.	737,939.	PLAYSOLE. U.S. CL. 39. REG. 9-18-1962.
737,741.	OLYMP. U.S. CL. 13. REG. 9-18-1962.	737,941.	DUDLEY (STYLIZED). U.S. CL. 39. REG. 9-18-1962.
737,746.	FAUCET-QUEEN (STYLIZED). U.S. CL. 13. REG. 9-18-1962.	737,943.	DON JUAN. U.S. CL. 39. REG. 9-18-1962.
737,748.	INAMEL (STYLIZED). U.S. CL. 14. REG. 9-18-1962.	737,946.	CAPITANO. U.S. CL. 39. REG. 9-18-1962.
737,760.	ULTRA-GUARD. U.S. CL. 16. REG. 9-18-1962.	737,952.	EVER-SOLE. U.S. CL. 39. REG. 9-18-1962.
737,761.	SIR BRUCE. U.S. CL. 17. REG. 9-18-1962.	737,964.	KENNETH. U.S. CL. 42. REG. 9-18-1962.
737,764.	M MENNEN QUALITY AND DESIGN. U.S. CL. 18. REG. 9-18-1962.	737,966.	WUND ALINER (STYLIZED). U.S. CL. 42. REG. 9-18-1962.
737,776.	DOMEFORM-HC. U.S. CL. 18. REG. 9-18-1962.	737,972.	COVER-SLING. U.S. CL. 44. REG. 9-18-1962.
		737,974.	LEILANI (STYLIZED). U.S. CL. 46. REG. 9-18-1962.
		737,977.	TOP OF THE DECK AND DESIGN. U.S. CL. 46. REG. 9-18-1962.
		737,979.	MAGIC FREEZE. U.S. CL. 46. REG. 9-18-1962.
		737,986.	RUSTY AND DESIGN. U.S. CL. 46. REG. 9-18-1962.
		737,995.	FLEX-O-GUIDES AND DESIGN. U.S. CL. 50. REG. 9-18-1962.
		737,998.	SIGNAL (STYLIZED). U.S. CL. 51. REG. 9-18-1962.
		738,000.	ULTRA WAVE. U.S. CL. 51. REG. 9-18-1962.
		738,002.	SEA BREEZE. U.S. CL. 51. REG. 9-18-1962.
		738,003.	EVERON. U.S. CL. 51. REG. 9-18-1962.
		738,006.	NOBEL (STYLIZED). U.S. CL. 52. REG. 9-18-1962.
		738,007.	MAPROSYL. U.S. CL. 52. REG. 9-18-1962.
		738,013.	FBC. U.S. CL. 52. REG. 9-18-1962.
		738,014.	CBC. U.S. CL. 52. REG. 9-18-1962.

- 738,023. BRAZIER AND DESIGN. U.S. CL. 100. REG. 9-18-1962.
- 738,027. REDD MAN AND DESIGN. U.S. CL. 103. REG. 9-18-1962.
- 738,038. DURBAN'S. U.S. CL. 29. REG. 9-18-1962.
- 738,039. MISCELLANEOUS DESIGN. U.S. CL. 37. REG. 9-18-1962.
- 738,050. IMPORTED VIRGIN DRY RALLO ESTABLISHED ITALY SINCE 1860 SUPERIOR EXTRA MARALA AND DESIGN. U.S. CL. 47. REG. 9-18-1962.
- 738,055. DURBAN'S. U.S. CL. 51. REG. 9-18-1962.
- 738,058. DURBAN'S. U.S. CL. 52. REG. 9-18-1962.
- 738,059. PRINTERS SERVICE BUREAU. U.S. CL. 101. REG. 9-18-1962.
- 952,963. DOLMAR. U.S. CLS. 2, 13 AND 15, ONLY. REG. 2-13-1973.
- 1,169,512. FORESTFARM (STYLIZED). INT. CL. 31. REG. 9-15-1981.
- 1,182,632. OTIS. INT. CLS. 3 AND 4 ONLY. REG. 12-22-1981.
- 1,207,683. SILIKAL AND DESIGN. INT. CL. 1. REG. 9-14-1982.
- 1,207,685. LIFE. INT. CL. 1. REG. 9-14-1982.
- 1,207,686. EUREDUR. INT. CL. 1. REG. 9-14-1982.
- 1,207,699. R-SYSTEM ROTHENBERGER AND DESIGN. INT. CL. 1. REG. 9-14-1982.
- 1,207,701. MN MC GHAN NUSIL CORPORATION (STYLIZED). INT. CL. 1. REG. 9-14-1982.
- 1,207,702. ISAFIL. INT. CLS. 1 AND 4. REG. 9-14-1982.
- 1,207,711. SILFLOR/50 (STYLIZED). INT. CL. 1. REG. 9-14-1982.
- 1,207,715. ACCOAL. INT. CL. 1. REG. 9-14-1982.
- 1,207,716. ACCOAL-FROTH. INT. CL. 1. REG. 9-14-1982.
- 1,207,717. ACCOAL-FLOC. INT. CL. 1. REG. 9-14-1982.
- 1,207,726. DURA-TILE (STYLIZED). INT. CL. 2. REG. 9-14-1982.
- 1,207,730. IRLON G-73. INT. CL. 2. REG. 9-14-1982.
- 1,207,731. IRLON D-70. INT. CL. 2. REG. 9-14-1982.
- 1,207,732. IRLON 66. INT. CL. 2. REG. 9-14-1982.
- 1,207,735. HYPER-OXIDE. INT. CL. 3. REG. 9-14-1982.
- 1,207,738. PROTEINKARE. INT. CL. 3. REG. 9-14-1982.
- 1,207,740. MORE THAN CLEAN ... SOFT AND CLEAN. INT. CL. 3. REG. 9-14-1982.
- 1,207,745. MACASSAR ROCHAS. INT. CL. 3. REG. 9-14-1982.
- 1,207,746. E-PHICIENT (STYLIZED). INT. CLS. 3 AND 4. REG. 9-14-1982.
- 1,207,749. PEARL FRESH. INT. CL. 3. REG. 9-14-1982.
- 1,207,752. P PEOPLES (STYLIZED). INT. CLS. 3 AND 5. REG. 9-14-1982.
- 1,207,755. PINE CROWN. INT. CL. 3. REG. 9-14-1982.
- 1,207,756. PORTOS. INT. CL. 3. REG. 9-14-1982.
- 1,207,759. DAMIEN. INT. CL. 3. REG. 9-14-1982.
- 1,207,760. ALUMI-GLO. INT. CL. 3. REG. 9-14-1982.
- 1,207,761. BOWL POWER. INT. CL. 3. REG. 9-14-1982.
- 1,207,764. POND'S PLUS. INT. CL. 3. REG. 9-14-1982.
- 1,207,768. MISTER VALET. INT. CL. 3. REG. 9-14-1982.
- 1,207,773. EASY-DRILL. INT. CL. 4. REG. 9-14-1982.
- 1,207,775. C (STYLIZED). INT. CL. 4. REG. 9-14-1982.
- 1,207,777. MERIT. INT. CL. 5. REG. 9-14-1982.
- 1,207,782. HEALTH CROSS AND DESIGN. INT. CL. 5. REG. 9-14-1982.
- 1,207,785. NEUTROGENA. INT. CL. 5. REG. 9-14-1982.
- 1,207,786. PROTAXOLIN. INT. CL. 5. REG. 9-14-1982.
- 1,207,798. STATE FORMULA 296. INT. CL. 5. REG. 9-14-1982.
- 1,207,805. SOLUJECT. INT. CL. 5. REG. 9-14-1982.
- 1,207,806. DURALYTE-S. INT. CL. 5. REG. 9-14-1982.
- 1,207,814. MAXIM-ALL. INT. CL. 5. REG. 9-14-1982.
- 1,207,816. VEGE-VITA-MIN. INT. CL. 5. REG. 9-14-1982.
- 1,207,818. WALT DE LAND'S. INT. CL. 5. REG. 9-14-1982.
- 1,207,819. VERAMIL. INT. CL. 5. REG. 9-14-1982.
- 1,207,820. TESTOSEX. INT. CL. 5. REG. 9-14-1982.
- 1,207,821. INFER-TEC. INT. CL. 5. REG. 9-14-1982.
- 1,207,822. OPTIPAQUE. INT. CL. 5. REG. 9-14-1982.
- 1,207,827. KNIPPING. INT. CL. 6. REG. 9-14-1982.
- 1,207,829. MISCELLANEOUS DESIGN. INT. CL. 6. REG. 9-14-1982.
- 1,207,851. LYFALUM. INT. CL. 6. REG. 9-14-1982.
- 1,207,853. ALUMINATE. INT. CL. 6. REG. 9-14-1982.
- 1,207,858. MU AND DESIGN. INT. CL. 7. REG. 9-14-1982.
- 1,207,862. K-LECTABLE (STYLIZED). INT. CLS. 7 AND 11. REG. 9-14-1982.
- 1,207,864. SANI-CAP. INT. CL. 7. REG. 9-14-1982.
- 1,207,874. GOTTSCHO PULSE-JET. INT. CL. 7. REG. 9-14-1982.
- 1,207,875. JIFFY (STYLIZED). INT. CLS. 7 AND 8. REG. 9-14-1982.
- 1,207,877. WATER BUG. INT. CL. 7. REG. 9-14-1982.
- 1,207,884. PETROSYSTEMS. INT. CL. 7. REG. 9-14-1982.
- 1,207,887. PRO=FLO AND DESIGN. INT. CL. 7. REG. 9-14-1982.
- 1,207,888. JP AND DESIGN. INT. CL. 7. REG. 9-14-1982.
- 1,207,889. MINI-ORBIT. INT. CL. 7. REG. 9-14-1982.
- 1,207,900. JOHNSON TAPPETS AND DESIGN. INT. CL. 7. REG. 9-14-1982.
- 1,207,901. EASY-TEST. INT. CLS. 8, 9, 11, 12 AND 17. REG. 9-14-1982.
- 1,207,902. A A ACE AND DESIGN. INT. CLS. 8, 16 AND 28. REG. 9-14-1982.
- 1,207,906. PROTECTOR. INT. CL. 8. REG. 9-14-1982.
- 1,207,908. COCK FIGHTER. INT. CL. 8. REG. 9-14-1982.
- 1,207,912. HELM AND DESIGN. INT. CLS. 9 AND 42. REG. 9-14-1982.
- 1,207,914. INSTA-CALL. INT. CL. 9. REG. 9-14-1982.
- 1,207,919. CYTOSPIN (STYLIZED). INT. CL. 9. REG. 9-14-1982.
- 1,207,922. QICPLAN. INT. CL. 9. REG. 9-14-1982.
- 1,207,924. BMS. INT. CLS. 9, 10 AND 21. REG. 9-14-1982.
- 1,207,925. BIOPAK. INT. CL. 9. REG. 9-14-1982.
- 1,207,926. BIOPAK 45 AND DESIGN. INT. CL. 9. REG. 9-14-1982.
- 1,207,927. BIOPAK 60. INT. CL. 9. REG. 9-14-1982.
- 1,207,932. HITE SYSTEM. INT. CL. 9. REG. 9-14-1982.
- 1,207,935. ALFATRONIC. INT. CL. 9. REG. 9-14-1982.
- 1,207,937. TOMORROW'S CONCEPTS TODAY AND DESIGN. INT. CL. 9. REG. 9-14-1982.
- 1,207,943. EIL. INT. CL. 9. REG. 9-14-1982.
- 1,207,947. ELECTRO-TACH. INT. CL. 9. REG. 9-14-1982.
- 1,207,948. THE AIR YOU WEAR. INT. CL. 9. REG. 9-14-1982.
- 1,207,951. SNOWEE. INT. CLS. 9 AND 22. REG. 9-14-1982.
- 1,207,952. N (STYLIZED). INT. CL. 9. REG. 9-14-1982.
- 1,207,958. NANOMETRICS AND DESIGN. INT. CL. 9. REG. 9-14-1982.
- 1,207,964. EAT RECORDS (STYLIZED). INT. CL. 9. REG. 9-14-1982.
- 1,207,970. OAKLEAF AND DESIGN. INT. CL. 9. REG. 9-14-1982.
- 1,207,982. CITATION. INT. CL. 9. REG. 9-14-1982.
- 1,207,987. SLIDER PAK (STYLIZED). INT. CL. 9. REG. 9-14-1982.
- 1,207,991. RTA WELDING (STYLIZED). INT. CL. 9. REG. 9-14-1982.
- 1,207,993. ACCESS. INT. CL. 9. REG. 9-14-1982.
- 1,207,995. LEVELSURE. INT. CL. 9. REG. 9-14-1982.
- 1,208,003. RINTO AND DESIGN. INT. CL. 9. REG. 9-14-1982.
- 1,208,004. FYRIZER. INT. CL. 9. REG. 9-14-1982.
- 1,208,005. FYRIZER (STYLIZED). INT. CL. 9. REG. 9-14-1982.
- 1,208,008. CIRCLE OF CONFIDENCE. INT. CL. 9. REG. 9-14-1982.
- 1,208,010. VIDEO-PAK. INT. CL. 9. REG. 9-14-1982.
- 1,208,012. PAC III. INT. CL. 9. REG. 9-14-1982.
- 1,208,013. VICOAX. INT. CL. 9. REG. 9-14-1982.
- 1,208,015. NYLOR ULTRA. INT. CL. 9. REG. 9-14-1982.
- 1,208,019. WV (STYLIZED). INT. CL. 9. REG. 9-14-1982.
- 1,208,023. KSHEL. INT. CL. 9. REG. 9-14-1982.
- 1,208,024. PIONEER ARTISTS AND DESIGN. INT. CL. 9. REG. 9-14-1982.
- 1,208,025. UNGERMANN-BASS (STYLIZED). INT. CL. 9. REG. 9-14-1982.
- 1,208,027. PROTEON. INT. CL. 9. REG. 9-14-1982.
- 1,208,039. PANAPOT (STYLIZED). INT. CL. 9. REG. 9-14-1982.
- 1,208,040. 895. INT. CL. 9. REG. 9-14-1982.
- 1,208,042. ANACON. INT. CL. 9. REG. 9-14-1982.
- 1,208,045. PAR. INT. CL. 10. REG. 9-14-1982.
- 1,208,048. CAM. INT. CL. 10. REG. 9-14-1982.

- 1,208,052. VIVONEX. INT. CL. 10. REG. 9-14-1982.
 1,208,054. MOLEX. INT. CL. 10. REG. 9-14-1982.
 1,208,055. FORCE 9 AND DESIGN. INT. CL. 10. REG. 9-14-1982.
 1,208,058. VISI-TUBE (STYLIZED). INT. CL. 10. REG. 9-14-1982.
 1,208,060. CLEAR-VIEW. INT. CL. 10. REG. 9-14-1982.
 1,208,064. FEM-CATH. INT. CL. 10. REG. 9-14-1982.
 1,208,065. BRACIA-CATH. INT. CL. 10. REG. 9-14-1982.
 1,208,068. SHADOW-STRIPES. INT. CL. 10. REG. 9-14-1982.
 1,208,069. AUTIMA. INT. CL. 10. REG. 9-14-1982.
 1,208,070. HEALTH FOAM. INT. CL. 10. REG. 9-14-1982.
 1,208,075. DEPEND. INT. CL. 10. REG. 9-14-1982.
 1,208,082. COLODRESS. INT. CL. 10. REG. 9-14-1982.
 1,208,083. ZYPLAST. INT. CL. 10. REG. 9-14-1982.
 1,208,084. PDF-20. INT. CL. 10. REG. 9-14-1982.
 1,208,085. ECONACRYL. INT. CL. 10. REG. 9-14-1982.
 1,208,088. VERTI-LIFT. INT. CL. 10. REG. 9-14-1982.
 1,208,089. DYNATRAK. INT. CLS. 10 AND 16. REG. 9-14-1982.
 1,208,099. ENERGY MARSHAL. INT. CL. 11. REG. 9-14-1982.
 1,208,101. EICHEN-RIPPLE. INT. CL. 11. REG. 9-14-1982.
 1,208,102. EICHEN ZIG-ZAG. INT. CL. 11. REG. 9-14-1982.
 1,208,106. FERONAL. INT. CL. 11. REG. 9-14-1982.
 1,208,110. HOMESTEAD CEILING FANS. INT. CL. 11. REG. 9-14-1982.
 1,208,111. FEMIA. INT. CL. 11. REG. 9-14-1982.
 1,208,112. METALFLEX. INT. CL. 11. REG. 9-14-1982.
 1,208,117. MINI-BRUTE. INT. CL. 11. REG. 9-14-1982.
 1,208,122. TOWNE HOUSE. INT. CL. 11. REG. 9-14-1982.
 1,208,126. LUGGIN' BUGGY (STYLIZED). INT. CL. 12. REG. 9-14-1982.
 1,208,137. STEEL WORKER. INT. CL. 12. REG. 9-14-1982.
 1,208,138. AUTO PORT. INT. CL. 12. REG. 9-14-1982.
 1,208,141. POZ-E-POWER. INT. CL. 12. REG. 9-14-1982.
 1,208,143. HELICOMATIC. INT. CL. 12. REG. 9-14-1982.
 1,208,146. PEDAL PUSHERS. INT. CL. 12. REG. 9-14-1982.
 1,208,161. DURA-KLAD (STYLIZED). INT. CL. 14. REG. 9-14-1982.
 1,208,163. COLLECTION CONCEPTS FROM MONET. INT. CL. 14. REG. 9-14-1982.
 1,208,174. GOLDDIGGERS. INT. CLS. 14 AND 42. REG. 9-14-1982.
 1,208,175. SHERMAN'S. INT. CL. 15. REG. 9-14-1982.
 1,208,176. SHARKFIN AND DESIGN. INT. CL. 15. REG. 9-14-1982.
 1,208,178. KAMFLON. INT. CL. 15. REG. 9-14-1982.
 1,208,185. FARMSTEAD MAGAZINE. INT. CL. 16. REG. 9-14-1982.
 1,208,186. BIG BEAUTIFUL WOMAN. INT. CL. 16. REG. 9-14-1982.
 1,208,191. THE WORKSHOP SCHEDULE. INT. CL. 16. REG. 9-14-1982.
 1,208,195. DUN'S CENSUS OF AMERICAN BUSINESS. INT. CL. 16. REG. 9-14-1982.
 1,208,201. BABSON'S. INT. CL. 16. REG. 9-14-1982.
 1,208,206. TWO MINUTES WITH. INT. CL. 16. REG. 9-14-1982.
 1,208,207. RAIL-BACK. INT. CL. 16. REG. 9-14-1982.
 1,208,211. FINS AND FEATHERS (STYLIZED). INT. CL. 16. REG. 9-14-1982.
 1,208,212. POOR BOY OIL CO.. INT. CL. 16. REG. 9-14-1982.
 1,208,213. WP AND DESIGN. INT. CLS. 16 AND 20. REG. 9-14-1982.
 1,208,214. PENN PRINT (STYLIZED). INT. CL. 16. REG. 9-14-1982.
 1,208,221. SHOPPING DAYS (STYLIZED). INT. CL. 16. REG. 9-14-1982.
 1,208,223. VISPATCH. INT. CL. 16. REG. 9-14-1982.
 1,208,224. FORMOST (STYLIZED). INT. CL. 16. REG. 9-14-1982.
 1,208,226. MINOLTA CONTACT SHEET. INT. CL. 16. REG. 9-14-1982.
 1,208,233. BONIFLEX. INT. CL. 16. REG. 9-14-1982.
 1,208,237. REMARK. INT. CL. 16. REG. 9-14-1982.
 1,208,239. MINI-RITER. INT. CL. 16. REG. 9-14-1982.
 1,208,246. CE AND DESIGN. INT. CL. 16. REG. 9-14-1982.
 1,208,258. DEAR MEG. INT. CL. 16. REG. 9-14-1982.
 1,208,260. CRC PRESS AND DESIGN. INT. CL. 16. REG. 9-14-1982.
 1,208,274. THE SCRIBNER LIBRARY AND DESIGN. INT. CL. 16. REG. 9-14-1982.
 1,208,275. SCRIBNERS AND DESIGN. INT. CL. 16. REG. 9-14-1982.
 1,208,277. LITTLE PEOPLE'S WORKSHOP AND DESIGN. INT. CL. 16. REG. 9-14-1982.
 1,208,281. FORWARD (STYLIZED). INT. CL. 16. REG. 9-14-1982.
 1,208,285. SURGITALK. INT. CL. 16. REG. 9-14-1982.
 1,208,286. COMICS SCENE. INT. CL. 16. REG. 9-14-1982.
 1,208,287. COMICS SCENE (STYLIZED). INT. CL. 16. REG. 9-14-1982.
 1,208,289. TRZ. INT. CL. 16. REG. 9-14-1982.
 1,208,291. GOOD YEAR AND DESIGN. INT. CL. 16. REG. 9-14-1982.
 1,208,293. SCM AND DESIGN. INT. CL. 16. REG. 9-14-1982.
 1,208,300. UPRIGHT (STYLIZED). INT. CL. 16. REG. 9-14-1982.
 1,208,309. LEGENDRY. INT. CL. 16. REG. 9-14-1982.
 1,208,313. UNDERSTANDING HEALTH. INT. CL. 16. REG. 9-14-1982.
 1,208,315. TIME: SYSTEMS AND DESIGN. INT. CL. 16. REG. 9-14-1982.
 1,208,318. INFO. INT. CL. 16. REG. 9-14-1982.
 1,208,319. SENTRY AND DESIGN. INT. CL. 16. REG. 9-14-1982.
 1,208,323. THE WATCHTOWER, ANNOUNCING JEHOVAH'S KINGDOM AND DESIGN. INT. CL. 16. REG. 9-14-1982.
 1,208,325. WONDER WOMAN (STYLIZED). INT. CL. 16. REG. 9-14-1982.
 1,208,326. DU BONNET. INT. CL. 16. REG. 9-14-1982.
 1,208,327. CLAREMONT. INT. CL. 16. REG. 9-14-1982.
 1,208,328. HEAT TREATING. INT. CL. 16. REG. 9-14-1982.
 1,208,329. SOLIDUR (STYLIZED). INT. CL. 17. REG. 9-14-1982.
 1,208,330. NOMACO INC. N (STYLIZED). INT. CL. 17. REG. 9-14-1982.
 1,208,333. SORBOTHANE. INT. CL. 17. REG. 9-14-1982.
 1,208,334. WIREFLEX (STYLIZED). INT. CL. 17. REG. 9-14-1982.
 1,208,335. SINGLE SEALER. INT. CL. 17. REG. 9-14-1982.
 1,208,336. POLYGROOVE (STYLIZED). INT. CL. 17. REG. 9-14-1982.
 1,208,340. TUFFLAM. INT. CL. 17. REG. 9-14-1982.
 1,208,341. FLEXTRA. INT. CL. 17. REG. 9-14-1982.
 1,208,343. DURA-POL. INT. CL. 17. REG. 9-14-1982.
 1,208,345. SOLARFIL. INT. CL. 17. REG. 9-14-1982.
 1,208,347. POLAPROOF. INT. CL. 17. REG. 9-14-1982.
 1,208,355. THERMA-COTE AND DESIGN. INT. CL. 17. REG. 9-14-1982.
 1,208,360. GEAR (STYLIZED). INT. CLS. 18 AND 28. REG. 9-14-1982.
 1,208,361. MISCELLANEOUS DESIGN. INT. CLS. 18, 25 AND 28. REG. 9-14-1982.
 1,208,364. E AND DESIGN. INT. CL. 18. REG. 9-14-1982.
 1,208,365. COUNTY COMPETITOR. INT. CLS. 18 AND 25. REG. 9-14-1982.
 1,208,380. CONTEMPRA-CLAD. INT. CL. 19. REG. 9-14-1982.
 1,208,384. CEDAR SELECT (STYLIZED). INT. CL. 19. REG. 9-14-1982.
 1,208,385. LIFETILE. INT. CL. 19. REG. 9-14-1982.
 1,208,387. AMGLAS AND DESIGN. INT. CL. 19. REG. 9-14-1982.
 1,208,404. STANFIELD SHUTTER CO., INC. SS (STYLIZED). INT. CL. 19. REG. 9-14-1982.
 1,208,411. WHEATON OAK. INT. CL. 20. REG. 9-14-1982.
 1,208,413. GORDIE HOWE'S PET PUCK (STYLIZED). INT. CL. 20. REG. 9-14-1982.
 1,208,414. PC AND DESIGN. INT. CL. 20. REG. 9-14-1982.
 1,208,416. THE PROBLEM CAN (STYLIZED). INT. CL. 20. REG. 9-14-1982.
 1,208,418. ROTOBED. INT. CL. 20. REG. 9-14-1982.

- 1,208,419. DISCOVERY (STYLIZED). INT. CL. 20. REG. 9-14-1982.
- 1,208,422. FACELIFTERS (STYLIZED). INT. CLS. 20 AND 37. REG. 9-14-1982.
- 1,208,431. DURA.RICH AND DESIGN. INT. CL. 20. REG. 9-14-1982.
- 1,208,432. END LITE. INT. CL. 20. REG. 9-14-1982.
- 1,208,433. PYROGUARD. INT. CL. 20. REG. 9-14-1982.
- 1,208,436. RAZ-L/DAZ-L. INT. CL. 20. REG. 9-14-1982.
- 1,208,438. AMBIANCE. INT. CL. 21. REG. 9-14-1982.
- 1,208,439. BONNE AUBERGE. INT. CL. 21. REG. 9-14-1982.
- 1,208,444. KELTCRAFT AND DESIGN. INT. CL. 21. REG. 9-14-1982.
- 1,208,449. COLUMBIA GREENHOUSE. INT. CLS. 21 AND 31. REG. 9-14-1982.
- 1,208,460. MISCELLANEOUS DESIGN. INT. CL. 21. REG. 9-14-1982.
- 1,208,461. DURANGO. INT. CL. 21. REG. 9-14-1982.
- 1,208,462. CALVERT COVE. INT. CL. 21. REG. 9-14-1982.
- 1,208,465. ICE ICE AND DESIGN. INT. CL. 22. REG. 9-14-1982.
- 1,208,466. ZIPPY PAC (STYLIZED). INT. CL. 22. REG. 9-14-1982.
- 1,208,467. MINITITE. INT. CL. 22. REG. 9-14-1982.
- 1,208,468. STA.SET. INT. CL. 22. REG. 9-14-1982.
- 1,208,469. DA-PRO. INT. CL. 22. REG. 9-14-1982.
- 1,208,471. SALUKI (STYLIZED). INT. CL. 23. REG. 9-14-1982.
- 1,208,472. BAYTEX. INT. CL. 23. REG. 9-14-1982.
- 1,208,475. HONEY BEAR AND DESIGN. INT. CLS. 24 AND 25. REG. 9-14-1982.
- 1,208,476. RUBY QUEEN. INT. CL. 24. REG. 9-14-1982.
- 1,208,478. GRILL TO ORDER AND DESIGN. INT. CLS. 24, 25 AND 30. REG. 9-14-1982.
- 1,208,481. TOLEX II. INT. CL. 24. REG. 9-14-1982.
- 1,208,485. AMERGLO. INT. CL. 24. REG. 9-14-1982.
- 1,208,488. EPIC. INT. CL. 24. REG. 9-14-1982.
- 1,208,489. CCCC (STYLIZED). INT. CL. 24. REG. 9-14-1982.
- 1,208,491. WICKLOW. INT. CL. 24. REG. 9-14-1982.
- 1,208,493. FEATHER SUEDE. INT. CL. 24. REG. 9-14-1982.
- 1,208,494. LUXOR. INT. CLS. 24 AND 27. REG. 9-14-1982.
- 1,208,499. COMFORT ZONE. INT. CL. 24. REG. 9-14-1982.
- 1,208,500. DISPOSAGUARD. INT. CL. 24. REG. 9-14-1982.
- 1,208,504. GABY. INT. CL. 25. REG. 9-14-1982.
- 1,208,506. GALERIES LAFAYETTE. INT. CL. 25. REG. 9-14-1982.
- 1,208,518. CHRISTIAN DIOR SPORT. INT. CL. 25. REG. 9-14-1982.
- 1,208,522. BTL. INT. CL. 25. REG. 9-14-1982.
- 1,208,524. THE WOOLRICH WOMAN AND DESIGN. INT. CL. 25. REG. 9-14-1982.
- 1,208,527. "THE ONEHOLER" AND DESIGN. INT. CL. 25. REG. 9-14-1982.
- 1,208,530. SENSUETTES. INT. CL. 25. REG. 9-14-1982.
- 1,208,539. ACT-I. INT. CL. 25. REG. 9-14-1982.
- 1,208,540. THIMBLES (STYLIZED). INT. CL. 25. REG. 9-14-1982.
- 1,208,548. PLAYSKIN. INT. CL. 25. REG. 9-14-1982.
- 1,208,554. BONNE PETITE (STYLIZED). INT. CL. 25. REG. 9-14-1982.
- 1,208,559. ZINNIA. INT. CL. 25. REG. 9-14-1982.
- 1,208,561. LAWMAN THE ACTION JEANS. INT. CL. 25. REG. 9-14-1982.
- 1,208,573. MISS GARLAND. INT. CL. 25. REG. 9-14-1982.
- 1,208,574. LIGHT MY FIRE AND DESIGN. INT. CL. 25. REG. 9-14-1982.
- 1,208,576. SEA TRACS AND DESIGN. INT. CL. 25. REG. 9-14-1982.
- 1,208,587. SARA JEAN. INT. CL. 25. REG. 9-14-1982.
- 1,208,588. CACTUS FLOWER. INT. CL. 25. REG. 9-14-1982.
- 1,208,593. SPORTSTYLE. INT. CL. 25. REG. 9-14-1982.
- 1,208,594. EXEC. INT. CL. 25. REG. 9-14-1982.
- 1,208,596. THE T. BARRY KNICKER CO. (STYLIZED). INT. CL. 25. REG. 9-14-1982.
- 1,208,603. WHOPPER TOPPER. INT. CL. 26. REG. 9-14-1982.
- 1,208,609. QUANTUM. INT. CL. 27. REG. 9-14-1982.
- 1,208,621. JET STEP. INT. CL. 28. REG. 9-14-1982.
- 1,208,637. SEA SEARCH. INT. CL. 28. REG. 9-14-1982.
- 1,208,639. ORDA. INT. CL. 28. REG. 9-14-1982.
- 1,208,645. HANDY GIRLS AND DESIGN. INT. CL. 28. REG. 9-14-1982.
- 1,208,646. REV'EM UP RACER (STYLIZED). INT. CL. 28. REG. 9-14-1982.
- 1,208,649. MUSCLE WHEELS. INT. CL. 28. REG. 9-14-1982.
- 1,208,656. GREAT WHITE. INT. CL. 28. REG. 9-14-1982.
- 1,208,657. GAMMA-GRAPHITE (STYLIZED). INT. CL. 28. REG. 9-14-1982.
- 1,208,665. HAVABALL. INT. CL. 28. REG. 9-14-1982.
- 1,208,667. GOLD (STYLIZED). INT. CL. 28. REG. 9-14-1982.
- 1,208,670. PACIFICSTIK AND DESIGN. INT. CL. 28. REG. 9-14-1982.
- 1,208,672. SRX 3. INT. CL. 28. REG. 9-14-1982.
- 1,208,673. CHAIRMAN. INT. CL. 28. REG. 9-14-1982.
- 1,208,674. RIGHT TACKLE. INT. CL. 28. REG. 9-14-1982.
- 1,208,675. WORD POWER. INT. CL. 28. REG. 9-14-1982.
- 1,208,679. EASY OUT. INT. CL. 28. REG. 9-14-1982.
- 1,208,680. D-20. INT. CL. 28. REG. 9-14-1982.
- 1,208,683. SOLID GEOMETRY. INT. CL. 28. REG. 9-14-1982.
- 1,208,684. FIREBALL. INT. CL. 28. REG. 9-14-1982.
- 1,208,701. WILDCATTER. INT. CL. 28. REG. 9-14-1982.
- 1,208,702. WILSON STING. INT. CL. 28. REG. 9-14-1982.
- 1,208,711. LEGACY. INT. CL. 28. REG. 9-14-1982.
- 1,208,720. ACCUBAR GOLD. INT. CL. 28. REG. 9-14-1982.
- 1,208,721. GAMMA WORLD. INT. CL. 28. REG. 9-14-1982.
- 1,208,727. MISCELLANEOUS DESIGN. INT. CL. 29. REG. 9-14-1982.
- 1,208,730. RED*RIVER AND DESIGN. INT. CL. 29. REG. 9-14-1982.
- 1,208,731. CERTI-FRESH AND DESIGN. INT. CL. 29. REG. 9-14-1982.
- 1,208,733. BRAZILIAN SEAFOOD MARKETING ASSOCIATES. INT. CL. 29. REG. 9-14-1982.
- 1,208,734. BRASMAR BRAZILIAN SEAFOOD MARKETING ASSOCIATES AND DESIGN. INT. CL. 29. REG. 9-14-1982.
- 1,208,735. BRASMAR. INT. CL. 29. REG. 9-14-1982.
- 1,208,742. SKINNY HAVEN, THE HEALTHY PLACE AND DESIGN. INT. CLS. 29, 30 AND 42. REG. 9-14-1982.
- 1,208,743. OCEAN SHELL AND DESIGN. INT. CL. 29. REG. 9-14-1982.
- 1,208,746. NOAH'S ARK AND DESIGN. INT. CL. 29. REG. 9-14-1982.
- 1,208,750. TACO TIME AND DESIGN. INT. CLS. 29, 30 AND 32. REG. 9-14-1982.
- 1,208,752. CHURCH'S FRIED CHICKEN. INT. CL. 29. REG. 9-14-1982.
- 1,208,755. REACH FOR THE SPOON. INT. CL. 29. REG. 9-14-1982.
- 1,208,763. MISCELLANEOUS DESIGN. INT. CL. 30. REG. 9-14-1982.
- 1,208,764. SHOTZELS (STYLIZED). INT. CL. 30. REG. 9-14-1982.
- 1,208,765. THE COOKIE STOP AND DESIGN. INT. CL. 30. REG. 9-14-1982.
- 1,208,768. SPICE TIME. INT. CLS. 30 AND 31. REG. 9-14-1982.
- 1,208,771. MISCELLANEOUS DESIGN. INT. CL. 30. REG. 9-14-1982.
- 1,208,772. TRIPLE. INT. CL. 30. REG. 9-14-1982.
- 1,208,775. CASA FLORES TORTILLAS AND DESIGN. INT. CL. 30. REG. 9-14-1982.
- 1,208,776. HAZELWOOD FARMS AND DESIGN. INT. CL. 30. REG. 9-14-1982.
- 1,208,781. GELATO CLASSICO (STYLIZED). INT. CL. 30. REG. 9-14-1982.
- 1,208,783. SCHWAN'S AND DESIGN. INT. CL. 30. REG. 9-14-1982.
- 1,208,785. TOFFYPOPS. INT. CL. 30. REG. 9-14-1982.
- 1,208,786. COUNTRY APPLE. INT. CL. 30. REG. 9-14-1982.
- 1,208,791. POPSICLE LITE. INT. CL. 30. REG. 9-14-1982.
- 1,208,794. START-N-GRO. INT. CL. 31. REG. 9-14-1982.
- 1,208,795. TRIUMPH. INT. CL. 31. REG. 9-14-1982.
- 1,208,809. CLASSY LASSIE. INT. CL. 31. REG. 9-14-1982.
- 1,208,814. PRIDE AND DESIGN. INT. CL. 31. REG. 9-14-1982.

- 1,208,816. LEE ANN'S. INT. CL. 31. REG. 9-14-1982.
 1,208,817. DANDY. INT. CL. 31. REG. 9-14-1982.
 1,208,818. STAR LINE. INT. CL. 31. REG. 9-14-1982.
 1,208,820. PUSH UP AND DESIGN. INT. CL. 31. REG. 9-14-1982.
 1,208,822. MISCELLANEOUS DESIGN. INT. CL. 31. REG. 9-14-1982.
 1,208,825. GAGAN. INT. CL. 31. REG. 9-14-1982.
 1,208,827. DWF AND DESIGN. INT. CL. 31. REG. 9-14-1982.
 1,208,828. DWF. INT. CL. 31. REG. 9-14-1982.
 1,208,829. REGAL. INT. CL. 31. REG. 9-14-1982.
 1,208,831. A REAL MASTERPIECE FROM HOLLAND. INT. CL. 32. REG. 9-14-1982.
 1,208,834. GOEBEL. INT. CL. 32. REG. 9-14-1982.
 1,208,839. ASKALON (STYLIZED). INT. CL. 33. REG. 9-14-1982.
 1,208,842. GREYTON HOYT. INT. CL. 33. REG. 9-14-1982.
 1,208,843. WALTER S. WHO?. INT. CL. 33. REG. 9-14-1982.
 1,208,847. JONATHAN. INT. CL. 33. REG. 9-14-1982.
 1,208,848. TORRALTA. INT. CL. 33. REG. 9-14-1982.
 1,208,852. WOODSMAN. INT. CL. 34. REG. 9-14-1982.
 1,208,854. PHARMACY PLUS. INT. CL. 35. REG. 9-14-1982.
 1,208,855. MISCELLANEOUS DESIGN. INT. CL. 35. REG. 9-14-1982.
 1,208,857. MISCELLANEOUS DESIGN. INT. CL. 35. REG. 9-14-1982.
 1,208,867. DECIDER. INT. CL. 35. REG. 9-14-1982.
 1,208,870. CUZZINS. INT. CL. 35. REG. 9-14-1982.
 1,208,872. I/A PUBLISHERS. INT. CL. 35. REG. 9-14-1982.
 1,208,873. CENTEL (STYLIZED). INT. CLS. 35, 38 AND 42. REG. 9-14-1982.
 1,208,875. SPRING.HOUSEHOLD SAVINGS. AND DESIGN. INT. CL. 35. REG. 9-14-1982.
 1,208,882. COMPU-CHECK A TOWNE- OLLER SERVICE. (STYLIZED). INT. CL. 35. REG. 9-14-1982.
 1,208,883. NRMA AND DESIGN. U.S. CLS. 200 AND 101. REG. 9-14-1982.
 1,208,884. TASCALL. INT. CL. 35. REG. 9-14-1982.
 1,208,885. MED-VERSE. INT. CL. 35. REG. 9-14-1982.
 1,208,887. PACE AND DESIGN. INT. CL. 35. REG. 9-14-1982.
 1,208,889. FRANCHISE SUPERMARKET. INT. CL. 35. REG. 9-14-1982.
 1,208,905. DON HOWARD PERSONNEL (STYLIZED). INT. CL. 35. REG. 9-14-1982.
 1,208,906. THE INCOME TAX STORE (STYLIZED). INT. CL. 35. REG. 9-14-1982.
 1,208,912. W (STYLIZED). INT. CL. 35. REG. 9-14-1982.
 1,208,928. UNITED FARM REAL ESTATE AND DESIGN. INT. CL. 36. REG. 9-14-1982.
 1,208,930. PAY-GROW. INT. CL. 36. REG. 9-14-1982.
 1,208,932. CCM (STYLIZED). INT. CL. 36. REG. 9-14-1982.
 1,208,934. DIRECT APPROACH. INT. CL. 36. REG. 9-14-1982.
 1,208,937. CENTRAL FIDELITY. INT. CL. 36. REG. 9-14-1982.
 1,208,938. GILL & DUFFUS GROUP AND DESIGN. INT. CL. 36. REG. 9-14-1982.
 1,208,951. CHICAGO LOVES ITS LAKE SHORE. INT. CL. 36. REG. 9-14-1982.
 1,208,953. CHROMACOPI. INT. CL. 36. REG. 9-14-1982.
 1,208,954. F AND DESIGN. INT. CL. 36. REG. 9-14-1982.
 1,208,961. CORPORATE LIFE CYCLE AND DESIGN. INT. CL. 36. REG. 9-14-1982.
 1,208,963. CENTRAL CASH. INT. CL. 36. REG. 9-14-1982.
 1,208,965. HOME GROWN. MONEY. AND DESIGN. INT. CL. 36. REG. 9-14-1982.
 1,208,966. HOME GROWN MONEY. INT. CL. 36. REG. 9-14-1982.
 1,208,974. BACHE THE WINNING ATTITUDE AND DESIGN. INT. CL. 36. REG. 9-14-1982.
 1,208,977. MIDCO. INT. CL. 36. REG. 9-14-1982.
 1,208,978. PERFORMANCE BANKING. INT. CL. 36. REG. 9-14-1982.
 1,208,980. RRS READY RETIREMENT SYSTEM (STYLIZED). INT. CL. 36. REG. 9-14-1982.
 1,208,982. CITISENIORS. INT. CL. 36. REG. 9-14-1982.
 1,208,983. AT (STYLIZED). INT. CLS. 36 AND 37. REG. 9-14-1982.
 1,208,984. S AND DESIGN. INT. CL. 36. REG. 9-14-1982.
 1,208,990. LITELAB (STYLIZED). INT. CLS. 37, 41 AND 42. REG. 9-14-1982.
 1,208,991. CAMCO CONSTRUCTION COMPANY. INT. CLS. 37 AND 42. REG. 9-14-1982.
 1,209,000. WE CAN EXTERMINATE ANY BUG IN THE WORLD EXCEPT THE LITTER BUG!. INT. CL. 37. REG. 9-14-1982.
 1,209,004. BIS AND DESIGN. INT. CL. 37. REG. 9-14-1982.
 1,209,015. MISCELLANEOUS DESIGN. INT. CL. 37. REG. 9-14-1982.
 1,209,020. THE HEART OF GOLD WVOR FM100 AND DESIGN. INT. CL. 38. REG. 9-14-1982.
 1,209,021. THE HEART OF GOLD AND DESIGN. INT. CL. 38. REG. 9-14-1982.
 1,209,024. SAT-PHONE. INT. CL. 38. REG. 9-14-1982.
 1,209,026. MISCELLANEOUS DESIGN. INT. CL. 38. REG. 9-14-1982.
 1,209,040. GENERATION 2. INT. CL. 39. REG. 9-14-1982.
 1,209,042. YOU DESERVE NATIONAL ATTENTION. INT. CL. 39. REG. 9-14-1982.
 1,209,043. PULLING FOR PROGRESS. INT. CL. 39. REG. 9-14-1982.
 1,209,048. CAN-AM. INT. CL. 39. REG. 9-14-1982.
 1,209,049. CAN-AM AND DESIGN. INT. CL. 39. REG. 9-14-1982.
 1,209,050. METROPOOL. INT. CL. 39. REG. 9-14-1982.
 1,209,053. B (STYLIZED). INT. CL. 39. REG. 9-14-1982.
 1,209,054. BLAZE MESSENGER SERVICE. INT. CL. 39. REG. 9-14-1982.
 1,209,058. COOPERS. INT. CL. 39. REG. 9-14-1982.
 1,209,062. TSL AND DESIGN. INT. CL. 39. REG. 9-14-1982.
 1,209,064. FIRSTWAY. INT. CL. 39. REG. 9-14-1982.
 1,209,068. POLORIT. INT. CL. 40. REG. 9-14-1982.
 1,209,070. MUSICOLOR. INT. CLS. 40 AND 41. REG. 9-14-1982.
 1,209,072. RO/CO AND DESIGN. INT. CL. 40. REG. 9-14-1982.
 1,209,074. MISCELLANEOUS DESIGN. INT. CL. 40. REG. 9-14-1982.
 1,209,075. JET-DRI. INT. CL. 40. REG. 9-14-1982.
 1,209,077. AUTEK. INT. CL. 40. REG. 9-14-1982.
 1,209,078. FONT CLINIC. INT. CL. 40. REG. 9-14-1982.
 1,209,085. PDI PROFESSIONAL DEVELOPMENT INSTITUTE (STYLIZED). INT. CL. 41. REG. 9-14-1982.
 1,209,090. JB AWARDS. INT. CL. 41. REG. 9-14-1982.
 1,209,091. VIDEO VILLAGE AND DESIGN. INT. CLS. 41 AND 42. REG. 9-14-1982.
 1,209,092. INTERNATIONAL GUILD OF MINIATURE ARTISANS LTD FELLOW FOUNDED 1979 G AND DESIGN. INT. CL. 41. REG. 9-14-1982.
 1,209,098. MOTORCON. INT. CL. 41. REG. 9-14-1982.
 1,209,107. MISS T.E.E.N. THE QUALITY PAGEANT FOR QUALITY GIRLS TEENS ENCOURAGING EXCELLENCE NATIONALLY AND DESIGN. INT. CL. 41. REG. 9-14-1982.
 1,209,108. MISCELLANEOUS DESIGN. INT. CL. 41. REG. 9-14-1982.
 1,209,115. UNIVERSITY OF NORTH DAKOTA 1883 LUX ET LEX AND DESIGN. INT. CL. 41. REG. 9-14-1982.
 1,209,116. UNIVERSITY OF NORTH DAKOTA 1883 LUX ET LEX AND DESIGN. INT. CL. 41. REG. 9-14-1982.
 1,209,124. ARCHIMEDES. INT. CL. 41. REG. 9-14-1982.
 1,209,131. GETTING THERE (AND ENJOYING IT). INT. CL. 41. REG. 9-14-1982.
 1,209,138. UA. INT. CL. 41. REG. 9-14-1982.
 1,209,139. UNIVERSITY ASSOCIATES. INT. CL. 41. REG. 9-14-1982.
 1,209,146. GEM. INT. CL. 41. REG. 9-14-1982.
 1,209,149. MASON-DIXON. INT. CL. 41. REG. 9-14-1982.
 1,209,153. SDI. INT. CL. 41. REG. 9-14-1982.
 1,209,154. 20/20 (STYLIZED). INT. CL. 41. REG. 9-14-1982.
 1,209,163. WAFFLE HOUSE OF AMERICA. INT. CL. 42. REG. 9-14-1982.
 1,209,169. USE INC. AND DESIGN. INT. CL. 42. REG. 9-14-1982.

- 1,209,170. SPARKY SAYS-CRAWL LOW IN SMOKE AND DESIGN. INT. CL. 42. REG. 9-14-1982.
- 1,209,173. AM AND DESIGN. INT. CL. 42. REG. 9-14-1982.
- 1,209,174. STAT. INT. CL. 42. REG. 9-14-1982.
- 1,209,175. STAT HEALTH SERVICES AND DESIGN. INT. CL. 42. REG. 9-14-1982.
- 1,209,179. CRIB N' CRADLE. INT. CL. 42. REG. 9-14-1982.
- 1,209,181. DESIGN 2. INT. CL. 42. REG. 9-14-1982.
- 1,209,182. NAPA AND DESIGN. INT. CL. 42. REG. 9-14-1982.
- 1,209,184. COURTESY DRUGS. INT. CL. 42. REG. 9-14-1982.
- 1,209,185. WCG AND DESIGN. INT. CL. 42. REG. 9-14-1982.
- 1,209,187. THE PRODUCTIVITY FORUM. INT. CL. 42. REG. 9-14-1982.
- 1,209,188. THE GREAT SPECTACLE AND DESIGN. INT. CL. 42. REG. 9-14-1982.
- 1,209,189. THE GREAT SPECTACLE. INT. CL. 42. REG. 9-14-1982.
- 1,209,190. THE LADIES SPORTSWEAR DISCOUNTERS AND DESIGN. INT. CL. 42. REG. 9-14-1982.
- 1,209,192. STOCKMAN'S NATIONAL SUPPLY. INT. CL. 42. REG. 9-14-1982.
- 1,209,193. AI (STYLIZED). INT. CL. 42. REG. 9-14-1982.
- 1,209,194. ANDREWS. INT. CL. 42. REG. 9-14-1982.
- 1,209,196. AMERICAN-INTERNATIONAL BUS EXCHANGE. INT. CL. 42. REG. 9-14-1982.
- 1,209,201. STAUB'S. INT. CL. 42. REG. 9-14-1982.
- 1,209,202. BAXTER'S AND DESIGN. INT. CL. 42. REG. 9-14-1982.
- 1,209,204. CEL AND DESIGN. INT. CL. 42. REG. 9-14-1982.
- 1,209,206. CORNER CUPBOARD COOKBOOKS. INT. CL. 42. REG. 9-14-1982.
- 1,209,209. MISCELLANEOUS DESIGN. INT. CL. 42. REG. 9-14-1982.
- 1,209,210. KVB AND DESIGN. INT. CL. 42. REG. 9-14-1982.
- 1,209,212. BARGAIN WORLD. INT. CL. 42. REG. 9-14-1982.
- 1,209,216. SHEAR COMFORT. INT. CL. 42. REG. 9-14-1982.
- 1,209,219. GARO'S FAMOUS HOTDOGS. INT. CL. 42. REG. 9-14-1982.
- 1,209,220. GARO'S FAMOUS HOTDOGS AND DESIGN. INT. CL. 42. REG. 9-14-1982.
- 1,209,221. MISCELLANEOUS DESIGN. INT. CL. 42. REG. 9-14-1982.
- 1,209,224. DDD (STYLIZED). INT. CL. 42. REG. 9-14-1982.
- 1,209,228. DAY-N-NITE FOODS AND DESIGN. INT. CL. 42. REG. 9-14-1982.
- 1,209,229. MISCELLANEOUS DESIGN. INT. CL. 42. REG. 9-14-1982.
- 1,209,233. 'SFAVORITES (STYLIZED). INT. CL. 42. REG. 9-14-1982.
- 1,209,234. 'SFANTASTIC (STYLIZED). INT. CL. 42. REG. 9-14-1982.
- 1,209,235. 'SFABULOUS (STYLIZED). INT. CL. 42. REG. 9-14-1982.
- 1,209,236. ENGLISH ACCENTS. INT. CL. 42. REG. 9-14-1982.
- 1,209,237. DRAPEMAN TEXXTILE OUTLET. INT. CL. 42. REG. 9-14-1982.
- 1,209,242. THANKS TO YOU, IT WORKS. FOR ALL OF US.. INT. CL. 42. REG. 9-14-1982.
- 1,209,248. SPAGHETTERIA SPAGHETTATA "THE HOME OF THE FLAMING SPAGHETTI" AND DESIGN. INT. CL. 42. REG. 9-14-1982.
- 1,209,249. SPAGHETTERIA AND DESIGN. INT. CL. 42. REG. 9-14-1982.
- 1,209,258. COMPUFIT. INT. CL. 42. REG. 9-14-1982.
- 1,209,259. THE DINGHY PLACE AND DESIGN. INT. CL. 42. REG. 9-14-1982.
- 1,209,261. PEDAL PUSHERS AND DESIGN. INT. CL. 42. REG. 9-14-1982.
- 1,209,262. PEDAL PUSHERS. INT. CL. 42. REG. 9-14-1982.
- 1,209,263. IT'S MORE THAN JUST ANOTHER JEWELRY STORE. INT. CL. 42. REG. 9-14-1982.
- 1,209,269. MISCELLANEOUS DESIGN. INT. CL. 42. REG. 9-14-1982.
- 1,209,271. MR. B'S BEST. INT. CL. 42. REG. 9-14-1982.
- 1,209,272. MODERN M AND DESIGN. INT. CL. 42. REG. 9-14-1982.
- 1,209,273. GIULIANO'S DELICATESSEN AND DESIGN. INT. CL. 42. REG. 9-14-1982.
- 1,209,274. GOLDEN BIRD. INT. CL. 42. REG. 9-14-1982.
- 1,209,276. WALL TO WALL SOUND & VIDEO AND DESIGN. INT. CL. 42. REG. 9-14-1982.
- 1,209,277. JOLLY ROYAL R AND DESIGN. INT. CL. 42. REG. 9-14-1982.
- 1,209,279. MUSTANG MARKET AND DESIGN. INT. CL. 42. REG. 9-14-1982.
- 1,209,289. J AND DESIGN. INT. CL. 42. REG. 9-14-1982.
- 1,209,295. CNI AND DESIGN. INT. CL. 42. REG. 9-14-1982.
- 1,209,299. H. I. RIBSTER'S (STYLIZED). INT. CL. 42. REG. 9-14-1982.
- 1,209,300. KLUBMATES AND DESIGN. INT. CL. 42. REG. 9-14-1982.
- 1,209,301. WING WAGON AND DESIGN. INT. CL. 42. REG. 9-14-1982.
- 1,209,303. MISCELLANEOUS DESIGN. INT. CL. 42. REG. 9-14-1982.
- 1,209,304. HARTS BRING VALUE HOME TO YOU. INT. CL. 42. REG. 9-14-1982.
- 1,209,305. HARTS AND DESIGN. INT. CL. 42. REG. 9-14-1982.
- 1,209,317. RUDOLPHS BAR. B. QUE AND DESIGN. INT. CL. 42. REG. 9-14-1982.
- 1,209,318. INSTITUTE OF CERTIFIED PROFESSIONAL BUSI AND DESIGN. U.S. CL. 200. REG. 9-14-1982.
- 1,209,324. OWENS-CORNING CERTIFIED INDEPENDENT INSULATION CONTRACTOR AND DESIGN. U.S. CL. B. REG. 9-14-1982.
- 1,209,329. MATHPAC. INT. CL. 9. REG. 9-14-1982.
- 1,209,330. INTEGRATED ELECTRONIC OFFICE. INT. CL. 9. REG. 9-14-1982.
- 1,209,335. CLOSE-TO-CEILING. INT. CL. 11. REG. 9-14-1982.
- 1,209,336. AMPSAVER. INT. CL. 12. REG. 9-14-1982.
- 1,209,343. MODERN PURCHASING. INT. CL. 16. REG. 9-14-1982.
- 1,209,344. INDUSTRIAL PRODUCT IDEAS!. INT. CL. 16. REG. 9-14-1982.
- 1,209,346. REGISTERED REPRESENTATIVE. INT. CL. 16. REG. 9-14-1982.
- 1,209,347. FAMOUS FACES. INT. CL. 16. REG. 9-14-1982.
- 1,209,360. GRAPE-GRAPE. INT. CL. 32. REG. 9-14-1982.
- 1,209,361. SUPER CARD. INT. CL. 35. REG. 9-14-1982.
- 1,209,362. TECHNICAL CAREER JOB FAIR ...THE ORIGINAL AND DESIGN. INT. CL. 41. REG. 9-14-1982.
- 1,700,710. ROYAL DRAGON AND DESIGN. INT. CL. 30. REG. 7-14-1992.
- 1,714,807. MICRO-SOLVE (STYLIZED). INT. CL. 1. REG. 9-15-1992.
- 1,714,809. MISCELLANEOUS DESIGN. INT. CLS. 1 AND 32. REG. 9-15-1992.
- 1,714,814. CMP-I. INT. CL. 1. REG. 9-15-1992.
- 1,714,816. MISCELLANEOUS DESIGN. INT. CL. 1. REG. 9-15-1992.
- 1,714,817. CHROMAPHOR. INT. CL. 1. REG. 9-15-1992.
- 1,714,846. PHOENATE. INT. CL. 1. REG. 9-15-1992.
- 1,714,851. MISCELLANEOUS DESIGN. INT. CL. 1. REG. 9-15-1992.
- 1,714,852. BIN BUSTER MICROS. INT. CL. 1. REG. 9-15-1992.
- 1,714,882. A (STYLIZED). INT. CL. 3. REG. 9-15-1992.
- 1,714,912. E-COLORS (STYLIZED). INT. CL. 3. REG. 9-15-1992.
- 1,714,913. FERITY (STYLIZED). INT. CL. 3. REG. 9-15-1992.
- 1,714,925. LIQUID STRIP. INT. CL. 3. REG. 9-15-1992.
- 1,714,929. OPTIMIST. INT. CL. 3. REG. 9-15-1992.
- 1,714,934. CNG AND DESIGN. INT. CL. 4. REG. 9-15-1992.
- 1,714,935. FUEL WORLD. INT. CL. 4. REG. 9-15-1992.
- 1,714,941. PEP TAB AND DESIGN. INT. CL. 5. REG. 9-15-1992.
- 1,714,943. MISCELLANEOUS DESIGN. INT. CL. 5. REG. 9-15-1992.
- 1,714,944. ONGO FIN. INT. CL. 5. REG. 9-15-1992.
- 1,714,952. DENTOPAQUE. INT. CL. 5. REG. 9-15-1992.
- 1,714,955. GET BACK INTO LIFE WITH DEPEND. INT. CL. 5. REG. 9-15-1992.
- 1,714,962. NUTRI BLAST. INT. CL. 5. REG. 9-15-1992.

- 1,714,964. PREMIUM PINE. INT. CL. 5. REG. 9-15-1992.
1,714,965. DIGEST-EASE. INT. CL. 5. REG. 9-15-1992.
1,714,975. DIMENSION AND DESIGN. INT. CL. 5. REG. 9-15-1992.
1,714,988. PTE. INT. CL. 6. REG. 9-15-1992.
1,714,994. MAIN STREET. INT. CL. 6. REG. 9-15-1992.
1,714,999. BANK VAULT. INT. CL. 6. REG. 9-15-1992.
1,715,000. AT AND DESIGN. INT. CL. 6. REG. 9-15-1992.
1,715,002. MISCELLANEOUS DESIGN. INT. CLS. 6 AND 7. REG. 9-15-1992.
1,715,005. STEELPAW. INT. CL. 6. REG. 9-15-1992.
1,715,009. MUSCLE WIRES. INT. CL. 6. REG. 9-15-1992.
1,715,019. LITTLE DUSTER. INT. CL. 7. REG. 9-15-1992.
1,715,021. JETECH. INT. CL. 7. REG. 9-15-1992.
1,715,032. ROTEL. INT. CLS. 7 AND 11. REG. 9-15-1992.
1,715,036. JUPITER PREFILTER SYSTEM AND DESIGN. INT. CL. 7. REG. 9-15-1992.
1,715,040. POWERLIFE AND DESIGN. INT. CL. 7. REG. 9-15-1992.
1,715,041. HAZVAC. INT. CL. 7. REG. 9-15-1992.
1,715,046. ACCU-SHEAR. INT. CL. 7. REG. 9-15-1992.
1,715,058. DURAHONE. INT. CL. 7. REG. 9-15-1992.
1,715,060. APPLIANCE SCIENCE. INT. CLS. 7 AND 11. REG. 9-15-1992.
1,715,070. CAPPELLA. INT. CL. 8. REG. 9-15-1992.
1,715,073. WARCO. INT. CLS. 8 AND 21. REG. 9-15-1992.
1,715,082. ECONODE. INT. CL. 9. REG. 9-15-1992.
1,715,085. COVER GIRL. INT. CLS. 9 AND 41. REG. 9-15-1992.
1,715,092. CRYSTAL CUT. INT. CL. 9. REG. 9-15-1992.
1,715,095. GRANITE EDGE. INT. CLS. 9 AND 20. REG. 9-15-1992.
1,715,096. MISCELLANEOUS DESIGN. INT. CL. 9. REG. 9-15-1992.
1,715,100. NORDIC VISION AND DESIGN. INT. CL. 9. REG. 9-15-1992.
1,715,110. NCSIMULATION. INT. CL. 9. REG. 9-15-1992.
1,715,111. DIRECT CONNECT. INT. CL. 9. REG. 9-15-1992.
1,715,118. PLOTS UNLIMITED (STYLIZED). INT. CL. 9. REG. 9-15-1992.
1,715,123. LANDMARK AND DESIGN. INT. CL. 9. REG. 9-15-1992.
1,715,124. M3MS. INT. CL. 9. REG. 9-15-1992.
1,715,129. FRANKLIN AND DESIGN. INT. CLS. 9 AND 16. REG. 9-15-1992.
1,715,176. LG LABOKEY (STYLIZED). INT. CL. 9. REG. 9-15-1992.
1,715,188. MISCELLANEOUS DESIGN. INT. CL. 9. REG. 9-15-1992.
1,715,197. INFO DESIGN AND DESIGN. INT. CL. 9. REG. 9-15-1992.
1,715,205. TELECARE (STYLIZED). INT. CL. 9. REG. 9-15-1992.
1,715,207. THE REP REPORT. INT. CL. 9. REG. 9-15-1992.
1,715,209. DIPLOMAT. INT. CL. 9. REG. 9-15-1992.
1,715,216. DATA-LINK. INT. CL. 9. REG. 9-15-1992.
1,715,220. D/ESAM. INT. CL. 9. REG. 9-15-1992.
1,715,221. ALC (STYLIZED). INT. CLS. 9, 11 AND 40. REG. 9-15-1992.
1,715,225. WORDMATE WM AND DESIGN. INT. CL. 9. REG. 9-15-1992.
1,715,235. CITY BLOCK RECORDS AND DESIGN. INT. CL. 9. REG. 9-15-1992.
1,715,239. SLEDGEHAMMER. INT. CL. 9. REG. 9-15-1992.
1,715,244. RELATIVITY. INT. CL. 9. REG. 9-15-1992.
1,715,246. METROMINING AND DESIGN. INT. CL. 9. REG. 9-15-1992.
1,715,253. STRAIGHT TALK ABOUT SCHOOL. INT. CL. 9. REG. 9-15-1992.
1,715,258. K1000. INT. CL. 9. REG. 9-15-1992.
1,715,265. CODEBOX. INT. CL. 9. REG. 9-15-1992.
1,715,266. M (STYLIZED). INT. CL. 9. REG. 9-15-1992.
1,715,267. MICROTRON. INT. CL. 9. REG. 9-15-1992.
1,715,271. NELSON AND DESIGN. INT. CL. 9. REG. 9-15-1992.
1,715,272. CARMEL RECORDS AND DESIGN. INT. CL. 9. REG. 9-15-1992.
1,715,279. MICRO-CHECK AND DESIGN. INT. CL. 9. REG. 9-15-1992.
1,715,281. SUP'R CUSH'N. INT. CL. 9. REG. 9-15-1992.
1,715,286. MISCELLANEOUS DESIGN. INT. CL. 9. REG. 9-15-1992.
1,715,295. PRODUCTMASTER (STYLIZED). INT. CL. 9. REG. 9-15-1992.
1,715,298. FACTS RELAY. INT. CL. 9. REG. 9-15-1992.
1,715,299. FACTS PROVIDER. INT. CL. 9. REG. 9-15-1992.
1,715,300. FACTS COURIER. INT. CL. 9. REG. 9-15-1992.
1,715,318. TAME. INT. CL. 9. REG. 9-15-1992.
1,715,322. ALTERNATIVES AND DESIGN. INT. CL. 9. REG. 9-15-1992.
1,715,326. CENTERLINE. INT. CL. 9. REG. 9-15-1992.
1,715,327. ADL. INT. CL. 9. REG. 9-15-1992.
1,715,331. UNIGUN. INT. CL. 9. REG. 9-15-1992.
1,715,332. M3000. INT. CL. 9. REG. 9-15-1992.
1,715,342. WABERSTRIP. INT. CL. 9. REG. 9-15-1992.
1,715,343. SMART BOX. INT. CL. 9. REG. 9-15-1992.
1,715,344. SPECCLIP. INT. CL. 9. REG. 9-15-1992.
1,715,345. E-SAFE. INT. CL. 9. REG. 9-15-1992.
1,715,351. DISK*CLOSEURE. INT. CL. 9. REG. 9-15-1992.
1,715,353. CHOSENLAN. INT. CL. 9. REG. 9-15-1992.
1,715,362. BESTSPEECH (STYLIZED). INT. CL. 9. REG. 9-15-1992.
1,715,377. SWEDE-VENT. INT. CL. 10. REG. 9-15-1992.
1,715,380. BROOKER TIBIAL. INT. CL. 10. REG. 9-15-1992.
1,715,387. TRIMED. INT. CL. 10. REG. 9-15-1992.
1,715,405. KELLER AND DESIGN. INT. CL. 10. REG. 9-15-1992.
1,715,406. ULTRAFLO. INT. CL. 10. REG. 9-15-1992.
1,715,407. VENNES. INT. CL. 10. REG. 9-15-1992.
1,715,409. CREMER-IKEDA. INT. CL. 10. REG. 9-15-1992.
1,715,416. MISCELLANEOUS DESIGN. INT. CL. 10. REG. 9-15-1992.
1,715,421. SITE. INT. CL. 10. REG. 9-15-1992.
1,715,424. COFFEE 1. INT. CL. 11. REG. 9-15-1992.
1,715,432. PLMA. INT. CL. 11. REG. 9-15-1992.
1,715,435. WSI. INT. CLS. 11 AND 37. REG. 9-15-1992.
1,715,440. THEADORE'S ACCENTS. INT. CL. 11. REG. 9-15-1992.
1,715,442. SANDERS AND DESIGN. INT. CL. 11. REG. 9-15-1992.
1,715,445. MIGHTY WATT PLUS. INT. CL. 11. REG. 9-15-1992.
1,715,459. ZERO ALTITUDE FLIGHT (STYLIZED). INT. CL. 12. REG. 9-15-1992.
1,715,483. CHATEAU. INT. CL. 12. REG. 9-15-1992.
1,715,484. BENDIX ... THE SOONER THE BETTER. INT. CL. 12. REG. 9-15-1992.
1,715,485. VILLAIN. INT. CL. 12. REG. 9-15-1992.
1,715,486. MONTEGO. INT. CL. 12. REG. 9-15-1992.
1,715,494. RTS. INT. CL. 12. REG. 9-15-1992.
1,715,497. OUTA-SITE. INT. CL. 12. REG. 9-15-1992.
1,715,498. SKY-GUARD. INT. CL. 12. REG. 9-15-1992.
1,715,511. HAMPTON UNIVERSITY 1868 AND DESIGN. INT. CLS. 14, 16, 21 AND 25. REG. 9-15-1992.
1,715,513. GD (STYLIZED). INT. CL. 14. REG. 9-15-1992.
1,715,518. UNIVERSITY OF VIRGINIA. INT. CLS. 14, 16, 25 AND 41. REG. 9-15-1992.
1,715,528. ESX (STYLIZED). INT. CL. 14. REG. 9-15-1992.
1,715,537. ST. MARIN. INT. CL. 14. REG. 9-15-1992.
1,715,545. GEMULETS. INT. CL. 14. REG. 9-15-1992.
1,715,552. LUCERNE (STYLIZED). INT. CL. 15. REG. 9-15-1992.
1,715,557. MISCELLANEOUS DESIGN. INT. CL. 16. REG. 9-15-1992.
1,715,558. ELBE-CESCO. INT. CL. 16. REG. 9-15-1992.
1,715,567. TRENDSETTER. INT. CL. 16. REG. 9-15-1992.
1,715,576. SPOT*ART. INT. CL. 16. REG. 9-15-1992.
1,715,577. YOUNG SISTERS & BROTHERS. INT. CL. 16. REG. 9-15-1992.
1,715,594. ENVIRO-YOUTH PRODUCTS AND DESIGN. INT. CL. 16. REG. 9-15-1992.
1,715,605. RECOGNITION WINDOW. INT. CL. 16. REG. 9-15-1992.
1,715,607. DESKSAVER. INT. CL. 16. REG. 9-15-1992.
1,715,619. ROLLITER. INT. CL. 16. REG. 9-15-1992.

- 1,715,628. TELEMAT AND DESIGN. INT. CL. 16. REG. 9-15-1992.
- 1,715,629. REGISTER TAPE INTERNATIONAL. INT. CL. 16. REG. 9-15-1992.
- 1,715,636. CONSUMER HEALTH ADVOCATE. INT. CL. 16. REG. 9-15-1992.
- 1,715,639. MONEY BOOK. INT. CL. 16. REG. 9-15-1992.
- 1,715,641. BIG NICKEL AND DESIGN. INT. CL. 16. REG. 9-15-1992.
- 1,715,644. SCREEN. INT. CL. 16. REG. 9-15-1992.
- 1,715,647. MEMORIES ARE THE TREASURES OF LIFE. INT. CL. 16. REG. 9-15-1992.
- 1,715,653. AG (STYLIZED). INT. CLS. 16 AND 35. REG. 9-15-1992.
- 1,715,657. MURLITE. INT. CL. 16. REG. 9-15-1992.
- 1,715,660. SMART PACK. INT. CL. 16. REG. 9-15-1992.
- 1,715,662. QUIK ADS & ARTICLES AND DESIGN. INT. CL. 16. REG. 9-15-1992.
- 1,715,687. PUZZLE MASTERS AND DESIGN. INT. CL. 16. REG. 9-15-1992.
- 1,715,691. THE FAMILY EMPOWERMENT SERIES AND DESIGN. INT. CL. 16. REG. 9-15-1992.
- 1,715,697. CORPORATE PHILANTHROPY REPORT. INT. CL. 16. REG. 9-15-1992.
- 1,715,700. PIRANHA MUSIC AND DESIGN. INT. CL. 16. REG. 9-15-1992.
- 1,715,701. PIRANHA MUSIC. INT. CL. 16. REG. 9-15-1992.
- 1,715,704. JOCKEY AND DESIGN. INT. CL. 16. REG. 9-15-1992.
- 1,715,727. MAX-INDEX (STYLIZED). INT. CL. 16. REG. 9-15-1992.
- 1,715,732. DISCLOSURES. INT. CL. 16. REG. 9-15-1992.
- 1,715,739. GATORBOARD FRP. INT. CL. 17. REG. 9-15-1992.
- 1,715,742. DROP ON DUCT. INT. CL. 17. REG. 9-15-1992.
- 1,715,768. BEND DOOR COMPANY. INT. CL. 19. REG. 9-15-1992.
- 1,715,769. REFLECTIONS. INT. CL. 19. REG. 9-15-1992.
- 1,715,771. COLONIAL CRAFT. INT. CL. 19. REG. 9-15-1992.
- 1,715,779. MISCELLANEOUS DESIGN. INT. CL. 19. REG. 9-15-1992.
- 1,715,795. RICHWOOD. INT. CL. 20. REG. 9-15-1992.
- 1,715,814. TRI-PLANE AND DESIGN. INT. CL. 20. REG. 9-15-1992.
- 1,715,816. BAKU. INT. CL. 20. REG. 9-15-1992.
- 1,715,818. ODYSSEY. INT. CL. 20. REG. 9-15-1992.
- 1,715,819. ALUM-A-WALL. INT. CL. 20. REG. 9-15-1992.
- 1,715,828. ILLUSIONS. INT. CL. 20. REG. 9-15-1992.
- 1,715,829. EXECUTASK. INT. CL. 20. REG. 9-15-1992.
- 1,715,832. SPORTSMATE. INT. CL. 21. REG. 9-15-1992.
- 1,715,835. ANT-FREE PET DISH PROTECT YOUR PET AND DESIGN. INT. CL. 21. REG. 9-15-1992.
- 1,715,842. BOYD'S MADISON AVE.. INT. CL. 21. REG. 9-15-1992.
- 1,715,848. CONSOLETTA. INT. CL. 21. REG. 9-15-1992.
- 1,715,849. CHILDREN OF THE DREAM. INT. CL. 21. REG. 9-15-1992.
- 1,715,850. THE FINISHING LINE (STYLIZED). INT. CL. 21. REG. 9-15-1992.
- 1,715,855. JOCKEY. INT. CL. 21. REG. 9-15-1992.
- 1,715,857. TRANSITION. INT. CL. 21. REG. 9-15-1992.
- 1,715,859. WELLINGTON COLLECTION. INT. CL. 21. REG. 9-15-1992.
- 1,715,863. EARTH HOME. INT. CL. 21. REG. 9-15-1992.
- 1,715,880. TNT COLLECTION. INT. CL. 24. REG. 9-15-1992.
- 1,715,883. CONCIERGE COLLECTION AND DESIGN. INT. CL. 24. REG. 9-15-1992.
- 1,715,890. ALL-AMERICAN BASCO SPORTSWEAR AND DESIGN. INT. CL. 25. REG. 9-15-1992.
- 1,715,895. GABBANINI FIRENZE. INT. CL. 25. REG. 9-15-1992.
- 1,715,902. DR (STYLIZED). INT. CL. 25. REG. 9-15-1992.
- 1,715,922. CERMET. INT. CL. 25. REG. 9-15-1992.
- 1,715,925. COTTONWOOD TRADERS. INT. CL. 25. REG. 9-15-1992.
- 1,715,938. RIATA. INT. CL. 25. REG. 9-15-1992.
- 1,715,946. LTC BASICS (STYLIZED). INT. CL. 25. REG. 9-15-1992.
- 1,715,947. S AND DESIGN. INT. CL. 25. REG. 9-15-1992.
- 1,715,949. DE NEVE (STYLIZED). INT. CL. 25. REG. 9-15-1992.
- 1,715,956. COPPER KEY. INT. CL. 25. REG. 9-15-1992.
- 1,715,964. MISCELLANEOUS DESIGN. INT. CL. 25. REG. 9-15-1992.
- 1,715,973. ARLANDO. INT. CL. 25. REG. 9-15-1992.
- 1,715,984. COTTON COTTON COTTON AND DESIGN. INT. CL. 25. REG. 9-15-1992.
- 1,715,988. EARTH HOME. INT. CL. 25. REG. 9-15-1992.
- 1,715,995. RUFF HOUSE (STYLIZED). INT. CL. 27. REG. 9-15-1992.
- 1,715,998. RIBBONS AND BOWS. INT. CL. 27. REG. 9-15-1992.
- 1,716,005. THE GAME OF GAMES. INT. CL. 28. REG. 9-15-1992.
- 1,716,007. OFFICIAL FIREMAN PLAY EQUIPMENT FIREMAN OFPE AND DESIGN. INT. CL. 28. REG. 9-15-1992.
- 1,716,033. GEARIOS. INT. CL. 28. REG. 9-15-1992.
- 1,716,037. DOLLS DELIGHT, INC. AND DESIGN. INT. CL. 28. REG. 9-15-1992.
- 1,716,047. HYBRID. INT. CL. 28. REG. 9-15-1992.
- 1,716,058. BABY ALL GONE. INT. CL. 28. REG. 9-15-1992.
- 1,716,068. HEADFREEZER. INT. CL. 28. REG. 9-15-1992.
- 1,716,069. TOUR STROKE! AND DESIGN. INT. CL. 28. REG. 9-15-1992.
- 1,716,071. RED BEANS N' RICE. INT. CL. 28. REG. 9-15-1992.
- 1,716,076. FRESH N' LIGHT. INT. CL. 29. REG. 9-15-1992.
- 1,716,082. TOPPING BRILLANCE. INT. CLS. 29 AND 30. REG. 9-15-1992.
- 1,716,091. MONARCH PREMIUM. INT. CL. 29. REG. 9-15-1992.
- 1,716,104. JIFFY SPREAD AND DESIGN. INT. CL. 29. REG. 9-15-1992.
- 1,716,105. NATURAL MASTERPIECE. INT. CL. 29. REG. 9-15-1992.
- 1,716,106. MAMASAN'S. INT. CLS. 29 AND 30. REG. 9-15-1992.
- 1,716,113. T.J.'S AND DESIGN. INT. CL. 29. REG. 9-15-1992.
- 1,716,116. BIG MAMA GIANT. INT. CL. 29. REG. 9-15-1992.
- 1,716,121. KING GOURMET. INT. CL. 29. REG. 9-15-1992.
- 1,716,125. MISCELLANEOUS DESIGN. INT. CL. 29. REG. 9-15-1992.
- 1,716,128. GOL PAK GOL CUTS AND DESIGN. INT. CL. 29. REG. 9-15-1992.
- 1,716,133. ROCKLANDS. INT. CLS. 29 AND 42. REG. 9-15-1992.
- 1,716,136. SONORA VALLEY. INT. CLS. 29 AND 30. REG. 9-15-1992.
- 1,716,137. FRY-WELL. INT. CL. 29. REG. 9-15-1992.
- 1,716,158. CHEF'S FANCY AND DESIGN. INT. CL. 30. REG. 9-15-1992.
- 1,716,165. PETITE SWEETS. INT. CL. 30. REG. 9-15-1992.
- 1,716,176. ALVARADO ST. BAKERY AND DESIGN. INT. CL. 30. REG. 9-15-1992.
- 1,716,183. MISCELLANEOUS DESIGN. INT. CL. 30. REG. 9-15-1992.
- 1,716,204. HOMESTYLE AND DESIGN. INT. CL. 30. REG. 9-15-1992.
- 1,716,205. TIERRA MADRE. INT. CL. 30. REG. 9-15-1992.
- 1,716,212. FOR PEOPLE WHO THINK THE WORLD OF COFFEE. INT. CL. 30. REG. 9-15-1992.
- 1,716,219. MISCELLANEOUS DESIGN. INT. CL. 30. REG. 9-15-1992.
- 1,716,222. CANDY BLOSSOMS AND DESIGN. INT. CL. 30. REG. 9-15-1992.
- 1,716,227. ENZO'S GOURMET (STYLIZED). INT. CL. 30. REG. 9-15-1992.
- 1,716,235. "THE LUXURY LINER". INT. CL. 31. REG. 9-15-1992.
- 1,716,236. "THE FINER LINER". INT. CL. 31. REG. 9-15-1992.
- 1,716,242. LAMBRIGHT AND DESIGN. INT. CL. 31. REG. 9-15-1992.
- 1,716,244. WRIGHT. INT. CL. 31. REG. 9-15-1992.
- 1,716,245. NORTHEASTERN. INT. CL. 31. REG. 9-15-1992.
- 1,716,246. SILVERMIST AND DESIGN. INT. CL. 31. REG. 9-15-1992.

- 1,716,247. OMEGA AND DESIGN. INT. CL. 31. REG. 9-15-1992.
- 1,716,249. ROYALTY. INT. CL. 31. REG. 9-15-1992.
- 1,716,261. CCI FARMS AND DESIGN. INT. CL. 31. REG. 9-15-1992.
- 1,716,262. TROPIC BLUSH. INT. CL. 31. REG. 9-15-1992.
- 1,716,263. MASTER & PET (STYLIZED). INT. CL. 31. REG. 9-15-1992.
- 1,716,270. EVER CLEAN ES. INT. CL. 31. REG. 9-15-1992.
- 1,716,271. EVER CLEAN HD. INT. CL. 31. REG. 9-15-1992.
- 1,716,277. SHINE AND DESIGN. INT. CL. 32. REG. 9-15-1992.
- 1,716,299. NO 12 OUZO KALOYANNIS AND DESIGN. INT. CL. 33. REG. 9-15-1992.
- 1,716,308. JAMAICA CROWN. INT. CL. 34. REG. 9-15-1992.
- 1,716,310. LOS ANGELES COASTAL COMBO AND DESIGN. INT. CL. 35. REG. 9-15-1992.
- 1,716,321. CC AND DESIGN. INT. CLS. 35 AND 37. REG. 9-15-1992.
- 1,716,330. CRADDOCK. INT. CLS. 35 AND 42. REG. 9-15-1992.
- 1,716,334. TEENAGE MUTANT NINJA TURTLES AND DESIGN. INT. CLS. 35 AND 41. REG. 9-15-1992.
- 1,716,336. NETWORK INTERNATIONAL. INT. CL. 35. REG. 9-15-1992.
- 1,716,357. THE PAST IS THE PREDICTOR OF THE FUTURE. INT. CL. 35. REG. 9-15-1992.
- 1,716,359. AGRIEDGE. INT. CLS. 35 AND 42. REG. 9-15-1992.
- 1,716,368. TEAM CRAFT. INT. CL. 35. REG. 9-15-1992.
- 1,716,376. CAR-TALK AND DESIGN. INT. CL. 35. REG. 9-15-1992.
- 1,716,379. FUTURE FORCE. INT. CL. 35. REG. 9-15-1992.
- 1,716,384. GLAMER. AND DESIGN. INT. CL. 35. REG. 9-15-1992.
- 1,716,386. WESTERN PLANT/FACILITY ENGINEERING & MAINTENANCE SHOW. INT. CL. 35. REG. 9-15-1992.
- 1,716,387. MIDWEST PLANT ENGINEERING & MAINTENANCE SHOW. INT. CL. 35. REG. 9-15-1992.
- 1,716,391. DUPLICATE NUMBER. INT. CL. 35. REG. 9-15-1992.
- 1,716,400. CARING FOR CHILDREN. INT. CLS. 36, 41 AND 42. REG. 9-15-1992.
- 1,716,418. MISCELLANEOUS DESIGN. INT. CL. 36. REG. 9-15-1992.
- 1,716,423. BANK OF SISSONVILLE. INT. CL. 36. REG. 9-15-1992.
- 1,716,435. OAKMARK FUND. INT. CL. 36. REG. 9-15-1992.
- 1,716,437. FLEXRITE. INT. CL. 36. REG. 9-15-1992.
- 1,716,470. RC AND DESIGN. INT. CL. 36. REG. 9-15-1992.
- 1,716,472. UNIVERSITY COMMONS AND DESIGN. INT. CL. 36. REG. 9-15-1992.
- 1,716,473. ALTCRG. INT. CL. 36. REG. 9-15-1992.
- 1,716,475. ROADMASTER. INT. CL. 36. REG. 9-15-1992.
- 1,716,477. RIVERWALK (STYLIZED). INT. CL. 37. REG. 9-15-1992.
- 1,716,483. DEVELOPING YOUR OPTIONS.. INT. CL. 37. REG. 9-15-1992.
- 1,716,495. BRANDY'S AUTOMOTIVE REPAIR AND DESIGN. INT. CL. 37. REG. 9-15-1992.
- 1,716,509. MISCELLANEOUS DESIGN. INT. CL. 37. REG. 9-15-1992.
- 1,716,514. HI-TUFF PLUS. INT. CL. 37. REG. 9-15-1992.
- 1,716,522. FIXTRONICS INCORPORATED. INT. CL. 37. REG. 9-15-1992.
- 1,716,529. MCI VISION. INT. CL. 38. REG. 9-15-1992.
- 1,716,536. AUTO-ACCESS. INT. CL. 38. REG. 9-15-1992.
- 1,716,542. MISCELLANEOUS DESIGN. INT. CL. 38. REG. 9-15-1992.
- 1,716,549. GATEWAY USA ... THE SYMBOL OF SERVICE AND DESIGN. INT. CL. 38. REG. 9-15-1992.
- 1,716,554. SAFEDIRECT. INT. CL. 38. REG. 9-15-1992.
- 1,716,557. LINKUP 800. INT. CL. 38. REG. 9-15-1992.
- 1,716,570. STERLING. INT. CL. 39. REG. 9-15-1992.
- 1,716,572. ROMAR AND DESIGN. INT. CL. 39. REG. 9-15-1992.
- 1,716,582. MISCELLANEOUS DESIGN. INT. CL. 39. REG. 9-15-1992.
- 1,716,584. VECTAR. INT. CL. 39. REG. 9-15-1992.
- 1,716,587. R AND DESIGN. INT. CL. 39. REG. 9-15-1992.
- 1,716,600. TAKE TWO. INT. CL. 40. REG. 9-15-1992.
- 1,716,605. LICAR. INT. CL. 40. REG. 9-15-1992.
- 1,716,625. Q RECORDS & VIDEO. INT. CLS. 41 AND 42. REG. 9-15-1992.
- 1,716,640. NCE AND DESIGN. INT. CL. 41. REG. 9-15-1992.
- 1,716,644. COMIN' HOME. INT. CL. 41. REG. 9-15-1992.
- 1,716,649. ENGINEERING THE ENTERPRISE FOR EXCELLENCE. INT. CLS. 41 AND 42. REG. 9-15-1992.
- 1,716,650. TOUR OF WORLD FIGURE SKATING CHAMPIONS AND DESIGN. INT. CL. 41. REG. 9-15-1992.
- 1,716,651. TOUR OF WORLD FIGURE SKATING CHAMPIONS PRESENTED BY TOM COLLINS AND DESIGN. INT. CL. 41. REG. 9-15-1992.
- 1,716,662. I-E-S AND DESIGN. INT. CLS. 41 AND 42. REG. 9-15-1992.
- 1,716,672. THE GREAT CHEFS OF HAMPTON ROADS. INT. CL. 41. REG. 9-15-1992.
- 1,716,676. AGRIEDGE. INT. CL. 41. REG. 9-15-1992.
- 1,716,679. BONE PONY AND DESIGN. INT. CL. 41. REG. 9-15-1992.
- 1,716,700. MC AND DESIGN. INT. CL. 41. REG. 9-15-1992.
- 1,716,701. FESTIVAL OF ANIMATION. INT. CL. 41. REG. 9-15-1992.
- 1,716,702. MASTERS SELF DEFENSE CENTERS AND DESIGN. INT. CL. 41. REG. 9-15-1992.
- 1,716,710. SKY WARRIORS AERIAL LASER COMBAT AND DESIGN. INT. CL. 41. REG. 9-15-1992.
- 1,716,716. WRESTLEMANIA (STYLIZED). INT. CL. 41. REG. 9-15-1992.
- 1,716,718. SOMATIC INTEGRATION. INT. CL. 41. REG. 9-15-1992.
- 1,716,719. PAT O'DOWD. INT. CL. 41. REG. 9-15-1992.
- 1,716,724. AD DEFINITUM FINEM AND DESIGN. INT. CL. 41. REG. 9-15-1992.
- 1,716,728. ONWARD AND UPWARD. INT. CL. 41. REG. 9-15-1992.
- 1,716,742. DIETITIAN'S WEIGHT CONTROL PROGRAM AND DESIGN. INT. CL. 42. REG. 9-15-1992.
- 1,716,743. SUPER SHOPS (STYLIZED). INT. CL. 42. REG. 9-15-1992.
- 1,716,748. SIDLEY & AUSTIN. INT. CL. 42. REG. 9-15-1992.
- 1,716,749. ECKENFELDER INC. AND DESIGN. INT. CL. 42. REG. 9-15-1992.
- 1,716,752. SUTTON HOUSE. INT. CL. 42. REG. 9-15-1992.
- 1,716,760. NATIONAL HEALTH LABORATORIES INCORPORATED. INT. CL. 42. REG. 9-15-1992.
- 1,716,763. S. O. S. SMALL ORGANIZATION SAVINGS AND DESIGN. INT. CL. 42. REG. 9-15-1992.
- 1,716,767. CITY ZOO AND DESIGN. INT. CL. 42. REG. 9-15-1992.
- 1,716,775. LE CAFE' AND DESIGN. INT. CL. 42. REG. 9-15-1992.
- 1,716,778. TOMORROW'S POWER. INT. CL. 42. REG. 9-15-1992.
- 1,716,781. SMI AND DESIGN. INT. CL. 42. REG. 9-15-1992.
- 1,716,789. OLE' TACOS (STYLIZED). INT. CL. 42. REG. 9-15-1992.
- 1,716,797. QDM AND DESIGN. INT. CL. 42. REG. 9-15-1992.
- 1,716,801. WEC WESTIN EXECUTIVE CLUB AND DESIGN. INT. CL. 42. REG. 9-15-1992.
- 1,716,813. IL MULINO OF ITALY. INT. CL. 42. REG. 9-15-1992.
- 1,716,823. LIGHTING BY FEDER (STYLIZED). INT. CL. 42. REG. 9-15-1992.
- 1,716,828. LEVEL PROPANE AND DESIGN. INT. CL. 42. REG. 9-15-1992.
- 1,716,840. CHIROPRACTIC LIFESTYLES AND DESIGN. INT. CL. 42. REG. 9-15-1992.
- 1,716,852. AVEDA CONCEPT SALON (STYLIZED). INT. CL. 42. REG. 9-15-1992.
- 1,716,857. MEMORIES ARE THE TREASURES OF LIFE. INT. CL. 42. REG. 9-15-1992.
- 1,716,858. C.A.L.M.. INT. CL. 42. REG. 9-15-1992.

- 1,716,860. MCBONUS. INT. CL. 42. REG. 9-15-1992.
 1,716,870. STRETCH & SEW. INT. CL. 42. REG. 9-15-1992.
 1,716,875. ECI ENVIRONMENTAL COMPLIANCE, INC. AND DESIGN. INT. CL. 42. REG. 9-15-1992.
 1,716,885. BACALLS CAFE AND DESIGN. INT. CL. 42. REG. 9-15-1992.
 1,716,886. BETA. INT. CL. 42. REG. 9-15-1992.
 1,716,889. DONUT VILLAGE. INT. CL. 42. REG. 9-15-1992.
 1,716,902. TRADE LIMITED TECHNICAL AND REGULATORY ASSISTANCE TO DIRECT EXPORTERS AND DESIGN. INT. CL. 42. REG. 9-15-1992.
 1,716,903. CDS. INT. CL. 42. REG. 9-15-1992.
 1,716,910. IOPO AND DESIGN. INT. CL. 42. REG. 9-15-1992.
 1,716,911. CASA GALLARDO GRILL AND DESIGN. INT. CL. 42. REG. 9-15-1992.
 1,716,915. CALICO CAT. INT. CL. 42. REG. 9-15-1992.
 1,716,916. TERRIFIC TOYS AND DESIGN. INT. CL. 42. REG. 9-15-1992.
 1,716,921. AMERISHIP CORPORATION (STYLIZED). INT. CL. 42. REG. 9-15-1992.
 1,716,935. CAT: A TONIC AND DESIGN. INT. CL. 42. REG. 9-15-1992.
 1,716,942. MONARCH PROCESS (STYLIZED). INT. CL. 42. REG. 9-15-1992.
 1,716,947. SAM'S CLUB MEMBERS ONLY. INT. CL. 42. REG. 9-15-1992.
 1,716,953. SERVISTAR GOOD NEIGHBOR. GOOD ADVICE. (STYLIZED). INT. CL. 42. REG. 9-15-1992.
 1,716,973. MISCELLANEOUS DESIGN. INT. CL. 42. REG. 9-15-1992.
 1,716,974. THE BENEFITS DEPARTMENT. INT. CL. 42. REG. 9-15-1992.
 1,716,975. B AND DESIGN. INT. CL. 42. REG. 9-15-1992.
 1,716,980. ITA (STYLIZED). INT. CL. 42. REG. 9-15-1992.
 1,716,984. WORKING TO STRENGTHEN THE CHAIN OF SURVIVAL. INT. CL. 42. REG. 9-15-1992.
 1,716,985. COMPLIANCE RESEARCH. INT. CL. 42. REG. 9-15-1992.
 1,716,989. ACI. U.S. CL. 200. REG. 9-15-1992.
 1,717,003. CHIQUITA. INT. CLS. 8 AND 11. REG. 9-15-1992.
 1,717,018. BEYOND BLUSHER. INT. CL. 3. REG. 9-15-1992.
 1,717,023. MISCELLANEOUS DESIGN. INT. CL. 5. REG. 9-15-1992.
 1,717,031. GUGULMAX. INT. CL. 5. REG. 9-15-1992.
 1,717,032. SHOW SHIPPER. INT. CL. 6. REG. 9-15-1992.
 1,717,039. BUDDYBELT. INT. CL. 8. REG. 9-15-1992.
 1,717,046. AT/COMM. INT. CL. 9. REG. 9-15-1992.
 1,717,047. SUNDEVIL SUNGLASSES AND DESIGN. INT. CL. 9. REG. 9-15-1992.
 1,717,057. FIN-PRO. INT. CL. 9. REG. 9-15-1992.
 1,717,066. INTIMATE SHOWER. INT. CL. 11. REG. 9-15-1992.
 1,717,069. FEDERAL AND DESIGN. INT. CL. 12. REG. 9-15-1992.
 1,717,077. CHILDHOOD TREASURES. INT. CL. 16. REG. 9-15-1992.
 1,717,081. SMITHMARK (STYLIZED). INT. CL. 16. REG. 9-15-1992.
 1,717,082. SHOCKERS. INT. CL. 16. REG. 9-15-1992.
 1,717,093. LEGAL LESSONS. INT. CL. 16. REG. 9-15-1992.
 1,717,094. ZEN INTERGALACTIC NINJA. INT. CL. 16. REG. 9-15-1992.
 1,717,096. XLR. INT. CL. 17. REG. 9-15-1992.
 1,717,099. E-Z STOW. INT. CL. 20. REG. 9-15-1992.
 1,717,105. SURPRISE CUP? AND DESIGN. INT. CL. 21. REG. 9-15-1992.
 1,717,110. INOVASE. INT. CL. 21. REG. 9-15-1992.
 1,717,111. TITAN. INT. CL. 22. REG. 9-15-1992.
 1,717,119. THE BUBBLE HEADS. INT. CL. 25. REG. 9-15-1992.
 1,717,128. AVALANCHE. INT. CL. 25. REG. 9-15-1992.
 1,717,141. A SPECIAL DELIVERY. INT. CL. 28. REG. 9-15-1992.
 1,717,143. BRIGHT STARTS. INT. CL. 28. REG. 9-15-1992.
 1,717,144. SCENIQUE AND DESIGN. INT. CL. 28. REG. 9-15-1992.
 1,717,145. RUMBLER. INT. CL. 28. REG. 9-15-1992.
 1,717,151. GREAT DATE. INT. CL. 28. REG. 9-15-1992.
 1,717,152. THE GOLFERS GALLERY. INT. CL. 28. REG. 9-15-1992.
 1,717,154. SYCAMORE FARMS. INT. CL. 29. REG. 9-15-1992.
 1,717,155. PASTRI-TEX. INT. CL. 29. REG. 9-15-1992.
 1,717,162. PROTEIN PLUS. INT. CL. 31. REG. 9-15-1992.
 1,717,163. SCOOP FORMULA. INT. CL. 31. REG. 9-15-1992.
 1,717,168. SENIOR SUPPORT RESOURCES. INT. CL. 35. REG. 9-15-1992.
 1,717,175. ART INTERNATIONAL. INT. CL. 37. REG. 9-15-1992.
 1,717,178. BIO VAC. INT. CL. 37. REG. 9-15-1992.
 1,717,192. IMAGINATION CROSSROADS. INT. CL. 42. REG. 9-15-1992.
 1,717,210. TEXTURE TREATMENT. INT. CL. 3. REG. 9-15-1992.
 1,717,217. FUNCTIONAL MULTIPROCESSOR. INT. CL. 9. REG. 9-15-1992.
 1,717,219. POWER MOS IV. INT. CL. 9. REG. 9-15-1992.
 1,717,223. ULTIMATE DIGITAL STUDIO. INT. CL. 9. REG. 9-15-1992.
 1,717,233. MISCELLANEOUS DESIGN. INT. CL. 16. REG. 9-15-1992.
 1,717,236. GERSTNER. INT. CL. 16. REG. 9-15-1992.
 1,717,237. POWER DELIVERY. INT. CL. 16. REG. 9-15-1992.
 1,717,239. YEARBOOK OF EXPERTS, AUTHORITIES & SPOKESPERSONS. INT. CL. 16. REG. 9-15-1992.
 1,717,254. RICHVALE RED. INT. CL. 30. REG. 9-15-1992.
 1,717,257. SURFACE MOUNT INTERNATIONAL. INT. CL. 35. REG. 9-15-1992.
 1,717,264. EXOTIC ADVENTURES. INT. CL. 39. REG. 9-15-1992.
 1,725,858. MEET ME IN CHEERS AND DESIGN. INT. CL. 25. REG. 10-20-1992.
 1,735,991. KERI. INT. CL. 3. REG. 12-1-1992.
 1,801,338. UN-CHAP. INT. CL. 5 ONLY. REG. 10-26-1993.
 1,930,416. ADMONT AND DESIGN. INT. CL. 14 ONLY. REG. 10-31-1995.
 1,931,427. FIRECHEK. INT. CL. 11. REG. 10-31-1995.
 1,982,912. ... GET ON THE BOAT!. INT. CL. 25 ONLY. REG. 6-25-1996.
 1,983,767. VALLEY ALUMINUM. INT. CL. 6. REG. 7-2-1996.
 2,000,487. ROLLJET. INT. CL. 7. REG. 9-17-1996.
 2,000,488. SAVECO. INT. CL. 35. REG. 9-17-1996.
 2,000,491. FIRST TRUST CALIFORNIA MEMBER FIRST BANK SYSTEM AND DESIGN. INT. CL. 36. REG. 9-17-1996.
 2,000,493. MISCELLANEOUS DESIGN. INT. CLS. 9, 16 AND 42. REG. 9-17-1996.
 2,000,496. INDUMAG-VITAL. INT. CL. 11. REG. 9-17-1996.
 2,000,497. STRIKOUT AND DESIGN. INT. CL. 28. REG. 9-17-1996.
 2,000,499. VENTEX (STYLIZED). INT. CL. 11. REG. 9-17-1996.
 2,000,500. OXMOX. INT. CL. 18. REG. 9-17-1996.
 2,000,501. VISIONS OF REALITY. INT. CL. 42. REG. 9-17-1996.
 2,000,503. JOURALLE. INT. CL. 25. REG. 9-17-1996.
 2,000,505. LEG PERFECTION. INT. CL. 25. REG. 9-17-1996.
 2,000,506. WCHA WESTERN COLLEGIATE HOCKEY ASSOCIATION AND DESIGN. INT. CLS. 14, 25 AND 26. REG. 9-17-1996.
 2,000,507. GO'CAT AND DESIGN. INT. CL. 31. REG. 9-17-1996.
 2,000,508. JUST MEMORY (STYLIZED). INT. CLS. 16 AND 18. REG. 9-17-1996.
 2,000,511. HURRICANE AND DESIGN. INT. CL. 7. REG. 9-17-1996.
 2,000,512. COCINA RAPIDA CON CHEF ELAINE AND DESIGN. INT. CL. 16. REG. 9-17-1996.
 2,000,513. E-Z FLOW. INT. CL. 1. REG. 9-17-1996.
 2,000,515. VINEYARD AND DESIGN. INT. CL. 9. REG. 9-17-1996.
 2,000,516. LIBERTY FINANCIAL. INT. CL. 36. REG. 9-17-1996.
 2,000,518. ROCKY MOUNTAIN RECORDS MANAGERS. INT. CLS. 16 AND 39. REG. 9-17-1996.
 2,000,522. NEURELAN. INT. CL. 5. REG. 9-17-1996.
 2,000,525. ENRO AND DESIGN. INT. CL. 25. REG. 9-17-1996.

- 2,000,526. QUINTECH. INT. CL. 4. REG. 9-17-1996.
2,000,528. HUBERT GASSER. INT. CL. 25. REG. 9-17-1996.
2,000,529. FREDERICKSBURG 1690 1990 AND DESIGN.
INT. CL. 33. REG. 9-17-1996.
2,000,533. SMEDVIG (STYLIZED). INT. CLS. 37 AND 39.
REG. 9-17-1996.
2,000,534. SYSTEM ARCHITECTONICS AND DESIGN. INT.
CL. 42. REG. 9-17-1996.
2,000,535. THE FRESHEST CHICKEN GOING. INT. CL. 29.
REG. 9-17-1996.
2,000,536. BUTTREY FOOD & DRUG. INT. CL. 42. REG. 9-
17-1996.
2,000,541. BPI THE BALANCED PROGRAM AND DESIGN.
INT. CL. 36. REG. 9-17-1996.
2,000,542. SYNAPTEL AND DESIGN. INT. CLS. 9, 35, 38
AND 42. REG. 9-17-1996.
2,000,543. RDI. INT. CL. 42. REG. 9-17-1996.
2,000,544. BEST/1 AND DESIGN. INT. CL. 16. REG. 9-17-
1996.
2,000,545. STRENESSE GROUP. INT. CLS. 3, 18 AND 25.
REG. 9-17-1996.
2,000,547. LE BOCCE CHIANTI CLASSICO FATTORIA LE
BOCCE PANZANO (ITALIA) AND DESIGN. INT. CL. 33.
REG. 9-17-1996.
2,000,553. EXPRESS AND DESIGN. INT. CL. 41. REG. 9-17-
1996.
2,000,555. MACCLASS. INT. CL. 9. REG. 9-17-1996.
2,000,557. OSTRICH WORLD. INT. CL. 25. REG. 9-17-1996.
2,000,558. FAIR ISAAC AND DESIGN. INT. CL. 36. REG. 9-
17-1996.
2,000,560. TRAVELER PLUS (STYLIZED). INT. CL. 39. REG.
9-17-1996.
2,000,561. MISCELLANEOUS DESIGN. INT. CL. 29. REG. 9-
17-1996.
2,000,562. SPHINX AND DESIGN. INT. CLS. 11, 19 AND 21.
REG. 9-17-1996.
2,000,565. JANE DOE SAFETY FUND. INT. CLS. 16, 41 AND
42. REG. 9-17-1996.
2,000,568. SHOOTER TUTOR. INT. CL. 28. REG. 9-17-1996.
2,000,569. SHUCKEY DUCKEY AND DESIGN. INT. CL. 41.
REG. 9-17-1996.
2,000,572. INTIMIDADES. INT. CL. 41. REG. 9-17-1996.
2,000,575. WORLDWIDE ASSOCIATION OF LOTUS NOTES
USERS & TECHNOLOGISTS AND DESIGN. INT. CL. 42.
REG. 9-17-1996.
2,000,577. INFOPROFILE. INT. CL. 16. REG. 9-17-1996.
2,000,579. INVESTING WITH BARRY ZISKIN. INT. CL. 16.
REG. 9-17-1996.
2,000,580. TDNI. INT. CLS. 35, 38 AND 42. REG. 9-17-1996.
2,000,582. DIAPERS KIDS BY PANNOLINI. INT. CL. 16.
REG. 9-17-1996.
2,000,583. BIOPUMP. INT. CL. 10. REG. 9-17-1996.
2,000,584. FLASH CODEBOOK METHODOLOGY. INT. CL.
42. REG. 9-17-1996.
2,000,586. EXCALIBUR. INT. CL. 41. REG. 9-17-1996.
2,000,588. CORLINK. INT. CL. 42. REG. 9-17-1996.
2,000,590. CHINA DREAM AND DESIGN. INT. CL. 21. REG.
9-17-1996.
2,000,594. READ SYSTEMS AND DESIGN. INT. CL. 9. REG.
9-17-1996.
2,000,597. TOPFIX. INT. CL. 6. REG. 9-17-1996.
2,000,602. CLO WHITE AND DESIGN. INT. CL. 3. REG. 9-
17-1996.
2,000,605. MECKLERMEDIA. INT. CLS. 16, 35 AND 41.
REG. 9-17-1996.
2,000,606. PHARMA-DISK. INT. CL. 9. REG. 9-17-1996.
2,000,608. LAVENDER LANE AND DESIGN. INT. CLS. 3
AND 31. REG. 9-17-1996.
2,000,610. SPI. INT. CLS. 16 AND 28. REG. 9-17-1996.
2,000,611. PROVEN PROJECTS AND TECHNIQUES SHOP
TESTED FROM THE WOOD BOOKS SHOP
AND DESIGN. INT. CL. 16. REG. 9-17-1996.
2,000,614. DEJA AND DESIGN. INT. CLS. 1, 3, 9 AND 21.
REG. 9-17-1996.
2,000,615. C CAPITAL EXPRESSWAY AND DESIGN. INT.
CL. 36. REG. 9-17-1996.
2,000,617. CHARTERMAX AND DESIGN. INT. CL. 39. REG.
9-17-1996.
2,000,618. INVESTMENT RECOVERY SYSTEMS. INT. CL.
35. REG. 9-17-1996.
2,000,619. PERSONAL SEARCHER AND DESIGN. INT. CL.
42. REG. 9-17-1996.
2,000,623. PLANT PROMOTIONS AND DESIGN. INT. CL.
31. REG. 9-17-1996.
2,000,624. INFORMATION EXCHANGE. INT. CL. 16. REG.
9-17-1996.
2,000,625. THE AVIATORS' ADVANTAGE. INT. CLS. 35, 36
AND 42. REG. 9-17-1996.
2,000,627. PILOT (STYLIZED). INT. CL. 16. REG. 9-17-1996.
2,000,630. PATRICK HENRY'S REVOLUTIONARY
BLOODY MARY MIX AND DESIGN. INT. CL.
32. REG. 9-17-1996.
2,000,633. THE JOCKEY. INT. CL. 38. REG. 9-17-1996.
2,000,634. IPIN AND DESIGN. INT. CLS. 30 AND 31. REG. 9-
17-1996.
2,000,635. INNOVATIVE HEALTH ALLIANCES. INT. CL.
35. REG. 9-17-1996.
2,000,651. PITCH IN! HELP KEEP AMERICA COOL. AND
DESIGN. INT. CL. 25. REG. 9-17-1996.
2,000,652. THE AUTOMATIC DUSTPAN (STYLIZED). INT.
CL. 9. REG. 9-17-1996.
2,000,654. SAFESITE. INT. CL. 9. REG. 9-17-1996.
2,000,659. TICOP. INT. CL. 5. REG. 9-17-1996.
2,000,660. O.D. SHAG CLUB SHAGGIN ON THE STRAND
OCEAN DRIVE S.C. AND DESIGN. INT. CL. 42.
REG. 9-17-1996.
2,000,661. THIRST THRASHER. INT. CL. 32. REG. 9-17-1996.
2,000,666. CALIFORNIA ENERGY WATCH. INT. CL. 16.
REG. 9-17-1996.
2,000,670. OPTOPUS. INT. CL. 9. REG. 9-17-1996.
2,000,671. FLYER. INT. CL. 12. REG. 9-17-1996.
2,000,673. LAT-AIR. INT. CL. 10. REG. 9-17-1996.
2,000,674. IRISH EYES AND DESIGN. INT. CL. 16. REG. 9-
17-1996.
2,000,676. HETTY. INT. CL. 30. REG. 9-17-1996.
2,000,678. P PROISME. INT. CL. 28. REG. 9-17-1996.
2,000,679. HORIZON PHARMACEUTICAL. INT. CL. 5.
REG. 9-17-1996.
2,000,681. TURBOTALK. INT. CL. 9. REG. 9-17-1996.
2,000,682. BLACK AND GREY AND DESIGN. INT. CL. 41.
REG. 9-17-1996.
2,000,685. BLOOMBERG INFORMATION RADIO. INT. CL.
38. REG. 9-17-1996.
2,000,687. TAX DESK. INT. CL. 9. REG. 9-17-1996.
2,000,691. POLYSORT. INT. CL. 42. REG. 9-17-1996.
2,000,692. LOYAL FUELER. INT. CL. 37. REG. 9-17-1996.
2,000,695. BLUE HOUSE AND DESIGN. INT. CL. 41. REG. 9-
17-1996.
2,000,696. HEALTH SHIELD. INT. CL. 36. REG. 9-17-1996.
2,000,697. THERESA DALE'S META-WELLNESS COURSE
AND DESIGN. INT. CL. 41. REG. 9-17-1996.
2,000,698. BUG STUFF. INT. CL. 5. REG. 9-17-1996.
2,000,699. BLASTEXX. INT. CL. 3. REG. 9-17-1996.
2,000,702. NOT YOUR TYPICAL BEAN COUNTERS. INT.
CLS. 35 AND 36. REG. 9-17-1996.
2,000,703. POINT-OF-ENTRY COMMUNICATIONS. INT.
CL. 35. REG. 9-17-1996.
2,000,708. VK VINCENT INTERTRANS AND DESIGN. INT.
CLS. 36 AND 39. REG. 9-17-1996.
2,000,713. MISCELLANEOUS DESIGN. INT. CL. 28. REG. 9-
17-1996.
2,000,714. AXIANT (STYLIZED). INT. CLS. 9 AND 16. REG.
9-17-1996.
2,000,715. LEATHER THERAPY AND DESIGN. INT. CL. 4.
REG. 9-17-1996.
2,000,716. LASER. INT. CL. 34. REG. 9-17-1996.
2,000,717. DYNAFLEX. INT. CL. 19. REG. 9-17-1996.
2,000,721. SPECIALTY ENVIRONMENTAL SERVICES AND
DESIGN. INT. CLS. 37, 39, 40 AND 42. REG. 9-
17-1996.
2,000,723. FIRST BANK IOWA. INT. CL. 36. REG. 9-17-1996.
2,000,724. VITANINE. INT. CL. 32. REG. 9-17-1996.
2,000,726. VIETNAM VETERANS MEMORIAL FUND AND
DESIGN. INT. CL. 42. REG. 9-17-1996.
2,000,727. KID PIX 2 AND DESIGN. INT. CL. 9. REG. 9-17-
1996.

- 2,000,728. BISONTE. INT. CL. 34. REG. 9-17-1996.
- 2,000,729. UNICORN ABRASIVES AND DESIGN. INT. CLS. 3, 7 AND 8. REG. 9-17-1996.
- 2,000,731. WOOD PRODUCTS MADE BY OREGON CRAFTSMEN FROM A RENEWABLE FOREST RESOURCE MADE IN AND DESIGN. U.S. CL. A. REG. 9-17-1996.
- 2,000,733. PARENTS PART OF THE TEAM!. INT. CL. 16. REG. 9-17-1996.
- 2,000,734. BE PROUD OF IT. INT. CL. 16. REG. 9-17-1996.
- 2,000,736. INTELLASEARCH. INT. CL. 42. REG. 9-17-1996.
- 2,000,737. THE ULTIMATE BEEF STEAK PIE!. INT. CL. 30. REG. 9-17-1996.
- 2,000,738. TNT EXPRESS WORLDWIDE AND DESIGN. INT. CL. 39. REG. 9-17-1996.
- 2,000,741. WAESPE. INT. CLS. 29 AND 30. REG. 9-17-1996.
- 2,000,742. KABIKINASE SIMPLIVE SYSTEM (STYLIZED). INT. CL. 10. REG. 9-17-1996.
- 2,000,743. TRUTH SOUL ARMOR. INT. CL. 25. REG. 9-17-1996.
- 2,000,745. S AND DESIGN. INT. CL. 16. REG. 9-17-1996.
- 2,000,746. MENUET COMPACT. INT. CL. 10. REG. 9-17-1996.
- 2,000,749. FLEXSORB. INT. CL. 1. REG. 9-17-1996.
- 2,000,759. SMART BOX AND DESIGN. INT. CLS. 5, 9 AND 20. REG. 9-17-1996.
- 2,000,761. E-MF. INT. CL. 17. REG. 9-17-1996.
- 2,000,762. SMARTMOUTH THE CHART. INT. CL. 9. REG. 9-17-1996.
- 2,000,763. MISCELLANEOUS DESIGN. INT. CL. 16. REG. 9-17-1996.
- 2,000,765. CTAT AND DESIGN. INT. CL. 42. REG. 9-17-1996.
- 2,000,768. HOLSTEIN ASSOCIATION AND DESIGN. INT. CL. 35. REG. 9-17-1996.
- 2,000,769. TIO LEO'S AND DESIGN. INT. CL. 29. REG. 9-17-1996.
- 2,000,770. IGUANA INTERNATIONAL AND DESIGN. INT. CL. 40. REG. 9-17-1996.
- 2,000,772. MISCELLANEOUS DESIGN. INT. CL. 42. REG. 9-17-1996.
- 2,000,773. SAFEWAY SELECT. INT. CL. 32. REG. 9-17-1996.
- 2,000,774. PHYSICIANS EYECARE NETWORK, INC. HELPING OPHTHALMOLOGY PROVIDE TOTAL QUALITY EYECARE AND DESIGN. INT. CL. 36. REG. 9-17-1996.
- 2,000,776. COLORCRETE SEALER. INT. CL. 2. REG. 9-17-1996.
- 2,000,779. CROWN ROYALE LTD. AND DESIGN. INT. CL. 3. REG. 9-17-1996.
- 2,000,787. WORLD BUG FEDERATION. INT. CL. 28. REG. 9-17-1996.
- 2,000,788. SPLATTER BUGS. INT. CL. 28. REG. 9-17-1996.
- 2,000,789. WINDSHIELD WACKERS!. INT. CL. 28. REG. 9-17-1996.
- 2,000,790. THE UNIFIED THEORY OF HEALTH. INT. CL. 42. REG. 9-17-1996.
- 2,000,791. AAMES CAPITAL CORPORATION. INT. CL. 36. REG. 9-17-1996.
- 2,000,792. LAMP. INT. CL. 42. REG. 9-17-1996.
- 2,000,794. DESIGNSHOP ONLINE ELECTRONICS SOURCE AND DESIGN. INT. CL. 42. REG. 9-17-1996.
- 2,000,798. SYRO AND DESIGN. INT. CL. 6. REG. 9-17-1996.
- 2,000,800. JUST DUCKY, INC. AND DESIGN. INT. CL. 37. REG. 9-17-1996.
- 2,000,802. SHOOTHOOPS! SCORE AND DESIGN. INT. CL. 30. REG. 9-17-1996.
- 2,000,804. COLORTRAP. INT. CL. 17. REG. 9-17-1996.
- 2,000,805. FAN SCAN (STYLIZED). INT. CLS. 9 AND 41. REG. 9-17-1996.
- 2,000,809. CPL CONCERT PRODUCTION LIGHTING. INT. CL. 41. REG. 9-17-1996.
- 2,000,810. BOOTH FIRE & SAFETY, INC. SALES AND SERVICE AND DESIGN. INT. CL. 42. REG. 9-17-1996.
- 2,000,812. TALK OF AMERICA. INT. CL. 25. REG. 9-17-1996.
- 2,000,813. FIDELITY FEDERAL SAVINGS BANK OF FLORIDA AND DESIGN. INT. CL. 36. REG. 9-17-1996.
- 2,000,814. FIDELITY BANKSHARES, MHC AND DESIGN. INT. CL. 36. REG. 9-17-1996.
- 2,000,815. TEKTACOTE. INT. CL. 2. REG. 9-17-1996.
- 2,000,819. ENVIROWOOD. INT. CL. 20. REG. 9-17-1996.
- 2,000,825. CYBERATLAS. INT. CL. 42. REG. 9-17-1996.
- 2,000,827. TERRABOR. INT. CL. 7. REG. 9-17-1996.
- 2,000,829. MISCELLANEOUS DESIGN. INT. CL. 30. REG. 9-17-1996.
- 2,000,833. L W G INCORPORATED AND DESIGN. INT. CLS. 36 AND 37. REG. 9-17-1996.
- 2,000,834. FAT LEAVES PACKED TIGHT. INT. CL. 34. REG. 9-17-1996.
- 2,000,835. ALFREDO'S. INT. CL. 30. REG. 9-17-1996.
- 2,000,838. HJ AND DESIGN. INT. CL. 31. REG. 9-17-1996.
- 2,000,843. MAGIC DOG ANIMATION AND DESIGN. INT. CL. 42. REG. 9-17-1996.
- 2,000,846. FAACT. INT. CLS. 9 AND 35. REG. 9-17-1996.
- 2,000,849. INDUSTRIAL LASER REVIEW. INT. CL. 16. REG. 9-17-1996.
- 2,000,851. TODAY'S SENIORS AND DESIGN. INT. CL. 16. REG. 9-17-1996.
- 2,000,853. REATA R TEXAS COWBOY CUISINE ALPINE, TEXAS AND DESIGN. INT. CL. 42. REG. 9-17-1996.
- 2,000,855. ENERGY COOKIES AND DESIGN. INT. CL. 30. REG. 9-17-1996.
- 2,000,856. HEART'S CHOICE AND DESIGN. INT. CL. 29. REG. 9-17-1996.
- 2,000,857. PHOENIX WING AND DESIGN. INT. CL. 30. REG. 9-17-1996.
- 2,000,858. MIDWEST ENTREPRENEURIAL EDUCATION CENTER AND DESIGN. INT. CL. 41. REG. 9-17-1996.
- 2,000,860. FASHION ICON AND DESIGN. INT. CL. 42. REG. 9-17-1996.
- 2,000,866. OMNIHEALTH. INT. CL. 36. REG. 9-17-1996.
- 2,000,867. JETSET AND DESIGN. INT. CL. 30. REG. 9-17-1996.
- 2,000,868. VIEW TECH INC. TECHNOLOGY WITH VISION AND DESIGN. INT. CLS. 41 AND 42. REG. 9-17-1996.
- 2,000,869. MISCELLANEOUS DESIGN. INT. CL. 42. REG. 9-17-1996.
- 2,000,870. TWIN CITIES SPORT AND RECREATION CLUB AND DESIGN. INT. CL. 41. REG. 9-17-1996.
- 2,000,873. WNA. INT. CLS. 35, 36 AND 39. REG. 9-17-1996.
- 2,000,876. JOBPACK. INT. CL. 35. REG. 9-17-1996.
- 2,000,878. INKMASTER. INT. CL. 2. REG. 9-17-1996.
- 2,000,880. TRANS WORLD ONE AND DESIGN. INT. CL. 39. REG. 9-17-1996.
- 2,000,884. VALVE DRIVER II. INT. CL. 9. REG. 9-17-1996.
- 2,000,888. CAFFE GIO. INT. CLS. 21, 30 AND 42. REG. 9-17-1996.
- 2,000,889. I.D. LINK. INT. CL. 42. REG. 9-17-1996.
- 2,000,890. MISCELLANEOUS DESIGN. INT. CLS. 16 AND 36. REG. 9-17-1996.
- 2,000,891. BANK OF ELMHURST. INT. CL. 36. REG. 9-17-1996.
- 2,000,892. PILGRIM ALE 1620 OLD HARBOR BREWING COMPANY GOV. WILLIAM BRADFORD AND DESIGN. INT. CL. 32. REG. 9-17-1996.
- 2,000,893. NORRELL FINANCIAL STAFFING AND DESIGN. INT. CL. 35. REG. 9-17-1996.
- 2,000,894. GOLD KEY SUGGESTION PROGRAM AND DESIGN. INT. CL. 35. REG. 9-17-1996.
- 2,000,895. 3-IN-1 LIFE. INT. CL. 36. REG. 9-17-1996.
- 2,000,898. NETWORKING. INT. CL. 16. REG. 9-17-1996.
- 2,000,899. GAMES OF NEVADA. INT. CL. 9. REG. 9-17-1996.
- 2,000,901. MISCELLANEOUS DESIGN. INT. CL. 30. REG. 9-17-1996.
- 2,000,902. LEE COLE'S 3/32ND SOLUTION THE BIO-MECHANICAL SOLUTION. INT. CL. 40. REG. 9-17-1996.
- 2,000,905. LINKSAVER. INT. CL. 38. REG. 9-17-1996.
- 2,000,908. REMEDY RESEARCH (STYLIZED). INT. CL. 35. REG. 9-17-1996.
- 2,000,909. WACKERS! (STYLIZED). INT. CLS. 25 AND 28. REG. 9-17-1996.

- 2,000,910. NETCHOICE (STYLIZED). INT. CL. 42. REG. 9-17-1996.
- 2,000,911. BILDO AND DESIGN. INT. CL. 25. REG. 9-17-1996.
- 2,000,913. POCHACCO. INT. CL. 42. REG. 9-17-1996.
- 2,000,915. THE ENERGY TEAM AND DESIGN. INT. CL. 35. REG. 9-17-1996.
- 2,000,916. THIS YEAR IN COUNTRY MUSIC. INT. CL. 41. REG. 9-17-1996.
- 2,000,919. AEREON SILVER METER SYSTEM AND DESIGN. INT. CL. 9. REG. 9-17-1996.
- 2,000,922. PROTECTION TECHNOLOGY RESOURCES. INT. CL. 42. REG. 9-17-1996.
- 2,000,923. TECH BOYZ HYPERACTIVE HEROES AND DESIGN. INT. CL. 16. REG. 9-17-1996.
- 2,000,924. E-MAG. INT. CL. 9. REG. 9-17-1996.
- 2,000,926. MISCELLANEOUS DESIGN. INT. CL. 12. REG. 9-17-1996.
- 2,000,929. ROYAL INSURANCE AND DESIGN. INT. CL. 36. REG. 9-17-1996.
- 2,000,933. SCOTLAND YARD. INT. CL. 9. REG. 9-17-1996.
- 2,000,934. LOUIS-GRAVATTI. INT. CL. 25. REG. 9-17-1996.
- 2,000,935. PORTA-VAC. INT. CL. 8. REG. 9-17-1996.
- 2,000,938. GOLDEN OLDIES. INT. CLS. 39 AND 41. REG. 9-17-1996.
- 2,000,939. MISCELLANEOUS DESIGN. INT. CL. 36. REG. 9-17-1996.
- 2,000,940. ROSA BELLA. INT. CL. 3. REG. 9-17-1996.
- 2,000,942. PROFIT-POWER SYSTEMS. INT. CL. 9. REG. 9-17-1996.
- 2,000,944. DRESOL. INT. CLS. 29 AND 30. REG. 9-17-1996.
- 2,000,945. SYBASE THE ARCHITECTURE FOR CHANGE AND DESIGN. INT. CLS. 37, 41 AND 42. REG. 9-17-1996.
- 2,000,947. P PATIENT PAYMENT PLAN AND DESIGN. INT. CLS. 35 AND 36. REG. 9-17-1996.
- 2,000,950. VILLY ALEXANDRAKIS JEWELRY V AND DESIGN. INT. CL. 14. REG. 9-17-1996.
- 2,000,951. AMD (STYLIZED). INT. CLS. 40 AND 42. REG. 9-17-1996.
- 2,000,952. HOT LAVA MAGAZINE AND DESIGN. INT. CL. 16. REG. 9-17-1996.
- 2,000,953. EMBRACE ME. INT. CL. 3. REG. 9-17-1996.
- 2,000,954. STUDIO CONFECTIONS. INT. CL. 30. REG. 9-17-1996.
- 2,000,955. HIGHER CALLING. INT. CL. 36. REG. 9-17-1996.
- 2,000,956. BESO DE LUNA DREAM TOOLS AND COMFORTS (STYLIZED). INT. CLS. 3, 4 AND 20. REG. 9-17-1996.
- 2,000,959. SPORTCARE. INT. CL. 3. REG. 9-17-1996.
- 2,000,962. G EXPRESS AND DESIGN. INT. CL. 42. REG. 9-17-1996.
- 2,000,965. HERBAL COMFORT. INT. CL. 5. REG. 9-17-1996.
- 2,000,966. URINOZINC AND DESIGN. INT. CL. 5. REG. 9-17-1996.
- 2,000,968. OPTIMA PLUS. INT. CLS. 9 AND 16. REG. 9-17-1996.
- 2,000,970. RISING STAR RITA. INT. CL. 33. REG. 9-17-1996.
- 2,000,971. THE WOOD BAND. INT. CL. 41. REG. 9-17-1996.
- 2,000,973. PARTNERGISTICS. INT. CL. 39. REG. 9-17-1996.
- 2,000,975. MONOMATIC. INT. CL. 11. REG. 9-17-1996.
- 2,000,976. AMERICAN PREMIER. INT. CL. 33. REG. 9-17-1996.
- 2,000,977. CLASSIFIEDS TO GO. INT. CL. 35. REG. 9-17-1996.
- 2,000,978. WALLA WALLA ONION AND DESIGN. INT. CL. 30. REG. 9-17-1996.
- 2,000,979. JAM. INT. CL. 16. REG. 9-17-1996.
- 2,000,980. MISCELLANEOUS DESIGN. INT. CL. 42. REG. 9-17-1996.
- 2,000,981. MISCELLANEOUS DESIGN. INT. CL. 36. REG. 9-17-1996.
- 2,000,984. RWH. INT. CL. 14. REG. 9-17-1996.
- 2,000,987. ESG THE SMARTEST REAL ESTATE MOVE YOU CAN MAKE. INT. CL. 36. REG. 9-17-1996.
- 2,000,988. BERTOLINI'S AUTHENTIC TRATTORIA AND DESIGN. INT. CL. 42. REG. 9-17-1996.
- 2,000,989. ANDREWS PREMIUM AND DESIGN. INT. CL. 29. REG. 9-17-1996.
- 2,000,990. VOICE IT MESSAGE CENTER. INT. CL. 9. REG. 9-17-1996.
- 2,000,991. HL HOTELOGIC AND DESIGN. INT. CLS. 9 AND 42. REG. 9-17-1996.
- 2,000,992. ROOTABAGA COUNTRY AND DESIGN. INT. CL. 31. REG. 9-17-1996.
- 2,000,994. PAN AM INTERNATIONAL FLIGHT ACADEMY AND DESIGN. INT. CL. 41. REG. 9-17-1996.
- 2,000,995. ELECTRONIC GOVERNMENT THE PEOPLE & TECHNOLOGIES BRINGING GOVERNMENT ONLINE AND DESIGN. INT. CL. 16. REG. 9-17-1996.
- 2,000,997. FIRST OF MICHIGAN. INT. CL. 36. REG. 9-17-1996.
- 2,000,998. CLUB PANACEA CHARTERS AND EXCURSIONS AND DESIGN. INT. CL. 39. REG. 9-17-1996.
- 2,000,999. THE GOLF THING AND DESIGN. INT. CL. 28. REG. 9-17-1996.
- 2,001,000. NEMESIS (STYLIZED). INT. CL. 41. REG. 9-17-1996.
- 2,001,001. GREAT SOUTHERN SAUCE COMPANY. INT. CL. 30. REG. 9-17-1996.
- 2,001,004. ANGEL STAR (STYLIZED). INT. CL. 16. REG. 9-17-1996.
- 2,001,005. FROM OUR HOME TO YOUR HOME. INT. CL. 41. REG. 9-17-1996.
- 2,001,006. T AND DESIGN. INT. CL. 5. REG. 9-17-1996.
- 2,001,007. HI H.L GOOD FOOD INC. MASTER SAUCE AND DESIGN. INT. CL. 30. REG. 9-17-1996.
- 2,001,008. MISCELLANEOUS DESIGN. INT. CLS. 41 AND 42. REG. 9-17-1996.
- 2,001,009. SPREE. INT. CL. 38. REG. 9-17-1996.
- 2,001,012. MY NEW FLAVORS CAN BE YOUR SECRET RECIPE. INT. CL. 29. REG. 9-17-1996.
- 2,001,013. INSTREAM AND DESIGN. INT. CL. 38. REG. 9-17-1996.
- 2,001,014. EARTH ESSENCE AND DESIGN. INT. CL. 3. REG. 9-17-1996.
- 2,001,018. QUALITY SEED FOR QUALITY PRODUCE. INT. CL. 16. REG. 9-17-1996.
- 2,001,019. CHILLS INTERGALACTIC PURIFIER AND DESIGN. INT. CLS. 16, 25 AND 34. REG. 9-17-1996.
- 2,001,024. ESCA AND DESIGN. INT. CL. 21. REG. 9-17-1996.
- 2,001,026. SN SPECIFIC NUTRITION (STYLIZED). INT. CL. 42. REG. 9-17-1996.
- 2,001,027. AMINO LEAN. INT. CL. 5. REG. 9-17-1996.
- 2,001,030. A ACRYMED AND DESIGN. INT. CL. 5. REG. 9-17-1996.
- 2,001,031. ACRYMED. INT. CL. 5. REG. 9-17-1996.
- 2,001,033. BOOMERANGLE. INT. CL. 7. REG. 9-17-1996.
- 2,001,035. SNACK BUDDIES. INT. CL. 29. REG. 9-17-1996.
- 2,001,036. THE AESTHETIC SURGERY EDUCATION AND RESEARCH FOUNDATION AND DESIGN. INT. CLS. 36 AND 42. REG. 9-17-1996.
- 2,001,041. ADEXOL. INT. CL. 5. REG. 9-17-1996.
- 2,001,042. COMMUNITY THREADS. INT. CL. 36. REG. 9-17-1996.
- 2,001,044. PENNUNION ENERGY SERVICES AND DESIGN. INT. CLS. 39 AND 42. REG. 9-17-1996.
- 2,001,045. CLINITOUCH. INT. CL. 9. REG. 9-17-1996.
- 2,001,048. EL CANARIO AND DESIGN. INT. CL. 30. REG. 9-17-1996.
- 2,001,050. WACKERS!. INT. CLS. 25 AND 28. REG. 9-17-1996.
- 2,001,051. KWIK BURN. INT. CL. 5. REG. 9-17-1996.
- 2,001,053. TASTE OF THE TOWN. INT. CL. 29. REG. 9-17-1996.
- 2,001,054. TAL-FLEX. INT. CL. 2. REG. 9-17-1996.
- 2,001,058. PERSONAL MARINE AND DESIGN. INT. CL. 12. REG. 9-17-1996.
- 2,001,059. HAIRGO. INT. CL. 8. REG. 9-17-1996.
- 2,001,061. TRAVEL TALK. INT. CL. 9. REG. 9-17-1996.
- 2,001,063. ROCKY MOUNTAIN ROAD. INT. CL. 30. REG. 9-17-1996.
- 2,001,066. CARMELLAS CHOICE AND DESIGN. INT. CL. 30. REG. 9-17-1996.

- 2,001,067. WHIMSIES, INC. "NURSING CRADLE" AND DESIGN. INT. CL. 20. REG. 9-17-1996.
- 2,001,069. I SOCCER I PASTA AND DESIGN. INT. CL. 30. REG. 9-17-1996.
- 2,001,070. EDU-ROM. INT. CL. 35. REG. 9-17-1996.
- 2,001,071. CURITY. INT. CL. 3. REG. 9-17-1996.
- 2,001,072. THE POWER CATALOG. INT. CL. 16. REG. 9-17-1996.
- 2,001,073. KINGCOCK WORM-ALL TRIPLE ACTION AND DESIGN. INT. CL. 5. REG. 9-17-1996.
- 2,001,074. PETER SCOTT'S. INT. CL. 42. REG. 9-17-1996.
- 2,001,075. THE COFFEE POT AND DESIGN. INT. CL. 30. REG. 9-17-1996.
- 2,001,076. PLAYERS PASTA. INT. CL. 30. REG. 9-17-1996.
- 2,001,080. MISCELLANEOUS DESIGN. INT. CL. 33. REG. 9-17-1996.
- 2,001,082. BECAUSE EVERY TRANSACTION COUNTS. INT. CL. 36. REG. 9-17-1996.
- 2,001,083. FESTIVAL MUSICAL BUDWEISER. INT. CL. 32. REG. 9-17-1996.
- 2,001,086. ARIZONA UNIQUE BUGGY ADVENTURES. INT. CL. 39. REG. 9-17-1996.
- 2,001,087. CINQ. INT. CL. 33. REG. 9-17-1996.
- 2,001,089. THE ACCESSIBILITY CENTER THE SHOW-PLACE FOR ACCESSIBILITY PRODUCTS AND INFORMATION AND DESIGN. INT. CL. 42. REG. 9-17-1996.
- 2,001,090. INCHES AND DESIGN. INT. CL. 16. REG. 9-17-1996.
- 2,001,091. CBHS. INT. CL. 42. REG. 9-17-1996.
- 2,001,092. SOUTHERN ELECTRIC INTERNATIONAL AND DESIGN. INT. CL. 36. REG. 9-17-1996.
- 2,001,094. UNION BUSINESS NETWORK. INT. CL. 36. REG. 9-17-1996.
- 2,001,095. TUMS ALIVIA LA ACIDEZ Y ADEMAS, HACE BIEN A LA SALUD. INT. CL. 5. REG. 9-17-1996.
- 2,001,096. VACUFRESH. INT. CL. 31. REG. 9-17-1996.
- 2,001,097. WILDERNESS SOFTWARE. INT. CLS. 9 AND 41. REG. 9-17-1996.
- 2,001,098. TUMS ALIVIA LA ACIDEZ Y HACE BIEN A LA SALUD. INT. CL. 5. REG. 9-17-1996.
- 2,001,099. THE TRICK THAT PAYS FOR ITSELF!. INT. CL. 28. REG. 9-17-1996.
- 2,001,100. ALL-STAR TRADERS HOTLINE. INT. CL. 36. REG. 9-17-1996.
- 2,001,101. MAZZIO'S ITALIAN GRILL. INT. CL. 42. REG. 9-17-1996.
- 2,001,103. PREZZIES!. INT. CL. 30. REG. 9-17-1996.
- 2,001,104. ENDUE. INT. CL. 3. REG. 9-17-1996.
- 2,001,110. REACHING EUROPE THROUGH HIGH-IMPACT CHURCHES. INT. CL. 42. REG. 9-17-1996.
- 2,001,112. SUBJONCTIF. INT. CLS. 3 AND 5. REG. 9-17-1996.
- 2,001,114. HOMEOWNERS 2000. INT. CL. 35. REG. 9-17-1996.
- 2,001,115. ULTRA SMOOTH. INT. CL. 30. REG. 9-17-1996.
- 2,001,116. WISHBOX AND DESIGN. INT. CL. 25. REG. 9-17-1996.
- 2,001,117. LUCKY CHENG'S. INT. CL. 42. REG. 9-17-1996.
- 2,001,121. THE PROFESSIONAL'S REAL ESTATE REPORT AND DESIGN. INT. CL. 16. REG. 9-17-1996.
- 2,001,124. SURVEYOR. INT. CL. 10. REG. 9-17-1996.
- 2,001,128. CREATIVE SOLUTIONS FOR TURFGRASS MANAGEMENT. INT. CL. 1. REG. 9-17-1996.
- 2,001,131. BREAKFAST BABY. INT. CL. 30. REG. 9-17-1996.
- 2,001,133. MISCELLANEOUS DESIGN. INT. CL. 9. REG. 9-17-1996.
- 2,001,134. SUB-ZERO BLEND AND DESIGN. INT. CL. 1. REG. 9-17-1996.
- 2,001,135. DW AND DESIGN. INT. CL. 25. REG. 9-17-1996.
- 2,001,137. SEEDY CHARACTERS. INT. CL. 29. REG. 9-17-1996.
- 2,001,141. FULLY FIELD AND DESIGN. INT. CL. 25. REG. 9-17-1996.
- 2,001,142. ACCESS AMERICA. INT. CLS. 16 AND 41. REG. 9-17-1996.
- 2,001,143. TKO MINIS. INT. CL. 29. REG. 9-17-1996.
- 2,001,146. RICHMOND'S TALKING BUSINESS. INT. CL. 16. REG. 9-17-1996.
- 2,001,147. MISCELLANEOUS DESIGN. INT. CL. 29. REG. 9-17-1996.
- 2,001,148. P. FERRAUD & FILS. INT. CL. 33. REG. 9-17-1996.
- 2,001,149. SATSUMA. INT. CL. 42. REG. 9-17-1996.
- 2,001,150. OTHER MOTHERS. INT. CL. 42. REG. 9-17-1996.
- 2,001,155. MAISON L'AIGLON. INT. CL. 33. REG. 9-17-1996.
- 2,001,156. SOUTHERN CINNAMON MIX. INT. CL. 30. REG. 9-17-1996.
- 2,001,158. BECOMING YOUR OWN WELLNESS COACH. INT. CL. 41. REG. 9-17-1996.
- 2,001,159. 4 AND DESIGN. INT. CL. 25. REG. 9-17-1996.
- 2,001,161. POWER CLUB. INT. CL. 28. REG. 9-17-1996.
- 2,001,163. SURFLINK. INT. CL. 42. REG. 9-17-1996.
- 2,001,164. MIGHTY ICE AND DESIGN. INT. CL. 10. REG. 9-17-1996.
- 2,001,165. TOMATOES THAT TASTE LIKE TOMATOES. INT. CL. 31. REG. 9-17-1996.
- 2,001,166. CLEANAWAY AND DESIGN. INT. CL. 37. REG. 9-17-1996.
- 2,001,171. SHAKEY'S PIZZA PLAYLAND. INT. CL. 42. REG. 9-17-1996.
- 2,001,172. INTIMATE PASSION PAINT. INT. CL. 30. REG. 9-17-1996.
- 2,001,178. TROCKS. INT. CL. 41. REG. 9-17-1996.
- 2,001,181. MISCELLANEOUS DESIGN. INT. CL. 9. REG. 9-17-1996.
- 2,001,182. TROCKADERO. INT. CL. 41. REG. 9-17-1996.
- 2,001,183. RJA (STYLIZED). INT. CL. 7. REG. 9-17-1996.
- 2,001,192. DOVE DISCOVERING OUR VALUE & ESTEEM AND DESIGN. INT. CL. 42. REG. 9-17-1996.
- 2,001,194. FIRE SAUSAGE. INT. CL. 29. REG. 9-17-1996.
- 2,001,195. DALLAS (STYLIZED). INT. CL. 34. REG. 9-17-1996.
- 2,001,196. AEROSMITH. INT. CLS. 6 AND 8. REG. 9-17-1996.
- 2,001,204. THE SOCIETY FOR LADIES WHO LAUGH OUT LOUD. INT. CL. 16. REG. 9-17-1996.
- 2,001,205. INWALL CREATIONS AND DESIGN. INT. CL. 20. REG. 9-17-1996.
- 2,001,208. 1ST DESK. INT. CL. 9. REG. 9-17-1996.
- 2,001,211. COB DRY. INT. CL. 31. REG. 9-17-1996.
- 2,001,212. THE CREDIT KING AND DESIGN. INT. CL. 42. REG. 9-17-1996.
- 2,001,213. BAD JUJU. INT. CLS. 16 AND 25. REG. 9-17-1996.
- 2,001,214. P PRESS - A - PRINT AND DESIGN. INT. CL. 7. REG. 9-17-1996.
- 2,001,216. ALL-WAYS TRAVEL CENTER. INT. CL. 39. REG. 9-17-1996.
- 2,001,217. MISCELLANEOUS DESIGN. INT. CL. 41. REG. 9-17-1996.
- 2,001,218. SAFETY GIRL. INT. CL. 10. REG. 9-17-1996.
- 2,001,219. C-FOLD. INT. CL. 18. REG. 9-17-1996.
- 2,001,220. MASCALIA. INT. CL. 3. REG. 9-17-1996.
- 2,001,224. @HOME. INT. CL. 41. REG. 9-17-1996.
- 2,001,226. R+/RESOURCE MAXIMIZER. INT. CL. 9. REG. 9-17-1996.
- 2,001,231. FATWISE. INT. CL. 42. REG. 9-17-1996.
- 2,001,232. COOL REWARDS AND DESIGN. INT. CL. 35. REG. 9-17-1996.
- 2,001,233. CLASS CLOCK. INT. CL. 42. REG. 9-17-1996.
- 2,001,234. SPORTSRAP. INT. CL. 41. REG. 9-17-1996.
- 2,001,235. LORE AND DESIGN. INT. CL. 16. REG. 9-17-1996.
- 2,001,240. PRECIOUS TIME. INT. CL. 14. REG. 9-17-1996.
- 2,001,242. GOODMAN SEGAR HOGAN HOFFLER AND DESIGN. INT. CL. 36. REG. 9-17-1996.
- 2,001,243. AS WAS AND DESIGN. INT. CL. 42. REG. 9-17-1996.
- 2,001,247. ELDERWOOD AFFILIATES. INT. CL. 35. REG. 9-17-1996.
- 2,001,249. NUTRATURF AND DESIGN. INT. CL. 1. REG. 9-17-1996.
- 2,001,253. POWERSTAFF AND DESIGN. INT. CL. 35. REG. 9-17-1996.
- 2,001,254. PROTROINICS AND DESIGN. INT. CL. 35. REG. 9-17-1996.
- 2,001,256. CRAZY OTTO'S DINER AND DESIGN. INT. CL. 42. REG. 9-17-1996.
- 2,001,257. RADIO SHACK EXPRESS. INT. CL. 42. REG. 9-17-1996.

- 2,001,262. C CONTRACTORS PROGRAM AND DESIGN. INT. CL. 36. REG. 9-17-1996.
- 2,001,265. WRITING TO GET THINGS DONE. INT. CL. 41. REG. 9-17-1996.
- 2,001,268. EZMOVE (STYLIZED). INT. CL. 39. REG. 9-17-1996.
- 2,001,272. AURORAPLUS. INT. CL. 36. REG. 9-17-1996.
- 2,001,273. VALUE USA. INT. CL. 38. REG. 9-17-1996.
- 2,001,274. VALUE WORLD. INT. CL. 38. REG. 9-17-1996.
- 2,001,276. KOR STONE AND DESIGN. INT. CL. 19. REG. 9-17-1996.
- 2,001,278. TAURUS. INT. CL. 16. REG. 9-17-1996.
- 2,001,284. PROCESS IDS. INT. CL. 5. REG. 9-17-1996.
- 2,001,288. ACCOUNTING MATTERS. INT. CL. 35. REG. 9-17-1996.
- 2,001,293. CELEBRATIONS ETC...WEDDING WHEEL AND DESIGN. INT. CL. 16. REG. 9-17-1996.
- 2,001,294. COLLEGE PERKS. INT. CL. 36. REG. 9-17-1996.
- 2,001,295. GALAXY FIGHT. INT. CL. 28. REG. 9-17-1996.
- 2,001,296. THE BLOCK REPORT. INT. CL. 16. REG. 9-17-1996.
- 2,001,299. TOP FUEL. INT. CL. 3. REG. 9-17-1996.
- 2,001,302. MIXXODERM. INT. CL. 3. REG. 9-17-1996.
- 2,001,304. RAINBOWSTAR AND DESIGN. INT. CL. 12. REG. 9-17-1996.
- 2,001,305. TOTALIST PC. INT. CL. 9. REG. 9-17-1996.
- 2,001,306. RIDERRISER. INT. CL. 28. REG. 9-17-1996.
- 2,001,309. STOREROOM AND DESIGN. INT. CL. 16. REG. 9-17-1996.
- 2,001,311. DIAL PLUS. INT. CL. 3. REG. 9-17-1996.
- 2,001,312. RSAREF. INT. CL. 9. REG. 9-17-1996.
- 2,001,313. S SCREENCO AND DESIGN. INT. CL. 41. REG. 9-17-1996.
- 2,001,314. GOVERNMENT EMPLOYEES CONNECTION. INT. CL. 36. REG. 9-17-1996.
- 2,001,316. HARBOR MASTER. INT. CL. 16. REG. 9-17-1996.
- 2,001,317. KLEARPURPOSE. INT. CL. 16. REG. 9-17-1996.
- 2,001,318. PET SAVERS. INT. CL. 16. REG. 9-17-1996.
- 2,001,322. W AND DESIGN. INT. CL. 11. REG. 9-17-1996.
- 2,001,323. FOODSERVICE EQUIPMENT 2000. INT. CL. 16. REG. 9-17-1996.
- 2,001,324. FIREPLUGS, INC. AND DESIGN. INT. CL. 16. REG. 9-17-1996.
- 2,001,325. PRO-RIDER. INT. CL. 41. REG. 9-17-1996.
- 2,001,326. INTENSIVES. INT. CL. 3. REG. 9-17-1996.
- 2,001,327. BLUE MARMALADE. INT. CL. 16. REG. 9-17-1996.
- 2,001,328. SOMERSET 2000. INT. CL. 36. REG. 9-17-1996.
- 2,001,329. CUSHION. INT. CL. 12. REG. 9-17-1996.
- 2,001,331. CASHCARD AND DESIGN. INT. CL. 16. REG. 9-17-1996.
- 2,001,335. BIOSOLUTIONS. INT. CL. 16. REG. 9-17-1996.
- 2,001,337. EVIDENT CRIME SCENE PRODUCTS AND DESIGN. INT. CL. 16. REG. 9-17-1996.
- 2,001,339. KMD INCORPORATED. INT. CL. 39. REG. 9-17-1996.
- 2,001,340. BAPTEN. INT. CL. 5. REG. 9-17-1996.
- 2,001,342. SHAMU: WORLD FOCUS. INT. CL. 41. REG. 9-17-1996.
- 2,001,345. SUMMERSET WOODS. INT. CL. 20. REG. 9-17-1996.
- 2,001,346. AQUA CYCLINE. INT. CL. 5. REG. 9-17-1996.
- 2,001,347. AQUA MOX. INT. CL. 5. REG. 9-17-1996.
- 2,001,348. AQUA MYCIN. INT. CL. 5. REG. 9-17-1996.
- 2,001,349. BEARTH CERTIFICATE AND DESIGN. INT. CL. 28. REG. 9-17-1996.
- 2,001,350. ALLSERVICE ENVIRONMENTAL. INT. CLS. 41 AND 42. REG. 9-17-1996.
- 2,001,351. ALLSERVICE ENVIRONMENTAL AND DESIGN. INT. CLS. 41 AND 42. REG. 9-17-1996.
- 2,001,352. PATHWAYS TO RETIREMENT WITH BANK ONE. INT. CL. 16. REG. 9-17-1996.
- 2,001,353. WAX POETIC AND DESIGN. INT. CL. 4. REG. 9-17-1996.
- 2,001,354. ACCOUNTABLE CARE AND DESIGN. INT. CL. 9. REG. 9-17-1996.
- 2,001,359. PERFORMANCE REWARD. INT. CL. 36. REG. 9-17-1996.
- 2,001,362. GREYSTONE. INT. CL. 24. REG. 9-17-1996.
- 2,001,363. WHERE INVESTORS SPEND THEIR REAL TIME. INT. CLS. 35 AND 36. REG. 9-17-1996.
- 2,001,371. OASIS. INT. CL. 9. REG. 9-17-1996.
- 2,001,372. VISION. INT. CL. 9. REG. 9-17-1996.
- 2,001,373. INFOSESSION. INT. CL. 9. REG. 9-17-1996.
- 2,001,374. SIFA. INT. CL. 20. REG. 9-17-1996.
- 2,001,378. LIVING MIMOSA. INT. CL. 1. REG. 9-17-1996.
- 2,001,379. AURA OF LIVING ROSE. INT. CL. 1. REG. 9-17-1996.
- 2,001,380. AURA OF AROMA. INT. CL. 1. REG. 9-17-1996.
- 2,001,381. LIVING MARIGOLD. INT. CL. 1. REG. 9-17-1996.
- 2,001,382. LIVING FENNEL STALK. INT. CL. 1. REG. 9-17-1996.
- 2,001,383. LIVING BLUE ROSE. INT. CL. 1. REG. 9-17-1996.
- 2,001,384. LIVING CORAL. INT. CL. 1. REG. 9-17-1996.
- 2,001,385. A + APARTMENT LOCATER. INT. CL. 36. REG. 9-17-1996.
- 2,001,387. PRESS-EVAC FLUID SYSTEMS. INT. CL. 7. REG. 9-17-1996.
- 2,001,388. LIVING GUAVA. INT. CL. 1. REG. 9-17-1996.
- 2,001,389. LIVING APRICOT FLOWER. INT. CL. 1. REG. 9-17-1996.
- 2,001,392. SERVICE PARK AND DESIGN. INT. CL. 39. REG. 9-17-1996.
- 2,001,393. SERVICE PARK AND DESIGN. INT. CL. 37. REG. 9-17-1996.
- 2,001,395. CONNECTIONS WITH QUALITY. INT. CLS. 9 AND 11. REG. 9-17-1996.
- 2,001,398. UAZ. INT. CLS. 20, 25 AND 37. REG. 9-17-1996.
- 2,001,401. IRON HORSE RENTALS. INT. CL. 39. REG. 9-17-1996.
- 2,001,402. IRON HORSE VACATIONS. INT. CL. 39. REG. 9-17-1996.
- 2,001,403. MRS. CLAUS OF BETHLEHEM. INT. CL. 41. REG. 9-17-1996.
- 2,001,404. INFOPOL (STYLIZED). INT. CL. 16. REG. 9-17-1996.
- 2,001,405. SODACT. INT. CL. 5. REG. 9-17-1996.
- 2,001,407. QUICK-FIX WRITING: THINK IT * WRITE IT!. INT. CL. 41. REG. 9-17-1996.
- 2,001,409. NAIL-KNEAD. INT. CL. 10. REG. 9-17-1996.
- 2,001,415. PAINLESS. INT. CL. 9. REG. 9-17-1996.
- 2,001,418. B.U.C.S.. INT. CL. 7. REG. 9-17-1996.
- 2,001,419. RIBOMARK. INT. CL. 1. REG. 9-17-1996.
- 2,001,420. PAINLESS APPAREL SYSTEMS. INT. CL. 9. REG. 9-17-1996.
- 2,001,421. VOLUME. INT. CL. 28. REG. 9-17-1996.
- 2,001,422. HARBOR PRINTING. INT. CLS. 36 AND 42. REG. 9-17-1996.
- 2,001,423. ADRIEN ARPEL. INT. CL. 42. REG. 9-17-1996.
- 2,001,426. ALVAR. INT. CL. 6. REG. 9-17-1996.
- 2,001,427. HYDROTRACK. INT. CL. 9. REG. 9-17-1996.
- 2,001,429. FEM-ACTIN. INT. CL. 5. REG. 9-17-1996.
- 2,001,430. SULFA-BAN. INT. CL. 1. REG. 9-17-1996.
- 2,001,431. FILL-A-BAR. INT. CL. 9. REG. 9-17-1996.
- 2,001,432. EXPAND-A-BAR. INT. CL. 9. REG. 9-17-1996.
- 2,001,433. K.C.'S TOBACCO TOWN. INT. CL. 42. REG. 9-17-1996.
- 2,001,436. STRICTLY GOLF (STYLIZED). INT. CL. 42. REG. 9-17-1996.
- 2,001,437. NATIONAL ASSOCIATION COUNTY ENGINEERS NACE AND DESIGN. INT. CLS. 16 AND 41. REG. 9-17-1996.
- 2,001,438. A/E/C SYSTEMS INTERNATIONAL (STYLIZED). INT. CLS. 16, 35 AND 41. REG. 9-17-1996.
- 2,001,439. TROLL BOOK FAIRS. INT. CL. 42. REG. 9-17-1996.
- 2,001,441. RINGS OF REFLECTION AND DESIGN. INT. CL. 14. REG. 9-17-1996.
- 2,001,443. MODERN OPTIONS. INT. CL. 2. REG. 9-17-1996.
- 2,001,450. BUD ON TAP. INT. CL. 42. REG. 9-17-1996.
- 2,001,454. THE REPO INDEX FROM GOVPX THE BENCHMARK FOR TREASURIES. AND DESIGN. INT. CL. 36. REG. 9-17-1996.
- 2,001,455. SUCCESS LITHO. INT. CL. 42. REG. 9-17-1996.
- 2,001,457. CUONG NHU ORIENTAL MARTIAL ARTS AND DESIGN. INT. CLS. 25 AND 41. REG. 9-17-1996.

- 2,001,462. NATURAL LABS. INT. CL. 3. REG. 9-17-1996.
 2,001,466. STATE LINE TACK WESTERN AND DESIGN. INT. CL. 42. REG. 9-17-1996.
 2,001,468. WOW MOM MATERNITY AND DESIGN. INT. CL. 25. REG. 9-17-1996.
 2,001,469. SEPTIC SAVER BIOTREATS SEPTICS SYSTEMS REDUCES ODORS AND DESIGN. INT. CL. 1. REG. 9-17-1996.
 2,001,470. LURE GARD. INT. CL. 2. REG. 9-17-1996.
 2,001,471. WORLD WIDE TOBACCO AND DESIGN. INT. CL. 34. REG. 9-17-1996.
 2,001,477. BEANWORLD. INT. CL. 16. REG. 9-17-1996.
 2,001,478. C AND DESIGN. INT. CL. 39. REG. 9-17-1996.
 2,001,480. GOLD PERFORMANCE AND DESIGN. INT. CL. 16. REG. 9-17-1996.
 2,001,482. NKOTB. INT. CL. 9. REG. 9-17-1996.
 2,001,483. K.O.B. AND DESIGN. INT. CL. 20. REG. 9-17-1996.
 2,001,484. COMPUTERS, ETC.. INT. CL. 42. REG. 9-17-1996.
 2,001,486. INTERSPUN AND DESIGN. INT. CL. 24. REG. 9-17-1996.
 2,001,487. CYCLONE. INT. CL. 13. REG. 9-17-1996.
 2,001,488. PW BETTERTECH. INT. CL. 35. REG. 9-17-1996.
 2,001,490. HAPPY MASSAGE OIL. INT. CL. 3. REG. 9-17-1996.
 2,001,492. RULEWARE. INT. CL. 9. REG. 9-17-1996.
 2,001,496. HAPPY NEWS. INT. CL. 16. REG. 9-17-1996.
 2,001,500. OWNER'S PRIDE. INT. CL. 37. REG. 9-17-1996.
 2,001,502. TOUCHGUARD. INT. CL. 21. REG. 9-17-1996.
 2,001,503. CODESOFT. INT. CL. 42. REG. 9-17-1996.
 2,001,504. ALEXANDER'S BELTS & BUCKLES. INT. CL. 14. REG. 9-17-1996.
 2,001,506. UNI-TEMP. INT. CL. 10. REG. 9-17-1996.
 2,001,507. LTS. INT. CL. 12. REG. 9-17-1996.
 2,001,518. SUN COAST. INT. CL. 19. REG. 9-17-1996.
 2,001,521. VISION. INT. CL. 42. REG. 9-17-1996.
 2,001,524. BRIAN BROTHERS AND DESIGN. INT. CL. 25. REG. 9-17-1996.
 2,001,525. RAPIDTRAK. INT. CL. 7. REG. 9-17-1996.
 2,001,526. THE TWELFTH HOUSE. INT. CL. 16. REG. 9-17-1996.
 2,001,529. HYPERFORMANCE AND DESIGN. INT. CL. 25. REG. 9-17-1996.
 2,001,530. STOP AND SMELL THE MEMORIES. INT. CL. 42. REG. 9-17-1996.
 2,001,531. IF A PICTURE IS WORTH A THOUSAND WORDS, THEN YOUR SENSE OF SMELL IS WORTH A MILLION. INT. CL. 42. REG. 9-17-1996.
 2,001,533. NEJAD GALLERY. INT. CLS. 37 AND 42. REG. 9-17-1996.
 2,001,536. JOSEPH M AND DESIGN. INT. CL. 25. REG. 9-17-1996.
 2,001,537. IT'S YOUR LIFE. DRESS FOR IT.. INT. CL. 42. REG. 9-17-1996.
 2,001,538. PAL-H ART DIRECT AND DESIGN. INT. CL. 16. REG. 9-17-1996.
 2,001,542. AVAST. INT. CL. 5. REG. 9-17-1996.
 2,001,543. DISFUNKTIONAL AND DESIGN. INT. CL. 25. REG. 9-17-1996.
 2,001,544. BUSTER THE AMAZING BEAR. INT. CL. 16. REG. 9-17-1996.
 2,001,545. DYNAMIC AND DESIGN. INT. CL. 35. REG. 9-17-1996.
 2,001,546. ICE JEWELRY. INT. CL. 14. REG. 9-17-1996.
 2,001,547. NOBODY OVER 10 ALLOWED. INT. CL. 42. REG. 9-17-1996.
 2,001,549. VIA. INT. CL. 10. REG. 9-17-1996.
 2,001,550. SIGNATURE FRAC. INT. CL. 40. REG. 9-17-1996.
 2,001,552. MISCELLANEOUS DESIGN. INT. CL. 14. REG. 9-17-1996.
 2,001,554. POINT-OF-CARE SYSTEMS AND DESIGN. INT. CL. 9. REG. 9-17-1996.
 2,001,556. REDLINE ASSIST. INT. CL. 42. REG. 9-17-1996.
 2,001,558. DISCIPE. INT. CL. 25. REG. 9-17-1996.
 2,001,561. 2-D RIDER. INT. CL. 16. REG. 9-17-1996.
 2,001,563. PERIPHERAL VISION. INT. CL. 9. REG. 9-17-1996.
 2,001,568. FEDEX COLLECTION. INT. CL. 42. REG. 9-17-1996.
 2,001,569. CAR SITTER. INT. CL. 39. REG. 9-17-1996.
 2,001,570. HRC (STYLIZED). INT. CL. 41. REG. 9-17-1996.
 2,001,571. THE FIRST GIFT OF CHRISTMAS. INT. CL. 14. REG. 9-17-1996.
 2,001,572. TRU-STITCH (STYLIZED). INT. CL. 25. REG. 9-17-1996.
 2,001,573. O.T.Y. ONLY THE YOUNG. INT. CL. 25. REG. 9-17-1996.
 2,001,575. MANUEL SORTING SYSTEMS. INT. CL. 37. REG. 9-17-1996.
 2,001,577. VOLUMINEX. INT. CL. 3. REG. 9-17-1996.
 2,001,578. PURIFIX. INT. CL. 3. REG. 9-17-1996.
 2,001,582. THE INITIATIVE AGAINST CRIME AND DESIGN. INT. CL. 16. REG. 9-17-1996.
 2,001,584. IUC. INT. CLS. 38, 41 AND 42. REG. 9-17-1996.
 2,001,586. JAMMERZ AND DESIGN. INT. CL. 14. REG. 9-17-1996.
 2,001,587. ROBES OF FAITH. INT. CL. 25. REG. 9-17-1996.
 2,001,590. NEOPERSIST. INT. CL. 9. REG. 9-17-1996.
 2,001,591. PRIME BUSINESS AND DESIGN. INT. CL. 38. REG. 9-17-1996.
 2,001,592. MUNI-TRAC. INT. CL. 36. REG. 9-17-1996.
 2,001,593. QUENCH YOUR THIRST FOR GOOD. INT. CL. 32. REG. 9-17-1996.
 2,001,595. HUSTLER'S VOYEUR. INT. CL. 16. REG. 9-17-1996.
 2,001,599. GIMME FIVE. INT. CL. 14. REG. 9-17-1996.
 2,001,600. MOTION COMMOTION (STYLIZED). INT. CL. 14. REG. 9-17-1996.
 2,001,601. LIES LIKE TRUTH. INT. CL. 41. REG. 9-17-1996.
 2,001,602. AT THE ZU (STYLIZED). INT. CL. 16. REG. 9-17-1996.
 2,001,603. ASTRO-PEN. INT. CL. 16. REG. 9-17-1996.
 2,001,604. CRATER. INT. CL. 18. REG. 9-17-1996.
 2,001,605. WEAR IT OUT. INT. CL. 24. REG. 9-17-1996.
 2,001,606. PTN. INT. CL. 35. REG. 9-17-1996.
 2,001,607. MYSTICAL FRIENDS. INT. CL. 25. REG. 9-17-1996.
 2,001,608. PROFESSIONAL MASSAGE THERAPIST AND DESIGN. INT. CL. 42. REG. 9-17-1996.
 2,001,613. MISCELLANEOUS DESIGN. INT. CL. 25. REG. 9-17-1996.
 2,001,616. DR. BOB'S GOLF LESSONS AND DESIGN. INT. CL. 25. REG. 9-17-1996.
 2,001,620. NEED MONEY? AND DESIGN. INT. CL. 36. REG. 9-17-1996.
 2,001,622. FIRMAMENT. INT. CL. 25. REG. 9-17-1996.
 2,001,623. PINWORKS. INT. CL. 14. REG. 9-17-1996.
 2,001,624. ,NOT EVEN THE RAIN (STYLIZED). INT. CL. 25. REG. 9-17-1996.
 2,001,625. DTK (STYLIZED). INT. CL. 14. REG. 9-17-1996.
 2,001,626. GLOBAL NEWS. INT. CL. 42. REG. 9-17-1996.
 2,001,629. PROJECT E EVOLUTION IN CLOTHING AND DESIGN. INT. CL. 25. REG. 9-17-1996.
 2,001,630. MISCELLANEOUS DESIGN. INT. CL. 16. REG. 9-17-1996.
 2,001,631. THERAROME. INT. CL. 3. REG. 9-17-1996.
 2,001,634. DESIGN AMERICA (STYLIZED). INT. CL. 16. REG. 9-17-1996.
 2,001,637. ECLIPSE CONSULTING GROUP, INC. AND DESIGN. INT. CL. 35. REG. 9-17-1996.
 2,001,638. SAVING TODAY IS TOMORROW WISE. INT. CL. 39. REG. 9-17-1996.
 2,001,646. THE FINE ART OF GOLF. INT. CL. 16. REG. 9-17-1996.
 2,001,647. GRANDMA ZOUPS. INT. CL. 16. REG. 9-17-1996.
 2,001,649. THE TATTERED RABBIT FARM. INT. CL. 28. REG. 9-17-1996.
 2,001,650. HUNTINGTON RIDGE. INT. CL. 25. REG. 9-17-1996.
 2,001,653. DINGBAT. INT. CL. 28. REG. 9-17-1996.
 2,001,654. MISCELLANEOUS DESIGN. INT. CL. 42. REG. 9-17-1996.
 2,001,655. MANHOOD COLLECTIONS. INT. CL. 16. REG. 9-17-1996.

- 2,001,657. MISCELLANEOUS DESIGN. INT. CL. 35. REG. 9-17-1996.
- 2,001,658. DIVERSIFIED. INT. CL. 35. REG. 9-17-1996.
- 2,001,661. WHERE'ABOUTS. INT. CL. 16. REG. 9-17-1996.
- 2,001,670. BANKING AT THE SPEED OF LIFE. INT. CL. 36. REG. 9-17-1996.
- 2,001,671. SUIT & SNEAKERS. INT. CL. 41. REG. 9-17-1996.
- 2,001,674. PRO-SPLICE. INT. CL. 17. REG. 9-17-1996.
- 2,001,676. OL'MAN. INT. CL. 28. REG. 9-17-1996.
- 2,001,677. SMILE TWO. INT. CL. 25. REG. 9-17-1996.
- 2,001,679. PRO-DUCT. INT. CL. 17. REG. 9-17-1996.
- 2,001,680. GOLDEN OPPORTUNITY. INT. CL. 14. REG. 9-17-1996.
- 2,001,682. MISCELLANEOUS DESIGN. INT. CLS. 25 AND 41. REG. 9-17-1996.
- 2,001,683. FREE AGENT AND DESIGN. INT. CL. 12. REG. 9-17-1996.
- 2,001,684. NYB. INT. CL. 25. REG. 9-17-1996.
- 2,001,685. SCHOOL OF AMERICAN BALLET. INT. CL. 41. REG. 9-17-1996.
- 2,001,686. TROPIGRILL CHICKEN. INT. CL. 42. REG. 9-17-1996.
- 2,001,687. ULTRAGARD. INT. CL. 9. REG. 9-17-1996.
- 2,001,689. PRO-FRAMER'S. INT. CL. 17. REG. 9-17-1996.
- 2,001,690. "KID'S LIKE TO FISH TOO". INT. CL. 42. REG. 9-17-1996.
- 2,001,691. VITAL YOUTH. INT. CL. 3. REG. 9-17-1996.
- 2,001,693. JUICEMAX. INT. CL. 5. REG. 9-17-1996.
- 2,001,694. ZOO PEOPLE. INT. CL. 41. REG. 9-17-1996.
- 2,001,695. UNDER PRESSURE. INT. CL. 28. REG. 9-17-1996.
- 2,001,696. SCARLET SPIDER. INT. CL. 16. REG. 9-17-1996.
- 2,001,697. BJ'S COMMUNITY VALUE GUIDE AND DESIGN. INT. CL. 35. REG. 9-17-1996.
- 2,001,698. EN PLENA VIDA. INT. CL. 16. REG. 9-17-1996.
- 2,001,699. MSRS. INT. CL. 3. REG. 9-17-1996.
- 2,001,700. MISCELLANEOUS DESIGN. INT. CL. 42. REG. 9-17-1996.
- 2,001,701. PRICE COSTCO (STYLIZED). INT. CL. 35. REG. 9-17-1996.
- 2,001,702. PRICE COSTCO (STYLIZED). INT. CL. 40. REG. 9-17-1996.
- 2,001,703. SMARTER TIME CONCEPTS, INC.. INT. CL. 35. REG. 9-17-1996.
- 2,001,704. WELLSMILES. INT. CL. 35. REG. 9-17-1996.
- 2,001,705. K.O.B. AND DESIGN. INT. CL. 20. REG. 9-17-1996.
- 2,001,713. WAGGLE. INT. CL. 25. REG. 9-17-1996.
- 2,001,715. KENRAN WAGYU. INT. CL. 29. REG. 9-17-1996.
- 2,001,720. NORWEST LEARNING SYSTEMS. INT. CL. 16. REG. 9-17-1996.
- 2,001,721. FOR THE LOVE OF MUSIC AND DESIGN. INT. CLS. 9, 16 AND 25. REG. 9-17-1996.
- 2,001,722. BUSTER BROS.. INT. CL. 28. REG. 9-17-1996.
- 2,001,724. THE NATURAL LEAGUE. INT. CL. 25. REG. 9-17-1996.
- 2,001,725. MINIMAX. INT. CLS. 16 AND 42. REG. 9-17-1996.
- 2,001,729. PULSE. INT. CLS. 35 AND 42. REG. 9-17-1996.
- 2,001,730. AAMAD. INT. CL. 25. REG. 9-17-1996.
- 2,001,731. IMAGIX KIDS. INT. CL. 28. REG. 9-17-1996.
- 2,001,732. MISCELLANEOUS DESIGN. INT. CLS. 9, 25 AND 41. REG. 9-17-1996.
- 2,001,733. SALSA KIDS. INT. CLS. 9 AND 41. REG. 9-17-1996.
- 2,001,734. POWER OF INTEGRATION. INT. CL. 9. REG. 9-17-1996.
- 2,001,735. MOUNTAINEER. INT. CL. 12. REG. 9-17-1996.
- 2,001,736. FORM FLEX. INT. CL. 17. REG. 9-17-1996.
- 2,001,740. CATERER'S SELECT. INT. CL. 21. REG. 9-17-1996.
- 2,001,741. PIONEER. INT. CL. 8. REG. 9-17-1996.
- 2,001,743. COMMERCE:COMPLETE. INT. CL. 42. REG. 9-17-1996.
- 2,001,744. SUPERPAC. INT. CL. 7. REG. 9-17-1996.
- 2,001,749. QUALITY BY DESIGN. INT. CL. 8. REG. 9-17-1996.
- 2,001,750. CRM. INT. CL. 9. REG. 9-17-1996.
- 2,001,752. REPLY. INT. CL. 25. REG. 9-17-1996.
- 2,001,754. DETECTIVE TOOL KIT. INT. CL. 9. REG. 9-17-1996.
- 2,001,755. SCHWAB BOND SOURCE. INT. CL. 36. REG. 9-17-1996.
- 2,001,758. TEKWAR. INT. CL. 28. REG. 9-17-1996.
- 2,001,759. OL' BUBBA. INT. CL. 21. REG. 9-17-1996.
- 2,001,761. SHRIMPWICH. INT. CL. 29. REG. 9-17-1996.
- 2,001,762. MRO AMERICA. INT. CL. 42. REG. 9-17-1996.
- 2,001,763. GRANNY SMITH. INT. CL. 24. REG. 9-17-1996.
- 2,001,764. INTERNET TELEVISION. INT. CL. 41. REG. 9-17-1996.
- 2,001,765. ATA FAX!. INT. CL. 9. REG. 9-17-1996.
- 2,001,768. YPN. INT. CLS. 38, 41 AND 42. REG. 9-17-1996.
- 2,001,769. MORGAN COOPER. INT. CL. 25. REG. 9-17-1996.
- 2,001,771. RIALTO. INT. CL. 16. REG. 9-17-1996.
- 2,001,772. SUPPORTWARE!. INT. CL. 42. REG. 9-17-1996.
- 2,001,773. I-125 RAPID STRAND. INT. CL. 5. REG. 9-17-1996.
- 2,001,774. T201 AND DESIGN. INT. CL. 12. REG. 9-17-1996.
- 2,001,775. VIRIDIS AND DESIGN. INT. CL. 14. REG. 9-17-1996.
- 2,001,777. SUPERKOOL. INT. CL. 7. REG. 9-17-1996.
- 2,001,780. ULTRAEDGE. INT. CL. 20. REG. 9-17-1996.
- 2,001,785. STEWARDSHIP FARMS. INT. CL. 42. REG. 9-17-1996.
- 2,001,787. FAN-A-SIGN. INT. CL. 9. REG. 9-17-1996.
- 2,001,788. CONSERVATION COUNTS. INT. CL. 16. REG. 9-17-1996.
- 2,001,789. UNITED CONCESSIONS. INT. CL. 42. REG. 9-17-1996.
- 2,001,791. SOUTHERN SAVORIES. INT. CL. 30. REG. 9-17-1996.
- 2,001,792. NOSERIDER. INT. CL. 25. REG. 9-17-1996.
- 2,001,793. FRESH MAX. INT. CL. 31. REG. 9-17-1996.
- 2,001,794. MEMORYMATS. INT. CL. 16. REG. 9-17-1996.
- 2,001,796. MEGA TALKING. INT. CL. 28. REG. 9-17-1996.
- 2,001,797. TRISHA'S DISHES. INT. CL. 30. REG. 9-17-1996.
- 2,001,798. HOME PRO. INT. CLS. 3 AND 5. REG. 9-17-1996.
- 2,001,802. AERO. INT. CL. 28. REG. 9-17-1996.
- 2,001,803. FRUITFUL. INT. CL. 3. REG. 9-17-1996.
- 2,001,804. R E C A P. INT. CL. 25. REG. 9-17-1996.
- 2,001,809. BEEFIT BLANKIT. INT. CL. 22. REG. 9-17-1996.
- 2,001,810. PRIMITIVE PAPAYA. INT. CL. 32. REG. 9-17-1996.
- 2,001,811. RB. INT. CL. 28. REG. 9-17-1996.
- 2,001,814. IMAGINE AUTOWARP. INT. CL. 9. REG. 9-17-1996.
- 2,001,817. FAROARM (STYLIZED). INT. CL. 9. REG. 9-17-1996.
- 2,001,820. HYRYZ. INT. CL. 29. REG. 9-17-1996.
- 2,001,822. AMERICAN SHOGUN AND DESIGN. INT. CL. 41. REG. 9-17-1996.
- 2,001,826. PENDLETON SECURITY INTERNATIONAL, LTD.. INT. CL. 42. REG. 9-17-1996.
- 2,001,827. METANETICS AND DESIGN. INT. CL. 9. REG. 9-17-1996.
- 2,001,831. CONTRACT FIRST. INT. CL. 9. REG. 9-17-1996.
- 2,001,832. BUSINESS FIRST. INT. CL. 9. REG. 9-17-1996.
- 2,001,833. REPAIR FIRST. INT. CL. 9. REG. 9-17-1996.
- 2,001,837. BOW TIE GIFT BAGS. INT. CL. 16. REG. 9-17-1996.
- 2,001,838. COTTON GENERATION. INT. CL. 25. REG. 9-17-1996.
- 2,001,839. VISORGEAR. INT. CL. 9. REG. 9-17-1996.
- 2,001,840. CLUB PACK. INT. CL. 28. REG. 9-17-1996.
- 2,001,842. ACCESS. INT. CL. 21. REG. 9-17-1996.
- 2,001,843. TOSS-UP. INT. CL. 20. REG. 9-17-1996.
- 2,001,845. WHITETAIL. INT. CL. 30. REG. 9-17-1996.
- 2,001,848. ENGLISH LINKS. INT. CL. 25. REG. 9-17-1996.
- 2,001,849. SPRINGBLOKS. INT. CL. 22. REG. 9-17-1996.
- 2,001,852. ROAD KILL. INT. CL. 3. REG. 9-17-1996.
- 2,001,854. STUFF 4 KIDS. INT. CL. 21. REG. 9-17-1996.
- 2,001,855. TRUEACCESS. INT. CL. 9. REG. 9-17-1996.
- 2,001,856. 02 AND DESIGN. INT. CL. 17. REG. 9-17-1996.
- 2,001,857. WEAREVER. INT. CL. 5. REG. 9-17-1996.
- 2,001,859. TURBOCLAIM. INT. CL. 9. REG. 9-17-1996.
- 2,001,860. PERMANENT TICKET. INT. CLS. 16 AND 41. REG. 9-17-1996.
- 2,001,866. XL TAGS. INT. CL. 20. REG. 9-17-1996.
- 2,001,867. ECOTRIM. INT. CL. 19. REG. 9-17-1996.
- 2,001,868. MARKIE. INT. CL. 25. REG. 9-17-1996.
- 2,001,869. THE SEWING WHEEL. INT. CL. 40. REG. 9-17-1996.

- 2,001,870. SMILEKEEPERS. INT. CL. 42. REG. 9-17-1996.
 2,001,871. KULTURE MAGZ. INT. CL. 9. REG. 9-17-1996.
 2,001,874. COLORFUL CONSTRUCTION. INT. CL. 16. REG. 9-17-1996.
 2,001,875. PAINT-A-LOON (STYLIZED). INT. CL. 28. REG. 9-17-1996.
 2,001,877. BUBBLE BRAIN. INT. CL. 30. REG. 9-17-1996.
 2,001,880. 24X7. INT. CL. 9. REG. 9-17-1996.
 2,001,881. POWER BUDDY. INT. CL. 28. REG. 9-17-1996.
 2,001,882. BLT. INT. CL. 9. REG. 9-17-1996.
 2,001,884. THE YELLOW SUBMARINE PLAYHOUSE. INT. CL. 28. REG. 9-17-1996.
 2,001,885. BRITTANY. INT. CL. 9. REG. 9-17-1996.
 2,001,888. LANTEGRITY. INT. CLS. 9 AND 16. REG. 9-17-1996.
 2,001,889. P PRINCE AND DESIGN. INT. CL. 28. REG. 9-17-1996.
 2,001,890. BEDTIME KENYA. INT. CL. 28. REG. 9-17-1996.
 2,001,893. BIOSTICK. INT. CL. 21. REG. 9-17-1996.
 2,001,895. HAUTE CELLARS. INT. CL. 33. REG. 9-17-1996.
 2,001,896. THE DRY ONE. INT. CL. 9. REG. 9-17-1996.
 2,001,897. THE COOL ONE. INT. CL. 9. REG. 9-17-1996.
 2,001,898. PASTA YA GOTCHA! AND DESIGN. INT. CL. 42. REG. 9-17-1996.
 2,001,902. SKINPLICITY OVERNIGHT EYE TREATMENT. INT. CL. 3. REG. 9-17-1996.
 2,001,904. QUALITY DRIVEN PERFORMANCE. INT. CL. 42. REG. 9-17-1996.
 2,001,906. E*COLITE. INT. CL. 9. REG. 9-17-1996.
 2,001,907. DINO-MITE. INT. CL. 16. REG. 9-17-1996.
 2,001,908. SOUNDIMALS. INT. CL. 25. REG. 9-17-1996.
 2,001,909. ROOMS IN BLOOM. INT. CL. 27. REG. 9-17-1996.
 2,001,910. WHITE MOONFLOWERS. INT. CL. 3. REG. 9-17-1996.
 2,001,911. WINTER'S EVE. INT. CL. 28. REG. 9-17-1996.
 2,001,912. DOUBLE FUN. INT. CL. 28. REG. 9-17-1996.
 2,001,913. DUNCAN HINES ANGEL CUPS. INT. CL. 30. REG. 9-17-1996.
 2,001,914. DUNCAN HINES KIDS CUPS. INT. CL. 30. REG. 9-17-1996.
 2,001,921. KEY ADVISOR. INT. CL. 36. REG. 9-17-1996.
 2,001,922. UNITED CENTRAL BANK. INT. CL. 36. REG. 9-17-1996.
 2,001,923. GOLFWEAR FOR AMERICA'S GAME. INT. CL. 25. REG. 9-17-1996.
 2,001,924. LOCCOM. INT. CL. 9. REG. 9-17-1996.
 2,001,927. CANCER ASSIST PLAN. INT. CL. 36. REG. 9-17-1996.
 2,001,929. ZEO-CARB. INT. CL. 31. REG. 9-17-1996.
 2,001,930. CARESOURCE. INT. CL. 42. REG. 9-17-1996.
 2,001,932. MI BY MEZLAN. INT. CL. 25. REG. 9-17-1996.
 2,001,933. DENIM WORKS. INT. CL. 25. REG. 9-17-1996.
 2,001,935. EX'S. INT. CL. 28. REG. 9-17-1996.
 2,001,936. YOUR DESIRES HAVE COME OF AGE. INT. CL. 42. REG. 9-17-1996.
 2,001,940. POOMPS. INT. CL. 28. REG. 9-17-1996.
 2,001,941. FRIGHT RIDERS. INT. CL. 28. REG. 9-17-1996.
 2,001,946. SOFTRIMS. INT. CL. 24. REG. 9-17-1996.
 2,001,947. SOFT 'N SNUG. INT. CL. 28. REG. 9-17-1996.
 2,001,948. CYBERMOUSE. INT. CL. 9. REG. 9-17-1996.
 2,001,951. TODAY'S KMART. INT. CL. 42. REG. 9-17-1996.
 2,001,952. EVERYTHING WE DO IS BUILT AROUND YOU. INT. CL. 42. REG. 9-17-1996.
 2,001,953. HAPPENING HAIR COLLECTION. INT. CL. 28. REG. 9-17-1996.
 2,001,954. CELEBRATE THE MAGIC. INT. CL. 42. REG. 9-17-1996.
 2,001,955. ROMANTIC ROSE BRIDE. INT. CL. 28. REG. 9-17-1996.
 2,001,956. LOVE 'N GO. INT. CL. 28. REG. 9-17-1996.
 2,001,957. AGNES B. LOLITA (STYLIZED). INT. CL. 3. REG. 9-17-1996.
 2,001,965. DOWN THE OCEAN. INT. CL. 25. REG. 9-17-1996.
 2,001,966. TOULOUSE LAUTREC. INT. CL. 25. REG. 9-17-1996.
 2,001,968. SCRATCH 'N SNIFF. INT. CL. 25. REG. 9-17-1996.
 2,001,971. BRAKE WAREHOUSE. INT. CL. 42. REG. 9-17-1996.
 2,001,972. BUSINESS TECHNOLOGY ASSOCIATION. INT. CL. 42. REG. 9-17-1996.
 2,001,978. BUSINESS PRODUCTS AND SYSTEMS. INT. CL. 16. REG. 9-17-1996.
 2,001,980. MISCELLANEOUS DESIGN. INT. CL. 19. REG. 9-17-1996.
 2,001,981. MISCELLANEOUS DESIGN. INT. CL. 19. REG. 9-17-1996.
 2,001,982. VERTICAL HOT FORGER. INT. CL. 7. REG. 9-17-1996.
 2,001,983. HUNTER SAFE. INT. CL. 28. REG. 9-17-1996.
 2,001,984. ACE IT AND DESIGN. INT. CL. 25. REG. 9-17-1996.
 2,001,985. MISCELLANEOUS DESIGN. INT. CL. 25. REG. 9-17-1996.
 2,001,986. WORLDWIDE CONFERENCE ON INFORMATION SYSTEMS EDUCATION. INT. CL. 35. REG. 9-17-1996.
 2,001,987. TECHNOLOGY ONLINE. INT. CL. 42. REG. 9-17-1996.
 2,001,988. INSTITUTE FOR THE ADVANCEMENT OF MEDICALACUPUNCTURE. INT. CL. 41. REG. 9-17-1996.
 2,001,991. 1-800-DIABETIC. INT. CL. 42. REG. 9-17-1996.
 2,001,993. STEAK HOUSE PREFERRED. INT. CL. 29. REG. 9-17-1996.
 2,001,995. EMPLOYEE BENEFITS POOLING. INT. CL. 35. REG. 9-17-1996.
 2,001,997. RETURN-TO-WORK. INT. CL. 36. REG. 9-17-1996.
 2,001,999. PAPERLESS COUPON NETWORK. INT. CL. 35. REG. 9-17-1996.
 2,002,000. COMPANY WORTH. INT. CL. 35. REG. 9-17-1996.
 2,002,001. INTERCONNECTIONS AND DESIGN. INT. CL. 16. REG. 9-17-1996.
 2,002,002. HOT 1000. INT. CLS. 16 AND 42. REG. 9-17-1996.
 2,002,003. IS YOUR YARD FLOODED OR WET?. INT. CL. 37. REG. 9-17-1996.
 2,002,004. YELLOW PAGES OF GOLF. INT. CL. 35. REG. 9-17-1996.
 2,002,005. COMEDIANS. INT. CL. 9. REG. 9-17-1996.
 2,002,006. LEARN THE ART OF MAGIC. INT. CL. 28. REG. 9-17-1996.
 2,002,007. ONE VALVE IN INVENTORY, ONE VALVE ON THE TRUCK...FOR FOUR DIFFERENT JOBS (STYLIZED). INT. CL. 6. REG. 9-17-1996.
 2,002,008. MUY BUENO. INT. CLS. 29 AND 30. REG. 9-17-1996.
 2,002,010. BARUCH. INT. CL. 25. REG. 9-17-1996.
 2,002,011. BARUCCI. INT. CL. 25. REG. 9-17-1996.
 2,002,012. SALONS USA. INT. CL. 35. REG. 9-17-1996.
 2,002,014. TN3270 ADDITION. INT. CL. 9. REG. 9-17-1996.
 2,002,015. MACWORLD DIRECTORY. INT. CL. 16. REG. 9-17-1996.
 2,002,016. 1-888 RESUMES. INT. CL. 35. REG. 9-17-1996.
 2,002,017. 1-888 AIRLINE. INT. CL. 35. REG. 9-17-1996.
 2,002,018. 1-888 DINEOUT. INT. CL. 35. REG. 9-17-1996.
 2,002,019. 1-888 A RESUME. INT. CL. 35. REG. 9-17-1996.
 2,002,020. ULTRAFRYER. INT. CL. 11. REG. 9-17-1996.
 2,002,021. INTERNATIONAL SOUP OR SAUCE. INT. CLS. 29 AND 30. REG. 9-17-1996.
 2,002,022. FROSTED EMBROIDERIES. INT. CL. 25. REG. 9-17-1996.
 2,002,024. VIRTUAL MORTGAGE NETWORK. INT. CL. 36. REG. 9-17-1996.
 2,002,025. PHYSICIAN'S CENTER FOR WEIGHT MANAGEMENT. INT. CL. 42. REG. 9-17-1996.
 2,002,026. CUSTOM STRAPPER. INT. CL. 26. REG. 9-17-1996.
 2,014,690. B TO B BACK TO BASICS AND DESIGN. INT. CL. 9. REG. 11-12-1996.
 2,015,050. THOMPSON CIGAR CO. BONUS BOX CLUB SINCE1915 AND DESIGN. INT. CL. 42. REG. 11-12-1996.
 2,020,476. MISCELLANEOUS DESIGN. INT. CL. 35. REG. 12-3-1996.
 2,038,638. PACWEST RACING GROUP AND DESIGN. INT. CL. 25 ONLY. REG. 2-18-1997.

- 2,046,937. ILIAD AN ODYSSEY IN LEARNING AND DESIGN. INT. CL. 9 ONLY. REG. 3-25-1997.
2,058,564. VIEWERNET (STYLIZED). INT. CL. 41 ONLY. REG. 5-6-1997.
2,063,105. NISSAN. INT. CL. 12 ONLY. REG. 5-20-1997.
2,121,979. BAYER AND DESIGN. INT. CL. 5 ONLY. REG. 12-16-1997.
-
- SECTION 18**
- 872,879. SKIN CLINIC BY NOXZEMA AND DESIGN. U.S. CL. 18. REG. 7-15-1969.
- 992,261. XYLOK (STYLIZED). INT. CL. 1. REG. 9-3-1974.
1,391,287. MOISTURE PERFECT. INT. CL. 3. REG. 4-29-1986.
2,016,977. TOTAL FRAMEWORK. INT. CL. 42. REG. 11-19-1996.
2,148,894. Z1. INT. CLS. 9 AND 25. REG. 4-7-1998.
2,270,931. BAD ASS WHITE BOYS. INT. CLS. 25 AND 42. REG. 8-17-1999.
2,290,053. OFFICEAGENT. INT. CL. 9. REG. 11-2-1999.
2,321,538. Z-BAR. INT. CL. 6. REG. 2-22-2000.
2,480,684. TIMBERLAND. INT. CL. 12. REG. 8-21-2001.
2,508,267. DECADENT CHOCOLATES. INT. CL. 30. REG. 11-13-2001.
2,563,176. ZE CREDIT. INT. CLS. 9, 35, 36, 38 AND 42. REG. 4-23-2002.
2,598,470. BIOSPHERE. INT. CL. 9. REG. 7-23-2002.

* * * * *

TRADEMARK REGISTRATIONS AMENDED, CORRECTED, ETC.

The designation "U.S. Cl." appearing in this section refers to the U.S. class in effect prior to Sep. 1, 1973 rather than the international class which applies to applications filed on or after that date. For adoption of international classification see notice in the OFFICIAL GAZETTE of Jun. 26, 1973 (911 O.G. TM 210).

Any change to the registration will be indicated at the bottom of each entry under ELEMENTS AMENDED, CORRECTED OR RESTRICTED. With the exception of changes to the goods and services, additions to the registration will appear in asterisks and deletions of the registration will appear in brackets. Elements which are only changed will be listed with no punctuation. As to the goods/services statement, amendments to the goods/services will appear in asterisks and deletions will appear in brackets. In addition if any change to the goods/services occurs, the element "Goods/Services" will be listed under ELEMENTS AMENDED, CORRECTED OR RESTRICTED.

401,235. REG. 5-4-1943. SECO/WARWICK OF DELAWARE, INC. (DELAWARE CORPORATION) 180 MERCER STREET, MEADVILLE, PA, 16335. BY CHANGE OF NAME, BY MERGER, BY CHANGE OF NAME, BY MERGER, BY CHANGE OF NAME, BY CHANGE OF NAME, BY ASSIGNMENT CHICAGO FLEXIBLE SHAFT COMPANY CORPORATION) CHICAGO, IL, SN 71-452,601. FILED 4-27-1942. PRINCIPAL REGISTER.

1,205,901. REG. 8-24-1982. LAS-STIK MANUFACTURING COMPANY, THE (OHIO CORPORATION) P. O. BOXZ 941, DAYTON, OH, 45401, BY CHANGE OF NAME, BY ASSIGNMENT, BY CHANGE OF NAME, BY CHANGE OF NAME AUTOMOTIVE APPEARANCE MATERIALS, INC. CORPORATION), A.K.A. LUSTRE GLAZE AUTO FINISHES, DAYTON, OH, SN 73-190,245. FILED 10-23-1978. PRINCIPAL REGISTER.

METAL MINUTES

NO CLAIM BEING MADE FOR THE WORD "METAL", APART FROM THE MARK SHOWN.

INT. CL. 16/U.S. CL. 38

FOR PERIODICAL PUBLICATION DEVOTED TO THE INDUSTRIAL FURNACE TRADE AND CONTAINING NOTES, COMMENTS, AND NEWS RELATING TO THE PROCESSING OF METALS.

FIRST USE 2-16-1942; IN COMMERCE 2-16-1942.

ELEMENTS AMENDED

OWNER NAME
OWNER ADDRESS
CITIZENSHIP
ENTITY
ASSIGNMENT/NAME CHANGE
MARK

The logo for LUSTRE GLAZE AUTO FINISHES features the words "LUSTRE" and "GLAZE" in a large, bold, sans-serif font, stacked vertically. Below them, the words "AUTO FINISHES" are written in a smaller, all-caps, sans-serif font, enclosed within a horizontal rectangular border.

WITHOUT WAIVER OF COMMON LAW RIGHTS, ANY EXCLUSIVE RIGHT TO THE WORDS "GLAZE" AND "AUTO FINISHES" IS DISCLAIMED APART FROM THE MARK AS SHOWN.

INT. CL. 2/U.S. CL. 16

FOR AUTOMOTIVE ENGINE PAINTS.

FIRST USE 10-6-1978; IN COMMERCE 10-6-1978.

INT. CL. 3/U.S. CLS. 4 AND 52

FOR AUTOMOTIVE WAXES, POLISHES AND CLEANERS.

FIRST USE 9-22-1978; IN COMMERCE 9-22-1978.

ELEMENTS AMENDED

OWNER NAME
OWNER ADDRESS
CITIZENSHIP
ENTITY
ASSIGNMENT/NAME CHANGE

563,449. REG. 8-26-1952. UNCLE BEN'S, INC. (DELAWARE CORPORATION) 3250 EAST 44TH STREET, VERNON, CA, 90058, BY CHANGE OF NAME FROM CONVERTED RICE, INC. CORPORATION) HOUSTON, TX, SN 71-619,568. FILED 10-4-1951. PRINCIPAL REGISTER.

1,219,762. REG. 12-14-1982. PACO RABANNE PARFUMS (FRANCE JOINT STOCK COMPANY) NEUILLY SUR SEINE, 6 BOULEVARD DU PARC, (HAUTS DE SEINE), FRANCE., SN 73-241,050. FILED 11-30-1979. PRINCIPAL REGISTER.

CONVERTED

OWNER OF U.S. REG. NO. 428,294.
SEC. 2(F).

INT. CL. 30/U.S. CL. 46

FOR RICE FOR FOOD.

FIRST USE 10-28-1942; IN COMMERCE 10-28-1942.

ELEMENTS AMENDED

MARK

The logo for paco rabanne features the words "paco rabanne" in a lowercase, sans-serif font, centered within a solid black rectangular background.

OWNER OF FRANCE REG. NO. 933,940, DATED 10-7-1975. PACO RABANNE IS THE FICTITIOUS NAME OF FRANCISCO RABANEDA CUERVO, WHOSE CONSENT IS OF RECORD.

INT. CL. 9/U.S. CL. 26

FOR SUNGLASSES AND SPECTACLE FRAMES.
 INT. CL. 14/U.S. CLS. 27 AND 28
 FOR WATCHES, NECKLACES, BRACELETS AND CHAINS.
 INT. CL. 18/U.S. CL. 3
 FOR LEATHER GOODS—NAMELY, LUGGAGE, HANDBAGS, WALLETS, BRIEFCASE-TYPE PORTFOLIOS, LEATHER TRAVELLING KITS CONTAINING CARD CASES, SPECTACLE CASES, PASSPORT CASES, TICKET CASES, COMB CASES AND TRAVELLING TOILET CASES.
 INT. CL. 26/U.S. CL. 28
 FOR EARRINGS, BROOCHES AND CLIPS.

ELEMENTS AMENDED
 MARK

1,255,294. REG. 10-25-1983. PINNACLE TRADING CARD COMPANY (DELAWARE CORPORATION) 1845 WOODALL RODGERS FREEWAY, SUITE 1300, DALLAS, TX, 75202, BY ASSIGNMENT, BY ASSIGNMENT, BY ASSIGNMENT, BY CHANGE OF NAME GENERAL MILLS, INC. CORPORATION) MINNEAPOLIS, MN, SN 73-357,849. FILED 4-2-1982. PRINCIPAL REGISTER.

DIAMOND KINGS

INT. CL. 16/U.S. CLS. 22 AND 38
 FOR BASEBALL TRADING CARDS AND PUZZLE PIECES SOLD AS A UNIT.
 FIRST USE 3-8-1982; IN COMMERCE 3-8-1982.

ELEMENTS AMENDED
 MARK

1,605,079. REG. 7-3-1990. DEMPTOS GLASS COMPANY LLC (KENTUCKY LIMITED LIABILITY COMPANY) 3651 COLLINS AVENUE, LOUISVILLE, KY, 40245, BY ASSIGNMENT, BY CHANGE OF NAME DEMPTOS GLASS CORPORATION CORPORATION) NAPA, CA, SN 73-789,384. FILED 3-27-1989. PRINCIPAL REGISTER.



DEMPOTOS
 GLASS
 CORPORATION

NO CLAIM IS MADE TO THE EXCLUSIVE RIGHT TO USE "GLASS CORPORATION", APART FROM THE MARK AS SHOWN.

INT. CL. 42/U.S. CL. 100
 FOR CUSTOM DESIGN OF GLASS BOTTLES.
 FIRST USE 4-1-1988; IN COMMERCE 4-1-1988.

ELEMENTS AMENDED
 MARK

1,761,828. REG. 3-30-1993. MEDICA HEALTH PLAN (MINNESOTA CORPORATION) 5601 SMETANA DRIVE, MINNETONKA, MN, 55343, BY ASSIGNMENT, BY ASSIGNMENT MEDICA CORPORATION) MINNEAPOLIS, MN, SN 74-213,533. FILED 10-21-1991. PRINCIPAL REGISTER.

MEDICA

INT. CL. 42/U.S. CL. 100
 FOR COMPREHENSIVE HEALTH CARE PLANS AND HEALTH PLAN MANAGEMENT SERVICES.
 FIRST USE 2-12-1991; IN COMMERCE 2-12-1991.

ELEMENTS AMENDED
 OWNER NAME
 OWNER ADDRESS
 CITIZENSHIP
 ENTITY
 ASSIGNMENT/NAME CHANGE
 MARK

1,769,822. REG. 5-11-1993. SCANSOFT, INC. (DELAWARE CORPORATION) 9 CENTENNIAL DRIVE, PEABODY, MA, 01960, BY MERGER, BY ASSIGNMENT DRAGON SYSTEMS, INC. CORPORATION) NEWTON, MA, SN 74-266,540. FILED 4-16-1992. PRINCIPAL REGISTER.

DRAGONDICTATE

OWNER OF U.S. REG. NOS. 1,419,515 AND 1,480,575.
 INT. CL. 9/U.S. CLS. 21, 23, 26, 36 AND 38
 FOR [ELECTRONIC AND COMPUTER HARDWARE; NAMELY, COMPUTER CIRCUIT BOARDS, SIGNAL PROCESSING AND PATTERN MATCHING UNITS, DATA ACQUISITIONS CIRCUITRY, INTERFACE LOGIC CIRCUITRY, ELECTRONIC SPEECH APPLICATION AND DEVELOPMENT UNITS, AND MICROPHONES;] COMPUTER PROGRAMS FOR USE IN SPEECH RECOGNITION AND PROCESSING APPLICATIONS.
 FIRST USE 12-0-1988; IN COMMERCE 12-0-1988.

ELEMENTS AMENDED
 OWNER NAME
 OWNER ADDRESS
 CITIZENSHIP
 ENTITY
 ASSIGNMENT/NAME CHANGE
 GOODS/SERVICES

1,771,176. REG. 5-18-1993. RUIZ-PICASSO, ANNE PALOMA (FRANCE INDIVIDUAL) 1021, PARK AVENUE, NEW YORK, NY, 10028, SN 74-233,658. FILED 12-26-1991. PRINCIPAL REGISTER.

Paloma Picasso

OWNER OF FRANCE REG. NO. 1593677, DATED 5-23-1990.

OWNER OF U.S. REG. NO. 1,460,510.
 THE MARK "PALOMA PICASSO" IDENTIFIES A LIVING INDIVIDUAL WHOSE CONSENT IS OF RECORD.
 INT. CL. 9/U.S. CLS. 2 AND 26

FOR EYEGLASSES, EYEGLASS FRAMES, SUNGLASSES, EYEGLASS CASES AND EYEGLASS FRAME CHAINS .

INT. CL. 19/U.S. CL. 12

FOR CERAMIC AND EARTHENWARE FLOOR COVERINGS.

INT. CL. 27/U.S. CLS. 20 AND 50

FOR WALL HANGINGS, NOT OF TEXTILE, WALL-PAPER, FLOOR COVERING, BATH MATS.

ELEMENTS AMENDED
MARK

1,815,267. REG. 1-4-1994. LARALEV, INC. (DELAWARE CORPORATION) 103 FOULK ROAD, SUITE 200, WILMINGTON, DE, 19803, SN 74-377,916. FILED 4-12-1993. PRINCIPAL REGISTER.

ADVANCE AUTO PARTS

REGISTRATION IS LIMITED TO THE ENTIRE UNITED STATES EXCEPT FOR JEFFERSON COUNTY, KENTUCKY. OWNER OF U.S. REG. NO. 1,484,796.

NO CLAIM IS MADE TO THE EXCLUSIVE RIGHT TO USE "AUTO PARTS", APART FROM THE MARK AS SHOWN.

INT. CL. 42/U.S. CL. 101

FOR RETAIL AUTO PART STORES .

FIRST USE 3-3-1984; IN COMMERCE 3-3-1984.

ELEMENTS AMENDED
CONCURRENT USE STATEMENT
ORDER RESTRICTING THE SCOPE OF REG.
[CONCURRENT USE STATEMENT]

2,003,264. REG. 9-24-1996. HEARST MAGAZINES PROPERTY, INC. (NEVADA CORPORATION) 2 SOUND VIEW DRIVE, SUITE 100, GREENWICH, CT. 06830, BY ASSIGNMENT HEARST CORPORATION, THE CORPORATION) NEW YORK, NY, SN 75-021,647. FILED 11-17-1995. PRINCIPAL REGISTER.

BEDSIDE ASTROLOGER

NO CLAIM IS MADE TO THE EXCLUSIVE RIGHT TO USE "ASTROLOGER", APART FROM THE MARK AS SHOWN.

INT. CL. 16/U.S. CLS. 2, 5, 22, 23, 29, 37, 38 AND 50
FOR BOOKS AND PAMPHLETS ABOUT ASTROLOGY.
FIRST USE 7-31-1994; IN COMMERCE 7-31-1994.

ELEMENTS AMENDED
OWNER NAME
OWNER ADDRESS
CITIZENSHIP
ENTITY
ASSIGNMENT/NAME CHANGE
MARK

2,010,872. REG. 10-22-1996. MESSE FRANKFURT GMBH (FED REP GERMANY COMPANY) 1 LUDWIG-ERHARD-ANLAGE, 60327 FRANKFURT AM MAIN, FED REP GERMANY., SN 74-604,483. FILED 11-30-1994. PRINCIPAL REGISTER.

HOMETEXTIL AMERICAS

NO CLAIM IS MADE TO THE EXCLUSIVE RIGHT TO USE "AMERICAS", APART FROM THE MARK AS SHOWN.

INT. CL. 35/U.S. CLS. 100, 101 AND 102

FOR ORGANIZING AND CONDUCTING TRADESHOWS AND EXHIBITIONS IN THE FIELD OF HOME AND HOUSEHOLD TEXTILES.

FIRST USE 1-12-1995; IN COMMERCE 1-12-1995.

ELEMENTS AMENDED
MARK

2,089,681. REG. 8-19-1997. TAYLOR, FLADGATE AND YEATMAN LIMITED (UNITED KINGDOM LTD LIAB CO) LA MOTTE CHAMBERS, ST. HELIER, JERSEY, CHANNEL ISLANDS, UNITED KINGDOM., SN 74-692,699. FILED 6-22-1995. PRINCIPAL REGISTER.

QUINTA DO PANASCAL

THE ENGLISH TRANSLATION OF THE WORDS "QUINTA DO PANASCAL" IS "A PLACE OF PASTURE LAND".

INT. CL. 33/U.S. CLS. 47 AND 49

FOR WINES, FORTIFIED WINES.

FIRST USE 0-0-1987; IN COMMERCE 0-0-1994.

ELEMENTS CORRECTED
ENTITY

2,143,635. REG. 3-10-1998. CECCO TRADING, INC. (NEW JERSEY CORPORATION) 18 W. STATE STREET, TRENTON, NJ, 08608, SN 75-002,158. FILED P.R. 10-5-1995; AM. S.R. 12-15-1997. SUPPLEMENTAL REGISTER.



NO CLAIM IS MADE TO THE EXCLUSIVE RIGHT TO USE "TIMBER" OR "LIMITED", APART FROM THE MARK AS SHOWN.

INT. CL. 19/U.S. CLS. 1, 12, 33 AND 50

FOR FINISHED PRODUCTS MADE FROM HARDWOOD LUMBER, NAMELY, BOXES, DECKING, DOORS, FENCING, FLOORS, MOLDINGS, PANELING, PATIO TILES, PICKETS, POSTS, RAILS, SHINGLES, SIDING, STAIRCASES, TRIM, WAINSCOTING, WALL BOARDS, WINDOW CASEMENTS, WINDOW FRAMES, WINDOW SILLS, WOOD BEAMS, WOOD JOINTS, WOOD JOISTS, WOOD MOLDING, AND WOOD VENEER.

FIRST USE 9-0-1995; IN COMMERCE 9-0-1995.

ELEMENTS CORRECTED
OWNER ADDRESS
CITIZENSHIP

2,162,241. REG. 6-2-1998. BUTCHER COMPANY, THE (DELAWARE CORPORATION) 67 FOREST STREET, MARLBOROUGH, MA, 01752, BY MERGER, BY CHANGE OF NAME RAMSEY COMPANY, THE CORPORATION) MARLBORO, MA, SN 75-342,101. FILED 8-18-1997. PRINCIPAL REGISTER.

SKY LIGHT

INT. CL. 3/U.S. CLS. 1, 4, 6, 50, 51 AND 52
FOR GLASS CLEANING COMPOUND.
FIRST USE 2-28-1997; IN COMMERCE 2-28-1997.

ELEMENTS CORRECTED
OWNER NAME

FOR ALL PURPOSE DISINFECTANT AND DEODORIZING CLEANING COMPOUND WITHOUT FRAGRANCE.
FIRST USE 2-28-1997; IN COMMERCE 2-28-1997.

ELEMENTS CORRECTED
OWNER ADDRESS
CITIZENSHIP
ENTITY
ASSIGNMENT/NAME CHANGE
DBA/AKA
OWNER NAME

2,162,242. REG. 6-2-1998. BUTCHER COMPANY, THE (DELAWARE CORPORATION) 67 FOREST STREET, MARLBOROUGH, MA, 01752, BY MERGER, BY CHANGE OF NAME RAMSEY COMPANY, THE CORPORATION) MARLBORO, MA, SN 75-342,103. FILED 8-18-1997. PRINCIPAL REGISTER.

HARD CHARGER

INT. CL. 3/U.S. CLS. 1, 4, 6, 50, 51 AND 52
FOR CARPET CLEANING COMPOUND.
FIRST USE 11-30-1991; IN COMMERCE 11-30-1991.

ELEMENTS CORRECTED
OWNER NAME

2,167,746. REG. 6-23-1998. BUTCHER COMPANY, THE (DELAWARE CORPORATION) 67 FOREST STREET, MARLBOROUGH, MA, 01752, BY MERGER BUTCHER COMPANY, INC., THE CORPORATION), DBA THE RAMSEY COMPANY, MARLBORO, MA, SN 75-342,104. FILED 8-18-1997. PRINCIPAL REGISTER.

KIL-ODER

INT. CL. 3/U.S. CLS. 1, 4, 6, 50, 51 AND 52
FOR ALL PURPOSE CONCENTRATED WATER SOLUBLE LIQUID DEODORIZING COMPOUND.
FIRST USE 2-28-1983; IN COMMERCE 2-28-1983.

ELEMENTS CORRECTED
OWNER ADDRESS
CITIZENSHIP
ENTITY
ASSIGNMENT/NAME CHANGE
DBA/AKA
OWNER NAME

2,164,174. REG. 6-9-1998. BUTCHER COMPANY, THE (DELAWARE CORPORATION) 67 FOREST STREET, MARLBOROUGH, MA, 01752, BY MERGER BUTCHER COMPANY, INC., THE CORPORATION), DBA THE RAMSEY COMPANY, MARLBORO, MA, SN 75-343,349. FILED 8-19-1997. PRINCIPAL REGISTER.

TOP SPIN

INT. CL. 3/U.S. CLS. 1, 4, 6, 50, 51 AND 52
FOR CARPET CLEANING COMPOUND.
FIRST USE 2-28-1983; IN COMMERCE 2-28-1983.

ELEMENTS CORRECTED
OWNER ADDRESS
CITIZENSHIP
ENTITY
ASSIGNMENT/NAME CHANGE
DBA/AKA
OWNER NAME

2,169,715. REG. 6-30-1998. BUTCHER COMPANY, THE (DELAWARE CORPORATION) 67 FOREST STREET, MARLBOROUGH, MA, 01752, BY MERGER BUTCHER COMPANY, INC., THE CORPORATION), DBA THE RAMSEY COMPANY, MARLBORO, MA, SN 75-342,479. FILED 8-18-1997. PRINCIPAL REGISTER.

CITRUS EXPRESS

NO CLAIM IS MADE TO THE EXCLUSIVE RIGHT TO USE "CITRUS", APART FROM THE MARK AS SHOWN.
INT. CL. 3/U.S. CLS. 1, 4, 6, 50, 51 AND 52
FOR CARPET CLEANING COMPOUND.
FIRST USE 11-30-1993; IN COMMERCE 11-30-1993.

ELEMENTS CORRECTED
OWNER ADDRESS
CITIZENSHIP
ENTITY
ASSIGNMENT/NAME CHANGE
DBA/AKA
OWNER NAME

2,167,745. REG. 6-23-1998. BUTCHER COMPANY, THE (DELAWARE CORPORATION) 67 FOREST STREET, MARLBOROUGH, MA, 01752, BY MERGER BUTCHER COMPANY, INC., THE CORPORATION), DBA THE RAMSEY COMPANY, MARLBORO, MA, SN 75-342,102. FILED 8-18-1997. PRINCIPAL REGISTER.

FREQUENCY 256

INT. CL. 5/U.S. CLS. 6, 18, 44, 46, 51 AND 52

2,236,538. REG. 4-6-1999. BUTCHER COMPANY, THE (DELAWARE CORPORATION) 67 FOREST STREET, MARLBOROUGH, MA, 01752, BY MERGER, BY CHANGE OF NAME BUTCHER COMPANY, INC., THE CORPORATION) MARLBORO, MA, SN 75-353,633. FILED 9-8-1997. PRINCIPAL REGISTER.

TRAIL BREAKER

INT. CL. 5/U.S. CLS. 6, 18, 44, 46, 51 AND 52
FOR COMBINATION CARPET DEODORIZER AND PRESPRAY PREPARATION.
FIRST USE 10-31-1991; IN COMMERCE 10-31-1991.

ELEMENTS CORRECTED
OWNER ADDRESS
CITIZENSHIP
ENTITY
ASSIGNMENT/NAME CHANGE
OWNER NAME

2,294,885. REG. 11-30-1999. ADERANS CO., LTD. (JAPAN CORPORATION) 1-6-3, SHINJUKU, SHINJUKU-KU, TOKYO, JAPAN., SN 75-249,605. FILED 2-28-1997. PRINCIPAL REGISTER.



PRIORITY CLAIMED UNDER SEC. 44(D) ON JAPAN APPLICATION NO. 8-104993, FILED 9-19-1996, REG. NO. 4164134, DATED 7-10-1998, EXPIRES 7-10-2008.

PRIORITY CLAIMED UNDER SEC. 44(D) ON JAPAN APPLICATION NO. 8-104992, FILED 9-19-1996, REG. NO. 4195821, DATED 10-9-1998, EXPIRES 10-9-2008.

PRIORITY CLAIMED UNDER SEC. 44(D) ON JAPAN APPLICATION NO. 8-104991, FILED 9-19-1996, REG. NO. 4148028, DATED 5-22-1998, EXPIRES 5-22-2008.

THE STIPPLING SHOWN IN THE DRAWING IS A FEATURE OF THE MARK AND IS NOT INTENDED TO INDICATE COLOR.

INT. CL. 3/U.S. CLS. 1, 4, 6, 50, 51 AND 52

FOR COSMETICS, HAIR AND HAIRPIECE CARE PRODUCTS, NAMELY, FACE POWDERS, SKIN LOTIONS, TOILET WATERS, HAIR CREAMS, FACE CREAMS, SKIN CREAMS, ROUGES, HAIR CARE PREPARATIONS, PERFUMES, EYE SHADOW, HAIR REMOVING CREAMS, NAIL ENAMELS, NAIL ENAMEL REMOVERS, BEAUTY MASKS, BABY OILS, BABY POWDERS, MASCARAS, EYEBROW PENCILS, HAIR BLEACHING PREPARATIONS, ARTIFICIAL FINGERNAILS, ARTIFICIAL EYELASHES, ADHESIVES FOR ATTACHING TOUPEES/FALSE HAIR, ADHESIVES FOR COSMETIC USE, BATH POWDER, SKIN POLISHING RICE BRANS FOR COSMETIC USE, NAMELY, WASHING AND TONING SKIN, HAIR WASHING POWDERS, TOILET SOAPS, SHAMPOOS FOR HUMAN HAIR AND TOUPEES/FALSE HAIR, HAIR OILS, HAIR LOTIONS, HAIR LOTIONS FOR ENHANCING SHINE.

FIRST USE; IN COMMERCE .

INT. CL. 26/U.S. CLS. 37, 39, 40, 42 AND 50

FOR HAIR ORNAMENTS, NAMELY, BARRETTES, KANZASHI (JAPANESE ORNAMENTAL HAIRPINS), HAIR NETS, HAIR BANDS, HAIR PINS, HAIR RIBBONS, HAIR ORNAMENTS IN THE NATURE OF ROUND COMBS FOR DECORATIVE USE; HAIR PIECES IN THE NATURE OF CHIGNONS, HAIR PIECES, KAMOJI (JAPANESE WIGS), TOUPEES/FALSE HAIR, FALSE BEARDS, FALSE MUSTACHES; NON-ELECTRIC HAIR CURLERS.

INT. CL. 42/U.S. CLS. 100 AND 101

FOR HAIRDRESSING SERVICES, HAIR STYLING SERVICES, HAIR REPLACEMENT SERVICES, HAIR IMPLANTING SERVICES, HAIR INCREASING SERVICES AND HAIR GROWING SERVICES.

ELEMENTS CORRECTED
OWNER ADDRESS

2,310,256. REG. 1-25-2000. BUTCHER COMPANY, THE (DELAWARE CORPORATION) 67 FOREST STREET, MARLBOROUGH, MA, 01752, BY MERGER, BY CHANGE OF NAME BUTCHER COMPANY, INC., THE CORPORATION) MARLBORO, MA, SN 75-342,124. FILED 8-18-1997. PRINCIPAL REGISTER.

BREAK AWAY

INT. CL. 3/U.S. CLS. 1, 4, 6, 50, 51 AND 52
FOR FLOOR STRIPPING COMPOUND.
FIRST USE 2-28-1997; IN COMMERCE 2-28-1997.

ELEMENTS CORRECTED
OWNER ADDRESS
CITIZENSHIP
ENTITY
ASSIGNMENT/NAME CHANGE
OWNER NAME

2,312,635. REG. 1-25-2000. BEAUTY BRANDS FRANCHISING CORPORATION (MISSOURI CORPORATION) 4600 MADISON, SUITE 1500, KANSAS CITY, MO, 64112, SN 75-431,068. FILED P.R. 2-9-1998; AM. S.R. 7-6-1999. SUPPLEMENTAL REGISTER.

BEAUTY BRANDS

INT. CL. 35/U.S. CLS. 100, 101 AND 102

FOR RETAIL STORE SERVICES IN THE FIELD OF MAGAZINES, BOOKS, COSMETICS, FRAGRANCES, SKIN CARE PREPARATIONS, HAIR CARE PREPARATIONS, SOAPS, NAIL CARE PRODUCTS, CANDLES, SUNGLASSES, MASSAGE OILS, ESSENTIAL OILS, BATH AND SHOWER OIL AND GELS, DEODORANTS, BASKETS, PANTYHOSE, PERSONAL CARE AND GROOMING ITEMS, TRAVEL CASES, HAIR ACCESSORIES, DIFFUSERS, BLOW DRYERS, CLEANSING PREPARATIONS, AROMA THERAPIES, JEWELRY AND FASHION ACCESSORIES, ATOMIZERS, SPRAY BOTTLES, SPA ACCESSORIES, AND GIFT NOVELTIES.
FIRST USE 8-23-1995; IN COMMERCE 8-23-1995.

INT. CL. 42/U.S. CLS. 100 AND 101

FOR BEAUTY SALON SERVICES FEATURING HAIR CARE, HAIR STYLING, SKIN CARE, FACIALS, BODY WRAPS, AND NAIL TREATMENTS.

FIRST USE 8-23-1995; IN COMMERCE 8-23-1995.

ELEMENTS CORRECTED
OWNER NAME

2,339,609. REG. 4-11-2000. FASHION BOX - S.P.A (ITALY JOINT STOCK COMPANY) VIA MARCOAI, 1 - ASOLO-FRAZIONE CASELLA, (TREVISO), ITALY., SN 75-378,035. FILED 10-23-1997. PRINCIPAL REGISTER.



PRIORITY CLAIMED UNDER SEC. 44(D) ON ITALY APPLICATION NO. PD97C000263, FILED 5-16-1997, REG. NO. 760245, DATED 9-16-1998, EXPIRES 5-16-2007.

THE MARK CONSISTS OF A DOTTED DEPICTION OF A SEAGULL IN FLIGHT.

INT. CL. 25/U.S. CLS. 22 AND 39

FOR CLOTHING, NAMELY, SINGLETS, PULLOVERS, BATH ROBES, BATHING SUITS, GLOVES, CARDIGANS, JERSEYS, NECKTIES, SCARVES, SWEATERS, SOCKS, TROUSERS, LEGGINGS, SKIRTS, JACKETS, JERKINS, SHIRTS, VESTS, WAISTCOATS, JUMPERS, TRACK SUITS, BLOUSES, JEANS, PANTS, BERMUDA SHORTS, T-SHIRTS, SWEAT-SHIRTS, SUITS AND DRESSES, ANORAKS IN THE NATURE OF PARKAS, BELTS, SHOES, BOOTS, HATS, CAPS, TOPS, OVERALLS, SHORTS, AND POLO SHIRTS.

FIRST USE ; IN COMMERCE .

ELEMENTS CORRECTED
FOREIGN REG. EXPIRATION DATE

2,396,703. REG. 10-24-2000. BUTCHER COMPANY, THE (DELAWARE CORPORATION) 67 FOREST STREET, MARLBOROUGH, MA, 01752, BY MERGER, BY CHANGE OF NAME BUTCHER COMPANY, INC., THE CORPORATION) MARLBORO, MA, SN 75-342,138. FILED 8-18-1997. PRINCIPAL REGISTER.

POWER BOLT

INT. CL. 3/U.S. CLS. 1, 4, 6, 50, 51 AND 52

FOR GENERAL PURPOSE CLEANING AND DEGREASING COMPOUND FOR INDUSTRIAL, COMMERCIAL AND INSTITUTIONAL USE.

FIRST USE 2-28-1997; IN COMMERCE 2-28-1997.

ELEMENTS CORRECTED
OWNER ADDRESS
CITIZENSHIP
ENTITY
ASSIGNMENT/NAME CHANGE
OWNER NAME

2,417,863. REG. 1-2-2001. BUTCHER COMPANY, THE (DELAWARE CORPORATION) 67 FOREST STREET, MARLBOROUGH, MA, 01752, BY MERGER, BY CHANGE OF NAME BUTCHER COMPANY, INC., THE CORPORATION) MARLBORO, MA, SN 75-368,252. FILED 10-6-1997. PRINCIPAL REGISTER.

CAST IRON

INT. CL. 3/U.S. CLS. 1, 4, 6, 50, 51 AND 52

FOR STAIN REMOVERS FOR REMOVING RUST FROM MATERIALS OTHER THAN METAL.
FIRST USE 1-31-1998; IN COMMERCE 1-31-1998.

ELEMENTS CORRECTED
OWNER ADDRESS
CITIZENSHIP
ENTITY
ASSIGNMENT/NAME CHANGE
OWNER NAME

2,433,197. REG. 3-6-2001. TRUSTMARK NATIONAL BANK (UNITED STATES FEDERALLY CHARTERED NATIONAL BANKING ASSOCIATION) 248 EAST CAPITOL STREET, P.O. BOX 291, JACKSON, MS, 39205, SN 75-833,006. FILED 10-27-1999. PRINCIPAL REGISTER.

TRUSTMARK FINANCIAL SERVICES, INC.

NO CLAIM IS MADE TO THE EXCLUSIVE RIGHT TO USE "FINANCIAL SERVICES, INC.", APART FROM THE MARK AS SHOWN.

INT. CL. 36/U.S. CLS. 100, 101 AND 102

FOR BANKING SERVICES, NAMELY CHECKING, SAVINGS AND LOAN SERVICES, INVESTMENT SERVICES, CASH MANAGEMENT AND ELECTRONIC BANKING; AND FINANCIAL SERVICES, NAMELY, CREDIT CARD SERVICES, FINANCIAL PLANNING, FINANCIAL PORTFOLIO MANAGEMENT, AND TRUST AND ASSET MANAGEMENT, AND PROVIDING [INSURANCE SERVICES RELATED TO THE ABOVE MENTIONED SERVICES, NAMELY,] ANNUITY BROKERAGE SERVICES.

FIRST USE 12-30-1991; IN COMMERCE 12-30-1991.

ELEMENTS AMENDED
GOODS/SERVICES

2,433,582. REG. 3-6-2001. LIFELINE II LLC (NEW JERSEY LIMITED LIABILITY COMPANY) 10 DELMAR AVE, GLEN ROCK, NJ, 07452, SN 76-008,821. FILED 3-24-2000. PRINCIPAL REGISTER.



INT. CL. 3/U.S. CLS. 1, 4, 6, 50, 51 AND 52

FOR SKIN MOISTURIZING LOTION AND CREAM.
FIRST USE 7-2-1999; IN COMMERCE 7-2-1999.

ELEMENTS CORRECTED
OWNER NAME

2,435,474. REG. 3-13-2001. IOP PUBLISHING LIMITED (UNITED KINGDOM COMPANY) DIRAC HOUSE, TEMPLE BACK, BRISTOL BS1 6BE, ENGLAND., SN 75-249,607. FILED 2-28-1997. PRINCIPAL REGISTER.

HYPERCITE

INT. CL. 42/U.S. CLS. 100 AND 101
 FOR INFORMATION SERVICES OFFERED VIA COMPUTER COMMUNICATIONS NETWORKS, NAMELY, RESEARCH SOURCE MATERIALS AND RESEARCH JOURNALS IN THE FIELDS OF SCIENCE AND APPLIED SCIENCE, INCLUDING PHYSICS, OPTICS, RADIOLOGICAL PROTECTION, MEDICINE, BIOLOGY, PHYSIOLOGICAL MEASUREMENTS AND ENGINEERING.
 FIRST USE 10-24-1997; IN COMMERCE 10-24-1997.

ELEMENTS AMENDED
 OWNER NAME

2,451,094. REG. 5-15-2001. NORTH AMERICAN COMPANY FOR LIFE AND HEALTH INSURANCE (ILLINOIS CORPORATION) 222 SOUTH RIVERSIDE PLAZA, CHICAGO, IL. 60606. SN 76-065,744. FILED 6-7-2000. PRINCIPAL REGISTER.

GRX-15

INT. CL. 36/U.S. CLS. 100, 101 AND 102
 FOR LIFE INSURANCE UNDERWRITING SERVICES.
 FIRST USE 11-15-1999; IN COMMERCE 11-15-1999.

ELEMENTS CORRECTED
 OWNER NAME

2,468,514. REG. 7-10-2001. EXACT EQUIPMENT CORPORATION (DELAWARE CORPORATION) 20 NORTH PENNSYLVANIA AVENUE, MORRISVILLE, PA, 19067. SN 75-883,121. FILED 12-29-1999. PRINCIPAL REGISTER.

POWERPACK

INT. CL. 7/U.S. CLS. 13, 19, 21, 23, 31, 34 AND 35
 FOR PACKAGING MACHINERY, NAMELY AUTOMATIC STRETCH WRAPPING MACHINES FOR PERISHABLE FOOD PRODUCTS.
 FIRST USE 7-28-2000; IN COMMERCE 12-29-2000.

ELEMENTS CORRECTED
 CITIZENSHIP

2,495,070. REG. 10-2-2001. FREIGHTLINER LLC (DELAWARE LTD LIAB CO) 4747 N. CHANNEL AVENUE, PORTLAND, OR, 97208. BY CHANGE OF NAME; BY CHANGE OF NAME FREIGHTLINER CORPORATION (CORPORATION) PORTLAND, OR, SN 75-931,145. FILED 2-29-2000. PRINCIPAL REGISTER.

CONDOR

INT. CL. 12/U.S. CLS. 19, 21, 23, 31, 35 AND 44

FOR REFUSE HAULING TRUCKS.
 FIRST USE 11-29-2000; IN COMMERCE 11-29-2000.

ELEMENTS CORRECTED
 OWNER NAME
 ENTITY
 ASSIGNMENT/NAME CHANGE

2,495,212. REG. 10-9-2001. TOSHIBA JOHO SYSTEM KABUSHIKI KAISHA (JAPAN CORPORATION), DBA TOSHIBA INFORMATION SYSTEMS (JAPAN) CORPORATION, 7-1 NISSIN-CHO KAWASAKI-KU KAWASAKI-SHI, KANAGAWA, JAPAN., SN 75-264,505. FILED 3-26-1997. PRINCIPAL REGISTER.

TISJ

PRIORITY CLAIMED UNDER SEC. 44(D) ON JAPAN APPLICATION NO. 8-108928, FILED 9-30-1996, REG. NO. 4166097, DATED 7-10-1998, EXPIRES 7-10-2008.

PRIORITY CLAIMED UNDER SEC. 44(D) ON JAPAN APPLICATION NO. 8-108927, FILED 9-30-1996, REG. NO. 4242295, DATED 2-19-1999, EXPIRES 2-19-2009.

INT. CL. 35/U.S. CLS. 100, 101 AND 102
 FOR TELEMARKETING SERVICES.

INT. CL. 36/U.S. CLS. 100, 101 AND 102

FOR BROKERAGE AND AGENCIES FOR TECHNOLOGY TRANSFER.

FIRST USE ; IN COMMERCE .

INT. CL. 38/U.S. CLS. 100, 101 AND 104

FOR ELECTRONIC TRANSMISSION OF DATA AND DOCUMENTS VIA COMPUTER TERMINALS; CELLULAR TELEPHONE SERVICES; DATA, IMAGE AND VOICE TELECOMMUNICATION; TELECOMMUNICATION SERVICES VIA IMAGING APPARATUS; ELECTRONIC VOICE MESSAGING, NAMELY, THE RECORDING, STORAGE AND SUBSEQUENT TRANSMISSION OF VOICE MESSAGES BY TELEPHONE; INTERNATIONAL WIRELESS COMMUNICATIONS; DIGITAL DATA TRANSMISSION AND TELECOMMUNICATION; CABLE, RADIO AND TELEVISION TRANSMISSION; SATELLITE COMMUNICATION SERVICES; VIDEO TELECONFERENCING; ELECTRONIC STORE-AND-FORWARD MESSAGING SERVICES; SUBSCRIPTION TELEPHONE COMMUNICATION SERVICES; SUBSCRIPTION PAGING SERVICES; SUBSCRIPTION TELEVISION BROADCASTING SERVICES; FACSIMILE TRANSMISSION SERVICES.

FIRST USE ; IN COMMERCE .

INT. CL. 42/U.S. CLS. 100 AND 101

FOR COMPUTERIZED INFORMATION SERVICES IN THE FIELDS OF DATA COMMUNICATION AND THE FOOD AND BEVERAGE INDUSTRY; OFFSET, PHOTOGRAPHERY, AND LETTER PRESS PRINTING SERVICES; NEWS ANALYSIS AND DISTRIBUTION SERVICES VIA TELEPHONE, COMPUTER AND FACSIMILE; NEWS-PAPER AND MAGAZINE CLIPPING SERVICES; PROVIDING BANQUET AND SOCIAL FUNCTION FACILITIES FOR SPECIAL OCCASIONS; CONSULTATION SERVICES IN THE FIELD OF WEDDING PLANNING; COMPUTER AND INTEGRATED CIRCUIT DESIGN FOR OTHERS; COMPUTER SOFTWARE AND COMPUTER NETWORK CONSULTATION, DESIGN AND MAINTENANCE; ON-LINE DATA PROCESSING SERVICES; DATA PROCESSING SERVICES; COMPUTER PROGRAMMING FOR OTHERS, INCLUDING PREPARATION OF OPERATION MANUALS; CONSULTATION SERVICES IN THE FIELDS OF COMPUTERS AND THE PERFORMANCE AND OPERATION METHOD OF MACHINES; CONSULTATION AND RESEARCH IN THE FIELDS OF CHEMISTRY, SCIENCE AND TECHNOLOGY; CONSULTATION AND RESEARCH IN THE FIELDS OF INDUSTRIAL PROPERTY, INTELLECTUAL PROPERTY; PROVIDING HEALTH AND MEDICAL INFORMATION VIA COMPUTER, INCLUDING INFORMATION RELATING TO DOCTORS, CLINICS, HOSPITALS, PHARMACIES AND MEDICAL TREATMENT; CONSULTATION AND RESEARCH SERVICES IN THE MEDICAL FIELD; LANGUAGE TRANSLATION SERVICES VIA COMPUTER; FORTUNE TELLING VIA COMPUTER; RENTAL AND LEASING OF COMPUTERS, INCLUDING CENTRAL PROCESSING UNITS, PROGRAMMED-DATA-CARRYING ELECTRONIC CIRCUITS, MAGNETIC DISKS AND TAPES, MESSAGING TRANSMISSION APPARATUS, AND OTHER PERIPHERAL EQUIPMENT.

FIRST USE : IN COMMERCE .

ELEMENTS CORRECTED
DBA/AKA

2,500,598. REG. 10-23-2001. IMAGINEER CO., LTD. (JAPAN CORPORATION) 2-7-1, NISHI-SHINJUKU, 15TH FLOOR SHINJUKU-KU, TOKYO 163-07, JAPAN., SN 75-318,828. FILED 7-3-1997. PRINCIPAL REGISTER.

IMAGINEER

INT. CL. 28/U.S. CLS. 22, 23, 38 AND 50
FOR ELECTRONIC GAMES, NAMELY, HAND HELD UNIT FOR PLAYING VIDEO GAMES.

FIRST USE 4-30-1999; IN COMMERCE 4-30-1999.

ELEMENTS CORRECTED
OWNER ADDRESS

2,512,444. REG. 11-27-2001. SPRINT COMMUNICATIONS COMPANY L.P. (DELAWARE LIMITED PARTNERSHIP) 2330 SHONEYMISSION PARKWAY, WESTWOOD, KS, 66205, SN 76-177,412. FILED 12-8-2000. PRINCIPAL REGISTER.

SPRINT RESOURCE ONE

OWNER OF U.S. REG. NO. 2,365,136.
INT. CL. 37/U.S. CLS. 100, 103 AND 106
FOR INSTALLATION, MAINTENANCE AND REPAIR SERVICES FOR VOICE, VIDEO AND DATA NETWORK INFRASTRUCTURES.

FIRST USE 8-0-2000; IN COMMERCE 8-0-2000.
INT. CL. 41/U.S. CLS. 100, 101 AND 107

FOR TRAINING IN THE USE AND OPERATION OF VOICE, VIDEO AND DATA NETWORK INFRASTRUCTURES.

FIRST USE 8-0-2000; IN COMMERCE 8-0-2000.
INT. CL. 42/U.S. CLS. 100 AND 101

FOR PROVIDING TECHNICAL CONSULTATION, MONITORING AND DESIGN SERVICES TO OTHERS IN THE FIELD OF VOICE, VIDEO AND DATA NETWORK INFRASTRUCTURES.

FIRST USE 8-0-2000; IN COMMERCE 8-0-2000.

ELEMENTS CORRECTED
OWNER NAME

2,533,031. REG. 1-22-2002. NORTH AMERICAN COMPANY FOR LIFE AND HEALTH INSURANCE (ILLINOIS CORPORATION) 222 SOUTH RIVERSIDE PLAZA, CHICAGO, IL, 60606, SN 76-096,978. FILED 7-27-2000. PRINCIPAL REGISTER.

MT-30

INT. CL. 36/U.S. CLS. 100, 101 AND 102
FOR LIFE INSURANCE UNDERWRITING SERVICES.
FIRST USE 9-0-2000; IN COMMERCE 9-0-2000.

ELEMENTS CORRECTED
OWNER NAME

2,534,285. REG. 1-29-2002. COLORLAB COSMETICS, INC. (ILLINOIS CORPORATION) 1112 5TH AVENUE, ROCKFORD, IL, 61104, SN 76-293,543. FILED 8-1-2001. PRINCIPAL REGISTER.

COLORLAB

OWNER OF U.S. REG. NO. 2,087,175.
INT. CL. 3/U.S. CLS. 1, 4, 6, 50, 51 AND 52
FOR COSMETICS, NAMELY, LIP PENCILS, EYE PENCILS, CONCEALER, MASCARA, COSMETIC KITS, SKINCARE, EYELINERS, LIPSTICK, FOUNDATIONS, MINERAL POWDERS, BLUSHES AND EYESHADOWS.
FIRST USE 9-0-1986; IN COMMERCE 9-0-1986.

ELEMENTS CORRECTED
DATE OF FIRST USE
DATE OF FIRST USE IN COMMERCE

2,544,553. REG. 3-5-2002. SOUTHTRUST BANK (ALABAMA BANKING CORPORATION) 420 NORTH 20TH STREET, 7TH FLOOR, BIRMINGHAM, AL, 35203, SN 76-180,408. FILED 12-14-2000. PRINCIPAL REGISTER.



INT. CL. 36/U.S. CLS. 100, 101 AND 102

FOR BANKING SERVICES; PROVIDING INFORMATION IN THE FIELD OF BANKING SERVICES.
FIRST USE 1-1-2001; IN COMMERCE 1-1-2001.

ELEMENTS CORRECTED
OWNER NAME
CITIZENSHIP
ENTITY

2,558,729. REG. 4-9-2002. GIMBORN PET SPECIALTIES, LLC (GEORGIA LIMITED LIABILITY COMPANY) 4280 NORTHEAST EXPRESSWAY, ATLANTA, GA, 30340, SN 76-276,607. FILED 6-26-2001. PRINCIPAL REGISTER.

DOGGONE DELICIOUS

NO CLAIM IS MADE TO THE EXCLUSIVE RIGHT TO USE DELICIOUS, APART FROM THE MARK AS SHOWN.
INT. CL. 31/U.S. CLS. 1 AND 46
FOR EDIBLE PET TREATS.
FIRST USE 4-30-2001; IN COMMERCE 4-30-2001.

ELEMENTS CORRECTED
OWNER NAME

2,545,313. REG. 3-5-2002. MICROPATENT LLC (DELAWARE LIMITED LIABILITY COMPANY) 250 DODGE AVENUE, EAST HAVEN, CT, 065123358, BY ASSIGNMENT; BY ASSIGNMENT INNOVATOR CORPORATION CORPORATION) BROWNS POINT, WA, SN 75-751,728. FILED P.R. 7-19-1999; AM. S.R. 8-2-2001. SUPPLEMENTAL REGISTER.



THE MARK CONSISTS OF THE WORD "IPATENT" WITH THE LETTER "I" IN LOWER CASE AND THE LETTERS "IP" ENCLOSED WITHIN A CIRCLE.
INT. CL. 38/U.S. CLS. 100, 101 AND 104
FOR DELIVERY OF PATENT-RELATED DOCUMENTS BY ELECTRONIC TRANSMISSION VIA A GLOBAL COMMUNICATION NETWORK.
FIRST USE 4-1-1998; IN COMMERCE 4-1-1998.

ELEMENTS CORRECTED
ASSIGNMENT/NAME CHANGE
OWNER ADDRESS

2,575,136. REG. 6-4-2002. FFASTFILL EUROPE LIMITED (UNITED KINGDOM CORPORATION) 78 CANNON STREET, LONDON, UNITED KINGDOM, EC4N 6HH, BY CHANGE OF NAME; BY CHANGE OF NAME CITY DERIVATIVES SYSTEMS LTD CORPORATION) LONDON, UNITED KINGDOM, SN 75-922,057. FILED 2-17-2000. PRINCIPAL REGISTER.

FFASTRISK

PRIORITY CLAIMED UNDER SEC. 44(D) ON UNITED KINGDOM APPLICATION NO. 2219649, FILED 1-18-2000, REG. NO. 2219649, DATED 6-30-2000, EXPIRES 1-18-2010.
INT. CL. 9/U.S. CLS. 21, 23, 26, 36 AND 38
FOR COMPUTER SOFTWARE FOR USE WITH FINANCIAL SERVICES IN THE NATURE OF FUTURES, OPTIONS, EQUITIES AND COMMODITIES TRADING ON RECOGNIZED MARKETS.
FIRST USE ; IN COMMERCE .
INT. CL. 36/U.S. CLS. 100, 101 AND 102
FOR FINANCIAL SERVICES IN THE NATURE OF FUTURES, OPTIONS, EQUITIES AND COMMODITIES TRADING FOR OTHERS ON RECOGNIZED MARKETS.
FIRST USE ; IN COMMERCE .

ELEMENTS CORRECTED
OWNER ADDRESS

2,550,248. REG. 3-19-2002. SHEIKH, SHAHID A. (UNITED STATES INDIVIDUAL), DBA PROSERIES, ATHLETIC EQUIPMENT COMPANY, 825 WILSHIRE BLVD., # 102, SANTA MONICA, CA, 90401, SN 75-370,161. FILED 10-8-1997. PRINCIPAL REGISTER.

PROSERIES

INT. CL. 10/U.S. CLS. 26, 39 AND 44
FOR HEAT PACKS AND COLD PACKS FOR MEDICAL USE, AND BRACES, SLEEVES AND SUPPORTS FOR MEDICAL USE ON LIMBS AND JOINTS.
FIRST USE 6-0-1999; IN COMMERCE 6-0-1999.
INT. CL. 25/U.S. CLS. 22 AND 39
FOR CLOTHING [AND FOOTWEAR,] NAMELY, CAPS, VISORS, SHIRTS [, JACKETS, PANTS,] SHORTS, SWIMWEAR [, SPORTS BRAS, SHOES AND SANDALS].
FIRST USE 6-0-1999; IN COMMERCE 6-0-1999.

ELEMENTS CORRECTED
GOODS/SERVICES

2,578,554. REG. 6-11-2002. FAMOUS SAM'S, INC. (NEVADA CORPORATION) 1930 S. ALMA SCHOOL ROAD SUITE C-105, MESA, AZ, 85210, SN 76-313,174. FILED 9-14-2001. PRINCIPAL REGISTER.



OWNER OF U.S. REG. NOS. 1,728,392, 2,256,400 AND OTHERS.
INT. CL. 35/U.S. CLS. 100, 101 AND 102
FOR RESTAURANT FRANCHISING.
FIRST USE 11-17-1996; IN COMMERCE 3-31-1997.
INT. CL. 42/U.S. CLS. 100 AND 101

FOR RESTAURANT AND BAR SERVICES.
FIRST USE 11-17-1996; IN COMMERCE 3-31-1997.

ELEMENTS CORRECTED
MARK

2,605,072. REG. 8-6-2002. NWL HOLDINGS, INC. (NEW YORK CORPORATION) 111 HEMPSTEAD TURNPIKE, WEST HEMPSTEAD, NY, 11552, SN 75-449,899. FILED 3-13-1998. PRINCIPAL REGISTER.

WILSON ROSS

2,578,602. REG. 6-11-2002. GIMBORN PET SPECIALTIES, LLC (GEORGIA LIMITED-LIABILITY COMPANY) 4280 NORTHEAST EXPRESSWAY, ATLANTA, GA, 30340, SN 76-317,254. FILED 9-26-2001. PRINCIPAL REGISTER.

R-7

OWNER OF U.S. REG. NO. 1,134,961.
INT. CL. 5/U.S. CLS. 6, 18, 44, 46, 51 AND 52
FOR PREPARATIONS USED ON DOMESTICATED ANIMALS FOR THE TREATMENT OF EAR CANCERS.
FIRST USE 3-1-1945; IN COMMERCE 3-1-1945.

ELEMENTS CORRECTED
OWNER NAME

2,594,691. REG. 7-16-2002. WILSON GREATBATCH LTD. (NEW YORK CORPORATION) 10,000 WEHRLE DRIVE, CLARENCE, NY, 14031, SN 75-632,227. FILED 2-2-1999. PRINCIPAL REGISTER.

REVIVE

INT. CL. 9/U.S. CLS. 21, 23, 26, 36 AND 38
FOR BATTERIES, NAMELY, RECHARGEABLE LITHIUM BATTERIES.
FIRST USE 12-14-2001; IN COMMERCE 12-14-2001.

ELEMENTS CORRECTED
OWNER ADDRESS

2,601,361. REG. 7-30-2002. MR. GATTI'S, INC. (TEXAS CORPORATION) 444 SIDNEY BAKER SOUTH, KERRVILLE, TX, 78028, SN 75-416,198. FILED 1-12-1998. PRINCIPAL REGISTER.

FOOD & FUN FOR ANY AGE

INT. CL. 42/U.S. CLS. 100 AND 101
FOR * PIZZA * RESTAURANT AND * PIZZA RESTAURANT * CARRY-OUT SERVICES.
FIRST USE 1-31-2002; IN COMMERCE 1-31-2002.

ELEMENTS AMENDED
GOODS/SERVICES

THE MARK "WILSON ROSS" DOES NOT IDENTIFY A LIVING INDIVIDUAL.

INT. CL. 8/U.S. CLS. 23, 28 AND 44

FOR [CHEESE SLICERS, HAND-OPERATED CHOPPERS, PIZZA CUTTERS, PIZZA SLICERS, EGG SLICERS, NAIL FILES, FINGERNAIL CLIPPERS, FORKS, GARDENING TOOLS, NAMELY, WEEDING FORKS, TROWELS, SPADES, HOES; HAND TOOLS, NAMELY, HAMMERS; BUTCHER KNIVES,] KITCHEN KNIVES, [NUT CRACKERS NOT OF PRECIOUS METALS, NON-ELECTRIC CAN OPENERS,] PARING KNIVES, [NON-ELECTRIC FRUIT AND VEGETABLE PEELERS, PLIERS, RAKES, SCISSORS, SPOONS,] TABLEWARE, NAMELY, KNIVES, FORKS AND SPOONS.

FIRST USE 3-0-1998; IN COMMERCE 3-0-1998.

INT. CL. 20/U.S. CLS. 2, 13, 22, 25, 32 AND 50

FOR [CERAMIC ORNAMENTS,] PICTURE FRAMES,] WOOD BOXES, JEWELRY BOXES NOT OF METAL, CHAIRS, FURNITURE CHESTS, DECK CHAIRS, LAWN FURNITURE, OUTDOOR FURNITURE, HAMPERS, CLOTHES HANGERS, NON-METAL CURTAIN RINGS, FURNITURE SCREENS].

FIRST USE 3-0-1998; IN COMMERCE 3-0-1998.

INT. CL. 21/U.S. CLS. 2, 13, 23, 29, 30, 33, 40 AND 50

FOR [HOUSEWARES, NAMELY, BAKEWARE, NOT TOYS, FLOWER BASKETS, WASTEPAPER BASKETS, WICKER BASKETS, STEAMER BASKETS, FITTED PICNIC BASKETS, BEVERAGE GLASSWARE, BEVERAGEWARE, BIRD FEEDERS, WOOD CHOPPING BLOCKS, BREAD BOARDS, CARVING BOARDS,] IRONING BOARDS, KNIFE BOARDS, PASTRY BOARDS, WASHING BOARDS, WOOD CHOPPING BOARDS FOR KITCHEN USE, CUTTING BOARDS, GRAVY BOATS, BOTTLE OPENERS, BOTTLES, SOLD EMPTY, BOWLS, BREAD BOXES, BROOMS, CLOTHES BRUSHES, COSMETIC BRUSHES, CRUMB BRUSHES, DISHWASHING BRUSHES, DUSTING BRUSHES, FLOOR BRUSHES, POT CLEANING BRUSHES, SCRAPING BRUSHES, SCRUBBING BRUSHES, SHOE BRUSHES, TOILET BRUSHES, TOOTH BRUSHES, ELECTRIC AND NON-ELECTRIC TOOTH BRUSHES, BRUSHES FOR BASTING MEAT, HAIR BRUSHES, HAIR COMBS, ICE BUCKETS, PLASTIC BUCKETS, WINE BUCKETS, CHAMPAGNE BUCKETS, BUTTER DISHES, SHOWER CADDIES, CAKE SERVERS, NON-ELECTRIC CANDELABRAS, NOT OF PRECIOUS METAL, CANDLE HOLDERS AND RINGS NOT OF PRECIOUS METAL, CANDLESTICKS NOT OF PRECIOUS METAL, CANNISTER SETS, WATERING CANS, CARAFES, SUN CATCHERS, WIND CHIMES, CHINA ORNAMENTS, CRYSTAL ORNAMENTS AND STATUS, CLEANING CLOTHES, COFFEE CUPS, CUPS, COMMEMORATIVE PLATES, ALL PURPOSE PORTABLE HOUSEHOLD CONTAINERS, SOAP CONTAINERS, THERMAL INSULATED CONTAINERS FOR FOOD OR BEVERAGES, CONTAINERS FOR FOODS, CONTAINERS FOR HOUSEHOLD OR KITCHEN USE, NOT OF PRECIOUS METAL, COOKIE CUTTERS, COOKIE JARS, STAINLESS STEEL COOKWARE, CORK SCREWS, CORN CON HOLDERS, NON-WOVEN FABRIC COSMETIC WIPES, NOT PAPER, DISPOSABLE LATEX GLOVES FOR GENERAL USE, DISPOSABLE PLASTIC GLOVES FOR GENERAL USE, GARDEN GLOVES, PLASTIC HOUSEHOLD GLOVES, RUBBER HOUSEHOLD GLOVES, DRINKING GLASSES, DUST PANS, FURNITURE DUSTERS, FEATHER DUSTERS, FRYING PANS, SAUCEPANS, FUNNELS, GARDEN HOSES, ENAMELLED GLASS, POLISHED PLATE GLASS, PRESSED GLASS, GLASS ETCHED BY ACID, NAPKIN HOLDERS, TOWEL HOLDERS, HOLDERS FOR TOILET PAPER, HOSE NOZZLES, KITCHEN LADLES, KNIFE BLOCKS, LAWN SPRINKLERS, LEMON SQUEEZERS, LOOFAHS

FOR HOUSEHOLD PURPOSES, MOPS, MUG TREES, MUGS, NAPKIN RINGS NOT OF PRECIOUS METAL, PLASTIC SPRAY NOZZLES, PAPER PLATES, PEPPER MILLS, GARLIC PRESSES, TOWEL RACKS, WINE RACKS, REAMERS FOR FRUIT JUICE, RECIPE BOXES, SALT AND PEPPER SHAKERS, SCOOPS, SERVING SPOONS, SLOTTED SPOONS, BASTING SPOONS, MIXING SPOONS, SOUP TUREENS, TEA KETTLES, TEA POTS NOT OF PRECIOUS METAL, TEA SERVICES NOT OF PRECIOUS METAL, TEA SETS, VASES, KITCHEN UTENSILS, NAMELY, SPATULAS, STRAINERS, WHISKS].

FIRST USE 3-0-1998; IN COMMERCE 3-0-1998.

ELEMENTS CORRECTED
GOODS/SERVICES

2,606,248. REG. 8-13-2002. SANDVIK AB (SWEDEN CORPORATION) S-811 81 SANDVIKEN, SWEDEN., SN 75-166,475. FILED 9-13-1996. PRINCIPAL REGISTER.

ALPHA

PRIORITY CLAIMED UNDER SEC. 44(D) ON FED REP GERMANY APPLICATION NO. 3961555669, FILED 3-29-1996.

INT. CL. 7/U.S. CLS. 13, 19, 21, 23, 31, 34 AND 35

FOR POWER OPERATED MACHINE TOOLS, NAMELY, DRILLS FOR CUTTING METAL IN INDUSTRIAL APPLICATIONS.

FIRST USE 3-0-1983; IN COMMERCE 3-0-1983.

ELEMENTS CORRECTED
FOREIGN COUNTRY OF ORIGIN
FOREIGN APPLICATION NO.
FOREIGN APPLICATION FILING DATE
PRIORITY CLAIMED STATEMENT

2,613,749. REG. 9-3-2002. MEZCALES DE GUSANO, S.P.R. DE R.L. (MEXICO CORPORATION) CARRETERA INTERNACIONAL MITLA OAXACA KM. 42.5, CRUCERO DE MITLA, 70430 MITLA, OAXACA, MEXICO., SN 75-859,088. FILED 11-29-1999. PRINCIPAL REGISTER.

DOS GUSANOS

THE ENGLISH TRANSLATION OF "DOS GUSANOS" IS "TWO WORMS".

SEC. 2(F).

INT. CL. 33/U.S. CLS. 47 AND 49

FOR MEZCAL.

FIRST USE 7-0-1992; IN COMMERCE 7-0-1992.

ELEMENTS CORRECTED
OWNER ADDRESS

2,614,298. REG. 9-3-2002. ARTISAN FOR HIRE, INC. (ILLINOIS CORPORATION) 216 SOUTH JEFFERSON STREET, SUITE 202, CHICAGO, IL, 60661, SN 76-169,251. FILED 11-21-2000. PRINCIPAL REGISTER.

ARTISAN

INT. CL. 35/U.S. CLS. 100, 101 AND 102

FOR PROVIDING TEMPORARY AND FREELANCE STAFFING OF ADVERTISING, GRAPHIC ARTS, AND DIGITAL PROFESSIONALS, NAMELY, ILLUSTRATORS, WRITERS, PHOTOGRAPHERS, GRAPHIC DESIGNERS, WEB SITE DEVELOPERS, MULTI-MEDIA PRODUCERS, PRODUCTION ARTISTS, COMPUTER PROGRAMMERS, AND INFORMATION ARCHITECTS.
FIRST USE 3-24-1994; IN COMMERCE 3-24-1994.

ELEMENTS CORRECTED
CITIZENSHIP

2,616,793. REG. 9-10-2002. FLODOR INDUSTRIE SA (FRANCE CORPORATION) ZONE INDUSTRIELLE LA CHAPELETTE, 80200 PERONNE, FRANCE., SN 76-139,936. FILED 10-3-2000. PRINCIPAL REGISTER.



OWNER OF FRANCE REG. NO. 93454673, DATED 2-10-1993.

OWNER OF U.S. REG. NOS. 1,324,854 AND 1,863,828.

THE APPLICANT CLAIMS THE COLORS YELLOW AND RED AS A PART OF THE MARK

INT. CL. 29/U.S. CL. 46

FOR FRUITS AND VEGETABLES PRODUCTS, ALL BEING PRESERVED AND/OR DRIED AND/OR COOKED, NAMELY, POTATO CHIPS, POTATO CRISPS, VEGETABLE BASED CHIPS; ROASTED, SALTED AND/OR SPICED AND/OR DESSICATED WALNUTS, PEANUTS, GROUND NUTS, ALMONDS, CAJEPUT NUTS, PISTACHIO NUTS; POTATO FLAKES FOR INSTANTANEOUS PUREE; DRIED FRUITS, IN PARTICULAR PINEAPPLES, BANANAS, PAPAYAS, KIWIS, COCONUTS, RAISINS, APPLIES.

FIRST USE ; IN COMMERCE .

INT. CL. 30/U.S. CL. 46

FOR PREPARATIONS MADE FROM PROCESSED CEREALS FOR FOOD FOR HUMAN CONSUMPTION, NAMELY OAT FLAKES, CORN FLAKES, STARCH FLAKES, MILLET FLAKES, BARLEY FLAKES, RICE FLAKES, SERGO FLAKES AND CRISPIES, BREAD, BISCUITS, CAKES, PASTRIES, BAKERY GOODS, CROUTONS, TORTILLA CHIPS, SALAD DRESSINGS, SALTED CRACKERS AND SALTINES.

FIRST USE ; IN COMMERCE .

ELEMENTS AMENDED
LINING/STIPPLING STATEMENT

2,617,620. REG. 9-10-2002. BEHROUZ NIK CORPORATION (CALIFORNIA CORPORATION) 26801 VISTA TERRACE, LAKE FOREST, CA, 92630, SN 76-266,031. FILED 5-31-2001. PRINCIPAL REGISTER.



THE ENGLISH TRANSLATION OF THE FARSI WORD "BEHROUZ" IS "BETTER DAY".

INT. CL. 29/U.S. CL. 46

FOR PROCESSED NUTS, RAISINS, PROCESSED EGGPLANT, PROCESSED GREEN PEAS, BAKED BEANS, TOMATO PASTE, * PICKLED GARLIC WHOLE/PEARL, MINCED PICKLES, * SOUR GRAPE PICKLES, * SHALLOT PICKLES, OLIVES PICKLES * CUCUMBER PICKLES, TORSHI EGGPLANT, * PROCESSED * VINE LEAVES, TUNA, CANNED FOOD, NAMELY CANNED FRUITS AND VEGETABLES, AND JAMS.

FIRST USE 0-0-1981; IN COMMERCE 0-0-2001.

INT. CL. 30/U.S. CL. 46

FOR SAFFRON, SUMAC SPICE, POMEGRANATE SYRUP, DRY LEMON SPICES, [RICE,] TOMATO KETCHUP, HOT CHILLY SAUCE, MAYONNAISE, TORSHI LITEH * , * [AND] HERB VINEGAR.

FIRST USE 0-0-1981; IN COMMERCE 0-0-2001.

ELEMENTS CORRECTED
GOODS/SERVICES

2,617,636. REG. 9-10-2002. SENSIBLE STORAGE, INC. (ILLINOIS CORPORATION) 120-130 NORTH LAKEVIEW PARKWAY, VERNON HILLS, IL, 60061. BY ASSIGNMENT; BY ASSIGNMENT L&P PROPERTY MANAGEMENT COMPANY CORPORATION) SOUTH GATE, CA, SN 76-268,655. FILED 6-8-2001. PRINCIPAL REGISTER.

WIRETECH OFFICE

NO CLAIM IS MADE TO THE EXCLUSIVE RIGHT TO USE "OFFICE", APART FROM THE MARK AS SHOWN.

INT. CL. 12/U.S. CLS. 19, 21, 23, 31, 35 AND 44

FOR NON-MOTORIZED WHEELED FILE AND STORAGE CARTS FOR OFFICE USE.

FIRST USE 6-0-1999; IN COMMERCE 6-0-1999.

ELEMENTS CORRECTED
OWNER NAME
OWNER ADDRESS
CITIZENSHIP
ENTITY
ASSIGNMENT/NAME CHANGE

2,619,752. REG. 9-17-2002. ELMAG S.P.A. (ITALY JOINT STOCK COMPANY) VIALE ELVEZIA, 35, 20052 MONZA, MILAN, ITALY., SN 76-116,500. FILED 8-25-2000. PRINCIPAL REGISTER.

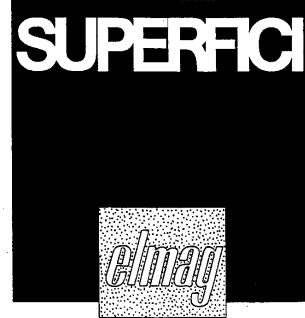

PRIORITY CLAIMED UNDER SEC. 44(D) ON ITALY APPLICATION NO. MI2000C8803, FILED 7-27-2000, REG. NO. 842988, DATED 4-27-2001, EXPIRES 7-27-2010.

THE STIPPLING CONTAINED IN THE DRAWING IS FOR SHADING PURPOSES ONLY AND IS NOT A FEATURE OF THE MARK NOR IS IT INTENDED TO INDICATE COLOR.

THE ENGLISH TRANSLATION OF THE TERM "SUPERFICI" IS "SURFACES".

INT. CL. 7/U.S. CLS. 13, 19, 21, 23, 31, 34 AND 35

FOR MACHINES THAT COMPRISE AUTOMATIC WOOD FINISHING LINES, NAMELY, HANDLING MACHINES FOR LOADING, UNLOADING, TRANSFERRING AND STACKING WOOD; MACHINES FOR PAINTING AND VARNISHING WOOD PANELS, PLATES, PRINTED CIRCUITS, PAPER AND PLASTIC MATERIALS, NAMELY ROLLER COATING MACHINES FOR APPLYING ALL TYPES OF LACQUERS, CURTAIN COATING MACHINES FOR APPLYING ALL TYPES OF FINISHING MATERIALS WITH LOW AND MEDIUM VISCOSITY, AND SURFACE SPRAYING MACHINES FOR APPLYING STAINS, SEALERS AND TOPCOATS; SANDING MACHINES; AND BRUSHING MACHINES FOR CLEANING SURFACES OF SANDED WOOD, ALL THE AFOREMENTIONED MACHINES FOR USE IN THE MANUFACTURE AND FINISHING OF WOOD FURNITURE, MOLDINGS FOR FURNITURE AND CABINETRY.

FIRST USE ; IN COMMERCE .

INT. CL. 11/U.S. CLS. 13, 21, 23, 31 AND 34

FOR DRYING APPARATUS FOR USE IN THE MANUFACTURE AND FINISHING OF WOOD FURNITURE, MOLDINGS FOR FURNITURE AND CABINETRY, NAMELY, INDUSTRIAL LAMPS, JET DRYERS, ULTRA VIOLET CURING RADIATORS, AND INFRARED LIGHTING DRYERS.

FIRST USE ; IN COMMERCE .

ELEMENTS CORRECTED
FOREIGN APPLICATION NO.

2,623,740. REG. 9-24-2002. CINTI S.P.A. (ITALY CORPORATION) 128, VIA DEI NOTAI - BLOCCO 31 CENTERGROSS, I - 40050 FUNO DI ARGELATO (BOLOGNA), ITALY., SN 76-203,979. FILED 2-2-2001. PRINCIPAL REGISTER.

CINTI

PRIORITY CLAIMED UNDER SEC. 44(D) ON ITALY APPLICATION NO. 000086, FILED 1-26-2001, REG. NO. 00845094, DATED 1-26-2001.

INT. CL. 25/U.S. CLS. 22 AND 39

FOR ARTICLES OF CLOTHING, NAMELY, HEADWEAR; FOOTWEAR FOR MEN, WOMEN AND CHILDREN, NAMELY, SHOES, BOOTS, SANDALS, CLOGS, SPORTS AND GYMNASTIC SHOES, SLIPPERS; SOLES FOR FOOTWEAR; GLOVES, BELTS, SCARVES, SHAWLS.

FIRST USE ; IN COMMERCE .

ELEMENTS AMENDED
OWNER ADDRESS

2,627,386. REG. 10-1-2002. LION BIOSCIENCE AG (FED REP GERMANY CORPORATION) IM NEUENHEIMER FELD 515, 69120 HEIDELBERG, FED REP GERMANY., SN 76-142,925. FILED 10-6-2000. PRINCIPAL REGISTER.

ID3

PRIORITY CLAIMED UNDER SEC. 44(D) ON FED REP GERMANY APPLICATION NO. 30030320.305, FILED 4-18-2000, REG. NO. 30030320.3, DATED 4-18-2000, EXPIRES 4-30-2010.

INT. CL. 1/U.S. CLS. 1

FOR CHEMICALS FOR USE IN THE MANUFACTURE OF PHARMACEUTICALS; CHEMICAL AND BIOLOGICAL REAGENTS FOR SCIENTIFIC OR RESEARCH USE; DIAGNOSTIC PREPARATIONS FOR SCIENTIFIC OR RESEARCH USE.

FIRST USE 7-11-2000; IN COMMERCE 7-11-2000.

INT. CL. 5/U.S. CLS. 6, 18, 44, 46, 51 AND 52

FOR CHEMICAL AND BIOLOGICAL REAGENTS FOR CLINICAL OR MEDICAL LABORATORY USE; AND DIAGNOSTIC PREPARATIONS FOR CLINICAL OR MEDICAL LABORATORY USE.

FIRST USE 7-11-2000; IN COMMERCE 7-11-2000.

INT. CL. 42/U.S. CLS. 100 AND 101

FOR COMPUTER PROGRAMMING FOR OTHERS; CHEMICAL RESEARCH, MEDICAL RESEARCH, AND SCIENTIFIC RESEARCH IN THE FIELD OF BIOCHEMISTRY, IMMUNOLOGY AND MICROBIOLOGY.

FIRST USE 7-11-2000; IN COMMERCE 7-11-2000.

ELEMENTS CORRECTED
OWNER NAME

2,632,525. REG. 10-8-2002. FASSI GRU IDRAULICHE S.P.A. (ITALY CORPORATION) VIA DEI CARMELITANI, 2, 24021 ALBINO (BG), ITALY., SN 76-007,794. FILED 3-23-2000. PRINCIPAL REGISTER.

FASSI

PRIORITY CLAIMED UNDER SEC. 44(D) ON ITALY APPLICATION NO. BG2000C00074, FILED 3-14-2000, REG. NO. 819982, DATED 7-13-2000, EXPIRES 3-14-2010.

INT. CL. 7/U.S. CLS. 13, 19, 21, 23, 31, 34 AND 35

FOR HYDRAULIC CRANES.

FIRST USE 1-22-1966; IN COMMERCE 1-22-1966.

INT. CL. 12/U.S. CLS. 19, 21, 23, 31, 35 AND 44

FOR TRUCKS EQUIPPED WITH HYDRAULIC CRANES.

FIRST USE 1-22-1966; IN COMMERCE 1-22-1966.

ELEMENTS CORRECTED
FOREIGN APPLICATION NO.

2,633,773. REG. 10-15-2002. CA' DEI FRATI DI DAL CERO PIETRO E FIGLI S.S. (PARTNERSHIP), VIA FRATI, 22, FRAZ LUGANA, 25019 SIRMIONE (BS), ITALY., SN 75-585,130. FILED 11-5-1998. PRINCIPAL REGISTER.

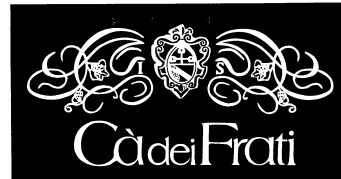

OWNER OF ERPN CMNTY TM OFC REG. NO. 608679, DATED 8-1-1999, EXPIRES 8-8-2007.

THE WORDS "CA' DEI FRATI" MEANS "FRIARS' HOUSE IN ENGLISH.

INT. CL. 33/U.S. CLS. 47 AND 49

FOR WINES.

FIRST USE ; IN COMMERCE .

ELEMENTS CORRECTED
OWNER NAME
FOREIGN REG. DATE
FOREIGN REG. EXPIRATION DATE

2,637,953. REG. 10-22-2002. PRUDENTIAL INSURANCE COMPANY OF AMERICA, THE (NEW JERSEY CORPORATION) 751 BROAD STREET, NEWARK, NJ, 071023777, SN 75-812,580. FILED 10-1-1999. PRINCIPAL REGISTER.

PRUDENTIAL ALLIANCE

NO CLAIM IS MADE TO THE EXCLUSIVE RIGHT TO USE "ALLIANCE", APART FROM THE MARK AS SHOWN. INT. CL. 35/U.S. CLS. 100, 101 AND 102

FOR FINANCIAL SERVICE PROVIDER REFERRALS.

FIRST USE 10-15-1999; IN COMMERCE 10-15-1999.

INT. CL. 36/U.S. CLS. 100, 101 AND 102

FOR FINANCIAL PLANNING SERVICES AND FINANCIAL INVESTMENT SERVICES IN THE FIELD OF SECURITIES, FEATURING [AND] * AN * AFFILIATION PROGRAM OFFERED TO FINANCIAL SERVICE PROVIDERS.

FIRST USE 10-15-1999; IN COMMERCE 10-15-1999.

ELEMENTS CORRECTED
GOODS/SERVICES

2,643,785. REG. 10-29-2002. TRENDIUM, INC. (DELAWARE CORPORATION) 13450 WEST SUNRISE BOULEVARD, SUITE 200, SUNRISE, FL. 33323, SN 76-049,844. FILED 5-16-2000. PRINCIPAL REGISTER.

2,645,403. REG. 11-5-2002. PEABODY, BENJAMIN (UNITED STATES INDIVIDUAL) P.O. BOX 38, HIRAM, ME, 04041, AND PEABODY DEMI (UNITED STATES INDIVIDUAL) P.O. BOX 38, HIRAM, ME, 04041, SN 76-258,632. FILED 5-16-2001. PRINCIPAL REGISTER.

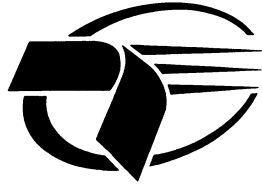

THE MARK CONSISTS, IN PART, OF A STYLIZED REPRESENTATION OF THE LETTER "T".
INT. CL. 9/U.S. CLS. 21, 23, 26, 36 AND 38

FOR COMPUTER SOFTWARE USED TO ENABLE REMOTE LOCATIONS TO ACCESS CORPORATE TELECOMMUNICATIONS SYSTEMS AND COMPUTER NETWORKS, FUNCTIONS, AND TELECOMMUNICATIONS SERVICE PROVIDER NETWORKS, TRANSMITTERS, RECEIVERS, TRANSCIVERS, SIGNAL AMPLIFIERS, ANTENNA, AND TELEPHONES; TELECOMMUNICATIONS AND COMMUNICATIONS SOFTWARE, NAMELY, [COMPUTER NETWORKS;] COMPUTER SOFTWARE USED FOR MONITORING, MEASURING AND ANALYZING THE PERFORMANCE, TRAFFIC, USAGE AND UTILIZATION LEVELS OF GLOBAL COMPUTER * AND TELECOMMUNICATIONS * NETWORKS; COMPUTER SOFTWARE FOR THE MANAGEMENT OF GLOBAL COMPUTER NETWORKS AND TELECOMMUNICATIONS NETWORKS; TELECOMMUNICATIONS SOFTWARE USED TO MANAGE, DIRECT, ROUTE, TRANSMIT AND RECEIVE TELEPHONE CALLS, ELECTRONIC MESSAGES, AND AUDIO AND DATA SIGNALS OVER COMPUTER NETWORKS AND TELECOMMUNICATIONS ACCESS LINES; AND USER MANUALS SOLD AS A UNIT THEREWITH.

FIRST USE 2-0-1999; IN COMMERCE 3-0-1999.
INT. CL. 42/U.S. CLS. 100 AND 101

FOR COMPUTER SERVICES, NAMELY, COMPUTER SOFTWARE DEVELOPMENT SERVICES FOR OTHERS; CUSTOMIZATION OF COMPUTER SOFTWARE FOR OTHERS; TECHNICAL SUPPORT SERVICES, NAMELY, TROUBLESHOOTING OF COMPUTER HARDWARE AND SOFTWARE PROBLEMS VIA TELEPHONE, ELECTRONIC MAIL, POSTINGS ON GLOBAL COMPUTER NETWORKS, AND REMOTE ACCESS; COMPUTER SOFTWARE INSTALLATION, MAINTENANCE AND UPDATING; PROVIDING INFORMATION IN THE FIELDS OF COMPUTER SOFTWARE, COMPUTER HARDWARE, GLOBAL COMPUTER NETWORKS, AND TELECOMMUNICATIONS COMPUTER NETWORKS; TECHNICAL CONSULTATION AND DESIGN IN THE FIELDS OF COMPUTER SOFTWARE, GLOBAL COMPUTER NETWORKS, AND TELECOMMUNICATIONS NETWORKS; WEBSITE AND APPLICATIONS HOSTING AND DEVELOPMENT SERVICES FOR OTHERS; AND COMPUTER CONSULTATION IN THE FIELD OF DEVELOPMENT OF WEB SITES AND TELECOMMUNICATIONS NETWORKS FOR ELECTRONIC COMMERCE PURPOSES.

FIRST USE 2-0-1999; IN COMMERCE 3-0-1999.

ELEMENTS CORRECTED
GOODS/SERVICES

HOT APPLE BUNS

NO CLAIM IS MADE TO THE EXCLUSIVE RIGHT TO USE "BUNS", APART FROM THE MARK AS SHOWN.
SEC. 2(F).

INT. CL. 30/U.S. CL. 46

FOR BAKERY DESSERTS.

FIRST USE 12-15-1989; IN COMMERCE 12-15-1989.

ELEMENTS CORRECTED
OWNER NAME

2,648,014. REG. 11-12-2002. DITTMANN, TITUS E. (FED REP GERMANY INDIVIDUAL) SUDMUHLENSTRASSE 188, D-48157 MUNSTER, FED REP GERMANY., SN 76-060,892. FILED 6-1-2000. PRINCIPAL REGISTER.

TITUS

OWNER OF FED REP GERMANY REG. NO. 2008743, DATED 1-30-1992, RENEWED AS REG. NO. 2008743, DATED 11-30-2000, EXPIRES 11-30-2010.

INT. CL. 9/U.S. CLS. 21, 23, 26, 36 AND 38

FOR SPORT HELMETS, NAMELY, HOCKEY HELMETS, FOOTBALL HELMETS, BICYCLE HELMETS, MOTORCYCLE HELMETS, SKATEBOARD HELMETS, AUTOMOBILE RACING DRIVER'S HELMETS, BASEBALL BATTING HELMETS, BASEBALL CATCHER'S HELMETS, AND JOCKEY HELMETS.

FIRST USE ; IN COMMERCE .

INT. CL. 18/U.S. CLS. 1, 2, 3, 22 AND 41

FOR ARTICLES OF LEATHER AND IMITATION LEATHER, NAMELY, TRUNKS AND SUITCASES, RUCKSACKS, SCHOOL BAGS, HANDBAGS, SHOULDER BAGS, SPORT BAGS, HIP BAGS AND FANNY PACKS.

FIRST USE ; IN COMMERCE .

INT. CL. 20/U.S. CLS. 2, 13, 22, 25, 32 AND 50

FOR LEATHER AND IMITATION * LEATHER * KEY RINGS .

FIRST USE ; IN COMMERCE .

INT. CL. 25/U.S. CLS. 22 AND 39

FOR CLOTHING, NAMELY, PANTS, JEANS PANTS, BOXER SHORTS, SLACKS, SKIRTS, CULOTTES, SHIRTS, BLOUSES, VESTS, JACKETS, JEANS JACKETS, COATS, SMOCKS, BLAZERS, LOUNGE JACKETS, FLYING JACKETS, BASEBALL JACKETS, DRESSES, OVERALLS, DUNGAREES, SKI PANTS, SKI OVER-ALLS, SKI JACKETS, SKI VESTS, KERCHIEFS, SCARVES, SHOULDER WRAPS, NECKTIES, BOW TIES, SUSPENDERS, BELTS, HATS, HOODS, CAPS, HEADBANDS, GLOVES, STOCK-STOCKINGS, SOCKS, PANTYHOSE, PULLOVERS, MUFFLERS, T-SHIRTS, UNDERPANTS, UNDERSHIRTS, SLEEVELESS SHIRTS, SLIPS, MINISKIRTS, BATHROBES, SWIMSUITS, BATHING TRUNKS, BIKINIS, SWEATSHIRTS, SWEATPANTS, SWEAT-SUITS, BRASSIERES, CORSAGES, AND BUSTIERS AND ARM BANDS; FOOTWEAR, NAMELY, CANVAS SHOES, LEATHER SHOES, ATHLETIC SHOES, GYMNASIIC SHOES, BEACH SHOES, SLIPPERS, BOOTS, SNOWSHOES, SNOWBOARD SHOES, AND SKI SHOES.

FIRST USE ; IN COMMERCE .

INT. CL. 26/U.S. CLS. 37, 39, 40, 42 AND 50

FOR SHOELACES; CLOTH PATCHES FOR CLOTHING AND FABRIC APPLIQUES.

FIRST USE ; IN COMMERCE .

ELEMENTS CORRECTED
GOODS/SERVICES

2,650,518. REG. 11-12-2002. STOP TECHNOLOGIES, LLC (CALIFORNIA LIMITED LIABILITY COMPANY) 3541-A LOMITA BOULEVARD, TORRANCE, CA, 90505, SN 76-248,886. FILED 4-30-2001. PRINCIPAL REGISTER.

2,655,675. REG. 12-3-2002. HANLEY-WOOD, LLC (DELAWARE LTD LIAB CO) ONE THOMAS CIRCLE, N.W. WASHINGTON, DC, 20005, BY ASSIGNMENT LEISURE PUBLICATIONS, INC CORPORATION) LOS ANGELES, CA, SN 76-173,774. FILED 11-30-2000. PRINCIPAL REGISTER.

SPORTSTOP

POOL & SPA NEWS

INT. CL. 8/U.S. CLS. 23, 28 AND 44
 FOR BRAKE ROTOR KITS COMPRISED OF A PAIR OF SLOTTED 2-PIECE 282 X 25MM OR 282 X 28MM HIGH PERFORMANCE DIRECTIONAL VANE FLOATING ROTORS PRE-MOUNTED TO A HARD BLACK ANODIZED 7075 T-6 BILLET ALUMINUM HATS, A FLOATING DRIVE PIN AND ANTI-RATTLE HARDWARE WITH ALL GOODS BEING.
 FIRST USE 5-4-2001; IN COMMERCE 5-4-2001.

NO CLAIM IS MADE TO THE EXCLUSIVE RIGHT TO USE "NEWS", APART FROM THE MARK AS SHOWN. SEC. 2(F).
 INT. CL. 16/U.S. CLS. 2, 5, 22, 23, 29, 37, 38 AND 50
 FOR TRADE MAGAZINE RELATING TO THE POOL AND SPA INDUSTRY.
 FIRST USE 3-19-1979; IN COMMERCE 3-19-1979.

ELEMENTS CORRECTED
 OWNER NAME

ELEMENTS CORRECTED
 ASSIGNMENT/NAME CHANGE
 OWNER NAME
 OWNER ADDRESS
 CITIZENSHIP
 ENTITY

2,655,198. REG. 12-3-2002. IMCOA LICENSING AMERICA, INC. (DELAWARE CORPORATION) 200 EAST TENTH STREET, GILROY, CA, 95020. BY ASSIGNMENT; BY ASSIGNMENT INDIAN MOTORCYCLE SUPPLY INC. CORPORATION) SUGAR GROVE, IL, SN 75-138,683. FILED 7-23-1996. PRINCIPAL REGISTER.

2,656,731. REG. 12-3-2002. RED KAP APPAREL CORP, INC. (DELAWARE CORPORATION) 3411 SILVERSIDE ROAD, WILMINGTON, DE, 19810, SN 78-111,353. FILED 2-27-2002. PRINCIPAL REGISTER.

NEW GENERATION

INT. CL. 25/U.S. CLS. 22 AND 39
 FOR IMAGE APPAREL, NAMELY, UNIFORM TROUSERS, JEANS, SHIRTS, COATS AND JACKETS.
 FIRST USE 3-8-1988; IN COMMERCE 3-8-1988.

ELEMENTS CORRECTED
 OWNER NAME



Indian

2,658,114. REG. 12-10-2002. COSTA RICA EXPEDICIONES, AVENTURA Y RECREACION S.A. (COSTA RICA CORPORATION) P.O. BOX 6941-1000, SAN JOSE, COSTA RICA., SN 76-198,061. FILED 1-23-2001. PRINCIPAL REGISTER.

**LEGENDARY SERVICE...
 UNFORGETTABLE
 MEMORIES SINCE 1978**

OWNER OF U.S. REG. NOS. 652,777 AND 921,459.
 THE LINING SHOWN ON THE DRAWING IS A FEATURE OF THE MARK AND DOES NOT INDICATE COLOR.
 INT. CL. 25/U.S. CLS. 22 AND 39
 FOR CLOTHING, NAMELY, PANTS, SHIRTS, JACKETS, SHORTS, SWEATERS, DRESSES, SKIRTS, UNDERWEAR, HATS, BELTS, TIES, AND SHOES.
 FIRST USE 3-4-1953; IN COMMERCE 3-4-1953.

NO CLAIM IS MADE TO THE EXCLUSIVE RIGHT TO USE SINCE 1978, APART FROM THE MARK AS SHOWN.
 INT. CL. 39/U.S. CLS. 100 AND 105
 FOR TRAVEL INFORMATION SERVICES; ARRANGING AND CONDUCTING SAFARI EXPEDITIONS.
 FIRST USE 6-0-1994; IN COMMERCE 6-0-1994.
 INT. CL. 42/U.S. CLS. 100 AND 101
 FOR TRAVEL AGENCY SERVICES, NAMELY, MAKING HOTEL RESERVATIONS AND BOOKING FOR TEMPORARY LODGING.
 FIRST USE 6-0-1994; IN COMMERCE 6-0-1994.

ELEMENTS CORRECTED
 ASSIGNMENT/NAME CHANGE
 OWNER ADDRESS

ELEMENTS CORRECTED
 DISCLAIMER

2,658,337. REG. 12-10-2002. MARKER INTERNATIONAL GMBH (SWITZERLAND CORPORATION) RUESSENSTRASSE 6, CH-6340 BAAR, SWITZERLAND., SN 76-252,861. FILED 5-7-2001. PRINCIPAL REGISTER.

PISTON

PRIORITY CLAIMED UNDER SEC. 44(D) ON FED REP GERMANY APPLICATION NO. 30085667.9/2, FILED 11-21-2000, REG. NO. 30085667, DATED 9-8-2001, EXPIRES 11-30-2010.

INT. CL. 28/U.S. CLS. 22, 23, 38 AND 50
FOR SKI AND SNOWBOARD BINDING AND BINDING PLATES.

FIRST USE 2-2-2000; IN COMMERCE 3-9-2001.

ELEMENTS CORRECTED
DATE OF FIRST USE IN COMMERCE

FOR DISSEMINATING ADVERTISING FOR OTHERS AND PROMOTING THE GOODS AND SERVICES OF OTHERS VIA ON-LINE TELECOMMUNICATIONS NETWORKS; RETAIL STORE SERVICES, OFFERED THROUGH INDIVIDUAL, SPECIALIZED RETAIL ESTABLISHMENTS, FEATURING COMPUTER-RELATED PRODUCTS, NAMELY, COMPUTER HARDWARE, SOFTWARE, PERIPHERALS, ACCESSORIES, SUPPLIES, BOOKS AND INSTRUCTIONAL MATERIALS; ELECTRONIC RETAILING SERVICES VIA COMPUTER FEATURING COMPUTER-RELATED PRODUCTS, NAMELY, COMPUTER HARDWARE, SOFTWARE, PERIPHERALS, ACCESSORIES, SUPPLIES, BOOKS AND INSTRUCTIONAL MATERIALS; AND OPERATING AN ON-LINE INFORMATION SERVICE PROVIDING INFORMATION IN THE NATURE OF CHARACTERISTICS, PRICING, AND RATING OF GOODS IN THE FIELD OF COMPUTER-RELATED PRODUCTS, NAMELY COMPUTER HARDWARE, SOFTWARE, PERIPHERALS, ACCESSORIES, SUPPLIES, BOOKS AND INSTRUCTIONAL MATERIALS.

FIRST USE 4-8-1995; IN COMMERCE 4-8-1995.

ELEMENTS CORRECTED
ASSIGNMENT/NAME CHANGE
OWNER NAME
OWNER ADDRESS

2,659,140. REG. 12-10-2002. CARL-ZEISS-STIFTUNG (FED REP GERMANY CORPORATION), DBA CARL ZEISS, 73446 OBERKOCHEN, FED REP GERMANY., SN 76-362,096. FILED 1-22-2002. PRINCIPAL REGISTER.

CONTAREX

OWNER OF FED REP GERMANY REG. NO. 481807, DATED 1-8-1936, RENEWED AS REG. NO. 481807, DATED 8-1-1995, EXPIRES 7-31-2005.

INT. CL. 9/U.S. CLS. 21, 23, 26, 36 AND 38
FOR CAMERAS AND* CAMERA * LENSES.
FIRST USE ; IN COMMERCE .

ELEMENTS CORRECTED
GOODS/SERVICES

2,662,614. REG. 12-17-2002. FREEMAN, MICHAEL W. (UNITED STATES INDIVIDUAL) 2119 MILDRED STREET WEST, FIRCREST, WA, 984666194, SN 76-333,735. FILED 11-2-2001. PRINCIPAL REGISTER.



INT. CL. 7/U.S. CLS. 13, 19, 21, 23, 31, 34 AND 35
FOR COMPONENTS OF MARINE AUTO PILOTS, NAMELY, MECHANICAL DRIVE UNITS, HYDRAULIC PUMPS, SPROCKETS, CHAINS, SHAFTS, FLEX SHAFTS, AND ELECTRIC MOTORS.

FIRST USE 10-0-1970; IN COMMERCE 10-0-1970.

INT. CL. 9/U.S. CLS. 21, 23, 26, 36 AND 38
FOR MARINE AUTO PILOTS; ELECTRONIC APPARATUS FOR COUPLING ELECTRONIC GEOGRAPHIC POSITION INDICATORS TO MARINE AUTO PILOTS; ELECTRONIC APPARATUS FOR CONNECTING MARINE GUIDANCE EQUIPMENT TO COMPUTER NETWORKS; RUDDER ANGLE INDICATORS; SPEED LOGS; COMPONENTS OF MARINE AUTO PILOTS, NAMELY, MAGNETIC AND HALL-EFFECT COMPASSES, COMPASS ENCLOSURES, COMPENSATING MAGNETS AND FERRITES FOR COMPASSES, HEELING TUBES, JUNCTION BOXES, REMOTE CONTROLS, RUDDER ANGLE INDICATORS, RUDDER ANGLE ENCODERS, LIMIT SWITCHES, RECTIFIER UNITS, SOLENOIDS, RELAYS, [ELECTRIC MOTORS,] AND CONTROLLERS; WIND VANES AND WIND DIRECTION INDICATORS.

FIRST USE 10-0-1970; IN COMMERCE 10-0-1970.

ELEMENTS CORRECTED
GOODS/SERVICES

2,660,968. REG. 12-17-2002. PC MALL SALES, INC. (CALIFORNIA CORPORATION) 2555 W 190TH STREET, TORRANCE, CA, 905046002, BY CHANGE OF NAME CREATIVE COMPUTERS, INC. CORPORATION) TORRANCE, CA, SN 75-096,678. FILED 4-30-1996. PRINCIPAL REGISTER.

PC MALL

OWNER OF U.S. REG. NOS. 2,006,944, 2,247,889 AND OTHERS.

SEC. 2(F).
INT. CL. 35/U.S. CLS. 100, 101 AND 102

2,663,574. REG. 12-17-2002. CLEARWIRE TECHNOLOGIES, INC. (DELAWARE CORPORATION) 19111 DALLAS NORTH PARKWAY, SUITE 200, DALLAS, TX, 75287, BY ASSIGNMENT INTERAIR WIRELESS, INC. CORPORATION) BUFFALO, NY, SN 75-584,937. FILED 11-9-1998. PRINCIPAL REGISTER.

CLEARWIRE

INT. CL. 37/U.S. CLS. 100, 103 AND 106
FOR MAINTENANCE AND INSTALLATION SERVICES RELATING TO HIGH SPEED WIRELESS DATA COMMUNICATIONS NETWORKS.
FIRST USE 7-31-1999; IN COMMERCE 7-31-1999.

ELEMENTS CORRECTED
OWNER ADDRESS
ASSIGNMENT/NAME CHANGE

2,664,372. REG. 12-17-2002. OVERTURE SERVICES, INC. (DELAWARE CORPORATION) 74 NORTH PASADENA AVENUE, 3RD FLOOR, PASADENA, CA, 91103, BY MERGER GOTO.COM, INC. CORPORATION) PASADENA, CA, SN 76-242,049. FILED 4-17-2001. PRINCIPAL REGISTER.

OVERTURE

INT. CL. 35/U.S. CLS. 100, 101 AND 102
FOR PROVIDING INFORMATION DIRECTORY SERVICES FOR A WIDE VARIETY OF TOPICS, AND REFERRALS TO WEB SITES THAT PROVIDE A WIDE VARIETY OF INFORMATION, PRODUCTS AND SERVICES, ALL VIA A GLOBAL COMPUTER NETWORK.
FIRST USE 10-8-2001; IN COMMERCE 10-8-2001.

INT. CL. 38/U.S. CLS. 100, 101 AND 104
FOR ELECTRONIC TRANSMISSION OF DATA VIA A GLOBAL COMPUTER NETWORK.

FIRST USE 10-8-2001; IN COMMERCE 10-8-2001.
INT. CL. 42/U.S. CLS. 100 AND 101
FOR ELECTRONIC NAVIGATION SERVICES, NAMELY, PROVIDING SEARCH ENGINE SERVICES FOR OBTAINING DATA VIA A GLOBAL COMPUTER NETWORK.
FIRST USE 10-8-2001; IN COMMERCE 10-8-2001.

ELEMENTS CORRECTED
ASSIGNMENT/NAME CHANGE
OWNER NAME

2,666,722. REG. 12-24-2002. NINTENDO OF AMERICA INC. (WASHINGTON CORPORATION) 4820-150TH N.E., REDMOND, WA, 98052. SN 75-416,894. FILED 1-12-1998. PRINCIPAL REGISTER.

PIKACHU

INT. CL. 28/U.S. CLS. 22, 23, 38 AND 50

FOR [BEAN BAG GAMES,] BOARD GAMES, [BOP BAGS, DECORATIVE WIND SOCKS,] ELECTRONIC GAME EQUIPMENT FOR PLAYING VIDEO GAMES, [ELECTRONIC TOYS WITH A CLOCK OR TIMEPIECE FEATURE,] GAME CARDS, [HAND-HELD PINBALL GAMES, KITES, NONELECTRIC HAND-HELD SKILL GAMES,] PLUSH DOLLS, [PUPPETS, RING TOSS GAMES, TARGET SETS COMPRISED OF TARGETS AND PROJECTILES,] TOY ACTION FIGURES, [TOY BALLOONS, TOY BANKS, TOY BINOCULARS, TOY BOWLING SETS COMPOSED OF BOWLING PINS AND BOWLING BALLS, TOY VEHICLES, TOY WHISTLES, BATH TOYS,] TOY BALLS, [TOY MUSIC BOXES, TOY BUILDING BLOCKS, TOY MODELING COMPOUNDS, TOY CONSTRUCTION SETS, TOY MOBILES, WATER SQUIRTING TOYS, ROLE PLAYING GAMES,] CARD GAMES, [ROLLER SKATES, IN-LINE SKATES, ACTION SKILL GAMES, MANIPULATIVE GAMES,] PARLOR GAMES, [MECHANICAL TOYS, INFLATABLE TOYS, JIGSAW PUZZLES, MANIPULATIVE PUZZLES, CUBE PUZZLES,] AND YO-YOS.

FIRST USE 11-0-1998; IN COMMERCE 11-0-1998.

ELEMENTS CORRECTED
GOODS/SERVICES

2,671,668. REG. 1-7-2003. PASS & SEYMOUR/LEGRAND (NEW YORK CORPORATION) P.O. BOX 4822, SYRACUSE, NY, 13221, SN 76-334,004. FILED 11-5-2001. PRINCIPAL REGISTER.

WIREUP

INT. CL. 9/U.S. CLS. 21, 23, 26, 36 AND 38
FOR ELECTRICAL WIRING DEVICES AND RELATED PRODUCTS FOR INDUSTRIAL, COMMERCIAL AND RESIDENTIAL APPLICATIONS, NAMELY, SWITCHES, [OUTLETS] *OUTLETS*, WALL PLATES AND CABLING.

FIRST USE 6-1-2001; IN COMMERCE 6-1-2001.

ELEMENTS CORRECTED
GOODS/SERVICES

2,673,328. REG. 1-7-2003. CRABTREE & EVELYN, LTD. (CONNECTICUT CORPORATION) PEAKE BROOK ROAD, WOODSTOCK, CT, 06281, SN 78-098,176. FILED 12-13-2001. PRINCIPAL REGISTER.

60 SECOND FIX

INT. CL. 3/U.S. CLS. 1, 4, 6, 50, 51 AND 52
FOR HAND LOTION.
FIRST USE 5-1-2002; IN COMMERCE 5-1-2002.

ELEMENTS CORRECTED
MARK

2,673,722. REG. 1-14-2003. RDE ADMINISTRATIVE TRUST (UNITED STATES INDIVIDUAL) C/O TERESA H. EARNHARDT, TRUSTEE, 1675 CODDLE CREEK HIGHWAY, MOORESVILLE, NC, 28115. BY ASSIGNMENT, BY ASSIGNMENT EARNHARDT, R. DALE INDIVIDUAL) MOORESVILLE, NC, SN 76-077,198. FILED 6-23-2000. PRINCIPAL REGISTER.

DALE EARNHARDT JR.

OWNER OF U.S. REG. NOS. 1,644,237 AND 2,035,107. THE NAME "DALE EARNHARDT JR." IDENTIFIES A LIVING INDIVIDUAL WHOSE CONSENT IS OF RECORD.

INT. CL. 5/U.S. CLS. 6, 18, 44, 46, 51 AND 52
FOR AIR FRESHENERS FOR AUTOMOBILES.
FIRST USE 2-0-1998; IN COMMERCE 2-0-1998.

INT. CL. 6/U.S. CLS. 2, 12, 13, 14, 23, 25 AND 50
FOR METAL ITEMS, NAMELY, KEY RINGS, KEY CHAINS, KEY CLIPS, KEY RACKS, MONEY CLIPS, COLLECTOR TIN CONTAINERS SOLD EMPTY, AUTOMOBILE LICENSE PLATES, AUTOMOBILE LICENSE PLATE FRAMES, ORNAMENTS AND DECORATIVE STREET SIGNS, NONE OF THE FOREGOING MADE OF PRECIOUS METALS.
FIRST USE 2-0-1998; IN COMMERCE 2-0-1998.

INT. CL. 8/U.S. CLS. 23, 28 AND 44
FOR KNIVES AND POCKET KNIVES, MANICURE SETS AND COLLECTOR SPOONS.
FIRST USE 2-0-1998; IN COMMERCE 2-0-1998.

INT. CL. 9/U.S. CLS. 21, 23, 26, 36 AND 38
FOR COMPUTER PERIPHERALS, NAMELY COMPUTER MOUSE AND MOUSE PADS; COMPUTER SOFTWARE, NAMELY, COMPUTER RACE GAMES AND COMPUTER PROGRAMS FEATURING SCREEN SAVERS; TELEPHONES; WALKIE-TALKIES; RADIOS; DECORATIVE MAGNETS; CELLULAR PHONE CASES AND COMPACT DISK ACCESSORIES, NAMELY, STORAGE CASES AND CARRYING CASES.
FIRST USE 2-0-1998; IN COMMERCE 2-0-1998.

INT. CL. 11/U.S. CLS. 13, 21, 23, 31 AND 34
FOR FLASHLIGHTS.
FIRST USE 2-0-1998; IN COMMERCE 2-0-1998.

INT. CL. 12/U.S. CLS. 19, 21, 23, 31, 35 AND 44
FOR AUTOMOBILE AND TRUCK WINDSHIELD SUN SHADES AND AUTOMOBILE SPLASH GUARDS.
FIRST USE 2-0-1998; IN COMMERCE 2-0-1998.

INT. CL. 14/U.S. CLS. 2, 27, 28 AND 50
FOR JEWELRY, NAMELY, EARRINGS, NECKLACES, BRACELETS, ID BRACELETS, BARRETTES, PINS, LAPEL PINS, AND BELT BUCKLES, ALL OF PRECIOUS METALS; WATCHES, AND POCKET WATCHES; CLOCKS; WALL CLOCKS AND WATCH BANDS.
FIRST USE 2-0-1998; IN COMMERCE 2-0-1998.

INT. CL. 16/U.S. CLS. 2, 5, 22, 23, 29, 37, 38 AND 50
FOR PAPER GOODS AND PRINTED MATTER, NAMELY, DECALS, STICKERS, BUMPER STICKERS, WINDOW STICKERS, CALENDARS, POSTCARDS, NOTE PADS, CUBES OF NOTE PAPER, FOLDERS, TRADING CARDS, PLAYING CARDS, MOUNTED AND UNMOUNTED PHOTOGRAPHS, POSTERS, THREE-RING BINDERS, LETTER OPENERS, CAKE DECORATING PRODUCTS AND CHECKBOOK COVERS.
FIRST USE 2-0-1998; IN COMMERCE 2-0-1998.

INT. CL. 18/U.S. CLS. 1, 2, 3, 22 AND 41
FOR LEATHER, IMITATION LEATHER, OR FABRIC GOODS, NAMELY, MONEY CLIPS, COIN PURSES, CREDIT CARD CASES, BUSINESS CARD CASES, TRAVEL CASES, PORTFOLIOS, LUGGAGE, BOOK BAGS, BACKPACKS, BELT BAGS, DUFFEL BAGS, HANDBAGS, WALLETS, TOTE BAGS, MESSENGER BAGS, ATTACHE CASES, AND SHOT GLASS BAGS; COASTERS, UMBRELLAS AND UMBRELLA BAGS, BEACH UMBRELLAS, AND GOLF UMBRELLAS.
FIRST USE 2-0-1998; IN COMMERCE 2-0-1998.

INT. CL. 20/U.S. CLS. 2, 13, 22, 25, 32 AND 50

FOR CHAIRS, FOLDING CHAIRS AND CARRYING CASES THEREFOR, OTTOMANS, STADIUM SEAT CUSHIONS, PICTURE FRAMES, PHOTO STANDS, KEEPSAKE BOXES, SHADOW BOXES, PLAQUES, NON-METAL KEY RINGS, LANYARDS, NON-METAL KEY CHAINS, NON-METAL KEY RACKS, DECORATIVE TINS, NON-METAL COLLECTOR TINS, WASTEBASKETS, TAPESTRY PILLOWS, PLASTIC ANTENNA FLAGS, PICTURE TELESCOPE KEY CHAINS, PLUSH KEY CHAINS, PLASTIC NOVELTY LICENSE PLATES AND PLASTIC BANNERS AND PLASTIC PENNANTS.
FIRST USE 2-0-1998; IN COMMERCE 2-0-1998.

INT. CL. 21/U.S. CLS. 2, 13, 23, 29, 30, 33, 40 AND 50
FOR HOUSEWARES AND GLASS, NAMELY, DRINKING GLASSES, SHOT GLASSES, CUPS, AND MUGS, COLLECTOR PLATES, SALT AND PEPPER SHAKERS, RUBBER, PLASTIC, OR FOAM INSULATING BEVERAGE HOLDERS, RUBBER, PLASTIC, OR FOAM INSULATING FOOD CONTAINERS AND COOLERS, WATER BOTTLES SOLD EMPTY, HIP FLASKS, STEINS, WASTEBASKETS, WIND CHIMES, PLASTIC COASTERS, RESIN FIGURINES, AND SCULPTURES.
FIRST USE 2-0-1998; IN COMMERCE 2-0-1998.

INT. CL. 24/U.S. CLS. 42 AND 50
FOR BANNERS, PENNANTS, AND FLAGS NOT MADE OF PAPER OR PLASTIC; AND BEDDING SETS CONSISTING OF SHEETS, PILLOW CASES, PILLOW SHAMS, COMFORTERS, AND DUST RUFFLES; AFGHANS, FABRIC WALL HANGINGS, WOOD PRODUCTS WITH TAPESTRY INSERTS, TAPESTRY STOCKINGS.
FIRST USE 2-0-1998; IN COMMERCE 2-0-1998.

INT. CL. 25/U.S. CLS. 22 AND 39
FOR CLOTHING, NAMELY, CAPS, HATS, SHIRTS, T-SHIRTS, POLO SHIRTS, WINDSHIRTS, FLEECE PULL-OVERS, LADIES' NIGHT SHIRTS, JACKETS, JEANS, SHORTS, PANTS, OVERALLS, RAINCOATS, RAIN PONCHOS, COSTUMES, NAMELY, DRIVER SUITS, CLOTH BABY BIBS, AND BELTS.
FIRST USE 2-0-1998; IN COMMERCE 2-0-1998.

INT. CL. 26/U.S. CLS. 37, 39, 40, 42 AND 50
FOR ORNAMENTAL NOVELTY PINS AND CLIPS FOR CLOTHING, AND BELT BUCKLES NOT OF PRECIOUS METAL, COLLECTOR THIMBLES, HAIR SCRUNCHIES, SHOELACES AND DECORATIVE ORNAMENTAL TAGS FOR SHOELACES.
FIRST USE 2-0-1998; IN COMMERCE 2-0-1998.

INT. CL. 27/U.S. CLS. 19, 20, 37, 42 AND 50
FOR RUGS, MATS, AND WALLPAPER BORDERS AND AUTOMOBILE FLOOR MATS.
FIRST USE 2-0-1998; IN COMMERCE 2-0-1998.

INT. CL. 28/U.S. CLS. 22, 23, 38 AND 50
FOR GOLF BALLS, GOLF BALL TAGS, BASEBALLS, YO-YOS, PLUSH ANIMALS, PLUSH TOY CARS, PLUSH COIN HOLDERS, FISHING ROD HOLSTERS, CONSTRUCTION TOYS, TOY BANKS, COLLECTOR DOLLS, MINIATURE CARS, MINIATURE AUTOMOBILE HOODS, MINIATURE AUTOMOBILE TRUNKS, MINIATURE AUTOMOBILE QUARTER PANELS, POOL CUES, POOL CUE CASES, SHOT BAGS, TOY AND MINIATURE DRIVER HELMETS AND TOY MODEL CAR KITS.
FIRST USE 2-0-1998; IN COMMERCE 2-0-1998.

INT. CL. 30/U.S. CL. 46
FOR CANDY AND POPPED POPCORN.
FIRST USE 2-0-1998; IN COMMERCE 2-0-1998.

INT. CL. 41/U.S. CLS. 100, 101 AND 107
FOR ENTERTAINMENT SERVICES IN THE NATURE OF PARTICIPATING IN PROFESSIONAL AUTOMOBILE RACES AND RELATED EXHIBITIONS.
FIRST USE 2-0-1998; IN COMMERCE 2-0-1998.

ELEMENTS CORRECTED
ASSIGNMENT/NAME CHANGE
OWNER NAME
OWNER ADDRESS

2,673,723. REG. 1-14-2003. RDE ADMINISTRATIVE TRUST (NORTH CAROLINA TRUST) C/O TERESA H. EARNHARDT, TRUSTEE, 1675 CODDLE CREEK HIGHWAY, MOORESVILLE, NC, 28115, BY ASSIGNMENT, BY ASSIGNMENT EAMHARDT, R. DALE INDIVIDUAL) MOORESVILLE, NC, SN 76-077,199. FILED 6-23-2000. PRINCIPAL REGISTER.



OWNER OF U.S. REG. NOS. 1,644,237 AND 2,035,107. THE NAME "DALE EARNHARDT JR." IDENTIFIES A LIVING INDIVIDUAL WHOSE CONSENT IS OF RECORD.

INT. CL. 5/U.S. CLS. 6, 18, 44, 46, 51 AND 52
FOR AIR FRESHENERS FOR AUTOMOBILES.
FIRST USE 2-0-1998; IN COMMERCE 2-0-1998.

INT. CL. 6/U.S. CLS. 2, 12, 13, 14, 23, 25 AND 50
FOR METAL ITEMS, NAMELY, KEY RINGS, KEY CHAINS, KEY CLIPS, KEY RACKS, MONEY CLIPS, COLLECTOR TIN CONTAINERS SOLD EMPTY, AUTOMOBILE LICENSE PLATES, AUTOMOBILE LICENSE PLATS FRAMES, ORNAMENTS AND DECORATIVE STREET SIGNS, NONE OF THE FOREGOING MADE OF PRECIOUS METALS.
FIRST USE 2-0-1998; IN COMMERCE 2-0-1998.

INT. CL. 8/U.S. CLS. 23, 28 AND 44
FOR KNIVES AND POCKET KNIVES MANICURE SETS AND COLLECTOR SPOONS.
FIRST USE 2-0-1998; IN COMMERCE 2-0-1998.

INT. CL. 9/U.S. CLS. 21, 23, 26, 36 AND 38
FOR COMPUTER PERIPHERALS, NAMELY, COMPUTER MOUSE AND MOUSE PADS; COMPUTER SOFTWARE, NAMELY, COMPUTER RACE GAMES, AND COMPUTER PROGRAMS FEATURING SCREEN SAVERS; TELEPHONES; WALKIE-TALKIES; RADIOS; DECORATIVE MAGNETS; CELLULAR PHONE CASES AND COMPACT DISK ACCESSORIES, NAMELY, STORAGE CASES AND CARRYING CASES.
FIRST USE 2-0-1998; IN COMMERCE 2-0-1998.

INT. CL. 11/U.S. CLS. 13, 21, 23, 31 AND 34
FOR FLASHLIGHTS.
FIRST USE 2-0-1998; IN COMMERCE 2-0-1998.

INT. CL. 12/U.S. CLS. 19, 21, 23, 31, 35 AND 44
FOR AUTOMOBILE AND TRUCK WINDSHIELD SUN SHADES AND AUTOMOBILE SPLASH GUARDS.
FIRST USE 2-0-1998; IN COMMERCE 2-0-1998.

INT. CL. 14/U.S. CLS. 2, 27, 28 AND 50
FOR JEWELRY, NAMELY, EARRINGS, NECKLACES, BRACELETS, ID BRACELETS, BARRETTES, PINS, LAPEL PINS, AND BELT BUCKLES, ALL OF PRECIOUS METALS; WATCHES, AND POCKET WATCHES; CLOCKS; WALL CLOCKS AND WATCH BANDS.
FIRST USE 2-0-1998; IN COMMERCE 2-0-1998.

INT. CL. 16/U.S. CLS. 2, 5, 22, 23, 29, 37, 38 AND 50
FOR PAPER GOODS AND PRINTED MATTER, NAMELY, DECALS, STICKERS, BUMPER STICKERS, WINDOW STICKERS, CALENDARS, POSTCARDS, NOTE PADS, CUBES OF NOTE PAPER, FOLDERS, TRADING CARDS, PLAYING CARDS, MOUNTED AND UNMOUNTED PHOTOGRAPHS, POSTERS, THREE-RING BINDERS, LETTER OPENERS, AND CAKE DECORATING PRODUCTS AND CHECKBOOK COVERS.
FIRST USE 2-0-1998; IN COMMERCE 2-0-1998.

INT. CL. 18/U.S. CLS. 1, 2, 3, 22 AND 41
FOR LEATHER, IMITATION LEATHER, OR FABRIC GOODS, NAMELY, MONEY CLIPS, COIN PURSES, CREDIT CARD CASES, BUSINESS CARD CASES, TRAVEL CASES, PORTFOLIOS, LUGGAGE, BOOK BAGS, BACKPACKS, BELT BAGS, DUFFEL BAGS, HANDBAGS, WALLETS, TOTE BAGS, MESSENGER BAGS, ATTACHE CASES, AND SHOT GLASS BAGS; COASTERS, UMBRELLAS AND UMBRELLA BAGS, BEACH UMBRELLAS, AND GOLF UMBRELLAS.
FIRST USE 2-0-1998; IN COMMERCE 2-0-1998.

INT. CL. 20/U.S. CLS. 2, 13, 22, 25, 32 AND 50

FOR CHAIRS, FOLDING CHAIRS AND CARRYING CASES THEREFOR, OTTOMANS, STADIUM SEAT CUSHIONS, PICTURE FRAMES, PHOTO STANDS, KEEPSAKE BOXES, SHADOW BOXES, PLAQUES, NON-METAL KEY RINGS, LANYARDS, NON-METAL KEY CHAINS, NON-METAL KEY RACKS, DECORATIVE TINS, NON-METAL COLLECTOR TINS, WASTEBASKETS, TAPESTRY PILLOWS, PLASTIC ANTENNA FLAGS, PICTURE TELESCOPE KEY CHAINS, PLUSH KEY CHAINS, PLASTIC NOVELTY LICENSE PLATES, PLASTIC BANNERS AND PLASTIC PENNANTS.
FIRST USE 2-0-1998; IN COMMERCE 2-0-1998.

INT. CL. 21/U.S. CLS. 2, 13, 23, 29, 30, 33, 40 AND 50
FOR HOUSEWARES AND GLASS, NAMELY, DRINKING GLASSES, SHOT GLASSES, CUPS, AND MUGS, COLLECTOR PLATES, SALT AND PEPPER SHAKERS, RUBBER, PLASTIC, OR FOAM INSULATING BEVERAGE HOLDERS, RUBBER, PLASTIC, OR FOAM INSULATING FOOD CONTAINERS AND COOLERS, WATER BOTTLES SOLD EMPTY, HIP FLASKS, STEINS, WASTEBASKETS, WIND CHIMES, PLASTIC COASTERS, RESIN FIGURINES, AND SCULPTURES.
FIRST USE 2-0-1998; IN COMMERCE 2-0-1998.

INT. CL. 24/U.S. CLS. 42 AND 50
FOR BANNERS, PENNANTS, AND FLAGS NOT MADE OF PAPER OR PLASTIC; AND BEDDING SETS CONSISTING OF SHEETS, PILLOW CASES, PILLOW SHAMS, COMFORTERS, AND DUST RUFFLES; AND AFGHANS, FABRIC WALL HANGINGS, WOOD PRODUCTS WITH TAPESTRY INSERTS, TAPESTRY STOCKINGS.
FIRST USE 2-0-1998; IN COMMERCE 2-0-1998.

INT. CL. 25/U.S. CLS. 22 AND 39
FOR CLOTHING, NAMELY, CAPS, HATS, SHIRTS, T-SHIRTS, POLO SHIRTS, WINDSHIRTS, FLEECE PULL-OVERS, LADIES' NIGHT SHIRTS, JACKETS, JEANS, SHORTS, PANTS, OVERALLS, RAINCOATS, RAIN PONCHOS, COSTUMES, NAMELY, DRIVER SUITS, CLOTH BABY BIBS, AND BELTS.
FIRST USE 2-0-1998; IN COMMERCE 2-0-1998.

INT. CL. 26/U.S. CLS. 37, 39, 40, 42 AND 50
FOR ORNAMENTAL NOVELTY PINS AND CLIPS FOR CLOTHING, AND BELT BUCKLES NOT OF PRECIOUS METAL, COLLECTOR THIMBLES, HAIR SCRUNCHIES, SHOELACES AND DECORATIVE ORNAMENTAL TAGS FOR SHOELACES.
FIRST USE 2-0-1998; IN COMMERCE 2-0-1998.

INT. CL. 27/U.S. CLS. 19, 20, 37, 42 AND 50
FOR RUGS, MATS, AND WALLPAPER BORDERS AND AUTOMOBILE FLOOR MATS.
FIRST USE 2-0-1998; IN COMMERCE 2-0-1998.

INT. CL. 28/U.S. CLS. 22, 23, 38 AND 50
FOR GOLF BALLS, GOLF BALL TAGS, BASEBALLS, YO-YOS, PLUSH ANIMALS, PLUSH TOY CARS, PLUSH COIN HOLDERS, FISHING ROD HOLSTERS, CONSTRUCTION TOYS, TOY BANKS, COLLECTOR DOLLS, MINIATURE CARS, MINIATURE AUTOMOBILE HOODS, MINIATURE AUTOMOBILE TRUNKS, MINIATURE AUTOMOBILE QUARTER PANELS, POOL CUES, POOL CUE CASES, SHOT BAGS, TOY AND MINIATURE DRIVER HELMETS AND TOY MODEL CAR KITS.
FIRST USE 2-0-1998; IN COMMERCE 2-0-1998.

INT. CL. 30/U.S. CL. 46
FOR CANDY AND POPPED POPCORN.
FIRST USE 2-0-1998; IN COMMERCE 2-0-1998.

INT. CL. 41/U.S. CLS. 100, 101 AND 107
FOR ENTERTAINMENT SERVICES IN THE NATURE OF PARTICIPATING IN PROFESSIONAL AUTOMOBILE RACES AND RELATED EXHIBITIONS.
FIRST USE 2-0-1998; IN COMMERCE 2-0-1998.

ELEMENTS CORRECTED
ASSIGNMENT/NAME CHANGE
OWNER NAME
OWNER ADDRESS
CITIZENSHIP
ENTITY

2,675,950. REG. 1-21-2003. SYPHER SPORTSWEAR & DESIGN, INC. (NEW YORK CORPORATION) 485 SEVENTH AVENUE, SUITE 800, NEW YORK, NY, 10018, SN 75-882,038. FILED 12-28-1999. PRINCIPAL REGISTER.

SY-PHER

INT. CL. 18/U.S. CLS. 1, 2, 3, 22 AND 41
FOR [LEATHER AND] FABRIC HANDBAGS, WALLET, LUGGAGE, BRIEFCASE [STYLE] * TYPE * PORTFOLIOS, ALL PURPOSE SPORTS BAGS [AND COSMETIC CASES SOLD EMPTY].
FIRST USE 7-31-2000; IN COMMERCE 11-20-2000.

INT. CL. 25/U.S. CLS. 22 AND 39
FOR CLOTHING, NAMELY LEATHER JACKETS, [COATS, RAINWEAR,] OVERALLS, [DUNGAREES, SKI SUITS, ANORAKS,] VESTS, SHIRTS, [BLOUSES, SWEAT-SHIRTS, KNIT TOPS, T-SHIRTS, SWEATERS,] PANTS, JEANS, SHORTS, [SHORTALLS, ROMPERS, SKIRTS, DRESSES, SARONGS, CAPES, UNDERWEAR, OTHER INTIMATE APPAREL, NAMELY, SLEEPWEAR, LINGERIE, LOUNGEWEAR, PAJAMAS, SWIMWEAR, ROBES, CYCLING CLOTHES, NAMELY, SHORTS, SHORTALLS, WINDBREAKERS, APRONS, BATH-ROBES, SHOES, HATS, AND HEADWEAR OF ALL TYPES, NAMELY, BANDANNAS, HEAD WRAPS, AND VISORS, SCARVES, GLOVES, SOCKS AND BELTS].
FIRST USE 7-31-2000; IN COMMERCE 11-20-2000.

ELEMENTS CORRECTED
GOODS/SERVICES

2,679,381. REG. 1-28-2003. PALMSOURCE, INC. (DELAWARE CORPORATION) 5470 GREAT AMERICA PARKWAY, SANTA CLARA, CA, 95052. BY MERGER; BY MERGER; BY MERGER, BY ASSIGNMENT PALM, INC. CORPORATION) SANTA CLARA, CA, SN 75-810,033. FILED 10-18-1999. PRINCIPAL REGISTER.

PALMPACK

INT. CL. 9/U.S. CLS. 21, 23, 26, 36 AND 38
FOR CARRYING CASE AND ACCESSORIES FOR USE WITH HANDHELD COMPUTERS.
FIRST USE 8-10-1999; IN COMMERCE 8-10-1999.

ELEMENTS CORRECTED
OWNER NAME
CITIZENSHIP
ENTITY
ASSIGNMENT/NAME CHANGE

2,680,220. REG. 1-28-2003. HOUSE OF PRINCE A/S (DENMARK CORPORATION) TOBAKSVEJEN 4, SOBORG, DENMARK, 2860, SN 76-323,856. FILED 10-11-2001. PRINCIPAL REGISTER.



OWNER OF DENMARK REG. NO. VR199305646, DATED 7-30-1993, EXPIRES 7-30-2003.
INT. CL. 34/U.S. CLS. 2, 8, 9 AND 17
FOR CIGARETTES.

ELEMENTS CORRECTED
OWNER ADDRESS

2,680,831. REG. 1-28-2003. PLACEWARE, INC. (DELAWARE CORPORATION) 295 N. BERNARDO AVENUE, MOUNTAIN VIEW, CA, 94043, SN 76-399,067. FILED 4-18-2002. PRINCIPAL REGISTER.

GREAT MEETINGS. NO TRAVEL.

INT. CL. 9/U.S. CLS. 21, 23, 26, 36 AND 38
FOR COMPUTER SOFTWARE FOR CREATING, OFFERING, HOSTING, AND DELIVERING ONLINE CONFERENCES, MEETINGS, DEMONSTRATIONS, TOURS, PRESENTATIONS, AND DISCUSSIONS.
FIRST USE 10-0-2001; IN COMMERCE 2-1-2002.

INT. CL. 35/U.S. CLS. 100, 101 AND 102
FOR BUSINESS CONSULTING SERVICES IN THE FIELDS OF ONLINE CONFERENCES, MEETINGS, DEMONSTRATIONS, TOURS, PRESENTATIONS, AND DISCUSSIONS; ORGANIZATION, MANAGEMENT, SCHEDULING, PLANNING, HOSTING AND MARKETING OF ONLINE CONFERENCES, MEETINGS, DEMONSTRATIONS, TOURS, PRESENTATIONS, AND DISCUSSIONS.
FIRST USE 10-0-2001; IN COMMERCE 2-1-2002.

INT. CL. 42/U.S. CLS. 100 AND 101
FOR COMPUTER SERVICES, NAMELY, HOSTING ONLINE WEB FACILITIES FOR OTHERS FOR CONDUCTING ONLINE CONFERENCES, MEETINGS, [DEMONSTRATION,] * DEMONSTRATIONS, * VIRTUAL TOURS, PRESENTATIONS AND INTERACTIVE DISCUSSIONS; TECHNICAL SUPPORT SERVICES, NAMELY, TROUBLESHOOTING OF COMPUTER NETWORKS, AND SOFTWARE VIA E-MAIL, TELEPHONE, AND THE INTERNET.
FIRST USE 10-0-2001; IN COMMERCE 2-1-2002.

ELEMENTS CORRECTED
GOODS/SERVICES

2,681,586. REG. 1-28-2003. WELLMAG TECHNOLOGY CO., LTD. (TAIWAN CORPORATION) NO. 137, CHING NINE ROAD, YOUTH INDUSTRY PARK, TACHIA, TAICHUNG HSIEN, TAIWAN., SN 75-913,027. FILED 2-9-2000. PRINCIPAL REGISTER.

FOR ONLINE MAGAZINES IN THE FIELDS OF POLITICS AND NATIONAL AND INTERNATIONAL NEWS, BUSINESS AND CULTURAL AFFAIRS.
FIRST USE 10-17-2002; IN COMMERCE 10-17-2002.

ELEMENTS CORRECTED
OWNER ADDRESS



INT. CL. 9/U.S. CLS. 21, 23, 26, 36 AND 38

FOR SHELLS FOR COMPUTERS, COMPUTER PRINTERS, MONITORS AND SCANNERS, TELEVISIONS, RECORD PLAYERS, VIDEOTAPE RECORDERS/PLAYERS, STEREO SYSTEMS COMPRISED OF RECEIVERS, AMPLIFIERS AND SPEAKERS, TELEPHONES, TELEGRAPH MACHINES, TELEPHONE ANSWERING MACHINES, FACSIMILE MACHINES, WIRELESS TELEPHONES, MOBILE TELEPHONES, AND PAGERS.

FIRST USE 9-5-2002; IN COMMERCE 9-5-2002.

INT. CL. 12/U.S. CLS. 19, 21, 23, 31, 35 AND 44

FOR PEDALS FOR BICYCLES, SADDLES FOR BICYCLES, ELECTRIC BICYCLES, BRAKES FOR BICYCLES.

FIRST USE 9-5-2002; IN COMMERCE 9-5-2002.

ELEMENTS CORRECTED
GOODS/SERVICES

2,682,990. REG. 2-4-2003. ALPHANET, INC. (FLORIDA CORPORATION) 2937 S.W. 27TH AVENUE, SUITE 302, MIAMI, FL, 33133, SN 76-347,809. FILED 12-13-2001. PRINCIPAL REGISTER.

ALPHANET

INT. CL. 42/U.S. CLS. 100 AND 101

FOR HEALTH MANAGEMENT SERVICES, NAMELY, NURSING, PHARMACEUTICAL DISPENSING, PHYSICAL THERAPY, AND OXYGEN THERAPY SERVICES FOR THOSE AFFLICTED WITH [ALPHAL-ANTITRYPSIN] * ALPHA1-ANTITRYPSIN * DEFICIENCY AND THEIR PRIMARY CARE PROVIDERS.

FIRST USE 1-1-1995; IN COMMERCE 1-1-1995.

ELEMENTS CORRECTED
GOODS/SERVICES

2,684,971. REG. 2-4-2003. AMERICAN CONSERVATIVE, LLC, THE (DELAWARE LIMITED LIABILITY COMPANY) 1300 WILSON BOULEVARD, SUITE 120, ARLINGTON, VA, 22209, SN 76-401,877. FILED P.R. 4-30-2002; AM. S.R. 11-21-2002. SUPPLEMENTAL REGISTER.

THE AMERICAN CONSERVATIVE

INT. CL. 41/U.S. CLS. 100, 101 AND 107

2,684,988. REG. 2-4-2003. FRANC JAMES PRODUCTIONS, INC. (NEW YORK CORPORATION) 306 BURNS STREET, FORESTVILLE HILLS, NY, 11375, AND HYBRID ENTERPRISES, INC. (NEW YORK CORPORATION) 306 BURNS STREET, FOREST HILLS, NY, 11375, BY ASSIGNMENT PRIVATE BRAND SERVICES, LLC (NEW YORK), FOREST HILLS, NY, SN 78-003,449. FILED P.R. 4-11-2000; AM. S.R. 12-18-2000. SUPPLEMENTAL REGISTER.

PRIVATE BRAND SERVICES

NO CLAIM IS MADE TO THE EXCLUSIVE RIGHT TO USE "SERVICES", APART FROM THE MARK AS SHOWN.
INT. CL. 35/U.S. CLS. 100, 101 AND 102

FOR CONSULTING SERVICES RELATING TO THE DEVELOPMENT OF BUSINESS STRATEGIES FOR DEPARTMENT STORES.

FIRST USE 2-1-1999; IN COMMERCE 2-1-1999.

INT. CL. 40/U.S. CLS. 100, 103 AND 106

FOR MANUFACTURE OF MEN'S, WOMEN'S AND CHILDREN'S APPAREL.

FIRST USE 7-12-1999; IN COMMERCE 7-12-1999.

ELEMENTS CORRECTED

OWNER NAME
CITIZENSHIP
ENTITY
ASSIGNMENT/NAME CHANGE
OWNER ADDRESS

2,687,160. REG. 2-11-2003. WHITE ROCK NETWORKS, INC. (DELAWARE CORPORATION) 1301 W. PRESIDENT GEORGE BUSH FREEWAY, SUITE 350, RICHARDSON, TX, 75080, SN 76-148,390. FILED 10-16-2000. PRINCIPAL REGISTER.



NO CLAIM IS MADE TO THE EXCLUSIVE RIGHT TO USE "NETWORKS", APART FROM THE MARK AS SHOWN.

INT. CL. 9/U.S. CLS. 21, 23, 26, 36 AND 38

FOR COMPUTER HARDWARE; OPTICAL COMMUNICATIONS NETWORK COMPUTER HARDWARE; PACKET-BASED COMMUNICATIONS NETWORK HARDWARE; COMMUNICATIONS NETWORK MANAGEMENT COMPUTER HARDWARE; WAVELENGTH DIVISION MULTIPLEXING COMPUTER HARDWARE DESIGNED TO ENHANCE TRANSMISSIONS VIA OPTICAL AND PACKET-BASED COMMUNICATIONS NETWORKS; COMPUTER NETWORK HARDWARE; COMPUTER SOFTWARE TO ENABLE THE DELIVERY OF TELECOMMUNICATIONS SERVICES IN THE FIELDS OF OPTICAL COMMUNICATIONS, PACKET-BASED COMMUNICATIONS, AND COMMUNICATIONS NETWORK MANAGEMENT; WAVELENGTH DIVISION MULTIPLEXING COMPUTER SOFTWARE DESIGNED TO ENHANCE TRANSMISSIONS VIA OPTICAL AND PACKET-BASED COMMUNICATIONS NETWORKS; COMPUTER SOFTWARE FOR NETWORK MANAGEMENT IN THE FIELD OF COMMUNICATIONS; COMPUTER SOFTWARE TO CONNECT VARIOUS COMPUTER NETWORKS IN THE FIELD OF COMMUNICATIONS.

FIRST USE 1-24-2002; IN COMMERCE 1-24-2002.

ELEMENTS CORRECTED
OWNER ADDRESS

2,687,470. REG. 2-11-2003. FIBERSPAR CORPORATION (DELAWARE CORPORATION) 28 PATTERSON BROOK ROAD, WEST WAREHAM, MA, 02576, BY CHANGE OF NAME FIBERSPAR SPOOLABLE PRODUCTS, INC. CORPORATION) WEST WAREHAM, MA, SN 78-022,406. FILED 8-22-2000. PRINCIPAL REGISTER.

FIBERSPAR 

OWNER OF U.S. REG. NOS. 1,607,409, 2,032,398 AND 2,377,068.

INT. CL. 17/U.S. CLS. 1, 5, 12, 13, 35 AND 50

FOR PIPES AND TUBES OF COMPOSITE MATERIAL AND CONNECTORS THEREFOR FOR USE IN THE TRANSPORT OF LIQUID AND GASEOUS FLUIDS; PIPES AND TUBES OF COMPOSITE MATERIAL THAT MAY BE STORED IN COILS OR SPOOLS FOR USE IN THE TRANSPORT OF LIQUIDS AND GASEOUS FLUIDS; NON-METAL PIPES AND TUBES OF COMPOSITE MATERIAL THAT MAY BE STORED IN COILS OR SPOOLS FOR USE IN OIL WELLS AND OTHER DEEP SUBTERRANEAN USES.

FIRST USE 9-6-1996; IN COMMERCE 3-15-1999.

ELEMENTS CORRECTED
ASSIGNMENT/NAME CHANGE
CITIZENSHIP

2,688,189. REG. 2-18-2003. R. L. POLK & CO. (DELAWARE CORPORATION) 26955 NORTHWESTERN HIGHWAY, SOUTHFIELD, MI, 48034, SN 76-334,778. FILED 11-7-2001. PRINCIPAL REGISTER.

**AUTOMOTIVE
INTELLIGENCE**

NO CLAIM IS MADE TO THE EXCLUSIVE RIGHT TO USE "AUTOMOTIVE", APART FROM THE MARK AS SHOWN.

INT. CL. 9/U.S. CLS. 21, 23, 26, 36 AND 38

FOR COMPUTER SOFTWARE FOR USE IN COLLECTING, COMPILING, MAINTAINING, INTERPRETING, AND MANAGING BUSINESS, MARKETING, AND DEMOGRAPHIC INFORMATION, MARKET RESEARCH, AND COMPUTER DATABASES; SOFTWARE FOR USE IN TRANSMITTING DATA AND OPERATING COMMUNICATIONS NETWORKS.

FIRST USE 7-21-2000; IN COMMERCE 7-21-2000.

INT. CL. 16/U.S. CLS. 2, 5, 22, 23, 29, 37, 38 AND 50

FOR NON-FICTION BOOKS, INSTRUCTION AND TEACHING MANUALS IN THE FIELD OF BUSINESS AND MARKETING, PRINTED MATTER, NAMELY, PRINTED DATA COMPILATIONS, PRINTED REPORTS GENERATED FROM COMPUTERIZED DATABASES, AND PRINTED REPORTS IN THE FIELDS OF BUSINESS AND MARKETING.

FIRST USE 7-21-2000; IN COMMERCE 7-21-2000.

INT. CL. 35/U.S. CLS. 100, 101 AND 102

FOR BUSINESS MARKETING AND CONSULTING SERVICES, NAMELY, THE RESEARCH, PREPARATION AND DISTRIBUTION OF DEMOGRAPHIC AND STATISTICAL MARKET RESEARCH SURVEYS; MARKET ANALYSIS SERVICES; DATA PROCESSING; COMPUTERIZED DATABASE MANAGEMENT AND THE COMPILATION OF STATISTICAL DATA; COMPUTER SERVICES, NAMELY, PROVIDING ONLINE INFORMATION IN THE FIELD OF BUSINESS AND CONSUMER STATISTICAL AND DEMOGRAPHIC DATA; LICENSING OF COMPUTER SOFTWARE.

FIRST USE 7-21-2000; IN COMMERCE 7-21-2000.

INT. CL. 39/U.S. CLS. 100 AND 105

FOR ELECTRONIC STORAGE OF BUSINESS AND CONSUMER STATISTICAL AND DEMOGRAPHIC DATA.

FIRST USE 7-21-2000; IN COMMERCE 7-21-2000.

INT. CL. 41/U.S. CLS. 100, 101 AND 107

FOR TRAINING SERVICES IN THE USE AND OPERATION OF SPECIALIZED SOFTWARE, DATABASES AND COMPUTERS.

FIRST USE 7-21-2000; IN COMMERCE 7-21-2000.

INT. CL. 42/U.S. CLS. 100 AND 101

FOR COMPUTER PROGRAMMING FOR OTHERS IN CONNECTION WITH SPECIALIZED SOFTWARE PROGRAMS AND COMPUTERIZED DATABASES.

FIRST USE 7-21-2000; IN COMMERCE 7-21-2000.

ELEMENTS CORRECTED
DATE OF FIRST USE
DATE OF FIRST USE IN COMMERCE

2,692,810. REG. 3-4-2003. C. R. BARD, INC. (NEW JERSEY CORPORATION) 730 CENTRAL AVENUE, MURRAY HILL, NJ, 07974, SN 76-385,989. FILED 3-21-2002. PRINCIPAL REGISTER.

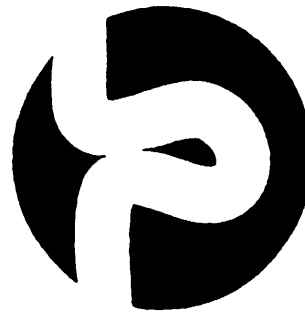

THE MARK CONSISTS OF A STYLIZED DESIGN OF AN ESOPHAGUS OR STOMACH CANAL.

INT. CL. 10/U.S. CLS. 26, 39 AND 44

FOR SUTURING KIT, NAMELY, HANDLE AND CAPSULE WITH SUCTION TUBING FOR ENDOSCOPES, NEEDLE ASSEMBLY, PUSHER WIRE AND GUIDE-WIRE, SUTURE LOADER AND CAPSULE ATTACHMENT TOOL, A SUTURE ANCHORING DEVICE, CUTTING DEVICE AND SUTURE THREADING TOOLS; AND PARTS THEREOF, ALL USED IN CONNECTION WITH THE TREATMENT OF GASTROESOPHAGEAL REFLUX DISEASE.

FIRST USE 10-31-2000; IN COMMERCE 10-31-2000.

ELEMENTS CORRECTED
DESCRIPTION OF MARK

2,694,456. REG. 3-11-2003. LYNNE, JEFFREY (UNITED KINGDOM INDIVIDUAL) C/O GELFAND RENNERT & FELDMAN, LLC, 1880 CENTURY PARK EAST, SUITE 1660, LOS ANGELES, CA, 90067, SN 76-037,599. FILED 5-1-2000. PRINCIPAL REGISTER.

ELECTRIC LIGHT ORCHESTRA PART II

NO CLAIM IS MADE TO THE EXCLUSIVE RIGHT TO USE "ORCHESTRA", APART FROM THE MARK AS SHOWN.

INT. CL. 9/U.S. CLS. 21, 23, 26, 36 AND 38

FOR PRE-RECORDED AUDIO RECORDINGS AND VIDEO RECORDINGS ON CD-ROM DISKS AND VIDEO CASSETTES ON THE SUBJECT OF POPULAR MUSIC.

FIRST USE 6-19-1991; IN COMMERCE 6-19-1991.

INT. CL. 16/U.S. CLS. 2, 5, 22, 23, 29, 37, 38 AND 50

FOR PRINTED MATTER, NAMELY SOUVENIR PROGRAMS CONCERNING BIOGRAPHICAL BOOKS, BROCHURES, MAGAZINES AND PAMPHLETS PERTAINING TO [ENTERTAINMENT] * ENTERTAINERS *

FIRST USE 6-19-1991; IN COMMERCE 6-19-1991.

INT. CL. 41/U.S. CLS. 100, 101 AND 107

FOR ENTERTAINMENT SERVICES, NAMELY, RENDERING LIVE VOCAL AND MUSICAL CONCERT PERFORMANCES .

FIRST USE 6-19-1991; IN COMMERCE 6-19-1991.

ELEMENTS CORRECTED
GOODS/SERVICES

2,694,519. REG. 3-11-2003. EURO PC GROUP, S.A. (FRANCE CORPORATION) 53 RUE LEON GAMBETTA, 59000 LILLE, FRANCE., SN 76-114,435. FILED 8-22-2000. PRINCIPAL REGISTER.

SOFTTHINKS

OWNER OF FRANCE REG. NO. 003008222, DATED 2-11-2000, EXPIRES 2-11-2010.

INT. CL. 9/U.S. CLS. 21, 23, 26, 36 AND 38

FOR MICROCOMPUTERS; PRINTERS; CIRCUIT CARDS; DISKETTE READERS; DIGITAL COMPACT DISKS FEATURING SOFTWARE FOR CONFIGURING, INSTALLATION AND MAINTENANCE OF PERSONAL COMPUTERS AND THEIR PROGRAMS; COMPUTER SOFTWARE, NAMELY WEB CONFIGURING SOFTWARE.

FIRST USE ; IN COMMERCE .

INT. CL. 42/U.S. CLS. 100 AND 101

FOR SOFTWARE DEVELOPMENT AND DESIGN; INSTALLATION, MAINTENANCE, TROUBLESHOOTING AND UPDATING OF COMPUTER SOFTWARE; PROVIDING TEMPORARY USAGE OF NON-DOWNLOADABLE SOFTWARE FOR DATABASE MANAGEMENT AND WORD-PROCESSING; PROVIDING TEMPORARY USAGE OF NON-DOWNLOADABLE SOFTWARE FOR [BUILD] * BUILT * TO ORDER COMPUTER PRODUCTION PRELOAD AND RECOVERY; PROVIDING NON-DOWNLOADABLE SOFTWARE FOR DATABASE MANAGEMENT AND DISTRIBUTION OF COMPUTER PRODUCTION PRELOAD SOFTWARE.

FIRST USE ; IN COMMERCE .

ELEMENTS CORRECTED
GOODS/SERVICES

2,695,303. REG. 3-11-2003. BURBANK DENTAL LAB. INC. (CALIFORNIA CORPORATION) 2101 FLOYD STREET, BURBANK, CA, 91504, SN 76-385,682. FILED 3-21-2002. PRINCIPAL REGISTER.

Pressed²^M

INT. CL. 10/U.S. CLS. 26, 39 AND 44

FOR DENTAL CROWNS MADE OF PORCELAIN FUSED TO METAL.

FIRST USE 2-15-2002; IN COMMERCE 2-15-2002.

ELEMENTS CORRECTED
MARK

2,695,557. REG. 3-11-2003. CAP GEMINI ERNST & YOUNG U.S. LLC (DELAWARE LIMITED LIABILITY COMPANY) 750 SEVENTH AVENUE, 18TH FLOOR, NEW YORK, NY, 10019, SN 76-417,790. FILED 6-5-2002. PRINCIPAL REGISTER.

XCITO

INT. CL. 44/U.S. CLS. 100 AND 101

FOR PROVIDING ACCESS TO A DATABASE OF HEALTH CARE INFORMATION FOR USE BY HEALTH CARE PROVIDERS, CONTRACT RESEARCH ORGANIZATIONS, PHARMACEUTICAL COMPANIES, AND CONTRACT LABORATORIES.

FIRST USE 9-0-2001; IN COMMERCE 9-0-2001.

ELEMENTS CORRECTED
OWNER ADDRESS

2,696,385. REG. 3-11-2003. BIRDDOG SOLUTIONS, INC. (NEBRASKA CORPORATION) 148 COOK STREET, BILLERICA, MA, 01821, BY CHANGE OF NAME TRANSPORT RECOVERY SERVICES, INC. CORPORATION) BILLERICA, MA. SN 76-192,452. FILED 1-10-2001. PRINCIPAL REGISTER.

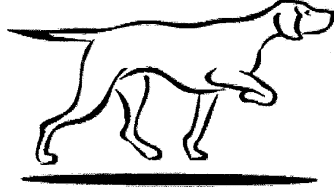

INT. CL. 35/U.S. CLS. 100, 101 AND 102
FOR AUDITING SERVICES, NAMELY THE AUDITING OF BILLS FOR FREIGHT, SHIPPING, ACCOUNTS PAYABLE RECOVERY AUDITING.
FIRST USE 12-15-2000; IN COMMERCE 12-15-2000.

ELEMENTS CORRECTED
ASSIGNMENT/NAME CHANGE
OWNER NAME

2,697,106. REG. 3-18-2003. VIKING RIVER CRUISES S.A. (LUXEMBOURG HOLDING COMPANY) 3 RUE DE LA CHAPELLE, L-2017 LUXEMBOURG, LUXEMBOURG., SN 76-199,468. FILED 1-23-2001. PRINCIPAL REGISTER.

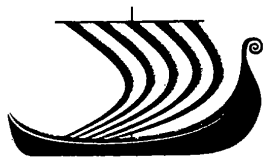

VIKING RIVER CRUISES

NO CLAIM IS MADE TO THE EXCLUSIVE RIGHT TO USE "RIVER CRUISES", APART FROM THE MARK AS SHOWN.
INT. CL. 39/U.S. CLS. 100 AND 105
FOR ARRANGING TRAVEL TOURS; CONDUCTING SIGHTSEEING TOURS FOR OTHERS; TOUR GUIDE SERVICES; RIVER BOAT TOURS; PROVIDING INFORMATION ON TRAVEL TOURS; PROVIDING INFORMATION ON RIVER BOAT TOURS.
FIRST USE 9-1-1997; IN COMMERCE 5-0-1998.

ELEMENTS CORRECTED
OWNER ADDRESS
CITIZENSHIP

2,697,272. REG. 3-18-2003. FOB, INC. (DELAWARE CORPORATION) 350 NORTH ORLEANS SUITE 950, CHICAGO, IL, 60654, SN 76-308,272. FILED 8-30-2001. PRINCIPAL REGISTER.

MSDSadvantage

NO CLAIM IS MADE TO THE EXCLUSIVE RIGHT TO USE "MSDS", APART FROM THE MARK AS SHOWN.
INT. CL. 9/U.S. CLS. 21, 23, 26, 36 AND 38
FOR COMPUTER SOFTWARE FOR USE IN MAINTAINING AN ONLINE DATA MANAGEMENT SERVICE THAT ALLOWS USERS TO LOCATE, COMPILE, INTEGRATE AND MANAGE DOCUMENTS IN ELECTRONIC FORMAT THAT ARE DOWNLOADED VIA GLOBAL COMPUTER NETWORK AND INDEXED IN ELECTRONIC FORMAT VIA DESKTOP SOFTWARE, IN THE FIELD OF INDUSTRIAL, CHEMICAL AND HAZARDOUS WASTE MANAGEMENT.
FIRST USE 4-1-2001; IN COMMERCE 5-15-2001.
INT. CL. 35/U.S. CLS. 100, 101 AND 102
FOR BUSINESS RECORDS MANAGEMENT SERVICES IN THE FIELD OF INDUSTRIAL, CHEMICAL AND HAZARDOUS WASTE MANAGEMENT PROVIDED OVER A GLOBAL COMPUTER INFORMATION NETWORK AND CONSULTATION RELATED THERETO.
FIRST USE 4-1-2001; IN COMMERCE 5-15-2001.
INT. CL. 42/U.S. CLS. 100 AND 101
FOR COMPUTER SERVICES, NAMELY, PROVIDING TEMPORARY USE OF ONLINE, DOWNLOADABLE SOFTWARE TO UPDATE, COMPILE, INTEGRATE AND MANAGE A LIBRARY OF REGULATORY FORMS IN THE FIELD OF INDUSTRIAL, CHEMICAL AND HAZARDOUS WASTE MANAGEMENT.
FIRST USE 4-1-2001; IN COMMERCE 5-15-2001.

ELEMENTS CORRECTED
OWNER ADDRESS

2,698,532. REG. 3-18-2003. TI GROUP AUTOMOTIVE SYSTEMS, L.L.C. (DELAWARE LTD LIAB CO) 12345 EAST NINE MILE ROAD, WARREN, MI, 480902001, BY ASSIGNMENT TI GROUP AUTOMOTIVE SYSTEMS CORPORATION CORPORATION) WARREN, MI, SN 76-268,309. FILED 6-7-2001. PRINCIPAL REGISTER.

TI Automotive

NO CLAIM IS MADE TO THE EXCLUSIVE RIGHT TO USE "AUTOMOTIVE", APART FROM THE MARK AS SHOWN.
INT. CL. 6/U.S. CLS. 2, 12, 13, 14, 23, 25 AND 50
FOR COLD ROLLED STEEL, MAGNETIC SHIELDING STEEL, COPPER COATED STEEL AND NICKEL COATED STEEL IN STRIP AND SHEET FORM FOR USE IN FURTHER MANUFACTURE OR CONSTRUCTION; METAL STRUCTURAL FORMS, NAMELY, SPACE FRAMES, METAL TUBES, INSTRUMENT PANEL BEAMS, RADIATOR CLOSURES AND ENGINE CRADLES; METAL FLUID LINES AND TUBES; COUPLINGS, QUICK CONNECTORS AND FITTINGS FOR FLUID LINES AND HOSES; METAL FUEL, OIL, BRAKE FLUID AND COOLANT HOSES.
FIRST USE 6-26-2002; IN COMMERCE 6-26-2002.
INT. CL. 7/U.S. CLS. 13, 19, 21, 23, 31, 34 AND 35

FOR PARTS AND ACCESSORIES FOR ENGINES, NAMELY, DIAPHRAGM CARBURETORS, ROTARY CARBURETORS AND FLOAT BOWL CARBURETORS, IGNITION UNITS, FUEL INJECTION UNITS, FUEL RAILS, PUSH RODS, CHAIN OILERS, MIXING OIL PUMPS, AIR FILTER UNITS, FUEL FILTER UNITS, AIR PURGE UNITS, FUEL TANKS, AND FUEL PUMPS; CHAIN OILERS FOR POWER CHAIN SAWS, AND PARTS AND ACCESSORIES FOR VEHICLES, NAMELY, AIR FILTER UNITS, FUEL FILTER UNITS, AIR PURGE UNITS, FUEL TANK UNITS, BELLOWS PUMPS, REFRIGERATION PUMPS, FUEL PUMPS, FUEL MODULES, FUEL LINES, OIL COOLERS; AND PARTS AND COMPONENTS FOR ALL OF THE ABOVE.

FIRST USE 6-26-2002; IN COMMERCE 6-26-2002.

INT. CL. 11/U.S. CLS. 13, 21, 23, 31 AND 34

FOR COMMERCIAL DOMESTIC, INDUSTRIAL, RESIDENTIAL AND VEHICLE AIR CONDITIONING, HEATING, FREEZING AND REFRIGERATION UNITS, NAMELY, COLD WALL EVAPORATORS, NO-FROST EVAPORATORS, ROLL-BOND EVAPORATORS, CHEST FREEZER EVAPORATORS, AIR CONDITIONING EVAPORATORS, EVAPORATORS, FREEZER SHELF UNITS, FREEZER CONDENSERS, WAVELINE CONDENSERS, STATIC CONDENSERS, DYNAMIC CONDENSERS, HOT WALL CONDENSERS, CONDENSERS, ACCUMULATORS, HEAT EXCHANGERS, DOOR WARMERS, SHOCK LOOPS, SUCTION AND DISCHARGE PIPES, COMPRESSORS, INTERNAL OIL COOLERS, OIL SUPPLY TUBES, TRUCK REFRIGERATION PUMPS, HEATER UNITS, OIL COOLING UNITS; AND PARTS AND COMPONENTS FOR ALL OF THE ABOVE.

FIRST USE 6-26-2002; IN COMMERCE 6-26-2002.

INT. CL. 12/U.S. CLS. 19, 21, 23, 31, 35 AND 44

FOR HYDRO-FORMED AUTOMOTIVE STRUCTURAL PARTS; VEHICLE STRUCTURAL PARTS, NAMELY, INSTRUMENT PANEL BEAMS, RADIATOR CLOSURES, ENGINE CRADLES, SPACE FRAMES, TUBES; VEHICLE ENGINE PARTS, NAMELY, DIAPHRAGM CARBURETORS, ROTARY CARBURETORS, FLOAT BOWL CARBURETORS, CARBURETORS, FUEL IGNITION UNITS, INJECTION UNITS, MIXING OIL PUMPS, AIR FILTER ASSEMBLIES, FUEL FILTER ASSEMBLIES, AIR PURGE UNITS, FUEL RAILS, DIESEL FUEL TUBING, PUSH RODS; VEHICLES PARTS AND ACCESSORIES, NAMELY, FUEL TANK UNITS, PLASTIC FUEL TANKS, FILLER NECKS, FUEL PUMP MODULES, FUEL PUMPS, TRANSMISSION OIL COOLERS, ENGINE OIL COOLERS, BELLOWS PUMPS, TRUCK REFRIGERATION PUMPS, FLEXIBLE EXHAUST COUPLINGS, RECEIVERS, DRYERS, ACCUMULATORS, HEATER UNITS, POWER STEERING UNITS, BRAKES, ABS/ESP UNITS, RADIATOR HOSES, HEATER HOSES, AIR CONDITIONING HOSES, FUEL LINES, VAPOR LINES, OIL LINES, COOLANT LINES, AND BRAKE LINES INCLUDING RIGID AND FLEXIBLE TUBES AND HOSES AND COUPLINGS, CONNECTORS, FITTINGS AND BUNDLES THEREFOR; AND PARTS AND COMPONENTS FOR ALL OF THE ABOVE.

FIRST USE 6-26-2002; IN COMMERCE 6-26-2002.

INT. CL. 17/U.S. CLS. 1, 5, 12, 13, 35 AND 50

FOR NON-METAL RIGID AND FLEXIBLE LINES AND HOSES FOR AIR, COOLANT, FUEL VAPOR, IDOL, BRAKE, TRANSMISSION, POWER STEERING, REFRIGERANT AND OTHER FLUIDS IN VEHICLES; AND COUPLINGS, CONNECTORS AND FITTING FOR ALL OF THE ABOVE.

FIRST USE 6-26-2002; IN COMMERCE 6-26-2002.

ELEMENTS CORRECTED
ASSIGNMENT/NAME CHANGE
OWNER NAME
CITIZENSHIP
ENTITY

2,700,296. REG. 3-25-2003. NEXANS (FRANCE PUBLIC LIMITED COMPANY) 16 RUE DE MONCEAU, PARIS, FRANCE, 75008, SN 78-038,017. FILED 12-6-2000. PRINCIPAL REGISTER.

NEXANS

PRIORITY CLAIMED UNDER SEC. 44(D) ON FRANCE APPLICATION NO. 003036871, FILED 6-26-2000, REG. NO. 003036871, DATED 6-26-2000, EXPIRES 6-26-2010.

INT. CL. 6/U.S. CLS. 2, 12, 13, 14, 23, 25 AND 50

FOR NON-ELECTRIC METAL CABLES AND WIRES AND PIPES OF METAL.

FIRST USE ; IN COMMERCE .

INT. CL. 9/U.S. CLS. 21, 23, 26, 36 AND 38

FOR ELECTRICAL AND ELECTRONIC CABLES AND WIRES; TELECOMMUNICATION[S] CABLES AND WIRES; ELECTRICAL WINDING WIRES; TELEPHONE WIRES; ELECTRICAL CONNECTORS; BRANCHING BOXES, JUNCTIONS BOXES AND SPLITTER BOXES, NAMELY* . * ELECTRICAL, OPTICAL AND INTERCONNECT ENCLOSURES FOR USE WITH DATA AND TELECOMMUNICATION CABLES AND WIRES AND WITH OPTICAL FIBERS*.* [AND] BRANCH JOINTS, STRAIGHT JOINTS AND DISTRIBUTION CABINETS AND PANELS FOR USE WITH ELECTRIC CABLES; COMPONENTS AND ACCESSORIES FOR CONNECTING ELECTRIC, ELECTRONIC AND TELECOMMUNICATION CABLES AND WIRES, NAMELY, PATCH CORDS, PROTECTION MODULES AND JUMPERS; JUNCTION SLEEVES AND JUNCTIONS SHEATHS USED FOR ELECTRICAL AND OPTICAL SPLICE PROTECTIONS AND ENCLOSURES FOR USE WITH [USE WITH] ELECTRIC, ELECTRONIC AND TELECOMMUNICATION [S] CABLES AND WITH OPTICAL FIBERS; ELECTRICAL CONDUCTORS; TRANSMITTERS, RECEIVERS, TRANSCEIVERS, MULTIPLEXERS, SWITCHES, CONVERTERS USED AT THE END OF ELECTRIC, ELECTRONIC AND TELECOMMUNICATION CABLES AND OPTICAL FIBERS FOR DATA AND TELECOMMUNICATION [S] SYSTEMS; AND COMPUTER SOFTWARE FOR DESIGN AND MANAGEMENT OF CABLE NETWORKS AND CABLING SYSTEMS, CABLE ADMINISTRATION, CABLING SYSTEM QUOTATION AND AUTOMATIC IDENTIFICATION OF THE CONFIGURATION OF PATCH PANELS AND DISTRIBUTION FRAMES.

FIRST USE ; IN COMMERCE .

ELEMENTS CORRECTED
GOODS/SERVICES
[OWNER ADDRESS]

2,701,796. REG. 4-1-2003. DAIRY MANAGEMENT INC. (ILLINOIS CORPORATION) 10255 WEST HIGGINS ROAD, SUITE 900, ROSEMONT, IL, 60018, SN 76-219,647. FILED 3-6-2001. PRINCIPAL REGISTER.

MOORU

INT. CL. 42/U.S. CLS. 100 AND 101

FOR PROVIDING INFORMATION IN THE FIELD OF DAIRY INGREDIENTS, THEIR USES, AND SUPPLIERS AND RECOMMENDATIONS ABOUT DAIRY INGREDIENTS TO [FOOL] *FOOD* L TECHNOLOGISTS VIA THE INTERNET.

FIRST USE 3-1-2001; IN COMMERCE 3-1-2001.

ELEMENTS CORRECTED
GOODS/SERVICES

2,702,107. REG. 4-1-2003. LIONSGATE COMMUNICATIONS INC. (TEXAS CORPORATION) P.O. BOX 222006, DALLAS, TX, 75222, SN 76-365,920. FILED 2-2-2002. PRINCIPAL REGISTER.

G.U.T.S. GYMNASTS USING THEIR STYLE

INT. CL. 41/U.S. CLS. 100, 101 AND 107
FOR CONDUCTING TRAINING SEMINARS AND TRAINING CAMPS IN THE FIELD OF GYMNASTICS; ORGANIZING AND CONDUCTING ATHLETIC EXHIBITS AND COMPETITIONS IN THE FIELD OF GYMNASTICS.
FIRST USE 9-30-2000; IN COMMERCE 9-30-2000.

ELEMENTS CORRECTED
OWNER ADDRESS

2,702,108. REG. 4-1-2003. LIONSGATE COMMUNICATIONS INC. (TEXAS CORPORATION) P.O. BOX 222006, DALLAS, TX, 75222, SN 76-365,929. FILED 2-2-2002. PRINCIPAL REGISTER.

NO MORE ROUTINE ROUTINES

INT. CL. 41/U.S. CLS. 100, 101 AND 107
FOR CONDUCTING TRAINING SEMINARS AND TRAINING CAMPS IN THE FIELD OF GYMNASTICS; ORGANIZING AND CONDUCTING ATHLETIC EXHIBITS AND COMPETITIONS IN THE FIELD OF GYMNASTICS.
FIRST USE 1-31-2001; IN COMMERCE 1-31-2001.

ELEMENTS CORRECTED
OWNER ADDRESS

2,702,782. REG. 4-1-2003. ADDISON WESLEY LONGMAN, INC. (MASSACHUSETTS CORPORATION) 1 JACOB PLACE, READING, MA, 01867, SN 75-469,604. FILED 4-17-1998. PRINCIPAL REGISTER.



INT. CL. 41/U.S. CLS. 100, 101 AND 107

FOR [PUBLICATION OF TEXT BOOKS AND EDUCATIONAL BOOKS; PUBLICATION OF EDUCATIONAL KITS COMPRISED OF BOOKS AND SOFTWARE; EDUCATIONAL SERVICES, NAMELY, ARRANGING AND CONDUCTING EDUCATIONAL SEMINARS, AND WORKSHOPS FOR EDUCATORS OF CHILDREN IN PRESCHOOL THROUGH GRADE 12 IN THE FIELD OF CHILDREN'S EDUCATION; ARRANGING AND CONDUCTING EDUCATIONAL CONFERENCES AND EXHIBITIONS FOR EDUCATORS OF CHILDREN IN PRESCHOOL THROUGH GRADE 12 ON A WIDE VARIETY OF CURRICULAR SUBJECTS, NAMELY, READING, LITERACY, PHONICS, SPELLING, LITERATURE, MATH, SCIENCE, HISTORY, ENGLISH, SOCIAL STUDIES, AND SPANISH AND DISTRIBUTION OF PRINTED MATERIALS, INCLUDING EDUCATIONAL BOOKS, CATALOGS AND BROCHURES IN CONJUNCTION WITH EDUCATIONAL EXHIBITS, WORKSHOPS AND SEMINARS] * PUBLICATION OF TEXT BOOKS AND EDUCATIONAL BOOKS, PUBLICATION OF EDUCATIONAL KITS COMPRISED OF BOOKS AND SOFTWARE; EDUCATIONAL SERVICES, NAMELY, ARRANGING AND CONDUCTING EDUCATIONAL SEMINARS, AND WORKSHOPS FOR EDUCATORS OF CHILDREN IN PRESCHOOL THROUGH GRADE 6 IN THE FIELD OF CHILDREN'S EDUCATION; ARRANGING AND CONDUCTING EDUCATIONAL CONFERENCES AND EXHIBITIONS FOR EDUCATORS OF CHILDREN IN PRESCHOOL THROUGH GRADE 6 ON A WIDE VARIETY OF CURRICULAR SUBJECTS, NAMELY, READING, LITERACY, PHONICS, SPELLING AND LITERATURE, AND DISTRIBUTION OF PRINTED MATERIALS, INCLUDING EDUCATIONAL BOOKS, CATALOGS AND BROCHURES IN CONJUNCTION WITH EDUCATIONAL EXHIBITS, WORKSHOPS AND SEMINARS *.
FIRST USE 5-0-1998; IN COMMERCE 5-0-1998.

ELEMENTS CORRECTED
GOODS/SERVICES

2,703,864. REG. 4-8-2003. VILLEROY & BOCH AG (FED REP GERMANY CORPORATION) P.O. BOX 1160, 66693 METTLACH, FED REP GERMANY,, SN 76-301,646. FILED 8-17-2001. PRINCIPAL REGISTER.

HOMMAGE

PRIORITY CLAIMED UNDER SEC. 44(D) ON FED REP GERMANY APPLICATION NO. 30111218.5, FILED 2-19-2001, REG. NO. 30111218, DATED 7-17-2001, EXPIRES 2-28-2011.
THE TRANSLATION OF "HOMMAGE" IS "HOMAGE"
INT. CL. 11/U.S. CLS. 13, 21, 23, 31 AND 34

FOR LAMPS, WALL LIGHT FIXTURES, AND LIGHT APPLIANCES, NAMELY, ELECTRIC TRACK LIGHTING UNITS, FLUORESCENT LIGHTING TUBES, SCONCES LIGHTING FIXTURE AND SOCKETS FOR ELECTRIC LIGHTS; SANITARY EQUIPMENT ITEMS, NAMELY, BATH TUBS, SHOWER TUBS, WHIRLPOOL TUBS AND STEAM BATHS, LAVATORIES, TOILET TANKS, TOILET SEATS, COVERS FOR URINALS, BIDETS AND URINALS; BATHROOM PLUMBING FITTINGS FOR CONNECTION, MIXING AND DISTRIBUTION OF WATER, NAMELY, [BIBS.] *BIBBS* COCKS, TRAPS AND VALVES; PLUMBING SUPPLIES, NAMELY, COUPLINGS, TAPS, VALVES, TRAPS, [BIBS.] *BIBBS* COCKS, FAUCET CONTROL FITTINGS, NAMELY, AERATORS, REDUCERS AND DIVERTERS; SHOWERS; SHOWER FITTINGS, NAMELY, COUPLINGS, TAPS, VALVES, TRAPS, [BIBS.] *BIBBS* AND SHOWER FAUCET CONTROL FITTINGS, NAMELY, AERATORS, REDUCERS AND DIVERTERS; SHOWER ENCLOSURES AND SHOWER TRAYS FOR BATHROOMS AND PUBLIC BATHS; STRUCTURAL CLAW-FEET FOR BATHTUBS; FITTINGS FOR WASH BASINS, SINKS, BATHTUBS AND SHOWERS, NAMELY, FAUCETS, TAPS, TUB FILLERS, SHOWER CONTROL VALVES AND SHOWER HEADS; CONTROL VALVES AND MIXING VALVES FOR SANITARY WATER SUPPLY; STRUCTURAL AND REPLACEMENT PARTS AND COMPONENTS FOR THE AFOREMENTIONED GOODS.

FIRST USE ; IN COMMERCE .

INT. CL. 20/U.S. CLS. 2, 13, 22, 25, 32 AND 50

FOR PICTURE FRAMES, MIRROR FRAMES, MIRRORS, MIRRORING BATHROOM CABINETS, FURNITURE FOR BATHROOMS, NAMELY VANITIES, SHELVES, CABINETS AND TABLES.

FIRST USE ; IN COMMERCE .

INT. CL. 21/U.S. CLS. 2, 13, 23, 29, 30, 33, 40 AND 50

FOR HOUSEHOLD CONTAINERS AND ARTICLES OF GLASS, CERAMIC AND PORCELAIN, NAMELY, DECORATIVE BOWLS, PLATES AND PLATTERS, FIGURINES, SCULPTURES, CENTERPIECES, TEAPOTS, CANDLESTICKS AND CANDLE HOLDERS, VASES, POTS FOR PLANTS; DINNERWARE, NAMELY, PLATES, CUPS, GLASSES, BOWLS, PLATTERS, PITCHERS, CASSEROLE DISHES; KITCHEN CONTAINERS, NAMELY, PITCHERS, VASES, BOWLS, TRAYS, PLATTERS, DISHES FOR COOKING AND BAKING; CERAMIC BATH ACCESSORIES, NAMELY, TOILET PAPER HOLDERS, TOILET BRUSH HOLDERS, TOWEL HOLDERS, TOWEL RACKS, BATH UTENSIL HOLDERS, TOOTHBRUSH HOLDERS, BATHROOM CUPS AND WASH BASINS; BASKETS OF WICKER, STRAW AND WOOD.

FIRST USE ; IN COMMERCE .

ELEMENTS CORRECTED
GOODS/SERVICES

2,703,871. REG. 4-8-2003. VILLEROY & BOCH AG (FED REP GERMANY CORPORATION) P.O. BOX 1160, 66688 METTLACH, FED REP GERMANY., SN 76-305,623. FILED 8-27-2001. PRINCIPAL REGISTER.

NAGANO

OWNER OF FED REP GERMANY REG. NO. 30113240, DATED 2-27-2001, EXPIRES 2-28-2011.
INT. CL. 11/U.S. CLS. 13, 21, 23, 31 AND 34

FOR LAMPS, WALL LIGHT FIXTURES, AND ELECTRIC LIGHT APPLIANCES, NAMELY, TRACK LIGHTING UNITS, FLUORESCENT LIGHTING TUBES, [SCONCES] *SCONCE* LIGHTING FIXTURES AND SOCKETS FOR ELECTRIC LIGHTS; SANITARY EQUIPMENT ITEMS, NAMELY BATH TUBS, SHOWER TUBS, WHIRLPOOL TUBS AND STEAM BATHS, LAVATORIES, TOILET TANKS, TOILET SEATS, STRUCTURAL COVERS FOR URINALS, BIDETS AND URINALS; BATHROOM FITTINGS FOR CONNECTION, MIXING AND DISTRIBUTION OF WATER, NAMELY BIBS, COCKS, TRAPS AND VALVES; PLUMBING FITTINGS, NAMELY COUPLINGS, TAPS, VALVES, TRAPS, BIBBS, COCKS, CONTROL FITTINGS, NAMELY AERATORS, REDUCERS AND DIVERTERS; WALL UNITS, NAMELY, SHOWER WALL PARTITIONS AND SINKS; SHOWERS; SHOWER FITTINGS, NAMELY COUPLINGS, TAPS, VALVES, TRAPS, BIBBS AND CONTROL FITTINGS, NAMELY AERATORS, REDUCERS AND DIVERTERS; SHOWER ENCLOSURES, SHOWER TUBS AND SHOWER TRAYS FOR BATHROOMS AND PUBLIC BATHS; BATHTUB FEET; PLUMBING FITTINGS FOR WASH BASINS, SINKS, BATHTUBS AND SHOWERS NAMELY, FAUCETS, TAPS, SHOWER HEADS AND SHOWER VALVES, TUB FILLERS; PLUMBING FITTINGS, NAMELY, PLUMBING VALVES FOR MIXING SANITARY WATER SUPPLY; STRUCTURAL AND REPLACEMENT PARTS AND COMPONENTS FOR THE AFOREMENTIONED GOODS.

FIRST USE ; IN COMMERCE .

INT. CL. 20/U.S. CLS. 2, 13, 22, 25, 32 AND 50

FOR PICTURE FRAMES, MIRROR FRAMES, MIRRORS, MIRRORING BATHROOM CABINETS; FURNITURE FOR BATHROOMS, NAMELY VANITIES, SHELVES, CABINETS, TABLES AND CHAIRS.

FIRST USE ; IN COMMERCE .

INT. CL. 21/U.S. CLS. 2, 13, 23, 29, 30, 33, 40 AND 50

FOR HOUSEHOLD CONTAINERS AND ARTICLES OF GLASS, CERAMIC AND PORCELAIN, NAMELY DECORATIVE BOWLS, PLATES AND PLATTERS, FIGURINES, SCULPTURES, CENTERPIECES, TEAPOTS, CANDLESTICKS AND CANDLE HOLDERS, VASES, POTS FOR PLANTS; DINNERWARE, NAMELY PLATES, CUPS, GLASSES, BOWLS, PLATTERS, PITCHERS, CASSEROLE DISHES; KITCHEN CONTAINERS, NAMELY PITCHERS, VASES, BOWLS, TRAYS, PLATTERS, DISHES FOR COOKING AND BAKING; CERAMIC BATH ACCESSORIES, NAMELY TOILET PAPER HOLDERS, TOILET BRUSH HOLDERS, TOWEL HOLDERS, TOWEL RACKS *,* BATH UTENSIL HOLDERS, TOOTHBRUSH HOLDERS, BATHROOM CUPS AND WASH BASINS; BASKETS OF WICKER, STRAW AND WOOD.

FIRST USE ; IN COMMERCE .

ELEMENTS CORRECTED
GOODS/SERVICES

2,703,966. REG. 4-8-2003. EMB SOFTWARE LIMITED (UNITED KINGDOM PRIVATE LIMITED COMPANY) NIGHTINGALE HOUSE, 46-48 EAST STREET, EPSOM, SURREY KT17 1HP, UNITED KINGDOM., SN 76-340,464. FILED 11-20-2001. PRINCIPAL REGISTER.

EMBLEM

INT. CL. 9/U.S. CLS. 21, 23, 26, 36 AND 38

FOR SOFTWARE AND COMPUTER PROGRAMS STORED ON COMPUTER DISCS AND TAPES FOR ANALYSIS OF POLICY AND CLAIMS EXPERIENCE, ANALYSIS OF RESULTS, AND FOR MODELING AND GRAPHICAL PRESENTATION IN THE FIELD OF INSURANCE PRICING FOR PERSONAL AND SMALL COMMERCIAL BUSINESS.

FIRST USE 5-31-2000; IN COMMERCE 5-31-2000.

INT. CL. 41/U.S. CLS. 100, 101 AND 107

FOR TRAINING IN THE USE OF INSURANCE PRICING SOFTWARE AND COMPUTER PROGRAMS; EDUCATIONAL SERVICES, NAMELY, CONDUCTING CLASSES AND WORKSHOPS IN THE FIELD OF SOFTWARE AND COMPUTER PROGRAMS FOR INSURANCE PRICING.

FIRST USE 5-30-2000; IN COMMERCE 5-31-2000.

ELEMENTS CORRECTED
DATE OF FIRST USE

2,704,565. REG. 4-8-2003. COX COMMUNICATIONS, INC. (DELAWARE CORPORATION) 1400 LAKE HEARN DRIVE, N.E. ATLANTA, GA. 30319, SN 76-438,471. FILED 8-5-2002. PRINCIPAL REGISTER.



autolocal.com

INT. CL. 35/U.S. CLS. 100, 101 AND 102
FOR PROVIDING CLASSIFIED ADVERTISEMENTS IN THE FIELD OF AUTOMOBILES VIA THE INTERNET.
FIRST USE 11-0-1999; IN COMMERCE 11-0-1999.

ELEMENTS CORRECTED
ENTITY

2,704,777. REG. 4-8-2003. RELIAKOR SERVICES, INC. (MINNESOTA CORPORATION) 8600 HANSEN AVENUE, SHAKOPEE, MN, 55379, BY CHANGE OF NAME CLEAN SWEEP, INC. CORPORATION) SHAKOPEE, MN, SN 78-128,281. FILED 5-13-2002. PRINCIPAL REGISTER.

RELIAKOR SERVICES

NO CLAIM IS MADE TO THE EXCLUSIVE RIGHT TO USE "SERVICES", APART FROM THE MARK AS SHOWN.
INT. CL. 37/U.S. CLS. 100, 103 AND 106

FOR STREET AND PARKING LOT MAINTENANCE, NAMELY, SWEEPING, SNOW REMOVAL, SANDING, AND PARKING SPACE PAINT STRIPING SERVICES FOR COMMERCIAL AND MUNICIPAL CUSTOMERS.

FIRST USE 9-2-2002; IN COMMERCE 9-2-2002.

INT. CL. 39/U.S. CLS. 100 AND 105

FOR GARBAGE COLLECTION SERVICES FOR COMMERCIAL AND MUNICIPAL CUSTOMERS.

FIRST USE 9-2-2002; IN COMMERCE 9-2-2002.

ELEMENTS CORRECTED
ASSIGNMENT/NAME CHANGE
OWNER NAME
OWNER ADDRESS

2,705,065. REG. 4-8-2003. PRINTERON CORPORATION (ONTARIO CORPORATION) 221 MCINTYRE DRIVE, KITCHENER, ONTARIO, CANADA, N2R 1G1, SN 76-015,612. FILED 4-3-2000. PRINCIPAL REGISTER.

PRINTERON

PRIORITY CLAIMED UNDER SEC. 44(D) ON CANADA APPLICATION NO. 1048154, FILED 2-24-2000, REG. NO. 0148154, DATED 2-24-2000, EXPIRES 2-24-2010.

INT. CL. 9/U.S. CLS. 21, 23, 26, 36 AND 38

FOR COMPUTER HARDWARE, COMPUTER SOFTWARE AND WIRELESS DEVICES NAMELY TEXT PAGERS, PERSONAL DATA ASSISTANTS, EMAIL ENABLED DEVICES AND INTERNET ENABLED CELLULAR PHONES, ALL COMPRISING A GLOBAL PRINT NETWORK AND A GLOBAL PRINT REGISTRY WHICH ENABLE GLOBAL COMPUTER NETWORK USERS TO LOCATE, ACCESS AND PRINT INFORMATION TO GLOBAL COMPUTER NETWORK ENABLED PRINTERS OR FAX MACHINES.

FIRST USE 12-2-2001; IN COMMERCE 12-2-2001.

INT. CL. 35/U.S. CLS. 100, 101 AND 102

FOR MANAGING, AND AUDITING DATA SERVICES NAMELY, SERVICES RELATING TO BILLING, REPORTING AND MANAGEMENT OF PRINTING COSTS.

FIRST USE 7-17-2000; IN COMMERCE 12-2-2001.

INT. CL. 38/U.S. CLS. 100, 101 AND 104

FOR FAXING SERVICES.

FIRST USE 7-17-2000; IN COMMERCE 12-2-2001.

INT. CL. 42/U.S. CLS. 100 AND 101

FOR PROVISION OF GLOBAL PRINT NETWORK AND A GLOBAL PRINT REGISTRY WHICH ENABLE GLOBAL COMPUTER NETWORK USERS TO LOCATE, ACCESS, SEARCH, STORE AND PRINT INFORMATION TO GLOBAL COMPUTER NETWORK ENABLED PRINTERS OR FAX MACHINES; CONVERTING ORDINARY PRINTERS INTO GLOBAL COMPUTER NETWORK ENABLED PRINTERS.

FIRST USE 7-17-2000; IN COMMERCE 12-2-2001.

ELEMENTS CORRECTED
FOREIGN APPLICATION NO.

2,705,881. REG. 4-15-2003. JENSON RACING LTD. (UNITED KINGDOM CORPORATION) EQUITY COURT, 73-75 MILLBROOK ROAD EAST, SOUTHAMPTON, UNITED KINGDOM, SO15 1RJ, SN 76-060,625. FILED 5-31-2000. PRINCIPAL REGISTER.

JENSON BUTTON

OWNER OF ERPN CMNTY TM OFC REG. NO. 1615673, DATED 8-9-2001, EXPIRES 4-13-2010.

"JENSON BUTTON" IS THE NAME OF A LIVING INDIVIDUAL WHOSE CONSENT IS OF RECORD.

INT. CL. 9/U.S. CLS. 21, 23, 26, 36 AND 38

FOR CLOTHING, FOOTWEAR, HEADGEAR, HELMETS, GLOVE, BELTS, GOGGLES, ALL OF A PROTECTIVE NATURE; LUMINOUS AND MECHANICAL SIGNS; SUN GLASSES, SPECTACLES AND CASES THEREFORE; CODED AND MAGNETIC CREDIT CARDS, TELEPHONE CARDS, BONUS CARDS, CHARGE CARDS, CONTROLLING SOFTWARE CARDS; BATTERIES; PRE-RECORDED VIDEO CASSETTES FOR EDUCATION, DOCUMENTARIES, ENTERTAINMENT IN THE FIELD OF AUTO RACING; PRE-RECORDED COMPACT DISCS FOR EDUCATION, DOCUMENTARIES, ENTERTAINMENT IN THE FIELD OF AUTO RACING; SOFTWARE FOR COMPUTERS FEATURING AUTO RACING; COMPUTER SOFTWARE FEATURING GAMES; PHOTOGRAPHIC APPARATUS NAMELY CAMERAS AND CAMCORDERS; BINOCULARS; DOWNLOADABLE COMPUTER SOFTWARE FOR USE AS A PROGRAM TO EDUCATE OR ENTERTAIN IN THE FIELD OF AUTO RACING; DOWNLOADABLE ONLINE ELECTRONIC PUBLICATIONS, NAMELY BOOKS, CATALOGUES, FACT SHEETS, NEWSPAPERS, MAGAZINES IN THE FIELD OF AUTO RACING; ELECTRONIC DATABASE IN THE FIELD OF AUTO RACING RECORDED ON COMPUTER MEDIA.

FIRST USE ; IN COMMERCE .

INT. CL. 14/U.S. CLS. 2, 27, 28 AND 50

FOR TIME PIECES, NAMELY, WATCHES, AND CLOCKS; ELECTRICAL TIMERS FOR USE IN THE FIELD OF AUTO RACING; WATCH BANDS; JEWELRY AND IMITATION JEWELRY; NON-MONETARY COINS; AND MEDALS; CUFFLINKS; TIE CLIPS AND PINS; MEDALLIONS; SCALE MOTOR VEHICLES AND MINIATURE TO SCALE SAFETY HELMETS, BADGES, BELT BUCKLES FOR CLOTHING, STUDS, JEWELRY LAPEL PINS, FIGURINES, BUSTS, CAMEOS, ASHTRAYS, SMOKERS' ARTICLES NAMELY CIGARETTE CASES; HAT AND SHOW ORNAMENTS, TROPHIES, KEY-RINGS, JEWELRY BOXES AND CASES AND KEY RINGS MADE OF PRECIOUS METAL; AND PARTS AND FITTINGS FOR ALL THE AFORESAID GOODS.

FIRST USE ; IN COMMERCE .

INT. CL. 16/U.S. CLS. 2, 5, 22, 23, 29, 37, 38 AND 50

FOR STATIONERY; PICTURES; MOUNTED PHOTOGRAPHS; UNMOUNTED PHOTOGRAPHS; POSTERS; RUBBER STAMPS; BOOK COVERS AND BINDINGS; STATIONERY-TYPE PORTFOLIOS; NEWSPAPERS AND MAGAZINES FEATURING AUTO RACING; COMIC BOOKS; CATALOGUES FEATURING AUTO RACING; ANNUAL PUBLICATIONS NAMELY BOOKS ON AUTO RACING; LEAFLETS AND MAILERS FEATURING AUTO RACING; ADDRESS BOOKS; PHOTO ALBUMS; AUTOGRAPH BOOKS; DIARIES; SCRAP BOOKS; WRITING PADS AND BLOCKS; BINDERS; CALENDARS; PERSONAL PLANNERS AND ORGANIZERS; GREETING CARDS; IMITATION BANK NOTES; ROUTE MAPS; PRINTING, PAINTING AND DRAWING SETS; PAPER KNIVES; COMPUTER GAME INSTRUCTION MANUALS; STICKERS; STENCILS; PLASTIC TRANSFERS; IRON-ON TRANSFERS; GIFT WRAPS AND STATIONERY; STATIONERY BAGS MADE OF PAPER, PLASTIC SANDWICH OR PAPER PARTY; WALLETS; PAPER BAGS FOR MERCHANDISE PACKAGING; PAPER NAME BADGES; PAPER PLACEMATS; CARDBOARD AND PAPER MACHE BUSTS, FIGURINES, ORNAMENTS, AND CAMEOS; LETTER OPENERS; PAPER-WEIGHTS.

FIRST USE ; IN COMMERCE .

INT. CL. 18/U.S. CLS. 1, 2, 3, 22 AND 41

FOR LUGGAGE; BACK PACKS; HANDBAGS; PURSES; BELT BAGS; ALL-PURPOSE SPORTS BAGS; SCHOOL BAGS; WRITING SET CASES; UMBRELLAS; BEACH UMBRELLAS; BRIEFCASE-TYPE PORTFOLIOS; CASES, WALLETS, KEY FOBS AND ATTACHE CASES OF LEATHER OR IMITATION LEATHER; PARTS AND FITTINGS FOR ALL THE AFORESAID GOODS.

FIRST USE ; IN COMMERCE .

INT. CL. 24/U.S. CLS. 42 AND 50

FOR CLOTH BANNERS AND FLAGS; TOWELS; FACE FLANNELS; BED LINEN; DUVET COVERS; CURTAINS; LINEN TABLE CLOTHES; LINEN NAPKINS; CLOTH BADGES AND LABELS; HANDKERCHIEFS; FRIEZES; TABLE LINEN NAMELY COASTERS, PRINTED TEXTILE LABELS; PARTS AND FITTINGS FOR ALL THE AFORESAID GOODS.

FIRST USE ; IN COMMERCE .

INT. CL. 25/U.S. CLS. 22 AND 39

FOR UNDERWEAR; TRACKSUITS; SHELL SUITS; OVERALLS; COATS; MANTLES; SUITS; JACKETS; WAIST COATS; BATH ROBES; JUMPERS; TROUSERS; SHORTS; SHIRTS; POLO SHIRTS; T-SHIRTS; SWEAT SHIRTS; SWEAT BANDS; FOOTWEAR; SKI BOOTS; GAITERS AND BAGS FOR SAME; SOCKS; CAP PEAKS; VISORS; BASEBALL CAPS; NECKWEAR; SCARVES; GLOVES; CLOTHING BELTS; BRACES; HEADBANDS; HATS.

FIRST USE ; IN COMMERCE .

INT. CL. 26/U.S. CLS. 37, 39, 40, 42 AND 50

FOR TEXTILE AND EMBROIDERED BADGES AND PATCHES TO BE SEWN ON OR IRONED ONTO CLOTHING; [EMBROIDERY; NAME,] * EMBROIDERY, NAMELY, * MONOGRAM LETTERING FOR APPLICATION TO FABRICS; ROSETTES IN THE NATURE OF FABRIC TRIMMING AND FRINGES; RIBBONS; HAIR RIBBONS AND BOWS; SHIRT AND ORNAMENTAL BUTTONS.

FIRST USE ; IN COMMERCE .

INT. CL. 28/U.S. CLS. 22, 23, 38 AND 50

FOR BALLOONS; BATH TOYS; BOARD GAMES; CARD GAMES; CONSTRUCTION SETS; DICE GAMES; HAND HELD UNIT FOR PLAYING ELECTRONIC GAMES; ELECTRONIC DART BOARDS; TOY FIGURINES; SPORT GLOVES FOR RECREATIONAL BICYCLING; FITNESS APPARATUS NAMELY, TREADMILLS AND ROWING MACHINES FOR RUNNING, WEIGHT LIFTING AND ROWING; INFLATABLE TOYS; JIGSAW PUZZLES; KITES; MODEL VEHICLES AND TOYS; TOY GARAGES; PAPER TOYS; STREAMERS; PLASTIC MODELS; PLAY TENTS; PLUSH AND SOFT TOYS; PUZZLES; RIDE ON TOYS NAMELY TOY BICYCLES AND TOY VEHICLES; IN-LINE SKATES AND ROLLER SKATES; SKATE BOARDS; SAIL AND SURF BOARDS; SNOW SLEDS FOR RECREATIONAL USE; TOY VEHICLE TRACKS AND RACING SETS; TOY MONEY BOXES; HOME PLATES; PARTY FAVORS IN THE NATURE OF SMALL TOYS; BEAN BAGS.

FIRST USE ; IN COMMERCE .

INT. CL. 41/U.S. CLS. 100, 101 AND 107

FOR PROVIDING INFORMATION VIA WEBSITES ON THE INTERNET CONTAINING INFORMATION ON ENTERTAINMENT IN RELATION TO AUTO RACING; ON-LINE COMPUTER GAMES.

FIRST USE ; IN COMMERCE .

ELEMENTS CORRECTED
GOODS/SERVICES
FOREIGN REG. EXPIRATION DATE

2,705,882, REG. 4-15-2003. JENSON RACING LTD. (UNITED KINGDOM CORPORATION) EQUITY COURT, 73-75 MILLBROOK ROAD EAST, SOUTHAMPTON, UNITED KINGDOM, SO15 1RJ, SN 76-060,631. FILED 5-31-2000. PRINCIPAL REGISTER.



OWNER OF ERPN CMNTY TM OFC REG. NO. 1654896, DATED 7-4-2002, EXPIRES 5-13-2010.

"JENSON BUTTON" IS THE NAME OF A LIVING INDIVIDUAL WHOSE CONSENT IS OF RECORD.

INT. CL. 9/U.S. CLS. 21, 23, 26, 36 AND 38

FOR CLOTHING; FOOTWEAR; HEADGEAR; HELMETS; GLOVE, BELTS, GOGGLES, ALL OF A PROTECTIVE NATURE; LUMINOUS AND MECHANICAL SIGNS; SUN GLASSES, SPECTACLES AND CASES THEREFORE; CODED AND MAGNETIC CREDIT CARDS; TELEPHONE CARDS, BONUS CARDS, CHARGE CARDS, CONTROLLING SOFTWARE CARDS; BATTERIES; PRE-RECORDED VIDEO CASSETTES FOR EDUCATION, DOCUMENTARIES, ENTERTAINMENT IN THE FIELD OF AUTO RACING; PRE-RECORDED COMPACT DISCS FOR EDUCATION, DOCUMENTARIES, ENTERTAINMENT IN THE FIELD OF AUTO RACING; SOFTWARE FOR COMPUTERS FEATURING AUTO RACING; COMPUTER SOFTWARE FEATURING GAMES; PHOTOGRAPHIC APPARATUS NAMELY CAMERAS AND CAMCORDERS; BINOCULARS; DOWNLOADABLE COMPUTER SOFTWARE FOR USE AS A PROGRAM TO EDUCATE OR ENTERTAIN IN THE FIELD OF AUTO RACING; DOWNLOADABLE ONLINE ELECTRONIC PUBLICATIONS, NAMELY BOOKS, CATALOGUES, FACT SHEETS, NEWSPAPERS, MAGAZINES IN THE FIELD OF AUTO RACING; ELECTRONIC DATABASE IN THE FIELD OF AUTO RACING RECORDED ON COMPUTER MEDIA.

FIRST USE ; IN COMMERCE .

INT. CL. 14/U.S. CLS. 2, 27, 28 AND 50

FOR TIME PIECES, NAMELY, WATCHES, AND CLOCKS; ELECTRICAL TIMERS FOR USE IN THE FIELD OF AUTO RACING; WATCH BANDS; JEWELRY AND IMITATION JEWELRY; NON-MONETARY COINS; AND MEDALS; CUFFLINKS; TIE CLIPS AND PINS; MEDALLIONS; SCALE MOTOR VEHICLES AND MINIATURE TO SCALE SAFETY HELMETS, BADGES, BELT BUCKLES FOR CLOTHING, STUDS, JEWELRY LAPEL PINS, FIGURINES, BUSTS, CAMEOS, ASHTRAYS, SMOKERS' ARTICLES NAMELY CIGARETTE CASES; HAT AND SHOW ORNAMENTS, TROPHIES, KEY-RINGS, JEWELRY BOXES AND CASES AND KEY RINGS MADE OF PRECIOUS METAL; AND PARTS AND FITTINGS FOR ALL THE AFORESAID GOODS.

FIRST USE ; IN COMMERCE .

INT. CL. 16/U.S. CLS. 2, 5, 22, 23, 29, 37, 38 AND 50

FOR STATIONERY; PICTURES; MOUNTED PHOTOGRAPHS; UNMOUNTED PHOTOGRAPHS; POSTERS; RUBBER STAMPS; BOOK COVERS AND BINDINGS; STATIONERY-TYPE PORTFOLIOS; NEWSPAPERS AND MAGAZINES FEATURING AUTO RACING; COMIC BOOKS; CATALOGUES FEATURING AUTO RACING; ANNUAL PUBLICATIONS NAMELY BOOKS ON AUTO RACING; LEAFLETS AND MAILERS FEATURING AUTO RACING; ADDRESS BOOKS; PHOTO ALBUMS; AUTOGRAPH BOOKS; DIARIES; SCRAP BOOKS; WRITING PADS AND BLOCKS; BINDERS; CALENDARS; PERSONAL PLANNERS AND ORGANIZERS; GREETING CARDS; IMITATION BANK NOTES; ROUTE MAPS; PRINTING, PAINTING AND DRAWING SETS; PAPER KNIVES; COMPUTER GAME INSTRUCTION MANUALS; STICKERS; STENCILS; PLASTIC TRANSFERS; IRON-ON TRANSFERS; GIFT WRAPS AND STATIONERY; STATIONERY BAGS MADE OF PAPER, PLASTIC SANDWICH OR PAPER PARTY; WALLETS; PAPER BAGS FOR MERCHANDISE PACKAGING; PAPER NAME BADGES; PAPER PLACEMATS; CARDBOARD AND PAPER MACHE BUSTS, FIGURINES, ORNAMENTS, AND CAMEOS; LETTER OPENERS; PAPER-WEIGHTS.

FIRST USE ; IN COMMERCE .

INT. CL. 18/U.S. CLS. 1, 2, 3, 22 AND 41

FOR LUGGAGE; BACK PACKS; HANDBAGS; PURSES; BELT BAGS; ALL-PURPOSE SPORTS BAGS; SCHOOL BAGS; WRITING SET CASES; UMBRELLAS; BEACH UMBRELLAS; BRIEFCASE-TYPE PORTFOLIOS; CASES, WALLETS, KEY FOBS AND ATTACHE CASES OF LEATHER OR IMITATION LEATHER; PARTS AND FITTINGS FOR ALL THE AFORESAID GOODS.

FIRST USE ; IN COMMERCE .

INT. CL. 24/U.S. CLS. 42 AND 50

FOR CLOTH BANNERS AND FLAGS; TOWELS; FACE FLANNELS; BED LINEN; DUVET COVERS; CURTAINS; LINEN TABLE CLOTHES; LINEN NAPKINS; CLOTH BADGES AND LABELS; HANDKERCHIEFS; FRIEZES; TABLE LINEN NAMELY COASTERS, PRINTED TEXTILE LABELS; PARTS AND FITTINGS FOR ALL THE AFORESAID GOODS.

FIRST USE ; IN COMMERCE .

INT. CL. 25/U.S. CLS. 22 AND 39

FOR UNDERWEAR; TRACKSUITS; SHELL SUITS; OVERALLS; COATS; MANTLES; SUITS; JACKETS; WAIST COATS; BATH ROBES; JUMPERS; TROUSERS; SHORTS; SHIRTS; POLO SHIRTS; T-SHIRTS; SWEAT SHIRTS; SWEAT BANDS; FOOTWEAR; SKI BOOTS; GAITERS AND BAGS FOR SAME; SOCKS; CAP PEAKS; VISORS; BASEBALL CAPS; NECKWEAR; SCARVES; GLOVES; CLOTHING BELTS; BRACES; HEADBANDS; HATS.

FIRST USE ; IN COMMERCE .

INT. CL. 26/U.S. CLS. 37, 39, 40, 42 AND 50

FOR TEXTILE AND EMBROIDERED BADGES AND PATCHES TO BE SEWN ON OR IRONED ONTO CLOTHING; [EMBROIDERY; NAME.] * EMBROIDERY, NAMELY, * MONOGRAM LETTERING FOR APPLICATION TO FABRICS; ROSETTES IN THE NATURE OF FABRIC TRIMMING AND FRINGES; RIBBONS; HAIR RIBBONS AND BOWS; SHIRT AND ORNAMENTAL BUTTONS.

FIRST USE ; IN COMMERCE .

INT. CL. 28/U.S. CLS. 22, 23, 38 AND 50

FOR BALLOONS; BATH TOYS; BOARD GAMES; CARD GAMES; CONSTRUCTION SETS; DICE GAMES; HAND HELD UNIT FOR PLAYING ELECTRONIC GAMES; ELECTRONIC DART BOARDS; TOY FIGURINES; SPORT GLOVES FOR RECREATIONAL BICYCLING; FITNESS APPARATUS NAMELY, TREADMILLS AND ROWING MACHINES FOR RUNNING, WEIGHT LIFTING AND ROWING; INFLATABLE TOYS; JIGSAW PUZZLES; KITES; MODEL VEHICLES AND TOYS; TOY GARAGES; PAPER TOYS; STREAMERS; PLASTIC MODELS; PLAY TENTS; PLUSH AND SOFT TOYS; PUZZLES; RIDE ON TOYS NAMELY TOY BICYCLES AND TOY VEHICLES; IN-LINE SKATES AND ROLLER SKATES; SKATE BOARDS; SAIL AND SURF BOARDS; SNOW SLEDS FOR RECREATIONAL USE; TOY VEHICLE TRACKS AND RACING SETS; TOY MONEY BOXES; HOME PLATES; PARTY FAVORS IN THE NATURE OF SMALL TOYS; BEAN BAGS.

FIRST USE ; IN COMMERCE .

INT. CL. 41/U.S. CLS. 100, 101 AND 107

FOR PROVIDING INFORMATION VIA WEBSITES ON THE INTERNET CONTAINING INFORMATION ON ENTERTAINMENT IN RELATION TO AUTO RACING; ON-LINE COMPUTER GAMES.

FIRST USE ; IN COMMERCE .

ELEMENTS CORRECTED
GOODS/SERVICES
FOREIGN REG. EXPIRATION DATE

2,705,887. REG. 4-15-2003. JENSON RACING LTD. (UNITED KINGDOM CORPORATION) EQUITY COURT, 73-75 MILLBROOK ROAD EAST, SOUTHAMPTON, UNITED KINGDOM, SO15 1RJ, SN 76-065,666. FILED 6-7-2000. PRINCIPAL REGISTER.

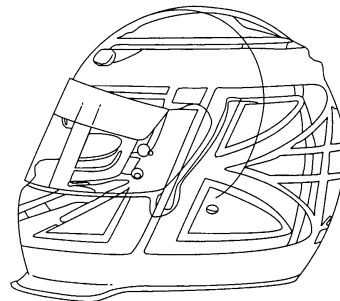

OWNER OF ERPN CMNTY TM OFC REG. NO. 1654946, DATED 7-4-2002, EXPIRES 5-13-2010.

THE MARK CONSISTS OF A DESIGN OF A MOTORCYCLE HELMET.

INT. CL. 9/U.S. CLS. 21, 23, 26, 36 AND 38

FOR CLOTHING, FOOTWEAR, HEADGEAR, HELMETS, GLOVE, BELTS, GOGGLES, ALL OF A PROTECTIVE NATURE; LUMINOUS AND MECHANICAL SIGNS; SUN GLASSES, SPECTACLES AND CASES THEREFORE; CODED AND MAGNETIC CREDIT CARDS, TELEPHONE CARDS, BONUS CARDS, CHARGE CARDS, CONTROLLING SOFTWARE CARDS; BATTERIES; PRE-RECORDED VIDEO CASSETTES FOR EDUCATION, DOCUMENTARIES, ENTERTAINMENT IN THE FIELD OF AUTO RACING; PRE-RECORDED COMPACT DISCS FOR EDUCATION, DOCUMENTARIES, ENTERTAINMENT IN THE FIELD OF AUTO RACING; SOFTWARE FOR COMPUTERS FEATURING AUTO RACING; COMPUTER SOFTWARE FEATURING GAMES; PHOTOGRAPHIC APPARATUS NAMELY CAMERAS AND CAMCORDERS; BINOCULARS; DOWNLOADABLE COMPUTER SOFTWARE FOR USE AS A PROGRAM TO EDUCATE OR ENTERTAIN IN THE FIELD OF AUTO RACING; DOWNLOADABLE ONLINE ELECTRONIC PUBLICATIONS, NAMELY BOOKS, CATALOGUES, FACT SHEETS, NEWSPAPERS, MAGAZINES IN THE FIELD OF AUTO RACING; ELECTRONIC DATABASE IN THE FIELD OF AUTO RACING RECORDED ON COMPUTER MEDIA.

FIRST USE ; IN COMMERCE .

INT. CL. 14/U.S. CLS. 2, 27, 28 AND 50

FOR TIME PIECES, NAMELY, WATCHES, AND CLOCKS; ELECTRICAL TIMERS FOR USE IN THE FIELD OF AUTO RACING; WATCH BANDS; JEWELRY AND IMITATION JEWELRY; NON-MONETARY COINS; AND MEDALS; CUFFLINKS; TIE CLIPS AND PINS; MEDALLIONS; SCALE MOTOR VEHICLES AND MINIATURE TO SCALE SAFETY HELMETS, BADGES, BELT BUCKLES FOR CLOTHING, STUDS, JEWELRY LAPEL PINS, FIGURINES, BUSTS, CAMEOS, ASHTRAYS, SMOKERS' ARTICLES NAMELY CIGARETTE CASES; HAT AND SHOW ORNAMENTS, TROPHIES, KEY-RINGS, JEWELRY BOXES AND CASES AND KEY RINGS MADE OF PRECIOUS METAL; AND PARTS AND FITTINGS FOR ALL THE AFORESAID GOODS.

FIRST USE ; IN COMMERCE .

INT. CL. 16/U.S. CLS. 2, 5, 22, 23, 29, 37, 38 AND 50

FOR STATIONERY; PICTURES; MOUNTED PHOTOGRAPHS; UNMOUNTED PHOTOGRAPHS; POSTERS; RUBBER STAMPS; BOOK COVERS AND BINDINGS; STATIONERY-TYPE PORTFOLIOS; NEWSPAPERS AND MAGAZINES FEATURING AUTO RACING; COMIC BOOKS; CATALOGUES FEATURING AUTO RACING; ANNUAL PUBLICATIONS NAMELY BOOKS ON AUTO RACING; LEAFLETS AND MAILERS FEATURING AUTO RACING; ADDRESS BOOKS; PHOTO ALBUMS; AUTOGRAPH BOOKS; DIARIES; SCRAP BOOKS; WRITING PADS AND BLOCKS; BINDERS; CALENDARS; PERSONAL PLANNERS AND ORGANIZERS; GREETING CARDS; IMITATION BANK NOTES; ROUTE MAPS; PRINTING, PAINTING AND DRAWING SETS; PAPER KNIVES; COMPUTER GAME INSTRUCTION MANUALS; STICKERS; STENCILS; PLASTIC TRANSFERS; IRON-ON TRANSFERS; GIFT WRAPS AND STATIONERY; STATIONERY BAGS MADE OF PAPER, PLASTIC SANDWICH OR PAPERY PARTY; WALLETS; PAPER BAGS FOR MERCHANDISE PACKAGING; PAPER NAME BADGES; PAPER PLACEMATS; CARDBOARD AND PAPER MACHE BUSTS, FIGURINES, ORNAMENTS, AND CAMEOS; LETTER OPENERS; PAPER-WEIGHTS.

FIRST USE ; IN COMMERCE .

INT. CL. 18/U.S. CLS. 1, 2, 3, 22 AND 41

FOR LUGGAGE; BACK PACKS; HANDBAGS; PURSES; BELT BAGS; ALL-PURPOSE SPORTS BAGS; SCHOOL BAGS; WRITING SET CASES; UMBRELLAS; BEACH UMBRELLAS; BRIEFCASE-TYPE PORTFOLIOS; CASES, WALLETS, KEY FOBS AND ATTACHE CASES OF LEATHER OR IMITATION LEATHER; PARTS AND FITTINGS FOR ALL THE AFORESAID GOODS.

FIRST USE ; IN COMMERCE .

INT. CL. 24/U.S. CLS. 42 AND 50

FOR CLOTH BANNERS AND FLAGS; TOWELS; FACE FLANNELS; BED LINEN; DUVET COVERS; CURTAINS; LINEN TABLE CLOTHES; LINEN NAPKINS; CLOTH BADGES AND LABELS; HANDKERCHIEFS; FRIEZES; TABLE LINEN NAMELY COASTERS, PRINTED TEXTILE LABELS; PARTS AND FITTINGS FOR ALL THE AFORESAID GOODS.

FIRST USE ; IN COMMERCE .

INT. CL. 25/U.S. CLS. 22 AND 39

FOR UNDERWEAR; TRACKSUITS; SHELL SUITS; OVERALLS; COATS; MANTLES; SUITS; JACKETS; WAIST COATS; BATH ROBES; JUMPERS; TROUSERS; SHORTS; SHIRTS; POLO SHIRTS; T-SHIRTS; SWEAT SHIRTS; SWEAT BANDS; FOOTWEAR; SKI BOOTS; GAITERS AND BAGS FOR SAME; SOCKS; CAP PEAKS; VISORS; BASEBALL CAPS; NECKWEAR; SCARVES; GLOVES; CLOTHING BELTS; BRACES; HEADBANDS; HATS.

FIRST USE ; IN COMMERCE .

INT. CL. 26/U.S. CLS. 37, 39, 40, 42 AND 50

FOR TEXTILE AND EMBROIDERED BADGES AND PATCHES TO BE SEWN ON OR IRONED ONTO CLOTHING; [EMBROIDERY; NAME,] * EMBROIDERY, NAMELY, * MONOGRAM LETTERING FOR APPLICATION TO FABRICS; ROSETTES IN THE NATURE OF FABRIC TRIMMING AND FRINGES; RIBBONS; HAIR RIBBONS AND BOWS; SHIRT AND ORNAMENTAL BUTTONS.

FIRST USE ; IN COMMERCE .

INT. CL. 28/U.S. CLS. 22, 23, 38 AND 50

FOR BALLOONS; BATH TOYS; BOARD GAMES; CARD GAMES; CONSTRUCTION SETS; DICE GAMES; HAND HELD UNIT FOR PLAYING ELECTRONIC GAMES; ELECTRONIC DART BOARDS; TOY FIGURINES; SPORT GLOVES FOR RECREATIONAL BICYCLING; FITNESS APPARATUS NAMELY, TREADMILLS AND ROWING MACHINES FOR RUNNING, WEIGHT LIFTING AND ROWING; INFLATABLE TOYS; JIGSAW PUZZLES; KITES; MODEL VEHICLES AND TOYS; TOY GARAGES; PAPER TOYS; STREAMERS; PLASTIC MODELS; PLAY TENTS; PLUSH AND SOFT TOYS; PUZZLES; RIDE ON TOYS NAMELY TOY BICYCLES AND TOY VEHICLES; IN-LINE SKATES AND ROLLER SKATES; SKATE BOARDS; SAIL AND SURF BOARDS; SNOW SLEDS FOR RECREATIONAL USE; TOY VEHICLE TRACKS AND RACING SETS; TOY MONEY BOXES; HOME PLATES; PARTY FAVORS IN THE NATURE OF SMALL TOYS; BEAN BAGS.

FIRST USE ; IN COMMERCE .

INT. CL. 41/U.S. CLS. 100, 101 AND 107

FOR PROVIDING INFORMATION VIA WEBSITES ON THE INTERNET CONTAINING INFORMATION ON ENTERTAINMENT IN RELATION TO AUTO RACING; ON-LINE COMPUTER GAMES.

FIRST USE ; IN COMMERCE .

ELEMENTS CORRECTED
GOODS/SERVICES

2,705,932. REG. 4-15-2003. AORTECH BIOMATERIALS PTY LTD (AUSTRALIA CORPORATION) C/O STEPHEN BLANKS & ASSOCIATES, 119 EVANS STREET, ROZELLE, NSW 2039, AUSTRALIA., BY CHANGE OF NAME ELASTOMEDIC PTY LTD (CORPORATION) CHATSWOOD NSW 2067, AUSTRALIA, SN 76-101,974. FILED 8-2-2000. PRINCIPAL REGISTER.

ELAST-EON

OWNER OF AUSTRALIA REG. NO. 769242, DATED 8-3-1998, EXPIRES 8-3-2008.

INT. CL. 10/U.S. CLS. 26, 39 AND 44

FOR MEDICAL AND VETERINARY APPARATUS AND INSTRUMENTS, MEDICAL DEVICES, NAMELY, INSULATION FOR NEURAL/MUSCULAR ELECTRODE LEADS, CARDIAC PACING, DEFIBRILLATION AND ELECTRODE LEADS AND SENSORS; INSULATION FOR ELECTRICAL STIMULATION AND CONTROL DEVICES, VASCULAR GRAFTS, STENT GRAFTS, AORTIC ANEURYSM ENDOPROSTHESES, VENOUS, EIP-DURAL, INTRASPINAL, INTRANERVE PLEXUS AND SUBCUTANEOUS WOUND INDWELLING AND SHORT TERM CATHETERS, COMPONENTS FOR HIP, KNEE, SPINE, FINGER AND OTHER JOINT [PROSTHESE] * PROSTHESES *, VASCULAR PROSTHESES, SHORT TERM CATHETERS, EAR, NOSE AND THROAT IMPLANTS AND DEVICES, IMPLANTABLE HEART AND VEIN VALVES, UROLOGICAL STENTS, CATHETERS AND INCONTINENCE DEVICES, PENILE PROSTHESES, VENTRICULAR ASSIST DEVICES, DIALYSIS, OXYGENATION AND OTHER PERFUSION SYSTEMS, WOUND DRESSINGS, BLOOD BAGS AND BIOMATERIALS.

FIRST USE ; IN COMMERCE .

ELEMENTS CORRECTED
GOODS/SERVICES
OWNER ADDRESS

2,707,801. REG. 4-15-2003. TXDC, L.P. (DELAWARE CORPORATION) 901 W. WALNUT HILL LANE, IRVING, TX, 75038, BY ASSIGNMENT ZALE DELAWARE, INC. CORPORATION) IRVING, TX, SN 76-288,002. FILED 7-21-2001. PRINCIPAL REGISTER.

EVOCATIVE GOLD

NO CLAIM IS MADE TO THE EXCLUSIVE RIGHT TO USE "GOLD", APART FROM THE MARK AS SHOWN.
INT. CL. 14/U.S. CLS. 2, 27, 28 AND 50
FOR JEWELRY MADE IN WHOLE OR SUBSTANTIAL PART OF GOLD.

FIRST USE 5-1-2002; IN COMMERCE 5-1-2002.

ELEMENTS CORRECTED
ASSIGNMENT/NAME CHANGE
OWNER NAME
OWNER ADDRESS

2,705,993. REG. 4-15-2003. CCA GLOBAL PARTNERS, INC. (DELAWARE CORPORATION) 4301 EARTH EXPRESSWAY, EARTH CITY, MO, 63045, BY CHANGE OF NAME CARPET CO-OP OF AMERICA ASSOCIATION (DELAWARE), EARTH CITY, MO, SN 76-150,023. FILED 10-19-2000. PRINCIPAL REGISTER.

ULTRA25

INT. CL. 36/U.S. CLS. 100, 101 AND 102
FOR PROVIDING EXTENDED WARRANTIES FOR CARPET STAIN PROTECTION SERVICES.
FIRST USE 7-0-1998; IN COMMERCE 7-0-1998.

ELEMENTS CORRECTED
REGISTER

2,709,738. REG. 4-22-2003. ORASURE TECHNOLOGIES, INC. (DELAWARE CORPORATION) 150 WEBSTER STREET, BETHLEHEM, PA, 18015, BY MERGER; BY MERGER STC TECHNOLOGIES, INC. CORPORATION) BETHLEHEM, PA, SN 76-019,396. FILED 4-6-2000. PRINCIPAL REGISTER.

UPlink

INT. CL. 1/U.S. CLS. 1
FOR PHOSPHOR-BASED STRIPS USED AS REPORTERS IN DIAGNOSTIC TESTING.
FIRST USE 12-1-2000; IN COMMERCE 12-1-2000.

INT. CL. 5/U.S. CLS. 6, 18, 44, 46, 51 AND 52
FOR DIAGNOSTIC DEVICE TESTING KITS COMPRISED OF CHEMICAL REAGENTS AND OTHER COMPONENTS FOR USE IN DETECTION IF QUANTITIES OF VARIOUS SUBSTANCES, NAMELY DRUGS, CHEMICALS, ANTIGENS, PROTEINS, DNA, BIOLOGICALS, AND OTHER ANALYTES.

FIRST USE 12-1-2000; IN COMMERCE 12-1-2000.
INT. CL. 42/U.S. CLS. 100 AND 101
FOR MEDICAL DIAGNOSTIC TESTING SERVICES USING INFRARED AND OTHER LIGHT SOURCES FOR DETECTION OF QUANTITIES OF VARIOUS SUBSTANCES, NAMELY, DRUGS, CHEMICALS, ANTIGENS, PROTEINS, DNA, BIOLOGICALS, AND OTHER ANALYTES; MEDICAL CONSULTING, RESEARCH AND DEVELOPMENT OF DETECTION SYSTEMS AND APPLICATIONS UTILIZING PHOSPHORS IN DIAGNOSTIC TESTING.

FIRST USE 12-1-2000; IN COMMERCE 12-1-2000.

2,706,861. REG. 4-15-2003. KQ CORPORATION (UTAH CORPORATION) 12159 SOUTH BUSINESS PARK DRIVE, SUITE 100, DRAPER, UT, 84020, SN 76-417,261. FILED 6-3-2002. PRINCIPAL REGISTER.

GLOBALSIM

INT. CL. 41/U.S. CLS. 100, 101 AND 107
FOR TRAINING IN VEHICLE SIMULATORS; NAMELY AUTOMOBILE, TRUCK, AIRPLANE, CRANE, HELICOPTER AND MATERIAL HANDLING EQUIPMENT SIMULATORS.
FIRST USE 5-20-2002; IN COMMERCE 5-20-2002.

ELEMENTS CORRECTED
MARK

ELEMENTS CORRECTED
OWNER ADDRESS

TM 768

OFFICIAL GAZETTE

AUGUST 5, 2003

2,712,090. REG. 4-29-2003. NATURE SOY, INC. (PENNSYLVANIA CORPORATION) 713 NORTH 10TH STREET, PHILADELPHIA, PA, 19123, SN 76-343,144. FILED 11-30-2001. PRINCIPAL REGISTER.

FOR TOFU, FRIED SOYBEANS, SOY-BASED FOOD BEVERAGE USED AS A MILK SUBSTITUTE, MARGARINE, MILK, CREAM, YOGURT, CHEESE, COTTAGE CHEESE, BUTTER.
FIRST USE 11-0-2001; IN COMMERCE 4-0-2002.

**HEALTHIER LIVING,
HEALTHIER LIFE**

ELEMENTS CORRECTED
OWNER NAME

INT. CL. 29/U.S. CL. 46

* * * * *

TRADEMARK REGISTRATIONS—NEW CERTIFICATES

New Certificates issued under section 7(e) of the Trademark Act of 1946 for the unexpired term of the original registrations.

2,023,573. HIGH APPALACHIAN HIGH QUALITY EST.
1988 AND DESIGN. INT. CL. 29. HIGH APPALACHIAN
LIMITED LIABILITY COMPANY, DANIELS, WV. REG.
12-17-1996. NEW CERT. SEC. 7(C) TO WEST VIRGINIA
JOBS INVESTMENT TRUST BOARD, CHARLESTON, WV.

2,622,426. ANNUITYNETADVISOR.COM. INT. CL. 36. AN-
NUITYNET, INC., HERNDON, VA. REG. 9-17-2002. NEW
CERT. SEC. 7(C) TO REGISTRANT.

2,315,819. THE ART OF SHAVING. INT. CL. 3. M.O.
INDUSTRIES, INC., NEW YORK, NY. REG. 2-8-2000.
NEW CERT. SEC. 7(C) TO MALKA, ERIC, MIAMI, FL.

2,628,353. F AND DESIGN. INT. CL. 42. MAJESTIC INVE-
STOR HOLDINGS, LLC, GARY, IN. REG. 10-1-2002. NEW
CERT. SEC. 7(C) TO REGISTRANT.

* * * * *

This page is intentionally blank

INDEX OF REGISTRANTS

AUGUST 5, 2003

(Registered; Renewed; Canceled; Amended, Corrected, etc.; New Certificates; 12c Publications.)

The designation "U.S. Cl." appearing in this section refers to the U.S. class in effect prior to Sep. 1, 1973 rather than the international class which applies to applications filed on or after that date. For adoption of international classification see notice in the OFFICIAL GAZETTE of Jun. 26, 1973 (911 O.G. TM 210).

- ,NOT EVEN THE RAIN, INC., NEW YORK, NY:
2,001,624, CANC. INT. CL. 25.
- "DJ HONDA" RECORDINGS CO. LTD. JAPAN, SHIBUYA-KU, TOKYO, JAPAN:
2,746,057, PUB. 5-13-2003. INT. CL. 9.
- "DR. MARTENS" INTERNATIONAL TRADING GMBH, D-82166 GRAFELFING DE, FED REP GERMANY:
2,747,178, PUB. 5-13-2003. INT. CL. 26.
- "DURABLE" HUNKE & JOCHHEIM GMBH. & CO. KG., 5860 ISERLOHN, FED REP GERMANY:
1,764,403, REN. 6-23-03. INT. CL. 16.
- A & H SPORTSWEAR CO., INC., STOCKERTOWN, PA:
1,819,041, REN. 6-27-03. INT. CL. 25.
- A & M PRODUCTS INC., DANBURY, CT:
1,716,270, CANC. INT. CL. 31.
1,716,271, CANC. INT. CL. 31.
1,717,163, CANC. INT. CL. 31.
- A. DUDA & SONS, INC., OVIEDO, FL:
1,208,817, CANC. INT. CL. 31.
- A. MAYER & COMPANY, L.L.C., WARREN, NJ:
2,748,322, INT. CL. 34.
- A. T. WALL COMPANY, WARWICK, RI:
2,746,218, PUB. 5-13-2003. INT. CL. 40.
- A.L.P. LIGHTING & CEILING PRODUCTS, INC., NILES, IL:
1,715,432, CANC. INT. CL. 11.
1,715,769, CANC. INT. CL. 19.
- A.S.V. WINES, INC., DELANO, CA:
2,748,063, INT. CL. 33.
- A+ APARTMENT LOCATER OF DALLAS, L.L.C., DALLAS, TX:
2,001,385, CANC. INT. CL. 36.
- A-VEDA CORPORATION, MINNEAPOLIS, MN:
1,716,852, CANC. INT. CL. 42.
- A/E/C SYSTEMS INTERNATIONAL, INC., NEWINGTON, CT:
2,001,438, CANC. MULTIPLE CLASS, INT. CLS. 16, 35 AND 41.
- A/S IVARANS REDERI, N-1324 LYSAKER, NORWAY:
2,001,478, CANC. INT. CL. 39.
- AAA ASSOCIATES, INC., NILES, MI:
1,208,117, CANC. INT. CL. 11.
- AAA SELF-STORAGE, LLC, CHATSWORTH, CA, AAA SELF STORAGE, INC., LOS ANGELES, CA:
1,771,902, REN. 6-23-03. INT. CL. 39.
- AAF-MCQUAY INC., LOUISVILLE, KY:
2,747,644, INT. CL. 11.
- AAIPHARMA INC., WILMINGTON, NC:
2,747,955, INT. CL. 5.
- AAMES CAPITAL CORPORATION, LOS ANGELES, CA:
2,000,791, CANC. INT. CL. 36.
- AARON LACANFORA, NEW YORK CITY, NY, DBA ALL SURFACE ENTERTAINMENT, INC.:
2,746,240, PUB. 11-12-2002. INT. CL. 25.
- AARONCO PET PRODUCTS, INC., NEW YORK, NY:
2,001,059, CANC. INT. CL. 8.
- AARONS, LOUIS, SKOKIE, IL:
1,715,225, CANC. INT. CL. 9.
- AB EL-SPIRALER, HALMSTAD, SWEDEN:
1,744,318, REN. 6-23-03. MULTIPLE CLASS, INT. CLS. 9 AND 11.
- AB OVO:
See— LEAPFROG ENTERPRISES, INC..
- AB STAFSJO BRUK, S-61895 STAVSJO, SWEDEN:
2,745,930, PUB. 5-13-2003. MULTIPLE CLASS, INT. CLS. 6, 7 AND 9.
- ABATEMENT TECHNOLOGIES, INC., DULUTH, GA:
2,748,160, MULTIPLE CLASS, INT. CLS. 2 AND 5.
- ABBOTT LABORATORIES, ABBOTT PARK, IL:
1,767,897, REN. 6-25-03. INT. CL. 5.
- ABC RADIO NETWORK, INC., NEW YORK, NY:
1,209,026, CANC. INT. CL. 38.
- ABELOW, DANIEL, LONGWOOD, FL:
2,747,699, INT. CL. 42.
2,749,005, INT. CL. 42.
- ABLE TIME, INC., LOS ANGELES, CA:
1,715,537, CANC. INT. CL. 14.
- ABN AMRO LEASE HOLDING N.V., 1314 CJ ALMERE-STAD, NETHERLANDS:
2,746,041, PUB. 5-13-2003. MULTIPLE CLASS, INT. CLS. 35, 36 AND 39.
- ABNA LIMITED, LONDON, UNITED KINGDOM:
2,748,962, INT. CL. 31.
- ABRAXIS LTD., LAS VEGAS, NV:
2,749,035, INT. CL. 43.
- ACADEMY OF SOUTH FLORIDA, INC., THE, COCONUT GROVE, FL:
2,746,424, PUB. 5-13-2003. INT. CL. 41.
- ACADIAN SEAPLANTS LIMITED, DARTMOUTH, NOVA SCOTIA, CANADA:
2,748,328, INT. CL. 1.
- ACCELLION, INC., SAN JOSE, CA FROM SPACEDISK PTE LTD., SINGAPORE, SINGAPORE:
2,747,757, MULTIPLE CLASS, INT. CLS. 38, 39 AND 42.
- ACCENTUA PHARMA AG, 80333 MUNICH, FED REP GERMANY:
2,746,129, PUB. 5-13-2003. MULTIPLE CLASS, INT. CLS. 5 AND 42.
- ACCENTURE GLOBAL SERVICES GMBH, 8212 NEUHAUSEN AM RHEINFALL, SWITZERLAND:
2,746,425, PUB. 5-13-2003. MULTIPLE CLASS, INT. CLS. 9, 16, 35, 36, 37, 41 AND 42.
- ACCO WORLD CORPORATION, DEERFIELD, IL:
2,001,907, CANC. INT. CL. 16.
- ACCORD PUBLISHING, LTD., DENVER, CO:
1,780,228, REN. 6-24-03. INT. CL. 16.
- ACCRETIVE SOLUTIONS, INC., HAUPPAUGE, NY FROM ACCOUNTEC, INC., HAUPPAUGE, NY:
2,747,885, MULTIPLE CLASS, INT. CLS. 35, 36 AND 42.
- ACCU-WEATHER, INC., STATE COLLEGE, PA:
2,747,005, PUB. 5-13-2003. INT. CL. 35.
- ACCUFITNESS, LLC, GREENWOOD VILLAGE, CO:
2,747,438, PUB. 5-13-2003. INT. CL. 9.
- ACCUFLEX INDUSTRIAL HOSE LTD., GUELPH, ONTARIO N1K 1A9, CANADA:
1,728,597, REN. 6-26-03. INT. CL. 17.
- ACCUFLEX INDUSTRIAL HOSE LTD., GUELPH, ONTARIO, CANADA:
2,746,697, PUB. 5-13-2003. INT. CL. 17.
- ACCURATE LOCATING, INC., GLEN ALLEN, VA:
2,746,543, PUB. 5-13-2003. INT. CL. 42.
2,746,544, PUB. 5-13-2003. INT. CL. 42.
- ACCURIDE CORPORATION, EVANSVILLE, IN, FIRESTONE TIRE & RUBBER COMPANY, THE, AKRON, OH:
759,558, REN. 6-23-03. U.S. CL. 19 (INT. CL. 12).

- ACE HARDWARE CORPORATION, OAK BROOK, IL:
1,208,887, CANC. INT. CL. 35.
- ACE-IT GOLF, INC., EVANSTON, IL:
2,748,060, MULTIPLE CLASS, INT. CLS. 41 AND 42.
- ACEITUNAS SARASA, S.A., 31261 ANDOSILLA (NAVARA), SPAIN:
2,747,727, INT. CL. 29.
- ACERALIA CORPORACION SIDERURGICA, S.A., 28046 MADRID, SPAIN:
2,745,440, PUB. 5-13-2003. MULTIPLE CLASS, INT. CLS. 6, 16, 39, 40 AND 42.
- ACRYMED, INC., PORTLAND, OR:
2,001,030, CANC. INT. CL. 5.
2,001,031, CANC. INT. CL. 5.
- ACT-I INTIMATE APPAREL INC., FREEPORT, NY:
1,208,539, CANC. INT. CL. 25.
- ACTIVE ORGANICS, INC, LEWISVILLE, TX:
2,747,243, PUB. 5-13-2003. INT. CL. 1.
- ACTIVEHEAD, LLC, JOPLIN, MO:
2,747,136, PUB. 5-13-2003. INT. CL. 42.
- ACTIVITY DIRECTORIES INTERNATIONAL, INC., LITTLETON, CO:
2,002,004, CANC. INT. CL. 35.
- ACUREX CORPORATION, MOUNTAIN VIEW, CA:
1,209,329, CANC. INT. CL. 9.
- ADAC CORPORATION, WOBURN, MA:
1,715,111, CANC. INT. CL. 9.
- ADAMSON, DARREL M., SARASOTA, FL:
1,770,451, REN. 6-25-03. INT. CL. 37.
- ADAPTIS INC., SEATTLE, WA:
2,748,479, MULTIPLE CLASS, INT. CLS. 35 AND 36.
- ADDISON WESLEY LONGMAN, INC., READING, MA:
2,702,782, COR. INT. CL. 41.
- ADERANS CO., LTD., TOKYO, JAPAN:
2,294,885, COR. MULTIPLE CLASS, INT. CLS. 3, 26 AND 42.
- ADERANS COMPANY, LTD., TOKYO, 1608429, JAPAN:
1,240,460, REN. 6-25-03. INT. CL. 26.
- ADMONT MODEN GMBH, D-8703 OCHSENFURT, FED REP GERMANY:
1,930,416, CANC. INT. CL. 14.
- ADNAGEN GMBH, D-30853 HANNOVER-LANGENHAGEN, FED REP GERMANY:
2,745,746, PUB. 9-11-2001. MULTIPLE CLASS, INT. CLS. 1 AND 5.
- ADOLPH GOTTSCHO, INC., UNION, NJ:
1,207,874, CANC. INT. CL. 7.
- ADRIEN ARPEL, INC., NEW YORK, NY:
2,001,423, CANC. INT. CL. 42.
- ADT SERVICES AG, CH-8200 SCHAFFHAUSEN, SWITZERLAND:
2,747,570, INT. CL. 42.
- ADTEC DETENTION SYSTEMS, L.L.C, SAN ANTONIO, TX:
1,715,000, CANC. INT. CL. 6.
- ADVANCE MAGAZINE PUBLISHERS INC., NEW YORK, NY:
2,746,797, PUB. 5-13-2003. INT. CL. 16.
- ADVANCE PUBLICATIONS INC., NEW YORK, NY:
2,748,999, INT. CL. 36.
- ADVANCED & WISE TECHNOLOGY CORP., HSIN-CHU CITY, TAIWAN:
2,745,883, PUB. 1-7-2003. INT. CL. 9.
- ADVANCED INTERCONNECTIONS CORPORATION, WEST WARWICK, RI:
1,771,239, REN. 6-25-03. INT. CL. 9.
1,771,240, REN. 6-25-03. INT. CL. 9.
- ADVANCED INTERNET TECHNOLOGIES, INC., FAYETTEVILLE, NC:
2,746,415, PUB. 5-13-2003. INT. CL. 42.
2,746,435, PUB. 5-13-2003. INT. CL. 42.
- ADVANCED INVENTORY TECHNOLOGIES, INC., KANSAS CITY, KS:
2,748,453, INT. CL. 35.
- ADVANCED MICRO DEVICES, INC., SUNNYVALE, CA:
2,748,070, INT. CL. 35.
2,748,489, INT. CL. 9.
- ADVANCED POWER TECHNOLOGY, INC., BEND, OR:
1,717,219, CANC. INT. CL. 9.
- ADVANCED REPRODUCTIVE CARE, INC., PALO ALTO, CA:
2,746,942, PUB. 5-13-2003. INT. CL. 36.
- ADVANCED THERMAL PRODUCTS INC., SANTA ANA, CA:
2,745,700, PUB. 5-13-2003. INT. CL. 17.
- ADVANTEST CORPORATION, NERIMA-KU, TOKYO, JAPAN:
2,745,454, PUB. 10-23-2001. INT. CL. 9.
- ADVANTIS TECHNOLOGIES, INC., ALPHARETTA, GA, ROBARB, INCORPORATED, DECATUR, GA:
1,763,996, REN. 6-24-03. INT. CL. 5.
- ADVANTIUM, INC., MACEDONIA, OH:
2,748,410, INT. CL. 35.
- ADVANTRX CORPORATION, CHANHASSEN, MN:
2,748,661, INT. CL. 5.
- ADVISORTECH CORPORATION, BOSTON, MA:
2,747,824, MULTIPLE CLASS, INT. CLS. 9 AND 36.
- ADVOCARE INTERNATIONAL, L.L.C., CARROLLTON, TX:
2,747,418, PUB. 5-13-2003. INT. CL. 5.
- AEBTEC CORPORATION, HOLLYWOOD, FL:
2,748,960, INT. CL. 7.
- AEGIS TECHNOLOGIES GROUP, INC., THE, HUNTSVILLE, AL:
2,748,911, INT. CL. 9.
- AEREON, INC., PARAMOUNT, CA:
2,000,919, CANC. INT. CL. 9.
- AERO PRODUCTS INTERNATIONAL, INC., WAUCONDA, IL FROM IMAGINAIR, INC., WAUCONDA, IL:
2,747,576, MULTIPLE CLASS, INT. CLS. 20 AND 28.
2,747,892, MULTIPLE CLASS, INT. CLS. 20 AND 28.
- AEROBICS AND FITNESS ASSOCIATION OF AMERICA, SHERMAN OAKS, CA:
2,747,516, INT. CL. 41.
- AEROBOUNCE, INC., HOUSTON, TX:
2,747,269, PUB. 5-13-2003. INT. CL. 28.
- AEROSPACE LIGHTING CORP., HOLBROOK, NY:
1,715,221, CANC. MULTIPLE CLASS, INT. CLS. 9, 11 AND 40.
- AEROSTAR AIRCRAFT CORPORATION, HAYDEN LAKE, ID:
1,768,570, REN. 6-21-03. MULTIPLE CLASS, INT. CLS. 12 AND 37.
- AESTHETIC SURGERY EDUCATION AND RESEARCH FOUNDATION, LONG BEACH, CA:
2,001,036, CANC. MULTIPLE CLASS, INT. CLS. 36 AND 42.
- AETECH CORPORATION, PEWAUKEE, WI:
1,796,230, REN. 6-22-03. INT. CL. 20.
- AETHER SYSTEMS, INC., OWINGS MILLS, MD:
2,747,751, MULTIPLE CLASS, INT. CLS. 9, 38 AND 42.
- AFFRONTI, JOHN, BARTLETT, IL:
2,747,653, INT. CL. 6.
- AFM CORPORATION, EXCELSIOR, MN:
2,748,199, INT. CL. 17.
2,748,200, INT. CL. 17.
- AF2 ENTERPRISES LLC, CHICAGO, IL:
2,748,433, INT. CL. 41.
- AG ASSOCIATES, INC., SAN JOSE, CA:
1,715,188, CANC. INT. CL. 9.
- AGAINST THE GRAIN PRODUCTIONS, INC., WESTPORT, CT:
2,747,480, MULTIPLE CLASS, INT. CLS. 9 AND 41.
- AGAMA INC.:
See—AGAMA LIMITED.
- AGAMA LIMITED, NICOSIA, CYPRUS FROM AGAMA INC., PHILADELPHIA, PA:
2,745,670, PUB. 12-18-2001. INT. CL. 42.
- AGAN CHEMICAL MANUFACTURERS LTD., ASHDOD, ISRAEL:
2,748,097, INT. CL. 5.
- AGC, INC., CLEVELAND, OH:
2,746,970, PUB. 5-13-2003. INT. CL. 16.
- AGILQUEST CORPORATION, RICHMOND, VA FROM V TECHNOLOGIES INTERNATIONAL CORPORATION, RICHMOND, VA:
2,746,336, PUB. 9-24-2002. MULTIPLE CLASS, INT. CLS. 35 AND 42.

- AGORA, INC., BALTIMORE, MD:
2,000,579, CANC. INT. CL. 16.
- AGRILIANCE, LLC, ST. PAUL, MN:
2,748,645, INT. CL. 1.
- AGRILIANCE, LLC, ARDEN HILLS, MN:
2,748,786, INT. CL. 5.
- AGROPLUS, INC., HAWKINS, TX:
2,001,542, CANC. INT. CL. 5.
- AGROSERVICES LLC, CEDAR HILL, TX:
2,001,866, CANC. INT. CL. 20.
- AGS MANAGEMENT SYSTEMS, INC., KING OF PRUSSIA, PA:
1,208,012, CANC. INT. CL. 9.
- AHC INC., ARLINGTON, VA:
2,746,978, PUB. 5-13-2003. INT. CL. 36.
- AIKAU, CLYDE, WAIMANALO, HI:
2,747,461, INT. CL. 25.
- AIR COMPRESSOR PRODUCTS, INC., JACKSONVILLE, FL:
2,000,511, CANC. INT. CL. 7.
- AIR INTERNATIONAL TRANSIT, INC., ADDISON, IL:
2,745,681, PUB. 9-24-2002. MULTIPLE CLASS, INT. CLS. 37 AND 40.
- AIR NEW ZEALAND LIMITED, AUCKLAND, NEW ZEALAND:
2,000,938, CANC. MULTIPLE CLASS, INT. CLS. 39 AND 41.
- AIR STREAM AIR CONDITIONING CORP., GARDEN CITY PARK, NY:
2,746,045, PUB. 9-17-2002. MULTIPLE CLASS, INT. CLS. 37 AND 42.
- AIRBOSS OF AMERICA CORP., TORONTO, ONTARIO, CANADA:
2,745,774, PUB. 12-31-2002. INT. CL. 12.
- AIRIA LIMITED, LONDON EC1Y 1AX, UNITED KINGDOM FROM CONTENTCO LIMITED, LONDON EC1Y 1AX, UNITED KINGDOM:
2,747,830, MULTIPLE CLASS, INT. CLS. 38 AND 41.
- AIRMAGNET, INC., SUNNYVALE, CA:
2,748,459, INT. CL. 9.
2,748,521, INT. CL. 9.
- AIRQC CORPORATION, CARROLLTON, TX, FORMERLY BREATHE EASY, INC.:
2,746,802, PUB. 5-13-2003. INT. CL. 11.
- AISLE MASTER LTD., CO MONAGHAN, IRELAND:
2,745,911, PUB. 5-13-2003. INT. CL. 12.
- AITEC HOLDINGS INC., OAKVILLE, ONTARIO, CANADA:
2,748,009, INT. CL. 42.
- AKKUMULATOREN AUFARBEITUNGS FRANCHISE GMBH, 72793 PFULLINGEN, FED REP GERMANY:
2,745,448, PUB. 2-8-2000. MULTIPLE CLASS, INT. CLS. 9 AND 37.
- AKTIEBOLAGET ELECTROLUX (PUBL.), S-105-45 STOCKHOLM, SWEDEN:
2,747,782, INT. CL. 7.
- AKZO NOBEL COATINGS INTERNATIONAL B.V., 6824 BM, ARNHEM, NETHERLANDS:
2,746,380, PUB. 5-13-2003. MULTIPLE CLASS, INT. CLS. 2, 9, 35, 36, 37, 39 AND 40.
- ALABAMA GRAPHICS & ENGINEERING SUPPLY, INC., BIRMINGHAM, AL:
2,746,194, PUB. 12-24-2002. MULTIPLE CLASS, INT. CLS. 35 AND 40.
- ALACO, INC., TUCSON, AZ:
2,001,340, CANC. INT. CL. 5.
- ALARIS MEDICAL SYSTEMS, INC., SAN DIEGO, CA:
2,747,615, INT. CL. 9.
- ALASKA AIRLINES, INC., SEATTLE, WA:
2,747,543, INT. CL. 39.
- ALBANESE, VINCENT R., CRESCENT SPRINGS, KY:
1,716,509, CANC. INT. CL. 37.
- ALBEMARLE CORPORATION, BATON ROUGE, LA:
2,747,048, PUB. 5-13-2003. MULTIPLE CLASS, INT. CLS. 1 AND 5.
- ALBRIGHT & WILSON LTD., WARLEY, WEST MIDLANDS B68 ONN, ENGLAND:
992,261, CANC. U.S. CL. 1.
- ALBUM X CORPORATION, PORT CHESTER, NY:
2,745,940, PUB. 9-18-2001. INT. CL. 16.
- ALCHEMY NOMINEES PTY LTD, QUEENSLAND, 4005, AUSTRALIA:
2,746,682, PUB. 5-13-2003. INT. CL. 6.
- ALCON MANUFACTURING, LTD., FORT WORTH, TX, ALCON SURGICAL, INC., FORT WORTH, TX:
1,822,561, REN. 6-23-03. INT. CL. 10.
- ALDER ASSOCIATES, LLC, BAYFIELD, CO:
2,746,153, PUB. 10-29-2002. INT. CL. 35.
- ALDI INC., BATAVIA, IL:
2,746,863, PUB. 5-13-2003. INT. CL. 25.
- ALECTA PENSIONSFORSÄKRING, OMSÄSIDIGT, STOCKHOLM, SWEDEN FROM ESSEN INTERNATIONAL AB, STOCKHOLM, SWEDEN:
2,747,067, PUB. 5-13-2003. MULTIPLE CLASS, INT. CLS. 35, 36 AND 42.
- ALEMIS, ALEXANDER G., PALOS HEIGHTS, IL:
2,746,987, PUB. 5-13-2003. INT. CL. 44.
- ALERUS FINANCIAL CORPORATION, GRAND FORKS, ND FROM FIRST NATIONAL CORPORATION NORTH DAKOTA, GRAND FORKS, ND:
2,747,763, INT. CL. 36.
2,747,780, MULTIPLE CLASS, INT. CLS. 36 AND 41.
- ALEXANDER DOLL COMPANY, INC., NEW YORK, NY:
2,746,492, PUB. 5-13-2003. INT. CL. 28.
- ALEXANDRAKIS, VILLY, 105-63 ATHENS, GREECE, DBA VILLY ALEXANDRAKIS JEWELRY:
2,000,950, CANC. INT. CL. 14.
- ALEXVIAN S.A.C.I.F.I.A., BUENOS AIRES, ARGENTINA:
2,746,117, PUB. 11-5-2002. INT. CL. 30.
- ALFA-LAVAL AB, TUMBA, SWEDEN:
1,207,935, CANC. INT. CL. 9.
- ALFA-LAVAL, INC., POUGHKEEPSIE, NY:
1,207,864, CANC. INT. CL. 7.
- ALFANO; JOHN L., RYE, NY:
1,208,872, CANC. INT. CL. 35.
- ALFRED & CHRISTIAN PETERSEN, LTD., OWENSBORO, KY:
1,208,852, CANC. INT. CL. 34.
- ALGONQUIN SCIENTIFIC, LLC, MADISON HEIGHTS, MI:
2,746,361, PUB. 5-13-2003. INT. CL. 9.
- ALIGNMENT SOFTWARE INC., SUPERIOR, CO:
2,746,837, PUB. 5-13-2003. INT. CL. 9.
- ALIMENTOS GRANIX, B1604 CDH, FLORIDA, BUENOS AIRES, ARGENTINA:
2,748,297, INT. CL. 30.
- ALIMENTOS NATURALES SABROZA, S.A. DE C.V., NUEVO LEON, MEXICO:
2,746,174, PUB. 1-21-2003. INT. CL. 30.
- ALL SAFE DOCUMENT DESTRUCTION SERVICE, INC., MONROEVILLE, PA:
2,747,350, PUB. 5-13-2003. INT. CL. 40.
- ALL-WAYS TRAVEL INC., JANESVILLE, WI:
2,001,216, CANC. INT. CL. 39.
- ALLAN LYONS, INC., LAS VEGAS, NV:
2,001,172, CANC. INT. CL. 30.
- ALLEGIANCE CORPORATION, MCGAW PARK, IL:
1,715,332, CANC. INT. CL. 9.
- ALLEN TELECOM INC., BEACHWOOD, OH, ORION INDUSTRIES, INC., CLEVELAND, OH:
1,251,031, REN. 6-25-03. INT. CL. 9.
- ALLENSPACH, NATALIE F., SAMMAMISH, WA:
2,747,079, PUB. 5-13-2003. INT. CL. 25.
- ALLENTOWN OSTEOPATHIC HOSPITAL, INC., ALLENTOWN, PA, AKA GERIATRIC EDUCATION MODULES:
1,209,146, CANC. INT. CL. 41.
- ALLERGAN ELITE, INC., IRVINE, CA:
1,715,732, CANC. INT. CL. 16.
- ALLERGAN, INC., IRVINE, CA:
2,748,674, INT. CL. 5.
- ALLEVARD, 92210 SAINT CLOUD, FRANCE:
2,001,426, CANC. INT. CL. 6.
- ALLFLEX USA, INC., DALLAS/FT. WORTH AIRPORT, TX:
2,746,289, PUB. 10-22-2002. INT. CL. 10.
- ALLIANCE APPAREL, INC., HUNTINGTON PARK, CA:
2,746,774, PUB. 5-13-2003. INT. CL. 25.
- ALLIANCE GLASS NETWORK, INC., CEDAR RAPIDS, IA:
2,747,354, PUB. 5-13-2003. INT. CL. 35.

- ALLIANCE HANGERS INC., HONG KONG, HONG KONG:
2,748,824, INT. CL. 20.
- ALLIANCE MACHINE SYSTEMS INTERNATIONAL, LLC,
SPOKANE, WA:
2,746,457, PUB. 5-13-2003. INT. CL. 7.
- ALLIANCE RESEARCH CORPORATION, CHATSWORTH,
CA:
2,001,061, CANC. INT. CL. 9.
- ALLIANT FOODSERVICE, INC., DEERFIELD, IL, NA-
TIONAL DAIRY PRODUCTS CORPORATION, CHICAGO,
IL:
738,768. REN. 6-22-03. U.S. CL. 46 (INT. CL. 29).
- ALLIED STARS, INC., CULVER CITY, CA, DBA ALLIED
STARS:
1,766,305. REN. 6-27-03. INT. CL. 41.
- ALLIED SYSTEMS COMPANY, SHERWOOD, OR:
1,208,137, CANC. INT. CL. 12.
- ALLIEDSIGNAL INC., MORRISTOWN, NJ:
1,715,484, CANC. INT. CL. 12.
- ALLMED FINANCIAL CORP., INDIANAPOLIS, IN:
2,000,947, CANC. MULTIPLE CLASS, INT. CLS. 35 AND
36.
- ALLMERICA FINANCIAL CORPORATION, WORCESTER,
MA:
2,747,814, INT. CL. 36.
- ALLOPTIC, INC., LIVERMORE, CA:
2,747,980, INT. CL. 9.
- ALLSERVICE ENVIRONMENTAL, INC., LAPORTE, TX:
2,001,350, CANC. MULTIPLE CLASS, INT. CLS. 41 AND
42.
2,001,351, CANC. MULTIPLE CLASS, INT. CLS. 41 AND
42.
- ALLSTAR MARKETING CORP., ELMSFORD, NY:
2,001,480, CANC. INT. CL. 16.
- ALLY, INC., SANTA CRUZ, CA:
2,748,794, MULTIPLE CLASS, INT. CLS. 18 AND 25.
- ALOHA PRODUCE CORPORATION, HONOLULU, HI:
737,974, CANC. U.S. CL. 46.
- ALPHA & OMEGA FINANCIAL MANAGEMENT CONSUL-
TANTS, INC., LA MESA, CA:
1,208,980, CANC. INT. CL. 36.
- ALPHA PRO TECH, INC., RICHBORO, PA, UNIRUG
CORPORATION, DALLAS, TX:
1,240,470. REN. 6-25-03. INT. CL. 27.
- ALPHA SCIENTIFIC CORPORATION, MALVERN, PA:
2,747,029, PUB. 5-13-2003. INT. CL. 10.
- ALPHA TECHNOLOGIES U.S., L.P., AKRON, OH:
2,745,622, PUB. 12-10-2002. INT. CL. 7.
- ALPHANET, INC., MIAMI, FL:
2,682,990, COR. INT. CL. 42.
- ALPHARMA, INC., FORT LEE, NJ, AMERICAN CYANA-
MID COMPANY, WAYNE, NJ:
964,021. REN. 6-23-03. U.S. CL. 18 (INT. CL. 5).
- ALPINE AROMATICS INTERNATIONAL, INC., PISCAT-
AWAY, NJ:
1,237,906. REN. 6-23-03. INT. CL. 3.
- ALPINE ELECTRONICS, INC., TOKYO 141-8501, JAPAN:
2,747,800, INT. CL. 9.
- ALPINE LOG HOMES INC., VICTOR, MT:
1,242,413. REN. 6-21-03. INT. CL. 42.
- ALSTOM, 75116 PARIS, FRANCE:
2,745,654, PUB. 5-14-2002. INT. CL. 9.
- ALTER GROUP, LTD., THE, SKOKIE, IL:
1,774,745. REN. 6-23-03. INT. CL. 36.
- ALTIUM LIMITED, FRENCHS FOREST NSW 2086, AUS-
TRALIA:
2,748,473, INT. CL. 9.
- ALTMAN STAGE LIGHTING CO., INC., YONKERS, NY:
2,748,334, INT. CL. 11.
- ALTRA TECHNOLOGIES, INC., WATERTOWN, MN:
2,746,186, PUB. 10-15-2002. INT. CL. 9.
- ALVARADO STREET BAKERY, ROHNERT PARK, CA:
1,716,176, CANC. INT. CL. 30.
- ALVAREZ, MIRABEL, PALM BEACH, FL:
2,746,907, PUB. 5-13-2003. INT. CL. 16.
- ALVEOLUS, INC, CHARLOTTE, NC:
2,748,874, INT. CL. 10.
- ALVIMAR MANUFACTURING COMPANY, INC., LONG
ISLAND CITY, NY:
737,836, CANC. U.S. CL. 22.
- ALYESKA PIPELINE SERVICE COMPANY, ANCHORAGE,
AK:
2,000,894, CANC. INT. CL. 35.
- ALZA CORPORATION, MOUNTAIN VIEW, CA, MARION
LABORATORIES, INC., KANSAS CITY, MO:
964,552. REN. 6-24-03. U.S. CL. 18 (INT. CL. 5).
- AM GENERAL LLC, SOUTH BEND, IN FROM AM GEN-
ERAL CORPORATION, SOUTH BEND, IN:
2,748,387, INT. CL. 37.
- AM I SAFE, INC., GREENVILLE, SC:
2,748,131, INT. CL. 42.
- AM RANCH COMPANY, LLC, SCOTTSDALE, AZ:
2,748,841, INT. CL. 43.
- AMANA TOOL COMPANY, FARMINGDALE, NY:
2,745,762, PUB. 5-13-2003. INT. CL. 7.
- AMATE, LTD., ROSWELL, GA, DELPHI HEALTH &
SCIENCE, ATLANTA, GA:
1,769,853. REN. 6-25-03. INT. CL. 9.
- AMAXA GMBH, 51105 KOLN, FED REP GERMANY:
2,745,846, PUB. 10-8-2002. MULTIPLE CLASS, INT. CLS.
1, 5 AND 9.
- AMBITION, SOUTH SAN FRANCISCO, CA:
2,748,553, INT. CL. 25.
- AMCO HOUSEWARE, LLC, VERNON HILLS, IL FROM L&P
PROPERTY MANAGEMENT COMPANY, SOUTH GATE,
CA:
2,745,904, PUB. 5-13-2003. INT. CL. 21.
- AMD INDUSTRIES, INC., CHICAGO, IL:
2,000,951, CANC. MULTIPLE CLASS, INT. CLS. 40 AND
42.
- AMERICA RECREATION PRODUCTS, INC., NEW HAVEN,
MI:
1,208,485, CANC. INT. CL. 24.
- AMERICA STANDARD INTERNATIONAL INC., NEW
YORK, NY FROM AMERICAN STANDARD INC., PIS-
CATAWAY, NJ:
2,748,985, INT. CL. 11.
- AMERICA'S FAVORITE CHICKEN COMPANY, ATLANTA,
GA:
2,002,020, CANC. INT. CL. 11.
- AMERICA'S GARDENING RESOURCE, INC., BURLING-
TON, VT:
2,001,785, CANC. INT. CL. 42.
- AMERICA'S HOMECOMING QUEEN, INC., MEMPHIS, TN:
1,232,370. REN. 6-24-03. INT. CL. 41.
- AMERICA'S JUNIOR MISS PAGEANT, INC., MOBILE, AL:
2,746,754, PUB. 5-13-2003. MULTIPLE CLASS, INT. CLS.
36 AND 41.
- AMERICA'S NOTE NETWORK, BOULDER, CO:
2,746,108, PUB. 2-4-2003. MULTIPLE CLASS, INT. CLS. 35
AND 41.
- AMERICAN ACADEMY OF OPHTHALMOLOGY, INC.,
SAN FRANCISCO, CA:
1,237,844. REN. 6-23-03. U.S. CL. 200.
- AMERICAN AUTOMOBILE ASSOCIATION, INC., HEA-
THROW, FL:
2,748,751, INT. CL. 42.
- AMERICAN AXLE & MANUFACTURING, INC., DETROIT,
MI, MSP INDUSTRIES CORPORATION, OXFORD, MI:
1,764,025. REN. 6-25-03. MULTIPLE CLASS, INT. CLS. 6,
7, 12 AND 42.
- AMERICAN BALLROOM COMPANY, INC., MIAMI, FL:
1,237,714. REN. 6-26-03. INT. CL. 41.
- AMERICAN BROADCASTING COMPANIES, INC., NEW
YORK, NY:
1,209,154, CANC. INT. CL. 41.
- AMERICAN CASEIN COMPANY, BURLINGTON, NJ:
1,714,814, CANC. INT. CL. 1.
- AMERICAN COLLEGE OF PHYSICIANS - AMERICAN
SOCIETY OF INTERNAL MEDICINE, PHILADELPHIA,
PA:
2,746,285, PUB. 5-13-2003. MULTIPLE CLASS, INT. CLS.
35 AND 41.
- AMERICAN CONCRETE INSTITUTE, DETROIT, MI:
1,716,989, CANC. U.S. CL. 200.

AMERICAN CONSERVATIVE, LLC, THE, WILMINGTON, DE:
2,684,971, COR. INT. CL. 41.

AMERICAN CORPORATE COUNSEL ASSOCIATION, WASHINGTON, DC:
2,746,931, PUB. 5-13-2003. INT. CL. 41.

AMERICAN CYANAMID COMPANY, WAYNE, NJ:
1,207,715, CANC. INT. CL. 1.
1,207,716, CANC. INT. CL. 1.
1,207,717, CANC. INT. CL. 1.

AMERICAN DAIRY QUEEN CORPORATION, MINNEAPOLIS, MN:
738,023, CANC. U.S. CL. 100.

AMERICAN EDUCATIONAL MUSIC PUBLICATIONS, INC., FAIRFIELD, IA, DBA MUSICIANSMART.COM:
2,749,050, INT. CL. 35.

AMERICAN EXPRESS COMPANY, NEW YORK, NY:
2,747,223, PUB. 5-13-2003. INT. CL. 36.

AMERICAN FASHION, INC., CHULA VISTA, CA:
1,715,895, CANC. INT. CL. 25.

AMERICAN FIDELITY ASSURANCE COMPANY, OKLAHOMA CITY, OK:
2,746,702, PUB. 5-13-2003. INT. CL. 36.

AMERICAN FLAMECOAT OF SOUTHERN CALIFORNIA, INC., CANYON COUNTRY, CA, DBA FIRETECT:
2,746,470, PUB. 5-13-2003. MULTIPLE CLASS, INT. CLS. 1, 35 AND 40.

AMERICAN HEALTH PLUS CORP., PEARL RIVER, NY:
1,207,814, CANC. INT. CL. 5.

AMERICAN HEALTH PLUS CORP., RAMSEY, NJ:
1,207,816, CANC. INT. CL. 5.

AMERICAN HEART ASSOCIATION, INC., DALLAS, TX:
1,814,523, REN. 6-27-03. INT. CL. 36.
2,746,976, PUB. 5-13-2003. INT. CL. 35.
2,746,977, PUB. 5-13-2003. INT. CL. 35.

AMERICAN INDIAN COLLEGE FUND, DENVER, CO:
2,746,363, PUB. 5-13-2003. MULTIPLE CLASS, INT. CLS. 35 AND 36.

AMERICAN INDUSTRIAL MANUFACTURING SERVICES, INC., MURRIETA, CA:
1,797,310, REN. 6-27-03. INT. CL. 40.

AMERICAN INNS OF COURT FOUNDATION, ALEXANDRIA, VA:
2,746,168, PUB. 11-19-2002. INT. CL. 36.
2,746,170, PUB. 11-19-2002. INT. CL. 36.

AMERICAN INSTITUTE FOR MANAGING DIVERSITY, INC., ATLANTA, GA:
2,746,644, PUB. 5-13-2003. INT. CL. 41.

AMERICAN INSTITUTE OF PHYSICS INCORPORATED, COLLEGE PARK, MD, AKA AIP:
2,746,143, PUB. 5-13-2003. INT. CL. 16.

AMERICAN INTERNATIONAL GROUP, INC., NEW YORK, NY:
2,001,359, CANC. INT. CL. 36.

AMERICAN ITALIAN PASTA COMPANY, KANSAS CITY, MO:
2,747,253, PUB. 5-13-2003. INT. CL. 30.

AMERICAN LIBRARY ASSOCIATION, CHICAGO, IL:
2,746,968, PUB. 5-13-2003. INT. CL. 35.

AMERICAN LOCK COMPANY, CRETE, IL, AMERICAN LOCK COMPANY, CRETE, IL:
1,772,781, REN. 6-25-03. INT. CL. 6.

AMERICAN LOCK COMPANY, CRETE, IL, JUNKUNC BROS. AMERICAN LOCK COMPANY, CRETE, IL:
1,773,400, REN. 6-25-03. INT. CL. 6.

AMERICAN MANAGEMENT ASSOCIATION, NEW YORK, NY:
2,001,407, CANC. INT. CL. 41.

AMERICAN MEDICAL SECURITY GROUP, INC., GREEN BAY, WI:
2,745,607, PUB. 1-21-2003. INT. CL. 36.

AMERICAN MEDICAL VIRTUAL INTEGRATION, LLC., MEDINA, OH:
2,747,606, INT. CL. 35.

AMERICAN MOTORCYCLE ASSOCIATION, WESTERVILLE, OH:
2,001,325, CANC. INT. CL. 41.

AMERICAN MULTI-TRADE, INC., CANOGA PARK, CA:
2,748,207, INT. CL. 5.

AMERICAN NATIONAL PROPERTY AND CASUALTY COMPANY, SPRINGFIELD, MO, DBA AMERICAN NATIONAL PROPERTY AND CASUALTY COMPANY, AND DBA ANPAC GENERAL INSURANCE COMPANY:
1,788,960, REN. 6-25-03. INT. CL. 36.

AMERICAN NATURAVIT INC., MIAMI, FL:
2,001,048, CANC. INT. CL. 30.

AMERICAN OCCUPATIONAL THERAPY CERTIFICATION BOARD, ROCKVILLE, MD:
2,000,624, CANC. INT. CL. 16.

AMERICAN OVERSEAS TRANSPORT LTD., WOOD DALE, IL:
2,747,151, PUB. 5-13-2003. INT. CL. 35.

AMERICAN PIPE & TANK LINING CO., INC., NEW YORK, NY:
2,745,697, PUB. 5-13-2003. INT. CL. 37.

AMERICAN PROMOTIONAL EVENTS, INC., FLORENCE, AL, PYROTRONICS CORPORATION, ANAHEIM, CA:
956,771, REN. 6-24-03. U.S. CL. 9 (INT. CL. 13).

AMERICAN PROMOTIONAL EVENTS, INC., FLORENCE, AL, CHINA PYROTECHNICS, INC., FLORENCE, AL:
1,774,181, REN. 6-21-03. INT. CL. 13.

AMERICAN PROMOTIONAL EVENTS, INC., FLORENCE, AL:
2,748,723, INT. CL. 13.

AMERICAN RECREATION GROUP, COMMACK, NY TO BRUNSWICK CORPORATION, LAKE FOREST, IL:
1,715,485, CANC. INT. CL. 12.

AMERICAN REPUBLIC INSURANCE COMPANY, DES MOINES, IA:
2,748,552, INT. CL. 36.

AMERICAN SIGNAL COMPANY, ATLANTA, GA:
1,815,748, REN. 6-25-03. INT. CL. 9.

AMERICAN SOCIETY FOR TRAINING & DEVELOPMENT, ALEXANDRIA, VA:
2,748,122, INT. CL. 42.

AMERICAN SOCIETY OF LAW ENFORCEMENT TRAINERS, FREDERICK, MD:
2,748,926, INT. CL. 41.

AMERICAN STORES COMPANY, SALT LAKE CITY, UT:
1,207,818, CANC. INT. CL. 5.
2,000,976, CANC. INT. CL. 33.

AMERICAN SUPPLEMENT TECHNOLOGIES, TEMPE, AZ:
2,001,462, CANC. INT. CL. 3.

AMERICAN TECTONICS, CINCINNATI, OH:
1,208,983, CANC. MULTIPLE CLASS, INT. CLS. 36 AND 37.

AMERICAN UNIVERSITY, WASHINGTON, DC:
2,746,195, PUB. 2-4-2003. MULTIPLE CLASS, INT. CLS. 16, 21, 25, 28 AND 41.

AMERICAN WOODMARK CORPORATION, WINCHESTER, VA:
1,208,411, CANC. INT. CL. 20.

AMERICATEL CORPORATION, MIAMI, FL:
2,747,504, INT. CL. 38.

AMERICREDIT CORP., FORT WORTH, TX:
2,745,945, PUB. 12-11-2001. INT. CL. 36.

AMERISERV FINANCIAL, INC., JOHNSTON, PA FROM USBANCORP, INC., JOHNSTOWN, PA:
2,748,573, INT. CL. 36.

AMERISHIP CORPORATION, FORT LAUDERDALE, FL:
1,716,921, CANC. INT. CL. 42.

AMERSHAM INTERNATIONAL PLC, BUCKINGHAMSHIRE, ENGLAND:
2,001,773, CANC. INT. CL. 5.

AMETHYST INVESTMENT GROUP, INC., CHICAGO, IL:
1,714,882, CANC. INT. CL. 3.

AMF INCORPORATED, WHITE PLAINS, NY:
737,818, CANC. U.S. CL. 22.

AMFAST CORPORATION, MENANDS, NY:
1,209,271, CANC. INT. CL. 42.

AMGEN INC., THOUSAND OAKS, CA:
2,748,844, INT. CL. 5.

AMGLAS, INC., IRWINDALE, CA:
1,208,387, CANC. INT. CL. 19.

- AMICON, INC., BEVERLY, MA:
2,001,335, CANC. INT. CL. 16.
- AMINO AGE, INC., FARMERS BRANCH, TX:
2,001,027, CANC. INT. CL. 5.
- AMITEE COSMETICS, INC., FOUNTAIN VALLEY, CA:
1,391,287, CANC. INT. CL. 3.
- AMMEEN, JEFFREY A., NEW YORK, NY:
1,823,925, REN. 6-23-03, INT. CL. 41.
- AMOCO OIL COMPANY, CHICAGO, IL:
1,714,934, CANC. INT. CL. 4.
2,001,500, CANC. INT. CL. 37.
- AMOS-WILLIAMS, JEAN, CARY, NC:
2,745,856, PUB. 5-13-2003, INT. CL. 44.
- AMPERSAND LABEL, INC., GARDEN GROVE, CA:
2,747,981, INT. CL. 16.
- AMR CORPORATION, DALLAS/FORT WORTH AIRPORT, TX:
1,766,182, REN. 6-23-03, INT. CL. 36.
- AMR CORPORATION, DFW AIRPORT, TX:
2,746,294, PUB. 5-13-2003, INT. CL. 28.
- AMSOIL, INC., SUPERIOR, WI:
2,001,470, CANC. INT. CL. 2.
- AMSTED INDUSTRIES INCORPORATED, CHICAGO, IL:
1,208,336, CANC. INT. CL. 17.
- AMT MACHINE SYSTEMS LTD., COLUMBUS, OH:
2,747,240, PUB. 5-13-2003, INT. CL. 9.
- AMUROL CONFECTIONS COMPANY, YORKVILLE, IL:
2,749,027, INT. CL. 30.
- AMUSEMENT AND MUSIC OPERATORS ASSOCIATION, INC., CHICAGO, IL:
1,209,090, CANC. INT. CL. 41.
- AMVESCAP PLC, ATLANTA, GA:
2,748,299, INT. CL. 36.
- AMYCEL, INC., WATSONVILLE, CA:
2,748,046, INT. CL. 31.
- ANACON CORPORATION, HOPKINTON, MA:
1,208,042, CANC. INT. CL. 9.
- ANDE ROONEY INC., HIGHLAND, NY:
2,746,972, PUB. 5-13-2003, INT. CL. 30.
2,746,995, PUB. 5-13-2003, INT. CL. 28.
2,746,996, PUB. 5-13-2003, INT. CL. 28.
2,746,997, PUB. 5-13-2003, INT. CL. 28.
2,747,015, PUB. 5-13-2003, INT. CL. 16.
2,747,016, PUB. 5-13-2003, INT. CL. 16.
- ANDERSON ERICKSON DAIRY CO., DES MOINES, IA:
2,001,053, CANC. INT. CL. 29.
- ANDERSON, DAVID BRADLEY, LA JOLLA, CA:
2,748,480, INT. CL. 28.
- ANDERSON, JUDITH A., STERLING HEIGHTS, MI, DBA BUSINESS GOLF UNLIMITED:
2,746,885, PUB. 5-13-2003, INT. CL. 42.
- ANDREW CORPORATION, ORLAND PARK, IL:
403,520, REN. 6-27-03, U.S. CL. 21 (INT. CL. 9).
- ANDREWS OFFICE SUPPLY AND EQUIPMENT COMPANY, WASHINGTON, DC:
1,209,194, CANC. INT. CL. 42.
- ANGEL ENGINEERS, INC., CONSHOHOCKEN, PA:
2,748,079, INT. CL. 35.
- ANGELMAN SYNDROME FOUNDATION, INC., WESTMONT, IL:
2,746,849, PUB. 5-13-2003, MULTIPLE CLASS, INT. CLS. 36 AND 41.
- ANGELSTAR, MORGAN HILL, CA:
2,001,004, CANC. INT. CL. 16.
- ANGOSTURA INTERNATIONAL LIMITED, AUBURN, ME:
2,747,117, PUB. 5-13-2003, INT. CL. 30.
- ANHEUSER-BUSCH, INCORPORATED, ST. LOUIS, MO:
2,001,083, CANC. INT. CL. 32.
2,001,450, CANC. INT. CL. 42.
2,001,483, CANC. INT. CL. 20.
2,001,705, CANC. INT. CL. 20.
2,748,948, INT. CL. 21.
- ANHING CORPORATION, LOS ANGELES, CA:
2,747,355, PUB. 5-13-2003, INT. CL. 30.
- ANNE FRANK STICHTING, 1016 DK AMSTERDAM, NETHERLANDS:
2,746,308, PUB. 5-13-2003, INT. CL. 9.
2,746,309, PUB. 5-13-2003, INT. CL. 9.
- ANNUITY INVESTORS LIFE INSURANCE COMPANY, CINCINNATI, OH:
2,748,547, INT. CL. 36.
- ANNUITYNET, INC., HERNDON, VA TO ANNUITYNET, INC., HERNDON, VA:
2,622,426 NEW CERT. 8-5-2003, INT. CL. 36.
- ANTENNA DOWN LINK, INC., SIMI VALLEY, CA:
1,715,326, CANC. INT. CL. 9.
1,715,327, CANC. INT. CL. 9.
- ANTHRO CORPORATION, TUALATIN, OR:
2,748,032, INT. CL. 20.
- ANTIQUES ABROAD, LTD. CHARLOTTE, NC:
2,746,815, PUB. 5-13-2003, INT. CL. 39.
- AORTECH BIOMATERIALS PTY LTD, FRENCHS FOREST, AUSTRALIA TO ELASTOMEDIC PTY LTD, CHATSWOOD NSW 2067, AUSTRALIA:
2,705,932, COR. INT. CL. 10.
- APA OF MADISON, INC., MADISON, WI:
2,746,377, PUB. 5-13-2003, INT. CL. 45.
- APC MISSOURI HOLDINGS, INC., LANAGAN, MO:
1,715,641, CANC. INT. CL. 16.
- API TECHNOLOGIES, INC., CARNEGIE, PA, AMERICAN PREMIER, INC., KING OF PRUSSIA, PA, DBA PREMIER REFRACTORIES AND CHEMICALS, INC.:
1,748,512, REN. 6-23-03, INT. CL. 19.
- APOLLINARIS BRUNNEN AG, 53474 BAD NEUENHR-
AHRWEILER, FED REP GERMANY:
2,745,657, PUB. 11-26-2002, INT. CL. 32.
- APPAREL AMERICA, INC., VESTAL, NY, HARBOUR CASUALS, LTD., NEW YORK, NY:
1,238,526, REN. 6-27-03, INT. CL. 25.
- APPAREL GROUP LTD., THE, NEW YORK, NY:
2,000,525, CANC. INT. CL. 25.
- APPIAN COMMUNICATIONS, INC., BOXBOROUGH, MA:
2,745,876, PUB. 5-13-2003, INT. CL. 9.
2,745,877, PUB. 5-13-2003, INT. CL. 9.
- APPLIANCE SCIENCE CORPORATION, SOUTH PORT, CT:
1,715,060, CANC. MULTIPLE CLASS, INT. CLS. 7 AND 11.
1,715,424, CANC. INT. CL. 11.
- APPLIED DATA TRENDS, INC., HUNTSVILLE, AL:
2,746,940, PUB. 5-13-2003, INT. CL. 42.
- APPLIED MATERIALS, INC., SANTA CLARA, CA:
2,747,904, INT. CL. 9.
- APPLIED MEDICAL RESOURCES, INC., RANCHO SANTA MARGARITA, CA:
1,810,631, REN. 6-24-03, INT. CL. 10.
- APPLIED PRECISION, INC.:
See— APPLIED PRECISION HOLDINGS, LLC.
- APPLIED PRECISION, INC.:
See— APPLIED PRECISION, LLC.
- APPLIED PRECISION, LLC., ISSAQUAH, WA FROM APPLIED PRECISION, INC., ISSAQUAH, WA:
2,749,001, INT. CL. 9.
- APPLIED PRECISION HOLDINGS, LLC, ISSAQUAH, WA FROM APPLIED PRECISION, INC., ISSAQUAH, WA:
2,745,760, PUB. 5-13-2003, INT. CL. 9.
- APT ADVANCED POLYMER TECHNOLOGY CORP., HARMONY, PA:
1,715,995, CANC. INT. CL. 27.
- AQUA MED LABORATORIES, INC., TUCSON, AZ:
2,001,346, CANC. INT. CL. 5.
2,001,347, CANC. INT. CL. 5.
2,001,348, CANC. INT. CL. 5.
- AQUA VITAE, INC., NEVADA CITY, CA:
2,746,426, PUB. 5-13-2003, INT. CL. 3.
- AQUASCUTUM LIMITED, LONDON, ENGLAND:
2,748,991, MULTIPLE CLASS, INT. CLS. 18 AND 25.
- ARADIANT CORPORATION, SAN DIEGO, CA FROM NATIONAL DISPATCH CENTER, INC., THE, SAN DIEGO, CA:
2,748,185, MULTIPLE CLASS, INT. CLS. 35, 36, 38 AND 42.
- ARAMARK CORPORATION, PHILADELPHIA, PA:
2,748,056, MULTIPLE CLASS, INT. CLS. 30 AND 42.
- ARAMIS INC., NEW YORK, NY:
1,207,756, CANC. INT. CL. 3.

- ARCHER DANIELS MIDLAND COMPANY:
See—GOOCH FOODS, INC.
- ARCHIPELAGO HOLDINGS, LLC, CHICAGO, IL:
 2,747,787, MULTIPLE CLASS, INT. CLS. 16, 36 AND 38.
- ARCONAS CORPORATION, MISSISSAUGA, ONTARIO L5A 3V7, CANADA:
 2,746,965, PUB. 5-13-2003. INT. CL. 20.
- ARCORDIA SOLUTIONS LIMITED, LONDON, EC2R 7AE, ENGLAND:
 2,745,783, PUB. 5-13-2003. MULTIPLE CLASS, INT. CLS. 9, 16, 35, 36 AND 42.
- ARCOS, ARMANDO L., ALEXANDRIA, VA:
 2,747,488, INT. CL. 9.
- ARENA FOOTBALL LEAGUE LLC, CHICAGO, IL:
 2,745,968, PUB. 11-5-2002. MULTIPLE CLASS, INT. CLS. 16, 25 AND 41.
- ARENA SYSTEMS, INC., GLENVIEW, IL:
 2,001,354, CANC. INT. CL. 9.
- ARENDS, WILLIAM R., CARSON CITY, NV:
 2,001,033, CANC. INT. CL. 7.
- ARGENT, OKLAHOMA CITY, OK:
 2,747,090, PUB. 5-13-2003. INT. CL. 35.
- ARGO-TECH CORPORATION, CLEVELAND, OH:
 1,725,044, REN. 6-23-03. INT. CL. 7.
- ARI ACQUISITION CORP., RENO, NV FROM IGO CORPORATION, RENO, NV:
 2,745,664, PUB. 12-10-2002. MULTIPLE CLASS, INT. CLS. 9 AND 42.
- ARIEL RESEARCH CORPORATION, BETHESDA, MD:
 2,747,932, MULTIPLE CLASS, INT. CLS. 9 AND 42.
- ARIUS3D INC., MISSISSAUGA, ONTARIO L5B 3C3, CANADA:
 2,745,540, PUB. 8-6-2002. MULTIPLE CLASS, INT. CLS. 9, 35 AND 40.
- ARIZONA BOARD OF REGENTS, FOR AND ON BEHALF OF ARIZONA STATE UNIVERSITY, TEMPE, AZ:
 2,748,637, INT. CL. 16.
- ARIZONA HEALTH FOODS, INC., PHOENIX, AZ:
 2,745,767, PUB. 4-30-2002. INT. CL. 35.
- ARIZONA INSTRUMENT, LLC, TEMPE, AZ:
 2,747,320, PUB. 5-13-2003. INT. CL. 9.
- ARKON SAFETY EQUIPMENT INC., VILLE D'ANJOU, QUEBEC HIJ 2K4, CANADA:
 1,715,345, CANC. INT. CL. 9.
- ARKOPHARMA LLC, BEDFORD, MA:
 2,748,901, INT. CL. 5.
- ARLINGTON INDUSTRIES, INC., ARLINGTON, VT:
 2,748,688, MULTIPLE CLASS, INT. CLS. 37 AND 40.
- ARMSTRONG, CECIL EARL, DALLAS, TX:
 2,000,569, CANC. INT. CL. 41.
- ARMSTRONG, YVONNE C., PICO RIVERA, CA:
 2,746,532, PUB. 5-13-2003. INT. CL. 16.
- ARNOLD, FONTAINE F., MORENO VALLEY, CA:
 2,746,411, PUB. 5-13-2003. INT. CL. 36.
- ARQUEST, INC., CRANBURY, NJ:
 1,803,732, REN. 6-23-03. INT. CL. 16.
- ART COMFRY & BETTE COMFRY, STONEBORO, PA, DBA SILVERMIST:
 1,716,246, CANC. INT. CL. 31.
- ART HENRY GOLF SALES, INC., LOUISVILLE, KY:
 2,747,938, INT. CL. 28.
- ART INTERNATIONAL, INC., DENVER, NJ:
 1,717,175, CANC. INT. CL. 37.
- ART THANG, INC., LOS ANGELES, CA:
 2,745,830, PUB. 11-12-2002. INT. CL. 25.
- ARTEMA S.P.A., 13030 VERRONE, PROVINCE OF VERCELLI, ITALY:
 1,715,902, CANC. INT. CL. 25.
- ARTGUARDIAN.COM.AG, CH-8032 ZIRICH, SWITZERLAND:
 2,745,756, PUB. 11-19-2002. MULTIPLE CLASS, INT. CLS. 35, 36, 38 AND 42.
- ARTHUR H. THOMAS COMPANY, SWEDSBORO, NJ:
 1,207,987, CANC. INT. CL. 9.
- ARTISAN FOR HIRE, INC., CHICAGO, IL:
 2,614,298, COR. INT. CL. 35.
- ARTS4ALL, LTD., NEW YORK, NY:
 2,747,080, PUB. 5-13-2003. MULTIPLE CLASS, INT. CLS. 9, 38, 41 AND 42.
- ARVEY CORPORATION, CHICAGO, IL:
 1,208,281, CANC. INT. CL. 16.
- ARZENO INSTITUTE, INC., THE, HILLSDALE, NJ:
 2,748,482, INT. CL. 44.
- ASAHI KOGAKU KOGYO KABUSHIKI KAISHA, ITABASHI-KU, TOKYO 174, JAPAN, DBA ASAHI OPTICAL CO., LTD.:
 1,715,258, CANC. INT. CL. 9.
- ASGROW SEED COMPANY, KALAMAZOO, MI:
 2,001,018, CANC. INT. CL. 16.
- ASHBROOK, DANIEL W., SAN FRANCISCO, CA:
 2,747,171, PUB. 5-13-2003. INT. CL. 14.
- ASHLAND INC., COVINGTON, KY, ASHCHEM I.P., INC., DUBLIN, OH:
 1,792,266, REN. 6-23-03. INT. CL. 1.
 1,810,343, REN. 6-23-03. INT. CL. 1.
 1,812,634, REN. 6-23-03. INT. CL. 1.
- ASHLEY FURNITURE INDUSTRIES, INC., ARCADIA, WI:
 2,746,265, PUB. 5-13-2003. INT. CL. 20.
- ASHLEYWILDE, INC., MALIBU, CA:
 1,715,118, CANC. INT. CL. 9.
- ASHWORTH BROS., INC., FALL RIVER, MA:
 1,798,484, REN. 6-26-03. INT. CL. 7.
- ASICS CORPORATION, CHUO-KU, KOBE 650, JAPAN:
 1,776,602, REN. 6-24-03. INT. CL. 25.
- ASICS CORPORATION, KOBE 650, JAPAN:
 1,780,294, REN. 6-24-03. INT. CL. 18.
- ASICS CORPORATION, CHUO-KU, KOBE 650, JAPAN:
 1,781,511, REN. 6-23-03. INT. CL. 25.
- ASICS CORPORATION, CHUO-KU KOBE 650-8555, JAPAN:
 2,746,768, PUB. 5-13-2003. INT. CL. 25.
 2,746,836, PUB. 5-13-2003. INT. CL. 25.
- ASM INTERNATIONAL N.V., 3723 BC BILTHOVEN, NETHERLANDS:
 2,746,559, PUB. 5-13-2003. INT. CL. 40.
- ASSETHOUSE TECHNOLOGY LIMITED, GUILDFORD, SURREY, UNITED KINGDOM:
 2,747,085, PUB. 5-13-2003. MULTIPLE CLASS, INT. CLS. 9, 38 AND 42.
- ASSIST AMERICA, INC., PRINCETON, NJ:
 1,751,679, REN. 6-26-03. INT. CL. 42.
- ASSOCIATED CITRUS PACKERS, YUMA, AZ:
 1,247,842, REN. 6-23-03. INT. CL. 31.
- ASSOCIATED DRUGGISTS, INC., WICHITA, KS:
 1,208,854, CANC. INT. CL. 35.
- ASSOCIATED LANDSCAPE CONTRACTORS OF AMERICA, INC., HERNDON, VA:
 2,746,257, PUB. 5-13-2003. MULTIPLE CLASS, INT. CLS. 16, 35 AND 41.
- ASSOCIATION OF AUTOMOTIVE AFTERMARKET DISTRIBUTORS, MEMPHIS, TN, PARTS, INC., MEMPHIS, TN:
 1,760,494, REN. 6-25-03. INT. CL. 42.
- ASSOCIATION OF GOVERNMENT ACCOUNTANTS, ALEXANDRIA, VA:
 2,746,993, PUB. 5-13-2003. INT. CL. 16.
- ASSOCIATION OF PRIVATE PENSION AND WELFARE PLANS, WASHINGTON, DC:
 2,747,771, INT. CL. 42.
- ASSPOCOATION FRENCH LINE, 76000 LE HAVRE, FRANCE, CAMPAGNIE GENERALE MARITIME, PARIS, LA DEFENSE, FRANCE:
 1,592,941, REN. 6-24-03. INT. CL. 16.
- ASSUREX GLOBAL CORP., COLUMBUS, OH FROM ASSUREX INTERNATIONAL CORPORATION, COLUMBUS, OH:
 2,748,451, INT. CL. 36.
- ASTRAZENECA AB, S-151 85 SODERTALJE, SWEDEN:
 2,746,429, PUB. 5-13-2003. INT. CL. 5.
- AT/COMM INCORPORATED, WAKEFIELD, MA TO AT/COMM INCORPORATED, WAKEFIELD, MA:
 1,717,046, CANC. INT. CL. 9.
- ATEECO, INC., SHENANDOAH, PA:
 2,748,195, MULTIPLE CLASS, INT. CLS. 25 AND 30.
 2,748,233, MULTIPLE CLASS, INT. CLS. 25 AND 30.

- ATLANTIC PACKAGING PRODUCTS LTD., SCARBOROUGH, ONTARIO, CANADA:
2,745,446, PUB. 1-22-2002. INT. CL. 16.
- ATLANTIC RECORDING CORPORATION, NEW YORK, NY:
749,139, REN. 6-25-03. U.S. CL. 36 (INT. CL. 9).
- ATLAS BUSINESS SOLUTIONS, INC., FARGO, ND, ATLAS FOODS, FARGO, ND:
1,767,959, REN. 6-21-03. INT. CL. 9.
- ATLAS COPCO CRAELIUS AB, S-195 82 MARSTA, SWEDEN:
2,000,827, CANC. INT. CL. 7.
- ATLAS COPCO CREPELLE S.A., LILLE, FRANCE:
2,745,810, PUB. 6-11-2002. MULTIPLE CLASS, INT. CLS. 7 AND 42.
- ATOFINA, 92800 PUTEAUX, FRANCE, ATLANTIC RICHFIELD COMPANY, LOS ANGELES, CA:
1,244,929, REN. 6-22-03. INT. CL. 1.
- ATOMSHOCKWAVE CORP., SAN FRANCISCO, CA FROM SHOCKWAVE.COM, INC., SAN FRANCISCO, CA:
2,747,952, INT. CL. 41.
- ATOSS SOFTWARE AG, MUNCHEN, FED REP GERMANY:
2,745,704, PUB. 6-11-2002. MULTIPLE CLASS, INT. CLS. 9, 16, 35, 37 AND 42.
2,745,705, PUB. 4-23-2002. MULTIPLE CLASS, INT. CLS. 9, 16, 35, 37 AND 42.
- ATTACHMATE CORPORATION, BELLEVUE, WA:
2,001,772, CANC. INT. CL. 42.
- ATTRONICA COMPUTERS, INC., GAITHERSBURG, MD:
2,747,303, PUB. 5-13-2003. INT. CL. 9.
- ATWOOD, BRIAN, MILAN, ITALY:
2,748,583, INT. CL. 25.
- AUDIOVOX CORPORATION, HAUPPAUGE, NY:
1,234,338, REN. 6-24-03. INT. CL. 9.
- AUGUST INCORPORATED, CENTERVILLE, OH:
1,715,816, CANC. INT. CL. 20.
- AUGUSTINE MEDICAL, INC., EDEN PRAIRIE, MN:
1,715,416, CANC. INT. CL. 10.
- AUNTIE ANNE'S, INC., GAP, PA:
1,736,872, REN. 6-26-03. MULTIPLE CLASS, INT. CLS. 30 AND 42.
2,748,693, MULTIPLE CLASS, INT. CLS. 30, 32 AND 42.
- AURORA NATIONAL LIFE ASSURANCE COMPANY, SANTA MONICA, CA:
2,001,272, CANC. INT. CL. 36.
- AUSPEX SYSTEMS, INC., SANTA CLARA, CA:
1,717,217, CANC. INT. CL. 9.
- AUSTIN COMMUNITY GARDENS DBA SUSTAINABLE FOOD CENTER, AUSTIN, TX:
2,747,358, PUB. 5-13-2003. INT. CL. 41.
- AUSTIN ROBAIRE VINTNERS, WOODINVILLE, WA:
2,748,039, INT. CL. 33.
- AUSTRALASIAN CONFERENCE ASSOCIATED LIMITED, WAHROONGA, NEW SOUTH WALES, AUSTRALIA:
2,745,526, PUB. 3-12-2002. MULTIPLE CLASS, INT. CLS. 29 AND 32.
- AUSTRALIAN GOLD, INC., INDIANAPOLIS, IN:
2,748,029, INT. CL. 3.
- AUSTRIA ALU-GUSS GESELLSCHAFT M.B.H., AUSTRIA:
2,746,058, PUB. 7-16-2002. INT. CL. 12.
- AUTOMATIX INCORPORATED, BURLINGTON, MA:
1,209,193, CANC. INT. CL. 42.
- AUTOMOBILE CLUB OF SOUTHERN CALIFORNIA, COSTA MESA, CA:
2,749,014, INT. CL. 35.
- AUTOMOTIVE ALLIANCE, INC., SANTA YNEZ, CA:
1,209,216, CANC. INT. CL. 42.
- AUTOMOTIVE APPEARANCE MATERIALS, INC., DAYTON, OH, AKA LUSTRE GLAZE AUTO FINISHES TO LAS-STIK MANUFACTURING COMPANY, THE, DAYTON, OH:
1,205,901, AM. MULTIPLE CLASS, INT. CLS. 2 AND 3.
- AUTUMN-HARP, INC., BRISTOL, VT TO AVALON NATURAL PRODUCTS, INC., PETALUMA, CA:
1,801,338, CANC. INT. CL. 5.
- AVADO BRANDS INC., MADISON, GA:
2,746,288, PUB. 5-13-2003. INT. CL. 32.
- AVALON HILL GAME COMPANY, THE, BALTIMORE, MD:
1,208,675, CANC. INT. CL. 28.
- AVALON NATURAL PRODUCTS, INC., PETALUMA, CA, AUTUMN-HARP, INC., BRISTOL, VT:
1,801,338, REN. 6-26-03. INT. CL. 3.
- AVANZA CORPORATION, RANCHO CUCAMONGA, CA:
2,001,803, CANC. INT. CL. 3.
- AVAYA INC., BASKING RIDGE, NJ:
2,748,864, INT. CL. 9.
- AVEMCO CORPORATION, FREDERICK, MD:
2,000,625, CANC. MULTIPLE CLASS, INT. CLS. 35, 36 AND 42.
- AVEMCO INSURANCE COMPANY, BETHESDA, MD:
1,208,934, CANC. INT. CL. 36.
- AVENO INC., ATLANTA, GA:
2,747,425, PUB. 5-13-2003. INT. CL. 20.
2,747,426, PUB. 5-13-2003. INT. CL. 20.
- AVENTIS CROPSCIENCE SA, LYON, FRANCE:
2,745,900, PUB. 3-4-2003. INT. CL. 5.
- AVENTOR, LLC, WASHINGTON, DC FROM BAKER & DANIELS, INDIANAPOLIS, IN:
2,745,971, PUB. 12-10-2002. MULTIPLE CLASS, INT. CLS. 35 AND 42.
- AVERY DENNISON CORPORATION, PASADENA, CA:
1,715,607, CANC. INT. CL. 16.
- AVESCO PLC, SURREY KT9 1TT, UNITED KINGDOM:
2,001,313, CANC. INT. CL. 41.
- AVIOR TECHNOLOGIES OPERATIONS, INC., KENNESAW, GA, DBA FLIGHTWORKS:
2,747,432, PUB. 5-13-2003. MULTIPLE CLASS, INT. CLS. 35, 37 AND 39.
- AVIREX LTD., LONG ISLAND CITY, NY:
2,745,794, PUB. 1-7-2003. INT. CL. 25.
- AVNET, INC., PHOENIX, AZ:
2,746,165, PUB. 5-13-2003. MULTIPLE CLASS, INT. CLS. 35 AND 42.
- AVON PRODUCTS, INC., NEW YORK, NY:
1,766,498, REN. 6-27-03. INT. CL. 3.
2,746,879, PUB. 5-13-2003. INT. CL. 3.
2,748,654, INT. CL. 3.
2,748,823, INT. CL. 3.
- AWARE DIAPER INC., GREELEY, CO:
1,745,852, REN. 6-27-03. INT. CL. 25.
- AWARTANI, NASER MUNIER A/R, DUBAI, ARAB EMIRATES:
2,745,580, PUB. 5-13-2003. INT. CL. 14.
- AWASHIMA AND COMPANY, LTD., IKUTA-KU, KOBE, JAPAN:
1,208,476, CANC. INT. CL. 24.
- AWI ACQUISITION COMPANY, SYLMAR, CA:
2,748,082, INT. CL. 8.
2,748,083, INT. CL. 8.
- AXERRA NETWORKS, INC., BOCA-RATON, FL FROM IPRAD LTD., TEL AVIV, ISRAEL:
2,747,785, INT. CL. 9.
- AXIOHM TRANSACTION SOLUTIONS, INC., ITHACA, NY:
2,747,759, INT. CL. 9.
- AZANDA NETWORK DEVICES, SUNNYVALE, CA:
2,748,639, INT. CL. 9.
- AZAR JEWELERS, INC., LOS ANGELES, CA:
2,748,092, INT. CL. 14.
- AZIMUTH, INC., MORGANTOWN, WV:
2,748,761, INT. CL. 9.
- B & J GABOR GMBH & CO., D-8200 ROSENHEIM, FED REP GERMANY:
1,208,504, CANC. INT. CL. 25.
- B AND L EQUIPMENT, INC., MIDLAND, TX:
2,748,873, INT. CL. 9.
- B. BRAUN MEDICAL, INC., BETHLEHEM, PA:
1,715,387, CANC. INT. CL. 10.
- B.A.W.B., NEW HAVEN, CT:
2,270,931, CANC. MULTIPLE CLASS, INT. CLS. 25 AND 42.
- B.V. KONINKLIJKE NEDERLANDSCHE GLASFABRIEK "LEERDAM", LEERDAM, NETHERLANDS:
1,208,438, CANC. INT. CL. 21.
1,208,439, CANC. INT. CL. 21.
- B-M-B COMPANY, INC., HOLTON, KS:
737,851, CANC. U.S. CL. 23.

- BABSON BROS. CO., NAPERVILLE, IL:
1,207,889, CANC. INT. CL. 7.
- BABSON-UNITED INVESTMENT ADVISORS, INC., BOSTON, MA:
1,208,201, CANC. INT. CL. 16.
- BABY BUNS, INC., NEW YORK, NY:
2,745,739, PUB. 3-26-2002. INT. CL. 25.
- BACCI, LLC, CROMWELL, CT:
2,747,447, PUB. 5-13-2003. INT. CL. 25.
- BACHARACH, INC., PITTSBURGH, PA:
1,208,004, CANC. INT. CL. 9.
1,208,005, CANC. INT. CL. 9.
- BADAB INC., FT LAUDERDALE, FL:
2,748,750, MULTIPLE CLASS, INT. CLS. 41 AND 42.
- BADER, CAROL, GRASS VALLEY, CA AND BADER, WALTER, GRASS VALLEY, CA:
2,748,224, MULTIPLE CLASS, INT. CLS. 20 AND 24.
- BAGS INTERNATIONAL LLC, COMPTON, CA:
2,748,344, INT. CL. 18.
- BAHWAN CYBERTEK TECHNOLOGIES, INC., NATICK, MA:
2,747,903, INT. CL. 37.
- BAILEY, STEVEN, CARLETON PLACE, ONTARIO K7C 4M3, CANADA:
2,746,213, PUB. 5-13-2003. MULTIPLE CLASS, INT. CLS. 3 AND 25.
- BAIRD, LISA B., SPRINGFIELD, MO:
2,747,990, INT. CL. 40.
- BAJA CHUY'S MESQUITE BROILER, INC., SIMI VALLEY, CA:
2,746,533, PUB. 5-13-2003. INT. CL. 41.
- BAKER & DANIELS:
See— AVENTOR, LLC.
- BAKER & TAYLOR, INC., CHARLOTTE, NC:
2,748,533, INT. CL. 42.
- BAKER HUGHES INCORPORATED, HOUSTON, TX:
2,748,671, MULTIPLE CLASS, INT. CLS. 7 AND 9.
2,748,755, INT. CL. 7.
- BAKER, WILLIAM E., TUCSON, AZ:
2,000,901, CANC. INT. CL. 30.
- BAKERS FOOTWEAR GROUP, INC., ST. LOUIS, MO FROM WEISS & NEUMAN SHOE COMPANY, ST. LOUIS, MO:
2,745,441, PUB. 5-13-2003. INT. CL. 35.
- BALANCE BAR COMPANY, NORTHFIELD, IL:
2,745,850, PUB. 11-5-2002. INT. CL. 29.
- BALANCED PROGRAM, INC., THE, SEATTLE, WA:
2,000,541, CANC. INT. CL. 36.
- BALDOR ELECTRIC COMPANY, FORTH SMITH, MO:
2,747,454, PUB. 5-13-2003. INT. CL. 9.
- BALDWIN GERMANY GMBH, AUGSBURG, FED REP GERMANY:
2,747,234, PUB. 5-13-2003. INT. CL. 7.
- BALL HORTICULTURAL COMPANY, WEST CHICAGO, IL:
2,746,724, PUB. 5-13-2003. INT. CL. 16.
- BALLIOL CORPORATION, THE, LANCASTER, PA, DBA THE BALLIOL CORPORATION:
2,746,893, PUB. 5-13-2003. INT. CL. 21.
- BALTIMORE AIRCOIL COMPANY, JESSUP, MD:
1,767,284, REN. 6-27-03. INT. CL. 9.
- BANC ONE CORPORATION, COLUMBUS, OH:
2,001,352, CANC. INT. CL. 16.
- BANCARD, INC., BOULDER, CO:
2,001,082, CANC. INT. CL. 36.
- BANDAI AMERICA INCORPORATED, CYPRESS, CA:
2,748,961, INT. CL. 28.
- BANFILL, STEVEN, PLAINWELL, MI, DBA OH PRODUCTS:
1,777,803, REN. 6-25-03. INT. CL. 13.
- BANK ASSET MANAGEMENT AG, 6301 ZUG, SWITZERLAND:
2,747,873, INT. CL. 36.
- BANK OF AMERICA CORPORATION, CHARLOTTE, NC:
2,746,927, PUB. 5-13-2003. INT. CL. 36.
2,746,928, PUB. 5-13-2003. INT. CL. 36.
- BANK OF ELMHURST, ELMHURST, IL:
2,000,891, CANC. INT. CL. 36.
- BANK OF NOVA SCOTIA, THE, TORONTO, ONTARIO, CANADA:
2,745,643, PUB. 7-2-2002. MULTIPLE CLASS, INT. CLS. 16 AND 36.
- BANKERS' COMPLIANCE GROUP, INC., IRVINE, CA:
2,746,676, PUB. 5-13-2003. INT. CL. 35.
- BANKNORTH GROUP, INC., PORTLAND, ME:
2,748,815, INT. CL. 36.
- BANKS, HAYDEN H. III, SAVANNAH, GA:
2,001,156, CANC. INT. CL. 30.
- BANNASTROW'S LLC, PEMBROKE PINES, FL:
2,747,006, PUB. 5-13-2003. INT. CL. 43.
- BANOR ENTERPRISES, INC., BOURNE, MA:
2,748,302, INT. CL. 28.
- BAR-S FOODS CO., PHOENIX, AZ:
2,746,151, PUB. 11-5-2002. INT. CL. 29.
- BAR'S PRODUCTS, INC., HOLLY, MI FROM FRE-BAR INC., HOLLY, MI:
2,748,526, INT. CL. 1.
- BARBARA BRENNAN, INC., EAST HAMPTON, NY:
2,747,530, MULTIPLE CLASS, INT. CLS. 9 AND 16.
- BARBARA REGER AND CHRISTINE BOUCHER:
See— SWEETSAR, INC..
- BARDWELL & MCALISTER, INC., SUN VALLEY, CA:
2,748,119, INT. CL. 21.
- BARKLEY KALPAK ASSOCIATES, NEW YORK, NY:
2,746,845, PUB. 5-13-2003. INT. CL. 41.
- BARNES & FLANAGAN, NEWARK, CA:
2,001,613, CANC. INT. CL. 25.
- BAROUH EATON ALLEN CORP., BROOKLYN, NY:
1,752,542, REN. 6-27-03. INT. CL. 16.
1,762,814, REN. 6-26-03. INT. CL. 16.
- BAROUH EATON ALLEN CORPORATION, BROOKLYN, NY:
2,745,521, PUB. 6-11-2002. INT. CL. 16.
- BARR SYSTEMS, INC., GAINESVILLE, FL:
2,747,479, MULTIPLE CLASS, INT. CLS. 9 AND 16.
- BARR, REGINALD E., TUCSON, AZ AND BARR, SANDRA E., TUCSON, AZ:
2,745,476, PUB. 12-7-1999. INT. CL. 41.
- BARRETT, JAMES G., BERLIN, MD:
2,001,965, CANC. INT. CL. 25.
- BARRINGTON MUSIC PRODUCTS, INC., SOUTH BEND, IN:
2,746,794, PUB. 5-13-2003. INT. CL. 15.
- BARRY GRANT, INC., DAHLONEGIA, GA FROM GPT 300, INC., DAHLONEGIA, GA:
2,748,628, INT. CL. 7.
- BARRY; TIM, PALM DESERT, CA, DBA THE T. BARRY KNICKER CO.:
1,208,596, CANC. INT. CL. 25.
- BARSKY, STEVEN MARK, VENTURA, CA:
2,748,744, INT. CL. 9.
- BARTON, JACK H., MIDLAND, TX:
2,746,749, PUB. 5-13-2003. INT. CL. 28.
- BARUCH INTERNATIONAL FASHION GROUP B.V., 3641 RZ MIJDRECHT, NETHERLANDS:
2,002,010, CANC. INT. CL. 25.
2,002,011, CANC. INT. CL. 25.
- BASCO SPORTSWEAR, INC., NEW YORK, NY:
1,715,890, CANC. INT. CL. 25.
- BASEMENT SYSTEMS, INC., SEYMOUR, CT:
2,746,210, PUB. 10-29-2002. INT. CL. 19.
- BASIC BROWN BEARS, INC., SAN FRANCISCO, CA:
2,746,590, PUB. 5-13-2003. MULTIPLE CLASS, INT. CLS. 28, 35 AND 41.
- BASSETTI S.P.A., RESCALDINA, ITALY, FINBASSETTI S.P.A., MILAN, ITALY:
1,216,769, REN. 6-25-03. MULTIPLE CLASS, INT. CLS. 24 AND 25.
- BATES WORLDWIDE, INC., NEW YORK, NY:
2,746,160, PUB. 12-10-2002. INT. CL. 35.
- BATESVILLE SERVICES, INC., BATESVILLE, IN:
2,746,663, PUB. 5-13-2003. INT. CL. 20.
- BATH & BODY WORKS, INC., REYNOLDSBURG, OH:
2,748,818, INT. CL. 4.
- BATH UNLIMITED, INC., PASSAIC, NJ FROM MELARD MANUFACTURING CORP., PASSAIC, NJ:
2,747,987, INT. CL. 21.

- BATHE, KLAUS-JURGEN, BELMONT, MA, ADINA ENGINEERING AB, VASTERAS, SWEDEN:
1,243,467. REN. 6-25-03. INT. CL. 9.
- BATON ENTERPRISES, INC., LIGONIER TOWNSHIP, WESTMORELAND COUNTY, PA, AKA E. R. CALDWELL LAND CLEARING CONTRACTORS, INC.:
1,209,015. CANC. INT. CL. 37.
- BATOOK CHEWING GUM IND., LTD., AL-KHOBAR 31952, SAUDI ARABIA:
2,745,933. PUB. 12-3-2002. INT. CL. 30.
- BAUSCH & LOMB INCORPORATED, ROCHESTER, NY, STORZ INSTRUMENT COMPANY, ST. LOUIS, MO:
1,773,537. REN. 6-21-03. INT. CL. 10.
- BAUSCH & LOMB SURGICAL, INC.:
1,715,421. CANC. INT. CL. 10.
- BAXTER INTERNATIONAL INC., DEERFIELD, IL:
1,208,084. CANC. INT. CL. 10.
- BAXTER, JOHN F., JR., MARCO ISLAND, FL:
2,748,600. INT. CL. 38.
- BAY CITY FLOWER CO., INC., HALF MOON BAY, CA:
2,747,928. INT. CL. 31.
- BAY WEST PAPER CORPORATION, HARRODSBURG, KY:
2,748,132. MULTIPLE CLASS, INT. CLS. 20 AND 21.
- BAYER AKTIENGESELLSCHAFT, LEVERKUSEN-BAYERWERK, FED REP GERMANY:
1,208,472. CANC. INT. CL. 23.
- BAYER AKTIENGESELLSCHAFT, LEVERKUSEN, FED REP GERMANY:
2,121,979. CANC. INT. CL. 5.
- BAYER AKTIENGESELLSCHAFT, FED REP GERMANY:
2,745,549. PUB. 12-19-2000. INT. CL. 5.
- BAYER AKTIENGESELLSCHAFT, D-51368, LEVERKUSEN-BAYERWERK, FED REP GERMANY:
2,745,627. PUB. 4-10-2001. INT. CL. 5.
- BAYER CORPORATION, PITTSBURGH, PA:
2,748,970. MULTIPLE CLASS, INT. CLS. 5 AND 10.
- BAYER POLYMERS LLC, PITTSBURGH, PA FROM BAYER CORPORATION, PITTSBURGH, PA:
2,748,801. INT. CL. 1.
- BAYERISCHE MOTOREN WERKE AKTIENGESELLSCHAFT, D-80788 MUENCHEN, FED REP GERMANY:
2,746,570. PUB. 5-13-2003. INT. CL. 12.
- BAYERISCHE MOTOREN WERKE AKTIENGESELLSCHAFT, 80788 MUENCHEN, FED REP GERMANY:
2,748,180. INT. CL. 36.
- BAYRON, HARRY, WEST PALM BEACH, FL AND BAYRON, SARA, WEST PALM BEACH, FL:
2,746,989. PUB. 5-13-2003. INT. CL. 44.
- BBT&T CORPORATION, WINSTON-SALEM, NC FROM SHEFFIELD FINANCIAL CORP., CLEMMONS, NC:
2,748,891. INT. CL. 36.
- BC-USA, INC., NEW HOLLAND, PA:
2,747,315. PUB. 5-13-2003. INT. CL. 29.
- BCATCO ARL, ST. HELLIER, JERSEY JE2 3JW, CHANNEL ISLANDS:
2,745,753. PUB. 5-13-2003. INT. CL. 12.
2,745,754. PUB. 5-13-2003. INT. CL. 12.
- BCD HOLDINGS N.V., CURACAO, NETHERLD ANTILLES:
2,747,591. MULTIPLE CLASS, INT. CLS. 16, 36 AND 39.
- BD ELECTRICAL, INC., WHITMORE LAKE, MI:
2,746,538. PUB. 5-13-2003. INT. CL. 37.
- BDC PROPERTIES/CONSTRUCTION, INC., FORT WORTH, TX, DBA TEXAS BURGER, COX; BOBBY D., MIDLAND, TX, DBA TEXAS BURGER:
1,233,819. REN. 6-27-03. INT. CL. 30.
- BDSP, INC., RHINEBECK, NY:
2,746,731. PUB. 5-13-2003. INT. CL. 9.
- BE THE BALL, INC., SALT LAKE CITY, UT:
2,748,454. INT. CL. 25.
- BEAGLE 1, INC., LOS ANGELES, CA:
2,746,817. PUB. 5-13-2003. INT. CL. 27.
- BEALLSVILLE PARTNERSHIP, POTOMAC, MD:
1,209,201. CANC. INT. CL. 42.
- BEANWORLD PRESS, INC., THE, WILMETTE, IL:
2,001,477. CANC. INT. CL. 16.
- BEAR MOUNTAIN, INC., BIG BEAR LAKE, CA:
2,001,860. CANC. MULTIPLE CLASS, INT. CLS. 16 AND 41.
- BEAR STUDIO CO. LTD., NEW YORK, NY:
2,746,841. PUB. 5-13-2003. INT. CL. 28.
- BEARCAT INTERNATIONAL (U.S.A.) LIMITED, CHICAGO, IL:
1,209,336. CANC. INT. CL. 12.
- BEARINGS, INC., CLEVELAND, OH:
2,001,762. CANC. INT. CL. 42.
- BEARRIFIC BEAR FACTORY, INC., THE, SUNRISE, FL:
2,001,349. CANC. INT. CL. 28.
- BEASLEY, ROBERT ALAN, CLEVELAND, TN:
1,715,814. CANC. INT. CL. 20.
- BEATRICE FOODS CO., CHICAGO, IL:
737,979. CANC. U.S. CL. 46.
- BEAUTE, INC., NEW YORK, NY:
2,001,910. CANC. INT. CL. 3.
- BEAUTY BRANDS FRANCHISING CORPORATION, KANSAS CITY, MO:
2,312,635. COR. MULTIPLE CLASS, INT. CLS. 35 AND 42.
- BEAUTY HOLDING COMPANY, INC, HAMILTON HM12, BERMUDA FROM SALLY BEAUTY HOLDINGS, INC., HAMILTON, BERMUDA:
2,748,694. INT. CL. 3.
- BEAVER STREET FISHERIES, INC., JACKSONVILLE, FL:
970,300. REN. 6-24-03. U.S. CL. 46 (INT. CL. 29).
- BECKMAN COULTER, INC., FULLERTON, CA:
2,746,864. PUB. 5-13-2003. INT. CL. 9.
- BECKSTOFFER VINEYARDS V, ST. HELENA, CA:
2,747,706. INT. CL. 33.
- BECTON DICKINSON AND COMPANY, FRANKLIN LAKES, NJ, HYNSON, WESTCOTT & DUNNING, INCORPORATED, BALTIMORE, MD:
572,120. REN. 6-25-03. U.S. CL. 18 (INT. CL. 5).
- BECTON DICKINSON AND COMPANY, FRANKLIN LAKES, NJ:
575,223. REN. 6-27-03. U.S. CL. 44 (INT. CL. 10).
- BEDORE, JOSEPH E., PHOENIX, AZ:
2,001,086. CANC. INT. CL. 39.
- BEE WINDOW INC., INDIANAPOLIS, IN:
1,715,779. CANC. INT. CL. 19.
- BEEBE BATTERIES, INC., INDEPENDENCE, MO:
1,248,850. REN. 6-26-03. INT. CL. 9.
- BEERCOOLER COM LLC, BRIGANTINE, NJ:
2,748,449. INT. CL. 11.
- BEGLEY, BARBARA, LEXINGTON, KY:
2,001,552. CANC. INT. CL. 14.
- BEHR PAINTS IT, INC., SANTA ANA, CA:
2,748,103. INT. CL. 37.
- BEHROUZ NIK CORPORATION, LAKE FOREST, CA:
2,617,620. COR. MULTIPLE CLASS, INT. CLS. 29 AND 30.
- BEL AIR INDUSTRIES, 69170 TARARE, FRANCE:
2,746,494. PUB. 5-13-2003. INT. CL. 24.
- BELAE BRANDS, INC., PHOENIX, AZ:
2,746,892. PUB. 5-13-2003. INT. CL. 3.
- BELDEN TECHNOLOGIES, INC., RICHMOND, IN:
2,748,860. MULTIPLE CLASS, INT. CLS. 35 AND 42.
- BELGIAN CHOCOLATES VAN DYCK, B-2250 OLEN, BELGIUM:
2,000,867. CANC. INT. CL. 30.
- BELL & HOWELL MAIL & MESSAGING TECHNOLOGIES COMPANY, DURHAM, NC:
2,748,175. INT. CL. 7.
- BELL ATLANTIC NETWORK SERVICES, INC., ARLINGTON, VA:
2,001,042. CANC. INT. CL. 36.
- BELL HELICOPTER TEXTRON INC., FORT WORTH, TX:
2,747,446. PUB. 5-13-2003. INT. CL. 41.
- BELL-CARTER FOODS, INC., LAFAYETTE, CA:
949,894. REN. 6-22-03. U.S. CL. 46 (INT. CLS. 29 AND 30).
- BELL, MICHELLE BEAUCLAIR, WAHPETON, ND:
2,746,173. PUB. 10-29-2002. INT. CL. 25.
- BEMIS MANUFACTURING COMPANY, SHEBOYAN FALLS, WI:
1,208,122. CANC. INT. CL. 11.
- BENCHMARK BRANDS, INC., MEMPHIS, TN:
2,747,881. INT. CL. 25.

- BEND MILLWORK SYSTEMS, INC., KLAMATH FALLS, OR:
1,715,768, CANC. INT. CL. 19.
- BENECOR, INC., WICHITA, KS:
2,748,360, INT. CL. 6.
- BENETTON GROUP S.P.A., TREVISO, ITALY:
2,746,066, PUB. 5-13-2003. MULTIPLE CLASS, INT. CLS. 6 AND 26.
- BENEV COMPANY INC., LAKE FOREST, CA FROM J.K.S.W.A. INTERNATIONAL SYSTEM, INC., COSTA MESA, CA:
2,747,665, MULTIPLE CLASS, INT. CLS. 3 AND 5.
- BENGAL TOBACCO CORPORATION, DAVIE, FL:
2,748,729, INT. CL. 34.
- BENJAMIN ANSEHL COMPANY, THE, ST. LOUIS, MO, DBA ANSEHL COMPANY:
1,207,749, CANC. INT. CL. 3.
- BENNETT; CAROLYN L., MEDIA, PA, DBA C. BENNETT SCOPES TO C. BENNETT SCOPES, INC., MEDIA, PA:
1,208,683, CANC. INT. CL. 28.
- BENSON, SCOT A., EARLVILLE, IL, DBA BEEFIT SERVICES:
2,001,809, CANC. INT. CL. 22.
- BENSON, SHAWN B., LENEXA, KS:
2,747,565, INT. CL. 28.
- BENTLEY MOTORS LIMITED, CREWE, CHESHIRE, ENGLAND, BENTLEY MOTORS LIMITED, CREWE, CHESHIRE, ENGLAND:
1,238,195, REN. 6-23-03, INT. CL. 12.
- BERARDI'S FRESH ROAST, INC., NORTH ROYALTON, OH:
2,001,075, CANC. INT. CL. 30.
- BERENTZEN BRENNEREIEN GMBH + CO. KG, D-49740 HASELUENNE, FED REP GERMANY:
2,747,685, INT. CL. 33.
- BERGENFIELD ASSEMBLY OF GOD CHURCH, INC, BERGENFIELD, NJ:
2,746,587, PUB. 5-13-2003, INT. CL. 41.
- BERINGER BLASS WINE ESTATES COMPANY, NAPA, CA:
2,748,471, INT. CL. 33.
- BERKSHIRE CORPORATION, GREAT BARRINGTON, MA, BERKSHIRE CORPORATION, GREAT BARRINGTON, MA:
1,765,924, REN. 6-26-03, INT. CL. 21.
- BERMUDA LIMOUSINE INTERNATIONAL, INC., NEW YORK, NY:
2,746,287, PUB. 5-13-2003, INT. CL. 39.
- BERNAT YARN & CRAFT CORPORATION, UXBRIDGE, MA:
1,208,471, CANC. INT. CL. 23.
- BERNSTEIN EDUCATION THROUGH THE ARTS FUND, INC., THE, NEW YORK, NY:
1,716,886, CANC. INT. CL. 42.
- BERRY & ASSOCIATES, INC., LONG LAKE, MN:
2,001,265, CANC. INT. CL. 41.
- BERRY, MELIA, MARION, SC:
2,747,172, PUB. 5-13-2003, INT. CL. 16.
- BERTHOLD TYPES LIMITED, CHICAGO, IL:
1,717,236, CANC. INT. CL. 16.
- BERTOLINI'S RESTAURANTS, INC., ATLANTA, GA:
2,000,988, CANC. INT. CL. 42.
- BESO DE LUNA, SEATTLE, WA:
2,000,956, CANC. MULTIPLE CLASS, INT. CLS. 3, 4 AND 20.
- BESS EATON DONUT FLOUR CO., INC., WESTERLY, RI:
1,770,275, REN. 6-24-03, INT. CL. 30.
- BEST SIDING CORPORATION, LORTON, VA:
2,747,225, PUB. 5-13-2003, INT. CL. 37.
- BESTREST PRODUCTS, L.L.C., MOUNTLAKE TERRACE, WA:
2,747,444, PUB. 5-13-2003, INT. CL. 12.
- BEVERLY ENTERPRISES INC., FORT SMITH, AR:
2,748,809, INT. CL. 35.
- BGF INDUSTRIES, INC., GREENSBORO, NC:
2,748,400, INT. CL. 17.
- BGS SYSTEMS, INC., WALTHAM, MA:
2,000,544, CANC. INT. CL. 16.
- BI PROPERTIES I INC., GREENSBORO, NC:
2,748,206, INT. CL. 24.
- BI-FOLKAL PRODUCTIONS, INC., MADISON, WI:
1,716,005, CANC. INT. CL. 28.
- BIANCHI INTERNATIONAL, TEMECULA, CA:
2,001,604, CANC. INT. CL. 18.
- BIBLICAL LIFE INSTITUTE, FREEPORT, PA:
2,746,678, PUB. 5-13-2003, INT. CL. 41.
- BIDDLE & ASSOCIATES, INC., SACRAMENTO, CA:
2,746,121, PUB. 5-13-2003, INT. CL. 35.
- BIG AND TALL ASSOCIATES, MURRAY, UT:
1,768,737, REN. 6-25-03, INT. CL. 25.
- BIG BROTHERS OF AMERICA, PHILADELPHIA, PA, BIG BROTHERS OF AMERICA, PHILADELPHIA, PA:
943,786, REN. 6-23-03, U.S. CL. 100 (INT. CL. 42).
- BIG BROTHERS/BIG SISTERS OF AMERICA, PHILADELPHIA, PA:
1,737,030, REN. 6-23-03, MULTIPLE CLASS, INT. CLS. 36 AND 41.
- BIG DOG HOLDINGS, INC., SANTA BARBARA, CA:
2,746,763, PUB. 5-13-2003, INT. CL. 25.
- BIG M, INC., TOTOWA, NJ:
2,746,260, PUB. 10-8-2002, INT. CL. 35.
- BIG SUR WATERBEDS, INC., LAKEWOOD, CO:
1,715,828, CANC. INT. CL. 20.
- BILL COMMUNICATIONS, INC., NEW YORK, NY:
2,001,323, CANC. INT. CL. 16.
- BILLINGZONE, LP, PITTSBURGH, PA FROM BILLINGZONE, LLC, PITTSBURGH, PA:
2,747,854, MULTIPLE CLASS, INT. CLS. 35, 36 AND 42.
- BILLY ALESSI, INC., EAST BRUNSWICK, NJ:
1,717,119, CANC. INT. CL. 25.
- BIMBO BAKERIES USA, INC., FORT WORTH, TX, ORO-WHEAT BAKING CO., LOS ANGELES, CA:
762,830, REN. 6-27-03, U.S. CL. 46 (INT. CL. 30).
- BIO-ENERGY SYSTEMS, INC., KALISPELL, MT:
2,745,432, PUB. 5-13-2003, MULTIPLE CLASS, INT. CLS. 5 AND 40.
- BIO-GENICS, INC., ST. GEORGE, UT, DBA E'OLA INTERNATIONAL:
2,747,039, PUB. 5-13-2003, INT. CL. 5.
2,747,040, PUB. 5-13-2003, INT. CL. 5.
- BIO-REFERENCE LABORATORIES, INC., ELMWOOD PARK, NJ:
2,747,755, MULTIPLE CLASS, INT. CLS. 35, 38 AND 42.
- BIOBALANCE INTERNATIONAL, INC., PACIFIC PALISADES, CA:
2,748,460, INT. CL. 5.
- BIOENVIROTECH, INC., TOMBALL, TX:
2,001,469, CANC. INT. CL. 1.
- BIOLEADS GMBH, 69123 HEIDELBERG, FED REP GERMANY:
2,745,530, PUB. 11-6-2001, MULTIPLE CLASS, INT. CLS. 1, 5 AND 42.
- BIOMARINE INCORPORATED, MALVERN, PA:
1,207,926, CANC. INT. CL. 9.
- BIOMARINE INCORPORATED, MALVERN, PA:
1,207,925, CANC. INT. CL. 9.
1,207,927, CANC. INT. CL. 9.
- BIOMERIEUX PIERRE FABRE, 69280 MARCY L'ETOILE, FRANCE:
2,746,027, PUB. 5-13-2003, MULTIPLE CLASS, INT. CLS. 3 AND 5.
- BIOMET, INC., WARSAW, IN:
1,715,380, CANC. INT. CL. 10.
2,748,374, INT. CL. 10.
- BIOPLASTICS COMPANY, N. RIDGEVILLE, OH:
2,748,946, INT. CL. 15.
- BIOSAN LABORATORIES, INC., DERRY, NH:
2,746,331, PUB. 10-1-2002, INT. CL. 5.
- BIOSECTOR 2, L.L.C., NEW YORK, NY:
2,746,685, PUB. 5-13-2003, INT. CL. 35.
- BIOTECH CORP., HAUPPAUGE, NY:
2,001,802, CANC. INT. CL. 28.
- BIRTHRIGHT, TORONTO, CANADA:
1,716,975, CANC. INT. CL. 42.
- BIZWORD LLC, SAN JOSE, CA:
2,747,259, PUB. 5-13-2003, INT. CL. 35.

- BJC HEALTH CARE, ST. LOUIS, MO:
2,746,710, PUB. 5-13-2003. INT. CL. 44.
- BK PUMICE PRODUCTS, INC., MALAD, ID:
2,747,306, PUB. 5-13-2003. INT. CL. 3.
- BL FLAME, INC., COSTA MESA, CA:
2,745,630, PUB. 11-12-2002. INT. CL. 28.
- BLACK ENTERTAINMENT TELEVISION, INC., WASHINGTON, DC:
1,715,577, CANC. INT. CL. 16.
- BLACK, MICHAEL A., STATE COLLEGE, PA:
2,747,158, PUB. 5-13-2003. MULTIPLE CLASS, INT. CLS. 40, 41 AND 42.
- BLACKBOARD INC., WASHINGTON, DC:
2,747,013, PUB. 5-13-2003. INT. CL. 21.
2,747,014, PUB. 5-13-2003. INT. CL. 21.
- BLACKBURN, R. GEOFFREY, SALT LAKE CITY, UT:
1,720,172, REN. 6-25-03. INT. CL. 16.
- BLAIR HOLDINGS, INC., NEWARK, DE:
2,000,772, CANC. INT. CL. 42.
- BLANCHARD TRAINING AND DEVELOPMENT, INC., ESCONDIDO, CA:
2,748,412, INT. CL. 41.
- BLANGIFORTI, ANNA CARNER, CHATHAM, NJ:
2,000,715, CANC. INT. CL. 4.
- BLAZE MESSENGER SERVICE, TEANECK, NJ:
1,209,053, CANC. INT. CL. 39.
1,209,054, CANC. INT. CL. 39.
- BLIMPIE INTERNATIONAL, INC., ATLANTA, GA:
2,747,233, PUB. 5-13-2003. INT. CL. 29.
- BLISS, GARETH, RICKMANSWORTH, HERTS. WD3 1HJ, UNITED KINGDOM:
2,745,855, PUB. 1-7-2003. MULTIPLE CLASS, INT. CLS. 9, 38 AND 42.
- BLOCH, ARMIN, D-85354 FREISING, FED REP GERMANY AND GOPPERT, MANFRED, D-85356 FREISING, FED REP GERMANY:
2,745,682, PUB. 5-13-2003. MULTIPLE CLASS, INT. CLS. 5, 14, 16, 25, 28, 35, 41 AND 42.
- BLOCK COMMUNICATIONS, INC., TOLEDO, OH, TOLEDO BLADE CO., THE, TOLEDO, OH:
1,243,863, REN. 6-22-03. INT. CL. 38.
- BLOCK, DANIEL W., PORTLAND, OR, DBA D. W. BLOCK, ASSOCIATES:
2,748,584, MULTIPLE CLASS, INT. CLS. 16, 35 AND 41.
- BLOOMBERG L.P., NEW YORK, NY:
2,000,685, CANC. INT. CL. 38.
- BLUE BELL INN, BLUE BELL, PA:
1,758,963, REN. 6-21-03. INT. CL. 42.
- BLUE BOX TOY FACTORY LIMITED, KOWLOON, HONG KONG:
2,747,998, INT. CL. 28.
- BLUE CROSS AND BLUE SHIELD ASSOCIATION, CHICAGO, IL:
2,000,696, CANC. INT. CL. 36.
- BLUE CROSS OF CALIFORNIA, WOODLAND HILLS, CA:
1,715,636, CANC. INT. CL. 16.
- BLUE HOUSE, SAN JOSE, CA:
2,000,695, CANC. INT. CL. 41.
- BLUE LEAF DESIGN, INC., MONTEREY, CA:
2,001,849, CANC. INT. CL. 22.
- BLUE MARMALADE, INC., MINNEAPOLIS, MN:
2,001,327, CANC. INT. CL. 16.
- BLUE SKY KENTUCKY, INC., LOUISVILLE, KY:
2,747,021, PUB. 5-13-2003. INT. CL. 41.
- BLUE VIDEO, INC., SEATTLE, WA:
2,745,741, PUB. 12-10-2002. INT. CL. 35.
- BLUEDESERT, LTD., KFAR MONASH 42875, ISRAEL FROM BLUEDESERT LTD., BELGRADE, MT:
2,748,475, INT. CL. 21.
- BLUEGREEN CORPORATION, BOCA RATON, FL:
2,748,741, MULTIPLE CLASS, INT. CLS. 36 AND 43.
- BLUEWIN AG, ZURICH, SWITZERLAND:
2,747,081, PUB. 5-13-2003. MULTIPLE CLASS, INT. CLS. 9, 16, 35, 38 AND 42.
- BLUM, O.D.; RONALD D., DBA THE GREAT SPECTACLE:
1,209,188, CANC. INT. CL. 42.
1,209,189, CANC. INT. CL. 42.
- BLUMER, ROBERT, HOLLYWOOD, CA:
2,746,438, PUB. 5-13-2003. INT. CL. 25.
- BLYTH HOLDINGS, INC., FOSTER CITY, CA:
2,001,855, CANC. INT. CL. 9.
- BMC SOFTWARE, INC., HOUSTON, TX:
2,001,226, CANC. INT. CL. 9.
- BNG ENTERPRISES, INC., TEMPE, AZ:
2,748,088, INT. CL. 5.
2,749,002, INT. CL. 3.
- BOARD OF REGENTS, THE UNIVERSITY OF TEXAS SYSTEM, AUSTIN, TX:
1,243,880, REN. 6-26-03. INT. CL. 41.
1,243,881, REN. 6-27-03. INT. CL. 41.
2,746,840, PUB. 5-13-2003. MULTIPLE CLASS, INT. CLS. 9, 12, 14, 16, 18, 20, 21, 25 AND 28.
2,746,842, PUB. 5-13-2003. INT. CL. 41.
- BOARD OF TRADE CLEARING CORPORATION, CHICAGO, IL:
2,747,761, INT. CL. 36.
- BOARDVANTAGE, INC., MENLO PARK, CA:
2,748,647, MULTIPLE CLASS, INT. CLS. 35 AND 42.
- BOB SCHMITT HOMES, INC., STRONGSVILLE, OH:
1,208,930, CANC. INT. CL. 36.
- BOB SUMEREL TIRE CO., INC., ERLANGER, KY:
2,746,453, PUB. 5-13-2003. INT. CL. 37.
- BOBO, DALTON, NORTHPORT, AL:
2,746,733, PUB. 5-13-2003. INT. CL. 28.
- BOC LIMITED, WINDLESHAM SURREY, ENGLAND:
2,747,883, MULTIPLE CLASS, INT. CLS. 9 AND 40.
- BODEGAS Y BEBIDAS, S.A., SAN SEBASTIAN, SPAIN:
2,748,716, INT. CL. 33.
2,748,717, INT. CL. 33.
- BOGGI INTERNATIONAL, INC., CARTERET, NJ:
2,746,003, PUB. 5-13-2003. INT. CL. 3.
- BOLLETTIERI, INC., BRADENTON, FL:
2,747,434, PUB. 5-13-2003. MULTIPLE CLASS, INT. CLS. 9 AND 16.
- BOLLHOFF GMBH, BIELEFELD, FED REP GERMANY:
2,745,790, PUB. 5-13-2003. INT. CL. 35.
- BONDS, BOBBY DAREL, SAMMAMISH, WA:
2,747,566, INT. CL. 42.
- BOOTH FIRE & SAFETY, INC., BOWLING GREEN, KY:
2,000,810, CANC. INT. CL. 42.
- BOOTIE BREWING COMPANY, WINTER PARK, FL:
2,747,154, PUB. 5-13-2003. MULTIPLE CLASS, INT. CLS. 16 AND 32.
- BORAL INDUSTRIES INC., LOS ANGELES, CA:
1,208,385, CANC. INT. CL. 19.
- BORDEN CHEMICAL INVESTMENTS, INC., WILMINGTON, DE:
166,026, REN. 6-27-03. U.S. CL. 1 (INT. CL. 1).
- BORDEN, INC., COLUMBUS, OH:
1,208,727, CANC. INT. CL. 29.
- BORDER PRODUCTS, INC., LAREDO, TX:
1,715,497, CANC. INT. CL. 12.
- BORLAND SOFTWARE CORPORATION, SCOTTS VALLEY, CA FROM INPRISE CORPORATION, SCOTTS VALLEY, CA:
2,747,762, MULTIPLE CLASS, INT. CLS. 9 AND 42.
2,747,950, MULTIPLE CLASS, INT. CLS. 9 AND 42.
- BOSS HOSS CYCLE, INC., DYERSBURG, TN:
1,784,829, REN. 6-23-03. INT. CL. 12.
- BOSS MANUFACTURING COMPANY, KEWANEE, IL:
1,244,619, REN. 6-24-03. INT. CL. 25.
- BOSTIK FINDLEY INC., WAUWATOSA, WI, UNITED SHOE MACHINERY CORPORATION, BOSTON, MA, DBA B. B. CHEMICAL CO.:
753,518, REN. 6-24-03. U.S. CL. 1 (INT. CL. 1).
- BOSTLAN, S.A., 48100 MUNGIA (VIZCAYA), SPAIN:
2,746,420, PUB. 5-13-2003. INT. CL. 6.
- BOSTON BEER CORPORATION, BOSTON, MA:
2,747,211, PUB. 5-13-2003. INT. CL. 41.
- BOSTON TRADING LTD., INC., LYNN, MA:
1,208,522, CANC. INT. CL. 25.
- BOSWELL, JOHN D., BURBANK, CA:
2,001,764, CANC. INT. CL. 41.
- BOTTLER'S INT. LTD., CLEARBROOK, VA:
1,716,277, CANC. INT. CL. 32.

BOULDER BROWNIE COMPANY, THE, STAMFORD, CT:
2,001,063, CANC. INT. CL. 30.

BOURGEOIS, DANA, BRUNSWICK, ME:
2,747,340, PUB. 5-13-2003. INT. CL. 15.

BOURJOIS, 92200 NEUILLY SUR SEINE, FRANCE:
2,746,255, PUB. 5-13-2003. INT. CL. 3.

BOWSMITH, INC., EXETER, CA, BOWSMITH IRRIGATION PRODUCTS, INC., EXETER, CA:
1,232,620. REN. 6-24-03. INT. CL. 11.

BOY SCOUTS OF AMERICA, IRVING, TX:
2,748,478, INT. CL. 26.

BOYAR INVESTMENTS, L.L.C., DALLAS, TX:
2,748,045, INT. CL. 41.

BOYD'S OF MADISON AVENUE, INC., NEW YORK, NY:
1,715,842, CANC. INT. CL. 21.

BOYDS COLLECTION, LTD, THE, MCSHERRYSTOWN, PA:
2,748,115, INT. CL. 20.

BRADEN MANUFACTURING, L.L.C., TULSA, OK, JASON INCORPORATED, TULSA, OK:
1,785,232. REN. 6-23-03. INT. CL. 7.

BRADLEY SPORTSWEAR, INC.:
1,208,554, CANC. INT. CL. 25.

BRADWELL INTERNATIONAL, INC., ELMHURST, IL:
1,715,279, CANC. INT. CL. 9.

BRADY USA, INC., MILWAUKEE, WI:
1,717,096, CANC. INT. CL. 17.

BRADY, F. WILLIAM, SANTA CRUZ, CA, DBA SALAMANDER:
2,001,724, CANC. INT. CL. 25.

BRAKE WAREHOUSE, INC., SAN DIEGO, CA:
2,001,971, CANC. INT. CL. 42.

BRAMBLES AUSTRALIA LIMITED, SYDNEY, NEW SOUTH WALES 2000, AUSTRALIA:
2,001,166, CANC. INT. CL. 37.
2,746,292, PUB. 5-13-2003. INT. CL. 40.

BRAND VELOCITY, INC., ATLANTA, GA:
2,746,223, PUB. 5-13-2003. INT. CL. 35.

BRANDJUICE CONSULTING, INC., DENVER, CO FROM JUICE BRANDING, INC., DENVER, CO:
2,747,844, INT. CL. 35.

BRASNER, MICHAEL, NEWINGTON, CT:
2,746,834, PUB. 5-13-2003. INT. CL. 41.

BRAUN-HUON, STARR, 94170 LEPPERREUX, FRANCE:
2,745,752, PUB. 5-13-2003. INT. CL. 39.

BRAUN, KATHRYN A., MONTGOMERY, AL:
2,748,629, INT. CL. 35.

BRAVOSOLUTION S.P.A., BERGAMO, ITALY FROM NEW-CO.COM S.P.A., 24100 BERGAMO, ITALY:
2,745,925, PUB. 10-8-2002. MULTIPLE CLASS, INT. CLS. 37, 38 AND 42.

BRENNEMAN, KATHIE L., EUGENE, OR:
2,001,318, CANC. INT. CL. 16.

BRENTON PRODUCTIONS, INC., SWANSEA, MA:
2,748,428, INT. CL. 41.

BREWER'S LEDGE INC., BOSTON, MA:
2,746,811, PUB. 5-13-2003. INT. CL. 28.

BRIAN BROTHERS, INC., HACKENSACK, NJ:
2,001,524, CANC. INT. CL. 25.

BRICK-HANAUER INC., WALTHAM, MA:
1,716,308, CANC. INT. CL. 34.

BRIDGE, KATHERINE L., KENNEBUNKPORT, ME:
2,001,204, CANC. INT. CL. 16.

BRIDGESTONE CORPORATION, CHUO-KU, TOKYO 104, JAPAN, BRIDGESTONE TIRE COMPANY LIMITED, CHUO-KU, TOKYO, JAPAN:
952,683. REN. 6-24-03. U.S. CL. 35 (INT. CL. 12).

BRIDGESTONE SPORTS CO., LTD, TOKYO, 140, JAPAN:
2,748,973, INT. CL. 28.

BRIDON PLC, LONDON EC4A ILY, ENGLAND:
745,276. REN. 6-27-03. U.S. CL. 7 (INT. CL. 6).

BRIDWELL, NORMAN, EDGARTOWN, MA:
2,745,944, PUB. 5-13-2003. INT. CL. 28.

BRIGGS & STRATTON CORPORATION, WAUWATOSA, WI:
737,894, CANC. U.S. CL. 31.

BRITANNICA HOME FASHIONS, INC., NEW YORK, NY:
2,747,349, PUB. 5-13-2003. MULTIPLE CLASS, INT. CLS. 20 AND 24.

BRITISH AEROSPACE PUBLIC LIMITED COMPANY, FARNBOROUGH, HAMPSHIRE, GU14 6YU, GBN, UNITED KINGDOM:
2,746,305, PUB. 5-13-2003. INT. CL. 9.

BRITISH SHOE CORPORATION LIMITED, LEICESTER, LE3 1UR, ENGLAND:
2,000,503, CANC. INT. CL. 25.

BROADCLOUD COMMUNICATIONS, INC., AUSTIN, TX:
2,748,013, INT. CL. 38.

BROADFIELDS WINE CELLARS, LLC, SOUTHOLD, NY:
2,747,657, INT. CL. 33.

BROADMARK, INC., THOUSAND OAKS, CA:
2,748,214, INT. CL. 6.

BROADVISION, INC., REDWOOD CITY, CA:
2,748,133, INT. CL. 9.

BROASTER COMPANY, THE, BELOIT, WI:
1,795,158. REN. 6-26-03. INT. CL. 29.

BROCK, HELENE M., LORTON, VA, DBA MOMS WITH A MISSION:
2,748,829, INT. CL. 14.

BRODERBUND SOFTWARE, INC., NOVATO, CA:
2,000,727, CANC. INT. CL. 9.
2,002,006, CANC. INT. CL. 28.

BROTHER INTERNATIONAL CORPORATION, PISCATAWAY, NJ:
1,208,239, CANC. INT. CL. 16.

BROUWERIJ CORSENDONK, 2360 OUD-TURNHOUT, BELGIUM:
2,746,598, PUB. 5-13-2003. INT. CL. 32.

BROWN & BIGELOW, INC., ST. PAUL, MN:
1,717,077, CANC. INT. CL. 16.

BROWN, BRUCE, SEGUIN, TX:
2,746,664, PUB. 5-13-2003. INT. CL. 35.

BROWN, DAVID L, WHEATON, IL, DBA NEON DOC SIGNS:
2,748,477, INT. CL. 37.

BROWN, TANYA L, YPSILANTI, MI:
2,001,218, CANC. INT. CL. 10.

BROWNVILLE SPECIALTY PAPER PRODUCTS, INC., BROWNVILLE, NY:
2,746,529, PUB. 5-13-2003. INT. CL. 16.

BRUDI BOLZONI AURAMO, INC., HOMEWOOD, IL, AURAMO, INC., CHARLESTON, SC:
1,704,794. REN. 6-22-03. INT. CL. 12.

BRUNET, PIERRE, 74160 SAINT JULIEN EN GENEVOIS, FRANCE:
2,745,820, PUB. 4-16-2002. INT. CL. 3.

BRUNSWICK BOWLING & BILLIARDS CORPORATION, MUSKEGON, MI:
2,748,525, INT. CL. 28.

BRUNTON COMPANY, INC., THE, RIVERTON, WY:
2,748,510, INT. CL. 9.

BRYAN WARD AND TABBY CRABB, CHARLOTTE HALL, MD TO BONEPONY, NASHVILLE, TN:
1,716,679, CANC. INT. CL. 41.

BRYANT, THOMAS R., COTTER, AR AND SOMERVILLE, MICHAEL, IRMA, WI:
2,746,147, PUB. 5-13-2003. INT. CL. 41.

BRYNDANA INTERNATIONAL, LTD., HAVERTOWN, PA:
2,747,497, INT. CL. 2.

BS&K HOLDING COMPANY, LLC, SYRACUSE, NY:
2,748,345, INT. CL. 9.
2,748,346, INT. CL. 9.

BSE CERTIFICATION, INC., COLORADO SPRINGS, CO:
2,748,291, U.S. CL. B.

BTA BIOTECHNISCHE ABFALLVERWERTUNG GMBH & CO. KG, D-80333 MUNCHEN, FED REP GERMANY:
2,745,548, PUB. 12-4-2001. MULTIPLE CLASS, INT. CLS. 11, 40 AND 42.

BUBENHEIM, GEORGE R., BROOKFIELD, OH:
2,000,617, CANC. INT. CL. 39.

BUCHER, JOE, EAGLE RIVER, WI:
2,746,856, PUB. 5-13-2003. INT. CL. 28.
2,746,857, PUB. 5-13-2003. INT. CL. 28.

BUCK KNIVES, INC., EL CAJON, CA:
2,746,500, PUB. 5-13-2003. INT. CL. 8.

- BUCKAROO COMMUNICATIONS, OXNARD, CA, PAISANO PUBLICATIONS, INC., AGOURA HILLS, CA: 1,809,154. REN. 6-21-03. INT. CL. 16.
- BUDDY L CORPORATION, NEW YORK, NY: 1,208,646. CANC. INT. CL. 28.
- BUFFALO MEDICAL SPECIALTIES MFG. INC., ST. PETERSBURG, FL: 1,207,924. CANC. MULTIPLE CLASS, INT. CLS. 9, 10 AND 21.
- BUHLER, RONALD, HUNTINGTON BEACH, CA: 1,768,758. REN. 6-27-03. INT. CL. 28.
- BUILD-A-BEAR WORKSHOP, INC., ST. LOUIS, MO: 2,747,394. PUB. 5-13-2003. INT. CL. 35. 2,748,855. INT. CL. 28.
- BUILD-A-BEAR WORKSHOP, L.L.C., ST. LOUIS, MO: 2,747,635. INT. CL. 35.
- BUILDER'S BEST, INC., JACKSONVILLE, TX, SERV-WELL BURNER CORPORATION, BLOOMFIELD, CT: 962,040. REN. 6-24-03. U.S. CL. 34 (INT. CL. 11).
- BUILDING INDUSTRY ASSOCIATION OF SOUTHEASTERN MICHIGAN, FARMINGTON HILLS, MI: 2,747,239. PUB. 5-13-2003. INT. CL. 35.
- BUKUR, THOMAS J., VALPARASIO, IN: 2,745,588. PUB. 5-13-2003. INT. CL. 28.
- BULLSONE CO., LTD., SEOCHO-GU, SEOUL, REPUBLIC OF KOREA: 2,748,167. INT. CL. 5.
- BULLY HILL VINEYARDS INC., HAMMONDSPORT, NY: 1,208,843. CANC. INT. CL. 33.
- BULLY HILL VINEYARDS, INC., HAMMONDSPORT, NY: 1,208,842. CANC. INT. CL. 33.
- BUNDESDRUCKEREI GMBH, D-10958 BERLIN, FED REP GERMANY: 2,745,679. PUB. 9-17-2002. MULTIPLE CLASS, INT. CLS. 2, 9, 16 AND 42.
- BUNING EXOTIC GARDENS, L.L.C., FORT LAUDERDALE, FL: 2,746,900. PUB. 5-13-2003. INT. CL. 31.
- BURBANK DENTAL LAB. INC., BURBANK, CA: 2,695,303. COR. INT. CL. 10.
- BURGER KING BRANDS, INC., MIAMI, FL: 2,746,263. PUB. 5-13-2003. INT. CL. 30.
- BURKE, JEFF, MENLO PARK, CA: 2,747,189. PUB. 5-13-2003. INT. CL. 42.
- BURNS BROS., INC., PORTLAND, OR: 2,000,692. CANC. INT. CL. 37.
- BURR, EVAN, BROOKLYN, NY: 2,747,664. INT. CL. 9.
- BURROUGHS & CHAPIN COMPANY, MYRTLE BEACH, SC: 2,748,555. INT. CL. 41.
- BURTON'S GOLD MEDAL BISCUITS LIMITED, LONDON, ENGLAND: 1,208,785. CANC. INT. CL. 30.
- BUSH AGRICULTURAL RESOURCES, INC., ST. LOUIS, MO: 1,208,771. CANC. INT. CL. 30. 1,208,772. CANC. INT. CL. 30.
- BUSHNELL PERFORMANCE OPTICS, OVERLAND PARK, KS FROM TASCOS SALES, INC., MIRAMAR, FL: 2,745,474. PUB. 5-13-2003. INT. CL. 9.
- BUSINESS & ENGINEERING COUNSELORS, INC., PITTSBURGH, PA: 2,002,000. CANC. INT. CL. 35.
- BUSINESS PEOPLE INCORPORATED, MINNEAPOLIS, MN: 1,209,362. CANC. INT. CL. 41.
- BUSINESS RESOURCE GROUP, LOS ANGELES, CA: 2,749,054. INT. CL. 35.
- BUSINESS TECHNOLOGY ASSOCIATION, KANSAS CITY, MO: 2,001,972. CANC. INT. CL. 42.
- BUSTIN & CO., INC., DALLAS, TX: 2,747,256. PUB. 5-13-2003. INT. CL. 35.
- BUTCHER COMPANY, INC., THE, MARLBORO, MA, DBA THE RAMSEY COMPANY TO BUTCHER COMPANY, INC., THE, MARLBORO, MA, DBA THE RAMSEY COMPANY: 2,164,174. COR. INT. CL. 3. 2,167,745. COR. INT. CL. 5. 2,167,746. COR. INT. CL. 3. 2,169,715. COR. INT. CL. 3.
- BUTCHER COMPANY, INC., THE, MARLBORO, MA TO BUTCHER COMPANY, INC., THE, MARLBORO, MA: 2,236,538. COR. INT. CL. 5. 2,310,256. COR. INT. CL. 3. 2,396,703. COR. INT. CL. 3. 2,417,863. COR. INT. CL. 3.
- BUTTENPAPIERFABRIK GMUND GMBH & CO. KG, 83701 GMUND AM TEGERNSEE, FED REP GERMANY: 2,747,768. INT. CL. 16.
- BUTTREY FOOD AND DRUG COMPANY, GREAT FALLS, MT: 2,000,536. CANC. INT. CL. 42.
- BUTY-WAVE PRODUCTS CO., INC., LOS ANGELES, CA: 1,207,738. CANC. INT. CL. 3.
- BUYMEDIA, INC.:
See—MARKETRON INTERNATIONAL, INC..
- BVS ENTERTAINMENT, INC., LOS ANGELES, CA: 2,746,406. PUB. 5-13-2003. INT. CL. 28.
- BVS, INC., CEDAR RAPIDS, IA, DBA BVS PERFORMANCE SYSTEMS: 2,746,813. PUB. 5-13-2003. MULTIPLE CLASS, INT. CLS. 9 AND 16.
- BYERS, STEPHEN T., HONEOYE FALLS, NY: 2,747,061. PUB. 3-12-2002. INT. CL. 42.
- BYOB* WATER STORES, INC., LEWISVILLE, TX: 2,745,479. PUB. 12-31-2002. INT. CL. 35.
- BYRD HARVEST, INC., GUADALUPE, CA, DBA BYRD PRODUCE COMPANY: 1,766,108. REN. 6-23-03. INT. CL. 31.
- C. E. PUBLICATIONS, INC., BOTHELL, WA: 1,208,246. CANC. INT. CL. 16.
- C. E. ZUERCHER & CO., INC., SKOKIE, IL: 172,534. REN. 6-25-03. U.S. CL. 46 (INT. CL. 30).
- C. R. BARD, INC., MURRAY HILL, NJ: 2,692,810. COR. INT. CL. 10.
- C.A.W., INC., CLEVELAND, OH: 1,715,040. CANC. INT. CL. 7.
- C.S. ASSOCIATES INC., CITY OF INDUSTRY, CA: 2,746,694. PUB. 5-13-2003. INT. CL. 25.
- C.S.F. CORP., WILMINGTON, DE, CHARMING SHOPPES, INC., BENSALEM, PA: 1,261,297. REN. 6-21-03. INT. CL. 42.
- C&K ASSOCIATES, INC., WASHINGTON, DC: 2,001,288. CANC. INT. CL. 35.
- C-LINE PRODUCTS, INC., MT. PROSPECT, IL: 2,748,899. INT. CL. 16.
- C-TECH ENTERPRISES, INC., CAMAS, WA: 2,746,898. PUB. 5-13-2003. INT. CL. 3.
- C/S SOLUTIONS, INC., MANHATTAN BEACH, CA: 2,746,672. PUB. 5-13-2003. INT. CL. 9.
- CA' DEI FRATI DI DAL CERO PIETRO E FIGLI S.S., 25019 SIRMIONE (BS), ITALY: 2,633,773. COR. INT. CL. 33.
- CABLE DESIGN TECHNOLOGIES INC., PITTSBURGH, PA, DBA THERMAX/CDT: 2,747,916. INT. CL. 9.
- CABOT SAFETY INTERMEDIATE CORPORATION, NEWARK, DE: 2,748,326. INT. CL. 9.
- CADENCE SOUND SYSTEMS INC., HOWELL, NJ: 1,774,108. REN. 6-27-03. INT. CL. 9.
- CADILLAC COFFEE COMPANY, DETROIT, MI: 2,001,066. CANC. INT. CL. 30.
- CADMUS COMMUNICATIONS CORPORATION, RICHMOND, VA: 2,000,979. CANC. INT. CL. 16.
- CALABRO, JOHN L., BUFFALO, NY: 2,747,793. INT. CL. 9.
- CALDERIN, DIEGO F., PHILADELPHIA, PA: 2,747,066. PUB. 5-13-2003. INT. CL. 42.

- CALDWELL-SMOLDT, DONNA, ROMEVILLE, IL:
2,746,119, PUB. 5-13-2003. INT. CL. 3.
- CALIBRON SYSTEMS, INC., SCOTTSDALE, AZ:
1,767,299. REN. 6-26-03. INT. CL. 9.
- CALICO CAT, INC., THE, TAMPA, FL:
1,716,915, CANC. INT. CL. 42.
- CALIFORNIA & WASHINGTON CO., SAN BRUNO, CA:
957,929. REN. 6-22-03. U.S. CL. 46 (INT. CLS. 29 AND 32).
- CALIFORNIA ACADEMY OF SCIENCES, THE, SAN FRANCISCO, CA:
1,767,239. REN. 6-27-03. MULTIPLE CLASS, INT. CLS. 9 AND 41.
- CALIFORNIA ART-IN-ACTION FOUNDATION, MENLO PARK, CA:
2,746,111, PUB. 5-13-2003. INT. CL. 16.
- CALIFORNIA EASTERN LABORATORIES, INC., SANTA CLARA, CA:
1,209,204, CANC. INT. CL. 42.
- CALIFORNIA FLAVOR LABS, INC., PACOIMA, CA, DBA AMERICAN FRUIT PROCESSORS:
1,787,095. REN. 6-23-03. INT. CL. 40.
- CALIFORNIA ORTHOPEDIC AND SPORTS THERAPY REHABILITATION SERVICES, INC, APTOS, CA:
2,747,122, PUB. 5-13-2003. INT. CL. 44.
- CALYTRIX TECHNOLOGIES PTY LTD., BENTLEY, AUSTRALIA:
2,747,181, PUB. 5-13-2003. INT. CL. 9.
- CAMBODIA RESOURCE INTERNATIONAL INC., NEW YORK, NY:
2,001,141, CANC. INT. CL. 25.
- CAMBRIDGE ENERGY RESEARCH ASSOCIATES, INC., CAMBRIDGE, MA:
2,000,666, CANC. INT. CL. 16.
- CAMBRIDGE SILICON RADIO LTD., CAMBRIDGE, ENGLAND:
2,748,724, INT. CL. 9.
- CAMCO CONSTRUCTION COMPANY, INC., SALT LAKE CITY, UT:
1,208,991, CANC. MULTIPLE CLASS, INT. CLS. 37 AND 42.
- CAMEO CURTAINS INC., NEW YORK, NY:
737,966, CANC. U.S. CL. 42.
- CAMERON MACKINTOSH LTD., LONDON WC1B 3RA, ENGLAND:
1,715,557, CANC. INT. CL. 16.
- CAMOUFLAGE ASSOCIATES, NEW YORK, NY:
2,747,458, MULTIPLE CLASS, INT. CLS. 9, 41 AND 42.
- CAMPBELL, WENDY W., OAKLAND, CA:
2,748,695, INT. CL. 35.
- CAMPER, S.L., BALEARES, SPAIN:
2,745,492, PUB. 12-24-2002. INT. CL. 25.
- CANADIAN (21) STOOK LTD., RED DEER, ALBERTA, CANADA:
2,748,959, INT. CL. 41.
- CANADIAN NATIONAL RAILWAY COMPANY, MONTREAL, QUEBEC, CANADA:
1,716,376, CANC. INT. CL. 35.
- CANANDAIGUA BRANDS INC., FAIRPORT, NY, GOLD SEAL PRODUCTS COMPANY, INC., URBANA, NY:
157,962. REN. 6-22-03. U.S. CL. 47 (INT. CL. 33).
- CANDLE CORPORATION, EL SEGUNDO, CA:
1,791,413. REN. 6-23-03. INT. CL. 9.
- CANDY BLOSSOMS, INC., DARIEN, IL:
1,716,222, CANC. INT. CL. 30.
- CANDYTREE U.S.A., INC., AIRMONT, NY:
2,745,844, PUB. 5-13-2003. INT. CL. 30.
- CANNON RUBBER LIMITED, LONDON, UNITED KINGDOM:
2,747,092, PUB. 6-18-2002. INT. CL. 20.
- CANTISANO FOODS, INC., ROCHESTER, NY, OMNI CONTINENTAL, INC., FT. LEE, NJ:
1,237,506. REN. 6-23-03. MULTIPLE CLASS, INT. CLS. 29 AND 30.
- CANTON MOTORSPORTS & EXPO PARK, INC., CANTON, NC FROM WESTMORELAND, STEPHEN C., CANTON, NC, DBA CANTON MOTORSPORTS PARK:
2,747,986, INT. CL. 25.
- CAP GEMINI ERNST & YOUNG U.S. LLC, NEW YORK, NY:
2,695,557, COR. INT. CL. 44.
2,748,073, INT. CL. 35.
- CAPCOM CO., LTD., CHUO-KU, OSAKA 540, JAPAN:
2,001,722, CANC. INT. CL. 28.
- CAPITAL CITIES MEDIA, INC., NEW YORK, NY:
1,208,328, CANC. INT. CL. 16.
- CAPITAL EXPRESSWAY, INC., SCOTTSDALE, AZ:
2,000,615, CANC. INT. CL. 36.
- CAPITAL GROWTH MANAGEMENT LIMITED PARTNERSHIP, BOSTON, MA:
1,778,082. REN. 6-24-03. INT. CL. 36.
- CAPPELLA, CARMEN J., NO. BRUNSWICK, NJ, DBA CAPPELLA PRODUCTS COMPANY:
1,715,070, CANC. INT. CL. 8.
- CAPPELLI; NINI POLI, LOS ANGELES, CA:
1,208,414, CANC. INT. CL. 20.
- CAPPELLO, JOHN, READING, MA:
2,747,413, PUB. 5-13-2003. INT. CL. 37.
- CAPRICE DE CHANTECLER S.N.C. DI APREA GABRIELE & C., 80133 NAPOLI, ITALY:
2,748,572, INT. CL. 14.
- CAPSTONE DEVELOPMENT CORP., BIRMINGHAM, AL:
1,716,472, CANC. INT. CL. 36.
- CAPT'N NEMO'S GROUP, L.L.C., CHICAGO, IL, RAGUSI, LOUIS, CHICAGO, IL, DBA CAPT'N NEMO'S:
965,262. REN. 6-27-03. U.S. CL. 100 (INT. CL. 42).
- CAR CARRIER, THE, PASADENA, CA:
1,716,582, CANC. INT. CL. 39.
- CARABELLA CORPORATION, IRVINE, CA, CARABELLA CORPORATION, IRVINE, CA:
1,770,814. REN. 6-23-03. INT. CL. 25.
- CARBON ASSOCIATES, INC., ANGLETON, TX:
2,747,960, INT. CL. 22.
- CARDIN, PIERRE, 75008 PARIS, FRANCE:
2,746,389, PUB. 5-13-2003. INT. CL. 3.
- CARECORP, POTOMAC, MD:
2,747,639, INT. CL. 42.
- CARESOURCE MEDICAL ASSOCIATES, P.C., CHERRY HILL, NJ:
2,001,930, CANC. INT. CL. 42.
- CARESTAF OF OKLAHOMA, INC., TULSA, OK:
2,747,165, PUB. 5-13-2003. INT. CL. 44.
- CARGILL, INCORPORATED, WAYZATA, MN, DIAMOND CRYSTAL SALT COMPANY, SAINT CLAIR, MI:
956,767. REN. 6-24-03. U.S. CL. 6 (INT. CL. 1).
- CARGILL, INCORPORATED, WAYZATA, MN:
1,760,832. REN. 6-25-03. INT. CL. 29.
1,772,692. REN. 6-25-03. INT. CL. 29.
- CARIBBEAN CHRISTIAN BROADCASTING NETWORK, INC., HALEDON, NJ:
2,745,909, PUB. 7-30-2002. INT. CL. 30.
- CARING FOR CHILDREN, INC., SAN FRANCISCO, CA:
1,716,400, CANC. MULTIPLE CLASS, INT. CLS. 36, 41 AND 42.
- CARL-ZEISS-STIFTUNG, 73446 OBERKOCHEN, FED REP GERMANY, DBA CARL ZEISS:
2,659,140, COR. INT. CL. 9.
- CARLETON, INC., SOUTHBEND, IN:
1,715,351, CANC. INT. CL. 9.
- CARLISLE FOODSERVICE PRODUCTS, INCORPORATED, OKLAHOMA CITY, OK, CONTINENTAL CARLISLE INC., OKLAHOMA CITY, OK:
1,809,224. REN. 6-25-03. INT. CL. 21.
- CARLSON TRAVEL GROUP, INC., MINNEAPOLIS, MN:
2,000,560, CANC. INT. CL. 39.
- CARMAZZI, KAREN, SACRAMENTO, CA, DBA CELEBRATIONS ETC...:
2,001,293, CANC. INT. CL. 16.
- CARMICHAEL, CHRIS AND CARMICHAEL, ALBERT R.:
See—INTERNATIONAL APPAREL GROUP LLC.
- CARNIVAL BRANDS, INC., NEW ORLEANS, LA:
2,746,501, PUB. 5-13-2003. INT. CL. 29.
- CARNVALE, EDWARD M., MOON TOWNSHIP, PA:
2,001,654, CANC. INT. CL. 42.
- CARRENO-REBOYO, CUAUHTEMOC, SAN DIEGO, CA:
2,000,923, CANC. INT. CL. 16.

- CARROWS RESTAURANTS, INC., IRVINE, CA:
2,001,547, CANC. INT. CL. 42.
- CARTER-WALLACE, INC., NEW YORK, NY:
1,207,821, CANC. INT. CL. 5.
1,714,943, CANC. INT. CL. 5.
- CARTER, PAUL, CHANTILLY, VA:
2,745,946, PUB. 5-13-2003. MULTIPLE CLASS, INT. CLS. 9
AND 42.
- CARTIER INTERNATIONAL B.V., 3980 AMSTERDAM,
NETHERLANDS:
2,745,822, PUB. 5-13-2003. INT. CL. 14.
- CARTNER, CURTIS C., THOMASVILLE, NC:
2,747,812, INT. CL. 21.
- CARTOON NETWORK LP, LLLP, ATLANTA, GA:
2,747,760, INT. CL. 41.
- CARTOON NETWORK LP, LLLP, THE, ATLANTA, GA:
2,747,993, INT. CL. 41.
- CARWASH CELL, INC., THE, PORT CHESTER, NY:
2,748,098, MULTIPLE CLASS, INT. CLS. 7, 35 AND 37.
- CASA FIORA, L.L.C., CHARLOTTE, NC:
2,747,280, PUB. 5-13-2003. MULTIPLE CLASS, INT. CLS.
20 AND 24.
- CASCADES INC., MONTREAL, PROVINCE OF QUEBEC,
CANADA:
2,745,604, PUB. 12-24-2002. INT. CL. 19.
- CASHCARD COMPANY, INC., THE, NASHVILLE, TN:
2,001,331, CANC. INT. CL. 16.
- CASTROL LIMITED, SWINDON, WILTSHIRE, UNITED
KINGDOM:
2,747,300, PUB. 5-13-2003. INT. CL. 4.
- CAT MEDIA PTY LIMITED, SYDNEY NSW 2000, AUSTRA-
LIA:
2,746,098, PUB. 5-13-2003. INT. CL. 3.
- CATES, JASON, PRINCETON, MA:
2,747,038, PUB. 5-13-2003. INT. CL. 44.
- CATFISH COVE OF FORT SMITH, INC., FORT SMITH, AR:
2,746,412, PUB. 5-13-2003. INT. CL. 43.
- CATHEY MARKETING CORP., CINCINNATI, OH:
1,715,964, CANC. INT. CL. 25.
- CATHOLIC HEALTHCARE PARTNERS, CINCINNATI, OH:
2,746,217, PUB. 10-8-2002. INT. CL. 41.
- CAVIT CANTINA VITICOLTORI CONSORZIO CANTINE
SOCIALI DEL TRENTO SOC. COOP. A R.I., 38040
RAVINA (PROV. OF TRENTO), ITALY:
2,745,773, PUB. 10-8-2002. INT. CL. 33.
- CBS INC., NEW YORK, NY:
159,063, CANC. U.S. CL. 6.
- CCA GLOBAL PARTNERS, INC., EARTH CITY, MO TO
CARPET CO-OP OF AMERICA ASSOCIATION, EARTH
CITY, MO:
2,705,993, COR. INT. CL. 36.
- CCC GROUP, INC., SAN ANTONIO, TX:
2,748,532, INT. CL. 12.
- CCN INTERNATIONAL, GENEVA, NY:
2,747,996, INT. CL. 20.
- CD LISTENING BAR, INC., IRVINE, CA:
2,748,811, INT. CL. 35.
- CDME WORLD TRADE, PARIS, FRANCE:
2,745,665, PUB. 9-24-2002. MULTIPLE CLASS, INT. CLS.
9, 11 AND 16.
- CECCO TRADING, INC., MILWAUKEE, WI:
2,143,635, COR. INT. CL. 19.
- CELAIR CORPORATION, NORCROSS, GA:
1,764,199, REN. 6-24-03. INT. CL. 9.
- CELESTIAL SEASONINGS, INC., GLENVIEW, IL:
1,208,786, CANC. INT. CL. 30.
- CELESTIAL SEASONINGS, INC., BOULDER, CO:
2,000,965, CANC. INT. CL. 5.
- CELLCO PARTNERSHIP, BEDMINSTER, NJ, DBA VERI-
ZON WIRELESS:
2,746,253, PUB. 11-12-2002. INT. CL. 38.
- CEMM THOME S.A., DONNEMARIE DONTILLY, FRANCE
FROM THOME S.A., BOISSY SAIANT LEGER, FRANCE:
2,748,016, MULTIPLE CLASS, INT. CLS. 40 AND 42.
- CENCI, HERMAN R., FRESNO, CA:
2,746,770, PUB. 5-13-2003. INT. CL. 5.
- CENTEL CORPORATION, CHICAGO, IL:
1,208,873, CANC. MULTIPLE CLASS, INT. CLS. 35, 38
AND 42.
- CENTENNIAL HOLDINGS, INC., DENVER, CO:
1,716,418, CANC. INT. CL. 36.
- CENTER FOR HOLISTIC MANAGEMENT, INC., ALBU-
QUERQUE, MN:
1,716,724, CANC. INT. CL. 41.
- CENTEX CORPORATION, DALLAS, TX:
2,747,410, PUB. 5-13-2003. INT. CL. 36.
- CENTRAL BANK, OAKLAND, CA:
1,208,963, CANC. INT. CL. 36.
- CENTRAL BANK GARLAND TEXAS, GARLAND, TX:
2,001,922, CANC. INT. CL. 36.
- CENTRAL FIDELITY BANKS, INC., RICHMOND, VA:
1,208,937, CANC. INT. CL. 36.
- CENTRAL MFG. CO., CHICAGO, IL, HOBBOCO, INC.,
CHAMPAIGN, IL:
1,766,806, REN. 6-26-03. INT. CL. 28.
- CENTRAL PARK MEDIA CORPORATION, NEW YORK,
NY:
2,747,147, PUB. 5-13-2003. INT. CL. 41.
- CENTRAL TANK OF OKLAHOMA, NORMAN, OK:
2,747,419, PUB. 5-13-2003. INT. CL. 7.
- CENTRE NATIONAL DE LA RECHERCHE SCIENTIFIQUE,
75794 PARIS CEDEX 16, FRANCE:
2,748,582, MULTIPLE CLASS, INT. CLS. 9 AND 42.
- CENTROS COMERCIALES SORIANA, S.A. DE C.V., MON-
TERREY, N.L., MEXICO:
2,747,514, INT. CL. 35.
- CENTURY CELLARS, INC., MIAMI, FL:
1,705,301, REN. 6-23-03. INT. CL. 33.
- CENTURY PETCARE, INC., MONARCH BEACH, CA:
2,001,096, CANC. INT. CL. 31.
- CENTURYTEL, INC., MONROE, LA, PACIFIC TELECOM,
INC., VANCOUVER, WA:
1,766,234, REN. 6-24-03. INT. CL. 38.
- CERAMICA STEFANI S.A., 14870-000 JABOTICABAL - SP,
BRAZIL:
2,746,082, PUB. 5-13-2003. INT. CL. 11.
- CERAMITEC INDUSTRIES, INC., CASA GRANDE, AZ
FROM MROS, BILL, PHOENIX, AZ:
2,747,551, INT. CL. 16.
- CERASIV GMBH INNOVATIVES KERAMIK-ENGINEER-
ING, D-73207 PLOCHINGEN, FED REP GERMANY:
2,000,583, CANC. INT. CL. 10.
- CERVELLE SOFTWARE INCORPORATED, ORLANDO, FL:
2,747,213, PUB. 5-13-2003. INT. CL. 9.
- CESCA, SAN FRANCISCO, CA, DBA COTTON, COTTON,
COTTON:
1,715,984, CANC. INT. CL. 25.
- CESSNA AIRCRAFT COMPANY, WICHITA, KS:
2,747,032, PUB. 5-13-2003. INT. CL. 39.
- CEVA SANTE ANIMALE, LIBOURNE, FRANCE:
2,745,942, PUB. 6-25-2002. INT. CL. 5.
- CEYLONSOFT TECHNOLOGIES INC., MAYNARD, MA:
2,747,108, PUB. 5-13-2003. INT. CL. 9.
- CF RANCH PROPERTIES, INC., WEATHERFORD, TX:
2,000,853, CANC. INT. CL. 42.
- CFRC, INC., LAS VEGAS, NV FROM CROSS COUNTRY,
INC., BOCA RATON, FL:
2,746,053, PUB. 9-24-2002. INT. CL. 35.
- CFS PRODUCTS, LLC, SANTA MARIA, CA:
2,748,797, INT. CL. 9.
- CHADWICK'S OF BOSTON, INC., WEST BRIDGEWATER,
MA:
2,747,265, PUB. 5-13-2003. INT. CL. 35.
- CHAI THAI SILP EXPORT LTD., PART., BANGKOK, 10110,
THAILAND, CHAI THAI SILP, BANGKOK, THAILAND:
1,772,926, REN. 6-25-03. INT. CL. 14.
- CHAMPION CHEMICAL CO., INC., WHITTIER, CA:
2,745,469, PUB. 11-19-2002. INT. CL. 3.
- CHAMPIONSHIP AUTO RACING TEAMS, INC., INDIANA-
POLIS, IN:
2,747,379, PUB. 5-13-2003. INT. CL. 41.
- CHAN, WILLIAM W.K., SHEUNG WAN, HONG KONG:
2,746,641, PUB. 5-13-2003. INT. CL. 21.
- CHANCE RESEARCH CORPORATION, FT. WORTH, TX:
1,208,701, CANC. INT. CL. 28.

- CHANG, HERLIN, SHEN-KENG, TAIPEI, TAIWAN, CHINA:
2,747,613, INT. CL. 9.
- CHANNEL NEWS NETWORK, INC., VIENNA, VA:
2,748,034, MULTIPLE CLASS, INT. CLS. 9, 35, 41 AND 42.
- CHANNING L. BETE CO., INC., SOUTH DEERFIELD, MA:
2,000,733, CANC. INT. CL. 16.
- CHANNOINE COSMETICS AG, FL-9495 TRIESEN, LIECHTENSTEIN:
2,745,729, PUB. 5-13-2003. MULTIPLE CLASS, INT. CLS. 3, 14 AND 18.
- CHARAK FURNITURE COMPANY, BOSTON, MA:
737,899, CANC. U.S. CL. 32.
- CHARGERS FOOTBALL COMPANY, LLC, SAN DIEGO, CA,
CHARGERS FOOTBALL COMPANY, SAN DIEGO, CA:
1,217,889, REN. 6-23-03, INT. CL. 41.
- CHARLES R. PARENT & LUCRETA M. PARENT, PARTNERSHIP, THE, CHATTANOOGA, TN:
2,001,233, CANC. INT. CL. 42.
- CHARLES SCHWAB & CO., INC., SAN FRANCISCO, CA:
2,001,755, CANC. INT. CL. 36.
- CHARM SCIENCES, INC., MALDEN, MA:
2,001,906, CANC. INT. CL. 9.
- CHARTER ONE FINANCIAL, INC., CLEVELAND, OH:
2,748,203, INT. CL. 36.
- CHARTPAK, INC., LEEDS, MA:
2,747,748, INT. CL. 16.
- CHASE GENERAL CORPORATION, ST. JOSEPH, MO, DBA
CHASE CANDY COMPANY:
1,791,789, REN. 6-24-03, INT. CL. 30.
- CHASE, STEPHEN, FREEPORT, NY:
2,746,686, PUB. 5-13-2003, INT. CL. 25.
- CHATEAU LAURENT, SACRAMENTO, CA:
2,746,950, PUB. 5-13-2003, INT. CL. 33.
- CHATEAU STORES OF CANADA LTD.:
See— LE CHATEAU INC.
- CHATTANOOGA CORPORATION, CHATTANOOGA, TN:
737,972, CANC. U.S. CL. 44.
- CHAVE, WILLIAM E., SANTA CRUZ, CA:
2,747,106, PUB. 5-13-2003, INT. CL. 42.
- CHAY MEDICAL, LLC, CALISTOGA, CA:
2,748,963, INT. CL. 5.
- CHECKERS DRIVE-IN RESTAURANTS, INC., TAMPA, FL:
2,748,527, INT. CL. 30.
- CHECKFREE SERVICES CORPORATION, NORCROSS, GA:
2,749,036, INT. CL. 36.
- CHEM-X INTERNATIONAL, L.L.C., MCKINNEY, TX:
2,748,274, INT. CL. 1.
- CHEMETALL GMBH, FRANKFURT AM MAIN, FED REP GERMANY, METALLGESELLSCHAFT AG, FRANKFURT AM MAIN 1, FED REP GERMANY:
1,769,571, REN. 6-25-03, INT. CL. 1.
- CHESEBROUGH-POND'S INC., GREENWICH, CT:
1,207,764, CANC. INT. CL. 3.
- CHESEBROUGH-POND'S INC., WILMINGTON, DE:
2,746,932, PUB. 5-13-2003, INT. CL. 3.
- CHESTERFIELD, DAVID LESLIE, SANTA BARBARA, CA, DBA GOLD MEDAL WINE CLUB:
1,816,254, REN. 6-26-03, INT. CL. 42.
- CHETAT PLAYING CARDS SDN BHD, 13400 BUTTERWORTH, MALAYSIA:
2,746,917, PUB. 5-13-2003, INT. CL. 28.
- CHEVRONTEXACO CORPORATION, SAN RAMON, CA, STANDARD OIL COMPANY OF CALIFORNIA, WILMINGTON, DE:
401,420, REN. 6-27-03, U.S. CL. 12 (INT. CL. 19).
- CHF INDUSTRIES, INC., NEW YORK, NY:
1,208,432, CANC. INT. CL. 20.
- CHIARO'S PIZZERIA & ITALIAN RESTAURANT, INC., RED HILL, PA:
1,784,544, REN. 6-24-03, INT. CL. 42.
- CHICAGO FLEXIBLE SHAFT COMPANY, CHICAGO, IL TO SECO/WARWICK OF DELAWARE, INC., MEADVILLE, PA:
401,235, AM. U.S. CL. 38.
- CHICAGOLAND PROCESSING CORPORATION, MT. PROSPECT, IL:
2,000,819, CANC. INT. CL. 20.
- CHICKS, INC., WOODSTOCK, NY:
2,747,509, INT. CL. 16.
- CHILDBIRTH SOLUTIONS, INC., THE PLAINS, VA:
2,747,835, INT. CL. 35.
- CHIP EXPRESS CORPORATION, SANTA CLARA, CA:
2,748,384, INT. CL. 9.
- CHIPOTLE MEXICAN GRILL, INC., DENVER, CO:
2,747,304, PUB. 5-13-2003, INT. CL. 43.
- CHIQUITA BRANDS, INC., CINCINNATI, OH:
1,717,003, CANC. MULTIPLE CLASS, INT. CLS. 8 AND 11.
2,001,793, CANC. INT. CL. 31.
2,748,373, INT. CL. 31.
- CHIU TING MACHINERY CO., LTD., TAIPING, TAI-CHUNG, TAIWAN:
1,823,589, REN. 6-21-03, INT. CL. 7.
- CHLOE SOCIETE ANONYME, 75008 PARIS, FRANCE:
2,745,487, PUB. 4-8-2003, INT. CL. 14.
- CHOICE HOTELS INTERNATIONAL, INC., SILVER SPRING, MD:
1,716,763, CANC. INT. CL. 42.
- CHOICE ONE COMMUNICATIONS INC., ROCHESTER, NY:
2,745,598, PUB. 9-24-2002, INT. CL. 36.
- CHOICE SYSTEMS, INC., RANCHO PALOS VERDES, CA:
2,748,728, INT. CL. 9.
- CHOLESTECH CORPORATION, HAYWARD, CA:
1,767,348, REN. 6-24-03, INT. CL. 10.
- CHOPARD HOLDING S.A., FRIBOURG, SWITZERLAND:
2,745,467, PUB. 4-11-2000. MULTIPLE CLASS, INT. CLS. 9 AND 16.
- CHOUDHURY, BIKRAM, LOS ANGELES, CA:
2,746,346, PUB. 10-8-2002, INT. CL. 41.
- CHOYA YOSHU JOZO CO., LTD., OSAKA 583-0841, JAPAN:
2,747,564, INT. CL. 29.
- CHRISTIAN ASSOCIATES INTERNATIONAL, INC., THOUSAND OAKS, CA:
2,001,110, CANC. INT. CL. 42.
- CHRISTIAN DIOR, S.A., PARIS, FRANCE:
1,208,518, CANC. INT. CL. 25.
- CHRISTMAS, EYON NEAL, HOLLYWOOD, CA:
2,747,400, PUB. 5-13-2003, INT. CL. 41.
- CHROMACOPY CORPORATION, CULVER CITY, CA:
1,208,953, CANC. INT. CL. 36.
- CHROMALLOY AMERICAN CORPORATION, ST. LOUIS, MO:
1,209,196, CANC. INT. CL. 42.
- CHRONOPOST, F-92795 ISSY LES MOULINEAUX, FRANCE:
2,745,686, PUB. 5-13-2003. MULTIPLE CLASS, INT. CLS. 35, 36, 38, 39 AND 42.
- CHURCH & DWIGHT COMPANY, GREEN RIVER, WY, CARTER-WALLACE, INC., NEW YORK, NY:
1,773,020, REN. 6-23-03, INT. CL. 21.
- CHURCH & DWIGHT COMPANY, GREEN RIVER, WY:
2,746,315, PUB. 12-10-2002, INT. CL. 3.
- CHURCH'S FRIED CHICKEN, INC., SAN ANTONIO, TX:
1,208,752, CANC. INT. CL. 29.
- CHURCHILL CASUALTY LTD., GRAND CAYMAN, CAYMAN ISLANDS:
2,746,709, PUB. 5-13-2003, INT. CL. 36.
- CHURCHILL, STEPHEN H., WOODBRIDGE, VA:
2,748,641, INT. CL. 16.
- CH2O INTERNATIONAL, OLYMPIA, WA:
2,001,852, CANC. INT. CL. 3.
- CI ACQUISITION, INC., NEW YORK, NY FROM CHF INDUSTRIES, INC., NEW YORK, NY:
2,748,853, MULTIPLE CLASS, INT. CLS. 20 AND 24.
- CIAVATTA, ANTHONY, IRVINE, CA:
2,745,804, PUB. 5-13-2003. MULTIPLE CLASS, INT. CLS. 35 AND 41.
- CID ENTREPRENEURIAL EDUCATION FOUNDATION, INC., INDIANAPOLIS, IN:
2,000,858, CANC. INT. CL. 41.
- CIENA CORPORATION, FREMONT, CA FROM CYRAS SYSTEMS, INC., FREMONT, CA:
2,747,705, INT. CL. 9.
- CIGNA CORPORATION, PHILADELPHIA, PA:
2,000,895, CANC. INT. CL. 36.

- CIGNA INTELLECTUAL PROPERTY, INC., CLAYMONT, DE, CONNECTICUT GENERAL LIFE INSURANCE COMPANY, BLOOMFIELD, CT:
748,210. REN. 6-24-03. U.S. CL. 102 (INT. CL. 36).
- CINCOM SYSTEMS, INC., CINCINNATI, OH:
2,016,977, CANC. INT. CL. 42.
- CINDI REID CORPORATION, PONTE VEDRA, FL:
2,747,958, INT. CL. 28.
- CINQUEMANI, ANTHONY M, STONE RIDGE, NY:
2,748,742, INT. CL. 41.
- CINTI S.P.A., I - 40050 FUNO DI ARGELATO (BOLOGNA), ITALY:
2,623,740, AM. INT. CL. 25.
- CIRCLE K STORES INC., TEMPE, AZ:
2,746,574, PUB. 5-13-2003. INT. CL. 35.
- CIRCLE OF BEAUTY, INC., NEW YORK, NY TO CIRCLE OF BEAUTY, INC., NEW YORK, NY:
2,001,902, CANC. INT. CL. 3.
- CIRIC, MILA, NEW YORK CITY, NY, AKA MILA RADU-LOVIC:
2,000,860, CANC. INT. CL. 42.
- CISCO TECHNOLOGY, INC., SAN JOSE, CA:
2,745,710, PUB. 5-13-2003. INT. CL. 41.
- CITA TOBACCO INTERNATIONAL, S.L, 38009 SANTA CRUZ DE TENERIFE, SPAIN:
2,745,953, PUB. 10-29-2002. INT. CL. 34.
- CITGO PETROLEUM CORPORATION, TULSA, OK:
2,748,983, INT. CL. 35.
- CITIBANK, N.A., NEW YORK, NY:
1,208,982, CANC. INT. CL. 36.
- CITICASTERS CO., BURBANK, CA:
2,748,945, INT. CL. 35.
- CITIZEN CPR FOUNDATION, INC., CARMEL, IN:
1,716,984, CANC. INT. CL. 42.
- CITRA-SOLV LLC, RIDGEFIELD, CT:
2,748,086, INT. CL. 3.
- CITREX, INC., MIAMI, FL:
2,746,656, PUB. 5-13-2003. INT. CL. 31.
2,746,657, PUB. 5-13-2003. INT. CL. 31.
- CITY BLOCK PRODUCTIONS, INC., PHILADELPHIA, PA:
1,715,235, CANC. INT. CL. 9.
- CITY DIRECTORIES, INC., OMAHA, NE:
2,746,803, PUB. 5-13-2003. INT. CL. 9.
- CITY OF FORT LAUDERDALE, FT. LAUDERDALE, FL:
1,716,477, CANC. INT. CL. 37.
- CITY OF HOPE, LOS ANGELES, CA:
1,209,229, CANC. INT. CL. 42.
- CITY OF THOMASVILLE, GEORGIA, THOMASVILLE, GA:
2,747,730, INT. CL. 38.
- CITY OPTICAL INC., TORONTO, ONTARIO, M4P 2C6, CANADA:
2,745,428, PUB. 10-24-2000. INT. CL. 35.
2,745,444, PUB. 5-8-2001. INT. CL. 9.
- CITY OPTICAL INC., TORONTO, ONTARIO, CANADA:
2,745,449, PUB. 4-10-2001. INT. CL. 9.
- CIVELLI, MARCELO, ELMHURST, NY:
2,748,101, INT. CL. 30.
- CIZZI, LTD., COLORADO SPRINGS, CO:
2,746,871, PUB. 5-13-2003. INT. CL. 16.
- CJB INDUSTRIES, VALDOSTA, GA:
2,748,877, INT. CL. 1.
- CLACK CORPORATION, WINDSOR, WI:
957,547. REN. 6-23-03. U.S. CL. 6 (INT. CL. 1).
- CLAD HOLDINGS CORP., CANONSBURG, PA:
2,747,390, PUB. 5-13-2003. INT. CL. 21.
- CLAIROL INCORPORATED, NEW YORK, NY:
738,002, CANC. U.S. CL. 51.
- CLARITY VISUAL SYSTEMS, INC., WILSONVILLE, OR:
2,746,635, PUB. 5-13-2003. INT. CL. 9.
- CLARK, MARGARET G., MADISON, TN:
2,745,593, PUB. 11-5-2002. INT. CL. 3.
- CLASSY MOTORS, INC., KNOXVILLE, TN:
2,001,212, CANC. INT. CL. 42.
- CLAY SMITH ENGINEERING INC., BUENA PARK, CA, CLAY SMITH ENGINEERING, BUENA PARK, CA:
1,768,442. REN. 6-27-03. MULTIPLE CLASS, INT. CLS. 7 AND 12.
- CLAY SMITH ENGINEERING, INC., BUENA PARK, CA, CLAY SMITH ENGINEERING, BUENA PARK, CA:
1,771,411. REN. 6-23-03. INT. CL. 16.
- CLAY TARGET, SHOTGUN SPORTS, LLC, CINCINNATI, OH:
2,749,004, INT. CL. 41.
- CLEAN SWEEP, INC., SHAKOPEE, MN TO CLEAN SWEEP, INC., SHAKOPEE, MN:
2,704,777, COR. MULTIPLE CLASS, INT. CLS. 37 AND 39.
- CLEARSNAP, INC., ANACORTES, WA:
2,747,267, PUB. 5-13-2003. INT. CL. 16.
- CLEARWIRE TECHNOLOGIES, INC., BUFFALO, NY TO INTERAIR WIRELESS, INC., BUFFALO, NY:
2,663,574, COR. INT. CL. 37.
- CLEARY, JEANNIE, M, EAST LANSING, MI:
2,747,199, PUB. 5-13-2003. INT. CL. 45.
- CLICK BOND, INC., CARSON CITY, NV:
2,747,341, PUB. 5-13-2003. INT. CL. 6.
- CLINE MEDIA GROUP LLC, BRADLEY, WV:
2,746,960, PUB. 5-13-2003. INT. CL. 35.
2,746,961, PUB. 5-13-2003. INT. CL. 35.
- CLINIC MANAGEMENT SERVICES, INC., KNOXVILLE, TN, ALWAYS CARE CLINIC, INC., KNOXVILLE, TN:
1,755,863, REN. 6-23-03. INT. CL. 42.
- CLINICAL TRIALS NET, INC., CHARLESTON, SC:
2,748,014, INT. CL. 42.
- CLINIQUE LABORATORIES, INC., NEW YORK, NY:
1,717,018, CANC. INT. CL. 3.
- CLO WHITE COMPANY, THE, HAMPTON, GA:
2,000,602, CANC. INT. CL. 3.
- CLOUD NINE SHEEPSKIN, INC., LYNNWOOD, WA:
2,745,685, PUB. 10-15-2002. INT. CL. 18.
- CLUB CAR, INC., AGUSTA, GA:
2,748,730, INT. CL. 12.
- CMA-CGM, 92158 SURESNES, CEDEX, FRANCE, COMPAGNIE GENERALE TRANSATLANTIQUE, PARIS, FRANCE:
553,247. REN. 6-22-03. U.S. CL. 105 (INT. CL. 39).
- CMP MEDIA LLC, SAN FRANCISCO, CA AND ATOMIC29, INC., LOS ALTOS, CA:
2,748,155, INT. CL. 41.
- CMP PUBLICATIONS, INC., MANHASSET, NY:
2,002,002, CANC. MULTIPLE CLASS, INT. CLS. 16 AND 42.
- CNET NETWORKS, INC., SAN FRANCISCO, CA:
2,747,738, MULTIPLE CLASS, INT. CLS. 9, 35, 36, 38, 41 AND 42.
- CO-OPERATIVE ROSE GROWERS, INC., TYLER, TX:
737,676, CANC. U.S. CL. 1.
- COACHMEN INDUSTRIES, INC., ELKHART, IN:
1,715,486, CANC. INT. CL. 12.
- COASTAL UNILUBE, INC., HOUSTON, TX:
1,776,195, REN. 6-24-03. INT. CL. 4.
- COASTLOG INDUSTRIES LIMITED (USA), NOVI, MI:
1,772,531, REN. 6-27-03. INT. CL. 32.
- CODE VALLEY CORP PTY LTD, ANNANDALE, QUEENSLAND, AUSTRALIA:
2,746,228, PUB. 5-13-2003. INT. CL. 42.
- CODESOFT INTERNATIONAL, INC., ATLANTA, GA:
2,001,503, CANC. INT. CL. 42.
- COGNAC GAUTIER, S.A., 16140 AIGRE, FRANCE, GAUTIER FRERES, AIGRE, FRANCE:
306,772. REN. 6-27-03. U.S. CL. 49 (INT. CL. 33).
- COGNIA CORPORATION, NEW YORK, NY:
2,745,532, PUB. 5-1-2001. INT. CL. 42.
- COGNIS DEUTSCHLAND GMBH, D-40191 DUESSELDORF, FED REP GERMANY FROM HENKEL KOMMANDITGESELLSCHAFT AUF AKTIEN, D-40191 DUESSELDORF, FED REP GERMANY:
2,747,528, MULTIPLE CLASS, INT. CLS. 1, 4, 5 AND 42.
- COGNOS INCORPORATED, OTTAWA, ONTARIO, CANADA:
2,000,714, CANC. MULTIPLE CLASS, INT. CLS. 9 AND 16.
- COGUN, INC., NORTH LIMA, OH:
2,747,052, PUB. 5-13-2003. INT. CL. 37.
- COHEN, RONALD, RUMSON, NJ:
1,717,039, CANC. INT. CL. 8.

- COILHOSE PNEUMATICS, INC., MIDDLESEX, NJ:
2,746,118, PUB. 9-10-2002. MULTIPLE CLASS, INT. CLS. 4, 6, 9 AND 17.
2,747,164, PUB. 10-22-2002. INT. CL. 17.
- COLBAR R&D LTD., RAMAT HASHARON, ISRAEL:
2,748,651, INT. CL. 10.
- COLBERTS, INC., DALLAS, TX:
1,715,973, CANC. INT. CL. 25.
- COLBOND B.V., ARNHEM, NETHERLANDS, AKZONA INCORPORATED, NEW YORK, NY:
1,196,797. REN. 6-22-03. INT. CL. 17.
- COLD CHAIN TECHNOLOGIES, INC., HOLLISTON, MA, RHOADS, E. LAWRIE, MEDFIELD, MA:
1,763,902. REN. 6-25-03. INT. CL. 1.
- COLD CUTS BOARDWEAR, SANTA BARBARA, CA:
2,001,558, CANC. INT. CL. 25.
- COLE, LEE, SOUTH SAN FRANCISCO, CA:
2,000,902, CANC. INT. CL. 40.
- COLGATE-PALMOLIVE COMPANY, NEW YORK, NY:
158,923, CANC. U.S. CL. 6.
2,747,182, PUB. 5-13-2003. INT. CL. 3.
- COLIBRIA AS, OSLO, NORWAY:
2,745,849, PUB. 10-1-2002. MULTIPLE CLASS, INT. CLS. 9, 38 AND 42.
- COLLAGEN CORPORATION, PALO ALTO, CA:
1,208,083, CANC. INT. CL. 10.
- COLLEEN CROSBY AND BRONSON BAKER, WATSONVILLE, CA, DBA THE SANTA CRUZ COFFEE ROASTING COMPANY:
2,747,107, PUB. 5-13-2003. INT. CL. 30.
- COLLEGE OF THE HOLY CROSS, THE, WORCESTER, MA:
1,723,703. REN. 6-23-03. MULTIPLE CLASS, INT. CLS. 16 AND 25.
- COLLEGEWARE U.S.A., INC., NEW YORK, NY:
2,745,456, PUB. 12-3-2002. INT. CL. 25.
- COLLEGIATE FUNDING SERVICES, LLC:
See—TCW/CRESCENT MEZZANE MANAGEMENT III, L.L.C. AS COLLATERAL AGENT.
- COLLEGIO TOSCANO DEGLI OLIVICOLTORI OL.MA.S.C.R.L., (PROV. OF GROSSETO), ITALY:
2,745,646, PUB. 5-13-2003. INT. CL. 29.
- COLLINS INTERNATIONAL CO., LTD., FAIR LAWN, NJ:
2,747,944, INT. CL. 11.
- COLONIAL CRAFT, INC., ROSEVILLE, MN:
1,715,771, CANC. INT. CL. 19.
- COLONIAL GUILD, LTD.:
See—YORK BRONZE COMPANY.
- COLONIAL METAL PRODUCTS, INC., PETERSBURG, VA:
2,747,507, INT. CL. 6.
- COLOR CAULK INC., KANSAS CITY, MO:
2,746,352, PUB. 5-13-2003. INT. CL. 17.
- COLOR COMMUNICATIONS, INC., CHICAGO, IL:
1,766,904. REN. 6-25-03. INT. CL. 35.
- COLOR KINETICS INCORPORATED, BOSTON, MA:
2,747,898, INT. CL. 9.
- COLORADO COMMODITIES MANAGEMENT CORPORATION, ENGLEWOOD, CO:
1,208,932, CANC. INT. CL. 36.
- COLORADO SATELLITE BROADCASTING, INC., BOULDER, CO:
2,746,092, PUB. 5-13-2003. INT. CL. 41.
- COLORBOK, INC., DEXTER, MI:
2,747,119, PUB. 5-13-2003. INT. CL. 16.
- COLORLAB COSMETICS, INC., ROCKFORD, IL:
2,534,285, COR. INT. CL. 3.
- COLUMBIA GAMES, INC., BLAINE, WA:
2,745,419, PUB. 10-8-1996. INT. CL. 28.
- COLUMBIA GREENHOUSE, INC., SEATTLE, WA:
1,208,449, CANC. MULTIPLE CLASS, INT. CLS. 21 AND 31.
- COLUMBIA INSURANCE COMPANY, OMAHA, NE:
1,727,771. REN. 6-23-03. INT. CL. 25.
- COLUMBIA PARCAR CORP., REEDSBURG, WI:
2,746,059, PUB. 7-30-2002. INT. CL. 12.
- COLUMBIAN CARNATIONS, INC., MIAMI, FL, DBA CCI FARMS:
1,716,261, CANC. INT. CL. 31.
- COMERICA INCORPORATED, DETROIT, MI:
2,747,735, INT. CL. 36.
- COMET INTERCONTINENTAL, INC., NEW YORK, NY:
2,748,415, INT. CL. 25.
- COMICS WORLD CORPORATION, NEW YORK, NY:
1,208,286, CANC. INT. CL. 16.
1,208,287, CANC. INT. CL. 16.
- COMIN' HOME COMMUNITY FOUNDATION, INC., THE, COLUMBUS, OH:
1,716,644, CANC. INT. CL. 41.
- COMMAND SOFTWARE SYSTEMS, INC., JUPITER, FL:
2,746,838, PUB. 5-13-2003. MULTIPLE CLASS, INT. CLS. 35 AND 42.
- COMMAND TOWER LLC, CENTERVILLE, OH:
2,746,586, PUB. 5-13-2003. INT. CL. 42.
- COMMÉMORATIVE BRANDS, INC., AUSTIN, TX:
2,746,405, PUB. 5-13-2003. INT. CL. 14.
- COMMODITY GLOVE COMPANY, INC., WAYNE, PA:
2,748,280, INT. CL. 9.
- COMMONS, THE, CINCINNATI, OH, DBA BACALLS CAFE ON THE AVENUE:
1,716,885, CANC. INT. CL. 42.
- COMMONWEALTH OF KENTUCKY, FRANKFORT, KY:
2,748,109, INT. CL. 41.
- COMMUNICARE, INC., NOVATO, CA:
2,747,142, PUB. 5-13-2003. INT. CL. 36.
- COMMUNICATING FOR AMERICA, INC., FERGUS FALLS, MN:
2,746,107, PUB. 11-12-2002. INT. CL. 36.
- COMMUNICATIONS TECHNOLOGY CORPORATION, DALLAS, TX:
2,001,882, CANC. INT. CL. 9.
- COMMUNITY BEHAVIORAL HEALTH SYSTEMS, METAIRIE, LA:
2,001,091, CANC. INT. CL. 42.
- COMMUNITY COFFEE COMPANY, LLC, BATON ROUGE, LA, DBA CC'S COFFEE HOUSE:
2,746,476, PUB. 5-13-2003. INT. CL. 30.
- COMMUNITY CREDIT UNION, PLANO, TX:
1,788,462. REN. 6-27-03. INT. CL. 36.
- COMPACT EQUIPMENT ATTACHMENTS, INC., MEQUON, WI:
2,748,447, INT. CL. 12.
- COMPAGNIE FINANCIERE ET DE PARTICIPATIONS ROULLIER, 35400 SAINT-MALO, FRANCE:
2,747,088, PUB. 4-30-2002. INT. CL. 1.
- COMPAGNIE GERVAIS DANONE, SOCIETE ANONYME, 92300 LEVALLOIS-PERRET, FRANCE:
2,745,480, PUB. 1-15-2002. MULTIPLE CLASS, INT. CLS. 5, 29, 30, 31 AND 32.
- COMPAGNIE INTERNATIONALE DES WAGONS-LITS ET DU TOURISME, BRUXELLES, BELGIUM:
2,747,749, INT. CL. 28.
- COMPANION CORPORATION, SALT LAKE CITY, UT:
2,001,563, CANC. INT. CL. 9.
- COMPASS AI, INC., EL DORADO HILLS, CA:
2,748,467, INT. CL. 9.
- COMPASS BANCSHARES, INC., BIRMINGHAM, AL:
2,746,252, PUB. 5-13-2003. INT. CL. 39.
- COMPASS GROUP PLC, CHERTSEY, SURRY, UNITED KINGDOM:
2,747,011, PUB. 5-13-2003. INT. CL. 43.
- COMPASS GROUP USA, INC., CHARLOTTE, NC:
2,747,334, PUB. 5-13-2003. INT. CL. 42.
- COMPLIANCE RESEARCH INCORPORATED, GRAND RAPIDS, MI:
1,716,985, CANC. INT. CL. 42.
- COMPOSITION MATERIALS CO., INC., FAIRFIELD, CT:
2,001,211, CANC. INT. CL. 31.
- COMPRESSORWORKS, INC., DALLAS, TX:
2,747,392, PUB. 5-13-2003. INT. CL. 7.
- COMPUT-A-SEARCH INC., SARNIA, ONTARIO N7T 5W6, CANADA:
1,233,898. REN. 6-26-03. INT. CL. 36.
- COMPUTATIONAL SYSTEMS INCORPORATED, KNOXVILLE, TN TO CSI TECHNOLOGY, INC., WILMINGTON, DE:
1,715,567, CANC. INT. CL. 16.

- COMPUTER ADVOCATE, INC., LANDENBERG, PA:
2,747,308, PUB. 5-13-2003. INT. CL. 42.
- COMPUTERS AND COMMUNICATION SYSTEMS, INC.,
POTOMAC, MD, DBA COMPUTERS, ETC.:
2,001,484, CANC. INT. CL. 42.
- COMTECH21, WALLINGFORD, CT:
2,745,651, PUB. 5-13-2003. INT. CL. 38.
- CONAGRA BRANDS, INC., OMAHA, NE:
2,746,537, PUB. 5-13-2003. INT. CL. 30.
- CONAGRA GROCERY PRODUCTS COMPANY, IRVINE,
CA:
2,748,362, INT. CL. 30.
- CONAIR CIP, INC., STAMFORD, CT FROM CONAIR
CORPORATION, STAMFORD, CT:
2,748,721, INT. CL. 26.
- CONAIR CIP, INC., STAMFORD, CT FROM CONAIR CIP,
INC., STAMFORD, CT:
2,748,798, INT. CL. 11.
- CONAIR CIP, INC., STAMFORD, CT:
2,748,902, MULTIPLE CLASS, INT. CLS. 9 AND 11.
- CONCEPT ENTERPRISES, INC., VERNON, CA:
1,715,286, CANC. INT. CL. 9.
- CONCRETE CONSTRUCTION PUBLICATIONS, INC., AD-
DISON, IL, DBA THE ABERDEEN GROUP:
1,715,653, CANC. MULTIPLE CLASS, INT. CLS. 16 AND
35.
- CONCURRENT TECHNOLOGIES CORPORATION, JOHNS-
TOWN, PA:
2,745,667, PUB. 5-13-2003. INT. CL. 42.
- CONDOMINIUM CONNECTION, AGOURA HILLS, CA:
2,746,545, PUB. 5-13-2003. MULTIPLE CLASS, INT. CLS.
39 AND 43.
- CONEXANT SYSTEMS, INC., NEWPORT BEACH, CA:
2,748,620, INT. CL. 9.
- CONITA TECHNOLOGIES, INC., COLUMBIA, SC:
2,747,820, INT. CL. 9.
- CONNECTEDU, INC., PROVIDENCE, RI:
2,746,911, PUB. 5-13-2003. INT. CL. 41.
- CONNECTICUT PACKAGING MATERIALS, INC., SOUTH
WINDSOR, CT:
2,748,381, INT. CL. 20.
- CONNECTICUT VALLEY TOBACCONIST, LLC, ENFIELD,
CT:
2,747,273, PUB. 5-13-2003. INT. CL. 34.
- CONNECTOR SET LIMITED PARTNERSHIP, HATFIELD,
PA:
1,777,983, REN. 6-27-03. INT. CL. 28.
2,748,340, INT. CL. 28.
- CONNOISSEUR ENCOUNTERS, LAKE BLUFF, IL, DBA
SHERMER SPECIALTIES:
2,746,653, PUB. 5-13-2003. INT. CL. 35.
- CONNOLLY, JOSEPH, ORLANDO, FL:
2,749,010, MULTIPLE CLASS, INT. CLS. 35 AND 41.
- CONOCO INC., PONCA CITY, OK:
737,865, CANC. U.S. CL. 26.
- CONSOL INC., STOUGHTON, MA:
1,716,321, CANC. MULTIPLE CLASS, INT. CLS. 35 AND
37.
- CONSOLIDATED ALUMINUM CORPORATION, ST. LOUIS,
MO:
1,207,853, CANC. INT. CL. 6.
- CONSOLIDATED PAPERS, INC., WISCONSIN RAPIDS, WI:
2,001,278, CANC. INT. CL. 16.
- CONSOLIDATED POPCORN, INC., SCHALLER, IA:
1,208,816, CANC. INT. CL. 31.
- CONSTANTINE, THEO A., OLD GREENWOICH, CT:
2,747,168, PUB. 5-13-2003. INT. CL. 16.
- CONSULTATION NETWORKS, INC., WASHINGTON, DC:
1,209,295, CANC. INT. CL. 42.
- CONSUMERS UNION OF UNITED STATES, INC., YON-
KERS, NY:
2,745,633, PUB. 5-13-2003. INT. CL. 42.
- CONTEC, INC., SPARTANBURG, SC:
1,754,765, REN. 6-24-03. INT. CL. 3.
- CONTECH TECHNOLOGIES, INC., MINNEAPOLIS, MN,
KAISER ALUMINUM & CHEMICAL CORPORATION,
OAKLAND, CA:
758,281, REN. 6-23-03. U.S. CL. 12 (INT. CL. 6).
- CONTESSA DA VINCI S.R.L., 00198 ROME, ITALY:
2,745,435, PUB. 11-6-2001. MULTIPLE CLASS, INT. CLS.
9, 14, 18 AND 25.
- CONTEXT MARKETING, SAUSALITO, CA:
2,745,755, PUB. 12-31-2002. INT. CL. 35.
- CONTINENTAL GRAIN COMPANY, CHICAGO, IL:
1,717,057, CANC. INT. CL. 9.
- CONTINENTAL MEDICAL SYSTEMS, INC., MECHANICS-
BURG, PA:
2,000,635, CANC. INT. CL. 35.
- CONTROL ENGINEERING, INC., BANGOR, ME:
2,748,748, INT. CL. 28.
- CONUS COMMUNICATIONS COMPANY LIMITED PART-
NERSHIP, ST. PAUL, MN:
2,745,874, PUB. 5-13-2003. INT. CL. 35.
- CONVENIENCE FOODS INTERNATIONAL, LIMITED, TAI
PO, N.T., HONG KONG TO DANONE ASIA PTE LTD,
SINGAPORE:
1,700,710, CANC. INT. CL. 30.
- CONVENTION NEWS COMPANY, INC., THE, MIDLAND
PARK, NY:
1,239,374, REN. 6-25-03. INT. CL. 16.
- CONVERSION TECHNOLOGY INC., NORCROSS, GA:
2,748,977, INT. CL. 9.
- CONVERTED RICE, INC., HOUSTON, TX TO UNCLE
BEN'S, INC., VERNON, CA:
563,449, AM. U.S. CL. 46.
- COOK INLET ENERGY SUPPLY L.L.C., LOS ANGELES, CA
FROM COOK INLET ENERGY SUPPLY LIMITED PART-
NERSHIP, LOS ANGELES, CA:
2,747,473, INT. CL. 36.
- COOKIE STOP, THE, SAN JOSE, CA:
1,208,765, CANC. INT. CL. 30.
- COOPER SPORTSWEAR MANUFACTURING CO., INC.,
NEWARK, NJ:
2,001,769, CANC. INT. CL. 25.
- COOPER TIRE & RUBBER COMPANY, FINDLAY, OH,
DEAN TIRE & RUBBER COMPANY, LOUISVILLE, KY:
1,725,435, REN. 6-23-03. INT. CL. 12.
- COOPER'S LTD., INC., BOSTON, MA:
1,209,058, CANC. INT. CL. 39.
- COPELAND'S OF NEW ORLEANS, INC., METAIRIE, LA,
MY FAVORITE YEAR, INC., JEFFERSON, LA, DBA
COPELAND'S:
1,771,978, REN. 6-22-03. INT. CL. 42.
- COPLEY PRESS, INC., THE, LA JOLLA, CA:
1,716,310, CANC. INT. CL. 35.
- COPPERHEAD BRANDS, INC., BOWLING GREEN, KY:
2,001,845, CANC. INT. CL. 30.
- CORBIN RUSSWIN, INC., BERLIN, CT:
2,747,619, INT. CL. 9.
2,747,621, INT. CL. 9.
- CORBIN, KATHALEEN M., PHOENIX, AZ:
1,712,404, REN. 6-22-03. INT. CL. 42.
- CORE CONTEMPORARY HOUSE, INC., WAYLAND, MA:
737,733, CANC. U.S. CL. 12.
- CORE LABORATORIES GLOBAL N.V., WILLEMSTAD,
CURACAO, NETHERLD ANTILLES:
2,745,688, PUB. 5-13-2003. INT. CL. 42.
- CORE-VENT CORPORATION, LAS VEGAS, NV:
1,715,377, CANC. INT. CL. 10.
- CORNERSTONE UNIVERSITY, GRAND RAPIDS, MI:
2,747,388, PUB. 5-13-2003. INT. CL. 41.
- CORNING INCORPORATED, CORNING, NY, COSTAR
CORPORATION, CAMBRIDGE, MA:
1,772,294, REN. 6-25-03. INT. CL. 9.
- CORPORATE LINK, THE, LOS ANGELES, CA:
1,761,845, REN. 6-25-03. INT. CL. 42.
- CORPORATE MANAGEMENT GROUP, L.L.C., CANFIELD,
OH:
2,747,870, INT. CL. 42.
- CORPORATIVO INTERNACIONAL MEXICANO, S. DE R.L.
DE C.V., COL. LOMAS DE CHAPULTEPEC, MEXICO,
MEXICO:
2,746,478, PUB. 5-13-2003. INT. CL. 30.
- CORRELANT COMMUNICATIONS, INC., SAN DIEGO, CA:
2,747,918, INT. CL. 9.

- CORRSYS-DATRON SENSORSYSTEME GMBH, D-35578 WETZLAR, FED REP GERMANY, ERNST LEITZ WETZLAR GMBH, WETZLAR, LAHN, FED REP GERMANY: 1,255,182. REN. 6-21-03. INT. CL. 9.
- CORRUGATED CHEMICALS, INC., CINCINNATI, OH: 2,747,043. PUB. 5-13-2003. INT. CL. 1.
- CORTECHS, INC., CLIFTON, VA: 2,745,628. PUB. 4-30-2002. INT. CL. 35.
- CORTEX BIOCHEM, INC., SAN LEANDRO, CA: 2,746,042. PUB. 1-14-2003. MULTIPLE CLASS, INT. CLS. 1 AND 5.
- CORTZ, INC., WEST CHICAGO, IL: 2,746,755. PUB. 5-13-2003. MULTIPLE CLASS, INT. CLS. 20 AND 28.
- CORVEL CORPORATION, IRVINE, CA: 2,000,588. CANC. INT. CL. 42.
- COSMO COSMETICS, INC., SANTA FE SPRINGS, CA: 1,714,912. CANC. INT. CL. 3.
1,714,913. CANC. INT. CL. 3.
- COSTA RICA EXPEDICIONES, AVENTURA Y RECREACION S.A., SAN JOSE, COSTA RICA: 2,658,114. COR. MULTIPLE CLASS, INT. CLS. 39 AND 42.
- COSTCO WHOLESALE CORPORATION, ISSAQUAH, WA: 2,745,485. PUB. 12-17-2002. INT. CL. 21.
2,745,486. PUB. 12-17-2002. INT. CL. 20.
2,745,488. PUB. 12-17-2002. INT. CL. 6.
- COTTER & COMPANY, CHICAGO, IL: 2,001,316. CANC. INT. CL. 16.
- COUGHLAN COMPANIES, INC., MANKATO, MN: 2,748,490. INT. CL. 16.
- COUNT ON ME, L.L.C., PASSAIC, NJ: 2,748,435. INT. CL. 35.
- COUNTRY MUSIC TELEVISION, INC., NASHVILLE, TN: 2,748,791. INT. CL. 41.
2,748,795. INT. CL. 41.
- COUNTY SADDLERY, INC., GAITHERSBURG, MD: 1,208,365. CANC. MULTIPLE CLASS, INT. CLS. 18 AND 25.
- COURTENEY BOOT COMPANY, THE, BULAWAYO, ZIMBABWE: 2,747,190. PUB. 5-13-2003. MULTIPLE CLASS, INT. CLS. 18 AND 25.
- COUVILLION, ALLEN J., FORT PAYNE, AL AND BURTON, RICHARD E., SPRINGDALE, AR: 2,747,235. PUB. 5-13-2003. INT. CL. 1.
- COVA PRODUCTS LIMITED, CRAMLINGTON, NORTHUMBERLAND, UNITED KINGDOM, FORBO-CP LIMITED, CRAMLINGTON, NORTHUMBERLAND NE23 8AQ, ENGLAND: 1,768,649. REN. 6-27-03. INT. CL. 17.
- COVER LOFT, INC., THE, ANNAPOLIS, MD: 1,219,172. REN. 6-23-03. INT. CL. 22.
- COX COMMUNICATIONS, INC., ATLANTA, GA: 2,704,565. COR. INT. CL. 35.
- COX, JOHN H., NORTHBROOK, IL: 2,746,981. PUB. 5-13-2003. INT. CL. 41.
- CRABTREE & EVELYN, LTD., WOODSTOCK, CT: 2,673,328. COR. INT. CL. 3.
- CRADDOCK ENGINEERING, INC., TUSTIN, CA: 1,716,330. CANC. MULTIPLE CLASS, INT. CLS. 35 AND 42.
- CRADDOCK-TERRY SHOE CORPORATION, LYNCHBURG, VA: 737,946. CANC. U.S. CL. 39.
- CRADDOCK, JOHN A., ST. LOUIS, MO: 2,747,201. PUB. 5-13-2003. INT. CL. 41.
- CRAIN WALNUT SHELLING, INC., LOS MOLINAS, CA: 2,746,459. PUB. 5-13-2003. INT. CL. 31.
- CRAMER INC., NORTH KANSAS CITY, MO: 1,789,436. REN. 6-24-03. INT. CL. 20.
- CRANITE SYSTEMS, INC., SAN JOSE, CA: 2,747,173. PUB. 5-13-2003. INT. CL. 9.
- CRAWLER PARTS, INC., PEARL, MS: 2,747,404. PUB. 5-13-2003. INT. CL. 37.
- CRC INDUSTRIES HOLDINGS, INC., WARMINSTER, PA, C. J. WEBB, INC., DRESHER, PA: 974,268. REN. 6-27-03. U.S. CL. 16 (INT. CL. 2).
- CRC PRESS, INC., BOCA RATON, FL: 1,208,260. CANC. INT. CL. 16.
- CREATIVE COMPUTERS, INC., TORRANCE, CA TO CREATIVE COMPUTERS, INC., TORRANCE, CA: 2,660,968. COR. INT. CL. 35.
- CREATIVE CONFECTION CONCEPTS, INC., MILWAUKEE, WI: 2,001,877. CANC. INT. CL. 30.
- CREATIVE EDUCATIONAL INSTITUTE, INC., WACO, TX: 2,000,745. CANC. INT. CL. 16.
- CREATIVE LABORATORIES, INC., EAGAN, MN: 2,001,299. CANC. INT. CL. 3.
- CREATIVE MARKETING AND DESIGN, INC., GARDEN CITY, NY: 2,746,914. PUB. 5-13-2003. INT. CL. 3.
- CREATIVE PRESENTATION RESOURCES LLC, SAN FRANCISCO, CA: 2,746,328. PUB. 5-13-2003. INT. CL. 42.
- CREATIVE PROCESS, INC., LONGWOOD, FL: 1,716,227. CANC. INT. CL. 30.
- CREATIVE RESPONSES, INC., ALEXANDRIA, VA: 2,002,001. CANC. INT. CL. 16.
- CREATIVE TECHNOLOGY LTD., SINGAPORE: 2,747,496. INT. CL. 9.
- CRECORP, INC., LITTLE ROCK, AR, DBA THE GREAT SOUTHERN SAUCE COMPANY: 2,001,001. CANC. INT. CL. 30.
- CREDIT LYONNAIS, 69002 LYON, FRANCE: 2,745,938. PUB. 5-13-2003. MULTIPLE CLASS, INT. CLS. 9, 35, 36 AND 38.
- CREDIT UNION NATIONAL ASSOCIATION, INC., MADISON, WI: 1,715,662. CANC. INT. CL. 16.
- CRIB N° CRADLE, INC.: 1,209,179. CANC. INT. CL. 42.
- CRISLU CORP., EL SEGUNDO, CA: 2,001,571. CANC. INT. CL. 14.
- CRISTINA STEMMLER AND JAMES MORRIS JOINT VENTURE, THE, HOUSTON, TX: 2,001,988. CANC. INT. CL. 41.
- CROMPTON GMBH, D-59180 BERGKAMEN, GERMAN DEM REP, SCHERING AKTIENGESSELLSCHAFT, FED REP GERMANY: 1,775,659. REN. 6-23-03. INT. CL. 1.
- CROSBY GROUP, INC., THE, TULSA, OK: 2,748,826. INT. CL. 35.
- CROSS COUNTRY, INC.:
See—CFRC, INC..
- CROSSGENERATION COMICS, INC., OLDSMAR, FL: 2,747,716. INT. CL. 16.
- CROSSPOINTE, INC., GULF BREEZE, FL: 2,748,067. INT. CL. 9.
- CROSSWORKS, INC., COOKEVILLE, TN: 2,748,569. MULTIPLE CLASS, INT. CLS. 25 AND 28.
- CROWN DEVELOPMENT, INC., DALLAS, TX: 2,748,603. MULTIPLE CLASS, INT. CLS. 36 AND 37.
- CROWN TECHNOLOGY CORPORATION, LAKE FOREST, IL: 1,795,687. REN. 6-26-03. INT. CL. 9.
- CROWNE ROYALE, LTD., PHILLIPSBURG, NJ: 2,000,779. CANC. INT. CL. 3.
- CRS HOLDINGS INC., WILMINGTON, DE, CARPENTER TECHNOLOGY CORPORATION, READING, PA: 1,739,440. REN. 6-26-03. INT. CL. 6.
- CRS HOLDINGS, INC., WILMINGTON, DE, CARPENTER TECHNOLOGY CORPORATION, READING, PA: 947,495. REN. 6-26-03. U.S. CL. 14 (INT. CL. 6).
- CRUISE AMERICA, INC., MESA, AZ, DBA RV DEPOT: 2,000,671. CANC. INT. CL. 12.
- CRYSTAL BRANDS, INC., WILMINGTON, DE: 1,208,163. CANC. INT. CL. 14.
- CRYSTALS INTERNATIONAL INC., PLANT CITY, FL: 2,747,293. PUB. 5-13-2003. INT. CL. 32.
- CS VENTURES LLC, SOUTHPORT, CT: 2,748,091. MULTIPLE CLASS, INT. CLS. 25 AND 42.
- CSC BRANDS LP, CAMDEN, NJ: 2,747,301. PUB. 5-13-2003. INT. CL. 29.

- CSF DYNAMICS APS, GLOSTRUP, DENMARK:
2,745,779, PUB. 10-1-2002. MULTIPLE CLASS, INT. CLS. 5, 10 AND 42.
- CTA, LLC., FORT WAYNE, IN:
2,748,003, MULTIPLE CLASS, INT. CLS. 9 AND 37.
- CTECH AG, LANDQUART, SWITZERLAND:
2,747,471, INT. CL. 8.
- CUBIC CORPORATION, SAN DIEGO, CA:
1,207,982, CANC. INT. CL. 9.
- CULTURAL EXPERIENCES ABROAD, INC., CHICAGO, IL:
2,747,095, PUB. 5-13-2003. INT. CL. 35.
- CUMBERLAND COUNTY HOSPITAL SYSTEM, INC., FAYETTEVILLE, NC, DBA SOUTHEASTERN REGIONAL REHABILITATION CENTER:
1,788,626, REN. 6-24-03. INT. CL. 42.
- CUMULUS BROADCASTING, INC., ATLANTA, GA:
2,746,581, PUB. 5-13-2003. INT. CL. 38.
- CUNARD LINE LIMITED, MIAMI, FL:
2,747,658, INT. CL. 39.
- CUNNINGHAM; MARK A., NEWAYGO, MI, DBA CUNNINGHAM COMB COMPANY:
1,208,460, CANC. INT. CL. 21.
- CUONG NHU ORIENTAL MARTIAL ARTS ASSOCIATION, INC., GAINESVILLE, FL:
2,001,457, CANC. MULTIPLE CLASS, INT. CLS. 25 AND 41.
- CUPP PUBLISHERS, INC., SAVANNAH, GA:
2,746,506, PUB. 5-13-2003. INT. CL. 16.
- CURL CORPORATION, CAMBRIDGE, MA:
2,747,475, MULTIPLE CLASS, INT. CLS. 9 AND 42.
- CURRENT REVIEWS FOR NURSE ANESTHETISTS, INC., MIAMI LAKES, FL:
2,747,159, PUB. 5-13-2003. INT. CL. 16.
- CURTICE-BURNS FOODS, INC., ROCHESTER, NY:
2,001,035, CANC. INT. CL. 29.
- CURTIS RANDOLPH AND STEVEN RANDOLPH PARTNERSHIP, THE, CHATSWORTH, CA, DBA RANDOLPH PRODUCTS:
2,001,561, CANC. INT. CL. 16.
- CUSTOM DESIGNS & MANUFACTURING COMPANY, INC., POCONO SUMMIT, PA:
2,748,084, INT. CL. 20.
- CUSTOMER INSIGHT COMPANY, ENGLEWOOD, CO:
2,001,133, CANC. INT. CL. 9.
- CVT PRODUCTIONS, INC., EUGENE, OR:
1,715,100, CANC. INT. CL. 9.
- CWI, INC., BOWLING GREEN, KY:
2,748,128, MULTIPLE CLASS, INT. CLS. 36, 37, 39 AND 42.
- CYBERALERT, INC., STRATFORD, CT:
2,747,047, PUB. 5-13-2003. INT. CL. 35.
- CYBERLINK CORP., HSIN-TIEN CITY TAIPEI HSIEN, TAIWAN:
2,747,271, PUB. 5-13-2003. INT. CL. 9.
- CYPRESS SEMICONDUCTOR CORPORATION, SAN JOSE, CA:
2,746,220, PUB. 5-13-2003. INT. CL. 9.
- C3BGROUP, INC., LAKEWOOD, CA FROM 4GL SOLUTIONS, INC., LONG BEACH, CA:
2,748,156, INT. CL. 9.
- D.O. MCCOMB & SONS, INC., FORT WAYNE, IN:
1,715,647, CANC. INT. CL. 16.
1,716,857, CANC. INT. CL. 42.
- D&K ENTERPRISES, INC., GIG HARBOR, WA:
2,747,440, PUB. 5-13-2003. INT. CL. 30.
- D&K INTERNATIONAL, INC., ELK GROVE VILLAGE, IL:
2,746,283, PUB. 5-13-2003. INT. CL. 17.
- DAH YANG TOY INDUSTRIAL CO., LTD., TAINAN, TAIWAN:
2,746,356, PUB. 5-13-2003. INT. CL. 28.
2,746,489, PUB. 5-13-2003. INT. CL. 28.
- DAILYSHOPPER.COM, INC., SEATTLE, WA:
2,747,895, INT. CL. 42.
- DAIMLERCHRYSLER AG, STUTTGART, FED REP GERMANY FROM MERCEDES-BENZ AKTIENGESELLSCHAFT, 70327 STUTTGART, FED REP GERMANY:
2,745,430, PUB. 12-10-2002. MULTIPLE CLASS, INT. CLS. 9, 35, 36, 37, 38 AND 39.
- DAIMLERCHRYSLER AG, 70567 STUTTGART, FED REP GERMANY:
2,745,503, PUB. 12-10-2002. MULTIPLE CLASS, INT. CLS. 9, 35, 36, 37, 38 AND 39.
2,745,634, PUB. 5-13-2003. MULTIPLE CLASS, INT. CLS. 7, 9, 12, 37 AND 42.
2,746,060, PUB. 9-10-2002. INT. CL. 12.
2,746,061, PUB. 9-10-2002. INT. CL. 12.
2,746,062, PUB. 9-10-2002. INT. CL. 12.
2,746,063, PUB. 10-8-2002. INT. CL. 12.
2,746,064, PUB. 9-10-2002. INT. CL. 12.
2,746,262, PUB. 5-13-2003. MULTIPLE CLASS, INT. CLS. 12, 28 AND 37.
- DAIMLERCHRYSLER CORPORATION, AUBURN HILLS, MI:
2,748,777, INT. CL. 12.
- DAINICHISEIKA COLOR & CHEMICALS MFG. CO., LTD., TOKYO, JAPAN:
2,747,943, INT. CL. 2.
- DAIRY MANAGEMENT INC., ROSEMONT, IL:
2,701,796, COR. INT. CL. 42.
- DAIWA SEIKO, INC., HIGASHIKURUME-CITY, TOKYO, JAPAN TO DAIWA GOLF CO., LTD., HIGASHIKURUMESHI, TOKYO, JAPAN:
1,208,672, CANC. INT. CL. 28.
1,208,673, CANC. INT. CL. 28.
- DALE, THERESA, MALIBU, CA:
2,000,697, CANC. INT. CL. 41.
- DALLAS AREA RAPID TRANSIT, DALLAS, TX AND FORT WORTH TRANSPORTATION AUTHORITY, FORT WORTH, TX:
2,746,497, PUB. 5-13-2003. INT. CL. 39.
- DALLAS CIGARETTE COMPANY LIMITED, BUCKINGHAMSHIRE HP21 8SZ, UNITED KINGDOM:
2,001,195, CANC. INT. CL. 34.
- DAMKOEHLER CHEMICAL & PAPER COMPANY, OCONTO, WI:
738,013, CANC. U.S. CL. 52.
738,014, CANC. U.S. CL. 52.
- DAMPSKIBSSELSKABET AF 1912, AKTIESELSKAB, 1098 COPENHAGEN K., DENMARK AND AKTIESELSKABET DAMPSKIBSSELSKABET SVENDBORG, 5700 SVENDBORG, DENMARK:
2,745,959, PUB. 5-13-2003. INT. CL. 39.
- DAN KROLL INDUSTRIES CORPORATION, CARSON CITY, NV:
1,208,906, CANC. INT. CL. 35.
- DAN-DEE INTERNATIONAL, LTD., JERSEY CITY, NJ:
2,748,053, MULTIPLE CLASS, INT. CLS. 19 AND 21.
- DANA CORPORATION, TOLEDO, OH:
2,001,525, CANC. INT. CL. 7.
- DANIELI TECHNOLOGY, INC., CRANBERRY TOWNSHIP, PA, UNITED ENGINEERING AND FOUNDRY COMPANY, PITTSBURGH, PA:
562,926, REN. 6-22-03. U.S. CL. 23 (INT. CL. 7).
- DANIELLE DESIGNS, DECATUR, GA, DBA GREAT WHITE HANDKERCHIEF CO.:
2,001,587, CANC. INT. CL. 25.
- DANTEC MEDICAL A/S, DK-2740 SKOVLUNDE, DENMARK:
2,000,746, CANC. INT. CL. 10.
- DANTZ DEVELOPMENT CORPORATION, ORINDA, CA:
1,793,472, REN. 6-23-03. INT. CL. 9.
- DART MART, INC., NEW YORK, NY:
1,208,667, CANC. INT. CL. 28.
- DATA FELLOWS OY, SF-00210 HELSINKI, FINLAND:
2,000,515, CANC. INT. CL. 9.
- DATA RETRIEVAL CORPORATION, HOUSTON, TX:
2,748,357, INT. CL. 9.
- DATACORE SOFTWARE CORPORATION, FT. LAUDERDALE, FL:
2,747,131, PUB. 5-13-2003. INT. CL. 9.
- DATAFLUX CORPORATION, CARY, NC:
2,747,116, PUB. 5-13-2003. INT. CL. 41.
- DATAPPOINT CORPORATION, SAN ANTONIO, TX:
1,209,330, CANC. INT. CL. 9.
- DATUM, INC., LEXINGTON, MA:
2,749,053, INT. CL. 9.

- DAVID J. MCGARVA, ORANGE PARK, FL:
1,714,807, CANC. INT. CL. 1.
- DAVID L. PHILLIPS, CHARLOTTE, NC, DBA CAR SITTER:
2,001,569, CANC. INT. CL. 39.
- DAVIS INSTRUMENTS, HAYWARD, CA:
1,772,257, REN. 6-24-03. INT. CL. 9.
- DAVIS, KEITH E., HAMPTON BAYS, NY:
1,730,063, REN. 6-26-03. INT. CL. 42.
- DAVIS, MITCHELL P., WASHINGTON, DC, TA BROAD-
CAST INTERVIEW SOURCE:
1,717,239, CANC. INT. CL. 16.
- DAVIS, RAYMOND E., GARLAND, TX:
2,747,957, INT. CL. 9.
- DAWN OF DAY CHILDRENS PUBLISHING CO., INC.,
LINDENHURST, NY:
2,747,839, INT. CL. 16.
- DAY AND NITE FOOD MARTS, INC., SHOREWOOD, IL:
1,209,228, CANC. INT. CL. 42.
- DAYTON HUDSON CORPORATION, MINNEAPOLIS, MN:
2,000,888, CANC. MULTIPLE CLASS, INT. CLS. 21, 30
AND 42.
- DAYTON LABORATORIES, INC., MIAMI, FL:
2,001,041, CANC. INT. CL. 5.
- DAYTON PROGRESS CORPORATION, DAYTON, OH:
2,747,278, PUB. 5-13-2003. INT. CL. 7.
- DAZZLE DONUTS, INC., NEW YORK, NY:
2,746,691, PUB. 5-13-2003. INT. CL. 35.
- DC COMICS, NEW YORK, NY:
1,715,700, CANC. INT. CL. 16.
1,715,701, CANC. INT. CL. 16.
- DC COMICS INC., NEW YORK, NY:
1,208,325, CANC. INT. CL. 16.
- DE ACERO S.A. DE C.V., 66260 GARZA GARCIA, NUEVO
LEON, MEXICO:
1,762,406, REN. 6-23-03. INT. CL. 6.
- DE BEER LAKFABRIEKEN B.V., 8243 PH LELYSTAD,
NETHERLANDS:
2,745,614, PUB. 7-23-2002. MULTIPLE CLASS, INT. CLS. 2
AND 3.
- DE BINDER, CAROLINE BRANDT, GROTON, MA:
2,747,417, PUB. 5-13-2003. INT. CL. 16.
- DE LA RUE INC, CHANTILLY, VA, BRANDT, INC.,
BENSALEM, PA:
1,777,741, REN. 6-22-03. INT. CL. 9.
- DE LOACH VINEYARDS, INC., SANTA ROSA, CA:
2,746,290, PUB. 7-30-2002. INT. CL. 33.
- DE LOS SANTOS, FEDERICO E., CHANDLER, AZ:
2,746,868, PUB. 5-13-2003. INT. CL. 3.
- DE PAOLI AMBROSI GIANFRANCO, SALO' (BRESCIA),
ITALY:
2,745,730, PUB. 5-13-2003. MULTIPLE CLASS, INT. CLS.
1, 3 AND 5.
- DE PAUL UNIVERSITY, CHICAGO, IL:
1,209,108, CANC. INT. CL. 41.
- DEALTEK, LTD., SYRACUSE, NY:
2,748,337, MULTIPLE CLASS, INT. CLS. 35 AND 42.
- DEBOW, JAY H.C., NEW YORK, NY:
2,000,915, CANC. INT. CL. 35.
- DEBRUYN PRODUCE CO., ZEELAND, MI:
1,238,674, REN. 6-25-03. INT. CL. 31.
- DECIPHER, INC., NORFOLK, VA:
2,747,673, INT. CL. 42.
- DECISION ANALYST, INC., ARLINGTON, TX:
2,747,221, PUB. 5-13-2003. INT. CL. 42.
- DECISION RESOURCES, INC., PITTSBURGH, PA:
2,746,540, PUB. 5-13-2003. INT. CL. 9.
- DECK PRODUCE COMPANY, MCALLEN, TX:
737,977, CANC. U.S. CL. 46.
- DECKER ESTATES CELLARS, LLC, SEDONA, AZ:
2,748,005, INT. CL. 33.
- DEEPOUTDOORS, INC., POWAY, CA:
2,748,966, INT. CL. 9.
2,748,967, INT. CL. 9.
2,748,968, INT. CL. 9.
2,748,969, INT. CL. 9.
- DEESSE AG, CH-8610 OETWIL AM SEE, SWITZERLAND:
2,745,431, PUB. 5-13-2003. INT. CL. 3.
- DEFENSE TECHNOLOGY CORP. OF AMERICA, CASPER,
WY, FEDERAL LABORATORIES, INC., SALTSBURG, PA:
957,550, REN. 6-23-03. U.S. CL. 9 (INT. CL. 13).
- DEFT, INCORPORATED, IRVINE, CA:
1,267,534, REN. 6-26-03. INT. CL. 2.
- DEISSGROUP, ST. HELENA, CA:
2,747,651, INT. CL. 9.
- DEJA-ACCESSOIRES GMBH, D-51427 BERGISCH GLAD-
BACH, FED REP GERMANY:
2,000,614, CANC. MULTIPLE CLASS, INT. CLS. 1, 3, 9
AND 21.
- DEL COLLO, ROBERT J., WILMINGTON, DE:
2,001,089, CANC. INT. CL. 42.
- DEL LABORATORIES, INC., FARMINGDALE, NY:
1,207,786, CANC. INT. CL. 5.
- DELABARTA, INC., WILMINGTON, DE:
2,749,056, INT. CL. 16.
- DELANEY, MAURICE, ST. JOSEPH, MO:
2,746,707, PUB. 5-13-2003. INT. CL. 35.
- DELAWARE CAPITAL FORMATION, INC., WILMINGTON,
DE:
2,749,021, INT. CL. 22.
2,749,022, INT. CL. 22.
- DELAWARE ELECTRO INDUSTRIES, INC., CHATS-
WORTH, CA, DBA FUSES UNLIMITED:
1,796,572, REN. 6-24-03. INT. CL. 42.
- DELAWARE LICENSING CORP., WILMINGTON, DE:
2,000,619, CANC. INT. CL. 42.
- DELAWARE LICENSING CORPORATION, CLAYMONT,
DE FROM TTC THOMSON HOLDING AG, CH 6300
ZUG, SWITZERLAND:
2,747,470, INT. CL. 42.
- DELL COMPUTER CORPORATION, AUSTIN, TX:
2,000,654, CANC. INT. CL. 9.
- DELLA FEMINA ENTERPRISES, INC., NEW YORK, NY:
2,747,263, PUB. 5-13-2003. INT. CL. 25.
- DELLAGNESE COMPANIES, AKRON, OH:
2,000,691, CANC. INT. CL. 42.
- DELLAR, MICHAEL D., SAN FRANCISCO, CA AND
OGDEN, BRADLEY M., SAN FRANCISCO, CA:
2,745,709, PUB. 1-22-2002. INT. CL. 42.
- DELONGHI AMERICA, INC., SADDLE BROOK, NJ:
2,748,574, MULTIPLE CLASS, INT. CLS. 7 AND 11.
- DELORME PUBLISHING COMPANY, INC., FREEPORT,
ME:
2,000,825, CANC. INT. CL. 42.
- DELTA EXPORTS (I), NEW DELHI, INDIA:
2,747,210, PUB. 5-13-2003. INT. CL. 3.
- DELTA INTERNATIONAL MACHINERY CORP., PITTS-
BURGH, PA, DELTA MANUFACTURING COMPANY,
MILWAUKEE, WI, DOING BUSINESS AS DELTA SPECI-
ALTY COMPANY:
302,012, REN. 6-25-03. U.S. CL. 26 (INT. CL. 9).
- DELTA INTERNATIONAL MACHINERY CORP., JACK-
SON, TN:
1,767,914, REN. 6-24-03. INT. CL. 7.
- DELTA STAR, INC., SAN CARLOS, CA, DELTA-STAR
ELECTRIC COMPANY, CHICAGO, IL:
158,423, REN. 6-26-03. U.S. CL. 21 (INT. CL. 9).
- DELUXE CORPORATION, ST. PAUL, MN:
2,001,859, CANC. INT. CL. 9.
- DEMAK S.R.L., 10156 TORINO, ITALY:
2,746,589, PUB. 5-13-2003. INT. CL. 7.
- DEMARAY, LINDA, ARVADA, CO:
2,747,910, MULTIPLE CLASS, INT. CLS. 16, 21, 35 AND
41.
2,747,911, MULTIPLE CLASS, INT. CLS. 16, 21, 35 AND
41.
- DEMARCO, JOSEPH, NEW YORK, NY:
2,748,442, INT. CL. 18.
- DEMARCO, PATRICIA, PALM HARBOR, FL:
2,001,797, CANC. INT. CL. 30.
- DEMMA ENTERPRISES, INC., NEW HARTFORD, NY TO
KA-LO ENTERPRISES INC., WATERTOWN, NY:
1,209,301, CANC. INT. CL. 42.
- DEMOCRATA CALCADOS E ARTEFATOS DE COURO
LTDA., SAO PAULO CEP 14405-140, BRAZIL:
2,746,486, PUB. 5-13-2003. INT. CL. 25.

- DEMPTOS GLASS CORPORATION, NAPA, CA TO DEMP-
TOS GLASS COMPANY LLC, LOUISVILLE, KY:
1,605,079, AM. INT. CL. 42.
- DENALI FLAVORS, L.L.C., HILLSDALE, MI:
2,745,468, PUB. 9-24-2002. INT. CL. 30.
- DENOIX, ELIE-ARNAUD, 19500 COLLONGES-LA-ROUGE,
FRANCE:
2,001,087, CANC. INT. CL. 33.
- DENTCO, INC., HUMACAO, PUERTO RICO:
2,748,954, INT. CL. 3.
- DENTSPLY INTERNATIONAL INC., YORK, PA:
2,748,858, INT. CL. 5.
2,748,875, INT. CL. 5.
- DENTSPLY RESEARCH & DEVELOPMENT CORP., MIL-
FORD, DE:
1,208,089, CANC. MULTIPLE CLASS, INT. CLS. 10 AND
16.
- DENVER OPTIONS, INC., DENVER, CO:
2,000,765, CANC. INT. CL. 42.
- DENVER WHOLESALE FLORISTS COMPANY, DENVER,
CO:
1,208,827, CANC. INT. CL. 31.
1,208,828, CANC. INT. CL. 31.
1,208,829, CANC. INT. CL. 31.
- DEON RAE ERICKSON, O.D., INC., BOYNTON BEACH, FL:
2,747,790, INT. CL. 35.
- DEPUY, INC., WARSAW, IN:
2,747,153, PUB. 5-13-2003. INT. CL. 10.
- DESA INTERNATIONAL INC., BOWLING GREEN, KY:
2,749,013, INT. CL. 8.
- DESERT WHALE JOJOBA COMPANY, TUCSON, AZ:
2,746,407, PUB. 5-13-2003. INT. CL. 3.
- DESIGNERS IN MOTION, INC., CORAL GABLES, FL:
2,001,966, CANC. INT. CL. 25.
- DESMOND CAGE, LYNNE, SANTA BARBARA, CA:
2,748,812, INT. CL. 16.
- DETECTIVE TOOLS CORPORATION, AUSTIN, TX:
2,001,754, CANC. INT. CL. 9.
- DETROIT STEEL PRODUCTS CO., INC., MORRISTOWN,
IN:
2,747,638, INT. CL. 12.
- DEUTER SPORT UND LEDER GMBH, 8900 AUGSBURG 31,
FED REP GERMANY:
2,000,500, CANC. INT. CL. 18.
- DEUTSCHE MESSE AG, D-30521 HANNOVER, FED REP
GERMANY:
2,746,226, PUB. 5-13-2003. INT. CL. 16.
- DEUTSCHE TELEKOM AG, D-53175 BONN, FED REP
GERMANY:
2,745,418, PUB. 7-17-2001. MULTIPLE CLASS, INT. CLS.
9, 14, 16, 18, 25, 28, 36, 37, 38, 41 AND 42.
- DEVELOPLUS, INC., CORONA, CA:
2,747,329, PUB. 5-13-2003. INT. CL. 3.
- DEVELOPMENTAL NATURAL RESOURCES, INC., INDIA-
NAPOLIS, IN:
1,807,015, REN. 6-23-03. INT. CL. 5.
- DEVILBISS HEALTH CARE, INC., SOMERSET, PA:
2,001,124, CANC. INT. CL. 10.
- DEVLIN DESIGN GROUP, INC., SAN DIEGO, CA:
2,747,467, INT. CL. 42.
- DEVOR NURSERIES, INC., WATSONVILLE, CA:
1,716,249, CANC. INT. CL. 31.
- DEXM CORPORATION, WAUKESHA, WI:
2,747,999, INT. CL. 40.
- DFREEDOMZONE, INC., SAN FRANCISCO, CA:
2,748,058, MULTIPLE CLASS, INT. CLS. 9 AND 42.
- DFS GROUP L.P., SAN FRANCISCO, CA:
2,747,926, INT. CL. 30.
- DHARMA HOLDINGS LTD., SEATTLE, WA, DBA RAISING
MORE MONEY:
2,749,009, MULTIPLE CLASS, INT. CLS. 9 AND 16.
- DI AUGUSTINE, ANGELA, PHILADELPHIA, PA:
2,747,599, INT. CL. 3.
- DI-MUONT, CARLO, MIAMI, FL:
2,001,608, CANC. INT. CL. 42.
- DIAL BRANDS, INC., SCOTTSDALE, AZ:
2,748,882, INT. CL. 4.
2,748,883, INT. CL. 4.
- DIAL CORP, THE, PHOENIX, AZ:
2,001,311, CANC. INT. CL. 3.
- DIALIGHT CORPORATION, MANASQUAN, NJ:
1,783,248, REN. 6-25-03. INT. CL. 9.
- DIALOGIC COMMUNICATIONS CORPORATION, FRANK-
LIN, TN:
2,746,215, PUB. 5-13-2003. INT. CL. 42.
- DIAMOND BEAR BREWING COMPANY, LITTLE ROCK,
AR:
2,745,711, PUB. 5-13-2003. MULTIPLE CLASS, INT. CLS.
21, 25 AND 32.
- DIATOMIC STUDIOS CORPORATION, BREMERTON, WA:
2,748,887, MULTIPLE CLASS, INT. CLS. 39, 40, 41 AND
42.
- DIAZ, MARY ELLEN, CHICAGO, IL:
2,746,866, PUB. 5-13-2003. INT. CL. 43.
- DICAPO FOODS LLC, KANSAS CITY, MO:
2,748,702, INT. CL. 42.
- DICKINSON RETAILING CO., DENVER, CO:
2,001,933, CANC. INT. CL. 25.
- DIDIMARS, INC., NEW HOPE, PA:
2,746,351, PUB. 5-13-2003. INT. CL. 3.
- DIEBOLD GOLDRING TOOLING LLC, SHARON, WI:
2,745,641, PUB. 5-14-2002. INT. CL. 7.
- DIEBOLD, INCORPORATED, NORTH CANTON, OH:
2,747,191, PUB. 5-13-2003. INT. CL. 9.
- DIECRAFT CORPORATION, JAMAICA, NY:
737,861, CANC. U.S. CL. 26.
- DIEGO RALLO & FIGLI, MARSALA, ITALY:
738,050, CANC. U.S. CL. 47.
- DIESEL S.P.A., 36060 MOLVENA, PROVINCE OF VICENZA,
ITALY:
2,745,550, PUB. 10-8-2002. MULTIPLE CLASS, INT. CLS.
3, 9, 14, 18, 25 AND 35.
- DIETFIT, INC., ALEXANDRIA, VA FROM DIETDESIGN-
COM, INC, ALEXANDRIA, VA:
2,747,853, INT. CL. 42.
- DIETITIAN'S WEIGHT CONTROL PROGRAM, SUISUN,
CA:
1,716,742, CANC. INT. CL. 42.
- DIGITAL ADCO, INC., NEW YORK, NY:
2,747,747, INT. CL. 35.
- DIGITAL INSIGHT CORPORATION, CALABASAS, CA:
2,745,537, PUB. 12-17-2002. INT. CL. 9.
- DIGITRAX, INC., NORCROSS, GA:
2,746,894, PUB. 5-13-2003. INT. CL. 28.
- DILLARD'S, INC., LITTLE ROCK, AR:
1,715,956, CANC. INT. CL. 25.
- DILLY'S, INC., BEVERLY HILLS, MI:
1,778,213, REN. 6-23-03. INT. CL. 42.
- DISALVO, JOYCE, BETHLEHEM, PA:
2,001,403, CANC. INT. CL. 41.
- DISC MARKETING, INC., PASADENA, CA:
2,748,339, INT. CL. 41.
- DISCOVERY COMMUNICATIONS, INC., BETHESDA, MD:
2,746,824, PUB. 5-13-2003. MULTIPLE CLASS, INT. CLS. 9
AND 41.
- DISETRONIC LICENSING AG, CH-3401 BURG DORF, SWIT-
ZERLAND:
2,745,984, PUB. 6-18-2002. MULTIPLE CLASS, INT. CLS.
9, 10 AND 42.
- DISNEY ENTERPRISES, INC., BURBANK, CA:
2,748,231, INT. CL. 38.
- DISOP, S.A., 28108 ALCOBENDAS (MADRID), SPAIN:
2,748,358, INT. CL. 24.
- DISPLAY INDUSTRIES, LLC., MARIETTA, GA:
2,746,865, PUB. 5-13-2003. INT. CL. 35.
- DISTILLERIE STOCK U.S.A., LTD., WOODSIDE, NY:
1,208,848, CANC. INT. CL. 33.
- DISTILLERS CORPORATION LIMITED, STELLENBOSCH,
SOUTH AFRICA:
2,745,981, PUB. 2-4-2003. INT. CL. 33.
- DISTRIBUTORCENTRAL L.L.C., GARDNER, KS:
2,746,786, PUB. 5-13-2003. INT. CL. 35.
- DITTMANN, TITUS E., D-48157 MUNSTER, FED REP
GERMANY:
2,648,014, COR. MULTIPLE CLASS, INT. CLS. 9, 18, 20, 25
AND 26.

- DIVERSIFIED PHARMACEUTICAL SERVICES, INC., EDINA, MN:
2,001,657, CANC. INT. CL. 35.
2,001,658, CANC. INT. CL. 35.
- DIVERSINET CORP., TORONTO, ONTARIO M2J 5C2, CANADA:
2,747,536, INT. CL. 9.
- DIZOGIO, FRANK P., III, JAMESTOWN, RI:
2,747,391, PUB. 5-13-2003. MULTIPLE CLASS, INT. CLS. 16 AND 21.
- DJ CONSULTANTS, INC., NORCROSS, GA:
2,745,571, PUB. 9-24-2002. MULTIPLE CLASS, INT. CLS. 9 AND 18.
- DJF ENTERPRISES, CULVER CITY, CA:
2,747,457, INT. CL. 25.
- DLC ENTERPRISES, INC., PARAMOUNT, CA, KESSARIS, SPERO, RANCHO PALOS VERDES, CA AND KESSARIS, CARMEN F., RANCHO PALOS VERDES, CA:
1,771,062, REN. 6-23-03, INT. CL. 5.
- DLOG REMEX, INC., ROLLING MEADOWS, IL:
2,000,876, CANC. INT. CL. 35.
- DO IT BEST CORP., FORT WAYNE, IN, HARDWARE WHOLESALEERS, INC., FORT WAYNE, IN:
1,791,284, REN. 6-27-03, INT. CL. 6.
- DOCK PRODUCTS CANADA INC., LONDON, ONTARIO N6M 1A3, CANADA:
2,746,449, PUB. 5-13-2003, INT. CL. 7.
2,746,450, PUB. 5-13-2003, INT. CL. 7.
- DODSON'S MFG. CO., SOUTH SAN GABRIEL, CA:
1,208,175, CANC. INT. CL. 15.
- DOLAN MEDIA COMPANY, MINNEAPOLIS, MN:
2,745,635, PUB. 5-13-2003, INT. CL. 16.
- DOLLS DELIGHT, INC., ALEXANDRIA, VA:
1,716,037, CANC. INT. CL. 28.
- DOLMAR NORTH AMERICAN CORPORATION, MONROVIA, CA TO DOLMAR GMBH, 2000 HAMBURG 70, FED REP GERMANY:
952,963, CANC. MULTIPLE CLASS, U.S. CLS. 2, 13 AND 15.
- DOLPHIN ACQUISITION CORPORATION, SAN FRANCISCO, CA:
2,745,500, PUB. 12-24-2002, INT. CL. 3.
- DOMINI SOCIAL INVESTMENTS LLC, NEW YORK, NY:
2,747,567, INT. CL. 36.
- DOMINION SURVEYORS, INC., ALEXANDRIA, VA:
2,746,717, PUB. 5-13-2003, INT. CL. 42.
- DOMINO PRINTING SCIENCES, PLC, CAMBRIDGE, ENGLAND:
1,715,265, CANC. INT. CL. 9.
- DON HOWARD/PERSONNEL, INC., NEW YORK, NY:
1,208,905, CANC. INT. CL. 35.
- DON JAMES, INC., MARIETTA, GA:
2,748,514, INT. CL. 3.
- DON JUAN SPORTSWEAR, INC., NEW YORK, NY:
737,943, CANC. U.S. CL. 39.
- DON MIGUEL MEXICAN FOODS, INC., ANAHEIM, CA:
2,745,516, PUB. 8-29-2000, INT. CL. 30.
- DON ROBERTO JEWELERS, INC., SAN CLEMENTE, CA:
1,730,124, REN. 6-22-03, INT. CL. 42.
- DONALD BROWN (BROWNALL) LIMITED, MANCHESTER M16 9AR, UNITED KINGDOM:
2,000,815, CANC. INT. CL. 2.
- DONATI & STEIN PARTNERSHIP, SANTA BARBARA, CA:
2,749,048, INT. CL. 41.
- DONUT VILLAGE, INC., GUILFORD, CT:
1,716,889, CANC. INT. CL. 42.
- DOOSAN CORPORATION, YOUNGDEUNGPO-KU, SEOUL, REPUBLIC OF KOREA:
2,745,998, PUB. 1-14-2003, INT. CL. 33.
- DOTS, INC., SOLON, OH:
2,748,444, INT. CL. 14.
- DOUBLECLICK INC., NEW YORK, NY:
2,746,086, PUB. 5-13-2003, INT. CL. 9.
- DOUGLASS INDUSTRIES, INC., EGG HARBOR CITY, NJ:
1,715,883, CANC. INT. CL. 24.
- DOUTHIT, HAROLD K., SANDUSKY, OH:
2,000,594, CANC. INT. CL. 9.
- DOVER DOWNS ENTERTAINMENT, INC., WILMINGTON, DE:
2,749,020, INT. CL. 41.
- DOW CONSUMER PRODUCTS INC., GREENVILLE, SC:
1,207,740, CANC. INT. CL. 3.
- DR. KENNETH J. MANGES & ASSOCIATES, INC., CINCINNATI, OH:
2,748,796, INT. CL. 16.
- DR. LARSON'S TEAT TUBE COMPANY, SPRING VALLEY, WI:
1,765,524, REN. 6-25-03, INT. CL. 5.
- DR. PEITHNER KG NUNMEHR GMBH & CO, A-1232 VIENNA, AUSTRIA:
2,746,585, PUB. 5-13-2003, INT. CL. 5.
- DR. RESTORATION, LLC, INDIANAPOLIS, IN:
2,747,346, PUB. 5-13-2003, INT. CL. 37.
- DR. TH. BOHME KG CHEM. FABRIK GMBH & CO., GERETSRIED 1, FED REP GERMANY:
1,207,702, CANC. MULTIPLE CLASS, INT. CLS. 1 AND 4.
- DRAGER SAFETY AG & CO. KGAA, D-23560 LUBECK, FED REP GERMANY FROM DRAGER SICHERHEITSTECHNIK GMBH, D-23560 LUBECK, FED REP GERMANY:
2,745,786, PUB. 10-29-2002. MULTIPLE CLASS, INT. CLS. 5 AND 10.
- DRAGER SICHERHEITSTECHNIK GMBH:
See— DRAGER SAFETY AG & CO. KGAA.
- DRAGON SYSTEMS, INC., NEWTON, MA TO SCANSOFT, INC., PEABODY, MA:
1,769,822, AM. INT. CL. 9.
- DRAKE, DAVID, PROVIDENCE, RI:
1,772,001, REN. 6-26-03, INT. CL. 42.
- DREAM STAGE ENTERTAINMENT, INC., TOKYO, JAPAN:
2,747,897, INT. CL. 9.
- DREAMWELL, LTD., LAS VEGAS, NV:
2,747,012, PUB. 5-13-2003, INT. CL. 20.
- DREAMWORKS L.L.C., UNIVERSAL CITY, CA:
2,748,529, INT. CL. 28.
- DREXEL HERITAGE FURNISHINGS INC., DREXEL, NC:
2,748,000, INT. CL. 20.
- DREYFUS SERVICE CORPORATION, NEW YORK, NY:
2,745,842, PUB. 12-3-2002. MULTIPLE CLASS, INT. CLS. 16 AND 36.
- DRIPLESS, INC., SANTA ROSA, CA:
2,746,359, PUB. 5-13-2003, INT. CL. 8.
- DRIVERMILL, LLC, ATLANTA, GA:
2,748,670, INT. CL. 9.
- DRM TECHNOLOGIES, INC., STERLING HEIGHTS, MI:
2,745,648, PUB. 9-17-2002. MULTIPLE CLASS, INT. CLS. 9 AND 42.
- DROSTDY WINES LIMITED, STELLENBOSCH, SOUTH AFRICA:
2,745,982, PUB. 2-18-2003, INT. CL. 33.
- DRUG HOUSES OF AUSTRALIA (OVERSEAS) LTD., CENTRAL DISTRICT, HONG KONG:
2,746,519, PUB. 5-13-2003, INT. CL. 30.
- DSA FILM FONT CORPORATION, NEW YORK, NY:
1,209,078, CANC. INT. CL. 40.
- DSM N.V., 6411 TE HEERLEN, NETHERLANDS:
2,746,234, PUB. 5-13-2003. MULTIPLE CLASS, INT. CLS. 1 AND 31.
- DSP TECHNOLOGY, INC., FREMONT, CA:
2,001,556, CANC. INT. CL. 42.
- DUAL-LITE INC., CHESHIRE, CT:
2,748,348, INT. CL. 9.
- DUARTE, ALEX, HON., HI:
2,001,693, CANC. INT. CL. 5.
- DUBY, DEBRA, NEW YORK, NY:
2,747,345, PUB. 5-13-2003. MULTIPLE CLASS, INT. CLS. 41 AND 44.
- DUET G.P., NEW YORK, NY:
2,746,404, PUB. 5-13-2003, INT. CL. 9.
- DUN & BRADSTREET CORPORATION FOUNDATION, THE, NEW YORK, NY:
2,001,606, CANC. INT. CL. 35.
- DUN & BRADSTREET CORPORATION, THE, NEW YORK, NY:
1,208,195, CANC. INT. CL. 16.

- DUNCANSON & HOLT, INC., NEW YORK, NY:
1,716,473, CANC. INT. CL. 36.
- DUNGAREES U.S.A., INC., MONTREAL QUEBEC, CANADA:
2,749,017, INT. CL. 25.
2,749,018, INT. CL. 25.
- DUNKIN' DONUTS USA, INC., DETROIT, MI:
2,747,378, PUB. 5-13-2003. INT. CL. 30.
2,748,147, MULTIPLE CLASS, INT. CLS. 29, 30, 32 AND 43.
- DURA*KOLD CORPORATION, OKLAHOMA CITY, OK:
2,001,164, CANC. INT. CL. 10.
- DURAMAX, INC., MIDDLEFIELD, OH:
2,748,230, INT. CL. 19.
- DURAND TECHNOLOGY LIMITED, ENGLAND, UNITED KINGDOM:
2,746,164, PUB. 12-17-2002. MULTIPLE CLASS, INT. CLS. 1, 9 AND 17.
- DURO-LAST, INC., SAGINAW, MI:
2,748,559, INT. CL. 19.
- DURON, INC., BELTSVILLE, MD:
1,207,726, CANC. INT. CL. 2.
2,745,583, PUB. 5-21-2002. MULTIPLE CLASS, INT. CLS. 2, 16, 17 AND 35.
- DURST CORPORATION, INC., MOUNTAINSIDE, NJ:
963,364, REN. 6-24-03. U.S. CL. 13 (INT. CL. 7).
- DURVET, INC., BLUE SPRINGS, MO:
1,207,806, CANC. INT. CL. 5.
- DV INTERNATIONAL, INC., ST. PAUL, MN:
2,748,289, INT. CL. 21.
- DW PARTNERS, INC., TULSA, OK:
2,001,135, CANC. INT. CL. 25.
- DWIGHT'S ENERGYDATA, INC., RICHARDSON, TX:
2,001,521, CANC. INT. CL. 42.
- DYG HOLDINGS, INC., DANBURY, CT:
2,746,597, PUB. 5-13-2003. MULTIPLE CLASS, INT. CLS. 9 AND 16.
- DYNACRAFT INDUSTRIES, INC., SAN RAFAEL, CA:
2,747,896, INT. CL. 12.
- DYNAMIC LIFE, INC., LARGO, FL:
2,748,136, INT. CL. 5.
- DYNAMIC MARKETING SERVICES, INC., HOUSTON, TX:
2,001,545, CANC. INT. CL. 35.
- DYNAMIC NETWORKS USA, INC., WEST LOS ANGELES, CA:
2,745,895, PUB. 5-13-2003. INT. CL. 41.
- DYNAMIT NOBEL GMBH EXPLOSIVSTOFF-UND SYSTEMTECHNIK, TROISDORF 53839, FED REP GERMANY:
2,746,365, PUB. 5-13-2003. INT. CL. 13.
- DYNAMIT NOBEL GMBH EXPLOSIVSTOFF-UND SYSTEMTECHNIK, TROISDORF, FED REP GERMANY:
2,746,367, PUB. 5-13-2003. INT. CL. 13.
- DYNASTY CONSOLIDATED INDUSTRIES, INC., DALLAS, TX:
2,747,307, PUB. 5-13-2003. INT. CL. 20.
- E. EXCEL INTERNATIONAL, INC., SPRINGVILLE, UT:
2,745,427, PUB. 12-3-2002. INT. CL. 5.
- E. I. L. INSTRUMENTS, INC., SPARKS, MD:
1,207,943, CANC. INT. CL. 9.
- E. R. SQUIBB & SONS, INC., PRINCETON, NJ:
1,208,082, CANC. INT. CL. 10.
2,001,284, CANC. INT. CL. 5.
- E. W. KNAUSS & SON, INC., QUAKERTOWN, PA:
2,000,989, CANC. INT. CL. 29.
- E.S. ORIGINALS INC., NEW YORK, NY:
1,244,593, REN. 6-24-03. INT. CL. 25.
- E.S. ORIGINALS, INC., NEW YORK, NY:
2,747,725, INT. CL. 25.
2,748,414, INT. CL. 25.
- E.T. BROWNE DRUG CO., INC., ENGLEWOOD CLIFFS, NJ:
2,748,197, INT. CL. 3.
- E-TRAFFIC, INC., MOUNTAIN VIEW, CA:
2,747,772, MULTIPLE CLASS, INT. CLS. 9 AND 42.
- EAC CORPORATION, ST. LOUIS, MO:
1,715,829, CANC. INT. CL. 20.
- EAMHARDT, R. DALE, MOORESVILLE, NC TO EAMHARDT, R. DALE, MOORESVILLE, NC:
2,673,723, COR. MULTIPLE CLASS, INT. CLS. 5, 6, 8, 9, 11, 12, 14, 16, 18, 20, 21, 24, 25, 26, 27, 28, 30 AND 41.
- EARL'S ORGANIC PRODUCE, INC., SAN FRANCISCO, CA:
2,747,244, PUB. 5-13-2003. INT. CL. 31.
- EARNHARDT, R. DALE, MOORESVILLE, NC TO EARNHARDT, R. DALE, MOORESVILLE, NC:
2,673,722, COR. MULTIPLE CLASS, INT. CLS. 5, 6, 8, 9, 11, 12, 14, 16, 18, 20, 21, 24, 25, 26, 27, 28, 30 AND 41.
- EARTH CHEM, INC., FORT COLLINS, CO:
2,747,352, PUB. 5-13-2003. INT. CL. 1.
- EAS TECHNOLOGIES, INC., LOUISVILLE, KY:
2,001,765, CANC. INT. CL. 9.
- EASTERN NATIONAL, CONSHOHOCKEN, PA:
2,747,483, INT. CL. 42.
- EASTERN WAY, LTD, THE, TUCSON, AZ:
2,747,101, PUB. 5-13-2003. INT. CL. 36.
- EASTMAN CHEMICAL COMPANY, KINGSPORT, TN:
2,748,915, INT. CL. 40.
- EASTMAN OUTDOORS, INC., FLUSHING, MI:
2,748,335, MULTIPLE CLASS, INT. CLS. 8, 21 AND 30.
- EASTMAN, HAROLD S., BOISE, ID:
2,748,312, INT. CL. 16.
- EASTWOOD, CLINT, TEHAMA, CA:
2,747,687, INT. CL. 25.
- EASY PICKINS, INC., NEW YORK, NY:
1,741,427, REN. 6-23-03. INT. CL. 25.
- EASYWARE HOUSEHOLD CORP., TAIPEI 106, TAIWAN:
2,746,580, PUB. 5-13-2003. INT. CL. 2.
- EBAA IRON INC., EASTLAND, TX:
1,807,041, REN. 6-27-03. INT. CL. 6.
- EBAN HOLDINGS (HONG KONG) LIMITED, CENTRAL, HONG KONG, CHINA:
2,745,878, PUB. 5-13-2003. INT. CL. 35.
- EBRO PULEVA, S.A., 28001 MADRID, SPAIN:
2,745,976, PUB. 5-13-2003. INT. CL. 29.
- EBSCO INDUSTRIES, INC., BIRMINGHAM, AL:
2,747,276, PUB. 5-13-2003. INT. CL. 16.
- EBSCO INDUSTRIES, INC., LEEDS, AL:
2,748,990, INT. CL. 28.
- ECKART AMERICA L.P., PAINESVILLE, OH:
2,746,994, PUB. 5-13-2003. INT. CL. 2.
- ECKENFELDER INC., NASHVILLE, TN TO BROWN AND CALDWELL, PLEASANT HILL, CA:
1,716,749, CANC. INT. CL. 42.
- ECLIPSE CONSULTING GROUP, INC., INDIANAPOLIS, IN:
2,001,637, CANC. INT. CL. 35.
- ECO SOIL SYSTEMS, INC.:
See— SIMPLOT TURF AND HORTICULTURE, A DIVISION OF J.R. SIMPLOT COMPANY.
- ECO-RIGHT, L.L.C., CAIRO, GA:
2,747,886, INT. CL. 5.
- ECO-TEC LIMITED, PICKERING, ONTARIO, CANADA:
1,715,082, CANC. INT. CL. 9.
- ECOLAB INC.:
1,209,000, CANC. INT. CL. 37.
- ECOLAB INC., ST. PAUL, MN:
2,747,362, PUB. 5-13-2003. INT. CL. 3.
- ECOMON COOKER INDUSTRIES LTD., TAIPEI, TAIWAN:
2,001,024, CANC. INT. CL. 21.
- ECOSMART TECHNOLOGIES, INC., FRANKLIN, TN:
2,747,713, MULTIPLE CLASS, INT. CLS. 1 AND 5.
2,747,714, MULTIPLE CLASS, INT. CLS. 1, 5 AND 42.
2,747,860, MULTIPLE CLASS, INT. CLS. 1, 5 AND 42.
- ECS HOLDINGS, INC., WILMINGTON, DE:
2,748,001, INT. CL. 36.
- ED TAR ASSOCIATES, INC., VENICE, CA:
1,209,131, CANC. INT. CL. 41.
- EDAPTING SOLUTIONS, L.L.C., MERIDAN, ID:
2,745,831, PUB. 9-11-2001. INT. CL. 9.
- EDCO PRODUCTS, INCORPORATED, HOPKINS, MN:
1,207,851, CANC. INT. CL. 6.
- EDEN FOUNDATION, SAN GABRIEL, CA:
2,746,083, PUB. 5-13-2003. INT. CL. 42.
- EDEN SPRING HERBS, SAN FRANCISCO, CA:
2,747,192, PUB. 5-13-2003. INT. CL. 5.

EDERIVATIVE.COM, INC., CHIYODA-KU, TOKYO, JAPAN:
2,745,775, PUB. 10-22-2002. INT. CL. 36.

EDITORA ULTIMA HORA, C. POR A., SANTO DOMINGO, APARTADO 1455, DOMINICAN REP:
2,746,047, PUB. 5-13-2003. INT. CL. 16.

EDITRICE ABITARE SEGESTA S.P.A., 20122 MILANO, ITALY:
2,746,049, PUB. 5-13-2003. INT. CL. 16.

EDLIFE HOLDINGS LTD., HAMILTON, BERMUDA FROM EDLIFE, INC., STUDIO CITY, CA:
2,747,582, MULTIPLE CLASS, INT. CLS. 36 AND 42.

EDMONTON INVESTORS GROUP LIMITED PARTNERSHIP, EDMONTON, ALBERTA T5G 3H7, CANADA:
2,747,970, INT. CL. 25.

EDU-ROM, INC., MELVILLE, NY:
2,001,070, CANC. INT. CL. 35.

EDUCATIONAL FUND TO STOP GUN VIOLENCE, THE, WASHINGTON, DC:
2,748,585, INT. CL. 41.

EDUCATIONAL SERVICE PROVIDERS INC., EDMONDS, WA:
1,715,691, CANC. INT. CL. 16.

EDUTECH LTD., SILVER SPRING, MD:
2,746,393, PUB. 5-13-2003. MULTIPLE CLASS, INT. CLS. 9, 16 AND 41.

EDWARD LOWE FOUNDATION, CASSOPOLIS, MI:
2,748,294, INT. CL. 16.

EDWARD S. GORDON COMPANY, NEW YORK, NY:
2,000,987, CANC. INT. CL. 36.

EDWARDS LIFESCIENCES CORPORATION, IRVINE, CA, AMERICAN HOSPITAL SUPPLY CORPORATION, EVANSTON, IL:
1,236,160, REN. 6-27-03. INT. CL. 10.

EDWARDS SYSTEMS TECHNOLOGY, INC., CHESHIRE, CT:
2,746,617, PUB. 5-13-2003. INT. CL. 9.

EEL LABORATORIES, LLC, STONY BROOK, NY:
2,747,062, PUB. 5-13-2003. INT. CL. 9.

EFCO, INC., ERIE, PA:
1,715,046, CANC. INT. CL. 7.

EFCO, INCORPORATED, ERIE, PA, DBA ERIE PRESS SYSTEMS:
2,001,982, CANC. INT. CL. 7.

EFFICIENT LABORATORIES, INC., SAN JUAN, PUERTO RICO:
1,714,944, CANC. INT. CL. 5.

EGENERA, INC., MARLBOROUGH, MA:
2,748,042, INT. CL. 9.

EHV WEIDMANN INDUSTRIES, INC., ST. JOHNSBURY, VT:
1,208,340, CANC. INT. CL. 17.

EINSTEIN MEDICAL, INC., LA JOLLA, CA:
2,745,461, PUB. 12-25-2001. INT. CL. 42.

EISEN, ARMAND, FAIRFIELD, CT, DBA ARIEL BOOKS:
2,745,950, PUB. 5-13-2003. INT. CL. 16.

EKLUND, G.W., BELLEVUE, WA:
2,747,682, INT. CL. 9.

EL TORITO RESTAURANTS, INC., IRVINE, CA:
1,716,911, CANC. INT. CL. 42.

ELAN CORPORATION, PLC, COUNTY WESTMEATH, IRELAND:
2,000,522, CANC. INT. CL. 5.

ELDERWOOD AFFILIATES, INC., WILLIAMSVILLE, NY:
2,001,247, CANC. INT. CL. 35.

ELECTRO CORPORATION, SARASOTA, FL:
1,207,947, CANC. INT. CL. 9.

ELECTROMED TECHNOLOGIES LLC, CHICAGO, IL FROM ELECTROMED TECHNOLOGIES, INC., CHICAGO, IL:
2,748,504, MULTIPLE CLASS, INT. CLS. 14 AND 16.

ELECTRONIC DATA SYSTEMS CORPORATION, PLANO, TX:
2,747,697, INT. CL. 9.

ELECTROSTIM MEDICAL SERVICES, INC., TAMPA, FL, DBA EMSI CORPORATION:
2,747,344, PUB. 5-13-2003. INT. CL. 10.

ELEGANCE CORPORATION, CITY OF INDUSTRY, CA:
2,747,384, PUB. 5-13-2003. INT. CL. 35.

ELITE COMPUTER CONSULTANTS CORP., KANSAS CITY, MO:
2,745,586, PUB. 10-8-2002. INT. CL. 35.

ELITE INTERNATIONAL, INC., BROOKLYN, NY:
2,747,979, INT. CL. 20.

ELITE LABORATORIES, INC., NORTHVALE, NJ:
1,779,366, REN. 6-24-03. INT. CL. 42.

ELITE PHYSICIAN SERVICES, LLC, CHATTANOOGA, TN:
2,746,560, PUB. 5-13-2003. INT. CL. 36.

ELIZABETH ARDEN SALON HOLDINGS, INC., PHOENIX, AZ:
2,747,766, MULTIPLE CLASS, INT. CLS. 3 AND 4.

ELIZABETH GRADY FACE FIRST, INC., MEDFORD, MA:
2,747,856, MULTIPLE CLASS, INT. CLS. 10 AND 11.

ELIZABETH PUGLIESE AND VICTOR PUGLIESE PARTNERSHIP, THE, WINDSOR, CT:
1,785,617, REN. 6-24-03. INT. CL. 25.

ELKIN COFFEE, INC., CONCORD, NH TO BROTHERS GOURMET COFFEES, INC., BOCO RATON, FL:
1,716,212, CANC. INT. CL. 30.

ELLIOTT ENERGY SYSTEMS, INC., STUART, FL:
2,748,423, INT. CL. 7.

ELLIPSIS COMMUNICATIONS, LLC, MOORESTOWN, NJ:
2,748,411, MULTIPLE CLASS, INT. CLS. 35 AND 42.

ELLIS ENTERPRISES, INC., OKLAHOMA CITY, OK:
2,748,768, INT. CL. 9.
2,748,770, INT. CL. 9.
2,748,771, INT. CL. 9.

ELMAG S.P.A., 20052 MONZA, MILAN, ITALY:
2,619,752, COR. MULTIPLE CLASS, INT. CLS. 7 AND 11.

ELVETIA ENGINEERING S.P.A., 20122 MILAN, ITALY:
2,745,626, PUB. 7-16-2002. MULTIPLE CLASS, INT. CLS. 36, 37, 39 AND 42.

EMANUEL UNGARO, 75008 PARIS, FRANCE, SOCIETE EMANUEL UNGARO, 75008 PARIS, FRANCE:
1,759,963, REN. 6-25-03. INT. CL. 25.

EMAP PLC., CAMBRIDSESHIRE PE1 2RF, UNITED KINGDOM:
2,745,528, PUB. 5-21-2002. MULTIPLE CLASS, INT. CLS. 9, 35, 38, 41 AND 42.

EMB SOFTWARE LIMITED, EPSOM, SURREY KT17 1HP, UNITED KINGDOM:
2,703,966, COR. MULTIPLE CLASS, INT. CLS. 9 AND 41.

EMCO, INC., VAN NUYS, CA:
2,746,005, PUB. 5-13-2003. INT. CL. 9.

EME HOLDING COMPANY, LLC, SALT LAKE CITY, UT:
2,747,905, INT. CL. 20.

EMERACHEM LLC, KNOXVILLE, TN:
2,748,263, MULTIPLE CLASS, INT. CLS. 1, 7 AND 40.

EMERALD HILLS COFFEE INC., MUKILTEO, WA:
2,748,567, INT. CL. 30.

EMERSON ELECTRIC CANADA LIMITED, MARKHAM, ONTARIO, CANADA:
2,000,734, CANC. INT. CL. 16.

EMHART INDUSTRIES, INC., CLEVELAND, OH:
1,208,621, CANC. INT. CL. 28.

EMIGRANT MORTGAGE COMPANY INC., NEW YORK, NY:
2,748,995, INT. CL. 36.

EMMANUEL FOUNDATION, MORRISTOWN, NJ:
2,746,302, PUB. 5-13-2003. INT. CL. 41.

EMMERLING COMMUNICATIONS LLC, NEW YORK, NY:
2,746,684, PUB. 5-13-2003. INT. CL. 35.

EMMERON, INC., PACIFIC PALISADES, CA:
2,746,468, PUB. 5-13-2003. INT. CL. 35.

EMPACADORA TOLEDO, S.A., COLONIA LOS CEDROS, GUATEMALA:
2,746,070, PUB. 1-21-2003. INT. CL. 29.

EMPIRE ENTERPRISES, INC., SHELBYVILLE, TN:
738,039, CANC. U.S. CL. 37.

EMPIRE INDUSTRIES, INC., DELRAY BEACH, FL:
1,717,145, CANC. INT. CL. 28.

EMPLOYEE BENEFITS CORPORATION, MIDDLETON, WI:
2,747,161, PUB. 10-22-2002. INT. CL. 36.

- EMPLOYERS MUTUAL CASUALTY COMPANY, DES MOINES, IA:
2,747,124, PUB. 5-13-2003. INT. CL. 36.
- EMS MEDICAL VERTRIEBS-UND FORSCHUNGSGESELLSCHAFT MBH, D-78462, KONSTANZ, FED REP GERMANY:
2,745,884, PUB. 5-13-2003. INT. CL. 10.
- EMSCO INC., GIRARD, PA:
2,746,610, PUB. 5-13-2003. INT. CL. 28.
- EMWARE, INC., SALT LAKE CITY, UT:
2,747,580, INT. CL. 9.
2,748,676, MULTIPLE CLASS, INT. CLS. 9 AND 42.
- ENCOMPASS SERVICES CORPORATION, HOUSTON, TX:
2,748,613, INT. CL. 37.
- ENCON SAFETY PRODUCTS, INC., HOUSTON, TX:
2,746,630, PUB. 5-13-2003. INT. CL. 9.
2,746,633, PUB. 5-13-2003. INT. CL. 9.
- ENCORE MEDICAL ASSET CORPORATION, AUSTIN, TX, CHATTANOOGA CORPORATION, HIXSON, TN:
1,767,341, REN. 6-24-03. INT. CL. 10.
- ENDURANCE SPORTS, INC., YARDLEY, PA:
2,745,836, PUB. 5-13-2003. INT. CL. 35.
- ENERCOM, INC., DENVER, CO:
2,747,208, PUB. 5-13-2003. INT. CL. 41.
- ENERGUS INTERNATIONAL, INC., HOUSTON, TX:
2,746,120, PUB. 12-3-2002. INT. CL. 30.
- ENERGY ABSORPTION SYSTEMS, INC., CHICAGO, IL:
1,766,660, REN. 6-22-03. INT. CL. 12.
1,800,112, REN. 6-22-03. INT. CL. 19.
- ENERGY SAVERS UNLIMITED, INC., CARSON, CA:
2,747,289, PUB. 5-13-2003. INT. CL. 9.
- ENGINEERED FLUID, INC., CENTRALIA, IL:
2,748,210, INT. CL. 7.
- ENGINEERED INTELLIGENCE CORPORATION, FORT COLLINS, CO:
2,747,200, PUB. 4-29-2003. INT. CL. 41.
- ENGINEERED PRODUCTS, INC., SEATTLE, WA, EASY UP SHELVING, INC., SEATTLE, WA, DBA EASY UP SHELVING, CO.:
1,219,538, REN. 6-24-03. INT. CL. 20.
- ENGLISH ACCENTS, ALLINDALE, NJ TO MERCHANT, JOANNE H., PALOS VERDES ESTATES, CA AND CALKINS, GLENDA J., ALLENDALE, NJ:
1,209,236, CANC. INT. CL. 42.
- ENIDINE INCORPORATED, ORCHARD PARK, NY:
1,715,005, CANC. INT. CL. 6.
- ENSLOW PUBLISHERS, INC., BERKELEY HEIGHTS, NJ:
2,746,648, PUB. 5-13-2003. MULTIPLE CLASS, INT. CLS. 16 AND 41.
- ENSOFTEC, INC., ROCKVILLE, MD:
2,748,683, INT. CL. 9.
- ENTENMANN'S, INC., BAY SHORE, NY:
1,716,183, CANC. INT. CL. 30.
- ENTERPRISE EVENTS GROUP, INC., SAN RAFAEL, CA:
2,746,154, PUB. 5-13-2003. INT. CL. 35.
- ENTERTAINMENT DECISIONS, INC., EVANSTON, IL:
2,747,743, MULTIPLE CLASS, INT. CLS. 9 AND 41.
- ENTRA COMPUTER CORP., CANFIELD, OH, DBA ALNU ENGINEERING CONCEPTS:
2,001,700, CANC. INT. CL. 42.
- ENTRACARE CORPORATION, LENEXA, KS:
1,715,406, CANC. INT. CL. 10.
- ENVIRO-COATINGS CANADA LTD., MISSISSAUGA, ONTARIO, CANADA:
2,745,720, PUB. 5-13-2003. INT. CL. 1.
- ENVIRONMENTAL COMPLIANCE, INC., WARREN, NJ:
1,716,875, CANC. INT. CL. 42.
- ENVIRONMENTAL FOOD GROUP, INC., ATLANTA, GA:
2,746,594, PUB. 5-13-2003. INT. CL. 43.
- ENVIROZONE TECHNOLOGIES, INC., WALNUT CREEK, CA:
2,745,504, PUB. 5-13-2003. MULTIPLE CLASS, INT. CLS. 11, 37, 40 AND 42.
- EPHEU; JUANDA, SHERMAN OAKS, CA:
1,208,574, CANC. INT. CL. 25.
- EPIC SYSTEMS CORPORATION, MADISON, WI:
2,748,402, INT. CL. 9.
- EPIGENOMICS GMBH, D-10435 BERLIN, FED REP GERMANY:
2,745,606, PUB. 7-30-2002. MULTIPLE CLASS, INT. CLS. 1, 5, 9, 38 AND 42.
- EPIGRAPH GROUP, INC., CHICAGO, IL:
2,745,990, PUB. 12-17-2002. INT. CL. 9.
- EPILAST SAS, 75008 PARIS, FRANCE:
2,745,915, PUB. 4-30-2002. MULTIPLE CLASS, INT. CLS. 8, 10 AND 42.
- EPOCH COMPOSITE PRODUCTS, INC., JOPLIN, MO:
2,745,869, PUB. 10-15-2002. INT. CL. 19.
- EQUIFAX INC., ATLANTA, GA:
2,001,114, CANC. INT. CL. 35.
- EQUIFIRST CORPORATION, CHARLOTTE, NC:
2,001,620, CANC. INT. CL. 36.
- EQUIPNET, INC., BRAINTREE, MA:
2,745,562, PUB. 10-15-2002. INT. CL. 42.
- EQUITABLE BAG CO., INC., LONG ISLAND CITY, NY:
2,001,837, CANC. INT. CL. 16.
- ERDAS, INC., ATLANTA, GA:
2,001,814, CANC. INT. CL. 9.
- ERGO WORKS INC., BELMONT, CA:
2,746,374, PUB. 5-13-2003. INT. CL. 42.
- ERGOAIR, INC., LAS VEGAS, NV:
2,746,946, PUB. 5-13-2003. INT. CL. 9.
- ERGONOMIC ACCESSORIES INTERNATIONAL CORPORATION, SCOTTSDALE, AZ FROM SPECTRACOM TECHNOLOGIES CORPORATION, SCOTTSDALE, AZ:
2,747,523, INT. CL. 20.
- ERIC COURT INDUSTRIES INC., NOVI, MI, DBA EVOLVE CORPORATION:
2,746,279, PUB. 5-13-2003. INT. CL. 11.
- ERIC LARSON ENTERPRISES, INC., SAN ANTONIO, TX:
1,759,555, REN. 6-25-03. INT. CL. 9.
- ERIEZ MANUFACTURING COMPANY, ERIE, PA:
737,845, CANC. U.S. CL. 23.
- ERMENEGILDO ZEGNA CORPORATION, NEW YORK, NY:
1,233,235, REN. 6-25-03. INT. CL. 3.
- ERNST & YOUNG U.S. LLP:
See— EYGN LIMITED.
- ERNST, JANICE T., HUNTINGTON BEACH, CA:
1,783,537, REN. 6-27-03. INT. CL. 29.
- ERVIN, THEARTRIS O., SUNNYVALE, CA:
2,001,317, CANC. INT. CL. 16.
- ESCHER GROUP LTD., CAMBRIDGE, MA:
2,746,507, PUB. 5-13-2003. INT. CL. 9.
- ESMARK APPAREL, INC., NEW YORK, NY:
1,208,548, CANC. INT. CL. 25.
- ESPACE PRODUCTION INTERNATIONALE AYANT POUR SIGLE "EPI", 67520 MARLENHEIM, FRANCE:
2,745,561, PUB. 11-20-2001. MULTIPLE CLASS, INT. CLS. 19 AND 27.
- ESPIRITU DEL ECUADOR SA, QUITO, PICHININCHA, ECUADOR:
2,746,295, PUB. 5-13-2003. INT. CL. 33.
- ESPN, INC., BRISTOL, CT:
1,788,523, REN. 6-27-03. INT. CL. 41.
2,745,922, PUB. 5-13-2003. INT. CL. 41.
- ESQUIRE-LEDERWAREN RUPP & RICKER, RODGAU 1, FED REP GERMANY TO ESQUIRE-LEDERWAREN RUPP & RICKER GMBH, 6054 RODGAU 1, FED REP GERMANY:
1,208,364, CANC. INT. CL. 18.
- ESSELTE CORPORATION, GARDEN CITY, NY:
1,715,727, CANC. INT. CL. 16.
- ESSELTE PENDAFLEX CORPORATION, PARAMUS, NJ:
1,715,795, CANC. INT. CL. 20.
- ESSEN INTERNATIONAL AB:
See— ALECTA PENSIONSFORSAKRING, OMSSEIDIGT.
- ESSENTIAL HOLDINGS INC., ENCINTAS, CA:
2,001,014, CANC. INT. CL. 3.
- ESSEX INTERNATIONAL CO., LTD., BANGKOK 10500, THAILAND:
1,715,528, CANC. INT. CL. 14.

- ESSILOR INTERNATIONAL (COMPAGNIE GENERALE D'OPTIQUE) S.A., ECHAT 902, CRETEIL, CEDEX, FRANCE:
1,208,015, CANC. INT. CL. 9.
- ESSILOR INTERNATIONAL (COMPAGNIE GENERALE D'OPTIQUE), 94220 CHARENTON LE PONT, FRANCE:
2,745,894, PUB. 12-11-2001. INT. CL. 9.
- ESTES-COX CORP., PENROSE, CO FROM CENTURI CORPORATION, PENROSE, CO:
2,747,846, INT. CL. 28.
- ETABLISSEMENT PIERRE FERRAUD ET FILS, 69220 BELLEVILLE, FRANCE:
2,001,148, CANC. INT. CL. 33.
- ETABLISSEMENTS MAURICE MAILLARD, INCHEVILLE, FRANCE:
1,208,143, CANC. INT. CL. 12.
- ETREBY COMPUTER COMPANY, INC., ANAHEIM, CA:
2,748,417, INT. CL. 35.
- EUNIVERSE, INC., LOS ANGELES, CA:
2,748,129, INT. CL. 41.
- EURO PC GROUP, S.A., 59000 LILLE, FRANCE:
2,694,519, COR. MULTIPLE CLASS, INT. CLS. 9 AND 42.
- EURO-LOG TELEKOMMUNIKATIONSMEHRWERTDIENSTE GMBH, 85399 HALLBERGMOOS, FED REP GERMANY:
2,746,001, PUB. 5-21-2002. INT. CL. 39.
- EUROKERA, SOCIETE EN NOM COLLECTIF, JOUARRE, FRANCE:
2,748,666, MULTIPLE CLASS, INT. CLS. 11 AND 21.
- EUROPA EYEWEAR CORP., WHEELING, IL:
1,715,322, CANC. INT. CL. 9.
- EUROPAEUS USA INC., PEEKSKILL, NY:
2,749,023, INT. CL. 42.
- EUROPEAN INSTALLATION BUS ASSOCIATION, BRUSSEL, BELGIUM:
2,745,759, PUB. 10-15-2002. MULTIPLE CLASS, INT. CLS. 9, 16 AND 42.
- EUROPEENNE DE PRODUITS DE BEAUTE, PARIS, FRANCE:
2,747,694, INT. CL. 3.
- EUROSENSE-BELFOTOP N.V., B-8880 TIELT, BELGIUM:
2,000,493, CANC. MULTIPLE CLASS, INT. CLS. 9, 16 AND 42.
- EVA-GLORY INDUSTRIAL CO., LTD., TAIWAN, CHINA:
2,746,209, PUB. 2-18-2003. MULTIPLE CLASS, INT. CLS. 17, 25 AND 28.
- EVANS PRODUCTS COMPANY, PORTLAND, OR:
737,910, CANC. U.S. CL. 34.
- EVEREADY BATTERY COMPANY, INC., ST. LOUIS, MO:
2,748,282, INT. CL. 11.
- EVERMORE SOFTWARE, INC., ROWLAND HEIGHTS, CA:
2,748,342, INT. CL. 9.
- EVERSHARP PEN COMPANY, FRANKLIN PARK, IL:
2,001,603, CANC. INT. CL. 16.
- EVERYBODY FITS, LP, COPPELL, TX:
2,746,757, PUB. 5-13-2003. INT. CL. 41.
- EVERYTHING FOR LOVE, INCORPORATED, PINE MOUNTAIN, CA:
2,748,965, INT. CL. 10.
- EVIDENT, INC., UNION HALL, VA:
2,001,337, CANC. INT. CL. 16.
- EXACT EQUIPMENT CORPORATION, MORRISVILLE, PA:
2,468,514, COR. INT. CL. 7.
- EXCEL CORPORATION, WICHITA, KS:
2,748,255, INT. CL. 29.
- EXCEL WORLD, INC., SAN FRANCISCO, CA:
2,746,332, PUB. 10-8-2002. INT. CL. 43.
- EXCLUSIVE MERCHANTISERS, INC., BUFFALO, NY:
1,251,107, REN. 6-25-03. INT. CL. 14.
- EXCLUSIVE PRODUCERS NETWORK, INC., THE WOODLANDS, TX:
2,747,176, PUB. 5-13-2003. INT. CL. 35.
- EXCOSOF AB, 164 40 KISTA, SWEDEN:
2,745,816, PUB. 5-13-2003. MULTIPLE CLASS, INT. CLS. 9, 38 AND 42.
- EXECUSHIELD, INC., SAN FRANCISCO, CA:
2,748,422, INT. CL. 45.
- EXECUTIVE SOFTWARE INTERNATIONAL, INC., BURBANK, CA:
1,765,683, REN. 6-24-03. INT. CL. 9.
- EXELON VENTURES COMPANY, LLC, CHICAGO, IL FROM PECO ENERGY COMPANY, PHILADELPHIA, PA:
2,747,477, INT. CL. 39.
- EXODERMIC BRIDGE DECK, INC., LAKEVILLE, CT:
2,747,531, INT. CL. 42.
- EXQUISITE APPAREL CORP., NEW YORK, NY:
2,745,471, PUB. 5-13-2003. INT. CL. 25.
2,745,472, PUB. 5-13-2003. INT. CL. 25.
- EXXON CORPORATION, NEW YORK, NY:
159,110, CANC. U.S. CL. 15.
- EYGN LIMITED, NASSAU, BAHAMAS FROM ERNST & YOUNG U.S. LLP, NEW YORK, NY:
2,746,095, PUB. 10-29-2002. INT. CL. 36.
- EZ COMMUNICATIONS, INC., FAIRFAX, VA:
1,209,361, CANC. INT. CL. 35.
- EZAKI GLICO KABUSHIKI KAISHI, NISHIYODOGAWA-KU, OSAKA, JAPAN, DBA EZAKI GLICO COMPANY, LIMITED:
2,748,236, INT. CL. 32.
- EZMOVE, INC., STERLING, VA:
2,001,268, CANC. INT. CL. 39.
- EZZELTE CORPORATION, GARDEN CITY, NY, ESSELTE PENDAFLEX CORPORATION, GARDEN CITY, NY:
1,756,812, REN. 6-21-03. INT. CL. 16.
- E4X, INC., 67060 TEL AVIV, ISRAEL:
2,748,048, INT. CL. 9.
- F. W. WOOLWORTH CO., NEW YORK, NY:
737,915, CANC. U.S. CL. 36.
- F.B. WASHBURN CANDY CORPORATION, BROCKTON, MA:
2,746,316, PUB. 5-13-2003. INT. CL. 30.
- F.F. ACQUISITION CORP., WEST POINT, MS:
2,746,073, PUB. 5-13-2003. INT. CL. 28.
- F-D-C REPORTS, INC., CHEVY CHASE, MD:
2,746,140, PUB. 5-13-2003. INT. CL. 16.
- FABRI TRAK SYSTEMS, INC., SOUTH RIVER, NJ:
2,746,222, PUB. 5-13-2003. INT. CL. 20.
- FACEGAMES, INC., BAYSIDE, NY:
2,747,799, INT. CL. 3.
- FACELIFTERS HOME SYSTEMS, INC.:
1,208,422, CANC. MULTIPLE CLASS, INT. CLS. 20 AND 37.
- FAIR WAY COMMUNICATIONS INC., SARATOGA SPRINGS, NY:
2,000,633, CANC. INT. CL. 38.
- FAIR, ISAAC AND COMPANY, INCORPORATED, SAN RAFAEL, CA:
2,000,558, CANC. INT. CL. 36.
- FAIRMONT HOTELS & RESORTS (U.S.) INC., TORONTO, ONTARIO, CANADA, PRINCESS HOTELS INTERNATIONAL, INC., NEW YORK, NY:
1,784,653, REN. 6-23-03. INT. CL. 42.
- FAIRMONT PRESS, ATLANTA, GA:
1,249,520, REN. 6-23-03. INT. CL. 35.
- FAIRMONT PRESS, LILBURN, GA:
1,259,606, REN. 6-23-03. INT. CL. 35.
- FAIRVIEW HEALTH SERVICES, MINNEAPOLIS, MN:
2,745,967, PUB. 10-29-2002. INT. CL. 16.
- FAIRYTALE BROWNIES, INC., CHANDLER, AZ:
2,746,930, PUB. 5-13-2003. INT. CL. 30.
- FALCON LURES, LLC, LAFAYETTE, LA:
2,746,654, PUB. 5-13-2003. INT. CL. 28.
- FAMILY CHRISTIAN STORES, INC., GRAND RAPIDS, MI:
2,747,385, PUB. 5-13-2003. INT. CL. 35.
- FAMILY COMMUNICATIONS, INC., PITTSBURGH, PA:
1,780,075, REN. 6-24-03. MULTIPLE CLASS, INT. CLS. 9 AND 16.
- FAMILY PRACTICE, INC., THE, MARIETTA, GA:
2,746,516, PUB. 5-13-2003. INT. CL. 41.
2,746,517, PUB. 5-13-2003. INT. CL. 9.
- FAMILY STATIONS, INC., OAKLAND, CA:
2,745,961, PUB. 11-5-2002. MULTIPLE CLASS, INT. CLS. 38 AND 41.
2,745,962, PUB. 11-5-2002. MULTIPLE CLASS, INT. CLS. 38 AND 41.

- FAMOUS SAM'S, INC., MESA, AZ:
2,578,554, COR. MULTIPLE CLASS, INT. CLS. 35 AND 42.
- FANATIC ENTERPRISES, LLC, GUTTENBERG, IA:
2,746,753, PUB. 5-13-2003. INT. CL. 16.
- FANTLE, DAVID A., BAYSIDE, WI:
2,745,429, PUB. 5-13-2003. INT. CL. 42.
- FANUC LTD., MINAMITSURU-GUN, YAMANASHI, JAPAN:
2,745,728, PUB. 11-5-2002. MULTIPLE CLASS, INT. CLS. 7, 9, 37 AND 42.
- FAO SCHWARZ, INC., KING OF PRUSSIA, PA FROM F.A.O. SCHWARZ, NEW YORK, NY:
2,747,625, INT. CL. 28.
- FARINA STEFANO S.R.L., 22036 ERBA (CO), ITALY:
2,000,547, CANC. INT. CL. 33.
- FARMLAND INDUSTRIES, INC., KANSAS CITY, MO:
1,234,236, REN. 6-26-03. INT. CL. 5.
- FARMSTEAD PRESS, THE, FREEDOM, ME:
1,208,185, CANC. INT. CL. 16.
- FARO TECHNOLOGIES, INC., LAKE MARY, FL:
2,001,817, CANC. INT. CL. 9.
2,747,498, INT. CL. 9.
- FAS-HOTLINE, INC., SCOTTSDALE, AZ:
2,000,977, CANC. INT. CL. 35.
- FASHION BOX - S.P.A. (TREVISO), ITALY:
2,339,609, COR. INT. CL. 25.
- FASHION BOX S.P.A., 30 - MASER - (TREVISO), ITALY:
2,001,752, CANC. INT. CL. 25.
- FASSI GRU IDRAULICHE S.P.A., 24021 ALBINO (BG), ITALY:
2,632,525, COR. MULTIPLE CLASS, INT. CLS. 7 AND 12.
- FAST FEEDERS, INC., LOVELY, KY:
2,747,332, PUB. 5-13-2003. INT. CL. 43.
- FAST GEAR RACING SPORTS, INC., KETCHUM, ID:
2,001,421, CANC. INT. CL. 28.
- FATWISE, EDISON, NJ:
2,001,231, CANC. INT. CL. 42.
- FAUCET-QUEENS, INC., THE, CHICAGO, IL:
737,746, CANC. U.S. CL. 13.
- FAULTLESS STARCH/BON AMI COMPANY, KANSAS CITY, MO:
1,207,768, CANC. INT. CL. 3.
- FAZOLI'S MANAGEMENT, INC., LEXINGTON, KY, FAZOLI'S RESTAURANTS, INC., LEXINGTON, KY:
1,819,276, REN. 6-27-03. INT. CL. 42.
- FEARON, REGEN H., DALLAS, TX:
2,746,593, PUB. 5-13-2003. INT. CL. 41.
- FED SERVICES, INCORPORATED, CENTREVILLE, VA:
2,000,995, CANC. INT. CL. 16.
- FEDERAL CORPORATION, TAIPEI, TAIWAN:
1,717,069, CANC. INT. CL. 12.
- FEDERAL EXPRESS CORPORATION, MEMPHIS, TN:
2,001,568, CANC. INT. CL. 42.
2,747,767, MULTIPLE CLASS, INT. CLS. 9 AND 42.
- FEDERAL SIGNAL CORPORATION, OAK BROOK, IL:
2,748,314, INT. CL. 9.
- FEDERAL TRAINING ACADEMY, LLC, MCLEAN, VA:
2,748,366, INT. CL. 41.
- FEDERAL-MOGUL WORLD WIDE, INC., SOUTHFIELD, MI:
2,747,805, INT. CL. 12.
2,748,226, INT. CL. 12.
- FEDERATED DEPARTMENT STORES, INC., CINCINNATI, OH, BURDINES, INC., CINCINNATI, OH:
1,763,501, REN. 6-25-03. INT. CL. 42.
- FEDERATED DEPARTMENT STORES, INC., CINCINNATI, OH:
2,748,054, INT. CL. 8.
- FEDERATION FRANCAISE DE FOOTBALL, 75016 PARIS, FRANCE:
2,746,148, PUB. 11-19-2002. MULTIPLE CLASS, INT. CLS. 14, 16, 18, 25, 28, 38 AND 41.
- FEI BEHAVIORAL HEALTH, INC., MILWAUKEE, WI:
2,746,146, PUB. 11-5-2002. INT. CL. 42.
- FELDMANN ENG. & MFG. CO., INC., SHEBOYGAN FALLS, WI:
1,207,875, CANC. MULTIPLE CLASS, INT. CLS. 7 AND 8.
- FELLOWES, INC., ITASCA, IL, BANKERS BOX COMPANY, FRANKLIN PARK, IL:
759,213, REN. 6-27-03. U.S. CL. 32 (INT. CL. 20).
- FELLOWES, INC., ITASCA, IL, FELLOWES MANUFACTURING COMPANY, ITASCA, IL:
1,805,318, REN. 6-24-03. INT. CL. 20.
- FENA DESIGN, INC., PLYMOUTH, MN:
2,748,464, INT. CL. 12.
- FENDER MUSEUM OF THE ARTS FOUNDATION, CORONA, CA:
2,747,894, MULTIPLE CLASS, INT. CLS. 16, 18 AND 20.
- FENDI ADELE S.R.L., 00166 ROME, ITALY:
2,745,743, PUB. 5-13-2003. INT. CL. 14.
- FERGUSON; ARTHUR F., WESTBROOK, CT, DBA THE DINGHY PLACE:
1,209,259, CANC. INT. CL. 42.
- FERGUSON, JEREL SCOTT, SAN DIEGO, CA:
2,747,443, PUB. 5-13-2003. INT. CL. 5.
- FERMAN/PANAMENO, MIGUEL A., LOS ANGELES, CA AND GARAY, RICHARD E, LOS ANGELES, CA:
2,748,611, INT. CL. 25.
- FERRANIA S.P.A., FERRANIA, ITALY:
2,745,693, PUB. 5-13-2003. MULTIPLE CLASS, INT. CLS. 1 AND 9.
- FERRARI IMPORTING CO., ROYAL OAK, MI:
1,208,657, CANC. INT. CL. 28.
- FERRERO S.P.A., ALBA (PROVINCE OF CUENO), ITALY, P. FERRERO & C. S.P.A., ALBA (PROVINCE OF CUNEO), ITALY:
1,248,547, REN. 6-27-03. INT. CL. 30.
- FERROLI, S.P.A., 37047, SAN BONIFACIO (VR), ITALY:
1,762,679, REN. 6-23-03. INT. CL. 11.
- FETERL MFG. CO.:
1,208,126, CANC. INT. CL. 12.
- FF SEELEY NOMINEES PTY LTD, ST. MARYS, SOUTH AUSTRALIA, AUSTRALIA:
2,746,723, PUB. 5-13-2003. INT. CL. 11.
- FFASTFILL EUROPE LIMITED, LONDON, UNITED KINGDOM TO CITY DERIVATIVES SYSTEMS LTD, LONDON, UNITED KINGDOM:
2,575,136, COR. MULTIPLE CLASS, INT. CLS. 9 AND 36.
- FPPE, LLC, SAN DIEGO, CA:
2,748,571, INT. CL. 16.
- FIBERSPAR CORPORATION, WEST WAREHAM, MA TO FIBERSPAR SPOOLABLE PRODUCTS, INC., WEST WAREHAM, MA:
2,687,470, COR. INT. CL. 17.
- FIDDLEHEAD CELLARS, DAVIS, CA, JOSEPH, KATHY, DAVIS, CA, DBA KJ ENTERPRISES:
1,749,556, REN. 6-25-03. INT. CL. 33.
- FIDELITY FEDERAL SAVINGS BANK OF FLORIDA, WEST PALM BEACH, FL:
2,000,813, CANC. INT. CL. 36.
2,000,814, CANC. INT. CL. 36.
- FIELDTURF INC., TOWN OF MONT-ROYAL, QUEBEC, CANADA:
2,748,397, INT. CL. 27.
- FIESTA FOODS, INC., SPRINGFIELD, OR:
2,000,856, CANC. INT. CL. 29.
- FIESTA PALMS, LLC, LAS VEGAS, NV:
2,746,548, PUB. 5-13-2003. INT. CL. 43.
- FIFTY-FIFTY CORPORATION, CHICAGO, IL:
1,207,755, CANC. INT. CL. 3.
- FIGARET, ALAIN, 78290 CROISSY SUR SEINE, FRANCE:
2,745,683, PUB. 6-11-2002. MULTIPLE CLASS, INT. CLS. 3, 9, 14, 18 AND 25.
- FIGUEROLA LABORATORIES, SANTA YNEZ, CA:
2,747,205, PUB. 5-13-2003. INT. CL. 5.
- FILLMER, SCOTT L., PELHAM, AL, DBA PIECES OF THE PAST:
2,747,060, PUB. 5-13-2003. INT. CL. 16.
- FILONET CORPORATION, VANCOUVER, BRITISH COLUMBIA, V6E 2E9, CANADA:
2,747,078, PUB. 5-13-2003. INT. CL. 42.
- FILTRONA UNITED KINGDOM LIMITED, NOTTINGHAM NG16 2GT, UNITED KINGDOM:
2,746,735, PUB. 5-13-2003. INT. CL. 17.

- FINALLY DANCE INC., CARMEL, NY:
2,748,278, INT. CL. 9.
- FINANCIAL TECHNOLOGY PARTNERS, INC., RAMSEY, NJ:
2,747,219, PUB. 5-13-2003. INT. CL. 42.
- FINAPLEX, INC., SAN FRANCISCO, CA:
2,748,727, INT. CL. 9.
- FINGER LAKES CHEMICALS, INC., ROCHESTER, NY:
1,778,265. REN. 6-21-03. INT. CL. 3.
- FINGERHUT DIRECT MARKETING, INC., MINNETONKA, MN, FINGERHUT CORPORATION, MINNETONKA, MN:
1,724,645. REN. 6-24-03. INT. CL. 18.
- FINN TAWIL VENTURES, LLC, HOLLYWOOD, CA:
2,748,041, MULTIPLE CLASS, INT. CLS. 11 AND 37.
- FINS AND FEATHERS PUBLISHING COMPANY, MINNEAPOLIS, MN:
1,208,211, CANC. INT. CL. 16.
- FIORAVANTI, GUIDO, 20125 MILANO, ITALY:
2,748,989, INT. CL. 30.
- FIORI-BRUNA PASTA PRODUCTS, INC., MIAMI, FL:
2,747,742, INT. CL. 30.
- FIORONI, RYAN, REMO, OAKLAND, CA:
2,748,878, INT. CL. 9.
- FIREMAN'S FUND INSURANCE COMPANY, NOVATO, CA:
1,208,961, CANC. INT. CL. 36.
- FIREPLUGS, INC., REDAN, GA:
2,001,324, CANC. INT. CL. 16.
- FIRMAMENT, INC., NEW YORK, NY:
2,001,622, CANC. INT. CL. 25.
- FIRST BANK AND TRUST COMPANY OF MURPHYSBORO, THE, MURPHYSBORO, IL:
1,235,818. REN. 6-27-03. INT. CL. 36.
- FIRST BANK SYSTEM, INC., MINNEAPOLIS, MN:
2,000,491, CANC. INT. CL. 36.
2,000,723, CANC. INT. CL. 36.
- FIRST CHOICE POWER, INC., FORT WORTH, TX:
2,748,470, INT. CL. 39.
- FIRST DATA MERCHANT SERVICES CORPORATION, GREENWOOD VILLAGE, CO:
2,745,963, PUB. 10-23-2001. INT. CL. 35.
- FIRST FEDERAL SAVINGS AND LOAN ASSOCIATION OF JACKSONVILLE, JACKSONVILLE, FL:
1,208,954, CANC. INT. CL. 36.
- FIRST FRANKLIN FINANCIAL CORPORATION, SAN JOSE, CA:
2,748,971, INT. CL. 36.
- FIRST HAND FOUNDATION, KANSAS CITY, MO:
2,745,921, PUB. 5-13-2003. INT. CL. 22.
- FIRST HORIZON CORPORATION, KANSAS CITY, MO:
1,770,019. REN. 6-22-03. INT. CL. 16.
- FIRST MIAMI SECURITIES, INC., NORTH MIAMI BEACH, FL:
2,001,592, CANC. INT. CL. 36.
- FIRST OF MICHIGAN CORPORATION, DETROIT, MI:
2,000,997, CANC. INT. CL. 36.
- FIRST PLAN OF MINNESOTA, INC., TWO HARBORS, MN:
2,747,700, INT. CL. 42.
- FIRST TENNESSEE NATIONAL CORPORATION, MEMPHIS, TN:
2,747,508, INT. CL. 36.
- FIRST UNION CORPORATION, CHARLOTTE, NC AND WACHOVIA CORPORATION, CHARLOTTE, NC FROM WACHOVIA CORPORATION, WINSTON-SALEM, NC:
2,747,845, INT. CL. 36.
- FIRST-CITIZENS BANK & TRUST COMPANY, RALEIGH, NC:
2,748,492, INT. CL. 36.
2,748,493, INT. CL. 36.
2,748,494, INT. CL. 36.
- FIRSTMERIT CORPORATION, AKRON, OH:
2,747,989, INT. CL. 36.
- FIRSTWAY INC., STANFORD, CT:
1,209,064, CANC. INT. CL. 39.
- FISCALINI CHEESE COMPANY, LLC, MODESTO, CA:
2,748,286, INT. CL. 29.
- FISCHER SOLUTIONS, INC., DALLAS, TX, DBA MANAGE-PATH:
2,746,230, PUB. 5-13-2003. INT. CL. 9.
- FISCHER, COE W., IRWIN, PA:
2,001,249, CANC. INT. CL. 1.
- FISCHER, DANIEL, AVENTURA, FL AND ZISMAN, SIMON, AVENTURA, FL:
2,747,732, INT. CL. 39.
- FISERV, INC., BROOKFIELD, WI:
2,748,763, INT. CL. 42.
- FISHER & PAYKEL HEALTHCARE LIMITED, EAST TAMAKI AUCKLAND, NEW ZEALAND:
2,745,814, PUB. 2-19-2002. INT. CL. 10.
- FISHER HAMILTON LLC, TWO RIVERS, WI:
2,748,557, INT. CL. 9.
- FISHER MILLS, INC.:
See—PURATOS BAKERY SUPPLY, INC..
- FISHING EXPEDITIONS OUTDOOR APPAREL, HUNTINGTON BEACH, CA:
2,746,847, PUB. 5-13-2003. INT. CL. 25.
- FIT-RITE, INC., WESTBURY, NY:
2,746,280, PUB. 11-12-2002. INT. CL. 28.
- FITNESS SYSTEMS, INC., LOS ANGELES, CA:
1,209,258, CANC. INT. CL. 42.
- FIVE OF US, INC., THE, SAN FRANCISCO, CA:
2,748,425, INT. CL. 18.
- FIVE STAR FINE PRODUCTS, INC., PLAINVIEW, NY:
2,748,170, INT. CL. 33.
- FIVESON'S FOODS, INC., MERRICK, NY:
2,745,964, PUB. 5-13-2003. INT. CL. 29.
- FIXTRONICS INCORPORATED, LAWRENCE, KS:
1,716,522, CANC. INT. CL. 37.
- FIXTURES MANUFACTURING COMPANY, KANSAS CITY, MO:
1,208,419, CANC. INT. CL. 20.
- FLAIR-NEW CASTLE, INC., NEW CASTLE, DE, DELTECH ENGINEERING, L.P., NEW CASTLE, DE:
1,724,613. REN. 6-24-03. INT. CL. 11.
- FLARION TECHNOLOGIES, INC., BEDMINSTER, NJ:
2,747,837, INT. CL. 9.
- FLASH CREATIVE MANAGEMENT, INC., RIVER EDGE, NJ:
2,000,584, CANC. INT. CL. 42.
- FLAVORCOFFEE CO. INC.:
See—ZAVIDA COFFEE COMPANY INC..
- FLEMING COMPANIES, INC., OKLAHOMA CITY, OK:
2,746,075, PUB. 1-14-2003. MULTIPLE CLASS, INT. CLS. 1, 3, 5, 8, 9, 10, 11, 16, 17, 21, 25 AND 34.
2,746,141, PUB. 10-8-2002. MULTIPLE CLASS, INT. CLS. 3 AND 5.
- FLEX-O-LITE, INC., ST. CHARLES, MO:
2,746,880, PUB. 5-13-2003. INT. CL. 9.
- FLEXAFILMS S.P.A., 21013 GALLARATE, PROVINCE OF VARESE, ITALY:
2,745,896, PUB. 5-13-2003. INT. CL. 17.
- FLEXIBLE PRODUCTS COMPANY, MARIETTA, GA:
2,001,054, CANC. INT. CL. 2.
- FLEXIBLE SAFETY ZONING CO., INC., CICERO, IL:
737,995, CANC. U.S. CL. 50.
- FLEXOR, S.A., 08210 BARBERA DEL VALLES, SPAIN:
2,000,673, CANC. INT. CL. 10.
- FLEXOTECNICA S.R.L., 26838 TAVAZZANO (LODI), ITALY:
1,765,557. REN. 6-25-03. INT. CL. 7.
- FLEXTILE LTD., TORONTO, ONTARIO, CANADA:
1,816,320. REN. 6-26-03. INT. CL. 1.
- FLINT & WALLING, INC., LOUISVILLE, KY, FLINT & WALLING INDUSTRIES, INC., KENDALLVILLE, IN, DBA STAR WATER SYSTEMS:
1,778,684. REN. 6-24-03. INT. CL. 7.
- FLIP YOUR LID, INC., WEST HILLS, CA:
2,746,963, PUB. 5-13-2003. INT. CL. 41.
- FLODOR INDUSTRIE SA, 80200 PERONNE, FRANCE:
2,616,793, AM. MULTIPLE CLASS, INT. CLS. 29 AND 30.
- FLORALIFE, INC., HINSDALE, IL:
1,207,711, CANC. INT. CL. 1.
- FLORATINE PRODUCTS GROUP, COLLIERVILLE, TN:
2,001,128, CANC. INT. CL. 1.

- FLORIDA BRACE CORPORATION, WINTER PARK, FL:
2,746,806, PUB. 5-13-2003. INT. CL. 10.
- FLORIDA BUILDING INSPECTION SERVICES, INC., MIAMI, FL:
1,209,004, CANC. INT. CL. 37.
- FLORIDA STATE UNIVERSITY, THE, TALLAHASSEE, FL:
2,748,333, INT. CL. 41.
- FLORISTS' MUTUAL INSURANCE COMPANY, EDWARDSVILLE, IL:
2,746,307, PUB. 5-13-2003. INT. CL. 36.
- FLOWMATRIX, INC., CARLSBAD, CA:
2,746,109, PUB. 12-10-2002. INT. CL. 9.
2,746,110, PUB. 12-24-2002. INT. CL. 9.
- FLUID IMAGING TECHNOLOGIES, INC., EDGECOMB, ME:
2,747,627, INT. CL. 40.
- FMR CORP., BOSTON, MA:
2,748,665, INT. CL. 35.
2,748,713, MULTIPLE CLASS, INT. CLS. 35, 41 AND 42.
2,748,814, INT. CL. 36.
- FMR CORPORATION, BOSTON, MA FROM FMR CORP., BOSTON, MA:
2,748,633, MULTIPLE CLASS, INT. CLS. 35 AND 36.
- FOB, INC., CHICAGO, IL:
2,697,272, COR. MULTIPLE CLASS, INT. CLS. 9, 35 AND 42.
- FOES FABRICATIONS INC., PASADENA, CA:
2,001,507, CANC. INT. CL. 12.
- FOG CUTTER CAPITAL GROUP INC., PORTLAND, OR FROM WILSHIRE REAL ESTATE INVESTMENT, INC., PORTLAND, OR:
2,747,945, MULTIPLE CLASS, INT. CLS. 36 AND 37.
- FOLEY, THOMAS P., FT. LAUDERDALE, FL:
2,000,953, CANC. INT. CL. 3.
- FONT BUREAU, INC., THE, BOSTON, MA:
2,747,027, PUB. 5-13-2003. INT. CL. 9.
2,747,028, PUB. 5-13-2003. INT. CL. 9.
- FOOD & HEALTH SERVICES, INC., CORAL GABLES, FL:
2,000,966, CANC. INT. CL. 5.
- FOOD ALLERGY INITIATIVE, NEW YORK, NY:
2,745,987, PUB. 6-11-2002. MULTIPLE CLASS, INT. CLS. 36, 41 AND 42.
- FOODSERVICE CONSULTANTS SOCIETY INTERNATIONAL, LOUISVILLE, KY:
2,746,983, PUB. 5-13-2003. INT. CL. 35.
- FOOTLOOSE DANCE WEAR, INC., JENKINTOWN, PA, JUNIMAN, DAVID, JENKINTOWN, PA:
1,809,254, REN. 6-25-03. INT. CL. 25.
- FOOTSTAR CORPORATION, WEST NYACK, NY FROM APACHE MINNESOTA THOM MCAN, INC., WEST NYACK, NY:
2,748,759, MULTIPLE CLASS, INT. CLS. 25 AND 35.
- FORAN, MICHAEL, OSSINING, NY:
2,746,822, PUB. 5-13-2003. INT. CL. 16.
- FORCE COMPUTERS GMBH, NEUBIBERG, FED REP GERMANY:
2,745,701, PUB. 5-13-2003. MULTIPLE CLASS, INT. CLS. 9, 38 AND 42.
- FORD MOTOR COMPANY, DEARBORN, MI:
1,715,483, CANC. INT. CL. 12.
2,001,735, CANC. INT. CL. 12.
2,747,583, INT. CL. 6.
2,747,859, INT. CL. 36.
- FORDEL, INC., FRESNO, CA:
1,208,825, CANC. INT. CL. 31.
- FOREST LAWN MORTUARY, GLENDALE, CA:
2,745,757, PUB. 9-24-2002. INT. CL. 42.
- FOREST RIVER, INC., GOSHEN, IN:
2,480,684, CANC. INT. CL. 12.
- FORESTEXPRESS LLC, ATLANTA, GA:
2,747,114, PUB. 5-13-2003. INT. CL. 35.
- FORESTFARM, WILLIAMS, OR:
1,169,512, CANC. INT. CL. 31.
- FORESTRY SUPPLIERS, INC., JACKSON, MS:
2,746,177, PUB. 5-13-2003. INT. CL. 9.
- FORMACARE SOLUTIONS, INC, OAKLAND, CA:
2,748,951, INT. CL. 3.
- FORT HAYS STATE UNIVERSITY, HAYS, KS:
2,745,520, PUB. 5-13-2003. INT. CL. 41.
- FORTUNE MACARONI COMPANY, FRESNO, CA:
2,001,069, CANC. INT. CL. 30.
2,001,076, CANC. INT. CL. 30.
- FORTUNEGLOBE GMBH, MUNCHEN, FED REP GERMANY FROM HOELLGER, THORSTEN, MUENCHEN, FED REP GERMANY:
2,745,582, PUB. 10-15-2002. MULTIPLE CLASS, INT. CLS. 3, 14, 18 AND 25.
- FORUM NETWORKS, INC., SANDY, UT:
2,748,117, INT. CL. 9.
- FORUM SNOWBOARDS, INC., SAN CLEMENTE, CA:
2,748,113, INT. CL. 28.
- FOSECO INTERNATIONAL LIMITED, STAFFORDSHIRE, ENGLAND:
1,241,718, REN. 6-27-03. INT. CL. 1.
- FOSTER & SMITH, INC., RHINELANDER, WI:
2,746,870, PUB. 5-13-2003. INT. CL. 18.
- FOUNDATION FOR CHILDREN'S CARE, THE, OAKLAND, CA, DBA FAMILY LEGACY FUND:
2,748,379, INT. CL. 36.
- FOX ACRES EQUITY CLUB, INC., RED FEATHER LAKES, CO, FOX ACRES COUNTRY CLUB, RED FEATHER LAKES, CO:
1,235,883, REN. 6-27-03. MULTIPLE CLASS, INT. CLS. 41 AND 42.
- FOX PHOTO, INC., SAN ANTONIO, TX:
1,209,074, CANC. INT. CL. 40.
- FOX RACING INC., MORGAN HILL, CA FROM FOX RACING USA, INC., MORGAN HILL, CA:
2,747,574, INT. CL. 18.
- FOX RACING, INC, MORGAN HILL, CA FROM FOX RACING USA, INC., MORGAN HILL, CA:
2,747,575, INT. CL. 16.
- FOX VALLEY CORPORATION, APPLETON, WI:
738,059, CANC. U.S. CL. 101.
- FPS FOOD PROCESSING SYSTEMS B.V., 2631 RE NOOTDORP, NETHERLANDS:
2,747,585, MULTIPLE CLASS, INT. CLS. 7 AND 9.
- FRAG UNLIMITED, INC., SAN GABRIEL, CA:
2,746,068, PUB. 5-13-2003. INT. CL. 41.
- FRAGRA-MATICS MANUFACTURING CO., INC., PINE BLUFF, AR:
1,801,839, REN. 6-22-03. INT. CL. 5.
- FRAGRANCE FOUNDATION, INC., THE, NEW YORK, NY:
2,001,530, CANC. INT. CL. 42.
2,001,531, CANC. INT. CL. 42.
- FRAMER, MORY B., LOS ANGELES, CA:
1,716,858, CANC. INT. CL. 42.
- FRANC JAMES PRODUCTIONS, INC., FORESTVILLE HILLS, NY TO PRIVATE BRAND SERVICES, LLC, FOREST HILLS, NY:
2,684,988, COR. MULTIPLE CLASS, INT. CLS. 35 AND 40.
- FRANCISCAN VINEYARDS, INC., ST. HELENA, CA:
2,748,662, INT. CL. 33.
- FRANCO MANUFACTURING CO., INC., METUCHEN, NJ:
2,747,588, INT. CL. 24.
- FRANCO-EUROPÉENNE DE MATÉRIEL POUR L'INDUSTRIE ALIMENTAIRE S.A., PARIS, FRANCE:
1,208,111, CANC. INT. CL. 11.
- FRANK RUSSELL COMPANY, TACOMA, WA:
2,747,754, INT. CL. 36.
- FRANKE (HESHAN) KITCHEN EQUIPMENT CO. LTD., HESHAN GUANDONG, CHINA:
2,747,942, INT. CL. 21.
- FRANKLIN COLLECTION SERVICE, INC., TUPELO, MS:
2,746,402, PUB. 5-13-2003. INT. CL. 36.
- FRANKLIN COVEY CO., SALT LAKE CITY, UT:
1,715,129, CANC. MULTIPLE CLASS, INT. CLS. 9 AND 16.
- FRANKLIN ESTIMATING SYSTEMS, INC., SALT LAKE CITY, UT:
2,747,128, PUB. 5-13-2003. INT. CL. 16.
2,747,129, PUB. 5-13-2003. INT. CL. 16.
2,747,130, PUB. 5-13-2003. INT. CL. 16.

- FRANKLIN FOODS, INC., ENOSBURG FALLS, VT:
2,748,865, INT. CL. 29.
- FRANKLIN INDUSTRIES, INC., FRANKLIN, PA:
1,207,829, CANC. INT. CL. 6.
- FRANKLIN UNIVERSITY, COLUMBUS, OH:
2,746,681, PUB. 5-13-2003. INT. CL. 41.
- FRANTSCHACH COATING BELGIUM N.V., DUFFEL,
BELGIUM:
2,746,106, PUB. 5-13-2003. INT. CL. 12.
- FRASER PAPERS INC., STAMFORD, CT:
2,746,542, PUB. 5-13-2003. INT. CL. 16.
- FRED MEYER STORES, INC., PORTLAND, OR:
2,746,167, PUB. 11-5-2002. INT. CL. 25.
2,746,801, PUB. 5-13-2003. INT. CL. 25.
2,746,846, PUB. 5-13-2003. INT. CL. 35.
2,748,396, MULTIPLE CLASS, INT. CLS. 28 AND 35.
- FREDERICKSBURG LANDGOED (EDMS) BEPERK,
PAARL, SOUTH AFRICA:
2,000,529, CANC. INT. CL. 33.
- FREEMAN, MICHAEL W., FIRCREST, WA:
2,662,614, COR. MULTIPLE CLASS, INT. CLS. 7 AND 9.
- FREIGHTLINER LLC, PORTLAND, OR TO FREIGHTLI-
NER CORPORATION, PORTLAND, OR:
2,495,070, COR. INT. CL. 12.
- FRENCH CONNECTION LIMITED, LONDON E3 8DA,
ENGLAND:
2,745,715, PUB. 5-21-2002. MULTIPLE CLASS, INT. CLS. 9
AND 14.
- FRENCH WEST, INC., LOS ANGELES, CA:
2,748,947, INT. CL. 25.
- FRESH INC, BOSTON, MA:
2,747,113, PUB. 7-2-2002. INT. CL. 3.
- FRESH INTELLECTUAL PROPERTIES, INC., WILMING-
TON, DE:
2,748,153, MULTIPLE CLASS, INT. CLS. 35 AND 38.
- FRICK, GLEN S., CHERRY HILL, NJ:
2,746,975, PUB. 5-13-2003. INT. CL. 9.
- FRIED, FRANK, HARRIS, SHRIVER & JACOBSON, WA-
SHINGTON, DC:
2,747,610, MULTIPLE CLASS, INT. CLS. 35, 36 AND 42.
- FRIEDLAND LIMITED, WEYBRIDGE, SURREY KT13 9UX,
UNITED KINGDOM, V. & E. FRIEDLAND LTD., RED-
DISH, STOCKPORT, CHESHIRE, SK5 6BP, UNITED
KINGDOM:
1,654,081. REN. 6-26-03. MULTIPLE CLASS, INT. CLS. 9
AND 11.
- FRIENDS COMMUNITY CHURCH, ORLANDO, FL:
2,746,044, PUB. 5-13-2003. INT. CL. 41.
- FRITZ EICHENAUER GMBH & CO. KG, KANDEL, PFALZ,
FED REP GERMANY:
1,208,101, CANC. INT. CL. 11.
- FRITZ EICHENAUER GMBH AND CO. KG, KANDEL,
PFALZ, FED REP GERMANY:
1,208,102, CANC. INT. CL. 11.
- FROGPAD L.L.C., HOUSTON, TX:
2,747,890, INT. CL. 9.
- FROMALP AG, ZOLLIKOFEN, SWITZERLAND:
2,747,086, PUB. 10-15-2002. MULTIPLE CLASS, INT. CLS.
29, 30 AND 31.
- FRONTIER INTERMODAL SYSTEMS, INC., ETOBICOKE,
ONTARIO, CANADA:
1,209,048, CANC. INT. CL. 39.
1,209,049, CANC. INT. CL. 39.
- FRONTIERS UNLIMITED, INC., SOUTHAMPTON, NY,
DBA MILLER PUBLISHING GROUP:
2,749,040, INT. CL. 16.
- FROST, JOY, BASKING RIDGE, NJ:
2,747,193, PUB. 5-13-2003. INT. CL. 9.
- FRUGOSA, S.A. DE C. V., ESTADO DE MEXICO, MEXICO:
2,746,272, PUB. 5-13-2003. INT. CL. 32.
- FRY, INC., ANN ARBOR, MI:
2,747,430, PUB. 5-13-2003. INT. CL. 42.
- FRYE, LEE P., OKLAHOMA CITY, OK:
2,002,025, CANC. INT. CL. 42.
- FUJI MACHINERY CO., LTD., NAGOYA-SHI, AICHI, JA-
PAN:
2,746,719, PUB. 5-13-2003. INT. CL. 7.
- FUJI PHOTO FILM CO., LTD., ASHIGARA-SHI KANAGA-
WA, JAPAN:
2,748,341, INT. CL. 9.
- FUJIAN SEPTWOLVES GROUP CORP., JINJING, JINJIANG,
FUJIAN, CHINA:
2,745,955, PUB. 8-20-2002. INT. CL. 25.
- FUJITSU LIMITED, KANAGAWA-KEN, JAPAN:
2,745,661, PUB. 4-30-2002. MULTIPLE CLASS, INT. CLS.
37, 38 AND 42.
- FUJITSU TAKAMIZAWA COMPONENT LIMITED, TOKYO,
JAPAN:
2,745,837, PUB. 5-13-2003. INT. CL. 9.
- FULGHUM INDUSTRIES, INC., WADLEY, GA:
735,264. REN. 6-25-03. U.S. CL. 23 (INT. CL. 7).
- FULLER TOOL CORPORATION, NEW YORK, NY:
2,001,749, CANC. INT. CL. 8.
- FULLRIVER BATTERY MANUFACTURE CO., LTD.,
GUANG ZHOU CITY, CHINA:
2,746,764, PUB. 5-13-2003. INT. CL. 9.
- FUN FACTORY, INC., KAPOLEI, HI, FERNANDEZ FUN
FACTORY, INC., EWA BEACH, HI:
1,246,616. REN. 6-23-03. INT. CL. 41.
- FUN-ONE INC., WESTERLY, RI:
2,748,298, INT. CL. 42.
- FUSED CONTACTS OF CHICAGO, INC., KANSAS CITY,
MO:
1,767,256. REN. 6-25-03. INT. CL. 9.
- FUTURECARE AFFILIATES, INC., IRVINE, CA:
2,745,415, PUB. 5-13-2003. INT. CL. 35.
- G. C. MURPHY COMPANY, MCKEESPORT, PA:
1,209,212, CANC. INT. CL. 42.
- G. CAULLET S.A., 59193 ERQUINGHEM LYS, FRANCE:
1,716,082, CANC. MULTIPLE CLASS, INT. CLS. 29 AND
30.
- G. D. SEARLE & CO., SKOKIE, IL:
1,717,023, CANC. INT. CL. 5.
- G. K. SKAGGS, INC., ZEPHYR COVE, NV:
2,749,045, INT. CL. 32.
- G. LOOMIS, INC., WOODLAND, WA:
1,716,047, CANC. INT. CL. 28.
- G.C. HUDSON INDUSTRIES, INC., BEVERLY, MA:
1,208,070, CANC. INT. CL. 10.
- G-III APPAREL GROUP, LTD., NEW YORK, NY:
1,717,128, CANC. INT. CL. 25.
- G-P DEVELOPMENT, LTD., HOUSTON, TX:
2,001,392, CANC. INT. CL. 39.
2,001,393, CANC. INT. CL. 37.
- GABAY, DAVID, NEW ROCHELLE, NY AND GABAY,
FRAN, NEW ROCHELLE, NY:
2,748,456, INT. CL. 20.
- GABBERTS INC., EDINA, MN:
2,746,502, PUB. 5-13-2003. INT. CL. 35.
2,746,503, PUB. 5-13-2003. INT. CL. 35.
2,746,504, PUB. 5-13-2003. INT. CL. 35.
- GABRIEL MEDIA GROUP, INC., DOVER, DE:
2,747,254, PUB. 5-13-2003. INT. CL. 16.
- GADAMS, MARY K., RICHMOND, VA:
2,747,848, INT. CL. 25.
- GAETANO, DRAKE, MANLIUS, NY:
2,748,221, INT. CL. 25.
- GAL SERVICES, INC., EAST SYRACUSE, NY:
2,748,205, INT. CL. 42.
- GALAXY SYSTEMS, INC., NEW YORK, NY:
2,745,452, PUB. 5-13-2003. MULTIPLE CLASS, INT. CLS.
35 AND 42.
- GALAXYCARD INC., CALGARY, ALBERTA, CANADA:
2,747,636, INT. CL. 36.
- GALLETTI BROTHERS FOOD, INC., LOS ANGELES, CA:
1,208,731, CANC. INT. CL. 29.
- GALLOWAY, JAY D., NEWHALL, CA:
2,746,848, PUB. 5-13-2003. INT. CL. 25.
- GAMEFLY, INC., SANTA MONICA, CA FROM SPECTOR,
SEAN, BEVERLY HILLS, CA:
2,746,496, PUB. 5-13-2003. MULTIPLE CLASS, INT. CLS.
35 AND 41.
- GAMEKITCHEN LLC, NEW YORK, NY:
2,747,252, PUB. 5-13-2003. INT. CL. 9.

- GAMETEK (FL), INC., AVENTURA, FL:
2,000,924, CANC. INT. CL. 9.
- GAO, ZHEN SHEN, BRISOL, CT:
2,747,041, PUB. 5-13-2003. INT. CL. 5.
- GARGIULO, L.P., NAPLES, FL:
2,001,165, CANC. INT. CL. 31.
- GARIMARK FOODS, INC., LAWRENCEVILLE, GA:
2,746,962, PUB. 5-13-2003. INT. CL. 29.
- GARITI, CHRISTOPHER, S., BLUFFTON, SC:
2,748,599, INT. CL. 42.
- GARLAND CORPORATION, BROCKTON, MA:
1,208,573, CANC. INT. CL. 25.
- GARMIN LTD., GRAND CAYMAN, CAYMAN ISLANDS:
2,745,956, PUB. 5-14-2002. INT. CL. 9.
- GARNER INDUSTRIES, INC., LINCOLN, NE:
2,746,951, PUB. 5-13-2003. INT. CL. 9.
- GARO'S, INC., LEXINGTON, KY, AKA GARO'S FAMOUS
HOTDOGS:
1,209,219, CANC. INT. CL. 42.
1,209,220, CANC. INT. CL. 42.
- GART BROS. SPORTING GOODS COMPANY, ENGLE-
WOOD, CO FROM DNS SPORTS LIMITED LIABILITY
COMPANY, LONGMONT, CO:
2,747,925, MULTIPLE CLASS, INT. CLS. 18, 20 AND 22.
2,748,078, INT. CL. 25.
- GARY YAMAMOTO CUSTOM BAITS, INC.:
See— YAMAMOTO, GARY.
- GATEWAY USA HOLDING CO., GREENWICH, CT:
1,716,549, CANC. INT. CL. 38.
- GAUGE WORKS, LLC, GREAT FALLS, VA:
2,748,383, INT. CL. 12.
- GC INVESTMENT HOLDINGS, INC., STONE MOUNTAIN,
GA:
2,748,183, INT. CL. 35.
- GCS GROUP, INC., PITTSBURGH, PA:
2,748,114, MULTIPLE CLASS, INT. CLS. 9, 35 AND 42.
- GE BETZ, INC., TREVISO, PA, BETZ LABORATORIES,
INC., TREVISO, PA:
1,246,711, REN. 6-24-03. INT. CL. 1.
- GE INTERLOGIX, INC., TUALATIN, OR, SENTROL, INC.,
PORTLAND, OR:
1,767,944, REN. 6-24-03. INT. CL. 9.
- GE INTERLOGIX, INC., TUALATIN, OR FROM INTER-
LOGIX, INC., BOCA RATON, FL:
2,747,858, MULTIPLE CLASS, INT. CLS. 9, 37 AND 42.
- GE MEDICAL SYSTEMS INFORMATION TECHNOLOG,
MILWAUKEE, WI, MARQUETTE ELECTRONICS, INC.,
MILWAUKEE, WI:
1,725,138, REN. 6-25-03. INT. CL. 9.
- GEAR: HOLDINGS, INC., NEW YORK, NY:
1,208,360, CANC. MULTIPLE CLASS, INT. CLS. 18 AND
28.
- GECKO ELECTRONIQUE, INC., QUEBEC, CANADA:
2,745,867, PUB. 5-13-2003. INT. CL. 9.
- GEDDES, ANNE, PARNELL, AUCKLAND, NEW ZEAL-
AND:
2,748,198, INT. CL. 25.
- GEI, INC., GREENWOOD, IN:
2,748,223, INT. CL. 41.
- GELATO CLASSICO ITALIAN ICE CREAM, SAN FRAN-
CISCO, CA:
1,208,781, CANC. INT. CL. 30.
- GEMINI, INC., CANNON FALLS, MN:
2,745,600, PUB. 10-22-2002. MULTIPLE CLASS, INT. CLS.
9, 10 AND 28.
- GENCORP INC., AKRON, OH:
1,208,481, CANC. INT. CL. 24.
- GENCORP INC., FAIRLAWN, OH:
1,715,998, CANC. INT. CL. 27.
2,001,909, CANC. INT. CL. 27.
- GENEMEDIX PLC, NEWMARKET, ENGLAND:
2,747,099, PUB. 5-7-2002. INT. CL. 5.
- GENENCOR INTERNATIONAL, INC., PALO ALTO, CA:
2,749,037, MULTIPLE CLASS, INT. CLS. 40 AND 42.
- GENERAL BINDING CORPORATION, NORTHBROOK, IL:
2,745,848, PUB. 1-21-2003. INT. CL. 16.
- GENERAL ELECTRIC COMPANY, SCHENECTADY, NY:
737,800, CANC. U.S. CL. 21.
- GENERAL ELECTRIC COMPANY, CLEVELAND, OH:
1,766,646, REN. 6-24-03. INT. CL. 11.
- GENERAL ELECTRIC COMPANY, SCHENECTADY, NY
FROM ADVANCED CERAMICS CORPORATION, LAKE-
WOOD, OH:
2,747,472, INT. CL. 17.
- GENERAL ELECTRIC COMPANY, PLAINVILLE, CT:
2,747,833, INT. CL. 9.
- GENERAL ELECTRIC COMPANY, SCHENECTADY, NY:
2,748,069, INT. CL. 17.
2,748,686, INT. CL. 17.
2,748,732, INT. CL. 17.
2,748,766, INT. CL. 7.
2,748,769, INT. CL. 9.
- GENERAL HOUSEWARES CORP., HYANNIS, MA:
1,208,489, CANC. INT. CL. 24.
- GENERAL HYDROPONICS, INC., SEBASTOPOL, CA:
2,748,936, INT. CL. 1.
- GENERAL MARKS, INC., CLEARWATER, FL:
2,748,919, INT. CL. 5.
- GENERAL MILLS, INC., MINNEAPOLIS, MN:
1,208,755, CANC. INT. CL. 29.
1,239,624, REN. 6-27-03. INT. CL. 30.
- GENERAL MILLS, INC., MINNEAPOLIS, MN TO PINNA-
CLE TRADING CARD COMPANY, DALLAS, TX:
1,255,294, AM. INT. CL. 16.
- GENERAL MILLS, INC.:
*See— INTERNATIONAL MULTIFOODS CORPORA-
TION.*
- GENERAL MILLS, INC., MINNEAPOLIS, MN:
2,748,625, INT. CL. 35.
- GENERAL MOTORS CORPORATION, DETROIT, MI:
1,715,295, CANC. INT. CL. 9.
- GENERAL RE CORPORATION, STAMFORD, CT:
2,000,890, CANC. MULTIPLE CLASS, INT. CLS. 16 AND
36.
- GENERAL RESOURCE CORPORATION, HOPKINS, MN:
1,715,041, CANC. INT. CL. 7.
- GENERAL SPORTCRAFT COMPANY, LTD., BERGEN-
FIELD, NJ:
1,208,665, CANC. INT. CL. 28.
- GENERATION 2 WORLDWIDE LLC, DOTHAN, AL:
2,748,544, INT. CL. 20.
- GENESCO INC., NASHVILLE, TN:
1,208,493, CANC. INT. CL. 24.
- GENESEEE BIOMEDICAL, INC., DENVER, CO:
2,748,839, INT. CL. 10.
- GENETICS COMPANY INC, THE, ZURICH, SWITZER-
LAND:
2,745,812, PUB. 5-13-2003. INT. CL. 42.
- GENPAK CORPORATION, GLEN FALLS, NY:
2,001,740, CANC. INT. CL. 21.
- GENTECH, 06410 BIOT, FRANCE:
2,745,644, PUB. 9-24-2002. MULTIPLE CLASS, INT. CLS.
9, 31 AND 42.
- GENTEON, INC., SAN DIEGO, CA:
2,748,631, MULTIPLE CLASS, INT. CLS. 1 AND 9.
- GENTRY, COREY S., LATHROP, MO:
2,746,854, PUB. 5-13-2003. INT. CL. 25.
- GEO. W. PARK SEED CO., INC., GREENWOOD, SC, PARK,
GEORGE BARRATT, GREENWOOD, SC, DBA GEO. W.
PARK SEED COMPANY AND PARK, WILLIAM JOHN,
GREENWOOD, SC:
739,221, REN. 6-25-03. U.S. CL. 1 (INT. CL. 31).
- GEOBRA BRANDSTATTER GMBH & CO. KG, D-90513
ZIRNDORF, FED REP GERMANY:
2,747,991, MULTIPLE CLASS, INT. CLS. 9 AND 21.
- GEOFFREY, INC., WILMINGTON, DE:
2,001,947, CANC. INT. CL. 28.
- GEORG FISCHER ROHRLEITUNGSSYSTEME AG, CH-8201
SCHAFFHAUSEN, SWITZERLAND:
2,747,495, INT. CL. 7.
- GEORGE C. MATTESON COMPANY, INC., BLUE SPRINGS,
MO:
1,247,063, REN. 6-23-03. INT. CL. 16.
- GEORGE KHOURY ASSOCIATION BASEBALL LEAGUES,
INC., THE, ST. LOUIS, MO:
747,979, REN. 6-27-03. U.S. CL. A.

GEORGE SHOE CORP., HSINCHU HSIEN, TAIWAN:
2,748,497, INT. CL. 25.
2,748,562, INT. CL. 25.

GEORGE, CAMILLE J., METAIRIE, LA:
2,745,865, PUB. 5-13-2003. INT. CL. 35.

GEORGIA-PACIFIC CORPORATION, PORTLAND, OR:
1,208,309, CANC. INT. CL. 16.

GEORGIA-PACIFIC CORPORATION, ATLANTA, GA:
1,240,279, REN. 6-22-03. INT. CL. 16.

GERARD DAVIS, NEW YORK, NY:
2,001,775, CANC. INT. CL. 14.

GERBER-ALLRED, CAROL, TWIN FALLS, ID:
2,746,912, PUB. 5-13-2003. INT. CL. 16.

GET RIGHT, INC., LOS ANGELES, CA:
2,746,752, PUB. 5-13-2003. INT. CL. 41.

GETTSET, INC., CHESTERFIELD, MO:
2,001,115, CANC. INT. CL. 30.

GETZOV, HARRY J., NEW YORK, NY:
2,748,018, MULTIPLE CLASS, INT. CLS. 9 AND 41.

GFD FABRICS, INC., GREENSBORO, NC:
2,748,168, INT. CL. 24.

GFSI, INC., LENEXA, KS:
2,745,687, PUB. 2-12-2002. INT. CL. 25.

GIANT FOOD INC., LANDOVER, MD:
2,000,962, CANC. INT. CL. 42.

GIBBS SYSTEM, INC., MOORPARK, CA, DBA GIBBS AND ASSOCIATES:
1,715,110, CANC. INT. CL. 9.

GIBSON, THOMAS, WASHINGTON, DC:
2,747,111, PUB. 5-13-2003. INT. CL. 42.

GIDEON, ERIC BERTRAND, SAUSALITO, CA:
2,001,874, CANC. INT. CL. 16.

GIESECKE & DEVRIENT GMBH, 81677 MUNICH, FED REP GERMANY:
2,745,463, PUB. 6-25-2002. MULTIPLE CLASS, INT. CLS. 9, 37 AND 42.

GIGATOY INC, LOS ANGELES, CA:
2,746,810, PUB. 5-13-2003. INT. CL. 28.

GIL, ALICIA ROJAS, 26004 LOGRONO, LA RIOJA, SPAIN:
2,746,037, PUB. 5-13-2003. INT. CL. 33.

GILES, SUSAN L., SAN MATEO, CA:
2,748,632, INT. CL. 9.

GILL & DUFFUS HOLDINGS, INC., DOVER, DE:
1,208,938, CANC. INT. CL. 36.

GILLMAN KNITWEAR CO., THE, CINCINNATI, OH:
2,001,848, CANC. INT. CL. 25.

GIMBORN PET SPECIALTIES, LLC, ATLANTA, GA:
2,558,729, COR. INT. CL. 31.
2,578,602, COR. INT. CL. 5.

GIN, BRIAN R., SAN JOSE, CA:
2,748,752, INT. CL. 9.

GINO'S INC., KING OF PRUSSIA, PA:
1,209,299, CANC. INT. CL. 42.

GOKAS FINANCIAL SERVICES, INC., WILLIAMSVILLE, NY:
2,746,033, PUB. 5-14-2002. INT. CL. 36.

GIORGIO GRATI S.P.A., MILANO (MI), ITALY:
2,745,858, PUB. 5-13-2003. INT. CL. 25.

GIRLS INCORPORATED, NEW YORK, NY:
2,748,804, INT. CL. 41.

GITLIN, BETTY, SOUTH BURLINGTON, VT:
1,768,270, REN. 6-27-03. INT. CL. 42.

GIULIANO'S DELICATESSEN & BAKERY, CARSON, CA:
1,209,273, CANC. INT. CL. 42.

GIZEH RAUCHERBEDARF GMBH, 51647 GUMMERS-BACH, FED REP GERMANY:
2,746,896, PUB. 5-13-2003. INT. CL. 34.

GLAS-CRAFT, INC., INDIANAPOLIS, IN:
1,239,971, REN. 6-24-03. INT. CL. 9.

GLASTIC CORPORATION, CLEVELAND, OH, MONOGRAM INDUSTRIES, INC., SANTA MONICA, CA:
1,237,325, REN. 6-23-03. INT. CL. 17.

GLOBAL AEROSPACE CORPORATION, ALTADENA, CA:
2,747,510, INT. CL. 12.

GLOBAL EXECUTIVE TRAVEL SELECTIONS, INC., NEW YORK, NY:
2,747,776, MULTIPLE CLASS, INT. CLS. 39 AND 42.

GLOBAL EXPRESS MONEY ORDERS, INC., SILVER SPRING, MD:
2,746,625, PUB. 5-13-2003. INT. CL. 36.

GLOBAL LOGISTICS TECHNOLOGIES, INC., SHELTON, CT:
2,747,597, MULTIPLE CLASS, INT. CLS. 9 AND 35.

GLOBAL SHARED SERVICES CONSULTING, SCOTTSDALE, AZ:
2,747,851, INT. CL. 41.

GLOBAL TRAVEL INTERNATIONAL, INC., MAITLAND, FL:
2,747,356, PUB. 5-13-2003. MULTIPLE CLASS, INT. CLS. 9 AND 35.

GLOBAL VALIDATORS INC., TROY, MI:
2,745,905, PUB. 12-10-2002. INT. CL. 42.

GLOBE LIFE AND ACCIDENT INSURANCE COMPANY, OKLAHOMA CITY, OK:
1,260,191, REN. 6-23-03. INT. CL. 36.

GMAC MORTGAGE CORPORATION, HORSHAM, PA:
2,746,771, PUB. 5-13-2003. INT. CL. 36.

GMD - GESELLSCHAFT FUR MEDIZINISCHE DATEN-VERARBEITUNG MBH, D-81671 MUENCHEN, FED REP GERMANY:
2,745,592, PUB. 5-13-2003. MULTIPLE CLASS, INT. CLS. 9, 35 AND 42.

GN RESOUND NORTH AMERICA CORPORATION, REDWOOD CITY, CA FROM GN RESOUND CORPORATION, REDWOOD CITY, CA:
2,747,867, INT. CL. 10.

GNLD INTERNATIONAL, LLC, FREMONT, CA:
2,748,980, INT. CL. 5.

GNVS ACQUISITION, LLC, VAIL, CO FROM TWELE, GERHARD, NAPA, CA, DBA GERHARD'S NAPA VALLEY SAUSAGE:
2,746,479, PUB. 4-1-2003. INT. CL. 29.

GODINGER SILVER ART CO., LTD., NEW YORK, NY:
2,747,594, INT. CL. 8.

GODSPEAKS, INC., ATLANTA, GA:
2,745,623, PUB. 5-13-2003. INT. CL. 42.
2,745,624, PUB. 5-13-2003. INT. CL. 42.
2,745,625, PUB. 5-13-2003. INT. CL. 42.

GOEKEN GROUP CORPORATION, NAPERVILLE, IL:
2,747,961, MULTIPLE CLASS, INT. CLS. 38 AND 42.

GOERTZ, JAMES L., UNIVERSITY PLACE, WA:
2,748,593, INT. CL. 25.

GOETZE AG, BURSCHEID 1, FED REP GERMANY:
1,166,153, REN. 6-22-03. INT. CL. 7.

GOL-PAK CORPORATION, ROCKY MOUNT, NC:
1,716,128, CANC. INT. CL. 29.

GOLD FORCE INTERNATIONAL, LTD., NEW YORK, NY:
2,748,123, INT. CL. 14.
2,748,124, INT. CL. 14.
2,748,125, INT. CL. 14.

GOLDBERG BROTHERS, INC., DENVER, CO:
1,717,032, CANC. INT. CL. 6.

GOLDDIGGERS, INC., MINNEAPOLIS, MN:
1,208,174, CANC. MULTIPLE CLASS, INT. CLS. 14 AND 42.

GOLDEN BAKE FOOD PRODUCTS, INC., ANAHEIM, CA:
2,748,942, INT. CL. 30.

GOLDEN BEAR INTERNATIONAL, INC., NORTH PALM BEACH, FL:
2,746,808, PUB. 5-13-2003. INT. CL. 28.

GOLDEN BIRD, INC., CULVER CITY, CA:
1,209,274, CANC. INT. CL. 42.

GOLDEN BOY ENTERPRISES, LLC, LOS ANGELES, CA:
2,748,581, MULTIPLE CLASS, INT. CLS. 16, 24 AND 25.

GOLDEN HARVEST SEEDS, INC., BLOOMINGTON, IL:
2,748,476, INT. CL. 31.

GOLDEN WEST PUBLISHING, INC., SANTA ANA, CA:
1,765,814, REN. 6-25-03. INT. CL. 16.

GOLDENBERG-GREEN, ARLEENE, GARDEN CITY, MI:
1,717,168, CANC. INT. CL. 35.

GOLDIG U.S.A. INC., HONOLULU, HI:
1,715,513, CANC. INT. CL. 14.

GOLDMARK, FRANCES, NEW HOPE, PA:
2,748,012, INT. CL. 3.

- GOLDSTEIN, JEFFREY, NEW YORK, NY:
2,747,373, PUB. 5-13-2003. INT. CL. 43.
- GOLDSTEIN, LEE R., SILVER SPRING, MD:
2,747,371, PUB. 5-13-2003. INT. CL. 36.
- GOLDSTEIN, REID ALAN, GAVIOTA, CA:
2,748,749, MULTIPLE CLASS, INT. CLS. 29 AND 30.
- GOLDSTREAM ENTERPRISES LTD., CENTRAL, HONG KONG:
2,000,708, CANC. MULTIPLE CLASS, INT. CLS. 36 AND 39.
- GOLF THING, INC., THE, WEST NYACK, NY:
2,000,999, CANC. INT. CL. 28.
- GOLFING INNOVATIONS, LLC, SANTA MONICA, CA:
2,747,357, PUB. 5-13-2003. INT. CL. 28.
- GOOCH FOODS, INC., LINCOLN, NE FROM ARCHER DANIELS MIDLAND COMPANY, DECATUR, IL:
2,745,885, PUB. 5-13-2003. INT. CL. 30.
- GOOD EARTH CORPORATION, THE, SANTA CRUZ, CA:
2,747,834, MULTIPLE CLASS, INT. CLS. 5 AND 30.
- GOOD HUMOR CORPORATION, GREEN BAY, WI, DBA GOOD HUMOR-BREYERS ICE CREAM:
2,000,802, CANC. INT. CL. 30.
- GOODHEART-WILCOX COMPANY, INC., SOUTH HOLLAND, IL:
737,931, CANC. U.S. CL. 38.
- GOODMAN AND CARR LLP, TORONTO M5H 3W5, ONTARIO, CANADA:
2,746,093, PUB. 5-13-2003. MULTIPLE CLASS, INT. CLS. 9, 14, 16, 18, 21, 24, 25, 28 AND 42.
2,746,094, PUB. 5-13-2003. INT. CL. 25.
- GOODMAN-SEGAR-HOGAN-HOFFLER, L.P., NORFOLK, VA:
2,001,242, CANC. INT. CL. 36.
- GOODMARK FOODS, INC., RALEIGH, NC:
1,716,116, CANC. INT. CL. 29.
- GOODRICH CORPORATION, CHARLOTTE, NC FROM B.F.GOODRICH COMPANY, THE, CHARLOTTE, NC:
2,748,020, MULTIPLE CLASS, INT. CLS. 8, 14, 16, 18, 21, 24, 25 AND 28.
- GOODYEAR TIRE & RUBBER COMPANY, THE, AKRON, OH:
1,208,291, CANC. INT. CL. 16.
2,001,774, CANC. INT. CL. 12.
- GORDON BANKSTON ENTERPRISES, INC., ODESSA, TX:
1,208,212, CANC. INT. CL. 16.
- GORDON, JON, PONTE VEDRA BEACH, FL:
2,746,776, PUB. 5-13-2003. INT. CL. 41.
- GOT IT PRODUCTIONS, LLC, ENCINAS, CA:
2,748,516, INT. CL. 41.
- GOTO.COM, INC., PASADENA, CA TO GOTO.COM, INC., PASADENA, CA:
2,664,372, COR. MULTIPLE CLASS, INT. CLS. 35, 38 AND 42.
- GOVERNMENT EMPLOYEES HOSPITAL ASSOCIATION, INC., INDEPENDENCE, MO:
2,001,314, CANC. INT. CL. 36.
2,747,407, PUB. 5-13-2003. INT. CL. 35.
- GOVPX, INC., NEW YORK, NY:
2,001,454, CANC. INT. CL. 36.
- GPS TRANSPORTATION, INC., BETHLEHEM, PA:
2,000,973, CANC. INT. CL. 39.
- GRACE RESTAURANT COMPANY, IRVINE, CA:
1,209,202, CANC. INT. CL. 42.
- GRACO INC., MINNEAPOLIS, MN:
2,745,601, PUB. 3-4-2003. INT. CL. 7.
- GRAHAM & BUFFETT, LTD., DALLAS, TX:
2,746,913, PUB. 5-13-2003. MULTIPLE CLASS, INT. CLS. 5 AND 32.
- GRAHAM WEBB INTERNATIONAL, DEEPHAVEN, MN:
2,001,326, CANC. INT. CL. 3.
- GRAHAM-PATTEN SYSTEMS, INC., GRASS VALLEY, CA:
1,715,220, CANC. INT. CL. 9.
- GRAHAM, LADAN P., DUBLIN, OH:
2,748,285, INT. CL. 25.
- GRAINGER, DAVID, WICHITA, KS:
2,749,015, INT. CL. 3.
- GRANITE SOLUTIONS INC., PORTAGE, MI:
2,748,228, INT. CL. 42.
- GRAPHIC CONTROLS CORPORATION, BUFFALO, NY:
1,764,347, REN. 6-25-03. INT. CL. 10.
- GRAPHIC TREE PRODUCTS, INC., SANTA ANA, CA:
1,209,181, CANC. INT. CL. 42.
- GREAT AMERICA INSURANCE COMPANY, CINCINNATI, OH:
1,716,475, CANC. INT. CL. 36.
- GREAT AMERICAN DUCK RACES, INC., SCOTTSDALE, AZ, DBA GAME: GREAT AMERICAN MERCHANDISE AND EVENTS:
2,747,180, PUB. 5-13-2003. INT. CL. 35.
2,748,949, INT. CL. 4.
- GREAT AMERICAN INSURANCE COMPANY, CINCINNATI, OH:
2,001,262, CANC. INT. CL. 36.
2,747,813, INT. CL. 41.
- GREAT BEAR ENTERPRISES, LLC, PHOENIX, AZ:
2,748,758, INT. CL. 30.
- GREATER HOUSTON CONVENTION AND VISITORS BUREAU, HOUSTON, TX:
2,746,514, PUB. 5-13-2003. INT. CL. 41.
- GREATER HOUSTON PARTNERSHIP, INC., HOUSTON, TX:
2,747,322, PUB. 5-13-2003. INT. CL. 35.
- GREEN BAY PACKAGING, INC., GREEN BAY, WI:
1,780,265, REN. 6-24-03. INT. CL. 16.
- GREEN GUERRILLAS, NEW YORK, NY:
2,747,094, PUB. 5-13-2003. MULTIPLE CLASS, INT. CLS. 41 AND 42.
- GREEN TEA TERRACE, INC., IRVINE, CA FROM G.T.JAPAN, INC., IRVINE, CA:
2,748,610, MULTIPLE CLASS, INT. CLS. 30, 35 AND 42.
- GREENBERG, ANN C., NEW YORK, NY:
2,001,968, CANC. INT. CL. 25.
- GREENHAUS, ANITA, SOUTH HUNTINGTON, NY:
1,812,470, REN. 6-26-03. INT. CL. 41.
- GREG MOSER ENGINEERING, INC., PORTLAND, IN:
2,748,353, INT. CL. 12.
2,748,354, INT. CL. 12.
2,748,355, INT. CL. 12.
- GREGOIRE, LILIANE, 75018, PARIS, FRANCE AND DUVALL, DANIEL, 75008 PARIS, FRANCE:
2,000,508, CANC. MULTIPLE CLASS, INT. CLS. 16 AND 18.
- GRIFFIN, ANNE, SAN FRANCISCO, CA:
2,745,531, PUB. 1-14-2003. INT. CL. 25.
- GRIPHOIST, INC., WESTWOOD, MA:
961,433, REN. 6-26-03. U.S. CL. 23 (INT. CL. 7).
- GRIZZARD ADVERTISING, INC., LOS ANGELES, CA:
2,746,408, PUB. 5-13-2003. INT. CL. 35.
- GROLSCHHE BIERBROUWERIJ B.V., ENSCHEDE, NETHERLANDS:
1,208,831, CANC. INT. CL. 32.
- GRONTMIJ GEO INFORMATIE B.V., NLX, NETHERLANDS FROM GRONTMIJ GEOGROEP B.V., ROOSENDAAL, NETHERLANDS:
2,748,640, INT. CL. 9.
- GROSHART, DON, PALO ALTO, CA, DBA CARMEL RECORDS:
1,715,272, CANC. INT. CL. 9.
- GROUP III INTERNATIONAL LTD., NEW YORK, NY:
2,001,219, CANC. INT. CL. 18.
- GROUP LEADERS OF AMERICA, INC., SALEM, OH:
1,716,384, CANC. INT. CL. 35.
- GROUPE ARNAULT SA, 75008 PARIS, FRANCE:
2,745,585, PUB. 5-15-2001. INT. CL. 36.
- GROUPE CASA FUEGO INC., QUEBEC, CANADA:
2,745,656, PUB. 9-17-2002. MULTIPLE CLASS, INT. CLS. 4, 5, 21 AND 35.
- GROVE, PAMELA E., REHOBOTH BEACH, DE, DBA TERRIFIC TOYS:
1,716,916, CANC. INT. CL. 42.
- GRUENE DISTR. BY T&M, INC., PHOENIX, AZ:
2,000,959, CANC. INT. CL. 3.
- GRUNDMAN, TERESA LEE, SANTA CLARITA, CA:
2,748,043, INT. CL. 35.
- GS DEVELOPMENT AB, S-21375 MALMO, SWEDEN:
2,747,806, MULTIPLE CLASS, INT. CLS. 5 AND 42.

- GTE SERVICE CORPORATION, STAMFORD, CT:
1,715,253, CANC. INT. CL. 9.
- GUANGXI YU LIN PHARMACEUTICAL FACTORY,
GUANGXI, CHINA, DBA YU LIN PHARMACEUTICAL
FACTORY:
2,745,539, PUB. 11-26-2002. INT. CL. 5.
- GUARDSMARK, LLC, MEMPHIS, TN, GUARDSMARK,
INC., MEMPHIS, TN:
1,774,392, REN. 6-21-03. INT. CL. 35.
- GUEITS, ADAMS & COMPANY, EASTON, MD:
2,001,296, CANC. INT. CL. 16.
- GUERLAIN S.A., 75008 PARIS, FRANCE:
2,746,456, PUB. 5-13-2003. INT. CL. 3.
- GUESTHOUSE INTERNATIONAL FRANCHISE SYSTEMS,
INC., HENDERSONVILLE, TN:
2,746,775, PUB. 5-13-2003. INT. CL. 43.
- GUEVREKIAN, JACK, MANHASSET, LONG ISLAND, NY:
2,747,550, INT. CL. 30.
- GULF SOUTH MEDICAL SUPPLY, INC., JACKSONVILLE,
FL:
2,748,108, INT. CL. 35.
- GULF STATES INTERNATIONAL, INC., UNION SPRINGS,
AL:
1,714,964, CANC. INT. CL. 5.
- GUSMER ENTERPRISES, INC., MOUNTAINESIDE, NJ,
CELLULO COMPANY, THE, HOBOKEN, NJ:
964,173, REN. 6-23-03. U.S. CL. 31 (INT. CL. 11).
- GUSMER ENTERPRISES, INC., MOUNTAINESIDE, NJ, CEL-
LULO CO., FRESNO, CA:
1,244,025, REN. 6-23-03. INT. CL. 1.
- GUSTY WINDS CORPORATION, COSTA MESA, CA:
2,747,557, INT. CL. 5.
- GUTMANN CUTLERY, INC., BELLINGHAM, WA, GUT-
MANN CUTLERY, INC., MT. VERNON, NY:
1,218,137, REN. 6-24-03. INT. CL. 8.
- GUYS WHO LOVE GOD, LLC, GLEN BURNIE, MD:
2,746,850, PUB. 5-13-2003. INT. CL. 41.
- GWE CONSULTING GROUP, LTD., CALGARY, ALBERTA,
CANADA TO XENTEL DM INCORPORATED, CAL-
GRAY, ALBERTA, CANADA:
1,715,594, CANC. INT. CL. 16.
- H & R SPECIAL SPRINGS, L.P., BELLINGHAM, WA:
2,748,437, INT. CL. 12.
2,748,438, INT. CL. 12.
- H & R 1871, LLC, GARDNER, MA, H&R 1871, INC.,
GARDNER, MA:
1,777,802, REN. 6-23-03. INT. CL. 13.
- H. LUNDBECK A/S, DK-2500 COPENHAGEN-VALBY, DEN-
MARK:
2,745,991, PUB. 9-17-2002. MULTIPLE CLASS, INT. CLS.
5, 9, 16, 41 AND 42.
- H.L. GOOD FOOD, INC., SAN GABRIEL, CA:
2,001,007, CANC. INT. CL. 30.
- H.P. INCORPORATED, RAMONA, CA, DBA HOMESTEAD
PRODUCTS:
1,208,110, CANC. INT. CL. 11.
- H&H ECO SYSTEMS, INC., NORTH BONNEVILLE, WA:
2,747,476, INT. CL. 40.
- H-D MICHIGAN, INC., ANN ARBOR, MI, HARLEY-DA-
VIDSON MOTOR CO. INC., MILWAUKEE, WI:
1,223,355, REN. 6-22-03. INT. CL. 14.
- HAAS BURSTENFABRIK GMBH, DONAUESCHINGEN,
FED REP GERMANY:
2,745,823, PUB. 7-16-2002. MULTIPLE CLASS, INT. CLS. 7
AND 21.
- HACKNEY, MORGAN E., WHITTIER, CA:
2,748,735, INT. CL. 16.
- HACKWORTH, SAMUEL R., LITTLE ROCK, AR:
2,748,602, INT. CL. 42.
- HADDAD, EARL S., COLUMBUS, OH, DBA BREAK-
THROUGH BROADCAST TROUPE & CANOE LIVERY:
2,001,671, CANC. INT. CL. 41.
- HADDENHAM LIMITED, HONG KONG:
2,000,590, CANC. INT. CL. 21.
- HAESTAD METHODS, INC., WATERBURY, CT:
2,748,701, INT. CL. 38.
2,748,745, INT. CL. 42.
- HAGEMEYER NORTH AMERICA, INC., ALPHARETTA,
GA, VALLEN SAFETY SUPPLY COMPANY, HOUSTON,
TX:
1,773,530, REN. 6-26-03. INT. CL. 10.
1,774,633, REN. 6-26-03. INT. CL. 9.
1,775,809, REN. 6-26-03. INT. CL. 10.
- HAGEMEYER NORTH AMERICA, INC., ALPHARETTA,
GA:
2,746,416, PUB. 5-13-2003. INT. CL. 35.
- HAIR COLLECTION INC., BROOKLYN, NY:
2,745,932, PUB. 5-13-2003. INT. CL. 26.
- HALAPIN LEARNING SYSTEMS, INC., TRUMBULL, CT,
HAPPY PRODUCTS, INC., TRUMBULL, CT:
1,232,708, REN. 6-26-03. INT. CL. 16.
- HALE COUNTY STATE BANK, PLAINVIEW, TX:
2,746,959, PUB. 5-13-2003. INT. CL. 36.
- HALE, GARY A., EAST HARTFORD, CT:
2,746,877, PUB. 5-13-2003. INT. CL. 25.
- HALF MOON FRUIT & PRODUCE CO., YOLO, CA:
176,507, REN. 6-27-03. U.S. CL. 46 (INT. CL. 31).
- HALIDAY; GEORGE C., BRICKTOWN, NJ:
1,208,637, CANC. INT. CL. 28.
- HALL, ANTHONY ROBERT, DURSEY, GLOUCESTER-
SHIRE, UNITED KINGDOM:
2,745,864, PUB. 10-15-2002. MULTIPLE CLASS, INT. CLS.
16 AND 28.
- HALL, RICHARD, NEW YORK, NY:
2,748,580, MULTIPLE CLASS, INT. CLS. 9, 16, 25 AND 41.
- HALLIBURTON COMPANY, CARROLLTON, TX:
2,001,550, CANC. INT. CL. 40.
- HALSTEAD INDUSTRIES, INC., GREENSBORO, NC:
1,208,330, CANC. INT. CL. 17.
- HAMILTON FIXTURE COMPANY, HAMILTON, OH:
1,715,819, CANC. INT. CL. 20.
- HAMILTON RESEARCH, INC., SOUTH HAMILTON, MA:
2,747,347, PUB. 5-13-2003. INT. CL. 20.
- HAMMER LLC, CANNON BEACH, OR:
2,748,988, INT. CL. 25.
- HAMMOND WORLD ATLAS CORPORATION, UNION, NJ:
2,748,673, INT. CL. 16.
- HAMMOND, JACQUELINE E, YIGO, GUAM:
2,745,851, PUB. 10-8-2002. INT. CL. 28.
- HAMON THERMAL EUROPE S.A., 1060 BRUSSELS, BEL-
GIUM:
2,745,813, PUB. 5-13-2003. INT. CL. 11.
- HAMPTON UNIVERSITY, HAMPTON, VA:
1,715,511, CANC. MULTIPLE CLASS, INT. CLS. 14, 16, 21
AND 25.
- HAMWORTHY COMBUSTION ENGINEERING LTD., DOR-
SET, GREAT BRITAIN:
2,746,721, PUB. 5-13-2003. INT. CL. 11.
- HAND TOOL DESIGN CORPORATION, WILMINGTON,
DE:
2,746,792, PUB. 5-13-2003. INT. CL. 7.
- HANDY GIRLS, INC., LAS VEGAS, NV:
1,208,645, CANC. INT. CL. 28.
- HANLEY, ALAN, GENEVA, IL:
2,746,072, PUB. 5-13-2003. INT. CL. 35.
- HANNA-BARBERA PRODUCTIONS, INC., SHERMAN
OAKS, CA:
1,799,749, REN. 6-23-03. INT. CL. 41.
2,747,019, PUB. 5-13-2003. INT. CL. 25.
- HANSEN BEVERAGE COMPANY, CORONA, CA:
2,748,021, INT. CL. 5.
- HANSEN, DONNA C., SYLMAR, CA:
2,001,309, CANC. INT. CL. 16.
- HARBOR ADVERTISING AND PROMOTION CORP., NEW
YORK, NY:
2,001,422, CANC. MULTIPLE CLASS, INT. CLS. 36 AND
42.
- HARCOURT, INC., ORLANDO, FL:
2,746,773, PUB. 5-13-2003. INT. CL. 16.
- HARDIGG INDUSTRIES, INC., SOUTH DEERFIELD, MA:
2,748,356, INT. CL. 1.
- HARDWARE TECHNOLOGIES, LTD.:
See— HOPPE NORTH AMERICA INC..
- HARPAK, INC., SOUTH EASTON, MA:
2,747,120, PUB. 5-13-2003. INT. CL. 9.

- HARPER, SANDRA, RIVERSIDE, CA:
2,748,268, MULTIPLE CLASS, INT. CLS. 16 AND 25.
- HARRIET & HENDERSON YARNS, INC., HENDERSON, NC:
1,234,678, REN. 6-24-03, INT. CL. 23.
- HARRIS ASSOCIATES L.P., CHICAGO, IL:
1,716,435, CANC. INT. CL. 36.
- HARRIS CORPORATION, MELBOURNE, FL:
2,748,023, INT. CL. 9.
- HARRIS, ORPHA LEE, ST. PETERSBURG, FL, DBA L&R CONCEPTS:
2,746,460, PUB. 5-13-2003, INT. CL. 3.
- HARRIS, TERRY L., MASCOT, TN:
2,748,099, INT. CL. 19.
- HARRISON P. T. SERVICES, P. C., DENVER, CO:
2,748,604, INT. CL. 42.
- HARRISON WHOLESALE PRODUCTS INC., HARRISON, TN:
2,001,073, CANC. INT. CL. 5.
- HART STORES, INC., COLUMBUS, OH:
1,209,305, CANC. INT. CL. 42.
- HART STORES, INC., COLUMBUS, OH:
1,209,304, CANC. INT. CL. 42.
- HARTFORD FIRE INSURANCE COMPANY, HARTFORD, CT:
2,001,997, CANC. INT. CL. 36.
2,020,476, CANC. INT. CL. 35.
- HARTFORD-JACKSON, LLC, WINDSOR, CA:
2,747,399, PUB. 5-13-2003, INT. CL. 33.
- HARVEL PLASTICS, INC., SLATINGTON, PA:
2,745,568, PUB. 5-13-2003, INT. CL. 17.
- HARVEST FOUNDATION, PHOENIX, AZ:
2,746,320, PUB. 5-13-2003, INT. CL. 41.
2,746,385, PUB. 5-13-2003, INT. CL. 41.
- HARVEST STATES COOPERATIVES, ST. PAUL, MN:
1,208,794, CANC. INT. CL. 31.
- HARVEY WESTBURY CORP., WESTBURY, NY:
1,207,901, CANC. MULTIPLE CLASS, INT. CLS. 8, 9, 11, 12 AND 17.
- HASBRO, INC., PAWTUCKET, RI:
1,716,058, CANC. INT. CL. 28.
- HASBRO, INC., PAWTUCKET, RI FROM TIGER ELECTRONICS, INC., VERNON HILLS, IL:
2,745,416, PUB. 6-6-1995, INT. CL. 28.
- HASBRO, INC., PAWTUCKET, RI:
2,746,862, PUB. 5-13-2003, INT. CL. 28.
2,748,390, INT. CL. 28.
2,748,427, INT. CL. 28.
2,748,481, INT. CL. 28.
2,748,503, INT. CL. 28.
- HAWAIIAN KONA COFFEE COMPANY, LTD., HONOLULU, HI:
1,773,789, REN. 6-23-03, INT. CL. 30.
- HAWKINS CHILDREN'S LLC, EUGENE, OR:
2,747,162, PUB. 5-13-2003, INT. CL. 21.
- HAYES MICROCOMPUTER PRODUCTS, INC., NORCROSS, GA:
2,000,555, CANC. INT. CL. 9.
- HAYNES INTERNATIONAL, INC., KOKOMO, IN, UNION CARBIDE CORPORATION, NEW YORK, NY:
756,690, REN. 6-26-03, U.S. CL. 14 (INT. CL. 6).
- HD ELECTRIC CO., DEERFIELD, IL:
737,802, CANC. U.S. CL. 21.
- HDN DEVELOPMENT CORPORATION, FLORENCE, KY:
2,748,338, INT. CL. 35.
- HDS COSMETIC LAB, INC., SUCCESS, NY:
2,001,104, CANC. INT. CL. 3.
- HEAD SPORT AG, A-6921 KENNELBACH, AUSTRIA:
2,748,430, MULTIPLE CLASS, INT. CLS. 18 AND 28.
- HEADWEST, INC., COMPTON, CA:
1,773,010, REN. 6-25-03, INT. CL. 20.
- HEALTH ASURE, INC., SUNRISE, FL:
2,746,317, PUB. 5-13-2003, INT. CL. 3.
- HEALTH AWARENESS PUBLICATIONS, INC., LIVERPOOL, NY:
1,208,313, CANC. INT. CL. 16.
- HEALTH NET, INC., WOODLAND HILLS, CA, HEALTH NET, WOODLAND HILLS, CA:
1,795,477, REN. 6-27-03, MULTIPLE CLASS, INT. CLS. 36 AND 42.
- HEALTH-AIRE CO. INC., NUTLEY, NJ:
1,775,494, REN. 6-25-03, INT. CL. 37.
- HEALTHAVENUE, INC., ASHEVILLE, NC:
2,747,515, INT. CL. 35.
- HEALTHCARE BUSINESS RESOURCES, INC., JACKSONVILLE, FL:
2,745,889, PUB. 10-8-2002, MULTIPLE CLASS, INT. CLS. 35, 36 AND 41.
- HEALTHCARE THERAPY SERVICES, INC., INDIANAPOLIS, IN:
2,746,908, PUB. 5-13-2003, INT. CL. 44.
- HEALTHKEEPERS, INC., RICHMOND, VA:
2,001,870, CANC. INT. CL. 42.
- HEALTHRIDER, INC, SALT LAKE CITY, UT:
2,001,306, CANC. INT. CL. 28.
- HEARST CORPORATION, THE, NEW YORK, NY TO HEARST MAGAZINES PROPERTY, INC., GREENWICH, CT:
2,003,264, AM. INT. CL. 16.
- HEART OF AMERICA FOUNDATION, THE, WASHINGTON, DC:
2,745,443, PUB. 12-3-2002, INT. CL. 41.
- HEART OF AMERICA UNITED WAY, INC., KANSAS CITY, MO:
2,748,530, INT. CL. 35.
- HEARTLAND PAYMENT SYSTEMS, INC., SCOTTSDALE, AZ:
2,747,285, PUB. 5-13-2003, INT. CL. 36.
- HEARTS ON FIRE COMPANY, BOSTON, MA:
2,746,882, PUB. 5-13-2003, INT. CL. 14.
- HEARTSINE TECHNOLOGIES, INC., MISSION VIEJO, CA:
2,747,023, PUB. 5-13-2003, INT. CL. 10.
- HEATH COMPANY, ST. JOSEPH, MI:
1,208,237, CANC. INT. CL. 16.
- HEATHER, RODNEY K., JR., MIDDLETOWN, NJ:
2,001,235, CANC. INT. CL. 16.
- HEATHSOUTH, BIRMINGHAM, AL:
2,748,134, MULTIPLE CLASS, INT. CLS. 16, 25, 41 AND 42.
- HEAVENLY CIGAR COMPANY, NAPLES, FL:
2,747,335, PUB. 5-13-2003, INT. CL. 34.
- HEAVERS, DEBRA L., HORSE CAVE, KY AND FOSTER, DAVID G., HORSE CAVE, KY:
2,747,206, PUB. 5-13-2003, INT. CL. 41.
- HEDSTROM CORPORATION, MOUNT PROSPECT, IL:
2,748,868, INT. CL. 16.
- HEIL-QUAKER CORPORATION, LAVERGNE, TN:
1,208,099, CANC. INT. CL. 11.
- HEIMAN, MARCIA, CAMBRIDGE, MA AND SLOMIANKO, JOSHUA, CAMBRIDGE, MA, DBA LEARNING SKILLS CONSULTANTS:
1,720,781, REN. 6-25-03, INT. CL. 41.
- HEINEKEN BROUWERIJEN B.V., 1017 ZD AMSTERDAM, NETHERLANDS:
2,747,298, PUB. 5-13-2003, MULTIPLE CLASS, INT. CLS. 9 AND 41.
- HEINRICH BERNDES KG, ARNSBERG 1, FED REP GERMANY:
1,260,960, REN. 6-24-03, INT. CL. 21.
- HELEN OF TROY LIMITED (BARBADOS), BRIDGEWATER, BARBADOS:
2,746,609, PUB. 5-13-2003, INT. CL. 9.
- HELENA CHEMICAL COMPANY, COLLIERVILLE, TN:
2,748,912, INT. CL. 5.
- HELENE CURTIS, INC., WILMINGTON, DE:
2,748,102, INT. CL. 3.
- HELIOGENESIS, INC., ROCHESTER, NY:
2,748,292, INT. CL. 28.
- HELLIWELL, TANIS, VANCOUVER, BRITISH COLUMBIA, CANADA:
2,745,649, PUB. 11-19-2002, MULTIPLE CLASS, INT. CLS. 9, 16 AND 41.
- HELMAN GROUP, LTD., THE, OXNARD, CA:
2,748,307, INT. CL. 11.

- HELIVA GOOD, LLC, SODUS, NY:
2,746,340, PUB. 11-26-2002. INT. CL. 29.
- HEMOPET, SANTA MONICA, CA:
1,787,801. REN. 6-23-03. INT. CL. 5.
- HEMSTREET, MARK S., PORTLAND, OR, DBA SHILO
INNS:
1,719,168. REN. 6-21-03. INT. CL. 42.
- HENDERSON BROTHERS, INC., PITTSBURGH, PA:
2,747,439, PUB. 5-13-2003. INT. CL. 36.
- HENNESSEE, PHIL MONTY, GAITHERSBURG, MD:
2,001,213, CANC. MULTIPLE CLASS, INT. CLS. 16 AND
25.
- HENRI STUDIO, INC., WAUCONDA, IL:
1,766,724. REN. 6-23-03. INT. CL. 19.
- HENRICKSEN & COMPANY, INC., ITASCA, IL:
2,746,513, PUB. 5-13-2003. MULTIPLE CLASS, INT. CLS.
37 AND 42.
- HENSON, THOMAS, RALEIGH, NC:
2,746,097, PUB. 5-13-2003. INT. CL. 42.
- HERAEUS ELECTRO-NITE INTERNATIONAL N.V., AN-
TWERPEN, BELGIUM, ELECTRO-NITE ENGINEERING
COMPANY, PHILADELPHIA, PA:
756,395. REN. 6-26-03. U.S. CL. 26 (INT. CL. 9).
- HERAEUS HOLDING GMBH, D-63450 HANAU, FED REP
GERMANY:
2,745,821, PUB. 2-18-2003. INT. CL. 9.
- HERAEUS KULZER GMBH, HANAU, FED REP GER-
MANY, HERAEUS KULZER GMBH, 6450 HANAU AM
MAIN, FED REP GERMANY:
1,771,048. REN. 6-24-03. INT. CL. 5.
- HERAEUS KULZER GMBH & CO KG, D-63450 HANAU,
FED REP GERMANY, HERAEUS KULZER GMBH, 6450
HANAU AM MAIN, FED REP GERMANY:
1,772,763. REN. 6-24-03. INT. CL. 5.
- HERAEUS QUARZGLAS GMBH & CO. KG, 63450 HANAU,
FED REP GERMANY:
2,745,854, PUB. 10-29-2002. MULTIPLE CLASS, INT. CLS.
1, 9 AND 19.
- HERB'S SEAFOOD, INC., MT. HOLLY, NJ:
2,746,443, PUB. 5-13-2003. INT. CL. 29.
- HERITAGE CAPITAL CORPORATION, DALLAS, TX:
2,746,296, PUB. 5-13-2003. INT. CL. 35.
- HERITAGE DECOYS LTD.:
See—3831558 CANDA INC.
- HERITAGE PRESERVATION CORPORATION, SPARTAN-
BURG, SC:
2,749,038, INT. CL. 35.
- HERMES INTERNATIONAL, 75008 PARIS, FRANCE:
2,746,454, PUB. 5-13-2003. INT. CL. 9.
- HERRICK, MARY, AMHERST, OH:
2,747,249, PUB. 5-13-2003. INT. CL. 41.
- HERRING, VICTORIA L., DES MOINES, IA:
2,747,010, PUB. 5-13-2003. INT. CL. 39.
- HESTER, CHARLES, MEMPHIS, TN:
2,748,548, INT. CL. 15.
- HETTY ENTERPRISE U.S.A. INC., ROSEMEAD, CA:
2,000,676, CANC. INT. CL. 30.
- HEWLETT-PACKARD COMPANY, PALO ALTO, CA:
2,748,619, INT. CL. 35.
- HI-TEK PRODUCTIONS, INC., BEVERLY HILLS, CA:
2,746,065, PUB. 5-13-2003. INT. CL. 9.
- HI-VI DOG FOOD COMPANY, RUSH SPRINGS, OK:
737,986, CANC. U.S. CL. 46.
- HIDDEN LINKS, INC., ROSWELL, GA:
2,746,250, PUB. 9-17-2002. INT. CL. 39.
- HIGA CORPORATION, LONG PRAIRIE, GA:
1,209,107, CANC. INT. CL. 41.
- HIGH APPALACHIAN LIMITED LIABILITY COMPANY,
DANIELS, WV TO WEST VIRGINIA JOBS INVESTMENT
TRUST BOARD, CHARLESTON, WV:
2,023,573 NEW CERT. 8-5-2003. INT. CL. 29.
- HIGH BRANDON INCORPORATED, NEI HU, TAIPEI,
TAIWAN:
2,746,022, PUB. 5-13-2003. INT. CL. 21.
- HIGH STANDARD, INC., EAST HARTFORD, CT:
737,715, CANC. U.S. CL. 9.
- HIGH VOLTAGE ENGINEERING CORPORATION, CLAY-
TON, NC:
2,000,761, CANC. INT. CL. 17.
- HIGHLAND HARDWARE, INC., ATLANTA, GA:
1,725,074. REN. 6-25-03. INT. CL. 8.
- HIGHLIGHTS FOR CHILDREN, INC., COLUMBUS, OH:
2,746,436, PUB. 5-13-2003. INT. CL. 41.
- HILL INDUSTRIES USA, INC., SARASOTA, FL:
2,001,019, CANC. MULTIPLE CLASS, INT. CLS. 16, 25
AND 34.
- HILL-ROM, INC., BATESVILLE, IN:
2,001,549, CANC. INT. CL. 10.
- HILLENBRAND INDUSTRIES, INC., BATESVILLE, IN:
1,773,201. REN. 6-23-03. INT. CL. 41.
1,793,017. REN. 6-23-03. INT. CL. 41.
- HILLTOP NEW MEDIA, INC., CULVER CITY, CA:
2,747,568, INT. CL. 41.
- HINDMAN; ALVIN W., KERRVILLE, TX, DBA ACE TAR-
GETS:
1,207,902, CANC. MULTIPLE CLASS, INT. CLS. 8, 16
AND 28.
- HINES NURSERIES, INC., IRVINE, CA, HINES NURSERIES,
INC., HOUSTON, TX:
1,764,767. REN. 6-25-03. INT. CL. 31.
- HINES NURSERIES, INC., IRVINE, CA FROM HINES
HORTICULTURE, INC., IRVINE, CA:
2,747,765, INT. CL. 31.
- HIRATA BOKUJO CO., LTD., SAKATA-SHI, YAMAGATA-
KEN, JAPAN:
2,001,715, CANC. INT. CL. 29.
- HIRERIGHT, INC., IRVINE, CA:
2,748,100, INT. CL. 35.
- HIRSCHMANN LABORGERATE GMBH & CO. KG, D-74246
EBERSTADT, FED REP GERMANY:
2,745,726, PUB. 10-15-2002. INT. CL. 9.
- HISAMITSU PHARMACEUTICAL CO., INC., SAGA, JAPAN:
2,747,214, PUB. 5-13-2003. INT. CL. 5.
- HIX, DANIEL H., LAWRENCE, KS:
2,747,290, PUB. 5-13-2003. MULTIPLE CLASS, INT. CLS.
35 AND 41.
- HME CORPORATION, GLEN RIDGE, NJ:
2,747,217, PUB. 5-13-2003. INT. CL. 25.
- HMI INDUSTRIES INC., CLEVELAND, OH:
2,000,968, CANC. MULTIPLE CLASS, INT. CLS. 9 AND
16.
- HO CHENG GARDEN TOOLS CO., LTD., FU SHING
HSIANG, CHANG HUA HSIEN, TAIWAN:
2,748,568, INT. CL. 8.
- HO-CHUNK NATION, BLACK RIVER FALLS, WI:
2,746,366, PUB. 5-13-2003. INT. CL. 41.
- HOCKEY-ROANOKE, INC., ROANOKE, VA:
2,000,553, CANC. INT. CL. 41.
- HOEFLER TYPE FOUNDRY, INC., THE, NEW YORK, NY:
2,746,692, PUB. 5-13-2003. INT. CL. 9.
2,746,693, PUB. 5-13-2003. INT. CL. 9.
- HOELLGER, THORSTEN:
See—FORTUNEGLOBE GMBH.
- HOFF, DAVID M., WEST HARTFORD, CT:
2,746,427, PUB. 5-13-2003. INT. CL. 25.
- HOFFMAN MARITIME CONSULTANTS, INC., WILD-
WOOD, LOCUST VALLEY, NY:
1,207,912, CANC. MULTIPLE CLASS, INT. CLS. 9 AND
42.
- HOLD EM, INC., WEST PALM BEACH, FL:
2,748,656, INT. CL. 21.
- HOLDUN INVESTMENT MANAGEMENT, INC., MON-
TREAL, QUEBEC, CANADA:
2,745,879, PUB. 12-24-2002. INT. CL. 36.
2,745,880, PUB. 11-12-2002. INT. CL. 36.
2,745,881, PUB. 11-12-2002. INT. CL. 36.
- HOLISTA HEALTH CORPORATION, LANGLEY, BRITISH
COLUMBIA, CANADA:
2,745,514, PUB. 11-13-2001. INT. CL. 5.
- HOLISTIC NATUROPATHIC CENTER, LLC, CLIFTON, NJ:
2,746,683, PUB. 5-13-2003. INT. CL. 5.
- HOLLY, CATHERINE LOCKE, KNOXVILLE, TN:
2,747,229, PUB. 5-13-2003. INT. CL. 43.

- HOLLYWOOD SYSTEMS, INC., CALLAHAN, FL:
2,745,647, PUB. 2-27-2001. INT. CL. 38.
- HOLMES GROUP, INC., THE, MILFORD, MA:
2,747,868, INT. CL. 11.
- HOLSTEIN ASSOCIATION USA, INC., BRATTLEBORO, VT,
DBA HOLSTEIN ASSOCIATION:
2,000,768, CANC. INT. CL. 35.
- HOLTZ HOUSE OF VEHICLES INC., ROCHESTER, NY:
2,746,343, PUB. 5-13-2003. INT. CL. 35.
- HOM/ADE FOODS, INC., BAGDAD, FL:
2,745,798, PUB. 12-10-2002. INT. CL. 30.
- HOMAC MFG. COMPANY, ORMOND BEACH, FL:
2,746,933, PUB. 5-13-2003. INT. CL. 9.
- HOME BOY CLOTHING (PTY) LTD., OBSERVATORY,
SOUTH AFRICA:
2,746,274, PUB. 5-13-2003. INT. CL. 25.
- HOME DYNAMIX, S. HACKENSACK, NJ:
2,748,163, INT. CL. 19.
- HOME ENTERTAINMENT SUPPLIERS PTY LTD, NEW
SOUTH WALES 2156, AUSTRALIA:
2,746,319, PUB. 5-13-2003. MULTIPLE CLASS, INT. CLS. 9
AND 35.
- HOME SHOPPING NETWORK, INC., CLEARWATER, FL:
2,001,009, CANC. INT. CL. 38.
- HOME SYSTEMS PLUS, LLC, OWING MILLS, MD:
2,745,507, PUB. 10-8-2002. INT. CL. 9.
- HOMESPUN TAPES, LTD., WOODSTOCK, NY:
2,746,510, PUB. 5-13-2003. INT. CL. 9.
- HOMEVESTORS OF AMERICA, INC., DALLAS, TX:
2,746,669, PUB. 5-13-2003. INT. CL. 35.
- HONDA GIKEN KOGYO KABUSHIKI KAISHA (HONDA
MOTOR CO., LTD.), MINATO-KU, TOKYO 107, JAPAN:
2,747,481, INT. CL. 12.
- HONEYWELL INTERNATIONAL INC., MORRISTOWN, NJ:
2,746,357, PUB. 5-13-2003. INT. CL. 1.
- HOODMAN CORPORATION, REDONDO BEACH, CA:
2,746,231, PUB. 5-13-2003. INT. CL. 9.
- HOOSIER HOOPS BASKETBALL SYSTEMS, INC., INDIA-
NAPOLIS, IN:
2,746,293, PUB. 5-13-2003. INT. CL. 28.
- HOOSIER HOOPS BASKETBALL SYSTEMS, INC., INDIA-
NAPOLIS, IN, TA HOOSIER HOOPS, INC.:
2,746,855, PUB. 5-13-2003. INT. CL. 28.
- HOPPE NORTH AMERICA INC., FORT ATKINSON, WI
FROM HARDWARE TECHNOLOGIES, LTD., FORT AT-
KINSON, WI:
2,746,512, PUB. 5-13-2003. MULTIPLE CLASS, INT. CLS. 6
AND 20.
- HORA, ROLAND, BARTELBERGERWEG 1, FED REP
GERMANY:
2,747,546, INT. CL. 31.
- HORIZON HOBBY, INC., CHAMPAIGN, IL:
2,746,674, PUB. 5-13-2003. INT. CL. 28.
2,746,675, PUB. 5-13-2003. INT. CL. 28.
- HORIZON PHARMACEUTICAL CORPORATION, ROS-
WELL, GA:
2,000,679, CANC. INT. CL. 5.
- HORIZON RESOURCES, INC., HOUSTON, TX, HORIZON
RESOURCES, INC., HOUSTON, TX:
1,239,813, REN. 6-23-03. INT. CL. 42.
- HORIZON SNACK FOODS, INC., LIVERMORE, CA:
2,746,650, PUB. 5-13-2003. INT. CL. 30.
2,747,324, PUB. 5-13-2003. INT. CL. 30.
- HOST MARRIOTT CORPORATION, BETHESDA, MD:
2,001,626, CANC. INT. CL. 42.
- HOT FUDGE VENTURE FUND, BURLINGTON, VT:
2,748,403, INT. CL. 25.
- HOTZE, EARL B., ST. LOUIS, MO, DBA VENTURE MAN-
AGEMENT COMPANY:
1,208,221, CANC. INT. CL. 16.
- HOULIHAN, MICHAEL C., HEALDSBURG, CA AND HAR-
VEY, BONNIE M., HEALDSBURG, CA, DBA GREAT
THINKS:
2,001,895, CANC. INT. CL. 33.
- HOUSE OF BLUES BRANDS CORP., HOLLYWOOD, CA:
2,746,582, PUB. 5-13-2003. INT. CL. 35.
- HOUSE OF DANIELS, INC., NOVATO, CA, DBA HOUSE OF
DANIELS AND DBA REDWOOD VINTNERS FINE WINE
& SPIRITS:
2,745,943, PUB. 5-13-2003. INT. CL. 33.
- HOUSE OF FARA, INC., LA PORTE, IN:
1,776,548, REN. 6-26-03. INT. CL. 19.
- HOUSE OF PRINCE A/S, SOBORG, DENMARK:
2,680,220, COR. INT. CL. 34.
- HOUSHIARNEJAD, ALI, DOYLESTOWN, PA:
2,001,533, CANC. MULTIPLE CLASS, INT. CLS. 37 AND
42.
- HOUSTON INDEPENDENT SCHOOL DISTRICT, HOUS-
TON, TX:
2,746,030, PUB. 5-13-2003. INT. CL. 41.
- HOUSTON TROPICARE, INC., THE WOODLANDS, TX:
2,748,833, INT. CL. 5.
- HOUZELL, PAUL ANTONELLE JR., CARSON, CA:
2,001,538, CANC. INT. CL. 16.
- HOWARD, DON, WICHITA FALLS, TX:
2,748,519, INT. CL. 6.
- HOWARD, MALCOLM B., SCOTTSDALE, AZ, UNIVERSAL
INDUSTRIES CORPORATION, COLUMBUS, MS:
1,232,093, REN. 6-24-03. MULTIPLE CLASS, INT. CLS. 30
AND 32.
- HSBC BUSINESS LOANS, INC., BOSTON, MA:
1,714,925, CANC. INT. CL. 3.
- HSS HIRE SERVICE GROUP PLC, MITCHAM SURREY,
UNITED KINGDOM:
2,746,297, PUB. 10-15-2002. INT. CL. 37.
- HUANG, ING-KAI, HSIN CHU, TAIWAN:
2,748,037, INT. CL. 16.
- HUBBARD & REVO-COHEN, INC., VIENNA, VA:
2,747,969, MULTIPLE CLASS, INT. CLS. 9, 35 AND 41.
- HUBERT GASSER DESIGN & CONSULTING SAS DI H.
GASSER & C., 39100 BOLZANO, ITALY:
2,000,528, CANC. INT. CL. 25.
- HUCK INTERNATIONAL, INC., TUCSON, AZ:
2,746,249, PUB. 11-26-2002. INT. CL. 6.
2,747,773, MULTIPLE CLASS, INT. CLS. 6 AND 7.
- HUFFY CORPORATION, MIAMISBURG, OH:
2,748,984, INT. CL. 12.
- HUGHES, ELIZABETH H., MYSTIC, CT:
1,716,935, CANC. INT. CL. 42.
- HUGHES, JOHN W., FORT WORTH, TX:
2,747,437, PUB. 5-13-2003. INT. CL. 42.
- HUGHES, LAURA B., KIRKWOOD, MO:
2,748,627, MULTIPLE CLASS, INT. CLS. 35 AND 42.
- HUGO BOSS AG, 72555 METZINGEN, FED REP GERMANY:
2,746,219, PUB. 5-13-2003. INT. CL. 35.
- HUKIC, ZLATKO, CHICAGO, IL, AKA BOBBY HUKIC:
2,745,703, PUB. 3-13-2001. INT. CL. 41.
- HULL, WILLIAM RANDALL, SUNNYVALE, CA:
2,745,497, PUB. 5-13-2003. MULTIPLE CLASS, INT. CLS.
35 AND 42.
- HUMAN BEAMS, KAILUA-KONA, HI:
2,748,646, INT. CL. 15.
- HUMAN LIFE INTERNATIONAL, INC., FRONT ROYAL,
VA:
2,747,733, INT. CL. 9.
- HUMOR CONSULTANTS, INC., POWELL, OH:
2,747,974, INT. CL. 41.
- HUNTER FAN COMPANY, MEMPHIS, TN:
2,747,435, PUB. 5-13-2003. INT. CL. 11.
2,747,436, PUB. 5-13-2003. INT. CL. 11.
- HUNTER MANUFACTURING GROUP, INC., LEXINGTON,
KY:
2,001,623, CANC. INT. CL. 14.
- HUNTER WINE AUSTRALIA PTY LIMITED, ROTHBURY
NSW 2320, AUSTRALIA:
2,746,556, PUB. 5-13-2003. INT. CL. 33.
2,746,557, PUB. 5-13-2003. INT. CL. 33.
- HUNTER'S SPECIALTIES, INC., CEDAR RAPIDS, IA:
2,748,935, INT. CL. 5.
- HUNZA HOLDINGS LIMITED, AUCKLAND, NEW ZEAL-
AND:
2,746,024, PUB. 5-13-2003. INT. CL. 9.
- HUNZA HOLDINGS LTD, PANMURE, NEW ZEALAND:
2,746,238, PUB. 5-13-2003. MULTIPLE CLASS, INT. CLS. 9

- AND 11.
 HURD, HOLLIS T., PITTSBURGH, PA:
 1,716,974, CANC. INT. CL. 42.
 HYATT CORPORATION, CHICAGO, IL:
 1,793,124, REN. 6-25-03. INT. CL. 42.
 HYPERFORMANCE, KIRKLAND, WA:
 2,001,529, CANC. INT. CL. 25.
 HYPOGUARD LIMITED, WOODBRIDGE, SUFFOLK, IP12
 IPE, UNITED KINGDOM:
 2,747,702, MULTIPLE CLASS, INT. CLS. 5 AND 10.
 HYPRO CORPORATION, NEW BRIGHTON, MN:
 2,748,496, INT. CL. 7.
 HYTECH PUMPS INTERNATIONAL INC., BEDFORD, MI,
 DBA JETECH, INC.:
 1,715,021, CANC. INT. CL. 7.
 IBI, 95420 HODENT, FRANCE:
 2,746,410, PUB. 5-13-2003. INT. CL. 21.
 IBX TECHNOLOGIES INC, DEERFIELD BEACH, FL:
 2,746,713, PUB. 5-13-2003. MULTIPLE CLASS, INT. CLS.
 35 AND 36.
 ICARUS CORP., ROCKVILLE, MD:
 1,715,096, CANC. INT. CL. 9.
 ICD GROUP INC., NEW YORK, NY:
 2,001,430, CANC. INT. CL. 1.
 ICN PHARMACEUTICALS, INC., COSTA MESA, CA:
 2,748,922, INT. CL. 3.
 ID BIOMEDICAL CORPORATION, CANADA:
 2,745,445, PUB. 11-27-2001. INT. CL. 5.
 IDMICRO, INC., TACOMA, WA:
 2,747,935, MULTIPLE CLASS, INT. CLS. 9, 35 AND 39.
 IFEX GLOBAL, INC., BENSALEM, PA, DBA RUSSIAN
 YELLOW PAGES:
 2,749,011, INT. CL. 16.
 IGO CORPORATION:
See—ARI ACQUISITION CORP.
 IGT, RENO, NV:
 1,765,995, REN. 6-25-03. INT. CL. 28.
 2,746,444, PUB. 11-19-2002. INT. CL. 9.
 IGUANA INTERNATIONAL, LTD., GRAYSLAKE, IL:
 2,000,770, CANC. INT. CL. 40.
 IL MULINO FOOD CORPORATION, FORT LAUDERDALE,
 FL:
 1,716,813, CANC. INT. CL. 42.
 ILD TELECOMMUNICATIONS, INC., PONTE VEDRA
 BEACH, FL:
 2,748,709, INT. CL. 38.
 ILKOVICS, VICTOR MIKLOS, AUSTIN, TX:
 2,748,359, INT. CL. 25.
 ILLINIOS TOOL WORKS INC., GLENVIEW, IL, MINIGRIP,
 INC., ORANGEBURG, NY:
 1,209,713, REN. 6-22-03. INT. CL. 17.
 ILLINOIS TOOL WORKS INC., GLENVIEW, IL, CRIMSCO,
 INCORPORATED, KANSAS CITY, MO:
 957,614, REN. 6-27-03. U.S. CL. 19 (INT. CL. 12).
 ILLINOIS TOOL WORKS INC., GLENVIEW, IL:
 2,747,339, PUB. 5-13-2003. INT. CL. 1.
 ILLUMINATING ENGINEERING SOCIETY OF NORTH
 AMERICA, INC., NEW YORK, NY:
 1,716,662, CANC. MULTIPLE CLASS, INT. CLS. 41 AND
 42.
 IMAGEID LTD., TEL-AVIV 64078, ISRAEL:
 2,747,533, MULTIPLE CLASS, INT. CLS. 38 AND 40.
 IMAGICA USA INC., LOS ANGELES, CA:
 2,748,173, INT. CL. 41.
 IMAGHX, INC., CINCINNATI, OH:
 2,001,731, CANC. INT. CL. 28.
 IMAGINARYPLANET.COM LLC, WARWICK, RI:
 2,745,914, PUB. 5-13-2003. INT. CL. 42.
 IMAGINATION CROSSROADS, INC., NASHVILLE, TN:
 1,717,192, CANC. INT. CL. 42.
 IMAGINEER CO., LTD., TOKYO 163-07, JAPAN:
 2,500,598, COR. INT. CL. 28.
 IMCOA LICENSING AMERICA, INC., TORONTO, ONTAR-
 IO, CANADA TO INDIAN MOTORCYCLE SUPPLY INC.,
 SUGAR GROVE, IL:
 2,655,198, COR. INT. CL. 25.
 IMI CORNELIUS INC., ANOKA, MN:
 2,747,337, PUB. 5-13-2003. INT. CL. 11.
 IMMUNOCLIN LABORATORIES LIMITED, LONDON N12
 8NP, UNITED KINGDOM:
 2,745,718, PUB. 5-13-2003. INT. CL. 16.
 IMPAX MARKETING COMMUNICATIONS, INC., PHILA-
 DELPHIA, PA:
 2,747,202, PUB. 5-13-2003. INT. CL. 39.
 IMPERIAL HEADWEAR, INC., DENVER, CO:
 950,855, REN. 6-24-03. U.S. CL. 39 (INT. CL. 25).
 IMPERIAL NOUGAT, CO., SANTA FE SPRINGS, CA:
 2,746,187, PUB. 12-3-2002. INT. CL. 30.
 IMPERIAL SCHRADER CORP., ELLENVILLE, NY:
 2,748,522, INT. CL. 8.
 IMPERIAL TOY CORPORATION, LOS ANGELES, CA:
 1,791,037, REN. 6-25-03. INT. CL. 28.
 IN ORBIT INC., CLEARWATER, FL:
 2,747,148, PUB. 5-13-2003. INT. CL. 25.
 INA ACQUISITION CORP., WILMINGTON, DE:
 2,746,137, PUB. 12-24-2002. INT. CL. 17.
 INALFA SUNROOFS USA, LLC, BRIGHTON, MI:
 2,745,995, PUB. 5-13-2003. INT. CL. 9.
 INCITO CAPITAL GROUP LLC, ST. LOUIS, MO, FAIR-
 MONT FOODS COMPANY, OMAHA, NE, DBA JOHNSON
 NUT COMPANY:
 930,102, REN. 6-23-03. U.S. CL. 46 (INT. CLS. 29 AND 30).
 IND. E COM. DE PRODUTOS ALIMENTICIOS CEPERA
 LTDA, SAO PAULO - SP, BRAZIL:
 2,747,822, MULTIPLE CLASS, INT. CLS. 29 AND 30.
 2,747,823, INT. CL. 29.
 INDEPENDENT COMMUNITY BANKERS OF AMERICA,
 WASHINGTON, DC:
 2,747,286, PUB. 5-13-2003. INT. CL. 35.
 INDEPENDENT INSURANCE AGENTS OF AMERICA, IN-
 CORPORATED, ALEXANDRIA, VA:
 1,716,379, CANC. INT. CL. 35.
 INDIAN INDUSTRIES, INC., EVANSVILLE, IN:
 2,748,457, INT. CL. 28.
 INDIANA ORGAN PROCUREMENT ORGANIZATION,
 INC., INDIANAPOLIS, IN:
 1,716,910, CANC. INT. CL. 42.
 INDIANA STAMP AND SEAL COMPANY, INC., FT.
 WAYNE, IN:
 1,208,207, CANC. INT. CL. 16.
 INDIGO CORPORATION, BELLEVUE, WA:
 1,717,110, CANC. INT. CL. 21.
 INDOPCO, INC., BRIDGEWATER, NJ, DBA NATIONAL
 STARCH & CHEMICAL COMPANY:
 2,748,925, INT. CL. 30.
 INDUSTRIAL VACUUM EQUIPMENT CORPORATION,
 IXONIA, WI:
 2,746,373, PUB. 5-13-2003. INT. CL. 7.
 INDUSTRIAL Y COMERCIAL NICOLAS, S.L., 300011 MUR-
 CIA, SPAIN:
 2,745,888, PUB. 5-13-2003. INT. CL. 25.
 INFINEON TECHNOLOGIES AG, MUNICH, FED REP
 GERMANY:
 2,745,584, PUB. 11-7-2000. INT. CL. 9.
 INFINICON SYSTEMS, INC., KING OF PRUSSIA, PA:
 2,748,217, INT. CL. 9.
 INFINITE CONCEPTIONS, INC., RICHMOND HILL, NY:
 2,001,871, CANC. INT. CL. 9.
 INFINITY BROADCASTING CORPORATION, NEW YORK,
 NY:
 2,000,572, CANC. INT. CL. 41.
 INFLEXION, INC., NEWTON, MA:
 2,746,726, PUB. 5-13-2003. INT. CL. 9.
 INFO DESIGN, INC., NEW YORK, NY:
 1,715,197, CANC. INT. CL. 9.
 INFOGRAMS, INC., NEW YORK, NY FROM HUMON-
 GOUS ENTERTAINMENT, INC., BOTHEL, WA:
 2,747,587, INT. CL. 9.
 INFOGRAMS, INC., NEW YORK, NY:
 2,748,455, INT. CL. 9.
 INFORMATICS, LTD., PLANO, TX:
 2,748,135, INT. CL. 9.
 INFORMATION MAPPING, INC., WALTHAM, MA:
 2,746,631, PUB. 5-13-2003. INT. CL. 9.

- INFORMATION PRESENTATION TECHNOLOGIES, INC., SAN LUIS OBISPO, CA:
2,000,681, CANC. INT. CL. 9.
- INFORMATION SYSTEMS ENGINEERING, INC., OCONOMOWOC, WI:
2,746,261, PUB. 5-13-2003. INT. CL. 9.
- INFOSPACE, INC., BELLEVUE, WA:
2,746,969, PUB. 5-13-2003. MULTIPLE CLASS, INT. CLS. 9 AND 36.
- INGENIUM PHARMACEUTICALS AG, 82152 MARTINSRIED, FED REP GERMANY:
2,745,535, PUB. 1-15-2002. MULTIPLE CLASS, INT. CLS. 1, 5 AND 42.
- INGERSOLL-RAND COMPANY, WOODCLIFF LAKE, NJ:
1,716,903, CANC. INT. CL. 42.
- INGREDIA, 62000 ARRAS, FRANCE:
2,747,539, INT. CL. 29.
2,747,540, INT. CL. 29.
2,747,541, INT. CL. 29.
2,747,542, INT. CL. 29.
- INGREDIENTS CORPORATION OF AMERICA, MEMPHIS, TN:
1,778,450, REN. 6-24-03. INT. CL. 30.
- INKMASTER, LTD., FREEPORT, NY:
2,000,878, CANC. INT. CL. 2.
- INLAND FINANCE COMPANY, DES MOINES, IA:
2,746,480, PUB. 5-13-2003. INT. CL. 9.
- INLAND STEEL COMPANY, CHICAGO, IL:
737,748, CANC. U.S. CL. 14.
- INNOVATION RANDERS A/S, 8900 RANDERS, DENMARK:
2,745,957, PUB. 10-15-2002. INT. CL. 20.
- INNOVATIVE IT SOLUTIONS, INC., OKEMOS, MI:
2,747,783, INT. CL. 9.
- INNOVATIVE LIGHTING, INC., ROLAND, IA:
2,747,100, PUB. 5-13-2003. INT. CL. 11.
- INNOVATIVE MARBLE & TILE INC., HAUPPAUGE, NY:
2,745,986, PUB. 5-13-2003. INT. CL. 41.
- INNOVENTIONS, INC., LITTLETON, CO:
2,616,107, CANC. INT. CL. 9.
- INNOVETA TECHNOLOGIES, INC., PLANO, TX:
2,746,224, PUB. 5-13-2003. INT. CL. 9.
- INNOVEX L.P., PARSIPPANY, NJ FROM EPDOL, INC., RALEIGH, NC:
2,748,609, INT. CL. 35.
- INOVEC, INC., EUGENE, OR:
2,749,052, INT. CL. 9.
- INSANITY HOUSE, INC., ALBUQUERQUE, NM:
2,748,458, MULTIPLE CLASS, INT. CLS. 35 AND 45.
- INSIGHT NETWORK LOGISTICS, AUBURN HILLS, MN:
2,746,992, PUB. 5-13-2003. INT. CL. 9.
- INSITUFORM TECHNOLOGIES LIMITED, EDMONTON, ALBERTA, UNITED PIPELINE SYSTEMS INC., EDMONTON, ALBERTA T6C 4E9, CANADA:
1,768,304, REN. 6-26-03. INT. CL. 17.
- INSL-X PRODUCTS CORPORATION, STONY POINT, NY, BRUNING PAINT COMPANY, BALTIMORE, MD:
1,762,261, REN. 6-24-03. INT. CL. 1.
- INSTAN, S.A. DE C.V., GRANJAS SAN ANTONIO C.P. 02760, MEXICO:
2,747,962, INT. CL. 30.
- INSTITUTE OF CERTIFIED PROFESSIONAL BUSINESS CONSULTANTS, CHICAGO, IL:
1,209,318, CANC. U.S. CL. 200.
- INSTITUTIONAL MARKETING SERVICES, LLC, LANHAM, MD:
2,748,256, INT. CL. 36.
- INSTITUTO DE EMPRESA, S.L., 28006 MADRID, SPAIN:
2,746,014, PUB. 5-13-2003. MULTIPLE CLASS, INT. CLS. 38 AND 41.
- INSTREAM CORPORATION, WOBURN, MA:
2,001,013, CANC. INT. CL. 38.
- INSURANCE REFERENCE SYSTEMS, INC., BOULDER, CO:
2,747,084, PUB. 11-5-2002. INT. CL. 36.
- INTEGER GROUP, L.L.C., THE, GOLDEN, CO:
2,748,554, INT. CL. 35.
- INTEGRAL CORPORATION, DALLAS, TX:
1,715,742, CANC. INT. CL. 17.
- INTEGRATED DOCUMENT TECHNOLOGIES, INC., ITASCACA, IL:
2,747,138, PUB. 5-13-2003. INT. CL. 42.
- INTEGRATED MARKETING TECHNOLOGY, INC., SAN FRANCISCO, CA:
2,746,487, PUB. 5-13-2003. INT. CL. 9.
- INTEGRATIVE AESTHETICS, LLC, BURNS, TN:
2,748,174, MULTIPLE CLASS, INT. CLS. 3 AND 5.
- INTEGRITY INCORPORATED, MOBILE, AL:
2,747,157, PUB. 5-13-2003. INT. CL. 35.
- INTELLIGENT DISTANCE LEARNING SYSTEMS, INC., CAMBRIDGE, MA:
2,748,850, INT. CL. 9.
- INTER-IKEA SYSTEMS B.V., 2616 LR DELFT, NETHERLANDS:
2,747,517, INT. CL. 9.
- INTER-PAC PACKAGING CORPORATION, MEMPHIS, TN:
1,208,466, CANC. INT. CL. 22.
- INTERACTIVE VIDEO TECHNOLOGIES, INC., NEW YORK, NY FROM DIGITAL LAVA, INC., MARINA DEL REY, CA:
2,747,707, INT. CL. 9.
- INTERCO INCORPORATED, ST. LOUIS, MO:
1,208,576, CANC. INT. CL. 25.
- INTERCONTINENTAL TRAVEL COMPANY S.R.L., 00167 ROME, ITALY:
2,745,960, PUB. 5-13-2003. INT. CL. 39.
- INTERDELTA GLOBAL CORPORATION, NEW CASTLE, DE:
2,746,188, PUB. 5-13-2003. INT. CL. 17.
- INTERFACE, INC., LAGRANGE, GA:
1,208,609, CANC. INT. CL. 27.
- INTERGRAPH CORPORATION, HUNTSVILLE, AL:
1,727,288, REN. 6-21-03. INT. CL. 9.
- INTERIOR DESIGN SERVICES, INC., BRENTWOOD, TN:
1,227,867, REN. 6-24-03. INT. CL. 42.
- INTERIOR STEEL EQUIPMENT COMPANY, THE, CLEVELAND, OH:
737,896, CANC. U.S. CL. 32.
- INTERNATIONAL AMERICAN CERAMICS, INC., TULSA, OK:
2,748,835, INT. CL. 19.
- INTERNATIONAL APPAREL GROUP LLC, ALISO VIEJO, CA FROM CARMICHAEL, CHRIS, LAGUNA HILLS, CA AND CARMICHAEL, ALBERT R., LAGUNA HILLS, CA, DBA INTERNATIONAL APPAREL GROUP LLC:
2,745,495, PUB. 4-8-2003. INT. CL. 25.
- INTERNATIONAL ASSOCIATION OF ADMINISTRATIVE PROFESSIONALS, KANSAS CITY, MO:
2,747,674, U.S. CL. B.
- INTERNATIONAL AUTOCARE SERVICES, INC., CATAWBA, NC:
1,209,077, CANC. INT. CL. 40.
- INTERNATIONAL BEAUTY EXCHANGE, MIAMI, FL:
2,746,727, PUB. 5-13-2003. INT. CL. 3.
- INTERNATIONAL BOARD OF LACTATION CONSULTANT EXAMINERS, FALLS CHURCH, VA:
2,749,041, U.S. CL. B.
- INTERNATIONAL BRIQUETTE HOLDING, CARACAS, VENEZUELA:
2,747,797, MULTIPLE CLASS, INT. CLS. 6 AND 40.
- INTERNATIONAL BUSINESS MACHINES CORPORATION, ARMONK, NY:
2,748,138, INT. CL. 41.
- INTERNATIONAL CHEMICAL & COSMETIC COMPANY S.P.A., MILAN, ITALY:
738,038, CANC. U.S. CL. 29.
738,055, CANC. U.S. CL. 51.
- INTERNATIONAL CHEMICAL & COSMETIC COMPANY, S.P.A., MILAN, ITALY:
738,058, CANC. U.S. CL. 52.
- INTERNATIONAL CHITIN PRODUCTION INC., VANCOUVER, BRITISH COLUMBIA V5X 3Y3, CANADA:
2,745,747, PUB. 12-3-2002. INT. CL. 1.
- INTERNATIONAL CITY MANAGEMENT ASSOCIATION RETIREMENT CORPORATION, THE, WASHINGTON, DC, DBA ICMA RETIREMENT CORPORATION:
1,716,470, CANC. INT. CL. 36.

- INTERNATIONAL DATA GROUP, INC., FRAMINGHAM, MA:
 1,764,424. REN. 6-24-03. INT. CL. 16.
 2,000,577. CANC. INT. CL. 16.
 2,001,986. CANC. INT. CL. 35.
 2,002,015. CANC. INT. CL. 16.
 2,747,167. PUB. 5-13-2003. MULTIPLE CLASS, INT. CLS. 16, 41 AND 42.
 2,747,490. MULTIPLE CLASS, INT. CLS. 16 AND 42.
- INTERNATIONAL DELTON FABRICS LTD., KOWLOON, HONG KONG:
 2,745,695. PUB. 10-8-2002. MULTIPLE CLASS, INT. CLS. 10, 11, 24, 25 AND 27.
- INTERNATIONAL DENIM INC., ARCADIA, CA:
 2,747,310. PUB. 5-13-2003. INT. CL. 25.
- INTERNATIONAL DEVELOPMENT CORPORATION, IRVING, DALLAS, TX:
 2,747,501. INT. CL. 11.
- INTERNATIONAL FLAVORS & FRAGRANCES INC., NEW YORK, NY:
 1,808,736. REN. 6-24-03. MULTIPLE CLASS, INT. CLS. 3 AND 30.
 1,813,331. REN. 6-24-03. MULTIPLE CLASS, INT. CLS. 3 AND 30.
 2,001,378. CANC. INT. CL. 1.
 2,001,379. CANC. INT. CL. 1.
 2,001,380. CANC. INT. CL. 1.
 2,001,381. CANC. INT. CL. 1.
 2,001,382. CANC. INT. CL. 1.
 2,001,383. CANC. INT. CL. 1.
 2,001,384. CANC. INT. CL. 1.
 2,001,388. CANC. INT. CL. 1.
 2,001,389. CANC. INT. CL. 1.
 2,748,273. INT. CL. 3.
- INTERNATIONAL FOOD SERVICE FOUNDATION, OREM, UT:
 2,000,942. CANC. INT. CL. 9.
- INTERNATIONAL GAMCO, INC., OMAHA, NE:
 2,001,161. CANC. INT. CL. 28.
- INTERNATIONAL GUILD OF MINIATURE ARTISANS, LTD., WILMINGTON, DE:
 1,209,092. CANC. INT. CL. 41.
- INTERNATIONAL HOLIDAYS, INC., NORTH EAST, MD:
 2,746,558. PUB. 5-13-2003. INT. CL. 35.
- INTERNATIONAL INFORMATION SYSTEMS SECURITY CERTIFICATION CONSORTIUM, INC., FRAMINGHAM, MA:
 2,746,114. PUB. 10-29-2002. MULTIPLE CLASS, INT. CLS. 16, 41 AND 42.
- INTERNATIONAL JUSTICE MISSION, THE, ARLINGTON, VA:
 2,746,074. PUB. 5-13-2003. INT. CL. 9.
- INTERNATIONAL LEARNING SYSTEMS, INC., GOLDEN, CO:
 2,001,217. CANC. INT. CL. 41.
- INTERNATIONAL MASS RETAIL ASSOCIATION, INC., ARLINGTON, VA:
 2,746,944. PUB. 5-13-2003. MULTIPLE CLASS, INT. CLS. 35 AND 41.
- INTERNATIONAL MULTIFOODS CORPORATION, MINNETONKA, MN FROM GENERAL MILLS, INC., MINNEAPOLIS, MN:
 2,745,639. PUB. 12-10-2002. INT. CL. 30.
- INTERNATIONAL MUNICIPAL SIGNAL ASSOCIATION, NEWARK, NY:
 2,746,511. PUB. 5-13-2003. INT. CL. 35.
- INTERNATIONAL PAPER COMPANY, PURCHASE, NY:
 1,715,739. CANC. INT. CL. 17.
 2,001,486. CANC. INT. CL. 24.
- INTERNATIONAL PAPER TRADEMARK COMPANY, TUXEDO, NY, HAMMERMILL PAPER COMPANY, ERIE, PA:
 1,239,396. REN. 6-25-03. INT. CL. 16.
- INTERNATIONAL RETAIL SERVICES GROUP, LLC, WOODINVILLE, WA:
 2,747,403. PUB. 5-13-2003. INT. CL. 20.
- INTERNATIONAL SEAFOOD DISTRIBUTORS, INC., HAYES, VA:
 1,716,105. CANC. INT. CL. 29.
- INTERNATIONAL SERVICE GROUP, INC., SOUTH SAN FRANCISCO, CA:
 2,745,632. PUB. 5-13-2003. INT. CL. 36.
- INTERNATIONAL SPAS, INC., TEMPE, AZ:
 1,209,209. CANC. INT. CL. 42.
- INTERNATIONAL SPEEDWAY, INC., RENO, NV, INTERNATIONAL SPEEDWAY CORPORATION, DAYTONA BEACH, FL:
 1,819,018. REN. 6-24-03. MULTIPLE CLASS, INT. CLS. 25 AND 28.
 1,822,849. REN. 6-24-03. MULTIPLE CLASS, INT. CLS. 25 AND 41.
- INTERNATIONAL STEEL WOOL CORPORATION, SPRINGFIELD, OH:
 1,715,850. CANC. INT. CL. 21.
- INTERNATIONAL TELEPHONE AND TELEGRAPH CORPORATION, NEW YORK, NY:
 737,842. CANC. U.S. CL. 23.
- INTERNATIONAL TYPEFACE CORPORATION, WILMINGTON, MA:
 1,232,718. REN. 6-24-03. INT. CL. 16.
 1,234,581. REN. 6-24-03. INT. CL. 16.
 1,235,714. REN. 6-24-03. INT. CL. 16.
- INTERNET ACCESS TECHNOLOGIES, INC., HOUSTON, TX:
 2,746,180. PUB. 12-10-2002. MULTIPLE CLASS, INT. CLS. 9 AND 42.
- INTERNET.COM CORPORATION:
See—JUPITERMEDIA CORPORATION.
- INTERNOR TRADE INC., NEW YORK, NY:
 1,208,733. CANC. INT. CL. 29.
 1,208,734. CANC. INT. CL. 29.
 1,208,735. CANC. INT. CL. 29.
- INTERPORT INTERNATIONAL, INC., CORONA DEL MAR, CA:
 2,001,893. CANC. INT. CL. 21.
- INTERSECT SOFTWARE CORPORATION, STERLING, VA:
 2,746,364. PUB. 5-13-2003. INT. CL. 9.
- INTERSHEZ CORP., CARMEL, IN:
 2,745,640. PUB. 5-13-2003. MULTIPLE CLASS, INT. CLS. 29, 30 AND 32.
- INTERSTATE GAS SUPPLY, INC., DUBLIN, OH:
 2,745,668. PUB. 5-13-2003. INT. CL. 36.
- INTERSTATE STEEL CORPORATION, BIG SPRING, TX:
 2,747,068. PUB. 5-13-2003. INT. CL. 6.
- INTERTEC COMMUNICATIONS, INC., OXNARD, CA:
 1,209,098. CANC. INT. CL. 41.
- INTERVEST HOLDINGS, INC., MALVERN, PA, INTERVEST, INC., FALLS CHURCH, VA:
 1,215,226. REN. 6-25-03. INT. CL. 36.
- INTERVISTA INSTITUTE INC., JACKSONVILLE, FL:
 2,747,788. INT. CL. 41.
- INTEX RECREATION CORP., LONG BEACH, CA:
 1,783,529. REN. 6-24-03. INT. CL. 28.
- INTREP IMPORTS, INC., BO. PALMAS CATANO, PUERTO RICO:
 2,000,934. CANC. INT. CL. 25.
- INTRINSITY, INC., AUSTIN, TX FROM EVSX, INC., AUSTIN, TX:
 2,748,597. INT. CL. 9.
- INVACARE CORPORATION, ELYRIA, OH:
 2,746,780. PUB. 5-13-2003. INT. CL. 12.
- INVENTION TECHNOLOGIES PTY LTD, PERTH, AUSTRALIA:
 2,747,059. PUB. 2-5-2002. INT. CL. 9.
- INVENTURE DEVELOPMENT CORPORATION, SAN FRANCISCO, CA:
 1,715,619. CANC. INT. CL. 16.
- INVERNESS CORPORATION, FAIR LAWN, NJ:
 2,747,939. INT. CL. 14.
- INVINITY SYSTEMS CORPORATION, CALAVASAS, CA:
 2,747,850. INT. CL. 35.
- INVISIBLE FENCE, INC., GARRETT, IN, INVISIBLE FENCE COMPANY, INC., WAYNE, PA:
 1,687,015. REN. 6-23-03. INT. CL. 9.
- IN2BOOKS, INC., WASHINGTON, DC:
 2,747,042. PUB. 5-13-2003. INT. CL. 41.

- IOP PUBLISHING LIMITED, BRISTOL BS1 6BE, ENGLAND:
2,435,474, AM. INT. CL. 42.
- IOWA STATE UNIVERSITY OF SCIENCE AND TECHNOLOGY, AMES, IA:
1,785,621, REN. 6-24-03, INT. CL. 25.
1,789,461, REN. 6-24-03, INT. CL. 25.
- IPC PERIPHERALS PTE. LTD., SINGAPORE:
2,001,948, CANC. INT. CL. 9.
- IPICOM, INC., CARLSBAD, CA:
2,747,696, INT. CL. 9.
- IRAD NV, LEUVEN, BELGIUM:
2,747,058, PUB. 5-13-2003, INT. CL. 9.
- IRON HORSE VACATIONS, INC., ORLANDO, FL:
2,001,401, CANC. INT. CL. 39.
2,001,402, CANC. INT. CL. 39.
- IRON MOUNTAIN INCORPORATED, BOSTON, MA:
2,746,344, PUB. 5-13-2003, MULTIPLE CLASS, INT. CLS. 39 AND 42.
- IRVING OIL CORPORATION, BANGOR, ME:
1,737,439, REN. 6-25-03, INT. CL. 1.
- ISCO, INC., LINCOLN, NE:
2,748,859, INT. CL. 9.
- ISFEL CO., INC., THE, NEW YORK, NY:
2,001,573, CANC. INT. CL. 25.
- ISOLUX AMERICA CORPORATION, NAPLES, FL:
2,747,601, MULTIPLE CLASS, INT. CLS. 10 AND 11.
- ISU CHEMICAL CO., LTD., SEOCHO-GU, SEOUL, REPUBLIC OF KOREA:
2,747,663, MULTIPLE CLASS, INT. CLS. 1, 4 AND 9.
- IT GLOBALSECURE, INC., WASHINGTON, DC:
2,747,134, PUB. 5-13-2003, MULTIPLE CLASS, INT. CLS. 9 AND 42.
- ITCENTRIX, INC., FRAMINGHAM, MA:
2,748,975, INT. CL. 9.
- ITRAC OF OHIO, INC., COLUMBUS, OH FROM PROFIT OR SAVINGS ENTERPRISE, INC., CLEVELAND, OH:
2,748,452, INT. CL. 35.
- IVERNESS GROUP, INC., THE, CINCINNATI, OH:
2,745,618, PUB. 2-4-2003, INT. CL. 37.
- IVIVITY INC., ATLANTA, GA:
2,747,977, INT. CL. 9.
- IVL TECHNOLOGIES, LTD., VICTORIA, BRITISH COLUMBIA V8M 1Z6, CANADA:
2,747,731, INT. CL. 9.
- IXIA, CALABASAS, CA:
2,747,250, PUB. 5-13-2003, INT. CL. 9.
- IXSEA, 78160 MARLY LE ROI, FRANCE:
2,745,969, PUB. 5-13-2003, INT. CL. 9.
- J. A. SCHMIDT & SOHNE GMBH & CO. KG., SOLINGEN, FED REP GERMANY:
1,235,624, REN. 6-24-03, INT. CL. 8.
- J. C. ROBINSON SEED CO., THE, WATERLOO, NE:
1,208,822, CANC. INT. CL. 31.
- J. DEBEER & SONS, INC., ALBANY, NY:
2,746,052, PUB. 5-13-2003, INT. CL. 28.
- J. KINDERMAN & SONS, INC., PHILADELPHIA, PA, DBA BRITE STAR MANUFACTURING CO., INC.:
1,774,325, REN. 6-21-03, INT. CL. 28.
- J. M. VOITH GMBH, W-7920 HEIDENHEIM, FED REP GERMANY:
2,000,487, CANC. INT. CL. 7.
- J.B.S., INC., WASHINGTON, DC:
1,716,133, CANC. MULTIPLE CLASS, INT. CLS. 29 AND 42.
- J.C. NEWMAN CIGAR COMPANY, INC., TAMPA, FL:
2,746,779, PUB. 5-13-2003, INT. CL. 34.
- J.M.H. TRADEMARK, INC., WILMINGTON, DE:
2,749,055, INT. CL. 35.
- J.R. SIMPLOT COMPANY, BOISE, ID:
1,794,638, REN. 6-26-03, INT. CL. 5.
- J-DAN, INC., ROMULUS, MI:
2,746,028, PUB. 12-17-2002, INT. CL. 8.
- J-STAR INDUSTRIES, INC., FORT ATKINSON, WI:
2,001,418, CANC. INT. CL. 7.
- JAC PRODUCTS, INC., MADISON HEIGHTS, MI:
2,745,898, PUB. 12-3-2002, MULTIPLE CLASS, INT. CLS. 6 AND 12.
- JACK SCHWARTZ SHOES, INC., NEW YORK, NY:
2,746,158, PUB. 11-5-2002, INT. CL. 25.
- JACK W. GULLAHORN, P.C., AUSTIN, TX:
2,001,404, CANC. INT. CL. 16.
- JACK WALTERS & SONS, CORP., ALLENTON, WI:
1,234,265, REN. 6-24-03, INT. CL. 6.
- JACKPINE ENGINEERED WOOD PRODUCTS INC., WEST VANCOUVER, BRITISH COLUMBIA, CANADA:
2,745,891, PUB. 5-13-2003, INT. CL. 19.
- JACKSON INTERNATIONAL TRADING COMPANY KURT D. BRUHL GMBH & CO. KG, 8010 GRAZ, AUSTRIA:
2,745,819, PUB. 4-23-2002, MULTIPLE CLASS, INT. CLS. 3, 18 AND 25.
- JACKSON NATIONAL LIFE INSURANCE COMPANY, LANSING, MI:
2,748,450, INT. CL. 36.
- JACKSON, ERIC, LEESPORT, PA:
2,749,025, INT. CL. 16.
- JADA TOYS, INC., LOS ANGELES, CA:
2,748,439, INT. CL. 28.
- JAE IL CO., LOS ANGELES, CA, DBA KEUNGAMA KOREAN RESTAURANT:
2,747,380, PUB. 5-13-2003, INT. CL. 43.
- JAEGER, ALAN, WOODLAND HILLS, CA, DBA JAEGER SPORTS ACADEMY:
2,746,867, PUB. 5-13-2003, INT. CL. 28.
- JAFRA COSMETICS INTERNATIONAL, INC., WESTLAKE VILLAGE, CA:
2,747,794, INT. CL. 3.
- JAGER DESIGN, INC., BURLINGTON, VT, DBA JAGER DIPAOLO KEMP DESIGN:
2,748,764, MULTIPLE CLASS, INT. CLS. 35 AND 42.
- JAKQUMAR A.G., 6300 ZUG, SWITZERLAND:
2,748,324, INT. CL. 17.
- JAM TECHNOLOGIES, LLC, BOSTON, MA:
2,747,538, INT. CL. 9.
- JAMES HARDIE IRRIGATION, INC., LAGUNA NIGUEL, CA:
1,208,343, CANC. INT. CL. 17.
- JAMES HARDIE RESEARCH PTY LIMITED, ROSEHILL, NEW SOUTH WALES 2142, AUSTRALIA:
2,746,670, PUB. 5-13-2003, INT. CL. 19.
- JAMES SOUTHALL & COMPANY LIMITED, NORWICH, NR3 4RD, ENGLAND:
1,243,709, REN. 6-24-03, INT. CL. 25.
- JAMIN' SUN SHAYDES, L.L.C., WIXOM, MI FROM BRIMZ, INC., ANN ARBOR, MI:
2,747,884, INT. CL. 9.
- JANA, PATRICIA O'DOWD, MONARCH BEACH, CA:
1,716,719, CANC. INT. CL. 41.
- JANUS INTERNATIONAL HOLDING LLC, RENO, NV FROM JANUS CAPITAL CORPORATION, DENVER, CO:
2,747,624, INT. CL. 36.
- JAPAN UMIX CO., LTD., TOKYO 174-0076, JAPAN:
2,745,862, PUB. 5-13-2003, INT. CL. 35.
- JAPANESE WEEKEND, SAN FRANCISCO, CA, DBA JWO:
2,001,468, CANC. INT. CL. 25.
- JARROW FORMULAS, INC., LOS ANGELES, CA:
2,748,944, INT. CL. 5.
- JAS. D. EASTON, INC., VAN NUYS, CA:
2,747,291, PUB. 5-13-2003, INT. CL. 28.
- JAS. D. EASTON, INC., LOS ANGELES, CA:
2,748,987, INT. CL. 28.
- JASON MARKETING COMPANY, HUNTINGTON BEACH, CA:
2,001,502, CANC. INT. CL. 21.
- JASON, INC., CONOVER, NC, JASON INCORPORATED, CONOVER, NC:
1,760,887, REN. 6-27-03, MULTIPLE CLASS, INT. CLS. 2, 3 AND 7.
- JASON, MARIUS J., VILNIUS, LITHUANIA:
2,745,566, PUB. 5-13-2003, INT. CL. 42.
- JAYNES CORPORATION, ALBUQUERQUE, NM:
2,747,318, PUB. 5-13-2003, INT. CL. 37.
- JCMB TECHNOLOGY INC., ST-LAURENT, QUEBEC H4T 1V6, CANADA:
2,746,520, PUB. 5-13-2003, INT. CL. 9.

- JDS INDUSTRIES, INC., SIOUX FALLS, SD, DBA JDS INDUSTRIES:
1,715,605, CANC. INT. CL. 16.
- JDV CONTROL VALVES CO., LTD., TAIPEI HSIEN, TAIWAN:
2,748,148, INT. CL. 7.
- JEAN CLAUDE FRANCOIS-FERDINAND BERNARD AND PATRICK CHAMBOREDON PARTNERSHIP, THE, PARIS; ROCQUENCOURT, FRANCE:
2,747,125, PUB. 5-13-2003. INT. CL. 25.
- JEFFCREST, INC., MIDDLETOWN, NY:
2,747,237, PUB. 5-13-2003. INT. CL. 41.
- JEFFERSON, NICOLA TOLLETT, SWARTHMORE, PA:
2,747,272, PUB. 5-13-2003. INT. CL. 41.
- JEFFREY SPECIALTY EQUIPMENT CORPORATION, WOODRUFF, SC:
2,748,144, INT. CL. 7.
- JEFFREY V. HEININGER, BELLINGHAM, WA:
2,748,634, INT. CL. 9.
- JELKS, GEORGE W., CARLSBAD, CA:
2,745,917, PUB. 5-13-2003. INT. CL. 16.
- JEN-CEL-LITE CORPORATION, THE, SEATTLE, WA:
1,208,345, CANC. INT. CL. 17.
- JENNMAR CORPORATION, PITTSBURGH, PA:
2,747,617, INT. CL. 6.
- JENSEN, ERNST A., SAN RAFAEL, CA, DBA ELCO-ELEVATOR COMPONENTS CO.:
2,748,406, INT. CL. 9.
- JENSON RACING LTD., SOUTHAMPTON, UNITED KINGDOM:
2,705,881, COR. MULTIPLE CLASS, INT. CLS. 9, 14, 16, 18, 24, 25, 26, 28 AND 41.
2,705,882, COR. MULTIPLE CLASS, INT. CLS. 9, 14, 16, 18, 24, 25, 26, 28 AND 41.
2,705,887, COR. MULTIPLE CLASS, INT. CLS. 9, 14, 16, 18, 24, 25, 26, 28 AND 41.
- JET CONNECTION BUSINESSFLIGHT AG, D-651B9 WEISBADEN, FED REP GERMANY:
2,745,499, PUB. 1-29-2002. MULTIPLE CLASS, INT. CLS. 35, 36, 39 AND 42.
- JET-DRI WATERPROOFING COMPANY, LTD., ADDISON, IL:
1,209,075, CANC. INT. CL. 40.
- JEWELBUTTON & CO., CHONGRO-KU SEOUL, REPUBLIC OF KOREA:
2,747,964, INT. CL. 14.
2,747,965, INT. CL. 26.
- JG NORTH RALEIGH, L.L.C., CLEVELAND, OH:
2,748,265, INT. CL. 37.
- JIANGSU DONGHAI OPTICAL GLASSES CO., LTD., JIANGSU, CHINA:
2,747,089, PUB. 11-5-2002. INT. CL. 9.
- JIFFY LUBE INTERNATIONAL, INC., HOUSTON, TX:
2,748,765, INT. CL. 37.
- JILLIAN'S ENTERTAINMENT CORPORATION, LOUISVILLE, KY:
2,746,430, PUB. 5-13-2003. MULTIPLE CLASS, INT. CLS. 41 AND 43.
- JIM HENBSON COMPANY, INC., LOS ANGELES, CA, MUPPETS, INC., NEW YORK, NY:
948,503, REN. 6-27-03. U.S. CL. 22 (INT. CL. 28).
- JIM JOHNSON ENTERPRISES, INC., SCHAUMBURG, IL:
1,716,495, CANC. INT. CL. 37.
- JIM OWENS AND ASSOCIATES, INC., NASHVILLE, TN:
2,000,916, CANC. INT. CL. 41.
- JIM'S FORMAL WEAR CO., TRENTON, IL:
1,209,289, CANC. INT. CL. 42.
- JLG INDUSTRIES, INC., MCCONNELLSBURG, PA:
2,748,257, INT. CL. 7.
- JMP HOLDING COMPANY, INC., GAITHERSBURG, MD:
2,747,828, MULTIPLE CLASS, INT. CLS. 35, 41 AND 42.
2,747,829, MULTIPLE CLASS, INT. CLS. 35, 41 AND 42.
- JOANNE HUDSON ASSOCIATES, LTD., PHILADELPHIA, PA:
2,746,206, PUB. 4-1-2003. MULTIPLE CLASS, INT. CLS. 35 AND 42.
- JOANNE'S BED & BACK STORES, INC., BELTSVILLE, MD:
2,748,096, INT. CL. 20.
- JOCKEY INTERNATIONAL, INC., KENOSHA, WI:
1,715,704, CANC. INT. CL. 16.
1,715,855, CANC. INT. CL. 21.
2,748,908, INT. CL. 25.
- JOE HALL'S SHOOTING PRODUCTS, INC., DOYLESTOWN, PA:
1,764,661, REN. 6-21-03. INT. CL. 28.
- JOHN CRANE UK LTD, TRAFFORD PARK, UNITED KINGDOM:
2,748,196, INT. CL. 7.
- JOHN HANSEN & SONS, INC., OAKAND, CA:
1,716,158, CANC. INT. CL. 30.
- JOHN JACOBS GOLF CLUB CO., SCOTTSDALE, AZ:
1,716,069, CANC. INT. CL. 28.
- JOHN SEXTON & CO., LISLE, IL:
1,716,137, CANC. INT. CL. 29.
- JOHN SMEDLEY, LIMITED, MATLOCK, DERBYSHIRE, ENGLAND:
1,715,947, CANC. INT. CL. 25.
- JOHNSON & JOHNSON, NEW BRUNSWICK, NJ:
568,161, REN. 6-24-03. U.S. CL. 44 (INT. CLS. 5 AND 10).
2,746,229, PUB. 5-13-2003. INT. CL. 41.
2,748,722, INT. CL. 3.
- JOHNSON MANUFACTURING COMPANY, GRANDVILLE, MI:
2,748,617, INT. CL. 9.
- JOHNSON PRODUCTS CO., INC., CHICAGO, IL:
738,000, CANC. U.S. CL. 51.
- JOHNSON SCALE COMPANY, WEST CALDWELL, NJ:
1,271,142, REN. 6-26-03. INT. CL. 42.
- JOHNSON, JAMES R., ST. HELENA, CA, DBA JAMES JOHNSON VINEYARDS:
2,747,966, INT. CL. 33.
- JOHNSON, PETER, SOMERVILLE, MA AND FERRARINI, DANTE, SOMERVILLE, MA:
2,746,347, PUB. 5-13-2003. INT. CL. 42.
2,746,348, PUB. 5-13-2003. INT. CL. 42.
2,746,349, PUB. 5-13-2003. INT. CL. 42.
- JOHNSONDIVERSEY, INC., STURTEVANT, WI, CHEMED CORPORATION, CINCINNATI, OH:
937,359, REN. 6-23-03. U.S. CL. 6 (INT. CL. 1).
- JOHNSONDIVERSEY, INC., STURTEVANT, WI, DIVERSEY CORPORATION, MISSISSAUGA, ONTARIO, CANADA:
1,702,687, REN. 6-24-03. INT. CL. 1.
- JOINT VENTURE TRADEMARK CORPORATION, NEW YORK, NY:
2,746,046, PUB. 5-13-2003. INT. CL. 42.
- JOMAR INTERNATIONAL, LTD., MADISON HEIGHTS, MI:
2,002,007, CANC. INT. CL. 6.
- JON ANDERSON, CHRIS SQUIRE AND ALAN WHITE, LOS ANGELES, CA, TOPOGRAPHIC MUSIC, INC., NEW YORK, NY:
1,199,922, REN. 6-22-03. INT. CL. 41.
- JON SHARP AND TRICIA SHARP PARTNERSHIP, THE, LANCASTER, CA:
2,001,000, CANC. INT. CL. 41.
- JONATHAN-JUNGE VINTNERS, SPRINGFIELD, MO:
1,208,847, CANC. INT. CL. 33.
- JONBIL, INC., NEW YORK, NY:
1,208,588, CANC. INT. CL. 25.
- JONES INTERNATIONAL, LTD., DENVER, CO:
2,001,584, CANC. MULTIPLE CLASS, INT. CLS. 38, 41 AND 42.
- JONES, CATHRINE ANN, OJAI, CA:
2,746,708, PUB. 5-13-2003. INT. CL. 41.
- JONES, D., N.Y.C., NY:
2,747,075, PUB. 5-13-2003. INT. CL. 16.
- JONES, GARY, IVINS, UT:
2,747,701, INT. CL. 42.
- JONES, STEVEN A., WEST COLUMBIA, SC:
1,716,840, CANC. INT. CL. 42.
- JORDAN NEUROSCIENCE, INC., SAN BERNARDINO, CA:
2,748,897, INT. CL. 10.
- JOSEF FRIEDERICH WEINGUTER-WEINKELLEREIEN GMBH & CO. KG, D-56856 ZELL, FED REP GERMANY:
2,745,575, PUB. 12-11-2001. INT. CL. 33.

- JOSIPOVICH, DOROTHY, LAKE FOREST, CA AND JOSIPOVICH, DANIEL E., LAKE FOREST, CA AND JOSIPOVICH, DANIEL T., LAKE FOREST, CA AND JOSIPOVICH, MARK, LAKE FOREST, CA AND JOSIPOVICH, MICHELA, LAKE FOREST, CA:
2,745,859, PUB. 12-24-2002. MULTIPLE CLASS, INT. CLS. 16 AND 42.
- JOSS, INC., VOORHEES, NJ:
2,001,908, CANC. INT. CL. 25.
- JOURNEYS LIMITED, STAFFORDSHIRE, ST1 3BT, UNITED KINGDOM:
2,747,478, INT. CL. 35.
- JOYCE-ANN, INC., MT. PLEASANT, IA:
1,209,279, CANC. INT. CL. 42.
- JPS ELASTOMERIC CORPORATION, HOLYOKE, MA:
1,716,514, CANC. INT. CL. 37.
- JR PLASTICS LLC, CHICAGO, IL, STYLEMASTER, INC., NILES, IL:
1,778,381, REN. 6-23-03, INT. CL. 21.
- JTECH COMMUNICATIONS, INC., BOCA RATON, FL:
2,746,979, PUB. 5-13-2003, INT. CL. 9.
- JUAREZ, MARK, SAN LEANDRO, CA:
2,001,490, CANC. INT. CL. 3.
2,001,496, CANC. INT. CL. 16.
- JUMA VENTURES, SAN FRANCISCO, CA:
2,748,107, INT. CL. 36.
- JUMP CORDS INCORPORATED, LAFAYETTE HILL, PA:
2,748,920, INT. CL. 28.
- JUMP, HELEN L., ZIONSVILLE, IN, DBA CORNER CUPBOARD COOKBOOKS, ETC.:
1,209,206, CANC. INT. CL. 42.
- JUNGLE VISION, FT. WALTON BEACH, FL:
2,747,463, INT. CL. 9.
- JUNGWOO ZIPPER CO., LTD.:
See—YKK CORPORATION.
- JUPA SPORTS INC., MONTREAL, QUEBEC H4S 1V9, CANADA:
1,778,997, REN. 6-23-03, INT. CL. 25.
- JUPITERMEDIA CORPORATION, DARIEN, CT FROM INTERNET.COM CORPORATION, DARIEN, CT:
2,745,910, PUB. 2-11-2003, INT. CL. 42.
- JUST DUCKY, INC., HENDERSONVILLE, TN:
2,000,800, CANC. INT. CL. 37.
- JV CARBOX CARL BELLINGER GMBH & CO. KG, 28832 ACHIM, FED REP GERMANY:
2,747,899, INT. CL. 27.
- JVL CORPORATION, CONCORD, ONTARIO L4K 4W8, CANADA:
2,745,653, PUB. 10-29-2002, INT. CL. 41.
- J2 GLOBAL COMMUNICATIONS, INC., HOLLYWOOD, CA FROM JFAX.COM, INC., LOS ANGELES, CA:
2,747,752, INT. CL. 38.
- K & M INTERNATIONAL, INC., TWINSBURG, OH:
2,001,788, CANC. INT. CL. 16.
- K MART CORPORATION, TROY, MI:
1,207,862, CANC. MULTIPLE CLASS, INT. CLS. 7 AND 11.
- K. J. LAW ENGINEERS, INC., NOVI, MI:
1,715,216, CANC. INT. CL. 9.
- K.C.'S TOBACCO TOWN, INC., PORTLAND, OR:
2,001,433, CANC. INT. CL. 42.
- KABBALAH CENTRE INTERNATIONAL, INCORPORATED, LOS ANGELES, CA FROM RESEARCH CENTRE OF KABBALAH, RICHMOND HILL, NY:
2,747,629, INT. CL. 25.
- KABRIK TRADING, LLC, NEW YORK, NY:
2,746,254, PUB. 5-13-2003, INT. CL. 36.
- KABUSHIKI KAISHA ADVICS, AICHI-KEN, JAPAN, AKA ADVICS CO., LTD.:
2,746,159, PUB. 5-13-2003. MULTIPLE CLASS, INT. CLS. 7 AND 12.
- KABUSHIKI KAISHA BEACON INFORMATION TECHNOLOGY, TOKYO, JAPAN, AKA BEACON INFORMATION TECHNOLOGY INC.:
2,748,242, MULTIPLE CLASS, INT. CLS. 9 AND 16.
- KABUSHIKI KAISHA PILOT, SHINAGAWA-KU, TOKYO, JAPAN, TA PILOT CORPORATION:
2,000,627, CANC. INT. CL. 16.
- KABUSHIKI KAISHA SEGA, TOKYO 144-0043, JAPAN, DBA SEGA CORPORATION FROM KABUSHIKI KAISHA SEGA ENTERPRISES, TOKYO 144-0043, JAPAN, DBA SEGA ENTERPRISES, LTD.:
2,747,647, MULTIPLE CLASS, INT. CLS. 9 AND 28.
- KABUSHIKI KAISHA SEGA ENTERPRISES, TOKYO 144-0043, JAPAN, DBA SEGA ENTERPRISES, LTD.:
2,747,825, MULTIPLE CLASS, INT. CLS. 16, 18, 21, 28 AND 41.
- KABUSHIKI KAISHA TOSHIBA, MINATO-KU, TOKYO, JAPAN, TA TOSHIBA CORPORATION:
2,746,469, PUB. 5-13-2003, INT. CL. 9.
- KABUSHIKI KAISHA UMEDA SHOKAI, TOSHIMA-KU, TOKYO, JAPAN:
2,746,477, PUB. 5-13-2003. MULTIPLE CLASS, INT. CLS. 25 AND 28.
- KABUSHIKI KAISHA YOHJI DESIGN KENKUJO, SHINAGAWA-KU, TOKYO, JAPAN, KABUSHIKI KAISHA Y'S, MINATO-KU, TOKYO, JAPAN, AKA Y'S COMPANY LIMITED:
1,232,849, REN. 6-25-03, INT. CL. 25.
- KABUSHIKI KAISHA BARUDAN, AICHI-KEN, JAPAN:
2,747,901, INT. CL. 23.
- KAL KAN FOODS, INC., VERNON, CA:
2,749,042, INT. CL. 41.
- KALAMAZOO VALLEY COMMUNITY COLLEGE, KALAMAZOO, MI:
2,747,351, PUB. 5-13-2003, INT. CL. 41.
- KALER; ALPIN K., LOS ANGELES, CA, DBA TU-K LABORATORIES:
1,207,735, CANC. INT. CL. 3.
- KALEXER BVBA, 2900 MECHELEN, BELGIUM:
2,745,808, PUB. 5-13-2003. MULTIPLE CLASS, INT. CLS. 9, 35, 36, 38, 41 AND 42.
- KALLE GMBH & CO. KG, D-65203 WIESBADEN, FED REP GERMANY:
2,746,561, PUB. 5-13-2003, INT. CL. 21.
- KALNINS; ARTURS, BETHLEHEM, PA:
1,208,023, CANC. INT. CL. 9.
- KALUZHSKOE OTKRYTOE AKTSIONERNOE OBSHCHESTVO KRISTALL, 248016, KALUGA, RUSSIAN FEDERATION:
2,746,103, PUB. 3-12-2002, INT. CL. 33.
- KAMAN MUSIC CORPORATION, BLOOMFIELD, CT, STRUM & DRUM INC., WHEELING, IL:
956,751, REN. 6-24-03, U.S. CL. 36 (INT. CL. 15).
- KAMAN MUSIC CORPORATION, BLOOMFIELD, CT, HAMER INC., ARLINGTON HEIGHTS, IL:
1,235,223, REN. 6-24-03, INT. CL. 15.
- KAMAN MUSICAL STRING CORPORATION, BLOOMFIELD, CT:
1,208,178, CANC. INT. CL. 15.
- KANEBO KABUSHIKI KAISHA (KANEBO, LTD.), SUMIDA-KU, TOKYO, JAPAN:
2,748,316, INT. CL. 3.
- KANEI INC., CHINO, CA:
2,746,266, PUB. 5-13-2003, INT. CL. 12.
- KANNER, AMI, PETACH TIKVA, ISRAEL:
2,746,878, PUB. 5-13-2003, INT. CL. 14.
- KANSAS CITY MASTER COMPANIES, GRANDVIEW, MO:
2,746,259, PUB. 9-24-2002, INT. CL. 37.
- KAPMAN AB, S-811 81 SANDVIKEN, SWEDEN, C. O. OBERG & CO'S AKTIEBOLAG, ESKILSTUNA, SWEDEN:
759,954, REN. 6-22-03, U.S. CL. 23 (INT. CL. 8).
- KAR-GARD MUFFLER CENTERS OF OHIO, INC., SPRINGFIELD, OH:
737,856, CANC. U.S. CL. 23.
- KAREN KREATIONS, INC., PROVIDENCE, RI:
2,001,600, CANC. INT. CL. 14.
- KARL HERZOG GMBH & CO., STUTTGART, FED REP GERMANY:
737,741, CANC. U.S. CL. 13.
- KARL STORZ GMBH & CO., 78532 TUTTLINGEN, FED REP GERMANY:
1,769,922, REN. 6-24-03, INT. CL. 10.

- KARL STORZ GMBH & CO. KG., D-78532 TUTTLINGEN, FED REP GERMANY FROM KARL STORZ GMBH, & CO., 78532 TUTTLINGEN, FED REP GERMANY: 2,745,459, PUB. 9-17-2002. INT. CL. 10.
- KARL STORZ GMBH, & CO.:
See— *KARL STORZ GMBH & CO. KG.*
- KARL, ALLAN F.:
See— *WIRESTONE, LLC.*
- KARLEN MANUFACTURING, INC., ST. CHARLES, MI: 1,714,929, CANC. INT. CL. 3.
- KARLSHAMNS USA INC., COLUMBUS, OH: 2,001,820, CANC. INT. CL. 29.
- KASYS, F-92100 BOULOGNE, FRANCE: 2,746,191, PUB. 12-24-2002. MULTIPLE CLASS, INT. CLS. 9, 41 AND 42.
- KATUN CORPORATION, MINNEAPOLIS, MN: 1,791,441, REN. 6-25-03. INT. CL. 9.
- KATZKIN LEATHER INTERIORS INC., MONTEBELLO, CA: 2,748,245, INT. CL. 12.
- KAUFMAN, HARLEY, NEW YORK, NY: 2,749,000, INT. CL. 42.
- KAVLICO CORPORATION, MOORPARK, CA: 2,747,524, INT. CL. 9.
- KAWASAKI JUKOGYO KABUSHIKI KAISHA, CHUO-KU, KOBE, JAPAN, DBA KAWASAKI HEAVY INDUSTRIES, LTD.: 2,746,102, PUB. 5-13-2003. INT. CL. 12.
- KAYE, BARRY, BOCA RATON, FL: 2,748,551, INT. CL. 36.
- KAYSER-ROTH CORPORATION, NEW YORK, NY: 1,207,759, CANC. INT. CL. 3.
- KEANE, TEAL ANN, STERLING, VA: 2,748,856, INT. CL. 28.
- KEENAN FARMS, INC., AVENAL, CA: 2,746,665, PUB. 5-13-2003. INT. CL. 29.
- KEENELAND ASSOCIATION, INC., LEXINGTON, KY: 2,746,100, PUB. 10-29-2002. MULTIPLE CLASS, INT. CLS. 6, 14, 16, 18, 20, 25, 33 AND 35.
- KEEPALIVE, INC., TARPON SPRINGS, FL: 2,746,156, PUB. 5-13-2003. MULTIPLE CLASS, INT. CLS. 7, 11 AND 21.
- KEESE, CHRISTIAN K., OKLAHOMA CITY, OK: 2,748,350, INT. CL. 39.
- KEIPER GMBH & CO., 67657 KAISERSLUTERN, FED REP GERMANY: 2,746,128, PUB. 10-29-2002. INT. CL. 12.
- KELLER MEDICAL SPECIALTIES PRODUCTS, INC., ANTI-OCH, IL: 1,715,405, CANC. INT. CL. 10.
- KELLOGG COMPANY, BATTLE CREEK, MI: 1,208,763, CANC. INT. CL. 30.
- KELLUM, HAROLD, CORPUS CHRISTI, TX, DBA OXFORD INTERNATIONAL: 1,715,849, CANC. INT. CL. 21.
- KELMSCOTT COMMUNICATIONS, LLC, SAN FRANCISCO, CA: 2,745,785, PUB. 9-24-2002. MULTIPLE CLASS, INT. CLS. 35, 39, 41 AND 42.
- KELSENBISCA A/S, DK-8766 NORRE-SNEDE, DENMARK, DANISH FANCY FOOD GROUP A/S, ODENSE C, DENMARK: 1,195,318, REN. 6-22-03. INT. CL. 30.
- KELSEYVILLE PACKING COMPANY, KELSEYVILLE, CA: 1,208,818, CANC. INT. CL. 31.
- KEMPER SYSTEM GMBH & CO. KG, D-3502 VELLMAR 3, FED REP GERMANY: 1,706,077, REN. 6-21-03. MULTIPLE CLASS, INT. CLS. 1, 17 AND 37.
- KEN DONE DOWN UNDER PTY. LIMITED, SYDNEY, NEW SOUTH WALES 2000, AUSTRALIA: 1,725,511, REN. 6-25-03. MULTIPLE CLASS, INT. CLS. 16, 18, 21 AND 24.
- KENDALL COMPANY, THE, MANSFIELD, MA: 2,001,071, CANC. INT. CL. 3.
- KENLOR INDUSTRIES, INC., SANTA ANA, CA: 2,001,302, CANC. INT. CL. 3.
- KENNEDY, GEORGINA E., SKANEATELES, NY: 2,745,825, PUB. 5-13-2003. INT. CL. 5.
- KENNETH FOX SUPPLY CO., MCALLEN, TX: 2,746,163, PUB. 5-13-2003. MULTIPLE CLASS, INT. CLS. 16, 40 AND 42.
- KENNEX GARMENT MFG. CO., LTD., HONG KONG, HONG KONG: 2,746,583, PUB. 5-13-2003. INT. CL. 18.
- KERMEL, 68000 COLMAR, FRANCE: 2,745,696, PUB. 4-23-2002. MULTIPLE CLASS, INT. CLS. 1, 6, 9, 16, 17, 22, 23 AND 24.
- KERR-MCGEE REFINING CORPORATION, OKLAHOMA CITY, OK: 1,207,773, CANC. INT. CL. 4.
- KERR, GRAHAM, CAMANO ISLAND, WA: 2,001,725, CANC. MULTIPLE CLASS, INT. CLS. 16 AND 42.
- KERRY'S BROMELIAD NURSERY, INC., HOMESTEAD, FL: 1,716,262, CANC. INT. CL. 31.
- KERYX BIOPHARMACEUTICALS, INC., CAMBRIDGE, MA: 2,746,216, PUB. 5-13-2003. INT. CL. 42.
- KEUTER, STEFAN, FED REP GERMANY: 2,745,674, PUB. 10-29-2002. INT. CL. 1.
- 2,745,675, PUB. 7-30-2002. INT. CL. 40.
- KEWANEE INDUSTRIES, INC., NEW YORK, NY: 737,705, CANC. U.S. CL. 6.
- 738,007, CANC. U.S. CL. 52.
- KEY BRIDGE CORPORATION, RESTON, VA: 2,748,130, MULTIPLE CLASS, INT. CLS. 35, 36, 38, 39 AND 42.
- KEY LIME, INC., SMYRNA, GA: 2,747,662, MULTIPLE CLASS, INT. CLS. 29 AND 30.
- KEY WEST BREWERY, INC.:
See— *YBOR CITY BREWING COMPANY.*
- KEY WEST BREWERY, INC.:
See— *YBOR CITY BREWING COMPANY.*
- KEYCORP, CLEVELAND, OH: 2,001,921, CANC. INT. CL. 36.
- 2,747,372, PUB. 5-13-2003. INT. CL. 36.
- KEYMRO, 92100 BOULOGNE-BILLANCOURT, FRANCE: 2,746,039, PUB. 1-14-2003. MULTIPLE CLASS, INT. CLS. 35, 36, 38 AND 42.
- KEYSTONE INDUSTRIES (1970) LTD/LTEE, ST-LAURENT, QUEBEC, CANADA: 2,746,473, PUB. 5-13-2003. INT. CL. 25.
- KEYSTONE MARKETING SERVICES, INC., LAS VEGAS, NV, KEYSTONE AUTOMOTIVE WAREHOUSE, EXETER, PA: 1,824,708, REN. 6-27-03. INT. CL. 42.
- KHALAF, ASHRAF, ASPEN, CO: 2,001,504, CANC. INT. CL. 14.
- KIA MOTORS CORPORATION, SEOUL, REPUBLIC OF KOREA: 2,745,929, PUB. 9-4-2001. INT. CL. 12.
- 2,748,779, INT. CL. 12.
- KIDDE RECREATION PRODUCTS, INC., CHICAGO, IL: 1,208,679, CANC. INT. CL. 28.
- 1,208,680, CANC. INT. CL. 28.
- KIDDE- GRAVINER LIMITED, BERKSHIRE SL3 0HB, UNITED KINGDOM, GRAVINER MANUFACTURING COMPANY LIMITED, LONDON, ENGLAND: 741,260, REN. 6-23-03. U.S. CL. 26 (INT. CL. 9).
- KIDQUEST, INC., DALLAS, TX, DBA WONDERWINGS-COM ENTERTAINMENT: 2,748,336, INT. CL. 21.
- KIDS II, INC., ALPHARETTA, GA: 1,717,143, CANC. INT. CL. 28.
- KIDS ONLY, FRAMINGHAM, MA: 2,746,552, PUB. 5-13-2003. INT. CL. 28.
- KILBURG, CHERYL, ALLEN PARK, MI: 2,746,475, PUB. 5-13-2003. INT. CL. 14.
- KILLERLINK, LLC, CORONA DEL MAR, CA: 2,747,840, MULTIPLE CLASS, INT. CLS. 35, 39 AND 42.
- KIM, CHOONG YUP, LOS ANGELES, CA: 2,748,303, MULTIPLE CLASS, INT. CLS. 2 AND 17.

- KIMBALL INTERNATIONAL, INC., JASPER, IN:
1,820,639, REN. 6-23-03. INT. CL. 20.
- KIMBERLY-CLARK CORPORATION, NEENAH, WI:
1,208,075, CANC. INT. CL. 10.
1,208,488, CANC. INT. CL. 24.
1,208,499, CANC. INT. CL. 24.
1,208,500, CANC. INT. CL. 24.
1,714,955, CANC. INT. CL. 5.
1,785,602, REN. 6-26-03. INT. CL. 21.
2,001,842, CANC. INT. CL. 21.
2,747,036, PUB. 5-13-2003. INT. CL. 16.
2,747,037, PUB. 5-13-2003. INT. CL. 3.
- KIMBERLY-CLARK TISSUE COMPANY, NEENAH, WI,
SCOTT PAPER COMPANY, DELAWARE COUNTY, PA:
1,803,775, REN. 6-26-03. INT. CL. 24.
- KIMBERLY-CLARK WORLDWIDE, INC., NEENAH, WI,
KIMBERLY-CLARK CORPORATION, NEENAH, WI:
1,784,186, REN. 6-21-03. INT. CL. 24.
- KIMBERLY-CLARK WORLDWIDE, INC., NEENAH, WI
FROM KIMBERLY-CLARK CORPORATION, NEENAH,
WI:
2,748,031, INT. CL. 19.
- KINDER MORGAN, INC., HOUSTON, TX:
2,747,976, INT. CL. 36.
- KINDER-CARE INC., MONTGOMERY, AL:
1,209,300, CANC. INT. CL. 42.
- KINESIS USA, INC., PORTLAND, OR:
2,748,244, INT. CL. 12.
- KINETIC CONCEPTS, INC., SAN ANTONIO, TX:
1,208,418, CANC. INT. CL. 20.
- KINEXUS CORPORATION, NEW YORK, NY FROM WITAN
GROUP, INC., THE, NEW YORK, NY:
2,747,922, INT. CL. 35.
- KING & PRINCE SEAFOOD CORPORATION, BRUNSWICK,
GA:
2,001,761, CANC. INT. CL. 29.
- KING CYCLES, INC., NORTH LITTLE ROCK, AR:
2,747,317, PUB. 5-13-2003. INT. CL. 28.
- KING TECHNOLOGY, INC., HOPKINS, MN:
2,748,329, INT. CL. 5.
- KINGDREAM PUBLIC LIMITED COMPANY, WUHAN
CITY, HUBEI PROVINCE, P.R., CHINA:
2,745,918, PUB. 6-11-2002. MULTIPLE CLASS, INT. CLS. 6
AND 7.
- KINI L.C., SALINA, KS:
1,716,542, CANC. INT. CL. 38.
- KIRBY MORGAN DIVE SYSTEMS, INC., SANTA BAR-
BARA, CA, DIVING SYSTEMS INTERNATIONAL, SAN-
TA BARBARA, CA:
1,767,264, REN. 6-27-03. MULTIPLE CLASS, INT. CLS. 9
AND 25.
- KIRIN BEER KABUSHIKI KAISHA, CHUO-KU, TOKYO,
JAPAN, TA KIRIN BREWERY CO., LTD.:
2,746,491, PUB. 5-13-2003. INT. CL. 32.
- KIRKBI A/S, DK-7190 BILLUND, DENMARK:
2,747,423, PUB. 5-13-2003. INT. CL. 41.
- KISS MY FACE, GARDINER, NY:
2,748,862, INT. CL. 3.
- KISSOON, KATHLEEN W., EDINA, MN:
2,748,004, MULTIPLE CLASS, INT. CLS. 38, 39 AND 42.
- KITE FACTORY, LIMITED, THE, TSIM SHA TSUI, KOW-
LOON, HONG KONG:
2,748,293, INT. CL. 28.
- KIWANIS CLUB OF KINGSPORT, INC., KINGSPORT, TN:
1,209,269, CANC. INT. CL. 42.
- KLAPAC, JANET W., NORTH LIMA, OH:
2,747,216, PUB. 5-13-2003. INT. CL. 31.
- KLEERWATER TECHNOLOGIES, CARSON CITY, NV:
2,747,396, PUB. 5-13-2003. INT. CL. 11.
2,747,397, PUB. 5-13-2003. INT. CL. 11.
- KLEIN AND COMPANY, INC., HOLLY SPRINGS, GA:
1,714,988, CANC. INT. CL. 6.
- KLEMM AUTOMOTIVE PRODUCTS CO., CHICAGO, IL:
1,208,106, CANC. INT. CL. 11.
- KLEYSER INVESTMENTS LIMITED, WINNIPEG, MANI-
TOBA, CANADA:
1,209,043, CANC. INT. CL. 39.
- KLOBER GMBH & CO. KG, 58256 ENNEPETAL, FED REP
GERMANY:
2,000,597, CANC. INT. CL. 6.
- KLONDIKE PIZZA, INC., ARROYO GRANDE, CA, DENNIS,
MICHAEL OWEN, ARROYO GRANDE, CA:
1,802,456, REN. 6-27-03. INT. CL. 42.
- KMART PROPERTIES, INC., TROY, MI:
2,001,951, CANC. INT. CL. 42.
2,001,952, CANC. INT. CL. 42.
2,001,954, CANC. INT. CL. 42.
- KMD INCORPORATED, AUBURN, WA:
2,001,339, CANC. INT. CL. 39.
- KNAGGS, SHAWN R., PHOENIX, AZ:
2,000,911, CANC. INT. CL. 25.
- KNIPP, LILLIAN H., BALTIMORE, MD:
2,748,229, MULTIPLE CLASS, INT. CLS. 35 AND 42.
- KNIPPING-HOLDING GMBH, ZUG, SWITZERLAND:
1,207,827, CANC. INT. CL. 6.
- KNOLL PHARMACEUTICAL COMPANY, WHIPPANY, NJ:
1,207,819, CANC. INT. CL. 5.
- KNOLL SYSTEMS CORP., CONCORD, CA:
2,748,468, INT. CL. 37.
- KNOLL, INC., EAST GREENVILLE, PA, WESTINGHOUSE
ELECTRIC CORPORATION, PITTSBURGH, PA:
1,773,588, REN. 6-27-03. INT. CL. 16.
- KNORR-MILLER, GLASTONBURY, CT:
2,746,277, PUB. 5-13-2003. INT. CL. 41.
- KNOWLEDGE ANALYSIS TECHNOLOGIES, LLC,
BOULDER, CO:
2,747,207, PUB. 5-13-2003. INT. CL. 9.
- KNOWLES, SHERRY LEIGH, WINTER PARK, FL:
2,747,469, INT. CL. 9.
- KNUD NIELSEN COMPANY, INC., EVERGREEN, AL:
2,748,157, MULTIPLE CLASS, INT. CLS. 3, 5 AND 21.
- KOBREN, SPENCER, WOODLAND HILLS, CA:
2,749,057, INT. CL. 35.
- KOCH PERFORMANCE ROADS, INC., WICHITA, KS:
2,747,941, INT. CL. 37.
- KOEI CO., LTD., YOKOHAMA 223-8503, JAPAN:
2,746,905, PUB. 5-13-2003. INT. CL. 9.
2,748,126, INT. CL. 9.
- KOHL'S ILLINOIS, INC., AURORA, IL:
2,748,483, MULTIPLE CLASS, INT. CLS. 18 AND 25.
- KOKUYO KABUSHIKI KAISHA, OSAKA-FU, JAPAN, TA
KOKUYO CO., LTD.:
2,747,698, INT. CL. 16.
- KOLD-DRAFT OF KANSAS CITY INC., GRANDVIEW, MO:
1,208,465, CANC. INT. CL. 22.
- KOLON INDUSTRIES, INC., KWACHON-CITY, KYUNGGI-
DO 427-040, REPUBLIC OF KOREA:
2,747,940, MULTIPLE CLASS, INT. CLS. 23, 24 AND 25.
- KOLPIN MANUFACTURING, INC., BERLIN, WI:
1,207,906, CANC. INT. CL. 8.
- KOMELON CORPORATION, SAHA-KU, PUSAN, REPUB-
LIC OF KOREA:
2,748,141, INT. CL. 9.
- KONAMI CORPORATION, MINATO-KU, TOKYO, JAPAN:
2,748,081, INT. CL. 9.
2,748,238, INT. CL. 9.
- KONICA CORPORATION, SHINJUKU-KU, TOKYO, JA-
PAN:
2,745,788, PUB. 11-5-2002. INT. CL. 9.
- KONINKLIJKE PHILIPS ELECTRONICS N.V., EINDHO-
VEN, NETHERLANDS:
2,745,594, PUB. 11-13-2001. INT. CL. 9.
2,747,681, INT. CL. 9.
- KOONTZ/MCCOMBS LLC, SAN ANTONIO, TX:
2,746,619, PUB. 5-13-2003. MULTIPLE CLASS, INT. CLS.
36 AND 37.
- KOOREY, DOUGLAS, VALLEY CITY, OH:
2,001,625, CANC. INT. CL. 14.
- KOSE CORPORATION, CHUO-KU, TOKYO, JAPAN:
2,747,953, INT. CL. 3.
- KOTOWSKI, ARNE, 52349 DUREN, FED REP GERMANY:
2,747,684, INT. CL. 21.
- KOVITZ, RANDY, LOS ANGELES, CA:
2,001,601, CANC. INT. CL. 41.

- KOZIN, MICHELLE J., BOSTON, MA:
2,748,843, MULTIPLE CLASS, INT. CLS. 16 AND 41.
- KPMG INTERNATIONAL, 1185 MC AMSTELVEEN, NETHERLANDS:
2,745,994, PUB. 5-13-2003. MULTIPLE CLASS, INT. CLS. 9, 16, 35, 36 AND 42.
- KQ CORPORATION, DRAPER, UT:
2,706,861, COR. INT. CL. 41.
- KR U.S.A., INC., SAN JOSE, CA:
2,747,914, INT. CL. 16.
- KRAFT FOODS HOLDINGS, INC., NORTHFIELD, IL:
2,745,781, PUB. 12-31-2002. INT. CL. 30.
2,748,845, INT. CL. 30.
2,748,861, INT. CL. 30.
2,748,955, INT. CL. 30.
- KRAFT FOODS, INC., NORTHFIELD, IL:
2,000,829, CANC. INT. CL. 30.
- KRAFT FOODSERVICE HOLDING CORPORATION, DEERFIELD, IL TO ALLIANT FOODSERVICES, INC., DEERFIELD, IL:
1,717,155, CANC. INT. CL. 29.
- KRAMER, NOELLE, LOS ANGELES, CA:
2,745,835, PUB. 8-20-2002. INT. CL. 3.
- KRASON, JAN, DENVER, CO:
2,748,590, INT. CL. 11.
- KROGER CO. OF MICHIGAN, THE, LIVONIA, MI:
2,747,287, PUB. 5-13-2003. MULTIPLE CLASS, INT. CLS. 1, 3, 7, 9 AND 21.
- KROSNIEWSKIE HUTY SZKLA "KROSNO" SA, KROSNO, POLSKA, POLAND:
2,746,360, PUB. 5-13-2003. INT. CL. 21.
- KRP ENTERPRISES, INC., GRANITE FALLS, MN:
1,715,019, CANC. INT. CL. 7.
- KRUEGER INTERNATIONAL, INC., GREEN BAY, WI:
2,748,502, INT. CL. 20.
- KRUPP BILSTEIN GMBH, D-58256 ENNEPETAL, FED REP GERMANY:
2,746,736, PUB. 5-13-2003. MULTIPLE CLASS, INT. CLS. 9 AND 12.
2,746,737, PUB. 5-13-2003. MULTIPLE CLASS, INT. CLS. 9 AND 12.
2,746,738, PUB. 5-13-2003. MULTIPLE CLASS, INT. CLS. 9 AND 12.
2,746,739, PUB. 5-13-2003. MULTIPLE CLASS, INT. CLS. 9 AND 12.
- KRUPP BILSTEIN GMBH, D-58256 ENNEPETAL, GERMAN DEM REP:
2,746,740, PUB. 5-13-2003. MULTIPLE CLASS, INT. CLS. 9 AND 12.
- KRUPP BILSTEIN GMBH, D-58256 ENNEPETAL, FED REP GERMANY:
2,746,742, PUB. 5-13-2003. MULTIPLE CLASS, INT. CLS. 9 AND 12.
2,746,743, PUB. 5-13-2003. MULTIPLE CLASS, INT. CLS. 9 AND 12.
2,746,744, PUB. 5-13-2003. MULTIPLE CLASS, INT. CLS. 9 AND 12.
2,746,745, PUB. 5-13-2003. MULTIPLE CLASS, INT. CLS. 9 AND 12.
2,746,746, PUB. 5-13-2003. MULTIPLE CLASS, INT. CLS. 9 AND 12.
- KRUPP BROTHERS WINERY LLC, NAPA, CA:
2,748,076, INT. CL. 33.
- KRYPTOGRAFICS GMBH, NURNBERG, FED REP GERMANY:
2,745,749, PUB. 1-21-2003. INT. CL. 9.
- KSLA, LLC., MONTGOMERY, AL:
2,745,919, PUB. 12-3-2002. INT. CL. 42.
- KT INDUSTRIES LTD., WINNIPEG, MANITOBA, R3E 2R9, CANADA:
1,814,878, REN. 6-24-03. INT. CL. 16.
- KUCERA INTERNATIONAL INC., WILLOUGHBY, OH:
2,748,545, MULTIPLE CLASS, INT. CLS. 40 AND 41.
- KUCERA, JOHN THOMAS, PALO ALTO, CA:
2,747,654, INT. CL. 9.
- KUDLA ENTERPRISES, INC., TAMPA, FL:
2,746,750, PUB. 5-13-2003. INT. CL. 35.
- KUN WHA PHARMACEUTICAL COMPANY LTD., SEOUL 138-804, REPUBLIC OF KOREA:
2,746,139, PUB. 5-13-2003. INT. CL. 29.
- KUNCHA, SAHADEVAN, GAITHERSBURG, MD:
2,746,778, PUB. 5-13-2003. INT. CL. 43.
- KUNG HSUE SHE, INC., CARSON, CA:
2,001,683, CANC. INT. CL. 12.
- KURACINA, THOMAS C., OJAI, CA:
2,747,166, PUB. 5-13-2003. MULTIPLE CLASS, INT. CLS. 14 AND 16.
- KURT MANUFACTURING COMPANY, INC., MINNEAPOLIS, MN:
1,796,760, REN. 6-23-03. INT. CL. 7.
- KVAERNER PANEL SYSTEMS GMBH MASCHINEN- UND ANLAGENBAU, 31832 SPRINGE, FED REP GERMANY:
2,745,523, PUB. 5-13-2003. INT. CL. 7.
- KW INTERNATIONAL, LTD, LONDON, UNITED KINGDOM:
2,748,630, INT. CL. 9.
- KWH MIRKA LTD., FIN-66850 JEPUA, FINLAND:
2,746,484, PUB. 5-13-2003. INT. CL. 3.
- KWS SAAT AG, D-37555 EINBECK, FED REP GERMANY:
2,745,766, PUB. 10-22-2002. MULTIPLE CLASS, INT. CLS. 7, 31 AND 42.
- KYOCERA CORPORATION, FUSHIMI-KU, KYOTO, 612-8501, JAPAN:
2,747,680, INT. CL. 9.
- KYONGSANGBUK-DO, PUK-KU, TAEGU, REPUBLIC OF KOREA:
2,746,588, PUB. 5-13-2003. MULTIPLE CLASS, INT. CLS. 6 AND 24.
- KZ GOLF, INC., STUDIO CITY, CA:
2,748,507, INT. CL. 28.
- L & L ENTERPRISES, INC., PETAL, MS:
2,001,676, CANC. INT. CL. 28.
- L.A. PROMOTION DEVELOPMENT, INC., OJAI, CA:
2,745,996, PUB. 5-13-2003. INT. CL. 28.
- L.C.T. GLASS & LIGHTING COMPANY, LLC, THE, WEST HARTFORD, CT:
2,747,937, INT. CL. 11.
- L.H. CARBIDE, CORPORATION, FORT WAYNE, IN:
1,715,002, CANC. MULTIPLE CLASS, INT. CLS. 6 AND 7.
- L&P PROPERTY MANAGEMENT COMPANY, SOUTH GATE, CA:
1,803,276, REN. 6-21-03. INT. CL. 20.
- L&P PROPERTY MANAGEMENT COMPANY, SOUTH GATE, CA, LEGGETT & PLATT, INCORPORATED, CARTHAGE, MO:
1,814,946, REN. 6-21-03. INT. CL. 20.
- L&P PROPERTY MANAGEMENT COMPANY, SOUTH GATE, CA TO L&P PROPERTY MANAGEMENT COMPANY, SOUTH GATE, CA:
2,617,636, COR. INT. CL. 12.
- L&P PROPERTY MANAGEMENT COMPANY:
See—AMCO HOUSEWARE, LLC.
- L'AIGLON WINE & SPIRITS IMPORT CO., INC., WILLIAMS ISLAND, FL:
2,001,155, CANC. INT. CL. 33.
- L'ALTRA MODA S.P.A, ROME, ITALY:
2,749,016, MULTIPLE CLASS, INT. CLS. 3, 18 AND 25.
- L'KORAL, INC., VERNON, CA:
2,001,543, CANC. INT. CL. 25.
- L'OREAL, 75008 PARIS, FRANCE:
2,001,220, CANC. INT. CL. 3.
2,745,843, PUB. 5-13-2003. INT. CL. 3.
- L'OREAL, PARIS, FRANCE:
2,748,074, INT. CL. 3.
- L'OREAL USA CREATIVE, INC., NEW YORK, NY:
2,748,036, INT. CL. 3.
- LA CONSTANCIA, S.A., SAN SALVADOR, EL SALVADOR:
2,748,707, INT. CL. 32.
- LA GRANGE PARK PUBLIC LIBRARY DISTRICT, LA GRANGE PARK, IL:
2,746,795, PUB. 5-13-2003. INT. CL. 41.
- LA ROCHE-POSAY LABORATOIRE PHARMACEUTIQUE, 86270 LA ROCHE-POSAY, FRANCE:
2,745,793, PUB. 5-13-2003. INT. CL. 3.

- LA TAZZA D'ORO S.R.L., 09122 CAGLIARI, ITALY:
2,745,529, PUB. 8-14-2001. INT. CL. 30.
- LABOGIKEN KABUSHIKI KAISHA, CHIYODA-KU, TOKYO, JAPAN, TA LABOGIKEN CO., LTD.:
1,715,176, CANC. INT. CL. 9.
- LABONE, INC., LENEXA, KS:
2,746,198, PUB. 5-13-2003. INT. CL. 42.
- LABORATOIRE GARNIER & CIE, 75008 PARIS, FRANCE:
2,745,974, PUB. 2-4-2003. INT. CL. 3.
2,746,105, PUB. 1-21-2003. INT. CL. 3.
- LABORATOIRES LIERAC S.A., 75008 PARIS, FRANCE:
2,746,127, PUB. 5-13-2003. INT. CL. 3.
- LABORATOIRES SEROBIOLOGIQUES, 54420 PULNOY, FRANCE:
1,753,516, REN. 6-25-03. INT. CL. 3.
- LABRADA NUTRITIONAL SYSTEMS, INC., TOMBALL, TX:
2,001,051, CANC. INT. CL. 5.
- LADY ROI, LTD., WALLINGTON, NJ:
2,001,677, CANC. INT. CL. 25.
- LAI, CHING HUA, TAICHUNG, TAIWAN:
2,748,669, MULTIPLE CLASS, INT. CLS. 7 AND 8.
- LAKE FOREST GRADUATE SCHOOL OF MANAGEMENT, LAKE FOREST, IL:
2,746,781, PUB. 5-13-2003. INT. CL. 41.
- LAKE LYNDON B. JOHNSON IMPROVEMENT CORPORATION, HORSESHOE BAY, TX:
2,000,939, CANC. INT. CL. 36.
- LAKE SHORE NATIONAL BANK, CHICAGO, IL:
1,208,951, CANC. INT. CL. 36.
- LALLEMAND USA, INC., DERRY, NH, GREAT LAKES BIOCHEMICAL CO., INC., MILWAUKEE, WI:
1,827,173, REN. 6-23-03. INT. CL. 5.
- LAMBDA CROSSING LTD., CAESAREA 38900, ISRAEL:
2,745,838, PUB. 8-13-2002. INT. CL. 9.
2,745,839, PUB. 8-13-2002. INT. CL. 9.
- LAMBRIGHT, J. H., SLATON, TX, DBA LAMBRIGHT SEED FARM:
1,716,242, CANC. INT. CL. 31.
- LAMOR CORPORATION AB, FIN-06150 PORVOO, FINLAND:
2,746,322, PUB. 5-13-2003. INT. CL. 6.
2,746,323, PUB. 5-13-2003. INT. CL. 17.
- LAMOT CORPORATION, STAFFORD, TX:
2,747,127, PUB. 4-8-2003. INT. CL. 6.
- LAMOUILLE, PIERRE, 38000 GRENOBLE, FRANCE:
2,747,721, INT. CL. 4.
- LANCOME PARFUMS ET BEAUTE & CIE, 75008 PARIS, FRANCE:
2,745,457, PUB. 6-22-1999. INT. CL. 3.
- LANCOME PARFUMS ET BEAUTE & CIE, PARIS, FRANCE:
2,746,370, PUB. 5-13-2003. INT. CL. 3.
2,746,488, PUB. 5-13-2003. INT. CL. 3.
- LAND-O-SUN DAIRIES, L.L.C., JOHNSON CITY, TN:
1,716,076, CANC. INT. CL. 29.
- LANDAU, JEROME ALAN, SCOTTSDALE, AZ:
2,746,690, PUB. 5-13-2003. INT. CL. 41.
- LANDMARK SYSTEMS CORPORATION, VIENNA, VA:
1,715,123, CANC. INT. CL. 9.
- LANDSCAPE ALTERNATIVES, INC., ST. PAUL, MN:
1,716,255, REN. 6-26-03. INT. CL. 31.
- LANDSTROM, STIG, STRANGNAS, SWEDEN:
1,208,176, CANC. INT. CL. 15.
- LANE LIMITED, NEW YORK, NY:
737,761, CANC. U.S. CL. 17.
- LANGUAGE LINE, LLC, MONTEREY, CA:
2,747,645, INT. CL. 9.
- LANNING, DOUGLAS D., RANDOLPH, NJ:
2,747,529, INT. CL. 36.
- LARALEV, INC., WILMINGTON, DE:
1,815,267, AM. INT. CL. 42.
- LARRY H. MILLER RESTAURANTS, INC., MURRAY, UT:
2,748,243, INT. CL. 42.
- LASERSIGHT TECHNOLOGIES, INC., WINTER PARK, FL:
2,748,072, INT. CL. 41.
- LASHMET, MICHAEL, INDIANAPOLIS, IN:
2,748,495, INT. CL. 16.
- LASKO METAL PRODUCTS, INC., WEST CHESTER, PA:
2,749,003, INT. CL. 11.
- LATE FOR THE SKY PRODUCTIONS, INC., CINCINNATI, OH:
2,746,843, PUB. 5-13-2003. INT. CL. 28.
2,746,844, PUB. 5-13-2003. INT. CL. 28.
- LAU, ANTHONY, FLUSHING, NY:
2,001,822, CANC. INT. CL. 41.
- LAURIA, KELLY M., WEST ALLIS, WI:
2,747,424, PUB. 5-13-2003. INT. CL. 3.
- LAVENDER LANE, INC., SACRAMENTO, CA:
2,000,608, CANC. MULTIPLE CLASS, INT. CLS. 3 AND 31.
- LAVENIR, LLC, FAIRFIELD, NJ:
2,746,291, PUB. 11-26-2002. INT. CL. 3.
- LAW OF THE JUNGLE PTY LIMITED, EVELEIGH, NEW SOUTH WALES, AUSTRALIA:
2,747,819, MULTIPLE CLASS, INT. CLS. 9, 16, 38, 41 AND 42.
- LAWMAN INTERNATIONAL LIMITED, KWUN TONG, KOWLOON, HONG KONG:
1,208,561, CANC. INT. CL. 25.
- LAWTER INTERNATIONAL, INC., NORTHBROOK, IL:
1,207,730, CANC. INT. CL. 2.
1,207,731, CANC. INT. CL. 2.
1,207,732, CANC. INT. CL. 2.
- LAYTON, CAROL S., TAMPA, FL:
2,001,661, CANC. INT. CL. 16.
- LAZANO, STEVEN L., NORCO, CA AND LAZANO, KRISTINA L., NORCO, CA:
2,748,740, INT. CL. 12.
- LBJ PAKKE, INC., WADDINGTON, NY:
1,768,401, REN. 6-27-03. INT. CL. 5.
- LCI CORPORATION INTERNATIONAL, CHARLOTTE, NC:
2,001,744, CANC. INT. CL. 7.
- LCN APPAREL, INC., NEW YORK, NY:
2,747,555, INT. CL. 25.
- LDR INDUSTRIES, INC., CHICAGO, IL:
2,747,659, MULTIPLE CLASS, INT. CLS. 11 AND 21.
- LE CAFE OF 1271, INC., NEW YORK, NY:
1,716,775, CANC. INT. CL. 42.
- LE CHATEAU INC., MONTREAL, QUEBEC, CANADA FROM CHATEAU STORES OF CANADA LTD., MONTREAL, QUEBEC H4P 1N1, CANADA:
2,745,478, PUB. 11-12-2002. MULTIPLE CLASS, INT. CLS. 18, 25 AND 35.
- LE TOURNEAU, RONALD G., SOUTHFIELD, MI:
2,748,158, INT. CL. 35.
- LE YUAN INDUSTRIAL CO. LTD, CHANG HUA HSIEN, TAIWAN:
2,747,660, INT. CL. 21.
- LEADBYTE CORPORATION, BELLEVUE, WA:
2,748,799, INT. CL. 9.
- LEAP SOFTWARE, INC., TAMPA, FL:
2,747,175, PUB. 5-13-2003. INT. CL. 9.
- LEAPFROG ENTERPRISES, INC., EMERYVILLE, CA FROM LEAPFROG, L.L.C., EMERYVILLE, CA:
2,745,425, PUB. 12-17-2002. INT. CL. 35.
- LEAPFROG ENTERPRISES, INC., EMERYVILLE, CA FROM AB OVO, RICHMOND, CA:
2,745,489, PUB. 12-31-2002. INT. CL. 9.
- LEAPFROG, L.L.C.:
See—LEAPFROG ENTERPRISES, INC.
- LEATHER BROTHERS, INC., CONWAY, AR:
2,746,362, PUB. 5-13-2003. INT. CL. 18.
- LEBANON CHEMICAL CORPORATION, LEBANON, PA, SWIFT AGRICULTURAL CHEMICALS CORPORATION, CHICAGO, IL:
961,242, REN. 6-23-03. U.S. CL. 10 (INT. CL. 1).
- LEBANON CHEMICAL CORPORATION, LEBANON, PA, ELI LILLY AND COMPANY, INDIANAPOLIS, IN:
963,326, REN. 6-23-03. U.S. CL. 6 (INT. CL. 1).
- LECLAIR, ROBERT S., HUMBLE, TX:
2,747,556, INT. CL. 28.
- LECTRA SYSTEMES, 33610 CESTAS, FRANCE:
2,745,952, PUB. 6-18-2002. INT. CL. 9.
- LEE, KENNETH D., OGDEN, UT:
2,748,626, MULTIPLE CLASS, INT. CLS. 16 AND 41.
- LEE, LINDA, ST. LOUIS, MO:
2,747,198, PUB. 5-13-2003. INT. CL. 35.

- LEE, WILLIAM K., MCLEAN, VA:
2,748,817, INT. CL. 41.
- LEGACY CONVERSIONS, INC., NOBLE, OK:
2,001,304, CANC. INT. CL. 12.
- LEGACY CREATIVE VENTURES L.L.C., SEATTLE, WA:
2,001,526, CANC. INT. CL. 16.
- LEGAL COMPUTER SOLUTIONS, INC., BOSTON, MA:
2,747,586, MULTIPLE CLASS, INT. CLS. 35 AND 42.
- LEGEND TECHNOLOGY CO., LTD., TAIPEI HSIEN, TAIWAN:
2,747,123, PUB. 5-13-2003. MULTIPLE CLASS, INT. CLS. 9 AND 28.
- LEGENDSOFT, INC., ALPHARETTA, GA:
2,748,880, INT. CL. 9.
- LEGENT CORPORATION, PITTSBURGH, PA:
2,001,880, CANC. INT. CL. 9.
- LEGG MASON PROPERTIES, INC., CHARLOTTE, NC,
LEGG MASON WOOD WALKER, INCORPORATED,
BALTIMORE, MD:
1,766,217. REN. 6-27-03. INT. CL. 36.
- LEIF JACOBSEN HOLDINGS LIMITED, MARKHAM, ONTARIO L3R 8N4, CANADA:
2,745,512, PUB. 8-13-2002. INT. CL. 20.
- LEISURE ARTS, INC., BIRMINGHAM, AL:
2,748,391, INT. CL. 20.
2,748,491, INT. CL. 20.
- LEISURE PUBLICATIONS, INC, LOS ANGELES, CA TO
LEISURE PUBLICATIONS, INC, LOS ANGELES, CA:
2,655,675, COR. INT. CL. 16.
- LEISURE STATION CO., LTD., TAICHUNG, TAIWAN:
2,748,247, MULTIPLE CLASS, INT. CLS. 35 AND 42.
- LEISURE TIME SERVICES, INC., STATEN ISLAND, NY:
2,745,464, PUB. 9-19-2000. MULTIPLE CLASS, INT. CLS. 16, 21, 29 AND 35.
- LEMOYNE SLEEPER CO., INC., LEMOYNE, PA:
2,746,446, PUB. 5-13-2003. INT. CL. 20.
- LEND LEASE REAL ESTATE INVESTMENTS, INC., ATLANTA, GA:
2,747,381, PUB. 5-13-2003. INT. CL. 42.
- LENDINGTREE, INC., CHARLOTTE, NC:
2,747,718, MULTIPLE CLASS, INT. CLS. 9, 36 AND 42.
- LENOX, INCORPORATED, LAWRENCEVILLE, NJ, WHITING MANUFACTURING COMPANY, BRIDGEPORT, CT:
164,714. REN. 6-24-03. U.S. CL. 28 (INT. CLS. 8 AND 14).
- LENZ ELEKTRONIK GMBH, 35398 GIESSEN, FED REP GERMANY:
2,746,080, PUB. 10-8-2002. INT. CL. 9.
- LEON J. BOOLE & L.J. BOOLE, INC., DEDHAM, NORFOLK COUNTY, MA:
2,746,680, PUB. 5-13-2003. INT. CL. 8.
- LEPRECAN, L.L.C., CHICAGO, IL:
2,748,178, MULTIPLE CLASS, INT. CLS. 11 AND 42.
- LERNOUT & HAUSPIE SPEECH PRODUCTS USA, INC., BURLINGTON, MA:
1,715,362, CANC. INT. CL. 9.
- LERUS CORPORATION, SAN DIEGO, CA:
2,000,769, CANC. INT. CL. 29.
- LES BALLETS TROCKADERO DE MONTE CARLO, INC., NEW YORK, NY:
2,001,178, CANC. INT. CL. 41.
2,001,182, CANC. INT. CL. 41.
- LES BOULANGERS ASSOCIES, INC., SEATTLE, WA:
1,716,218. REN. 6-26-03. INT. CL. 30.
- LES DESSOUS BOUTIQUE DIFFUSION S.A., SEYSSINET PARISSET, FRANCE, LOU, GRENOBLE (ISERE), FRANCE:
748,831. REN. 6-27-03. U.S. CL. 39 (INT. CL. 25).
- LES JOLIES CERAMIQUES SANS KAOLIN, 75007 PARIS, FRANCE, EMAUX DE BRIARE TECHNOLOGIES, 92150 SURESNES (HAUTS-DE-SEINE), FRANCE:
1,759,896. REN. 6-25-03. INT. CL. 19.
- LES PRODUITS ASSOCIES LPA-BROXO S.A., CHENEBOURG, GENEVA, SWITZERLAND, AESUP EST., VAUDUZ, LIECHTENSTEIN:
698,137. REN. 6-24-03. U.S. CL. 29 (INT. CL. 21).
- LESLIE ALLEN FOUNDATION, INC., NEW YORK, NY:
2,746,784, PUB. 5-13-2003. INT. CL. 41.
2,746,785, PUB. 5-13-2003. INT. CL. 41.
- LESSARD, RANDY, OAK RIDGE, TN:
2,745,510, PUB. 5-13-2003. INT. CL. 9.
- LEVEL ENERGY GROUP, INC., WESTLAKE, OH:
1,716,828, CANC. INT. CL. 42.
- LEVEL GROUP S.R.L., 1-52025 MONTEVARCHI - AREZZO, ITALY:
2,746,688, PUB. 5-13-2003. INT. CL. 25.
- LEVINGER COMPANY, DELRAY BEACH, FL:
2,746,565, PUB. 5-13-2003. INT. CL. 20.
- LEVER BROTHERS COMPANY, NEW YORK, NY:
737,998, CANC. U.S. CL. 51.
- LEVITON MANUFACTURING CO., INC., LITTLE NECK, NY:
2,746,920, PUB. 5-13-2003. INT. CL. 9.
- LEVITT, DEBORAH, MASSAPEQUA, NY, DBA AS WAS:
2,001,243, CANC. INT. CL. 42.
- LEVY, DORAN J., MINNEAPOLIS, MN:
1,208,867, CANC. INT. CL. 35.
- LEWISVILLE LSF, L.P., ADDISON, TX:
2,748,121, INT. CL. 36.
- LEXITECH INTERNATIONAL CORPORATION, INDIANAPOLIS, IN:
1,772,227. REN. 6-25-03. INT. CL. 9.
- LEXMARK INTERNATIONAL, INC., LEXINGTON, KY:
2,746,392, PUB. 5-13-2003. INT. CL. 9.
- LF CORPORATION, WILMINGTON, DE:
1,714,994, CANC. INT. CL. 6.
- LF, LLC, WILMINGTON, DE, LF CORPORATION, WILMINGTON, DE:
1,701,629. REN. 6-24-03. INT. CL. 11.
- LF, LLC, WILMINGTON, DE:
2,746,673, PUB. 5-13-2003. INT. CL. 35.
- LFP, INC., BEVERLY HILLS, CA:
1,208,186, CANC. INT. CL. 16.
2,001,595, CANC. INT. CL. 16.
- LG ELECTRONICS INC., SEOUL, REPUBLIC OF KOREA:
2,748,446, INT. CL. 11.
- LGI DEVELOPMENT CORP., CONROE, TX:
2,746,439, PUB. 5-13-2003. INT. CL. 37.
- LHOIST RECHERCHE ET DEVELOPPEMENT S.A., 1342 OTTIGNIES-LOUVAIN-LA NEUVE, BELGIUM:
1,765,426. REN. 6-27-03. MULTIPLE CLASS, INT. CLS. 1 AND 19.
- LI'S INTERNATIONAL COMPANY, LLC, LA JOLLA, CA:
2,001,691, CANC. INT. CL. 3.
- LIBERTY CHILDRENSWEAR COMPANY, L.L.C., BIRMINGHAM, AL:
1,715,946, CANC. INT. CL. 25.
- LIBERTY FINANCIAL COMPANIES, INC., BOSTON, MA:
2,000,516, CANC. INT. CL. 36.
- LIBERTY IMPORTS USA, INC, BETHLEHEM, PA:
2,745,744, PUB. 5-13-2003. INT. CL. 32.
- LIBERTY INSURANCE SERVICES CORPORATION, GREENVILLE, SC:
2,747,033, PUB. 5-13-2003. INT. CL. 9.
2,747,034, PUB. 5-13-2003. INT. CL. 9.
2,747,035, PUB. 5-13-2003. INT. CL. 9.
- LIDL STIFTUNG & CO. KG, 74172 NECKARSULM, FED REP GERMANY:
2,746,152, PUB. 5-13-2003. INT. CL. 9.
2,746,202, PUB. 5-13-2003. INT. CL. 29.
- LIFE COPING, INC., NASHUA, NH:
2,746,419, PUB. 5-13-2003. INT. CL. 45.
- LIFELINE II LLC, GLEN ROCK, NJ:
2,433,582, COR. INT. CL. 3.
- LIFELONG INC., MORTON GROVE, IL:
2,000,855, CANC. INT. CL. 30.
- LIFETIME ENTERTAINMENT SERVICES, NEW YORK, NY:
2,001,005, CANC. INT. CL. 41.
- LIFETIME FILTER, INC., HOUSTON, TX:
2,748,675, INT. CL. 11.
- LIFETIME TOOL COMPANY, INC., MADISON HEIGHTS, MI:
2,413,449, CANC. INT. CL. 8.
- LIFETONE INTERNATIONAL, INC., BOCA RATON, FL:
1,235,814. REN. 6-21-03. INT. CL. 35.
- LIGHT FORCE S.R.L., CARPI (MODENA), ITALY:
2,748,075, INT. CL. 25.

- LIGHTDIAL CORPORATION, IRVINE, CA:
2,748,401, INT. CL. 38.
- LIGHTNER, LEE J., BALTIMORE, MD:
2,748,708, MULTIPLE CLASS, INT. CLS. 37 AND 42.
- LIGHTNING2, LLC, WILLISTON, VT:
2,748,900, MULTIPLE CLASS, INT. CLS. 10 AND 25.
- LIK SANG INTERNATIONAL LIMITED, KWAI CHUNG,
NEW TERRITORIES, HONG KONG:
2,747,323, PUB. 5-13-2003. INT. CL. 35.
- LILLBACKA OY, FIN-62200 KAUHAVA, FINLAND:
2,745,672, PUB. 12-11-2001. MULTIPLE CLASS, INT. CLS.
7 AND 9.
2,745,673, PUB. 1-15-2002. MULTIPLE CLASS, INT. CLS. 7
AND 9.
- LILLIPUT CHILDREN'S SERVICES, STOCKTON, CA:
1,766,378, REN. 6-23-03. INT. CL. 42.
1,766,379, REN. 6-23-03. INT. CL. 42.
- LILLY SOFTWARE ASSOCIATES, INC., HAMPTON, NH:
2,746,301, PUB. 5-13-2003. INT. CL. 9.
- LIN, KU-SHEN, TAIPEI, TAIWAN:
2,746,437, PUB. 5-13-2003. INT. CL. 10.
- LINCOLN GROUP, LTD., THE, ROCHESTER, NY:
1,209,020, CANC. INT. CL. 38.
1,209,021, CANC. INT. CL. 38.
- LINCOLN SNACKS COMPANY, STAMFORD, CT:
2,747,359, PUB. 5-13-2003. INT. CL. 30.
2,747,360, PUB. 5-13-2003. INT. CL. 30.
- LINDEN CORPORATION, WILMINGTON, DE:
2,747,855, MULTIPLE CLASS, INT. CLS. 3 AND 5.
- LINDEN OAKS CORPORATION, WILMINGTON, DE,
BERNSTEINS' OF LONG BEACH, INC., SEAL BEACH,
CA, DBA BERNSTEIN FOODS, INC.:
958,255, REN. 6-27-03. U.S. CL. 46 (INT. CLS. 29 AND 30).
- LINDTNER, MONIKA, D-59510 LIPPETAL, FED REP GER-
MANY:
2,745,980, PUB. 5-13-2003. INT. CL. 9.
- LINDY PROMOTIONS, INC., BETHESDA, MD:
2,747,503, INT. CL. 41.
- LINGUISTIQUE ET INTELLIGENCE ARTIFICIELLE, 45000
ORLEANS, FRANCE, DBA LIDIA S.A:
2,747,512, INT. CL. 35.
- LINSEY FOODS LTD., MARKHAM, ONTARIO, CANADA:
2,748,872, INT. CL. 29.
- LION APPAREL, INC., DAYTON, OH:
2,746,947, PUB. 5-13-2003. INT. CL. 9.
- LION BIOSCIENCE AG, 69120 HEIDELBERG, FED REP
GERMANY:
2,627,386, COR. MULTIPLE CLASS, INT. CLS. 1, 5 AND
42.
- LION TECHNOLOGY INC., LAFAYETTE, NJ:
2,746,124, PUB. 5-13-2003. MULTIPLE CLASS, INT. CLS.
16 AND 41.
- LIONSGATE COMMUNICATIONS INC., DALLAS, TX:
2,702,107, COR. INT. CL. 41.
2,702,108, COR. INT. CL. 41.
- LIONSING FOOD GROUP CO., LTD., GUIYANG GUIZ-
HOU, CHINA:
2,747,110, PUB. 5-13-2003. INT. CL. 30.
- LIPO CHEMICALS, INC., PATERSON, NJ:
2,746,079, PUB. 5-13-2003. MULTIPLE CLASS, INT. CLS.
1, 3 AND 5.
- LIPSCHULTZ, LEVIN & GRAY, NORTHBROOK, IL:
2,000,702, CANC. MULTIPLE CLASS, INT. CLS. 35 AND
36.
- LIPSCOMB, CURTIS ALEXANDER, DETROIT, MI:
2,746,298, PUB. 5-13-2003. INT. CL. 25.
- LIPTON INVESTMENTS, INC., WILMINGTON, DE:
2,748,311, MULTIPLE CLASS, INT. CLS. 29 AND 30.
- LISA FRANK, INC., TUCSON, AZ:
2,001,868, CANC. INT. CL. 25.
2,748,953, INT. CL. 16.
- LISE WATIER COSMETIQUES INC., MONTREAL, QUEBEC
H4T 1B4, CANADA:
2,745,569, PUB. 12-24-2002. MULTIPLE CLASS, INT. CLS.
3, 18 AND 21.
- LISS, ELAINE, PHILADELPHIA, PA:
2,001,159, CANC. INT. CL. 25.
- LISTENPOINT, INC., SAN RAMON, CA:
2,747,695, INT. CL. 9.
- LITELAB CORPORATION, BUFFALO, NY:
1,208,990, CANC. MULTIPLE CLASS, INT. CLS. 37, 41
AND 42.
- LITTLE CAESAR ENTERPRISES, INC., DETROIT, MI:
2,001,131, CANC. INT. CL. 30.
- LITTLE FRIENDS, INC., MONTEZUMA, GA:
1,717,141, CANC. INT. CL. 28.
- LITTLE PEOPLE'S WORKSHOP, LTD., LOUISVILLE, KY:
1,208,277, CANC. INT. CL. 16.
- LITTLE RAPIDS CORPORATION, GREEN BAY, WI:
2,747,246, PUB. 5-13-2003. INT. CL. 24.
2,747,247, PUB. 5-13-2003. INT. CL. 10.
2,747,248, PUB. 5-13-2003. INT. CL. 35.
- LITTLE TIKES COMMERCIAL PLAY SYSTEMS INC.,
FARMINGTON, MO, IRON MOUNTAIN FORGE, FARM-
INGTON, MO:
1,766,847, REN. 6-27-03. INT. CL. 28.
- LITTLE, ANTHONY, ST. PETERSBURG, FL:
2,747,519, INT. CL. 30.
- LITTLER MENDELSON, P.C., SAN FRANCISCO, CA:
2,749,007, INT. CL. 41.
- LIVING HIS LIFE ABUNDANTLY INTERNATIONAL, OLD-
SMAR, FL, OUR LADY OF DIVINE PROVIDENCE
HOUSE OF PRAYER, INC., CLEARWATER, FL, DBA
LIVING HIS LIFE ABUNDANTLY:
1,715,190, REN. 6-25-03. MULTIPLE CLASS, INT. CLS. 9
AND 16.
- LIZARD RESEARCH PTY LTD, NORTH SYDNEY NSW,
AUSTRALIA:
2,747,056, PUB. 5-13-2003. MULTIPLE CLASS, INT. CLS. 9
AND 42.
- LIZZIE*KATE, INC., WICHITA, KS:
2,746,766, PUB. 5-13-2003. INT. CL. 16.
2,746,767, PUB. 5-13-2003. INT. CL. 16.
- LMLM INC., CRYSTAL BEACH, FL:
2,747,552, INT. CL. 9.
- LO, DAVID, ALHAMBRA, CA:
2,746,747, PUB. 5-13-2003. INT. CL. 16.
- LOCATION INC GROUP CORPORATION, WORCESTER,
MA, DBA LOCATION INC:
2,748,616, INT. CL. 35.
- LOCATIONNET SYSTEMS 2000 LTD., NATANYA 42505,
ISRAEL:
2,745,870, PUB. 5-13-2003. INT. CL. 42.
- LOCKERROOM PRODUCTIONS, L.L.C., BLOOMFIELD
HILLS, MI:
2,745,458, PUB. 5-1-2001. INT. CL. 41.
- LOCKHEED WINDOW CORP., PASCOAG, RI:
2,745,954, PUB. 5-14-2002. MULTIPLE CLASS, INT. CLS.
6, 19 AND 37.
- LODI WINE GRAPES LLC, LODI, CA:
2,746,671, PUB. 5-13-2003. INT. CL. 31.
- LOE, TOM E., MAMMOTH LAKES, CA AND LOE, MI-
CHELE L., MAMMOTH LAKES, CA:
2,748,323, INT. CL. 41.
- LOFT, INC., THE, MINNEAPOLIS, MN:
2,748,540, INT. CL. 16.
- LOMAS & NETTLETON COMPANY, THE, DALLAS, TX:
1,208,966, CANC. INT. CL. 36.
- LOMAS MORTGAGE. USA, INC., DALLAS, TX:
1,208,965, CANC. INT. CL. 36.
- LOMBARDI RESEARCH GROUP, L.L.C., BALTIMORE, MD:
2,001,577, CANC. INT. CL. 3.
2,001,578, CANC. INT. CL. 3.
- LONDON METAL EXCHANGE LIMITED, THE, LONDON,
ENGLAND:
2,745,483, PUB. 11-27-2001. MULTIPLE CLASS, INT. CLS.
36, 38 AND 39.
- LONGEVITY RESEARCH, INC., MEDIA, PA:
2,747,204, PUB. 5-13-2003. INT. CL. 44.
- LOOKOUT PARTNERS, L/P, HOUSTON, TX:
2,748,924, INT. CL. 37.
- LOOMWORKS APPAREL, INC., IRVINE, CA:
2,747,666, INT. CL. 24.

- LOTUS BRANDS, INC., TWIN LAKES, WI, LOTUS LIGHT ENTERPRISES, INC., WILMOT, WI:
1,765,459. REN. 6-27-03. INT. CL. 3.
- LOTUS DEVELOPMENT CORPORATION, CAMBRIDGE, MA:
2,000,575. CANC. INT. CL. 42.
- LOUFRANI, FRANKLIN, LONDON, UNITED KINGDOM:
2,747,618. INT. CL. 3.
- LOUISVILLE LADDER GROUP LLC, LOUISVILLE, KY:
2,747,709. MULTIPLE CLASS, INT. CLS. 6 AND 20.
- LOWELL COOPERATIVE BANK, THE, LOWELL, MA:
1,249,274. REN. 6-25-03. INT. CL. 36.
- LOYOLA PRODUCTIONS, INC., LOS ANGELES, CA:
2,748,635. INT. CL. 41.
- LPG SYSTEMS, 26000 VALENCE, FRANCE:
2,745,629. PUB. 8-28-2001. MULTIPLE CLASS, INT. CLS. 9 AND 10.
- LSI LOGIC CORPORATION, MILPITAS, CA:
2,748,030. INT. CL. 9.
- LUBECKI TECHNICAL HOLDINGS INC., GRANBY, QC. J2G 8Y4, CANADA:
2,746,007. PUB. 5-13-2003. INT. CL. 17.
- LUCAS, STUART M., BEL AIR, MD:
2,001,923. CANC. INT. CL. 25.
- LUCENTE, VINCENT, ALLENTOWN, PA:
2,749,058. INT. CL. 44.
- LUCINI ITALIA COMPANY, CHICAGO, IL:
2,745,875. PUB. 5-13-2003. INT. CL. 30.
- LUCKY TOUCH ENTERPRISES, LLC, CHICAGO, IL:
2,746,618. PUB. 5-13-2003. INT. CL. 3.
- LUDLOW CORPORATION, CHICOPEE, MA, CONTOUR MEDICAL TECHNOLOGY, INC., LAVERGNE, TN:
1,774,157. REN. 6-21-03. INT. CL. 10.
- LUMENOS, INC., ALEXANDRIA, VA:
2,747,923. INT. CL. 42.
- LUMINATOR HOLDING L.P., PLANO, TX, GULTON INDUSTRIES, INC., PLANO, TX:
1,764,093. REN. 6-24-03. MULTIPLE CLASS, INT. CLS. 9 AND 11.
- LUND'S, INC., EDINA, MN:
2,748,364. INT. CL. 35.
- LWG INCORPORATED, NORTHBROOK, IL:
2,000,833. CANC. MULTIPLE CLASS, INT. CLS. 36 AND 37.
- LYLE ANDERSON COMPANY, INC., THE, SCOTTSDALE, AZ:
2,748,416. INT. CL. 35.
- LYNDEN INCORPORATED, SEATTLE, WA:
1,768,902. REN. 6-25-03. INT. CL. 39.
- LYNK SOFTWARE, INC., SCOTTSDALE, AZ:
2,748,714. INT. CL. 9.
- LYNNE, JEFFREY, LOS ANGELES, CA:
2,694,456. COR. MULTIPLE CLASS, INT. CLS. 9, 16 AND 41.
- LYNX CORPORATION PTY. LTD., RHODES NSW 2138, AUSTRALIA:
1,232,640. REN. 6-27-03. INT. CL. 12.
- LZB PROPERTIES, INC., MONROE, MI:
2,746,376. PUB. 5-13-2003. INT. CL. 20.
- M & J VENTURES, INC., SPOKANE, WA, DBA LOST & FOUND COMPANY:
2,000,889. CANC. INT. CL. 42.
- M & L ONLINE L.L.C., FARMINGTON HILLS, MI:
2,747,781. INT. CL. 42.
2,748,376. MULTIPLE CLASS, INT. CLS. 16, 18, 20, 21 AND 25.
- M & M INDUSTRIES, REDWOOD CITY, CA:
2,001,980. CANC. INT. CL. 19.
2,001,981. CANC. INT. CL. 19.
- M & M PROGRAMMING, INC., LEBANON, KY:
2,747,909. INT. CL. 9.
- M L LABORATORIES PLC, LIVERPOOL, L13 1EN, UNITED KINGDOM:
2,745,490. PUB. 10-15-2002. INT. CL. 5.
- M R S ENTERPRISES LLC, HONOLULU, HI:
2,746,716. PUB. 5-13-2003. INT. CL. 25.
- M. KAINDL, A-5071, WALS/SALZBURG, AUSTRIA:
2,745,564. PUB. 7-30-2002. INT. CL. 27.
- M.B. FOSTER ASSOCIATES LIMITED, CHESTERVILLE, ONTARIO, CANADA:
2,001,734. CANC. INT. CL. 9.
- M.C. DEAN, INC., CHANTILLY, VA:
2,747,809. MULTIPLE CLASS, INT. CLS. 37 AND 42.
2,748,264. INT. CL. 38.
- M.D. NATURALS, LTD., BETHESDA, MD:
2,747,442. PUB. 5-13-2003. INT. CL. 5.
- M.J. DE BEL MANAGEMENT B.V., AMSTERDAM, NETHERLANDS, GHERARDINI S.R.L., S. COLOMBANO - SCANDICCI, FLORENCE, ITALY:
1,763,924. REN. 6-26-03. INT. CL. 25.
- M.K. MEDITECH CO., LTD., TAOYUAN CITY, TAIWAN:
2,747,876. INT. CL. 10.
- M.O. INDUSTRIES, INC., NEW YORK, NY TO MALKA, ERIC, MIAMI, FL:
2,315,819. NEW CERT. 8-5-2003. INT. CL. 3.
- M&J TRIMMING CO., INC., NEW YORK, NY:
2,746,455. PUB. 5-13-2003. INT. CL. 35.
- M-PHASY GMBH, 72070 TUBINGEN, FED REP GERMANY:
2,745,617. PUB. 10-23-2001. MULTIPLE CLASS, INT. CLS. 1, 5 AND 42.
- M'OTTO ENTERPRISES, INC., SEATTLE, WA:
1,208,587. CANC. INT. CL. 25.
- MABEL MABEL, CHICAGO, IL:
2,746,596. PUB. 5-13-2003. INT. CL. 41.
- MACDERMID ACUMEN, INC., MIDDLETOWN, DE, STAUFFER CHEMICAL COMPANY, NEW YORK, NY:
938,393. REN. 6-27-03. U.S. CL. 6 (INT. CLS. 1, 2, 3, 4 AND 5).
- MACERICH PARTNERSHIP, L.P., SANTA MONICA, CA:
2,745,866. PUB. 5-13-2003. INT. CL. 36.
- MACK, JOSEPH, ST. PAUL, MN:
2,001,536. CANC. INT. CL. 25.
- MACLEAN-HUNTER LIMITED, TORONTO, CANADA:
1,209,343. CANC. INT. CL. 16.
1,209,344. CANC. INT. CL. 16.
- MACMILLAN PUBLISHERS (AUST.) PTY. LTD., VICTORIA 3141, AUSTRALIA:
2,748,110. INT. CL. 16.
- MADISON SQUARE GARDEN, L.P., NEW YORK, NY:
2,747,098. PUB. 5-13-2003. INT. CL. 16.
- MAG AEROSPACE INDUSTRIES, INC., COMPTON, CA:
2,000,975. CANC. INT. CL. 11.
- MAG INSTRUMENT, INC., ONTARIO, CA:
2,745,460. PUB. 4-2-2002. INT. CL. 11.
- MAGGY LONDON INTERNATIONAL, LTD., NEW YORK, NY:
2,748,343. INT. CL. 25.
- MAGIC EARTH, INC., HOUSTON, TX:
2,748,011. INT. CL. 9.
- MAGIC GREEN CORPORATION, SILEX, MO:
2,747,741. INT. CL. 35.
- MAGIC HAT BREWING COMPANY & PERFORMING ARTS CENTER, INC., SOUTH BURLINGTON, VT:
2,747,534. INT. CL. 32.
2,748,972. INT. CL. 32.
- MAGNA-DYNE PRODUCTS COMPANY, BELDING, MI, ENDE; DENNIS, HOLLAND, MI, DBA MAGNA-DYNE PRODUCTS COMPANY:
1,228,599. REN. 6-26-03. INT. CL. 28.
- MAGNASYNC/MOVIOLA CORPORATION, NORTH HOLLYWOOD, CA:
1,207,914. CANC. INT. CL. 9.
- MAGNET INTERACTIVE STUDIOS, INC., WASHINGTON, DC:
2,002,005. CANC. INT. CL. 9.
- MAGNETEK, INC., LOS ANGELES, CA:
2,748,152. INT. CL. 9.
- MAGNETIC ANALYSIS CORPORATION, MT. VERNON, NY:
1,213,120. REN. 6-23-03. INT. CL. 9.
- MAGNUM OPTIC & RESEARCH, INC., DENVER, CO:
1,207,993. CANC. INT. CL. 9.
- MAGNUM PIERING, INC., WEST CHESTER, OH:
2,746,284. PUB. 9-24-2002. INT. CL. 6.

- MAGNUSON-HAWKINS, SHELBY, TUCSON, AZ:
2,748,258, INT. CL. 37.
- MAHR FEDERAL, INC., PROVIDENCE, RI:
2,747,983, INT. CL. 9.
- MAIDENFORM, INC., NEW YORK, NY:
2,745,563, PUB. 5-13-2003. INT. CL. 25.
- MAIDWARE PRODUCTS, INC., NEWARK, OH:
2,001,854, CANC. INT. CL. 21.
- MAIHAK AG, 79183 WALDKIRCH, FED REP GERMANY:
2,746,327, PUB. 5-13-2003. MULTIPLE CLASS, INT. CLS. 9 AND 41.
- MAILBOX 24 HR EXPRESS, INC., MARSHFIELD, MO:
2,748,327, INT. CL. 39.
- MAILCODE, INC., LAFAYETTE, IN:
2,748,642, INT. CL. 35.
- MAIN MANAGEMENT INSPIRATION AG, CH-6052 HERGISWIL, SWITZERLAND:
2,746,569, PUB. 5-13-2003. INT. CL. 7.
- MAIZORO, S.A. DE C.V., 02300 MEXICO, D.F., MEXICO:
2,746,929, PUB. 5-13-2003. INT. CL. 30.
- MAJESTIC INSURANCE COMPANY, SAN FRANCISCO, CA:
2,747,203, PUB. 5-13-2003. INT. CL. 36.
- MAJESTIC INVESTOR HOLDINGS, LLC, GARY, IN TO MAJESTIC INVESTOR HOLDINGS, LLC, GARY, IN:
2,628,353 NEW CERT. 8-5-2003. INT. CL. 42.
- MAJOR LEAGUE BASEBALL PLAYERS ALUMNI ASSOCIATION, COLORADO SPRINGS, CO:
2,745,769, PUB. 12-18-2001. INT. CL. 41.
- MAKAR, RAMSEY, R., FREMONT, CA:
2,747,387, PUB. 5-13-2003. INT. CL. 30.
- MAKE YOUR MARK GOLF ACCESSORIES, INC., CAPE CORAL, FL:
2,748,649, INT. CL. 28.
- MAKMAN, MIKE, NEW YORK, NY:
1,793,019. REN. 6-26-03. INT. CL. 41.
- MAKROLOG GESELLSCHAFT FUR LOGIK UND COMPUTERANWENDUNGEN MBH, D-65191 WIESBADEN, FED REP GERMANY:
2,000,670, CANC. INT. CL. 9.
- MALCOLM, CHRISTINE, SANTA FE, NM, DBA SANTA FE BOTANICAL FRAGRANCE INC:
2,001,631, CANC. INT. CL. 3.
- MALLOY, J. MICHAEL, OREGON HOUSE, CA:
2,748,007, INT. CL. 36.
- MALUEG-RAY, TERRI LYNN, ALPHARETTA, GA:
2,748,212, INT. CL. 31.
- MALZONE, STEVEN J., TAMPA, FL:
1,242,913. REN. 6-23-03. INT. CL. 25.
- MAMASAN'S, INC., ROCHESTER, NY:
1,716,106, CANC. MULTIPLE CLASS, INT. CLS. 29 AND 30.
- MAMIYE BROTHERS, INC., NEW YORK, NY:
2,748,019, INT. CL. 25.
- MAMMA.COM INC., MONTREAL, QUEBEC:
2,745,572, PUB. 12-3-2002. MULTIPLE CLASS, INT. CLS. 9, 35 AND 42.
- MAMMA.COM INC., MONTREAL, MONTREAL, CANADA:
2,745,573, PUB. 12-3-2002. MULTIPLE CLASS, INT. CLS. 9, 35 AND 42.
- MANA PRODUCTS, INC., LONG ISLAND CITY, NY:
2,745,493, PUB. 10-29-2002. INT. CL. 3.
- MANAGEMENT CONCEPTS, INC., VIENNA, VA:
2,000,869, CANC. INT. CL. 42.
- MANAGEMENT REPORTS INTERNATIONAL, CLEVELAND, OH:
2,745,698, PUB. 12-10-2002. INT. CL. 35.
2,745,713, PUB. 12-10-2002. INT. CL. 35.
- MANGAN COMMUNICATIONS, INC., DAVENPORT, IA:
2,748,808, INT. CL. 16.
2,749,047, INT. CL. 16.
- MANHATTAN WIRELESS LLC, NEW YORK, NY:
2,747,549, INT. CL. 9.
- MANHOOD COLLECTIONS, INC., CHAPMAN, NE:
2,001,655, CANC. INT. CL. 16.
- MANLEY TOYS (USA) LTD., NEW YORK, NY:
1,716,007, CANC. INT. CL. 28.
- MANNING & NAPIER INFORMATION SERVICES, LLC, ROCHESTER, NY:
2,748,191, INT. CL. 35.
- MANNING OPAL & GEM CO., NEW YORK, NY:
1,715,545, CANC. INT. CL. 14.
- MANNINGTON MILLS, INC, SALEM, NJ:
2,745,620, PUB. 1-7-2003. INT. CL. 19.
- MANORAIL CORPORATION, NEW YORK, NY AND MANORAIL CORPORATION, NEW YORK, NY:
2,747,353, PUB. 5-13-2003. INT. CL. 41.
- MANTEY-MON AMI-LONZ WINERIES, INC., CLEVELAND, OH:
2,747,022, PUB. 5-13-2003. INT. CL. 33.
- MANUFACTURE D'IMPRESSION SUR ETOFFES S.A., 68150 RIBEAUVILLE, FRANCE:
1,782,725. REN. 6-23-03. INT. CL. 24.
- MANUFACTURERS HANOVER TRUST COMPANY, NEW YORK, NY:
1,208,045, CANC. INT. CL. 10.
1,208,978, CANC. INT. CL. 36.
- MANVILLE SERVICE CORPORATION, DENVER, CO:
737,724, CANC. U.S. CL. 12.
- MAPINFO CORPORATION, TROY, NY:
2,747,927, INT. CL. 9.
- MAPLES INDUSTRIES, INC., SCOTTSBORO, AL:
2,748,377, INT. CL. 27.
- MARATHON CORPORATION, CHILDERSBURG, AL, DBA PRINCE ISLAND APPAREL:
2,001,616, CANC. INT. CL. 25.
- MARBLE SPORTSWEAR, INC., BEVERLY HILLS, CA:
2,748,772, INT. CL. 25.
2,748,773, INT. CL. 25.
- MARBLE-LITE CORPORATION, HIALEAH GARDENS, FL:
2,748,382, INT. CL. 11.
- MARC LAZAR INC., NEW YORK, NY:
2,747,348, PUB. 5-13-2003. INT. CL. 14.
- MARIA-MADELINE PROJECT, INC., OAK PARK, MI:
2,747,144, PUB. 5-13-2003. INT. CL. 41.
- MARINE HOLDINGS, INC., ST. LOUIS, MO:
2,745,834, PUB. 8-6-2002. INT. CL. 12.
- MARINEGLO CORP., EDEN PRAIRIE, MN:
2,747,491, INT. CL. 17.
- MARINER INTERNATIONAL TRAVEL, INC., CLEARWATER, FL:
2,747,183, PUB. 5-13-2003. INT. CL. 25.
- MARINO BUILDING SYSTEMS CORP., SOUTH PLAINFIELD, NJ:
2,745,782, PUB. 1-14-2003. MULTIPLE CLASS, INT. CLS. 37 AND 42.
- MARK J. HOFFMAN AND MARY HRAMIEC HOFFMAN PARTNERSHIP, THE, HARBOR SPRINGS, MI:
2,746,748, PUB. 5-13-2003. INT. CL. 16.
- MARKEL CORPORATION, NORRISTOWN, PA:
2,001,736, CANC. INT. CL. 17.
- MARKER INTERNATIONAL GMBH, CH-6340 BAAR, SWITZERLAND:
2,658,337, COR. INT. CL. 28.
- MARKET DIRECTIONS, INC., KANSAS CITY, MO:
2,748,436, INT. CL. 35.
- MARKETBRIDGE CORP., BETHESDA, MD FROM OXFORD ASSOCIATES, INC., BETHESDA, MD:
2,747,796, MULTIPLE CLASS, INT. CLS. 35, 36 AND 42.
- MARKETING & FINANCIAL MANAGEMENT ENTERPRISES, INC., WOODLAND HILLS, CA:
2,001,729, CANC. MULTIPLE CLASS, INT. CLS. 35 AND 42.
- MARKETING CONSULTANTS OF AMERICA, CORPORATION, MEMPHIS, TN:
1,208,889, CANC. INT. CL. 35.
- MARKETING INVESTORS CORPORATION, DALLAS, TX:
2,748,866, INT. CL. 9.
- MARKETRON INTERNATIONAL, INC., BURINGAME, DE FROM BUYMEDIA, INC., BURLINGAME, CA:
2,747,327, PUB. 5-13-2003. INT. CL. 9.
- MARMON/KEYSTONE, INC., BUTLER, PA:
2,001,904, CANC. INT. CL. 42.
- MARNELL CORRAO ASSOCIATES, INC., LAS VEGAS, NV:
1,801,101. REN. 6-23-03. INT. CL. 37.

- MARO JEWELRY CO., LTD., SEOUL, REPUBLIC OF KOREA:
2,746,423, PUB. 5-13-2003. MULTIPLE CLASS, INT. CLS. 14, 26 AND 35.
- MARRA BROS. DIST., INC., MORGAN HILL, CA:
1,249,171, REN. 6-23-03. INT. CL. 29.
- MARRICH, FRED, ROYAL OAK, MI, DBA CUSTOM MUSIC COMPANY:
1,715,552, CANC. INT. CL. 15.
- MARS INCORPORATED, MCLEAN, VA:
1,208,764, CANC. INT. CL. 30.
- MARSHALL DURBIN COMPANIES, BIRMINGHAM, AL:
2,000,535, CANC. INT. CL. 29.
- MARTELLO, GILBERT A., WILLOUGHBY HILLS, OH:
2,747,553, INT. CL. 12.
- MARTEX NUTRITION, INC., MIAMI, FL:
2,746,051, PUB. 5-13-2003. INT. CL. 5.
- MARTHA STEWART LIVING OMNIMEDIA LLC, NEW YORK, NY FROM MARTHA STEWART LIVING OMNIMEDIA LLC, NEW YORK, NY:
2,747,544, INT. CL. 35.
- MARTHA STEWART LIVING OMNIMEDIA, INC., NEW YORK, NY FROM MSO IP HOLDINGS, INC., LOS ANGELES, CA:
2,746,013, PUB. 5-13-2003. MULTIPLE CLASS, INT. CLS. 18, 20 AND 22.
- MARTIN, HOWARD, SILVER SPRING, MD:
2,747,581, INT. CL. 5.
- MARTIN, SHANIN MARIE, GRASS VALLEY, CA AND WOLK-NELSON, CATHY E., NEVADA CITY, CA:
2,746,971, PUB. 5-13-2003. MULTIPLE CLASS, INT. CLS. 16, 21 AND 25.
- MARTOPIA, MANCHESTER, MI:
2,746,493, PUB. 5-13-2003. INT. CL. 35.
- MARVEL CHARACTERS, INC., CALABASAS, CA:
2,001,696, CANC. INT. CL. 16.
- MARVEL CHARACTERS, INC., LOS ANGELES, CA:
2,748,685, INT. CL. 16.
- MARX, STEVEN J., CHICAGO, IL:
2,747,087, PUB. 10-22-2002. INT. CL. 42.
- MARY KAY INC., DALLAS, TX:
2,746,662, PUB. 3-18-2003. INT. CL. 38.
- MARYLAND STATE DEPARTMENT OF EDUCATION-DIVISION OF LIBRARY DEVELOPMENT SERVICES, BALTIMORE, MD:
2,747,309, PUB. 5-13-2003. INT. CL. 41.
- MARYLAND STATE LOTTERY AGENCY, BALTIMORE, MD:
2,746,397, PUB. 10-22-2002. MULTIPLE CLASS, INT. CLS. 16, 28 AND 41.
- MARYN INTERNATIONAL, LTD., CALGARY, ALBERTA, CANADA:
2,745,513, PUB. 10-15-2002. INT. CL. 4.
- MASCOT METROPOLITAN INC., SOUTH SAN FRANCISCO, CA:
2,748,038, INT. CL. 9.
- MASIMO CORPORATION, IRVINE, CA:
2,747,499, INT. CL. 10.
- MASON-DIXON MUSIC, INC., CHANDLER, TX:
1,209,149, CANC. INT. CL. 41.
- MASONIC HOME, INC., THE, CHARLTON, MA:
2,748,010, MULTIPLE CLASS, INT. CLS. 35, 36 AND 42.
- MASSACHUSETTS COALITION OF BATTERED WOMEN'S SERVICES GROUPS, BOSTON, MA:
2,000,565, CANC. MULTIPLE CLASS, INT. CLS. 16, 41 AND 42.
- MASSACHUSETTS FINANCIAL SERVICES COMPANY, BOSTON, MA:
2,745,748, PUB. 11-5-2002. INT. CL. 36.
- MASSACHUSETTS HORTICULTURAL SOCIETY, THE, WELLESLEY, MA:
1,793,928, REN. 6-27-03. INT. CL. 41.
- MASSON, ELAINE, NORTH MIAMI, FL:
2,000,512, CANC. INT. CL. 16.
- MASTER CONTROL SYSTEMS, INC., LAKE BLUFF, IL:
2,747,004, PUB. 5-13-2003. INT. CL. 9.
- MASTER RECORDING COMPANY LIMITED, THE, LONDON W10 4BQ, UNITED KINGDOM:
2,001,721, CANC. MULTIPLE CLASS, INT. CLS. 9, 16 AND 25.
- MASTERCARVER, INC., ENGLEWOOD, FL, PROCORP, INC., ENGLEWOOD, FL:
1,769,697, REN. 6-21-03. INT. CL. 7.
- MASTERCRAFT BOAT COMPANY, INC., VONORE, TN:
2,746,144, PUB. 3-26-2002. INT. CL. 12.
- MASTERS SELF DEFENSE CENTERS, INC., WESTWOOD, MA:
1,716,702, CANC. INT. CL. 41.
- MASTERTON, BONNIE, TULSA, OK:
2,747,527, INT. CL. 31.
- MATERIALS MANAGEMENT MICROSYSTEMS, MEQUON, WI:
2,746,182, PUB. 11-26-2002. INT. CL. 42.
2,746,183, PUB. 11-26-2002. INT. CL. 42.
- MATRIX GROUP LIMITED, INC., SAFETY HARBOR, FL:
2,746,181, PUB. 6-25-2002. INT. CL. 25.
- MATSUSHITA ELECTRIC INDUSTRIAL CO., LTD., KADOMA-SHI, OSAKA PREFECTURE, JAPAN:
1,208,039, CANC. INT. CL. 9.
- MATTEL, INC., EL SEGUNDO, CA:
1,717,151, CANC. INT. CL. 28.
2,001,796, CANC. INT. CL. 28.
2,001,911, CANC. INT. CL. 28.
2,001,912, CANC. INT. CL. 28.
2,001,940, CANC. INT. CL. 28.
2,001,941, CANC. INT. CL. 28.
2,001,953, CANC. INT. CL. 28.
2,001,955, CANC. INT. CL. 28.
2,001,956, CANC. INT. CL. 28.
2,747,572, INT. CL. 28.
2,748,594, INT. CL. 9.
2,748,595, INT. CL. 28.
2,748,624, INT. CL. 28.
2,748,650, INT. CL. 28.
2,748,659, INT. CL. 28.
2,748,677, INT. CL. 28.
2,748,678, INT. CL. 28.
2,748,679, INT. CL. 28.
2,748,680, INT. CL. 28.
2,748,681, INT. CL. 28.
2,748,696, INT. CL. 28.
2,748,715, INT. CL. 28.
2,748,718, INT. CL. 28.
2,748,719, INT. CL. 28.
2,748,720, INT. CL. 28.
2,748,733, INT. CL. 28.
2,748,734, INT. CL. 28.
2,748,743, INT. CL. 28.
- MATTRESS GIANT CORPORATION, ADDISON, TX:
2,746,704, PUB. 5-13-2003. INT. CL. 40.
- MATTRESS WAREHOUSE INC., FREDERICK, MD:
2,746,530, PUB. 5-13-2003. INT. CL. 35.
2,746,531, PUB. 5-13-2003. INT. CL. 35.
- MATYE, RANDY, SAN ANTONIO, TX, DBA JAMMERZ:
2,001,586, CANC. INT. CL. 14.
- MAUND RICHARDS & ASSOCIATES, INC., POSEN, IL:
1,715,343, CANC. INT. CL. 9.
- MAURICES INCORPORATED, DULUTH, MN:
2,001,537, CANC. INT. CL. 42.
- MAURIELLO, FRANK, PLEASANTVILLE, NJ:
2,748,181, INT. CL. 18.
- MAUSER-WERKE GMBH:
See— MAUSER-WERKE GMBH & CO. KG.
- MAUSER-WERKE GMBH & CO. KG, 50321 BRUHL, FED REP GERMANY FROM MAUSER-WERKE GMBH, 50321 BRUHL, FED REP GERMANY:
2,745,761, PUB. 11-5-2002. MULTIPLE CLASS, INT. CLS. 20 AND 37.
- MAVEN COSMETICS, LLC, CHICAGO, IL:
2,748,703, INT. CL. 3.
- MAVETY MEDIA GROUP LTD., NEW YORK, NY:
2,001,090, CANC. INT. CL. 16.
- MAXI SAVER GROUP, INC., NEW YORK, NY:
2,748,838, INT. CL. 16.

- MAXIM HEALTHCARE SERVICES, INC., COLUMBIA, MD:
2,748,370, INT. CL. 35.
- MAYACAMAS FINE FOODS, INC., SONOMA, CA:
2,002,021, CANC. MULTIPLE CLASS, INT. CLS. 29 AND 30.
- MAYRON COLE MUSIC CONSERVATORY, INC., THE, HOUSTON, TX:
1,716,700, CANC. INT. CL. 41.
- MAYS MISSION FOR THE HANDICAPPED, INC., GREENBRIER, AR:
1,789,809, REN. 6-26-03, INT. CL. 42.
- MAZDA MOTOR OF AMERICA, INC., IRVINE, CA:
2,748,783, INT. CL. 12.
- MAZINGO NETWORK, INC., SAN FRANCISCO, CA:
2,747,386, PUB. 5-13-2003, INT. CL. 38.
- MAZZIO'S CORPORATION, TULSA, OK:
2,001,101, CANC. INT. CL. 42.
- MB DYNAMICS INC., CLEVELAND, OH:
2,746,149, PUB. 11-12-2002, INT. CL. 9.
- MBNA AMERICA BANK, NATIONAL ASSOCIATION, WILMINGTON, DE:
2,745,659, PUB. 5-13-2003, INT. CL. 36.
- MBNA AMERICA BANK, NATIONAL ASSOCIATION, NEWARK, DE:
2,748,187, INT. CL. 36.
- MC GHAN NUSIL CORPORATION, CARPINTERIA, CA:
1,207,701, CANC. INT. CL. 1.
- MCA TELEVISION LIMITED, UNIVERSAL CITY, CA:
2,001,758, CANC. INT. CL. 28.
- MCCANN, SUZANNE KATHLEEN, GLENDALE, CA:
2,001,869, CANC. INT. CL. 40.
- MCCLATCHY MANAGEMENT SERVICES, INC., SACRAMENTO, CA:
2,746,677, PUB. 5-13-2003, INT. CL. 16.
- MCCLURE, JOHN M., MERIDIAN, ID:
2,748,690, INT. CL. 36.
- MCCULLOUGH, MICHAEL, COSTA MESA, CA AND MARTINEZ, JACK, COSTA MESA, CA:
2,000,952, CANC. INT. CL. 16.
- MCDONALD'S CORPORATION, OAK BROOK, IL:
1,716,860, CANC. INT. CL. 42.
1,784,417, REN. 6-23-03, INT. CL. 36.
2,748,667, INT. CL. 42.
- MCGEAN-ROHCO, INC., CLEVELAND, OH:
1,769,623, REN. 6-24-03, INT. CL. 3.
- MCGRAW-HILL COMPANIES, INC., THE, NEW YORK, NY:
2,746,375, PUB. 5-13-2003, INT. CL. 36.
- MCI COMMUNICATIONS CORPORATION, WASHINGTON, DC:
1,716,529, CANC. INT. CL. 38.
1,716,554, CANC. INT. CL. 38.
2,001,698, CANC. INT. CL. 16.
- MCLEARY, TIFFANIE, CHICAGO, IL:
2,748,421, INT. CL. 16.
- MCLELLAND, MITCHELL, TRACY, CA AND ARNESEN, LISA, TRACY, CA:
2,746,964, PUB. 5-13-2003, INT. CL. 41.
- MCMILLIAN, ADRIAN, HERMOSA BEACH, CA:
2,748,149, INT. CL. 35.
- MDG DEVELOPMENT GROUP, INC., CHESTER, NJ, DBA MARKET DEVELOPMENT GROUP:
2,747,420, PUB. 5-13-2003, INT. CL. 16.
- MDL INFORMATION SYSTEMS, INC., SAN LEANDRO, CA:
2,748,287, INT. CL. 42.
- ME & MY BIG IDEAS, INC., RANCHO SANTA MARGARITA, CA:
2,747,209, PUB. 5-13-2003, INT. CL. 16.
- MEAD CORPORATION, THE, DAYTON, OH:
1,208,318, CANC. INT. CL. 16.
- MEADOWBROOK GOLF GROUP, INC., CHAMPIONS-GATE, FL:
2,746,306, PUB. 5-13-2003, MULTIPLE CLASS, INT. CLS. 35, 37 AND 44.
- MEADOWS, JOSEPH KEITH, KETTERING, OH:
2,747,608, INT. CL. 42.
- MEANS INDUSTRIES, INC., SAGINAW, MI:
2,001,777, CANC. INT. CL. 7.
- MEATS BY LINZ, INC., CALUMET CITY, IL:
2,001,993, CANC. INT. CL. 29.
- MECHOSHADE SYSTEMS, INC., LONG ISLAND CITY, NY:
2,746,467, PUB. 5-13-2003, INT. CL. 20.
- MECKLERMEDIA CORPORATION, WESTPORT, CT:
2,000,605, CANC. MULTIPLE CLASS, INT. CLS. 16, 35 AND 41.
- MEDALIST INDUSTRIES, INC., MEQUON, WI:
737,939, CANC. U.S. CL. 39.
- MEDART, INC., GREENWOOD, MS:
737,900, CANC. U.S. CL. 32.
- MEDIA FACTORY, INC., CHUO-KU, TOKYO, JAPAN:
2,747,505, INT. CL. 9.
2,747,506, INT. CL. 9.
- MEDIA WEST - GSI, INC., RENO, NV:
2,747,008, PUB. 5-13-2003, INT. CL. 16.
- MEDIALAB B.V., 1697 KD SCHELLINKHOUT, NETHERLANDS:
2,745,734, PUB. 11-19-2002, MULTIPLE CLASS, INT. CLS. 38 AND 42.
- MEDIAMAP, INC., WATERTOWN, MA:
2,748,372, INT. CL. 9.
- MEDIANEWS GROUP INTERACTIVE, INC., DENVER, CO, POST PUBLISHING CO., THE, BRIDGEPORT, CT:
1,762,789, REN. 6-23-03, INT. CL. 16.
- MEDIAOCEAN, INC., ATLANTA, GA FROM MEDIAOCEAN PARTNERSHIP, THE, ATLANTA, GA:
2,747,602, INT. CL. 35.
- MEDIATROPE LLC, SAN FRANCISCO, CA:
2,746,612, PUB. 5-13-2003, INT. CL. 9.
- MEDICA, MINNEAPOLIS, MN TO MEDICA HEALTH PLAN, MINNETONKA, MN:
1,761,828, AM. INT. CL. 42.
- MEDICAL DEPOT, INC., FARMINGDALE, NY FROM MOBILITY USA, L.C., CAPE CORAL, FL:
2,747,600, INT. CL. 10.
- MEDICAL ENGINEERING CORPORATION, RACINE, WI:
1,208,285, CANC. INT. CL. 16.
- MEDICAL SUPPLY FOUNDATION, INC., DEERFIELD BEACH, FL:
2,001,991, CANC. INT. CL. 42.
- MEDICORP, INC., ST. PETERS, MO:
2,747,268, PUB. 5-13-2003, INT. CL. 35.
2,747,270, PUB. 5-13-2003, INT. CL. 35.
- MEDIFAX-EDI, INC., NASHVILLE, TN:
2,746,184, PUB. 12-10-2002, INT. CL. 44.
- MEDIMART PHARMACY, L.L.C., NORTH KANSAS CITY, MO:
2,748,165, INT. CL. 35.
- MEDIS MEDICAL IMAGING SYSTEMS, B.V., 2333 AA LEIDEN, NETHERLANDS:
2,745,970, PUB. 12-10-2002, INT. CL. 9.
- MEDLINE INDUSTRIES, INC., MUNDELEIN, IL, JASON MARKETING COMPANY, HUNTINGTON BEACH, CA:
1,785,400, REN. 6-23-03, INT. CL. 10.
- MEDORDER, INC., SEATTLE, WA:
2,748,095, MULTIPLE CLASS, INT. CLS. 9 AND 42.
2,748,218, INT. CL. 9.
- MEDOS MEDIZINTECHNIK GMBH, 52222 STOLBERG, FED REP GERMANY:
2,745,560, PUB. 12-11-2001, MULTIPLE CLASS, INT. CLS. 1, 5 AND 40.
- MEDPORT LLC, PROVIDENCE, RI FROM MEDPORT INVESTMENT INC., PROVIDENCE, RI:
2,747,777, INT. CL. 20.
- MEDSOURCE TECHNOLOGIES, INC., MINNEAPOLIS, MN:
2,746,010, PUB. 5-13-2003, MULTIPLE CLASS, INT. CLS. 10 AND 35.
2,746,011, PUB. 5-13-2003, MULTIPLE CLASS, INT. CLS. 10 AND 35.
- MEDSPACE.COM, INC.:
See—ONCOLOGY.COM, INC.
- MEDTRONIC XOMED, INC., JACKSONVILLE, FL, MICROTEK MEDICAL, INC., COLUMBUS, MS:
1,772,896, REN. 6-21-03, INT. CL. 10.

- MEDTRONIC, INC., MINNEAPOLIS, MN:
2,747,401, PUB. 5-13-2003. INT. CL. 9.
2,747,402, PUB. 5-13-2003. INT. CL. 9.
2,748,638, INT. CL. 10.
2,748,689, INT. CL. 10.
- MEEKS, JOSEPH A., CORONA, CA AND MEEKS, MARY GROSSMAN, CORONA, CA:
2,747,795, INT. CL. 3.
- MEESE FRANKBURT GMBH, FRANKBURT AM MAIN, FED REP GERMANY, MESSE- UND AUSSTELLUNGS-GESELLSCHAFT MBH, FRANKFURT 97, FED REP GERMANY:
1,237,607, REN. 6-23-03. INT. CL. 35.
- MEGASUN INC., ST LOUIS, MO:
2,747,951, INT. CL. 9.
- MEINEKE DISCOUNT MUFFLER SHOPS, INC., CHARLOTTE, NC:
2,748,431, INT. CL. 9.
- MELGRATI, ROBERTO, LISSONE (MILANO), ITALY:
2,745,527, PUB. 9-17-2002. INT. CL. 20.
- MELLOW MANOR PRODUCTIONS, INC., LA JOLLA, CA:
1,716,701, CANC. INT. CL. 41.
- MELSERNET, INC., INDIANAPOLIS, IN:
2,747,406, PUB. 5-13-2003. INT. CL. 42.
- MELVCO, INC., SISTERS, OR, DBA HAKEN RAIN COUNTRY:
2,746,409, PUB. 5-13-2003. INT. CL. 3.
- MELVCO, INC., SISTERS, OR:
2,748,318, INT. CL. 28.
- MELVILLE CORPORATION, HARRISON, NY:
737,952, CANC. U.S. CL. 39.
- MEMETRICS INC., SAUSALITO, CA:
2,745,853, PUB. 10-8-2002. MULTIPLE CLASS, INT. CLS. 9, 35 AND 42.
- MEMOREX INTERNATIONAL INC., KWUN TONG, KOWLOON, HONG KONG FROM MEMTEK INTERNATIONAL, INC., KOWLOON, HONG KONG:
2,748,810, MULTIPLE CLASS, INT. CLS. 9 AND 16.
- MEMRY CORP., BROOKFIELD, CT:
1,931,427, CANC. INT. CL. 11.
- MENASHA CORPORATION, NEENAH, WI:
1,715,657, CANC. INT. CL. 16.
2,748,918, INT. CL. 35.
- MENEGATTI FRATELLI SPA., VICENZA, ITALY:
2,746,564, PUB. 5-13-2003. INT. CL. 14.
- MENNEN COMPANY, THE, MORRISTOWN, NJ:
737,764, CANC. U.S. CL. 18.
- MENOPAUSAL TOURS LLC, SAN LEANDRO, CA:
2,747,230, PUB. 5-13-2003. INT. CL. 39.
- MERANGUE INTERNATIONAL LIMITED, DON MILLS, ONTARIO, CANADA:
2,745,708, PUB. 5-13-2003. INT. CL. 16.
- MERANT INC., HILLSBORO, OR:
2,747,007, PUB. 5-13-2003. INT. CL. 9.
- MERCEDES-BENZ AKTIENGESELLSCHAFT:
See— DAIMLERCHRYSLER AG.
- MERCK & CO., INC., WHITEHOUSE STATION, NJ:
2,747,775, INT. CL. 5.
- MEREDITH CORPORATION, DES MOINES, IA:
2,000,611, CANC. INT. CL. 16.
- MERELINDA FARM LLC, WHITMORE LAKE, MI, DBA ALPACA.COM LLC:
2,747,186, PUB. 5-13-2003. INT. CL. 25.
2,747,187, PUB. 5-13-2003. INT. CL. 25.
- MERIDIAN INDUSTRIES, INC., MILWAUKEE, WI:
2,748,576, INT. CL. 23.
- MERIT MERCHANDISERS, INC., AVON, MA:
1,207,777, CANC. INT. CL. 5.
- MERLINONE, INC., QUINCY, MA FROM MERLIN-NET INC., QUINCY, MA:
2,747,642, INT. CL. 16.
- MERLITE INDUSTRIES, INC., NEW YORK, NY:
1,208,161, CANC. INT. CL. 14.
- MERRILL LYNCH & CO., INC., NEW YORK, NY:
2,747,934, INT. CL. 36.
- MERRYDOWN PLC, EAST SUSSEX, UNITED KINGDOM:
2,747,065, PUB. 11-19-2002. INT. CL. 32.
- MESSE FRANKFURT GMBH, FRANKFURT AM MAIN, FED REP GERMANY, MESSE -UND AUSSTELLUNGS-GESELLSCHAFT MBH, FRANKFURT 97, FED REP GERMANY:
1,237,608, REN. 6-23-03. INT. CL. 35.
- MESSE FRANKFURT GMBH, FRANKFURT AMMAIN, FED REP GERMANY, MESSE-UND AUSSTELLUNGS-GESELLSCHAFT MBH, FRANKFURT 97, FED REP GERMANY:
1,237,609, REN. 6-23-03. INT. CL. 35.
- MESSE FRANKFURT GMBH, 60327 FRANKFURT AM MAIN, FED REP GERMANY:
2,010,872, AM. INT. CL. 35.
- MESSER GRIESHEIM GMBH, D-65933 FRANKFURT, FED REP GERMANY:
1,762,429, REN. 6-22-03. MULTIPLE CLASS, INT. CLS. 7 AND 9.
- META GROUP, INC., STAMFORD, CT:
2,748,774, INT. CL. 35.
- METALFLEX CORPORATION, BALTIMORE, MD:
1,208,112, CANC. INT. CL. 11.
- METANETICS CORPORATION, FT. MYERS, FL:
2,001,827, CANC. INT. CL. 9.
- METEORLOGIX, LLC, BURNSVILLE, MN FROM DTN WEATHER SERVICES, LLC, BURNSVILLE, MN:
2,748,388, MULTIPLE CLASS, INT. CLS. 9 AND 42.
- METERLOGIX, LLC, BURNSVILLE, MN FROM DTN WEATHER SERVICES, LLC, BURNSVILLE, MN:
2,748,389, INT. CL. 42.
- METRACOR TECHNOLOGIES, INC., SAN DIEGO, CA:
2,748,204, INT. CL. 10.
- METRO ONE TELECOMMUNICATIONS, INC., BEAVERTON, OR:
2,747,756, MULTIPLE CLASS, INT. CLS. 35 AND 42.
- METROBUILD ASSOCIATES, INC., NEW YORK, NY:
2,748,330, INT. CL. 37.
- METROLAND PRINTING, PUBLISHING & DISTRIBUTING LTD., TORONTO, ONTARIO M5E 1E5, CANADA:
2,000,851, CANC. INT. CL. 16.
- METROLOGIC INSTRUMENTS, INC., BLACKWOOD, NJ:
2,746,991, PUB. 5-13-2003. INT. CL. 9.
- METROMEDIA STEAKHOUSES COMPANY, L.P., DALLAS, TX:
2,000,970, CANC. INT. CL. 33.
- METROPOLITAN LIFE INSURANCE COMPANY, NEW YORK, NY:
2,748,910, INT. CL. 36.
- METROPOLITAN MINING COMPANY, INC., MASPETH, NY:
1,715,246, CANC. INT. CL. 9.
- METROPOOL, INC., STAMFORD, CT:
1,209,050, CANC. INT. CL. 39.
- METRO3D, INC., SAN JOSE, CA:
2,748,800, INT. CL. 9.
- METRY COMPANIES, LLC, WHITE BEAR LAKE, MN:
2,746,888, PUB. 5-13-2003. INT. CL. 11.
- METZELER AUTOMOTIVE PROFILE SYSTEMS GMBH, D-88131 LINDAU, FED REP GERMANY FROM METZELER AUTOMOTIVE PROFILES GMBH, D-88131 LINDAU, FED REP GERMANY:
2,745,926, PUB. 10-22-2002. MULTIPLE CLASS, INT. CLS. 9, 12, 17 AND 27.
- METZELER AUTOMOTIVE PROFILES GMBH:
See— METZELER AUTOMOTIVE PROFILE SYSTEMS GMBH.
- METZNER, JAMES G., YORKTOWN HEIGHTS, NY:
2,747,715, MULTIPLE CLASS, INT. CLS. 9, 16 AND 41.
- MEYER MANUFACTURING COMPANY LIMITED, KOWLOON, HONG KONG:
2,747,054, PUB. 10-9-2001. INT. CL. 21.
- MEZCALES DE GUSANO, S.P.R. DE R.L., 70430 MITLA, OAXACA, MEXICO:
2,613,749, COR. INT. CL. 33.
- MG INDUSTRIES, VALLEY FORGE, PA:
1,716,584, CANC. INT. CL. 39.
- MGM JEWELRY MANUFACTURING, INC., LOS ANGELES, CA:
2,748,605, INT. CL. 14.

- MI HOME PRODUCTS, INC., CLEARWATER, FL:
2,747,502, INT. CL. 19.
- MIAMI-DADE COUNTY, SEAPORT DEPARTMENT, MIAMI, FL:
2,745,581, PUB. 5-13-2003. INT. CL. 39.
- MIC SYSTEMS & SOFTWARE, INC., HUNTINGTON BEACH, CA:
2,745,613, PUB. 12-3-2002. INT. CL. 9.
- MICHAEL HOBAN, INC., SAN FRANCISCO, CA:
2,746,869, PUB. 5-13-2003. INT. CL. 25.
- MICHAEL SMITH CUSTOM CLOTHIERS, INC., SYLVANIA, OH. CUSTOM SHOP LEXINGTON AVE. CORPORATION, THE, NEW YORK, NY:
1,753,837. REN. 6-25-03. MULTIPLE CLASS, INT. CLS. 14, 25 AND 42.
- MICHAEL WEINIG, INC., MOORESVILLE, NC:
2,746,399, PUB. 5-13-2003. INT. CL. 9.
- MICHAEL WOLFF & COMPANY, INC., NEW YORK, NY:
2,001,768, CANC. MULTIPLE CLASS, INT. CLS. 38, 41 AND 42.
- MICHELI, DON, ESCONDIDO, CA, DBA CONSUMER ELECTRONICS UNLIMITED:
2,747,448, PUB. 5-13-2003. INT. CL. 9.
- MICHELIN AIRCRAFT TIRE CORPORATION, CHARLOTTE, NC:
1,780,177. REN. 6-27-03. INT. CL. 12.
1,780,178. REN. 6-27-03. INT. CL. 12.
- MICHELIN NORTH AMERICA, INC., GREENVILLE, SC, UNITED STATES RUBBER COMPANY, NEW YORK, NY:
756,434. REN. 6-27-03. U.S. CL. 35 (INT. CLS. 12 AND 17).
- MICHELIN NORTH AMERICA, INC., GREENVILLE, SC, B. F. GOODRICH COMPANY, THE, AKRON, OH:
1,239,297. REN. 6-27-03. INT. CL. 12.
- MICHELIN NORTH AMERICA, INC., GREENVILLE, SC, B. F. GOODRICH COMPANY, THE, AKRON, OH:
1,240,179. REN. 6-27-03. INT. CL. 12.
1,250,266. REN. 6-27-03. INT. CL. 12.
- MICHIGAN METRO GIRL SCOUT COUNCIL, DETROIT, MI:
1,716,778, CANC. INT. CL. 42.
- MICHIGAN WIND ENERGY LLC, OKEMOS, MI:
2,746,539, PUB. 5-13-2003. INT. CL. 40.
- MICRO DENTAL LABORATORIES, DUBLIN, CA:
2,001,506, CANC. INT. CL. 10.
- MICRO MEGA, S.A., 25000 BESANCON, FRANCE:
2,746,324, PUB. 4-15-2003. INT. CL. 10.
2,746,325, PUB. 4-15-2003. INT. CL. 10.
2,746,326, PUB. 5-13-2003. INT. CL. 10.
- MICROBIOLOGICAL RESEARCH AUTHORITY, SALISBURY, WILTSHIRE SP4 0JG, ENGLAND:
2,746,536, PUB. 5-13-2003. INT. CL. 5.
- MICROPATENT LLC, EAST HAVEN, CT TO INNOVATOR CORPORATION, BROWNS POINT, WA:
2,545,313, COR. INT. CL. 38.
- MICROSOFT CORPORATION, REDMOND, WA:
2,747,804, INT. CL. 9.
2,748,832, INT. CL. 9.
- MICROTEK MEDICAL, INC., COLUMBUS, MS:
1,781,266. REN. 6-26-03. INT. CL. 10.
1,817,848. REN. 6-27-03. INT. CL. 10.
- MICROTRON, INC., MINNEAPOLIS, MN:
1,715,266, CANC. INT. CL. 9.
1,715,267, CANC. INT. CL. 9.
- MICROWAVE FILTER COMPANY, INC., EAST SYRACUSE, NY:
2,000,749, CANC. INT. CL. 1.
- MID AMERICA DIRECT, INC., EFFINGHAM, IL:
2,746,089, PUB. 5-13-2003. INT. CL. 41.
- MID-AMERICA DAIRYMEN, INC., SPRINGFIELD, MO:
1,716,104, CANC. INT. CL. 29.
- MIDI MUSIC CENTER, INC., LAGRANGE PARK, IL, DBA LOWREY ORGAN COMPANY:
2,748,215, INT. CL. 15.
- MIDWEST RETINA, INC., COLUMBUS, OH:
2,748,869, INT. CL. 44.
- MIKOHN GAMING CORPORATION, LAS VEGAS, NV:
2,000,899, CANC. INT. CL. 9.
- MIKRON PRODUCTS, INC., GLENDALE, CA:
2,745,473, PUB. 5-15-2001. INT. CL. 17.
- MILA, INC., LYNNWOOD, WA:
2,748,472, INT. CL. 36.
- MILANIAN, CYRUS, POMPANO BEACH, FL:
2,748,706, INT. CL. 35.
- MILES LABORATORIES, INC., ELKHART, IN:
737,776, CANC. U.S. CL. 18.
- MILES LABORATORIES, INC., ELKHART, IN TO BAYER CORPORATION, ELKHART, IN:
795,903, CANC. U.S. CL. 18.
- MILIEFSKY, GARY, S, TYNGSBORO, MA:
2,748,894, INT. CL. 41.
- MILITARY OFFICERS ASSOCIATION OF AMERICA, ALEXANDRIA, VA FROM RETIRED OFFICERS ASSOCIATION, THE, ALEXANDRIA, VA:
2,748,120, INT. CL. 16.
- MILITARY OFFICERS ASSOCIATION OF AMERICA, ALEXANDRIA, VA FROM RETIRED OFFICERS ASSOCIATION, THE, ALEXANDRIA, VA:
2,748,508, INT. CL. 35.
- MILLER CHEMICAL & FERTILIZER CORPORATION, HANOVER, PA:
2,747,046, PUB. 5-13-2003. INT. CL. 1.
- MILLER FREEMAN, INC., SAN FRANCISCO, CA:
1,717,257, CANC. INT. CL. 35.
- MILLER PIPELINE CORPORATION, INDIANAPOLIS, IN:
1,783,845. REN. 6-22-03. INT. CL. 6.
- MILLER, THERESA C., SOUTH SAN FRANCISCO, CA:
2,747,197, PUB. 5-13-2003. INT. CL. 3.
- MILLERSPORT, INC., PLAINVIEW, NY, DRYBRANCH INC., PLAINVIEW, NY:
1,771,588. REN. 6-27-03. INT. CL. 28.
- MILLIKEN & COMPANY, NEW YORK, NY, DEERING MILLIKEN, INC., NEW YORK, NY:
960,982. REN. 6-25-03. U.S. CL. 42 (INT. CL. 24).
- MILLIKEN & COMPANY, NEW YORK, NY:
1,208,491, CANC. INT. CL. 24.
1,781,388. REN. 6-25-03. INT. CL. 16.
2,748,692, MULTIPLE CLASS, INT. CLS. 12 AND 24.
2,748,957, INT. CL. 24.
- MILLIPORE CORPORATION, BEDFORD, MA:
2,747,313, PUB. 5-13-2003. INT. CL. 11.
- MILLS, JENNIFER, GREENVILLE, NC:
2,001,730, CANC. INT. CL. 25.
- MILTON ROY COMPANY, ST. PETERSBURG, FL:
397,665, CANC. U.S. CL. 26.
- MILWAUKEE VALVE COMPANY, INC., MILWAUKEE, WI, PRAIRIE MANUFACTURING CORPORATION, PRAIRIE DU SAC, WI:
1,767,906. REN. 6-27-03. INT. CL. 6.
- MIMI S. JEWELRY, INC., NEW YORK, NY, DBA MIMI SO:
2,748,531, INT. CL. 14.
- MIMRAN GROUP INC., TORONTO, ONTARIO, CANADA:
2,747,485, INT. CL. 25.
- MINACS GROUP INC., THE:
See—MINACS WORLDWIDE, INC.
- MINACS WORLDWIDE, INC., PICKERING, ONTARIO, CANADA FROM MINACS GROUP INC., THE, ONTARIO, CANADA:
2,745,505, PUB. 9-24-2002. MULTIPLE CLASS, INT. CLS. 35, 38 AND 41.
- MINDSET BIOPHARMACEUTICALS (USA) INC., NEW YORK, NY:
2,747,137, PUB. 5-13-2003. MULTIPLE CLASS, INT. CLS. 9, 42 AND 44.
- MINE SAFETY APPLIANCES COMPANY, PITTSBURGH, PA:
2,001,687, CANC. INT. CL. 9.
- MINEBEA CO., LTD., KITASAKU-GUN, NAGANO-KEN, JAPAN:
2,745,602, PUB. 10-15-2002. INT. CL. 6.
- MINEBEA CO., LTD., NAGANO-KEN, JAPAN:
2,745,736, PUB. 1-28-2003. INT. CL. 7.
2,745,737, PUB. 12-24-2002. INT. CL. 7.
2,745,738, PUB. 12-24-2002. INT. CL. 7.

- MING PAO FINANCE LIMITED, TORTOLA, BR. VIRGIN ISLANDS, MING PAO FINANCE LIMITED, TORTOLA, US VIRGIN ISLANDS:
1,776,461. REN. 6-25-03. INT. CL. 16.
- MINIBIKEWORLD.COM LLC, SCOTTS VALLEY, CA:
2,746,652. PUB. 5-13-2003. INT. CL. 12.
- MINIGRIP, INC., ORANGEBURG, NY:
1,208,467. CANC. INT. CL. 22.
- MINITAB, INC., STATE COLLEGE, PA:
2,747,522. INT. CL. 9.
- MINKOWITZ, BARBARA, NEW YORK, NY:
2,746,902. PUB. 5-13-2003. INT. CL. 44.
- MINOLTA CAMERA CO., LTD., AZUCHI-MACHI, HIGASHI-KU, OSAKA, JAPAN:
1,208,226. CANC. INT. CL. 16.
- MINOLTA KABUSHIKI KAISHA (MINOLTA CO., LTD.), CHUO-KU, OSAKA 541-8556, JAPAN:
1,715,124. CANC. INT. CL. 9.
- MINORITY CORPORATE COUNSEL ASSOCIATION, WASHINGTON, DC:
2,748,201. INT. CL. 41.
- MIO MECHANICAL CORPORATION, PHILADELPHIA, PA:
2,746,390. PUB. 5-13-2003. INT. CL. 9.
- MIONETTO S.P.A., VALDOBBIADENE (TREVISO), ITALY:
2,746,056. PUB. 10-8-2002. INT. CL. 33.
- MIRA ENTERPRISES, INC., LOS ANGELES, CA:
2,746,012. PUB. 5-13-2003. INT. CL. 9.
- MIRAGE STUDIOS, NORTHAMPTON, MA:
1,716,334. CANC. MULTIPLE CLASS, INT. CLS. 35 AND 41.
- MIRAL, NADINE A, NEW YORK, NY:
2,747,874. INT. CL. 9.
- MIRUS, INC., MADISON, WI:
2,748,648. INT. CL. 1.
- MISNER, THOMAS, D-81737 MUNICH, FED REP GERMANY:
2,747,933. INT. CL. 41.
- MISSION CITY PRESS, INC., SAN ANTONIO, TX:
2,747,577. INT. CL. 16.
- MISSION FOODS CORPORATION, CANOGA PARK, CA:
1,208,775. CANC. INT. CL. 30.
- MISTOGEN EQUIPMENT COMPANY, SAN FRANCISCO, CA:
1,208,048. CANC. INT. CL. 10.
- MITEK INDUSTRIES, INC., CHESTERFIELD, MO:
2,746,483. PUB. 2-25-2003. INT. CL. 6.
- MITOLO WINES PTY LTD, PARKSIDE, SOUTH AUSTRALIA, AUSTRALIA:
2,748,227. INT. CL. 33.
- MITSUBISHI ELECTRIC POWER PRODUCTS, WARRENDALE, PA FROM MITSUBISHI ELECTRIC & ELECTRONICS USA, INC., CYPRESS, CA:
2,748,249. INT. CL. 9.
- MITSUBISHI CHEMICAL CORPORATION, CHIYODA-KU, TOYKO, JAPAN, MITSUBISHI PETROCHEMICAL CO., LTD., CHIYODA-KU, TOKYO, JAPAN:
1,806,641. REN. 6-25-03. INT. CL. 1.
- MITSUBISHI CHEMICAL CORPORATION, CHIYODA-KU, TOKYO, JAPAN:
2,747,792. INT. CL. 1.
- MIYOSHI; SABUROMARU, YODOGAWA-KU, OSAKA CITY, JAPAN:
1,207,858. CANC. INT. CL. 7.
- MIZRAHI, SHARI LYNN, BOCA RATON, FL:
2,001,546. CANC. INT. CL. 14.
- MIZUNO KABUSHIKI KAISHA (MIZUNO CORPORATION), CHUO-KU, OSAKA, JAPAN:
2,748,413. INT. CL. 25.
- MIZUNO USA, INC., NORCROSS, GA:
1,715,922. CANC. INT. CL. 25.
- MJ BIOWORKS, INC., SOUTH SAN FRANCISCO, CA:
2,747,831. INT. CL. 42.
- MLEGAL CONSULTING, INC., PALO ALTO, CA:
2,747,441. PUB. 5-13-2003. INT. CL. 35.
- MMH PRESTIGE HOMES INC., SUSSEX, NEW BRUNSWICK, CANADA:
2,746,433. PUB. 5-13-2003. MULTIPLE CLASS, INT. CLS. 19, 35 AND 37.
- MMWAVE SYSTEMS INC., CORNWALL, ONTARIO, CANADA FROM MMWAVE TECHNOLOGIES INC., MISSISSAUGA, ONTARIO:
2,745,470. PUB. 12-4-2001. INT. CL. 9.
- MMWAVE TECHNOLOGIES INC.:
See—MMWAVE SYSTEMS INC..
- MOBILEVILLAGE LLC, PACIFICA, CA:
2,748,151. INT. CL. 35.
- MOBIUS MANAGEMENT SYSTEMS, INC., RYE, NY:
2,746,952. PUB. 5-13-2003. INT. CL. 9.
- MOCON, INC., MINNEAPOLIS, MN:
2,746,573. PUB. 5-13-2003. INT. CL. 9.
- MODERN INSULATION, INC., SPENCER, WI:
1,781,429. REN. 6-25-03. INT. CL. 17.
- MODERN OPTIONS, INC., SAN FRANCISCO, CA:
2,001,443. CANC. INT. CL. 2.
- MODIANO IND. CARTE DA GIOCO ED AFFINI S.R.L., TRIESTE, ITALY, MODIANO, INDUSTRIE CARTOTECNICHE S.P.A., TRIESTE, ITALY:
1,217,101. REN. 6-26-03. INT. CL. 16.
- MOEN INCORPORATED, NORTH OLMSTED, OH:
2,748,636. MULTIPLE CLASS, INT. CLS. 6 AND 21.
- MOHAWK BRANDS, INC., WILMINGTON, DE:
2,748,822. INT. CL. 19.
2,748,852. INT. CL. 27.
- MOJAVE FOODS CORPORATION, COMMERCE, CA:
2,747,261. PUB. 5-13-2003. MULTIPLE CLASS, INT. CLS. 16 AND 29.
- MOLINIER S.A., VEAUCHE, FRANCE:
1,208,054. CANC. INT. CL. 10.
- MOLLENAUER, MARTHA A., SAN RAMON, CA:
2,746,938. PUB. 5-13-2003. INT. CL. 41.
- MONARCH INDUSTRIES LIMITED, WINNIPEG, MANITOBA, CANADA:
2,747,750. INT. CL. 7.
- MONDOTRONICS, SAN LEANDRO, CA:
1,715,009. CANC. INT. CL. 6.
- MONEY BOOK, INC., THE, SOMERVILLE, NJ:
1,715,639. CANC. INT. CL. 16.
- MONIN, INC., CLEARWATER, FL:
2,748,279. INT. CL. 32.
- MONNOT, SUSAN, PRICE, METAIRIE, LA:
2,747,222. PUB. 5-13-2003. INT. CL. 41.
- MONSANTO COMPANY, ST. LOUIS, MO:
1,716,942. CANC. INT. CL. 42.
- MONSANTO TECHNOLOGY LLC, ST. LOUIS, MO:
2,746,884. PUB. 5-13-2003. INT. CL. 42.
2,747,382. PUB. 5-13-2003. INT. CL. 5.
- MONTBLANC-SIMPLO GMBH, HAMBURG, FED REP GERMANY:
2,747,460. INT. CL. 14.
- MONTEBLANCO LIMITED, VALENCIA, SPAIN:
2,745,796. PUB. 5-13-2003. MULTIPLE CLASS, INT. CLS. 18, 25 AND 28.
- MONTEREY BAY AQUARIUM FOUNDATION, MONTEREY BAY, CA:
2,748,682. INT. CL. 41.
- MONTEREY, INC., JANESVILLE, WI:
2,001,605. CANC. INT. CL. 24.
- MONTGOMERY WARD & CO., INCORPORATED, CHICAGO, IL:
737,857. CANC. U.S. CL. 23.
- MONTMORENCY CORPORATION, NEW YORK, NY:
2,001,117. CANC. INT. CL. 42.
- MONTRES LEROY S.A., FL-9490 VADUZ, LIECHTENSTEIN:
2,747,520. INT. CL. 14.
- MONUMENTAL LIFE INSURANCE COMPANY, BALTIMORE, MD:
1,660,078. REN. 6-21-03. INT. CL. 36.
- MOON, RONALD T. Y., JR., BIRMINGHAM, AL:
2,748,996. INT. CL. 42.
- MOORE MEDICAL CORP., NEW BRITAIN, CT:
2,746,428. PUB. 5-13-2003. INT. CL. 35.
- MOORE, GREGORY, FOREST HILLS, NY:
2,747,083. PUB. 5-13-2003. INT. CL. 9.
- MOORES ROWLAND INTERNATIONAL LIMITED, SURREY, UNITED KINGDOM:
2,745,750. PUB. 7-30-2002. INT. CL. 35.

- MOOSE INTERNATIONAL, INC., MOOSEHEART, IL:
2,746,887, PUB. 5-13-2003. INT. CL. 35.
- MOREHANDS.COM, INC., AUSTIN, TX:
2,748,612, MULTIPLE CLASS, INT. CLS. 37 AND 39.
- MORENO, S.A., 14006 CORDOBA, SPAIN:
2,746,899, PUB. 5-13-2003. INT. CL. 29.
- MORGAN STANLEY DEAN WITTER & CO., NEW YORK,
NY FROM MORGAN STANLEY DEAN WITTER & CO.,
NEW YORK, NY:
2,745,481, PUB. 12-28-1999. INT. CL. 36.
- MORGAN STANLEY DEAN WITTER & CO.:
See— MORGAN STANLEY DEAN WITTER & CO..
- MORGAN, MORRIS, MURRAY, UT:
2,001,699, CANC. INT. CL. 3.
- MORIN, DANIEL, QUEBEC H8P 1S6, CANADA:
2,746,221, PUB. 5-13-2003. INT. CL. 9.
- MORNINGSTAR SERVICES, INC., WILMINGTON, DE:
2,748,938, INT. CL. 30.
- MORRISSEY MOTORS, INC., OMAHA, NE:
2,745,997, PUB. 10-15-2002. INT. CL. 35.
- MORTARA INSTRUMENT, INC., MILWAUKEE, WI:
1,761,202, REN. 6-25-03. INT. CL. 10.
- MORTON INTERNATIONAL, INC., CHICAGO, IL:
2,001,134, CANC. INT. CL. 1.
- MORTON'S OF CHICAGO, INC., CHICAGO, IL:
2,001,936, CANC. INT. CL. 42.
- MOSES COMPUTERS, LOS GATOS, CA:
1,715,353, CANC. INT. CL. 9.
- MOSLER AUTO CARE CENTER, INC., RIVIERA BEACH,
FL:
2,747,492, INT. CL. 12.
- MOTC, L.P., DALLAS, TX:
2,746,413, PUB. 5-13-2003. MULTIPLE CLASS, INT. CLS.
16, 29 AND 30.
- MOTOPSYCHO LLC, ALAMO, CA:
2,747,279, PUB. 5-13-2003. INT. CL. 35.
- MOTORCARE SERVICES INTERNATIONAL B.V., 1077 ZX
AMSTERDAM, NETHERLANDS:
2,745,591, PUB. 7-3-2001. INT. CL. 35.
- MOTORICITY, INC, LAMBERTVILLE, NJ:
2,748,272, INT. CL. 41.
- MOUNT GAY DISTILLERIES, LIMITED, BRIDGETOWN,
BARBADOS:
1,226,842, REN. 6-26-03. INT. CL. 33.
- MOUNT VERNON MILLS, INC.:
1,208,475, CANC. MULTIPLE CLASS, INT. CLS. 24 AND
25.
- MOUNT VINTAGE INTERNATIONAL CHAMPIONSHIP,
INC., EDGEFIELD, SC:
2,746,313, PUB. 5-13-2003. MULTIPLE CLASS, INT. CLS.
18, 25 AND 41.
- MOVER SPORTSWEAR AB, S-830 13 ARE, SWEDEN:
2,745,795, PUB. 5-13-2003. INT. CL. 25.
- MOXIE INDUSTRIES, INC., ATLANTA, GA:
158,917, CANC. U.S. CL. 45.
- MPL COMMUNICATIONS LIMITED, LONDON W1V 6BQ,
UNITED KINGDOM:
2,745,439, PUB. 10-29-2002. MULTIPLE CLASS, INT. CLS.
9, 16, 25 AND 41.
- MPO SYSTEMS, INC., WESTLAKE, OH:
2,746,084, PUB. 5-13-2003. INT. CL. 40.
- MR. GATTI'S, INC., KERRVILLE, TX:
2,601,361, AM. INT. CL. 42.
- MR. TIRE, INC., BALTIMORE, MD:
2,746,923, PUB. 5-13-2003. INT. CL. 35.
- MSCL, INC., SANTA MONICA, CA:
2,747,992, MULTIPLE CLASS, INT. CLS. 39, 40 AND 41.
- MSM INDUSTRIES, SMYRNA, TN:
2,746,945, PUB. 5-13-2003. INT. CL. 27.
- MSN CORPORATION, MANCHESTER, NH, DBA BUDD
FOODS INCORPORATED:
2,000,737, CANC. INT. CL. 30.
- MSN MERCHANT MARKETING, INC., WELLINGTON, FL:
2,746,906, PUB. 5-13-2003. INT. CL. 36.
- MSO IP HOLDINGS, INC.:
See— MARTHA STEWART LIVING OMNIMEDIA, INC..
- MTD PRODUCTS INC, CLEVELAND, OH:
2,748,161, INT. CL. 7.
2,748,426, MULTIPLE CLASS, INT. CLS. 7 AND 12.
- MTI TECHNOLOGY CORPORATION, ANAHEIM, CA:
2,747,548, INT. CL. 9.
- MUDD, L.L.C., NEW YORK, NY:
2,748,577, INT. CL. 25.
- MUHAMMAD, KAMAL, NEW YORK, NY:
2,746,447, PUB. 5-13-2003. INT. CL. 25.
- MULBERRY COMPANY (DESIGN) LIMITED, SOMERSET
BA4 5NF, UNITED KINGDOM:
2,748,219, MULTIPLE CLASS, INT. CLS. 16, 18, 25 AND
35.
- MULBERRY GRAPHICS CORPORATION, RED BANK, NJ:
2,001,794, CANC. INT. CL. 16.
- MULHALL, LAWRENCE, JEFFERSON CITY, MO:
1,716,071, CANC. INT. CL. 28.
- MULTICHANNEL LABS CO., LTD., INCHON-CITY, RE-
PUBLIC OF KOREA:
2,747,091, PUB. 1-28-2003. INT. CL. 9.
- MULTIMEDIA PLUS, INC., NEW YORK, NY:
2,746,401, PUB. 5-13-2003. INT. CL. 41.
- MULTISALES, INC., CLEVELAND, GA:
2,748,142, INT. CL. 35.
- MUNGER, TOLLES & OLSON, LOS ANGELES, CA:
2,748,270, INT. CL. 42.
- MUNSINGWEAR, INC., MINNEAPOLIS, MN:
1,208,530, CANC. INT. CL. 25.
1,208,593, CANC. INT. CL. 25.
1,208,594, CANC. INT. CL. 25.
- MURAN DE ASSERETO; JOSEPH A., WASHINGTON, DC:
1,209,248, CANC. INT. CL. 42.
- MURAN DE ASSERETO, JOSEPH A., WASHINGTON, DC:
1,209,249, CANC. INT. CL. 42.
- MUSCO CORPORATION, OSKALOOSA, IA:
2,745,597, PUB. 5-13-2003. MULTIPLE CLASS, INT. CLS.
9, 35, 37, 41 AND 42.
- MUSI, RICHARD ALEXANDER, FORT WAYNE, IN:
2,747,115, PUB. 5-13-2003. INT. CL. 25.
- MUSICAL KIDS CLOTHES BY HI-D-ZINES, LLC, PALM
HARBOR, FL:
2,746,642, PUB. 5-13-2003. INT. CL. 35.
2,746,643, PUB. 5-13-2003. INT. CL. 35.
- MUTALER, INC., ROCKAWAY, NJ:
2,746,883, PUB. 5-13-2003. INT. CL. 44.
- MUTUAL GROUP USA, INC., SAN JOSE, CA:
2,000,838, CANC. INT. CL. 31.
- MY FAVORITE COMPANY, INC., LOS ANGELES, CA:
2,747,319, PUB. 5-13-2003. INT. CL. 28.
- MYRIAD LICENSING, INC., COLUMBUS, OH:
2,001,759, CANC. INT. CL. 21.
- N. KALOYANNIS BROS. S.A., KALLITHEA, ATHENS 176 72,
GREECE:
1,716,299, CANC. INT. CL. 33.
- N.V. KONINKLIJKE SPHINX GUSTAVSBERG, 6211 LE
MAASTRICHT, NETHERLANDS:
2,000,562, CANC. MULTIPLE CLASS, INT. CLS. 11, 19
AND 21.
- N.V. ORGANON, 5349 AB OSS, NETHERLANDS:
2,745,809, PUB. 7-16-2002. INT. CL. 9.
- NADIN COMPANY, GLENDALE, CA, DBA WHITEWING
LABS FROM WHITEWING LABS, INC., MISSION HILLS,
CA:
2,747,620, INT. CL. 5.
- NAEGER, JULIE, ST. LOUIS, MO:
2,001,192, CANC. INT. CL. 42.
- NAHINU, PATSY W., MARYSVILLE, WA:
2,747,264, PUB. 5-13-2003. INT. CL. 24.
- NALCO CHEMICAL COMPANY, OAK BROOK, IL:
737,694, CANC. U.S. CL. 6.
1,208,223, CANC. INT. CL. 16.
- NAMCO LTD., TOKYO, JAPAN:
2,748,424, MULTIPLE CLASS, INT. CLS. 9 AND 28.
- NAMCO, LTD., TOKYO 146, JAPAN:
1,799,709, REN. 6-27-03. INT. CL. 41.
- NAMEPROTECT INC., MADISON, WI:
2,749,030, INT. CL. 42.

- NANOCHRON, LLC, ARLINGTON, VA FROM MERCURY LOGIC, LLC, ARLINGTON, VA:
2,748,049, MULTIPLE CLASS, INT. CLS. 9 AND 42.
- NANOMETRICS INCORPORATED, SUNNYVALE, CA:
1,207,958, CANC. INT. CL. 9.
- NARDI ITALIA SPA, VARESE, ITALY:
2,001,058, CANC. INT. CL. 12.
- NAS MANUFACTURING, INC., CLARKSVILLE, GA:
2,748,277, INT. CL. 24.
- NASDAQ LIFFE MARKETS, LLC, NEW YORK, NY FROM NASDAQ LIFFE LLC, NEW YORK, NY:
2,748,352, INT. CL. 36.
- NATHANSON, MATT, SAN FRANCISCO, CA:
2,747,428, PUB. 5-13-2003. INT. CL. 9.
- NATICK CORPORATION, WILMINGTON, DE:
2,001,697, CANC. INT. CL. 35.
- NATIONAL ASSOCIATION OF BOARDS OF PHARMACY, PARK RIDGE, IL:
2,746,575, PUB. 5-13-2003. INT. CL. 35.
- NATIONAL ASSOCIATION OF COUNTY ENGINEERS, WASHINGTON, DC:
2,001,437, CANC. MULTIPLE CLASS, INT. CLS. 16 AND 41.
- NATIONAL ASSOCIATION OF INVESTORS CORPORATION, MADISON HEIGHTS, MI:
2,746,342, PUB. 5-13-2003. INT. CL. 41.
- NATIONAL ASSOCIATION OF SMALL BUSINESS INVESTMENT COMPANIES, WASHINGTON, DC:
2,745,780, PUB. 5-13-2003. MULTIPLE CLASS, INT. CLS. 9, 16 AND 41.
- NATIONAL AUSTRALIA BANK LIMITED, MELBOURNE, VICTORIA 3000, AUSTRALIA:
2,745,547, PUB. 5-13-2003. MULTIPLE CLASS, INT. CLS. 9 AND 36.
- NATIONAL AUTOMOTIVE PARTS ASSOCIATION, DEARBORN, MI:
1,209,182, CANC. INT. CL. 42.
- NATIONAL AUTOMOTIVE PARTS ASSOCIATION, ATLANTA, GA:
2,746,175, PUB. 1-7-2003. INT. CL. 35.
- NATIONAL BASEBALL HALL OF FAME AND MUSEUM, INC., COOPERSTOWN, NY:
2,748,305, INT. CL. 21.
- NATIONAL BROACH & MACHINE COMPANY, MT. CLEMENS, MI:
1,715,058, CANC. INT. CL. 7.
- NATIONAL BUSINESS SOLUTIONS, CLEARWATER, FL:
2,001,995, CANC. INT. CL. 35.
- NATIONAL CAN CORPORATION, CHICAGO, IL TO AMERICAN NATIONAL CAN COMPANY, CHICAGO, IL:
1,207,952, CANC. INT. CL. 9.
- NATIONAL CAR RENTAL SYSTEM, INC., MINNEAPOLIS, MN:
1,209,042, CANC. INT. CL. 39.
- NATIONAL CHILD SAFETY COUNCIL, JACKSON, MI:
1,728,238, REN. 6-24-03. INT. CL. 41.
1,738,714, REN. 6-24-03. INT. CL. 41.
- NATIONAL COUNCIL OF EXCHANGORS, MORRO BAY, CA:
1,716,640, CANC. INT. CL. 41.
- NATIONAL COUNCIL OF FARMER COOPERATIVES, WASHINGTON, DC:
1,209,303, CANC. INT. CL. 42.
- NATIONAL COUNCIL OF YOUNG MEN'S CHRISTIAN ASSOCIATIONS OF THE UNITED STATES OF AMERICA, THE, CHICAGO, IL:
2,746,081, PUB. 5-13-2003. MULTIPLE CLASS, INT. CLS. 36 AND 41.
- NATIONAL EXCHANGE CLUB, THE, TOLEDO, OH:
159,045, CANC. U.S. CL. 38.
- NATIONAL FIRE PROTECTION ASSOCIATION, INC., BOSTON, MA:
1,209,170, CANC. INT. CL. 42.
- NATIONAL HEALTH LABORATORIES INCORPORATED, LA JOLLA, CA TO LABORATORY CORPORATION OF AMERICA, BURLINGTON, NC:
1,716,760, CANC. INT. CL. 42.
- NATIONAL HONEY BOARD, LONGMONT, CO:
1,766,152, REN. 6-24-03. INT. CL. 35.
- NATIONAL INSURANCE CRIME BUREAU, PALOS HILL, IL:
2,747,518, INT. CL. 41.
- NATIONAL INTERNATIONAL ROOFING CORPORATION, HUNTLEY, IL, NORTHERN ILLINOIS ROOFING, INC., HUNTLEY, IL:
1,744,032, REN. 6-22-03. INT. CL. 37.
- NATIONAL JOURNAL GROUP, INC., WASHINGTON, DC:
2,746,337, PUB. 5-13-2003. MULTIPLE CLASS, INT. CLS. 16 AND 41.
- NATIONAL JUNIOR ANGLERS ASSOCIATION, INC., SARASOTA, FL:
2,001,690, CANC. INT. CL. 42.
- NATIONAL LATEX PRODUCTS COMPANY, THE, ASHLAND, OH:
2,001,875, CANC. INT. CL. 28.
- NATIONAL LATINO PEACE OFFICERS ASSOCIATION, PETALUMA, CA:
2,746,718, PUB. 5-13-2003. U.S. CL. 200.
- NATIONAL MOTOR CLUB OF AMERICA, INC., IRVINE, TX:
2,746,269, PUB. 5-13-2003. MULTIPLE CLASS, INT. CLS. 37 AND 39.
- NATIONAL PLAN SERVICE USA, INC., BENSENVILLE, IL:
2,001,634, CANC. INT. CL. 16.
- NATIONAL RECOVERY TECHNOLOGIES, INC., NASHVILLE, TN:
1,765,559, REN. 6-23-03. INT. CL. 7.
- NATIONAL RESOURCES, INC., ROCKVILLE, MD:
1,208,855, CANC. INT. CL. 35.
- NATIONAL RESTAURANTS MANAGEMENT, INC.:
See— TRADEMARK HOLDING, INC..
- NATIONAL RETAIL MERCHANTS ASSOCIATION (NRMA), NEW YORK, NY:
1,208,883, CANC. MULTIPLE CLASS, U.S. CL. 200 INT. CL. 35.
- NATIONAL THOROUGHBRED RACING ASSOCIATION, INC., LEXINGTON, KY:
2,746,658, PUB. 5-13-2003. INT. CL. 41.
- NATIONAL TIRES, INC., DENVER, CO, AKA NATIONAL PRODUCTS, INC.:
1,208,334, CANC. INT. CL. 17.
- NATIONAL TRADE PUBLICATIONS, INC., LATHAM, NY:
2,000,898, CANC. INT. CL. 16.
- NATIONAL VENTURE CAPITAL ASSOCIATION, ARLINGTON, VA:
2,746,957, PUB. 5-13-2003. INT. CL. 35.
2,746,958, PUB. 5-13-2003. INT. CL. 35.
- NATIONSRENT, INC., FT. LAUDERDALE, FL:
1,716,728, CANC. INT. CL. 41.
- NATIONWIDE LLC, LOS ANGELES, CA:
2,745,778, PUB. 11-12-2002. INT. CL. 25.
- NATIONWIDE TIME INC., MOONACHIE, NJ:
1,702,482, REN. 6-21-03. INT. CL. 14.
- NATUR-PHARMA, INC., AMERICAN FORK, UT:
1,714,965, CANC. INT. CL. 5.
- NATURAL ORGANICS, INC., MELVILLE, NY:
2,001,429, CANC. INT. CL. 5.
- NATURAL SCIENCE INDUSTRIES, LTD., WEST HEMPSTEAD, NY:
2,747,947, INT. CL. 28.
- NATURALLY WOMEN FITNESS CENTERS, TUCSON, AZ:
2,746,860, PUB. 5-13-2003. INT. CL. 41.
- NATURE SOY, INC., PHILADELPHIA, PA:
2,712,090, COR. INT. CL. 29.
- NATUREL WEST CORP., ONTARIO, CA:
2,748,928, INT. CL. 33.
2,748,932, INT. CL. 33.
- NAVISON A/S, 2950 VEDBAEK, DENMARK:
2,746,130, PUB. 10-8-2002. MULTIPLE CLASS, INT. CLS. 9 AND 42.
- NBA PROPERTIES, INC., NEW YORK, NY:
1,763,361, REN. 6-25-03. INT. CL. 41.
2,748,093, INT. CL. 25.
2,748,837, INT. CL. 25.

- NBDL ENTERPRISES, LLC, SECAUCUS, NJ:
2,748,711, INT. CL. 18.
2,748,712, INT. CL. 28.
- NCH CORPORATION, IRVING, TX:
958,061, REN. 6-26-03. U.S. CL. 6 (INT. CL. 3).
- NCIPHER CORPORATION LIMITED, CAMBRIDGE, ENGLAND:
2,745,770, PUB. 9-24-2002. INT. CL. 9.
- NDI TECHNOLOGIES LTD., WEST LOTHIAN, UNITED KINGDOM:
2,748,785, INT. CL. 9.
- NEAL, KENNETH W., CLEARWATER, FL:
2,747,160, PUB. 5-13-2003. INT. CL. 9.
- NEBRASKA PLASTICS, INC., COZAD, NE:
1,755,339, REN. 6-23-03. INT. CL. 19.
1,771,474, REN. 6-23-03. INT. CL. 19.
1,771,475, REN. 6-23-03. INT. CL. 19.
- NEC AMERICA, INC., MELVILLE, NY:
1,715,298, CANC. INT. CL. 9.
1,715,299, CANC. INT. CL. 9.
1,715,300, CANC. INT. CL. 9.
- NEEDHAM & COMPANY, INC., NEW YORK, NY:
2,745,610, PUB. 5-13-2003. MULTIPLE CLASS, INT. CLS. 35 AND 36.
- NEEFE OPTICAL LABORATORY, BIG SPRING, TX:
1,208,008, CANC. INT. CL. 9.
- NEES COMMUNICATIONS, INC., WESTBOROUGH, MA:
2,747,849, MULTIPLE CLASS, INT. CLS. 36 AND 38.
- NEIGHBORHOOD BAKING COMPANY, THE, PORTLAND, OR:
2,000,835, CANC. INT. CL. 30.
- NEIGHBORHOOD WRITING ALLIANCE, CHICAGO, IL:
2,747,282, PUB. 5-13-2003. INT. CL. 41.
2,747,283, PUB. 5-13-2003. INT. CL. 41.
- NEIMAN-MARCUS GROUP, INC., THE, CHESTNUT HILL, MA:
1,208,730, CANC. INT. CL. 29.
- NEIMAN-MARCUS GROUP, INC., THE, DALLAS, TX:
1,793,077, REN. 6-25-03. INT. CL. 42.
- NELL HILL'S CORPORATION, ATCHISON, KS:
2,746,706, PUB. 5-13-2003. INT. CL. 35.
- NELSON INDUSTRIES, INC., STOUGHTON, WI:
1,715,271, CANC. INT. CL. 9.
- NELSON, GALEN D., IDAHO FALLS, ID AND PETERSON, RAY G., IDAHO FALLS, ID:
2,001,214, CANC. INT. CL. 7.
- NEMO S.P.A., COMO, ITALY FROM NEMO S.R.L., 69 22069 ROVELLASCA (COMO), ITALY:
2,746,069, PUB. 5-13-2003. INT. CL. 11.
- NEMO S.R.L.:
See— NEMO S.P.A..
- NEOLOGIC SYSTEMS, INC., BERKELEY, CA:
2,001,590, CANC. INT. CL. 9.
- NEON SPORTS, LLC, DENHAM SPRINGS, LA:
2,746,432, PUB. 5-13-2003. INT. CL. 9.
- NEOPARADIGM LABS, INC., SAN JOSE, CA, DBA VIVODA COMMUNICATIONS:
2,746,624, PUB. 5-13-2003. INT. CL. 9.
- NEOPETS, INC, GLENDALE, CA:
2,746,605, PUB. 5-13-2003. INT. CL. 16.
2,746,608, PUB. 5-13-2003. INT. CL. 16.
- NEOPETS, INC., GLENDALE, CA:
2,746,541, PUB. 5-13-2003. INT. CL. 41.
2,746,604, PUB. 5-13-2003. INT. CL. 16.
2,746,606, PUB. 5-13-2003. INT. CL. 16.
2,746,607, PUB. 5-13-2003. INT. CL. 16.
- NEOPHARMICA, INC., PORTOLA HILLS, CA:
2,748,876, INT. CL. 5.
- NEORX CORPORATION, SEATTLE, WA:
1,751,775, REN. 6-21-03. INT. CL. 5.
- NEPHROLOGY EDUCATIONAL SERVICES AND RESEARCH, INC., TARZANA, CA:
2,748,232, INT. CL. 9.
- NESTLE PURINA PETCARE COMPANY, ST. LOUIS, MO FROM RALSTON PURINA COMPANY, ST. LOUIS, MO:
2,748,754, INT. CL. 31.
- NET VENTURES, INC., WEST BLOOMFIELD, MI:
2,748,705, INT. CL. 42.
- NET-INSPECT, LLC, KIRKLAND, WA:
2,747,228, PUB. 5-13-2003. INT. CL. 42.
- NETCARRIER, INC., LANSDALE, PA:
2,746,474, PUB. 5-13-2003. INT. CL. 42.
2,748,052, INT. CL. 42.
- NETKIN, ROBERT S., MOUNTAIN VIEW, CA:
2,748,347, INT. CL. 35.
- NETTLES, JENNIFER, DECATUR, GA AND HALL, KRISTEN A., STONE MOUNTAIN, GA AND BUSH, KRISTIAN, AVONDALE ESTATES, GA:
2,747,326, PUB. 5-13-2003. INT. CL. 41.
- NETWORK GROUP INTERNATIONAL, L.P., PHILADELPHIA, PA:
1,716,336, CANC. INT. CL. 35.
- NETWORK INTEGRITY, INC., MARLBOROUGH, MA:
2,001,888, CANC. MULTIPLE CLASS, INT. CLS. 9 AND 16.
- NETWORK TECHNOLOGIES, INC., AURORA, OH:
2,747,455, PUB. 5-13-2003. INT. CL. 9.
- NETWORKS ASSOCIATES TECHNOLOGY, INC., SANTA CLARA, CA, MCAFEE ASSOCIATES, INC., SANTA CLARA, CA:
1,818,780, REN. 6-22-03. INT. CL. 9.
- NEULEVEL, INC., STERLING, VA:
2,746,004, PUB. 5-13-2003. MULTIPLE CLASS, INT. CLS. 35 AND 42.
- NEURODAN A/S, AALBORG OST., DENMARK:
2,746,207, PUB. 5-13-2003. INT. CL. 10.
- NEUTROGENA CORPORATION, LOS ANGELES, CA:
1,207,785, CANC. INT. CL. 5.
- NEW ENGLAND PATRIOTS L.P., BOSTON, MA:
2,746,155, PUB. 12-24-2002. INT. CL. 41.
- NEW ENGLAND ROPES, INC., POPES ISLAND, NEW BEDFORD, MA:
1,208,468, CANC. INT. CL. 22.
1,208,469, CANC. INT. CL. 22.
- NEW GENERATION RESEARCH GROUP, INC., FORT LEE, NJ:
1,716,391, CANC. INT. CL. 35.
- NEW LEAF ENTERPRISES, LLC, BALTIMORE, MD:
2,746,953, PUB. 5-13-2003. INT. CL. 35.
- NEW PENDULUM CORP., WILMINGTON, DE:
1,786,367, REN. 6-21-03. MULTIPLE CLASS, INT. CLS. 1 AND 42.
- NEW WINE PRODUCTIONS, INC., JACKSON, MS:
2,747,815, INT. CL. 41.
- NEW YORK ASSOCIATION FOR NEW AMERICANS, INC., THE, NEW YORK, NY:
2,748,586, MULTIPLE CLASS, INT. CLS. 35, 36 AND 42.
- NEW YORK HEALTH AND RACQUET CLUB, NEW YORK, NY:
2,001,570, CANC. INT. CL. 41.
- NEW YORK STATE HISTORICAL ASSOCIATION, COOPERSTOWN, NY:
2,746,919, PUB. 5-13-2003. INT. CL. 41.
- NEW YORK STOCK EXCHANGE, INC., NEW YORK, NY:
2,745,612, PUB. 10-29-2002. INT. CL. 36.
- NEWCO.COM S.P.A.:
See— BRAVOSOLUTION S.P.A..
- NEWFREY LLC, NEWARK, DE FROM EMHART LLC, NEWARK, DE:
2,748,881, INT. CL. 21.
- NEWHOME BATH AND MIRROR, INC., WOODBURY, MN:
2,746,522, PUB. 5-13-2003. INT. CL. 11.
- NEWMAN, ANTHONY, SHAKOPEE, MN, DBA SUNBURST CO. INC.:
2,001,983, CANC. INT. CL. 28.
- NEWS AMERICA MARKETING PROPERTIES, INC., CHICAGO, IL:
2,746,112, PUB. 10-22-2002. MULTIPLE CLASS, INT. CLS. 35 AND 42.
2,746,113, PUB. 10-15-2002. INT. CL. 38.
- NEWSCANNER LTD, LLC, NEW YORK, NY:
2,747,864, INT. CL. 9.
- NEWSGRADE.COM, INC., NEW YORK, NY:
2,745,789, PUB. 5-13-2003. MULTIPLE CLASS, INT. CLS. 35 AND 36.

- NEWYORK-PRESBYTERIAN HOSPITAL, NEW YORK, NY:
2,746,915, PUB. 5-13-2003. MULTIPLE CLASS, INT. CLS.
16 AND 35.
- NEXANS, PARIS, FRANCE:
2,700,296, COR. MULTIPLE CLASS, INT. CLS. 6 AND 9.
- NEXANS FRANCE, 75008 PARIS, FRANCE:
2,745,978, PUB. 5-13-2003. INT. CL. 9.
- NEXCOR TECHNOLOGIES, INC., SUWANEE, GA:
2,747,121, PUB. 5-13-2003. INT. CL. 9.
- NEXEN TIRE CORPORATION, KYONGSANGNAM-DO,
REPUBLIC OF KOREA:
2,747,817, INT. CL. 12.
- NEXPLO VIHTAVUORI OY, FINLAND:
2,746,490, PUB. 5-13-2003. INT. CL. 13.
- NEY DENTAL, INC., BLOOMFIELD, CT:
1,714,952, CANC. INT. CL. 5.
- NF DISTRIBUTION CANADA LTD., COQUITLAM, BC,
CANADA FROM NATURAL FACTORS NUTRITIONAL
PRODUCTS LTD., COQUITLAM, BC, CANADA:
2,747,810, INT. CL. 5.
- NF DISTRIBUTION CANADA LTD., COQUITLAM, BRIT-
ISH COLUMBIA, CANADA FROM NATURAL FACTORS
NUTRITIONAL PRODUCTS LTD., COQUITLAM, BRIT-
ISH COLUMBIA, CANADA:
2,748,664, INT. CL. 5.
- NGC NETWORK INTERNATIONAL LLC, WASHINGTON,
DC:
2,748,588, INT. CL. 41.
- NGUYEN, JOHN, SANTA ANA, CA:
2,746,179, PUB. 11-19-2002. INT. CL. 3.
- NICEGOOD U.S.A. LTD., WALNUT, CA:
2,747,414, PUB. 5-13-2003. INT. CL. 8.
2,747,415, PUB. 5-13-2003. INT. CL. 11.
- NICHINO AMERICA, INC., WILMINGTON, DE:
2,746,162, PUB. 5-13-2003. MULTIPLE CLASS, INT. CLS. 1
AND 5.
- NICHOLS, ANNE, HEALDSBURG, CA:
2,748,905, INT. CL. 18.
- NIGHT MOON, INCORPORATED, GARLAND, TX:
2,746,982, PUB. 5-13-2003. INT. CL. 33.
- NIGHTINGALE, JOHN T., AUBURN, CA AND WILSON,
SHERRIE L., AUBURN, CA:
2,001,099, CANC. INT. CL. 28.
- NIHC, INC., PORTLAND, OR:
2,747,163, PUB. 5-13-2003. INT. CL. 36.
- NIHON MICRO COATING KABUSHIKI KAISHA, TOKYO,
JAPAN:
2,746,271, PUB. 5-13-2003. MULTIPLE CLASS, INT. CLS. 3
AND 7.
- NIHON SANMO SENSOKU KABUSHIKI KAISHA, KYO-
TO-FU, JAPAN, TA NIHON SANMO DYEING CO., LTD.:
1,755,398, REN. 6-24-03. INT. CL. 22.
- NILFISK-ADVANCE, INC., PLYMOUTH, MN:
2,748,976, INT. CL. 7.
- NIM IMPORT & EXPORTGESELLSCHAFT MBH FUR
NATUR-, GENUB- AND INDUSTRIE-ERZEUGNISSE,
GRUNWALD, FED REP GERMANY:
2,746,576, PUB. 5-13-2003. MULTIPLE CLASS, INT. CLS.
30 AND 33.
- NINA FOOTWEAR CORP., NEW YORK, NY:
2,748,512, INT. CL. 25.
- NINE GROUP, INC., THE, CHICAGO, IL:
2,747,596, INT. CL. 25.
- NINE WEST DEVELOPMENT CORPORATION, WILMING-
TON, DE:
2,747,302, PUB. 5-13-2003. INT. CL. 25.
2,748,784, INT. CL. 9.
2,748,857, INT. CL. 25.
- NINFAS'S HOLDINGS, L.P., HOUSTON, TX, NINFAS, INC.,
HOUSTON, TX:
1,233,794, REN. 6-21-03. INT. CL. 30.
- NINTENDO OF AMERICA INC., REDMOND, WA:
2,666,722, COR. INT. CL. 28.
- NIPPON SHEET GLASS CO., LTD., CHUO-KU, OSAKA,
JAPAN:
2,747,616, INT. CL. 9.
- NIS, INC., FAIRFAX, VA, DBA THE PARENT INSTITUTE:
2,746,471, PUB. 5-13-2003. MULTIPLE CLASS, INT. CLS.
9, 16 AND 42.
- 2,749,024, MULTIPLE CLASS, INT. CLS. 9 AND 16.
- NISSAN JIDOSHA KABUSHIKI KAISHA, YOKOHAMA-SHI,
KANAGAWA-KEN, JAPAN, TA NISSAN MOTOR CO.,
LTD.:
2,063,105, CANC. INT. CL. 12.
- NITTO CO., LTD., HIGASHI-OSAKA, JAPAN:
1,208,003, CANC. INT. CL. 9.
- NKOTB, INC., BOSTON, MA:
2,001,482, CANC. INT. CL. 9.
- NKT RESEARCH A/S, DK-2605 BRONDBY, DENMARK:
2,745,826, PUB. 5-13-2003. MULTIPLE CLASS, INT. CLS.
11, 40 AND 42.
- NLP IP COMPANY, NEWARK, DE:
2,746,505, PUB. 5-13-2003. INT. CL. 16.
- NO PLACE LIKE HOME COMMUNITIES, WAYZATA, MN:
2,748,171, INT. CL. 43.
2,748,261, INT. CL. 43.
- NOBEL, INC., DENVER, CO:
738,006, CANC. U.S. CL. 52.
- NOBLE GRACE LLC, NEW YORK, NY:
2,746,901, PUB. 5-13-2003. INT. CL. 45.
- NOKIA CORPORATION, 02150 ESPOO, FINLAND:
2,746,549, PUB. 5-13-2003. MULTIPLE CLASS, INT. CLS.
9, 28 AND 41.
- NONLINEAR DYNAMICS LIMITED, NEWCASTLE UPON
TYNE, UNITED KINGDOM:
2,746,008, PUB. 1-7-2003. MULTIPLE CLASS, INT. CLS. 9
AND 42.
- NONNI'S FOOD COMPANY, INC., TULSA, OK, NONNI'S,
INC., SAN FRANCISCO, CA:
1,727,905, REN. 6-22-03. INT. CL. 30.
- NOR'EASTERN TRAWL SYSTEMS, INC., BAINBRIDGE
ISLAND, WA:
1,717,111, CANC. INT. CL. 22.
- NORDIC SPRINGWATER, INC., CHERRY HILL, NJ:
1,784,345, REN. 6-23-03. INT. CL. 32.
- NORFOLK INVESTMENTS, INC., WIMINGTON, DE:
2,746,085, PUB. 11-5-2002. INT. CL. 14.
- NORITAKE CO., LIMITED, NISHI-KU, NAGOYA, JAPAN:
1,208,444, CANC. INT. CL. 21.
- NORRELL CORPORATION, ATLANTA, GA:
2,000,893, CANC. INT. CL. 35.
- NORSTAR CONSUMER PRODUCTS CO., INC., KENOSHA,
WI:
2,749,039, INT. CL. 3.
- NORTH AMERICAN COMPANY FOR LIFE AND HEALTH
INSURANCE, CHICAGO, IL:
2,451,094, COR. INT. CL. 36.
2,533,031, COR. INT. CL. 36.
2,746,973, PUB. 5-13-2003. INT. CL. 36.
- NORTH AMERICAN INSTRUMENT CORPORATION,
GLENS FALLS, NY:
1,208,064, CANC. INT. CL. 10.
1,208,065, CANC. INT. CL. 10.
- NORTH CENTRAL INDUSTRIES, INC., MUNCIE, IN:
2,745,764, PUB. 10-16-2001. INT. CL. 13.
- NORTH DAKOTA STATE UNIVERSITY OF AGRICUL-
TURE AND APPLIED SCIENCE, FARGO, ND:
1,768,576, REN. 6-23-03. MULTIPLE CLASS, INT. CLS. 14,
16, 25, 28 AND 41.
- NORTH STAR UNIVERSAL INC., MINNEAPOLIS, MN:
1,208,436, CANC. INT. CL. 20.
- NORTHEAST BLADDER RESEARCH GROUP, INC., HO-
LYOKE, MA:
2,748,992, INT. CL. 42.
- NORTHEASTERN PLASTICS, INC., BROOKLYN, NY:
2,001,395, CANC. MULTIPLE CLASS, INT. CLS. 9 AND
11.
- NORTHEASTERN PRODUCTS CORPORATION, WAR-
RENSBURG, NY:
1,716,245, CANC. INT. CL. 31.
- NORTHEASTERN UNIVERSITY, BOSTON, MA:
2,747,736, INT. CL. 41.
- NORTHERN BREWERS, INC., HUDSON, MA:
2,000,892, CANC. INT. CL. 32.

- NORTHERN LITE MFG. LTD., BRITISH COLUMBIA VIX 5W6, CANADA:
2,745,707, PUB. 5-13-2003. INT. CL. 12.
- NORTHERN PIPELINE CONSTRUCTION CO., PHOENIX, AZ:
2,747,017, PUB. 5-13-2003. INT. CL. 37.
- NORTHERN SAFETY CO., INC., FRANKFORT, NY:
2,746,948, PUB. 5-13-2003. INT. CL. 9.
2,746,949, PUB. 5-13-2003. INT. CL. 9.
- NORTHRIDGE MOVING & STORAGE, INC., SIMI VALLEY, CA:
2,748,831, INT. CL. 39.
- NORTHROP GRUMMAN CORPORATION, LOS ANGELES, CA:
2,746,353, PUB. 5-13-2003. INT. CL. 28.
- NORWAY CANNING CO. A/S, N-5136 MASTREVIK, NORWAY:
2,000,507, CANC. INT. CL. 31.
- NORWEST CORPORATION, MINNEAPOLIS, MN:
2,001,720, CANC. INT. CL. 16.
- NORWICH EATON PHARMACEUTICAL, INC., NORWICH, NY:
1,208,052, CANC. INT. CL. 10.
- NOTRA TRADING, INC., WOODBRIDGE, NJ:
2,001,763, CANC. INT. CL. 24.
- NOVALUX, INC., SUNNYVALE, CA:
2,747,789, INT. CL. 9.
2,747,791, INT. CL. 9.
- NOVAMEDIA B.V., 1071 EX AMSTERDAM, NETHERLANDS:
2,745,951, PUB. 2-25-2003. MULTIPLE CLASS, INT. CLS. 16 AND 41.
- NOVAMETRIX MEDICAL SYSTEMS INC.:
See— RESPIRONICS NOVAMETRIX, INC.
- NOVARTIS AG, BASEL, SWITZERLAND:
2,747,102, PUB. 5-13-2003. INT. CL. 16.
2,747,139, PUB. 5-13-2003. INT. CL. 5.
2,747,312, PUB. 5-13-2003. INT. CL. 44.
2,747,643, INT. CL. 5.
2,748,757, INT. CL. 3.
2,748,840, INT. CL. 10.
- NOVARTIS CORPORATION, NEW YORK, NY, CIBA-GEIGY CORPORATION, ARDSLEY, NY:
1,751,244, REN. 6-24-03. INT. CL. 16.
- NOVEON IP HOLDINGS CORP., BRECKSVILLE, OH:
2,748,209, MULTIPLE CLASS, INT. CLS. 1 AND 17.
- NOVUS CREDIT SERVICES INC., RIVERWOODS, IL, SEARS CONSUMER FINANCIAL CORPORATION, RIVERWOODS, IL:
1,712,212, REN. 6-26-03. INT. CL. 36.
- NOVUS INTERNATIONAL, INC., ST. LOUIS, MO:
1,817,340, REN. 6-26-03. INT. CL. 5.
- NOXELL CORPORATION, HUNT VALLEY, MD:
872,879, CANC. U.S. CL. 18.
1,715,085, CANC. MULTIPLE CLASS, INT. CLS. 9 AND 41.
2,748,854, INT. CL. 3.
- NPORTA, INC., ATLANTA, GA:
2,746,935, PUB. 5-13-2003. INT. CL. 42.
2,746,936, PUB. 5-13-2003. INT. CL. 42.
- NRV, INC., IXONIA, WI:
1,716,247, CANC. INT. CL. 31.
- NRZ, INC., MIAMI, FL:
2,748,325, MULTIPLE CLASS, INT. CLS. 25 AND 35.
- NTERO SURGICAL, PALO ALTO, CA:
2,747,103, PUB. 5-13-2003. INT. CL. 10.
- NTT COMMUNICATIONWARE KABUSHIKI KAISHA, TOKYO, JAPAN, DBA NTT COMMUNICATIONWARE CORPORATION:
2,747,486, INT. CL. 37.
- NTT SOFTWARE KABUSHIKI KAISHA, KANAGAWA, JAPAN, DBA NTT SOFTWARE CORPORATION:
2,746,203, PUB. 5-13-2003. INT. CL. 9.
- NUCALGON WHOLESALER, INC., ST. LOUIS, MO:
2,746,603, PUB. 5-13-2003. INT. CL. 1.
- NUCORE TECHNOLOGY INC., SANTA CLARA, CA:
2,748,140, INT. CL. 9.
- NUMA JEANNIN S.A., SWITZERLAND, SWITZERLAND:
1,773,570, REN. 6-24-03. INT. CL. 14.
- NUOVO PIGNONE HOLDING S.P.A., 50127 FLORENCE, ITALY:
2,745,666, PUB. 7-16-2002. MULTIPLE CLASS, INT. CLS. 7, 9, 11, 37 AND 42.
- NUTRILAB CORPORATION, ST. PETERSBURG, FL:
2,745,603, PUB. 5-13-2003. INT. CL. 5.
- NUTRILAWN INC., ETOBICOKE, CANADA:
2,746,571, PUB. 5-13-2003. INT. CL. 44.
- NUTRO PRODUCTS, INC., CITY OF INDUSTRY, CA:
2,748,008, INT. CL. 31.
- NUTS & SPICE CO., UNION CITY, CA:
2,747,648, INT. CL. 30.
- NUVO TECHNOLOGIES, INC., SCOTTSDALE, AZ, DBA PLP DIGITAL SYSTEMS, INC.:
2,745,999, PUB. 4-15-2003. INT. CL. 9.
- NWL HOLDINGS, INC., WEST HEMPSTEAD, NY:
2,605,072, COR. MULTIPLE CLASS, INT. CLS. 8, 20 AND 21.
- NYB CORPORATION, SALT LAKE CITY, UT:
2,001,684, CANC. INT. CL. 25.
- O.A.S.I.S. COUNSELING, INC., ATLANTA, GA:
1,772,041, REN. 6-24-03. INT. CL. 42.
- O.D. SHAG CLUB, N. MYRTLE BEACH, SC:
2,000,660, CANC. INT. CL. 42.
- O.W.A., INC., SPOKANE, WA:
1,778,823, REN. 6-21-03. MULTIPLE CLASS, INT. CLS. 11, 15, 20, 21 AND 28.
- O'HAGAN, ARTHUR C., PHOENIX, AZ AND O'HAGAN, MICHELE M., PHOENIX, AZ:
2,000,674, CANC. INT. CL. 16.
- O'SHEA, DIVINE AND COMPANY, INC., NEWPORT BEACH, CA:
2,746,122, PUB. 5-13-2003. INT. CL. 35.
- OAK LAWN HARLEY DAVIDSON, L.L.C., OAK LAWN, IL:
2,747,879, INT. CL. 12.
- OAKLAND SOLID SURFACING & COUNTERTOP, INC., BLOOMFIELD HILLS, MI:
2,001,276, CANC. INT. CL. 19.
- OAKLEAF & ASSOCIATES, INC., PANORAMA CITY, CA TO CONVERGENT BUSINESS SYSTEMS, INC., SAN JOSE, CA:
1,207,970, CANC. INT. CL. 9.
- OAKLEY, INC., FOOTHILL RANCH, CA:
1,765,631, REN. 6-23-03. INT. CL. 9.
2,748,836, INT. CL. 9.
- OBJET GEOMETRIES LTD., REHOVOT, ISRAEL:
2,748,753, INT. CL. 1.
- OCASH, INC., WHITE BEAR LAKE, MN FROM OCASH-COM, INC., WHITE BEAR LAKE, MN:
2,748,697, INT. CL. 36.
- OCEAN GARDEN PRODUCTS, INC., SAN DIEGO, CA:
1,208,743, CANC. INT. CL. 29.
- OCEAN PACIFIC APPAREL CORP., IRVINE, CA:
2,001,792, CANC. INT. CL. 25.
2,748,118, MULTIPLE CLASS, INT. CLS. 18, 25 AND 41.
- OCULAR RESEARCH OF BOSTON, INC., BOSTON, MA:
1,789,098, REN. 6-24-03. INT. CL. 5.
- ODOM'S TENNESSEE PRIDE SAUSAGE, INC., MADISON, TN:
1,785,704, REN. 6-27-03. INT. CL. 29.
- ODOMO, WATARU, SARATOGA, CA:
2,747,001, PUB. 5-13-2003. INT. CL. 44.
- OFFICE DOMAIN, AUSTIN, TX:
2,290,053, CANC. INT. CL. 9.
- OFFICE OF THE COMMISSIONER OF BASEBALL, NEW YORK, NY:
1,768,105, REN. 6-27-03. INT. CL. 25.
1,768,106, REN. 6-27-03. INT. CL. 25.
- OFFICIAL BUGLE BOY, LLC, COLUMBUS, OH:
2,748,306, INT. CL. 25.
- OGDEN MANUFACTURING CO., ARLINGTON HEIGHTS, IL:
1,715,445, CANC. INT. CL. 11.
- OGUSHI, YOSHIYUKI, MINAMI-KU, FUKUOKA, JAPAN:
1,724,864, REN. 6-23-03. INT. CL. 2.
1,725,695, REN. 6-23-03. INT. CL. 19.

- OHIO PET FOODS, INC., LISBON, OH:
1,716,263, CANC. INT. CL. 31.
- OIL PROCESS SYSTEMS INC., ALLENTOWN, PA:
1,207,685, CANC. INT. CL. 1.
- OKAYA ELECTRIC INDUSTRIES CO., LTD., TOKYO, JAPAN:
2,746,566, PUB. 5-13-2003. INT. CL. 9.
2,746,567, PUB. 5-13-2003. INT. CL. 9.
- OLD FASHIONED MONEY, LIMITED PARTNERSHIP, RENO, NV:
2,746,943, PUB. 5-13-2003. INT. CL. 35.
- OLD HARBOR CAPITAL MANAGEMENT, LLC, BOSTON, MA:
2,748,246, INT. CL. 36.
- OLD MOTHER HUBBARD DOG FOOD CO., INC., LOWELL, MA:
2,747,000, PUB. 5-13-2003. INT. CL. 31.
- OLD PASADENA MANAGEMENT DISTRICT, PASADENA, CA:
2,748,137, INT. CL. 41.
- OLE' TACOS INC., WYOMING, MI:
1,716,789, CANC. INT. CL. 42.
- OLGA'S KITCHEN, INC., TROY, MI:
2,748,283, INT. CL. 42.
- OLIN CORPORATION, NEW HAVEN, CT:
737,698, CANC. U.S. CL. 6.
- OLIVA, CARLOS, FIRTH, ID AND GONZALEZ, MODESTO, FIRTH, ID:
2,746,796, PUB. 5-13-2003. INT. CL. 41.
- OLYMPIA GROUP, INC., CITY OF INDUSTRY, CA:
2,746,602, PUB. 5-13-2003. INT. CL. 7.
- OLYMPUS CORPORATION, NEW HYDE PARK, NY:
1,207,932, CANC. INT. CL. 9.
- OMEGA ENGINEERING, INC., STAMFORD, CT:
1,221,650, REN. 6-21-03. INT. CL. 16.
- OMEGA SA (OMEGA AG) (OMEGA LTD.), BIEL/BIENNE, SWITZERLAND:
2,747,149, PUB. 5-13-2003. INT. CL. 14.
- OMNIHEALTH FINANCIAL SERVICES, LLC., WHITE PLAINS, NY:
2,000,866, CANC. INT. CL. 36.
- OMNISYS, INC., GREENVILLE, TX:
1,715,205, CANC. INT. CL. 9.
- OMRI M. BEHR AND MARION R. BEHR, N. BRANCH STN, NJ, DBA ELECTROETCH ENTERPRISES:
1,784,836, REN. 6-21-03. INT. CL. 16.
- OMRI M. BEHR AND MARION R. BEHR PARTNERSHIP, THE, N BRANCH STN, NJ, DBA ELECTROETCH ENTERPRISES:
1,762,779, REN. 6-21-03. INT. CL. 16.
- ON AIR WORLDWIDE MEDIA, INC., SANTA MONICA, CA:
1,717,223, CANC. INT. CL. 9.
- ONCOLOGY.COM, INC., NEW YORK, NY FROM MEDSPACE.COM, INC., NEW YORK, NY:
2,748,993, INT. CL. 42.
- ONCOTECH, INC., IRVINE, CA:
2,745,806, PUB. 5-13-2003. INT. CL. 42.
2,745,807, PUB. 5-13-2003. INT. CL. 42.
- ONDEO NALCO COMPANY, NAPERVILLE, IL:
2,746,299, PUB. 5-13-2003. INT. CL. 42.
- ONE TOUCH SYSTEMS, INC., SANTA CLARA, CA, MICROLOGIC APPLICATION ENGINEERING, INC., SANTA CLARA, CA, DBA ONE TOUCH SYSTEMS, INC.:
1,730,730, REN. 6-22-03. INT. CL. 9.
- ONENECK IT SERVICES, CORPORATION, SCOTTSDALE, AZ:
2,748,704, INT. CL. 35.
- ONESUITE CORPORATION, LOS ANGELES, CA FROM ONESUITE.COM CORPORATION, LOS ANGELES, CA:
2,747,803, INT. CL. 38.
- ONLINE ENGLISH PTY LTD, BROADWAY, NSW, AUSTRALIA:
2,745,565, PUB. 12-3-2002. INT. CL. 42.
- ON SLOW COUNTY HOSPITAL AUTHORITY, JACKSONVILLE, NC:
2,746,689, PUB. 5-13-2003. INT. CL. 44.
- OPENWAVE SYSTEMS INC., REDWOOD CITY, CA FROM PHONE.COM, INC., REDWOOD CITY, CA:
2,747,921, INT. CL. 9.
- OPERATION ROLE MODELS OF AMERICA, INC., NEW YORK, NY:
2,748,066, MULTIPLE CLASS, INT. CLS. 35 AND 41.
- OPI PRODUCTS, INC., NORTH HOLLYWOOD, CA:
2,748,469, INT. CL. 3.
- OPSWARE, INC., SUNNYVALE, CA FROM LOUDCLOUD, INC., SUNNYVALE, CA:
2,747,691, INT. CL. 37.
- OPTEGON AG, CH-2563 IPSACH, SWITZERLAND:
2,748,202, INT. CL. 9.
- OPTICAL ACCESS OAL LTD., 20692 YOKNEAM, ISRAEL:
2,747,973, INT. CL. 9.
- OPTIMAL CARE MANAGEMENT SYSTEM, INC., AUSTIN, TX:
2,001,045, CANC. INT. CL. 9.
- OPTIMAL ROBOTICS CORP., MONTREAL, QUEBEC, CANADA:
2,746,400, PUB. 5-13-2003. INT. CL. 9.
- ORAL ROBERTS UNIVERSITY, TULSA, OK:
2,747,363, PUB. 5-13-2003. INT. CL. 16.
- ORASURE TECHNOLOGIES, INC., BEAVERTON, OR TO STC TECHNOLOGIES, INC., BETHLEHEM, PA:
2,709,738, COR. MULTIPLE CLASS, INT. CLS. 1, 5 AND 42.
- ORBITEL S.A. E.S.P., MEDELLIN, COLOMBIA:
2,748,254, MULTIPLE CLASS, INT. CLS. 16 AND 38.
- ORCHARD INTERNATIONAL INC., MISSISSAUGA, ONTARIO, CANADA:
2,747,690, INT. CL. 3.
- ORCON CORPORATION, UNION CITY, CA:
2,747,412, PUB. 5-13-2003. INT. CL. 22.
- ORDA INDUSTRIES (1969) LTD., KIRYAT WEIZMANN, REHOVOT, ISRAEL:
1,208,639, CANC. INT. CL. 28.
- OREGON CORRECTIONS ENTERPRISES, SALEM, OR:
2,747,692, MULTIPLE CLASS, INT. CLS. 16, 18 AND 25.
- ORGANITECH CLEANERS, INC., BROOKLYN, NY:
2,747,295, PUB. 5-13-2003. INT. CL. 3.
- ORGANON INC., WEST ORANGE, NJ:
737,791, CANC. U.S. CL. 18.
- ORIGINAL OATMEAL BAKING CO., THE, PORTLAND, OR:
2,000,978, CANC. INT. CL. 30.
- ORIGINS NATURAL RESOURCES INC., NEW YORK, NY:
2,747,865, INT. CL. 3.
- ORION CORPORATION, 02200 ESPOO, FINLAND:
2,746,636, PUB. 5-13-2003. INT. CL. 5.
2,746,637, PUB. 5-13-2003. INT. CL. 5.
- ORION MACHINERY CO., LTD., SUZAKA-SHI, NAGANO-KEN 382-8502, JAPAN:
2,747,603, INT. CL. 11.
- ORION SYSTEMS NEW ZEALAND LIMITED, AUCKLAND, NEW ZEALAND:
2,747,179, PUB. 5-13-2003. INT. CL. 9.
- ORMCO CORPORATION, GLENDORA, CA:
1,208,055, CANC. INT. CL. 10.
- ORNAGHI FILATI S.A.S., SEREGNO, MILAN, ITALY:
1,205,487, REN. 6-26-03. INT. CL. 23.
- ORPHAN GRAIN TRAIN, INC., NORFOLK, NE:
2,746,451, PUB. 5-13-2003. MULTIPLE CLASS, INT. CLS. 43, 44 AND 45.
- ORTHOPAEDIC SPECIALITY CENTER OF BALTIMORE, P. A., BALTIMORE, MD:
2,745,538, PUB. 5-13-2003. INT. CL. 42.
- ORTIZ, LEROY, JR., SANTA FE, NM:
2,748,271, INT. CL. 42.
- OS ASSET, INC., TAMPA, FL, OUTBACK STEAKHOUSE OF FLORIDA, INC., TAMPA, FL:
1,780,666, REN. 6-24-03. INT. CL. 42.
1,789,557, REN. 6-21-03. INT. CL. 30.
- OSBOURNE, ARTON MARK MARTIN, STATEN ISLAND, NY:
2,748,182, INT. CL. 9.
- OSCAR III, INC., WILDWOOD, MO:
2,747,975, MULTIPLE CLASS, INT. CLS. 14, 16 AND 20.

- OSR OPEN SYSTEM RESOURCES, INC., AMHERST, NH:
2,746,793, PUB. 5-13-2003. INT. CL. 42.
- OSTEOMED CORPORATION:
See—OSTEOMED L.P..
- OSTEOMED L.P., ADDISON, TX FROM OSTEOMED CORPORATION, ADDISON, TX:
2,747,074, PUB. 5-13-2003. INT. CL. 10.
- OSTER COMMUNICATIONS, INC., CEDAR FALLS, IA, DBA FUTURES MAGAZINE:
2,001,100, CANC. INT. CL. 36.
- OSTRICH WORLD, INC., SANTA YNEZ, CA:
2,000,557, CANC. INT. CL. 25.
- OTHER MOTHERS INC., COLBERT, WA:
2,001,150, CANC. INT. CL. 42.
- OTIS ELEVATOR COMPANY, FARMINGTON, CT:
1,182,632, REN. 6-25-03. MULTIPLE CLASS, INT. CLS. 7 AND 9.
1,182,632, CANC. MULTIPLE CLASS, INT. CLS. 3 AND 4.
2,747,650, INT. CL. 7.
- OTTO MANNER HEISSKANALSYSTEME GMBH & CO. KG, 79353 BAHLINGEN, FED REP GERMANY:
2,746,372, PUB. 5-13-2003. INT. CL. 7.
- OUT OF THE BOX PUBLISHING, INC., MADISON, WI:
2,748,849, INT. CL. 9.
- OUTPOST OUTPOST, INC., PRINCETON, NJ:
2,747,614, INT. CL. 42.
- OVAL CORPORATION, SHINJYUKU-KU, TOKYO, JAPAN:
2,745,776, PUB. 9-24-2002. INT. CL. 9.
- OVEJERO, ANGEL FERNANDEZ, 28001 MADRID, SPAIN:
2,746,508, PUB. 5-13-2003. INT. CL. 3.
- OVERLAND, ARVE, PORLTAND, OR:
2,747,024, PUB. 5-13-2003. INT. CL. 9.
- OWATROL INTERNATIONAL CORP., VADUZ, LIECHTENSTEIN:
749,681, REN. 6-24-03. U.S. CL. 16 (INT. CL. 2).
- OWEN HEALTHCARE INC., HOUSTON, TX:
2,747,431, PUB. 5-13-2003. INT. CL. 35.
- OWENS-CORNING FIBERGLAS CORPORATION, TOLEDO, OH:
1,209,324, CANC. U.S. CL. B.
- OWENS-CORNING FIBERGLAS TECHNOLOGY INC., SUMMIT, IL:
2,748,892, INT. CL. 37.
- OX-YOKE ORIGINALS, INC., MILO, ME:
2,001,487, CANC. INT. CL. 13.
- OXFORD BIOMEDICA PLC, OXFORD, UNITED KINGDOM:
2,747,063, PUB. 7-2-2002. MULTIPLE CLASS, INT. CLS. 5, 10 AND 42.
- OXYGEN S.P.A., 42100 REGGIO EMILIA, ITALY:
2,746,341, PUB. 5-13-2003. INT. CL. 12.
- OZAN, INC., MALIBU, CA:
2,748,488, INT. CL. 8.
- OZARK MOUNTAIN SMOKE HOUSE, INC., FAYETTEVILLE, AR:
2,745,800, PUB. 5-13-2003. MULTIPLE CLASS, INT. CLS. 29 AND 30.
- OZKLEEN EURASIA LIMITED, EAST MALAYSIA, MALAYSIA:
2,747,740, INT. CL. 3.
- OZONEX LIMITED, LONDON N14 5BP, UNITED KINGDOM:
2,747,605, INT. CL. 21.
- P H DREW, INC., INDIANAPOLIS, IN:
2,746,799, PUB. 5-13-2003. INT. CL. 40.
2,746,800, PUB. 5-13-2003. INT. CL. 40.
- P. H. GLATFELTER COMPANY, YORK, PA:
940,978, REN. 6-22-03. U.S. CL. 37 (INT. CL. 16).
- P.H. GLATFELTER COMPANY, YORK, PA, BERGSTROM PAPER COMPANY, NEENAH, WI:
957,786, REN. 6-22-03. U.S. CL. 37 (INT. CL. 16).
- PABST BREWING COMPANY, MILL VALLEY, CA, STROH BREWERY COMPANY, THE, DETROIT, MI:
1,722,283, REN. 6-23-03. INT. CL. 32.
- PACE-EDWARDS CO., CENTRALIA, WA:
2,745,784, PUB. 5-13-2003. INT. CL. 12.
- PACIFIC COAST FEATHER COMPANY, SEATTLE, WA:
2,747,025, PUB. 5-13-2003. MULTIPLE CLASS, INT. CLS. 20 AND 24.
2,747,902, MULTIPLE CLASS, INT. CLS. 20 AND 24.
- PACIFIC CONTINENTAL APPAREL, INC., RANCHO DOMINGUEZ, CA:
2,748,566, MULTIPLE CLASS, INT. CLS. 18, 25 AND 26.
- PACIFIC CREST INDUSTRIES, LAKE ELSINOR, CA:
2,748,065, MULTIPLE CLASS, INT. CLS. 6 AND 40.
- PACIFIC ISLE IMPORTS, INC., TAMUNING, GUAM:
2,745,616, PUB. 12-24-2002. MULTIPLE CLASS, INT. CLS. 18 AND 25.
- PACIFIC MEDIA CENTER, INC., SANTA CLARA, CA:
2,747,744, MULTIPLE CLASS, INT. CLS. 9, 38 AND 41.
- PACIFIC PRESS TECHNOLOGIES, L.P., MT. CARMEL, IL, PACIFIC PRESS AND SHEAR, INC., MT. CARMEL, IL:
1,830,163, REN. 6-21-03. INT. CL. 7.
- PACIFIC RESOURCE DEVELOPMENT GROUP, INC., SHORELINE, WA:
1,793,501, REN. 6-24-03. INT. CL. 9.
- PACIFIC SALES KITCHEN AND BATH CENTERS, INC., TORRANCE, CA:
2,748,380, INT. CL. 35.
- PACIFIC SHOE CORPORATION, IRVINE, CA:
2,001,932, CANC. INT. CL. 25.
- PACIFIC TELESIS GROUP, SAN FRANCISCO, CA TO AIR-TOUCH COMMUNICATIONS, INC., SAN FRANCISCO, CA:
1,716,536, CANC. INT. CL. 38.
- PACIFICO, INC., SAN JOSE, CA:
2,746,138, PUB. 9-24-2002. INT. CL. 35.
- PACO RABANNE PARFUMS, (HAUTS DE SEINE), FRANCE:
1,219,762, AM. MULTIPLE CLASS, INT. CLS. 9, 14, 18 AND 26.
- PACO RABANNE PARFUMS, 92200 NEUILLY SUR SIENE, FRANCE:
2,746,481, PUB. 5-13-2003. INT. CL. 3.
- PACWEST RACING GROUP, BELLEVUE, WA:
2,038,638, CANC. INT. CL. 25.
- PADRES L.P., SAN DIEGO, CA:
2,748,393, INT. CL. 9.
- PAINWEBBER INCORPORATED, WEEHAWKEN, NJ:
2,745,501, PUB. 12-31-2002. INT. CL. 36.
2,745,502, PUB. 12-3-2002. INT. CL. 36.
2,745,832, PUB. 11-26-2002. INT. CL. 36.
- PALADIN ENTERTAINMENT HOLDINGS, LLC, LAS VEGAS, NV FROM ADVENT COMMUNICATIONS & ENTERTAINMENT COMPANY, LLC, LAS VEGAS, NV:
2,747,968, INT. CL. 42.
- PALM BEACH COMPANY, CINCINNATI, OH:
737,941, CANC. U.S. CL. 39.
- PALM, INC., SANTA CLARA, CA TO PALM, INC., SANTA CLARA, CA:
2,679,381, COR. INT. CL. 9.
- PALMER LUCK LIMITED, TSIMSHATSUI, KOWLOON, HONG KONG:
2,745,927, PUB. 11-19-2002. INT. CL. 42.
- PALOUSE HOLDINGS, L.L.C., HAYDEN LAKE, ID, U. S. PRODUCTS, INC., HAYDEN LAKE, ID:
1,786,495, REN. 6-27-03. INT. CL. 7.
- PAN AM INTERNATIONAL FLIGHT ACADEMY, INC., MIAMI, FL:
2,000,994, CANC. INT. CL. 41.
- PAN AMERICAN GRAIN MFG. CO., INC., GUAYNABO, PUERTO RICO:
2,746,015, PUB. 8-6-2002. INT. CL. 32.
- PAN AMERICAN GRAIN MFG. CO., INC., GUAYNABO, PUERTO RICO:
2,746,016, PUB. 8-6-2002. INT. CL. 32.
- PAN-AMERICAN LIFE INSURANCE COMPANY, NEW ORLEANS, LA:
2,747,598, INT. CL. 36.
- PANDUIT CORP., TINLEY PARK, IL:
2,747,641, MULTIPLE CLASS, INT. CLS. 16 AND 20.
- PANNOLINI DE MEXICO, S.A. DE C.V., ZAPOPAN, JAL. C.P. 45132, MEXICO:
2,000,582, CANC. INT. CL. 16.
- PANTIM WOOD PRODUCTS, INC., PORTLAND, ME:
2,747,416, PUB. 5-13-2003. INT. CL. 19.

- PAPER AUSTRALIA PTY LTD., MT. WAVERLEY, VICTORIA 3149, AUSTRALIA:
2,746,236, PUB. 5-13-2003. INT. CL. 16.
- PARA ME COSMETICS, LLC, SANTA ANA, CA:
2,746,620, PUB. 5-13-2003. INT. CL. 3.
- PARACLETE ARMOR & EQUIPMENT, INC., ST. PAULS, NC:
2,746,101, PUB. 5-13-2003. MULTIPLE CLASS, INT. CLS. 9, 10 AND 18.
- PARADISE BEVERAGES, INC., WAIPAHU, HI, CONSOLIDATED FOODS CORPORATION, CHICAGO, IL:
1,265,186. REN. 6-24-03. INT. CL. 30.
- PARADISE BEVERAGES, INC., WAIPAHU, HI, WOOLSON SPICE COMPANY, INC., THE, HONOLULU, HI, DBA LION COFFEE:
1,809,432. REN. 6-27-03. INT. CL. 30.
- PARAGON ELECTRIC COMPANY, INC., TWO RIVERS, WI:
2,001,924, CANC. INT. CL. 9.
- PARAMOUNT PICTURES CORPORATION, LOS ANGELES, CA:
1,218,491. REN. 6-24-03. INT. CL. 28.
1,725,858, CANC. INT. CL. 25.
2,747,900, INT. CL. 41.
- PARATEK MICROWAVE, INC., COLUMBIA, MD FROM PARATEK, INC., ABERDEEN, MD:
2,747,500, INT. CL. 9.
- PARCO FOODS, L.L.C., BLUE ISLAND, IL, PARCO FOODS, INC., BLUE ISLAND, IL:
1,816,449. REN. 6-22-03. INT. CL. 30.
- PARFUMS CHRISTIAN DIOR, S.A., 75008 PARIS, FRANCE:
2,747,948, INT. CL. 3.
- PARFUMS ROCHAS, PARIS, FRANCE:
1,207,745, CANC. INT. CL. 3.
- PARICON TECHNOLOGIES CORPORATION, FALL RIVER, MA:
2,747,758, INT. CL. 9.
- PARK NICOLLET HEALTH SERVICES, ST. LOUIS PARK, MN FROM INSTITUTE FOR RESEARCH AND EDUCATION, ST. LOUIS PARK, MN:
2,747,847, INT. CL. 42.
- PARKER PEN (I.P) LTD., ISLEWORTH, MIDDLESEX TW7 5NP, ENGLAND:
2,001,771, CANC. INT. CL. 16.
- PARKER-HANNIFIN CORPORATION, CLEVELAND, OH:
2,000,884, CANC. INT. CL. 9.
- PARKER, EDWIN C., BOWIE, MD:
2,746,711, PUB. 5-13-2003. INT. CL. 25.
- PARLUX FRAGRANCES, INC., FT. LAUDERDALE, FL, ALEXANDRA DE MARKOFF, LTD., NEW YORK, NY:
1,783,185. REN. 6-23-03. INT. CL. 3.
- PARTLY POTTED COMPANY, BLOWING ROCK, NC:
1,208,416, CANC. INT. CL. 20.
- PARTNERS IN MEDICAL COMMUNICATIONS LLC, CLIFTON, NJ:
1,717,093, CANC. INT. CL. 16.
- PAS-CO INTERCORP, INC., KEYSTONE, CO:
2,747,266, PUB. 5-13-2003. INT. CL. 40.
- PASS & SEYMOUR/LEGRAND, SYRACUSE, NY:
2,671,668, COR. INT. CL. 9.
- PASSAGEWAYS TRAVEL, TRAVERSE CITY, MI:
2,745,559, PUB. 9-4-2001. MULTIPLE CLASS, INT. CLS. 39 AND 42.
- PASSPORT ONLINE, INC., PORTLAND, OR:
2,746,515, PUB. 5-13-2003. INT. CL. 35.
- PASTA JAY'S, INCORPORATED, BOULDER, CO:
1,766,994. REN. 6-26-03. INT. CL. 42.
- PASTEURIZADORA RICA, C. X A., SANTO DOMINGO, DOMINICAN REP:
2,745,484, PUB. 10-8-2002. INT. CL. 32.
- PATCH PRODUCTS, INC., BELOIT, WI:
2,747,288, PUB. 5-13-2003. INT. CL. 28.
- PATIENT COACH, INC., DOYLESTOWN, PA:
2,748,737, INT. CL. 42.
- PATRICK, STEVE VANCE, WEST HOLLYWOOD, CA:
2,748,657, INT. CL. 41.
- PATTERSON, J. MICHAEL, LAKE FOREST, IL:
2,001,630, CANC. INT. CL. 16.
- PATTI, JAMES J., BOCA RATON, FL:
2,747,704, INT. CL. 32.
- PATTON MEDICAL CORPORATION, AUSTIN, TX:
2,749,034, INT. CL. 10.
- PAUL REBER GMBH & CO. KG, D-83435 BAD REICHENHALL, FED REP GERMANY:
2,745,903, PUB. 5-13-2003. INT. CL. 30.
- PAUL, STEPHEN, F., WEST ORANGE, NJ:
2,748,802, INT. CL. 4.
- PAYSYSTEMS CORPORATION, MONTREAL, QUEBEC, H3A2L1, CANADA:
2,746,819, PUB. 5-13-2003. INT. CL. 36.
2,746,820, PUB. 5-13-2003. INT. CL. 36.
- PAZ, SONYA, SAN JOSE, CA:
2,748,828, INT. CL. 35.
- PBN MEDICALS DENMARK A/S, 3660 STENLOSE, DENMARK:
2,746,017, PUB. 5-13-2003. INT. CL. 10.
- PCI INDUSTRIES, INC., RIVIERA BEACH, FL:
2,000,513, CANC. INT. CL. 1.
- PCL PACKAGING, INC., BARRIE, ONTARIO, CANADA, BERESFORD PACKAGING, INC., TAUNTON, MA:
1,694,457. REN. 6-25-03. INT. CL. 22.
- PCM LIMITED, STOUFFVILLE L4A 1A4 ONTARIO, CANADA:
2,745,872, PUB. 5-13-2003. INT. CL. 16.
- PCTV, INC., NEWPORT, NH:
2,001,224, CANC. INT. CL. 41.
- PDMA CORPORATION, TAMPA, FL:
2,001,371, CANC. INT. CL. 9.
2,001,372, CANC. INT. CL. 9.
- PDS ELECTRONICS, INC., AKRON, OH:
2,748,762, INT. CL. 9.
- PEABODY, BENJAMIN, HIRAM, ME:
2,645,403, COR. INT. CL. 30.
- PEANOTZ, INC., CARPENTER, SD:
2,747,405, PUB. 5-13-2003. INT. CL. 29.
- PEARSON TELEVISION OPERATIONS B.V., HILVERSUM, NETHERLANDS:
2,745,735, PUB. 12-18-2001. INT. CL. 28.
- PEARSON, MARCIA L., ATLANTA, GA AND PEARSON, DANIEL S., ATLANTA, GA, COMPUTER TEMPS, INC., ATLANTA, GA:
1,767,602. REN. 6-23-03. INT. CL. 35.
- PEAVEY ELECTRONICS CORPORATION, MERIDIAN, MS:
2,746,527, PUB. 5-13-2003. INT. CL. 9.
- PEBBLE BEACH COMPANY, PEBBLE BEACH, CA:
1,765,946. REN. 6-24-03. INT. CL. 25.
- PEDAL PUSHERS, INC., JACKSONVILLE, FL:
1,208,146, CANC. INT. CL. 12.
1,209,261, CANC. INT. CL. 42.
1,209,262, CANC. INT. CL. 42.
- PEDER SMEDVIG A/S, 4001 STAVANGER, NORWAY:
2,000,533, CANC. MULTIPLE CLASS, INT. CLS. 37 AND 39.
- PEDIAMED PHARMACEUTICAL, INC., DOWNINGTOWN, PA:
2,747,784, INT. CL. 5.
- PEDIATRIC CANCER RESEARCH FOUNDATION, ORANGE, CA:
2,000,980, CANC. INT. CL. 42.
2,000,981, CANC. INT. CL. 36.
- PEGASUS INTERNATIONAL, INC., FORT WASHINGTON, PA:
2,747,917, INT. CL. 3.
- PEGASUS MARKETING GROUP, INC., MANCHESTER, MA:
2,745,939, PUB. 6-18-2002. INT. CL. 32.
- PEGULA, CHRIS J., SANTA MONICA, CA:
2,748,565, INT. CL. 18.
- PELICAN LANDING GOLF RESORT VENTURES, BONITA SPRINGS, FL:
2,746,465, PUB. 5-13-2003. INT. CL. 41.
- PENFORD PRODUCTS CO., CEDAR RAPIDS, IA:
2,748,561, INT. CL. 1.
- PENGUIN PUTNAM INC., NEW YORK, NY:
2,747,009, PUB. 5-13-2003. MULTIPLE CLASS, INT. CLS. 16, 20 AND 28.

- PENNINGTON SEED OF NEBRASKA, INC., MADISON, GA,
PENNINGTON ENTERPRISES, INC., MADISON, GA:
1,767,821. REN. 6-25-03. MULTIPLE CLASS, INT. CLS. 1
AND 5.
- PENNTTECH PAPERS, INC., WHITE PLAINS, NY:
1,208,214, CANC. INT. CL. 16.
- PENNTTECH PAPERS, INC., NEW YORK, NY:
1,208,224, CANC. INT. CL. 16.
- PENNUNION ENGERGY SERVICES, L.L.C., HOUSTON, TX:
2,001,044, CANC. MULTIPLE CLASS, INT. CLS. 39 AND
42.
- PENNWELL CORPORATION, TULSA, OK, IHS PUBLISH-
ING GROUP, INC., LIBERTYVILLE, IL:
1,777,192. REN. 6-26-03. INT. CL. 16.
- PENNWELL CORPORATION, TULSA, OK:
2,748,044, INT. CL. 35.
- PENNWELL PUBLISHING COMPANY, TULSA, OK:
1,717,237, CANC. INT. CL. 16.
2,000,849, CANC. INT. CL. 16.
- PENNZOIL-QUAKER STATE COMPANY, HOUSTON, TX,
BLUE CORAL, INC., CLEVELAND, OH:
1,234,215. REN. 6-26-03. INT. CL. 3.
- PENSACOLA RESTAURANT SUPPLY COMPANY, PENSACOLA,
FL:
955,452. REN. 6-27-03. U.S. CL. 101 (INT. CLS. 35 AND 42).
- PENTECH INTERNATIONAL INC., EDISON, NJ:
1,717,082, CANC. INT. CL. 16.
- PEOPLES DRUG STORES, INCORPORATED, ALEXANDRIA,
VA:
1,207,752, CANC. MULTIPLE CLASS, INT. CLS. 3 AND 5.
- PEPITONE, PEGGY S., SAN ANTONIO, TX, DBA SPECIFIC
NUTRITION:
2,001,026, CANC. INT. CL. 42.
- PEPPERL + FUCHS GMBH, D-68307 MANNHEIM, FED
REP GERMANY:
2,745,615, PUB. 11-12-2002. MULTIPLE CLASS, INT. CLS.
9, 16 AND 42.
- PEPSICO, INC., PURCHASE, NY:
737,816, CANC. U.S. CL. 22.
- PEPTAB DIET/ALERT CENTER, INC., LOUISVILLE, KY:
1,714,941, CANC. INT. CL. 5.
- PERCY'S HIGH PERFORMANCE, INC, LINN CREEK, MO:
2,745,768, PUB. 10-8-2002. INT. CL. 12.
- PERDUE HOLDINGS, INC., SALISBURY, MD:
2,001,012, CANC. INT. CL. 29.
- PEREGRINE SEMICONDUCTOR CORPORATION, SAN
DIEGO, CA:
2,748,310, INT. CL. 9.
- PEREGRINE SYSTEMS, INC., SAN DIEGO, CA:
2,747,826, INT. CL. 42.
2,747,827, INT. CL. 42.
- PERFECT CHOICE PRODUCTS CORPORATION, ST. ALBANS,
MO, AMERICAN SHEET EXTRUSION CORP.,
EVANSVILLE, IN:
1,730,338. REN. 6-21-03. INT. CL. 19.
- PERFECT FIT INDUSTRIES, INC., MONROE, NC:
2,001,843, CANC. INT. CL. 20.
- PERFECT IMAGE FILM & VIDEO PRODUCTION, INC.,
MIAMI, FL:
2,746,651, PUB. 5-13-2003. INT. CL. 41.
- PERFOREX, L.P., BELLINGHAM, WA:
2,748,035, INT. CL. 42.
- PERFORMANCE CONTRACTING, INC., LENEXA, KS:
2,001,896, CANC. INT. CL. 9.
2,001,897, CANC. INT. CL. 9.
- PERICH + PARTNERS, INC, ANN ARBOR, MI:
2,747,328, PUB. 5-13-2003. INT. CL. 35.
- PERKINS, NORALEE A., JACKSONVILLE, AR, DBA HEAVENLY
HOUNDS:
2,746,858, PUB. 5-13-2003. INT. CL. 44.
- PERKINS, ROBERT, BATON ROUGE, LA:
2,749,043, INT. CL. 42.
- PERMA-FLEX MOLD CO., THE, COLUMBUS, OH:
756,279. REN. 6-25-03. U.S. CL. 1 (INT. CL. 1).
- PERMAFIEBER CORPORATION:
1,208,233, CANC. INT. CL. 16.
- PERMOBIL AB, 861 23 TIMARA, SWEDEN:
2,745,524, PUB. 7-3-2001. MULTIPLE CLASS, INT. CLS. 9,
10 AND 12.
2,745,525, PUB. 7-17-2001. MULTIPLE CLASS, INT. CLS. 9
AND 10.
- PERNOD RICARD, 75008 PARIS, FRANCE:
2,746,649, PUB. 5-13-2003. INT. CL. 33.
- PERRIN MANUFACTURING COMPANY, CITY OF INDUS-
TRY, CA:
2,747,862, INT. CL. 21.
- PERSOFT, INC., MADISON, WI:
2,002,014, CANC. INT. CL. 9.
- PERSONAL CARE GROUP, INC., WESTPORT, CT:
2,748,259, INT. CL. 30.
- PERTRONIX, INC., SAN DIMAS, CA:
2,748,332, INT. CL. 9.
- PET AFFAIRS, INC., TUCSON, AZ:
2,001,653, CANC. INT. CL. 28.
- PETCO ANIMAL SUPPLIES, INC., SAN DIEGO, CA:
1,637,200, CANC. INT. CL. 42.
- PETE'S PIZZA, INC., NEW ROCHELLE, NY:
2,747,245, PUB. 5-13-2003. INT. CL. 43.
- PETER SCOTT'S INC., HEATHROW, FL:
2,001,074, CANC. INT. CL. 42.
- PETERSON, JEFF, D, ELGIN, IL:
2,508,267, CANC. INT. CL. 30.
- PETRIK LABORATORIES, INC., WOODLAND, CA, V. J.
PETRIK LABORATORIES, INC., WOODLAND, CA:
1,262,074. REN. 6-22-03. INT. CL. 1.
- PETROLEUM COMMUNICATIONS, INC., HARAHAN, LA:
2,748,486, INT. CL. 38.
2,748,498, INT. CL. 38.
- PETRONI, ERIK B., ATLANTIC BEACH, FL AND PETRONI,
KARINA B., ATLANTIC BEACH, FL:
2,748,607, INT. CL. 25.
- PETROSYSTEMS INTERNATIONAL, INC., NASHVILLE,
TN:
1,207,884, CANC. INT. CL. 7.
- PFIZER INC., NEW YORK, NY, NORDEN LABORATORIES,
INC., LINCOLN, NE:
1,730,462. REN. 6-26-03. INT. CL. 1.
- PFIZER INC., NEW YORK, NY:
2,747,535, INT. CL. 5.
2,747,554, INT. CL. 5.
- PGA TOUR, INC., PONTE VEDRA BEACH, FL:
2,748,361, INT. CL. 41.
- PHARMACIA AB, S-171 97 STOCKHOLM, SWEDEN:
2,000,742, CANC. INT. CL. 10.
- PHARMACYCLICS, INC., SUNNYVALE, CA:
2,746,029, PUB. 5-13-2003. INT. CL. 16.
- PHARMANEX, LLC, PROVO, UT:
2,748,952, INT. CL. 5.
- PHIL SMIDT & SON, INC., HAMMOND, IN:
1,254,012. REN. 6-24-03. INT. CL. 42.
- PHILIP MORRIS INCORPORATED, NEW YORK, NY, DBA
DAVE'S TOBACCO CO.:
2,000,834, CANC. INT. CL. 34.
- PHILIP ROBERT'S, INC., BELLEVUE, WA:
2,001,898, CANC. INT. CL. 42.
- PHILLIPS-VAN HEUSEN CORPORATION, NEW YORK, NY:
2,748,317, INT. CL. 25.
- PHOENIX CHEMICAL INC., SOMERVILLE, NJ:
1,714,846, CANC. INT. CL. 1.
- PHOENIX GROUP, INC., ATLANTA, GA:
2,747,728, INT. CL. 35.
- PHOENIX LEATHER PRODUCTS, INC., CINCINNATI, OH:
2,748,315, INT. CL. 18.
- PHOENIX SOCIETY, INC., THE, EAST GRAND RAPIDS, MI,
DBA THE PHOENIX SOCIETY FOR BURN SURVIVORS,
INC.:
2,748,027, INT. CL. 41.
- PHOENIX SYSTEMS, INC., ATLANTA, GA:
2,745,491, PUB. 11-5-2002. INT. CL. 9.
- PHONAK HOLDING AG, CH-8712 STAFA, SWITZERLAND:
2,745,912, PUB. 11-19-2002. INT. CL. 10.
- PHONE COMPANY, INC., THE, SALEM, MA, DBA EAT
RECORDS:
1,207,964, CANC. INT. CL. 9.
- PHORMION SALES TOOLS, INC., LINCROFT, NJ:
2,748,105, INT. CL. 9.

- PHOTO RESEARCH, INC., CHATSWORTH, CA:
2,747,719, INT. CL. 9.
- PHYSICIANS EYECARE NETWORK, INC., CONCORD, CA:
2,000,774, CANC. INT. CL. 36.
- PI-LAH-TEEZ ZONE INC., ARLINGTON, TX:
2,746,048, PUB. 10-8-2002. INT. CL. 41.
- PI-ROD, INC., PLYMOUTH, IN:
1,769,005, REN. 6-24-03. INT. CL. 42.
- PIANEGONDA S.R.L., 36043 CAMISANO VICENTINO VI,
ITALY:
2,747,670, INT. CL. 14.
- PICADILLY KIDS, INC., HURST, TX:
2,747,218, PUB. 5-13-2003. INT. CL. 24.
- PICCARRETO, RICHARD, NEWTON, MA:
1,716,600, CANC. INT. CL. 40.
- PICK, DOUGLAS A., SHERMAN OAKS, CA:
1,787,441, REN. 6-24-03. INT. CL. 10.
- PICKERING & SIMMONS LLC, EDISON, NJ:
2,748,775, INT. CL. 35.
- PIERCE & STEVENS CORPORATION, BUFFALO, NY:
2,747,537, INT. CL. 1.
- PIERCE BIOTECHNOLOGY, INC., ROCKFORD, IL:
2,747,299, PUB. 5-13-2003. INT. CL. 1.
- PIERRE FABRE DERMO-COSMETIQUE, 92100 BOU-
LOGNE, FRANCE:
2,745,890, PUB. 5-13-2003. MULTIPLE CLASS, INT. CLS. 3
AND 5.
2,746,595, PUB. 5-13-2003. INT. CL. 3.
- PIERRE FABRE S.A., 92100 BOULOGNE, FRANCE:
2,001,112, CANC. MULTIPLE CLASS, INT. CLS. 3 AND 5.
- PIERRE FASHIONS, INC., CAGUAS, PUERTO RICO:
2,746,839, PUB. 5-13-2003. INT. CL. 25.
- PILKINGTON PLC, MERSEYSIDE WA10 3TT, UNITED
KINGDOM:
2,746,720, PUB. 5-13-2003. INT. CL. 19.
- PILOT PRODUCTIONS VIDEO, SAN FRANCISCO, CA:
1,209,070, CANC. MULTIPLE CLASS, INT. CLS. 40 AND
41.
- PINKERTON TOBACCO CO. LP, RICHMOND, VA:
2,747,281, PUB. 5-13-2003. INT. CL. 34.
- PINNACLE ENTERTAINMENT, INC., GLENDALE, CA:
2,747,802, INT. CL. 41.
- PIONEER HI-BRED INTERNATIONAL, INC., DES MOINES,
IA:
1,716,359, CANC. MULTIPLE CLASS, INT. CLS. 35 AND
42.
1,716,676, CANC. INT. CL. 41.
- PIONEER KABUSHIKI KAISHA, MEGURO-KU, TOKYO
153, JAPAN, AKA PIONEER ELECTRONIC CORPORA-
TION:
1,208,024, CANC. INT. CL. 9.
- PIPEBEACH AB, S-113 56 STOCKHOLM, SWEDEN:
2,747,511, INT. CL. 9.
- PIPELIFE INTERNATIONAL GMBH, WIENER NEUDORF
A-2355, AUSTRIA:
2,748,179, MULTIPLE CLASS, INT. CLS. 17, 19 AND 20.
- PISTACHIO AUSTRALIA PTY. LTD., AUSTRALIAN CAPI-
TAL TERRITORY, 2902, AUSTRALIA:
2,747,832, INT. CL. 16.
- PITA-ROMERO, JOSE L., MIAMI, FL:
1,780,372, REN. 6-23-03. INT. CL. 25.
- PITKOFF AND ASSOCIATES, INC., KENNEWICK, WA:
2,748,776, INT. CL. 5.
- PITZER, KAREN A, DENVER, CO:
2,747,257, PUB. 5-13-2003. INT. CL. 16.
- PIVOTAL CENTURY PLAZA HOTEL, LLC, PHOENIX, AZ:
2,748,127, INT. CL. 42.
- PIVOTAL PROMONTORY DEVELOPMENT, L.L.C., PHOE-
NIX, AZ:
2,748,407, INT. CL. 25.
- PIXEL MAGIC IMAGING, INC., SAN MARCOS, TX:
2,747,677, INT. CL. 40.
- PIZZA RANCH, INC., HULL, IA:
2,747,241, PUB. 5-13-2003. INT. CL. 43.
- PIZZERIA UNO CORPORATION, DOVER, DE:
1,780,720, REN. 6-26-03. INT. CL. 42.
1,795,389, REN. 6-26-03. INT. CL. 42.
1,800,755, REN. 6-26-03. INT. CL. 16.
- PIZZERIA UNO CORPORATION, WEST ROXBURY, MA:
1,814,299, REN. 6-25-03. MULTIPLE CLASS, INT. CLS. 29
AND 30.
- PLACEWARE, INC., MOUNTAIN VIEW, CA:
2,680,831, COR. MULTIPLE CLASS, INT. CLS. 9, 35 AND
42.
- PLANET EARTH INC., LIMITED, 46 LYNDHURST TER-
RACE, CENTRAL, HONG KONG:
2,747,672, INT. CL. 16.
- PLANET ICE CREAM, INC., MEDFORD, NY:
2,747,275, PUB. 5-13-2003. INT. CL. 30.
- PLANNED PARENTHOOD FEDERATION OF AMERICA,
INC., NEW YORK, NY:
2,748,907, INT. CL. 35.
- PLANT PROMOTIONS, INC., SOUTHFIELD, MI:
2,000,623, CANC. INT. CL. 31.
- PLANTAGENET WINES PTY LTD., MOUNT BARKER
WESTERN AUSTRALIA, AUSTRALIA:
2,746,267, PUB. 5-13-2003. INT. CL. 33.
- PLASTIFLEX COMPANY INC., ANAHEIM, CA:
2,000,652, CANC. INT. CL. 9.
- PLATINUM STUDIOS LLC., BEVERLY HILLS, CA:
2,747,633, INT. CL. 41.
2,747,634, INT. CL. 41.
- PLATINUM TECHNOLOGY, INC., OAKBROOK TERRACE,
IL:
2,001,373, CANC. INT. CL. 9.
- PLATTE CHEMICAL CO., FREMONT, NE, AMOCO OIL
COMPANY, CHICAGO, IL:
958,080, REN. 6-21-03. U.S. CL. 10 (INT. CL. 1).
- PLAY LIKE THE PROS, LLC, EDGEWOOD, KY:
2,746,395, PUB. 5-13-2003. INT. CL. 35.
- PLAZA COMMUNICATIONS, INC., IRVINE, CA:
1,209,346, CANC. INT. CL. 16.
- PLEASANT COMPANY, MIDDLETON, WI:
2,746,554, PUB. 5-13-2003. INT. CL. 16.
2,746,734, PUB. 5-13-2003. INT. CL. 43.
2,746,772, PUB. 5-13-2003. INT. CL. 16.
2,746,789, PUB. 5-13-2003. INT. CL. 43.
2,748,371, MULTIPLE CLASS, INT. CLS. 16 AND 28.
- PLUS COMPANIES, INC., THE, BRIDGEWATER, NJ:
2,745,931, PUB. 7-16-2002. INT. CL. 36.
- PMT CORPORATION, CHANHASSEN, MN:
1,765,723, REN. 6-25-03. INT. CL. 10.
- PNC FINANCIAL SERVICES GROUP, INC., THE, PITTS-
BURGH, PA:
2,747,906, INT. CL. 36.
- POINT OF CARE SYSTEMS, INC., SAN DIEGO, CA:
2,001,554, CANC. INT. CL. 9.
- POINTCROSS.COM, INC., FOSTER CITY, CA FROM I3
TECHNOLOGIES, INC., FOSTER CITY, CA:
2,747,611, INT. CL. 9.
- POINTSTREAK.COM INC., VANCOUVER BRITISH CO-
LUMBIA, CANADA:
2,746,126, PUB. 7-23-2002. INT. CL. 35.
- POLAIRS INDUSTRIES INC., MEDINA, MN, POLARIS
INDUSTRIES L.P., MINNEAPOLIS, MN:
1,767,382, REN. 6-22-03. INT. CL. 12.
- POLAKOW, JASON NICHOLAS, TORQUAY, VICTORIA
3228, AUSTRALIA:
2,745,551, PUB. 5-13-2003. INT. CL. 28.
- POLAKOW, JASON NICHOLAS, VICTORIA 3228, AUSTRALIA:
2,747,857, INT. CL. 25.
- POLANER, INC., PARSIPPANY, NJ:
2,748,239, INT. CL. 29.
- POLARIS INDUSTRIES INC., MEDINA, MN:
2,749,008, INT. CL. 41.
- POLAROID CORPORATION, CAMBRIDGE, MA:
1,208,347, CANC. INT. CL. 17.
- POLE/ZERO CORPORATION, WEST CHESTER, OH:
2,747,421, PUB. 5-13-2003. INT. CL. 9.
- POLLO TROPICAL, INC., MIAMI, FL:
2,001,686, CANC. INT. CL. 42.
- POLY-BIO-MARINE INC., ORANGE, NJ:
1,271,689, REN. 6-21-03. INT. CL. 11.
- POLYCHEM CORPORATION, NEW HAVEN, CT:
1,207,746, CANC. MULTIPLE CLASS, INT. CLS. 3 AND 4.

- POLYMER TECHNOLOGY GROUP INC, THE, BERKELEY, CA:
2,747,584, MULTIPLE CLASS, INT. CLS. 1 AND 17.
- POLYPHENOLICS, INC., BURLINGAME, CA:
2,747,532, INT. CL. 5.
- PONTIS ELECTRONIC GMBH, 92521 SCHWARZENFELD, FED REP GERMANY:
2,747,929, INT. CL. 9.
- PONY INTERNATIONAL, INC., BEVERLY HILLS, CA:
2,746,334, PUB. 5-13-2003, INT. CL. 18.
2,746,335, PUB. 5-13-2003, INT. CL. 18.
- POP WORLD MEDIA, LLC, BRUNSWICK, OH:
2,748,746, INT. CL. 42.
- POPPER, JOHN, NEW YORK, NY AND HILL, BRENDAN, NEW YORK, NY AND SHEEHAN, BOBBY, NEW YORK, NY AND KINCHLA, CHAN, NEW YORK, NY:
2,001,682, CANC. MULTIPLE CLASS, INT. CLS. 25 AND 41.
- POPSICLE INDUSTRIES, INC., ENGLEWOOD, NJ:
1,208,791, CANC. INT. CL. 30.
- POPWORLD LIMITED, LONDON, ENGLAND:
2,745,692, PUB. 1-21-2003, MULTIPLE CLASS, INT. CLS. 9, 16, 25, 28, 35, 36, 38 AND 41.
- PORCELAIN PLUS, INC., VAN NUYS, CA:
2,747,913, INT. CL. 16.
- PORONUI RANCH LIMITED, TAUPO, RANGITAIKI, NEW ZEALAND:
2,745,992, PUB. 5-13-2003, INT. CL. 42.
- POROUS MEDIA CORPORATION, ST. PAUL, MN:
1,746,791, REN. 6-24-03, INT. CL. 7.
2,746,025, PUB. 10-22-2002, INT. CL. 11.
- PORTAFIRE, INC., LITTLETON, CO:
2,747,997, INT. CL. 11.
- PORTEC AG, 8404 WINTERTHUR, SWITZERLAND:
2,745,475, PUB. 12-18-2001, MULTIPLE CLASS, INT. CLS. 1 AND 7.
- PORTEX, INC., KEENE, NH FROM SIMS PORTEX INC., KEENE, NH:
2,745,908, PUB. 5-13-2003, INT. CL. 10.
- POSEY PARK, LLC, CARROLLTON, TX:
2,747,816, INT. CL. 16.
- POSITION TECHNOLOGY INC./TECHNOLOGIE POSITION INC, QUEBEC J7R 5V3, CANADA:
2,748,386, INT. CL. 9.
- POSITIVE IMAGE PERSONAL TRAINING, INC., WEST-FORD, MA:
2,746,823, PUB. 5-13-2003, INT. CL. 41.
- POST OFFICE, THE:
See—VIACODE LIMITED.
- POTBELLY SANDWICH WORKS, LLC, CHICAGO, IL:
2,748,556, INT. CL. 43.
- POTEL & CHABOT, PARIS, FRANCE:
1,252,567, REN. 6-26-03, INT. CL. 42.
- POTLATCH CORPORATION, SPOKANE, WA:
2,745,608, PUB. 5-13-2003, INT. CL. 16.
- POWER PLAY LTD., BIRMINGHAM, MI:
1,208,413, CANC. INT. CL. 20.
- POWER-SELLES IMPORTS, INC., SEATTLE, WA:
2,747,251, PUB. 5-13-2003, INT. CL. 30.
- POWERS AND SONS CONSTRUCTION COMPANY, INCORPORATED, GARY, IN:
2,747,156, PUB. 5-13-2003, INT. CL. 37.
- POWERS FASTENERS, INC., NEW ROCHELLE, NY, RAW-PLUG COMPANY, INC., THE, NEW ROCHELLE, NY:
1,724,985, REN. 6-25-03, INT. CL. 6.
- POWERSURGE TECHNOLOGIES, INC., CEDAR FALLS, IA:
2,747,055, PUB. 7-16-2002, INT. CL. 42.
- PRATT INDUSTRIES (U.S.A.), INC., CONYERS, GA:
2,001,575, CANC. INT. CL. 37.
- PRAXAIR TECHNOLOGY, INC., DANBURY, CT, UNION CARBIDE CORPORATION, DANBURY, CT:
1,223,815, REN. 6-27-03, INT. CL. 1.
- PRECISE EXERCISE EQUIPMENT, INC., CHESTER, NJ:
2,746,006, PUB. 5-13-2003, INT. CL. 28.
- PRECISE SOFTWARE SOLUTIONS, INC., OR-YEHUDA, ISRAEL FROM PRECISE SOFTWARE SOLUTIONS, INC., OR-YEHUDA, ISRAEL:
2,747,474, INT. CL. 9.
- PRECISION ENDOSCOPY OF AMERICA, INC., HUNT VALLEY, MD:
2,748,622, INT. CL. 42.
- PRECITECH, INC., KEENE, NH:
2,748,931, INT. CL. 7.
- PREDICTOR SYSTEMS CORPORATION, WESTLAKE VIL-LAGE, CA:
1,716,357, CANC. INT. CL. 35.
- PREGER & WERTENTEIL, INC., NEW YORK, NY:
1,784,199, REN. 6-27-03, INT. CL. 25.
- PREMARK RWP HOLDINGS, INC., WILMINGTON, DE:
2,748,879, INT. CL. 19.
- PREMIER ASSET MANAGEMENT, INC., INCLINE VIL-LAGE, NV:
2,748,068, MULTIPLE CLASS, INT. CLS. 36, 37, 40 AND 42.
- PREMIER GEM CORPORATION, NEW YORK, NY:
2,748,904, INT. CL. 14.
- PREMIER SEARCH, INC., LAS VEGAS, NV:
2,745,805, PUB. 5-13-2003, INT. CL. 35.
- PREMIUM BALLOON ACCESSORIES, INC., SHARON CEN-TER, OH, ZIBI-CORE INC., COPLEY, OH:
1,704,405, REN. 6-22-03, INT. CL. 7.
- PREMIUMSELECT INSURANCE & FINANCIAL SERVICES BROKERAGE, INC., HARVEY, LA:
2,747,170, PUB. 5-13-2003, INT. CL. 36.
- PRESIDENT AND FELLOWS OF HARVARD COLLEGE, CAMBRIDGE, MA:
2,746,526, PUB. 5-13-2003, INT. CL. 16.
- PRESIDEO, INC., SEBASTIAN, FL FROM INTEGRATED VISIONS, INC., SEBASTIAN, FL:
2,747,722, INT. CL. 35.
- PREST-O-FIT MFG., INC., CHANDLER, AZ:
2,748,474, INT. CL. 35.
- PRESTIGE DE MEXICO SA DE CV, TLAQUEPAQUE, JALISCO, MEXICO:
2,748,700, INT. CL. 21.
- PRESTOLITE WIRE CORPORATION, FARMINGTON HILL, MI:
1,207,888, CANC. INT. CL. 7.
- PRETTY PRODUCTS, INC., COSHOCTON, OH:
1,715,848, CANC. INT. CL. 21.
- PRICE ADVANCED INNOVATIONS, INC., RENO, NV:
2,748,077, INT. CL. 28.
- PRICE WATERHOUSE LLP, NEW YORK, NY:
2,001,488, CANC. INT. CL. 35.
2,001,492, CANC. INT. CL. 9.
- PRICE/COSTCO, INC., ISSAQUAH, WA:
2,001,701, CANC. INT. CL. 35.
2,001,702, CANC. INT. CL. 40.
- PRICEBARGAINS.COM, LLC, CHATHAM, NJ:
2,748,445, INT. CL. 35.
- PRICK APPAREL L.L.C., HENDERSON, NV:
2,746,546, PUB. 5-13-2003, INT. CL. 25.
- PRIDE MOBILITY PRODUCTS CORPORATION, EXETER, PA:
2,748,172, INT. CL. 12.
- PRIMARY PAYMENT SYSTEMS, INC., SCOTTSDALE, AZ:
2,747,450, PUB. 5-13-2003, INT. CL. 36.
2,747,451, PUB. 5-13-2003, INT. CL. 36.
2,747,452, PUB. 5-13-2003, INT. CL. 36.
2,747,453, PUB. 5-13-2003, INT. CL. 36.
- PRIMEDIA ENTHUSIAST PUBLICATIONS, INC., STAM-FORD, CT, EMPIRE PRESS, INC., LEESBURG, VA:
1,780,275, REN. 6-24-03, INT. CL. 16.
- PRIMEDIA WORKERPLACE LEARNING, INC., CARROLL-TON, TX, WESTCOTT COMMUNICATIONS, INC., CAR-ROLLTON, TX:
1,781,352, REN. 6-21-03, INT. CL. 16.
- PRIMEDIA WORKPLACE LEARNING, INC., CARROLL-TON, TX, WESTCOTT COMMUNICATIONS, INC., CAR-ROLLTON, TX:
1,780,597, REN. 6-21-03, INT. CL. 38.
1,781,765, REN. 6-21-03, INT. CL. 38.
- PRIMERA FOODS CORPORATION, CAMERON, WI, ZUM-BRO, INC., HAYFIELD, MN:
1,695,498, REN. 6-27-03, INT. CL. 30.

- PRIMERA RED INTERACTIVA DE MEDIOS ARGENTINOS (PRIMA) S.A., 1339 BUENOS AIRES, ARGENTINA:
2,745,655, PUB. 5-13-2003. MULTIPLE CLASS, INT. CLS. 38 AND 42.
- PRIMESOURCE BUILDING PRODUCTS, INC., CARROLLTON, TX:
2,748,057, INT. CL. 7.
- PRIMION TECHNOLOGY AG, 72510 STETTEN, FED REP GERMANY:
2,745,857, PUB. 10-22-2002. MULTIPLE CLASS, INT. CLS. 9, 37 AND 42.
- PRINCE OF PEACE ENTERPRISES, INC., HAYWARD, CA:
2,747,411, PUB. 5-13-2003. INT. CL. 30.
- PRINCE SPORTS GROUP, INC., BORDENTOWN, NJ:
2,001,889, CANC. INT. CL. 28.
- PRINCESS CRUISES, INC., LOS ANGELES, CA:
1,717,264, CANC. INT. CL. 39.
- PRINCESS HOUSE, INC., TAUNTON, MA:
1,230,855, REN. 6-24-03. INT. CL. 21.
- PRINTCAFE IP MANAGEMENT, INC., PITTSBURGH, PA:
2,747,188, PUB. 5-13-2003. INT. CL. 42.
- PRINTERON CORPORATION, ONTARIO, CANADA:
2,705,065, COR. MULTIPLE CLASS, INT. CLS. 9, 35, 38 AND 42.
- PRINTEX PACKAGING CORPORATION, HAUPPAUGE, NY:
2,746,986, PUB. 5-13-2003. MULTIPLE CLASS, INT. CLS. 20, 40 AND 42.
- PRINTING INDUSTRIES OF AMERICA, ALEXANDRIA, VA:
1,716,980, CANC. INT. CL. 42.
- PRIORITY FULFILLMENT SERVICES, INC., PLANO, TX:
2,748,162, INT. CL. 35.
- PRIORITY ONE INTERNATIONAL, INC., PLANO, TX:
2,746,150, PUB. 10-8-2002. MULTIPLE CLASS, INT. CLS. 9, 16, 41 AND 45.
- PRISM ENTERPRISES, L.P., SAN ANTONIO, TX, PRISM TECHNOLOGIES, CHICAGO, IL:
1,784,015, REN. 6-24-03. INT. CL. 10.
- PRISM VISUAL SOFTWARE, INC., PORT WASHINGTON, NY:
2,746,256, PUB. 10-29-2002. INT. CL. 9.
- PRISON FELLOWSHIP MINISTRIES, WASHINGTON, DC:
2,001,582, CANC. INT. CL. 16.
- PRL USA HOLDINGS, INC., WILMINGTON, DE, KAPLAN, CO-TRUSTEES OF THE RALPH LAUREN TRUST OF 9/21/76; MARK N., NEW YORK, NY:
1,259,033, REN. 6-23-03. INT. CL. 3.
- PRO TAPES & SPECIALTIES, INC., EDISON, NJ:
2,001,674, CANC. INT. CL. 17.
2,001,679, CANC. INT. CL. 17.
2,001,689, CANC. INT. CL. 17.
- PRO-FOOTBALL, INC., ASHBURN, VA:
1,228,991, REN. 6-24-03. INT. CL. 41.
- PROCESADORA LAGO MAR, C.A., MARACAIBO EDO., VENEZUELA:
2,748,921, INT. CL. 29.
- PROCESS & TECHNOLOGY CORPORATION, MIAMI, FL:
2,748,929, INT. CL. 9.
- PROCHROM, CHAMPIGNEULLES, FRANCE:
2,745,455, PUB. 6-18-2002. MULTIPLE CLASS, INT. CLS. 1, 9, 40 AND 42.
- PROCTER & GAMBLE COMPANY, THE, CINCINNATI, OH:
1,773,806, REN. 6-21-03. INT. CL. 32.
2,001,913, CANC. INT. CL. 30.
2,001,914, CANC. INT. CL. 30.
2,748,846, INT. CL. 3.
2,748,847, INT. CL. 3.
- PRODEMA, S.A., LEGORRETA, GUIPUZCOA, SPAIN:
2,747,260, PUB. 5-13-2003. INT. CL. 19.
- PRODUCT QUEST MANUFACTURING, INC., DAYTONA BEACH, FL:
2,746,578, PUB. 5-13-2003. INT. CL. 5.
- PRODUCTS & VENTURES INTERNATIONAL, INC., SANTA BARBARA, CA:
2,748,691, INT. CL. 20.
- PRODUCTWORKS LLC, DEERFIELD, IL:
2,747,238, PUB. 5-13-2003. INT. CL. 11.
- PROEIN SA, 28001, MADRID, SPAIN:
2,747,737, INT. CL. 16.
- PROFESSIONAL LEARNING NETWORK, LLC, GREENWICH, CT:
2,746,318, PUB. 5-13-2003. INT. CL. 41.
- PROFESSIONAL PRODUCT RESEARCH, INC., BROOKLYN, NY:
1,715,835, CANC. INT. CL. 21.
- PROFESSIONAL TRADE SHOWS, INC., FREMONT, CA:
1,716,386, CANC. INT. CL. 35.
- PROFESSIONAL'S EDUCATION NETWORK, INC., THE, PRINCETON, NJ:
2,001,121, CANC. INT. CL. 16.
- PROFESSIONAL TRADE SHOWS, INC., FREMONT, CA:
1,716,387, CANC. INT. CL. 35.
- PROFIT ENHANCEMENT GROUP, INC., THE, MARINA DEL REY, CA:
2,745,421, PUB. 9-24-2002. INT. CL. 41.
- PROGRESSIVE TOOL & INDUSTRIES CO., SOUTHFIELD, MI:
2,748,296, INT. CL. 7.
- PROJECT E, INC., ATLANTA, GA:
2,001,629, CANC. INT. CL. 25.
- PROLAMSA, INC., STAFFORD, TX:
2,748,851, INT. CL. 6.
- PROLMAN, MICHAEL, NEEDHAM, MA:
2,748,653, INT. CL. 25.
- PROMEGA CORPORATION, MADISON, WI:
1,714,817, CANC. INT. CL. 1.
2,001,419, CANC. INT. CL. 1.
- PROMOSQUAD LLC, SARATOGA SPRINGS, NY:
2,748,658, INT. CL. 35.
- PROMOTIONAL PRODUCTS ASSOCIATION INTERNATIONAL, IRVING, TX:
2,749,049, INT. CL. 35.
- PROPARK, INC., HARTFORD, CT:
2,746,967, PUB. 5-13-2003. INT. CL. 9.
- PROPHARMA, INC., MIAMI, FL:
1,207,820, CANC. INT. CL. 5.
- PROTEC MANUFACTURING INC., CALGARY, ALBERTA, T2H 0T3, CANADA:
2,747,668, INT. CL. 35.
- PROTECTION ONE ALARM MONITORING INC., IRVING, TX, DYNAMARK SECURITY CENTERS, INC., HAGERS-TOWN, MD:
1,761,698, REN. 6-27-03. INT. CL. 37.
- PROTECTION ONE ALARM MONITORING, INC., IRVING, TX:
2,746,659, PUB. 5-13-2003. MULTIPLE CLASS, INT. CLS. 37 AND 45.
2,746,660, PUB. 5-13-2003. MULTIPLE CLASS, INT. CLS. 37 AND 45.
2,746,730, PUB. 5-13-2003. MULTIPLE CLASS, INT. CLS. 37 AND 45.
- PROTECTION TECHNOLOGY RESOURCES, LTD., LAS VEGAS, NV:
2,000,922, CANC. INT. CL. 42.
- PROTEON, INC., WALTHAM, MA:
1,208,027, CANC. INT. CL. 9.
- PROTON ENGINEERING INC., PALM CITY, FL:
2,000,526, CANC. INT. CL. 4.
- PROXIMION FIBER OPTICS AB, KISTA, SWEDEN:
2,747,057, PUB. 5-13-2003. INT. CL. 9.
- PRUDENTIAL INSURANCE COMPANY OF AMERICA, NEWARK, NY:
1,208,974, CANC. INT. CL. 36.
- PRUDENTIAL INSURANCE COMPANY OF AMERICA; THE, NEWARK, NJ:
1,208,977, CANC. INT. CL. 36.
- PRUDENTIAL INSURANCE COMPANY OF AMERICA, THE, NEWARK, NJ:
2,637,953, COR. MULTIPLE CLASS, INT. CLS. 35 AND 36.
2,747,132, PUB. 8-13-2002. MULTIPLE CLASS, INT. CLS. 36 AND 41.
- PRUFTECHNIK DIETER BUSCH AG, ISMANING, BAVARIA D 85737, FED REP GERMANY:
2,748,006, INT. CL. 9.

- PSYCHOLOGICAL CORPORATION, THE, SAN ANTONIO, TX:
2,745,897, PUB. 5-13-2003. INT. CL. 16.
2,747,294, PUB. 5-13-2003. INT. CL. 16.
- PUBLISHER'S DEVELOPMENT CORPORATION, SAN DIEGO, CA:
2,746,071, PUB. 12-10-2002. MULTIPLE CLASS, INT. CLS. 35 AND 42.
- PUEBLO MILLWORK, INC., GLENDALE, AZ:
2,001,867, CANC. INT. CL. 19.
- PUGH, KENNETH, DURHAM, NC, DBA PUGH-KILLEEN ASSOCIATES:
2,000,534, CANC. INT. CL. 42.
- PUJALS, EDUARDO FERNANDEZ, 28020 MADRID, SPAIN:
2,748,166, INT. CL. 34.
- PULP AND PAPER RESEARCH INSTITUTE OF CANADA/ INSTITUT CANADIEN DE RECHERCHES SUR LES PATES ET PAPIERS, QUEBEC, CANADA:
2,747,985, INT. CL. 42.
- PUMP SERVICES, INC., WEST MONROE, LA:
1,767,209, REN. 6-24-03. INT. CL. 7.
- PUMPERNICKEL ASSOCIATES, LLC, RICHMOND HEIGHTS, MO:
2,746,495, PUB. 5-13-2003. INT. CL. 41.
- PURAFIL, INC., DORAVILLE, GA:
2,748,275, INT. CL. 11.
- PURATOS BAKERY SUPPLY, INC., CHERRY HILL, NJ FROM FISHER MILLS, INC., SEATTLE, WA:
2,745,937, PUB. 10-15-2002. INT. CL. 29.
- PURE TECHNOLOGY, INC., SPRINGFIELD, MO:
2,001,387, CANC. INT. CL. 7.
- PURE WATER CORPORATION, SEATTLE, WA:
1,714,809, CANC. MULTIPLE CLASS, INT. CLS. 1 AND 32.
- PURPLE PEBBLE GAMES, L.L.C., MARBLEHEAD, MA:
2,748,558, INT. CL. 28.
- PYRAMID ELECTRIC SERVICE INC., MASSAPEQUA, NY:
2,746,695, PUB. 5-13-2003. INT. CL. 37.
- PYTHON USA, INC., TONAWANDA, NY:
2,000,926, CANC. INT. CL. 12.
- PYUNGHWA INDUSTRIAL CO., LTD., GIJANG-GUN BUSAN, REPUBLIC OF KOREA:
1,238,606, REN. 6-23-03. INT. CL. 28.
- P4 GROUP, LLC, DENVER, CO:
2,746,758, PUB. 5-13-2003. INT. CL. 12.
- P45 L.L.C., CHICAGO, IL FROM PHOEBE 45, L.L.C., CHICAGO, IL:
2,747,590, INT. CL. 25.
- Q RECORDS & TAPES, INC., MIAMI, FL TO OVC, INC., WEST CHESTER, PA:
1,716,625, CANC. MULTIPLE CLASS, INT. CLS. 41 AND 42.
- QANTEL BUSINESS SYSTEMS, INC., HAYWARD, CA:
1,207,922, CANC. INT. CL. 9.
- QUAKER HILL FARMS, INC., VERONA, NJ:
2,746,268, PUB. 10-29-2002. INT. CL. 30.
- QUAKER STATE CORPORATION, OIL CITY, PA:
2,000,721, CANC. MULTIPLE CLASS, INT. CLS. 37, 39, 40 AND 42.
- QUALCOMM INCORPORATED, SAN DIEGO, CA:
2,747,573, INT. CL. 9.
2,748,643, INT. CL. 42.
- QUALITY CARE SOLUTIONS INC., PHOENIX, AZ:
2,748,623, INT. CL. 9.
- QUALITY CLEANING FLUID CO., INC., FRANKLIN PARK, IL:
1,715,036, CANC. INT. CL. 7.
- QUALITY DECISION MANAGEMENT, INC., NORTH ANDOVER, MA:
1,716,797, CANC. INT. CL. 42.
- QUALITY HEALTH PRODUCTS, INC., BELLPORT, NY, FEMINIQUE PRODUCTS CORPORATION, EDISON, NJ:
1,203,338, REN. 6-22-03. INT. CL. 5.
- QUALYS, INC., REDWOOD SHORES, CA:
2,746,403, PUB. 5-13-2003. INT. CL. 45.
- QUESOS FORLASA, S.A., 02600 - VILLARROBLEDO (ALBACETE), SPAIN:
2,745,702, PUB. 4-30-2002. INT. CL. 29.
- QUEST SOFTWARE, INC., NEWPORT BEACH, CA:
2,745,496, PUB. 11-26-2002. INT. CL. 9.
- QUESTAR DATA SYSTEMS, INC., EAGAN, MN:
2,746,829, PUB. 5-13-2003. INT. CL. 35.
- QUICK CHICK RACING, LLC., BROOMFIELD, CO:
2,748,917, INT. CL. 25.
- QUICK SCAN, INC., PLANTATION, FL:
2,001,431, CANC. INT. CL. 9.
2,001,432, CANC. INT. CL. 9.
- QUICKSET INTERNATIONAL, INC., NORTHBROOK, IL:
2,747,150, PUB. 5-13-2003. INT. CL. 9.
- QUIES CORP, SALT LAKE CITY, UT:
2,000,762, CANC. INT. CL. 9.
- QUIET CORE, INC., BETHLEHEM, PA:
1,778,944, REN. 6-27-03. INT. CL. 17.
- QUIKRETE COMPANIES, INC., THE, ATLANTA, GA, QUIKRETE COMPANIES, THE, ATLANTA, GA:
1,740,593, REN. 6-22-03. INT. CL. 19.
- QUIKSILVER, INC., HUNTINGTON BEACH, CA:
2,748,895, INT. CL. 41.
- QUIMBY, WILLIAM S., RAMSEY, NJ:
2,002,016, CANC. INT. CL. 35.
2,002,017, CANC. INT. CL. 35.
2,002,018, CANC. INT. CL. 35.
2,002,019, CANC. INT. CL. 35.
- QUINTON INSTRUMENT CO., SEATTLE, WA:
1,208,068, CANC. INT. CL. 10.
- QUITA KILOS, S.A. DE C.V., MONTERREY, NUEVO LEON, MEXICO:
2,747,818, INT. CL. 42.
- QUIZNO'S MASTER LLC, THE, DENVER, CO, JOLLES, BERNARD, PHILADELPHIA, PA, DBA BAIN'S CAFETERIA:
959,079, REN. 6-26-03. U.S. CL. 100 (INT. CL. 42).
- QVC, INC., WEST CHESTER, PA:
2,001,838, CANC. INT. CL. 25.
2,746,034, PUB. 5-13-2003. INT. CL. 14.
2,748,269, INT. CL. 8.
2,748,284, INT. CL. 25.
2,748,392, INT. CL. 25.
2,748,420, INT. CL. 14.
- R & D INDUSTRIES, INC., BELLEVUE, WA:
2,000,543, CANC. INT. CL. 42.
- R & D PRODUCTS, INC., DOYLESTOWN, PA:
1,208,300, CANC. INT. CL. 16.
- R & M ITALIA S.P.A., 30020 QUARTO D'ALTINO (VE), ITALY:
2,745,515, PUB. 10-15-2002. MULTIPLE CLASS, INT. CLS. 6 AND 11.
- R. & A. BAILEY & CO., DUBLIN, IRELAND:
2,001,080, CANC. INT. CL. 33.
- R. H. MACY & CO., INC., NEW YORK, NY:
159,030, CANC. U.S. CL. 42.
- R. L. POLK & CO., DETROIT, MI:
2,001,305, CANC. INT. CL. 9.
- R. L. POLK & CO., SOUTHFIELD, MI:
2,688,189, COR. MULTIPLE CLASS, INT. CLS. 9, 16, 35, 39, 41 AND 42.
- R. W. BECKETT CORPORATION, ELYRIA, OH:
970,198, REN. 6-26-03. U.S. CL. 34 (INT. CL. 11).
- R.D. RYAN & ASSOCIATES, INC., MCLEAN, VA:
2,001,103, CANC. INT. CL. 30.
- R.J. RUDDEN ASSOCIATES, INC., HAUPPAUGE, NY:
2,748,169, MULTIPLE CLASS, INT. CLS. 35, 36, 39 AND 42.
- R.R.C.B. LLC, SAN DIEGO, CA:
2,747,877, INT. CL. 35.
- R.T. NIELSON COMPANY, SALT LAKE CITY, UT:
2,745,763, PUB. 2-19-2002. MULTIPLE CLASS, INT. CLS. 35 AND 42.
- R&R CONCEPTS, INC., NORTH PRAIRIE, WI:
2,748,886, INT. CL. 28.
- RACAL AIRSTREAM, INC., ROCKVILLE, MD:
1,207,948, CANC. INT. CL. 9.
- RACHEL SIEGEL AND NATALIA REICHER PARTNERSHIP, THE, OAKLAND, CA, DBA SPRUCE:
2,747,105, PUB. 5-13-2003. INT. CL. 42.

- RACING PRODUCTS GROUP, INC., WOODINVILLE, WA:
2,747,177, PUB. 5-13-2003. INT. CL. 9.
- RACING RADIOS, INC., FOREST PARK, GA:
2,000,805, CANC. MULTIPLE CLASS, INT. CLS. 9 AND 41.
- RADIAN GROUP INC., PHILADELPHIA, PA:
2,747,020, PUB. 5-13-2003. INT. CL. 36.
- RADICA CHINA LTD., ROAD TOWN, TORTOLA, BR. VIRGIN ISLANDS:
2,748,441, INT. CL. 28.
- RADIO FREQUENCY SYSTEMS, INC., MERIDEN, CT:
1,764,150, REN. 6-27-03. INT. CL. 9.
- RAFFINERIE TIRLEMONTAISE S.A., EN NEERLANDAIS TIENSE SUIKERAFFINADERIJ N.V., 1150 BRUXELLES (WOLUWE-SAINT-PIERRE), BELGIUM:
2,745,482, PUB. 1-21-2003. MULTIPLE CLASS, INT. CLS. 5, 29, 30 AND 31.
- RAFT, INC., SAN JOSE, CA:
2,746,534, PUB. 5-13-2003. MULTIPLE CLASS, INT. CLS. 37 AND 41.
2,746,535, PUB. 5-13-2003. MULTIPLE CLASS, INT. CLS. 37 AND 41.
- RAGDOLL LIMITED, BUCKINGHAMSHIRE, SLO ONH, ENGLAND:
2,745,636, PUB. 5-13-2003. MULTIPLE CLASS, INT. CLS. 3, 9, 16, 18, 21 AND 41.
- RAGSDALE, SCOTT D., SAN RAFAEL, CA:
2,747,152, PUB. 5-13-2003. INT. CL. 35.
- RAINBOW PLAY SYSTEMS, INC., PRIOR LAKE, MN:
2,001,884, CANC. INT. CL. 28.
- RAINIER CASE MANAGEMENT, INC., VANCOUVER, WA:
2,747,073, PUB. 2-26-2002. INT. CL. 42.
- RALCORP HOLDINGS, INC., ST. LOUIS, MO, RALSTON PURINA COMPANY, ST. LOUIS, MO:
1,753,343, REN. 6-23-03. INT. CL. 30.
- RALEY'S TM, INC., WEST SACRAMENTO, CA:
2,746,934, PUB. 5-13-2003. INT. CL. 16.
- RAM GOLF CORPORATION, MELROSE PARK, IL:
1,208,361, CANC. MULTIPLE CLASS, INT. CLS. 18, 25 AND 28.
1,208,720, CANC. INT. CL. 28.
- RAMPAGE LICENSING, LLC, NEW YORK, NY, RAMPAGE CLOTHING COMPANY, LOS ANGELES, CA:
1,762,936, REN. 6-24-03. INT. CL. 25.
- RAMPART CAPITAL CORPORATION, HOUSTON, TX:
2,747,652, MULTIPLE CLASS, INT. CLS. 35, 36, 41 AND 42.
- RAMSEY COMPANY, THE, MARLBORO, MA TO RAMSEY COMPANY, THE, MARLBORO, MA:
2,162,241, COR. INT. CL. 3.
2,162,242, COR. INT. CL. 3.
- RANDO MACHINE CORPORATION, MACEDON, NY:
1,207,995, CANC. INT. CL. 9.
- RANDOM HOUSE, INC., NEW YORK, NY:
2,747,872, MULTIPLE CLASS, INT. CLS. 9, 16 AND 41.
- RANDOM WALK COMPUTING, INC., NEW YORK, NY:
2,745,873, PUB. 11-5-2002. INT. CL. 42.
- RANPAK CORP., CONCORD TOWNSHIP, OH:
2,748,738, INT. CL. 16.
- RAPID MAT S.A.R.L., CH1006 LAUSANNE, SWITZERLAND FROM RAPID MAT, LLC, WASHINGTON, DC:
2,747,774, INT. CL. 19.
- RAPISCAN SECURITY PRODUCTS (U.S.A.), INC., HAWTHORNE, CA, IRT CORPORATION, SAN DIEGO, CA:
1,769,161, REN. 6-23-03. INT. CL. 9.
- RARE LIMITED, WARSICKSHIRE, ENGLAND, RARE COIN-IT, INC., MIAMI, FL:
1,754,550, REN. 6-25-03. INT. CL. 28.
- RASKIN BENEFITS ADVISORS, LLC, ROCKVILLE CENTRE, NY:
2,747,724, INT. CL. 36.
- RATH, MATTHIAS, NL-7609 KL ALMELO, NETHERLANDS:
2,745,533, PUB. 8-22-2000. MULTIPLE CLASS, INT. CLS. 5, 16 AND 41.
2,745,578, PUB. 12-3-2002. MULTIPLE CLASS, INT. CLS. 5, 16, 31, 41 AND 42.
2,747,589, INT. CL. 5.
- RATIONAL RECOVERY SYSTEMS, INC., LOTUS, CA:
2,748,644, INT. CL. 42.
- RATRIX ANALYTICS LLC, BEDMINSTER, NJ:
2,748,578, INT. CL. 35.
- RATTI S.P.A., 22070 GUANZATE (CO), ITALY:
2,745,928, PUB. 5-13-2003. MULTIPLE CLASS, INT. CLS. 24 AND 25.
- RAVELLA, JOSEPH A., ROUGEMONT, NC:
2,001,857, CANC. INT. CL. 5.
- RAVEN INDUSTRIES, INC., SIOUX FALLS, SD:
1,715,949, CANC. INT. CL. 25.
- RAYBESTOS-MANHATTAN, INC., TRUMBULL, CT TO RM INDUSTRIAL PRODUCTS COMPANY, INC., NORTH CHARLESTON, SC:
1,208,341, CANC. INT. CL. 17.
- RAYMOND A. PENDLETON & ASSOCIATES, INC., NEW ORLEANS, LA:
2,001,826, CANC. INT. CL. 42.
- RAYOVAC CORPORATION, MADISON, WI:
1,715,660, CANC. INT. CL. 16.
- RBC CENTURA BANKS, INC., ROCKY MOUNT, NC, CENTURA BANKS, INC., ROCKY MOUNT, NC:
1,675,581, REN. 6-22-03. INT. CL. 36.
1,697,078, REN. 6-22-03. INT. CL. 36.
- RE/MAX INTERNATIONAL, INC., GREENWOOD VILLAGES, CO:
2,747,212, PUB. 5-13-2003. INT. CL. 35.
2,748,981, INT. CL. 36.
- REACHHOME.COM INC., ENGLEWOOD CLIFFS, NJ:
2,745,658, PUB. 10-15-2002. MULTIPLE CLASS, INT. CLS. 35 AND 42.
- REACTION DESIGN, SAN DIEGO, CA:
2,746,988, PUB. 5-13-2003. INT. CL. 9.
- READER'S DIGEST ASSOCIATION, INC., THE, PLEASANTVILLE, NY:
1,715,687, CANC. INT. CL. 16.
- READING EXCELLENT AND DISCOVERY FOUNDATION, INC., NEW YORK, NY:
2,746,825, PUB. 5-13-2003. INT. CL. 41.
- READING IS FUNDAMENTAL, INC., WASHINGTON, DC:
1,773,246, REN. 6-23-03. INT. CL. 42.
- REAGAN, PHIL, CAZENOVIA, NY:
2,748,606, INT. CL. 41.
- REAL ESTATE LAW INSTITUTE, INC., SAN ANTONIO, TX:
1,766,297, REN. 6-23-03. INT. CL. 41.
- REALLY USEFUL GROUP LIMITED, THE, LONDON, WC2H 9NS, UNITED KINGDOM:
2,745,660, PUB. 8-27-2002. MULTIPLE CLASS, INT. CLS. 9, 16, 25 AND 41.
- REALWINWIN, INC., PHILADELPHIA, PA:
2,746,909, PUB. 5-13-2003. INT. CL. 35.
2,746,910, PUB. 5-13-2003. INT. CL. 35.
- RECKLEIN, MARY KATHERINE, TUCSON, AZ:
1,786,122, REN. 6-27-03. INT. CL. 14.
- RECTOR AND VISITORS OF THE UNIVERSITY OF VIRGINIA, CHARLOTTESVILLE, VA:
1,715,518, CANC. MULTIPLE CLASS, INT. CLS. 14, 16, 25 AND 41.
- RECTORSEAL CORPORATION, THE, HOUSTON, TX:
1,783,169, REN. 6-25-03. INT. CL. 1.
- RED CLOUD FILMS, LLC, TUCSON, AZ:
2,746,655, PUB. 5-13-2003. INT. CL. 36.
- RED KAP APPAREL CORP, INC., WILMINGTON, DE:
2,656,731, COR. INT. CL. 25.
- RED RIVER REVEL, SHREVEPORT, LA:
1,268,241, REN. 6-25-03. INT. CL. 41.
- RED ROCK CLOTHING COMPANY, LTD., MUTTONTOWN, NY:
2,747,076, PUB. 5-13-2003. INT. CL. 25.
- REDD PEST CONTROL COMPANY, INC., JACKSON, MS:
738,027, CANC. U.S. CL. 103.
- REDINGTON INC., BELLWOOD, IL:
737,848, CANC. U.S. CL. 23.
- REDOUND INDUSTRIES, INC., BROOKLYN, NY:
2,000,804, CANC. INT. CL. 17.

- REED ELSEVIER U.S. HOLDINGS INC., WILMINGTON, DE, N.V. UITGEVERSMMAATSCHAPPIJ ELSEVIER, AMSTERDAM, NETHERLANDS:
749,444. REN. 6-26-03. U.S. CL. 38 (INT. CL. 16).
- REEMAY, INC., OLD HICKORY, TN:
1,786,167. REN. 6-27-03. INT. CL. 24.
- REFERBACK LIMITED, DOUGLAS, UNITED KINGDOM:
2,746,023. PUB. 5-13-2003. INT. CL. 35.
- REFLEC PLC, WINSFORD, GREAT BRITAIN FROM VIEWERCOM LIMITED, EALING GREEN, ENGLAND:
2,746,115. PUB. 5-13-2003. MULTIPLE CLASS, INT. CLS. 9 AND 24.
- REGAN, LARA JO, LOS ANGELES, CA:
2,747,880. INT. CL. 28.
- REGENERON PHARMACEUTICALS, INC., TARRYTOWN, NY:
2,748,184. INT. CL. 42.
- REHAU INCORPORATED, LEESBURG, VA:
2,747,376. PUB. 5-13-2003. INT. CL. 17.
2,747,377. PUB. 5-13-2003. INT. CL. 17.
- REIKER COMPANY, THE, SHALIMAR, FL:
2,748,260. INT. CL. 11.
- RELATIONAL TECHNOLOGY SYSTEMS, INC., WALTHAM, MA:
2,001,831. CANC. INT. CL. 9.
2,001,832. CANC. INT. CL. 9.
2,001,833. CANC. INT. CL. 9.
- RELIANCE SUPPLY COMPANY, POMPANO BEACH, FL:
2,000,776. CANC. INT. CL. 2.
- RELIANT RESOURCES, INC., HOUSTON, TX FROM RELIANT ENERGY, INCORPORATED, WILMINGTON, DE:
2,747,525. INT. CL. 35.
- REMO, INC., VALENCIA, CA:
2,747,924. INT. CL. 15.
2,748,570. MULTIPLE CLASS, INT. CLS. 15, 41 AND 42.
- RENEGADE THERAPEUTICS INC., NEW YORK, NY:
2,748,731. INT. CL. 42.
- RENNER SMITH MANUFACTURING, INC., MILWAUKEE, WI:
1,207,887. CANC. INT. CL. 7.
- REPUBLIC CLOTHING CORPORATION, NEW YORK, NY:
2,745,689. PUB. 11-26-2002. INT. CL. 25.
- REPUBLIC GROUP CORPORATION, THE, ARLINGTON, VA:
1,773,241. REN. 6-27-03. INT. CL. 42.
- RESCUE PHONE, INC., CROFTON, MD:
2,745,840. PUB. 10-29-2002. INT. CL. 9.
- RESEARCH INSTITUTE, SAN DIEGO, CA:
2,747,321. PUB. 5-13-2003. INT. CL. 9.
- RESEARCH INSTITUTE OF AMERICA INC., NEW YORK, NY:
2,000,687. CANC. INT. CL. 9.
- RESEARCH-COTTRELL TECHNOLOGIES, INC., TUSTIN, CA, AKA KVB, INC.:
1,209,210. CANC. INT. CL. 42.
- RESINALL CORPORATION, SEVERN, NC:
1,792,271. REN. 6-21-03. INT. CL. 1.
- RESPIRONICS NOVAMETRIX, INC., PITTSBURGH, PA FROM NOVAMETRIX MEDICAL SYSTEMS INC., WALLINGFORD, CT:
2,746,096. PUB. 5-13-2003. INT. CL. 10.
- RESTON HOMEOWNER'S ASSOCIATION, RESTON, VA, DBA RESTON ASSOCIATION:
2,745,923. PUB. 5-13-2003. MULTIPLE CLASS, INT. CLS. 41 AND 42.
- RESTONIC CORPORATION, ROSEMONT, IL:
2,745,498. PUB. 11-5-2002. INT. CL. 20.
2,748,541. INT. CL. 20.
- RESTORAN ESTUDIO GIGANTE S.A., SANTIAGO, CHILE:
2,746,258. PUB. 4-22-2003. INT. CL. 43.
- RESULTSWARE LIMITED, SHREWSBURY, SHROPSHIRE, SY3 8RW, UNITED KINGDOM:
2,746,889. PUB. 5-13-2003. INT. CL. 35.
- RETAIL MARKETING NETWORK, INC., NORWALK, CT:
2,001,999. CANC. INT. CL. 35.
- REV-UP, INC., CORINTH, MS:
2,746,104. PUB. 5-13-2003. INT. CL. 5.
- REVCO D.S., INC., TWINSBURG, OH:
1,207,782. CANC. INT. CL. 5.
- REVOLUTIONARY COOLING SYSTEMS, INC., SALT POINT, NY:
2,748,933. INT. CL. 11.
- REVOLUTIONS, LTD., PITTSBURGH, PA:
2,000,651. CANC. INT. CL. 25.
- REWDALE PRECISION TOOLS PRIVATE LIMITED, BANGALORE, INDIA:
2,746,135. PUB. 5-13-2003. INT. CL. 7.
- REXNORD CORPORATION, MILWAUKEE, WI:
1,672,258. REN. 6-21-03. INT. CL. 42.
- REXNORD INDUSTRIES, INC., MILWAUKEE, WI, REXNORD CORPORATION, MILWAUKEE, WI:
1,769,187. REN. 6-24-03. INT. CL. 9.
- REXON INDUSTRIAL CORP., LTD., HSIEN, TAIWAN:
2,000,499. CANC. INT. CL. 11.
- REYNOLDS MEDICAL LIMITED, HERTFORD, HERTFORDSHIRE, ENGLAND:
1,237,188. REN. 6-27-03. INT. CL. 10.
- RGH ENTERPRISES, INC., TWINSBURG, OH:
2,745,852. PUB. 4-2-2002. INT. CL. 35.
- RHE HATCO INC, GARLAND, TX, CHARLIE 1 HORSE HAT COMPANY, BATAVIA, IL:
1,824,477. REN. 6-25-03. INT. CL. 25.
- RHEE BROS., INC., COLUMBIA, MD:
2,000,561. CANC. INT. CL. 29.
- RHEINZINK GMBH & CO. KG, 45711 DATTELN, FED REP GERMANY:
2,746,668. PUB. 5-13-2003. INT. CL. 6.
- RHONE-POULENC RORER SA, 92160 ANTONY, FRANCE:
2,001,006. CANC. INT. CL. 5.
- RHONE-POULENC-TEXTILE, PARIS, FRANCE:
737,685. CANC. U.S. CL. 1.
- RIAC PRODUCT & MARKETING, INC., FORT COLLINS, CO:
1,717,099. CANC. INT. CL. 20.
- RICARD, PERNOD, 75008 PARIS, FRANCE:
2,745,733. PUB. 5-13-2003. INT. CL. 33.
- RICH INSULATION COMPANY, WINDHAM, ME:
1,208,355. CANC. INT. CL. 17.
- RICH LADDER COMPANY, CARROLLTON, KY:
1,208,431. CANC. INT. CL. 20.
- RICH STAR PRECISION INDUSTRIAL CO., LTD., TAICHUNG, TAIWAN:
2,748,542. INT. CL. 7.
- RICHARD A. VOIT, KETCHUM, ID, DORNAUS AND DIXON ENTERPRISES, CERRITOS, CA:
1,234,529. REN. 6-27-03. INT. CL. 13.
- RICHARD B. DAVIS CO., INC., SMITH RIVER, CA:
2,000,792. CANC. INT. CL. 42.
- RICHARD W. EASTMAN & SARAH WEBSTER-EASTMAN PARTNERSHIP, THE, CHESAPEAKE, VA, DBA FLAMING ASS DISTRIBUTORS:
2,000,857. CANC. INT. CL. 30.
- RICHLAND CALABASAS, L.P., SANTA ANA, CA:
2,748,164. INT. CL. 37.
- RICHMOND HILL-BRYAN COUNTY CHAMBER OF COMMERCE, RICHMOND HILL, GA:
2,747,026. PUB. 5-13-2003. INT. CL. 41.
- RICHMOND INTERNATIONAL RACEWAY, INC., RICHMOND, VA:
2,747,930. INT. CL. 28.
- RICHMOND NEWSPAPERS, INC., RICHMOND, VA:
2,001,146. CANC. INT. CL. 16.
- RIDE CONNECTION, INC., PORTLAND, OR:
2,746,984. PUB. 5-13-2003. INT. CL. 39.
- RIDGLASS MANUFACTURING COMPANY, INC., FRESNO, CA:
2,747,689. INT. CL. 19.
- RIEMERSCHMID; HEINRICH, MUNICH, FED REP GERMANY, DBA ANTON RIEMERSCHMID WEINBRENNER-EL:
1,208,839. CANC. INT. CL. 33.
- RIKA INTERNATIONAL LIMITED, OLDHAM GREATER MANCHESTER, ENGLAND:
2,746,043. PUB. 5-13-2003. INT. CL. 17.

- RIM - TECH A.S., 760 01 ZLIN, CZECH REPUBLIC:
2,745,740, PUB. 5-13-2003. MULTIPLE CLASS, INT. CLS. 1 AND 3.
- RINGS OF REFLECTION L.L.C., ANNAPOLIS, MD:
2,001,441, CANC. INT. CL. 14.
- RIORDAN SPORTS WAREHOUSE OUTLETS INC., CONCORD, ONTARIO, CANADA:
2,745,423, PUB. 5-13-2003. INT. CL. 35.
- RISK MANAGEMENT SOLUTIONS, INC., MENLO PARK, CA:
2,747,807, MULTIPLE CLASS, INT. CLS. 35, 36 AND 42.
- RIVERDEEP INTERACTIVE LEARNING LIMITED, DUBLIN 2, IRELAND FROM EDMARK CORPORATION, REDMOND, WA:
2,747,811, INT. CL. 9.
- RIVIERA MARINE (MFG.) PTY. LTD., COOMERA QUEENSLAND, AUSTRALIA:
2,746,791, PUB. 5-13-2003. INT. CL. 12.
- RK2, INC., ANN ARBOR, MI:
2,001,427, CANC. INT. CL. 9.
- RMR DISTRIBUTORS, INC., TAMPA, FL:
2,001,607, CANC. INT. CL. 25.
- RMRM, INC., DENVER, CO:
2,000,518, CANC. MULTIPLE CLASS, INT. CLS. 16 AND 39.
- RO-MAR TRANSPORTATION SYSTEMS, INC., CHICAGO, IL:
1,716,572, CANC. INT. CL. 39.
- RO/CO CHEMICAL SYSTEMS, INC., BRENTWOOD, MD:
1,209,072, CANC. INT. CL. 40.
- ROASTY'S RESTAURANT HOLDINGS LLC, HEWLETT, NY:
2,747,936, MULTIPLE CLASS, INT. CLS. 29 AND 42.
- ROBBINS INDUSTRIES, INC., FLORENCE, AL:
2,748,537, MULTIPLE CLASS, INT. CLS. 8 AND 21.
- ROBBINS, RACHEL, M, FORT COLLINS, CO:
2,747,395, PUB. 5-13-2003. INT. CL. 42.
- ROBERT A. HERSCH & ASSOCIATES, INC., MILWAUKEE, WI:
2,001,985, CANC. INT. CL. 25.
- ROBERT F. GROTTKAU, JR., NEW BERLIN, WI:
2,748,788, INT. CL. 12.
- ROBERT HOLT AND ADAMS SHIPMAN PARTNERSHIP, THE, NEEDHAM, MA:
1,717,047, CANC. INT. CL. 9.
- ROBERT PINO CENTER FOR GROWTH B.V., 2911 CD NIEUWERKERK A/D YSSEL, NETHERLANDS:
2,745,587, PUB. 5-13-2003. MULTIPLE CLASS, INT. CLS. 35 AND 41.
- ROBERT RIGSBY, N. FORT MYERS, FL, PURSLEY/RIGSBY, INC., BRADENTON, FL:
1,718,212, REN. 6-22-03. INT. CL. 21.
- ROBERT WOOD JOHNSON FOUNDATION, THE, PRINCETON, NJ:
2,746,472, PUB. 5-13-2003. INT. CL. 36.
- ROBERTO TRAVISIO, SAS, 10128 TORINO, ITALY:
2,746,563, PUB. 5-13-2003. INT. CL. 14.
- ROBERTS, KATHERINE, CAVE CREEK, AZ:
2,748,979, INT. CL. 9.
- ROBERTS, KEITH A., LITTLE CANADA, MN:
2,746,087, PUB. 12-24-2002. INT. CL. 3.
- ROBERTS, MATTHEW A, BRIDGEWATER, NJ:
2,748,903, INT. CL. 41.
- ROBINSON, KEITH, PONTIAC, MI:
2,748,394, INT. CL. 34.
- ROBYN ANN, INC., WEST COLUMBIA, SC:
1,209,263, CANC. INT. CL. 42.
- ROCCA ASSOCIATES, INC., PHILADELPHIA, PA:
2,748,982, INT. CL. 36.
- ROCCA S.P.A., 21018 SESTO CALENDE, VARESE, ITALY:
2,745,799, PUB. 5-13-2003. MULTIPLE CLASS, INT. CLS. 8 AND 14.
- ROCK BOTTOM STORES, INC., PORT WASHINGTON, NY:
1,209,184, CANC. INT. CL. 42.
- ROCKET SCIENCE GAMES, INC., SAN FRANCISCO, CA:
2,001,695, CANC. INT. CL. 28.
- ROCKWOOD, CLIFF H, WESTFORD, MA:
2,747,174, PUB. 5-13-2003. INT. CL. 37.
- RODAN & FIELDS, LLC, OAKLAND, CA:
2,746,592, PUB. 5-13-2003. MULTIPLE CLASS, INT. CLS. 3 AND 5.
- RODENSTOCK PRAZISIONSOPTIK, MUNCHEN, FED REP GERMANY, OPTISCHE WERKE G. RODENSTOCK, K.G., MUNICH 5, FED REP GERMANY:
1,193,535, REN. 6-22-03. INT. CL. 9.
- RODNEY LOOMIS, TRANSFER, PA, DBA LOOMCO INTERNATIONAL:
2,745,576, PUB. 8-29-2000. INT. CL. 16.
- RODRIGUEZ, ANDRES CANO, 11404 JEREZ DE LA FRONTERA (CADIZ), SPAIN:
2,000,496, CANC. INT. CL. 11.
- ROEBIC LABORATORIES, INC., ORANGE, CT:
1,237,922, REN. 6-24-03. INT. CL. 3.
- ROEHM ENZYME GMBH, D-64212 DARMSTADT, FED REP GERMANY, ROHM G.M.B.H., DARMSTADT, FED REP GERMANY:
1,244,022, REN. 6-25-03. INT. CL. 1.
- ROGER N. WRIGHT, INC., REXFORD, NY:
2,746,020, PUB. 5-13-2003. INT. CL. 41.
- ROGERS, CHARLES WILLIAM, HOUSTON, TX:
1,712,354, REN. 6-25-03. INT. CL. 41.
- ROLAND CORPORATION, OSAKA, JAPAN:
2,747,907, MULTIPLE CLASS, INT. CLS. 9 AND 16.
- ROLLER DERBY SKATE CORPORATION, LITCHFIELD, IL:
1,208,684, CANC. INT. CL. 28.
- ROLLERBALL INTERNATIONAL INC., LOS ANGELES, CA:
2,001,811, CANC. INT. CL. 28.
- ROMAINE PIERSON PUBLISHERS, INC., PORT WASHINGTON, NY:
1,208,206, CANC. INT. CL. 16.
- RONALD L. LYMAN, FOLSOM, CA:
1,716,033, CANC. INT. CL. 28.
- ROOMS TO GO INC, SEFFNER, FL, ROOMS TO GO INC, SEFFNER, FL:
1,801,702, REN. 6-25-03. INT. CL. 42.
- ROOTABAGA ENTERPRISES INCORPORATED, SEDRO-WOOLLEY, WA, DBA CF FRESH:
2,000,992, CANC. INT. CL. 31.
- ROSE ASSOCIATES, INC., NEW YORK, NY:
2,747,361, PUB. 5-13-2003. MULTIPLE CLASS, INT. CLS. 36 AND 37.
- ROSE INTERNATIONAL, INC., HOBOKEN, NJ:
1,716,587, CANC. INT. CL. 39.
- ROSEN SUNVISOR SYSTEMS, INC., EUGENE, OR FROM ROSEN PRODUCTS LLC, EUGENE, OR:
2,747,626, INT. CL. 12.
- ROSENBERG, WILBERT S., HOPE, RI:
2,747,364, PUB. 5-13-2003. INT. CL. 35.
- ROSKAM BAKING COMPANY, GRAND RAPIDS, MI:
2,747,484, INT. CL. 30.
- ROSSIGNOL SKI COMPANY, INC., WILLISTON, VT:
2,001,935, CANC. INT. CL. 28.
- ROSTON, LAVERNE, NEW YORK, NY:
1,716,823, CANC. INT. CL. 42.
- ROTEL AG, AARBURG, SWITZERLAND:
1,209,068, CANC. INT. CL. 40.
- ROTEL AG, 4663 AARBURG, SWITZERLAND:
1,715,032, CANC. MULTIPLE CLASS, INT. CLS. 7 AND 11.
- ROTHENBERGER WERKZEUGE-MASCHINEN GMBH, FRANKFURT AM MAIN, FED REP GERMANY:
1,207,699, CANC. INT. CL. 1.
- ROTO-JET OF AMERICA CO., INC., BURBANK, CA:
2,001,183, CANC. INT. CL. 7.
- ROTOVAC CORPORATION, REDMOND, WA:
2,746,133, PUB. 10-8-2002. INT. CL. 7.
- ROUSSEL-UCLAF, 75007 PARIS, FRANCE:
2,000,659, CANC. INT. CL. 5.
- ROUX LABORATORIES, INC., JACKSONVILLE, FL, DELUXOL LABORATORIES, INC., CHICAGO, IL:
1,236,958, REN. 6-27-03. INT. CL. 3.
- ROVER GROUP LIMITED, WARWICK, ENGLAND:
2,745,436, PUB. 10-1-2002. MULTIPLE CLASS, INT. CLS. 6, 14, 18 AND 25.

- ROWE, A. ALLEN, SAN DIEGO, CA:
 2,046,937, CANC. INT. CL. 9.
- ROWLAND WORLDWIDE INC, NEW YORK, NY, TA THE
 ROWLAND COMPANY:
 2,000,703, CANC. INT. CL. 35.
- ROXUL INC., MILTON, ONTARIO, CANADA:
 2,746,275, PUB. 11-19-2002. INT. CL. 17.
- ROYAL & SUNALLIANCE USA, INC., CHARLOTTE, NC:
 2,745,989, PUB. 5-13-2003. INT. CL. 36.
- ROYAL CONSUMER INFORMATION PRODUCTS, INC.,
 BRIDGEWATER, NJ FROM OLIVETTI OFFICE USA,
 INC., BRIDGEWATER, NJ:
 2,747,465, INT. CL. 9.
- ROYAL COUNTRY, INC., LOS ANGELES, CA:
 2,000,940, CANC. INT. CL. 3.
- ROYAL CROWN COMPANY, INC., FT. LAUDERDALE, FL:
 2,000,661, CANC. INT. CL. 32.
- ROYAL DOULTON (UK) LIMITED, STOKE-ON-TRENT,
 STAFFS ST1 5NN, UNITED KINGDOM, JOHN BESWICK
 LIMITED, LONGTON, STOKE-ON-TRENT, ENGLAND:
 959,819. REN. 6-27-03. MULTIPLE CLASS, U.S. CLS. 30
 (INT. CL. 21) AND 50 (INT. CL. 21).
- ROYAL FURNITURE COMPANY, MEMPHIS, TN:
 1,209,277, CANC. INT. CL. 42.
- ROYAL GROUP TECHNOLOGIES LIMITED, VAUGHAN,
 ONTARIO, CANADA:
 2,745,975, PUB. 6-11-2002. MULTIPLE CLASS, INT. CLS.
 17 AND 19.
- ROYAL GROUP, INC., CHARLOTTE, NC:
 2,000,929, CANC. INT. CL. 36.
- ROYAL ONTARIO MUSEUM, THE, TORONTO, ONTARIO
 M5S 2C6, CANADA:
 2,745,676, PUB. 5-13-2003. INT. CL. 28.
- ROYAL THOUGHTS, LLC, MINNEAPOLIS, MN:
 2,748,112, INT. CL. 38.
- RSA DATA SECURITY, INC., REDWOOD CITY, CA:
 2,001,312, CANC. INT. CL. 9.
- RSR LIMITED, CARDIFF CF23 8HE, UNITED KINGDOM:
 2,745,827, PUB. 11-12-2002. MULTIPLE CLASS, INT. CLS.
 5 AND 10.
- RSVP DEVELOPMENT CORP., CLEARWATER, FL:
 2,745,916, PUB. 5-13-2003. INT. CL. 35.
- RT FOODS, INC., SCOTTSDALE, AZ:
 2,747,242, PUB. 5-13-2003. INT. CL. 29.
- RTA WELDING S.A., MONTREUX, SWITZERLAND:
 1,207,991, CANC. INT. CL. 9.
- RTL 102.500 HIT RADIO S.R.L., 24121 BERGAMO, ITALY:
 2,745,717, PUB. 7-16-2002. MULTIPLE CLASS, INT. CLS.
 38 AND 41.
- RUDOLPH'S BAR-B-QUE, INC., MINNEAPOLIS, MN:
 1,209,317, CANC. INT. CL. 42.
- RUELLE, RON, ANTIOCH, TN:
 2,001,602, CANC. INT. CL. 16.
- RUG DOCTOR, L.P., PLANO, TX:
 2,747,284, PUB. 5-13-2003. INT. CL. 7.
- RUGBY-DARBY GROUP COMPANIES, INC., ROCKVILLE
 CENTRE, NY:
 1,209,272, CANC. INT. CL. 42.
- RUIZ-PICASSO, ANNE PALOMA, NEW YORK, NY:
 1,771,176, AM. MULTIPLE CLASS, INT. CLS. 9, 19 AND
 27.
- RUNDLE, SCOTT, LAKE ARROWHEAD, CA, DBA ALL
 SOURCE:
 2,748,913, INT. CL. 28.
 2,748,914, INT. CL. 28.
- RUSSELL ASSET MANAGEMENT, INC., WILMINGTON,
 DE, DESOTO HOSIERY MILLS, INC., FORT PAYNE, AL:
 1,826,428. REN. 6-24-03. INT. CL. 25.
- RUTH L. RATNY A U.S. CITIZEN, AS TRUSTEE OF THE
 RUTH LUCILLE RATNY, CHICAGO, IL:
 1,715,644, CANC. INT. CL. 16.
- RUTLAND FIRE CLAY COMPANY, RUTLAND, VT, DBA
 RUTLAND PRODUCTS:
 1,797,467. REN. 6-27-03. MULTIPLE CLASS, INT. CLS. 17
 AND 19.
 1,797,468. REN. 6-27-03. MULTIPLE CLASS, INT. CLS. 17
 AND 19.
- RX ON WHEELS, ALLEN PARK, MI:
 2,746,798, PUB. 5-13-2003. INT. CL. 39.
- RX REMEDY, INC., WESTPORT, CT:
 2,000,908, CANC. INT. CL. 35.
- RYAN CURTIS O'NEAL, LOS ANGELES, CA:
 2,747,336, PUB. 5-13-2003. INT. CL. 9.
- RYAN HOLDINGS LLC, NEW YORK, NY:
 2,747,931, INT. CL. 36.
- RYAN, MARK A., KENNEWICK, WA:
 2,000,984, CANC. INT. CL. 14.
- RYLAND ORGANIZATION COMPANY, CALABASAS, CA:
 2,748,515, INT. CL. 9.
- RYOHIN KEIKAKU CO., LTD., TOKYO, JAPAN:
 2,747,717, INT. CL. 35.
- S & S FIRESTONE, INC., LEXINGTON, KY:
 2,747,753, INT. CL. 12.
- S & W MANUFACTURING COMPANY, INC., BENSEN-
 VILLE, IL:
 2,745,901, PUB. 5-13-2003. MULTIPLE CLASS, INT. CLS. 7
 AND 17.
- S. C. JOHNSON COMMERCIAL MARKETS, INC., STURTE-
 VANT, WI:
 2,745,466, PUB. 11-26-2002. MULTIPLE CLASS, INT. CLS.
 3, 5 AND 21.
- S. PARKER HARDWARE MFG. CORP., ENGLEWOOD, NJ:
 1,714,999, CANC. INT. CL. 6.
- S. TOUS, S.L., 08240 MANRESA, SPAIN:
 2,746,232, PUB. 9-24-2002. INT. CL. 9.
- S.A. DYERS, LTD., CHESTERFIELD, MO FROM PLAID
 ENTERPRISES, INC., NORCROSS, GA:
 2,748,146, INT. CL. 16.
- S.D. WARREN SERVICES COMPANY, BOSTON, MA:
 2,746,200, PUB. 5-13-2003. MULTIPLE CLASS, INT. CLS.
 16 AND 42.
- S.L.E. FOUNDATION, INC., THE, NEW YORK, NY:
 2,747,887, INT. CL. 16.
- S.N.M. MANUFACTURING, INC., GRAHAM, NC:
 2,747,231, PUB. 5-13-2003. INT. CL. 7.
- S&A RESTAURANT CORP., PLANO, TX:
 2,746,714, PUB. 5-13-2003. INT. CL. 33.
- S&S BRANDS, INC., WILMINGTON, DE:
 2,748,523, INT. CL. 30.
- S-T-N HOLDINGS, INC., LAS VEGAS, NV, OSMOSE WOOD
 PRESERVING CO. OF AMERICA, INC., BUFFALO, NY:
 1,239,892. REN. 6-26-03. INT. CL. 2.
- SACAL, ELIAS, MEXICO CITY, MEXICO:
 2,748,756, INT. CL. 36.
- SAES GETTERS S.P.A., 20020 LAINATE, MILANO, ITALY:
 2,747,959, INT. CL. 17.
- SAFECO PLASTICS, INC., GARDEN GROVE, CA:
 2,000,610, CANC. MULTIPLE CLASS, INT. CLS. 16 AND
 28.
- SAFETY EXPRESS LTD., CANADA:
 2,745,557, PUB. 10-8-2002. INT. CL. 9.
- SAFEWAY INC., PLEASANTON, CA:
 2,000,773, CANC. INT. CL. 32.
- SAFINT B.V., 3012 AG ROTTERDAM, NETHERLANDS:
 2,014,690, CANC. INT. CL. 9.
- SAILERBRAU FRANZ SAILER, LEUTERSCHACH, FED
 REP GERMANY:
 1,212,638. REN. 6-24-03. INT. CL. 32.
- SAINT CHARLES INTERNATIONAL, INC., INDIANAPOLIS,
 IN:
 2,748,251, INT. CL. 3.
- SAKRETE, INC., CINCINNATI, OH, SAKRETE, INC., CIN-
 CINNATI, OH:
 568,874. REN. 6-25-03. U.S. CL. 12 (INT. CL. 19).
- SAKS & COMPANY, NEW YORK, NY:
 1,209,233, CANC. INT. CL. 42.
 1,209,234, CANC. INT. CL. 42.
 1,209,235, CANC. INT. CL. 42.
 2,000,505, CANC. INT. CL. 25.
- SALENTICA SYSTEMS INC., TORONTO, ONTARIO, CANA-
 DA:
 2,748,429, INT. CL. 9.
- SALES DYNAMICS INSTITUTE, INC., BALTIMORE, MD:
 1,209,153, CANC. INT. CL. 41.

- SALINEN AUSTRIA GESELLSCHAFT M.B.H., A-1010 WIEN, AUSTRIA, BIOSAXON-SALZ GESELLSCHAFT M.B.H., A-8990 BAD AUSSEE (STIEIERMARK), AUSTRIA: 1,668,141. REN. 6-22-03. INT. CL. 1.
- SALIX CORPORATION, DELRAY BEACH, FL: 2,747,342. PUB. 5-13-2003. INT. CL. 31.
- SALOMON S.A., 74370 METZ-TESSY, FRANCE: 2,746,725. PUB. 5-13-2003. INT. CL. 28.
- SALTON/MAXIM HOUSEWARES, INC., MT. PROSPECT, IL: 1,715,857. CANC. INT. CL. 21.
- SALUBA-TEKKO GMBH, D-79639, GRENZACH-WYHLEN, FED REP GERMANY, SALUBRA AG (SALUBRA SA) (SALUBRA LTD), BASEL, SWITZERLAND: 286,880. REN. 6-22-03. U.S. CL. 37 (INT. CL. 27).
- SAM JIN TRADING COMPANY, LTD., DONGDAEMUN-KU, SEOUL, REPUBLIC OF KOREA: 2,001,147. CANC. INT. CL. 29.
- SAMICK MUSIC CORPORATION, CITY OF INDUSTRY, CA: 2,749,031. INT. CL. 15.
2,749,032. INT. CL. 15.
- SAMSUNG ELECTRONICS CO., LTD., SUWON-CITY KYUNGKI-DO, REPUBLIC OF KOREA: 2,746,055. PUB. 5-13-2003. INT. CL. 9.
- SAMY MARK, INC., MIAMI, FL: 2,746,851. PUB. 5-13-2003. INT. CL. 44.
2,746,853. PUB. 5-13-2003. MULTIPLE CLASS, INT. CLS. 3 AND 21.
- SAN ANTONIO SPURS, L.L.C., SAN ANTONIO, TX: 2,748,978. INT. CL. 41.
- SAN CARLO GRUPPO ALIMENTARE S.P.A., MILANO, ITALY: 2,745,662. PUB. 11-12-2002. MULTIPLE CLASS, INT. CLS. 16, 25, 28, 29, 30, 32, 35, 41 AND 42.
- SAN DIEGO FORENSIC CONSULTANTS ASSOCIATION, EL CAJON, CA: 2,746,712. PUB. 5-13-2003. INT. CL. 35.
- SAN FRANCISCO LESBIAN, GAY, BISEXUAL, TRANSGENDER PRIDE CELEBRATION COMMITTEE, INC., SAN FRANCISCO, CA: 2,747,678. INT. CL. 16.
- SANCHO TRADING V.O.F., NETHERLD ANTILLES: 2,000,944. CANC. MULTIPLE CLASS, INT. CLS. 29 AND 30.
- SANDBERG & SIKORSKI DIAMOND CORPORATION, NEW YORK, NY: 2,748,331. INT. CL. 14.
- SANDERS INTERNATIONAL CORP., CREST HILL, IL: 1,715,442. CANC. INT. CL. 11.
- SANDHILLS PUBLISHING COMPANY, LINCOLN, NE, PEED CORPORATION, LINCOLN, NE: 1,774,228. REN. 6-21-03. INT. CL. 16.
- SANDHILLS PUBLISHING COMPANY, LINCOLN, NE: 2,746,421. PUB. 5-13-2003. MULTIPLE CLASS, INT. CLS. 16 AND 41.
- SANDOZ LTD. (SANDOZ A.G.), BASLE, SWITZERLAND: 1,208,814. CANC. INT. CL. 31.
- SANDSTORM ENTERPRISES, INC., CAMBRIDGE, MA: 2,747,071. PUB. 5-13-2003. INT. CL. 9.
- SANDVIK AB, S-811 81 SANDVIKEN, SWEDEN: 2,606,248. COR. INT. CL. 7.
- SANDVIK AB, SANDVIKEN, SWEDEN: 2,747,871. INT. CL. 9.
- SANRIO COMPANY, LTD., TOKYO 141, JAPAN: 2,000,913. CANC. INT. CL. 42.
2,747,571. INT. CL. 5.
- SANSEGAL SPORTSWEAR, INC., SANDY, UT: 2,748,059. INT. CL. 25.
- SANTANA PRODUCTS, INC., SCRANTON, PA: 1,772,990. REN. 6-27-03. INT. CL. 19.
- SANTILLANA USA PUBLISHING COMPANY, INC., MIAMI, FL: 2,746,381. PUB. 5-13-2003. INT. CL. 16.
2,746,382. PUB. 5-13-2003. INT. CL. 16.
- SANTINELLI INTERNATIONAL INC., HAUPPAUGE, NY: 1,715,092. CANC. INT. CL. 9.
- SANTINI FINE WINES, INC., SAN LORENZO, CA: 2,746,985. PUB. 5-13-2003. INT. CL. 33.
- SANTOON PRODUCTIONS INC., TARZANA, CA: 2,747,712. INT. CL. 9.
- SANUK ENTERPRISES, INC., NEW YORK, NY: 2,746,386. PUB. 5-13-2003. MULTIPLE CLASS, INT. CLS. 39 AND 43.
2,746,387. PUB. 5-13-2003. MULTIPLE CLASS, INT. CLS. 39 AND 43.
- SANYO MANUFACTURING CORPORATION, FORREST CITY, AR: 2,747,375. PUB. 5-13-2003. INT. CL. 9.
- SARA LEE CORPORATION, WINSTON-SALEM, NC: 2,747,545. INT. CL. 9.
2,748,736. INT. CL. 25.
- SARAMAR, L.L.C., DOVER, DE: 1,716,091. CANC. INT. CL. 29.
- SARGENTO FOODS INC., PLYMOUTH, WI: 1,716,136. CANC. MULTIPLE CLASS, INT. CLS. 29 AND 30.
- SASA GROUP, LLC, SAN DIEGO, CA: 2,748,313. INT. CL. 42.
- SASH MANAGEMENT L.L.C., BLUFFDALE, UT, DBA GIFT CHECK SOLUTIONS: 2,748,793. INT. CL. 35.
- SATNAM OVERSEAS LIMITED, NEW DELHI-110 048, INDIA: 2,746,189. PUB. 5-13-2003. INT. CL. 30.
- SATOR LASER GMBH, 22525 HAMBURG, FED REP GERMANY: 2,748,213. INT. CL. 9.
- SATSUMA TEA ROOM, LLC, NASHVILLE, TN: 2,001,149. CANC. INT. CL. 42.
- SAVE LUCY COMMITTEE, INC., MARGATE, NJ: 1,725,076. REN. 6-25-03. INT. CL. 8.
- SAVE-A-LOT FOOD STORES, INC., ST. LOUIS, MO, MORAN FOODS, INC., ST. LOUIS, MO: 1,773,785. REN. 6-21-03. INT. CL. 30.
- SAVECO, INC., PHILADELPHIA, PA: 2,000,488. CANC. INT. CL. 35.
- SAVIN CORPORATION, VALHALLA, NY: 1,208,040. CANC. INT. CL. 9.
- SAVISA (PTY) LTD, WINDEMEUL, SOUTH AFRICA: 2,748,150. MULTIPLE CLASS, INT. CLS. 32 AND 33.
- SAWIN COMPANY, NEW YORK, NY: 2,747,778. INT. CL. 36.
- SAWYER'S PEST CONTROL OF IDAHO, INC., BOISE, ID: 2,746,990. PUB. 5-13-2003. INT. CL. 37.
- SAXO BANK A/S, DK-2820 GENTOFTE, DENMARK: 2,746,090. PUB. 5-13-2003. INT. CL. 36.
2,746,547. PUB. 5-13-2003. INT. CL. 36.
- SCALA BUSINESS SOLUTIONS N.V., 107 JX AMSTERDAM, NETHERLANDS: 2,745,861. PUB. 5-13-2003. MULTIPLE CLASS, INT. CLS. 9 AND 16.
- SCAND TECH USA, L.L.C., SOUTH WINDSOR, CT: 2,746,123. PUB. 5-13-2003. INT. CL. 7.
- SCAPA GROUP PLC, BLACKBURN, LANCASHIRE, BB2 6AY, UNITED KINGDOM: 2,747,628. MULTIPLE CLASS, INT. CLS. 7 AND 24.
- SCAPES, LLC, SMYRNA, GA: 2,746,482. PUB. 5-13-2003. MULTIPLE CLASS, INT. CLS. 37, 42 AND 44.
- SCARLET CIRCLE MINISTRIES, MINNEAPOLIS, MN: 2,746,881. PUB. 5-13-2003. INT. CL. 45.
- SCARY STORIES, INC., NEW YORK, NY: 2,748,485. INT. CL. 16.
- SCEA DU CHATEAU DE BEAUREGARD, 33500 POMEROL, FRANCE: 2,746,391. PUB. 5-13-2003. INT. CL. 33.
- SCENIQUE TOYS, INCORPORATED, SAN FRANCISCO, CA: 1,717,144. CANC. INT. CL. 28.
- SCENT-SATION, INC., NEW YORK, NY: 2,747,277. PUB. 5-13-2003. INT. CL. 24.
- SCHAEFER VENTILATION EQUIPMENT, LLC, ST. COLUD, MN, SCHAEFER FAN CO., INC., ST. CLOUD, MN: 1,764,368. REN. 6-25-03. INT. CL. 11.
- SCHAFFEN INTERNATIONAL, INC., CHESHIRE, CT: 2,746,701. PUB. 5-13-2003. INT. CL. 35.

- SCHER, ROBERT, RANCHO PALOS VERDES, CA:
2,748,560, INT. CL. 20.
- SCHERING AKTIENGESELLSCHAFT, 13342 BERLIN, FED REP GERMANY:
2,745,517, PUB. 1-11-2000. INT. CL. 5.
- SCHERING AKTIENGESELLSCHAFT, BERLIN, FED REP GERMANY:
2,745,801, PUB. 10-8-2002. INT. CL. 5.
- SCHERING CORPORATION, KENILWORTH, NJ:
1,775,694, REN. 6-23-03. INT. CL. 5.
1,777,006, REN. 6-23-03. INT. CL. 5.
2,747,044, PUB. 5-13-2003. INT. CL. 5.
2,747,045, PUB. 5-13-2003. INT. CL. 5.
- SCHIFFER, ERIC M., WEST BLOOMFIELD, MI:
2,746,031, PUB. 5-13-2003. INT. CL. 41.
- SCHIMMEL GROUP, INC., THE, LITTLE ROCK, AR:
2,745,712, PUB. 9-17-2002. INT. CL. 28.
- SCHIPUL, RICHARD WAKEMAN, NEW MILFORD, CT:
2,746,751, PUB. 5-13-2003. INT. CL. 44.
- SCHLUMBERGER RESOURCE MANAGEMENT SERVICE INC., NORCROSS, GA:
1,715,331, CANC. INT. CL. 9.
- SCHLUMBERGER TECHNOLOGIES, INC., SAN JOSE, CA:
1,774,080, REN. 6-21-03. INT. CL. 9.
- SCHLUMBERGER TECHNOLOGY CORPORATION, HOUSTON, TX:
2,748,211, INT. CL. 9.
- SCHMALTZ, LARRY, KANSAS CITY, KS:
2,000,971, CANC. INT. CL. 41.
- SCHMIDT-PETERSEN, HELMUT, SANTA ROSA, CA:
2,001,205, CANC. INT. CL. 20.
- SCHNARCH, DAVID, EVERGREEN, CO:
2,747,462, INT. CL. 25.
- SCHNEIDER SA, F 92100 BOULOGNE BILLANCOURT, FRANCE:
2,745,506, PUB. 1-16-2001. MULTIPLE CLASS, INT. CLS. 6, 9, 11, 36, 37, 39 AND 42.
- SCHNEIDER, DAVID L., SAN DIEGO, CA:
2,746,821, PUB. 5-13-2003. INT. CL. 35.
- SCHNITZLBAUMER, HANS, 83052 BRUCKMUHL, FED REP GERMANY:
2,745,536, PUB. 12-4-2001. MULTIPLE CLASS, INT. CLS. 9 AND 16.
- SCHOCH, JUAN VICENTE, SOUTH DAYTONA, FL:
2,747,711, INT. CL. 42.
- SCHOLASTIC INC., NEW YORK, NY:
2,746,895, PUB. 5-13-2003. INT. CL. 41.
- SCHONFELD, MYRON, NEW YORK, NY:
2,747,632, INT. CL. 35.
- SCHOOL OF AMERICAN BALLET, INC., NEW YORK, NY:
2,001,685, CANC. INT. CL. 41.
- SCHOOL-LINK TECHNOLOGIES, INC., SANTA MONICA, CA:
2,748,710, INT. CL. 36.
- SCHRADER-BRIDGEPORT INTERNATIONAL, INC., DENVER, CO. BRIDGE PRODUCTS, INC., NORTHBROOK, IL:
1,725,002, REN. 6-22-03. INT. CL. 6.
- SCHUCK INDUSTRIES, INC., CELINA, OH:
2,001,329, CANC. INT. CL. 12.
- SCHULLER INTERNATIONAL, INC., DENVER, CO:
2,000,717, CANC. INT. CL. 19.
- SCHULTZ, MARK, CLINTON, NJ:
2,748,192, INT. CL. 36.
2,748,193, INT. CL. 36.
- SCHURHAMMER MANUFACTURING, INC., WABASHA, MN:
2,748,385, INT. CL. 14.
- SCHWAN-STABILO SCHWANHAEUSSER GMBH & CO., D-90562 HEROLDSBERG, FED REP GERMANY:
2,748,002, INT. CL. 16.
- SCHWAN'S SALES ENTERPRISES, INC., MARSHALL, MN:
1,208,783, CANC. INT. CL. 30.
- SCHWEIZERISCHE EFFEKTENBORSE (BOURSE SUISSE DE VALEURS MOBILIERES) (SWISS STOCK EXCHANGE) (BORSA VALORI SVIZZERA):
See—SWX SWISS EXCHANGE.
- SCI SYSTEMS, INC., HUNTSVILLE, AL:
2,746,591, PUB. 5-13-2003. INT. CL. 9.
- SCIMED LIFE SYSTEMS, INC., MAPLE GROVE, MN:
1,728,558, REN. 6-24-03. INT. CL. 10.
- SCINTO, GREGORY, SOUTH ORLEANS, MA:
2,747,559, INT. CL. 14.
- SCITECK, INC., ARDEN, NC:
2,747,330, PUB. 5-13-2003. INT. CL. 5.
- SCLC, INC., WILMINGTON, DE:
2,747,311, PUB. 5-13-2003. INT. CL. 35.
- SCOPE INC., SEOUL, REPUBLIC OF KOREA:
2,747,072, PUB. 10-22-2002. INT. CL. 9.
- SCOTT HAZELCORN MEMORIAL CHILDREN'S FOUNDATION, NEW YORK, NY:
2,746,831, PUB. 5-13-2003. MULTIPLE CLASS, INT. CLS. 36 AND 41.
- SCOTT PAINT COMPANY, SARASOTA, FL:
2,746,941, PUB. 5-13-2003. INT. CL. 2.
- SCOTT PAPER COMPANY, DELAWARE COUNTY, PA:
1,208,326, CANC. INT. CL. 16.
1,208,327, CANC. INT. CL. 16.
- SCOTT-LEVIN ASSOCIATES, INC., NEWTOWN, PA:
1,715,207, CANC. INT. CL. 9.
- SCOTT, MURDOCK, DALLAS, TX AND O'NEILL, SHAWN, LEWISVILLE, TX:
2,748,909, INT. CL. 9.
- SCR ELECTRIC, INC., WARREN, MI:
2,745,988, PUB. 5-13-2003. INT. CL. 37.
- SCREAMING CRAB PRODUCTIONS, ORANGE, CA:
2,001,732, CANC. MULTIPLE CLASS, INT. CLS. 9, 25 AND 41.
- SCREENY MEDIA S.A., 75010 PARIS, FRANCE:
2,745,818, PUB. 11-5-2002. MULTIPLE CLASS, INT. CLS. 9, 16, 28, 35, 38, 41 AND 42.
- SCREENY MEDIA S.A., 75010 PARIS, FRANCE:
2,745,817, PUB. 10-29-2002. MULTIPLE CLASS, INT. CLS. 9, 16, 28, 35, 38, 41 AND 42.
- SCREW MACHINE WORLD, INC., OAK FOREST, IL:
2,746,621, PUB. 5-13-2003. MULTIPLE CLASS, INT. CLS. 16 AND 41.
- SCRIBNER BOOK COMPANIES, INCORPORATED; THE, NEW YORK, NY:
1,208,274, CANC. INT. CL. 16.
1,208,275, CANC. INT. CL. 16.
- SCRIPTPRO, L.L.C., MISSION, KS, DISPENSING TECHNOLOGIES, INCORPORATED, MANHATTAN, KS:
1,797,550, REN. 6-23-03. INT. CL. 7.
- SDC INNOVATIONS, INC., DECATUR, GA:
2,746,805, PUB. 5-13-2003. INT. CL. 7.
- SDGI HOLDINGS, INC., WILMINGTON, DE, DANEK MEDICAL, INC., MEMPHIS, TN:
1,767,986, REN. 6-25-03. INT. CL. 10.
- SDI LEGRAND PUBLISHING, INC., JACKSONVILLE, FL:
2,746,116, PUB. 5-13-2003. MULTIPLE CLASS, INT. CLS. 9 AND 36.
- SEA CHANGE CORPORATION, MISSISSAUGA, ONTARIO, L5N 5R8, CANADA:
2,745,579, PUB. 5-13-2003. INT. CL. 9.
- SEA WORLD, INC., ST. LOUIS, MO:
2,001,342, CANC. INT. CL. 41.
2,747,333, PUB. 5-13-2003. INT. CL. 14.
- SEABURY & SMITH, INC., WASHINGTON, DC:
2,748,513, INT. CL. 36.
- SEALED POWER CORPORATION, MUSKEGON, MI:
1,207,900, CANC. INT. CL. 7.
- SEALMASTER INDUSTRIES, INC., SANDUSKY, OH:
2,746,379, PUB. 5-13-2003. MULTIPLE CLASS, INT. CLS. 2 AND 17.
- SEALY TECHNOLOGY LLC, TRINITY, NC:
2,747,155, PUB. 5-13-2003. INT. CL. 20.
- SEARFOSS, ROBERT, ATLANTA, GA:
2,748,827, INT. CL. 11.
- SEAROCK, INC., MIAMI, FL, AKA ALLIED MARINE COMPANY:
1,209,173, CANC. INT. CL. 42.
- SEARS, ROEBUCK AND CO., CHICAGO, IL:
737,822, CANC. U.S. CL. 22.

- SEARS, ROEBUCK AND CO., HOFFMAN ESTATES, IL:
2,748,026, INT. CL. 16.
2,748,536, INT. CL. 18.
2,748,806, INT. CL. 37.
- SEATTLE'S BEST COFFEE, INC., SEATTLE, WA:
1,716,205, CANC. INT. CL. 30.
- SEB, FRANCE:
2,745,669, PUB. 10-9-2001. MULTIPLE CLASS, INT. CLS. 7, 8 AND 21.
- SECRETARY OF STATE FOR DEFENCE IN HER BRITANNIC MAJESTY'S GOVERNMENT OF THE UNITED KINGDOM OF GREAT BRITAIN AND NORTHERN IRELAND, THE, LONDON SW1A 2HB, UNITED KINGDOM:
2,745,777, PUB. 12-17-2002. MULTIPLE CLASS, INT. CLS. 9, 16, 25, 28, 35, 38, 41 AND 42.
- SECTORAL ASSET MANAGEMENT INC., MONTREAL, QC H3A 3G4, CANADA:
2,746,417, PUB. 5-13-2003. INT. CL. 36.
- SECURELOGIX CORPORATION, SAN ANTONIO, TX:
2,748,024, INT. CL. 9.
- SECURITY APPLICATIONS, INC., FISHKILL, NY:
2,747,003, PUB. 5-13-2003. INT. CL. 9.
- SECURITY TECHNOLOGY VENTURES, LLC, SAN JOSE, CA:
2,748,443, INT. CL. 36.
- SEDUS STOLL AG, 79761 WALDSHUT-TIENGEN, FED REP GERMANY:
2,745,577, PUB. 10-1-2002. INT. CL. 20.
- SEGAL COMPANY (EASTERN STATES), INC., THE, NEW YORK, NY:
2,746,956, PUB. 5-13-2003. INT. CL. 9.
- SEIKO EPSON KABUSHIKI KAISHA, SHINJUKU-KU, TOKYO, JAPAN, TA SEIKO EPSON CORPORATION:
2,749,012, INT. CL. 9.
- SELLERS & JOSEPHSON INC., ST. LOUIS, MO:
1,768,602, REN. 6-21-03. INT. CL. 16.
- SELLING SOLUTIONS, INC., ATLANTA, GA:
1,717,105, CANC. INT. CL. 21.
- SELLSTROM MANUFACTURING CO., PALATINE, IL:
1,715,281, CANC. INT. CL. 9.
- SEMMEL, NEIL S., BEAR, DE:
2,746,859, PUB. 5-13-2003. INT. CL. 41.
- SEMORE INC., LOS ANGELES, CA:
2,747,956, INT. CL. 25.
- SENECA KNITTING MILLS CORPORATION, SENECA FALLS, NY:
159,104, CANC. U.S. CL. 39.
- SENKIR, DAMIEN, FONTANA, CA:
2,746,584, PUB. 5-13-2003. INT. CL. 25.
- SENN-DELANEY LEADERSHIP CONSULTING GROUP, INC., LONG BEACH, CA:
2,745,534, PUB. 12-31-2002. MULTIPLE CLASS, INT. CLS. 16 AND 42.
- SENNHEISER ELECTRONIC GMBH & CO. KG, 30900 WEDEMARK, FED REP GERMANY:
2,745,680, PUB. 10-8-2002. MULTIPLE CLASS, INT. CLS. 3, 9, 18, 21, 25, 28 AND 42.
- SENTIAT TECHNOLOGIES, INC., DALLAS, TX:
2,747,893, INT. CL. 42.
- SENTRY HARDWARE CORPORATION, DES PLAINES, IL:
1,208,319, CANC. INT. CL. 16.
- SEPHORA, 92300 LEVALLOIS-PERRET, FRANCE FROM SEPHORA HOLDING, 75009 PARIS, FRANCE:
2,745,684, PUB. 11-5-2002. MULTIPLE CLASS, INT. CLS. 3 AND 26.
- SEPHORA HOLDING:
See—SEPHORA.
- SERCOMP INC., KANSAS CITY, MO:
2,746,761, PUB. 5-13-2003. INT. CL. 37.
- SERENDIPITEA LIFE INC., RIDGEFIELD, CT, DBA SERENDIPITEA:
2,745,438, PUB. 5-8-2001. MULTIPLE CLASS, INT. CLS. 21 AND 30.
- SERVAAS LABORATORIES, INC., INDIANAPOLIS, IN:
1,207,760, CANC. INT. CL. 3.
- SERVICE EMPLOYEES INTERNATIONAL UNION, WASHINGTON, DC:
2,747,393, PUB. 5-13-2003. INT. CL. 35.
- SERVICE MERCHANDISE COMPANY, INC., BRENTWOOD, TN:
1,715,859, CANC. INT. CL. 21.
- SERVICYS INC., BANNOCKBURN, IL:
2,748,139, MULTIPLE CLASS, INT. CLS. 35 AND 41.
- SERVLET INC., YELLOW SPRINGS, OH:
2,745,935, PUB. 10-8-2002. MULTIPLE CLASS, INT. CLS. 36 AND 38.
- SETHI & SETHI INC., NEW YORK, NY:
2,747,069, PUB. 5-13-2003. INT. CL. 24.
- SETI INSTITUTE, MOUNTAIN VIEW, CA:
2,748,589, MULTIPLE CLASS, INT. CLS. 16, 25, 41 AND 42.
- SETON MEDICAL CENTER, DALY CITY, CA:
2,746,509, PUB. 5-13-2003. MULTIPLE CLASS, INT. CLS. 36 AND 41.
- SEW-EURODRIVE, INC., LYMAN, SC:
2,746,703, PUB. 5-13-2003. INT. CL. 7.
- SFX SPORTS GROUP, INC., SAN ANTONIO, TX:
2,746,937, PUB. 5-13-2003. INT. CL. 41.
- SGL CARBON AG, WIEBADEN, FED REP GERMANY, SIGRI ELEKTROGRAPHIT GMBH, MEITINGEN, FED REP GERMANY:
1,233,280, REN. 6-27-03. MULTIPLE CLASS, INT. CLS. 7, 9, 11 AND 17.
- SHA SHA FINE SHOES, INC., IRVINE, CA:
2,746,131, PUB. 8-27-2002. INT. CL. 25.
- SHABBY CHIC, INC., LOS ANGELES, CA:
2,746,924, PUB. 5-13-2003. INT. CL. 41.
- SHAH, SURENDRA, MELVILLE, NY:
2,746,705, PUB. 5-13-2003. INT. CL. 35.
- SHAKEN BABY ALLIANCE, THE, FORT WORTH, TX:
2,748,994, MULTIPLE CLASS, INT. CLS. 9, 16, 41 AND 42.
- SHAKESPEARE COMPANY, LLC, COLUMBIA, SC:
2,748,234, INT. CL. 22.
- SHAKY'S INCORPORATED, SOUTH SAN FRANCISCO, CA:
2,001,171, CANC. INT. CL. 42.
- SHAKLEE CORPORATION, PLEASANTON, CA FROM SHAKLEE CORPORATION, SAN FRANCISCO, CA:
2,747,631, INT. CL. 9.
- SHAMROCK DENTAL CO., INC., ST. PETE BEACH, FL:
2,746,741, PUB. 5-13-2003. INT. CL. 37.
- SHANDON SOUTHERN INSTRUMENTS LIMITED, RUNCORN, CHESHIRE, ENGLAND:
1,207,919, CANC. INT. CL. 9.
- SHANE, MICHAEL, DUNEDIN, FL:
2,748,726, INT. CL. 41.
- SHANGHAI BESTWAY PLASTIC PRODUCTS CO., LTD., SHANGHAI, 201812, CHINA:
2,748,177, MULTIPLE CLASS, INT. CLS. 9, 12, 20 AND 28.
- SHANTOU LONGFENG FOODSTUFF CO., LTD, SHANTOU, CHINA:
2,746,282, PUB. 5-13-2003. INT. CL. 29.
- SHAPES 30 MINUTE WORKOUT FOR WOMEN LIMITED LIABILITY COMPANY, YARDLEY, PA:
2,746,645, PUB. 5-13-2003. INT. CL. 35.
- SHARED MEDICAL SYSTEMS CORPORATION, KING OF PRUSSIA, PA:
1,208,885, CANC. INT. CL. 35.
- SHARP KABUSHIKI KAISHA, ABENO-KU, OSAKA, JAPAN, TA SHARP CORPORATION:
1,765,216, REN. 6-24-03. INT. CL. 9.
- SHAW INDUSTRIES, INC., DALTON, GA FROM SHAW INDUSTRIES, INC., DALTON, GA:
2,748,419, INT. CL. 27.
- SHAW WALLACE & COMPANY LIMITED, WEST BENGAL, INDIA:
2,748,266, INT. CL. 32.
- SHAW, JAMES G., CUPERTINO, CA, DBA SHAW RESOURCES:
1,801,048, REN. 6-24-03. INT. CL. 35.
- SHEAFFER EATON, INC., PITTSFIELD, MA:
1,208,289, CANC. INT. CL. 16.
- SHEARER, MARK, MORRISTOWN, NJ:
2,746,414, PUB. 5-13-2003. INT. CL. 41.

- SHEIKH, SHAHID A., SANTA MONICA, CA, DBA PRO-SERIES, ATHLETIC EQUIPMENT COMPANY:
2,550,248, COR. MULTIPLE CLASS, INT. CLS. 10 AND 25.
- SHELburne SHIRT CO., INC., NEW YORK, NY:
737,937, CANC. U.S. CL. 39.
- SHELBY WILLIAMS INDUSTRIES, INC., CHICAGO, IL:
1,208,433, CANC. INT. CL. 20.
- SHELDON MARKETING LLC, PRESCOTT VALLEY, AZ:
2,748,601, INT. CL. 3.
- SHEPHERD, COREY, ARVERN, NY:
2,748,499, INT. CL. 9.
- SHERIDAN RESEARCH COMPANY, WILMETTE, IL:
2,002,012, CANC. INT. CL. 35.
- SHERMAN, CLAY & CO., SAN BRUNO, CA:
1,826,669, REN. 6-24-03, INT. CL. 41.
- SHERWIN-WILLIAMS COMPANY, THE, CLEVELAND, OH:
2,748,621, INT. CL. 20.
- SHERWOOD DASH, INC., ONTARIO, CANADA:
2,747,920, INT. CL. 12.
- SHIELD-CALIFORNIA HEALTH CARE CENTER, INC., VALENCIA, CA:
2,746,826, PUB. 5-13-2003, INT. CL. 45.
- SHILOH FOODS, INC., SHILOH, TN:
1,716,204, CANC. INT. CL. 30.
- SHIMANO INC., OSAKA, JAPAN:
1,766,655, REN. 6-23-03, INT. CL. 12.
- SHIPLEY COMPANY, L.L.C., MARLBOROUGH, MA:
2,747,622, INT. CL. 1.
- SHIPPENSBURG UNIVERSITY OF PENNSYLVANIA, SHIPPENSBURG, PA:
2,746,441, PUB. 5-13-2003, INT. CL. 41.
2,746,442, PUB. 5-13-2003, INT. CL. 41.
- SHN, INC., PLYMOUTH, MN:
2,748,434, MULTIPLE CLASS, INT. CLS. 35 AND 36.
- SHOOTER TUTOR INC., EDMONTON, ALBERTA, CANADA:
2,000,568, CANC. INT. CL. 28.
- SHOPKO STORES, INC., GREEN BAY, WI:
2,747,798, MULTIPLE CLASS, INT. CLS. 35 AND 42.
- SHOWCASE ENTERPRISES, INC., MINNEAPOLIS, MN:
2,746,550, PUB. 5-13-2003, INT. CL. 41.
2,746,551, PUB. 5-13-2003, INT. CL. 41.
2,746,555, PUB. 5-13-2003, INT. CL. 41.
- SHOWTIME NETWORKS INC., NEW YORK, NY:
2,748,789, INT. CL. 41.
- SHURGARD INCORPORATED, SEATTLE, WA:
2,000,763, CANC. INT. CL. 16.
- SIDLEY & AUSTIN, CHICAGO, IL:
1,716,748, CANC. INT. CL. 42.
- SIEGEL LANDSCAPE SERVICES, INC., GETZVILLE, NY:
2,002,003, CANC. INT. CL. 37.
- SIEGLER, STEVEN N., NEW ORLEANS, LA:
2,000,618, CANC. INT. CL. 35.
- SIEMENS AKTIENGESELLSCHAFT, MUNICH, FED REP GERMANY:
2,745,509, PUB. 10-15-2002, MULTIPLE CLASS, INT. CLS. 37 AND 42.
- SIEMENS AKTIENGESELLSCHAFT, WITTELSBACHER-PLATZ 2, MUNICH, FED REP GERMANY:
2,745,553, PUB. 12-17-2002, MULTIPLE CLASS, INT. CLS. 9, 35, 37, 39, 41 AND 42.
- SIEMENS AKTIENGESELLSCHAFT, MUNICH, FED REP GERMANY:
2,745,637, PUB. 12-4-2001, INT. CL. 42.
2,745,645, PUB. 11-19-2002, INT. CL. 9.
- SIEMENS AKTIENGESELLSCHAFT, MUNCHEN, FED REP GERMANY:
2,745,758, PUB. 12-24-2002, INT. CL. 9.
- SIEMENS AKTIENGESELLSCHAFT, MUNICH, FED REP GERMANY:
2,745,920, PUB. 11-12-2002, INT. CL. 9.
- SIEMENS METERING AG, CH-6300 ZUG, SWITZERLAND:
2,745,570, PUB. 7-16-2002, MULTIPLE CLASS, INT. CLS. 9, 35, 37 AND 42.
- SIEMON COMPANY, THE, WATERTOWN, CT:
2,747,988, INT. CL. 36.
- SIFA SITZFABRIK GMBH, W-8458 SULZBACH-ROSENBERG, FED REP GERMANY:
2,001,374, CANC. INT. CL. 20.
- SIGMA ALPHA IOTA - INTERNATIONAL MUSIC FRATERNITY, ASHEVILLE, NC:
2,746,759, PUB. 5-13-2003, U.S. CL. 200.
- SIGMA DIVERSIFIED SPORTS, INC., MOJAVE, CA, AKA SIGMA GOLF COMPANY:
1,208,656, CANC. INT. CL. 28.
- SIGMA PHI EPSILON FRATERNITY, RICHMOND, VA:
573,579, REN. 6-25-03, U.S. CL. 100 (INT. CL. 42).
- SIGMA SYSTEMS ENGINEERING CO., LTD., TOKYO 169-0072, JAPAN:
2,746,088, PUB. 5-13-2003, INT. CL. 9.
- SIGNAL HILL, INC., WINNETKA, IL:
2,747,703, INT. CL. 35.
- SIGNCHEF, INC., FOLSOM, CA:
2,746,873, PUB. 5-13-2003, INT. CL. 40.
- SIGNHERE ONLINE, RIDGEFIELD, NJ:
2,748,825, INT. CL. 35.
- SIKKINK, TRACI, LOS ANGELES, CA:
2,748,015, INT. CL. 16.
- SIL-MED CORPORATION, TAUNTON, MA:
1,208,058, CANC. INT. CL. 10.
- SILENT WITNESS ENTERPRISES LTD., SURREY, BRITISH COLUMBIA V3S 4G5, CANADA:
2,749,028, INT. CL. 9.
- SILIKAL NORTH AMERICA, INC., HARTFORD, CT:
1,207,683, CANC. INT. CL. 1.
- SILVER SEAL PRODUCTS CO., INC., TRENTON, MI:
956,887, REN. 6-27-03, U.S. CL. 23 (INT. CL. 7).
- SILVER STAR CORP., NEW YORK, NY:
1,716,973, CANC. INT. CL. 42.
- SILVERSTREAM SOFTWARE, INC., BILLERICA, MA:
2,745,638, PUB. 4-2-2002, INT. CL. 9.
- SIMMERMAN, SCOTT J., TAYLORS, SC, DBA PERFORMANCE MANAGEMENT CO.:
2,746,019, PUB. 10-1-2002, INT. CL. 35.
- SIMMONDS HEALTHCARE, INC., MARIETTA, GA, SIMMONDS "S" CORPORATION, MERCER ISLAND, WA:
1,776,929, REN. 6-23-03, MULTIPLE CLASS, INT. CLS. 37 AND 42.
- SIMMONS MACHINE TOOL CORPORATION, ALBANY, NY:
1,764,061, REN. 6-21-03, INT. CL. 7.
- SIMON PARTNERSHIP, GRAND FORKS, BRITISH COLUMBIA, CANADA:
2,746,728, PUB. 5-13-2003, INT. CL. 41.
2,746,729, PUB. 5-13-2003, INT. CL. 41.
- SIMON PROPERTY GROUP, L.P., INDIANAPOLIS, IN:
2,746,921, PUB. 5-13-2003, INT. CL. 39.
- SIMON, DAVID F., GWYNEDD VALLEY, PA:
2,749,006, INT. CL. 42.
- SIMON, GUDRUN RIA, CUPERTINO, CA:
2,747,296, PUB. 5-13-2003, INT. CL. 28.
- SIMONSON, ROGER, CALGARY, ALBERTA T3H 1N1, CANADA:
2,745,422, PUB. 5-13-2003, INT. CL. 7.
- SIMPLIFIED ATHLETIC TECHNOLOGIES, LLC, SWARTHMORE, PA:
2,746,814, PUB. 5-13-2003, INT. CL. 42.
- SIMPLOT TURF AND HORTICULTURE, A DIVISION OF J.R. SIMPLOT COMPANY, BOISE, ID FROM ECO SOIL SYSTEMS, INC., SAN DIEGO, CA:
2,745,983, PUB. 12-10-2002, INT. CL. 1.
- SIMPLY FASHIONS STORE, LTD., BIRMINGHAM, AL:
2,748,500, INT. CL. 25.
- SIMPSON, JOHN H., EL MONTE, CA, DBA ON THE BALL:
2,000,787, CANC. INT. CL. 28.
2,000,788, CANC. INT. CL. 28.
2,000,789, CANC. INT. CL. 28.
2,000,909, CANC. MULTIPLE CLASS, INT. CLS. 25 AND 28.
- 2,001,050, CANC. MULTIPLE CLASS, INT. CLS. 25 AND 28.
- SIMPSON FINANCIAL, INC., NEW BRAUNFELS, TX, SIMPSON; ELWOOD JESSE BILL, PALOS VERDES, CA:
1,243,427, REN. 6-25-03, MULTIPLE CLASS, INT. CLS. 9,

- 12 AND 18.
SIMS AGRICULTURAL PRODUCTS CO., MT. GILEAD, OH:
1,714,852, CANC. INT. CL. 1.
SIMS PORTEX INC.:
See—PORTEX, INC.
SIMULA, INC., PHOENIX, AZ:
1,716,605, CANC. INT. CL. 40.
SIMULEARN, INC., WILTON, CT:
2,748,071, MULTIPLE CLASS, INT. CLS. 9, 35 AND 41.
SINGAPORE MERITUS INTERNATIONAL HOTELS PTE LTD., SINGAPORE, SINGAPORE, SMI HOTELS & RESORTS PTE LTD., SINGAPORE 0923, SINGAPORE:
1,767,815, REN. 6-23-03, MULTIPLE CLASS, INT. CLS. 35, 41 AND 42.
SINGH, MICHAEL TODD, PORTLAND, OR:
2,001,839, CANC. INT. CL. 9.
SINGLES IN AGRICULTURE, INC., STOCKTON, IL:
2,746,525, PUB. 5-13-2003, INT. CL. 45.
SINOHUI, ANDRES JR., BEAUMONT, CA:
2,748,288, INT. CL. 14.
SITECO BELEUCHTUNGSTECHNIK GMBH, 83295 TRAUNREUT, FED REP GERMANY:
2,745,447, PUB. 4-23-2002, MULTIPLE CLASS, INT. CLS. 9, 11 AND 42.
SIX FLAGS THEME PARKS, INC., OKLAHOMA CITY, OK, SIX FLAGS CORPORATION, LOS ANGELES, CA:
1,252,513, REN. 6-21-03, INT. CL. 41.
SIX FLAGS THEME PARKS, INC., ARLINGTON, TX, SIX FLAGS THEME PARKS, INC., ARLINGTON, TX:
1,794,449, REN. 6-21-03, INT. CL. 41.
SKATE ONE CORP., GOLETA, CA:
2,746,875, PUB. 5-13-2003, MULTIPLE CLASS, INT. CLS. 25, 28 AND 35.
SKINNY HAVEN, INC., ANAHEIM, CA:
1,208,742, CANC. MULTIPLE CLASS, INT. CLS. 29, 30 AND 42.
SKY WARRIORS, INC., ATLANTA, GA:
1,716,710, CANC. INT. CL. 41.
SKY-TOP SUNROOFS LTD., CLAYTON, MO:
1,208,141, CANC. INT. CL. 12.
SKYSHAPERS FITNESS FOUNDATION, INC., NEW YORK, NY:
2,746,647, PUB. 5-13-2003, MULTIPLE CLASS, INT. CLS. 9, 16 AND 41.
SL WABER, INC., MT. LAUREL, NJ:
1,715,342, CANC. INT. CL. 9.
SLEEP DISORDERS LABORATORY, EAST BRUNSWICK, NJ:
2,748,395, INT. CL. 42.
SMACK ON TIME PTY LIMITED, NORTH PARRAMALTA NSW 2151, AUSTRALIA:
2,745,958, PUB. 5-13-2003, INT. CL. 39.
SMART INDUSTRIES CORPORATION, DES MOINES, IA:
2,749,044, INT. CL. 9.
SMART MEALS, INC., HOUSTON, TX:
2,746,134, PUB. 7-2-2002, INT. CL. 29.
SMART MEDICAL SOFTWARE, LOS ANGELES, CA:
2,747,297, PUB. 5-13-2003, INT. CL. 9.
SMART VISIONS, INC., PORTLAND, OR:
2,747,595, INT. CL. 16.
SMARTER TIME CONCEPTS, INC., JACKSON, WY:
2,001,703, CANC. INT. CL. 35.
SMARTWOOL CORP., STEAMBOAT SPRINGS, CO:
2,748,939, INT. CL. 25.
SMEAD MANUFACTURING COMPANY, HASTINGS, MN:
2,748,241, MULTIPLE CLASS, INT. CLS. 9 AND 16.
SMEAD MANUFACTURING COMPANY, THE, HASTINGS, MN:
1,241,113, REN. 6-27-03, INT. CL. 16.
1,774,676, REN. 6-27-03, INT. CL. 16.
SMITH CORONA CORPORATION, NEW CANAAN, PA:
1,208,293, CANC. INT. CL. 16.
SMITH DETECTION-EDGEWOOD INC., EDGEWOOD, MD FROM ENVIRONMENTAL TECHNOLOGIES GROUP, INC., BALTIMORE, MD:
2,748,463, INT. CL. 9.
SMITH INTERNATIONAL, INC., HOUSTON, TX:
2,748,699, INT. CL. 7.
SMITH WEAVER SMITH, INC., INDIANAPOLIS, IN:
2,748,546, INT. CL. 35.
SMITH, CRAIG, SEATTLE, WA, DBA CORPORATE PHILANTHROPY REPORT TO CAPITOL PUBLICATIONS, INC., ALEXANDRIA, VA:
1,715,697, CANC. INT. CL. 16.
SMITH, DAVE, OSWEGO, IL:
2,746,553, PUB. 5-13-2003, INT. CL. 41.
SMITH, ROBERT D., BLAIRSVILLE, GA:
2,747,135, PUB. 5-13-2003, INT. CL. 6.
SMITH, ROBERT W., GULF BREEZE, FL:
2,746,273, PUB. 10-15-2002, INT. CL. 35.
SMITH, THIERRY M., AURORA, CO:
2,001,234, CANC. INT. CL. 41.
SMITH, WHIT H., LOS ANGELES, CA:
2,001,240, CANC. INT. CL. 14.
SMITHKLINE BEECHAM BIOLOGICALS S.A., RIXENSART, BELGIUM:
2,747,185, PUB. 5-13-2003, INT. CL. 5.
SMITHKLINE BEECHAM CORPORATION, PHILADELPHIA, PA:
2,001,095, CANC. INT. CL. 5.
2,001,098, CANC. INT. CL. 5.
2,745,663, PUB. 1-8-2002, INT. CL. 21.
SMOOTHIE KING FRANCHISES, INC., KENNER, LA:
2,748,190, INT. CL. 32.
2,748,575, INT. CL. 32.
SMOOTHKIN, INC., LONDONDERRY, NH:
2,746,852, PUB. 5-13-2003, INT. CL. 44.
SNEAK PEEK VIDEO, INC., LAS VEGAS, NV:
2,748,520, INT. CL. 44.
SNELL & WILCOX LTD., TWICKENHAM MIDDLESEX, ENGLAND:
2,745,518, PUB. 5-13-2003, INT. CL. 9.
SNOWEE PRODUCTS, INC., KANSAS CITY, MO:
1,207,951, CANC. MULTIPLE CLASS, INT. CLS. 9 AND 22.
SNPCHIP, L.L.C., SAN ANTONIO, TX:
2,745,863, PUB. 5-13-2003, INT. CL. 35.
SNPE, 75181 PARIS, CEDEX 4, FRANCE:
2,746,338, PUB. 5-13-2003, INT. CL. 13.
SO SLO LURES, INC., NORTH OWASSO, OK:
2,746,243, PUB. 5-13-2003, INT. CL. 28.
SO.CAP.S.R.L., 80029 SANT'ANTIMO (NAPOLI), ITALY:
2,746,422, PUB. 5-13-2003, MULTIPLE CLASS, INT. CLS. 22 AND 26.
SO, HO YUN, CARSON, CA:
2,748,176, INT. CL. 9.
SOCCER CRAZY & MORE!! INC., SAN DIEGO, CA:
2,745,845, PUB. 5-13-2003, INT. CL. 35.
SOCIETA' PER I SERVIZI BANCARI - SSB S.P.A., 20129 MILANO, ITALY:
2,745,554, PUB. 7-16-2002, MULTIPLE CLASS, INT. CLS. 9, 35, 36, 38 AND 42.
SOCIETE ANONYME DE LA MONTRE ROYALE, GENEVA, SWITZERLAND:
747,853, REN. 6-24-03, U.S. CL. 27 (INT. CL. 14).
SOCIETE ANONYME DES GALERIES LAFAYETTE, PARIS, FRANCE:
1,208,506, CANC. INT. CL. 25.
SOCIETE COMMERCIALE ET D'ENGINEERING - S C E, 85500 LES HERBIERS, FRANCE:
2,746,434, PUB. 5-13-2003, MULTIPLE CLASS, INT. CLS. 7 AND 12.
SOCIETE DE CONSEILS DE RECHERCHES ET D'APPLICATIONS SCIENTIFIQUES (S.C.R.A.S.), 75780 PARIS, FRANCE:
2,745,993, PUB. 12-3-2002, INT. CL. 5.
SOCIETE DE PARTICIPATIONS ET D'INVESTISSEMENTS DE MOTELS, 75755 PARIS CEDEX 15, FRANCE:
2,746,818, PUB. 5-13-2003, INT. CL. 43.
SOCIETE DES PRODUITS NESTLE S.A., 1800 VEVEY, SWITZERLAND:
1,717,162, CANC. INT. CL. 31.
SODACT, INC., LAS VEGAS, NV:
2,001,405, CANC. INT. CL. 5.

- SOEXPORTA-SOCIEDADE EXPORTADORA PORTUGUESA, LDA, 1200 LISBON, PORTUGAL:
2,745,426, PUB. 7-24-2001. MULTIPLE CLASS, INT. CLS. 9 AND 42.
- SOFRADIM PRODUCTION, 01600 TREVOUX, FRANCE:
2,745,899, PUB. 5-13-2003. MULTIPLE CLASS, INT. CLS. 5 AND 10.
- SOFTLIFE CORPORATION, THE, NORTHBROOK, IL:
2,748,367, MULTIPLE CLASS, INT. CLS. 35 AND 36.
- SOIL & ENVIRONMENTAL CONSULTANTS, PA, RALEIGH, NC:
2,746,769, PUB. 5-13-2003. INT. CL. 42.
- SOKOL ENTERTAINMENT ENTERPRISES, INC., NEW YORK, NY:
1,208,870, CANC. INT. CL. 35.
- SOLAR HOME PRODUCTS, INC., CHICAGO, IL:
737,730, CANC. U.S. CL. 12.
- SOLARA MEDICAL SUPPLIES, SOLANA BEACH, CA:
2,746,050, PUB. 5-13-2003. INT. CL. 35.
- SOLEIMANZADEH, AIMEE, NEW YORK, NY:
2,746,572, PUB. 5-13-2003. INT. CL. 25.
- SOLID TEAM, LLC, THE, SANTA ANA, CA:
2,747,669, INT. CL. 35.
- SOLIDSOURCE CORPORATION, COSTA MESA, CA:
2,748,319, INT. CL. 42.
- SOLIDUR PLASTICS CO., PITTSBURGH, PA:
1,208,329, CANC. INT. CL. 17.
- SOLTRIS, INC., MINNETONKA, MN:
2,746,204, PUB. 2-4-2003. MULTIPLE CLASS, INT. CLS. 35 AND 42.
- SOLUTIA INC., ST. LOUIS, MO, MONSANTO COMPANY, ST. LOUIS, MO:
1,813,280, REN. 6-26-03. INT. CL. 1.
- SOLUTION SELLING, INC., CHARLOTTE, NC:
2,746,939, PUB. 5-13-2003. INT. CL. 9.
- SOMA INTERNATIONAL LTD., TSIMSHATSUI EAST, KOWLOON, HONG KONG:
2,292,655, CANC. INT. CL. 28.
- SOMERSET SAVINGS BANK, SOMERVILLE, MA:
2,001,328, CANC. INT. CL. 36.
- SONIC CHAIN LLC, CLEVELAND, OH:
2,746,077, PUB. 5-13-2003. INT. CL. 35.
- SONIC FOUNDRY, INC., MADISON, WI:
2,748,159, INT. CL. 9.
- SONIX IV CORPORATION, HUNTINGTON BEACH, CA:
2,746,169, PUB. 5-13-2003. INT. CL. 7.
- SONY ELECTRONICS INC., PARK RIDGE, NJ:
2,748,461, INT. CL. 9.
- SONY KABUSHIKI KAISHA, SHINAGAWA-KU, TOKYO, JAPAN, TA SONY CORPORATION:
2,746,614, PUB. 5-13-2003. INT. CL. 9.
- SONY KABUSJIKI KAISHA, TOKYO 141, JAPAN, TA SONY CORPORATION:
2,747,513, INT. CL. 9.
- SONY MUSIC ENTERTAINMENT INC., NEW YORK, NY:
2,747,609, INT. CL. 9.
- SOPRA, AURORA, IL:
2,749,051, INT. CL. 30.
- SORBOTHANE, INC., KENT, OH:
1,208,333, CANC. INT. CL. 17.
- SOREMARTEC S.A., SCHOPPACH-ARLON, BELGIUM:
2,747,118, PUB. 1-28-2003. INT. CL. 30.
- SOUNDCRAFT, INC., CHATSWORTH, CA, DBA SECURA KEY:
2,745,596, PUB. 8-20-2002. INT. CL. 9.
- SOUNDSMITH PRODUCTIONS, INC., HUNTINGTON, NY:
2,746,371, PUB. 5-13-2003. MULTIPLE CLASS, INT. CLS. 35 AND 41.
- SOUNDTUBE ENTERTAINMENT, INC., PARK CITY, UT:
2,746,067, PUB. 5-13-2003. INT. CL. 9.
- SOUTH POLE SMOOTHIES FRANCHISE SYSTEMS, INC., TAMPA, FL:
2,747,184, PUB. 5-13-2003. MULTIPLE CLASS, INT. CLS. 35 AND 43.
- SOUTHAMPTON PHOTONICS, INC., CUPERTINO, CA:
2,748,050, INT. CL. 9.
- SOUTHEAST VENTURE PARTNERS, MORRISVILLE, NC:
2,747,739, INT. CL. 36.
- SOUTHERN COMFORT PROPERTIES, INC., SAN RAFAEL, CA:
2,748,064, INT. CL. 9.
- SOUTHERN DREAM FOODS, INC., LOUISVILLE, KY
FROM INCLAN ENTERPRISES, INC., LOUISVILLE, KY,
DBA BOURBON COUNTRY, INC.:
2,747,686, MULTIPLE CLASS, INT. CLS. 29 AND 30.
- SOUTHERN ELECTRIC INTERNATIONAL, INC., ATLANTA, GA:
2,001,092, CANC. INT. CL. 36.
- SOUTHERN HIGHLANDS, L.L.C., SCOTTSDALE, AZ:
2,747,494, INT. CL. 36.
- SOUTHERN SMOKE LLC, ATLANTA, GA:
2,747,051, PUB. 5-13-2003. INT. CL. 34.
- SOUTHLAND CORPORATION, THE, DALLAS, TX:
1,209,360, CANC. INT. CL. 32.
- SOUTHTRUST BANK, BIRMINGHAM, AL:
2,544,553, COR. INT. CL. 36.
- SOUTHWEST AES, INC., SCOTTSDALE, AZ:
2,001,881, CANC. INT. CL. 28.
- SOUTHWEST SOFTWARE, INC., AUSTIN, TX:
1,767,319, REN. 6-21-03. INT. CL. 9.
- SOUTHWESTERN LIFE INSURANCE COMPANY, DALLAS, TX:
1,716,437, CANC. INT. CL. 36.
- SOUTHWIRE COMPANY, CARROLLTON, GA:
2,746,762, PUB. 5-13-2003. MULTIPLE CLASS, INT. CLS. 6 AND 7.
- SPA DE SOLEIL, INC., VAN NUYS, CA:
2,748,262, INT. CL. 3.
- SPALDING & EVENFLO COMPANIES, INC., TAMPA, FL:
1,208,711, CANC. INT. CL. 28.
- SPARK INTERACTIVE CORPORATION, GREENWOOD, IN:
2,746,142, PUB. 10-8-2002. MULTIPLE CLASS, INT. CLS. 38 AND 41.
- SPARKNOTES LLC, NEW YORK, NY:
2,745,941, PUB. 10-15-2002. INT. CL. 42.
- SPARTAN BRANDS INCORPORATED, NEW YORK, NY:
2,747,224, PUB. 5-13-2003. INT. CL. 3.
- SPEC IMPORTS, INC., IRVING, TX:
2,001,680, CANC. INT. CL. 14.
- SPECIAL OLYMPICS, INC., WASHINGTON, DC:
2,746,310, PUB. 5-13-2003. MULTIPLE CLASS, INT. CLS. 36 AND 44.
- 2,746,311, PUB. 5-13-2003. MULTIPLE CLASS, INT. CLS. 36 AND 44.
- SPECIALTY BRANDS LIMITED, GREY LYNN AUCKLAND, NEW ZEALAND:
2,747,954, INT. CL. 25.
- SPECIALTY CHEMICAL RESOURCES, INC., MACEDONIA, OH:
2,001,798, CANC. MULTIPLE CLASS, INT. CLS. 3 AND 5.
- SPECIALTY MEASUREMENTS, INC., WHITEHOUSE, NJ:
1,716,781, CANC. INT. CL. 42.
- SPECIALTY ULTRAVISION, INC., CAMPBELL, CA:
2,598,470, CANC. INT. CL. 9.
- SPECTOR, SEAN:
See—GAMEFLY, INC..
- SPECTRA SYSTEMS CORP., PROVIDENCE, RI:
2,748,281, MULTIPLE CLASS, INT. CLS. 2 AND 17.
- SPECTRAMET, LLC, BEDFORD, MA:
2,747,693, INT. CL. 6.
- SPECTROS CORPORATION, PORTOLA VALLEY, CA:
2,746,197, PUB. 11-19-2002. MULTIPLE CLASS, INT. CLS. 9 AND 10.
- SPECTRUM CONCEPTS, INC., CARLSBAD, CA:
2,746,999, PUB. 5-13-2003. INT. CL. 20.
- SPECTRUM INVESTMENT COMPANY, LLC, MIAMI, FL:
2,746,199, PUB. 11-19-2002. INT. CL. 35.
- SPEEDBAR, INC., NASSAU, BAHAMAS:
2,746,897, PUB. 5-13-2003. INT. CL. 35.
- SPEEDWAY MOTORSPORTS, INC., RENO, NV, CHARLOTTE MOTOR SPEEDWAY, INC., HARRISBURG, NC:
1,261,202, REN. 6-27-03. INT. CL. 41.
- SPEEDWISE TECHNOLOGIES LTD., 43000 RA'ANANA, ISRAEL:
2,747,838, INT. CL. 9.

- SPENCE COMMUNICATIONS, INC., AUSTIN, TX:
2,748,106, U.S. CL. 200.
- SPENCE INDUSTRIES, INC., WARREN, MI:
957,725. REN. 6-24-03. U.S. CL. 26 (INT. CL. 9).
- SPENGOLD LIMITED, LONDON W2 1HY, GREAT BRITAIN:
2,745,558, PUB. 2-5-2002. MULTIPLE CLASS, INT. CLS. 3, 9, 18 AND 25.
- SPICE TIME FOODS, INC., BROOKLYN, NY:
1,208,768, CANC. MULTIPLE CLASS, INT. CLS. 30 AND 31.
- SPIER PROPERTIES (PTY) LIMITED, STELLENBOSCH 7600, SOUTH AFRICA:
2,745,465, PUB. 5-13-2003. INT. CL. 33.
- SPIETH GYMNASSTIC GMBH, D-73730 ESSLINGEN, FED REP GERMANY:
2,745,841, PUB. 12-10-2002. MULTIPLE CLASS, INT. CLS. 27 AND 28.
- SPIRALOCK CORPORATION, MADISON HEIGHTS, MI:
2,746,264, PUB. 5-13-2003. INT. CL. 28.
- SPONSORWISE, FREMONT, CA:
2,747,843, INT. CL. 35.
- SPORT SUPPLY GROUP, INC., FARMERS BRANCH, TX, BSN CORPORATION, DALLAS, TX:
1,262,511. REN. 6-27-03. INT. CL. 28.
- SPORT-ELLE, INC., NEW YORK, NY:
2,746,804, PUB. 5-13-2003. INT. CL. 25.
- SPORTEK L.L.C., LANSING, MI:
1,716,068, CANC. INT. CL. 28.
- SPORTNIKS, INC., OTIS, OR:
2,001,787, CANC. INT. CL. 9.
- SPORTS AUTHORITY MICHIGAN, INC., THE, ROYAL OAK, MI:
2,747,769, INT. CL. 28.
- SPORTS CLUB COMPANY, INC., THE, LOS ANGELES, CA:
2,747,640, INT. CL. 41.
- SPORTSFIELDS, INCORPORATED, BLUE ISLAND, IL:
1,714,851, CANC. INT. CL. 1.
- SPORTSFRAGRANCE INC., SCOTTSDALE, AZ:
2,747,852, INT. CL. 3.
- SPORTSTRAC SYSTEMS, INC., BOULDER, CO:
2,746,760, PUB. 5-13-2003. INT. CL. 10.
- SPOT IMAGE CORPORATION, RESTON, VA:
1,715,576, CANC. INT. CL. 16.
- SPOT IMAGE S.A., TOULOUSE, FRANCE, SPOT IMAGE CORPORATION, RESTON, VA:
1,770,790. REN. 6-27-03. INT. CL. 16.
- SPOTLIGHT SOLUTIONS, INC., MASON, OH:
2,745,934, PUB. 10-29-2002. MULTIPLE CLASS, INT. CLS. 9 AND 42.
- SPOTWAVE WIRELESS INC., OTTAWA, ONTARIO, CANADA:
2,747,140, PUB. 5-13-2003. INT. CL. 9.
- SPRING LICENSING GROUP, INC., FORT MILL, SC, M. LOWENSTEIN CORPORATION, NEW YORK, NY:
1,233,623. REN. 6-27-03. INT. CL. 24.
- SPRINGS INDUSTRIES, INC., FORT MILL, SC:
2,001,946, CANC. INT. CL. 24.
- SPRINT COMMUNICATIONS COMPANY L.P., KANSAS CITY, MO:
2,001,232, CANC. INT. CL. 35.
- SPRINT COMMUNICATIONS COMPANY L.P., WESTWOOD, KS:
2,512,444, COR. MULTIPLE CLASS, INT. CLS. 37, 41 AND 42.
- SPRINT CORPORATION, WESTWOOD, KS:
2,001,273, CANC. INT. CL. 38.
2,001,274, CANC. INT. CL. 38.
- SPRUCE FOODS, INC., PRESCOTT, AZ:
2,748,927, INT. CL. 29.
- SPS STUDIOS, INC., BOULDER, CO:
2,746,350, PUB. 5-13-2003. INT. CL. 16.
- SPX DEVELOPMENT CORPORATION, CHARLOTTE, NC, OWATONNA TOOL COMPANY, OWATONNA, MN:
1,189,120. REN. 6-21-03. INT. CL. 7.
- SQUEEZE BREEZE/CIRCULAIR, A DIVISION OF GLJ, LCC., ADDISON, IL:
2,748,528, INT. CL. 11.
- SRIQUI, VERONIQUE, POTOMAC, MD, DBA ARTISTIC FRAMES BY V.V.:
2,748,062, MULTIPLE CLASS, INT. CLS. 4, 21 AND 35.
- SSA GLOBAL TECHNOLOGIES, INC., CHICAGO, IL:
2,746,396, PUB. 5-13-2003. INT. CL. 9.
2,746,622, PUB. 5-13-2003. INT. CL. 9.
- SSB ENTERPRISES OF MIAMI, INC., SOUTH MIAMI, FL:
2,746,891, PUB. 5-13-2003. MULTIPLE CLASS, INT. CLS. 25 AND 35.
- ST. IVES LABORATORIES, INC., MELROSE PARK, IL:
2,748,930, INT. CL. 3.
- ST. JOHN HEALTH SYSTEM, DETROIT, MI:
2,748,509, INT. CL. 44.
- ST. PHILIP, FRANK E., COVINGTON, LA:
2,748,596, MULTIPLE CLASS, INT. CLS. 25, 28 AND 35.
- STAD, CHARLES I., LA MIRADA, CA:
2,000,724, CANC. INT. CL. 32.
- STADTHERR, MELODY, A., AURORA, CO:
2,747,070, PUB. 5-13-2003. INT. CL. 16.
- STAFFING RESOURCES, INC., IRVING, TX:
2,001,253, CANC. INT. CL. 35.
2,001,254, CANC. INT. CL. 35.
- STAG-PARKWAY, INC., ATLANTA, GA:
2,746,026, PUB. 5-13-2003. INT. CL. 35.
- STANDARD HOLDINGS, LLC, NEW YORK, NY:
2,747,808, INT. CL. 9.
- STANDARD MOTOR PRODUCTS, INC., LONG ISLAND CITY, NY:
2,746,601, PUB. 5-13-2003. INT. CL. 9.
- STANDARD OIL COMPANY, THE, CLEVELAND, OH:
737,726, CANC. U.S. CL. 12.
- STANDARD PRODUCTS COMPANY, INC., KILMARNOCK, VA:
737,718, CANC. U.S. CL. 10.
- STANDARD SALES CO., INC., BIRMINGHAM, AL, DBA RADIATOR SEAL CO.:
737,695, CANC. U.S. CL. 6.
- STANDEX INTERNATIONAL CORPORATION, SALEM, NH:
1,208,088, CANC. INT. CL. 10.
- STANFIELD SHUTTER CO., INC., PALM DESERT, CA:
1,208,404, CANC. INT. CL. 19.
- STANFORD INTERNATIONAL HOLDING CORPORATION, LOS ANGELES, CA:
2,747,226, PUB. 5-13-2003. INT. CL. 14.
- STANLEY H. KAPLAN EDUCATIONAL CENTER LTD., NEW YORK, NY:
2,001,142, CANC. MULTIPLE CLASS, INT. CLS. 16 AND 41.
- STAR GAS CORPORATION, STAMFORD, CT:
1,769,632. REN. 6-27-03. INT. CL. 4.
- STAR MICRONICS CO., LTD., SHIZUOKA-SHI, SHIZUOKA 422-8654, JAPAN:
2,748,250, INT. CL. 7.
- STARBUCKS U.S. BRANDS CORPORATION, BURLINGAME, CA, STARBUCKS CORPORATION, SEATTLE, WA:
1,760,103. REN. 6-22-03. INT. CL. 30.
- STARGEN, INC., MARLBOROUGH, MA FROM STARGEN, INC., MARLBOROUGH, MA:
2,747,982, INT. CL. 9.
- STARK BRO'S NURSERIES & ORCHARDS CO., LOUISIANA, MO FROM FOSTER & GALLAGHER, INC., PEORIA, IL:
2,748,051, INT. CL. 31.
- STARWOOD HOTELS & RESORTS WORLDWIDE, INC., WHITE PLAINS, NY:
2,746,698, PUB. 5-13-2003. INT. CL. 43.
- STAT HEALTH AND SURGICAL SERVICES, INCORPORATED, OCEAN, NJ:
1,209,174, CANC. INT. CL. 42.
1,209,175, CANC. INT. CL. 42.
- STATE CHEMICAL MANUFACTURING CO., THE, CLEVELAND, OH:
1,207,798, CANC. INT. CL. 5.
- STATE CHEMICAL MANUFACTURING COMPANY, THE, CLEVELAND, OH:
2,002,026, CANC. INT. CL. 26.

- STATE LINE TACK, INC., PLAISTOW, NH:
2,001,466, CANC. INT. CL. 42.
- STATE OF FLORIDA DEPARTMENT OF CITRUS, LAKE-
LAND, FL, DBA FLORIDA CITRUS COMMISSION:
982,104, REN. 6-24-03. U.S. CL. 101 (INT. CL. 35).
- STATE PRESERVATION BOARD, AUSTIN, TX:
2,747,972, INT. CL. 41.
- STATER B.V.:
See— STATER N.V.
- STATER N.V., AMERSFOORT, NETHERLANDS FROM
STATER B.V., 3823 LL AMERSFOORT, NETHERLANDS:
2,745,621, PUB. 5-13-2003. MULTIPLE CLASS, INT. CLS.
35, 36 AND 42.
- STATION CASINOS, INC., LAS VEGAS, NV:
2,746,368, PUB. 5-13-2003. INT. CL. 41.
2,746,827, PUB. 5-13-2003. INT. CL. 41.
2,746,828, PUB. 5-13-2003. INT. CL. 41.
- STATON HOLDINGS, INC., DALLAS, TX, DBA STATON
WHOLESALE:
1,763,495, REN. 6-25-03. INT. CL. 42.
- STAYWELL COMPANY, THE, SAN BRUNO, CA:
2,747,675, INT. CL. 41.
- STEARNS & FOSTER BEDDING COMPANY, THE, CLEVE-
LAND, OH:
2,001,780, CANC. INT. CL. 20.
- STEINBACH, INGO, HAMM, FED REP GERMANY:
2,745,721, PUB. 5-13-2003. INT. CL. 9.
- STEINER-OPTIK GMBH, D-95448 BAYREUTH, FED REP
GERMANY:
2,746,333, PUB. 5-13-2003. INT. CL. 9.
- STENGER, BARBARA J., BRIMFIELD, IL:
2,748,792, INT. CL. 42.
- STENOGRAPH, L.L.C., LISLE, IL, STENOGRAPH COR-
PORATION, MT. PROSPECT, IL:
1,795,699, REN. 6-24-03. INT. CL. 9.
- STENZLER, JACQUELINE, CARLSBAD, CA:
2,746,699, PUB. 5-13-2003. INT. CL. 41.
- STEPHAN CO., THE, FORT LAUDERDALE, FL:
2,748,295, INT. CL. 3.
- STEPHANNA'S CURVES, STUDIO CITY, CA:
2,746,872, PUB. 5-13-2003. INT. CL. 25.
- STEPHEN CO., THE, FORT LAUDERDALE, FL:
1,717,210, CANC. INT. CL. 3.
- STEPHEN MARKS (LONDON) LIMITED, LONDOND, ENG-
LAND:
2,748,614, INT. CL. 25.
- STERLICCHIO, LUIS ALBERTO, CITY OF BUENOS AIRES,
ARGENTINA AND STERLICCHIO DE ELIZALDE, ANA
MARÍA, PERGAMINO, ARGENTINA:
2,747,236, PUB. 5-13-2003. MULTIPLE CLASS, INT. CLS.
25 AND 35.
- STERLING CONSULTING GROUP, INC., NEW YORK, NY,
CLARKE HOOPER AMERICA, INC., IRVINE, CA:
1,766,902, REN. 6-27-03. INT. CL. 35.
- STERLING CORPORATION, BILLERICA, MA:
1,716,570, CANC. INT. CL. 39.
- STERLING DRUG INC., NEW YORK, NY:
737,786, CANC. U.S. CL. 18.
1,207,761, CANC. INT. CL. 3.
1,207,822, CANC. INT. CL. 5.
- STERLING HEALTHCARE GROUP, INC., CORAL GABLES,
FL:
2,001,008, CANC. MULTIPLE CLASS, INT. CLS. 41 AND
42.
- STERLING JEWELERS INC., AKRON, OH, DBA J. B.
ROBINSON JEWELERS:
1,781,330, REN. 6-27-03. INT. CL. 14.
- STERLING SOFTWARE, INC., DALLAS, TX:
2,001,743, CANC. INT. CL. 42.
- STERN, PATRICIA, WOODBURY, NY:
2,748,782, INT. CL. 3.
- STEVE HUNTER ENTERPRISES INC., MISSISSAUGA, ON-
TARIO L5M 5E4, CANADA:
2,000,606, CANC. INT. CL. 9.
- STEWART & STEVENSON SERVICES, INC., HOUSTON, TX:
2,748,418, INT. CL. 37.
- STEWART, JEFFREY, ALISO VIEJO, CA, DBA PARA TECH
COATING CO.:
1,777,054, REN. 6-23-03. INT. CL. 9.
- STEWART, THOMAS D., CROSSVILLE, TN:
2,001,415, CANC. INT. CL. 9.
2,001,420, CANC. INT. CL. 9.
- STI LICENSING CORPORATION, BEACHWOOD, OH:
2,746,890, PUB. 5-13-2003. INT. CL. 9.
- STIEFEL LABORATORIES, INC., CORAL GABLES, FL:
2,748,501, INT. CL. 5.
- STILGENBAUER, INGRID, 66957 SCHWEIX, FED REP
GERMANY:
2,746,237, PUB. 5-13-2003. MULTIPLE CLASS, INT. CLS.
16 AND 18.
- STINNES AG, D-45472 MUHLHEIM AND DER RUHR, FED
REP GERMANY:
2,745,544, PUB. 4-23-2002. INT. CL. 20.
- STOCKMAN'S NATIONAL SUPPLY CO., INC., PUEBLO,
CO, AKA STOCKMAN'S NATIONAL SUPPLY:
1,209,192, CANC. INT. CL. 42.
- STONE MILL KITCHENS, INC., PORTLAND, OR:
2,002,008, CANC. MULTIPLE CLASS, INT. CLS. 29 AND
30.
- STONEHOUSE PUBLISHING CO., OMAHA, NE:
2,001,646, CANC. INT. CL. 16.
- STOP TECHNOLOGIES, LLC, TORRANCE, CA:
2,650,518, COR. INT. CL. 8.
- STORA KOPPARBERGS BERGSLAGS AB, 791 80 FALUN,
SWEDEN:
2,745,424, PUB. 10-29-2002. MULTIPLE CLASS, INT. CLS.
9 AND 42.
- STORANDT PANN MARGOLIS & PARTNERS, LA-
GRANGE, IL:
2,748,511, INT. CL. 44.
- STORARO, FABRIZIO, 00040, FRATTOCCHIE, MARINO,
(ROME), ITALY AND STORARO, VITTORIO, 00040,
FRATTOCCHIE, MARINO, (ROME), ITALY:
2,746,241, PUB. 5-13-2003. MULTIPLE CLASS, INT. CLS. 9
AND 40.
- STORE KRAFT MANUFACTURING COMPANY, THE,
BEATRICE, NE:
959,368, REN. 6-23-03. U.S. CL. 32 (INT. CL. 20).
- STORYDOG, INC., CHICAGO, IL:
2,747,726, MULTIPLE CLASS, INT. CLS. 16 AND 28.
- STRATA DECISION TECHNOLOGY, LLC, CHAMPAIGN,
IL:
2,746,192, PUB. 5-7-2002. INT. CL. 9.
- STRATEGIC CLAIM SERVICES, INC., WOBURN, MA:
2,745,815, PUB. 5-13-2003. INT. CL. 36.
- STRATEGIC MARKETING CONCEPTS, INC., CLEAR-
WATER, FL, DBA TECHNOLOGY HOTLINES:
2,001,987, CANC. INT. CL. 42.
- STRAUSS VEAL, INC., FRANKLIN, WI FROM RCMC
L.L.C., CHICAGO, IL:
2,747,637, INT. CL. 29.
- STRAUSS, CORINNE SOIKIN, WAINSCOTT, NY:
2,747,655, INT. CL. 42.
- STREAMLOGIC CORPORATION, NEWARK, CA:
1,715,239, CANC. INT. CL. 9.
- STREHLE GMBH & CO. KG, 8860 NORDLINGEN, FED REP
GERMANY:
2,000,545, CANC. MULTIPLE CLASS, INT. CLS. 3, 18
AND 25.
- STRETCH & SEW, INC., TEMPE, AZ:
1,716,870, CANC. INT. CL. 42.
- STRETCH FORMING CORPORATION, MURRIETA, CA:
1,208,138, CANC. INT. CL. 12.
- STRICTLY GOLF, INC., NAPERVILLE, IL:
2,001,436, CANC. INT. CL. 42.
- STRIKE KING LURE COMPANY, 38017, TN:
1,770,836, REN. 6-25-03. INT. CL. 28.
- STROH BREWERY COMPANY, THE, DETROIT, MI:
1,208,834, CANC. INT. CL. 32.
- STRONG WOMEN ORGANIZING OUTRAGEOUS PRO-
JECTS, RALEIGH, NC:
2,746,661, PUB. 5-13-2003. INT. CL. 37.
- STRUCTRON CORPORATION, SAN MARCOS, CA:
1,785,247, REN. 6-24-03. INT. CL. 8.

STRY-LENKOFF COMPANY, LOUISVILLE, KY, DBA LEE PUBLICATIONS:
1,209,347, CANC. INT. CL. 16.

STS BREITSTRECKWALZEN GMBH, RATINGEN, FED REP GERMANY:
2,747,710, INT. CL. 7.

STUDEBAKER NATIONAL MUSEUM, INC., SOUTH BEND, IN:
2,746,078, PUB. 6-25-2002. MULTIPLE CLASS, INT. CLS. 35 AND 41.

STUDENT LOAN MARKETING ASSOCIATION, WASHINGTON, DC:
2,001,294, CANC. INT. CL. 36.

STUDIO ACOUSTICS, INC., WALNUT, CA:
2,748,368, INT. CL. 9.

STUDY GROUP INTERNATIONAL LIMITED, EAST SUSSEX, UNITED KINGDOM FROM CENTER FOR ENGLISH STUDIES, INC., THE, FORT LAUDERDALE, FL:
2,747,521, MULTIPLE CLASS, INT. CLS. 41 AND 42.

STULLER, INC., LAFAYETTE, LA:
2,746,445, PUB. 5-13-2003. MULTIPLE CLASS, INT. CLS. 14 AND 35.

STURM, RUGER & COMPANY, INC., SOUTHPORT, CT:
2,747,561, INT. CL. 8.

STYLEX, INC., DELANCO, NJ:
2,748,564, INT. CL. 20.

SU, JE GEM, PENANG, MALAYSIA:
2,746,599, PUB. 5-13-2003. INT. CL. 35.
2,746,600, PUB. 5-13-2003. INT. CL. 35.

SUBA; PETER, TORONTO, ONTARIO, CANADA:
1,209,124, CANC. INT. CL. 41.

SUCCESS LITHO, INC., LENEXA, KS:
2,001,455, CANC. INT. CL. 42.

SUCCESS PRODUCTS, INC., BIRMINGHAM, AL:
2,745,714, PUB. 5-13-2003. INT. CL. 16.

SUDSIES, INC., MIAMI BEACH, FL:
2,747,292, PUB. 5-13-2003. INT. CL. 37.

SUELTHAUS & WALSH, P.C., ST. LOUIS, MO:
2,747,367, PUB. 5-13-2003. INT. CL. 42.
2,747,368, PUB. 5-13-2003. INT. CL. 42.
2,747,369, PUB. 5-13-2003. INT. CL. 42.

SUFFOLK UNIVERSITY, BOSTON, MA:
2,747,875, INT. CL. 36.

SUGAR CREEK PUBLISHING, INC., FAIRLAND, IN:
2,746,886, PUB. 5-13-2003. INT. CL. 41.

SUJDAK, KEVIN SEAN, PLEASANTON, CA:
2,000,998, CANC. INT. CL. 39.

SULLIVAN; WILLIAM K., VEAZIE, ME:
1,235,920, REN. 6-25-03. INT. CL. 42.

SULLIVAN, MARY ELLEN, VALLEY CENTER, CA AND BERNHARDY, B. PAUL, VALLEY CENTER, CA:
2,746,161, PUB. 10-8-2002. INT. CL. 3.

SUMARA, FRANK, CLIFTON, NJ AND SANTI, DANIEL DELLI, NUTLEY, NJ:
2,745,545, PUB. 12-10-2002. INT. CL. 28.

SUMBURGER, INC., CHILLICOTHE, OH:
1,270,147, REN. 6-25-03. MULTIPLE CLASS, INT. CLS. 40 AND 42.

SUN CHEMICAL CORP, FORT LEE, NJ, MOBAY CHEMICAL CORPORATION, PITTSBURGH, PA:
1,235,968, REN. 6-26-03. INT. CL. 2.

SUN CHEMICAL CORPORATION, FORT LEE, NJ:
2,745,765, PUB. 12-10-2002. INT. CL. 2.
2,746,235, PUB. 5-13-2003. INT. CL. 42.

SUN COAST HOLDINGS, INC., HENDERSON, NV:
2,001,518, CANC. INT. CL. 19.

SUN CORPORATION, AICHI-KEN, JAPAN:
2,001,295, CANC. INT. CL. 28.

SUN LLC, WINTER PARK, FL:
2,745,719, PUB. 12-31-2002. INT. CL. 35.

SUN OWN INDUSTRIAL CO., LTD., CHANG HUA HSIEN, TAIWAN:
1,765,689, REN. 6-24-03. INT. CL. 9.

SUN PHARMACEUTICALS CORP., WESTPORT, CT:
1,982,912, CANC. INT. CL. 25.

SUNBEAM PRODUCTS, INC., BOCA RATON, FL:
2,748,834, MULTIPLE CLASS, INT. CLS. 10 AND 11.

SUNDANCE PUBLISHING LLC, LITTLETON, MA:
2,746,783, PUB. 5-13-2003. INT. CL. 9.

SUNGARD RECOVERY SERVICES L.P., WAYNE, PA FROM SUNGARD RECOVERY SERVICES INC., WAYNE, PA:
2,747,547, INT. CL. 9.

SUNGLASS DESIGNS, INC., SCOTTSDALE, AZ:
1,794,811, REN. 6-27-03. INT. CL. 9.

SUNGLO TECHNOLOGIES, INC., UPLAND, CA:
2,746,638, PUB. 5-13-2003. MULTIPLE CLASS, INT. CLS. 37 AND 42.

SUNLIGHT, INC., GLENWOOD SPRINGS, CO:
2,746,021, PUB. 10-29-2002. MULTIPLE CLASS, INT. CLS. 25 AND 41.

SUNNEN PRODUCTS COMPANY, ST. LOUIS, MO:
1,776,258, REN. 6-27-03. INT. CL. 7.

SUNOVA CAPITAL, L.P., NEW YORK, NY:
2,746,627, PUB. 5-13-2003. INT. CL. 36.
2,746,628, PUB. 5-13-2003. INT. CL. 36.
2,746,629, PUB. 5-13-2003. INT. CL. 36.

SUNRIDER CORPORATION, THE, TORRANCE, CA, DBA SUNRIDER INTERNATIONAL:
2,745,802, PUB. 5-13-2003. INT. CL. 5.

SUNRISE BANK, CITRUS HEIGHTS, CA:
1,208,984, CANC. INT. CL. 36.

SUNRISE MEDICAL HHG INC., LONGMONT, CA:
2,748,974, INT. CL. 12.

SUNSTONE IMPORTS, INC., EVANSTON, IL:
2,001,599, CANC. INT. CL. 14.

SUNTORY WATER GROUP, INC., ATLANTA, GA:
2,746,002, PUB. 11-5-2002. MULTIPLE CLASS, INT. CLS. 1, 21 AND 32.

SUPER SHOPS, INC., RENO, NV:
1,716,743, CANC. INT. CL. 42.

SUPERB RECORDS, LTD., LOS ANGELES, CA:
2,748,687, INT. CL. 9.

SUPERIOR COMMUNICATIONS PRODUCTS, INC., COVINA, CA:
2,747,723, INT. CL. 9.

SUPERIOR MANUFACTURING GROUP, INC., CHICAGO, IL:
2,748,550, INT. CL. 27.

SUPERIOR TELECOMMUNICATIONS, INC., ATLANTA, GA:
2,745,650, PUB. 5-13-2003. INT. CL. 36.

SUPERVALU INC., MINNEAPOLIS, MN:
2,748,253, INT. CL. 29.

SUPREME GRAND LODGE OF THE ANCIENT AND MYSTICAL ORDER ROSAE CRUCIS, THE, SAN JOSE, CA:
1,768,912, REN. 6-25-03. INT. CL. 41.

SURCO PRODUCTS, INC., PITTSBURGH, PA:
1,235,584, REN. 6-25-03. INT. CL. 5.

SURFLINK, INC., NEWPORT BEACH, CA:
2,001,163, CANC. INT. CL. 42.

SURFTRAN MANUFACTURING CO, L.L.C., MADISON HEIGHTS, MI, CHEMOTRONICS INTERNATIONAL, INC., ANN ARBOR, MI:
943,205, REN. 6-24-03. U.S. CL. 23 (INT. CL. 7).

SURGICAL MECHANICAL RESEARCH, INC., ST. LOUIS, MO, AKA SMR:
1,208,060, CANC. INT. CL. 10.

SURVIVAL TECHNOLOGY, INC., BETHESDA, MD:
1,207,805, CANC. INT. CL. 5.

SUSAN BATES, INC., STAMFORD, CT:
397,698, CANC. U.S. CL. 40.

SUTER COMPANY, INC., THE, SYCAMORE, IL, DBA SYCAMORE FARMS:
1,717,154, CANC. INT. CL. 29.

SUTTON CREATIONS, INC., NEW YORK, NY:
2,747,888, INT. CL. 25.

SUTTON HOUSE, INC., WINSTON-SALEM, NC:
1,716,752, CANC. INT. CL. 42.

SVENGALI MERCHANDISING INCORPORATED, ALLSTON, MA:
2,001,196, CANC. MULTIPLE CLASS, INT. CLS. 6 AND 8.

SVI SYSTEMS, INC., PEORIA, IL:
2,748,807, INT. CL. 9.

- SWANK, INC., NEW YORK, NY:
749,612. REN. 6-23-03. U.S. CL. 3 (INT. CL. 18).
960,189. REN. 6-23-03. U.S. CL. 3 (INT. CL. 18).
- SWEET LIFE ENTERPRISE, INC., IRVINE, CA:
2,747,967. INT. CL. 28.
- SWEETSAR, INC., LOS ANGELES, CA FROM BARBARA
REGER AND CHRISTINE BOUCHER, LOS ANGELES,
CA, DBA SWEETSAR:
2,745,965. PUB. 5-13-2003. INT. CL. 16.
- SWIMC, INC., WILMINGTON, DE, SHERWIN-WILLIAMS
COMPANY, THE, CLEVELAND, OH:
1,773,338. REN. 6-21-03. INT. CL. 2.
- SWISS AMERICAN IMPORTING CO., ST. LOUIS, MO:
1,208,478. CANC. MULTIPLE CLASS, INT. CLS. 24, 25
AND 30.
- SWISSLAND PACKING COMPANY, ASHKUM, IL:
2,746,251. PUB. 5-13-2003. INT. CL. 29.
- SWX SWISS EXCHANGE, 8021 ZURICH, SWITZERLAND
FROM SCHWEIZERISCHE EFFEKTENBORSE (BOURSE
SUISSE DE VALEURS MOBILIERS) (SWISS STOCK EX-
CHANGE) (BORSA VALORI SVIZZERA, 8001 ZURICH,
SWITZERLAND:
2,746,125. PUB. 5-13-2003. MULTIPLE CLASS, INT. CLS.
9, 16, 35, 36, 38, 41 AND 42.
- SYBASE, INC., DUBLIN, CA, COGNOS INCORPORATED,
OTTAWA, ONTARIO, K1G 3Z4, CANADA:
1,762,778. REN. 6-25-03. INT. CL. 16.
- SYBASE, INC., EMERYVILLE, CA:
2,000,945. CANC. MULTIPLE CLASS, INT. CLS. 37, 41
AND 42.
- SYLOG CONSULTING S.A., CH-1025 ST-SULPICE VD,
SWITZERLAND:
2,745,677. PUB. 2-19-2002. MULTIPLE CLASS, INT. CLS.
35, 37, 41 AND 42.
- SYLVAN LEARNING SYSTEMS, INC., BALTIMORE, MD:
2,748,188. INT. CL. 41.
- SYMBIAN LIMITED, LONDON W1H 1DS, UNITED KING-
DOM:
2,745,574. PUB. 8-13-2002. MULTIPLE CLASS, INT. CLS.
9, 16, 35, 37, 38 AND 42.
- SYMTRON SYSTEMS INC., FAIR LAWN, NJ, AAI COR-
PORATION, HUNT VALLEY, MD:
1,723,385. REN. 6-24-03. MULTIPLE CLASS, INT. CLS. 9
AND 37.
- SYN X PHARMA, INC., MISSISSAUGA, ONTARIO, L4V,
1H3, CANADA:
2,745,979. PUB. 5-13-2003. MULTIPLE CLASS, INT. CLS.
1, 5 AND 42.
- SYNAPSE ENGINEERING INCORPORATED, SAN DIEGO,
CA:
2,747,374. PUB. 5-13-2003. INT. CL. 7.
- SYNAPTEL S.A., 78140 VELIZY, FRANCE:
2,000,542. CANC. MULTIPLE CLASS, INT. CLS. 9, 35, 38
AND 42.
- SYNERGISTIC MARKETING, INC., NEW YORK, NY:
1,208,875. CANC. INT. CL. 35.
- SYNERGOS HOLDINGS CORPORATION, CALGARY, AL-
BERTA, CANADA:
2,747,398. PUB. 5-13-2003. INT. CL. 11.
- SYNERGY MICROWAVE CORPORATION, PATERSON, NJ:
1,817,248. REN. 6-27-03. INT. CL. 42.
- SYNGENTA PARTICIPATIONS AG, BASEL, SWITZER-
LAND:
2,748,923. INT. CL. 31.
- SYMPHER SPORTSWEAR & DESIGN, INC., NEW YORK, NY:
2,675,950. COR. MULTIPLE CLASS, INT. CLS. 18 AND
25.
- SYRACUSE CHINA CORPORATION, SYRACUSE, NY:
1,208,461. CANC. INT. CL. 21.
1,208,462. CANC. INT. CL. 21.
- SYSMARK INFORMATION SYSTEMS, INC., ROLLING
HILLS ESTATES, CA:
2,747,325. PUB. 5-13-2003. INT. CL. 9.
- SYSTEC, INC., MINNEAPOLIS, MN:
2,001,856. CANC. INT. CL. 17.
- SYSTEMAX CORPORATION, SPRINGFIELD, IL:
2,000,910. CANC. INT. CL. 42.
- SYSTEMS AND COMPUTER TECHNOLOGY CORPORA-
TION, MALVERN, PA:
1,789,590. REN. 6-27-03. MULTIPLE CLASS, INT. CLS. 35
AND 42.
- SYSTEMS MANUFACTURING CORPORATION, CONKLIN,
NY:
2,749,019. INT. CL. 9.
- SYSTOLIX LIMITED, LIVERPOOL L2 0QT, UNITED KING-
DOM:
2,745,678. PUB. 4-9-2002. INT. CL. 9.
- SYSTOR GMBH & CO. KG, KÖLN, FED REP GERMANY:
2,747,077. PUB. 10-8-2002. MULTIPLE CLASS, INT. CLS. 9
AND 42.
- SYVA COMPANY, SAN JOSE, CA, SYVA CORPORATION,
PALO ALTO, CA:
963,319. REN. 6-26-03. U.S. CL. 6 (INT. CL. 1).
2,748,398. INT. CL. 9.
2,748,399. INT. CL. 9.
- SZCZYPEK, RYSZARD, HAMDEN, CT:
2,748,375. INT. CL. 42.
- T SQUARED, LLC, ROME, GA:
2,747,861. INT. CL. 8.
- T.D.N.I. TRANSPORT DATA NETWORK INTERNATIONAL
CORP., SAN DIEGO, CA:
2,000,580. CANC. MULTIPLE CLASS, INT. CLS. 35, 38
AND 42.
- T.N.T. VENTURES LTD., VANCOUVER, BRITISH COLUM-
BIA:
2,746,528. PUB. 5-13-2003. MULTIPLE CLASS, INT. CLS.
35 AND 40.
- T.R.A.D.E., LTD., PORTLAND, OR:
1,716,902. CANC. INT. CL. 42.
- T.V. TRAVEL, INC., DAYTON, OH:
1,209,040. CANC. INT. CL. 39.
- TABACALERA, S.A., 28014 MADRID, SPAIN:
2,000,728. CANC. INT. CL. 34.
- TABACALERA,S.A., 28014 MADRID, SPAIN:
2,000,716. CANC. INT. CL. 34.
- TABLES INTERNATIONAL CORPORATION, MORTON
GROVE, IL:
1,715,095. CANC. MULTIPLE CLASS, INT. CLS. 9 AND
20.
- TABLET, INC., NEW YORK, NY:
2,747,779. MULTIPLE CLASS, INT. CLS. 35, 42 AND 43.
- TACO TIME INTERNATIONAL, INC., EUGENE, OR:
1,208,750. CANC. MULTIPLE CLASS, INT. CLS. 29, 30
AND 32.
- TACONY CORPORATION, FENTON, MO, SOUTHWEST
MANUFACTURERS & DISTRIBUTORS, INC., FORT
WORTH, TX:
1,766,708. REN. 6-27-03. INT. CL. 16.
- TACTICA INTERNATIONAL, INC., NEW YORK, NY:
2,745,791. PUB. 5-13-2003. INT. CL. 10.
- TADLOCK, DOLORES R., SHELTON, WA:
1,804,998. REN. 6-26-03. MULTIPLE CLASS, INT. CLS. 9,
16 AND 41.
- TAFELMUSIK, TORONTO, ONTARIO, CANADA:
1,744,303. REN. 6-22-03. MULTIPLE CLASS, INT. CLS. 9
AND 41.
- TAGGETT, MICHAEL BLAKE, HURRICANE, UT:
1,715,209. CANC. INT. CL. 9.
- TAI WING HONG IMPORTER, INC., BROOKLYN, NY:
1,716,125. CANC. INT. CL. 29.
- TAKAOKAYA CO., LTD., TAITO-KU, TOKYO, JAPAN:
1,249,960. REN. 6-23-03. INT. CL. 29.
- TAKE THE LEAD... AND STEP INTO A BETTER WORLD,
INC., FORT LEE, NJ:
2,001,804. CANC. INT. CL. 25.
- TAKEUCHI MIKIO DESIGN OFFICE CO., LTD., MINATO-
KU, TOKYO, JAPAN:
2,000,678. CANC. INT. CL. 28.
- TALBOTT-DUHON, TONI J., LITCHFIELD, IL:
2,001,649. CANC. INT. CL. 28.
- TALCOTT PUBLISHING CORPORATION, CHICAGO, IL:
2,746,157. PUB. 11-26-2002. INT. CL. 16.
- TALKING RAIN BEVERAGE CO. INC., PRESTON, WA:
2,748,448. INT. CL. 32.

- TAMA PLASTIC INDUSTRY, C/O KIBBUTZ MISHMAR HA'EMEK 19236, ISRAEL:
1,806,167. REN. 6-23-03. INT. CL. 22.
- TAMKO ROOFING PRODUCTS, INC., JOPLIN, MO:
2,748,094. INT. CL. 19.
- TAPSCAN, INC., BIRMINGHAM, AL:
2,747,770. INT. CL. 35.
- TARGET BRANDS, INC., MINNEAPOLIS, MN:
2,748,787. INT. CL. 43.
- TARGET THERAPEUTICS, INC., FREMONT, CA:
1,765,241. REN. 6-24-03. INT. CL. 10.
- TARICCO CORPORATION, LONG BEACH, CA:
2,748,300. INT. CL. 11.
- TARES, SANTIAGO MARCO, MONT-RAS (GIRONA), SPAIN:
2,746,038. PUB. 10-29-2002. INT. CL. 16.
- TASCO SALES, INC.:
See— BUSHNELL PERFORMANCE OPTICS.
- TASK CANADA INC., MISSISSAUGA, ONTARIO, CANADA:
2,745,590. PUB. 5-13-2003. INT. CL. 3.
- TAU KAPPA EPSILON FRATERNITY, INC., INDIANAPOLIS, IN:
2,747,112. PUB. 5-13-2003. INT. CL. 42.
- TAWA SUPERMARKET, INC., BUENA PARK, CA:
2,000,634. CANC. MULTIPLE CLASS, INT. CLS. 30 AND 31.
- TAYLOR CORPORATION, NORTH MANKATO, MN FROM NOWDOCS, INC., ALISO VIEJO, CA:
2,748,534. MULTIPLE CLASS, INT. CLS. 9 AND 42.
- TAYLOR MADE GOLF COMPANY, INC., CARLSBAD, CA:
2,000,713. CANC. INT. CL. 28.
- TAYLOR; STEWART A., KINGSPORT, TN:
1,207,908. CANC. INT. CL. 8.
- TAYLOR, AARON MICHAEL, EAST LANSING, MI:
2,745,609. PUB. 5-13-2003. INT. CL. 25.
- TAYLOR, FLADGATE AND YEATMAN LIMITED, JERSEY, CHANNEL ISLANDS, UNITED KINGDOM:
2,089,681. COR. INT. CL. 33.
- TCHIBO INTERNATIONAL LTD., MISSISSAUGA, ONTARIO, CANADA:
1,253,895. REN. 6-27-03. INT. CL. 30.
- TCPIP, INC., WILMINGTON, DE:
2,748,506. INT. CL. 25.
- TCW/CRESCENT MEZZANE MANAGEMENT III, L.L.C. AS COLLATERAL AGENT, NEW YORK, NY FROM COLLEGIATE FUNDING SERVICES, LLC, FREDERICKSBURG, VA:
2,746,388. PUB. 5-13-2003. MULTIPLE CLASS, INT. CLS. 35 AND 36.
- TEAM CRAFT, INC., AUSTIN, TX:
1,716,368. CANC. INT. CL. 35.
- TEAM HEALTH, INC., KNOXVILLE, TN:
2,745,652. PUB. 12-31-2002. MULTIPLE CLASS, INT. CLS. 35 AND 42.
- TEAM INDUSTRIES, INC., BAGLEY, MN:
2,748,608. MULTIPLE CLASS, INT. CLS. 35 AND 42.
- TEAM LOST BOYS B.V., 1017 BX AMSTERDAM, NETHERLANDS:
2,745,671. PUB. 11-12-2002. MULTIPLE CLASS, INT. CLS. 9, 35, 38, 41 AND 42.
- TEAMEFFORT, INC., CLEARWATER, FL:
2,000,955. CANC. INT. CL. 36.
- TEAMON.COM, INC., ISSAQUAH, WA FROM 123OFFICE.COM, INC., BELLEVUE, WA:
2,747,679. MULTIPLE CLASS, INT. CLS. 9, 38 AND 42.
- TEAMTECHNIK MASCHINEN UND ANLAGEN GMBH, D-71691 FREIBERG, FED REP GERMANY:
2,747,764. MULTIPLE CLASS, INT. CLS. 7, 9, 20 AND 42.
- TECHNICO PTY. LIMITED, BOWRAL, NEW SOUTH WALES 2576, AUSTRALIA:
2,747,676. INT. CL. 31.
- TECHNIWELD PRODUCTS CORPORATION, MISSISSAUGA, ONTARIO, CANADA:
2,748,189. INT. CL. 9.
- TECHNOLOGY PROPERTIES, INC., FORT WORTH, TX:
2,001,257. CANC. INT. CL. 42.
- TECHNOLOGY SERVICE CORPORATION, SILVER SPRING, MD:
2,746,756. PUB. 5-13-2003. INT. CL. 42.
- TECHRX INCORPORATED, CORAOPOLIS, PA:
2,746,980. PUB. 5-13-2003. INT. CL. 9.
- TECHSONIC INDUSTRIES, INC., EUFAULA, AL, DBA RIGHT TACKLE COMPANY:
1,208,674. CANC. INT. CL. 28.
- TEEPAK PROPERTIES, LLC, LISLE, IL:
2,748,819. INT. CL. 18.
- TEICHER, JAMES S., GUTTENBERG, NJ:
2,001,363. CANC. MULTIPLE CLASS, INT. CLS. 35 AND 36.
- TEIJIN KABUSHIKI KAISHA (TEIJIN LIMITED), OSAKA, JAPAN:
2,747,912. INT. CL. 23.
- TEK CHAIN DEVELOPMENT INC., TAOYUAN, TAIWAN:
2,746,394. PUB. 5-13-2003. INT. CL. 9.
- TELCO COMMUNICATIONS GROUP, INC., CHANTILLY, VA:
2,001,591. CANC. INT. CL. 38.
- TELE-IP LIMITED, VICTORIA, 3149, AUSTRALIA:
2,747,801. INT. CL. 9.
- TELECOMMUNICATION SYSTEMS, INC., ANNAPOLIS, MD:
2,748,767. INT. CL. 9.
2,748,813. INT. CL. 42.
- TELECOMMUNICATIONS EXPORT COMPANY LTD., DANVERS, MA:
2,747,232. PUB. 5-13-2003. INT. CL. 35.
- TELELECTRONICS PTY LIMITED, LONE COVE, NEW SOUTH WALES, AUSTRALIA:
1,208,069. CANC. INT. CL. 10.
- TELEDYNE INDUSTRIES, INC., LOS ANGELES, CA:
737,872. CANC. U.S. CL. 26.
1,715,832. CANC. INT. CL. 21.
- TELEFLEX INCORPORATED, LIMERICK, PA:
2,747,656. INT. CL. 10.
- TELEFONAKTIEBOLAGET LM ERICSSON, SE-126 25 STOCKHOLM, SWEDEN:
2,745,936. PUB. 5-13-2003. MULTIPLE CLASS, INT. CLS. 9, 38 AND 42.
- TELEFONICA, S.A., 28013 MADRID, SPAIN:
2,745,731. PUB. 11-5-2002. INT. CL. 9.
2,745,797. PUB. 5-13-2003. INT. CL. 35.
- TELEHOUSE INTERNATIONAL CORPORATION OF AMERICA, STATEN ISLAND, NY:
2,000,905. CANC. INT. CL. 38.
- TELEMAP, CHICAGO, IL:
1,715,628. CANC. INT. CL. 16.
- TELEMESSAGING SERVICES, INC., BALTIMORE, MD:
1,208,884. CANC. INT. CL. 35.
- TEMBEC INDUSTRIES INC., TEMISCAMING, QUEBEC:
2,748,320. INT. CL. 1.
- TEMS, LLC, CLAWSON, MI:
2,746,732. PUB. 5-13-2003. INT. CL. 40.
- TEN MINUTES BY TRACTOR PTY LTD, MAIN RIDGE, VICTORIA 3928, AUSTRALIA:
2,746,303. PUB. 5-13-2003. INT. CL. 33.
2,746,304. PUB. 5-13-2003. INT. CL. 33.
- TENDA DORICA - S.R.L., ANCONA (AN), ITALY:
2,746,321. PUB. 5-13-2003. MULTIPLE CLASS, INT. CLS. 20 AND 21.
- TENGO INTERNET, INC., AUSTIN, TX:
2,746,626. PUB. 5-13-2003. INT. CL. 42.
- TEQUILA DON JULIO, S.A. DE C.V., GUADALAJARA, JALISCO, MEXICO:
2,747,671. INT. CL. 33.
- TER WEE, PATRICK, 1693 ZH, WERVERSHOOF, NETHERLANDS:
2,746,211. PUB. 5-13-2003. MULTIPLE CLASS, INT. CLS. 35, 36, 38 AND 41.
- TERRA NETWORKS, S.A., 28224 POZUELO DE ALARCON (MADRID), SPAIN:
2,745,977. PUB. 3-18-2003. MULTIPLE CLASS, INT. CLS. 9, 16, 38 AND 42.
- TERRA VAC, INC., SAN JUAN, PUERTO RICO:
1,717,178. CANC. INT. CL. 37.

- TESDANE NANNY SERVICES, INC., BOCA RATON, FL:
2,746,300, PUB. 5-13-2003. INT. CL. 35.
- TESSCO COMMUNICATIONS INCORPORATED, HUNT VALLEY, MD:
2,746,611, PUB. 5-13-2003. INT. CL. 8.
- TESTOR CORPORATION, THE, ROCKFORD, IL, PACTRA INDUSTRIES, INC., LOS ANGELES, CA:
975,263. REN. 6-27-03. MULTIPLE CLASS, U.S. CLS. 5 (INT. CL. 1) AND 16 (INT. CL. 2).
- TEX IN THE CITY LLC, NEW YORK CITY, NY:
2,747,262, PUB. 5-13-2003. INT. CL. 41.
- TEXACE CORPORATION, SAN ANTONIO, TX:
2,001,984, CANC. INT. CL. 25.
- TEXAS RANGERS BASEBALL PARTNERS, ARLINGTON, TX, TEXAS RANGERS, LTD., THE, ARLINGTON, TX:
1,216,139. REN. 6-25-03. INT. CL. 41.
- TEXTILE OUTLET OF TAMPA NO. 1, INC., TAMPA, FL:
1,209,237, CANC. INT. CL. 42.
- TEXTRON INC., PROVIDENCE, RI:
737,924, CANC. U.S. CL. 37.
1,207,877, CANC. INT. CL. 7.
- TH-RODVEN RECORDS, INC., MIAMI, FL:
2,001,733, CANC. MULTIPLE CLASS, INT. CLS. 9 AND 41.
- THE ACTIVE NETWORK, INC., LA JOLLA, CA:
2,747,427, PUB. 5-13-2003. INT. CL. 36.
- THE AMERICAN-HELLENIC EDUCATIONAL PROGRESSIVE ASSOCIATION, WASHINGTON, DC AND AHEPA MOTHER LODGE CHAPER #1, DECATUR, GA:
2,746,696, PUB. 5-13-2003. INT. CL. 35.
- THE BOARD OF TRUSTEES OF THE UNIVERSITY OF ALABAMA, UNIVERSITY, AL:
2,745,882, PUB. 12-3-2002. MULTIPLE CLASS, INT. CLS. 6, 14, 16, 20, 21, 25, 28 AND 41.
- THE CHROMALINE CORPORATION, DULUTH, MN:
2,747,049, PUB. 5-13-2003. INT. CL. 1.
2,747,050, PUB. 5-13-2003. INT. CL. 1.
- THE CONSULTING EXCHANGE, INC., CAMBRIDGE, MA:
2,747,143, PUB. 5-13-2003. INT. CL. 35.
- THE DRAMBUIE LIQUEUR COMPANY LIMITED, EDINBURGH EH12 6UX, SCOTLAND:
2,745,751, PUB. 5-13-2003. MULTIPLE CLASS, INT. CLS. 25, 30 AND 33.
- THE DREW PHILIPS CORP., ROSLYN, NY:
2,745,599, PUB. 5-13-2003. INT. CL. 25.
- THE FACE PLACE, WEST HOLLYWOOD, CA:
2,746,832, PUB. 5-13-2003. MULTIPLE CLASS, INT. CLS. 3 AND 44.
- THE FULLER BRUSH COMPANY, GREAT BEND, KS:
2,748,964, INT. CL. 3.
- THE H.D. LEE COMPANY, INC., WILMINGTON, DE:
2,748,906, INT. CL. 25.
- THE HAWKIN'S CHILDREN'S LLC, EUGENE, OR:
2,747,408, PUB. 5-13-2003. INT. CL. 16.
- THE HIGGINS GROUP CORP., MIAMI, FL:
2,746,715, PUB. 5-13-2003. INT. CL. 31.
- THE HOLMES GROUP, INC., MILFORD, MA:
2,746,787, PUB. 5-13-2003. INT. CL. 11.
- THE JOHN AKRIDGE COMPANY, WASHINGTON, DC:
2,749,029, INT. CL. 36.
- THE LEATHER FACTORY, INC., FORT WORTH, VA:
2,746,926, PUB. 5-13-2003. INT. CL. 5.
- THE LORDS COMMISSIONERS OF HER MAJESTY'S TREASURY ACTING THROUGH THE OFFICE OF GOVERNMENT COMMERCE, NORWICH NR7 0HS, UNITED KINGDOM:
2,746,458, PUB. 5-13-2003. MULTIPLE CLASS, INT. CLS. 9, 16, 35 AND 41.
- THE MORF CORPORATION, WESTERVILLE, OH:
2,746,998, PUB. 5-13-2003. INT. CL. 9.
- THE OHIO STATE UNIVERSITY, COLUMBUS, OH:
2,746,765, PUB. 5-13-2003. INT. CL. 42.
- THE POLARIS GROUP, LA MESA, CA:
2,746,777, PUB. 5-13-2003. INT. CL. 42.
- THE PROCTER & GAMBLE COMPANY, CINCINNATI, OH:
2,748,820, INT. CL. 5.
2,748,821, INT. CL. 5.
- THE SPRING AIR COMPANY, ELK GROVES VILLAGE, IL:
2,748,563, INT. CL. 20.
- THE TRUSTEES OF AMERICA'S DRIVE-IN TRUST, RENO, NV:
2,748,672, INT. CL. 32.
- THE TRUSTEES OF COLUMBIA UNIVERSITY IN THE CITY OF NEW YORK, NEW YORK, NY:
2,747,688, INT. CL. 25.
- THE TRUSTEES OF THE EDUCATIONAL ENTERPRISES, AN ARIZONA TRUST, THE TRUSTEES COMPRISING J.C. CHISUM AND JOHN WILDE, BOTH U.S. CITIZENS, NEW RIVER, AZ:
2,746,431, PUB. 5-13-2003. INT. CL. 9.
- THE UNIVERSITY OF SOUTH DAKOTA, VERMILLION, SD:
2,747,366, PUB. 5-13-2003. INT. CL. 41.
- THE UPPER DECK COMPANY, LLC, CARLSBAD, CA:
2,746,918, PUB. 5-13-2003. INT. CL. 16.
- THE WINE GROUP LLC, RIPON, CA:
2,746,816, PUB. 5-13-2003. INT. CL. 41.
- THE WORD AMONG US, INC., IJAMSVILLE, MD:
2,746,568, PUB. 5-13-2003. INT. CL. 16.
- THE YORK CHILDREN'S FOUNDATION, HOUSTON, TX:
2,748,290, INT. CL. 36.
- THE ZONDERVAN CORPORATION, GRAND RAPIDS, MI:
2,747,338, PUB. 5-13-2003. INT. CL. 16.
- THEORIS, INC., CARMEL, IN FROM SOFTWARE SYNERGY, INC., FISHERS, IN:
2,747,821, INT. CL. 42.
- THER-A-PEDIC ASSOCIATES, INC., CLARK, NJ:
1,715,818, CANC. INT. CL. 20.
- THERMO CIDTEC INC., LIVERPOOL, NY:
2,748,539, INT. CL. 9.
- THERMOPATCH CORPORATION, SYRACUSE, NY, TEXTILE MARKING MACHINE CO., INC., SYRACUSE, NY:
738,560. REN. 6-25-03. U.S. CL. 23 (INT. CL. 7).
- THEURER, HAROLD, JR., BROOKLYN, NY:
2,748,941, INT. CL. 21.
- THIMBLES SPECIALTY STORE, INC., NEW YORK, NY:
1,208,540, CANC. INT. CL. 25.
- THIN FILM TECHNOLOGY, INC., HOUSTON, TX:
2,746,812, PUB. 5-13-2003. INT. CL. 1.
- THINKBOX INC., GLENDALE, CA FROM THINKBOX MEDIA, LLC, HOLLYWOOD, CA:
2,747,562, INT. CL. 41.
- THINKBOX MEDIA, INC., GLENDALE, CA FROM THINKBOX MEDIA, LLC, HOLLYWOOD, CA:
2,747,563, INT. CL. 9.
- THOMAS AND KING, INC., LEXINGTON, KY:
2,745,631, PUB. 7-16-2002. INT. CL. 16.
- THOMAS HOLDING COMPANY, CHICAGO, IL:
2,000,870, CANC. INT. CL. 41.
- THOMAS INDUSTRIES INC., LOUISVILLE, KY:
1,209,335, CANC. INT. CL. 11.
- THOMAS-OBERDORFER PUMPS, INC., LOUISVILLE, KY, OBERDORFER PUMPS, INC., SYRACUSE, NY:
1,727,057. REN. 6-23-03. INT. CL. 7.
- THOMAS, DAVID G., KENNESAW, GA:
1,715,318, CANC. INT. CL. 9.
- THOMAS, STEPHEN, LAKE HILL, NY AND THOMAS, MYRNA, LAKE HILL, NY:
2,747,141, PUB. 5-13-2003. INT. CL. 9.
- THOMPSON & CO., INC., TAMPA, FL, DBA THOMPSON CIGAR:
2,015,050, CANC. INT. CL. 42.
- THOMPSON, SHANE, M, SEATTLE, WA:
2,748,934, INT. CL. 42.
- THOMSON, 92100 BOULOGNE-BILLANCOURT, FRANCE FROM PHILIPS ELECTRONICS NORTH AMERICA CORPORATION, NEW YORK, NY:
2,748,080, INT. CL. 9.
- THOMSON INFORMATION LICENSING CORPORATION, CLAYMONT, DE:
2,746,807, PUB. 5-13-2003. INT. CL. 40.
- THOR TECH, INC., LAS VEGAS, NV:
2,745,772, PUB. 10-23-2001. INT. CL. 12.

- THOSE CHARACTERS FROM CLEVELAND, INC., CLEVELAND, OH:
1,773,296. REN. 6-27-03. MULTIPLE CLASS, INT. CLS. 16 AND 25.
- THREE DIMENSION SYSTEMS, INC., PITTSBURGH, PA:
2,747,729. MULTIPLE CLASS, INT. CLS. 10 AND 25.
- THRESHER & GLENNY LIMITED, STRAND, LONDON, ENGLAND:
1,208,527. CANC. INT. CL. 25.
- TI GROUP AUTOMOTIVE SYSTEMS CORPORATION, WARREN, MI TO TI GROUP AUTOMOTIVE SYSTEMS CORPORATION, WARREN, MI:
2,698,532. COR. MULTIPLE CLASS, INT. CLS. 6, 7, 11, 12 AND 17.
- TIDYMAN'S MANAGEMENT SERVICES, INC., GREENACRES, WA. TIDYMAN'S, INC., GREENACRES, WA:
1,816,290. REN. 6-23-03. INT. CL. 42.
- TIGER ELECTRONICS, INC.:
See— HASBRO, INC..
- TIMCO, LANCE A., SEATTLE, WA:
2,747,196. PUB. 5-13-2003. INT. CL. 35.
- TIME SYSTEMS, INC., PHOENIX, AZ:
1,208,315. CANC. INT. CL. 16.
- TIME WARNER ENTERTAINMENT COMPANY, L.P., NEW YORK, NY:
2,746,562. PUB. 5-13-2003. INT. CL. 41.
2,748,668. INT. CL. 28.
- TITAN SPORTS, INC., STAMFORD, CT, DBA THE WORLD WRESTLING FEDERATION:
1,716,716. CANC. INT. CL. 41.
- TITAN TOOL, INC., OAKLAND, NJ, TITAN TOOL INCORPORATED, OAKLAND, NJ:
1,751,011. REN. 6-23-03. INT. CL. 7.
- TITLEX.COM, INC., PALESTINE, TX:
2,748,684. MULTIPLE CLASS, INT. CLS. 35 AND 42.
- TJAHJANA, ATJING, BANDUNG 40173, INDONESIA:
2,748,301. INT. CL. 24.
- TJX COMPANIES, INC., THE, FRAMINGHAM, MA:
2,746,518. PUB. 5-13-2003. INT. CL. 25.
- TK "VIST-SERVICE" LIMITED, RU-129336 MOSCOW, RUSSIAN FEDERATIO:
2,745,522. PUB. 8-13-2002. MULTIPLE CLASS, INT. CLS. 9 AND 12.
- TKO FARMS, INC., HOLLISTER, CA:
2,001,143. CANC. INT. CL. 29.
- TLC TRADEMARK COMPANY, SANTA BARBARA, CA:
2,745,924. PUB. 5-13-2003. INT. CL. 30.
- TM ACQUISITION CORP., PHOENIX, AZ:
2,748,404. MULTIPLE CLASS, INT. CLS. 35 AND 43.
- TM ACQUISITION CORPORATION, PHOENIX, AZ:
2,748,663. MULTIPLE CLASS, INT. CLS. 35 AND 42.
- TMG LIFE INSURANCE COMPANY, BROOKFIELD, WI:
2,001,927. CANC. INT. CL. 36.
- TNT LIMITED, REDFERN, NEW SOUTH WALES 2016, AUSTRALIA:
2,000,738. CANC. INT. CL. 39.
- TOBIAS, STEVEN, BELLAIRE, TX:
2,747,734. INT. CL. 42.
- TODD, ALVIN E., JR., PIGEON FORGE, TN, DBA THEADORE'S ACCENTS:
1,715,440. CANC. INT. CL. 11.
- TODD, GROVER ELTON, JR., GREER, SC:
2,748,524. INT. CL. 36.
- TOGETHER MANAGEMENT GROUP, INC., ELLICOTT CITY, MD:
2,746,809. PUB. 5-13-2003. INT. CL. 45.
- TOKAI INTERNATIONAL CORPORATION, SCRIPTO, INC., DORAVILLE, GA:
1,201,978. REN. 6-22-03. INT. CL. 16.
- TOKYO TOKUSHU DENSEN KABUSHIKI KAISHA, SHINJUKU-KU, TOKYO, JAPAN, TA TOTOKU ELECTRIC CO., LTD.:
2,746,639. PUB. 5-13-2003. INT. CL. 9.
- TOM COLLINS ENTERPRISES, INC., MINNEAPOLIS, MN:
1,716,650. CANC. INT. CL. 41.
1,716,651. CANC. INT. CL. 41.
- TOM MORRIS LIMITED, SCOTLAND, UNITED KINGDOM:
2,747,456. INT. CL. 25.
- TOM'S FOODS, INC., COLUMBUS, GA:
1,774,531. REN. 6-27-03. INT. CL. 42.
- TOMCO, INC., ST. LOUIS, MO:
1,715,498. CANC. INT. CL. 12.
- TOMORROW INTERNATIONAL, INC., TORTOLA, BR. VIRGIN ISLANDS:
2,747,683. INT. CL. 25.
- TONE PRODUCTS, INC., MELROSE PARK, IL:
2,745,508. PUB. 11-23-1999. MULTIPLE CLASS, INT. CLS. 30 AND 32.
- TOP TOBACCO L.P., GLENVIEW, IL:
1,771,755. REN. 6-27-03. INT. CL. 34.
- TOPCO ASSOCIATES, INC., SKOKIE, IL:
1,766,891. REN. 6-23-03. INT. CL. 32.
- TOPHOSTS INTERNATIONAL.COM LIMITED:
See— VERTICALSCOPE INC..
- TOPPS COMPANY, INC., THE, NEW YORK, NY:
2,748,365. INT. CL. 30.
- TORCA PRODUCTS, INC., AUBURN HILLS, MI:
2,745,907. PUB. 5-13-2003. INT. CL. 6.
- TORRENCE, DANA STEVEN, POTOMAC, MD:
2,745,555. PUB. 6-5-2001. INT. CL. 41.
- TORSANA A/S, 2942 SKODSBORG, DENMARK:
2,745,434. PUB. 8-1-2000. MULTIPLE CLASS, INT. CLS. 9 AND 10.
- TOSHIBA AMERCIA CONSUMER PRODUCTS, INC., WAYNE, NJ:
2,747,274. PUB. 5-13-2003. INT. CL. 9.
- TOSHIBA JOHO SYSTEM KABUSHIKI KAISHA, KANAGAWA, JAPAN, DBA TOSHIBA INFORMATION SYSTEMS (JAPAN) CORPORATION:
2,495,212. COR. MULTIPLE CLASS, INT. CLS. 35, 36, 38 AND 42.
- TOTO U.S.A., INC., MORROW, GA:
2,747,836. INT. CL. 2.
- TOUR LOGIC NETWORK, INC., NASHVILLE, TN:
2,000,991. CANC. MULTIPLE CLASS, INT. CLS. 9 AND 42.
- TOURIGNY, MARC S., SOUTH BOSTON, MA:
2,000,682. CANC. INT. CL. 41.
- TOWER CLEANING SYSTEMS, INC., NORRISTOWN, PA:
1,807,863. REN. 6-25-03. INT. CL. 35.
- TOWN FAIR TIRE CENTERS, INC., EAST HAVEN, CT:
2,746,782. PUB. 5-13-2003. INT. CL. 35.
- TOWNE-OLLER & ASSOCIATES, INC., NEW YORK, NY:
1,208,882. CANC. INT. CL. 35.
- TOYMAX INC., MALIBU, CA:
1,763,736. REN. 6-27-03. INT. CL. 28.
- TOYO BOSEKI KABUSHIKI KAISHA, KITA-KU, OSAKA, JAPAN, TA TOYOBO CO., LTD.:
1,764,454. REN. 6-25-03. INT. CL. 16.
- TOYTRONIX LLC, SCOTTSDALE, AZ:
2,746,613. PUB. 5-13-2003. INT. CL. 28.
- TPG ENTERPRISES, INC., OTHELLO, WA:
2,746,634. PUB. 5-13-2003. INT. CL. 32.
- TRADE WEST PUBLISHING, INC., WALNUT, CA:
2,001,978. CANC. INT. CL. 16.
- TRADEMARK HOLDING, INC., NEW YORK, NY FROM NATIONAL RESTAURANTS MANAGEMENT, INC., NEW YORK, NY:
2,745,716. PUB. 7-31-2001. INT. CL. 42.
- TRAMONTINA USA, INC., HOUSTON, TX:
2,001,741. CANC. INT. CL. 8.
- TRANS SERV ASSOCIATES, INC., WOODSTOCK, VA:
1,780,569. REN. 6-23-03. INT. CL. 36.
- TRANS UNION L.L.C., CHICAGO, IL:
2,748,248. INT. CL. 36.
- TRANS WORLD AIRLINES, INC., ST. LOUIS, MO:
2,000,880. CANC. INT. CL. 39.
- TRANS-STATES LINES, INC., FT. SMITH, AR:
1,209,062. CANC. INT. CL. 39.
- TRANS/MID-AMERICA, INC., OMAHA, NE:
2,748,781. INT. CL. 35.
- TRANSACTIONAL MARKETING PARTNERS, INC., SANTA MONICA, CA:
2,748,940. INT. CL. 16.

- TRANSAMERICA ASSURANCE COMPANY, LOS ANGELES, CA:
2,746,646, PUB. 11-5-2002. INT. CL. 36.
- TRANSAMERICA OCCIDENTAL LIFE INSURANCE COMPANY, LOS ANGELES, CA:
2,747,445, PUB. 5-13-2003. INT. CL. 36.
- TRANSCEND SYSTEMS GROUP, INC., SIOUX FALLS, SD:
2,001,181, CANC. INT. CL. 9.
- TRANSPORT RECOVERY SERVICES, INC., BILLERICA, MA TO TRANSPORT RECOVERY SERVICES, INC., BILLERICA, MA:
2,696,385, COR. INT. CL. 35.
- TRANSPORTATION MANUFACTURING CORPORATION, PHOENIX, AZ TO NOVABUS INCORPORATED, ROSWELL, NM:
1,715,494, CANC. INT. CL. 12.
- TRANTER, SCOTT J., LANCASTER, CA:
2,001,256, CANC. INT. CL. 42.
- TRAVEL ANALYTICS, INC., CLEVELAND, OH:
2,746,354, PUB. 5-13-2003. INT. CL. 35.
- TRAVERSE BAY WOOLEN COMPANY, TRAVERSE CITY, MI:
958,203, REN. 6-27-03. U.S. CL. 39 (INT. CL. 25).
- TREAT ENTERTAINMENT, INC., FLORENCE, AL:
2,745,595, PUB. 5-13-2003. MULTIPLE CLASS, INT. CLS. 16 AND 35.
- TREK BICYCLE CORPORATION, WATERLOO, WI:
2,745,442, PUB. 5-13-2003. MULTIPLE CLASS, INT. CLS. 25 AND 28.
- TRENDIUM, INC., SUNRISE, FL:
2,643,785, COR. MULTIPLE CLASS, INT. CLS. 9 AND 42.
- TREVENOL LABORATORIES, INC.:
1,209,221, CANC. INT. CL. 42.
- TRIAB TRI INNOVATION AB, 431 50 MOLODAL, SWEDEN:
1,768,436, REN. 6-21-03. INT. CL. 7.
- TRIBECA BEVERAGE COMPANY, LARGO, FL:
2,748,208, MULTIPLE CLASS, INT. CLS. 5 AND 32.
- TRIMARCO, WILLIAM A., SOUTH AMBOY, NJ, DBA BILL TURNER:
2,745,589, PUB. 5-13-2003. INT. CL. 41.
- TRIMARK ATHLETIC SUPPLIES INC., MARKHAM, ONTARIO L3R 8B9, CANADA:
2,745,742, PUB. 5-13-2003. INT. CL. 18.
- TRINITY INDUSTRIES, INC., DALLAS, TX:
2,000,798, CANC. INT. CL. 6.
- TRINITY RIVER COMMISSION FOUNDATION, INC., DALLAS, TX, DBA TRINITY COMMONS FOUNDATION:
2,747,195, PUB. 5-13-2003. INT. CL. 41.
- TRION, INC., DULUTH, GA, DBA THE CRATE:
2,746,398, PUB. 5-13-2003. INT. CL. 24.
- TRITON TIRE & BATTERY, LLC, MINNEAPOLIS, MN:
2,747,464, INT. CL. 35.
- TRIUMPH SEED CO., INC., RALLS, TX:
1,208,795, CANC. INT. CL. 31.
- TRODYNE CORPORATION, MAHWAH, NJ:
1,207,937, CANC. INT. CL. 9.
- TROLL BOOK FAIRS L.L.C., MAHWAH, NJ:
2,001,439, CANC. INT. CL. 42.
- TROON GOLF, L.L.C., SCOTTSDALE, AZ:
2,747,560, INT. CL. 25.
- TROPICAL SPORTSWEAR INTERNATIONAL CORPORATION, TAMPA, FL:
1,715,925, CANC. INT. CL. 25.
- TROPICANA PRODUCTS, INC., BRADENTON, FL:
2,747,370, PUB. 5-13-2003. INT. CL. 32.
2,748,760, INT. CL. 32.
- TROUBLE, AGNES, 75001 PARIS, FRANCE:
2,001,957, CANC. INT. CL. 3.
- TROUTT, KEVIN, BOISE, ID, DBA FIRST CHOICE AUTO GLASS:
2,747,963, INT. CL. 37.
- TROXELL, MICKEY K., HUNTINGTON BEACH, CA:
2,748,465, INT. CL. 35.
- TROY CORPORATION, CHICAGO, IL, DBA TROY:
1,715,880, CANC. INT. CL. 24.
- TROYER, LLOYD, OSCEOLA, IN:
2,746,000, PUB. 6-11-2002. INT. CL. 7.
- TRS QUALITY, INC., WILMINGTON, DE, TECHNOLOGY PROPERTIES, INC., FORT WORTH, TX:
1,720,904, REN. 6-22-03. INT. CL. 42.
- TRS QUALITY, INC., WILMINGTON, DE:
2,748,958, INT. CL. 9.
- TRU-FORM INTERNET, INC., SPRINGFIELD, NJ:
2,746,448, PUB. 5-13-2003. INT. CL. 8.
- TRUCK-LITE CO., INC., FALCONER, NY:
2,745,771, PUB. 11-5-2002. MULTIPLE CLASS, INT. CLS. 9 AND 11.
- TRUEQUEST COMMUNICATIONS, LLC, CHICAGO, IL:
2,746,974, PUB. 5-13-2003. INT. CL. 16.
- TRUESPECTRA, INC., BURLINGAME, CA:
2,747,978, INT. CL. 42.
- TRUETIME, INC., SANTA ROSA, CA:
1,769,839, REN. 6-27-03. INT. CL. 9.
- TRUPER HERRAMIENTAS, S.A. DE C.V., JILOTEPEC ESTADO DE MEXICO, MEXICO:
2,747,919, MULTIPLE CLASS, INT. CLS. 7, 8 AND 9.
- TRUSERV CORPORATION, CHICAGO, IL:
1,716,953, CANC. INT. CL. 42.
- TRUSTMARK NATIONAL BANK, JACKSON, MS:
2,433,197, AM. INT. CL. 36.
- TRUTH CLOTHING, IRVINE, CA:
2,000,743, CANC. INT. CL. 25.
- TSR, INC., LAKE GENEVA, WI:
1,208,721, CANC. INT. CL. 28.
- TTS TOOLTECHNIC SYSTEMS AG & CO. KG, D-73240 WENDLINGEN, FED REP GERMANY:
2,746,201, PUB. 11-19-2002. MULTIPLE CLASS, INT. CLS. 7, 8, 9 AND 20.
- TUBEPACK LIMITED, GLENFIELD, AUKLAND, NEW ZEALAND:
2,745,690, PUB. 11-12-2002. MULTIPLE CLASS, INT. CLS. 20 AND 40.
- TUBEPACK LIMITED, GLENFIELD, AUKLAND, NEW ZEALAND:
2,745,691, PUB. 11-12-2002. MULTIPLE CLASS, INT. CLS. 20 AND 40.
- TUFTIN, LESLIE, PRINEVILLE, OR:
2,748,538, MULTIPLE CLASS, INT. CLS. 9 AND 35.
- TUFTS ASSOCIATED HEALTH MAINTENANCE ORGANIZATION, INC., WALTHAM, MA:
2,748,017, MULTIPLE CLASS, INT. CLS. 16, 36, 39 AND 41.
- TUM YETO, INC., SAN DIEGO, CA:
2,748,216, MULTIPLE CLASS, INT. CLS. 25 AND 28.
- TUNDRA TRADING, INC., LOS ANGELES, CA:
2,745,792, PUB. 11-5-2002. INT. CL. 30.
- TUNECASTER, INC., ST. JAMES, NY:
2,748,591, INT. CL. 9.
2,748,592, INT. CL. 9.
- TURBO-CHEM INTERNATIONAL, INC., LAFAYETTE, LA:
1,774,804, REN. 6-21-03. INT. CL. 1.
- TURING STUDIO, THE, BERKELEY, CA:
2,745,828, PUB. 5-13-2003. MULTIPLE CLASS, INT. CLS. 9 AND 42.
- TUTORBOTS, INC., JENKINTOWN, PA:
2,748,848, INT. CL. 9.
- TV FANFARE PUBLICATIONS, INC., VALENCIA, CA:
1,715,629, CANC. INT. CL. 16.
- TWELE, GERHARD DBA GERHARD'S NAPA VALLEY SAUSAGE:
See—GNVS ACQUISITION, LLC.
- TWENTIETH CENTURY FOX FILM CORPORATION, LOS ANGELES, CA:
1,783,915, REN. 6-24-03. INT. CL. 9.
2,747,558, INT. CL. 25.
- TWIN LABORATORIES INC., HAPPAUGE, NY, TWIN LABORATORIES, INC., RONKONKOMA, NY:
1,763,989, REN. 6-23-03. INT. CL. 5.
- TWIN LABORATORIES, INC., RONKONKOMA, NY TO TWIN LABORATORIES INC., HAPPAUGE, NY:
1,717,031, CANC. INT. CL. 5.
- TWINNER AKTIEBOLAG, S-390 06 KALMAR, SWEDEN:
2,745,437, PUB. 9-5-2000. MULTIPLE CLASS, INT. CLS. 7 AND 16.

- TWO BLONDE LIZZARDS, LLC., DALLAS, TX:
2,747,169, PUB. 5-13-2003. MULTIPLE CLASS, INT. CLS. 14 AND 25.
- TXU ENERGY SERVICES COMPANY, DALLAS, TX:
2,748,698, INT. CL. 35.
- TYCO INDUSTRIES, INC., MOUNT LAUREL, NJ:
2,001,890, CANC. INT. CL. 28.
- TYCO INTERNATIONAL (US) INC., EXETER, NH:
1,714,975, CANC. INT. CL. 5.
- TYSON FOODS, INC., SPRINGDALE, AR, TYSON FOODS, INC., SPRINGDALE, AR:
1,748,683, REN. 6-23-03. MULTIPLE CLASS, INT. CLS. 29 AND 30.
- U B FOUNDATION ACTIVITIES, INC., BUFFALO, NY:
2,747,995, INT. CL. 9.
- U.I. LAPP GMBH, STUTTGART, FED REP GERMANY:
2,747,002, PUB. 5-13-2003. INT. CL. 9.
- U.S. CIGAR SALES INC., GREENWICH, CT:
2,748,432, INT. CL. 34.
- U.S. LINK, INC., PEQUOT LAKES, MN:
1,716,557, CANC. INT. CL. 38.
- U.S. MEDIA HOLDINGS, INC., NEW YORK, NY:
1,717,081, CANC. INT. CL. 16.
- U-SAVE AUTO RENTAL OF AMERICA, INC., JACKSON, MS:
2,746,172, PUB. 5-13-2003. MULTIPLE CLASS, INT. CLS. 35 AND 36.
- UBI SOFT ENTERTAINMENT S.A., BOIS CEDEX, FRANCE:
2,748,543, INT. CL. 9.
- UBI SOFT, INC., SAN FRANCISCO, CA AND ENTERTAINMENT SOFTWARE PUBLISHING INC., TOKYO 151-0053, JAPAN:
2,748,517, INT. CL. 9.
- UBS AG, CH-8001 ZURICH, SWITZERLAND:
2,745,892, PUB. 5-13-2003. MULTIPLE CLASS, INT. CLS. 36, 38 AND 41.
- UCC VINEYARDS GROUP, INC., NAPA, CA:
2,746,922, PUB. 5-13-2003. INT. CL. 31.
- UCL FINANCIAL GROUP, LLC, MEMPHIS, TN:
2,748,143, INT. CL. 36.
- ULIANOVSK AUTOMOBILE PLANT, ULIANOVSK, RUSSIAN FEDERATIO:
2,001,398, CANC. MULTIPLE CLASS, INT. CLS. 20, 25 AND 37.
- ULTAMA SWIMWEAR, LLC, JACKSONVILLE, FL FROM JACKSON, LESTER M., JACKSONVILLE, FL:
2,748,518, INT. CL. 25.
- ULTIMATE NUT COMPANY, INC., THE, BURBANK, CA, DBA THE ULTIMATE NUT & CANDY CO.:
2,000,954, CANC. INT. CL. 30.
- ULTIMATE SCOREBOOKS INC., THE, TULSA, OK:
2,746,339, PUB. 5-13-2003. INT. CL. 16.
- ULTRA PRO LP, CITY OF COMMERCE, CA, REMBRANDT PHOTO SERVICES, LOS ANGELES, CA:
1,766,700, REN. 6-26-03. INT. CL. 16.
- ULTRA PRO LP, CITY OF COMMERCE, CA FROM REMBRANDT PHOTO SERVICES, CITY OF COMMERCE, CA:
2,747,994, INT. CL. 16.
- ULTRACHEM, INC., WILMINGTON, DE:
1,207,775, CANC. INT. CL. 4.
- ULTRAVATION, INC., BRANDON, VT:
2,746,452, PUB. 5-13-2003. INT. CL. 11.
- UMBERSHOOT, NEW YORK, NY:
2,745,725, PUB. 7-2-2002. INT. CL. 41.
- UN-DU PRODUCTS, INC., DALLAS, TX:
2,748,321, INT. CL. 3.
- UNDER A FOOT PLANT COMPANY, SALEM, OR:
2,747,433, PUB. 5-13-2003. INT. CL. 31.
- UNELKO CORPORATION, SCOTTSDALE, AZ:
1,714,816, CANC. INT. CL. 1.
- UNFILTERED NAPA LLC, NAPA, CA:
2,748,937, INT. CL. 33.
- UNGERMANN-BASS, INC., SANTA CLARA, CA:
1,208,025, CANC. INT. CL. 9.
- UNI HOSIERY CO., INC., LOS ANGELES, CA:
1,798,763, REN. 6-26-03. INT. CL. 25.
- UNI LAC CORP., HATFIELD, PA:
1,208,085, CANC. INT. CL. 10.
- UNICORN ABRASIVES LIMITED, STAFFORD, ST16 1EA, ENGLAND:
2,000,729, CANC. MULTIPLE CLASS, INT. CLS. 3, 7 AND 8.
- UNIEXCEL CHEMICAL SOLUTIONS, L.L.C., BROWNSVILLE, TX:
2,745,973, PUB. 5-13-2003. INT. CL. 1.
- UNIFIED SCHOOL DISTRICT NO. 259, SEDGWICK COUNTY, KANSAS, WICHITA, KS:
2,746,171, PUB. 12-24-2002. INT. CL. 41.
- UNIGARD INSURANCE COMPANY, BELLEVUE, WA:
2,748,240, INT. CL. 36.
- UNIGLOBE TRAVEL (INTERNATIONAL) INC., VANCOUVER, BRITISH COLUMBIA, CANADA:
1,241,491, REN. 6-26-03. MULTIPLE CLASS, INT. CLS. 39 AND 41.
- UNILEVER N.V., 3013 AL ROTTERDAM, NETHERLANDS:
2,748,505, INT. CL. 30.
- UNION BANK, SAN FRANCISCO, CA:
2,001,094, CANC. INT. CL. 36.
- UNION BOOKBINDING CO., INC., MEDFORD, MA:
1,715,558, CANC. INT. CL. 16.
- UNION CARBIDE CORPORATION, DANBURY, CT:
737,777, CANC. U.S. CL. 18.
- UNION DIE CASTING COMPANY, WHITTIER, CA:
737,813, CANC. U.S. CL. 21.
- UNION SWITCH & SIGNAL, INC., PITTSBURGH, PA:
2,748,888, INT. CL. 9.
2,748,889, INT. CL. 9.
- UNION VITI-VINICOLA, S.A. VINEDOS EN CENICERO, 26350 CENICERO (RIOJA), SPAIN:
2,746,329, PUB. 5-13-2003. INT. CL. 33.
- UNIPRO FOODSERVICE, INC., ATLANTA, GA:
2,748,725, MULTIPLE CLASS, INT. CLS. 8, 16 AND 21.
- UNIPSYCH CORP., HOLLYWOOD, FL:
1,794,464, REN. 6-23-03. INT. CL. 42.
- UNIROYAL CHEMICAL COMPANY, INC., MIDDLEBURY, CT:
2,746,524, PUB. 5-13-2003. INT. CL. 1.
- UNISEAL, INC., EVANSVILLE, IN:
2,748,085, INT. CL. 17.
- UNITE, INC., GROSSE POINT WOODS, MI:
2,746,966, PUB. 5-13-2003. INT. CL. 35.
- UNITED AMERICAN INSURANCE COMPANY, MCKINNEY, TX:
2,746,861, PUB. 5-13-2003. INT. CL. 44.
- UNITED BREWERIES LIMITED, BANGALORE-560001, INDIA, KALYANI BREWERIES LIMITED, WEST BENGAL, INDIA:
1,763,162, REN. 6-25-03. INT. CL. 32.
- UNITED CONCESSIONS, INC., CHARLOTTE, NC:
2,001,789, CANC. INT. CL. 42.
- UNITED DESIGN CORPORATION, NOBLE, OK:
1,715,863, CANC. INT. CL. 21.
1,715,988, CANC. INT. CL. 25.
- UNITED FARM AGENCY, INCORPORATED, KANSAS CITY, MO:
1,208,928, CANC. INT. CL. 36.
- UNITED GOVERNMENT SERVICES, LLC., MILWAUKEE, WI:
2,745,871, PUB. 5-13-2003. MULTIPLE CLASS, INT. CLS. 35 AND 45.
- UNITED INDUSTRIES CORPORATION, ST. LOUIS, MO:
2,747,030, PUB. 5-13-2003. INT. CL. 5.
2,747,031, PUB. 5-13-2003. MULTIPLE CLASS, INT. CLS. 1 AND 5.
- UNITED JEWISH APPEAL - FEDERATION OF JEWISH PHILANTHROPIES OF NEW YORK, INC., NEW YORK, NY:
2,746,954, PUB. 5-13-2003. INT. CL. 36.
2,746,955, PUB. 5-13-2003. INT. CL. 36.
- UNITED MERCHANTS AND MANUFACTURERS, INC., NEW YORK, NY:
737,964, CANC. U.S. CL. 42.

- UNITED METHODIST COMMUNICATIONS, NASHVILLE, TN:
1,233,372. REN. 6-23-03. MULTIPLE CLASS, INT. CLS. 9, 16, 35 AND 41.
- UNITED NATURAL TRADING CO., EDISON, NJ, DBA HERSHEY IMPORT CO., INC., HERSHEY IMPORT CO., INC., RAHWAY, NJ:
1,731,357. REN. 6-25-03. MULTIPLE CLASS, INT. CLS. 29 AND 30.
- UNITED OIL COMPANY, MIAMI, FL:
1,716,121, CANC. INT. CL. 29.
- UNITED PARCEL SERVICE OF AMERICA, INC., GREENWICH, CT:
1,208,335, CANC. INT. CL. 17.
- UNITED PLASTIC FILM, INC., ATLANTA, GA TO CONAGRA, INC., OMAHA, NE:
1,717,233, CANC. INT. CL. 16.
- UNITED SALES ASSOCIATES INC., JAMESTOWN, NC:
2,747,258, PUB. 5-13-2003. INT. CL. 15.
- UNITED STATES FILTER CORPORATION, PALM DESERT, CA:
2,746,276, PUB. 6-25-2002. INT. CL. 1.
- UNITED STATES PONY CLUBS, INC., LEXINGTON, KY:
1,782,625. REN. 6-25-03. INT. CL. 16.
- UNITED STATES SHOE CORPORATION, THE, CINCINNATI, OH:
1,209,190, CANC. INT. CL. 42.
- UNITED STATES SKI ASSOCIATION, PARK CITY, UT, DBA UNITED STATES SKI & SNOWBOARD ASSOCIATION:
2,745,887, PUB. 5-13-2003. U.S. CL. 200.
- UNITED STATES TRUST COMPANY OF NEW YORK, NEW YORK, NY:
2,746,358, PUB. 5-13-2003. INT. CL. 36.
- UNITED WAY OF AMERICA, ALEXANDRIA, VA:
1,209,242, CANC. INT. CL. 42.
- UNITEDHEALTH GROUP INCORPORATED, MINNETONKA, MN:
2,747,882, INT. CL. 35.
- UNITRON HEARING, INC., PLYMOUTH, MN, ARGOSY ELECTRONICS, INC., EDEN PRAIRIE, MN:
1,677,488. REN. 6-22-03. INT. CL. 10.
- UNIVERSAL CITY STUDIOS LLLP, UNIVERSITY CITY, CA FROM UNIVERSAL CITY STUDIOS, LP, UNIVERSAL CITY, CA:
2,747,949, INT. CL. 16.
- UNIVERSAL FOOD MARKETING, INC., MANCHESTER, MO:
1,716,113, CANC. INT. CL. 29.
- UNIVERSAL FURNITURE LIMITED, HIGH POINT, NC:
2,748,222, INT. CL. 20.
- UNIVERSAL LIGHTING TECHNOLOGIES, INC., NASHVILLE, TN:
2,746,722, PUB. 5-13-2003. INT. CL. 9.
- UNIVERSAL MANUFACTURING CO., INC., KANSAS CITY, MO:
1,766,026. REN. 6-23-03. INT. CL. 28.
- UNIVERSAL TECHNOLOGY CORP., WILMINGTON, DE:
1,691,168. REN. 6-21-03. MULTIPLE CLASS, INT. CLS. 7, 9, 37 AND 42.
- UNIVERSITY ASSOCIATES, INC., SAN DIEGO, CA:
1,209,138, CANC. INT. CL. 41.
1,209,139, CANC. INT. CL. 41.
- UNIVERSITY COLLEGE LONDON, LONDON, UNITED KINGDOM:
2,746,185, PUB. 5-13-2003. MULTIPLE CLASS, INT. CLS. 10 AND 25.
- UNIVERSITY OF GUELPH, LABORATORY SERVICES DIVISION, GUELPH, ONTARIO, CANADA:
2,745,450, PUB. 4-30-2002. MULTIPLE CLASS, INT. CLS. 35 AND 42.
- UNIVERSITY OF NORTH DAKOTA, THE, GRAND FORKS, ND:
1,209,115, CANC. INT. CL. 41.
1,209,116, CANC. INT. CL. 41.
- UNIVERSITY OF NORTH TEXAS, N.T. STATION, DENTON, TX:
1,209,085, CANC. INT. CL. 41.
- UNIVESSENCE DIGITAL STUDIOS (USA), INC., CULVER CITY, CA:
2,748,111, INT. CL. 42.
- UNIWELED PRODUCTS, INCORPORATED, FT. LAUDERDALE, FL:
1,773,599. REN. 6-27-03. INT. CL. 17.
1,773,600. REN. 6-27-03. INT. CL. 17.
1,773,601. REN. 6-27-03. INT. CL. 17.
- UNLIMITED HOLDINGS, INC., NEW YORK, NY, DBA ADDED EXTRAS, INC.:
2,747,607, MULTIPLE CLASS, INT. CLS. 3 AND 26.
- UNO DOS TRES.COM INC., COCONUT GROVE, FL:
2,747,526, MULTIPLE CLASS, INT. CLS. 35 AND 42.
- UOP LLC, DES PLAINES, IL, UOP INC., DES PLAINES, IL:
1,233,099. REN. 6-23-03. INT. CL. 42.
- UPTON, JOHN K., MINNEAPOLIS, MN:
2,748,780, INT. CL. 36.
- URBAN BRANDS, INC., SECAUCUS, NJ FROM ASHLEY STEWART GROUP LTD, THE, SECAUCUS, NJ:
2,747,468, INT. CL. 35.
- URBAN STREET WEAR, INC., LA MIRADA, CA:
2,747,449, PUB. 5-13-2003. INT. CL. 25.
- URBAN TELEVISION NETWORK, INC., MARINA DEL RAY, CA:
2,747,487, INT. CL. 36.
- URBANSTONE PTY LTD., JANDAKOT, WESTERN AUSTRALIA, AUSTRALIA:
2,745,833, PUB. 11-5-2002. INT. CL. 19.
- URENCO LIMITED, MARLOW BUCKINGHAMSHIRE, UNITED KINGDOM:
2,745,811, PUB. 5-13-2003. MULTIPLE CLASS, INT. CLS. 1, 35, 37, 39, 40 AND 42.
- URRA CO., INC., MERCER, PA:
2,746,623, PUB. 5-13-2003. INT. CL. 35.
- US CONEC LTD., HICKORY, NC:
2,748,033, INT. CL. 9.
- US TUMBLERS, INC., VA BEACH, VA:
2,747,971, INT. CL. 41.
- USA FEDERAL CREDIT UNION, TROY, MI:
2,745,417, PUB. 9-24-2002. INT. CL. 36.
- USBX, INC., SANTA MONICA, CA FROM MAINEMARINAS, INC., SANTA MONICA, CA:
2,747,745, INT. CL. 35.
- USBX, INC., SANTA MONICA, CA:
2,748,655, INT. CL. 35.
- USE INC., BLADENSBURG, MD:
1,209,169, CANC. INT. CL. 42.
- UTILIMASTER CORPORATION, WAKARUSA, IN, HOLIDAY RAMBLER CORPORATION, WAKARUSA, IN:
1,761,239. REN. 6-26-03. INT. CL. 12.
- UV COATINGS LIMITED, BEREA, OH:
2,745,567, PUB. 12-3-2002. MULTIPLE CLASS, INT. CLS. 2 AND 19.
- V STAR INC., SANTA BARBARA, CA:
2,747,593, INT. CL. 42.
- V TECHNOLOGIES INTERNATIONAL CORPORATION:
See—AGILQUEST CORPORATION.
- V. CIRACE & SON, INC., BOSTON, MA:
2,748,549, INT. CL. 33.
- V.I.P. WORLD TRADE CONSULTING LLC, PORTLAND, OR:
2,748,986, INT. CL. 34.
- VACU-DRY COMPANY, EMERYVILLE, CA:
1,208,746, CANC. INT. CL. 29.
- VAISALA OY, 00421 HELSINKI 42, FINLAND:
1,774,081. REN. 6-24-03. INT. CL. 9.
- VALENCE L.L.C., ST. LOUIS PARK, MN:
2,001,072, CANC. INT. CL. 16.
- VALENCIA, URIEL A., BALDWIN PARK, CA:
2,000,586, CANC. INT. CL. 41.
- VALLEY ALUMINUM CO., PHOENIX, AZ:
1,983,767, CANC. INT. CL. 6.
- VALLEY, DIANE C., SALISBURY, NC:
2,748,842, INT. CL. 24.
- VALOR LIMITED, BIRMINGHAM B24 9QP, ENGLAND:
2,745,546, PUB. 5-13-2003. INT. CL. 11.

- VALORIS (SOCIETE ANONYME), ISSY-LES-MOULINEAUX, FRANCE:
2,746,032, PUB. 2-11-2003. MULTIPLE CLASS, INT. CLS. 35 AND 42.
- VALRICO FOODS, INC., MEDLEY, FL:
2,747,409, PUB. 5-13-2003. INT. CL. 30.
- VALUE GARDEN SUPPLY, LLC, BLOOMINGTON, MN, DEXOL INDUSTRIES, TORRANCE, CA:
1,241,707. REN. 6-22-03. MULTIPLE CLASS, INT. CLS. 1 AND 5.
- VAN BUREN COUNTY FRUIT EXCHANGE, INC., HARTFORD, MI:
1,208,809, CANC. INT. CL. 31.
- VAN LOEN TECHNIEK B.V., 3824 MJ AMERSFOORT, NETHERLANDS:
2,746,312, PUB. 12-10-2002. INT. CL. 7.
- VANDERBILT UNIVERSITY, NASHVILLE, TN:
2,746,009, PUB. 5-13-2003. INT. CL. 25.
- VANDYKE SOFTWARE, INC., ALBUQUERQUE, NM:
2,747,314, PUB. 4-8-2003. INT. CL. 9.
- VANS, INC., SANTE FE SPRINGS, CA FROM SWITCH MANUFACTURING, SAN FRANCISCO, CA:
2,747,482, INT. CL. 25.
- VARGA, GEORGE, EDMONTON, ALBERTA, CANADA:
2,000,497, CANC. INT. CL. 28.
- VARI-LITE, INC., DALLAS, TX:
2,000,809, CANC. INT. CL. 41.
- VARIANT, INC., MINNEAPOLIS, MN, DBA WARCO VARIANT:
1,715,073, CANC. MULTIPLE CLASS, INT. CLS. 8 AND 21.
- VARIETY CHILDREN'S LIFELINE, SOLANA BEACH, CA:
2,746,176, PUB. 5-13-2003. INT. CL. 42.
- VARIFORM, INC., KEARNEY, MO:
1,208,384, CANC. INT. CL. 19.
- VARNI BROTHERS CORPORATION, MODESTO, CA:
1,763,157. REN. 6-25-03. INT. CL. 32.
- VASCULAR ARCHITECTS, INC., SAN JOSE, CA:
2,748,116, INT. CL. 10.
- VAZQUEZ, ESTELA MARIA, BUENOS AIRES, ARGENTINA:
2,747,869, INT. CL. 25.
- VECTOR PRODUCTS, INC., MIAMI, FL:
2,747,459, INT. CL. 11.
- VECTOR TOBACCO LTD., HAMILTON, HMCX, BERMUDA:
2,748,408, INT. CL. 34.
- VEDIOR INTERNATIONAL B.V.:
See— VEDIOR INTERNATIONAL CONTRACTS B.V.
- VEDIOR INTERNATIONAL CONTRACTS B.V., AMSTERDAM, NETHERLANDS FROM VEDIOR INTERNATIONAL B.V., 1076 GR AMSTERDAM, NETHERLANDS:
2,745,453, PUB. 8-24-1999. MULTIPLE CLASS, INT. CLS. 35, 41 AND 42.
- VELQUEST CORPORATION, HOPKINTON, MA:
2,747,915, INT. CL. 9.
- VELSICOL CHEMICAL CORPORATION, ROSEMONT, IL:
1,759,320. REN. 6-26-03. INT. CL. 1.
- VELUZAT, RENAUD, NEWHALL, CA:
2,746,166, PUB. 5-13-2003. INT. CL. 41.
- VENDARIA, INC., SEATTLE, WA, FORMERLY BROADCASTZONE, INC.:
2,747,866, MULTIPLE CLASS, INT. CLS. 35, 41 AND 42.
- VENTANA PRODUCTIONS, WASHINGTON, DC:
2,746,577, PUB. 5-13-2003. INT. CL. 41.
- VENVEST, INC., ST. LOUIS, MO:
2,746,214, PUB. 8-20-2002. INT. CL. 36.
2,746,418, PUB. 5-13-2003. INT. CL. 41.
- VERATEX CORPORATION, THE, TROY, MI:
1,209,224, CANC. INT. CL. 42.
- VERIPACK.COM, INC., NEWARK, DE:
2,745,724, PUB. 5-13-2003. MULTIPLE CLASS, INT. CLS. 6, 16, 17, 22 AND 35.
- VERITAS PARTNERS, LLC, OVERLAND PARK, KS:
2,748,884, INT. CL. 45.
- VERN REATH, COSTA MESA, CA:
1,715,344, CANC. INT. CL. 9.
- VERTEX INC., BERWYN, PA:
2,746,687, PUB. 5-13-2003. INT. CL. 35.
- VERTICALSCOPE INC., TORONTO, ONTARIO, CANADA FROM TOPHOSTS INTERNATIONAL.COM LIMITED, TORONTO, ONTARIO:
2,745,706, PUB. 3-4-2003. INT. CL. 35.
- VERWATER ENVIRONMENTAL, LLC, SALINA, KS:
2,746,384, PUB. 5-13-2003. INT. CL. 11.
- VIACODE LIMITED, LONDON, UNITED KINGDOM FROM POST OFFICE, THE, LONDON, UNITED KINGDOM:
2,745,541, PUB. 8-27-2002. MULTIPLE CLASS, INT. CLS. 9, 16, 35, 38, 40 AND 42.
- VIACOM INTERNATIONAL INC., NEW YORK, NY:
2,748,598, INT. CL. 28.
- VIAQUO CORPORATION, SAN JOSE, CA:
2,748,308, INT. CL. 9.
2,748,309, INT. CL. 9.
- VIBEX VENTURES, CRESTON, BC, CANADA:
2,747,878, INT. CL. 28.
- VIBRAM S.P.A., 21041 ALBIZZATE, VARESE, ITALY:
956,548. REN. 6-23-03. U.S. CL. 39 (INT. CL. 25).
- VICARIO, VICTORIANO MARTINEZ, 08185 LLICA DE VALL (BARCELONA), SPAIN:
2,747,984, INT. CL. 3.
- VICON INDUSTRIES, INC., PLAINVIEW, NY:
1,208,013, CANC. INT. CL. 9.
- VICTAULIC COMPANY OF AMERICA, EASTON, PA:
581,095. REN. 6-26-03. U.S. CL. 13 (INT. CL. 6).
968,496. REN. 6-26-03. U.S. CL. 13 (INT. CL. 6).
- VICTORINOX AG, 6438 IBACH-SCHWYZ, SWITZERLAND:
2,746,579, PUB. 5-13-2003. MULTIPLE CLASS, INT. CLS. 8, 11 AND 34.
- VICTORY COLLECTIBLES, LTD., ST. CHARLES, IL:
2,746,355, PUB. 5-13-2003. INT. CL. 9.
- VICTORY PACKAGING, INC., HOUSTON, TX:
2,746,076, PUB. 5-13-2003. MULTIPLE CLASS, INT. CLS. 16, 17, 35 AND 40.
- VIDEO VILLAGE, INC., LEXINGTON, KY:
1,209,091, CANC. MULTIPLE CLASS, INT. CLS. 41 AND 42.
- VIDEODISCOVERY, INC., SEATTLE, WA:
2,746,345, PUB. 9-24-2002. INT. CL. 9.
- VIETNAM VETERANS MEMORIAL FUND, INC., WASHINGTON, DC:
2,000,726, CANC. INT. CL. 42.
- VIEW TECH, INC., CAMARILLO, CA:
2,000,868, CANC. MULTIPLE CLASS, INT. CLS. 41 AND 42.
- VIEWERCOM LIMITED:
See— REFLEC PLC.
- VIKING RIVER CRUISES S.A., L-2017 LUXEMBOURG, LUXEMBOURG:
2,697,106, COR. INT. CL. 39.
- VILLA MARIA ESTATE LIMITED, MANQERE, AUCKLAND, NEW ZEALAND:
2,746,615, PUB. 5-13-2003. INT. CL. 33.
- VILLABELLA AZ. AGR.DI DELIBORI T. E CRISTOFORETTI G. S.S., 37010 AFFI (VR), ITALY:
2,746,227, PUB. 5-13-2003. INT. CL. 33.
- VILLAGE HOMES OF COLORADO, INC., LITTLETON, CO:
2,746,225, PUB. 5-13-2003. INT. CL. 37.
- VILLEROY & BOCH AG, 66693 METTLACH, FED REP GERMANY:
2,703,864, COR. MULTIPLE CLASS, INT. CLS. 11, 20 AND 21.
- VILLEROY & BOCH AG, 66688 METTLACH, FED REP GERMANY:
2,703,871, COR. MULTIPLE CLASS, INT. CLS. 11, 20 AND 21.
- VINA CALITERRA S.A., OF. 503 SANTIAGO, CHILE:
2,745,552, PUB. 5-13-2003. INT. CL. 33.
- VINA FUNDACION DE MENDOZA S.A., BUENOS AIRES, ARGENTINA:
2,748,660, INT. CL. 33.
- VINEDOS ERRAZURIZ OVALLE S.A., SANTIAGO, CHILE:
2,746,036, PUB. 10-22-2002. INT. CL. 33.

- VINEYARD MUSIC GROUP, INC., ANAHEIM, CA:
2,746,244, PUB. 5-13-2003. INT. CL. 9.
2,746,245, PUB. 5-13-2003. INT. CL. 41.
2,746,248, PUB. 5-13-2003. INT. CL. 9.
2,746,278, PUB. 5-13-2003. INT. CL. 9.
- VIRAGE LOGIC CORPORATION, FREMONT, CA:
2,748,363, INT. CL. 9.
- VIRBAC AH, INC., FORT WORTH, TX:
2,747,365, PUB. 5-13-2003. INT. CL. 5.
- VIRGINIA NATURAL GAS, INC., NORFOLK, VA:
1,716,672, CANC. INT. CL. 41.
- VIRON INTERNATIONAL CORPORATION, OWOSSO, MI:
1,269,089, REN. 6-22-03. INT. CL. 11.
- VIRTU, LLC, CHICAGO, IL:
2,746,208, PUB. 5-13-2003. INT. CL. 35.
- VIRTUAL INDUSTRIES, INC., COLORADO SPRINGS, CO:
2,000,935, CANC. INT. CL. 8.
- VIRTUAL REALTY NETWORK, INC., NEWPORT BEACH, CA:
2,002,024, CANC. INT. CL. 36.
- VISAGE INTERNATIONAL LIMITED, ESSEX, ENGLAND, UNITED KINGDOM:
2,747,064, PUB. 11-5-2002. INT. CL. 3.
- VISIBLE SYSTEMS CORPORATION, WALTHAM, MA:
1,716,649, CANC. MULTIPLE CLASS, INT. CLS. 41 AND 42.
- VISIONQUEST INDUSTRIES, INC., IRVINE, CA, DBA VQ ORTHOCARE:
2,746,498, PUB. 5-13-2003. INT. CL. 10.
- VISIONS OF REALITY CORPORATION, SOUTH SAN FRANCISCO, CA:
2,000,501, CANC. INT. CL. 42.
- VISMA ASA, LYSAKER, NORWAY:
2,747,082, PUB. 11-5-2002. INT. CL. 36.
- VISONIC LTD., 61220 TEL AVIV, ISRAEL:
2,745,745, PUB. 5-13-2003. INT. CL. 9.
- VISTA DEVELOPMENT INC., WALBRIDGE, OH, DBA VISTA:
1,716,483, CANC. INT. CL. 37.
- VISUALAG, L.C., SOUIX CITY, IA:
2,747,331, PUB. 5-13-2003. INT. CL. 42.
- VISUALIZATION TECHNOLOGY, INC., LAWRENCE, MA:
2,745,902, PUB. 10-8-2002. INT. CL. 10.
- VITA CUBE SYSTEMS, INC., DENVER, CO:
2,748,061, INT. CL. 5.
- VITA LICENSING, INC., WILMINGTON, DE FROM ORTHOVITA, INC., MALVERN, PA:
2,748,040, INT. CL. 10.
- VITALWORKS INC., RIDGEFIELD, CT FROM INFOCURE CORPORATION, ATLANTA, GA:
2,747,746, INT. CL. 9.
- VIVADERM SKIN CARE LTD., IRVING, TX:
2,747,604, INT. CL. 42.
- VIVENTIA BIOTECH INC., TORONTO, ONTARIO, CANADA:
2,745,868, PUB. 9-17-2002. MULTIPLE CLASS, INT. CLS. 1, 5 AND 42.
- VIVIL A. MUELLER GMBH & CO. KG, OFFENBURG, FED REP GERMANY:
2,747,305, PUB. 5-13-2003. INT. CL. 30.
- VIVOMETRICS, INC., VENTURA, CA:
2,748,022, MULTIPLE CLASS, INT. CLS. 9 AND 42.
- VIX, FRANCOIS, 92200 NEUILLY SUR SEINE, FRANCE:
2,746,314, PUB. 5-13-2003. INT. CL. 5.
- VNU BUSINESS MEDIA, INC., NEW YORK, NY, BPI COMMUNICATIONS L.P., NEW YORK, NY:
1,768,293, REN. 6-23-03. INT. CL. 16.
- VODAVI COMMUNICATIONS SYSTEMS, INC., SCOTTS-DALE, AZ:
2,748,267, INT. CL. 9.
- VOGUE TYRE & RUBBER COMPANY, MOUNT PROSPECT, IL:
1,791,502, REN. 6-25-03. INT. CL. 12.
- VOICE IT WORLDWIDE, INC., FORT COLLINS, CO:
2,000,990, CANC. INT. CL. 9.
- VOLANTIS SYSTEMS LIMITED, GUILDFOR, SURREY GU27TYT, UNITED KINGDOM:
2,745,949, PUB. 12-10-2002. MULTIPLE CLASS, INT. CLS. 9 AND 42.
- VOLKSWAGEN AKTIENGESELLSCHAFT, D-38436 WOLFSBURG, FED REP GERMANY:
2,745,787, PUB. 1-14-2003. MULTIPLE CLASS, INT. CLS. 4, 7, 12, 25, 28, 37 AND 41.
- VOLVO TRADEMARK HOLDING AB, 405 08 GOTEBOURG, SWEDEN:
2,748,025, MULTIPLE CLASS, INT. CLS. 35 AND 36.
- VON ALMEN, GARY, HIGHLAND, IN AND VON ALMEN, SANDRA, HIGHLAND, IN:
2,746,679, PUB. 5-13-2003. INT. CL. 41.
- VON STRUNCKEL, SHELLEY, LONDON SW1P-1QE, ENGLAND:
2,748,579, INT. CL. 14.
- VOUVAKIS, JAMES M., LOS ANGELES, CA AND TAKAHASHI, YUMI, LOS ANGELES, CA:
2,746,464, PUB. 5-13-2003. INT. CL. 3.
- VSM GROUP AB, SWEDEN:
2,746,835, PUB. 5-13-2003. INT. CL. 9.
- VUGRINEC, THOMAS H., ROCK SPRINGS, WY:
2,001,137, CANC. INT. CL. 29.
- VULCANA, INC., ALEXANDRIA, VA:
2,747,578, INT. CL. 18.
2,747,579, INT. CL. 16.
- VUOCOLO, JAMES S., REDLANDS, CA:
2,745,847, PUB. 5-13-2003. INT. CL. 41.
- VYCAN BUILDING PRODUCTS, INC., TORONTO ONTARIO, CANADA:
1,208,380, CANC. INT. CL. 19.
- W GOEBEL PORZELLANFABRIK GMBH & CO. KG, D-96472 ROEDENTAL, FED REP GERMANY, W. GOEBEL PORZELLANFABRIK, 8633 RODENTAL, BAVARIA, FED REP GERMANY:
1,765,795, REN. 6-27-03. MULTIPLE CLASS, INT. CLS. 16, 21, 39 AND 42.
- W. MOORCROFT P.L.C., STAFFORDSHIRE, ST6 2DQ, UNITED KINGDOM:
2,745,972, PUB. 5-13-2003. MULTIPLE CLASS, INT. CLS. 11, 14, 16, 19, 21 AND 24.
- W. NEUDORFF GMBH KG, EMMERTHAL 1, FED REP GERMANY:
2,747,093, PUB. 10-15-2002. MULTIPLE CLASS, INT. CLS. 1 AND 5.
- W. R. GRACE & CO.-CONN., COLUMBIA, MD:
1,795,502, REN. 6-23-03. INT. CL. 1.
- W. W. DISTRIBUTORS, INC., RICHMOND, VA:
2,000,630, CANC. INT. CL. 32.
- W.R. GRACE & CO.-CONN., NEW YORK, NY:
2,748,871, INT. CL. 19.
- WACHOVIA CORPORATION, WINSTON-SALEM, NC:
2,001,670, CANC. INT. CL. 36.
- WACO INTERNATIONAL CORPORATION, CLEVELAND, OH:
2,745,420, PUB. 1-21-2003. INT. CL. 6.
- WAESPE AG, CH-8184 BACHENBULACH, SWITZERLAND:
2,000,741, CANC. MULTIPLE CLASS, INT. CLS. 29 AND 30.
- WAFFLE HOUSE OF AMERICA, INC., BUCHANAN, MI:
1,209,163, CANC. INT. CL. 42.
- WAGGLE PTY. LTD., UPPER COOMERA QUEENSLAND 4210, AUSTRALIA:
2,001,713, CANC. INT. CL. 25.
- WAGNER, CHARLES G., MILTON, DE:
2,001,409, CANC. INT. CL. 10.
- WAITERS ON WHEELS, INC., SAN FRANCISCO, CA:
1,726,308, REN. 6-24-03. INT. CL. 39.
- WAKAMOTO PHARMACEUTICAL COMPANY LIMITED, TOKYO, JAPAN:
2,746,788, PUB. 5-13-2003. INT. CL. 5.
- WAL-MART STORES, INC., BENTONVILLE, AR:
1,716,947, CANC. INT. CL. 42.
1,783,039, REN. 6-24-03. INT. CL. 42.
2,001,650, CANC. INT. CL. 25.
2,749,033, INT. CL. 29.
- WALDEMAR LINK (GMBH & CO.), HAMBURG, FED REP GERMANY:
2,747,708, INT. CL. 10.

- WALKER & ZANGER, INC., SYLMAR, CA:
2,746,190, PUB. 11-19-2002. INT. CL. 19.
- WALKMILL, LLC., HATBORO, PA:
2,748,950, INT. CL. 28.
- WALLACH & COMPANY, INC., MIDDLEBURG, VA:
2,746,521, PUB. 5-13-2003. INT. CL. 36.
- WALTER V. CLARKE ASSOCIATES, INCORPORATED,
PITTSBURGH, PA:
2,746,833, PUB. 5-13-2003. INT. CL. 35.
- WARD ACCESSORIES, INC., DAYTON, OH, KEATING
KOUPLING INC., SIX MILE, SC:
1,745,502, REN. 6-27-03. INT. CL. 6.
- WARD-KRAFT, INC., FT. SCOTT, KS:
2,748,252, INT. CL. 20.
- WARM SPIRIT, INC., NEW YORK, NY:
2,746,178, PUB. 5-13-2003. INT. CL. 25.
- WARNACO INC., NEW YORK, NY:
2,002,022, CANC. INT. CL. 25.
- WARNER PRESS, INC., ANDERSON, IN:
1,208,213, CANC. MULTIPLE CLASS, INT. CLS. 16 AND
20.
- WARREN I. BLUM PRODUCTIONS, LOS ANGELES, CA:
2,748,615, INT. CL. 9.
- WARSTEINER BRAUEREI HAUS CRAMER KG, WAR-
STEIN, FED REP GERMANY:
2,746,035, PUB. 5-13-2003. INT. CL. 32.
2,746,040, PUB. 10-1-2002. MULTIPLE CLASS, INT. CLS.
32 AND 43.
- WASCHUTZA, STEFANIE, LEHRTE D-31275, FED REP
GERMANY:
2,745,860, PUB. 9-4-2001. INT. CL. 5.
- WASTE MANAGEMENT, INC., HOUSTON, TX:
2,746,916, PUB. 5-13-2003. INT. CL. 16.
- WATCH TOWER BIBLE AND TRACT SOCIETY OF PENN-
SYLVANIA, BROOKLYN, NY:
1,208,323, CANC. INT. CL. 16.
- WATER TIME, INC., PITTSSTON, PA:
2,748,896, INT. CL. 32.
- WATERFORD, GARY WAYNE, KOGARAH, NEW SOUTH
WALES, 2217, AUSTRALIA:
2,746,242, PUB. 5-13-2003. MULTIPLE CLASS, INT. CLS.
27 AND 37.
- WATKINS MANUFACTURING CORPORATION, VISTA,
CA:
2,748,409, INT. CL. 11.
- WATSON PHARMACEUTICALS, INC., CORONA, CA:
2,745,642, PUB. 9-24-2002. INT. CL. 5.
- WAUPACA ELEVATOR COMPANY, INC., APPLETON, WI:
2,747,096, PUB. 5-13-2003. INT. CL. 7.
- WAVE2WAVE COMMUNICATIONS, INC., HACKENSACK,
NJ:
2,747,786, MULTIPLE CLASS, INT. CLS. 9, 38, 39 AND 42.
- WAX POETIC, INC., BERNALILLO, NM:
2,001,353, CANC. INT. CL. 4.
- WAY TO GO SPORTSWEAR, INC., NEW YORK, NY:
2,000,812, CANC. INT. CL. 25.
- WAY2SMART, INC., JACKSON, MS:
2,747,145, PUB. 5-13-2003. INT. CL. 42.
- WCI COMMUNITIES, INC., BONITA SPRINGS, FL:
2,746,876, PUB. 5-13-2003. INT. CL. 37.
- WE PHARMACEUTICALS, INC., RAMONA, CA:
2,746,145, PUB. 10-22-2002. INT. CL. 5.
- WEALTH PLANNING INSTITUTE, LLC, SCOTTSDALE, AZ:
2,748,028, INT. CL. 9.
- WEATHER RESEARCH CENTER, HOUSTON, TX:
2,746,874, PUB. 5-13-2003. INT. CL. 42.
2,748,885, INT. CL. 41.
- WEAVER BROS. INSURANCE ASSOCIATES, INC., BETHES-
DA, MD:
1,806,398, REN. 6-27-03. INT. CL. 36.
- WEB SERVICE COMPANY, INC., REDONDO BEACH, CA:
2,748,870, INT. CL. 35.
- WEB SERVICES-INTEROPERABILITY ORGANIZATION,
INC., NEW YORK, NY, DBA D/B/A WEB SERVICES-
INTEROPERABILITY ORGANIZATION:
2,746,466, PUB. 5-13-2003. INT. CL. 35.
- WEBB COMPANY, THE, ST. PAUL, MN:
159,149, CANC. U.S. CL. 38.
- WEBER, ALBERT, LOS ANGELES, CA:
2,745,906, PUB. 5-13-2003. INT. CL. 28.
- WEBLINK WIRELESS, INC., DALLAS, TX FROM PAGE-
MART, INC., DALLAS, TX:
2,747,466, INT. CL. 38.
- WEDDING WICKS, LLC, MARINA DEL REY, CA:
2,748,618, MULTIPLE CLASS, INT. CLS. 4 AND 21.
- WEDDINGCHANNEL.COM, INC., LOS ANGELES, CA
FROM WEDCOM, INC., LOS ANGELES, CA:
2,747,661, MULTIPLE CLASS, INT. CLS. 35 AND 42.
- WEEKLY READER CORPORATION, STAMFORD, CT:
2,746,383, PUB. 5-13-2003. INT. CL. 42.
- WEGNER, JAMES, ELMHURST, IL, DBA GUARDIAN
DATA SYSTEMS:
1,715,244, CANC. INT. CL. 9.
- WEHAH FARM, INC., RICHVALE, CA, DBA LUNDBERG
FAMILY FARMS:
1,717,254, CANC. INT. CL. 30.
- WEIDNER, RANDALL N., EAST HAVEN, CT AND WEID-
NER, JOHN G., EAST HAVEN, CT:
1,715,459, CANC. INT. CL. 12.
- WEISS & NEUMAN SHOE COMPANY:
See — BAKERS FOOTWEAR GROUP, INC..
- WELD TOOLING CORPORATION, PITTSBURGH, PA:
1,767,198, REN. 6-27-03. INT. CL. 7.
- WELEDA A.G. (WELEDA CO. LTD.), ARLESHEIM, SWIT-
ZERLAND:
738,003, CANC. U.S. CL. 51.
- WELLMAG TECHNOLOGY CO., LTD., TACHIA, TAI-
CHUNG HSIEN, TAIWAN:
2,681,586, COR. MULTIPLE CLASS, INT. CLS. 9 AND 12.
- WELLNESS COACHES OF AMERICA, INC., LAKE FOREST,
CA:
2,001,158, CANC. INT. CL. 41.
- WELLPOINT HEALTH NETWORKS, INC., THOUSAND
OAKS, CA:
2,748,462, INT. CL. 36.
- WELLS FARGO & COMPANY, SAN FRANCISCO, CA:
2,001,704, CANC. INT. CL. 35.
- WELLS FARGO & COMPANY, MINNEAPOLIS, MN:
2,748,237, INT. CL. 36.
2,748,997, MULTIPLE CLASS, INT. CLS. 16 AND 36.
- WENDT & KUEHN KG, D-09579 GRUENHAINICHEN, FED
REP GERMANY:
2,746,091, PUB. 5-13-2003. MULTIPLE CLASS, INT. CLS.
15, 20 AND 28.
- WESBANCO, INC., WHEELING, WV:
1,716,423, CANC. INT. CL. 36.
- WESCOR, INC., LOGAN, UT:
1,762,583, REN. 6-26-03. MULTIPLE CLASS, INT. CLS. 9
AND 10.
- WEST COAST GROCERY COMPANY, TACOMA, WA:
1,209,185, CANC. INT. CL. 42.
- WEST JERSEY HEALTH SYSTEM, CAMDEN, NJ:
2,747,489, INT. CL. 42.
- WEST LINN PAPER COMPER, WEST LINN, OR, CROWN
ZELLERBACH CORPORATION, SAN FRANCISCO, CA:
958,596, REN. 6-24-03. U.S. CL. 37 (INT. CL. 16).
- WEST PALM BEACH TECHNOLOGIES, INC., DELRAY
BEACH, FL:
2,745,605, PUB. 10-1-2002. INT. CL. 42.
- WEST POINT-PEPPERELL, INC., WEST POINT, GA:
1,208,494, CANC. MULTIPLE CLASS, INT. CLS. 24 AND
27.
- WESTERN COLLEGIATE HOCKEY ASSOCIATION, MADI-
SON, WI:
2,000,506, CANC. MULTIPLE CLASS, INT. CLS. 14, 25
AND 26.
- WESTERN FAMILY FOODS, INC., TIGARD, OR:
1,716,219, CANC. INT. CL. 30.
- WESTERN HOLDINGS, L.L.C., CASPER, WY:
2,747,389, PUB. 5-13-2003. INT. CL. 3.
- WESTERN MEDICAL INC., TENAFLY, NJ:
2,748,104, INT. CL. 10.
- WESTERN MICRO TECHNOLOGY, INC., SARATOGA, CA:
2,000,794, CANC. INT. CL. 42.
- WESTERN TELE-COMMUNICATIONS, INC., DENVER, CO:
1,209,024, CANC. INT. CL. 38.

- WESTERRA SOUTHLAKE, L.P., DALLAS, TX:
2,748,587, INT. CL. 37.
- WESTEX INTERNATIONAL (CANADA) LTD., MISSISSAUGA, ONTARIO, CANADA:
2,745,462, PUB. 5-13-2003. MULTIPLE CLASS, INT. CLS. 20 AND 24.
- WESTIN LICENSE COMPANY, SEATTLE, WA:
1,716,801, CANC. INT. CL. 42.
- WESTIN LICENSE COMPANY, WHITE PLAINS, NY:
2,748,378, INT. CL. 42.
- WESTWAY TRADING CORPORATION, NEW ORLEANS, LA:
2,747,889, INT. CL. 31.
- WESTWOOD-SQUIBB PHARMACEUTICALS INC., BUFFALO, NY:
1,735,991, CANC. INT. CL. 3.
- WETTERAU INCORPORATED, HAZELWOOD, MO:
1,208,776, CANC. INT. CL. 30.
- WF ACQUISITION SUB, INC., IRVINE, CA FROM PACIFIC ONLINE COMPUTERS, INC., IRVINE, CA, DBA ONLINE CONNECTING POINT:
2,747,493, INT. CL. 35.
- WGM SAFETY CORP., READING, PA:
2,001,885, CANC. INT. CL. 9.
- WHC, INC., KIRKLAND, WA:
2,748,830, INT. CL. 33.
- WHEAT, JARED R., NORCROSS, GA:
2,745,913, PUB. 11-12-2002. INT. CL. 5.
- WHEATON VILLAGE, INC., MILLVILLE, NJ:
2,746,485, PUB. 5-13-2003. INT. CL. 41.
- WHEELS OF SOUL, PHILADELPHIA, PA:
2,748,898, INT. CL. 25.
- WHIMSIES, INC., ALAMOGORDO, NM:
2,001,067, CANC. INT. CL. 20.
- WHIPPLE & COMPANY PROFESSIONAL CORPORATION, INDIANAPOLIS, IN, AKA WHIPPLE & COMPANY, P.C.:
1,208,912, CANC. INT. CL. 35.
- WHIRLPOOL PROPERTIES, INC., ST. JOSEPH, MI:
2,747,255, PUB. 5-13-2003. INT. CL. 11.
- WHITCOMB; MEG WHITTLE, BRONXVILLE, NY:
1,208,258, CANC. INT. CL. 16.
- WHITE ROCK NETWORKS, INC., DALLAS, TX:
2,687,160, COR. INT. CL. 9.
- WHITEMARSH INDUSTRIES, INC., NEW YORK, NY:
1,208,559, CANC. INT. CL. 25.
- WHITING AND DAVIS COMPANY, INC., PLAINVILLE, MA:
159,154, CANC. U.S. CL. 3.
- WHOLE FOODS MARKET SERVICES, INC., AUSTIN, TX:
2,745,699, PUB. 3-26-2002. INT. CL. 30.
- WICKER FOOD PRODUCTS, INC., HORNERSVILLE, MO, DBA WICKER'S FOOD PRODUCTS, INC., WICKER BARBECUE PRODUCTS COMPANY, HORNERSVILLE, MO:
1,226,822, REN. 6-26-03. INT. CL. 30.
- WIDEPENWEST NETWORKS, LLC, LITTLETON, CO:
2,745,619, PUB. 5-14-2002. INT. CL. 38.
- WIELAND ELECTRIC GMBH, DE-96052 BAMBERG, FED REP GERMANY:
2,746,461, PUB. 5-13-2003. INT. CL. 9.
- WIELAND-WERKE AG, D-89079 ULM, FED REP GERMANY:
2,746,132, PUB. 5-13-2003. INT. CL. 6.
- WIGGANS, THOMAS G., ATHERTON, CA:
2,748,089, MULTIPLE CLASS, INT. CLS. 16 AND 25.
- WIGSTON'S LURES, NEW NORFOLK, TASMANIA, AUSTRALIA:
1,766,817, REN. 6-25-03. INT. CL. 28.
- WILBERT, INC., FOREST PARK, IL:
2,746,499, PUB. 5-13-2003. INT. CL. 42.
- WILCOX INFORMATION SECURITY GROUP, INC., KALAMAZOO, MI:
2,748,535, INT. CL. 9.
- WILD WILLY'S BURGERS, INC., YORK, ME:
2,746,233, PUB. 5-13-2003. INT. CL. 43.
- WILDERNESS SOFTWARE LTD., ST. JOHNS, NF., CANADA:
2,001,097, CANC. MULTIPLE CLASS, INT. CLS. 9 AND 41.
- WILDOLPHIN, LTD., CHICAGO, IL FROM MONACO, MARK S., CHICAGO, IL:
2,747,623, INT. CL. 35.
- WILHELM; ROBERT A., MARYSVILLE, OH, DBA COUNTRY ACRES GREENHOUSE:
1,208,820, CANC. INT. CL. 31.
- WILLI VOGTLIN AKTIENGESELLSCHAFT, BASEL, SWITZERLAND:
1,208,019, CANC. INT. CL. 9.
- WILLIAM CHRISTOPHER HILL, COSTA MESA, CA:
2,000,933, CANC. INT. CL. 9.
- WILLIAM L. BONNELL COMAPNY, INC., THE, NEWNAN, GA:
737,731, CANC. U.S. CL. 12.
- WILLIAMS SCOTSMAN, INC., BALTIMORE, MD:
1,766,208, REN. 6-25-03. INT. CL. 36.
- WILLIAMS, CHRISTABEL M., HOLLISTER, CA:
2,747,146, PUB. 5-13-2003. INT. CL. 42.
- WILLIAMSON PRINTING CORPORATION, DALLAS, TX:
2,747,646, INT. CL. 42.
- WILLIAMSON, CRAIG, SOUTH PORTLAND, ME:
1,716,718, CANC. INT. CL. 41.
- WILLIS CORROON CORPORATION, NASHVILLE, TN:
2,000,846, CANC. MULTIPLE CLASS, INT. CLS. 9 AND 35.
- WILLIS, THERESA ANNE, SAN ANTONIO, TX AND BAUER, PATRICIA ANN, SAN ANTONIO, TX:
2,747,316, PUB. 5-13-2003. INT. CL. 35.
- WILLIX, ROBERT D., JR., DELRAY BEACH, FL:
2,000,790, CANC. INT. CL. 42.
- WILLY BOGNER GMBH & CO. KOMMANDITGESELLSCHAFT AUF AKTIEN, 81673 MUENCHEN, FED REP GERMANY:
2,745,829, PUB. 11-19-2002. INT. CL. 14.
- WILSON GREATBATCH LTD., CLARENCE, NY:
2,594,691, COR. INT. CL. 9.
- WILSON SPORTING GOODS CO., CHICAGO, IL:
2,001,840, CANC. INT. CL. 28.
- WILSON SPORTING GOODS, CO., RIVER GROVE, IL:
1,208,702, CANC. INT. CL. 28.
- WILSON TOOL INTERNATIONAL, INC., WHITE BEAR LAKE, MN:
1,765,561, REN. 6-23-03. INT. CL. 7.
- WILSON-COOK MEDICAL INC., WINSTON-SALEM, NC:
1,715,407, CANC. INT. CL. 10.
1,715,409, CANC. INT. CL. 10.
- WILTON INDUSTRIES, INC., WOODRIDGE, IL:
2,746,018, PUB. 4-30-2002. INT. CL. 21.
2,748,369, INT. CL. 21.
- WIMAN BEVERAGE COMPANY, INC., BRISBANE, CA:
2,001,810, CANC. INT. CL. 32.
- WINCHESTER; HILDRED, SPOKANE, WA, DBA GO-BABY-GO MFG. CO.:
1,208,603, CANC. INT. CL. 26.
- WINDMERE CORPORATION, MIAMI LAKES, FL:
1,717,066, CANC. INT. CL. 11.
- WINDMILL FARMS NURSERIES, INC., ZOLFO SPRINGS, FL:
1,716,235, CANC. INT. CL. 31.
1,716,236, CANC. INT. CL. 31.
- WINDOW & DOOR MANUFACTURERS ASSOCIATION, DES PLAINES, IL:
2,745,886, PUB. 5-13-2003. U.S. CL. A.
- WINEWORLD LONDON PLC, LONDON, UNITED KINGDOM:
2,745,477, PUB. 5-13-2003. INT. CL. 41.
- WINKLER + DUNNEBIER AKTIENGESELLSCHAFT, 56562 NEUWIED, FED REP GERMANY:
2,747,891, INT. CL. 7.
- WINKLEVOSS, HAROLD, GREENWICH, CT AND WINKLEVOSS, CAROL, GREENWICH, CT:
2,748,145, MULTIPLE CLASS, INT. CLS. 41 AND 42.
- WINOKUR WATER SYSTEMS CORP., BETHEL, CT:
2,001,322, CANC. INT. CL. 11.
- WINSTON, SCOTT & BRYANT INTERNATIONAL, INC., CHICAGO, IL, DBA GRANDMA ZOUPS:
2,001,647, CANC. INT. CL. 16.

- WINTHROP CORPORATION, THE, MILFORD, CT, DBA WRIGHT INVESTORS' SERVICE:
1,763,251. REN. 6-26-03. INT. CL. 36.
- WINTHROP MEDIA GROUP LLC, NEW YORK, NY:
2,748,998, INT. CL. 9.
- WIPAK WALSRÖDE GMBH & CO. KG, DE-29656 WALSRÖDE, FED REP GERMANY:
2,746,330, PUB. 5-13-2003. MULTIPLE CLASS, INT. CLS. 16 AND 17.
- WIRESTONE, LLC, EMERYVILLE, CA FROM KARL, ALAN F., COSTA MESA, CA:
2,747,053, PUB. 5-13-2003. MULTIPLE CLASS, INT. CLS. 35, 41 AND 42.
- WIREWAY/HUSKY CORP., DENVER, NC:
2,748,916, INT. CL. 6.
- WISCONSIN ENERGY CORPORATION, MILWAUKEE, WI:
2,748,304, MULTIPLE CLASS, INT. CLS. 36, 39, 40 AND 42.
- WISCONSIN PUBLIC SERVICE CORPORATION, GREEN BAY, WI:
2,001,638, CANC. INT. CL. 39.
- WISEMAN, BRIAN, M., SAUGUS, MA:
2,747,215, PUB. 5-13-2003. INT. CL. 9.
- WISHBOX, INC., ESSEX FIELDS, NJ:
2,001,116, CANC. INT. CL. 25.
- WITHOUSE, INC., LOS ANGELES, CA:
2,746,270, PUB. 5-13-2003. INT. CL. 25.
- WITCO CHEMICAL CORPORATION, NEW YORK, NY:
737,760, CANC. U.S. CL. 16.
- WITCO GMBH, D-59180 BERGKAMEN, FED REP GERMANY:
1,207,686, CANC. INT. CL. 1.
- WITEX USA, INC., KENNESAW, GA:
2,746,790, PUB. 5-13-2003. MULTIPLE CLASS, INT. CLS. 19 AND 27.
- WIZARD PUBLICATIONS, INC., LIHU'E, HI:
2,746,667, PUB. 5-13-2003. INT. CL. 41.
- WIZARD TECHNOLOGIES, INC., PURCHASE, NY:
2,747,612, INT. CL. 42.
- WMS GAMING INC., WAUKEGAN, IL:
2,748,747, INT. CL. 9.
2,748,790, INT. CL. 9.
- WNBA ENTERPRISES, LLC, SECAUCUS, NJ:
2,747,667, INT. CL. 28.
- WOLF ORGANIZATION, INC., THE, YORK, PA:
2,748,154, INT. CL. 20.
2,748,220, INT. CL. 20.
- WOLFE, SCOTT, CHALMETTE, LA AND WOLFE, JANE, CHALMETTE, LA:
2,747,194, PUB. 5-13-2003. INT. CL. 43.
- WOLFORD AKTIENGESELLSCHAFT, A-6901 BREGENZ, AUSTRIA:
2,746,523, PUB. 5-13-2003. INT. CL. 25.
- WOLVERINE WORLD WIDE, INC., ROCKFORD, MI:
2,001,572, CANC. INT. CL. 25.
- WOMENS CARE RESOURCES, INC., BRANDON, FL:
2,001,750, CANC. INT. CL. 9.
- WOMYNS' WARE INC., VANCOUVER, BRITISH COLUMBIA, CANADA:
2,745,985, PUB. 5-13-2003. INT. CL. 35.
- WONDERS: THE MEMPHIS INTERNATIONAL CULTURAL SERIES, MEMPHIS, TN:
2,746,632, PUB. 5-13-2003. INT. CL. 41.
- WOOD CARVERS SUPPLY, INC., ENGLEWOOD, FL:
1,726,480. REN. 6-21-03. INT. CL. 42.
1,737,285. REN. 6-21-03. INT. CL. 42.
- WOOD, JUDY, MIDLOTHIAN, VA:
2,745,966, PUB. 3-12-2002. MULTIPLE CLASS, INT. CLS. 16 AND 42.
- WOODLAND PARK ZOOLOGICAL SOCIETY, SEATTLE, WA:
2,746,054, PUB. 5-13-2003. INT. CL. 41.
- WOODMARC, L.C., WINTERSET, IA:
2,001,345, CANC. INT. CL. 20.
- WOODROAST SYSTEMS, INC., EDEN PRAIRIE, MN:
2,001,194, CANC. INT. CL. 29.
- WOODROW WILSON SCHOOL, PRINCETON, NJ:
2,748,405, INT. CL. 41.
- WOODSTREAM CORPORATION, LITITZ, PA:
1,208,670, CANC. INT. CL. 28.
- WOODY INDUSTRIAL CORPORATION, TORRANCE, CA:
2,747,908, INT. CL. 42.
- WOOLPERT DESIGN-BUILD, LLC, DAYTON, OH:
2,748,225, MULTIPLE CLASS, INT. CLS. 37 AND 42.
- WOOLRICH WOOLEN MILLS, WOOLRICH, PA, WOOLRICH, INC.:
1,208,524, CANC. INT. CL. 25.
- WORCESTER COMPANY (CORPORATED), THE, NORTH PROVIDENCE, RI:
2,001,362, CANC. INT. CL. 24.
- WORK IN AMERICA INSTITUTE, INC., SCARSDALE, NY:
1,209,187, CANC. INT. CL. 42.
- WORK WINE COMPANY, LLC, CALISTOGA, CA:
2,746,925, PUB. 5-13-2003. INT. CL. 33.
- WORKDYNAMICS TECHNOLOGIES, INC., OTTAWA, ONTARIO, K1H 8N3, CANADA:
2,745,824, PUB. 5-13-2003. MULTIPLE CLASS, INT. CLS. 9, 41 AND 42.
- WORKHORSE CUSTOM CHASSIS, LLC, HIGHLAND PARK, IL:
2,745,556, PUB. 9-12-2000. INT. CL. 12.
- WORKMAN, LARRY EDWARD, WEST HOLLYWOOD, CA:
2,748,893, INT. CL. 25.
- WORKSHOP WAY, INC., THE, NEW ORLEANS, LA:
1,208,191, CANC. INT. CL. 16.
- WORLD NET ASSOCIATES, INC., SOUTH SAN FRANCISCO, CA:
2,000,873, CANC. MULTIPLE CLASS, INT. CLS. 35, 36 AND 39.
- WORLD OF PEACE, LLC, DANBURY, CT:
2,001,593, CANC. INT. CL. 32.
- WORLD SNOWMOBILE ASSOCIATION, MAPLE GROVE, MN:
2,749,026, INT. CL. 16.
- WORLD WIDE SOURCES, INCORPORATED, PALO ALTO, CA:
1,208,857, CANC. INT. CL. 35.
- WORLD WIDE TABACCO, INC., CHICAGO, IL:
2,001,471, CANC. INT. CL. 34.
- WORLD WIDE WEB APPLICATIONS, LLC, INDIANAPOLIS, IN:
2,747,946, MULTIPLE CLASS, INT. CLS. 38 AND 42.
- WORLDCOM, INC., JACKSON, MS:
2,748,652, INT. CL. 38.
- WORLDSPAN, L.P., ATLANTA, GA:
2,748,194, INT. CL. 39.
- WORLDWIDE DISTRIBUTORS, INC., KENT, WA:
2,746,193, PUB. 10-29-2002. INT. CL. 25.
2,746,196, PUB. 10-22-2002. INT. CL. 22.
2,746,205, PUB. 10-29-2002. INT. CL. 20.
- WORLDWIDE TARGET DEMOGRAPHIC TELEVISION, INC., DEERFIELD BEACH, FL:
2,000,843, CANC. INT. CL. 42.
- WORSLEY COMPANIES, INC., WILMINGTON, NC:
1,714,935, CANC. INT. CL. 4.
- WOW! TECHNOLOGIES, INC., LAS VEGAS, NV:
2,747,343, PUB. 5-13-2003. INT. CL. 36.
- WPC HOLDINGS, INC., JACKSON, WI:
2,000,698, CANC. INT. CL. 5.
- WPCC, INC., BEND, OR:
2,000,731, CANC. U.S. CL. A.
- WRANGLER CLOTHING CORP., WILMINGTON, DE:
1,715,938, CANC. INT. CL. 25.
- WRENCHHEAD.COM, INC., WHITE PLAINS, NY:
2,747,422, PUB. 5-13-2003. INT. CL. 9.
- WRIGHT BROTHERS, INC., MONTE VISTA, CO:
1,716,244, CANC. INT. CL. 31.
- WRITERS IN THE SCHOOLS, HOUSTON, TX:
2,747,109, PUB. 5-13-2003. INT. CL. 41.
- WSI TECHNOLOGIES, INC., ST. LOUIS, MO:
1,715,435, CANC. MULTIPLE CLASS, INT. CLS. 11 AND 37.
- WTWS, INC., WILMINGTON, DE:
1,209,276, CANC. INT. CL. 42.
- WUCHTERL, JOSEPH E., PALATINE, IL:
2,745,611, PUB. 11-26-2002. INT. CL. 41.

- WYE-YOSHI HOLDING CORPORATION, SENNEVILLE, QUEBEC, CANADA:
2,745,727, PUB. 9-17-2002. INT. CL. 35.
- WYKA, MICHAEL H., FLORAL CITY, FL AND MCCRAVE, JOHN J., KENNESAW, GA AND MCCRAVE, JOHN V., INVERNESS, FL:
2,747,133, PUB. 5-13-2003. INT. CL. 41.
- WYKO INDUSTRIAL SERVICES LIMITED, WEST MIDLANDS, B62 8WG, ENGLAND:
2,748,440, INT. CL. 17.
- XANTREX INTERNATIONAL, ST. MICHAEL, BARBADOS:
2,746,440, PUB. 5-13-2003. INT. CL. 9.
- XDIMENSIONAL TECHNOLOGIES, INC., BREA, CA:
2,747,841, INT. CL. 42.
2,747,842, INT. CL. 42.
- XDL CAPITAL CORPORATION, TORONTO, ONTARIO, CANADA:
2,747,126, PUB. 5-13-2003. MULTIPLE CLASS, INT. CLS. 35 AND 36.
- XEROX CORPORATION, STAMFORD, CT:
2,746,904, PUB. 5-13-2003. INT. CL. 9.
2,748,803, INT. CL. 9.
- XM SATELLITE RADIO INC., WASHINGTON, DC:
2,748,047, INT. CL. 41.
- XPAYS, INC., SAN FRANCISCO, CA:
2,748,956, INT. CL. 35.
- XTTRIUM LABORATORIES, INC., CHICAGO, IL:
2,747,630, INT. CL. 5.
- XU, JIA MAN, GREENWOOD, AUSTRALIA:
2,748,739, INT. CL. 25.
- XWAVE SOLUTIONS INC., ST. JOHN'S, NEWFOUNDLAND A1C 6J7, CANADA:
2,745,519, PUB. 5-13-2003. INT. CL. 42.
- XXX PUBLISHING ENTERPRISES, LTD., NORTHFIELD, IL:
2,747,227, PUB. 5-13-2003. INT. CL. 16.
- Y-BEAM TECHNOLOGIES, INC., LAKE FOREST, CA:
2,746,369, PUB. 5-13-2003. INT. CL. 44.
- YALE CORDAGE INC., BIDDEFORD, ME:
2,748,805, INT. CL. 22.
- YALE WHIFFENPOOF ALUMNI, INC., BRONXVILLE, NY:
1,773,210, REN. 6-26-03. INT. CL. 41.
- YAMAMOTO, GARY, PAGE, AZ FROM GARY YAMAMOTO CUSTOM BAITS, INC., PAGE, AZ:
2,746,136, PUB. 5-13-2003. INT. CL. 28.
- YAROS COMMUNICATIONS, INC., ST. LOUIS, MO TO YAROS COMMUNICATIONS, INC., MADISON, WI:
2,058,564, CANC. INT. CL. 41.
- YBOR CITY BREWING COMPANY, TAMPA, FL FROM KEY WEST BREWERY, INC., KEY WEST, FL:
2,746,246, PUB. 5-13-2003. INT. CL. 32.
2,746,247, PUB. 5-13-2003. INT. CL. 35.
- YCP SALISHAN OPERATOR, INC., ATLANTA, GA:
2,746,616, PUB. 5-13-2003. MULTIPLE CLASS, INT. CLS. 35, 41 AND 43.
- YELLOW PAGES INTEGRATED MEDIA ASSOCIATION, BERKELEY HTS, NJ:
2,746,830, PUB. 5-13-2003. INT. CL. 38.
- YELLOW PAGES INTEGRATED MEDIA ASSOCIATION, BERKELEY HTS, NJ FROM YELLOW PAGES PUBLISHERS ASSOCIATION, BERKLEY HTS, NJ:
2,748,487, INT. CL. 35.
- YEUNG, BAN, SAN JOSE, CA:
2,748,863, INT. CL. 42.
- YKK CORPORATION, CHIYODA-KU, TOKYO, JAPAN FROM JUNGWOO ZIPPER CO., LTD., KYUNGGI-DO, REPUBLIC OF KOREA:
2,745,494, PUB. 11-16-1999. INT. CL. 26.
- YKK CORPORATION, TOKYO, JAPAN:
2,745,893, PUB. 5-13-2003. INT. CL. 26.
- YOKOGAWA ELECTRIC CORPORATION, TOKYO, JAPAN:
2,746,700, PUB. 5-13-2003. INT. CL. 9.
- YOMTAOBIAN ENTERPRISES INC, ENCINO, CA:
2,747,649, INT. CL. 42.
- YOMTOBIAN ENTERPRISES INC., MALIBU, CA:
2,748,055, INT. CL. 42.
- YORK BRONZE COMPANY, HOUSTON, TX FROM COLONIAL GUILD, LTD., KINGWOOD, WV:
2,745,451, PUB. 10-23-2001. INT. CL. 40.
- YORK INTERNATIONAL CORPORATION, YORK, PA:
2,748,351, INT. CL. 9.
- YORK WALLCOVERINGS, INC., YORK, PA:
2,748,090, INT. CL. 27.
2,748,235, INT. CL. 27.
- YOSEMITE CONCESSION SERVICES CORPORATION, YOSEMITE, CA:
2,746,640, PUB. 5-13-2003. INT. CL. 43.
- YOUNG'S WELDING, INC., CHANUTE, KS:
2,748,778, INT. CL. 12.
- YUMS UNLIMITED, INC., ATHENS, GA:
2,001,791, CANC. INT. CL. 30.
- YUN, TOM, CERRITOS, CA:
2,001,544, CANC. INT. CL. 16.
- YVES SAINT LAURENT PARFUMS, 92521 NEUILLY CEDEX, FRANCE:
2,746,666, PUB. 5-13-2003. INT. CL. 3.
- Z GALLERIE, INC., GARDENA, CA:
2,747,220, PUB. 5-13-2003. INT. CL. 35.
- ZAIRMAIL, INC., PORTLAND, OR:
2,745,732, PUB. 5-13-2003. INT. CL. 38.
- ZALE DELAWARE, INC., IRVING, TX TO ZALE DELAWARE, INC., IRVING, TX:
2,707,801, COR. INT. CL. 14.
- ZANGAS, GEORGE, PALOS VERDES ESTATES, CA, DBA MARATHON NUTRITION:
1,714,962, CANC. INT. CL. 5.
- ZANIN, KRISTINA M., TORRANCE, CA:
2,746,903, PUB. 5-13-2003. INT. CL. 25.
- ZAPPOS.COM, INC., SAN FRANCISCO, CA:
2,747,104, PUB. 5-13-2003. INT. CL. 35.
- ZAVIDA COFFEE COMPANY INC., CONCORD, ONTARIO, CANADA FROM FLAVORCOFFEE CO. INC., CONCORD, ONTARIO, ONTARIO:
2,745,694, PUB. 11-19-2002. MULTIPLE CLASS, INT. CLS. 30, 35 AND 42.
- ZEBANK, SOCIETE ANONYME, PARIS, FRANCE:
2,563,176, CANC. MULTIPLE CLASS, INT. CLS. 9, 35, 36, 38 AND 42.
- ZEDECK, MAURICE, WEST BAYSHORE, NY:
1,716,165, CANC. INT. CL. 30.
- ZEGNA BARUFFA LANE BORGOSERIA S.P.A., 13825 VALLEMOSSO (BIELLA), ITALY:
2,746,212, PUB. 10-15-2002. MULTIPLE CLASS, INT. CLS. 9 AND 14.
- ZEKIAN, LEVON, FRESNO, CA:
2,745,723, PUB. 5-13-2003. INT. CL. 20.
- ZELBY INDUSTRIES, L.L.C., PROVIDENCE, RI:
2,747,592, INT. CL. 35.
- ZEN COMICS, AUBURN, ME TO ZEN COMICS, INC., BOCA RATON, FL:
1,717,094, CANC. INT. CL. 16.
- ZENECA INC., WILMINGTON, DE:
2,000,759, CANC. MULTIPLE CLASS, INT. CLS. 5, 9 AND 20.
- ZENGIGI DESIGN, INC., BETHESDA, MD:
2,748,466, INT. CL. 35.
- ZENIMAX MEDIA INC., ROCKVILLE, MD:
2,748,484, INT. CL. 9.
- ZENSYS A/S, DK-2100 COPENHAGEN, DENMARK:
2,745,803, PUB. 12-10-2002. MULTIPLE CLASS, INT. CLS. 9, 16 AND 42.
- ZENTO INTERNATIONAL LTD., TSUEN WAN, NEW TERRITORIES, HONG KONG:
2,746,099, PUB. 12-17-2002. INT. CL. 25.
- ZEOTECH CORPORATION, ALBUQUERQUE, NM:
2,001,929, CANC. INT. CL. 31.
- ZETEX PLC, BUCKINGHAMSHIRE, UNITED KINGDOM:
1,728,961, REN. 6-25-03. INT. CL. 9.
- ZHENG ZHANG USA, INC., EDISON, NJ:
2,748,186, INT. CL. 24.
- ZHIHONG, XU, JIANGYIN, JIANGSU, PRC 2 1443, CHINA AND JIANLUN, FEI, JIANGYIN, JIANGSU, PRC 214400, CHINA:
2,745,542, PUB. 1-14-2003. MULTIPLE CLASS, INT. CLS.

7, 11, 16, 18, 24 AND 25.
 ZHIHONG, XU, JIANGYIN, JIANGSU, PRC 214431, CHINA
 AND JIANLUN, FEI, JIANGYIN, JIANGSU, PRC 214400,
 CHINA:
 2,745,543, PUB. 10-8-2002. MULTIPLE CLASS, INT. CLS.
 18, 24 AND 25.
 ZIFF DAVIS PUBLISHING HOLDINGS INC., NEW YORK,
 NY:
 2,745,722, PUB. 5-13-2003. INT. CL. 42.
 ZILNEK, INC., PARK CITY, UT:
 1,717,152, CANC. INT. CL. 28.
 ZIMA PRODUCTS, LTD., HUNG HOM, KOWLOON, HONG
 KONG:
 1,208,649, CANC. INT. CL. 28.
 ZIMELMAN, STEVEN T, MARINA DEL REY, CO:
 2,747,429, PUB. 5-13-2003. INT. CL. 9.
 ZINC MATRIX POWER, INC., SANTA BARBARA, CA:
 2,747,569, INT. CL. 9.
 ZINK, RAINER, 72622 NURTINGEN, FED REP GERMANY:
 2,746,378, PUB. 5-13-2003. MULTIPLE CLASS, INT. CLS.
 19 AND 31.
 ZINTEXX CORPORATION, LENEXA, KS:
 2,000,699, CANC. INT. CL. 3.
 ZOM OCEAN DRIVE, LTD., ORLANDO, FL:
 2,748,276, INT. CL. 42.
 ZONAR, LLC, SOUTH MERIDEN, CT:
 2,748,867, INT. CL. 28.
 ZONE, INC., THE, PHOENIX, AZ:
 2,148,894, CANC. MULTIPLE CLASS, INT. CLS. 9 AND
 25.
 ZOO PEOPLE ENTERPRISES, DENVER, CO:
 2,001,694, CANC. INT. CL. 41.
 ZOOKEEPERS, INC., PROVINCETOWN, MA:
 1,716,767, CANC. INT. CL. 42.
 ZOOMTOWN.COM INC., CINCINNATI, OH:
 2,745,947, PUB. 5-13-2003. MULTIPLE CLASS, INT. CLS.
 9, 36, 38 AND 41.
 2,745,948, PUB. 5-13-2003. MULTIPLE CLASS, INT. CLS.
 9, 36, 38 AND 41.
 ZOYA COMPANY, BEDFORD HEIGHTS, OH:
 2,746,281, PUB. 5-13-2003. INT. CL. 3.
 ZUMTOBEL STAFF GMBH, AUSTRIA:
 2,745,511, PUB. 5-13-2003. MULTIPLE CLASS, INT. CLS.
 9, 11 AND 42.
 ZUMTOBEL STAFF GMBH, A-6850 DORNBIRN, AUSTRIA:
 2,746,462, PUB. 5-13-2003. MULTIPLE CLASS, INT. CLS.
 9, 11 AND 42.
 2,746,463, PUB. 5-13-2003. MULTIPLE CLASS, INT. CLS.
 9, 11 AND 42.
 ZYBER PHARMACEUTICALS, INC, GONZALES, LA:
 2,748,943, INT. CL. 5.
 ZYRAY WIRELESS INC., SAN DIEGO, CA:
 2,748,087, INT. CL. 42.
 1A DIRECTORS' CHAMPS PROGRAM, INC., SOUTHLAKE,
 TX:
 2,747,720, INT. CL. 41.
 1ST SOURCE BANK, SOUTH BEND, IN:
 1,769,447, REN. 6-22-03. INT. CL. 36.
 1STDESK SYSTEMS, INC., MEDWAY, MA:
 2,001,208, CANC. INT. CL. 9.
 2ND C A/S, 3450 ALLEROD, DENMARK:
 2,747,863, MULTIPLE CLASS, INT. CLS. 9 AND 42.
 2028, INC., CAMBRIDGE, MA:
 2,748,349, INT. CL. 42.
 206 MACOPIN CORP., BLOOMINGDALE, NJ:
 2,747,018, PUB. 5-13-2003. INT. CL. 5.
 21ST CENTURY VIDEO CORPORATION, WOOD RIDGE,
 NJ:
 1,208,010, CANC. INT. CL. 9.
 24 HOUR FITNESS USA, INC., PLEASANTON, CA:
 2,746,286, PUB. 5-13-2003. INT. CL. 41.
 241 PIZZA (1997) INC., BURLINGTON, ONTARIO, CANA-
 DA:
 2,747,097, PUB. 5-13-2003. MULTIPLE CLASS, INT. CLS.
 30 AND 42.
 3D SYSTEMS, INC., VALENCIA, CA:
 2,748,816, INT. CL. 7.
 3M COMPANY, ST PAUL, MN FROM MINNESOTA
 MINING AND MANUFACTURING COMPANY, ST.
 PAUL, MN:
 2,748,890, INT. CL. 17.
 3SI SECURITY SYSTEMS, EXTON, PA:
 2,747,383, PUB. 5-13-2003. INT. CL. 9.
 333 BAYVILLE AVENUE RESTAURANT CORPORATION,
 OYSTER BAY, NY:
 1,766,420, REN. 6-24-03. INT. CL. 42.
 3831558 CANDA INC., MONTREAL, QUEBEC, CANADA
 FROM HERITAGE DECOYS LTD., MONATREAL, QUE-
 BEC, H3L 2A3, CANADA:
 2,745,433, PUB. 5-13-2003. INT. CL. 20.
 4 ELBOWS, LLC, NEW YORK, NY:
 2,746,239, PUB. 5-13-2003. INT. CL. 35.
 4/C COMMUNICATIONS, INC., LAKEVIEW, OR:
 2,000,736, CANC. INT. CL. 42.

* * * * *