

MARKS PUBLISHED FOR OPPOSITION

The following marks are published in compliance with section 12(a) of the Trademark Act of 1946. Applications for the registration of marks in more than one class have been filed as provided in section 30 of said act as amended by Public Law 772, 87th Congress, approved Oct. 9, 1962, 76 Stat. 769. Opposition under section 13 may be filed within thirty days of the date of this publication. See rules 2.101 to 2.105.

A separate fee of two hundred dollars for opposing each mark in each class must accompany the opposition.

SECTION 1.— INTERNATIONAL CLASSIFICATION

The short titles associated below with the international class numbers are terms designed merely for quick identification and are not an official part of the international classification. The full names of international classes are given in section 6.1 of the trademark rules of practice.

The designation "U.S. Cl." appearing in this section refers to the U.S. class in effect prior to Sep. 1, 1973 rather than the international class which applies to applications filed on or after that date. For adoption of international classification see notice in the OFFICIAL GAZETTE of Jun. 26, 1973 (911 O.G. TM 210).

Application in more than one class

SN 75-393,565. ACERALIA CORPORACION SIDERURGICA, S.A., 28046 MADRID, SPAIN, FILED 11-20-1997.



OWNER OF SPAIN REG. NO. 21077967, DATED 1-28-1998, EXPIRES 1-28-2008.

OWNER OF SPAIN REG. NO. 21077940, DATED 1-28-1998, EXPIRES 1-28-2008.

OWNER OF SPAIN REG. NO. 2107793, DATED 1-28-1998, EXPIRES 1-28-2008.

OWNER OF SPAIN REG. NO. 21077703, DATED 1-20-1998, EXPIRES 1-20-2008.

OWNER OF SPAIN REG. NO. 21077606, DATED 1-29-1998, EXPIRES 1-29-2008.

NO CLAIM IS MADE TO THE EXCLUSIVE RIGHT TO USE "CORPORACION SIDERURGICA", APART FROM THE MARK AS SHOWN.

THE MARK CONSISTS OF A STYLIZED DESIGN OF FOUR INTERCONNECTING CIRCLES NEXT TO WHICH ARE THE WORDS "ACERALIA CORPORACION SIDERURGICA".

THE ENGLISH TRANSLATION OF "CORPORACION SIDERURGICA" IS "METALLURGICAL CORPORATION".

CLASS 6—METAL GOODS

FOR ANCHORS FOR FASTENING, ANVILS, BELLS, RAILS FOR RAILWAY TRACKS, CHAINS, EXCLUDING DRIVING CHAINS FOR CARS, NON-ELECTRIC CABLES, NON-ELECTRIC WIRES, LOCKS, PIPES AND TUBES, SAFES, CASH BOXES, STEEL BALLS, NAILS AND SCREWS, ALL OF THE ABOVE MADE OF METAL; ROLLED AND CAST METAL BUILDING MATERIALS, NAMELY, WALL PANELS AND ROOFING PANELS (U.S. CLS. 2, 12, 13, 14, 23, 25 AND 50).

CLASS 16—PAPER GOODS AND PRINTED MATTER

FOR INFORMATIONAL LETTERS IN THE FIELD OF METAL PRODUCTS; NEWSPAPERS FOR GENERAL CIRCULATION; ACCOUNT AND COMPOSITION BOOKS; ENVELOPES, GREETING CARDS; NEWS BULLETINS (U.S. CLS. 2, 5, 22, 23, 29, 37, 38 AND 50).

CLASS 39—TRANSPORTATION AND STORAGE

FOR WAREHOUSE STORAGE AND TRANSPORT BY RAIL AND TRUCK OF PRODUCTS FOR THE IRON AND STEEL INDUSTRIES (U.S. CLS. 100 AND 105).

CLASS 40—MATERIAL TREATMENT

FOR METAL TREATMENT WITH SPECIAL REFERENCE TO THE IRON AND STEEL INDUSTRIES (U.S. CLS. 100, 103 AND 106).

CLASS 42—SCIENTIFIC, COMPUTER AND LEGAL SERVICES

FOR TESTING, ANALYSIS AND EVALUATION OF THE GOODS AND SERVICES OF OTHERS (U.S. CLS. 100 AND 101).

CYNTHIA SLOAN, EXAMINING ATTORNEY

SN 75-463,440. RAVEN USA, LLC, BALDWIN PARK, CA, FILED 3-31-1998.

RAVEN

CLASS 9—ELECTRICAL AND SCIENTIFIC APPARATUS

FOR PROTECTIVE GOGGLES FOR USE IN PLAYING A SURVIVAL GAME; PROTECTIVE CLOTHING, NAMELY, GLOVES AND PANTS (U.S. CLS. 21, 23, 26, 36 AND 38).

FIRST USE 1-2-1998; IN COMMERCE 1-2-1998.

CLASS 28—TOYS AND SPORTING GOODS

FOR ATHLETIC EQUIPMENT, NAMELY, PAINTBALL MASKS AND STRAPS THEREFOR, PAINTBALL GLOVES, PROTECTIVE KNEE AND ELBOW PADS FOR ATHLETIC USE, PROTECTIVE PADDING FOR ATHLETIC USE; EQUIPMENT FOR USE IN PLAYING A SURVIVAL GAME, NAMELY, PAINTBALLS AND PAINTBALL GUNS (U.S. CLS. 22, 23, 38 AND 50).

FIRST USE 1-2-1998; IN COMMERCE 1-2-1998.

AMOS T. MATTHEWS, JR., EXAMINING ATTORNEY

SN 75-509,248. TOTAL ENTERTAINMENT RESTAURANT CORP., WICHITA, KS. FILED 6-26-1998.

SN 75-652,998. CONWAY FARMS, LAKE FOREST, IL. FILED 2-26-1999.

Bailey's
PUB & GRILLE



OWNER OF U.S. REG. NOS. 1,935,127, 2,092,808 AND 2,191,854.

NO CLAIM IS MADE TO THE EXCLUSIVE RIGHT TO USE "PUB & GRILLE", APART FROM THE MARK AS SHOWN.

THE DRAWING IS LINED FOR THE COLOR(S) RED AND GREEN.

SEC. 2(F) AS TO "BAILEY'S".

NO CLAIM IS MADE TO THE EXCLUSIVE RIGHT TO USE "FARMS" AND "LAKE FOREST", APART FROM THE MARK AS SHOWN.

CLASS 41—EDUCATION AND ENTERTAINMENT

FOR PROVIDING FACILITIES FOR RECREATIONAL ACTIVITIES, NAMELY BILLIARDS, DARTS, SHUFFLEBOARD, AND POOL (U.S. CLS. 100, 101 AND 107).

CLASS 35—ADVERTISING AND BUSINESS

FOR ASSOCIATION SERVICES, NAMELY, PROMOTING THE INTERESTS OF HOMEOWNERS (U.S. CLS. 100, 101 AND 102).

FIRST USE 0-0-1988; IN COMMERCE 0-0-1991.

CLASS 42—SCIENTIFIC, COMPUTER AND LEGAL SERVICES

FOR RESTAURANT SERVICES (U.S. CLS. 100 AND 101).

BRIAN NEVILLE, EXAMINING ATTORNEY

CLASS 36—INSURANCE AND FINANCIAL

FOR REAL ESTATE BROKERAGE SERVICES (U.S. CLS. 100, 101 AND 102).

FIRST USE 0-0-1988; IN COMMERCE 0-0-1991.

BRIAN BROWN, EXAMINING ATTORNEY

SN 75-624,661. ABELLA, FRANCOIS, DBA CABINET ABELLA, 92800, PUTEAUX, FRANCE, FILED 1-20-1999.

SN 75-708,746. ASP-ONE, INC., ELK GROVE VILLAGE, IL. FILED 5-18-1999.

BIZ@LARGE

TEST & GO

PRIORITY CLAIMED UNDER SEC. 44(D) ON FRANCE APPLICATION NO. 98/742376, FILED 7-20-1998.

CLASS 9—ELECTRICAL AND SCIENTIFIC APPARATUS

FOR COMPUTER SOFTWARE FOR DATABASE MANAGEMENT (U.S. CLS. 21, 23, 26, 36 AND 38).

CLASS 9—ELECTRICAL AND SCIENTIFIC APPARATUS

FOR COMPUTER SOFTWARE FOR ACCESSING, SHARING, AND MANAGING DATABASE APPLICATIONS, AND INSTRUCTIONAL MANUALS PROVIDED AS A UNIT THEREWITH (U.S. CLS. 21, 23, 26, 36 AND 38).

CLASS 42—SCIENTIFIC, COMPUTER AND LEGAL SERVICES

FOR COMPUTER SOFTWARE DESIGN FOR OTHERS (U.S. CLS. 100 AND 101).

DAVID TAYLOR, EXAMINING ATTORNEY

CLASS 42—SCIENTIFIC, COMPUTER AND LEGAL SERVICES

FOR PROVIDING TEMPORARY USE OF NON-DOWNLOADABLE SOFTWARE FOR CUSTOMER GROUPS TO SECURELY ACCESS AND ADMINISTER SOFTWARE ON A REMOTE SERVER, INCLUDING PROVISIONING, METERING, BILLING, AND END-USER HELP DESK FUNCTIONS (U.S. CLS. 100 AND 101).

CAROLYN CATALDO, EXAMINING ATTORNEY

SN 75-747,204. ATTICUS, L.L.C., SANTA FE, NM. FILED 7-8-1999.

SN 75-849,157. SANDVIK TAMROCK OY, 33330 TAMPERE, FINLAND, FILED 11-15-1999.



NO CLAIM IS MADE TO THE EXCLUSIVE RIGHT TO USE "CAF" ONLY IN INTERNATIONAL CLASSES 9, 16, 30 AND 43, APART FROM THE MARK AS SHOWN.

THE MARK CONSISTS IN PART OF A STYLIZED REPRESENTATION OF A MAN AND A WOMAN, WHICH DOES NOT DEPICT ANY LIVING INDIVIDUAL.

THE ENGLISH TRANSLATION OF THE WORDING "CAFE LIBERTAD" IS "LIBERTY CAFE".

CLASS 9—ELECTRICAL AND SCIENTIFIC APPARATUS

FOR INSTRUCTIONAL COOKING VIDEO CASSETTES AND CD-ROMS (U.S. CLS. 21, 23, 26, 36 AND 38).

CLASS 30—STAPLE FOODS

FOR SAUCES FOR MEATS, POULTRY AND SEA-FOOD; SALAD DRESSING (U.S. CL. 46).

CLASS 43—HOTEL AND RESTAURANT SERVICES

FOR RESTAURANT SERVICES (U.S. CLS. 100 AND 101).
J. TINGLEY, EXAMINING ATTORNEY

SN 75-826,934. MY FAVORITE PC.COM, INC., HILLIARD, OH. FILED 10-20-1999.

MYFAVORITEPC

CLASS 9—ELECTRICAL AND SCIENTIFIC APPARATUS

FOR PERSONAL COMPUTERS AND PERSONAL COMPUTER PERIPHERAL EQUIPMENT, DEVICES AND ACCESSORIES, NAMELY, HARD DRIVES, FLOPPY DISC DRIVES, CD-ROM DRIVES AND SPEAKERS, AND INPUT DEVICES, NAMELY, MICE, KEYBOARDS, SPEAKERS AND MONITORS (U.S. CLS. 21, 23, 26, 36 AND 38).
FIRST USE 9-7-1999; IN COMMERCE 9-7-1999.

CLASS 35—ADVERTISING AND BUSINESS

FOR COMPUTERIZED ONLINE RETAIL STORE SERVICES IN THE FIELD OF COMPUTERS, COMPUTER HARDWARE AND COMPUTER PERIPHERALS (U.S. CLS. 100, 101 AND 102).
FIRST USE 9-7-1999; IN COMMERCE 9-7-1999.
LORETTA C. BECK, EXAMINING ATTORNEY

ROCK SOLID PERFORMANCE

NO CLAIM IS MADE TO THE EXCLUSIVE RIGHT TO USE "PERFORMANCE", APART FROM THE MARK AS SHOWN.

CLASS 7—MACHINERY

FOR ROCK DRILLING, MINING AND TUNNELING MACHINES AND MACHINE TOOLS (U.S. CLS. 13, 19, 21, 23, 31, 34 AND 35).

CLASS 12—VEHICLES

FOR MINING VEHICLES, NAMELY TUNNELING AND DRIFTING JUMBOS, MOBILE LOADING AND HAULING EQUIPMENT FOR FRAGMENTED ROCK AND SOIL, NAMELY LOADERS, EXCAVATORS, DUMPERS AND TRUCKS (U.S. CLS. 19, 21, 23, 31, 35 AND 44).
MARY ROSSMAN, EXAMINING ATTORNEY

SN 75-868,210. CITY AND COUNTY OF SAN FRANCISCO, SAN FRANCISCO, CA. FILED 12-10-1999.

SAN FRANCISCO MUNICIPAL RAILWAY

NO CLAIM IS MADE TO THE EXCLUSIVE RIGHT TO USE "SAN FRANCISCO" AND "RAILWAY", APART FROM THE MARK AS SHOWN.

CLASS 25—CLOTHING

FOR SHIRTS; PANTS; SCARVES, AND HATS (U.S. CLS. 22 AND 39).

CLASS 28—TOYS AND SPORTING GOODS

FOR ELECTRIC ACTION TOYS; MECHANICAL ACTION TOYS; MODELS, NAMELY TOY MODEL TRAIN SETS; TOY MODEL VEHICLES AND RELATED ACCESSORIES SOLD AS UNITS; TOY MODEL HOBBYCRAFT KITS; GAMES, NAMELY ACTION SKILL GAMES, BOARD GAMES AND CARD GAMES (U.S. CLS. 22, 23, 38 AND 50).
INGA ERVIN, EXAMINING ATTORNEY

SN 75-981,190. ORANGE PERSONAL COMMUNICATIONS SERVICES LIMITED, BRISTOL BS12 4QJ, UNITED KINGDOM, FILED 6-16-1999.

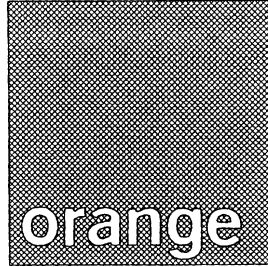

CLASS 16—PAPER GOODS AND PRINTED MATTER

FOR PRINTED MATTER, NAMELY POSTERS; LEAFLETS, BROCHURES, BOOKLETS, INSTRUCTION MANUALS, TEXTBOOKS AND INFORMATIONAL FLYERS ALL RELATING TO TELECOMMUNICATIONS, COMPUTERS, THE INTERNET, MOTOR RACING, THE ARTS, BUSINESS PRODUCT PROMOTION, FINANCE, REAL ESTATE, STOCKS AND SHARES, MAINTENANCE AND PRODUCT REPAIR OF PROPERTY, HOUSEHOLD ITEMS, VEHICLES, MAINTENANCE AND REPAIR OF TELECOMMUNICATIONS INSTALLATIONS, NETWORKS, TELEPHONES AND COMPUTER EQUIPMENT, TRAVEL, ENTERTAINMENT, SPORTS, CULTURAL EVENTS, TRAVEL AND RESTAURANTS; BOOKS, MAGAZINES, NEWSPAPER AND MAGAZINE PERIODICALS, NEWSLETTERS RELATING TO THE SUBJECT OF TELECOMMUNICATIONS AND COMPUTING; NOTEBOOKS, NOTE CARDS, NOTE PADS, NOTE PAPER, GIFT WRAPPING PAPER, METALLIC GIFT WRAPPING PAPER, PAPER BANNERS, PAPER CONTAINERS; RUBBER STAMPS; STAMP PADS STAMP ALBUMS; STANDS FOR HOLDERS OF PENS, PENCILS AND INK; STAPLE REMOVERS; PAPER STAPLERS; STATIONERY; STATIONERY BOXES; DESK BASKETS FOR DESK ACCESSORIES; DESK CALENDARS; DESK FILE TRAYS; DESK PADS; DESK SETS; DESK STANDS AND HOLDERS FOR PENS, PENCILS AND INK; DESK TOP ORGANIZERS; DESK TOP PLANNERS; CLIP BOARDS; PAPER CLIPS; ART PAPER; ART MOUNTS; DRAWING BRUSHES; DRAWING PENCILS; DRAWING BOARDS; DRAWING TRAYS; DRAWING RULERS; DRAWING INSTRUMENTS; DAILY PLANNERS; DESK TOP PLANNERS; PERSONAL PLANNERS; POCKET PLANNERS; WALL PLANNERS; WRITING INSTRUMENTS, NAMELY, PENS, PENCILS AND FELT PENS; NOT INCLUDING ANY OF THE AFORESAID GOODS RELATING TO ORANGES (U.S. CLS. 2, 5, 22, 23, 29, 37, 38 AND 50).

CLASS 18—LEATHER GOODS

FOR GOODS MADE FROM LEATHER OR IMITATION LEATHER, NAMELY DUFFEL BAGS, TOTE BAGS, HAND BAGS, ATHLETIC BAGS, BEACH BAGS, BOOK BAGS, CARRY-ON BAGS, DIAPER BAGS, GYM BAGS, OVERNIGHT BAGS, MESH BAGS, SCHOOL BAGS, SHOULDER BAGS, LEATHER SHOPPING BAGS, MESH SHOPPING BAGS, TEXTILE SHOPPING BAGS, ATACHE CASES, BUSINESS CARD CASES, CALLING CARD CASES, CREDIT CARD CASES, DOCUMENT CASES, KEY CASES, OVERNIGHT CASES, SUITCASES; UMBRELLAS AND PARASOLS (U.S. CLS. 1, 2, 3, 22 AND 41).

CLASS 25—CLOTHING

FOR HATS; TIES; T-SHIRTS; SWEAT SHIRTS; POLO SHIRTS; GOLF SHIRTS; UNDER SHIRTS; NIGHT SHIRTS; KNIT SHIRTS; GYM SHORTS; SWEAT SHORTS; FLEECE JACKETS; WIND RESISTANT JACKETS; LEATHER JACKETS; LONG SLEEVE SWEAT SHIRTS; SHIRTS; BASEBALL CAPS; HATS; HEAD BANDS; HEAD WEAR; RAIN COATS; BELTS (U.S. CLS. 22 AND 39).

JAMES A. RAUEN, EXAMINING ATTORNEY

SN 76-024,393. A2 CORPORATION LIMITED, DUNEDIN, NEW ZEALAND, FILED 4-12-2000.

A2 TRUE

PRIORITY CLAIMED UNDER SEC. 44(D) ON NEW ZEALAND APPLICATION NO. 608898, FILED 2-22-2000, REG. NO. 608898, DATED 8-24-2000, EXPIRES 2-22-2007.

PRIORITY CLAIMED UNDER SEC. 44(D) ON NEW ZEALAND APPLICATION NO. 608897, FILED 2-22-2000, REG. NO. 608897, DATED 8-24-2000, EXPIRES 2-22-2007.

CLASS 5—PHARMACEUTICALS

FOR PHARMACEUTICAL SUBSTANCES USED FOR CARDIOVASCULAR TREATMENT, FOR ANTI-BACTERIAL TREATMENT AND FOR TREATMENT OF DIABETES AND CORONARY HEART DISEASE; DIETETIC SUBSTANCES, NAMELY, DIETARY SUBSTANCES AND DIETARY FOOD SUPPLEMENTS; AND BABY FOOD (U.S. CLS. 6, 18, 44, 46, 51 AND 52).

CLASS 29—MEATS AND PROCESSED FOODS

FOR MILK AND MILK PRODUCTS, EXCLUDING ICE CREAM, ICE MILK AND FROZEN YOGURT (U.S. CL. 46).

ROBERT LORENZO, EXAMINING ATTORNEY

SN 76-037,028. RUNWAY, INC., SANTA MONICA, CA, FILED 4-28-2000.

RUNWAY

CLASS 37—CONSTRUCTION AND REPAIR

FOR MAINTENANCE AND REPAIR OF VIDEO EDITING EQUIPMENT (U.S. CLS. 100, 103 AND 106). FIRST USE 10-0-1992; IN COMMERCE 10-0-1992.

CLASS 41—EDUCATION AND ENTERTAINMENT

FOR RENTAL OF VIDEO EDITING EQUIPMENT AND FACILITIES (U.S. CLS. 100, 101 AND 107). FIRST USE 10-0-1992; IN COMMERCE 10-0-1992.

CLASS 42—SCIENTIFIC, COMPUTER AND LEGAL SERVICES

FOR (BASED ON INTENT TO USE) DESIGN OF CUSTOM VIDEO EDITING SYSTEMS FOR OTHERS (U.S. CLS. 100 AND 101).

CIMMERIAN COLEMAN, EXAMINING ATTORNEY

SN 76-054,632. BLUETOOTH SIG, INC., WASHINGTON, DC.
FILED 5-19-2000.

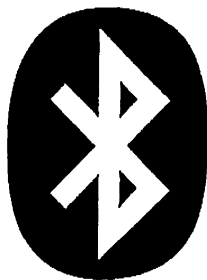

PRIORITY CLAIMED UNDER SEC. 44(D) ON SWEDEN
APPLICATION NO. 9908540, FILED 11-22-1999.

CLASS 7—MACHINERY

FOR MACHINES AND MACHINE TOOLS, NAMELY, DRILLS, SANDERS, TAPE DISPENSING MACHINES, AIR BRUSHES, VACUUM MACHINES, ALTIMETERS, ALTERNATORS, SOLDERING MACHINES, FLOOR SCRUBBERS, INDUSTRIAL EXHAUST FANS, BORING MACHINES, CLUTCHES FOR MACHINES, COMPRESSORS, CYCLONE SEPARATORS, AND DRIVES FOR VACUUM PUMPS; KITCHEN MACHINES, NAMELY, ELECTRIC FOOD CHOPPERS, BLENDERS, AND MIXERS; ELECTRIC GENERATORS; ELECTRONIC VEHICLE IGNITIONS; STARTERS FOR MOTORS AND ENGINES; FANS FOR MACHINE ENGINES; AGRICULTURAL IMPLEMENTS, NAMELY, SEED DRILLS, INCORPORATORS, IRRIGATION UNITS, CULTIVATORS, COMBINES, HARVESTERS, THRESHERS, TILLERS, WINDROWERS, FERTILIZER APPLIERS; CONTROL MECHANISMS, COMPRISED OF RADIO FREQUENCY TRANSMITTERS AND RECEIVERS, FOR CRANES, VALVES, AND LIQUID AND GAS PRESSURE GAUGES, ACTUATORS AND SENSORS; DISHWASHERS, WASHING MACHINES, AND VACUUM CLEANERS (U.S. CLS. 13, 19, 21, 23, 31, 34 AND 35).

CLASS 9—ELECTRICAL AND SCIENTIFIC APPARATUS

FOR APPARATUS FOR RECORDING, TRANSMISSION OR REPRODUCTION OF SOUND, IMAGES, AND LIGHT, NAMELY, PHONOGRAPHS, CASSETTE TAPE RECORDERS, COMPACT DISC RECORDERS, DVD RECORDERS, VIDEO RECORDERS, RADIO RECEIVERS, STILL CAMERAS, VIDEO CAMERAS, TRANSEIVERS, RADIO AND TELEVISION TRANSMITTERS, SOUND ENCODERS AND DECODERS, VIDEO ENCODERS AND DECODERS, RADIO FREQUENCY BASEBAND PROCESSORS AND MODEMS; APPARATUS AND INSTRUMENTS FOR DATA COMMUNICATION, SATELLITE COMMUNICATION AND TELECOMMUNICATION, NAMELY, TELEPHONE, SATELLITE, AND RADIO RECEIVERS, TRANSMITTERS AND TELEPHONE HEADSETS; COMPUTER HARDWARE; COMPUTER PROGRAMS FOR WIRELESS COMMUNICATION; COMPUTER INTERFACES, MODEMS AND PERIPHERAL EQUIPMENT, COMPRISED OF PRINTERS, MICE, MONITORS, KEYBOARDS, AND DONGLE CABLES; OPTICAL APPARATUS AND INSTRUMENTS, NAMELY LASERS, LASER SCANNING MICROSCOPES, ELECTRICALLY-CONTROLLED LENSES, AND OPTICAL READERS; APPARATUS AND INSTRUMENTS FOR THE MONITORING OF TELECOMMUNICATION NETWORKS AND DATA COMMUNICATION NETWORKS, NAMELY, NETWORK STATUS INDICATORS, DYSFUNCTION ALARMS AND NETWORK TRAFFIC ANALYSIS SOFTWARE; INSTALLATION APPARATUS AND INSTRUMENTS FOR DATA COMMUNICATION NETWORKS AND TELECOMMUNICATION NETWORKS, NAMELY, TELECOMMUNICA-

TIONS SERVERS; BATTERIES, AND RELATED ELECTRONIC COMPONENTS, COMPRISING CHARGERS, POWER LEVEL INDICATORS, AND SWITCHES; ELECTRICAL AND OPTICAL CABLES; ELECTRICAL WIRES; TELEPHONE BASE STATIONS; RADAR EQUIPMENT, COMPOSED OF RADAR RECEIVERS AND TRANSMITTERS; AERIALS FOR TELEVISION AND RADIO; CIPHERING AND CRYPTO AID ENCODERS AND DECODERS; TELEVISION APPARATUS, NAMELY, SCREENS, TUNERS, AND RECEIVERS; ELECTRONIC AMUSEMENT APPARATUS ADAPTED FOR USE WITH TELEVISION RECEIVERS; GAMES ADAPTED FOR USE WITH TELEVISION RECEIVERS, NAMELY, COMPUTER GAMES, COMPUTER VIDEO GAMES, GAME CONSOLES AND JOY STICKS; ANTI-THEFT WARNING APPARATUS, NAMELY, SOUND ALARMS; ELECTRIC AMMETERS; CASH REGISTERS; COPYING APPARATUS, NAMELY PHOTOCOPYING MACHINES; DETECTORS FOR SMOKE, METAL, RADAR AND MOTION; ELECTRIC LIGHT DIMMERS; ELECTRONIC DOOR CLOSERS, OPENERS AND LOCKS; ELECTRONIC CONTROLS FOR MOTORS; ELECTRONIC INSTALLATIONS FOR THE REMOTE CONTROL OF INDUSTRIAL OPERATIONS, NAMELY, COMPUTERS, CENTRAL PROCESSING UNITS, COMPUTER KEYBOARDS, PRINTERS FOR USE WITH COMPUTERS, CONTROL PANELS, MONITORS, PATCHBOARDS AND DISTRIBUTION BOARDS; ELECTRONIC PENS; ENCODERS AND MAGNETICALLY ENCODED CARDS; CALCULATING MACHINES, NAMELY, CALCULATORS; METERED GASOLINE PUMPS FOR SERVICE STATIONS, SELF REGULATING FUEL PUMPS; PROTECTIVE HELMETS; MAGNETIC IDENTITY CARDS; LEVELING INSTRUMENTS, NAMELY, SURVEYORS' LEVELS; LIFT OPERATING APPARATUS, NAMELY, ELEVATOR CONTROL PANELS; LOUDSPEAKERS; NAVAL SIGNALING APPARATUS, NAMELY, MARINE RADIOS; PARKING METERS; ELECTRONIC PLOTTERS; ELECTRONIC RADIOS; TRANSMITTERS; RADIO AND TELEPHONE SCALES; SIGNAL BELLS; SIGNALING PANELS, LUMINOUS AND MECHANICAL SIRENS; ELECTRIC SOCKETS; SONARS; SPECTACLES; AUTOMATIC STEERING APPARATUS FOR VEHICLES, NAMELY, CRASH DETECTION SENSORS; SWITCHBOARDS; SWITCHES; TELEPHONE TAXIMETERS; TELEPHONE APPARATUS, NAMELY HANDSETS, BASE STATIONS AND RECEIVERS; TRANSMITTERS; THERMOSTATS; AUTOMATIC TICKET DISPENSER; TIME RECORDING APPARATUS, NAMELY, CLOCKS, WATCHES, ATOMIC CLOCKS; AUTOMATIC TIME SWITCHES; ELECTRONIC TRANSISTORS; FIRE EXTINGUISHING APPARATUS, NAMELY, FIRE EXTINGUISHERS AND FIRE ALARMS (U.S. CLS. 21, 23, 26, 36 AND 38).

CLASS 10—MEDICAL APPARATUS

FOR SURGICAL IMPLANTS; SURGICAL LAMPS; CATHETER TUBES; THERMOMETERS FOR MEDICAL PURPOSES; TRACTION APPARATUS FOR MEDICAL USE; ULTRASONIC MEDICAL DIAGNOSTIC APPARATUS; BASEBAND PROCESSORS AND INTEGRATED CIRCUITS USED IN MEDICAL IMAGING SYSTEMS; ACUPUNCTURE INSTRUMENTS; AIR PILLOWS FOR MEDICAL PURPOSES; AUTOCLAVES FOR MEDICAL USE; BED VIBRATORS; BREAST PUMPS; ENEMA APPARATUS; TESTING APPARATUS, NAMELY, BLOOD TESTING DEVICES, BLOOD PRESSURE MONITORS, BREATH GAS ANALYZERS; FETAL PULSE MONITORS; HEART MONITORS; HEMO-DIALYSIS APPARATUS; WIRELESS NETWORKS FOR MEDICAL AND ORTHOPEDIC SYSTEMS AND INSTRUMENTS; ORTHOPEDIC ARTICLES, NAMELY, ORTHOPEDIC HARNESES; BELTS, ARTIFICIAL LIMBS; AMBULANCE, STRETCHERS AND ANESTHETIC APPARATUS, NAMELY, HOSPITAL GURNEYS, ANESTHETIC MASKS, AND HOSPITAL BEDS FOR USE BY BURN PATIENTS; HEARING PROTECTORS, NAMELY, EARPLUGS; EXERCISE MACHINES FOR THERAPEUTIC PURPOSES; HEARING AIDS FOR THE DEAF; AUTOMATED MEDICAL DISPENSERS; RADIO FREQUENCY PROCESSORS USED IN LIFE SUPPORT EQUIPMENT (U.S. CLS. 26, 39 AND 44).

CLASS 11—ENVIRONMENTAL CONTROL APPARATUS

FOR LAMPS; ROOF VENTILATORS; WATER PUMPS; WATER FILTERS; TOILET BOWLS AND TANKS; SINKS; WATER LEVEL MONITORS; AIR CONDITIONERS FOR VEHICLES; AIR CONDITIONERS FOR HOUSES AND BUILDINGS; AIR DEODORIZERS; ELECTRIC BREAD TOASTERS; BURNERS, GAS AND ELECTRIC; HEATING APPARATUS, NAMELY, FURNACE EXCHANGERS AND HEAT BLOWERS; REFRIGERATORS; REFRIGERATING APPARATUS, NAMELY, COMPRESSORS AND PUMPS; AUTOMATIC BREAD-MAKING MACHINES FOR DOMESTIC USE; DOMESTIC ELECTRIC APPLIANCES, NAMELY, FRYPANS, SLOW COOKERS, STEAMERS HOME OVENS, CAN OPENERS, ELECTRIC COFFEE MAKERS, FOOD DRYERS, AND TRASH COMPACTORS, INCLUDING ELECTRONIC COMPONENTS THEREFOR (U.S. CLS. 13, 21, 23, 31 AND 34).

CLASS 12—VEHICLES

FOR AIRBAGS FOR VEHICLES; MOTORS FOR LAND VEHICLES; VEHICLE ANTI-THEFT LOCKS; VEHICLE ANTI-THEFT ALARM SYSTEMS; AUTOMOTIVE BRAKING EQUIPMENT; AEROPLANES; AIRCRAFTS; SEAPLANES AND AMPHIBIOUS AIRPLANES; AMBULANCES; AUTOMOBILES; BICYCLES; BOATS; MOTORIZED GOLF CARTS MOPEDS; MOTOR BUSES; MOTOR CARS; MOTORCYCLES; OMNIBUSES; YACHTS (U.S. CLS. 19, 21, 23, 31, 35 AND 44).

CLASS 16—PAPER GOODS AND PRINTED MATTER

FOR PRINTED MATTER, NAMELY, STATIONERY, BUSINESS CARDS, ALMANACS, BOOKLETS, CALENDARS, GREETING CARDS, HANDBOOKS, PLAYING CARDS, POSTCARDS, POSTERS, BOOKS, PERIODICALS, MANUALS, BROCHURES, MAGAZINES AND PUBLICATIONS IN THE NATURE OF INSTRUCTIONAL AND TEACHING MATERIALS, ALL IN THE FIELD OF TELECOMMUNICATIONS AND RADIO COMMUNICATIONS; PAPER, CARDBOARD AND GOODS MADE FROM THESE MATERIALS, NAMELY, FLYERS, MANUALS, AND CALENDARS CONTAINING INFORMATION ON TELECOMMUNICATIONS, COMPUTERS, SOFTWARE, AND RADIO FREQUENCY DEVICES; BAGS, GENERAL PURPOSE; NON-METAL CASES FOR STAMPS; COASTERS OF PAPER; SCHOOL SUPPLIES, NAMELY, FOUNTAIN PENS, PENCILS, PENS, SCRAPBOOKS, AND STEEL PENS; LITHOGRAPHIC PRINTS (U.S. CLS. 2, 5, 22, 23, 29, 37, 38 AND 50).

CLASS 28—TOYS AND SPORTING GOODS

FOR COIN-OPERATED APPARATUS, NAMELY, VIDEO GAMES; GAMES AND PLAYTHINGS, NAMELY, ACTION FIGURES AND ACCESSORIES, ACTION SKILL GAMES, TARGET GAMES; BILLIARD PLAYING EQUIPMENT; DOLLS AND ACCESSORIES, MODEL VEHICLES, GYMNASTICS AND SPORTING ARTICLES, NAMELY AEROBIC STEPS; BALL PITCHING MACHINES; TENNIS EQUIPMENT; VOLLEYBALL NET ANTENNAS; MACHINES FOR PHYSICAL EXERCISES, NAMELY, STATIONARY BICYCLES, TREADMILLS, ROWING MACHINES; MODEL VEHICLES AND RELATED ACCESSORIES SOLD AS UNIT; TOY MOBILES (U.S. CLS. 22, 23, 38 AND 50).

CLASS 37—CONSTRUCTION AND REPAIR

FOR REPAIR AND INSTALLATION OF TELECOMMUNICATIONS EQUIPMENT AND SATELLITE COMMUNICATIONS EQUIPMENT AND NETWORKS (U.S. CLS. 100, 103 AND 106).

CLASS 38—COMMUNICATION

FOR TELECOMMUNICATION SERVICES, NAMELY, SHORT-RANGE RADIO COMMUNICATIONS, AND PERSONAL AREA NETWORK COMMUNICATIONS; CELLULAR TELEPHONE COMMUNICATION SERVICES; COMMUNICATIONS BY COMPUTER TERMINALS, NAMELY, ELECTRONIC TRANSMISSION OF DATA AND DOCUMENTS VIA COMPUTER TERMINALS, COMMUNICATION BY TELEPHONE, FACSIMILE TRANSMISSION, ELECTRONIC MAIL SERVICES AND PAGING SERVICES; COMPUTER AIDED TRANSMISSION OF MESSAGES AND IMAGES; RENTAL OF MESSAGE SENDING APPARATUS; PROVIDING INFORMATION ABOUT TELECOMMUNICATIONS GOODS AND SERVICES; TELEVISION BROADCASTING (U.S. CLS. 100, 101 AND 104).

CLASS 40—MATERIAL TREATMENT

FOR CUSTOM CONSTRUCTION OF TELECOMMUNICATIONS EQUIPMENT AND SATELLITE COMMUNICATIONS EQUIPMENT TO THE ORDER AND SPECIFICATION OF OTHERS (U.S. CLS. 100, 103 AND 106).

CLASS 41—EDUCATION AND ENTERTAINMENT

FOR EDUCATIONAL SERVICES, NAMELY, CONDUCTING CLASSES, SEMINARS, CONFERENCES, CORRESPONDENCE COURSES, WORKSHOPS AND TRAINING IN THE FIELDS OF DATA COMMUNICATIONS, PERSONAL AREA NETWORK COMMUNICATIONS, SATELLITE COMMUNICATIONS AND TELECOMMUNICATIONS (U.S. CLS. 100, 101 AND 107).

CLASS 42—SCIENTIFIC, COMPUTER AND LEGAL SERVICES

FOR TECHNICAL CONSULTATION IN THE FIELD OF DATA COMMUNICATIONS, PERSONAL AREA NETWORK COMMUNICATIONS, SATELLITE COMMUNICATIONS AND TELECOMMUNICATIONS; BASIC RESEARCH IN THE FIELD OF PHYSICS, CHEMISTRY AND ENGINEERING; COMPUTER PROGRAMMING SERVICES FOR OTHERS; LEASING OF DATA PROCESSING EQUIPMENT; CUSTOMER SERVICES, NAMELY, PROVIDING TECHNICAL ASSISTANCE AND CONSULTATION, COMPUTER DIAGNOSTIC SERVICES, REMOTE AND ON-SITE MONITORING OF COMPUTER SYSTEMS (U.S. CLS. 100 AND 101).

BARBARA A. LOUGHRAN, EXAMINING ATTORNEY

SN 76-056,498. PARENTING GROUP INC., THE, NEW YORK, NY. FILED 5-25-2000.

GROWING ALONG WITH THE EXPERT

CLASS 16—PAPER GOODS AND PRINTED MATTER

FOR MAGAZINES AND BOOKS IN THE FIELD OF HEALTH, PREGNANCY, PRE-NATAL AND POST-NATAL CARE, CHILD BIRTH, BABY CARE, DIET, EXERCISE AND OTHER INFORMATION FOR AND ABOUT PARENTS AND EXPECTANT PARENTS, PHOTO ALBUMS, SCRAPBOOKS, STATIONERY, PAINT SETS, ARTS AND CRAFTS PAINT SETS, CRAYONS AND COLORING BOOKS (U.S. CLS. 2, 5, 22, 23, 29, 37, 38 AND 50).

CLASS 28—TOYS AND SPORTING GOODS

FOR TOYS, GAMES AND EDUCATIONAL TEACHING TOOLS, NAMELY, HOBBY CRAFT SETS FOR PRESCHOOL AGED CHILDREN, FOR MAKING OR DECORATING THE FOLLOWING ITEMS - PICTURE FRAMES, CHILDREN'S HATS AND APPAREL ACCESSORIES, PUPPETS, SOFT TOY ANIMAL FIGURES, MEMORY BOOKS, JIGSAW PUZZLES, COSTUMES AND GROWTH CHARTS; BABY MULTIPLE ACTIVITY TOYS, CHILDREN'S MULTIPLE ACTIVITY TOYS, BATHTUB TOYS, CHILDREN'S ACTIVITY TABLES CONTAINING MANIPULATIVE TOYS, INFANT TOYS, SKETCHING TOYS, TALKING TOYS, BOARD GAMES, CARD GAMES, AND HAND-HELD UNITS FOR PLAYING ELECTRONIC GAMES (U.S. CLS. 22, 23, 38 AND 50).

BARBARA GAYNOR, EXAMINING ATTORNEY

CLASS 36—INSURANCE AND FINANCIAL

FOR FINANCIAL INVESTMENT IN THE FIELD OF SECURITIES BROKERAGE IN THE FIELD OF INSURANCE; REAL ESTATE INVESTMENT (U.S. CLS. 100, 101 AND 102).

CLASS 42—SCIENTIFIC, COMPUTER AND LEGAL SERVICES

FOR COMPUTER SOFTWARE DESIGN OF DATA PROCESSING PROGRAMS FOR THE ACQUISITION, BROKERAGE AND COMPLETION OF SECURITIES TRANSACTIONS OVER THE GLOBAL COMPUTER NETWORK; INTEGRATION OF COMPUTER SYSTEMS AND NETWORKS FOR E-COMMERCE BUSINESS (U.S. CLS. 100 AND 101).

DAVID C. REIHNER, EXAMINING ATTORNEY

SN 76-085,132. BL & HF COMPANIES, INC., BEDFORD, TX.
FILED 7-7-2000.

UGLY YELLOW SIGN

NO CLAIM IS MADE TO THE EXCLUSIVE RIGHT TO USE "YELLOW SIGN", APART FROM THE MARK AS SHOWN.

SN 76-117,221. HOUSE ON F STREET, LLC, THE, CLEVELAND, OH. FILED 8-25-2000.

CLASS 35—ADVERTISING AND BUSINESS

FOR REAL ESTATE ADVERTISING, NAMELY ELECTRONIC BILLBOARD ADVERTISING; DISSEMINATION OF REAL ESTATE ADVERTISING FOR OTHERS VIA AN ON-LINE ELECTRONIC COMMUNICATIONS NETWORK; DISSEMINATION OF REAL ESTATE ADVERTISING MATTER (U.S. CLS. 100, 101 AND 102).

FIRST USE 3-20-2000; IN COMMERCE 3-20-2000.

CLASS 36—INSURANCE AND FINANCIAL

FOR REAL ESTATE AGENCY; REAL ESTATE LEAD SERVICES, NAMELY REAL ESTATE LISTING (U.S. CLS. 100, 101 AND 102).

FIRST USE 3-20-2000; IN COMMERCE 3-20-2000.
GEOFFREY FOSDICK, EXAMINING ATTORNEY

SN 76-092,571. EUROPEAN TRANSACTION BANK AG, D-65760 ESCHBORN, FED REP GERMANY, FILED 7-20-2000.

ETB EUROPEAN TRANSACTION BANK

PRIORITY CLAIMED UNDER SEC. 44(D) ON FED REP GERMANY APPLICATION NO. 30024122.436, FILED 3-28-2000, REG. NO. 30024122, DATED 11-6-2000, EXPIRES 3-31-2010.

NO CLAIM IS MADE TO THE EXCLUSIVE RIGHT TO USE THE WORDING "EUROPEAN TRANSACTION BANK", APART FROM THE MARK AS SHOWN.

THE MARK CONSISTS OF THE DESIGN OF THREE SMALL SQUARES IN ORANGE ON THE LEFT AND THE LETTERING "ETB EUROPEAN TRANSACTION BANK" TO THE RIGHT IN DARK GREY.

CLASS 35—ADVERTISING AND BUSINESS

FOR BUSINESS MANAGEMENT AND CONSULTATION OF INDUSTRIAL, FINANCIAL INSTITUTIONS, STOCK CORPORATIONS AND SERVICE PROVIDER, NAMELY, PROVIDING ORGANIZATION, OPERATIONS AND PERSONNEL ADVICE (U.S. CLS. 100, 101 AND 102).

CLASS 41—EDUCATION AND ENTERTAINMENT

FOR ENTERTAINMENT SERVICES, NAMELY, PROVIDING CASINO FACILITIES AND INDOOR AMUSEMENT COMPLEXES FEATURING INTERACTIVE VIDEO MACHINES AND GAMES, BOTH OF THE FOREGOING WITH AN INTRIGUE AND ESPIONAGE MOTIF (U.S. CLS. 100, 101 AND 107).

CLASS 42—SCIENTIFIC, COMPUTER AND LEGAL SERVICES

FOR HOTEL SERVICES; PROVIDING CONVENTION FACILITIES FOR GENERAL PURPOSES, NOT A SPACE DEVOTED TO A SINGLE TYPE OF ACTIVITY; RESTAURANT SERVICES; AND PROVIDING NIGHTCLUB FACILITIES, ALL OF THE FOREGOING WITH AN INTRIGUE AND ESPIONAGE MOTIF (U.S. CLS. 100 AND 101).

TRICIA SONNEBORN, EXAMINING ATTORNEY



NO CLAIM IS MADE TO THE EXCLUSIVE RIGHT TO USE SPY, APART FROM THE MARK AS SHOWN.

SN 76-117,236. THE HOUSE ON F STREET, LLC., CLEVELAND, OH. FILED 8-25-2000.



NO CLAIM IS MADE TO THE EXCLUSIVE RIGHT TO USE SPY, APART FROM THE MARK AS SHOWN.

CLASS 41—EDUCATION AND ENTERTAINMENT

FOR ENTERTAINMENT SERVICES, NAMELY PROVIDING CASINO FACILITIES AND INDOOR AMUSEMENT COMPLEXES FEATURING INTERACTIVE VIDEO MACHINES AND GAMES, BOTH OF THE FOREGOING WITH AN INTRIGUE AND ESPIONAGE MOTIF (U.S. CLS. 100, 101 AND 107).

CLASS 42—SCIENTIFIC, COMPUTER AND LEGAL SERVICES

FOR HOTEL SERVICES; PROVIDING CONVENTION FACILITIES FOR GENERAL PURPOSES, NOT A SPACE DEVOTED TO A SINGLE TYPE OF ACTIVITY; RESTAURANT SERVICES; AND PROVIDING NIGHTCLUB FACILITIES, ALL WITH AN INTRIGUE AND ESPIONAGE MOTIF (U.S. CLS. 100 AND 101).

TRICIA SONNEBORN, EXAMINING ATTORNEY

SN 76-124,562. GROUP LOTUS LIMITED, NORFOLK, GREAT BRITAIN, FILED 9-8-2000.

LOTUS CHALLENGE

PRIORITY CLAIMED UNDER SEC. 44(D) ON ERPNCMNTY TM OFC APPLICATION NO. 001760164, FILED 7-7-2000, REG. NO. 1760164, DATED 11-5-2001, EXPIRES 7-7-2010.

CLASS 9—ELECTRICAL AND SCIENTIFIC APPARATUS

FOR COMPUTER SOFTWARE, NAMELY COMPUTER GAME SOFTWARE; COMPUTER GAMES ADAPTED FOR USE WITH VISUAL DISPLAY UNITS; GAMES CARTRIDGES; GAMES FOR USE WITH COMPUTERS; HAND HELD COMPUTER GAMES; INTERACTIVE GAMES FOR USE WITH VIDEO APPARATUS; MAGNETIC MEDIA STORING VIDEO GAMES; PROGRAMMED VIDEO GAMES RECORDED ON MAGNETIC DISC AND CD ROM; COMPUTER SOFTWARE NAMELY COMPUTER GAMES SOFTWARE, DOWNLOADABLE FROM THE INTERNET OR ANOTHER COMPUTER NETWORK; INTERACTIVE MULTIMEDIA COMPUTER PROGRAMS RECORDED ON MAGNETIC DISC AND CD ROM OR DOWNLOADABLE FROM THE INTERNET OR OTHER COMPUTER NETWORK; COMPACT DISKS, DVD'S, CD ROM'S AND RECORDINGS OF SOUND AND/OR IMAGES ON MAGNETIC TAPE, MAGNETIC DISC, DAT TAPE, DVD ROM, AND CD ROM; PARTS AND FITTINGS FOR THE AFORESAID GOODS; ELECTRONIC PUBLICATIONS DOWNLOADABLE FROM THE INTERNET OR OTHER COMPUTER NETWORKS; ALL OF THE AFORESAID GOODS RELATING TO ENGINEERING OR TO VEHICLES OR TO PARTS AND FITTINGS OF VEHICLES (U.S. CLS. 21, 23, 26, 36 AND 38).

CLASS 28—TOYS AND SPORTING GOODS

FOR ELECTRONIC AMUSEMENT APPARATUS; NAMELY, ELECTRONIC GAMES; HAND HELD ELECTRONIC GAMES; AND PARTS AND FITTINGS FOR THE AFORESAID GOODS; ALL OF THE AFORESAID GOODS EMBODYING GAMES RELATING TO ENGINEERING OR TO VEHICLES OR TO PARTS AND FITTINGS FOR VEHICLES (U.S. CLS. 22, 23, 38 AND 50).

CLASS 41—EDUCATION AND ENTERTAINMENT

FOR ENTERTAINMENT SERVICES, NAMELY PROVIDING AN ONLINE COMPUTER GAME RELATING TO ENGINEERING OR TO VEHICLES OR TO PARTS AND FITTINGS FOR VEHICLES (U.S. CLS. 100, 101 AND 107).

CLASS 42—SCIENTIFIC, COMPUTER AND LEGAL SERVICES

FOR PROVIDING ON-LINE ELECTRONIC PUBLICATIONS RELATING TO ENGINEERING OR VEHICLES OR PARTS AND FITTINGS OF VEHICLES (U.S. CLS. 100 AND 101).

CHERYL STEPLIGHT, EXAMINING ATTORNEY

SN 76-170,860. VIRCO CENTRAL VIROLOGICAL LABORATORY (IRELAND) LTD., DUBLIN, 15, IRELAND, FILED 11-22-2000.

SN 76-180,652. ANDAMIRO CO., LTD., MAPO-GU, SEOUL, REPUBLIC OF KOREA, FILED 12-13-2000.



VIRCOVIRIS

CLASS 9—ELECTRICAL AND SCIENTIFIC APPARATUS

FOR COMPUTER SOFTWARE FOR ENTERING, GENERATING, PROCESSING, STORING AND RETRIEVING BIOLOGICAL TEST DATA AND RESULTS, DRUG SCREENING AND DRUG TESTING DATA AND RESULTS; COMPUTER SOFTWARE FOR ENTERING, GENERATING, PROCESSING, STORING AND RETRIEVING MEDICAL AND CLINICAL PATIENT AND RESEARCH DATA AND RESULTS; COMPUTER SOFTWARE FOR ENTERING, GENERATING, PROCESSING, STORING AND RETRIEVING DIAGNOSTIC AND LABORATORY DATA AND RESULTS; PRE-RECORDED MAGNETIC DATA CARRIERS AND COMPACT DISKS CONTAINING COMPUTER SOFTWARE AND DATABASES FOR ENTERING, STORING, RETRIEVING, PROCESSING AND GENERATING BIOLOGICAL TEST DATA AND RESULTS, DRUG SCREENING AND DRUG TESTING DATA AND RESULTS, COMPUTER SOFTWARE FOR ENTERING, STORING, RETRIEVING, PROCESSING AND GENERATING MEDICAL, CLINICAL PATIENT AND RESEARCH DATA AND RESULTS, AND COMPUTER SOFTWARE FOR ENTERING, STORING, RETRIEVING, PROCESSING AND GENERATING DIAGNOSTIC AND LABORATORY DATA AND RESULTS (U.S. CLS. 21, 23, 26, 36 AND 38).

CLASS 42—SCIENTIFIC, COMPUTER AND LEGAL SERVICES

FOR MEDICAL CARE; BIOLOGICAL RESEARCH; CLINICAL MEDICAL RESEARCH, NAMELY MANAGING TREATMENT OF PATIENTS UNDERGOING THERAPY; MEDICAL DIAGNOSIS OF DISEASE; MEDICAL SERVICES, NAMELY, MANAGING TREATMENT OF PATIENTS UNDERGOING THERAPY; THERAPEUTIC DRUG SCREENING AND THERAPEUTIC DRUG TESTING PROGRAMS; DIAGNOSTIC LABORATORY SERVICES IN THE MANAGEMENT OF DISEASE (U.S. CLS. 100 AND 101).

MARC LEIPZIG, EXAMINING ATTORNEY

PRIORITY CLAIMED UNDER SEC. 44(D) ON REPUBLIC OF KOREA APPLICATION NO. 2000-0017439, FILED 6-16-2000, REG. NO. 0074389, DATED 3-20-2002, EXPIRES 3-20-2012.

PRIORITY CLAIMED UNDER SEC. 44(D) ON REPUBLIC OF KOREA APPLICATION NO. 2000-0028950, FILED 6-16-2000, REG. NO. 0504800, DATED 10-29-2001, EXPIRES 10-29-2011.

PRIORITY CLAIMED UNDER SEC. 44(D) ON REPUBLIC OF KOREA APPLICATION NO. 2000-0028948, FILED 6-16-2000, REG. NO. 0500899, DATED 9-7-2001, EXPIRES 9-7-2011.

PRIORITY CLAIMED UNDER SEC. 44(D) ON REPUBLIC OF KOREA APPLICATION NO. 2000-0028947, FILED 6-16-2000, REG. NO. 0500900, DATED 9-7-2001, EXPIRES 9-7-2011.

PRIORITY CLAIMED UNDER SEC. 44(D) ON REPUBLIC OF KOREA APPLICATION NO. 2000-0028946, FILED 6-16-2000, REG. NO. 0502505, DATED 9-26-2001, EXPIRES 9-26-2011.

PRIORITY CLAIMED UNDER SEC. 44(D) ON REPUBLIC OF KOREA APPLICATION NO. 2000-0028945, FILED 6-16-2000, REG. NO. 0505118, DATED 8-9-2001, EXPIRES 8-9-2011.

PRIORITY CLAIMED UNDER SEC. 44(D) ON REPUBLIC OF KOREA APPLICATION NO. 2000-0028944, FILED 6-16-2000, REG. NO. 0500901, DATED 9-7-2001, EXPIRES 9-7-2011.

PRIORITY CLAIMED UNDER SEC. 44(D) ON REPUBLIC OF KOREA APPLICATION NO. 2000-0028943, FILED 6-16-2000, REG. NO. 0504799, DATED 10-29-2001, EXPIRES 10-29-2011.

PRIORITY CLAIMED UNDER SEC. 44(D) ON REPUBLIC OF KOREA APPLICATION NO. 2000-0028942, FILED 6-16-2000, REG. NO. 0504798, DATED 10-29-2001, EXPIRES 10-29-2011.

PRIORITY CLAIMED UNDER SEC. 44(D) ON REPUBLIC OF KOREA APPLICATION NO. 2000-0028940, FILED 6-16-2000, REG. NO. 0504797, DATED 10-29-2001, EXPIRES 10-29-2011.

PRIORITY CLAIMED UNDER SEC. 44(D) ON REPUBLIC OF KOREA APPLICATION NO. 2000-0028939, FILED 6-16-2000, REG. NO. 0501269, DATED 9-13-2001, EXPIRES 9-13-2011.

PRIORITY CLAIMED UNDER SEC. 44(D) ON REPUBLIC OF KOREA APPLICATION NO. 2000-0028937, FILED 6-16-2000, REG. NO. 0511666, DATED 2-1-2002, EXPIRES 2-1-2012.

THE MARK CONSISTS OF THE WORD "ANDAMIRO" WITH AN ARC SHAPE THROUGH THE FIRST THREE LETTERS OF THE WORD.

THE WORD "ANDAMIRO" IS A TRANSLITERATION OF A KOREAN WORD WHICH MEANS "OVERWHELMINGLY FILLED".

CLASS 3—COSMETICS AND CLEANING PREPARATIONS

FOR BABY OIL, BABY POWDER, AFTER-SHAVE LOTIONS, COSMETIC PREPARATIONS FOR SLIMMING PURPOSES, PERFUMES, HAIR MOUSSE, HAIR SPRAY, HAIR LOTIONS, SKIN SOAP, HAIR RINSE, DENTIFRICES (U.S. CLS. 1, 4, 6, 50, 51 AND 52).

CLASS 8—HAND TOOLS

FOR TEA SPOONS, NON-ELECTRIC CAN OPENERS, SPOONS, DINNER KNIVES FOR RESTAURANT, FORKS, NAIL NIPPERS, CHOPSTICKS, NAIL CLIPPERS, FINGERNAIL FILES, ELECTRIC RAZORS (U.S. CLS. 23, 28 AND 44).

CLASS 9—ELECTRICAL AND SCIENTIFIC APPARATUS

FOR MONEY COUNTING AND SORTING MACHINES, TICKET DISPENSING MACHINES, INTERACTIVE VIDEO GAMES OF VIRTUAL REALITY COMPRISED OF COMPUTER GAME HARDWARE AND SOFTWARE, MUSICAL JUKE BOXES, RECORDED SOFTWARE, NAMELY FOR GAME PROGRAMS, GAME MUSIC AND GAME GRAPHICS, VIDEO GAME CARTRIDGES, VENDING MACHINES, SLOT MACHINES (U.S. CLS. 21, 23, 26, 36 AND 38).

CLASS 14—JEWELRY

FOR NAPKIN RINGS OF PRECIOUS METAL, SERVING TRAYS OF PRECIOUS METAL, MEMORIAL PLAQUES OF PRECIOUS METAL, KEY HOLDERS MADE OF PRECIOUS METAL, DESK CLOCK, WRISTWATCHES, EARRINGS, BUCKLES OF PRECIOUS METAL, NECKTIE PINS, NECKLACES (U.S. CLS. 2, 27, 28 AND 50).

CLASS 15—MUSICAL INSTRUMENTS

FOR MUSICAL INSTRUMENTS FOR CHILDREN (U.S. CLS. 2, 21 AND 36).

CLASS 16—PAPER GOODS AND PRINTED MATTER

FOR NOTEBOOKS, SKETCHBOOKS, BALL-POINT PENS, PENS, MECHANICAL PENCILS, PENCILS, PENCIL CASES, CALENDARS, COMIC BOOKS, MAGAZINES FEATURING INFORMATION ON ELECTRONIC GAME MACHINES (U.S. CLS. 2, 5, 22, 23, 29, 37, 38 AND 50).

CLASS 18—LEATHER GOODS

FOR BAGS FOR CLIMBERS, CALLING CARD CASES, BEACH BAGS, GARMENT BAGS FOR TRAVEL, LUGGAGE, NAMELY, TRUNKS, UMBRELLAS, AND PARASOLS, SCHOOL BAGS, HANDBAGS (U.S. CLS. 1, 2, 3, 22 AND 41).

CLASS 20—FURNITURE AND ARTICLES NOT OTHERWISE CLASSIFIED

FOR DRINKING STRAWS, CHAIRS, BOOK SHELVES, DESKS, BOOK CASES, PICTURE FRAMES, KOREAN FLOOR CUSHIONS, PILLOWS, CUSHIONS, PLAYPENS FOR BABIES, INFANT WALKERS (U.S. CLS. 2, 13, 22, 25, 32 AND 50).

CLASS 21—HOUSEWARES AND GLASS

FOR SOAP HOLDERS, SOAP IMPREGNATED PAPER, HAIR COMBS, NAIL BRUSHES, PORTABLE TOILET CASES SOLD EMPTY, TOOTH BRUSHES, DRINKING GLASSES, VACUUM BOTTLES (U.S. CLS. 2, 13, 23, 29, 30, 33, 40 AND 50).

CLASS 24—FABRICS

FOR SHOWER CURTAINS, SHAMS, BED SPREADS, QUILTS, BED LINENS, COVERS FOR CUSHIONS, TOWELS FOR EYE GLASSES, HANDKERCHIEFS OF TEXTILE, TOWELS OF TEXTILE, SEAT COVERS OF TEXTILE FOR TOILET BOWLS (U.S. CLS. 42 AND 50).

CLASS 25—CLOTHING

FOR BASKETBALL SHOES, SANDALS, SHORTS, BABY CLOTHING, NAMELY SHIRTS, BLOUSES, PANTS, SKIRTS, UNDERWEAR AND SOCKS, LAYETTES, SHIRTS, SWEATERS, UNIFORMS FOR SPORTS, SOCKS, HATS (U.S. CLS. 22 AND 39).

CLASS 28—TOYS AND SPORTING GOODS

FOR TOYS FOR CHILDREN, NAMELY ELECTRICAL TOYS, INTELLIGENT TOYS, NAMELY BABY MULTIPLE ACTIVITY TOYS, MODEL TOYS, NAMELY SCALE MODEL VEHICLES FOR CHILDREN, TOY CARS, TOY GUNS, AND RADIO CONTROLLED TOYS, GOLF BAGS, SKATEBOARDS, BASEBALL GLOVES, FOOTBALLS; FAIRGROUND RIDE APPARATUS (U.S. CLS. 22, 23, 38 AND 50).

CLASS 41—EDUCATION AND ENTERTAINMENT

FOR PROVIDING THEATER SERVICE, FILM PRODUCTION, ENTERTAINMENT SERVICES, NAMELY, THE SCREENING OF FILMS, PROVIDING AMUSEMENT ARCADE SERVICE, PROVIDING CASINO SERVICE, PROVIDING BOWLING ALLEY SERVICE, PROVIDING CHILDREN'S PLAYGROUND SERVICE, PROVIDING FACILITIES FOR RECREATION ACTIVITIES, PROVIDING VIDEO ARCADE SERVICE, PROVIDING AMUSEMENT PARKS (U.S. CLS. 100, 101 AND 107).

AMOS T. MATTHEWS, JR., EXAMINING ATTORNEY

SN 76-180,874. MOONROCK NEW MEDIA LIMITED, LONDON EC1V 9BW, UNITED KINGDOM, FILED 12-14-2000.

INVESTED WITH ATTITUDE

PRIORITY CLAIMED UNDER SEC. 44(D) ON ERPN CMNTY TM OFC APPLICATION NO. 001965540, FILED 11-22-2000, REG. NO. 1965540, DATED 4-3-2002, EXPIRES 11-22-2010.

NO CLAIM IS MADE TO THE EXCLUSIVE RIGHT TO USE "INVESTED", APART FROM THE MARK AS SHOWN.

CLASS 36—INSURANCE AND FINANCIAL

FOR FINANCIAL ANALYSIS SERVICES; FINANCIAL INFORMATION SERVICES; FINANCIAL CONSULTATION SERVICES, NAMELY, PROVIDING FINANCIAL ADVICE; BROKERAGE IN THE FIELD OF INSURANCE, STOCKS AND COMMODITIES; FINANCIAL RESEARCH; ALL SERVICES PROVIDED ON-LINE VIA THE INTERNET (U.S. CLS. 100, 101 AND 102).

CLASS 41—EDUCATION AND ENTERTAINMENT

FOR ENTERTAINMENT SERVICES, NAMELY, PRODUCTION OF RADIO AND TELEVISION PROGRAMS; VIDEOTAPE PRODUCTIONS; ELECTRONIC PUBLISHING SERVICES, NAMELY, PUBLICATION OF TEXT AND GRAPHIC WORKS OF OTHERS ON CD-ROMS FEATURING ENTERTAINMENT AND FINANCE; MUSIC PUBLISHING SERVICES; AND ENTERTAINMENT, NAMELY, LIVE MUSIC CONCERTS (U.S. CLS. 100, 101 AND 107).

MITCHELL FRONT, EXAMINING ATTORNEY

SN 76-184,045. VIRCO CENTRAL VIROLOGICAL LABORATORY (IRELAND) LTD., DUBLIN 15, IRELAND, FILED 12-20-2000.

VIRCOTRACK

CLASS 9—ELECTRICAL AND SCIENTIFIC APPARATUS

FOR PRE-RECORDED MAGNETIC DATA CARRIERS AND COMPACT DISCS CONTAINING COMPUTER SOFTWARE AND DATABASES FOR ENTERING, STORING, RETRIEVING, PROCESSING AND GENERATING BIOLOGICAL TEST DATA AND RESULTS, DRUG SCREENING AND DRUG TESTING DATA AND RESULTS, COMPUTER SOFTWARE FOR ENTERING, STORING, RETRIEVING, PROCESSING AND GENERATING MEDICAL, CLINICAL PATIENT AND RESEARCH DATA AND RESULTS, AND COMPUTER SOFTWARE FOR ENTERING, STORING, RETRIEVING, PROCESSING AND GENERATING DIAGNOSTIC AND LABORATORY DATA AND RESULTS (U.S. CLS. 21, 23, 26, 36 AND 38).

CLASS 42—SCIENTIFIC, COMPUTER AND LEGAL SERVICES

FOR MEDICAL CARE; BIOLOGICAL RESEARCH AND CLINICAL MEDICAL RESEARCH, NAMELY MANAGING TREATMENT OF PATIENTS UNDERGOING THERAPY; MEDICAL DIAGNOSIS OF DISEASE; MEDICAL SERVICES, NAMELY, MANAGING TREATMENT OF PATIENTS UNDERGOING THERAPY; THERAPEUTIC DRUG SCREENING AND TESTING PROGRAMS, MEASUREMENTS OF THERAPEUTIC DRUG LEVELS, AND TRACKING OF DATA IN CONNECTION THEREWITH; SERVICES ENABLING THE FOLLOW-UP OF PATIENT TESTING PROGRESS AND THE TRACKING OF PATIENT TESTING RESULTS IN CONNECTION WITH THE MANAGEMENT OF DISEASE (U.S. CLS. 100 AND 101).

MARC LEIPZIG, EXAMINING ATTORNEY

SN 76-191,830. GLOBAL RENTAL CO., INC., BIRMINGHAM, AL. FILED 1-9-2001.

GLOBAL

OWNER OF U.S. REG. NO. 2,774,461.

CLASS 37—CONSTRUCTION AND REPAIR

FOR RENTAL OF EQUIPMENT USED IN THE CONSTRUCTION, TELECOMMUNICATIONS AND UTILITY INDUSTRIES, NAMELY, AERIAL BUCKETS, DERRICKS, WINCHES, HYDRAULIC AUGER UNITS, DIGGERS AND JACKS, AND REPLACEMENT PARTS THEREFOR; AND MOTOR DRIVEN TOOLS, NAMELY WOOD CHIPPERS FOR CUTTING TREE LIMBS AND BRUSH INTO SMALL CHIPS (U.S. CLS. 100, 103 AND 106).

FIRST USE 4-17-1990; IN COMMERCE 4-17-1990.

CLASS 39—TRANSPORTATION AND STORAGE

FOR RENTAL OF UTILITY SERVICE TRUCKS AND SPECIAL DUTY TRUCKS (U.S. CLS. 100 AND 105).
FIRST USE 4-17-1990; IN COMMERCE 4-17-1990.
TANYA AMOS, EXAMINING ATTORNEY

SN 76-199,372. CLOVERTREE SPRING WATER, LLC, SMITHFIELD, KY. FILED 1-26-2001.

THE WATER BUGGY

NO CLAIM IS MADE TO THE EXCLUSIVE RIGHT TO USE "WATER", APART FROM THE MARK AS SHOWN.

CLASS 12—VEHICLES

FOR TRAVEL TRAILERS FOR TRANSPORTING AND DISPLAYING BOTTLED BEVERAGES (U.S. CLS. 19, 21, 23, 31, 35 AND 44).

FIRST USE 9-0-1999; IN COMMERCE 9-0-1999.

CLASS 35—ADVERTISING AND BUSINESS

FOR RETAIL STORE SERVICES FEATURING BOTTLED WATER (U.S. CLS. 100, 101 AND 102).

FIRST USE 9-0-1999; IN COMMERCE 9-0-1999.

CHARLES L. JENKINS, EXAMINING ATTORNEY

SN 76-199,803. JACKSON PARTNERS, LTD., PARK CITY, UT. FILED 1-25-2001.

LANDSHARK

CLASS 9—ELECTRICAL AND SCIENTIFIC APPARATUS

FOR COMPUTER HARDWARE, AND USER MANUALS SOLD AS A UNIT THEREWITH; COMPUTER SOFTWARE FOR USE IN COMMUNICATION VIA COMMUNICATION TELEPHONE, ELECTRONIC MESSAGING, E-MAIL, AND WIRELESS PERSONAL DIGITAL ASSISTANTS, AND USER MANUALS SOLD AS A UNIT THEREWITH; COMPUTER SOFTWARE FOR USE IN COLLECTION, PROCESSING, MANAGEMENT AND DISTRIBUTION OF INFORMATION REGARDING A WIDE VARIETY OF GOODS AND SERVICES, IN THE FIELDS OF REAL ESTATE, GEOGRAPHIC, MAP, ENGINEERING, CONSTRUCTION, TRAVEL, AND TOURISM, AND USER MANUALS SOLD AS A UNIT THEREWITH; COMPUTER SOFTWARE FOR ANALYZING REAL ESTATE DATA FOR REAL ESTATE DEVELOPMENT AND INVESTMENT OPPORTUNITIES; GLOBAL POSITION SYSTEMS FEATURING SATELLITE OR WIRELESS CONNECTION, AND USER MANUALS SOLD AS A UNIT THEREWITH (U.S. CLS. 21, 23, 26, 36 AND 38).

CLASS 35—ADVERTISING AND BUSINESS

FOR BUSINESS INFORMATION MANAGEMENT SERVICES; NAMELY INFORMATION COLLECTION, PROCESSING, MANAGEMENT AND DISTRIBUTION SERVICES VIA COMPUTER AND ONLINE COMPUTER INFORMATION SYSTEMS; MANAGEMENT, COLLECTION AND PROCESSING OF BUSINESS INFORMATION IN THE REAL ESTATE, ENGINEERING, CONSTRUCTION, TRAVEL AND TOURISM INDUSTRIES (U.S. CLS. 100, 101 AND 102).

CLASS 38—COMMUNICATION

FOR WIRELESS ANALOGUE AND DIGITAL MESSAGING AND EMAIL SERVICES; TELEPHONE COMMUNICATION SERVICES (U.S. CLS. 100, 101 AND 104).
ANDREW BENZMILLER, EXAMINING ATTORNEY

SN 76-220,331. KANSAS STATE UNIVERSITY, MANHATTAN, KS. FILED 3-6-2001.

SN 76-248,018. IHT RECORDS LIMITED, LONDON, SW4 6DH, UNITED KINGDOM. FILED 4-27-2001.



CLASS 25—CLOTHING

FOR CLOTHING, NAMELY, GOLF SHIRTS, SOCKS, SHORTS, HATS, CAPS, VISORS, VESTS, WIND RESISTANT JACKETS, TURTLENECKS, SWEATSHIRTS, SWEATERS AND RAINWEAR (U.S. CLS. 22 AND 39).
FIRST USE 0-0-1999; IN COMMERCE 0-0-1999.

CLASS 41—EDUCATION AND ENTERTAINMENT

FOR GOLF COURSES (U.S. CLS. 100, 101 AND 107).
FIRST USE 0-0-1999; IN COMMERCE 0-0-1999.
SONYA STEPHENS, EXAMINING ATTORNEY



PRIORITY CLAIMED UNDER SEC. 44(D) ON UNITED KINGDOM APPLICATION NO. 2251248, FILED 11-1-2000, REG. NO. 2251248, DATED 11-1-2000, EXPIRES 11-1-2010.

SN 76-236,893. LITTLE MISS HENNA INC., THORNHILL, ONTARIO, L4J 3J8, CANADA, FILED 4-6-2001.

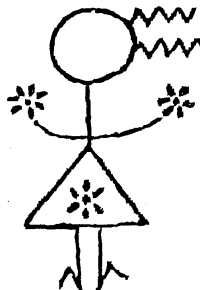

CLASS 9—ELECTRICAL AND SCIENTIFIC APPARATUS

FOR MUSICAL VIDEO RECORDINGS AND MUSICAL SOUND RECORDINGS; PRE-RECORDED GRAMOPHONE RECORDS FEATURING MUSIC; COMPACT DISCS FEATURING MUSIC; PRE-RECORDED AUDIO TAPES, CASSETTES AND CARTRIDGES FEATURING MUSIC; PRE-RECORDED VIDEO TAPES, CASSETTES AND CARTRIDGES FEATURING IMAGES OF MUSICAL PERFORMERS AND MUSIC; BLANK MAGNETIC COMPUTER TAPES; AUDIO DISCS FEATURING MUSIC; VIDEO DISCS FEATURING IMAGES OF MUSICAL PERFORMERS AND MUSIC; OPTICAL DISCS BEARING SOUND, OPTICAL DISCS BEARING VIDEO RECORDINGS; MOTION PICTURE FILMS FEATURING MUSIC ARTISTS; DVDS FEATURING MUSIC; DIGITAL MUSIC DOWNLOADABLE FROM THE INTERNET; DIGITAL MUSIC DOWNLOADABLE FROM MP3 PLAYERS; VIDEO GAME DISCS AND CASSETTES; EYEGASSES; SUNGLASSES; SPECTACLES; AND PARTS FOR ALL THE AFORESAID GOODS (U.S. CLS. 21, 23, 26, 36 AND 38).

PRIORITY CLAIMED UNDER SEC. 44(D) ON CANADA APPLICATION NO. 1,077,783, FILED 10-6-2000, REG. NO. TMA593101, DATED 10-27-2003, EXPIRES 10-27-2018.

CLASS 16—PAPER GOODS AND PRINTED MATTER

FOR PRINTED MATTERS, NAMELY, BOOKS, NEWSPAPERS, NEWSLETTERS, PAMPHLETS, MAGAZINES, PERIODICALS, CATALOGUES, BROCHURES AND PROGRAMS, ALL RELATING TO ENTERTAINMENT, MUSIC AND MUSIC ARTISTS; BOOK COVERS; CALENDARS; PICTURES; MOUNTED PHOTOGRAPHS; UNMOUNTED PHOTOGRAPHS; STATIONERY; PENCILS; PENS; PRINTED PLANS; CHARTS; POSTERS; ORDINARY PLAYING CARDS; PAINT BRUSHES; DIARIES; DRAWING INSTRUMENTS; GREETING CARDS; ADDRESS BOOKS; ADHESIVES FOR STATIONERY PURPOSES; PAPER HANDKERCHIEFS; TABLE NAPKINS OF PAPER; AND BINDERS (U.S. CLS. 2, 5, 22, 23, 29, 37, 38 AND 50).

CLASS 6—METAL GOODS

FOR KEYCHAINS OF METAL (U.S. CLS. 2, 12, 13, 14, 23, 25 AND 50).

CLASS 14—JEWELRY

FOR JEWELRY, NAMELY, NECKLACES, BRACELETS, EARRINGS AND WATCHES (U.S. CLS. 2, 27, 28 AND 50).

CLASS 25—CLOTHING

FOR WEARING APPAREL, NAMELY, T-SHIRTS, SWEATSHIRTS, SWEATPANTS, PANTS, SKIRTS, DRESSES, JACKETS, BELTS, AND SHOES (U.S. CLS. 22 AND 39).
AMOS T. MATTHEWS, JR., EXAMINING ATTORNEY

CLASS 25—CLOTHING

FOR ARTICLES OF CLOTHING, NAMELY T-SHIRTS, SHIRTS, SWEATSHIRTS, JACKETS, PAJAMAS, TROUSERS, WRISTBANDS, HEADBANDS, PANTS, HATS, SOCKS, UNDERWEAR, SHORTS, SCARVES, PULL-OVERS, TIES, GLOVES, CAPS AND FOOTWEAR (U.S. CLS. 22 AND 39).

CLASS 41—EDUCATION AND ENTERTAINMENT

FOR ENTERTAINMENT SERVICES, NAMELY, PERSONAL APPEARANCES BY A MUSIC ARTIST; ENTERTAINMENT, NAMELY, LIVE MUSICAL CONCERT PERFORMANCES; ENTERTAINMENT, NAMELY, MUSIC VARIETY AND COMEDY SHOWS DISTRIBUTED OVER TELEVISION, SATELLITE, AUDIO AND VIDEO MEDIA; RADIO ENTERTAINMENT SERVICES, NAMELY, RADIO PROGRAMS FEATURING PERFORMANCES AND SOUND RECORDINGS BY MUSIC ARTISTS; ENTERTAINMENT IN THE NATURE OF THEATRE PRODUCTIONS; ENTERTAINMENT, NAMELY, PRODUCTION OF SHOWS, MUSICAL SHOWS, CONCERTS, VIDEOS, SOUND RECORDINGS AND RADIO AND TELEVISION PROGRAMS; FILM PRODUCTION AND DISTRIBUTION SERVICES; ARRANGING AND CONDUCTING EDUCATIONAL SEMINARS AND CONFERENCES (U.S. CLS. 100, 101 AND 107).

STACY WAHLBERG, EXAMINING ATTORNEY

SN 76-251,560. THUS PLC, GLASGOW, UNITED KINGDOM, FILED 5-4-2001.

THUS

OWNER OF UNITED KINGDOM REG. NO. 2206811, DATED 7-13-2001, EXPIRES 8-24-2009.

CLASS 9—ELECTRICAL AND SCIENTIFIC APPARATUS

FOR TELECOMMUNICATIONS PRODUCTS, NAMELY, TELEPHONES; TELEPHONE SYSTEMS, COMPRISED OF A HANDSET AND CONSOLE UNIT WITH CONSOLE FEATURES, NAMELY, STANDARD TELEPHONE FUNCTIONS, ONE-TOUCH DIALING, CALL PROGRESS MONITORING, GROUP LISTENING, CLOCK/CALENDAR AND ALARM, ELECTRONIC DISPLAY, AND MODULES FOR FEATURES, NAMELY, AUTOMATIC DIALING, CALL RESTRICTION, STORED MESSAGE RECALL, AND CUSTOM CALLING, ALSO KNOWN AS TELESYSTEMS; CORDLESS TELEPHONES; SPEAKER PHONES, ALSO KNOWN AS HANDS FREE TELEPHONE APPARATUS; TELEPHONE DIALERS; TELEPHONE STATION MESSAGE DETAIL RECORDERS; MOBILE TELECOMMUNICATION EQUIPMENT COMPRISING A CONTROL TELEPHONE UNIT, TRANSCIEVER AND ANTENNA; MOBILE TELEPHONES AND COMPONENT PARTS THEREOF; BATTERY POWER PLANTS FOR USE IN PROVIDING AND MANAGING ENERGY SUPPLY REQUIREMENTS IN THE TELECOMMUNICATIONS INDUSTRY; CLOCK RADIO TELEPHONES; LIGHTWAVE DATA LINKS, NAMELY, TELECOMMUNICATIONS TRANSMITTERS AND RECEIVERS; MODEMS AND SPLITTERS FOR MODEMS; TELEPHONE INSTALLATION APPARATUS, NAMELY, PHONE MOUNTS, DUAL OUTLET ADAPTERS, TELEPHONE OUTLETS, MODULAR JACKS, WIRE JUNCTIONS AND PLUG-IN CONVERTERS; INTERACTIVE TELEVISION UNITS FOR ACQUISITION OF INFORMATION FROM DATABASES; TELECOMMUNICATIONS SWITCHING APPARATUS; TELECOMMUNICATION TRANSPONDERS; FACSIMILE MACHINES; COMPUTER PROGRAMS FOR MANAGING TELECOMMUNICATIONS NETWORKS; VOICE AND DATA TRANSMITTING, CARRYING AND RECEIVING EQUIPMENT, NAMELY, TELECOMMUNICATION CARRIERS, CENTRAL OFFICE AND REMOTE TERMINALS, CHANNEL BANKS, ELECTRONIC PLUG-INS AND PAIR-GAIN APPARATUS; NETWORK MULTIPLEXER; DATA COMMUNICATION MULTIPLEXERS AND CONCENTRATOR; VIDEOTEX TERMINALS; AND ELECTRIC EMERGENCY CALL UNITS; TELEPHONE ANSWERING MACHINES; VIDEOPHONES; PAGERS, FIBER OPTIC CABLE; COOPER CABLE AND WIRE; COAXIAL CABLE; MICROWAVE TRANSMITTERS; FIBER OPTIC CONNECTORS; PARTS AND FITTINGS FOR TELECOMMUNICATIONS APPARATUS, NAMELY, INTEGRATED CIRCUITS AND MICROPROCESSORS; MI-

CROPROCESSOR BASED COMMUNICATORS, NAMELY, WRITING STYLI AND TABLETS THAT ENABLE INDIVIDUALS TO COMMUNICATE OVER A WIRED OR WIRELESS TELECOMMUNICATIONS NETWORK, VIDEO TELECONFERENCING PRODUCTS, NAMELY, SWITCHES, MODEMS, AND AUDIO SPEAKERS AND VIDEO DISPLAY TUBES; MOUSE PADS (U.S. CLS. 21, 23, 26, 36 AND 38).

CLASS 16—PAPER GOODS AND PRINTED MATTER

FOR PUBLICATIONS AND PRINTED MATTER, NAMELY, BOOKS, PAMPHLETS, POSTERS, NEWSLETTERS, MAGAZINE DEALING WITH THE SUBJECT MATTER OF TELECOMMUNICATIONS, COMPUTERS, THE INTERNET; STATIONERY; INSTRUCTION MANUALS DEALING WITH THE SUBJECT MATTER OF TELECOMMUNICATIONS, COMPUTERS, THE INTERNET; TELEPHONE DIRECTORIES (U.S. CLS. 2, 5, 22, 23, 29, 37, 38 AND 50).

CLASS 35—ADVERTISING AND BUSINESS

FOR BUSINESS MANAGEMENT SERVICES; BUSINESS APPRAISALS; PREPARING BUSINESS REPORTS; BUSINESS ADMINISTRATION, NAMELY, OPERATION OF A BUSINESS FOR OTHERS NAMELY, OPERATION OF A TELECOMMUNICATIONS BUSINESS FOR OTHERS; ADVERTISING AGENCY SERVICES; PROVIDING STATISTICAL INFORMATION, MERCHANDISE PACKAGING FOR OTHERS, BUSINESS CONSULTATION IN THE FIELD OF TELECOMMUNICATIONS (U.S. CLS. 100, 101 AND 102).

CLASS 36—INSURANCE AND FINANCIAL

FOR FINANCIAL SERVICES, NAMELY, FINANCIAL MANAGEMENT, BANKING; CREDIT CARD SERVICES; ELECTRONIC CREDIT CARD TRANSACTIONS; PROVIDING SECURE FINANCIAL TRANSACTIONS IN THE NATURE OF ELECTRONIC CASH TRANSACTIONS, ELECTRONIC CREDIT CARD TRANSACTIONS, ELECTRONIC DEBIT TRANSACTIONS AND ELECTRONIC TRANSMISSION OF BILL PAYMENT DATA VIA A GLOBAL COMPUTER NETWORK; INSURANCE SERVICES, NAMELY, UNDERWRITING AND BROKERAGE OF PROPERTY, CASUALTY AND LIFE INSURANCE POLICIES AND ANNUITY CONTRACTS; REAL ESTATE AGENCY SERVICES (U.S. CLS. 100, 101 AND 102).

CLASS 37—CONSTRUCTION AND REPAIR

FOR INSTALLATION, CONSTRUCTION, MAINTENANCE, REPAIR AND SERVICING OF TELECOMMUNICATIONS APPARATUS AND EQUIPMENT; TELECOMMUNICATIONS NETWORK SUPPORT SERVICES, NAMELY, REPAIR AND MAINTENANCE (U.S. CLS. 100, 103 AND 106).

CLASS 38—COMMUNICATION

FOR TELECOMMUNICATIONS SERVICES, NAMELY, GATEWAY SERVICES, ELECTRONIC TRANSMISSION OF DATA, ELECTRONIC TRANSMISSION OF VOICE, TEXT, FACSIMILE AND VIDEO; PROVIDING FRAME RELAY CONNECTIVITY SERVICES FOR DATA TRANSFER; ELECTRONIC MAIL AND VOICE MAIL AND MESSAGING SERVICES; COMPUTER AIDED TRANSMISSION OF MESSAGES AND IMAGES; AUDIO AND VIDEO TELECONFERENCING SERVICES; PRIVATE LINE VOICE, TEXT, FACSIMILE, VIDEO AND DATA TELECOMMUNICATIONS SERVICES; TELEVISION AND RADIO BROADCASTING SERVICES; STREAMING OF AUDIO AND VIDEO MATERIAL ON THE INTERNET; INTEGRATED SERVICES DIGITAL NETWORK

(ISDN) SERVICES; ASYMMETRICAL DIGITAL SUBSCRIBER LINE (ADSL) SERVICES; G.LITE HIGH-SPEED INTERNET SERVICES; VERY HIGH SPEED DIGITAL SUBSCRIBER LINE (VDSL) SERVICES; SYMMETRICAL DIGITAL SUBSCRIBER LINE (SDSL) SERVICES; DIGITAL SIMULTANEOUS VOICE AND DATA (DSVD) SERVICES; RENTAL OF TELECOMMUNICATIONS APPARATUS; PROVIDING INFORMATION REGARDING THE AFORESAID SERVICES AND PROVIDING THIS INFORMATION VIA A GLOBAL COMPUTER NETWORK OR AN ONLINE DATABASE (U.S. CLS. 100, 101 AND 104).

CLASS 39—TRANSPORTATION AND STORAGE

FOR DISTRIBUTION OF ENERGY AND PUBLIC UTILITY SERVICES IN THE NATURE OF WATER DISTRIBUTION (U.S. CLS. 100 AND 105).

CLASS 40—MATERIAL TREATMENT

FOR GENERATION OF ENERGY (U.S. CLS. 100, 103 AND 106).

CLASS 41—EDUCATION AND ENTERTAINMENT

FOR TRAINING IN THE USE AND OPERATION OF TELECOMMUNICATIONS EQUIPMENT; PUBLICATION OF REPORTS, BOOKS, PAMPHLETS, NEWSLETTERS, MAGAZINES FOR OTHERS, DESKTOP PUBLISHING FOR OTHERS; ENTERTAINMENT SERVICES, NAMELY, TELEVISION PROGRAMS IN THE FIELD OF SCIENCE AND TECHNOLOGY; ENTERTAINMENT IN THE NATURE OF ON-GOING RADIO PROGRAMS IN THE FIELD OF SCIENCE AND TECHNOLOGY; ENTERTAINMENT SERVICES, NAMELY, PROVIDING RADIO AND TELEVISION PROGRAMS IN THE FIELD OF SCIENCE AND TECHNOLOGY; SCHEDULING OF TELEVISION PROGRAMMING; SCHEDULING OF MULTIMEDIA PROGRAMS, NAMELY, VOICE, VIDEO AND DATA ON A GLOBAL COMPUTER NETWORK; DISTRIBUTION OF TELEVISION AND RADIO PROGRAMS FOR OTHERS; DISTRIBUTION OF MULTIMEDIA PROGRAMS FOR OTHERS SUITABLE FOR BROADCAST ON A GLOBAL COMPUTER NETWORK (U.S. CLS. 100, 101 AND 107).

CLASS 42—SCIENTIFIC, COMPUTER AND LEGAL SERVICES

FOR TELECOMMUNICATIONS NETWORK PLANNING SERVICES; COMPUTER PROGRAMMING SERVICES FOR OTHERS AND COMPUTER CONSULTATION SERVICES; DESIGN OF COMPUTER SOFTWARE; MAINTENANCE AND UPDATING OF COMPUTER SOFTWARE; PROVIDING DATABASES FEATURING INFORMATION ON TELECOMMUNICATIONS NETWORK PLANNING, CREATING COMPUTER SITES FOR USE ON A GLOBAL COMPUTER NETWORK FOR OTHERS (U.S. CLS. 100 AND 101).

JAMES GRIFFIN, EXAMINING ATTORNEY

SN 76-253,468. HUBBARD & WELLS, INC., DBA HUBBARD ONE, CHICAGO, IL. FILED 5-9-2001.

HUBBARDONE.XXX

CLASS 9—ELECTRICAL AND SCIENTIFIC APPARATUS

FOR COMPUTER SOFTWARE FOR PROVIDING BUSINESS AND LAW FIRM MANAGEMENT WITH USER-DEFINED INFORMATION, FOR MANAGING MARKETING CONTENT, FOR WEB SITE CONTENT MANAGEMENT, FOR DATABASE MANAGEMENT, AND FOR CONNECTING INTERNAL COMPUTER NETWORKS WITH THE INTERNET AND CLIENT AND CUSTOMERS' INTERNAL COMPUTER NETWORKS AND WIRELESS DEVICES (U.S. CLS. 21, 23, 26, 36 AND 38).

CLASS 35—ADVERTISING AND BUSINESS

FOR ADVERTISING AGENCY SERVICES, AND BUSINESS MARKETING CONSULTING AND MARKET RESEARCH SERVICES IN THE FIELDS OF BRANDS AND BRAND DEVELOPMENT (U.S. CLS. 100, 101 AND 102).

CLASS 42—SCIENTIFIC, COMPUTER AND LEGAL SERVICES

FOR COMPUTER SERVICES FOR OTHERS, NAMELY CREATING, DESIGNING, IMPLEMENTING AND MAINTAINING WEB SITES, NETWORK WEB PAGES, LOCAL AREA NETWORKS AND INTERNAL COMPUTER NETWORKS AVAILABLE TO OUTSIDE USERS; HOSTING THE WEB SITES AND NETWORK WEB PAGES OF OTHERS ON A COMPUTER SERVER FOR A GLOBAL COMPUTER NETWORK; TECHNICAL CONSULTING SERVICES IN THE FIELDS OF DATABASE MANAGEMENT SOFTWARE AND CREATING, DESIGNING, IMPLEMENTING AND MAINTAINING WEB SITES, NETWORK WEB PAGES, LOCAL AREA NETWORKS AND INTERNAL COMPUTER NETWORKS AVAILABLE TO OUTSIDE USERS (U.S. CLS. 100 AND 101).

JOHN LINCOSKI, EXAMINING ATTORNEY

SN 76-262,847. CANAL + TECHNOLOGIES, INC., CUPERTINO, CA. FILED 5-25-2001.

A NEW DIMENSION IN ENTERTAINMENT

NO CLAIM IS MADE TO THE EXCLUSIVE RIGHT TO USE "ENTERTAINMENT", APART FROM THE MARK AS SHOWN.

CLASS 9—ELECTRICAL AND SCIENTIFIC APPARATUS

FOR INTERACTIVE ENTERTAINMENT SOFTWARE; INTERACTIVE VIDEO GAME PROGRAMS; INTERACTIVE MULTIMEDIA COMPUTER GAME PROGRAMS; INTERACTIVE VIDEO GAMES OF VIRTUAL REALITY COMPRISED OF COMPUTER HARDWARE AND SOFTWARE; COMPUTER GAME SOFTWARE; VIDEO GAME MACHINES FOR USE WITH TELEVISIONS; DOWNLOADABLE SOFTWARE ALLOWING USERS TO ACCESS AND INTERACT VIA THEIR TELEVISIONS WITH AUDIO, VISUAL, AND AUDIOVISUAL PROGRAMMING PROVIDED BY TELEVISION, CABLE, AND SATELLITE BROADCAST NETWORK OPERATORS; INTERACTIVE TV MIDDLEWARE BASED ON OPEN SOFTWARE AND BROADCAST STANDARDS ALLOWING USERS TO ACCESS AND INTERACT VIA THEIR TELEVISIONS WITH AUDIO, VISUAL, AND AUDIOVISUAL PROGRAMMING PROVIDED BY TELEVISION, CABLE, AND SATELLITE BROADCAST NETWORK OPERATORS; DIGITAL SET-TOP BOXES; INTEGRATED DIGITAL TV SETS AND PC CARDS; DIGITAL AND INTERACTIVE TV SOFTWARE ALLOWING USERS TO ACCESS AND INTERACT VIA THEIR TELEVISIONS WITH AUDIO, VISUAL, AND AUDIOVISUAL PROGRAMMING PROVIDED BY TELEVISION, CABLE, AND SATELLITE BROADCAST NETWORK OPERATORS; MAGNETS; MOUSE PADS; AND MAGNETICALLY ENCODED TELEPHONE CALLING CARDS (U.S. CLS. 21, 23, 26, 36 AND 38).

CLASS 35—ADVERTISING AND BUSINESS

FOR ADVERTISING SERVICES, NAMELY, ADVERTISING FOR TELEVISION, RADIO; ARRANGING SUBSCRIPTIONS FOR PERIODICALS INCLUDING NEWSPAPERS AND MAGAZINES FOR OTHERS; RETAIL STORE AND COMPUTERIZED ELECTRONIC ON-LINE RETAILING AND ORDERING SERVICES FEATURING GENERAL MERCHANDISE, NAMELY, CLOTHING, CHRISTMAS TREE DECORATIONS, TOYS, SPORTING GOODS, GYMNASIAC ARTICLES, INTERACTIVE SOFTWARE, COMPUTER GAMES, COMPUTER GAME SOFTWARE, COMPUTER PERIPHERALS, INTERACTIVE VIDEO GAMES, PRE-RECORDED VIDEO CASSETTES, PRE-RECORDED AUDIO CASSETTES, VIDEO GAME MACHINES, LASER DISCS, DVD DISCS, VIDEO DISCS, PHONOGRAPH RECORDS, COMPACT DISCS, PRE-RECORDED CD-ROMS, ELECTRONICS CALCULATORS, CD PLAYERS, DVD PLAYERS, MAGNETS, MOUSE PADS, MAGNETICALLY ENCODED CREDIT CARDS, TELEPHONE CALLING CARDS AND TRANSPORTATION FARE CARDS, ELECTRONIC COIN BANKS, CAMERAS, ELECTRONIC PLANNERS AND ORGANIZERS, PERSONAL DIGITAL ASSISTANTS, ELECTRONIC DIARIES, VCERS, PAGERS, TELEVISIONS, SET TOP BOXES, STEREO EQUIPMENT, PIGGY BANKS, COIN BANKS, MONEY CLIPS, KEY CHAINS, WATCHES, CLOCKS INCORPORATING RADIOS, JEWELRY, PHONE CARDS, DECORATIVE BOXES, REPLICAS OF MOTION PICTURE SCENES, PROPS, COSTUME REPLICAS, TRADING CARDS, COLLECTIBLE PLATES, KEY CHAINS, PRINTS OF ORIGINAL ARTWORK, CARDBOARD FIGURES, FANNY PACKS, BACK PACKS, AND WALLETS (U.S. CLS. 100, 101 AND 102).

CLASS 38—COMMUNICATION

FOR CABLE, SATELLITE, HERTZIAN, INTERNET, AND TELEVISION BROADCASTING SERVICES; TELEPHONE COMMUNICATIONS SERVICES VIA TELEPHONE COMMUNICATION CHANNELS USING COMPUTER TERMINALS; PAY PER VIEW TELEVISION BROADCASTING SERVICES; SUBSCRIPTION SERVICES FOR TELEVISION PROGRAMS AND RADIO BROADCASTS; ELECTRONIC MAIL SERVICES AND ELECTRONIC STORE-AND-FORWARD MESSAGING SERVICES; INTERNET BROADCASTING OF SHOWS FEATURING PHOTOS AND CLIPS OF MOTION PICTURES; PROVIDING ACCESS VIA TELEVISION TO SCHEDULES FOR AUDIO, VISUAL, AND AUDIOVISUAL PROGRAMS PROVIDED BY TELEVISION, CABLE, AND SATELLITE BROADCAST NETWORK OPERATORS (U.S. CLS. 100, 101 AND 104).

CLASS 41—EDUCATION AND ENTERTAINMENT

FOR ENTERTAINMENT SERVICES, NAMELY, DISTRIBUTION OF TELEVISION PROGRAMS FOR OTHERS; DISTRIBUTION OF MOVIES FOR OTHERS; PROVIDING AUDIOVISUAL ENTERTAINMENT, NAMELY, LINEAR AND INTERACTIVE VIDEO, MUSIC, AND ON-GOING EDUCATIONAL TELEVISION SHOWS FEATURING VARIETY, NEWS, AND COMEDY, AND COMPUTER GAMES VIA A GLOBAL COMPUTER INFORMATION NETWORK AND OTHER ELECTRONIC COMPUTER NETWORKS; FAN CLUB SERVICES; ENTERTAINMENT IN THE NATURE OF COMPETITIONS IN THE FIELD OF ENTERTAINMENT TRIVIA; PROVIDING ENTERTAINMENT PROGRAMS, NAMELY, CONTINUING VARIETY, NEWS, AND COMEDY PROGRAMS VIA TELEVISION, CABLE TELEVISION, AND SATELLITES; PRODUCTION AND DISTRIBUTION OF CABLE TELEVISION PROGRAMS; PROVIDING INTERACTIVE COMPUTER GAMES OVER ELECTRONIC NETWORKS; SWEEPSTAKE SERVICES; LOTTERY SERVICES; PROVIDING ON-LINE COMPUTER INFORMATION NETWORKS; PROVIDING A WIDE RANGE OF INFORMATION IN THE FIELD OF MOVIES, MUSIC, AND GAMES VIA THE INTERNET, TERRESTRIAL, CABLE, AND SATELLITE NETWORKS; PRODUCTION AND DISTRIBUTION OF A VARIETY OF ANIMATED AND LIVE ACTION MOTION PICTURES; PRODUCTION FOR OTHERS OF MULTIMEDIA PROGRAMMING FOR ENTERTAINMENT, NAMELY, MUSIC AND MOVIES; PRODUCTION FOR OTHERS OF MULTIMEDIA PROGRAMMING FOR EDUCATION AND TRAINING, NAMELY, PROVIDING INSTRUCTIONAL COURSES IN MATH, SCIENCE, LANGUAGE ARTS, VOCATIONAL SKILLS, AND CONTINUING PROFESSIONAL EDUCATION; PROVIDING AN ON-LINE GUIDE OF MOTION PICTURES FEATURING STORY LINES, FILMING, CAST, CREW AND FILM CLIPS VIA ELECTRONIC NETWORKS; CONCERT PRODUCTION; PRODUCTION OF TELEVISION PROGRAMS BROADCAST VIA THE INTERNET, TERRESTRIAL, CABLE, AND SATELLITE NETWORKS; MOTION PICTURE FILM PRODUCTION; ENTERTAINMENT SERVICES IN THE NATURE OF A GAME SHOW OVER GLOBAL COMPUTER NETWORK; PROVIDING A WEBSITE ON ELECTRONIC NETWORKS FEATURING GAMES AND INFORMATION ABOUT PERSONALITIES, ANIMATION, TRIVIA, MOVIES, ENTERTAINMENT INDUSTRY INFORMATION AND RELATED TOPICS; LEASING TELEVISION EQUIPMENT (U.S. CLS. 100, 101 AND 107).

CLASS 42—SCIENTIFIC, COMPUTER AND LEGAL SERVICES

FOR COMPUTER GAME DEVELOPMENT (U.S. CLS. 100 AND 101).
SCOTT OSLICK, EXAMINING ATTORNEY

SN 76-278,403. KONAMI CORPORATION, MINATO-KU, TOKYO, JAPAN, FILED 6-29-2001.

KAGENINGEN

THE INDIVIDUAL TERM "KAGE" MAY BE TRANSLATED INTO ENGLISH AS "SHADOW" AND THE TERM "NINGEN" MAY BE TRANSLATED INTO ENGLISH AS "MAN".

CLASS 9—ELECTRICAL AND SCIENTIFIC APPARATUS

FOR COMPUTER PRODUCTS, NAMELY, COMPUTER GAME PROGRAMS; VIDEO GAME CARTRIDGES; VIDEO GAME CD-ROMS; VIDEO GAME MACHINES FOR USE WITH TELEVISIONS; COMPUTER GAME CD-ROMS; VIDEO GAME PROGRAMS; VIDEO GAME PROGRAMS FOR USE WITH TELEVISION SETS; VIDEO GAME JOYSTICKS (U.S. CLS. 21, 23, 26, 36 AND 38).

CLASS 16—PAPER GOODS AND PRINTED MATTER

FOR BROCHURES AND BOOKLETS RELATING TO COMPUTER AND VIDEO GAMES; VIDEO GAME STRATEGY GUIDE BOOKS; VIDEO GAME STRATEGY GUIDE MAGAZINES; CARD GAME STRATEGY GUIDE BOOKS; CARD GAME STRATEGY GUIDE MAGAZINES; CARD GAME INSTRUCTION BOOKS; CARD GAME INSTRUCTION MAGAZINES; POSTERS; COMPUTER GAME INSTRUCTION MANUALS; PRINTED GAME INSTRUCTION SHEETS; PRINTED SCORING SHEETS; TRADING CARDS; CALENDARS; LOOSE-LEAF BINDERS AND STATIONERY (U.S. CLS. 2, 5, 22, 23, 29, 37, 38 AND 50).

CLASS 28—TOYS AND SPORTING GOODS

FOR STAND-ALONE VIDEO GAME MACHINES; HAND-HELD UNITS FOR PLAYING ELECTRONIC GAMES; BOARD GAMES AND INSTRUCTION MANUALS SOLD AS A UNIT THEREWITH; PLAYING CARDS AND INSTRUCTION MANUAL SOLD THEREWITH; CARD GAMES; DICE; PROMOTIONAL GAME MATERIALS; GAME EQUIPMENT, NAMELY, CHIPS; TOYS, NAMELY ACTION FIGURES; DOLLS AND PLAYSETS THEREFOR (U.S. CLS. 22, 23, 38 AND 50).
KEVON CHISOLM, EXAMINING ATTORNEY

SN 76-297,858. ROYAL BANK OF CANADA, MONTREAL, QUEBEC H3C 3A9, CANADA, FILED 8-10-2001.



PRIORITY CLAIMED UNDER SEC. 44(D) ON CANADA APPLICATION NO. 1112009, FILED 8-8-2001, REG. NO. TMA601555, DATED 2-6-2004, EXPIRES 2-6-2019.
OWNER OF U.S. REG. NO. 2,463,205.

CLASS 35—ADVERTISING AND BUSINESS

FOR LOYALTY PROGRAM SERVICES, NAMELY, PROMOTING THE SALE OF GOODS AND SERVICES OF OTHERS BY AWARDING PURCHASE POINTS FOR CREDIT CARD USE; BUSINESS CONSULTANCY; PROVIDING ADVICE REGARDING BUSINESS OPERATIONS AND MANAGEMENT; FINANCIAL ADVICE AND ASSISTANCE WITH RESPECT TO MERGERS AND ACQUISITIONS (U.S. CLS. 100, 101 AND 102).

CLASS 36—INSURANCE AND FINANCIAL

FOR BANKING SERVICES; INVESTMENT BANKING; MERCHANT BANKING; INVESTMENT SERVICES, NAMELY, INVESTMENT ADVICE AND INVESTMENT CONSULTATION; INVESTMENT AND PORTFOLIO MANAGEMENT SERVICES; INVESTMENT COUNSELING AND ADVISORY SERVICES; VENTURE CAPITAL INVESTMENT SERVICES, NAMELY, PROVIDING FINANCING TO EMERGING AND START-UP COMPANIES; REAL ESTATE INVESTMENT ADVICE AND PROPERTY MANAGEMENT SERVICES, REAL ESTATE ADVISORY SERVICES; REAL ESTATE BROKERAGE; FINANCIAL PLANNING IN THE NATURE OR PROVIDING TAX-REGISTERED PLANS; PROVIDING FINANCIAL PLANNING ADVICE AND INFORMATION; MUTUAL FUND SERVICES; MUTUAL FUND BROKERAGE; MUTUAL FUND INVESTMENT AND MUTUAL FUND DISTRIBUTION; SECURITIES BROKERAGE SERVICES; FINANCIAL MANAGEMENT SERVICES RELATED TO THE MANAGEMENT OF POOLED FUNDS AND PENSION FUNDS; CUSTODIAL AND PENSION SERVICES, NAMELY, ADMINISTRATION OF EMPLOYEE PENSION PLANS; FINANCIAL SERVICES RELATED TO ADMINISTRATION OF FINANCIAL AND MONETARY ASSETS, NAMELY, CUSTODY AND SETTLEMENT, SECURITIES ADMINISTRATION, FINANCIAL REPORTING, AND SECURITIES LENDING; PROVIDING AND STRUCTURING SYNDICATED LOANS, SECURING OF ASSETS THROUGH RECORDATION OF SECURITY INSTRUMENTS, AND STRUCTURING FINANCIAL RE-PAYMENTS; TRUST AND ESTATE SERVICES; CREDIT SERVICES, NAMELY, CREDIT CARD TRANSACTION PROCESSING SERVICES; CREDIT CARD SERVICES; INSTALLMENT LOANS; MORTGAGE LENDING; DEBIT CARD SERVICES; SAFE DEPOSIT BOX SERVICES; PROVIDING BANKING SERVICES FEATURING SAVINGS, CHECKING AND GUARANTEED INVESTMENT ACCOUNT SERVICES; CURRENCY EXCHANGE AND ADVICE SERVICES; MONEY MARKET, CLEARING, TRADE, FOREIGN EXCHANGE, LENDING AND CURRENCY MANAGEMENT SERVICES; CASH MANAGEMENT SERVICES; LEASE-PURCHASING FINANCING; TRANSACTION PROCESSING OF GLOBAL SECURITIES, AND FOR CASH MANAGEMENT, PAYMENTS AND TRADE BUSINESS IN SELECT MARKETS; TRADE FINANCING SERVICES; FIXED-

SN 76-290,504. TORREFAZIONE IONIA S.P.A., 95014 GIARRE (CT), ITALY, FILED 7-27-2001.



NO CLAIM IS MADE TO THE EXCLUSIVE RIGHT TO USE "GRAN CAFFÈ ITALIA", APART FROM THE MARK AS SHOWN.
THE ENGLISH TRANSLATION OF "GRAN CAFFÈ ITALIA" IS "GRAND ITALIAN COFFEE".

CLASS 21—HOUSEWARES AND GLASS

FOR (BASED ON INTENT TO USE) HAND OPERATED COFFEE GRINDERS; NON-ELECTRIC COFFEE POTS NOT OF PRECIOUS METAL; FRYING PANS; DISHES NOT OF PRECIOUS METAL (U.S. CLS. 2, 13, 23, 29, 30, 33, 40 AND 50).

CLASS 30—STAPLE FOODS

FOR (BASED ON USE IN COMMERCE) COFFEE, ROASTED COFFEE, SOLUBLE COFFEE, DECAFFEINATED COFFEE, GREEN COFFEE, CHOCOLATE SOLUBLE AND IN BARS, CAPPUCCINO SOLUBLE, TEA IN FILTER BAGS, TEAS SOLUBLE (U.S. CL. 46).
FIRST USE 0-0-1992; IN COMMERCE 9-0-2000.
MITCHELL FRONT, EXAMINING ATTORNEY

INCOME FINANCIAL RESEARCH; PURCHASE AND TRADING OF COMMODITIES FOR OTHERS; TRADING OF EQUITIES, EQUITY DERIVATIVES, SWAPS AND OPTIONS; INSURANCE SERVICES, NAMELY, INSURANCE BROKERAGE; INSURANCE UNDERWRITING OF PROPERTY AND CASUALTY INSURANCE, AND LIFE AND HEALTH INSURANCE; ANNUITY UNDERWRITING; MANAGEMENT AND DISTRIBUTION OF SEGREGATED FUNDS; PROVIDING TRAVEL INSURANCE; PROVIDING LIFE, HEALTH, PROPERTY AND CASUALTY REINSURANCE; PROVIDING STRUCTURED FINANCIAL SERVICES, NAMELY, INVESTMENT MANAGEMENT AND DISTRIBUTION OF VARIABLE ANNUITIES; PROVIDING CREDITOR INSURANCE; INSURANCE UNDERWRITING SERVICES FOR ALL TYPES OF INSURANCE, INSURANCE ADMINISTRATION; INFORMATION AND ADVICE RELATED TO INSURANCE AND RE-INSURANCE, NAMELY, PROPERTY, CASUALTY, LIFE, HEALTH, TRAVEL AND CREDITOR INSURANCE AND RE-INSURANCE (U.S. CLS. 100, 101 AND 102).

CLASS 42—SCIENTIFIC, COMPUTER AND LEGAL SERVICES

FOR CONSULTANCY, INFORMATION AND ADVICE SERVICES RELATING TO INTERNET-SECURE ELECTRONIC TRANSACTION SOLUTIONS FOR E-COMMERCE; RENTAL OF POINT-OF-SALE COMPUTER TERMINALS AND AUTOMATIC TELLER MACHINES (U.S. CLS. 100 AND 101).

CURTIS FRENCH, EXAMINING ATTORNEY

CLASS 30—STAPLE FOODS

FOR COFFEE, TEA, COCOA, SUGAR, RICE, TAPIOCA, SAGO, ARTIFICIAL COFFEE, FLOUR AND PREPARATIONS MADE FROM CEREALS, BREAD, PASTRY AND CONFECTIONARY, NAMELY CANDY AND FROZEN CONFECTIONS, FLAVORED ICES; HONEY, TREATLE; YEAST, BAKING-POWDER; SALT, MUSTARD, VINEGAR, SAUCES; SPICES; ICE; COFFEE, TEA, COCOA AND CHOCOLATE DRINKS; BREAKFAST AND SNACK CEREALS FOR HUMAN CONSUMPTION, IN PARTICULAR, OAT FLAKES AND OTHER CEREAL FLAKES; FOOD FLAVORINGS, NOT BEING ESSENTIAL OILS; CONFECTIONARY, NAMELY, SWEETS, FRUIT GUMS, CHOCOLATE, CHOCOLATE-BASED SNACK PRODUCTS, PRALINES WITH LIQUEUR FILLINGS; CHOCOLATE MIXTURES CONTAINING ALCOHOL; CHEWING GUMS; GRAIN-BASED MUESLI BARS AND GRAIN-BASED MUESLI BARS WITH FRUIT FILLINGS (U.S. CL. 46).

CLASS 32—LIGHT BEVERAGES

FOR BEER, NUTRIENT BEER; KVASS, A RYE-BASED FERMENTED SOFT DRINK; NON-ALCOHOLIC BEVERAGES, NAMELY, FRUIT DRINKS, FRUIT JUICES, LEMONADES; SOFT DRINK BEVERAGES WITH A BASE OF TEA, SUGAR, SUCROSE, GLUCOSE, FRUCTOSE, YEAST AND LACTIC ACID, AND REFRESHMENT SOFT DRINKS; SYRUPS ESSENCES, EFFERVESCENT OR SHERBET TABLETS AND POWDERS, AND OTHER PREPARATIONS FOR MAKING SOFT DRINK BEVERAGES; ISOTONIC DRINKS AND PREPARATIONS FOR MAKING ISOTONIC DRINKS (U.S. CLS. 45, 46 AND 48).

CLASS 42—SCIENTIFIC, COMPUTER AND LEGAL SERVICES

FOR CATERING; ACCOMMODATION OF GUESTS, NAMELY HOTEL AND LODGING SERVICES; RESTAURANT AND BAR SERVICES, NAMELY OPERATION OF BARS, PUBS, CAFE'S, TAVERNS AND OTHER PERMANENT, TEMPORARY, PORTABLE OR MOBILE ESTABLISHMENTS SERVING BEER, WINE AND/OR ALCOHOLIC OR NON-ALCOHOLIC BEVERAGES; RESTAURANT AND BAR SERVICES, NAMELY OPERATION OF SNACK BARS, RESTAURANTS, DINERS, CAFE'S AND OTHER PERMANENT, TEMPORARY, PORTABLE OR MOBILE ESTABLISHMENTS SERVING FOOD, BEVERAGES AND/OR SNACKS OF ALL TYPES; MEDICAL SERVICES, NAMELY, MEDICAL CARE; HEALTH CARE; BEAUTY SALON SERVICES, NAMELY BEAUTY CARE AND PERSONAL GROOMING SERVICES; VETERINARY SERVICES; SCIENTIFIC RESEARCH SERVICES; LICENSING OF INTELLECTUAL PROPERTY AND CONSULTATION IN THE FIELD OF INTELLECTUAL PROPERTY RIGHTS; TECHNICAL CONSULTATION AND RESEARCH SERVICES IN THE FIELD OF FOOD AND BEVERAGES, RESTAURANTS AND BAR SERVICES, HEALTH AND FITNESS, SPORTS, SPORTS TRAINING AND PHYSICAL PERFORMANCE; COMPUTER PROGRAMMING, NAMELY DEVELOPMENT, MAINTENANCE AND SUPPORT OF COMPUTER PROGRAMS (U.S. CLS. 100 AND 101).

ROBERT LORENZO, EXAMINING ATTORNEY

SN 76-310,312. STOCK VITAL GMBH & CO. KG, FUSCHL AM SEE, AUSTRIA, FILED 9-7-2001.

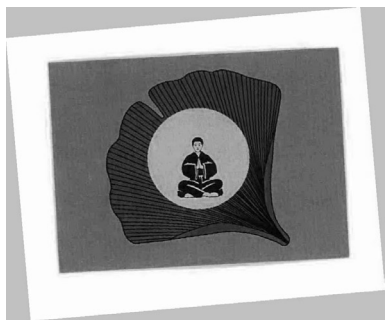

PRIORITY CLAIMED UNDER SEC. 44(D) ON AUSTRIA APPLICATION NO. AM5293/2001, FILED 7-25-2001, REG. NO. 199406, DATED 10-1-2001, EXPIRES 10-31-2011.

THE COLOR(S) LIGHT GREEN, LIGHT GREEN/YELLOW, DARK GREEN AND BLACK IS/ARE CLAIMED AS A FEATURE OF THE MARK.

THE DRAWING IS DEPICTED IN COLOR, WITH THE BACKGROUND RECTANGLE IN LIGHT GREEN, THE PETAL DESIGN IN DARKER GREEN WITH BLACK LINES, THE ROUND CENTRAL CIRCLE IS LIGHT GREEN/YELLOW AND THE SEATED CHARACTER IN BLACK.

SN 76-329,488. ACO SEVERIN AHLMANN GMBH & CO. KG, D-24755 RENDSBURG, FED REP GERMANY, FILED 10-25-2001.

EUROLOCK

PRIORITY CLAIMED UNDER SEC. 44(D) ON FED REP GERMANY APPLICATION NO. 30127205.0, FILED 4-27-2001, REG. NO. 30127205, DATED 1-26-2004, EXPIRES 4-30-2011.

CLASS 6—METAL GOODS

FOR CONSTRUCTION MATERIAL OUT OF METAL, IN PARTICULAR GUTTERS, BOX DRAINS AND SHAFTS AS WELL AS COVERS THERETO AND THEIR SPARE PARTS (U.S. CLS. 2, 12, 13, 14, 23, 25 AND 50).

CLASS 19—NON-METALLIC BUILDING MATERIALS

FOR CONSTRUCTION MATERIAL OUT OF CONCRETE, SYNTHETICS AND SYNTHETIC CEMENT, IN PARTICULAR GUTTERS, BOX DRAINS AND SHAFTS AS WELL AS COVERS THERETO AND THEIR SPARE PARTS (U.S. CLS. 1, 12, 33 AND 50).

DAVID H. STINE, EXAMINING ATTORNEY

CLASS 38—COMMUNICATION

FOR TELECOMMUNICATIONS GATEWAY SERVICES; DATA AND VOICE TELECOMMUNICATIONS, NAMELY, TELECOMMUNICATION SERVICES, NAMELY, LOCAL AND LONG DISTANCE TRANSMISSION OF VOICE AND DATA BY MEANS OF TELEPHONE, TELEGRAPHIC, CABLE, AND SATELLITE TRANSMISSIONS; TELECOMMUNICATION SERVICES, NAMELY, LEASING AND RENTAL OF TELECOMMUNICATION EQUIPMENT; TELECOMMUNICATION SERVICES, NAMELY, LOCAL AND LONG-DISTANCE TRANSMISSION OF VOICE, DATA AND GRAPHICS BY MEANS OF TELEPHONE, TELEGRAPHIC, CABLE AND SATELLITE TRANSMISSIONS; TELECOMMUNICATION SERVICES IN THE FIELD OF PROVIDING LONG DISTANCE WITH AUDIO ADVERTISING FOR OTHERS AS A COMPONENT OF LONG-DISTANCE SERVICE; TELECOMMUNICATIONS WITH RESELLER SERVICES, NAMELY, PROVIDING LONG-DISTANCE TELECOMMUNICATION SERVICES; TRANSMISSION OF MESSAGES FROM ONE PERSON TO ANOTHER VIA DELIVERY OF MESSAGES BY ELECTRONIC TRANSMISSION; WIRELESS DIGITAL MESSAGING SERVICES; WIRELESS FACSIMILE MAIL SERVICES; WIRELESS VOICE MAIL SERVICES AND WIRELESS PBX SERVICES; TEXT AND NUMERIC WIRELESS DIGITAL MESSAGING SERVICES; WORLDWIDE SWITCHED TEXT AND MESSAGE TRANSMISSION SERVICES (U.S. CLS. 100, 101 AND 104).

CLASS 41—EDUCATION AND ENTERTAINMENT

FOR TRAINING SERVICES IN THE FIELD OF COMPUTING; PROVIDING TRAINING COURSES AND SEMINARS IN THE AREA OF ELECTRONIC DATA PROCESSING; PROVIDING A WEBSITE FEATURING MUSICAL PERFORMANCES, MUSICAL VIDEOS, RELATED FILM CLIPS, PHOTOGRAPHS AND OTHER MULTIMEDIA MATERIALS (U.S. CLS. 100, 101 AND 107).

CLASS 42—SCIENTIFIC, COMPUTER AND LEGAL SERVICES

FOR DESIGN, DEVELOPMENT AND UPDATING OF COMPUTER PROGRAMS FOR DATA PROCESSING FOR OTHERS; COMPUTER SERVICES, NAMELY, DESIGNING AND IMPLEMENTING NETWORKS FOR OTHERS; DEVELOPMENT AND DESIGN OF COMPUTER DATABASES FOR OTHERS; DEVELOPMENT AND DESIGN OF COMPUTER PROGRAMS FOR DATA PROCESSING FOR OTHERS; DEVELOPMENT AND DESIGN OF VOICE AND DATA TELECOMMUNICATIONS NETWORKS FOR OTHERS; TECHNICAL CONSULTATION IN THE FIELD OF REAL-TIME RECONFIGURABLE WIRELESS COMMUNICATION HANDSETS AND NETWORK EQUIPMENT FOR USE IN WIDE BAND COMMUNICATIONS; HOSTING THE WEB SITES OF OTHERS ON A COMPUTER SERVER FOR A GLOBAL COMPUTER NETWORK; COMPUTER CONSULTATION IN THE FIELD OF NETWORK SECURITY; DEVELOPING, DESIGNING AND PROGRAMMING OF COMPUTER INFORMATION SYSTEMS, NAMELY, ENTERPRISE PORTAL AND KNOWLEDGE MANAGEMENT FOR OTHERS, SPECIFICALLY, COMPUTER SERVICES, NAMELY, ACTING AS AN APPLICATION SERVICE PROVIDER IN THE FIELD OF KNOWLEDGE MANAGEMENT TO HOST COMPUTER APPLICATION SOFTWARE FOR CREATING SEARCHABLE DATABASES OF INFORMATION AND DATA, FOR SEARCHING AND RETRIEVAL OF INFORMATION FROM DATABASES AND COMPUTER NETWORKS, AND FOR THE COLLECTING, EDITING, ORGANIZING, MODIFYING, BOOK MARKING, TRANSMISSION, STORAGE AND SHARING OF DATA AND INFORMATION; COMPUTER SERVICES, NAMELY, THE DEVELOPMENT AND ADMINISTRATION OF COMPUTER NETWORKS FOR OTHERS; DESIGNING AND DRAFTING A NETWORK TOPOLOGY FOR ELECTRONIC DATA PROCESSING (EDP) SYSTEMS, NAMELY, ELECTRONIC-DATA-PROCESSING, NAMELY, USER AND RESOURCE MANAGEMENT AND SYSTEMS MANAGEMENT; COMPUTER SERVICES, NAMELY, DESIGNING AND IMPLEMENTING WEB SITES FOR OTHERS BY PROVIDING A SPECIFIC INFORMATION AS REQUESTED

SN 76-332,992. MATERNA GMBH INFORMATION & COMMUNICATIONS, D-44141 DORTMUND, FED REP GERMANY, FILED 11-1-2001.

MATERNA

PRIORITY CLAIMED UNDER SEC. 44(D) ON ERPNCMNTY TM OFC APPLICATION NO. 002355881, FILED 8-24-2001, REG. NO. 2355881, DATED 5-22-2003, EXPIRES 8-24-2011.

CLASS 9—ELECTRICAL AND SCIENTIFIC APPARATUS

FOR COMPUTER SOFTWARE FOR APPLICATION AND DATABASE INTEGRATION; COMPUTER SOFTWARE FOR USE IN DATABASE MANAGEMENT (U.S. CLS. 21, 23, 26, 36 AND 38).

CLASS 35—ADVERTISING AND BUSINESS

FOR OPERATION OF A VOICE AND DATA TELECOMMUNICATIONS NETWORK FOR OTHERS; OPERATION OF TELECOMMUNICATION SYSTEMS; OPERATION OF COMPUTER SYSTEMS FOR OTHERS; TECHNICAL, ORGANIZATIONAL AND ELECTRONIC DATA PROCESSING (EDP) CONSULTATION; DATA PROCESSING SERVICES; COMPUTERIZED DATABASE MANAGEMENT; BUSINESS MANAGEMENT SERVICES, NAMELY, MANAGING LOGISTICS, REVERSE LOGISTICS, SUPPLY CHAIN SERVICES, SUPPLY CHAIN VISIBILITY AND SYNCHRONIZATION, SUPPLY AND DEMAND FORECASTING AND PRODUCT DISTRIBUTION PROCESSES FOR OTHERS (U.S. CLS. 100, 101 AND 102).

CLASS 37—CONSTRUCTION AND REPAIR

FOR INSTALLATION OF COMPUTER NETWORKS; MAINTENANCE OF VOICE AND DATA TELECOMMUNICATIONS NETWORKS; INSTALLATION OF COMPUTER INFORMATION SYSTEMS FOR OTHERS (U.S. CLS. 100, 103 AND 106).

BY CUSTOMERS VIA THE INTERNET (CUSTOMIZED SEARCHING); COMPUTER SOFTWARE DESIGN FOR OTHERS; COMPUTER SERVICES, NAMELY, THE DESIGN AND DEVELOPMENT OF COMPUTER SYSTEMS FOR OTHERS; IT MANAGEMENT AND INFRASTRUCTURE MANAGEMENT; BUILDING OF INTERCONNECTION NETWORKS FOR TELECOMMUNICATION PURPOSES AS WELL AS FOR OPEN SYSTEMS INTERCONNECTION (OSI) (U.S. CLS. 100 AND 101).

CAROLYN CATALDO, EXAMINING ATTORNEY

SN 76-335,069. ICF ENERGY SOLUTIONS, INC., FAIRFAX, VA. FILED 11-7-2001.

ENERGY VISION ENTERPRISE

NO CLAIM IS MADE TO THE EXCLUSIVE RIGHT TO USE "ENERGY" AND "ENTERPRISE", APART FROM THE MARK AS SHOWN.

CLASS 35—ADVERTISING AND BUSINESS

FOR BUSINESS CONSULTING SERVICES FOR OTHERS IN THE ENERGY INDUSTRY RELATING TO WEB-BASED SOFTWARE APPLICATIONS IN SUPPORTING FUNDAMENTAL, BACK-OFFICE BUSINESS PROCESSES AND MANAGING CRITICAL CUSTOMER DATA FOR RETAIL MARKETERS AND WIRE COMPANIES (U.S. CLS. 100, 101 AND 102).

CLASS 42—SCIENTIFIC, COMPUTER AND LEGAL SERVICES

FOR PROVIDING TEMPORARY USE OF ON-LINE NON-DOWNLOADABLE SOFTWARE INSTALLED ON APPLICATION AND DATABASE SERVERS ACCESSED BY THE WORLD WIDE WEB TO PROVIDE ANALYTICAL TOOLS FOR USE TO SUPPORT FUNDAMENTAL, BACK-OFFICE BUSINESS PROCESSES AND MANAGE CRITICAL CUSTOMER DATA FOR ENERGY MARKET OPERATORS, RETAIL MARKETERS AND WIRE COMPANIES (U.S. CLS. 100 AND 101).

MICHAEL KAZAZIAN, EXAMINING ATTORNEY

SN 76-341,338. M-X-SPORT OY, FIN-00320 HELSINKI, FINLAND, FILED 11-26-2001.

232 SYSTEMS

PRIORITY CLAIMED UNDER SEC. 44(D) ON FINLAND APPLICATION NO. T200101752, FILED 5-31-2001, REG. NO. 225620, DATED 10-31-2002, EXPIRES 10-31-2012.

CLASS 25—CLOTHING

FOR CLOTHES, NAMELY, FOOTWEAR, HEADADDRESS AND GLOVES (U.S. CLS. 22 AND 39).

CLASS 28—TOYS AND SPORTING GOODS

FOR GYMNASTICS AND SPORT ACCESSORIES, NAMELY, SKI POLES (U.S. CLS. 22, 23, 38 AND 50).

KIM SAITO, EXAMINING ATTORNEY

SN 76-360,366. THERMAL INDUSTRIES, INC., PITTSBURGH, PA. FILED 1-18-2002.

PARK AVENUE

CLASS 6—METAL GOODS

FOR METALLIC WALL PANELS, SUPPORT BEAMS AND HARDWARE, NAMELY, HINGES, HANDLES AND LOCKS (U.S. CLS. 2, 12, 13, 14, 23, 25 AND 50).

CLASS 19—NON-METALLIC BUILDING MATERIALS

FOR WINDOWS; DOORS; PATIO ENCLOSURES; FINISHED AND SEMI-FINISHED GLASS FOR DOORS AND WINDOWS; DECKS CONSTRUCTED PRIMARILY OF VINYL AND RAILINGS THEREFOR; AND BOAT DOCKS AND PARTS THEREOF PARTIALLY CONSTRUCTED OF VINYL (U.S. CLS. 1, 12, 33 AND 50).

JILL C. ALT, EXAMINING ATTORNEY

SN 76-363,059. SOCIETE DES PRODUITS NESTLE S.A., 1800 VEVEY, SWITZERLAND, FILED 1-28-2002.



CLASS 5—PHARMACEUTICALS

FOR MEDICATED CONFECTIONERY FOR USE IN VITAMIN FORTIFICATION; VITAMIN SUPPLEMENTS (U.S. CLS. 6, 18, 44, 46, 51 AND 52).

CLASS 30—STAPLE FOODS

FOR CONFECTIONERY, NAMELY, CANDIES AND TOFFEES; CHEWING GUM (U.S. CL. 46).

KELLEY WELLS, EXAMINING ATTORNEY

SN 76-366,314. THOROUGHbred TIMES COMPANY, INC., LEXINGTON, KY. FILED 2-1-2002.

THOROUGHbred TIMES TODAY

OWNER OF U.S. REG. NOS. 1,916,404, 2,582,491 AND OTHERS.
SEC. 2(F) AS TO "THOROUGHbred".

CLASS 16—PAPER GOODS AND PRINTED MATTER

FOR PERIODIC PUBLICATIONS, NAMELY, MAGAZINES, JOURNALS AND NEWSLETTERS, IN THE FIELD OF EQUINE SPECIES (U.S. CLS. 2, 5, 22, 23, 29, 37, 38 AND 50).

CLASS 41—EDUCATION AND ENTERTAINMENT

FOR PROVIDING ON-LINE, PERIODIC PUBLICATIONS, NAMELY, MAGAZINES, JOURNALS AND NEWSLETTERS, IN THE FIELD OF EQUINE SPECIES (U.S. CLS. 100, 101 AND 107).

AMY GEARIN, EXAMINING ATTORNEY

CLASS 41—EDUCATION AND ENTERTAINMENT

FOR ENTERTAINMENT IN THE NATURE OF THEATER PRODUCTIONS; ENTERTAINMENT IN THE NATURE OF VISUAL AND AUDIO PERFORMANCES, AND MUSICAL, VARIETY, NEWS AND COMEDY SHOWS; ENTERTAINMENT IN THE NATURE OF VISUAL AND AUDIO PERFORMANCES, NAMELY, MUSICAL BAND, ROCK GROUP; ENTERTAINMENT SERVICES, NAMELY, PROVIDING A WEB SITE FEATURING MUSICAL PERFORMANCES, MUSICAL VIDEOS, RELATED FILM CLIPS, PHOTOGRAPHS, AND OTHER MULTIMEDIA MATERIALS; ENTERTAINMENT SERVICES, NAMELY, PROVIDING PRERECORDED MUSIC, INFORMATION IN THE FIELD OF MUSIC, AND COMMENTARY AND ARTICLES ABOUT MUSIC, ALL ON-LINE VIA A GLOBAL COMPUTER NETWORK; ENTERTAINMENT, NAMELY LIVE PERFORMANCES BY A MUSICAL BANDS, LIVE MUSIC CONCERTS, LIVE PERFORMANCES BY ROCK GROUPS, RADIO ENTERTAINMENT PRODUCTION (U.S. CLS. 100, 101 AND 107).

ELIZABETH J. WINTER, EXAMINING ATTORNEY

SN 76-367,699. OBLIQSOUND GMBH, MUNICH, FED REP GERMANY, FILED 2-6-2002.

OBLIQSOUND

PRIORITY CLAIMED UNDER SEC. 44(D) ON FED REP GERMANY APPLICATION NO. 30121761, FILED 12-20-2001, REG. NO. 30121761, DATED 12-20-2001, EXPIRES 12-20-2011.

CLASS 9—ELECTRICAL AND SCIENTIFIC APPARATUS

FOR BLANK COMPACT DISCS, BLANK RECORDING DISCS AND PRERECORDED COMPACT DISCS AND PRERECORDED DISCS, NAMELY, AUDIO DISCS, MINIDISC, MULTIOPTICAL COMPACT DISC, CD-ROM, CD-I, CD-PLUS, 3 DO, DISKETTES, ALL FEATURING MUSIC, COMPACT DISCS FEATURING MUSIC; BLANK AUDIO AND BLANK VIDEO CASSETTES; PRERECORDED AUDIO CASSETTES FEATURING MUSIC AND VIDEO CASSETTES FEATURING MUSIC; BLANK MAGNETIC DATA CARRIERS AND PRERECORDED MAGNETIC DATA CARRIERS FEATURING MUSIC, DVDS FEATURING MUSIC AND BLANK DIGITAL VIDEO DISKS; BLANK AND PRERECORDED PHONOGRAPH RECORDS FEATURING MUSIC; AND ELECTRONIC PUBLICATIONS, NAMELY MAGAZINES, PERIODICALS, AND JOURNALS ON THE SUBJECT OF MUSIC RECORDED ON COMPUTER MEDIA (U.S. CLS. 21, 23, 26, 36 AND 38).

CLASS 16—PAPER GOODS AND PRINTED MATTER

FOR PRINTED MATTER NAMELY, PRINTED ART REPRODUCTIONS, PRINTED INVITATIONS, PRINTED STATIONERY; PRINTED INSTRUCTIONAL, EDUCATIONAL, AND TEACHING MATERIALS IN THE AREA OF MUSIC; PRINTED BOOKS IN THE AREA OF MUSIC, PRINTED TICKETS, BROCHURES AND MANUALS IN THE AREA OF MUSIC; AND PAPER, NAMELY, PRINTED PAPER PACKING FOR MERCHANDISE, NAMELY, FOR PACKING MUSICAL COMPACT DISCS (U.S. CLS. 2, 5, 22, 23, 29, 37, 38 AND 50).

CLASS 38—COMMUNICATION

FOR MUSIC SERVICES THROUGH THE INTERNET, NAMELY, STREAMING OF AUDIO MATERIAL ON THE INTERNET; TELEVISION AND RADIO BROADCASTING OF MUSICAL PROGRAMS (U.S. CLS. 100, 101 AND 104).

SN 76-373,650. AMERICA'S PROMISE - THE ALLIANCE FOR YOUTH, INC., ALEXANDRIA, VA. FILED 2-15-2002.

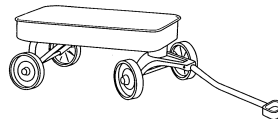
AMERICA'S PROMISE
THE ALLIANCE FOR YOUTH

OWNER OF U.S. REG. NOS. 2,231,636, 2,505,710 AND OTHERS.

SEC. 2(F) AS TO "AMERICA'S PROMISE-THE ALLIANCE FOR YOUTH".

CLASS 14—JEWELRY

FOR ORNAMENTAL PINS AND JEWELRY (U.S. CLS. 2, 27, 28 AND 50).
FIRST USE 4-27-1997; IN COMMERCE 4-27-1997.

CLASS 16—PAPER GOODS AND PRINTED MATTER

FOR PRINTED MATERIALS AND PUBLICATIONS, NAMELY, BOOKLETS, PAMPHLETS, BROCHURES, NEWSLETTERS, INFORMATIONAL FLYERS, INSTRUCTIONAL AND EDUCATIONAL MATERIALS AND MANUALS, ALL FEATURING INFORMATION IN THE FIELD OF PROMOTING VOLUNTEERISM AND COMMUNITY SERVICE; POSTERS, PENS, PAPER FLAGS AND PAPER WALL BANNERS, LETTERHEAD STATIONERY, STATIONERY, ENVELOPES, BUSINESS CARDS, STICKERS, MAILING ADDRESS LABELS, FOLDERS, PACKING PAPER, HOLIDAY GREETING CARDS AND NOTE CARDS, MERCHANDISE HANG PRICE TAGS, PRODUCT PACKAGING CARDBOARD, BOOK MARKS, BOOK COVERS, MEMORANDUM AND FACSIMILE COVER SHEETS, BUMPER STICKERS, DECALS, PRINTED CERTIFICATES AND PRINTED PAPER SIGNS, NAMELY, TABLE TENTS IN THE FIELD OF VOLUNTEERISM AND COMMUNITY SERVICES (U.S. CLS. 2, 5, 22, 23, 29, 37, 38 AND 50).

FIRST USE 4-27-1997; IN COMMERCE 4-27-1997.

CLASS 25—CLOTHING

FOR CLOTHING, FOOTWEAR, AND HEADGEAR, NAMELY, TEE-SHIRTS, SWEATSHIRTS, FLEECE JACKETS, DENIM SHIRTS, POLO SHIRTS, AND BASEBALL CAPS (U.S. CLS. 22 AND 39).

FIRST USE 4-27-1997; IN COMMERCE 4-27-1997.

CLASS 35—ADVERTISING AND BUSINESS

FOR PROMOTING PUBLIC AWARENESS OF THE NEED FOR HEALTHY, SAFE, EDUCATED, AND MARKETABLE YOUTH, AND THE NEED FOR ADULT MENTORS FOR YOUTH AND ASSOCIATION SERVICES, NAMELY, PROMOTING THE INTERESTS OF YOUTH AND PROMOTING VOLUNTEERISM AND COMMUNITY SERVICES (U.S. CLS. 100, 101 AND 102).
FIRST USE 4-27-1997; IN COMMERCE 4-27-1997.

CLASS 36—INSURANCE AND FINANCIAL

FOR CHARITABLE FUND RAISING; PHILANTHROPIC SERVICES CONCERNING MONETARY DONATIONS, NAMELY, PROVIDING MONETARY RESOURCES, TOOLS AND SUPPORT TO VOLUNTEERS AND SUPPORTING COMMUNITY SERVICES THAT FULFILL THE PLEDGES TO YOUTH OF CARING ADULTS, SAFE PLACES, A HEALTHY START, MARKETABLE SKILLS AND AN OPPORTUNITY TO SERVE (U.S. CLS. 100, 101 AND 102).
FIRST USE 4-27-1997; IN COMMERCE 4-27-1997.

CLASS 42—SCIENTIFIC, COMPUTER AND LEGAL SERVICES

FOR APPLICATION SERVICE PROVIDER, NAMELY HOSTING COMPUTER SOFTWARE APPLICATIONS OF OTHERS FOR THE PURPOSE OF ENABLING COMMUNITIES TO BUILD LOCALLY BRANDED WEB SITES (U.S. CLS. 100 AND 101).
FIRST USE 4-27-1997; IN COMMERCE 4-27-1997.

CLASS 45—PERSONAL SERVICES

FOR EDUCATIONAL SERVICES, NAMELY, PROVIDING EDUCATIONAL INFORMATION ON VOLUNTEERISM AND COMMUNITY SERVICES TO YOUTH, ADULTS, AND YOUTH SERVING ORGANIZATIONS, AND OPPORTUNITIES FOR SUPPORTING COMMUNITY SERVICES THAT FULFILL THE PROMISES TO YOUTH OF CARING ADULTS, SAFE PLACES, A HEALTHY START, MARKETABLE SKILLS AND AN OPPORTUNITY TO SERVE (U.S. CLS. 100 AND 101).
FIRST USE 4-27-1997; IN COMMERCE 4-27-1997.
GIANCARLO CASTRO, EXAMINING ATTORNEY

CLASS 16—PAPER GOODS AND PRINTED MATTER

FOR PRINTED MATERIALS AND PUBLICATIONS, NAMELY, BOOKLETS, PAMPHLETS, BROCHURES, NEWSLETTERS, INFORMATIONAL FLYERS, INSTRUCTIONAL AND EDUCATIONAL MATERIALS AND MANUALS, ALL FEATURING INFORMATION IN THE FIELD OF PROMOTING VOLUNTEERISM AND COMMUNITY SERVICE; POSTERS, PENS, PAPER FLAGS AND PAPER WALL BANNERS, LETTERHEAD STATIONERY, STATIONARY, ENVELOPES, BUSINESS CARDS, STICKERS, MAILING ADDRESS LABELS, FOLDERS, PACKING PAPER, HOLIDAY GREETING CARDS AND NOTE CARDS, MERCHANDISE HANG PRICE TAGS, PRODUCT PACKAGING CARDBOARD, BOOK MARKS, BOOK COVERS, MEMORANDUM AND FACSIMILE COVER SHEETS, BUMPER STICKERS, DECALS, PRINTED CERTIFICATES AND PRINTED PAPER SIGNS, NAMELY, TABLE TENTS IN THE FIELD OF VOLUNTEERISM AND COMMUNITY SERVICES (U.S. CLS. 2, 5, 22, 23, 29, 37, 38 AND 50).
FIRST USE 4-27-1997; IN COMMERCE 4-27-1997.

CLASS 35—ADVERTISING AND BUSINESS

FOR ASSOCIATION SERVICES, NAMELY, PROMOTING THE INTERESTS OF YOUTH; PROMOTING PUBLIC AWARENESS OF THE NEED FOR HEALTHY, SAFE, EDUCATED, AND MARKETABLE YOUTH, AND THE NEED FOR ADULT MENTORS FOR YOUTH; PROMOTING VOLUNTEERISM AND COMMUNITY SERVICES (U.S. CLS. 100, 101 AND 102).
FIRST USE 4-27-1997; IN COMMERCE 4-27-1999.

CLASS 36—INSURANCE AND FINANCIAL

FOR CHARITABLE FUND RAISING (U.S. CLS. 100, 101 AND 102).
FIRST USE 4-27-1997; IN COMMERCE 4-27-1997.

SN 76-373,652. AMERICA'S PROMISE - THE ALLIANCE FOR YOUTH, INC., ALEXANDRIA, VA. FILED 2-15-2002.

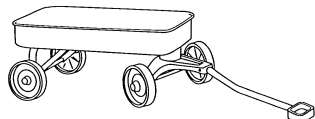
**CLASS 45—PERSONAL SERVICES**

FOR EDUCATIONAL SERVICES, NAMELY, PROVIDING EDUCATIONAL INFORMATION ON VOLUNTEERISM AND COMMUNITY SERVICES TO YOUTH, ADULTS, AND YOUTH SERVING ORGANIZATIONS, AND OPPORTUNITIES FOR SUPPORTING COMMUNITY SERVICES THAT FULFILL THE PROMISES TO YOUTH OF CARING ADULTS, SAFE PLACES, A HEALTHY START, MARKETABLE SKILLS AND AN OPPORTUNITY TO SERVE (U.S. CLS. 100 AND 101).
FIRST USE 4-27-1997; IN COMMERCE 4-27-1997.
GIANCARLO CASTRO, EXAMINING ATTORNEY

OWNER OF U.S. REG. NOS. 2,468,659, 2,484,101 AND 2,505,710.

SN 76-378,793. POPULATION CONNECTION, WASHINGTON, DC. FILED 3-5-2002.



CLASS 9—ELECTRICAL AND SCIENTIFIC APPARATUS

FOR PRE-RECORDED COMPACT DISCS, VIDEOTAPES AND DVD'S FEATURING INFORMATION IN THE FIELD OF NATIONAL AND GLOBAL POPULATION ISSUES AND RELATED CONCERNS (U.S. CLS. 21, 23, 26, 36 AND 38).

FIRST USE 2-5-2002; IN COMMERCE 5-1-2002.

CLASS 16—PAPER GOODS AND PRINTED MATTER

FOR PRINTED PUBLICATIONS IN THE FORM OF BOOKS, JOURNALS, PAMPHLETS, MAGAZINES, NEWSLETTERS AND FLIERS FEATURING INFORMATION IN THE FIELD OF NATIONAL AND GLOBAL POPULATION ISSUES AND RELATED CONCERNS (U.S. CLS. 2, 5, 22, 23, 29, 37, 38 AND 50).

FIRST USE 2-5-2002; IN COMMERCE 5-1-2002.

CLASS 35—ADVERTISING AND BUSINESS

FOR PROMOTING PUBLIC AWARENESS OF POPULATION ISSUES AND THEIR ENVIRONMENTAL, ECONOMIC AND SOCIAL IMPACT; LOBBYING LEGISLATIVE BODIES WITH RESPECT TO LAWS AFFECTING POPULATION ISSUES; ASSOCIATION SERVICES, NAMELY, PROMOTING THE INTERESTS OF THE PUBLIC IN NATIONAL AND GLOBAL POPULATION ISSUES AND RELATED CONCERNS (U.S. CLS. 100, 101 AND 102).

FIRST USE 2-5-2002; IN COMMERCE 5-1-2002.

CLASS 41—EDUCATION AND ENTERTAINMENT

FOR EDUCATIONAL SERVICES, NAMELY, CONDUCTING TRAINING WORKSHOPS FOR TEACHERS IN THE FIELD OF NATIONAL AND GLOBAL POPULATION ISSUES AND RELATED CONCERNS AND DISTRIBUTING COURSE MATERIALS IN CONNECTION THEREWITH; ENTERTAINMENT SERVICES, NAMELY, PROVIDING A CONTINUOUS RADIO PROGRAM IN THE FIELD OF INDEPENDENT POP MUSIC AND THE ENVIRONMENT VIA A GLOBAL COMPUTER NETWORK; AND DISTRIBUTION OF RADIO PROGRAMS FOR OTHERS; EDUCATIONAL RESEARCH IN THE FIELD OF NATIONAL AND GLOBAL POPULATION ISSUES AND RELATED CONCERNS (U.S. CLS. 100, 101 AND 107).

FIRST USE 2-5-2002; IN COMMERCE 5-1-2002.

CLASS 44—MEDICAL, BEAUTY AND AGRICULTURAL SERVICES

FOR PROVIDING HEALTH INFORMATION AND CONSULTATION IN THE FIELD OF NATIONAL AND GLOBAL POPULATION ISSUES AND RELATED CONCERNS (U.S. CLS. 100 AND 101).

FIRST USE 2-5-2002; IN COMMERCE 5-1-2002.

GINA FINK, EXAMINING ATTORNEY

SN 76-379,869. GONZALEZ-CAMPO, DIEGO, BROOKLYN, NY. FILED 3-7-2002.

NOBLE SOCIETY

OWNER OF SWITZERLAND REG. NO. 493827, DATED 1-16-2002, EXPIRES 11-16-2010.

CLASS 9—ELECTRICAL AND SCIENTIFIC APPARATUS

FOR (BASED ON INTENT TO USE) MUSICAL AUDIO AND VIDEO RECORDINGS; PRE-RECORDED AUDIO AND VIDEO TAPES, CASSETTES, DVDS AND CDS FEATURING MUSIC (U.S. CLS. 21, 23, 26, 36 AND 38).

CLASS 15—MUSICAL INSTRUMENTS

FOR (BASED ON 44(E)) MUSICAL INSTRUMENTS, NAMELY, GUITARS (U.S. CLS. 2, 21 AND 36).

CLASS 16—PAPER GOODS AND PRINTED MATTER

FOR (BASED ON INTENT TO USE) PRINTED MATTER, NAMELY, POSTERS, FLYERS, PAPER FLAGS, (BASED ON 44(E)) PHOTOGRAPHS AND (BASED ON INTENT TO USE) STICKERS (U.S. CLS. 2, 5, 22, 23, 29, 37, 38 AND 50).

CLASS 25—CLOTHING

FOR (BASED ON 44(E)) CLOTHING, NAMELY, T-SHIRTS, SHIRTS, PANTS, JACKETS, HATS, SHORTS, PULLOVERS, AND SWEAT SHIRTS (U.S. CLS. 22 AND 39).

CLASS 41—EDUCATION AND ENTERTAINMENT

FOR (BASED ON 44(E)) ENTERTAINMENT SERVICES IN THE NATURE OF LIVE MUSICAL PERFORMANCES (U.S. CLS. 100, 101 AND 107).

LESLEY LAMOTHE, EXAMINING ATTORNEY

SN 76-395,881. LINEWEIGHT LLC, BROOKLYN, NY. FILED 4-15-2002.

SN 76-403,520. DISCOVERY COMMUNICATIONS, INC., BETHESDA, MD. FILED 5-3-2002.

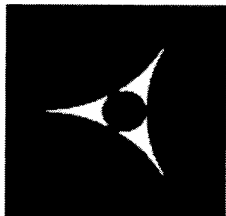

THE APPLICANT IS NOT CLAIMING COLOR AS A FEATURE OF THE MARK. THE STIPPLING IS FOR SHADING PURPOSES ONLY.

CLASS 40—MATERIAL TREATMENT

FOR CUSTOM PRODUCTION OF CLOTHING FOR OTHERS (U.S. CLS. 100, 103 AND 106).
FIRST USE 5-1-2000; IN COMMERCE 5-1-2000.

CLASS 42—SCIENTIFIC, COMPUTER AND LEGAL SERVICES

FOR DESIGN FOR OTHERS IN THE FIELD OF ENGINEERING, DESIGN FOR OTHERS IN THE FIELD OF CLOTHING, DESIGN AND TESTING FOR NEW PRODUCT DEVELOPMENT; COMMERCIAL ART DESIGN (U.S. CLS. 100 AND 101).
FIRST USE 5-1-2000; IN COMMERCE 5-1-2000.
MARLENE BELL, EXAMINING ATTORNEY

SN 76-397,680. SOFTWARE AKTIENGESELLSCHAFT, DARMSTADT, FED REP GERMANY, FILED 4-18-2002.

ENTIREX COMMUNICATOR

NO CLAIM IS MADE TO THE EXCLUSIVE RIGHT TO USE "COMMUNICATOR", APART FROM THE MARK AS SHOWN.

CLASS 9—ELECTRICAL AND SCIENTIFIC APPARATUS

FOR INTEGRATION SOFTWARE ALLOWING THE MUTUAL COMMUNICATION OF DIFFERENT SOFTWARE PROGRAMS OPERATING UNDER DIFFERENT OPERATING SYSTEMS (U.S. CLS. 21, 23, 26, 36 AND 38).

CLASS 42—SCIENTIFIC, COMPUTER AND LEGAL SERVICES

FOR COMPUTER SOFTWARE DESIGN FOR OTHERS; MAINTENANCE OF COMPUTER SOFTWARE; UPDATING OF COMPUTER SOFTWARE; COMPUTER CONSULTATION; COMPUTER SYSTEMS ANALYSIS; COMPUTER PROGRAMMING FOR OTHERS (U.S. CLS. 100 AND 101).
BRENDAN REGAN, EXAMINING ATTORNEY

DISCOVERY SPONSOR CINEMA

OWNER OF U.S. REG. NOS. 2,172,031, 2,455,590 AND OTHERS.

NO CLAIM IS MADE TO THE EXCLUSIVE RIGHT TO USE SPONSOR CINEMA, APART FROM THE MARK AS SHOWN.

CLASS 38—COMMUNICATION

FOR TELEVISION AND VIDEO-ON-DEMAND TRANSMISSION SERVICES (U.S. CLS. 100, 101 AND 104).

CLASS 41—EDUCATION AND ENTERTAINMENT

FOR ON-DEMAND TELEVISION SHOW PRODUCTION SERVICES (U.S. CLS. 100, 101 AND 107).
KATHERINE STOIDES, EXAMINING ATTORNEY

SN 76-404,069. AGEWELL, P.C., INDIANAPOLIS, IN. FILED 5-6-2002.

YOUR HEALTH IS OUR BIZ

CLASS 3—COSMETICS AND CLEANING PREPARATIONS

FOR COSMETIC PREPARATIONS, NAMELY, SKIN CREAM, LOTIONS, SOAPS, CLEANSERS AND SHAMPOOS FOR THE BODY (U.S. CLS. 1, 4, 6, 50, 51 AND 52).

CLASS 5—PHARMACEUTICALS

FOR THERAPEUTIC, HYGIENIC, AND PHARMACEUTICAL PREPARATIONS FOR THE TREATMENT OF COLDS, DRY SKIN, MEMORY LOSS, ARTHRITIS, SLEEPING DISORDERS, EATING DISORDERS, WEIGHT MANAGEMENT; VITAMINS, MINERALS, NUTRITIONAL AND DIETARY SUPPLEMENTS; POWDERED AND READY-TO-DRINK BEVERAGES THAT ARE VITAMIN AND MINERAL FORTIFIED; GRAIN BASED NUTRITIONAL FOOD SUPPLEMENTS THAT ARE VITAMIN AND MINERAL FORTIFIED FORMED AND PACKAGED AS BARS (U.S. CLS. 6, 18, 44, 46, 51 AND 52).

CLASS 10—MEDICAL APPARATUS

FOR SURGICAL AND MEDICAL APPARATUS AND INSTRUMENTS, NAMELY, MEDICAL VENTILATORS, BLOOD PRESSURE MONITORS, THERMOMETERS, FIRST AID KITS, EYE SHIELDS, EAR CURETTES, COMPRESSORS, MEDICATION DISPENSERS, BREATHING MASKS, HEART RATE MONITORS, ELECTRIC OR CHEMICALLY ACTIVATED HEATING PADS FOR MEDICAL PURPOSES; PHYSICAL THERAPY EQUIPMENT, NAMELY, LIMB CRADLES, BATH GUARDS, LUMBAR, NECK, WRIST, KNEE AND JOINT SUPPORTS, WALKERS, MASSAGERS, PULLEYS, SHOULDER EXERCISERS, BALANCE BOARDS, BOLSTER/WEDGES (U.S. CLS. 26, 39 AND 44).

CLASS 28—TOYS AND SPORTING GOODS

FOR SPORTING GOODS EQUIPMENT, NAMELY, DUMBBELLS, CUFF WEIGHTS, EXERCISE BALLS, EXERCISE BIKES, EXERCISE MATS, ROWING MACHINES, STEPPERS, TREADMILLS, UPPER BODY ERGOMETERS, RESISTANCE BANDS, ATHLETIC SUPPORTS (U.S. CLS. 22, 23, 38 AND 50).

CLASS 30—STAPLE FOODS

FOR NUTRITIONAL FOODS, NAMELY, PROCESSED CEREAL BASED SNACK FOODS AND WHEAT BASED SNACK FOODS THAT ARE VITAMIN AND MINERAL FORTIFIED (U.S. CL. 46).

CAROLINE WEIMER, EXAMINING ATTORNEY

CLASS 25—CLOTHING

FOR CLOTHING, NAMELY BOOTS, SHOES AND SLIPPERS (U.S. CLS. 22 AND 39).

CLASS 28—TOYS AND SPORTING GOODS

FOR EDUCATIONAL TOYS AND GAMES, NAMELY INFANT AND CHILD DEVELOPMENT TOYS AND GAMES; GYMNAS TIC AND SPORTING ARTICLES, NAMELY BASKETBALLS; CHRISTMAS TREE ORNAMENTS AND DECORATIONS; PLAYING CARDS (U.S. CLS. 22, 23, 38 AND 50).

JOHN SCHUYLER YARD, EXAMINING ATTORNEY

SN 76-414,796. I.P. INTERNATIONAL, INC., GRAND CAYMAN ISLANDS, CAYMAN ISLANDS, FILED 5-30-2002.

4MYBABY**CLASS 5—PHARMACEUTICALS**

FOR PHARMACEUTICAL PREPARATIONS FOR THE TREATMENT OF CEREBRAL PALSY AND AUTISM; DIETARY SUPPLEMENTS AND FOOD SUPPLEMENTS FOR INVALIDS; MEDICAL PLASTERS; ADHESIVE AND SURGICAL BANDAGES (U.S. CLS. 6, 18, 44, 46, 51 AND 52).

CLASS 12—VEHICLES

FOR CHILDREN'S CAR SEATS (U.S. CLS. 19, 21, 23, 31, 35 AND 44).

CLASS 14—JEWELRY

FOR CLOCKS (U.S. CLS. 2, 27, 28 AND 50).

CLASS 15—MUSICAL INSTRUMENTS

FOR MUSICAL INSTRUMENTS (U.S. CLS. 2, 21 AND 36).

CLASS 16—PAPER GOODS AND PRINTED MATTER

FOR PRINTED MATTER, NAMELY MAGAZINES; NEWSPAPERS FOR GENERAL CIRCULATION; PERIODICALS IN THE NATURE OF A MONTHLY MAGAZINE CONTAINING INFORMATION PERTAINING TO PARENTAL CONCERNS ABOUT CHILDREN; CHILDREN'S BOOKS; BOOKBINDING MATERIALS, NAMELY, CLOTH, TAPE AND WIRE; MOUNTED AND UNMOUNTED PHOTOGRAPHS; STATIONERY; ADHESIVE TAPE FOR STATIONERY AND HOUSEHOLD USE; PRINTED INSTRUCTIONAL, EDUCATIONAL, AND TEACHING MATERIALS FOR CHILDREN (U.S. CLS. 2, 5, 22, 23, 29, 37, 38 AND 50).

CLASS 20—FURNITURE AND ARTICLES NOT OTHERWISE CLASSIFIED

FOR FURNITURE; CRIBS; MIRRORS; PICTURE FRAMES (U.S. CLS. 2, 13, 22, 25, 32 AND 50).

CLASS 24—FABRICS

FOR BEDSPREADS; TABLECLOTHS NOT OF PAPER (U.S. CLS. 42 AND 50).

SN 76-420,153. LAUBACH LITERACY INTERNATIONAL, SYRACUSE, NY. FILED 6-13-2002.

ENGLISH-NO PROBLEM**CLASS 16—PAPER GOODS AND PRINTED MATTER**

FOR STUDENT BOOKS, WORKBOOKS, TEACHING MANUALS USED IN TEACHING ADULT EDUCATION IN THE FIELD OF LANGUAGE ARTS (U.S. CLS. 2, 5, 22, 23, 29, 37, 38 AND 50).

CLASS 41—EDUCATION AND ENTERTAINMENT

FOR EDUCATIONAL SERVICES FOR USE IN TEACHING ADULT EDUCATION, NAMELY, PROVIDING WEB SITE FOR TEACHERS FEATURING CUSTOMIZABLE LESSON PLANS, OPENERS, LESSONS, CHALLENGE READINGS, UNIT PROJECTS AND MASTERS WITH SUPPORTING TEACHING MATERIALS ALL IN THE FIELD OF ADULT EDUCATION (U.S. CLS. 100, 101 AND 107).

SOPHIA S. KIM, EXAMINING ATTORNEY

SN 76-421,843. SUCAMPO AG, 6300 ZUG, SWITZERLAND, FILED 6-17-2002.

SUCAMPO

PRIORITY CLAIMED UNDER SEC. 44(D) ON SWITZERLAND APPLICATION NO. 1424/2002, FILED 12-17-2001, REG. NO. 500055, DATED 12-17-2001, EXPIRES 12-17-2011.

CLASS 3—COSMETICS AND CLEANING PREPARATIONS

FOR COSMETICS (U.S. CLS. 1, 4, 6, 50, 51 AND 52).

CLASS 5—PHARMACEUTICALS

FOR PHARMACEUTICAL, VETERINARY AND DENTAL PREPARATIONS AND SUBSTANCES, NAMELY PREPARATIONS AND SUBSTANCE FOR OPHTHALMIC USE, FOR THE TREATMENT OF DISEASES AND DISORDERS OF THE CARDIOVASCULAR SYSTEM AND THE METABOLISM AND OF INTERNAL AND SKIN DISEASES (U.S. CLS. 6, 18, 44, 46, 51 AND 52).

CLASS 16—PAPER GOODS AND PRINTED MATTER

FOR PRINTED MATTER, NAMELY BOOKS, MAGAZINES, PAMPHLETS, LEAFLETS AND CATALOGS IN THE MEDICAL, PHARMACEUTICAL, VETERINARY, DENTAL, CLINICAL, DIAGNOSTIC, SCIENTIFIC AND CHEMICAL FIELDS; PRINTED PAPER LABELS (U.S. CLS. 2, 5, 22, 23, 29, 37, 38 AND 50).

CLASS 35—ADVERTISING AND BUSINESS

FOR BUSINESS MARKETING CONSULTING; BUSINESS MANAGEMENT; CONDUCTING MARKET STUDIES; MARKET ANALYSIS; BUSINESS ORGANIZATION CONSULTATION AND MANAGEMENT (U.S. CLS. 100, 101 AND 102).

CLASS 36—INSURANCE AND FINANCIAL

FOR FINANCIAL AFFAIRS, NAMELY FINANCIAL MANAGEMENT, INVESTMENT MANAGEMENT; REAL ESTATE AGENCIES (U.S. CLS. 100, 101 AND 102).

CLASS 42—SCIENTIFIC, COMPUTER AND LEGAL SERVICES

FOR CONSULTANCY AND SERVICES IN THE AREA OF SCIENCE AND TECHNOLOGY NAMELY CONSULTATION IN THE MEDICAL, PHARMACEUTICAL, VETERINARY, DENTAL AND DRUG FORMULATION FIELDS; PRODUCT RESEARCH AND DEVELOPMENT SERVICES; RESEARCH IN THE FIELDS OF HEALTH-CARE, PHARMACY, VETERINARY AND DENTAL MEDICINE (U.S. CLS. 100 AND 101).

SHAUNIA WALLACE, EXAMINING ATTORNEY

SN 76-423,509. SALONS ONLY, INC., VISTA, CA. FILED 6-18-2002.

PHYSO AMINO**CLASS 3—COSMETICS AND CLEANING PREPARATIONS**

FOR HAIR CARE PRODUCTS, NAMELY, SHAMPOOS, CONDITIONERS, HAIR SPRAYS, GELS, MOUSSES, AND SERUMS; SKIN CARE PRODUCTS, NAMELY, SOAPS, LOTIONS, CREAMS, SCRUBS AND MASKS (U.S. CLS. 1, 4, 6, 50, 51 AND 52).

CLASS 5—PHARMACEUTICALS

FOR VITAMIN AND NUTRITIONAL SUPPLEMENTS (U.S. CLS. 6, 18, 44, 46, 51 AND 52).

MARGERY A. TIERNEY, EXAMINING ATTORNEY

SN 76-423,620. TEAM DUCT TAPE, LLC, DES MOINES, IA. FILED 6-18-2002.

TEAM DUCT TAPE**CLASS 16—PAPER GOODS AND PRINTED MATTER**

FOR STICKERS AND TEMPORARY TATTOO DECALS (U.S. CLS. 2, 5, 22, 23, 29, 37, 38 AND 50).

CLASS 25—CLOTHING

FOR CLOTHING, NAMELY, T-SHIRTS, JACKETS, SWEATSHIRTS, AND HATS (U.S. CLS. 22 AND 39).

ROBERT COGGINS, EXAMINING ATTORNEY

SN 76-432,411. JAMIESON LABORATORIES LTD., WINDSOR, ONTARIO, CANADA, FILED 7-19-2002.

PROMEDIS

OWNER OF CANADA REG. NO. TMA507575, DATED 2-4-1999, EXPIRES 2-4-2014.

CLASS 5—PHARMACEUTICALS

FOR FOODS FOR DIETETIC USE, NAMELY, MEAL REPLACEMENT AND DIETARY SUPPLEMENT DRINK MIXES AND FOOD BARS, ALL ENRICHED WITH PROTEINS, VITAMINS AND MINERALS (U.S. CLS. 6, 18, 44, 46, 51 AND 52).

FIRST USE 1-11-1999; IN COMMERCE 11-19-1999.

CLASS 29—MEATS AND PROCESSED FOODS

FOR FOODS FOR DIETETIC USE NAMELY, CONSOMME SOUP AND OMELETS (U.S. CL. 46).

FIRST USE 7-19-2002; IN COMMERCE 7-19-2002.

CLASS 30—STAPLE FOODS

FOR FOOD FOR DIETETIC USE, NAMELY, PUDDINGS, HOT CHOCOLATE, CUSTARD TARTS AND SALAD DRESSINGS (U.S. CL. 46).

FIRST USE 7-19-2002; IN COMMERCE 7-19-2002.

CLASS 32—LIGHT BEVERAGES

FOR FOODS FOR DIETETIC USE, NAMELY, FRUIT JUICE BASE, VEGETABLE JUICE BASE, TOMATO JUICE BASE, AND FRUIT JUICE CONCENTRATES (U.S. CLS. 45, 46 AND 48).

FIRST USE 7-19-2002; IN COMMERCE 7-19-2002.

VERNA BETH RIRIE, EXAMINING ATTORNEY

SN 76-433,132. CARTE BLANCHE GREETINGS LIMITED, WEST SUSSEX BN176BD, UNITED KINGDOM, FILED 7-19-2002.

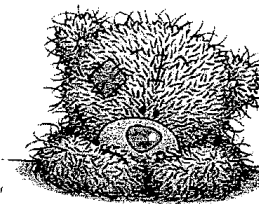

PRIORITY CLAIMED UNDER SEC. 44(D) ON ERPNTY TM OFC APPLICATION NO. 2552149, FILED 1-28-2002, REG. NO. 2552149, DATED 5-7-2003, EXPIRES 1-28-2012.

THE STIPPLING IS A FEATURE OF THE MARK.

THE MARK PRESENTS THE BEAR IN THE COLOR GREY AND THE BEAR'S NOSE IS COLORED BLUE, BUT NO CLAIM OR LIMITATION TO COLOR IS MADE.

CLASS 6—METAL GOODS

FOR METAL KEY RINGS, METAL KEY FOBS; TRINKETS OR JEWELRY BOXES MADE OF METAL (U.S. CLS. 2, 12, 13, 14, 23, 25 AND 50).

CLASS 14—JEWELRY

FOR TRINKETS AND ARTICLES OF COSTUME OR NOVELTY JEWELRY; JEWELRY; WATCH FOBS, KEY RINGS, AND KEY FOBS OF PRECIOUS METALS, PRECIOUS METALS AND THEIR ALLOYS SOLD IN BULK, PRECIOUS GEMSTONES; TRINKET OR JEWELRY BOXES MADE OF PRECIOUS METALS; JEWELRY CASES OF PRECIOUS METALS; HOROLOGICAL AND CHRONOMETRIC INSTRUMENTS, NAMELY, CLOCKS AND WATCHES (U.S. CLS. 2, 27, 28 AND 50).

CLASS 16—PAPER GOODS AND PRINTED MATTER

FOR STATIONERY, SCRAPBOOKS, ADDRESS BOOKS, PHOTO ALBUMS, DIARIES; PHOTOGRAPHS, PICTURES AND POSTERS; ERASERS, PENS, PENCILS, CRAYONS, PEN AND PENCIL STANDS, HOLDERS OR CASES; GREETING CARDS; STICKERS, WRAPPING PAPER, ENVELOPES MADE OF CARDBOARD, PAPER OR PLASTIC MATERIALS; PAPER AND CARD-BOARD BOWS FOR GIFT WRAP, PAPER AND CARDBOARD GIFT RIBBONS, CARDBOARD BOXES, PAPER BOXES, PAPER BAGS; PAPER, CARDBOARD AND PLASTIC BAGS FOR PACKAGING; PAPER, CARDBOARD AND PLASTIC POUCHES FOR PACKAGING; PAINT BRUSHES; BOOKS, NAMELY, FICTIONAL STORY BOOKS, NOTEBOOKS, AUTOGRAPH BOOKS, EXERCISE BOOKS, EDUCATIONAL PICTURE BOOKS, ACTIVITY BOOKS, COLORING BOOKS, CHILDREN'S BOOKS; PUBLICATIONS AND PRINTED MATTER, NAMELY, BROCHURES RELATING TO GIFTWARE AND SOFT TOYS; SECRET BOOKS, NAMELY, LOCKABLE NOTEBOOKS AND LOCKABLE DIARIES; AND DRAWING RULERS (U.S. CLS. 2, 5, 22, 23, 29, 37, 38 AND 50).

CLASS 18—LEATHER GOODS

FOR BACKPACKS; RUCKSACKS, SATCHELS, BAGS, NAMELY, SCHOOL BAGS, GYM BAGS, DUFFEL BAGS, CLUTCH BAGS, SHOULDER BAGS, TRAVEL BAGS, TOTE BAGS, OVERNIGHT BAGS, BEACH BAGS, ATHLETIC BAGS; PURSES AND WALLETS; ANIMAL SKINS, HIDES; TRUNKS AND TRAVELING BAGS; UMBRELLAS, PARASOLS AND WALKING STICKS; WHIPS, HARNESS AND SADDLERY; LEATHER AND IMITATIONS OF LEATHER, AND GOODS MADE OF THESE MATERIALS, NAMELY, LEATHER KEY FOBS AND KEY RINGS (U.S. CLS. 1, 2, 3, 22 AND 41).

CLASS 20—FURNITURE AND ARTICLES NOT OTHERWISE CLASSIFIED

FOR PLASTIC BOXES; TRINKET OR JEWELRY BOXES NOT OF METAL; JEWELRY CASES NOT OF PRECIOUS METALS; PICTURE FRAMES; NOVELTY AND/OR DECORATIVE PICTURE FRAMES; MOULDINGS FOR PICTURE FRAMES; FURNITURE; MIRRORS; GOODS OF WOOD, CORK, REED, CANE, WICKER, HORN, BONE, IVORY, WHALEBONE, SHELL, AMBER, MOTHER OF PEARL, MEERSCHAUM, AND SUBSTITUTES FOR ALL THESE MATERIALS, OR OF PLASTIC, NAMELY, KEY RINGS AND KEY FOBS (U.S. CLS. 2, 13, 22, 25, 32 AND 50).

CLASS 21—HOUSEWARES AND GLASS

FOR CANDLEHOLDERS AND MUGS; BRUSHES AND COMBS, NAMELY, HAIRBRUSHES AND HAIR COMBS; GLASSWARE, CHINAWARE, PORCELAIN, EARTHENWARE, HOUSEHOLD OR KITCHEN UTENSILS AND CONTAINERS, NAMELY, MUGS, PLATES, BOWLS, ORNAMENTS AND FIGURINES (U.S. CLS. 2, 13, 23, 29, 30, 33, 40 AND 50).

CLASS 26—FANCY GOODS

FOR PLASTIC RIBBONS; HAIR BANDS AND EMBROIDERY; HAIR BOWS, HAIR RIBBONS, HAIR SCRUNCHIES, HAIR PINS, HAIR CLIPS, HAIR ACCESSORIES, NAMELY, HAIR SLIDES AND GRIPS; BRAIDS; RIBBONS; ORNAMENTAL NOVELTY BADGES; ORNAMENTAL NOVELTY BROOCHES; ORNAMENTAL NOVELTY PINS; ORNAMENTAL NOVELTY BUTTONS; AND LACE TRIM (U.S. CLS. 37, 39, 40, 42 AND 50).

CLASS 28—TOYS AND SPORTING GOODS

FOR PLUSH TOYS, STUFFED TOYS AND BEAN-FILLED TOYS; PUZZLES, BALLOONS; DECORATIONS FOR CHRISTMAS TREES; JIGSAW PUZZLES; TOYS, PLAYTHINGS, AND SOFT TOYS, NAMELY, TEDDY BEARS, TOY FIGURINES, AND ACTION FIGURES (U.S. CLS. 22, 23, 38 AND 50).

KIM SAITO, EXAMINING ATTORNEY

SN 76-433,162. STANLEY LOGISTICS, INC., NEW BRITAIN, CT. FILED 7-19-2002.



OWNER OF U.S. REG. NOS. 67,119, 2,678,769 AND OTHERS.

CLASS 7—MACHINERY

FOR AIR COMPRESSORS, AND HYDRAULIC JACKS (U.S. CLS. 13, 19, 21, 23, 31, 34 AND 35).

CLASS 8—HAND TOOLS

FOR STANDS FOR HAND JACKS, MANUALLY-OPERATED JACKS, AND UTILITY KNIVES (U.S. CLS. 23, 28 AND 44).

CLASS 9—ELECTRICAL AND SCIENTIFIC APPARATUS

FOR BATTERY CHARGERS AND POWER INVERTERS (U.S. CLS. 21, 23, 26, 36 AND 38).

WON TEAK OH, EXAMINING ATTORNEY

SN 76-439,970. SOUTHERN BELLE FROZEN FOODS, INC., JACKSONVILLE, FL. FILED 8-12-2002.

MAMA SHAW'S

OWNER OF U.S. REG. NO. 1,215,027.
THE NAME "MAMA SHAW'S" IDENTIFIES A LIVING INDIVIDUAL WHOSE CONSENT IS OF RECORD.

CLASS 29—MEATS AND PROCESSED FOODS

FOR SEAFOOD THAT IS FROZEN, NAMELY DEVILED CRAB; MARYLAND CRAB CAKES; GOURMET DEVILED CRAB; CONCH FRITTERS; CRABMEAT STUFFING (U.S. CL. 46).

FIRST USE 4-28-1978; IN COMMERCE 11-1-1979.

CLASS 30—STAPLE FOODS

FOR PASTRIES, NAMELY, GOURMET CREAMY CRAB FILLOS, AND GOURMET CHEESE AND SHRIMP FILLOS (U.S. CL. 46).

FIRST USE 3-30-2001; IN COMMERCE 3-30-2001.
TRACY WHITAKER-BOWN, EXAMINING ATTORNEY

SN 76-443,673. QUEEN PRODUCTIONS LIMITED, COOKHAM, BERKSHIRE, SL6 9QT, GREAT BRITAIN, FILED 8-26-2002.

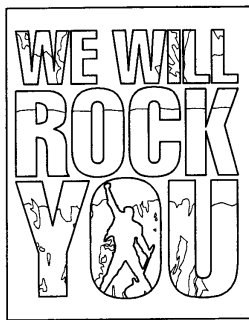

PRIORITY CLAIMED UNDER SEC. 44(D) ON ERPN CMNTY TM OFC APPLICATION NO. 2591592, FILED 2-26-2002, REG. NO. 2591592, DATED 7-29-2003, EXPIRES 7-29-2013.

CLASS 9—ELECTRICAL AND SCIENTIFIC APPARATUS

FOR BLANK MAGNETIC DATA CARRIERS, BLANK RECORDING DISCS, BLANK AUDIO AND VIDEO TAPES, CASSETTES, AND COMPACT DISCS; COIN-OPERATED GAME MACHINES FOR USE WITH TELEVISIONS; VIDEO AND/OR SOUND RECORDINGS, MOTION PICTURE FILMS, AND FILM STRIPS, FEATURING MUSIC AND CONCERT PERFORMANCES; PRE-RECORDED COMPACT DISCS, GRAMAPHONE RECORDS, AND AUDIO CASSETTES FEATURING MUSIC; COMPUTER GAMES SOFTWARE FEATURING MUSIC AND ENTERTAINMENT IN THE NATURE OF ANIMATION AND VIDEOS FEATURING MUSICAL AND CONCERT PERFORMANCES AND STORIES; VIDEO GAME DISCS AND ELECTRONIC COMPUTER DISCS, SCREEN SAVER PROGRAMS, POSTER ART PROGRAMS, AND GRAPHICS PROGRAMS, FOR ENTERTAINMENT AND AMUSEMENT; DOWNLOADABLE AUDIO AND VIDEO RECORDINGS FEATURING MUSIC AND CONCERT PERFORMANCES (U.S. CLS. 21, 23, 26, 36 AND 38).

CLASS 16—PAPER GOODS AND PRINTED MATTER

FOR PAPER AND PAPER ARTICLES, NAMELY, TOUR PROGRAMS, DECALCOMANIAS, HEAT TRANSFERS FOR CLOTHING, POSTERS, AND SHEET MUSIC; CARDBOARD AND CARDBOARD ARTICLES, NAMELY, TOUR PROGRAMS, DECALCOMANIAS, POSTERS, AND SHEET MUSIC; PRINTED MATTER, NAMELY, TOUR PROGRAMS, DECALCOMANIAS, HEAT TRANSFERS FOR CLOTHING, POSTERS, SHEET MUSIC, PRINTED RADIO AND TELEVISION PROGRAMS FEATURING OR PERTAINING TO A MUSICAL GROUP; GREETING CARDS, RECORD SLEEVES; PAPER BADGES; PHOTOGRAPHS, NAMELY, MOUNTED AND UNMOUNTED PHOTOGRAPHS; STATIONERY FEATURING OR PERTAINING TO A MUSICAL GROUP (U.S. CLS. 2, 5, 22, 23, 29, 37, 38 AND 50).

CLASS 21—HOUSEWARES AND GLASS

FOR PORCELAIN MUGS, CUPS, PLATES; CHINA MUGS, CUPS, PLATES; HOUSEHOLD OR KITCHEN UTENSILS, NAMELY DRINKING VESSELS, ALL PURPOSE PORTABLE HOUSEHOLD CONTAINERS; FIGURES OF PORCELAIN, TERRA COTTA OR GLASS; COASTERS; WORKS OF ART, NAMELY, SCULPTURES, MODELS, PLAQUES, VASES OF PORCELAIN, TERRA COTTA, OR GLASS (U.S. CLS. 2, 13, 23, 29, 30, 33, 40 AND 50).

CLASS 25—CLOTHING

FOR ARTICLES OF CLOTHING FEATURING OR PERTAINING TO A MUSICAL GROUP, NAMELY, T-SHIRTS, JACKETS, ANORAKS, TROUSERS, DRESSES; FOOTWEAR, HEADWEAR, NAMELY CAPS (U.S. CLS. 22 AND 39).

CLASS 26—FANCY GOODS

FOR BROOCHES; ORNAMENTS, NAMELY ORNAMENTAL CLOTH PATCHES, ORNAMENTAL RIBBONS MADE OF TEXTILES, AND ORNAMENTAL NOVELTY PINS AND BUTTONS; HAIR ORNAMENTS; FASTENERS FOR CLOTHING; CLOTHING BUCKLES (U.S. CLS. 37, 39, 40, 42 AND 50).

CLASS 41—EDUCATION AND ENTERTAINMENT

FOR ENTERTAINMENT IN THE NATURE OF LIVE MUSICAL CONCERTS; RADIO PROGRAM PRODUCTION AND TELEVISION SHOW PRODUCTION; PRODUCTION OF RECORDS AND AUDIO AND VIDEOTAPES, DISCS AND CASSETTES; ENTERTAINMENT SERVICES, NAMELY, PRODUCTION OF PLAYS, MUSICALS, CONCERTS, LIVE THEATRICAL PERFORMANCES; PUBLICATION OF BOOKS AND CONCERT PROGRAMS, MUSICAL TOUR PROGRAMS AND MUSICAL SCORE BOOKS (U.S. CLS. 100, 101 AND 107).

KATHLEEN M. VANSTON, EXAMINING ATTORNEY

SN 76-444,590. TOTAL ACCESS MEDICAL LLC, BALA CYNWYD, PA. FILED 8-28-2002.

TOTAL ACCESS MEDICAL LLC

NO CLAIM IS MADE TO THE EXCLUSIVE RIGHT TO USE "MEDICAL LLC", APART FROM THE MARK AS SHOWN.

CLASS 35—ADVERTISING AND BUSINESS

FOR MANAGEMENT OF PRIMARY PHYSICIAN SERVICES FOR OTHERS, NAMELY, MANAGING APPOINTMENTS, SCHEDULING VISITS, AND MANAGING AND SCHEDULING ACCESS TO PRIMARY CARE PHYSICIANS (U.S. CLS. 100, 101 AND 102).

CLASS 44—MEDICAL, BEAUTY AND AGRICULTURAL SERVICES

FOR MANAGEMENT OF PRIMARY PHYSICIAN SERVICES FOR OTHERS, NAMELY PROVIDING INFORMATIONAL SERVICES IN THE MEDICAL FIELD, NAMELY, PROVIDING INFORMATION REGARDING HEALTHY LIFESTYLE CHOICES (U.S. CLS. 100 AND 101).

EUGENIA MARTIN, EXAMINING ATTORNEY

SN 76-446,187. 2007 SOCIEDAD ANONIMA, 08016 BARCELONA, SPAIN, FILED 8-30-2002.

SN 76-447,079. WOMEN OF PURPOSE, EL CAJON, CA. FILED 9-4-2002.

MOPEC



CLASS 16—PAPER GOODS AND PRINTED MATTER

FOR BOOKBINDING MATERIAL, NAMELY, BOOKBINDINGS, BOOKBINDING TAPE, BOOKBINDING WIRE; PHOTOGRAPHS; STATIONERY; ADHESIVES FOR STATIONERY OR HOUSEHOLD PURPOSES; ARTISTS' MATERIALS, NAMELY, ARTISTS' BRUSHES, ARTISTS' PASTELS, ARTISTS' PENCILS, ARTISTS' PENS; PAINT BRUSHES; TYPEWRITERS; PLASTIC BAGS AND WRAP FOR PACKAGING; PRINTING TYPE; PRINTING BLOCKS; PAPER BAGS; PASTEBOARD BAGS; CARDBOARD CARTONS; GENERAL PURPOSE PLASTIC BAGS; CATALOGUES IN THE FIELDS OF MODEL FIGURES, DECORATIVE ITEMS, AND GIFTS; PRINTED MATERIALS, NAMELY, EXERCISE BOOKS, NOTEBOOKS, STORY BOOKS, WEDDING BOOKS, COLORING BOOKS AND PHOTOGRAPH BOOKS; GREETING CARDS; PAPER TAGS; CONTAINERS NOT OF PRECIOUS METAL OR COATED THEREWITH, NAMELY, DECORATIVE BOXES MADE OF CARDBOARD (U.S. CLS. 2, 5, 22, 23, 29, 37, 38 AND 50).

FIRST USE 6-0-2001; IN COMMERCE 6-0-2001.

CLASS 20—FURNITURE AND ARTICLES NOT OTHERWISE CLASSIFIED

FOR STATUETTES OF WOOD AND PLASTIC; CONTAINERS NOT OF PRECIOUS METAL OR COATED THEREWITH, NAMELY, WOODEN BOXES (U.S. CLS. 2, 13, 22, 25, 32 AND 50).

FIRST USE 6-0-2001; IN COMMERCE 6-0-2001.

CLASS 21—HOUSEWARES AND GLASS

FOR NON-ELECTRIC KITCHEN UTENSILS, NAMELY, NAPKIN RINGS, BOTTLE OPENERS; CONTAINERS NOT OF PRECIOUS METAL OR COATED THEREWITH, NAMELY, DECORATIVE BOXES MADE OF PORCELAIN, CERAMICS, TERRA-COTTA, AND GLASS; CONTAINERS NOT OF PRECIOUS METAL OR COATED THEREWITH FOR HOUSEHOLD USE, NAMELY, DECORATIVE BOXES MADE OF PLASTIC; HAIR COMBS; FIGURINES MADE OF PORCELAIN, TERRA-COTTA, GLASS, AND CERAMIC (U.S. CLS. 2, 13, 23, 29, 30, 33, 40 AND 50).

FIRST USE 6-0-2001; IN COMMERCE 6-0-2001.

CLASS 30—STAPLE FOODS

FOR CHOCOLATE; COCOA; CANDIES (U.S. CL. 46).

FIRST USE 6-0-2001; IN COMMERCE 6-0-2001.

MARGERY A. TIERNEY, EXAMINING ATTORNEY

CLASS 9—ELECTRICAL AND SCIENTIFIC APPARATUS

FOR AUDIO CASSETTE TAPES, VIDEO CASSETTE TAPES, AND COMPACT DISCS FEATURING PROGRAMS ON TOPICS RELEVANT TO WOMEN TODAY (U.S. CLS. 21, 23, 26, 36 AND 38).

FIRST USE 3-26-1997; IN COMMERCE 3-26-1997.

CLASS 41—EDUCATION AND ENTERTAINMENT

FOR CONDUCTING CLASSES, WORKSHOPS AND SEMINARS IN THE AREA OF SPIRITUAL GROWTH AND SHARING OF THE GOSPEL; PUBLICATION OF BOOKS, PAMPHLETS, AND OTHER WRITTEN MATERIALS, NAMELY, NEWSLETTERS, BROCHURES, LEAFLETS, MAGAZINES, AND JOURNALS (U.S. CLS. 100, 101 AND 107).

FIRST USE 3-26-1997; IN COMMERCE 3-26-1997.

CLASS 45—PERSONAL SERVICES

FOR EVANGELICAL AND MINISTERIAL SERVICES; AND COUNSELING IN THE FIELD OF RELIGION; PROVIDING INFORMATION REGARDING CHRISTIAN STUDY IN THE AREA OF SPIRITUAL GROWTH AND SHARING OF THE GOSPEL (U.S. CLS. 100 AND 101).

FIRST USE 3-26-1997; IN COMMERCE 3-26-1997.

CAROLYN CATALDO, EXAMINING ATTORNEY

SN 76-447,212. ORSCHELN MANAGEMENT CO, MOBERLY, MO. FILED 9-6-2002.

LET'S ROLL

CLASS 9—ELECTRICAL AND SCIENTIFIC APPARATUS

FOR COMPUTER SOFTWARE FOR KEEPING SCORE IN BOWLING (U.S. CLS. 21, 23, 26, 36 AND 38).

CLASS 16—PAPER GOODS AND PRINTED MATTER

FOR SCORE KEEPING DEVICES, NAMELY, SCORE CARDS AND SCORE SHEETS FOR BOWLING (U.S. CLS. 2, 5, 22, 23, 29, 37, 38 AND 50).

CLASS 28—TOYS AND SPORTING GOODS

FOR BOWLING PINSETTERS AND PARTS THEREFORE, BOWLING BALLS, BOWLING BALL BAGS, BOWLING PINS AND BOWLING GLOVES (U.S. CLS. 22, 23, 38 AND 50).

BRENDAN MCCAULEY, EXAMINING ATTORNEY

SN 76-448,534. PATCO ENTERPRISES, INC., BEDFORD, IN. FILED 9-11-2002.

SN 76-450,096. ZYVEX CORPORATION, RICHARDSON, TX. FILED 9-16-2002.



THE MARK CONSISTS OF A RECTANGLE WITH A CHECKERED BORDER CONTAINING THE WORDS "SHELL FAIRY", A SAND CASTLE, SEASHELL, AND STARFISH.

CLASS 16—PAPER GOODS AND PRINTED MATTER

FOR NOTE BOOKS, WRITING PAPER, GREETING CARDS, ENVELOPES (U.S. CLS. 2, 5, 22, 23, 29, 37, 38 AND 50).

CLASS 25—CLOTHING

FOR SWIMMING SUITS, T-SHIRTS, HATS, SHORTS, SANDALS, AND KNIT SHIRTS (U.S. CLS. 22 AND 39).
DAVID C. REIHNER, EXAMINING ATTORNEY

SN 76-448,816. MICHAEL F. CORBETT & ASSOCIATES, LTD., LAGRANGEVILLE, NY. FILED 9-12-2002.

**THE OUTSOURCING
WORLD SUMMIT**

NO CLAIM IS MADE TO THE EXCLUSIVE RIGHT TO USE OUTSOURCING, APART FROM THE MARK AS SHOWN.
SEC. 2(F).

CLASS 35—ADVERTISING AND BUSINESS

FOR ORGANIZING AND CONDUCTING TRADE SHOWS IN THE FIELD OF OUTSOURCING; ORGANIZING AND CONDUCTING EXHIBITIONS IN THE FIELD OF OUTSOURCING (U.S. CLS. 100, 101 AND 102).
FIRST USE 6-0-1997; IN COMMERCE 6-0-1997.

CLASS 41—EDUCATION AND ENTERTAINMENT

FOR EDUCATIONAL SERVICES, NAMELY CONDUCTING SEMINARS AND CONFERENCES IN THE FIELD OF OUTSOURCING, AND DISTRIBUTING COURSE MATERIALS IN CONNECTION THEREWITH (U.S. CLS. 100, 101 AND 107).
FIRST USE 6-0-1997; IN COMMERCE 6-0-1997.
WANDA KAY PRICE, EXAMINING ATTORNEY

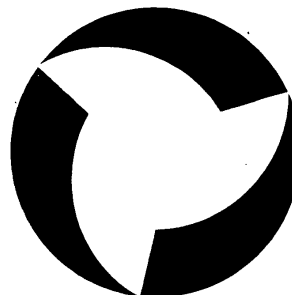

OWNER OF U.S. REG. NO. 2,474,096.

CLASS 16—PAPER GOODS AND PRINTED MATTER

FOR PRINTED MATTER NAMELY, PAPERS, ARTICLES AND BOOKS IN THE FIELD OF NANOTECHNOLOGY (U.S. CLS. 2, 5, 22, 23, 29, 37, 38 AND 50).
FIRST USE 8-1-2002; IN COMMERCE 8-1-2002.

CLASS 40—MATERIAL TREATMENT

FOR CUSTOM MANUFACTURE OF NANOTECHNOLOGY COMPONENTS, ASSEMBLERS AND NANO, MACRO AND MICRO DEVICES FOR OTHERS (U.S. CLS. 100, 103 AND 106).
FIRST USE 10-1-2001; IN COMMERCE 10-1-2001.

CLASS 41—EDUCATION AND ENTERTAINMENT

FOR DEVELOPMENT AND DISSEMINATION OF EDUCATIONAL MATERIALS FOR OTHERS IN THE FIELD OF NANOTECHNOLOGY; ELECTRONIC PUBLISHING SERVICES, NAMELY, PUBLICATION OF TEXT AND GRAPHIC WORKS OF OTHERS VIA THE INTERNET FEATURING INFORMATION IN THE FIELD OF NANOTECHNOLOGY (U.S. CLS. 100, 101 AND 107).
FIRST USE 6-13-2000; IN COMMERCE 6-13-2000.

CLASS 42—SCIENTIFIC, COMPUTER AND LEGAL SERVICES

FOR PROVIDING INFORMATION VIA THE INTERNET ON THE SUBJECT OF NANOTECHNOLOGY; DESIGN AND TESTING FOR NEW PRODUCT DEVELOPMENT; DESIGN FOR OTHERS IN THE FIELD OF NANOTECHNOLOGY; RESEARCH AND DEVELOPMENT FOR NEW PRODUCTS FOR OTHERS; SCIENTIFIC RESEARCH; TECHNICAL CONSULTATION AND RESEARCH IN THE FIELD OF NANOTECHNOLOGY; SCIENTIFIC RESEARCH AND DEVELOPMENT OF EQUIPMENT, PROCESSES, AND APPLICATIONS FOR OTHERS IN THE FIELD OF NANOTECHNOLOGY; DESIGN OF NANOTECHNOLOGY COMPONENTS, ASSEMBLERS AND NANO, MACRO AND MICRO DEVICES (U.S. CLS. 100 AND 101).
FIRST USE 6-13-2000; IN COMMERCE 6-13-2000.
ROBERT COGGINS, EXAMINING ATTORNEY

SN 76-456,055. OILFIELD CATALOGUING SERVICES LIMITED, ABERDEENSHIRE AB51 0AY, UNITED KINGDOM, FILED 10-2-2002.

OILCATS

PRIORITY CLAIMED UNDER SEC. 44(D) ON UNITED KINGDOM APPLICATION NO. 2297018, FILED 4-3-2002, REG. NO. 2297018, DATED 4-3-2002, EXPIRES 4-3-2012.

CLASS 9—ELECTRICAL AND SCIENTIFIC APPARATUS

FOR COMPUTER SOFTWARE AND COMPUTER PROGRAMS FOR CATALOGUING INFORMATION AND FOR USE IN DATABASE AND INVENTORY MANAGEMENT; PRE-RECORDED CDS, DVDS AND OTHER DIGITAL AND ANALOGUE MEDIA, NAMELY, CDS, CDRS, CD-ROMS, DVD-ROMS, DVDS AND FLOPPY DISCS FEATURING INFORMATION AND COMPUTER PROGRAMS FOR DATABASE AND INVENTORY MANAGEMENT AND FOR CATALOGUING INFORMATION; BLANK CDS, DVDS AND OTHER DIGITAL AND ANALOGUE MEDIA, NAMELY, CDS, CDRS, CD-ROMS, DVD-ROMS, DVDS AND FLOPPY DISCS; COMPUTER SOFTWARE CONTAINING CUSTOMIZED MATERIALS AND INVENTORY DATABASES (U.S. CLS. 21, 23, 26, 36 AND 38).

CLASS 35—ADVERTISING AND BUSINESS

FOR COMPUTERIZED DATABASE MANAGEMENT SERVICES, NAMELY, COMPILATION OF AND SYSTEMIZATION OF INFORMATION INTO COMPUTER DATABASES; COMPUTERIZED FILE MANAGEMENT SERVICES; BUSINESS MANAGEMENT AND BUSINESS DATA ANALYSIS, NAMELY, INVENTORY AND MATERIALS DATA ANALYSIS; INVENTORY CONTROL; INVENTORY MANAGEMENT IN THE OIL AND GAS INDUSTRY AND OTHER ENERGY GENERATING INDUSTRIES; BUSINESS ANALYSIS FOR IDENTIFICATION OF DUPLICATIONS OF INVENTORY DATA AND FOR VENDOR AND SUPPLIER ANALYSIS; PROVIDING BUSINESS INFORMATION IN THE OIL AND GAS INDUSTRY AND OTHER ENERGY GENERATING INDUSTRIES; PROVIDING ON-LINE BUSINESS INFORMATION IN THE OIL AND GAS INDUSTRY AND OTHER ENERGY GENERATING INDUSTRIES; PROVIDING BUSINESS CONSULTATION SERVICES; PROVIDING ON-LINE BUSINESS CONSULTATION SERVICES; PROVIDING A BUSINESS COMPUTER DATABASE CONTAINING A COMPILATION OF MAINTENANCE AND INVENTORY DATA, AND BILLS OF MATERIALS (U.S. CLS. 100, 101 AND 102).

CLASS 40—MATERIAL TREATMENT

FOR DOCUMENT DATA TRANSFER AND PHYSICAL CONVERSION SERVICES FROM ONE MEDIA TO ANOTHER; CONVERSION OF DATA OR DOCUMENTS FROM PHYSICAL TO ELECTRONIC MEDIA (U.S. CLS. 100, 103 AND 106).

CLASS 41—EDUCATION AND ENTERTAINMENT

FOR TRANSLATION SERVICES; MULTI-LINGUAL MATERIALS AND INVENTORY DATA TRANSLATION; CUSTOM WRITING SERVICES FOR COMPILATION INTO WEB PAGES; PROVIDING TRANSLATION INFORMATION, PROVIDING ON-LINE TRANSLATION INFORMATION; PROVIDING TRANSLATION CONSULTATION AND PROVIDING ON-LINE TRANSLATION CONSULTATION (U.S. CLS. 100, 101 AND 107).

CLASS 42—SCIENTIFIC, COMPUTER AND LEGAL SERVICES

FOR MATERIALS AND INVENTORY DATABASE DESIGN SERVICES FOR OTHERS; MAINTENANCE AND INSTALLATION OF COMPUTER SOFTWARE CONTAINING MATERIALS AND INVENTORY DATABASES; DATABASE DEVELOPMENT SERVICES, NAMELY, COMPILATION OF MAINTENANCE AND INVENTORY DATA, AND BILLS OF MATERIALS INTO A COMPUTER DATABASE; DATA CONVERSION OF COMPUTER PROGRAMS AND DATA; CONVERSION OF LEGACY AND INVENTORY DATA INTO STANDARDIZED AND ENHANCED FORMATS; COMPUTER PROGRAMMING; HELP-LINE SERVICES, NAMELY, TECHNICAL SUPPORT SERVICES RELATING TO COMPUTER HARDWARE, SOFTWARE AND PROGRAMS FOR CATALOGUING INFORMATION AND FOR USE IN DATABASE AND INVENTORY MANAGEMENT; DATABASE DEVELOPMENT SERVICES; RECOVERY OF COMPUTER DATA; CREATING, DESIGNING, MAINTAINING AND UPDATING WEBSITES FOR OTHERS; DESIGN, UPGRADING AND OPTIMIZATION OF DATABASES AND MATERIALS MANAGEMENT COMPUTER SYSTEMS; STORE AND STOCK ROOM DESIGN SERVICES; CONSULTATION SERVICES, NAMELY, REVIEWING THE LAYOUT, CONTENT AND DESIGN OF STORES AND STOCK ROOMS OF OTHERS, AND PROVIDING ADVICE AND CONSULTANCY SERVICES TO OTHERS ON WAYS TO IMPROVE THE LAYOUT, CONTENT AND DESIGN THEREOF (U.S. CLS. 100 AND 101).

KATHLEEN M. VANSTON, EXAMINING ATTORNEY

SN 76-457,636. BRETTFORD MANUFACTURING, INC., FRANKLIN PARK, IL. FILED 10-11-2002.



THE MARK CONSISTS OF THE WORDING LETTER B AND SOLID OVAL.

CLASS 9—ELECTRICAL AND SCIENTIFIC APPARATUS

FOR PHOTOGRAPHY EQUIPMENT, NAMELY, PROJECTION SCREENS, ELECTRICAL LIGHT DISTRIBUTION BOXES AND PHOTOGRAPHIC SLIDE TRANSPARENCIES VIEWERS; TELEVISION AND VIDEO DISPLAY MOUNTING SYSTEMS COMPRISED PRIMARILY OF MOUNTING RACKS FOR TELEVISIONS AND VIDEO MONITORS; PROJECTION SCREEN; COMPUTER MONITORS; POWER AND DATA DELIVERY SYSTEMS COMPRISED OF ELECTRICAL WIRE, SUBSTATIONS, SUPPORTS AND CHANNELS (U.S. CLS. 21, 23, 26, 36 AND 38).

CLASS 12—VEHICLES

FOR NON-MOTORIZED OFFICE CARTS; MOBILE UTILITY HAND TRUCKS (U.S. CLS. 19, 21, 23, 31, 35 AND 44).

CLASS 16—PAPER GOODS AND PRINTED MATTER

FOR WRITING BOARDS, NAMELY, CHALKBOARDS, ERASABLE BOARDS, DRAWING BOARDS, FLIP CHARTS, DISPLAY BOARDS, BULLETIN BOARDS, AND MOUNTING STRIPS OR TRACKS SOLD TOGETHER AS A UNIT; EASELS (U.S. CLS. 2, 5, 22, 23, 29, 37, 38 AND 50).

CLASS 20—FURNITURE AND ARTICLES NOT OTHERWISE CLASSIFIED

FOR COMPUTER FURNITURE; OFFICE AND LIBRARY FURNITURE; FURNITURE, NAMELY, TABLES, CONSOLES, BOOK STANDS, METAL DISPLAY STANDS, DESK, LECTERNS, SHELVES, CABINET, FILE DRAWERS, BOOK DISPLAY CAROUSELS, DESKS, COMPUTER WORKSTATIONS COMPRISING A DESK, STUDY DESK CARRELS AND WORKSTATION DESK CARRELS, LOCKABLE SECURITY CABINETS (U.S. CLS. 2, 13, 22, 25, 32 AND 50).

TRACY FLETCHER, EXAMINING ATTORNEY

SN 76-457,700. KAYDON ACQUISITION XI, INC., ANN ARBOR, MI. FILED 10-11-2002.

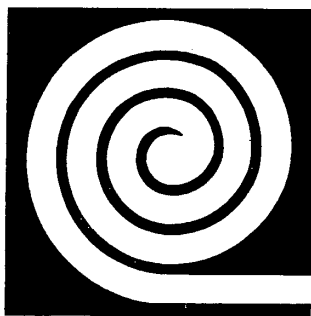
**CLASS 1—CHEMICALS**

FOR SOLDERING FLUXES, SOLDERING PASTES, AND SOLDERING CREAMS (U.S. CLS. 1, 5, 6, 10, 26 AND 46).

FIRST USE 0-0-1967; IN COMMERCE 0-0-1967.

CLASS 2—PAINTS

FOR COATING IN THE NATURE OF TINNING PAINTS (U.S. CLS. 6, 11 AND 16).

FIRST USE 0-0-1967; IN COMMERCE 0-0-1967.

CLASS 6—METAL GOODS

FOR FULL LINE OF SOLDERS AND SOLDER ALLOYS, EXCLUDING LEAD-FREE SOLDERS IN THE ELECTRONICS INDUSTRY (U.S. CLS. 2, 12, 13, 14, 23, 25 AND 50).

FIRST USE 0-0-1967; IN COMMERCE 0-0-1967.

CLASS 9—ELECTRICAL AND SCIENTIFIC APPARATUS

FOR LEAD-FREE SOLDERS IN THE ELECTRONICS INDUSTRY (U.S. CLS. 21, 23, 26, 36 AND 38).

FIRST USE 0-0-1967; IN COMMERCE 0-0-1967.
CURTIS FRENCH, EXAMINING ATTORNEY

SN 76-460,626. HEALTH CARE AND RETIREMENT CORPORATION OF AMERICA, TOLEDO, OH. FILED 10-22-2002.

CIRCLE OF CARE**CLASS 41—EDUCATION AND ENTERTAINMENT**

FOR EDUCATIONAL SERVICES, NAMELY, CONDUCTING CLASSES, SEMINARS, AND WORKSHOPS FOR HEALTH CARE WORKERS IN THE FIELD OF HEALTH CARE TRAINING (U.S. CLS. 100, 101 AND 107).

FIRST USE 10-10-1988; IN COMMERCE 10-10-1988.

CLASS 44—MEDICAL, BEAUTY AND AGRICULTURAL SERVICES

FOR PHYSICAL AND OCCUPATIONAL REHABILITATION; TRANSITIONAL HEALTH CARE; HOME HEALTH AND HOSPICE CARE; AND NURSING HOME CARE (U.S. CLS. 100 AND 101).

FIRST USE 10-10-1988; IN COMMERCE 10-10-1988.

TARAH HARDY, EXAMINING ATTORNEY

SN 76-461,165. KABUSHIKI KAISHA TOSHIBA, MINATOKU, TOKYO, JAPAN, FILED 10-18-2002.

APLIPURE

PRIORITY CLAIMED UNDER SEC. 44(D) ON JAPAN APPLICATION NO. 2002-075568, FILED 9-5-2002, REG. NO. 4675728, DATED 5-23-2003, EXPIRES 5-23-2013.

CLASS 9—ELECTRICAL AND SCIENTIFIC APPARATUS

FOR COMPUTER SOFTWARE FOR USE IN ANALYZING DATA FROM TESTS CONDUCTED WITH ULTRASONIC DIAGNOSTIC APPARATUS FOR MEDICAL USE (U.S. CLS. 21, 23, 26, 36 AND 38).

CLASS 10—MEDICAL APPARATUS

FOR ULTRASONIC DIAGNOSTIC APPARATUS FOR MEDICAL USE (U.S. CLS. 26, 39 AND 44).

CLASS 42—SCIENTIFIC, COMPUTER AND LEGAL SERVICES

FOR MAINTENANCE OF SOFTWARE USED WITH ULTRASONIC DIAGNOSTIC APPARATUS FOR MEDICAL USE (U.S. CLS. 100 AND 101).

JAMES GRIFFIN, EXAMINING ATTORNEY

SN 76-463,924. PARK B. SMITH, INC., NEW YORK, NY.
FILED 11-4-2002.

SN 76-465,969. CLUB DEPORTIVO SOCIAL Y CULTURAL
CRUZ AZUL, A.C., C.P. 03100 MEXICO, D.F., MEXICO,
FILED 11-1-2002.



NO CLAIM IS MADE TO THE EXCLUSIVE RIGHT TO USE "DEPORTIVO" AND "MEXICO", APART FROM THE MARK AS SHOWN.

THE ENGLISH TRANSLATION OF THE WORD "DEPORTIVO CRUZ AZUL" IN THE MARK IS "BLUE CROSS SPORTS".

CLASS 20—FURNITURE AND ARTICLES NOT OTHERWISE CLASSIFIED

FOR PILLOWS, DECORATIVE PILLOWS AND CHAIR PADS (U.S. CLS. 2, 13, 22, 25, 32 AND 50).

CLASS 21—HOUSEWARES AND GLASS

FOR BATHROOM ACCESSORIES, NAMELY TUMBLERS AND TOOTHBRUSH HOLDERS; SOAP DISH, LOTION DISPENSER; SOAP DISPENSER; TRASH CONTAINER FOR HOUSEHOLD USE; WASTEBASKETS; VOITIVE CANDLEHOLDERS NOT OF PRECIOUS METAL AND CANDLEHOLDERS NOT OF PRECIOUS METAL (U.S. CLS. 2, 13, 23, 29, 30, 33, 40 AND 50).

CLASS 24—FABRICS

FOR COMFORTERS; BLANKET THROWS; AFGHANS; COVERLETS; BED SHEETS; PILLOW CASES; DUVETS; SHAMS; DUST RUFFLES; UNFITTED FABRIC FURNITURE COVERS; SHOWER CURTAINS; WINDOW TREATMENTS, NAMELY DRAPERIES, CURTAINS, FABRIC VALENCES, CURTAIN PANELS AND TIE-BACKS; TABLE LINENS, NAMELY PLACEMATS MADE OF FABRIC AND NAPKINS MADE OF FABRIC; KITCHEN TOWELS; POT HOLDERS; AND OVEN MITS (U.S. CLS. 42 AND 50).

CLASS 25—CLOTHING

FOR APRONS (U.S. CLS. 22 AND 39).

CLASS 27—FLOOR COVERINGS

FOR RUGS (U.S. CLS. 19, 20, 37, 42 AND 50).
INGRID C. EULIN, EXAMINING ATTORNEY

CLASS 18—LEATHER GOODS

FOR ATHLETIC BAGS, BACKPACKS, DUFFEL BAGS, TOTE BAGS, GYM BAGS, WALLET, PURSES, UMBRELLAS (U.S. CLS. 1, 2, 3, 22 AND 41).

CLASS 25—CLOTHING

FOR CLOTHING, NAMELY, UNIFORMS, SHIRTS, SWEATSHIRTS, T-SHIRTS, JACKETS, PANTS, SHORTS, JERSEYS, TRACKSUITS, SCRIMMAGE VESTS, VISORS, HATS, CAPS, HEADBANDS, WRISTBANDS AND FOOTWEAR (U.S. CLS. 22 AND 39).

CLASS 28—TOYS AND SPORTING GOODS

FOR SPORTING GOODS, NAMELY, SOCCER BALLS, GLOVES, ELBOW PADS, KNEE PADS, SHIN GUARDS, BALL SACKS, GOALS, NETS; TOYS, NAMELY, PLAY ACTION FIGURES, BOARD GAMES (U.S. CLS. 22, 23, 38 AND 50).

CLASS 35—ADVERTISING AND BUSINESS

FOR ON-LINE RETAIL STORE SERVICES FEATURING SOCCER APPAREL, EQUIPMENT AND RELATED GOODS; MAIL ORDER SERVICES FEATURING SOCCER APPAREL, EQUIPMENT AND RELATED GOODS (U.S. CLS. 100, 101 AND 102).

CLASS 41—EDUCATION AND ENTERTAINMENT

FOR RADIO AND TV PROGRAM PRODUCTION; PUBLICATION OF NEWSPAPERS, BOOKS AND MAGAZINES IN THE FIELD OF SOCCER; ARRANGING AND CONDUCTING SOCCER CLINICS; ORGANIZING SOCCER LEAGUES, SOCCER EXHIBITIONS AND SOCCER MATCHES; RENTAL OF VIDEO GAMES;(BASED ON USE IN COMMERCE) ENTERTAINMENT SERVICES IN THE NATURE OF SOCCER GAMES (U.S. CLS. 100, 101 AND 107).

TRICIA SONNEBORN, EXAMINING ATTORNEY

SN 76-467,648. CHAILLARD, ROLAND, 75003 PARIS, FRANCE, FILED 11-18-2002.

ROLAND CHAILLARD

PRIORITY CLAIMED UNDER SEC. 44(D) ON FRANCE APPLICATION NO. 023187671, FILED 10-8-2002, REG. NO. 023187671, DATED 10-8-2002, EXPIRES 10-8-2012.

THE NAME ROLAND CHAILLARD IDENTIFIES A LIVING INDIVIDUAL WHOSE CONSENT IS OF RECORD.

CLASS 24—FABRICS

FOR BED AND TABLE COVERS, TOILET GLOVES, BATH LINEN, FACE TOWELS (U.S. CLS. 42 AND 50).

CLASS 25—CLOTHING

FOR FOOTWEAR, HEADWEAR, BATHING SUITS, BATHING DRAWERS, BATH SANDALS, BATH ROBES, BEACH SHOES, UNDERCLOTHING, UNDERWEAR (U.S. CLS. 22 AND 39).

LINDA E. BLOHM, EXAMINING ATTORNEY

SN 76-467,879. RETIREMENT ENGINEERING, INC., BOSTON, MA. FILED 11-18-2002.

PENSIONSHARES

CLASS 35—ADVERTISING AND BUSINESS

FOR LICENSING OF FINANCIAL INVESTMENT SECURITIES; LICENSING OF INSURANCE PRODUCTS, SERVICES AND CONTRACTS (U.S. CLS. 100, 101 AND 102).

CLASS 36—INSURANCE AND FINANCIAL

FOR FINANCIAL SERVICES IN THE NATURE OF INVESTMENT SECURITIES; MUTUAL FUND INVESTMENT AND INVESTMENT MANAGEMENT SERVICES (U.S. CLS. 100, 101 AND 102).

ALICIA COLLINS, EXAMINING ATTORNEY

SN 76-468,050. ACADEMY FOR EDUCATIONAL DEVELOPMENT, INC., WASHINGTON, DC. FILED 11-19-2002.

BLUEPACK

CLASS 36—INSURANCE AND FINANCIAL

FOR CHARITABLE FUND RAISING SERVICES, NAMELY THE RAISING OF DONATIONS OF FUNDS IN ORDER TO PROVIDE SERVICES AND GOODS FOR THE PROVISION OF EDUCATIONAL AND HEALTH-RELATED RESOURCES, GOODS AND SERVICES TO CHILDREN IN DEVELOPING COUNTRIES (U.S. CLS. 100, 101 AND 102).

FIRST USE 7-24-2002; IN COMMERCE 7-24-2002.

CLASS 41—EDUCATION AND ENTERTAINMENT

FOR EDUCATIONAL RESEARCH AND CONSULTATION; RESEARCH AND CONSULTATION IN THE FIELD OF TEACHER TRAINING (U.S. CLS. 100, 101 AND 107).

FIRST USE 7-24-2002; IN COMMERCE 7-24-2002.

CLASS 42—SCIENTIFIC, COMPUTER AND LEGAL SERVICES

FOR TECHNICAL RESEARCH AND CONSULTATION IN THE FIELD OF EDUCATION, TECHNICAL RESEARCH AND CONSULTATION IN THE FIELD OF TEACHER TRAINING (U.S. CLS. 100 AND 101).

FIRST USE 7-24-2002; IN COMMERCE 7-24-2002.

GINA FINK, EXAMINING ATTORNEY

SN 76-468,885. JIMENEZ, JAVIER F., VENICE, CA. AND CULLEN, MATHEW M., VENICE, CA. FILED 11-21-2002.

MOTION THEORY

CLASS 35—ADVERTISING AND BUSINESS

FOR ADVERTISING SERVICES, NAMELY, CREATING CORPORATE LOGOS AND BRAND IDENTITY FOR OTHERS; PRODUCTION SERVICES FOR COMMERCIALS (U.S. CLS. 100, 101 AND 102).

FIRST USE 5-15-2000; IN COMMERCE 5-15-2000.

CLASS 41—EDUCATION AND ENTERTAINMENT

FOR ENTERTAINMENT SERVICES IN THE NATURE OF PRODUCTION OF TELEVISION SHOWS AND MOTION PICTURE FILMS; PRODUCTION OF VIDEOCASSETTES, VIDEOTAPES AND VIDEO DISCS FOR OTHERS (U.S. CLS. 100, 101 AND 107).

FIRST USE 5-15-2000; IN COMMERCE 5-15-2000.

CLASS 42—SCIENTIFIC, COMPUTER AND LEGAL SERVICES

FOR COMMERCIAL ART DESIGN, NAMELY, COMPUTER GRAPHICS DESIGN SERVICES, CONCEPTION AND CREATION OF ART DESIGN AND GRAPHIC DESIGN FOR COMMERCIALS, TELEVISION SHOWS, FEATURE FILMS, PRINTED MATERIALS AND INTERACTIVE MEDIA; ANIMATION DESIGN FOR OTHERS (U.S. CLS. 100 AND 101).

FIRST USE 5-15-2000; IN COMMERCE 5-15-2000.

LINDA ESTRADA, EXAMINING ATTORNEY

SN 76-471,668. PARK, YOUNG-SEONG, PUSAN, REPUBLIC OF KOREA, FILED 11-21-2002.

PENCRA

CLASS 2—PAINTS

FOR WATERCOLOR PAINTS; PAINT FOR ARTISTS; AND PAINTS FOR ARTS AND CRAFTS (U.S. CLS. 6, 11 AND 16).

CLASS 16—PAPER GOODS AND PRINTED MATTER

FOR STATIONARY, WRITING IMPLEMENTS AND OFFICE REQUISITES, NAMELY BALL POINT PENS, ROLLER BALL PENS, MARKER PENS, JELLING PENS, CORRECTION PENS, WRITING INK, MECHANICAL PENCILS, FOUNTAIN PENS, PENCILS, CRAYONS, PASTEL CRAYONS, PAINT APPLICATORS AND PAINT BRUSHES, PAINTING SETS, PAINTING SETS FOR ARTISTS, PAINTING SETS FOR CHILDREN, PENCIL SHARPENERS, FIBER PENS, HI-LIGHTING PENS, AND SIGN PENS (U.S. CLS. 2, 5, 22, 23, 29, 37, 38 AND 50).

TARAH HARDY, EXAMINING ATTORNEY

SN 76-471,691. STROUP, THOMAS, WINDERMERE, FL.
FILED 11-25-2002.

SN 76-477,380. GRAND CYPRESS FLORIDA, INC., ORLAN-
DO, FL. FILED 12-23-2002.

S.W.A.T.WORKOUT

NO CLAIM IS MADE TO THE EXCLUSIVE RIGHT TO
USE "WORKOUT", APART FROM THE MARK AS SHOWN.

CLASS 9—ELECTRICAL AND SCIENTIFIC APPARATUS

FOR PHYSICAL FITNESS VIDEOS (U.S. CLS. 21, 23, 26,
36 AND 38).
FIRST USE 3-4-2002; IN COMMERCE 3-4-2002.

CLASS 41—EDUCATION AND ENTERTAIN- MENT

FOR PHYSICAL FITNESS INSTRUCTION SERVICES
(U.S. CLS. 100, 101 AND 107).
FIRST USE 3-4-2002; IN COMMERCE 3-4-2002.
CAROLYN CATALDO, EXAMINING ATTORNEY



OWNER OF U.S. REG. NOS. 1,309,413, 1,842,099 AND
OTHERS.

NO CLAIM IS MADE TO THE EXCLUSIVE RIGHT TO
USE "EQUESTRIAN CENTER", APART FROM THE MARK
AS SHOWN.

CLASS 25—CLOTHING

FOR CLOTHING, NAMELY SWEATSHIRTS, T-
SHIRTS, SHIRTS, JACKETS, HATS (U.S. CLS. 22 AND
39).
FIRST USE 2-0-2001; IN COMMERCE 2-0-2001.

CLASS 41—EDUCATION AND ENTERTAIN- MENT

FOR ENTERTAINMENT SERVICES IN THE NATURE
OF PROVIDING FACILITIES FOR EQUESTRIAN TRAIL
RIDES, CROSS-COUNTRY, CLINICS AND HORSE
SHOWS; INSTRUCTION IN THE FIELD OF HORSE-
BACK RIDING, DRESSAGE, HUNT SEAT, COMBINED
TRAINING, JUMPING, AND WESTERN; HORSE TRAIN-
ING (U.S. CLS. 100, 101 AND 107).

FIRST USE 2-0-2001; IN COMMERCE 2-0-2001.

CLASS 43—HOTEL AND RESTAURANT SER- VICES

FOR FULL SERVICE HORSE BOARDING (U.S. CLS.
100 AND 101).

FIRST USE 2-0-2001; IN COMMERCE 2-0-2001.

BILL DAWE, EXAMINING ATTORNEY

SN 76-475,731. E.P. HENRY CORPORATION, WOODBURY,
NJ. FILED 12-16-2002.

EP HENRY

THE NAME "EP HENRY" DOES NOT IDENTIFY A
LIVING INDIVIDUAL.

CLASS 19—NON-METALLIC BUILDING MA- TERIALS

FOR HARDSCAPING MATERIALS, NAMELY PA-
VERS, PAVING BLOCKS, PERMEABLE PAVING
BLOCKS; NON-METAL CURBING AND EDGING
BLOCKS; CONCRETE RETAINING AND GARDEN
WALL BLOCKS AND CAPS; CONCRETE MASONRY
PRODUCTS, NAMELY BUILDING BLOCKS AND SLABS
(U.S. CLS. 1, 12, 33 AND 50).
FIRST USE 0-0-1903; IN COMMERCE 0-0-1903.

CLASS 35—ADVERTISING AND BUSINESS

FOR WHOLESALE DISTRIBUTORSHIP OF HARD-
SCAPING MATERIALS, NAMELY PAVERS, PAVING
BLOCKS, RETAINING AND GARDEN WALL BLOCKS
AND CAPS; CONCRETE MASONRY PRODUCTS,
NAMELY BUILDING BLOCKS AND SLABS; AND MA-
TERIALS FOR INSTALLING, PRESERVING AND SEAL-
ING CEMENT PRODUCTS (U.S. CLS. 100, 101 AND 102).
FIRST USE 0-0-1903; IN COMMERCE 0-0-1903.
MARY BOAGNI, EXAMINING ATTORNEY

SN 76-482,810. CALIFORNIA NEWSPAPERS PARTNERSHIP,
DENVER, CO. FILED 1-16-2003.

THE OAKLAND TRIBUNE

OWNER OF U.S. REG. NO. 2,752,172.
SEC. 2(F).

CLASS 35—ADVERTISING AND BUSINESS

FOR ADVERTISING SERVICES, NAMELY, PROMOT-
ING THE SERVICES OF OTHERS BY PROVIDING
HYPERTEXT LINKS TO THE WEBSITES OF OTHERS
(U.S. CLS. 100, 101 AND 102).

FIRST USE 7-0-1997; IN COMMERCE 7-0-1997.

CLASS 41—EDUCATION AND ENTERTAIN- MENT

FOR ON-LINE NEWS IN THE NATURE OF CURRENT
EVENTS REPORTING; PROVIDING INFORMATION IN
THE FIELD OF NEWS BY LINKING USERS TO OTHER
WEBSITES CONTAINING INFORMATION IN THE
FIELD OF NEWS (U.S. CLS. 100, 101 AND 107).

FIRST USE 7-0-1997; IN COMMERCE 7-0-1997.

CHARLES L. JENKINS, EXAMINING ATTORNEY

SN 76-483,432. DESTINATION AMERICA, INC., ANAHEIM, CA. FILED 1-21-2003.

DESTINATION AMERICA

NO CLAIM IS MADE TO THE EXCLUSIVE RIGHT TO USE "AMERICA", APART FROM THE MARK AS SHOWN.

CLASS 39—TRANSPORTATION AND STORAGE

FOR ARRANGING TRAVEL TOURS, TRAVEL AGENCY SERVICES, NAMELY, MAKING RESERVATIONS AND BOOKINGS FOR TRANSPORTATION, TRAVEL GUIDE SERVICES AND TRAVEL INFORMATION SERVICES (U.S. CLS. 100 AND 105).

FIRST USE 8-13-1990; IN COMMERCE 8-13-1990.

CLASS 43—HOTEL AND RESTAURANT SERVICES

FOR TRAVEL AGENCY SERVICES, NAMELY, MAKING RESERVATIONS AND BOOKINGS FOR TEMPORARY LODGING AND FOR RESTAURANTS AND MEALS (U.S. CLS. 100 AND 101).

FIRST USE 8-13-1990; IN COMMERCE 8-13-1990.
JEAN IM, EXAMINING ATTORNEY

SN 76-483,722. ANTEON INTERNATIONAL CORPORATION, FAIRFAX, VA. FILED 1-21-2003.

SIRIXS

CLASS 9—ELECTRICAL AND SCIENTIFIC APPARATUS

FOR COMPUTER HARDWARE AND COMPUTER SOFTWARE FOR USE TO INTERCONNECT COMMUNICATIONS NETWORKS AND COMPUTER NETWORKS, INCLUDING GEOGRAPHICAL INFORMATION SYSTEMS, TO ENABLE FEDERAL, STATE AND LOCAL GOVERNMENT LAW ENFORCEMENT AND EMERGENCY RESPONSE ENTITIES TO COMMUNICATE AND COORDINATE WITH EACH OTHER IN DAILY OPERATIONS AND IN RESPONSE TO CRISES, EMERGENCIES AND DISASTERS ALL IN THE FIELD OF INFORMATION TECHNOLOGY (U.S. CLS. 21, 23, 26, 36 AND 38).

CLASS 42—SCIENTIFIC, COMPUTER AND LEGAL SERVICES

FOR COMPUTER SERVICES NAMELY, INTEGRATING COMMERCIAL AND GOVERNMENT COMPUTER HARDWARE AND COMPUTER SOFTWARE FOR THE EXCHANGE OF INFORMATION OVER SECURED VOICE AND DATA COMMUNICATIONS LINES (U.S. CLS. 100 AND 101).

SONYA STEPHENS, EXAMINING ATTORNEY

SN 76-484,300. JACKSON NATIONAL LIFE INSURANCE COMPANY, LANSING, MI. FILED 1-23-2003.

JACKSON FUND SERVICES

OWNER OF U.S. REG. NOS. 1,489,625, 2,568,853 AND OTHERS.

NO CLAIM IS MADE TO THE EXCLUSIVE RIGHT TO USE FUND SERVICES, APART FROM THE MARK AS SHOWN.

CLASS 35—ADVERTISING AND BUSINESS

FOR ACCOUNTING SERVICES; TAX SERVICES, NAMELY, CALCULATION OF DIVIDEND AND CAPITAL GAIN DISTRIBUTIONS, AND FILING OF TAX RETURNS; ADMINISTRATIVE SERVICES, NAMELY, SELECTING AND MONITORING OUTSIDE VENDORS, MONITORING EXPENSES, PREPARING FINANCIAL REPORTS; MONITORING COMPLIANCE WITH STATED PROSPECTUS GUIDELINES; FOR ENTITIES THAT OPERATE MUTUAL FUNDS AND OTHER INVESTMENT VEHICLES (U.S. CLS. 100, 101 AND 102).

CLASS 42—SCIENTIFIC, COMPUTER AND LEGAL SERVICES

FOR REVIEWING STANDARDS AND PRACTICES TO ENSURE COMPLIANCE WITH IRS AND SEC REGULATIONS; FOR ENTITIES THAT OPERATE MUTUAL FUNDS AND OTHER INVESTMENT VEHICLES (U.S. CLS. 100 AND 101).

BILL DAWE, EXAMINING ATTORNEY

SN 76-486,051. THE GIN JOINT, LLC, DBA FORTY DEUCE, LOS ANGELES, CA. FILED 1-30-2003.

FORTY DEUCE

CLASS 25—CLOTHING

FOR CLOTHING, NAMELY, SHIRTS, SWEATSHIRTS, SWEAT PANTS, GYM SUITS, JOGGING SUITS, SWEATERS, JACKETS, HEAD WEAR, BELTS, DRESSES, SHOES, SLIPPERS, BATHING SUITS, TEE SHIRTS, WORKOUT GEAR, NAMELY, ATHLETIC UNIFORMS, SPORTS BRAS, TOPS AND BOTTOMS FOR USE IN AEROBICS, WARM-UP SUITS AND PANTS, SINGLETTS, LEOTARDS, TIGHTS, HEADBANDS, WRISTBANDS, TANK TOPS, ATHLETIC SHORTS, ATHLETIC AND LEISURE SHIRTS; STOCKINGS, SOCKS, SOCK GARTERS FOR MEN, GARTER BELTS FOR WOMEN, BRAS, SLIPS, PANTIES, BOXER SHORTS, GLOVES, SCARVES, UNDERWEAR, BATHING SUITS, PAJAMAS; AND INTIMATE APPAREL, NAMELY, LINGERIE (U.S. CLS. 22 AND 39).

CLASS 41—EDUCATION AND ENTERTAINMENT

FOR ENTERTAINMENT SERVICES IN THE NATURE OF LIVE AND PRERECORDED CABARETS, STRIP TEASE SHOWS, BURLESQUE SHOWS, MUSICAL AND DANCE PERFORMANCES, BURLESQUE, AND REALITY AND VARIETY SHOWS DISTRIBUTED OVER BROADCAST TELEVISION, CABLE TELEVISION, SATELLITE TELEVISION, AND AUDIO AND VIDEO MEDIA; NIGHT CLUBS AND OTHER VENUES FEATURING CABARETS, STRIP TEASE SHOWS, BURLESQUE SHOWS, MUSICAL AND DANCE PERFORMANCES, AND BURLESQUE (U.S. CLS. 100, 101 AND 107).

DOUGLAS LEE, EXAMINING ATTORNEY

SN 76-488,217. ROLLSEAL, INC., BREMEN, AL. FILED 2-7-2003.



CLASS 6—METAL GOODS

FOR PREFABRICATED AND VENTILATED METAL GREENHOUSES AND METAL ROLL SHUTTERS (U.S. CLS. 2, 12, 13, 14, 23, 25 AND 50).
FIRST USE 2-0-1996; IN COMMERCE 2-0-1996.

CLASS 9—ELECTRICAL AND SCIENTIFIC APPARATUS

FOR ELECTRONIC REMOTE CONTROLS FOR HEATING AND VENTILATION UNITS (U.S. CLS. 21, 23, 26, 36 AND 38).
FIRST USE 2-0-1996; IN COMMERCE 2-0-1996.

CLASS 19—NON-METALLIC BUILDING MATERIALS

FOR NON-METAL ROLL SHUTTERS AND DOORS (U.S. CLS. 1, 12, 33 AND 50).
FIRST USE 2-0-1996; IN COMMERCE 2-0-1996.
WON TEAK OH, EXAMINING ATTORNEY

CLASS 9—ELECTRICAL AND SCIENTIFIC APPARATUS

FOR ELECTRIC MODULES AND ELECTRIC BUS HARDWARE FOR CONNECTING AND LINKING ELECTRIC BUS CONNECTORS, NAMELY, SEGMENT COUPLERS, SEGMENT PROTECTORS, PROCESS INTERFACES, TERMINATORS, TERMINATION RESISTORS, JUNCTION BOXES, CABLES, SWITCHES, WIRES, SIGNAL REPEATERS, DISCRETE I/O FIELDBOXES, CORDSETS, AND FOR FIELD BUS HARDWARE, NAMELY, POWER SUPPLY UNITS AND UNITS FOR CONNECTION TO ELECTRIC BUS CONNECTIONS, NAMELY, VALVE CONNECTORS FOR CONNECTING VALVES TO ELECTRIC BUS CONNECTIONS, SENSOR CONNECTORS FOR CONNECTING SENSORS TO ELECTRIC BUS CONNECTIONS, ELECTRIC AUTOMATION UNITS FOR CONNECTION TO ELECTRIC BUS CONNECTIONS; ELECTRIC DEVICES FOR DISTRIBUTING ELECTRIC BUS CONNECTIONS, NAMELY, JUNCTION BOXES, CABLES, SWITCHES, WIRES, DISCRETE I/O FIELDBOXES, CORDSETS; ELECTRIC COUNTERS FOR CONNECTION TO ELECTRIC BUS CONNECTIONS; ELECTRIC SEGMENT COUPLERS FOR CONNECTION TO ELECTRIC BUS CONNECTIONS; ELECTRIC POWER REPEATERS FOR THE POWER SUPPLIES AND ELECTRIC BUS HARDWARE AND FOR CONNECTORS TO ELECTRIC BUS CONNECTIONS; ELECTRIC JUNCTION BOXES FOR ELECTRIC BUS CONNECTORS USED TO LINK ELECTRIC BUS HARDWARE INSTALLED IN THE FIELD WITH AUTOMATION UNITS; ELECTRIC CONNECTION PARTS FOR BUS CONNECTIONS, NAMELY, ELECTRIC CONNECTING CABLES AND EXTENSION CABLES; ELECTRIC BUS CONNECTORS FOR FIELD BUS CONNECTIONS; COMPUTER PROGRAMS, RECORDED ON DATA CARRIERS, FOR CONNECTING AND LINKING ELECTRIC MODULES AND ELECTRIC BUS DEVICES TO BUS CONNECTIONS, NAMELY, FIELD BUS CONNECTIONS (U.S. CLS. 21, 23, 26, 36 AND 38).

CLASS 16—PAPER GOODS AND PRINTED MATTER

FOR DOCUMENTATION PERTAINING TO COMPUTER PROGRAMS, NAMELY, COMPUTER PROGRAM MANUALS, OPERATING MANUALS AND USER GUIDES FOR ELECTRIC MODULES AND ELECTRIC BUS HARDWARE FOR CONNECTING AND LINKING ELECTRIC BUS CONNECTIONS, FOR ELECTRIC MODULES AND DEVICES FOR FIELD BUS HARDWARE (U.S. CLS. 2, 5, 22, 23, 29, 37, 38 AND 50).

CLASS 42—SCIENTIFIC, COMPUTER AND LEGAL SERVICES

FOR COMPUTER SOFTWARE AUTHORIZING, DEVELOPMENT AND MAINTENANCE FOR OTHERS, NAMELY SOFTWARE FOR CONNECTING AND LINKING ELECTRIC MODULES AND ELECTRIC BUS HARDWARE TO BUS CONNECTIONS, NAMELY, FIELD BUS CONNECTIONS (U.S. CLS. 100 AND 101).
TRACY CROSS, EXAMINING ATTORNEY

SN 76-491,151. GORDY'S LAKEFRONT MARINE, INC., FONTANA, WI. FILED 2-21-2003.

GORDY'S

THE NAME "GORDY'S" DOES NOT IDENTIFY A LIVING INDIVIDUAL.
SEC. 2(F).

CLASS 35—ADVERTISING AND BUSINESS

FOR BOAT DEALERSHIPS, RETAIL STORE SERVICES IN THE FIELD OF MARINE EQUIPMENT AND BOATING ACCESSORIES (U.S. CLS. 100, 101 AND 102).
FIRST USE 1-0-1955; IN COMMERCE 1-0-1955.

SN 76-489,819. PEPPERL + FUCHS GMBH, MANNHEIM D-68307, FED REP GERMANY, FILED 1-28-2003.

FIELDCONNEX

PRIORITY CLAIMED UNDER SEC. 44(D) ON FED REP GERMANY APPLICATION NO. 30240948.3, FILED 8-15-2002, REG. NO. 30240948, DATED 2-7-2003, EXPIRES 8-31-2012.

CLASS 39—TRANSPORTATION AND STORAGE

FOR MARINE TRANSPORT SERVICES, NAMELY MARINE TRANSPORT BY BOAT; BOAT RENTAL; BOAT STORAGE; CHARTER BOAT CRUISES (U.S. CLS. 100 AND 105).

FIRST USE 1-0-1955; IN COMMERCE 1-0-1955.

CLASS 41—EDUCATION AND ENTERTAINMENT

FOR WATER SPORT EQUIPMENT RENTAL (U.S. CLS. 100, 101 AND 107).

FIRST USE 1-0-1995; IN COMMERCE 1-0-1995.

CLASS 43—HOTEL AND RESTAURANT SERVICES

FOR RESTAURANT AND BAR SERVICES (U.S. CLS. 100 AND 101).

FIRST USE 1-0-1955; IN COMMERCE 1-0-1955.
SONYA STEPHENS, EXAMINING ATTORNEY

SN 76-491,976. NETWORKS ASSOCIATES TECHNOLOGY, INC., SANTA CLARA, CA. FILED 2-24-2003.

MCAFEE SECURITY

OWNER OF U.S. REG. NOS. 1,818,780 AND 2,601,537.
NO CLAIM IS MADE TO THE EXCLUSIVE RIGHT TO USE "SECURITY", APART FROM THE MARK AS SHOWN. SEC. 2(F).

CLASS 9—ELECTRICAL AND SCIENTIFIC APPARATUS

FOR COMPUTER UTILITY SOFTWARE; COMPUTER SOFTWARE FOR THE DETECTION AND REMOVAL OF COMPUTER VIRUSES AND THREATS; COMPUTER SOFTWARE FOR MANAGING AND FILTERING ELECTRONIC COMMUNICATIONS; COMPUTER SOFTWARE FOR PROTECTING AND SECURING COMPUTER NETWORKS AND APPLICATIONS; COMPUTER SOFTWARE FOR ENCRYPTING AND AUTHENTICATING DATA; COMPUTER SOFTWARE FOR DETECTING AND REPAIRING COMPUTER SOFTWARE AND HARDWARE PROBLEMS; AND MANUALS THEREFORE PACKAGED AS A UNIT (U.S. CLS. 21, 23, 26, 36 AND 38).

FIRST USE 2-11-2002; IN COMMERCE 2-11-2002.

CLASS 42—SCIENTIFIC, COMPUTER AND LEGAL SERVICES

FOR COMPUTER CONSULTING SERVICES; TECHNICAL CONSULTING AND RESEARCH SERVICES FOR OTHERS IN THE FIELDS OF COMPUTER, DATA, AND NETWORK SECURITY; TECHNICAL SUPPORT SERVICES FOR OTHERS IN THE FIELDS OF COMPUTER, DATA, AND NETWORK SECURITY, NAMELY TROUBLESHOOTING OF COMPUTER HARDWARE AND SOFTWARE PROBLEMS, MONITORING OF NETWORK SYSTEMS; APPLICATION SERVICE PROVIDER FEATURING SOFTWARE FOR THE DETECTION AND REMOVAL OF COMPUTER VIRUSES AND THREATS, PROTECTING AND SECURING COMPUTER NETWORKS AND APPLICATIONS, ENCRYPTING AND AUTHENTICATING DATA, MANAGING AND FILTERING OF ELECTRONIC COMMUNICATIONS, AND DETECTING AND REPAIRING COMPUTER SOFTWARE AND HARDWARE PROBLEMS; PROVIDING INFORMATION IN THE FIELDS OF NETWORK, DATA, AND COMPUTER SECURITY (U.S. CLS. 100 AND 101).

FIRST USE 2-11-2002; IN COMMERCE 2-11-2002.
JOHN HWANG, EXAMINING ATTORNEY

SN 76-496,318. IMEDIA COMMUNICATIONS, INC., DANA POINT, CA. FILED 3-11-2003.

IMEDIA CONNECTION**CLASS 35—ADVERTISING AND BUSINESS**

FOR ARRANGING AND CONDUCTING TRADE SHOW EXHIBITIONS IN THE FIELD OF INTERACTIVE MEDIA AND MARKETING; PROVIDING TRADE INFORMATION IN THE FIELD OF INTERACTIVE MEDIA AND MARKETING; DISSEMINATION OF ADVERTISING MATTER FOR OTHERS (U.S. CLS. 100, 101 AND 102).

FIRST USE 10-1-2001; IN COMMERCE 10-1-2001.

CLASS 41—EDUCATION AND ENTERTAINMENT

FOR PUBLICATION OF TEXT AND GRAPHIC WORKS OF OTHERS FEATURING NEWS AND COMMENTARY IN THE FIELD OF INTERACTIVE MEDIA AND MARKETING; PROVIDING ONLINE NEWSLETTER FEATURING NEWS AND COMMENTARY IN THE FIELD OF INTERACTIVE MEDIA AND MARKETING; NEWS ANALYSIS AND FEATURES DISTRIBUTION (U.S. CLS. 100, 101 AND 107).

FIRST USE 10-1-2001; IN COMMERCE 10-1-2001.
ESTHER BELENKER, EXAMINING ATTORNEY

SN 76-496,725. INNOCO, L-1526, LUXEMBOURG, FILED 3-12-2003.



THE MARK CONSISTS OF THE WORD "ESSENCE" IN ALL LOWER CASE LETTERS WITH AN "E" IN A CIRCLE DESIGN ABOVE THE WORD "ESSENCE".

CLASS 3—COSMETICS AND CLEANING PREPARATIONS

FOR COSMETICS AND HAIR LOTIONS (U.S. CLS. 1, 4, 6, 50, 51 AND 52).

CLASS 21—HOUSEWARES AND GLASS

FOR COSMETIC BRUSHES FOR THE APPLICATION OF COSMETICS PRODUCTS AND POWDER PUFFS (U.S. CLS. 2, 13, 23, 29, 30, 33, 40 AND 50).

TRACY WHITAKER-BOWN, EXAMINING ATTORNEY

SN 76-497,365. PETROLEO BRASILEIRO S/A - PETROBRAS, RJ, BRAZIL, FILED 3-12-2003.



NO CLAIM IS MADE TO THE EXCLUSIVE RIGHT TO USE "CENTER", APART FROM THE MARK AS SHOWN.

CLASS 4—LUBRICANTS AND FUELS

FOR FUEL FOR MOTOR VEHICLES, NAMELY GASOLINE AND DIESEL FUEL; LUBRICANTS IN THE AUTOMOTIVE FIELD (U.S. CLS. 1, 6 AND 15).

CLASS 35—ADVERTISING AND BUSINESS

FOR TWENTY-FOUR HOUR RETAIL CONVENIENCE STORES IN GAS STATIONS (U.S. CLS. 100, 101 AND 102).

CLASS 37—CONSTRUCTION AND REPAIR

FOR REPAIR, MAINTENANCE AND CLEANING SERVICES RELATING TO VEHICLES, ENGINES AND THEIR PARTS (U.S. CLS. 100, 103 AND 106).
TONI HICKEY, EXAMINING ATTORNEY

SN 76-497,647. ZAHOUREK SYSTEMS, INCORPORATED, LOVELAND, CO. FILED 3-17-2003.

MYOLOGIK**CLASS 9—ELECTRICAL AND SCIENTIFIC APPARATUS**

FOR EDUCATIONAL AND INSTRUCTIONAL VIDEOS, COMPUTER SOFTWARE, AND DOWNLOADABLE INTERNET-BASED SOFTWARE FEATURING INSTRUCTION IN THE FIELDS OF ZOOLOGY, BIOLOGY, ANATOMY, PHYSIOLOGY, KINESIOLOGY, PHYSICS, AND PSYCHOLOGY (U.S. CLS. 21, 23, 26, 36 AND 38).

CLASS 16—PAPER GOODS AND PRINTED MATTER

FOR PUBLICATIONS AND PRINTED MATERIALS, NAMELY, BOOKS, MANUALS, WORK BOOKS, FLASH CARDS, NEWSLETTERS, PAMPHLETS, BROCHURES, INFORMATION SHEETS, TESTS, AND ARTWORK IN THE FIELDS OF ZOOLOGY, BIOLOGY, ANATOMY, PHYSIOLOGY, KINESIOLOGY, PHYSICS, AND PSYCHOLOGY (U.S. CLS. 2, 5, 22, 23, 29, 37, 38 AND 50).
FIRST USE 12-31-1981; IN COMMERCE 12-31-1981.

SN 76-497,536. JUDICIAL AND ADMINISTRATIVE RESEARCH ASSOCIATES, INC., TALLAHASSEE, FL. FILED 3-17-2003.

CLASS 41—EDUCATION AND ENTERTAINMENT

FOR EDUCATION AND INSTRUCTIONAL SERVICES, NAMELY, COURSES, SEMINARS, WORKSHOPS, TRAININGS, CLASSES, LECTURES, PRESENTATIONS, AND DEMONSTRATIONS IN THE FIELDS OF ZOOLOGY, BIOLOGY, ANATOMY, PHYSIOLOGY, KINESIOLOGY, PHYSICS, AND PSYCHOLOGY (U.S. CLS. 100, 101 AND 107).

FLORIDA LAW WEEKLY

NO CLAIM IS MADE TO THE EXCLUSIVE RIGHT TO USE "WEEKLY", APART FROM THE MARK AS SHOWN. SEC. 2(F).

CLASS 42—SCIENTIFIC, COMPUTER AND LEGAL SERVICES

FOR PROVIDING NON-DOWNLOADABLE INTERNET-BASED SOFTWARE FEATURING INSTRUCTION IN THE FIELDS OF ZOOLOGY, BIOLOGY, ANATOMY, PHYSIOLOGY, KINESIOLOGY, PHYSICS, AND PSYCHOLOGY (U.S. CLS. 100 AND 101).
SHAUNIA WALLACE, EXAMINING ATTORNEY

CLASS 16—PAPER GOODS AND PRINTED MATTER

FOR PRINTED WEEKLY, MONTHLY, QUARTERLY AND ANNUAL PUBLICATIONS, NAMELY BOUND BOOKLETS, INSERTS AND BOOKS IN THE FIELD OF LAW (U.S. CLS. 2, 5, 22, 23, 29, 37, 38 AND 50).
FIRST USE 1-1-1976; IN COMMERCE 1-1-1976.

SN 76-497,868. MAGNA INTERNATIONAL INC., AURORA, ONTARIO L4G 7K1, CANADA, FILED 3-17-2003.

CLASS 41—EDUCATION AND ENTERTAINMENT

FOR PROVIDING ON-LINE BOOKLETS REPORTING CONTENT OF WEEKLY AND MONTHLY PUBLICATIONS IN THE FIELD OF LAW (U.S. CLS. 100, 101 AND 107).
FIRST USE 7-1-1995; IN COMMERCE 7-1-1995.

MAGNA DONNELLY

PRIORITY CLAIMED UNDER SEC. 44(D) ON CANADA APPLICATION NO. 1,152,998, FILED 9-17-2002.
OWNER OF U.S. REG. NOS. 1,308,611, 2,619,587 AND OTHERS.

CLASS 42—SCIENTIFIC, COMPUTER AND LEGAL SERVICES

FOR PROVIDING DATABASES FEATURING COURT OPINIONS, SUMMARIES OF COURT OPINIONS, AND SUBJECT MATTER INDEXES IN THE FIELD OF LAW (U.S. CLS. 100 AND 101).
FIRST USE 7-1-1995; IN COMMERCE 7-1-1995.
MARC LEIPZIG, EXAMINING ATTORNEY

CLASS 9—ELECTRICAL AND SCIENTIFIC APPARATUS

FOR OPTICAL APPARATUS, NAMELY, PRISMS, OPTICAL MIRRORS AND CASES THEREFORE, OPTICAL MIRROR MOUNTING ARMS, ELECTRIC ACTUATORS FOR OPTICAL MIRRORS; AND VIDEO TOUCH SCREENS (U.S. CLS. 21, 23, 26, 36 AND 38).

CLASS 12—VEHICLES

FOR VEHICULAR PARTS AND ACCESSORIES, NAMELY INTERNAL AND EXTERNAL MIRRORS AND PRISMS ESPECIALLY ADAPTED FOR USE IN INTERNAL AND EXTERNAL MIRRORS FOR AUTOMOBILES, TRUCKS, AND OTHER VEHICLES; INTERNAL AND EXTERNAL MIRROR CASES, INTERNAL AND EXTERNAL MIRROR MOUNTING ARMS; DECORATIVE VEHICLE WINDOWS FOR USE IN AUTOMOBILE AND OTHER VEHICULAR ROOFS; OPTICALLY COATED VEHICLE WINDOWS, NAMELY, WINDOWS HAVING REFLECTIVE COATINGS THEREON USED AS SUN ROOFS IN VEHICLES; COATED VEHICLE WINDOWS, NAMELY, WINDOWS HAVING ELECTRICALLY CONDUCTIVE COATINGS THEREON; AND ARM RESTS, DOOR LATCHES, AND TRUNK RELEASES, ALL FOR INCORPORATION WITH AUTOMOBILES, TRUCKS, MINI-VANS, AND SPORT UTILITY VEHICLES AS ORIGINALS OR REPLACEMENTS (U.S. CLS. 19, 21, 23, 31, 35 AND 44).

SCOTT BALDWIN, EXAMINING ATTORNEY

SN 76-498,340. THE UNIVERSITY CLUB OF WASHINGTON D.C., WASHINGTON, DC. FILED 3-18-2003.

THE UNIVERSITY CLUB OF WASHINGTON D.C.

NO CLAIM IS MADE TO THE EXCLUSIVE RIGHT TO USE CLUB OF WASHINGTON, D.C., APART FROM THE MARK AS SHOWN.

CLASS 41—EDUCATION AND ENTERTAINMENT

FOR HEALTH CLUB SERVICES, NAMELY, PROVIDING INSTRUCTION AND EQUIPMENT IN THE FIELD OF PHYSICAL EXERCISES (U.S. CLS. 100, 101 AND 107). FIRST USE 12-31-1904; IN COMMERCE 12-31-1904.

CLASS 45—PERSONAL SERVICES

FOR ENTERTAINMENT SERVICES, NAMELY, A PRIVATE SOCIAL CLUB (U.S. CLS. 100 AND 101). FIRST USE 12-31-1904; IN COMMERCE 12-31-1904. ODESSA BIBBINS, EXAMINING ATTORNEY

SN 76-498,214. ECNORROT, L.L.C., ASHBURN, VA. FILED 3-17-2003.

EMPOWERING YOUNG MINDS TO EXHIBIT INSPIRED PURPOSE

CLASS 35—ADVERTISING AND BUSINESS

FOR BUSINESS NETWORKING (U.S. CLS. 100, 101 AND 102).

CLASS 41—EDUCATION AND ENTERTAINMENT

FOR EDUCATIONAL SERVICES, NAMELY PROVIDING LECTURES, SEMINARS, CLASSES, AND WORKSHOPS IN THE FIELD OF BUILDING BUSINESSES AND BUSINESS MANAGEMENT FOR ENTREPRENEURS (U.S. CLS. 100, 101 AND 107).

LINDA POWELL, EXAMINING ATTORNEY

SN 76-498,217. ECNORROT, L.L.C., ASHBURN, VA. FILED 3-17-2003.

ECNORROT INNOVATION FOUNDATION

OWNER OF U.S. REG. NO. 2,446,460. NO CLAIM IS MADE TO THE EXCLUSIVE RIGHT TO USE "FOUNDATION", APART FROM THE MARK AS SHOWN.

CLASS 35—ADVERTISING AND BUSINESS

FOR BUSINESS NETWORKING (U.S. CLS. 100, 101 AND 102).

CLASS 41—EDUCATION AND ENTERTAINMENT

FOR EDUCATIONAL SERVICES, NAMELY PROVIDING LECTURES, SEMINARS, CLASSES, AND WORKSHOPS IN THE FIELD OF BUILDING BUSINESSES AND BUSINESS MANAGEMENT FOR ENTREPRENEURS (U.S. CLS. 100, 101 AND 107).

LINDA POWELL, EXAMINING ATTORNEY

SN 76-499,308. CONTRACT MANAGEMENT SOLUTIONS, INC., WINTER PARK, FL. FILED 3-13-2003.

CMSI

CLASS 9—ELECTRICAL AND SCIENTIFIC APPARATUS

FOR COMPUTER SOFTWARE FOR USE IN DATABASE MANAGEMENT (U.S. CLS. 21, 23, 26, 36 AND 38).

CLASS 42—SCIENTIFIC, COMPUTER AND LEGAL SERVICES

FOR ALLOWING SUBSCRIBERS TO ACCESS AND USE PROPRIETY NON-DOWNLOADABLE SOFTWARE FOR USE IN DATABASE MANAGEMENT (U.S. CLS. 100 AND 101).

FIRST USE 4-16-2002; IN COMMERCE 4-16-2002. AISHA CLARKE, EXAMINING ATTORNEY

SN 76-499,585. TRILEGIANT CORPORATION, NORWALK, CT. FILED 3-21-2003.

SN 76-500,811. GOTEE RECORDS, INC., FRANKLIN, TN. FILED 2-28-2003.

EVERYDAYVALUESO NLINE.COM

CLASS 35—ADVERTISING AND BUSINESS

FOR ADMINISTRATION OF A DISCOUNT CONSUMER MEMBERSHIP PROGRAM FOR ENABLING PARTICIPANTS TO OBTAIN DISCOUNTS, SAVINGS AND REBATES ON CONSUMER MERCHANDISE, FOOD AND DINING, TRAVEL AND LODGING GIFTS, HEALTHCARE SERVICES AND PRODUCTS, FITNESS AND EXERCISE PRODUCTS AND SERVICES, PERSONAL FINANCE PRODUCTS AND SERVICES, MAGAZINES AND NEWSPAPERS, HOME IMPROVEMENT PRODUCTS AND SERVICES, GASOLINE AND OTHER AUTOMOTIVE PRODUCTS AND SERVICES, AND MOVIES, RECREATION AND OTHER LEISURE AND ENTERTAINMENT ACTIVITIES THROUGH USE OF A DISCOUNT MEMBERSHIP CARD, PROVIDING ON-LINE CONSUMER PRODUCT GUIDES, REVIEWS AND COMPARISONS; PROVIDING CONSUMER HOTLINE SERVICES FOR PRODUCT QUESTIONS AND COMPARISONS (U.S. CLS. 100, 101 AND 102).

CLASS 36—INSURANCE AND FINANCIAL

FOR PROVIDING MEMBERS WITH INFORMATION ABOUT, ACCESS TO AND SAVINGS ON CREDIT REPORTS AND OTHER FINANCIAL INFORMATION ON THEMSELVES AND THEIR FAMILIES (U.S. CLS. 100, 101 AND 102).

CLASS 37—CONSTRUCTION AND REPAIR

FOR PROVIDING AUTOMOTIVE MECHANIC INFORMATION BY TELEPHONE (U.S. CLS. 100, 103 AND 106).
WILLIAM BRECKENFELD, EXAMINING ATTORNEY

SN 76-500,284. GLOBAL INFORMATION LICENSING CORPORATION, CLAYMONT, DE. FILED 3-25-2003.

ADVANCED INITIATIVE FOR RESPIRATORY EDUCATION

CLASS 16—PAPER GOODS AND PRINTED MATTER

FOR PRINT PUBLICATIONS, NAMELY, PROGRAMS, AND PRESENTATION HANDOUTS FOR USE BY MEDICAL PROFESSION REGARDING TREATMENT ADVANCES FOR RESPIRATORY DISEASES (U.S. CLS. 2, 5, 22, 23, 29, 37, 38 AND 50).

CLASS 41—EDUCATION AND ENTERTAINMENT

FOR EDUCATIONAL SERVICES, NAMELY, CONDUCTING PROGRAMS IN THE FIELD OF MEDICAL ADVANCES IN THE TREATMENT OF RESPIRATORY DISEASES (U.S. CLS. 100, 101 AND 107).
SHARI SHEFFIELD, EXAMINING ATTORNEY



CLASS 9—ELECTRICAL AND SCIENTIFIC APPARATUS

FOR PRE-RECORDED MUSICAL SOUND RECORDINGS (U.S. CLS. 21, 23, 26, 36 AND 38).

CLASS 35—ADVERTISING AND BUSINESS

FOR DISTRIBUTORSHIP SERVICES IN THE FIELD OF PRE-RECORDED MUSICAL SOUND RECORDINGS; PROMOTING THE PRE-RECORDED MUSICAL SOUND RECORDINGS OF OTHERS THROUGH ON-LINE ORDERING AND CATALOGING OF THOSE GOODS, DISTRIBUTION OF PRINTED ADVERTISEMENTS, AND THROUGH THE PRODUCTION AND DISTRIBUTION OF RADIO AND TELEVISION COMMERCIALS (U.S. CLS. 100, 101 AND 102).

AMOS T. MATTHEWS, JR., EXAMINING ATTORNEY

SN 76-501,350. SOLUTE, SAN DIEGO, CA. FILED 3-21-2003.

SOLUTE

CLASS 41—EDUCATION AND ENTERTAINMENT

FOR TRAINING SERVICES IN THE FIELD OF NETWORK CENTRIC WARFARE, USING COLLABORATIVE SOFTWARE APPLICATIONS, KNOWLEDGE MANAGEMENT, AND AVIATION SYSTEMS DESIGN AND INTEGRATION, TO HELP THE WAR FIGHTER TO MAKE TIMELY AND ACCURATE OPERATIONAL DECISIONS (U.S. CLS. 100, 101 AND 107).

FIRST USE 6-0-2002; IN COMMERCE 6-0-2002.

CLASS 42—SCIENTIFIC, COMPUTER AND LEGAL SERVICES

FOR CONSULTATION AND TECHNICAL CONSULTATION IN THE FIELD OF NETWORK CENTRIC WARFARE, NAMELY, THE USE OF COLLABORATIVE SOFTWARE APPLICATIONS, KNOWLEDGE MANAGEMENT, AND AVIATION SYSTEMS DESIGN AND INTEGRATION, TO HELP THE WAR FIGHTER TO MAKE TIMELY AND ACCURATE OPERATIONAL DECISIONS (U.S. CLS. 100 AND 101).

FIRST USE 6-0-2002; IN COMMERCE 6-0-2002.
LINDA M. KING, EXAMINING ATTORNEY

SN 76-501,605. ANSHARA, SHERRY, SCOTTSDALE, AZ.
FILED 3-28-2003.

QUANTUMPATHIC

CLASS 41—EDUCATION AND ENTERTAINMENT

FOR EDUCATIONAL SERVICES, NAMELY, CONDUCTING CLASSES, SEMINARS, CONFERENCES AND WORKSHOPS IN THE FIELDS OF QUANTUM ENERGY, VIBRATIONAL ENERGY, ENERGY FREQUENCY, INTUITION AND CONSCIOUSNESS (U.S. CLS. 100, 101 AND 107).

FIRST USE 3-23-2003; IN COMMERCE 3-23-2003.

CLASS 44—MEDICAL, BEAUTY AND AGRICULTURAL SERVICES

FOR PSYCHOLOGICAL AND MEDICAL COUNSELING IN THE FIELDS OF QUANTUM ENERGY, VIBRATIONAL ENERGY, ENERGY FREQUENCY, INTUITION AND CONSCIOUSNESS (U.S. CLS. 100 AND 101).

FIRST USE 3-23-2003; IN COMMERCE 3-23-2003.
SONYA STEPHENS, EXAMINING ATTORNEY

SN 76-501,838. ISLAND CO., LTD., GOTENBA-SHI, SHIZUOKA 412-0025, JAPAN, FILED 3-27-2003.

GRACE CONTINENTAL

CLASS 14—JEWELRY

FOR ORNAMENTS OF PRECIOUS METAL, JEWELRY, RINGS, CUFF-LINKS, CIGARETTE CASES AND COMPACTS MADE OF PRECIOUS METAL (U.S. CLS. 2, 27, 28 AND 50).

CLASS 16—PAPER GOODS AND PRINTED MATTER

FOR STATIONERY (U.S. CLS. 2, 5, 22, 23, 29, 37, 38 AND 50).

CLASS 18—LEATHER GOODS

FOR HANDBAGS, TRUNKS, LUGGAGE, SUITCASES, BACKPACKS, BUSINESS CARD AND CREDIT CARD CASES, UMBRELLAS AND PURSES (U.S. CLS. 1, 2, 3, 22 AND 41).

CLASS 20—FURNITURE AND ARTICLES NOT OTHERWISE CLASSIFIED

FOR MIRRORS (U.S. CLS. 2, 13, 22, 25, 32 AND 50).

CLASS 24—FABRICS

FOR HANDKERCHIEFS AND TEXTILE FABRICS FOR THE MANUFACTURE OF CLOTHING (U.S. CLS. 42 AND 50).

CLASS 25—CLOTHING

FOR CLOTHING, NAMELY, DRESSES, BLOUSES, SHIRTS, SUITS, JACKETS, TROUSERS, JOGGING PANTS, SWEAT PANTS, SCHOOL UNIFORMS, INFANT WEAR; WORK ATTIRE, NAMELY, OVERALLS AND DUNGAREES; SMOCKS; FORMAL ATTIRE, NAMELY, ROBES, FROCKS AND TUXEDOS; COATS, SWEATERS, SLEEP WEAR, UNDERWEAR, SWIMWEAR, APRONS, STOLE, WRAPS, SHAWLS, NECKTIES, MUFFLERS, SCARFS, SOCKS, GLOVES, HEADWEAR, BELTS, SHOES, SKI WEAR AND SKIRTS (U.S. CLS. 22 AND 39).
ROBERT LORENZO, EXAMINING ATTORNEY

SN 76-501,839. ISLAND CO., LTD., GOTENBA-SHI, SHIZUOKA 412-0025, JAPAN, FILED 3-27-2003.



CLASS 14—JEWELRY

FOR ORNAMENTS OF PRECIOUS METAL, JEWELRY, RINGS, CUFF-LINKS, CIGARETTE CASES AND COMPACTS MADE OF PRECIOUS METAL (U.S. CLS. 2, 27, 28 AND 50).

CLASS 16—PAPER GOODS AND PRINTED MATTER

FOR STATIONERY (U.S. CLS. 2, 5, 22, 23, 29, 37, 38 AND 50).

CLASS 18—LEATHER GOODS

FOR HANDBAGS, TRUNKS, LUGGAGE, SUITCASES, BACKPACKS, BUSINESS CARD AND CREDIT CARD CASES, UMBRELLAS AND PURSES (U.S. CLS. 1, 2, 3, 22 AND 41).

CLASS 20—FURNITURE AND ARTICLES NOT OTHERWISE CLASSIFIED

FOR MIRRORS (U.S. CLS. 2, 13, 22, 25, 32 AND 50).

CLASS 24—FABRICS

FOR HANDKERCHIEFS AND TEXTILE FABRICS FOR THE MANUFACTURE OF CLOTHING (U.S. CLS. 42 AND 50).

CLASS 25—CLOTHING

FOR CLOTHING, NAMELY, DRESSES, BLOUSES, SHIRTS, SUITS, JACKETS, TROUSERS, JOGGING PANTS, SWEAT PANTS, SCHOOL UNIFORMS, INFANT WEAR; WORK ATTIRE, NAMELY, OVERALLS AND DUNGAREES; SMOCKS; FORMAL ATTIRE, NAMELY, ROBES, FROCKS AND TUXEDOS; COATS, SWEATERS, SLEEP WEAR, UNDERWEAR, SWIMWEAR, APRONS, STOLE, WRAPS, SHAWLS, NECKTIES, MUFFLERS, SCARFS, SOCKS, GLOVES, HEADWEAR, BELTS, SHOES, SKI WEAR AND SKIRTS (U.S. CLS. 22 AND 39).
ROBERT LORENZO, EXAMINING ATTORNEY

SN 76-503,499. MARS, INCORPORATED, MCLEAN, VA.
FILED 4-2-2003.



THE MARK CONSISTS OF A HEART ENCIRCLED BY THE WORDS PROMOTES A HEALTHY HEART.

CLASS 5—PHARMACEUTICALS

FOR DIETARY DRINK MIX FOR USE AS A MEAL REPLACEMENT, DIETARY SUPPLEMENTAL DRINKS, MEAL REPLACEMENT BARS, MEAL REPLACEMENT NUTRITION BARS, MEAL REPLACEMENT DRINKS, MEAL REPLACEMENT POWDERS, NUTRITIONAL DRINK MIX FOR USE AS A MEAL REPLACEMENT, NUTRITIONAL ENERGY BARS, NUTRITIONALLY FORTIFIED BEVERAGES, READY-TO-EAT ENERGY BARS FOR MEAL REPLACEMENT (U.S. CLS. 6, 18, 44, 46, 51 AND 52).

CLASS 31—NATURAL AGRICULTURAL PRODUCTS

FOR UNPROCESSED CEREALS, UNPROCESSED GRAINS, UNPROCESSED NUTS (U.S. CLS. 1 AND 46).

CLASS 32—LIGHT BEVERAGES

FOR FRUIT DRINKS, ISOTONIC DRINKS, SMOOTHIES, SPORTS DRINKS (U.S. CLS. 45, 46 AND 48).

SUELLEN HICKEY, EXAMINING ATTORNEY

SN 76-503,551. FOX CONVERTING, INC., GREEN BAY, WI.
FILED 4-2-2003.



NO CLAIM IS MADE TO THE EXCLUSIVE RIGHT TO USE "CONVERTING", APART FROM THE MARK AS SHOWN.

CLASS 10—MEDICAL APPARATUS

FOR PACKAGING, NAMELY, PAPER BAGS FOR PROTECTING MEDICAL INSTRUMENTS; INFECTION CONTROL STERILIZER BAGS FOR STERILIZING MEDICAL INSTRUMENTS; MEDICAL WRAPS IN THE NATURE OF WRAPPING LARGE MEDICAL INSTRUMENTS FOR STERILIZATION; X-RAY ENVELOPES; PAPER SANITARY DISPOSAL BAGS FOR MEDICAL WASTE WITH SELF-ADHESIVE TABS FOR CLOSING, ALL AFOREMENTIONED GOODS FOR MEDICAL, MEDICAL CLINIC, DENTAL, MEDICAL LABORATORY, AND PHARMACEUTICAL USE (U.S. CLS. 26, 39 AND 44).

FIRST USE 5-8-2001; IN COMMERCE 5-8-2001.

CLASS 40—MATERIAL TREATMENT

FOR MANUFACTURE OF FOIL AND PAPER BAGS TO THE ORDER AND/OR SPECIFICATION OF OTHERS; MANUFACTURE OF INFECTION CONTROL STERILIZER BAGS AND MEDICAL WRAPS IN THE NATURE OF WRAPPING LARGE MEDICAL INSTRUMENTS FOR STERILIZATION TO THE ORDER AND/OR SPECIFICATION OF OTHERS; MANUFACTURE OF PAPER SANITARY DISPOSAL BAGS FOR MEDICAL WASTE WITH SELF-ADHESIVE TABS FOR CLOSING TO THE ORDER AND/OR SPECIFICATION OF OTHERS; MANUFACTURE OF X-RAY ENVELOPES TO THE ORDER AND/OR SPECIFICATION OF OTHERS; MANUFACTURE OF PACKAGING, CUSTOM PRINTED PAPER, FOIL BAGS AND FOIL SHEETS TO THE ORDER AND/OR SPECIFICATION OF OTHERS BY MEANS OF CONVERTING PAPER, FILM, FOIL, LINERBOARD, TISSUE PAPER, AND NON-WOVEN PAPER BASED MATERIAL; COATING AND LAMINATING OF PAPER, FILM, FOIL, LINERBOARD, TISSUE PAPER, AND NON-WOVEN PAPER FOR OTHERS; SLITTING AND REWINDING OF PAPER, FILM, FOIL, LINERBOARD, TISSUE PAPER, AND NON-WOVEN PAPER FOR OTHERS; FLEXOGRAPHIC ROLL TO ROLL PRINTING FOR OTHERS (U.S. CLS. 100, 103 AND 106).

FIRST USE 1-1-2002; IN COMMERCE 1-1-2002.

BRENDAN MCCAULEY, EXAMINING ATTORNEY

SN 76-503,552. FOX CONVERTING, INC., GREEN BAY, WI.
FILED 4-2-2003.

FOX CONVERTING

NO CLAIM IS MADE TO THE EXCLUSIVE RIGHT TO USE "CONVERTING", APART FROM THE MARK AS SHOWN.

CLASS 5—PHARMACEUTICALS

FOR STERILIZABLE MEDICAL SWABS (U.S. CLS. 6, 18, 44, 46, 51 AND 52).

FIRST USE 12-31-1981; IN COMMERCE 12-31-1981.

CLASS 10—MEDICAL APPARATUS

FOR PACKAGING, NAMELY, PAPER BAGS FOR PROTECTING MEDICAL INSTRUMENTS; INFECTION CONTROL STERILIZER BAGS FOR STERILIZING MEDICAL INSTRUMENTS; MEDICAL WRAPS IN THE NATURE OF WRAPPING LARGE MEDICAL INSTRUMENTS FOR STERILIZATION; X-RAY ENVELOPES; PAPER SANITARY DISPOSAL BAGS FOR MEDICAL WASTE WITH SELF-ADHESIVE TABS FOR CLOSING, ALL AFOREMENTIONED GOODS FOR MEDICAL, MEDICAL CLINIC, DENTAL, MEDICAL LABORATORY, AND PHARMACEUTICAL USE (U.S. CLS. 26, 39 AND 44).

FIRST USE 11-29-1963; IN COMMERCE 11-29-1963.

CLASS 40—MATERIAL TREATMENT

FOR MANUFACTURE OF FOIL AND PAPER BAGS TO THE ORDER AND/OR SPECIFICATION OF OTHERS; MANUFACTURE OF INFECTION CONTROL STERILIZER BAGS AND MEDICAL WRAPS IN THE NATURE OF WRAPPING LARGE MEDICAL INSTRUMENTS FOR STERILIZATION TO THE ORDER AND/OR SPECIFICATION OF OTHERS; MANUFACTURE OF PAPER SANITARY DISPOSAL BAGS FOR MEDICAL WASTE WITH SELF-ADHESIVE TABS FOR CLOSING TO THE ORDER AND/OR SPECIFICATION OF OTHERS; MANUFACTURE OF X-RAY ENVELOPES TO THE ORDER AND/OR SPECIFICATION OF OTHERS; MANUFACTURE OF PACKAGING, CUSTOM PRINTED PAPER, FOIL BAGS AND FOIL SHEETS TO THE ORDER AND/OR SPECIFICATION OF OTHERS BY MEANS OF CONVERTING PAPER, FILM, FOIL, LINERBOARD, TISSUE PAPER, AND NON-WOVEN PAPER BASED MATERIAL; COATING AND LAMINATING OF PAPER, FILM, FOIL, LINERBOARD, TISSUE PAPER, AND NON-WOVEN PAPER FOR OTHERS; SLITTING AND REWINDING OF PAPER, FILM, FOIL, LINERBOARD, TISSUE PAPER, AND NON-WOVEN PAPER FOR OTHERS; FLEXOGRAPHIC ROLL TO ROLL PRINTING FOR OTHERS (U.S. CLS. 100, 103 AND 106).

FIRST USE 11-29-1963; IN COMMERCE 11-29-1963.
BRENDAN MCCAULEY, EXAMINING ATTORNEY

CLASS 40—MATERIAL TREATMENT

FOR MANUFACTURE OF FOIL AND PAPER BAGS TO THE ORDER AND/OR SPECIFICATION OF OTHERS; MANUFACTURE OF INFECTION CONTROL STERILIZER BAGS AND MEDICAL WRAPS IN THE NATURE OF WRAPPING LARGE MEDICAL INSTRUMENTS FOR STERILIZATION TO THE ORDER AND/OR SPECIFICATION OF OTHERS; MANUFACTURE OF PAPER SANITARY DISPOSAL BAGS FOR MEDICAL WASTE WITH SELF-ADHESIVE TABS FOR CLOSING TO THE ORDER AND/OR SPECIFICATION OF OTHERS; MANUFACTURE OF X-RAY ENVELOPES TO THE ORDER AND/OR SPECIFICATION OF OTHERS; MANUFACTURE OF PACKAGING, CUSTOM PRINTED PAPER, FOIL BAGS AND FOIL SHEETS TO THE ORDER AND/OR SPECIFICATION OF OTHERS BY MEANS OF CONVERTING PAPER, FILM, FOIL, LINERBOARD, TISSUE PAPER, AND NON-WOVEN PAPER BASED MATERIAL; COATING AND LAMINATING OF PAPER, FILM, FOIL, LINERBOARD, TISSUE PAPER, AND NON-WOVEN PAPER FOR OTHERS; SLITTING AND REWINDING OF PAPER, FILM, FOIL, LINERBOARD, TISSUE PAPER, AND NON-WOVEN PAPER FOR OTHERS; FLEXOGRAPHIC ROLL TO ROLL PRINTING FOR OTHERS (U.S. CLS. 100, 103 AND 106).

FIRST USE 8-1-2000; IN COMMERCE 8-1-2000.
BRENDAN MCCAULEY, EXAMINING ATTORNEY

SN 76-503,553, FOX CONVERTING, INC., GREEN BAY, WI.
FILED 4-2-2003.

SN 76-503,770, INTERNATIONAL ASSOCIATION OF DRILLING CONTRACTORS, HOUSTON, TX. FILED 4-3-2003.



INTERNATIONAL ASSOCIATION OF DRILLING CONTRACTORS

OWNER OF U.S. REG. NOS. 1,231,874 AND 1,744,490.
SEC. 2(F).

CLASS 5—PHARMACEUTICALS

FOR STERILIZABLE MEDICAL SWABS (U.S. CLS. 6, 18, 44, 46, 51 AND 52).

FIRST USE 8-1-2000; IN COMMERCE 8-1-2000.

CLASS 10—MEDICAL APPARATUS

FOR PACKAGING, NAMELY, PAPER BAGS FOR PROTECTING MEDICAL INSTRUMENTS; INFECTION CONTROL STERILIZER BAGS FOR STERILIZING MEDICAL INSTRUMENTS; MEDICAL WRAPS IN THE NATURE OF WRAPPING LARGE MEDICAL INSTRUMENTS FOR STERILIZATION; X-RAY ENVELOPES; PAPER SANITARY DISPOSAL BAGS FOR MEDICAL WASTE WITH SELF-ADHESIVE TABS FOR CLOSING, ALL AFOREMENTIONED GOODS FOR MEDICAL, MEDICAL CLINIC, DENTAL, MEDICAL LABORATORY, AND PHARMACEUTICAL USE (U.S. CLS. 26, 39 AND 44).

FIRST USE 8-1-2000; IN COMMERCE 8-1-2000.

CLASS 16—PAPER GOODS AND PRINTED MATTER

FOR PUBLICATIONS, NAMELY, MANUALS, NEWSLETTERS, BOOKS, MAGAZINES, HANDBOOKS IN THE FIELD OF DRILLING (U.S. CLS. 2, 5, 22, 23, 29, 37, 38 AND 50).

FIRST USE 1-3-1972; IN COMMERCE 1-3-1972.

CLASS 35—ADVERTISING AND BUSINESS

FOR ASSOCIATION SERVICES, NAMELY, PROMOTING THE INTERESTS OF DRILLING PROFESSIONALS AND PRODUCER, AND ARRANGING AND CONDUCTING CONFERENCES IN THE FIELD OF THE DRILLING (U.S. CLS. 100, 101 AND 102).

FIRST USE 1-3-1972; IN COMMERCE 1-3-1972.

CLASS 41—EDUCATION AND ENTERTAINMENT

FOR EDUCATIONAL SERVICES, NAMELY, CONFERENCES, TRAINING SEMINARS, AND ACCREDITATION PROGRAM IN THE FIELD OF DRILLING (U.S. CLS. 100, 101 AND 107).

FIRST USE 1-3-1972; IN COMMERCE 1-3-1972.
ALLISON HOLTZ, EXAMINING ATTORNEY

SN 76-503,771. INTERNATIONAL ASSOCIATION OF DRILLING CONTRACTORS, HOUSTON, TX. FILED 4-3-2003.

SN 76-504,299. ANDERSON, MICHAEL R., ORLANDO, FL. FILED 4-7-2003.



OWNER OF U.S. REG. NOS. 1,231,874 AND 1,744,490. SEC. 2(F) AS TO "INTERNATIONAL ASSOCIATION OF DRILLING CONTRACTORS".

CLASS 35—ADVERTISING AND BUSINESS

FOR ASSOCIATION SERVICES, NAMELY, PROMOTING THE INTERESTS OF DRILLING PROFESSIONALS AND PRODUCERS, AND ARRANGING AND CONDUCTING BUSINESS CONFERENCES IN THE FIELD OF DRILLING (U.S. CLS. 100, 101 AND 102).
FIRST USE 1-3-1972; IN COMMERCE 1-3-1972.

CLASS 41—EDUCATION AND ENTERTAINMENT

FOR EDUCATIONAL SERVICES, NAMELY, CONFERENCES, TRAINING SEMINARS, AND ACCREDITATION PROGRAM IN THE FIELD OF DRILLING (U.S. CLS. 100, 101 AND 107).
FIRST USE 1-3-1972; IN COMMERCE 1-3-1972.
ALLISON HOLTZ, EXAMINING ATTORNEY

SN 76-503,783. CESAR, CLAUDIO, HILLSBOROUGH, CA. FILED 4-3-2003.

CHROMATRANSFUSION

OWNER OF U.S. REG. NO. 1,693,006.

CLASS 19—NON-METALLIC BUILDING MATERIALS

FOR ARCHITECTURAL GLASS PANELS FOR WINDOWS AND WALLS DESIGNED TO EMIT ANY COLOR (U.S. CLS. 1, 12, 33 AND 50).
FIRST USE 2-28-2001; IN COMMERCE 2-28-2001.

CLASS 21—HOUSEWARES AND GLASS

FOR ARCHITECTURAL GLASS PANELS FOR WINDOWS AND WALLS USED FOR LIGHTING AND SIGNAGE (U.S. CLS. 2, 13, 23, 29, 30, 33, 40 AND 50).
FIRST USE 2-28-2001; IN COMMERCE 2-28-2001.
MARLENE BELL, EXAMINING ATTORNEY

BOOTY BEACH

NO CLAIM IS MADE TO THE EXCLUSIVE RIGHT TO USE "BEACH", APART FROM THE MARK AS SHOWN.

CLASS 3—COSMETICS AND CLEANING PREPARATIONS

FOR SUN TAN, SUN BLOCK, SUN CARE, AND SUN SCREEN PRODUCTS, NAMELY OILS, LOTIONS, CREAMS, AND GELS (U.S. CLS. 1, 4, 6, 50, 51 AND 52).

CLASS 25—CLOTHING

FOR CLOTHING, NAMELY, BEACH WEAR, BEACH SHOES, BIKINIS, SWIMWEAR, HATS, AND HEADWEAR (U.S. CLS. 22 AND 39).
PAULA MAYS, EXAMINING ATTORNEY

SN 76-504,663. DEUTSCHE POST AG, 53113 BONN, FED REP GERMANY, FILED 4-7-2003.

GLOBAL MAIL IT

OWNER OF U.S. REG. NOS. 1,528,573 AND 2,094,445.

CLASS 35—ADVERTISING AND BUSINESS

FOR DIRECT MARKETING SERVICES, NAMELY, CUSTOMS CLEARANCE SERVICES, INVOICING SERVICES, CONSULTATION SERVICES IN THE FIELD OF DIRECT MARKETING, AFTER-SALES SUPPORT SERVICES, RETURN MANAGEMENT SERVICES, ACCOUNTS RECEIVABLE PROCESSING, ORDER MANAGEMENT, ADDRESS MAINTENANCE, LIST MANAGEMENT, MARKET ENTRY CONSULTATION SERVICES; DISSEMINATING ADVERTISING FOR OTHERS; PROMOTING THE GOODS AND SERVICES OF OTHERS BY ARRANGING FOR SPONSORS; BUSINESS MARKETING PLANNING IN THE FIELDS OF PRESS LIAISON, PUBLIC RELATIONS EVENTS, PRODUCT ADVERTISING AND CONDUCTING ADVERTISING CAMPAIGNS FOR THE GOODS AND SERVICES OF OTHERS; PROVIDING CUSTOMER INFORMATION IN THE FIELDS OF ELECTRONIC MAIL ORDER SERVICES; ELECTRONIC BILLBOARD ADVERTISING; MARKET ANALYSES; AND PROVIDING INFORMATION IN ALL OF THE FOREGOING FIELDS BY MEANS OF A GLOBAL COMPUTER INFORMATION NETWORK (U.S. CLS. 100, 101 AND 102).

CLASS 39—TRANSPORTATION AND STORAGE

FOR TRANSPORT, STORAGE AND DELIVERY OF CORRESPONDENCE, PACKETS, PACKAGES, PARCELS, NEWSPAPERS, FREIGHT AND OF GOODS, ALL BY ROAD, RAIL, AIR OR WATER; OF MAIL AND PACKAGES BY TRUCK, FERRY, BOAT, AIR, RAIL, AND FOOT; PACKAGING OF ARTICLES FOR TRANSPORTATION; POSTAL SERVICES, NAMELY, TRANSPORT AND DELIVERY OF LETTERS, PARCELS AND SMALL PACKETS FOR THIRD PARTIES; WAREHOUSE STORAGE SERVICES; COURIER SERVICES; UNLOADING OF CARGO (U.S. CLS. 100 AND 105).
PAUL F. GAST, EXAMINING ATTORNEY

SN 76-504,875. K+S KALI GMBH, KASSEL, FED REP GERMANY, FILED 4-7-2003.



OWNER OF FED REP GERMANY REG. NO. 30204054, DATED 1-26-2002, EXPIRES 1-31-2012.

CLASS 1—CHEMICALS

FOR POTASSIUM SALTS, POTASSIUM CHLORIDE, POTASSIUM SULFATE, MAGNESIUM SALTS, MAGNESIUM CHLORIDE AND MAGNESIUM HYDROXIDE, KIESERITE, MAGNESIUM SULFATE; MAGNESIUM OXIDE; SODIUM SALTS, ROCK SALT AND SODIUM CHLORIDE ALL CHEMICAL PREPARATIONS FOR USE IN THE PHARMACEUTICAL, FOODSTUFFS, GLASS, ALUMINUM, GAS, OIL, METALLURGY, CONSTRUCTION, PAINT AND PAPER INDUSTRIES; MINERAL FERTILIZING PREPARATIONS, NAMELY POTASSIUM FERTILIZING SALT CONTAINING STRAIGHT OR COMPOUND FERTILIZER, ORGANIC FERTILIZER, FOR US AS COMPOST, PULP FERTILIZER AND LIQUID MANURE FERTILIZER (U.S. CLS. 1, 5, 6, 10, 26 AND 46).

FIRST USE 2-8-2002; IN COMMERCE 2-8-2002.

CLASS 42—SCIENTIFIC, COMPUTER AND LEGAL SERVICES

FOR ENGINEERING SERVICES; CHEMISTRY SERVICES; SURVEYING; TECHNICAL CONSULTANCY IN THE EXPLORING FOR, AND THE EXTRACTION, PROCESSING AND MARKETING OF NATURAL MINERALS, IN PARTICULAR POTASSIUM SALTS AND ROCK SALTS (U.S. CLS. 100 AND 101).

FIRST USE 2-8-2002; IN COMMERCE 2-8-2002.

CLASS 44—MEDICAL, BEAUTY AND AGRICULTURAL SERVICES

FOR AGRICULTURAL CONSULTANCY (U.S. CLS. 100 AND 101).

FIRST USE 2-8-2002; IN COMMERCE 2-8-2002.
STEPHANIE DAVIS, EXAMINING ATTORNEY

SN 76-504,994. PRIME RESOURCES CORPORATION, BRIDGEPORT, CT. FILED 4-1-2003.

PRIME PENS

OWNER OF U.S. REG. NOS. 2,180,026 AND 2,353,373. NO CLAIM IS MADE TO THE EXCLUSIVE RIGHT TO USE "PENS", APART FROM THE MARK AS SHOWN.

CLASS 35—ADVERTISING AND BUSINESS

FOR WHOLESALE DISTRIBUTORSHIP SERVICES OF WRITING INSTRUMENTS SOLD EXCLUSIVELY TO THE PROMOTIONS INDUSTRY (U.S. CLS. 100, 101 AND 102).

FIRST USE 12-0-2002; IN COMMERCE 12-0-2002.

CLASS 40—MATERIAL TREATMENT

FOR CUSTOM MANUFACTURE OF WRITING INSTRUMENTS AND CUSTOM IMPRINTING SERVICES OF WRITING INSTRUMENTS SOLD EXCLUSIVELY TO THE PROMOTIONS INDUSTRY (U.S. CLS. 100, 103 AND 106).

FIRST USE 12-0-2002; IN COMMERCE 12-0-2002.
JENNIFER CHICOSKI, EXAMINING ATTORNEY

SN 76-505,002. BURNEY, PHILLIP DEAN, WEST PALM BEACH, FL. FILED 4-7-2003.

PHILTHER

CLASS 9—ELECTRICAL AND SCIENTIFIC APPARATUS

FOR MUSICAL SOUND RECORDINGS (U.S. CLS. 21, 23, 26, 36 AND 38).

FIRST USE 11-1-2001; IN COMMERCE 11-1-2001.

CLASS 41—EDUCATION AND ENTERTAINMENT

FOR ENTERTAINMENT, NAMELY LIVE PERFORMANCES BY A MUSICAL BAND (U.S. CLS. 100, 101 AND 107).

FIRST USE 11-14-2001; IN COMMERCE 11-14-2001.
CATHERINE FAINT, EXAMINING ATTORNEY

SN 76-505,836. REGAL ENTERTAINMENT GROUP, KNOXVILLE, TN. FILED 4-11-2003.

REGAL ENTERTAINMENT GROUP

NO CLAIM IS MADE TO THE EXCLUSIVE RIGHT TO USE ENTERTAINMENT GROUP, APART FROM THE MARK AS SHOWN.

CLASS 35—ADVERTISING AND BUSINESS

FOR BUSINESS SERVICES, NAMELY, PROMOTING THE GOODS AND SERVICES OF OTHERS BY MEANS OF A PREFERRED CUSTOMER LOYALTY PROGRAM FEATURING INCENTIVES AND REWARDS TO ENCOURAGE INCREASED MOVIE ATTENDANCE, INCREASED AFFINITY AND BRAND LOYALTY; CONCESSION STANDS FEATURING FOOD AND MOTION PICTURE RELATED MERCHANDISE (U.S. CLS. 100, 101 AND 102).

FIRST USE 4-0-2002; IN COMMERCE 4-0-2002.

CLASS 41—EDUCATION AND ENTERTAINMENT

FOR ENTERTAINMENT SERVICES, NAMELY, MOTION PICTURE THEATER SERVICES FEATURING OPERATION OF MOVIE THEATERS AND CONDUCTING ENTERTAINMENT EXHIBITIONS IN THE NATURE OF MOTION PICTURE DISPLAYS (U.S. CLS. 100, 101 AND 107).

FIRST USE 4-0-2002; IN COMMERCE 4-0-2002.
TARAH HARDY, EXAMINING ATTORNEY

SN 76-506,327. WILKINSON-HI-RISE, LLC, RALEIGH, NC.
FILED 4-15-2003.

TRISORTER**CLASS 6—METAL GOODS**

FOR METAL RECYCLING BINS FOR RECYCLING GLASS, ALUMINUM, PLASTIC AND PAPER (U.S. CLS. 2, 12, 13, 14, 23, 25 AND 50).

FIRST USE 1-0-1981; IN COMMERCE 1-0-1981.

CLASS 7—MACHINERY

FOR GARBAGE DISPOSALS FOR RUBBISH, GARBAGE, PAPER LINEN AND/OR CONSTRUCTION MATERIALS (U.S. CLS. 13, 19, 21, 23, 31, 34 AND 35).

FIRST USE 1-0-1981; IN COMMERCE 1-0-1981.
JASON TURNER, EXAMINING ATTORNEY

SN 76-506,389. JETX2, INC., REDONDO BEACH, CA. FILED
4-14-2003.

**CLASS 25—CLOTHING**

FOR MEN'S, WOMEN'S, AND CHILDREN'S CLOTHING, NAMELY T-SHIRTS, SWEATSHIRTS, JACKETS, AND GLOVES (U.S. CLS. 22 AND 39).

CLASS 38—COMMUNICATION

FOR PROVIDING MULTIPLE-USER ACCESS TO A GLOBAL COMPUTER INFORMATION NETWORK (U.S. CLS. 100, 101 AND 104).

MARC LEIPZIG, EXAMINING ATTORNEY

SN 76-506,682. SCHERING AKTIENGESELLSCHAFT, BERLIN, FED REP GERMANY, FILED 4-3-2003.

**INSIDE THE DISCOVERY
PROCESS****CLASS 41—EDUCATION AND ENTERTAINMENT**

FOR EDUCATIONAL SERVICES, NAMELY, CONDUCTING WORKSHOPS, CONFERENCES, CLASSES, SEMINARS AND THE LIKE, IN THE FIELD OF MEDICINE (U.S. CLS. 100, 101 AND 107).

CLASS 44—MEDICAL, BEAUTY AND AGRICULTURAL SERVICES

FOR MEDICAL SERVICES (U.S. CLS. 100 AND 101).
ANDREW BENZMILLER, EXAMINING ATTORNEY

SN 76-508,044. ZAMANSKY, RONALD A., MINNETONKA, MN. FILED 4-21-2003.

**I STILL WANT TO BE A
FARMER****CLASS 16—PAPER GOODS AND PRINTED MATTER**

FOR BOOKS THAT DISCUSS PRACTICAL REASONS AND BENEFITS OF A CHOICE OF PROFESSION THAT ARE IDENTIFIED AND COME FROM EXPERIENCE; STICKERS AND STATIONARY (U.S. CLS. 2, 5, 22, 23, 29, 37, 38 AND 50).

CLASS 25—CLOTHING

FOR HATS; TEE SHIRTS (U.S. CLS. 22 AND 39).
CHERYL CLAYTON, EXAMINING ATTORNEY

SN 76-508,266. JABBERBLABBER, INC., MEMPHIS, TN.
FILED 4-21-2003.

JABBERBLABBER**CLASS 16—PAPER GOODS AND PRINTED MATTER**

FOR PENS, PENCILS AND DRAFTING RULERS AND CHILDREN'S MAGAZINES (U.S. CLS. 2, 5, 22, 23, 29, 37, 38 AND 50).

FIRST USE 3-1-2000; IN COMMERCE 3-1-2000.

CLASS 41—EDUCATION AND ENTERTAINMENT

FOR TELEVISION PROGRAMMING SERVICES (U.S. CLS. 100, 101 AND 107).

FIRST USE 6-1-2001; IN COMMERCE 6-1-2001.
GLENN CLARK, EXAMINING ATTORNEY

SN 76-508,342. SPOT IMAGE, 31400 TOULOUSE, FRANCE,
FILED 4-18-2003.

SPOT IMAGE

OWNER OF U.S. REG. NOS. 1,266,212, 2,082,785 AND OTHERS.
SEC. 2(F) AS TO "IMAGE".

CLASS 9—ELECTRICAL AND SCIENTIFIC APPARATUS

FOR ELECTRONIC PHOTOGRAPHIC APPARATUS, DIGITAL DATA RECORDERS, DIGITAL DATA TRANSMITTERS FROM SATELLITE TO GROUND, DIGITAL DATA RECEIVER SATELLITES, ELECTRONIC IMAGE DATA PROCESSING APPARATUS, AND MEDIA FOR IMAGE DATA, NAMELY, PRERECORDED FLOPPY COMPUTER DISKS, COMPUTER DISK CARTRIDGES, COMPUTER TAPE CARTRIDGES, VIDEO DISKS AND COMPACT DISKS FEATURING DIGITAL SATELLITE IMAGERY (U.S. CLS. 21, 23, 26, 36 AND 38).

FIRST USE 7-0-1982; IN COMMERCE 12-7-1982.

CLASS 16—PAPER GOODS AND PRINTED MATTER

FOR PRINTED MATTER, NAMELY, NEWSLETTERS, MOUNTED AND UNMOUNTED PHOTOGRAPHS AND PHOTOGRAPHIC PRINTED IMAGES RELATING TO SATELLITE REMOTE SENSING DATA (U.S. CLS. 2, 5, 22, 23, 29, 37, 38 AND 50).

FIRST USE 7-0-1982; IN COMMERCE 12-7-1982.

CLASS 38—COMMUNICATION

FOR ELECTRONIC TRANSMISSION AND RECEPTION OF GEOGRAPHICAL DATA (U.S. CLS. 100, 101 AND 104).

FIRST USE 7-0-1982; IN COMMERCE 12-7-1982.

CLASS 42—SCIENTIFIC, COMPUTER AND LEGAL SERVICES

FOR CONSULTATION TO INDUSTRIAL AND COMMERCIAL COMPANIES IN THE FIELD OF IMAGE PROCESSING AND DOCUMENT DUPLICATION, AND CONSULTATION REGARDING PHOTOGRAPHIC PRINTING AND FINISHING SERVICES IN THE FIELD OF STATIONS FOR RECEIVING AND PROCESSING SATELLITE TAKING IMAGES (U.S. CLS. 100 AND 101).

FIRST USE 7-0-1982; IN COMMERCE 12-7-1982.

MICHELE SWAIN, EXAMINING ATTORNEY

SN 76-509,255. BEISSBARTH USA, INC., NASHVILLE, DAVIDSON COUNTY, TN. FILED 4-24-2003.

**CLASS 7—MACHINERY**

FOR AUTOMOTIVE REPAIR AND SHOP TOOLS, NAMELY BRAKE LATHES, AND RELATED WHEEL AND BRAKE PARTS AND ACCESSORIES, NAMELY, TOOL BITS FOR MACHINES WHICH MAY BE CONNECTED TO THE MACHINES TO ALLOW THE MACHINE TO FUNCTION ON COMPONENTS OF VARIOUS MODELS AND TYPES OF LAND VEHICLES, FOR CONSUMER AND INDUSTRIAL APPLICATIONS (U.S. CLS. 13, 19, 21, 23, 31, 34 AND 35).

FIRST USE 6-25-1985; IN COMMERCE 6-25-1985.

CLASS 9—ELECTRICAL AND SCIENTIFIC APPARATUS

FOR AUTOMOTIVE REPAIR AND SHOP TOOLS, NAMELY TIRE BALANCING MACHINES FOR LAND VEHICLES AND TIRE CHANGING MACHINES FOR LAND VEHICLES, FOR CONSUMER AND INDUSTRIAL APPLICATIONS (U.S. CLS. 21, 23, 26, 36 AND 38).

FIRST USE 6-25-1985; IN COMMERCE 6-25-1985.

TRACY CROSS, EXAMINING ATTORNEY

SN 76-509,375. GRETTA ENTERPRISES, LLC, WELLESLEY, MA. FILED 4-25-2003.

GHAIR**CLASS 3—COSMETICS AND CLEANING PREPARATIONS**

FOR HAIR CARE PREPARATIONS (U.S. CLS. 1, 4, 6, 50, 51 AND 52).

CLASS 21—HOUSEWARES AND GLASS

FOR HAIR BRUSHES AND COMBS (U.S. CLS. 2, 13, 23, 29, 30, 33, 40 AND 50).

CLASS 26—FANCY GOODS

FOR HAIR ACCESSORIES, NAMELY, BANDS, BARRETTES, PINS, HAIR CLIPS, CLAW CLIPS, CURL CLIPS, BOWS, BUCKLES, EXTENSION PIECES, AND SCRUNCHIES (U.S. CLS. 37, 39, 40, 42 AND 50).

JASON TURNER, EXAMINING ATTORNEY

SN 76-510,393. ANSCHUTZ MANCHESTER HOCKEY, LLC, LOS ANGELES, CA. FILED 4-29-2003.

**CLASS 16—PAPER GOODS AND PRINTED MATTER**

FOR STICKERS/DECALS; PENS; AND ERASERS (U.S. CLS. 2, 5, 22, 23, 29, 37, 38 AND 50).

FIRST USE 4-0-2001; IN COMMERCE 4-0-2001.

CLASS 21—HOUSEWARES AND GLASS

FOR BEVERAGE GLASSWARE; DRINKING GLASSES; SHOT GLASSES; WATER BOTTLES SOLD EMPTY; CUPS; AND MUGS (U.S. CLS. 2, 13, 23, 29, 30, 33, 40 AND 50).

FIRST USE 4-0-2001; IN COMMERCE 4-0-2001.

CLASS 25—CLOTHING

FOR CLOTHING, NAMELY, SHIRTS, JERSEYS, SWEATERS, SWEATSHIRTS, JACKETS, VESTS, T-SHIRTS, GOLF SHIRTS, POLO SHIRTS, WINDSHIRTS, WRISTBANDS, SWEATBANDS, SHORTS, CAPS, HATS, SOCKS, NIGHTSHIRTS, BOXER SHORTS, MITTENS, GLOVES, AND CLOTH BABY BIBS (U.S. CLS. 22 AND 39).

FIRST USE 4-0-2001; IN COMMERCE 4-0-2001.

CLASS 28—TOYS AND SPORTING GOODS

FOR TOYS AND SPORTING GOODS, NAMELY, HOCKEY STICKS; MINI HOCKEY STICKS; HOCKEY PUCKS; AND TOY ICE RESURFACING MACHINES (U.S. CLS. 22, 23, 38 AND 50).

FIRST USE 4-0-2001; IN COMMERCE 4-0-2001.

CLASS 41—EDUCATION AND ENTERTAINMENT

FOR ENTERTAINMENT SERVICES, NAMELY, PROFESSIONAL ICE HOCKEY GAMES AND EXHIBITIONS; AND CHARITABLE SERVICES, NAMELY, PROVIDING YOUTH HOCKEY INSTRUCTION, AND TEACHING CHILDREN THE IMPORTANCE OF GOAL SETTING AND HEALTHY LIFESTYLES (U.S. CLS. 100, 101 AND 107).

FIRST USE 4-0-2001; IN COMMERCE 4-0-2001.
PAULA MAYS, EXAMINING ATTORNEY

CLASS 35—ADVERTISING AND BUSINESS

FOR CONDUCTING ON-LINE TRADING, NAMELY ON-LINE TRADING SERVICES IN WHICH SELLER POSTS PRODUCTS TO BE AUCTIONED AND BIDDING IS DONE VIA THE INTERNET; ON-LINE AUCTIONEERING; PROVIDING ON-LINE BUYERS GUIDES; CONDUCTING TRADE SHOWS IN THE FIELDS OF COMMODITIES, FINANCIAL ANALYSIS AND CONSULTATION, CURRENCY, AND MONEY EXCHANGE; PROVIDING NEWS BY ELECTRONIC COMMUNICATIONS NETWORKS IN THE FIELDS OF BUSINESS, GOVERNMENT AFFAIRS AND ECONOMICS (U.S. CLS. 100, 101 AND 102).

CLASS 36—INSURANCE AND FINANCIAL

FOR CONSULTING SERVICES IN THE FIELD OF COMMODITIES EXCHANGE, FINANCIAL EXCHANGE, MONETARY EXCHANGE, AND CURRENCY EXCHANGE; CONDUCTING ON-LINE COMMODITIES EXCHANGE, FINANCIAL EXCHANGE, MONETARY EXCHANGE, AND CURRENCY EXCHANGE; BROKERAGE SERVICES INVESTMENT INFORMATION, ANALYSIS, ADVICE AND MANAGEMENT IN THE FIELDS OF SECURITIES, STOCKS, BONDS, MUTUAL FUNDS, MONEY MARKET FUNDS, COMMODITIES, FUTURES, OPTIONS, AND INDICES OF ANY OF THEM; INVESTMENT SERVICES IN THE FIELDS OF SECURITIES, STOCKS, MONEY MARKET FUNDS, BONDS, MUTUAL FUNDS, COMMODITIES, FUTURES, OPTIONS, AND INDICES OF ANY OF THEM; SECURITIES BROKERAGE ACCOUNT SERVICES; INVESTMENT ACCOUNT INFORMATION SERVICES; PENSION FUND AND RETIREMENT PLAN MANAGEMENT SERVICES, NAMELY, INVESTMENT OF PENSION AND RETIREMENT FUNDS FOR OTHERS, AND ADMINISTRATION OF EMPLOYEE PENSION AND RETIREMENT PLANS; PROVIDING FINANCIAL INFORMATION IN THE FIELD OF RETIREMENT PLANNING; FINANCIAL PLANNING SERVICES; CASH MANAGEMENT ACCOUNT SERVICES; FIXED INCOME INVESTMENT SERVICES; BILL PAYMENT SERVICES AND ELECTRONIC FUND TRANSFER SERVICES; PROVIDING FINANCIAL INFORMATION, INVESTMENT RESEARCH INFORMATION, AND INVESTMENT RESEARCH TOOLS, NAMELY, TOOLS FOR MONITORING INVESTMENT MARKET VALUE AND PERFORMANCE OF INVESTMENTS, TOOLS FOR ANALYZING INVESTMENT PERFORMANCE, TOOLS FOR EVALUATING ASSET ALLOCATION, RISK TOLERANCE, ALTERNATIVE PLAN INVESTING TIMEFRAME AND INVESTMENT ALTERNATIVE PLANNING; PROVIDING NEWS BY ELECTRONIC COMMUNICATION NETWORKS IN THE FIELDS OF INVESTING, FINANCE, AND FINANCIAL PLANNING; PROVIDING PORTFOLIO MANAGEMENT SERVICES AND ACCOUNT INFORMATION VIA ELECTRONIC MEANS (U.S. CLS. 100, 101 AND 102).

SN 76-510,620. KABUSHIKI KAISHA HITACHI SEISAKUSHO, DBA HITACHI, LTD., CHIYODA-KU, TOKYO 101-8010, JAPAN, FILED 4-14-2003.

EPIT**CLASS 9—ELECTRICAL AND SCIENTIFIC APPARATUS**

FOR COMPUTER SOFTWARE FOR USE IN ACCESSING ACCOUNT INFORMATION AND CONDUCTING PORTFOLIO MANAGEMENT SERVICES; COMPUTER SOFTWARE FOR USE IN ACCESSING AND CONDUCTING ON-LINE COMMODITIES EXCHANGES, ACCESSING AND CONDUCTING ON-LINE FINANCIAL EXCHANGES, ACCESSING AND CONDUCTING ON-LINE MONETARY EXCHANGES AND ACCESSING AND CONDUCTING ON-LINE CURRENCY EXCHANGES; COMPUTER SOFTWARE FOR USE IN ANALYSIS, ADVICE AND MANAGEMENT IN THE FIELDS OF SECURITIES, STOCKS, BONDS, MUTUAL FUNDS, MONEY MARKET FUNDS, COMMODITIES, FUTURES, OPTIONS, AND INDICES; COMPUTER SOFTWARE FOR USE IN INVESTMENT SERVICES, NAMELY COMPUTER SOFTWARE FOR USE IN PROVIDING SECURITIES BROKERAGE ACCOUNT SERVICES, INVESTMENT ACCOUNT INFORMATION SERVICES, RETIREMENT PLANNING SERVICES, FINANCIAL PLANNING SERVICES, CASH MANAGEMENT ACCOUNT SERVICES, FIXED INCOME INVESTMENT SERVICES, BILL PAYMENT SERVICES AND ELECTRONIC FUND TRANSFER SERVICES; COMPUTER SOFTWARE FOR USE IN DATABASE MANAGEMENT IN THE FIELDS OF SECURITIES, STOCKS, BONDS, MUTUAL FUNDS, MONEY MARKET FUNDS, COMMODITIES, FUTURES, OPTIONS, AND INDICES; COMPUTER SOFTWARE FOR USE IN PROVIDING BROKERAGE SERVICES INVESTMENT INFORMATION; COMPUTER SOFTWARE FOR RETRIEVING, ACCESSING, ANALYZING AND MANAGING CONSUMER INFORMATION AND PREFERENCES (U.S. CLS. 21, 23, 26, 36 AND 38).

CLASS 16—PAPER GOODS AND PRINTED MATTER

FOR PRINTED MATERIALS, NAMELY, MANUALS, MAGAZINES, NEWSLETTERS, BROCHURES, PAMPHLETS, LEAFLETS AND PRINTED INSTRUCTIONAL MATERIALS IN THE FIELDS OF COMMODITIES EXCHANGE, FINANCIAL EXCHANGE AND ANALYSIS, MONETARY EXCHANGE AND CURRENCY EXCHANGE (U.S. CLS. 2, 5, 22, 23, 29, 37, 38 AND 50).

CLASS 41—EDUCATION AND ENTERTAINMENT

FOR EDUCATIONAL SERVICES, NAMELY, CLASSES, SEMINARS, CONFERENCES AND WORKSHOPS IN THE FIELDS OF COMMODITIES EXCHANGE, FINANCIAL ANALYSIS AND CONSULTATION, CURRENCY, AND MONEY EXCHANGE, INVESTMENTS, FINANCE, ECONOMICS, BUSINESS, FINANCIAL PLANNING, PORTFOLIO MANAGEMENT, RETIREMENT PLANNING, MONEY MANAGEMENT, INVESTMENT STRATEGY, AND ASSET ALLOCATION AND PRINTED MATERIALS DISTRIBUTED IN CONNECTION THEREWITH; PROVIDING NEWS BY ELECTRONIC COMMUNICATIONS NETWORKS IN THE NATURE OF CURRENT EVENTS REPORTING (U.S. CLS. 100, 101 AND 107).

CLASS 42—SCIENTIFIC, COMPUTER AND LEGAL SERVICES

FOR COMPUTER SOFTWARE DESIGN, CUSTOMIZATION, INTEGRATION, ANALYSIS AND CONSULTING SERVICES FOR OTHERS; COMPUTER SOFTWARE MAINTENANCE, INSTALLATION AND UPDATING SERVICES; COMPUTER NETWORK AND COMPUTER SYSTEMS DESIGN, CUSTOMIZATION, INTEGRATION, ANALYSIS AND CONSULTING SERVICES FOR OTHERS; TECHNICAL AND COMPUTER CONSULTING SERVICES RELATING TO INFORMATION TECHNOLOGY AND ELECTRONIC COMMERCE; PROVIDING TEMPORARY USE OF ON-LINE NON-DOWNLOADABLE SOFTWARE FOR ACCESSING ACCOUNT INFORMATION AND CONDUCTING PORTFOLIO MANAGEMENT SERVICES; PROVIDING TEMPORARY USE OF ON-LINE NON-DOWNLOADABLE SOFTWARE FOR ON-LINE COMMODITIES EXCHANGE, FINANCIAL EXCHANGE, MONETARY EXCHANGE, AND CURRENCY EXCHANGE; PROVIDING TEMPORARY USE OF ON-LINE NON-DOWNLOADABLE SOFTWARE FOR ANALYSIS, ADVICE AND MANAGEMENT IN THE FIELDS OF SECURITIES, STOCKS, BONDS, MUTUAL FUNDS, MONEY MARKET FUNDS, COMMODITIES, FUTURES, OPTIONS, AND INDICES OF ANY OF THEM; PROVIDING TEMPORARY USE OF ON-LINE NON-DOWNLOADABLE SOFTWARE FOR USE IN PROVIDING INVESTMENT ACCOUNT SERVICES IN THE FIELDS OF SECURITIES, STOCKS, MONEY MARKET FUNDS, BONDS, MUTUAL FUNDS, COMMODITIES, FUTURES, OPTIONS, AND INDICES OF ANY OF THEM; PROVIDING TEMPORARY USE OF ON-LINE NON-DOWNLOADABLE SOFTWARE FOR SECURITIES BROKERAGE ACCOUNT SERVICES, INVESTMENT ACCOUNT INFORMATION SERVICES, RETIREMENT PLANNING SERVICES, FINANCIAL PLANNING SERVICES, CASH MANAGEMENT ACCOUNT SERVICES, FIXED INCOME INVESTMENT SERVICES, BILL PAYMENT SERVICES AND ELECTRONIC FUND TRANSFER SERVICES; PROVIDING TEMPORARY USE OF ON-LINE NON-DOWNLOADABLE SOFTWARE FOR DATABASE MANAGEMENT VIA ELECTRONIC MEANS IN THE FIELDS OF SECURITIES, STOCKS, MONEY MARKET FUNDS, BONDS, MUTUAL FUNDS, COMMODITIES, FUTURES, OPTIONS, AND INDICES OF ANY OF THEM; PROVIDING TEMPORARY USE OF ON-LINE NON-DOWNLOADABLE SOFTWARE FOR USE IN PROVIDING BROKERAGE SERVICES INVESTMENT INFORMATION VIA ELECTRONIC MEANS (U.S. CLS. 100 AND 101).

GINA FINK, EXAMINING ATTORNEY

SN 76-510,875. CONSERVAS LA COSTENA, S.A. DE C.V., EDO. DE MEXICO, MEXICO, FILED 4-30-2003.



OWNER OF U.S. REG. NO. 1,216,023.

THE SPANISH WORDS "LA COSTENA" TRANSLATE INTO THE ENGLISH LANGUAGE WITH THE FOLLOWING DUAL MEANINGS: "A WOMEN WHO LIVES BY THE COAST" AND "A TOWN WHICH IS LOCATED BY THE COAST".

CLASS 29—MEATS AND PROCESSED FOODS

FOR CANNED OR BOTTLED FOODS, NAMELY, RED AND GREEN JALAPENO PEPPERS, SERRANO PEPPERS, BELL PEPPERS, CHIPOTLE PEPPERS, BEANS, BEANS WITH MEAT, BEANS WITH CHEESE, FRUIT PUREE, FRUIT MARMALADE, FRUIT JELLY, FRUIT PASTE, FRUIT COCKTAIL, SLICED FRUITS, FRUIT HALVES, MUSHROOMS, CORN, CORN GRAINS, PEAS, PEAS WITH CARROTS, CARROTS, VEGETABLE SALAD, OLIVES, TENDER CACTUS, TOMATO, TOMATO PUREE, TOMATILLO, TOMATILLO PUREE AND CUITLACOCHÉ (U.S. CL. 46).

FIRST USE 11-25-1923; IN COMMERCE 10-31-1980.

CLASS 30—STAPLE FOODS

FOR CANNED OR BOTTLED SAUCES, NAMELY HOME STYLE MEXICAN GREEN SAUCE, HOME STYLE MEXICAN RED SAUCE, TOMATO SAUCE, TOMATILLO SAUCE, HOME STYLE MEXICAN SAUCE, PICO DE GALLO SAUCE, SAUCE FOR SNACKS MADE OF CHILE DE ARBOL, GUAJILLO PEPPER SAUCE, CHIPOTLE PEPPER SAUCE, MULATTO PEPPER SAUCE, PASILLA PEPPER SAUCE, MOLE SAUCE, PIPIAN SAUCE, ADOBADO SAUCE; SALAD DRESSING, MAYONNAISE, KETCHUP AND VINEGAR (U.S. CL. 46).

FIRST USE 11-25-1923; IN COMMERCE 10-31-1980.

MATTHEW PAPPAS, EXAMINING ATTORNEY

SN 76-510,713. JACKSON, ANN P., NORWELL, MA. FILED 5-1-2003.

SPAJMA

CLASS 14—JEWELRY

FOR JEWELRY (U.S. CLS. 2, 27, 28 AND 50).
FIRST USE 10-24-2003; IN COMMERCE 3-8-2004.

CLASS 42—SCIENTIFIC, COMPUTER AND LEGAL SERVICES

FOR DESIGNING JEWELRY FOR OTHERS (U.S. CLS. 100 AND 101).
FIRST USE 10-24-2003; IN COMMERCE 3-8-2004.
ALICIA COLLINS, EXAMINING ATTORNEY

SN 76-510,893. OVERHEAD DOOR CORPORATION, FARMERS BRANCH, TX. FILED 4-30-2003.



OWNER OF U.S. REG. NO. 863,435.

CLASS 11—ENVIRONMENTAL CONTROL APPARATUS

FOR REFLECTOR DISCS FOR VEHICLES (U.S. CLS. 13, 21, 23, 31 AND 34).
FIRST USE 5-25-1973; IN COMMERCE 5-25-1973.

CLASS 12—VEHICLES

FOR DOORS AND PARTS THEREOF FOR LAND VEHICLES, NAMELY, TRUCKS, TRAILERS, RAILROAD CARS, COVERED THREE-WHEEL MOTOR VEHICLES; DOORS FOR AIRPLANES AND PARTS THEREOF; DOORS AND PARTS THEREOF FOR FREIGHT CARGO CONTAINERS TO BE MOUNTED ON TRUCK TRAILERS AND RAILWAY FLAT CARS; VEHICLE SKYLIGHTS (U.S. CLS. 19, 21, 23, 31, 35 AND 44).

FIRST USE 5-25-1973; IN COMMERCE 5-25-1973.
H. M. FISHER, EXAMINING ATTORNEY

SN 76-511,417. UNIVERSITY OF INDIANAPOLIS, INDIANAPOLIS, IN. FILED 5-2-2003.

SN 76-510,973. PIERRE FABRE S.A., 75008 PARIS, FRANCE, FILED 5-1-2003.

ADEQUAT

OWNER OF FRANCE REG. NO. 96648100, DATED 10-22-1996, EXPIRES 10-22-2006.

OWNER OF FRANCE REG. NO. 1,480,763, DATED 6-10-1988, EXPIRES 6-10-2008.

THE ENGLISH TRANSLATION OF THE WORD "ADEQUAT" IN THE MARK IS "ADEQUATE."

CLASS 3—COSMETICS AND CLEANING PREPARATIONS

FOR COSMETICS AND CLEANING PREPARATIONS, NAMELY, TOILET SOAPS, PERFUMES, ESSENTIAL OILS FOR PERSONAL USE; PREPARATIONS FOR BEAUTY AND CARE OF THE SKIN, NAMELY, GELS, LOTIONS, MILKS, AND EMULSIONS; MAKEUP; NON-MEDICATED HAIR CARE PREPARATIONS, NAMELY, GELS, AND LOTIONS; SHAMPOO (U.S. CLS. 1, 4, 6, 50, 51 AND 52).

CLASS 5—PHARMACEUTICALS

FOR DERMATOLOGICALS FOR HYGIENE AND CARE OF THE SKIN AND THE HAIR (U.S. CLS. 6, 18, 44, 46, 51 AND 52).

IRA J. GOODSAD, EXAMINING ATTORNEY

SN 76-511,166. KABUSHIKI KAISHA ATLUS, TOKYO, JAPAN, FILED 5-2-2003.

VENUS**CLASS 9—ELECTRICAL AND SCIENTIFIC APPARATUS**

FOR AUTOMATIC AND COIN-OPERATED MACHINES, NAMELY VIDEO PRINT MACHINES TO TAKE PHOTOGRAPHS AND TO PRINT THE SAME WITH VIGNETTES ON STICKERS AND/OR LABELS AND/OR ALL PAPER MATERIALS; AUTOMATIC AND COIN-OPERATED VIDEO PRINT MACHINES WITH MONITOR (U.S. CLS. 21, 23, 26, 36 AND 38).

CLASS 28—TOYS AND SPORTING GOODS

FOR AUTOMATIC AND COIN-OPERATED AMUSEMENT MACHINES; PLAYING CARDS; MAH-JONGS; CHESS GAME; PARLOR GAMES; AND BASEBALL GLOVES (U.S. CLS. 22, 23, 38 AND 50).

KEVON CHISOLM, EXAMINING ATTORNEY



OWNER OF U.S. REG. NO. 2,695,240.

NO CLAIM IS MADE TO THE EXCLUSIVE RIGHT TO USE "UNIVERSITY OF INDIANAPOLIS", APART FROM THE MARK AS SHOWN.

CLASS 6—METAL GOODS

FOR METAL KEY CHAINS, METAL LICENSE PLATES AND METAL KEY RINGS (U.S. CLS. 2, 12, 13, 14, 23, 25 AND 50).

FIRST USE 0-0-1992; IN COMMERCE 0-0-1992.

CLASS 14—JEWELRY

FOR JEWELRY, NAMELY, LAPEL PINS, CLASS RINGS, AND CHARMS (U.S. CLS. 2, 27, 28 AND 50).

FIRST USE 0-0-1992; IN COMMERCE 0-0-1992.

CLASS 16—PAPER GOODS AND PRINTED MATTER

FOR NOTEBOOKS, PENS, NOTEPADS; DESK ACCESSORIES, NAMELY, PEN AND PENCIL SETS; BUMPER STICKERS, PAPER PENNANTS AND PAPER FLAGS (U.S. CLS. 2, 5, 22, 23, 29, 37, 38 AND 50).

FIRST USE 0-0-1992; IN COMMERCE 0-0-1992.

CLASS 21—HOUSEWARES AND GLASS

FOR CUPS, MUGS, PORTABLE BEVERAGE COOLERS AND SPORTS BOTTLES, SOLD EMPTY (U.S. CLS. 2, 13, 23, 29, 30, 33, 40 AND 50).

FIRST USE 0-0-1992; IN COMMERCE 0-0-1992.

CLASS 24—FABRICS

FOR CLOTH PENNANTS, CLOTH FLAGS AND TOWELS (U.S. CLS. 42 AND 50).

FIRST USE 0-0-1992; IN COMMERCE 0-0-1992.

CLASS 25—CLOTHING

FOR CLOTHING, NAMELY, SHIRTS, T-SHIRTS, SWEAT SHIRTS, SWEAT PANTS, CAPS, SWEATERS, SHORTS, JACKETS, AND JERSEYS (U.S. CLS. 22 AND 39).

FIRST USE 0-0-1992; IN COMMERCE 0-0-1992.

CLASS 41—EDUCATION AND ENTERTAINMENT

FOR EDUCATION AND ENTERTAINMENT SERVICES, NAMELY, PROVIDING COURSES OF INSTRUCTION AT THE UNIVERSITY LEVEL; EDUCATIONAL RESEARCH; ARRANGING AND CONDUCTING ATHLETIC EVENTS AND TOURNAMENTS, EXHIBITIONS, CONFERENCES, LIVE PERFORMANCES AND FESTIVALS; PROVIDING INFORMATION THROUGH THE USE OF A WORLD WIDE COMPUTER INFORMATION NETWORK REGARDING EDUCATION AND ENTERTAINMENT SERVICES, NAMELY, PROVIDING COURSES OF INSTRUCTION AT THE UNIVERSITY LEVEL, EDUCATIONAL RESEARCH, ATHLETIC EVENTS AND TOURNAMENTS, EXHIBITIONS, CONFERENCES, LIVE PERFORMANCES AND FESTIVALS (U.S. CLS. 100, 101 AND 107).

FIRST USE 0-0-1992; IN COMMERCE 0-0-1992.
MATTHEW KLINE, EXAMINING ATTORNEY

SN 76-512,140. GINSENG SCIENCE INC., SEOUL 151-742, REPUBLIC OF KOREA, FILED 5-6-2003.

仙 蔘

NO CLAIM IS MADE TO THE EXCLUSIVE RIGHT TO USE THE CHINESE CHARACTER REPRESENTING "GINSENG" AND THE CHINESE TRANSLITERATION "SAM", APART FROM THE MARK AS SHOWN.

THE CHINESE CHARACTERS IN THE MARK TRANSLITERATE TO "SUN SAM" AND THIS MEANS "HERMIT GINSENG" IN ENGLISH.

CLASS 5—PHARMACEUTICALS

FOR PRODUCTS MADE IN WHOLE OR IN PART FROM GINSENG, NAMELY, PHARMACEUTICAL PREPARATIONS FOR THE TREATMENT OF TUMORS; CARDIOVASCULAR PHARMACEUTICALS; PHARMACEUTICAL PREPARATIONS FOR THE TREATMENT OF CENTRAL NERVOUS SYSTEM DISORDERS; PHARMACEUTICAL PREPARATIONS FOR THE TREATMENT OF DIGESTIVE ORGANS; VITAMINS; GINSENG CAPSULES FOR MEDICINAL USE; PHARMACEUTICAL PREPARATIONS FOR THE TREATMENT OF METABOLIC DISORDERS; PHARMACEUTICAL PREPARATIONS FOR THE TREATMENT OF IMMUNITY DISORDERS; PHARMACEUTICAL PREPARATIONS FOR THE TREATMENT OF ALLERGIC REACTIONS; PHARMACEUTICAL PREPARATIONS FOR THE TREATMENT OF HYPOGLYCEMIA; GINSENG POWDERS AND GINSENG EXTRACTS; ALL OF THE AFOREMENTIONED GINSENG PRODUCTS FOR MEDICINAL USE (U.S. CLS. 6, 18, 44, 46, 51 AND 52).

CLASS 29—MEATS AND PROCESSED FOODS

FOR PRESERVED AND PROCESSED GINSENG FOR USE AS A VEGETABLE (U.S. CL. 46).

CLASS 30—STAPLE FOODS

FOR GINSENG TEA AND RED GINSENG TEA (U.S. CL. 46).

CLASS 32—LIGHT BEVERAGES

FOR GINSENG JUICES (U.S. CLS. 45, 46 AND 48).
NICHOLAS ALTREE, EXAMINING ATTORNEY

SN 76-512,121. OUR HAPPY FAMILY, LLC, STAMFORD, CT. FILED 5-5-2003.



Our Happy Family, LLC.

NO CLAIM IS MADE TO THE EXCLUSIVE RIGHT TO USE "LLC", APART FROM THE MARK AS SHOWN.

THE NAME(S), PORTRAIT(S), AND/OR SIGNATURE(S) SHOWN IN THE MARK IDENTIFIES LINNEY JOSEPH O'MALLEY III, WHOSE CONSENT(S) TO REGISTER IS SUBMITTED.

THE COLOR(S) LIGHT GRAY, BROWN, TAN, PINK, DARK PINK AND WHITE IS/ARE CLAIMED AS A FEATURE OF THE MARK.

LIGHT GREY APPEARS ATOP THE HEAD AROUND AND AS PART OF THE HAIR. BROWN IS THE COLOR OF INDIVIDUAL STRANDS OF HAIR WITHIN THE LIGHT GREY. THE FACE IS TAN AROUND THE FOREHEAD, EYES, NOSE AND EARS. THE CHEEKS ARE TAN AND PINK. THE LIPS ARE DARK PINK. THE TEETH ARE WHITE.

THE MARK CONSISTS OF A COLOR PHOTOGRAPH OF A SMILING BABY BOY.

CLASS 21—HOUSEWARES AND GLASS

FOR SOUVENIR PLATES (U.S. CLS. 2, 13, 23, 29, 30, 33, 40 AND 50).
FIRST USE 5-9-2003; IN COMMERCE 5-9-2003.

CLASS 25—CLOTHING

FOR PRINTED T-SHIRTS (U.S. CLS. 22 AND 39).
FIRST USE 5-9-2003; IN COMMERCE 5-9-2003.
DAWN FELDMAN, EXAMINING ATTORNEY

SN 76-512,555. EXPANSION JOINT MANUFACTURERS ASSOCIATION, TARRYTOWN, NY. FILED 5-8-2003.

EJMA

CLASS 16—PAPER GOODS AND PRINTED MATTER

FOR PUBLICATIONS, NAMELY, PERIODICALLY-PUBLISHED MANUALS OF INDUSTRY STANDARDS FOR THE SPECIFICATION, DESIGN, MANUFACTURE, QUALITY CONTROL, TESTING, SHIPPING, AND INSTALLATION OF BELLOWS-CONTAINING EXPANSION JOINTS FOR PIPE LINES, DUCTS, AND VESSELS; AND GUIDE BOOKS FOR PERSONS BUYING, SELLING, SPECIFYING, AND INSTALLING BELLOW-CONTAINING EXPANSION JOINTS IN PIPE LINES, DUCTS, AND VESSELS (U.S. CLS. 2, 5, 22, 23, 29, 37, 38 AND 50).

CLASS 35—ADVERTISING AND BUSINESS

FOR ASSOCIATION SERVICES, NAMELY, PROMOTING THE INTERESTS OF MEMBERS OF THE EXPANSION JOINT MANUFACTURERS INDUSTRY (U.S. CLS. 100, 101 AND 102).

CLASS 41—EDUCATION AND ENTERTAINMENT

FOR EDUCATIONAL SERVICES, NAMELY, PROVIDING DISCUSSION FORUMS IN THE FIELD OF EXPANSION JOINT RESEARCH, DESIGN, MANUFACTURING, AND TESTING, AND CORRELATING AND DISSEMINATING EDUCATIONAL MATERIALS FROM VARIOUS RESOURCES, NAMELY, ASSOCIATION MEMBERS, INDUSTRY, ENGINEERING SOCIETIES, UNIVERSITIES, AND GOVERNMENT, RELATING TO THE FOREGOING TECHNICAL FIELDS (U.S. CLS. 100, 101 AND 107).

CLASS 42—SCIENTIFIC, COMPUTER AND LEGAL SERVICES

FOR PROVIDING INTERPRETATIONS OF THE MANUAL OF INDUSTRY STANDARDS FOR THE SPECIFICATION, DESIGN, AND INSTALLATION OF BELLOWS-CONTAINING EXPANSION JOINTS TO THE USERS OF THE AFORESAID MANUAL (U.S. CLS. 100 AND 101).
STEVEN R. FOSTER, EXAMINING ATTORNEY

SN 76-512,883. PLAINSCAPITAL CORPORATION, DALLAS, TX. FILED 5-9-2003.



NO CLAIM IS MADE TO THE EXCLUSIVE RIGHT TO USE "CORPORATION", APART FROM THE MARK AS SHOWN.

CLASS 36—INSURANCE AND FINANCIAL

FOR BANKING SERVICES; FINANCIAL MANAGEMENT AND CONSULTATION SERVICES; CASH MANAGEMENT SERVICES; TRUST SERVICES; ASSET MANAGEMENT SERVICES; INVESTMENT MANAGEMENT AND CONSULTATION SERVICES; SECURITIES MANAGEMENT AND CONSULTATION SERVICES; INSURANCE AGENCY FOR ALL TYPES OF INSURANCE; MORTGAGE SERVICES; MONEY LENDING SERVICES; COMMERCIAL LENDING SERVICES; MORTGAGE LENDING SERVICES; PERSONAL LENDING SERVICES; COMMERCIAL REAL ESTATE LENDING SERVICES; AND CAPITAL FUNDING INVESTMENT ASSISTANCE AND CONSULTATION SERVICES (U.S. CLS. 100, 101 AND 102).

CLASS 39—TRANSPORTATION AND STORAGE

FOR LEASING OF VEHICLES AND TRANSPORTATION EQUIPMENT (U.S. CLS. 100 AND 105).

CLASS 40—MATERIAL TREATMENT

FOR LEASING OF MANUFACTURING EQUIPMENT, NAMELY SEMICONDUCTOR AND ELECTRONICS; LEASING OF MACHINE TOOL EQUIPMENT (U.S. CLS. 100, 103 AND 106).

CLASS 41—EDUCATION AND ENTERTAINMENT

FOR LEASING OF AUDIO-VISUAL EQUIPMENT (U.S. CLS. 100, 101 AND 107).

CLASS 44—MEDICAL, BEAUTY AND AGRICULTURAL SERVICES

FOR LEASING OF MEDICAL EQUIPMENT (U.S. CLS. 100 AND 101).
ROBERT COGGINS, EXAMINING ATTORNEY

SN 76-512,886. PLAINSCAPITAL CORPORATION, DALLAS, TX. FILED 5-9-2003.

**CLASS 36—INSURANCE AND FINANCIAL**

FOR BANKING SERVICES; FINANCIAL MANAGEMENT AND CONSULTATION SERVICES; CASH MANAGEMENT SERVICES; TRUST SERVICES; ASSET MANAGEMENT SERVICES; INVESTMENT MANAGEMENT AND CONSULTATION SERVICES; SECURITIES MANAGEMENT AND CONSULTATION SERVICES; INSURANCE AGENCY FOR ALL TYPES OF INSURANCE; MORTGAGE SERVICES; MONEY LENDING SERVICES; COMMERCIAL LENDING SERVICES; MORTGAGE LENDING SERVICES; PERSONAL LENDING SERVICES; COMMERCIAL REAL ESTATE LENDING SERVICES; AND CAPITAL FUNDING INVESTMENT ASSISTANCE AND CONSULTATION SERVICES (U.S. CLS. 100, 101 AND 102).

CLASS 39—TRANSPORTATION AND STORAGE

FOR LEASING OF VEHICLES AND TRANSPORTATION EQUIPMENT (U.S. CLS. 100 AND 105).

CLASS 40—MATERIAL TREATMENT

FOR LEASING OF MANUFACTURING EQUIPMENT, NAMELY SEMICONDUCTOR AND ELECTRONICS; LEASING OF MACHINE TOOL EQUIPMENT (U.S. CLS. 100, 103 AND 106).

CLASS 41—EDUCATION AND ENTERTAINMENT

FOR LEASING OF AUDIO-VISUAL EQUIPMENT (U.S. CLS. 100, 101 AND 107).

CLASS 44—MEDICAL, BEAUTY AND AGRICULTURAL SERVICES

FOR LEASING OF MEDICAL EQUIPMENT (U.S. CLS. 100 AND 101).
ROBERT COGGINS, EXAMINING ATTORNEY

SN 76-513,054. APPLIED BIOSCIENCES CORPORATION,
SALT LAKE CITY, UT. FILED 5-9-2003.

ABMET

CLASS 1—CHEMICALS

FOR WATER TREATMENT CHEMICALS FOR USE IN
WASTE WATER INDUSTRIAL USE OR DRINKING
WATER PROCESSING (U.S. CLS. 1, 5, 6, 10, 26 AND 46).

CLASS 11—ENVIRONMENTAL CONTROL AP- PARATUS

FOR WATER TREATMENT EQUIPMENT, NAMELY
BIO-REACTORS (U.S. CLS. 13, 21, 23, 31 AND 34).
MICHAEL WEBSTER, EXAMINING ATTORNEY

SN 76-513,376. HOPELESS RECORDS, INC., VAN NUYS, CA.
FILED 5-6-2003.



CLASS 6—METAL GOODS

FOR SMALL METAL HARDWARE, NAMELY, KEY
CHAINS (U.S. CLS. 2, 12, 13, 14, 23, 25 AND 50).

CLASS 25—CLOTHING

FOR ARTICLES OF CLOTHING, NAMELY, SHIRTS,
SWEATSHIRTS, SHORTS, JACKETS, FOOTWEAR,
HEADWEAR (U.S. CLS. 22 AND 39).
TARAH HARDY, EXAMINING ATTORNEY

SN 76-513,467. RAYTECH SYSTEMS, INC., SULLIVAN, IN.
FILED 5-12-2003.



CLASS 7—MACHINERY

FOR TORQUE CONVERTER FRICTION RING USED
IN THE FLUID COUPLER DEVICE THAT IS USED
BETWEEN AND CONNECTS AN ENGINE OR MOTOR
TO A TRANSMISSION NOT FOR USE IN LAND VEHI-
CLES (U.S. CLS. 13, 19, 21, 23, 31, 34 AND 35).

CLASS 12—VEHICLES

FOR TORQUE CONVERTER FRICTION RING USED
IN THE FLUID COUPLER DEVICE THAT IS USED
BETWEEN AND CONNECTS AN ENGINE OR MOTOR
TO A TRANSMISSION IN LAND VEHICLES (U.S. CLS.
19, 21, 23, 31, 35 AND 44).

SHAUNIA WALLACE, EXAMINING ATTORNEY

SN 76-513,692. KONAMI CORPORATION, TOKYO, JAPAN,
FILED 5-12-2003.



CLASS 9—ELECTRICAL AND SCIENTIFIC APPARATUS

FOR VIDEO GAME SOFTWARE; VIDEO GAME PRO-
GRAMS; VIDEO GAME CD-ROMS; VIDEO GAME DIGI-
TAL VERSATILE DISC-ROMS; COMPUTER GAME
PROGRAMS; COMPUTER GAME CD-ROMS; COMPU-
TER GAME DIGITAL VERSATILE DISC-ROMS; ELEC-
TRONIC GAME PROGRAMS; ELECTRONIC GAME CD-
ROMS; ELECTRONIC GAME DIGITAL VERSATILE
DISC-ROMS; CARTRIDGES AND CASSETTES FOR USE
WITH HAND-HELD VIDEO GAME MACHINE; CIRCUIT
BOARDS CONTAINING GAME PROGRAMS FOR USE
WITH HAND-HELD VIDEO GAME MACHINE; VIDEO
OUTPUT GAME MACHINES; DOWNLOADABLE ELEC-
TRONIC GAME SOFTWARE, DOWNLOADABLE COM-
PUTER GAME SOFTWARE AND DOWNLOADABLE
VIDEO GAME SOFTWARE; DOWNLOADABLE VIDEO
GAME PROGRAMS; VIDEO GAME PROGRAMS; DISCS,
CARTRIDGES, CD-ROM, DVD-ROM, DVD-RAM,
CARDS, WIRE AND FILAMENTS; GAMING EQUIP-
MENT, NAMELY, SLOT MACHINES WITH OR WITH-
OUT VIDEO OUTPUT (U.S. CLS. 21, 23, 26, 36 AND 38).

CLASS 28—TOYS AND SPORTING GOODS

FOR TOYS, NAMELY ACTION FIGURES, DOLLS,
AND PLAYSETS THEREFOR; HAND-HELD ELECTRO-
NIC GAMES; HAND-HELD VIDEO GAME SYSTEMS
COMPRISING HAND-HELD UNITS FOR PLAYING VIE-
DO GAMES AND ASSOCIATED GAME CARTRIDGES
SOLD AS A UNIT; BOARD GAMES; CARD GAMES;
PLAYING CARDS; ARCADE GAMES; ARCADE GAME
MACHINES FOR USE IN AMUSEMENT ARCADES;
STAND-ALONE VIDEO GAME MACHINES; COIN-OP-
ERATED VIDEO GAMES (U.S. CLS. 22, 23, 38 AND 50).

CLASS 41—EDUCATION AND ENTERTAIN- MENT

FOR ENTERTAINMENT SERVICES, NAMELY PRO-
VIDING ON-LINE COMPUTER GAMES; PROVIDING
TEMPORARY USE OF ON-LINE NON-DOWNLOAD-
ABLE SOFTWARE FOR USE IN OPERATION OF VIDEO,
COMPUTER AND ELECTRONIC GAMES; PROVIDING
ON-LINE COMPUTER DATABASE IN THE FIELD OF
COMPUTER GAMES; PROVIDING INFORMATION TO
GAME PLAYERS ABOUT THE RANKING OF THEIR
SCORES OF GAME THROUGH THE WEB SITES; PRO-
VIDING INFORMATION ABOUT COMPUTER GAMES
THROUGH THE WEB SITES; PROVIDING COMPUTER
GAME BY MEANS OF COMPUTER TERMINALS OR
CELLULAR PHONES; BROADCASTING IMAGES, MUS-
IC AND MOVIES PROVIDED BY MEANS OF COMMU-
NICATIONS BY COMPUTER TERMINALS OR
CELLULAR PHONES (U.S. CLS. 100, 101 AND 107).

CAROLYN CATALDO, EXAMINING ATTORNEY

SN 76-514,147. ZAMANSKY, RONALD A., MINNETONKA, MN. FILED 5-12-2003.

I STILL WANT TO BE A PAINTER

CLASS 16—PAPER GOODS AND PRINTED MATTER

FOR BOOKS THAT DISCUSS PRACTICAL REASONS AND BENEFITS OF A CHOICE OF PROFESSION THAT ARE IDENTIFIED AND COME FROM EXPERIENCE; STICKERS AND STATIONARY (U.S. CLS. 2, 5, 22, 23, 29, 37, 38 AND 50).

CLASS 25—CLOTHING

FOR HATS; TEE SHIRTS (U.S. CLS. 22 AND 39).
CHERYL CLAYTON, EXAMINING ATTORNEY

SN 76-514,248. LAURICE EL BADRY RAHME LTD., DBA LAURICE & CO., NEW YORK, NY. FILED 5-12-2003.

NEW HAARLEM

CLASS 3—COSMETICS AND CLEANING PREPARATIONS

FOR FRAGRANCES, NAMELY, PERFUMES, COLOGNES, AFTER BATH SPLASHES, BODY SPRAYS, SHOWER GELS, SCENTED BODY SOAPS, BODY LOTIONS AND MASSAGE OILS (U.S. CLS. 1, 4, 6, 50, 51 AND 52).

CLASS 4—LUBRICANTS AND FUELS

FOR CANDLES (U.S. CLS. 1, 6 AND 15).
INGRID C. EULIN, EXAMINING ATTORNEY

SN 76-514,566. ATHENS REGIONAL MEDICAL CENTER, INC., ATHENS, GA. FILED 5-14-2003.



Athens Regional

SEC. 2(F) AS TO "ATHENS REGIONAL".

CLASS 41—EDUCATION AND ENTERTAINMENT

FOR EDUCATIONAL SERVICES, NAMELY CONDUCTING CLASSES, SEMINARS, CONFERENCES, PROGRAMS, FAIRS AND WORKSHOPS IN THE FIELD OF HEALTH CARE, SAFETY AND FIRST AID, CARDIOPULMONARY RESUSCITATION CERTIFICATION, NUTRITION, PARENTING, REHABILITATION, EXERCISE AND RELAXATION, AND DISEASE PREVENTION (U.S. CLS. 100, 101 AND 107).

FIRST USE 10-0-2002; IN COMMERCE 10-0-2002.

CLASS 44—MEDICAL, BEAUTY AND AGRICULTURAL SERVICES

FOR HEALTHCARE SERVICES (U.S. CLS. 100 AND 101).
FIRST USE 10-0-2002; IN COMMERCE 10-0-2002.
MICHAEL WEBSTER, EXAMINING ATTORNEY

SN 76-514,589. ARCADE PLANET, INC., PLEASANTON, CA. FILED 5-14-2003.

INSTA-CASH

CLASS 9—ELECTRICAL AND SCIENTIFIC APPARATUS

FOR COMPUTER GAME PROGRAMS AND SOFTWARE FEATURING ARCADE AND ACTION GAMES (U.S. CLS. 21, 23, 26, 36 AND 38).

CLASS 28—TOYS AND SPORTING GOODS

FOR ARCADE GAMES, NAMELY ARCADE GAMES PLAYED FROM A REMOTE COMPUTER SITE (U.S. CLS. 22, 23, 38 AND 50).
STEVEN BERK, EXAMINING ATTORNEY

SN 76-514,892. AAF-MCQUAY INC., LOUISVILLE, KY. FILED 5-15-2003.

AmericanAirFilter

OWNER OF U.S. REG. NO. 1,887,056.
SEC. 2(F).

CLASS 11—ENVIRONMENTAL CONTROL APPARATUS

FOR PRECIPITATORS USED TO REMOVE DUST FROM THE AIR, NAMELY, HYDROSTATIC PRECIPITATORS, ELECTRONIC PRECIPITATORS, AND DYNAMIC PRECIPITATORS; AIR FILTERS; CARBON AIR FILTERS; MIST COLLECTORS; AIR INTAKE SYSTEMS COMPRISING WEATHER LOUVERS, MIST ELIMINATORS, INERTIAL SEPARATORS, TRASH SCREENS, SELF-CLEANING FILTERS, OIL BATH FILTERS, BARRIER FILTERS, CARTRIDGE FILTERS, EVAPORATIVE COOLERS, AND HEATING OR COOLING COILS; AIR FILTRATION UNITS, NAMELY DUST ARRESTORS AND DUST COLLECTORS; AIR FILTER PADS; REPLACEMENTS FOR AIR FILTERS; ALL FOR DOMESTIC, COMMERCIAL AND INDUSTRIAL USE (U.S. CLS. 13, 21, 23, 31 AND 34).

FIRST USE 0-0-1985; IN COMMERCE 0-0-1985.

CLASS 17—RUBBER GOODS

FOR SILENCERS/SOUND ATTENUATION DEVICES, NAMELY BLOWDOWN MUTES, TUBULAR DUCT MUTES, LINE MUTES, RECTANGULAR DUCT MUTES, SPLITTER DUCT MUTES, CHAMBER MUTES, FOR USE WITH COMPRESSORS, TURBINE INTAKES, INDUSTRIAL FANS, RECIPROCATING ENGINE EXHAUST, PRESSURE RELIEF VALVES, HIGH PRESSURE GAS OR STEAM LINES; FAN SILENCERS, AND INSULATED ENCLOSURE PANELS (U.S. CLS. 1, 5, 12, 13, 35 AND 50).

FIRST USE 0-0-1985; IN COMMERCE 0-0-1985.
KARLA PERKINS, EXAMINING ATTORNEY

SN 76-515,445. MILSO INDUSTRIES, INC., BROOKLYN, NY.
FILED 5-19-2003.



OWNER OF U.S. REG. NO. 2,519,957.
NO CLAIM IS MADE TO THE EXCLUSIVE RIGHT TO USE "INDUSTRIES", APART FROM THE MARK AS SHOWN.

CLASS 6—METAL GOODS

FOR METAL CASKET CORNER ORNAMENTS (U.S. CLS. 2, 12, 13, 14, 23, 25 AND 50).
FIRST USE 1-1-1996; IN COMMERCE 1-1-1996.

CLASS 20—FURNITURE AND ARTICLES NOT OTHERWISE CLASSIFIED

FOR BURIAL CASKETS, BURIAL CASKET PARTS, NAMELY, CASKET LID INTERIOR PANELS, CASKET CORNER ORNAMENTS OF WOOD, CASKET CORNER ORNAMENTS OF PLASTIC AND POINT-OF-PURCHASE DISPLAYS FOR BOTH BURIAL CASKETS AND BURIAL CASKET ACCESSORIES (U.S. CLS. 2, 13, 22, 25, 32 AND 50).
FIRST USE 1-1-1996; IN COMMERCE 1-1-1996.

CLASS 24—FABRICS

FOR BED BLANKETS FOR USE WITH BURIAL CASKETS AND FABRIC CASKET OVERLAYS IN THE NATURE OF QUILTS (U.S. CLS. 42 AND 50).
FIRST USE 1-1-1996; IN COMMERCE 1-1-1996.
TONJA GASKINS, EXAMINING ATTORNEY

SN 76-515,555. ATLANTA UNION MISSION CORPORATION, ATLANTA, GA. FILED 5-19-2003.

SAVING LIVES WITH YOUR HELP

CLASS 41—EDUCATION AND ENTERTAINMENT

FOR EDUCATIONAL SERVICES, NAMELY, PROVIDING VOCATIONAL TRAINING IN THE FIELD OF APPLIANCE REPAIR AND CARPENTRY AND PROVIDING CLASSES IN THE FIELD OF LIFE SKILLS (U.S. CLS. 100, 101 AND 107).
FIRST USE 5-0-2003; IN COMMERCE 5-0-2003.

CLASS 43—HOTEL AND RESTAURANT SERVICES

FOR CHARITABLE SERVICES, NAMELY PROVIDING EMERGENCY FOOD AND TEMPORARY SHELTER TO HOMELESS PERSONS (U.S. CLS. 100 AND 101).
FIRST USE 5-0-2003; IN COMMERCE 5-0-2003.

CLASS 44—MEDICAL, BEAUTY AND AGRICULTURAL SERVICES

FOR PROVIDING RESIDENTIAL ADDICTION TREATMENT SERVICES TO HOMELESS AND CHEMICALLY ADDICTED PERSONS (U.S. CLS. 100 AND 101).
FIRST USE 5-0-2003; IN COMMERCE 5-0-2003.
BRETT J. GOLDEN, EXAMINING ATTORNEY

SN 76-517,192. IVEY, FRANK W., CANOGA PARK, CA. FILED 5-28-2003.



NO CLAIM IS MADE TO THE EXCLUSIVE RIGHT TO USE "ACTION SPORTS", APART FROM THE MARK AS SHOWN.

CLASS 25—CLOTHING

FOR APPAREL, NAMELY, BASEBALL CAPS, T-SHIRTS, SHIRTS, SHOES, PANTS, SKIRTS, LEOTARDS, BLOUSES, JUMPSUITS, JACKETS, SHORTS, SWIMWEAR, LINGERIE AND JERSEYS (U.S. CLS. 22 AND 39).
FIRST USE 1-1-1999; IN COMMERCE 6-6-1999.

CLASS 28—TOYS AND SPORTING GOODS

FOR SPORTING GOODS, NAMELY, FOOTBALLS, BASEBALLS, BASKETBALLS, SOCCER BALLS, TENNIS BALLS AND GOLF BALLS (U.S. CLS. 22, 23, 38 AND 50).
FIRST USE 1-1-1999; IN COMMERCE 6-6-1999.
MITCHELL FRONT, EXAMINING ATTORNEY

SN 76-517,491. SHECTER, JONATHAN, NEW YORK, NY. FILED 5-5-2003.

HIP-HOP HONEYS

NO CLAIM IS MADE TO THE EXCLUSIVE RIGHT TO USE "HIP-HOP", APART FROM THE MARK AS SHOWN.

CLASS 9—ELECTRICAL AND SCIENTIFIC APPARATUS

FOR PRE-RECORDED PHONOGRAPH RECORDS, COMPACT DISCS, AUDIO AND VIDEO CASSETTES, AND DVDS FEATURING ALL FEATURING MUSIC AND PERFORMANCES BY MODELS (U.S. CLS. 21, 23, 26, 36 AND 38).
FIRST USE 10-1-2001; IN COMMERCE 10-1-2001.

CLASS 25—CLOTHING

FOR MEN'S, WOMEN'S, AND CHILDREN'S APPAREL, NAMELY, BOTTOMS, SHIRTS, T-SHIRTS, POLO SHIRTS, SHORTS, SKORTS, PANTS, DENIM JEANS, OVERALLS, VESTS, TOPS, BLOUSES, SKIRTS, SOCKS, BELTS, HALTER TOPS, SUSPENDERS, NECKTIES, DRESSES, SUITS, SWEATERS; SPORTSWEAR, NAMELY, WARM UP SUITS, SWEAT SUITS, SWEAT SHORTS, JOGGING SUITS, SWEAT BANDS, TANK TOPS, CROP TOPS, TRACK PANTS, JERSEYS, SWEAT SHIRTS, SWEAT PANTS, CYCLE PANTS, SPORTS TOPS, SPORTS SHORTS, HEAD BANDS, LEGGINGS, SPORTS BRAS, GYM SHORTS, AND GYM SUITS; SLEEPWEAR; UNDERWEAR, NAMELY, STOCKINGS, BOXER BRIEFS, BOXER SHORTS, BRAS, AND PANTIES; HEADGEAR, NAMELY, HATS, CAPS, AND BEANIES; FOOTWEAR, NAMELY, SHOES, BOOTS, SNEAKERS, AND ATHLETIC FOOTWEAR; OUTERWEAR, NAMELY, JACKETS, COATS, PULLOVERS, GLOVES, PARKAS, AND SCARVES IN ALL FABRICATIONS NAMELY, CLOTH, DENIM, LEATHER AND SUEDE; RAINWEAR (U.S. CLS. 22 AND 39).

CLASS 41—EDUCATION AND ENTERTAINMENT

FOR ENTERTAINMENT SERVICES, NAMELY, LIVE PERFORMANCES BY ONE OR MORE MODELS (U.S. CLS. 100, 101 AND 107).

FIRST USE 10-1-2001; IN COMMERCE 10-1-2001.
AMY GEARIN, EXAMINING ATTORNEY

SN 76-518,185. ADVANCED MICRO DEVICES, INC., SUNNYVALE, CA. FILED 5-30-2003.

**CLASS 9—ELECTRICAL AND SCIENTIFIC APPARATUS**

FOR VOLATILE AND NON-VOLATILE MEMORY DEVICES, NAMELY, FLASH MEMORY SEMICONDUCTOR CHIPS AND MASS STORAGE SEMICONDUCTOR CHIPS; APPLICATIONS SOFTWARE AND UTILITY SOFTWARE FOR FUNCTIONS ASSOCIATED WITH MEMORY DEVICES, NAMELY, CODE AND DATA MANAGEMENT, FILE SYSTEM MANAGEMENT, FLASH MEMORY SEMICONDUCTOR CHIP DRIVERS, MASS STORAGE SEMICONDUCTOR CHIP DRIVERS, FLASH MEDIA DRIVERS, AND BLOCK DRIVERS (U.S. CLS. 21, 23, 26, 36 AND 38).

FIRST USE 10-21-2003; IN COMMERCE 11-30-2003.

CLASS 42—SCIENTIFIC, COMPUTER AND LEGAL SERVICES

FOR COMPUTER SOFTWARE CONSULTATION AND SOFTWARE DEVELOPMENT SERVICES, NAMELY, COMPUTER SOFTWARE DESIGN, COMPUTER PROGRAMMING, AND MAINTENANCE OF COMPUTER SOFTWARE FOR OTHERS; COMPUTER SYSTEMS ANALYSIS; CUSTOMIZATION OF COMPUTER HARDWARE AND SOFTWARE; CONSULTING SERVICES IN THE FIELD OF DESIGN, SELECTION, IMPLEMENTATION, MAINTENANCE AND USE OF COMPUTER HARDWARE AND SOFTWARE SYSTEMS FOR OTHERS; CREATING, DESIGNING, MAINTAINING, MANAGING AND IMPLEMENTING WEB SITES FOR OTHERS; LEASING ACCESS TIME TO COMPUTER DATABASE AND COMPUTER SERVERS; RENTAL AND LEASING OF COMPUTER HARDWARE AND SOFTWARE; CUSTOM DESIGN OF ELECTRONIC MACHINES, APPARATUS OR TELECOMMUNICATION DEVICES (U.S. CLS. 100 AND 101).

FIRST USE 10-21-2003; IN COMMERCE 11-30-2003.
APRIL L. RADEMACHER, EXAMINING ATTORNEY

SN 76-518,010. AEGON DIRECT MARKETING SERVICES, INC., FRAZER, PA. FILED 5-9-2003.

TAKING CARE**CLASS 35—ADVERTISING AND BUSINESS**

FOR ADMINISTRATION OF A DISCOUNT PROGRAM FOR ENABLING PARTICIPANTS TO OBTAIN DISCOUNTS ON TRAVEL, AUTO CLUBS, WARRANTY PROGRAMS, HEALTH INSURANCE, PRESCRIPTIONS, AND DENTAL SERVICES, THROUGH MEMBERSHIP IN A DISCOUNT PROGRAM (U.S. CLS. 100, 101 AND 102).

CLASS 36—INSURANCE AND FINANCIAL

FOR INSURANCE SERVICES, NAMELY INSURANCE BROKERAGE, CONSULTATION, ADMINISTRATION, UNDERWRITING, PROVIDER, AGENT AND CLAIMS PROCESSING SERVICES FOR ALL TYPES OF INSURANCE (U.S. CLS. 100, 101 AND 102).

MARY CRAWFORD, EXAMINING ATTORNEY

SN 76-519,132. BLUE CROSS AND BLUE SHIELD ASSOCIATION, CHICAGO, IL. FILED 6-3-2003.

BLUEANGEL

THE MARK CONSISTS OF STANDARD CHARACTERS WITHOUT CLAIM TO ANY PARTICULAR FONT, STYLE, SIZE, OR COLOR.

CLASS 36—INSURANCE AND FINANCIAL

FOR CHARITABLE FUNDRAISING SERVICES (U.S. CLS. 100, 101 AND 102).

FIRST USE 1-1-2002; IN COMMERCE 1-1-2002.

CLASS 37—CONSTRUCTION AND REPAIR

FOR CHARITABLE SUPPORT SERVICES, NAMELY, RENOVATING AND CONSTRUCTING HOMES FOR OTHERS (U.S. CLS. 100, 103 AND 106).

FIRST USE 1-1-2002; IN COMMERCE 1-1-2002.
JAMES GRIFFIN, EXAMINING ATTORNEY

SN 76-519,898. RAVEN USA, LLC, BALDWIN PARK, CA.
FILED 6-5-2003.

SN 76-519,730. CARNIVAL CORPORATION, MIAMI, FL.
FILED 6-3-2003.

CARNIVAL PRIDE

OWNER OF U.S. REG. NOS. 1,489,408, 2,707,369 AND OTHERS.

CLASS 39—TRANSPORTATION AND STORAGE

FOR PASSENGER CRUISE SHIP SERVICES (U.S. CLS. 100 AND 105).

CLASS 41—EDUCATION AND ENTERTAINMENT

FOR ENTERTAINMENT SERVICES, NAMELY CASINO SERVICES, ORGANIZING AND CONDUCTING STAGE SHOWS, NIGHTCLUB SHOWS, CONTESTS, DANCES AND PARTIES (U.S. CLS. 100, 101 AND 107).

CLASS 43—HOTEL AND RESTAURANT SERVICES

FOR PROVIDING LODGING, RESTAURANT, CATERING AND PARTY FACILITIES RENTAL SERVICES ON BOARD SHIPS (U.S. CLS. 100 AND 101).

MICHAEL WEBSTER, EXAMINING ATTORNEY

SN 76-519,832. FREIGHT SAFETY, LLC, NORTH HUNTINGDON, PA. FILED 6-5-2003.

SAFETY DISPATCH TEAM

NO CLAIM IS MADE TO THE EXCLUSIVE RIGHT TO USE "SAFETY DISPATCH", APART FROM THE MARK AS SHOWN.

CLASS 9—ELECTRICAL AND SCIENTIFIC APPARATUS

FOR COMPUTER SOFTWARE, NAMELY, COMPUTER SOFTWARE THAT FACILITATES THE DISSEMINATION OF INFORMATION AND DATA CONCERNING HIJACKINGS, CARGO THEFT, FREIGHT SECURITY, AND TRANSPORTATION EMERGENCIES, AND OTHER EMERGENCIES, AND WHICH AIDS IN RESPONSE MANAGEMENT AND COORDINATION THEREFOR (U.S. CLS. 21, 23, 26, 36 AND 38).

CLASS 45—PERSONAL SERVICES

FOR SECURITY NOTIFICATION SERVICES, NAMELY, PROVIDING INFORMATION AND DATA CONCERNING HIJACKINGS, CARGO THEFT, FREIGHT SECURITY, AND TRANSPORTATION EMERGENCIES, AND OTHER EMERGENCIES, VIA ELECTRONIC COMMUNICATION MEANS, TELECOMMUNICATION MEANS, AND/OR THE INTERNET (U.S. CLS. 100 AND 101).

RAUL CORDOVA, EXAMINING ATTORNEY

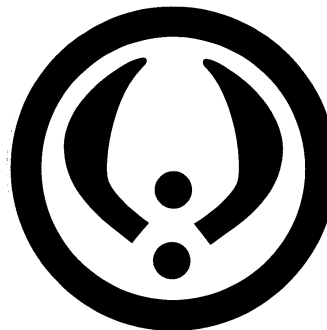
**CLASS 25—CLOTHING**

FOR TOPS, BOTTOMS, HEADWEAR AND FOOTWEAR (U.S. CLS. 22 AND 39).

FIRST USE 3-0-1999; IN COMMERCE 6-0-1999.

CLASS 28—TOYS AND SPORTING GOODS

FOR PAINTBALL GUNS, AND ACCESSORIES THEREFOR IN THE NATURE OF BARRELS, GRIP FRAMES, FRAME COVERS, GRIPS, EXPANSION CHAMBERS, SIGHT RAILS, TRIGGER ASSEMBLIES, BARREL PLUGS AND TURBULENCE BOLTS; KNEE AND SHIN GUARDS FOR ATHLETIC USE; THROAT PROTECTORS FOR ATHLETIC USE; ELBOW AND KNEE PADS FOR ATHLETIC USE; PAINTBALL GEAR BAGS AND HYDRO-PACKS (U.S. CLS. 22, 23, 38 AND 50).

FIRST USE 6-0-1999; IN COMMERCE 6-0-1999.

TARAH HARDY, EXAMINING ATTORNEY

SN 76-521,538. EASTERN ADVERTISING, INC., NEWTON, MA. FILED 6-9-2003.

BOSTON BLACK & GOLD LEGENDS

NO CLAIM IS MADE TO THE EXCLUSIVE RIGHT TO USE "BOSTON", APART FROM THE MARK AS SHOWN.

CLASS 36—INSURANCE AND FINANCIAL

FOR CHARITABLE FUND RAISING SERVICES (U.S. CLS. 100, 101 AND 102).

FIRST USE 1-21-2002; IN COMMERCE 1-21-2002.

CLASS 41—EDUCATION AND ENTERTAINMENT

FOR ORGANIZING AND ADMINISTERING AMATEUR HOCKEY TEAMS COMPOSED OF CELEBRITY TEAM MEMBERS (U.S. CLS. 100, 101 AND 107).

FIRST USE 1-21-2002; IN COMMERCE 1-21-2002.

PAUL F. GAST, EXAMINING ATTORNEY

SN 76-524,429. HARRIS RESEARCH, INC., LOGAN, UT.
FILED 6-23-2003.

SN 76-525,748. RDS-AMERICA, LLC, PINCONNING, MI.
FILED 6-27-2003.

NHance

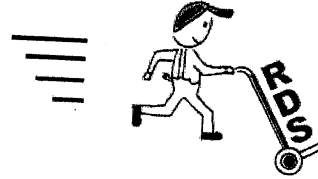

THE LETTER "N" IS A SHADE OF BROWN, THE LETTERS "HANCE" ARE A LIGHTER SHADE OF BROWN THAN THE "N", AND THE TAPERED BAND, INTERSECTING THE LETTER "N" IS A SHADE OF GREEN.

CLASS 2—PAINTS

FOR WOOD SURFACE FINISHING AND REFINISHING COATINGS AND RESURFACING COATING, ALL THE AFOREMENTIONED FOR USE ON WOOD SURFACES, FURNITURE, FLOORS, CABINETS, DOORS, AND TRIM (U.S. CLS. 6, 11 AND 16).

CLASS 37—CONSTRUCTION AND REPAIR

FOR REFINISHING AND RESURFACING SERVICES FOR WOOD SURFACES, FURNITURE, FLOORS, CABINETS, DOORS, TRIMS (U.S. CLS. 100, 103 AND 106).
JOHN GARTNER, EXAMINING ATTORNEY

CLASS 35—ADVERTISING AND BUSINESS

FOR BUSINESS MARKETING SERVICES IN THE FIELD OF HAND TRUCKS, DELIVERY TRUCKS, PALLET TRUCKS, DELIVERY AND MATERIAL HANDLING PRODUCTS, AND CONSULTATION RELATED THERETO (U.S. CLS. 100, 101 AND 102).
FIRST USE 5-1-2003; IN COMMERCE 5-1-2003.

CLASS 37—CONSTRUCTION AND REPAIR

FOR MAINTENANCE, INSTALLATION, AND REPAIR OF HAND TRUCKS, DELIVERY TRUCKS, PALLET TRUCKS, DELIVERY AND MATERIAL HANDLING EQUIPMENT, AND CONSULTATION RELATED THERETO (U.S. CLS. 100, 103 AND 106).
FIRST USE 5-1-2003; IN COMMERCE 5-1-2003.
TARAH HARDY, EXAMINING ATTORNEY

SN 76-525,539. NORTHSTAR TRAVEL MEDIA, LLC, SECAUCUS, NJ. FILED 6-18-2003.

GOPNR

CLASS 39—TRANSPORTATION AND STORAGE

FOR PROVIDING TRAVEL INFORMATION, NAMELY, INFORMATION ABOUT TRAVEL DESTINATIONS AND SECURITY INFORMATION AS WELL AS TIMELY INFORMATION ABOUT THE TRAVEL INDUSTRY, VIA EMAIL AND TELEPHONE ACCOUNTS AND OTHER ELECTRONIC DEVICES SYNCHRONIZED WITH TRAVEL INDUSTRY COMPUTERIZED RESERVATION SYSTEMS AND INDIVIDUAL TRAVELER ITINERARIES (U.S. CLS. 100 AND 105).
FIRST USE 1-1-2003; IN COMMERCE 1-1-2003.

CLASS 41—EDUCATION AND ENTERTAINMENT

FOR PROVIDING NEWS ALERTS IN THE NATURE OF CURRENT EVENTS REPORTING VIA EMAIL AND TELEPHONE ACCOUNTS AND OTHER ELECTRONIC DEVICES SYNCHRONIZED WITH TRAVEL INDUSTRY COMPUTERIZED RESERVATION SYSTEMS AND INDIVIDUAL TRAVELER ITINERARIES (U.S. CLS. 100, 101 AND 107).
FIRST USE 1-1-2003; IN COMMERCE 1-1-2003.
CURTIS FRENCH, EXAMINING ATTORNEY

SN 76-525,749. RDS-AMERICA, LLC, PINCONNING, MI.
FILED 6-27-2003.

RDS

CLASS 35—ADVERTISING AND BUSINESS

FOR BUSINESS MARKETING SERVICES IN THE FIELD OF HAND TRUCKS, DELIVERY TRUCKS, PALLET TRUCKS, DELIVERY AND MATERIAL HANDLING PRODUCTS, AND CONSULTATION RELATED THERETO (U.S. CLS. 100, 101 AND 102).
FIRST USE 5-1-2003; IN COMMERCE 5-1-2003.

CLASS 37—CONSTRUCTION AND REPAIR

FOR MAINTENANCE, INSTALLATION, AND REPAIR OF HAND TRUCKS, DELIVERY TRUCKS, PALLET TRUCKS, DELIVERY AND MATERIAL HANDLING EQUIPMENT, AND CONSULTATION RELATED THERETO (U.S. CLS. 100, 103 AND 106).
FIRST USE 5-1-2003; IN COMMERCE 5-1-2003.
TARAH HARDY, EXAMINING ATTORNEY

SN 76-526,365. SUN VALLEY FLORAL FARMS LLC, ARCA-
TA, CA. FILED 6-30-2003.

SN 76-527,287. BENETZ, LLC, GREENVILLE, SC. FILED 6-
30-2003.



OWNER OF U.S. REG. NO. 1,826,535.
NO CLAIM IS MADE TO THE EXCLUSIVE RIGHT TO
USE "GROUP", APART FROM THE MARK AS SHOWN.
SEC. 2(F).

CLASS 31—NATURAL AGRICULTURAL PRODUCTS

FOR LIVING, CUT, AND DRIED FLOWERS; LIVING
PLANTS AND FLOWER BULBS (U.S. CLS. 1 AND 46).
FIRST USE 11-4-2003; IN COMMERCE 11-4-2003.

CLASS 35—ADVERTISING AND BUSINESS

FOR WHOLESALE DISTRIBUTORSHIPS FEATURING
HORTICULTURAL PRODUCTS, NAMELY CUT FLOW-
ERS, PLANTS AND BULBS (U.S. CLS. 100, 101 AND 102).
FIRST USE 11-4-2003; IN COMMERCE 11-4-2003.
IRENE D. WILLIAMS, EXAMINING ATTORNEY

SN 76-526,892. BOOMERANG TRACKING INC., MON-
TREAL QUEBEC, CANADA. FILED 6-24-2003.

STOLEN? NOT FOR LONG!

CLASS 9—ELECTRICAL AND SCIENTIFIC APPARATUS

FOR WIRELESS AND RADIO BASED SYSTEM COM-
PRISING ANTENNAS, BEACONS, MODULATORS, DE-
MODULATORS, INTEGRATED CIRCUITS, INTERNET
APPLIANCES, MODEMS, NETWORK MULTIPLEXERS,
PAGERS, RADIOS, RECEIVERS, TELEPHONES, TRANS-
CEIVERS, TRANSMITTERS, COMPUTER SOFTWARE
FOR OPERATING THE FOREGOING DEVICES FOR
TRACKING AND RECOVERING VEHICLES, OBJECTS
AND/OR PEOPLE (U.S. CLS. 21, 23, 26, 36 AND 38).

CLASS 35—ADVERTISING AND BUSINESS

FOR TRACKING OF VEHICLES, OBJECTS AND PEOP-
LE (U.S. CLS. 100, 101 AND 102).

CLASS 45—PERSONAL SERVICES

FOR RECOVERY OF VEHICLES, OBJECTS AND
PEOPLE (U.S. CLS. 100 AND 101).
KEVON CHISOLM, EXAMINING ATTORNEY

BENETZ

CLASS 35—ADVERTISING AND BUSINESS

FOR RETAIL STORE SERVICES FEATURING COS-
METICS AND SKIN CARE PRODUCTS, NAMELY, EYE-
SHADOW, LIPSTICK, EYE LINER, EYEBROW KITS,
POWDER, MASCARA, FOUNDATION, MOISTURIZERS,
TONERS, CONCEALER, BLUSH, SHOWER GEL, BODY
LOTION, SOAP, BUBBLE BATH, BATH SALTS AND
HAND CREAM; RETAIL STORE SERVICES FEATUR-
ING HAIR CARE PRODUCTS, NAMELY, SHAMPOOS,
CONDITIONERS, MOISTURIZERS (U.S. CLS. 100, 101
AND 102).

CLASS 44—MEDICAL, BEAUTY AND AGRICULTURAL SERVICES

FOR SKIN CARE SALONS AND PROVIDING SKIN
CARE TREATMENTS (U.S. CLS. 100 AND 101).
ANNE MADDEN, EXAMINING ATTORNEY

SN 76-527,691. VETINSITE.COM, INC., SILVER SPRING,
MD. FILED 7-2-2003.

VETINSITE

CLASS 35—ADVERTISING AND BUSINESS

FOR PROVIDING CUSTOMIZED ADMINISTRATIVE
INFORMATIONAL SERVICES VIA THE INTERNET IN
THE FIELD OF VETERINARY OFFICES, NAMELY,
APPOINTMENT SCHEDULING, REVIEW OF CUS-
TOMER RECORDS, AND ADMINISTRATIVE COMMUN-
ICATION BETWEEN BUSINESS AND CUSTOMER;
PROMOTING THE GOODS AND SERVICES OF OTHERS
IN THE FIELD OF PETS AND PET CARE THROUGH
THE USE OF TARGETED MARKETING, NAMELY
DIRECT MAIL, COUPONS AND EMAIL COUPONS,
AND ELECTRONIC MAIL (U.S. CLS. 100, 101 AND 102).
FIRST USE 11-0-2000; IN COMMERCE 11-0-2000.

CLASS 42—SCIENTIFIC, COMPUTER AND LEGAL SERVICES

FOR PROVIDING TEMPORARY USE OF ONLINE
NON-DOWNLOADABLE COMPUTER SOFTWARE FOR
COMMUNICATIONS ALLOWING VETERINARY BUSI-
NESS TO PROVIDE INFORMATIONAL SERVICES VIA
THE INTERNET TO PET OWNERS IN THE FIELD OF
VETERINARY MEDICINE AND PET CARE, NAMELY
APPOINTMENT SCHEDULING, REVIEW OF CUS-
TOMER RECORDS, COMMUNICATIONS BETWEEN THE
BUSINESS AND CUSTOMER, PRESCRIPTION FILLING,
PRODUCT AND SERVICE RESEARCH, AND PURCHAS-
ING OF PRODUCTS AND SERVICES; PROVIDING
WEBSITE DEVELOPMENT SERVICES FOR ENTITIES
IN THE VETERINARY FIELD (U.S. CLS. 100 AND 101).
FIRST USE 11-0-2000; IN COMMERCE 11-0-2000.

CLASS 44—MEDICAL, BEAUTY AND AGRICULTURAL SERVICES

FOR PROVIDING CUSTOMIZED INFORMATIONAL
SERVICES VIA THE INTERNET IN THE FIELD OF
VETERINARY MEDICINE, NAMELY, PROVIDING PET
CARE INFORMATION AND ADVICE; PROVIDING A
WEBSITE FEATURING INFORMATION IN THE FIELD
OF VETERINARY MEDICINE AND PET CARE (U.S.
CLS. 100 AND 101).
FIRST USE 11-0-2000; IN COMMERCE 11-0-2000.
STACY WAHLBERG, EXAMINING ATTORNEY

SN 76-529,017. OFFICIAL PILLOWTEX LLC, COLUMBUS, OH. FILED 7-11-2003.

SN 76-529,766. ARENA FOOTBALL LEAGUE, LLC, CHICAGO, IL. FILED 7-14-2003.

OPULENCE BY FIELDCREST

CLASS 20—FURNITURE AND ARTICLES NOT OTHERWISE CLASSIFIED

FOR PILLOWS AND FITTED FURNITURE COVERS OF FABRIC (U.S. CLS. 2, 13, 22, 25, 32 AND 50).

CLASS 24—FABRICS

FOR TOWELS AND TOWELING, NAMELY, DISH TOWELS AND KITCHEN TOWELS, BED SHEETS, PILLOWCASES, PILLOW SHAMS, BEDSPREADS AND COVERLETS, BED BLANKETS, DUVET COVERS, TABLECLOTHS AND NAPKINS, DRAPES AND CURTAINS, SHOWER CURTAINS, DECORATIVE DRAPERY AND DRAPERY FABRICS, FITTED TOILET SEAT COVERS, WASHCLOTHS, HOUSEHOLD UTILITY CLOTHS, NAMELY, DISH CLOTHS, POTHOLDERS, TERRY CLOTH, MATTRESS PADS, QUILTS, COMFORTERS, DUST RUFFLES, WALL HANGINGS, UNFITTED FABRIC FURNITURE COVERS, BLANKET THROWS, PLACE MATS, OVEN MITTS, POT GRABBERS, TOASTER COVERS, BLENDER COVERS, DUVET COVERS AND VALANCES, ALL MADE OF FABRIC (U.S. CLS. 42 AND 50).
MATTHEW KLINE, EXAMINING ATTORNEY

SN 76-529,248. RTIX LIMITED, HARROGATE HG2 8PB, UNITED KINGDOM, FILED 7-15-2003.

onCore

OWNER OF ERPN CMNTY TM OFC REG. NO. 002634517, DATED 9-11-2003, EXPIRES 3-27-2012.

CLASS 9—ELECTRICAL AND SCIENTIFIC APPARATUS

FOR SOFTWARE FOR MANAGEMENT OF PERSONNEL TRAINING ASSESSMENT AND APPRAISAL (U.S. CLS. 21, 23, 26, 36 AND 38).

CLASS 16—PAPER GOODS AND PRINTED MATTER

FOR INSTRUCTION MANUALS RELATING TO PERSONNEL TRAINING AND ASSESSMENT AND APPRAISAL (U.S. CLS. 2, 5, 22, 23, 29, 37, 38 AND 50).

CLASS 42—SCIENTIFIC, COMPUTER AND LEGAL SERVICES

FOR COMPUTER PROGRAMMING AND COMPUTER CONSULTATION SERVICES FOR OTHERS RELATING TO PERSONNEL TRAINING ASSESSMENT AND APPRAISAL (U.S. CLS. 100 AND 101).
LINDA E. BLOHM, EXAMINING ATTORNEY



OWNER OF U.S. REG. NOS. 2,057,890, 2,525,112 AND 2,668,630.

NO CLAIM IS MADE TO THE EXCLUSIVE RIGHT TO USE SAN JOSE AND EST. 1995, APART FROM THE MARK AS SHOWN.

THE MARK CONSISTS, IN PART, OF THE HEAD OF A SABER TOOTH TIGER.

CLASS 16—PAPER GOODS AND PRINTED MATTER

FOR PRINTED ANNUAL MEDIA GUIDES CONTAINING INFORMATION ABOUT FOOTBALL, GENERAL MERCHANDISE CATALOGS, BUMPER STICKERS, WRITING PADS AND PENS, PENCILS, TRADING CARDS, POSTERS, PAPER PENNANTS, POST CARDS, CALENDARS, PAPER STICKERS IN THE FORM OF DECALS, PRINTED EVENT ADMISSION TICKETS, GREETING CARDS, STATISTICAL BOOKS, NEWSLETTERS AND PAMPHLETS IN THE FIELD OF FOOTBALL FOR DISTRIBUTION TO TELEVISION AND RADIO MEDIA (U.S. CLS. 2, 5, 22, 23, 29, 37, 38 AND 50).
FIRST USE 2-22-1995; IN COMMERCE 2-22-1995.

CLASS 25—CLOTHING

FOR MEN'S, WOMEN'S AND CHILDREN'S CLOTHING, NAMELY, PLAYER UNIFORMS, FOOTWEAR, JERSEY TOPS AND PANTS; CHEERLEADER UNIFORMS; REPLICAS UNIFORM SHIRTS, COACHES' CAPS, WOOL HATS, PAINTERS' CAPS, BASEBALL CAPS, VISORS, HEADBANDS, BELTS, T-SHIRTS, TANK TOPS, GOLF SHIRTS, SWEATERS, SWEATSHIRTS, LEATHER JACKETS, NECKTIES, COATS, SHORTS, SWEATPANTS, PANTS, SOCKS AND UNDERWEAR (U.S. CLS. 22 AND 39).

FIRST USE 2-22-1995; IN COMMERCE 2-22-1995.
HOWARD SMIGA, EXAMINING ATTORNEY

SN 76-530,393. ECOVAP SA, 2300 LA CHAUX-DE-FONDS, SWITZERLAND, FILED 7-8-2003.

VAP(O)FACE

PRIORITY CLAIMED UNDER SEC. 44(D) ON SWITZERLAND APPLICATION NO. 50840/2003, FILED 3-14-2003, REG. NO. 509103, DATED 4-3-2003, EXPIRES 3-14-2013.

CLASS 11—ENVIRONMENTAL CONTROL APPARATUS

FOR ELECTRIC VAPORIZERS; FACIAL SAUNAS; HUMIDIFIERS (U.S. CLS. 13, 21, 23, 31 AND 34).

CLASS 21—HOUSEWARES AND GLASS

FOR SPRAYERS FOR CLEANING AND TONING THE FACE FOR COSMETIC USE (U.S. CLS. 2, 13, 23, 29, 30, 33, 40 AND 50).

G. MAYERSCHOFF, EXAMINING ATTORNEY

SN 76-531,283. ROSEVINE ENTERPRISES, ATLANTA, GA. FILED 7-10-2003.

1810 WINERY

NO CLAIM IS MADE TO THE EXCLUSIVE RIGHT TO USE "WINERY", APART FROM THE MARK AS SHOWN.

CLASS 32—LIGHT BEVERAGES

FOR WINE GRAPE JUICE (U.S. CLS. 45, 46 AND 48).

CLASS 33—WINES AND SPIRITS

FOR WINE (U.S. CLS. 47 AND 49).
LAURA KOVAISKY, EXAMINING ATTORNEY

SN 76-531,547. SPORTS CAR CLUB OF AMERICA, INC., TOPEKA, KS. FILED 7-23-2003.

GET REAL FAST**CLASS 35—ADVERTISING AND BUSINESS**

FOR ASSOCIATION SERVICES, NAMELY, PROMOTING THE INTERESTS OF SPORTS CAR ENTHUSIASTS THROUGHOUT THE UNITED STATES AND IN FOREIGN COUNTRIES; PROMOTING PUBLIC INTEREST IN SPORTS CARS AND SPORT CAR RACING THROUGHOUT THE UNITED STATES AND IN FOREIGN COUNTRIES (U.S. CLS. 100, 101 AND 102).

FIRST USE 2-7-2003; IN COMMERCE 2-10-2003.

CLASS 41—EDUCATION AND ENTERTAINMENT

FOR PROVIDING INFORMATION IN THE FIELD OF SPORTS CARS AND SPORTS CAR ACTIVITIES (U.S. CLS. 100, 101 AND 107).

FIRST USE 2-7-2003; IN COMMERCE 2-10-2003.

AMY GEARIN, EXAMINING ATTORNEY

SN 76-531,558. COMBE INCORPORATED, WHITE PLAINS, NY. FILED 7-2-2003.



OWNER OF U.S. REG. NOS. 1,012,978, 2,669,406 AND OTHERS.

CLASS 16—PAPER GOODS AND PRINTED MATTER

FOR DISPOSABLE PADS WITH DEODORIZING PROPERTIES FOR USE INSIDE CRATES, CUSHIONS, HUTCHES, LOUNGERS, PERCHES, AND PILLOWS FOR PETS; DISPOSABLE TRAINING PADS WITH DEODORIZING PROPERTIES FOR PETS (U.S. CLS. 2, 5, 22, 23, 29, 37, 38 AND 50).

CLASS 20—FURNITURE AND ARTICLES NOT OTHERWISE CLASSIFIED

FOR CUSHIONS AND MATS WITH DEODORIZING PROPERTIES FOR PETS (U.S. CLS. 2, 13, 22, 25, 32 AND 50).

AISHA CLARKE, EXAMINING ATTORNEY

SN 76-531,941. LA COLLINA TOSCANA S.R.L., AREZZO, ITALY, FILED 7-24-2003.

LA COLLINA

THE ENGLISH TRANSLATION OF THE WORD LA COLLINA IN THE MARK IS THE HILL.

CLASS 29—MEATS AND PROCESSED FOODS

FOR OLIVE OILS, MEAT EXTRACTS, TUSCANY SPECIALTIES, NAMELY SOUPS, MARMALADES AND JAMS, PROCESSED VEGETABLES PRESERVED IN OIL, CONDIMENTS, NAMELY PEPPER OIL AND PICKLES (U.S. CL. 46).

FIRST USE 4-0-2003; IN COMMERCE 6-0-2003.

CLASS 30—STAPLE FOODS

FOR CONDIMENTS, NAMELY KETCHUP AND RELISH, VINEGAR, NOODLES, HONEY, BISCUITS, AND CAKES (U.S. CL. 46).

FIRST USE 4-0-2003; IN COMMERCE 6-0-2003.

INGRID C. EULIN, EXAMINING ATTORNEY

SN 76-531,996. TEA TRAIN, LTD., LONGMONT, CO. FILED 7-14-2003.

PEKOE SIP HOUSE

NO CLAIM IS MADE TO THE EXCLUSIVE RIGHT TO USE PEKOE, APART FROM THE MARK AS SHOWN.

CLASS 30—STAPLE FOODS

FOR TEA AND TEA-BASED BEVERAGES (U.S. CL. 46).

CLASS 35—ADVERTISING AND BUSINESS

FOR RETAIL STORE SERVICES AND MAIL ORDER SERVICES FEATURING TEA AND TEA RELATED ITEMS (U.S. CLS. 100, 101 AND 102).

ODESSA BIBBINS, EXAMINING ATTORNEY

SN 76-532,249. PERRON, LAURENT, DBA THE MARGARITA MAN, BERGHEIM, TX. FILED 7-25-2003.

THE MARGARITA MAN

OWNER OF U.S. REG. NO. 2,253,686.
NO CLAIM IS MADE TO THE EXCLUSIVE RIGHT TO USE MARGARITA, APART FROM THE MARK AS SHOWN.

CLASS 35—ADVERTISING AND BUSINESS

FOR RETAIL STORE SERVICES FEATURING MARGARITA MACHINES (U.S. CLS. 100, 101 AND 102).
FIRST USE 12-31-1987; IN COMMERCE 12-31-1987.

CLASS 43—HOTEL AND RESTAURANT SERVICES

FOR RENTAL OF BEVERAGE SERVICE EQUIPMENT, NAMELY, MARGARITA MACHINES (U.S. CLS. 100 AND 101).
FIRST USE 12-31-1987; IN COMMERCE 12-31-1987.
MARC LEIPZIG, EXAMINING ATTORNEY

SN 76-533,473. HAVILAND PRODUCTS COMPANY, GRAND RAPIDS, MI. FILED 7-30-2003.

HAVILAND

OWNER OF U.S. REG. NOS. 964,944 AND 1,015,588.

CLASS 1—CHEMICALS

FOR INDUSTRIAL AND COMMERCIAL CHEMICALS, NAMELY, CHEMICALS TO INHIBIT DECARBURIZATION, RUST AND CORROSION, ETCHANTS AND BRIGHTENERS, SOLDERING FLUX FOR REMOVING IMPURITIES IN ZINC, SEQUESTERING AGENTS, QUENCHING AGENTS, FLOCCULANTS, CHLORIDE, POLYELECTROLYTE COAGULANTS, SODIUM CARBONATE, SODIUM BISULFATE AND DEGREASERS (U.S. CLS. 1, 5, 6, 10, 26 AND 46).
FIRST USE 6-30-1939; IN COMMERCE 6-30-1939.

CLASS 2—PAINTS

FOR DYES AND DYESTUFFS FOR USE IN METAL FINISHING (U.S. CLS. 6, 11 AND 16).
FIRST USE 12-31-1949; IN COMMERCE 12-31-1949.

CLASS 3—COSMETICS AND CLEANING PREPARATIONS

FOR INDUSTRIAL AND COMMERCIAL CLEANERS, NAMELY, WATER SOFTENERS, SOLVENT CLEANERS, GERMICIDAL CLEANERS, ALL-PURPOSE LIQUID CLEANERS, PAINT STRIPPERS, CONCRETE CLEANERS, ACID CLEANERS, ALKALINE CLEANERS, VEHICLE WASH COMPOUNDS, LIME AND SCALE REMOVERS, ELECTROLYTIC CLEANERS, METAL SOAK CLEANERS, EGG CLEANERS, AND PAPER INDUSTRY FELT CLEANERS (U.S. CLS. 1, 4, 6, 50, 51 AND 52).
FIRST USE 6-0-1939; IN COMMERCE 6-0-1939.

CLASS 5—PHARMACEUTICALS

FOR INDUSTRIAL CHEMICAL DISINFECTANTS AND SANITIZERS (U.S. CLS. 6, 18, 44, 46, 51 AND 52).
FIRST USE 12-31-1965; IN COMMERCE 12-31-1965.
ZACHARY BELLO, EXAMINING ATTORNEY

SN 76-533,528. THE ASSOCIATION OF PUBLIC HEALTH LABORATORIES, INC., WASHINGTON, DC. FILED 7-30-2003.

ASSOCIATION OF PUBLIC HEALTH LABORATORIES

NO CLAIM IS MADE TO THE EXCLUSIVE RIGHT TO USE "ASSOCIATION", APART FROM THE MARK AS SHOWN.

SEC. 2(F).

CLASS 16—PAPER GOODS AND PRINTED MATTER

FOR PUBLICATIONS, NAMELY NEWSLETTERS, PAMPHLETS, ISSUE BRIEFS, REPORTS AND CONFERENCE PROCEEDINGS IN THE FIELD OF PUBLIC HEALTH LABORATORIES (U.S. CLS. 2, 5, 22, 23, 29, 37, 38 AND 50).
FIRST USE 9-0-1998; IN COMMERCE 9-0-1998.

CLASS 35—ADVERTISING AND BUSINESS

FOR ASSOCIATION SERVICES, NAMELY PROMOTING THE ROLE OF PUBLIC HEALTH LABORATORIES IN SUPPORT OF NATIONAL AND GLOBAL OBJECTIVES, AND PROMOTING POLICIES AND PROGRAMS TO ASSURE IMPROVEMENT IN THE QUALITY OF PUBLIC HEALTH LABORATORY PRACTICES (U.S. CLS. 100, 101 AND 102).
FIRST USE 9-0-1998; IN COMMERCE 9-0-1998.

CLASS 41—EDUCATION AND ENTERTAINMENT

FOR EDUCATIONAL SERVICES, NAMELY, CONDUCTING PROGRAMS, CLASSES, SEMINARS, CONFERENCES, LECTURES, AND WORKSHOPS IN THE FIELD OF PUBLIC HEALTH LABORATORIES (U.S. CLS. 100, 101 AND 107).
FIRST USE 9-0-1998; IN COMMERCE 9-0-1998.
CATHERINE CAIN, EXAMINING ATTORNEY

SN 76-534,932. ALVES, JEFF, WOODLAND HILLS, CA. FILED 8-6-2003.



NO CLAIM IS MADE TO THE EXCLUSIVE RIGHT TO USE "BABY PRODUCTS", APART FROM THE MARK AS SHOWN.
THE ENGLISH TRANSLATION OF BEL IS BEAUTIFUL.

CLASS 16—PAPER GOODS AND PRINTED MATTER

FOR SCENTED T-SHIRT BAGS, NAMELY, SCENTED PLASTIC BAGS FOR DISPOSABLE DIAPERS (U.S. CLS. 2, 5, 22, 23, 29, 37, 38 AND 50).

CLASS 24—FABRICS

FOR CLOTH LABELS (U.S. CLS. 42 AND 50).
BRETT J. GOLDEN, EXAMINING ATTORNEY

SN 76-535,633. RODRIGUEZ, EDUARDO, MIAMI BEACH, FL. FILED 8-8-2003.

EDDIE RODRIGUEZ

THE NAME EDDIE RODRIGUEZ SHOWN IN THE MARK IDENTIFIES EDUARDO RODRIGUEZ, WHOSE CONSENT TO REGISTER IS OF RECORD.

CLASS 2—PAINTS

FOR EXTERIOR PAINT, HOUSE PAINT, INTERIOR PAINT (U.S. CLS. 6, 11 AND 16).

CLASS 3—COSMETICS AND CLEANING PREPARATIONS

FOR MEN'S AND WOMEN'S PERFUMES AND COSMETICS; COSMETICS, NAMELY FACE AND BODY MOISTURIZERS, TONICS, CREAMS, AND LOTIONS; SUN TAN AND SUN BLOCK LOTIONS AND CREAMS, LIPSTICKS; EYE SHADOWS, COLORING PENCILS, MASCARA, BLUSH, FACE POWDER, FOUNDATIONS; NAIL POLISH; HAIR LOTIONS; SHAVING CREAM, SHAVING FOAM, SHAVING GEL, SHAVING LOTION; DENTIFRICES, AND MEN'S AND WOMEN'S ACCESSORIES, NAMELY, COSMETIC BALLS AND PADS (U.S. CLS. 1, 4, 6, 50, 51 AND 52).

CLASS 9—ELECTRICAL AND SCIENTIFIC APPARATUS

FOR EYEGLASS FRAMES; EYEGLASS LENSES; SUNGLASS LENSES; PROTECTION EYEGLASSES; CONTACT LENSES; SPORTS EYEGLASSES, AND ACCESSORIES, NAMELY, EYEGLASS CASES AND EYEGLASS CHAINS (U.S. CLS. 21, 23, 26, 36 AND 38).

CLASS 14—JEWELRY

FOR GOOD IN PRECIOUS METALS AND THEIR ALLOYS, NAMELY, RINGS BEING JEWELRY, NECKLACES, BRACELETS BEING JEWELRY, BROOCHES, EARRINGS, TIE PINS, TIE CLASPS, CUFFLINKS; JEWELRY ARTICLES, NAMELY, KEY CHAINS; WRISTWATCHES; CLOCKS; CHRONOMETERS; FITTED CASES FOR WATCHES; AND, FITTED CASES OF PRECIOUS METAL FOR JEWELRY (U.S. CLS. 2, 27, 28 AND 50).

CLASS 16—PAPER GOODS AND PRINTED MATTER

FOR STATIONERY ARTICLES, NAMELY, ADDRESS BOOKS AND NOTE BOOKS, ENVELOPES, CALENDARS; WRITING AND MARKING INSTRUMENTS, NAMELY, FOUNTAIN PENS, BALL POINT PENS, FELT-TIPPED PENS AND ROLLER BALL PENS, MARKERS, HIGHLIGHTERS, PENCILS AND LEAD PENCILS, PEN INK REFILLS FOR PENS, AND ACCESSORIES, NAMELY, ADDRESS LABELS AND BLOTTERS (U.S. CLS. 2, 5, 22, 23, 29, 37, 38 AND 50).

CLASS 18—LEATHER GOODS

FOR HANDBAGS, WALLETS, LUGGAGE, ATTACHÉ CASES, TOTE BAGS, BRIEFCASES, ALL PURPOSE SPORT BAGS, SCHOOL BAGS, TRAVELING TRUNKS AND CARRY-ON BAGS, SHOULDER BAGS, KEY CASES, UMBRELLAS, PARASOLS AND WALKING STICKS, WHIPS, HARNESSES AND SADDLERY; AND ACCESSORIES, NAMELY, COIN PURSES AND COSMETIC CASES SOLD EMPTY; LEATHER KEY CHAINS; LEATHER SOLD IN BULK AND LEATHER GOODS, NAMELY, SUEDE SOLD IN BULK (U.S. CLS. 1, 2, 3, 22 AND 41).

CLASS 20—FURNITURE AND ARTICLES NOT OTHERWISE CLASSIFIED

FOR OUTDOOR FURNITURE AND ACCESSORIES, NAMELY, TABLES, CHAIRS AND OUTDOOR FURNITURE CUSHIONS; JEWELRY CASES NOT OF PRECIOUS METAL; AND FABRIC WINDOW SHADES (U.S. CLS. 2, 13, 22, 25, 32 AND 50).

CLASS 24—FABRICS

FOR DECORATIVE FABRICS OF CLOTH, WOOL, NYLON, POLYESTER COTTON, POLYESTER, AND SILK; AND ACCESSORIES, NAMELY, FABRIC OF IMITATION ANIMAL SKIN; DECORATIVE UPHOLSTERY FABRICS, DRAPERIES, CURTAIN AND WINDOW TREATMENT FABRICS; BED SHEETS, MATTRESS PADS, PILLOW CASES, PILLOW SHAMS, COMFORTERS, QUILTS, BED SPREADS, BED SKIRTS, DUVETS, COMFORTER COVERS, BED BLANKETS, AFGHANS, TOWELS, POT HOLDERS, DISH CLOTHS, TABLE CLOTHS NOT OF PAPER, TABLE LINEN, NAMELY, CLOTH NAPKINS, TEXTILE PLACE MATS, UNFITTED FABRIC FURNITURE COVERS AND SHOWER CURTAINS; FABRIC WINDOW TREATMENTS, NAMELY, TOPPERS, TIERS, CURTAINS, FABRIC SHADES, CURTAIN VALANCES, DRAPERIES, AND TAB TOPS (U.S. CLS. 42 AND 50).

CLASS 27—FLOOR COVERINGS

FOR CARPETS, REED MATS; TEXTILE FLOOR MATS FOR USE IN THE HOME; LINOLEUM FOR USE ON FLOOR; HARD SURFACE COVERINGS FOR FLOORS; WALLPAPER AND DECORATIVE WALL BORDERS; AND ACCESSORIES; NAMELY, CARPET PADDING (U.S. CLS. 19, 20, 37, 42 AND 50).

CLASS 35—ADVERTISING AND BUSINESS

FOR RETAIL STORE SERVICES IN THE FIELDS OF PERSONAL CARE PRODUCTS, PERFUMES AND COSMETICS, JEWELRY, EYEWEAR, FABRICS, FLOOR COVERINGS, STATIONERY ARTICLES AND WRITING INSTRUMENT (U.S. CLS. 100, 101 AND 102).

ANDREA K. NADELMAN, EXAMINING ATTORNEY

SN 76-535,696. RUIZ FOOD PRODUCTS, INC., DINUBA, CA. FILED 8-8-2003.

MONTEREY CAFE

OWNER OF U.S. REG. NOS. 1,932,924 AND 1,935,183.

CLASS 29—MEATS AND PROCESSED FOODS

FOR PREPARED MEXICAN APPETIZERS CONSISTING PRIMARILY OF MEAT AND CHEESE; FROZEN, MEXICAN-STYLE FOOD PRODUCTS, NAMELY, CHILE RELLENOS (U.S. CL. 46).

CLASS 30—STAPLE FOODS

FOR FROZEN, MEXICAN-STYLE FOOD PRODUCTS, NAMELY, TAMALES, BURRITOS, ENCHILADAS, CHIMICHANGAS, TAQUITOS, FLAUTAS, TACOS, SOFT TACOS (U.S. CL. 46).

JENNIFER DIXON, EXAMINING ATTORNEY

SN 76-536,176. PRUETT, HEATHER, MOUNT DORA, FL.
FILED 8-12-2003.

SN 76-536,475. WYNN RESORTS HOLDINGS, LLC, LAS
VEGAS, NV. FILED 7-31-2003.

VITALIFE

CLASS 11—ENVIRONMENTAL CONTROL APPARATUS

FOR ELECTRIC GRIDDLES; ELECTRIC SLOW COOKERS; WATER DISTILLING UNITS (U.S. CLS. 13, 21, 23, 31 AND 34).

CLASS 21—HOUSEWARES AND GLASS

FOR COOKWARE AND BAKEWARE, NAMELY SAUCEPANS, POTS, SKILLETS, RICERS, STEAMERS, STRAINERS, PASTA BASKETS, DUTCH OVENS, NON-ELECTRIC GRIDDLES, BAKING PANS, ROASTING PANS, CAKE PANS, COOKIE SHEETS, PIE PANS, NON-ELECTRIC SLOW COOKERS, COOKIE CUTTERS, KITCHEN TOOLS, NAMELY, LADLES, SPATULAS, TONGS, SERVING FORKS, PASTA FORKS, SERVING SPOONS, AND CHOPPING BOARDS, AND NON-ELECTRIC JUICERS (U.S. CLS. 2, 13, 23, 29, 30, 33, 40 AND 50).
MARC LEIPZIG, EXAMINING ATTORNEY

SN 76-536,402. AARP, WASHINGTON, DC. FILED 8-12-2003.

AARP ANDRUS FOUNDATION

OWNER OF U.S. REG. NOS. 741,334, 2,461,155 AND OTHERS.

NO CLAIM IS MADE TO THE EXCLUSIVE RIGHT TO USE "FOUNDATION", APART FROM THE MARK AS SHOWN.

CLASS 35—ADVERTISING AND BUSINESS

FOR PROMOTING THE INTERESTS OF MATURE INDIVIDUALS; PROMOTING PUBLIC AWARENESS AND ADVOCACY IN THE FIELDS OF CAREGIVING, MEDICAL SERVICES, ELDERCARE, ASSISTED CARE FACILITIES, ELDER ASSISTANCE, RETIREMENT, MATURE OR RETIRED LIFESTYLES, AGING, FAMILY RELATIONSHIPS, INDEPENDENT LIVING, AND ELDER HEALTH AND FITNESS (U.S. CLS. 100, 101 AND 102).

FIRST USE 0-0-1968; IN COMMERCE 0-0-1968.

CLASS 36—INSURANCE AND FINANCIAL

FOR CHARITABLE FUNDRAISING SERVICES; PROVIDING EDUCATIONAL SCHOLARSHIPS; AND PROVIDING GRANTS TO EDUCATIONAL INSTITUTIONS, RESEARCH INSTITUTIONS, COMMUNITY ORGANIZATIONS AND NON-PROFIT ORGANIZATIONS FURTHERING THE INTERESTS, ISSUES AND NEEDS OF MATURE INDIVIDUALS (U.S. CLS. 100, 101 AND 102).

FIRST USE 0-0-1968; IN COMMERCE 0-0-1968.
PAULA MAYS, EXAMINING ATTORNEY

ZOOZA CRACKER

CLASS 41—EDUCATION AND ENTERTAINMENT

FOR CASINO SERVICES (U.S. CLS. 100, 101 AND 107).

CLASS 43—HOTEL AND RESTAURANT SERVICES

FOR RESTAURANT AND BAR SERVICES (U.S. CLS. 100 AND 101).
MONIQUE MILLER, EXAMINING ATTORNEY

SN 76-536,501. CLOUDMARK, INC., SAN FRANCISCO, CA.
FILED 8-11-2003.

SPAMNET

CLASS 9—ELECTRICAL AND SCIENTIFIC APPARATUS

FOR COMPUTER SOFTWARE FOR DETECTING, FILTERING, MONITORING, REPORTING, BLOCKING, REMOVING, AND PREVENTING UNSOLICITED, BULK, UNWANTED OR CONTENT-INAPPROPRIATE ELECTRONIC MAIL, DATA, SOUNDS AND IMAGES; SOFTWARE FOR USE IN TRACKING SENDERS OF UNSOLICITED, BULK, UNWANTED OR CONTENT-INAPPROPRIATE ELECTRONIC MAIL, DATA, SOUNDS AND IMAGES (U.S. CLS. 21, 23, 26, 36 AND 38).
FIRST USE 6-19-2002; IN COMMERCE 6-19-2002.

CLASS 42—SCIENTIFIC, COMPUTER AND LEGAL SERVICES

FOR COMPUTER SERVICES, NAMELY DETECTING, FILTERING, MONITORING, REPORTING, BLOCKING, REMOVING, TRACKING AND PREVENTING UNWANTED AND UNSOLICITED ELECTRONIC MESSAGES SENT VIA ELECTRONIC MEANS (U.S. CLS. 100 AND 101).

FIRST USE 6-19-2002; IN COMMERCE 6-19-2002.
KAREN K. BUSH, EXAMINING ATTORNEY

SN 76-536,502. CLOUDMARK, INC., SAN FRANCISCO, CA.
FILED 8-11-2003.

CLOUDMARK

CLASS 9—ELECTRICAL AND SCIENTIFIC APPARATUS

FOR COMPUTER SOFTWARE FOR DETECTING, FILTERING, MONITORING, REPORTING, BLOCKING, REMOVING, AND PREVENTING UNSOLICITED, BULK, UNWANTED OR CONTENT-INAPPROPRIATE ELECTRONIC MAIL, DATA, SOUNDS AND IMAGES; SOFTWARE FOR USE IN TRACKING SENDERS OF UNSOLICITED, BULK, UNWANTED OR CONTENT-INAPPROPRIATE ELECTRONIC MAIL, DATA, SOUNDS AND IMAGES (U.S. CLS. 21, 23, 26, 36 AND 38).

FIRST USE 6-19-2002; IN COMMERCE 6-19-2002.

CLASS 42—SCIENTIFIC, COMPUTER AND LEGAL SERVICES

FOR COMPUTER SERVICES, NAMELY DETECTING, FILTERING, MONITORING, REPORTING, BLOCKING, REMOVING, TRACKING AND PREVENTING UNWANTED AND UNSOLICITED ELECTRONIC MESSAGES SENT VIA ELECTRONIC MEANS (U.S. CLS. 100 AND 101).

FIRST USE 6-19-2002; IN COMMERCE 6-19-2002.
KAREN K. BUSH, EXAMINING ATTORNEY

SN 76-537,436. O'MEARA, INC., NEW ORLEANS, LA. FILED 8-14-2003.

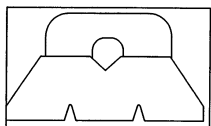

O'MEARA, INC.

NO CLAIM IS MADE TO THE EXCLUSIVE RIGHT TO USE INC., APART FROM THE MARK AS SHOWN. "O'MEARA" DOES IDENTIFY A PARTICULAR LIVING INDIVIDUAL.

CLASS 37—CONSTRUCTION AND REPAIR

FOR OIL AND GAS WELL CONTRACTING SERVICES AND DRILLING AND PUMPING OF OIL AND GAS (U.S. CLS. 100, 103 AND 106).

FIRST USE 8-0-1992; IN COMMERCE 9-0-1992.

CLASS 42—SCIENTIFIC, COMPUTER AND LEGAL SERVICES

FOR GEOPHYSICAL EXPLORATION FOR THE OIL AND GAS INDUSTRY, TECHNICAL CONSULTATION AND RESEARCH IN THE FIELD OF OIL AND GAS EXPLORATION, WELL LOGGING AND OIL FIELD SURVEYING (U.S. CLS. 100 AND 101).

FIRST USE 8-0-1992; IN COMMERCE 9-0-1992.
MARK T. MULLEN, EXAMINING ATTORNEY

SN 76-538,702. DUALSTAR ENTERTAINMENT GROUP, LLC, LOS ANGELES, CA. FILED 8-20-2003.

DUALSTAR

OWNER OF U.S. REG. NOS. 1,911,846, 2,039,339 AND OTHERS.

CLASS 9—ELECTRICAL AND SCIENTIFIC APPARATUS

FOR MUSICAL AND DRAMATIC AUDIOVISUAL AND SOUND RECORDINGS; PRE-RECORDED COMPACT DISCS FEATURING MUSIC, COMEDY AND DRAMA; COMPUTER SOFTWARE FOR VIDEO GAMES AND COMPUTER GAMES; VIDEO GAME CARTRIDGES AND DISCS, HAIR APPLIANCES, NAMELY, ELECTRIC HAND HELD CURLING IRONS, STRAIGHTENERS AND BRAIDERS, TELEPHONES AND CD PLAYERS (U.S. CLS. 21, 23, 26, 36 AND 38).

FIRST USE 9-1-1994; IN COMMERCE 9-1-1994.

CLASS 11—ENVIRONMENTAL CONTROL APPARATUS

FOR HAND HELD ELECTRIC HAIR DRYERS (U.S. CLS. 13, 21, 23, 31 AND 34).

FIRST USE 4-7-2002; IN COMMERCE 4-7-2002.

CLASS 16—PAPER GOODS AND PRINTED MATTER

FOR PAPER AND PRINTED MATTER, NAMELY, ORGANIZERS, POSTERS, PERSONAL PLANNERS, CALENDARS, MAGAZINES REGARDING ENTERTAINMENT AND ISSUES IMPORTANT TO YOUNG TEENS; SERIES OF FICTION BOOKS (U.S. CLS. 2, 5, 22, 23, 29, 37, 38 AND 50).

FIRST USE 4-0-1996; IN COMMERCE 4-0-1996.

CLASS 18—LEATHER GOODS

FOR BAGS, NAMELY, HANDBAGS, TOTE BAGS AND UMBRELLAS (U.S. CLS. 1, 2, 3, 22 AND 41).

FIRST USE 12-15-2000; IN COMMERCE 12-15-2000.

CLASS 25—CLOTHING

FOR CLOTHING, NAMELY, TOPS, BOTTOMS, SWEATERS, CARDIGANS, JACKETS, PANTS, SKIRTS, SHORTS, CAPRI PANTS, NIGHTGOWNS, NIGHT-SHIRTS, SLEEP PANTS, ROBES, PAJAMAS, STRETCH PANTS, WARM UP PANTS, WARM UP JACKETS, CAMISOLES, BRAS, PANTIES, BOXERS, TANK TOPS, HATS, VISORS, BELTS, HEAD BANDS, KERCHIEFS; SWIMWEAR, NAMELY, ONE-PIECE SUITS, TWO PIECE SUITS, BOARD SHORTS, WRAPS; FOOTWEAR, NAMELY, ATHLETIC SHOES, SANDALS, SLIPPERS, BOOTS AND CLOGS (U.S. CLS. 22 AND 39).

FIRST USE 12-15-2000; IN COMMERCE 12-15-2000.

CLASS 26—FANCY GOODS

FOR HAIR ORNAMENTS AND ACCESSORIES, NAMELY, BARRETTES, CLAW CLIPS, MINI CLAWS CLIPS, SNAP CLIPS AND ELASTIC RIBBONS (U.S. CLS. 37, 39, 40, 42 AND 50).

FIRST USE 1-15-2001; IN COMMERCE 1-15-2001.

CLASS 28—TOYS AND SPORTING GOODS

FOR TOYS, NAMELY DOLLS AND DOLL ACCESSORIES; BOARD GAMES (U.S. CLS. 22, 23, 38 AND 50).

FIRST USE 4-0-2000; IN COMMERCE 4-0-2000.

CLASS 41—EDUCATION AND ENTERTAINMENT

FOR PRODUCTION OF AND DISTRIBUTION OF MOTION PICTURES, FILMS, TELEVISION SHOWS, ON-LINE WEBSITE PROGRAMS AND RADIO PROGRAMS; PRODUCTION OF VIDEOTAPES, DVDS, AUDIO TAPES AND COMPACT DISCS; PRODUCTION OF ON-LINE WEB CAST PROGRAMMING ON A VARIETY OF SUBJECTS; DISTRIBUTION FOR OTHERS OF ON-LINE WEB CAST PROGRAMMING ON A VARIETY OF SUBJECTS; FAN CLUB SERVICES OVER A GLOBAL COMPUTER INFORMATION NETWORK (U.S. CLS. 100, 101 AND 107).

FIRST USE 5-9-1993; IN COMMERCE 5-9-1993.
BRENDAN REGAN, EXAMINING ATTORNEY

SN 76-539,294. PARK PLACE MOTORCARS OF TEXAS, INC., DALLAS, TX. FILED 8-8-2003.

SN 76-539,672. SUSTAINABILITY SYSTEMS, INC., MARIETTA, GA. FILED 8-25-2003.

EXPERTS IN EXCELLENCE

CLASS 35—ADVERTISING AND BUSINESS

FOR AUTOMOBILE DEALERSHIPS, FEATURING NEW AND USED AUTOMOBILES; RETAIL AUTOMOBILE PARTS AND ACCESSORIES STORES (U.S. CLS. 100, 101 AND 102).

FIRST USE 10-17-2002; IN COMMERCE 10-17-2002.

CLASS 37—CONSTRUCTION AND REPAIR

FOR AUTOMOTIVE REPAIR, BODY SHOP, MAINTENANCE AND CLEANING SERVICES (U.S. CLS. 100, 103 AND 106).

FIRST USE 10-17-2002; IN COMMERCE 10-17-2002.
KATHRYN COWARD, EXAMINING ATTORNEY

SN 76-539,671. SUSTAINABILITY SYSTEMS, INC., MARIETTA, GA. FILED 8-25-2003.



Sustainability System

NO CLAIM IS MADE TO THE EXCLUSIVE RIGHT TO USE "SYSTEM", APART FROM THE MARK AS SHOWN.

THE MARK CONSISTS OF THE WORDS "SUSTAINABILITY SYSTEM" IN THE GEORGIA FONT WITH DESIGN. DESIGN CONSISTS OF A HOLLOW OVAL SHAPE SITUATED ABOVE THE WORDS "SUSTAINABILITY SYSTEM" AND CONTAINED INSIDE THE OVAL SHAPE, THE LETTER "S" WHICH IS SUPERIMPOSED OVER AN EIGHT PERSON ROWING SHELL AND DEPICTING EIGHT OARS, FOUR ON EACH SIDE OF THE ROWING SHELL.

CLASS 35—ADVERTISING AND BUSINESS

FOR BUSINESS MANAGEMENT CONSULTING SERVICES, INCLUDING ANALYSIS OF CURRENT OPERATIONS, BUSINESS SOLUTION PLANNING, BUSINESS SOLUTION IMPLEMENTATION, PROJECT MANAGEMENT, OUTSOURCING IN THE FIELD OF BUSINESS MANAGEMENT, AND FOLLOW-UP ASSESSMENTS (U.S. CLS. 100, 101 AND 102).

CLASS 41—EDUCATION AND ENTERTAINMENT

FOR EDUCATIONAL SERVICES, NAMELY, CONDUCTING SEMINARS, LECTURES, WORKSHOPS, CONFERENCES AND SYMPOSIUMS IN THE FIELD OF BUSINESS MANAGEMENT CONSULTING, PROJECT MANAGEMENT AND CLIENT SUPPORT; AND TRAINING SERVICES IN THE FIELD OF BUSINESS MANAGEMENT (U.S. CLS. 100, 101 AND 107).

LINDA M. KING, EXAMINING ATTORNEY

Sustainability System

NO CLAIM IS MADE TO THE EXCLUSIVE RIGHT TO USE "SYSTEM", APART FROM THE MARK AS SHOWN.

THE MARK CONSISTS OF THE WORDS "SUSTAINABILITY SYSTEM" IN THE GEORGIA FONT.

CLASS 35—ADVERTISING AND BUSINESS

FOR BUSINESS MANAGEMENT CONSULTING SERVICES, INCLUDING ANALYSIS OF CURRENT OPERATIONS, BUSINESS SOLUTION PLANNING, BUSINESS SOLUTION IMPLEMENTATION, PROJECT MANAGEMENT, OUTSOURCING IN THE FIELD OF BUSINESS MANAGEMENT, AND FOLLOW-UP ASSESSMENTS (U.S. CLS. 100, 101 AND 102).

CLASS 41—EDUCATION AND ENTERTAINMENT

FOR EDUCATIONAL SERVICES, NAMELY, CONDUCTING SEMINARS, LECTURES, WORKSHOPS, CONFERENCES AND SYMPOSIUMS IN THE FIELD OF BUSINESS MANAGEMENT CONSULTING, PROJECT MANAGEMENT AND CLIENT SUPPORT; AND TRAINING SERVICES IN THE FIELD OF BUSINESS MANAGEMENT (U.S. CLS. 100, 101 AND 107).

LINDA M. KING, EXAMINING ATTORNEY

SN 76-540,293. BILL BLASS INTERNATIONAL LLC, NEW YORK, NY. FILED 8-13-2003.

BILL BLASS HOME DÉCOR

OWNER OF U.S. REG. NOS. 2,068,077, 2,605,780 AND OTHERS.

NO CLAIM IS MADE TO THE EXCLUSIVE RIGHT TO USE "HOME DECOR", APART FROM THE MARK AS SHOWN.

THE NAME BILL BLASS DOES NOT IDENTIFY A LIVING INDIVIDUAL.

CLASS 4—LUBRICANTS AND FUELS

FOR CANDLES (U.S. CLS. 1, 6 AND 15).
FIRST USE 3-1-2003; IN COMMERCE 3-1-2003.

CLASS 20—FURNITURE AND ARTICLES NOT OTHERWISE CLASSIFIED

FOR PICTURE FRAMES (U.S. CLS. 2, 13, 22, 25, 32 AND 50).
FIRST USE 3-1-2003; IN COMMERCE 3-1-2003.

CLASS 21—HOUSEWARES AND GLASS

FOR CANDLE HOLDERS NOT OF PRECIOUS METAL AND VASES (U.S. CLS. 2, 13, 23, 29, 30, 33, 40 AND 50).
FIRST USE 3-1-2003; IN COMMERCE 3-1-2003.
CHRISIE B. KING, EXAMINING ATTORNEY

SN 76-540,884. KAUFMANN, CHRISTOPHER P., PALM BEACH, FL. FILED 8-28-2003.

COULD THIS BE YOU?

CLASS 14—JEWELRY

FOR JEWELRY (U.S. CLS. 2, 27, 28 AND 50).
FIRST USE 7-14-2003; IN COMMERCE 7-14-2003.

CLASS 35—ADVERTISING AND BUSINESS

FOR RETAIL JEWELRY STORES (U.S. CLS. 100, 101 AND 102).
FIRST USE 7-14-2003; IN COMMERCE 7-14-2003.
GENE MACIOL, EXAMINING ATTORNEY

SN 76-541,307. BSH HOME APPLIANCES CORPORATION, HUNTINGTON BEACH, CA. FILED 8-18-2003.

FORWARD THINKING

CLASS 7—MACHINERY

FOR ELECTRIC KITCHEN MACHINES AND EQUIPMENT FOR DOMESTIC FOOD AND BEVERAGE PREPARATION AND PROCESSING, NAMELY MINCING MACHINES, MIXING AND KNEADING MACHINES, PRESSING MACHINES, JUICE EXTRACTORS, JUICE CENTRIFUGES, GRINDERS, SLICING MACHINES, AND PARTS THEREFORE; ELECTRIC MOTOR-DRIVEN TOOLS, NAMELY, ELECTRIC CAN OPENERS, KNIFE SHARPENERS AND PARTS THEREFORE; ELECTRIC WASTE DISPOSAL UNITS, NAMELY, WASTE MASTICATORS AND COMPRESSORS AND PARTS THEREFORE; DISHWASHERS AND PARTS THEREFORE; ELECTRIC MACHINES AND APPLIANCES FOR TREATING LAUNDRY AND CLOTHING, NAMELY, WASHING MACHINES, LAUNDRY PRESSES, CLOTHES IRONING MACHINES AND PARTS THEREFORE; ELECTRIC CLEANING EQUIPMENT FOR HOUSEHOLD USE, NAMELY, WINDOW CLEANING MACHINES, SHOE CLEANING MACHINES AND PARTS THEREFORE; VACUUM CLEANERS AND PARTS THEREFORE, NAMELY, VACUUM CLEANER HOSES, PIPES, DUST FILTERS AND DUST FILTER BAGS (U.S. CLS. 13, 19, 21, 23, 31, 34 AND 35).

CLASS 9—ELECTRICAL AND SCIENTIFIC APPARATUS

FOR ELECTRIC IRONS AND PARTS THEREFORE; KITCHEN SCALES, PERSONAL SCALES AND PARTS THEREFORE; ELECTRIC HEAT SEALING MACHINES FOR WRAPPING FOOD IN PLASTIC FILM AND PARTS THEREFORE; REMOTE CONTROL AND MONITORING DEVICES, NAMELY, REMOTE CONTROLS FOR HOUSEHOLD APPLIANCES AND PARTS THEREFORE; SIGNALING DEVICES, NAMELY, SIGNAL BELLS FOR HOUSEHOLD APPLIANCES AND PARTS THEREFORE; ELECTRIC CONTROLLERS FOR HOUSEHOLD APPLIANCES AND PARTS THEREFORE; COMPUTER SOFTWARE FOR OPERATING HOUSEHOLD APPLIANCES; ELECTRIC APPARATUS FOR DISPENSING BEVERAGE OR FOOD, NAMELY, VENDING MACHINES AND PARTS THEREFORE; COMPUTERS FOR CONTROLLING AND OPERATING HOUSEHOLD APPLIANCES AND PARTS THEREFORE (U.S. CLS. 21, 23, 26, 36 AND 38).

CLASS 11—ENVIRONMENTAL CONTROL APPARATUS

FOR ELECTRIC AND/OR FUEL OPERATED KITCHEN APPLIANCES FOR COOKING, BAKING, FRYING, GRILLING, TOASTING, THAWING, AND HOT-KEEPING OF FOODS, NAMELY, ELECTRIC AND GAS RANGES, DOMESTIC COOKING OVENS, ELECTRIC HOT PLATES, IMMERSION HEATERS, ELECTRIC COOKING POTS, MICROWAVE OVENS FOR COOKING AND PARTS THEREFORE; ELECTRIC COFFEE MAKERS AND PARTS THEREFORE; COOLING MACHINES, NAMELY, REFRIGERATORS, FREEZERS, ICE MAKING MACHINES, ICE-CREAM MAKERS AND PARTS THEREFORE; CLOTHES DRYERS, NAMELY, SPIN CLOTHES DRYERS, TUMBLE LAUNDRY DRYERS AND PARTS THEREFORE; ELECTRIC HOT AIR HAND DRIERS; HAND-HELD ELECTRIC HAIR DRIERS AND PARTS THEREFORE; VENTILATION MACHINES, NAMELY, VENTILATING EXHAUST FANS, GREASE FILTER DEVICES AND EXTRACTOR DEVICES, NAMELY, VENTILATION HOODS FOR STOVES; AIR CONDITIONING UNITS, AND MACHINES TO IMPROVE AIR QUALITY, NAMELY, AIR HUMIDIFIERS AND PARTS THEREFORE; HEAT PUMPS; STORAGE WATER HEATERS AND CONTINUOUS FLOW WATER HEATERS FOR DOMESTIC USE AND PARTS THEREFORE; WATER FILTERING UNITS FOR DOMESTIC USE AND PARTS THEREFORE; KITCHEN SINKS AND PARTS THEREFORE (U.S. CLS. 13, 21, 23, 31 AND 34).

THEODORE MCBRIDE, EXAMINING ATTORNEY

SN 76-542,161. HOME INTERIORS & GIFTS, INC., CARROLLTON, TX. FILED 9-2-2003.



Two Rivers

DOMISTYLE

CLASS 14—JEWELRY

FOR CLOCKS (U.S. CLS. 2, 27, 28 AND 50).

CLASS 20—FURNITURE AND ARTICLES NOT OTHERWISE CLASSIFIED

FOR MIRRORS; SHELVES; PLAQUES; PICTURE FRAMES (U.S. CLS. 2, 13, 22, 25, 32 AND 50).

CLASS 21—HOUSEWARES AND GLASS

FOR DECORATIVE ACCESSORIES AND WALL DECORATIONS, NAMELY, DECORATIVE PLATES, DECORATIVE PLATE HOLDERS, CANDLE HOLDERS AND PLANTERS; MOLDED CANDLE SCONCES; AND VASES (U.S. CLS. 2, 13, 23, 29, 30, 33, 40 AND 50).

LAURA KOVAISKY, EXAMINING ATTORNEY

SN 76-542,167. HOME INTERIORS & GIFTS, INC., CARROLLTON, TX. FILED 9-2-2003.

TWO RIVERS DOMISTYLE

CLASS 14—JEWELRY

FOR CLOCKS (U.S. CLS. 2, 27, 28 AND 50).

CLASS 20—FURNITURE AND ARTICLES NOT OTHERWISE CLASSIFIED

FOR MIRRORS; SHELVES; PLAQUES; PICTURE FRAMES (U.S. CLS. 2, 13, 22, 25, 32 AND 50).

CLASS 21—HOUSEWARES AND GLASS

FOR DECORATIVE ACCESSORIES AND WALL DECORATIONS, NAMELY, DECORATIVE PLATES, DECORATIVE PLATE HOLDERS, CANDLE HOLDERS AND PLANTERS; MOLDED CANDLE SCONCES; AND VASES (U.S. CLS. 2, 13, 23, 29, 30, 33, 40 AND 50).
LAURA KOVAISKY, EXAMINING ATTORNEY

SN 76-542,193. HOME INTERIORS & GIFTS, INC., CARROLLTON, TX. FILED 9-2-2003.



SN 76-542,190. HOME INTERIORS & GIFTS, INC., CARROLLTON, TX. FILED 9-2-2003.

**ARTISTA GROVE
DOMISTYLE**

CLASS 16—PAPER GOODS AND PRINTED MATTER

FOR FRAMED ART PRINTS AND FRAMED ART PICTURES (U.S. CLS. 2, 5, 22, 23, 29, 37, 38 AND 50).

CLASS 20—FURNITURE AND ARTICLES NOT OTHERWISE CLASSIFIED

FOR MIRRORS; SHELVING; PICTURE FRAMES; WOODEN DECORATIVE ACCESSORIES AND WALL DECORATIONS, NAMELY, PLAQUES (U.S. CLS. 2, 13, 22, 25, 32 AND 50).
LAURA KOVAISKY, EXAMINING ATTORNEY

NO CLAIM IS MADE TO THE EXCLUSIVE RIGHT TO USE MODA AND METALICA, APART FROM THE MARK AS SHOWN.

THE FOREIGN WORDING IN THE MARK TRANSLATES INTO ENGLISH AS FASHION AND METALLIC.

CLASS 20—FURNITURE AND ARTICLES NOT OTHERWISE CLASSIFIED

FOR SMALL FURNITURE; SHELVES; MIRRORS; UMBRELLA STANDS; BAR STOOLS; FIREPLACE SCREENS; PICTURE FRAMES; AND KITCHEN STORAGE RACKS (U.S. CLS. 2, 13, 22, 25, 32 AND 50).

CLASS 21—HOUSEWARES AND GLASS

FOR DECORATIVE ACCESSORIES AND WALL DECORATIONS, NAMELY, DECORATIVE BIRDCAGES, FLOWER POTS AND WALL PLANTERS; CANDLE HOLDERS AND ACCESSORIES OF NON-PRECIOUS METAL, NAMELY, RINGS, SNUFFERS AND PLATES; WINE RACKS; VASES; CANDLE SCONCES; KITCHEN AND BATH ACCESSORIES, NAMELY, TOWELS RACKS AND TOWEL HOLDERS (U.S. CLS. 2, 13, 23, 29, 30, 33, 40 AND 50).
LAURA KOVAISKY, EXAMINING ATTORNEY

SN 76-542,192. HOME INTERIORS & GIFTS, INC., CARROLLTON, TX. FILED 9-2-2003.



SN 76-542,802. PRO PHOTO CONNECTION, INC., IRVINE, CA. FILED 9-8-2003.

K. SCHORLE PANOMAN

THE NAME K. SCHORLE IDENTIFIES A LIVING INDIVIDUAL WHOSE CONSENT IS OF RECORD.

CLASS 16—PAPER GOODS AND PRINTED MATTER

FOR FRAMED ART PRINTS AND FRAMED ART PICTURES (U.S. CLS. 2, 5, 22, 23, 29, 37, 38 AND 50).

CLASS 20—FURNITURE AND ARTICLES NOT OTHERWISE CLASSIFIED

FOR MIRRORS; SHELVING; PICTURE FRAMES; WOODEN DECORATIVE ACCESSORIES AND WALL DECORATIONS, NAMELY, PLAQUES (U.S. CLS. 2, 13, 22, 25, 32 AND 50).
LAURA KOVAISKY, EXAMINING ATTORNEY

CLASS 16—PAPER GOODS AND PRINTED MATTER

FOR PRINTED MATERIALS, NAMELY, BOOKS AND BOOKLETS IN THE FIELD OF PHOTOGRAPHY, PHOTOGRAPHS, POSTERS AND CALENDARS (U.S. CLS. 2, 5, 22, 23, 29, 37, 38 AND 50).

CLASS 41—EDUCATION AND ENTERTAINMENT

FOR PHOTOGRAPHY SERVICES IN THE FIELD OF PANORAMA PHOTOS (U.S. CLS. 100, 101 AND 107).
JANICE L. MCMORROW, EXAMINING ATTORNEY

SN 76-544,055. HAWAIIAN VACATIONS, INC., ANCHORAGE, AK. FILED 8-29-2003.

SN 76-545,277. REED ELSEVIER INC., NEWTON, MA. FILED 9-5-2003.



CLASS 39—TRANSPORTATION AND STORAGE

FOR WHOLESALE AND RETAIL TRAVEL AGENCY SERVICES, NAMELY, THE MAKING OF RESERVATIONS AND THE BOOKING OF TRANSPORTATION FOR OTHERS (U.S. CLS. 100 AND 105).

CLASS 43—HOTEL AND RESTAURANT SERVICES

FOR WHOLESALE AND RETAIL TRAVEL AGENCY SERVICES, NAMELY, THE MAKING OF RESERVATIONS AND THE BOOKING OF TEMPORARY LODGING FOR OTHERS (U.S. CLS. 100 AND 101).
TARAH HARDY, EXAMINING ATTORNEY

SN 76-544,878. HOMESTEAD TECHNOLOGIES INC., MENLO PARK, CA. FILED 9-4-2003.



NO CLAIM IS MADE TO THE EXCLUSIVE RIGHT TO USE "PHOTOSITE", APART FROM THE MARK AS SHOWN.

CLASS 9—ELECTRICAL AND SCIENTIFIC APPARATUS

FOR COMPUTER SOFTWARE FOR CREATING, PUBLISHING AND ANIMATING ONLINE PHOTO ALBUMS AND WEB SITES; DOWNLOADABLE SOFTWARE FOR USE IN DESIGNING AND BUILDING ONLINE PHOTO ALBUMS AND WEBSITES THAT FEATURE IMAGES, TEST AND SOUND (U.S. CLS. 21, 23, 26, 36 AND 38).

CLASS 42—SCIENTIFIC, COMPUTER AND LEGAL SERVICES

FOR COMPUTER SERVICES, NAMELY, DESIGN, CONSTRUCTION, MAINTENANCE AND HOSTING OF WEB SITES AND ONLINE PHOTO ALBUMS FOR OTHERS ON A GLOBAL COMPUTER NETWORK, INTERNAL NETWORKS AND EXTRANETS; COMPUTER SERVICES, NAMELY, PROVIDING ONLINE TECHNICAL SUPPORT AND CONSULTATION REGARDING WEB SITE DESIGN, CONSTRUCTION, MAINTENANCE AND OPTIMIZATION, THE CREATION OF ONLINE COMMUNITIES AND PERSONAL PORTALS; COMPUTER SERVICES, NAMELY, PROVIDING TEMPORARY USE OF ONLINE NON-DOWNLOADABLE SOFTWARE FOR USE IN DESIGNING AND BUILDING ONLINE PHOTO ALBUMS AND WEB SITES THAT FEATURE IMAGES, TEST AND SOUND (U.S. CLS. 100 AND 101).
DANIEL CAPSHAW, EXAMINING ATTORNEY

BIZSITES

CLASS 36—INSURANCE AND FINANCIAL

FOR PROVIDING ONLINE INFORMATION RELATING TO REAL ESTATE AND RELOCATION AND RELATED BUSINESS DECISIONS AND CONSEQUENCES (U.S. CLS. 100, 101 AND 102).

FIRST USE 1-0-1996; IN COMMERCE 1-0-1996.

CLASS 41—EDUCATION AND ENTERTAINMENT

FOR PROVIDING OF ONLINE NEWS IN THE NATURE OF CURRENT EVENTS REPORTING (U.S. CLS. 100, 101 AND 107).

FIRST USE 1-0-1996; IN COMMERCE 1-0-1996.

SUSAN HAYASH, EXAMINING ATTORNEY

SN 76-545,538. THOMSON PROFESSIONAL & REGULATORY INC., CARROLLTON, TX. FILED 9-17-2003.

FAST-TAX TRUST SERVICES

OWNER OF U.S. REG. NOS. 892,213 AND 1,787,910.
NO CLAIM IS MADE TO THE EXCLUSIVE RIGHT TO USE "TRUST SERVICES", APART FROM THE MARK AS SHOWN.

CLASS 9—ELECTRICAL AND SCIENTIFIC APPARATUS

FOR COMPUTER SOFTWARE, NAMELY, CD-ROMS FOR USE IN CONNECTION WITH THE PREPARATION OF FEDERAL AND STATE TAX RETURNS AND COURT ACCOUNTING FOR USE BY BANKS, LAW FIRMS, BROKERAGE FIRMS, INSURANCE COMPANIES, AND TRUST COMPANIES (U.S. CLS. 21, 23, 26, 36 AND 38).

CLASS 35—ADVERTISING AND BUSINESS

FOR PROVIDING INFORMATION ON THE TOPIC OF FEDERAL AND STATE TAX RETURNS, AND COURT ACCOUNTING FOR USE BY BANKS, LAW FIRMS, BROKERAGE FIRMS, INSURANCE COMPANIES, AND TRUST COMPANIES, NAMELY, PREPARATION OF FEDERAL AND STATE TAX RETURNS; COURT ACCOUNTING FOR BANKS, LAW FIRMS, BROKERAGE FIRMS, INSURANCE COMPANIES, AND TRUST COMPANIES, NAMELY ACCOUNTING SERVICES (U.S. CLS. 100, 101 AND 102).

KIM SAITO, EXAMINING ATTORNEY

SN 76-545,587. BACKYARD PRODUCTS LIMITED, ONTARIO L9X 4X6, CANADA, FILED 9-17-2003.

SN 76-546,292. THE BROASTER COMPANY, BELOIT, WI. FILED 9-22-2003.



NO CLAIM IS MADE TO THE EXCLUSIVE RIGHT TO USE BACKYARD PRODUCTS, APART FROM THE MARK AS SHOWN.

OWNER OF U.S. REG. NOS. 1,654,425, 2,688,611 AND OTHERS.

CLASS 20—FURNITURE AND ARTICLES NOT OTHERWISE CLASSIFIED

FOR WOOD FURNITURE, NAMELY, TABLES AND CHAIRS (U.S. CLS. 2, 13, 22, 25, 32 AND 50).
FIRST USE 4-0-1999; IN COMMERCE 4-0-1999.

CLASS 29—MEATS AND PROCESSED FOODS

FOR BEEF, CHICKEN, FISH FILLETS, FRENCH FRIED POTATOES, MOZZARELLA CHEESE STICKS, PORK, PROCESSED MUSHROOMS, PROCESSED POTATOES, AND SHRIMP (U.S. CL. 46).
FIRST USE 5-0-2001; IN COMMERCE 5-0-2001.

CLASS 28—TOYS AND SPORTING GOODS

FOR WOOD PLAYTHINGS, NAMELY, SWING SETS, CLIMBING TOWERS AND PLAY GYMS (U.S. CLS. 22, 23, 38 AND 50).
FIRST USE 4-0-1999; IN COMMERCE 4-0-1999.
RONALD AIKENS, EXAMINING ATTORNEY

CLASS 43—HOTEL AND RESTAURANT SERVICES

FOR RESTAURANT SERVICES (U.S. CLS. 100 AND 101).
FIRST USE 5-0-2001; IN COMMERCE 5-0-2001.
GWEN STOKOLS, EXAMINING ATTORNEY

SN 76-546,259. ACTIVEAID, INC., REDWOOD FALLS, MN. FILED 9-22-2003.

SN 76-546,802. HOME LINE FURNITURE INDUSTRIES, INC., PHILADELPHIA, PA. FILED 9-22-2003.

ACTIVEAID

HOME LINE FURNITURE

OWNER OF U.S. REG. NOS. 808,160, 1,263,098 AND OTHERS.

OWNER OF U.S. REG. NO. 1,465,998.
NO CLAIM IS MADE TO THE EXCLUSIVE RIGHT TO USE "FURNITURE", APART FROM THE MARK AS SHOWN.
SEC. 2(F) AS TO "HOME LINE".

CLASS 10—MEDICAL APPARATUS

FOR MEDICAL APPARATUS, NAMELY, SHOWER CHAIRS (U.S. CLS. 26, 39 AND 44).
FIRST USE 1-1-1970; IN COMMERCE 1-1-1970.

CLASS 20—FURNITURE AND ARTICLES NOT OTHERWISE CLASSIFIED

FOR FURNITURE (U.S. CLS. 2, 13, 22, 25, 32 AND 50).
FIRST USE 12-0-2002; IN COMMERCE 12-0-2002.

CLASS 12—VEHICLES

FOR WHEELED CHAIRS (U.S. CLS. 19, 21, 23, 31, 35 AND 44).
FIRST USE 1-1-1970; IN COMMERCE 1-1-1970.
HOWARD SMIGA, EXAMINING ATTORNEY

CLASS 35—ADVERTISING AND BUSINESS

FOR DISTRIBUTORSHIPS IN THE FIELD OF FURNITURE (U.S. CLS. 100, 101 AND 102).
FIRST USE 12-0-2002; IN COMMERCE 12-0-2002.
CAROLINE WOOD, EXAMINING ATTORNEY

SN 76-546,956. OBERKOTTER FOUNDATION, PHILADELPHIA, PA. FILED 9-25-2003.

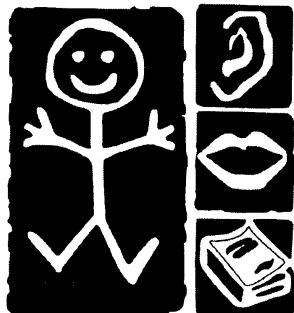

CLASS 9—ELECTRICAL AND SCIENTIFIC APPARATUS

FOR PRERECORDED COMPACT DISKS AND VIDEOS ON THE SUBJECT OF ORAL DEAF EDUCATION (U.S. CLS. 21, 23, 26, 36 AND 38).
FIRST USE 0-0-1997; IN COMMERCE 0-0-1998.

CLASS 16—PAPER GOODS AND PRINTED MATTER

FOR PRINTED MATERIALS, NAMELY PARENT HANDBOOKS, MANUALS, TEACHING MATERIALS AND PAMPHLETS ON THE SUBJECT OF ORAL DEAF EDUCATION (U.S. CLS. 2, 5, 22, 23, 29, 37, 38 AND 50).
FIRST USE 0-0-1997; IN COMMERCE 0-0-1998.

CLASS 41—EDUCATION AND ENTERTAINMENT

FOR EDUCATION SERVICES, NAMELY PROVIDING TEACHING MATERIALS AND ON-LINE INFORMATION ON THE SUBJECT OF ORAL DEAF EDUCATION (U.S. CLS. 100, 101 AND 107).
FIRST USE 0-0-1997; IN COMMERCE 0-0-1998.
DAWN FELDMAN, EXAMINING ATTORNEY

SN 76-547,223. PONZIO, FRANK J. JR., MANTOLOKING, NJ. FILED 9-26-2003.

DATATIVITY

CLASS 9—ELECTRICAL AND SCIENTIFIC APPARATUS

FOR COMPUTER SOFTWARE FOR DIGITAL DATA INSPECTION, MONITORING, ANALYSIS AND TRANSMISSION FOR THE MANAGEMENT OF DATA (U.S. CLS. 21, 23, 26, 36 AND 38).

CLASS 38—COMMUNICATION

FOR TRANSMISSION OF DIGITAL DATA RELATING TO DATA INSPECTION, DATA MONITORING, DATA ANALYSIS FOR THE MANAGEMENT OF DATA (U.S. CLS. 100, 101 AND 104).

CLASS 42—SCIENTIFIC, COMPUTER AND LEGAL SERVICES

FOR ON-LINE INSPECTION, MONITORING AND ANALYSIS OF DIGITAL DATA FOR THE MANAGEMENT OF DATA (U.S. CLS. 100 AND 101).
BRIDGETT SMITH, EXAMINING ATTORNEY

SN 76-547,511. IP DEVELOPMENT, LTD., 98000MC, MONACO, FILED 9-30-2003.

PALEOPERFECT

CLASS 29—MEATS AND PROCESSED FOODS

FOR PREPARED REFRIGERATED AND FROZEN ENTREES, SIDE DISHES, SOUPS AND APPETIZERS ALL CONSISTING PRIMARILY OF MEAT, POULTRY, FISH AND VEGETABLES; MEAT SNACKS AND JERKY (U.S. CL. 46).

CLASS 30—STAPLE FOODS

FOR FROZEN SORBET; PIES, NAMELY, MEAT PIES, POT PIES AND DESSERT PIES (U.S. CL. 46).
GEORGIA CARTY, EXAMINING ATTORNEY

SN 76-547,906. SCHAEFFER EYE CENTER, INC., BIRMINGHAM, AL. FILED 9-29-2003.



CLASS 35—ADVERTISING AND BUSINESS

FOR RETAIL OPTICAL STORE SERVICES (U.S. CLS. 100, 101 AND 102).
FIRST USE 12-31-1992; IN COMMERCE 12-31-1992.

CLASS 44—MEDICAL, BEAUTY AND AGRICULTURAL SERVICES

FOR OPHTHALMOLOGY SERVICES INCLUDING EYE SURGERY (U.S. CLS. 100 AND 101).
FIRST USE 12-31-1992; IN COMMERCE 12-31-1992.
ZHALEH DELANEY, EXAMINING ATTORNEY

SN 76-548,179. HURLEY, BRYAN, MT. DORA, FL. FILED 9-11-2003.

VAPOR

CLASS 11—ENVIRONMENTAL CONTROL APPARATUS

FOR ELECTRIC SLOW COOKERS AND ELECTRIC RICE COOKERS (U.S. CLS. 13, 21, 23, 31 AND 34).

CLASS 21—HOUSEWARES AND GLASS

FOR COOKWARE, NAMELY SAUCEPANS, POTS, SKILLETS, STEAMERS, DUTCH OVENS, NON-ELECTRIC GRIDDLES, AND NON-ELECTRIC PRESSURE COOKERS (U.S. CLS. 2, 13, 23, 29, 30, 33, 40 AND 50).
TARAH HARDY, EXAMINING ATTORNEY

SN 76-548,268. DISPLAYCRAFT, INC., PLAINVILLE, CT.
FILED 10-1-2003.

DISPLAYCRAFT**CLASS 20—FURNITURE AND ARTICLES NOT OTHERWISE CLASSIFIED**

FOR FURNITURE, NAMELY DISPLAY UNITS (U.S. CLS. 2, 13, 22, 25, 32 AND 50).
FIRST USE 12-31-1957; IN COMMERCE 12-31-1957.

CLASS 35—ADVERTISING AND BUSINESS

FOR BUSINESS MERCHANDISING DISPLAY SERVICES AND ARRANGING FOR PICK UP, DELIVERY, STORAGE AND TRANSPORTATION OF FREIGHT AND PARCELS VIA GROUND AND AIR CARRIERS (U.S. CLS. 100, 101 AND 102).
FIRST USE 12-31-1957; IN COMMERCE 12-31-1957.

CLASS 37—CONSTRUCTION AND REPAIR

FOR INSTALLATION OF CUSTOM DESIGNED DISPLAY UNITS (U.S. CLS. 100, 103 AND 106).
FIRST USE 12-31-1957; IN COMMERCE 12-31-1957.

CLASS 40—MATERIAL TREATMENT

FOR CUSTOM MANUFACTURE OF DISPLAY UNITS (U.S. CLS. 100, 103 AND 106).
FIRST USE 12-31-1957; IN COMMERCE 12-31-1957.

CLASS 42—SCIENTIFIC, COMPUTER AND LEGAL SERVICES

FOR DESIGN FOR OTHERS IN THE FIELD OF DESIGN, SELECTION, IMPLEMENTATION AND USE OF DISPLAY UNITS (U.S. CLS. 100 AND 101).
FIRST USE 12-31-1957; IN COMMERCE 12-31-1957.
EDWARD NELSON, EXAMINING ATTORNEY

SN 76-548,267. DISPLAYCRAFT, INC., PLAINVILLE, CT.
FILED 10-1-2003.

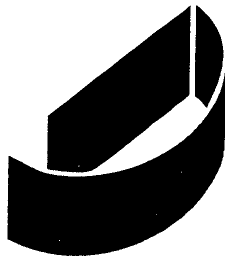

DisplayCraft

THE MARK CONSISTS OF THE WORD "DISPLAY-CRAFT" WITH A SOLID LETTER "D" SLANTED TO THE RIGHT CENTERED ABOVE "DISPLAYCRAFT".
SEC. 2(F).

CLASS 20—FURNITURE AND ARTICLES NOT OTHERWISE CLASSIFIED

FOR FURNITURE, NAMELY DISPLAY UNITS (U.S. CLS. 2, 13, 22, 25, 32 AND 50).
FIRST USE 4-4-1991; IN COMMERCE 4-4-1991.

CLASS 35—ADVERTISING AND BUSINESS

FOR BUSINESS MERCHANDISING DISPLAY SERVICES AND ARRANGING FOR PICK UP, DELIVERY, STORAGE AND TRANSPORTATION OF FREIGHT AND PARCELS VIA GROUND AND AIR CARRIERS (U.S. CLS. 100, 101 AND 102).
FIRST USE 4-4-1991; IN COMMERCE 4-4-1991.

CLASS 37—CONSTRUCTION AND REPAIR

FOR INSTALLATION OF CUSTOM DESIGNED DISPLAY UNITS (U.S. CLS. 100, 103 AND 106).
FIRST USE 4-4-1991; IN COMMERCE 4-4-1991.

CLASS 40—MATERIAL TREATMENT

FOR CUSTOM MANUFACTURE OF DISPLAY UNITS (U.S. CLS. 100, 103 AND 106).
FIRST USE 4-4-1991; IN COMMERCE 4-4-1991.

CLASS 42—SCIENTIFIC, COMPUTER AND LEGAL SERVICES

FOR DESIGN FOR OTHERS IN THE FIELD OF DESIGN, SELECTION, IMPLEMENTATION AND USE OF DISPLAY UNITS (U.S. CLS. 100 AND 101).
FIRST USE 4-4-1991; IN COMMERCE 4-4-1991.
EDWARD NELSON, EXAMINING ATTORNEY

SN 76-548,304. HORMEL FOODS, LLC, AUSTIN, MN. FILED
10-1-2003.

REAL FOOD, REAL FAST!

OWNER OF U.S. REG. NO. 2,397,726.

CLASS 29—MEATS AND PROCESSED FOODS

FOR SHELF-STABLE, FULLY COOKED ENTREES CONSISTING PRIMARILY OF MEAT AND/OR POULTRY AND/OR VEGETABLES WITH OR WITHOUT SAUCE, EXCLUDING CRANBERRY OR APPLE SAUCE (U.S. CL. 46).

CLASS 30—STAPLE FOODS

FOR SHELF-STABLE, FULLY COOKED ENTREES CONSISTING PRIMARILY OF PASTA AND/OR RICE WITH OR WITHOUT SAUCE, EXCLUDING CRANBERRY OR APPLE SAUCE (U.S. CL. 46).
ELLEN PERKINS, EXAMINING ATTORNEY

SN 76-548,493. BARR LABORATORIES, INC., POMONA, NY.
FILED 10-2-2003.

SN 76-548,926. BSH HOME APPLIANCES CORPORATION,
HUNTINGTON BEACH, CA. FILED 9-11-2003.

OUTLOOKS & OPINIONS

CLASS 16—PAPER GOODS AND PRINTED MATTER

FOR PRINTED MATTER, NAMELY, BROCHURES, PAMPHLETS, LEAFLETS, NEWSLETTERS, BOOKS IN THE FIELD OF PHARMACEUTICALS AND ON VARIOUS HEALTH ISSUES (U.S. CLS. 2, 5, 22, 23, 29, 37, 38 AND 50).

CLASS 41—EDUCATION AND ENTERTAINMENT

FOR EDUCATIONAL SERVICES, NAMELY, PROVIDING EDUCATIONAL PROGRAMS IN THE FIELD OF PHARMACEUTICALS AND ON VARIOUS HEALTH ISSUES; EDUCATIONAL SERVICES, NAMELY, EDUCATIONAL PROGRAMS IN THE FIELD OF PHARMACEUTICALS AND ON VARIOUS HEALTH ISSUES BROADCAST VIA THE INTERNET (U.S. CLS. 100, 101 AND 107).

CLASS 44—MEDICAL, BEAUTY AND AGRICULTURAL SERVICES

FOR MEDICAL SERVICES, NAMELY, PROVIDING INFORMATION IN THE FIELD OF PHARMACEUTICALS AND ON VARIOUS HEALTH ISSUES; PROVIDING INFORMATION IN THE FIELD OF PHARMACEUTICALS AND ON VARIOUS HEALTH ISSUES VIA THE INTERNET (U.S. CLS. 100 AND 101).
JEFFREY S. MOLINOFF, EXAMINING ATTORNEY

SN 76-548,880. MACROVISION CORPORATION, SANTA CLARA, CA. FILED 9-12-2003.



FLEXCERTIFIED

CLASS 9—ELECTRICAL AND SCIENTIFIC APPARATUS

FOR COMPUTER SOFTWARE USED TO TRACK, MONITOR AND MANAGE APPLICATION SOFTWARE USAGE IN THE FIELD OF SOFTWARE LICENSING MANAGEMENT (U.S. CLS. 21, 23, 26, 36 AND 38).

CLASS 42—SCIENTIFIC, COMPUTER AND LEGAL SERVICES

FOR COMPUTER SOFTWARE DESIGN AND DEVELOPMENT FOR OTHERS IN THE FIELD OF SOFTWARE LICENSING MANAGEMENT (U.S. CLS. 100 AND 101).
SUELLEN HICKEY, EXAMINING ATTORNEY

QUADSTEP

CLASS 7—MACHINERY

FOR ELECTRIC KITCHEN MACHINES AND EQUIPMENT FOR DOMESTIC FOOD AND BEVERAGE PREPARATION AND PROCESSING, NAMELY MINCING MACHINES, MIXING AND KNEADING MACHINES, PRESSING MACHINES, JUICE EXTRACTORS, JUICE CENTRIFUGES, GRINDERS, SLICING MACHINES, AND PARTS THEREFORE; ELECTRIC MOTOR-DRIVEN TOOLS, NAMELY, ELECTRIC CAN OPENERS, KNIFE SHARPENERS AND PARTS THEREFORE; ELECTRIC WASTE DISPOSAL UNITS, NAMELY, WASTE MASTICATORS AND COMPRESSORS AND PARTS THEREFORE; DISHWASHERS AND PARTS THEREFORE; ELECTRIC MACHINES AND APPLIANCES FOR TREATING LAUNDRY AND CLOTHING, NAMELY, WASHING MACHINES, LAUNDRY PRESSES, CLOTHES IRONING MACHINES AND PARTS THEREFORE; ELECTRIC CLEANING EQUIPMENT FOR HOUSEHOLD USE, NAMELY, WINDOW CLEANING MACHINES, SHOE CLEANING MACHINES AND PARTS THEREFORE; VACUUM CLEANERS AND PARTS THEREFORE, NAMELY, VACUUM CLEANER HOSES, PIPES, DUST FILTERS AND DUST FILTER BAGS. (U.S. CLS. 13, 19, 21, 23, 31, 34 AND 35).

CLASS 9—ELECTRICAL AND SCIENTIFIC APPARATUS

FOR ELECTRIC IRONS AND PARTS THEREFORE; KITCHEN SCALES, PERSONAL SCALES AND PARTS THEREFORE; ELECTRIC HEAT SEALING MACHINES FOR WRAPPING FOOD IN PLASTIC FILM AND PARTS THEREFORE; REMOTE CONTROL AND MONITORING DEVICES, NAMELY, REMOTE CONTROLS FOR HOUSEHOLD APPLIANCES AND PARTS THEREFORE; SIGNALING DEVICES, NAMELY, SIGNAL BELLS FOR HOUSEHOLD APPLIANCES AND PARTS THEREFORE; ELECTRIC CONTROLLERS FOR HOUSEHOLD APPLIANCES AND PARTS THEREFORE; COMPUTER SOFTWARE FOR OPERATING HOUSEHOLD APPLIANCES; ELECTRIC APPARATUS FOR DISPENSING BEVERAGE OR FOOD, NAMELY, VENDING MACHINES AND PARTS THEREFORE; COMPUTERS FOR CONTROLLING AND OPERATING HOUSEHOLD APPLIANCES AND PARTS THEREFORE. (U.S. CLS. 21, 23, 26, 36 AND 38).

CLASS 11—ENVIRONMENTAL CONTROL APPARATUS

FOR ELECTRIC AND/OR FUEL OPERATED KITCHEN APPLIANCES FOR COOKING, BAKING, FRYING, GRILLING, TOASTING, THAWING, AND HOT-KEEPING OF FOODS, NAMELY, ELECTRIC AND GAS RANGES, DOMESTIC COOKING OVENS, ELECTRIC HOT PLATES, IMMERSION HEATERS, ELECTRIC COOKING POTS, MICROWAVE OVENS FOR COOKING AND PARTS THEREFORE; ELECTRIC COFFEE MAKERS AND PARTS THEREFORE; COOLING MACHINES, NAMELY, REFRIGERATORS, FREEZERS, ICE MAKING MACHINES, ICE-CREAM MAKERS AND PARTS THEREFORE; CLOTHES DRYERS, NAMELY, SPIN CLOTHES DRYERS, TUMBLE LAUNDRY DRYERS AND PARTS THEREFORE; ELECTRIC HOT AIR HAND DRIERS; HAND-HELD ELECTRIC HAIR DRIERS AND PARTS THEREFORE; VENTILATION MACHINES, NAMELY, VENTILATING EXHAUST FANS, GREASE FILTER DEVICES AND EXTRACTOR DEVICES, NAMELY, VENTILATION HOODS FOR STOVES; AIR CONDITIONING UNITS, AND MACHINES TO IMPROVE AIR QUALITY, NAMELY, AIR HUMIDIFIERS AND PARTS THEREFORE; HEAT PUMPS; STORAGE WATER HEATERS AND CONTINUOUS FLOW WATER HEATERS FOR DOMESTIC USE AND PARTS THEREFORE; WATER FILTERING UNITS FOR DOMESTIC USE AND PARTS THEREFORE; KITCHEN SINKS AND PARTS THEREFORE. (U.S. CLS. 13, 21, 23, 31 AND 34).

THEODORE MCBRIDE, EXAMINING ATTORNEY

SN 76-549,437. JASO'L ENTERTAINMENT, INC., NEW YORK, NY. FILED 9-17-2003.

SADA-POP!**CLASS 9—ELECTRICAL AND SCIENTIFIC APPARATUS**

FOR PRE-RECORDED PHONOGRAPH RECORDS, COMPACT DISCS, AUDIO AND VIDEO CASSETTES, AND DVDS FEATURING MUSIC (U.S. CLS. 21, 23, 26, 36 AND 38).

CLASS 25—CLOTHING

FOR CLOTHING, NAMELY, HATS, T-SHIRTS, JACKETS, SHIRTS, SWEATSHIRTS AND SWEAT PANTS, AND JERSEYS (U.S. CLS. 22 AND 39).

CLASS 41—EDUCATION AND ENTERTAINMENT

FOR ENTERTAINMENT SERVICES, NAMELY LIVE MUSICAL PERFORMANCES BY A MUSICAL ARTIST (U.S. CLS. 100, 101 AND 107).

JOHN SCHUYLER YARD, EXAMINING ATTORNEY

SN 76-550,180. FRIEND, JOHN, THE WOODLANDS, TX. FILED 10-8-2003.

ANUSARA

OWNER OF U.S. REG. NO. 2,634,294.

CLASS 35—ADVERTISING AND BUSINESS

FOR RETAIL STORE AND ONLINE ORDERING SERVICES FEATURING BOOKS AND MANUALS (U.S. CLS. 100, 101 AND 102).

CLASS 41—EDUCATION AND ENTERTAINMENT

FOR PUBLICATION OF BOOKS AND MANUALS (U.S. CLS. 100, 101 AND 107).

ALEX KEAM, EXAMINING ATTORNEY

SN 76-551,246. PEPE JEANS LONDON, LLC, NEW YORK, NY. FILED 9-24-2003.

PEPE JEANS LONDON

OWNER OF U.S. REG. NOS. 1,943,125, 2,192,800 AND OTHERS.

SEC. 2(F) AS TO "JEANS LONDON".

CLASS 3—COSMETICS AND CLEANING PREPARATIONS

FOR COSMETICS AND COLOGNE (U.S. CLS. 1, 4, 6, 50, 51 AND 52).

CLASS 9—ELECTRICAL AND SCIENTIFIC APPARATUS

FOR SUNGLASSES AND EYEWEAR (U.S. CLS. 21, 23, 26, 36 AND 38).

CLASS 14—JEWELRY

FOR JEWELRY (U.S. CLS. 2, 27, 28 AND 50).

CLASS 24—FABRICS

FOR BED AND BATH LINENS, SHEETS, BLANKETS, TOWELS (U.S. CLS. 42 AND 50).

CLASS 25—CLOTHING

FOR HOSEY, SOCKS, UNDERWEAR, LINGERIE, ROBES, AND HEADWEAR (U.S. CLS. 22 AND 39).

CURTIS FRENCH, EXAMINING ATTORNEY

SN 76-551,247. PEPE JEANS LONDON, LLC, NEW YORK, NY. FILED 9-24-2003.

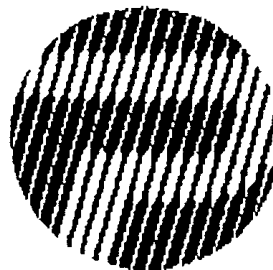

OWNER OF U.S. REG. NOS. 2,137,767 AND 2,167,993.
THE MARK CONSISTS OF A STYLIZED LETTER P.

CLASS 3—COSMETICS AND CLEANING PREPARATIONS

FOR COSMETICS AND COLOGNE (U.S. CLS. 1, 4, 6, 50, 51 AND 52).

CLASS 9—ELECTRICAL AND SCIENTIFIC APPARATUS

FOR SUNGLASSES AND EYEWEAR (U.S. CLS. 21, 23, 26, 36 AND 38).

CLASS 14—JEWELRY

FOR JEWELRY (U.S. CLS. 2, 27, 28 AND 50).

CLASS 24—FABRICS

FOR BED AND BATH LINENS, SHEETS, BLANKETS, TOWELS (U.S. CLS. 42 AND 50).

CLASS 25—CLOTHING

FOR HOSIERY, SOCKS, UNDERWEAR, LINGERIE, ROBES, AND HEADWEAR (U.S. CLS. 22 AND 39).
CURTIS FRENCH, EXAMINING ATTORNEY

SN 76-552,441. TELEBRANDS CORP., FAIRFIELD, NJ. FILED 9-29-2003.

SWEDA

CLASS 7—MACHINERY

FOR ELECTRICAL HOUSEHOLD APPLIANCE, NAMELY, BLENDER (U.S. CLS. 13, 19, 21, 23, 31, 34 AND 35).

CLASS 8—HAND TOOLS

FOR RAZORS AND RAZOR BLADES (U.S. CLS. 23, 28 AND 44).

CLASS 9—ELECTRICAL AND SCIENTIFIC APPARATUS

FOR ELECTRICAL HOUSEHOLD APPLIANCE, NAMELY, STEAM IRON (U.S. CLS. 21, 23, 26, 36 AND 38).

CLASS 11—ENVIRONMENTAL CONTROL APPARATUS

FOR ELECTRICAL HOUSEHOLD APPLIANCE, NAMELY, SANDWICH MAKER (U.S. CLS. 13, 21, 23, 31 AND 34).
PAULA MAYS, EXAMINING ATTORNEY

SN 76-553,025. LANCO, INC., WILMINGTON, DE. FILED 10-21-2003.

VENEZIA

OWNER OF U.S. REG. NOS. 2,074,250, 2,625,568 AND OTHERS.
THE FOREIGN WORDING IN THE MARK TRANSLATES INTO ENGLISH AS VENICE.

CLASS 14—JEWELRY

FOR WATCHES (U.S. CLS. 2, 27, 28 AND 50).
FIRST USE 6-1-2003; IN COMMERCE 6-1-2003.

CLASS 25—CLOTHING

FOR JACKETS, JEANS, JOGGINGS SUITS, PANTS, SHIRTS, SHORTS, SKIRTS, SOCKS, SWEATERS, SWEATPANTS, SWEATSHIRTS, SWEATSHORTS, SWEATSUITS, SWIMSUITS, T-SHIRTS, TANK TOPS, TOPS (U.S. CLS. 22 AND 39).
FIRST USE 9-1-1995; IN COMMERCE 9-1-1995.
CHARLES JOYNER, EXAMINING ATTORNEY

SN 76-553,032. IBACORP, INC., PLANO, TX. FILED 10-21-2003.

ANGEL'S CHOICE

CLASS 29—MEATS AND PROCESSED FOODS

FOR CANDIED NUTS (U.S. CL. 46).
FIRST USE 8-0-1998; IN COMMERCE 1-0-1999.

CLASS 30—STAPLE FOODS

FOR CANDY (U.S. CL. 46).
FIRST USE 8-0-1998; IN COMMERCE 1-0-1999.
CHARLES JOYNER, EXAMINING ATTORNEY

SN 76-553,138. GENERAL CONFERENCE CORPORATION OF SEVENTH-DAY ADVENTISTS, SILVER SPRING, MD. FILED 10-21-2003.



OWNER OF U.S. REG. NO. 2,288,929.

CLASS 35—ADVERTISING AND BUSINESS

FOR HOSPITAL ADMINISTRATION SERVICES (U.S. CLS. 100, 101 AND 102).
FIRST USE 9-11-2003; IN COMMERCE 9-11-2003.

CLASS 36—INSURANCE AND FINANCIAL

FOR ESTABLISHMENT AND ADMINISTRATION OF EMPLOYEE HEALTH CARE AND BENEFITS PROGRAMS, MEDICAL INSURANCE PROGRAMS AND RISK MANAGEMENT PROGRAMS; AND UNDERWRITING IN THE FIELD OF PROPERTY, CASUALTY, ACCIDENT, HEALTH AND LIFE INSURANCE (U.S. CLS. 100, 101 AND 102).
FIRST USE 9-11-2003; IN COMMERCE 9-11-2003.
MIDGE BUTLER, EXAMINING ATTORNEY

SN 76-553,258. PDS ASSOCIATES, INC., DANBURY, CT.
FILED 9-22-2003.

ARCADIA

CLASS 6—METAL GOODS

FOR METAL CLOTHES HOOKS (U.S. CLS. 2, 12, 13, 14,
23, 25 AND 50).
FIRST USE 3-0-1993; IN COMMERCE 3-0-1993.

CLASS 21—HOUSEWARES AND GLASS

FOR BATH ACCESSORIES, NAMELY, HOLDERS FOR
TOILET PAPER; TOWEL BARS; SOAP DISH; AND
BATHROOM GLASS HOLDERS NOT OF PRECIOUS
METAL (U.S. CLS. 2, 13, 23, 29, 30, 33, 40 AND 50).
FIRST USE 3-0-1993; IN COMMERCE 3-0-1993.
BARBARA GAYNOR, EXAMINING ATTORNEY

SN 76-554,040. ARAMARK CORPORATION, PHILADEL-
PHIA, PA. FILED 10-24-2003.

PRESERVING OUR PLANET FOR FUTURE GENERATIONS

CLASS 35—ADVERTISING AND BUSINESS

FOR RETAIL STORE SERVICES FEATURING A WIDE
VARIETY OF CONSUMER GOODS OF OTHERS (U.S.
CLS. 100, 101 AND 102).

CLASS 41—EDUCATION AND ENTERTAIN- MENT

FOR EDUCATIONAL SERVICES NAMELY, CON-
DUCTING PROGRAMS AND COURSES OF INSTRU-
CTION IN THE AREA OF ENVIRONMENTAL
AWARENESS AND PROTECTING THE ENVIRONMENT;
PROVIDING FACILITIES FOR RECREATION AND RE-
CREATIONAL ACTIVITIES (U.S. CLS. 100, 101 AND 107).

CLASS 43—HOTEL AND RESTAURANT SER- VICES

FOR RESTAURANT SERVICES (U.S. CLS. 100 AND
101).
DOMINIC J. FERRAIUOLO, EXAMINING ATTORNEY

SN 76-554,869. CHRISTMAS TREE SHOPS, INC., SOUTH
YARMOUTH, MA. FILED 10-6-2003.

GRANITE TOOLS

NO CLAIM IS MADE TO THE EXCLUSIVE RIGHT TO
USE "TOOLS", APART FROM THE MARK AS SHOWN.

CLASS 7—MACHINERY

FOR POWER TOOLS, NAMELY, DRILLS, ROUTERS,
WRENCHES, NAILING GUNS, POLISHERS, RATCHET
WRENCHES, SAWS, SCREWDRIVERS, STAPLE GUNS,
GRINDERS, BUFFERS (U.S. CLS. 13, 19, 21, 23, 31, 34
AND 35).
FIRST USE 5-1-2003; IN COMMERCE 5-1-2003.

CLASS 8—HAND TOOLS

FOR HAND TOOLS, NAMELY, HACK SAWS, WOOD
SAWS, CLAMPS, DRILLS, HAMMERS, RATCHET
WRENCHES, SAWS, SCREWDRIVERS, SOCKET SETS,
WRENCHES, CHALK LINE REELS, SANDERS, MITER
BOXES, BOLT CUTTERS, WIRE CUTTERS, PUNCHES,
SOCKET WRENCHES (U.S. CLS. 23, 28 AND 44).
FIRST USE 5-1-2003; IN COMMERCE 5-1-2003.
JOHN DALIER, EXAMINING ATTORNEY

SN 76-557,788. INTERNATIONAL ASSOCIATION OF ORAL
AND MAXILLOFACIAL SURGEONS, ROSEMONT, IL.
FILED 10-20-2003.



CLASS 16—PAPER GOODS AND PRINTED MATTER

FOR MAGAZINES, JOURNALS, AND NEWSLETTERS
IN THE FIELD OF ORAL AND MAXILLOFACIAL
SURGERY (U.S. CLS. 2, 5, 22, 23, 29, 37, 38 AND 50).
FIRST USE 6-0-1983; IN COMMERCE 6-0-1983.

CLASS 35—ADVERTISING AND BUSINESS

FOR ASSOCIATION SERVICES, NAMELY, PROMOT-
ING THE INTERESTS OF ORAL AND MAXILLOFACIAL
SURGEONS (U.S. CLS. 100, 101 AND 102).
FIRST USE 6-0-1983; IN COMMERCE 6-0-1983.
RON FAIRBANKS, EXAMINING ATTORNEY

SN 76-559,579. LOW CARB CRAZY, INC., CHARLOTTE, NC.
FILED 11-19-2003.



NO CLAIM IS MADE TO THE EXCLUSIVE RIGHT TO
USE LOW CARB, APART FROM THE MARK AS SHOWN.

CLASS 29—MEATS AND PROCESSED FOODS

FOR LOW CARBOHYDRATE FOODS, NAMELY, FROZEN PREPARED ENTREES CONSISTING PRIMARILY OF VEGETABLES AND CHEESE WITH PASTA, FROZEN PREPARED ENTREES CONSISTING PRIMARILY OF MEAT OR SEAFOOD AND VEGETABLES AND CHEESE WITH PASTA, PORK RINDS, ROASTED NUTS, JELLIES, JAMS, SOY-BASED AND FLAX SEED-BASED SNACK FOODS, DAIRY-BASED DIPS, AND SNACK DIPS EXCLUDING SALSA AND SAUCES USED AS DIPS (U.S. CL. 46).

CLASS 30—STAPLE FOODS

FOR LOW CARBOHYDRATE FOODS, NAMELY, BREAD, PANCAKE, WAFFLE AND MUFFIN MIXES, BREADCRUMBS, PASTA, TORTILLAS, SOY FLOUR, CHEESECAKE, ICE CREAM, CORN-BASED SNACK FOODS, FLAVORING SYRUPS AND PANCAKE SYRUPS, SALSA AND SAUCES USED AS DIPS, SAUCES, AND SALAD DRESSING (U.S. CL. 46).
DAWN FELDMAN, EXAMINING ATTORNEY

SN 76-564,861. VITA POWER LIMITED, WANGANUI, NEW ZEALAND, FILED 12-12-2003.



THE MARK IS IN BLACK AND WHITE AND THE COLORS ARE NOT A FEATURE OF THE MARK.

THE MARK CONSISTS OF A TERM IN A STYLIZED DEPICTION OF TWO MOUNTAIN PEAKS ENCIRCLED BY A CARRIER INCORPORATING THE TERMS PALAMOUNTAINS.

CLASS 5—PHARMACEUTICALS

FOR ANIMAL FOOD SUPPLEMENTS; ANIMAL CONDITIONING SUPPLEMENTS (U.S. CLS. 6, 18, 44, 46, 51 AND 52).

CLASS 31—NATURAL AGRICULTURAL PRODUCTS

FOR ANIMAL FOODSTUFFS (U.S. CLS. 1 AND 46).
REBECCA GILBERT, EXAMINING ATTORNEY

SN 76-976,612. NEXANT, INC., SAN FRANCISCO, CA. FILED 5-20-2002.

HEDGE**CLASS 41—EDUCATION AND ENTERTAINMENT**

FOR EDUCATIONAL SERVICES, NAMELY SEMINARS IN THE FIELD OF COMPUTER SOFTWARE FOR USE IN THE FIELD OF ENERGY TRADING AND CONTINGENCY MANAGEMENT (U.S. CLS. 100, 101 AND 107).

FIRST USE 7-1-2002; IN COMMERCE 7-1-2002.

CLASS 42—SCIENTIFIC, COMPUTER AND LEGAL SERVICES

FOR COMPUTER SERVICES, NAMELY COMPUTER PROGRAMMING FOR OTHERS IN THE FIELD OF ENERGY TRADING AND CONTINGENCY MANAGEMENT (U.S. CLS. 100 AND 101).

FIRST USE 7-1-2002; IN COMMERCE 7-1-2002.

MELVIN AXILBUND, EXAMINING ATTORNEY

SN 78-072,364. GENERAL ELECTRIC COMPANY, SCHENECTADY, NY. FILED 7-5-2001.

MVP**CLASS 10—MEDICAL APPARATUS**

FOR MEDICAL DIAGNOSTIC IMAGING EQUIPMENT, NAMELY, NUCLEAR MEDICINE, X-RAY, COMPUTED TOMOGRAPHY, MAGNETIC RESONANCE, POSITRON EMISSION TOMOGRAPHY, ULTRASOUND, MAMMOGRAPHY, BONE DENSITOMETRY AND DENTAL IMAGING EQUIPMENT, RESTAGED THROUGH A CONTROLLED PROCESS FOR REMARKETING (U.S. CLS. 26, 39 AND 44).

CLASS 37—CONSTRUCTION AND REPAIR

FOR INSTALLATION, MAINTENANCE AND REPAIR, NAMELY, COSMETIC RECONDITIONING AND RESTAGING OF MEDICAL DIAGNOSTIC IMAGING EQUIPMENT (U.S. CLS. 100, 103 AND 106).

AMY HELLA, EXAMINING ATTORNEY

SN 78-078,909. FYSIO EDUCATIEF B.V., AMSTERDAM, NETHERLANDS, FILED 8-13-2001.

The Class Moves!

THE MARK CONSISTS OF UPPER AND LOWER CASE LETTERING, WITH EACH LETTER A DIFFERENT SHADE OF COLOR; THE WORD "THE" CONSISTS OF A GREEN "T", A BROWN "H" AND A GREEN "E"; THE WORD "CLASS" CONSISTS OF A BLUE "C", AN ORANGE "L", A RED "A", A PINK "S" AND A BLUE "S"; THE WORD "MOVES" CONSISTS OF A RED "M", A YELLOW "O", A GREY "V", A BROWN "E", A BLUE "S" AND A GREEN EXCLAMATION POINT.

CLASS 16—PAPER GOODS AND PRINTED MATTER

FOR PAPER, CARDBOARD AND GOODS MADE FROM THESE MATERIALS, NAMELY WALL-MOUNTED CALENDARS, HARDBACK MANUALS IN THE FIELD OF CHILD DEVELOPMENT, POSITIVE PHYSICAL AWARENESS, SENSORY MOTOR DEVELOPMENT, PHYSICAL CONDITIONING, INJURY PREVENTION, PARENT INVOLVEMENT IN EDUCATION, COMMUNITY RELAXATION AND COMMUNITY CONCENTRATION, SELF-CARE AND SELF-ESTEEM; CARDBOARD BOXES, CARDBOARD CARTONS; CALENDARS; PRINTED MATTER, NAMELY MAGAZINES, BOOKS, BROCHURES AND FOLDERS IN THE FIELD OF MOTOR-EXERCISE AND MOTOR TRAINING, MAINLY FOR CHILDREN; BOOKBINDING MATERIAL, NAMELY BOOKBINDINGS, ADHESIVES FOR BINDING BOOKS; PHOTOGRAPHS; EDUCATIONAL AND INSTRUCTIONAL TOOLS AND TEACHING MATERIAL, NAMELY TEXTBOOKS, WORKBOOKS, WALL-MOUNTED CALENDARS IN THE FIELD OF MOTOR-EXERCISE AND MOTOR-TRAINING, MAINLY FOR CHILDREN; PLASTIC MATERIAL FOR PACKAGING, NAMELY PLASTIC BUBBLE PACKS FOR WRAPPING AND PACKAGING, PLASTIC BAGS FOR MERCHANDISE PACKAGING; PLAYING CARDS (U.S. CLS. 2, 5, 22, 23, 29, 37, 38 AND 50).

CLASS 35—ADVERTISING AND BUSINESS

FOR ADVERTISING AND BUSINESS, NAMELY ADVERTISING AGENCIES; PROMOTING THE GOODS AND SERVICES OF OTHERS BY PREPARING PRINT ADVERTISEMENTS FOR OTHERS AND THROUGH THE DISTRIBUTION OF PROMOTIONAL ITEMS; ORDER FULFILLMENT SERVICES FOR THE MAIL ORDER BUSINESSES OF OTHERS, NAMELY PROCESSING ORDERS FOR THE GOODS OF OTHERS; MARKETING SERVICES, NAMELY MARKET RESEARCH AND ANALYSIS, PROMOTING THE GOODS AND SERVICES OF OTHERS BY ARRANGING FOR THE DISTRIBUTION OF FLYERS, WALL-MOUNTED CALENDARS, PLASTIC BAGS, CARDBOARD PACKAGING BOXES; CONDUCTING PUBLIC OPINION POLL SURVEYS IN THE FIELD OF MARKETING AND BUSINESS; SHOP WINDOW DISPLAY ARRANGEMENT SERVICES; CONSULTING SERVICES IN THE FIELD OF PURCHASING, TRADING AND SUPPLYING OF GOODS; DISTRIBUTORSHIPS IN THE FIELD OF BOOKS, MAGAZINES AND OTHER PERIODICALS (U.S. CLS. 100, 101 AND 102).

CLASS 41—EDUCATION AND ENTERTAINMENT

FOR EDUCATIONAL SERVICES, NAMELY CONDUCTING CLASSES, TRAINING, SEMINARS AND CORRESPONDENCE COURSES IN THE FIELD OF CHILD DEVELOPMENT, POSITIVE PHYSICAL AWARENESS, SENSORY MOTOR DEVELOPMENT, PHYSICAL CONDITIONING, INJURY PREVENTION, PARENT INVOLVEMENT IN EDUCATION, COMMUNITY RELAXATION AND COMMUNITY CONCENTRATION, SELF-CARE AND SELF-ESTEEM; ENTERTAINMENT SERVICES, NAMELY ORGANIZATION OF FAIRS AND EXHIBITIONS IN THE FIELD OF CHILD DEVELOPMENT, POSITIVE PHYSICAL AWARENESS, SENSORY MOTOR DEVELOPMENT, PHYSICAL CONDITIONING, INJURY PREVENTION, PARENT INVOLVEMENT IN EDUCATION, COMMUNITY RELAXATION AND COMMUNITY CONCENTRATION, SELF-CARE AND SELF-ESTEEM; ONGOING RADIO AND TELEVISION PROGRAMS IN THE FIELD OF DOCUMENTARY, INSTRUCTION AND EDUCATION ON CHILD DEVELOPMENT, PHYSICAL CONDITIONING, INJURY PREVENTION, PARENT INVOLVEMENT IN EDUCATION, COMMUNITY RELAXATION AND COMMUNITY CONCENTRATION, SELF-CARE AND SELF-ESTEEM; SPORTS INSTRUCTION, NAMELY INTRODUCTION TO SPORTS IN GENERAL AND INJURY PREVENTION; PUBLICATION AND EDITING OF BOOKS, MAGAZINES AND OTHER PERIODICALS (U.S. CLS. 100, 101 AND 107).

CLASS 42—SCIENTIFIC, COMPUTER AND LEGAL SERVICES

FOR PHYSICAL THERAPY IN THE FIELD OF CHILD DEVELOPMENT, POSITIVE PHYSICAL AWARENESS, SENSORY MOTOR DEVELOPMENT, PHYSICAL CONDITIONING, INJURY PREVENTION, SELF-CARE AND SELF-ESTEEM (U.S. CLS. 100 AND 101).

KELLY BOULTON, EXAMINING ATTORNEY

SN 78-081,749. GSI COMMERCE SOLUTIONS, INC., KING OF PRUSSIA, PA. FILED 8-29-2001.

GLOBAL SPORTS

NO CLAIM IS MADE TO THE EXCLUSIVE RIGHT TO USE "SPORTS", APART FROM THE MARK AS SHOWN.

CLASS 35—ADVERTISING AND BUSINESS

FOR PRODUCT MERCHANDISING, NAMELY, PURCHASING AND MAINTAINING INVENTORY OF PRODUCTS FOR OTHERS; ORDER FULFILLMENT SERVICES; BUSINESS MARKETING CONSULTING SERVICES, NAMELY, PROVIDING BUSINESS ADVICE TO OTHERS IN DEVELOPING ONLINE RETAIL SITES AND DIRECT MARKETING RESPONSE BUSINESSES; CUSTOMER SERVICES IN THE FIELD OF RETAIL STORE SERVICES (U.S. CLS. 100, 101 AND 102).

FIRST USE 12-1-1997; IN COMMERCE 12-1-1997.

CLASS 42—SCIENTIFIC, COMPUTER AND LEGAL SERVICES

FOR DEVELOPMENT OF NEW TECHNOLOGY FOR OTHERS IN THE FIELD OF RETAIL STORE SERVICES; COMPUTER SERVICES, NAMELY, CREATING AND MAINTAINING WEB SITES FOR OTHERS; COMPUTER SERVICES, NAMELY DESIGNING AND IMPLEMENTING WEB SITES FOR OTHERS; COMPUTER SERVICES, NAMELY MANAGING WEB SITES FOR OTHERS; DISPLAYING THE WEB SITES AND IMAGES OF OTHERS ON A COMPUTER SERVER (U.S. CLS. 100 AND 101).

FIRST USE 12-1-1997; IN COMMERCE 12-1-1997.

EUGENIA MARTIN, EXAMINING ATTORNEY

SN 78-091,894. WMODE INC., CALGARY, CANADA, FILED 11-6-2001.

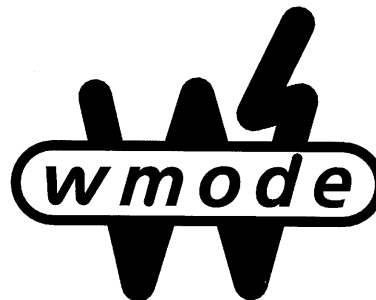
**CLASS 9—ELECTRICAL AND SCIENTIFIC APPARATUS**

FOR COMPUTER SOFTWARE USED FOR BILLING AND VALIDATION OF TRANSACTIONS CARRIED OUT VIA A COMMUNICATION NETWORK; AND COMPUTER HARDWARE (U.S. CLS. 21, 23, 26, 36 AND 38).

CLASS 42—SCIENTIFIC, COMPUTER AND LEGAL SERVICES

FOR COMPUTER SOFTWARE DEVELOPMENT; INSTALLATION OF COMPUTER SOFTWARE; TECHNICAL SUPPORT SERVICES, NAMELY, TROUBLESHOOTING OF COMPUTER HARDWARE AND SOFTWARE PROBLEMS; MONITORING OF NETWORK SYSTEMS AND PROVIDING BACK-UP COMPUTER PROGRAMS AND FACILITIES (U.S. CLS. 100 AND 101).

MARY CRAWFORD, EXAMINING ATTORNEY

SN 78-093,889. PARTY PRONTO, INC., ARCADIA, CA. FILED 11-16-2001.

JUMP AND RIDE**CLASS 41—EDUCATION AND ENTERTAINMENT**

FOR PARTY PLANNING SERVICES; ENTERTAINMENT SERVICES IN THE NATURE OF LIVE PERFORMANCES AND ATTRACTIONS PROVIDED AT CHILDREN'S PARTIES, NAMELY, CLOWNS, MAGIC SHOWS, PONY RIDES, PETTING ZOOS AND PUPPETEERS; RENTAL OF INFLATABLE BOUNCERS, MERRY-GO-ROUNDS, AND SLIDES; RENTAL OF PARTY SUPPLIES NAMELY, ACTION SKILL GAMES (U.S. CLS. 100, 101 AND 107).

FIRST USE 3-1-1993; IN COMMERCE 3-1-1993.

CLASS 43—HOTEL AND RESTAURANT SERVICES

FOR RENTAL OF CHILDREN'S PARTY EQUIPMENT AND ATTRACTIONS, NAMELY, TABLES AND CHAIRS, SNOW-CONE MACHINES, COTTON CANDY MACHINES AND FOOD COURTS (U.S. CLS. 100 AND 101).

FIRST USE 3-1-1993; IN COMMERCE 3-1-1993.

PAULA MAYS, EXAMINING ATTORNEY

SN 78-118,970. GLOBAL MOTORSPORT GROUP, INC., MORGAN HILL, CA. FILED 4-2-2002.

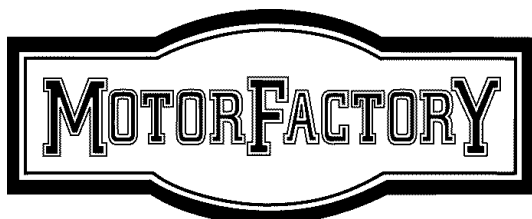

OWNER OF U.S. REG. NO. 2,114,906.
SEC. 2(F).

CLASS 1—CHEMICALS

FOR BRAKE FLUID (U.S. CLS. 1, 5, 6, 10, 26 AND 46).

CLASS 4—LUBRICANTS AND FUELS

FOR MOTORCYCLE OILS AND LUBRICANTS, NAMELY, MOTOR OIL, TRANSMISSION LUBRICANT, PRIMARY CASE LUBRICANT, AND FORK OIL (U.S. CLS. 1, 6 AND 15).

CLASS 7—MACHINERY

FOR AFTERMARKET PARTS FOR MOTORCYCLES, NAMELY, ELECTRONIC IGNITIONS, OIL COOLERS; MOTORCYCLE TUNE-UP KITS COMPRISED OF POINTS, CONDENSERS, GREASE CAPSULE, FEELER GAUGE AND TUNE-UP SPECIFICATIONS; CRANK PINS, AIR FILTERS FOR MOTORS AND ENGINES, SPARK PLUG WIRES, SPROCKET SHAFTS, OIL FILTERS FOR MOTORS AND ENGINES, GENERATOR BRUSHES FOR MOTORCYCLES, FILTER ELEMENTS, PINION SHAFTS, SPARK PLUGS, AND INTERNAL COMBUSTION ENGINE LAND VEHICLE PARTS, NAMELY DISTRIBUTOR ROTORS (U.S. CLS. 13, 19, 21, 23, 31, 34 AND 35).

CLASS 8—HAND TOOLS

FOR HAND TOOLS MANUFACTURED FOR MOTORCYCLES, NAMELY, MOTORCYCLE LIFTS, TRANSMISSION STANDS, TIE DOWNS, TIRE IRON TOOLS, CHAIN BREAKERS, AND SHOCK SPANNER WRENCHES (U.S. CLS. 23, 28 AND 44).

CLASS 9—ELECTRICAL AND SCIENTIFIC APPARATUS

FOR AFTERMARKET PARTS FOR MOTORCYCLES, NAMELY, STARTER RELAYS, SPEEDOMETERS, TACHOMETERS, ODOMETERS, SPEEDOMETER GAUGES, TACHOMETER GAUGES, OIL PRESSURE GAUGES, AMP METER GAUGES, FUEL GAUGES, TURN SIGNALS, SWITCHES AND ELECTRIC RELAYS, SPEEDOMETER CABLES, TACHOMETER CABLES, AND COILS, NAMELY, ELECTRIC COILS, IGNITION COILS, MAGNETO COILS AND SPARK COILS (U.S. CLS. 21, 23, 26, 36 AND 38).

CLASS 11—ENVIRONMENTAL CONTROL APPARATUS

FOR AFTERMARKET PARTS FOR MOTORCYCLES, NAMELY, LIGHTS AND PARTS THEREFOR (U.S. CLS. 13, 21, 23, 31 AND 34).

CLASS 12—VEHICLES

FOR AFTERMARKET PARTS FOR MOTORCYCLES, NAMELY, TAPPETS, TRANSMISSION CASES, CLUTCHES, BUSHINGS, TRANSMISSION PULLEYS, SHOCK STUD KITS COMPRISED OF A VARIETY OF SHOCK STUDS, GASKETS, VALVE SPRINGS, HANDLE BAR CLAMPS, FRAME CLAMPS, LIGHT CLAMPS, FENDER CLAMPS, FOOTREST CLAMPS, FUEL LINE CLAMPS, BAR CLAMPS, GAUGE CLAMPS, MINOR CLAMPS, FOOTRESTS, HANDLE BARS, LUGGAGE RACKS, GEAR SHIFTS, PEDALS, MIRRORS, HANDLE BAR GRIPS CLUTCH GRIPS, BRAKE SHIFTER GRIPS, HANDLE BAR LEVERS, CLUTCH LEVERS, BRAKE SHIFTER LEVERS, CLUTCH CABLES, BRAKE AND THROTTLE CABLES, KICKSTAND FRAMES, HORNS, DRIVE CHAINS, AIR CLEANERS, INSTRUMENT PANELS, HANDLE BAR BRAKE CONTROLS, HYDRAULIC AND MECHANICAL HANDLE BAR CLUTCH CONTROLS, MECHANICAL AND HYDRAULIC FOOT SHIFT CONTROLS, MECHANICAL AND HYDRAULIC HAND SHIFT CONTROLS, OIL LINE HOSES, FUEL HOSES, BRAKE HOSES, TURN SIGNALS, PARTS OF MOTORCYCLES, NAMELY, BRAKE ROTORS AND IGNITION ROTORS, AND AUTOMATIC AND MANUAL TRANSMISSION PARTS FOR LAND VEHICLES, NAMELY, STATORS (U.S. CLS. 19, 21, 23, 31, 35 AND 44).

WILLIAM BRECKENFELD, EXAMINING ATTORNEY

SN 78-120,866. MEDICART INTERNATIONAL LIMITED, SOUTHEND-ON-SEA, UNITED KINGDOM, FILED 4-10-2002.

CLEANASCOPE

PRIORITY CLAIMED UNDER SEC. 44(D) ON ERP N CMNTY TM OFC APPLICATION NO. 002431799, FILED 10-30-2001, REG. NO. 002431799, DATED 1-23-2003, EXPIRES 10-30-2011.

THE MARK CONSISTS OF THE WORD "CLEANASCOPE" HAVING AN ENDOSCOPE FORMING A PART OF THE STYLIZED A.

CLASS 10—MEDICAL APPARATUS

FOR SURGICAL, MEDICAL, DENTAL AND VETERINARY APPARATUS AND INSTRUMENTS, NAMELY, MEDICAL ENDOSCOPES; MEDICAL TRAYS; TRAYS FOR HOLDING MEDICAL, SURGICAL, DENTAL AND VETERINARY INSTRUMENTS; MEDICAL BAGS FOR APPARATUS AND INSTRUMENTS SOLD EMPTY; DISPOSABLE BAGS FOR MEDICAL USE; APPARATUS FOR DECONTAMINATING, CLEANING, DISINFECTING, PRESERVING AND TRANSPORTING MEDICAL APPARATUS AND INSTRUMENTS, NAMELY, MEDICAL TRAYS AND DISPOSABLE BAGS FOR MEDICAL USE; PARTS AND FITTINGS FOR ALL AFORESAID GOODS (U.S. CLS. 26, 39 AND 44).

CLASS 12—VEHICLES

FOR MOBILE TROLLEYS FOR TRANSPORTING MEDICAL TRAYS; MOBILE TROLLEYS FOR TRANSPORTING SURGICAL INSTRUMENTS TO BE CLEANED, DISINFECTED OR DECONTAMINATED (U.S. CLS. 19, 21, 23, 31, 35 AND 44).

CAROLINE WOOD, EXAMINING ATTORNEY

SN 78-139,642. JOHN WHITAKER INTERNATIONAL LIMITED, MILNROW, UNITED KINGDOM, FILED 6-27-2002.



PRIORITY CLAIMED UNDER SEC. 44(D) ON UNITED KINGDOM APPLICATION NO. 2294543, FILED 3-5-2002, REG. NO. 2294543, DATED 3-5-2002, EXPIRES 3-5-2009.

NO CLAIM IS MADE TO THE EXCLUSIVE RIGHT TO USE "INTERNATIONAL LTD", APART FROM THE MARK AS SHOWN.

THE STIPLING IS FOR SHADING PURPOSES ONLY.

THE NAME "JOHN WHITAKER" IDENTIFIES A LIVING INDIVIDUAL WHOSE CONSENT IS OF RECORD.

THE MARK CONSISTS OF A HORSE AND RIDER OVER THE WORDS "JOHN WHITAKER INTERNATIONAL" IN FRONT OF A GLOBE BACKGROUND.

CLASS 18—LEATHER GOODS

FOR HORSE RIDING APPARATUS, NAMELY, SADDLERY, RIDING WHIPS, RIDING CROPS, BRIDLES, REINS, HARNESSES FOR HORSES, NOSE BANDS AND BROW BANDS FOR HORSES, HORSE PROTECTORS, NAMELY, HORSE BOOTS, HEAD BUMPERS; TENDON AND FETLOCK BOOTS; SADDLE CLOTHS AND SADDLE PADS; HORSE RUGS AND COATS; PARTS AND FITTINGS FOR THE AFORESAID GOODS (U.S. CLS. 1, 2, 3, 22 AND 41).

CLASS 25—CLOTHING

FOR CLOTHING, NAMELY, SHORTS, SHIRTS, T-SHIRTS, SWIMSUITS, BLOUSES, SKIRTS, SCARVES, GLOVES, PANTS, SWEATERS, JERSEYS, SOCKS, JACKETS, SUITS, WARM-UP SUITS, VESTS, NECKTIES, BELTS, SUSPENDERS, DRESSES, COATS, RAINCOATS, RIDING COATS, OVERCOATS, SMOCKS, UNDERWEAR, PAJAMAS, BRASSIERES, CORSETS, SLIPS, LINGERIE; HEADWEAR, NAMELY, HATS, RIDING HATS, CAPS AND BERETS; FOOTWEAR, NAMELY, BOOTS, RIDING BOOTS, SANDALS, SHOES AND SLIPPERS (U.S. CLS. 22 AND 39).

AMY HELLA, EXAMINING ATTORNEY

SN 78-139,787. THREE POINTS RECORDS, INC., BEVERLY HILLS, CA. FILED 6-28-2002.

THREE POINTS RECORDS

NO CLAIM IS MADE TO THE EXCLUSIVE RIGHT TO USE "RECORDS", APART FROM THE MARK AS SHOWN.

CLASS 9—ELECTRICAL AND SCIENTIFIC APPARATUS

FOR MUSICAL SOUND RECORDINGS, DOWNLOADABLE MUSICAL SOUND RECORDINGS; VISUAL RECORDINGS AND DVDS FEATURING MUSIC AND MUSICAL BASED ENTERTAINMENT AND DOWNLOADABLE VISUAL RECORDINGS FEATURING MUSIC AND MUSICAL BASED ENTERTAINMENT (U.S. CLS. 21, 23, 26, 36 AND 38).

CLASS 38—COMMUNICATION

FOR STREAMING OF SOUND AND VISUAL RECORDINGS FEATURING MUSIC BASED ENTERTAINMENT (U.S. CLS. 100, 101 AND 104).

CLASS 41—EDUCATION AND ENTERTAINMENT

FOR SOUND AND VISUAL RECORDING PRODUCTION SERVICES; SOUND AND VISUAL RECORDING DISTRIBUTION SERVICES; SOUND AND VISUAL RECORDING PUBLISHING SERVICES; PROVIDING A WEBSITE ON A GLOBAL COMPUTER NETWORK FEATURING INFORMATION ON RECORDING ARTISTS, RECORDINGS, A RECORD LABEL, MUSIC, MUSICAL ENTERTAINMENT AND MUSIC ORIENTED EVENTS (U.S. CLS. 100, 101 AND 107).

PAULA MAYS, EXAMINING ATTORNEY

SN 78-140,469. TELEKURS-HOLDING AG, ZÜRICH, SWITZERLAND, FILED 7-1-2002.



PRIORITY CLAIMED UNDER SEC. 44(D) ON SWITZERLAND APPLICATION NO. 05430/2002, FILED 6-19-2002, REG. NO. 502539, DATED 8-28-2002, EXPIRES 6-19-2012.

THE MARK CONSISTS IN PART OF A STYLIZED LETTER "T".

CLASS 9—ELECTRICAL AND SCIENTIFIC APPARATUS

FOR COMPUTERS, PARTS AND ACCESSORIES, NAMELY COMPUTER PERIPHERALS; APPARATUS FOR DATA INPUT, NAMELY, DATA PROCESSORS, KEYBOARDS, SCANNERS, AND PAYMENT TERMINALS; CASH DISPENSERS, NAMELY, AUTOMATED TELLER MACHINES, AND CASH REGISTERS; APPARATUS FOR COLLECTING CASH, NAMELY, AUTOMATED TELLER MACHINES, AND CASH REGISTERS; MONEY CHANGING APPARATUS, NAMELY, AUTOMATED PAPER MONEY AND COIN SORTING MACHINES; COMPUTER SOFTWARE, NAMELY, COMPUTER E-COMMERCE SOFTWARE TO ALLOW USERS TO PERFORM ELECTRONIC BUSINESS TRANSACTIONS VIA A GLOBAL COMPUTER NETWORK, AND SOFTWARE FOR MULTI-CURRENCY TRANSACTIONS; COMPUTER COMMUNICATIONS AND COMPUTER SOFTWARE FOR PROCESSING DATA AND IMAGES, FOR WORD PROCESSING, FOR COMMUNICATION BETWEEN FINANCIAL INSTITUTIONS AND THEIR CUSTOMERS, AND FOR SETTLING AND MONITORING PAYMENTS; ELECTRONIC PAYMENT SYSTEMS FOR GOODS AND SERVICES COMPRISED OF AUTOMATIC TELLER MACHINES, COMPUTERS, DATA PROCESSORS, AND PAYMENT TERMINALS; INTERNET PAYMENT SOFTWARE; MACHINE-READABLE DATA MEDIA, NAMELY, MAGNETICALLY ENCODED CREDIT CARDS, MAGNETICALLY ENCODED DEBIT CARDS, MAGNETICALLY CODED CARDS FOR THE PURPOSE OF FACILITATING CASH PAYMENTS, CHIP CARDS, NAMELY, ENCODED ELECTRONIC CHIP CARDS FOR THE PURPOSE OF FACILITATING CASH PAYMENTS (U.S. CLS. 21, 23, 26, 36 AND 38).

CLASS 16—PAPER GOODS AND PRINTED MATTER

FOR PRINTED MATTER, NAMELY, BOOKS, INFORMATIONAL BROCHURES, REVIEWS NEWSLETTERS, AND MAGAZINES, ALL FEATURING INFORMATION IN THE FIELDS OF FINANCE, BANKING AND MONETARY; PRINTED FORMS FOR FINANCIAL OPERATIONS, BANK CHECKS; INSTRUCTIONAL AND TEACHING MATERIALS, NAMELY, PRINTED INSTRUCTIONAL, EDUCATIONAL AND TEACHING MATERIALS IN THE FIELDS OF FINANCIAL TRANSACTIONS AND PROVIDING FINANCIAL INFORMATION (U.S. CLS. 2, 5, 22, 23, 29, 37, 38 AND 50).

CLASS 35—ADVERTISING AND BUSINESS

FOR ADVERTISING AGENCIES, CONDUCTING MARKET STUDIES AND MARKET RESEARCH; PUBLIC RELATIONS; ORGANIZATION AND PRESENTATION OF EXHIBITIONS FOR COMMERCIAL OR ADVERTISING PURPOSES; CLERICAL SERVICES FOR CASH PAYMENTS AND PAYMENTS BY TRANSFER OF FUNDS; COMMERCIAL INFORMATION AND ADVICE FOR CONSUMERS, NAMELY, SUPPLY OF COMMERCIAL INFORMATION AND COMMERCIAL DATA BY COMPUTER TELECOMMUNICATION NETWORKS, INCLUDING THE INTERNET, AND PROVIDING OF DATA BANKS FEATURING COMMERCIAL INFORMATION AND ADVICE FOR CONSUMERS VIA TELECOMMUNICATION NETWORKS (U.S. CLS. 100, 101 AND 102).

CLASS 36—INSURANCE AND FINANCIAL

FOR FINANCIAL RESEARCH AND FINANCIAL INFORMATION PROCESSING SERVICES IN COMMERCIAL MATTERS, NAMELY, RESEARCH AND INFORMATION PROCESSING FOR CONTRACTING PARTIES FOR CASH PAYMENTS AND PAYMENTS BY TRANSFER OF FUNDS; BANKING SERVICES; FINANCIAL AND MONETARY AFFAIRS SERVICES, NAMELY, FINANCIAL EXCHANGE AND FINANCIAL FORECASTING SERVICES; CREDIT CARD AND DEBIT CARD SERVICES; FINANCIAL CLEARING HOUSE SERVICES; BILL PAYMENT SERVICES; FINANCIAL ANALYSIS AND CONSULTATION SERVICES; INSURANCE BROKERAGE (U.S. CLS. 100, 101 AND 102).

CLASS 37—CONSTRUCTION AND REPAIR

FOR INSTALLATION, REPAIR AND MAINTENANCE OF ELECTRONIC, ELECTRIC AND MECHANICAL APPLIANCES THAT CONDUCT CASH, CREDIT CARD AND DEBIT CARD TRANSACTIONS, OF CASH DISPENSERS AND APPARATUS FOR THE RECORDING, CAPTURE, TRANSFORMATION AND TRANSMISSION OF DATA, NAMELY, COMPUTER HARDWARE AND SOFTWARE, COMPUTER NETWORKS, TELECOMMUNICATIONS NETWORKS, APPARATUS AND INSTRUMENTS THAT CONDUCT CASH, CREDIT CARD AND DEBIT CARD TRANSACTIONS (U.S. CLS. 100, 103 AND 106).

CLASS 38—COMMUNICATION

FOR TELECOMMUNICATIONS SERVICES, NAMELY, ELECTRONIC TRANSMISSION OF INFORMATION, DATA AND IMAGES; DELIVERY OF MESSAGES BY ELECTRONIC TRANSMISSION; PROVIDING MULTIPLE-USER ACCESS TO A GLOBAL COMPUTER INFORMATION NETWORK FOR THE PURPOSE OF DATABASE ACCESS VIA TELECOMMUNICATIONS COMPUTER NETWORKS INCLUDING VIA THE INTERNET; TELECOMMUNICATIONS CONSULTATION IN THE FIELD OF PAYMENT TRANSACTIONS; PROVIDING A HIGH SPEED ACCESS TO AREA NETWORKS AND A GLOBAL COMPUTER INFORMATION NETWORK FOR PAYMENT TRANSACTIONS (U.S. CLS. 100, 101 AND 104).

CLASS 41—EDUCATION AND ENTERTAINMENT

FOR TRAINING SERVICES IN THE FIELD OF PAYMENTS TRANSACTION FACILITATION, TELECOMMUNICATIONS INVOLVING PAYMENT TRANSACTIONS, AND DATA PROCESSING; ORGANIZATION AND CONDUCTING OF EDUCATIONAL CONFERENCES, SEMINARS AND TRAINING WORKSHOPS, ALL IN THE FIELD OF PAYMENT TRANSACTION FACILITATION, TELECOMMUNICATIONS INVOLVING PAYMENT TRANSACTIONS, AND DATA PROCESSING (U.S. CLS. 100, 101 AND 107).

CLASS 42—SCIENTIFIC, COMPUTER AND LEGAL SERVICES

FOR LEASING AND RENTAL OF COMPUTERS AND COMPUTER FACILITIES FOR DATA BANKS ACCESS; DEVELOPMENT OF COMPUTER SOFTWARE FOR DATA PROCESSING, AND FOR DEVELOPING MEANS OF PAYMENT AND ELECTRONIC PAYMENT SYSTEMS; PROFESSIONAL TECHNICAL CONSULTATION IN THE FIELDS OF ELECTRONIC SETTLEMENT OF COMMERCIAL TRANSACTIONS, PAYMENT SYSTEMS, AND DATA PROCESSING; PROFESSIONAL COMPUTER CONSULTATION SERVICES FOR BANKS AND TELEFORMATICS ENTERPRISES IN THE FIELD OF ELECTRONIC SIGNATURE AND IN THE FIELD OF IDENTIFICATION; LEGAL SERVICES, NAMELY, LEGAL COUNSELING; DATA ENCRYPTION SERVICES, NAMELY, ENCRYPTION AND DECRYPTION OF INFORMATION; PROFESSIONAL COMPUTER CONSULTATION FOR COMPUTER USERS; TESTING, ANALYSIS AND EVALUATION OF THE GOODS AND SERVICES OF OTHERS FOR THE PURPOSE OF CERTIFICATION, NAMELY, SYSTEM AND ORGANIZATION CERTIFICATION IN THE FIELDS OF ELECTRONIC TRANSFER OF FUNDS, PAYMENT, INFORMATION RECORDING, TRANSMISSION, PROCESSING AND BACK UP SYSTEMS (U.S. CLS. 100 AND 101).
STEVEN BERK, EXAMINING ATTORNEY

SN 78-145,089, ASAHI THERMOFIL, INC, FOWLerville, MI. FILED 7-18-2002.



OWNER OF U.S. REG. NOS. 1,653,574, 2,525,999 AND OTHERS.
THE FOREIGN WORDING IN THE MARK TRANSLATES INTO ENGLISH AS "RISING SUN".

SN 78-140,770, A. OPPENHEIMER & CO., LIMITED, ESSEX, ENGLAND, FILED 7-2-2002.

**CLASS 1—CHEMICALS**

FOR REINFORCED THERMOPLASTIC COMPOUNDS, LUBRICATED THERMOPLASTIC COMPOUNDS, INJECTION MOLD PROCESSING CHEMICALS, ELECTRICALLY CONDUCTIVE THERMOPLASTIC COMPOUNDS, PELLETIZED FLAME RETARDANT COMPOUNDS, AND PELLETIZED CHEMICAL BLOWING AGENT CONCENTRATES, ALL FOR USE IN THE FURTHER MANUFACTURE OF PLASTIC ARTICLES (U.S. CLS. 1, 5, 6, 10, 26 AND 46).
FIRST USE 1-1-2001; IN COMMERCE 1-1-2001.

CLASS 35—ADVERTISING AND BUSINESS

FOR BUSINESS CONSULTING SERVICES IN THE FIELD OF THERMOPLASTIC TECHNOLOGY (U.S. CLS. 100, 101 AND 102).
FIRST USE 1-1-2001; IN COMMERCE 1-1-2001.
ELLEN B. AWRICH, EXAMINING ATTORNEY

OWNER OF UNITED KINGDOM REG. NO. 2288663, DATED 5-31-2002, EXPIRES 12-20-2011.

CLASS 14—JEWELRY

FOR CIGARETTE AND CIGAR BOXES; CIGARETTE AND CIGAR CASES; CIGARETTE AND CIGAR HOLDERS; ALL OF THE AFORESAID MADE OF PRECIOUS METALS (U.S. CLS. 2, 27, 28 AND 50).

CLASS 34—SMOKERS' ARTICLES

FOR TOBACCO AND TOBACCO PRODUCTS AND SMOKERS' ARTICLES, NAMELY, PIPES, TOBACCO POUCHES, PIPE RACKS, PIPE CLEANING MATERIALS AND HUMIDORS; LIGHTERS, CIGARETTE AND CIGAR HOLDERS, CIGARETTE AND CIGAR CASES MADE OF NON-PRECIOUS METAL (U.S. CLS. 2, 8, 9 AND 17).
HOWARD SMIGA, EXAMINING ATTORNEY

SN 78-145,850, LITTLE CALUMET HOLDINGS, LLC, SILVER SPRING, MD. FILED 7-19-2002.

LACTOB**CLASS 5—PHARMACEUTICALS**

FOR NUTRACEUTICALS FOR USE AS A DIETARY SUPPLEMENT (U.S. CLS. 6, 18, 44, 46, 51 AND 52).

CLASS 29—MEATS AND PROCESSED FOODS

FOR FUNCTIONAL FOOD PRODUCTS, NAMELY, MILK PRODUCTS AND MILK BEVERAGES BEING MILK, CHOCOLATE MILK, HALF AND HALF, CREAM, MILK-BASED BEVERAGES CONTAINING COFFEE, ACIDOPHILUS MILK, AS WELL AS CHEESE, YOGURT, BLACK PUDDING, BUTTER, PROTEIN BASED, NUTRIENT-DENSE SNACK BARS, PEANUT BUTTER, ALL CONTAINING DIETARY SUPPLEMENTS (U.S. CL. 46).

CLASS 30—STAPLE FOODS

FOR FUNCTIONAL FOOD PRODUCTS, NAMELY, MILK PRODUCTS AND MILK BEVERAGES BEING, BASES FOR MAKING MILK SHAKES, ICE MILK, MILK SHADES, AS WELL AS PUDDINGS, CHOCOLATE, PASTRIES, CONFECTIONARY PRODUCTS BEING CONFECTIONARY CHIPS FOR BAKING, CAKES, CANDY, COOKIES, BROWNIES, BAKERY DESSERTS, BONBONS, AS WELL AS BUBBLE GUM, CHEWING GUM, GRANOLA BASED SNACK BARS, CANDY BARS, CANDY MINTS, CARAMELS, READY TO EAT CEREAL DERIVED FOOD BARS, ICE CREAM, ALL CONTAINING DIETARY SUPPLEMENTS (U.S. CL. 46).

CLASS 35—ADVERTISING AND BUSINESS

FOR RETAIL AND WHOLESALE STORE SERVICES, ONLINE RETAIL AND WHOLESALE SERVICES, MAIL ORDER CATALOG SERVICES FEATURING NUTRACEUTICALS FOR USE AS DELIVERY SUPPLEMENTS, FUNCTIONAL FOOD PRODUCTS, NAMELY, MILK PRODUCTS AND MILK BEVERAGES CONTAINING COFFEE, ACIDOPHILUS MILK, AS WELL AS CHEESE, CREAM, YOGURT, BLACK PUDDING, BUTTER, PROTEIN BASED, NUTRIENT-DENSE SNACK BARS, PEANUT BUTTER, MILK PRODUCTS AND MILK BEVERAGES BEING BASES FOR MAKING MILK SHAKES, ICE MILK, MILK SHAKES, AS WELL AS PUDDINGS, CHOCOLATE, PASTRIES, CONFECTIONARY PRODUCTS BEING CONFECTIONARY CHIPS FOR BAKING, CAKES, CANDY, COOKIES, BROWNIES, BAKERY DESSERTS, BONBONS, AS WELL AS BUBBLE GUM, CHEWING GUM, GRANOLA BASED SNACK BARS, CANDY BARS, CANDY MINTS, CARAMELS, READY TO EAT CEREAL DERIVED FOOD BARS, ICE CREAM, ALL CONTAINING DIETARY SUPPLEMENTS (U.S. CLS. 100, 101 AND 102).

MARY CRAWFORD, EXAMINING ATTORNEY

SN 78-146,594. MERVYN'S BRANDS, INC., MINNEAPOLIS, MN. FILED 7-23-2002.

FRENCH LAUNDRY

OWNER OF U.S. REG. NO. 2,570,917.

CLASS 14—JEWELRY

FOR JEWELRY, NAMELY, EARRINGS, NECKLACES AND BRACELETS (U.S. CLS. 2, 27, 28 AND 50).
FIRST USE 12-31-2002; IN COMMERCE 12-31-2002.

CLASS 25—CLOTHING

FOR WOMEN'S CLOTHING, NAMELY, SKIRTS, SHORTS, DRESSES AND JACKETS (U.S. CLS. 22 AND 39).
FIRST USE 1-31-2003; IN COMMERCE 1-31-2003.
ELLEN B. AWRICH, EXAMINING ATTORNEY

SN 78-148,354. BRITANNICA HOME FASHIONS, INC., NEW YORK, NY. FILED 7-29-2002.

MIX AND MATCH HOME COLLECTION

NO CLAIM IS MADE TO THE EXCLUSIVE RIGHT TO USE "HOME COLLECTION", APART FROM THE MARK AS SHOWN.

CLASS 20—FURNITURE AND ARTICLES NOT OTHERWISE CLASSIFIED

FOR PILLOWS (U.S. CLS. 2, 13, 22, 25, 32 AND 50).

CLASS 24—FABRICS

FOR SHEETS, COMFORTERS, PILLOW SHAMS, COMFORTER COVERS, DOWN COMFORTERS, BED RUFFLES, BED SKIRTS AND QUILTS (U.S. CLS. 42 AND 50).
CIMMERIAN COLEMAN, EXAMINING ATTORNEY

SN 78-153,198. GEA AG, BOCHUM, FED REP GERMANY, FILED 8-12-2002.

GEA COM4

PRIORITY CLAIMED UNDER SEC. 44(D) ON FED REP GERMANY APPLICATION NO. 30218142342, FILED 4-10-2002, REG. NO. 30218142, DATED 4-25-2002, EXPIRES 4-30-2012.

OWNER OF U.S. REG. NOS. 1,259,607, 1,321,758 AND 1,422,508.

CLASS 11—ENVIRONMENTAL CONTROL APPARATUS

FOR ENVIRONMENTAL CONTROL APPARATUS FOR COOLING, HEATING, FILTERING AND HEAT RECOVERY IN RESIDENTIAL, COMMERCIAL AND INDUSTRIAL ENVIRONMENTS, NAMELY, CENTRAL AIR CONDITIONING UNITS AND PARTS AND COMPONENTS THEREFOR (U.S. CLS. 13, 21, 23, 31 AND 34).

CLASS 37—CONSTRUCTION AND REPAIR

FOR CONSTRUCTION AND INSTALLATION OF AIR CONDITIONING SYSTEMS FOR RESIDENTIAL, COMMERCIAL AND INDUSTRIAL ENVIRONMENTS; REPAIR OF AIR CONDITIONING SYSTEMS IN RESIDENTIAL, COMMERCIAL AND INDUSTRIAL ENVIRONMENTS (U.S. CLS. 100, 103 AND 106).

CLASS 42—SCIENTIFIC, COMPUTER AND LEGAL SERVICES

FOR ENGINEERING AND TECHNICAL CONSULTATION FOR OTHERS IN THE FIELD OF CENTRAL AIR CONDITIONING UNITS AND CENTRAL AIR CONDITIONING SYSTEMS FOR RESIDENTIAL, COMMERCIAL AND INDUSTRIAL USE; DESIGN FOR OTHERS OF CENTRAL AIR CONDITIONING UNITS AND CENTRAL AIR CONDITIONING SYSTEMS FOR RESIDENTIAL, COMMERCIAL AND INDUSTRIAL USE; COMPUTER SOFTWARE DESIGN FOR OTHERS IN THE FIELD OF ENVIRONMENTAL CONTROL APPARATUS; TECHNICAL RESEARCH AND CONSULTATION IN THE FIELD OF AIR CONDITIONING TECHNOLOGY; AND DESIGN AND TESTING FOR OTHERS OF AIR CONDITIONING SYSTEMS AND PARTS AND COMPONENTS THEREFORE (U.S. CLS. 100 AND 101).

TARAH HARDY, EXAMINING ATTORNEY

SN 78-153,344. ENTOCOSM PTY LTD, PARKVILLE, AUSTRALIA, FILED 8-12-2002.

SN 78-156,420. LEDGERPLUS, INC., TALLAHASSEE, FL. FILED 8-21-2002.

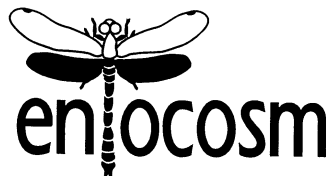

PRIORITY CLAIMED UNDER SEC. 44(D) ON AUSTRALIA APPLICATION NO. 920674, FILED 7-22-2002, REG. NO. 920674, DATED 7-22-2002, EXPIRES 7-22-2012.

THE MARK CONSISTS OF THE TERM ENTOCOSM WITH THE BODY OF A DRAGONFLY FORMING THE LETTER "T".

CLASS 1—CHEMICALS

FOR CHEMICALS AND CHEMICAL SUBSTANCES CONTAINING ARTHROPODIC SUBSTANCES FOR USE IN MANUFACTURING PHARMACEUTICAL PREPARATIONS THESE BEING UTILIZED IN SCIENTIFIC INDUSTRIES (U.S. CLS. 1, 5, 6, 10, 26 AND 46).

CLASS 5—PHARMACEUTICALS

FOR PHARMACEUTICAL PREPARATIONS CONTAINING ARTHROPODIC DERIVED SUBSTANCES FOR THE TREATMENT OF HUMAN AILMENTS, MEDICAL DISORDERS AND DISEASES, NAMELY— INFECTIOUS DISEASES CAUSED BY BACTERIA, FUNGI, VIRUSES, HELMINTHS, PROTOZOA AND PARASITES, INCLUDING AIDS AND HEPATITIS C; CANCER INCLUDING CANCERS OF THE BREAST, PROSTATE, LUNG, COLON, SKIN, BRAIN, BLOOD AND ERYTHROPOIETIC CELLS (LEUKEMIAS, MYELOMAS); HEART DISEASE; CARDIOVASCULAR DISEASE INCLUDING STROKE, HYPERTENSION AND ATHEROSCLEROSIS; NEUROSES AND PSYCHOSES—ANXIETY, SCHIZOPHRENIA, DEPRESSION, AND BIPOLAR DISORDER; OBESITY; DIABETES (TYPE 1 AND TYPE 2); ASTHMA; HYPERTENSION; HYPERCHOLESTEROLEMIA; PAIN (CHRONIC AND ACUTE); INFLAMMATION INCLUDING ARTHRITIS, OSTEOARTHRITIS; AUTOIMMUNE DISEASES; PSORIASIS, ECZEMA; CYSTIC FIBROSIS; GASTRO-INTESTINAL DISEASE, INCLUDING ULCERS, HELICOBACTER PYLORI INFECTIONS; SEXUAL DYSFUNCTION; OPHTHALMIC DISORDERS INCLUDING GLAUCOMA; IMMUNE SUPPRESSION FOLLOWING TRANSPLANTATION; REPRODUCTIVE DISORDERS; CONTRACEPTION AND CONTROL OF REPRODUCTION; CYSTIC FIBROSIS AND GENETIC DISORDERS; AND DEGENERATIVE DISEASES INCLUDING ALZHEIMER'S DEMENTIA (U.S. CLS. 6, 18, 44, 46, 51 AND 52).

CLASS 42—SCIENTIFIC, COMPUTER AND LEGAL SERVICES

FOR PHARMACEUTICAL DRUG DEVELOPMENT SERVICES FOR DRUGS CONTAINING ARTHROPODIC DERIVED SUBSTANCES (U.S. CLS. 100 AND 101).

CLASS 44—MEDICAL, BEAUTY AND AGRICULTURAL SERVICES

FOR PHARMACEUTICAL CONSULTATION IN THE FIELD OF DRUGS CONTAINING ARTHROPODIC DERIVED SUBSTANCES (U.S. CLS. 100 AND 101).
REBECCA SMITH, EXAMINING ATTORNEY

CFOTODAY

CLASS 35—ADVERTISING AND BUSINESS

FOR ACCOUNTING SERVICES, NAMELY, BOOK-KEEPING AND FINANCIAL STATEMENT, RECEIPT AND DISBURSEMENT STATEMENT PREPARATION AND ANALYSIS FOR BUSINESSES; TAX SERVICES, NAMELY INCOME TAX CONSULTATION, INCOME TAX PREPARATION, TAX CONSULTATION; PAYROLL, NAMELY ADMINISTRATION OF BUSINESS PAYROLL PREPARATION AND WAGE PAYROLL PREPARATION (U.S. CLS. 100, 101 AND 102).

FIRST USE 8-20-2002; IN COMMERCE 8-20-2002.

CLASS 36—INSURANCE AND FINANCIAL

FOR FINANCIAL SERVICES, NAMELY FINANCIAL ANALYSIS, FINANCIAL FORECASTING, FINANCIAL INFORMATION PROVIDED BY ELECTRONIC MEANS, FINANCIAL INFORMATION PROCESSING, FINANCIAL MANAGEMENT, FINANCIAL PLANNING, FINANCIAL PORTFOLIO MANAGEMENT; SECURITIES, NAMELY FINANCIAL INVESTMENT IN THE FIELD OF SECURITIES; INSURANCE SERVICES, NAMELY INSURANCE BROKERAGE SERVICES (U.S. CLS. 100, 101 AND 102).

FIRST USE 8-20-2002; IN COMMERCE 8-20-2002.

HOWARD SMIGA, EXAMINING ATTORNEY

SN 78-156,496. SUNGNAM ELECTRONICS CO. LTD., SUNGNAM-SI, KYONGGI-DO, REPUBLIC OF KOREA, FILED 8-21-2002.

KINORI

PRIORITY CLAIMED UNDER SEC. 44(D) ON REPUBLIC OF KOREA APPLICATION NO. 200232162, FILED 7-12-2002, REG. NO. 0563890, DATED 10-28-2003, EXPIRES 10-28-2013.

CLASS 9—ELECTRICAL AND SCIENTIFIC APPARATUS

FOR LIGHTING BALLASTS, BATTERIES AND BATTERY CHARGERS (U.S. CLS. 21, 23, 26, 36 AND 38).

CLASS 11—ENVIRONMENTAL CONTROL APPARATUS

FOR ELECTRIC LIGHT BULBS, ELECTRIC LIGHTING TUBES AND LAMPS, NAMELY, INCANDESCENT BULBS, SAFETY LAMPS, ORNAMENTAL LAMPS, LIGHTING LAMPS, COMPACT LAMPS, STANDARD LAMPS, FLUORESCENT LAMPS, POWER SAVING FLUORESCENT LAMPS (U.S. CLS. 13, 21, 23, 31 AND 34).
MICHAEL WEBSTER, EXAMINING ATTORNEY

SN 78-158,920. REAL TIME SOLUTIONS, INC., EMERYVILLE, CA. FILED 8-28-2002.

REAL TIME SOLUTIONS

SEC. 2(F).

CLASS 9—ELECTRICAL AND SCIENTIFIC APPARATUS

FOR COMPUTER ASSISTED ORDER FILLING, PICKING, PROCESSING, AND INVENTORY MANAGEMENT SYSTEMS, NAMELY, COMPUTERS, COMPUTER HARDWARE AND SOFTWARE, AND MANUALS SOLD THEREWITH AS A UNIT (U.S. CLS. 21, 23, 26, 36 AND 38).

FIRST USE 2-0-1988; IN COMMERCE 2-0-1988.

CLASS 37—CONSTRUCTION AND REPAIR

FOR INSTALLATION OF ORDER FILLING, PICKING AND PROCESSING SYSTEMS FOR WAREHOUSES AND MANUFACTURING AND DISTRIBUTION CENTERS (U.S. CLS. 100, 103 AND 106).

FIRST USE 0-0-1988; IN COMMERCE 0-0-1988.

CLASS 42—SCIENTIFIC, COMPUTER AND LEGAL SERVICES

FOR CUSTOMIZED DESIGN OF ORDER FILLING, PICKING AND PROCESSING SYSTEMS FOR WAREHOUSES AND MANUFACTURING AND DISTRIBUTION CENTERS (U.S. CLS. 100 AND 101).

FIRST USE 0-0-1988; IN COMMERCE 0-0-1988.

WANDA KAY PRICE, EXAMINING ATTORNEY

SN 78-161,259. EXA S.A., COLOGNY, SWITZERLAND, FILED 9-6-2002.



OWNER OF SWITZERLAND REG. NO. 501998, DATED 8-31-2002, EXPIRES 8-31-2012.

CLASS 3—COSMETICS AND CLEANING PREPARATIONS

FOR CLEANING, POLISHING, SCOURING AND ABRASIVE PREPARATIONS, IN THE FORM OF GAS, LIQUID, SOLID AND POWDER FOR CLEANING STAINLESS ALLOYS IN STEEL, IRON AND METALS OF VARIOUS COLORS (U.S. CLS. 1, 4, 6, 50, 51 AND 52).

CLASS 7—MACHINERY

FOR MACHINES AND MACHINE TOOLS FOR CLEANING; PULVERIZERS; ELECTRICAL AND PNEUMATIC APPARATUS, NAMELY ERASING, BLASTING AND CLEANING MACHINES, SCRUBBERS, SWEEPERS, SANDERS FOR CLEANING AND TREATMENT OF SURFACES (U.S. CLS. 13, 19, 21, 23, 31, 34 AND 35).

CLASS 9—ELECTRICAL AND SCIENTIFIC APPARATUS

FOR MEASURING APPARATUS, NAMELY MEASURING UNITS; DOSING UNITS FOR DOSING AND DISTRIBUTION OF PRODUCTS IN THE FORM OF GAS, LIQUID, POWDER AND PELLET; REGULATING AND CONTROLLING APPARATUS, NAMELY FLOW CONTROLLERS (U.S. CLS. 21, 23, 26, 36 AND 38).

MICHELE SWAIN, EXAMINING ATTORNEY

SN 78-161,276. PROCAPS ENCAPSULATION INC., ST. LAURENT, QUEBEC, CANADA, FILED 9-6-2002.



NO CLAIM IS MADE TO THE EXCLUSIVE RIGHT TO USE PAINTBALL, APART FROM THE MARK AS SHOWN.

CLASS 3—COSMETICS AND CLEANING PREPARATIONS

FOR PAINTBALL BARREL CLEANERS (U.S. CLS. 1, 4, 6, 50, 51 AND 52).

CLASS 4—LUBRICANTS AND FUELS

FOR PAINTBALL BARREL LUBRICATING OIL (U.S. CLS. 1, 6 AND 15).

CLASS 25—CLOTHING

FOR CLOTHING, NAMELY, SHIRTS, JERSEYS, SHORTS, PANTS, T-SHIRTS, SWEATSHIRTS, SWEATPANTS, GLOVES, AND SOCKS; FOOTWEAR; HEADGEAR, NAMELY HATS, CAPS AND VISORS; PAINTBALL GLOVES AND JERSEYS; SKI AND SNOWBOARD GLOVES, PANTS, BOOTS, AND JERSEYS AND MOTORCYCLE AND MOTOCROSS GLOVES, PANTS, BOOTS AND JERSEYS (U.S. CLS. 22 AND 39).

CLASS 28—TOYS AND SPORTING GOODS

FOR PAINTBALLS; PAINTBALL EQUIPMENT, NAMELY PNEUMATIC GUNS FOR FIRING OF PAINTBALLS, PAINTBALL MARKERS, PAINTBALL HOPPERS, PAINTBALL LOADING EQUIPMENT, HARNESSSES, PAINTBALL BARRELS, PAINTBALL ACCESSORIES, NAMELY EQUIPMENT BELTS, PROTECTIVE PADDING AND PROTECTIVE FACE MASKS; SPORTING GOODS, NAMELY SKI AND SNOWBOARD PROTECTIVE FACE MASKS AND PADDING; SPORTING GOODS, NAMELY MOTORCYCLE AND MOTOCROSS PROTECTIVE FACE MASKS AND PADDING (U.S. CLS. 22, 23, 38 AND 50).

MICHELE SWAIN, EXAMINING ATTORNEY

SN 78-161,281. PROCAPS ENCAPSULATION INC., ST. LAURENT, QUEBEC, CANADA, FILED 9-6-2002.



NO CLAIM IS MADE TO THE EXCLUSIVE RIGHT TO USE PAINTBALLS, APART FROM THE MARK AS SHOWN.

CLASS 3—COSMETICS AND CLEANING PREPARATIONS

FOR PAINTBALL BARREL CLEANERS (U.S. CLS. 1, 4, 6, 50, 51 AND 52).

CLASS 4—LUBRICANTS AND FUELS

FOR PAINTBALL BARREL LUBRICATING OIL (U.S. CLS. 1, 6 AND 15).

CLASS 25—CLOTHING

FOR CLOTHING, NAMELY, SHIRTS, JERSEYS, SHORTS, PANTS, T-SHIRTS, SWEATSHIRTS, SWEAT-PANTS, GLOVES, AND SOCKS; FOOTWEAR; HEAD-GEAR, NAMELY HATS, CAPS AND VISORS; PAINTBALL GLOVES AND JERSEYS; SKI AND SNOW-BOARD GLOVES, PANTS, BOOTS, AND JERSEYS AND MOTORCYCLE AND MOTOCROSS GLOVES, PANTS, BOOTS AND JERSEYS (U.S. CLS. 22 AND 39).

CLASS 28—TOYS AND SPORTING GOODS

FOR PAINTBALLS; PAINTBALL EQUIPMENT, NAMELY PNEUMATIC GUNS FOR FIRING OF PAINT-BALLS, PAINTBALL MARKERS, PAINTBALL HOPPERS, PAINTBALL LOADING EQUIPMENT, HARNESSSES, PAINTBALL BARRELS, PAINTBALL ACCESSORIES, NAMELY EQUIPMENT BELTS, PROTECTIVE PADDING AND PROTECTIVE FACE MASKS; SPORTING GOODS, NAMELY SKI AND SNOWBOARD PROTECTIVE FACE MASKS AND PADDING; SPORTING GOODS, NAMELY MOTORCYCLE AND MOTOCROSS PROTECTIVE FACE MASKS AND PADDING (U.S. CLS. 22, 23, 38 AND 50).
MICHELE SWAIN, EXAMINING ATTORNEY

SN 78-161,631. AMERICAN CREDIT SYSTEMS, INC., TEME-CULA, CA. FILED 9-6-2002.

**CLASS 35—ADVERTISING AND BUSINESS**

FOR FRANCHISING, NAMELY, OFFERING TECHNICAL ASSISTANCE IN THE ESTABLISHMENT AND/OR OPERATION OF CREDIT RECOVERY AND DEBT COL-LECTION SERVICES. (U.S. CLS. 100, 101 AND 102).

CLASS 36—INSURANCE AND FINANCIAL

FOR CREDIT RECOVERY AND DEBT COLLECTION SERVICES. (U.S. CLS. 100, 101 AND 102).
JOHN SCHUYLER YARD, EXAMINING ATTORNEY

SN 78-164,888. BI PROPERTIES I INC., GREENSBORO, NC. FILED 9-17-2002.

PERMALINK

CLASS 17—RUBBER GOODS

FOR ADHESIVE TAPE FOR INDUSTRIAL AND COM-MERCIAL USE (U.S. CLS. 1, 5, 12, 13, 35 AND 50).
FIRST USE 3-31-2003; IN COMMERCE 3-31-2003.

CLASS 27—FLOOR COVERINGS

FOR TEXTILE FLOORCOVERINGS, NAMELY CAR-PET AND CARPET TILES (U.S. CLS. 19, 20, 37, 42 AND 50).
FIRST USE 3-31-2003; IN COMMERCE 3-31-2003.
ELLEN B. AWRICH, EXAMINING ATTORNEY

SN 78-165,939. MAGICI, LTD., NISSEQUOGUE, NY. FILED 9-19-2002.

MAGICI

CLASS 16—PAPER GOODS AND PRINTED MATTER

FOR CHILDREN'S BOOKS (U.S. CLS. 2, 5, 22, 23, 29, 37, 38 AND 50).

CLASS 28—TOYS AND SPORTING GOODS

FOR STUFFED TOY ANIMAL (U.S. CLS. 22, 23, 38 AND 50).

ROBIN CHOSID, EXAMINING ATTORNEY

SN 78-167,410. THE PBN COMPANY, WASHINGTON, DC. FILED 9-24-2002.



The PBN Company

OWNER OF UNITED KINGDOM REG. NO. 2279113, DATED 8-28-2001, EXPIRES 8-28-2011.

NO CLAIM IS MADE TO THE EXCLUSIVE RIGHT TO USE "COMPANY", APART FROM THE MARK AS SHOWN.

THE MARK CONSISTS OF THE MARK PBN THE PBN COMPANY AND THE COLOR PURPLE FOR THE REC-TANGLE AND THE PHRASE THE PBN COMPANY, THE COLOR WHITE FOR THE LETTERS PBN, AND THE COLOR BEIGE FOR THE TRIANGLE DESIGNS BETWEEN THE LETTERS P AND B AND N.

CLASS 9—ELECTRICAL AND SCIENTIFIC APPARATUS

FOR BLANK MAGNETIC DATA CARRIERS, BLANK OPTICAL DATA CARRIERS, BLANK COMPUTER DISKS, PRERECORDED MAGNETIC DATA CARRIERS FEATURING DATABASES, ARTICLES, LAWS, PRESEN-TATIONS, SPEECHES ON ADVERTISEMENTS, CLIENT, THE OIL AND GAS INDUSTRY, INTELLECTUAL PROP-ERTY, AND DOING BLUISHNESS IN RUSSIA; COMPU-TER GAME SOFTWARE AND COMPUTER GAME PROGRAMS, PHOTOGRAPHIC SLIDE TRANSPAREN-CIES, BLANK OPTICAL DISKS, ELECTRONIC NOTICE BOARDS, CINEMATOGRAPHIC FILM, VIDEO DISKS FEATURING COMPANY AND CLIENT EXECUTIVES FILMS, TELEVISIONS NEWS STORIES, SPEECHES, NEWS CONFERENCES, CHILDREN'S VIDEO TAPES, PRERECORDED COMPACT DISKS FEATURING SPEECHES, LECTURES, AND SEMINARS; BLANK COMPUTER DISCS (U.S. CLS. 21, 23, 26, 36 AND 38).

CLASS 16—PAPER GOODS AND PRINTED MATTER

FOR PRINTED MATTER, NAMELY, CARTOON PRINTS, MOUNTED AND UNMOUNTED PHOTO-GRAPHS, STATIONERY, PRINTED INSTRUCTIONAL AND TEACHING MATERIALS IN THE FIELD OF STRATEGIC COMMUNICATIONS, CRISIS MANAGE-MENT, HANDBOOKS, MANUALS AND PERIODICALS ALL OF THE FOREGOING IN THE FIELD OF STRATE-GIC COMMUNICATIONS, CRISIS MANAGEMENT (U.S. CLS. 2, 5, 22, 23, 29, 37, 38 AND 50).

CLASS 35—ADVERTISING AND BUSINESS

FOR ADVERTISING SERVICES, NAMELY, CREATING CORPORATE AND BRAND IDENTITY FOR OTHERS; BUSINESS MANAGEMENT AND CONSULTATION; CLERICAL SERVICES; ARRANGING AND CONDUCTING TRADE SHOW EXHIBITIONS IN THE FIELD OF PUBLIC RELATIONS AND ADVERTISING; BUSINESS INVESTIGATION; APPRAISALS, BUSINESS EVALUATION OF CONSUMER AND FINANCIAL MARKETS; PRODUCT DEMONSTRATION; DOCUMENT REPRODUCTION; STENOGRAPHIC TRANSCRIPTION; MARKET RESEARCH AND MARKET ANALYSIS; PROVIDING BUSINESS MARKETING INFORMATION AND CONSUMER INFORMATION IN THE FIELD OF STRATEGIC COMMUNICATIONS, INTELLECTUAL PROPERTY, GOVERNMENT RELATIONS, OPINION AND MARKET RESEARCH; PERSONNEL MANAGEMENT CONSULTANCY, BUSINESS ORGANIZATIONAL CONSULTANCY; BUSINESS SERVICES, NAMELY, PROVIDING COMPUTER DATABASES REGARDING THE PURCHASE AND SALE OF A WIDE VARIETY OF PRODUCTS AND SERVICES OF OTHERS; TYPING; PUBLIC RELATIONS; DISSEMINATION OF ADVERTISING MATTER FOR OTHERS; COST/PRICE ANALYSIS; SECRETARIAL SERVICES; WORD PROCESSING; PHOTOCOPYING (U.S. CLS. 100, 101 AND 102).

CLASS 41—EDUCATION AND ENTERTAINMENT

FOR EDUCATION AND TRAINING SERVICES, NAMELY, CONDUCTING SEMINARS AND WORKSHOPS LIVE AND THROUGH CORRESPONDENCE COURSES AND CONDUCTING EDUCATIONAL COMPETITIONS IN THE FIELDS OF INTELLECTUAL PROPERTY, REPUTATION MANAGEMENT, AVIATION, OIL AND GAS INDUSTRY, INTERNATIONAL TRADE, FINANCIAL INSTITUTIONS, INSURANCE, AND BUSINESS ETHICS; ENTERTAINMENT, NAMELY, ORGANIZATION OF EXHIBITIONS FOR CULTURAL AND SPORTING EVENTS; CONDUCTING LOTTERIES FOR OTHERS; PARTY PLANNING; PUBLICATION OF BOOKS; MOTION PICTURE FILM PRODUCTION; PUBLICATION OF BROCHURES, MAGAZINES AND LEAFLETS; ENTERTAINMENT IN THE NATURE OF LIVE PERFORMANCES BY A MUSICAL GROUP; SCRIPT WRITING SERVICES; NEWS REPORTING SERVICES; PHOTOGRAPHY SERVICES; PHOTOGRAPHIC REPORTING; VIDEOTAPING; TRANSLATION SERVICES (U.S. CLS. 100, 101 AND 107).

CLASS 42—SCIENTIFIC, COMPUTER AND LEGAL SERVICES

FOR LEGAL RESEARCH; SCIENTIFIC RESEARCH AND DEVELOPMENT; COMPUTER PROGRAMMING FOR OTHERS; INTELLECTUAL PROPERTY CONSULTANCY; COPYRIGHT MANAGEMENT (U.S. CLS. 100 AND 101).

CLASS 45—PERSONAL SERVICES

FOR SOCIAL CLUBS (U.S. CLS. 100 AND 101).
BERYL GARDNER, EXAMINING ATTORNEY

SN 78-168,343. PROCAPS ENCAPSULATION INC., ST. LAURENT QUEBEC, CANADA, FILED 9-26-2002.

NXL**CLASS 28—TOYS AND SPORTING GOODS**

FOR PAINTBALLS; PAINTBALL EQUIPMENT AND ACCESSORIES, NAMELY PAINTBALLS AND PAINTBALL MARKERS; SPORTING EQUIPMENT, NAMELY, PAINTBALL HOPPERS, PAINTBALL LOADING EQUIPMENT, AND HARNESES, PAINTBALL BARRELS; SPORTING EQUIPMENT, NAMELY, SKI AND SNOWBOARD PROTECTIVE FACE MASKS AND PADDING; MOTORCYCLE AND MOTOCROSS PROTECTIVE FACE MASKS AND PADDING; APPARATUS FOR USE IN PAINTBALL COMBAT GAMES, NAMELY EQUIPMENT BELTS, PROTECTIVE PADDING, GLOVES; PROTECTIVE FACE MASKS (U.S. CLS. 22, 23, 38 AND 50).

CLASS 41—EDUCATION AND ENTERTAINMENT

FOR ORGANIZING EXHIBITIONS FOR PAINTBALL COMPETITIONS; ENTERTAINMENT IN THE NATURE OF PAINTBALL GAMES (U.S. CLS. 100, 101 AND 107).
MARIA-VICTORIA SUAREZ, EXAMINING ATTORNEY

SN 78-170,589. FOUNDATION FOR EUROPEAN LANGUAGE AND EDUCATIONAL CENTRES, ZURICH, SWITZERLAND, FILED 10-3-2002.

EUROCENTRES

OWNER OF U.S. REG. NO. 1,495,646.

CLASS 9—ELECTRICAL AND SCIENTIFIC APPARATUS

FOR COMPUTER SOFTWARE, PRE-RECORDED MAGNETIC DATA CARRIERS, PRE-RECORDED DIGITAL VIDEO DISCS, AND PRE-RECORDED COMPACT DISCS; ALL FEATURING INSTRUCTION IN LEARNING LANGUAGES; DATA PROCESSORS AND COMPUTERS (U.S. CLS. 21, 23, 26, 36 AND 38).

CLASS 16—PAPER GOODS AND PRINTED MATTER

FOR BOOKS, INSTRUCTIONAL WORKSHEETS, TEACHER MANUALS, INFORMATIONAL BROCHURES, MAGAZINES AND NEWSPAPERS IN THE FIELD OF LANGUAGE LEARNING; TRAVEL GUIDE BOOKS; PRINTED MATTER, NAMELY, STATIONERY; OFFICE REQUISITES, NAMELY, POSTERS, NOTE BOOKS, RING BINDERS, BUSINESS CARDS (U.S. CLS. 2, 5, 22, 23, 29, 37, 38 AND 50).

CLASS 41—EDUCATION AND ENTERTAINMENT

FOR EDUCATIONAL SERVICES, NAMELY, CONDUCTING CLASSES AND COURSES, SEMINARS, CONFERENCES, WORKSHOPS IN THE FIELD OF LANGUAGE LEARNING (U.S. CLS. 100, 101 AND 107).

CLASS 42—SCIENTIFIC, COMPUTER AND LEGAL SERVICES

FOR PROVIDING TEMPORARY USE OF NON-DOWNLOADABLE COMPUTER SOFTWARE FEATURING INSTRUCTION IN LEARNING LANGUAGES (U.S. CLS. 100 AND 101).

CLASS 43—HOTEL AND RESTAURANT SERVICES

FOR FOOD PREPARATION SERVICES, NAMELY PROVISION OF FOOD AND DRINK FOR COURSE PARTICIPANTS (U.S. CLS. 100 AND 101).
STEVEN BERK, EXAMINING ATTORNEY

SN 78-173,973. MWG BIOTECH AG, EBERSBERG, FED REP GERMANY, FILED 10-14-2002.

MWG**CLASS 1—CHEMICALS**

FOR CHEMICAL PREPARATIONS FOR INDUSTRIAL AND SCIENTIFIC PURPOSES, NAMELY, FOR USE IN PERFORMING SCIENTIFIC RESEARCH; BIOCHEMICALS, NAMELY, OLIGONUCLEOTIDES, POLYNUCLEOTIDES, AND SYNTHETIC GENES USED IN SCIENTIFIC RESEARCH, FORENSIC, MEDICAL RESEARCH, DIAGNOSTIC RESEARCH, SEQUENCING, PCR, GENETIC ENGINEERING; BIOCHEMICAL PREPARATIONS, NAMELY, DNA-CHIPS, PEPTIDE-CHIPS, DNA-MICROARRAYS, PEPTIDE-MICROARRAYS, FOR USE IN DEVELOPMENTAL BIOLOGY, CANCER RESEARCH, PHARMACEUTICAL RESEARCH, DNA SEQUENCING, AND EXPRESSION PROFILING; BIOCHEMICALS, NAMELY, OLIGONUCLEOTIDE SETS FOR SCIENTIFIC RESEARCH AND FOR DNA-MICROARRAYS; GENE LIBRARY, NAMELY, BIOLOGICAL PREPARATIONS CONSISTING OF GENETIC MATERIAL COLLECTED FOR SCIENTIFIC RESEARCH PURPOSES (U.S. CLS. 1, 5, 6, 10, 26 AND 46).

SN 78-170,594. FOUNDATION FOR EUROPEAN LANGUAGE AND EDUCATIONAL CENTRES, ZURICH, SWITZERLAND, FILED 10-3-2002.

EUROCENTRES

OWNER OF U.S. REG. NO. 1,495,646.

CLASS 9—ELECTRICAL AND SCIENTIFIC APPARATUS

FOR COMPUTER SOFTWARE, PRE-RECORDED MAGNETIC DATA CARRIERS, PRE-RECORDED DIGITAL VIDEO DISCS, AND PRE-RECORDED COMPACT DISCS; ALL FEATURING INSTRUCTION IN LEARNING LANGUAGES; DATA PROCESSORS AND COMPUTERS (U.S. CLS. 21, 23, 26, 36 AND 38).

CLASS 16—PAPER GOODS AND PRINTED MATTER

FOR BOOKS, INSTRUCTIONAL WORKSHEETS, TEACHER MANUALS, INFORMATIONAL BROCHURES, MAGAZINES AND NEWSPAPERS IN THE FIELD OF LANGUAGE LEARNING; TRAVEL GUIDE BOOKS; PRINTED MATTER, NAMELY, STATIONERY; OFFICE REQUISITES, NAMELY, POSTERS, NOTE BOOKS, RING BINDERS, BUSINESS CARDS (U.S. CLS. 2, 5, 22, 23, 29, 37, 38 AND 50).

CLASS 41—EDUCATION AND ENTERTAINMENT

FOR EDUCATIONAL SERVICES, NAMELY, CONDUCTING CLASSES AND COURSES, SEMINARS, CONFERENCES, WORKSHOPS IN THE FIELD OF LANGUAGE LEARNING (U.S. CLS. 100, 101 AND 107).

CLASS 42—SCIENTIFIC, COMPUTER AND LEGAL SERVICES

FOR PROVIDING TEMPORARY USE OF NON-DOWNLOADABLE COMPUTER SOFTWARE FEATURING INSTRUCTION IN LEARNING LANGUAGES (U.S. CLS. 100 AND 101).

CLASS 43—HOTEL AND RESTAURANT SERVICES

FOR FOOD PREPARATION SERVICES, NAMELY PROVISION OF FOOD AND DRINK FOR COURSE PARTICIPANTS (U.S. CLS. 100 AND 101).
STEVEN BERK, EXAMINING ATTORNEY

CLASS 9—ELECTRICAL AND SCIENTIFIC APPARATUS

FOR ELECTRICAL, OPTICAL MEASURING, SIGNALING AND CONTROLLING DEVICES, NAMELY, OPTICAL SCANNERS AND READERS; MACHINE READABLE PRE-RECORDED OPTICAL DATA CARRIERS CONTAINING SOFTWARE FOR CONTROLLING SCIENTIFIC ROBOTS AND FOR ANALYZING BIOLOGICAL DATA; APPARATUS AND INSTRUMENTS FOR RESEARCH IN LABORATORIES, NAMELY, THERMOCYCLERS, AUTOMATED MICROPLATE WASHERS, REAGENT DISPENSERS, GEL IMAGING SYSTEMS COMPRISED OF COMPUTER HARDWARE, COMPUTER MONITORS, DIGITAL CAMERAS AND PRINTERS, PLATE HANDLERS, HYBRIDIZATION CHAMBERS; APPARATUS FOR CARRYING OUT CHEMICAL, BIOLOGICAL OR MOLECULARBIOLOGICAL METHODS, NAMELY, THERMOCYCLERS, AUTOMATED MICROPLATE WASHERS, REAGENT DISPENSERS, GEL IMAGING SYSTEMS COMPRISED OF COMPUTER HARDWARE, COMPUTER MONITORS, DIGITAL CAMERAS AND PRINTERS, PLATE HANDLERS, HYBRIDIZATION CHAMBERS; APPARATUS FOR CARRYING OUT FULL, HALF OR PARTIALLY AUTOMATICALLY CHEMICAL, BIOLOGICAL OR MOLECULARBIOLOGICAL METHODS, NAMELY, THERMOCYCLERS, ROBOTS, SCANNERS, READERS FOR MICROTITER PLATES, ARRAYERS FOR PRODUCING MICROARRAYS; SOFTWARE USED FOR CONTROLLING CHEMICAL OR BIOLOGICAL METHODS, SOFTWARE USED FOR ANALYZING BIOLOGICAL DATA, SOFTWARE USED FOR ADMINISTRATION OF CHEMICAL AND BIOLOGICAL SUBSTANCES (U.S. CLS. 21, 23, 26, 36 AND 38).

CLASS 42—SCIENTIFIC, COMPUTER AND LEGAL SERVICES

FOR SCIENTIFIC RESEARCH; INDUSTRIAL RESEARCH, NAMELY, DEVELOPMENTAL BIOLOGY, CANCER RESEARCH, PHARMACEUTICAL RESEARCH, AND SEQUENCING OF DNA, AND BIOINFORMATIC ANALYSIS COMPRISING EST CLUSTERING/ASSEMBLY AND DESIGN OF PROBES AND PRIMERS; CARRYING OUT OF CHEMICAL, BIOLOGICAL AND MOLECULAR BIOLOGICAL METHODS, NAMELY SEQUENCING OF DNA, ANALYZING OF BIOLOGICAL DATA, CREATING OF GENE LIBRARIES; CUSTOM DEVELOPMENT AND DESIGN OF DNA-CHIPS, PEPTIDE-CHIPS, DNA-MICROARRAYS, PEPTIDE-MICROARRAYS, BIOCHIPS (U.S. CLS. 100 AND 101).
AMY HELLA, EXAMINING ATTORNEY

SN 78-174,316. FINE METAL POWDERS CO., EKATERINBOURG, RUSSIAN FED., FILED 10-15-2002.

SN 78-175,102. DAXTEN INDUSTRIES LIMITED, ST. SAMPSON GY2 4LH, BR. VIRGIN ISLANDS, FILED 10-16-2002.

REMETALL

CLASS 1—CHEMICALS

FOR CHEMICAL ADDITIVES TO MOTOR FUELS AND GASOLINE, CHEMICAL ADDITIVES TO MOTOR AND TRANSMISSION OILS; ANTI-KNOCK SUBSTANCES FOR INTERNAL COMBUSTION ENGINES; AND ENGINE-DECARBONISING CHEMICALS (U.S. CLS. 1, 5, 6, 10, 26 AND 46).

CLASS 4—LUBRICANTS AND FUELS

FOR AUTOMOBILE LUBRICANTS; INDUSTRIAL OILS AND GREASES AND NON-CHEMICAL ADDITIVES TO MOTOR FUELS, MOTOR OILS, TRANSMISSION OILS AND GASOLINE (U.S. CLS. 1, 6 AND 15).
MELVIN AXILBUND, EXAMINING ATTORNEY

SN 78-174,324. FINE METAL POWDERS CO., EKATERINBOURG, RUSSIAN FED., FILED 10-15-2002.

MOTOR HEALER

NO CLAIM IS MADE TO THE EXCLUSIVE RIGHT TO USE "MOTOR", APART FROM THE MARK AS SHOWN.

CLASS 1—CHEMICALS

FOR CHEMICAL ADDITIVES TO MOTOR FUELS AND GASOLINE, CHEMICAL ADDITIVES TO MOTOR AND TRANSMISSION OILS; ANTI-KNOCK SUBSTANCES FOR INTERNAL COMBUSTION ENGINES; AND ENGINE-DECARBONISING CHEMICALS (U.S. CLS. 1, 5, 6, 10, 26 AND 46).

CLASS 4—LUBRICANTS AND FUELS

FOR AUTOMOBILE LUBRICANTS; INDUSTRIAL OILS AND GREASES AND NON-CHEMICAL ADDITIVES TO MOTOR FUELS, MOTOR OILS, TRANSMISSION OILS AND GASOLINE (U.S. CLS. 1, 6 AND 15).
MELVIN AXILBUND, EXAMINING ATTORNEY

DAXTON

CLASS 9—ELECTRICAL AND SCIENTIFIC APPARATUS

FOR ISDN DEVICES, NAMELY, ISDN TERMINAL, ISDN TELEPHONE AND ISDN TELECOMMUNICATIONS TRANSMITTERS, RECEIVERS AND MODEMS AND ISDN MAGNETICALLY ENCODED CARDS; COMPUTER HARDWARE, FIRMWARE, SOFTWARE AND COMPUTER PERIPHERALS FOR USE IN DATA NETWORK CABLING OPERATING SYSTEM APPLICATIONS, FOR USE IN CONTROLLING, OPERATING OR MONITORING LOCAL AREA NETWORK SYSTEMS AND CLIENT/SERVER SYSTEMS; COMPUTER HARDWARE, NAMELY, PARALLEL AND SERIAL PORTS; COMPUTER ROUTERS AND BRIDGES; CABLING DEVICES, NAMELY, CABLE CONNECTORS, CABLE MODEMS, COAXIAL CABLES, COMPUTER CABLES, ELECTRICAL CABLES, ELECTRONIC CABLES, ETHERNET CABLES, FIBER OPTIC CABLES; ELECTRICAL WIRE, ELECTRICITY CONDUITS AND COMMUNICATION CHANNELS TRUNKS; ELECTRIC JUNCTION BOXES; ELECTRIC SOCKETS; COMPUTER MODEMS; SWITCHES, NAMELY, ELECTRIC SWITCHES, SWITCH BOXES, TELECOMMUNICATION SWITCHES, KVM SWITCHES; ELECTRONIC DATA SWITCHES; ELECTRONIC TERMINAL SWITCHES; COMPUTER MONITOR SPLITTERS; COMPUTER KEYBOARD AND MONITOR EXTENDERS; ELECTRONIC AND TELECOMMUNICATIONS CABLES AND CONNECTORS; COMPUTER OPERATING SYSTEM SOFTWARE FOR USE IN THE OPERATION OF ALL THE AFORESAID GOODS (U.S. CLS. 21, 23, 26, 36 AND 38).

CLASS 35—ADVERTISING AND BUSINESS

FOR BUSINESS MANAGEMENT SERVICES; BUSINESS ADMINISTRATION CONSULTATION SERVICES; BUSINESS ADMINISTRATION, NAMELY ADMINISTRATIVE PROCESSING AND ORGANIZING OF MAIL ORDER SERVICES; COMPUTERIZED DATABASE MANAGEMENT AND ELECTRONIC INVENTORY CONTROL SERVICES; BUSINESS CONSULTATION SERVICES RELATING TO THE ESTABLISHMENT AND DEVELOPMENT OF FRANCHISE OPERATIONS; FRANCHISING SERVICES, NAMELY, OFFERING TECHNICAL ASSISTANCE IN THE ESTABLISHMENT AND/OR OPERATION OF OUTLETS FEATURING COMPUTER HARDWARE, COMPUTER SOFTWARE, ELECTRONIC AND ELECTRICAL GOODS; BUSINESS SERVICES, NAMELY PROVIDING COMPUTER DATABASES REGARDING PURCHASE AND SALE OF A WIDE VARIETY OF PRODUCTS AND SERVICES OF OTHERS; RETAIL OUTLETS FEATURING COMPUTER GOODS, TELECOMMUNICATIONS, ELECTRONIC AND ELECTRICAL GOODS; MAIL ORDER AND COMPUTERIZED ONLINE CATALOG SERVICES FEATURING COMPUTER GOODS, TELECOMMUNICATIONS, ELECTRONIC AND ELECTRICAL GOODS (U.S. CLS. 100, 101 AND 102).

CLASS 38—COMMUNICATION

FOR COMPUTER COMMUNICATION SERVICES, NAMELY, PROVIDING MULTIPLE-USER ACCESS TO A GLOBAL COMPUTER INFORMATION NETWORK; TELECOMMUNICATIONS SERVICES, NAMELY, ISDN SERVICES; PROVIDING A HIGH SPEED ACCESS TO AREA NETWORKS AND A GLOBAL COMPUTER INFORMATION NETWORK, NAMELY, PROVIDING ACCESS POINTS AND NETWORK INFRASTRUCTURES FOR TRANSMISSION OF SOUND, IMAGE AND DATA (U.S. CLS. 100, 101 AND 104).

CLASS 42—SCIENTIFIC, COMPUTER AND LEGAL SERVICES

FOR PRODUCT DESIGN SERVICES, NAMELY, DESIGN AND TESTING OF TELECOMMUNICATIONS SWITCHES; DESIGN AND TESTING OF COMPUTER HARDWARE, SOFTWARE AND COMPUTER PERIPHERALS FOR USE IN DATA NETWORK CABLING OPERATING SYSTEM APPLICATIONS, LOCAL AREA NETWORK SYSTEMS AND CLIENT/SERVER SYSTEMS; CUSTOM DESIGN AND ENGINEERING OF TELECOMMUNICATION SYSTEMS; DESIGN OF COMPUTER CABLING; DESIGN OF ELECTRONIC CABLING; DESIGN OF CABLE AND CABLING SYSTEMS; DESIGN OF COMPUTER CABLING, COMMUNICATIONS CABLING AND NETWORK CABLING SYSTEMS; DESIGN OF ELECTRICAL CONNECTORS FOR CABLES AND CABLING SYSTEMS; COMPUTER NETWORK DESIGN FOR OTHERS; COMPUTER PROJECT MANAGEMENT SERVICES; COMPUTER CONSULTATION SERVICES IN THE FIELD OF COMPUTER HARDWARE AND COMPUTER NETWORK SYSTEMS; DESIGN, MAINTENANCE AND UPDATING OF COMPUTER SOFTWARE; DEVELOPMENT AND TESTING OF ELECTRONIC COMMUNICATIONS NETWORKS; TECHNICAL ADVISORY AND SUPPORT SERVICES NAMELY MONITORING AND TROUBLESHOOTING COMPUTER NETWORKS, COMPUTER HARDWARE AND COMPUTER SOFTWARE, AND MAINTAINING COMPUTER SOFTWARE RELATING TO THE AFORESAID SERVICES (U.S. CLS. 100 AND 101).

JAMES A. RAUEN, EXAMINING ATTORNEY

SN 78-177,127. FERAL FRIENDS ANIMAL RESCUE & ASSISTANCE, INC., DALLAS, TX. FILED 10-22-2002.



NO CLAIM IS MADE TO THE EXCLUSIVE RIGHT TO USE "FERAL", APART FROM THE MARK AS SHOWN.

CLASS 16—PAPER GOODS AND PRINTED MATTER

FOR PAPER GOODS AND PRINTED MATTER NAMELY NEWSLETTERS, BOOKS, BROCHURES, BULLETINS, BUSINESS CARDS, GUIDES, FORMS, MANUALS, CATALOGS, CIRCULARS AND PAMPHLETS IN THE FIELDS OF ANIMAL RESCUE AND ADOPTION AND FERAL CAT MANAGEMENT; INSTRUCTIONAL AND TEACHING MATERIAL REGARDING DOMESTIC AND FERAL CAT CARE AND MANAGEMENT; NOTE CARDS, GREETING CARDS, ENVELOPES, POSTCARDS, BUMPER STICKERS, CALENDARS, COLOR PRINTS, GRAPHIC ART REPRODUCTIONS, ILLUSTRATIONS, LITHOGRAPHS, PAPER GIFT AND PAPER SHOPPING BAGS, PHOTOGRAPHIC PRINTS, POSTERS, PRINTED CERTIFICATES, AND STATIONERY (U.S. CLS. 2, 5, 22, 23, 29, 37, 38 AND 50).

FIRST USE 4-1-2001; IN COMMERCE 12-1-2001.

CLASS 45—PERSONAL SERVICES

FOR ADOPTION PLACEMENT SERVICES FOR ANIMALS (U.S. CLS. 100 AND 101).

FIRST USE 4-1-2001; IN COMMERCE 12-1-2001.
WON TEAK OH, EXAMINING ATTORNEY

SN 78-177,301. HEIDELBERGER DRUCKMASCHINEN AG, D-69115 HEIDELBERG, FED REP GERMANY, FILED 10-23-2002.

Prinect

PRIORITY CLAIMED UNDER SEC. 44(D) ON FED REP GERMANY APPLICATION NO. 30221984607, FILED 4-30-2002, REG. NO. 30221984, DATED 7-5-2002, EXPIRES 4-30-2012.

OWNER OF U.S. REG. NO. 2,596,983.

CLASS 7—MACHINERY

FOR PRINTING PRESSES; MACHINES AND DEVICES FOR THE FURTHER PROCESSING OF PRINT SHOP PRODUCTS, NAMELY, BINDING MACHINES, STITCHING MACHINES, CUTTING MACHINES, FOLDING MACHINES; AND PARTS FOR THE AFORESAID MENTIONED GOODS (U.S. CLS. 13, 19, 21, 23, 31, 34 AND 35).

CLASS 9—ELECTRICAL AND SCIENTIFIC APPARATUS

FOR DATA PROCESSING COMPUTER SOFTWARE PROGRAMS; PREPRESS STAGING DEVICES, NAMELY, SCANNERS, PROOFERS AND EXPOSURE READERS; COPYING DEVICES, NAMELY, ELECTRONIC DIGITAL COPIERS AND COMPUTER NETWORK COPIERS; DATA PROCESSING DEVICES, NAMELY, CONTROLLERS FOR PRINTER PROCESS COMPUTER NETWORKS; ELECTRONIC RECORDERS, TRANSMITTERS AND REPRODUCERS FOR COMPUTERIZED IMAGES AND DATA; AND STRUCTURAL PARTS FOR ALL THE FOREGOING GOODS (U.S. CLS. 21, 23, 26, 36 AND 38).

RICHARD A. STRASER, EXAMINING ATTORNEY

SN 78-181,708. TLUX ONE S.A., N/A, LUXEMBOURG, FILED 11-5-2002.

transmec 

CLASS 35—ADVERTISING AND BUSINESS

FOR SHIPMENT PROCESSING AND PREPARING SHIPPING DOCUMENTS FOR OTHERS INCLUDING BILLS OF LADING (U.S. CLS. 100, 101 AND 102).

CLASS 39—TRANSPORTATION AND STORAGE

FOR TRANSPORT OF GOODS BY FERRY, SHIP, CAR, TRUCK, AIRPLANE, OR HELICOPTER; PACKAGING GOODS FOR TRANSPORTATION; STORAGE OF GOODS FOR OTHERS; TRAVEL AGENCY SERVICES; NAMELY, MAKING RESERVATIONS AND BOOKINGS FOR TRANSPORTATION AND ARRANGING TRAVEL TOURS (U.S. CLS. 100 AND 105).

ROBIN CHOSID, EXAMINING ATTORNEY

SN 78-184,640. GENRE STYLE, INC., SCOTTSDALE, AZ.
FILED 11-13-2002.

SN 78-185,275. ALARIS MEDICAL SYSTEMS, INC, SAN
DIEGO, CA. FILED 11-14-2002.

GENRE

CLASS 18—LEATHER GOODS

FOR PURSES, CHANGE PURSES, CLUTCH PURSES,
AND COIN PURSES (U.S. CLS. 1, 2, 3, 22 AND 41).

CLASS 25—CLOTHING

FOR CLOTHING, NAMELY BELTS, PANTS, HATS,
TOPS, DRESSES, SHOES, AND COATS (U.S. CLS. 22
AND 39).

KAREN K. BUSH, EXAMINING ATTORNEY

SN 78-184,888. COHEN BROWN PICTURE COMPANY, INC.,
LOS ANGELES, CA. FILED 11-13-2002.

TECHNO-BEHAVIORAL

CLASS 9—ELECTRICAL AND SCIENTIFIC APPARATUS

FOR MOTION PICTURE FILMS, PRE-RECORDED
VIDEOTAPES AND VIDEODISCS, PRE-RECORDED
COMPACT DISCS AND DVDS CONTAINING DIGITAL
INFORMATION FOR THE DISPLAY OF FILMED PRO-
DUCTS, PRE-RECORDED AUDIO TAPES AND DIGITAL
AUDIO TAPES, AND CD-ROMS ALL IN THE FIELDS OF
BANKING, BROKERAGE, MORTGAGE, INSURANCE,
FINANCE, SALES, AND CLIENT AND CUSTOMER
SERVICE (U.S. CLS. 21, 23, 26, 36 AND 38).

CLASS 16—PAPER GOODS AND PRINTED MATTER

FOR MAGAZINES, NEWSLETTERS, PAMPHLETS,
LEAFLETS, BROCHURES, EDUCATIONAL PUBLICA-
TIONS, BOOKS, COURSE MATERIALS AND OTHER
PRINTED MATTER IN THE FIELDS OF BANKING,
BROKERAGE, MORTGAGE, INSURANCE, FINANCE,
SALES, AND CLIENT AND CUSTOMER SERVICE (U.S.
CLS. 2, 5, 22, 23, 29, 37, 38 AND 50).

CLASS 35—ADVERTISING AND BUSINESS

FOR BUSINESS MANAGEMENT AND CONSULTING
SERVICES IN THE FIELDS OF BANKING, BROKER-
AGE, MORTGAGE, INSURANCE, FINANCE, SALES,
AND CLIENT AND CUSTOMER SERVICE (U.S. CLS.
100, 101 AND 102).

FIRST USE 11-30-2000; IN COMMERCE 11-30-2000.

CLASS 41—EDUCATION AND ENTERTAIN- MENT

FOR EDUCATIONAL SERVICES, NAMELY, COACH-
ING, TRAINING, CONDUCTING CLASSES, SEMINARS,
CONFERENCES AND WORKSHOPS IN THE FIELD OF
BANKING, BROKERAGE, MORTGAGE, INSURANCE,
FINANCE, SALES, AND CLIENT AND CUSTOMER
SERVICE, AND DISTRIBUTING PRINTED AND AUDIO-
VISUAL COURSE MATERIALS IN CONNECTION
THEREWITH; DEVELOPING AND DISSEMINATING
PRINTED AND AUDIOVISUAL EDUCATIONAL MATE-
RIALS FOR OTHERS IN THE FIELDS OF BANKING,
BROKERAGE, MORTGAGE, INSURANCE, FINANCE,
SALES, AND CLIENT AND CUSTOMER SERVICE (U.S.
CLS. 100, 101 AND 107).

FIRST USE 11-30-2000; IN COMMERCE 11-30-2000.
MARLENE BELL, EXAMINING ATTORNEY

SMARTPRACTICE

CLASS 35—ADVERTISING AND BUSINESS

FOR BUSINESS CONSULTATION WITH PHARMA-
CIES AND MEDICAL PRACTICES, NAMELY, ANALY-
SIS OF FAILURE MODES AND EFFECTS IN CRITICAL
INTRAVENOUS DRUG ADMINISTRATION, EVALUA-
TION OF HIGH RISK PROCESSES AND TECHNOLO-
GIES IN INTRAVENOUS DRUG ADMINISTRATION,
EVALUATION AND OPTIMIZATION OF WORKFLOW
AND CLINICAL PROCESSES IN INTRAVENOUS DRUG
ADMINISTRATION, ANALYSIS OF MEDICATION
SAFETY SYSTEMS, AND RE-ENGINEERING OF BUSI-
NESS PRACTICES CONCERNING MEDICATION
SAFETY SYSTEMS AND CONTINUOUS QUALITY IM-
PROVEMENT (U.S. CLS. 100, 101 AND 102).

CLASS 44—MEDICAL, BEAUTY AND AGRICULTURAL SERVICES

FOR MEDICAL DRUG RESEARCH SERVICES,
NAMELY, ANALYSIS OF FAILURE MODES AND EF-
FECTS IN CRITICAL INTRAVENOUS DRUG ADMINIS-
TRATION, EVALUATION OF HIGH RISK PROCESSES
AND TECHNOLOGIES IN INTRAVENOUS DRUG AD-
MINISTRATION, EVALUATION AND OPTIMIZATION
OF WORKFLOW AND CLINICAL PROCESSES IN IN-
TRAVENOUS DRUG ADMINISTRATION, AND ANALY-
SIS OF MEDICATION SAFETY SYSTEMS TO ENSURE
QUALITY IMPROVEMENT (U.S. CLS. 100 AND 101).

MARY CRAWFORD, EXAMINING ATTORNEY

SN 78-189,329. CHOU, BELLE, UNION CITY, CA. FILED 11-
26-2002.

IN HARMONY WITH NATURE

CLASS 9—ELECTRICAL AND SCIENTIFIC APPARATUS

FOR PROTECTIVE METAL GLOVES FOR MEAT
CUTTING; PROTECTIVE GLOVES FOR INDUSTRIAL
USE (U.S. CLS. 21, 23, 26, 36 AND 38).

FIRST USE 11-26-2003; IN COMMERCE 11-26-2003.

CLASS 10—MEDICAL APPARATUS

FOR GLOVES FOR MEDICAL USE, SURGICAL
GLOVES (U.S. CLS. 26, 39 AND 44).

FIRST USE 11-26-2003; IN COMMERCE 11-26-2003.
ELLEN B. AWRICH, EXAMINING ATTORNEY

SN 78-190,105. PLANO MOLDING COMPANY, PLANO, IL.
FILED 12-2-2002.

SN 78-191,919. SINCLAIR OIL CORPORATION, SALT LAKE
CITY, UT. FILED 12-6-2002.

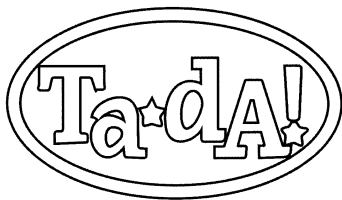

CLASS 3—COSMETICS AND CLEANING PREPARATIONS

FOR COSMETICS; BATH AND BODY PRODUCTS, NAMELY BODY LOTION AND GEL (U.S. CLS. 1, 4, 6, 50, 51 AND 52).

CLASS 18—LEATHER GOODS

FOR SOFT-SIDED COSMETIC CASES AND BAGS AND HAIR CARE PRODUCT CASES AND BAGS SOLD EMPTY; BACKPACKS (U.S. CLS. 1, 2, 3, 22 AND 41).
AMY HELLA, EXAMINING ATTORNEY

SN 78-190,270. SYNGENTA PARTICIPATIONS AG, BASEL,
SWITZERLAND, FILED 12-2-2002.

WHERE INNOVATION GROWS

CLASS 31—NATURAL AGRICULTURAL PRODUCTS

FOR SEEDS, NAMELY, AGRICULTURAL, VEGETABLE, PLANT AND FRUIT SEEDS, AND LIVING PLANTS (U.S. CLS. 1 AND 46).

CLASS 35—ADVERTISING AND BUSINESS

FOR MANAGEMENT ASSISTANCE PROVIDED VIA THE INTERNET FOR AGRICULTURAL PROFESSIONALS; ORGANIZATION OF EXHIBITS OR EVENTS FOR COMMERCIAL OR ADVERTISING PURPOSES, NAMELY, ARRANGING AND CONDUCTING TRADE SHOW EXHIBITIONS IN THE FIELD OF AGRICULTURE AND HORTICULTURE (U.S. CLS. 100, 101 AND 102).

CLASS 41—EDUCATION AND ENTERTAINMENT

FOR EDUCATIONAL SERVICES, NAMELY, CONDUCTING WORKSHOPS VIA THE INTERNET IN THE FIELD OF AGRICULTURE AND HORTICULTURE (U.S. CLS. 100, 101 AND 107).

CLASS 42—SCIENTIFIC, COMPUTER AND LEGAL SERVICES

FOR AGRICULTURAL RESEARCH, NAMELY, DEVELOPING AND APPLYING TECHNOLOGIES FOR ENHANCING THE QUALITY AND LIFE CYCLE OF SEEDS AND PLANTS (U.S. CLS. 100 AND 101).
JOHN GARTNER, EXAMINING ATTORNEY

PETE LANE'S

THE NAME "PETE LANE" DOES NOT IDENTIFY A LIVING INDIVIDUAL.

CLASS 35—ADVERTISING AND BUSINESS

FOR RETAIL STORE SERVICES FEATURING SPORTING GOODS, SPORTS CLOTHING, T-SHIRTS, BICYCLES, BICYCLE TAG-ALONGS, SKI AND SNOWBOARD EQUIPMENT, SWIMWEAR, SCOOTERS, BABY JOGGERS, BICYCLE TRAILERS, HELMETS AND METAL LOCKS (U.S. CLS. 100, 101 AND 102).

CLASS 37—CONSTRUCTION AND REPAIR

FOR BICYCLE REPAIR AND SKI AND SNOWBOARD REPAIR AND TUNING SERVICES (U.S. CLS. 100, 103 AND 106).

CLASS 39—TRANSPORTATION AND STORAGE

FOR BICYCLE RENTALS (U.S. CLS. 100 AND 105).

CLASS 41—EDUCATION AND ENTERTAINMENT

FOR SKI AND SNOWBOARD EQUIPMENT RENTALS (U.S. CLS. 100, 101 AND 107).
SAMUEL E. SHARPER JR., EXAMINING ATTORNEY

SN 78-192,623. PRATT CORPORATION, INDIANAPOLIS, IN.
FILED 12-9-2002.

PRATT SMART RETAIL GRAPHICS

NO CLAIM IS MADE TO THE EXCLUSIVE RIGHT TO USE "RETAIL GRAPHICS", APART FROM THE MARK AS SHOWN.

CLASS 35—ADVERTISING AND BUSINESS

FOR RETAIL PRODUCT MERCHANDISING AND WINDOW DISPLAY ARRANGEMENT AND BUSINESS AUDITING OF PRODUCT DISPLAYS (U.S. CLS. 100, 101 AND 102).

FIRST USE 1-17-2002; IN COMMERCE 3-1-2002.

CLASS 37—CONSTRUCTION AND REPAIR

FOR POINT-OF-PURCHASE AND POINT-OF-SALE DISPLAY INSTALLATION SERVICES (U.S. CLS. 100, 103 AND 106).

FIRST USE 1-17-2002; IN COMMERCE 3-1-2002.

CLASS 40—MATERIAL TREATMENT

FOR SILK SCREEN PRINTING; DIGITAL IMAGING AND PRINTING (U.S. CLS. 100, 103 AND 106).

FIRST USE 1-17-2002; IN COMMERCE 3-1-2002.

CLASS 42—SCIENTIFIC, COMPUTER AND LEGAL SERVICES

FOR GRAPHIC ART DESIGN AND GRAPHIC ART DESIGN CONSULTATION (U.S. CLS. 100 AND 101).
FIRST USE 1-17-2002; IN COMMERCE 3-1-2002.
STEVEN BERK, EXAMINING ATTORNEY

SN 78-194,026. FUZE BEVERAGE, INC., ENGLEWOOD, NJ.
FILED 12-12-2002.

FUZE HEALTHY INFUZIONS

OWNER OF U.S. REG. NO. 2,599,318.
NO CLAIM IS MADE TO THE EXCLUSIVE RIGHT TO USE "HEALTHY INFUSIONS", APART FROM THE MARK AS SHOWN.

CLASS 5—PHARMACEUTICALS

FOR CANDY, FRUIT AND DAIRY BASED NUTRITIONAL SUPPLEMENTS IN THE FORM OF FOOD BARS AND DAIRY BASED FOOD BARS FOR USE AS A MEAL REPLACEMENT (U.S. CLS. 6, 18, 44, 46, 51 AND 52).

CLASS 30—STAPLE FOODS

FOR FROZEN CONFECTIONS, NAMELY, FROZEN FRUIT SNACK BARS AND CANDY BARS; FROZEN DAIRY BARS (U.S. CL. 46).
BRIAN BROWN, EXAMINING ATTORNEY

SN 78-194,863. VORTECH ENGINEERING, INC., OXNARD, CA. FILED 12-16-2002.

AIR SUPERIORITY

NO CLAIM IS MADE TO THE EXCLUSIVE RIGHT TO USE "AIR", APART FROM THE MARK AS SHOWN.

CLASS 7—MACHINERY

FOR INDUSTRIAL AIR COMPRESSORS (U.S. CLS. 13, 19, 21, 23, 31, 34 AND 35).

CLASS 11—ENVIRONMENTAL CONTROL APPARATUS

FOR HIGH PRESSURE AIR BLOWERS FOR INDUSTRIAL USE (U.S. CLS. 13, 21, 23, 31 AND 34).
MARTHA FROMM, EXAMINING ATTORNEY

SN 78-196,337. KASPER, CRAIG, A, BELLEROSE, NY. FILED 12-19-2002.

LabToWallStreet

THE MARK CONSISTS OF STANDARD CHARACTERS WITHOUT CLAIM TO ANY PARTICULAR FONT, STYLE, SIZE, OR COLOR.

CLASS 9—ELECTRICAL AND SCIENTIFIC APPARATUS

FOR DOWNLOADABLE ELECTRONIC PUBLICATIONS IN THE NATURE OF NEWSLETTERS IN THE FIELDS OF BUSINESS AND SCIENCE (U.S. CLS. 21, 23, 26, 36 AND 38).
FIRST USE 11-1-2002; IN COMMERCE 11-1-2002.

CLASS 41—EDUCATION AND ENTERTAINMENT

FOR PROVIDING NON-DOWNLOADABLE, ON-LINE NEWSLETTERS IN THE FIELDS OF BUSINESS AND SCIENCE (U.S. CLS. 100, 101 AND 107).
FIRST USE 11-1-2002; IN COMMERCE 11-1-2002.
JANICE L. MCMORROW, EXAMINING ATTORNEY

SN 78-196,380. COMMUNITY FIRST BANKSHARES, INC., FARGO, ND. FILED 12-19-2002.

IT'S TIME FOR COMMUNITY FIRST**CLASS 9—ELECTRICAL AND SCIENTIFIC APPARATUS**

FOR FINANCIAL COMPUTER SOFTWARE, NAMELY, DOWNLOADABLE SOFTWARE AND SOFTWARE ON DISKS PROVIDING ACCOUNT ACCESS AND ALLOWING BANKING TRANSACTIONS FOR USE BY BANKING CUSTOMERS (U.S. CLS. 21, 23, 26, 36 AND 38).

CLASS 36—INSURANCE AND FINANCIAL

FOR BANKING SERVICES; CREDIT CARD SERVICES; SAFETY DEPOSIT BOX SERVICES; AND INVESTMENT BROKERAGE SERVICES (U.S. CLS. 100, 101 AND 102).
ROBERT COGGINS, EXAMINING ATTORNEY

SN 78-196,661. PENN STATE RESEARCH FOUNDATION, UNIVERSITY PARK, PA. FILED 12-20-2002.

CALF TRACK

NO CLAIM IS MADE TO THE EXCLUSIVE RIGHT TO USE "CALF", APART FROM THE MARK AS SHOWN.

CLASS 9—ELECTRICAL AND SCIENTIFIC APPARATUS

FOR TRAINING SYSTEM CONSISTING PRIMARILY OF PRERECORDED VIDEO TAPES FEATURING INFORMATION FOR THE CARE AND MANAGEMENT OF CALVES (U.S. CLS. 21, 23, 26, 36 AND 38).

CLASS 16—PAPER GOODS AND PRINTED MATTER

FOR TRAINING SYSTEM CONSISTING PRIMARILY OF BOOKS, HANDOUTS, MANUALS, AND BROCHURES IN THE FIELD OF THE CARE AND MANAGEMENT OF CALVES (U.S. CLS. 2, 5, 22, 23, 29, 37, 38 AND 50).
MICHAEL SOUDERS, EXAMINING ATTORNEY

SN 78-196,893. OXFORD BIOMEDICA PLC, OXFORD OX4 4GA, UNITED KINGDOM, FILED 12-20-2002.

PONY

PRIORITY CLAIMED UNDER SEC. 44(D) ON UNITED KINGDOM APPLICATION NO. 2313624, FILED 10-21-2002, REG. NO. 2313624, DATED 7-4-2003, EXPIRES 10-21-2012.

CLASS 1—CHEMICALS

FOR CHEMICALS FOR USE IN THE MANUFACTURE OF VIRUSES, VECTORS, PHARMACEUTICALS AND RETROVIRAL VECTOR PREPARATIONS FOR USE IN INDUSTRY, SCIENCE AND MEDICAL SCIENCE; ENZYMES AND CHEMICAL PRODUCTS FOR IN VITRO USE IN LABORATORIES AND FOR ANALYSIS IN AND DEVELOPMENT OF GENE DELIVERY TECHNOLOGY; MICRO ORGANISMS, CELL CULTURES, PLASMIDS AND CULTURES OF MICRO ORGANISMS, DEOXYRIBONUCLEIC ACID SEQUENCES, CLONING VEHICLES AND RECOMBINANT DEOXYRIBONUCLEIC ACID AND VARIATIONS THEREOF, ALL FOR IN VIVO OR EX VIVO USE IN GENE DELIVERY TECHNOLOGY AND CLONING TECHNOLOGY, NONE OF THE AFORESAID GOODS RELATING TO THE TREATMENT OF EQUIDAE (U.S. CLS. 1, 5, 6, 10, 26 AND 46).

CLASS 5—PHARMACEUTICALS

FOR CLINICAL MEDICAL REAGENTS FOR USE IN GENE THERAPY, PHARMACEUTICAL PREPARATIONS FOR USE IN GENE THERAPY, ENZYMES AND ENZYME PREPARATIONS FOR MEDICAL PURPOSE, FOR USE IN GENE DELIVERY AND CLOTHING TECHNOLOGY, RETROVIRAL VECTOR AND RETROVIRAL VECTOR MANUFACTURING PREPARATIONS FOR USE IN GENE DELIVERY AND CLONING TECHNOLOGY, NONE OF THE AFORESAID GOODS RELATING TO THE TREATMENT OF EQUIDAE (U.S. CLS. 6, 18, 44, 46, 51 AND 52).

CLASS 42—SCIENTIFIC, COMPUTER AND LEGAL SERVICES

FOR SCIENTIFIC AND MEDICAL RESEARCH AND DEVELOPMENT, AND PRODUCT DEVELOPMENT; GENETIC ENGINEERING SERVICES, BIOTECHNOLOGY SERVICES, NAMELY RESEARCH AND DEVELOPMENT OF NEW PRODUCTS FOR OTHERS IN THE FIELD OF GENE TECHNOLOGY AND GENE THERAPY, NONE OF THE AFORESAID SERVICES RELATING TO THE TREATMENT OF EQUIDAE (U.S. CLS. 100 AND 101).

CLASS 44—MEDICAL, BEAUTY AND AGRICULTURAL SERVICES

FOR MEDICAL SERVICES (U.S. CLS. 100 AND 101).
CAROL SPILS, EXAMINING ATTORNEY

SN 78-196,933. QUILL LINCOLNSHIRE, INC., LINCOLNSHIRE, IL. FILED 12-20-2002.

QUILL BRAND

OWNER OF U.S. REG. NOS. 1,132,012, 2,668,324 AND OTHERS.

NO CLAIM IS MADE TO THE EXCLUSIVE RIGHT TO USE "BRAND", APART FROM THE MARK AS SHOWN.

CLASS 2—PAINTS

FOR TONER CARTRIDGES AND INK JET CARTRIDGES FOR COMPUTER PRINTERS AND FACSIMILE MACHINES (U.S. CLS. 6, 11 AND 16).

CLASS 16—PAPER GOODS AND PRINTED MATTER

FOR WRITING PAPER, FACSIMILE TRANSMISSION PAPER, LASER PRINTING PAPER, BOND PAPER, COMPUTER PAPER, COPY PAPER, ENVELOPES, FILE FOLDERS, HANGING FOLDERS, BINDERS, LOOSE LEAF BINDERS, ADDRESS LABELS, SHIPPING LABELS, COMPUTER PRINTER RIBBONS, OFFICE MACHINE RIBBONS, TYPEWRITER RIBBONS, NON-MECHANICAL AND NON-REFILLABLE PENS, NON-MECHANICAL AND NON-REFILLABLE PENCILS, NON-MECHANICAL AND NON-REFILLABLE MARKERS, AND CARDBOARD CARTONS; ADHESIVE TAPE FOR STATIONERY AND HOUSEHOLD PURPOSES (U.S. CLS. 2, 5, 22, 23, 29, 37, 38 AND 50).

CLASS 20—FURNITURE AND ARTICLES NOT OTHERWISE CLASSIFIED

FOR OFFICE FURNITURE AND FILING CABINETS (U.S. CLS. 2, 13, 22, 25, 32 AND 50).
MARLENE BELL, EXAMINING ATTORNEY

SN 78-198,048. PHILD CO., LTD., KYOTO CITY, KYOTO PREF., JAPAN, FILED 12-26-2002.

PHITEN SUN-FIELD

OWNER OF U.S. REG. NOS. 2,233,191, 2,762,121 AND OTHERS.

CLASS 1—CHEMICALS

FOR CHEMICALS, NAMELY, PLANT GROWTH REGULATORS AND FERTILIZERS FOR AGRICULTURAL USE (U.S. CLS. 1, 5, 6, 10, 26 AND 46).

CLASS 7—MACHINERY

FOR AGRICULTURAL MACHINERY, NAMELY, PLOWS, CULTIVATORS, HARVESTERS, FEED COMPRESSORS, FEED CUTTERS, FEED BLENDERS, FEED GRINDERS AND FEED DRYERS (U.S. CLS. 13, 19, 21, 23, 31, 34 AND 35).

CLASS 8—HAND TOOLS

FOR MANUALLY DRIVEN HAND IMPLEMENTS, NAMELY, HOES, PLOWS AND RAKES (U.S. CLS. 23, 28 AND 44).

CLASS 17—RUBBER GOODS

FOR PLASTIC FILMS FOR PACKAGING AND WRAPPING AGRICULTURAL PRODUCTS AND COVERING AGRICULTURAL CROPS (U.S. CLS. 1, 5, 12, 13, 35 AND 50).

CLASS 37—CONSTRUCTION AND REPAIR

FOR REPAIR AND MAINTENANCE OF PLOWING MACHINERY, CULTIVATING MACHINERY, HARVESTING MACHINERY, FEED COMPRESSORS, FEED CUTTERS, FEED BLENDERS AND FEED GRINDERS (U.S. CLS. 100, 103 AND 106).

CLASS 42—SCIENTIFIC, COMPUTER AND LEGAL SERVICES

FOR COMPUTER SOFTWARE DESIGN AND MAINTENANCE; SCIENTIFIC EXAMINATION, INSPECTION AND RESEARCH IN THE FIELDS OF AGRICULTURE, ANIMAL HUSBANDRY AND FISHERIES; AND PRODUCT RESEARCH IN THE FIELD OF AGRICULTURAL MACHINERY (U.S. CLS. 100 AND 101).

CLASS 44—MEDICAL, BEAUTY AND AGRICULTURAL SERVICES

FOR LEASING OF FARMING MACHINERY (U.S. CLS. 100 AND 101).
ERICA GLEMBOCKI, EXAMINING ATTORNEY

SN 78-200,218. W.A.B. BAKERY FRANCHISING LTD., THORNHILL ONTARIO, CANADA, FILED 1-6-2003.



OWNER OF CANADA REG. NO. TMA534,751, DATED 10-17-2000, EXPIRES 10-17-2015.
NO CLAIM IS MADE TO THE EXCLUSIVE RIGHT TO USE BAGEL, APART FROM THE MARK AS SHOWN.
THE STIPPLING IN THE DRAWING IS A FEATURE OF THE MARK AND DOES NOT INDICATE COLOR.

CLASS 30—STAPLE FOODS

FOR BAGELS, BREADS, DONUTS, PASTRIES, AND BEVERAGES, NAMELY, COFFEE, INCLUDING SPECIALTY COFFEES, TEA AND HOT CHOCOLATE (U.S. CL. 46).

CLASS 43—HOTEL AND RESTAURANT SERVICES

FOR RESTAURANT SERVICES, NAMELY, OPERATING BAKERIES, BAKERY SHOPS, BAGEL SHOPS, DONUT SHOPS AND PASTRY/PÂTISSERIE TAKEOUT RESTAURANTS (U.S. CLS. 100 AND 101).
KATHERINE STOIDES, EXAMINING ATTORNEY

SN 78-202,747. SOCIETE DES PRODUITS NESTLE S.A., 1800 VEVEY, SWITZERLAND, FILED 1-13-2003.

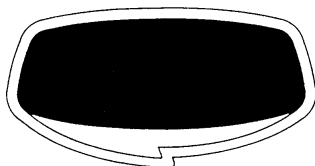

THE MARK CONSISTS OF A BUBBLE DESIGN.

CLASS 5—PHARMACEUTICALS

FOR INFANT FORMULAS; DIETETIC NUTRITIONALLY FORTIFIED FOODS FOR BABIES AND INFANTS; INFANT AND BABY FOODS, NAMELY, CEREALS, VEGETABLES, FRUITS, MEATS, FISH, EGGS, BISCUITS, FRUIT JUICES, VEGETABLE JUICES; NUTRITIONAL SUPPLEMENTS (U.S. CLS. 6, 18, 44, 46, 51 AND 52).

CLASS 29—MEATS AND PROCESSED FOODS

FOR PRESERVED, DRIED AND COOKED VEGETABLES AND FRUIT; MEAT; POULTRY; GAME; FISH; SEAFOOD; SOUPS; JELLIES; PASTES, NAMELY, ANCHOVY, ARTICHOKE, FRUIT, GUAVA, LIVER, MEAT, TOMATO, VEGETABLE; PRESERVES; PREPARED OR PACKAGED ENTREES CONSISTING PRIMARILY OF MEAT, FISH, POULTRY OR VEGETABLES; JAMS; EGGS; MILK; CHEESE; MILK SUBSTITUTES, NAMELY SOYA MILK; EDIBLE OILS AND FATS; PROTEIN FOR USE AS A FOOD ADDITIVE (U.S. CL. 46).

CLASS 30—STAPLE FOODS

FOR COFFEE, COFFEE EXTRACTS AND COFFEE-BASED PREPARATIONS FOR MAKING NON-ALCOHOLIC, COFFEE-BASED BEVERAGES; COFFEE SUBSTITUTES; EXTRACTS USED AS FLAVORING, NAMELY, EXTRACTS OF COFFEE SUBSTITUTES; TEA, TEA EXTRACTS AND TEA-BASED BEVERAGES; COCOA AND COCOA-BASED BEVERAGES; CHOCOLATE; CONFECTIONERY, NAMELY, CANDY AND TOFFEES; SUGAR; NATURAL SWEETENERS; BAKERY GOODS; BREAD; YEAST; PASTRIES; BISCUITS; CAKES; BAKERY DESSERTS; PUDDINGS; ICE CREAM; PREPARATIONS FOR MAKING ICE CREAM, NAMELY, SALTED AND SWEETENED POWDERED OR LIQUID MIXES, FOOD FLAVORING AND SUGAR; HONEY AND HONEY SUBSTITUTES; BREAKFAST CEREALS; RICE; PASTA; PREPARED OR PACKAGED ENTREES CONSISTING PRIMARILY OF RICE OR PASTA; SAUCES; SEASONINGS; SALAD DRESSINGS; MAYONNAISE (U.S. CL. 46).

ESTHER A. BORSUK, EXAMINING ATTORNEY

SN 78-203,758. VIRTUAL TRANSACTIONS TECHNOLOGIES, INC., TUSTIN, CA, FILED 1-15-2003.

VTTI WIRELESS

NO CLAIM IS MADE TO THE EXCLUSIVE RIGHT TO USE "WIRELESS", APART FROM THE MARK AS SHOWN.

CLASS 9—ELECTRICAL AND SCIENTIFIC APPARATUS

FOR HARDWARE AND SOFTWARE FOR DATA COMMUNICATION AND MANIPULATION, NAMELY, FOR RECEIVING, TRANSMITTING, DISPLAYING, ACQUIRING, STORING, PROCESSING, AND USING DATA FROM AUTOMOBILE DIAGNOSTIC PORTS, POOL AND SPA EQUIPMENT, AND HEALTH MONITORING EQUIPMENT; COMPUTER CABLES AND ADAPTORS FOR DATA COMMUNICATION (U.S. CLS. 21, 23, 26, 36 AND 38).

CLASS 38—COMMUNICATION

FOR ELECTRONIC TRANSMISSION OF DATA AND MESSAGES FOR DATA COMMUNICATION, RETRIEVAL, AND MANIPULATION, INCLUDING FOR RECEIVING, TRANSMITTING, DISPLAYING, ACQUIRING, STORING, PROCESSING, AND USING DATA FROM AUTOMOBILE DIAGNOSTIC PORTS, POOL AND SPA EQUIPMENT, AND HEALTH MONITORING EQUIPMENT, NAMELY MEDICAL AND SCIENTIFIC INSTRUMENTATION FOR MEASURING VITAL STATISTICS OF PATIENTS, AND MEDICAL AND SCIENTIFIC INSTRUMENTATION FOR DIAGNOSING MEDICAL PROBLEMS; ELECTRONIC TRANSMISSION OF DATA AND MESSAGES FOR OTHERS FOR PURPOSES OF DATA ACQUISITION FOR USE IN AUTOMOBILE MAINTENANCE AND IN TROUBLESHOOTING TECHNICAL PROBLEMS WITH AUTOMOBILES; TEXT AND NUMERIC WIRELESS DIGITAL MESSAGING SERVICES; FACSIMILE TRANSMISSION SERVICES; PROVIDING MULTIPLE-USER ACCESS TO A GLOBAL COMPUTER INFORMATION NETWORK; CELLULAR TELEPHONE SERVICES (U.S. CLS. 100, 101 AND 104).

CLASS 42—SCIENTIFIC, COMPUTER AND LEGAL SERVICES

FOR REMOTE MONITORING OF AUTOMATED DIAGNOSTIC SYSTEMS OF OTHERS FOR USE IN AUTOMOBILE MAINTENANCE AND TROUBLESHOOTING THE TECHNICAL PERFORMANCE AND PROBLEMS OF AUTOMOBILES, POOL AND SPA EQUIPMENT, AND HEALTH MONITORING EQUIPMENT, NAMELY MEDICAL AND SCIENTIFIC INSTRUMENTATION FOR MEASURING VITAL STATISTICS OF PATIENTS, AND MEDICAL AND SCIENTIFIC INSTRUMENTATION FOR DIAGNOSING MEDICAL PROBLEMS; MONITORING THE TELECOMMUNICATIONS SYSTEMS OF OTHERS FOR TECHNICAL PURPOSES; AND PROVIDING BACK-UP COMPUTER PROGRAMS AND FACILITIES (U.S. CLS. 100 AND 101).

WANDA KAY PRICE, EXAMINING ATTORNEY

SN 78-204,010. HEB GROCERY COMPANY, LP, SAN ANTONIO, TX. FILED 1-16-2003.

SCHOOL STYLE

NO CLAIM IS MADE TO THE EXCLUSIVE RIGHT TO USE SCHOOL, APART FROM THE MARK AS SHOWN.

CLASS 9—ELECTRICAL AND SCIENTIFIC APPARATUS

FOR MEASURING RULERS (U.S. CLS. 21, 23, 26, 36 AND 38).

CLASS 16—PAPER GOODS AND PRINTED MATTER

FOR NOTEBOOKS; NOTEBOOK FILLER PAPER; THEME BOOKS; NOTE PADS; PAPER NOTE TABLETS; BINDERS; FOLDERS; WRITING INSTRUMENTS, NAMELY PENS, HIGHLIGHTERS, MARKERS, AND LEAD PENCILS; PENCIL CASES; PENCIL BOXES; DRAWING RULERS (U.S. CLS. 2, 5, 22, 23, 29, 37, 38 AND 50).

LINDA ESTRADA, EXAMINING ATTORNEY

SN 78-205,131. LODGENET ENTERTAINMENT CORPORATION, SIOUX FALLS, SD. FILED 1-20-2003.

POWERSTATION**CLASS 38—COMMUNICATION**

FOR TRANSMISSION OF TELEVISION, INFORMATIONAL, INTERACTIVE HOTEL GUEST ENTERTAINMENT, AND VIEWER ON-DEMAND PROGRAMMING FOR USE IN HOTELS, INNS AND TEMPORARY LODGING ESTABLISHMENTS (U.S. CLS. 100, 101 AND 104).

CLASS 41—EDUCATION AND ENTERTAINMENT

FOR ENTERTAINMENT SERVICES, NAMELY THE DISTRIBUTION FOR OTHERS OF TELEVISION, INFORMATIONAL, INTERACTIVE HOTEL GUEST ENTERTAINMENT, AND VIEWER-ON DEMAND PROGRAMMING FOR USE IN HOTELS, INNS AND TEMPORARY LODGING ESTABLISHMENTS (U.S. CLS. 100, 101 AND 107).

RUDY R. SINGLETON, EXAMINING ATTORNEY

SN 78-206,429. MEGASOL COSMETIC GMBH, FOEHREN, FED REP GERMANY, FILED 1-23-2003.

EROTICX

PRIORITY CLAIMED UNDER SEC. 44(D) ON FED REP GERMANY APPLICATION NO. 30237329.203, FILED 7-30-2002, REG. NO. 30237329, DATED 10-16-2002, EXPIRES 7-31-2012.

CLASS 3—COSMETICS AND CLEANING PREPARATIONS

FOR PERFUMERY, ETHEREAL OILS FOR PERSONAL USE, NAIL AND HAIR CARE PREPARATIONS, DEODORANT SOAPS, MASSAGE OILS (U.S. CLS. 1, 4, 6, 50, 51 AND 52).

CLASS 5—PHARMACEUTICALS

FOR MEDICAL LUBRICANTS, NAMELY, VAGINAL LUBRICANTS, WATER BASED PERSONAL LUBRICANTS (U.S. CLS. 6, 18, 44, 46, 51 AND 52).

HEATHER THOMPSON, EXAMINING ATTORNEY

SN 78-206,803. WTA TOUR, INC., DBA WTA TOUR, SAINT PETERSBURG, FL. FILED 1-24-2003.

SN 78-209,357. HERMANN PFANNER GETRANKE GESELLSCHAFT M.B.H., LAUTERACH, AUSTRIA, FILED 1-31-2003.



OWNER OF U.S. REG. NOS. 1,692,134, 2,399,587 AND OTHERS.
NO CLAIM IS MADE TO THE EXCLUSIVE RIGHT TO USE TOUR, APART FROM THE MARK AS SHOWN.

CLASS 25—CLOTHING

FOR CLOTHING, NAMELY, SWEATERS, SWEATPANTS, WARM-UP SUITS, SHORTS, COMPRESSION SHORTS, RUNNING SHORTS, SKIRTS, DRESSES, TENNIS UNDERGARMENTS, SPORTS BRAS, ATHLETIC SHOES, FOOTWEAR, GLOVES, HATS, VISORS, BANDANNAS, HEADBANDS, HEADWEAR, T-SHIRTS, SWEATSHIRTS, POLO SHIRTS, JACKETS, SWEATBANDS, SOCKS, WRISTBANDS (U.S. CLS. 22 AND 39).

CLASS 28—TOYS AND SPORTING GOODS

FOR TENNIS RACQUETS; TENNIS BALLS; TENNIS BAGS (U.S. CLS. 22, 23, 38 AND 50).

CLASS 35—ADVERTISING AND BUSINESS

FOR ADMINISTRATION AND PROMOTION OF A CIRCUIT OF COMPETITIVE, PROFESSIONAL WOMEN'S TENNIS; ASSOCIATION SERVICES, NAMELY, PROMOTING THE INTERESTS OF WOMEN'S TENNIS (U.S. CLS. 100, 101 AND 102).
LINDA ESTRADA, EXAMINING ATTORNEY

SN 78-208,968. CERTIKIN INTERNATIONAL LTD., WITNEY, OXON, UNITED KINGDOM, FILED 1-30-2003.

AROMASTEAM

PRIORITY CLAIMED UNDER SEC. 44(D) ON ERPN CMNTY TM OFC APPLICATION NO. 002793230, FILED 7-30-2002.

CLASS 10—MEDICAL APPARATUS

FOR THERAPEUTIC APPARATUS, NAMELY AROMATHERAPY STEAM SAUNA BOOTHS AND REPLACEMENT PARTS AND FITTINGS THEREFORE (U.S. CLS. 26, 39 AND 44).
FIRST USE 9-0-1998; IN COMMERCE 9-0-1999.

CLASS 11—ENVIRONMENTAL CONTROL APPARATUS

FOR APPARATUS FOR HEATING AND STEAM GENERATING, NAMELY, AROMATHERAPY STEAM SAUNA BOOTHS AND REPLACEMENT PARTS AND FITTINGS THEREFORE (U.S. CLS. 13, 21, 23, 31 AND 34).
FIRST USE 9-0-1998; IN COMMERCE 9-0-1999.
APRIL L. RADEMACHER, EXAMINING ATTORNEY

PFANNER

PRIORITY CLAIMED UNDER SEC. 44(D) ON AUSTRIA APPLICATION NO. AM57592002, FILED 9-9-2002, REG. NO. 206728, DATED 10-28-2002, EXPIRES 10-28-2012.
SEC. 2(F).

CLASS 5—PHARMACEUTICALS

FOR DIETETIC BEVERAGES ADAPTED FOR MEDICAL PURPOSES (U.S. CLS. 6, 18, 44, 46, 51 AND 52).

CLASS 30—STAPLE FOODS

FOR TEA AND TEA-BASED BEVERAGES, ICED TEA (U.S. CL. 46).

CLASS 32—LIGHT BEVERAGES

FOR MINERAL WATER AND AERATED WATERS AND OTHER NON-ALCOHOLIC DRINKS, NAMELY, FRUIT DRINKS, SPORTS DRINKS, LEMONADE, SODA WATER; FRUIT JUICE BEVERAGES AND FRUIT JUICES; SYRUPS FOR BEVERAGES AND OTHER PREPARATIONS FOR MAKING BEVERAGES, NAMELY, ESSENCES, CONCENTRATES, POWDERS USED IN MAKING SOFT DRINKS, FRUIT DRINKS (U.S. CLS. 45, 46 AND 48).

CLASS 33—WINES AND SPIRITS

FOR ALCOHOLIC BEVERAGES NOT INCLUDING BEER, NAMELY, WINE, DISTILLED SPIRITS, DISTILLED LIQUOR, ALCOHOLIC FRUIT DRINKS, BRANDY, CORDIALS, GIN, VODKA, WHISKEY, TEQUILA, RUM, ALCOHOLIC COFFEE OR TEA BASED BEVERAGES (U.S. CLS. 47 AND 49).
ROBIN CHOSID, EXAMINING ATTORNEY

SN 78-209,803. BOOTS HEALTHCARE USA, INC., WILMINGTON, DE. FILED 2-1-2003.



OWNER OF U.S. REG. NOS. 620,540, 2,710,837 AND OTHERS.

CLASS 3—COSMETICS AND CLEANING PREPARATIONS

FOR SKIN CLEANSING PREPARATION CREAMS AND LOTIONS (U.S. CLS. 1, 4, 6, 50, 51 AND 52).

CLASS 5—PHARMACEUTICALS

FOR ANTI-ACNE TREATMENT PREPARATIONS (U.S. CLS. 6, 18, 44, 46, 51 AND 52).
INGA ERVIN, EXAMINING ATTORNEY

SN 78-210,085. PINNACOR FINANCIAL GROUP, INC., DENVER, CO. FILED 2-3-2003.

PINNACOR

CLASS 35—ADVERTISING AND BUSINESS

FOR PROVIDING INFORMATION, CONSULTATION, AND ANALYSIS IN THE FIELD OF BUSINESS (U.S. CLS. 100, 101 AND 102).

FIRST USE 6-1-2000; IN COMMERCE 6-1-2000.

CLASS 36—INSURANCE AND FINANCIAL

FOR BROKERAGE SERVICES, NAMELY, BROKERAGE SERVICES IN THE FIELDS OF STOCKS, BONDS, MUTUAL FUNDS, MONEY MARKET FUNDS, STOCK OPTIONS, AND RELATED SECURITIES, ANNUITIES, VARIABLE INSURANCE, UNIVERSAL LIFE INSURANCE, AND WHOLE LIFE INSURANCE; INVESTMENT SERVICES, NAMELY, INVESTMENT ADVICE AND CONSULTATION IN THE FIELDS OF STOCKS, BONDS, MUTUAL FUNDS, MONEY MARKET FUNDS, STOCK OPTIONS, AND RELATED SECURITIES, ANNUITIES, VARIABLE INSURANCE, UNIVERSAL LIFE INSURANCE, AND WHOLE LIFE INSURANCE; INVESTMENT MANAGEMENT AND PORTFOLIO MANAGEMENT SERVICES; PROVIDING INFORMATION, CONSULTATION, AND ANALYSIS IN THE FIELDS OF FINANCE, ECONOMICS, INVESTMENT, FINANCIAL PLANNING, INVESTMENT STRATEGY, AND RETIREMENT PLANNING (U.S. CLS. 100, 101 AND 102).

FIRST USE 6-1-2000; IN COMMERCE 6-1-2000.
PAULA MAYS, EXAMINING ATTORNEY

SN 78-210,921. INTERNATIONAL BUSINESS MACHINES CORPORATION, ARMONK, NY. FILED 2-4-2003.

SERVICESUITE

CLASS 37—CONSTRUCTION AND REPAIR

FOR COMPUTER SERVICES NAMELY, CUSTOM INSTALLATION, REPAIR AND MAINTENANCE OF COMPUTER HARDWARE (U.S. CLS. 100, 103 AND 106).

FIRST USE 2-16-1998; IN COMMERCE 2-16-1998.

CLASS 42—SCIENTIFIC, COMPUTER AND LEGAL SERVICES

FOR COMPUTER SERVICES NAMELY, TECHNICAL SUPPORT SERVICES FOR COMPUTER HARDWARE AND COMPUTER SOFTWARE; COMPUTER SOFTWARE AND HARDWARE DESIGN FOR OTHERS; INTEGRATION OF COMPUTER HARDWARE AND SOFTWARE SYSTEMS FOR OTHERS; INSTALLATION, UPDATING AND MAINTENANCE OF COMPUTER SOFTWARE; COMPUTER PROGRAMMING FOR OTHERS; CONSULTING SERVICES IN THE FIELD OF COMPUTER HARDWARE AND SOFTWARE; COMPUTER SYSTEMS ANALYSIS (U.S. CLS. 100 AND 101).

FIRST USE 2-16-1998; IN COMMERCE 2-16-1998.
APRIL L. RADEMACHER, EXAMINING ATTORNEY

SN 78-211,278. BUTIFARRA LIMITED, WHILSHIRE, UNITED KINGDOM, FILED 2-5-2003.

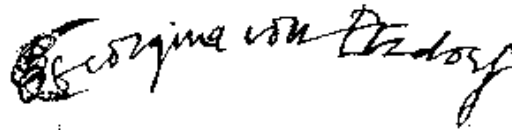

OWNER OF UNITED KINGDOM REG. NO. UK002153316, DATED 1-28-2000, EXPIRES 12-11-2007.

THE NAME GEORGINA VON ETZDORF IDENTIFIES A LIVING INDIVIDUAL WHOSE CONSENT IS OF RECORD.

THE MARK CONSISTS OF THE STYLIZED NAME GEORGINA VON ETZDORF AND A STYLIZED DRAWING OF A CRESCENT.

CLASS 3—COSMETICS AND CLEANING PREPARATIONS

FOR NON-MEDICATED PREPARATIONS FOR THE CARE OF THE HAIR AND SKIN; NON-MEDICATED SCALP TREATMENT CREAM, MASCARA, EYE SHADOW, LIPSTICK, FACE POWDERS, MAKE-UP, ROUGE, EYEBROW PENCILS, EYELINER PENCILS; HAIR SHAMPOOS, HAIR CONDITIONERS, HAIR LOTIONS, HAIR SETTING LOTIONS, HAIR LACQUER, HAIR OIL, HAIR DYES; FACIAL SOAPS AND BODY SOAPS; DEODORANTS FOR PERSONAL USE, BODY LOTIONS, SHAVING CREAMS, AFTER-SHAVE GEL AND LOTIONS, NON-MEDICATED BATH SALTS, BATH MILK, BATH OIL, FACIAL CLEANSING LOTIONS, FACIAL MOISTURIZING CREAMS, NON-MEDICATED SUN-TANNING LOTIONS, SUNTANNING PREPARATIONS, AFTER-SUN LOTIONS, PERFUME, FLOWERS, FRUIT AND FRUIT SEEDS ALL BEING POTPOURRI, ROOM FRAGRANCES, SCENTED ROOM SPRAYS (U.S. CLS. 1, 4, 6, 50, 51 AND 52).

CLASS 20—FURNITURE AND ARTICLES NOT OTHERWISE CLASSIFIED

FOR FURNITURE, BEDS, MATTRESSES, CUSHIONS, PILLOWS, WINDOW BLINDS, CHAIRS, SOFAS, SETTEES, COUCHES, BENCHES, TABLES, CABINETS, COFFEE TABLES, CHESTS OF DRAWERS, SLEEPING BAGS, CLOTHES HANGERS, COAT STANDS, COTS, INFANT CRADLES, CUPBOARDS, WARDROBES, CURTAIN RODS, CURTAIN RAILS, NON-METALLIC CURTAIN RINGS, DECK CHAIRS, DESKS, DIVANS, PLASTIC AND WOODEN HANDLES FOR DOORS, NON-METALLIC DOOR HINGES, NON-METALLIC DOOR LOCKS AND BOLTS, DOORS FOR FURNITURE, DRESSING TABLES, HAND-HELD FANS; FIGURINES AND STATUETTES OF WOOD, WAX, PLASTER OR PLASTIC; FILING CABINETS, FLOWERING PLANT STANDS MADE OF WIRE AND METAL FOR HOLDING PLANTS, FOOTSTOOLS, PICTURE FRAMES, HAND HELD MIRRORS, FURNITURE MIRRORS, HAMPERS, NONMETAL HAT RACKS, FURNITURE PARTS, NAMELY, HEAD RESTS, JEWELRY CASES NOT OF PRECIOUS METAL, DECORATIVE MOBILES, SHELVES, SIDEBOARDS, STOOLS, UMBRELLA STANDS, AND FITTED FABRIC FURNITURE COVERS (U.S. CLS. 2, 13, 22, 25, 32 AND 50).

CLASS 21—HOUSEWARES AND GLASS

FOR TABLEWARE BEING PLATES, BOWLS, DISHES, SOUP BOWLS, SERVING PLATES AND DISHES, SALAD BOWLS, SAUCERS, CUPS, DRINKING GLASSES, HAIR COMBS, CASES FOR HAIR COMBS, SPONGES FOR HOUSEHOLD PURPOSES, HAIR BRUSHES, BRUSHES FOR CLEANING POTS, BRUSHES FOR CLEANING FOOTWEAR, DISHWASHING BRUSHES, GLASS BEVERAGEWARE AND CRYSTAL BEVERAGEWARE NAMELY, WINE DRINKING GLASSES, GOBLET, WATER DRINKING GLASSES; DECANTERS, MUGS, CUPS, SAUCERS, ROLLING PINS, JUGS, GLASS STORAGE JARS, BUTTER DISHES AND BUTTER DISH COVERS, COOKIE JARS, EGG CUPS, SUGAR BOWLS, NON-ELECTRIC COFFEE PERCOLATORS, NON-ELECTRIC COFFEE POTS NOT OF PRECIOUS METAL, HAND-OPERATED COFFEE GRINDERS, NON-ELEC-

TRIC KETTLES, TEAPOTS NOT OF PRECIOUS METAL, TEA STRAINERS, SOAP HOLDERS, SOAP DISHES, SOAP DISPENSERS, TOILET BRUSHES, TOILET PAPER HOLDERS, PLASTIC BATH RACKS AND TOWEL BARS, DUSTBINS, EMPTY BOTTLES, GLASS BOXES, BREAD BOXES, BREAD BOARDS, CANDLE HOLDERS NOT OF PRECIOUS METAL, CHINA ORNAMENTS, COASTERS NOT OF PAPER OR LINEN, CORK SCREWS, COOKING POTS, COOKWARE, NAMELY, ROASTING PANS, COOKING SKEWERS OF METAL, ICE BUCKETS FOR COOLING WINE BOTTLES, LIDS FOR COOKING POTS AND PANS, FRYING PANS, SAUCEPANS, ICE BUCKETS, FIGURINES AND STATUETTES OF PORCELAIN, TERRA COTTA OR GLASS; FLASKS, FLOWER POTS, COOKERY MOLDS, NAPKIN HOLDERS AND NAPKIN RINGS NOT OF PRECIOUS METAL, PAPER PLATES, HAND-OPERATED PEPPER MILLS NOT OF PRECIOUS METAL, SALT CELLARS NOT OF PRECIOUS METAL, PERFUME BOTTLES AND PERFUME VAPORIZERS SOLD EMPTY, FITTED PICNIC BASKETS, PIE SERVERS, POWDER COMPACTS SOLD EMPTY NOT OF PRECIOUS METAL, SHAVING BRUSHES, SHAVING BRUSH STANDS, TEA CADDIES, TEA INFUSERS NOT OF PRECIOUS METAL, TOOTHBRUSHES, TOOTHPICK HOLDERS NOT OF PRECIOUS METAL, TOOTHPICKS, VASES NOT OF PRECIOUS METAL, SERVING TRAYS NOT OF PRECIOUS METAL, EYEBROW BRUSHES, COSMETIC BRUSHES FOR APPLYING MAKE-UP, AND SERVIETTE RINGS NOT OF PRECIOUS METAL (U.S. CLS. 2, 13, 23, 29, 30, 33, 40 AND 50).

CLASS 24—FABRICS

FOR CURTAINS, NET CURTAINS, FABRIC CURTAIN TIE BACKS, SHOWER AND BATH CURTAINS, BED LINEN, FACE TOWELS OF FABRIC, BATH TOWELS, TOWELS, FLANNEL POLISHING CLOTHS, BED BLANKETS, BED SHEETS, BEDSPREADS, PILLOWCASES, EIDERDOWNS, QUILTS, DUVETS, DUVET COVERS, MATTRESS COVERS, TABLE CLOTHS NOT OF PAPER, CLOTH COASTERS, PLACE MATS OF TEXTILE, TEXTILE TABLE NAPKINS, UPHOLSTERY FABRICS; TEXTILE WALL HANGINGS, TEA TOWELS, HANDKERCHIEFS, UNFITTED FABRIC FURNITURE COVERS, BLANKET THROWS, CUSHION COVERS (U.S. CLS. 42 AND 50).

CLASS 25—CLOTHING

FOR ARTICLES OF CLOTHING, HEADGEAR AND FOOTWEAR, NAMELY, SCARVES, SHAWLS, GLOVES, HATS, COATS, JACKETS, TROUSERS, POLO SHIRTS, T-SHIRTS, TUNICS, PAJAMA TOPS, PAJAMA BOTTOMS, WRAPS, BOW TIES, CRAVATS, GIRDLES, CUMMERBUNDS, WAISTCOATS, DRESSES, SKIRTS, CAMISOLES, UNDERWEAR, BOXER SHORTS, SOCKS, HOSIERY, NAMELY PANTYHOSE AND STOCKINGS; GARTER BELTS, BRASSIERES, PANTS, BRIEFS, JUMPERS, SWEATERS, CARDIGANS, BOOTS, SLIPPERS, SHOES, BLOUSES, SHORTS, BELTS FOR CLOTHING, VESTS, SWIM WEAR, SUSPENDERS FOR HOLDING UP TROUSERS (U.S. CLS. 22 AND 39).

CLASS 27—FLOOR COVERINGS

FOR CLOTH WALL COVERINGS, FABRIC BATH MATS, PLASTIC AND RUBBER BATH MATS, CARPETS, DOOR MATS, RUGS, TEXTILE FLOOR MATS FOR USE IN THE HOME (U.S. CLS. 19, 20, 37, 42 AND 50).
NELSON SNYDER, EXAMINING ATTORNEY

SN 78-211,565. ALLIANT ENERGY CORPORATION, MADISON, WI. FILED 2-6-2003.

ACCUPOWER

CLASS 35—ADVERTISING AND BUSINESS

FOR ENERGY USAGE MANAGEMENT SERVICES, NAMELY, PROVIDING EQUIPMENT CONTROL SERVICES, ENERGY MONITORING SERVICES, AND ENERGY ANALYSIS SERVICES (U.S. CLS. 100, 101 AND 102).

CLASS 42—SCIENTIFIC, COMPUTER AND LEGAL SERVICES

FOR APPLICATION SERVICE PROVIDER (ASP) FEATURING SOFTWARE IN THE FIELD OF ENERGY LOAD CONTROL FOR UTILITIES AND THEIR CUSTOMERS (U.S. CLS. 100 AND 101).

JOHN KELLY, EXAMINING ATTORNEY

SN 78-211,863. COMPONENT MANUFACTURING COMPANY, SIOUX FALLS, SD. FILED 2-6-2003.

REAVES

SEC. 2(F).

CLASS 19—NON-METALLIC BUILDING MATERIALS

FOR PREFABRICATED BUILDINGS COMPRISED PRIMARILY OF NON-METAL MATERIALS (U.S. CLS. 1, 12, 33 AND 50).

FIRST USE 0-0-1989; IN COMMERCE 0-0-1989.

CLASS 42—SCIENTIFIC, COMPUTER AND LEGAL SERVICES

FOR STRUCTURAL ENGINEERING SUPPORT SERVICES AND DESIGN ENGINEERING SERVICES ALL IN THE FIELD OF PREFABRICATED BUILDINGS. (U.S. CLS. 100 AND 101).

FIRST USE 0-0-1989; IN COMMERCE 0-0-1989.

RON FAIRBANKS, EXAMINING ATTORNEY

SN 78-213,433. MCCAIN FOODS USA, INC., OAK BROOK, IL. FILED 2-11-2003.

THE CUSTOMIZER LIVE

OWNER OF U.S. REG. NO. 2,336,889.

CLASS 40—MATERIAL TREATMENT

FOR PRINTING OF MENUS AND OTHER MERCHANDISING MATERIALS FOR USE BY RESTAURANTS AND OTHER INSTITUTIONAL EATING ESTABLISHMENTS (U.S. CLS. 100, 103 AND 106).

FIRST USE 7-10-2003; IN COMMERCE 7-10-2003.

CLASS 42—SCIENTIFIC, COMPUTER AND LEGAL SERVICES

FOR CUSTOM DESIGN OF MENUS AND OTHER MERCHANDISING MATERIALS FOR USE BY RESTAURANTS AND OTHER INSTITUTIONAL EATING ESTABLISHMENTS (U.S. CLS. 100 AND 101).

FIRST USE 7-10-2003; IN COMMERCE 7-10-2003.

MARIA-VICTORIA SUAREZ, EXAMINING ATTORNEY

SN 78-213,998. GIOVANELI, JORGE MARTIN, OLIVOS, ARGENTINA, FILED 2-12-2003.



SN 78-213,508. BARNABEI, TELEMACO, MILAN, ITALY, FILED 2-11-2003.



PRIORITY CLAIMED UNDER SEC. 44(D) ON ITALY APPLICATION NO. MI2002C01245, FILED 12-23-2002, REG. NO. 891370, DATED 5-13-2003, EXPIRES 12-23-2012.

THE STIPLING IS A FEATURE OF THE MARK.

THE MARK CONSIST OF THE STYLIZED DESIGN OF A HUMAN HEAD RESTING ON A PARALLELEPIPED WITH THE WORDS YOUINWEB READY-SITE IN STYLIZED LETTERING.

PRIORITY CLAIMED UNDER SEC. 44(D) ON ARGENTINA APPLICATION NO. 2395909, FILED 10-28-2002.

PRIORITY CLAIMED UNDER SEC. 44(D) ON ARGENTINA APPLICATION NO. 2395226, FILED 10-23-2002.

NO CLAIM IS MADE TO THE EXCLUSIVE RIGHT TO USE "HALL OF FAME", APART FROM THE MARK AS SHOWN.

CLASS 35—ADVERTISING AND BUSINESS

FOR PROMOTING THE SALE OF GOODS AND SERVICES OF AMATEUR AND PROFESSIONAL SPORTS TEAMS THROUGH THE DISTRIBUTION OF MERCHANDISE ITEMS AND RECOGNITION AWARDS TO SPORTS FANS (U.S. CLS. 100, 101 AND 102).

CLASS 41—EDUCATION AND ENTERTAINMENT

FOR PROVIDING RECOGNITION AND INCENTIVES BY THE WAY OF AWARDS TO DEMONSTRATE EXCELLENCE IN THE FIELD OF BEING A SPORT FAN (U.S. CLS. 100, 101 AND 107).

DOUGLAS LEE, EXAMINING ATTORNEY

CLASS 9—ELECTRICAL AND SCIENTIFIC APPARATUS

FOR DATA PROCESSORS AND COMPUTERS; COMPUTER SOFTWARE FOR THE CREATION, MANAGEMENT, AND DEVELOPMENT OF WEB SITES AND PORTALS; COMPUTER HARDWARE; PRE-RECORDED MAGNETIC DATA CARRIERS OF SOFTWARE FOR THE CREATION, MANAGEMENT, AND DEVELOPMENT OF WEB SITES AND PORTALS; INTERACTIVE MULTIMEDIA COMPUTER PROGRAMS FOR THE CREATION, MANAGEMENT, AND DEVELOPMENT OF WEB SITES AND PORTALS; PRE-RECORDED CD-ROMS, DISCS AND VIDEOCASSETTES FOR THE CREATION, MANAGEMENT, AND DEVELOPMENT OF WEB SITES AND PORTALS (U.S. CLS. 21, 23, 26, 36 AND 38).

CLASS 38—COMMUNICATION

FOR TELECOMMUNICATION, NAMELY RECEIVING AND FORWARDING MESSAGES, DOCUMENTS AND OTHER DATA BY ELECTRONICS TRANSMISSION (U.S. CLS. 100, 101 AND 104).

CLASS 42—SCIENTIFIC, COMPUTER AND LEGAL SERVICES

FOR DESIGN AND DEVELOPMENT OF COMPUTER AND SOFTWARE FOR OTHERS; CONSULTANCY IN THE FIELD OF COMPUTER HARDWARE AND SOFTWARE (U.S. CLS. 100 AND 101).

JAMES A. RAUEN, EXAMINING ATTORNEY

SN 78-214,089. AUTOMATION ENGINEERING CORPORATION, GREENVILLE, SC. FILED 2-12-2003.

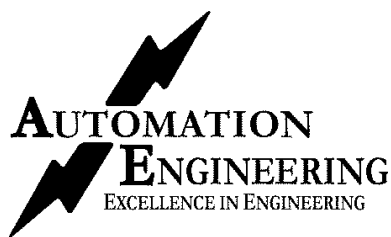

NO CLAIM IS MADE TO THE EXCLUSIVE RIGHT TO USE "AUTOMATION" AND "ENGINEERING", APART FROM THE MARK AS SHOWN.

SEC. 2(F) AS TO "EXCELLENCE IN ENGINEERING".

CLASS 7—MACHINERY

FOR PACKAGING MACHINES FOR GOODS MADE BY OTHERS (U.S. CLS. 13, 19, 21, 23, 31, 34 AND 35).

FIRST USE 0-0-1981; IN COMMERCE 0-0-1981.

CLASS 40—MATERIAL TREATMENT

FOR MANUFACTURE OF AUTOMATED MANUFACTURING MACHINES FOR OTHERS (U.S. CLS. 100, 103 AND 106).

FIRST USE 0-0-1981; IN COMMERCE 0-0-1981.

CLASS 42—SCIENTIFIC, COMPUTER AND LEGAL SERVICES

FOR DESIGN OF AUTOMATED MANUFACTURING MACHINES FOR OTHERS (U.S. CLS. 100 AND 101).
FIRST USE 0-0-1981; IN COMMERCE 0-0-1981.
PAULA MAYS, EXAMINING ATTORNEY

SN 78-215,543. COMPETENET, INC., ATLANTA, GA. FILED
2-17-2003.

SIMSELL**CLASS 9—ELECTRICAL AND SCIENTIFIC APPARATUS**

FOR SOFTWARE FOR SALES SIMULATION AND SALES/MANAGEMENT TRAINING (U.S. CLS. 21, 23, 26, 36 AND 38).
FIRST USE 11-14-2002; IN COMMERCE 1-7-2003.

CLASS 35—ADVERTISING AND BUSINESS

FOR CONSULTING SERVICES RELATING TO SALES AND MANAGEMENT TRAINING (U.S. CLS. 100, 101 AND 102).
FIRST USE 12-1-1997; IN COMMERCE 12-1-1997.
LEIGH CAROLINE CASE, EXAMINING ATTORNEY

SN 78-217,737. VENDIO SERVICES, INC., SAN BRUNO, CA.
FILED 2-21-2003.

VENDIO**CLASS 9—ELECTRICAL AND SCIENTIFIC APPARATUS**

FOR COMPUTER SOFTWARE FOR USE IN MANAGING ON-LINE MERCHANT SALES AND PRE-SALES AND POST-SALES ACTIVITIES; COMPUTER SOFTWARE FOR USE IN LINKING TO AN ON-LINE APPLICATION FOR THE PURPOSE OF TRANSFERRING OFFLINE INFORMATION ON-LINE AND ON-LINE INFORMATION OFFLINE (U.S. CLS. 21, 23, 26, 36 AND 38).

CLASS 35—ADVERTISING AND BUSINESS

FOR BUSINESS MANAGEMENT, NAMELY, DYNAMIC PRICING BUSINESS ENVIRONMENT MANAGEMENT; E-MAIL SALES, NAMELY, DISSEMINATION OF ADVERTISING FOR OTHERS VIA THE INTERNET; BUSINESS MANAGEMENT; BUSINESS MARKETING CONSULTING AND ANALYSIS; PROVIDING BUSINESS INFORMATION VIA THE INTERNET, NAMELY, SCHEDULES OF LAUNCH LISTINGS FOR ONLINE MARKETPLACES; POST SALE CUSTOMER SERVICES, NAMELY, FACILITATING INTERACTIONS WITH CUSTOMERS REGARDING SALES AND ORDERS; PROVIDING A WEB SITE FEATURING ON-LINE INVOICING SERVICES, ELECTRONIC PROCESSING OF BILL PAYMENT DATA, PAYMENT NOTIFICATION, SHIPPING NOTIFICATIONS, ORDER TRACKING, RECORD MAINTENANCE, AND ACCOUNTING SERVICES; CUSTOMER RELATION MANAGEMENT (CRM) SERVICES IN THE FIELD OF ONLINE SALES; MARKET RESEARCH SERVICES, NAMELY, MANAGING, TRACKING AND ANALYZING DATA IN THE FIELDS OF MARKETING, PROMOTION, SALES, AND CUSTOMER INFORMATION MANAGEMENT; CUSTOMER SUPPORT SERVICES IN THE FIELD OF ONLINE SALES; PREPARING BUSINESS REPORTS, NAMELY, STATISTICAL AND MANAGEMENT REPORTS ON MARKETING, PROMOTION, SALES, CUSTOMER INFORMATION MANAGEMENT, CUSTOMER SUPPORT SERVICES AND EMPLOYEE EFFICIENCY; INVENTORY MANAGEMENT IN THE FIELD OF ONLINE SALES; DIRECT MAIL CONSULTING SERVICES AND DIRECT MAIL ADVERTISING; PREPARING AND SORTING OF MAILING LISTS; SALES VOLUME TRACKING FOR OTHERS, NAMELY, METRICS TRACKING FOR MAILING LIST RESPONSES; DIRECT MAIL ADVERTISING, NAMELY, TARGETED PROMOTIONS AND NEWSLETTERS; COMMERCIAL INFORMATION AGENCIES, NAMELY, MANAGING SEARCH, TRANSACTION AND RELATED CONTACT DATA; SALES VOLUME TRACKING FOR OTHERS, NAMELY, AUTOMATED SEARCHING AND MONITORING OF PROSPECTIVE AND ACTUAL ONLINE TRANSACTIONS OR OFFERS; BUSINESS MANAGEMENT OF PURCHASING ACTIVITIES; PROVIDING A WEB SITE WHEREBY BUYERS OF GOODS OR SERVICES LOCATE AND RECEIVE QUOTATIONS FROM MULTIPLE COMPETITIVE SOURCES AND SELLERS OF GOODS OR SERVICES IDENTIFY AND BID ON MULTIPLE NEW SALES OPPORTUNITIES; PROMOTING THE GOODS AND SERVICES OF OTHERS BY PROVIDING HYPERTEXT LINKS TO THE WEB SITES OF OTHERS; BUYER TOOLS, NAMELY, ONLINE TOOLS TO PROVIDE INFORMATION ABOUT POTENTIAL PURCHASES OR MERCHANTS (U.S. CLS. 100, 101 AND 102).

CLASS 36—INSURANCE AND FINANCIAL

FOR FINANCIAL MANAGEMENT (U.S. CLS. 100, 101 AND 102).

CLASS 38—COMMUNICATION

FOR ONLINE MESSAGES, NAMELY, WEB MESSAGING; BULK E-MAIL FORWARDING; PROVIDING ON-LINE CHAT ROOMS FOR THE TRANSMISSION OF MESSAGES AMONG COMPUTER USERS CONCERNING ELECTRONIC COMMERCE AND AUCTIONS; PROVIDING ON-LINE ELECTRONIC BULLETIN BOARDS FOR THE TRANSMISSION OF MESSAGES AMONG COMPUTER USERS CONCERNING ELECTRONIC COMMERCE AND AUCTIONS; ON-LINE COMMUNITY SERVICES, NAMELY, PROVIDING ON-LINE ELECTRONIC BULLETIN BOARDS FOR THE TRANSMISSION OF MESSAGES AMONG COMPUTER USERS CONCERNING ON-LINE MERCHANTS (U.S. CLS. 100, 101 AND 104).

CLASS 39—TRANSPORTATION AND STORAGE

FOR STORAGE SERVICES FOR ARCHIVING DATABASES, IMAGES AND OTHER ELECTRONIC DATA (U.S. CLS. 100 AND 105).

CLASS 40—MATERIAL TREATMENT

FOR PRINTING OF PACKING SLIPS AND ADDRESS LABELS (U.S. CLS. 100, 103 AND 106).

CLASS 41—EDUCATION AND ENTERTAINMENT

FOR ENTERTAINMENT SERVICES, NAMELY, PROVIDING ON-LINE REVIEWS OF MERCHANDISE AND SERVICES OF OTHERS; PROVIDING NEWS IN THE NATURE OF CURRENT EVENTS REPORTING; ELECTRONIC PUBLISHING SERVICES, NAMELY, PUBLICATION OF TEXT AND GRAPHIC WORKS OF OTHERS ON-LINE FEATURING GRAPHICS AND IMAGES USED TO MERCHANDISE PRODUCTS ON ON-LINE MARKETPLACES (U.S. CLS. 100, 101 AND 107).

CLASS 42—SCIENTIFIC, COMPUTER AND LEGAL SERVICES

FOR COMPUTER SERVICES, NAMELY, DESIGNING AND IMPLEMENTING E-COMMERCE WEB SITES FOR OTHERS; HOSTING THE REAL ESTATE WEB SITES OF OTHERS ON A COMPUTER SERVER FOR A GLOBAL COMPUTER NETWORK; HOSTING THE ELECTRONIC COMMERCE WEB SITES OF OTHERS ON A COMPUTER SERVER FOR A GLOBAL COMPUTER NETWORK; HOSTING THE WEB SITES OF OTHERS CONTAINING ONLINE IMAGES AND POSTINGS ON A COMPUTER SERVER FOR A GLOBAL COMPUTER NETWORK; MANAGING WEB SITES FOR OTHERS, NAMELY, UPLOADING AND DOWNLOADING IMAGES AND PREFERENCES BETWEEN WEBSITES; MANAGING WEB SITES FOR OTHERS, NAMELY, IMPORTING DATA FROM ONLINE MARKETPLACES OF OTHERS; COMPUTER SERVICES, NAMELY, PROVIDING SEARCH ENGINES FOR OBTAINING INFORMATION VIA A GLOBAL COMPUTER NETWORK; HOSTING OF DOMAIN NAMES, NAMELY, WEB HOSTING; COUNTER SYSTEM SERVICES (U.S. CLS. 100 AND 101).

JOHN GARTNER, EXAMINING ATTORNEY

SN 78-217,984. COPY SECURE, INC., PHILADELPHIA, PA. FILED 2-24-2003.

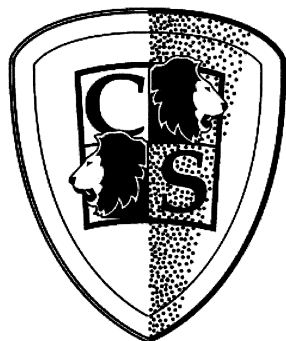

THE STIPPLING IS FOR SHADING PURPOSES.

CLASS 35—ADVERTISING AND BUSINESS

FOR COPYING OF DOCUMENTS FOR OTHERS, DIGITAL COPYING OF DOCUMENTS FOR OTHERS, COPYING OF DOCUMENTS FOR USE IN LITIGATION BY LAW FIRMS, ONSITE COPYING OF DOCUMENTS FOR OTHERS, AND DOCUMENT NUMBERING AND DOCUMENT PAGINATION (U.S. CLS. 100, 101 AND 102).

FIRST USE 6-1-2001; IN COMMERCE 6-1-2001.

CLASS 40—MATERIAL TREATMENT

FOR DIGITAL IMAGING SERVICES, DATA SCANNING, COMPACT DISC DUPLICATION, MEDIA DUPLICATION OF DATA AND DIGITAL INFORMATION, DUPLICATION OF AUDIO AND VIDEO MEDIA, AND BINDING OF DOCUMENTS FOR OTHERS (U.S. CLS. 100, 103 AND 106).

FIRST USE 6-1-2001; IN COMMERCE 6-1-2001.

CLASS 42—SCIENTIFIC, COMPUTER AND LEGAL SERVICES

FOR LITIGATION SUPPORT SERVICES, NAMELY, PREPARATION OF TRAIL EXHIBITS AND ELECTRONIC DISCOVERY SERVICES (U.S. CLS. 100 AND 101).

FIRST USE 6-1-2001; IN COMMERCE 6-1-2001.

RONALD MCMORROW, EXAMINING ATTORNEY

SN 78-218,988. CUMBERLAND FARMS, INC., CANTON, MA. FILED 2-26-2003.

CUMBERLAND FARMS

OWNER OF U.S. REG. NOS. 813,569, 1,285,634 AND OTHERS.

CLASS 29—MEATS AND PROCESSED FOODS

FOR COTTAGE CHEESE, SOUR CREAM, FRESH EGGS, FRESH WHOLE MILK, FRESH SKIM MILK, CHOCOLATE DAIRY DRINK, FRESH CREAM, NON-ALCOHOLIC EGGNOG (U.S. CL. 46).

FIRST USE 1-15-1944; IN COMMERCE 1-0-1956.

CLASS 30—STAPLE FOODS

FOR ICE CREAM, BREAD (U.S. CL. 46).

FIRST USE 1-15-1944; IN COMMERCE 1-0-1956.

CLASS 32—LIGHT BEVERAGES

FOR FRESH ORANGE JUICE, APPLE CIDER (U.S. CLS. 45, 46 AND 48).

FIRST USE 1-15-1944; IN COMMERCE 1-0-1956.

LEIGH CAROLINE CASE, EXAMINING ATTORNEY

SN 78-219,760. KURARAY CO., LTD., KURASHIKI CITY, OKAYAMA PREFECTURE, JAPAN, FILED 2-27-2003.

SERDIA

PRIORITY CLAIMED UNDER SEC. 44(D) ON JAPAN APPLICATION NO. 106089, FILED 12-16-2002, REG. NO. 4717105, DATED 10-10-2003, EXPIRES 10-10-2013.

PRIORITY CLAIMED UNDER SEC. 44(D) ON JAPAN APPLICATION NO. 106088, FILED 12-16-2002, REG. NO. 4709354, DATED 9-12-2003, EXPIRES 9-12-2013.

CLASS 18—LEATHER GOODS

FOR LEATHER CLOTH SOLD IN BULK; IMITATION LEATHER SOLD IN BULK; SYNTHETIC LEATHER SOLD IN BULK (U.S. CLS. 1, 2, 3, 22 AND 41).

CLASS 25—CLOTHING

FOR FOOTWEAR; FOOTWEAR FOR SPORTS, NAMELY, GOLF SHOES, SOCCER SHOES, SKI BOOTS, GYMNAS TIC SHOES, TENNIS SHOES, CLIMBING BOOTS, BASKETBALL SNEAKERS, VOLLEYBALL SHOES, HANDBALL SHOES, BOWLING SHOES, BOXING SHOES, HOCKEY SHOES, BASEBALL SHOES, RUGBY SHOES, FOOTWEAR FOR TRACK AND FIELD ATHLETICS AND HORSE-RIDING BOOTS (U.S. CLS. 22 AND 39).

JAMES GRIFFIN, EXAMINING ATTORNEY

SN 78-220,611. GUMLINK A/S, 7100 VEJLE, DENMARK, FILED 3-2-2003.

GUMLINK

PRIORITY CLAIMED UNDER SEC. 44(D) ON DENMARK APPLICATION NO. VA200203594, FILED 9-9-2002, REG. NO. VR200300038, DATED 1-7-2003, EXPIRES 1-7-2013.

CLASS 5—PHARMACEUTICALS

FOR CONFECTIONERY FOR MEDICINAL PURPOSES, NAMELY, MEDICATED CHEWING GUM, PASTILLES, SWEET CANDY AND CANDY DROPS (U.S. CLS. 6, 18, 44, 46, 51 AND 52).

CLASS 30—STAPLE FOODS

FOR CONFECTIONERY, NAMELY, NON-MEDICATED CHEWING GUM, PASTILLES, SWEET CANDY AND CANDY DROPS (U.S. CL. 46).

CLASS 40—MATERIAL TREATMENT

FOR MANUFACTURE OF MEDICATED AS WELL AS NON-MEDICATED CHEWING GUM, PASTILLES, SWEET CANDY AND CANDY DROPS TO THE ORDER AND/OR SPECIFICATION OF OTHERS (U.S. CLS. 100, 103 AND 106).

ALICE SUE CARRUTHERS, EXAMINING ATTORNEY

SN 78-220,982. MOLKEREI ALOIS MUELLER GMBH & CO., FISCHACH-ARETSRIED, FED REP GERMANY, FILED 3-3-2003.



OWNER OF FED REP GERMANY REG. NO. 1162113, DATED 8-6-1990, RENEWED AS REG. NO. 1162113, DATED 5-31-2010, EXPIRES 5-31-2010.

CLASS 29—MEATS AND PROCESSED FOODS

FOR MILK, BUTTERMILK, SOUR MILK AND MILK PRODUCTS, NAMELY, BUTTER, CHEESE, CREAM, YOGURT, KEFIR MADE FROM MILK WITH SPECIFIC KEFIR CULTURES CONSISTING OF KEFIR BULBS, BUTTERMILK, POWDERED MILK, DAIRY-BASED FOOD BEVERAGES; PROCESSED BEAN CURD. (U.S. CL. 46).

CLASS 30—STAPLE FOODS

FOR MILKSHAKES, FROZEN YOGURT, FROZEN CONFECTIONS CONTAINING YOGURT, BEAN CURD AND CREAM; ICE CREAM. (U.S. CL. 46).

CLASS 32—LIGHT BEVERAGES

FOR MINERAL WATER, CARBONIZED DRINKING WATER, SOFT DRINKS, FRUIT DRINKS AND FRUIT JUICES. (U.S. CLS. 45, 46 AND 48).

KIMBERLY PERRY, EXAMINING ATTORNEY

SN 78-221,248. XYLITOL INC., OREM, UT. FILED 3-4-2003.

SPRY DENTAL DEFENSE SYSTEM

NO CLAIM IS MADE TO THE EXCLUSIVE RIGHT TO USE "DENTAL DEFENSE SYSTEM", APART FROM THE MARK AS SHOWN.

CLASS 3—COSMETICS AND CLEANING PREPARATIONS

FOR GOODS INVOLVED IN ORAL HYGIENE, NAMELY, TOOTHPASTE, MOUTH WASH, AND NON-MEDICATED MOUTH RINSE (U.S. CLS. 1, 4, 6, 50, 51 AND 52).

FIRST USE 11-1-2002; IN COMMERCE 12-13-2002.

CLASS 30—STAPLE FOODS

FOR CANDY MINTS; AND CHEWING GUM (U.S. CL. 46).

FIRST USE 11-1-2002; IN COMMERCE 12-13-2002.

ALEXANDER L. POWERS, EXAMINING ATTORNEY

SN 78-223,686. QUALIFACTS SYSTEMS, INC., NASHVILLE, TN. FILED 3-10-2003.

CALCIS

CLASS 9—ELECTRICAL AND SCIENTIFIC APPARATUS

FOR SOFTWARE FOR HEALTHCARE SERVICE MANAGEMENT, BILLING, PAYMENT, AND CLAIMS; SOFTWARE FOR ELECTRONIC HEALTH AND MEDICAL RECORD KEEPING. (U.S. CLS. 21, 23, 26, 36 AND 38).

CLASS 35—ADVERTISING AND BUSINESS

FOR HEALTHCARE RECORD KEEPING SERVICES; SCHEDULING AND TRACKING HEALTHCARE SERVICES; HEALTHCARE BILLING AND COLLECTIONS SERVICES. (U.S. CLS. 100, 101 AND 102).

ANDREA SAUNDERS, EXAMINING ATTORNEY

SN 78-225,604. HIGHLAND CAPITAL CORP., LITTLE FALLS, NJ. FILED 3-14-2003.

HIGHLAND CAPITAL

NO CLAIM IS MADE TO THE EXCLUSIVE RIGHT TO USE "CAPITAL", APART FROM THE MARK AS SHOWN.

CLASS 35—ADVERTISING AND BUSINESS

FOR LEASING OF EQUIPMENT, NAMELY, OFFICE EQUIPMENT (U.S. CLS. 100, 101 AND 102).
FIRST USE 2-20-1998; IN COMMERCE 2-20-1998.

CLASS 36—INSURANCE AND FINANCIAL

FOR EQUIPMENT FINANCING SERVICES (U.S. CLS. 100, 101 AND 102).
FIRST USE 2-20-1998; IN COMMERCE 2-20-1998.

CLASS 37—CONSTRUCTION AND REPAIR

FOR LEASING OF EQUIPMENT, NAMELY, CONSTRUCTION EQUIPMENT (U.S. CLS. 100, 103 AND 106).
FIRST USE 2-20-1998; IN COMMERCE 2-20-1998.

CLASS 38—COMMUNICATION

FOR LEASING OF EQUIPMENT, NAMELY, TELECOMMUNICATIONS EQUIPMENT (U.S. CLS. 100, 101 AND 104).
FIRST USE 2-20-1998; IN COMMERCE 2-20-1998.

CLASS 44—MEDICAL, BEAUTY AND AGRICULTURAL SERVICES

FOR LEASING OF EQUIPMENT, NAMELY, MEDICAL EQUIPMENT (U.S. CLS. 100 AND 101).
FIRST USE 2-20-1998; IN COMMERCE 2-20-1998.
GINNY ISAACSON, EXAMINING ATTORNEY

CLASS 35—ADVERTISING AND BUSINESS

FOR ARRANGING AND CONDUCTING BUSINESS MEETINGS, CONFERENCES, CONVENTIONS IN THE FIELD OF PRINTING; GROUP PURCHASING, NAMELY, BUYING CLUBS AND FUNCTIONING AS PURCHASING AGENTS, AND CONDUCTING BUSINESS RESEARCH, MARKET AND SALES RESEARCH, OPERATION AND PROCEDURAL RESEARCH, AND EQUIPMENT AND TECHNICAL RESEARCH FOR AND ABOUT SMALL PRINTERS (U.S. CLS. 100, 101 AND 102).

CLASS 40—MATERIAL TREATMENT

FOR PROVIDING INTERNET WEB SITE FEATURING PRINTING INFORMATION AND OTHER MULTIMEDIA MATERIALS RESOURCES IN THE NATURE OF SURVEYS, STUDIES, VIDEOS, CD'S, DVD'S AND INTERACTIVE COMPUTER PROGRAMS IN THE FIELD OF PRINTING (U.S. CLS. 100, 103 AND 106).

CLASS 41—EDUCATION AND ENTERTAINMENT

FOR PUBLICATION OF BOOKS, MAGAZINES, SURVEYS, PLANS, PROGRAMS AND STUDIES IN THE FIELD OF PRINTING; PRODUCTION OF VIDEO CASSETTES, CD'S DVD'S AND INTERACTIVE COMPUTER PROGRAMS IN THE FIELD OF PRINTING; TRAINING SERVICES IN THE FIELD OF PRINTING AND THE DISTRIBUTION OF BOOKS, REPORTS AND RELATED COURSE MATERIALS IN CONNECTION THEREWITH; EDUCATIONAL SERVICES, NAMELY, CONDUCTING SEMINARS AND COURSES IN THE FIELD OF PRINTING LEADING TO CERTIFICATION OF INDIVIDUALS AS WELL AS COURSES LEADING TO THE GRANTING OF COLLEGE CREDITS (U.S. CLS. 100, 101 AND 107).
MARLENE BELL, EXAMINING ATTORNEY

SN 78-226,186. ANTARES INVESTMENT PARTNERS, ARMONK, NY. FILED 3-17-2003.

ANTARES REAL ESTATE SERVICES

NO CLAIM IS MADE TO THE EXCLUSIVE RIGHT TO USE "REAL ESTATE SERVICES", APART FROM THE MARK AS SHOWN.

CLASS 35—ADVERTISING AND BUSINESS

FOR ASSET MANAGEMENT SERVICES, NAMELY, INDUSTRIAL ASSET MANAGEMENT SERVICES, AUCTIONING, LIQUIDATING AND RE-MARKETING INDUSTRIAL ASSETS (U.S. CLS. 100, 101 AND 102).
FIRST USE 1-31-1997; IN COMMERCE 1-31-1997.

CLASS 36—INSURANCE AND FINANCIAL

FOR REAL ESTATE MANAGEMENT SERVICES; REAL ESTATE BROKERAGE SERVICES; REAL ESTATE ACQUISITION AND INVESTMENT SERVICES (U.S. CLS. 100, 101 AND 102).
FIRST USE 1-31-1997; IN COMMERCE 1-31-1997.

CLASS 37—CONSTRUCTION AND REPAIR

FOR CONSTRUCTION MANAGEMENT AND DEVELOPMENT SERVICES; REAL ESTATE DEVELOPMENT SERVICES (U.S. CLS. 100, 103 AND 106).
FIRST USE 1-31-1997; IN COMMERCE 1-31-1997.
MICHAEL WEBSTER, EXAMINING ATTORNEY

SN 78-225,795. CROUSER & ASSOCIATES, INC., CHARLESTON, WV. FILED 3-14-2003.

NAQP

CLASS 9—ELECTRICAL AND SCIENTIFIC APPARATUS

FOR COMPUTER SOFTWARE FOR CREATING SEARCHABLE DATABASES OF INFORMATION AND DATA IN THE FIELD OF PRINTING (U.S. CLS. 21, 23, 26, 36 AND 38).

CLASS 16—PAPER GOODS AND PRINTED MATTER

FOR PAPER GOODS AND PRINTED MATTER, NAMELY, GUIDES, PRICING GUIDES, PRICING STANDARDS, INSTRUCTIONAL AND TRAINING MANUALS AND MATERIALS, BOOKS, REPORTS, TEACHING AND EDUCATIONAL MATERIALS AND PUBLICATION PAPER, SURVEYS AND STUDIES IN THE FIELD OF PRINTING (U.S. CLS. 2, 5, 22, 23, 29, 37, 38 AND 50).

SN 78-226,249. PARTNERSOLVE LLC, ASHLAND, MA. FILED 3-17-2003.

PARTNERSOLVE

CLASS 35—ADVERTISING AND BUSINESS

FOR BUSINESS MANAGEMENT CONSULTING SERVICES IN THE FIELDS OF CUSTOMER INFORMATION SYSTEMS, EFFICIENCY IMPROVEMENT, OPERATIONS MANAGEMENT, USE AND APPLICATION OF INFORMATION TECHNOLOGY SYSTEMS, IMPROVED MANAGEMENT OF BILLING SYSTEMS, AND PROBLEM IDENTIFICATION AND RESOLUTION IN THE AREA OF ACCOUNTS RECEIVABLE, MAIL ROOM, CUSTOMER SERVICE AND REMITTANCE OPERATIONS (U.S. CLS. 100, 101 AND 102).

FIRST USE 5-3-2001; IN COMMERCE 5-3-2001.

CLASS 42—SCIENTIFIC, COMPUTER AND LEGAL SERVICES

FOR CONSULTATION, DESIGN, DEVELOPMENT AND IMPLEMENTATION OF COMPUTER SOFTWARE FOR OTHERS IN THE FIELD OF CUSTOMER INFORMATION SYSTEMS, BILLING AND ACCOUNTS RECEIVABLE MANAGEMENT, MAIL ROOM, CUSTOMER SERVICE AND REMITTANCE OPERATIONS (U.S. CLS. 100 AND 101).

FIRST USE 5-3-2001; IN COMMERCE 5-3-2001.

JANICE L. MCMORROW, EXAMINING ATTORNEY

SN 78-227,426. KOHLER CO., KOHLER, WI. FILED 3-19-2003.

MEMOIRS

CLASS 6—METAL GOODS

FOR METAL ROBE HOOKS (U.S. CLS. 2, 12, 13, 14, 23, 25 AND 50).

CLASS 20—FURNITURE AND ARTICLES NOT OTHERWISE CLASSIFIED

FOR SHELVES MADE OF GLASS OR PORCELAIN FOR BATHROOM USE (U.S. CLS. 2, 13, 22, 25, 32 AND 50).

CLASS 21—HOUSEWARES AND GLASS

FOR BATHROOM ACCESSORIES, NAMELY DRINKING GLASSES; WASH BASINS; SOAP DISHES; SOAP DISPENSERS; PAPER TOWEL DISPENSERS; TOILET PAPER HOLDERS AND DISPENSERS; TOWEL BARS AND TOWEL HOLDERS; AND TOOTHBRUSH HOLDERS (U.S. CLS. 2, 13, 23, 29, 30, 33, 40 AND 50).

JAMES A. RAUEN, EXAMINING ATTORNEY

SN 78-227,428. KOHLER CO., KOHLER, WI. FILED 3-19-2003.

PORTRAIT

CLASS 20—FURNITURE AND ARTICLES NOT OTHERWISE CLASSIFIED

FOR SHELVES MADE OF GLASS OR PORCELAIN FOR BATHROOM USE; NON-METAL ROBE HOOKS (U.S. CLS. 2, 13, 22, 25, 32 AND 50).

CLASS 21—HOUSEWARES AND GLASS

FOR BATHROOM ACCESSORIES, NAMELY DRINKING GLASSES; WASH BASINS; SOAP DISHES; SOAP DISPENSERS; PAPER TOWEL DISPENSERS; TOILET PAPER HOLDERS AND DISPENSERS; TOWEL BARS AND TOWEL HOLDERS; AND TOOTHBRUSH HOLDERS (U.S. CLS. 2, 13, 23, 29, 30, 33, 40 AND 50).

JAMES A. RAUEN, EXAMINING ATTORNEY

SN 78-228,025. ASSOCIATION OF BONE AND JOINT SURGEONS, THE, ROSEMONT, IL. FILED 3-20-2003.

CLINICAL ORTHOPAEDICS AND RELATED RESEARCH

SEC. 2(F).

CLASS 16—PAPER GOODS AND PRINTED MATTER

FOR PERIODICALS, BOOKS, AND ARTICLE REPRINTS, ALL RELATING TO ORTHOPAEDIC MEDICINE (U.S. CLS. 2, 5, 22, 23, 29, 37, 38 AND 50).

FIRST USE 0-0-1953; IN COMMERCE 0-0-1953.

CLASS 41—EDUCATION AND ENTERTAINMENT

FOR ONLINE PUBLICATIONS, NAMELY PERIODICALS AND ARTICLE REPRINTS RELATING TO ORTHOPAEDIC MEDICINE (U.S. CLS. 100, 101 AND 107).

FIRST USE 6-0-1999; IN COMMERCE 6-0-1999.

KARLA PERKINS, EXAMINING ATTORNEY

SN 78-228,641. ATLAS COPCO TOOLS AB, STOCKHOLM, SWEDEN, FILED 3-21-2003.



ServAid

THE MARK CONSISTS OF THE WORD SERVAID IN SPECIAL LETTERING WITHIN A RECTANGLE AND A REPRESENTATION OF A HAND HOLDING A WRENCH.

CLASS 9—ELECTRICAL AND SCIENTIFIC APPARATUS

FOR SPARE-PARTS CATALOGUES RECORDED ON COMPACT DISCS (U.S. CLS. 21, 23, 26, 36 AND 38).

FIRST USE 6-0-1999; IN COMMERCE 6-0-1999.

CLASS 41—EDUCATION AND ENTERTAINMENT

FOR PROVIDING ON-LINE PUBLICATIONS IN THE FIELD OF SPARE PARTS (U.S. CLS. 100, 101 AND 107).
FIRST USE 6-0-1999; IN COMMERCE 6-0-1999.
APRIL L. RADEMACHER, EXAMINING ATTORNEY

SN 78-229,235. THE INTERNATIONAL SCHOOL OF MINNESOTA, INC., DBA SABIS EDUCATIONAL SYSTEMS, INC., EDEN PRAIRIE, MN. FILED 3-24-2003.

SABIS ACADEMIC MONITORING SYSTEM

OWNER OF U.S. REG. NO. 1,969,253.
NO CLAIM IS MADE TO THE EXCLUSIVE RIGHT TO USE ACADEMIC MONITORING SYSTEM, APART FROM THE MARK AS SHOWN.

SN 78-228,692. C.M.I. ENTERPRISES, INC., HIALEAH, FL. FILED 3-21-2003.

OLD GLORY

CLASS 12—VEHICLES

FOR LEATHER AND MATCHING VINYL FOR AUTOMOBILE UPHOLSTERY AND TRIM, SOLD AS A FINISHED PRODUCT READY FOR INSTALLATION (U.S. CLS. 19, 21, 23, 31, 35 AND 44).

CLASS 16—PAPER GOODS AND PRINTED MATTER

FOR PRINTED MATTER, NAMELY, EDUCATIONAL AND TESTING MATERIALS FOR TEACHERS AND STUDENTS IN THE AREAS OF MATH, SCIENCE, ENGLISH, HISTORY, SOCIAL STUDIES, FOREIGN LANGUAGE (U.S. CLS. 2, 5, 22, 23, 29, 37, 38 AND 50).

CLASS 18—LEATHER GOODS

FOR LEATHER HIDES FOR UPHOLSTERY AND TRIM (U.S. CLS. 1, 2, 3, 22 AND 41).

CLASS 41—EDUCATION AND ENTERTAINMENT

FOR EDUCATIONAL SERVICES, NAMELY, CONDUCTING CLASSES, SEMINARS AND WORKSHOPS FOR TEACHERS IN THE FIELDS OF TEACHING METHODS, TESTING METHODS AND EVALUATION OF THE ACADEMIC PERFORMANCE OF STUDENTS, AND DISTRIBUTING COURSE MATERIALS IN CONNECTION THEREWITH; EDUCATIONAL CONSULTING SERVICES FOR OTHERS, NAMELY, PROVIDING ASSISTANCE AND CONSULTATION TO TEACHERS IN EVALUATING THE ACADEMIC PERFORMANCE OF STUDENTS (U.S. CLS. 100, 101 AND 107).

CLASS 24—FABRICS

FOR VINYL IN ROLLS FOR UPHOLSTERY AND TRIM (U.S. CLS. 42 AND 50).
LEIGH CAROLINE CASE, EXAMINING ATTORNEY

CHRISTOPHER BUONGIORNO, EXAMINING ATTORNEY

SN 78-228,966. RIMKUS CONSULTING GROUP, INC., HOUSTON, TX. FILED 3-24-2003.

RIMKUS CONSULTING GROUP, INC.

NO CLAIM IS MADE TO THE EXCLUSIVE RIGHT TO USE "CONSULTING GROUP, INC.", APART FROM THE MARK AS SHOWN.

SN 78-229,838. LEAPFROG ENTERPRISES, INC., EMERYVILLE, CA. FILED 3-25-2003.

LITTLETOUCH

CLASS 35—ADVERTISING AND BUSINESS

FOR FORENSIC CONSULTATION IN THE FIELD OF BUSINESS ANALYSIS, NAMELY, BUSINESS INTERRUPTION ANALYSIS (U.S. CLS. 100, 101 AND 102).
FIRST USE 0-0-1983; IN COMMERCE 0-0-1983.

CLASS 9—ELECTRICAL AND SCIENTIFIC APPARATUS

FOR SOFTWARE, NAMELY, CHILDREN'S EDUCATIONAL SOFTWARE (U.S. CLS. 21, 23, 26, 36 AND 38).

CLASS 37—CONSTRUCTION AND REPAIR

FOR FORENSIC CONSULTATION IN THE FIELD OF CONSTRUCTION, NAMELY BUILDING CONSTRUCTION AND BUILDING CONSTRUCTION DEFECTS (U.S. CLS. 100, 103 AND 106).
FIRST USE 0-0-1983; IN COMMERCE 0-0-1983.

CLASS 16—PAPER GOODS AND PRINTED MATTER

FOR PRINTED MATTER, NAMELY, INSTRUCTIONAL, EDUCATIONAL, AND TEACHING MATERIALS FOR INFANTS AND TODDLERS; BOOKS, NAMELY, CHILDREN'S BOOKS, CHILDREN'S ACTIVITY BOOKS, EDUCATIONAL BOOKS FOR PRESCHOOL AND ELEMENTARY SCHOOL CHILDREN; NEWSLETTERS IN THE FIELDS OF PARENTING AND CHILD DEVELOPMENT; MAGAZINES IN THE FIELDS OF PARENTING AND CHILD DEVELOPMENT (U.S. CLS. 2, 5, 22, 23, 29, 37, 38 AND 50).

CLASS 42—SCIENTIFIC, COMPUTER AND LEGAL SERVICES

FOR FORENSIC CONSULTATION IN THE FIELD OF SCIENCE AS IT RELATES TO ENVIRONMENT, MOLD AND INDOOR AIR QUALITY, PRODUCT LIABILITY, VEHICLE ACCIDENT RECONSTRUCTION, INDUSTRIAL LOSSES, AND CATASTROPHES; FORENSIC CONSULTATION IN THE FIELD OF ENGINEERING AS IT RELATES TO CONSTRUCTION, PRODUCT LIABILITY, INDUSTRIAL LOSSES, AND CATASTROPHES (U.S. CLS. 100 AND 101).

CLASS 28—TOYS AND SPORTING GOODS

FOR TOYS, NAMELY, CHILDREN'S MULTIPLE ACTIVITY TOYS (U.S. CLS. 22, 23, 38 AND 50).
ALLISON HOLTZ, EXAMINING ATTORNEY

FIRST USE 0-0-1983; IN COMMERCE 0-0-1983.
SHAUNIA WALLACE, EXAMINING ATTORNEY

SN 78-229,941. MAAKESTAD, JAN, DBA MINT FOR YOU, SAN FRANCISCO, CA. FILED 3-25-2003.

NECKMAX

CLASS 10—MEDICAL APPARATUS

FOR SUPPORTS FOR THE NECK TO BE USED WHILE EXERCISING FOR MEDICAL PURPOSES (U.S. CLS. 26, 39 AND 44).

CLASS 28—TOYS AND SPORTING GOODS

FOR EXERCISE EQUIPMENT, NAMELY, NECK SUPPORTS FOR ATHLETIC PURPOSES (U.S. CLS. 22, 23, 38 AND 50).

MICHAEL SOUDERS, EXAMINING ATTORNEY

SN 78-230,086. IWASAKI TSUSHINKI KABUSHIKI KAISHA (IWATSU ELECTRIC CO., LTD), TOKYO, JAPAN, FILED 3-26-2003.

ELEFAX

CLASS 1—CHEMICALS

FOR CHEMICAL PREPARATIONS FOR ELECTROSTATIC PLATE MAKERS, NAMELY, DEVELOPER AND CHEMICAL FOUNTAIN SOLUTIONS (U.S. CLS. 1, 5, 6, 10, 26 AND 46).

CLASS 7—MACHINERY

FOR PRINTING PLATES; PRINTING PRESS COMPONENTS, NAMELY, ELECTROSTATIC PLATE MAKERS, DIGITAL PLATE MAKERS AND COMPUTER-TO-PLATE SYSTEMS COMPRISED OF COMPUTER, ELECTROSTATIC PLATE MARKERS, SERVER, AND OFFSET PRINTING SYSTEM (U.S. CLS. 13, 19, 21, 23, 31, 34 AND 35).

INGRID C. EULIN, EXAMINING ATTORNEY

SN 78-230,283. 3-DAC GOLF CORPORATION, VAUGHAN, ONTARIO, CANADA, FILED 3-26-2003.



NO CLAIM IS MADE TO THE EXCLUSIVE RIGHT TO USE "GOLF LEARNING SYSTEM", APART FROM THE MARK AS SHOWN.

CLASS 35—ADVERTISING AND BUSINESS

FOR RETAIL STORE SERVICES FEATURING GOLF MERCHANDISE (U.S. CLS. 100, 101 AND 102).

CLASS 41—EDUCATION AND ENTERTAINMENT

FOR GOLF INSTRUCTION (U.S. CLS. 100, 101 AND 107).

LINDA POWELL, EXAMINING ATTORNEY

SN 78-230,871. ROGER GREEN & ASSOCIATES, INC., WASHINGTON CROSSING, PA. FILED 3-27-2003.

DPS

CLASS 35—ADVERTISING AND BUSINESS

FOR MEDICAL, SCIENTIFIC, AND PHARMACEUTICAL PRODUCT MARKETING RESEARCH AND MARKETING RESEARCH METHODOLOGIES; CONDUCTING MARKETING RESEARCH STUDIES FOR OTHERS (U.S. CLS. 100, 101 AND 102).

CLASS 42—SCIENTIFIC, COMPUTER AND LEGAL SERVICES

FOR TECHNICAL CONSULTATION IN THE FIELDS OF MEDICINE, PHARMACEUTICALS, AND BIOTECHNOLOGY (U.S. CLS. 100 AND 101).

M. E. BODSON, EXAMINING ATTORNEY

SN 78-231,221. AIR2, LLC, CORAL GABLES, FL. FILED 3-28-2003.

AIR2

CLASS 37—CONSTRUCTION AND REPAIR

FOR AIRBORNE AND GROUND BASED CONSTRUCTION, MAINTENANCE, REPAIR AND REFURBISHMENT OF ELECTRIC POWER TRANSMISSION LINES AND ASSOCIATED STRUCTURES AND PARTS THEREOF, NAMELY— INSTALLATION, MAINTENANCE, CLEANING, POWER WASHING, REPAIR AND REPLACEMENT (CHANGEOUTS), ON POWER TRANSMISSION LINES AND THEIR POWER CONDUCTORS, SHIELD WIRES, SUPPORT STRUCTURES AND ASSOCIATED PARTS, AERIAL LINE MARKERS, INSULATOR STRINGS, INSULATOR CONTAMINATION SHIELDING, BIRD DISCOURAGES, SPACERS, VIBRATION DAMPERS, CROSSARMS AND COMPONENTS THEREOF (U.S. CLS. 100, 103 AND 106).

FIRST USE 3-31-1999; IN COMMERCE 3-31-1999.

CLASS 42—SCIENTIFIC, COMPUTER AND LEGAL SERVICES

FOR POWER TRANSMISSION LINE AND POWER TRANSMISSION LINE SUPPORT STRUCTURE INSPECTIONS AND ASSESSMENTS, ASSET MAPPING AND COMPONENT ASSESSMENT, USING AIRBORNE AND GROUND BASED VEHICLES, FOR DEFINING TRANSMISSION LINE COMPONENTS AND STRUCTURES AND THEIR CHARACTER, CONDITION AND LOCATION, AND REPORTING RESULTS THEREOF (U.S. CLS. 100 AND 101).

FIRST USE 8-31-1999; IN COMMERCE 8-31-1999. STEVEN BERK, EXAMINING ATTORNEY

SN 78-231,903. RICHELL U.S.A., INC., GRAND PRAIRIE, TX.
FILED 3-31-2003.



NO CLAIM IS MADE TO THE EXCLUSIVE RIGHT TO USE STORAGE SYSTEM, APART FROM THE MARK AS SHOWN.

CLASS 20—FURNITURE AND ARTICLES NOT OTHERWISE CLASSIFIED

FOR NON-METAL STORAGE UNITS WITH OR WITHOUT WHEELS; NON-METAL STORAGE DRAWERS; NON-METAL STORAGE CABINETS; DRAWER SYSTEMS CONSISTING OF WOOD FRAMES AND PLASTIC DRAWERS; DRAWER SYSTEMS CONSISTING OF NON-METAL FRAMES AND DRAWERS; PLASTIC LAUNDRY HAMPERS; NON-METAL STORAGE CABINETS FOR HOUSEHOLD AND KITCHEN USE (U.S. CLS. 2, 13, 22, 25, 32 AND 50).

CLASS 21—HOUSEWARES AND GLASS

FOR PORTABLE PLASTIC CONTAINERS FOR HOUSEHOLD AND KITCHEN USE (U.S. CLS. 2, 13, 23, 29, 30, 33, 40 AND 50).
TARAH HARDY, EXAMINING ATTORNEY

SN 78-232,123. OMNITURE, INC., OREM, UT. FILED 3-31-2003.

OMNITURE

CLASS 9—ELECTRICAL AND SCIENTIFIC APPARATUS

FOR COMPUTER SOFTWARE FOR MANAGING, COLLECTING, AND SHARING A WIDE VARIETY OF DATA AND INFORMATION; WEB SITE DEVELOPMENT SOFTWARE; COMPUTER SOFTWARE FOR TRACKING WEB SITE ACTIVITY AND MANAGING, MONITORING AND OPTIMIZING THE PERFORMANCE AND EFFECTIVENESS OF WEBSITES AND ONLINE MARKETING CAMPAIGNS; COMPUTER SOFTWARE FOR WEB SITE DIAGNOSTIC ANALYSIS (U.S. CLS. 21, 23, 26, 36 AND 38).

CLASS 35—ADVERTISING AND BUSINESS

FOR MARKET RESEARCH; CONDUCTING ONLINE MARKET RESEARCH SURVEYS RELATING TO CUSTOMER AND EMPLOYEE SATISFACTION AND ATTITUDE, AND ORGANIZATIONAL CLIMATE OR EFFECTIVENESS; PREPARING BUSINESS REPORTS ELECTRONICALLY RELATING TO CUSTOMER AND EMPLOYEE SATISFACTION AND ATTITUDE, ORGANIZATIONAL CLIMATE OR EFFECTIVENESS, AND THE USE OF WEB SITES; COLLECTION, REPORTING, ANALYSIS AND INTEGRATION OF DATA RELATED TO THE USE OF WEBSITES AND THE EFFECTIVENESS OF MARKETING CAMPAIGNS; COMPUTERIZED DATABASE MANAGEMENT; LICENSING OF COMPUTER SOFTWARE (U.S. CLS. 100, 101 AND 102).

CLASS 41—EDUCATION AND ENTERTAINMENT

FOR EDUCATIONAL SERVICES, NAMELY, CONDUCTING CLASSES REGARDING THE DESIGN, IMPLEMENTATION, USABILITY, FUNCTIONING AND OPTIMIZATION OF WEB SITES AND ONLINE MARKETING CAMPAIGNS (U.S. CLS. 100, 101 AND 107).

CLASS 42—SCIENTIFIC, COMPUTER AND LEGAL SERVICES

FOR COMPUTER SERVICES, NAMELY, DESIGNING AND IMPLEMENTING WEB SITES FOR OTHERS, AND CONSULTATION SERVICES RELATED THERETO; COMPUTER AND WEBSITE DIAGNOSTIC SERVICES; TRACKING, ANALYZING, EVALUATING AND ADVISING OTHERS REGARDING WEBSITE DESIGN, IMPLEMENTATION, USABILITY, FUNCTIONING, PERFORMANCE, AND OPTIMIZATION; PERFORMANCE MONITORING SERVICES, WEBSITE DIAGNOSTIC SERVICES; MANAGING AND OPTIMIZING WEBSITE PERFORMANCE; PROVIDING SEARCH ENGINES FOR OBTAINING DATA ON THE INTERNET; TECHNICAL SUPPORT, NAMELY, MONITORING NETWORK SYSTEMS (U.S. CLS. 100 AND 101).
H. M. FISHER, EXAMINING ATTORNEY

SN 78-232,128. OMNITURE, INC., OREM, UT. FILED 3-31-2003.

SITECATALYST

CLASS 9—ELECTRICAL AND SCIENTIFIC APPARATUS

FOR COMPUTER SOFTWARE FOR MANAGING, COLLECTING, AND SHARING A WIDE VARIETY OF DATA AND INFORMATION; WEB SITE DEVELOPMENT SOFTWARE; COMPUTER SOFTWARE FOR TRACKING WEB SITE ACTIVITY AND MANAGING, MONITORING AND OPTIMIZING THE PERFORMANCE AND EFFECTIVENESS OF WEBSITES AND ONLINE MARKETING CAMPAIGNS; COMPUTER SOFTWARE FOR WEB SITE DIAGNOSTIC ANALYSIS (U.S. CLS. 21, 23, 26, 36 AND 38).

CLASS 35—ADVERTISING AND BUSINESS

FOR MARKET RESEARCH; CONDUCTING ONLINE MARKET RESEARCH SURVEYS RELATING TO CUSTOMER AND EMPLOYEE SATISFACTION AND ATTITUDE, AND ORGANIZATIONAL CLIMATE OR EFFECTIVENESS; PREPARING BUSINESS REPORTS ELECTRONICALLY RELATING TO CUSTOMER AND EMPLOYEE SATISFACTION AND ATTITUDE, ORGANIZATIONAL CLIMATE OR EFFECTIVENESS, AND THE USE OF WEB SITES; COLLECTION, REPORTING, ANALYSIS AND INTEGRATION OF DATA RELATED TO THE USE OF WEBSITES AND THE EFFECTIVENESS OF MARKETING CAMPAIGNS; COMPUTERIZED DATABASE MANAGEMENT; LICENSING OF COMPUTER SOFTWARE (U.S. CLS. 100, 101 AND 102).

CLASS 41—EDUCATION AND ENTERTAINMENT

FOR EDUCATIONAL SERVICES, NAMELY, CONDUCTING CLASSES REGARDING THE DESIGN, IMPLEMENTATION, USABILITY, FUNCTIONING AND OPTIMIZATION OF WEB SITES AND ONLINE MARKETING CAMPAIGNS (U.S. CLS. 100, 101 AND 107).

CLASS 42—SCIENTIFIC, COMPUTER AND LEGAL SERVICES

FOR COMPUTER SERVICES, NAMELY, DESIGNING AND IMPLEMENTING WEB SITES FOR OTHERS, AND CONSULTATION SERVICES RELATED THERETO; COMPUTER AND WEBSITE DIAGNOSTIC SERVICES; TRACKING, ANALYZING, EVALUATING AND ADVISING OTHERS REGARDING WEBSITE DESIGN, IMPLEMENTATION, USABILITY, FUNCTIONING, PERFORMANCE, AND OPTIMIZATION; PERFORMANCE MONITORING SERVICES, WEBSITE DIAGNOSTIC SERVICES; MANAGING AND OPTIMIZING WEBSITE PERFORMANCE AND THE EFFECTIVENESS OF ONLINE MARKETING CAMPAIGNS; PROVIDING SEARCH ENGINES FOR OBTAINING DATA ON THE INTERNET; TECHNICAL SUPPORT, NAMELY, MONITORING NETWORK SYSTEMS (U.S. CLS. 100 AND 101).
WANDA KAY PRICE, EXAMINING ATTORNEY

SN 78-233,560. CORT DIRECTIONS, INC., BEND, OR. FILED 4-3-2003.

CORT DIRECTIONS**CLASS 9—ELECTRICAL AND SCIENTIFIC APPARATUS**

FOR COMPUTER SOFTWARE FOR THE USE IN CAPTURING AND PROCESSING INFORMATION IN THE FIELDS OF TIME MANAGEMENT, PAYROLL, TAX REPORTING, HIRING, BENEFITS MANAGEMENT, TRAINING, AND HUMAN RESOURCES MANAGEMENT (U.S. CLS. 21, 23, 26, 36 AND 38).

FIRST USE 0-0-1989; IN COMMERCE 0-0-1989.

CLASS 35—ADVERTISING AND BUSINESS

FOR BUSINESS MANAGEMENT CONSULTING REGARDING TIME MANAGEMENT PAYROLL, TAX REPORTING, HIRING, BENEFITS MANAGEMENT, TRAINING AND HUMAN RESOURCES MANAGEMENT (U.S. CLS. 100, 101 AND 102).

FIRST USE 0-0-1989; IN COMMERCE 0-0-1989.

CLASS 41—EDUCATION AND ENTERTAINMENT

FOR PROVIDING TRAINING REGARDING PAYROLL SOFTWARE AND TIME MANAGEMENT, PAYROLL, TAX REPORTING, HIRING, BENEFITS MANAGEMENT, EMPLOYEE TRAINING, AND HUMAN RESOURCES MANAGEMENT (U.S. CLS. 100, 101 AND 107).

FIRST USE 0-0-1989; IN COMMERCE 0-0-1989.

CLASS 42—SCIENTIFIC, COMPUTER AND LEGAL SERVICES

FOR CUSTOMIZATION OF COMPUTER SOFTWARE AND COMPUTER PROJECT MANAGEMENT SERVICES, BOTH REGARDING TIME MANAGEMENT, PAYROLL, TAX REPORTING, HIRING, BENEFITS MANAGEMENT, TRAINING AND HUMAN RESOURCES MANAGEMENT (U.S. CLS. 100 AND 101).

FIRST USE 0-0-1989; IN COMMERCE 0-0-1989.

VERNA BETH RIRIE, EXAMINING ATTORNEY

SN 78-232,333. LEAN BODY NUTRITION INC, SOLANA BEACH, CA. FILED 4-1-2003.

GRID**CLASS 5—PHARMACEUTICALS**

FOR (BASED ON USE IN COMMERCE) FOOD SUPPLEMENTS (U.S. CLS. 6, 18, 44, 46, 51 AND 52).

FIRST USE 6-1-2001; IN COMMERCE 8-8-2001.

CLASS 29—MEATS AND PROCESSED FOODS

FOR (BASED ON INTENT TO USE) READY-TO-EAT-PROTEIN BASED FOOD BARS (U.S. CL. 46).

CLASS 44—MEDICAL, BEAUTY AND AGRICULTURAL SERVICES

FOR (BASED ON USE IN COMMERCE) DIETARY COUNSELING, NAMELY, WEIGHT REDUCTION DIET PLANNING AND SUPERVISION (U.S. CLS. 100 AND 101).

FIRST USE 6-1-2001; IN COMMERCE 8-1-2001.

ALLISON HOLTZ, EXAMINING ATTORNEY

SN 78-232,889. PRIMEDIA WORKPLACE LEARNING, INC., CARROLLTON, TX. FILED 4-2-2003.

HOMELAND ONE

NO CLAIM IS MADE TO THE EXCLUSIVE RIGHT TO USE "HOMELAND", APART FROM THE MARK AS SHOWN.

CLASS 9—ELECTRICAL AND SCIENTIFIC APPARATUS

FOR VIDEOS AND CD ROMS CONTAINING INFORMATION FOR FIRST RESPONDERS (U.S. CLS. 21, 23, 26, 36 AND 38).

FIRST USE 7-4-2003; IN COMMERCE 7-4-2003.

CLASS 41—EDUCATION AND ENTERTAINMENT

FOR PROVIDING SEMINARS AND ONLINE TRAINING FOR FIRST RESPONDERS (U.S. CLS. 100, 101 AND 107).

FIRST USE 7-1-2003; IN COMMERCE 7-1-2003.

JANICE L. MCMORROW, EXAMINING ATTORNEY

SN 78-233,577. HOWMEDICA OSTEONICS CORP., ALLENDALE, NJ. FILED 4-3-2003.

BPX BUSINESS PROCESS EXCELLENCE

NO CLAIM IS MADE TO THE EXCLUSIVE RIGHT TO USE "BUSINESS PROCESS", APART FROM THE MARK AS SHOWN.

CLASS 35—ADVERTISING AND BUSINESS

FOR BUSINESS AND ADVERTISING SERVICES, NAMELY, BUSINESS MANAGEMENT SERVICES. (U.S. CLS. 100, 101 AND 102).

CLASS 41—EDUCATION AND ENTERTAINMENT

FOR EDUCATIONAL SERVICES, NAMELY, PROVIDING COURSES OR SEMINARS AND COURSE MATERIALS THEREFOR IN THE FIELD OF BUSINESS MANAGEMENT AND BUSINESS PRACTICE TECHNIQUES. (U.S. CLS. 100, 101 AND 107).

REBECCA SMITH, EXAMINING ATTORNEY

SN 78-233,976. LML PAYMENT SYSTEMS CORP., DALLAS, TX. FILED 4-4-2003.

LASR

CLASS 36—INSURANCE AND FINANCIAL

FOR CHECK VERIFICATION, CREDIT RECOVERY AND COLLECTION SERVICES; CHECK AUTHORIZATION SERVICES; ONLINE, REAL-TIME CHECK AUTHORIZATION SERVICES; CHECK ACCEPTANCE SERVICES; CHECK GUARANTEE SERVICES; PAYMENT PROCESSING, NAMELY, ELECTRONIC PROCESSING OF CHECK, CREDIT CARD AND DEBIT CARD PAYMENT TRANSACTIONS, AUTOMATIC PAYMENT DEDUCTION SERVICES FOR CUSTOMERS AND ONLINE, REAL-TIME DEBIT OF FUNDS FROM PAYOR'S ACCOUNT AND DEPOSIT TO PAYEE'S ACCOUNT; FINANCIAL RISK MANAGEMENT SERVICES; PROCESSING RECURRENT PAYMENTS AND AUTOMATICALLY DEDUCTING SUCH PAYMENTS FROM BANK ACCOUNTS FOR CUSTOMERS; CHECK CHARGE SERVICES BY TELEPHONE AND OVER THE INTERNET, NAMELY, ELECTRONIC AND TELEPHONIC ACCEPTANCE, AUTHORIZATION AND PROCESSING OF CHECK TRANSACTIONS AND ELECTRONIC CHECK CONVERSION RENDERED TO RETAIL ESTABLISHMENTS AT THE POINT OF SALE OR POINT OF PURCHASE, WHOLESALERS, THIRD PARTY PROVIDERS OF CHECK AUTHORIZATION AND LOCKBOX AND BILL REMITTANCE PROVIDERS; AND FINANCIAL TRANSACTION PROCESSING SERVICES, NAMELY, ELECTRONIC FUNDS TRANSFER, ELECTRONIC BENEFITS TRANSFER, PROCESSING EMPLOYEE DISCOUNT AND LOYALTY PROGRAM TRANSACTIONS FOR OTHERS; COLLECTION AGENCY SERVICES; ELECTRONIC CHECK RE-PRESENTMENT SERVICES, NAMELY, ELECTRONIC RE-SUBMISSION TO FINANCIAL INSTITUTION ON WHICH CHECK HAS BEEN DRAWN FOR PAYMENT OF A CHECK WHICH PREVIOUSLY HAS BEEN DISHONORED DUE TO INSUFFICIENT FUNDS IN PAYOR'S ACCOUNT; AND ELECTRONIC CHECK PROCESSING SERVICES OVER THE INTERNET (U.S. CLS. 100, 101 AND 102).

CLASS 45—PERSONAL SERVICES

FOR FRAUD CONTROL SERVICES IN THE NATURE OF CORRECTING BANK INFORMATION ON CHECKS PRESENTED FOR PAYMENT; AND RELATED FRAUD SCREENING SERVICES, NAMELY, VERIFICATION OF PAYMENT REQUESTS AND FUNDS SUFFICIENCY, AND FRAUD AND RISK MANAGEMENT SERVICES, NAMELY POINT OF SALE OR POINT OF PURCHASE, INTERNET -BASED AND TELEPHONIC DETECTION OF CHECK FRAUD AND INFORMATION COMPARISON AND IDENTITY MANIPULATION SEARCHING (U.S. CLS. 100 AND 101).

MITCHELL FRONT, EXAMINING ATTORNEY

CLASS 36—INSURANCE AND FINANCIAL

FOR CHECK VERIFICATION, CREDIT RECOVERY AND COLLECTION SERVICES; CHECK AUTHORIZATION SERVICES; ONLINE, REAL-TIME CHECK AUTHORIZATION SERVICES; CHECK ACCEPTANCE SERVICES; CHECK GUARANTEE SERVICES; PAYMENT PROCESSING, NAMELY, ELECTRONIC PROCESSING OF CHECK, CREDIT CARD AND DEBIT CARD PAYMENT TRANSACTIONS, AUTOMATIC PAYMENT DEDUCTION SERVICES FOR CUSTOMERS AND ONLINE, REAL-TIME DEBIT OF FUNDS FROM PAYOR'S ACCOUNT AND DEPOSIT TO PAYEE'S ACCOUNT; FINANCIAL RISK MANAGEMENT SERVICES; PROCESSING RECURRENT PAYMENTS AND AUTOMATICALLY DEDUCTING SUCH PAYMENTS FROM BANK ACCOUNTS FOR CUSTOMERS; CHECK CHARGE SERVICES BY TELEPHONE AND OVER THE INTERNET, NAMELY, ELECTRONIC AND TELEPHONIC ACCEPTANCE, AUTHORIZATION AND PROCESSING OF CHECK TRANSACTIONS AND ELECTRONIC CHECK CONVERSION RENDERED TO RETAIL ESTABLISHMENTS AT THE POINT OF SALE OR POINT OF PURCHASE, WHOLESALERS, THIRD PARTY PROVIDERS OF CHECK AUTHORIZATION AND LOCKBOX AND BILL REMITTANCE PROVIDERS; AND FINANCIAL TRANSACTION PROCESSING SERVICES, NAMELY, ELECTRONIC FUNDS TRANSFER, ELECTRONIC BENEFITS TRANSFER, PROCESSING EMPLOYEE DISCOUNT AND LOYALTY PROGRAM TRANSACTIONS FOR OTHERS; COLLECTION AGENCY SERVICES; ELECTRONIC CHECK RE-PRESENTMENT SERVICES, NAMELY, ELECTRONIC RE-SUBMISSION TO FINANCIAL INSTITUTION ON WHICH CHECK HAS BEEN DRAWN FOR PAYMENT OF A CHECK WHICH PREVIOUSLY HAS BEEN DISHONORED DUE TO INSUFFICIENT FUNDS IN PAYOR'S ACCOUNT; AND ELECTRONIC CHECK PROCESSING SERVICES OVER THE INTERNET (U.S. CLS. 100, 101 AND 102).

CLASS 45—PERSONAL SERVICES

FOR FRAUD CONTROL SERVICES IN THE NATURE OF CORRECTING BANK INFORMATION ON CHECKS PRESENTED FOR PAYMENT; AND RELATED FRAUD SCREENING SERVICES, NAMELY, VERIFICATION OF PAYMENT REQUESTS AND FUNDS SUFFICIENCY, AND FRAUD AND RISK MANAGEMENT SERVICES, NAMELY POINT OF SALE OR POINT OF PURCHASE, INTERNET -BASED AND TELEPHONIC DETECTION OF CHECK FRAUD AND INFORMATION COMPARISON AND IDENTITY MANIPULATION SEARCHING (U.S. CLS. 100 AND 101).

MITCHELL FRONT, EXAMINING ATTORNEY

SN 78-233,988. LML PAYMENT SYSTEMS CORP., DALLAS, TX. FILED 4-4-2003.

LASR LIVE AUTHORIZATION SETTLEMENT RECOVERY

NO CLAIM IS MADE TO THE EXCLUSIVE RIGHT TO USE LIVE AUTHORIZATION SETTLEMENT RECOVERY, APART FROM THE MARK AS SHOWN.

SN 78-233,995. LML PAYMENT SYSTEMS CORP., DALLAS, TX. FILED 4-4-2003.

LASR DATA

NO CLAIM IS MADE TO THE EXCLUSIVE RIGHT TO USE DATA, APART FROM THE MARK AS SHOWN.

CLASS 36—INSURANCE AND FINANCIAL

FOR CHECK VERIFICATION, CREDIT RECOVERY AND COLLECTION SERVICES; CHECK AUTHORIZATION SERVICES; ONLINE, REAL-TIME CHECK AUTHORIZATION SERVICES; CHECK ACCEPTANCE SERVICES; CHECK GUARANTEE SERVICES; PAYMENT PROCESSING, NAMELY, ELECTRONIC PROCESSING OF CHECK, CREDIT CARD AND DEBIT CARD PAYMENT TRANSACTIONS, AUTOMATIC PAYMENT DEDUCTION SERVICES FOR CUSTOMERS AND ONLINE, REAL-TIME DEBIT OF FUNDS FROM PAYOR'S ACCOUNT AND DEPOSIT TO PAYEE'S ACCOUNT; FINANCIAL RISK MANAGEMENT SERVICES; PROCESSING RECURRENT PAYMENTS AND AUTOMATICALLY DEDUCTING SUCH PAYMENTS FROM BANK ACCOUNTS FOR CUSTOMERS; CHECK CHARGE SERVICES BY TELEPHONE AND OVER THE INTERNET, NAMELY, ELECTRONIC AND TELEPHONIC ACCEPTANCE, AUTHORIZATION AND PROCESSING OF CHECK TRANSACTIONS AND ELECTRONIC CHECK CONVERSION RENDERED TO RETAIL ESTABLISHMENTS AT THE POINT OF SALE OR POINT OF PURCHASE, WHOLESALERS, THIRD PARTY PROVIDERS OF CHECK AUTHORIZATION AND LOCKBOX AND BILL REMITTANCE PROVIDERS; AND FINANCIAL TRANSACTION PROCESSING SERVICES, NAMELY, ELECTRONIC FUNDS TRANSFER, ELECTRONIC BENEFITS TRANSFER, PROCESSING EMPLOYEE DISCOUNT AND LOYALTY PROGRAM TRANSACTIONS FOR OTHERS; COLLECTION AGENCY SERVICES; ELECTRONIC CHECK REPRESENTMENT SERVICES, NAMELY, ELECTRONIC RESUBMISSION TO FINANCIAL INSTITUTION ON WHICH CHECK HAS BEEN DRAWN FOR PAYMENT OF A CHECK WHICH PREVIOUSLY HAS BEEN DISHONORED DUE TO INSUFFICIENT FUNDS IN PAYOR'S ACCOUNT; AND ELECTRONIC CHECK PROCESSING SERVICES OVER THE INTERNET (U.S. CLS. 100, 101 AND 102).

CLASS 45—PERSONAL SERVICES

FOR FRAUD CONTROL SERVICES IN THE NATURE OF CORRECTING BANK INFORMATION ON CHECKS PRESENTED FOR PAYMENT; AND RELATED FRAUD SCREENING SERVICES, NAMELY, VERIFICATION OF PAYMENT REQUESTS AND FUNDS SUFFICIENCY, AND FRAUD AND RISK MANAGEMENT SERVICES, NAMELY POINT OF SALE OR POINT OF PURCHASE, INTERNET -BASED AND TELEPHONIC DETECTION OF CHECK FRAUD AND INFORMATION COMPARISON AND IDENTITY MANIPULATION SEARCHING (U.S. CLS. 100 AND 101).
MITCHELL FRONT, EXAMINING ATTORNEY

CLASS 36—INSURANCE AND FINANCIAL

FOR CHECK VERIFICATION, CREDIT RECOVERY AND COLLECTION SERVICES; CHECK AUTHORIZATION SERVICES; ONLINE, REAL-TIME CHECK AUTHORIZATION SERVICES; CHECK ACCEPTANCE SERVICES; CHECK GUARANTEE SERVICES; PAYMENT PROCESSING, NAMELY, ELECTRONIC PROCESSING OF CHECK, CREDIT CARD AND DEBIT CARD PAYMENT TRANSACTIONS, AUTOMATIC PAYMENT DEDUCTION SERVICES FOR CUSTOMERS AND ONLINE, REAL-TIME DEBIT OF FUNDS FROM PAYOR'S ACCOUNT AND DEPOSIT TO PAYEE'S ACCOUNT; FINANCIAL RISK MANAGEMENT SERVICES; PROCESSING RECURRENT PAYMENTS AND AUTOMATICALLY DEDUCTING SUCH PAYMENTS FROM BANK ACCOUNTS FOR CUSTOMERS; CHECK CHARGE SERVICES BY TELEPHONE AND OVER THE INTERNET, NAMELY, ELECTRONIC AND TELEPHONIC ACCEPTANCE, AUTHORIZATION AND PROCESSING OF CHECK TRANSACTIONS AND ELECTRONIC CHECK CONVERSION RENDERED TO RETAIL ESTABLISHMENTS AT THE POINT OF SALE OR POINT OF PURCHASE, WHOLESALERS, THIRD PARTY PROVIDERS OF CHECK AUTHORIZATION AND LOCKBOX AND BILL REMITTANCE PROVIDERS; AND FINANCIAL TRANSACTION PROCESSING SERVICES, NAMELY, ELECTRONIC FUNDS TRANSFER, ELECTRONIC BENEFITS TRANSFER, PROCESSING EMPLOYEE DISCOUNT AND LOYALTY PROGRAM TRANSACTIONS FOR OTHERS; COLLECTION AGENCY SERVICES; ELECTRONIC CHECK REPRESENTMENT SERVICES, NAMELY, ELECTRONIC RESUBMISSION TO FINANCIAL INSTITUTION ON WHICH CHECK HAS BEEN DRAWN FOR PAYMENT OF A CHECK WHICH PREVIOUSLY HAS BEEN DISHONORED DUE TO INSUFFICIENT FUNDS IN PAYOR'S ACCOUNT; AND ELECTRONIC CHECK PROCESSING SERVICES OVER THE INTERNET (U.S. CLS. 100, 101 AND 102).

CLASS 45—PERSONAL SERVICES

FOR FRAUD CONTROL SERVICES IN THE NATURE OF CORRECTING BANK INFORMATION ON CHECKS PRESENTED FOR PAYMENT; AND RELATED FRAUD SCREENING SERVICES, NAMELY, VERIFICATION OF PAYMENT REQUESTS AND FUNDS SUFFICIENCY, AND FRAUD AND RISK MANAGEMENT SERVICES, NAMELY POINT OF SALE OR POINT OF PURCHASE, INTERNET -BASED AND TELEPHONIC DETECTION OF CHECK FRAUD AND INFORMATION COMPARISON AND IDENTITY MANIPULATION SEARCHING (U.S. CLS. 100 AND 101).
MITCHELL FRONT, EXAMINING ATTORNEY

SN 78-233,999. LML PAYMENT SYSTEMS CORP., DALLAS, TX. FILED 4-4-2003.

SN 78-234,012. LML PAYMENT SYSTEMS CORP., DALLAS, TX. FILED 4-4-2003.

LASR DIRECT

LASR DEBIT

NO CLAIM IS MADE TO THE EXCLUSIVE RIGHT TO USE DIRECT, APART FROM THE MARK AS SHOWN.

NO CLAIM IS MADE TO THE EXCLUSIVE RIGHT TO USE DEBIT, APART FROM THE MARK AS SHOWN.

CLASS 36—INSURANCE AND FINANCIAL

FOR CHECK VERIFICATION, CREDIT RECOVERY AND COLLECTION SERVICES; CHECK AUTHORIZATION SERVICES; ONLINE, REAL-TIME CHECK AUTHORIZATION SERVICES; CHECK ACCEPTANCE SERVICES; CHECK GUARANTEE SERVICES; PAYMENT PROCESSING, NAMELY, ELECTRONIC PROCESSING OF CHECK, CREDIT CARD AND DEBIT CARD PAYMENT TRANSACTIONS, AUTOMATIC PAYMENT DEDUCTION SERVICES FOR CUSTOMERS AND ONLINE, REAL-TIME DEBIT OF FUNDS FROM PAYOR'S ACCOUNT AND DEPOSIT TO PAYEE'S ACCOUNT; FINANCIAL RISK MANAGEMENT SERVICES; PROCESSING RECURRENT PAYMENTS AND AUTOMATICALLY DEDUCTING SUCH PAYMENTS FROM BANK ACCOUNTS FOR CUSTOMERS; CHECK CHARGE SERVICES BY TELEPHONE AND OVER THE INTERNET, NAMELY, ELECTRONIC AND TELEPHONIC ACCEPTANCE, AUTHORIZATION AND PROCESSING OF CHECK TRANSACTIONS AND ELECTRONIC CHECK CONVERSION RENDERED TO RETAIL ESTABLISHMENTS AT THE POINT OF SALE OR POINT OF PURCHASE, WHOLESALERS, THIRD PARTY PROVIDERS OF CHECK AUTHORIZATION AND LOCKBOX AND BILL REMITTANCE PROVIDERS; AND FINANCIAL TRANSACTION PROCESSING SERVICES, NAMELY, ELECTRONIC FUNDS TRANSFER, ELECTRONIC BENEFITS TRANSFER, PROCESSING EMPLOYEE DISCOUNT AND LOYALTY PROGRAM TRANSACTIONS FOR OTHERS; COLLECTION AGENCY SERVICES; ELECTRONIC CHECK REPRESENTMENT SERVICES, NAMELY, ELECTRONIC RESUBMISSION TO FINANCIAL INSTITUTION ON WHICH CHECK HAS BEEN DRAWN FOR PAYMENT OF A CHECK WHICH PREVIOUSLY HAS BEEN DISHONORED DUE TO INSUFFICIENT FUNDS IN PAYOR'S ACCOUNT; AND ELECTRONIC CHECK PROCESSING SERVICES OVER THE INTERNET (U.S. CLS. 100, 101 AND 102).

CLASS 45—PERSONAL SERVICES

FOR FRAUD CONTROL SERVICES IN THE NATURE OF CORRECTING BANK INFORMATION ON CHECKS PRESENTED FOR PAYMENT; AND RELATED FRAUD SCREENING SERVICES, NAMELY, VERIFICATION OF PAYMENT REQUESTS AND FUNDS SUFFICIENCY, AND FRAUD AND RISK MANAGEMENT SERVICES, NAMELY POINT OF SALE OR POINT OF PURCHASE, INTERNET -BASED AND TELEPHONIC DETECTION OF CHECK FRAUD AND INFORMATION COMPARISON AND IDENTITY MANIPULATION SEARCHING (U.S. CLS. 100 AND 101).

MITCHELL FRONT, EXAMINING ATTORNEY

SN 78-234,176. INTERSTATE GOURMET COFFEE ROASTERS, INC., SOUTH EASTON, MA. FILED 4-4-2003.

BOSTON'S BEST

OWNER OF U.S. REG. NOS. 2,271,387, 2,560,777 AND OTHERS.
SEC. 2(F).

CLASS 16—PAPER GOODS AND PRINTED MATTER

FOR PAPER BAGS (U.S. CLS. 2, 5, 22, 23, 29, 37, 38 AND 50).
FIRST USE 0-0-1995; IN COMMERCE 0-0-1995.

CLASS 21—HOUSEWARES AND GLASS

FOR PAPER CUPS (U.S. CLS. 2, 13, 23, 29, 30, 33, 40 AND 50).
FIRST USE 0-0-1995; IN COMMERCE 0-0-1995.

CLASS 30—STAPLE FOODS

FOR COFFEE, TEA, COCOA, SUGAR AND CAPUCCINO MIX (U.S. CL. 46).
FIRST USE 0-0-1995; IN COMMERCE 0-0-1995.
GEORGIA CARTY, EXAMINING ATTORNEY

SN 78-234,510. MARMANIDIS, KERRY, NORWOOD, MA. FILED 4-7-2003.

FOREVER FRENCH**CLASS 3—COSMETICS AND CLEANING PREPARATIONS**

FOR LIQUID AND POWDER ARTIFICIAL NAIL CARE PREPARATIONS (U.S. CLS. 1, 4, 6, 50, 51 AND 52).

CLASS 44—MEDICAL, BEAUTY AND AGRICULTURAL SERVICES

FOR SALON SERVICES, NAMELY, MANICURING (U.S. CLS. 100 AND 101).
THEODORE MCBRIDE, EXAMINING ATTORNEY

SN 78-234,632. INSTANT COMMA, INC., SAN FRANCISCO, CA. FILED 4-7-2003.

THE MAGAZINE OF MODERN EATING

NO CLAIM IS MADE TO THE EXCLUSIVE RIGHT TO USE "THE MAGAZINE OF" AND "EATING", APART FROM THE MARK AS SHOWN.

CLASS 16—PAPER GOODS AND PRINTED MATTER

FOR PRINTED MATTER AND PRINTED PUBLICATIONS, NAMELY MAGAZINES, NEWSLETTERS, CATALOGUES AND BOOKS IN THE FIELDS OF FOOD, WINE, DINING, COOKING, GASTRONOMY, LIFESTYLE AND TRAVEL (U.S. CLS. 2, 5, 22, 23, 29, 37, 38 AND 50).

CLASS 41—EDUCATION AND ENTERTAINMENT

FOR ONLINE PUBLICATION OF MAGAZINES, NEWSLETTERS, CATALOGUES AND BOOKS IN THE FIELDS OF FOOD, WINE, DINING, COOKING, GASTRONOMY, LIFESTYLE AND TRAVEL (U.S. CLS. 100, 101 AND 107).

ALLISON HOLTZ, EXAMINING ATTORNEY

SN 78-234,642. ATRIUM MEDICAL CORPORATION, HUDSON, NH. FILED 4-7-2003.

DRUGLINER**CLASS 2—PAINTS**

FOR THERAPEUTIC ELUTING SURFACE COATING USED ON MEDICAL DEVICES (U.S. CLS. 6, 11 AND 16).

CLASS 10—MEDICAL APPARATUS

FOR MEDICAL DEVICES, NAMELY, THERAPEUTIC ELUTING SURFACE COATING USED ON MEDICAL DEVICES, MEDICATED INKS, MEDICATED INK MARKINGS, MARKING DEVICES, PRINTERS, PADS, APPLICATORS AND CARTRIDGES (U.S. CLS. 26, 39 AND 44).

KARLA PERKINS, EXAMINING ATTORNEY

SN 78-234,968. ARC RISK MANAGEMENT, LOND, UNITED KINGDOM, FILED 4-8-2003.



SN 78-234,688. ALL ARC ENTERPRISES INCORPORATED, MIAMI, FL. FILED 4-7-2003.

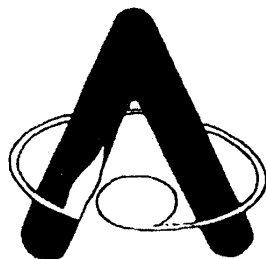

THE MARK CONSISTS OF AN UPSIDE-DOWN "V" WITH A GOLD MUSICAL NOTE WRAPPED AROUND THE MIDDLE OF THE "V" TO CREATE THE LETTER "A".

CLASS 9—ELECTRICAL AND SCIENTIFIC APPARATUS

FOR PRE-RECORDED COMPACT DISCS AND PHONOGRAPH RECORDS FEATURING MUSIC (U.S. CLS. 21, 23, 26, 36 AND 38).

FIRST USE 5-1-2001; IN COMMERCE 8-1-2001.

CLASS 35—ADVERTISING AND BUSINESS

FOR MANAGEMENT OF PERFORMING ARTISTS; DISTRIBUTORSHIP SERVICES FEATURING COMPACT DISCS AND VINYL RECORDINGS (U.S. CLS. 100, 101 AND 102).

FIRST USE 5-1-2001; IN COMMERCE 8-1-2001.

CLASS 41—EDUCATION AND ENTERTAINMENT

FOR MUSIC PRODUCTION AND MUSIC PUBLISHING SERVICES (U.S. CLS. 100, 101 AND 107).

FIRST USE 5-1-2001; IN COMMERCE 8-1-2001.
BRETT J. GOLDEN, EXAMINING ATTORNEY

CLASS 35—ADVERTISING AND BUSINESS

FOR BUSINESS RESEARCH RELATING TO PHYSICAL SECURITY (U.S. CLS. 100, 101 AND 102).

CLASS 41—EDUCATION AND ENTERTAINMENT

FOR TRAINING SERVICES IN THE FIELD OF PHYSICAL SECURITY AND BODYGUARD PROTECTION; NEWS REPORTING SERVICES VIA AN INTERNET WEB SITE (U.S. CLS. 100, 101 AND 107).

CLASS 45—PERSONAL SERVICES

FOR CONSULTATION IN THE FIELD OF PHYSICAL SECURITY AND BODYGUARD PROTECTION; SECURITY CONSULTATION, NAMELY, SECURITY ASSESSMENT OF RISKS RELATING TO THE PHYSICAL PROTECTION OF PERSONS AND FACILITIES; BODYGUARD SERVICES; DETECTIVE AGENCIES; MONITORING OF COMPUTER SYSTEMS FOR SECURITY PURPOSES (U.S. CLS. 100 AND 101).

BRETT J. GOLDEN, EXAMINING ATTORNEY

SN 78-235,046. ILLINOIS TOOL WORKS INC., GLENVIEW, IL. FILED 4-8-2003.

STA'-PUT

CLASS 1—CHEMICALS

FOR MULTI-PURPOSE ADHESIVES FOR USE IN THE BUILDING AND CONSTRUCTION INDUSTRIES AND FOR USE IN THE MANUFACTURE OF MOBILE HOMES (U.S. CLS. 1, 5, 6, 10, 26 AND 46).

FIRST USE 8-25-1986; IN COMMERCE 8-25-1986.

CLASS 16—PAPER GOODS AND PRINTED MATTER

FOR ADHESIVES FOR HOUSEHOLD PURPOSES (U.S. CLS. 2, 5, 22, 23, 29, 37, 38 AND 50).

FIRST USE 8-25-1986; IN COMMERCE 8-25-1986.
ROBERT LORENZO, EXAMINING ATTORNEY

SN 78-235,053. TELEMOTIX, LLC, IRVINE, CA. FILED 4-8-2003.

TELEMOTIX

CLASS 9—ELECTRICAL AND SCIENTIFIC APPARATUS

FOR TELEMATICS AND GLOBAL POSITIONING SYSTEMS CONSISTING OF COMPUTERS, COMPUTER SOFTWARE, TRANSMITTERS, RECEIVERS, AND NETWORK INTERFACE DEVICES, AND NAVIGATION APPARATUS FOR ALL TYPES OF VEHICLES IN THE NATURE OF ON-BOARD COMPUTERS (U.S. CLS. 21, 23, 26, 36 AND 38).

CLASS 38—COMMUNICATION

FOR TELEMATIC SENDING OF INFORMATION (U.S. CLS. 100, 101 AND 104).
ROBERT LORENZO, EXAMINING ATTORNEY

SN 78-235,842. OBVIENT STRATEGIES, INC., MARIETTA, GA. FILED 4-9-2003.

OBVIENT

CLASS 9—ELECTRICAL AND SCIENTIFIC APPARATUS

FOR COMPUTER SOFTWARE FOR DATA WAREHOUSING AND DATA ANALYSIS FOR USE BY DISTRIBUTED ASSET INDUSTRIES (U.S. CLS. 21, 23, 26, 36 AND 38).

CLASS 42—SCIENTIFIC, COMPUTER AND LEGAL SERVICES

FOR CONSULTING SERVICES IN THE FIELD OF COMPUTER SOFTWARE (U.S. CLS. 100 AND 101).
DAWN FELDMAN, EXAMINING ATTORNEY

SN 78-235,898. ESET, SPOL. S.R.O., BRATISLAVA, SLOVAKIA, FILED 4-9-2003.

ESET

PRIORITY CLAIMED UNDER SEC. 44(D) ON SLOVAKIA APPLICATION NO. POZ2984200, FILED 10-18-2002, REG. NO. 202097, DATED 3-5-2003, EXPIRES 10-18-2012.

CLASS 9—ELECTRICAL AND SCIENTIFIC APPARATUS

FOR COMPUTER SOFTWARE FOR USE IN PROTECTING COMPUTER DATABASES, OPERATING PROGRAMS AND APPLICATION PROGRAMS AGAINST UNAUTHORIZED INFILTRATION AND CORRUPTION (U.S. CLS. 21, 23, 26, 36 AND 38).

CLASS 16—PAPER GOODS AND PRINTED MATTER

FOR PRINTED SOFTWARE USER GUIDE (U.S. CLS. 2, 5, 22, 23, 29, 37, 38 AND 50).

CLASS 42—SCIENTIFIC, COMPUTER AND LEGAL SERVICES

FOR COMPUTER SOFTWARE CONSULTATION SERVICES (U.S. CLS. 100 AND 101).
JUDITH GRUNDY, EXAMINING ATTORNEY

SN 78-236,099. UNITED ASSOCIATION OF JOURNEYMEN AND APPRENTICES OF THE PLUMBING AND PIPE FITTING INDUSTRY OF THE UNITED STATES AND CANADA, WASHINGTON, DC. FILED 4-10-2003.



OWNER OF U.S. REG. NO. 1,247,026.

CLASS 6—METAL GOODS

FOR METAL KEY RINGS (U.S. CLS. 2, 12, 13, 14, 23, 25 AND 50).
FIRST USE 8-6-2001; IN COMMERCE 8-6-2001.

CLASS 14—JEWELRY

FOR LAPEL PINS AND WATCHES (U.S. CLS. 2, 27, 28 AND 50).
FIRST USE 8-6-2001; IN COMMERCE 8-6-2001.

CLASS 16—PAPER GOODS AND PRINTED MATTER

FOR DECALS (U.S. CLS. 2, 5, 22, 23, 29, 37, 38 AND 50).
FIRST USE 8-6-2001; IN COMMERCE 8-6-2001.

CLASS 25—CLOTHING

FOR CLOTHING NAMELY T-SHIRTS, KNIT SHIRTS, JACKETS (U.S. CLS. 22 AND 39).
FIRST USE 8-6-2001; IN COMMERCE 8-6-2001.
WILLIAM VERHOSEK, EXAMINING ATTORNEY

SN 78-237,677. KIMBAL, ROSEMARY, CARDIFF-BY-THE-SEA, CA. FILED 4-14-2003.

DANCING BRUSH

OWNER OF U.S. REG. NO. 1,562,155.

CLASS 35—ADVERTISING AND BUSINESS

FOR RETAIL ART STORES (U.S. CLS. 100, 101 AND 102).
FIRST USE 12-1-1975; IN COMMERCE 12-1-1975.

CLASS 40—MATERIAL TREATMENT

FOR CERAMIC GLAZING (U.S. CLS. 100, 103 AND 106).
FIRST USE 2-5-1985; IN COMMERCE 2-5-1985.

CLASS 41—EDUCATION AND ENTERTAINMENT

FOR INSTRUCTION IN THE FIELD OF ART; DEMONSTRATIONS, WORKSHOPS AND SEMINARS IN THE FIELD OF ART (U.S. CLS. 100, 101 AND 107).
FIRST USE 8-10-1983; IN COMMERCE 8-10-1983.
THEODORE MCBRIDE, EXAMINING ATTORNEY

CLASS 16—PAPER GOODS AND PRINTED MATTER

FOR NEWSPAPERS, PERIODICALS, JOURNALS, AND BOOKS IN THE FIELDS OF PHARMACEUTICALS AND MEDICAL DEVELOPMENTS (U.S. CLS. 2, 5, 22, 23, 29, 37, 38 AND 50).

CLASS 36—INSURANCE AND FINANCIAL

FOR RENTAL OF TEMPORARY OFFICE SPACE AND LABORATORY SPACE (U.S. CLS. 100, 101 AND 102).

CLASS 38—COMMUNICATION

FOR ELECTRONIC DELIVERY OF TEXT, IMAGES AND PHOTOGRAPHS; PROVIDING ONLINE CHAT ROOMS FOR TRANSMISSION OF MESSAGES AMONG COMPUTER USERS IN THE FIELD OF PHARMACEUTICAL AND MEDICAL DEVELOPMENTS (U.S. CLS. 100, 101 AND 104).

SN 78-237,938. SANOFI-SYNTHELABO, PARIS, FRANCE, FILED 4-15-2003.

I ♥ SANOFI-SYNTHELABO

CLASS 41—EDUCATION AND ENTERTAINMENT

FOR ORGANIZATION OF SEMINARS, WORKING GROUPS, STUDY GROUPS AND CONGRESSES, IN THE MEDICAL FIELD; MEDICAL AND PHARMACEUTICAL TRAINING; PUBLISHING OF PERIODICALS, BOOKS, GUIDES AND DATA BASES IN THE MEDICAL FIELD (U.S. CLS. 100, 101 AND 107).

PRIORITY CLAIMED UNDER SEC. 44(D) ON FRANCE APPLICATION NO. 023190276, FILED 10-23-2002, REG. NO. 023190276, DATED 3-28-2003, EXPIRES 3-28-2013.

PRIORITY CLAIMED UNDER SEC. 44(D) ON FRANCE APPLICATION NO. 023190276, FILED 10-23-2002, REG. NO. 023190276, DATED 3-28-2003, EXPIRES 3-28-2013.

PRIORITY CLAIMED UNDER SEC. 44(D) ON FRANCE APPLICATION NO. 023190276, FILED 10-23-2002, REG. NO. 023190276, DATED 3-28-2003, EXPIRES 3-28-2013.

PRIORITY CLAIMED UNDER SEC. 44(D) ON FRANCE APPLICATION NO. 023190276, FILED 10-23-2002, REG. NO. 023190276, DATED 3-28-2003, EXPIRES 3-28-2013.

PRIORITY CLAIMED UNDER SEC. 44(D) ON FRANCE APPLICATION NO. 023190276, FILED 10-23-2002, REG. NO. 023190276, DATED 3-28-2003, EXPIRES 3-28-2013.

PRIORITY CLAIMED UNDER SEC. 44(D) ON FRANCE APPLICATION NO. 023190276, FILED 10-23-2002, REG. NO. 023190276, DATED 3-28-2003, EXPIRES 3-28-2013.

PRIORITY CLAIMED UNDER SEC. 44(D) ON FRANCE APPLICATION NO. 023190276, FILED 10-23-2002, REG. NO. 023190276, DATED 3-28-2003, EXPIRES 3-28-2013.

PRIORITY CLAIMED UNDER SEC. 44(D) ON FRANCE APPLICATION NO. 023190276, FILED 10-23-2002, REG. NO. 023190276, DATED 3-28-2003, EXPIRES 3-28-2013.

PRIORITY CLAIMED UNDER SEC. 44(D) ON FRANCE APPLICATION NO. 023190276, FILED 10-23-2002, REG. NO. 023190276, DATED 3-28-2003, EXPIRES 3-28-2013.

OWNER OF U.S. REG. NOS. 2,113,500, 2,129,809 AND OTHERS.

CLASS 42—SCIENTIFIC, COMPUTER AND LEGAL SERVICES

FOR PROVIDING MEDICAL RESEARCH ASSISTANCE TO MEDICAL RESEARCHERS; RENTAL OF LABORATORY EQUIPMENT; BIOLOGICAL, PHARMACEUTICAL AND MEDICAL RESEARCH; CLINICAL RESEARCH (U.S. CLS. 100 AND 101).

CLASS 44—MEDICAL, BEAUTY AND AGRICULTURAL SERVICES

FOR MEDICAL EVALUATION SERVICES, NAMELY, FUNCTIONAL ASSESSMENT PROGRAMS FOR PATIENTS RECEIVING MEDICAL TREATMENT FOR THE PURPOSE OF ASSESSING MEDICAL TREATMENT EFFECTIVENESS; PROVIDING MEDICAL AND PHARMACEUTICAL INFORMATION VIA THE INTERNET (U.S. CLS. 100 AND 101).

LINDA M. KING, EXAMINING ATTORNEY

CLASS 3—COSMETICS AND CLEANING PREPARATIONS

FOR NON-MEDICATED SKIN CARE PREPARATIONS; BODY SOAPS (U.S. CLS. 1, 4, 6, 50, 51 AND 52).

CLASS 5—PHARMACEUTICALS

FOR PHARMACEUTICAL PREPARATIONS FOR THE TREATMENT AND/OR PREVENTION OF CARDIOVASCULAR, ONCOLOGICAL, THROMBOSIS, CENTRAL NERVOUS SYSTEM, INSOMNIA AND OBESITY RELATED ILLNESSES (U.S. CLS. 6, 18, 44, 46, 51 AND 52).

SN 78-237,947. CHRISTINEWILLIAM DESIGN COMPANY, INC., FORT WAYNE, IN. FILED 4-15-2003.

CLASS 9—ELECTRICAL AND SCIENTIFIC APPARATUS

FOR AUDIO CASSETTES, VIDEO CASSETTES, CD-ROMS AND SOFTWARE IN THE FIELDS OF PHARMACEUTICAL AND MEDICAL DEVELOPMENTS (U.S. CLS. 21, 23, 26, 36 AND 38).

IOTTA SHOP!

CLASS 14—JEWELRY

FOR ORNAMENTAL PINS AND ORNAMENTAL LAPEL PINS; WATCHES (U.S. CLS. 2, 27, 28 AND 50).

CLASS 16—PAPER GOODS AND PRINTED MATTER

FOR DIARIES, BUSINESS CARDS, MAILING LABELS, BANK CHECKS AND CHECK BOOK COVERS, NEWSLETTERS RELATED TO SHOPPING, MAGAZINES RELATED TO SHOPPING, BOOKS RELATED TO SHOPPING, GIFT WRAP, BOOKS WITH BLANK PAGES, CALENDARS AND DATE BOOKS, ADDRESS BOOKS, PAPER TABLE LINENS, PAPER PARTY DECORATIONS, PAPER NAPKINS, PAPER TABLE CLOTHS, KITS FOR PARTIES CONTAINING PAPER TABLE LINENS, PAPER DECORATIONS, AND STATIONERY, NAMELY NOTE PADS, PADS OF PAPER, NOTES CONTAINING ADHESIVE ON ONE SIDE FOR ATTACHMENT TO SURFACES, GREETING CARDS, NOTE CARDS, THANK YOU CARDS, INVITATIONS, WRITING PAPER AND ENVELOPES THEREFOR (U.S. CLS. 2, 5, 22, 23, 29, 37, 38 AND 50).

CLASS 21—HOUSEWARES AND GLASS

FOR PAPER DISHWARE, NAMELY, PAPER PLATES AND PAPER CUPS; NONMETAL PIGGY BANKS NOT MADE OF PRECIOUS METAL; MUGS AND FLOWER POTS (U.S. CLS. 2, 13, 23, 29, 30, 33, 40 AND 50).

CLASS 25—CLOTHING

FOR SOCKS, VISORS, SHIRTS, NAMELY T-SHIRTS, TANK SHIRTS AND SWEATSHIRTS (U.S. CLS. 22 AND 39).

CLASS 28—TOYS AND SPORTING GOODS

FOR DOLLS, DOLL CLOTHES, AND BOARD GAMES RELATED TO SHOPPING; PLAYING CARDS (U.S. CLS. 22, 23, 38 AND 50).
BRIAN BROWN, EXAMINING ATTORNEY

SN 78-237,992. KANSAS CITY COUNTRY CLUB, MISSION HILLS, KS. FILED 4-15-2003.

KANSAS CITY COUNTRY CLUB

NO CLAIM IS MADE TO THE EXCLUSIVE RIGHT TO USE "COUNTRY CLUB", APART FROM THE MARK AS SHOWN.
SEC. 2(F).

CLASS 21—HOUSEWARES AND GLASS

FOR DECANTERS AND VASES ALL MADE OF CRYSTAL, BEVERAGE GLASSWARE AND MUGS (U.S. CLS. 2, 13, 23, 29, 30, 33, 40 AND 50).
FIRST USE 0-0-1896; IN COMMERCE 0-0-1896.

CLASS 25—CLOTHING

FOR CLOTHING AND APPAREL, NAMELY, HATS, T-SHIRTS, WINDSHIRTS, RAINSUITS, SWEATERS, SWEATSHIRTS, COATS, VISORS, SOCKS, SPORT JACKETS, JACKETS, PANTS, SHORTS, CAPS, FOOTWEAR, GLOVES AND VESTS (U.S. CLS. 22 AND 39).
FIRST USE 0-0-1896; IN COMMERCE 0-0-1896.

CLASS 28—TOYS AND SPORTING GOODS

FOR SPORTING GOODS, NAMELY, GOLF BALLS, GOLF GLOVES, TENNIS BALLS, GOLF CLUB HEADCOVERS, DIVOT REPAIR TOOLS, GOLF BALL MARKERS, GOLF TEES, GOLF BAG TAGS, TENNIS RACQUET COVERS, AND GOLF BAGS (U.S. CLS. 22, 23, 38 AND 50).
FIRST USE 0-0-1896; IN COMMERCE 0-0-1896.

CLASS 41—EDUCATION AND ENTERTAINMENT

FOR COUNTRY CLUB AND GOLF COURSE SERVICES (U.S. CLS. 100, 101 AND 107).
FIRST USE 0-0-1896; IN COMMERCE 0-0-1896.
HEATHER THOMPSON, EXAMINING ATTORNEY

SN 78-238,127. ACOM SOLUTIONS, INC., LONG BEACH, CA. FILED 4-15-2003.

ACOM SOLUTIONS

NO CLAIM IS MADE TO THE EXCLUSIVE RIGHT TO USE "SOLUTIONS", APART FROM THE MARK AS SHOWN.

CLASS 9—ELECTRICAL AND SCIENTIFIC APPARATUS

FOR COMPUTER PERIPHERAL EQUIPMENT, NAMELY, PRINTERS AND SERVERS, TO EXTEND THE CAPABILITIES OF THE COMPUTER ENVIRONMENT FOR FINANCIAL AND BUSINESS MANAGEMENT/ENTERPRISE PLANNING SOFTWARE SOLUTIONS (U.S. CLS. 21, 23, 26, 36 AND 38).
FIRST USE 12-20-1999; IN COMMERCE 1-3-2000.

CLASS 42—SCIENTIFIC, COMPUTER AND LEGAL SERVICES

FOR COMPUTER SOFTWARE DEVELOPMENT, IMPLEMENTATION AND TECHNICAL SUPPORT, NAMELY, TROUBLESHOOTING SOFTWARE PROBLEMS, "BUG" FIXES, PROVIDING UPGRADES, TRACKING ISSUES, AND PROACTIVELY REPORTING UPGRADE AVAILABILITY FOR PAYMENT MANAGEMENT SOLUTIONS, DOCUMENT MANAGEMENT SOLUTIONS, AND E-COMMERCE DATA TRANSLATION FOR FINANCIAL AND BUSINESS MANAGEMENT/ENTERPRISE PLANNING SOLUTIONS (U.S. CLS. 100 AND 101).
FIRST USE 12-20-1999; IN COMMERCE 1-3-2000.
MARIA-VICTORIA SUAREZ, EXAMINING ATTORNEY

SN 78-238,742. CLEANING CENTER, INC., POCATELLO, ID. FILED 4-17-2003.

DON ASLETT'S CLEANING CENTER

NO CLAIM IS MADE TO THE EXCLUSIVE RIGHT TO USE "CLEANING CENTER", APART FROM THE MARK AS SHOWN.
THE NAME(S), PORTRAIT(S), AND/OR SIGNATURE(S) SHOWN IN THE MARK IDENTIFIES DON ASLETT, WHOSE CONSENT(S) TO REGISTER IS SUBMITTED.

CLASS 3—COSMETICS AND CLEANING PREPARATIONS

FOR CLEANING PRODUCTS, NAMELY ALL-PURPOSE CLEANERS, BATHROOM AND SHOWER CLEANERS AND CARPET CLEANERS (U.S. CLS. 1, 4, 6, 50, 51 AND 52).
FIRST USE 4-10-2002; IN COMMERCE 4-10-2002.

CLASS 35—ADVERTISING AND BUSINESS

FOR RETAIL STORE SERVICES FEATURING CLEANING PRODUCTS AND PREPARATIONS (U.S. CLS. 100, 101 AND 102).

FIRST USE 4-10-2002; IN COMMERCE 4-10-2002.
LEIGH CAROLINE CASE, EXAMINING ATTORNEY

SN 78-240,797. JIWIRE, LLC, SOUTH SAN FRANCISCO, CA.
FILED 4-22-2003.

JIWIRE

SN 78-238,857. WRAPPED APPS CORPORATION, KANATA,
ONTARIO, CANADA, FILED 4-17-2003.



THE STIPPLING IN THE DRAWING APPEARS FOR SHADING PURPOSES ONLY.

THE MARK CONSISTS OF A THREE-DIMENSIONAL DESIGN WITH THE LETTER "W" ENCASED IN A BALL.

CLASS 9—ELECTRICAL AND SCIENTIFIC APPARATUS

FOR COMPUTER SOFTWARE PROGRAMS FOR THE DEVELOPMENT, INTEGRATION, CONVERSION, AND DISTRIBUTION OF COMPUTER PROGRAMS, DATABASES, CONTENT, AND UPGRADES, NAMELY, DATA, AUDIO, TEXT, GRAPHICS AND ANIMATION DEVELOPED BY THIRD PARTIES IN CROSS PLATFORM ENVIRONMENTS (U.S. CLS. 21, 23, 26, 36 AND 38).

CLASS 42—SCIENTIFIC, COMPUTER AND LEGAL SERVICES

FOR COMPUTER SOFTWARE DEVELOPMENT, INTEGRATION, CONVERSION, AND DISTRIBUTION OF COMPUTER PROGRAMS, DATABASES, CONTENT, AND UPGRADES, NAMELY, DATA, AUDIO, TEXT, GRAPHICS, AND ANIMATION IN CROSS PLATFORM ENVIRONMENTS; COMPUTER CONSULTATION SERVICES IN THE AREA OF COMPUTER SOFTWARE, NAMELY, THE DESIGN, DEVELOPMENT, INTEGRATION, CONVERSION AND MANAGEMENT OF COMPUTER SOFTWARE; COMPUTER TECHNICAL SUPPORT SERVICES (U.S. CLS. 100 AND 101).

JULIA HARDY COFIELD, EXAMINING ATTORNEY

CLASS 35—ADVERTISING AND BUSINESS

FOR PROVIDING CONSUMER PRODUCT AND SERVICE INFORMATION RELATING TO THE WIRELESS INDUSTRY VIA THE INTERNET; PROVIDING BUYING GUIDE INFORMATION ABOUT THE GOODS AND SERVICES OF OTHERS IN THE WIRELESS INDUSTRY VIA THE INTERNET; PROVIDING AN ON-LINE BUSINESS DIRECTORY FEATURING PROVIDERS OF WIRELESS GOODS AND WIRELESS SERVICES; PROMOTING THE GOODS AND SERVICES OF OTHERS IN THE WIRELESS INDUSTRY BY PROVIDING A WEB SITE AT WHICH USERS CAN LINK TO PROVIDERS OF WIRELESS GOODS AND SERVICES (U.S. CLS. 100, 101 AND 102).

CLASS 38—COMMUNICATION

FOR PROVIDING AN ON-LINE FORUM FOR TRANSMISSION OF MESSAGES AMONG COMPUTER USERS CONCERNING THE WIRELESS INDUSTRY (U.S. CLS. 100, 101 AND 104).

CLASS 41—EDUCATION AND ENTERTAINMENT

FOR PROVIDING ON-LINE NEWS RELATING TO THE WIRELESS INDUSTRY (U.S. CLS. 100, 101 AND 107).

YONG KIM, EXAMINING ATTORNEY

SN 78-239,781. A&E TELEVISION NETWORKS, NEW YORK,
NY. FILED 4-19-2003.

TIME TITANS**CLASS 9—ELECTRICAL AND SCIENTIFIC APPARATUS**

FOR PRE-RECORDED AUDIO AND VIDEO TAPES AND DISCS FEATURING HISTORICAL SUBJECT MATTER (U.S. CLS. 21, 23, 26, 36 AND 38).

CLASS 41—EDUCATION AND ENTERTAINMENT

FOR ENTERTAINMENT SERVICES, NAMELY, CONTINUING SERIES OF CABLE TELEVISION PROGRAMS FEATURING HISTORICAL SUBJECT MATTER (U.S. CLS. 100, 101 AND 107).

BRETT J. GOLDEN, EXAMINING ATTORNEY

SN 78-241,471. ADESSO INC., NEW YORK, NY. FILED 4-24-2003.

ADESSO

OWNER OF U.S. REG. NOS. 1,990,398, 2,728,755 AND OTHERS.

THE ENGLISH TRANSLATION OF THE WORD ADESSO IN THE MARK IS NOW.

CLASS 6—METAL GOODS

FOR METAL PULLS FOR WINDOW TREATMENTS (U.S. CLS. 2, 12, 13, 14, 23, 25 AND 50).

CLASS 20—FURNITURE AND ARTICLES NOT OTHERWISE CLASSIFIED

FOR HARDWARE FOR WINDOW TREATMENTS, NAMELY, TRAVERSE RODS, POLES, CURTAIN HOOKS, CURTAIN RODS AND FINIALS (U.S. CLS. 2, 13, 22, 25, 32 AND 50).

BRETT J. GOLDEN, EXAMINING ATTORNEY

SN 78-241,573. WORKSPACES BY WALDORF, INC., OAKDALE, MN. FILED 4-24-2003.

CREATING WARMTH WITH WOOD

CLASS 40—MATERIAL TREATMENT

FOR CUSTOM MANUFACTURE OF WOOD FURNITURE (U.S. CLS. 100, 103 AND 106).

CLASS 42—SCIENTIFIC, COMPUTER AND LEGAL SERVICES

FOR CUSTOM DESIGN OF WOOD FURNITURE (U.S. CLS. 100 AND 101).
MICHAEL ENGEL, EXAMINING ATTORNEY

SN 78-242,161. MONTEREY CHEMICAL COMPANY, FRESNO, CA. FILED 4-25-2003.

M MONTEREY AGRESOURCES

OWNER OF U.S. REG. NOS. 2,405,459 AND 2,405,757.

CLASS 1—CHEMICALS

FOR MICRO-NUTRIENT FERTILIZERS; MACRO-NUTRIENT FERTILIZERS; DEFOLIANTS; AND ADJUVANTS FOR USE WITH PESTICIDES ALL FOR AGRICULTURAL, HORTICULTURAL, RESIDENTIAL AND COMMERCIAL USE. (U.S. CLS. 1, 5, 6, 10, 26 AND 46).

CLASS 5—PHARMACEUTICALS

FOR HERBICIDES; FUNGICIDES; AND ALL-PURPOSE OUTDOOR DISINFECTANTS ALL FOR AGRICULTURAL USE. (U.S. CLS. 6, 18, 44, 46, 51 AND 52).
RON FAIRBANKS, EXAMINING ATTORNEY

SN 78-243,719. STOUT, MARY ELLEN, GARLAND, TX. FILED 4-30-2003.

DESIGN VISIONS

NO CLAIM IS MADE TO THE EXCLUSIVE RIGHT TO USE "DESIGN", APART FROM THE MARK AS SHOWN.

CLASS 6—METAL GOODS

FOR METAL BOXES, METAL CHARMS FOR IDENTIFYING DRINKS, DECORATIVE METAL BOXES, METAL GARMENT HOOKS, METAL KEY CHAINS, METAL KEY HOLDERS, METAL KEY RINGS, PEWTER FIGURINES, METAL HAT RACKS, TIN CANS-SOLD EMPTY (U.S. CLS. 2, 12, 13, 14, 23, 25 AND 50).
FIRST USE 9-30-1987; IN COMMERCE 11-30-1998.

CLASS 9—ELECTRICAL AND SCIENTIFIC APPARATUS

FOR COMPACT DISC CASES, DECORATIVE MAGNETS, DECORATIVE REFRIGERATOR MAGNETS (U.S. CLS. 21, 23, 26, 36 AND 38).
FIRST USE 2-28-1998; IN COMMERCE 5-31-1998.

CLASS 14—JEWELRY

FOR CHARMS, EARRINGS, JEWELRY, NAMELY, CROSSES, ORNAMENTAL PINS, PENDANTS, PINS BEING JEWELRY (U.S. CLS. 2, 27, 28 AND 50).
FIRST USE 9-30-1987; IN COMMERCE 1-31-1988.

CLASS 16—PAPER GOODS AND PRINTED MATTER

FOR BOOKMARKS, NOTE PADS, PHOTOGRAPH ALBUMS (U.S. CLS. 2, 5, 22, 23, 29, 37, 38 AND 50).
FIRST USE 3-31-1998; IN COMMERCE 6-30-1998.

CLASS 21—HOUSEWARES AND GLASS

FOR CHARMS FOR ATTACHMENT TO GLASSWARE FOR IDENTIFICATION PURPOSES, GLASS BOXES, NON-METAL DECORATIVE BOXES NAMELY CHARMS FOR ATTACHMENT TO GLASSWARE FOR IDENTIFICATION PURPOSES, GLASS BOXES, NON-METAL DECORATIVE BOXES NAMELY, GLASS BOXES WITH HINGED LID AND PEWTER ACCENTS, VASES, CANDLE HOLDERS NOT OF PRECIOUS METAL, NAMELY GLASS (U.S. CLS. 2, 13, 23, 29, 30, 33, 40 AND 50).
FIRST USE 11-30-1997; IN COMMERCE 12-31-1998.
DARRYL SPRUILL, EXAMINING ATTORNEY

SN 78-243,858. SANOFI-SYNTHELABO, PARIS, FRANCE, FILED 4-30-2003.

I:REMS

CLASS 41—EDUCATION AND ENTERTAINMENT

FOR EDUCATIONAL SERVICES, NAMELY, CONDUCTING PROGRAMS IN THE FIELD OF INSOMNIA; EDUCATIONAL AND ENTERTAINMENT SERVICES, NAMELY, PROVIDING MOTIVATIONAL AND EDUCATIONAL SPEAKERS (U.S. CLS. 100, 101 AND 107).

CLASS 42—SCIENTIFIC, COMPUTER AND LEGAL SERVICES

FOR MEDICAL AND SCIENTIFIC RESEARCH, NAMELY, CONDUCTING CLINICAL TRIALS (U.S. CLS. 100 AND 101).

CLASS 44—MEDICAL, BEAUTY AND AGRICULTURAL SERVICES

FOR MEDICAL SERVICES; EMERGENCY MEDICAL ASSISTANCE (U.S. CLS. 100 AND 101).
LAVERNE THOMPSON, EXAMINING ATTORNEY

SN 78-244,103. ASIA PACIFIC FUEL CELL TECHNOLOGIES, LTD., TAIPEI, TAIWAN, FILED 4-30-2003.

APFCT

PRIORITY CLAIMED UNDER SEC. 44(D) ON TAIWAN APPLICATION NO. 92018548, FILED 4-17-2003, REG. NO. 01076439, DATED 12-1-2003, EXPIRES 11-30-2013.

CLASS 6—METAL GOODS

FOR (BASED ON INTENT TO USE) METAL GAS STORAGE TANKS, NAMELY, HYDROGEN STORAGE CANISTERS AND TANKS MADE OF METAL (U.S. CLS. 2, 12, 13, 14, 23, 25 AND 50).

CLASS 7—MACHINERY

FOR (BASED ON INTENT TO USE) ELECTRIC GENERATORS, NAMELY, FUEL CELL POWER GENERATORS, DC POWER GENERATORS, AC POWER GENERATORS, AND EMERGENCY POWER GENERATORS; POWER GENERATORS FOR MOTORIZED LAND VEHICLES (U.S. CLS. 13, 19, 21, 23, 31, 34 AND 35).

CLASS 9—ELECTRICAL AND SCIENTIFIC APPARATUS

FOR (BASED ON INTENT TO USE AND ON 44(D)) FUEL CELLS; BATTERIES, NAMELY ALKALINE BATTERIES, MOBILE PHONE BATTERIES, AND BATTERY PACKS; ELECTROLYZERS; SOLAR CELLS; SEPARATORS FOR USE IN FUEL CELLS; BATTERY FRAMES, NAMELY FRAMES FOR HOLDING FUEL CELLS; AND ELECTRODES FOR USE IN FUEL CELLS (U.S. CLS. 21, 23, 26, 36 AND 38).

CLASS 12—VEHICLES

FOR (BASED ON INTENT TO USE) MOTORIZED SCOOTERS; POWER-ASSISTED SCOOTERS; THREE-WHEELED VEHICLES, NAMELY, FUEL CELL POWERED CARS; ELECTRIC CARS; ELECTRIC MOTORS FOR LAND VEHICLES; LAND VEHICLE PARTS, NAMELY, BATTERY TRAYS (U.S. CLS. 19, 21, 23, 31, 35 AND 44).

CLASS 42—SCIENTIFIC, COMPUTER AND LEGAL SERVICES

FOR (BASED ON INTENT TO USE) FUEL CELL RELATED PRODUCT RESEARCH, PRODUCT DEVELOPMENT AND PRODUCT DEVELOPMENT CONSULTATION; TECHNICAL CONSULTING SERVICES IN THE FIELD OF AIR POLLUTION PREVENTION; ENERGY USAGE FACILITY DESIGNING, NAMELY, ENGINEERING DESIGN SERVICES FOR EFFICIENT ENERGY USAGE; ENVIRONMENTAL PROTECTION TECHNICAL CONSULTING; TECHNICAL RESEARCH, NAMELY, MEASUREMENT OF ENVIRONMENTAL POLLUTION; MECHANICAL AND ELECTRICAL ENGINEERING TECHNICAL CONSULTING (U.S. CLS. 100 AND 101).
JOHN GARTNER, EXAMINING ATTORNEY

SN 78-244,484. LIBERTY PACIFIC CAPITAL, LLC, SEATTLE, WA. FILED 5-1-2003.

LIBERTY PACIFIC

NO CLAIM IS MADE TO THE EXCLUSIVE RIGHT TO USE "PACIFIC", APART FROM THE MARK AS SHOWN.

CLASS 36—INSURANCE AND FINANCIAL

FOR FINANCIAL INVESTMENT AND MANAGEMENT SERVICES IN THE FIELDS OF REAL ESTATE, SECURITIES, PRIVATE EQUITY, LEVERAGED FINANCING, CAPITAL INVESTMENTS, FUND INVESTMENTS, SPECIALTY FUNDS, ALTERNATIVE INVESTMENTS, STRUCTURED DEBT CAPITAL MARKET FINANCING, ASSET-BACKED FINANCING AND CURRENCY MARKET RISK MANAGEMENT; FINANCIAL ANALYSIS AND CONSULTING; REAL ESTATE SERVICES, NAMELY, REAL ESTATE SERVICES, NAMELY, REAL ESTATE INVESTMENT, LEASING, FINANCING, ACQUISITION, AND CONSULTING SERVICES IN THE FIELD OF REAL ESTATE (U.S. CLS. 100, 101 AND 102).

CLASS 44—MEDICAL, BEAUTY AND AGRICULTURAL SERVICES

FOR MEDICAL IMAGING SERVICES. (U.S. CLS. 100 AND 101).
H. M. FISHER, EXAMINING ATTORNEY

SN 78-244,509. PEREZ, IVAN SEVILLANO, 28024 MADRID, SPAIN, FILED 5-1-2003.

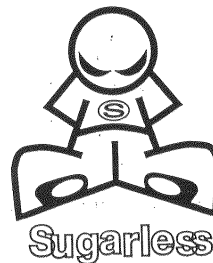

THE MARK CONSISTS OF THE WORD SUGARLESS WITH A REPRESENTATION OF A FIGURE.

CLASS 25—CLOTHING

FOR CLOTHING, FOOTWEAR AND HEADWEAR NAMELY, TROUSERS, T-SHIRTS, SHIRTS, SWEATERS, HUNTING CAPS, AND SHOES (U.S. CLS. 22 AND 39).

CLASS 41—EDUCATION AND ENTERTAINMENT

FOR ENTERTAINMENT SERVICES NAMELY, PROVIDING MUSICAL PERFORMANCES BY A LIVE BAND (U.S. CLS. 100, 101 AND 107).
DAVID C. REIHNER, EXAMINING ATTORNEY

SN 78-245,465. Y FEST, INC., CENTERVILLE, MA. FILED 5-5-2003.

Y FEST

NO CLAIM IS MADE TO THE EXCLUSIVE RIGHT TO USE "FEST", APART FROM THE MARK AS SHOWN.

CLASS 41—EDUCATION AND ENTERTAINMENT

FOR ENTERTAINMENT, NAMELY LIVE MUSIC CONCERTS (U.S. CLS. 100, 101 AND 107).
FIRST USE 12-21-2001; IN COMMERCE 12-21-2001.

CLASS 45—PERSONAL SERVICES

FOR EVANGELISTIC AND MINISTERIAL SERVICES (U.S. CLS. 100 AND 101).
FIRST USE 12-21-2001; IN COMMERCE 12-21-2001.
DARRYL SPRUILL, EXAMINING ATTORNEY

SN 78-245,686. WINGS S.P.A., BOLOGNA, ITALY, FILED 5-5-2003.

SEA ANGEL

OWNER OF ITALY REG. NO. 767567, DATED 1-7-1999, EXPIRES 1-17-2006.

OWNER OF U.S. REG. NO. 2,141,862.

CLASS 18—LEATHER GOODS

FOR (BASED ON INTENT TO USE) (BASED ON 44(E)) LEATHER GOODS, NAMELY, BACKPACKS, WALLETS, AND BAGS, NAMELY HANDBAGS, SPORTBAGS, BEACHBAGS, TRAVELBAGS AND SURFBAGS (U.S. CLS. 1, 2, 3, 22 AND 41).

CLASS 25—CLOTHING

FOR (BASED ON USE IN COMMERCE) (BASED ON 44(E)) MEN'S, WOMEN'S AND CHILDREN'S CLOTHING, NAMELY, TROUSERS, SHIRTS, T-SHIRTS, JACKETS, SKIRTS, OVERCOATS, RAINCOATS, BATHING SUITS, UNDERWEAR, SCARVES, HATS AND CAPS AND KNITWEAR, NAMELY, SWEATERS (U.S. CLS. 22 AND 39).

FIRST USE 9-1-1997; IN COMMERCE 9-1-1997.
NICHOLAS ALTREE, EXAMINING ATTORNEY

SN 78-246,130. TRUSTAR SOLUTIONS, INC., DBA TRUSTAR SOLUTIONS, FISHERS, IN. FILED 5-6-2003.

HIREYIELD

CLASS 35—ADVERTISING AND BUSINESS

FOR ADMINISTRATIVE, CONSULTING, REPORTING, RESEARCH AND NEGOTIATING SERVICES IN THE FIELDS OF HUMAN RESOURCES AND RECRUITING VIA A GLOBAL COMPUTER NETWORK, NAMELY, ADVERTISING SERVICES, NAMELY, CREATING CORPORATE AND BRAND IDENTITY FOR OTHERS, PROVIDING JOB POSTINGS, PROVIDING TRACKING AND TESTING TO DETERMINE PROFESSIONAL COMPETENCY FOR APPLICANTS FOR EMPLOYMENT, AND RESUME EVALUATION, RANKING AND SELECTION OF PERSONNEL; AND LICENSING OF COMPUTER SOFTWARE FOR USE IN THE FIELDS OF HUMAN RESOURCES AND RECRUITING VIA A GLOBAL COMPUTER NETWORK (U.S. CLS. 100, 101 AND 102).

CLASS 42—SCIENTIFIC, COMPUTER AND LEGAL SERVICES

FOR HOSTING THE WEB SITES OF OTHERS ON A COMPUTER SERVER FOR A GLOBAL COMPUTER NETWORK IN THE FIELDS OF HUMAN RESOURCES AND RECRUITING; AND CONSULTING SERVICES IN THE FIELD OF DESIGN, SELECTION, IMPLEMENTATION AND USE OF COMPUTER HARDWARE AND SOFTWARE SYSTEMS FOR OTHERS IN THE FIELDS OF HUMAN RESOURCES AND RECRUITING VIA A GLOBAL COMPUTER NETWORK (U.S. CLS. 100 AND 101).

CLASS 45—PERSONAL SERVICES

FOR PRE-EMPLOYMENT BACKGROUND SCREENING (U.S. CLS. 100 AND 101).
AMY ALFIERI, EXAMINING ATTORNEY

SN 78-246,518. GITOMER, JEFFREY H., CHARLOTTE, NC. FILED 5-7-2003.

FORE! BUSINESS

CLASS 9—ELECTRICAL AND SCIENTIFIC APPARATUS

FOR CD'S, DVD'S, VIDEOTAPE RECORDINGS OF SEMINAR MATERIALS ON THE SUBJECT OF HOW TO USE GOLF OUTINGS WITH CLIENTS, CUSTOMERS, AND OTHERS TO GAIN NEW BUSINESS, INCREASE EXISTING BUSINESS AND RECAPTURE LOST BUSINESS (U.S. CLS. 21, 23, 26, 36 AND 38).

FIRST USE 5-30-2002; IN COMMERCE 5-30-2002.

CLASS 41—EDUCATION AND ENTERTAINMENT

FOR EDUCATIONAL SERVICES, NAMELY, CONDUCTING SEMINARS, COURSES, CONFERENCES AND WORKSHOPS ON THE SUBJECT OF HOW TO USE GOLF OUTINGS WITH CLIENTS, CUSTOMERS, AND OTHERS TO GAIN NEW BUSINESS, INCREASE EXISTING BUSINESS AND RECAPTURE LOST BUSINESS (U.S. CLS. 100, 101 AND 107).

FIRST USE 5-30-2002; IN COMMERCE 5-30-2002.
MICHAEL SOUDERS, EXAMINING ATTORNEY

SN 78-247,845. LIFEMARQUE LIMITED, BERKSHIRE, UNITED KINGDOM, FILED 5-9-2003.



THE MARK CONSISTS OF TWO FIGURES CONTAINED WITHIN A SQUARE BACKGROUND.

CLASS 9—ELECTRICAL AND SCIENTIFIC APPARATUS

FOR SUNGLASSES; AND COMPUTER CARRYING CASES (U.S. CLS. 21, 23, 26, 36 AND 38).

CLASS 18—LEATHER GOODS

FOR ATTACHE CASES, HOLDALLS, CARRYALL BAGS, RUCKSACKS, BACKPACKS, HIPSACKS, FANNY PACKS, DITTY BAGS, WALLETS, PURSES, TOILETRY BAGS SOLD EMPTY; CARRY-ON BAGS; TRAVEL BAGS; SLING BAGS; PERSONAL CHILD CARRYING DEVICES, NAMELY CHILD CARRYING SLINGS AND RUCKSACKS; INFANT AND BABY-CARRYING SLINGS AND RUCKSACKS; AND PARTS FOR ALL THE AFORESAID GOODS (U.S. CLS. 1, 2, 3, 22 AND 41).

CLASS 20—FURNITURE AND ARTICLES NOT OTHERWISE CLASSIFIED

FOR COTS; TRAVEL COTS; FOLDING COTS; SLEEPING BAGS; SLEEPING BAGS FOR CHILDREN; SLEEPING BAGS FOR INFANTS; SLEEPING BAG LINERS; SLEEPING MATS; PILLOWS; INFLATABLE PILLOWS; PICNIC MATS NAMELY, PICNIC MATS FEATURING PLASTIC SHEETS; PICNIC MATS FEATURING A PLASTIC BASE AND FABRIC COATING; AND PICNIC MATS FEATURING A RUBBER BASE AND FABRIC COATING (U.S. CLS. 2, 13, 22, 25, 32 AND 50).

CLASS 21—HOUSEWARES AND GLASS

FOR PICNIC WARE, NAMELY, CONTAINERS FOR FOODS; BOTTLES, SOLD EMPTY; PLASTIC BOTTLES, SOLD EMPTY; FLASKS; VACUUM FLASKS; MUGS; CUPS; PLASTIC CUPS; PLASTIC ANY-WAY-UP CUPS, NAMELY, SPILL RESISTANT CUPS; PLATES; BOWLS; PLASTIC PLATES AND BOWLS; TOOTHBRUSH CASES; TOOTHBRUSH COVERS (U.S. CLS. 2, 13, 23, 29, 30, 33, 40 AND 50).

CLASS 25—CLOTHING

FOR ARTICLES OF CLOTHING AND FOOTWEAR, NAMELY, PANTS, TROUSERS, SHORTS, SWEATPANTS, OVERALLS, SHIRTS, TEE-SHIRTS, SWEATSHIRTS, PULLOVER SWEATERS; FLEECE PULLOVER SWEATERS, SWEATERS, BLOUSES, SKIRTS, DRESSES, JACKETS, WIND RESISTANT JACKETS, RAIN JACKETS, FLEECE JACKETS, VESTS, FLEECE VESTS, COATS, RAINCOATS, UNDERWEAR, THERMAL UNDERWEAR, LINGERIE, SLEEPWEAR, SWIMWEAR, WET SUITS, GLOVES, SOCKS, HOSIERY, BELTS, SCARVES, HATS, CAPS, TIES, SHOES, BOOTS, GALOSHES, SNEAKERS, SANDALS, SLIPPERS, AND MONEY BELTS (U.S. CLS. 22 AND 39).

ESTHER BELENKER, EXAMINING ATTORNEY

SN 78-248,237. LEVENSON, FREDERICK, B., MASSAPEQUA, NY. FILED 5-11-2003.

ENTROPIC ANALYSIS

NO CLAIM IS MADE TO THE EXCLUSIVE RIGHT TO USE ANALYSIS, APART FROM THE MARK AS SHOWN.

CLASS 44—MEDICAL, BEAUTY AND AGRICULTURAL SERVICES

FOR PSYCHOLOGICAL COUNSELING AND PSYCHOLOGICAL TESTING SERVICES (U.S. CLS. 100 AND 101).

CLASS 45—PERSONAL SERVICES

FOR DATING SERVICES (U.S. CLS. 100 AND 101).
INGA ERVIN, EXAMINING ATTORNEY

SN 78-248,242. OVERTON, JAMES ALEXANDER, SAN DIEGO, CA. FILED 5-11-2003.



SN 78-248,056. HEWLETT-PACKARD DEVELOPMENT COMPANY, L.P., HOUSTON, TX. FILED 5-9-2003.

LIGHTSCRIBE

CLASS 2—PAINTS

FOR OPTICAL MEDIA COATINGS TO ENABLE DEPOSITING A PRINTABLE SURFACE THEREON (U.S. CLS. 6, 11 AND 16).

CLASS 9—ELECTRICAL AND SCIENTIFIC APPARATUS

FOR COMPUTER SOFTWARE FOR CREATING AND INSCRIBING TEXT AND IMAGES ONTO OPTICAL RECORDING MEDIA; BLANK CDS AND DVDS; COMPUTER DISK DRIVES; OPTICAL DISK DRIVES; AUDIO AND VIDEO RECORDING AND REPRODUCTION MACHINES, NAMELY, VIDEO DISC RECORDERS AND PLAYERS, COMPACT DISC RECORDERS AND PLAYERS, OPTICAL DISC RECORDERS AND PLAYERS; COMPUTER HARDWARE; COMPUTER PERIPHERALS (U.S. CLS. 21, 23, 26, 36 AND 38).
REBECCA SMITH, EXAMINING ATTORNEY

NO CLAIM IS MADE TO THE EXCLUSIVE RIGHT TO USE COMBAT, APART FROM THE MARK AS SHOWN.

THE STIPPLING IS FOR SHADING PURPOSES ONLY.
THE FOREIGN WORDING IN THE MARK TRANSLATES INTO ENGLISH AS MAMBA IS AN ARBITRARY DESIGNATION. RYU MAY MEAN SOCIETY OR TRADITION.

CLASS 25—CLOTHING

FOR SPORTSWEAR AND CLOTHING, NAMELY, T-SHIRTS, MARTIAL-ARTS UNIFORMS, JACKETS, RANK BELTS AND SASHES, PANTS, GLOVES, SWEAT SHIRTS, SWEAT PANTS, EXERCISE PANTS, BANDANAS, VISORS, HEADBANDS, WRISTBANDS, WARM-UP SUITS, AND FOOTWEAR (U.S. CLS. 22 AND 39).
FIRST USE 1-1-2003; IN COMMERCE 2-1-2003.

CLASS 41—EDUCATION AND ENTERTAINMENT

FOR EDUCATIONAL SERVICES, NAMELY, CONDUCTING TRAINING CLASSES IN THE FIELD OF MARTIAL ARTS (U.S. CLS. 100, 101 AND 107).
FIRST USE 1-1-2003; IN COMMERCE 2-1-2003.
MARK T. MULLEN, EXAMINING ATTORNEY

SN 78-249,201. SIEMENS AKTIENGESELLSCHAFT, MÜNCHEN, FED REP GERMANY, FILED 5-13-2003.

PG AID

PRIORITY CLAIMED UNDER SEC. 44(D) ON FED REP GERMANY APPLICATION NO. 30305179509, FILED 1-31-2003, REG. NO. 30305179, DATED 3-20-2003, EXPIRES 1-31-2013.

PRIORITY CLAIMED UNDER SEC. 44(D) ON FED REP GERMANY APPLICATION NO. 30305179509, FILED 1-31-2003, REG. NO. 30350179, DATED 3-20-2003, EXPIRES 1-31-2013.

PRIORITY CLAIMED UNDER SEC. 44(D) ON FED REP GERMANY APPLICATION NO. 30305179509, FILED 1-31-2003, REG. NO. 30305179, DATED 3-20-2003, EXPIRES 1-31-2013.

PRIORITY CLAIMED UNDER SEC. 44(D) ON FED REP GERMANY APPLICATION NO. 30305179509, FILED 1-31-2003, REG. NO. 30305179, DATED 3-20-2003, EXPIRES 1-31-2013.

NO CLAIM IS MADE TO THE EXCLUSIVE RIGHT TO USE PG, APART FROM THE MARK AS SHOWN.

CLASS 9—ELECTRICAL AND SCIENTIFIC APPARATUS

FOR COMPUTER HARDWARE AND COMPUTER PERIPHERALS FOR USE IN POWER PLANTS; COMPUTER SOFTWARE FOR USE IN PROCESS CONTROL AND EQUIPMENT OPERATION FOR POWER PLANTS; COMPUTER SOFTWARE FOR USE IN POWER PLANTS TO DETECT AND CORRECT DISTURBANCES IN INDUSTRIAL POWER GENERATING PROCESSES (U.S. CLS. 21, 23, 26, 36 AND 38).

CLASS 42—SCIENTIFIC, COMPUTER AND LEGAL SERVICES

FOR PLANNING OF, RESEARCH FOR, AND DEVELOPMENT OF INSTALLATIONS AND FACILITIES IN THE FIELDS OF POWER GENERATION AND TECHNICAL PROCESS ENGINEERING AND TECHNICAL SUPERVISION/MONITORING OF SUCH INSTALLATIONS AND FACILITIES; SERVICES OF AN ENGINEER, TECHNICAL CONSULTANCY, RENDERING OF EXPERTS OPINIONS; RENTAL OF COMPUTER SOFTWARE FOR DATA PROCESSING AND PROCESS ENGINEERING, IN PARTICULAR FOR SETTING-UP, EQUIPPING AND OPERATING INDUSTRIAL, POWER GENERATION AND PROCESS ENGINEERING PLANTS AND SYSTEMS (U.S. CLS. 100 AND 101).

CYNTHIA SLOAN, EXAMINING ATTORNEY

SN 78-249,318. AMCOR SUNCLIPSE NORTH AMERICA, BUENA PARK, CA. FILED 5-13-2003.

KHL EXPRESS

OWNER OF U.S. REG. NO. 2,547,150.

CLASS 6—METAL GOODS

FOR METAL STRAPPING (U.S. CLS. 2, 12, 13, 14, 23, 25 AND 50).

CLASS 8—HAND TOOLS

FOR HAND TOOLS, NAMELY, BANDING TOOLS AND BANDING TOOLS FOR NON-METAL STRAPPING; FLATWARE (U.S. CLS. 23, 28 AND 44).

CLASS 9—ELECTRICAL AND SCIENTIFIC APPARATUS

FOR SAFETY EQUIPMENT, NAMELY, SAFETY GOGGLES (U.S. CLS. 21, 23, 26, 36 AND 38).

CLASS 16—PAPER GOODS AND PRINTED MATTER

FOR PAPER BAGS; ENVELOPES; PAPER SHIPPING POUCHES; PAPER NAPKINS; PAPER TABLE CLOTHS; PAPER TOWELS; TOILET PAPER; PAPER BOXES; CORRUGATED SHIPPING CONTAINERS; PAPER LABELS; PAPER TAPE; PRESSURE-SENSITIVE PAPER TAPE; CARDBOARD MAILING TUBES; PLASTIC BAGS; PLASTIC BUBBLE PACKAGING; PLASTIC WRAP; STATIC CONTROL BAGS FOR ELECTRONIC PARTS, NAMELY, PLASTIC BAGS FOR ELECTROSTATIC SENSITIVE DEVICES; MEDIA PACKAGING FOR ALBUMS, CDS AND TAPES, NAMELY, CORRUGATED CONTAINERS (U.S. CLS. 2, 5, 22, 23, 29, 37, 38 AND 50).

CLASS 17—RUBBER GOODS

FOR MOLDED FOAM INSULATED CONTAINER CUSHIONING AND PACKING FOR COMMERCIAL TRANSPORTATION; STRAPPING TAPE; ADHESIVE TAPE FOR INDUSTRIAL AND COMMERCIAL USE, NAMELY, FILAMENT TAPE AND PACKING TAPE; PLASTIC STRETCH FILM FOR INDUSTRIAL AND COMMERCIAL PACKING USE (U.S. CLS. 1, 5, 12, 13, 35 AND 50).

CLASS 20—FURNITURE AND ARTICLES NOT OTHERWISE CLASSIFIED

FOR STATIC CONTROL PACKING CONTAINERS OF PLASTIC MATERIAL FOR STORING ELECTRONIC PARTS, NAMELY, PLASTIC CONTAINERS FOR ELECTROSTATIC DEVICES (U.S. CLS. 2, 13, 22, 25, 32 AND 50).

CLASS 21—HOUSEWARES AND GLASS

FOR STATIC CONTROL PORTABLE PLASTIC CONTAINERS FOR STORING HOUSEHOLD ELECTRONIC PARTS, NAMELY, PLASTIC CONTAINERS FOR ELECTROSTATIC DEVICES (U.S. CLS. 2, 13, 23, 29, 30, 33, 40 AND 50).

CLASS 22—CORDAGE AND FIBERS

FOR NON-METAL STRAPPING; FABRIC MAILING POUCHES (U.S. CLS. 1, 2, 7, 19, 22, 42 AND 50).

JOHN GARTNER, EXAMINING ATTORNEY

SN 78-251,452. HAVE FAITH WE LIVE-HAVE LOVE WE WIN, INC., SOUTH PASADENA, CA. FILED 5-19-2003.

HAVE FAITH WE LIVE - HAVE LOVE WE WIN

CLASS 16—PAPER GOODS AND PRINTED MATTER

FOR RELIGIOUS MATERIALS, NAMELY, ADULT RELIGIOUS BOOKS, CHILDREN'S BOOKS, PRINTED SOUVENIR PROGRAMS CONCERNING RELIGION, BLANK CARDS AND PRINTED POSTCARDS, PRINTED MATERIALS, NAMELY, CONSULTING BOOKS ON RELIGION, ADDRESS BOOKS, NOTE BOOKS, BOOK COVERS (U.S. CLS. 2, 5, 22, 23, 29, 37, 38 AND 50).

CLASS 25—CLOTHING

FOR RELIGIOUS MATERIALS, NAMELY, T-SHIRTS, POLO SHIRTS, SWEATERS, CAPS (U.S. CLS. 22 AND 39).
AMY HELLA, EXAMINING ATTORNEY

CLASS 41—EDUCATION AND ENTERTAINMENT

FOR TRAINING IN THE USE OF COMPUTER SOFTWARE FOR SECURING AND MANAGING BUSINESS INFORMATION AND BUSINESS PROCESSES (U.S. CLS. 100, 101 AND 107).

SN 78-252,033. DELFT IMAGING SYSTEMS B.V., 3905 TB VEENENDAAL, NETHERLANDS, FILED 5-20-2003.

DIGITAL CHEST IMAGING

PRIORITY CLAIMED UNDER SEC. 44(D) ON BENELUX APPLICATION NO. 1022527, FILED 11-27-2002, REG. NO. 0728001, DATED 11-27-2002, EXPIRES 11-27-2012.

NO CLAIM IS MADE TO THE EXCLUSIVE RIGHT TO USE "DIGITAL CHEST IMAGING", APART FROM THE MARK AS SHOWN.

CLASS 42—SCIENTIFIC, COMPUTER AND LEGAL SERVICES

FOR PROVIDING TEMPORARY USE OF NON-DOWNLOADABLE COMPUTER SOFTWARE AND UPDATES THEREOF FOR SECURING AND MANAGING BUSINESS INFORMATION AND BUSINESS PROCESSES; TECHNICAL SUPPORT AND HELPDESK SERVICES, NAMELY, TROUBLESHOOTING OF PROBLEMS AND SUPPORT OF USERS IN OPERATING COMPUTER SOFTWARE FOR SECURING AND MANAGING BUSINESS INFORMATION AND BUSINESS PROCESSES; PROVIDING CONSULTATION, DESIGN, AND DEVELOPMENT SERVICES IN CONNECTION WITH SOFTWARE FOR SECURING AND MANAGING BUSINESS INFORMATION AND BUSINESS PROCESSES (U.S. CLS. 100 AND 101).

DARLENE BULLOCK, EXAMINING ATTORNEY

CLASS 9—ELECTRICAL AND SCIENTIFIC APPARATUS

FOR X-RAY APPARATUS FOR NON-DESTRUCTIVE, NON-INVASIVE TESTING OF INDUSTRIAL MATERIALS, NATURAL MATERIALS AND FOOD PRODUCTS AND FOR (AIRPORT)SECURITY SURVEILLANCE (U.S. CLS. 21, 23, 26, 36 AND 38).

SN 78-254,241. SWISS CORNER, INC., DBA SALTWATER CAFE, NOKOMIS, FL. FILED 5-26-2003.

CLASS 10—MEDICAL APPARATUS

FOR X-RAY APPARATUS FOR MEDICAL IMAGING (U.S. CLS. 26, 39 AND 44).
G. T. GLYNN, EXAMINING ATTORNEY

CHEF ROLF

NO CLAIM IS MADE TO THE EXCLUSIVE RIGHT TO USE CHEF, APART FROM THE MARK AS SHOWN.

THE NAME(S), PORTRAIT(S), AND/OR SIGNATURE(S) SHOWN IN THE MARK IDENTIFIES A LIVING INDIVIDUAL WHOSE CONSENT(S) TO REGISTER IS SUBMITTED.

SN 78-253,262. LIQUID MACHINES, INC., LEXINGTON, MA. FILED 5-22-2003.

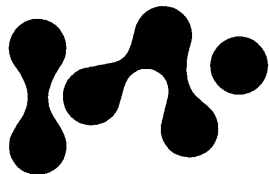
**CLASS 9—ELECTRICAL AND SCIENTIFIC APPARATUS**

FOR PRE-RECORDED VIDEOTAPES FEATURING A TELEVISION PROGRAM IN THE FIELD OF COOKING (U.S. CLS. 21, 23, 26, 36 AND 38).

CLASS 30—STAPLE FOODS

FOR SPICES AND SAUCES (U.S. CL. 46).

CLASS 9—ELECTRICAL AND SCIENTIFIC APPARATUS

FOR COMPUTER SOFTWARE FOR SECURING AND MANAGING BUSINESS INFORMATION AND BUSINESS PROCESSES (U.S. CLS. 21, 23, 26, 36 AND 38).

CLASS 41—EDUCATION AND ENTERTAINMENT

FOR ENTERTAINMENT SERVICES, NAMELY, PROVIDING A TELEVISION PROGRAM IN THE FIELD OF COOKING VIA LIVE TRANSMISSION, VIA TELEVISION AND A GLOBAL COMPUTER NETWORK (U.S. CLS. 100, 101 AND 107).

CLASS 35—ADVERTISING AND BUSINESS

FOR LICENSING OF COMPUTER SOFTWARE FOR SECURING AND MANAGING BUSINESS INFORMATION AND BUSINESS PROCESSES (U.S. CLS. 100, 101 AND 102).

CLASS 43—HOTEL AND RESTAURANT SERVICES

FOR RESTAURANT SERVICES (U.S. CLS. 100 AND 101).
LAURIEL DALIER, EXAMINING ATTORNEY

SN 78-258,047. SANDINO-JOSEPH, RENA, DBA CALMING DESIGNS CREATIONS, RIO RICO, AZ. FILED 6-4-2003.

CALMING DESIGNS CREATIONS

NO CLAIM IS MADE TO THE EXCLUSIVE RIGHT TO USE DESIGNS CREATIONS, APART FROM THE MARK AS SHOWN.

CLASS 24—FABRICS

FOR BEDDING, NAMELY, BED SHEETS, PILLOW CASES, LINENS, TOWELS AND WASH CLOTHS (U.S. CLS. 42 AND 50).

CLASS 25—CLOTHING

FOR CLOTHING, NAMELY, SHIRTS, HATS, PANTS, T-SHIRTS, CAPS, SHOES, SLIPPERS, JACKETS AND ROBES (U.S. CLS. 22 AND 39).
MICHELE SWAIN, EXAMINING ATTORNEY

SN 78-258,433. HOLDON LOG LLC, LOS ANGELES, CA. FILED 6-4-2003.

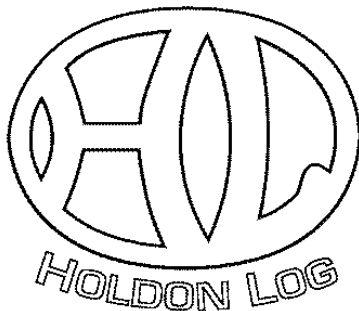

NO CLAIM IS MADE TO THE EXCLUSIVE RIGHT TO USE "LOG", APART FROM THE MARK AS SHOWN.

THE MARK CONSISTS OF THE STYLIZED LETTERS "HL" IN AN OVAL SHAPE UNDERNEATH WHICH ARE THE WORDS HOLDON LOG.

CLASS 9—ELECTRICAL AND SCIENTIFIC APPARATUS

FOR ORGANIZATIONAL TOOLS, NAMELY CAREER MANAGEMENT COMPUTER SOFTWARE FOR USE IN LOGGING AND TRACKING AUDITIONS, CALLBACKS, BOOKINGS, EXPENSES, INCOME, INDUSTRY CONTACTS, CALENDAR EVENTS, AND CAREER STATISTICS FOR USE BY THOSE IN THE ENTERTAINMENT INDUSTRY FOR USE BY INDIVIDUALS SUCH AS ACTORS, MODELS, BACKGROUND ARTISTS, AGENTS, MANAGERS, CASTING DIRECTORS, STAND-UP COMEDIANS, SINGERS, DANCERS, MUSICIANS, AND MAGICIANS (U.S. CLS. 21, 23, 26, 36 AND 38).

FIRST USE 9-1-2002; IN COMMERCE 4-25-2003.

CLASS 16—PAPER GOODS AND PRINTED MATTER

FOR ORGANIZATIONAL TOOLS, NAMELY LOG BOOKS, PRINTED AUDITION TRACKING AND BOOKING SHEETS DESIGNED PRIMARILY FOR CAREER MANAGEMENT FOR THOSE IN THE ENTERTAINMENT INDUSTRY FOR USE BY INDIVIDUALS SUCH AS ACTORS, MODELS, BACKGROUND ARTISTS, AGENTS, MANAGERS, CASTING DIRECTORS, STAND-UP COMEDIANS, SINGERS, DANCERS, MUSICIANS, AND MAGICIANS (U.S. CLS. 2, 5, 22, 23, 29, 38 AND 50).

FIRST USE 4-9-2001; IN COMMERCE 4-9-2001.
GINNY ISAACSON, EXAMINING ATTORNEY

SN 78-259,877. NET COM DATA CORP. OF N.Y., SEA CLIFF, NY. FILED 6-9-2003.

THE TERMINAL THAT TALKS

NO CLAIM IS MADE TO THE EXCLUSIVE RIGHT TO USE "TERMINAL", APART FROM THE MARK AS SHOWN.

CLASS 9—ELECTRICAL AND SCIENTIFIC APPARATUS

FOR ELECTRONIC POINT OF SALE TERMINALS FOR ACCEPTING CREDIT CARDS, DEBIT CARDS, GIFT CARDS, SMART CARDS, CHECK VERIFICATION, STORED VALUE CARDS, ELECTRONIC BUSINESS TRANSACTIONS, EBT, AND OTHER POINT OF PURCHASE TRANSACTIONS; COMPUTER HARDWARE AND SOFTWARE FOR PERFORMING FINANCIAL TRANSACTIONS, NAMELY, PURCHASING GOODS AND SERVICES USING CREDIT CARDS, CHARGE CARDS, DEBIT CARDS, GIFT CARDS, CHECK VERIFICATION, STORED VALUE CARDS AND SMART CARDS IN CONJUNCTION WITH A POINT OF SALE TERMINAL; HARDWARE AND SOFTWARE FOR PROVIDING ACCESS TO A GLOBAL COMPUTER NETWORK VIA AN INTERACTIVE POINT OF SALE TERMINAL (U.S. CLS. 21, 23, 26, 36 AND 38).

CLASS 36—INSURANCE AND FINANCIAL

FOR FINANCIAL SERVICES NAMELY, CREDIT CARD, DEBIT CARD, CHARGE CARD, ELECTRONIC CREDIT CARD, POINT OF SALE CARD, CASH ADVANCE CREDIT CARD, AND STORED VALUE PREPAID CARD SERVICES (U.S. CLS. 100, 101 AND 102).

RICHARD A. STRASER, EXAMINING ATTORNEY

SN 78-261,590. INHABIT, INC., LOS ANGELES, CA. FILED 6-12-2003.

INHABIT

CLASS 9—ELECTRICAL AND SCIENTIFIC APPARATUS

FOR DVDS, AUDIO, VIDEOTAPES AND COMPACT DISKS, ALL FEATURING MUSIC, ENTERTAINMENT, AND EDUCATIONAL PROGRAMMING; AND BLANK AUDIO AND VIDEOTAPES (U.S. CLS. 21, 23, 26, 36 AND 38).

CLASS 35—ADVERTISING AND BUSINESS

FOR BUSINESS MANAGEMENT AND MARKETING CONSULTATION SERVICES; BUSINESS MARKETING SERVICES; AND ADVERTISING SERVICES, NAMELY, CREATING CORPORATE AND BRAND IDENTITIES FOR OTHERS (U.S. CLS. 100, 101 AND 102).

CLASS 41—EDUCATION AND ENTERTAINMENT

FOR MOTION PICTURE FILM PRODUCTION AND POST-PRODUCTION SERVICES; AND MUSIC PRODUCTION SERVICES (U.S. CLS. 100, 101 AND 107).

CLASS 42—SCIENTIFIC, COMPUTER AND LEGAL SERVICES

FOR COMMERCIAL ART DESIGN FOR OTHERS; AND DESIGNING, CREATING, IMPLEMENTING, AND MAINTAINING WEB SITES FOR OTHERS (U.S. CLS. 100 AND 101).

SAMUEL E. SHARPER JR., EXAMINING ATTORNEY

SN 78-264,748. IDENTASEARCH, LTD., WATER MILL, NY. FILED 6-19-2003.

REAL ME**CLASS 39—TRANSPORTATION AND STORAGE**

FOR STORAGE OF HUMAN BIOLOGICAL AND BIOMETRIC SPECIMENS (U.S. CLS. 100 AND 105).

CLASS 44—MEDICAL, BEAUTY AND AGRICULTURAL SERVICES

FOR MEDICAL SERVICES, NAMELY, COLLECTION AND ANALYSIS OF HUMAN BIOLOGICAL AND BIOMETRIC SPECIMENS (U.S. CLS. 100 AND 101).

TRACY WHITAKER-BOWN, EXAMINING ATTORNEY

SN 78-263,701. THE COLLEGE OF WILLIAM & MARY, WILLIAMSBURG, VA. FILED 6-18-2003.

**CLASS 9—ELECTRICAL AND SCIENTIFIC APPARATUS**

FOR MAGNETICALLY ENCODED CREDIT CARDS AND ID CARDS USED FOR ASSESSING STUDENT'S ACCOUNTS, NAMELY, MEAL PLANS, PURCHASES AT OFF-SITE LOCATIONS AND CAMPUS LOCATIONS (U.S. CLS. 21, 23, 26, 36 AND 38).

FIRST USE 8-1-1996; IN COMMERCE 8-1-1996.

CLASS 16—PAPER GOODS AND PRINTED MATTER

FOR PRINTED MATERIAL, NAMELY, STATIONERY, FOLDERS, BINDERS, AND NOTEPADS; BROCHURES, PAMPHLETS IN THE FIELD OF EDUCATION; PUBLICATIONS, NAMELY, STUDENT HANDBOOKS, FOR PROVIDING GUIDANCE REGARDING ACTIVITIES AND CLASSES ON CAMPUS, AND COLLEGE NEWSPAPERS REGARDING THE AFOREMENTIONED CREDIT CARDS AND ID CARDS (U.S. CLS. 2, 5, 22, 23, 29, 37, 38 AND 50).

FIRST USE 8-1-1996; IN COMMERCE 8-1-1996.

CLASS 25—CLOTHING

FOR CLOTHING, NAMELY, T-SHIRTS, SWEATSHIRTS, PANTS, SHIRTS, BLOUSES AND HATS (U.S. CLS. 22 AND 39).

FIRST USE 8-1-1996; IN COMMERCE 8-1-1996.
KEVON CHISOLM, EXAMINING ATTORNEY

SN 78-266,041. MERIDIUM, INC., ROANOKE, VA. FILED 6-23-2003.

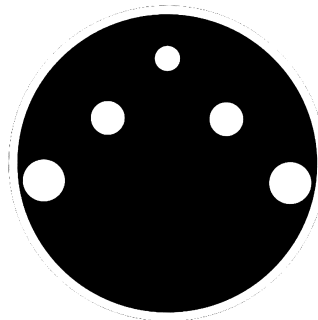
**CLASS 9—ELECTRICAL AND SCIENTIFIC APPARATUS**

FOR COMPUTER SOFTWARE FOR TRACKING AND REPORTING EQUIPMENT MAINTENANCE (U.S. CLS. 21, 23, 26, 36 AND 38).

FIRST USE 4-28-2003; IN COMMERCE 4-28-2003.

CLASS 42—SCIENTIFIC, COMPUTER AND LEGAL SERVICES

FOR PROVIDING TEMPORARY USE OF NON-DOWNLOADABLE SOFTWARE FOR EQUIPMENT MAINTENANCE REPORTING AND TRACKING SERVICES OVER A GLOBAL COMPUTER NETWORK (U.S. CLS. 100 AND 101).

FIRST USE 4-28-2003; IN COMMERCE 4-28-2003.
JENNIFER KRISP, EXAMINING ATTORNEY

SN 78-267,313. ROBISON'S INC., IDAHO FALLS, ID. FILED 6-26-2003.

TORQUE STAR

CLASS 18—LEATHER GOODS

FOR LUGGAGE; TRAVEL BAGS, NAMELY, BACKPACKS, HELMET BAGS, MAP POUCHES, MOTORCYCLE AND ATV SADDLE BAGS, MOTORCYCLE AND ATV FUEL TANK BAGS, MOTORCYCLE AND ATV TAIL BAGS, TRUNK BAGS, HANDLEBAR POUCHES, WINDSHIELD BAGS, BACKREST BAGS, AND DUFFLE BAGS (U.S. CLS. 1, 2, 3, 22 AND 41).

CLASS 25—CLOTHING

FOR CLOTHING, NAMELY, JACKETS, SHIRTS, T-SHIRTS, PANTS, SHORTS, VESTS, RACING SUITS OF THE TYPE USED WHILE RIDING A MOTOR VEHICLE, UNDERGARMENTS, SCARVES, CHAPS, GLOVES, AND HATS (U.S. CLS. 22 AND 39).
LAURA KOVAISKY, EXAMINING ATTORNEY

SN 78-267,365. GLOBAL ACCESSORIES, INC., LOGAN, UT. FILED 6-26-2003.

RIPTIDE

CLASS 12—VEHICLES

FOR FITTED BOAT COVERS (U.S. CLS. 19, 21, 23, 31, 35 AND 44).
FIRST USE 12-4-2002; IN COMMERCE 4-1-2003.

CLASS 22—CORDAGE AND FIBERS

FOR UNFITTED BOAT COVERS (U.S. CLS. 1, 2, 7, 19, 22, 42 AND 50).
FIRST USE 12-4-2002; IN COMMERCE 4-1-2003.
SCOTT OSCLICK, EXAMINING ATTORNEY

SN 78-267,815. FEDERATED BRANDS, INC., MANCHESTER, NH. FILED 6-27-2003.



HOTEL COLLECTION
BY CHARTER CLUB

NO CLAIM IS MADE TO THE EXCLUSIVE RIGHT TO USE "COLLECTION", APART FROM THE MARK AS SHOWN.

CLASS 3—COSMETICS AND CLEANING PREPARATIONS

FOR BODY, FACIAL, AND SKIN LOTIONS, BODY AND FACIAL SCRUBS, BUBBLE BATH, SHAMPOO AND CONDITIONER (U.S. CLS. 1, 4, 6, 50, 51 AND 52).

CLASS 4—LUBRICANTS AND FUELS

FOR CANDLES (U.S. CLS. 1, 6 AND 15).

CLASS 20—FURNITURE AND ARTICLES NOT OTHERWISE CLASSIFIED

FOR PICTURE FRAMES (U.S. CLS. 2, 13, 22, 25, 32 AND 50).

CLASS 21—HOUSEWARES AND GLASS

FOR TABLETOP, NAMELY, VASES, BOWLS, DECANTERS, SERVING TRAYS NOT OF PRECIOUS METAL, CANDLE HOLDERS NOT OF PRECIOUS METAL (U.S. CLS. 2, 13, 23, 29, 30, 33, 40 AND 50).

FIRST USE 2-28-2003; IN COMMERCE 2-28-2003.

CLASS 24—FABRICS

FOR BEDDING, NAMELY, SHEETS, PILLOWCASES, QUILTS, BLANKETS, COMFORTERS, DUVETS, BLANKET THROWS, MATTRESS PADS; BATH PRODUCTS, NAMELY, TOWELS, SHOWER CURTAINS (U.S. CLS. 42 AND 50).

FIRST USE 2-28-2003; IN COMMERCE 2-28-2003.

CLASS 25—CLOTHING

FOR ROBES (U.S. CLS. 22 AND 39).

CLASS 27—FLOOR COVERINGS

FOR BATH MATS (U.S. CLS. 19, 20, 37, 42 AND 50).
CAROL SPILS, EXAMINING ATTORNEY

SN 78-267,822. FEDERATED BRANDS, INC., MANCHESTER, NH. FILED 6-27-2003.



HOTEL COLLECTION

NO CLAIM IS MADE TO THE EXCLUSIVE RIGHT TO USE "COLLECTION", APART FROM THE MARK AS SHOWN.

CLASS 3—COSMETICS AND CLEANING PREPARATIONS

FOR BODY, FACIAL, AND SKIN LOTIONS, BODY AND FACIAL SCRUBS, BUBBLE BATH, SHAMPOO AND CONDITIONER (U.S. CLS. 1, 4, 6, 50, 51 AND 52).

CLASS 4—LUBRICANTS AND FUELS

FOR CANDLES (U.S. CLS. 1, 6 AND 15).

CLASS 20—FURNITURE AND ARTICLES NOT OTHERWISE CLASSIFIED

FOR PICTURE FRAMES (U.S. CLS. 2, 13, 22, 25, 32 AND 50).

CLASS 21—HOUSEWARES AND GLASS

FOR TABLETOP, NAMELY, VASES, BOWLS, DECANTERS, SERVING TRAYS NOT OF PRECIOUS METAL, CANDLE HOLDERS NOT OF PRECIOUS METAL (U.S. CLS. 2, 13, 23, 29, 30, 33, 40 AND 50).

FIRST USE 2-28-2003; IN COMMERCE 2-28-2003.

CLASS 24—FABRICS

FOR BEDDING, NAMELY, SHEETS, PILLOWCASES, QUILTS, BLANKETS, COMFORTERS, DUVETS, BLANKET THROWS, MATTRESS PADS; BATH PRODUCTS, NAMELY, TOWELS, SHOWER CURTAINS (U.S. CLS. 42 AND 50).

FIRST USE 2-28-2003; IN COMMERCE 2-28-2003.

CLASS 25—CLOTHING

FOR ROBES (U.S. CLS. 22 AND 39).

CLASS 27—FLOOR COVERINGS

FOR BATH MATS (U.S. CLS. 19, 20, 37, 42 AND 50).
FIRST USE 2-28-2003; IN COMMERCE 2-28-2003.
CAROL SPILS, EXAMINING ATTORNEY

SN 78-269,135. ALFRED DUNHILL LIMITED, LONDON
SW1Y 6DL, UNITED KINGDOM, FILED 7-1-2003.

HAWKSMOOR

PRIORITY CLAIMED UNDER SEC. 44(D) ON UNITED KINGDOM APPLICATION NO. 2325185, FILED 3-3-2003, REG. NO. 235185, DATED 12-19-2003, EXPIRES 3-3-2013.

CLASS 18—LEATHER GOODS

FOR GOODS MADE OF LEATHER OR IMITATIONS OF LEATHER, NAMELY, TRUNKS AND TRAVELING BAGS, UMBRELLAS, WALKING STICKS, SHOOTING STICKS, LUGGAGE, BAGS AND CASES, NAMELY CARRY ON BAGS, ALL PURPOSE ATHLETIC BAGS, FLIGHT BAGS AND SUITCASES; BRIEFCASES, ATTACHE CASES, DOCUMENT CASES, WALLETS, HOLLERS, POUCHETTES, NAMELY, A HANDHELD CARRYING CASE WITH COMPARTMENTS FOR PENS, NOTEPADS, CALENDARS, MONEY, CREDIT CARDS, AND OTHER PERSONAL ITEMS, SUITBAGS, CREDIT CARD CASES, KEY CASES, COIN PURSES; PARTS FOR ALL OF THE AFORESAID GOODS (U.S. CLS. 1, 2, 3, 22 AND 41).

CLASS 25—CLOTHING

FOR LEATHER CLOTHING, NAMELY, JACKETS, COATS, GLOVES, DRIVING GLOVES, BRACES, NAMELY, SUSPENDERS; HEADWEAR AND BELTS; FOOTWEAR (U.S. CLS. 22 AND 39).
CHERYL CLAYTON, EXAMINING ATTORNEY

SN 78-269,778. INTELLIGENT NUTRIENTS, INC., MINNEAPOLIS, MN. FILED 7-2-2003.



OWNER OF U.S. REG. NOS. 1,983,856 AND 2,098,544.
NO CLAIM IS MADE TO THE EXCLUSIVE RIGHT TO USE "NUTRIENTS", APART FROM THE MARK AS SHOWN.

CLASS 3—COSMETICS AND CLEANING PREPARATIONS

FOR NONMEDICAL LUBRICANTS AND BODY OILS FOR PERSONAL USE (U.S. CLS. 1, 4, 6, 50, 51 AND 52).

CLASS 5—PHARMACEUTICALS

FOR DIETARY AND NUTRITIONAL SUPPLEMENTS AND BEVERAGES CONTAINING NUTRITIONAL SUPPLEMENTS (U.S. CLS. 6, 18, 44, 46, 51 AND 52).

CLASS 32—LIGHT BEVERAGES

FOR ESSENCES, SYRUPS AND POWDERS USED IN THE PREPARATION OF SOFT DRINKS AND BEVERAGES (U.S. CLS. 45, 46 AND 48).
GEORGIA CARTY, EXAMINING ATTORNEY

SN 78-270,529. EURO-PRO OPERATING LLC, WEST NEWTON, MA. FILED 7-3-2003.

EURO-PRO

OWNER OF U.S. REG. NOS. 1,899,467, 2,390,249 AND OTHERS.

CLASS 3—COSMETICS AND CLEANING PREPARATIONS

FOR ALL-PURPOSE DETERGENTS, ALL-PURPOSE CLEANING PREPARATIONS, CARPET SHAMPOO, CARPET CLEANING PREPARATIONS; FLOOR AND FURNITURE WAX, FLOOR AND FURNITURE POLISH, SOAPS, DISPOSABLE WIPES IMPREGNATED WITH CHEMICALS OR COMPOUNDS, SCOURING AND ABRASIVE LIQUIDS AND POWDERS ALL FOR HOUSEHOLD USE (U.S. CLS. 1, 4, 6, 50, 51 AND 52).

CLASS 5—PHARMACEUTICALS

FOR ALL PURPOSE DISINFECTING AND DEODORIZING CHEMICAL PREPARATIONS FOR HOUSEHOLD USE (U.S. CLS. 6, 18, 44, 46, 51 AND 52).

CLASS 21—HOUSEWARES AND GLASS

FOR MOPS, BROOMS, DUST PANS, NON-ELECTRIC CARPET SWEEPERS, SCRUB BRUSHES, CLEANING CLOTHS, DUST CLOTHS, POLISHING CLOTHS, BUCKETS, NON-ELECTRIC CARPET CLEANERS, CLEANING PADS, GARBAGE BIN, SCOURING PADS AND SPONGES, FLOOR CLEANING DEVICE CONSISTING OF CLEANING PAD WITH LIQUID CLEANING PREPARATION SOLD AS A UNIT, FURNITURE AND WINDOW DUSTERS, ALL FOR HOUSEHOLD USE (U.S. CLS. 2, 13, 23, 29, 30, 33, 40 AND 50).

MARK T. MULLEN, EXAMINING ATTORNEY

SN 78-271,027. UNIVERSITY OF CENTRAL FLORIDA,
ORLANDO, FL. FILED 7-7-2003.

H204U

CLASS 16—PAPER GOODS AND PRINTED MATTER

FOR EDUCATIONAL AND MARKETING PUBLICATIONS, NAMELY A SERIES OF BOOKS, MAGAZINES, BUMPER STICKERS, POSTERS, BOOKMARKS, MANUALS, BOOKLETS, BROCHURES, ILLUSTRATIONS, MOUNTED PHOTOGRAPHS, SEALS AND UNMOUNTED PHOTOGRAPHS AND TECHNICAL DRAWINGS ALL FEATURING STORMWATER PROGRAMS AND SYSTEMS, ALTERNATIVE WATER CONSERVATION PROGRAMS AND SYSTEMS, ENVIRONMENTAL PRESERVATION AND RESTORATION OF WATER RESOURCES, IMPROVING STORMWATER QUALITY PROGRAMS AND SYSTEMS, STORMWATER FOR IRRIGATION AND OTHER NON-POTABLE APPLICATIONS, AWARENESS PROGRAMS AND SYSTEMS ON WATER CONSUMPTION; PRINTED INSTRUCTIONAL AND TEACHING MATERIAL IN THE FIELD OF STORMWATER MANAGEMENT PROGRAMS AND SYSTEMS, ALTERNATIVE WATER CONSERVATION PROGRAMS AND SYSTEMS, ENVIRONMENTAL PRESERVATION AND RESTORATION OF WATER RESOURCES, IMPROVING STORMWATER QUALITY PROGRAMS AND SYSTEMS, STORMWATER FOR IRRIGATION AND OTHER NON-POTABLE APPLICATIONS, AWARENESS PROGRAMS AND SYSTEMS ON WATER CONSUMPTION; DECALS, APPLIQUES IN THE FORM OF DECALS, ART PRINTS, PENS, PENCILS, BINDERS, MAGNETIC BOARDS, BOOK COVERS, CALENDARS, AND PRESSURE SENSITIVE GRAPHICS FOR APPLICATION TO STORMWATER MANAGEMENT PROGRAMS AND SYSTEMS, ALTERNATIVE WATER CONSERVATION PROGRAMS AND SYSTEMS, ENVIRONMENTAL PRESERVATION AND RESTORATION OF WATER RESOURCES, IMPROVING STORMWATER QUALITY PROGRAMS AND SYSTEMS, STORMWATER FOR IRRIGATION AND OTHER NON-POTABLE APPLICATIONS, AND AWARENESS PROGRAMS AND SYSTEMS ON WATER CONSUMPTION (U.S. CLS. 2, 5, 22, 23, 29, 37, 38 AND 50).

FIRST USE 1-31-2003; IN COMMERCE 1-31-2003.

CLASS 41—EDUCATION AND ENTERTAINMENT

FOR EDUCATIONAL SERVICES, NAMELY, PROVIDING COURSES OF INSTRUCTION, CONFERENCES, SEMINARS, AND WORKSHOPS FOR PRACTICING PROFESSIONALS AT THE PRIMARY, SECONDARY AND COLLEGIATE LEVELS IN THE FIELD OF STORMWATER MANAGEMENT PROGRAMS AND SYSTEMS, ALTERNATIVE WATER CONSERVATION PROGRAMS AND SYSTEMS, ENVIRONMENTAL PRESERVATION AND RESTORATION OF WATER RESOURCES, IMPROVING STORMWATER QUALITY PROGRAMS AND SYSTEMS, STORMWATER FOR IRRIGATION AND OTHER NON-POTABLE APPLICATIONS, AWARENESS PROGRAMS AND SYSTEMS ON WATER CONSUMPTION ALL PROVIDED VIA GLOBAL COMPUTER AND PROVIDING ON-LINE REGISTRATION IN CONNECTION THEREWITH; EDUCATIONAL SERVICES, NAMELY, PROVIDING COURSES OF INSTRUCTION FOR PRACTICING PROFESSIONALS AT THE PRIMARY, SECONDARY AND COLLEGIATE LEVEL AND CONDUCTING CLASSES, SEMINARS, CONFERENCES AND WORKSHOPS IN THE FIELD OF STORMWATER MANAGEMENT PROGRAMS AND SYSTEMS, ALTERNATIVE WATER CONSERVATION PROGRAMS AND SYSTEMS, ENVIRONMENTAL PRESERVATION AND RESTORATION OF WATER RESOURCES, IMPROVING WATER QUALITY PROGRAMS AND SYSTEMS, STORMWATER FOR IRRIGATION AND OTHER NON-POTABLE APPLICATIONS, AWARENESS PROGRAMS AND SYSTEMS ON WATER CONSUMPTION, ALL IN PERSON; PROVIDING COURSES OF INSTRUCTION, CONFERENCES, SEMINARS, WORKSHOPS AND TRAINING FOR PRACTICING PROFESSIONALS AT THE PRIMARY, SECONDARY AND COLLEGIATE LEVELS AND OUTREACH PROGRAMS TO PUBLIC COM-

MUNITIES, BUSINESSES AND TECHNICAL PERSONNEL IN THE FIELD OF STORMWATER MANAGEMENT PROGRAMS AND SYSTEMS, ALTERNATIVE WATER CONSERVATION PROGRAMS AND SYSTEMS, ENVIRONMENTAL PRESERVATION AND RESTORATION OF WATER RESOURCES, IMPROVING STORMWATER QUALITY PROGRAMS AND SYSTEMS, STORMWATER FOR IRRIGATION AND OTHER NON-POTABLE APPLICATIONS, AWARENESS PROGRAMS AND SYSTEMS ON WATER CONSUMPTION ALL PROVIDED VIA GLOBAL COMPUTER AND PROVIDING ON-LINE REGISTRATION IN CONNECTION THEREWITH; AND PROVIDING COURSES OF INSTRUCTION IN THE FIELD OF STORMWATER MANAGEMENT PROGRAMS AND SYSTEMS, ALTERNATIVE WATER CONSERVATION PROGRAMS AND SYSTEMS, ENVIRONMENTAL PRESERVATION AND RESTORATION OF WATER RESOURCES, IMPROVING STORMWATER QUALITY PROGRAMS AND SYSTEMS, STORMWATER FOR IRRIGATION AND OTHER NON-POTABLE APPLICATIONS, AND AWARENESS PROGRAMS AND SYSTEMS ON WATER CONSUMPTION, ALL IN PERSON (U.S. CLS. 100, 101 AND 107).

FIRST USE 1-31-2003; IN COMMERCE 1-31-2003.
DAVID H. STINE, EXAMINING ATTORNEY

SN 78-272,799. STRAIGHT LINE ENTERPRISES, INC., SAN JUAN CAPISTRANO, CA. FILED 7-10-2003.



CLASS 41—EDUCATION AND ENTERTAINMENT

FOR CASINO SERVICE (U.S. CLS. 100, 101 AND 107).

CLASS 43—HOTEL AND RESTAURANT SERVICES

FOR HOTEL SERVICES (U.S. CLS. 100 AND 101).
CYNTHIA SLOAN, EXAMINING ATTORNEY

SN 78-274,622. OAK RIDGE SOLUTIONS, INC., WESTFIELD, IN. FILED 7-15-2003.

OAK RIDGE SOLUTIONS

NO CLAIM IS MADE TO THE EXCLUSIVE RIGHT TO USE "SOLUTIONS", APART FROM THE MARK AS SHOWN.

CLASS 9—ELECTRICAL AND SCIENTIFIC APPARATUS

FOR COMPUTER SOFTWARE FOR USE BY CONTRACTORS AS A PRODUCTION MANAGEMENT TOOL (U.S. CLS. 21, 23, 26, 36 AND 38).

CLASS 42—SCIENTIFIC, COMPUTER AND LEGAL SERVICES

FOR CUSTOMIZATION, MAINTENANCE AND TECHNICAL SUPPORT OF COMPUTER SOFTWARE (U.S. CLS. 100 AND 101).

ZACHARY BELLO, EXAMINING ATTORNEY

SN 78-276,280. ZEPHTEX INDUSTRIES, INC., LAGUNA NIGUEL, CA. FILED 7-18-2003.

ONE IN EIGHT**CLASS 21—HOUSEWARES AND GLASS**

FOR JEWELRY MADE FROM NON-PRECIOUS METALS AND OTHER NON-PRECIOUS MATERIALS (U.S. CLS. 2, 13, 23, 29, 30, 33, 40 AND 50).

FIRST USE 6-27-2003; IN COMMERCE 6-27-2003.

CLASS 25—CLOTHING

FOR CLOTHING, NAMELY, SHIRTS, PANTS, SHORTS, JACKETS, HATS, SOCKS, SKIRTS (U.S. CLS. 22 AND 39).

FIRST USE 6-27-2003; IN COMMERCE 6-27-2003.
MARY CRAWFORD, EXAMINING ATTORNEY

SN 78-274,628. INPUT, RESTON, VA. FILED 7-15-2003.

FEDBD TOOLKIT

NO CLAIM IS MADE TO THE EXCLUSIVE RIGHT TO USE TOOLKIT, APART FROM THE MARK AS SHOWN.

CLASS 35—ADVERTISING AND BUSINESS

FOR PROVIDING DATABASES FEATURING BUSINESS AND TRADE INFORMATION IN THE FIELD OF TECHNOLOGY PRODUCTS AND SERVICES (U.S. CLS. 100, 101 AND 102).

FIRST USE 6-9-2003; IN COMMERCE 6-9-2003.

SN 78-276,749. ASPEN SKIING COMPANY, ASPEN, CO. FILED 7-21-2003.

THE DIFFERENCE IS NIGHT AND DAY**CLASS 42—SCIENTIFIC, COMPUTER AND LEGAL SERVICES**

FOR PROVIDING TEMPORARY USE OF NON-DOWNLOADABLE COMPUTER SOFTWARE FOR USE IN ACCESSING COMPUTER DATABASES IN THE FIELD OF INFORMATION TECHNOLOGY PRODUCTS AND SERVICES (U.S. CLS. 100 AND 101).

FIRST USE 6-9-2003; IN COMMERCE 6-9-2003.
ZACHARY BELLO, EXAMINING ATTORNEY

CLASS 41—EDUCATION AND ENTERTAINMENT

FOR SKI AND SNOWBOARD RESORT SERVICES (U.S. CLS. 100, 101 AND 107).

FIRST USE 11-30-2002; IN COMMERCE 11-30-2002.

CLASS 43—HOTEL AND RESTAURANT SERVICES

FOR SUMMER RESORT SERVICES, NAMELY RESORT HOTEL SERVICES, RESORT LODGING SERVICES, HEALTH RESORT SERVICES, NAMELY, PROVIDING FOOD AND LODGING THAT SPECIALIZE IN PROMOTING PATRONS' GENERAL HEALTH AND WELL BEING (U.S. CLS. 100 AND 101).

FIRST USE 11-30-2002; IN COMMERCE 11-30-2002.
MARY CRAWFORD, EXAMINING ATTORNEY

SN 78-275,175. GREENWORKS, P.C., PORTLAND, OR. FILED 7-16-2003.

PEOPLE + NATURE BY DESIGN**CLASS 37—CONSTRUCTION AND REPAIR**

FOR LAND DEVELOPMENT SERVICES, NAMELY, PLANNING AND LAYING OUT OF RESIDENTIAL AND COMMERCIAL COMMUNITIES. (U.S. CLS. 100, 103 AND 106).

CLASS 42—SCIENTIFIC, COMPUTER AND LEGAL SERVICES

FOR LAND DEVELOPMENT SERVICES, NAMELY, PLANNING AND LAYOUT DESIGN SERVICES FOR SITE DEVELOPMENT; AND LANDSCAPE ARCHITECTURAL DESIGN SERVICES (U.S. CLS. 100 AND 101).

SAMUEL E. SHARPER JR., EXAMINING ATTORNEY

SN 78-278,721. ISAAC, JEFFREY A., SAN DIEGO, CA. FILED 7-24-2003.

THE LAWYER IN BLUE JEANS

NO CLAIM IS MADE TO THE EXCLUSIVE RIGHT TO USE "LAWYER", APART FROM THE MARK AS SHOWN.

CLASS 41—EDUCATION AND ENTERTAINMENT

FOR ENTERTAINMENT SERVICES, NAMELY AN ONGOING RADIO TALK SHOW CONSISTING OF LEGAL COMMENTARY (U.S. CLS. 100, 101 AND 107).

FIRST USE 4-30-1999; IN COMMERCE 4-30-1999.

CLASS 42—SCIENTIFIC, COMPUTER AND LEGAL SERVICES

FOR LEGAL AND ATTORNEY SERVICES (U.S. CLS. 100 AND 101).
FIRST USE 4-30-1999; IN COMMERCE 4-30-1999.
IRA J. GOODSaid, EXAMINING ATTORNEY

CLASS 9—ELECTRICAL AND SCIENTIFIC APPARATUS

FOR INDUSTRIAL AUTOMATION CONTROLS; CONTACTORS; CIRCUIT OVERLOAD PROTECTOR DEVICES; CIRCUIT BREAKERS; DRIVE AND DRIVE INVERTORS; PROGRAMMABLE LOGIC CONTROLLERS (U.S. CLS. 21, 23, 26, 36 AND 38).
KAREN K. BUSH, EXAMINING ATTORNEY

SN 78-279,649. ADMET, INC., NORWOOD, MA. FILED 7-28-2003.

ADMET**CLASS 7—MACHINERY**

FOR MACHINES FOR USE IN MATERIAL TESTING, NAMELY, HYDRAULIC AND ELECTROMECHANICAL TESTING MACHINES FOR USE IN TESTING METALS, PLASTICS, BUILDING MATERIALS, SOIL, ADHESIVES, RUBBERS, TEXTILES, AND HUMAN TISSUE AND BONE (U.S. CLS. 13, 19, 21, 23, 31, 34 AND 35).
FIRST USE 1-0-1997; IN COMMERCE 4-0-1997.

CLASS 9—ELECTRICAL AND SCIENTIFIC APPARATUS

FOR INSTRUMENTS NAMELY, DIGITAL INDICATORS AND CONTROLLERS FOR MEASURING PROPERTIES OF MATERIALS, METALS, PLASTICS, BUILDING MATERIALS, SOIL, ADHESIVES, RUBBERS, TEXTILE AND HUMAN TISSUE AND BONE; ELECTROMECHANICAL TESTING MACHINES (U.S. CLS. 21, 23, 26, 36 AND 38).
FIRST USE 1-0-1997; IN COMMERCE 4-0-1997.
PAULA MAYS, EXAMINING ATTORNEY

SN 78-280,178. CULLIGAN INTERNATIONAL COMPANY, NORTHBROOK, IL. FILED 7-29-2003.

CLEAR PROMISE

NO CLAIM IS MADE TO THE EXCLUSIVE RIGHT TO USE CLEAR, APART FROM THE MARK AS SHOWN.

CLASS 11—ENVIRONMENTAL CONTROL APPARATUS

FOR WATER TREATMENT AND PURIFICATION UNITS (U.S. CLS. 13, 21, 23, 31 AND 34).

CLASS 40—MATERIAL TREATMENT

FOR WATER PURIFICATION SERVICES (U.S. CLS. 100, 103 AND 106).
KAREN K. BUSH, EXAMINING ATTORNEY

SN 78-281,394. CERUS INDUSTRIAL CORPORATION, BEAVERTON, OR. FILED 7-31-2003.

CERUS**CLASS 7—MACHINERY**

FOR ELECTRIC MOTORS FOR MACHINES; ELECTRIC STARTERS (U.S. CLS. 13, 19, 21, 23, 31, 34 AND 35).

SN 78-282,742. THE GO DETROIT, LLC, BLOOMFIELD HILLS, MI. FILED 8-4-2003.

THE GO**CLASS 25—CLOTHING**

FOR CLOTHING, NAMELY, SHIRTS, HATS, JACKETS, AND T-SHIRTS (U.S. CLS. 22 AND 39).
FIRST USE 1-1-1998; IN COMMERCE 1-1-1998.

CLASS 41—EDUCATION AND ENTERTAINMENT

FOR ENTERTAINMENT SERVICES NAMELY, MUSIC PRODUCTION, MUSIC PUBLISHING, AND LIVE PERFORMANCES BY A MUSICAL BAND (U.S. CLS. 100, 101 AND 107).
FIRST USE 1-1-1998; IN COMMERCE 1-1-1998.
MICHAEL KEATING, EXAMINING ATTORNEY

SN 78-283,544. TEXAS LOTTERY COMMISSION, AUSTIN, TX. FILED 8-5-2003.

MEGA-PLIER**CLASS 28—TOYS AND SPORTING GOODS**

FOR LOTTERY RELATED PRODUCTS, NAMELY, LOTTERY TICKETS, LOTTERY GAMES, AND GAMES OF CHANCE (U.S. CLS. 22, 23, 38 AND 50).

CLASS 41—EDUCATION AND ENTERTAINMENT

FOR LOTTERY SERVICES, NAMELY, ORGANIZING, CONDUCTING AND ADMINISTERING LOTTERIES; ORGANIZING, CONDUCTING AND ADMINISTERING GAMES OF CHANCE; ORGANIZING, CONDUCTING AND ADMINISTERING "ONLINE" LOTTERIES AND GAMES OF CHANCE IN WHICH TICKETS ARE PURCHASED AT RETAILERS THROUGH A CENTRAL COMPUTER, FOR AWARDED MONETARY AND OTHER PRIZES; ORGANIZING, CONDUCTING AND ADMINISTERING "ONLINE" GAMES OF CHANCE, NAMELY, "ONLINE" LOTTERIES, AND "ONLINE" GAMES PURCHASED AT RETAILERS THROUGH A CENTRAL COMPUTER, FOR AWARDED MONETARY AND OTHER PRIZES (U.S. CLS. 100, 101 AND 107).
RICHARD WHITE, EXAMINING ATTORNEY

SN 78-283,558. TEXAS LOTTERY COMMISSION, AUSTIN, TX. FILED 8-5-2003.

MEGA-PLY

CLASS 28—TOYS AND SPORTING GOODS

FOR LOTTERY RELATED PRODUCTS, NAMELY, LOTTERY TICKETS, LOTTERY GAMES, AND GAMES OF CHANCE (U.S. CLS. 22, 23, 38 AND 50).

CLASS 41—EDUCATION AND ENTERTAINMENT

FOR LOTTERY SERVICES, NAMELY, ORGANIZING, CONDUCTING AND ADMINISTERING LOTTERIES; ORGANIZING, CONDUCTING AND ADMINISTERING GAMES OF CHANCE; ORGANIZING, CONDUCTING AND ADMINISTERING "ONLINE" LOTTERIES AND GAMES OF CHANCE IN WHICH TICKETS ARE PURCHASED AT RETAILERS THROUGH A CENTRAL COMPUTER, FOR AWARDED MONETARY AND OTHER PRIZES; ORGANIZING, CONDUCTING AND ADMINISTERING "ONLINE" GAMES OF CHANCE, NAMELY, "ONLINE" LOTTERIES, AND "ONLINE" GAMES PURCHASED AT RETAILERS THROUGH A CENTRAL COMPUTER, FOR AWARDED MONETARY AND OTHER PRIZES (U.S. CLS. 100, 101 AND 107).

RICHARD WHITE, EXAMINING ATTORNEY

SN 78-285,281. AIRESpace, INC., SAN JOSE, CA. FILED 8-8-2003.

AIRSPACE - PUT IT TO WORK

CLASS 9—ELECTRICAL AND SCIENTIFIC APPARATUS

FOR COMPUTER HARDWARE FOR TELECOMMUNICATIONS NETWORKING AND COMPUTER SOFTWARE FOR USE IN TELECOMMUNICATIONS NETWORKING, NAMELY, AN EMBEDDED OPERATING SYSTEM THAT ALLOWS FOR THE TRANSFER OF DATA BETWEEN STATIONS OVER A WIRELESS NETWORK (U.S. CLS. 21, 23, 26, 36 AND 38).

CLASS 37—CONSTRUCTION AND REPAIR

FOR INSTALLATION OF TELECOMMUNICATIONS NETWORKING SYSTEMS (U.S. CLS. 100, 103 AND 106).

CLASS 42—SCIENTIFIC, COMPUTER AND LEGAL SERVICES

FOR TECHNICAL SUPPORT SERVICES IN THE FIELD OF TELECOMMUNICATIONS NETWORKS (U.S. CLS. 100 AND 101).

APRIL L. RADEMACHER, EXAMINING ATTORNEY

SN 78-286,644. THE RODALE INSTITUTE, EMMAUS, PA. FILED 8-13-2003.

THE NEW FARM

OWNER OF U.S. REG. NO. 2,606,503.
NO CLAIM IS MADE TO THE EXCLUSIVE RIGHT TO USE FARM, APART FROM THE MARK AS SHOWN.

CLASS 41—EDUCATION AND ENTERTAINMENT

FOR COMPUTER SERVICES, NAMELY, PROVIDING ON-LINE MAGAZINES IN THE FIELDS OF HEALTH, FITNESS, DIET, EXERCISE, LIFESTYLE, GARDENING AND FARMING; PROVIDING A WEBSITE FEATURING INFORMATION ABOUT PHYSICAL FITNESS, EXERCISE AND A PHYSICALLY FIT LIFESTYLE (U.S. CLS. 100, 101 AND 107).

FIRST USE 8-0-2002; IN COMMERCE 8-0-2002.

CLASS 44—MEDICAL, BEAUTY AND AGRICULTURAL SERVICES

FOR PROVIDING A WEBSITE FEATURING INFORMATION ABOUT HEALTH, A HEALTHY DIET, GARDENING AND FARMING (U.S. CLS. 100 AND 101).

FIRST USE 8-0-2002; IN COMMERCE 8-0-2002.

CATHERINE CAIN, EXAMINING ATTORNEY

SN 78-287,189. GEN-X SPORTS SARL, CHATEL ST. DENIS, SWITZERLAND, FILED 8-14-2003.

TEARDROP

CLASS 18—LEATHER GOODS

FOR GOLF UMBRELLAS; GOLF BAG TRAVEL CASES (U.S. CLS. 1, 2, 3, 22 AND 41).

CLASS 25—CLOTHING

FOR MEN'S, WOMEN'S, AND YOUTH APPAREL, NAMELY, LONG AND SHORT SLEEVE T-SHIRTS; SHIRTS; SWEATERS; SWEATER VESTS AND SWEATER JACKETS; TURTLENECKS, MOCK TURTLENECKS; FLEECE PULLOVERS; POLO SHIRTS; SHORTS; SLACKS; JACKETS; VESTS; WIND SHIRTS AND WIND RESISTANT JACKETS AND VESTS; WATERPROOF JACKETS AND PANTS; CAPRI PANTS; SKORTS; SKIRTS; FOOTWEAR; GLOVES; SWEATSHIRTS AND SWEATPANTS; SOCKS; AND HEADWEAR, NAMELY, HATS, CAPS AND VISORS (U.S. CLS. 22 AND 39).

CLASS 28—TOYS AND SPORTING GOODS

FOR GOLF EQUIPMENT, NAMELY, GOLF CLUBS, GOLF BALLS, GOLF TEES, GOLF GLOVES, GOLF ACCESSORY POUCHES, GOLF BAGS, GOLF BAG COVERS, GOLF CLUB COVERS, GOLF BAG TAGS, GOLF BALL MARKERS, GOLF BALL SLEEVES; GOLF PUTTING AND GOLF CLUB SWING AIDS, NAMELY, PRACTICE NETS, BALLS, TARGETS, MATS, GOLF BALL DISPENSERS, AND PUTTING AND CHIPPING PADS; HAND-PULLED GOLF BAG CARTS; GOLF BALL RETRIEVERS; CLUB ORGANIZERS (U.S. CLS. 22, 23, 38 AND 50).

JULIA HARDY COFIELD, EXAMINING ATTORNEY

SN 78-287,414. LENDER TECHNOLOGIES CORPORATION, WASHINGTON, DC. FILED 8-14-2003.

PROTECTINFO

CLASS 9—ELECTRICAL AND SCIENTIFIC APPARATUS

FOR COMPUTER SOFTWARE FOR USE IN THE DEVELOPMENT AND IMPLEMENTATION OF A COMPREHENSIVE INFORMATION SECURITY PLAN (U.S. CLS. 21, 23, 26, 36 AND 38).

CLASS 42—SCIENTIFIC, COMPUTER AND LEGAL SERVICES

FOR PROVIDING INFORMATION AND TECHNICAL CONSULTATION IN THE FIELD OF INFORMATION SECURITY (U.S. CLS. 100 AND 101).

GEOFFREY FOSDICK, EXAMINING ATTORNEY

SN 78-290,496. AMARC, INC., EDWARDS, CO. FILED 8-21-2003.

UNIQUE VENUES

NO CLAIM IS MADE TO THE EXCLUSIVE RIGHT TO USE "VENUES", APART FROM THE MARK AS SHOWN.

CLASS 16—PAPER GOODS AND PRINTED MATTER

FOR PRINT DIRECTORIES FEATURING MEETING FACILITIES SUCH AS COLLEGES, UNIVERSITIES, MUSEUMS, MANSIONS, EXHIBITION FACILITIES, THEATERS, RACETRACKS, CONFERENCE CENTERS, ENTERTAINMENT FACILITIES, PLANETARIUMS, ZOOS, AND ARENAS; NEWSLETTERS AND PRINTED EDUCATIONAL MATERIALS IN THE FIELD OF MEETING PLANNING, FACILITIES AND EVENT ORGANIZATION (U.S. CLS. 2, 5, 22, 23, 29, 37, 38 AND 50).

FIRST USE 0-0-2001; IN COMMERCE 0-0-2001.

CLASS 35—ADVERTISING AND BUSINESS

FOR PROVIDING ONLINE DIRECTORIES FEATURING MEETING FACILITIES SUCH AS COLLEGES, UNIVERSITIES, MUSEUMS, MANSIONS, EXHIBITION FACILITIES, THEATERS, RACETRACKS, CONFERENCE CENTERS, ENTERTAINMENT FACILITIES, PLANETARIUMS, ZOOS, AND ARENAS; PROMOTING THE GOODS AND SERVICES OF OTHERS THROUGH DISTRIBUTION OF PRINTED AND ONLINE DIRECTORIES AND ADVERTISEMENTS, REFERRALS IN THE FIELD OF BUSINESS AND ENTERTAINMENT MEETING FACILITIES (U.S. CLS. 100, 101 AND 102).

FIRST USE 0-0-2000; IN COMMERCE 0-0-2000.

CLASS 41—EDUCATION AND ENTERTAINMENT

FOR ELECTRONIC NEWSLETTERS IN THE FIELD OF MEETING PLANNING, FACILITIES AND EVENT ORGANIZATION (U.S. CLS. 100, 101 AND 107).

FIRST USE 0-0-2000; IN COMMERCE 0-0-2000.

ROBIN CHOSID, EXAMINING ATTORNEY

SN 78-290,794. BLUEBONNET NUTRITION CORP., SUGAR LAND, TX. FILED 8-21-2003.

EARTH SWEET

NO CLAIM IS MADE TO THE EXCLUSIVE RIGHT TO USE "SWEET", APART FROM THE MARK AS SHOWN.

CLASS 1—CHEMICALS

FOR ARTIFICIAL SWEETENERS (U.S. CLS. 1, 5, 6, 10, 26 AND 46).

CLASS 5—PHARMACEUTICALS

FOR DIETARY AND NUTRITIONAL SUPPLEMENTS (U.S. CLS. 6, 18, 44, 46, 51 AND 52).

CHRISIE B. KING, EXAMINING ATTORNEY

SN 78-291,817. HYOSUNG CORPORATION, SEOUL, REPUBLIC OF KOREA, FILED 8-25-2003.

AEROSILVER

OWNER OF U.S. REG. NOS. 2,732,770 AND 2,732,781.

CLASS 23—YARNS AND THREADS

FOR ANTI BACTERIAL POLYESTER YARN; ANTI BACTERIAL NYLON YARN; POLYAMIDE YARN; ELASTIC YARN FOR USE IN THE MANUFACTURE OF WOVEN FABRIC; MIXED SPUN YARN; SPUN WOOL YARN; SEWING YARN; SEMI SYNTHETIC YARN FOR TEXTILE USE; SYNTHETIC FIBER YARN; MIXED CHEMICAL FIBER YARN; YARN CONTAINING METAL; AND SPANDEX YARN (U.S. CL. 43).

CLASS 24—FABRICS

FOR SEMI-SYNTHETIC FIBER FABRICS; EMBROIDERY FABRICS; RECLAIMED FIBER FABRICS; JERSEY FABRICS; ELASTIC WOVEN FABRICS; PILE FABRICS; SYNTHETIC FIBER FABRICS; MIXED COTTON FABRICS; MIXED CHEMICAL FIBER FABRICS; AND CHEMICAL FIBER KNIT FABRICS (U.S. CLS. 42 AND 50).

CLASS 25—CLOTHING

FOR WET SUITS FOR WATER-SKIING; ANORAKS; DRESS SUITS; SPORTS SUITS, NAMELY, JOGGING SUITS AND GYM SUITS; EVENING SUITS; CARDIGAN JACKETS; SKIRTS; POLO SHIRTS; T-SHIRTS; BLOUSES; JACKETS; COATS; SWIMSUITS; UNDERWEAR; ONE-PIECE DRESSES; JEANS; STOCKINGS; SOCKS; TROUSERS; SCARVES; HEADBANDS; HATS AND CAPS; SHOES; SANDALS; LEATHER SHOES; SLIPPERS; AND GOLF SHOES (U.S. CLS. 22 AND 39).

LAURA KOVAISKY, EXAMINING ATTORNEY

SN 78-292,193. MEYERS, SCOTT S., BIG SKY, MT. FILED 8-26-2003.



NO CLAIM IS MADE TO THE EXCLUSIVE RIGHT TO USE "ROCKY MOUNTAIN CHOPPERS", APART FROM THE MARK AS SHOWN.

CLASS 12—VEHICLES

FOR MOTORCYCLES AND MOTORCYCLE STRUCTURAL PARTS AND ACCESSORIES, NAMELY, FRAMES, FENDERS, FENDER SPACERS, HANDLE BARS, BRAKE PEDALS, KICK STANDS, FILLER PANELS, BELT GUARDS, RISERS, RISER CAPS, OIL CAPS, OIL TANKS AND GAS TANKS (U.S. CLS. 19, 21, 23, 31, 35 AND 44).

CLASS 25—CLOTHING

FOR CLOTHING, NAMELY, LONG SLEEVE AND SHORT SLEEVE T-SHIRTS, COLLARED SHIRTS, SWEATSHIRTS, HATS, CAPS, VESTS, FLEECES AND JACKETS (U.S. CLS. 22 AND 39).

CLASS 37—CONSTRUCTION AND REPAIR

FOR MOTORCYCLE MAINTENANCE, REPAIR AND CUSTOMIZATION USING BOTH CUSTOM-MADE AND AFTER-MARKET PARTS (U.S. CLS. 100, 103 AND 106).
DAVID TAYLOR, EXAMINING ATTORNEY

SN 78-293,053. WELSCO, INC., NORTH LITTLE ROCK, AR.
FILED 8-27-2003.

WELSCO**CLASS 1—CHEMICALS**

FOR GASES FOR WELDING, NAMELY, ACETYLENE, ARGON, CARBON DIOXIDE, HELIUM, HYDROGEN, NITROGEN, OXYGEN AND PROPYLENE GASES AND WELDING FLUXES (U.S. CLS. 1, 5, 6, 10, 26 AND 46).
FIRST USE 9-1-1976; IN COMMERCE 9-1-1976.

CLASS 9—ELECTRICAL AND SCIENTIFIC APPARATUS

FOR WELDING ELECTRODES, WELDERS' GOGGLES AND WELDERS' GLOVES (U.S. CLS. 21, 23, 26, 36 AND 38).
FIRST USE 9-1-1976; IN COMMERCE 9-1-1976.

CLASS 35—ADVERTISING AND BUSINESS

FOR DISTRIBUTORSHIP SERVICES IN THE FIELD OF WELDING EQUIPMENT, WELDING SUPPLIES AND INDUSTRIAL GAS (U.S. CLS. 100, 101 AND 102).
FIRST USE 9-1-1976; IN COMMERCE 9-1-1976.
BILL DAWE, EXAMINING ATTORNEY

SN 78-294,078. L.I.C. CAPITAL LLC, KEY BISCAYNE, FL.
FILED 8-29-2003.

MENSCIENCE
ANDROCEUTICALS**CLASS 3—COSMETICS AND CLEANING PREPARATIONS**

FOR AFTER-SHAVE LOTIONS, ANTI-BACTERIAL SOAP, BODY POWDER, BODY SCRUB, COSMETIC PREPARATIONS FOR SKIN RENEWAL, COSMETICS, DENTAL BLEACHING GEL, DENTIFRICES, DEODORANTS AND ANTIPERSPIRANTS, DEPILATORIES, FACIAL CLEANSERS, HAIR CARE PREPARATIONS, HAIR CLEANING PREPARATIONS, HAIR COLOR, HAIR STYLING PREPARATIONS, LIP BALM, LIQUID SOAPS FOR HANDS, FACE AND BODY, MOUTHWASH, PERFUME, SHAVING PREPARATIONS, SKIN CLEANSERS, SKIN CREAM, SUN BLOCK PREPARATIONS, SUN CARE LOTIONS (U.S. CLS. 1, 4, 6, 50, 51 AND 52).

CLASS 5—PHARMACEUTICALS

FOR ACNE TREATMENT PREPARATIONS, ANTI-BACTERIAL HANDWASH, ASTRINGENTS FOR MEDICINAL PURPOSES, DERMATOLOGICALS, DIETARY SUPPLEMENTS, DIET PILLS, FOOD SUPPLEMENTS, FUNGAL MEDICATIONS, MEDICATED HAIR CARE PREPARATIONS, MEDICATED SKIN CARE PREPARATIONS, NUTRITIONAL SUPPLEMENTS, PREPARATION FOR THE RELIEF OF PAIN, VITAMINS (U.S. CLS. 6, 18, 44, 46, 51 AND 52).

INGRID C. EULIN, EXAMINING ATTORNEY

SN 78-294,659. UNITED STONERWORKS INC., EVERETT, MA. FILED 9-2-2003.

UNITED STONERWORKS

NO CLAIM IS MADE TO THE EXCLUSIVE RIGHT TO USE STONERWORKS, APART FROM THE MARK AS SHOWN.

CLASS 19—NON-METALLIC BUILDING MATERIALS

FOR CUSTOM DESIGNED PRODUCTS, FIXTURES, AND FURNISHINGS MADE FROM VARIOUS STONE AND TILE BULK MATERIALS, DEVELOPED PRIMARILY FOR, BUT NOT LIMITED TO, INDOOR RESIDENTIAL AND COMMERCIAL APPLICATIONS, NAMELY FLOOR AND COUNTERTOP SURFACES, BACK-SPLASHES, FIREPLACE MANTELS AND ENCLOSURES, AND PRE-PACKAGED INSTALLATION-READY KITS RELATED THERETO (U.S. CLS. 1, 12, 33 AND 50).

FIRST USE 6-2-2003; IN COMMERCE 6-2-2003.

CLASS 37—CONSTRUCTION AND REPAIR

FOR CUSTOM INSTALLATION, FINISHING, AND RESTORATION OF SURFACES, FIXTURES, AND FURNISHINGS USING VARIOUS STONE AND TILE BULK MATERIALS (U.S. CLS. 100, 103 AND 106).
FIRST USE 6-2-2003; IN COMMERCE 6-2-2003.
JOHN HWANG, EXAMINING ATTORNEY

SN 78-294,832. CONSUMER PROGRAMS INCORPORATED, ST. LOUIS, MO. FILED 9-2-2003.

**WE TAKE A BEAUTIFUL
PORTRAIT. YOU MAKE IT
YOUR VERY OWN
CREATION.****CLASS 40—MATERIAL TREATMENT**

FOR ELECTRONIC OR PHOTOGRAPHIC MANIPULATION OF PORTRAIT IMAGES WITH ARTISTIC AND DECORATIVE BACKGROUNDS ELECTRONICALLY OR PHOTOGRAPHICALLY PRINTED ON PAPER (U.S. CLS. 100, 103 AND 106).

CLASS 41—EDUCATION AND ENTERTAINMENT

FOR PORTRAIT PHOTOGRAPHY SERVICES (U.S. CLS. 100, 101 AND 107).
ELIZABETH PIGNATELLO, EXAMINING ATTORNEY

SN 78-296,020. HOMESTEAD FABRICS LTD., NEW YORK, NY. FILED 9-4-2003.

WINDSOR FOOTBALL CLUB

CLASS 20—FURNITURE AND ARTICLES NOT OTHERWISE CLASSIFIED

FOR PILLOWS (U.S. CLS. 2, 13, 22, 25, 32 AND 50).

CLASS 24—FABRICS

FOR BED LINEN, BED COVERS, NAMELY, BED-SPREADS AND BLANKETS, BEDSHEETS, PILLOW CASES; WINDOW CURTAINS AND TABLE COVERS NOT MADE OF PAPER (U.S. CLS. 42 AND 50).

CLASS 25—CLOTHING

FOR CLOTHING, NAMELY, SHIRTS, DRESSES, PANTS, SKIRTS, SWEATERS, SHORTS, SHOES, SCARVES, JACKETS, SOCKS, UNDERWEAR, HATS AND CAPS (U.S. CLS. 22 AND 39).

TARAH HARDY, EXAMINING ATTORNEY

SN 78-296,025. HOMESTEAD FABRICS LTD., NEW YORK, NY. FILED 9-4-2003.

WINDSOR TENNIS CLUB

CLASS 20—FURNITURE AND ARTICLES NOT OTHERWISE CLASSIFIED

FOR PILLOWS (U.S. CLS. 2, 13, 22, 25, 32 AND 50).

CLASS 24—FABRICS

FOR BED LINEN, BED COVERS, NAMELY, BED-SPREADS AND BLANKETS, BED SHEETS, PILLOW CASES; WINDOW CURTAINS AND TABLE COVERS NOT MADE OF PAPER (U.S. CLS. 42 AND 50).

CLASS 25—CLOTHING

FOR CLOTHING, NAMELY, SHIRTS, DRESSES, PANTS, SKIRTS, SWEATERS, SHORTS, SHOES, SCARVES, JACKETS, SOCKS, UNDERWEAR, HATS AND CAPS (U.S. CLS. 22 AND 39).

TARAH HARDY, EXAMINING ATTORNEY

SN 78-298,545. LF, LLC, WILMINGTON, DE. FILED 9-10-2003.



OWNER OF U.S. REG. NO. 2,388,800.

CLASS 11—ENVIRONMENTAL CONTROL APPARATUS

FOR FAUCETS, SHOWER MASSAGE HEADS, SINK DRAINS, SINKS, PLUMBING FITTINGS, NAMELY, TRAPS, VALVES, DRAIN COVERS, HOOKUP AND DO-IT-YOURSELF KITS CONTAINING FAUCETS, DRAINS, GASKETS, WASHERS AND TRAPS (U.S. CLS. 13, 21, 23, 31 AND 34).

FIRST USE 1-31-2003; IN COMMERCE 1-31-2003.

CLASS 21—HOUSEWARES AND GLASS

FOR BATH ACCESSORIES, NAMELY, TOWEL RINGS, ROBE HOOKS, TOILET TISSUE HOLDERS, TOWEL HOLDERS AND TOWEL RODS FOR WALLS (U.S. CLS. 2, 13, 23, 29, 30, 33, 40 AND 50).

FIRST USE 3-0-2002; IN COMMERCE 3-0-2002.

ZACHARY BELLO, EXAMINING ATTORNEY

SN 78-298,771. L.C. LICENSING, INC., NEW YORK, NY. FILED 9-10-2003.

ELISABETH BY LIZ CLAIBORNE

OWNER OF U.S. REG. NOS. 1,687,927, 2,373,276 AND OTHERS.

THE NAME LIZ CLAIBORNE IDENTIFIES A LIVING INDIVIDUAL WHOSE CONSENT IS OF RECORD.

CLASS 9—ELECTRICAL AND SCIENTIFIC APPARATUS

FOR (BASED ON INTENT TO USE) EYEGLASSES, SUNGLASSES, EYEGLASS FRAMES, EYEGLASS CASES AND EYEGLASS RETAINER CORDS (U.S. CLS. 21, 23, 26, 36 AND 38).

CLASS 25—CLOTHING

FOR (BASED ON USE IN COMMERCE) SLEEPWEAR, NAMELY, NIGHTGOWNS, PAJAMAS, SLEEPSHIRTS, BEDJACKETS AND ROBES (U.S. CLS. 22 AND 39).

FIRST USE 5-8-2001; IN COMMERCE 5-8-2001.

ZACHARY BELLO, EXAMINING ATTORNEY

SN 78-300,194. LF, LLC, WILMINGTON, DE. FILED 9-15-2003.

DECORATIVE EFFECTS

OWNER OF U.S. REG. NO. 2,153,208.
SEC. 2(F).

CLASS 2—PAINTS

FOR PAINTS IN THE NATURE OF FAUX FINISHES (U.S. CLS. 6, 11 AND 16).

FIRST USE 2-14-1997; IN COMMERCE 2-14-1997.

CLASS 16—PAPER GOODS AND PRINTED MATTER

FOR INSTRUCTIONAL BOOKS AND BOOKLETS IN THE FIELD OF PAINTS AND FAUX FINISHES, SAMPLE CARDS AND COLOR CHIPS OF PAINTS AND FAUX FINISHES (U.S. CLS. 2, 5, 22, 23, 29, 37, 38 AND 50).

FIRST USE 2-14-1997; IN COMMERCE 2-14-1997.

ZACHARY BELLO, EXAMINING ATTORNEY

SN 78-300,489. COMMONWEALTH CAPITAL SECURITIES CORP., EXTON, PA. FILED 9-15-2003.

SN 78-303,292. MAPLESTAR DEVELOPMENT COMPANY, LLC, ROCHESTER, NY. FILED 9-22-2003.



NO CLAIM IS MADE TO THE EXCLUSIVE RIGHT TO USE "CAPITAL SECURITIES CORP.", APART FROM THE MARK AS SHOWN.

THE MARK CONSISTS OF RIGHT FACING GRYPHON WITH CLAW EXTENDING ENCIRCLED BY THE NAME OF COMMONWEALTH CAPITAL SECURITIES CORP.

CLASS 36—INSURANCE AND FINANCIAL

FOR FINANCIAL INVESTMENT IN THE FIELD OF HIGH TECHNOLOGY EQUIPMENT LEASING, SPECIFICALLY COMPUTER PERIPHERAL EQUIPMENT, THROUGH NATIONALLY DISTRIBUTED INCOME AND GROWTH FUNDS IN THE STRUCTURE OF LIMITED PARTNERSHIPS (U.S. CLS. 100, 101 AND 102).
FIRST USE 6-15-1991; IN COMMERCE 6-15-1991.

CLASS 42—SCIENTIFIC, COMPUTER AND LEGAL SERVICES

FOR LEASING OF HIGH TECHNOLOGY EQUIPMENT, SPECIFICALLY COMPUTER PERIPHERAL EQUIPMENT (U.S. CLS. 100 AND 101).
FIRST USE 6-15-1991; IN COMMERCE 6-15-1991.
KARANENDRA S. CHHINA, EXAMINING ATTORNEY

SN 78-300,682. BURROWS GOLF, INC., VALENCIA, CA. FILED 9-15-2003.

MORE FAIRWAYS, MORE PARS

CLASS 35—ADVERTISING AND BUSINESS

FOR PROMOTING THE GOLF TOURNAMENTS OF OTHERS; BUSINESS MANAGEMENT OF GOLF COURSES FOR OTHERS (U.S. CLS. 100, 101 AND 102).

CLASS 41—EDUCATION AND ENTERTAINMENT

FOR ORGANIZING GOLF TOURNAMENTS; PROVIDING GOLF CLUB SERVICES (U.S. CLS. 100, 101 AND 107).
NELSON SNYDER, EXAMINING ATTORNEY

MAPLESTAR

CLASS 18—LEATHER GOODS

FOR ALL PURPOSE SPORT BAGS, ALL PURPOSE ATHLETIC BAGS, ATHLETIC BAGS, BEACH BAGS, DAYPACKS, DUFFEL BAGS, GOLF UMBRELLAS, GYM BAGS, LUGGAGE TAGS, SOUVENIR BAGS, TRAVEL BAGS, UMBRELLAS (U.S. CLS. 1, 2, 3, 22 AND 41).

CLASS 25—CLOTHING

FOR BASEBALL CAPS, BEACHWEAR, COATS, FLEECE PULLOVERS, GOLF SHIRTS, HEADGEAR, NAMELY HATS, CAPS AND VISORS, JACKETS, JERSEYS, PARKAS, SHIRTS, SWEAT SHIRTS (U.S. CLS. 22 AND 39).

CLASS 36—INSURANCE AND FINANCIAL

FOR COMMERCIAL LENDING SERVICES, FINANCING SERVICES, INVESTMENT MANAGEMENT, INVESTMENT OF FUNDS FOR OTHERS, LEASING OF APARTMENTS, LEASING OF OFFICE SPACE, LEASING OF REAL ESTATE, LEASING OF REAL PROPERTY, LEASING OF SHOPPING MALL SPACE, LOAN FINANCING, MORTGAGE LENDING, REAL ESTATE INVESTMENT, REAL ESTATE MANAGEMENT, RENTAL OF APARTMENTS, TRAVELERS CHECK ISSUANCE (U.S. CLS. 100, 101 AND 102).

CLASS 37—CONSTRUCTION AND REPAIR

FOR REAL ESTATE DEVELOPMENT, REAL ESTATE SITE SELECTION, RESIDENTIAL AND COMMERCIAL BUILDING CONSTRUCTION (U.S. CLS. 100, 103 AND 106).

CLASS 39—TRANSPORTATION AND STORAGE

FOR ARRANGING EXCURSIONS FOR TOURISTS, ARRANGING TRAVEL TOURS, MARINE TRANSPORT, PARCEL DELIVERY, PARKING GARAGE SERVICES, PARKING LOT SERVICES, PLEASURE BOAT CRUISES, RENTAL OF CAR PARKING SPACES, RENTAL OF VEHICLE PARKING SPACES, RENTAL OF VEHICLES, RIVER TRANSPORT BY BOAT, SHIP PILOTING, SHIP UNLOADING, TAXI TRANSPORT, TOURIST AGENCY SERVICES, TRANSPORTATION SERVICES, NAMELY, CHECKING OF BAGGAGE, TRANSPORT BY FERRY, TRAIN, TROLLEY, BUS AND AUTOMOBILE, TRANSPORTATION OF PASSENGERS AND/OR GOODS BY FERRY, BUS, TRAIN OR AUTOMOBILE, TRAVEL AGENCY SERVICES, NAMELY, MAKING RESERVATIONS, TRAVEL GUIDE SERVICES, TRAVEL INFORMATION SERVICES, VALET PARKING, WAREHOUSE STORAGE, WAREHOUSING SERVICES (U.S. CLS. 100 AND 105).

IRENE D. WILLIAMS, EXAMINING ATTORNEY

SN 78-303,310. SOUTH BEACH BEVERAGE COMPANY, INC., NORWALK, CT. FILED 9-22-2003.

LIZARD LAVA

OWNER OF U.S. REG. NO. 2,065,837.

CLASS 29—MEATS AND PROCESSED FOODS

FOR DAIRY BASED BEVERAGES (U.S. CL. 46).
FIRST USE 10-1-2001; IN COMMERCE 10-1-2001.

CLASS 32—LIGHT BEVERAGES

FOR FRUIT DRINKS, FRUIT JUICE DRINK, SOFT DRINKS, AND SYRUPS AND CONCENTRATES FOR MAKING THE SAME (U.S. CLS. 45, 46 AND 48).

FIRST USE 10-1-2001; IN COMMERCE 10-1-2001.
JACQUELINE A. LAVINE, EXAMINING ATTORNEY

SN 78-303,440. PLCK HOLDINGS, LLC, PHOENIX, AZ.
FILED 9-22-2003.

MOST FORTUNATE CHINESE FOOD

NO CLAIM IS MADE TO THE EXCLUSIVE RIGHT TO USE CHINESE FOOD, APART FROM THE MARK AS SHOWN.

CLASS 25—CLOTHING

FOR HATS AND T-SHIRTS (U.S. CLS. 22 AND 39).

CLASS 29—MEATS AND PROCESSED FOODS

FOR PREPARED, PACKAGED AND FROZEN ENTRIES AND MEALS CONSISTING PRIMARILY OF MEAT, FISH, POULTRY OR VEGETABLES; FROZEN VEGETABLES AND FRUIT (U.S. CL. 46).

CLASS 30—STAPLE FOODS

FOR PREPARED, PACKAGED AND FROZEN ENTRIES OR MEALS CONSISTING PRIMARILY OF PASTA OR RICE (U.S. CL. 46).

CLASS 43—HOTEL AND RESTAURANT SERVICES

FOR RESTAURANT, TAKE-OUT AND CATERING SERVICES (U.S. CLS. 100 AND 101).

JANICE L. MCMORROW, EXAMINING ATTORNEY

SN 78-303,459. NESI APPAREL GROUP, LLC, OXNARD, CA.
FILED 9-22-2003.

SHANGHAI BABY

CLASS 18—LEATHER GOODS

FOR HANDBAGS, SHOULDER BAGS, TOTE BAGS, PURSES, CLUTCH PURSES, COSMETICS CASES SOLD EMPTY, TOILETRY BAGS SOLD EMPTY, OVERNIGHT BAGS, ATHLETIC BAGS, BACKPACKS, KNAPSACKS, DAYPACKS, FANNY PACKS, WALLETS, COIN PURSES, CLUTCH PURSES, CREDIT CARD CASES, KEY CASES, LEATHER KEY CHAINS, CARRY-ON BAGS AND LUGGAGE (U.S. CLS. 1, 2, 3, 22 AND 41).

CLASS 25—CLOTHING

FOR WOMEN'S AND JUNIORS WEARING APPAREL, NAMELY, TOPS, BLOUSES, SHIRTS, DRESSES, SKIRTS, PANTS, SUITS, JEANS, SHORTS, T-SHIRTS, SWEATSHIRTS, SWEATPANTS, SWEATSUITS, JACKETS, SWEATERS, VESTS, JUMPSUITS, PAJAMAS, ROBES, NIGHTGOWNS, SLEEPWEAR, LEOTARDS, LINGERIE, PANTIES, BRAS, UNDERWEAR, SWIMWEAR, BATHING SUITS, COVER-UPS, HATS, CAPS, HEADBANDS, SCARVES, BELTS, SOCKS, STOCKINGS, TIGHTS, LEGGINGS, GLOVES; OUTERWEAR, NAMELY, COATS AND RAINCOATS; FOOTWEAR, NAMELY, SHOES, SLIPPERS, BOOTS, SANDALS, FLIP-FLOPS, AND ATHLETIC SHOES (U.S. CLS. 22 AND 39).

ASMAT KHAN, EXAMINING ATTORNEY

SN 78-303,694. A & F TRADEMARK, INC., NEW ALBANY, OH. FILED 9-22-2003.



OWNER OF U.S. REG. NOS. 951,410, 2,061,284 AND 2,235,069.

CLASS 25—CLOTHING

FOR CLOTHING, NAMELY, PANTS, SHIRTS, SWEATERS AND TOPS (U.S. CLS. 22 AND 39).

CLASS 35—ADVERTISING AND BUSINESS

FOR RETAIL CLOTHING STORE SERVICES (U.S. CLS. 100, 101 AND 102).

BRETT J. GOLDEN, EXAMINING ATTORNEY

SN 78-304,241. HARRIS TEETER, INC., MATTHEWS, NC.
FILED 9-23-2003.

FRESHNESS VERIFIED

NO CLAIM IS MADE TO THE EXCLUSIVE RIGHT TO USE "FRESHNESS", APART FROM THE MARK AS SHOWN.

CLASS 29—MEATS AND PROCESSED FOODS

FOR PRE-PACKAGED GARDEN AND FRUIT SALADS. (U.S. CL. 46).

CLASS 31—NATURAL AGRICULTURAL PRODUCTS

FOR FRESH VEGETABLES, NAMELY, TOMATOES, POTATOES, LETTUCE, CELERY, CABBAGE, CORN, GREEN BEANS, CARROTS, MUSHROOMS, ONIONS, CUCUMBERS, AND FRESH NUTS IN THE SHELL; FRESH FRUIT, NAMELY, APPLES, ORANGES, PEARS, STRAWBERRIES, GRAPES, CHERRIES AND TANGERINES. (U.S. CLS. 1 AND 46).

CLASS 32—LIGHT BEVERAGES

FOR JUICES, NAMELY, APPLE JUICE, APPLE CIDER, PINEAPPLE JUICE, ORANGE JUICE, GRAPE JUICE AND TOMATO JUICE. (U.S. CLS. 45, 46 AND 48).
GIANCARLO CASTRO, EXAMINING ATTORNEY

SN 78-304,394. LOCKWOOD ASSOCIATES, LLC, KING OF PRUSSIA, PA. FILED 9-23-2003.

LOCKWOOD PLACE**CLASS 36—INSURANCE AND FINANCIAL**

FOR REAL ESTATE MANAGEMENT SERVICES FOR OFFICE AND RETAIL SPACE (U.S. CLS. 100, 101 AND 102).
FIRST USE 10-0-1999; IN COMMERCE 10-0-1999.

CLASS 39—TRANSPORTATION AND STORAGE

FOR PARKING LOT AND PARKING GARAGE SERVICES (U.S. CLS. 100 AND 105).
FIRST USE 10-0-1999; IN COMMERCE 10-0-1999.
MARK T. MULLEN, EXAMINING ATTORNEY

SN 78-304,925. INTERNATIONAL RESTAURANT GROUP, L.L.C., DALLAS, TX. FILED 9-24-2003.

FAJITA RITA'S**CLASS 25—CLOTHING**

FOR CLOTHING, NAMELY, SHIRTS, SWEATSHIRTS, HATS, CAPS AND SHORTS (U.S. CLS. 22 AND 39).

CLASS 43—HOTEL AND RESTAURANT SERVICES

FOR RESTAURANT AND BAR SERVICES (U.S. CLS. 100 AND 101).
MARK T. MULLEN, EXAMINING ATTORNEY

SN 78-304,935. IVAR'S, INC., SEATTLE, WA. FILED 9-24-2003.

SPIRIT BAY**CLASS 29—MEATS AND PROCESSED FOODS**

FOR SOUP MIXES, SOUPS, STEWS AND CHOWDER (U.S. CL. 46).

CLASS 30—STAPLE FOODS

FOR SALAD DRESSING, SAUCES, MARINADES, DIPS AND CONDIMENTS NAMELY MUSTARD, RELISH AND TARTAR (U.S. CL. 46).
DAWN FELDMAN, EXAMINING ATTORNEY

SN 78-304,965. ALLIANZ LIFE INSURANCE COMPANY OF NORTH AMERICA, MINNEAPOLIS, MN. FILED 9-24-2003.

TOTALTRADE**CLASS 36—INSURANCE AND FINANCIAL**

FOR FINANCIAL SERVICES, NAMELY, SECURITIES BROKERAGE, ELECTRONIC FINANCIAL INFORMATION SERVICES, NAMELY, PROVIDING OVER A GLOBAL COMPUTER NETWORK QUOTES ON SECURITIES, ECONOMIC RESEARCH, ECONOMIC NEWS, INVESTMENT INFORMATION, AND ELECTRONIC INTERNET ORDER EXECUTIONS. (U.S. CLS. 100, 101 AND 102).

CLASS 42—SCIENTIFIC, COMPUTER AND LEGAL SERVICES

FOR PROVIDING TEMPORARY USE OF NON-DOWNLOADABLE COMPUTER SOFTWARE FOR FACILITATING CUSTOMER ACCOUNT TRACKING AND REGULATORY COMPLIANCE FOR THE FINANCIAL SERVICES INDUSTRY OVER COMPUTER NETWORKS, INTRANETS AND THE INTERNET (U.S. CLS. 100 AND 101).
KARLA PERKINS, EXAMINING ATTORNEY

SN 78-304,973. TIFFANY (NJ) INC., PARSIPPANY, NJ. FILED 9-24-2003.

ATLAS

OWNER OF U.S. REG. NO. 1,605,467.

CLASS 14—JEWELRY

FOR JEWELRY; RINGS; BRACELETS; EARRINGS; NECKLACES; PENDANTS; TIE CLIPS; CUFF-LINKS; AND PRECIOUS METAL MONEY CLIPS (U.S. CLS. 2, 27, 28 AND 50).
FIRST USE 5-19-1995; IN COMMERCE 5-19-1995.

CLASS 21—HOUSEWARES AND GLASS

FOR CRYSTAL BOWLS; CRYSTAL CANDLESTICKS; CRYSTAL VASES; CRYSTAL ICE BUCKETS; CRYSTAL BOXES; CRYSTAL TUMBLERS; CRYSTAL BEVERAGE WARE; CRYSTAL HIGH-BALL GLASSES; CRYSTAL PILSNER STEMWARE; CRYSTAL WINE GLASSES; AND CRYSTAL CARAFES (U.S. CLS. 2, 13, 23, 29, 30, 33, 40 AND 50).
FIRST USE 8-0-1998; IN COMMERCE 8-0-1998.
ERICA GLEMBOCKI, EXAMINING ATTORNEY

SN 78-305,463. PHARMACHEM LABORATORIES, INC., KEARNY, NJ. FILED 9-25-2003.

SN 78-306,762. PARTYLITE WORLDWIDE, INC., PLYMOUTH, MA. FILED 9-29-2003.

APPLECEUTICAL

CLASS 1—CHEMICALS

FOR CHEMICALS FOR USE IN THE MANUFACTURE OF PHARMACEUTICAL PREPARATIONS AND DIETARY NUTRITIONAL SUPPLEMENTS (U.S. CLS. 1, 5, 6, 10, 26 AND 46).

CLASS 5—PHARMACEUTICALS

FOR NUTRITIONAL AND DIETARY SUPPLEMENTS (U.S. CLS. 6, 18, 44, 46, 51 AND 52).
CURTIS FRENCH, EXAMINING ATTORNEY

SN 78-305,493. PHARMACHEM LABORATORIES, INC., KEARNY, NJ. FILED 9-25-2003.

CHERRYCEUTICAL

CLASS 1—CHEMICALS

FOR CHEMICALS FOR USE IN THE MANUFACTURE OF PHARMACEUTICAL PREPARATIONS AND DIETARY NUTRITIONAL SUPPLEMENTS (U.S. CLS. 1, 5, 6, 10, 26 AND 46).

CLASS 5—PHARMACEUTICALS

FOR NUTRITIONAL AND DIETARY SUPPLEMENTS (U.S. CLS. 6, 18, 44, 46, 51 AND 52).
CURTIS FRENCH, EXAMINING ATTORNEY

SN 78-305,936. INTERMETTAL DO BRASIL LTDA, SÃO PAULO, BRAZIL, FILED 9-26-2003.



CLASS 6—METAL GOODS

FOR METAL FENCE STANCHIONS, PARTITIONS, BOOTHS, SIGN POSTS, AND SIGN FRAMES FOR CONTROLLING PEDESTRIAN TRAFFIC (U.S. CLS. 2, 12, 13, 14, 23, 25 AND 50).

CLASS 19—NON-METALLIC BUILDING MATERIALS

FOR NON-METAL FENCE STANCHIONS, PARTITIONS, BOOTHS, SIGN POSTS, AND SIGN FRAMES FOR CONTROLLING PEDESTRIAN TRAFFIC (U.S. CLS. 1, 12, 33 AND 50).
GEORGIA CARTY, EXAMINING ATTORNEY

BESTBURN

CLASS 4—LUBRICANTS AND FUELS

FOR CANDLES, FRAGRANT WAX FOR USE IN POTPOURRI BURNERS (U.S. CLS. 1, 6 AND 15).

CLASS 21—HOUSEWARES AND GLASS

FOR CANDLE HOLDERS NOT OF PRECIOUS METALS (U.S. CLS. 2, 13, 23, 29, 30, 33, 40 AND 50).
HOWARD B. LEVINE, EXAMINING ATTORNEY

SN 78-307,162. ECCA ENTERPRISES, INC., SAN ANTONIO, TX. FILED 9-30-2003.

IT'S UN-AMERICAN TO PAY MORE

CLASS 35—ADVERTISING AND BUSINESS

FOR RETAIL STORE SERVICES FEATURING OPTICAL GOODS (U.S. CLS. 100, 101 AND 102).

CLASS 44—MEDICAL, BEAUTY AND AGRICULTURAL SERVICES

FOR OPTICIAN AND OPTOMETRIC SERVICES (U.S. CLS. 100 AND 101).
CHRIS WELLS, EXAMINING ATTORNEY

SN 78-307,380. L.C. LICENSING, INC., NEW YORK, NY. FILED 9-30-2003.

SIGN ON

CLASS 14—JEWELRY

FOR WATCHES AND JEWELRY (U.S. CLS. 2, 27, 28 AND 50).

CLASS 18—LEATHER GOODS

FOR HANDBAGS, WALLETS, CHANGE PURSES, CLUTCH PURSES, COSMETIC AND TOILETRY CASES SOLD EMPTY, KEY CASES, BACKPACKS, RUCKSACKS, FANNY PACKS, DUFFEL BAGS AND LUGGAGE (U.S. CLS. 1, 2, 3, 22 AND 41).

CLASS 25—CLOTHING

FOR SCARVES, HATS, GLOVES, MITTENS, SOCKS, VESTS, SWEATERS, BELTS, SKIRTS, SHIRTS, PANTS, BLOUSES, JACKETS (U.S. CLS. 22 AND 39).
ROBERT LORENZO, EXAMINING ATTORNEY

SN 78-307,402. UNITED STATES POSTAL SERVICE, WASHINGTON DC, DC. FILED 9-30-2003.

SN 78-307,632. UNITED STATES POSTAL SERVICE, WASHINGTON DC, DC. FILED 9-30-2003.

CITY CARRIER

CLASS 18—LEATHER GOODS

FOR LEATHER KEY CHAINS, COSMETIC BAGS SOLD EMPTY, BAGS FOR WOMEN AND CHILDREN, NAMELY, BACKPACKS, MESSENGER BAGS, COIN PURSES, TOTE BAGS, SCHOOL BAGS, SCHOOL BOOK BAGS, PURSES, ALL-PURPOSE SPORTS BAGS, DUFFLE BAGS, AND OVERNIGHT LUGGAGE AND ROLLING LUGGAGE (U.S. CLS. 1, 2, 3, 22 AND 41).

CLASS 20—FURNITURE AND ARTICLES NOT OTHERWISE CLASSIFIED

FOR NON-METAL AND NON-LEATHER KEY CHAINS AND KEY RINGS, AND HAND-HELD, PERSONAL COMPACT AND FURNITURE MIRRORS (U.S. CLS. 2, 13, 22, 25, 32 AND 50).

CLASS 21—HOUSEWARES AND GLASS

FOR CUPS, MUGS, PLATES, WATER BOTTLES SOLD EMPTY, SPECIALTY HOLDERS FOR CARRYING WATER BOTTLES, LUNCH BOXES AND HAIR COMBS (U.S. CLS. 2, 13, 23, 29, 30, 33, 40 AND 50).
JEFFERY COWARD, EXAMINING ATTORNEY

SN 78-307,428. UNITED STATES POSTAL SERVICE, WASHINGTON DC, DC. FILED 9-30-2003.

LETTER CARRIERS WE KNOW THE ELEMENTS

CLASS 6—METAL GOODS

FOR METAL KEY CHAINS AND KEY RINGS (U.S. CLS. 2, 12, 13, 14, 23, 25 AND 50).

CLASS 18—LEATHER GOODS

FOR LEATHER KEY CHAINS, COSMETIC BAGS SOLD EMPTY, BAGS FOR WOMEN AND CHILDREN, NAMELY, BACKPACKS, MESSENGER BAGS, COIN PURSES, TOTE BAGS, SCHOOL BAGS, SCHOOL BOOK BAGS, PURSES, ALL-PURPOSE SPORTS BAGS, DUFFLE BAGS, AND OVERNIGHT LUGGAGE AND ROLLING LUGGAGE (U.S. CLS. 1, 2, 3, 22 AND 41).

CLASS 20—FURNITURE AND ARTICLES NOT OTHERWISE CLASSIFIED

FOR NON-METAL AND NON-LEATHER KEY CHAINS AND KEY RINGS, AND HAND-HELD, PERSONAL COMPACT AND FURNITURE MIRRORS (U.S. CLS. 2, 13, 22, 25, 32 AND 50).

CLASS 21—HOUSEWARES AND GLASS

FOR CUPS, MUGS, PLATES, WATER BOTTLES SOLD EMPTY, SPECIALTY HOLDERS FOR CARRYING WATER BOTTLES, LUNCH BOXES AND HAIR COMBS (U.S. CLS. 2, 13, 23, 29, 30, 33, 40 AND 50).
JEFFERY COWARD, EXAMINING ATTORNEY

POSTAGE PAID

CLASS 6—METAL GOODS

FOR METAL KEY CHAINS AND KEY RINGS (U.S. CLS. 2, 12, 13, 14, 23, 25 AND 50).

CLASS 18—LEATHER GOODS

FOR LEATHER KEY CHAINS, COSMETIC BAGS SOLD EMPTY, BAGS FOR WOMEN AND CHILDREN, NAMELY, BACKPACKS, MESSENGER BAGS, COIN PURSES, TOTE BAGS, SCHOOL BAGS, SCHOOL BOOK BAGS, PURSES, ALL-PURPOSE SPORTS BAGS, DUFFLE BAGS, AND OVERNIGHT LUGGAGE AND ROLLING LUGGAGE (U.S. CLS. 1, 2, 3, 22 AND 41).

CLASS 20—FURNITURE AND ARTICLES NOT OTHERWISE CLASSIFIED

FOR NON-METAL AND NON-LEATHER KEY CHAINS AND KEY RINGS, AND HAND-HELD, PERSONAL COMPACT AND FURNITURE MIRRORS (U.S. CLS. 2, 13, 22, 25, 32 AND 50).

CLASS 21—HOUSEWARES AND GLASS

FOR CUPS, MUGS, PLATES, WATER BOTTLES SOLD EMPTY, SPECIALTY HOLDERS FOR CARRYING WATER BOTTLES, LUNCH BOXES AND HAIR COMBS (U.S. CLS. 2, 13, 23, 29, 30, 33, 40 AND 50).
JEFFERY COWARD, EXAMINING ATTORNEY

SN 78-307,662. UNITED STATES POSTAL SERVICE, WASHINGTON DC, DC. FILED 9-30-2003.

RETURN TO SENDER

CLASS 6—METAL GOODS

FOR METAL KEY CHAINS AND KEY RINGS (U.S. CLS. 2, 12, 13, 14, 23, 25 AND 50).

CLASS 18—LEATHER GOODS

FOR LEATHER KEY CHAINS, COSMETIC BAGS SOLD EMPTY, BAGS FOR WOMEN AND CHILDREN, NAMELY, BACKPACKS, MESSENGER BAGS, COIN PURSES, TOTE BAGS, SCHOOL BAGS, SCHOOL BOOK BAGS, PURSES, ALL-PURPOSE SPORTS BAGS, DUFFLE BAGS, AND OVERNIGHT LUGGAGE AND ROLLING LUGGAGE (U.S. CLS. 1, 2, 3, 22 AND 41).

CLASS 20—FURNITURE AND ARTICLES NOT OTHERWISE CLASSIFIED

FOR NON-METAL AND NON-LEATHER KEY CHAINS AND KEY RINGS, AND HAND-HELD, PERSONAL COMPACT AND FURNITURE MIRRORS (U.S. CLS. 2, 13, 22, 25, 32 AND 50).

CLASS 21—HOUSEWARES AND GLASS

FOR CUPS, MUGS, PLATES, WATER BOTTLES SOLD EMPTY, SPECIALTY HOLDERS FOR CARRYING WATER BOTTLES, LUNCH BOXES AND HAIR COMBS (U.S. CLS. 2, 13, 23, 29, 30, 33, 40 AND 50).
JEFFERY COWARD, EXAMINING ATTORNEY

SN 78-307,693. UNITED STATES POSTAL SERVICE, WASHINGTON DC, DC. FILED 9-30-2003.

SN 78-308,175. CAPITAL ONE FINANCIAL CORPORATION, RICHMOND, VA. FILED 10-1-2003.

SILENT SERVICE WHO ARE THOSE GUYS?

CLASS 18—LEATHER GOODS

FOR LEATHER KEY CHAINS, COSMETIC BAGS SOLD EMPTY, BAGS FOR WOMEN AND CHILDREN, NAMELY, BACKPACKS, MESSENGER BAGS, COIN PURSES, TOTE BAGS, SCHOOL BAGS, SCHOOL BOOK BAGS, PURSES, ALL-PURPOSE SPORTS BAGS, DUFFLE BAGS, AND OVERNIGHT LUGGAGE AND ROLLING LUGGAGE (U.S. CLS. 1, 2, 3, 22 AND 41).

CLASS 20—FURNITURE AND ARTICLES NOT OTHERWISE CLASSIFIED

FOR NON-METAL AND NON-LEATHER KEY CHAINS AND KEY RINGS, AND HAND-HELD, PERSONAL COMPACT AND FURNITURE MIRRORS (U.S. CLS. 2, 13, 22, 25, 32 AND 50).

CLASS 21—HOUSEWARES AND GLASS

FOR WATER BOTTLES SOLD EMPTY, SPECIALTY HOLDERS FOR CARRYING WATER BOTTLES, LUNCH BOXES AND HAIR COMBS (U.S. CLS. 2, 13, 23, 29, 30, 33, 40 AND 50).
JEFFERY COWARD, EXAMINING ATTORNEY

SN 78-307,803. SOJRN INC, KENNESAW, GA. FILED 9-30-2003.

BAMCELL

CLASS 23—YARNS AND THREADS

FOR KNITTING YARN, SPUN YARN, TWISTED YARN, WORSTED YARN, YARN, YARN FIBERS (U.S. CL. 43).

CLASS 25—CLOTHING

FOR SWEATERS, MOCK TURTLE-NECK SWEATERS, TURTLENECK SWEATERS, V-NECK SWEATERS, CAMP SHIRTS, GOLF SHIRTS, KNIT SHIRTS, NIGHT SHIRTS, POLO SHIRTS, SHIRTS, SLEEP SHIRTS, SPORT SHIRTS, SWEAT SHIRTS, T-SHIRTS, WIND SHIRTS, BLOUSES, JACKETS, FISHING VESTS, HUNTING VESTS, QUILTED VESTS, VESTS, PANTS, SHORTS, SOCKS, SCARVES, SUITS, VESTED SUITS, DRESSING GOWNS, EVENING GOWNS, GOWNS, NIGHT GOWNS, SKIRTS, DRESSES, MUFFLERS, TOPS, WRAPS, JOGGING SUITS, PLAY SUITS, WARM UP SUITS, SHIRTS, SHORT SETS, CLOTHING, NAMELY, WRAP-AROUNDS (U.S. CLS. 22 AND 39).
CYNTHIA SLOAN, EXAMINING ATTORNEY

GOMILES

CLASS 35—ADVERTISING AND BUSINESS

FOR PROMOTING THE SALE OF CREDIT CARD ACCOUNTS THROUGH THE ADMINISTRATION OF INCENTIVE AWARD PROGRAMS (U.S. CLS. 100, 101 AND 102).

CLASS 36—INSURANCE AND FINANCIAL

FOR FINANCIAL SERVICES, NAMELY CREDIT CARD SERVICES (U.S. CLS. 100, 101 AND 102).
RONALD MCMORROW, EXAMINING ATTORNEY

SN 78-308,181. CAPITAL ONE FINANCIAL CORPORATION, RICHMOND, VA. FILED 10-1-2003.

GOREWARDS

CLASS 35—ADVERTISING AND BUSINESS

FOR PROMOTING THE SALE OF CREDIT CARD ACCOUNTS THROUGH THE ADMINISTRATION OF INCENTIVE AWARD PROGRAMS (U.S. CLS. 100, 101 AND 102).

CLASS 36—INSURANCE AND FINANCIAL

FOR FINANCIAL SERVICES, NAMELY CREDIT CARD SERVICES (U.S. CLS. 100, 101 AND 102).
RONALD MCMORROW, EXAMINING ATTORNEY

SN 78-308,186. CAPITAL ONE FINANCIAL CORPORATION, RICHMOND, VA. FILED 10-1-2003.

GOCASH

CLASS 35—ADVERTISING AND BUSINESS

FOR PROMOTING THE SALE OF CREDIT CARD ACCOUNTS THROUGH THE ADMINISTRATION OF INCENTIVE AWARD PROGRAMS (U.S. CLS. 100, 101 AND 102).

CLASS 36—INSURANCE AND FINANCIAL

FOR FINANCIAL SERVICES, NAMELY CREDIT CARD SERVICES (U.S. CLS. 100, 101 AND 102).
RONALD MCMORROW, EXAMINING ATTORNEY

SN 78-308,448. JD DESIGN, LLC, COMMERCE, CA. FILED 10-2-2003.



OWNER OF U.S. REG. NOS. 2,653,566 AND 2,715,038.

CLASS 18—LEATHER GOODS

FOR LEATHER BRIEFCASES, TRAVELING AND CARRYING BAGS, PURSES AND HANDBAGS (U.S. CLS. 1, 2, 3, 22 AND 41).
FIRST USE 8-1-2003; IN COMMERCE 8-1-2003.

SN 78-308,539. NESI APPAREL GROUP, LLC, OXNARD, CA. FILED 10-2-2003.

INTERSTATE JEANS COMPANY

CLASS 25—CLOTHING

FOR MEN'S, WOMEN'S AND CHILDREN'S CLOTHING, NAMELY, JEANS, DRESSES, BLOUSES, TOPS, PANTS, JUMPSUITS, SHORTS, ROBES, SKIRTS, BELTS, HATS, SWEATERS, SCARVES, JACKETS, VESTS, COATS, T-SHIRTS, LINGERIE AND SHOES (U.S. CLS. 22 AND 39).
FIRST USE 8-1-2003; IN COMMERCE 8-1-2003.
ROBERT COGGINS, EXAMINING ATTORNEY

NO CLAIM IS MADE TO THE EXCLUSIVE RIGHT TO USE "JEANS COMPANY", APART FROM THE MARK AS SHOWN.

CLASS 18—LEATHER GOODS

FOR BACKPACKS, DAYPACKS, FANNY PACKS, ATHLETIC BAGS, WALLETS AND PURSES (U.S. CLS. 1, 2, 3, 22 AND 41).

CLASS 25—CLOTHING

FOR CLOTHING, NAMELY, JEANS, PANTS, SHORTS, SHIRTS, T-SHIRTS, SWEATSHIRTS, SWEATPANTS, SWEATSUITS, OVERALLS, SKIRTS, DRESSES, BLOUSES, JACKETS, SWEATERS, VESTS, OUTERWEAR, NAMELY, COATS, OVERCOATS AND RAINCOATS, HATS, CAPS, SOCKS AND FOOTWEAR (U.S. CLS. 22 AND 39).
ASMAT KHAN, EXAMINING ATTORNEY

SN 78-308,471. JD DESIGN, LLC, COMMERCE, CA. FILED 10-2-2003.



SN 78-308,545. NESI APPAREL GROUP, LLC, OXNARD, CA. FILED 10-2-2003.

OWNER OF U.S. REG. NO. 2,715,038.

IJC

CLASS 18—LEATHER GOODS

FOR LEATHER BRIEFCASES, TRAVELING AND CARRYING BAGS, PURSES AND HANDBAGS (U.S. CLS. 1, 2, 3, 22 AND 41).

CLASS 18—LEATHER GOODS

FOR BACKPACKS, DAYPACKS, FANNY PACKS, ATHLETIC BAGS, WALLETS AND PURSES (U.S. CLS. 1, 2, 3, 22 AND 41).

CLASS 25—CLOTHING

FOR MEN'S WOMEN'S AND CHILDREN'S CLOTHING, NAMELY, JEANS, DRESSES, BLOUSES, TOPS, PANTS, JUMPSUITS, SHORTS, ROBES, SKIRTS, BELTS (U.S. CLS. 22 AND 39).
ROBERT COGGINS, EXAMINING ATTORNEY

CLASS 25—CLOTHING

FOR CLOTHING, NAMELY, JEANS, PANTS, SHORTS, SHIRTS, T-SHIRTS, SWEATSHIRTS, SWEATPANTS, SWEATSUITS, OVERALLS, SKIRTS, DRESSES, BLOUSES, JACKETS, SWEATERS, VESTS, OUTERWEAR, NAMELY, COATS, OVERCOATS AND RAINCOATS, HATS, CAPS, SOCKS AND FOOTWEAR (U.S. CLS. 22 AND 39).
ASMAT KHAN, EXAMINING ATTORNEY

SN 78-308,531. NESI APPAREL GROUP, LLC, OXNARD, CA. FILED 10-2-2003.

INTERSTATE

SN 78-308,603. CAPITAL ONE FINANCIAL CORPORATION, RICHMOND, VA. FILED 10-2-2003.

CLASS 18—LEATHER GOODS

FOR BACKPACKS, DAYPACKS, FANNY PACKS, ATHLETIC BAGS, WALLETS AND PURSES (U.S. CLS. 1, 2, 3, 22 AND 41).

GOPTIONS

CLASS 35—ADVERTISING AND BUSINESS

FOR PROMOTING THE SALE OF CREDIT CARD ACCOUNTS THROUGH THE ADMINISTRATION OF INCENTIVE AWARD PROGRAMS (U.S. CLS. 100, 101 AND 102).

CLASS 25—CLOTHING

FOR CLOTHING, NAMELY, JEANS, PANTS, SHORTS, SHIRTS, T-SHIRTS, SWEATSHIRTS, SWEATPANTS, SWEATSUITS, OVERALLS, SKIRTS, DRESSES, BLOUSES, JACKETS, SWEATERS, VESTS, OUTERWEAR, NAMELY, COATS, OVERCOATS AND RAINCOATS, HATS, CAPS, SOCKS AND FOOTWEAR (U.S. CLS. 22 AND 39).
ASMAT KHAN, EXAMINING ATTORNEY

CLASS 36—INSURANCE AND FINANCIAL

FOR FINANCIAL SERVICES, NAMELY CREDIT CARD SERVICES (U.S. CLS. 100, 101 AND 102).
BRIAN BROWN, EXAMINING ATTORNEY

SN 78-308,635. LATHAM PLASTICS, INC., LATHAM, NY.
FILED 10-2-2003.

PERMALIFE POOLS

NO CLAIM IS MADE TO THE EXCLUSIVE RIGHT TO USE "POOLS", APART FROM THE MARK AS SHOWN.

CLASS 19—NON-METALLIC BUILDING MATERIALS

FOR NON-METALLIC, MOLDED PLASTIC SWIMMING POOL STEPS; FITTED SWIMMING POOL COVERS; AND NON-METALLIC SWIMMING POOL COMPONENTS AND BUILDING MATERIALS, NAMELY, SWIMMING POOL WALL PANELS, WALL BRACES, PANEL CORNERS, BRACING SUPPORTS, SWIMMING POOL STEPS AND SWIMMING POOL DECKS (U.S. CLS. 1, 12, 33 AND 50).

CLASS 22—CORDAGE AND FIBERS

FOR PROTECTIVE VINYL LINERS FOR SWIMMING POOLS; AND UNFITTED SWIMMING POOL COVERS (U.S. CLS. 1, 2, 7, 19, 22, 42 AND 50).
GINA HAYES, EXAMINING ATTORNEY

SN 78-308,788. HEWLETT-PACKARD DEVELOPMENT COMPANY, L.P., HOUSTON, TX. FILED 10-2-2003.

READY OFFICE

CLASS 35—ADVERTISING AND BUSINESS

FOR BUSINESS MARKETING CONSULTING AND BUSINESS MANAGEMENT; PROVIDING INFORMATION IN THE FIELD OF BUSINESS AND COMMERCE CONDUCTED VIA THE INTERNET (U.S. CLS. 100, 101 AND 102).

CLASS 42—SCIENTIFIC, COMPUTER AND LEGAL SERVICES

FOR COMPUTER CONSULTATION; TECHNICAL SUPPORT SERVICES, NAMELY, TROUBLESHOOTING OF COMPUTER HARDWARE AND SOFTWARE PROBLEMS; AND PROVIDING INFORMATION IN THE FIELD OF COMPUTER PRODUCTS AND SERVICES (U.S. CLS. 100 AND 101).
GIANCARLO CASTRO, EXAMINING ATTORNEY

SN 78-309,125. BATH & BODY WORKS, INC., REYNOLDSBURG, OH. FILED 10-3-2003.

THE PERFECT SPRING

CLASS 3—COSMETICS AND CLEANING PREPARATIONS

FOR SCENTED ROOM SPRAYS AND POTPOURRI (U.S. CLS. 1, 4, 6, 50, 51 AND 52).

CLASS 4—LUBRICANTS AND FUELS

FOR CANDLES (U.S. CLS. 1, 6 AND 15).
NELSON SNYDER, EXAMINING ATTORNEY

SN 78-310,937. CURRENT COMMUNICATIONS SERVICES, LLC, GERMANTOWN, MD. FILED 10-8-2003.

CURRENTNET

CLASS 9—ELECTRICAL AND SCIENTIFIC APPARATUS

FOR VOICE AND DATA COMMUNICATIONS DEVICES, NAMELY, MODEMS, TELEPHONES, IP-ENABLED HOUSEHOLD APPLIANCES, NAMELY PERSONAL COMPUTERS, INTERNET BRIDGES, ROUTERS, REPEATERS, IP-ENABLED ELECTRIC METERS, MEDIUM VOLTAGE COUPLERS, POWER LINE SERVERS; TELECOMMUNICATIONS SOFTWARE, NAMELY, DRIVER SOFTWARE FOR THE MODEMS; COMMUNICATIONS SOFTWARE FOR TRANSMITTING INFORMATION VIA POWER LINES, RADIO FREQUENCIES, FIBER, AND COPPER, AND FOR PROVIDING ACCESS TO POWER LINE SERVERS (U.S. CLS. 21, 23, 26, 36 AND 38).

CLASS 38—COMMUNICATION

FOR ELECTRONIC COMMUNICATIONS NETWORKS, NAMELY, TRANSMISSION OF AUDIO AND VIDEO VIA ELECTRONIC COMMUNICATIONS NETWORKS; AUTOMATIC METER READING, REAL-TIME FAULT DETECTION AND ISOLATION, POWER QUALITY MONITORING, DEMAND-SIDE MANAGEMENT, REMOTE CONNECT/DISCONNECT (U.S. CLS. 100, 101 AND 104).
RONALD MCMORROW, EXAMINING ATTORNEY

SN 78-311,717. CARTER, TODD, RANCHO SANTA MARGARITA, CA. FILED 10-9-2003.

STRATICA

CLASS 9—ELECTRICAL AND SCIENTIFIC APPARATUS

FOR COMPUTER SYSTEMS HARDWARE FOR SMALL AND MEDIUM SIZED BUSINESSES (U.S. CLS. 21, 23, 26, 36 AND 38).

CLASS 42—SCIENTIFIC, COMPUTER AND LEGAL SERVICES

FOR CONSULTING AND MONITORING SERVICES IN THE FIELD OF SOFTWARE AND HARDWARE APPLICATIONS INTEGRATION AND MANAGEMENT (U.S. CLS. 100 AND 101).
CHARLES L. JENKINS, EXAMINING ATTORNEY

SN 78-312,011. CAPITAL ONE FINANCIAL CORPORATION, RICHMOND, VA. FILED 10-10-2003.

GOUNIVERSITY

CLASS 35—ADVERTISING AND BUSINESS

FOR PROMOTING THE SALE OF CREDIT CARD ACCOUNTS THROUGH THE ADMINISTRATION OF INCENTIVE AWARDS PROGRAMS (U.S. CLS. 100, 101 AND 102).

CLASS 36—INSURANCE AND FINANCIAL

FOR FINANCIAL SERVICES, NAMELY CREDIT CARD SERVICES (U.S. CLS. 100, 101 AND 102).
RONALD MCMORROW, EXAMINING ATTORNEY

SN 78-312,017. CAPITAL ONE FINANCIAL CORPORATION, RICHMOND, VA. FILED 10-10-2003.

GOEDUCATION

CLASS 35—ADVERTISING AND BUSINESS

FOR PROMOTING THE SALE OF CREDIT CARD ACCOUNTS THROUGH THE ADMINISTRATION OF INCENTIVE AWARD PROGRAMS (U.S. CLS. 100, 101 AND 102).

CLASS 36—INSURANCE AND FINANCIAL

FOR FINANCIAL SERVICES, NAMELY CREDIT CARD SERVICES (U.S. CLS. 100, 101 AND 102).
VERNA BETH RIRIE, EXAMINING ATTORNEY

SN 78-312,805. SHERROD, PATSY SPIKES, LUBBOCK, TX. FILED 10-13-2003.

FUNKERATION

CLASS 20—FURNITURE AND ARTICLES NOT OTHERWISE CLASSIFIED

FOR FURNITURE (U.S. CLS. 2, 13, 22, 25, 32 AND 50).

CLASS 24—FABRICS

FOR UPHOLSTERY FABRICS (U.S. CLS. 42 AND 50).

CLASS 42—SCIENTIFIC, COMPUTER AND LEGAL SERVICES

FOR INTERIOR DECORATING AND INTERIOR DECORATING CONSULTATION SERVICES (U.S. CLS. 100 AND 101).
JOHN SCHUYLER YARD, EXAMINING ATTORNEY

SN 78-313,210. LATHAM PLASTICS, INC., LATHAM, NY. FILED 10-14-2003.



NO CLAIM IS MADE TO THE EXCLUSIVE RIGHT TO USE "POOLS", APART FROM THE MARK AS SHOWN.

CLASS 19—NON-METALLIC BUILDING MATERIALS

FOR NON-METALLIC, MOLDED PLASTIC SWIMMING POOL STEPS; FITTED SWIMMING POOL COVERS; AND NON-METALLIC SWIMMING POOL COMPONENTS AND BUILDING MATERIALS, NAMELY, SWIMMING POOL WALL PANELS, WALL BRACES, PANEL CORNERS, BRACING SUPPORTS, SWIMMING POOL STEPS AND SWIMMING POOL DECKS (U.S. CLS. 1, 12, 33 AND 50).

CLASS 22—CORDAGE AND FIBERS

FOR PROTECTIVE VINYL LINERS FOR SWIMMING POOLS; AND UNFITTED SWIMMING POOL COVERS (U.S. CLS. 1, 2, 7, 19, 22, 42 AND 50).
GINA HAYES, EXAMINING ATTORNEY

SN 78-314,381. ILLINOIS TOOL WORKS INC., GLENVIEW, IL. FILED 10-16-2003.

DRIVING JOBSITE SPEED

CLASS 6—METAL GOODS

FOR METAL FASTENERS, NAMELY BOLTS, NAILS, PINS, RIVETS, STUDS, SCREWS, PLUGS AND CONCRETE ANCHORS (U.S. CLS. 2, 12, 13, 14, 23, 25 AND 50).

CLASS 7—MACHINERY

FOR POWER ACTUATED TOOLS DESIGNED FOR FIRING PINS, BOLTS, STUDS, SCREW, RIVETS, CONCRETE ANCHORS AND PLUGS INTO OR THROUGH METAL, CONCRETE, MASONRY AND THE LIKE (U.S. CLS. 13, 19, 21, 23, 31, 34 AND 35).

CLASS 9—ELECTRICAL AND SCIENTIFIC APPARATUS

FOR FUEL CELLS (U.S. CLS. 21, 23, 26, 36 AND 38).
ZACHARY BELLO, EXAMINING ATTORNEY

SN 78-314,749. URCULLU, JAIME D, NEW CANAAN, CT. FILED 10-16-2003.

GORILON

THE FOREIGN WORDING IN THE MARK TRANSLATES INTO ENGLISH AS BIG GORILLA.

CLASS 30—STAPLE FOODS

FOR CANDY; CANDY BARS; FLAVORED ICES; FRUIT ICE; ICE CREAM; FROZEN CONFECTIONS (U.S. CL. 46).

CLASS 32—LIGHT BEVERAGES

FOR CONCENTRATES, SYRUPS OR POWDERS USED IN THE PREPARATION OF SOFT DRINKS (U.S. CLS. 45, 46 AND 48).
JOHN HWANG, EXAMINING ATTORNEY

SN 78-317,634. NSIGHT TECHNOLOGIES, LLC, RIDGE-
LAND, MS. FILED 10-23-2003.

SN 78-319,474. NEOPHARM, INC., LAKE FOREST, IL. FILED
10-28-2003.

NTRUST

CLASS 42—SCIENTIFIC, COMPUTER AND LEGAL SERVICES

FOR INTEGRATION OF COMPUTER SYSTEMS AND
NETWORKS; COMPUTER SOFTWARE CONSULTA-
TION; COMPUTER SYSTEM ANALYSIS; CONSULTING
SERVICES IN THE FIELD OF DESIGN, SELECTION,
IMPLEMENTATION AND USE OF COMPUTER HARD-
WARE AND SOFTWARE SYSTEMS FOR OTHERS;
COMPUTER DIAGNOSTIC SERVICES; TECHNICAL
SUPPORT SERVICES, NAMELY, TROUBLESHOOTING
OF COMPUTER HARDWARE AND SOFTWARE PRO-
BLEMS; TECHNICAL SUPPORT, NAMELY, MONITOR-
ING OF NETWORK SYSTEMS (U.S. CLS. 100 AND 101).
FIRST USE 3-15-2003; IN COMMERCE 3-15-2003.

CLASS 45—PERSONAL SERVICES

FOR MONITORING OF COMPUTER SYSTEMS FOR
SECURITY PURPOSES (U.S. CLS. 100 AND 101).
FIRST USE 3-15-2003; IN COMMERCE 3-15-2003.
MATTHEW KLINE, EXAMINING ATTORNEY

SN 78-318,923. AUDI A.G., INGOLSTADT, FED REP GER-
MANY, FILED 10-27-2003.

A8

OWNER OF U.S. REG. NO. 2,067,529.

CLASS 12—VEHICLES

FOR AUTOMOBILE TIRE VALVE STEM CAP (U.S.
CLS. 19, 21, 23, 31, 35 AND 44).
FIRST USE 12-31-2000; IN COMMERCE 12-31-2000.

CLASS 27—FLOOR COVERINGS

FOR RUBBER AND CARPET FLOOR MATS FOR
VEHICLES (U.S. CLS. 19, 20, 37, 42 AND 50).
FIRST USE 9-30-2003; IN COMMERCE 9-30-2003.
KIM SAITO, EXAMINING ATTORNEY

NEOPHECTIN

CLASS 1—CHEMICALS

FOR LIPOSOME FOR USE IN TRANSFECTING CELLS
IN LABORATORY RESEARCH (U.S. CLS. 1, 5, 6, 10, 26
AND 46).

CLASS 5—PHARMACEUTICALS

FOR LIPOSOME FOR USE IN TRANSFECTING CELLS
(U.S. CLS. 6, 18, 44, 46, 51 AND 52).
EUGENIA MARTIN, EXAMINING ATTORNEY

SN 78-342,860. BATH & BODY WORKS, INC., REYNOLDS-
BURG, OH. FILED 12-18-2003.

THE PERFECT SUMMER

THE MARK CONSISTS OF STANDARD CHARACTERS
WITHOUT CLAIM TO ANY PARTICULAR FONT, STYLE,
SIZE, OR COLOR.

CLASS 3—COSMETICS AND CLEANING PRE- PARATIONS

FOR SCENTED ROOM SPRAYS AND POTPOURRI
(U.S. CLS. 1, 4, 6, 50, 51 AND 52).

CLASS 4—LUBRICANTS AND FUELS

FOR CANDLES (U.S. CLS. 1, 6 AND 15).
NELSON SNYDER, EXAMINING ATTORNEY

* * * * *

SECTION 2.— INTERNATIONAL CLASSIFICATION

The short titles associated below with the international class numbers are terms designed merely for quick identification and are not an official part of the international classification. The full names of international classes are given in section 6.1 of the trademark rules of practice.

The designation "U.S. Cl." appearing in this section refers to the U.S. class in effect prior to Sep. 1, 1973 rather than the international class which applies to applications filed on or after that date. For adoption of international classification see notice in the OFFICIAL GAZETTE of Jun. 26, 1973 (911 O.G. TM 210).

Application in one class

CLASS 1—CHEMICALS

SN 76-451,302. ICI AMERICAS INC., BRIDGEWATER, NJ. FILED 8-29-2002.

TWEEN

OWNER OF U.S. REG. NO. 739,448.
FOR SURFACE ACTIVE AGENTS FOR USE IN THE PERSONAL CARE PRODUCT, HOUSEHOLD, INDUSTRIAL AND INSTITUTIONAL CHEMICAL, DETERGENT, CLEANER, TOBACCO, PETROLEUM, TEXTILE, POLYMER, COATING AND PAINT INDUSTRIES; SURFACE ACTIVE AGENTS FOR USE IN THE MANUFACTURE OF FOODS, BEVERAGES, PHARMACEUTICALS, VETERINARY PRODUCTS, AGROCHEMICALS, LUBRICANTS, ADHESIVES AND PULP AND PAPER; EMULSIFIERS FOR USE IN THE PERSONAL CARE PRODUCTS, HOUSEHOLD CHEMICAL, PETROLEUM, TEXTILE, POLYMER, COATING AND PAINTING INDUSTRIES; EMULSIFIERS FOR USE IN THE MANUFACTURE OF CHEMICALS, PHARMACEUTICALS, VETERINARY PRODUCTS, AGROCHEMICALS, LUBRICANTS, FOODS, BEVERAGES, ADHESIVES AND PULP AND PAPER; WETTING AGENTS FOR USE IN THE PERSONAL CARE PRODUCT, HOUSEHOLD, INDUSTRIAL AND INSTITUTIONAL CHEMICALS, DETERGENT, CLEANERS, TOBACCO, PETROLEUM, TEXTILE, POLYMER, COATING AND PAINT INDUSTRIES; WETTING AGENTS FOR USE IN THE MANUFACTURE OF CHEMICALS, PHARMACEUTICALS, VETERINARY PRODUCTS, AGROCHEMICALS, LUBRICANTS, FOODS, BEVERAGES, ADHESIVES AND PULP AND PAPER DISPERSING AND SOLUBILIZING AGENTS FOR USE IN THE PERSONAL CARE PRODUCTS, HOUSEHOLD CHEMICAL, PETROLEUM, TEXTILE, POLYMER, COATING AND PAINT INDUSTRIES; AND DISPERSING AND SOLUBILIZING AGENTS FOR USE IN THE MANUFACTURE OF CHEMICALS, PHARMACEUTICALS, VETERINARY PRODUCTS, AGROCHEMICALS, LUBRICANTS, FOODS, BEVERAGES, ADHESIVES AND PULP AND PAPER (U.S. CLS. 1, 5, 6, 10, 26 AND 46).

FIRST USE 4-25-1941; IN COMMERCE 4-25-1941.
MARC LEIPZIG, EXAMINING ATTORNEY

CLASS 1—(Continued).

SN 76-497,132. ROSARIO, ERWIN F.G., DBA ATAMI, 4128 CC LEXMOND, NETHERLANDS, FILED 3-13-2003.

COPITO

PRIORITY CLAIMED UNDER SEC. 44(D) ON BENELUX APPLICATION NO. 1021795, FILED 11-14-2002, REG. NO. 0725008, DATED 11-14-2002, EXPIRES 11-14-2012.

FOR FERTILIZERS FOR AGRICULTURAL USE; HUMUS; SUBSTRATES CONTAINING COCO PIECES AS GROWTH MEDIA FOR PLANTS; POTTING COMPOST; MOLD RELEASE AGENT FOR GENERAL AGRICULTURAL USE (U.S. CLS. 1, 5, 6, 10, 26 AND 46).

ANDREA K. NADELMAN, EXAMINING ATTORNEY

SN 76-521,364. A.E. STALEY MANUFACTURING COMPANY, DECATUR, IL. FILED 6-9-2003.

STARPOL

FOR INEDIBLE STARCH FOR MANUFACTURING AND INDUSTRIAL USES, NAMELY AS A COMPONENT IN WALL TREATMENTS, ADHESIVES, TILE MORTAR, TILE GROUT, OIL DRILLING MUD, AND OTHER WATER-HOLDING, THICKENING, BINDING, RHEOLOGY MODIFYING, FILM FORMING, SUSPENDING, AND PROTECTIVE COLLOID INDUSTRIAL APPLICATIONS (U.S. CLS. 1, 5, 6, 10, 26 AND 46).

FIRST USE 5-12-1977; IN COMMERCE 5-12-1977.
KIM SAITO, EXAMINING ATTORNEY

SN 76-521,563. A.E. STALEY MANUFACTURING COMPANY, DECATUR, IL. FILED 6-9-2003.

STA-LOK

FOR INDUSTRIAL STARCHES FOR USE IN THE MANUFACTURE OF PAPER (U.S. CLS. 1, 5, 6, 10, 26 AND 46).

FIRST USE 7-11-1961; IN COMMERCE 7-11-1961.
ROBIN CHOSID, EXAMINING ATTORNEY

CLASS 1—(Continued).

SN 76-548,666. ZEA CORPORATION, INC., DBA UNITEX, KANSAS CITY, MO. FILED 9-16-2003.

UNITEX

FOR EPOXY ADHESIVES AND BINDERS FOR CONCRETE CONSTRUCTION APPLICATIONS; FORM RELEASE COMPOUNDS FOR USE IN CONCRETE FABRICATION; AND CONCRETE ADDITIVES, NAMELY, CURING COMPOUNDS AND SEALING COMPOUNDS (U.S. CLS. 1, 5, 6, 10, 26 AND 46).

FIRST USE 0-0-1971; IN COMMERCE 0-0-1971.
APRIL L. RADEMACHER, EXAMINING ATTORNEY

SN 76-548,684. ANATRACE, INC., MAUMEE, OH. FILED 9-16-2003.

PMAL

FOR POLYMERIC REAGENT FOR SCIENTIFIC OR MEDICAL RESEARCH FOR SOLUBILIZING PROTEIN, NAMELY, A REAGENT THAT WRAPS AROUND THE HYDROPHOBIC PORTION OF THE PROTEIN SO THAT THE HYDROPHOBIC SIDE CHAINS OF THE POLYMER STABILIZE THE HYDROPHOBIC SURFACE OF THE PROTEIN, WHILE THE POLAR SIDE CHAINS OF THE POLYMER CONFER AQUEOUS SOLUBILITY TO THE PROTEIN COMPLEX (U.S. CLS. 1, 5, 6, 10, 26 AND 46).

FIRST USE 10-24-2001; IN COMMERCE 10-24-2001.
APRIL L. RADEMACHER, EXAMINING ATTORNEY

SN 76-549,404. TETRA GMBH, 49324 MELLE, FED REP GERMANY, FILED 9-15-2003.

AquaRem

FOR WATER CONDITIONERS FOR GARDEN PONDS (U.S. CLS. 1, 5, 6, 10, 26 AND 46).

FIRST USE 0-0-1993; IN COMMERCE 0-0-1993.
WILLIAM BRECKENFELD, EXAMINING ATTORNEY

SN 76-552,925. BIO-OREGON, INC., WARRENTON, OR. FILED 10-2-2003.

BIOGAN

FOR FERTILIZER FOR AGRICULTURAL AND DOMESTIC USE (U.S. CLS. 1, 5, 6, 10, 26 AND 46).

FIRST USE 1-1-1955; IN COMMERCE 1-1-1955.
KEVON CHISOLM, EXAMINING ATTORNEY

CLASS 1—(Continued).

SN 76-557,610. ATOTECH DEUTSCHLAND GMBH, BERLIN, FED REP GERMANY, FILED 10-20-2003.

ZYLITE

FOR ELECTROPLATING CHEMICALS FOR USE IN ZINC PLATING BATHS (U.S. CLS. 1, 5, 6, 10, 26 AND 46).

FIRST USE 1-26-1995; IN COMMERCE 1-26-1995.
NANCY CLARKE, EXAMINING ATTORNEY

SN 78-227,107. APPLERA CORPORATION, FOSTER CITY, CA. FILED 3-18-2003.

QUANTIFILER

FOR REAGENTS FOR SCIENTIFIC OR RESEARCH USE; REAGENTS FOR FORENSICS, PATERNITY, AND HUMAN IDENTIFICATION USE (U.S. CLS. 1, 5, 6, 10, 26 AND 46).

PAULA MAYS, EXAMINING ATTORNEY

SN 78-227,599. ILLINOIS TOOL WORKS INC., GLENVIEW, IL. FILED 3-19-2003.

GLASS-LITE

FOR COMPOUND FILLER USED FOR REPAIR PURPOSES, NAMELY POLYESTER MATERIAL FOR USE AS A RUST REPAIR, FILLER FOR HOLES, DENTS, CRACKS AND SURFACE FLAWS FOR BARE STEEL, GALVANIZED STEEL, ALUMINUM, FIBERGLASS, PLASTIC, SMC (SHEET MOLDING COMPOUND), PLASTER, CONCRETE, MASONRY AND WOOD (U.S. CLS. 1, 5, 6, 10, 26 AND 46).

FIRST USE 3-6-2003; IN COMMERCE 3-6-2003.
WANDA KAY PRICE, EXAMINING ATTORNEY

SN 78-227,610. ILLINOIS TOOL WORKS INC., GLENVIEW, IL. FILED 3-19-2003.

FIBER TECH

FOR COMPOUND FILLER USED FOR REPAIR PURPOSES, NAMELY POLYESTER MATERIAL FOR USE AS A RUST REPAIR, FILLER FOR HOLES, DENTS, CRACKS AND SURFACE FLAWS FOR BARE STEEL, GALVANIZED STEEL, ALUMINUM, FIBERGLASS, PLASTIC, SMC (SHEET MOLDING COMPOUND), PLASTER, CONCRETE, MASONRY AND WOOD (U.S. CLS. 1, 5, 6, 10, 26 AND 46).

FIRST USE 3-6-2003; IN COMMERCE 3-6-2003.
WANDA KAY PRICE, EXAMINING ATTORNEY

CLASS 1—(Continued).

SN 78-232,195. TRUE WEST COMPANY, LLC, AURORA, CO.
FILED 3-31-2003.

THE GARDEN THAT WATERS ITSELF

FOR GARDEN KIT COMPRISING WATER-ABSORBING CROSS-LINKED POLYACRYLAMIDE POLYMER GEL, WEED-BARRIER FABRIC AND LANDSCAPE PINS (U.S. CLS. 1, 5, 6, 10, 26 AND 46).

WILLIAM BRECKENFELD, EXAMINING ATTORNEY

SN 78-239,039. KIDDE FIRE FIGHTING, INC., EXTON, PA.
FILED 4-17-2003.

COBRA FOAM

OWNER OF U.S. REG. NO. 2,735,384.

NO CLAIM IS MADE TO THE EXCLUSIVE RIGHT TO USE "FOAM", APART FROM THE MARK AS SHOWN.

FOR FIRE-EXTINGUISHING COMPOSITIONS IN THE FORM OF FOAM CONCENTRATE (U.S. CLS. 1, 5, 6, 10, 26 AND 46).

THEODORE MCBRIDE, EXAMINING ATTORNEY

SN 78-241,921. ARIZONA CHEMICAL COMPANY, JACKSONVILLE, FL. FILED 4-25-2003.

CENWAX

OWNER OF U.S. REG. NO. 729,039.

FOR CASTOR AND TALL OIL PRODUCTS AND THEIR DERIVATIVES, NAMELY, FATTY ACIDS, DISTILLED TALL OILS, DIMER ACIDS, MONOMER ACIDS, PINE OILS AND DIPENTENE, FOR USE IN THE MINING, FUELS, DUST CONTROL, CONCRETE, ASPHALT, ROAD BUILDING, RUBBER PROCESSING, PLASTICS, TEXTILES, PAPER, AND OIL FIELD INDUSTRIES, AND FOR USE IN THE MANUFACTURE OF FUELS, CONCRETE, ASPHALT, RUBBER, PLASTICS, DETERGENTS AND CLEANERS, SOLVENTS, RESINS, TEXTILES AND PAPER (U.S. CLS. 1, 5, 6, 10, 26 AND 46).

FIRST USE 1-1-2002; IN COMMERCE 1-1-2002.

CHERYL CLAYTON, EXAMINING ATTORNEY

SN 78-249,786. POLYONE CORPORATION, AVON LAKE, OH. FILED 5-14-2003.

ONCAP

FOR CHEMICALS TO IMPROVE PROCESSING OR PERFORMANCE OF POLYMERS IN THE MANUFACTURING OF EXTRUDED OR MOLDED ARTICLES. (U.S. CLS. 1, 5, 6, 10, 26 AND 46).

JANICE L. MCMORROW, EXAMINING ATTORNEY

CLASS 1—(Continued).

SN 78-254,579. SANKYO COMPANY LIMITED, TOKYO, JAPAN, FILED 5-27-2003.

SANKYO LIFETECH

OWNER OF U.S. REG. NOS. 2,045,823 AND 2,096,384.

THE FOREIGN WORDING IN THE MARK TRANSLATES INTO ENGLISH AS THREE TOGETHER.

FOR CHEMICAL FOOD PRESERVATIVES; PREPARATIONS FOR USE AS HIGH POLYMER STABILIZERS IN THE MANUFACTURE OF PLASTICS AND PAINTS, SYNTHETIC POLYMER STABILIZING PREPARATIONS FOR USE AS LIGHT STABILIZERS IN THE MANUFACTURE OF PLASTICS AND COATINGS, ANTIOXIDIZING CHEMICALS PREPARATIONS FOR USE IN THE MANUFACTURE OF DYES AND TANNING AGENTS, CHEMICAL ADDITIVES FOR USE IN THE MANUFACTURE OF FOOD; ANTIOXIDIZING CHEMICAL PREPARATIONS FOR USE IN THE MANUFACTURE OF DRINKS, CAKES, FLAVORING AGENTS, DAIRY PRODUCTS AND FISH PASTE PRODUCTS, PLANT GROWTH REGULATORS FOR AGRICULTURAL USE IN CONTROLLING GROWTH IN GRAPES, ORANGES, AND CEDARS TREES AND SHRUBS; DIAGNOSTIC REAGENTS FOR IN VITRO USE, DIAGNOSTIC PREPARATIONS AND REAGENTS FOR IN VITRO BIOLOGICAL TESTS, NAMELY FOR URINE AND BLOOD TESTS, FOR BLOOD GLUCOSE TESTS, FOR CLOTTING TESTS, ENZYME PREPARATIONS FOR IN VITRO USE, ALL FOR SCIENTIFIC AND RESEARCH USE; SOIL IMPROVING AGENTS, AND PLANT GROWTH REGULATORS FOR AGRICULTURAL USE, HORMONE-BASED PREPARATIONS FOR APPLICATION TO DOMESTIC AND/OR AGRICULTURAL PLANTS FOR USE AS PLANT GROWTH REGULATORS; DIAGNOSTIC PREPARATIONS, TETRODOTOXINS FOR SCIENTIFIC OR RESEARCH USE (U.S. CLS. 1, 5, 6, 10, 26 AND 46).

NORA BUCHANAN WILL, EXAMINING ATTORNEY

SN 78-265,159. ILFORD IMAGING UK LIMITED, CHESHIRE WA16 7JL, UNITED KINGDOM, FILED 6-20-2003.

GALERIE

FOR SENSITIZED PHOTOGRAPHIC PAPER (U.S. CLS. 1, 5, 6, 10, 26 AND 46).

FIRST USE 0-0-1979; IN COMMERCE 0-0-1979.

ZACHARY BELLO, EXAMINING ATTORNEY

SN 78-294,791. UNITED SUPPLIERS, INC., ELDORA, IA. FILED 9-2-2003.

SPEEDWAY

FOR ADJUVANT FOR INCLUSION WITH HERBICIDES THAT ACTS AS A MULTI-FUNCTIONING SPRAY ACTIVATOR AND WATER CONDITIONER (U.S. CLS. 1, 5, 6, 10, 26 AND 46).

BRIAN NEVILLE, EXAMINING ATTORNEY

CLASS 1—(Continued).

SN 78-295,867. AIR PRODUCTS AND CHEMICALS, INC., ALLENTOWN, PA. FILED 9-4-2003.

FLEXFYL

FOR AQUEOUS PRESSURE SENSITIVE ADHESIVES FOR THE END-USER AFFIXED; PRESSURE-SENSITIVE PRODUCTS INDUSTRY AND FILLERS FOR THE USE IN THE MANUFACTURE OF SUCH ADHESIVES (U.S. CLS. 1, 5, 6, 10, 26 AND 46).

APRIL L. RADEMACHER, EXAMINING ATTORNEY

CLASS 1—(Continued).

SN 78-306,947. RICELAND FOODS, INC., STUTTGART, IL. FILED 9-29-2003.

LECIPRIME

OWNER OF U.S. REG. NO. 1,747,998.
FOR LECITHIN USED IN THE MANUFACTURE OF FOOD PRODUCTS AND AS AN EMULSIFIER IN OTHER INDUSTRIAL APPLICATIONS (U.S. CLS. 1, 5, 6, 10, 26 AND 46).

FIRST USE 1-0-1982; IN COMMERCE 1-0-1982.
REBECCA SMITH, EXAMINING ATTORNEY

SN 78-300,619. CHEVRONTXACO CORPORATION, SAN RAMON, CA. FILED 9-15-2003.

FLEETFIX

OWNER OF U.S. REG. NO. 2,793,073.
FOR CHEMICAL ADDITIVE TO COOLANT SYSTEMS, NAMELY A COOLANT SYSTEM CORROSION INHIBITOR (U.S. CLS. 1, 5, 6, 10, 26 AND 46).

FIRST USE 10-31-2002; IN COMMERCE 10-31-2002.
MATTHEW KLINE, EXAMINING ATTORNEY

SN 78-306,961. RICELAND FOODS, INC., STUTTGART, AR. FILED 9-29-2003.

LECISPERSE

OWNER OF U.S. REG. NO. 1,747,998.
FOR LECITHIN USED IN THE MANUFACTURE OF FOOD PRODUCTS AND AS AN EMULSIFIER IN OTHER INDUSTRIAL APPLICATIONS (U.S. CLS. 1, 5, 6, 10, 26 AND 46).

FIRST USE 12-0-1982; IN COMMERCE 12-0-1982.
REBECCA SMITH, EXAMINING ATTORNEY

SN 78-301,562. INTERMOUNTAIN SCIENTIFIC CORPORATION, KAYSVILLE, UT. FILED 9-17-2003.

GENEMATE

FOR DIAGNOSTIC REAGENTS, SOLVENTS AND SOLUTIONS FOR SCIENTIFIC LABORATORY USE (U.S. CLS. 1, 5, 6, 10, 26 AND 46).

FIRST USE 5-0-1992; IN COMMERCE 5-0-1992.
MARGERY A. TIERNEY, EXAMINING ATTORNEY

SN 78-306,966. RICELAND FOODS, INC., STUTTGART, AR. FILED 9-29-2003.

LECIKOTE

OWNER OF U.S. REG. NO. 1,747,998.
FOR LECITHIN USED IN THE MANUFACTURE OF FOOD PRODUCTS AND AS AN EMULSIFIER IN OTHER INDUSTRIAL APPLICATIONS (U.S. CLS. 1, 5, 6, 10, 26 AND 46).

FIRST USE 5-0-1982; IN COMMERCE 6-0-1982.
REBECCA SMITH, EXAMINING ATTORNEY

SN 78-303,261. VITECH ENTERPRISES, INC., BLOOMINGDALE, NJ. FILED 9-21-2003.

PROVINO

THE ENGLISH TRANSLATION OF THE WORD PROVINO IN THE MARK IS SCREEN TEST.
FOR AMINO ACID AND VITAMIN-BASED FERTILIZER FOR AGRICULTURAL USE (U.S. CLS. 1, 5, 6, 10, 26 AND 46).

FIRST USE 6-11-2002; IN COMMERCE 6-11-2002.
KELLY BOULTON, EXAMINING ATTORNEY

SN 78-307,488. SLUSSER, LARRY F., JR., SPRING, TX. FILED 9-30-2003.

PIRANHA

FOR BIOREMEDIATION EFFECTIVENESS AGENTS, NAMELY, COMBINED CHEMICAL AND MICROBIAL FORMULATIONS FOR SPILL CONTROL AND CLEAN-UP, SOIL REMEDIATION, WATER REMEDIATION, WASTE TREATMENT, AND BIOREMEDIATION OR ORGANIC OR HYDROCARBON-BASED MATERIALS (U.S. CLS. 1, 5, 6, 10, 26 AND 46).

FIRST USE 6-6-2003; IN COMMERCE 6-6-2003.
SUSAN LESLIE DUBOIS, EXAMINING ATTORNEY

CLASS 1—(Continued).

SN 78-310,125. CASITE INTRACO, L.L.C., TROY, MI. FILED 10-7-2003.

BUZZ

FOR CHEMICAL ADDITIVES FOR USE IN CONNECTION WITH INTERNAL COMBUSTION ENGINE FLUIDS (U.S. CLS. 1, 5, 6, 10, 26 AND 46).
CHARLES L. JENKINS, EXAMINING ATTORNEY

SN 78-311,351. VOGEL SEED & FERTILIZER, INC., DBA SPRING VALLEY TURF PRODUCTS, JACKSON, WI. FILED 10-9-2003.

DEFROST

FOR CHEMICAL ADDITIVE FOR USE IN THE MANUFACTURE OF CHEMICAL SUBSTANCES FOR MELTING ICE AND SNOW (U.S. CLS. 1, 5, 6, 10, 26 AND 46).
JOHN LINCOSKI, EXAMINING ATTORNEY

SN 78-314,560. ROCHE MOLECULAR SYSTEMS, INC., ALAMEDA, CA. FILED 10-16-2003.

ACCURT

FOR REAGENT KIT CONSISTING OF A DNA POLYMERASE ENZYME FOR LABORATORY RESEARCH (U.S. CLS. 1, 5, 6, 10, 26 AND 46).
SHAUNIA WALLACE, EXAMINING ATTORNEY

SN 78-356,115. CYTEC TECHNOLOGY CORP., WILMINGTON, DE. FILED 1-23-2004.

CYBREAK

THE MARK CONSISTS OF STANDARD CHARACTERS WITHOUT CLAIM TO ANY PARTICULAR FONT, STYLE, SIZE, OR COLOR.

OWNER OF U.S. REG. NO. 2,203,217.
FOR SURFACTANTS FOR USE IN OIL PROCESSING INDUSTRIES (U.S. CLS. 1, 5, 6, 10, 26 AND 46).
LEIGH CAROLINE CASE, EXAMINING ATTORNEY

CLASS 2—PAINTS

SN 76-430,897. KHOURI, KEVIN M, CANYON COUNTRY, CA. FILED 7-11-2002.

COLORFLAKE

FOR SOLID COLOR PIGMENTS AND MULTI-COLOR PIGMENTS IN FLAKE FORM FOR USE OVER A CONCRETE SUBSTRATE (U.S. CLS. 6, 11 AND 16).
FIRST USE 6-25-2002; IN COMMERCE 6-25-2002.
LEIGH CAROLINE CASE, EXAMINING ATTORNEY

SN 76-452,890. DURON, INC., BELTSVILLE, MD. FILED 9-20-2002.

BOND-N-SEAL

SEC. 2(F).
FOR PAINT PRIMERS FOR SALE AT THE RETAIL LEVEL (U.S. CLS. 6, 11 AND 16).
FIRST USE 1-0-1985; IN COMMERCE 1-0-1985.
BRIDGETT SMITH, EXAMINING ATTORNEY

SN 76-470,628. MILLS PAINT SALES LTD., DELTA, BRITISH COLUMBIA, CANADA, FILED 11-29-2002.



PRIORITY CLAIMED UNDER SEC. 44(D) ON CANADA APPLICATION NO. 1146894, FILED 7-12-2002, REG. NO. TMA600889, DATED 1-29-2004, EXPIRES 1-29-2019.

NO CLAIM IS MADE TO THE EXCLUSIVE RIGHT TO USE "SINCE 1930" AND "PAINT", APART FROM THE MARK AS SHOWN.

FOR ANTI-CORROSIVE, PROTECTIVE AND DECORATIVE COATINGS FOR INTERIOR, EXTERIOR, MARINE, RESIDENTIAL, COMMERCIAL, AND INDUSTRIAL APPLICATIONS, NAMELY, INTERIOR AND EXTERIOR PAINTS, PAINT FOR INDUSTRIAL EQUIPMENT AND MACHINERY, CORROSION INHIBITING PAINT TYPE COATINGS FOR COMMERCIAL MARINE USE, VARNISHES, ENAMELS IN THE NATURE OF HOUSE PAINT, CERAMIC ENAMELS FOR INDUSTRIAL TANKS AND PIPING, LACQUERS, WOOD STAINS, PAINT PRIMERS, PAINT SEATERS, SEALER COATINGS, AND UNDERCOATS FOR SURFACES TO BE PAINTED (U.S. CLS. 6, 11 AND 16).

JOHN SCHUYLER YARD, EXAMINING ATTORNEY

CLASS 2—(Continued).

SN 76-536,345. FINE PAINTS OF EUROPE, INC., WOOD-STOCK, VT. FILED 8-11-2003.

FINE PAINTS

NO CLAIM IS MADE TO THE EXCLUSIVE RIGHT TO USE "PAINTS", APART FROM THE MARK AS SHOWN.

FOR HOUSE PAINTS, EXTERIOR PAINTS, INTERIOR PAINTS, ENAMELS IN THE NATURE OF HOUSE PAINTS, PAINT SEALERS, PAINT THINNERS, SHEL-LAC FOR USE AS SURFACE COATINGS, PRIMERS FOR PREPARING SURFACES TO BE PAINTED, PAINT GLAZES AND LACQUERS, GUM TURPENTINE, SIZE FOR WALLS, WOOD STAINS AND WOOD PRESERVA-TIVES (U.S. CLS. 6, 11 AND 16).

FIRST USE 6-15-1991; IN COMMERCE 6-15-1991.
ANN LINNEHAN, EXAMINING ATTORNEY

SN 76-545,711. THE GLIDDEN COMPANY, CLEVELAND, OH. FILED 9-22-2003.

EZ TRACK

OWNER OF U.S. REG. NO. 2,806,587.
SEC. 2(F) AS TO "TRACK".
FOR COATINGS IN THE NATURE OF PAINTS (U.S. CLS. 6, 11 AND 16).
FIRST USE 3-13-2003; IN COMMERCE 3-13-2003.
RUDY R. SINGLETON, EXAMINING ATTORNEY

SN 76-546,528. STRUCTURES WOOD CARE, INC., NISSWA, MN. FILED 8-15-2003.

NATURECOLOR

FOR COATINGS FOR WOOD, NAMELY, PAINTS, STAINS, SEALERS AND PRESERVATIVES (U.S. CLS. 6, 11 AND 16).
FIRST USE 11-1-2002; IN COMMERCE 11-1-2002.
LINDA M. KING, EXAMINING ATTORNEY

SN 76-547,552. INSL-X PRODUCTS CORPORATION, STONY POINT, NY. FILED 9-30-2003.

CLEAR-THROUGH

FOR CLEAR COATINGS USED IN THE NATURE OF PAINT (U.S. CLS. 6, 11 AND 16).
ELIZABETH HUGHITT, EXAMINING ATTORNEY

SN 78-233,058. INTERCONTINENTAL CHEMICAL COR-PORATION, CINCINNATI, OH. FILED 4-2-2003.

POUR-A-MAT

FOR PEELABLE PROTECTIVE COATINGS FOR FLOORS AND FLOORING MATERIALS (U.S. CLS. 6, 11 AND 16).
ALLISON HOLTZ, EXAMINING ATTORNEY

CLASS 2—(Continued).

SN 78-233,349. THE BABCOCK & WILCOX COMPANY, NEW ORLEANS, LA. FILED 4-3-2003.

GENCLAD

FOR CORROSION INHIBITING COATING METAL-LURGICALLY BONDED TO METAL TUBES (U.S. CLS. 6, 11 AND 16).

FIRST USE 1-7-2003; IN COMMERCE 1-7-2003.
JOHN LINCOSKI, EXAMINING ATTORNEY

SN 78-253,663. GNT INTERNATIONAL BV, BP VAALS, NETHERLANDS, FILED 5-23-2003.

DANCOLOR

FOR FOOD COLORINGS FOR AGRICULTURAL USE, FOR COMMERCIAL USE, FOR PHARMACEUTICAL USE, FOR INDUSTRIAL USE, FOR CHEMICAL USE AND FOR GENERAL PURPOSE COLORING; NATURAL COLORINGS MADE FROM FRUIT AND PLANTS FOR COMESTIBLES AND BEVERAGES (U.S. CLS. 6, 11 AND 16).

ANDREA SAUNDERS, EXAMINING ATTORNEY

SN 78-255,752. KANSAI PAINT CO., LTD., HYOGO, JAPAN, FILED 5-29-2003.



FOR ACRYLIC RESIN PAINTS (U.S. CLS. 6, 11 AND 16).
FIRST USE 6-3-1988; IN COMMERCE 12-1-1993.
KEVON CHISOLM, EXAMINING ATTORNEY

SN 78-301,330. VOGEL PAINT AND WAX COMPANY, INCORPORATED, ORANGE CITY, IA. FILED 9-17-2003.

NEXGEN

FOR PAINT FOR INDUSTRIAL EQUIPMENT AND MACHINERY (U.S. CLS. 6, 11 AND 16).
FIRST USE 8-12-2003; IN COMMERCE 8-12-2003.
KELLY BOULTON, EXAMINING ATTORNEY

CLASS 2—(Continued).

SN 78-304,801. OCI USA, INC., MIAMI, FL. FILED 9-24-2003.



FOR MULTIPURPOSE AEROSOL SPRAY PAINT FOR GENERAL INDOOR AND OUTDOOR PAINTING PURPOSES (U.S. CLS. 6, 11 AND 16).
FIRST USE 4-30-2003; IN COMMERCE 4-30-2003.
DAWN FELDMAN, EXAMINING ATTORNEY

SN 78-309,255. VAN SON HOLLAND INK CORPORATION OF AMERICA, MINEOLA, NY. FILED 10-3-2003.

VS5

FOR PRINTING INKS (U.S. CLS. 6, 11 AND 16).
DAWN HAN, EXAMINING ATTORNEY

CLASS 3—COSMETICS AND CLEANING PREPARATIONS

SN 76-262,712. MYBEAUTYCENTER.COM, LLC, NEW YORK, NY. FILED 5-25-2001.

MYBEAUTY

FOR COSMETICS, NAMELY NAIL POLISH, NAIL STRENGTHENER, CUTICLE RE-VITALIZER, LIPSTICK, LIP GLOSS, LIP PENCILS, LIP LINER, EYE PENCILS, MASCARA, EYE SHADOW, EYE LINER, BLUSH, FOUNDATION, CONCEALER, LOOSE POWDER, FACIAL TONER, FACIAL CLEANSER, FACIAL MASQUE, FACIAL LOTION, MAKEUP REMOVER, HAND AND BODY LOTION, SHOWER GEL, SOAP, BUBBLE BATH, BATH CRYSTALS, SUN PROTECTION LOTION, SELF-TANNING LOTION, SKIN LIGHTENER, EYE GEL, NIGHT CREAM, DAY CREAM, ANTI-WRINKLE CREAM, LIP TREATMENT, LIP BALM (U.S. CLS. 1, 4, 6, 50, 51 AND 52).
INGA ERVIN, EXAMINING ATTORNEY

CLASS 3—(Continued).

SN 76-342,524. PROXIMA, INC., DBA NICKA K. COSMETICS, MASPETH, NY. FILED 11-27-2001.

ABSOLUTE

FOR COSMETICS, NAMELY, LIP AND EYE PENCILS, MASCARA, EYELINER, LIP GLOSS AND EYE SHADOW (U.S. CLS. 1, 4, 6, 50, 51 AND 52).
FIRST USE 5-0-1998; IN COMMERCE 5-0-1998.
MICHAEL KEATING, EXAMINING ATTORNEY

SN 76-415,768. L'OREAL, PARIS, FRANCE, FILED 6-4-2002.

TRULY SUPERIOR

NO CLAIM IS MADE TO THE EXCLUSIVE RIGHT TO USE SUPERIOR, APART FROM THE MARK AS SHOWN.
FOR FOUNDATION MAKEUP (U.S. CLS. 1, 4, 6, 50, 51 AND 52).
MICHAEL SOUDERS, EXAMINING ATTORNEY

SN 76-418,560. LAKME COSMETICS, S.L., 08029 BARCELONA, SPAIN, FILED 6-7-2002.

TEKNIA

PRIORITY CLAIMED UNDER SEC. 44(D) ON ERPNTY TM OFC APPLICATION NO. 2,579,464, FILED 2-15-2002, REG. NO. 002579464, DATED 2-15-2002, EXPIRES 2-15-2012.
FOR TOILET SOAPS; PERFUME, COLOGNE, AFTER-SHAVE LOTIONS, EAU DE TOILETTE; ESSENTIAL OILS FOR PERSONAL USE; COSMETICS, NAMELY, LIPSTICK, EYELINER PENCIL, ROUGE, EYE SHADOW, EYEBROW PENCIL, LIP CONTOUR PENCIL, LIQUID MAKE-UP, MAKE-UP REMOVER, FACIAL LOTIONS AND ASTRINGENTS, BEAUTY MASKS, FACE POWDER, AND DENTIFRICES; HAIR CARE PREPARATIONS, NAMELY HAIR OXIDATION DYES, HAIR COLOR AND HAIR COLOR REMOVERS, HYDROGEN PEROXIDE FOR USE ON HAIR, LOTIONS TO WAVE AND DECURL HAIR, HAIR SPRAYS, HAIR CREAMS, HAIR GELS, HAIR WAXES, HAIR SHAMPOOS, HAIR CONDITIONERS, AND HAIR SETTING LOTION (U.S. CLS. 1, 4, 6, 50, 51 AND 52).
JEAN IM, EXAMINING ATTORNEY

SN 76-436,004. SASSY SCENTS, L.L.C., SCARSDALE, NY. FILED 7-31-2002.

SASSY SCENTS

NO CLAIM IS MADE TO THE EXCLUSIVE RIGHT TO USE "SCENTS", APART FROM THE MARK AS SHOWN.
FOR SACHETS (U.S. CLS. 1, 4, 6, 50, 51 AND 52).
H. M. FISHER, EXAMINING ATTORNEY

CLASS 3—(Continued).

SN 76-486,153. PH BEAUTY LABS LLC, LOS ANGELES, CA.
FILED 1-30-2003.

BO-TOPICAL

FOR NON-MEDICATED ANTI-WRINKLE TREATMENT CONSISTING OF NON-MEDICATED SKIN CREAM OINTMENT, GEL AND SPRAYS (U.S. CLS. 1, 4, 6, 50, 51 AND 52).

REBECCA SMITH, EXAMINING ATTORNEY

SN 76-492,876. BIOLAB SERVICES, INC., WILMINGTON, DE.
FILED 2-25-2003.



NO CLAIM IS MADE TO THE EXCLUSIVE RIGHT TO USE "HOUSEHOLD PRODUCTS", APART FROM THE MARK AS SHOWN.

FOR CLEANING PREPARATIONS CONTAINING SANITIZING PROPERTIES FOR HOUSEHOLD AND JANITORIAL APPLICATIONS, NAMELY, KITCHEN AND BATHROOM CLEANERS; TOILET CLEANERS; FLOOR CLEANERS AND POLISH; FURNITURE CLEANERS AND POLISH; TILE AND GROUT CLEANERS AND BLEACHES; DISHWASHING DETERGENT AND LIQUID SOAPS; DECK, FENCE, AND PATIO CLEANERS; CLEANERS FOR OUTDOOR SURFACES, NAMELY CONCRETE, WOOD, TILE, AND SIDING; HOUSE EXTERIOR CLEANING PREPARATIONS; CARPET CLEANERS; WINDOW CLEANERS; DRAIN CLEANERS AND OPENERS; SEPTIC SYSTEM CLEANERS; OVEN CLEANERS AND DEGREASERS; GENERAL PURPOSE CLEANERS, DEGREASERS AND DISPOSABLE CLEANING WIPES IMPREGNATED WITH CHEMICALS OR COMPOUNDS; CLEANING PREPARATIONS FOR AUTOMOTIVE, RECREATIONAL VEHICLE, AND MARINE APPLICATIONS (U.S. CLS. 1, 4, 6, 50, 51 AND 52).

ALICIA COLLINS, EXAMINING ATTORNEY

CLASS 3—(Continued).

SN 76-492,878. BIOLAB SERVICES, INC., WILMINGTON, DE.
FILED 2-25-2003.

BIOLAB HOUSEHOLD PRODUCTS

NO CLAIM IS MADE TO THE EXCLUSIVE RIGHT TO USE "HOUSEHOLD PRODUCTS", APART FROM THE MARK AS SHOWN.

FOR CLEANING PREPARATIONS CONTAINING SANITIZING PROPERTIES FOR HOUSEHOLD AND JANITORIAL APPLICATIONS, NAMELY, KITCHEN AND BATHROOM CLEANERS; TOILET CLEANERS; FLOOR CLEANERS AND POLISH; FURNITURE CLEANERS AND POLISH; TILE AND GROUT CLEANERS AND BLEACHES; DISHWASHING DETERGENT AND LIQUID SOAPS; DECK, FENCE, AND PATIO CLEANERS; CLEANERS FOR OUTDOOR SURFACES, NAMELY CONCRETE, WOOD, TILE, AND SIDING; HOUSE EXTERIOR CLEANING PREPARATIONS; CARPET CLEANERS; WINDOW CLEANERS; DRAIN CLEANERS AND OPENERS; SEPTIC SYSTEM CLEANERS; OVEN CLEANERS AND DEGREASERS; GENERAL PURPOSE CLEANERS, DEGREASERS AND DISPOSABLE CLEANING WIPES IMPREGNATED WITH CHEMICALS OR COMPOUNDS; CLEANING PREPARATIONS FOR AUTOMOTIVE, RECREATIONAL VEHICLE, AND MARINE APPLICATIONS (U.S. CLS. 1, 4, 6, 50, 51 AND 52).

ALICIA COLLINS, EXAMINING ATTORNEY

SN 76-499,036. NICHE MARKETING GROUP, INC., HICKSVILLE, NY. FILED 3-20-2003.

PEROSE

FOR PERFUMERY PRODUCTS, NAMELY PERFUMES, EAU DE COLOGNE, EAU DE PARFUM, EAU DE TOILETTE, PERFUMED WATER, ESSENTIAL OILS FOR PERSONAL USE; FRAGRANCED SKIN CARE PRODUCTS, NAMELY, SKIN LOTIONS, SKIN CREAM, SKIN EMOLLIENTS, SOAPS, SHAMPOOS, BATH AND SHOWER GELS, BATH OILS, BODY OIL, BODY DEODORANTS, AND BODY SPRAYS; AFTER-SHAVE LOTIONS AND GELS (U.S. CLS. 1, 4, 6, 50, 51 AND 52).

ALEX KEAM, EXAMINING ATTORNEY

SN 76-501,897. J&J TECHNOLOGY, LLC, JACKSON, TN.
FILED 3-28-2003.

RENUIT

FOR CLEANING PRODUCTS, NAMELY, EXTERIOR WOOD CLEANER FOR DECKS, FENCES, LAWN FURNITURE, AND BUILDINGS, INTERIOR WOOD AND FLOOR CLEANER, ALUMINUM AND VINYL SIDING CLEANER, CONCRETE AND ASPHALT CLEANER, MOLD AND MILDEW CLEANER, MULTI PURPOSE CLEANER FOR HOUSEHOLD, COMMERCIAL AND INDUSTRIAL USE, ALL PURPOSE DEGREASING PREPARATIONS NOT FOR USE IN MANUFACTURING PROCESSES FOR USE IN THE HOUSEHOLD, COMMERCIAL AND INDUSTRIAL FIELDS, HOUSE WASH, SUPER METAL POLISH, CLEANING PREPARATIONS FOR USE ON MARINE VEHICLES, CARPET CLEANERS, FLOOR CLEANERS, SPOT AND SPRAY CLEANERS FOR CLOTHING AND FABRIC (U.S. CLS. 1, 4, 6, 50, 51 AND 52).

GLENN CLARK, EXAMINING ATTORNEY

CLASS 3—(Continued).

SN 76-503,805. L'OREAL, PARIS, FRANCE, FILED 4-3-2003.

**COLOR SO MULTI-TONAL
AND PERSONAL, IT'S
YOURS ALONE**

NO CLAIM IS MADE TO THE EXCLUSIVE RIGHT TO USE "COLOR" OR "MULTI-TONAL", APART FROM THE MARK AS SHOWN.

FOR HAIRCOLOR (U.S. CLS. 1, 4, 6, 50, 51 AND 52).
H. M. FISHER, EXAMINING ATTORNEY

SN 76-505,544. HOUSECHEM, INC., WALDWICK, NJ. FILED 4-10-2003.



OWNER OF U.S. REG. NO. 2,638,253.
FOR TOILET BOWL CLEANERS AND ALL PURPOSE
CLEANING PREPARATIONS (U.S. CLS. 1, 4, 6, 50, 51
AND 52).
FIRST USE 7-30-2003; IN COMMERCE 7-30-2003.
TARAH HARDY, EXAMINING ATTORNEY

SN 76-508,815. AMOREPACIFIC CORPORATION, YONG-SAN-KU, SEOUL, REPUBLIC OF KOREA, FILED 4-8-2003.

WATER BANK ESSENCE

NO CLAIM IS MADE TO THE EXCLUSIVE RIGHT TO USE ESSENCE, APART FROM THE MARK AS SHOWN.

FOR NON-MEDICATED SKIN MOISTURIZING SERUMS, SKIN MILK LOTIONS, COSMETIC SOAPS, SHAMPOOS, FOUNDATION CREAMS, BODY LOTIONS, LIPSTICKS, LIQUID ROUGES, PERFUMES (U.S. CLS. 1, 4, 6, 50, 51 AND 52).

KELLY BOULTON, EXAMINING ATTORNEY

SN 76-509,922. ZUPFER, SHAWNA K., AVA, MO. FILED 4-28-2003.

BUGS SUDS

FOR PERSONAL CARE PRODUCTS, NAMELY SOAP IN LIQUID OR SOLID BAR FORM THAT IS IMPREGNATED WITH OILS AND ESSENTIAL OILS SELECTED FOR INSECT REPELLING PROPERTIES, FOR USE ON HANDS, FACE, HAIR AND BODY (U.S. CLS. 1, 4, 6, 50, 51 AND 52).

FIRST USE 4-25-2003; IN COMMERCE 4-25-2003.
GWEN STOKOLS, EXAMINING ATTORNEY

CLASS 3—(Continued).

SN 76-511,700. KING J. M. SHU ENTERPRISE INC., TAMSUI CHEN, TAIPEI HSIEN, TAIWAN, FILED 5-6-2003.

JEN-MU-SHU

FOR FACE CLEANSING OIL, SKIN LOTION, DAY CREAM, NIGHT CREAM, LIP STICKS, MAKE UP FOUNDATION, EYE SHADOW, MASSAGE CREAM, BEAUTY MASKS, NAIL ENAMEL, SHAMPOO, BODY MOISTURE CREAM (U.S. CLS. 1, 4, 6, 50, 51 AND 52).

FIRST USE 5-16-1988; IN COMMERCE 3-1-2003.
TRACY CROSS, EXAMINING ATTORNEY

SN 76-512,751. L'OREAL, PARIS, FRANCE, FILED 5-8-2003.

MEN EXPERTISE

NO CLAIM IS MADE TO THE EXCLUSIVE RIGHT TO USE MEN, APART FROM THE MARK AS SHOWN.

FOR COSMETICS NAMELY CREAMS, MILKS, LOTIONS, GELS AND POWDERS FOR THE FACE, THE BODY AND THE HANDS, SHAMPOOS, GELS, CREAMS AND LOTIONS FOR THE HAIR (U.S. CLS. 1, 4, 6, 50, 51 AND 52).

MITCHELL FRONT, EXAMINING ATTORNEY

SN 76-515,425. BARE ESSENTUALS, INC., SAN FRANCISCO, CA. FILED 5-19-2003.

MINERAL VEIL

NO CLAIM IS MADE TO THE EXCLUSIVE RIGHT TO USE MINERAL, APART FROM THE MARK AS SHOWN.

FOR COSMETICS, NAMELY, FACIAL POWDER (U.S. CLS. 1, 4, 6, 50, 51 AND 52).

FIRST USE 12-0-1995; IN COMMERCE 12-0-1995.
LESLEY LAMOTHE, EXAMINING ATTORNEY

SN 76-521,123. NARIS COSMETICS CO., LTD., OSAKA, JAPAN, FILED 6-6-2003.

REJUARNA

FOR FACIAL SOAPS, FACIAL MOISTURIZING CREAMS AND LOTIONS, FACIAL MASKS, BODY SKIN MOISTURIZING LOTIONS (U.S. CLS. 1, 4, 6, 50, 51 AND 52).

FIRST USE 4-1-2001; IN COMMERCE 9-27-2001.
KARANENDRA S. CHHINA, EXAMINING ATTORNEY

CLASS 3—(Continued).

SN 76-521,143. NARIS COSMETICS CO., LTD., FUKUSHIMA-KU, OSAKA, JAPAN, FILED 6-6-2003.

SELGRACE

FOR FACIAL SOAPS, FACIAL MOISTURIZING CREAMS AND LOTIONS, FACIAL MASKS, BODY SKIN MOISTURIZING LOTIONS (U.S. CLS. 1, 4, 6, 50, 51 AND 52).

FIRST USE 10-1-2001; IN COMMERCE 12-31-2002.
KARANENDRA S. CHHINA, EXAMINING ATTORNEY

SN 76-524,815. PROVITE, INC., ANAHEIM HILLS, CA. FILED 6-16-2003.

PROVITE

FOR TOOTH WHITENING PRODUCTS, NAMELY, TOOTH BLEACHING GEL AND COSMETIC TOOTH WHITENER; TOOTH PASTES; NON-MEDICATED MOUTH RINSE AND MOUTH WASH (U.S. CLS. 1, 4, 6, 50, 51 AND 52).

FIRST USE 5-13-2003; IN COMMERCE 5-13-2003.
YONG KIM, EXAMINING ATTORNEY

SN 76-527,425. L'OREAL, PARIS, FRANCE, FILED 6-24-2003.

PERFECT CURLS

NO CLAIM IS MADE TO THE EXCLUSIVE RIGHT TO USE CURLS, APART FROM THE MARK AS SHOWN.

FOR HAIR SHAMPOO, HAIR CONDITIONER, HAIR STYLING GEL, HAIR DEFINING CREME AND LEAVE-IN HAIR CONDITIONING TREATMENT (U.S. CLS. 1, 4, 6, 50, 51 AND 52).

DAVID C. REIHNER, EXAMINING ATTORNEY

SN 76-527,965. AVANZA, LLC, WESTFIELD, MA. FILED 7-7-2003.

BIOBELLA

FOR HOUSE MARK FOR A LINE OF COSMETICS, NAMELY, FACE MAKEUP, COMPACTS, EYE SHADOWS, LIPSTICKS, COSMETIC PENCILS, MASCARAS, BLUSHES AND LIP LINERS; NAIL CARE PREPARATIONS AND GROOMING PRODUCTS, NAMELY, POLISHES, HARDENERS, TIPS, GLUE, AND LACQUER; SKIN CARE PRODUCTS, NAMELY, CLEANERS, CREAMS, LOTIONS AND MOISTURIZERS; HAIR CLEANING PREPARATIONS AND CONDITIONERS; AND COLOGNES AND FRAGRANCES FOR PERSONAL USE (U.S. CLS. 1, 4, 6, 50, 51 AND 52).

STANLEY I. OSBORNE, EXAMINING ATTORNEY

CLASS 3—(Continued).

SN 76-531,066. AVECIA INC., WILMINGTON, DE. FILED 7-21-2003.



OWNER OF U.S. REG. NO. 2,504,032.
NO CLAIM IS MADE TO THE EXCLUSIVE RIGHT TO USE THE REPRESENTATION OF THE OUTLINE OF THE BOTTLE CAP, APART FROM THE MARK AS SHOWN.

THE MARK CONSISTS OF A BOTTLE DESIGN WITH A LEAF DESIGN AROUND THE CAP AND THE DESIGN OF FLOWERS ON THE BOTTLE ALONG WITH THE WORDS "BEING" AND "UPLIFT".

FOR AROMATHERAPY PRODUCTS, NAMELY, GELS, LOTIONS, POWDERS AND LIQUIDS FOR USE IN POOLS, HOT TUBS AND JETTED BATHS (U.S. CLS. 1, 4, 6, 50, 51 AND 52).

FIRST USE 2-10-2002; IN COMMERCE 2-10-2002.
CIMMERIAN COLEMAN, EXAMINING ATTORNEY

SN 76-531,321. CHUCKLES, INC., MANCHESTER, NH. FILED 7-22-2003.

SOLAR LITES

FOR HAIR CARE PREPARATIONS (U.S. CLS. 1, 4, 6, 50, 51 AND 52).

FIRST USE 7-10-2003; IN COMMERCE 7-10-2003.
ALEXANDER L. POWERS, EXAMINING ATTORNEY

SN 76-531,596. JUSBEN & ASSOCIATES, LTD., OLD BROOKVILLE, NY. FILED 7-21-2003.

SKINHELP

FOR ANTI-AGING CREAMS (U.S. CLS. 1, 4, 6, 50, 51 AND 52).

JANICE L. MCMORROW, EXAMINING ATTORNEY

CLASS 3—(Continued).

SN 76-533,751. THE VINCIT COMPANY, LLC, CHATTANOOGA, TN. FILED 7-21-2003.

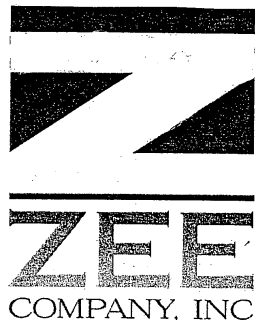

NO CLAIM IS MADE TO THE EXCLUSIVE RIGHT TO USE "COMPANY, INC", APART FROM THE MARK AS SHOWN.

THE STIPPLING IS A FEATURE OF THE MARK AND DOES NOT INDICATE COLOR.

THE MARK CONSISTS OF A DESIGN ELEMENT WHICH INCLUDES A RECTANGLE WITH A "Z". BENEATH THE DESIGN ARE THE WORDS "ZEE COMPANY, INC".

FOR CLEANING PREPARATIONS, NAMELY DETERGENTS, DISINFECTANTS, SANITIZERS, DEODORANTS, ANTI-FOAMING AGENTS, SCALD ENHANCERS AND HAND CARE PRODUCTS USED FOR CLEANING FOOD PROCESSING EQUIPMENT AND FACILITIES (U.S. CLS. 1, 4, 6, 50, 51 AND 52).

FIRST USE 6-30-1968; IN COMMERCE 6-30-1968.
CHRISTOPHER ADKINS, EXAMINING ATTORNEY

SN 76-536,422. LANCOME PARFUMS ET BEAUTE & CIE, PARIS, FRANCE, FILED 7-31-2003.

DERMO-GUIDE SYSTEM

NO CLAIM IS MADE TO THE EXCLUSIVE RIGHT TO USE "SYSTEM", APART FROM THE MARK AS SHOWN.

FOR COSMETICS NAMELY CREAMS, GELS, LOTIONS, MILKS AND POWDER FOR THE FACE, THE BODY AND THE HANDS (U.S. CLS. 1, 4, 6, 50, 51 AND 52).

INGRID C. EULIN, EXAMINING ATTORNEY

SN 76-536,423. LANCOME PARFUMS ET BEAUTE & CIE, PARIS, FRANCE, FILED 7-31-2003.

ACNO FOCUS

FOR COSMETICS NAMELY CREAMS, GELS, LOTIONS, MILKS AND POWDER FOR THE FACE, THE BODY AND THE HANDS (U.S. CLS. 1, 4, 6, 50, 51 AND 52).

INGRID C. EULIN, EXAMINING ATTORNEY

CLASS 3—(Continued).

SN 76-536,820. HRA PTY LTD., MELBOURNE, VICTORIA, AUSTRALIA, FILED 8-11-2003.



NO CLAIM IS MADE TO THE EXCLUSIVE RIGHT TO USE "LE MAQUILLAGE" AND "MAKE-UP", APART FROM THE MARK AS SHOWN.

THE ENGLISH LANGUAGE TRANSLATION OF LE MAQUILLAGE IS "MAKE-UP".

FOR LIPSTICK, LIP GLOSS, MASCARA, EYE SHADOW, BLUSH COMPACT POWDER, LOOSE POWDER, COMPACT FOUNDATION, FLUID MAKEUP, MAKEUP CONCEALER, EYE PENCIL, LIP PENCIL, NAIL POLISH, SKIN CARE AND PERSONAL CARE PRODUCTS, NAMELY, EYEBROW PENCILS, AND COSMETICS EXCLUDING PERFUME AND PERSONAL FRAGRANCES (U.S. CLS. 1, 4, 6, 50, 51 AND 52).

STEVEN R. FINE, EXAMINING ATTORNEY

SN 76-536,821. HRA PTY LTD., MELBOURNE, VICTORIA, AUSTRALIA, FILED 8-11-2003.



NO CLAIM IS MADE TO THE EXCLUSIVE RIGHT TO USE "LE MAQUILLAGE PROFESSIONNEL", APART FROM THE MARK AS SHOWN.

THE ENGLISH LANGUAGE TRANSLATION OF LE MAQUILLAGE PROFESSIONNEL IS "PROFESSIONAL MAKE-UP".

FOR LIPSTICK, LIP GLOSS, MASCARA, EYE SHADOW, BLUSH COMPACT POWDER, LOOSE POWDER, COMPACT FOUNDATION, FLUID MAKEUP, MAKEUP CONCEALER, EYE PENCIL, LIP PENCIL, BROW AND PERSONAL CARE PRODUCTS, NAMELY, EYEBROW PENCILS, NAIL POLISH, AND COSMETICS EXCLUDING PERFUME AND PERSONAL FRAGRANCES (U.S. CLS. 1, 4, 6, 50, 51 AND 52).

STEVEN R. FINE, EXAMINING ATTORNEY

SN 76-540,106. L'OREAL, PARIS, FRANCE, FILED 8-12-2003.

PENCIL PERFECT

NO CLAIM IS MADE TO THE EXCLUSIVE RIGHT TO USE PENCIL, APART FROM THE MARK AS SHOWN.

FOR COSMETICS, NAMELY, EYELINER (U.S. CLS. 1, 4, 6, 50, 51 AND 52).

FIRST USE 0-0-1993; IN COMMERCE 0-0-1993.
ZACHARY BELLO, EXAMINING ATTORNEY

CLASS 3—(Continued).

SN 76-543,927. L'OREAL, PARIS, FRANCE, FILED 8-29-2003.

MEGA MOISTURE

NO CLAIM IS MADE TO THE EXCLUSIVE RIGHT TO USE "MOISTURE", APART FROM THE MARK AS SHOWN. FOR HAIR SHAMPOO AND NON-MEDICATED HAIR TREATMENT PREPARATIONS (U.S. CLS. 1, 4, 6, 50, 51 AND 52).

FIRST USE 2-1-1999; IN COMMERCE 2-1-1999.
ZACHARY BELLO, EXAMINING ATTORNEY

SN 76-545,457. L'OREAL, PARIS, FRANCE, FILED 9-5-2003.

BROW STYLIST

NO CLAIM IS MADE TO THE EXCLUSIVE RIGHT TO USE BROW, APART FROM THE MARK AS SHOWN. FOR EYEBROW PENCIL (U.S. CLS. 1, 4, 6, 50, 51 AND 52).

ZACHARY BELLO, EXAMINING ATTORNEY

SN 76-545,729. HOUSE OF MOHAN CORPORATION, WASHINGTON, DC. FILED 9-22-2003.

CELEBRITY SCENTS

NO CLAIM IS MADE TO THE EXCLUSIVE RIGHT TO USE SCENTS, APART FROM THE MARK AS SHOWN. FOR STICK INCENSE (U.S. CLS. 1, 4, 6, 50, 51 AND 52). DEZMONA MIZELLE, EXAMINING ATTORNEY

SN 76-545,950. LINDQUIST, PHILIP V., NAPLES, FL. FILED 9-22-2003.

**PHILIP DOUGLAS
PLATINUM BLONDE**

OWNER OF U.S. REG. NOS. 1,810,386 AND 2,350,173. NO CLAIM IS MADE TO THE EXCLUSIVE RIGHT TO USE "BLONDE", APART FROM THE MARK AS SHOWN. THE NAME SHOWN IN THE MARK, PHILIP DOUGLAS, DOES NOT IDENTIFY A LIVING INDIVIDUAL.

FOR NON MEDICATED SKINCARE AND FRAGRANCES FOR PERSONAL USE NAMELY: COLOGNE, TOILET WATER, BODY LOTION, BODY CREAM, SHOWER GEL, AFTER SHAVE, PERUME, BODY POWDER, LIPSTICK AND MOISTURIZERS (U.S. CLS. 1, 4, 6, 50, 51 AND 52).

ALLISON HOLTZ, EXAMINING ATTORNEY

CLASS 3—(Continued).

SN 76-546,089. CHESEBROUGH-POND'S INC., WILMINGTON, DE. FILED 9-22-2003.

STAINGRABBER

FOR LAUNDRY DETERGENT (U.S. CLS. 1, 4, 6, 50, 51 AND 52).

JOHN E. MICHOS, EXAMINING ATTORNEY

SN 76-546,803. BOSSLEY, SUE, VANCOUVER, BRITISH COLUMBIA, CANADA, FILED 9-22-2003.

**THRONE GUARD PERSONAL
ANTI-BACTERIAL WEAPON
FOR PUBLIC WASHROOMS**

NO CLAIM IS MADE TO THE EXCLUSIVE RIGHT TO USE "PERSONAL ANTI-BACTERIAL" AND "FOR PUBLIC WASHROOMS", APART FROM THE MARK AS SHOWN.

FOR ANTI-BACTERIAL SPRAY FOR USE IN WASHROOMS, BATHROOMS AND ON TOILETS (U.S. CLS. 1, 4, 6, 50, 51 AND 52).

SUSAN STIGLITZ, EXAMINING ATTORNEY

SN 76-547,700. NATURAL ORGANICS INC., MELVILLE, NY. FILED 9-26-2003.

RX-AGELOSS

OWNER OF U.S. REG. NOS. 2,152,590, 2,660,521 AND OTHERS.

FOR COSMETIC CREAM (U.S. CLS. 1, 4, 6, 50, 51 AND 52).

FIRST USE 10-11-2001; IN COMMERCE 10-11-2001.

ANN LINNEHAN, EXAMINING ATTORNEY

SN 76-549,087. FINANZ ST. HONORE, B.V., 1017 CG AMSTERDAM, NETHERLANDS, FILED 10-6-2003.

ENGLISH LEATHER

FOR COLOGNE, EAU DE COLOGNE, AFTER SHAVE SPLASH, ALL-PURPOSE SKIN LOTION, SOAP, DEODORANT, ANTIPERSPIRANT DEODORANT, ALCOHOL FREE DEODORANT AND PUMICE SHOWER GEL (U.S. CLS. 1, 4, 6, 50, 51 AND 52).

FIRST USE 1-1-1951; IN COMMERCE 1-1-1951.

KARANENDRA S. CHHINA, EXAMINING ATTORNEY

SN 76-551,278. LADY BURD EXCLUSIVE COSMETICS, INC., FARMINGDALE, NY. FILED 9-24-2003.

COVER RELEASE

FOR COSMETICS (U.S. CLS. 1, 4, 6, 50, 51 AND 52). MARGERY A. TIERNEY, EXAMINING ATTORNEY

CLASS 3—(Continued).

SN 76-551,710. L'OREAL, PARIS, FRANCE, FILED 9-25-2003.

**OPTI-MATCH
TECHNOLOGY**

NO CLAIM IS MADE TO THE EXCLUSIVE RIGHT TO USE "TECHNOLOGY", APART FROM THE MARK AS SHOWN.

FOR COSMETIC INGREDIENT COMPLEX USED AS A COMPONENT IN THE MANUFACTURE OF FOUNDATION MAKEUP (U.S. CLS. 1, 4, 6, 50, 51 AND 52).
ZACHARY BELLO, EXAMINING ATTORNEY

SN 76-551,966. LENACO CORPORATION, SOUTH SAN FRANCISCO, CA. FILED 10-14-2003.

HOLCOMBE & MOORE

FOR HAIR SHAMPOO, TOILET SOAP, SKIN LOTION, BODY WASH AND BATH GEL (U.S. CLS. 1, 4, 6, 50, 51 AND 52).

FIRST USE 5-23-1997; IN COMMERCE 5-23-1997.
H. M. FISHER, EXAMINING ATTORNEY

SN 76-555,262. RANIR/DCP CORPORATION, GRAND RAPIDS, MI. FILED 10-14-2003.

EASY AS 1, 2, ZZZ...

FOR TEETH WHITENING GEL (U.S. CLS. 1, 4, 6, 50, 51 AND 52).

FIRST USE 9-3-2003; IN COMMERCE 9-3-2003.
LAURA KOVAISKY, EXAMINING ATTORNEY

SN 76-555,368. LANCOME PARFUMS ET BEAUTE & CIE, PARIS, FRANCE, FILED 10-14-2003.

SUMMER DELIGHT

FOR PERFUME, TOILET WATER; GELS, SALTS FOR THE BATH AND THE SHOWER NOT FOR MEDICAL PURPOSE; TOILET SOAPS, BODY DEODORANTS; COSMETICS, NAMELY CREAMS, MILKS, LOTIONS, GELS AND POWDERS FOR THE FACE, BODY AND HANDS; MAKE-UP PREPARATIONS, NAMELY EYE SHADOWS, EYEBROW PENCILS, EYE LINER, MASCARA, LIPSTICKS, NAIL POLISH, BLUSHERS, ROUGE FOR CHEEKS (U.S. CLS. 1, 4, 6, 50, 51 AND 52).

GINA HAYES, EXAMINING ATTORNEY

SN 76-556,797. HARD CANDY LLC, COSTA MESA, CA. FILED 10-21-2003.

PUPPY LOVEFOR PERFUME (U.S. CLS. 1, 4, 6, 50, 51 AND 52).
ANDREA K. NADELMAN, EXAMINING ATTORNEY**CLASS 3—(Continued).**

SN 76-558,361. LANCOME PARFUMS ET BEAUTE & CIE, PARIS, FRANCE, FILED 10-27-2003.

AQUACELLULAR

FOR COSMETICS NAMELY CREAMS, GELS, MILKS, LOTIONS AND POWDERS FOR THE FACE, BODY AND HANDS (U.S. CLS. 1, 4, 6, 50, 51 AND 52).

BERYL GARDNER, EXAMINING ATTORNEY

SN 76-558,569. ORLY INTERNATIONAL, INC., CHATSWORTH, CA. FILED 10-27-2003.

TOP 2 BOTTOM

FOR NAIL CARE PREPARATIONS (U.S. CLS. 1, 4, 6, 50, 51 AND 52).

FIRST USE 1-0-1993; IN COMMERCE 1-0-1993.
BERYL GARDNER, EXAMINING ATTORNEY

SN 76-560,543. L'OREAL, PARIS, FRANCE, FILED 10-29-2003.

EYE SHAPER

NO CLAIM IS MADE TO THE EXCLUSIVE RIGHT TO USE "EYE", APART FROM THE MARK AS SHOWN.

FOR EYEBROW PENCIL AND EYELINER (U.S. CLS. 1, 4, 6, 50, 51 AND 52).

ZACHARY BELLO, EXAMINING ATTORNEY

SN 76-560,544. L'OREAL, PARIS, FRANCE, FILED 10-29-2003.

MOISTURE RUSH

NO CLAIM IS MADE TO THE EXCLUSIVE RIGHT TO USE "MOISTURE", APART FROM THE MARK AS SHOWN. FOR FACIAL MOISTURIZER (U.S. CLS. 1, 4, 6, 50, 51 AND 52).

ZACHARY BELLO, EXAMINING ATTORNEY

SN 78-159,867. JADE HEMP COMPANY S.A.R.L., AUMONT, SWITZERLAND, FILED 8-30-2002.

DOUBLE GUM

OWNER OF SWITZERLAND REG. NO. 489634, DATED 9-27-2001, EXPIRES 5-4-2010.

FOR SOAPS, PERFUMERY, ESSENTIAL OILS FOR PERSONAL USE, COSMETICS, HAIR LOTIONS, AND DENTIFRICES (U.S. CLS. 1, 4, 6, 50, 51 AND 52).

MITCHELL FRONT, EXAMINING ATTORNEY

CLASS 3—(Continued).

SN 78-164,534. ULTRA PRO, L.L.C., VENICE, CA. FILED 9-16-2002.

REAL COLORS

NO CLAIM IS MADE TO THE EXCLUSIVE RIGHT TO USE "COLORS", APART FROM THE MARK AS SHOWN.

FOR COLOR COSMETICS, NAMELY, LIP COLOR, LIP GLITTER GEL, LIP GLOSS, SHIMMERING BODY POWDER, EYE SHADOW, CREAM TO POWDER EYE SHADOW, LOOSE BODY GLITTER, FACE POWDER, LIP STICK, LIP LINER, BLUSH, NAIL POLISH, NAIL POLISH BASE COAT, NAIL POLISH TOP COAT, NAIL ENAMEL, NAIL GLITTER, FOUNDATION, STICK AND CREME CONCEALER (U.S. CLS. 1, 4, 6, 50, 51 AND 52).

FIRST USE 11-1-2000; IN COMMERCE 11-1-2000.

KELLY BOULTON, EXAMINING ATTORNEY

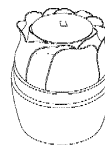

SN 78-179,951. NESH COSMETICS (1992) LTD, BNEI BRAK 51200, ISRAEL, FILED 10-30-2002.

Natural
FORMULA
ALTERNATIVE CARE

NO CLAIM IS MADE TO THE EXCLUSIVE RIGHT TO USE "NATURAL FORMULA ALTERNATIVE CARE", APART FROM THE MARK AS SHOWN.

FOR COSMETIC AND TOILET PRODUCTS, NAMELY, CREAMS, MILKS AND MOISTURIZERS FOR USE ON THE FACE AND BODY, HAIR SHAMPOOS, HAIR LOTIONS, HAIR MOISTURIZERS, HAIR CREAMS, LEAVE-IN HAIR CARE PREPARATIONS, HAIR CONDITIONERS, HAIR GELS, HAIR MILKS, HAIR COLORANTS, BODY AND FACIAL SOAPS, PERFUMES, ESSENTIAL OILS FOR PERSONAL USE, BODY LOTIONS, BATH FOAMS, SKIN CREAMS, SKIN MOISTURIZERS, SKIN MILKS, SKIN POWDERS, AFTER SHAVE LOTIONS, MAKE-UP, DEODORANTS FOR PERSONAL USE AND DENTIFRICES (U.S. CLS. 1, 4, 6, 50, 51 AND 52).

MARC LEIPZIG, EXAMINING ATTORNEY

SN 78-184,253. JOY'S PRIDE, LLC, SHELTON, WA. FILED 11-12-2002.

BRING THE SPA HOME

FOR HAIR SHAMPOO, HAIR CONDITIONER, SKIN LOTION, FACIAL CLEANSER, FACIAL CREAM, BATH OILS, NON-MEDICATED BATH SALTS, AND BUBBLE BATH (U.S. CLS. 1, 4, 6, 50, 51 AND 52).

TONJA GASKINS, EXAMINING ATTORNEY

CLASS 3—(Continued).

SN 78-189,718. THIBIANT INTERNATIONAL, INC., CHATSWORTH, CA. FILED 11-27-2002.

FOR SKIN CARE PRODUCTS, NAMELY, CREAMS (U.S. CLS. 1, 4, 6, 50, 51 AND 52).

JENNIFER KRISP, EXAMINING ATTORNEY

SN 78-193,985. ESTEE LAUDER COSMETICS LTD., AGINCOURT, ONTARIO, CANADA, FILED 12-12-2002.

MAC
SPLASHPROOF LASH

OWNER OF U.S. REG. NOS. 1,642,532, 2,495,840 AND OTHERS.

NO CLAIM IS MADE TO THE EXCLUSIVE RIGHT TO USE "SPLASHPROOF" AND "LASH", APART FROM THE MARK AS SHOWN.

FOR MASCARA (U.S. CLS. 1, 4, 6, 50, 51 AND 52).

LINDA ESTRADA, EXAMINING ATTORNEY

SN 78-213,942. AMOREPACIFIC CORPORATION, SEOUL, REPUBLIC OF KOREA, FILED 2-12-2003.

VOLUME FINISH BLUSHER

PRIORITY CLAIMED UNDER SEC. 44(D) ON REPUBLIC OF KOREA APPLICATION NO. 40-2002-0037, FILED 8-14-2002.

NO CLAIM IS MADE TO THE EXCLUSIVE RIGHT TO USE "FINISH BLUSHER", APART FROM THE MARK AS SHOWN.

FOR BLUSHER, CHEEK ROUGE, COSMETICS (U.S. CLS. 1, 4, 6, 50, 51 AND 52).

PAULA MAYS, EXAMINING ATTORNEY

CLASS 3—(Continued).

SN 78-215,133. AVON PRODUCTS, INC., NEW YORK, NY.
FILED 2-14-2003.

CRYSTAL SHIMMER

FOR COSMETICS, NAMELY, FACIAL POWDER. (U.S.
CLS. 1, 4, 6, 50, 51 AND 52).
CHERYL CLAYTON, EXAMINING ATTORNEY

SN 78-225,015. SIGNATURE CLUB A LTD., TAMPA, FL.
FILED 3-13-2003.

NON-TOXIC SILICONE PLUS

NO CLAIM IS MADE TO THE EXCLUSIVE RIGHT TO
USE "NON TOXIC SILICONE", APART FROM THE MARK
AS SHOWN.

FOR COSMETICS, NAMELY, SKIN CARE LOTIONS,
CREAMS, OILS, AND GELS (U.S. CLS. 1, 4, 6, 50, 51 AND
52).

MICHELE SWAIN, EXAMINING ATTORNEY

SN 78-230,293. NORMA KAMALI, INC., NEW YORK, NY.
FILED 3-26-2003.

NORMA KAMALI

OWNER OF U.S. REG. NOS. 1,327,105, 2,267,456 AND
OTHERS.

THE NAME "NORMA KAMALI" IDENTIFIES A LIVING
INDIVIDUAL WHOSE CONSENT IS OF RECORD.

FOR BATH AND SHOWER GEL, NON-MEDICATED
BATH SALTS, BEAUTY MASKS, BLUSH, BODY CREAM,
MOISTURIZER AND LOTION, BUBBLE BATH, COLD
CREAM, HAIR SHAMPOO, HAIR CONDITIONER, COS-
METIC PENCILS, COLD CREAM, EYE CREAM, HAND
CREAM, MOISTURIZER, AND LOTION, SHAVING
BALM, LOTION, GEL AND CREAM, SKIN CREAM,
MOISTURIZER, AND LOTION, FACIAL CREAM,
MOISTURIZER, AND LOTION, FOOT CREAM, MOIST-
URIZER, SCRUB, AND LOTION, PERSONAL DEODOR-
ANTS AND ANTIPERSPIRANTS, ESSENTIAL OILS FOR
PERSONAL USE, ESSENTIAL OILS FOR USE IN MAN-
UFACTURING COSMETICS, EYE MAKEUP, EYE SHAD-
OW, EYELINERS, FACE POWDER, FACIAL SCRUBS,
FACIAL MAKEUP, FOUNDATION MAKEUP, HAIR
GEL, SHAVING GEL, SHOWER GEL, LIP GLOSS, HAIR
RINSES, NON-MEDICATED LIP BALM, LIPSTICK, EYE
MAKEUP REMOVER, MASCARA, NAIL CREAM,
MOISTURIZER, AND LOTION, MASSAGE OIL, BATH
OIL, PRE-MOISTENED COSMETIC TISSUES, WIPES,
AND TOWELETTES, SOAP, SUNTANNING PREPARA-
TIONS, AND NON-MEDICATED WRINKLE REMOVING
SKIN CARE PREPARATIONS (U.S. CLS. 1, 4, 6, 50, 51
AND 52).

ALEX KEAM, EXAMINING ATTORNEY

CLASS 3—(Continued).

SN 78-238,607. ORANGE LIGHTNING, LLC, GREENVILLE,
SC. FILED 4-17-2003.

ORANGE LIGHTNING

OWNER OF U.S. REG. NO. 2,001,782.

NO CLAIM IS MADE TO THE EXCLUSIVE RIGHT TO
USE "ORANGE", APART FROM THE MARK AS SHOWN.

FOR DISPOSABLE WIPES IMPREGNATED WITH
CHEMICALS OR CHEMICAL COMPOUNDS FOR GEN-
ERAL COMMERCIAL OR INDUSTRIAL USE; SPRAY
ON AND AEROSOL ALL PURPOSE CLEANER (U.S. CLS.
1, 4, 6, 50, 51 AND 52).

DAWN FELDMAN, EXAMINING ATTORNEY

SN 78-253,834. ALCHIMIE FOREVER LLC, DOVER, DE.
FILED 5-23-2003.

DIODE

FOR SKIN CARE AND ANTI-AGING PRODUCTS,
NAMELY, SKIN CREAMS, SOAPS, SCRUBS, TONERS,
LOTIONS, NON-MEDICATED SERUMS, MOISTURI-
ZERS, GELS, CONDITIONERS, CLEANSING PREPARA-
TIONS; SHAVING CREAMS, AFTER-SHAVE CREAMS
AND LOTIONS; BODY MASSAGE CREAMS AND OILS;
COSMETICS; BATH OILS AND SHOWER GELS; AND
FRAGRANCES, NAMELY, PERFUMES, COLOGNES
AND ESSENCES (U.S. CLS. 1, 4, 6, 50, 51 AND 52).

NANCY CLARKE, EXAMINING ATTORNEY

SN 78-253,850. ALCHIMIE FOREVER LLC, DOVER, DE.
FILED 5-23-2003.

YTTRIUM

FOR SKIN CARE AND ANTI-AGING PRODUCTS,
NAMELY, SKIN CREAMS, SOAPS, SCRUBS, TONERS,
LOTIONS, NON-MEDICATED SERUMS, MOISTURI-
ZERS, GELS, CONDITIONERS, CLEANSING PREPARA-
TIONS; SHAVING CREAMS, AFTER-SHAVE CREAMS
AND LOTIONS; BODY MASSAGE CREAMS AND OILS;
COSMETICS; BATH OILS AND SHOWER GELS; AND
FRAGRANCES FOR PERSONAL USE, NAMELY, PER-
FUMES, COLOGNES AND FRAGRANT ESSENCE OILS
(U.S. CLS. 1, 4, 6, 50, 51 AND 52).

ROBIN CHOSID, EXAMINING ATTORNEY

SN 78-253,879. ALCHIMIE FOREVER LLC, DOVER, DE.
FILED 5-23-2003.

ALEXANDRITE

FOR SKIN CARE AND ANTI-AGING PRODUCTS,
NAMELY, SKIN CREAMS, SOAPS, SCRUBS, TONERS,
LOTIONS, NON-MEDICATED SERUMS, MOISTURI-
ZERS, GELS, CONDITIONERS, CLEANSING PREPARA-
TIONS; SHAVING CREAMS, AFTER-SHAVE CREAMS
AND LOTIONS; BODY MASSAGE CREAMS AND OILS;
COSMETICS; BATH OILS AND SHOWER GELS; AND
FRAGRANCES, NAMELY, PERFUMES, COLOGNES
AND ESSENCES (U.S. CLS. 1, 4, 6, 50, 51 AND 52).

NANCY CLARKE, EXAMINING ATTORNEY

CLASS 3—(Continued).

SN 78-254,597. MISS UNIVERSE L.P., LLLP, NEW YORK, NY. FILED 5-27-2003.

MISS UNIVERSE

OWNER OF U.S. REG. NOS. 1,146,211, 1,597,876 AND OTHERS.

FOR COSMETICS, NAMELY FOUNDATION MAKE-UP, EYELINER, EYESHADOW, MASCARA, BLUSH, CONCEALERS, LIPSTICKS, LIP GLOSS, COSMETIC PENCILS, FACE AND BODY POWDER, AND MAKE-UP KITS COMPRISED OF EYELINER, EYESHADOW, MASCARA, BLUSH, CONCEALERS, LIPSTICKS, LIP GLOSS, COSMETIC PENCILS, AND FACE AND BODY POWDER (U.S. CLS. 1, 4, 6, 50, 51 AND 52).

JENNIFER KRISP, EXAMINING ATTORNEY

SN 78-258,154. HOYU KABUSHIKI KAISHA, ALSO TRADING AS HOYU CO., LTD., HIGASHI-KU, NAGOYA-SHI, AICHI KEN, JAPAN, FILED 6-4-2003.

美源
花果香

OWNER OF U.S. REG. NO. 783,348.
THE TWO SMALL CHINESE CHARACTERS AT THE TOP TRANSLITERATE TO BI-GEN AND MEAN SOURCE OF ORIGIN OF BEAUTY. THE THREE LARGE CHINESE CHARACTERS AT THE BOTTOM OF THE MARK TRANSLITERATE TO HUA-GUA-XHANG AND MEAN FLAVOR OF FLORAL FRUIT.

FOR HAIR COLORING PREPARATIONS (U.S. CLS. 1, 4, 6, 50, 51 AND 52).

CAROLINE WOOD, EXAMINING ATTORNEY

SN 78-260,815. ZOTOS INTERNATIONAL, INC., DARIEN, CT. FILED 6-11-2003.

hairxpothics

FOR HAIR STYLING PREPARATIONS, HAIR SHAMPOOS AND CONDITIONERS (U.S. CLS. 1, 4, 6, 50, 51 AND 52).

STANLEY I. OSBORNE, EXAMINING ATTORNEY

CLASS 3—(Continued).

SN 78-284,529. WEISE, STEPHANIE, COWICHE, WA. FILED 8-7-2003.



FOR SKIN CARE PRODUCTS, NAMELY, SKIN LOTIONS, SOAP, LIP BALM AND BODY SCRUBS (U.S. CLS. 1, 4, 6, 50, 51 AND 52).

FIRST USE 4-1-2001; IN COMMERCE 9-1-2001.

NICHOLAS ALTREE, EXAMINING ATTORNEY

SN 78-285,712. CHESEBROUGH-POND'S INC., WILMINGTON, DE. FILED 8-11-2003.

TOTAL CARE

OWNER OF U.S. REG. NO. 2,238,434.
FOR HAIR SHAMPOO, AND HAIR CONDITIONER (U.S. CLS. 1, 4, 6, 50, 51 AND 52).

KAREN K. BUSH, EXAMINING ATTORNEY

SN 78-286,236. INFUSION BIOTECHNOLOGIES, L.L.C., WEST PALM BEACH, FL. FILED 8-12-2003.

I-ZOMES

FOR CHEMICAL INGREDIENT IN ANTI-AGING SKIN CARE PRODUCTS, NAMELY, FACE CREAM, EYE CREAM, HAND CREAM AND LIP BALM (U.S. CLS. 1, 4, 6, 50, 51 AND 52).

DAVID C. REIHNER, EXAMINING ATTORNEY

SN 78-291,484. SINFUL SUDS, POTOMAC, MD. FILED 8-23-2003.

SIN TIN

FOR GIFT TINS COMPRISED OF NON MEDICATED BATH AND SHOWER GELS, FOOT SCRUBS, FOOT SOAKS, LOTIONS, MASSAGE OILS, AFTER BATH/SHOWER SPRAY AND SPLASH, SALT SCRUBS, SUGAR SCRUBS, POWDERS, EFFERVESCENT BATH BALLS, CREAMS BATH OIL, BATH SALTS AND BATH AND SHOWER SOAP (U.S. CLS. 1, 4, 6, 50, 51 AND 52).

LINDA M. KING, EXAMINING ATTORNEY

CLASS 3—(Continued).

SN 78-293,273. KEENEY-KENNICUTT, WENDY L., COLLEGE STATION, TX. FILED 8-28-2003.

BALM SQUAD

NO CLAIM IS MADE TO THE EXCLUSIVE RIGHT TO USE BALM, APART FROM THE MARK AS SHOWN, FOR SKIN LOTION (U.S. CLS. 1, 4, 6, 50, 51 AND 52). FIRST USE 7-5-2003; IN COMMERCE 7-9-2003. ANDREA SAUNDERS, EXAMINING ATTORNEY

SN 78-298,483. HENRY, MONTE P., POMPANO BEACH, FL. FILED 9-10-2003.

MIRACLE RUST-AWAY

FOR RUST REMOVAL PREPARATION FOR USE ON SURFACES SUCH AS CONCRETE, FIBERGLASS, WOOD, DRIVEWAYS, AND HOUSES (U.S. CLS. 1, 4, 6, 50, 51 AND 52). M. E. BODSON, EXAMINING ATTORNEY

SN 78-299,713. HELENE CURTIS, INC., WILMINGTON, DE. FILED 9-12-2003.

SATIN STRAIGHT

NO CLAIM IS MADE TO THE EXCLUSIVE RIGHT TO USE "STRAIGHT", APART FROM THE MARK AS SHOWN, FOR HAIR CARE PRODUCTS, NAMELY, SHAMPOO AND CONDITIONER. (U.S. CLS. 1, 4, 6, 50, 51 AND 52). DEZMONA MIZELLE, EXAMINING ATTORNEY

SN 78-299,717. HELENE CURTIS, INC., WILMINGTON, DE. FILED 9-12-2003.

NUTRI-COLLAGEN

FOR HAIR CARE PRODUCTS, NAMELY, SHAMPOO AND CONDITIONER. (U.S. CLS. 1, 4, 6, 50, 51 AND 52). DEZMONA MIZELLE, EXAMINING ATTORNEY

SN 78-299,722. HELENE CURTIS, INC., WILMINGTON, DE. FILED 9-12-2003.

NUTRILOCK

FOR HAIR CARE PRODUCTS, NAMELY, SHAMPOO AND CONDITIONER. (U.S. CLS. 1, 4, 6, 50, 51 AND 52). DEZMONA MIZELLE, EXAMINING ATTORNEY

CLASS 3—(Continued).

SN 78-301,440. L'OREAL USA CREATIVE, INC., NEW YORK, NY. FILED 9-17-2003.

FIRM RESULT

FOR COSMETICS, NAMELY, FOUNDATION, CONCEALER, PRESSED POWDER AND BLUSH (U.S. CLS. 1, 4, 6, 50, 51 AND 52). GEOFFREY FOSDICK, EXAMINING ATTORNEY

SN 78-301,595. REVLON CONSUMER PRODUCTS CORPORATION, NEW YORK, NY. FILED 9-17-2003.

REVLON

OWNER OF U.S. REG. NOS. 647,222, 2,662,778 AND OTHERS.

FOR ARTIFICIAL NAILS, NAMELY, GLUE ON NAILS, SELF-STICK NAILS, AND NAIL TIPS; ACRYLIC POWDER KIT USED TO PUT ON ACRYLIC NAILS COMPRISED OF NAILS, GLUE, ACRYLIC POWDER, ACRYLIC LIQUID, MANICURE STICK, MANICURE BRUSH, MANICURE FILE, AND MANICURE BUFFER ALL SOLD AS A UNIT; ACRYLIC SCULPTING KIT FOR ARTIFICIAL NAILS COMPRISED OF NAIL STRENGTHENER AND CUTICLE PUSHERS ALL SOLD AS A UNIT, GLUE FOR USE IN APPLYING ARTIFICIAL NAILS, NAIL TIPS, AND NAIL WRAPS (U.S. CLS. 1, 4, 6, 50, 51 AND 52).

FIRST USE 3-30-2003; IN COMMERCE 3-30-2003. TARAH HARDY, EXAMINING ATTORNEY

SN 78-301,808. DEL LABORATORIES, INC., UNIONDALE, NY. FILED 9-17-2003.

AIRBRUSH LEGS

NO CLAIM IS MADE TO THE EXCLUSIVE RIGHT TO USE "LEGS", APART FROM THE MARK AS SHOWN, FOR COSMETICS (U.S. CLS. 1, 4, 6, 50, 51 AND 52). LINDA MICKLEBURGH, EXAMINING ATTORNEY

SN 78-304,366. LIZZIE'S LATHER LLC, WILDWOOD, MO. FILED 9-23-2003.

LIZZIE'S LATHER

FOR HANDMADE BODY SOAPS (U.S. CLS. 1, 4, 6, 50, 51 AND 52). FIRST USE 1-14-2003; IN COMMERCE 2-14-2003. MARK T. MULLEN, EXAMINING ATTORNEY

CLASS 3—(Continued).

SN 78-304,818. L'OREAL USA CREATIVE, INC., NEW YORK, NY. FILED 9-24-2003.

EXPERT WEAR

FOR COSMETICS, NAMELY, EYE SHADOW, BLUSH, FOUNDATION MAKEUP, CONCEALER AND PRESSED POWDER (U.S. CLS. 1, 4, 6, 50, 51 AND 52).
DAWN FELDMAN, EXAMINING ATTORNEY

SN 78-305,877. KAO KABUSHIKI KAISHA, TA KAO CORPORATION, TOKYO, JAPAN, FILED 9-26-2003.

THERAPY PLUS

NO CLAIM IS MADE TO THE EXCLUSIVE RIGHT TO USE "THERAPY", APART FROM THE MARK AS SHOWN.
FOR HAIR CARE PREPARATIONS (U.S. CLS. 1, 4, 6, 50, 51 AND 52).
GENE MACIOL, EXAMINING ATTORNEY

SN 78-306,960. TRUESCENTS, LLC, SEATTLE, WA. FILED 9-29-2003.

GENUINE HAIR

NO CLAIM IS MADE TO THE EXCLUSIVE RIGHT TO USE "HAIR", APART FROM THE MARK AS SHOWN.
FOR HAIR CARE PRODUCTS, NAMELY, SHAMPOO, CONDITIONER, HAIR GEL, HAIR CLEANING PREPARATIONS, NON-MEDICATED HAIR CARE PREPARATIONS, HAIR MOUSSE, HAIR POMADES, HAIR SPRAY, HAIR BLEACH AND BLEACHING PREPARATIONS, HAIR CARE PREPARATIONS, HAIR COLOR AND COLOR REMOVERS, HAIR DYE, HAIR EMOLLIENTS, HAIR FROSTS, HAIR GEL, HAIR LIGHTENERS, HAIR LOTIONS, HAIR MASCARA, HAIR RELAXING PREPARATIONS, HAIR REMOVING CREAM, HAIR STRAIGHTENING, PREPARATIONS, HAIR STYLING PREPARATIONS, AND HAIR WAVING LOTION (U.S. CLS. 1, 4, 6, 50, 51 AND 52).
CIMMERIAN COLEMAN, EXAMINING ATTORNEY

SN 78-307,672. PHILOSOPHY, INC., PHOENIX, AZ. FILED 9-30-2003.

THE BRIDE

FOR COSMETICS, NAMELY, LIPSTICK, LIP GLOSS, LIP LINER, LIP BALM, BLUSH, FOUNDATION, EYE SHADOW, EYE LINER, MASCARA, CONCEALER, COSMETIC PENCILS, AND FACIAL POWDER; FRAGRANCES, NAMELY, PERFUME, COLOGNE, AND AFTER-SHAVE LOTION AND GEL; NON-MEDICATED SKIN CARE PRODUCTS, NAMELY, SOAP, SCRUBS, TONER, CONDITIONER, EXFOLIATORS, SKIN CLARIFIER, WRINKLE REMOVING SKIN CARE PREPARATIONS, AND MOISTURIZER; FACE AND BODY LOTION, CREAM, OIL, GEL AND SPRAY; SUN SCREEN PREPARATIONS, NAMELY, LOTION, CREAM, GEL AND SPRAY; NON-MEDICATED FACE AND BODY SKIN LIGHTENER; HAIR CARE PRODUCTS, NAMELY, SHAMPOO, CONDITIONER, RINSE, GEL, MOUSSE, SPRAY AND TONIC; BATH CARE PRODUCTS,

CLASS 3—(Continued).

NAMELY, SOAP, SALTS CRYSTALS, BEADS, GEL, OIL, POWDER, AND BUBBLE BATH; SCENTED HEAD-TO-TOE BODY WASH; NAIL CARE PREPARATIONS, NAMELY, CUTICLE CREAM, CUTICLE REMOVING PREPARATIONS, NAIL ENAMEL, NAIL POLISH, NAIL POLISH REMOVER, NAIL POLISH BASE COAT, NAIL POLISH TOP COAT, AND NAIL STRENGTHENERS; PERSONAL DEODORANT; TOOTH WHITENING GELS, CREAMS, AND PASTES; FOOT CARE PRODUCTS, NAMELY SCRUBS, LOTIONS, CREAMS, DEODORANT, AND EXFOLIATORS; MEN'S TOILETRIES, NAMELY COLOGNE, AFTER-SHAVE LOTION AND GEL; SKIN CLEANSER, SKIN SCRUBS, SKIN TONER, SKIN CREAM, SHAVING GEL, SHAVING CREAM, TOILET WATER, PERSONAL DEODORANT, SHAMPOO, BODY LOTION, BODY TALC, AND SKIN MOISTURIZER; BABY CARE PRODUCTS, NAMELY, BABY LOTIONS, CREAMS, OINTMENTS, SOAPS, POWDERS, AND SHAMPOO; FACIAL AND BODY HAIR DEPILATORY WAXES, CREAMS, LOTIONS, BLEACHING AND COLORING PREPARATIONS; MAKE-UP KITS AND GIFT SETS COMPRISED OF ONE OR MORE OF LIPSTICK, LIP GLOSS, LIP LINER, LIP BALM, BLUSH, FOUNDATION, EYE SHADOW, EYE LINER, MASCARA, CONCEALER, COSMETIC PENCILS, AND FACIAL POWDER, FRAGRANCES, NAMELY, PERFUME, COLOGNE, AND AFTER-SHAVE LOTION AND GEL, NON-MEDICATED SKIN CARE PRODUCTS, NAMELY, SOAP, SCRUBS, TONER, CONDITIONER, EXFOLIATORS, SKIN CLARIFIER, WRINKLE REMOVING SKIN CARE PREPARATIONS, AND MOISTURIZER, FACE AND BODY LOTION, CREAM, OIL, GEL AND SPRAY, SUN SCREEN PREPARATIONS, NAMELY, LOTION, CREAM, GEL, AND SPRAY, NON-MEDICATED FACE AND BODY SKIN LIGHTENER, HAIR CARE PRODUCTS, NAMELY, SHAMPOO, CONDITIONER, RINSE, GEL MOUSSE, SPRAY AND TONIC, BATH CARE PRODUCTS, NAMELY, SOAP, SALTS, CRYSTALS, BEADS, GEL OIL, POWDER, AND BUBBLE BATH, SCENTED HEAD-TO-TOE BODY WASH, NAIL CARE PREPARATIONS, NAMELY, CUTICLE CREAM, CUTICLE REMOVING PREPARATIONS, NAIL ENAMEL, NAIL POLISH, NAIL POLISH REMOVER, NAIL POLISH BASE COAT, NAIL POLISH TOP COAT, AND NAIL STRENGTHENERS, PERSONAL DEODORANT, TOOTH WHITENING GELS, CREAMS, AND PASTES, FOOT CARE PRODUCTS, NAMELY, SCRUBS, LOTIONS, CREAMS, DEODORANT, AND EXFOLIATORS, MEN'S TOILETRIES, NAMELY, COLOGNE, AFTER-SHAVE LOTION AND GEL, SKIN CLEANSER, SKIN SCRUBS, SKIN TONER, SKIN CREAM, SHAVING GEL, SHAVING CREAM, TOILET WATER, PERSONAL DEODORANT, SHAMPOO, BODY LOTION, BODY TALC AND SKIN MOISTURIZER, BABY CARE PRODUCTS, NAMELY, BABY LOTIONS, CREAMS, OINTMENTS, SOAPS, POWDERS AND SHAMPOO, FACIAL AND BODY HAIR DEPILATORY WAXES, CREAMS, LOTIONS, BLEACHING AND COLORING PREPARATIONS (U.S. CLS. 1, 4, 6, 50, 51 AND 52).
CAROLINE WEIMER, EXAMINING ATTORNEY

SN 78-307,675. INTEGRATED ENTITIES MANAGEMENT, INC., ROCHESTER, NY. FILED 9-30-2003.

MAN BERRIES

FOR (BASED ON USE IN COMMERCE) SOAP FOR BATH AND DISPLAY; (BASED ON INTENT TO USE) SKIN SOAP (U.S. CLS. 1, 4, 6, 50, 51 AND 52).
FIRST USE 7-30-2003; IN COMMERCE 9-30-2003.
MARK T. MULLEN, EXAMINING ATTORNEY

CLASS 3—(Continued).

SN 78-308,595. CONNETICS CORPORATION, PALO ALTO, CA. FILED 10-2-2003.

CONNETICS

OWNER OF U.S. REG. NO. 2,202,143.
FOR SUNSCREEN (U.S. CLS. 1, 4, 6, 50, 51 AND 52).
FIRST USE 2-14-2003; IN COMMERCE 2-14-2003.
BRIAN BROWN, EXAMINING ATTORNEY

SN 78-311,666. CONAIR CORPORATION, STAMFORD, CT. FILED 10-9-2003.

KNOT NICE

FOR HAIR CARE AND STYLING PREPARATONS (U.S. CLS. 1, 4, 6, 50, 51 AND 52).
CHARLES L. JENKINS, EXAMINING ATTORNEY

SN 78-313,550. LOAEZA, DAVID ALI, CUAHUTEMOC, MEXICO, FILED 10-14-2003.

VIVELLE

FOR HAIR CARE PRODUCTS, NAMELY, SHAMPOOS, FINISHING RINSE, CONDITIONERS, STYLING SPRAY, STYLING GEL, STYLING MOUSSE, WAX FOR HAIR; COSMETICS (U.S. CLS. 1, 4, 6, 50, 51 AND 52).
DARRYL SPRUILL, EXAMINING ATTORNEY

SN 78-317,624. NBL PRODUCTS, LLC, WEST BLOOMFIELD, MI. FILED 10-23-2003.

"BAAM" BUGS AWAY AND MORE

NO CLAIM IS MADE TO THE EXCLUSIVE RIGHT TO USE BUGS, APART FROM THE MARK AS SHOWN.
FOR ALL PURPOSE CLEANERS (U.S. CLS. 1, 4, 6, 50, 51 AND 52).
FIRST USE 7-0-2003; IN COMMERCE 8-0-2003.
MATTHEW KLINE, EXAMINING ATTORNEY

CLASS 4—LUBRICANTS AND FUELS

SN 76-429,295. GREENLEAF, INC., SPARTANBURG, SC. FILED 7-11-2002.

GOURMET AVENUE

FOR CANDLES, NAMELY, SCENTED CANDLES, UNSCENTED CANDLES, JAR CANDLES, GEL CANDLES, VOTIVE CANDLES, AND PILLAR CANDLES (U.S. CLS. 1, 6 AND 15).
JOHN SCHUYLER YARD, EXAMINING ATTORNEY

SN 76-497,480. RONALD L. COTNER, ACTON, ME. FILED 3-14-2003.



NO CLAIM IS MADE TO THE EXCLUSIVE RIGHT TO USE CHARCOAL LIGHTER FLUID, APART FROM THE MARK AS SHOWN.
FOR CHARCOAL LIGHTER FLUID (U.S. CLS. 1, 6 AND 15).
M. E. BODSON, EXAMINING ATTORNEY

SN 76-542,168. HOME INTERIORS & GIFTS, INC., CARROLLTON, TX. FILED 9-2-2003.



DOMISTYLE

THE MARK CONSISTS OF A CIRCLE WITHIN A CIRCLE AND THE WORD CANDELARIA INSIDE THE OUTER RING. A FILIGREE DESIGN IS IN THE CENTER OF THE RING, AND THE WORD DOMISTYLE IS CENTERED BELOW THE DOUBLE RING.
FOR CANDLES (U.S. CLS. 1, 6 AND 15).
LAURA KOVAISKY, EXAMINING ATTORNEY

CLASS 4—(Continued).

SN 76-550,163. GLOBAL CANDLE GALLERY LICENSING COMPANY, APOLLO BEACH, FL. FILED 10-8-2003.



NO CLAIM IS MADE TO THE EXCLUSIVE RIGHT TO USE CANDLE AND INC., APART FROM THE MARK AS SHOWN.

FOR CANDLES (U.S. CLS. 1, 6 AND 15).
FIRST USE 9-2-2003; IN COMMERCE 9-2-2003.
MONIQUE MILLER, EXAMINING ATTORNEY

SN 76-552,375. PADDYWAX, INC., DECATUR, GA. FILED 9-29-2003.



OWNER OF U.S. REG. NO. 2,459,271.
FOR CANDLES (U.S. CLS. 1, 6 AND 15).
FIRST USE 10-1-2003; IN COMMERCE 10-1-2003.
BARBARA GAYNOR, EXAMINING ATTORNEY

SN 76-556,188. THE W.S. BADGER COMPANY, INC., GILSUM, NH. FILED 10-15-2003.

BADGER

FOR CANDLES (U.S. CLS. 1, 6 AND 15).
MICHAEL KAZAZIAN, EXAMINING ATTORNEY

CLASS 4—(Continued).

SN 78-240,378. BORD NA MONA FUELS LTD., NEWBRIDGE, CO. KILDARE, IRELAND, FILED 4-22-2003.

FIREPAK

FOR PACKAGED FUEL IN THE FORM OF BRIQUETTED PEAT AND/OR MANUFACTURED COAL BASED OVOIDS AND/OR WOOD CHUNKS AND/OR CHARCOAL WITH OR WITHOUT A SEPARATE IGNITION AGENT, PELLET FUEL MADE FROM ANY OF THE ABOVE AND WAX, ANY OF THE ABOVE COATED WITH AN IGNITION AGENT, ALL OF THE FOREGOING FOR USE IN OPEN FIRES, HEATING APPLIANCES AND FIREPLACES (U.S. CLS. 1, 6 AND 15).
KEVON CHISOLM, EXAMINING ATTORNEY

SN 78-248,295. CANDLEART CANDLE COMPANY, DIETRICH, IL. FILED 5-12-2003.

TURNING SCENTS INTO DOLLARS

FOR CANDLES USED IN FUNDRAISING (U.S. CLS. 1, 6 AND 15).
FIRST USE 9-1-2000; IN COMMERCE 9-1-2000.
JEAN IM, EXAMINING ATTORNEY

SN 78-275,928. HARVEST LIGHTS, LTD., DAKOTA DUNES, SD. FILED 7-18-2003.

HARVEST LIGHTS

NO CLAIM IS MADE TO THE EXCLUSIVE RIGHT TO USE "LIGHTS", APART FROM THE MARK AS SHOWN.
FOR CANDLES (U.S. CLS. 1, 6 AND 15).
FIRST USE 5-10-2003; IN COMMERCE 5-10-2003.
SUSAN HAYASH, EXAMINING ATTORNEY

SN 78-303,693. PTP SERVICES, LLC, WILMINGTON, DE. FILED 9-22-2003.

GAS TRANSMISSION NORTHWEST

NO CLAIM IS MADE TO THE EXCLUSIVE RIGHT TO USE GAS, APART FROM THE MARK AS SHOWN.
FOR ENERGY COMMODITIES, NAMELY, NATURAL GAS, CRUDE OIL, FUEL OIL, COAL AND LIQUID FUELS, NAMELY, LIQUIFIED PROPANE AND NATURAL GAS LIQUIDS (U.S. CLS. 1, 6 AND 15).
JANICE L. MCMORROW, EXAMINING ATTORNEY

CLASS 4—(Continued).

SN 78-306,028. CHARLOTTE MOSS & CO., NEW YORK, NY.
FILED 9-26-2003.

LITTLE LUXURIES

FOR CANDLES (U.S. CLS. 1, 6 AND 15).
CAROL SPILS, EXAMINING ATTORNEY

SN 78-306,834. ECOLAB INC., ST. PAUL, MN. FILED 9-29-
2003.

LUBOCLEAN

FOR CONVEYOR LUBRICANTS (U.S. CLS. 1, 6 AND
15).
J. TINGLEY, EXAMINING ATTORNEY

SN 78-311,551. CROSS CHEMICAL COMPANY, INC., DE-
TROIT, MI. FILED 10-9-2003.

CYCLE-RITE

FOR LUBRICANTS FOR USE IN DIE CASTING
OPERATIONS (U.S. CLS. 1, 6 AND 15).
FIRST USE 9-15-2003; IN COMMERCE 9-15-2003.
KELLEY WELLS, EXAMINING ATTORNEY

CLASS 5—PHARMACEUTICALS

SN 75-178,457. HTZ INVESTMENT CORP., WILMINGTON,
DE. FILED 10-8-1996.



OWNER OF U.S. REG. NOS. 782,948, 1,645,786 AND
OTHERS.

NO CLAIM IS MADE TO THE EXCLUSIVE RIGHT TO
USE "FLEA", APART FROM THE MARK AS SHOWN.
SEC. 2(F) AS TO 2 IN ONE.
FOR INSECTICIDAL SHAMPOOS FOR DOGS (U.S.
CLS. 6, 18, 44, 46, 51 AND 52).
FIRST USE 10-0-1994; IN COMMERCE 10-0-1994.
JENNIFER CHICOSKI, EXAMINING ATTORNEY

CLASS 5—(Continued).

SN 76-170,416. NUTRITION 21, INC., NEW YORK, NY.
FILED 11-22-2000.

DIACHROME

FOR DIETARY AND NUTRITIONAL SUPPLEMENTS
(U.S. CLS. 6, 18, 44, 46, 51 AND 52).
ALICIA COLLINS, EXAMINING ATTORNEY

SN 76-258,712. FORTIUS INC., CALGARY T2T 1X2, CANA-
DA, FILED 5-17-2001.

MENOSOY

FOR NUTRITIONAL SUPPLEMENTS CONTAINING
SOY (U.S. CLS. 6, 18, 44, 46, 51 AND 52).
FIRST USE 2-0-2000; IN COMMERCE 2-0-2000.
JENNIFER CHICOSKI, EXAMINING ATTORNEY

SN 76-367,004. SINUSPHARMA, INC., CARPINTERIA, CA.
FILED 2-4-2002.

CLINDANASE

FOR PHARMACEUTICAL PREPARATIONS FOR THE
TREATMENT OF SINUS INFECTIONS (U.S. CLS. 6, 18,
44, 46, 51 AND 52).
GLENN CLARK, EXAMINING ATTORNEY

SN 76-369,143. LEO PHARMACEUTICAL PRODUCTS LTD.
A/S (LOVENS KEMISKE FABRIK PRODUKTIONSAKTIE-
SELSKAB), DK-2750 BALLERUP, DENMARK, FILED 2-8-
2002.

DAIVOBET

OWNER OF DENMARK REG. NO. VR199800143, DATED
1-9-1998, EXPIRES 1-9-2008.
FOR DERMATOLOGICAL PREPARATIONS FOR THE
TREATMENT OF HYPERPROLIFERATIVE DISEASES
(U.S. CLS. 6, 18, 44, 46, 51 AND 52).
DORITT L. CARROLL, EXAMINING ATTORNEY

SN 76-389,470. MANNKIND CORPORATION, SYLMAR, CA.
FILED 3-28-2002.

INHALIN

FOR PHARMACEUTICAL PREPARATIONS, NAMELY
INSULIN FORMULATED FOR INHALATION (U.S. CLS.
6, 18, 44, 46, 51 AND 52).
IRA J. GOODSaid, EXAMINING ATTORNEY

CLASS 5—(Continued).

SN 76-440,518. FERRING B.V., 2132 JX HOOFDDORP, NETHERLANDS, FILED 8-14-2002.

FERRIPEPTYL

OWNER OF SOUTH AFRICA REG. NO. 1998/13848, DATED 8-5-1998, EXPIRES 8-5-2008.

OWNER OF IRELAND REG. NO. 211440, DATED 8-10-1998, EXPIRES 8-10-2008.

OWNER OF HONG KONG REG. NO. 09454/1999, DATED 7-23-1998, EXPIRES 7-23-2008.

OWNER OF AUSTRALIA REG. NO. 779874, DATED 12-2-1998, EXPIRES 12-2-2008.

FOR PHARMACEUTICAL PREPARATIONS FOR USE IN MODULATING HUMAN FERTILITY AND TREATING ONCOLOGICAL DISEASES (U.S. CLS. 6, 18, 44, 46, 51 AND 52).

YONG KIM, EXAMINING ATTORNEY

SN 76-444,323. GEN-PROBE INCORPORATED, SAN DIEGO, CA. FILED 8-23-2002.



FOR REAGENTS FOR CLINICAL OR MEDICAL LABORATORY USE AND KITS COMPRISED OF REAGENTS FOR CLINICAL OR MEDICAL LABORATORY USE (U.S. CLS. 6, 18, 44, 46, 51 AND 52).

FIRST USE 9-21-2001; IN COMMERCE 10-12-2001.

LINDA ESTRADA, EXAMINING ATTORNEY

SN 76-500,007. ADHAMI, HEDAYAT, LOS ANGELES, CA. FILED 3-24-2003.

MOLEAWAY

FOR SKIN CARE TOPICAL SOLUTION FOR TREATING SKIN DISORDERS, NAMELY, MOLES, WARTS, DARK PIGMENTATION, AGE SPOTS, DERMATOSIS PAPULOSA NIGRA, SEBORRHEIC KERATOSIS (U.S. CLS. 6, 18, 44, 46, 51 AND 52).

STANLEY I. OSBORNE, EXAMINING ATTORNEY

CLASS 5—(Continued).

SN 76-501,777. JOHNSON & JOHNSON, NEW BRUNSWICK, NJ. FILED 3-21-2003.

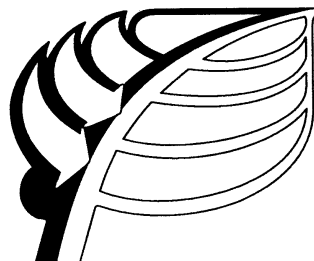

FOR PHARMACEUTICAL, NAMELY, A NEUROLOGICAL PREPARATION (U.S. CLS. 6, 18, 44, 46, 51 AND 52). FIRST USE 12-9-2002; IN COMMERCE 12-9-2002.

GLENN CLARK, EXAMINING ATTORNEY

SN 76-501,935. PEDIAMED PHARMACEUTICALS, INC., FLORENCE, KY. FILED 3-27-2003.

KIDPLIANCE

FOR PHARMACEUTICAL PREPARATIONS FOR THE TREATMENT OF COUGH/COLD SYMPTOMS, ALLERGY/RESPIRATORY SYMPTOMS, AND NASAL SYMPTOMS, AND PAIN ASSOCIATED THEREWITH (U.S. CLS. 6, 18, 44, 46, 51 AND 52).

MARC LEIPZIG, EXAMINING ATTORNEY

SN 76-503,347. INSTITUT PASTEUR, 75724 PARIS CEDEX 15, FRANCE, FILED 4-3-2003.

STAMARIL

OWNER OF FRANCE REG. NO. 1328561, DATED 10-28-1985, RENEWED AS REG. NO. 1328561, DATED 10-9-1995, EXPIRES 10-9-2005.

FOR THERMOSTABLE VACCINE AGAINST YELLOW FEVER (U.S. CLS. 6, 18, 44, 46, 51 AND 52).

GEOFFREY FOSDICK, EXAMINING ATTORNEY

CLASS 5—(Continued).

SN 76-505,545. HOUSECHEM, INC., WALDWICK, NJ. FILED 4-10-2003.



OWNER OF U.S. REG. NO. 2,638,253.
FOR AIR FRESHNERS (U.S. CLS. 6, 18, 44, 46, 51 AND 52).
FIRST USE 7-30-2003; IN COMMERCE 7-30-2003.
TARAH HARDY, EXAMINING ATTORNEY

SN 76-506,280. HERITAGE HEALTH PRODUCTS COMPANY, FORT COLLINS, CO. FILED 4-14-2003.

HERITAGE E-LITE

FOR WEIGHT MANAGEMENT PRODUCTS, NAMELY DIETARY SUPPLEMENTS, VITAMIN AND MINERAL SUPPLEMENTS, HERBAL SUPPLEMENTS AND MEAL REPLACEMENT DRINKS AND POWDERS (U.S. CLS. 6, 18, 44, 46, 51 AND 52).
FIRST USE 5-3-1993; IN COMMERCE 5-3-1993.
LAURA KOVAISKY, EXAMINING ATTORNEY

SN 76-506,301. BIOVAIL LABORATORIES, INC., COLLYMORE, ST. MICHAEL, BARBADOS, FILED 4-4-2003.

RALIVIA

FOR PHARMACEUTICAL PREPARATIONS FOR THE TREATMENT OF CNS AND CNS RELATED DISORDERS AND CONDITIONS; PHARMACEUTICAL PREPARATIONS FOR THE TREATMENT OF PAIN; PAIN RELIEF MEDICATIONS; ANALGESICS AND TRAMADOL (U.S. CLS. 6, 18, 44, 46, 51 AND 52).
KEVON CHISOLM, EXAMINING ATTORNEY

SN 76-514,305. ATOS MEDICAL AB, HORBY, SWEDEN, FILED 5-15-2003.

XTRABASE

PRIORITY CLAIMED UNDER SEC. 44(D) ON SWEDEN APPLICATION NO. 2003/02144, FILED 3-31-2003, REG. NO. 363718, DATED 10-31-2003, EXPIRES 10-31-2013.
FOR STICKING PLASTERS FOR MEDICAL USE; SOLVENTS FOR REMOVING ADHESIVE PLASTERS FOR MEDICAL USE; PLASTERS FOR MEDICAL PURPOSES; PLASTERS AND MATERIALS, NAMELY, BANDAGES, FOR DRESSING SKIN WOUNDS; DISINFECTANTS FOR MEDICAL INSTRUMENTS; GUMMED TAFFETA PLASTERS FOR MEDICAL USE; SELF-ADHESIVE BASE PLATES FOR USE WITH TRACHEOSTOMA PRODUCTS (U.S. CLS. 6, 18, 44, 46, 51 AND 52).
GWEN STOKOLS, EXAMINING ATTORNEY

CLASS 5—(Continued).

SN 76-515,044. HELTHYZ INTERNATIONAL, INC., PALM HARBOR, FL. FILED 5-16-2003.

TEBS

Eye Formula for Macula Support

OWNER OF U.S. REG. NO. 2,681,641.
NO CLAIM IS MADE TO THE EXCLUSIVE RIGHT TO USE EYE FORMULA FOR MEDICAL SUPPORT, APART FROM THE MARK AS SHOWN.
FOR VITAMIN AND MINERAL SUPPLEMENTS FOR EYE CARE (U.S. CLS. 6, 18, 44, 46, 51 AND 52).
FIRST USE 12-1-2002; IN COMMERCE 12-1-2002.
DANIEL CAPSHAW, EXAMINING ATTORNEY

SN 76-515,876. BIOMIMETIC PHARMACEUTICALS, INC., FRANKLIN, TN. FILED 5-21-2003.

GEM 21S

FOR GROWTH FACTOR ENHANCED PHARMACEUTICAL PREPARATIONS FOR THE TREATMENT OF PERIODONTAL AND CRANIO-MAXILLOFACIAL (CMF) BONE AND SOFT TISSUE DEFECTS, NAMELY BONE AND TISSUE DEFECTS OF THE HEAD, JAW, AND FACE AND RELATED WOUND HEALING AND TISSUE REPAIR (U.S. CLS. 6, 18, 44, 46, 51 AND 52).
KEVON CHISOLM, EXAMINING ATTORNEY

SN 76-517,243. IP DEVELOPMENT LIMITED, MONACO 98000MC, BR.VIRGIN ISLANDS, FILED 5-27-2003.

SONA

FOR DIETARY SUPPLEMENTS, HERBAL SUPPLEMENTS AND NUTRITIONAL SUPPLEMENTS (U.S. CLS. 6, 18, 44, 46, 51 AND 52).
CAROLYN GRAY, EXAMINING ATTORNEY

SN 76-519,464. B & B HERBAL FUTURES, SANDY, OR. FILED 5-12-2003.

OREGON'S WILD HARVEST

SERIOUSLY ORGANIC

NO CLAIM IS MADE TO THE EXCLUSIVE RIGHT TO USE OREGON'S AND ORGANIC, APART FROM THE MARK AS SHOWN.
FOR HERBAL SUPPLEMENTS (U.S. CLS. 6, 18, 44, 46, 51 AND 52).
FIRST USE 1-0-2003; IN COMMERCE 1-0-2003.
CAROLYN CATALDO, EXAMINING ATTORNEY

CLASS 5—(Continued).

SN 76-525,246. EDC LABORATORIES, INC., KELLER, TX. FILED 6-25-2003.

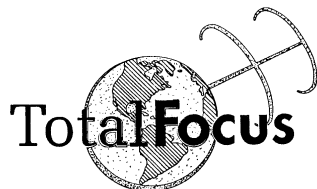

THE DRAWING IS LINED FOR COLOR, BUT COLOR IS NOT A FEATURE OF THE MARK.
FOR NUTRACEUTICALS FOR USE AS A DIETARY SUPPLEMENT (U.S. CLS. 6, 18, 44, 46, 51 AND 52).
FIRST USE 3-28-2003; IN COMMERCE 3-28-2003.
SOPHIA S. KIM, EXAMINING ATTORNEY

SN 76-534,469. PRODUCT PARTNERS, LLC, BEVERLY HILLS, CA. FILED 8-4-2003.

P90X PEAK HEALTH FORMULA

NO CLAIM IS MADE TO THE EXCLUSIVE RIGHT TO USE "HEALTH FORMULA", APART FROM THE MARK AS SHOWN.
FOR DIETARY SUPPLEMENTS IN THE FORM OF PROTEIN BARS; NUTRITIONAL DRINK MIX FOR USE AS A MEAL REPLACEMENT (U.S. CLS. 6, 18, 44, 46, 51 AND 52).
FIRST USE 7-21-2003; IN COMMERCE 7-21-2003.
BARBARA GAYNOR, EXAMINING ATTORNEY

SN 76-534,676. YASOO HEALTH, INC., JOHNSON CITY, TN. FILED 8-4-2003.

AQUA E

NO CLAIM IS MADE TO THE EXCLUSIVE RIGHT TO USE "E", APART FROM THE MARK AS SHOWN.
FOR PHARMACEUTICALS IN THE NATURE OF DIETARY SUPPLEMENTS FOR MEDICAL USE (U.S. CLS. 6, 18, 44, 46, 51 AND 52).
DARRYL SPRUILL, EXAMINING ATTORNEY

SN 76-536,360. IVAX RESEARCH, INC., MIAMI, FL. FILED 7-31-2003.

KINAMPA

FOR PHARMACEUTICAL PREPARATION FOR THE TREATMENT OF PARKINSON'S DISEASE (U.S. CLS. 6, 18, 44, 46, 51 AND 52).
INGRID C. EULIN, EXAMINING ATTORNEY

CLASS 5—(Continued).

SN 76-539,648. WATER-JEL TECHNOLOGIES, LLC, CARLSTADT, NJ. FILED 8-25-2003.

BURN STOP

OWNER OF U.S. REG. NOS. 1,762,382, 1,854,013 AND 2,567,184.

NO CLAIM IS MADE TO THE EXCLUSIVE RIGHT TO USE "BURN", APART FROM THE MARK AS SHOWN.

FOR PHARMACEUTICAL PREPARATIONS FOR THE TREATMENT OF BURNS (U.S. CLS. 6, 18, 44, 46, 51 AND 52).

SONYA STEPHENS, EXAMINING ATTORNEY

SN 76-541,313. PERFECT IMAGE MEDICAL CORP., DBA NEW ME, LOS ANGELES, CA. FILED 8-18-2003.

SCAR GONE

NO CLAIM IS MADE TO THE EXCLUSIVE RIGHT TO USE "SCAR", APART FROM THE MARK AS SHOWN.

THE MARK CONSISTS OF THE WORDS "SCAR GONE" AS SHOWN IN THE DRAWING.

FOR MEDICATED COSMETICS, NAMELY, MEDICATED COSMETIC REMOVERS; MEDICATED EYE CREAMS; MEDICATED COSMETIC FACIAL CLEANERS, MEDICATED SKIN BALANCERS AND MOISTURIZERS; MEDICATED HERBAL BATH GEL FLUID; MEDICATED FOUNDATION MAKEUP; MEDICATED FACE POWDERS; MEDICATED MASCARA; MEDICATED LIP POLISH; MEDICATED LIP GLOSS; MEDICATED EYE MAKEUP POWDERS; MEDICATED EYE SHADOWS; MEDICATED LIP COLOR IN THE FORM OF LIPSTICKS; MEDICATED NAIL ENAMEL; MEDICATED ROUGE; MEDICATED CONTOUR POWDER; MEDICATED EYEBROW PENCILS; MEDICATED CONTOUR POWDERS FOR USE ON CHEEKS; MEDICATED LIP SEALERS; MEDICATED FACE AND BODY CREAMS AND TONERS; AND MEDICATED FACIAL MASKS (U.S. CLS. 6, 18, 44, 46, 51 AND 52).

KATHRYN COWARD, EXAMINING ATTORNEY

SN 76-541,376. PERFECT IMAGE MEDICAL CORP., DBA NEW ME, LOS ANGELES, CA. FILED 8-18-2003.

BRUISE AWAY

NO CLAIM IS MADE TO THE EXCLUSIVE RIGHT TO USE "BRUISE", APART FROM THE MARK AS SHOWN.

FOR MEDICATED COSMETICS, NAMELY, MEDICATED COSMETIC REMOVERS; MEDICATED EYE CREAMS; MEDICATED COSMETIC FACIAL CLEANERS, MEDICATED SKIN BALANCERS AND MOISTURIZERS; MEDICATED HERBAL BATH GEL FLUID; MEDICATED FOUNDATION MAKEUP; MEDICATED FACE POWDERS; MEDICATED MASCARA; MEDICATED LIP POLISH; MEDICATED LIP GLOSS; MEDICATED EYE MAKEUP POWDERS; MEDICATED EYE SHADOWS; MEDICATED LIP COLOR IN THE FORM OF LIPSTICKS; MEDICATED NAIL ENAMEL; MEDICATED ROUGE; MEDICATED CONTOUR POWDER; MEDICATED EYEBROW PENCILS; MEDICATED CONTOUR POWDERS FOR USE ON CHEEKS; MEDICATED LIP SEALERS; MEDICATED FACE AND BODY CREAMS AND TONERS; AND MEDICATED FACIAL MASKS (U.S. CLS. 6, 18, 44, 46, 51 AND 52).

LANA PHAM, EXAMINING ATTORNEY

CLASS 5—(Continued).

SN 76-541,377. PERFECT IMAGE MEDICAL CORP., DBA NEW ME, LOS ANGELES, CA. FILED 8-18-2003.

SCAR AWAY

NO CLAIM IS MADE TO THE EXCLUSIVE RIGHT TO USE "SCAR", APART FROM THE MARK AS SHOWN.

THE MARK CONSISTS OF THE WORDS "SCAR AWAY" AS SHOWN IN THE DRAWING.

FOR MEDICATED COSMETICS, NAMELY, MEDICATED COSMETIC REMOVERS; MEDICATED EYE CREAMS; MEDICATED COSMETIC FACIAL CLEANERS; MEDICATED SKIN BALANCERS AND MOISTURIZERS; MEDICATED HERBAL BATH GEL FLUID; MEDICATED FOUNDATION MAKEUP; MEDICATED FACE POWDERS; MEDICATED MASCARA; MEDICATED LIP POLISH; MEDICATED LIP GLOSS; MEDICATED EYE MAKEUP POWDERS; MEDICATED EYE SHADOWS; MEDICATED LIP COLOR IN THE FORM OF LIPSTICKS; MEDICATED NAIL ENAMEL; MEDICATED ROUGE; MEDICATED CONTOUR POWDER; MEDICATED EYEBROW PENCILS; MEDICATED CONTOUR POWDERS FOR USE ON CHEEKS; MEDICATED LIP SEALERS; MEDICATED FACE AND BODY CREAMS AND TONERS; AND MEDICATED FACIAL MASKS (U.S. CLS. 6, 18, 44, 46, 51 AND 52).

KATHRYN COWARD, EXAMINING ATTORNEY

SN 76-541,381. PERFECT IMAGE MEDICAL CORP., DBA NEW ME, LOS ANGELES, CA. FILED 8-18-2003.

OIL AWAY

NO CLAIM IS MADE TO THE EXCLUSIVE RIGHT TO USE "OIL", APART FROM THE MARK AS SHOWN.

FOR MEDICATED COSMETICS, NAMELY, MEDICATED COSMETIC REMOVERS; MEDICATED EYE CREAMS; MEDICATED COSMETIC FACIAL CLEANERS; MEDICATED SKIN BALANCERS AND MOISTURIZERS; MEDICATED HERBAL BATH GEL FLUID; MEDICATED FOUNDATION MAKEUP; MEDICATED FACE POWDERS; MEDICATED MASCARA; MEDICATED LIP POLISH; MEDICATED LIP GLOSS; MEDICATED EYE MAKEUP POWDERS; MEDICATED EYE SHADOWS; MEDICATED LIP COLOR IN THE FORM OF LIPSTICKS; MEDICATED NAIL ENAMEL; MEDICATED ROUGE; MEDICATED CONTOUR POWDER; MEDICATED EYEBROW PENCILS; MEDICATED CONTOUR POWDERS FOR USE ON CHEEKS; MEDICATED LIP SEALERS; MEDICATED FACE AND BODY CREAMS AND TONERS; AND MEDICATED FACIAL MASKS (U.S. CLS. 6, 18, 44, 46, 51 AND 52).

KATHRYN COWARD, EXAMINING ATTORNEY

CLASS 5—(Continued).

SN 76-541,382. PERFECT IMAGE MEDICAL CORP., DBA NEW ME, LOS ANGELES, CA. FILED 8-18-2003.

YOUNG AND BEAUTIFUL

FOR MEDICATED COSMETICS, NAMELY, MEDICATED COSMETIC REMOVERS; MEDICATED EYE CREAMS; MEDICATED COSMETIC FACIAL CLEANERS; MEDICATED SKIN BALANCERS AND MOISTURIZERS; MEDICATED HERBAL BATH GEL FLUID; MEDICATED FOUNDATION MAKEUP; MEDICATED FACE POWDERS; MEDICATED MASCARA; MEDICATED LIP POLISH; MEDICATED LIP GLOSS; MEDICATED EYE MAKEUP POWDERS; MEDICATED EYE SHADOWS; MEDICATED LIP COLOR IN THE FORM OF LIPSTICKS; MEDICATED NAIL ENAMEL; MEDICATED ROUGE; MEDICATED CONTOUR POWDER; MEDICATED EYEBROW PENCILS; MEDICATED CONTOUR POWDERS FOR USE ON CHEEKS; MEDICATED LIP SEALERS; MEDICATED FACE AND BODY CREAMS AND TONERS; AND MEDICATED FACIAL MASKS (U.S. CLS. 6, 18, 44, 46, 51 AND 52).

KATHRYN COWARD, EXAMINING ATTORNEY

SN 76-544,129. ALKERMES, INC., CAMBRIDGE, MA. FILED 9-11-2003.



OWNER OF U.S. REG. NO. 2,660,659.

FOR POLYMER-BASED DRUG DELIVERY FORMULATIONS FOR CLINICAL USE; AND PHARMACEUTICAL PRODUCTS, NAMELY, INJECTABLE DRUG DELIVERY FORMULATIONS USED AS FACILITATING AGENTS FOR OTHER PHARMACEUTICAL PREPARATIONS (U.S. CLS. 6, 18, 44, 46, 51 AND 52).

MARIA-VICTORIA SUAREZ, EXAMINING ATTORNEY

SN 76-545,625. IMS TRADING, LLC, STUDIO CITY, CA. FILED 9-22-2003.

MALIBU BREEZE

FOR AIR FRESHENERS (U.S. CLS. 6, 18, 44, 46, 51 AND 52).

MARGERY A. TIERNEY, EXAMINING ATTORNEY

SN 76-545,641. PHARMATON S.A., BIOGGIO, SWITZERLAND, FILED 9-22-2003.

SERESIS

FOR DIETARY SUPPLEMENTS WITH ANTIOXIDANT PROPERTIES SUPPORTING THE CELL PROTECTION SYSTEM OF HUMANS (U.S. CLS. 6, 18, 44, 46, 51 AND 52).

MARC LEIPZIG, EXAMINING ATTORNEY

CLASS 5—(Continued).

SN 76-546,015. L A WEIGHT LOSS CENTERS, INC., HORSHAM, PA. FILED 9-22-2003.

LA SMOOTHIES

NO CLAIM IS MADE TO THE EXCLUSIVE RIGHT TO USE "SMOOTHIES", APART FROM THE MARK AS SHOWN.

FOR NUTRITIONAL DRINKS (U.S. CLS. 6, 18, 44, 46, 51 AND 52).

DAVID C. REIHNER, EXAMINING ATTORNEY

SN 76-546,236. AMERICAN BODY BUILDING PRODUCTS, L.L.C., AURORA, IL. FILED 9-8-2003.

GLUTAFORCE

FOR DIETARY SUPPLEMENTS; NAMELY, POWDERED DRINK MIXES (U.S. CLS. 6, 18, 44, 46, 51 AND 52).

FIRST USE 11-1-2003; IN COMMERCE 11-1-2003.
MICHAEL WEBSTER, EXAMINING ATTORNEY

SN 76-546,999. L. PERRIGO COMPANY, ALLEGAN, MI. FILED 9-25-2003.

DOLLAR LABS

NO CLAIM IS MADE TO THE EXCLUSIVE RIGHT TO USE "LABS", APART FROM THE MARK AS SHOWN.

FOR PHARMACEUTICAL PREPARATIONS, NAMELY, ACID REDUCERS, ANALGESICS, ANTACIDS, ANTI-DIARRHEALS, ANTI-GAS PREPARATIONS, ANTIHISTAMINES, CHEMICALLY ACTIVATED HEAT RELEASING WRAPS FOR THERAPEUTIC PURPOSES, COLD AND ALLERGY RELIEF MEDICATIONS, COUGH SUPPRESSANTS, DIET PILLS/TABLETS, DIETARY SUPPLEMENTS, EXPECTORANTS, FUNGICIDAL AGENTS IN THE FORM OF SUPPOSITORIES AND CREAMS, GASTROINTESTINAL TREATMENT PREPARATIONS, HAIR RE-GROWTH TREATMENTS, HEMORRHOID TREATMENT PREPARATIONS, LAXATIVES, MIGRAINE TREATMENT PREPARATIONS, NUTRITIONAL DRINKS, NASAL SPRAY PREPARATIONS, NASAL DECONGESTANTS, NUTRITIONAL SUPPLEMENTS, OVULATION TEST KITS, PAIN RELIEVER AND FEVER REDUCER MEDICATIONS, PREGNANCY TEST KITS FOR HOME USE, SLEEP AID PILLS/TABLETS, AND SMOKING CESSATION AIDS (U.S. CLS. 6, 18, 44, 46, 51 AND 52).

FIRST USE 3-22-2004; IN COMMERCE 3-22-2004.
DAWN FELDMAN, EXAMINING ATTORNEY

SN 76-547,492. INTERFERAL, INC., BOULDER, CO. FILED 9-24-2003.

PHYTOVIR

FOR ANTIVIRALS (U.S. CLS. 6, 18, 44, 46, 51 AND 52).
MARGERY A. TIERNEY, EXAMINING ATTORNEY

CLASS 5—(Continued).

SN 76-547,592. P.L. THOMAS & CO., INC., MORRISTOWN, NJ. FILED 9-30-2003.

5-LOXIN

FOR EXTRACTS OF THE BOSWELLIA PLANT SOLD AS INTEGRAL COMPONENTS OF NUTRITIONAL SUPPLEMENTS, DIETARY SUPPLEMENTS, MINERAL SUPPLEMENTS, HERB SUPPLEMENTS AND VITAMIN SUPPLEMENTS (U.S. CLS. 6, 18, 44, 46, 51 AND 52).

FIRST USE 7-18-2003; IN COMMERCE 7-18-2003.
MICHAEL SOUDERS, EXAMINING ATTORNEY

SN 76-548,465. COHEN, MORTON H., BEAVER FALLS, PA. FILED 10-2-2003.

URINCO

FOR UNDERSHORTS FOR INCONTINENT MALES (U.S. CLS. 6, 18, 44, 46, 51 AND 52).

RICHARD A. STRASER, EXAMINING ATTORNEY

SN 76-548,494. BARR LABORATORIES, INC., POMONA, NY. FILED 10-2-2003.

ROZAIC

FOR PHARMACEUTICALS, NAMELY, ORAL CONTRACEPTIVES (U.S. CLS. 6, 18, 44, 46, 51 AND 52).
JEFFREY S. MOLINOFF, EXAMINING ATTORNEY

SN 76-548,497. BARR LABORATORIES, INC., POMONA, NY. FILED 10-2-2003.

JUNEL

FOR PHARMACEUTICALS, NAMELY, ORAL CONTRACEPTIVES (U.S. CLS. 6, 18, 44, 46, 51 AND 52).
FIRST USE 9-18-2003; IN COMMERCE 9-18-2003.
JEFFREY S. MOLINOFF, EXAMINING ATTORNEY

SN 76-548,731. BARR LABORATORIES, INC., POMONA, NY. FILED 10-2-2003.

OVISI

FOR PHARMACEUTICALS, NAMELY, ORAL CONTRACEPTIVES (U.S. CLS. 6, 18, 44, 46, 51 AND 52).
KEVON CHISOLM, EXAMINING ATTORNEY

CLASS 5—(Continued).

SN 76-549,272. HERO NUTRITIONAL PRODUCTS L.L.C., SAN CLEMENTE, CA. FILED 10-6-2003.

JUICE FOR LIFE

NO CLAIM IS MADE TO THE EXCLUSIVE RIGHT TO USE JUICE, APART FROM THE MARK AS SHOWN. FOR DIETARY SUPPLEMENTS, NAMELY WHOLE FOOD CONCENTRATES (U.S. CLS. 6, 18, 44, 46, 51 AND 52).
FIRST USE 1-15-1995; IN COMMERCE 1-15-1995.
TARAH HARDY, EXAMINING ATTORNEY

CLASS 5—(Continued).

SN 76-552,988. L. PERRIGO COMPANY, ALLEGAN, MI. FILED 10-21-2003.

CARB-VANTAGE

FOR DIETARY SUPPLEMENT PRODUCTS IN THE FORM OF NUTRITIONAL BARS (U.S. CLS. 6, 18, 44, 46, 51 AND 52).
SCOTT BALDWIN, EXAMINING ATTORNEY

SN 76-549,687. INTERFERAL, INC., BOULDER, CO. FILED 9-22-2003.

Immuna

FOR ANTIVIRALS (U.S. CLS. 6, 18, 44, 46, 51 AND 52).
ELIZABETH HUGHITT, EXAMINING ATTORNEY

SN 76-554,142. WHEAT, JARED R., NORCROSS, GA. FILED 10-23-2003.

ESTROGEN-RX

FOR VITAMINS AND DIETARY SUPPLEMENTS (U.S. CLS. 6, 18, 44, 46, 51 AND 52).
DOUGLAS LEE, EXAMINING ATTORNEY

SN 76-550,480. WEIGHT LOSS DIRECT, LLC, MAPLE GROVE, MN. FILED 10-10-2003.

HEALTHY OPTIONS

FOR DIETARY DRINK MIX FOR USE AS A MEAL REPLACEMENT (U.S. CLS. 6, 18, 44, 46, 51 AND 52).
BILL DAWE, EXAMINING ATTORNEY

SN 76-555,348. ULTIMATE NUTRITION, INC., FARMINGTON, CT. FILED 10-29-2003.

MUSCLE JUICE

SN 76-551,923. AWARENESS CORPORATION, CHANDLER, AZ. FILED 9-25-2003.

SYNERGY DEFENSE

NO CLAIM IS MADE TO THE EXCLUSIVE RIGHT TO USE SYNERGY, APART FROM THE MARK AS SHOWN. FOR DIETARY SUPPLEMENTS, FOOD SUPPLEMENTS AND HERBAL SUPPLEMENTS (U.S. CLS. 6, 18, 44, 46, 51 AND 52).
FIRST USE 9-2-2003; IN COMMERCE 9-2-2003.
HOWARD SMIGA, EXAMINING ATTORNEY

FOR NUTRITIONAL PRODUCTS, NAMELY DIETARY FOOD SUPPLEMENTS (U.S. CLS. 6, 18, 44, 46, 51 AND 52).
JOHN HWANG, EXAMINING ATTORNEY

SN 76-557,837. FLEMING, JON, SACRAMENTO, CA. FILED 10-21-2003.

GHR PLATINUM

SN 76-552,180. HUBBARD, DAVID R., POWAY, CA. FILED 10-17-2003.

MYOX

FOR INJECTABLE PHARMACEUTICALS FOR TREATMENT OF MYOFASCIAL TRIGGER POINTS (U.S. CLS. 6, 18, 44, 46, 51 AND 52).
TARAH HARDY, EXAMINING ATTORNEY

NO CLAIM IS MADE TO THE EXCLUSIVE RIGHT TO USE "GHR", APART FROM THE MARK AS SHOWN. FOR ALL NATURAL HEALTH SUPPLEMENT THAT IS TAKEN ORALLY TO HELP HUMAN BODIES TO NATURALLY RELEASE MORE HUMAN GROWTH HORMONE (U.S. CLS. 6, 18, 44, 46, 51 AND 52).
WON TEAK OH, EXAMINING ATTORNEY

CLASS 5—(Continued).

SN 76-578,521. MERCK & CO., INC., WHITEHOUSE STATION, NJ. FILED 3-1-2004.

FOSAVANCE

FOR PHARMACEUTICAL PREPARATIONS FOR THE TREATMENT AND PREVENTION OF BONE DISEASES (U.S. CLS. 6, 18, 44, 46, 51 AND 52).
RON FAIRBANKS, EXAMINING ATTORNEY

SN 78-057,027. LIGAND PHARMACEUTICALS INCORPORATED, SAN DIEGO, CA. FILED 4-5-2001.

SAVARA

FOR PHARMACEUTICAL PREPARATIONS FOR THE TREATMENT OF PAIN. (U.S. CLS. 6, 18, 44, 46, 51 AND 52).
STEVEN BERK, EXAMINING ATTORNEY

SN 78-086,707. LG LIFE SCIENCES, LTD., SEOUL, REPUBLIC OF KOREA, FILED 10-3-2001.

FACPAC7 DAY

OWNER OF U.S. REG. NO. 2,281,877.
FOR PHARMACEUTICALS, NAMELY, ANTIBIOTICS IN TABLET FORM PACKAGED IN CONVENIENCE CARTONS TO ENSURE PATIENT COMPLIANCE WITH RESPECT TO COMPLETE COURSE OF MEDICATION (U.S. CLS. 6, 18, 44, 46, 51 AND 52).
PAULA MAYS, EXAMINING ATTORNEY

SN 78-092,637. NATURE'S BEST INC., NEW YORK, NY. FILED 11-9-2001.

GRENADÉ

FOR DIETARY SUPPLEMENT (U.S. CLS. 6, 18, 44, 46, 51 AND 52).
FIRST USE 8-31-2001; IN COMMERCE 8-31-2001.
TRICIA SONNEBORN, EXAMINING ATTORNEY

CLASS 5—(Continued).

SN 78-130,062. COLLEGIUM PHARMACEUTICAL, INC., HINGHAM, MA. FILED 5-20-2002.

MEDI-SAVER

FOR PHARMACEUTICAL TABLETS, NAMELY, ALLERGY, ANALGESIC, ANTIBIOTIC, ANTIHISTAMINE, ANTI-DIARRHEAL, ANXIOLYTIC, HYPNOTICS, STIMULANT, CARDIOVASCULAR, PULMONARY, ANTI-HYPERTENSIVE, ANTI-EMETIC, ANTI-INFLAMMATORY, RENAL, STEROID, NEUROLOGICAL-TREATMENT ANTI-CONVULSANT, ENDOCRINE-DISORDER, SEXUAL DYSFUNCTION, IMMUNOLOGICAL, OSTEOARTHRITIS, GLAUCOMA, ANEMIA, HEMATOLOGICAL DISORDER, ANTI-INFECTIVE, CANCER TREATMENT, INSOMNIA AND ANTIDIABETIC TABLETS (U.S. CLS. 6, 18, 44, 46, 51 AND 52).
FIRST USE 4-20-2002; IN COMMERCE 4-20-2002.
STANLEY I. OSBORNE, EXAMINING ATTORNEY

SN 78-159,123. PREFERRED NUTRITION INC., ACTON, ONTARIO, CANADA, FILED 8-29-2002.

ADRENASENSE

PRIORITY CLAIMED UNDER SEC. 44(D) ON CANADA APPLICATION NO. 1150642, FILED 8-28-2002, REG. NO. TMA601566, DATED 2-6-2004, EXPIRES 2-6-2019.
FOR DIETARY SUPPLEMENTS, NUTRITIONAL SUPPLEMENTS AND HERBAL SUPPLEMENTS (U.S. CLS. 6, 18, 44, 46, 51 AND 52).
JACQUELINE A. LAVINE, EXAMINING ATTORNEY

SN 78-173,515. SMITHKLINE BEECHAM CORPORATION, PHILADELPHIA, PA. FILED 10-11-2002.

CLEAR BY DESIGN

NO CLAIM IS MADE TO THE EXCLUSIVE RIGHT TO USE "CLEAR", APART FROM THE MARK AS SHOWN.
FOR ACNE SKIN MEDICATION. (U.S. CLS. 6, 18, 44, 46, 51 AND 52).
HOWARD SMIGA, EXAMINING ATTORNEY

SN 78-177,940. MAXCELL BIOSCIENCE, INC., DBA OASIS WELLNESS NETWORK, BROOMFIELD, CO. FILED 10-24-2002.

ULTRA IMMUNE MAX

NO CLAIM IS MADE TO THE EXCLUSIVE RIGHT TO USE "IMMUNE", APART FROM THE MARK AS SHOWN.
FOR DIETARY SUPPLEMENTS (U.S. CLS. 6, 18, 44, 46, 51 AND 52).
BARBARA RUTLAND, EXAMINING ATTORNEY

CLASS 5—(Continued).

SN 78-190,429. ATHERA BIOTECHNICS AB, STOCKHOLM, SWEDEN, FILED 12-2-2002.

ATHERA ALPC

FOR DIAGNOSTIC TOOL, PRIMARILY CONSISTING OF REAGENTS, FOR MEDICAL PURPOSES FOR TESTING OF BLOOD AND OTHER BODY FLUIDS FOR PRESENCE OF ANTIBODIES AGAINST PAF, PAF-LIKE LIPIDS AND LPC (U.S. CLS. 6, 18, 44, 46, 51 AND 52).
GINA HAYES, EXAMINING ATTORNEY

SN 78-194,302. ELAN PHARMA INTERNATIONAL LIMITED, COUNTY CLARE, IRELAND, FILED 12-13-2002.

VATUDE

PRIORITY CLAIMED UNDER SEC. 44(D) ON IRELAND APPLICATION NO. 2002/01195, FILED 6-13-2002, REG. NO. 224641, DATED 6-13-2002, EXPIRES 6-13-2009.

FOR PHARMACEUTICAL PREPARATIONS FOR THE PREVENTION, TREATMENT AND DIAGNOSIS OF INFLAMMATORY DISORDERS, DISEASES AND CONDITIONS, AND FOR THE PREVENTION, TREATMENT AND DIAGNOSIS OF PHYSIOLOGICAL CONDITIONS RELATING TO CELL ADHESION, SIGNALING AND MIGRATION (U.S. CLS. 6, 18, 44, 46, 51 AND 52).
THEODORE MCBRIDE, EXAMINING ATTORNEY

SN 78-194,925. CARDINAL HEALTH TECHNOLOGIES, LLC, PARADISE VALLEY, NV. FILED 12-16-2002.



FOR SOFT AND HARD UNIT DOSE CAPSULES AND TABLETS SOLD EMPTY USED AS A DRUG DELIVERY SYSTEM FOR PRESCRIPTION AND NON-PRESCRIPTION DRUGS FOR HUMAN AND VETERINARY USE; FAST-DISSOLVING ORALLY ADMINISTERED UNIT DOSE TABLETS SOLD EMPTY USED AS A DRUG DELIVERY SYSTEM FOR PRESCRIPTION AND NON-PRESCRIPTION DRUGS FOR HUMAN AND VETERINARY USE; DISINFECTANTS FOR MEDICAL INSTRUMENTS; DISINFECTING HAND WASH; SURGICAL BANDAGES; ADHESIVE TAPE FOR MEDICAL PURPOSES; BURN DRESSINGS; SURGICAL DRESSINGS; WOUND DRESSINGS; SANITARY PADS; ALL-PURPOSE DISINFECTANTS; ADHESIVE BANDAGES; BANDAGES FOR SKIN WOUNDS; MEDICAL CLEANSERS FOR SKIN WOUNDS, NAMELY, SOLUTIONS FOR IRRIGATING WOUNDS AND FOR USE IN RESPIRATORY THERAPY; SURGICAL IMPLANTS COMPRISING LIVING TISSUE; DIAGNOSTIC TISSUE PROCESSING REAGENTS FOR CLINICAL OR MEDICAL LABORATORY USE; RADIOLOGICAL CONTRAST MEDIA FOR USE WITH MEDICAL EQUIPMENT, MAINLY, X-RAY, POSITRON EMISSION TOMOGRAPHY, ULTRASOUND, COMPUTERIZED TOMOGRAPHY AND GAMMA CAMERA IMAGING; NUCLEAR PHARMAEUTICALS FOR THE TREATMENT OF HYPERTHYROIDISM, THYROID CARCINOMA, INTRACAVITY MALIGNANCIES, POLYCYTHEMIA VERA, PALLIATIVE TREATMENT OF SKELETAL METASTASES, AND NON-HODGKIN'S LYMPHOMA. (U.S. CLS. 6, 18, 44, 46, 51 AND 52).
JOHN GARTNER, EXAMINING ATTORNEY

CLASS 5—(Continued).

SN 78-214,838. CONJUGON, INC., MADISON, WI. FILED 2-14-2003.

CONJUCIN

FOR BIOTECHNOLOGICALLY-DEVELOPED THERAPEUTIC AGENTS, NAMELY, ANTIMICROBIAL AGENTS USED TO COMBAT INFECTIOUS DISEASE (U.S. CLS. 6, 18, 44, 46, 51 AND 52).
VERNA BETH RIRIE, EXAMINING ATTORNEY

SN 78-221,182. PAPERPAK PRODUCTS, INC., SAN DIMAS, CA. FILED 3-4-2003.



NO CLAIM IS MADE TO THE EXCLUSIVE RIGHT TO USE "SYSTEM", APART FROM THE MARK AS SHOWN.
THE LINING IS A FEATURE OF THE MARK AND DOES NOT INDICATE COLOR.
FOR INCONTINENCE PRODUCTS, NAMELY BRIEFS, PADS AND SHIELDS (U.S. CLS. 6, 18, 44, 46, 51 AND 52).
FIRST USE 11-15-2002; IN COMMERCE 2-3-2003.
ROBERT COGGINS, EXAMINING ATTORNEY

SN 78-222,714. HINZ, MARTIN CHARLES, DULUTH, MN. FILED 3-6-2003.

CysReplete

FOR AMINO ACIDS AND COFACTORS USED IN THE TREATMENT OF NEUROTRANSMITTER DYSFUNCTION (U.S. CLS. 6, 18, 44, 46, 51 AND 52).
LINDA E. BLOHM, EXAMINING ATTORNEY

CLASS 5—(Continued).

SN 78-227,677. CHUGAI SEIYAKU KABUSHIKI KAISHA, TOKYO, JAPAN, FILED 3-19-2003.

LOGIVIK

FOR PHARMACEUTICAL PREPARATIONS, NAMELY, ANTI-INTERLEUKIN-6 (IL-6) RECEPTOR MONOCLONAL ANTIBODY FOR THE TREATMENT OF DISEASES CAUSED BY IL-6 PRODUCTION (U.S. CLS. 6, 18, 44, 46, 51 AND 52).

LEIGH CAROLINE CASE, EXAMINING ATTORNEY

SN 78-234,812. IDEAL AROMA, INC., ONTARIO, CANADA, FILED 4-7-2003.

SMELL-X

FOR ODOR NEUTRALIZING PREPARATION FOR HOUSEHOLD AND COMMERCIAL USE (U.S. CLS. 6, 18, 44, 46, 51 AND 52).

ALLISON HOLTZ, EXAMINING ATTORNEY

SN 78-235,324. FAYZANO, FERNANDO, TORRANCE, CA. FILED 4-8-2003.

NATURON

FOR DIETARY SUPPLEMENTS, NAMELY, A DRINK MIX OF GINSENG, GUARANA, AND CATUABA EXTRACT IN A HONEY BASE (U.S. CLS. 6, 18, 44, 46, 51 AND 52).

FIRST USE 12-0-2000; IN COMMERCE 12-0-2000.
BRENDAN MCCAULEY, EXAMINING ATTORNEY

SN 78-237,739. LODERS CROKLAAN B.V., WORMERVEER, NETHERLANDS, FILED 4-15-2003.

SAFFLORIN

FOR FOOD STUFFS, NAMELY FOOD CONTAINING FATTY AND LINOLIC ACIDS FOR MEDICALLY RESTRICTED DIETS; FOOD SUPPLEMENTS CONTAINING FATTY AND LINOLIC ACIDS FOR PHARMACEUTICAL USE FOR THE IMPROVEMENT OF HEALTH; DIETETIC FOOD SUPPLEMENTS FOR MEDICAL USE (U.S. CLS. 6, 18, 44, 46, 51 AND 52).

ALLISON HOLTZ, EXAMINING ATTORNEY

SN 78-238,329. PHARMACIA & UPJOHN COMPANY, PEAPACK, NJ. FILED 4-16-2003.

EXCEDE

FOR PHARMACEUTICAL PREPARATIONS, NAMELY, ANTI-INFECTIVES FOR LIVESTOCK (U.S. CLS. 6, 18, 44, 46, 51 AND 52).

MARC LEIPZIG, EXAMINING ATTORNEY

CLASS 5—(Continued).

SN 78-239,511. JOHNSON & JOHNSON, NEW BRUNSWICK, NJ. FILED 4-18-2003.

M-TAB

FOR PHARMACEUTICALS, NAMELY, ANTIPSYCHOTIC PREPARATIONS, IN ORALLY DISINTEGRATING TABLET FORM (U.S. CLS. 6, 18, 44, 46, 51 AND 52).

MARC LEIPZIG, EXAMINING ATTORNEY

SN 78-240,953. META BALANCE, INC., ROCKFORD, IL. FILED 4-23-2003.

YEASTROL

FOR DIETARY SUPPLEMENTS AND HERBAL SUPPLEMENTS (U.S. CLS. 6, 18, 44, 46, 51 AND 52).

FIRST USE 7-20-2001; IN COMMERCE 7-20-2001.
KIMBERLY PERRY, EXAMINING ATTORNEY

SN 78-240,957. META BALANCE, INC., ROCKFORD, IL. FILED 4-23-2003.

CLEARSITE

FOR DIETARY SUPPLEMENTS AND HERBAL SUPPLEMENTS (U.S. CLS. 6, 18, 44, 46, 51 AND 52).

FIRST USE 10-1-2001; IN COMMERCE 10-1-2001.
KIMBERLY PERRY, EXAMINING ATTORNEY

SN 78-247,900. M D SCIENCE LAB, LLC, FORT LAUDERDALE, FL. FILED 5-9-2003.

MAX STAMINA

FOR HERBAL DIETARY SUPPLEMENTS (U.S. CLS. 6, 18, 44, 46, 51 AND 52).

FIRST USE 11-15-2002; IN COMMERCE 1-10-2003.
KIMBERLY PERRY, EXAMINING ATTORNEY

SN 78-251,900. ABBOTT LABORATORIES, ABBOTT PARK, IL. FILED 5-20-2003.

WELCOME ADDITIONPAC

OWNER OF U.S. REG. NOS. 1,878,047 AND 2,256,990.
FOR INFANT FEEDING KIT CONSISTING PRIMARILY OF INFANT FORMULA, DIAPER BAG, AND INFORMATIONAL LITERATURE REGARDING INFANT FEEDING (U.S. CLS. 6, 18, 44, 46, 51 AND 52).

FIRST USE 2-28-2003; IN COMMERCE 2-28-2003.
NANCY CLARKE, EXAMINING ATTORNEY

CLASS 5—(Continued).

SN 78-254,556. BIONORICA AG, D-92318 NEUMARKT, FED REP GERMANY, FILED 5-27-2003.

KLIMADYNON

OWNER OF FED REP GERMANY REG. NO. 1171146, DATED 1-21-1991, EXPIRES 3-31-2010.

FOR PHARMACEUTICAL PREPARATIONS FOR THE TREATMENT OF ENDOCRINOLOGICAL DISORDERS. (U.S. CLS. 6, 18, 44, 46, 51 AND 52).

ANNE MADDEN, EXAMINING ATTORNEY

SN 78-259,876. VITALSTATE CANADA LTD., MONTREAL, QUEBEC, CANADA, FILED 6-9-2003.



PRIORITY CLAIMED UNDER SEC. 44(D) ON CANADA APPLICATION NO. 1179033, FILED 6-3-2003.

FOR NUTRITIONAL SUPPLEMENTS IN TABLET, POWDERED, CHEWABLE, CONFECTIONERY, LOZENGE OR CAPSULE FORM, NUTRITIONAL ENERGY BARS, NUTRITIONAL MEAL REPLACEMENT BARS, NUTRITIONAL DRINKS IN LIQUID OR POWDERED FORM FOR USE AS A MEAL REPLACEMENT AND DIETARY DRINKS IN LIQUID OR POWDERED FOR USE AS A MEAL REPLACEMENT (U.S. CLS. 6, 18, 44, 46, 51 AND 52).

ERICA GLEMBOCKI, EXAMINING ATTORNEY

SN 78-269,715. NAN LESTER INC., CLEARWATER, FL. FILED 7-2-2003.

STRAIGHT TO GAY

FOR FRUIT SCENTED AIR FRESHENER (U.S. CLS. 6, 18, 44, 46, 51 AND 52).

FIRST USE 6-30-2003; IN COMMERCE 7-1-2003.

JOHN HWANG, EXAMINING ATTORNEY

SN 78-280,044. BRADLEY PHARMACEUTICALS, INC., FAIRFIELD, NJ. FILED 7-29-2003.

BLS-FLORA

FOR NUTRITIONAL VITAMIN SUPPLEMENTS; NUTRICEUTICALS, NAMELY, DIETARY SUPPLEMENTS; AND NUTRITIONAL SUPPLEMENTS PREPARED WITH PROBIOTICS (U.S. CLS. 6, 18, 44, 46, 51 AND 52).

GENE MACIOL, EXAMINING ATTORNEY

CLASS 5—(Continued).

SN 78-280,045. BRADLEY PHARMACEUTICALS, INC., FAIRFIELD, NJ. FILED 7-29-2003.

FLORA-Q

FOR NUTRITIONAL VITAMIN SUPPLEMENTS; NUTRICEUTICALS, NAMELY, DIETARY SUPPLEMENTS; AND NUTRITIONAL SUPPLEMENTS PREPARED WITH PROBIOTICS (U.S. CLS. 6, 18, 44, 46, 51 AND 52).

FIRST USE 3-30-2004; IN COMMERCE 3-30-2004.

GENE MACIOL, EXAMINING ATTORNEY

SN 78-287,245. WYETH, MADISON, NJ. FILED 8-14-2003.

PREMIA

THE ENGLISH TRANSLATION OF THE WORD "PREMIA" IN THE MARK IS "IT REWARDS".

FOR PHARMACEUTICAL PREPARATIONS USED IN FEMALE HORMONAL REPLACEMENT THERAPY (U.S. CLS. 6, 18, 44, 46, 51 AND 52).

RUSS HERMAN, EXAMINING ATTORNEY

SN 78-287,800. PHARMACIA & UPJOHN COMPANY, PEAPACK, NJ. FILED 8-15-2003.

WISPra

FOR PHARMACEUTICAL PREPARATIONS, NAMELY, INJECTABLE CONTRACEPTIVES (U.S. CLS. 6, 18, 44, 46, 51 AND 52).

GLENN CLARK, EXAMINING ATTORNEY

SN 78-288,482. NOVARTIS AG, BASEL, SWITZERLAND, FILED 8-18-2003.

EFFIGRAX

PRIORITY CLAIMED UNDER SEC. 44(D) ON SWITZERLAND APPLICATION NO. 38642003, FILED 7-23-2003, REG. NO. 513119, DATED 7-30-2003, EXPIRES 7-23-2013.

OWNER OF U.S. REG. NO. 2,683,704.

FOR PHARMACEUTICAL PREPARATIONS FOR THE PREVENTION AND/OR TREATMENT OF DISORDERS OF THE NERVOUS SYSTEM, THE IMMUNE SYSTEM, THE CARDIO-VASCULAR SYSTEM, THE RESPIRATORY SYSTEM, THE MUSCULO-SKELETAL SYSTEM, THE GENITOURINARY SYSTEM, FOR THE TREATMENT OF INFLAMMATORY DISORDERS, FOR USE IN DERMATOLOGY, IN ONCOLOGY, IN OPHTHALMOLOGY, FOR USE IN THE GASTROENTEROLOGICAL AREA AND THE PREVENTION AND TREATMENT OF OCULAR DISORDERS OR DISEASES; ANTI-INFECTIVES, ANTIBACTERIALS, ANTIVIRALS, ANTIBIOTICS, AND ANTIFUNGALS (U.S. CLS. 6, 18, 44, 46, 51 AND 52).

RICHARD A. STRASER, EXAMINING ATTORNEY

CLASS 5—(Continued).

SN 78-291,643. BOEHRINGER INGELHEIM PHARMA GMBH & CO. KG, INGELHEIM AM RHEIN, FED REP GERMANY, FILED 8-25-2003.

TIRENIS

PRIORITY CLAIMED UNDER SEC. 44(D) ON FED REP GERMANY APPLICATION NO. 30313242, FILED 3-11-2003, REG. NO. 30313242, DATED 5-26-2003, EXPIRES 3-31-2013.

FOR PHARMACEUTICAL PREPARATIONS AND SUBSTANCES FOR THE TREATMENT OF THE ALIMENTARY TRACT AND METABOLISM, BLOOD AND BLOOD FORMING ORGANS, THE CARDIOVASCULAR SYSTEM, THE MUSCULOSKELETAL SYSTEM, THE CENTRAL NERVOUS SYSTEM, THE PERIPHERAL NERVOUS SYSTEM, THE GENITOURINARY SYSTEM, THE RESPIRATORY SYSTEM, AND DERMATOLOGICAL DISORDERS; HORMONES FOR MEDICAL PURPOSES; ANTI-INFECTIVE PREPARATIONS; ANTI-VIRAL PREPARATIONS; CYTOSTATIC PREPARATIONS; ALLERGY MEDICATION; NUTRIENT DIETARY PREPARATIONS ADAPTED FOR MEDICAL PURPOSES (U.S. CLS. 6, 18, 44, 46, 51 AND 52).

HEATHER THOMPSON, EXAMINING ATTORNEY

SN 78-294,535. BODYONICS, LTD., HICKSVILLE, NY. FILED 9-1-2003.



OWNER OF U.S. REG. NO. 2,806,548.
FOR DIETARY AND NUTRITIONAL SUPPLEMENTS (U.S. CLS. 6, 18, 44, 46, 51 AND 52).
FIRST USE 12-0-2002; IN COMMERCE 12-0-2002.
JAMES GRIFFIN, EXAMINING ATTORNEY

SN 78-294,573. HOLY TERRA PRODUCTS, INC., PORTLAND, ME. FILED 9-1-2003.

PLANT PROTECTION THAT SENDS PESTS PACKING

NO CLAIM IS MADE TO THE EXCLUSIVE RIGHT TO USE PLANT PROTECTION, APART FROM THE MARK AS SHOWN.

FOR INSECT REPELLENT FOR PLANTS (U.S. CLS. 6, 18, 44, 46, 51 AND 52).

SHAUNIA WALLACE, EXAMINING ATTORNEY

CLASS 5—(Continued).

SN 78-296,408. ADVANCED NUTRITIONAL INNOVATIONS, INC., RENO, NV. FILED 9-5-2003.

GOLDEN HEALTH

NO CLAIM IS MADE TO THE EXCLUSIVE RIGHT TO USE "HEALTH", APART FROM THE MARK AS SHOWN.

FOR DIETARY SUPPLEMENTS CONTAINING CALCIUM, VITAMINS, MINERALS, AND OTHER NUTRACEUTICALS. (U.S. CLS. 6, 18, 44, 46, 51 AND 52).

HOWARD SMIGA, EXAMINING ATTORNEY

SN 78-298,378. THE PROCTER & GAMBLE COMPANY, CINCINNATI, OH. FILED 9-10-2003.

STAND-UP PROTECTION

NO CLAIM IS MADE TO THE EXCLUSIVE RIGHT TO USE "PROTECTION", APART FROM THE MARK AS SHOWN.

FOR CATAMENIAL PRODUCTS, NAMELY, MAXI PADS, MINI PADS, AND PANTILINERS (U.S. CLS. 6, 18, 44, 46, 51 AND 52).

CATHERINE CAIN, EXAMINING ATTORNEY

SN 78-299,345. GUSTAFSON, LLC, PLANO, TX. FILED 9-11-2003.

TELSEN

FOR SEED-APPLIED FUNGICIDE TO PROTECT CORN AGAINST DISEASES, FOR USE IN THE AGRICULTURE INDUSTRY (U.S. CLS. 6, 18, 44, 46, 51 AND 52).

SONYA STEPHENS, EXAMINING ATTORNEY

SN 78-299,769. H. LUNDBECK A/S, COPENHAGEN-VALBY, DENMARK, FILED 9-12-2003.

ENTACTOS

FOR PHARMACEUTICAL PREPARATIONS FOR THE TREATMENT OF CENTRAL NERVOUS SYSTEM DISORDERS (U.S. CLS. 6, 18, 44, 46, 51 AND 52).

DEZMONA MIZELLE, EXAMINING ATTORNEY

CLASS 5—(Continued).

SN 78-299,828. GENTA INCORPORATED, BERKELEY HEIGHTS, NJ. FILED 9-12-2003.



FOR OLIGONUCLEOTIDE PHARMACEUTICAL PREPARATIONS FOR THE TREATMENT OF CANCER, AUTOIMMUNE AND RHEUMATOLOGICAL DISEASES (U.S. CLS. 6, 18, 44, 46, 51 AND 52).
SONYA STEPHENS, EXAMINING ATTORNEY

SN 78-299,964. DILSIZIAN, RAFFI, LAS VEGAS, NV. FILED 9-12-2003.

TERAVITE

FOR NUTRITIONAL SUPPLEMENTS (U.S. CLS. 6, 18, 44, 46, 51 AND 52).
FIRST USE 9-12-1999; IN COMMERCE 9-12-1999.
PRISCILLA MILTON, EXAMINING ATTORNEY

SN 78-299,969. DILSIZIAN, RAFFI, LAS VEGAS, NV. FILED 9-12-2003.

SUPERMIN

FOR NUTRITIONAL SUPPLEMENTS (U.S. CLS. 6, 18, 44, 46, 51 AND 52).
FIRST USE 12-24-1999; IN COMMERCE 12-24-1999.
PRISCILLA MILTON, EXAMINING ATTORNEY

SN 78-300,388. B. BRAUN MEDICAL INC., BETHLEHEM, PA. FILED 9-15-2003.

DIALYTE

OWNER OF U.S. REG. NO. 1,252,709.
FOR ELECTROLYTE SOLUTIONS FOR DIALYSIS (U.S. CLS. 6, 18, 44, 46, 51 AND 52).
FIRST USE 2-25-1982; IN COMMERCE 2-25-1982.
JEFFREY S. MOLINOFF, EXAMINING ATTORNEY

CLASS 5—(Continued).

SN 78-300,753. TRIARCO INDUSTRIES, INC., WAYNE, NJ. FILED 9-16-2003.

GO Q 10

NO CLAIM IS MADE TO THE EXCLUSIVE RIGHT TO USE "Q 10", APART FROM THE MARK AS SHOWN.
FOR VITAMINS, MINERAL SUPPLEMENTS, DIETARY AND NUTRITIONAL SUPPLEMENTS (U.S. CLS. 6, 18, 44, 46, 51 AND 52).
MICHAEL KAZAZIAN, EXAMINING ATTORNEY

SN 78-301,412. LONZA AG (LONZA LTD.), BASEL, SWITZERLAND, FILED 9-17-2003.

OSTEZIN

FOR MINERAL FOOD SUPPLEMENTS, NOT FOR MEDICAL PURPOSES (U.S. CLS. 6, 18, 44, 46, 51 AND 52).
CAROLYN GRAY, EXAMINING ATTORNEY

SN 78-303,475. THE PROCTER & GAMBLE COMPANY, CINCINNATI, OH. FILED 9-22-2003.

CLENZAIRE

FOR DEODORIZER FOR FABRICS, UPHOLSTERY AND CARPETS; AIR FRESHENER; INGREDIENT USED TO ENHANCE ODOR ELIMINATION PROPERTIES OF DEODORIZERS AND AIR FRESHENERS (U.S. CLS. 6, 18, 44, 46, 51 AND 52).
DOMINIC J. FERRAIUOLO, EXAMINING ATTORNEY

SN 78-304,083. BIONICHE LIFE SCIENCES INC., BELLEVILLE, ONTARIO, CANADA, FILED 9-23-2003.

IMMUNOBOOST

OWNER OF U.S. REG. NO. 2,114,141.
FOR IMMUNE SYSTEM ASSISTANT FOR CALVES, NAMELY A PHARMACEUTICAL PRODUCT FOR USE IN CALVES AS A ONE TIME THERAPEUTIC TREATMENT FOR THE REDUCTION OF CLINICAL SIGNS AND MORTALITY ASSOCIATED WITH E; COLI DIARRHEA (U.S. CLS. 6, 18, 44, 46, 51 AND 52).
FIRST USE 1-0-1999; IN COMMERCE 1-0-1999.
JEFFREY S. MOLINOFF, EXAMINING ATTORNEY

SN 78-304,207. LINARDAKIS, NIKOS. M., SALT LAKE CITY, UT. FILED 9-23-2003.

THAROCRAN

FOR NUTRACEUTICALS FOR USE AS A DIETARY SUPPLEMENT (U.S. CLS. 6, 18, 44, 46, 51 AND 52).
BRIAN NEVILLE, EXAMINING ATTORNEY

CLASS 5—(Continued).

SN 78-304,771. LIQUID FENCE CO., INC., BRODHEADS-VILLE, PA. FILED 9-24-2003.

IT REALLY WORKS

FOR INSECT REPELLENT (U.S. CLS. 6, 18, 44, 46, 51 AND 52).
H. M. FISHER, EXAMINING ATTORNEY

SN 78-305,949. BAXTER INTERNATIONAL INC., DEERFIELD, IL. FILED 9-26-2003.

DASELYST

FOR HYALURONIDASE IN INJECTABLE FORM (U.S. CLS. 6, 18, 44, 46, 51 AND 52).
GENE MACIOL, EXAMINING ATTORNEY

SN 78-305,958. BAXTER INTERNATIONAL INC., DEERFIELD, IL. FILED 9-26-2003.

HYLENEX

FOR HYALURONIDASE IN INJECTABLE FORM (U.S. CLS. 6, 18, 44, 46, 51 AND 52).
GENE MACIOL, EXAMINING ATTORNEY

SN 78-306,514. JONES, JEFF A., WEST BARNSTABLE, MA. FILED 9-29-2003.

ISLAND MIRACLE

FOR VITAMIN AND MINERAL SUPPLEMENTS (U.S. CLS. 6, 18, 44, 46, 51 AND 52).
KATHRYN COWARD, EXAMINING ATTORNEY

SN 78-306,613. BIOMET, INC., WARSAW, IN. FILED 9-29-2003.

SYNTHOCAST

OWNER OF U.S. REG. NO. 1,827,180.
FOR FIBERGLASS BLEND MATERIAL THAT IS LAMINATED WITH A PRE-POLYMER COATING THAT IS ACTIVATED WHEN EXPOSED TO WATER, AND HARDENS TO FORM A CAST WHICH IS USED TO IMMOBILE LIMBS THAT HAVE BEEN FRACTURED (U.S. CLS. 6, 18, 44, 46, 51 AND 52).
FIRST USE 11-1-1981; IN COMMERCE 11-1-1981.
SUSAN STIGLITZ, EXAMINING ATTORNEY

CLASS 5—(Continued).

SN 78-306,930. TBK MEDICAL, LLC, LAKEWOOD, CO. FILED 9-29-2003.

VALOXA

FOR TOPICAL PHARMACEUTICAL PREPARATIONS FOR USE IN TREATING FEMALE SEXUAL DYSFUNCTION (U.S. CLS. 6, 18, 44, 46, 51 AND 52).
GWEN STOKOLS, EXAMINING ATTORNEY

SN 78-307,517. HYALOGIC, LLC, EDWARDSVILLE, KS. FILED 9-30-2003.

HYALUN

FOR DIETARY SUPPLEMENTS (U.S. CLS. 6, 18, 44, 46, 51 AND 52).
FIRST USE 1-30-2003; IN COMMERCE 1-30-2003.
SUSAN HAYASH, EXAMINING ATTORNEY

SN 78-307,920. BRISTOL-MYERS SQUIBB COMPANY, NEW YORK, NY. FILED 10-1-2003.

EQUATOR

FOR PHARMACEUTICAL PREPARATIONS FOR THE TREATMENT AND PREVENTION OF DIABETES, INCONTINENCE, CARDIOVASCULAR DISEASES, CENTRAL NERVOUS SYSTEM DISEASES AND DISORDERS, STROKE, CANCER, INFLAMMATION AND INFLAMMATORY DISEASES, RESPIRATORY AND INFECTIOUS DISEASES, AUTO-IMMUNE DISEASES, SOLID ORGAN TRANSPLANT REJECTION; PHARMACEUTICAL PREPARATIONS, NAMELY, ANTI-BIOTICS, ANTI-FUNGALS, ANTI-VIRALS AND IMMUNOSUPPRESSANTS (U.S. CLS. 6, 18, 44, 46, 51 AND 52).
JEFFREY S. MOLINOFF, EXAMINING ATTORNEY

SN 78-308,095. CEREXAGRI, INC., PHILADELPHIA, PA. FILED 10-1-2003.

KOMBO

FOR FUNGICIDES FOR USE ON TURF AND ORNAMENTS (U.S. CLS. 6, 18, 44, 46, 51 AND 52).
FRED MANDIR, EXAMINING ATTORNEY

SN 78-309,263. CONFIDENCE INC., FLUSHING, NY. FILED 10-3-2003.

DR. HAIR

FOR HERBAL AND VITAMIN SUPPLEMENTS (U.S. CLS. 6, 18, 44, 46, 51 AND 52).
KELLEY WELLS, EXAMINING ATTORNEY

CLASS 5—(Continued).

SN 78-309,689. XETAPHARM, INC., NEW BRUNSWICK, NJ. FILED 10-6-2003.

GUGULON

FOR DIETARY SUPPLEMENTS AND NEUTRACEUTICALS WHICH ASSIST THE BODY IN BIOCHEMICAL REACTIONS (U.S. CLS. 6, 18, 44, 46, 51 AND 52).
FIRST USE 5-0-1998; IN COMMERCE 5-0-1998.
RONALD MCMORROW, EXAMINING ATTORNEY

SN 78-310,528. VOYAGER PHARMACEUTICAL CORPORATION, RALEIGH, NC. FILED 10-7-2003.

MEMRYTE

FOR PHARMACEUTICAL PREPARATIONS FOR THE TREATMENT OF ALZHEIMER'S DISEASE (U.S. CLS. 6, 18, 44, 46, 51 AND 52).
CATHERINE CAIN, EXAMINING ATTORNEY

SN 78-310,970. COLTENE/WHALEDENT GMBH & CO. KG, LANGENAU, FED REP GERMANY, FILED 10-8-2003.

COMPRECAP

FOR MATERIALS FOR THE PREPARATION OF DENTAL IMPRESSIONS (U.S. CLS. 6, 18, 44, 46, 51 AND 52).
FIRST USE 1-1-1986; IN COMMERCE 1-1-1986.
CHARLES L. JENKINS, EXAMINING ATTORNEY

SN 78-311,692. CHEMCO INDUSTRIES, INC., LOS ANGELES, CA. FILED 10-9-2003.

PHARMAFEW

FOR DIETARY AND NUTRITIONAL SUPPLEMENTS (U.S. CLS. 6, 18, 44, 46, 51 AND 52).
FIRST USE 6-26-2003; IN COMMERCE 6-26-2003.
CHARLES L. JENKINS, EXAMINING ATTORNEY

SN 78-311,874. WESTRIDGE LABORATORIES, INC., LAKE FOREST, CA. FILED 10-9-2003.

ID CREAM

OWNER OF U.S. REG. NOS. 2,515,606 AND 2,573,871.
NO CLAIM IS MADE TO THE EXCLUSIVE RIGHT TO USE "CREAM", APART FROM THE MARK AS SHOWN.
FOR PERSONAL LUBRICANTS (U.S. CLS. 6, 18, 44, 46, 51 AND 52).
FIRST USE 7-19-2002; IN COMMERCE 7-19-2002.
MARY ROSSMAN, EXAMINING ATTORNEY

CLASS 5—(Continued).

SN 78-311,952. CONNAUGHT TECHNOLOGY CORPORATION, GREENVILLE, DE. FILED 10-10-2003.

DECAVAC

FOR VACCINES FOR HUMAN USE (U.S. CLS. 6, 18, 44, 46, 51 AND 52).
GRETTA YAO, EXAMINING ATTORNEY

SN 78-311,955. CONNAUGHT TECHNOLOGY CORPORATION, GREENVILLE, DE. FILED 10-10-2003.

IMPERATEN

FOR VACCINES FOR HUMAN USE (U.S. CLS. 6, 18, 44, 46, 51 AND 52).
GRETTA YAO, EXAMINING ATTORNEY

SN 78-312,791. INTERVET INC., MILLSBORO, DE. FILED 10-13-2003.

KOBAXAN

FOR PHARMACEUTICALS FOR CATTLE, NAMELY, FOR THE TREATMENT OF CLINICAL AND SUBCLINICAL MASTITIS IN LACTATING DAIRY CATTLE, AND FOR THE TREATMENT OF BOVINE RESPIRATORY DISEASE (BRD) (U.S. CLS. 6, 18, 44, 46, 51 AND 52).
PATRICIA EVANKO, EXAMINING ATTORNEY

SN 78-312,988. ISATORI GLOBAL TECHNOLOGIES, GOLDEN, CO. FILED 10-13-2003.

EAT SMART

FOR MEAL REPLACEMENT AND DIETARY SUPPLEMENT DRINK MIXES AND NUTRITIONAL BAR (U.S. CLS. 6, 18, 44, 46, 51 AND 52).
KIMBERLY PERRY, EXAMINING ATTORNEY

SN 78-313,350. LAKE CONSUMER PRODUCTS, INC., VERNON HILLS, IL. FILED 10-14-2003.

FERTILBOOST

FOR VITAMINS AND DIETARY SUPPLEMENTS (U.S. CLS. 6, 18, 44, 46, 51 AND 52).
ANN E. SAPPENFIELD, EXAMINING ATTORNEY

CLASS 5—(Continued).

SN 78-313,361. LAKE CONSUMER PRODUCTS, INC., VERNON HILLS, IL. FILED 10-14-2003.

FRESH AGAIN

FOR FEMININE DEODORANT SUPPOSITORIES (U.S. CLS. 6, 18, 44, 46, 51 AND 52).
ANN E. SAPPENFIELD, EXAMINING ATTORNEY

SN 78-313,579. HPD LABORATORIES, INC., WESTPORT, CT. FILED 10-14-2003.

SPRING MEADOW

FOR TOILET BOWL SANITIZERS (U.S. CLS. 6, 18, 44, 46, 51 AND 52).
CAROLINE WOOD, EXAMINING ATTORNEY

SN 78-315,862. HORSETECH, INC., LAURENS, IA. FILED 10-20-2003.

HYLARON

FOR NUTRITIONAL AND DIETARY SUPPLEMENTS FOR HORSES AND OTHER ANIMALS (U.S. CLS. 6, 18, 44, 46, 51 AND 52).
FIRST USE 1-15-2003; IN COMMERCE 10-15-2003.
TARAH HARDY, EXAMINING ATTORNEY

SN 78-316,142. HERSHEY CHOCOLATE & CONFECTIONERY CORPORATION, WHEAT RIDGE, CO. FILED 10-20-2003.

BARVANA

FOR DIETARY AND NUTRITIONAL FOOD SUPPLEMENT BARS, NUTRITIONAL ENERGY BARS, MEAL REPLACEMENT BARS (U.S. CLS. 6, 18, 44, 46, 51 AND 52).
LAURA KOVAISKY, EXAMINING ATTORNEY

SN 78-316,143. HERSHEY CHOCOLATE & CONFECTIONERY CORPORATION, WHEAT RIDGE, CO. FILED 10-20-2003.

FORTIGO

FOR DIETARY AND NUTRITIONAL FOOD SUPPLEMENT BARS, NUTRITIONAL ENERGY BARS, MEAL REPLACEMENT BARS (U.S. CLS. 6, 18, 44, 46, 51 AND 52).
GINNY ISAACSON, EXAMINING ATTORNEY

CLASS 5—(Continued).

SN 78-316,144. HERSHEY CHOCOLATE & CONFECTIONERY CORPORATION, WHEAT RIDGE, CO. FILED 10-20-2003.

MAX-UP

FOR DIETARY AND NUTRITIONAL FOOD SUPPLEMENT BARS, NUTRITIONAL ENERGY BARS, MEAL REPLACEMENT BARS (U.S. CLS. 6, 18, 44, 46, 51 AND 52).
GINNY ISAACSON, EXAMINING ATTORNEY

SN 78-316,301. NUFARM AMERICAS, INC., BURR RIDGE, IL. FILED 10-21-2003.

CERTROL

FOR PESTICIDES AND HERBICIDES FOR AGRICULTURAL AND COMMERCIAL USE (U.S. CLS. 6, 18, 44, 46, 51 AND 52).
ASMAT KHAN, EXAMINING ATTORNEY

SN 78-319,467. NATROL, INC., CHATSWORTH, CA. FILED 10-28-2003.

GIMME 5

FOR DIETARY SUPPLEMENTS (U.S. CLS. 6, 18, 44, 46, 51 AND 52).
EUGENIA MARTIN, EXAMINING ATTORNEY

CLASS 6—METAL GOODS

SN 75-729,569. MILLENNIUM MONUMENT COMPANY, THE, NEWPORT, KY. FILED 6-16-1999.

WORLD PEACE BELL

NO CLAIM IS MADE TO THE EXCLUSIVE RIGHT TO USE "BELL", APART FROM THE MARK AS SHOWN.
FOR CAST METAL BELLS (U.S. CLS. 2, 12, 13, 14, 23, 25 AND 50).
IRENE D. WILLIAMS, EXAMINING ATTORNEY

SN 75-824,369. TRICAM INDUSTRIES, INC., MINNEAPOLIS, MN. FILED 10-18-1999.

UNIFRAME

FOR NATURE OF METAL LADDERS (U.S. CLS. 2, 12, 13, 14, 23, 25 AND 50).
CIMMERIAN COLEMAN, EXAMINING ATTORNEY

CLASS 6—(Continued).

SN 76-235,445. THERMALCAST, L.L.C., WORCESTER, MA.
FILED 4-4-2001.

THERMALCAST 130

FOR ALUMINUM DIE CAST ALLOYS IN BAR, CHIP
AND INGOT FORM (U.S. CLS. 2, 12, 13, 14, 23, 25 AND
50).
MATTHEW PAPPAS, EXAMINING ATTORNEY

CLASS 6—(Continued).

SN 76-501,466. ATI PROPERTIES, INC., ALBANY, OR. FILED
3-27-2003.

718 +

OWNER OF U.S. REG. NOS. 1,615,415 AND 2,127,753.
FOR NICKEL-BASED METAL SUPERALLOYS FOR
USE IN FURTHER MANUFACTURING (U.S. CLS. 2,
12, 13, 14, 23, 25 AND 50).
KELLY BOULTON, EXAMINING ATTORNEY

SN 76-415,986. ALLOY STEEL INTERNATIONAL, INC.,
UNION, NJ. FILED 5-29-2002.

ARCOPLATE

FOR WEAR PLATES, NAMELY, BIMETALLIC ALLOY
WEAR PLATES; BIMETALLIC ALLOY WEAR PLATES
IN SHEET FORM; PRE-FORMED BIMETALLIC ALLOY
WEAR PLATES FOR USE IN LINING TRUCK TRAY
BODIES, EXCAVATOR CHUTES AND HOPPERS, SHO-
VEL BUCKETS, DRAG LINE BUCKETS, MINING SHO-
VELS AND BULLDOZER BLADES (U.S. CLS. 2, 12, 13, 14,
23, 25 AND 50).
FIRST USE 0-0-1994; IN COMMERCE 6-0-1996.
JILL C. ALT, EXAMINING ATTORNEY

SN 76-501,497. ATI PROPERTIES, INC., ALBANY, OR. FILED
3-27-2003.

718 PLUS

OWNER OF U.S. REG. NOS. 1,615,425 AND 2,127,753.
FOR NICKEL-BASED METAL SUPERALLOYS FOR
USE IN FURTHER MANUFACTURING (U.S. CLS. 2,
12, 13, 14, 23, 25 AND 50).
KELLY BOULTON, EXAMINING ATTORNEY

SN 76-489,651. C TEK INDUSTRIAL PRODUCTS, INC.,
HUNTERSVILLE, NC. FILED 2-14-2003.

AMERICAN PRO-PIPE

NO CLAIM IS MADE TO THE EXCLUSIVE RIGHT TO
USE "AMERICAN", APART FROM THE MARK AS SHOWN.
FOR METAL CLAMPS, METAL FITTINGS AND MET-
AL PIPES FOR MAKING CUSTOMIZED MODULAR
STRUCTURES SUCH AS RACKS, CARTS AND WORK-
SPACES (U.S. CLS. 2, 12, 13, 14, 23, 25 AND 50).
FIRST USE 1-1-2000; IN COMMERCE 1-1-2000.
JOHN HWANG, EXAMINING ATTORNEY

SN 76-533,278. AB BRODERNA EKBERGS VERKSTADER,
SWEDEN, FILED 7-21-2003.

ABE

FOR STAINLESS STEEL WELDED AND SEAMLESS
BUTT WELD PIPE FITTINGS, NAMELY, PRESSED PIPE
BENDS, TEES, REDUCERS, STUB ENDS, PRESSED
COLLARS, ANGLE STOCK COLLARS, COUPLINGS,
HANGER CLIPS, EXPANSION BELLOWS MADE OF
METAL, AND METAL VESSELS AND COLUMNS (U.S.
CLS. 2, 12, 13, 14, 23, 25 AND 50).
FIRST USE 11-13-1974; IN COMMERCE 11-13-1974.
MARY CRAWFORD, EXAMINING ATTORNEY

SN 76-498,269. SIGNATURE HARDWARE, L.L.C., ROGERS-
VILLE, MO. FILED 3-17-2003.

DESIGN HARDWARE

NO CLAIM IS MADE TO THE EXCLUSIVE RIGHT TO
USE HARDWARE, APART FROM THE MARK AS SHOWN.
FOR METAL HINGES (U.S. CLS. 2, 12, 13, 14, 23, 25
AND 50).
CYNTHIA SLOAN, EXAMINING ATTORNEY

SN 76-534,828. BALDWIN HARDWARE CORPORATION,
READING, PA. FILED 8-5-2003.

**BALDWIN AMERICAN
LEGACY COLLECTION**

NO CLAIM IS MADE TO THE EXCLUSIVE RIGHT TO
USE "AMERICAN" AND "COLLECTION", APART FROM
THE MARK AS SHOWN.
FOR METAL DECORATIVE ORNAMENTS (U.S. CLS.
2, 12, 13, 14, 23, 25 AND 50).
FIRST USE 6-0-2002; IN COMMERCE 6-0-2002.
KEVON CHISOLM, EXAMINING ATTORNEY

CLASS 6—(Continued).

SN 76-544,966. AMX CORPORATION, RICHARDSON, TX. FILED 9-2-2003.

SMOOTHTILT

FOR ASYMMETRICALLY LOADED METAL HINGES USED IN TOUCH PANEL PRODUCTS (U.S. CLS. 2, 12, 13, 14, 23, 25 AND 50).
CHERYL CLAYTON, EXAMINING ATTORNEY

CLASS 6—(Continued).

SN 78-121,452. O'BRIEN, J.R., DBA X-TREME FENCING, ALPHARETTA, GA. FILED 4-12-2002.

X-TREME

FOR METAL FENCING (U.S. CLS. 2, 12, 13, 14, 23, 25 AND 50).
FIRST USE 5-0-2001; IN COMMERCE 5-0-2001.
JOHN LINCOSKI, EXAMINING ATTORNEY

SN 76-545,568. CAGE-IT ENTERPRISES, INC., GLENDALE, AZ. FILED 9-17-2003.

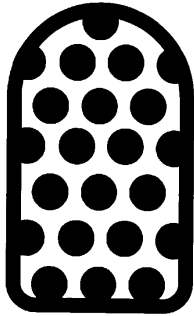

FOR ENCLOSURES FOR PROTECTION OF OUTDOOR PLUMBING, ELECTRICAL EQUIPMENT, AND TIME AND TIMER EQUIPMENT, NAMELY A METAL CAGE PLACED OVER BACKFLOW ASSEMBLIES, ELECTRICAL JUNCTION BOXES, ELECTRICAL TIMERS, AND CLOCKS (U.S. CLS. 2, 12, 13, 14, 23, 25 AND 50).
BRIAN BROWN, EXAMINING ATTORNEY

SN 78-203,715. TWENTIETH CENTURY FOX FILM CORPORATION, LOS ANGELES, CA. FILED 1-15-2003.



OWNER OF U.S. REG. NOS. 1,932,252, 2,492,197 AND OTHERS.
FOR METAL KEY CHAINS; METAL KEY CHAIN TAGS. (U.S. CLS. 2, 12, 13, 14, 23, 25 AND 50).
H. M. FISHER, EXAMINING ATTORNEY

SN 76-550,914. KARAS & ROCHA, EAST PROVIDENCE, RI. FILED 9-22-2003.



NO CLAIM IS MADE TO THE EXCLUSIVE RIGHT TO USE COLLECTION, APART FROM THE MARK AS SHOWN. FOR COLLECTIBLES, NAMELY, PEWTER FIGURINES (U.S. CLS. 2, 12, 13, 14, 23, 25 AND 50).
FIRST USE 9-3-2003; IN COMMERCE 9-3-2003.
KEVON CHISOLM, EXAMINING ATTORNEY

SN 78-206,433. INTERNATIONAL STEEL GROUP INC., RICHFIELD, OH. FILED 1-23-2003.



FOR FLAT ROLLED STEEL PRODUCTS, NAMELY, HOT ROLLED, COLD ROLLED AND COATED STEEL SHEET (U.S. CLS. 2, 12, 13, 14, 23, 25 AND 50).
FIRST USE 3-22-2002; IN COMMERCE 5-3-2002.
NELSON SNYDER, EXAMINING ATTORNEY

CLASS 6—(Continued).

SN 78-222,588. 924ASSOCIATES, SARASOTA, FL. FILED 3-6-2003.



NO CLAIM IS MADE TO THE EXCLUSIVE RIGHT TO USE "STRONGER, LIGHTER, BETTER", APART FROM THE MARK AS SHOWN.

THE LINING AND STIPLING IN THE DRAWING ARE A FEATURE OF THE MARK AND ARE NOT INTENDED TO REPRESENT COLOR.

FOR NAILS (U.S. CLS. 2, 12, 13, 14, 23, 25 AND 50).
PAULA MAYS, EXAMINING ATTORNEY

SN 78-238,722. DORIC PRODUCTS, INC., MARSHALL, IL. FILED 4-17-2003.

LAUREL

FOR BURIAL VAULTS OF METAL (U.S. CLS. 2, 12, 13, 14, 23, 25 AND 50).
FIRST USE 11-30-2001; IN COMMERCE 11-30-2001.
SOPHIA S. KIM, EXAMINING ATTORNEY

SN 78-240,022. KNAPE & VOGT MANUFACTURING COMPANY, GRAND RAPIDS, MI. FILED 4-21-2003.

KNAPE & VOGT TKO

FOR METAL DRAWER HARDWARE, NAMELY, TRACKS, SLIDES, ROLLERS, LOCKS AND PULLS; DOOR AND GATE HARDWARE—NAMELY, HINGES, LOCKS AND LATCHES, METAL SLIDING DOOR TRACKS AND DOOR FIXTURES; METAL SHELVING HARDWARE, NAMELY, STANDARDS, BRACKETS, AND SUPPORTS (U.S. CLS. 2, 12, 13, 14, 23, 25 AND 50).
TRACY CROSS, EXAMINING ATTORNEY

SN 78-243,337. ALCOA INC., PITTSBURGH, PA. FILED 4-29-2003.

FLOW FREE

FOR METAL PROTECTIVE COVERINGS FOR RAIN GUTTERS (U.S. CLS. 2, 12, 13, 14, 23, 25 AND 50).
ROBIN CHOSID, EXAMINING ATTORNEY

CLASS 6—(Continued).

SN 78-275,942. HUF COR, INC., JANESVILLE, WI. FILED 7-18-2003.

HUF COR

OWNER OF U.S. REG. NOS. 781,616 AND 1,654,336. FOR DOORS, PARTITIONS AND FITTINGS AND HARDWARE THEREFORE, MADE OF METAL (U.S. CLS. 2, 12, 13, 14, 23, 25 AND 50).
FIRST USE 0-0-1965; IN COMMERCE 0-0-1965.
SUSAN HAYASH, EXAMINING ATTORNEY

SN 78-286,042. ISPAT INLAND, INC., EAST CHICAGO, IN. FILED 8-12-2003.

DI-FORM HB

FOR VARIOUS FORMS OF ROLLED OR GALVANIZED OR ELECTRO GALVANIZED STEEL (U.S. CLS. 2, 12, 13, 14, 23, 25 AND 50).
MARGERY A. TIERNEY, EXAMINING ATTORNEY

SN 78-289,642. THYSSENKRUPP VDM GMBH, WERDOHL, FED REP GERMANY, FILED 8-20-2003.

NICROFER

OWNER OF U.S. REG. NO. 2,096,360. FOR METAL SHEET, STRIP, BARS, WIRES AND TUBES MADE OF NICKEL-CHROMIUM-IRON ALLOYS (U.S. CLS. 2, 12, 13, 14, 23, 25 AND 50).
FIRST USE 2-3-1960; IN COMMERCE 0-0-1973.
JOHN LINCOSKI, EXAMINING ATTORNEY

SN 78-293,459. CONSTRUCTION METALS, INC., ONTARIO, CA. FILED 8-28-2003.

WEATHER GUARDIAN

FOR RAIN CARRYING BUILDING MATERIALS, NAMELY, METAL GUTTERS, DOWNSPOUTS, AND LEAF SCREENS (U.S. CLS. 2, 12, 13, 14, 23, 25 AND 50).
LEIGH CAROLINE CASE, EXAMINING ATTORNEY

SN 78-302,175. OIL EQUIPMENT MANUFACTURING LLC, ANSONIA, CT. FILED 9-18-2003.

SPEEDFILL

FOR OIL TANK EQUIPMENT AND ACCESSORIES, NAMELY METAL PIPE COLLARS, ADAPTORS, CONNECTORS, CAPS AND FITTINGS FOR USE IN CONNECTION WITH OIL TANK FILL PIPES (U.S. CLS. 2, 12, 13, 14, 23, 25 AND 50).
DAVID C. REIHNER, EXAMINING ATTORNEY

CLASS 6—(Continued).

SN 78-304,880. BASS & HAYS FOUNDRY, INC., GRAND PRAIRIE, TX. FILED 9-24-2003.

CLASS 6—(Continued).

SN 78-344,443. LOUISVILLE LADDER GROUP LLC, LOUISVILLE, KY. FILED 12-22-2003.

103

FOR MUNICIPAL TYPE MANHOLE RINGS, COVERS, FRAMES AND GRATES CAST OF METAL AND IRON (U.S. CLS. 2, 12, 13, 14, 23, 25 AND 50).
FIRST USE 12-31-1958; IN COMMERCE 12-31-1958.
CHERYL STEPLIGHT, EXAMINING ATTORNEY

QWIK STEP

SN 78-310,793. CONTRARIAN METAL RESOURCES, INC., CRANBERRY TOWNSHIP, PA. FILED 10-8-2003.

INVARITIQUE

THE MARK CONSISTS OF STANDARD CHARACTERS WITHOUT CLAIM TO ANY PARTICULAR FONT, STYLE, SIZE, OR COLOR.

FOR METAL LADDERS (U.S. CLS. 2, 12, 13, 14, 23, 25 AND 50).

FIRST USE 9-30-1994; IN COMMERCE 9-30-1994.
ZACHARY BELLO, EXAMINING ATTORNEY

FOR ZINC ALLOY SHEET AND STRIP (U.S. CLS. 2, 12, 13, 14, 23, 25 AND 50).
FIRST USE 9-30-2001; IN COMMERCE 10-18-2002.
BARNEY CHARLON, EXAMINING ATTORNEY

CLASS 7—MACHINERY

SN 78-317,669. U.S. ANCHOR CORPORATION, POMPANO BEACH, FL. FILED 10-23-2003.

ULTRAWEDGE

SN 76-263,321. HOOVER COMPANY, THE, NORTH CANTON, OH. FILED 5-25-2001.

MAX EXTRACT

FOR MECHANICAL METAL EXPANSION ANCHORS (U.S. CLS. 2, 12, 13, 14, 23, 25 AND 50).
FIRST USE 10-1-2001; IN COMMERCE 10-1-2001.
MATTHEW KLINE, EXAMINING ATTORNEY

NO CLAIM IS MADE TO THE EXCLUSIVE RIGHT TO USE "EXTRACT", APART FROM THE MARK AS SHOWN.

FOR FLOOR CLEANING APPLIANCES, NAMELY CARPET CLEANING EXTRACTORS (U.S. CLS. 13, 19, 21, 23, 31, 34 AND 35).

JOHN SCHUYLER YARD, EXAMINING ATTORNEY

SN 78-321,370. UNIVERSAL VALVE CORPORATION, ELIZABETH, NJ. FILED 10-31-2003.

THE ZAPPER

SN 76-374,037. ALL-FILL, INC., EXTON, PA. FILED 2-25-2002.

ALLFILL

FOR METAL TOUCH PLATES FOR DISCHARGING STATIC ELECTRICITY NEAR FUEL STORAGE TANKS AND FUEL DISPENSERS (U.S. CLS. 2, 12, 13, 14, 23, 25 AND 50).

FIRST USE 4-16-2003; IN COMMERCE 4-16-2003.
RICHARD A. STRASER, EXAMINING ATTORNEY

FOR MACHINERY, NAMELY AUGER FILLERS, FEEDERS AND CONVEYORS AND UNSCRAMBLERS, AND PARTS THEREFORE, FOR USE WITH POWDERS AND LIQUIDS (U.S. CLS. 13, 19, 21, 23, 31, 34 AND 35).

FIRST USE 0-0-1969; IN COMMERCE 0-0-1969.
JOHN HWANG, EXAMINING ATTORNEY

CLASS 7—(Continued).

SN 76-450,727. GREEN TECHNOLOGY GROUP, INC., PAWLING, NY. FILED 9-18-2002.

PHAR

FOR INDUSTRIAL MACHINES USED FOR REGENERATING ACIDS PRODUCED DURING THE PROCESSING OF STEEL (U.S. CLS. 13, 19, 21, 23, 31, 34 AND 35).
FIRST USE 6-0-2000; IN COMMERCE 6-0-2000.
RICHARD A. STRASER, EXAMINING ATTORNEY

SN 76-462,477. YORK INTERNATIONAL CORPORATION, YORK, PA. FILED 10-18-2002.

BENCHMARK

FOR COMPRESSORS FOR USE IN REFRIGERATION AND AIR CONDITIONING SYSTEMS (U.S. CLS. 13, 19, 21, 23, 31, 34 AND 35).
JOHN SCHUYLER YARD, EXAMINING ATTORNEY

SN 76-482,074. WOOD GROUP ESP, INC., OKLAHOMA CITY, OK. FILED 1-13-2003.

SMARTPOWER

FOR ELECTRIC SUBMERSIBLE MOTORS FOR USE IN POWERING ELECTRIC SUBMERSIBLE PUMPS IN DOWNHOLE WELL APPLICATIONS (U.S. CLS. 13, 19, 21, 23, 31, 34 AND 35).
ALICIA COLLINS, EXAMINING ATTORNEY

SN 76-485,034. YOUNG ENGINEERING MANUFACTURING, INC., MONROVIA, CA. FILED 1-27-2003.

YOUNG ENGINEERING MANUFACTURING, INC.

NO CLAIM IS MADE TO THE EXCLUSIVE RIGHT TO USE "ENGINEERING MANUFACTURING, INC.", APART FROM THE MARK AS SHOWN.
FOR MACHINERY; NAMELY, DAMPENERS, SUPPRESSORS, ACCUMULATORS AND EXPANSION TANKS USED IN FLUID HANDLING APPLICATIONS SUCH AS PUMPING SYSTEMS, PURIFICATION SYSTEMS, PETRO-CHEMICAL, FOOD PROCESSING, AND SURGE CONTROL (U.S. CLS. 13, 19, 21, 23, 31, 34 AND 35).
FIRST USE 0-0-1983; IN COMMERCE 0-0-1987.
BRIAN BROWN, EXAMINING ATTORNEY

CLASS 7—(Continued).

SN 76-502,562. OTIS ELEVATOR COMPANY, FARMINGTON, CT. FILED 3-31-2003.

HIGEN

PRIORITY CLAIMED UNDER SEC. 44(D) ON REPUBLIC OF KOREA APPLICATION NO. 40-2002-0044, FILED 9-28-2002, REG. NO. 570921, DATED 1-6-2004, EXPIRES 1-6-2014.
FOR ELEVATORS; ESCALATORS; AUTOMATED PARKING SYSTEMS, NAMELY, POWER OPERATED LIFTS FOR MOVING, PARKING, AND STORING LAND VEHICLES; CONVEYORS WITH THE EXCEPTION OF AERIAL CONVEYORS; AUTOMATED MOVING WALKWAYS; AND ELECTRIC DC, AC AND SERVO MOTORS FOR MACHINES (U.S. CLS. 13, 19, 21, 23, 31, 34 AND 35).
ROBERT LORENZO, EXAMINING ATTORNEY

SN 76-507,315. LANTECH.COM LLC, LOUISVILLE, KY. FILED 4-16-2003.

PALLET GRIP

NO CLAIM IS MADE TO THE EXCLUSIVE RIGHT TO USE "PALLET", APART FROM THE MARK AS SHOWN.
FOR PACKING AND PACKAGING MACHINES AND EQUIPMENT (U.S. CLS. 13, 19, 21, 23, 31, 34 AND 35).
GEORGIA CARTY, EXAMINING ATTORNEY

SN 76-507,506. NORTHWESTERN SYSTEMS CORP., SOUTHEAST MERCER, WA. FILED 4-18-2003.



NO CLAIM IS MADE TO THE EXCLUSIVE RIGHT TO USE "BETTER BUILT", APART FROM THE MARK AS SHOWN.
FOR WASHING AND RINSING MACHINES FOR LABORATORY EQUIPMENT (U.S. CLS. 13, 19, 21, 23, 31, 34 AND 35).
ASMAT KHAN, EXAMINING ATTORNEY

CLASS 7—(Continued).

SN 76-510,030. B&B MFG. CORP., SANTURCE, PUERTO RICO, FILED 4-24-2003.

OML "THE PLATINUM RACING WIRE"

OWNER OF U.S. REG. NO. 1.692,340.
NO CLAIM IS MADE TO THE EXCLUSIVE RIGHT TO USE "THE PLATINUM RACING WIRE", APART FROM THE MARK AS SHOWN.
FOR SPARK PLUG CABLE SET FOR USE IN RACING CARS (U.S. CLS. 13, 19, 21, 23, 31, 34 AND 35).
FIRST USE 7-0-2002; IN COMMERCE 7-0-2002.
TRACY CROSS, EXAMINING ATTORNEY

SN 76-515,034. ATLAS MATERIAL TESTING TECHNOLOGY, L.L.C., CHICAGO, IL. FILED 5-16-2003.

LAUNDER-OMETER

OWNER OF U.S. REG. NO. 259,521.
FOR MACHINES USED TO TEST THE EFFECT OF WASHING UPON TEXTILES (U.S. CLS. 13, 19, 21, 23, 31, 34 AND 35).
FIRST USE 4-27-1928; IN COMMERCE 4-27-1928.
KELLY BOULTON, EXAMINING ATTORNEY

SN 76-515,382. HANNON HYDRAULICS, L.P., IRVING, TX. FILED 4-24-2003.

REMCO HYDRAULICS

NO CLAIM IS MADE TO THE EXCLUSIVE RIGHT TO USE HYDRAULICS, APART FROM THE MARK AS SHOWN.
FOR HYDRAULIC CYLINDERS FOR USE IN MACHINES AND VEHICLES OTHER THAN LAND VEHICLES (U.S. CLS. 13, 19, 21, 23, 31, 34 AND 35).
FIRST USE 3-0-2003; IN COMMERCE 3-0-2003.
SUSAN HAYASH, EXAMINING ATTORNEY

SN 76-527,272. PRINTING RESEARCH, INC., DALLAS, TX. FILED 6-30-2003.

ZONE

FOR PRINTING PRESS EQUIPMENT, NAMELY, DRYERS AND CURING SYSTEMS CONSISTING PRIMARILY OF LAMPS, FORCED AIR EXTRACTORS AND FLOW THROUGH AIR EXTRACTORS FOR USE IN ACCELERATING THE DRYING AND CURING OF INK AND OTHER MATERIALS PRINTED SUBSTRATES (U.S. CLS. 13, 19, 21, 23, 31, 34 AND 35).
MICHAEL SOUDERS, EXAMINING ATTORNEY

CLASS 7—(Continued).

SN 76-543,064. CTB IP, INC., WILMINGTON, DE. FILED 8-25-2003.

REVOLUTION

FOR MECHANIZED POULTRY FEEDERS (U.S. CLS. 13, 19, 21, 23, 31, 34 AND 35).
FIRST USE 9-3-2003; IN COMMERCE 9-3-2003.
VERNA BETH RIRIE, EXAMINING ATTORNEY

SN 76-546,634. VITA-MIX CORPORATION, CLEVELAND, OH. FILED 9-24-2003.

SERIOUS PRODUCTS FOR SERIOUS BLENDING

FOR ELECTRIC FOOD PROCESSORS (U.S. CLS. 13, 19, 21, 23, 31, 34 AND 35).
KARLA PERKINS, EXAMINING ATTORNEY

SN 76-547,183. ELECTROLUX HOME PRODUCTS, INC., CLEVELAND, OH. FILED 9-26-2003.

DURALIFE

OWNER OF U.S. REG. NO. 2,016,851.
FOR ENGINES FOR GAS TRIMMERS, BRUSHCUTTERS, CHAIN SAWS, BLOWERS AND HEDGE TRIMMERS (U.S. CLS. 13, 19, 21, 23, 31, 34 AND 35).
LOURDES AYALA, EXAMINING ATTORNEY

SN 76-550,909. TURBOFORCE INTERNATIONAL, INC., GLENDALE, AZ. FILED 9-22-2003.



NO CLAIM IS MADE TO THE EXCLUSIVE RIGHT TO USE "INTERNATIONAL", APART FROM THE MARK AS SHOWN.
FOR FLOOR CLEANING MACHINES (U.S. CLS. 13, 19, 21, 23, 31, 34 AND 35).
KELLY BOULTON, EXAMINING ATTORNEY

SN 76-552,900. LAKE RESTORATION, INC., ROGERS, MN. FILED 10-20-2003.

LAKEMAID

FOR AUTOMATIC WEED DEVICE DESIGNED FOR THE REMOVAL OF WEEDS FROM LAKES AND RIVERS (U.S. CLS. 13, 19, 21, 23, 31, 34 AND 35).
GINA HAYES, EXAMINING ATTORNEY

CLASS 7—(Continued).

SN 76-553,501. KASH, EDWARD, HOUSTON, TX. FILED 10-3-2003.

PYROSTRAN

FOR OILFIELD EQUIPMENT; NAMELY, OILFIELD DRILLING EQUIPMENT (U.S. CLS. 13, 19, 21, 23, 31, 34 AND 35).

JEFFREY S. MOLINOFF, EXAMINING ATTORNEY



SN 76-553,502. KASH, EDWARD, HOUSTON, TX. FILED 10-3-2003.

PYROCOR

FOR OILFIELD EQUIPMENT; NAMELY, OILFIELD DRILLING EQUIPMENT (U.S. CLS. 13, 19, 21, 23, 31, 34 AND 35).

JEFFREY S. MOLINOFF, EXAMINING ATTORNEY



SN 76-554,782. OMS INVESTMENTS, INC., LOS ANGELES, CA. FILED 10-28-2003.

DEDICATED TO A BEAUTIFUL WORLD

OWNER OF U.S. REG. NO. 2,771,509. FOR MECHANICAL SPREADERS (U.S. CLS. 13, 19, 21, 23, 31, 34 AND 35).

PATRICIA EVANKO, EXAMINING ATTORNEY



SN 78-018,657. ACTIVE MACHINERY SALES, INC., APEX, NC. FILED 7-27-2000.

PRESSWORKS

FOR METAL WORKING MACHINE TOOLS AND EQUIPMENT, NAMELY PUNCH PRESSES, PRESS BRAKES (U.S. CLS. 13, 19, 21, 23, 31, 34 AND 35).

CIMMERIAN COLEMAN, EXAMINING ATTORNEY



SN 78-092,853. CLARKE POWER PRODUCTS, INC., PERYSBURG, OH. FILED 11-13-2001.

PLASMA-CUT

FOR ABRASIVE DISCS AND GRINDING DISCS FOR POWER OPERATED GRINDERS (U.S. CLS. 13, 19, 21, 23, 31, 34 AND 35).

IRENE D. WILLIAMS, EXAMINING ATTORNEY

CLASS 7—(Continued).

SN 78-179,251. THE GATES CORPORATION, DENVER, CO. FILED 10-28-2002.

BLADERUNNER

FOR POWER TRANSMISSION BELTS FOR MACHINES, MOTORS AND ENGINES USED IN INDUSTRIAL APPLICATIONS; TIMING BELTS FOR MACHINES, MOTORS AND ENGINES USED IN INDUSTRIAL APPLICATIONS (U.S. CLS. 13, 19, 21, 23, 31, 34 AND 35).

CIMMERIAN COLEMAN, EXAMINING ATTORNEY



SN 78-199,311. DIELS, MANFRED, MEINERZHAGEN, FED REP GERMANY, FILED 1-2-2003.

FLEXFIN

PRIORITY CLAIMED UNDER SEC. 44(D) ON ERP N CMNTY TM OFC APPLICATION NO. 002827996, FILED 8-27-2002, REG. NO. 002827996, DATED 11-21-2003, EXPIRES 8-27-2012.

FOR LIQUID AND AIR-COOLED CONDENSERS FOR ELECTRONIC INSTALLATIONS, EXCEPT FOR USE IN CONNECTION WITH AUTOMOBILE COMBUSTION ENGINES (U.S. CLS. 13, 19, 21, 23, 31, 34 AND 35).

ALEXANDER L. POWERS, EXAMINING ATTORNEY



SN 78-212,803. HITACHI KOKUSAI ELECTRIC INC., TOKYO, JAPAN, FILED 2-10-2003.

QUIXACE

PRIORITY CLAIMED UNDER SEC. 44(D) ON JAPAN APPLICATION NO. 2002-071669, FILED 8-23-2002, REG. NO. 4683092, DATED 6-20-2003, EXPIRES 6-20-2013.

FOR SEMICONDUCTOR MANUFACTURING MACHINES AND SYSTEMS; SEMICONDUCTOR ELEMENT MANUFACTURING MACHINES; INTEGRATED CIRCUIT MANUFACTURING MACHINES; CVD (CHEMICAL VAPOR DEPOSITION) MACHINES USED FOR SEMICONDUCTOR MANUFACTURING; DIFFUSION MACHINES USED FOR SEMICONDUCTOR MANUFACTURING; OXIDATION MACHINES USED FOR SEMICONDUCTOR MANUFACTURING; ETCHING MACHINES USED FOR SEMICONDUCTOR MANUFACTURING; EPITAXIAL REACTION MACHINES USED FOR SEMICONDUCTOR MANUFACTURING; EPITAXIAL GROWTH MACHINES USED FOR SEMICONDUCTOR MANUFACTURING; ION IMPLANTATION MACHINES USED FOR SEMICONDUCTOR MANUFACTURING; SEMICONDUCTOR WAFER PROCESSING MACHINES; WASHING MACHINES USED FOR SEMICONDUCTOR MANUFACTURING; ANNEALING MACHINES USED FOR SEMICONDUCTOR MANUFACTURING; HEAT TREATMENT MACHINES USED FOR SEMICONDUCTOR MANUFACTURING AND PARTS FOR ALL THE FOREGOING (U.S. CLS. 13, 19, 21, 23, 31, 34 AND 35).

JEFFREY S. MOLINOFF, EXAMINING ATTORNEY

CLASS 7—(Continued).

SN 78-222,455. WMH TOOL GROUP, INC., PALATINE, IL.
FILED 3-6-2003.

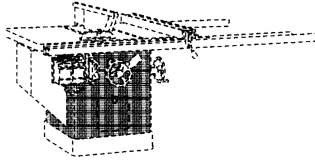

THE DRAWING IS LINED FOR THE COLOR GOLD.
THE MARK CONSISTS OF THE COLOR GOLD AS APPLIED TO THE EXTERIOR SURFACES OF THE GOODS AT THE RECTANGULAR BASE THEREOF EXCLUDING THE TOP SURFACE, WHEEL AND INSTRUMENTATION. THE DOTTED OUTLINE OF THE GOODS IS INTENDED TO SHOW THE POSITION OF THE MARK AND IS NOT A PART OF THE MARK.

SEC. 2(F).

FOR WOODWORKING AND METALWORKING MACHINES, NAMELY, POWER SAWS, TABLE SAWS, PANEL SAWS, SCROLLSAWS, DRILLS, JOINTERS, PLANERS, MOLDERS, MORTISERS, SHAPERS, SANDERS, AND STRUCTURAL PARTS THEREOF, AND SOLD AS A COMPLETE UNIT (U.S. CLS. 13, 19, 21, 23, 31, 34 AND 35).

FIRST USE 1-1-1998; IN COMMERCE 1-1-1998.

WILLIAM VERHOSEK, EXAMINING ATTORNEY

SN 78-222,985. HUB CITY, INC., ABERDEEN, SD. FILED 3-7-2003.

HUB3

FOR POWER TRANSMISSION PRODUCTS, SPECIFICALLY STAINLESS STEEL WORM SPEED REDUCERS, BEVEL GEAR DRIVES, HELICAL BEVEL GEAR DRIVES AND CONCENTRIC GEAR DRIVES (U.S. CLS. 13, 19, 21, 23, 31, 34 AND 35).

PRISCILLA MILTON, EXAMINING ATTORNEY

SN 78-231,040. LIPP MISCHTECHNIK GMBH, MANNHEIM, FED REP GERMANY, FILED 3-27-2003.

TRIQUENCE

PRIORITY CLAIMED UNDER SEC. 44(D) ON FED REP GERMANY APPLICATION NO. 30254664207, FILED 11-12-2002, REG. NO. 30254664, DATED 12-5-2002, EXPIRES 11-30-2012.

FOR MECHANICAL MIXING MACHINES, NAMELY, CONFECTIONERY MIXERS, CHOCOLATE MIXERS, MACHINES FOR CONCHING, DRYING AND MIX-REACTING, ALL FOR COMMERCIAL USE, AND PARTS FOR THE FOREMENTIONED MACHINES (U.S. CLS. 13, 19, 21, 23, 31, 34 AND 35).

SUSAN LESLIE DUBOIS, EXAMINING ATTORNEY

CLASS 7—(Continued).

SN 78-232,678. FLOW INTERNATIONAL CORPORATION, KENT, WA. FILED 4-1-2003.

ECL PLUS

FOR CUTTING HEADS FOR ULTRAHIGH-PRESSURE FLUID JET SYSTEMS AND REPLACEMENT PARTS THEREFOR (U.S. CLS. 13, 19, 21, 23, 31, 34 AND 35).

FIRST USE 4-19-2002; IN COMMERCE 4-19-2002.

JOHN HWANG, EXAMINING ATTORNEY

SN 78-268,037. MAXWELL MARINE LIMITED, AUCKLAND, NEW ZEALAND, FILED 6-27-2003.

INDEPENDENCE

PRIORITY CLAIMED UNDER SEC. 44(D) ON NEW ZEALAND APPLICATION NO. 681261, FILED 6-25-2003, REG. NO. 681261, DATED 6-25-2003, EXPIRES 6-25-2010.

FOR WINCHES FOR LAND, WATER AND AIR CRAFT (U.S. CLS. 13, 19, 21, 23, 31, 34 AND 35).

JENNIFER KRISP, EXAMINING ATTORNEY

SN 78-291,640. THE FALK CORPORATION, MILWAUKEE, WI. FILED 8-25-2003.

AIRMAX

FOR AIR FILTERS FOR USE IN ENCLOSED GEAR DRIVES (U.S. CLS. 13, 19, 21, 23, 31, 34 AND 35).

FIRST USE 3-1-2002; IN COMMERCE 3-1-2002.

JOHN LINCOSKI, EXAMINING ATTORNEY

SN 78-300,371. HASTINGS MANUFACTURING COMPANY, HASTINGS, MI. FILED 9-15-2003.

HASTINGS

OWNER OF U.S. REG. NOS. 1,008,785, 2,040,277 AND 2,122,792.

SEC. 2(F).

FOR PARTS FOR INTERNAL COMBUSTION ENGINES OF THE RECIPROCATING PISTON TYPE, NAMELY, PISTONS (U.S. CLS. 13, 19, 21, 23, 31, 34 AND 35).

GIANCARLO CASTRO, EXAMINING ATTORNEY

SN 78-301,144. TURBONETICS, INC., SIMI VALLEY, CA. FILED 9-16-2003.

NEWGEN

FOR WASTEGATE VALVE FOR TURBOCHARGERS (U.S. CLS. 13, 19, 21, 23, 31, 34 AND 35).

FIRST USE 9-12-2002; IN COMMERCE 9-12-2002.

MICHAEL WEBSTER, EXAMINING ATTORNEY

CLASS 7—(Continued).

SN 78-306,973. CHOI, JAE K., SANTA FE SPRINGS, CA. FILED 9-29-2003.

DYNAMIX

FOR ELECTRIC JUICERS AND ELECTRIC FOOD BLENDERS (U.S. CLS. 13, 19, 21, 23, 31, 34 AND 35). JOHN DALIER, EXAMINING ATTORNEY

SN 78-307,055. BISSELL HOMECARE, INC., GRAND RAPIDS, MI. FILED 9-30-2003.

TURBOBOOST

FOR EXTRACTION CLEANING MACHINES (U.S. CLS. 13, 19, 21, 23, 31, 34 AND 35). KATHLEEN M. VANSTON, EXAMINING ATTORNEY

SN 78-307,489. PITNEY BOWES INC., STAMFORD, CT. FILED 9-30-2003.

OFFICERIGHT

FOR INSERTING SYSTEM, NAMELY, AN INSERTER WITH AN ENVELOPE SEALER, FEEDER, SORTER, SCANNER AND ELECTRONIC CONTROL PANEL FOR SCANNING IMAGES, TRACKING JOB PROCESSING AND PERFORMANCE AND CREATING JOB SET-UP (U.S. CLS. 13, 19, 21, 23, 31, 34 AND 35). FIRST USE 2-28-2002; IN COMMERCE 2-28-2002. CAROLINE WEIMER, EXAMINING ATTORNEY

SN 78-315,726. WILLIAM C. GREER, GADSDEN, AL. FILED 10-20-2003.

BRUSHWHACKER

FOR ROTARY CUTTER FOR SKID STEER LOADERS (U.S. CLS. 13, 19, 21, 23, 31, 34 AND 35). SAMUEL E. SHARPER JR., EXAMINING ATTORNEY

SN 78-315,848. HP INTELLECTUAL CORP., WILMINGTON, DE. FILED 10-20-2003.

OPEN-IT-ALL

FOR ELECTRIC CAN, BOTTLE, AND JAR OPENERS FOR DOMESTIC USE (U.S. CLS. 13, 19, 21, 23, 31, 34 AND 35). TARAH HARDY, EXAMINING ATTORNEY

CLASS 7—(Continued).

SN 78-334,292. PRIMESOURCE BUILDING PRODUCTS, INC., CARROLLTON, TX. FILED 12-1-2003.



OWNER OF U.S. REG. NOS. 907,843, 2,511,849 AND OTHERS. FOR PNEUMATIC AND ELECTRIC TOOLS FOR BLOWING AIR AND DRIVING NAILS, SCREWS, AND STAPLES (U.S. CLS. 13, 19, 21, 23, 31, 34 AND 35). CURTIS FRENCH, EXAMINING ATTORNEY

CLASS 8—HAND TOOLS

SN 76-520,339. TAJIMA TOOL CORP., TOKYO 174-0051, JAPAN, FILED 5-20-2003.

INK-RITE

FOR JAPANESE-STYLE HAND TOOLS FOR USE BY CARPENTERS, NAMELY, MARKING SNAP-LINE IN THE NATURE OF INK LINE REELS, AND INK AND INKPOTS THEREFOR (U.S. CLS. 23, 28 AND 44). FIRST USE 12-31-2002; IN COMMERCE 12-31-2002. AMY ALFIERI, EXAMINING ATTORNEY

SN 76-552,559. THE B & F SYSTEM, INC., DALLAS, TX. FILED 9-29-2003.

MEYERCO

OWNER OF U.S. REG. NO. 2,283,819. FOR KNIVES, NAMELY, BUTCHER, FISHING, HUNTING, POCKET, PRUNING, SIDE ARMS, SPORT, PARING, FOLDING, KITCHEN AND CHEF (U.S. CLS. 23, 28 AND 44). FIRST USE 11-1-1997; IN COMMERCE 11-1-1997. PAULA MAYS, EXAMINING ATTORNEY

SN 76-558,712. NGUYEN, THANH VAN, SACRAMENTO, CA. FILED 10-27-2003.

WHALE OF A NAIL

FOR NAIL CLIPPERS (U.S. CLS. 23, 28 AND 44). BRIAN PINO, EXAMINING ATTORNEY

CLASS 8—(Continued).

SN 78-237,704. LEWIS LIFETIME TOOLS, POWAY, CA. FILED 4-14-2003.

HEIRLOOM TOOLS

NO CLAIM IS MADE TO THE EXCLUSIVE RIGHT TO USE "TOOLS", APART FROM THE MARK AS SHOWN.

FOR HAND OPERATED LAWN AND GARDEN TOOLS, NAMELY, AERATORS, EDGERS, WEEDERS, TILLERS, RAKES, CULTIVATORS, BULB PLANTERS, MATTOCKS, HOES, TROWELS, BAIT APPLICATORS, IRRIGATORS, SOD PLUGGERS (U.S. CLS. 23, 28 AND 44).

FIRST USE 3-1-1998; IN COMMERCE 3-1-1998.
INGA ERVIN, EXAMINING ATTORNEY

SN 78-244,553. INNOVATION IP HOLDING CO., DAVENPORT, IA. FILED 5-1-2003.

ULTREX SUR-CUT

FOR KITCHEN KNIVES AND CUTLERY, NAMELY, BONING KNIVES, CHEF'S KNIVES, SLICING KNIVES, BREAD KNIVES, PARING KNIVES, UTILITY KNIVES, SANDWICH KNIVES, STEAK KNIVES, AND KITCHEN SHEARS (U.S. CLS. 23, 28 AND 44).

INGA ERVIN, EXAMINING ATTORNEY

SN 78-249,624. JACCARD CORPORATION, ORCHARD PARK, NY. FILED 5-14-2003.

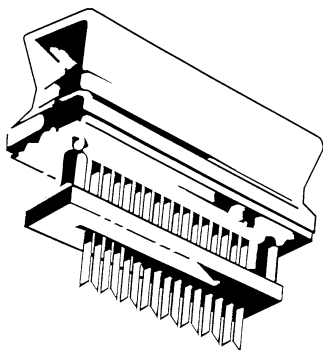

THE MARK CONSISTS OF A PICTORIAL REPRESENTATION OF A MEAT TENDERIZER.

SEC. 2(F).
FOR HAND-HELD MEAT TENDERIZERS (U.S. CLS. 23, 28 AND 44).

FIRST USE 2-14-1982; IN COMMERCE 2-14-1982.
JANICE L. MCMORROW, EXAMINING ATTORNEY

CLASS 8—(Continued).

SN 78-302,973. CHONG, WUN, DELTA, CANADA, FILED 9-19-2003.

ARTHRITIS FRIENDLY

NO CLAIM IS MADE TO THE EXCLUSIVE RIGHT TO USE "ARTHRITIS", APART FROM THE MARK AS SHOWN. FOR MANUAL HOUSEHOLD CAN OPENERS (U.S. CLS. 23, 28 AND 44).

FIRST USE 9-12-2003; IN COMMERCE 9-12-2003.
SCOTT OSLICK, EXAMINING ATTORNEY

SN 78-308,657. LESS SWEAT PRODUCTS LLC, CLEVELAND, OH. FILED 10-2-2003.

PUNISHER

FOR MANUALLY OPERATED ROOF SHINGLE REMOVING TOOL (U.S. CLS. 23, 28 AND 44).

ESTHER A. BORSUK, EXAMINING ATTORNEY

SN 78-308,973. COLD STEEL, INC., VENTURA, CA. FILED 10-3-2003.

OZARK HUNTER

FOR HUNTING AND SPORT KNIVES (U.S. CLS. 23, 28 AND 44).

JOHN DALIER, EXAMINING ATTORNEY

SN 78-312,208. INTERNATIONAL STYLING TOOLS, INC., SUNRISE, FL. FILED 10-10-2003.



FOR MANICURE, PEDICURE, FACIAL, HAIR, SKIN, AND BEAUTY CARE IMPLEMENTS, NAMELY, RAZORS, RAZOR BLADES, SCISSORS, SCISSOR BLADES, SHEARS, HAIR CLIPPERS, HAIR TRIMMERS, SHAVERS, TWEEZERS, NAIL CLIPPERS, AND NAIL FILES (U.S. CLS. 23, 28 AND 44).

JENNIFER KRISP, EXAMINING ATTORNEY

SN 78-314,420. IPS CORPORATION, COLLIERVILLE, TN. FILED 10-16-2003.

TWIST 'N SEAL

FOR HAND TOOLS, NAMELY, RUBBER SEAL INSERTION TOOLS FOR USE PRIMARILY BY PLUMBERS TO INSTALL RUBBER SEALS INTO PIPES (U.S. CLS. 23, 28 AND 44).

KIMBERLY PERRY, EXAMINING ATTORNEY

CLASS 8—(Continued).

SN 78-319,869. MECHANICS CUSTOM TOOLS CORPORATION, CHRISTIANA, DE. FILED 10-28-2003.

UNI PRO

FOR HAND TOOLS, NAMELY PLIERS (U.S. CLS. 23, 28 AND 44).
BRIAN PINO, EXAMINING ATTORNEY

SN 78-319,876. MECHANICS CUSTOM TOOLS CORPORATION, CHRISTIANA, DE. FILED 10-28-2003.

NEXT GENERATION

FOR HAND TOOLS, NAMELY SCREWDRIVERS (U.S. CLS. 23, 28 AND 44).
BRIAN PINO, EXAMINING ATTORNEY

SN 78-320,741. CONOCOPHILLIPS COMPANY, HOUSTON, TX. FILED 10-30-2003.



FOR POCKET KNIVES; FISHING KNIFE; COMPACT FOLDING MULTI-FUNCTION HAND TOOL COMPRISED OF KNIFE, PLIERS, SCREWDRIVER, CAN OPENER, FILE, AND MULTIPLE BLADES, AND LEATHER AND FABRIC KNIFE SHEATHS THEREOF; HAND TOOLS, NAMELY, SCRAPERS (U.S. CLS. 23, 28 AND 44).
CAROL SPILS, EXAMINING ATTORNEY

CLASS 8—(Continued).

SN 78-327,984. CONOCOPHILLIPS COMPANY, HOUSTON, TX. FILED 11-14-2003.



FOR POCKET KNIVES; FISHING KNIFE; COMPACT FOLDING MULTI-FUNCTION HAND TOOL COMPRISED OF KNIFE, PLIERS, SCREWDRIVER, CAN OPENER, FILE, AND MULTIPLE BLADES, AND LEATHER AND FABRIC KNIFE SHEATHS THEREOF; HAND TOOLS, NAMELY, SCRAPERS (U.S. CLS. 23, 28 AND 44).
CAROL SPILS, EXAMINING ATTORNEY

SN 78-341,636. CONOCOPHILLIPS COMPANY, HOUSTON, TX. FILED 12-16-2003.



FOR POCKET KNIVES; FISHING KNIFE; COMPACT FOLDING MULTI-FUNCTION HAND TOOL COMPRISED OF KNIFE, PLIERS, SCREWDRIVER, CAN OPENER, FILE, AND MULTIPLE BLADES, AND LEATHER AND FABRIC KNIFE SHEATHS THEREOF; HAND TOOLS, NAMELY, SCRAPERS (U.S. CLS. 23, 28 AND 44).
CAROL SPILS, EXAMINING ATTORNEY

CLASS 9—ELECTRICAL AND SCIENTIFIC APPARATUS

SN 75-159,158. SIMONS ENGINEERING, INC., DECATUR, GA. FILED 9-3-1996.

EXPERTTRAC

FOR SOFTWARE AND INSTRUCTIONAL MANUALS SOLD THEREWITH, NAMELY, SOFTWARE FOR TRACKING CUSTOMER ORDERS AND INVENTORY IN MANUFACTURING AND RELATED TRACKING, INVENTORY, AND SCHEDULING MANAGEMENT (U.S. CLS. 21, 23, 26, 36 AND 38).
WANDA KAY PRICE, EXAMINING ATTORNEY

CLASS 9—(Continued).

SN 75-505,930. INTER SPACE COMPUTERS INC., LOUISVILLE, KY. FILED 6-22-1998.

INTER SPACE COMPUTERS

NO CLAIM IS MADE TO THE EXCLUSIVE RIGHT TO USE "COMPUTERS", APART FROM THE MARK AS SHOWN.

FOR COMPUTERS AND RELATED COMPONENTS, NAMELY, COMPUTER PERIPHERALS; AND COMPUTER NETWORKS COMPRISING COMPUTER HARDWARE AND COMPUTER NETWORK OPERATING SOFTWARE (U.S. CLS. 21, 23, 26, 36 AND 38).

FIRST USE 8-19-1996; IN COMMERCE 8-19-1996.
GWEN STOKOLS, EXAMINING ATTORNEY

SN 75-567,249. NETMANSYS, INC., FLOWER MOUND, TX. FILED 10-8-1998.

NETMANSYS

FOR COMPUTER SOFTWARE FOR TELECOMMUNICATIONS NETWORK MANAGEMENT (U.S. CLS. 21, 23, 26, 36 AND 38).

FIRST USE 4-30-1997; IN COMMERCE 4-30-1997.
HOWARD SMIGA, EXAMINING ATTORNEY

SN 75-701,885. CLOAKWARE CORPORATION, KANATA, ONTARIO M5H 3Z7, CANADA, FILED 5-10-1999.

CLOAKWARE

PRIORITY CLAIMED UNDER SEC. 44(D) ON CANADA APPLICATION NO. 1011134, FILED 4-7-1999, REG. NO. TMA540765, DATED 2-5-2001, EXPIRES 2-5-2016.

FOR COMPUTER SOFTWARE USED TO PRODUCE EXECUTABLE SOFTWARE THAT IS RESISTANT TO TAMPERING AND REVERSE ENGINEERING, HIDES CRYPTOGRAPHIC KEYS AND OTHER INFORMATION OR ALGORITHMS (U.S. CLS. 21, 23, 26, 36 AND 38).

MICHAEL WEBSTER, EXAMINING ATTORNEY

SN 75-888,535. SEIDENSTICKER, STEVE, SAN DIEGO, CA. FILED 1-6-2000.

GOLFRANGER

FOR ELECTRONIC GOLF COURSE NAVIGATIONAL SYSTEM, NAMELY, AN ELECTRONIC POSITIONING SYSTEM FOR USE BY GOLF PATRONS TO DETERMINE THE PROXIMITY OF THE GREEN (U.S. CLS. 21, 23, 26, 36 AND 38).

PAULA MAYS, EXAMINING ATTORNEY

CLASS 9—(Continued).

SN 75-894,425. PELCO, CLOVIS, CA. FILED 1-10-2000.

PLANET

FOR ELECTRONIC VIDEO SURVEILLANCE EQUIPMENT, NAMELY, VIDEO AND AUDIO TRANSMITTERS AND RECEIVERS, AND COMPUTER SOFTWARE FOR OPERATING SAME IN CONJUNCTION WITH TCP/IP (LAN/WAN) COMPUTER NETWORKS (U.S. CLS. 21, 23, 26, 36 AND 38).

HOWARD SMIGA, EXAMINING ATTORNEY

SN 75-915,294. LUCENT TECHNOLOGIES INC., MURRAY HILL, NJ. FILED 2-1-2000.

LUCENT STARTRAC

FOR COMPUTER SOFTWARE FOR MONITORING THE LOCATION OF SATELLITES (U.S. CLS. 21, 23, 26, 36 AND 38).

CATHERINE FAINT, EXAMINING ATTORNEY

SN 76-086,621. REBELLION DEVELOPMENTS LIMITED, OXFORD, UNITED KINGDOM, FILED 7-11-2000.

EARTHWAR

PRIORITY CLAIMED UNDER SEC. 44(D) ON ERPNCMNTY TM OFC APPLICATION NO. 1456888, FILED 1-11-2000, REG. NO. 1456888, DATED 2-14-2001, EXPIRES 1-11-2010.

FOR PRE-RECORDED COMPACT DISCS CONTAINING COMPUTER PROGRAMS FEATURING ANIMATED IMAGES, RELATED SOUNDS, SPEECH AND MUSIC, AND COMPUTER SOFTWARE FOR ACCESSING THE MATERIAL CONTAINED THEREON; PRE-RECORDED CDROMS CONTAINING COMPUTER PROGRAMS FOR USE IN PLAYING COMPUTER GAMES AND CREATING ANIMATED IMAGES, RELATED SOUNDS, SPEECH AND MUSIC, AND COMPUTER SOFTWARE FOR ACCESSING THE MATERIAL THEREON; DATA CARRIERS, NAMELY, BLANK MAGNETIC TAPES AND DISCS AND BLANK RECORDABLE CD-ROMS; PRE-RECORDED MAGNETIC TAPES AND DISCS AND PRE-RECORDED RE-RECORDABLE COMPACT DISCS CONTAINING COMPUTER PROGRAMS FEATURING ANIMATED IMAGES, RELATED SOUNDS, SPEECH AND MUSIC, AND COMPUTER SOFTWARE FOR ACCESSING THE MATERIAL THEREON; FIXED AND REMOVABLE COMPUTER HARDWARE MEMORY CARDS; COMPUTER GAMES, NAMELY, SOFTWARE COMPUTER GAMES; VIDEO GAMES, NAMELY, VIDEO GAME CARTRIDGES, VIDEO GAME DISCS, VIDEO GAME CDS, VIDEO GAME CD-ROMS; VIDEO GAME PROGRAMS; COMPUTER SOFTWARE, NAMELY, COMPUTER GAME SOFTWARE, AND COMPUTER SOFTWARE FOR MANIPULATING IMAGES FOR USE IN CREATING MOTION PICTURE FILMS FEATURING ACTION, COMPUTER GAMES, COMPUTER ANIMATED MOVIES AND COMPUTER ANIMATED CARTOONS; CINEMATOGRAPHIC FILMS FEATURING COMPUTER ANIMATION; VIDEO FILMS, NAMELY, MOTION PICTURE FILMS AND VIDEO CASSETTE TAPES FEATURING ACTION, COMPUTER GAMES, COMPUTER ANIMATED MOVIES AND COMPUTER ANIMATED CARTOONS; AMUSEMENT APPARATUS ADAPTED FOR USE WITH TELEVISION RECEIVERS, NAMELY, VIDEO GAME MACHINES FOR USE WITH TELEVISIONS; COIN AND COUNTER-FED SLOT MACHINES (U.S. CLS. 21, 23, 26, 36 AND 38).

REBECCA GILBERT, EXAMINING ATTORNEY

CLASS 9—(Continued).

SN 76-098,087. E-ONE, INC., OCALA, FL. FILED 7-26-2000.

PUMA

FOR FIRE TRUCK (U.S. CLS. 21, 23, 26, 36 AND 38).
FIRST USE 3-0-2001; IN COMMERCE 3-0-2001.
ELLEN B. AWRICH, EXAMINING ATTORNEY

SN 76-145,434. NEW YORK AIR BRAKE CORPORATION,
WATERDOWN, NY. FILED 10-11-2000.

MARK II

FOR ELECTRONIC PNEUMATIC BRAKE CONTROL-
LERS (U.S. CLS. 21, 23, 26, 36 AND 38).
CAROLYN CATALDO, EXAMINING ATTORNEY

SN 76-195,021. SPX CORPORATION, MUSKEGON, MI.
FILED 1-17-2001.

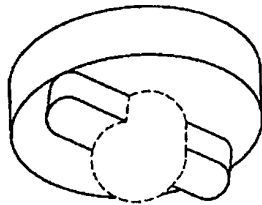

THE MARK CONSISTS OF THE OVERALL CONFIGURA-
TION OF A VEHICLE ELECTRONIC FUEL INJECTOR
TESTER.
SEC. 2(F).
FOR VEHICLE ELECTRONIC FUEL INJECTOR TES-
TER (U.S. CLS. 21, 23, 26, 36 AND 38).
FIRST USE 0-0-1983; IN COMMERCE 0-0-1983.
LAURIEL DALIER, EXAMINING ATTORNEY

SN 76-197,073. PARADYNE CORPORATION, LARGO, FL.
FILED 1-17-2001.

REACHDSL

FOR DATA TRANSCEIVERS FOR TELEPHONE LINE
COMMUNICATIONS, NAMELY, MODEMS AND ELEC-
TRICAL CIRCUIT BOARDS, THE CIRCUIT BOARDS
FOR INSTALLATION AT A TELEPHONE CENTRAL
OFFICE OR SWITCHING OFFICE (U.S. CLS. 21, 23, 26,
36 AND 38).
FIRST USE 12-0-2000; IN COMMERCE 12-0-2000.
CATHERINE FAINT, EXAMINING ATTORNEY

CLASS 9—(Continued).

SN 76-260,952. NETPOST, INC., MOUNTAIN VIEW, CA.
FILED 5-21-2001.

CREAM

FOR COMPUTER SOFTWARE FOR CREATING, DE-
LIVERING AND PRESENTING CONTENT ON ELEC-
TRONIC DEVICES, NAMELY, COMPUTERS,
TELEVISIONS, PERSONAL DIGITAL ASSISTANTS
AND CELLULAR PHONES (U.S. CLS. 21, 23, 26, 36
AND 38).
JOHN LINCOSKI, EXAMINING ATTORNEY

SN 76-264,605. MARCONI APPLIED TECHNOLOGIES LIM-
ITED, LONDON, ENGLAND, FILED 5-30-2001.



PRIORITY CLAIMED UNDER SEC. 44(D) ON UNITED
KINGDOM APPLICATION NO. 2,257,368, FILED 1-8-2001,
REG. NO. 2257368, DATED 6-29-2001, EXPIRES 1-8-2011.
FOR LOW LIGHT IMAGE SENSORS AND ELECTRO-
NIC DRIVE CIRCUITS THEREFOR; ELECTRONIC CIR-
CUITS FOR HANDLING AND TRANSMITTING IMAGE
DATA; VIDEO CAMERAS AND PARTS THEREFOR;
VIDEO CAMERA ACCESSORIES, NAMELY, POWER
SUPPLIES, CONTROLS, COOLERS AND SHUTTERS
(U.S. CLS. 21, 23, 26, 36 AND 38).
JAMES A. RAUEN, EXAMINING ATTORNEY

SN 76-286,024. DICARTA, INC., REDWOOD CITY, CA.
FILED 7-17-2001.

DICARTA

OWNER OF U.S. REG. NO. 2,463,605.
THE ENGLISH TRANSLATION OF THE MARK IS "OF
PAPER".
FOR COMPUTER SOFTWARE FOR MANAGING CON-
TRACTS, NAMELY, SOFTWARE FOR RECORDING,
TRACKING, MONITORING AND ALERTING CUSTOM-
ERS TO COMPLIANCE WITH TERMS OF CON-
TRACTS, RELEVANT EVENTS IN THE LIFE CYCLES
OF CONTRACTS, AND FINANCIAL IMPACT OF SUCH
CONTRACTS (U.S. CLS. 21, 23, 26, 36 AND 38).
FIRST USE 11-23-1999; IN COMMERCE 11-23-1999.
SONYA STEPHENS, EXAMINING ATTORNEY

CLASS 9—(Continued).

SN 76-301,802. SONY ELECTRONICS, PARK RIDGE, NJ. FILED 8-20-2001.

CONNECT & CREATE

FOR DIGITAL VOICE RECORDERS USING INTEGRATED CIRCUIT STORAGE MEDIA; DIGITAL VOICE RECORDERS USING PACKAGED SEMICONDUCTOR STORAGE MEDIA; DIGITAL AUDIO RECORDERS/PLAYERS USING INTEGRATED CIRCUIT STORAGE MEDIA; DIGITAL AUDIO RECORDERS/PLAYERS USING PACKAGED SEMICONDUCTOR STORAGE MEDIA; DIGITAL AUDIO DEVICES, NAMELY, PACKAGED SEMICONDUCTOR STORAGE RECORDERS/PLAYERS, MINIDISC RECORDERS/PLAYERS, AND MP3 RECORDERS/PLAYERS; LAPTOP COMPUTERS; AND HANDHELD DEVICES, NAMELY, PERSONAL DIGITAL ASSISTANTS AND PERSONAL ENTERTAINMENT ORGANIZERS (U.S. CLS. 21, 23, 26, 36 AND 38).
FIRST USE 6-1-2001; IN COMMERCE 6-1-2001.
BRENDAN REGAN, EXAMINING ATTORNEY

SN 76-326,447. PRIVAPLAN ASSOCIATES, INC., SANTA FE, NM. FILED 10-15-2001.

PRIVAPLAN

FOR ELECTRONIC PUBLICATION, NAMELY, A COMPLIANCE MANUAL FEATURING INFORMATION TO ASSIST HEALTH CARE PROVIDERS IN COMPLYING WITH GOVERNMENT REGULATIONS RECORDED ON CD ROM AND RELATED COMPUTER SOFTWARE FOR USE WITH THE COMPLIANCE MANUAL FOR ASSISTING HEALTH CARE PROVIDERS IN COMPLYING WITH GOVERNMENT REGULATIONS (U.S. CLS. 21, 23, 26, 36 AND 38).
FIRST USE 9-1-2001; IN COMMERCE 9-25-2001.
CATHERINE CAIN, EXAMINING ATTORNEY

SN 76-353,453. SONY ELECTRONICS INC., PARK RIDGE, NJ. FILED 12-26-2001.

CONNECT & CREATE

FOR COMPUTERS; VIDEO CAMCORDERS; DIGITAL STILL CAMERAS; DIGITAL VOICE RECORDERS USING INTEGRATED CIRCUIT STORAGE MEDIA; DIGITAL VOICE RECORDERS USING PACKAGED SEMICONDUCTOR STORAGE MEDIA; DIGITAL AUDIO RECORDERS/PLAYERS USING INTEGRATED CIRCUIT STORAGE MEDIA; DIGITAL AUDIO RECORDERS/PLAYERS USING PACKAGED SEMICONDUCTOR STORAGE MEDIA; DIGITAL AUDIO DEVICES, NAMELY, PACKAGED SEMICONDUCTOR STORAGE RECORDERS/PLAYERS, MINIDISC RECORDERS/PLAYERS, AND MP3 RECORDERS/PLAYERS; LAPTOP COMPUTER AND HANDHELD DEVICES, NAMELY, PERSONAL DIGITAL ASSISTANTS AND PERSONAL ENTERTAINMENT ORGANIZERS (U.S. CLS. 21, 23, 26, 36 AND 38).

FIRST USE 10-31-2000; IN COMMERCE 10-31-2000.
BRENDAN REGAN, EXAMINING ATTORNEY

CLASS 9—(Continued).

SN 76-400,378. ALPHA SECURITY PRODUCTS, INC., NORTH CANTON, OH. FILED 4-25-2002.



FOR SECURITY DEVICES ATTACHABLE TO PACKAGES FOR CONSUMER GOODS TO PREVENT THE OPENING OF THE PACKAGE, AND SECURITY DEVICES ATTACHABLE TO CONSUMER GOODS AND PACKAGING FOR CONSUMER GOODS FOR RETAINING AN ELECTRONIC ARTICLE SURVEILLANCE TAG, MANUFACTURED PRIMARILY OF PLASTIC (U.S. CLS. 21, 23, 26, 36 AND 38).
DOUGLAS LEE, EXAMINING ATTORNEY

SN 76-400,379. ALPHA SECURITY PRODUCTS, INC., NORTH CANTON, OH. FILED 4-25-2002.

sharktag

FOR SECURITY DEVICES ATTACHABLE TO PACKAGES FOR CONSUMER GOODS TO PREVENT THE OPENING OF THE PACKAGE, AND SECURITY DEVICES ATTACHABLE TO CONSUMER GOODS AND PACKAGING FOR CONSUMER GOODS FOR RETAINING AN ELECTRONIC ARTICLE SURVEILLANCE TAG, MANUFACTURED PRIMARILY OF PLASTIC (U.S. CLS. 21, 23, 26, 36 AND 38).
DOUGLAS LEE, EXAMINING ATTORNEY

SN 76-434,370. DEALERMINE INC., SAINT JOHN, NEW BRUNSWICK, E2L 3T5, CANADA, FILED 7-23-2002.

DEALERMINE

PRIORITY CLAIMED UNDER SEC. 44(D) ON CANADA APPLICATION NO. 1,140,012, FILED 5-7-2002, REG. NO. TMA603795, DATED 3-2-2004, EXPIRES 3-2-2019.

FOR COMPUTER SOFTWARE, NAMELY, CUSTOMER TRACKING, SCHEDULING AND REPORTING SOFTWARE FOR USE IN THE AUTOMOTIVE INDUSTRY (U.S. CLS. 21, 23, 26, 36 AND 38).
SONYA STEPHENS, EXAMINING ATTORNEY

CLASS 9—(Continued).

SN 76-434,399. EVANS, CANDACE, DALLAS, TX. FILED 7-23-2002.

THERE'S ALWAYS A STORY

FOR PRERECORDED READINGS OF ANNOUNCEMENTS, STORIES, ESSAYS, AND POETRY PROVIDED ON COMPACT AUDIO DISCS (U.S. CLS. 21, 23, 26, 36 AND 38).

AMY HELLA, EXAMINING ATTORNEY

SN 76-442,763. DUCK CREEK TECHNOLOGIES, INC., BOLLIVAR, MO. FILED 8-22-2002.



OWNER OF U.S. REG. NO. 2,610,474.
NO CLAIM IS MADE TO THE EXCLUSIVE RIGHT TO USE "TECHNOLOGIES", APART FROM THE MARK AS SHOWN.

FOR COMPUTER SOFTWARE FOR DEVELOPING AND MANAGING RATING, UNDERWRITING POLICY PROCESSING AND SUBMISSION SERVICES IN THE FIELD OF INSURANCE (U.S. CLS. 21, 23, 26, 36 AND 38).
FIRST USE 3-7-2000; IN COMMERCE 3-7-2000.
BILL DAWE, EXAMINING ATTORNEY

SN 76-442,764. DUCK CREEK TECHNOLOGIES, INC., BOLLIVAR, MO. FILED 8-22-2002.

EXAMPLE EXPRESS

FOR COMPUTER SOFTWARE FOR DEVELOPING AND MANAGING WEB-ENABLED RATING, UNDERWRITING, POLICY PROCESSING AND SUBMISSION SERVICES IN THE FIELD OF INSURANCE (U.S. CLS. 21, 23, 26, 36 AND 38).

FIRST USE 2-26-2002; IN COMMERCE 2-26-2002.
BILL DAWE, EXAMINING ATTORNEY

SN 76-442,765. DUCK CREEK TECHNOLOGIES, INC., BOLLIVAR, MO. FILED 8-22-2002.

EXAMPLE PLATFORM

NO CLAIM IS MADE TO THE EXCLUSIVE RIGHT TO USE "PLATFORM", APART FROM THE MARK AS SHOWN.

FOR COMPUTER SOFTWARE FOR DEVELOPING AND DELIVERING MANAGEMENT SERVICES IN THE FIELD OF INSURANCE (U.S. CLS. 21, 23, 26, 36 AND 38).
FIRST USE 5-21-2001; IN COMMERCE 5-21-2001.
BILL DAWE, EXAMINING ATTORNEY

CLASS 9—(Continued).

SN 76-446,003. PULSE DATA INTERNATIONAL LIMITED, CHRISTCHURCH, NEW ZEALAND, FILED 8-28-2002.

PULSE DATA

OWNER OF NEW ZEALAND REG. NO. 656385, DATED 5-1-2002, EXPIRES 5-1-2012.

FOR COMPUTERS; COMPUTER HARDWARE; COMPUTER ACCESS SOFTWARE FOR USE IN PROVIDING ACCESS TO THE INTERNET BY BLIND AND LOW VISION USERS BY CONVERTING PRINTED TEXT INTO SYNTHESIZED SPEECH; READING MACHINES FOR THE BLIND AND VISUALLY IMPAIRED, NAMELY, A DEVICE THAT INCLUDES A MICROPROCESSOR WHICH IS PROGRAMMED TO CONVERT STORED DIGITAL INFORMATION INTO AUDIBLE SYNTHESIZED SPEECH; COMPUTER SOFTWARE FOR USE IN OUTPUTTING THE CONTENTS OF THE USER'S COMPUTER SCREEN TO AN AUDIO SOUND REPRODUCER IN THE FORM OF AUDIBLE SYNTHESIZED SPEECH; READING MACHINES FOR THE BLIND AND VISUALLY IMPAIRED, NAMELY, A DEVICE THAT CONVERTS ELECTRONIC TEXT INTO SYNTHESIZED SPEECH; PROGRAM-CONTROLLED MICROPROCESSORS FOR SCANNING WRITTEN TEXT AND CONVERTING THE SCANNED TEXT INTO SYNTHESIZED SPEECH; MAGNIFICATION COMPUTER HARDWARE AND SOFTWARE FOR USE IN MAGNIFYING THE SIZE OF TEXT AND IMAGES DISPLAYED ON A COMPUTER MONITOR, FOR USE BY THE VISUALLY IMPAIRED; COMPUTER SOFTWARE FOR USE IN ALTERING THE WAY THE INFORMATION ON A COMPUTER SCREEN IS PRESENTED BY MAGNIFYING TEXT, FOR HELPING PEOPLE WITH LEARNING DISABILITIES OR REMEDIAL NEEDS IN READING, WRITING, STUDYING, AND COMPREHENSION; COMPUTER SOFTWARE AND RELATED HARDWARE FOR THE SPEECH IMPAIRED, NAMELY, COMPUTER HARDWARE AND SOFTWARE FOR CONVERTING ICONS FROM A TOUCH SCREEN, TEXT FROM A KEYBOARD, AND TEXT FROM DIGITAL MEMORY INTO SYNTHESIZED SPEECH; PERSONAL DIGITAL ASSISTANTS AND PORTABLE COMPUTERS FOR THE VISUALLY IMPAIRED, NAMELY, PERSONAL DIGITAL ASSISTANTS AND PORTABLE COMPUTERS HAVING A BRAILLE KEYBOARDS, AND PERSONAL DIGITAL ASSISTANTS AND PORTABLE COMPUTERS HAVING A CONVENTIONAL KEYBOARD INPUT WHICH PRODUCES OUTPUT IN THE FORM OF SYNTHESIZED SPEECH, BRAILLE CELL DISPLAY, OR COMPUTER TEXT; BRAILLE COMPUTER MONITORS; BRAILLE COMPUTER PRINTERS AND EMOSSERS; AND BRAILLE KEYBOARDS; APPARATUS FOR REWRITING, TRANSMISSION, OR REPRODUCTION OF SOUND OR IMAGES, NAMELY, NOTE TAKERS, WORD AND INFORMATION PROCESSORS, DICTATING MACHINES, BRAILLE TRANSCRIPTION MACHINES, PROJECTION SCREENS, TAPE RECORDERS, PERSONAL DIGITAL ASSISTANTS, SPEECH SYNTHESIZERS, VIDEO MAGNIFICATION UNITS, AND SCANNERS (U.S. CLS. 21, 23, 26, 36 AND 38).

JACQUELINE A. LAVINE, EXAMINING ATTORNEY

SN 76-446,612. FIFE CORPORATION, OKLAHOMA CITY, OK. FILED 9-4-2002.

POLARIS

FOR REMOTE CONTROLS FOR WEB AND STEERING GUIDES FOR WEB PROCESS LINES; NAMELY CONTROLS DIRECTION OF MATERIAL RUNNING OVER THE GUIDING ELEMENTS OF MACHINE USING READ-OUTS AND REMOTE SETTINGS/ADJUSTMENTS (U.S. CLS. 21, 23, 26, 36 AND 38).

ESTHER A. BORSUK, EXAMINING ATTORNEY

CLASS 9—(Continued).

SN 76-457,430. HERFF JONES, INC., INDIANAPOLIS, IN.
FILED 10-10-2002.

ACTIVE CHEMISTRY

NO CLAIM IS MADE TO THE EXCLUSIVE RIGHT TO USE "CHEMISTRY", APART FROM THE MARK AS SHOWN.

FOR EDUCATIONAL VIDEOS IN THE FIELD OF CHEMISTRY; EDUCATIONAL SOFTWARE FEATURING INSTRUCTION IN THE FIELD OF CHEMISTRY (U.S. CLS. 21, 23, 26, 36 AND 38).

KEVON CHISOLM, EXAMINING ATTORNEY

CLASS 9—(Continued).

SN 76-458,221. MANAGEMENT INFORMATION TECHNOLOGY USA, INC., ATLANTA, GA. FILED 10-15-2002.



OWNER OF U.S. REG. NO. 2,686,340.

THE MARK CONSISTS OF THE STYLIZED FIGURE OF A CHILD WITHIN A BOX REACHING TOWARD A STAR OUTSIDE OF THE BOX.

FOR SOFTWARE PROGRAM FOR MANAGING PRE-SCHOOL AND PRE-KINDERGARTEN PROGRAMS FOR CHILDREN (U.S. CLS. 21, 23, 26, 36 AND 38).

FIRST USE 3-0-1988; IN COMMERCE 3-0-1988.

KATHLEEN M. VANSTON, EXAMINING ATTORNEY

SN 76-458,214. MANAGEMENT INFORMATION TECHNOLOGY USA, INC., ATLANTA, GA. FILED 10-15-2002.

SN 76-461,547. CORDELIA LIGHTING, INC., RANCHO DOMINGUEZ, CA. FILED 10-23-2002.

AVENGER

CHILDPLUS

FOR SECURITY SYSTEMS AND SECURITY SYSTEM COMPONENTS, NAMELY, MOTION DETECTORS, SECURITY LIGHTS, SECURITY TIMERS AND SECURITY LIGHTING CONTROLS (U.S. CLS. 21, 23, 26, 36 AND 38).

FIRST USE 3-1-2004; IN COMMERCE 3-1-2004.

MATTHEW KLINE, EXAMINING ATTORNEY

SN 76-468,952. LEMAY, BRUNO, LA QUNITA, CA. FILED 9-9-2002.

GUARDIAN ALARM SYSTEMS

THE MARK CONSISTS OF STANDARD CHARACTERS WITHOUT CLAIM TO ANY PARTICULAR FONT, STYLE, SIZE, OR COLOR.

OWNER OF U.S. REG. NO. 2,686,340.

FOR SOFTWARE PROGRAM FOR MANAGING PRE-SCHOOL AND PRE-KINDERGARTEN PROGRAMS FOR CHILDREN (U.S. CLS. 21, 23, 26, 36 AND 38).

FIRST USE 3-0-1988; IN COMMERCE 3-0-1988.

KATHLEEN M. VANSTON, EXAMINING ATTORNEY

NO CLAIM IS MADE TO THE EXCLUSIVE RIGHT TO USE "ALARM SYSTEMS", APART FROM THE MARK AS SHOWN.

FOR ELECTRONIC PERSONAL ITEM ALARM SYSTEMS, NAMELY TRANSMITTERS AND RECEIVERS ATTACHED TO PERSONAL ITEMS FOR LOCATING SAME (U.S. CLS. 21, 23, 26, 36 AND 38).

KATHLEEN M. VANSTON, EXAMINING ATTORNEY

CLASS 9—(Continued).

SN 76-472,523. ECLIPSYS TECHNOLOGIES CORPORATION,
BOCA RATON, FL. FILED 12-5-2002.

TABLETXA

FOR INPUT DEVICE, NAMELY, A PERSONAL DIGITAL ASSISTANT AND MOBILE TELEPHONE USED AT THE POINT OF PATIENT CARE FOR INPUTTING PATIENT DATA INTO A COMPUTER (U.S. CLS. 21, 23, 26, 36 AND 38).

TRACY CROSS, EXAMINING ATTORNEY

SN 76-473,080. UNIVERSITY OF AKRON, THE, AKRON, OH.
FILED 12-9-2002.

QUIZWHIZ

FOR SURVEY RESEARCH COMPUTER PROGRAM FOR CONDUCTING INTERVIEWS AND SURVEYS; AND FOR TEACHING INTERVIEWING AND SURVEYING TECHNIQUES (U.S. CLS. 21, 23, 26, 36 AND 38).

KATHLEEN M. VANSTON, EXAMINING ATTORNEY

SN 76-473,847. CORASPEC SYSTEMS LTD., CALGARY,
ALBERTA, CANADA, FILED 12-11-2002.

MAXI-TRAK

PRIORITY CLAIMED UNDER SEC. 44(D) ON CANADA APPLICATION NO. 1145147, FILED 6-26-2002, REG. NO. TMA604158, DATED 3-4-2004, EXPIRES 3-4-2019.

FOR COMPUTER SOFTWARE IN THE FORM OF DISKETTES, CD ROM'S AND DVD'S USED TO EDIT AND ELECTRONICALLY TRANSFER INVENTORY, INSPECTION AND SERVICE INFORMATION FOR PRESSURE VESSELS, PRESSURE RELIEVING DEVICES AND TANKAGE (U.S. CLS. 21, 23, 26, 36 AND 38).

INGA ERVIN, EXAMINING ATTORNEY

SN 76-481,710. COMMONWEALTH SPRAGUE CAPACITOR,
INC., NORTH ADAMS, MA. FILED 12-27-2002.

AUTOVAR

FOR CAPACITORS AND CAPACITOR ASSEMBLIES (U.S. CLS. 21, 23, 26, 36 AND 38).

FIRST USE 4-0-1980; IN COMMERCE 4-0-1980.

MIDGE BUTLER, EXAMINING ATTORNEY

CLASS 9—(Continued).

SN 76-490,655. KINKEAD, MARK, HOUSTON, TX. FILED 12-23-2002.

EMPIRE DELUXE

NO CLAIM IS MADE TO THE EXCLUSIVE RIGHT TO USE "DELUXE", APART FROM THE MARK AS SHOWN.

FOR TURN-BASED WAR GAME STRATEGY SOFTWARE FOR USE ON A COMPUTER PLATFORM (U.S. CLS. 21, 23, 26, 36 AND 38).

FIRST USE 4-6-2003; IN COMMERCE 4-6-2003.

JOHN HWANG, EXAMINING ATTORNEY

SN 76-490,743. INFRAGISTICS, INC., EAST WINDSOR, NJ.
FILED 2-11-2003.



The logo for Infragistics features the word "Infragistics" in a bold, sans-serif font. The letter "i" in "Infragistics" has a small circle above it. The entire word is underlined with a thick, black, hand-drawn style line that tapers at the ends.

FOR COMPUTER SOFTWARE, NAMELY, COMPONENT BASED DEVELOPMENT TOOLS, AND PRESENTATION LAYER COMPONENT DEVELOPMENT SOFTWARE FOR BUILDING AN INTERFACE FOR COMPUTER SOFTWARE APPLICATIONS, INTERNET SOFTWARE APPLICATIONS, XML WEB SERVICES AND WEB SITE SOFTWARE (U.S. CLS. 21, 23, 26, 36 AND 38).

FIRST USE 1-1-2001; IN COMMERCE 1-1-2001.

TRACY CROSS, EXAMINING ATTORNEY

SN 76-492,908. HIJK, CARLSBAD, CA. FILED 2-27-2003.

GO AHEAD, PRINT

NO CLAIM IS MADE TO THE EXCLUSIVE RIGHT TO USE "PRINT", APART FROM THE MARK AS SHOWN.

FOR COMPUTER PROGRAMS AND COMPUTER PROGRAMS DOWNLOADABLE FROM A GLOBAL COMPUTER INFORMATION NETWORK USED TO PRINT INFORMATION AND FORM DOCUMENTS AVAILABLE THROUGH THE USE OF A GLOBAL COMPUTER INFORMATION NETWORK (U.S. CLS. 21, 23, 26, 36 AND 38).

FIRST USE 8-0-1999; IN COMMERCE 8-0-1999.

M. E. BODSON, EXAMINING ATTORNEY

SN 76-493,925. BLACKBALL, INC, SAN DIEGO, CA. FILED 3-3-2003.

VISION INTERNET

NO CLAIM IS MADE TO THE EXCLUSIVE RIGHT TO USE INTERNET, APART FROM THE MARK AS SHOWN.

FOR COMPUTER SOFTWARE FOR THE COLLECTION, EDITING, ORGANIZING, MODIFYING, BOOK MARKING, TRANSMISSION, STORAGE AND SHARING OF DATA AND INFORMATION (U.S. CLS. 21, 23, 26, 36 AND 38).

KEVON CHISOLM, EXAMINING ATTORNEY

CLASS 9—(Continued).

SN 76-495,816. CENTURION TECHNOLOGIES, INC., FENTON, MO. FILED 3-10-2003.

MACSHIELD

FOR COMPUTER SOFTWARE FOR USE IN PROTECTING A HARD DRIVE FROM ACCIDENTAL OR UNAUTHORIZED ALTERATIONS AND DELETIONS (U.S. CLS. 21, 23, 26, 36 AND 38).

MARLENE BELL, EXAMINING ATTORNEY

SN 76-496,319. IDATIX CORPORATION, CLEARWATER, FL. FILED 2-27-2003.

ISYNERGY

FOR COMPUTER SOFTWARE FOR USE IN PROVIDING A PAPERLESS OFFICE, NAMELY FOR THE CAPTURE OF PAPER-BASED IMAGES BY SCANNING, THE STORING OF THE IMAGES IN A DATABASE, THE APPLICATION OF ARTIFICIAL INTELLIGENCE TECHNIQUES TO RECOGNIZE CONTENT AND DISTRIBUTING THE CONTENT TO THIRD-PARTY APPLICATIONS TO AUTOMATE WORKFLOW (U.S. CLS. 21, 23, 26, 36 AND 38).

FIRST USE 1-2-2003; IN COMMERCE 1-8-2003.
GEORGIA CARTY, EXAMINING ATTORNEY

SN 76-496,599. THE BLACK & DECKER CORPORATION, TOWSON, MD. FILED 3-12-2003.

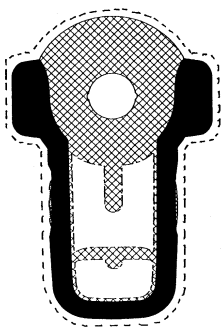

THE DRAWING IS LINED FOR THE COLOR ORANGE AND THE COLOR BLACK IS REPRESENTED IN SOLID COLORING.

THE COLORS ORANGE AND THE COLOR BLACK ARE CLAIMED AS A FEATURE OF THE MARK.

THE MARK CONSISTS OF A COMBINATION OF TWO COLORS-ORANGE AND BLACK WHEREIN THE COLOR ORANGE IS APPLIED TO THE BODY OF THE COMBINED LASER LEVEL AND STUD FINDER AND THE COLOR BLACK IS APPLIED AS TRIM. THE DOTTED LINE SHOWS THE POSITION OF THE MARK ON THE GOODS AND IS NOT PART OF THE MARK SHOWN.

SEC. 2(F).

FOR COMBINED LASER PLUMB, LEVEL AND MAGNETIC STUD FINDER SOLD PRINCIPALLY FOR CONSUMER USE (U.S. CLS. 21, 23, 26, 36 AND 38).

FIRST USE 8-30-2002; IN COMMERCE 8-30-2002.

WILLIAM VERHOSEK, EXAMINING ATTORNEY

CLASS 9—(Continued).

SN 76-496,913. COBE CARDIOVASCULAR, INC., ARVADA, CO. FILED 3-13-2003.

ANGEL

FOR MEDICAL DEVICE, NAMELY A BLOOD CENTRIFUGE (U.S. CLS. 21, 23, 26, 36 AND 38).

BARBARA RUTLAND, EXAMINING ATTORNEY

SN 76-498,572. RUTHERFORD CONTROLS INT'L. CORP., VIRGINIA BEACH, VA. FILED 3-19-2003.

MULTIMAG

FOR ELECTRONIC DOOR LOCKS, DOOR ALARMS AND PARTS THEREFOR; ACCESS CONTROLS, NAMELY, MECHANICAL, ELECTRICAL AND ELECTROMAGNETIC CONTROLS FOR DOORS, AND PARTS THEREFOR (U.S. CLS. 21, 23, 26, 36 AND 38).

FIRST USE 1-1-1999; IN COMMERCE 1-1-1999.

KATHERINE STOIDES, EXAMINING ATTORNEY

SN 76-499,572. FRIELING USA, INC., CHARLOTTE, NC. FILED 3-21-2003.

ACCU BALANCE

FOR KITCHEN SCALES (U.S. CLS. 21, 23, 26, 36 AND 38).

FIRST USE 1-12-2003; IN COMMERCE 1-12-2003.

JOHN HWANG, EXAMINING ATTORNEY

SN 76-499,627. NORTHROP GRUMMAN CORPORATION, LOS ANGELES, CA. FILED 3-21-2003.

GUARDIAN

FOR AIRBORNE ELECTRO-OPTIC COUNTERMEASURES PRODUCT, INCLUDING AT LEAST ONE INFRARED SENSOR, A ROTATABLE BALL TURRET, AN INFRARED RADIATION SOURCE, ELECTRONICS FOR TRACKING A MISSILE TRACKING THE AIRBORNE PLATFORM UPON WHICH THE PRODUCT IS MOUNTED AND FOR COUPLING THE INFRARED SENSOR TO A CONTROLLER FOR DIRECTING THE TURRET AND INFRARED RADIATION SOURCE TOWARD THE MISSILE FOR DIRECTING JAMMING INFRARED RADIATION TO JAM THE MISSILE'S INFRARED SEEKER (U.S. CLS. 21, 23, 26, 36 AND 38).

JOHN HWANG, EXAMINING ATTORNEY

CLASS 9—(Continued).

SN 76-502,342. PRIVACY COUNCIL, INC., RICHARDSON, TX. FILED 3-31-2003.

PRIVACY WISE

NO CLAIM IS MADE TO THE EXCLUSIVE RIGHT TO USE "PRIVACY", APART FROM THE MARK AS SHOWN.
FOR COMPUTER SOFTWARE FOR USE BY BUSINESSES AND INDIVIDUALS FOR USE IN MONITORING AND ESTABLISHING COMPUTER NETWORK COMPLIANCE WITH FEDERAL PRIVACY REGULATIONS THAT MAY BE DOWNLOADED FROM A GLOBAL COMPUTER NETWORK (U.S. CLS. 21, 23, 26, 36 AND 38).
MARC LEIPZIG, EXAMINING ATTORNEY

SN 76-502,343. PRIVACY COUNCIL, INC., RICHARDSON, TX. FILED 3-31-2003.

PRIVACYWISE

FOR COMPUTER SOFTWARE FOR USE BY BUSINESSES AND INDIVIDUALS FOR USE IN MONITORING AND ESTABLISHING COMPUTER NETWORK COMPLIANCE WITH FEDERAL PRIVACY REGULATIONS THAT MAY BY DOWNLOADED FROM A GLOBAL COMPUTER NETWORK (U.S. CLS. 21, 23, 26, 36 AND 38).
MARC LEIPZIG, EXAMINING ATTORNEY

SN 76-502,935. NETLATENCY, SUNNYVALE, CA. FILED 3-31-2003.

SWITCHMONITOR

FOR COMPUTER SOFTWARE FOR USE IN CONFIGURING NETWORK EQUIPMENT AS WELL AS MANAGING AND MONITORING A COMMUNICATIONS NETWORK; COMPUTER SOFTWARE FOR NETWORK ANALYSIS, MANAGEMENT AND MAINTENANCE, INCLUDING TRACKING, AGGREGATING, REPORTING, AND DISPLAYING OF NETWORK PERFORMANCE, UTILIZATION, CAPACITY, CONFIGURATION, TRAFFIC EXPANSION AND FRAUD, ERRORS, FAULTS, AND OTHER PROBLEMS, AND FOR STORAGE OF COLLECTED DATA AND OTHER INFORMATION RELATED THERETO (U.S. CLS. 21, 23, 26, 36 AND 38).
FIRST USE 3-18-1999; IN COMMERCE 1-30-2001.
BRIAN NEVILLE, EXAMINING ATTORNEY

CLASS 9—(Continued).

SN 76-503,030. GENE LOGIC, INC., GAITHERSBURG, MD. FILED 4-1-2003.

GENESIS ENTERPRISE SYSTEM

NO CLAIM IS MADE TO THE EXCLUSIVE RIGHT TO USE ENTERPRISE SYSTEM, APART FROM THE MARK AS SHOWN.
FOR COMPUTER SOFTWARE DESIGNED TO INCREASE THE SPEED AND EFFICIENCY OF DRUG DISCOVERY AND DRUG RESEARCH PROGRAMS BY INTEGRATING AND MANAGING LARGE VOLUMES OF GENOMIC DATA THROUGH COORDINATION, ANALYSIS, VISUALIZATION AND MINING CAPABILITIES (U.S. CLS. 21, 23, 26, 36 AND 38).
FIRST USE 6-25-2001; IN COMMERCE 6-25-2001.
GINNY ISAACSON, EXAMINING ATTORNEY

SN 76-503,525. FLANAGAN, BARRY, HONOLULU, HI. FILED 4-2-2003.

HAPA

FOR AUDIO TAPES FEATURING MUSIC; AUDIO DISCS FEATURING MUSIC; COMPACT DISCS FEATURING MUSIC; DOWNLOADABLE MUSICAL RECORDINGS; DOWNLOADABLE VIDEO RECORDINGS FEATURING MUSIC; LASER DISCS FEATURING MUSIC; MOTION PICTURE FILMS OF MUSICAL PERFORMANCES; PHONOGRAPH RECORDS FEATURING MUSIC; VIDEO TAPES FEATURING MUSIC; VIDEO DISCS FEATURING MUSIC; VIDEO RECORDINGS OF MUSICAL PERFORMANCES; SOUND RECORDINGS, NAMELY MUSICAL RECORDINGS (U.S. CLS. 21, 23, 26, 36 AND 38).
FIRST USE 12-31-1992; IN COMMERCE 12-31-1992.
BRIAN NEVILLE, EXAMINING ATTORNEY

SN 76-503,538. TSUI, PHILIP Y.W., FULLERTON, CA. FILED 4-2-2003.

SKYLINK

OWNER OF U.S. REG. NO. 2,472,617.
FOR REMOTE CONTROLLER FOR GARAGE DOORS (U.S. CLS. 21, 23, 26, 36 AND 38).
FIRST USE 3-18-1993; IN COMMERCE 4-15-1993.
CATHERINE CAIN, EXAMINING ATTORNEY

SN 76-505,071. RED MIRA, LLC, KANSAS CITY, MO. FILED 4-7-2003.

RED MIRA

FOR COMPUTER SOFTWARE FOR NETWORK SECURITY AND BILLING PURPOSES (U.S. CLS. 21, 23, 26, 36 AND 38).
SUSAN HAYASH, EXAMINING ATTORNEY

CLASS 9—(Continued).

SN 76-505,325. RAXCO SOFTWARE, INC., GAITHERSBURG, MD. FILED 4-9-2003.

PERFECTFILE

OWNER OF U.S. REG. NOS. 1,801,410 AND 1,801,411. FOR COMPUTER SOFTWARE USED TO REORGANIZE AND OPTIMIZE COMPUTER MEMORY FILES AND TO REORGANIZE AND OPTIMIZE DATA IN VIRTUAL MEMORY SYSTEMS (U.S. CLS. 21, 23, 26, 36 AND 38).

FIRST USE 12-31-1992; IN COMMERCE 12-31-1992. DANIEL CAPSHAW, EXAMINING ATTORNEY

SN 76-505,576. RAXCO SOFTWARE, INC., GAITHERSBURG, MD. FILED 4-9-2003.

RAXMASTER

FOR COMPUTER SOFTWARE USED FOR DISK DEFRAGMENTATION, FILE CACHING, MEMORY MANAGEMENT, DATA RECORD MANAGEMENT, OPEN FILE MANAGEMENT AND DISK MONITORING (U.S. CLS. 21, 23, 26, 36 AND 38).

FIRST USE 6-17-1989; IN COMMERCE 6-17-1989. DANIEL CAPSHAW, EXAMINING ATTORNEY

SN 76-505,591. RAXCO SOFTWARE, INC., GAITHERSBURG, MD. FILED 4-9-2003.

INSTRUCTOR

FOR COMPUTER SOFTWARE USED TO ENABLE REMOTE USERS TO PARTICIPATE IN FORUMS AND TRAINING SESSIONS OVER CHARACTER CELL TERMINALS (U.S. CLS. 21, 23, 26, 36 AND 38).

FIRST USE 7-15-1987; IN COMMERCE 7-15-1987. GIANCARLO CASTRO, EXAMINING ATTORNEY

SN 76-506,034. TIME PLUS, INC., ROSWELL, GA. FILED 4-11-2003.

CHECKCONNECT

FOR COMPUTER SOFTWARE USED FOR TIMEKEEPING AND PAYROLL BY BUSINESSES THAT MAY BE DOWNLOADED FROM A REMOTE COMPUTER SITE, OR THAT IS RECORDED ON AN OPTICAL DISK, FOR USE IN ASSOCIATION WITH PAYROLL SERVICES (U.S. CLS. 21, 23, 26, 36 AND 38).

FIRST USE 6-0-2002; IN COMMERCE 6-0-2002. ODESSA BIBBINS, EXAMINING ATTORNEY

CLASS 9—(Continued).

SN 76-506,081. WCONNECT, LLC, DAVENPORT, FL. FILED 4-1-2003.

WCONNECT

FOR WIRELESS TELEPHONE INTEGRATED WITH AN AUTOMOBILE AUDIO SYSTEM, NAMELY SPEAKERS AND RECEIVERS (U.S. CLS. 21, 23, 26, 36 AND 38). JASON TURNER, EXAMINING ATTORNEY

SN 76-508,784. DAIDO METAL CO., LTD., NAKA-KU, NAGOYA, JAPAN, FILED 4-23-2003.

DEL • ECO

FOR ELECTRODES USED A MAJOR ELEMENT OF DOUBLE-LAYER CAPACITORS (U.S. CLS. 21, 23, 26, 36 AND 38).

SOPHIA S. KIM, EXAMINING ATTORNEY

SN 76-508,788. FOSSIL STEAM TECHNOLOGIES, INC., DARTMOUTH, NOVA SCOTIA, CANADA, FILED 4-23-2003.

AQUARIAN

PRIORITY CLAIMED UNDER SEC. 44(D) ON CANADA APPLICATION NO. 1,156,811, FILED 10-24-2002, REG. NO. TMA604377, DATED 3-8-2004, EXPIRES 3-8-2019.

OWNER OF U.S. REG. NO. 2,736,055.

FOR WATER LEVEL INDICATION AND MEASUREMENT SYSTEMS, NAMELY, GAUGES, PROBES, DETECTION AND VERIFICATION UNITS, WATER COLUMNS, CIRCUIT BOARDS, WATER LEVEL DISCREPANCY ALARMS, LED DISPLAYS, AND PARTS THEREFOR (U.S. CLS. 21, 23, 26, 36 AND 38).

FIRST USE 0-0-1982; IN COMMERCE 0-0-1982. JOHN HWANG, EXAMINING ATTORNEY

SN 76-509,216. INTERNATIONAL NEWS, INC., KENT, WA. FILED 4-10-2003.

MECCAZINE

FOR DOWNLOADABLE ELECTRONIC PUBLICATIONS IN THE NATURE OF MAGAZINES AND NEWSLETTERS IN THE FIELD OF APPAREL AND ACCESSORIES (U.S. CLS. 21, 23, 26, 36 AND 38).

FIRST USE 10-4-2002; IN COMMERCE 10-4-2002. MARK T. MULLEN, EXAMINING ATTORNEY

CLASS 9—(Continued).

SN 76-509,394. BALTIC LATVIAN UNIVERSAL ELECTRONICS, LLC, WESTLAKE VILLAGE, CA. FILED 4-25-2003.

MOUSE

FOR MICROPHONES (U.S. CLS. 21, 23, 26, 36 AND 38).
FIRST USE 7-25-1999; IN COMMERCE 7-25-1999.
ANNE MADDEN, EXAMINING ATTORNEY

SN 76-512,171. HEALTH INTERNATIONAL CORPORATION, INDIAN SHORES, FL. FILED 5-6-2003.

FIT TRAX

NO CLAIM IS MADE TO THE EXCLUSIVE RIGHT TO USE "TRACKS", APART FROM THE MARK AS SHOWN.
FOR PRERECORDED VIDEO AND AUDIO TAPES, COMPACT DISKS, AND DIGITAL VIDEO DISKS FEATURING MUSIC FOR USE IN ACCOMPANYING AND MOTIVATING INDIVIDUALS DOING EXERCISE AND PHYSICAL FITNESS TRAINING (U.S. CLS. 21, 23, 26, 36 AND 38).
FIRST USE 9-3-2003; IN COMMERCE 9-3-2003.
CAROLINE WOOD, EXAMINING ATTORNEY

SN 76-512,902. ZYXEL COMMUNICATIONS CORPORATION, PARK, HSIN-CHU, TAIWAN, FILED 5-9-2003.



NO CLAIM IS MADE TO THE EXCLUSIVE RIGHT TO USE "VPN", APART FROM THE MARK AS SHOWN.
FOR SOFTWARE FOR USE IN THE FIELD OF INTEGRATED TELECOMMUNICATIONS NETWORK MANAGEMENT, NAMELY, SOFTWARE USED FOR ANALYZING TELECOMMUNICATIONS NETWORK PERFORMANCE, FOR ENSURING THE AVAILABILITY OF SUFFICIENT BANDWIDTH FOR TELECOMMUNICATIONS NETWORKS AND FOR CONFIGURING TELECOMMUNICATIONS NETWORKS (U.S. CLS. 21, 23, 26, 36 AND 38).
GWEN STOKOLS, EXAMINING ATTORNEY

CLASS 9—(Continued).

SN 76-513,015. ALLTOP TECHNOLOGY CO., LTD., TAIPEI HSIANG, TAIWAN, FILED 5-9-2003.



FOR CABLE CONNECTORS; CABLES, NAMELY, COMPUTER AND ELECTRICAL CABLES FOR HIGH-SPEED INTERNET ACCESS (U.S. CLS. 21, 23, 26, 36 AND 38).
MICHAEL WEBSTER, EXAMINING ATTORNEY

SN 76-513,072. SPENCER, EUVIN, SOLANA BEACH, CA. FILED 5-9-2003.

DON CARLOS

THE NAME "DON CARLOS" IDENTIFIES A LIVING INDIVIDUAL WHOSE CONSENT IS OF RECORD.
FOR MUSICAL SOUND RECORDINGS (U.S. CLS. 21, 23, 26, 36 AND 38).
FIRST USE 0-0-1972; IN COMMERCE 0-0-1972.
ANDREW BENZMILLER, EXAMINING ATTORNEY

SN 76-513,359. AMERICAN BIBLE SOCIETY, NEW YORK, NY. FILED 4-24-2003.



NO CLAIM IS MADE TO THE EXCLUSIVE RIGHT TO USE 1960, APART FROM THE MARK AS SHOWN.
FOR PRE-RECORDED AUDIO CASSETTES, PRE-RECORDED VIDEO CASSETTES, CDS, DVDS, CD-ROMS, AND MULTIMEDIA CD-ROMS CONTAINING THE BIBLE, COMPUTER ANIMATION, MUSIC AND INFORMATION IN THE FIELDS OF THE BIBLE, CHRISTIANITY, RELIGION AND SPIRITUALITY; VIDEO GAME SOFTWARE, INTERACTIVE VIDEO GAME PROGRAMS; MOUSE PADS (U.S. CLS. 21, 23, 26, 36 AND 38).
MARIA-VICTORIA SUAREZ, EXAMINING ATTORNEY

CLASS 9—(Continued).

SN 76-514,259. CENTURION RESEARCH CORPORATION, CHANTILLY, VA. FILED 5-13-2003.

COMPASS^GS

THE MARK CONSISTS OF STANDARD CHARACTERS WITHOUT CLAIM TO ANY PARTICULAR FONT, STYLE, SIZE, OR COLOR.

FOR COMPUTER SOFTWARE FOR USE IN DATABASE MANAGEMENT IN THE FIELD OF BUSINESS PLANNING (U.S. CLS. 21, 23, 26, 36 AND 38).

ALEXANDER L. POWERS, EXAMINING ATTORNEY

SN 76-515,025. MAVERICK SKATEBOARDS, INC., BEVERLY HILLS, CA. FILED 5-16-2003.

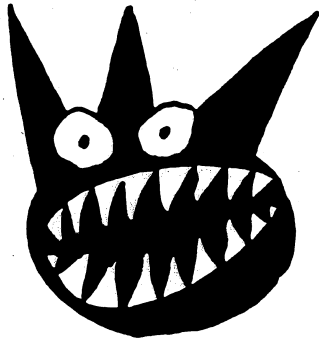

THE MARK CONSISTS OF A FANCIFUL CARTOON DRAWING OF A CAT.

FOR CDS, DVDS, VIDEO TAPES AND COMPUTER SOFTWARE ALL FEATURING PHOTOGRAPHS, IMAGES, INFORMATION, VIDEO AND SIMILAR ENTERTAINMENT IN THE FIELD OF SKATEBOARDS; MUSICAL SOUND RECORDINGS (U.S. CLS. 21, 23, 26, 36 AND 38).

FIRST USE 6-0-1993; IN COMMERCE 6-0-1993.

FLORENTINA BLANDU, EXAMINING ATTORNEY

SN 76-515,170. VOMHOF, DANIEL W., LA MESA, CA. FILED 5-19-2003.

4N6XPRT STIFCALCS

OWNER OF U.S. REG. NOS. 2,021,759, 2,162,157 AND OTHERS.

FOR COMPUTER SOFTWARE CONTAINING AUTOMOBILE CRASH TEST DATA AND CRASH TEST CALCULATORS (U.S. CLS. 21, 23, 26, 36 AND 38).

FIRST USE 4-1-2003; IN COMMERCE 4-1-2003.

AMY ALFIERI, EXAMINING ATTORNEY

CLASS 9—(Continued).

SN 76-516,092. PERSONAL SAFETY PRODUCTS CORPORATION, LOCKPORT, IL. FILED 5-23-2003.

SURE ALERT

NO CLAIM IS MADE TO THE EXCLUSIVE RIGHT TO USE "ALERT", APART FROM THE MARK AS SHOWN.

FOR ALERT SYSTEM, COMPRISED OF A DETECTABLE SIGNAL GENERATOR, FOR ATTACHMENT TO A HANDICAP ASSISTANCE DEVICE, SUCH AS A CANE, WALKER, OR WHEELCHAIR, TO PRODUCE A DETECTABLE SIGNAL TO THEREBY ALERT OTHERS OF THE NEED FOR HELP (U.S. CLS. 21, 23, 26, 36 AND 38).

JANICE L. MCMORROW, EXAMINING ATTORNEY

SN 76-517,115. MPC INC., WILMINGTON, DE. FILED 5-27-2003.

FLEX-SENSE

FOR PARTICLE EMISSION SENSOR (U.S. CLS. 21, 23, 26, 36 AND 38).

FIRST USE 3-11-1996; IN COMMERCE 3-11-1996.

PATRICIA EVANKO, EXAMINING ATTORNEY

SN 76-517,988. DEEP LIGHT, LLC, BEVERLY HILLS, CA. FILED 5-29-2003.

DEEP LIGHT

FOR TELEVISION SETS, VIDEO MONITORS, VIDEO DISPLAYS, COMPUTER CHIPS, COMPUTER GRAPHICS SOFTWARE, COMPUTER GRAPHICS AUTHORIZING TOOLS; NAMELY, MODELING PROGRAMS FOR 3D ANIMATION, SPECIAL EFFECTS AND MOTION CAPTURE; COMPUTER SOFTWARE AND HARDWARE TO ENHANCE THE AUDIO VISUAL CAPABILITIES OF MULTI MEDIA APPLICATIONS, NAMELY DISPLAY OF 3D IMAGES, VIDEO CAMERAS (U.S. CLS. 21, 23, 26, 36 AND 38).

PAUL F. GAST, EXAMINING ATTORNEY

CLASS 9—(Continued).

SN 76-518,039. POLISON CORPORATION, KAOHSIUNG, TAIWAN, FILED 5-30-2003.

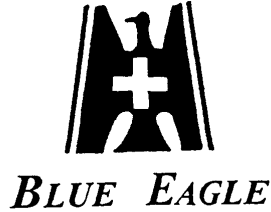

FOR INDUSTRIAL SAFETY EQUIPMENT, NAMELY, SAFETY GOGGLES, GAS WELDING GOGGLES, SAFETY SPECTACLES, SAFETY HELMETS; BROW-GUARDS; BUMP CAPS, CHIN STRAPS, INDUSTRIAL SAFETY ANTI-DUST RESPIRATORS AND CARTRIDGES, INDUSTRIAL SAFETY ANTI-CHEMICAL RESPIRATORS AND CARTRIDGES, INDUSTRIAL PROTECTIVE EAR PLUGS, INDUSTRIAL PROTECTIVE EAR MUFFS, AIR-SUPPLIED SANDBLAST HOODS, AIR-SUPPLIED SPRAY PAINTING HOODS, ANTI-CHEMICAL HOODS, AIR-SUPPLIED MASKS, ARC-WELDING HELMETS, INDUSTRIAL SAFETY FACE SHIELDS AND COMPONENT PARTS, INDUSTRIAL SAFETY BELTS FOR USE AS A SAFETY HARNESS; PROTECTIVE CLOTHING, NAMELY, ALUMINIZED GLOVES, ALUMINIZED HOODS, ALUMINIZED COATS, ALUMINIZED TROUSERS, ALUMINIZED BOOTS, ALUMINIZED GAITERS, ALUMINIZED APRONS WITH SLEEVES, ALUMINIZED APRONS, ALUMINIZED SLEEVES; SAFETY GROUND CLAMPS (U.S. CLS. 21, 23, 26, 36 AND 38).

FIRST USE 12-1-1982; IN COMMERCE 4-10-1996.
CURTIS FRENCH, EXAMINING ATTORNEY

SN 76-519,738. ALBERT METZ GMBH & CO. KG, D-78176 BLUMBERG, FED REP GERMANY, FILED 6-3-2003.

FOR A BETTER LINK

FOR ACTIVE AND PASSIVE COUPLING AND INTERFACING COMPONENTS, NAMELY CONNECTOR CABLES, ADAPTERS, CONNECTOR SOCKETS, CONNECTOR PLUGS, CONNECTORS, RELAYS, DISTRIBUTORS, PATCH PANELS AND COUPLING MODULES; TESTING AND MEASURING INSTRUMENTS; ALL GOODS FOR ELECTRICAL INSTALLATIONS, FOR DATA AND TELECOMMUNICATION NETWORKS AND FOR FIBER OPTIC NETWORKS (U.S. CLS. 21, 23, 26, 36 AND 38).

MICHAEL WEBSTER, EXAMINING ATTORNEY

SN 76-519,932. AIRFLOW NETWORKS, INC., SUNNYVALE, CA. FILED 5-23-2003.

AIRSWITCH

FOR COMPUTER HARDWARE AND COMPUTER SOFTWARE USED FOR SWITCHING AND ROUTING IN THE FIELD OF WIRELESS LOCAL AREA NETWORKS (U.S. CLS. 21, 23, 26, 36 AND 38).

MARY CRAWFORD, EXAMINING ATTORNEY

CLASS 9—(Continued).

SN 76-521,133. PARAGON TECHNOLOGIES, INC., EASTON, PA. FILED 6-6-2003.

DISTRIBUTION SYSTEM OPTIMIZER

NO CLAIM IS MADE TO THE EXCLUSIVE RIGHT TO USE DISTRIBUTION SYSTEM, APART FROM THE MARK AS SHOWN.

FOR COMPUTER SOFTWARE FOR SALE OR LEASE FOR ANALYZING CUSTOMERS' ORDERS AND TRACKING DELIVERY, STORAGE, AND SALES TO IMPROVE THE EFFICIENCY OF THE FLOW OF PRODUCTS (U.S. CLS. 21, 23, 26, 36 AND 38).

FIRST USE 10-16-2003; IN COMMERCE 10-16-2003.
GLENN CLARK, EXAMINING ATTORNEY

SN 76-523,490. SEQUENCE DESIGN, INC., SANTA CLARA, CA. FILED 6-18-2003.

ELMO

FOR COMPUTER SOFTWARE FOR USE IN DESIGNING INTEGRATED CIRCUITS (U.S. CLS. 21, 23, 26, 36 AND 38).

FIRST USE 3-31-2003; IN COMMERCE 3-31-2003.
JACQUELINE A. LAVINE, EXAMINING ATTORNEY

SN 76-524,660. DELAWARE CAPITAL FORMATION, INC., WILMINGTON, DE. FILED 6-19-2003.

MAESTRO

FOR ELECTRONIC TOUCH HUMAN MACHINE INTERFACE SCREENS (U.S. CLS. 21, 23, 26, 36 AND 38).

SOPHIA S. KIM, EXAMINING ATTORNEY

SN 76-526,363. COMMSCOPE PROPERTIES LLC, SPARKS, NV. FILED 6-30-2003.

FXL

FOR COAXIAL CABLES AND CONNECTORS THEREFOR (U.S. CLS. 21, 23, 26, 36 AND 38).

FIRST USE 3-0-2001; IN COMMERCE 3-0-2001.
MATTHEW PAPPAS, EXAMINING ATTORNEY

CLASS 9—(Continued).

SN 76-528,477. RENESAS TECHNOLOGY CORP., TOKYO, JAPAN, FILED 7-8-2003.

X-MOBILE CARD

NO CLAIM IS MADE TO THE EXCLUSIVE RIGHT TO USE CARD, APART FROM THE MARK AS SHOWN.

FOR FLASH MEMORY CARDS; MULTIMEDIA CARDS; BLANK SMART CARDS; ENCODED SMART CARDS CONTAINING PROGRAMMING USED TO CONTROL AND ACCESS SENSITIVE DATA, PROVIDE DATA SECURITY AUTHENTICATION, AND PROVIDE MOBILE COMMERCE CAPABILITIES; SEMI-CONDUCTORS AND SEMI-CONDUCTOR DEVICES; THERMISTORS; DIODES; TRANSISTORS; INTEGRATED CIRCUITS; LARGE SCALE INTEGRATED CIRCUITS; CENTRAL PROCESSING UNIT (CPU); ELECTRONIC CIRCUITS; COMPUTER HARDWARE; COMPUTER PRINTERS; PHOTOCOPYING MACHINES; CAMCORDERS; VIDEO DISC PLAYERS; VIDEO CASSETTE RECORDERS; VIDEO PROJECTORS; COMPACT DISC PLAYERS; TAPE RECORDERS; DVD MACHINES; DVD RECORDERS; DVD CAMERAS; DIGITAL CAMERAS; TELEVISION RECEIVERS; TELEVISION SETS; RADIOS; PERSONAL DIGITAL ASSISTANTS (PDAS); PORTABLE TELEPHONES; TELEPHONE SETS; MOBILE TELEPHONES; CELLULAR TELEPHONES; WIRELESS TELEPHONES; RADIO TELEPHONES; SATELLITE TELEPHONES; FACSIMILE MACHINES— NAVIGATION APPARATUS FOR VEHICLES IN THE NATURE OF ON-BOARD COMPUTERS; VIDEO GAME CARTRIDGES; VIDEO GAME DISCS; VIDEO GAME INTERACTIVE CONTROL FLOOR PADS OR MATS; VIDEO GAME INTERACTIVE REMOTE CONTROL UNITS; VIDEO GAME INTERACTIVE HAND HELD REMOTE CONTROLS FOR PLAYING ELECTRONIC GAMES; VIDEO GAME JOYSTICKS; VIDEO GAME MACHINES FOR USE WITH TELEVISIONS; VIDEO GAME SOFTWARE; VIDEO GAME TAPE CASSETTES; VIDEO GAME PLAYER MACHINES FOR USE WITH TELEVISIONS AND COMPUTERS, AND OPERATING SYSTEM SOFTWARE PROGRAMS AND COMPUTER UTILITY PROGRAMS FOR USE THEREWITH; FLASH MEMORY CARD READERS, MULTIMEDIA CARD READERS, MAGNETIC DRUMS, MAGNETIC DISCS, MAGNETIC TAPES, CD-ROM, ELECTRONIC CIRCUITS AND OTHER STORAGE MEDIUMS RECORDED WITH PROGRAMS FOR DEVELOPING AND DESIGNING OF INTEGRATED CIRCUITS AND ELECTRONIC CIRCUITS INCLUDING SEMI-CONDUCTOR DEVICES AND CPU; COMPUTER SOFTWARE IN THE FIELDS OF RESEARCH, DEVELOPMENT, DESIGN, PROGRAMMING AND MAINTENANCE OF COMPUTERS SOFTWARE FOR OTHERS; COMPUTER SOFTWARE IN THE FIELD OF DESIGNING OF SEMI-CONDUCTOR MEMORY; SOFTWARE AND SOFTWARE DEVELOPMENT KITS FOR USE WITH SECURE FLASH MEMORY CARDS AND MULTIMEDIA CARDS UTILIZING SMART CARD TECHNOLOGY; SOFTWARE AND SOFTWARE DEVELOPMENT KITS TO DEPLOY AND DEVELOP SOFTWARE APPLICATIONS FOR SECURE SOFTWARE TO ALLOW DIGITAL SIGNATURES AND DIGITAL CERTIFICATION, PRIVACY PROTECTION, SECURITY INFRASTRUCTURE SUPPORT, PERSONAL IDENTIFICATION NUMBER SECURITY PROTECTION, FLEXIBLE DIGITAL INTELLECTUAL PROPERTY RIGHTS MANAGEMENT, SECURE NETWORK ACCESS, DATA SECURITY APPLICATIONS, AND APPLICATIONS PROVIDING A SECURE PLATFORM FOR COPYRIGHT-PROTECTED MATERIALS; SOFTWARE ALLOWING USERS TO MANAGE MULTIPLE APPLICATIONS FOR USE WITH SECURE FLASH MEMORY CARDS AND MULTIMEDIA CARDS (U.S. CLS. 21, 23, 26, 36 AND 38).

M. E. BODSON, EXAMINING ATTORNEY

CLASS 9—(Continued).

SN 76-531,497. ZYXEL COMMUNICATIONS CORPORATION, HSIN-CHU, TAIWAN, FILED 7-21-2003.



FOR SOFTWARE FOR USE IN THE FIELD OF INTEGRATED TELECOMMUNICATIONS NETWORK MANAGEMENT, NAMELY, SOFTWARE USED FOR ANALYZING TELECOMMUNICATIONS NETWORK PERFORMANCE, FOR ENSURING THE AVAILABILITY OF SUFFICIENT BANDWIDTH FOR TELECOMMUNICATIONS NETWORKS AND FOR CONFIGURING TELECOMMUNICATIONS NETWORKS (U.S. CLS. 21, 23, 26, 36 AND 38).

GWEN STOKOLS, EXAMINING ATTORNEY

SN 76-532,441. THE CARTOON NETWORK LP, LLLP, ATLANTA, GA. FILED 7-25-2003.

FOSTER'S HOME FOR IMAGINARY FRIENDS

FOR MOTION PICTURE FILMS FEATURING COMEDY, DRAMA, ACTION, ADVENTURE AND/OR ANIMATION, AND MOTION PICTURE FILMS FOR BROADCAST ON TELEVISION FEATURING COMEDY, DRAMA, ACTION, ADVENTURE AND/OR ANIMATION; PRERECORDED VINYL RECORDS, AUDIO TAPES, AUDIO-VIDEO TAPES, AUDIO VIDEO CASSETTES, AUDIO-VIDEO DISCS, AND DIGITAL VERSATILE DISCS FEATURING MUSIC, COMEDY, DRAMA, ACTION, ADVENTURE, AND/OR ANIMATION; STEREO HEADPHONES; BATTERIES; CORDLESS TELEPHONES; HANDHELD CALCULATORS; AUDIO CASSETTE AND CD PLAYERS; CD ROMS CONTAINING COMPUTER GAME PROGRAMS; HAND-HELD KARAOKE PLAYERS, TELEPHONE AND/OR RADIO PAGES; PRE-RECORDED SHORT MOTION PICTURE FILM CASSETTES FEATURING COMEDY, DRAMA, ACTION, ADVENTURE AND/OR ANIMATION TO BE USED WITH HAND-HELD VIEWERS OR PROJECTORS; VIDEO CASSETTE RECORDERS AND PLAYERS, COMPACT DISC PLAYERS, DIGITAL AUDIO TAPE RECORDERS AND PLAYERS, ELECTRONIC DIARIES; RADIOS; MOUSE PADS; EYEGLASSES, SUNGLASSES AND CASES THEREFOR; PRE-RECORDED AUDIO TAPES AND BOOKLETS SOLD TOGETHER AS A UNIT; COMPUTER PROGRAMS, NAMELY, SOFTWARE LINKING DIGITIZED VIDEO AND AUDIO MEDIA TO A GLOBAL COMPUTER INFORMATION NETWORK; GAME EQUIPMENT SOLD AS A UNIT FOR PLAYING A PARLOR-TYPE COMPUTER GAME; VIDEO AND COMPUTER GAME PROGRAMS; VIDEO GAME CARTRIDGES AND CASSETTES; ENCODED MAGNETIC CARDS, NAMELY, KEY CARDS, PHONE CARDS, CREDIT CARDS, DEBIT CARDS AND CASH CARDS; DECORATIVE MAGNETS; ALL OF THE FOREGOING RELATED TO AN ANIMATED SERIES AND/OR THE CHARACTERS CONTAINED THEREIN (U.S. CLS. 21, 23, 26, 36 AND 38).

RICHARD WHITE, EXAMINING ATTORNEY

CLASS 9—(Continued).

SN 76-532,808. HACH COMPANY, LOVELAND, CO. FILED 7-11-2003.

AUTOCAT

FOR ELECTROMECHANICAL INSTRUMENT THAT TESTS FOR THE PRESENCE OF FREE OR TOTAL CHLORINE, CHLORITE, SULFITE, OR CHLORINE DIOXIDE AND QUANTIFIES THE AMOUNT (U.S. CLS. 21, 23, 26, 36 AND 38).

FIRST USE 10-15-2002; IN COMMERCE 10-15-2002.
TARAH HARDY, EXAMINING ATTORNEY

CLASS 9—(Continued).

SN 76-533,804. CAPATIVA TECH, INC., SAN DIEGO, CA. FILED 7-29-2003.



FOR ELECTRICAL WIRES, ELECTRICAL CABLES, ELECTRICAL PLUGS, ELECTRIC SOCKETS, AND ELECTRICAL CONNECTORS (U.S. CLS. 21, 23, 26, 36 AND 38).

FIRST USE 6-1-2002; IN COMMERCE 6-1-2002.
MARLENE BELL, EXAMINING ATTORNEY

SN 76-533,253. ALLOQUENT SYSTEMS INC., AUSTIN, TX. FILED 7-28-2003.

FABTRACKER

FOR COMPUTER SOFTWARE FOR ACCESSING, CREATING, EDITING, AND MANAGING DATABASES AND TRANSFERRING DATA TO AND FROM DATABASES; SOFTWARE FOR DESIGNING, CREATING, MAINTAINING, AND ACCESSING DOCUMENT MANAGEMENT SYSTEMS, AUTHORING SYSTEMS, STORAGE SYSTEMS, AND RETRIVAL SYSTEMS; SOFTWARE FOR DOCUMENT AUTHORING, VERSION HISTORY TRACKING, AND PROFILING; SOFTWARE FOR ACCESS CONTROL AND SECURITY, NAMELY, USER IDENTIFICATION, REGISTRATION, AND AUTHORIZATION TO CONTROL AND ARCHIVE DATABASE CHANGES; SOFTWARE FOR AUTOMATICALLY NOTIFYING USERS WHEN DOCUMENTS OR DATA HAVE BEEN UPDATED; SOFTWARE FOR CREATING PROCESS -AND-INSTRUMENTATION AND DIAGRAMS AND DRAWINGS; SOFTWARE FOR CREATING CUSTOM REPORTS FROM INFORMATION AND DATA CONTAINED IN DATABASES; AND SOFTWARE FOR EVALUATING RESOURCE REQUIREMENTS AND AVAILABILITY IN A MANUFACTURING ENVIRONMENT (U.S. CLS. 21, 23, 26, 36 AND 38).

FIRST USE 6-3-2003; IN COMMERCE 6-3-2003.
NANCY CLARKE, EXAMINING ATTORNEY

SN 76-535,587. AUTOSALES, INCORPORATED, TALLMADGE, OH. FILED 7-25-2003.



OWNER OF U.S. REG. NOS. 1,741,692, 2,781,919 AND OTHERS.

NO CLAIM IS MADE TO THE EXCLUSIVE RIGHT TO USE "PERFORMANCE", APART FROM THE MARK AS SHOWN.

FOR FUEL PRESSURE REGULATORS, FUEL CELLS, FUEL CELL MOUNTS; THERMOSTATS; WATER NECKS; GAUGES FOR FUEL PRESSURE, OIL PRESSURE, WATER TEMPERATURE, VOLTAGE AND VACUUM; ELECTRICAL CONNECTORS, AND SWITCHES FOR BATTERIES (U.S. CLS. 21, 23, 26, 36 AND 38).

FIRST USE 10-15-2002; IN COMMERCE 10-15-2002.
NANCY CLARKE, EXAMINING ATTORNEY

SN 76-533,607. RICKEY PAT MUSIC, INC., DANVILLE, CA. FILED 7-30-2003.



NO CLAIM IS MADE TO THE EXCLUSIVE RIGHT TO USE "RECORDS", APART FROM THE MARK AS SHOWN. FOR PRERECORDED COMPACT DISCS FEATURING MUSIC (U.S. CLS. 21, 23, 26, 36 AND 38).

FIRST USE 12-10-2003; IN COMMERCE 12-10-2003.
CAROLINE WOOD, EXAMINING ATTORNEY

SN 76-536,089. APPRO TECHNOLOGY, HSINCHUAN CITY, TAIPEI HSIEN, TAIWAN, FILED 7-21-2003.



OWNER OF U.S. REG. NO. 2,171,310. THE MARK INCLUDES A DEPICTION OF A RED STAR CONTAINED IN THE LETTER O.

FOR VIDEO SURVEILLANCE EQUIPMENT, NAMELY, VIDEO CAMERAS, DIGITAL IMAGE PROCESSORS AND VIDEO MULTIPLEXERS, WIRELESS TELEPHONES AND TELEPHONE TRANSMITTERS (U.S. CLS. 21, 23, 26, 36 AND 38).

FIRST USE 7-29-1993; IN COMMERCE 2-18-1994.
CIMMERIAN COLEMAN, EXAMINING ATTORNEY

CLASS 9—(Continued).

SN 76-536,277. NAMCO LTD., TOKYO, JAPAN, FILED 8-11-2003.

PACTONES

FOR VIDEO GAME CARTRIDGES, COMPUTER GAME PROGRAMS; DOWNLOADABLE MUSIC SOUND RECORDINGS AND VIDEO GAMES AND COMPUTER GAMES VIA THE INTERNET OR TELECOMMUNICATION NETWORK (U.S. CLS. 21, 23, 26, 36 AND 38).
ALEX KEAM, EXAMINING ATTORNEY

CLASS 9—(Continued).

SN 76-542,883. AGFA-GEVAERT N.V., B-2640 MORTSEL, BELGIUM, FILED 9-5-2003.

:ARKITEX

FOR COMPUTER SOFTWARE, NAMELY FOR PRODUCTION PLANNING, PRODUCTION DISTRIBUTION MANAGEMENT, OUTPUT AT PRINT SITES, PUBLICATION MANAGEMENT, ELECTRONIC PLATE MAKE-UP, IMPORTING OF PRODUCTION PLANS, PRODUCTION STATUS MONITORING, PROOFING, VIEWING, STORING FOR RE-OUTPUT OR ARCHIVE, PAGE DISTRIBUTION, IMAGE MANIPULATION, LOAD BALANCING, FAULT TOLERANCE, AND INTERFACE TO INPUT AND OUTPUT DEVICES IN THE FIELD OF NEWSPAPER PUBLISHING (U.S. CLS. 21, 23, 26, 36 AND 38).

MARY CRAWFORD, EXAMINING ATTORNEY

SN 76-537,153. VCI VISION COMPUTER, INC., CHANDLER, AZ. FILED 8-4-2003.



FOR COMPUTERS AND COMPUTER PERIPHERAL DEVICES, MONITORS, KEYBOARDS, PRINTERS, MICE, MODEMS, HARD AND FLOPPY DISK DRIVES, TAPE DRIVES, CD-ROM DRIVES, DVD-DRIVES, MEMORY BOARDS AND CHIPS, CABLES AND CONNECTORS, ALL FOR USE WITH COMPUTERS (U.S. CLS. 21, 23, 26, 36 AND 38).

FIRST USE 8-1-1999; IN COMMERCE 7-23-2003.

WILLIAM BRECKENFELD, EXAMINING ATTORNEY

SN 76-543,915. PDS ELECTRONICS, INC., AKRON, OH. FILED 8-29-2003.

SN 76-541,614. UBL RECORDINGS, LLC, SAN FRANCISCO, CA. FILED 8-25-2003.



NO CLAIM IS MADE TO THE EXCLUSIVE RIGHT TO USE ROCK, APART FROM THE MARK AS SHOWN.
FOR COMPACT DISCS AND AUDIO CASSETTES FEATURING MUSICAL SOUND RECORDINGS (U.S. CLS. 21, 23, 26, 36 AND 38).

ASMAT KHAN, EXAMINING ATTORNEY



NO CLAIM IS MADE TO THE EXCLUSIVE RIGHT TO USE "ANTENNA DESIGNER", APART FROM THE MARK AS SHOWN.

FOR COMPUTER SOFTWARE FOR DEFINING AND ANALYZING EXISTING OR FUTURE MATERIALS SPECIFICATIONS OF HIGH PERFORMANCE, LONG DISTANCE ANTENNAS USING HF, VHF, OR UHF FREQUENCY BANDS FOR PARASITIC AND ALL-DRIVEN ARRAYS, INCLUDING STACKED YAGI AND LOG-PERIODIC DESIGNS, FOR DETERMINING THE RESONANT FREQUENCY OF SUCH ANTENNAS AND ITS RELATIONSHIP TO SIZE, AND FOR DETERMINING WIND SPEED SURVIVABILITY OF LONG DISTANCE ANTENNAS (U.S. CLS. 21, 23, 26, 36 AND 38).

BARBARA GAYNOR, EXAMINING ATTORNEY

SN 76-541,945. INFORMATIVE GRAPHICS CORPORATION, SCOTTSDALE, AZ. FILED 8-29-2003.

VISUAL RIGHTS

FOR COMPUTER PROGRAMS IN THE FIELD OF ELECTRONIC STORAGE, MANIPULATION, TRANSFER, RETRIEVAL, AND DIGITAL-RIGHTS SECURITY CONTROL OF DATA AND DATA FUNCTIONALITY IN THE FIELD OF GRAPHICS, TEXT, VIDEO, AND AUDIO DATA FILES, AND USER MANUALS SOLD THEREWITH (U.S. CLS. 21, 23, 26, 36 AND 38).

MARK T. MULLEN, EXAMINING ATTORNEY

CLASS 9—(Continued).

SN 76-543,966. INFOTREND TECHNOLOGY, INC., CHUNG-HO. CITY TAIPEI HSIEN, TAIWAN, FILED 9-10-2003.

EonStor

THE MARK CONSISTS OF STANDARD CHARACTERS WITHOUT CLAIM TO ANY PARTICULAR FONT, STYLE, SIZE, OR COLOR.

FOR COMPUTER HARDWARE AND SOFTWARE USED IN COMPUTER HARDWARE IMPLEMENTATION AND OPERATION OR USED IN INTERNET OR INTRANET COMMUNICATION AND CONTROL, AND NOT FOR USE IN CONNECTION WITH MARKET AND SOCIAL RESEARCH SERVICES; SEMICONDUCTOR, CHIP AND INTEGRATED CIRCUIT USED IN COMPUTER HARDWARE (U.S. CLS. 21, 23, 26, 36 AND 38).

ZACHARY BELLO, EXAMINING ATTORNEY

CLASS 9—(Continued).

SN 76-544,833. ON CENTER SOFTWARE, INC., WOODLANDS, TX. FILED 9-12-2003.

DIGITAL % COMPLETE

NO CLAIM IS MADE TO THE EXCLUSIVE RIGHT TO USE "DIGITAL", APART FROM THE MARK AS SHOWN. FOR COMPUTER SOFTWARE, NAMELY GRAPHICS-BASED SOFTWARE USED TO VISUALLY TRACK QUANTITIES OF WORK OR MATERIALS INSTALLED AT CONSTRUCTION JOB SITES (U.S. CLS. 21, 23, 26, 36 AND 38).

FIRST USE 7-20-2003; IN COMMERCE 8-15-2003.
INGA ERVIN, EXAMINING ATTORNEY

SN 76-544,888. TELEDYNE TECHNOLOGIES INCORPORATED, LOS ANGELES, CA. FILED 9-5-2003.

T2R

OWNER OF U.S. REG. NO. 1,751,096. FOR ELECTROMECHANICAL RELAYS (U.S. CLS. 21, 23, 26, 36 AND 38).
FIRST USE 2-14-1992; IN COMMERCE 2-14-1992.
TANYA AMOS, EXAMINING ATTORNEY

SN 76-544,331. INTERACTIVE EDUCATIONAL VIDEO, LLC, ST. LOUIS, MO. FILED 9-12-2003.

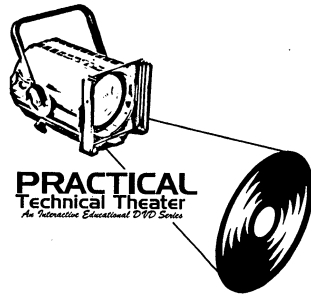

NO CLAIM IS MADE TO THE EXCLUSIVE RIGHT TO USE "PRACTICAL TECHNICAL THEATER AN INTERACTIVE EDUCATIONAL DVD SERIES", APART FROM THE MARK AS SHOWN.

THE MARK CONSISTS IN PART OF A STYLIZED REPRESENTATION OF A STAGE LIGHT AND A DVD.

FOR DVD'S AND PRINTED STUDY MANUALS AND TEACHERS' MANUALS, SOLD TOGETHER AS A UNIT, IN THE FIELD OF SECONDARY SCHOOL THEATER, DRAMA AND FINE ARTS (U.S. CLS. 21, 23, 26, 36 AND 38).

FIRST USE 1-2-2003; IN COMMERCE 1-2-2003.
ESTHER BELENKER, EXAMINING ATTORNEY

SN 76-545,527. IRESOURCES, INC., MERIDIAN, ID. FILED 9-17-2003.

INTERCUE

FOR SOFTWARE, NAMELY, SOFTWARE FOR CREATION OF CUSTOMIZED ELECTRONIC FORMS FOR PERSONAL COMPUTERS AND PERSONAL DIGITAL ASSISTANTS (U.S. CLS. 21, 23, 26, 36 AND 38).
CAROLYN GRAY, EXAMINING ATTORNEY

SN 76-545,919. INTERACTIVE ENTERPRISES INC., PALATINE, IL. FILED 9-15-2003.

DRIVERS EDGE: INTERACTIVE SLIDES AND VIDEOS

NO CLAIM IS MADE TO THE EXCLUSIVE RIGHT TO USE "DRIVERS"; "INTERACTIVES SLIDES AND VIDEOS", APART FROM THE MARK AS SHOWN.

FOR COMPUTER SOFTWARE FOR DRIVER EDUCATION INSTRUCTION PURPOSES (U.S. CLS. 21, 23, 26, 36 AND 38).

FIRST USE 1-20-2003; IN COMMERCE 1-20-2003.
CAROLYN GRAY, EXAMINING ATTORNEY

CLASS 9—(Continued).

SN 76-546,610. L-3 COMMUNICATIONS CORP., NEW YORK, NY. FILED 9-24-2003.

SimuStealth

THE MARK CONSISTS OF STANDARD CHARACTERS WITHOUT CLAIM TO ANY PARTICULAR FONT, STYLE, SIZE, OR COLOR.

FOR SIMULATION COMPUTER SOFTWARE FOR USE IN TRAINING, FOR PROVIDING GRAPHIC REPRESENTATIONS OF SIMULATED WARFARE SITUATIONS IN THE AIR AND ON THE GROUND FOR USE BY INSTRUCTORS AND BATTLEFIELD MANAGERS (U.S. CLS. 21, 23, 26, 36 AND 38).

ESTHER BELENKER, EXAMINING ATTORNEY

SN 76-546,760. HARCOURT ACHIEVE INC., AUSTIN, TX. FILED 9-8-2003.

ON OUR WAY TO ENGLISH

FOR PRERECORDED COMPACT DISKS AND MULTIMEDIA SOFTWARE RECORDED ON CD ROM ALL FEATURING INSTRUCTIONS FOR TEACHING AND ASSESSING LITERACY, FLUENCY, LANGUAGE AND READING TO KINDERGARTEN AND ELEMENTARY SCHOOL CHILDREN (U.S. CLS. 21, 23, 26, 36 AND 38).

FIRST USE 1-2-2003; IN COMMERCE 1-2-2003.

REBECCA SMITH, EXAMINING ATTORNEY

SN 76-547,401. THE CBORD GROUP, INC., ITHACA, NY. FILED 9-29-2003.

ACCUMENU

FOR COMPUTER PROGRAMS FOR USE IN FOOD SERVICE IN THE ACUTE HEALTHCARE INDUSTRY (U.S. CLS. 21, 23, 26, 36 AND 38).

MICHAEL WEBSTER, EXAMINING ATTORNEY

SN 76-547,540. OVERHEAD CAMERA SYSTEMS, INC., SOUTH HUTCHINSON, KS. FILED 9-30-2003.

SKY-EYE

FOR VIDEO CAMERA SYSTEMS; NAMELY, PORTABLE BOOM MOUNTED REMOTELY CONTROLLABLE VIDEO CAMERA SYSTEMS (U.S. CLS. 21, 23, 26, 36 AND 38).

FIRST USE 7-1-1977; IN COMMERCE 6-15-1991.

GEORGIA CARTY, EXAMINING ATTORNEY

CLASS 9—(Continued).

SN 76-548,323. BEAMREACH NETWORKS, INC., SUNNYVALE, CA. FILED 10-1-2003.

BEAMREACH

FOR WIRELESS COMMUNICATIONS EQUIPMENT, NAMELY, ANTENNAS, COMPUTER HARDWARE, NAMELY, BASE STATIONS AND SUBSCRIBER UNITS AND COMPUTER SOFTWARE, NAMELY, NETWORK MANAGERS FOR USE IN MONITORING A NETWORK OF BASE STATIONS AND SUBSCRIBER UNITS, ALL IN THE FIELD OF BROADBAND WIRELESS NETWORK OPERATIONS (U.S. CLS. 21, 23, 26, 36 AND 38).

RONALD AIKENS, EXAMINING ATTORNEY

SN 76-548,785. BID2WIN SOFTWARE, INC., PORTSMOUTH, NH. FILED 10-3-2003.

THE ART OF BIDDING INTELLIGENCE

FOR COMPUTER SOFTWARE FOR USE IN BIDDING CONSTRUCTION INDUSTRY PROJECTS (U.S. CLS. 21, 23, 26, 36 AND 38).

FIRST USE 1-10-2002; IN COMMERCE 1-10-2002.

KEVON CHISOLM, EXAMINING ATTORNEY

SN 76-549,034. BACOU-DALLOZ USA SAFETY, INC., SMITHFIELD, RI. FILED 10-6-2003.

ToxiLTD

FOR ELECTRONIC GAS MONITORS AND DETECTORS FOR MONITORING AND DETECTING THE PRESENCE OF GAS IN THE AIR (U.S. CLS. 21, 23, 26, 36 AND 38).

LESLEY LAMOTHE, EXAMINING ATTORNEY

SN 76-549,063. SILLY GROOVE, L.L.C., MIAMI, FL. FILED 10-6-2003.

ARC

FOR SOUND RECORDINGS FEATURING MUSIC (U.S. CLS. 21, 23, 26, 36 AND 38).

CYNTHIA SLOAN, EXAMINING ATTORNEY

CLASS 9—(Continued).

SN 76-549,088. STOMP, INC., IRVINE, CA. FILED 10-6-2003.

ADEXTERMINATOR

OWNER OF U.S. REG. NOS. 1,275,888, 2,687,334 AND OTHERS.

FOR SOFTWARE FOR BLOCKING OF UNWANTED EMAIL AND ADVERTISEMENTS (U.S. CLS. 21, 23, 26, 36 AND 38).

DORITT L. CARROLL, EXAMINING ATTORNEY

SN 76-549,618. INONE TECHNOLOGY, LLC, TIMONIUM, MD. FILED 10-3-2003.

DEXMATE

FOR COMPUTER HARDWARE AND SOFTWARE FOR EXCHANGING DATA WITH VENDING MACHINES (U.S. CLS. 21, 23, 26, 36 AND 38).

FIRST USE 7-31-2003; IN COMMERCE 7-31-2003.
H. M. FISHER, EXAMINING ATTORNEY

SN 76-551,046. REED BUSINESS INFORMATION LIMITED, SUTTON SURREY SM2 5AS, UNITED KINGDOM, FILED 9-22-2003.

BANKBASEOWNER OF U.S. REG. NO. 2,376,238.
FOR MULTIMEDIA SOFTWARE RECORDED ON CD ROM FEATURING INFORMATION ABOUT FINANCIAL INSTITUTIONS AND FINANCIAL SERVICES (U.S. CLS. 21, 23, 26, 36 AND 38).FIRST USE 12-31-1996; IN COMMERCE 1-30-1997.
GIANCARLO CASTRO, EXAMINING ATTORNEY

SN 76-551,511. TOUCH TECHNOLOGIES, INC., SAN DIEGO, CA. FILED 9-22-2003.

POSTALCARE

FOR COMPUTER SOFTWARE IN THE FIELD OF ELECTRONIC MAIL SECURITY (U.S. CLS. 21, 23, 26, 36 AND 38).

CIMMERIAN COLEMAN, EXAMINING ATTORNEY

SN 76-551,512. TOUCH TECHNOLOGIES, INC., SAN DIEGO, CA. FILED 9-22-2003.

POSTTRAP

FOR COMPUTER SOFTWARE IN THE FIELD OF ELECTRONIC MAIL SECURITY (U.S. CLS. 21, 23, 26, 36 AND 38).

KARLA PERKINS, EXAMINING ATTORNEY

CLASS 9—(Continued).

SN 76-552,138. VICARENT INCORPORATED, COLORADO SPRINGS, CO. FILED 9-26-2003.

VICARENT

FOR COMPUTER SOFTWARE USED TO FACILITATE CODING OF PROCEDURES PERFORMED BY MEDICAL PERSONNEL FOR PURPOSES OF ALLOWING USER TO MAKE AND SUBMIT CLAIMS TO INSURERS (U.S. CLS. 21, 23, 26, 36 AND 38).

CIMMERIAN COLEMAN, EXAMINING ATTORNEY

SN 76-552,538. EDMONT P. D'ASCOLI REVOCABLE LIVING TRUST, COMPRISING EDMONT P. D'ASCOLI, A U.S. CITIZEN, HALEIWA, HI. FILED 9-29-2003.

XCEL

OWNER OF U.S. REG. NOS. 1,292,982, 2,217,115 AND OTHERS.

FOR LIFE JACKETS (U.S. CLS. 21, 23, 26, 36 AND 38).
EDWARD NELSON, EXAMINING ATTORNEY

SN 76-552,626. HUBBELL INCORPORATED, ORANGE, CT. FILED 10-20-2003.

RED ALERTOWNER OF U.S. REG. NO. 2,565,052.
FOR ELECTRICAL OUTLET BOXES AND COVERS (U.S. CLS. 21, 23, 26, 36 AND 38).

GIANCARLO CASTRO, EXAMINING ATTORNEY

SN 76-552,663. LEXORLOGIC CORP., NEW YORK, NY. FILED 10-20-2003.

PERSEUS

FOR COLLECTION MANAGEMENT SOFTWARE USED TO AUTOMATE THE PROCESS OF COLLECTING PAST-DUE RECEIVABLES (U.S. CLS. 21, 23, 26, 36 AND 38).

KIMBERLY PERRY, EXAMINING ATTORNEY

SN 76-552,884. HORTICULTURAL ASSET MANAGEMENT, INC., RALEIGH, NC. FILED 10-20-2003.

MONEY GROWS ON TREES AND WE CAN PROVE IT

FOR COMPUTER SOFTWARE FOR THE VALUATION OF LANDSCAPING ON COMMERCIAL AND CONSUMER REAL ESTATE PROPERTIES (U.S. CLS. 21, 23, 26, 36 AND 38).

AMY HELLA, EXAMINING ATTORNEY

CLASS 9—(Continued).

SN 76-552,885. HORTICULTURAL ASSET MANAGEMENT, INC., RALEIGH, NC. FILED 10-20-2003.

HS²

FOR COMPUTER SOFTWARE FOR THE VALUATION OF LANDSCAPING ON COMMERCIAL AND CONSUMER REAL ESTATE PROPERTIES (U.S. CLS. 21, 23, 26, 36 AND 38).

AMY HELLA, EXAMINING ATTORNEY

SN 76-553,827. LEVI, RAY & SHOUP, INC., SPRINGFIELD, IL. FILED 10-17-2003.

HANDOFF

FOR SOFTWARE THAT RECORDS SPORTS GAME DATA IN A HANDHELD PLATFORM (U.S. CLS. 21, 23, 26, 36 AND 38).

FIRST USE 7-7-2003; IN COMMERCE 7-7-2003.
JOSETTE BEVERLY, EXAMINING ATTORNEY

SN 76-554,855. INTER-INDUSTRY CONFERENCE ON AUTO COLLISION REPAIR, ROLLING MEADOWS, IL. FILED 10-6-2003.

UNIFORM PROCEDURES FOR COLLISION REPAIR

OWNER OF U.S. REG. NO. 2,164,892.
SEC. 2(F).

FOR AUTOBODY REPAIR INSTRUCTIONAL MATERIALS IN THE FORM OF SOFTWARE RECORDED ON CD ROM (U.S. CLS. 21, 23, 26, 36 AND 38).

FIRST USE 11-0-1996; IN COMMERCE 11-0-1996.
FLORENTINA BLANDU, EXAMINING ATTORNEY

SN 76-554,875. OMNITI COMPUTER CONSULTING, INC., COLUMBIA, MD. FILED 10-24-2003.

MULTIVIP

OWNER OF U.S. REG. NO. 2,730,214.

FOR SOFTWARE, NAMELY A FEATURE THAT ALLOWS FOR THE DELIVERY OF EACH CLIENT'S E-MAIL FROM DIFFERENT IP ADDRESSES SO THAT IP-BASED FILTERS THAT AFFECT ONE CLIENT WILL NOT ACCIDENTALLY AFFECT OTHER CLIENTS; THE FEATURE PREVENTS ANY BLOCKING ISSUES INCURRED BY ONE CLIENT FROM GREATLY AFFECTING CLIENTS USING THE SAME SERVICES (U.S. CLS. 21, 23, 26, 36 AND 38).

FIRST USE 9-1-2003; IN COMMERCE 9-1-2003.
CHARLES JOYNER, EXAMINING ATTORNEY

CLASS 9—(Continued).

SN 76-557,114. SPEEDCOM, DBA WAVE WIRELESS NETWORKING, SARASOTA, FL. FILED 10-6-2003.

SPEEDMANAGE

FOR COMPUTER SOFTWARE FOR WIRELESS ROUTER MANAGEMENT (U.S. CLS. 21, 23, 26, 36 AND 38).
KAREN BRACEY, EXAMINING ATTORNEY

SN 76-557,954. REMOTE SOLUTIONS, L.L.C., TUCSON, AZ. FILED 10-20-2003.

LIMITILT

FOR DIGITAL INCLINOMETER (U.S. CLS. 21, 23, 26, 36 AND 38).

FIRST USE 8-31-2003; IN COMMERCE 8-31-2003.
LAURA KOVAISKY, EXAMINING ATTORNEY

SN 76-557,965. LEXIA LEARNING SYSTEMS, INC., LINCOLN, MA. FILED 10-20-2003.

NUESTRO MUNDO EMPIEZA CON LA LECTURA

THE SPANISH TRANSLATION OF "OUR WORLD BEGINS WITH READING".

FOR EDUCATIONAL SOFTWARE, NAMELY, SOFTWARE DESIGNED TO ENABLE STUDENTS TO MASTER READING SKILLS (U.S. CLS. 21, 23, 26, 36 AND 38).

FIRST USE 5-23-2003; IN COMMERCE 5-23-2003.
RON FAIRBANKS, EXAMINING ATTORNEY

SN 76-558,162. INFINITY SOFTWARES, INC., BEAVERTON, OR. FILED 10-24-2003.

POWERONE

FOR CALCULATION AND ANALYSIS SOFTWARE; CALCULATION TEMPLATES; CALCULATOR SOFTWARE; USER AND TRAINING MANUALS FOR USE THEREWITH ALL SOLD AS A UNIT (U.S. CLS. 21, 23, 26, 36 AND 38).

FIRST USE 12-0-1999; IN COMMERCE 4-0-2000.
CHARLES JOYNER, EXAMINING ATTORNEY

CLASS 9—(Continued).

SN 76-560,256. FLIR SYSTEMS, INC., PORTLAND, OR.
FILED 11-3-2003.

SEESPOT

FOR ELECTROMAGNETIC SENSITIVE IMAGING SYSTEMS COMPRISED OF INFRARED CAMERAS, LENSES, DISPLAY UNITS, MOUNTING DEVICES, CIRCUIT BOARDS, PROGRAMMABLE SEMICONDUCTOR MICROPROCESSORS, AND OPERATING SOFTWARE; AND PARTS FOR ELECTROMAGNETIC SENSITIVE IMAGING SYSTEMS, NAMELY, INFRARED CAMERAS, LENSES, DISPLAY UNITS, MOUNTING DEVICES, CIRCUIT BOARDS, PROGRAMMABLE SEMICONDUCTOR MICROPROCESSORS, AND OPERATING SOFTWARE (U.S. CLS. 21, 23, 26, 36 AND 38).

FIRST USE 3-0-1995; IN COMMERCE 3-0-1995.
JILL C. ALT, EXAMINING ATTORNEY

SN 76-975,823. MONARC HOLDINGS, LLC, WHITE PLAINS, NY. FILED 6-19-2002.

MONARC

FOR MUSICAL SOUND RECORDINGS AND DOWNLOADABLE MUSICAL SOUND RECORDINGS NONE OF THE FOREGOING EMANATING FROM A CASINO OR RESORT WITH THE SAME NAME (U.S. CLS. 21, 23, 26, 36 AND 38).

FIRST USE 12-0-2002; IN COMMERCE 12-0-2002.
REBECCA GILBERT, EXAMINING ATTORNEY

SN 78-029,311. SHELTERED WINGS, INC., MIDDLETON, WI. FILED 10-5-2000.

EAGLE OPTICS

NO CLAIM IS MADE TO THE EXCLUSIVE RIGHT TO USE "OPTICS", APART FROM THE MARK AS SHOWN.

FOR BINOCULARS, SPOTTING SCOPES, AND TELESCOPES, ALL FOR USE IN BIRD WATCHING, AND STORAGE CASES THEREFORE (U.S. CLS. 21, 23, 26, 36 AND 38).

FIRST USE 1-1-1996; IN COMMERCE 4-1-1996.
APRIL L. RADEMACHER, EXAMINING ATTORNEY

SN 78-053,692. CHIP PC ISRAEL LTD, TIART-CARMEL, ISRAEL, FILED 3-17-2001.

XTREME PC

NO CLAIM IS MADE TO THE EXCLUSIVE RIGHT TO USE "PC", APART FROM THE MARK AS SHOWN.

FOR COMPUTER HARDWARE (U.S. CLS. 21, 23, 26, 36 AND 38).

PAULA MAYS, EXAMINING ATTORNEY

CLASS 9—(Continued).

SN 78-065,304. QUEST GROUP, INC., THE, IRVINE, CA.
FILED 5-23-2001.

VIDEOQUEST

FOR VIDEO COMPONENTS AND ACCESSORIES, NAMELY, SPEAKER CABLES, SHIELDED INTERCONNECT CABLES, FIBER-OPTIC CABLES, CABLES FOR CARRYING ANALOG OR DIGITAL VIDEO, VIDEO EQUIPMENT CLEANERS, CABLES AND CABLING PARTS FOR INTERCONNECTING VIDEO AND AUDIO/VIDEO COMPONENTS, NAMELY, RECEIVERS, TUNERS, CONTROLLERS FOR AUDIO/VIDEO COMPONENTS, COMPACT DISC PLAYERS, COMPACT DISC TRANSPORTS, LASER DISC PLAYERS, TELEVISIONS, VIDEO MONITORS, CRT MONITORS, PLASMA DISPLAY SCREENS, LCD MONITORS, MULTIMEDIA COMPUTERS, DVD PLAYERS, VIDEO CASSETTE RECORDERS, EQUIPMENT FOR RECORDING AND/OR EDITING VIDEO, NAMELY, VHS, HD-VHS, CD-R AND DVD-R RECORDING AND/OR EDITING EQUIPMENT (U.S. CLS. 21, 23, 26, 36 AND 38).

FIRST USE 5-15-1995; IN COMMERCE 5-15-1995.
INGA ERVIN, EXAMINING ATTORNEY

SN 78-078,427. SER SYSTEMS AG, NEUSTADT/WIED, FED REP GERMANY, FILED 8-9-2001.

SERBRAINFAMILY

PRIORITY CLAIMED UNDER SEC. 44(D) ON FED REP GERMANY APPLICATION NO. 002314797, FILED 7-25-2001. OWNER OF U.S. REG. NOS. 2,800,212 AND 2,810,429.

FOR COMPUTER SOFTWARE FOR DATABASE MANAGEMENT; COMPUTER SOFTWARE FOR WORKFLOW MANAGEMENT; COMPUTER SOFTWARE FOR ARCHIVING AND DOCUMENT MANAGEMENT; COMPUTER SOFTWARE FOR ELECTRONIC DATA PROCESSING OF STRUCTURED AND UNSTRUCTURED INFORMATION FOR PURPOSES OF RECOGNITION, CLASSIFICATION, AND RETRIEVAL, AS WELL AS INTELLIGENT CONTENT IDENTIFICATION AND MATCHING; COMPUTER SOFTWARE FOR AUTOMATICALLY RESPONDING TO INCOMING ELECTRONIC MAIL; COMPUTER SOFTWARE FOR KNOWLEDGE MANAGEMENT AND EXPERT SYSTEMS.; COMPUTER SOFTWARE FOR DATABASE MANAGEMENT; COMPUTER SOFTWARE FOR WORKFLOW MANAGEMENT; COMPUTER SOFTWARE FOR ARCHIVING AND DOCUMENT MANAGEMENT; COMPUTER SOFTWARE FOR ELECTRONIC DATA PROCESSING OF STRUCTURED AND UNSTRUCTURED INFORMATION FOR PURPOSES OF RECOGNITION, CLASSIFICATION, AND RETRIEVAL, AS WELL AS INTELLIGENT CONTENT IDENTIFICATION AND MATCHING; COMPUTER SOFTWARE FOR AUTOMATICALLY RESPONDING TO INCOMING ELECTRONIC MAIL; COMPUTER SOFTWARE FOR KNOWLEDGE MANAGEMENT AND EXPERT SYSTEMS. (U.S. CLS. 21, 23, 26, 36 AND 38).

SUELLEN HICKEY, EXAMINING ATTORNEY

CLASS 9—(Continued).

SN 78-082,442. CAMBRIDGE SILICON RADIO LTD., CAMBRIDGE, ENGLAND, FILED 9-4-2001.

CSRbetween

FOR ELECTRICAL AND ELECTRONIC APPARATUS AND INSTRUMENTS FOR COMMUNICATIONS AND CONTROLS, NAMELY, CAMERAS, CELL PHONES, VIDEO CAMERAS, CORDLESS PHONES, DVD PLAYERS, TELEVISIONS, VCRS, RADIOS, LOUDSPEAKERS, PAGERS, PERSONAL DIGITAL ASSISTANTS, ALL INCORPORATING RADIO OR WIRELESS COMMUNICATION TECHNOLOGY AND PARTS AND ACCESSORIES THEREFOR; COMPUTER HARDWARE; COMPUTER SOFTWARE FOR USE WITH INTEGRATED CIRCUITS WHICH LINK DEVICES BY RADIO OR WIRELESS COMMUNICATION TECHNOLOGY; SEMICONDUCTOR WIRELESS TRANSMITTERS AND RECEIVERS WITH EMBEDDED PROCESSOR, BASEBAND LOGIC AND MEMORY FUNCTION; SEMICONDUCTOR DEVICES IN ELECTRONIC FORM USED IN CONNECTION WITH RADIO OR WIRELESS COMMUNICATIONS TRANSMITTERS, RECEIVERS AND SYNTHESIZERS; INTEGRATED CIRCUITS; SEMICONDUCTOR CHIPS; CIRCUIT BOARD ASSEMBLIES (U.S. CLS. 21, 23, 26, 36 AND 38).

KARLA PERKINS, EXAMINING ATTORNEY

SN 78-101,965. WORLD WRESTLING ENTERTAINMENT, INC., STAMFORD, CT. FILED 1-10-2002.

NWO NEW WORLD ORDER

FOR MAGNETS; ELECTRONIC GAME PROGRAMS; CINEMATOGRAPHIC AND TELEVISION FILMS FEATURING SPORTS ENTERTAINMENT; PHONOGRAPHIC RECORDS FEATURING MUSIC RELATING TO SPORTS ENTERTAINMENT; PRE-RECORDED CD DISCS AND AUDIO TAPES FEATURING SPORTS ENTERTAINMENT; COIN-FED AMUSEMENT GAMING MACHINES; COMPUTER GAME SOFTWARE; VIDEO GAME SOFTWARE; AUDIO AND VISUAL CASSETTES FEATURING MUSIC AND SPORTS ENTERTAINMENT; VIDEO TAPES FEATURING MUSIC AND SPORTS ENTERTAINMENT; AUDIO CASSETTES FEATURING MUSIC RELATING TO SPORTS ENTERTAINMENT; COMPUTER GAME AND VIDEO GAME CARTRIDGES; DIGITAL CAMERAS WITH CD ROM; MOUSE PADS; DISPOSABLE CAMERAS; SUNGLASSES; SUNGLASS CASES; SUNGLASS CORDS; PRESCRIPTION GLASSES; OPTICAL CASES FOR STORING GLASSES, SAFETY HELMETS, WALKIE-TALKIES. (U.S. CLS. 21, 23, 26, 36 AND 38).

M. E. BODSON, EXAMINING ATTORNEY

CLASS 9—(Continued).

SN 78-117,711. MOHAMMAD, REZA R. RAY, VAN NUYS, CA. FILED 3-27-2002.

ABSOLUTE USA

NO CLAIM IS MADE TO THE EXCLUSIVE RIGHT TO USE USA, APART FROM THE MARK AS SHOWN.

FOR COMPACT DISC PLAYERS; AUDIO TAPE, CASSETTE AND DISC RECORDERS AND PLAYERS; COMPACT DISC PLAYER WITH MAGAZINE FOR HOLDING AND PLAYING MULTIPLE DISCS AND HARD DISC DRIVE MEMORY FOR TEMPORARILY STORING DISC CONTENT FOR EASIER ACCESS; VIDEO DISC RECORDERS AND PLAYERS; PORTABLE COMPACT DISC PLAYERS; PORTABLE AUDIO TAPE, CASSETTE AND DISC PLAYERS; DIGITAL AUDIO TAPE RECORDERS AND PLAYERS; COMBINATION DISC PLAYERS WHICH PLAY BOTH VIDEO DISCS AND COMPACT OR OTHER AUDIO DISCS; AUDIO CASSETTE PLAYERS; VIDEO DISC PLAYERS CAPABLE OF STORING AND AUTOMATICALLY LOADING AND PLAYING MULTIPLE DISCS; ELECTRONIC UNIT FOR ADJUSTING THE KEY OF MUSIC PLAYED ON A VIDEO DISC PLAYER TO THE VOICE OF A PERSON SINGING ALONG WITH THAT MUSIC; ELECTRONIC UNIT FOR CONTROLLING VIDEO DISC PLAYERS ACTUATED BY INSERTION OF CURRENCY, NAMELY, JUKE BOXES; STEREO EQUALIZERS; STEREO AND SURROUND SOUND AMPLIFIERS; STEREO AND SURROUND SOUND RECEIVERS; STEREO AND HIGH DEFINITION TELEVISION TUNERS; RECORD TURNABLES; LOUDSPEAKERS; LOUDSPEAKERS FOR USE IN CARS AND BOATS; LOUD SPEAKER SYSTEMS SOLD SEPARATELY OR TOGETHER AS A UNIT COMPRISED OF WOOFERS, TWEETERS, OR MID-RANGE SPEAKER CONES CONTAINED IN A CABINET; SPEAKERS FOR PERSONAL COMPUTERS; OUTDOOR AND ILLUMINATED LOUDSPEAKERS; REMOTE CONTROLLERS FOR AUDIO DISC PLAYERS, VIDEO DISC PLAYERS, VIDEO CASSETTE RECORDERS, STEREO SYSTEMS, VIDEO SYSTEMS AND TELEVISIONS; MICROPHONES; WIRELESS MICROPHONES; MICROPHONE RECEIVERS; CONNECTION BOXES FOR MULTIPLE MICROPHONES; HEADPHONES; VIDEO CASSETTE RECORDERS; MONITOR TELEVISIONS; FLAT PANEL TELEVISION AND DISPLAY MONITORS; VIDEO AMPLIFIERS; VIDEO TUNERS; COMBINATION RADIO AND AUDIO CASSETTE PLAYERS FOR USE IN CARS AND BOATS; VIDEO MONITORS FOR USE IN VEHICLES; TWEETERS; POWERED TWEETERS; WOOFERS; POWERED SUBWOOFERS; SUBWOOFERS; AUDIO DYNAMIC EXPANDERS; AUDIO DUAL AMP BALANCERS; AUDIO FOUR CHANNEL SWITCHING BOXES; AUDIO NOISE SUPPRESSOR; AUDIO ELECTRONIC CROSSOVERS; ELECTRICAL ADAPTORS AND ELECTRICAL POWER EXTENSION CORDS FOR USE IN CONNECTING AUDIO AND VIDEO PRODUCTS; QUICK RELEASE MOUNTING BRACKET AND WIRING HARNESSSES FOR CAR STEREO RADIO/CASSETTE PLAYERS; WATER-RESISTANT COVERS FOR STEREO RADIO/CASSETTE PLAYERS; GLOBAL POSITIONING SYSTEMS FOR USE IN CARS AND BOATS; COIN-OPERATED VIDEO DISC PLAYERS; RADIO PAGERS (U.S. CLS. 21, 23, 26, 36 AND 38).

FIRST USE 1-10-2001; IN COMMERCE 1-10-2001.

HOWARD SMIGA, EXAMINING ATTORNEY

SN 78-147,254. REVOLUTION EYEWEAR, INC., SIMI VALLEY, CA. FILED 7-24-2002.

CLIP-CLIPS

FOR DEVICES, NAMELY, FASTENERS FOR SECURING AUXILIARY EYEGLASS FRAMES TO AN ARTICLE OF CLOTHING (U.S. CLS. 21, 23, 26, 36 AND 38).

LINDA E. BLOHM, EXAMINING ATTORNEY

CLASS 9—(Continued).

SN 78-153,893. POWERCOM CO., LTD., TAIPEI HSIEN, TAIWAN, FILED 8-13-2002.



FOR VOLTAGE REGULATORS FOR ELECTRIC POWER; UNINTERRUPTIBLE POWER SUPPLIES; ELECTRICAL POWER SUPPLIES; POWER REGULATORS; VOLTAGE SURGE PROTECTORS; COMPUTER SOFTWARE FOR CONTROLLING, MONITORING, PROGRAMMING AND OPERATING UTILITY METERS (U.S. CLS. 21, 23, 26, 36 AND 38).

MARIA-VICTORIA SUAREZ, EXAMINING ATTORNEY

SN 78-157,743. BITS LIMITED, NORTHPORT, NY. FILED 8-26-2002.



NO CLAIM IS MADE TO THE EXCLUSIVE RIGHT TO USE "ENERGYSAVER", APART FROM THE MARK AS SHOWN.

FOR ELECTRICAL EQUIPMENT FOR USE BY CONSUMERS, NAMELY, POWER STRIPS, VOLTAGE SURGE PROTECTORS, COMPUTERS, AND COMPUTER PERIPHERALS (U.S. CLS. 21, 23, 26, 36 AND 38).

ALICE SUE CARRUTHERS, EXAMINING ATTORNEY

CLASS 9—(Continued).

SN 78-158,285. HLCISOFT, LLC, CAMBRIDGE, MA. FILED 8-27-2002.

POCKETLINGO

FOR COMPUTER SOFTWARE FOR USE IN PERSONAL DIGITAL ASSISTANTS (PDAS), AS WELL AS PERSONAL COMPUTERS, FOR ACCESSING, SEARCHING, COMPILING, INDEXING, ORGANIZING, RETRIEVING AND STORING INFORMATION AND OTHER RESOURCES FROM MULTIPLE DATABASES; COMPUTER SOFTWARE FOR RETRIEVING TEXT, ELECTRONIC DOCUMENTS, DATABASES, GRAPHICS, AUDIO AND VISUAL DATA; COMPUTER SOFTWARE FOR USE WITH INSTRUCTIONAL MATERIALS AND DATA AS AIDS IN LEARNING, IN THE FIELDS OF ENGLISH LANGUAGE, LEARNING A FOREIGN LANGUAGE, FINANCIAL INFORMATION, MEDICAL INFORMATION, ENGLISH AS A SECOND LANGUAGE, CULTURAL LITERACY, AND POPULAR PHRASES; INTERACTIVE COMPUTER SOFTWARE FOR TEACHING AND LEARNING VOCABULARY, FOREIGN LANGUAGES, PRACTICING AND TESTING WORD USAGE, CONVERSATION AND TRANSLATION SKILLS; COMPUTER SOFTWARE FOR USE WITH ELECTRONIC DICTIONARIES, THESAURUSES, NOTEBOOKS AND FOREIGN-LANGUAGE TRANSLATIONS; AND COMPUTER SOFTWARE FOR USE IN PERFORMING WORD-SEARCHES, FOREIGN-LANGUAGE TRANSLATIONS, RETRIEVAL OF REAL-VOICE PRONUNCIATIONS, AND CROSS-REFERENCING MULTIPLE SOURCE MATERIALS IN THE FIELDS OF ENGLISH LANGUAGE, FOREIGN LANGUAGES, FINANCIAL INFORMATION, MEDICAL INFORMATION, CULTURAL LITERACY, POPULAR PHRASES, VOCABULARY DEVELOPMENT AND FOREIGN LANGUAGE DEVELOPMENT (U.S. CLS. 21, 23, 26, 36 AND 38).

FIRST USE 8-27-2002; IN COMMERCE 8-27-2002.

INGA ERVIN, EXAMINING ATTORNEY

SN 78-163,499. BECTON, DICKINSON AND COMPANY, FRANKLIN LAKES, NJ. FILED 9-12-2002.

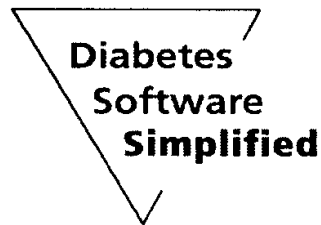

NO CLAIM IS MADE TO THE EXCLUSIVE RIGHT TO USE "DIABETES SOFTWARE SIMPLIFIED", APART FROM THE MARK AS SHOWN.

FOR COMPUTER SOFTWARE FOR MANAGING DIABETES PATIENTS' BLOOD GLUCOSE DATA (U.S. CLS. 21, 23, 26, 36 AND 38).

WON TEAK OH, EXAMINING ATTORNEY

CLASS 9—(Continued).

SN 78-165,276. HALLIBURTON ENERGY SERVICES, INC., CARROLLTON, TX. FILED 9-18-2002.

FASLINK

FOR WIRELINE LOGGING TELEMETRY EQUIPMENT, NAMELY, A TRANSMITTER-TO-RECEIVER TOOL, NAMELY, COMMUNICATION CABLE AND CHIP SETS, MODEM, COMPUTER SOFTWARE AND HARDWARE FOR DATA ACQUISITION IN THE OIL AND GAS INDUSTRY (U.S. CLS. 21, 23, 26, 36 AND 38).
CYNTHIA SLOAN, EXAMINING ATTORNEY

SN 78-187,542. DC COMICS, NEW YORK, NY. FILED 11-21-2002.

STATIC SHOCK

FOR MOTION PICTURE FILMS FEATURING COMEDY, DRAMA, ACTION, ADVENTURE AND/OR ANIMATION, AND MOTION PICTURE FILMS FOR BROADCAST ON TELEVISION FEATURING COMEDY, DRAMA, ACTION, ADVENTURE AND/OR ANIMATION; PRERECORDED VINYL RECORDS, AUDIO TAPES, AUDIO-VIDEO TAPES, AUDIO VIDEO CASSETTES, AUDIO VIDEO DISCS, AND DIGITAL VERSATILE DISCS FEATURING MUSIC, COMEDY, DRAMA, ACTION, ADVENTURE, AND/OR ANIMATION; STEREO HEADPHONES; BATTERIES; CORDLESS TELEPHONES, HAND-HELD CALCULATORS; AUDIO CASSETTE AND CD PLAYERS; CD ROM COMPUTER GAME DISCS; HAND-HELD KARAOKE PLAYERS, TELEPHONE AND/OR RADIO PAGERS; SHORT MOTION PICTURE FILM CASSETTES FEATURING COMEDY, DRAMA, ACTION, ADVENTURE AND/OR ANIMATION TO BE USED WITH HAND-HELD VIEWERS OR PROJECTORS; VIDEO CASSETTE RECORDERS AND PLAYERS, COMPACT DISC PLAYERS, DIGITAL AUDIO TAPE RECORDERS AND PLAYERS, ELECTRONIC DIARIES; RADIOS; MOUSE PADS; EYEGLASSES, SUNGLASSES AND CASES THEREFORE; AUDIO TAPES AND BOOKLETS SOLD AS A UNIT FEATURING COMEDY, DRAMA, ACTION, ADVENTURE, ANIMATION AND MUSIC INFORMATION; COMPUTER PROGRAMS, NAMELY, SOFTWARE LINKING DIGITIZED VIDEO AND AUDIO MEDIA TO A GLOBAL COMPUTER INFORMATION NETWORK; GAME EQUIPMENT SOLD AS A UNIT FOR PLAYING A PARLOR-TYPE COMPUTER GAME; VIDEO AND COMPUTER GAME PROGRAMS; VIDEO GAME CARTRIDGES AND CASSETTES; CELLULAR TELEPHONE ACCESSORIES, NAMELY HANDS-FREE HEADSETS, CELLULAR TELEPHONE COVERS AND CELLULAR TELEPHONE FACE COVERS; ENCODED MAGNETIC CARDS, NAMELY, PHONE CARDS, CREDIT CARDS, CASH CARDS, DEBIT CARDS AND MAGNETIC KEY CARDS; AND DECORATIVE MAGNETS (U.S. CLS. 21, 23, 26, 36 AND 38).
JOSETTE BEVERLY, EXAMINING ATTORNEY

CLASS 9—(Continued).

SN 78-190,116. DOTY, LEWIS, JR., BLACKWOOD, NJ. AND SHERRY, PAULA, PENNSAUKEN, NJ. FILED 12-2-2002.

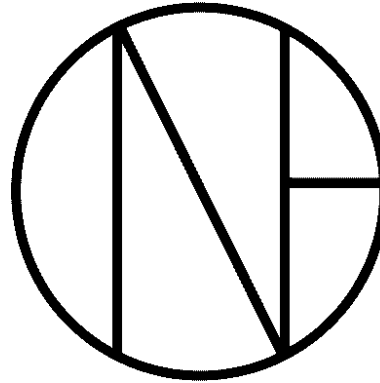

IT IS A STYLIZED DESIGN INTENDED TO INDICATE THE WORD "ONE". THE DESIGN IS A LARGE CIRCLE, INDICATING THE "O" IN "ONE". INSIDE THAT LARGE CIRCLE ARE TWO STRAIGHT VERTICAL LINES WHICH INDICATE THE LETTER "N" IN "ONE". A HORIZONTAL LINE GOING FROM THE RIGHT EDGE OF THE SECOND VERTICAL LINE AND TOUCHING THE "O" INDICATES THE LETTER "E" IN THE WORD "ONE".

FOR PRE-RECORDED COMPACT DISCS FEATURING MUSIC (U.S. CLS. 21, 23, 26, 36 AND 38).
LAURIEL DALIER, EXAMINING ATTORNEY

SN 78-192,590. VEGA GRIESHABER KG, WOLFACH, FED REP GERMANY, FILED 12-9-2002.

plics

PRIORITY CLAIMED UNDER SEC. 44(D) ON FED REP GERMANY APPLICATION NO. 30234810.7/0, FILED 7-16-2002, REG. NO. 30234810, DATED 8-12-2002, EXPIRES 7-31-2012.

FOR ELECTRIC AND ELECTRONIC MEASURING DEVICES FOR MEASURING AND CONTROLLING THE FILLING LEVEL OF TANKS AND CONTAINERS, NAMELY, LEVEL DETECTION SENSORS AND DISPLAYS, MULTI-CHANNEL SCANNERS, LINEARIZERS, COMPUTERS, MICROPROCESSORS, ANALOG MOVING COIL INDICATORS, SENSOR INTERFACES, OVER VOLTAGE PROTECTORS, LEVEL SWITCHES, LEVEL RESPONSIVE SWITCHES, ULTRASONIC LEVEL MEASURING INSTRUMENTS AND EXPLOSION SAFETY BARRIERS FOR SEPARATING SENSORS IN AREA OF EXPLOSIVE MATERIALS FROM READ-OUT DEVICES; PRESSURE SENSORS; REMOTE LEVEL AND PRESSURE INDICATORS (U.S. CLS. 21, 23, 26, 36 AND 38).
BILL DAWE, EXAMINING ATTORNEY

CLASS 9—(Continued).

SN 78-193,350. CALL ONE, INC., CAPE CANAVERAL, FL. FILED 12-11-2002.



FOR TELEPHONES, ELECTRONIC PRODUCTS, NAMELY, ANSWERING MACHINES, HEADSETS AND BASE SETS FOR TELEPHONES AND SPEAKER PHONES; VIDEO CONFERENCING PRODUCTS, NAMELY, CAMERAS AND MONITORS (U.S. CLS. 21, 23, 26, 36 AND 38).

FIRST USE 12-31-1984; IN COMMERCE 12-31-1984.
MICHELE SWAIN, EXAMINING ATTORNEY

SN 78-195,100. ACUID CORPORATION LIMITED, DALK-EITH, EDINBURGH, UNITED KINGDOM, FILED 12-17-2002.

ADRAM

FOR MEMORY INTEGRATED CIRCUITS (U.S. CLS. 21, 23, 26, 36 AND 38).
STEVEN BERK, EXAMINING ATTORNEY

SN 78-201,517. DFI INC., TAIPEI HSIEN, TAIWAN, FILED 1-9-2003.



THE MARK CONSISTS OF THE LETTERS "L" AND "P" IN A STYLIZED FORM, WHEREIN A STYLIZED REPRESENTATION OF A SKULL IS POSITIONED BETWEEN THE LETTERS "L" AND "P" AND THE STYLIZED REPRESENTATION OF A FLAME BORDERS THE LEFT SIDE OF THE LETTER "L".

FOR LIQUID CRYSTAL DISPLAYS (LCD) FOR COMPUTERS; COMPUTER MONITORS; MAINFRAMES FOR PERSONAL COMPUTERS; COMPUTERS; PERSONAL COMPUTER CHASSIS SOLD SEPARATELY TO HOUSE CENTRAL PROCESSING UNITS AND DRIVES; INTERFACE CARDS FOR COMPUTERS; COMPUTER MOTHERBOARDS; VGA CARDS; GRAPHIC CARDS; INTERFACE CARDS (U.S. CLS. 21, 23, 26, 36 AND 38).

ALLISON HOLTZ, EXAMINING ATTORNEY

CLASS 9—(Continued).

SN 78-201,519. DFI INC., TAIPEI HSIEN, TAIWAN, FILED 1-9-2003.

LAN PARTY

NO CLAIM IS MADE TO THE EXCLUSIVE RIGHT TO USE LAN, APART FROM THE MARK AS SHOWN.

FOR LIQUID CRYSTAL DISPLAYS (LCD) FOR COMPUTERS; COMPUTER MONITORS; MAINFRAMES FOR PERSONAL COMPUTERS; COMPUTERS; PERSONAL COMPUTER CHASSIS SOLD SEPARATELY TO HOUSE CENTRAL PROCESSING UNITS AND DRIVES; INTERFACE CARDS FOR COMPUTERS; COMPUTER MOTHERBOARDS; VGA CARDS; GRAPHIC CARDS; INTERFACE CARDS (U.S. CLS. 21, 23, 26, 36 AND 38).

ALLISON HOLTZ, EXAMINING ATTORNEY

SN 78-202,685. A.C.R.S., INC., GARLAND, TX. FILED 1-13-2003.

SERIAL KILLER

FOR COMPUTER SYSTEMS, NAMELY COMPUTERS, COMPUTER HARDWARE, AND COMPUTER PERIPHERALS (U.S. CLS. 21, 23, 26, 36 AND 38).

FIRST USE 9-5-2002; IN COMMERCE 9-5-2002.
JOHN KELLY, EXAMINING ATTORNEY

SN 78-203,544. PALMSOURCE, INC., SUNNYVALE, CA. FILED 1-15-2003.

PALMONE

OWNER OF U.S. REG. NOS. 2,613,597, 2,653,036 AND OTHERS.

FOR SCIENTIFIC, PHOTOGRAPHIC, CINEMATOGRAPHIC, OPTICAL, ELECTRONIC AND TEACHING APPARATUS AND INSTRUMENTS, AS WELL AS APPARATUS FOR RECORDING, TRANSMISSION OF REPRODUCTION OF DATA, TEXT, GRAPHICS, SOUND OR IMAGES, NAMELY, BLANK AND RECORDED MAGNETIC DATA CARRIERS AND RECORDING DISCS CONTAINING COMPUTER APPLICATIONS AND OPERATING SYSTEMS AND AUDIO AND VIDEO CONTENT; CALCULATING MACHINES, DATA PROCESSING EQUIPMENT; COMPUTERS; COMPUTER HARDWARE; PERSONAL DIGITAL ASSISTANTS; MOBILE COMPUTERS; HANDHELD COMPUTERS; TABLET COMPUTERS; COMPUTER MEMORIES; COMPUTER STORAGE HARDWARE; CIRCUIT BOARDS; INTEGRATED CIRCUITS; SEMICONDUCTORS; COMPUTER KEYBOARDS; INPUT BOARDS; INPUT DEVICES, NAMELY, COMPUTER KEYPADS, MICE, TRACKBALLS, JOYSTICKS AND GAME PADS, MICROPHONES AND HEADSETS; STORAGE DEVICES, NAMELY, COMPUTER HARD DRIVES, MEMORY CHIPS AND BLANK FLOPPY AND COMPACT DISCS; HANDHELD OR PORTABLE COMPUTER DISPLAYS; EBOOKS; EBOOK DISPLAYS; GLOBAL POSITIONING SYSTEM RECEIVERS; TRANSMITTERS AND RECEIVERS OF THE MOBILE, PORTABLE, OR FIXED TYPE; RADIOS; SCANNERS; PRINTERS; BATTERY CHARGERS; POWER CONVERTERS, NAMELY, VOLTAGE REGULATORS FOR ELECTRICAL POWER; COMPUTER CABLES; ELECTRICAL INTERFACES, APPARATUS AND INSTRUMENTS FOR INTERCONNECTING ELECTRICAL AND ELECTRONIC EQUIPMENT, NAMELY, ELECTRICAL CABLES, ELECTRICAL CONNECTORS, TERMINALS, ADAPTER BOARDS, AND ELECTRICAL CONVERTER BOXES; COMPUTER STYLUSES; COMMUNICATIONS COMPUTER HARDWARE; COMPUTER PERIPHERALS; TELE-

CLASS 9—(Continued).

COMMUNICATIONS COMPUTER HARDWARE; TELEPHONES; MOBILE TELEPHONES; PAGERS; DIGITAL AUDIO PLAYERS; DIGITAL VIDEO PLAYERS; DIGITAL MULTIMEDIA PLAYERS; TRANSCEIVERS; DIGITAL AUDIO AND VIDEO RECORDERS; DIGITAL CAMERAS; COMPUTER SOFTWARE, NAMELY, OPERATING SYSTEMS PROGRAMS, HANDWRITING RECOGNITION SOFTWARE, PERSONAL INFORMATION MANAGEMENT SOFTWARE, DATA SYNCHRONIZATION PROGRAMS, SERVER SOFTWARE, MOBILE COMMUNICATIONS SOFTWARE, APPLICATIONS AND APPLICATION DEVELOPMENT TOOLS PROGRAMS FOR PERSONAL AND HAND-HELD COMPUTERS; COMPUTER COMMUNICATIONS SOFTWARE; TELECOMMUNICATIONS SOFTWARE; COMPUTER CARRYING CASES; ACCESSORIES, PARTS AND CASES FOR ALL THE FOREGOING; DOWNLOADABLE ELECTRONIC OR DIGITAL PUBLICATIONS, NAMELY, BROCHURES, MANUALS, MAGAZINES AND NEWSLETTERS IN THE FIELDS OF COMPUTER HARDWARE AND COMPUTER SOFTWARE (U.S. CLS. 21, 23, 26, 36 AND 38).

H. M. FISHER, EXAMINING ATTORNEY

SN 78-206,291. XENOC S.A., SASSENAGE, FRANCE, FILED 1-23-2003.

XENOC S

PRIORITY CLAIMED UNDER SEC. 44(D) ON FRANCE APPLICATION NO. 023178029, FILED 8-2-2002, REG. NO. 023178029, DATED 8-2-2002, EXPIRES 8-2-2012.

FOR OPTICAL DEVICES AND INSTRUMENTS, NAMELY REFLECTING OPTICAL COMPONENTS AND DEVICES FOR INFLUENCING RADIATION, ESPECIALLY SHORT-WAVELENGTH RADIATION, ESPECIALLY FLAT AND CURVED OPTICAL MIRRORS, NOT INCLUDING OPTICAL COMPONENTS AND DEVICES USED IN CONNECTION WITH INFRARED RADIATION AND NOT INCLUDING DETECTORS AND LASER SOURCES (U.S. CLS. 21, 23, 26, 36 AND 38).

MITCHELL FRONT, EXAMINING ATTORNEY

SN 78-210,358. CHOW, ALAN Y., WHEATON, IL. FILED 2-3-2003.

OPSI TOR

FOR OPTO-ELECTRONIC SEMICONDUCTOR (U.S. CLS. 21, 23, 26, 36 AND 38).

JOHN GARTNER, EXAMINING ATTORNEY

SN 78-211,495. VIRTUAL PERSONALITIES, INC., MALIBU, CA. FILED 2-6-2003.

READYAGENT

FOR COMPUTER PROGRAMS, NAMELY AN INTERACTIVE NATURAL LANGUAGE PROCESSING KNOWLEDGE BASE USED TO BUILD AND CUSTOMIZE INTERACTIVE CONVERSATIONAL MECHANISMS WHICH ASSIST, ANSWER QUESTIONS AND PROVIDE INFORMATION TO USERS OF WEB SITES, FOR USE IN REAL-TIME INTERNET RELAY COMMUNICATIONS PLATFORMS (U.S. CLS. 21, 23, 26, 36 AND 38).

RON FAIRBANKS, EXAMINING ATTORNEY

CLASS 9—(Continued).

SN 78-214,528. VULCAN INC., SEATTLE, WA. FILED 2-13-2003.

DRUMCORE

FOR COMPUTER SOFTWARE FEATURING A DATABASE OF MUSICAL INSTRUMENTAL SAMPLES AND LOOPS; AND COMPUTER SOFTWARE, FEATURING A DATABASE OF MUSICAL INSTRUMENTAL SAMPLES AND LOOPS THAT MAY BE DOWNLOADED FROM A GLOBAL COMPUTER NETWORK (U.S. CLS. 21, 23, 26, 36 AND 38).

ODESSA BIBBINS, EXAMINING ATTORNEY

SN 78-215,277. KYOCERA WIRELESS CORP., SAN DIEGO, CA. FILED 2-14-2003.

BLADE

FOR TELEPHONES, MOBILE AND CELLULAR TELEPHONES AND HANDSETS; ACCESSORIES FOR USE WITH TELEPHONES, MOBILE AND CELLULAR TELEPHONES AND HANDSETS, NAMELY, CELLULAR TELEPHONE BATTERIES, CELLULAR TELEPHONE POWER ADAPTERS, CAR POWER ADAPTERS FOR CELLULAR TELEPHONES AND HEADSET KITS COMPRISING OF HANDS FREE EARPIECE WITH MICROPHONE FOR CELLULAR TELEPHONES (U.S. CLS. 21, 23, 26, 36 AND 38).

TRACY CROSS, EXAMINING ATTORNEY

SN 78-221,768. XTHINK, INC., ROUND ROCK, TX. FILED 3-5-2003.

MATHJOURNAL

FOR TABLET PCS AND RECOGNITION SOFTWARE, NAMELY HANDWRITING AND VOICE RECOGNITION SOFTWARE FOR TABLET PCS (U.S. CLS. 21, 23, 26, 36 AND 38).

MATTHEW PAPPAS, EXAMINING ATTORNEY

SN 78-222,699. ION STORM, L.P., DALLAS, TX. FILED 3-6-2003.

DEUS EX: INVISIBLE WAR

NO CLAIM IS MADE TO THE EXCLUSIVE RIGHT TO USE "WAR", APART FROM THE MARK AS SHOWN.

FOR COMPUTER GAME SOFTWARE; COMPUTER GAME CARTRIDGES, COMPUTER GAME CASSETTES, COMPUTER GAME DISCS, VIDEO GAME CARTRIDGES, VIDEO GAME DISCS AND VIDEO GAME SOFTWARE; DOWNLOADABLE COMPUTER GAME SOFTWARE SUPPLIED ON-LINE BY MEANS OF MULTIMEDIA ELECTRONIC BROADCAST OR NETWORK TRANSMISSION; DOWNLOADABLE ELECTRONIC PUBLICATIONS, NAMELY, MAGAZINES AND NEWSLETTERS FEATURING ACTION AND ADVENTURE GAMES RECORDED ON COMPUTER MEDIA (U.S. CLS. 21, 23, 26, 36 AND 38).

INGA ERVIN, EXAMINING ATTORNEY

CLASS 9—(Continued).

SN 78-223,992. ONKYO CORPORATION, OSAKA, JAPAN, FILED 3-11-2003.

VLSC

OWNER OF JAPAN REG. NO. 4643196, DATED 2-7-2003, EXPIRES 2-7-2013.

FOR APPARATUS AND INSTRUMENTS FOR RECORDING, TRANSMISSION, REPRODUCTION, RECEIVING, DOWNLOADING, STORAGE AND EDITING OF SOUND IMAGES, NAMELY, PERSONAL STEREO, STEREO AMPLIFIERS, STEREO RECEIVERS, STEREO TUNERS, AUDIO AND VIDEO RECEIVERS, TELEVISION RECEIVERS, OPTICAL DISC PLAYERS AND RECORDERS, AUDIO AND VIDEO CASSETTE PLAYERS AND RECORDERS, PORTABLE DIGITAL MUSIC PLAYERS, RECORD PLAYERS, CAR STEREO, AUDIO SPEAKERS, AUDIO AND VIDEO BOARDS, HARD DISK PLAYERS AND RECORDERS, VIDEO PROJECTORS, VIDEO PROJECTOR SCREENS, VIDEO DISPLAYS, LOUDSPEAKERS, CABINETS FOR LOUDSPEAKERS, HEADPHONES, HORNS FOR LOUDSPEAKERS, SPEAKERS, DIGITAL AUDIO AND VIDEO SIGNAL PROCESSORS, DIGITAL AUDIO AND VIDEO NETWORK RECEIVERS, DIGITAL AUDIO AND VIDEO NETWORK SERVERS, COMPUTERS, PDA (PERSONAL DIGITAL ASSISTANTS), HARD DISK DRIVES, COMPUTER SOFTWARE FOR RECORDING, TRANSMISSION, REPRODUCTION, RECEIVING, DOWNLOADING, STORAGE AND EDITING OF SOUND OR IMAGES, STORAGE MEDIA HAVING COMPUTER SOFTWARE RECORDED THEREON, BLANK MEMORY CARRIERS FOR RECORDING, BLANK MEMORY DEVICES IN THE FORM OF CARDS, DISCS OR TAPES, COMPUTER SOFTWARE FOR RECORDED CARRIERS, CABLES FOR USE WITH AUDIO AND VIDEO APPARATUS; AND COMPUTERS; RACKS FOR USE WITH AUDIO AND VIDEO APPARATUS AND COMPUTERS, CABINETS FOR USE WITH AUDIO AND VIDEO APPARATUS AND COMPUTERS, SPEAKER MOUNTING BRACKETS, SPEAKER MOUNTING STANDS, REMOTE CONTROLLERS, ELECTRIC POWER SUPPLY FOR USE WITH AUDIO-VIDEO APPARATUS AND COMPUTERS (U.S. CLS. 21, 23, 26, 36 AND 38).

INGA ERVIN, EXAMINING ATTORNEY

SN 78-226,615. URBAN, KEITH, NASHVILLE, TN. FILED 3-17-2003.

KEITH URBAN

THE NAME KEITH URBAN IDENTIFIES A LIVING INDIVIDUAL WHOSE CONSENT IS OF RECORD.

FOR SERIES OF MUSICAL SOUND RECORDINGS, NAMELY COMPACT DISCS; AND DECORATIVE MAGNETS (U.S. CLS. 21, 23, 26, 36 AND 38).

FIRST USE 0-0-1999; IN COMMERCE 0-0-1999.

WON TEAK OH, EXAMINING ATTORNEY

CLASS 9—(Continued).

SN 78-229,103. ADT SECURITY SERVICES, INC., BOCA RATON, FL. FILED 3-24-2003.

VIDEOPPOINT

FOR VIDEO-BASED INFORMATION DISPLAY SYSTEM COMPRISING PLASMA FLAT-PANEL DISPLAY SCREEN, COMMUNICATIONS SERVER, STAND-BY POWER SUPPLY, PUSHBUTTON CONTROL PANEL, HARD DISK DRIVE AND DIGITAL VIDEO DISK DRIVES, FOR USE AS A PORTABLE ELECTRONIC INFORMATION KIOSK THAT PROVIDES PRE-RECORDED INFORMATIONAL CLIPS OR LIVE DATA DISPLAYS IN VARIOUS VENUES, INCLUDING AIRPORTS, BANKS, RETAIL OUTLETS, TRADE SHOWS AND HOTELS, AND FOR WIRELESS COMMUNICATION BETWEEN THE PORTABLE ELECTRONIC INFORMATION KIOSK AND THE CENTRAL SERVER (U.S. CLS. 21, 23, 26, 36 AND 38).

KIM SAITO, EXAMINING ATTORNEY

SN 78-229,650. IGT, RENO, NV. FILED 3-25-2003.

BONUS TIMES PAY

OWNER OF U.S. REG. NOS. 2,148,114, 2,765,273 AND OTHERS.

NO CLAIM IS MADE TO THE EXCLUSIVE RIGHT TO USE PAY, APART FROM THE MARK AS SHOWN.

FOR GAMING MACHINES, NAMELY, SLOT MACHINES OR LOTTERY TERMINALS WITH OR WITHOUT VIDEO OUTPUT (U.S. CLS. 21, 23, 26, 36 AND 38).

GEOFFREY FOSDICK, EXAMINING ATTORNEY

SN 78-230,478. GURNEY, CAROL, AGOURA, CA. FILED 3-26-2003.

HEARTTALK PROGRAM

NO CLAIM IS MADE TO THE EXCLUSIVE RIGHT TO USE "PROGRAM", APART FROM THE MARK AS SHOWN.

FOR PRE-RECORDED AUDIO AND VIDEO TAPES, PRE-RECORDED AUDIO AND VIDEO CASSETTES, AND PRE-RECORDED COMPACT DISCS, DVDS AND CD-ROMS, ALL FEATURING EDUCATIONAL INFORMATION ON THE SUBJECT OF TELEPATHIC COMMUNICATION WITH ANIMALS; EDUCATIONAL COMPUTER SOFTWARE FEATURING INSTRUCTION ON THE SUBJECT OF TELEPATHIC COMMUNICATION WITH ANIMALS (U.S. CLS. 21, 23, 26, 36 AND 38).

FIRST USE 12-14-1999; IN COMMERCE 12-14-1999.

SONYA STEPHENS, EXAMINING ATTORNEY

CLASS 9—(Continued).

SN 78-231,586. FLUENT ENTERTAINMENT, INC., NOVATO, CA. FILED 3-28-2003.

MAJESTIC CHESS

NO CLAIM IS MADE TO THE EXCLUSIVE RIGHT TO USE CHESS, APART FROM THE MARK AS SHOWN.

FOR COMPUTER CHESS GAME SOFTWARE AND USER INSTRUCTION MANUALS SOLD AS A UNIT; COMPUTER GAME SOFTWARE FOR USE IN PLAYING ONLINE COMPUTER GAMES, NAMELY, CHESS. (U.S. CLS. 21, 23, 26, 36 AND 38).

ALEX KEAM, EXAMINING ATTORNEY

SN 78-231,829. AMERICAN INTERNATIONAL GROUP, INC., NEW YORK, NY. FILED 3-31-2003.

AIG RISK MANAGEMENT JOURNAL

OWNER OF U.S. REG. NOS. 1,151,229, 1,172,557 AND 1,273,845.

NO CLAIM IS MADE TO THE EXCLUSIVE RIGHT TO USE "RISK MANAGEMENT JOURNAL", APART FROM THE MARK AS SHOWN.

FOR DOWNLOADABLE ONLINE NEWSLETTER IN THE FIELD OF INSURANCE AND RISK MANAGEMENT (U.S. CLS. 21, 23, 26, 36 AND 38).

FIRST USE 1-1-2003; IN COMMERCE 1-1-2003.

MARIA-VICTORIA SUAREZ, EXAMINING ATTORNEY

SN 78-233,074. PPT VISION, INC., EDEN PRAIRIE, MN. FILED 4-2-2003.

INSPECTION BUILDER

NO CLAIM IS MADE TO THE EXCLUSIVE RIGHT TO USE "INSPECTION", APART FROM THE MARK AS SHOWN.

FOR COMPUTER SOFTWARE USED IN MACHINE VISION APPLICATIONS FOR AUTOMATED INSPECTION AND PROCESS CONTROL OF MANUFACTURED PARTS FOR COMPUTER HARDWARE AND CAMERA FOR MANUFACTURING AND ASSEMBLY APPLICATIONS, NAMELY, LOCATING, IDENTIFYING, MEASURING AND EXAMINING OBJECTS FOR USE IN COMPLYING WITH INSPECTION REQUIREMENT IN THE AUTOMOTIVE, ELECTRONIC, SEMICONDUCTOR, FOOD AND BEVERAGE, PHARMACEUTICAL, MEDICAL DEVICE, COMPONENT PARTS, PLASTICS, WOOD AND CONSUMER PRODUCTS INDUSTRIES (U.S. CLS. 21, 23, 26, 36 AND 38).

FIRST USE 5-15-2002; IN COMMERCE 9-5-2002.

MARC LEIPZIG, EXAMINING ATTORNEY

CLASS 9—(Continued).

SN 78-233,394. THE SNUFFER CORPORATION INC., OAK BLUFF, MANITOBA, CANADA, FILED 4-3-2003.

ONE TOUCH

FOR PROGRAMMABLE FOAM CONTROL VALVES USED FOR FIREFIGHTING (U.S. CLS. 21, 23, 26, 36 AND 38).

JOHN LINCOSKI, EXAMINING ATTORNEY

SN 78-233,806. NIKKO STIRLING PTY LTD, DARLINGHURST, AUSTRALIA, FILED 4-3-2003.

NIKKO STIRLING

OWNER OF AUSTRALIA REG. NO. 762367, DATED 5-18-1998, EXPIRES 5-18-2008.

NO CLAIM IS MADE TO THE EXCLUSIVE RIGHT TO USE "STIRLING", APART FROM THE MARK AS SHOWN. THE ENGLISH TRANSLATION OF "NIKKO" IS "SUNSHINE", "SUNLIGHT", "SUNRAYS".

FOR TELESCOPIC RIFLE SCOPES, BINOCULARS AND TELESCOPES (U.S. CLS. 21, 23, 26, 36 AND 38).

FIRST USE 1-1-1970; IN COMMERCE 12-1-2002.

WILLIAM VERHOSEK, EXAMINING ATTORNEY

SN 78-235,347. NOVA DEVELOPMENT CORPORATION, CALABASAS, CA. FILED 4-8-2003.

PRINT MANIA

OWNER OF U.S. REG. NO. 2,168,005.

NO CLAIM IS MADE TO THE EXCLUSIVE RIGHT TO USE "PRINT", APART FROM THE MARK AS SHOWN.

FOR PRINT CREATIVITY COMPUTER SOFTWARE, NAMELY SOFTWARE FOR CREATING GREETING CARDS, SIGNS, BANNERS, AWARD CERTIFICATES, CRAFTS AND OTHER CUSTOM PRINTED MATERIALS, FOR HOME, HOME OFFICE AND PROFESSIONAL USE AND END USER INSTRUCTIONAL MANUALS SOLD AS A UNIT (U.S. CLS. 21, 23, 26, 36 AND 38).

BRENDAN MCCAULEY, EXAMINING ATTORNEY

SN 78-235,990. IGT, RENO, NV. FILED 4-9-2003.

ANYTHING'S WILD POKER

NO CLAIM IS MADE TO THE EXCLUSIVE RIGHT TO USE POKER, APART FROM THE MARK AS SHOWN.

FOR GAMING MACHINES, NAMELY, SLOT MACHINES WITH OR WITHOUT VIDEO OUTPUT OR VIDEO LOTTERY TERMINALS (U.S. CLS. 21, 23, 26, 36 AND 38).

MITCHELL FRONT, EXAMINING ATTORNEY

CLASS 9—(Continued).

SN 78-236,058. PMS SYSTEMS CORPORATION, SANTA MONICA, CA. FILED 4-10-2003.

ARO + ASSET REDUCTION AND OPTIMIZATION

NO CLAIM IS MADE TO THE EXCLUSIVE RIGHT TO USE "ASSET REDUCTION AND OPTIMIZATION", APART FROM THE MARK AS SHOWN.

FOR COMPUTER SOFTWARE FOR TRACKING AND MANAGING PHYSICAL ASSETS IN INDUSTRIAL ORGANIZATIONS AND GOVERNMENT AGENCIES (U.S. CLS. 21, 23, 26, 36 AND 38).

TRACY FLETCHER, EXAMINING ATTORNEY

SN 78-236,641. POSITRON PUBLIC SAFETY SYSTEMS CORPORATION, MONTREAL, QUEBEC, FILED 4-11-2003.

POWER MOBILE

FOR COMPUTER SOFTWARE FOR USE IN CONNECTION WITH RESOURCE AND INCIDENT MANAGEMENT SYSTEMS WHICH PROVIDE INSTANT COMMUNICATION AND ACCESS TO INCIDENT RELATED INFORMATION BY DISPATCHERS AND OTHER PERSONNEL WITHIN EMERGENCY RESPONSE VEHICLES AND EMERGENCY RESPONSE AGENCIES, NAMELY, POLICE DEPARTMENTS, FIRE DEPARTMENTS, PUBLIC SAFETY ANSWERING POINTS AND PUBLIC UTILITIES (U.S. CLS. 21, 23, 26, 36 AND 38).

FIRST USE 7-26-2000; IN COMMERCE 7-26-2000.
ALICIA COLLINS, EXAMINING ATTORNEY

SN 78-237,005. MECA COMMUNICATIONS, INC., REDDING, CA. FILED 4-11-2003.

EMERGE

FOR INSTANT MESSAGING SOFTWARE DIRECTED TO MUSIC MARKETERS FOR USE IN MUSIC AND ARTIST PROMOTION (U.S. CLS. 21, 23, 26, 36 AND 38).

FLORENTINA BLANDU, EXAMINING ATTORNEY

SN 78-237,241. FIBRE-METAL PRODUCTS COMPANY, THE, CONCARDVILLE, PA. FILED 4-14-2003.

TIGERHOOD FUTURA

OWNER OF U.S. REG. NOS. 2,025,365 AND 2,400,660.
THE ENGLISH TRANSLATION OF FUTURA IN THE MARK IS FUTURE.
FOR WELDING HELMETS (U.S. CLS. 21, 23, 26, 36 AND 38).

FIRST USE 9-1-2001; IN COMMERCE 9-1-2001.
STACY WAHLBERG, EXAMINING ATTORNEY

CLASS 9—(Continued).

SN 78-239,035. ZODIAC INTERNATIONAL, ISSY LES MOULINEAUX, FRANCE, FILED 4-17-2003.

OWNER OF U.S. REG. NO. 2,045,460.

FOR SAFETY APPARATUS DESIGNED TO PROTECT A PERSON AGAINST DROWING, NAMELY, LIFE JACKETS, LIFE PRESERVERS, FLOATING COLLARS, LIFE BELTS, LIFE SAVING RAFTS, LIFE SAVING FLOATS, LIFE SAVING PILLOWS, AND SAFETY FLOTATION DEVICES (U.S. CLS. 21, 23, 26, 36 AND 38).

HOWARD SMIGA, EXAMINING ATTORNEY

SN 78-239,311. AICO SYSTEMS INC, CITY OF INDUSTRY, CA. FILED 4-17-2003.

FOR TELEPHONE, NAMELY, AN INTERNET PROTOCOL TELEPHONE DEVICE FOR COMMUNICATING OR CALLING PURPOSES (U.S. CLS. 21, 23, 26, 36 AND 38).

KARLA PERKINS, EXAMINING ATTORNEY

SN 78-239,586. JIANGSU SHINCO ELECTRONICS GROUP CO., LTD., JIANGSU, CHINA, FILED 4-18-2003.

THE NON-LATIN CHARACTER(S) IN THE MARK TRANSLITERATES INTO LU LU TONG, AND THIS MEANS NOTHING IN ENGLISH.

FOR DIGITAL VIDEO DISC PLAYERS; VIDEO COMPACT DISC PLAYERS; COMPACT DISC PLAYERS; COMPUTERS; DISK DRIVES FOR COMPUTERS; TELEPHONES; NAVIGATION APPARATUS FOR VEHICLES, NAMELY, NAVIGATION APPARATUS FOR VEHICLES IN THE NATURE OF ONBOARD COMPUTERS; APPARATUS FOR AMUSEMENT GAME USE WITH TELEVISION RECEIVERS ONLY; PRERECORDED COMPACT DISCS FEATURING MUSIC; AND CAMCORDERS (U.S. CLS. 21, 23, 26, 36 AND 38).

JANICE L. MCMORROW, EXAMINING ATTORNEY

CLASS 9—(Continued).

SN 78-241,226. ANALOG DEVICES, INC., NORWOOD, MA. FILED 4-23-2003.

SIMPLE SEQUENCING

NO CLAIM IS MADE TO THE EXCLUSIVE RIGHT TO USE SEQUENCING, APART FROM THE MARK AS SHOWN.

FOR INTEGRATED CIRCUITS (U.S. CLS. 21, 23, 26, 36 AND 38).
CHERYL CLAYTON, EXAMINING ATTORNEY

SN 78-241,775. XILINX, INC., SAN JOSE, CA. FILED 4-24-2003.

ROCKETPHY

FOR COMPUTER HARDWARE, COMPUTER PERIPHERALS, TELECOMMUNICATIONS AND NETWORKING EQUIPMENT, NAMELY, INTEGRATED CIRCUITS AND TRANSCEIVERS; COMPUTER SOFTWARE FOR USE IN TELECOMMUNICATION AND DATA COMMUNICATION TRANSCIEVER APPLICATIONS AND FOR USE IN PROGRAMMING INTEGRATED CIRCUITS (U.S. CLS. 21, 23, 26, 36 AND 38).

LEIGH CAROLINE CASE, EXAMINING ATTORNEY

SN 78-242,469. INFOASSURE, INC., ARNOLD, MD. FILED 4-26-2003.

INFOCENSEC

FOR INTEGRATED COMPUTER SOFTWARE AND HARDWARE USED TO CONTROL THE ACCESS TO AND USE OF INFORMATION OBJECTS (U.S. CLS. 21, 23, 26, 36 AND 38).

MITCHELL FRONT, EXAMINING ATTORNEY

SN 78-243,413. EXPERT DEALER SERVICES, LLC, CAMARILLO, CA. FILED 4-29-2003.

MAGIC TRAK

FOR VEHICLE LOCATING, TRACKING, AND SECURITY SYSTEM INCORPORATING A GLOBAL POSITIONING SYSTEM (GPS) (U.S. CLS. 21, 23, 26, 36 AND 38).

SOPHIA S. KIM, EXAMINING ATTORNEY

CLASS 9—(Continued).

SN 78-243,627. REPRESENTACIONES ARTISTICAS APODACA, S.A. DE C.V., MONTERREY, MEXICO, FILED 4-30-2003.



OWNER OF MEXICO REG. NO. 424433, DATED 10-24-1991. EXPIRES 10-24-2011.

OWNER OF MEXICO REG. NO. 630941, DATED 3-6-1998, EXPIRES 3-6-2008.

FOR PRERECORDED AUDIO AND VISUAL RECORDINGS IN ALL FORMS, NAMELY, CASSETTE TAPES, COMPACT DISCS, PHONOGRAPH RECORDS, AUDIO AND VIDEO TAPES ALL FEATURING MUSIC (U.S. CLS. 21, 23, 26, 36 AND 38).

FIRST USE 1-1-1985; IN COMMERCE 1-1-1985.

GIANCARLO CASTRO, EXAMINING ATTORNEY

SN 78-243,835. SENSORMATIC ELECTRONICS CORPORATION, BOCA RATON, FL. FILED 4-30-2003.

SENSORID

FOR COMPUTER HARDWARE AND SOFTWARE FOR USE CONTROLLING AND MONITORING RFID SYSTEMS AND ELECTRONIC ARTICLE SURVEILLANCE SYSTEMS, INCLUDING TAGS, LABELS, READERS, ANTENNAS, AND MULTIPLEXERS (U.S. CLS. 21, 23, 26, 36 AND 38).

LAVERNE THOMPSON, EXAMINING ATTORNEY

SN 78-244,131. OREGON CATHOLIC PRESS, PORTLAND, OR. FILED 4-30-2003.

SPIRIT & SONG

FOR SERIES OF PRERECORDED COMPACT DISCS CONTAINING RELIGIOUS MUSIC (U.S. CLS. 21, 23, 26, 36 AND 38).

FIRST USE 11-0-1998; IN COMMERCE 10-21-1999.

DARLENE BULLOCK, EXAMINING ATTORNEY

CLASS 9—(Continued).

SN 78-244,972. APOLLO TELEMEDICINE, INC., FALLS CHURCH, VA. FILED 5-2-2003.

ASAP IMAGING

NO CLAIM IS MADE TO THE EXCLUSIVE RIGHT TO USE IMAGING, APART FROM THE MARK AS SHOWN.

FOR COMPUTER SOFTWARE FOR MANAGING, MANIPULATING, TRANSMITTING, DISPLAYING AND RECEIVING MEDICAL IMAGES; COMPUTER SOFTWARE NAMED STREAMING SOFTWARE FOR SENDING MEDICAL IMAGES OVER A COMPUTER NETWORK, INTRANET OR INTERNET; COMPUTER SOFTWARE FOR PROVIDING REMOTE ACCESS TO A MICROSCOPE; COMPUTER SOFTWARE FOR TRANSMITTING MICROSCOPE IMAGES TO REMOTE SITES; MEDICAL DIAGNOSTIC IMAGING SOFTWARE; COMPUTER SOFTWARE FOR CONSOLIDATING IMAGES INTO MEDICAL REPORTS; COMPUTER HARDWARE FOR MANAGING, MANIPULATING, TRANSMITTING, DISPLAYING AND RECEIVING MEDICAL IMAGES; COMPUTER HARDWARE FOR SENDING MEDICAL IMAGES OVER A COMPUTER NETWORK, INTRANET OR INTERNET; COMPUTER HARDWARE FOR PROVIDING REMOTE ACCESS TO A MICROSCOPE; COMPUTER HARDWARE FOR TRANSMITTING MICROSCOPE IMAGES TO REMOTE SITES (U.S. CLS. 21, 23, 26, 36 AND 38).

FIRST USE 3-24-2003; IN COMMERCE 3-24-2003.
MARY CRAWFORD, EXAMINING ATTORNEY

SN 78-245,768. AMERICAN TECHNOLOGY CORPORATION, SAN DIEGO, CA. FILED 5-5-2003.

HYPER DIRECTIONAL

NO CLAIM IS MADE TO THE EXCLUSIVE RIGHT TO USE DIRECTIONAL, APART FROM THE MARK AS SHOWN.

FOR PARAMETRIC LOUDSPEAKERS; LOUDSPEAKERS WITH CONTROLLED DISPERSION; LOUDSPEAKERS FOR USE AS A COMPONENT IN SOUND REPRODUCTION EQUIPMENT (U.S. CLS. 21, 23, 26, 36 AND 38).

GWEN STOKOLS, EXAMINING ATTORNEY

SN 78-246,349. PROTEL, INC., LAKELAND, FL. FILED 5-6-2003.

PROSCAN

FOR MECHANISMS FOR COIN-OPERATED TELEPHONES, NAMED ELECTROMAGNETIC DETECTORS FOR IDENTIFYING THE TYPE OF COIN INSERTED INTO THE TELEPHONE (U.S. CLS. 21, 23, 26, 36 AND 38).

AMY GEARIN, EXAMINING ATTORNEY

CLASS 9—(Continued).

SN 78-246,791. CYRIL, PACIULLO, LONGUEUIL, CANADA, FILED 5-7-2003.

PATCHOU

FOR DOWNLOADABLE INTERNET RELAY CHAT LOG VIEWER SOFTWARE USED TO READ MESSAGES PREVIOUSLY RECORDED ON INTERNET RELAY CHAT SERVERS (U.S. CLS. 21, 23, 26, 36 AND 38).

FIRST USE 1-12-2004; IN COMMERCE 1-12-2004.
BARBARA GAYNOR, EXAMINING ATTORNEY

SN 78-247,433. FERRITTO, GEORGE ANTHONY, COLUMBUS, OH. FILED 5-8-2003.



NO CLAIM IS MADE TO THE EXCLUSIVE RIGHT TO USE "BIG SOUND", APART FROM THE MARK AS SHOWN.

THE MARK CONSISTS OF THE WORDING MACROLINE BIG SOUND AND THE STYLIZED REPRESENTATION OF A LOUDSPEAKER AND A CATERPILLAR PLAYING AN ELECTRIC GUITAR.

FOR AMPLIFIERS, AUDIO MIXERS, AUDIO SPEAKERS, ELECTRONIC EFFECT PEDALS FOR USE WITH SOUND AMPLIFIERS, GUITAR AMPLIFIERS, LOUDSPEAKERS (U.S. CLS. 21, 23, 26, 36 AND 38).

BRIAN PINO, EXAMINING ATTORNEY

SN 78-249,122. HEYMANN, FRED, NEW YORK, NY. FILED 5-13-2003.



FOR ONLINE AND ONSITE COMPUTER SOFTWARE FOR COMPLETE REGISTRATION PROCESS FOR CONFERENCES AND TRADESHOWS (U.S. CLS. 21, 23, 26, 36 AND 38).

GIANCARLO CASTRO, EXAMINING ATTORNEY

CLASS 9—(Continued).

SN 78-252,584. AURARIA NETWORKS, INC., BOLTON, MA. FILED 5-21-2003.

AURARIA

FOR COMPUTER HARDWARE PLATFORM, NAMELY PACKET SWITCH AND PROCESSOR FOR PERFORMING PACKET SWITCHING, PROTOCOL TRANSLATION, AND ENABLING MANAGED SERVICES OVER EXISTING NETWORK INFRASTRUCTURE; COMPUTER PROGRAMS FOR PERFORMING PACKET SWITCHING, PROTOCOL TRANSLATION, AND ENABLING MANAGED SERVICES OVER EXISTING NETWORK INFRASTRUCTURE (U.S. CLS. 21, 23, 26, 36 AND 38).

RUDY R. SINGLETON, EXAMINING ATTORNEY

SN 78-252,823. ZBECKER INDUSTRIES, LAKEWOOD, CA. FILED 5-21-2003.

ZBECKER

FOR SECURITY PRODUCTS, NAMELY, ANTI-INTRUSION ALARMS (U.S. CLS. 21, 23, 26, 36 AND 38). FIRST USE 7-0-2002; IN COMMERCE 7-0-2002. MARY CRAWFORD, EXAMINING ATTORNEY

CLASS 9—(Continued).

SN 78-254,331. INSIGHT TECHNOLOGY INCORPORATED, LONDONDERRY, NH. FILED 5-27-2003.

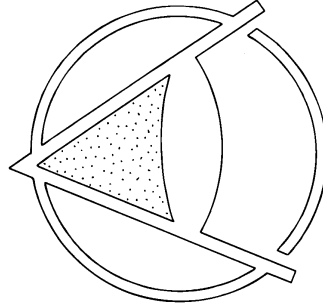

OWNER OF U.S. REG. NO. 2,282,440. THE STIPPLING IN THE MARK IS FOR SHADING PURPOSES ONLY.

FOR LIGHT BEAM EMITTERS FOR TARGET ILLUMINATION, AND FILTERS, INTERFACES, CONTROLLERS AND MOUNTING ASSEMBLIES THEREFOR; NIGHT VISION SYSTEMS, NAMELY NIGHT VISION GOGGLES, NIGHT VISION MONOCULARS, NIGHT VISION SCOPES, NIGHT VISION WEAPON SIGHTS, PANORAMIC NIGHT VISION GOGGLES, FUSION GOGGLES, FUSION MONOCULARS, FUSION SCOPES, FUSION WEAPON SIGHTS, GPS UNITS, ELECTRONIC COMPASSES, FRIEND OR FOE IDENTIFIERS, TARGET DESIGNATORS, FIRE CONTROLLERS, LASER BASED TRAINERS AND ENGAGEMENT INSTRUMENTS, AND INTERFACES, CONTROLLERS AND MOUNTING ASSEMBLIES THEREFOR (U.S. CLS. 21, 23, 26, 36 AND 38).

FIRST USE 12-0-2002, THE MARK WAS FIRST USED ANYWHERE IN A DIFFERENT FORM OTHER THAN THAT SOUGHT TO BE REGISTERED ON 04/00/1988.; IN COMMERCE 12-0-2002, THE MARK WAS FIRST USED IN COMMERCE IN A DIFFERENT FORM OTHER THAN THAT SOUGHT TO BE REGISTERED ON 04/00/1988..

GEORGIA CARTY, EXAMINING ATTORNEY

SN 78-254,990. G COM 2 SOLUTIONS, INC., ASTON, PA. FILED 5-28-2003.

FUNDSUITE SX

OWNER OF U.S. REG. NOS. 2,691,702 AND 2,698,704. NO CLAIM IS MADE TO THE EXCLUSIVE RIGHT TO USE "FUNDSUITE", APART FROM THE MARK AS SHOWN.

FOR COMPUTER SOFTWARE, NAMELY, FINANCIAL SOFTWARE FOR THE AUTOMATED PREPARATION, MANAGEMENT, AND PRODUCTION OF MUTUAL FUND FINANCIAL REPORTS AS TYPICALLY USED IN SHAREHOLDER REPORTS, INCLUDING GENERAL LEDGER FINANCIAL STATEMENTS, STATEMENTS OF INVESTMENTS, AND RELATED FOOTNOTE MATERIAL (U.S. CLS. 21, 23, 26, 36 AND 38).

FIRST USE 9-1-2000; IN COMMERCE 9-1-2000.

DOUGLAS LEE, EXAMINING ATTORNEY

CLASS 9—(Continued).

SN 78-255,897. ADVANCED BATTERY SYSTEMS, INC., STOUGHTON, MA. FILED 5-29-2003.

BATTERIES ON THE GO

NO CLAIM IS MADE TO THE EXCLUSIVE RIGHT TO USE "BATTERIES", APART FROM THE MARK AS SHOWN. FOR BATTERIES, BATTERY PACKS, AND BATTERY CHARGERS FOR CONSUMER AND INDUSTRIAL ELECTRONICS (U.S. CLS. 21, 23, 26, 36 AND 38).
PAULA MAYS, EXAMINING ATTORNEY

SN 78-260,586. BECTON, DICKINSON AND COMPANY, FRANKLIN LAKES, NJ. FILED 6-10-2003.



OWNER OF U.S. REG. NO. 2,730,480 AND OTHERS. THE MARK CONSISTS IN PART OF A SHADED CIRCLE WITH SUNBURST AND PARTIAL ARC DESIGN. FOR PATIENT IDENTIFICATION SYSTEMS, NAMELY COMPUTER HARDWARE AND SOFTWARE FOR MANAGING, TRACKING AND PROCESSING PATIENT DATA INFORMATION (U.S. CLS. 21, 23, 26, 36 AND 38).
GENE MACIOL, EXAMINING ATTORNEY

SN 78-261,652. INTERFACE CORPORATION, HIROSHIMA, JAPAN, FILED 6-12-2003.



OWNER OF U.S. REG. NO. 2,507,463. FOR COMPUTER INTERFACE BOARDS, CPU BOARDS, COMPUTER BUS ADD-IN UNITS AND COMPUTER BUS SLOTS. (U.S. CLS. 21, 23, 26, 36 AND 38).
SAMUEL E. SHARPER JR., EXAMINING ATTORNEY

SN 78-268,001. SAFT AMERICA INC., VALDOSTA, GA. FILED 6-27-2003.

CANProbe

FOR ELECTRONIC CONTROLS FOR BATTERY SYSTEMS, NAMELY, ELECTRONIC CONTROLS USED TO PROTECT BATTERY CELLS AGAINST OVERCHARGING, OVERDISCHARGING AND OVERHEATING AND TO PROVIDE FOR BATTERY CELL CHARGE EQUALIZATION (U.S. CLS. 21, 23, 26, 36 AND 38).
DORITT L. CARROLL, EXAMINING ATTORNEY

CLASS 9—(Continued).

SN 78-268,448. MATTEL, INC., EL SEGUNDO, CA. FILED 6-29-2003.

MERMAID ADVENTURE

OWNER OF U.S. REG. NO. 2,155,292. NO CLAIM IS MADE TO THE EXCLUSIVE RIGHT TO USE "MERMAID", APART FROM THE MARK AS SHOWN. FOR COMPUTER GAME CARTRIDGES, VIDEO GAME CARTRIDGES, INTERACTIVE VIDEO GAME PROGRAMS, INTERACTIVE MULTIMEDIA COMPUTER GAME PROGRAMS, PRERECORDED COMPUTER STORYTELLING SOFTWARE, AUDIO AND VIDEO CASSETTES FEATURING GAMES AND STORYTELLING, MUSICAL, AUDIO AND VIDEO SOUND RECORDINGS FEATURING GAMES AND STORYTELLING, SCREENSAVER PROGRAMS, CD-ROMS FEATURING DIRECTORIES OF DOLLS AND COLLECTIBLES, SUNGLASSES (U.S. CLS. 21, 23, 26, 36 AND 38).
SUELLEN HICKEY, EXAMINING ATTORNEY

SN 78-268,450. MATTEL, INC., EL SEGUNDO, CA. FILED 6-29-2003.

MIXIN' IT

FOR COMPUTER GAME CARTRIDGES, VIDEO GAME CARTRIDGES, INTERACTIVE VIDEO GAME PROGRAMS, INTERACTIVE MULTIMEDIA COMPUTER GAME PROGRAMS, PRERECORDED COMPUTER STORYTELLING SOFTWARE, AUDIO AND VIDEO CASSETTES FEATURING GAMES AND STORYTELLING, MUSICAL, AUDIO AND VIDEO SOUND RECORDINGS FEATURING GAMES AND STORYTELLING, SCREENSAVER PROGRAMS, CD-ROMS FEATURING DIRECTORIES OF DOLLS AND COLLECTIBLES, SUNGLASSES (U.S. CLS. 21, 23, 26, 36 AND 38).
SUELLEN HICKEY, EXAMINING ATTORNEY

SN 78-270,628. OLIVE TREE BIBLE SOFTWARE, INC, LAKE OSWEGO, OR. FILED 7-4-2003.

BIBLEREADER

FOR COMPUTER SOFTWARE FOR USE IN ELECTRONIC DOCUMENT STORAGE, MANIPULATION, TRANSFER AND RETRIEVAL IN THE FIELD OF BIBLE READING AND PROFESSIONAL BIBLE RESEARCH (U.S. CLS. 21, 23, 26, 36 AND 38).
FIRST USE 10-11-1998; IN COMMERCE 7-1-1999.
MARGERY A. TIERNEY, EXAMINING ATTORNEY

CLASS 9—(Continued).

SN 78-272,686. PS ENGINEERING, INC., LENOIR CITY, TN.
FILED 7-10-2003.

FLYING NEVER SOUNDED SO GOOD!

FOR AUDIO CONTROL SYSTEMS COMPRISING AIRCRAFT AUDIO SELECTOR PANELS, DIGITAL RECORDERS AND ORAL WARNING SYSTEMS COMPRISING A DIGITAL RECORDING DEVICE FOR AUTOMATIC STORAGE AND PLAYBACK OF AUDIO AND AIRCRAFT RADIO MESSAGES, IN-FLIGHT ENTERTAINMENT SYSTEMS COMPRISING AM/FM RADIO, SATELLITE RADIO, CD, MP3, AND DVD PLAYERS, AND INTERCOMS (U.S. CLS. 21, 23, 26, 36 AND 38).

FIRST USE 9-5-2002; IN COMMERCE 9-5-2002.
CURTIS FRENCH, EXAMINING ATTORNEY

SN 78-273,912. U.S.A. C-MARK LIGHT & AUDIO INC., SAN GABRIEL, CA. FILED 7-14-2003.

PALACE

FOR AUDIO SPEAKERS, SPEAKER BOXES, SPEAKER ENCLOSURES, AMPLIFIERS, AUDIO MIXERS, GRAPHIC EQUALIZERS, SURROUND SOUND PROCESSORS, RADIO TUNERS, WIRED OR WIRELESS MICROPHONE, LIGHTING EQUIPMENT FOR STAGE, NAMELY, ELECTRIC LIGHT CONNECTORS AND SWITCHES, AND REPLACEMENT PARTS FOR ALL OF THE AFOREMENTIONED GOODS (U.S. CLS. 21, 23, 26, 36 AND 38).

FIRST USE 2-15-2003; IN COMMERCE 2-15-2003.
ALEX KEAM, EXAMINING ATTORNEY

SN 78-273,983. DRB LIT LTD., IRVING, TX. FILED 7-14-2003.

TULIP

FOR COMPUTER SOFTWARE FOR USE IN THE FIELDS OF WORKFORCE DEVELOPMENT AND PERSONAL LEARNING (U.S. CLS. 21, 23, 26, 36 AND 38).

DOMINICK J. SALEMI, EXAMINING ATTORNEY

SN 78-274,108. DRB LIT LTD., IRVING, TX. FILED 7-14-2003.

THE ULTIMATE LEARNING INTERNET PROGRAM

NO CLAIM IS MADE TO THE EXCLUSIVE RIGHT TO USE "INTERNET PROGRAM", APART FROM THE MARK AS SHOWN.

FOR COMPUTER SOFTWARE FOR USE IN THE FIELDS OF WORKFORCE DEVELOPMENT AND PERSONAL LEARNING (U.S. CLS. 21, 23, 26, 36 AND 38).

DOMINICK J. SALEMI, EXAMINING ATTORNEY

CLASS 9—(Continued).

SN 78-278,132. WMS GAMING INC., WAUKEGAN, IL.
FILED 7-24-2003.

CASH FLOW

NO CLAIM IS MADE TO THE EXCLUSIVE RIGHT TO USE CASH, APART FROM THE MARK AS SHOWN.

FOR CURRENCY AND CREDIT OPERATED SLOT MACHINES AND GAMING DEVICES, NAMELY, GAMING MACHINES FOR USE IN GAMING ESTABLISHMENTS (U.S. CLS. 21, 23, 26, 36 AND 38).

SONYA STEPHENS, EXAMINING ATTORNEY

SN 78-279,717. ARLEX TECHNOLOGIES, INC., CHICAGO, IL. FILED 7-28-2003.

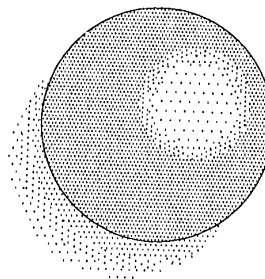

THE STIPLING IS A FEATURE OF THE MARK.
THE MARK CONSISTS OF A MEDIUM TONALITY GREEN SPHERE CASTING A SHADOW BELOW AND TO THE LEFT, AS IF IN FRONT OF A WHITE WALL, ILLUMINATED FROM A LIGHT SOURCE ABOVE AND TO THE RIGHT OF THE SPHERE.

FOR COMPUTER AUTOMATION SOFTWARE FOR USE IN AUTOMATING THE GENERATION OF SOFTWARE, PRINTED AND ELECTRONIC DOCUMENTATION, AND AUTOMATING THE GENERATION OF INTERNET WEB PAGES (U.S. CLS. 21, 23, 26, 36 AND 38).

PAULA MAYS, EXAMINING ATTORNEY

SN 78-283,896. CON-CISE LENS CO., INC., SAN LEANDRO, CA. FILED 8-6-2003.

REVLENS

FOR CONTACT LENSES (U.S. CLS. 21, 23, 26, 36 AND 38).

CHARLES L. JENKINS, EXAMINING ATTORNEY

CLASS 9—(Continued).

SN 78-284,094. THE STAYWELL COMPANY, YARDLEY, PA. FILED 8-6-2003.

STAYWELL SOLUTIONS

OWNER OF U.S. REG. NO. 1,189,585.
NO CLAIM IS MADE TO THE EXCLUSIVE RIGHT TO USE SOLUTIONS, APART FROM THE MARK AS SHOWN.
FOR PRE-RECORDED VIDEOTAPES AND COMPUTER SOFTWARE PROGRAMS ON CD ROM, DATABASE COMPUTER PROGRAMS AND SOFTWARE ACCESSIBLE ON WEBSITES, ALL OF WHICH FEATURE INFORMATION ABOUT HEALTH, WELLNESS, NUTRITION, AND SELF-IMPROVEMENT (U.S. CLS. 21, 23, 26, 36 AND 38).

ODESSA BIBBINS, EXAMINING ATTORNEY

SN 78-294,567. VIDEO GAMING TECHNOLOGIES, INC., ROEBUCK, TN. FILED 9-1-2003.

HOT RED RUBY

FOR COMPUTER SOFTWARE OR FIRMWARE FOR OPERATING GAMES OF CHANCE ON ANY COMPUTERIZED PLATFORM, INCLUDING DEDICATED GAMING CONSOLES, VIDEO AND REEL BASED SLOT MACHINES, AND VIDEO LOTTERY TERMINALS; GAMING DEVICES, NAMELY, GAMING MACHINES, SLOT MACHINES, COMPUTERIZED BINGO MACHINES, WITH OR WITHOUT VIDEO OUTPUT (U.S. CLS. 21, 23, 26, 36 AND 38).

MELVIN AXILBUND, EXAMINING ATTORNEY

SN 78-294,570. VIDEO GAMING TECHNOLOGIES, INC., ROEBUCK, TN. FILED 9-1-2003.

MAMA'S MILLIONS

FOR COMPUTER SOFTWARE OR FIRMWARE FOR OPERATING GAMES OF CHANCE ON ANY COMPUTERIZED PLATFORM, INCLUDING DEDICATED GAMING CONSOLES, VIDEO AND REEL BASED SLOT MACHINES, AND VIDEO LOTTERY TERMINALS; GAMING DEVICES, NAMELY, GAMING MACHINES, SLOT MACHINES, COMPUTERIZED BINGO MACHINES, WITH OR WITHOUT VIDEO OUTPUT (U.S. CLS. 21, 23, 26, 36 AND 38).

MELVIN AXILBUND, EXAMINING ATTORNEY

SN 78-294,580. VIDEO GAMING TECHNOLOGIES, INC., ROEBUCK, TN. FILED 9-1-2003.

HOT SEAT

FOR COMPUTER SOFTWARE OR FIRMWARE FOR OPERATING GAMES OF CHANCE ON ANY COMPUTERIZED PLATFORM, INCLUDING DEDICATED GAMING CONSOLES, VIDEO AND REEL BASED SLOT MACHINES, AND VIDEO LOTTERY TERMINALS; GAMING DEVICES, NAMELY, GAMING MACHINES, SLOT MACHINES, COMPUTERIZED BINGO MACHINES, WITH OR WITHOUT VIDEO OUTPUT (U.S. CLS. 21, 23, 26, 36 AND 38).

MELVIN AXILBUND, EXAMINING ATTORNEY

CLASS 9—(Continued).

SN 78-295,317. NIPPON DENKI KABUSHIKI KAISHA, DBA NEC CORPORATION, TOKYO, JAPAN, FILED 9-3-2003.

UNIVERGE

FOR COMPUTER HARDWARE; NETWORKING HARDWARE FOR WIRELESS COMMUNICATIONS; NETWORK APPARATUS, NAMELY, COMPUTERS, COMPUTER SERVERS, TELEPHONES, ASYNCHRONOUS TRANSFER MODE SWITCHES, PRIVATE BRANCH EXCHANGES, ELECTRICAL SWITCHES, FIBER OPTIC CABLES, ROUTERS, TRANSMITTERS, MULTIPLEXERS, MODEMS, AMPLIFIERS, HUBS AND BUS; NETWORKING SOFTWARE FOR WIRELESS COMMUNICATIONS AND CONNECTIVITY; COMPUTER SOFTWARE FOR ESTABLISHING, ENABLING, MONITORING, AND MANAGING WIRELESS COMMUNICATIONS AND CONNECTIVITY BETWEEN WIRELESS DEVICES AND COMMUNICATIONS NETWORKS; COMPUTER SOFTWARE FOR INTERCONNECTING, MANAGING, SECURING AND OPERATING LOCAL AND WIDE AREA NETWORKS AND TELEPHONY SYSTEMS; COMPUTER SOFTWARE FOR USE IN CONTROLLING AND MANAGING COMPUTERS, COMPUTER SERVERS, TELEPHONES, ASYNCHRONOUS TRANSFER MODE SWITCHES, PRIVATE BRANCH EXCHANGES, ELECTRICAL SWITCHES, FIBER OPTIC CABLES, ROUTERS, TRANSMITTERS, MULTIPLEXERS, MODEMS, AMPLIFIERS, HUBS AND BUS (U.S. CLS. 21, 23, 26, 36 AND 38).

MATTHEW KLINE, EXAMINING ATTORNEY

SN 78-296,534. GRAECO, AUSTIN, TX. FILED 9-5-2003.

EDUTAINER

FOR ELECTRONIC APPARATI, NAMELY, REMOTE CONTROLS FOR SWITCHING BETWEEN SELECTED TELEVISION INPUTS (U.S. CLS. 21, 23, 26, 36 AND 38).

NICHOLAS ALTREE, EXAMINING ATTORNEY

SN 78-296,542. GOLDHIL HOME MEDIA INTERNATIONAL, INC., THOUSAND OAKS, CA. FILED 9-5-2003.

ISLAND GIRL

FOR PRERECORDED VIDEO TAPES AND DVD'S, ALL IN THE FIELDS OF FITNESS, DANCE AND EXERCISE (U.S. CLS. 21, 23, 26, 36 AND 38).

NICHOLAS ALTREE, EXAMINING ATTORNEY

SN 78-296,886. TRUSTGENIX, INC., SAN JOSE, CA. FILED 9-5-2003.

IDENTITYBRIDGE

FOR COMPUTER HARDWARE; COMPUTER PERIPHERALS; COMPUTER SECURITY SOFTWARE TO ENABLE SECURE PROVISION, TRANSMISSION AND SHARING OF PERSONAL IDENTIFICATION AND AUTHENTICATION INFORMATION OVER GLOBAL COMPUTER NETWORKS (U.S. CLS. 21, 23, 26, 36 AND 38).

CATHERINE CAIN, EXAMINING ATTORNEY

CLASS 9—(Continued).

SN 78-297,684. LOGIC SOFTWARE, INC., RICHARDSON, TX. FILED 9-9-2003.

SALON IQ

NO CLAIM IS MADE TO THE EXCLUSIVE RIGHT TO USE SALON, APART FROM THE MARK AS SHOWN.

FOR COMPUTER SOFTWARE FOR PROVIDING APPOINTMENT SCHEDULING FOR USE IN THE FIELD OF BEAUTY SALON MANAGEMENT (U.S. CLS. 21, 23, 26, 36 AND 38).

MARK T. MULLEN, EXAMINING ATTORNEY

SN 78-297,715. ACCESSORIT, INC., BROOKLYN, NY. FILED 9-9-2003.

MobileGlove

NO CLAIM IS MADE TO THE EXCLUSIVE RIGHT TO USE "MOBILE", APART FROM THE MARK AS SHOWN.

FOR CARRYING CASES FOR CELLULAR PHONES, PERSONAL DIGITAL ASSISTANTS, DIGITAL CAMERAS, CAMCORDERS, AND OTHER ELECTRONIC AND WIRELESS DEVICES (U.S. CLS. 21, 23, 26, 36 AND 38).

BILL DAWE, EXAMINING ATTORNEY

SN 78-300,286. ARGO-TECH CORPORATION COSTA MESA, COSTA MESA, CA. FILED 9-15-2003.

AVR2000

FOR COMPUTER SOFTWARE AND HARDWARE USED TO RECEIVE, STORE AND TRANSMIT AIRCRAFT REFUELING DATA, AND ASSOCIATED MANUALS AND WRITTEN MATERIALS SOLD AS A UNIT THEREWITH (U.S. CLS. 21, 23, 26, 36 AND 38).

FIRST USE 2-0-1998; IN COMMERCE 2-0-1998.
HOWARD SMIGA, EXAMINING ATTORNEY

SN 78-301,005. NEGOTIATION SKILLS COMPANY, INC. THE, PRIDE'S CROSSING, MA. FILED 9-16-2003.

**THE NEGOTIATOR'S
INTEREST MAP**

NO CLAIM IS MADE TO THE EXCLUSIVE RIGHT TO USE "NEGOTIATOR'S", APART FROM THE MARK AS SHOWN.

FOR COMPUTER SOFTWARE FOR USE IN PREPARING FOR NEGOTIATION, NAMELY, FOR USE IN IDENTIFYING RELEVANT ISSUES, ANALYZING THE INTERESTS OF STAKEHOLDERS, STRUCTURING ARGUMENTS, AND DEVELOPING NEGOTIATION STRATEGIES (U.S. CLS. 21, 23, 26, 36 AND 38).

CHRISTOPHER BUONGIORNO, EXAMINING ATTORNEY

CLASS 9—(Continued).

SN 78-301,345. TOPOLOGY LIMITED, YORK, NORTH YORKSHIRE, UNITED KINGDOM, FILED 9-17-2003.

DEEP SPACE

FOR COMPUTER SOFTWARE FOR USE IN COMPUTER FILE SYSTEM MANAGEMENT, COMPUTER DATA STORAGE MANAGEMENT, COMPUTER STORAGE RESOURCE MANAGEMENT, COMPUTER DISK VOLUME MANAGEMENT, COMPUTER FILE MANAGEMENT, COMPUTER DOCUMENT MANAGEMENT, COMPUTER DATA MANAGEMENT, COMPUTER INFORMATION LIFECYCLE MANAGEMENT, COMPUTER CONTENT MANAGEMENT, COMPUTER RESOURCE MANAGEMENT, COMPUTER NETWORK MANAGEMENT, COMPUTER SECURITY MANAGEMENT, COMPUTER NETWORK RESOURCE MANAGEMENT, COMPUTER ENTERPRISE MANAGEMENT, COMPUTER WORKSTATION MANAGEMENT, COMPUTER APPLICATION MANAGEMENT, AND COMPUTER SYSTEMS MANAGEMENT (U.S. CLS. 21, 23, 26, 36 AND 38).

KELLY BOULTON, EXAMINING ATTORNEY

SN 78-301,369. ONEAC CORPORATION, LIBERTYVILLE, IL. FILED 9-17-2003.

TRISTAR

FOR UNINTERRUPTIBLE ELECTRICAL POWER SUPPLIES (U.S. CLS. 21, 23, 26, 36 AND 38).

CAROLYN GRAY, EXAMINING ATTORNEY

SN 78-301,848. TWINHAN TECHNOLOGY INC., HSI-CHIH, TAIPEI HSIEN, TAIWAN, FILED 9-17-2003.

VISIONDTV

FOR APPLICATION PROGRAMS AND SOFTWARE AS DRIVERS TO DIGITAL TV RECEPTION CARDS (U.S. CLS. 21, 23, 26, 36 AND 38).

RUDY R. SINGLETON, EXAMINING ATTORNEY

SN 78-302,943. IM-AGE SOFTWARE INC., HOUSTON, TX. FILED 9-19-2003.

IM-PROTECTOR

FOR COMPUTER SOFTWARE USED TO MONITOR THE USE AND CONTENT OF INSTANT MESSAGING (IM) AND OTHER PEER TO PEER COMMUNICATIONS OVER THE INTERNET (U.S. CLS. 21, 23, 26, 36 AND 38).

ALLISON HOLTZ, EXAMINING ATTORNEY

CLASS 9—(Continued).

SN 78-303,088. VICHIP CORPORATION, SAN JOSE, CA. FILED 9-19-2003.

VICHIP

FOR INTEGRATED CIRCUITS (U.S. CLS. 21, 23, 26, 36 AND 38).
CHRISTOPHER BUONGIORNO, EXAMINING ATTORNEY

SN 78-303,346. THE PCA GROUP, INC., BUFFALO, NY. FILED 9-22-2003.

MAILMIRROR

FOR COMPUTER SOFTWARE FOR E-MAIL DISASTER RECOVERY (U.S. CLS. 21, 23, 26, 36 AND 38).
DOMINIC J. FERRAIUOLO, EXAMINING ATTORNEY

SN 78-303,413. THE PCA GROUP, INC., BUFFALO, NY. FILED 9-22-2003.

CARTOBJECTS

FOR COMPUTER SOFTWARE USED FOR E-COMMERCE CUSTOMER MANAGEMENT (U.S. CLS. 21, 23, 26, 36 AND 38).
FIRST USE 1-1-2003; IN COMMERCE 1-1-2003.
DOMINIC J. FERRAIUOLO, EXAMINING ATTORNEY

SN 78-303,473. THE MOVING VISUALS CO. PTE LTD, SINGAPORE, SINGAPORE, FILED 9-22-2003.



FOR PRE-RECORDED CD'S, VIDEO TAPES, LASER DISKS AND DVD'S FEATURING TRAVEL ADVENTURE PROGRAMS FOR SALE AND FOR BROADCAST OVER TELEVISION, CABLE, STREAMING VIDEO AND THE INTERNET (U.S. CLS. 21, 23, 26, 36 AND 38).
DOMINIC J. FERRAIUOLO, EXAMINING ATTORNEY

CLASS 9—(Continued).

SN 78-303,881. THOMAS, THOMAS, N., RIVERSIDE, NJ. FILED 9-22-2003.

SOUL DEMENTIA

FOR SERIES OF PRE-RECORDED CD'S FEATURING MUSIC (U.S. CLS. 21, 23, 26, 36 AND 38).
CIMMERIAN COLEMAN, EXAMINING ATTORNEY

SN 78-303,983. CORNACCHIO, MICHAEL, WANTAGH, NY. FILED 9-23-2003.

ZIP-RIP

FOR UTILITY KNIFE GUIDE FOR ATTACHMENT TO A STANDARD TAPE MEASURE (U.S. CLS. 21, 23, 26, 36 AND 38).
ASMAT KHAN, EXAMINING ATTORNEY

SN 78-304,689. OWENS-CORNING FIBERGLAS TECHNOLOGY INC., SUMMIT, IL. FILED 9-24-2003.

INSPECT-R

FOR GAUGES FOR USE WITH INSULATION (U.S. CLS. 21, 23, 26, 36 AND 38).
GEOFFREY FOSDICK, EXAMINING ATTORNEY

SN 78-305,290. INTERACT SYSTEMS DEVELOPMENT, INC., DARIEN, IL. FILED 9-25-2003.

THE REAL ESTATE SKINNY

FOR COMPUTER SOFTWARE FOR REAL ESTATE INVESTMENT ANALYSIS (U.S. CLS. 21, 23, 26, 36 AND 38).
DAVID C. REIHNER, EXAMINING ATTORNEY

SN 78-305,618. INTEGRATED MICROMACHINES INCORPORATED, IRVINDALE, CA. FILED 9-25-2003.

SEMPIPEDE

FOR SEMICONDUCTOR TEST EQUIPMENT; NAMELY, WAFER PROBE CARDS AND SEMICONDUCTOR TEST CONTACTORS (U.S. CLS. 21, 23, 26, 36 AND 38).
ELIZABETH HUGHITT, EXAMINING ATTORNEY

CLASS 9—(Continued).

SN 78-305,623. JENSEN MEDIA, ISSAQUAH, WA. FILED 9-25-2003.

VISYNC

FOR COMPUTER SOFTWARE FOR AUDIO VIDEO SYNCHRONIZATION PURPOSES (U.S. CLS. 21, 23, 26, 36 AND 38).

KATHRYN COWARD, EXAMINING ATTORNEY

SN 78-305,946. SODEXHO OPERATIONS, LLC, GAITHERSBURG, MD. FILED 9-26-2003.

TRAKCASH

FOR COMPUTER HARDWARE AND COMPUTER PERIPHERALS; ELECTRONIC CASH REGISTERS; POINT OF SALE COMPUTER TERMINALS, COMPUTER KEYBOARDS, COMPUTER PRINTERS, ELECTRONIC CREDIT CARD READERS AND BAR CODE SCANNERS ALL FOR USE PRIMARILY BY RESTAURANTS AND OTHER DINING FACILITIES; COMPUTER SOFTWARE FOR COLLECTING, MAINTAINING, ORGANIZING, REPORTING AND PRINTING DATA RELATING TO MENUS, COSTS, PRICES, SALES AND INVENTORIES OF FOODS AND BEVERAGES; COMPUTER SOFTWARE FOR PRINTING MENU SIGNS AND LABELS FOR FOODS AND BEVERAGES (U.S. CLS. 21, 23, 26, 36 AND 38).

ZHALEH DELANEY, EXAMINING ATTORNEY

SN 78-306,221. L.R. NELSON CORPORATION, PEORIA, IL. FILED 9-26-2003.

CONTROL FREAK

FOR AUTOMATIC IRRIGATION AND WATERING CONTROLS, NAMELY, ELECTRONIC WATER TIMERS AND CONTROLS (U.S. CLS. 21, 23, 26, 36 AND 38).

INGA ERVIN, EXAMINING ATTORNEY

SN 78-306,562. AVISION ELECTRONICS COMPANY LIMITED, KOWLOON, HONG KONG, FILED 9-29-2003.

AVIOUS

FOR TELEVISION SETS; LCD TELEVISION RECEIVERS; VCD PLAYERS AND RECORDERS; DVD PLAYERS AND RECORDERS; MP3 PLAYERS AND RECORDERS; CD PLAYERS AND RECORDERS; DVD HOME CINEMA SYSTEMS CONSISTING OF A DVD PLAYER, AN AUDIO SPEAKER, A DISPLAY SCREEN, AND AN AMPLIFIER; AUDIO SPEAKERS; CASSETTE PLAYERS AND RECORDERS; RADIO RECEIVERS; TELEPHONES; VIDEO GAMES ON TAPES AND/OR DISK; PARTS AND FITTINGS FOR ALL OF THE AFORESAID GOODS (U.S. CLS. 21, 23, 26, 36 AND 38).

NANCY CLARKE, EXAMINING ATTORNEY

CLASS 9—(Continued).

SN 78-306,685. BOXWAVE CORP., MERCER ISLAND, WA. FILED 9-29-2003.

INSTASYNC

FOR COMPUTER SOFTWARE FOR ENABLING COMPUTER CONNECTIVITY TO OTHER DEVICES; COMPUTER NETWORK HARDWARE (U.S. CLS. 21, 23, 26, 36 AND 38).

LESLEY LAMOTHE, EXAMINING ATTORNEY

SN 78-307,116. ERB INDUSTRIES, INC., WOODSTOCK, GA. FILED 9-30-2003.

SWITCHBACK

FOR INDUSTRIAL SAFETY EYEWEAR (U.S. CLS. 21, 23, 26, 36 AND 38).

CHRIS WELLS, EXAMINING ATTORNEY

SN 78-307,265. CIENA CORPORATION, LINTHICUM, MD. FILED 9-30-2003.

DN 7050

FOR HARDWARE, SOFTWARE AND ACCOMPANYING MANUALS FOR MULTISERVICE SWITCHING OF DATA COMPLIANT WITH ATM, FRAME RELAY, CIRCUIT EMULATION SERVICES, AND MULTIPROTOCOL LABEL SWITCHING PROTOCOLS (U.S. CLS. 21, 23, 26, 36 AND 38).

JOHN DALIER, EXAMINING ATTORNEY

SN 78-307,268. CIENA CORPORATION, LINTHICUM, MD. FILED 9-30-2003.

DN 7000

FOR HARDWARE, SOFTWARE AND ACCOMPANYING MANUALS FOR MULTISERVICE SWITCHING OF DATA COMPLIANT WITH ATM, FRAME RELAY, CIRCUIT EMULATION SERVICES, AND MULTIPROTOCOL LABEL SWITCHING PROTOCOLS (U.S. CLS. 21, 23, 26, 36 AND 38).

AISHA CLARKE, EXAMINING ATTORNEY

SN 78-307,270. CIENA CORPORATION, LINTHICUM, MD. FILED 9-30-2003.

DN 7200

FOR HARDWARE, SOFTWARE AND ACCOMPANYING MANUALS FOR MULTISERVICE SWITCHING OF DATA COMPLIANT WITH ATM, FRAME RELAY, CIRCUIT EMULATION SERVICES, AND MULTIPROTOCOL LABEL SWITCHING PROTOCOLS (U.S. CLS. 21, 23, 26, 36 AND 38).

AISHA CLARKE, EXAMINING ATTORNEY

CLASS 9—(Continued).

SN 78-307,271. CIENA CORPORATION, LINTHICUM, MD.
FILED 9-30-2003.

DN 7100

FOR HARDWARE, SOFTWARE AND ACCOMPANYING MANUALS FOR MULTISERVICE SWITCHING OF DATA COMPLIANT WITH ATM, FRAME RELAY, CIRCUIT EMULATION SERVICES, AND MULTIPROTOCOL LABEL SWITCHING PROTOCOLS (U.S. CLS. 21, 23, 26, 36 AND 38).

AISHA CLARKE, EXAMINING ATTORNEY

SN 78-307,320. CIENA CORPORATION, LINTHICUM, MD.
FILED 9-30-2003.

CN 2000

FOR EQUIPMENT, RELATED SOFTWARE AND ACCOMPANYING MANUALS FOR FACILITATING DATA STORAGE THROUGH MULTIPLEXING DIFFERENT PROTOCOL DATA SIGNALS INTO SONET (SYNCHRONOUS OPTICAL NETWORK) PAYLOAD SIGNALS AND TRANSPORTING THE PAYLOAD SIGNALS USING SONET/SDH (SYNCHRONOUS DIGITAL HIERARCHY), WAVELENGTH DIVISION MULTIPLEXING (WDM) AND DARK FIBER NETWORKS (U.S. CLS. 21, 23, 26, 36 AND 38).

AISHA CLARKE, EXAMINING ATTORNEY

SN 78-307,538. CHASNOV, CRAIG, BONITA SPRINGS, FL.
FILED 9-30-2003.

PERFECT FOCUS

FOR OPTICAL LENSES FOR EYEGLASSES (U.S. CLS. 21, 23, 26, 36 AND 38).

FRED MANDIR, EXAMINING ATTORNEY

SN 78-307,644. INTERMOUNTAIN HEALTH CARE, INC.,
SALT LAKE CITY, UT. FILED 9-30-2003.

TRAINER ON THE RUN

FOR COMPUTER PROGRAM FOR TRACKING THE HEALTH, PERFORMANCE AND PROGRESS OF PATIENTS AND ATHLETES, AND FOR STORING AND MAINTAINING RECORDS ON PATIENTS AND ATHLETES (U.S. CLS. 21, 23, 26, 36 AND 38).

DAVID C. REIHNER, EXAMINING ATTORNEY

CLASS 9—(Continued).

SN 78-307,737. LOOKAHEAD, INC., LA QUINTA, CA. FILED
9-30-2003.

SALESACTION

FOR COMPUTER SOFTWARE FOR BUSINESS MANAGEMENT, NAMELY, SOFTWARE USED FOR DATABASE MANAGEMENT, TRANSFER AND SYNCHRONIZATION (U.S. CLS. 21, 23, 26, 36 AND 38).

MARK T. MULLEN, EXAMINING ATTORNEY

SN 78-308,019. BAYER HEALTHCARE LLC, PITTSBURGH,
PA. FILED 10-1-2003.

TRUWEIGHT

FOR SCALE USED AS A COMPONENT OF A MEDICAL LABORATORY CENTRIFUGE (U.S. CLS. 21, 23, 26, 36 AND 38).

JAMES GRIFFIN, EXAMINING ATTORNEY

SN 78-308,231. SOFTWARE995 INC., PALO ALTO, CA. FILED
10-1-2003.

SEARCHWITHIN

FOR COMPUTER UTILITY SOFTWARE; COMPUTER SOFTWARE FOR LOCATING AND RETRIEVING INFORMATION FROM ELECTRONIC DOCUMENTS AND FILES; COMPUTER SOFTWARE FOR CREATING AND PUBLISHING INDEXES OF ELECTRONIC DOCUMENTS AND FILES (U.S. CLS. 21, 23, 26, 36 AND 38).

FIRST USE 4-16-2003; IN COMMERCE 4-16-2003.

JACQUELINE A. LAVINE, EXAMINING ATTORNEY

SN 78-309,524. SIERRA ENTERTAINMENT, INC., BELLEVUE, WA. FILED 10-5-2003.

LEISURE SUIT LARRY

FOR PRE-RECORDED VIDEO TAPES FEATURING ACTION MOTION PICTURES AND TELEVISION PROGRAMMING; PRE-RECORDED AUDIO CASSETTE TAPES, DVDS AND CD-ROMS FEATURING MUSICAL SCORES AND DIALOG; AND ENTERTAINMENT COMPUTER SOFTWARE IN THE NATURE OF A GAME CAPABLE OF BEING PLAYED ON A PERSONAL COMPUTER OR A GLOBAL COMPUTER NETWORK (U.S. CLS. 21, 23, 26, 36 AND 38).

JACQUELINE A. LAVINE, EXAMINING ATTORNEY

CLASS 9—(Continued).

SN 78-309,824. ROSEN, DAVID J., NEW YORK, NY. FILED 10-6-2003.

GEOWAVE

FOR SYSTEM TO PROVIDE EARTHQUAKE EARLY WARNINGS BY DETECTION AND LOCATION OF SUB-SURFACE GEOLOGIC PERTURBATIONS WHICH RELATE TO SEISMIC ACTIVITY, SUCH SYSTEM COMPRISED OF COMPUTER HARDWARE, ELECTRONIC HARDWARE, COMPUTER SOFTWARE AND SENSORS, NAMELY, REMOTE SENSORS, MODEMS, RECEIVERS, A MAINFRAME COMPUTER WITH A CONTROLLER, AND COMPUTER SOFTWARE TO CORRELATE AND INTERPRET THE DETECTED SIGNALS; A SYSTEM USED FOR DETECTION AND LOCATION OF SUB-SURFACE MINERAL AND HYDROCARBON BEARING STRUCTURES, SUCH SYSTEM COMPRISED OF COMPUTER HARDWARE, ELECTRONIC HARDWARE, TRANSMITTER AND ASSOCIATED ANTENNAS, A RECEIVER, AND COMPUTER SOFTWARE TO ANALYZE THE SIGNAL RETURNS; A SUBSURFACE MAPPING SYSTEM FOR DETECTION AND LOCATION OF SUB-SURFACE WATER RESOURCES AND UNDERGROUND UTILITY INFRASTRUCTURE, SUCH SYSTEM COMPRISED OF COMPUTER HARDWARE, ELECTRONIC HARDWARE, TRANSMITTER AND ASSOCIATED ANTENNAS, A RECEIVER, AND COMPUTER SOFTWARE TO ANALYZE THE SIGNAL RETURNS; ANTENNAS FOR USE WITH CELLULAR TELEPHONES AND MOBILE AND BASE STATION RADIOS (U.S. CLS. 21, 23, 26, 36 AND 38).

TRICIA SONNEBORN, EXAMINING ATTORNEY

SN 78-309,843. CRANE PRODUCTIONS, INC., LOUISVILLE, KY. FILED 10-6-2003.

ROLL-A-MAG

FOR MAGNETS FEATURING ADVERTISING (U.S. CLS. 21, 23, 26, 36 AND 38).
FIRST USE 10-1-2003; IN COMMERCE 10-1-2003.
BARNEY CHARLON, EXAMINING ATTORNEY

SN 78-310,081. REPORT DYNAMICS, NORTHRIDGE, CA. FILED 10-7-2003.

REPORT DYNAMICS

NO CLAIM IS MADE TO THE EXCLUSIVE RIGHT TO USE REPORT, APART FROM THE MARK AS SHOWN.
FOR COMPUTER SOFTWARE FOR USE IN GENERATING MEDICAL REPORTS FOR PATIENT MEDICAL RECORDS (U.S. CLS. 21, 23, 26, 36 AND 38).
AMY HELLA, EXAMINING ATTORNEY

CLASS 9—(Continued).

SN 78-310,105. ADAR CORPORATION, ARLINGTON HEIGHTS, IL. FILED 10-7-2003.

AIRCAT

FOR TESTING SYSTEMS NAMELY TESTERS THAT DETECT GAS, LIQUID, OR FLUID LEAKS IN PACKAGING BAGS OR CONTAINERS (U.S. CLS. 21, 23, 26, 36 AND 38).

FIRST USE 2-1-2003; IN COMMERCE 2-1-2003.
DOMINIC J. FERRAIUOLO, EXAMINING ATTORNEY

SN 78-310,113. ADAR CORPORATION, ARLINGTON HEIGHTS, IL. FILED 10-7-2003.

LYNX

FOR TESTING SYSTEMS NAMELY TESTERS THAT DETECT GAS, LIQUID, OR FLUID LEAKS IN PACKAGING BAGS OR CONTAINERS (U.S. CLS. 21, 23, 26, 36 AND 38).

FIRST USE 2-1-2003; IN COMMERCE 2-1-2003.
DOMINIC J. FERRAIUOLO, EXAMINING ATTORNEY

SN 78-310,116. ADAR CORPORATION, ARLINGTON HEIGHTS, IL. FILED 10-7-2003.

PANTERA

FOR TESTING SYSTEMS NAMELY TESTERS THAT DETECT GAS, LIQUID, OR FLUID LEAKS IN PACKAGING BAGS OR CONTAINERS (U.S. CLS. 21, 23, 26, 36 AND 38).

FIRST USE 2-1-2003; IN COMMERCE 2-1-2003.
DOMINIC J. FERRAIUOLO, EXAMINING ATTORNEY

SN 78-310,124. ADAR CORPORATION, ARLINGTON HEIGHTS, IL. FILED 10-7-2003.

Z-MICRON

FOR TESTING SYSTEMS NAMELY TESTERS THAT DETECT GAS, LIQUID, OR FLUID LEAKS IN PACKAGING BAGS OR CONTAINERS (U.S. CLS. 21, 23, 26, 36 AND 38).

FIRST USE 2-1-2003; IN COMMERCE 2-1-2003.
DOMINIC J. FERRAIUOLO, EXAMINING ATTORNEY

SN 78-310,427. HARRIS CORPORATION, MELBOURNE, FL. FILED 10-7-2003.

SMARTTONE

FOR TELECOMMUNICATIONS LINE TESTING AND TROUBLESHOOTING DEVICE (U.S. CLS. 21, 23, 26, 36 AND 38).

STEVEN R. FINE, EXAMINING ATTORNEY

CLASS 9—(Continued).

SN 78-310,476. CAMERON LIMBRICK, FREDERICKSBURG, VA. FILED 10-7-2003.



FOR PRE-RECORDED CD'S FEATURING SOUND RECORDINGS OF MUSICAL, INSTRUMENTAL AND VOCAL PERFORMANCES (U.S. CLS. 21, 23, 26, 36 AND 38).

FIRST USE 6-3-1988; IN COMMERCE 7-20-1988.
AISHA CLARKE, EXAMINING ATTORNEY

SN 78-311,564. CYA TECHNOLOGIES, INC., TRUMBULL, CT. FILED 10-9-2003.

CYA

OWNER OF U.S. REG. NO. 2,471,881.
FOR SOFTWARE FOR DATA PROTECTION AND SECURITY, DATA BACKUP, DATA RECOVERY, CHECKING INTEGRITY OF DATA, DATA ARCHIVING AND RETRIEVAL, DATA TRANSFER, AND SECURE DATA DURING COLLABORATION (U.S. CLS. 21, 23, 26, 36 AND 38).

FIRST USE 8-0-1998; IN COMMERCE 8-0-1998.
KELLEY WELLS, EXAMINING ATTORNEY

SN 78-311,762. COGERT, HARMON, OXNARD, CA. FILED 10-9-2003.

PLACEMAT TOP

FOR COMPUTER (U.S. CLS. 21, 23, 26, 36 AND 38).
CHARLES L. JENKINS, EXAMINING ATTORNEY

SN 78-312,176. ORION ENGINEERING CORPORATION, WESTFORD, MA. FILED 10-10-2003.

DENNIS

FOR ARTIFICIAL INTELLIGENCE SYSTEM COMPRISING OF SOFTWARE AND COMPUTER HARDWARE TO CONTROL POWER GENERATION FROM DISTRIBUTED RESOURCES AND ENERGY STORAGE DEVICES THAT COORDINATES THE MANAGEMENT AND DISPATCH OF ELECTRIC AND OR THERMAL POWER INTO ENERGY DISTRIBUTION NETWORKS (U.S. CLS. 21, 23, 26, 36 AND 38).

JENNIFER KRISP, EXAMINING ATTORNEY

CLASS 9—(Continued).

SN 78-312,610. THE ICONFACTORY, INC., GREENSBORO, NC. FILED 10-13-2003.

XSCOPE

FOR COMPUTER SOFTWARE FOR MEASURING ON-SCREEN GRAPHICS FOR VISUAL DESIGN (U.S. CLS. 21, 23, 26, 36 AND 38).

RICHARD WHITE, EXAMINING ATTORNEY

SN 78-312,806. PIONEER KABUSHIKI KAISHA, MEGURO-KU, TOKYO, JAPAN, FILED 10-13-2003.

PIONEERDVR.COM

OWNER OF U.S. REG. NOS. 696,688, 1,631,375 AND OTHERS.

FOR DIGITAL VERSATILE DISC RECORDERS, DIGITAL VIDEO RECORDERS, VIDEO DISC RECORDERS, BLANK, RE-WRITABLE DIGITAL VERSATILE DISCS; COMBINATION DIGITAL VERSATILE DISC RECORDERS AND PLAYERS (U.S. CLS. 21, 23, 26, 36 AND 38).

JOHN SCHUYLER YARD, EXAMINING ATTORNEY

SN 78-312,931. PIONEER KABUSHIKI KAISHA, MEGURO-KU, TOKYO, JAPAN, FILED 10-13-2003.

PIONEERBURNER.COM

OWNER OF U.S. REG. NOS. 696,688, 1,631,375 AND OTHERS.

FOR DIGITAL VERSATILE DISC RECORDERS, DIGITAL VIDEO RECORDERS, VIDEO DISC RECORDERS, BLANK, RE-WRITABLE DIGITAL VERSATILE DISCS; COMBINATION DIGITAL VERSATILE DISC RECORDERS AND PLAYERS (U.S. CLS. 21, 23, 26, 36 AND 38).

CURTIS FRENCH, EXAMINING ATTORNEY

SN 78-312,979. PIONEER KABUSHIKI KAISHA, MEGURO-KU, TOKYO, JAPAN, FILED 10-13-2003.

PIONEERPUREVISION.COM

OWNER OF U.S. REG. NOS. 696,688, 1,631,375 AND OTHERS.

FOR MONITOR TELEVISIONS, FLAT PANEL TELEVISION AND DISPLAY MONITORS, PLASMA DISPLAYS, PROJECTION TELEVISIONS, HIGH DEFINITION PROJECTION TELEVISIONS (U.S. CLS. 21, 23, 26, 36 AND 38).

CURTIS FRENCH, EXAMINING ATTORNEY

CLASS 9—(Continued).

SN 78-313,584. FREMANTLE MEDIA NORTH AMERICA, INC., SANTA MONICA, CA. FILED 10-14-2003.

WORLD IDOL

FOR PRERECORDED AUDIO AND VIDEO CASSETTES, COMPACT DISCS, VIDEO DISCS, RECORDS, AND CD-ROMS, ALL OF THE FOREGOING FEATURING TALENT SHOWS; VIDEO GAME MACHINE THAT IS ADAPTED OR INTENDED FOR USE WITH A TELEVISION, MONITOR OR SOME OTHER FORM OF DISPLAY APPARATUS WHICH IS SEPARATE FROM THE VIDEO GAME MACHINE; COMPUTER GAME EQUIPMENT CONTAINING MEMORY DEVICES, NAMELY, DISCS; INTERACTIVE VIDEO GAME PROGRAMS; ELECTRONICALLY OR MAGNETICALLY ACTIVATED PRE-PAID TELEPHONE DEBIT CARDS; MAGNETS; INTERACTIVE COMPUTER GAME SOFTWARE DOWNLOADED FROM A GLOBAL COMPUTER NETWORK; EYEGLASSES AND SUNGLASSES; GAMING MACHINES; GAMING EQUIPMENT, NAMELY, SLOT MACHINES WITH OR WITHOUT VIDEO OUTPUT (U.S. CLS. 21, 23, 26, 36 AND 38).

KARANENDRA S. CHHINA, EXAMINING ATTORNEY

SN 78-313,594. INTERMOUNTAIN SOLAR TECHNOLOGIES INC., SOUTH JORDAN, UT. FILED 10-14-2003.

SUNEXPLORER

FOR SOLAR POWERED BATTERY CHARGERS FOR RECREATIONAL VEHICLES, BOATS, TRAILERS, CABINS, AND PARTS THEREFOR (U.S. CLS. 21, 23, 26, 36 AND 38).

JENNIFER KRISP, EXAMINING ATTORNEY

SN 78-313,621. LASER VISION TECHNOLOGIES, INC., ALOHA, OR. FILED 10-14-2003.

LIGHTRUSH

FOR LASER BASED DISPLAY SYSTEM COMPRISING LASERS, OPTICS, AND A PROJECTION LENS USED TO DISPLAY STILL AND VIDEO IMAGES (U.S. CLS. 21, 23, 26, 36 AND 38).

JENNIFER KRISP, EXAMINING ATTORNEY

CLASS 9—(Continued).

SN 78-313,861. LAWWRITER LLC, CINCINNATI, OH. FILED 10-15-2003.

casecheck

FOR COMPUTER SOFTWARE IN THE FIELD OF LEGAL RESEARCH (U.S. CLS. 21, 23, 26, 36 AND 38).

FLORENTINA BLANDU, EXAMINING ATTORNEY

SN 78-313,910. JOHNSON & JOHNSON, NEW BRUNSWICK, NJ. FILED 10-15-2003.

ACUVUE ADVANCE

OWNER OF U.S. REG. NO. 1,458,177.
FOR CONTACT LENSES (U.S. CLS. 21, 23, 26, 36 AND 38).

GINA HAYES, EXAMINING ATTORNEY

SN 78-314,438. INFOBUILD NETWORKS INC., POINT ROBERTS, WA. FILED 10-16-2003.

BLIVE

FOR COMPUTER SOFTWARE, NAMELY, DOWNLOADABLE SOFTWARE PROVIDING REAL-TIME CONNECTIVITY ENABLING USERS TO CONNECT WITH REMOTE USERS OVER A GLOBAL INFORMATION NETWORK FROM ANY GLOBAL COMMUNICATIONS NETWORK BROWSER OR LOCALIZED DESKTOP FOR USE IN SECURE PERSONAL COMMUNICATION, TO SHARE DESKTOPS AND TO COMMUNICATE THROUGH SECURE INSTANT MESSAGING (U.S. CLS. 21, 23, 26, 36 AND 38).

FIRST USE 12-31-2000; IN COMMERCE 12-31-2000.

STEVEN JACKSON, EXAMINING ATTORNEY

SN 78-314,659. HONEYWELL INTERNATIONAL INC., MORRISTOWN, NJ. FILED 10-16-2003.

RAPIDBALANCE

FOR SOFTWARE FOR SETTING PARAMETERS IN HEATING, VENTILATION AND AIR CONDITIONING CONTROL DEVICES (U.S. CLS. 21, 23, 26, 36 AND 38).

SHAUNIA WALLACE, EXAMINING ATTORNEY

CLASS 9—(Continued).

SN 78-314,686. HONEYWELL INTERNATIONAL INC., MORRISTOWN, NJ. FILED 10-16-2003.

RAPIDLINK

FOR COMPUTER INTERFACE BOARDS (U.S. CLS. 21, 23, 26, 36 AND 38).

DANIEL CAPSHAW, EXAMINING ATTORNEY

CLASS 9—(Continued).

SN 78-316,322. FTEN, INC., NEW YORK, NY. FILED 10-21-2003.

RISKMONTAGE

FOR SECURITIES TRADING APPLICATION SOFTWARE (U.S. CLS. 21, 23, 26, 36 AND 38).

ASMAT KHAN, EXAMINING ATTORNEY

SN 78-314,781. APANI NETWORKS, BREA, CA. FILED 10-16-2003.

APANI NETWORKS

NO CLAIM IS MADE TO THE EXCLUSIVE RIGHT TO USE "NETWORKS", APART FROM THE MARK AS SHOWN.

FOR COMPUTER SOFTWARE AND HARDWARE FOR USE IN NETWORK SECURITY; COMPUTER SOFTWARE AND HARDWARE FOR USE IN ANALYZING NETWORK CONNECTIVITY (U.S. CLS. 21, 23, 26, 36 AND 38).

DOMINIC J. FERRAIUOLO, EXAMINING ATTORNEY

SN 78-319,830. NANOSCALE MATERIALS, INC., MANHATTAN, KS. FILED 10-28-2003.



FOR PRESSURIZED CHEMICAL DISPENSERS FOR DECONTAMINATION OF CHEMICAL AND BIOLOGICAL AGENTS (U.S. CLS. 21, 23, 26, 36 AND 38).

FIRST USE 6-2-2003; IN COMMERCE 6-2-2003.

BRIAN PINO, EXAMINING ATTORNEY

SN 78-315,834. REVLOX CONSUMER PRODUCTS CORPORATION, NEW YORK, NY. FILED 10-20-2003.

REVLOX

OWNER OF U.S. REG. NOS. 647,222, 1,886,476 AND OTHERS.

FOR ELECTRIC OR BATTERY OPERATED APPLIANCES FOR THE HAIR, NAMELY; CURLING AND STRAIGHTENING APPLIANCES, HOT CURLING BRUSHES, HOT ROLLERS, HAIR SETTERS AND ATTACHMENT ACCESSORIES (U.S. CLS. 21, 23, 26, 36 AND 38).

FIRST USE 9-30-1992; IN COMMERCE 9-30-1992.

TARAH HARDY, EXAMINING ATTORNEY

SN 78-327,794. MICROSOFT CORPORATION, REDMOND, WA. FILED 11-13-2003.

SMARTSCREEN

SN 78-316,160. GOLDLINE (U.S.A.) INC., MARION, IL. FILED 10-20-2003.

SUPREMA

THE ENGLISH TRANSLATION OF "SUPREMA" IS "SUPREME".

FOR CAMERAS (U.S. CLS. 21, 23, 26, 36 AND 38).

FIRST USE 5-29-1996; IN COMMERCE 5-29-1996.

MICHAEL ENGEL, EXAMINING ATTORNEY

THE MARK CONSISTS OF STANDARD CHARACTERS WITHOUT CLAIM TO ANY PARTICULAR FONT, STYLE, SIZE, OR COLOR.

FOR COMPUTER SOFTWARE FOR FILTERING UNWANTED ELECTRONIC MAIL, WEB MESSAGES AND ON-LINE "POP-UP" ADVERTISEMENTS; AND ELECTRONIC MAIL, WEB MESSAGING AND INTERNET BROWSER SOFTWARE FEATURING FILTERING TECHNOLOGY TO FILTER UNWANTED ELECTRONIC MAIL, WEB MESSAGES AND ON-LINE "POP-UP" ADVERTISEMENTS (U.S. CLS. 21, 23, 26, 36 AND 38).

IRENE D. WILLIAMS, EXAMINING ATTORNEY

CLASS 9—(Continued).

SN 78-361,143. IGT, RENO, NV. FILED 2-2-2004.

DOLLAR DAYS

THE MARK CONSISTS OF STANDARD CHARACTERS WITHOUT CLAIM TO ANY PARTICULAR FONT, STYLE, SIZE, OR COLOR.

NO CLAIM IS MADE TO THE EXCLUSIVE RIGHT TO USE "DOLLAR", APART FROM THE MARK AS SHOWN.

FOR GAMING MACHINES, NAMELY, SLOT MACHINES WITH OR WITHOUT VIDEO OUTPUT, VIDEO LOTTERY TERMINALS, GAMING MACHINES FOR PLAY OF AN INTERACTIVE, ELECTRONIC BINGO GAME (U.S. CLS. 21, 23, 26, 36 AND 38).

BRENDAN REGAN, EXAMINING ATTORNEY

SN 78-374,255. IGT, RENO, NV. FILED 2-26-2004.

WINTASTIK

THE MARK CONSISTS OF STANDARD CHARACTERS WITHOUT CLAIM TO ANY PARTICULAR FONT, STYLE, SIZE, OR COLOR.

FOR GAMING MACHINES, NAMELY, SLOT MACHINES WITH OR WITHOUT VIDEO OUTPUT, VIDEO LOTTERY TERMINALS, GAMING MACHINES FOR PLAY OF AN INTERACTIVE, ELECTRONIC BINGO GAME (U.S. CLS. 21, 23, 26, 36 AND 38).

BRENDAN REGAN, EXAMINING ATTORNEY

CLASS 10—MEDICAL APPARATUS

SN 75-106,132. OLYMPUS AMERICA INC., MELVILLE, NY. FILED 5-17-1996.

IMAGEMANAGER

SEC. 2(F).

FOR MEDICAL IMAGING SYSTEM COMPRISED OF COMPUTER HARDWARE, COMPUTER SOFTWARE, A MONITOR AND A CABLE PACKAGE (U.S. CLS. 26, 39 AND 44).

FIRST USE 8-31-1989; IN COMMERCE 8-31-1989.

GLENN CLARK, EXAMINING ATTORNEY

SN 76-180,871. KALTENBACH & VOIGT GMBH & CO. D-88400 BIBERACH, FED REP GERMANY, FILED 12-14-2000.

THE ENVIRONMENT

PRIORITY CLAIMED UNDER SEC. 44(D) ON FED REP GERMANY APPLICATION NO. 30063221.5/1, FILED 8-23-2000, REG. NO. 30063221, DATED 12-21-2000, EXPIRES 8-31-2010.

FOR DENTAL HANDPIECES; DENTAL BITE TRAYS AND DRILLS; DENTAL FURNITURE, NAMELY, DENTAL CHAIRS; DENTAL HEADRESTS; DENTAL SEATS; DENTAL ARMRESTS; DENTAL FOOT CONTROLS; CUSPIDORS; DENTAL WATER AND DISINFECTION SYSTEMS CONSISTING OF LIQUID BINS AND DOSING PUMPS; DENTAL SYRINGES; SALIVA EJECTORS; HIGH VOLUME EVACUATORS; DENTAL STOOLS; DENTAL OPERATING LIGHTS; DENTAL REFLECTORS; DENTAL INSTRUMENTS AND APPARATUS, NAMELY, HAND AND ANGLE PIECES, ELECTRIC AND PNEUMATIC DRIVES FOR THESE INSTRUMENTS, DRIVING MOTORS FOR DENTAL INSTRUMENTS, DENTAL MOTOR INSTRUMENTS COUPLINGS, DENTAL ARTICULATORS, SUCTION APPARATUS FOR DENTAL USE, VIBRATORS USED TO CONDENSE OR COMPACT MATERIALS IN MEDICAL AND DENTAL LABORATORIES, DENTAL LABORATORY BENCHES, WORKTOPS, DRAWERS, CABINETS, LABORATORY CHAIRS, HOODS, SUCTION HOODS, ARM RESTS, SAFETY SHIELDS, WORK TRAYS, INSTRUMENT DRAWER INSERTS, DELIVERY ARMS, TABLES, TABLETOPS, DENTAL LABORATORY WORKSTATIONS, BRACKETS, DUST COLLECTORS, LABORATORY LIGHT FIXTURES, WORK TRAYS WITH BENCH HOLDERS, DENTAL COUPLINGS FOR MOTORS, INSTRUMENTS FOR POWER SUPPLY HOSES, DENTAL DRILLING MACHINES, FLEXIBLE HOSE TUBING, ARTICULATED SLIDING CONNECTIONS, RODS, RIGID AND FLEXIBLE RODS; DRIVE SHAFTS, DENTAL TURBINES, COMPUTER-AIDED IMAGE PROCESSING DEVICES; TABLES FOR DENTISTS AND DENTAL TECHNICIANS; FILES FOR PREPARATION OF ROOT CANALS; DRIVE CONTROLLERS FOR HANDPIECES FOR DENTISTS AND DENTAL TECHNICIANS; CARIES DETECTORS; DENTAL TOOLS AND THREE-DIMENSIONAL MODELS FOR USE BY DENTISTS AND DENTAL TECHNICIANS (U.S. CLS. 26, 39 AND 44).

LEIGH CAROLINE CASE, EXAMINING ATTORNEY

CLASS 10—(Continued).

SN 76-191,857. ATRIUM MEDICAL CORPORATION, HUDSON, NH. FILED 1-9-2001.

SLIDER GDS

FOR MEDICAL DEVICES, NAMELY, FLEXIBLE, REMOVABLE PROTECTIVE SHEATHS FOR CATHETERS, VASCULAR GRAFTS, AND OTHER IMPLANTABLE DEVICES (U.S. CLS. 26, 39 AND 44).

JOHN E. MICHOS, EXAMINING ATTORNEY

SN 76-254,600. KARL STORZ GMBH & CO. KG, D-78532 TUTTLINGEN, FED REP GERMANY, FILED 5-9-2001.

C-CUT

PRIORITY CLAIMED UNDER SEC. 44(D) ON FED REP GERMANY APPLICATION NO. 30085811.6/1, FILED 11-22-2000, REG. NO. 300085811, DATED 1-25-2001, EXPIRES 11-30-2010.

FOR MEDICAL AND SURGICAL INSTRUMENTS AND APPARATUS, NAMELY HIGH FREQUENCY MEDICAL AND SURGICAL INSTRUMENTS AND APPARATUS IN THE NATURE OF HIGH-FREQUENCY POWER SUPPLIES, SCISSORS, FORCEPS, BLADES AND ELECTRODES FOR USE IN HIGH-FREQUENCY SURGERY (U.S. CLS. 26, 39 AND 44).

MARC LEIPZIG, EXAMINING ATTORNEY

SN 76-415,237. BIOTRONIK MESS-UND THERAPIEGERATE GMBH & CO. INGENIEURBURO BERLIN, 12359 BERLIN, FED REP GERMANY, FILED 6-6-2002.

PROTOS

PRIORITY CLAIMED UNDER SEC. 44(D) ON ERPN CMNTY TM OFC APPLICATION NO. 002649168-EM, FILED 4-10-2002.

FOR ELECTRO MEDICAL DEVICES AND PARTS THEREOF, NAMELY, EXTERNAL AND IMPLANTABLE PACEMAKERS, PROGRAMMING AND INSPECTION DEVICES FOR PACEMAKERS, ELECTRODES, BLOOD CIRCULATION SUPPORT EQUIPMENT, SURGICAL IMPLANTS COMPRISING ARTIFICIAL MATERIAL (U.S. CLS. 26, 39 AND 44).

YONG KIM, EXAMINING ATTORNEY

SN 76-432,949. ORTHO DEVELOPMENT CORPORATION, DRAPER, UT. FILED 7-22-2002.

HEMISPHERE

FOR ORTHOPEDIC JOINT IMPLANTS (U.S. CLS. 26, 39 AND 44).

CHARLES L. JENKINS, EXAMINING ATTORNEY

CLASS 10—(Continued).

SN 76-471,716. FORD, CHRISTOPHER W., HOLLY, MI. FILED 9-10-2002.

OPTI-ROOT

FOR DENTAL IMPLANTS (U.S. CLS. 26, 39 AND 44).

CURTIS FRENCH, EXAMINING ATTORNEY

SN 76-497,110. OMNI INTERNATIONAL, LLC, BEDFORD, NH. FILED 3-13-2003.

COMFORT FORMULATION

NO CLAIM IS MADE TO THE EXCLUSIVE RIGHT TO USE COMFORT, APART FROM THE MARK AS SHOWN. FOR LATEX GLOVES FOR MEDICAL, SURGICAL AND DENTAL USE (U.S. CLS. 26, 39 AND 44).

FIRST USE 4-1-2000; IN COMMERCE 8-1-2000.

ESTHER BELENKER, EXAMINING ATTORNEY

SN 76-501,322. FOOT MANAGEMENT, INC., PITTSVILLE, MD. FILED 3-25-2003.

AQUA-TEMPS

FOR PRE-CUT THERMOPLASTIC BLANKS USED FOR THE MANUFACTURE OF TEMPORARY ORTHOTICS (U.S. CLS. 26, 39 AND 44).

FIRST USE 3-0-2002; IN COMMERCE 3-0-2002.

ALEX KEAM, EXAMINING ATTORNEY

SN 76-503,017. ROCHE DIAGNOSTICS CORPORATION, INDIANAPOLIS, IN. FILED 4-1-2003.

HEALTHWEAR

FOR MULTI-SENSOR MONITORING DEVICE, NAMELY, ARMBAND FOR USE IN CLINICAL WEIGHT MANAGEMENT TO CALCULATE ENERGY INTAKE AND ENERGY EXPENDITURE OF USER AND ASSOCIATED SOFTWARE FOR ANALYZING, STORING AND REPORTING PHYSICAL ACTIVITY, SOLD AS A UNIT THEREWITH (U.S. CLS. 26, 39 AND 44).

AMY HELLA, EXAMINING ATTORNEY

CLASS 10—(Continued).

SN 76-503,021. ROCHE DIAGNOSTICS CORPORATION, INDIANAPOLIS, IN. FILED 4-1-2003.



FOR MULTI-SENSOR MONITORING DEVICE, NAMELY, ARMBAND FOR USE IN CLINICAL WEIGHT MANAGEMENT TO CALCULATE ENERGY INTAKE AND ENERGY EXPENDITURE OF USER AND ASSOCIATED SOFTWARE FOR ANALYZING, STORING AND REPORTING PHYSICAL ACTIVITY, SOLD AS A UNIT THEREWITH (U.S. CLS. 26, 39 AND 44).

AMY HELLA, EXAMINING ATTORNEY

SN 76-506,485. LUIGI, GIANCARLO, AGUADILLA, PUERTO RICO, FILED 4-14-2003.

LESDIC

FOR MEDICAL INSTRUMENT, NAMELY AN ELECTROCAUTERIZER, SUCTION, DISSECTOR, IRRIGATOR, AND CUTTER, FOR SURGICAL PURPOSES (U.S. CLS. 26, 39 AND 44).

INGRID C. EULIN, EXAMINING ATTORNEY

SN 76-514,332. KABUSHIKI KAISHA YOSHIDA SEISAKUSHO, DBA THE YOSHIDA DENTAL MFG. CO., LTD., SUMIDA-KU, TOKYO, JAPAN, FILED 5-15-2003.

INTELLIVISION

PRIORITY CLAIMED UNDER SEC. 44(D) ON JAPAN APPLICATION NO. 2003-021189, FILED 3-18-2003, REG. NO. 4714462, DATED 10-3-2003, EXPIRES 10-3-2013.

FOR MEDICAL EQUIPMENT AND INSTRUMENTS, NAMELY, AN IMAGING CAMERA, AN IMAGING CAMERA USED WITH AN IMAGE PROCESSOR, AND AN IMAGE PROCESSOR FOR MEDICAL USE (U.S. CLS. 26, 39 AND 44).

KEVON CHISOLM, EXAMINING ATTORNEY

CLASS 10—(Continued).

SN 76-523,736. BIO ART EQUIPAMENTOS ODONTOLÓGICOS LTDA., 13568-000 SAO CARLOS, SP, BRAZIL, FILED 6-11-2003.



FOR DENTAL INSTRUMENTS, NAMELY, ALL OF THE FOLLOWING— ARTICULATOR, ARTICULATOR ACCESSORIES, NAMELY, FACE BOW, CALIBRATOR BLOCK, JIG TRANSFER, ADJUSTABLE INCISAL GUIDING METALLIC TABLE, FOX RULER, FORK SUPPORT, TOOTHLESS FORK; CAMPER'S PLAN; MAGNETIC MOUNTING PLATE, METALLIC MOUNTING PLATE; MILLING MACHINE; SURVEYOR PARALLELOMETER; SURVEYOR PARALLELOMETER'S GAUGE; MICROBLASTER; BIO-CHAMBER; MICROCHAMBER; ALUMINUM OXIDE; PLASTIC PLATES FOR THE VACUUM FORMING MACHINE; ULTRASONIC WASHING MACHINE; STERILIZATION ROLLS OF PAPER; AIR GUN; CASTING MACHINE; CRUCIBLE; BIOLUX CURING LIGHT; MAGNIFYING LENS; PORTABLE X-RAY VIEWER; VERTICULATOR; AND PARTS THEREFOR (U.S. CLS. 26, 39 AND 44).

FIRST USE 5-29-1981; IN COMMERCE 10-1-1994.
CATHERINE FAINT, EXAMINING ATTORNEY

SN 76-523,767. C.R. BARD, INC., MURRAY HILL, NJ. FILED 6-16-2003.

VACORA

FOR BIOPSY DEVICE (U.S. CLS. 26, 39 AND 44).
CAROL SPILS, EXAMINING ATTORNEY

SN 76-531,688. CAMBRIDGE SCIENTIFIC, INC., CAMBRIDGE, MA. FILED 7-18-2003.

WISORB

FOR INTERNAL FIXATION DEVICES, NAMELY, SCREWS, PINS, RODS AND PLATES; SPINAL FUSION DEVICES, NAMELY, CAGES, SCREWS, PLATES AND RODS (U.S. CLS. 26, 39 AND 44).

MATTHEW PAPPAS, EXAMINING ATTORNEY

CLASS 10—(Continued).

SN 76-535,789. TP ORTHODONTICS, INC., LAPORTE, IN. FILED 8-11-2003.

PASTEL PALATES

NO CLAIM IS MADE TO THE EXCLUSIVE RIGHT TO USE PASTEL, APART FROM THE MARK AS SHOWN. FOR CUSTOM ORTHODONTIC APPLIANCES, NAMELY ACTIVATORS, RETAINERS, POSITIONERS, SPRING ALIGNERS, BIONATORS, CORRECTORS AND FUNCTIONAL APPLIANCES (U.S. CLS. 26, 39 AND 44). FIRST USE 3-22-1989; IN COMMERCE 3-22-1989. TANYA AMOS, EXAMINING ATTORNEY

SN 76-535,790. TP ORTHODONTICS, INC., LAPORTE, IN. FILED 8-11-2003.

POSITION-ETTE

FOR APPLIANCES TO BE USED IN THE MOUTH TO MOVE AND HOLD THE TEETH, MORE SPECIFICALLY ONE PIECE, ELASTIC MOUTHPIECES OR TOOTH POSITIONERS USED IN DENTAL AND ORTHODONTIC TREATMENT (U.S. CLS. 26, 39 AND 44). FIRST USE 2-4-1970; IN COMMERCE 2-4-1970. TANYA AMOS, EXAMINING ATTORNEY

SN 76-540,272. MEDICAL COMPONENTS, INC., HARLEYSVILLE, PA. FILED 8-26-2003.



OWNER OF U.S. REG. NO. 1,345,908. THE TERM MED IS LINED FOR THE COLOR(S) RED. FOR CATHETERS AND CATHETER KITS; MEDICAL GUIDE WIRE BULB INTRODUCERS AND MEDICAL GUIDE WIRES; CATHETER INTRODUCERS; CATHETER INSERTION TRAYS; INTRODUCER SHEATHS AND DILATORS; HYPODERMIC NEEDLES; AND CAPS FOR MEDICAL OR SURGICAL PURPOSES (U.S. CLS. 26, 39 AND 44). FIRST USE 12-31-2000; IN COMMERCE 12-31-2000. KIMBERLY PERRY, EXAMINING ATTORNEY

CLASS 10—(Continued).

SN 76-545,897. FOOT LEVELERS, INC., ROANOKE, VA. FILED 9-22-2003.



Gait Cycle System

OWNER OF U.S. REG. NOS. 2,782,840, 2,793,318 AND 2,818,079. NO CLAIM IS MADE TO THE EXCLUSIVE RIGHT TO USE SUPPORT AND GAIT CYCLE SYSTEM, APART FROM THE MARK AS SHOWN. FOR ORTHOPEDIC FOOTWEAR AND ORTHOTIC INSERTS FOR FOOTWEAR (U.S. CLS. 26, 39 AND 44). FIRST USE 11-19-2001; IN COMMERCE 11-19-2001. WILLIAM VERHOSEK, EXAMINING ATTORNEY

SN 76-549,204. BARRIERMED, INC., LAKE MARY, FL. FILED 10-6-2003.

SCIS,1-4MULATION

FOR LATEX GLOVES FOR MEDICAL USE (U.S. CLS. 26, 39 AND 44). FIRST USE 3-0-2002; IN COMMERCE 3-0-2002. LESLEY LAMOTHE, EXAMINING ATTORNEY

SN 76-551,456. KORR MEDICAL TECHNOLOGIES, SALT LAKE CITY, UT. FILED 9-15-2003.

VT JR.

FOR PORTABLE HAND HELD MEDICAL DEVICE DESIGNED FOR VENTILATOR CALIBRATION AND DATA STORAGE (U.S. CLS. 26, 39 AND 44). FIRST USE 5-1-2003; IN COMMERCE 5-1-2003. LESLEY LAMOTHE, EXAMINING ATTORNEY

SN 76-551,646. IVOCLAR VIVADENT, INC., AMHERST, NY. FILED 10-16-2003.

IHOSTAR

FOR ARTIFICIAL TEETH (U.S. CLS. 26, 39 AND 44). ZACHARY BELLO, EXAMINING ATTORNEY

CLASS 10—(Continued).

SN 76-553,749. CLINICIAN'S CHOICE DENTAL PRODUCTS INC., LONDON, ONTARIO, CANADA, FILED 10-6-2003.

CLING2

FOR TEMPORARY DENTAL CEMENT (U.S. CLS. 26, 39 AND 44).
JOHN DALIER, EXAMINING ATTORNEY

SN 76-553,984. HAWAII MEDICAL, LLC, PEMBROKE, MA. FILED 10-6-2003.

NEATNICK

FOR AUTOMATED LANCING DEVICE WHICH CREATES AN INCISION OR NICK IN AN INFANT'S HEEL FOR THE PURPOSE OF DRAWING A BLOOD SAMPLE (U.S. CLS. 26, 39 AND 44).
FIRST USE 8-0-2003; IN COMMERCE 8-0-2003.
SHAUNIA WALLACE, EXAMINING ATTORNEY

SN 76-559,666. UNITED STATES SURGICAL CORPORATION, NORWALK, CT. FILED 10-31-2003.

HERCULON

FOR SURGICAL DEVICES NAMELY, SUTURE ANCHORS, STERILIZATION TRAYS, DRILL GUIDES, OBTURATORS, DRILL BITS AND GUIDE WIRES (U.S. CLS. 26, 39 AND 44).
DAVID H. STINE, EXAMINING ATTORNEY

SN 78-067,144. ENDOJETT, WAMEGO, KS. FILED 6-4-2001.

ENDOJETT

FOR ENDOSCOPY APPARATUS FOR MEDICAL USE, NAMELY CATHETERS, FLUID JET FITTINGS, PUMPS AND CONTROL DEVICES FOR THE CATHETERS AND FLUID JET FITTING (U.S. CLS. 26, 39 AND 44).
STEVEN BERK, EXAMINING ATTORNEY

SN 78-165,836. INTEGRATED MEDICAL SYSTEMS, INC., SIGNAL HILL, CA. FILED 9-19-2002.

WHEN EVERY SECOND COUNTS

FOR MEDICAL EQUIPMENT, NAMELY, MEDICAL STRETCHERS COMPRISED OF TRANSPORTABLE PATIENT PLATFORMS CONSISTING OF AN INSTRUMENT BED FOR CRITICAL CARE AND TRANSPORT (U.S. CLS. 26, 39 AND 44).
STEVEN BERK, EXAMINING ATTORNEY

CLASS 10—(Continued).

SN 78-188,508. MEDTRONIC, INC., MINNEAPOLIS, MN. FILED 11-25-2002.

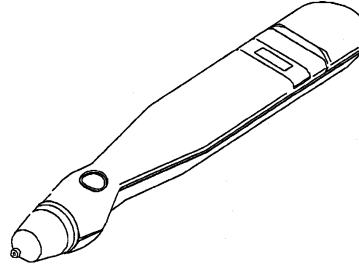

THE MARK CONSISTS OF THE DESIGN FOR A HAND-HELD TONOMETER WITH AN LCD DISPLAY IN THE UPPER PORTION OF THE HANDLE AND A NARROW GRIP.
SEC. 2(F).
FOR HAND HELD ELECTRONIC TONOMETER FOR MEASURING THE PRESSURE WITHIN THE EYE (U.S. CLS. 26, 39 AND 44).
FIRST USE 12-31-1985; IN COMMERCE 12-31-1985.
DORITT L. CARROLL, EXAMINING ATTORNEY

SN 78-213,448. ARTHROSURFACE INCORPORATED, STOUGHTON, MA. FILED 2-11-2003.

CAP^{Ceramic}

FOR PROSTHETIC IMPLANTS FOR ARTICULAR RESURFACING (U.S. CLS. 26, 39 AND 44).
KARLA PERKINS, EXAMINING ATTORNEY

SN 78-214,297. LANX, LLC, BOULDER, CO. FILED 2-13-2003.

LANX

FOR MEDICAL DEVICES, NAMELY A FULL LINE OF IMPLANTS AND INSTRUMENTS FOR ORTHOPEDIC SURGERY, NAMELY, BONE, JOINT AND OTHER TISSUE-BASED DIAGNOSTIC AND THERAPEUTIC PROCEDURES (U.S. CLS. 26, 39 AND 44).
FIRST USE 12-0-2003; IN COMMERCE 1-29-2004.
ZACHARY BELLO, EXAMINING ATTORNEY

CLASS 10—(Continued).

SN 78-225,421. ALUNG TECHNOLOGIES, INC., PITTSBURGH, PA. FILED 3-13-2003.

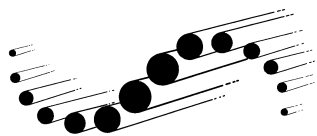

FOR MEDICAL CATHETERS, MEDICAL GUIDE WIRES, MEDICAL GUIDE WIRE INTRODUCERS, CATHETER TIPS, CATHETER SHEATHS, CATHETER INTRODUCERS, HEMOSTATIC SIDE-ARM ADAPTERS, HEMOSTATIC VALVES, VENT TUBES, PRESSURE INDICATOR/REGULATORS, FLUSHING TOOLS, FUNNEL INTRODUCERS, HAND-OPERATED BALLOON INFLATING/DEFLATING DEVICES, MEDICAL APPARATUS SYSTEM CONSISTING OF MEDICAL CATHETERS, MEDICAL GUIDE WIRES, OXYGEN FLOW REGULATORS, TUBING, AN ELECTRIC CONSOLE, COMPUTER SOFTWARE FOR OPERATING ELECTRIC CONSOLE AND INSTRUCTION MANUALS SOLD AS A UNIT; ARTIFICIAL LUNGS AND OXYGENATORS (U.S. CLS. 26, 39 AND 44).

DOMINIC J. FERRAIUOLO, EXAMINING ATTORNEY

SN 78-225,620. ROUX, CHRISTIAN B., YPSILANTI, MI. FILED 3-14-2003.

SWITCH GRIP

NO CLAIM IS MADE TO THE EXCLUSIVE RIGHT TO USE GRIP, APART FROM THE MARK AS SHOWN.

FOR DURABLE MEDICAL SUPPLIES, NAMELY INVALID WALKERS, THREE-WHEELER, AND CRUTCHES (U.S. CLS. 26, 39 AND 44).

GINNY ISAACSON, EXAMINING ATTORNEY

SN 78-231,341. INVERNESS MEDICAL SWITZERLAND GMBH, CH-6300, ZUG, SWITZERLAND, FILED 3-28-2003.

CLEARBLUE

FOR DIAGNOSTIC APPARATUS FOR MEDICAL PURPOSES, NAMELY DIAGNOSING PREGNANCY, FERTILITY AND OVULATION (U.S. CLS. 26, 39 AND 44).

WANDA KAY PRICE, EXAMINING ATTORNEY

CLASS 10—(Continued).

SN 78-236,135. SMITHS MEDICAL ASD, INC., KEANE, NH. FILED 4-10-2003.

PORTEX

OWNER OF U.S. REG. NOS. 444,703 AND 2,417,963.

FOR SURGICAL AND MEDICAL APPARATUS AND INSTRUMENTS, NAMELY, CATHETERS, CANNULAS, MEDICAL TUBES AND TUBING, NAMELY ENDOTRACHEAL, ENDOBRONCHIAL, TRACHEOSTOMY, TRACHEOTOMY, PERCUTANEOUS TRACHEOSTOMY TUBES, LARYNGECTOMY, TRACHEAL, LARYNGOTOMY, AND FEEDING TUBES, AND FITTINGS THEREFOR IN THE NATURE OF CONNECTORS, ADAPTERS, STOPCOCKS, MANIFOLDS, SWIVEL COUPLINGS, VALVES, ELBOW JOINTS; INTUBATION STYLETS; MEDICAL SYRINGES; MEDICAL NEEDLES; FILTERS, NAMELY, EPIDURAL FILTERS USED WITH EPIDURAL DRUG ADMINISTRATION DEVICE AND FILTERS USED WITH ARTERIAL BLOOD SAMPLING SYRINGES; BREATHING AND RESUSCITATION BAGS; MEDICAL MANOMETERS; RESUSCITATION DEVICES; HEAT AND MOISTURE EXCHANGERS (HME) FOR MEDICAL USE; HUMIDIFIERS FOR MEDICAL USE, LARYNGOSCOPES; ENDOTRACHEAL TUBE HOLDERS; TRACHEAL TUBE INTRODUCERS AND GUIDES; CUFF BLOOD PRESSURE GAUGE AND TUBING; EPIDURAL CANNULAS; AMNIOCENTESIS INSTRUMENTS AND APPARATUS; ANESTHESIA DELIVERY INSTRUMENTS AND APPARATUS; EPIDURAL AND SPINAL ANESTHESIA DELIVERY INSTRUMENTS AND APPARATUS; INNER LINERS FOR TRACHEOSTOMY TUBES; INTUBATION MOUTHPIECES; MEDICAL AND SURGICAL PROCEDURAL KITS CONSISTING ESSENTIALLY OF MEDICAL NEEDLES AND TUBING; NEBULIZERS FOR RESPIRATION THERAPY; TUNNELING DEVICES USED FOR PLACEMENT OF EPIDURAL, SPINAL AND PERIPHERAL NERVE BLOCK CATHETERS; BLOOD SAMPLING DEVICES, NAMELY, MEDICAL NEEDLES AND MEDICAL SYRINGES; PULSE OXIMETERS; PATIENT MONITORS INCLUDING PATIENT OXYGEN MONITORS, SPO2 MONITORS, CARBON DIOXIDE MONITORS, BLOOD GAS MONITORS, HEART MONITORS, RESPIRATION MONITORS, BLOOD PRESSURE MONITORS, TEMPERATURE MONITORS, AND PULSE RATE MONITORS; SKIN TEMPERATURE PROBES FOR MEDICAL PURPOSES; URETERAL DRAINAGE BAGS; DEVICES FOR PROTECTING NEEDLES AND SHARPS NAMELY, PROTECTIVE SHEATHS FOR COVERING NEEDLES AND PERMANENT RECAPPING DEVICES FOR USE WITH SURGICAL SHARPS, NEEDLES AND STYLETS; DEVICES FOR INJECTION OR ADMINISTRATION OF PHARMACEUTICALS OR MEDICAL FLUIDS, OR FOR SAMPLING BODILY FLUID OR TISSUE, COMPRISING A MEDICAL NEEDLE AND NEEDLE PROTECTION DEVICE COMBINED WITH A SYRINGE, TUBE HOLDER, CARTRIDGE, EVACUATED CONTAINER, VACUUM TUBE, OR OTHER FLUID OR TISSUE HOLDING CONTAINER; SPECIALLY DESIGNED CONTAINERS FOR THE DISPOSAL OF BIOHAZARD WASTE; APPARATUS AND INSTRUMENTS FOR USE IN NERVE LOCATION, NERVE STIMULATION AND NERVE BLOCK PROCEDURES, NAMELY NERVE STIMULATORS, NERVE LOCATORS, AND COMPONENT PARTS THEREFOR IN THE NATURE OF ELECTRONIC FOOT PEDAL CONTROLS, MEDICAL NEEDLES, INJECTION PORTS, CATHETERS, INSERTION GUIDES, CABLES, WIRES AND CONNECTORS, AND PARTS AND FITTINGS THEREFOR; KITS FOR NERVE LOCATION, NERVE STIMULATION AND NERVE BLOCK PROCEDURES, CONSISTING PRIMARILY OF NERVE STIMULATORS, NERVE LOCATORS, ELECTRONIC FOOT PEDAL CONTROLS, MEDICAL NEEDLES, INJECTION PORTS, CATHETERS, INSERTION GUIDES, CABLES, WIRES AND/OR CONNECTORS (U.S. CLS. 26, 39 AND 44).

FIRST USE 0-0-1947; IN COMMERCE 0-0-1947.

TRACY FLETCHER, EXAMINING ATTORNEY

CLASS 10—(Continued).

SN 78-236,216. MEDTRONIC MINIMED, INC., NORTH-RIDGE, CA. FILED 4-10-2003.

SQUARE WAVE

FOR FEATURE OF MEDICATION INFUSION PUMPS WITH DEFINABLE SETS THAT CHANGE PUMP FUNCTION PERFORMANCE OR OPERATION IN THE DELIVERY OF INSULIN (U.S. CLS. 26, 39 AND 44).

FIRST USE 3-29-2002; IN COMMERCE 3-29-2002.
KIMBERLY PERRY, EXAMINING ATTORNEY

CLASS 10—(Continued).

SN 78-243,327. GRACO CHILDREN'S PRODUCTS INC., FREEPORT, IL. FILED 4-29-2003.

CENTURY

OWNER OF U.S. REG. NO. 1,262,306.
FOR BABY BOTTLES, BABY BOTTLE NIPPLES, BABY NURSERS, TEETHING RINGS, PACIFIERS, PACIFIER CLIPS, BABY THERMOMETERS AND MEDICINE DROPPERS SOLD EMPTY, NASAL ASPIRATORS (U.S. CLS. 26, 39 AND 44).

JASON TURNER, EXAMINING ATTORNEY

SN 78-237,549. IDEV TECHNOLOGIES, INC., HOUSTON, TX. FILED 4-14-2003.

JUNCTION

FOR MEDICAL DEVICE, NAMELY, A SELF-EXPANDABLE BIFURCATED STENT MADE OF NITINOL (U.S. CLS. 26, 39 AND 44).

ALLISON HOLTZ, EXAMINING ATTORNEY

SN 78-250,575. ARCOA INDUSTRIES, INC., SAN MARCOS, CA. FILED 5-15-2003.

EZ PUSH

NO CLAIM IS MADE TO THE EXCLUSIVE RIGHT TO USE "PUSH", APART FROM THE MARK AS SHOWN.

FOR SLIDES FOR ATTACHMENT TO THE FEET OF INVALID WALKER SYSTEMS (U.S. CLS. 26, 39 AND 44).
HOWARD SMIGA, EXAMINING ATTORNEY

SN 78-238,941. ACROSTAK CORP., WINTERTHUR, SWITZERLAND, FILED 4-17-2003.

HYDROLUBRIC

PRIORITY CLAIMED UNDER SEC. 44(D) ON SWITZERLAND APPLICATION NO. 09152/2002, FILED 10-23-2002, REG. NO. 508693, DATED 3-26-2003, EXPIRES 10-23-2012.

FOR CATHETERS, DILATATION, CATHETERS, DIAGNOSTIC CATHETERS, BALLOON CATHETERS, COATED CATHETERS, COATED BALLOON CATHETERS (U.S. CLS. 26, 39 AND 44).

HOWARD SMIGA, EXAMINING ATTORNEY

SN 78-270,897. C. R. BARD, INC., MURRAY HILL, NJ. FILED 7-7-2003.

SCOPE SAVER

NO CLAIM IS MADE TO THE EXCLUSIVE RIGHT TO USE "SCOPE", APART FROM THE MARK AS SHOWN.

FOR MEDICAL DEVICES AND APPARATUS, NAMELY, BITE BLOCKS FOR USE IN CONNECTION WITH UPPER GASTROINTESTINAL PROCEDURES (U.S. CLS. 26, 39 AND 44).

MARLENE BELL, EXAMINING ATTORNEY

SN 78-240,730. ARTHROCARE CORPORATION, SUNNYVALE, CA. FILED 4-22-2003.

TIGER SHARK

FOR MEDICAL DEVICES FOR REMOVAL OF TISSUE IN ORTHOPAEDIC SURGICAL PROCEDURES, NAMELY SCISSORS AND PUNCHES (U.S. CLS. 26, 39 AND 44).

ROBIN CHOSID, EXAMINING ATTORNEY

SN 78-282,754. ASAHI INTECC CO., LTD., AICHI, JAPAN, FILED 8-4-2003.

PROWATER

FOR PTCA (PERCUTANEOUS TRANSLUMINAL CORONARY ANGIOPLASTY) GUIDE WIRES, MEDICAL INSTRUMENTS AND APPARATUS, NAMELY, MEDICAL GUIDE WIRES (U.S. CLS. 26, 39 AND 44).

FIRST USE 3-11-2003; IN COMMERCE 3-11-2003.
KARLA PERKINS, EXAMINING ATTORNEY

CLASS 10—(Continued).

SN 78-282,761. ASAHI INTECC CO., LTD., AICHI, JAPAN,
FILED 8-4-2003.

GRAND SLAM

FOR PTCA (PERCUTANEOUS TRANSLUMINAL CORONARY ANGIOPLASTY) GUIDE WIRES; MEDICAL INSTRUMENTS AND APPARATUS, NAMELY, MEDICAL GUIDE WIRES (U.S. CLS. 26, 39 AND 44).
FIRST USE 7-4-1996; IN COMMERCE 3-11-2003.
KARLA PERKINS, EXAMINING ATTORNEY

SN 78-291,051. BECTON, DICKINSON AND COMPANY,
FRANKLIN LAKES, NJ. FILED 8-22-2003.

BD Microtainer

OWNER OF U.S. REG. NOS. 1,042,544, 2,783,108 AND OTHERS.
THE MARK CONSISTS IN PART OF A SHADED CIRCLE WITH SUNBURST AND PARTIAL ARC DESIGN.
FOR MEDICAL DEVICES, NAMELY TUBES AND LANCETS FOR THE ACQUISITION AND COLLECTION OF BLOOD (U.S. CLS. 26, 39 AND 44).
GENE MACIOL, EXAMINING ATTORNEY

SN 78-295,103. COOK INCORPORATED, BLOOMINGTON,
IN. FILED 9-2-2003.

PNEUMO FLOW

FOR MEDICAL DEVICES, NAMELY VALVES FOR USE IN RELIEVING PNEUMOTHORAX (U.S. CLS. 26, 39 AND 44).
AISHA CLARKE, EXAMINING ATTORNEY

SN 78-297,390. ANIMARK, INC., AURORA, CO. FILED 9-8-2003.

ANIMARK

FOR MEDICAL INSTRUMENTS FOR VETERINARY USE, NAMELY ELECTROMAGNETIC MEDICAL DIAGNOSTIC IMAGING APPARATUS AND ULTRASOUND DIAGNOSTIC APPARATUS (U.S. CLS. 26, 39 AND 44).
FIRST USE 1-13-1976; IN COMMERCE 1-13-1976.
STEVEN BERK, EXAMINING ATTORNEY

CLASS 10—(Continued).

SN 78-301,017. BUNHEADS, INC., SARATOGA SPRINGS,
NY. FILED 9-16-2003.

JITTERBUG GELS

NO CLAIM IS MADE TO THE EXCLUSIVE RIGHT TO USE GELS, APART FROM THE MARK AS SHOWN.
FOR REUSABLE MEDICAL SHOE INSERTS MADE OF FABRIC COVERED POLYMER GEL DESIGNED TO CUSHION AND PROTECT AREAS OF THE FOOT (U.S. CLS. 26, 39 AND 44).
FIRST USE 6-30-2003; IN COMMERCE 6-30-2003.
LESLEY LAMOTHE, EXAMINING ATTORNEY

SN 78-303,393. THE CDM COMPANY, NEWPORT BEACH,
CA. FILED 9-22-2003.

SPINFLOSS

FOR MOTORIZED DENTAL FLOSSING DEVICE (U.S. CLS. 26, 39 AND 44).
DOMINIC J. FERRAIUOLO, EXAMINING ATTORNEY

SN 78-303,778. INNOVATIVE ORTHOTICS, INC, FOUNTAIN
VALLEY, CA. FILED 9-22-2003.

**INNOVATIVE ORTHOTICS,
INC.**

NO CLAIM IS MADE TO THE EXCLUSIVE RIGHT TO USE "ORTHOTICS INC.", APART FROM THE MARK AS SHOWN.
FOR FOOT ORTHOTICS (U.S. CLS. 26, 39 AND 44).
H. M. FISHER, EXAMINING ATTORNEY

SN 78-305,635. 3F THERAPEUTICS, INC., LAKE FOREST,
CA. FILED 9-25-2003.

**3F ENGAGE AORTIC HEART
VALVE**

NO CLAIM IS MADE TO THE EXCLUSIVE RIGHT TO USE "AORTIC HEART VALVE", APART FROM THE MARK AS SHOWN.
FOR AORTIC BIO-PROSTHESES (U.S. CLS. 26, 39 AND 44).
RICHARD A. STRASER, EXAMINING ATTORNEY

CLASS 10—(Continued).

SN 78-307,425. HSI SERVICE CORP., NEWARK, DE. FILED 9-30-2003.

MAXIMA

OWNER OF U.S. REG. NOS. 1,937,410, 2,412,695 AND 2,480,871.

FOR DENTAL INSTRUMENTS AND APPARATUS, NAMELY DENTAL CURING LIGHTS, MIRRORS AND ENDODONTIC INSTRUMENTS (U.S. CLS. 26, 39 AND 44).

FIRST USE 3-0-1995; IN COMMERCE 3-0-1995.
SUSAN HAYASH, EXAMINING ATTORNEY

SN 78-308,771. LA MONT LLC, MADISON, WI. FILED 10-2-2003.

LA MONT PRO-AMP

OWNER OF U.S. REG. NOS. 2,659,452 AND 2,705,445.
THE ENGLISH TRANSLATION OF "LA MONT" IS "THE MOUNTAIN".

FOR MEDICAL DIAGNOSTIC EQUIPMENT, NAMELY, NEUROPHYSIOLOGICAL AND CARDIAC MONITORING EQUIPMENT; SPECIFICALLY NEUROPHYSIOLOGICAL AMPLIFIER MODULES THAT ACQUIRE, AMPLIFY, FILTER, DIGITIZE AND TRANSMIT PATIENT PHYSIOLOGICAL SIGNALS SUCH AS ELECTROENCEPHALOGRAM (EEG), POLYSOMNOGRAPHIC (PSG), ELECTROOCULAR (EOG), ELECTROMUSCULAR (EMG) OR ELECTROCARDIOGRAM (ECG) APPARATUS (U.S. CLS. 26, 39 AND 44).

FIRST USE 10-1-2003; IN COMMERCE 10-1-2003.
ROBERT LORENZO, EXAMINING ATTORNEY

SN 78-311,430. LINKS MEDICAL PRODUCTS, INC., IRVINE, CA. FILED 10-9-2003.

ACCUCUTRX

FOR MEDICAL PRODUCTS, NAMELY, HAND-HELD DEVICES USED TO CUT PILLS, TABLETS, OR CAPLETS, AND PLASTIC TRAYS THEREFORE DESIGNED TO HOLD PILLS, TABLETS, OR CAPLETS DURING CUTTING (U.S. CLS. 26, 39 AND 44).

FIRST USE 8-31-2001; IN COMMERCE 8-31-2001.
JENNIFER KRISP, EXAMINING ATTORNEY

SN 78-316,236. HESKA CORPORATION, FT. COLLINS, CO. FILED 10-21-2003.

HEALTHSCREEN

FOR TESTING APPARATUS FOR THE DETECTION OF MICROALBUMINURIA IN ANIMALS; ANIMAL SPECIMEN COLLECTION APPARATUS, NAMELY URINE COLLECTION SPONGES (U.S. CLS. 26, 39 AND 44).
STEVEN R. FINE, EXAMINING ATTORNEY

CLASS 10—(Continued).

SN 78-319,194. FREEDOM INNOVATIONS, INC., CORONA, CA. FILED 10-27-2003.

RUNWAY

FOR PROSTHETIC FEET (U.S. CLS. 26, 39 AND 44).
WON TEAK OH, EXAMINING ATTORNEY

SN 78-320,064. VIACOR, INC., WILMINGTON, MA. FILED 10-29-2003.

VIACOR

FOR PERCUTANEOUS TRANSVENOUS MITRAL ANULOPLASTY DEVICE FOR POSITIONING IN THE CORONARY SINUS OF THE HEART AND RESHAPING THE GEOMETRY OF A MALFUNCTIONING MITRAL VALVE, WHEREBY TO IMPROVE MITRAL VALVE FUNCTION (U.S. CLS. 26, 39 AND 44).

TANYA AMOS, EXAMINING ATTORNEY

CLASS 11—ENVIRONMENTAL CONTROL APPARATUS

SN 76-454,531. DAN'S FAN CITY, INC., OLDSMAR, FL. FILED 9-24-2002.

ARBOR

FOR CEILING FAN BLADES (U.S. CLS. 13, 21, 23, 31 AND 34).

FIRST USE 5-10-2002; IN COMMERCE 6-18-2002.
BRENDAN MCCAULEY, EXAMINING ATTORNEY

SN 76-460,960. LINERS DIRECT, INC., ITASCA, IL. FILED 10-15-2002.

KIOSET

FOR SHOWER ENCLOSURES, NAMELY, ACRYLIC BATHTUB LINERS, ACRYLIC SHOWER LINERS, AND ACRYLIC WALL SURROUND SYSTEMS COMPRISED OF ACRYLIC WALL SHOWERS, ACRYLIC SOAP DISHES, ACRYLIC CORNER CADDIES, ACRYLIC SHELF CADDIES, ACRYLIC SAFETY GRAB BARS, ACRYLIC SAFETY STANDS (U.S. CLS. 13, 21, 23, 31 AND 34).

FIRST USE 4-0-2002; IN COMMERCE 4-0-2002.
CURTIS FRENCH, EXAMINING ATTORNEY

CLASS 11—(Continued).

SN 76-461,527. HYDRANAUTICS, OCEANSIDE, CA. FILED 10-23-2002.

SANRO

FOR FILTER UNITS FOR RESIDENTIAL COMMERCIAL AND INDUSTRIAL WATER FILTRATION; FILTRATION MEMBRANES FOR WATER FILTERING UNITS FOR RESIDENTIAL, COMMERCIAL AND INDUSTRIAL USE (U.S. CLS. 13, 21, 23, 31 AND 34).

FIRST USE 10-24-2002; IN COMMERCE 10-24-2002.
MATTHEW KLINE, EXAMINING ATTORNEY

SN 76-477,107. AMERSHAM BIOSCIENCES AB, UPPSALA, SWEDEN, FILED 12-19-2002.

QUIXSTAND

PRIORITY CLAIMED UNDER SEC. 44(D) ON UNITED KINGDOM APPLICATION NO. 2309376, FILED 8-30-2002, REG. NO. 2309376, DATED 3-28-2003, EXPIRES 8-30-2012.

FOR BENCHTOP FILTRATION SYSTEM, NAMELY, FILTER CARTRIDGE, MANIFOLD, PUMP, BACK-PRESSURE VALVE, PRESSURE GAUGES AND RESERVOIR FOR USE IN BIOSEPARATION PROCESSES AND MEMBRANE SEPARATION PROCEDURES (U.S. CLS. 13, 21, 23, 31 AND 34).

FIRST USE 0-0-1995; IN COMMERCE 0-0-1995.
ALICE SUE CARRÜTERS, EXAMINING ATTORNEY

SN 76-477,110. AMERSHAM BIOSCIENCES AB, UPPSALA, SWEDEN, FILED 12-19-2002.

FLEXSTAND

PRIORITY CLAIMED UNDER SEC. 44(D) ON UNITED KINGDOM APPLICATION NO. 2309403, FILED 8-30-2002, REG. NO. 2309403, DATED 4-4-2003, EXPIRES 8-30-2012.

FOR BENCHTOP FILTRATION SYSTEM, NAMELY, FILTER CARTRIDGE, MANIFOLD, PUMP, BACK-PRESSURE VALVE, PRESSURE GAUGES AND RESERVOIR FOR USE IN BIOSEPARATION PROCESSES AND MEMBRANE SEPARATION PROCEDURES (U.S. CLS. 13, 21, 23, 31 AND 34).

FIRST USE 0-0-1992; IN COMMERCE 0-0-1992.
ALICE SUE CARRÜTERS, EXAMINING ATTORNEY

SN 76-477,112. AMERSHAM BIOSCIENCES AB, UPPSALA, SWEDEN, FILED 12-19-2002.

GRANDSTAND

PRIORITY CLAIMED UNDER SEC. 44(D) ON UNITED KINGDOM APPLICATION NO. 2309401, FILED 8-30-2002, REG. NO. 2309401, DATED 8-30-2002, EXPIRES 8-30-2012.

FOR FILTRATION SYSTEM, NAMELY, FILTER CARTRIDGE, MANIFOLD, PUMP, BACK-PRESSURE VALVE, PRESSURE GAUGES AND TANK FOR USE IN BIOSEPARATION PROCESSES AND MEMBRANE SEPARATION PROCEDURES (U.S. CLS. 13, 21, 23, 31 AND 34).

FIRST USE 0-0-1996; IN COMMERCE 0-0-1996.
ALICE SUE CARRÜTERS, EXAMINING ATTORNEY

CLASS 11—(Continued).

SN 76-491,405. LIGHT EMISSION TECHNOLOGIES AG, CH 8733 ESCHENBACH, SWITZERLAND, FILED 2-24-2003.

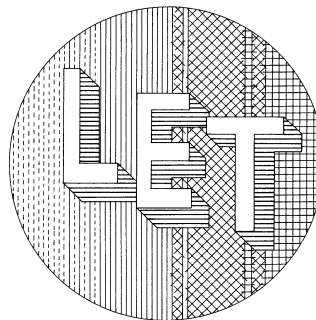

THE MARK IS LINED FOR THE COLOR PURPLE AT THE LEFT FADING INTO THE COLOR RED AT THE CENTER FADING INTO THE COLOR YELLOW AT THE LEFT, WITH THE LINING AT THE BOTTOM AND RIGHT SIDE OF THE LETTERS TO INDICATE SOLID BLUE SHADOW.

FOR ELECTRIC LIGHT BULBS FOR SUN LAMPS AND ELECTRICAL LIGHTING FIXTURES FOR SUN LAMPS (U.S. CLS. 13, 21, 23, 31 AND 34).

ROBERT LORENZO, EXAMINING ATTORNEY

SN 76-504,516. WESTINGHOUSE LIGHTING CORPORATION, PHILADELPHIA, PA. FILED 4-7-2003.

EYE SAVER

FOR ELECTRIC LIGHT BULBS, FLUORESCENT LIGHTING TUBES, ELECTRIC LIGHTING FIXTURES (U.S. CLS. 13, 21, 23, 31 AND 34).

GIANCARLO CASTRO, EXAMINING ATTORNEY

SN 76-506,349. SHAEFER, LISA CAVETT, SAN ANTONIO, TX. FILED 4-15-2003.



NO CLAIM IS MADE TO THE EXCLUSIVE RIGHT TO USE "LIGHT", APART FROM THE MARK AS SHOWN.

FOR LIGHTING DEVICES, NAMELY, ELECTRIC NIGHT LIGHT (U.S. CLS. 13, 21, 23, 31 AND 34).

LINDA M. KING, EXAMINING ATTORNEY

CLASS 11—(Continued).

SN 76-510,051. ROCKY MOUNTAIN PORTABLE COOLING, INC., DENVER, CO. FILED 4-28-2003.

SURECOOL

OWNER OF U.S. REG. NO. 2,628,757.
FOR COOLING EQUIPMENT, NAMELY, ELECTRIC FANS, REFRIGERATION UNITS FOR CHILLING RESIDENTIAL, COMMERCIAL AND INDUSTRIAL STRUCTURES, AND PORTABLE COOLING EQUIPMENT IN THE NATURE OF AIR CONDITIONING UNITS, EXCLUDING VORTEX TUBES FOR COOLING SYSTEMS (U.S. CLS. 13, 21, 23, 31 AND 34).

FIRST USE 6-1-2001; IN COMMERCE 7-10-2001.
LAURA KOVAISKY, EXAMINING ATTORNEY

SN 76-513,254. GE OSMONICS, INC., MINNETONKA, MN. FILED 5-12-2003.

MINIWIZARD

OWNER OF U.S. REG. NO. 2,063,117.
FOR FLUID SEPARATION UNITS, NAMELY INDUSTRIAL FLUID FILTERS; RECYCLING UNITS, NAMELY, FLUID PURIFICATION UNITS (U.S. CLS. 13, 21, 23, 31 AND 34).

FIRST USE 7-0-2002; IN COMMERCE 8-0-2002.
JOANNA MATEJA, EXAMINING ATTORNEY

SN 76-517,314. ARK GROUP INC., WALNUT, CA. FILED 5-23-2003.

EASY LIGHTING SYSTEM

NO CLAIM IS MADE TO THE EXCLUSIVE RIGHT TO USE "LIGHTING SYSTEM", APART FROM THE MARK AS SHOWN.

FOR CHANDELIERS; LAMP SHADES; WALL LAMPS; ELECTRIC LIGHTS FOR CHRISTMAS TREES; ELECTRIC LIGHTING FIXTURES; NAMELY, CEILING LIGHTS; FITTINGS FOR ELECTRIC LAMPS, NAMELY, HANGINGS FOR LAMPS, LAMP CASTINGS, LAMP HANGING SUPPORTS, AND LAMPSHADE HOLDERS; AND DESK LAMPS (U.S. CLS. 13, 21, 23, 31 AND 34).

FIRST USE 3-2-2003; IN COMMERCE 3-25-2003.
MARY CRAWFORD, EXAMINING ATTORNEY

CLASS 11—(Continued).

SN 76-519,631. CORDELIA LIGHTING, INC., RANCHO DOMINGUEZ, CA. FILED 6-4-2003.

CANDOR LIGHTING

NO CLAIM IS MADE TO THE EXCLUSIVE RIGHT TO USE "LIGHTING", APART FROM THE MARK AS SHOWN.

FOR LIGHTING FIXTURES, NAMELY, CEILING LIGHT FIXTURES, CHANDELIER LIGHT FIXTURES, WALL LIGHT FIXTURES, BATHROOM LIGHT FIXTURES, SPOT LIGHTING FIXTURES, RECESSED LIGHT FIXTURES, TRACK LIGHTING FIXTURES, SCENCE LIGHTING FIXTURES, HANGING LAMP FIXTURES, LAMPS, NAMELY, TABLE LAMPS, FLOOR LAMPS, STREET LAMPS, PARKING LOT LAMPS, Klieg LAMPS, ELECTRIC LANTERNS, ELECTRIC NIGHT LIGHTS, SECURITY LIGHTING, MOTION DETECTOR LIGHTING, SHOP LIGHTS, LAMP SHADES, LIGHT REFLECTORS, LIGHT DIFFUSERS, VEHICLE LIGHTING, NAMELY HEADLIGHTS, TAIL LIGHTS, SIDE MARKERS, AND CEILING FANS (U.S. CLS. 13, 21, 23, 31 AND 34).

FIRST USE 6-30-2003; IN COMMERCE 6-30-2003.
VERNA BETH RIRIE, EXAMINING ATTORNEY

SN 76-524,221. HELEN OF TROY LIMITED, BRIDGETOWN, BARBADOS, FILED 6-19-2003.

GOLD STANDARD

OWNER OF U.S. REG. NO. 2,350,716.
FOR ELECTRIC HAND-HELD HAIR DRYERS (U.S. CLS. 13, 21, 23, 31 AND 34).

JENNIFER DIXON, EXAMINING ATTORNEY

SN 76-537,441. LASER DEVICES, INC., MONTEREY, CA. FILED 8-14-2003.

OPERATOR

FOR FLASHLIGHT POINTERS (U.S. CLS. 13, 21, 23, 31 AND 34).

FIRST USE 9-1-2003; IN COMMERCE 10-1-2003.
TRACY WHITAKER-BOWN, EXAMINING ATTORNEY

SN 76-547,585. NIKKEN, INC., IRVINE, CA. FILED 9-30-2003.

WELLNESS IN THE AIR

FOR AIR PURIFIER FILTERING UNITS FOR RESIDENTIAL AND COMMERCIAL USE (U.S. CLS. 13, 21, 23, 31 AND 34).

KATHRYN COWARD, EXAMINING ATTORNEY

CLASS 11—(Continued).

SN 76-547,652. FERGUSON, JOHNNY W., SEARCY, AR. FILED 9-12-2003.

HITCH-A-QUE

FOR BARBEQUE GRILLS THAT CAN BE ATTACHED TO THE RECEIVING HITCH OF A VEHICLE FOR TAILGATING PURPOSES OR USED ON FLAT SURFACES (U.S. CLS. 13, 21, 23, 31 AND 34).
GLENN CLARK, EXAMINING ATTORNEY

SN 76-548,822. LIGHTWAVE ENERGY SYSTEMS CO., INC., TORRANCE, CA. FILED 10-3-2003.

CUREMAX

FOR ULTRAVIOLET LAMPS USED FOR CURING RADIATION SENSITIVE ADHESIVES AND COATINGS (U.S. CLS. 13, 21, 23, 31 AND 34).
H. M. FISHER, EXAMINING ATTORNEY

SN 78-091,196. TRAJET PRODUCTS INC., GLENWOOD, IA. FILED 11-1-2001.



FOR FITTED PROTECTIVE LINERS FOR WHIRLPOOL BATHS (U.S. CLS. 13, 21, 23, 31 AND 34).
FIRST USE 5-1-2001; IN COMMERCE 5-5-2001.
REBECCA SMITH, EXAMINING ATTORNEY

SN 78-094,365. FILTREX INDUSTRIES, LLC., TULSA, OK. FILED 11-20-2001.

FX-30

THE MARK CONSISTS OF STANDARD CHARACTERS WITHOUT CLAIM TO ANY PARTICULAR FONT, STYLE, SIZE, OR COLOR.

FOR AIR FILTERS FOR AIR CONDITIONING AND HEATING UNITS, FOR DOMESTIC COMMERCIAL USE, FOR INDUSTRIAL INSTALLATIONS (U.S. CLS. 13, 21, 23, 31 AND 34).
FIRST USE 11-30-2000; IN COMMERCE 11-30-2000.
MARY CRAWFORD, EXAMINING ATTORNEY

CLASS 11—(Continued).

SN 78-217,437. ARLEC BARBEQUES PTY LIMITED, CHATSWOOD, NEW SOUTH WALES, AUSTRALIA, FILED 2-21-2003.

HORIZON

FOR GAS BARBECUES AND GRILLS AND STRUCTURAL PARTS THEREFOR; STANDS FOR BARBECUES, WITH AND WITHOUT WHEELS (U.S. CLS. 13, 21, 23, 31 AND 34).
MARY CRAWFORD, EXAMINING ATTORNEY

SN 78-220,893. NORDYNE, INC., O'FALLON, MO. FILED 3-3-2003.

MEDALLION

FOR AIR CONDITIONERS, FURNACERS AND HEAT PUMPS SOLD EXCLUSIVELY THROUGH LICENSED HVAC CONTRACTORS (U.S. CLS. 13, 21, 23, 31 AND 34).
KARANENDRA S. CHHINA, EXAMINING ATTORNEY

SN 78-221,869. GILLETTE COMPANY, THE, BOSTON, MA. FILED 3-5-2003.

FOCUS-GRIP

FOR FLASHLIGHTS; PORTABLE BATTERY-POWERED LIGHTS. (U.S. CLS. 13, 21, 23, 31 AND 34).
CHRISTOPHER BUONGIORNO, EXAMINING ATTORNEY

SN 78-225,832. SONIC SOLUTIONS, LLC, WEST HATFIELD, MA. FILED 3-14-2003.

SONICSOLUTIONS

FOR WATER TREATMENT EQUIPMENT, NAMELY, ULTRASONIC DEVICE USED TO DESTROY ORGANISMS, NAMELY ALGAE, IN BOTH NATURAL AND MAN-MADE BODIES OF WATER (U.S. CLS. 13, 21, 23, 31 AND 34).
FIRST USE 5-31-2002; IN COMMERCE 5-31-2002.
DORITT L. CARROLL, EXAMINING ATTORNEY

SN 78-234,581. HUNTER FAN COMPANY, MEMPHIS, TN. FILED 4-7-2003.

EASY LOCK

FOR ELECTRONIC VAPORIZERS (U.S. CLS. 13, 21, 23, 31 AND 34).
M. E. BODSON, EXAMINING ATTORNEY

CLASS 11—(Continued).

SN 78-243,721. WESTINGHOUSE ELECTRIC CORPORATION, NEW YORK, NY. FILED 4-30-2003.

WESTINGHOUSE

OWNER OF U.S. REG. NO. 2,538,110.
FOR FLASHLIGHTS, TROUBLE LIGHTS, NIGHT LIGHTS; BATTERY OPERATED RADIO FREQUENCY DOMESTIC LIGHTING CONTROL SYSTEMS, COMPRISED OF LAMP SOCKET ADAPTERS AND RECEIVERS, WALL ADAPTERS AND RECEIVERS, WALL SWITCH ADAPTERS AND RECEIVERS, AND INTERCHANGEABLE TRANSMITTERS, SOLD AS A UNIT (U.S. CLS. 13, 21, 23, 31 AND 34).

SCOTT OSCLICK, EXAMINING ATTORNEY

SN 78-243,731. WESTINGHOUSE ELECTRIC CORPORATION, NEW YORK, NY. FILED 4-30-2003.



OWNER OF U.S. REG. NO. 2,617,250.
FOR FLASHLIGHTS, TROUBLE LIGHTS, NIGHT LIGHTS; BATTERY OPERATED RADIO FREQUENCY DOMESTIC LIGHTING CONTROL SYSTEMS, COMPRISED OF LAMP SOCKET ADAPTERS AND RECEIVERS, WALL ADAPTERS AND RECEIVERS, WALL SWITCH ADAPTERS AND RECEIVERS, AND INTERCHANGEABLE TRANSMITTERS, SOLD AS A UNIT (U.S. CLS. 13, 21, 23, 31 AND 34).

SCOTT OSCLICK, EXAMINING ATTORNEY

SN 78-243,741. WESTINGHOUSE ELECTRIC CORPORATION, NEW YORK, NY. FILED 4-30-2003.

**YOU CAN BE SURE...IF IT'S
WESTINGHOUSE**

OWNER OF U.S. REG. NOS. 2,538,110 AND 2,617,250.
FOR FLASHLIGHTS, TROUBLE LIGHTS, NIGHT LIGHTS; BATTERY OPERATED RADIO FREQUENCY DOMESTIC LIGHTING CONTROL SYSTEMS, COMPRISED OF LAMP SOCKET ADAPTERS AND RECEIVERS, WALL ADAPTERS AND RECEIVERS, WALL SWITCH ADAPTERS AND RECEIVERS, AND INTERCHANGEABLE TRANSMITTERS SOLD AS A UNIT (U.S. CLS. 13, 21, 23, 31 AND 34).

SCOTT OSCLICK, EXAMINING ATTORNEY

CLASS 11—(Continued).

SN 78-250,515. KOHLER FRANCE SAS, PARIS 75139 CEDEX 03, FRANCE, FILED 5-15-2003.

CLEANCOAT

FOR BATHTUBS, SINKS, BIDETS, TOILETS AND SANITARY WARE MADE PREDOMINATELY OF VITREOUS CHINA, NAMELY WATER CLOSETS, WATER FAUCET SPOUTS, FAUCET HANDLES, URINAL AND WHIRLPOOL BATHS (U.S. CLS. 13, 21, 23, 31 AND 34).

RONALD AIKENS, EXAMINING ATTORNEY

SN 78-250,719. PACIFIC ENERGY FIREPLACE PRODUCTS LTD., DUNCAN, CANADA, FILED 5-16-2003.

DDV TECHNOLOGY

NO CLAIM IS MADE TO THE EXCLUSIVE RIGHT TO USE "TECHNOLOGY", APART FROM THE MARK AS SHOWN.

FOR FIREPLACES; FIREPLACE PARTS AND FITTINGS, NAMELY, FIREPLACE INSERTS IN THE NATURE OF HEAT EXCHANGERS, HOT AIR BLOWERS, AND FIREPLACE INSERTS COMPRISED OF ANDIRONS, ARTIFICIAL LOGS AND GAS-POWERED ARTIFICIAL EMBERS (U.S. CLS. 13, 21, 23, 31 AND 34).

FIRST USE 11-15-2002; IN COMMERCE 11-15-2002.

MARC LEIPZIG, EXAMINING ATTORNEY

SN 78-257,147. OLSON IRRIGATION SYSTEMS, SANTEE, CA. FILED 6-2-2003.

VACLEEN

FOR IRRIGATION AND INDUSTRIAL FILTRATION SYSTEMS, COMPRISED OF TANKS, NOZZLES, VALVES, CLEANING MECHANISMS, MOVABLE NOZZLES, AND FILTER SCREENS (U.S. CLS. 13, 21, 23, 31 AND 34).

FIRST USE 5-29-2001; IN COMMERCE 11-26-2001.

ROBERT LORENZO, EXAMINING ATTORNEY

SN 78-263,465. POLYMER & STEEL TECHNOLOGIES, INC., DBA ENPAC CORPORATION, EASTLAKE, OH. FILED 6-17-2003.

STORM SENTINEL

NO CLAIM IS MADE TO THE EXCLUSIVE RIGHT TO USE STORM, APART FROM THE MARK AS SHOWN.

FOR STORMWATER HANDLING AND TREATMENT PRODUCTS, NAMELY CATCH BASIN INSERTS FOR FILTERING STORM DRAIN WATER, FLEXIBLE NON-METALLIC CULVERT EXTENSIONS AND FILTER BAGS FOR OUTLETS FROM WATER CONTAINMENTS (U.S. CLS. 13, 21, 23, 31 AND 34).

JANICE L. MCMORROW, EXAMINING ATTORNEY

CLASS 11—(Continued).

SN 78-271,782. BEST, WARREN R, HENDERSON, NV. FILED 7-8-2003.

THE FILTER SHOWER

NO CLAIM IS MADE TO THE EXCLUSIVE RIGHT TO USE "FILTER", APART FROM THE MARK AS SHOWN.

FOR SWIMMING POOL AND SPA CARTRIDGE WATER CLEANING AND FILTERING UNIT (U.S. CLS. 13, 21, 23, 31 AND 34).

KATHLEEN M. VANSTON, EXAMINING ATTORNEY

SN 78-278,213. HOLLAND PUMP COMPANY, WEST PALM BEACH, FL. FILED 7-24-2003.

PRIME³

FOR PORTABLE INDUSTRIAL PUMPS FOR CONSTRUCTION DE-WATERING (U.S. CLS. 13, 21, 23, 31 AND 34).

FIRST USE 6-30-2003; IN COMMERCE 6-30-2003.
CAROLINE WOOD, EXAMINING ATTORNEY

SN 78-280,933. LIQUID AIR, INC., LONG BEACH, CA. FILED 7-30-2003.



NO CLAIM IS MADE TO THE EXCLUSIVE RIGHT TO USE "INC.", APART FROM THE MARK AS SHOWN.

THE MARK CONSISTS OF "H2O LIQUID AIR INC." WITH THE LETTER "Q" FORMED WITH A DROPLET, "PURE DRINKING WATER OUT OF THIN AIR", AND WAVY DESIGNS DEPICTING AIR AND WATER CURRENTS.

FOR WATER CONDENSATION MACHINES USED TO PRODUCE DRINKING WATER FROM MOISTURE IN THE AMBIENT AIR (U.S. CLS. 13, 21, 23, 31 AND 34).

DAVID C. REIHNER, EXAMINING ATTORNEY

CLASS 11—(Continued).

SN 78-283,980. CONAIR CORPORATION, STAMFORD, CT. FILED 8-6-2003.

BABYBIRD

THE MARK CONSISTS OF STANDARD CHARACTERS WITHOUT CLAIM TO ANY PARTICULAR FONT, STYLE, SIZE, OR COLOR.

FOR HAIR APPLIANCES, NAMELY HAND-HELD ELECTRIC HAIR DRYERS (U.S. CLS. 13, 21, 23, 31 AND 34).

FIRST USE 7-26-2003; IN COMMERCE 7-26-2003.
CHARLES L. JENKINS, EXAMINING ATTORNEY

SN 78-292,437. BOSS PRODUCTS, INC., WAKARUSA, IN. FILED 8-26-2003.

PORT-A-PIT

FOR PORTABLE COOKER FOR MEATS AND OTHER FOODS (U.S. CLS. 13, 21, 23, 31 AND 34).

FIRST USE 6-6-1973; IN COMMERCE 6-6-1973.
CAROLYN CATALDO, EXAMINING ATTORNEY

SN 78-294,568. GENEVRO, WILLIAM, ENCINITAS, CA. FILED 9-1-2003.

LICENSED TO CHILL

FOR AIR CONDITIONERS FOR AIRCRAFT (U.S. CLS. 13, 21, 23, 31 AND 34).

ALICE SUE CARRUTHERS, EXAMINING ATTORNEY

SN 78-298,655. ADOBEAIR, INC., PHOENIX, AZ. FILED 9-10-2003.

ECO PAD

NO CLAIM IS MADE TO THE EXCLUSIVE RIGHT TO USE PAD, APART FROM THE MARK AS SHOWN.

FOR EVAPORATIVE COOLERS (U.S. CLS. 13, 21, 23, 31 AND 34).

CIMMERIAN COLEMAN, EXAMINING ATTORNEY

CLASS 11—(Continued).

SN 78-299,663. ALPHA SUN N.V., HASSELT, BELGIUM, FILED 9-12-2003.

SOL ID

THE ENGLISH TRANSLATION OF THE WORD SOL IN THE MARK IS SUN.

FOR TANNING EQUIPMENT, NAMELY, SUN TANNING BEDS WITH ULTRAVIOLET LAMPS; LIGHT BULBS FOR TANNING SKIN USING ULTRAVIOLET LIGHT (U.S. CLS. 13, 21, 23, 31 AND 34).

DOMINIC J. FERRAIUOLO, EXAMINING ATTORNEY

CLASS 11—(Continued).

SN 78-308,587. CONAIR CORPORATION, STAMFORD, CT. FILED 10-2-2003.

SPEED FREAK

FOR HAND-HELD ELECTRIC HAIR DRYERS (U.S. CLS. 13, 21, 23, 31 AND 34).

BRIAN BROWN, EXAMINING ATTORNEY

SN 78-300,264. GENLYTE THOMAS GROUP LLC, LOUISVILLE, KY. FILED 9-15-2003.

WATT WATCHER

OWNER OF U.S. REG. NO. 1,245,162. FOR ELECTRICAL LIGHTING FIXTURES (U.S. CLS. 13, 21, 23, 31 AND 34).

FIRST USE 4-0-1999; IN COMMERCE 4-0-1999. SCOTT OSICK, EXAMINING ATTORNEY

SN 78-309,310. OSRAM SYLVANIA INC., DANVERS, MA. FILED 10-3-2003.

HaloDECO

THE MARK CONSISTS OF STANDARD CHARACTERS WITHOUT CLAIM TO ANY PARTICULAR FONT, STYLE, SIZE, OR COLOR.

FOR ELECTRIC LAMPS; HALOGEN LAMPS (U.S. CLS. 13, 21, 23, 31 AND 34).

FLORENTINA BLANDU, EXAMINING ATTORNEY

SN 78-301,101. TEAM PRODUCTS INTERNATIONAL, PAR-SIPPANY, NJ. FILED 9-16-2003.

SMARTBEAM

FOR SPOTLIGHTS (U.S. CLS. 13, 21, 23, 31 AND 34). FIRST USE 5-0-2003; IN COMMERCE 5-0-2003. MICHAEL WEBSTER, EXAMINING ATTORNEY

SN 78-301,109. TEAM PRODUCTS INTERNATIONAL, PAR-SIPPANY, NJ. FILED 9-16-2003.

SMARTBEAM

FOR FLASHLIGHTS AND NIGHTLIGHTS (U.S. CLS. 13, 21, 23, 31 AND 34). FIRST USE 10-1-2003; IN COMMERCE 10-1-2003. MICHAEL WEBSTER, EXAMINING ATTORNEY

SN 78-302,334. HUSKY PRODUCTS LTD., LEICESTER-SHIRE, UNITED KINGDOM, FILED 9-18-2003.

HUSKY

FOR FREEZERS; REFRIGERATORS; REFRIGERATION EQUIPMENT, NAMELY, FOOD AND BEVERAGE CHILLING UNITS; REFRIGERATED SHIPPING CONTAINERS; REFRIGERATED MERCHANDISE DISPLAY CASES; REFRIGERATED DISPENSING UNITS FOR BEVERAGES; WALK-IN COOLERS; WALK-IN FREEZERS; DOMESTIC AND COMMERCIAL APPLIANCES, NAMELY, COOKING OVENS (U.S. CLS. 13, 21, 23, 31 AND 34).

SUSAN HAYASH, EXAMINING ATTORNEY

CLASS 12—VEHICLES

SN 76-152,577. METZELER REIFEN GMBH, D-64747 BREU-BERG, FED REP GERMANY, FILED 10-24-2000.



PRIORITY CLAIMED UNDER SEC. 44(D) ON FED REP GERMANY APPLICATION NO. 30032398.0, FILED 4-26-2000, REG. NO. 30032398, DATED 7-11-2000, EXPIRES 4-30-2010.

FOR TIRES; PNEUMATIC TIRES; SOLID TIRES; TIRES FOR VEHICLE WHEELS; WHEELS FOR VEHICLES; INNER TUBES; RIMS; PARTS AND FITTINGS FOR ALL OF THE AFORESAID GOODS, NAMELY VALVES, RIM BANDS AND SPONGE RUBBER RINGS (U.S. CLS. 19, 21, 23, 31, 35 AND 44).

JILL C. ALT, EXAMINING ATTORNEY

CLASS 12—(Continued).

SN 76-295,272. PREMIER MARINE, INC., WYOMING, MN. FILED 8-7-2001.

LEISURE

OWNER OF U.S. REG. NO. 2,772,250. SEC. 2(F). FOR WATERCRAFT, NAMELY, BOATS AND PONTOONS BOATS (U.S. CLS. 19, 21, 23, 31, 35 AND 44). JILL C. ALT, EXAMINING ATTORNEY

SN 76-369,510. OXYGEN S.P.A., 42100 REGGIO EMILIA, ITALY, FILED 2-12-2002.

OXYGEN

FOR ELECTRIC MOTORCYCLES (U.S. CLS. 19, 21, 23, 31, 35 AND 44). BARBARA GAYNOR, EXAMINING ATTORNEY

SN 76-494,338. VOLVO TRUCKS NORTH AMERICA, INC., GREENSBORO, NC. FILED 3-4-2003.

TUNGSTEN

FOR TRUCKS (U.S. CLS. 19, 21, 23, 31, 35 AND 44). STACY WAHLBERG, EXAMINING ATTORNEY

SN 76-505,835. ZAP, SEBASTOPOL, CA. FILED 4-11-2003.

ZAP SEASCOOTER

OWNER OF U.S. REG. NO. 1,794,866. FOR PERSONAL WATERCRAFT, NAMELY, SUBMERSIBLE ELECTRIC WATER PROPULSION VEHICLES FOR USE IN PULLING PERSONS THROUGH WATER (U.S. CLS. 19, 21, 23, 31, 35 AND 44). FIRST USE 5-1-2000, 07/27/1999.; IN COMMERCE 5-1-2000, 07/27/1999.. JOHN GARTNER, EXAMINING ATTORNEY

CLASS 12—(Continued).

SN 76-506,415. MCLAREN ENGINES, INC., LIVONIA, MI. FILED 4-14-2003.

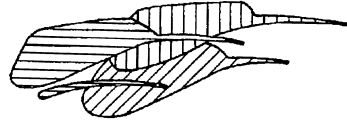

THE MARK IS LINED FOR THE COLORS RED, BLUE AND BROWN, BUT COLOR IS NOT A FEATURE OF THE MARK.

THE MARK CONSISTS OF THE STYLIZED RENDITION OF THREE KIWI BIRDS. FOR MOTOR LAND VEHICLES, NAMELY RACING CARS, AND FOR STRUCTURAL PARTS THEREFOR (U.S. CLS. 19, 21, 23, 31, 35 AND 44). FIRST USE 8-1-1971; IN COMMERCE 11-1-1971. JOHN KELLY, EXAMINING ATTORNEY

SN 76-511,552. BILLET FABRICATION, INC., SIMI VALLEY, CA. FILED 5-2-2003.

BILLET FABRICATION

SEC. 2(F). FOR AUTOMOTIVE RACING PRODUCTS AND AUTOMOTIVE PRODUCTS, NAMELY, OIL PANS, VALVE COVERS AND AIR CLEANERS (U.S. CLS. 19, 21, 23, 31, 35 AND 44). FIRST USE 1-5-1996; IN COMMERCE 2-1-1996. CATHERINE FAINT, EXAMINING ATTORNEY

SN 76-528,497. VOLUME BIKE CO., BUENA PARK, CA. FILED 6-23-2003.

VOLUME

FOR BICYCLE AND BICYCLE PARTS, NAMELY FORKS, HANDLEBARS, SPROCKETS, BAR-ENDS FOR HANDLEBAR'S PLUGS, STEMS, TIRES, WHEELS, RIMS, FREEWHEELS, GRIPS, PEDALS, CRANKS, BOTTOM BRACKET SETS, CHAINS, HUBS, SEATS, SEAT-POSTS, FRAMES, SEAT-POST'S CLAMPS, FOOT-PEGS AND HEAD-SETS (U.S. CLS. 19, 21, 23, 31, 35 AND 44). FIRST USE 6-0-1999; IN COMMERCE 6-0-1999. CIMMERIAN COLEMAN, EXAMINING ATTORNEY

SN 76-548,477. Lenco INDUSTRIES, INC., PITTSFIELD, MA. FILED 10-2-2003.

LENCO B.E.A.S.T.

OWNER OF U.S. REG. NOS. 2,480,906 AND 2,694,035. FOR ARMORED TRUCKS FOR POLICE RESPONSE AND RESCUE TEAMS (U.S. CLS. 19, 21, 23, 31, 35 AND 44). FIRST USE 3-13-2003; IN COMMERCE 3-13-2003. GEOFFREY FOSDICK, EXAMINING ATTORNEY

CLASS 12—(Continued).

SN 76-548,478. Lenco Industries, Inc., Pittsfield, MA. Filed 10-2-2003.

LENCO PROCAT

OWNER OF U.S. REG. NOS. 2,480,906 AND 2,694,035. FOR ARMORED TRUCKS FOR PERSONAL PROTECTION AND FOR POLICE RESPONSE AND RESCUE TEAMS (U.S. CLS. 19, 21, 23, 31, 35 AND 44).
 GEOFFREY FOSDICK, EXAMINING ATTORNEY

CLASS 12—(Continued).

SN 78-205,300. BUSH HOG, L.L.C., Chicago, IL. Filed 1-21-2003.

TRAIL HAND

FOR ALL TERRAIN LIGHT UTILITY VEHICLES (U.S. CLS. 19, 21, 23, 31, 35 AND 44).
 MICHAEL KAZAZIAN, EXAMINING ATTORNEY

SN 76-548,838. O'Donnell, Norman J., Taylors, SC. Filed 10-3-2003.

LOOKOUT

FOR PET CAR SEATS (U.S. CLS. 19, 21, 23, 31, 35 AND 44).
 FIRST USE 0-0-1994; IN COMMERCE 0-0-1994.
 H. M. FISHER, EXAMINING ATTORNEY

SN 78-211,814. Cervelo Cycles Inc., Toronto, Ontario, Canada, Filed 2-6-2003.

P5

PRIORITY CLAIMED UNDER SEC. 44(D) ON CANADA APPLICATION NO. 1148629, FILED 8-6-2002.
 FOR BICYCLE FRAMES AND BICYCLE FORKS (U.S. CLS. 19, 21, 23, 31, 35 AND 44).
 RON FAIRBANKS, EXAMINING ATTORNEY

SN 78-172,198. Kongsberg Automotive ASA, Kongsberg, Norway, Filed 10-8-2002.



OWNER OF NORWAY REG. NO. 178826, DATED 12-26-1996, EXPIRES 12-26-2006.

NO CLAIM IS MADE TO THE EXCLUSIVE RIGHT TO USE "AUTOMOTIVE", APART FROM THE MARK AS SHOWN.

FOR VEHICLES FOR LOCOMOTION BY LAND, AIR OR WATER, NAMELY, AUTOMOBILES, TRUCKS, SHIPS, BOATS, RAIL LOCOMOTIVES, AND STRUCTURAL PARTS THEREFOR (U.S. CLS. 19, 21, 23, 31, 35 AND 44).

JOSETTE BEVERLY, EXAMINING ATTORNEY

SN 78-224,399. ICER Brakes, S.A., Pamplona (Navarra), Spain, Filed 3-11-2003.



FOR BRAKES FOR LAND VEHICLES; CLUTCHES FOR LAND VEHICLES; BRAKE PADS FOR LAND VEHICLES; BRAKE LININGS FOR LAND VEHICLES; BRAKE BLOCKS FOR LAND VEHICLES; BRAKE SHOES FOR LAND VEHICLES (U.S. CLS. 19, 21, 23, 31, 35 AND 44).

ALLISON HOLTZ, EXAMINING ATTORNEY

SN 78-190,374. Trustee of the Carroll Shelby Trust, The, Los Angeles, CA. Filed 12-2-2002.

SHELBY KING COBRA

OWNER OF U.S. REG. NOS. 1,376,672, 2,357,468 AND OTHERS.

FOR VEHICLES, NAMELY AUTOMOBILES, STRUCTURAL PARTS FOR AUTOMOBILES, ENGINES FOR LAND VEHICLES (U.S. CLS. 19, 21, 23, 31, 35 AND 44).

BERYL GARDNER, EXAMINING ATTORNEY

SN 78-233,198. Takara Co., Ltd., Tokyo, Japan, Filed 4-2-2003.



FOR MOTORBIKES, MOTORBIKE PARTS; ELECTRICALLY POWERED MOTORBIKES; AND FOLDABLE MOTORBIKES FOR STORAGE (U.S. CLS. 19, 21, 23, 31, 35 AND 44).

MELVIN AXILBUND, EXAMINING ATTORNEY

CLASS 12—(Continued).

SN 78-233,448. GUANGZHOU SOUTH CHINA TIRE & RUBBER CO., LTD., GUANGDONG, CHINA, FILED 4-3-2003.



FOR INNER TUBES FOR PNEUMATIC TIRES OF AUTOMOBILES; VEHICLE TIRES; AUTOMOBILE TIRES; SOLID TIRES FOR VEHICLE WHEELS; PNEUMATIC TIRES FOR VEHICLE WHEELS (U.S. CLS. 19, 21, 23, 31, 35 AND 44).

RUSS HERMAN, EXAMINING ATTORNEY

SN 78-241,048. ADRIAN STEEL COMPANY, ADRIAN, MI. FILED 4-23-2003.

LOADFLEX

FOR STEEL ACCESSORIES FOR VEHICLES, NAMELY, AN EXPANDABLE RACK FOR CARRYING LADDERS (U.S. CLS. 19, 21, 23, 31, 35 AND 44).

FIRST USE 3-3-2003; IN COMMERCE 3-3-2003.
APRIL L. RADEMACHER, EXAMINING ATTORNEY

SN 78-241,132. AUDI A. G., INGOLSTADT, FED REP GERMANY, FILED 4-23-2003.

PIKES PEAK QUATTRO

PRIORITY CLAIMED UNDER SEC. 44(D) ON FED REP GERMANY APPLICATION NO. 302583076/12, FILED 11-27-2002, REG. NO. 30258307, DATED 10-3-2003, EXPIRES 11-30-2012.

THE FOREIGN WORDING IN THE MARK TRANSLATES INTO ENGLISH AS FOUR.

FOR AUTOMOBILES AND STRUCTURAL PARTS THEREFORE (U.S. CLS. 19, 21, 23, 31, 35 AND 44).

APRIL L. RADEMACHER, EXAMINING ATTORNEY

CLASS 12—(Continued).

SN 78-251,886. ZAW TIEN PRECISION IND. CO., LTD., CHANG HWA 500, TAIWAN, FILED 5-20-2003.



FOR BICYCLES, PEDALS FOR BICYCLES, SAFETY PADS FOR BICYCLES, BRAKE PADS FOR BICYCLES, BICYCLE HANDLEBARS, FRAMES FOR RACING BIKES, BICYCLE SADDLES, BICYCLE HANDLEBAR GRIPS, BICYCLE FRAMES, BICYCLE PUMPS, ELECTRIC BICYCLES, BICYCLE SEAT STEMS, NAMELY, BICYCLE SEAT POSTS; BICYCLE DERAILLEURS, NAMELY, GEARS, BASKETS FOR BICYCLES, BICYCLE RACKS FOR LAND VEHICLES (U.S. CLS. 19, 21, 23, 31, 35 AND 44).

MARY CRAWFORD, EXAMINING ATTORNEY

SN 78-262,414. SALVITTI, ALFRED W., GLEN RIDDLE, PA. FILED 6-13-2003.

GUNVISOR

FOR VEHICLE ACCESSORIES, NAMELY, CONTAINERS FOR HOLDING ARTICLES IN A VEHICLE INTERIOR (U.S. CLS. 19, 21, 23, 31, 35 AND 44).

CIMMERIAN COLEMAN, EXAMINING ATTORNEY

SN 78-265,660. KALIL, ANTHONY, WEST FRANKFORT, IL. FILED 6-23-2003.

STRAITTRAC

FOR STRUCTURAL PARTS OF BOATS, NAMELY, VESSEL HULLS. (U.S. CLS. 19, 21, 23, 31, 35 AND 44).

CIMMERIAN COLEMAN, EXAMINING ATTORNEY

CLASS 12—(Continued).

SN 78-269,862. NEURAL ROBOTICS, INC., HUNTSVILLE, AL. FILED 7-2-2003.



NO CLAIM IS MADE TO THE EXCLUSIVE RIGHT TO USE INCORPORATED, APART FROM THE MARK AS SHOWN.

FOR UNMANNED, MINIATURE, REMOTELY PILOTED HELICOPTERS FOR MILITARY PURPOSES, AERIAL PHOTOGRAPHY, REMOTE IMAGING, SENSING, AND SURVEILLANCE (U.S. CLS. 19, 21, 23, 31, 35 AND 44).

BRENDAN MCCAULEY, EXAMINING ATTORNEY

SN 78-277,319. PACIFIC CYCLE, LLC, MADISON, WI. FILED 7-22-2003.

SCHWINN SELECT SERIES

OWNER OF U.S. REG. NOS. 371,422, 616,120 AND OTHERS.

NO CLAIM IS MADE TO THE EXCLUSIVE RIGHT TO USE "SERIES", APART FROM THE MARK AS SHOWN.

FOR BICYCLES (U.S. CLS. 19, 21, 23, 31, 35 AND 44).

MARC LEIPZIG, EXAMINING ATTORNEY

SN 78-287,601. JONES PERFORMANCE PRODUCTS, INC., WEST MIDDLESEX, PA. FILED 8-14-2003.

TRUK-RODZ

FOR HOOD FOR ENGINE COMPARTMENT OF MOTOR VEHICLE, PARTICULARLY TRUCKS (U.S. CLS. 19, 21, 23, 31, 35 AND 44).

FIRST USE 6-1-2003; IN COMMERCE 6-1-2003.

JANICE L. MCMORROW, EXAMINING ATTORNEY

SN 78-293,878. LAND ROVER, WARWICKSHIRE, UNITED KINGDOM, FILED 8-29-2003.

RANGE SPORT

OWNER OF U.S. REG. NO. 929,034.

NO CLAIM IS MADE TO THE EXCLUSIVE RIGHT TO USE "SPORT", APART FROM THE MARK AS SHOWN.

FOR AUTOMOTIVE VEHICLES, NAMELY AUTOMOBILES, TRUCKS, VANS, AND SPORT UTILITY VEHICLES (U.S. CLS. 19, 21, 23, 31, 35 AND 44).

MARK T. MULLEN, EXAMINING ATTORNEY

CLASS 12—(Continued).

SN 78-295,934. PARAPHASE, INC., ALPHARETTA, GA. FILED 9-4-2003.

FUEL WIZARD JUST FLIP AND FILL

NO CLAIM IS MADE TO THE EXCLUSIVE RIGHT TO USE "FUEL", APART FROM THE MARK AS SHOWN.

FOR AUTOMOTIVE ACCESSORIES, NAMELY, GAS CAPS (U.S. CLS. 19, 21, 23, 31, 35 AND 44).

LANA PHAM, EXAMINING ATTORNEY

SN 78-297,319. ALABAMA CYLINDER HEAD, INC., RAINBOW CITY, AL. FILED 9-8-2003.



NO CLAIM IS MADE TO THE EXCLUSIVE RIGHT TO USE "PERFORMANCE", APART FROM THE MARK AS SHOWN.

FOR AUTOMOTIVE RACING CYLINDER HEAD (U.S. CLS. 19, 21, 23, 31, 35 AND 44).

ROBIN CHOSID, EXAMINING ATTORNEY

SN 78-300,807. FEAGIN, DARRELL L., TALLAHASSEE, FL. FILED 9-16-2003.

RIMSHIELD

FOR TIRE RIM COVER (U.S. CLS. 19, 21, 23, 31, 35 AND 44).

JOHN HWANG, EXAMINING ATTORNEY

SN 78-301,085. TAILWALKER BOATS LLC, MT. PLEASANT, SC. FILED 9-16-2003.

TAILWALKER

FOR RECREATIONAL BOATS (U.S. CLS. 19, 21, 23, 31, 35 AND 44).

STEVEN BERK, EXAMINING ATTORNEY

SN 78-301,929. VECTOR BOATS, LLC, NORTH CHARLESTON, SC. FILED 9-18-2003.

VECTOR

FOR FIBERGLASS BOATS (U.S. CLS. 19, 21, 23, 31, 35 AND 44).

STEVEN BERK, EXAMINING ATTORNEY

CLASS 12—(Continued).

SN 78-302,240. THE BOLER COMPANY., ITASCA, IL. FILED 9-18-2003.

HENDRICKSON AERO BRIGHT

OWNER OF U.S. REG. NO. 697,383.
FOR VEHICLE GRILL SURROUNDS, VEHICLE HEADLIGHT BEZELS, VEHICLE BUMPERS, VEHICLE FAIRINGS, VEHICLE FENDERS, VEHICLE DEFLECTORS, VEHICLE BUG SHIELDS, VEHICLE DASHBOARD BEZELS, VEHICLE INTERIOR TRIM COMPONENTS FOR USE WITH TRUCKS, TRACTORS, BUSES AND TRAILERS (U.S. CLS. 19, 21, 23, 31, 35 AND 44).

GWEN STOKOLS, EXAMINING ATTORNEY

SN 78-305,121. JAG MANUFACTURING, INC., JOHNSTOWN, NY. FILED 9-25-2003.

SEALS

FOR KAYAK PARTS MADE OF FABRIC, NAMELY, KAYAK SPRAYSKIRTS AND KAYAK COCKPIT COVERS (U.S. CLS. 19, 21, 23, 31, 35 AND 44).
FIRST USE 12-31-1989; IN COMMERCE 12-31-1989.
MARC LEIPZIG, EXAMINING ATTORNEY

SN 78-309,181. BRIDGESTONE CORPORATION, TOKYO, JAPAN, FILED 10-3-2003.

BRIDGESTONE

OWNER OF U.S. REG. NOS. 952,683, 1,342,473 AND 2,607,465.

FOR TIRES; WHEELS FOR VEHICLES; INNER TUBES, RIMS AND COVERS FOR VEHICLE WHEELS; INNER TUBES FOR VEHICLE TIRES; PARTS AND FITTINGS FOR ALL THE AFORESAID GOODS (U.S. CLS. 19, 21, 23, 31, 35 AND 44).

FIRST USE 0-0-1928; IN COMMERCE 12-31-1956.
NELSON SNYDER, EXAMINING ATTORNEY

SN 78-313,435. HYDROGEN CAR COMPANY, LOS ANGELES, CA. FILED 10-14-2003.

DRIVE THE REVOLUTION

FOR AUTOMOBILES AND ENGINES FOR AUTOMOBILES (U.S. CLS. 19, 21, 23, 31, 35 AND 44).
CAROLINE WOOD, EXAMINING ATTORNEY

CLASS 12—(Continued).

SN 78-318,646. U CAN B, INC., BALTIMORE, MD. FILED 10-26-2003.

MOTOR MAMA

FOR AUTOMOBILES (U.S. CLS. 19, 21, 23, 31, 35 AND 44).

JILL C. ALT, EXAMINING ATTORNEY

CLASS 13—FIREARMS

SN 76-398,303. SAEILO, INC., BLAUVELT, NY. FILED 4-19-2002.

TOMMY GUN

OWNER OF U.S. REG. NO. 1,360,435.
NO CLAIM IS MADE TO THE EXCLUSIVE RIGHT TO USE "GUN", APART FROM THE MARK AS SHOWN.
FOR FIREARMS (U.S. CLS. 2 AND 9).
FIRST USE 0-0-1919; IN COMMERCE 0-0-1920.
THEODORE MCBRIDE, EXAMINING ATTORNEY

SN 76-546,468. INGRAM ENTERPRISES, INC., SPRINGFIELD, MO. FILED 9-23-2003.

TEXAS RATTLESNAKE

NO CLAIM IS MADE TO THE EXCLUSIVE RIGHT TO USE "TEXAS", APART FROM THE MARK AS SHOWN.
FOR FIREWORKS (U.S. CLS. 2 AND 9).
ZACHARY BELLO, EXAMINING ATTORNEY

SN 76-546,697. INGRAM ENTERPRISES, INC., SPRINGFIELD, MO. FILED 9-23-2003.

POCO DIABLOS

THE TERM "POCO DIABLOS" MEANS "LITTLE DEVIL" IN SPANISH.
FOR FIREWORKS (U.S. CLS. 2 AND 9).
ZACHARY BELLO, EXAMINING ATTORNEY

CLASS 13—(Continued).

SN 76-574,970. INGRAM ENTERPRISES, INC., SPRINGFIELD, MO. FILED 2-10-2004.

THE BIG TICKET

THE MARK CONSISTS OF STANDARD CHARACTERS WITHOUT CLAIM TO ANY PARTICULAR FONT, STYLE, SIZE, OR COLOR.
FOR FIREWORKS (U.S. CLS. 2 AND 9).
ZACHARY BELLO, EXAMINING ATTORNEY

SN 78-275,505. AMERICAN PROMOTIONAL EVENTS, INC., FLORENCE, AL. FILED 7-17-2003.

BULL'S EYE

FOR FIREWORKS (U.S. CLS. 2 AND 9).
FIRST USE 12-18-2001; IN COMMERCE 12-18-2001.
KARLA PERKINS, EXAMINING ATTORNEY

SN 78-306,813. JFS, INC., SALEM, OR. FILED 9-29-2003.

REDI-MAG

FOR CARRIER FOR SPARE MAGAZINE FOR REPEATING WEAPON (U.S. CLS. 2 AND 9).
FIRST USE 12-31-1983; IN COMMERCE 12-31-1983.
HOWARD B. LEVINE, EXAMINING ATTORNEY

SN 78-308,042. B.J. ALAN COMPANY, YOUNGSTOWN, OH. FILED 10-1-2003.

PANTHERA

FOR FIREWORKS (U.S. CLS. 2 AND 9).
JAMES GRIFFIN, EXAMINING ATTORNEY

SN 78-313,188. B.J. ALAN COMPANY, YOUNGSTOWN, OH. FILED 10-14-2003.

BLASTEROIDS

FOR FIREWORKS (U.S. CLS. 2 AND 9).
JAMES GRIFFIN, EXAMINING ATTORNEY

CLASS 13—(Continued).

SN 78-313,269. B.J. ALAN COMPANY, YOUNGSTOWN, OH. FILED 10-14-2003.

LIVE FREE OR DIE

FOR FIREWORKS (U.S. CLS. 2 AND 9).
JAMES GRIFFIN, EXAMINING ATTORNEY

SN 78-317,513. B.J. ALAN COMPANY, YOUNGSTOWN, OH. FILED 10-23-2003.

PHANDEMONIUM

FOR FIREWORKS (U.S. CLS. 2 AND 9).
JAMES GRIFFIN, EXAMINING ATTORNEY

SN 78-384,894. B.J. ALAN COMPANY, YOUNGSTOWN, OH. FILED 3-16-2004.

SWIFTBOAT

THE MARK CONSISTS OF STANDARD CHARACTERS WITHOUT CLAIM TO ANY PARTICULAR FONT, STYLE, SIZE, OR COLOR.
FOR FIREWORKS (U.S. CLS. 2 AND 9).
JAMES GRIFFIN, EXAMINING ATTORNEY

CLASS 14—JEWELRY

SN 76-256,771. AM-GOLD PRODUCTS, INC., NEW YORK, NY. FILED 5-15-2001.

ROMANCE CUT

NO CLAIM IS MADE TO THE EXCLUSIVE RIGHT TO USE "CUT", APART FROM THE MARK AS SHOWN.
FOR JEWELRY (U.S. CLS. 2, 27, 28 AND 50).
GINA FINK, EXAMINING ATTORNEY

CLASS 14—(Continued).

SN 76-493,236. SWAROVSKI AKTIENGESELLSCHAFT, FL-9495 TRIESEN, LIECHTENSTEIN, FILED 2-27-2003.

MAXIMILIAN DIAMOND

PRIORITY CLAIMED UNDER SEC. 44(D) ON LIECHTENSTEIN APPLICATION NO. 12667, FILED 10-4-2002, REG. NO. 12667, DATED 10-4-2002, EXPIRES 10-4-2012.

NO CLAIM IS MADE TO THE EXCLUSIVE RIGHT TO USE DIAMOND, APART FROM THE MARK AS SHOWN.

THE NAME IN THE MARK DOES NOT NAME ANY LIVING INDIVIDUAL.

FOR DIAMONDS, EXCLUDING DIAMONDS CUT OR DESIGNED TO RESEMBLE ANY FAMOUS DIAMONDS (U.S. CLS. 2, 27, 28 AND 50).

ELISSA GARBER KON, EXAMINING ATTORNEY

SN 76-493,238. SWAROVSKI AKTIENGESELLSCHAFT, FL-9495 TRIESEN, LIECHTENSTEIN, FILED 2-27-2003.

EMPEROR MAXIMILIAN DIAMOND

PRIORITY CLAIMED UNDER SEC. 44(D) ON LIECHTENSTEIN APPLICATION NO. 12666, FILED 10-4-2002, REG. NO. 12666, DATED 10-4-2002, EXPIRES 10-4-2012.

NO CLAIM IS MADE TO THE EXCLUSIVE RIGHT TO USE DIAMOND, APART FROM THE MARK AS SHOWN.

THE NAME IN THE MARK DOES NOT NAME ANY LIVING INDIVIDUAL.

FOR DIAMONDS, EXCLUDING DIAMONDS CUT OR DESIGNED TO RESEMBLE ANY FAMOUS DIAMONDS (U.S. CLS. 2, 27, 28 AND 50).

ELISSA GARBER KON, EXAMINING ATTORNEY

SN 76-508,346. AUDEMARS PIGUET HOLDING S.A., LE BRASSUS, SWITZERLAND, FILED 4-18-2003.

ROYAL OAK

OWNER OF U.S. REG. NOS. 965,112, 1,572,003 AND 1,979,935.

FOR HOROLOGICAL AND CHRONOMETRIC INSTRUMENTS, NAMELY, WATCH CASES, WATCH BANDS, CHRONOGRAPHS FOR USE AS WATCHES, CHRONOMETERS, CLOCKS, WATCHES, WRIST-WATCHES, JEWELRY, NAMELY, RINGS, EARRINGS, CUFF LINKS, BRACELETS, PENDANTS, BROOCHES, CHAINS, NECKLACES, TIE PINS, PINS FOR USE AS JEWELRY (U.S. CLS. 2, 27, 28 AND 50).

FIRST USE 1-1-1974; IN COMMERCE 1-1-1974.

STEVEN BERK, EXAMINING ATTORNEY

CLASS 14—(Continued).

SN 76-522,881. MURPHY, MICHELLE, DBA DYNAMIC JEWELRY DESIGNS, EDEN PRAIRIE, MN. FILED 6-16-2003.

Milana

FOR JEWELRY (U.S. CLS. 2, 27, 28 AND 50). FIRST USE 5-10-2003; IN COMMERCE 5-10-2003. SUELLEN HICKEY, EXAMINING ATTORNEY

SN 76-526,039. SO, DAVID, NEW YORK, NY. FILED 6-30-2003.

SOLASFERA

FOR DIAMOND JEWELRY, FINE JEWELRY (U.S. CLS. 2, 27, 28 AND 50). DAVID TAYLOR, EXAMINING ATTORNEY

SN 76-537,796. RICHEMONT INTERNATIONAL SA, VIL-LARS-SUR-GLANE, SWITZERLAND, FILED 8-4-2003.

TOUR DE L'ILE

OWNER OF SWITZERLAND REG. NO. 508767, DATED 3-27-2003, EXPIRES 1-28-2013.

THE ENGLISH TRANSLATION OF THE MARK TOUR DE L'ILE IS ISLAND TOWER.

FOR CUFF-LINKS, RINGS, BRACELETS, EARRINGS, NECKLACES, BROOCHES; WATCHES, CHRONOMETERS, CLOCKS (U.S. CLS. 2, 27, 28 AND 50).

AMY HELLA, EXAMINING ATTORNEY

SN 76-542,729. LEWIS, DEVON L., OAK PARK, IL. FILED 8-5-2003.

FOUNTAIN TIMEZ

NO CLAIM IS MADE TO THE EXCLUSIVE RIGHT TO USE "FOUNTAIN", APART FROM THE MARK AS SHOWN. FOR DECORATIVE CLOCK WITH WATER DISPLAY (U.S. CLS. 2, 27, 28 AND 50).

GEOFFREY FOSDICK, EXAMINING ATTORNEY

CLASS 14—(Continued).

SN 76-547,053. LOPETEGUY, JOY A., BAKERSFIELD, CA.
FILED 9-25-2003.

BUNCO

OWNER OF U.S. REG. NO. 1,694,622.
FOR JEWELRY, NAMELY RINGS, BRACELETS,
NECKLACES, CHARMS, PINS, WATCHES, WATCH
BANDS AND CLOCKS (U.S. CLS. 2, 27, 28 AND 50).
FIRST USE 12-1-1987; IN COMMERCE 1-17-2003.
SUSAN LESLIE DUBOIS, EXAMINING ATTORNEY

SN 76-550,183. FRIEND, JOHN, THE WOODLANDS, TX.
FILED 10-8-2003.

ANUSARA

FOR JEWELRY (U.S. CLS. 2, 27, 28 AND 50).
ALEX KEAM, EXAMINING ATTORNEY

SN 76-552,927. BROWN, ALLISON, LOS ANGELES, CA.
FILED 10-2-2003.

YOU & ME CHARMED

FOR JEWELRY (U.S. CLS. 2, 27, 28 AND 50).
KEVON CHISOLM, EXAMINING ATTORNEY

SN 76-554,353. AGAIN TRADING CORP., NEW YORK, NY.
FILED 10-6-2003.

LEO GIOIELLI

NO CLAIM IS MADE TO THE EXCLUSIVE RIGHT TO
USE GIOIELLI, APART FROM THE MARK AS SHOWN.
THE NAME LEO GIOIELLI DOES NOT IDENTIFY A
LIVING INDIVIDUAL.
THE TERM GIOIELLI TRANSLATES TO "JEWELRY".
FOR COSTUME JEWELRY, NAMELY, BRACELETS,
EARRINGS, NECKLACES, AND RINGS (U.S. CLS. 2, 27,
28 AND 50).
DOMINIC J. FERRAIUOLO, EXAMINING ATTORNEY

SN 78-213,236. LANCECO INDUSTRIES INCORPORATED,
DBA C.G. CREATIONS, PEARL RIVER, NY. FILED 2-11-
2003.

DARIA

FOR JEWELRY AND WATCHES (U.S. CLS. 2, 27, 28
AND 50).
FIRST USE 1-17-2003; IN COMMERCE 1-17-2003.
ODESSA BIBBINS, EXAMINING ATTORNEY

CLASS 14—(Continued).

SN 78-219,969. OLMES, JAMES, B, AGOURA HILLS, CA.
FILED 2-27-2003.

REACTOR

FOR TIME PIECES AND TIME KEEPING INSTRU-
MENTS, NAMELY, WRIST WATCHES, STOP WATCHES,
POCKET WATCHES (U.S. CLS. 2, 27, 28 AND 50).
ALLISON HOLTZ, EXAMINING ATTORNEY

SN 78-229,775. KING, CHAD W., ROWLETT, TX. FILED 3-25-
2003.

MISSION

FOR WATCHES, STOPWATCHES, WATCH GIFT
BOXES, AND JEWELRY (U.S. CLS. 2, 27, 28 AND 50).
TRACY CROSS, EXAMINING ATTORNEY

SN 78-229,863. HOMAN, LESLIE DAWN, CORONA, CA.
FILED 3-25-2003.



FOR STERLING SILVER JEWELRY (U.S. CLS. 2, 27, 28
AND 50).
FIRST USE 2-1-2003; IN COMMERCE 2-1-2003.
LINDA E. BLOHM, EXAMINING ATTORNEY

SN 78-231,881. SEIKO INSTRUMENTS KABUSHIKI
KAISHA, TA SEIKO INSTRUMENTS INC, CHIBA-SHI,
CHIBA 261-8507, JAPAN, FILED 3-31-2003.

THINK THE EARTH

FOR CLOCKS, WATCHES, STRUCTURAL AND RE-
PLACEMENT PARTS THEREFOR, AND ACCESSORIES,
NAMELY, WATCH BANDS (U.S. CLS. 2, 27, 28 AND 50).
LINDA M. KING, EXAMINING ATTORNEY

SN 78-246,952. AMKO INTERNATIONAL, INC., HOUSTON,
TX. FILED 5-7-2003.

JENNIE B

FOR JEWELRY AND TIMEPIECES, NAMELY,
WATCHES (U.S. CLS. 2, 27, 28 AND 50).
FIRST USE 6-3-1998; IN COMMERCE 6-3-1998.
ROBIN CHOSID, EXAMINING ATTORNEY

CLASS 14—(Continued).

SN 78-247,959. ZEON LIMITED, LONDON, UNITED KINGDOM, FILED 5-9-2003.

ZEON

OWNER OF UNITED KINGDOM REG. NO. 1403106, DATED 12-20-1991, EXPIRES 11-9-2006.

FOR WATCHES; CLOCKS; WATCH BANDS; WATCH BRACELETS (U.S. CLS. 2, 27, 28 AND 50).
KARLA PERKINS, EXAMINING ATTORNEY

SN 78-261,425. ATRIX INTERNATIONAL, INC., DBA ILENE JOY DESIGNS, BEDFORD, NY. FILED 6-12-2003.

ILENE JOY

THE NAME ILENE JOY IDENTIFIES A LIVING INDIVIDUAL WHOSE CONSENT IS OF RECORD.

FOR JEWELRY (U.S. CLS. 2, 27, 28 AND 50).
FIRST USE 2-0-2003; IN COMMERCE 2-0-2003.
NANCY CLARKE, EXAMINING ATTORNEY

SN 78-261,461. ATRIX INTERNATIONAL, INC., DBA ILENE JOY DESIGNS, BEDFORD, NY. FILED 6-12-2003.



THE NAME ILENE JOY IDENTIFIES A LIVING INDIVIDUAL WHOSE CONSENT IS OF RECORD.

FOR JEWELRY (U.S. CLS. 2, 27, 28 AND 50).
FIRST USE 2-0-2003; IN COMMERCE 2-0-2003.
CIMMERIAN COLEMAN, EXAMINING ATTORNEY

SN 78-273,834. EBEL S.A., CH-2301 LA CHAUX-DE-FONDS, SWITZERLAND, FILED 7-14-2003.

1911

PRIORITY CLAIMED UNDER SEC. 44(D) ON SWITZERLAND APPLICATION NO. 12053/2001, FILED 1-20-2003, REG. NO. 507855, DATED 2-27-2003, EXPIRES 1-20-2023.

FOR HOROLOGICAL INSTRUMENTS AND CHRONOMETRICAL INSTRUMENTS, NAMELY, WATCHES, WRISTWATCHES, STRAPS FOR WRISTWATCHES, WATCH CASES, TRAVEL CLOCKS, CLOCKS AND PARTS THEREOF, CHRONOGRAPHS FOR USE AS WATCHES, AND CHRONOMETERS; FACE POWDER COMPACTS SOLD EMPTY AND JEWEL CASES MADE OF PRECIOUS METALS OR COATED WITH PRECIOUS METALS; JEWELRY MADE OF PRECIOUS METALS OR COATED WITH PRECIOUS METALS; PRECIOUS GEMSTONES (U.S. CLS. 2, 27, 28 AND 50).

BARBARA A. GOLD, EXAMINING ATTORNEY

CLASS 14—(Continued).

SN 78-305,986. CHARLOTTE MOSS & CO., NEW YORK, NY. FILED 9-26-2003.

**CHARLOTTE MOSS
ESSENTIAL CONTRASTS**

THE NAME(S), PORTRAIT(S), AND/OR SIGNATURE(S) SHOWN IN THE MARK IDENTIFIES "CHARLOTTE MOSS", WHOSE CONSENT(S) TO REGISTER IS SUBMITTED.
FOR JEWELRY (U.S. CLS. 2, 27, 28 AND 50).
CAROL SPILS, EXAMINING ATTORNEY

SN 78-306,277. LOWENSTEIN, EVAN M, BEVERLY HILLS, CA. FILED 9-26-2003.

COMMON GROUND

FOR JEWELRY, NAMELY WITH PENDANTS, NECKLACES, CHAINS, BRACELETS, AMULETS (U.S. CLS. 2, 27, 28 AND 50).

FIRST USE 9-15-2003; IN COMMERCE 9-15-2003.
MARK T. MULLEN, EXAMINING ATTORNEY

SN 78-308,391. BUILD-A-BEAR WORKSHOP, INC., ST. LOUIS, MO. FILED 10-2-2003.

CHARMOLOGY

FOR JEWELRY (U.S. CLS. 2, 27, 28 AND 50).
KEVON CHISOLM, EXAMINING ATTORNEY

CLASS 15—MUSICAL INSTRUMENTS

SN 76-552,835. OLD DOG, LLC, LAUREL, MD. FILED 10-20-2003.



FOR MUSICAL INSTRUMENT STANDS (U.S. CLS. 2, 21 AND 36).

GINA HAYES, EXAMINING ATTORNEY

CLASS 15—(Continued).

SN 78-290,100. KAYSOUND IMPORTS INC., LACHINE, QUEBEC, CANADA, FILED 8-20-2003.

ADAGIO PIANOS

NO CLAIM IS MADE TO THE EXCLUSIVE RIGHT TO USE PIANOS, APART FROM THE MARK AS SHOWN.

FOR PIANOS, DIGITAL PIANOS, MUSICAL INSTRUMENTS, ELECTRONIC MUSICAL INSTRUMENTS (U.S. CLS. 2, 21 AND 36).

FIRST USE 5-1-2003; IN COMMERCE 6-1-2003.
GENE MACIOL, EXAMINING ATTORNEY

CLASS 16—(Continued).

SN 75-692,110. LAUREUS WORLD SPORTS AWARDS LIMITED, LONDON W1J 5QT, UNITED KINGDOM, FILED 4-27-1999.

SPIRIT OF SPORT

PRIORITY CLAIMED UNDER SEC. 44(D) ON ERPN CMNTY TM OFC APPLICATION NO. 001107481, FILED 3-16-1999, REG. NO. 001107481, DATED 3-22-2000, EXPIRES 3-16-2009.

NO CLAIM IS MADE TO THE EXCLUSIVE RIGHT TO USE "SPORT", APART FROM THE MARK AS SHOWN.

FOR STATIONERY; PRINTED MATTER, NAMELY, POSTERS, PRINTED BOOKLETS OF SPORTS INFORMATION AND BIOGRAPHICAL INFORMATION, PRINTED INSTRUCTIONAL, EDUCATIONAL, AND TEACHING MATERIALS IN THE FIELD OF SPORTS, AND PRINTED PROGRAMS OF AWARD NOMINEES; ALMANACS; MOUNTED AND UNMOUNTED PHOTOGRAPHS; PERIODICAL PUBLICATIONS, NAMELY, NEWSLETTERS FEATURING SPORTS INFORMATION, SPORTS EVENTS, SPORTS EVENT SCHEDULING, AND SPORTS BROADCASTING, MAGAZINES FEATURING SPORTS, AND JOURNALS FEATURING SPORTS BROADCASTING; CALENDARS; PHOTOGRAPHIC ALBUMS; PORTRAITS; PENS (U.S. CLS. 2, 5, 22, 23, 29, 37, 38 AND 50).

MARY CRAWFORD, EXAMINING ATTORNEY

SN 75-849,469. SAKURA COLOR PRODUCTS OF AMERICA, INC., HAYWARD, CA. FILED 11-16-1999.

GELLY**CLASS 16—PAPER GOODS AND PRINTED MATTER**

SN 74-380,801. SELF-REALIZATION FELLOWSHIP CHURCH, LOS ANGELES, CA. FILED 4-16-1993.

OWNER OF U.S. REG. NOS. 1,692,910, 2,274,564 AND 2,327,375.

FOR WRITING INSTRUMENTS (U.S. CLS. 2, 5, 22, 23, 29, 37, 38 AND 50).

ROBERT COGGINS, EXAMINING ATTORNEY

SN 76-133,624. DESIGN IDEAS, LTD., SPRINGFIELD, IL. FILED 9-22-2000.



OWNER OF U.S. REG. NO. 1,637,873.
NO CLAIM IS MADE TO THE EXCLUSIVE RIGHT TO USE "SELF-REALIZATION FELLOWSHIP FOUNDED 1920", APART FROM THE MARK AS SHOWN.

PARAMAHANSA YOGANANDA IS THE PROPER NAME OF A DECEASED INDIVIDUAL.

THE MARK CONSISTS OF A LOTUS FLOWER WITH A STAR IN A CIRCLE, A FRAME DESIGN, AND THE WORDS "SELF REALIZATION FELLOWSHIP FOUNDED 1920 PARAMAHANSA YOGANANDA".

SEC. 2(F) AS TO "SELF-REALIZATION FELLOWSHIP FOUNDED 1920 PARAMAHANSA YOGANANDA".

FOR BOOKS, MAGAZINES, CALENDARS, POSTCARDS, BOOKLETS, BROCHURES, AND PAMPHLETS ON THE SUBJECT OF RELIGION AND SPIRITUALITY (U.S. CLS. 2, 5, 22, 23, 29, 37, 38 AND 50).

FIRST USE 8-20-1993; IN COMMERCE 8-20-1993.
DAVID C. REIHNER, EXAMINING ATTORNEY

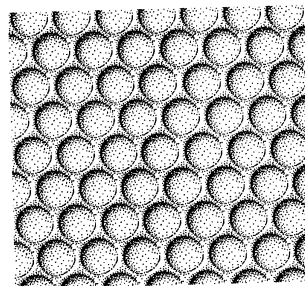

OWNER OF U.S. REG. NO. 2,233,126.
THE STIPPLING IN THE DRAWING IS FOR SHADING PURPOSES ONLY.

THE MARK CONSISTS OF A REPEATING PATTERN OF CIRCLES ON A SHINY OUTER SURFACE OF STATIONERY-TYPE PORTFOLIOS, FOLDERS, AND ENVELOPES.

SEC. 2(F).
FOR STATIONERY-TYPE PORTFOLIOS, FOLDERS, AND ENVELOPES (U.S. CLS. 2, 5, 22, 23, 29, 37, 38 AND 50).

FIRST USE 1-31-1990; IN COMMERCE 1-31-1990.
DAVID C. REIHNER, EXAMINING ATTORNEY

CLASS 16—(Continued).

SN 76-172,935. GO GODDESS!, INC., MIAMI, FL. FILED 11-29-2000.

GO GODDESS!

OWNER OF U.S. REG. NOS. 2,071,059, 2,454,007 AND OTHERS.

FOR ADDRESS BOOKS, APPOINTMENT BOOKS, AUTOGRAPH BOOKS, CHILDREN'S ACTIVITY BOOKS, CHILDREN'S BOOKS, COLORING BOOKS, COMPOSITION BOOKS, MEMORANDUM BOOKS, PRINTED MUSIC BOOKS, PICTURE BOOKS, PHOTOGRAPH ALBUMS, SCRAPBOOK ALBUMS, NOTE CARDS, ANNOUNCEMENT CARDS, BLANK CARDS, ARTS AND CRAFT PAINT KITS, PRINTED AWARDS, BABY BOOKS, PAPER PARTY BAGS, BALLPOINT AND FOUNTAIN PENS, PENCILS, PAPER BANNERS, BASKETS FOR DESK ACCESSORIES, PAPER BATH MATS, BATHROOM TISSUE, PAPER BIBS, BINDERS AND LOOSE LEAF BINDERS, BOOK BINDINGS, BLACKBOARDS, BLOTTERS, ART SKETCHING BOARDS, BULLETIN BOARDS, PAPER OR WOODEN DRAWING BOARDS, ILLUSTRATION BOARDS, MAGNETIC BOARDS, MEMORANDUM BOARDS, PAPER BOARDS, PICTURE FRAMING MAT BOARDS, PRESENTATION BOARDS, WATERCOLOR BOARDS, LAP BOARDS FOR READING AND WRITING, BOND PAPER, BOOKENDS, BOOKMARKS, RECIPE BOOKS, COOKBOOKS, PAPER GIFT WRAP BOWS, CARDBOARD BOXES, PAPER BOXES, PEN AND PENCIL BOXES, STATIONERY BOXES, BUMPER STICKERS, BUSINESS CARDS, DESK TOP MOUNTED STATIONERY CABINETS, CALENDAR DESK PADS, CALENDAR DESK STANDS, CALENDAR STANDS, CALENDARS, DESK CALENDARS, POCKET CALENDARS, PLAYING CARD CASES, CARD FILES, INDEX CARDS, CARDBOARD MAILING TUBES, GREETING CARDS, CHRISTMAS CARDS, GIFT CARDS, MOTIVATIONAL CARDS, NOTE CARDS, OCCASION CARDS, PACKAGING, NAMELY, BLISTER CARDS, PLAYING CARDS, RECORD CARDS, SCORE CARDS, TRADING CARDS, TRIVIA CARDS, CARDS BEARING UNIVERSAL GREETINGS, CARICATURES, FLIP CHART CARRYING CASES, CARTOON PRINTS, NEWSPAPER CARTOONS, PEN AND PENCIL CASES, CELESTIAL GLOBES, DECORATIVE PAPER CENTERPIECES, CHALK BOARDS FOR SCHOOL AND HOME USE, CHALK ERASERS, PRINTED CHARTS, BANK CHECKS, CHECKBOOKS, CHECKBOOK AND PASSBOOK WALLETS, CHECKBOOK COVERS AND HOLDERS, CLIP BOARDS, PAPER CLIPS, CLOTH FOR BOOKBINDING, PATTERNS FOR MAKING CLOTHES, PAPER TABLECLOTHS, COASTERS MADE OF PAPER, COLLAGES, COLOR PRINTS, COMPUTER GAME INSTRUCTION MANUALS, COMPUTER PAPER, CONFETTI, CONSTRUCTION PAPER, COSMETIC PENCIL SHARPENERS, CORRUGATED PAPER, BOOK COVERS, PAPER COVERS FOR TELEPHONE RECEIVERS, CRAFT PAPER, CRAYONS, CROSSWORD PUZZLES, PAPER CUTTERS, DAILY PLANNERS, DATA BOOKS, DATE BOOKS, PAPER CAKE DECORATIONS, PAPER PARTY DECORATIONS, DESK BASKETS FOR DESK ACCESSORIES, DESK CALENDARS, DESK FILE TRAYS, DESK SETS, DESK STANDS AND HOLDERS FOR PENS AND PENCILS, DESK TOP ORGANIZERS, DESK TOP PLANNERS, DESK TOP REVOLVING ROTARY CARD FILES, DIARIES, DICTIONARIES, TELEPHONE DIRECTORIES, ADHESIVE TAPE DISPENSERS FOR STATIONERY OR HOUSEHOLD PURPOSES, CARDBOARD FLOOR DISPLAY UNITS FOR MERCHANDISING PRODUCTS, DOCUMENT FILE RACKS, DOCUMENT FILE TRAYS, DRAWING BOARDS, DRAWING PENCILS, SANDPAPER PADS FOR SHARPENING PENCILS, DRAWING RULERS (U.S. CLS. 2, 5, 22, 23, 29, 37, 38 AND 50).

VERNA BETH RIRIE, EXAMINING ATTORNEY

CLASS 16—(Continued).

SN 76-295,913. PANLINE, USA, NORTHVALE, NJ. FILED 8-7-2001.

CRAYONS TO GO

NO CLAIM IS MADE TO THE EXCLUSIVE RIGHT TO USE CRAYONS, APART FROM THE MARK AS SHOWN.

FOR VARIETY OF COLORED CRAYONS IN A BRIGHTLY COLORED STORAGE CASE WITH ZIPPERED COMPARTMENTS (U.S. CLS. 2, 5, 22, 23, 29, 37, 38 AND 50).

FIRST USE 2-14-2000; IN COMMERCE 2-14-2000.
KIM SAITO, EXAMINING ATTORNEY

SN 76-337,347. SAKURA COLOR PRODUCTS OF AMERICA, INC., HAYWARD, CA. FILED 11-14-2001.



OWNER OF U.S. REG. NOS. 1,692,910, 2,497,138 AND OTHERS.

FOR WRITING INSTRUMENTS, NAMELY, PENCILS, BALL-POINT PENS, FOUNTAIN PENS, MARKERS, ROLLER BALL PENS, HIGHLIGHTING MARKERS AND PENS, DRAFTING PENS, CALLIGRAPHY PENS, ALL SOLD INDIVIDUALLY AND IN SETS; DRAWING MATERIALS, NAMELY, CRAYONS, PASTELS, DRAFTING INKS, ALL SOLD INDIVIDUALLY AND IN SETS (U.S. CLS. 2, 5, 22, 23, 29, 37, 38 AND 50).

FIRST USE 10-12-2001; IN COMMERCE 10-12-2001.
ROBERT COGGINS, EXAMINING ATTORNEY

SN 76-338,304. TIME INC., NEW YORK, NY. FILED 11-16-2001.

TIME FOR KIDS

OWNER OF U.S. REG. NO. 1,987,691.
NO CLAIM IS MADE TO THE EXCLUSIVE RIGHT TO USE "KIDS", APART FROM THE MARK AS SHOWN.

FOR NON-FICTION ENCYCLOPEDIA GUIDES ON TOPICS OF GENERAL INTEREST, EDUCATIONAL WORKBOOKS AND JOURNALS, FLASHCARDS, STICKERS, BLANK CERTIFICATE FORMS, FICTION AND NON-FICTION BOOKS ON A VARIETY OF TOPICS, CHARTS AND FLIP CHARTS AND REFERENCE MATERIALS, NAMELY, DICTIONARIES AND ENCYCLOPEDIAS (U.S. CLS. 2, 5, 22, 23, 29, 37, 38 AND 50).

INGA ERVIN, EXAMINING ATTORNEY

CLASS 16—(Continued).

SN 76-368,219. COLBERT PACKAGING CORPORATION, LAKE FOREST, IL. FILED 2-7-2002.

PEEK-A-BOO

FOR PAPER AND FILM LAMINATE FOLDABLE PACKAGING FOR MANUFACTURERS OF PHARMACEUTICAL, MEDICAL, FOOD, AND OTHER PRODUCTS DISPLAYED IN RETAIL STORES, HAVING A FEATURE WHEREBY AN ADDITIONAL PANEL OR TAB OF PACKAGE LABELING COULD BECOME VISIBLE TO CONSUMERS (U.S. CLS. 2, 5, 22, 23, 29, 37, 38 AND 50).

AMY HELLA, EXAMINING ATTORNEY

SN 76-402,023. GOLD LINE TELEMANAGEMENT INC., RICHMOND HILL, ONTARIO, CANADA, FILED 5-1-2002.

DANUBE

PRIORITY CLAIMED UNDER SEC. 44(D) ON CANADA APPLICATION NO. 1136321, FILED 4-4-2002, REG. NO. TMA605282, DATED 3-16-2004, EXPIRES 3-16-2019.

FOR PRE-PAID TELEPHONE CALLING CARDS, NOT MAGNETICALLY ENCODED; TELEPHONE CALLING CARDS NOT MAGNETICALLY ENCODED (U.S. CLS. 2, 5, 22, 23, 29, 37, 38 AND 50).

JOHN LINCOSKI, EXAMINING ATTORNEY

SN 76-402,094. GOLD LINE TELEMANAGEMENT INC., RICHMOND HILL, ONTARIO, CANADA, FILED 5-1-2002.

ZEBRA

PRIORITY CLAIMED UNDER SEC. 44(D) ON CANADA APPLICATION NO. 1136322, FILED 4-4-2002, REG. NO. TMA604715, DATED 3-10-2004, EXPIRES 3-10-2019.

FOR PRE-PAID TELEPHONE CALLING CARDS, NOT MAGNETICALLY ENCODED; TELEPHONE CALLING CARDS NOT MAGNETICALLY ENCODED (U.S. CLS. 2, 5, 22, 23, 29, 37, 38 AND 50).

JOHN LINCOSKI, EXAMINING ATTORNEY

SN 76-416,730. BESV MEDIA, INC., NEW YORK, NY. FILED 6-11-2002.



FOR MAGAZINES FEATURING MEN'S LIFESTYLE, POPULAR CULTURE, FASHION, ENTERTAINMENT, HEALTH AND OTHER TOPICS OF GENERAL INTEREST (U.S. CLS. 2, 5, 22, 23, 29, 37, 38 AND 50).

FIRST USE 9-24-2002; IN COMMERCE 9-24-2002.
CHARLES L. JENKINS, EXAMINING ATTORNEY

CLASS 16—(Continued).

SN 76-419,179. GONE SCRAPPIN', INC., PARK CITY, UT. FILED 6-6-2002.

GONE SCRAPPIN'

NO CLAIM IS MADE TO THE EXCLUSIVE RIGHT TO USE "SCRAPPIN'", APART FROM THE MARK AS SHOWN.

FOR PAPER PRODUCTS, NAMELY PATTERNED PAPER FOR USE IN SCRAP BOOKING; BORDER PAPER FOR USE IN SCRAP BOOKING; CARDSTOCK; PATTERNED CARDSTOCK; SPECIALTY PAPERS, NAMELY, MULBERRY, VELLUM, EMBOSSED PAPER, HAND-MADE PAPERS, AND GLITTER PAPER; PRE-PRINTED DIE-CUT IMAGES OF PAPER OF VARIOUS PEOPLE, ANIMALS, PHRASES, TITLES, AND OBJECTS; PRE-PRINTED UN-CUT IMAGES ON PAPER, NAMELY, THEMED PAGES PRINTED ON CARDSTOCK WEIGHT MATERIAL; PREPRINTED PAPER STICKERS, NAMELY, STICKERS INCLUDING ALPHABET LETTERS, IMAGES, SHAPES, BORDERS, EMBOSSED, AND PHOTOGRAPHIC IMAGES; MAGAZINES AND BROCHURES FEATURING INFORMATION ABOUT SCRAP BOOKING; PRINTED INSTRUCTIONAL AND TEACHING MATERIAL ON THE TOPICS OF ARTS, CRAFTS, COLLECTING AND SCRAP BOOKING; PAPER PIECING TEMPLATES; DIE-CUT PAPER SHAPES, INCLUDING PHRASES AND LETTERS; PAPER PUNCHES; PAPER CUTTERS FOR CUTTING CIRCLES AND OVALS; PAPER TRIMMERS; PAPER DIE CUTTERS; STATIONERY; STENCILS FEATURING ALPHABET LETTERS AND SHAPES; JOURNALING GUIDEBOOKS; GUIDES FOR USE IN CREATING LETTERS, SHAPES AND NUMBERS FOR USE IN JOURNALS; PAPER FASTENERS OF VARIOUS SIZES AND SHAPES; PENS; SPECIALTY PENS, NAMELY, ACID IDENTIFIER, RED-EYE REMOVER, AND WATERCOLOR BLENDER; MARKERS; WATERCOLOR PENCILS; COLOR PENCILS; ADHESIVES FOR HOUSEHOLD PURPOSES INCLUDING SCRAP BOOKING; PHOTOGRAPHS; PHOTO ORGANIZERS; SCRAP BOOKING TOOL AND PRODUCT ORGANIZERS; PHOTO ALBUMS; SCRAP BOOKING ALBUMS; PAGE PROTECTORS INCLUDING FOR USE IN ALBUMS; PHOTO PROTECTORS INCLUDING FOR USE IN ALBUMS; PREPRINTED PLASTIC STICKERS, NAMELY, STICKERS INCLUDING ALPHABET LETTERS, IMAGES, SHAPES, BORDERS, EMBOSSED, AND PHOTOGRAPHIC IMAGES; AND, PAPER RIBBONS (U.S. CLS. 2, 5, 22, 23, 29, 37, 38 AND 50).

JOHN LINCOSKI, EXAMINING ATTORNEY

SN 76-423,312. PHILADELPHIA TRIBUNE, THE, PHILADELPHIA, PA. FILED 6-21-2002.

**PHILADELPHIA TRIBUNE
PA LEARNING KEY**

NO CLAIM IS MADE TO THE EXCLUSIVE RIGHT TO USE PHILADELPHIA AND LEARNING KEY AND PA, APART FROM THE MARK AS SHOWN.

FOR MAGAZINE SUPPLEMENT TO NEWSPAPERS FOR GENERAL CIRCULATION, BASED IN PHILADELPHIA, PENNSYLVANIA, THAT FOCUSES ON ISSUES AND EVENTS PERTAINING TO THE AFRICAN AMERICAN COMMUNITY (U.S. CLS. 2, 5, 22, 23, 29, 37, 38 AND 50).

FIRST USE 1-3-1978; IN COMMERCE 1-3-1978.
GWEN STOKOLS, EXAMINING ATTORNEY

CLASS 16—(Continued).

SN 76-446,792. AUSLAND, KELLY, DBA SHARDS DESIGN, BEND, OR. AND SMITH, BROOKE, DBA SHARDS DESIGN, BEND, OR. FILED 9-3-2002.

POP INK

FOR PAPER PRODUCTS, NAMELY, NOTE CARDS, GREETING CARDS, POSTCARDS, PHOTOGRAPH ALBUMS, CALENDARS, APPOINTMENT REMINDER CALENDARS, STICKERS, AND DIARIES (U.S. CLS. 2, 5, 23, 29, 37, 38 AND 50).

DAVID C. REIHNER, EXAMINING ATTORNEY

SN 76-466,959. SPIRAL SPRL, B-1190 BRUSSELS, BELGIUM, FILED 11-7-2002.

PRISMMO

OWNER OF ERPN CMNTY TM OFC REG. NO. 002221653, DATED 6-14-2002, EXPIRES 5-16-2011.

FOR PRINTED PROMOTIONAL MATERIAL, NAMELY; CATALOGUES, LOTTERY TICKETS, CHECKS, ENVELOPES, FILE COVERS; PRINTED VALUABLES AND PERSONALIZED PRINTED DOCUMENTS IN A SECURE COVER, NAMELY LOTTERY TICKETS, CHECKS, NON-MAGNETICALLY ENCODED PREPAID TELEPHONE CARDS, BOOKLET CONTAINING A PREPAID CELLULAR TELEPHONE ACCOUNT RECHARGING CODE AS WELL AS PRINTED PROMOTIONAL MATERIALS (U.S. CLS. 2, 5, 22, 23, 29, 37, 38 AND 50).

M. E. BODSON, EXAMINING ATTORNEY

SN 76-483,331. PUTNAM-SCHOLES, JO ANN S., BARRINGTON, RI. FILED 1-15-2003.

Hand-Ease

FOR FOLDABLE, HAND-HELD, CARDBOARD DISKS USED TO HOLD GROCERY BAG HANDLES (U.S. CLS. 2, 5, 22, 23, 29, 37, 38 AND 50).

FIRST USE 1-9-2003; IN COMMERCE 1-9-2003.

DAVID C. REIHNER, EXAMINING ATTORNEY

CLASS 16—(Continued).

SN 76-492,290. UNI-PACK INTERNATIONAL, INC., MONTECLAIR, CA. FILED 2-25-2003.

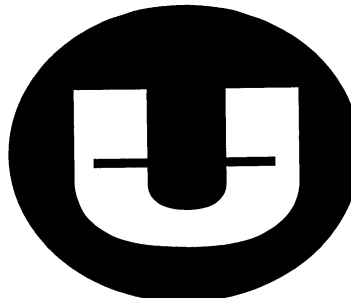

FOR CATALOGS FEATURING, NAMELY, SALES CATALOG, NEW PRODUCT CATALOG, SEASONAL CATALOG; PHOTOGRAPHS; STATIONERY (U.S. CLS. 2, 5, 22, 23, 29, 37, 38 AND 50).

FIRST USE 10-5-2001; IN COMMERCE 10-5-2001.

TRICIA THOMPSON, EXAMINING ATTORNEY

SN 76-500,306. JOHNSTON, DONALD L., LOUISVILLE, KY. FILED 3-25-2003.

FLEUR DE LOUISVILLE

NO CLAIM IS MADE TO THE EXCLUSIVE RIGHT TO USE LOUISVILLE, APART FROM THE MARK AS SHOWN.

THE ENGLISH TRANSLATION OF THE WORD "FLEUR DE" IN THE MARK IS "FLOWER OF".

FOR PAPER GOODS AND PRINTED MATTER, NAMELY, POSTERS, MOUNTED OR UNMOUNTED PHOTOGRAPHS, COASTERS MADE OF PAPER, NEWSLETTERS AND MAGAZINES ABOUT SOCIAL MATTERS AND CIVIC ACTIVITIES, MENUS, NAPKINS, PAPER TOWELS, BROCHURES, STUDY GUIDES, LESSON PLANNERS, BUMPER STICKERS, CALENDARS, AND PICTURES, DRAWINGS, SKETCHES, LIMITED EDITION PRINTS, WRITING TABLETS, NOTE CARDS, POST CARDS, CROSSWORD PUZZLES, BOOKMARKS, DECALS, BUMPER STICKERS, PAPER SIGNS, STATIONERY, BUSINESS CARDS, PRINTS, LITHOGRAPHS, DRAWING BOARDS, PAINTING BOARDS, PENCILS, PENS, DRAWING AND DRAFTING TEMPLATES, MAGAZINES PROMOTING COMMUNITY AND BUSINESS INTERESTS, NOTEBOOKS, GREETING CARDS, PAPER COASTERS, POSTER ART, AND STICKERS (U.S. CLS. 2, 5, 22, 23, 29, 37, 38 AND 50).

JANICE L. MCMORROW, EXAMINING ATTORNEY

SN 76-502,886. PEACHTREE COMMUNICATIONS, INC., GREENVILLE, SC. FILED 4-1-2003.

PEOPLE, PLACES, LURE & LEGEND

FOR GENERAL FEATURE MAGAZINES (U.S. CLS. 2, 5, 22, 23, 29, 37, 38 AND 50).

FIRST USE 3-15-2003; IN COMMERCE 3-15-2003.

TRACY FLETCHER, EXAMINING ATTORNEY

CLASS 16—(Continued).

SN 76-503,437. LARUE, ROBERT, TIPTON, TN. FILED 3-31-2003.

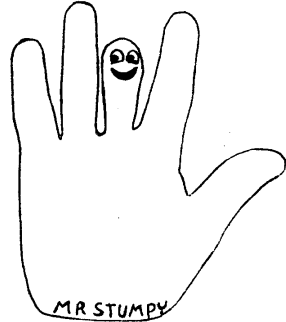

THE MARK IDENTIFIES A LIVING INDIVIDUAL WHOSE CONSENT IS OF RECORD.

FOR PRINTED MATTER: NAMELY, STICKERS, DECALS, PHOTOGRAPHS, COMIC BOOKS, COLORING BOOKS, POSTERS, AND PAMPHLETS, IN THE FIELD OF HEALTHY EATING, WEIGHT LOSS AND HOME AND INDUSTRIAL SAFETY (U.S. CLS. 2, 5, 22, 23, 29, 37, 38 AND 50).

ROBERT LORENZO, EXAMINING ATTORNEY

SN 76-504,414. HAMODIA CORP., BROOKLYN, NY. FILED 4-4-2003.



THE NON-LATIN CHARACTER IN THE MARK TRANSLITERATES INTO HAMODIA AND THIS MEANS "THE ONE WHO MAKES ONE KNOW A THING" "INFORMER" OR "INFORMANT".

FOR NEWSPAPER FOR JEWISH RELIGION AND ETHNICITY (U.S. CLS. 2, 5, 22, 23, 29, 37, 38 AND 50).

FIRST USE 4-27-1998; IN COMMERCE 4-27-1998.

TARAH HARDY, EXAMINING ATTORNEY

SN 76-504,415. HAMODIA CORP., BROOKLYN, NY. FILED 4-4-2003.



THE ENGLISH TRANSLATION OF HAMODIA IS "THE ONE WHO MAKES ONE KNOW A THING" "INFORMER" OR "INFORMANT".

FOR NEWSPAPER FOR JEWISH RELIGION AND ETHNICITY (U.S. CLS. 2, 5, 22, 23, 29, 37, 38 AND 50).

FIRST USE 4-27-1998; IN COMMERCE 4-27-1998.

TARAH HARDY, EXAMINING ATTORNEY

CLASS 16—(Continued).

SN 76-504,671. RBC MINISTRIES, GRAND RAPIDS, MI. FILED 4-7-2003.

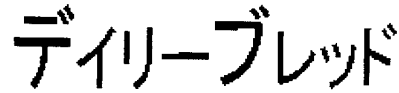

OWNER OF U.S. REG. NOS. 725,657, 731,961 AND 2,607,446.

THE ENGLISH TRANSLATION OF THE MARK, WHICH IS IN JAPANESE, IS "OUR DAILY BREAD".

THE NON-LATIN CHARACTERS IN THE MARK TRANSLITERATE TO DEILII BULEDDO AND THIS MEANS OUR DAILY BREAD IN ENGLISH.

FOR PUBLICATIONS, NAMELY, PERIODICALS IN THE FIELD OF RELIGION (U.S. CLS. 2, 5, 22, 23, 29, 37, 38 AND 50).

FIRST USE 1-0-2000; IN COMMERCE 1-0-2000.

TARAH HARDY, EXAMINING ATTORNEY

SN 76-504,672. RBC MINISTRIES, GRAND RAPIDS, MI. FILED 4-7-2003.



OWNER OF U.S. REG. NOS. 725,657, 731,961 AND 2,607,446.

THE ENGLISH TRANSLATION OF THE MARK, WHICH IS IN KOREAN, IS "OUR DAILY BREAD".

THE NON-LATIN CHARACTERS IN THE MARK TRANSLITERATE TO O NEUL EUI YANG SHIK AND THIS MEANS OUR DAILY BREAD IN ENGLISH.

FOR PUBLICATIONS, NAMELY, PERIODICALS IN THE FIELD OF RELIGION (U.S. CLS. 2, 5, 22, 23, 29, 37, 38 AND 50).

FIRST USE 1-0-2000; IN COMMERCE 1-0-2000.

TARAH HARDY, EXAMINING ATTORNEY

CLASS 16—(Continued).

SN 76-505,646. INTERNATIONAL ASSOCIATION OF DRILLING CONTRACTORS, HOUSTON, TX. FILED 4-10-2003.



OWNER OF U.S. REG. NO. 1,744,490.
FOR NEWSLETTERS IN THE FIELD OF DRILLING
(U.S. CLS. 2, 5, 22, 23, 29, 37, 38 AND 50).
FIRST USE 6-0-2002; IN COMMERCE 6-0-2002.
ALLISON HOLTZ, EXAMINING ATTORNEY

CLASS 16—(Continued).

SN 76-515,005. MAVERICK SKATEBOARDS, INC., BEVERLY HILLS, CA. FILED 5-16-2003.

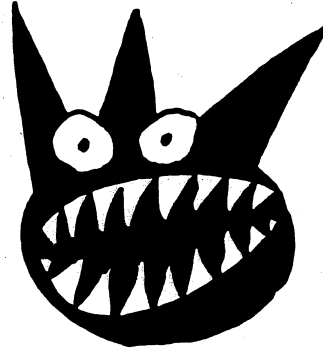

THE MARK CONSISTS OF A FANCIFUL CARTOON DRAWING OF A CAT.
FOR PRINTED MATERIALS, NAMELY, CALENDARS, POSTERS, FLASH CARDS, NOTE CARDS, POSTCARDS AND STICKERS (U.S. CLS. 2, 5, 22, 23, 29, 37, 38 AND 50).
FIRST USE 6-0-1993; IN COMMERCE 6-0-1993.
FLORENTINA BLANDU, EXAMINING ATTORNEY

SN 76-519,979. AWARDS.COM, LLC, FORT LEE, NJ. FILED 5-23-2003.

INSPIRE SOMEONE

SN 76-510,625. KREGEL PUBLICATIONS, INC., GRAND RAPIDS, MI. FILED 4-30-2003.

OWNER OF U.S. REG. NO. 2,756,615.
FOR NEWSLETTERS, MAGAZINES, IN THE FIELDS OF AWARDS, EMPLOYEE MOTIVATION AND RECOGNITION (U.S. CLS. 2, 5, 22, 23, 29, 37, 38 AND 50).
DOMINIC J. FERRAIUOLO, EXAMINING ATTORNEY



NO CLAIM IS MADE TO THE EXCLUSIVE RIGHT TO USE "CHILD", APART FROM THE MARK AS SHOWN.
FOR PRINTED PUBLICATIONS, NAMELY, CHILDREN'S BOOKS (U.S. CLS. 2, 5, 22, 23, 29, 37, 38 AND 50).
FIRST USE 9-0-2002; IN COMMERCE 9-0-2002.
HEATHER THOMPSON, EXAMINING ATTORNEY

SN 76-523,243. AMERICAN TRAVELER STAFFING PROFESSIONALS, LLC, BOCA RATON, FL. FILED 6-11-2003.

TRAVELER TIMES

NO CLAIM IS MADE TO THE EXCLUSIVE RIGHT TO USE TRAVELER, APART FROM THE MARK AS SHOWN.
FOR NEWSLETTERS IN THE FIELD OF EMPLOYING HIRING, PLACEMENT AND STAFFING, NAMELY, PLACEMENT OF HEALTHCARE PROVIDERS ON WORK ASSIGNMENTS IN VARIOUS LOCATIONS THROUGHOUT THE COUNTRY (U.S. CLS. 2, 5, 22, 23, 29, 37, 38 AND 50).
FIRST USE 10-0-2000; IN COMMERCE 10-0-2000.
STANLEY I. OSBORNE, EXAMINING ATTORNEY

CLASS 16—(Continued).

SN 76-524,469. JANNOUN, JANET, TAMPA, FL. FILED 6-23-2003.

COLOR ON A ROPE

FOR ORGANIZER FOR CRAYONS OR COLORED PENCILS, SAID ORGANIZER CONSISTING OF MULTIPLE PENCIL AND CRAYON HOLDERS (U.S. CLS. 2, 5, 22, 23, 29, 37, 38 AND 50).

MARC LEIPZIG, EXAMINING ATTORNEY

SN 76-524,773. THE CHANCELLOR MASTERS AND SCHOLARS OF THE UNIVERSITY OF OXFORD, OXFORD, UNITED KINGDOM, FILED 6-16-2003.

BODLEIAN LIBRARY

NO CLAIM IS MADE TO THE EXCLUSIVE RIGHT TO USE LIBRARY, APART FROM THE MARK AS SHOWN.

FOR PRINTED MATTER NAMELY GUIDEBOOKS RELATING TO ARCHITECTURE, HISTORICAL BUILDINGS, LITERATURE, UNIVERSITIES AND LIBRARIES; STATIONERY; INSTRUCTIONAL AND TEACHING MATERIALS EXCEPT APPARATUS RELATING TO ARCHITECTURE, HISTORICAL BUILDINGS, LITERATURE, UNIVERSITIES AND LIBRARIES; PAPERWEIGHTS; NOTEBOOKS; NOTE PADS; BOOKMARKS; WRITING PAPER; WRITING SETS; PENS; PENCILS; LETTER WRITING SETS; POSTCARDS; GIFT WRAP; GREETING CARDS; FOLDING CARDS; NOTE CARDS; AND BOOKS RELATING TO ARCHITECTURE, HISTORICAL BUILDINGS, LITERATURE, UNIVERSITIES AND LIBRARIES (U.S. CLS. 2, 5, 22, 23, 29, 37, 38 AND 50).

FIRST USE 0-0-1986; IN COMMERCE 0-0-1995.

WILLIAM BRECKENFELD, EXAMINING ATTORNEY

SN 76-529,033. STROUP & CARPENTER, FORT WAYNE, IN. FILED 7-2-2003.

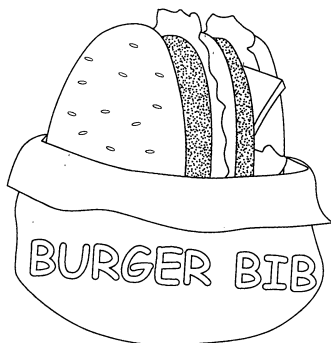

NO CLAIM IS MADE TO THE EXCLUSIVE RIGHT TO USE "BURGER", APART FROM THE MARK AS SHOWN.

FOR HAMBURGER SANDWICH BAGS (U.S. CLS. 2, 5, 22, 23, 29, 37, 38 AND 50).

JOHN KELLY, EXAMINING ATTORNEY

CLASS 16—(Continued).

SN 76-530,366. COOK COMMUNICATIONS MINISTRIES, COLORADO SPRINGS, CO. FILED 6-30-2003.

JUST ADD KIDZ

FOR PRINTED TEACHING AND INSTRUCTIONAL MATERIALS, NAMELY, BOOKS, PAMPHLETS, NEWSLETTERS, BIBLES, BROCHURES, POSTERS, STUDENT BOOKS, PRINTED TEACHING ACTIVITY GUIDES, ADULT STUDY GUIDES, DEVOTIONAL BOOKS, WORKBOOKS, INFORMATIONAL FLYERS, PRINTED ADVERTISING BROCHURES, BOOKMARKS, STICKER BOOKS, PAINT BOOKS, COLORING BOOKS, COOK BOOKS, PENCIL BOOKS, SONG BOOKS, MUSIC BOOKS, SERIES OF FICTION AND NON-FICTION BOOKS, ALL IN THE FIELD OF CHRISTIAN EDUCATION (U.S. CLS. 2, 5, 22, 23, 29, 37, 38 AND 50).

CHARLES L. JENKINS, EXAMINING ATTORNEY

SN 76-530,611. LIU, YUJIAN, NEW YORK, NY. FILED 7-17-2003.



NO CLAIM IS MADE TO THE EXCLUSIVE RIGHT TO USE THE REPRESENTATION OF THE CHINESE TRANSLATION, APART FROM THE MARK AS SHOWN.

THE NON-LATIN CHARACTER IN THE MARK TRANSLITERATES TO (PRONOUNCE- "BI", MEANS- "THE OTHER") AND (PRONOUNCE- "AN", MEANS- "COAST" OR "BANK") AND MEANS "THE OTHER COAST" OR "THE OTHER BANK" IN ENGLISH.

FOR MAGAZINES FEATURING PUBLIC INTERESTS IN SOCIAL, CULTURE, ART AND TRAVEL, PAPER GOODS, NAMELY, PAPER FLOWERS, NEW YEAR CARDS, CONGRATULATORY CARDS, AND PRINTER MATTER, NAMELY, BOOKS, BROCHURES, ALBUMS, GUIDES, BOOKLETS, PAMPHLETS ALL IN THE FIELD OF PUBLIC INTERESTS IN SOCIAL, CULTURE, ART AND TRAVEL (U.S. CLS. 2, 5, 22, 23, 29, 37, 38 AND 50).

FIRST USE 9-1-2001; IN COMMERCE 9-1-2001.

GEORGIA CARTY, EXAMINING ATTORNEY

SN 76-531,665. A&P ENTERPRISES, INC., LANCASTER, CA. FILED 7-23-2003.

A&P Enterprises, Inc.

NO CLAIM IS MADE TO THE EXCLUSIVE RIGHT TO USE "ENTERPRISES, INC.", APART FROM THE MARK AS SHOWN.

FOR PRINTED TEACHING MATERIAL IN THE FIELD OF BUSINESS START-UP AND MANAGEMENT (U.S. CLS. 2, 5, 22, 23, 29, 37, 38 AND 50).

FIRST USE 4-2-2003; IN COMMERCE 4-2-2003.

STANLEY I. OSBORNE, EXAMINING ATTORNEY

CLASS 16—(Continued).

SN 76-534,505. TPI HOLDINGS, INC., NORFOLK, VA. FILED 8-4-2003.

TRADER PLUS

OWNER OF U.S. REG. NOS. 1,911,290, 2,288,432 AND OTHERS.

FOR PERIODICAL MAGAZINES AND NEWSLETTERS FEATURING CLASSIFIED AND DISPLAY ADVERTISEMENTS, INFORMATION RELATED TO VEHICLE SALES, AND GENERAL VEHICLE INDUSTRY NEWS (U.S. CLS. 2, 5, 22, 23, 29, 37, 38 AND 50).

FIRST USE 6-27-2003; IN COMMERCE 6-27-2003.

WILLIAM BRECKENFELD, EXAMINING ATTORNEY

SN 76-535,359. WARD KRAFT, INC., FORT SCOTT, KS. FILED 8-1-2003.

IDEELINK

FOR PAPER IDENTIFICATION TAGS, PAPER LABELS, BUSINESS FORMS HAVING IDENTIFICATION BANDS (U.S. CLS. 2, 5, 22, 23, 29, 37, 38 AND 50).

SCOTT OSICK, EXAMINING ATTORNEY

SN 76-537,448. TNT ACTION PHOTOGRAPHY, SAN JOSE, CA. FILED 8-14-2003.

TNT

FOR PHOTOGRAPHS (U.S. CLS. 2, 5, 22, 23, 29, 37, 38 AND 50).

FIRST USE 4-30-2002; IN COMMERCE 5-12-2002.

JOHN LINCOSKI, EXAMINING ATTORNEY

SN 76-538,943. RAGS TO RICHES DISTRIBUTION, LLC, BENTONVILLE, AR. FILED 7-11-2003.

REFER ME

FOR CARDBOARD DISPLAY BOARDS, PAPER BANNERS, GUEST NOTE CARDS, PAPER HANGTAGS FOR MIRRORS (U.S. CLS. 2, 5, 22, 23, 29, 37, 38 AND 50).

FIRST USE 6-9-2003; IN COMMERCE 6-9-2003.

TARAH HARDY, EXAMINING ATTORNEY

SN 76-545,930. J. C. PENNEY CORPORATION, INC., PLANO, TX. FILED 9-16-2003.

JOYVILLE

FOR GENERAL MERCHANDISE MAIL ORDER CATALOG (U.S. CLS. 2, 5, 22, 23, 29, 37, 38 AND 50).

FIRST USE 8-31-2003; IN COMMERCE 8-31-2003.

TONI HICKEY, EXAMINING ATTORNEY

CLASS 16—(Continued).

SN 76-546,328. VIRGO PUBLISHING, INC., PHOENIX, AZ. FILED 9-22-2003.

ICT

OWNER OF U.S. REG. NO. 2,180,566.

FOR TRADE MAGAZINE PROVIDING NEWS AND INFORMATION TO HEALTHCARE PRACTITIONERS AND NURSES REGARDING CLEANING, DISINFECTING, DECONTAMINATION AND STERILIZATION METHODS, PRODUCTS AND SERVICES (U.S. CLS. 2, 5, 22, 23, 29, 37, 38 AND 50).

FIRST USE 9-16-2003; IN COMMERCE 9-16-2003.

CIMMERIAN COLEMAN, EXAMINING ATTORNEY

SN 76-546,375. THE UPPER DECK COMPANY, LLC, CARLSBAD, CA. FILED 9-22-2003.

BEEHIVE

FOR TRADING CARDS (U.S. CLS. 2, 5, 22, 23, 29, 37, 38 AND 50).

CIMMERIAN COLEMAN, EXAMINING ATTORNEY

SN 76-549,414. ONEIDA INDIAN NATION, ONEIDA, NY. FILED 9-15-2003.

INDIAN COUNTRY TODAY

NO CLAIM IS MADE TO THE EXCLUSIVE RIGHT TO USE "INDIAN", APART FROM THE MARK AS SHOWN.

FOR NEWSPAPERS FOR GENERAL CIRCULATION AND MAGAZINES ABOUT INDIAN ISSUES (U.S. CLS. 2, 5, 22, 23, 29, 37, 38 AND 50).

FIRST USE 10-8-1992; IN COMMERCE 10-8-1992.

GEOFFREY FOSDICK, EXAMINING ATTORNEY

SN 76-549,669. RBC MINISTRIES, GRAND RAPIDS, MI. FILED 10-3-2003.

NUESTRO ANDAR DIARIO

OWNER OF U.S. REG. NOS. 725,657 AND 2,607,446.

THE ENGLISH TRANSLATION OF THE MARK, WHICH IS IN SPANISH, IS "OUR DAILY WALKING."

FOR PUBLICATIONS IN THE NATURE OF PERIODICALS IN THE FIELD OF RELIGION (U.S. CLS. 2, 5, 22, 23, 29, 37, 38 AND 50).

FIRST USE 9-0-2003; IN COMMERCE 9-0-2003.

LAURA KOVAISKY, EXAMINING ATTORNEY

CLASS 16—(Continued).

SN 76-550,026. AMERICAN LIBRARY ASSOCIATION, CHICAGO, IL. FILED 9-22-2003.

SMART LIBRARIES

NO CLAIM IS MADE TO THE EXCLUSIVE RIGHT TO USE LIBRARIES, APART FROM THE MARK AS SHOWN. FOR NEWSLETTER IN THE FIELD OF INFORMATION TECHNOLOGY FOR LIBRARIES (U.S. CLS. 2, 5, 22, 23, 29, 37, 38 AND 50).

FIRST USE 1-1-2003; IN COMMERCE 1-1-2003.
ERICA GLEMBOCKI, EXAMINING ATTORNEY

SN 76-552,700. HORTICULTURAL ASSET MANAGEMENT, INC., RALEIGH, NC. FILED 10-20-2003.

HS²

FOR PRINTED MATTER, NAMELY, MANUALS FOR THE CARE AND VALUATION OF LANDSCAPING ON COMMERCIAL AND CONSUMER REAL ESTATE PROPERTIES (U.S. CLS. 2, 5, 22, 23, 29, 37, 38 AND 50).

GIANCARLO CASTRO, EXAMINING ATTORNEY

SN 76-552,701. HORTICULTURAL ASSET MANAGEMENT, INC., RALEIGH, NC. FILED 10-20-2003.

**MONEY GROWS ON TREES
AND WE CAN PROVE IT**

FOR PRINTED MATTER, NAMELY, MANUALS FOR THE CARE AND VALUATION OF LANDSCAPING ON COMMERCIAL AND CONSUMER REAL ESTATE PROPERTIES (U.S. CLS. 2, 5, 22, 23, 29, 37, 38 AND 50).

GIANCARLO CASTRO, EXAMINING ATTORNEY

SN 76-553,103. KWIK SEW PATTERN CO., INC., MINNEAPOLIS, MN. FILED 10-2-2003.

KWIK START

OWNER OF U.S. REG. NOS. 967,035 AND 1,758,315. FOR PAPER CLOTHING PATTERNS FOR HOME SEWING (U.S. CLS. 2, 5, 22, 23, 29, 37, 38 AND 50).

FIRST USE 1-0-1993; IN COMMERCE 1-0-1993.
KEVON CHISOLM, EXAMINING ATTORNEY

CLASS 16—(Continued).

SN 76-553,348. GRANT, LINDA H., SAN FRANCISCO, CA. FILED 10-22-2003.

SPOT'N'JOT

FOR CARDS FOR RECORDING BIRD SIGHTINGS (U.S. CLS. 2, 5, 22, 23, 29, 37, 38 AND 50).

FIRST USE 11-20-2002; IN COMMERCE 8-6-2003.
DOUGLAS LEE, EXAMINING ATTORNEY

SN 76-554,004. LOG HOUSE PLANTS, COTTAGE GROVE, OR. FILED 10-21-2003.

WINDOWPANE

FOR CLEAR VINYL PREPRINTED LABELS (U.S. CLS. 2, 5, 22, 23, 29, 37, 38 AND 50).

FIRST USE 9-30-2003; IN COMMERCE 9-30-2003.
CHARLES JOYNER, EXAMINING ATTORNEY

SN 76-554,730. INNOVATION AND DESIGN, INC., BETHLEHEM, GA. FILED 10-14-2003.

NOTESTER

FOR WRITING INSTRUMENTS AND ACCESSORIES, NAMELY INK PENS, PENCILS, MARKERS AND ADHESIVE-BACKED NOTE PAPER (U.S. CLS. 2, 5, 22, 23, 29, 37, 38 AND 50).

GINA HAYES, EXAMINING ATTORNEY

SN 76-555,656. YOUTH COMMUNICATION, NEW YORK, NY. FILED 10-10-2003.

REPRESENT

FOR MAGAZINE WRITTEN BY AND FOR TEENS CONCERNING FOSTER CARE LIFE (U.S. CLS. 2, 5, 22, 23, 29, 37, 38 AND 50).

FIRST USE 7-0-2003; IN COMMERCE 7-0-2003.
PATRICIA EVANKO, EXAMINING ATTORNEY

CLASS 16—(Continued).

SN 76-556,749. RODRIGUEZ-LONG, RICARDO, COMMERCE, CA. FILED 10-21-2003.



NO CLAIM IS MADE TO THE EXCLUSIVE RIGHT TO USE "MAGAZINE TRANSPORTE LATINO", APART FROM THE MARK AS SHOWN.

THE ENGLISH TRANSLATION OF TRANSPORTE LATINO IN THE MARK IS "HISPANICS IN TRUCKING" AND "LATIN TRANSPORTATION".

FOR MAGAZINE PUBLICATION WITH NEWS AND INFORMATION PERTAINING TO OVER THE ROAD TRUCKING IN SPANISH LANGUAGE (U.S. CLS. 2, 5, 22, 23, 29, 37, 38 AND 50).

FIRST USE 6-1-1999; IN COMMERCE 7-1-2000.
TRICIA SONNEBORN, EXAMINING ATTORNEY

CLASS 16—(Continued).

SN 76-559,612. MAGNA ENTERTAINMENT CORP., AURORA, ONTARIO L4G 7K1, CANADA, FILED 11-12-2003.



THE MARK CONSISTS OF STANDARD CHARACTERS WITHOUT CLAIM TO ANY PARTICULAR FONT, STYLE, SIZE, OR COLOR.

FOR PRINTED NEWSLETTER FEATURING HORSE RACING INFORMATION (U.S. CLS. 2, 5, 22, 23, 29, 37, 38 AND 50).

FIRST USE 2-0-2003; IN COMMERCE 2-0-2003.
PATRICIA EVANKO, EXAMINING ATTORNEY

SN 76-556,855. LIFEWAY CHRISTIAN RESOURCES OF THE SOUTHERN BAPTIST CONVENTION, NASHVILLE, TN. FILED 10-21-2003.

**RAMBLIN' ROAD TRIP:
WHICH WAY DO I GO?**

FOR PRINTED RELIGIOUS BOOKS, RELIGIOUS PAMPHLETS, RELIGIOUS MAGAZINES, RELIGIOUS NEWSLETTERS, RELIGIOUS BULLETINS, PRINTED RELIGIOUS TEACHING MATERIALS (U.S. CLS. 2, 5, 22, 23, 29, 37, 38 AND 50).

GINA HAYES, EXAMINING ATTORNEY

SN 76-579,425. BRAIN TECHNOLOGIES CORPORATION, PLANO, TX. FILED 3-5-2004.

MINDMAKER6

FOR PRINTED EDUCATIONAL MATERIALS, NAMELY TESTING BOOKLETS IN THE FIELD OF SELF-ASSESSMENT AND THINKING SKILLS (U.S. CLS. 2, 5, 22, 23, 29, 37, 38 AND 50).

FIRST USE 3-1-1986; IN COMMERCE 3-1-1986.
CHRISIE B. KING, EXAMINING ATTORNEY

SN 76-557,517. ART FOR CHILDREN CHARITIES, INC., EL DORADO HILLS, CA. FILED 10-20-2003.

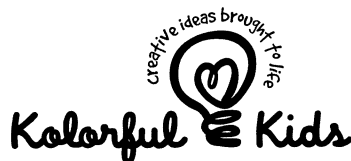

NO CLAIM IS MADE TO THE EXCLUSIVE RIGHT TO USE "KIDS", APART FROM THE MARK AS SHOWN.

FOR ART SUPPLIES, NAMELY EASELS, PENCILS, COLORED PENS, DRAWING PAPER, ERASERS, SKETCH PADS, CANVAS FOR PAINTING, CRAYONS, AND CHALK (U.S. CLS. 2, 5, 22, 23, 29, 37, 38 AND 50).

NANCY CLARKE, EXAMINING ATTORNEY

SN 76-579,427. BRAIN TECHNOLOGIES CORPORATION, PLANO, TX. FILED 3-5-2004.

BRAINMAP

FOR PRINTED EDUCATIONAL MATERIALS, NAMELY TESTING BOOKLETS IN THE FIELD OF SELF-ASSESSMENT AND THINKING SKILLS (U.S. CLS. 2, 5, 22, 23, 29, 37, 38 AND 50).

FIRST USE 12-0-1982; IN COMMERCE 12-0-1982.
CHRISIE B. KING, EXAMINING ATTORNEY

CLASS 16—(Continued).

SN 78-019,096. GROFIT PLASTICS, M.P. EILOT, ISRAEL, FILED 8-1-2000.



OWNER OF ISRAEL REG. NO. 128482, DATED 6-6-2000, EXPIRES 6-17-2006.

FOR PLASTIC FLEXIBLE PACKAGES WHICH CREATE MODIFIED ATMOSPHERE TO INCREASE SHELF LIFE OF FRUITS AND VEGETABLES (U.S. CLS. 2, 5, 22, 23, 29, 37, 38 AND 50).

DOMINIC J. FERRAIUOLO, EXAMINING ATTORNEY

SN 78-128,946. CANON COMMUNICATIONS, LLC., LOS ANGELES, CA. FILED 5-15-2002.

COSMETIC/PERSONAL CARE PACKAGING

SEC. 2(F).

FOR MAGAZINES FOR INFORMING COSMETIC, FRAGRANCE AND PERSONAL CARE PACKAGING PROFESSIONALS HOW TO DEVELOP CREATIVE PACKAGES (U.S. CLS. 2, 5, 22, 23, 29, 37, 38 AND 50).

FIRST USE 1-15-1994; IN COMMERCE 1-15-1994.

NANCY CLARKE, EXAMINING ATTORNEY

SN 78-131,277. HELICOPTER ASSOCIATION INTERNATIONAL, INC., ALEXANDRIA, VA. FILED 5-26-2002.



THE MARK CONSISTS OF HANDSHAKE ABOVE TOWN AND BELOW A HELICOPTER.

FOR BOOKS, INFORMATIONAL FLYERS AND POSTERS FEATURING A FLIGHT PROGRAM THAT ENABLES PILOTS TO FLY HELICOPTERS AT ALTITUDES AND SETTINGS THAT CREATE MINIMUM NOISE (U.S. CLS. 2, 5, 22, 23, 29, 37, 38 AND 50).

FIRST USE 1-1-1981; IN COMMERCE 1-1-1981.

ROBERT LORENZO, EXAMINING ATTORNEY

CLASS 16—(Continued).

SN 78-159,660. BOWTIE, INC., LOS ANGELES, CA. FILED 8-30-2002.

FISH KEEPING MADE EASY

NO CLAIM IS MADE TO THE EXCLUSIVE RIGHT TO USE "FISH", APART FROM THE MARK AS SHOWN.

FOR SERIES OF BOOKS PROVIDING ADVICE AND INFORMATION ON AQUATIC PETS (U.S. CLS. 2, 5, 22, 23, 29, 37, 38 AND 50).

MATTHEW PAPPAS, EXAMINING ATTORNEY

SN 78-159,776. DISNEY ENTERPRISES, INC., BURBANK, CA. FILED 8-30-2002.

WINNIE THE POOH

FOR ADDRESS BOOKS; PHOTOGRAPH ALBUMS; APPLIQUES IN THE FORM OF DECALS; APPOINTMENT BOOKS; ARTS AND CRAFT PAINT KITS; AUTOGRAPH BOOKS; BABY BOOKS; PAPER PARTY BAGS; BALL-POINT PENS; BINDERS; BOOKENDS; BOOKMARKS; BOOKS, NAMELY A SERIES OF FICTION BOOKS; PERIODICALS, MAGAZINES AND NEWSPAPERS, FEATURING STORIES, GAMES AND ACTIVITIES FOR CHILDREN; PAPER GIFT WRAP BOWS; PAPER CAKE DECORATIONS; CALENDARS; GIFT CARDS; GREETING CARDS; CARTOON PRINTS, CARTOON STRIPS AND NEWSPAPER CARTOONS; PEN AND PENCIL CASES; DECORATIVE PAPER CENTERPIECES; CHALK; CHILDREN'S ACTIVITY BOOKS; MODELING CLAY; PAPER TABLE CLOTHS; COLORING BOOKS; COMIC STRIPS; COMIC BOOKS; PAPER PARTY DECORATIONS; DIARIES; GIFT WRAPPING PAPER; PAPER PARTY HATS; PAPER NAPKINS; PENS; PENCILS; STATIONERY; STICKERS; POSTERS; NOTEBOOKS; MEMO PADS; ERASERS; PENCIL SHARPENERS; STAPLERS; WRITING PAPER; ENVELOPES; PAPER WEIGHTS; PAPER COASTERS; PAPER MATS; NON-CALIBRATED DRAWING RULERS; PHOTOGRAPHS; POSTCARDS; TRADING CARDS (U.S. CLS. 2, 5, 22, 23, 29, 37, 38 AND 50).

TANYA AMOS, EXAMINING ATTORNEY

SN 78-162,977. GREAT AMERICAN QUILT FACTORY, INC., DENVER, CO. FILED 9-11-2002.



FOR INSTRUCTION MANUALS, BOOKS, PHAMPLETS, AND PRINTED PATTERNS CONCERNING QUILT MAKING AND SEWING (U.S. CLS. 2, 5, 22, 23, 29, 37, 38 AND 50).

FIRST USE 4-1-1990; IN COMMERCE 4-1-1990.

WILLIAM VERHOSEK, EXAMINING ATTORNEY

CLASS 16—(Continued).

SN 78-196,656. HOOK-N-LINE MAP COMPANY, INC., HOUSTON, TX. FILED 12-20-2002.

HOOK-N-LINE

FOR FISHING MAPS (U.S. CLS. 2, 5, 22, 23, 29, 37, 38 AND 50).
MICHAEL SOUDERS, EXAMINING ATTORNEY

SN 78-209,301. SPIN CLEAN INCORPORATED, ATLANTA, GA. FILED 1-31-2003.

THE GRIPPER

FOR PAINT ACCESSORIES, NAMELY, MANUALLY OPERATED PAINT ROLLER BRUSH REMOVAL DEVICES FOR ASSISTING IN THE REMOVAL OF PAINT ROLLER BRUSHES FROM A HANDLE FRAMEWORK (U.S. CLS. 2, 5, 22, 23, 29, 37, 38 AND 50).
NANCY CLARKE, EXAMINING ATTORNEY

SN 78-215,246. APPLETON PAPERS INC., APPLETON, WI. FILED 2-14-2003.

MONDIAL MARK

NO CLAIM IS MADE TO THE EXCLUSIVE RIGHT TO USE MARK, APART FROM THE MARK AS SHOWN.
THE ENGLISH TRANSLATION OF MONDIAL IS "WORLD".
FOR CARBONLESS, THERMAL, AND SECURITY WRITING PAPERS, PAPER TAGS AND PAPER LABELS WITH AUTHENTICITY INDICATORS (U.S. CLS. 2, 5, 22, 23, 29, 37, 38 AND 50).
KARLA PERKINS, EXAMINING ATTORNEY

SN 78-215,253. MACLELLAN WOLFSON ASSOCIATES, WALNUT CREEK, CA. FILED 2-14-2003.



FOR BOOKS, MANUALS AND GUIDES FEATURING INFORMATION ABOUT CONSTRUCTION, REPAIR, AND MAINTENANCE PROJECTS FOR BUILDINGS, STRUCTURES AND IMPROVEMENTS (U.S. CLS. 2, 5, 22, 23, 29, 37, 38 AND 50).
JOHN KELLY, EXAMINING ATTORNEY

CLASS 16—(Continued).

SN 78-215,585. INTERNATIONAL COUNCIL OF E-COMMERCE CONSULTANTS, NEW YORK, NY. FILED 2-17-2003.



NO CLAIM IS MADE TO THE EXCLUSIVE RIGHT TO USE "CERTIFIED" AND "HACKER", APART FROM THE MARK AS SHOWN.
FOR EDUCATIONAL PUBLICATIONS, NAMELY, EDUCATIONAL TECHNOLOGY TRAINING MANUALS FOR E-BUSINESS, E-COMMERCE AND SECURITY TECHNOLOGIES; PRINTED INSTRUCTIONAL, EDUCATIONAL, AND TEACHING MATERIALS AND VOUCHERS FOR E-BUSINESS, E-COMMERCE AND SECURITY TECHNOLOGIES (U.S. CLS. 2, 5, 22, 23, 29, 37, 38 AND 50).
FIRST USE 10-23-2001; IN COMMERCE 10-23-2001.
ROBERT LORENZO, EXAMINING ATTORNEY

SN 78-215,927. BMI FEDERAL CREDIT UNION, COLUMBUS, OH. FILED 2-18-2003.

**TECHNICALLY MINDED,
PEOPLE DRIVEN**

FOR PRINTED PUBLICATIONS, NAMELY NEWSLETTERS AND BROCHURES IN THE FIELD OF BANKING, LOANS AND MORTGAGES (U.S. CLS. 2, 5, 22, 23, 29, 37, 38 AND 50).
JANICE L. MCMORROW, EXAMINING ATTORNEY

SN 78-222,458. HACHETTE FILIPACCHI MEDIA U.S., INC., NEW YORK, NY. FILED 3-6-2003.

POP PHOTO

OWNER OF U.S. REG. NOS. 511,952 AND 1,613,788. SEC. 2(F).
FOR PRINTED PUBLICATIONS, NAMELY A MAGAZINE IN THE FIELD OF PHOTOGRAPHY AND IMAGING (U.S. CLS. 2, 5, 22, 23, 29, 37, 38 AND 50).
REBECCA SMITH, EXAMINING ATTORNEY

CLASS 16—(Continued).

SN 78-223,140. KRAFT FOODS HOLDINGS, INC., NORTH-FIELD, IL. FILED 3-7-2003.

FOOD & FAMILY

NO CLAIM IS MADE TO THE EXCLUSIVE RIGHT TO USE "FOOD", APART FROM THE MARK AS SHOWN. FOR MAGAZINES FEATURING ARTICLES RELATED TO FOOD AND BEVERAGE PRODUCTS, FOOD PREPARATIONS AND PRINTED RECIPES (U.S. CLS. 2, 5, 22, 23, 29, 37, 38 AND 50).

FIRST USE 6-1-1999; IN COMMERCE 6-1-1999.
JAMES GRIFFIN, EXAMINING ATTORNEY

SN 78-226,801. WORLD WRESTLING ENTERTAINMENT, INC., STAMFORD, CT. FILED 3-18-2003.

DIVAS UNTAMED

FOR PUBLICATIONS, NAMELY, MAGAZINES FEATURING WOMEN IN SPORTS ENTERTAINMENT. (U.S. CLS. 2, 5, 22, 23, 29, 37, 38 AND 50).

AMOS T. MATTHEWS, JR., EXAMINING ATTORNEY

SN 78-226,848. THE TAUNTON PRESS, INC., NEWTOWN, CT. FILED 3-18-2003.

TAUNTON'S HOUSE CHECK

NO CLAIM IS MADE TO THE EXCLUSIVE RIGHT TO USE HOUSE, APART FROM THE MARK AS SHOWN.

FOR SERIES OF BOOKS IN THE FIELDS OF HOME BUILDING, HOME CONSTRUCTION, HOME REMODELING, HOME REPAIR, HOME DESIGN, HOME PROJECTS, HOME LANDSCAPING, AND HOME GARDENING (U.S. CLS. 2, 5, 22, 23, 29, 37, 38 AND 50).

REBECCA GILBERT, EXAMINING ATTORNEY

SN 78-227,024. 9278 COMMUNICATIONS, INC., BRONX, NY. FILED 3-18-2003.

CHOICE

FOR PREPAID PHONE CARDS, NOT MAGNETICALLY ENCODED (U.S. CLS. 2, 5, 22, 23, 29, 37, 38 AND 50).

FIRST USE 10-1-2001; IN COMMERCE 10-1-2001.
JOHN DALIER, EXAMINING ATTORNEY

SN 78-229,627. SUMITOMO RUBBER INDUSTRIES, LTD., KOBE-SHI, HYOGO-KEN, JAPAN, FILED 3-25-2003.

FALKEN

FOR STICKERS (U.S. CLS. 2, 5, 22, 23, 29, 37, 38 AND 50).

ANDREW BENZMILLER, EXAMINING ATTORNEY

CLASS 16—(Continued).

SN 78-229,875. CANGIARELLA, KEITH, FULLERTON, CA. FILED 3-25-2003.

MESSAGE IN A BOTTLE

FOR NOVELTY, FAVOR, AND SOUVENIR BOTTLE CONTAINING MESSAGES AND GREETINGS, INVITATIONS, PROMOTIONAL MATERIALS OF OTHERS, AND ADVERTISING MATERIALS OF OTHERS; KITS COMPRISED OF BOTTLES, PAPER FOR CREATING PROMOTIONAL MESSAGES, ADVERTISING MESSAGES, GREETINGS, MESSAGES AND INVITATIONS AND PACKAGING AND BOXES FOR MAILING (U.S. CLS. 2, 5, 22, 23, 29, 37, 38 AND 50).

FIRST USE 3-10-1998; IN COMMERCE 6-10-1998.
KELLEY WELLS, EXAMINING ATTORNEY

SN 78-232,006. ZAMMARELLI, THOMAS G., JOHNSTON, RI. FILED 3-31-2003.



FOR BOOKS WRITTEN FOR CHILDREN (U.S. CLS. 2, 5, 22, 23, 29, 37, 38 AND 50).

KIM SAITO, EXAMINING ATTORNEY

SN 78-232,478. NIELSEN & BAINBRIDGE L.L.C., PARAMUS, NJ. FILED 4-1-2003.

SPEEDMOUNT

FOR PAPER PRODUCTS, NAMELY, MOUNTING BOARD, MATTING BOARD AND FOAM BOARD FOR SIGNAGE OR DISPLAY PURPOSES (U.S. CLS. 2, 5, 22, 23, 29, 37, 38 AND 50).

FIRST USE 9-0-2000; IN COMMERCE 9-0-2000.
JOHN HWANG, EXAMINING ATTORNEY

CLASS 16—(Continued).

SN 78-233,056. HIGHLAND SUPPORT SERVICES, INC., NEWPORT BEACH, CA. FILED 4-2-2003.

QUEENWORKS

FOR BOOKS, NEWSLETTERS, PRINTED TRAINING MANUALS, PRINTED WORKBOOKS, AND BROCHURES IN THE FIELD OF WOMEN'S EMPOWERMENT; DECALS; STICKERS; PRINTED INSPIRATIONAL CARDS; TAROT CARDS; GREETING CARDS; POSTCARDS; PRINTED INVITATIONS; PLACE CARDS; BLANK JOURNALS AND STATIONERY (U.S. CLS. 2, 5, 22, 23, 29, 37, 38 AND 50).

TARAH HARDY, EXAMINING ATTORNEY

SN 78-235,818. LISA FRANK, INC., TUCSON, AZ. FILED 4-9-2003.

STUFF THAT MAKES YOU HAPPY!

FOR PRINTED ITEMS FOR CHILDREN, NAMELY STATIONERY-TYPE PORTFOLIOS, NOTEBOOKS, FOLDERS, BINDERS, WRITING TABLETS, MEMO PADS, STATIONERY, STICKERS, STICKER BOOKS, ORGANIZERS FOR STATIONERY AND PERSONAL ORGANIZERS, JOURNALS, PAPER POSTCARDS TO COLOR, PAPER BOXES TO PAINT OR COLOR, PAPER POSTERS TO PAINT OR COLOR, PENCILS, PENS, ERASERS, PENCIL SHARPENERS, PAPER CLIPS, DIARIES, WORD OR MAZE PUZZLES ON PAPER, RUBBER STAMPS AND PADS, COLORING BOOKS, COLOR MARKERS, CHALK, STENCILS, PUZZLER ACTIVITY PADS, TRADING CARDS, ARTS AND CRAFTS PAINTING AND DRAWING KITS FOR CHILDREN CONSISTING OF TWO OR MORE OF THE PRECEDING ITEMS, SCRAPBOOKS, PAPER PARTY GOODS, NAMELY HATS, PRINTED INVITATIONS, PAPER PLATES, NAPKINS, TABLECLOTHS, PAPER PARTY DECORATIONS, AND PAPER GIFTWRAP (U.S. CLS. 2, 5, 22, 23, 29, 37, 38 AND 50).

DAWN FELDMAN, EXAMINING ATTORNEY

SN 78-237,199. POSH 8, INC., STUDIO CITY, CA. FILED 4-13-2003.

POSH 8

FOR STATIONERY; GREETING CARDS, CARDBOARD BOXES, NOTEBOOKS, BLANK JOURNALS, CALENDAR PHOTO ALBUMS, CALENDARS, PAPER GIFT BAGS, WRAPPING PAPER, PAPER BOWS FOR GIFT WRAP, TISSUE PAPER, RECIPE BOOKS, MEMO NOTE PADS, STICKERS, STATIONERY FOLDERS, PRINTED INVITATIONS, HANG TAGS, DATE BOOKS (U.S. CLS. 2, 5, 22, 23, 29, 37, 38 AND 50).

CAROLINE WEIMER, EXAMINING ATTORNEY

CLASS 16—(Continued).

SN 78-237,729. POSH 8, STUDIO CITY, CA. FILED 4-15-2003.

GODDESS OF THE GARDEN

FOR STATIONERY; GREETING CARDS, CARDBOARD BOXES, NOTEBOOKS, BLANK JOURNALS, CALENDAR PHOTO ALBUMS, CALENDARS, PAPER GIFT BAGS, WRAPPING PAPER, PAPER BOWS FOR GIFT WRAP, TISSUE PAPER, RECIPE BOOKS, MEMO NOTE PADS, STICKERS, STATIONERY FOLDERS, PRINTED INVITATIONS, HANG TAGS, DATE BOOKS (U.S. CLS. 2, 5, 22, 23, 29, 37, 38 AND 50).

MICHAEL SOUDERS, EXAMINING ATTORNEY

SN 78-239,926. WILSON, MATTHEW T., WOODLAND HILLS, CA. FILED 4-21-2003.

TRUNK TRACTS

FOR BUMPER STICKERS AND SIGNS IN THE NATURE OF DECALS THAT MAY BE ATTACHED TO VEHICLES (U.S. CLS. 2, 5, 22, 23, 29, 37, 38 AND 50).

MONIQUE MILLER, EXAMINING ATTORNEY

SN 78-244,129. OREGON CATHOLIC PRESS, PORTLAND, OR. FILED 4-30-2003.

SPIRIT & SONG

FOR SERIES OF BOOKS WITH RELIGIOUS MUSIC (U.S. CLS. 2, 5, 22, 23, 29, 37, 38 AND 50).

FIRST USE 11-0-1998; IN COMMERCE 10-21-1999.

DARLENE BULLOCK, EXAMINING ATTORNEY

SN 78-244,222. GENIO CARDS, LLC, GREAT NECK, NY. FILED 5-1-2003.

GENIO

THE ENGLISH TRANSLATION OF THE WORD GENIO IN THE MARK IS GENIUS.

FOR COLLECTIBLE EDUCATIONAL CARDS, ALBUMS FOR CARDS, AND POSTERS, ALL FEATURING ACTION CHARACTERS AND THEMES; AND PRINT INSTRUCTIONAL GAME MANUALS (U.S. CLS. 2, 5, 22, 23, 29, 37, 38 AND 50).

FIRST USE 9-0-2003; IN COMMERCE 9-0-2003.

ANDREA SAUNDERS, EXAMINING ATTORNEY

CLASS 16—(Continued).

SN 78-245,155. WORLD WRESTLING ENTERTAINMENT, INC., STAMFORD, CT. FILED 5-2-2003.

BAD BLOOD

FOR COLLECTOR ALBUMS, NAMELY, FOR COINS, STICKERS, COLLECTABLE CARDS; LABELS, NAMELY, PRINTED LABELS NOT OF TEXTILE; FOLDERS; PACKAGING, NAMELY, PAPER FOR WRAPPING AND PACKAGING PAPER; PLASTIC BAGS FOR GENERAL USE; PAPER TABLEWARE, NAMELY, PAPER PLACE MATS, PAPER TABLE MATS, PAPER TABLE LINENS; STICKERS; FRAMED PICTURES; PENS; PENCILS; BOOK COVERS; POSTERS; NOTEBOOKS; TRADING CARDS; CALENDARS; PAPER TABLECLOTHS; PHOTOGRAPHS; CHALK; BROCHURES, MAGAZINES, AND NEWSPAPERS CONCERNING SPORTS ENTERTAINMENT; PHOTOGRAPHIC PRINTS; POSTCARDS; GREETING CARDS; PICTURES; DECALS; TEMPORARY TATTOO TRANSFERS; COLORING BOOKS; CHILDREN'S ACTIVITY BOOKS; SOUVENIR PROGRAMS CONCERNING SPORTS ENTERTAINMENT; BOOKS FEATURING PICTORIAL BIOGRAPHIES; COMIC BOOKS; BOOK COVERS; PAPER BOOK MARKERS; BOOKPLATES; PAPER LUNCH SACKS; PAPER NAPKINS; PICTURE BOOKS; STICKER ALBUMS; MEMO PADS; DATE BOOKS; ADDRESS BOOKS; AGENDA BOOKS; PENCIL SHARPENERS; RUBBER STAMPS; STAMP PADS; COLLECTIBLE PREPAID TELEPHONE CARDS NOT MAGNETICALLY ENCODED; COLLECTOR STAMPS, NAMELY, COMMEMORATIVE STAMP SHEETS; CUSTOMIZED PERSONAL BANK CHECKS; CHECKBOOK COVERS AND RETURN ADDRESS LABELS NOT OF TEXTILE; PAPER BANNERS; PRINTED PAPER SIGNS FOR DOORS; PENCIL CASES; DRAWING RULERS; ERASERS, NAMELY, RUBBER ERASERS, CHALK ERASERS, BLACKBOARD ERASERS; SCRATCH PADS; PHOTO ALBUMS; BUMPER STICKERS; WINDOW DECALS; COLLECTOR STAMPS; LITHOGRAPHS; PAPER PARTY BAGS; PAPER PARTY FAVORS, NAMELY, PAPER HATS; STENCILS FOR TRACING DESIGNS ONTO PAPER; PAPER GIFT WRAP; PAPER CAKE DECORATIONS. (U.S. CLS. 2, 5, 22, 23, 29, 37, 38 AND 50).

JASON TURNER, EXAMINING ATTORNEY

SN 78-245,289. ASPEN MLT, INC., MARINA DEL REY, CA. FILED 5-2-2003.

EKOS

FOR COMIC BOOKS (U.S. CLS. 2, 5, 22, 23, 29, 37, 38 AND 50).
FIRST USE 4-25-2003; IN COMMERCE 4-25-2003.
CIMMERIAN COLEMAN, EXAMINING ATTORNEY

CLASS 16—(Continued).

SN 78-245,292. ASPEN MLT, INC., MARINA DEL REY, CA. FILED 5-2-2003.



FOR COMIC BOOKS (U.S. CLS. 2, 5, 22, 23, 29, 37, 38 AND 50).

FIRST USE 4-25-2004; IN COMMERCE 4-25-2004.
CIMMERIAN COLEMAN, EXAMINING ATTORNEY

SN 78-245,298. ASPEN MLT, INC., MARINA DEL REY, CA. FILED 5-2-2003.



THE NAME MICHAEL TURNER IDENTIFIES A LIVING INDIVIDUAL WHOSE CONSENT IS OF RECORD.
FOR COMIC BOOKS (U.S. CLS. 2, 5, 22, 23, 29, 37, 38 AND 50).
CIMMERIAN COLEMAN, EXAMINING ATTORNEY

SN 78-245,300. ASPEN MLT, INC., MARINA DEL REY, CA. FILED 5-2-2003.

**MICHAEL TURNER'S
SOULFIRE**

THE NAME MICHAEL TURNER IDENTIFIES A LIVING INDIVIDUAL WHOSE CONSENT IS OF RECORD.
FOR COMIC BOOKS (U.S. CLS. 2, 5, 22, 23, 29, 37, 38 AND 50).
CIMMERIAN COLEMAN, EXAMINING ATTORNEY

CLASS 16—(Continued).

SN 78-245,506. ARTE GRAFICO EDITORIAL ARGENTINO S.A., BUENOS AIRES, ARGENTINA, FILED 5-5-2003.

OLE EE UU

OWNER OF U.S. REG. NOS. 2,138,476 AND 2,140,356.
NO CLAIM IS MADE TO THE EXCLUSIVE RIGHT TO USE "EE UU", APART FROM THE MARK AS SHOWN.
THE ENGLISH TRANSLATION OF "OLE EE UU" IS "BRAVO UNITED STATES".
FOR NEWSPAPERS REGARDING SPORTS (U.S. CLS. 2, 5, 22, 23, 29, 37, 38 AND 50).
MARY CRAWFORD, EXAMINING ATTORNEY

SN 78-245,509. ARTE GRAFICO EDITORIAL ARGENTINO S.A., BUENOS AIRES, ARGENTINA, FILED 5-5-2003.

OLE INTERNACIONAL

OWNER OF U.S. REG. NOS. 2,138,476 AND 2,140,356.
NO CLAIM IS MADE TO THE EXCLUSIVE RIGHT TO USE "INTERNACIONAL", APART FROM THE MARK AS SHOWN.
THE ENGLISH TRANSLATION OF "OLE INTERNACIONAL" IS "BRAVO INTERNATIONAL".
FOR NEWSPAPERS REGARDING SPORTS (U.S. CLS. 2, 5, 22, 23, 29, 37, 38 AND 50).
MARY CRAWFORD, EXAMINING ATTORNEY

SN 78-245,511. ARTE GRAFICO EDITORIAL ARGENTINO S.A., BUENOS AIRES, ARGENTINA, FILED 5-5-2003.

OLE MIAMI

OWNER OF U.S. REG. NOS. 2,138,476 AND 2,140,356.
NO CLAIM IS MADE TO THE EXCLUSIVE RIGHT TO USE "MIAMI", APART FROM THE MARK AS SHOWN.
THE ENGLISH TRANSLATION OF "OLE" IS "BRAVO".
FOR NEWSPAPERS REGARDING SPORTS (U.S. CLS. 2, 5, 22, 23, 29, 37, 38 AND 50).
MARY CRAWFORD, EXAMINING ATTORNEY

SN 78-245,895. POTLATCH CORPORATION, SPOKANE, WA. FILED 5-5-2003.

WITH HYDRASORB TECHNOLOGY

NO CLAIM IS MADE TO THE EXCLUSIVE RIGHT TO USE TECHNOLOGY, APART FROM THE MARK AS SHOWN.
FOR PAPER TOWELS (U.S. CLS. 2, 5, 22, 23, 29, 37, 38 AND 50).
AMY GEARIN, EXAMINING ATTORNEY

CLASS 16—(Continued).

SN 78-250,763. SOLAUS HOUSE, LLC, ACWORTH, GA. FILED 5-16-2003.

PRESSTO!

FOR COOK BOOK KITS COMPOSED PRIMARILY OF COLORED BINDERS FROM WHICH A CONSUMER CAN SELECT PAPER, LABELS, ENVELOPES AND TAB PAGES TO CREATE A CUSTOMIZED COOKBOOK THAT ENABLES INDIVIDUALS TO PRESERVE, ORGANIZE AND MAINTAIN RECIPES, INCLUDING FAMILY RECIPES (U.S. CLS. 2, 5, 22, 23, 29, 37, 38 AND 50).
DORITT L. CARROLL, EXAMINING ATTORNEY

SN 78-252,879. COX, LAURANCE T, HENDERSON, NV. FILED 5-21-2003.

DO-IT-YOURSELF DRUMS

NO CLAIM IS MADE TO THE EXCLUSIVE RIGHT TO USE "DRUMS", APART FROM THE MARK AS SHOWN.
FOR EDUCATIONAL BOOKS FOR LEARNING TO PLAY THE DRUM SET (U.S. CLS. 2, 5, 22, 23, 29, 37, 38 AND 50).
FIRST USE 7-1-2000; IN COMMERCE 4-15-2003.
MATTHEW PAPPAS, EXAMINING ATTORNEY

SN 78-261,826. ROBIN'S INK, LLC, VANCOUVER, WA. FILED 6-12-2003.

SISTERCHICKS

THE MARK CONSISTS OF STANDARD CHARACTERS WITHOUT CLAIM TO ANY PARTICULAR FONT, STYLE, SIZE, OR COLOR.
FOR SERIES OF BOOKS FOR WOMEN (U.S. CLS. 2, 5, 22, 23, 29, 37, 38 AND 50).
FIRST USE 5-1-2003; IN COMMERCE 5-1-2003.
JENNIFER DIXON, EXAMINING ATTORNEY

SN 78-263,128. LYNCH, KAREN, A., NEWBURYPORT, MA. FILED 6-17-2003.

LITTERMITT

FOR PLASTIC BAGS FOR DISPOSING OF PET WASTE (U.S. CLS. 2, 5, 22, 23, 29, 37, 38 AND 50).
INGRID C. EULIN, EXAMINING ATTORNEY

CLASS 16—(Continued).

SN 78-268,852. OFF THE MAP PRESS, LLC, NEW HAVEN, CT. FILED 6-30-2003.



NO CLAIM IS MADE TO THE EXCLUSIVE RIGHT TO USE "THE MENU", APART FROM THE MARK AS SHOWN. FOR SERIES OF DINING GUIDES FEATURING DETAILED RESTAURANT REVIEWS (U.S. CLS. 2, 5, 22, 23, 29, 37, 38 AND 50).

FIRST USE 1-15-2003; IN COMMERCE 5-9-2003.
H. M. FISHER, EXAMINING ATTORNEY

SN 78-276,025. LOVING LIGHT PRODUCTIONS, INC, DENVER, CO. FILED 7-18-2003.

HEART, PAPER, SCISSORS

FOR ART AND CRAFT ACTIVITY KITS CONTAINING PAPER DOLL MAKING SUPPLIES AND A BOOKLET OF ACTIVITIES DESIGNED TO PROMOTE SELF ESTEEM (U.S. CLS. 2, 5, 22, 23, 29, 37, 38 AND 50).

FIRST USE 1-17-2003; IN COMMERCE 3-7-2003.
DAWN FELDMAN, EXAMINING ATTORNEY

SN 78-277,574. SLICKFORCE ENTERTAINMENT, LLC, LOS ANGELES, CA. FILED 7-23-2003.



NO CLAIM IS MADE TO THE EXCLUSIVE RIGHT TO USE "MUSIC VIDEO BEAUTIES.COM", APART FROM THE MARK AS SHOWN.

FOR CALENDARS, POSTERS, AND PHOTOGRAPHS OF OUR MODELS (U.S. CLS. 2, 5, 22, 23, 29, 37, 38 AND 50).

FIRST USE 6-1-2003; IN COMMERCE 6-1-2003.
CYNTHIA SLOAN, EXAMINING ATTORNEY

CLASS 16—(Continued).

SN 78-278,107. LEWIS OFFSHORE LTD. / LEVIN M. LEWIS JR., CEO, OCEAN CITY, MD. FILED 7-24-2003.

FAR BAHAMAS

NO CLAIM IS MADE TO THE EXCLUSIVE RIGHT TO USE "BAHAMAS", APART FROM THE MARK AS SHOWN. FOR BOOK OF NAVIGATIONAL CHARTS OF THE BAHAMAS (U.S. CLS. 2, 5, 22, 23, 29, 37, 38 AND 50). FIRST USE 11-12-1999; IN COMMERCE 11-12-1999.
WANDA KAY PRICE, EXAMINING ATTORNEY

SN 78-280,879. POTLATCH CORPORATION, SPOKANE, WA. FILED 7-30-2003.

WITH AQUASORB TECHNOLOGY

NO CLAIM IS MADE TO THE EXCLUSIVE RIGHT TO USE "TECHNOLOGY", APART FROM THE MARK AS SHOWN.

FOR PAPER TOWELS (U.S. CLS. 2, 5, 22, 23, 29, 37, 38 AND 50).

AMY GEARIN, EXAMINING ATTORNEY

SN 78-282,959. THE STENO TRUST, BELLEVUE, WA. FILED 8-4-2003.

WRITING AT THE SPEED OF THOUGHT

FOR PRINTED LESSONS ON NEWRITE, A PHONETIC WRITING SYSTEM, DICTIONARY ON THE NEWRITE PHONETIC WRITING SYSTEM THAT IS ALSO TRANSCRIBED INTO NEWRITE, AND BOOKS IN THE FIELD OF LITERATURE TRANSCRIBED INTO THE NEWRITE PHONETIC WRITING SYSTEM (U.S. CLS. 2, 5, 22, 23, 29, 37, 38 AND 50).

CHRISTOPHER BUONGIORNO, EXAMINING ATTORNEY

SN 78-283,673. CONTECH TECHNOLOGIES, INC., MINNEAPOLIS, MN. FILED 8-6-2003.

SITE SOLUTIONS

NO CLAIM IS MADE TO THE EXCLUSIVE RIGHT TO USE SITE, APART FROM THE MARK AS SHOWN.

FOR NEWSLETTERS ON THE SUBJECTS OF STORMWATER TREATMENT, SANITARY AND STORMWATER SEWERS, BRIDGES, SOIL REINFORCEMENT TECHNOLOGY, RETAINING WALLS, EROSION CONTROL, TUNNELS AND THE REHABILITATION OF FAILING DRAINAGE AND BRIDGE STRUCTURES (U.S. CLS. 2, 5, 22, 23, 29, 37, 38 AND 50).

LINDA ESTRADA, EXAMINING ATTORNEY

CLASS 16—(Continued).

SN 78-285,272. CHARDON, ROY, HOLLISTER, CA. FILED 8-8-2003.

POIGNANT PORTRAITURE

NO CLAIM IS MADE TO THE EXCLUSIVE RIGHT TO USE "PORTRAITURE", APART FROM THE MARK AS SHOWN.

FOR ATYPICAL PORTRAITS THAT PROVIDE PIERCING PERSONAL PERSPECTIVES, ABSTRACTIONS OF PLACE OR TIME, OR EVOKE PARTICULAR THOUGHTS (U.S. CLS. 2, 5, 22, 23, 29, 37, 38 AND 50).

FIRST USE 7-24-2003; IN COMMERCE 7-24-2003.
MARLENE BELL, EXAMINING ATTORNEY

SN 78-286,062. MICROGISTIX OPERATIONS, INC., MINNEAPOLIS, MN. FILED 8-12-2003.

CREATIVE REFLECTIONS

FOR SCRAPBOOK ALBUMS, PHOTO FOLDERS, AND PAPER PHOTO BOXES SOLD INDIVIDUALLY AND TOGETHER AS A KIT; SCRAPBOOKS; SCRAPBOOK ALBUMS; SCRAPBOOK PAGES; ART PAPER; CRAFT PAPER; HEAT TRANSFER PAPER; PAPER LETTERS AND NUMBERS FOR USE IN MAKING SCRAPBOOKS; STICKERS; PAPER CUTOUTS (U.S. CLS. 2, 5, 22, 23, 29, 37, 38 AND 50).

KIMBERLY PERRY, EXAMINING ATTORNEY

SN 78-286,245. CD PUBLICATIONS, SILVER SPRING, MD. FILED 8-12-2003.

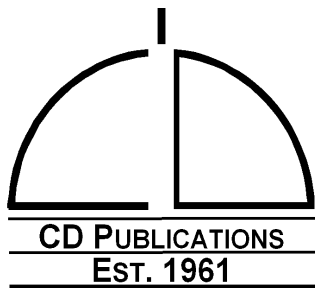

OWNER OF U.S. REG. NO. 2,161,113.
NO CLAIM IS MADE TO THE EXCLUSIVE RIGHT TO USE "CD PUBLICATIONS" OR "EST. 1961", APART FROM THE MARK AS SHOWN.

FOR NEWSLETTERS, DIRECTORIES, PAMPHLETS, AND BOOKS IN THE FIELDS OF HOUSING AND COMMUNITY DEVELOPMENT, THE ELDERLY, BUSINESS, AND GOVERNMENT AND PRIVATE FUNDING, INCLUDING CORPORATE AND FOUNDATION, IN EDUCATION, HEALTH, AND COMMUNITY SERVICES (U.S. CLS. 2, 5, 22, 23, 29, 37, 38 AND 50).

FIRST USE 1-1-1981; IN COMMERCE 1-1-1981.
ELIZABETH PIGNATELLO, EXAMINING ATTORNEY

CLASS 16—(Continued).

SN 78-286,452. SCHOFIELD, ROBIN, ARLINGTON HEIGHTS, IL. FILED 8-12-2003.

PAPER LOVE

NO CLAIM IS MADE TO THE EXCLUSIVE RIGHT TO USE PAPER, APART FROM THE MARK AS SHOWN.

FOR HAND MADE WEDDING AND OCCASION INVITATIONS AND ANNOUNCEMENTS; HAND MADE WEDDING AND OCCASION ACCESSORY CARDS (U.S. CLS. 2, 5, 22, 23, 29, 37, 38 AND 50).

JENNIFER DIXON, EXAMINING ATTORNEY

SN 78-290,315. POTLATCH CORPORATION, SPOKANE, WA. FILED 8-21-2003.

WITH HYDRASORB

FOR PAPER TOWELS (U.S. CLS. 2, 5, 22, 23, 29, 37, 38 AND 50).

AMY GEARIN, EXAMINING ATTORNEY

SN 78-290,323. POTLATCH CORPORATION, SPOKANE, WA. FILED 8-21-2003.

WITH HYDRASORB FIBERS

NO CLAIM IS MADE TO THE EXCLUSIVE RIGHT TO USE "FIBERS", APART FROM THE MARK AS SHOWN.

FOR PAPER TOWELS (U.S. CLS. 2, 5, 22, 23, 29, 37, 38 AND 50).

AMY GEARIN, EXAMINING ATTORNEY

SN 78-292,670. CANDO, KATHRYN M., WILMINGTON, NC. FILED 8-27-2003.

ENTREATING CARDS

NO CLAIM IS MADE TO THE EXCLUSIVE RIGHT TO USE "CARDS", APART FROM THE MARK AS SHOWN.

FOR GREETING CARDS (U.S. CLS. 2, 5, 22, 23, 29, 37, 38 AND 50).

ELIZABETH PIGNATELLO, EXAMINING ATTORNEY

CLASS 16—(Continued).

SN 78-292,865. AIKEN, CLAY, ATLANTA, GA. FILED 8-27-2003.

CLAY AIKEN

FOR PAPER GOODS AND PRINTED MATTER, NAMELY, INFORMATIONAL FLYERS, CIRCULARS AND PRINTED HAND-OUTS FEATURING INFORMATION ABOUT MUSICAL PERFORMERS; SOUVENIR BOOKS FOR MUSICAL CONCERTS; SONG BOOKS, SHEET MUSIC BOOKS, AND PICTURE BOOKS; PAPER BANNERS; NOTEBOOKS; LITHOGRAPHS; POSTERS; STICKERS AND DECALS; CALENDARS; AND FAN CLUB NEWSLETTERS (U.S. CLS. 2, 5, 22, 23, 29, 37, 38 AND 50).

NANCY CLARKE, EXAMINING ATTORNEY

SN 78-293,079. LISA FRANK, INC., TUCSON, AZ. FILED 8-27-2003.

CANDY SHOP

FOR PRINTED MATERIAL FOR CHILDREN, NAMELY A STATIONERY KIT CONSISTING PRIMARILY OF TWO OR MORE OF THE FOLLOWING ITEMS—STICKERS, NOTEPADS, NOTES, ENVELOPES, STATIONERY, PENS, PENCILS, MARKERS, PAPER CLIPS, ERASERS, RUBBER STAMPS, STAMP PADS, PENCIL SHARPENERS; ALSO CONTAINING PLASTIC STUDS FOR DECORATING STATIONERY AND PLASTIC BEADS (U.S. CLS. 2, 5, 22, 23, 29, 37, 38 AND 50).

DARLENE BULLOCK, EXAMINING ATTORNEY

SN 78-301,156. FREEDOM ARIZONA INFORMATION, INC., IRVINE, CA. FILED 9-16-2003.

SURPRISE TODAY

FOR NEWSPAPERS FOR GENERAL CIRCULATION (U.S. CLS. 2, 5, 22, 23, 29, 37, 38 AND 50). FIRST USE 10-0-1996; IN COMMERCE 10-0-1996.

ALEX KEAM, EXAMINING ATTORNEY

SN 78-301,544. CINTAS CORP. NO. 3, SPARKS, NV. FILED 9-17-2003.

SANI DRY

NO CLAIM IS MADE TO THE EXCLUSIVE RIGHT TO USE DRY, APART FROM THE MARK AS SHOWN.

FOR PAPER TOWELS AND TISSUES (U.S. CLS. 2, 5, 22, 23, 29, 37, 38 AND 50).

JOHN HWANG, EXAMINING ATTORNEY

CLASS 16—(Continued).

SN 78-301,652. VU BAY, LAS VEGAS, NV. FILED 9-17-2003.

VUBABES

FOR PRINTED PUBLICATIONS, NAMELY, CALENDARS; POSTERS; PHOTOGRAPHS (U.S. CLS. 2, 5, 22, 23, 29, 37, 38 AND 50).

CHRISTOPHER BUONGIORNO, EXAMINING ATTORNEY

SN 78-303,137. JAZEL COMPANY, THE, ROSWELL, GA. FILED 9-20-2003.

Jazèl

FOR FASHION MAGAZINE (U.S. CLS. 2, 5, 22, 23, 29, 37, 38 AND 50).

KELLY BOULTON, EXAMINING ATTORNEY

SN 78-304,293. SILBERSTEIN, IVY, NEW YORK, NY. FILED 9-23-2003.

IVY SUPERSONIC

OWNER OF U.S. REG. NO. 2,522,340. FOR ANIMATED COMIC BOOKS, CARTOON PRINTS AND CARTOON STRIPS IN NEWSPAPERS, MAGAZINES OR OTHER PRINT MEDIA, AND STATIONERY (U.S. CLS. 2, 5, 22, 23, 29, 37, 38 AND 50).

MARGERY A. TIERNEY, EXAMINING ATTORNEY

SN 78-305,240. ORGANIZED SOLUTIONS, LLC, TOWN & COUNTRY, MO. FILED 9-25-2003.

CHECK ONCE

FOR CHECKLIST FOR USE WHEN AWAY FROM HOME FOR AN EXTENDED PERIOD OF TIME (U.S. CLS. 2, 5, 22, 23, 29, 37, 38 AND 50).

DAWN FELDMAN, EXAMINING ATTORNEY

CLASS 16—(Continued).

SN 78-305,743. MESSENGERS FOR CHRIST, INC., ASHLAND, KY. FILED 9-26-2003.

MESSENGERS FOR CHRIST

FOR PRINTED MATERIALS AND PUBLICATIONS, NAMELY, BOOKS, NEWSPAPERS, BOOKLETS, WORKBOOKS, BROCHURES, MAGAZINES, PAMPHLETS, NEWSLETTERS, LEAFLETS, BOOKMARKS, AND STATIONARY PAPER IN THE FIELD OF TEACHING AND TRAINING OTHERS IN RELIGIOUS, CHARITABLE AND LEADERSHIP PRINCIPLES (U.S. CLS. 2, 5, 22, 23, 29, 37, 38 AND 50).

FIRST USE 10-31-1993; IN COMMERCE 10-31-1993.
FLORENTINA BLANDU, EXAMINING ATTORNEY

SN 78-306,867. VIRTUAL REALITY MEDICAL CENTER, SAN DIEGO, CA. FILED 9-29-2003.

EXPOSE YOURSELF!

FOR SERIES OF SELF-HELP BOOKS FOR GETTING OVER ONE'S PANICS, ANXIETIES AND PHOBIAS IN VARIOUS CITIES (U.S. CLS. 2, 5, 22, 23, 29, 37, 38 AND 50).

CIMMERIAN COLEMAN, EXAMINING ATTORNEY

SN 78-306,909. JUAREZ, MARK, SAN LEANDRO, CA. FILED 9-29-2003.

HAPPY NEWS

OWNER OF U.S. REG. NO. 2,118,470.
NO CLAIM IS MADE TO THE EXCLUSIVE RIGHT TO USE "NEWS", APART FROM THE MARK AS SHOWN.
FOR NEWSLETTERS RELATING TO MASSAGERS AND RELATED PRODUCTS (U.S. CLS. 2, 5, 22, 23, 29, 37, 38 AND 50).

FIRST USE 1-1-1994; IN COMMERCE 1-1-1994.
PATRICIA EVANKO, EXAMINING ATTORNEY

SN 78-307,281. SOUTHWORTH COMPANY, AGAWAM, MA. FILED 9-30-2003.

HAMPTON ROSE

OWNER OF U.S. REG. NO. 2,175,762.
FOR PRINTED INVITATIONS AND ANNOUNCEMENTS CARDS MADE OF PAPER (U.S. CLS. 2, 5, 22, 23, 29, 37, 38 AND 50).

CYNTHIA SLOAN, EXAMINING ATTORNEY

CLASS 16—(Continued).

SN 78-307,932. B'NAI B'RITH, DBA B'NAI B'RITH INTERNATIONAL, WASHINGTON, DC. FILED 10-1-2003.

B'NAI B'RITH JQ

OWNER OF U.S. REG. NOS. 1,631,938, 2,374,300 AND 2,638,120.

THE WORDING IN THE MARK TRANSLATES TO "CHILDREN OF THE COVENANT" OR "SONS OF THE COVENANT".

FOR PRINTED PUBLICATIONS, NAMELY, PERIODICALS PRINCIPALLY DIRECTED TO THE JEWISH COMMUNITY IN THE FIELDS OF JUDAISM, JEWISH COMMUNITY, ISRAELI AND INTERNATIONAL AFFAIRS (U.S. CLS. 2, 5, 22, 23, 29, 37, 38 AND 50).

JEFFREY S. MOLINOFF, EXAMINING ATTORNEY

SN 78-308,569. BANDAI ENTERTAINMENT INC., CYPRESS, CA. FILED 10-2-2003.

DINOBREAKER

FOR BOOKS, NAMELY COMIC BOOKS AND COLLECTOR GUIDE BOOKS; STICKERS; MAGAZINES, NAMELY GENERAL FEATURE MAGAZINES AND ANIMATION MAGAZINES; POSTERS; TRADING CARDS; PLASTIC PAGES FOR HOLDING TRADING CARDS; THREE RING BINDERS; AND ALBUMS USED TO STORE TRADING CARDS (U.S. CLS. 2, 5, 22, 23, 29, 37, 38 AND 50).

LESLEY LAMOTHE, EXAMINING ATTORNEY

SN 78-309,248. THE PROCTER & GAMBLE COMPANY, CINCINNATI, OH. FILED 10-3-2003.

ABSORB-AWAY

FOR DISPOSABLE DIAPERS (U.S. CLS. 2, 5, 22, 23, 29, 37, 38 AND 50).

DAWN HAN, EXAMINING ATTORNEY

CLASS 16—(Continued).

SN 78-309,809. TOCCARE DESIGN, LLC, NEW YORK, NY.
FILED 10-6-2003.



NO CLAIM IS MADE TO THE EXCLUSIVE RIGHT TO USE "DESIGN", APART FROM THE MARK AS SHOWN.

FOR STATIONERY PRODUCT KITS COMPOSED PRIMARILY OF NOTE CARDS, PRINTED INVITATIONS, MENU CARDS, PLACE CARDS, STICKERS, PHOTO ALBUMS, GIFT REGISTRY NOTEBOOKS, GREETING CARDS, PAPER PARTY DECORATIONS, NAPKIN RINGS, AND FABRIC PARTY BAGS; NOTE CARDS; PRINTED INVITATIONS, MENU CARDS, PLACE CARDS, STICKERS, PHOTO ALBUMS, GIFT REGISTRY NOTEBOOKS, GREETING CARDS, AND PAPER PARTY DECORATIONS (U.S. CLS. 2, 5, 22, 23, 29, 37, 38 AND 50).

FIRST USE 10-1-2002; IN COMMERCE 6-25-2003.
KHANH LE, EXAMINING ATTORNEY

SN 78-311,910. PARR, GENE E., WELLS, ME. FILED 10-10-2003.

PARRTOONS

FOR COMIC STRIPS (U.S. CLS. 2, 5, 22, 23, 29, 37, 38 AND 50).
KATHRYN COWARD, EXAMINING ATTORNEY

SN 78-312,498. ADVANTAGE ONE, INC., PRESCOTT, AZ.
FILED 10-11-2003.

TUTOR AT YOUR SIDE

FOR USER'S MANUALS FOR CONSUMER AND INDUSTRIAL GOODS AND EQUIPMENT (U.S. CLS. 2, 5, 22, 23, 29, 37, 38 AND 50).
MARIA-VICTORIA SUAREZ, EXAMINING ATTORNEY

SN 78-312,672. ROSE ART INDUSTRIES, INC., LIVINGSTON, NJ. FILED 10-13-2003.

TALK N' WRITE

FOR PENS (U.S. CLS. 2, 5, 22, 23, 29, 37, 38 AND 50).
LINDA E. BLOHM, EXAMINING ATTORNEY

CLASS 16—(Continued).

SN 78-313,044. HOUDINI'S MAGIC SHOP, INC., LAS VEGAS, NV. FILED 10-13-2003.

HOUDINI'S

FOR INSTRUCTIONAL BOOKS IN THE FIELD OF MAGIC; PRINTED INSTRUCTIONAL, EDUCATIONAL, AND TEACHING MATERIALS IN THE FIELD OF MAGIC; TRAINING MANUALS IN THE FIELD OF MAGIC (U.S. CLS. 2, 5, 22, 23, 29, 37, 38 AND 50).

FIRST USE 0-0-1997; IN COMMERCE 0-0-1997.
ELLEN PERKINS, EXAMINING ATTORNEY

SN 78-313,254. NEWELL OPERATING COMPANY, FREEPORT, IL. FILED 10-14-2003.

EASY GRIP

FOR PAINT BRUSHES AND PAINT BRUSH COMPONENTS, NAMELY, HANDLES (U.S. CLS. 2, 5, 22, 23, 29, 37, 38 AND 50).

KARANENDRA S. CHHINA, EXAMINING ATTORNEY

SN 78-313,273. NEWELL OPERATING COMPANY, FREEPORT, IL. FILED 10-14-2003.

CONTOUR GRIP

FOR PAINT BRUSHES AND PAINT BRUSH COMPONENTS, NAMELY, HANDLES (U.S. CLS. 2, 5, 22, 23, 29, 37, 38 AND 50).

KARANENDRA S. CHHINA, EXAMINING ATTORNEY

SN 78-313,346. LIFETIME ENTERTAINMENT SERVICES, NEW YORK, NY. FILED 10-14-2003.

WHAT MOM FORGOT TO TEACH ME

FOR SERIES OF BOOKS IN THE FIELD OF PRACTICAL ADVICE (U.S. CLS. 2, 5, 22, 23, 29, 37, 38 AND 50).
ANN E. SAPPENFIELD, EXAMINING ATTORNEY

SN 78-313,362. LIFETIME ENTERTAINMENT SERVICES, NEW YORK, NY. FILED 10-14-2003.

WHAT MOM FORGOT TO TEACH ME

FOR MAGAZINE COLUMN FEATURING INFORMATION IN THE FIELD OF PRACTICAL ADVICE (U.S. CLS. 2, 5, 22, 23, 29, 37, 38 AND 50).

FIRST USE 4-22-2003; IN COMMERCE 4-22-2003.
ANN E. SAPPENFIELD, EXAMINING ATTORNEY

CLASS 16—(Continued).

SN 78-315,783. GAMA PUBLISHING, INC., GOLETA, CA. FILED 10-20-2003.

BLUE EDGE MAGAZINE

NO CLAIM IS MADE TO THE EXCLUSIVE RIGHT TO USE "MAGAZINE", APART FROM THE MARK AS SHOWN. FOR MAGAZINE ABOUT SURFING AND OUTDOOR SPORTS (U.S. CLS. 2, 5, 22, 23, 29, 37, 38 AND 50). SAMUEL E. SHARPER JR., EXAMINING ATTORNEY

CLASS 16—(Continued).

SN 78-320,414. TRIBUNE NEW YORK NEWSPAPER HOLDINGS, LLC, NEW YORK, NY. FILED 10-29-2003.



NO CLAIM IS MADE TO THE EXCLUSIVE RIGHT TO USE NEW YORK, APART FROM THE MARK AS SHOWN. FOR NEWSPAPER FOR GENERAL CIRCULATION (U.S. CLS. 2, 5, 22, 23, 29, 37, 38 AND 50). FIRST USE 10-10-2003; IN COMMERCE 10-10-2003. MELVIN AXILBUND, EXAMINING ATTORNEY

SN 78-317,375. FRANKLIN, ALISON, NEW YORK, NY. FILED 10-22-2003.

TYPE A GREETINGS

NO CLAIM IS MADE TO THE EXCLUSIVE RIGHT TO USE "GREETINGS", APART FROM THE MARK AS SHOWN. FOR GREETING CARDS (U.S. CLS. 2, 5, 22, 23, 29, 37, 38 AND 50). KELLY BOULTON, EXAMINING ATTORNEY

SN 78-320,716. CONOCOPHILLIPS COMPANY, HOUSTON, TX. FILED 10-30-2003.



FOR STICKERS; PAPERWIGHTS; NOTEPADS; BRIEF-CASE-TYPE PORTFOLIOS; NOTEBOOKS; PAD FOLIOS; PENS; PEN SETS; PENCILS; GENERAL PURPOSE PLASTIC BAGS; CALENDARS (U.S. CLS. 2, 5, 22, 23, 29, 37, 38 AND 50). CAROL SPILS, EXAMINING ATTORNEY

SN 78-317,435. WEYERHAEUSER COMPANY, FEDERAL WAY, WA. FILED 10-23-2003.

ARTICA

OWNER OF U.S. REG. NO. 2,108,626. FOR PUBLISHING PAPER (U.S. CLS. 2, 5, 22, 23, 29, 37, 38 AND 50). MICHAEL ENGEL, EXAMINING ATTORNEY

SN 78-326,288. MEADWESTVACO CORPORATION, STAMFORD, CT. FILED 11-11-2003.

EXECUTIVE A/V

SN 78-317,438. WEYERHAEUSER COMPANY, FEDERAL WAY, WA. FILED 10-23-2003.

SONORA

FOR PAPER, NAMELY, UNCOATED GROUNDWOOD PAPER FOR USE IN PRINTING AND PUBLISHING (U.S. CLS. 2, 5, 22, 23, 29, 37, 38 AND 50). MICHAEL ENGEL, EXAMINING ATTORNEY

THE MARK CONSISTS OF STANDARD CHARACTERS WITHOUT CLAIM TO ANY PARTICULAR FONT, STYLE, SIZE, OR COLOR. FOR ENVELOPES (U.S. CLS. 2, 5, 22, 23, 29, 37, 38 AND 50). FLORENTINA BLANDU, EXAMINING ATTORNEY

CLASS 16—(Continued).

SN 78-327,372. MEADWESTVACO CORPORATION, STAMFORD, CT. FILED 11-13-2003.

REDI-STIK

THE MARK CONSISTS OF STANDARD CHARACTERS WITHOUT CLAIM TO ANY PARTICULAR FONT, STYLE, SIZE, OR COLOR.

FOR ENVELOPES (U.S. CLS. 2, 5, 22, 23, 29, 37, 38 AND 50).

FIRST USE 1-16-2001; IN COMMERCE 1-16-2001.
ARETHA MASTERSON, EXAMINING ATTORNEY

CLASS 16—(Continued).

SN 78-341,658. CONOCOPHILLIPS COMPANY, HOUSTON, TX. FILED 12-16-2003.



FOR STICKERS; PAPERWEIGHTS; NOTEPADS; BRIEFCASE-TYPE PORTFOLIOS; NOTEBOOKS; PAD FOLIOS; PENS; PEN SETS; PENCILS; GENERAL PURPOSE PLASTIC BAGS; CALENDARS (U.S. CLS. 2, 5, 22, 23, 29, 37, 38 AND 50).

CAROL SPILS, EXAMINING ATTORNEY

SN 78-382,320. THE HAWORTH PRESS, INC., BINGHAMTON, NY. FILED 3-11-2004.

HAWORTH POSITRONIC PRESS

THE MARK CONSISTS OF STANDARD CHARACTERS WITHOUT CLAIM TO ANY PARTICULAR FONT, STYLE, SIZE, OR COLOR.

OWNER OF U.S. REG. NOS. 2,307,122, 2,399,324 AND OTHERS.

NO CLAIM IS MADE TO THE EXCLUSIVE RIGHT TO USE PRESS, APART FROM THE MARK AS SHOWN.

FOR BOOKS AND JOURNALS DIRECTED TO SCIENCE FICTION (U.S. CLS. 2, 5, 22, 23, 29, 37, 38 AND 50).

KIMBERLY FRYE, EXAMINING ATTORNEY

SN 78-327,963. CONOCOPHILLIPS COMPANY, HOUSTON, TX. FILED 11-14-2003.



FOR STICKERS; PAPERWEIGHTS; NOTEPADS; BRIEFCASE-TYPE PORTFOLIOS; NOTEBOOKS; PAD FOLIOS; PENS; PEN SETS; PENCILS; GENERAL PURPOSE PLASTIC BAGS; CALENDARS (U.S. CLS. 2, 5, 22, 23, 29, 37, 38 AND 50).

CAROL SPILS, EXAMINING ATTORNEY

CLASS 17—RUBBER GOODS

SN 76-411,949. ROXUL INC., MILTON, ONTARIO, CANADA, FILED 5-17-2002.

ROXUL RHT

PRIORITY CLAIMED UNDER SEC. 44(D) ON CANADA APPLICATION NO. 1139112, FILED 4-29-2002, REG. NO. TMA590208, DATED 9-18-2003, EXPIRES 9-18-2018.

OWNER OF U.S. REG. NOS. 1,358,037, 2,600,730 AND OTHERS.

FOR ROCK WOOL AND MINERAL WOOL INSULATION FOR THERMAL, SOUND AND FIRE CONTROL FOR RESIDENTIAL, COMMERCIAL AND INDUSTRIAL CONSTRUCTION (U.S. CLS. 1, 5, 12, 13, 35 AND 50).

MARK T. MULLEN, EXAMINING ATTORNEY

CLASS 17—(Continued).

SN 76-491,701. PECHINEY PLASTIC PACKAGING, INC., CHICAGO, IL. FILED 2-21-2003.

MOLDGARD

FOR FLEXIBLE PLASTIC FILM FOR USE IN MANUFACTURE OF FLEXIBLE AIR DUCTS FOR HEATING, VENTILATION AND COOLING (U.S. CLS. 1, 5, 12, 13, 35 AND 50).

CURTIS FRENCH, EXAMINING ATTORNEY

SN 76-493,892. ENGINEERED PLASTICS CORPORATION, AKRON, OH. FILED 2-28-2003.

PermaFlex

OWNER OF U.S. REG. NOS. 1,350,382 AND 1,753,716. FOR PLASTIC PELLETS FOR GENERAL INDUSTRIAL USE AND MANUFACTURING USE (U.S. CLS. 1, 5, 12, 13, 35 AND 50).

FIRST USE 1-31-2003; IN COMMERCE 1-31-2003. LESLIE RICHARDS, EXAMINING ATTORNEY

SN 76-543,137. FORSBERG, ROBERT W., MEQUON, WI. FILED 8-26-2003.

SILVER TAIL

FOR REFLECTIVE TAPE USED IN COMMERCIAL AGRICULTURE TO REPEL INSECTS (U.S. CLS. 1, 5, 12, 13, 35 AND 50).

ANN LINNEHAN, EXAMINING ATTORNEY

SN 76-544,562. ARCH ALUMINUM & GLASS CO., INC., TAMARAC, FL. FILED 9-12-2003.

SOUND ZONE PLUS

NO CLAIM IS MADE TO THE EXCLUSIVE RIGHT TO USE "SOUND", APART FROM THE MARK AS SHOWN.

FOR PLASTIC LAMINATED FILM FOR USE IN BUILDING WINDOW GLASS (U.S. CLS. 1, 5, 12, 13, 35 AND 50).

ROBIN CHOSID, EXAMINING ATTORNEY

CLASS 17—(Continued).

SN 78-216,037. WILDCAT CIVIL SERVICES, LLC, WICHITA, KS. FILED 2-18-2003.

CIVILINER

FOR LINERS FOR SEWER LINES, NAMELY, LINERS OF POLYMERIC MATERIALS FOR THE REPAIR AND RECONSTRUCTION OF PIPES, INCLUDING LAMINATED TUBULAR LINERS OF THERMOSETTING RESINS AND RESIN ABSORBENT MATERIALS WITH POLYMERIC COATINGS REINFORCED WITH FIBERS WHICH ARE APPLIED AGAINST THE INTERNAL WALLS OF THE EXISTING CONDUITS, PIPELINES AND PASSAGEWAYS (U.S. CLS. 1, 5, 12, 13, 35 AND 50).

CAROL SPILS, EXAMINING ATTORNEY

SN 78-226,135. TYCO PLASTICS SERVICES AG, SCHAFFHAUSEN, SWITZERLAND, FILED 3-17-2003.

MARVELSEAL

FOR LAMINATED FOIL BARRIER USED IN PACKAGING (U.S. CLS. 1, 5, 12, 13, 35 AND 50).

CHRISTOPHER BUONGIORNO, EXAMINING ATTORNEY

SN 78-241,951. AMERICAN MICRO INDUSTRIES, INC., CHAMBERSBURG, PA. FILED 4-25-2003.



NO CLAIM IS MADE TO THE EXCLUSIVE RIGHT TO USE SOUNDPROOF FOAM, APART FROM THE MARK AS SHOWN.

FOR CONVOLUTED POLYESTER URETHANE FOAM USED FOR SOUND PROOFING ROOMS AND STUDIOS (U.S. CLS. 1, 5, 12, 13, 35 AND 50).

FIRST USE 4-24-2003; IN COMMERCE 4-24-2003. NANCY CLARKE, EXAMINING ATTORNEY

SN 78-243,707. WESTINGHOUSE ELECTRIC CORPORATION, NEW YORK, NY. FILED 4-30-2003.

YOU CAN BE SURE...IF IT'S WESTINGHOUSE

OWNER OF U.S. REG. NOS. 299,083, 2,753,776 AND OTHERS.

FOR ELECTRICAL TAPE (U.S. CLS. 1, 5, 12, 13, 35 AND 50).

SCOTT OSLICK, EXAMINING ATTORNEY

CLASS 17—(Continued).

SN 78-247,764. ILLINOIS TOOL WORKS INC., GLENVIEW, IL. FILED 5-9-2003.

STATEX

FOR FLAME RETARDANT POLYPROPYLENE SHEETS USED AS ELECTRICAL INSULATION MATERIAL FOR BOTH ELECTRONIC CONSUMER AND OFFICE PRODUCTS AND FOR APPLIANCES (U.S. CLS. 1, 5, 12, 13, 35 AND 50).

FIRST USE 2-20-1989; IN COMMERCE 2-20-1989.
H. M. FISHER, EXAMINING ATTORNEY

SN 78-253,524. BARNHARDT MANUFACTURING COMPANY, DBA NORTH CAROLINA FOAM INDUSTRIES, MOUNT AIRY, NC. FILED 5-23-2003.

THERMALSTOP

FOR SPRAY-APPLIED POLYURETHANE FOAM INSULATION FOR USE IN RESIDENTIAL AND COMMERCIAL CONSTRUCTION (U.S. CLS. 1, 5, 12, 13, 35 AND 50).

LESLEY LAMOTHE, EXAMINING ATTORNEY

SN 78-299,126. TITAN INDUSTRIES, SOUT GATE, CA. FILED 9-11-2003.

TITANFLEX

FOR NON-METAL TEXTILE REINFORCED INDUSTRIAL HOSE USED IN A WIDE VARIETY OF INDUSTRIES (U.S. CLS. 1, 5, 12, 13, 35 AND 50).

ODESSA BIBBINS, EXAMINING ATTORNEY

SN 78-300,559. CLARION CONSULTANTS, LLC, AKRON, OH. FILED 9-15-2003.

OMPREENE

FOR THERMOPLASTIC ELASTOMERS— NAMELY, RECYCLABLE THERMOPLASTIC RUBBER COMPOSITIONS IN THE FORM OF PELLETS FOR FURTHER MANUFACTURE (U.S. CLS. 1, 5, 12, 13, 35 AND 50).

KARANENDRA S. CHHINA, EXAMINING ATTORNEY

CLASS 17—(Continued).

SN 78-305,830. TMTS, INC., SAITAMA, JAPAN, FILED 9-26-2003.

TOUGHBOY

FOR NON-METALLIC PIPE FITTINGS; NON-METALLIC PIPE JOINTS AND COUPLINGS (U.S. CLS. 1, 5, 12, 13, 35 AND 50).

PAULA MAYS, EXAMINING ATTORNEY

SN 78-305,842. TMTS, INC., SAITAMA, JAPAN, FILED 9-26-2003.

TOUGHGUY

FOR NON-METALLIC PIPE FITTINGS; NON-METALLIC PIPE JOINTS AND COUPLINGS (U.S. CLS. 1, 5, 12, 13, 35 AND 50).

PAULA MAYS, EXAMINING ATTORNEY

CLASS 18—LEATHER GOODS

SN 75-652,945. EFTIMOFF, ELLEN LOUISE, CHESTERFIELD, MO. FILED 3-3-1999.

PAWPACK

FOR TOTE BAG DESIGNED FOR HOLDING DOG PARAPHERNALIA SOLD WITH A WATER DISH, A DOG FOOD DISH, WATER BOTTLES, LEASH AND STORAGE SPACE FOR MISCELLANEOUS ITEMS (U.S. CLS. 1, 2, 3, 22 AND 41).

KIM SAITO, EXAMINING ATTORNEY

SN 76-140,925. HORSEWARE PRODUCTS LTD., COUNTY LOUTH, IRELAND, FILED 10-4-2000.

RHINO

FOR HARNESSSES AND SADDLERY; HORSE BLANKETS AND COVERS; HORSE TRAVELING BOOTS AND HORSE LEG PROTECTIVE BOOTS (U.S. CLS. 1, 2, 3, 12 AND 41).

FIRST USE 0-0-1993; IN COMMERCE 0-0-1995.
CHRISIE B. KING, EXAMINING ATTORNEY

SN 76-262,711. MYBEAUTYCENTER.COM, LLC, NEW YORK, NY. FILED 5-25-2001.

MYBEAUTY

FOR MAKE-UP BAGS AND HAND BAGS (U.S. CLS. 1, 2, 3, 22 AND 41).

INGA ERVIN, EXAMINING ATTORNEY

CLASS 18—(Continued).

SN 76-398,491. MANSTON WORLDWIDE LIMITED, TORTOLA, BR. VIRGIN ISLANDS, FILED 4-19-2002.

KAISER
凱 撒

THE NON-LATIN CHARACTERS IN THE MARK TRANSLITERATE TO "HOI SAT" AND THIS MEANS "CAESAR" IN ENGLISH.

FOR LEATHER SOLD IN BULK AND IMITATION LEATHER SOLD IN BULK; HANDBAGS, ALL-PURPOSE SPORTS BAGS, SCHOOL BAGS, BACKPACKS, BRIEFCASES, COIN PURSES, KEY CASES, WALLETS, PURSES, RUCKSACKS, SUITCASES, TRAVELING BAGS, TRAVELING LUGGAGE TRUNKS (U.S. CLS. 1, 2, 3, 22 AND 41).

NICHOLAS ALTREE, EXAMINING ATTORNEY

SN 76-462,148. CMG WORLDWIDE, INC., INDIANAPOLIS, IN. FILED 10-28-2002.

AMELIA EARHART

THE NAME "AMELIA EARHART" DOES NOT IDENTIFY A LIVING INDIVIDUAL.

FOR LEATHER AND IMITATIONS OF LEATHER, AND GOODS MADE OF THESE MATERIALS AND NOT INCLUDED IN OTHER CLASSES, NAMELY HAND LUGGAGE, SUITCASES, TRUNKS, HAT BOXES, WARDROBE CASES, HAND BAGS, WALLETS; TRAVEL WARE, NAMELY ATTACHE CASES, BRIEFCASE-TYPE PORTFOLIOS, KEY CASES, TRAVEL KIT BAGS SOLD EMPTY, SHOPPING BAGS MADE OF LEATHER, POCKETBOOKS AND PURSES (U.S. CLS. 1, 2, 3, 22 AND 41).

MICHAEL ENGEL, EXAMINING ATTORNEY

SN 76-506,257. FAMOUS BOARDING WAXES, LLC, LA JOLLA, CA. FILED 4-14-2003.

FAMOUS BOARDING WAXES

FOR ALL PURPOSE SPORT AND ATHLETIC BAGS (U.S. CLS. 1, 2, 3, 22 AND 41).

JILL C. ALT, EXAMINING ATTORNEY

CLASS 18—(Continued).

SN 76-517,034. UNISON ENTERPRISE, INC., LOS ANGELES, CA. FILED 5-27-2003.

LA CONIA

FOR HANDBAGS, PURSES, TOTE BAGS, SHOULDER BAGS, ATTACHE CASES, BRIEFCASES, LUGGAGE, SCHOOL BAGS, ALL PURPOSE SPORT TOTE BAGS, DUFFEL BAGS, BEACH BAGS, TRAVEL BAGS, COSMETIC BAGS SOLD EMPTY, BRIEFCASE TYPE PORTFOLIOS, UMBRELLAS, SMALL LEATHER GOODS, NAMELY CLUTCH PURSES, LEATHER KEY CASES, CREDIT CARD CASES, COSMETIC CASES SOLD EMPTY, CHANGE PURSES, WALLETS, BUSINESS CARD CASES AND PASSPORT CASES (U.S. CLS. 1, 2, 3, 22 AND 41).

FIRST USE 5-1-2003; IN COMMERCE 5-1-2003.
ANN LINNEHAN, EXAMINING ATTORNEY

SN 76-517,037. UNISON ENTERPRISE, INC., LOS ANGELES, CA. FILED 5-27-2003.

ERGANE

FOR HANDBAGS, PURSES, TOTE BAGS, SHOULDER BAGS, ATTACHE CASES, BRIEFCASES, LUGGAGE, SCHOOL BAGS, ALL PURPOSE SPORT TOTE BAGS, DUFFEL BAGS, BEACH BAGS, TRAVEL BAGS, COSMETIC BAGS SOLD EMPTY, BRIEFCASE TYPE PORTFOLIOS, UMBRELLAS, SMALL LEATHER GOODS, NAMELY CLUTCH PURSES, LEATHER KEY CASES, CREDIT CARD CASES, COSMETIC CASES SOLD EMPTY, CHANGE PURSES, WALLETS, BUSINESS CARD CASES AND PASSPORT CASES (U.S. CLS. 1, 2, 3, 22 AND 41).

FIRST USE 5-1-2003; IN COMMERCE 5-1-2003.
ANN LINNEHAN, EXAMINING ATTORNEY

SN 76-518,637. WRIGHT & MCGILL CO., DENVER, CO. FILED 6-2-2003.

PAK-A-SEAT

FOR BACKPACK WITH SEAT CUSHION ATTACHMENT (U.S. CLS. 1, 2, 3, 22 AND 41).

DOUGLAS LEE, EXAMINING ATTORNEY

CLASS 18—(Continued).

SN 76-532,620. CYGNUS, INC., REDWOOD CITY, CA. FILED 7-25-2003.



FOR BACKPACKS (U.S. CLS. 1, 2, 3, 22 AND 41).
JOHN DALIER, EXAMINING ATTORNEY

SN 76-547,533. EASYCARE, INC., TUCSON, AZ. FILED 9-30-2003.

EASYBOOT

FOR HOOF GUARD (U.S. CLS. 1, 2, 3, 22 AND 41).
FIRST USE 1-1-1970; IN COMMERCE 1-1-1970.
CHRIS WELLS, EXAMINING ATTORNEY

SN 76-548,122. CHATEAU INTERNATIONAL INC., NEW YORK, NY. FILED 9-12-2003.

RETRO-BAG.COM

FOR HANDBAGS, LUGGAGE, TOTE BAGS, SCHOOL BAGS, SPORTS BAGS, BACKPACKS, MINI BACKPACKS, CARRY-ALL BAGS, WAIST BAGS, FANNY PACKS, KEY CASES, BRIEFCASES, DUFFLE BAGS, ALL-PURPOSE SPORT BAGS, BUSINESS CARD CASES, CREDIT CARD CASES, PASSPORT CASES, CHANGE PURSES, ATTACHE CASES AND BILLFOLDS (U.S. CLS. 1, 2, 3, 22 AND 41).
FIRST USE 1-1-1995; IN COMMERCE 1-1-1995.
FRED MANDIR, EXAMINING ATTORNEY

SN 76-551,291. LASKIN, BARBARA, NEW YORK, NY. FILED 9-24-2003.

PORTAPOOCH

FOR SECURE, BICYCLE CARRIER FOR SMALL DOGS (UP TO 12 LBS) (U.S. CLS. 1, 2, 3, 22 AND 41).
MARGERY A. TIERNEY, EXAMINING ATTORNEY

CLASS 18—(Continued).

SN 76-555,758. TORI RICHARD, LTD., HONOLULU, HI. FILED 10-6-2003.



OWNER OF U.S. REG. NOS. 1,120,583 AND 2,821,519.
THE NAME TORI RICHARD DOES NOT IDENTIFY A LIVING INDIVIDUAL.
FOR WOMEN'S BAGS, NAMELY, PURSES, HANDBAGS, CLUTCHES, BEACH BAGS, GARMENT BAGS, LUGGAGE, WALLETS, COIN PURSES, SHOULDER BAGS AND BACK PACKS (U.S. CLS. 1, 2, 3, 22 AND 41).
MICHAEL KEATING, EXAMINING ATTORNEY

SN 78-203,717. TWENTIETH CENTURY FOX FILM CORPORATION, LOS ANGELES, CA. FILED 1-15-2003.



OWNER OF U.S. REG. NOS. 1,932,252, 2,492,197 AND OTHERS.
NO CLAIM IS MADE TO THE EXCLUSIVE RIGHT TO USE "SPORTS", APART FROM THE MARK AS SHOWN.
FOR ALL-PURPOSE SPORT BAGS; WAIST PACKS; BEACH BAGS; KNAPSACKS; BACKPACKS. (U.S. CLS. 1, 2, 3, 22 AND 41).
H. M. FISHER, EXAMINING ATTORNEY

SN 78-217,863. MERCHANDISE SERVICES ONLINE, INC., MIAMI BEACH, FL. FILED 2-22-2003.

EGOCENTRAL

FOR HANDBAGS, WALLETS, BACKPACKS, TRAVEL BAGS (U.S. CLS. 1, 2, 3, 22 AND 41).
FIRST USE 2-1-2003; IN COMMERCE 2-1-2003.
ROBERT LORENZO, EXAMINING ATTORNEY

CLASS 18—(Continued).

SN 78-230,976. THOMAS WAGNER GMBH, PENZBERG, FED REP GERMANY, FILED 3-27-2003.

TITAN

FOR TRUNKS, TRAVELLING BAGS, VANITY CASES SOLD EMPTY, COSMETICS BAGS SOLD EMPTY, RUCKSACKS, TROLLEY BAGS FOR TRAVEL WITH WHEELS ATTACHED, CARRY-ON SHOULDER BAGS, GARMENT BAGS FOR TRAVEL, SPONGE BAGS SOLD EMPTY (U.S. CLS. 1, 2, 3, 22 AND 41).

CATHERINE CAIN, EXAMINING ATTORNEY

SN 78-282,884. SPOT PETS, INC., NEW YORK, NY. FILED 8-4-2003.

PETOMETER

FOR ELECTRONIC PET COLLARS THAT MEASURE THE TIME AND DISTANCE IT TAKES FOR A PET TO WALK FROM ONE POINT TO ANOTHER (U.S. CLS. 1, 2, 3, 22 AND 41).

LANA PHAM, EXAMINING ATTORNEY

SN 78-290,908. ALPHA INDUSTRIES, INC., VIENNA, VA. FILED 8-22-2003.

**ALPHA INDUSTRIES**

OWNER OF U.S. REG. NOS. 1,243,749, 2,294,089 AND OTHERS.

NO CLAIM IS MADE TO THE EXCLUSIVE RIGHT TO USE INDUSTRIES, APART FROM THE MARK AS SHOWN. FOR BAGS, NAMELY, BEACH BAGS, ATHLETIC BAGS, DUFFEL BAGS, TRAVEL BAGS, BOOK BAGS, OVERNIGHT BAGS, SHOULDER BAGS; BACKPACKS (U.S. CLS. 1, 2, 3, 22 AND 41).

FIRST USE 0-0-2000; IN COMMERCE 0-0-2000.
KELLY BOULTON, EXAMINING ATTORNEY

CLASS 18—(Continued).

SN 78-294,531. GRUIA, ANTON FLORIN, JERSEY CITY, NJ. FILED 8-31-2003.

THE TRADEMARK DOES NOT IDENTIFY A LIVING INDIVIDUAL. IT IS SIMPLY A BRAND NAME.

FOR BAGS, PURSES, TOTES, WALLETS, BELTS, BACKPACKS, HANDBAGS, DOG COLLARS AND LEASHES, GLOVES, ALL MADE OF NATURAL LEATHER ALSO NAMED ANIMAL SKIN (U.S. CLS. 1, 2, 3, 22 AND 41).

FIRST USE 6-1-2003; IN COMMERCE 6-1-2003.

DOMINIC J. FERRAIUOLO, EXAMINING ATTORNEY

SN 78-298,434. J. MITTON & ASSOCIATES, INC., NEW HOLLAND, PA. FILED 9-10-2003.

LEGACY BRIDLERY

NO CLAIM IS MADE TO THE EXCLUSIVE RIGHT TO USE "BRIDLERY", APART FROM THE MARK AS SHOWN.

FOR EQUESTRIAN GEAR, NAMELY BRIDLES, REINS, STIRRUP LEATHERS, SADDLES AND GIRTHS (U.S. CLS. 1, 2, 3, 22 AND 41).

JENNIFER CHICOSKI, EXAMINING ATTORNEY

SN 78-301,607. J. MITTON & ASSOCIATES, INC., DBA INTREPID INTERNATIONAL, NEW HOLLAND, PA. FILED 9-17-2003.

COMFORT PLUS

NO CLAIM IS MADE TO THE EXCLUSIVE RIGHT TO USE "COMFORT", APART FROM THE MARK AS SHOWN.

FOR PRODUCTS FOR HORSES, NAMELY SADDLE PADS; HORSE BLANKETS; POLO WRAPS; FLY MASKS; LEG PROTECTION, NAMELY LEG QUILTS, SHIPPING BOOTS AND PILLOW WRAPS; AND STANDING WRAPS, NAMELY KNIT BANDAGES, COLD WATER BANDAGES, STANDING BANDAGES AND TURF KNITS (U.S. CLS. 1, 2, 3, 22 AND 41).

FIRST USE 10-31-1998; IN COMMERCE 2-28-1999.

YONG KIM, EXAMINING ATTORNEY

SN 78-303,306. SAMSONITE CORPORATION, DENVER, CO. FILED 9-22-2003.

HOMMAGE

THE TRANSLATION OF "HOMMAGE" IS "HOMAGE". FOR LUGGAGE (U.S. CLS. 1, 2, 3, 22 AND 41).

JACQUELINE A. LAVINE, EXAMINING ATTORNEY

CLASS 18—(Continued).

SN 78-312,698. PGA TOUR, INC., PONTE VEDRA BEACH, FL. FILED 10-13-2003.

GOLF STARTS HERE

FOR ATHLETIC BAGS; TOILETRY CASES SOLD EMPTY; LUGGAGE; ATTACHE CASES; TOTE BAGS; UMBRELLAS; BRIEFCASES; BUSINESS CARD CASES; LUGGAGE TAGS; WALLETS; CREDIT CARD CASES AND KEY CASES (U.S. CLS. 1, 2, 3, 22 AND 41).

JOHN SCHUYLER YARD, EXAMINING ATTORNEY

CLASS 18—(Continued).

SN 78-341,665. CONOCOPHILLIPS COMPANY, HOUSTON, TX. FILED 12-16-2003.



FOR LUGGAGE; LUGGAGE TAGS; BACKPACKS; DAYPACKS; TOYS BAGS; DUFFEL BAGS; BRIEFCASE-TYPE PORTFOLIOS; BRIEFCASES; GARMENT BAGS FOR TRAVEL; SHOE BAGS FOR TRAVEL; UMBRELLAS; ALL PURPOSE SPORTS BAGS (U.S. CLS. 1, 2, 3, 22 AND 41).

CAROL SPILS, EXAMINING ATTORNEY

SN 78-320,727. CONOCOPHILLIPS COMPANY, HOUSTON, TX. FILED 10-30-2003.



FOR LUGGAGE; LUGGAGE TAGS; BACKPACKS; DAYPACKS; TOTE BAGS; DUFFEL BAGS; BRIEFCASE-TYPE PORTFOLIOS; BRIEFCASES; GARMENT BAGS FOR TRAVEL; SHOE BAGS FOR TRAVEL; UMBRELLAS; ALL PURPOSE SPORTS BAGS (U.S. CLS. 1, 2, 3, 22 AND 41).

CAROL SPILS, EXAMINING ATTORNEY

CLASS 19—NON-METALLIC BUILDING MATERIALS

SN 76-380,538. NUDURA CORPORATION, BARRIE, ONTARIO L4M 6E7, CANADA, FILED 3-11-2002.

NUDURA

PRIORITY CLAIMED UNDER SEC. 44(D) ON CANADA APPLICATION NO. 1,115,978, FILED 9-18-2001.

FOR INSULATED FORMS MADE FROM EXPANDED POLYSTYRENE WITH BUILT-IN PLASTIC WEBS, DESIGNED TO BE FILLED WITH CONCRETE AND USED TO HOLD REINFORCING RODS IN PLACE IN CONSTRUCTING RESIDENTIAL, COMMERCIAL, AND INDUSTRIAL BUILDING (U.S. CLS. 1, 12, 33 AND 50).

FIRST USE 11-1-2001; IN COMMERCE 4-8-2002.

ALEX KEAM, EXAMINING ATTORNEY

SN 78-327,955. CONOCOPHILLIPS COMPANY, HOUSTON, TX. FILED 11-14-2003.



FOR LUGGAGE; LUGGAGE TAGS; BACKPACKS; DAYPACKS; TOTE BAGS; DUFFEL BAGS; BRIEFCASE-TYPE PORTFOLIOS; BRIEFCASES; GARMENT BAGS FOR TRAVEL; SHOE BAGS FOR TRAVEL; UMBRELLAS; ALL PURPOSE SPORTS BAGS (U.S. CLS. 1, 2, 3, 22 AND 41).

CAROL SPILS, EXAMINING ATTORNEY

SN 76-387,096. MARSHFIELD DOORSYSTEMS, INC., MARSHFIELD, WI. FILED 3-25-2002.

COOL CORE

NO CLAIM IS MADE TO THE EXCLUSIVE RIGHT TO USE "CORE", APART FROM THE MARK AS SHOWN.

FOR BUILDING MATERIALS, NAMELY, COMPONENTS FOR DOORS IN THE NATURE OF NONCOMBUSTIBLE MINERAL COMPOSITE SHAPED INTO SHEET FORM (U.S. CLS. 1, 12, 33 AND 50).

TRICIA THOMPSON, EXAMINING ATTORNEY

SN 76-459,052. IKO INDUSTRIES LTD., TORONTO, ONTARIO M6A 3A1, CANADA, FILED 10-15-2002.

FAST-N-WELD

PRIORITY CLAIMED UNDER SEC. 44(D) ON CANADA APPLICATION NO. 1153280, FILED 9-19-2002, REG. NO. TMA600879, DATED 1-29-2004, EXPIRES 1-29-2019.

FOR ROOFING MEMBRANES (U.S. CLS. 1, 12, 33 AND 50).

MARC LEIPZIG, EXAMINING ATTORNEY

CLASS 19—(Continued).

SN 76-497,366. BUILDERS FIRSTSOURCE - ATLANTIC GROUP, INC., FREDERICK, MD. FILED 3-12-2003.

SYNBOARD

FOR SYNTHETIC LUMBER COMPOSED OF CELLULAR PVC (U.S. CLS. 1, 12, 33 AND 50).
FIRST USE 0-0-1996; IN COMMERCE 0-0-1996.
GINA FINK, EXAMINING ATTORNEY

SN 76-499,110. TARCO SPECIALTY PRODUCTS, INC., NORTH LITTLE ROCK, AR. FILED 3-20-2003.



NO CLAIM IS MADE TO THE EXCLUSIVE RIGHT TO USE "LEAKBARRIER", APART FROM THE MARK AS SHOWN.

THE BACKGROUND IS COLORED BLUE. THE WORD "LEAK" IS COLORED WHITE. THE WORD "BARRIER" IS COLORED YELLOW. THE RAINDROP IS COLORED GRAY-BLUE.

FOR ROOFING PRODUCTS, NAMELY UNDERLAYMENT FOR ROOFING MATERIALS (U.S. CLS. 1, 12, 33 AND 50).

FIRST USE 9-3-2001; IN COMMERCE 9-3-2001.
MELVIN AXILBUND, EXAMINING ATTORNEY

SN 76-509,656. IKO INDUSTRIES LTD., TORONTO, ONTARIO M6A 3A1, CANADA, FILED 4-25-2003.

FAST-N-STICK

PRIORITY CLAIMED UNDER SEC. 44(D) ON CANADA APPLICATION NO. 1157346, FILED 10-29-2002, REG. NO. TMA603279, DATED 2-25-2004, EXPIRES 2-25-2019.

FOR BITUMINOUS ROLLED ROOFING COVERINGS (U.S. CLS. 1, 12, 33 AND 50).

DAVID C. REIHNER, EXAMINING ATTORNEY

CLASS 19—(Continued).

SN 76-543,588. SQUIRES-BELT MATERIAL COMPANY, SAN DIEGO, CA. FILED 9-10-2003.



OWNER OF U.S. REG. NO. 2,825,011.
NO CLAIM IS MADE TO THE EXCLUSIVE RIGHT TO USE "QUALITY", APART FROM THE MARK AS SHOWN.
FOR CEMENTITIOUS MATERIAL, NAMELY EXTERIOR CEMENT FINISH IN THE NATURE OF STUCCO AND BASECOAT (U.S. CLS. 1, 12, 33 AND 50).
NORA BUCHANAN WILL, EXAMINING ATTORNEY

SN 76-547,201. LAFARGE NORTH AMERICA INC., HERNDON, VA. FILED 9-26-2003.

DURATINT

FOR ASPHALT (U.S. CLS. 1, 12, 33 AND 50).
ELIZABETH HUGHITT, EXAMINING ATTORNEY

SN 76-548,857. LAFARGE NORTH AMERICA INC., HERNDON, VA. FILED 9-16-2003.

DURAGREEN

FOR ASPHALT (U.S. CLS. 1, 12, 33 AND 50).
INGRID C. EULIN, EXAMINING ATTORNEY

SN 76-551,975. AMCOL INTERNATIONAL CORPORATION, ARLINGTON HEIGHTS, IL. FILED 9-25-2003.



NO CLAIM IS MADE TO THE EXCLUSIVE RIGHT TO USE ROOFING MATERIALS, APART FROM THE MARK AS SHOWN.

FOR ROOFING UNDERLAYMENTS (U.S. CLS. 1, 12, 33 AND 50).

FIRST USE 10-20-2003; IN COMMERCE 10-20-2003.
HOWARD SMIGA, EXAMINING ATTORNEY

CLASS 19—(Continued).

SN 78-169,838. REWARD WALL SYSTEMS, INC., OMAHA, NE. FILED 10-1-2002.



OWNER OF U.S. REG. NO. 1,996,136.
NO CLAIM IS MADE TO THE EXCLUSIVE RIGHT TO USE "WALL SYSTEMS", APART FROM THE MARK AS SHOWN.

FOR INSULATING CONCRETE FORM BUILDING SYSTEMS COMPRISING FORM SIDE WALLS AND FORM TIES (U.S. CLS. 1, 12, 33 AND 50).

FIRST USE 1-31-2001; IN COMMERCE 1-31-2001.
CIMMERIAN COLEMAN, EXAMINING ATTORNEY

CLASS 19—(Continued).

SN 78-234,142. PAWLING CORPORATION, PAWLING, NY. FILED 4-4-2003.

CRESCENT

FOR NON-METAL HAND RAILS; NON-METAL BUILDING MATERIALS, NAMELY, WALL PROTECTION DEVICES IN THE NATURE OF WALL GUARDS, AND CORNER GUARDS (U.S. CLS. 1, 12, 33 AND 50).
TRACY FLETCHER, EXAMINING ATTORNEY

SN 78-236,344. LFF SYSTEMS, INC., HOUSTON, TX. FILED 4-10-2003.

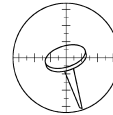

SN 78-179,427. WEYERHAEUSER COMPANY, FEDERAL WAY, WA. FILED 10-29-2002.



FOR SATURATED FELT ROOFING MATERIAL NAMELY, UNDERLAYMENT AND SHINGLES AND INSTRUCTIONS FOR INSTALLING SAID MATERIAL SOLD AS A UNIT (U.S. CLS. 1, 12, 33 AND 50).
DARLENE BULLOCK, EXAMINING ATTORNEY

OWNER OF U.S. REG. NOS. 817,632, 2,306,787 AND OTHERS.

FOR NONMETALLIC BUILDING MATERIALS, NAMELY, DECKING ENGINEERED FROM WOOD FIBER AND RECYCLED PLASTIC (U.S. CLS. 1, 12, 33 AND 50).

FIRST USE 3-1-2000; IN COMMERCE 3-1-2000.
ELIZABETH J. WINTER, EXAMINING ATTORNEY

SN 78-249,404. PEREZ, STEVEN, D, BOULDER CREEK, CA. FILED 5-14-2003.

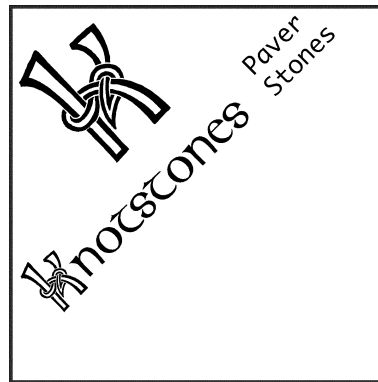

SN 78-202,203. GREENLAND COMPOSITES, INC., FAYETTEVILLE, AR. FILED 1-10-2003.

GREENLAND COMPOSITES

NO CLAIM IS MADE TO THE EXCLUSIVE RIGHT TO USE "COMPOSITES", APART FROM THE MARK AS SHOWN.

FOR WOOD BASED BUILDING MATERIALS, NAMELY, BOARDS, DECKING BOARDS, MOLDINGS, PAVERS, SHINGLES, SOFFITS, FASCIA, DECORATIVE FACER MOLDINGS, AND DOOR SILLS (U.S. CLS. 1, 12, 33 AND 50).
JOHN GARTNER, EXAMINING ATTORNEY

NO CLAIM IS MADE TO THE EXCLUSIVE RIGHT TO USE PAVER STONES, APART FROM THE MARK AS SHOWN.

FOR PAVER STONES (U.S. CLS. 1, 12, 33 AND 50).
FIRST USE 5-7-2003; IN COMMERCE 5-7-2003.
CURTIS FRENCH, EXAMINING ATTORNEY

CLASS 19—(Continued).

SN 78-276,144. UNIVERSAL FOREST PRODUCTS, INC., GRAND RAPIDS, MI. FILED 7-18-2003.

EASY RISER

OWNER OF U.S. REG. NO. 2,073,808.
FOR STAIR STRINGER COMPONENT USED IN THE CONSTRUCTION OF STAIRWAYS, NAMELY, A NON-METAL STAIR RISER (U.S. CLS. 1, 12, 33 AND 50).
FIRST USE 4-10-1996; IN COMMERCE 4-10-1996.
RICHARD A. STRASER, EXAMINING ATTORNEY

SN 78-287,896. ZINSSER BRANDS COMPANY, MEDINA, OH. FILED 8-15-2003.

READY PATCH

NO CLAIM IS MADE TO THE EXCLUSIVE RIGHT TO USE "PATCH", APART FROM THE MARK AS SHOWN.
FOR SPACKLING AND PATCHING COMPOUND FOR INTERIOR AND EXTERIOR SURFACES (U.S. CLS. 1, 12, 33 AND 50).
FIRST USE 1-15-1943; IN COMMERCE 1-15-1943.
DOMINIC J. FERRAIUOLO, EXAMINING ATTORNEY

SN 78-295,337. ANCHOR WALL SYSTEMS, INC., MINNETONKA, MN. FILED 9-3-2003.

NATURAL IMPRESSIONS

FOR CONCRETE LANDSCAPE PRODUCTS, NAMELY, PAVERS, SLABS, STEP UNITS, EDGERS, RETAINING WALLS, LANDSCAPING WALLS, FREE STANDING WALLS, BORDER WALLS, AND MODULAR CONCRETE UNITS FOR BUILDING SUCH WALLS (U.S. CLS. 1, 12, 33 AND 50).
ROBIN CHOSID, EXAMINING ATTORNEY

SN 78-307,588. OLDCASTLE PRECAST, INC., AUBURN, WA. FILED 9-30-2003.

CARBONCRETE

FOR PRECAST CONCRETE PRODUCTS REINFORCED WITH CARBON FIBER, NAMELY, MODULAR LIVING UNITS IN THE NATURE OF STORM AND ENVIRONMENTAL SHELTERS, CLASSROOM AND DORM ROOM BUILDINGS, HOTELS, BATHROOM AND EQUIPMENT VAULTS, STORAGE VAULTS AND GENERAL UTILITY VAULTS, AND COMMERCIAL, ARCHITECTURAL AND HOUSING PANELS (U.S. CLS. 1, 12, 33 AND 50).
FIRST USE 3-1-2003; IN COMMERCE 7-17-2003.
SUSAN LESLIE DUBOIS, EXAMINING ATTORNEY

CLASS 20—FURNITURE AND ARTICLES NOT OTHERWISE CLASSIFIED

SN 76-174,736. JEFKOM CO., LTD., OSAKA, JAPAN, FILED 11-30-2000.

JEFKOM

OWNER OF JAPAN REG. NO. 4741764, DATED 1-23-2004, EXPIRES 1-23-2014.
FOR PLASTIC BOXES; NON-METAL TOOL BOXES; TOOL CHESTS; AND FREESTANDING NON-METAL TOOL RACKS (U.S. CLS. 2, 13, 22, 25, 32 AND 50).
JOHN DWYER, EXAMINING ATTORNEY

SN 76-433,021. BRUNNER GMBH, D-77666 RHEINAU, FED REP GERMANY, FILED 7-19-2002.



PRIORITY CLAIMED UNDER SEC. 44(D) ON ERP N CMNTY TM OFC APPLICATION NO. 2634996, FILED 3-27-2002, REG. NO. 002634996, DATED 5-26-2003, EXPIRES 3-27-2012.
THE MARK CONSISTS OF THE WORD "BRUNNER" IN BLACK, WITH FOUR SMALL ORANGE-RED SQUARES ON THE SIDE. THE COLORS BLACK AND ORANGE-RED ARE CLAIMED AS A FEATURE OF THE MARK.
FOR FURNITURE (U.S. CLS. 2, 13, 22, 25, 32 AND 50).
TRACY CROSS, EXAMINING ATTORNEY

SN 76-507,267. BERGEAUD BIBLIOTHEQUES, S.A., 92541 MONTROUGE, FRANCE, FILED 4-15-2003.

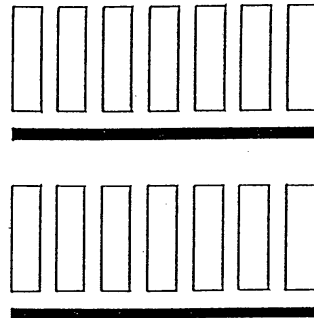

FOR FURNITURE SYSTEMS; NAMELY, SHELVING FOR LIBRARIES, SCHOOLS, KITCHEN, LIVING, BED, AND BATH ROOMS, AND STORAGE FACILITIES, LIBRARY AND SCHOOL FURNITURE, KITCHEN FURNITURE, DINING ROOM FURNITURE, BEDROOM FURNITURE, OFFICE FURNITURE AND LOUNGE FURNITURE; NAMELY, TABLES, STUDY CARRELS, CHAIRS, DESKS, AND WET AND DRY BARS (U.S. CLS. 2, 13, 22, 25, 32 AND 50).
FIRST USE 1-18-1993; IN COMMERCE 1-18-1993.
CAROLYN CATALDO, EXAMINING ATTORNEY

CLASS 20—(Continued).

SN 76-533,205. KATZ, ELIZABETH I., SHELTON, CT. FILED 7-28-2003.



THE ENGLISH TRANSLATION OF LA PALETTE IS THE PALETTE.

FOR HAND PAINTED CHILDREN'S FURNITURE NAMELY CHAIRS, TABLES AND STOOLS (U.S. CLS. 2, 13, 22, 25, 32 AND 50).

FIRST USE 4-1-2003; IN COMMERCE 4-1-2003.
LESLEY LAMOTHE, EXAMINING ATTORNEY

SN 76-548,500. JAMISON BEDDING, INC., FRANKLIN, TN. FILED 10-2-2003.

**GOOD MORNINGS START
WITH A GREAT NIGHT'S
SLEEP**

FOR BEDDING, NAMELY MATTRESSES AND BOX SPRINGS (U.S. CLS. 2, 13, 22, 25, 32 AND 50).
BRIDGETT SMITH, EXAMINING ATTORNEY

SN 76-549,777. SHARK STAINLESS SYSTEMS, INC., BELLEVUE, WA. FILED 10-6-2003.

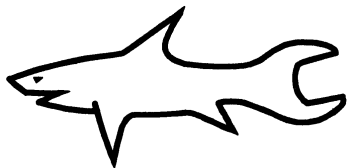

FOR TOOL CABINETS AND STORAGE CABINETS (U.S. CLS. 2, 13, 22, 25, 32 AND 50).
FIRST USE 6-1-2003; IN COMMERCE 8-10-2003.
LAURIEL DALIER, EXAMINING ATTORNEY

CLASS 20—(Continued).

SN 76-553,514. HONDA GIKEN KOGYO KABUSHIKI KAISHA, DBA HONDA MOTOR CO., LTD., TOKYO 107-8556, JAPAN, FILED 10-3-2003.



FOR NON-METAL KEY FOBs (U.S. CLS. 2, 13, 22, 25, 32 AND 50).

FIRST USE 6-0-2003; IN COMMERCE 6-0-2003.
LAURA KOVAISKY, EXAMINING ATTORNEY

SN 78-153,147. OBADIAH ENTERPRISES, INC., HASTINGS, NY. FILED 8-12-2002.



NO CLAIM IS MADE TO THE EXCLUSIVE RIGHT TO USE "BUSH", APART FROM THE MARK AS SHOWN.

THE STIPPLING IS A FEATURE OF THE MARK.
FOR LANDSCAPE AND SHRUB PROTECTION SYSTEM COMPRISED OF MODULAR MOLDED PVC OR OTHER PLASTIC PANELS AND TUBE OR PIPE-LIKE CONNECTORS THAT WHEN ASSEMBLED FORM A TENT-LIKE PROTECTIVE COVERING (U.S. CLS. 2, 13, 22, 25, 32 AND 50).

AMY HELLA, EXAMINING ATTORNEY

SN 78-176,660. SILVER LINE BUILDING PRODUCTS CORPORATION, NORTH BRUNSWICK, NJ. FILED 10-21-2002.

CUSTOM CRAFT PLASTICS

NO CLAIM IS MADE TO THE EXCLUSIVE RIGHT TO USE PLASTICS, APART FROM THE MARK AS SHOWN.

FOR PLASTIC COMPONENT PARTS, NAMELY, ROLLER ASSEMBLIES, TILT LATCHES, WEEP HOODS, BALANCE SHOES, PLUGS, LATCH BRACKET ASSEMBLIES, THUMB GRIPS, WEEP HOLE COVERS, PIVOT BARS, VINYL SLIDERS, FLEX VENT LOCKS, SASH HANDLES, WINDOW BALANCES, BEARING PADS, MUNTIN CLIPS, SCREEN POLES, SWIVEL CLIPS, SLIDE BOLTS, DUST COVERS, BUSHINGS, SASH CAMS, SCREEN CORNERS, AND SCREEN SLIDE BOLTS FOR WINDOWS (U.S. CLS. 2, 13, 22, 25, 32 AND 50).

CIMMERIAN COLEMAN, EXAMINING ATTORNEY

CLASS 20—(Continued).

SN 78-225,888. DODGE, RICHARD, A., SONORA, CA. FILED 3-14-2003.

BAMBINO BATS

NO CLAIM IS MADE TO THE EXCLUSIVE RIGHT TO USE "BATS", APART FROM THE MARK AS SHOWN.

THE ENGLISH TRANSLATION OF "BAMBINO" IS "BABY".

FOR ENGRAVED MINIATURE BASEBALL BAT REPLICAS MADE OF WOOD, USED AS SOUVENIRS, AWARDS AND TROPHIES (U.S. CLS. 2, 13, 22, 25, 32 AND 50).

LINDA POWELL, EXAMINING ATTORNEY

SN 78-226,630. URBAN, KEITH, NASHVILLE, TN. FILED 3-17-2003.

KEITH URBAN

THE NAME KEITH URBAN IDENTIFIES A LIVING INDIVIDUAL WHOSE CONSENT IS OF RECORD.

FOR DECORATIVE PLAQUES, NON-METAL ORNAMENTAL NOVELTY BUTTONS AND NON-METAL KEY CHAINS (U.S. CLS. 2, 13, 22, 25, 32 AND 50).

FIRST USE 0-0-2000; IN COMMERCE 0-0-2000.

WON TEAK OH, EXAMINING ATTORNEY

SN 78-240,369. HYLAND, JAMES, RONALD, LONG BEACH, CA. FILED 4-22-2003.

MUGTOPPER

FOR PLASTIC LIDS FOR MUGS THAT CAN BE USED AS A COASTER (U.S. CLS. 2, 13, 22, 25, 32 AND 50).

FIRST USE 3-1-2003; IN COMMERCE 4-1-2003.

PRISCILLA MILTON, EXAMINING ATTORNEY

SN 78-285,462. STORAGE2 SYSTEMS LLC, COLLEGEVILLE, PA. FILED 8-11-2003.

STORAGE2 SYSTEMS

OWNER OF U.S. REG. NO. 2,795,539.
NO CLAIM IS MADE TO THE EXCLUSIVE RIGHT TO USE SYSTEMS, APART FROM THE MARK AS SHOWN.

FOR FURNITURE, NAMELY, CABINETS AND STORAGE RACKS (U.S. CLS. 2, 13, 22, 25, 32 AND 50).

FIRST USE 1-31-2003; IN COMMERCE 1-31-2003.

ZHALEH DELANEY, EXAMINING ATTORNEY

CLASS 20—(Continued).

SN 78-285,463. STORAGE2 SYSTEMS LLC, COLLEGEVILLE, PA. FILED 8-11-2003.

STORAGE SQUARED SYSTEMS

OWNER OF U.S. REG. NO. 2,795,539.

NO CLAIM IS MADE TO THE EXCLUSIVE RIGHT TO USE STORAGE AND SYSTEMS, APART FROM THE MARK AS SHOWN.

FOR FURNITURE, NAMELY, CABINETS AND STORAGE RACKS (U.S. CLS. 2, 13, 22, 25, 32 AND 50).

FIRST USE 1-31-2003; IN COMMERCE 1-31-2003.

ZHALEH DELANEY, EXAMINING ATTORNEY

SN 78-287,194. ANGELES GROUP LLC, PACIFIC, MO. FILED 8-14-2003.

QUIET DIVIDER

NO CLAIM IS MADE TO THE EXCLUSIVE RIGHT TO USE "DIVIDER", APART FROM THE MARK AS SHOWN.

FOR FREE STANDING OR WALL MOUNTABLE PANELS, PARTITIONS, ROOM DIVIDERS, AND BARRIERS HAVING NOISE AND SOUND REDUCING COVERINGS (U.S. CLS. 2, 13, 22, 25, 32 AND 50).

BRETT J. GOLDEN, EXAMINING ATTORNEY

SN 78-296,271. COLUMBIA CASCADE COMPANY, PORTLAND, OR. FILED 9-4-2003.

TIMBERFORM BROADWAY

OWNER OF U.S. REG. NOS. 1,151,817, 2,091,019 AND OTHERS.

FOR PUBLIC SEATING AND LANDSCAPE FURNITURE (U.S. CLS. 2, 13, 22, 25, 32 AND 50).

AISHA CLARKE, EXAMINING ATTORNEY

SN 78-298,556. LF, LLC, WILMINGTON, DE. FILED 9-10-2003.



OWNER OF U.S. REG. NO. 2,388,800.

FOR BATHROOM FURNITURE, NAMELY, VANITIES, MEDICINE CABINETS, MIRRORS, CORNER SHELF UNITS, HAMPERS, BATH ETAGERES AND BATHROOM STORAGE ORGANIZERS (U.S. CLS. 2, 13, 22, 25, 32 AND 50).

ZACHARY BELLO, EXAMINING ATTORNEY

CLASS 20—(Continued).

SN 78-300,638. HUNTER DOUGLAS INC., UPPER SADDLE RIVER, NJ. FILED 9-15-2003.

RETROLIFT

FOR PLASTIC AND METAL HARDWARE AND PULL-EY SYSTEM FOR USE IN ADJUSTING THE TILT AND IN RAISING AND LOWERING WINDOW BLINDS AND WINDOW SHADES (U.S. CLS. 2, 13, 22, 25, 32 AND 50).
SHARI SHEFFIELD, EXAMINING ATTORNEY

SN 78-304,198. PAWLUK, THOMAS, FARMINGDALE, NY. FILED 9-23-2003.

SCRAP-FRAMES

FOR PICTURE FRAMES FOR THREE-DIMENSIONAL OBJECTS (U.S. CLS. 2, 13, 22, 25, 32 AND 50).
KATHRYN COWARD, EXAMINING ATTORNEY

SN 78-305,398. LOUISVILLE BEDDING COMPANY, LOUISVILLE, KY. FILED 9-25-2003.

VISCO MAX

FOR PILLOWS; FOAM PILLOWS (U.S. CLS. 2, 13, 22, 25, 32 AND 50).
H. M. FISHER, EXAMINING ATTORNEY

SN 78-305,403. LOUISVILLE BEDDING COMPANY, LOUISVILLE, KY. FILED 9-25-2003.

MICRO VISCO

FOR PILLOWS; FOAM PILLOWS (U.S. CLS. 2, 13, 22, 25, 32 AND 50).
H. M. FISHER, EXAMINING ATTORNEY

SN 78-308,402. PUMPA TECHNOLOGY PRODUCTS, INC., WHITE LAKE, MI. FILED 10-2-2003.

CHEEK CHILLER

FOR SEAT CUSHIONS (U.S. CLS. 2, 13, 22, 25, 32 AND 50).
ROBERT COGGINS, EXAMINING ATTORNEY

CLASS 20—(Continued).

SN 78-313,459. VIRCO MGMT. CORPORATION, TORRANCE, CA. FILED 10-14-2003.

ERGOCOMBO

FOR FURNITURE, NAMELY INTEGRAL FURNITURE UNITS INCLUDING A CHAIR AND A DESK (U.S. CLS. 2, 13, 22, 25, 32 AND 50).
KHANH LE, EXAMINING ATTORNEY

SN 78-313,582. ORCHARD COUNTRREE MARKET, INC., LA CRESCENT, MN. FILED 10-14-2003.

THE TWO WORLDS

FOR FURNITURE (U.S. CLS. 2, 13, 22, 25, 32 AND 50).
JENNIFER KRISP, EXAMINING ATTORNEY

SN 78-314,387. LOUISVILLE BEDDING COMPANY, LOUISVILLE, KY. FILED 10-16-2003.

**SCHOOL'S HARD, YOUR
BED SHOULDN'T BE**

FOR PILLOWS (U.S. CLS. 2, 13, 22, 25, 32 AND 50).
KIMBERLY PERRY, EXAMINING ATTORNEY

SN 78-315,714. REVLON CONSUMER PRODUCTS CORPORATION, NEW YORK, NY. FILED 10-20-2003.

REVLON

OWNER OF U.S. REG. NOS. 647,222, 1,886,476 AND OTHERS.
FOR HAND-HELD MIRRORS (U.S. CLS. 2, 13, 22, 25, 32 AND 50).
FIRST USE 1-1-1992; IN COMMERCE 1-1-1992.
LINDA E. BLOHM, EXAMINING ATTORNEY

SN 78-319,654. LOUISVILLE BEDDING COMPANY, LOUISVILLE, KY. FILED 10-28-2003.

VISCOPOSTURE

FOR FOAM PILLOWS (U.S. CLS. 2, 13, 22, 25, 32 AND 50).
H. M. FISHER, EXAMINING ATTORNEY

CLASS 20—(Continued).

SN 78-320,718. CONOCOPHILLIPS COMPANY, HOUSTON, TX. FILED 10-30-2003.



FOR PLASTIC BADGE HOLDERS; NON-METAL AND NON-LEATHER KEY CHAINS (U.S. CLS. 2, 13, 22, 25, 32 AND 50).
CAROL SPILS, EXAMINING ATTORNEY

CLASS 20—(Continued).

SN 78-975,411. STOUT, MARY ELLEN, GARLAND, TX. FILED 4-30-2003.

DESIGN VISIONS

NO CLAIM IS MADE TO THE EXCLUSIVE RIGHT TO USE "DESIGN", APART FROM THE MARK AS SHOWN.
FOR PICTURE FRAMES (U.S. CLS. 2, 13, 22, 25, 32 AND 50).
FIRST USE 1-31-2000; IN COMMERCE 4-30-2000.
DARRYL SPRUILL, EXAMINING ATTORNEY

SN 78-327,962. CONOCOPHILLIPS COMPANY, HOUSTON, TX. FILED 11-14-2003.



FOR PLASTIC BADGE HOLDERS; NON-METAL AND NON-LEATHER KEY CHAINS (U.S. CLS. 2, 13, 22, 25, 32 AND 50).
CAROL SPILS, EXAMINING ATTORNEY

CLASS 21—HOUSEWARES AND GLASS

SN 76-265,490. MOMO PANACHE LIMITED PARTNERSHIP, SAN ANTONIO, TX. FILED 6-4-2001.

MO MO PANACHE

FOR GLASS, STONEWARE AND EARTHEN-WARE DINNERWARE AND TABLEWARE, NAMELY, BEVERAGE GLASSES AND CUPS, STEMWARE, DECANTERS, SUGAR AND CREAMER SETS, ICE BUCKETS, CANDLE HOLDERS NOT OF PRECIOUS METAL, SERVING BOWLS, SERVING PLATTERS, PITCHERS, JAM AND JELLY JARS, CANDY DISHES, VASES AND URNS (U.S. CLS. 2, 13, 23, 29, 30, 33, 40 AND 50).
KAREN M. STRZYZ, EXAMINING ATTORNEY

SN 78-348,518. THE WINE GROUP LLC, LATHROP, CA. FILED 1-6-2004.

THE UN-CORK

THE MARK CONSISTS OF STANDARD CHARACTERS WITHOUT CLAIM TO ANY PARTICULAR FONT, STYLE, SIZE, OR COLOR.
FOR CORKS (U.S. CLS. 2, 13, 22, 25, 32 AND 50).
RICHARD WHITE, EXAMINING ATTORNEY

SN 76-376,143. HOMEDICS, INC., COMMERCE TOWNSHIP, MI. FILED 2-25-2002.

ID BRUSH

NO CLAIM IS MADE TO THE EXCLUSIVE RIGHT TO USE "BRUSH", APART FROM THE MARK AS SHOWN.
FOR ELECTRIC TOOTHBRUSHES (U.S. CLS. 2, 13, 23, 29, 30, 33, 40 AND 50).
MARK T. MULLEN, EXAMINING ATTORNEY

CLASS 21—(Continued).

SN 76-452,938. THE BABY EINSTEIN COMPANY, LLC, BURBANK, CA. FILED 9-25-2002.

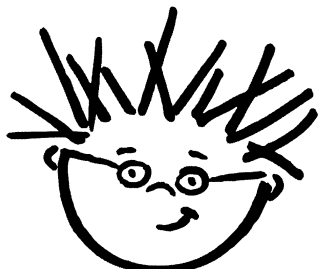

FOR WASTEPAPER BASKETS; BEVERAGE GLASSWARE; BOWLS; LUNCH BOXES; HAIR BRUSHES; CAKE MOLDS; WIND CHIMES; HAIR COMBS; CUPS; DECORATIVE BOXES; DECORATIVE PLATES; FIGURINES OF CHINA, CRYSTAL, EARTHENWARE, GLASS, PORCELAIN, AND TERRA COTTA; COOKIE JARS; TEA KETTLES; MUGS; PAPER CUPS; PAPER PLATES; DISHES; PLATES; SOAP DISHES; TRIVETS; VACUUM BOTTLES; TOOTHBRUSHES; COASTERS NOT OF PAPER AND NOT BEING TABLE LINEN; PLASTIC CUPS; REMOVABLE INSULATING SLEEVE HOLDERS FOR DRINK CANS AND BOTTLES; INSULATED CONTAINERS FOR HOUSEHOLD AND KITCHEN USE; PLASTIC MEAL TRAYS (U.S. CLS. 2, 13, 23, 29, 30, 33, 40 AND 50). DANIELLE MATTESSICH, EXAMINING ATTORNEY

SN 76-506,255. FAMOUS BOARDING WAXES, LLC, LA JOLLA, CA. FILED 4-14-2003.



NO CLAIM IS MADE TO THE EXCLUSIVE RIGHT TO USE SURF WAX, APART FROM THE MARK AS SHOWN. FOR SURF WAX COMBS (U.S. CLS. 2, 13, 23, 29, 30, 33, 40 AND 50). JILL C. ALT, EXAMINING ATTORNEY

SN 76-507,409. WORLD KITCHEN, INC., RESTON, VA. FILED 4-4-2003.

FRENCH COLOURS

FOR BAKING AND SERVING DISHES AND COVERS; CONTAINERS FOR STORING FOOD. (U.S. CLS. 2, 13, 23, 29, 30, 33, 40 AND 50). ANDREA SAUNDERS, EXAMINING ATTORNEY

CLASS 21—(Continued).

SN 76-523,632. DRIP-IT SYSTEMS INTERNATIONAL INC., LACHINE (QUEBEC) H8S 4L8, CANADA, FILED 6-18-2003.



FOR PLANT WATERING UNIT COMPRISING A WATER CONTAINER MOUNTED ON A SOIL ANCHOR HAVING WATER CHANNELS TO WICK WATER AT A PRE-DETERMINED RATE ON THE SOIL OVER A DETERMINED PERIOD (U.S. CLS. 2, 13, 23, 29, 30, 33, 40 AND 50). SOPHIA S. KIM, EXAMINING ATTORNEY

SN 76-526,469. PINEIRA, ANDRES L., MIAMI, FL. FILED 6-20-2003.

Christian's Memorial of Victory

THE MARK CONSISTS OF STANDARD CHARACTERS WITHOUT CLAIM TO ANY PARTICULAR FONT, STYLE, SIZE, OR COLOR.

FOR COMMEMORATIVE STATUARY IN THE NATURE OF AN ORNAMENTAL VIAL FOR DISPLAY TO MEMORIALIZE THE SHED BLOOD OF CHRIST AND ITS SIGNIFICANCE FOR CHRISTIAN BELIEVERS (U.S. CLS. 2, 13, 23, 29, 30, 33, 40 AND 50). TRACY FLETCHER, EXAMINING ATTORNEY

SN 76-530,905. VITA CRAFT CORPORATION, SHAWNEE, KS. FILED 7-21-2003.

MAGIC-COAT

OWNER OF U.S. REG. NO. 2,729,977. FOR NON-ELECTRIC COOKWARE; NAMELY, COOKING PANS, FRY PANS AND BAKING PANS (U.S. CLS. 2, 13, 23, 29, 30, 33, 40 AND 50). KHANH LE, EXAMINING ATTORNEY

SN 76-534,861. TESH, WILLIAM A., SUMMERFIELD, NC. FILED 8-4-2003.

TERMI-A-MONITOR

FOR TERMITE MONITOR IN THE NATURE OF A CONTAINER INTO WHICH BAIT CAN BE PLACED FOR DETERMINING INSECT INFESTATION (U.S. CLS. 2, 13, 23, 29, 30, 33, 40 AND 50). WILLIAM BRECKENFELD, EXAMINING ATTORNEY

CLASS 21—(Continued).

SN 76-538,601. LEIFHEIT INTERNATIONAL USA, INC., MELVILLE, NY. FILED 8-20-2003.

airboard

FOR IRONING BOARDS WITH SPECIAL SURFACE AND COVER (U.S. CLS. 2, 13, 23, 29, 30, 33, 40 AND 50).
FIRST USE 5-1-2000; IN COMMERCE 5-1-2000.
GEORGIA CARTY, EXAMINING ATTORNEY

SN 76-542,194. HOME INTERIORS & GIFTS, INC., CARROLLTON, TX. FILED 9-2-2003.



casa cristal
DOMISTYLE

NO CLAIM IS MADE TO THE EXCLUSIVE RIGHT TO USE CASA AND CRISTAL, APART FROM THE MARK AS SHOWN.

THE MARK CONSISTS OF A WHIMSICAL CURLICUE DESIGN THAT FORMS THE LETTERS "CC", THE WORDS CASA CRISTAL BELOW THE DESIGN IN A STYLIZED LOWER CASE PRINT STYLE AND THE WORD DOMISTYLE IN CAPITAL LETTERS CENTERED BELOW THE WORDS CASA CRISTAL.

THE FOREIGN WORDING IN THE MARK TRANSLATES INTO ENGLISH AS "HOUS" AND "CRYSTAL".

FOR BEVERAGE GLASSWARE; CANDLE HOLDERS AND ACCESSORIES OF NON-PRECIOUS METAL, NAMELY, RINGS, SNUFFERS AND PLATES; VASES; DECORATIVE ACCESSORIES AND WALL DECORATIONS, NAMELY DECORATIVE PLATES AND BOWLS. (U.S. CLS. 2, 13, 23, 29, 30, 33, 40 AND 50).

LAURA KOVAISKY, EXAMINING ATTORNEY

SN 76-544,416. HOME INTERIORS & GIFTS, INC., CARROLLTON, TX. FILED 9-2-2003.



Sol Cerámica
DOMISTYLE

NO CLAIM IS MADE TO THE EXCLUSIVE RIGHT TO USE CERAMICA, APART FROM THE MARK AS SHOWN.

THE STIPPLING IS FOR SHADING PURPOSES ONLY.
THE ENGLISH TRANSLATION OF SOL CERAMICA IS SUN CERAMICS.

FOR DECORATIVE ACCESSORIES AND CERAMIC WALL DECORATIONS, NAMELY, DECORATIVE PLATES, FLOWER POTS, WALL PLANTERS AND CERAMIC FRUIT ORNAMENTS; DINNERWARE; CANDLE HOLDERS AND ACCESSORIES OF NON-PRECIOUS METAL, NAMELY RINGS, SNUFFERS AND PLATES; AND VASES (U.S. CLS. 2, 13, 23, 29, 30, 33, 40 AND 50).

TARAH HARDY, EXAMINING ATTORNEY

CLASS 21—(Continued).

SN 76-547,357. ROBBIE MANUFACTURING, INC., LENEXA, KS. FILED 9-26-2003.

HANDY POUCH

NO CLAIM IS MADE TO THE EXCLUSIVE RIGHT TO USE "POUCH", APART FROM THE MARK AS SHOWN.

FOR PLASTIC FOOD STORAGE CONTAINERS (U.S. CLS. 2, 13, 23, 29, 30, 33, 40 AND 50).

CAROLINE WOOD, EXAMINING ATTORNEY

SN 76-549,953. RENAISSANCE GROUP INTERNATIONAL, TOMS RIVER, NJ. FILED 9-17-2003.

TASKETS

THE MARK CONSISTS OF TASKETS.
FOR WOVEN WOOD BASKETS (U.S. CLS. 2, 13, 23, 29, 30, 33, 40 AND 50).

FIRST USE 11-1-2002; IN COMMERCE 6-1-2003.

LAURA KOVAISKY, EXAMINING ATTORNEY

SN 76-553,135. ROYAL ALLIANCE INC., WOODBRIDGE, ONTARIO, CANADA, FILED 10-21-2003.

DURA-LITE

FOR PLASTIC GARBAGE CONTAINERS (U.S. CLS. 2, 13, 23, 29, 30, 33, 40 AND 50).

DEZMONA MIZELLE, EXAMINING ATTORNEY

SN 76-553,842. RICHARDS, LEIGH, BREA, CA. FILED 10-17-2003.

MR. ALICE

FOR PRINTED BEVERAGE GLASSWARE AND COASTERS NOT OF PAPER NOT BEING TABLE LINEN (U.S. CLS. 2, 13, 23, 29, 30, 33, 40 AND 50).

TARAH HARDY, EXAMINING ATTORNEY

SN 76-553,843. RICHARDS, LEIGH, BREA, CA. FILED 10-17-2003.

GIGGLE SPORTS

NO CLAIM IS MADE TO THE EXCLUSIVE RIGHT TO USE SPORTS, APART FROM THE MARK AS SHOWN.

FOR PRINTED BEVERAGE GLASSWARE AND COASTERS NOT OF PAPER NOT BEING TABLE LINEN (U.S. CLS. 2, 13, 23, 29, 30, 33, 40 AND 50).

TARAH HARDY, EXAMINING ATTORNEY

CLASS 21—(Continued).

SN 76-555,137. UNKENHOLZ, BRIAN, HUEYTOWN, AL.
FILED 10-29-2003.

CHUGGLER

FOR BEER MUGS (U.S. CLS. 2, 13, 23, 29, 30, 33, 40
AND 50).
MATTHEW KLINE, EXAMINING ATTORNEY

SN 76-558,226. GEMBERLING, JERILYN J., HOBE SOUND,
FL. FILED 10-24-2003.

RIBBON OF LIGHT

FOR CRYSTAL GIFT WARE, NAMELY DECORATIVE
SUN CATCHERS MADE OF CRYSTAL SUSPENDED IN
DECORATIVE AND COLLECTIBLE GIFT BOXES, AC-
COMPANIED BY SENTIMENT CARDS (U.S. CLS. 2, 13,
23, 29, 30, 33, 40 AND 50).
DOUGLAS LEE, EXAMINING ATTORNEY

SN 78-222,809. ALTICOR INC., ADA, MI. FILED 3-7-2003.

OPTITEMP

FOR HEAT CONDUCTING BOTTOM SOLD AS AN
INTEGRAL COMPONENT OF COOKWARE (U.S. CLS. 2,
13, 23, 29, 30, 33, 40 AND 50).
MARY CRAWFORD, EXAMINING ATTORNEY

SN 78-224,387. COILHOSE PNEUMATICS, INC., EAST
BRUNSWICK, NJ. FILED 3-11-2003.

TYPHOON

FOR SPRAY NOZZLES FOR USE WITH AIR HOSES
(U.S. CLS. 2, 13, 23, 29, 30, 33, 40 AND 50).
FIRST USE 11-0-2002; IN COMMERCE 11-0-2002.
LINDA ESTRADA, EXAMINING ATTORNEY

SN 78-228,872. THE GOOD MANORS COMPANY, COEUR
D'ALENE, ID. FILED 3-23-2003.

SANI-PLUNGE

FOR ANTI-BACTERIAL AND DECORATIVE TOILET
PLUNGER CONTAINERS (U.S. CLS. 2, 13, 23, 29, 30, 33,
40 AND 50).
FIRST USE 1-30-2003; IN COMMERCE 2-14-2003.
ODESSA BIBBINS, EXAMINING ATTORNEY

CLASS 21—(Continued).

SN 78-233,846. SERVICE IDEAS, INC., WOODBURY, MN.
FILED 4-4-2003.

SELECT-AIR

FOR THERMAL INSULATED DISPENSERS FOR BEV-
ERAGES, NAMELY, COFFEE (U.S. CLS. 2, 13, 23, 29, 30,
33, 40 AND 50).
FIRST USE 3-19-2003; IN COMMERCE 3-19-2003.
LAVERNE THOMPSON, EXAMINING ATTORNEY

SN 78-239,182. LLARDO USA, INC., MOONACHIE, NJ.
FILED 4-17-2003.



FOR PORCELAIN AND CERAMIC VASES, STATU-
ETTES AND FIGURINES (U.S. CLS. 2, 13, 23, 29, 30, 33,
40 AND 50).
GEOFFREY FOSDICK, EXAMINING ATTORNEY

SN 78-245,309. TVS S.P.A., 61020 TRASANNI-URBINO,
ITALY, FILED 5-2-2003.

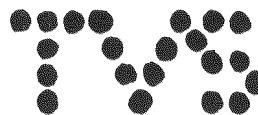

OWNER OF ITALY REG. NO. 00608557, DATED 7-30-1993,
RENEWED AS REG. NO. 00608557, DATED 7-30-2003,
EXPIRES 7-30-2013.

THE STIPPLING SHOWN IN THE DRAWING IS A
FEATURE OF THE MARK AND NOT INTENDED TO
INDICATE COLOR.

THE MARK CONSISTS OF THE LETTERS "TVS" IN
SPECIAL TYPE.

FOR NON-ELECTRICAL COOKING TOOLS, NAMELY
NON-ELECTRIC KETTLES, TEA KETTLES, NON-ELEC-
TRIC MILK BOILERS; KITCHENWARE, NAMELY
POTS, COOKING POTS, TEA POTS NOT MADE OF
PRECIOUS METAL; METAL COOKING POTS AND
PANS, NAMELY CAKE PANS, ROASTING PANS, FRY-
ING PANS, PIE PANS (U.S. CLS. 2, 13, 23, 29, 30, 33, 40
AND 50).

RICHARD WHITE, EXAMINING ATTORNEY

CLASS 21—(Continued).

SN 78-255,864. OMS INVESTMENTS, INC., SANTA MONICA, CA. FILED 5-29-2003.

CELEBRATE THE BEAUTY OF HEALTHY PLANTS

FOR POTTERY, NAMELY FLOWER POTS, PLANT POTS, AND PLANTERS (U.S. CLS. 2, 13, 23, 29, 30, 33, 40 AND 50).

FIRST USE 1-15-2004; IN COMMERCE 1-15-2004.
INGA ERVIN, EXAMINING ATTORNEY

SN 78-267,277. HOMER TLC, INC., CLAYMONT, DE. FILED 6-26-2003.



OWNER OF U.S. REG. NOS. 2,314,081, 2,492,817 AND OTHERS.

FOR WATER BOTTLES SOLD EMPTY, DRINKING GLASSES, MUGS (U.S. CLS. 2, 13, 23, 29, 30, 33, 40 AND 50).

TARAH HARDY, EXAMINING ATTORNEY

SN 78-272,277. SHINE KOHGEI CO., LTD., OSAKA, JAPAN, FILED 7-9-2003.



FOR FRYING PANS, COOKING POTS, GRILL PANS, COOKING UTENSILS IN THE NATURE OF GRILLS, AND CHINESE WOKPANS (U.S. CLS. 2, 13, 23, 29, 30, 33, 40 AND 50).

ELLEN B. AWRICH, EXAMINING ATTORNEY

CLASS 21—(Continued).

SN 78-287,004. BOSTON 2004, INC., BOSTON, MA. FILED 8-13-2003.

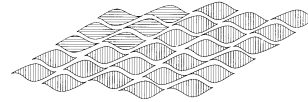

Boston ☆ 2004

Nothing conventional about it.

NO CLAIM IS MADE TO THE EXCLUSIVE RIGHT TO USE "BOSTON" AND "2004", APART FROM THE MARK AS SHOWN.

THE LINING SHOWN IN THE MARK IS TO INDICATE SHADING.

FOR MUGS; THERMAL INSULATED SIPPER CUPS FOR FOODS AND BEVERAGES; BOTTLES SOLD EMPTY; PLASTIC DRINKING GLASS TUMBLERS; THERMAL INSULATED CONTAINERS FOR FOODS AND BEVERAGES; PLATES; NON-METAL PIGGY BANKS; DRINKING GLASSES; BOWLS; DINNERWARE SETS; THERMAL INSULATED CONTAINERS FOR FOODS AND BEVERAGES, NAMELY, INSULATED CAN HOLDERS, THERMAL INSULATED BEVERAGE TOTE BAGS AND INSULATED PORTABLE LUNCH BOX COOLER BAGS; SPORT BOTTLES, SOLD EMPTY; INSULATED BOTTLES, SOLD EMPTY, SHOT GLASSES; BOTTLE OPENERS; AND CERAMIC FIGURINES, NAMELY, ANIMALS (U.S. CLS. 2, 13, 23, 29, 30, 33, 40 AND 50).

GINA FINK, EXAMINING ATTORNEY

SN 78-288,433. PROFESSIONAL DENTAL TECHNOLOGIES, INC., BATESVILLE, AR. FILED 8-18-2003.

PROCLEAN

FOR TOOTH BRUSHES (U.S. CLS. 2, 13, 23, 29, 30, 33, 40 AND 50).

FIRST USE 10-31-2000; IN COMMERCE 10-31-2000.
LANA PHAM, EXAMINING ATTORNEY

SN 78-296,825. 7-ELEVEN, INC., DALLAS, TX. FILED 9-5-2003.

7-ELEVEN BREW KEG

OWNER OF U.S. REG. NOS. 717,344, 2,726,399 AND OTHERS.

NO CLAIM IS MADE TO THE EXCLUSIVE RIGHT TO USE "BREW", APART FROM THE MARK AS SHOWN.

FOR COMBINATION DRINKING CUP AND BEVERAGE CONTAINER (U.S. CLS. 2, 13, 23, 29, 30, 33, 40 AND 50).

FIRST USE 11-3-2003; IN COMMERCE 11-3-2003.
PAUL F. GAST, EXAMINING ATTORNEY

CLASS 21—(Continued).

SN 78-301,599. CINTAS CORP. NO. 3, SPARKS, NV. FILED 9-17-2003.

SANI BIN

NO CLAIM IS MADE TO THE EXCLUSIVE RIGHT TO USE BIN, APART FROM THE MARK AS SHOWN.
FOR RECEPTACLES FOR THE DISPOSAL OF FEMINE HYGIENE PRODUCTS AND WASTE MATERIALS (U.S. CLS. 2, 13, 23, 29, 30, 33, 40 AND 50).
JOHN HWANG, EXAMINING ATTORNEY

SN 78-307,346. SMEDI, HEIDI BETH, PHILADELPHIA, PA. FILED 9-30-2003.

BAGS OF TRUTH: THE ONLY METHOD FOR DISPOSAL / CONTAINMENT / ENTERTAINMENT

FOR DISPOSABLE GLOVES FOR GENERAL USE (U.S. CLS. 2, 13, 23, 29, 30, 33, 40 AND 50).
SUSAN HAYASH, EXAMINING ATTORNEY

SN 78-307,508. SAFCO PRODUCTS CO., MINNEAPOLIS, MN. FILED 9-30-2003.

AT-YOUR-DISPOSAL

FOR TRASH CANS (U.S. CLS. 2, 13, 23, 29, 30, 33, 40 AND 50).
CYNTHIA SLOAN, EXAMINING ATTORNEY

SN 78-309,528. SIERRA ENTERTAINMENT, INC., BELLEVUE, WA. FILED 10-5-2003.

LEISURE SUIT LARRY

FOR LUNCH BOXES, VACUUM FLASKS AND THERMALLY INSULATED CONTAINERS FOR FOOD AND BEVERAGES; PAPER PLATES, PAPER CUPS; MUGS AND CUPS (U.S. CLS. 2, 13, 23, 29, 30, 33, 40 AND 50).
JACQUELINE A. LAVINE, EXAMINING ATTORNEY

SN 78-313,218. LIPTON INVESTMENTS, INC., WILMINGTON, DE. FILED 10-14-2003.

POPSICLE

OWNER OF U.S. REG. NOS. 2,395,882, 2,421,400 AND OTHERS.
FOR TOOTHBRUSHES (U.S. CLS. 2, 13, 23, 29, 30, 33, 40 AND 50).
IRENE D. WILLIAMS, EXAMINING ATTORNEY

CLASS 21—(Continued).

SN 78-315,790. REVLON CONSUMER PRODUCTS CORPORATION, NEW YORK, NY. FILED 10-20-2003.

REVLON

OWNER OF U.S. REG. NOS. 647,222, 1,886,476 AND OTHERS.
FOR LOOFAH SPONGES (U.S. CLS. 2, 13, 23, 29, 30, 33, 40 AND 50).
GEORGE LORENZO, EXAMINING ATTORNEY

SN 78-317,916. FOAMEX ASIA CO., LTD., VISTA, CA. FILED 10-23-2003.

ERGOSAFE

FOR FOAM AND ABRASIVE CLEANING SURFACES WITH HANDLES TO REMOVE PAINTS, INKS, POLYMERS AND OTHER RESIDUE FROM THREE-ROLL MILLS AND OTHER INDUSTRIAL SURFACES, HOLDERS FOR POSITIONING THE CLEANING TOOLS AGAINST THE SURFACES, AND DASHERS TO RECOVER THE RESIDUE FROM THE CLEANING TOOLS (U.S. CLS. 2, 13, 23, 29, 30, 33, 40 AND 50).
RAUL CORDOVA, EXAMINING ATTORNEY

SN 78-328,275. CONOCOPHILLIPS COMPANY, HOUSTON, TX. FILED 11-14-2003.



FOR MUGS; CUPS; BOTTLE OPENERS; SPORTS BOTTLES SOLD EMPTY; SERVING TRAYS NOT OF PRECIOUS METAL; THERMAL INSULATED CONTAINERS FOR FOOD AND BEVERAGE; PORTABLE BEVERAGE COOLERS; PLASTIC WATER BOTTLES SOLD EMPTY; INSULATING SLEEVE HOLDERS FOR BEVERAGE CANS; CRYSTAL FIGURINES; CHINA, CRYSTAL, GLASS, PORCELAIN, AND TERRACOTTA ORNAMENTS; PLASTIC COASTERS (U.S. CLS. 2, 13, 23, 29, 30, 33, 40 AND 50).
CAROL SPILS, EXAMINING ATTORNEY

CLASS 21—(Continued).

SN 78-341,711. CONOCOPHILLIPS COMPANY, HOUSTON, TX. FILED 12-16-2003.



FOR MUGS; CUPS; BOTTLE OPENERS; SPORTS BOTTLES SOLD EMPTY; SERVING TRAYS NOT OF PRECIOUS METAL; THERMAL INSULATED CONTAINERS FOR FOOD AND BEVERAGE; PORTABLE BEVERAGE COOLERS; PLASTIC WATER BOTTLES SOLD (U.S. CLS. 2, 13, 23, 29, 30, 33, 40 AND 50).
CAROL SPILS, EXAMINING ATTORNEY

CLASS 22—(Continued).

SN 78-223,024. QINETIQ LIMITED, LONDON, UNITED KINGDOM, FILED 3-7-2003.

X-NET

PRIORITY CLAIMED UNDER SEC. 44(D) ON ERPN CMNTY TM OFC APPLICATION NO. 002957033, FILED 12-4-2002.

FOR VEHICLE ARRESTING DEVICE, NAMELY A SPIKED NON-METALLIC NET TO WRAP AROUND AND PREVENT ROTATION OF VEHICLE'S WHEELS (U.S. CLS. 1, 2, 7, 19, 22, 42 AND 50).
FIRST USE 9-15-2003; IN COMMERCE 9-15-2003.
MONIQUE MILLER, EXAMINING ATTORNEY

CLASS 22—CORDAGE AND FIBERS

SN 76-549,771. CORDOARIA SAO LEOPOLDO S.A., RIO GRANDE DO SUL, BRAZIL, FILED 9-15-2003.



FOR NON-METALLIC CORDS, STRINGS AND ROPES, NAMELY, MOORING AND ANCHORING ROPES (U.S. CLS. 1, 2, 7, 19, 22, 42 AND 50).
FIRST USE 1-10-1997; IN COMMERCE 1-10-1997.
MICHAEL HALL, EXAMINING ATTORNEY

HARBOR SHELL

FOR UNFITTED BOAT COVERS (U.S. CLS. 1, 2, 7, 19, 22, 42 AND 50).
FIRST USE 11-18-2002; IN COMMERCE 3-1-2003.
SCOTT OSCLICK, EXAMINING ATTORNEY

SN 78-277,362. THE COLEMAN COMPANY, INC., WICHITA, KS. FILED 7-22-2003.

SIERRA TRAILS

OWNER OF U.S. REG. NO. 2,175,999.
FOR TENTS, FABRIC TARPAULINS, FABRIC CANOPIES, AWNINGS NOT OF METAL, AWNINGS OF FABRIC USED TO PROVIDE SHADE FROM THE SUN (U.S. CLS. 1, 2, 7, 19, 22, 42 AND 50).
CHRISTOPHER ADKINS, EXAMINING ATTORNEY

SN 76-552,399. SHARPS MANUFACTURING, INC., HOUSTON, TX. FILED 9-29-2003.

ISOWASH

FOR POLYVINYL ALCOHOL FILM COLLECTION AND WASH BAGS FOR CONTAMINATED LINENS (U.S. CLS. 1, 2, 7, 19, 22, 42 AND 50).
FIRST USE 8-0-2003; IN COMMERCE 8-0-2003.
CYNTHIA SLOAN, EXAMINING ATTORNEY

CLASS 23—YARNS AND THREADS

SN 78-305,854. LUDLOW TEXTILES COMPANY, INC., LUDLOW, MA. FILED 9-26-2003.

VICTOR

FOR LINEN THREAD (U.S. CL. 43).
FIRST USE 9-7-1896; IN COMMERCE 9-7-1896.
CAROLYN GRAY, EXAMINING ATTORNEY

CLASS 24—FABRICS

SN 76-503,418. ALMOST NOTHING, INC., LOS ANGELES, CA. FILED 4-1-2003.

WARM AS TOAST

FOR THROWS AND PILLOWS (U.S. CLS. 42 AND 50).
FIRST USE 2-0-2003; IN COMMERCE 2-0-2003.
ROBIN CHOSID, EXAMINING ATTORNEY

SN 76-526,984. SOZO LLC, FARMINGTON, CT. FILED 6-30-2003.

SOZO

THE FOREIGN WORDING IN THE MARK TRANSLATES INTO ENGLISH AS CREATION AND IMAGINATION.

FOR WINDOW CURTAINS, BED SHEETS, BED BLANKETS, RECEIVING BLANKETS, QUILTS, PILLOW CASES, BED SKIRTS, CRIB BUMPERS, CRIB SKIRTS, TOWELS, WASHCLOTHS, SHOWER CURTAINS, TEXTILE WALL HANGINGS, AND FABRIC DIAPER STACKERS (U.S. CLS. 42 AND 50).

AMY LOHR, EXAMINING ATTORNEY

SN 76-530,952. MP N.Y. INDUSTRIES, INC., NEW YORK, NY. FILED 7-21-2003.

OLLIE & ME

FOR TEXTILE TABLE CLOTHES, CURTAINS, DRAPERIES AND BULK FABRICS SOLD TO HOME SEWING INDUSTRY AND APPAREL MANUFACTURERS; BEDDING, NAMELY, BED SPREADS, QUILTS, COMFORTERS, PILLOWCASES, BED SHEETS, MATTRESS PADS AND MATTRESS COVERS (U.S. CLS. 42 AND 50).

FIRST USE 12-1-2001; IN COMMERCE 12-1-2001.

RON FAIRBANKS, EXAMINING ATTORNEY

CLASS 24—(Continued).

SN 76-533,230. MAYER-PAETZ, INC., INDIANAPOLIS, IN. FILED 7-29-2003.

**Eco System**

OWNER OF U.S. REG. NO. 2,065,637.
NO CLAIM IS MADE TO THE EXCLUSIVE RIGHT TO USE "SYSTEM", APART FROM THE MARK AS SHOWN.
FOR FABRIC FOR USE IN MANUFACTURE OF PANELS AND FURNITURE (U.S. CLS. 42 AND 50).
ARETHA MASTERSON, EXAMINING ATTORNEY

SN 76-534,136. FLAPPIN' FLAGS, EUGENE, OR. FILED 8-4-2003.

PIRATEHEADS

FOR CLOTH FLAGS (U.S. CLS. 42 AND 50).
FIRST USE 1-1-2000; IN COMMERCE 1-1-2000.
JOHN HWANG, EXAMINING ATTORNEY

SN 76-548,034. BED DESIGN STUDIO, INC., MIAMI, FL. FILED 9-29-2003.



FOR BEDDING, NAMELY, COMFORTERS, BED COVERS, BED SHEETS, BED SHEET SETS, SHAMS, PILLOW CASES, DUST RUFFLES, DUVET COVERS, BED BLANKETS, QUILTS, BED SKIRTS; CURTAINS, FABRIC VALANCES (U.S. CLS. 42 AND 50).

JEFFREY S. MOLINOFF, EXAMINING ATTORNEY

CLASS 24—(Continued).

SN 76-552,115. BED DESIGN STUDIO, INC., MIAMI, FL. FILED 9-29-2003.

DO-BED IN A PACK

FOR BEDDING, NAMELY, COMFORTERS, BED COVERS, BED SHEETS, BED SHEET SETS, SHAMS, PILLOW CASES, DUST RUFFLES, DUVET COVERS, BED BLANKETS, QUILTS, BED SKIRTS; CURTAINS, FABRIC VALANCES (U.S. CLS. 42 AND 50).

JEFFREY S. MOLINOFF, EXAMINING ATTORNEY

SN 78-241,064. HOLLANDER HOME FASHIONS CORP., BOCA RATON, FL. FILED 4-23-2003.

FENG SHUI AURA

NO CLAIM IS MADE TO THE EXCLUSIVE RIGHT TO USE "FENG SHUI", APART FROM THE MARK AS SHOWN.

FOR COMFORTERS, BED SHEETS, PILLOW CASES, BED RUFFLES, PILLOW SHAMS, DUVET COVERS, TABLE ROUNDS AND WINDOW TREATMENTS NAMELY WINDOW CURTAINS, WINDOW SCARVES, FABRIC CURTAIN TIEBACKS AND TEXTILE WINDOW COVERING PANELS, DUST RUFFLES, MATTRESS PADS, MATTRESS TOPPERS, MATTRESS COVERS, FEATHERBEDS AND BED BLANKETS (U.S. CLS. 42 AND 50).

LAURA KOVAISKY, EXAMINING ATTORNEY

SN 78-249,574. LKG, INC., CHATSWORTH, CA. FILED 5-14-2003.

THE CUDDLER

FOR BLANKETS (U.S. CLS. 42 AND 50).
FIRST USE 2-15-2003; IN COMMERCE 2-15-2003.
DAWN FELDMAN, EXAMINING ATTORNEY

SN 78-283,371. JADEN FABRICS, INC., DALLAS, TX. FILED 8-5-2003.

METROPOLIS

FOR MOISTURE BARRIER FABRICS FOR THE MANUFACTURE OF UPHOLSTERY, BOOTH BACKS AND TABLECLOTHS (U.S. CLS. 42 AND 50).

JENNIFER CHICOSKI, EXAMINING ATTORNEY

SN 78-292,094. QVC, INC., WEST CHESTER, PA. FILED 8-26-2003.

SENSIVE

FOR FABRICS FOR THE MANUFACTURE OF THROWS, COMFORTERS AND PILLOWS (U.S. CLS. 42 AND 50).

ANDREA SAUNDERS, EXAMINING ATTORNEY

CLASS 24—(Continued).

SN 78-294,253. 2THEPOINT INNOVATION, INC., CHESTERFIELD, MO. FILED 8-29-2003.



FOR TOWELS (U.S. CLS. 42 AND 50).
FIRST USE 11-1-2001; IN COMMERCE 4-1-2002.
STACY WAHLBERG, EXAMINING ATTORNEY

SN 78-305,401. LOUISVILLE BEDDING COMPANY, LOUISVILLE, KY. FILED 9-25-2003.

VISCO MAX

FOR MATTRESS PADS; FOAM MATTRESS PADS (U.S. CLS. 42 AND 50).
H. M. FISHER, EXAMINING ATTORNEY

SN 78-305,408. LOUISVILLE BEDDING COMPANY, LOUISVILLE, KY. FILED 9-25-2003.

MICRO VISCO

FOR MATTRESS PADS; FOAM MATTRESS PADS (U.S. CLS. 42 AND 50).
H. M. FISHER, EXAMINING ATTORNEY

SN 78-310,722. ROTH FABRIC, INC., NORWALK, CT. FILED 10-8-2003.

FOCUS FABRICS

NO CLAIM IS MADE TO THE EXCLUSIVE RIGHT TO USE "FABRICS", APART FROM THE MARK AS SHOWN.
FOR UPHOLSTERY AND DRAPERY FABRICS (U.S. CLS. 42 AND 50).
SUSAN HAYASH, EXAMINING ATTORNEY

SN 78-314,385. LOUISVILLE BEDDING COMPANY, LOUISVILLE, KY. FILED 10-16-2003.

EDU-GEAR

FOR MATTRESS PADS, BED COVERS, FOAM AND QUILTED MATTRESS PADS (U.S. CLS. 42 AND 50).
KIMBERLY PERRY, EXAMINING ATTORNEY

CLASS 24—(Continued).

SN 78-314,392. LOUISVILLE BEDDING COMPANY, LOUISVILLE, KY. FILED 10-16-2003.

SCHOOL'S HARD, YOUR BED SHOULDN'T BE

FOR MATTRESS PADS, BED COVERS, FOAM AND QUILTED MATTRESS PADS (U.S. CLS. 42 AND 50).
KIMBERLY PERRY, EXAMINING ATTORNEY

SN 78-315,706. SAUCONY, INC., PEABODY, MA. FILED 10-20-2003.

PROLETE

FOR FABRIC FOR APPAREL (U.S. CLS. 42 AND 50).
STEVEN R. FINE, EXAMINING ATTORNEY

SN 78-319,658. LOUISVILLE BEDDING COMPANY, LOUISVILLE, KY. FILED 10-28-2003.

VISCOPOSTURE

FOR FOAM MATTRESS PADS (U.S. CLS. 42 AND 50).
H. M. FISHER, EXAMINING ATTORNEY

CLASS 25—CLOTHING

SN 75-247,513. LA LINS COMPANY LIMITED, KWUN TONG, KOWLOON, HONG KONG, FILED 2-25-1997.



Fairway

THE STIPPLING SHOWN IN THE DRAWING IS FOR SHADING PURPOSES ONLY, AND IS NOT A FEATURE OF THE MARK.

FOR UNDERWEAR, SINGLETs, SWIMMING SUITS, BEACHWEAR, VESTS, SUITS, TROUSERS, SKIRTS, CHILDREN'S CLOTHING, NAMELY, SHORTS, SKIRTS, DRESSES, SLACKS, HOSIERY, COATS, JACKETS; OVERCOATS, SWEATERS, T-SHIRTS, SPORT SHIRTS, POLO SHIRTS, BLOUSES, PANTS, SOCKS, STOCKINGS, SCARVES, HATS, BELTS (FOR WEAR), SHOES, BOOTS (U.S. CLS. 22 AND 39).

STEVEN BERK, EXAMINING ATTORNEY

SN 75-427,036. MINNESOTA WILD HOCKEY CLUB, L.P., ST. PAUL, MN. FILED 2-2-1998.

MINNESOTA WILD

SEC. 2(F) AS TO "MINNESOTA".
FOR CLOTHING, NAMELY, SHIRTS, SWEATSHIRTS, AND HATS (U.S. CLS. 22 AND 39).

FIRST USE 6-11-1991; IN COMMERCE 4-22-1996.
MARK T. MULLEN, EXAMINING ATTORNEY

SN 75-642,072. INTERSPORT FASHIONS WEST, TUSTIN, CA. FILED 2-17-1999.

SCOUT

FOR CLOTHING, NAMELY JACKETS MADE PRINCIPALLY OF LEATHER FOR WEAR BY MOTORCYCLE RIDERS (U.S. CLS. 22 AND 39).

FIRST USE 12-0-1991; IN COMMERCE 12-0-1991.
MONIQUE MILLER, EXAMINING ATTORNEY

CLASS 25—(Continued).

SN 75-786,953. KABUSHIKI KAISHA HEIWA SENI, OSAKA-SHI, OSAKA, JAPAN, FILED 8-27-1999.

NOBU NAKANO

FOR CLOTHING, NAMELY, BLOUSES, SKIRTS, PANTS, JACKETS, VESTS, COATS, SUITS, DRESSES, JUMPERS AND SHIRTS (U.S. CLS. 22 AND 39).
TARAH HARDY, EXAMINING ATTORNEY

SN 76-159,579. STUPID BOY STUFF, INC., CLARENCE CENTER, NY. FILED 11-6-2000.



FOR CLOTHING, NAMELY SWEATSHIRTS, SHIRTS, HATS, JACKETS, SHORTS, AND PANTS (U.S. CLS. 22 AND 39).

FIRST USE 1-15-2001; IN COMMERCE 1-15-2001.
KIM SAITO, EXAMINING ATTORNEY

SN 76-220,188. NATIONAL CORSET SUPPLY HOUSE, LOS ANGELES, CA. FILED 3-5-2001.

FEMME FORM

NO CLAIM IS MADE TO THE EXCLUSIVE RIGHT TO USE FEMME, APART FROM THE MARK AS SHOWN.

FOR CLOTHING; NAMELY WOMEN'S UNDERGARMENTS, LINGERIE, BODYSUITS, BRASSIERES, CHEMISES, CORSETS, GARTER BELTS, GARTERS, GIRDLES, HALF SLIPS, HOSIERY, NIGHTGOWNS, PAJAMAS, PANTIES, PANTYHOSE, PEIGNOIR SETS, ROBES, SHIRTS (U.S. CLS. 22 AND 39).

SHARI SHEFFIELD, EXAMINING ATTORNEY

SN 76-259,399. FLESH GEAR, LLC, MALIBU, CA. FILED 5-18-2001.

FLESH GIRL

NO CLAIM IS MADE TO THE EXCLUSIVE RIGHT TO USE "GIRL", APART FROM THE MARK AS SHOWN.

FOR CLOTHING, NAMELY, TOPS, T-SHIRTS, JERSEYS, BLOUSES, SWEATERS, PULLOVERS, PANTS, TROUSERS, DENIM JEANS, SHORTS, RIDING PANTS, MOTOCROSS PANTS, WOMEN'S SUITS, DRESSES, SKIRTS, HALTER TOPS, NIGHTGOWNS, SWEATPANTS, SWEATSHIRTS, BEACH WEAR, SWIMWEAR, BIKINIS, BATHING SUITS, SWIM TRUNKS, PAREUS, UNDERWEAR, LINGERIE, CAMISOLES, SCARVES, BELTS, GLOVES, JACKETS, COATS, VESTS, BLAZERS, CARDIGANS; HEADWEAR, NAMELY, CAPS, HATS, VISORS, BANDANAS, BERETS, BEANIES; FOOTWEAR, NAMELY, SHOES, SOCKS, HOSIERY, SLIPPERS, BOOTS, MOTOCROSS SHOES, RIDING BOOTS, SANDALS, THONGS (U.S. CLS. 22 AND 39).

MICHAEL BAIRD, EXAMINING ATTORNEY

CLASS 25—(Continued).

SN 76-299,060. RBR, LLC, VERNON, CA. FILED 8-13-2001.



NO CLAIM IS MADE TO THE EXCLUSIVE RIGHT TO USE "JEANS", APART FROM THE MARK AS SHOWN.

THE FOREIGN WORDING IN THE MARK TRANSLATES INTO ENGLISH AS "JOY".

FOR WOMEN'S SPORTSWEAR, NAMELY, JEANS, PANTS, SHIRTS, JACKETS, T-SHIRTS, DRESSES AND SKIRTS (U.S. CLS. 22 AND 39).

FIRST USE 8-0-2001; IN COMMERCE 8-0-2001.
KIM SAITO, EXAMINING ATTORNEY

SN 76-401,764. AB BLAKLADER, S-512 53 SVENLJUNGA, SWEDEN, FILED 4-26-2002.



OWNER OF SWEDEN REG. NO. 330,158, DATED 2-12-1999, EXPIRES 2-12-2009.

NO CLAIM IS MADE TO THE EXCLUSIVE RIGHT TO USE BLAKLADER, APART FROM THE MARK AS SHOWN.

THE STIPPLING IS FOR SHADING PURPOSES.

THE ENGLISH TRANSLATION OF THE WORD BLÄKLÄDER IN THE MARK IS BLUE CLOTHES.

FOR CLOTHING, NAMELY, FOOTWEAR, HEADWEAR, JACKETS, TROUSERS, VESTS, BIB OVERALLS, SLEEVELESS OVERALLS, OVERALLS, SHORTS, PARKA JACKETS, PULLOVERS, SHIRTS, T-SHIRTS, POLO-SHIRTS, CAPS, BELTS, UNDERWEAR, AND FLAME RETARDANT CLOTHING, NAMELY, JACKETS, TROUSERS, AND UNDERWEAR (U.S. CLS. 22 AND 39).

MICHAEL BAIRD, EXAMINING ATTORNEY

SN 76-403,207. JASMINE ENTERPRISES, INC., HANOVER PARK, IL. FILED 5-2-2002.

JADE BY JASMINE

OWNER OF U.S. REG. NO. 1,390,916.

FOR BRIDAL DRESSES, LADIES' EVENING DRESSES, LADIES' DAYTIME DRESSES, CHILDREN'S DRESSES AND SUITS, BRIDAL HEADGEAR, NAMELY BRIDAL HEADBANDS, BRIDAL GARLANDS AND BRIDAL VEILS, VEILS, GLOVES, HOSIERY, MEN'S TUXEDOS AND SUITS AND SPECIFICALLY EXCLUDING FOOTWEAR (U.S. CLS. 22 AND 39).

LAVERNE THOMPSON, EXAMINING ATTORNEY

CLASS 25—(Continued).

SN 76-434,908. SUZUKI, NOBUYUKI, NISHIKASUGAI-GUN, AICHI, JAPAN, FILED 7-26-2002.



THE MARK CONSISTS OF STYLIZED LETTERS FORMED BY A MULTIPLEX LINE, COMPRISING A LOWER CASE "G" CONTIGUOUSLY ENCOMPASSED BY AN "S", IN TURN CONTIGUOUSLY BOUNDED BY AN "O" THUS FORMING THE OUTSIDE EDGE OF THE DESIGN. FOR CLOTHING NAMELY BELTS, BOOTS, BRACES, CAPS, COATS, GARTERS, GLOVES, HATS, JACKETS, JERSEYS, JUMPERS, KNITWEAR, NAMELY KNIT SHIRTS AND PANTS, SCARVES, OVERALLS, OVERCOATS, PAJAMAS, PANTS, PULLOVERS, SANDALS, SHIRTS, SHOES, SOCK SUSPENDERS, SOCKS, SPORTS JERSEYS, ATHLETIC SHOES, SPORTSWEAR, NAMELY POLO SHIRTS, ATHLETIC JERSEYS, STOCKINGS, SUSPENDERS, SWEATERS, UNDERCLOTHING, UNDERPANTS, UNIFORMS, FOOTWEAR AND HEADGEAR, NAMELY, HEADWEAR, HATS, CAPS (U.S. CLS. 22 AND 39).

FIRST USE 4-1-2002; IN COMMERCE 4-1-2002.
SONYA STEPHENS, EXAMINING ATTORNEY

SN 76-440,055. DILLARD'S INC., LITTLE ROCK, AR. FILED 8-12-2002.



FOR WOMEN'S TOPS, SHORTS, PANTS, SWEATERS, JACKETS AND SKIRTS (U.S. CLS. 22 AND 39).
BILL DAWE, EXAMINING ATTORNEY

CLASS 25—(Continued).

SN 76-443,678. CONFEDERATE ENTERPRISES, INC., PIEDMONT, AL. FILED 8-23-2002.



NO CLAIM IS MADE TO THE EXCLUSIVE RIGHT TO USE "APPAREL CO." AND "THE DESIGN OF THE OUTLINE OF THE SOUTHERN STATES OF THE UNITED STATES", APART FROM THE MARK AS SHOWN.

THE COLOR(S) RED, WHITE, BLUE AND BLACK IS/ARE CLAIMED AS A DISTINCTIVE FEATURE OF THE MARK.

THE COLOR WHITE APPEARS IN THE STARS AND THE OUTER BORDER OF THE CROSSING STRIPES. THE COLOR BLUE APPEARS IN THE CROSSING STRIPES. THE COLOR RED APPEARS ON THE OUTER PORTION OF THE CROSSED STRIPES. THE COLOR BLACK APPEARS IN THE WORDING, THE BARS AND ARROWHEAD AND THE OUTLINE OF THE INDIVIDUAL STATES.

THE MARK CONSISTS OF AN IMAGE OF THIRTEEN (13) SOUTHERN STATES (TEXAS, LOUISIANA, ARKANSAS, MISSOURI, MISSISSIPPI, ALABAMA, KENTUCKY, TENNESSEE, GEORGIA, FLORIDA, SOUTH CAROLINA, NORTH CAROLINA AND VIRGINIA) WITH AN BACKGROUND OF AN IMAGE OF A CONFEDERATE FLAG.

FOR CLOTHING, NAMELY, SHIRTS, PANTS, HEADWEAR AND SHOES (U.S. CLS. 22 AND 39).

FIRST USE 12-1-2000; IN COMMERCE 12-1-2000.
RUDY R. SINGLETON, EXAMINING ATTORNEY

SN 76-444,865. COLORLAND ANIMATION PRODUCTIONS LIMITED, HONG KONG, FILED 8-28-2002.

IN SEARCH OF SANTA

FOR CLOTHING, NAMELY, JACKETS, DRESSING GOWNS, PAJAMAS, PULLOVERS, T-SHIRTS, SHIRTS, BATHING TRUNKS, BATHING SUITS, RAINCOATS, RAINCAPS, SHAWLS, SOCKS, GLOVES, NECKTIES, SCARVES; FOOTWEAR, NAMELY, SANDALS, SLIPPERS, SHOES, RAIN BOOTS; HEADWEAR, NAMELY, CAPS; CHILDREN'S CLOTHING, NAMELY, JACKETS, DRESSING GOWNS, PAJAMAS, PULLOVERS, T-SHIRTS, SHIRTS, BATHING TRUNKS, BATHING SUITS, RAINCAPS, SHAWLS, SOCKS, GLOVES, NECKTIES, SCARVES (U.S. CLS. 22 AND 39).

CHRISIE B. KING, EXAMINING ATTORNEY

CLASS 25—(Continued).

SN 76-450,048. BURRELL-UZOR, ALONA ROCHELLE, SIGNAL HILL, CA. FILED 9-9-2002.



FOR CLOTHING; NAMELY SWEATSHIRTS, T-SHIRTS, SPORTS SHIRTS AND JERSEYS, TANK TOPS, JACKETS, HATS, CAPS, SUN VISORS, SOCKS, SHORTS, BATHING SUITS AND CHILDREN'S CLOTHING EATING BIBS AND CREEPERS (U.S. CLS. 22 AND 39).

FIRST USE 6-0-1984; IN COMMERCE 6-0-1984.
CHRISTOPHER BUONGIORNO, EXAMINING ATTORNEY

SN 76-462,198. SANTOS LAGUNA, S.A. DE C.V., TORREON, COAHUILA, C.P. 27000, MEXICO, FILED 10-28-2002.



OWNER OF MEXICO REG. NO. 589929, DATED 10-10-1996, EXPIRES 10-10-2006.

THE ENGLISH TRANSLATION OF THE WORD "SANTOS LAGUNA" IN THE MARK IS "SAINTS OF THE LAGOON".

FOR CLOTHING, NAMELY SWEATSHIRTS, T-SHIRTS, GOLF AND TENNIS SHIRTS, JACKETS, HATS, CAPS, SUN VISORS, SOCKS, PATCHES, SHORTS, SPORTSWEAR AND BATHING SUITS (U.S. CLS. 22 AND 39).

SCOTT OSLICK, EXAMINING ATTORNEY

CLASS 25—(Continued).

SN 76-488,945. GEORGE PINA AND SANDRA PINA, PARTNERSHIP, THE, DBA PENDING MOTHERHOOD STYLES, CALIFORNIA, CA. FILED 2-10-2003.



NO CLAIM IS MADE TO THE EXCLUSIVE RIGHT TO USE STYLES, APART FROM THE MARK AS SHOWN.

THE MARK CONSIST OF A GREEN TURTLE WITH AN ORANGE BODY, HATCHED FROM AN EGG. THE EGG IS SPLIT IN HALF, PALE YELLOW OUTSIDE AND BLACK INSIDE. BOTH TURTLE AND EGG ARE ON THE BACKDROP OF A PALE BLUE SKY WITH WHITE STARS. THE WORDING "P.M.S." PENDING MOTHERHOOD STYLES APPEARS ON THE BOTTOM RIGHT. JUST A SMALL SECTION OF AN ECLIPSED SUN APPEARS ON LOWER RIGHT SIDE OF THE BACKGROUND.

FOR CLOTHING, NAMELY, T-SHIRTS, SWEATSHIRTS, DRESSES, SKIRTS, SHORTS, PANTS, CAPS, ROBES, PAJAMAS (U.S. CLS. 22 AND 39).

NICHOLAS ALTREE, EXAMINING ATTORNEY

SN 76-491,985. NATIONAL ASSOCIATION FOR STOCK CAR AUTO RACING, INC., DAYTONA BEACH, FL. FILED 2-24-2003.



OWNER OF U.S. REG. NOS. 967,256, 2,273,535 AND OTHERS.

THE LINING SHOWN IN THE DRAWING IS A FEATURE OF THE MARK AND NOT INTENDED TO INDICATE COLOR.

FOR CLOTHING, NAMELY T-SHIRTS, COLLARED SHIRTS, SPORT SHIRTS, SWEATSHIRTS, SLEEVELESS TANK TOPS, JACKETS, SWEATERS, CAPS, HATS, SUN VISORS, SHORTS, PANTS, SHOES, SOCKS, AND BELTS (U.S. CLS. 22 AND 39).

FIRST USE 7-18-2002; IN COMMERCE 7-18-2002.

JOHN HWANG, EXAMINING ATTORNEY

CLASS 25—(Continued).

SN 76-494,268. RALSEY GROUP, LTD., NEW YORK, NY.
FILED 3-3-2003.



FOR WOMEN'S WEARING APPAREL, NAMELY, SWEATERS, T-SHIRTS, CARDIGANS, AND SKIRTS (U.S. CLS. 22 AND 39).

FIRST USE 2-17-1999; IN COMMERCE 2-17-1999.
TARAH HARDY, EXAMINING ATTORNEY

SN 76-496,144. FIESTA PALMS, LLC, LAS VEGAS, NV.
FILED 3-10-2003.

PALMS

FOR WEARING APPAREL, NAMELY, POLO SHIRTS, T-SHIRTS, TANK TOPS, SHIRTS, JACKETS, JOGGING SUITS, SWEAT SHIRTS, SWEAT PANTS, JEANS, PANTS, ROBES, SLEEPWEAR, ROMPERS, BELTS, SCARVES, HATS AND CAPS, SOLD ONLY AT RETAIL STORES LOCATED IN APPLICANT'S CASINO RESORT HOTEL (U.S. CLS. 22 AND 39).

JILL C. ALT, EXAMINING ATTORNEY

SN 76-497,182. CERVECERIA DEL PACIFICO, S.A. DE C.V.,
82000 MAZATLAN, SINALOA, MEXICO, FILED 3-14-2003.

PACIFICO

OWNER OF U.S. REG. NOS. 1,726,063 AND 2,534,167.
THE ENGLISH TRANSLATION OF THE WORD "PACIFICO" IN THE MARK IS "PACIFIC".

FOR CLOTHING, NAMELY SWEATSHIRTS, T-SHIRTS, GOLF AND TENNIS SHIRTS, JACKETS, HATS, CAPS, SUN VISORS, SOCKS, PATCHES, SHORTS; SPORTSWEAR, NAMELY, BATHING SUITS AND SWEAT SUITS (U.S. CLS. 22 AND 39).

FIRST USE 0-0-1986; IN COMMERCE 0-0-1986.
LINDA ESTRADA, EXAMINING ATTORNEY

SN 76-497,886. STRATEGIC PARTNERS, INC., PACOIMA,
CA. FILED 3-17-2003.

SCRUBS U

NO CLAIM IS MADE TO THE EXCLUSIVE RIGHT TO USE "SCRUBS", APART FROM THE MARK AS SHOWN.

FOR NON-SURGICAL MEDICAL AND HEALTHCARE UNIFORMS AND FASHION APPAREL, NAMELY, TOPS, BOTTOMS, HEADWEAR AND FOOTWEAR (U.S. CLS. 22 AND 39).

CYNTHIA SLOAN, EXAMINING ATTORNEY

CLASS 25—(Continued).

SN 76-498,111. WEIZMAN, ALAIN, F-75017 PARIS, FRANCE,
FILED 2-19-2003.



OWNER OF FRANCE REG. NO. 013089948, DATED 3-20-2001, EXPIRES 3-20-2011.

FOR CLOTHING, NAMELY, PETTICOATS, SPORTS JACKETS, VESTS, JACKETS, COATS, RAINCOATS, OVERCOATS, ANORAKS, WAIST COATS, CAPES, CLOAKS, PULLOVERS, CARDIGANS, JERSEYS, JERKINS, JUMPERS, TRACK SUITS, PANTS, TROUSERS, SLACKS, LEGGINGS, SWEATERS, SWEATSHIRTS, SWEAT PANTS, JACKETS, BLOUSES, BODYSUITS, DRESSES, SKIRTS, T-SHIRTS, TANK TOPS, SHORTS, JEANS, SUITS, SOCKS, STOLE, SCARVES, HATS, GLOVES, BELTS, UNDERWEAR, CORSETS AND BATHING SUITS (U.S. CLS. 22 AND 39).

REBECCA SMITH, EXAMINING ATTORNEY

SN 76-500,308. JOHNSTON, DONALD L., LOUISVILLE, KY.
FILED 3-25-2003.

FLEUR DE LOUISVILLE

NO CLAIM IS MADE TO THE EXCLUSIVE RIGHT TO USE LOUISVILLE, APART FROM THE MARK AS SHOWN.
THE ENGLISH TRANSLATION OF THE WORD FLEUR DE IN THE MARK IS FLOWER OF.

FOR CLOTHING, NAMELY, JOGGING SUITS, DRESSES, WARM-UP SUITS, SWEAT SUITS, SKIRTS, CROP TOPS, SWEAT PANTS AND BODY SUITS, WRAPS, SKI JACKETS, LEOTARDS, UNITARDS, SWIMWEAR NAMELY BATHING SUITS, TIGHTS, BATHING SUITS, BLOUSES, BEACH AND BATHING COVERUPS, SUITS, SLACKS, PANTS JEANS, SHORTS, SWEAT SHIRTS SWEAT SHORTS, GYM SHORTS, TOPS, JACKETS, COATS, SPORT COATS, SHIRTS, SPORT SHIRTS, T-SHIRTS, KNIT SHIRTS, BIKINIS, POLO SHIRTS, PULL-OVERS, SWEATERS, VESTS, TANK TOPS, BLAZERS, JUMPSUITS, PLAYSUITS, OVERCOATS, PARKAS, WIND RESISTANT JACKETS, LEATHER JACKETS, FOOTWEAR, SHOES, BOOTS, SLIPPERS, ATHLETIC FOOTWEAR, BASKETBALL SHOES, CASUAL FOOTWEAR, SANDALS, HEAD WEAR, HATS CAPS, VISORS, HOODS, BERETS, HEADBANDS, SWEAT BANDS, WRIST BANDS, EAR MUFFS, NECKWEAR, NECKTIES, NECKERCHIEFS, SCARVES, BANDANNAS, SLEEPWEAR, ROBES, PAJAMAS, NIGHTSHIRTS, RAINWEAR, GLOVES, MITTENS, GALOSHES, LOUNGEWEAR, UNDERWEAR, BRIERS, UNDERPANTS, BOXER SHORTS, UNDERSHIRTS, SUSPENDERS, HOSIERY, SOCKS, BELTS, AND APRONS, AND SHOES (U.S. CLS. 22 AND 39).

JANICE L. MCMORROW, EXAMINING ATTORNEY

CLASS 25—(Continued).

SN 76-501,995. FORMAN MILLS, INC., PENNSAUKEN, NJ. FILED 3-27-2003.

BIG MA HOFF

FOR CLOTHING AND ACCESSORIES, NAMELY, SHORTS, TANK-TOPS, T-SHIRTS, WARM-UP SUITS, SWEATPANTS, SWEATSHIRTS, KNIT SHIRTS, GOLF SHIRTS, SWEATERS, PAJAMAS, UNDERWEAR, HATS, CAPS, VISORS, FOOTWEAR, ROBES, SHOES AND OUTERWEAR, NAMELY, RAIN WEAR, SKI WEAR, COATS AND JACKETS (U.S. CLS. 22 AND 39).

RAUL CORDOVA, EXAMINING ATTORNEY

SN 76-501,997. FORMAN MILLS, INC., PENNSAUKEN, NJ. FILED 3-27-2003.

PHILADELPHIA 215

NO CLAIM IS MADE TO THE EXCLUSIVE RIGHT TO USE PHILADELPHIA, APART FROM THE MARK AS SHOWN.

FOR CLOTHING AND ACCESSORIES, NAMELY, SHORTS, TANK-TOPS, T-SHIRTS, WARM-UP SUITS, SWEATPANTS, SWEATSHIRTS, KNIT SHIRTS, GOLF SHIRTS, SWEATERS, PAJAMAS, UNDERWEAR, HATS, CAPS, VISORS, FOOTWEAR, ROBES, SHOES AND OUTERWEAR, NAMELY, RAIN WEAR, SKI WEAR, COATS AND JACKETS (U.S. CLS. 22 AND 39).

RAUL CORDOVA, EXAMINING ATTORNEY

SN 76-502,712. SHLANSKY, YVONNE MARIE, WESTON, CT. FILED 3-18-2003.

YVONNE MARIE

"YVONNE MARIE" IS THE NAME OF APPLICANT, A LIVING INDIVIDUAL, WHOSE CONSENT IS OF RECORD.

FOR WOMEN'S OUTERWEAR AND SPORTSWEAR, NAMELY JACKETS, COATS, BLAZERS, SUITS, SHIRTS, PANTS, BLOUSES AND VESTS (U.S. CLS. 22 AND 39).

FIRST USE 2-15-1999; IN COMMERCE 2-15-1999. ZHALEH DELANEY, EXAMINING ATTORNEY

CLASS 25—(Continued).

SN 76-506,391. RAVENEAU, LEONARD, PLAINFIELD, NJ. FILED 4-14-2003.

GHETTOFFICIAL DESIGNS



NO CLAIM IS MADE TO THE EXCLUSIVE RIGHT TO USE "DESIGNS", APART FROM THE MARK AS SHOWN. THE MARK CONSISTS OF THE WORDING GHETTOFFICIAL DESIGNS ABOVE A SKYLINE DESIGN WITHIN A FIVE-POINT STAR.

FOR CLOTHING, NAMELY, T-SHIRTS, POLO SHIRTS, SWEATERS, SWEATSHIRTS, SWEATPANTS, JACKETS, PANTS, JEANS, TANK TOPS, PANTIES, BRAS, PAJAMAS, SKIRTS AND DRESSES (U.S. CLS. 22 AND 39).

FIRST USE 2-11-2001; IN COMMERCE 3-18-2001. LAURA KOVAISKY, EXAMINING ATTORNEY

SN 76-507,435. L.C. LICENSING, INC., NEW YORK, NY. FILED 3-31-2003.

MADE IN THE GLAMOROUS U.S.A.

FOR CLOTHING, NAMELY, SHIRTS, SWEATERS, COATS, SUITS, DRESSING GOWNS, SOCKS, DRESSES, BATHING SUITS, SKIRTS, JACKETS, JOGGING SUITS, SWEATSHIRTS, SWEATPANTS, SHORTS, JEANS, PANTS, SHIRTS, LINGERIE, SWIMWEAR, VESTS, BLOUSES, OVERALLS, TEE SHIRTS, ROBES, PAJAMAS, KNIT TOPS, CAMISOLES, TANK TOPS, GLOVES, BOXER SHORTS, UNDERSHIRTS, TROUSERS, BLAZERS, LEGGINGS, PANTIES, BRAS, TEDDIES AND SCARVES; FOOTWEAR; HEADWEAR, NAMELY, HATS (U.S. CLS. 22 AND 39).

FIRST USE 0-0-1994; IN COMMERCE 0-0-1994. CATHERINE CAIN, EXAMINING ATTORNEY

SN 76-512,406. MARSH, KRISTINA, HESPERIA, CA. FILED 5-7-2003.



FOR MEN'S AND WOMEN'S T-SHIRTS AND TANK TOPS (U.S. CLS. 22 AND 39).

KIMBERLY PERRY, EXAMINING ATTORNEY

CLASS 25—(Continued).

SN 76-513,342. LOON MOUNTAIN RECREATION CORPORATION, LINCOLN, NH. FILED 4-28-2003.

LOON

FOR CLOTHING AND HEADWEAR, NAMELY, JACKETS, CAPS, T-SHIRTS, SPORT SHIRTS, BUTTON-DOWN SHIRTS, TURTLENECKS, SWEATSHIRTS, SWEATERS AND FLEECE SHIRTS (U.S. CLS. 22 AND 39).
INGRID C. EULIN, EXAMINING ATTORNEY

SN 76-515,006. MAVERICK SKATEBOARDS, INC., BEVERLY HILLS, CA. FILED 5-16-2003.

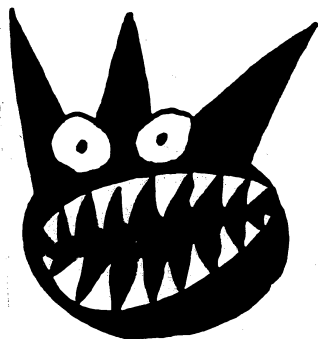

THE MARK CONSISTS OF A FANCIFUL CARTOON DRAWING OF A CAT.

FOR CLOTHING, NAMELY, TOPS, BOTTOMS, UNDERWEAR, HEADWEAR, FOOTWEAR, T-SHIRTS, SLEEPWEAR AND SWEATSHIRTS (U.S. CLS. 22 AND 39).

FIRST USE 6-0-1993; IN COMMERCE 6-0-1993.
FLORENTINA BLANDU, EXAMINING ATTORNEY

SN 76-515,033. HOSEA, ELSIE M., MONTGOMERY, AL. FILED 5-16-2003.

NUGADI

FOR CLOTHING FOR MEN, WOMEN AND CHILDREN, NAMELY, PANTS, DENIM JEANS, OVERALLS, SHORTS, SHIRTS, BLOUSES, SKIRTS, DRESSES, SWEATERS, JACKETS IN ALL FABRICATIONS AND WEIGHTS, VESTS, T-SHIRTS, SWEATSHIRTS, SWEATPANTS, SWIMWEAR, CAPS, HEADBANDS, HATS, BELTS, UNDERWEAR, SOCKS, SLEEPWEAR, SCARVES, AND OUTERWEAR IN ALL FABRICATIONS, NAMELY, CLOTH JACKETS, TIES, DENIM JACKETS, LEATHER JACKETS AND SUEDE JACKETS; RAINWEAR AND SHOES (U.S. CLS. 22 AND 39).

FIRST USE 5-1-2002; IN COMMERCE 5-1-2002.
GIANCARLO CASTRO, EXAMINING ATTORNEY

CLASS 25—(Continued).

SN 76-516,179. MAJESTIC ATHLETIC, LTD., BANGOR, PA. FILED 4-28-2003.

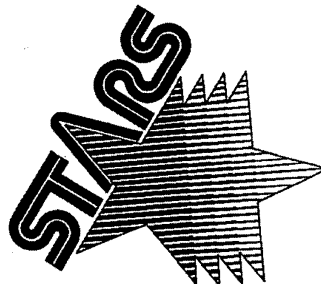

THE LINING IN THE DRAWING IS A FEATURE OF THE MARK AND IS NOT INTENDED TO INDICATE COLOR.

FOR SPORTS CLOTHING, NAMELY, JACKETS, COATS, SWEATSHIRTS, SWEATPANTS, T-SHIRTS, SHORTS, JERSEYS, TURTLENECKS, HATS AND CAPS (U.S. CLS. 22 AND 39).

DAVID TAYLOR, EXAMINING ATTORNEY

SN 76-517,371. JONES, CARL DARNELL, HOUSTON, TX. FILED 2-28-2003.



FOR PANTS, SHIRTS, JACKETS, SHOES (U.S. CLS. 22 AND 39).

FIRST USE 0-0-2002; IN COMMERCE 0-0-2002.
ALEXANDER L. POWERS, EXAMINING ATTORNEY

CLASS 25—(Continued).

SN 76-529,057. BRITTON, KYMM, SANTA MONICA, CA.
FILED 7-3-2003.



NO CLAIM IS MADE TO THE EXCLUSIVE RIGHT TO
USE GIRLS, APART FROM THE MARK AS SHOWN.
FOR CLOTHING, NAMELY T-SHIRTS, SWEAT
SHIRTS AND TANK TOPS (U.S. CLS. 22 AND 39).
KEVON CHISOLM, EXAMINING ATTORNEY

SN 76-533,028. NAT SHERMAN, INC., FORT LEE, NJ. FILED
7-17-2003.

NAT SHERMAN

OWNER OF U.S. REG. NOS. 2,019,294 AND 2,456,182.
THE NAME NAT SHERMAN DOES NOT IDENTIFY A
PARTICULAR LIVING INDIVIDUAL.
FOR CLOTHING AND HEADGEAR, NAMELY, T-
SHIRTS, SHIRTS, VESTS, JACKETS, AND CAPS (U.S.
CLS. 22 AND 39).
FIRST USE 9-0-1972; IN COMMERCE 1-0-1980.
EUGENIA MARTIN, EXAMINING ATTORNEY

SN 76-534,902. STEPHENSON, MIKE, MIAMI, FL. FILED 8-5-
2003.

MIAMI WIND SPOILER

NO CLAIM IS MADE TO THE EXCLUSIVE RIGHT TO
USE "MIAMI", APART FROM THE MARK AS SHOWN.
FOR HEADGEAR, NAMELY, HATS AND CAPS (U.S.
CLS. 22 AND 39).
MICHAEL WEBSTER, EXAMINING ATTORNEY

SN 76-535,577. BIMINI BAY OUTFITTERS, LTD, MAHWAH,
NJ. FILED 7-25-2003.

BUG GUARD

NO CLAIM IS MADE TO THE EXCLUSIVE RIGHT TO
USE "BUG", APART FROM THE MARK AS SHOWN.
FOR CLOTHING, NAMELY MEN'S AND WOMEN'S
SHIRTS, SHORTS, PANTS, JACKETS AND SWIMWEAR
(U.S. CLS. 22 AND 39).
THEODORE MCBRIDE, EXAMINING ATTORNEY

CLASS 25—(Continued).

SN 76-538,329. BUTTERFLY FITNESS, INC., SAN RAMON,
CA. FILED 8-18-2003.



FOR CLOTHING, NAMELY HATS, VISORS, FOOT
WEAR, SPORTSWEAR, NAMELY SWEATERS, PANTS,
T-SHIRTS, SWEATSHIRTS, AND POLO SHIRTS AND
EXERCISE WEAR, NAMELY JOGGING SUITS, SHORTS,
LEOTARDS, LEG WARMERS, AND LEGGINGS (U.S.
CLS. 22 AND 39).
THEODORE MCBRIDE, EXAMINING ATTORNEY

SN 76-540,504. OFFICIAL BUGLE BOY, LLC, COLUMBUS,
OH. FILED 8-27-2003.

CLOUD WASH

OWNER OF U.S. REG. NO. 1,798,776.
FOR CLOTHING, NAMELY, TOPS, SHIRTS, T-
SHIRTS, HALTER TOPS, BLOUSES, PANTS, SHORTS,
SKIRTS, VESTS, JEANS, OVERALLS, DRESSES, JUM-
PERS, ROMPERS, JUMPSUITS, CAPRIS, SKORTS, BLA-
ZERS, JACKETS, COATS, WIND JACKETS, SWEAT
PANTS, SWEATSHIRTS, SWEATERS, BANDANNAS,
SCARVES, SWEATBANDS; AND HEADWEAR, INCLUD-
ING HEADBANDS, VISORS, BASEBALL CAPS, HATS,
AND CAPS (U.S. CLS. 22 AND 39).
ALLISON HOLTZ, EXAMINING ATTORNEY

SN 76-541,715. MENDEZ, SARA ARAQUE, NEW YORK, NY.
FILED 8-29-2003.

MISS TRASH

FOR CLOTHING NAMELY— T-SHIRTS, PANTS,
SHORTS, BLOUSES, SKIRTS, UNDERWEAR, JACKETS,
COATS, HATS, SHOES, BATH ROBE, SWIMSUITS,
STOCKINGS, SOCKS (U.S. CLS. 22 AND 39).
SUELLEN HICKEY, EXAMINING ATTORNEY

CLASS 25—(Continued).

SN 76-543,543. INTERTEX APPAREL LTD., NEW YORK, NY. FILED 8-27-2003.



FOR WOMEN'S AND CHILDREN'S APPAREL, NAMELY, SHIRTS, PANTS, SKIRTS AND SWEATERS; AND WOMEN'S AND CHILDREN'S SLEEPWEAR (U.S. CLS. 22 AND 39).

INGRID C. EULIN, EXAMINING ATTORNEY

SN 76-545,237. COLORADO KNITTING COMPANY, LLC, BROOMFIELD, CO. FILED 9-5-2003.



FOR CLOTHING, NAMELY SOCKS, HATS, CAPS AND T-SHIRTS (U.S. CLS. 22 AND 39). FIRST USE 8-14-2003; IN COMMERCE 8-14-2003. DANIELLE MATTESSICH, EXAMINING ATTORNEY

SN 76-545,453. J & L FOOTWEAR, INC., CITY OF INDUSTRY, CA. FILED 9-16-2003.



FOR CHILDREN'S FOOTWEAR (U.S. CLS. 22 AND 39). FIRST USE 7-1-1986; IN COMMERCE 7-1-1986. BRIDGETT SMITH, EXAMINING ATTORNEY

SN 76-547,910. VELVET, INC., LOS ANGELES, CA. FILED 9-29-2003.

BLUE VELVET

FOR APPAREL, NAMELY TOPS, BOTTOMS AND HEAD WEAR (U.S. CLS. 22 AND 39). PAULA MAYS, EXAMINING ATTORNEY

CLASS 25—(Continued).

SN 76-548,028. TOP LEVEL APPAREL, INC., MEDLEY, FL. FILED 9-29-2003.

4SPORT

FOR SPORTSWEAR, NAMELY SHORTS, SHIRTS, PANTS, JACKETS, SKIRTS, DRESSES, JOGGING SUITS, CAPS AND HATS (U.S. CLS. 22 AND 39). PAULA MAYS, EXAMINING ATTORNEY

SN 76-548,505. INTERNATIONAL ALLIANCE, INC., DBA TRADERS ALLIANCE, FOUNTAIN VALLEY, CA. FILED 10-2-2003.



THE MARK CONSISTS OF AN "X". FOR CLOTHING, NAMELY, SHIRTS, T-SHIRTS, SWEAT SHIRTS, DRESSES, SKIRTS, SHORTS, PANTS, TROUSERS, SWEATERS, JACKETS, VESTS, SWIM SUITS, AND HATS (U.S. CLS. 22 AND 39). GEOFFREY FOSDICK, EXAMINING ATTORNEY

SN 76-548,506. INTERNATIONAL ALLIANCE, INC., DBA TRADERS ALLIANCE, FOUNTAIN VALLEY, CA. FILED 10-2-2003.

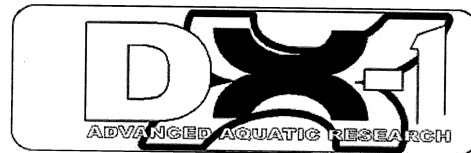

NO CLAIM IS MADE TO THE EXCLUSIVE RIGHT TO USE "ADVANCED AQUATIC RESEARCH", APART FROM THE MARK AS SHOWN.

THE MARK CONSISTS OF "X" IN THE BACKGROUND WITH "DX-1" AND "ADVANCED AQUATIC RESEARCH" IN THE FOREGROUND.

FOR CLOTHING, NAMELY, SHIRTS, T-SHIRTS, SWEAT SHIRTS, DRESSES, SKIRTS, SHORTS, PANTS, TROUSERS, SWEATERS, JACKETS, VESTS, SWIM SUITS, AND HATS (U.S. CLS. 22 AND 39).

GEOFFREY FOSDICK, EXAMINING ATTORNEY

CLASS 25—(Continued).

SN 76-548,630. LICENSE MANAGEMENT, INC., NEW YORK, NY. FILED 10-3-2003.

PROJAM

FOR CLOTHING, NAMELY, T-SHIRTS, CAPS AND HATS, JACKETS, SWEATSHIRTS, SHIRTS AND SHORTS (U.S. CLS. 22 AND 39).
ELIZABETH HUGHITT, EXAMINING ATTORNEY

SN 76-549,085. BARRY SANDERS, INC., MIAMI, FL. FILED 10-6-2003.



THE NAME "BARRY SANDERS" IS A LIVING INDIVIDUAL WHO CONSENT IS OF RECORD.
THE MARK CONSISTS OF THE STYLIZED FORM OF THE NAME "BARRY SANDERS".
FOR CLOTHING, NAMELY SHIRTS, T-SHIRTS, JERSEYS, HATS, PANTS, SHORTS, AND JACKETS (U.S. CLS. 22 AND 39).
FIRST USE 12-31-1989; IN COMMERCE 12-31-1989.
LESLEY LAMOTHE, EXAMINING ATTORNEY

SN 76-549,488. JUVENILE DIABETES RESEARCH FOUNDATION INTERNATIONAL, NEW YORK, NY. FILED 9-22-2003.

CHILDREN'S CONGRESS

OWNER OF U.S. REG. NOS. 2,405,174 AND 2,406,292.
FOR T-SHIRTS (U.S. CLS. 22 AND 39).
FIRST USE 1-27-1999; IN COMMERCE 1-27-1999.
MARC LEIPZIG, EXAMINING ATTORNEY

SN 76-551,244. PEPE JEANS LONDON, LLC, NEW YORK, NY. FILED 9-24-2003.

PEPE JEANS LONDON

OWNER OF U.S. REG. NOS. 1,943,125, 2,192,800 AND OTHERS.
SEC. 2(F) AS TO "JEANS LONDON".
FOR FOOTWEAR (U.S. CLS. 22 AND 39).
FIRST USE 6-1-2003; IN COMMERCE 6-1-2003.
CURTIS FRENCH, EXAMINING ATTORNEY

CLASS 25—(Continued).

SN 76-551,454. PIAZZA, CHRISTOPHER J., HOUSTON, TX. FILED 9-9-2003.

CHRISTOPHER J. PIAZZA

FOR CLOTHING NAMELY SHIRTS, TANK TOPS, SWEATSHIRTS, SHORTS, BATHING SUITS, SARONGS, BEACH SHIRTS, HEADWEAR, JACKETS, PANTS, SWIM WEAR, GOLF SHIRTS, T-SHIRTS, CLOTHING TOPS, HATS, CAPS, AND WARM-UP SUITS (U.S. CLS. 22 AND 39).
FIRST USE 8-5-2000; IN COMMERCE 11-1-2000.
AISHA CLARKE, EXAMINING ATTORNEY

SN 76-551,607. LOCAL MOTION, INC., HONOLULU, HI. FILED 10-16-2003.

BEACH HUT

FOR CLOTHING, NAMELY, MEN'S, WOMEN'S AND CHILDREN'S SHIRTS, BOTH WOVEN AND KNITTED, SLACKS, SHORTS, SWIM TRUNKS, AND SWIM SUITS (U.S. CLS. 22 AND 39).
ZACHARY BELLO, EXAMINING ATTORNEY

SN 76-551,856. ROCXYGEN INTERNATIONAL, INC., NEW YORK, NY. FILED 10-14-2003.

6170

FOR PANTS, JEANS, SHORTS, SKIRTS, OVERALLS, SHIRTS, BLOUSES, JACKETS, SWEATSHIRTS, SWEATERS, COATS AND HATS (U.S. CLS. 22 AND 39).
AMY HELLA, EXAMINING ATTORNEY

SN 76-551,860. ROCXYGEN INTERNATIONAL, INC., NEW YORK, NY. FILED 10-14-2003.

ROCXYGEN

FOR PANTS, JEANS, SHORTS, SKIRTS, OVERALLS, SHIRTS, BLOUSES, JACKETS, SWEATSHIRTS, SWEATERS, COATS AND HATS (U.S. CLS. 22 AND 39).
AMY HELLA, EXAMINING ATTORNEY

SN 76-551,874. L.C. LICENSING, INC., NEW YORK, NY. FILED 10-16-2003.

EXTRA JUICY

OWNER OF U.S. REG. NOS. 2,285,232, 2,348,674 AND 2,387,924.
FOR CLOTHING, NAMELY PANTS, TOPS, COATS, SKIRTS, DRESSES, SCARVES, GLOVES, HOSIERY, SWIMWEAR, BELTS, FOOTWEAR AND HEADWEAR (U.S. CLS. 22 AND 39).
GEORGIA CARTY, EXAMINING ATTORNEY

CLASS 25—(Continued).

SN 76-551,878. JOHN B. STETSON COMPANY, MT. KISCO, NY. FILED 9-25-2003.

VITA-FELT

FOR HEADWEAR (U.S. CLS. 22 AND 39).
LANA PHAM, EXAMINING ATTORNEY

SN 76-552,308. POD PRODUCTIONS, LLC, PHOENIX, AZ. FILED 9-29-2003.

**NABI NATIVE AMERICAN
BASKETBALL
INVITATIONAL**

FOR CLOTHING, NAMELY, POLO SHIRTS, T-SHIRTS AND CAPS (U.S. CLS. 22 AND 39).
FIRST USE 7-11-2003; IN COMMERCE 8-0-2003.
BARBARA GAYNOR, EXAMINING ATTORNEY

SN 76-552,714. FOX RACING, INC., MORGAN HILL, CA. FILED 10-20-2003.

RIDE.RACE.LIVE.

FOR MEN'S AND WOMEN'S CLOTHING, NAMELY, SWIMWEAR, BATHING SUITS, BIKINIS, COVER-UPS, TANK TOPS, T-SHIRTS, COLLARED SHIRTS, SWEATSHIRTS, TRACK SUITS, LEISURE SUITS, BELTS AND VESTS; HEADWEAR, NAMELY, HATS, CAPS, BEANIES, SWEATBANDS AND VISORS; AND FOOTWEAR, NAMELY, SANDALS, SLIPPERS, BOOTS AND ATHLETIC SHOES (U.S. CLS. 22 AND 39).
VIVIAN MICZNIK FIRST, EXAMINING ATTORNEY

SN 76-555,188. OWERKA-MOORE, ALYASHA, SAN DIEGO, CA. FILED 10-29-2003.

FIBEROPS

FOR CASUAL CLOTHING, NAMELY T-SHIRTS, SHIRTS, SHORTS, PANTS, AND JEANS; JACKETS AND VESTS MADE OF DENIM, LEATHER, CLOTH AND SUEDE; ATHLETIC CLOTHING, NAMELY TRACK-SUITS, SWEATSHIRTS, SWEATPANTS, AND SWIMWEAR; AND FOOTWEAR CONSISTING OF ATHLETIC SHOES, DRESS SHOES, AND SNEAKERS; AND HATS AND CLOTHING CAPS (U.S. CLS. 22 AND 39).
STEVEN JACKSON, EXAMINING ATTORNEY

CLASS 25—(Continued).

SN 76-555,757. TORI RICHARD, LTD., HONOLULU, HI. FILED 10-6-2003.



OWNER OF U.S. REG. NOS. 1,120,583 AND 2,821,519.
THE NAME "TORI RICHARD" DOES NOT IDENTIFY A LIVING INDIVIDUAL.

FOR WOMEN'S APPAREL, NAMELY, BLOUSES, TOPS, DRESSES, SKIRTS, PANTS, JACKETS, SHORTS, SWIMWEAR, SWEATERS, T-SHIRTS, COATS, SLEEPWEAR, SCARVES, AND VESTS (U.S. CLS. 22 AND 39).
MICHAEL KEATING, EXAMINING ATTORNEY

SN 76-555,929. FOX, BONNIE, NEW YORK, NY. FILED 11-3-2003.

DARE A FREE THOUGHT

FOR MEN'S WOMEN'S AND CHILDREN'S APPAREL, NAMELY SHIRTS, BLOUSES, PANTS, SHORTS, SKIRTS, DRESSES, JACKETS, SOCKS, HATS, SCARVES, GLOVES, SHOES, SWEATERS, SWEATSHIRTS, SWEATPANTS, SPORT SHIRTS, UNDERWEAR, BELTS, ROBES AND NIGHTGOWNS (U.S. CLS. 22 AND 39).
YSA DEJESUS, EXAMINING ATTORNEY

SN 76-556,668. REINER, ROBIN, LOS ANGELES, CA. FILED 10-17-2003.

TRAGIC

FOR T-SHIRTS, JERSEYS, JEANS, JEAN JACKETS, PANTS, BELTS, UNDERWEAR, LEATHER UNDERWEAR, LEATHER PANTS, LEATHER JACKETS, LEATHER BLOUSES; HATS, CAPS, HOODS, TOPS, SKIRTS, LEATHER SKIRTS, DRESSES AND LEATHER DRESSES (U.S. CLS. 22 AND 39).
AMY HELLA, EXAMINING ATTORNEY

CLASS 25—(Continued).

SN 76-556,771. GOTHE, AXEL, NEW YORK, NY. FILED 10-22-2003.



FOR CLOTHING, NAMELY- T-SHIRTS, SWEATSUITS, HEADWEAR, JACKETS, SHIRTS, ROBES, PANTS, TIES (U.S. CLS. 22 AND 39).
HENRY S. ZAK, EXAMINING ATTORNEY

SN 76-556,772. GOTHE, AXEL, NEW YORK, NY. FILED 10-22-2003.



FOR CLOTHING, NAMELY- T-SHIRTS, SWEATSUITS, HEADWEAR, JACKETS, ROBES PANTS (U.S. CLS. 22 AND 39).
HENRY S. ZAK, EXAMINING ATTORNEY

SN 76-556,773. GOTHE, AXEL, NEW YORK, NY. FILED 10-22-2003.



FOR CLOTHING, NAMELY- T-SHIRTS, SWEATSUITS, HEADWEAR, PANTS, ROBES, FOOTWEAR (U.S. CLS. 22 AND 39).
HENRY S. ZAK, EXAMINING ATTORNEY

CLASS 25—(Continued).

SN 76-557,651. OFFICIAL STARTER LLC, COLUMBUS, OH. FILED 10-27-2003.

DURA-STAR

FOR SHIRTS, SWEATSHIRTS, SHORTS, PANTS, WIND RESISTANT JACKETS AND SUITS, SOCKS, UNDERWEAR AND FOOTWEAR (U.S. CLS. 22 AND 39).
BERYL GARDNER, EXAMINING ATTORNEY

SN 76-558,271. AUSTELL, KARL, LEVITTOWN, PA. AND AUSTELL, TRACY, LEVITTOWN, PA. FILED 10-24-2003.



FOR SHIRTS, TEE SHIRTS, SKIRTS AND SOCKS (U.S. CLS. 22 AND 39).
DOMINIC J. FERRAIUOLO, EXAMINING ATTORNEY

SN 78-030,702. WHISENANT, JEFFERSON P., MOORE, SC. AND WHISENANT, PALMER L., MOORE, SC. FILED 10-15-2000.

BLAME THE GAME

FOR SPORTS APPAREL, NAMELY, SHIRTS, JERSEYS, HATS, CAPS, COATS, SHORTS, SOCKS, FOOTWEAR, BANDANNAS, BELTS, SWEATERS, BEACHWEAR, BATHING SUITS, BATHROBES, SKI WEAR, VISORS, SUSPENDERS, UNDERCLOTHES, HEADWEAR, SWEATPANTS, WARM-UPS, PAJAMAS, VESTS AND PANTS (U.S. CLS. 22 AND 39).
STANLEY I. OSBORNE, EXAMINING ATTORNEY

SN 78-041,546. ABEL AXE LLC, EVANSTON, WY. FILED 1-3-2001.

EITHER YOU ROCK OR YOU SUCK!

FOR SHIRTS, T-SHIRTS, JACKETS, VESTS, HATS (U.S. CLS. 22 AND 39).
CIMMERIAN COLEMAN, EXAMINING ATTORNEY

CLASS 25—(Continued).

SN 78-065,275. BARBARIAN RUGBY WEAR, INC., KITCHENER, ONTARIO, CANADA, FILED 5-23-2001.



PRIORITY CLAIMED UNDER SEC. 44(D) ON CANADA APPLICATION NO. 1101072, FILED 4-26-2001, REG. NO. TMA601077, DATED 2-2-2004, EXPIRES 2-2-2019.

NO CLAIM IS MADE TO THE EXCLUSIVE RIGHT TO USE "WORLD RUGBY", APART FROM THE MARK AS SHOWN.

FOR RUGBY SHIRTS (U.S. CLS. 22 AND 39).
MARIA-VICTORIA SUAREZ, EXAMINING ATTORNEY

SN 78-127,385. MOORE, FELICIA, R, CAPITOL HEIGHTS, MD. FILED 5-9-2002.



THE MARK CONSISTS OF A WHITE DOVE WITH THE "&" SYMBOL, WHICH IS SHADED BLACK AND THE WORD "TRUTH", WHICH IS ITALICIZED, CAPITALIZED AND SHADED RED AND A CAPITALIZED "N" WHICH IS SHADED WHITE.

FOR SHORT AND LONG SLEEVE TEE-SHIRTS, PANTS, SHORTS, HATS, WRIST BANDS, HEADBANDS, SCARVES, JACKETS, COATS, JEANS, SWEATERS, DRESS SHIRTS, SOCKS, HEADWEAR, JUMPERS, JOGGING SUITS, SMOCKS, LAB COATS, SWEAT SUITS, LEATHER JACKETS, LEATHER COATS, PANTSUITS, DRESSES, SKIRT SUITS, PAJAMAS, NIGHT GOWNS, ROBES, BLOUSES, SHOES, BOOTS, SLACKS AND TIES (U.S. CLS. 22 AND 39).

FIRST USE 4-7-2002; IN COMMERCE 4-12-2002.
PAULA MAYS, EXAMINING ATTORNEY

CLASS 25—(Continued).

SN 78-142,904. VANITY FAIR, INC., WILMINGTON, DE. FILED 7-11-2002.

RACY LACE

NO CLAIM IS MADE TO THE EXCLUSIVE RIGHT TO USE "LACE", APART FROM THE MARK AS SHOWN. FOR LINGERIE (U.S. CLS. 22 AND 39).
FIRST USE 3-25-2003; IN COMMERCE 3-25-2003.
CYNTHIA SLOAN, EXAMINING ATTORNEY

SN 78-157,821. GREDICO FOOTWEAR LTD., MISSISSAUGA, ONTARIO, CANADA, FILED 8-26-2002.

FOAMTREADS LEISURE

PRIORITY CLAIMED UNDER SEC. 44(D) ON CANADA APPLICATION NO. 1132278, FILED 2-26-2002. FOR WOMEN'S, MEN'S AND CHILDREN'S INDOOR AND OUTDOOR SLIPPERS (U.S. CLS. 22 AND 39).
FIRST USE 7-1-2001; IN COMMERCE 7-1-2001.
MIDGE BUTLER, EXAMINING ATTORNEY

SN 78-168,553. BOHBOT, MARC, LOS ANGELES, CA. AND BOHBOT, MICHELE, LOS ANGELES, CA. FILED 9-27-2002.

TRUE MEANING

OWNER OF U.S. REG. NOS. 1,806,214, 2,446,498 AND OTHERS.

FOR CLOTHING, NAMELY, SHIRTS, JEANS, PANTS, T-SHIRTS, FOOTWEAR, DRESSES, SKIRTS, AND HEADWEAR (U.S. CLS. 22 AND 39).

FIRST USE 11-30-2002; IN COMMERCE 11-30-2002.
KARLA PERKINS, EXAMINING ATTORNEY

SN 78-188,672. NEW WORLD CREATION, INC., OAKLAND, NJ. FILED 11-25-2002.



FOR JEANS, DENIM SKIRTS, DENIM DRESSES, JACKETS, SHIRTS, SWEATERS, JOGGING SUITS AND SHORTS (U.S. CLS. 22 AND 39).

FIRST USE 11-25-2002; IN COMMERCE 11-25-2002.
JOHN GARTNER, EXAMINING ATTORNEY

CLASS 25—(Continued).

SN 78-189,787. WALCOFF, GREGORY D., LOS ANGELES, CA. AND BERGE, DARLA K., LOS ANGELES, CA. AND WALCOFF, GEORGE M., HOUSTON, TX. FILED 11-28-2002.

MING DYNASTY

FOR T-SHIRTS, FLEECE PULLOVERS, CAPS, HATS, JACKETS, COATS, SWEAT SHIRTS, SPORT SHIRTS, SWEAT PANTS, SWEAT SHORTS (U.S. CLS. 22 AND 39).
JENNIFER KRISP, EXAMINING ATTORNEY

CLASS 25—(Continued).

SN 78-214,883. FORMAN MILLS, INC., PENNSAUKEN, NJ. FILED 2-14-2003.



OWNER OF U.S. REG. NO. 2,801,424.
THE STIPPLING IN THE DRAWING INDICATES SHADING.

FOR CLOTHING, NAMELY SHIRTS, CAPS, SHORTS, T-SHIRTS, SOCKS, UNDERWEAR, JACKETS, SWEATERS, VISORS, SWEATSHIRTS, SWEATPANTS, HEADWEAR, FOOTWEAR, ROBES AND SHOES (U.S. CLS. 22 AND 39).

FIRST USE 6-14-2003; IN COMMERCE 6-14-2003.
RAUL CORDOVA, EXAMINING ATTORNEY

SN 78-203,415. ISLAND TRADING COMPANY, INC., NEW YORK, NY. FILED 1-15-2003.

ISLAND LIFE

OWNER OF U.S. REG. NO. 2,713,686.
FOR BLOUSES, DRESSES, PANTS, SKIRTS, SHORTS, T-SHIRTS, SARONGS, AND HATS FOR CHILDREN; DRESS SHIRTS, PANTS, SHORTS, T-SHIRTS, POLOS, HATS, AND SARONGS FOR MEN; DRESS SHIRTS, SKIRTS, T-SHIRTS, POLOS, SARONGS, SWIMWEAR, HATS, AND DRESSES FOR WOMEN (U.S. CLS. 22 AND 39).

FIRST USE 11-15-2002; IN COMMERCE 11-15-2002.
MARC LEIPZIG, EXAMINING ATTORNEY

SN 78-220,471. YAMAMOTO ENTERPRISES, LLC, MESA, AZ. FILED 2-28-2003.



FOR CLOTHING; NAMELY, SHIRTS, T-SHIRTS, SHORTS, PANTS, JACKETS, VESTS, PONCHOS, GLOVES, BANDANAS, FISHING WADERS, BIB OVERALLS, THERMAL UNDERWEAR; THERMAL OUTERWEAR, NAMELY, COATS, JACKETS, SWEATERS, SHIRTS, VESTS AND GLOVES; SWEATSUITS, WARM-UP AND JOGGING SUITS, SWEAT BANDS, BOXER SHORTS; FOOTWEAR; HEADGEAR, NAMELY, CAPS, HATS AND VISORS; WATERPROOF AND WEATHER PROOF CLOTHING, NAMELY, SHIRTS, SHORTS, PANTS, JACKETS, VESTS, PONCHOS, GLOVES, FISHING WADERS, BIB OVERALLS, THERMAL UNDERWEAR, THERMAL OUTERWEAR, NAMELY, COATS, JACKETS, SWEATERS, SHIRTS, VEST AND GLOVES, SWEATSUITS, WARM-UP AND JOGGING SUITS, SHOES, BOOTS; SPORTSWEAR, NAMELY, T-SHIRTS, SHORTS, PANTS, JACKETS, VESTS, PONCHOS, GLOVES, BANDANAS, FISHING WADERS, BIB OVERALLS, THERMAL UNDERWEAR, THERMAL OUTERWEAR, NAMELY, COATS, JACKETS, SHIRTS, VESTS, SWEATERS AND GLOVES, SWEATSUITS, WARM-UP AND JOGGING SUITS, SWEATBANDS, BOXER SHORTS, SHOES, BOOTS, SANDALS; AND BEACHWEAR (U.S. CLS. 22 AND 39).

FIRST USE 6-1-2001; IN COMMERCE 6-1-2001.
JENNIFER KRISP, EXAMINING ATTORNEY

SN 78-207,771. RIGHT BRAIN HOLDINGS LIMITED, LYNDHURST, OH. FILED 1-28-2003.

BLACK COAT

NO CLAIM IS MADE TO THE EXCLUSIVE RIGHT TO USE "BLACK", APART FROM THE MARK AS SHOWN.
FOR T-SHIRTS, UNDERGARMENTS, AND HATS (U.S. CLS. 22 AND 39).

ANDREW BENZMILLER, EXAMINING ATTORNEY

CLASS 25—(Continued).

SN 78-221,371. SARA LEE CORPORATION, WINSTON-SALEM, NC. FILED 3-4-2003.

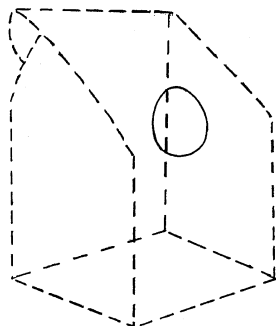

OWNER OF U.S. REG. NOS. 891,626, 2,710,553 AND OTHERS.

THE MARK CONSISTS OF AN EGG-SHAPED WINDOW ON A THREE-DIMENSIONAL PACKAGE.

FOR HOSE, PANTYHOSE, TIGHTS AND KNEE-HIGHS (U.S. CLS. 22 AND 39).

FIRST USE 6-26-2000; IN COMMERCE 6-26-2000.
MICHELE SWAIN, EXAMINING ATTORNEY

SN 78-229,517. FOOTSTAR CORPORATION, WEST NYACK, NY. FILED 3-25-2003.

SGT

FOR FOOTWEAR COMPONENTS, NAMELY, A SHANK (U.S. CLS. 22 AND 39).

JILL C. ALT, EXAMINING ATTORNEY

SN 78-231,105. PROFESSIONAL MOTORSPORTS MERCHANDISE COMPANY, INC., BLAINE, MN. FILED 3-28-2003.

BEYONDRACEWEAR

FOR MOTORSPORT THEMED JERSEYS AND HATS (U.S. CLS. 22 AND 39).

TRACY FLETCHER, EXAMINING ATTORNEY

SN 78-231,493. NAUTICAL NEEDS, INC., ST. PETERSBURG, FL. FILED 3-28-2003.

HONEY, I'VE GOT NAUTICAL NEEDS

FOR CLOTHING NAMELY; SHIRTS, CAPS, SHORTS, PANTS, JACKETS, SCARFS AND SOCKS (U.S. CLS. 22 AND 39).

FIRST USE 3-26-2003; IN COMMERCE 3-28-2003.
ANN LINNEHAN, EXAMINING ATTORNEY

CLASS 25—(Continued).

SN 78-232,005. VANITY FAIR, INC., WILMINGTON, DE. FILED 3-31-2003.

INVISILIFT

OWNER OF U.S. REG. NO. 2,100,250.
FOR LINGERIE (U.S. CLS. 22 AND 39).
FIRST USE 1-28-1998; IN COMMERCE 1-28-1998.
ODESSA BIBBINS, EXAMINING ATTORNEY

SN 78-235,240. A & F TRADEMARK, INC., NEW ALBANY, OH. FILED 4-8-2003.

AIRBORNE VINTAGE FATIGUES

OWNER OF U.S. REG. NO. 2,603,245.
NO CLAIM IS MADE TO THE EXCLUSIVE RIGHT TO USE "VINTAGE FATIGUES", APART FROM THE MARK AS SHOWN.

FOR CLOTHING, NAMELY, PANTS AND JEANS (U.S. CLS. 22 AND 39).
JOHN GARTNER, EXAMINING ATTORNEY

SN 78-235,245. A & F TRADEMARK, INC., NEW ALBANY, OH. FILED 4-8-2003.

AVIATOR CARGO

NO CLAIM IS MADE TO THE EXCLUSIVE RIGHT TO USE "CARGO". APART FROM THE MARK AS SHOWN.

FOR CLOTHING, NAMELY, PANTS AND JEANS (U.S. CLS. 22 AND 39).
JOHN GARTNER, EXAMINING ATTORNEY

SN 78-237,554. WAI, FUNG TAK, LANTAU ISLAND, HONG KONG, FILED 4-14-2003.

OWNER OF CHINA REG. NO. 1720995, DATED 2-28-2002, EXPIRES 2-27-2013.

THE NON-LATIN CHARACTERS IN THE MARK TRANSLITERATE TO XIU QIAO AND THIS MEANS, INDIRECTLY, "ELEGANT AND SKILLFUL" IN ENGLISH.

FOR CLOTHING, NAMELY, SKIRTS, TROUSERS, JACKETS, COATS, SHIRTS, LAYETTES, SWIMMING SUITS, WATERPROOF DRESSES, DANCE DRESSES, FOOTWEAR, HEADWEAR, HOSE, GLOVES, SHAWLS, WEDDING DRESSES, AND KNITWEAR, NAMELY, KNIT SHIRTS, UNDERWEAR, LINGERIE, VESTS, CAMISOLES, T-SHIRTS, CHEMISETTES (U.S. CLS. 22 AND 39).

BRIAN PINO, EXAMINING ATTORNEY

CLASS 25—(Continued).

SN 78-240,223. ROLLSTONE INTERNATIONAL HATS, INC., PARAMOUNT, CA. FILED 4-21-2003.

BOCCACCIO

THE FOREIGN WORDING IN THE MARK TRANSLATES INTO ENGLISH AS SMALL MOUTH.
 FOR CLOTHING, NAMELY HATS, BELTS, SHOES, BOOTS, JEANS, SHIRTS, JACKETS, T-SHIRTS (U.S. CLS. 22 AND 39).
 FIRST USE 4-15-2003; IN COMMERCE 4-15-2003.
 TARAH HARDY, EXAMINING ATTORNEY

CLASS 25—(Continued).

SN 78-243,095. KCNY LLC, NEW YORK, NY. FILED 4-29-2003.

Charles & 1/2

FOR CLOTHING NAMELY JEANS, PANTS, SHIRTS, SWEATERS, CLOTHING BELTS, SKIRTS, DRESSES, UNDERWEAR, SHORTS, SNEAKERS, SHOES, HATS, CAPS, BANDANAS, BLAZERS, OUTERWEAR NAMELY JACKETS AND COATS (U.S. CLS. 22 AND 39).
 FIRST USE 5-1-2003; IN COMMERCE 6-1-2003.
 LESLEY LAMOTHE, EXAMINING ATTORNEY

SN 78-243,258. METRO-GOLDWYN-MAYER STUDIOS INC., LOS ANGELES, CA. FILED 4-29-2003.

HAPPY TIMES

FOR CLOTHING FOR MEN, WOMEN AND CHILDREN, NAMELY, T-SHIRTS; TANK TOPS; SHIRTS; SWEAT SUITS; SWEATSHIRTS; SWEAT PANTS; EXERCISE WEAR, NAMELY, BODY SUITS, TOPS, LEOTARDS AND TIGHTS; JOGGING SUITS; SWEATERS; SHORTS; JACKETS; UNDERWEAR; UNDERSHIRTS; SLEEPWEAR; NIGHTGOWNS; ROBES AND PAJAMAS; NIGHTSHIRTS; HEADWEAR; CAPS; HATS; VISORS; HEADBANDS; SWEATBANDS; SCARVES; BANDANAS; AND SOCKS (U.S. CLS. 22 AND 39).
 FLORENTINA BLANDU, EXAMINING ATTORNEY

SN 78-241,849. MEDELA HOLDING AG, 6340 BAAR, SWITZERLAND, FILED 4-24-2003.

Beautiful Beginnings
Intimate Apparel

NO CLAIM IS MADE TO THE EXCLUSIVE RIGHT TO USE "INTIMATE APPAREL", APART FROM THE MARK AS SHOWN.
 THE MARK CONSISTS OF THE WORDS BEAUTIFUL BEGINNINGS IN A FANCIFUL FORM AND THE WORDS INTIMATE APPAREL ON A BLUE RECTANGLE.
 FOR INTIMATE APPAREL, NAMELY, BRAS, MATERNITY AND NURSING BRAS, UNDERWEAR, PANTIES, BRA PADS AND BRA SHELLS (U.S. CLS. 22 AND 39).
 FIRST USE 10-15-2002; IN COMMERCE 10-15-2002.
 DAVID TAYLOR, EXAMINING ATTORNEY

SN 78-244,351. HARTZ & CO., INC., FREDERICK, MD. FILED 5-1-2003.



SN 78-241,864. MEDELA HOLDING AG, 6340 BAAR, SWITZERLAND, FILED 4-24-2003.

BEAUTIFUL BEGINNINGS

FOR INTIMATE APPAREL, NAMELY, BRAS, MATERNITY AND NURSING BRAS, UNDERWEAR, PANTIES, BRA PADS AND BRA SHELLS (U.S. CLS. 22 AND 39).
 FIRST USE 10-15-2002; IN COMMERCE 10-15-2002.
 JOSETTE BEVERLY, EXAMINING ATTORNEY

FOR CLOTHING, NAMELY, MEN'S TAILORED CLOTHING, NAMELY SUITS, TROUSERS, COATS, BLAZERS, VESTS, AND TUXEDOS, AND WOMEN'S TAILORED CLOTHING, NAMELY SUITS, SKIRTS, PANTS, BLAZERS, AND DRESSES (U.S. CLS. 22 AND 39).
 GIANCARLO CASTRO, EXAMINING ATTORNEY

CLASS 25—(Continued).

SN 78-244,909. KINGSID VENTURES, LTD., LAS VEGAS, NV. FILED 5-2-2003.



OWNER OF U.S. REG. NOS. 1,878,090, 2,449,310 AND OTHERS.

THE NAME SHOWN IN THE MARK IDENTIFIES RILEY B. KING, PROFESSIONALLY KNOWN AS B.B. KING, WHOSE CONSENT IS OF RECORD.

FOR CLOTHING, NAMELY SHIRTS, T-SHIRTS, BASEBALL JERSEYS, HATS, CAPS, SWEATSHIRTS, AND JACKETS (U.S. CLS. 22 AND 39).

TRACY CROSS, EXAMINING ATTORNEY

SN 78-245,882. SOLE DESIGN, LLC, NEW YORK, NY. FILED 5-5-2003.

MADemoISELLE

THE WORD "MADemoISELLE" TRANSLATES INTO THE WORD "MISS" IN ENGLISH.

FOR WOMEN'S, GIRLS' AND CHILDREN'S APPAREL, NAMELY, BLOUSES, SHIRTS, SKIRTS, SHORTS, PANTS, SWEATERS, CARDIGANS, JACKETS, DRESSES, BODYSUITS, COATS AND CARDIGANS (U.S. CLS. 22 AND 39).

JACQUELINE A. LAVINE, EXAMINING ATTORNEY

SN 78-250,469. ABC-MART, INC., TOKYO, JAPAN, FILED 5-15-2003.



FOR FOOTWEAR (U.S. CLS. 22 AND 39).
FIRST USE 12-31-2000; IN COMMERCE 5-20-2003.
HOWARD SMIGA, EXAMINING ATTORNEY

CLASS 25—(Continued).

SN 78-250,473. ABC-MART, INC., TOKYO, JAPAN, FILED 5-15-2003.



FOR FOOTWEAR (U.S. CLS. 22 AND 39).
FIRST USE 12-31-2000; IN COMMERCE 5-20-2003.
HOWARD SMIGA, EXAMINING ATTORNEY

SN 78-253,043. BRUSSELS SPROUTS LLC, NEWTON, MA. FILED 5-22-2003.

BRUSSELS SPROUTS

FOR CHILDREN'S CLOTHING, HEADWEAR, AND FOOTWEAR, NAMELY, HATS, CAPS, VISORS, SCARVES, GLOVES, MITTENS, JACKETS, COATS, PARKAS, JERSEYS, SWEATSHIRTS, SWEATERS, VESTS, TIES, SHIRTS, T-SHIRTS, POLO SHIRTS, BLOUSES, PANTS, SHORTS, SKORTS, SKIRTS, DRESSES, LEGGINGS, STOCKINGS, TIGHTS, HOSIERY, JUMPERS, COVERALLS, OVERALLS, BABY AND INFANT BUNTING, LAYETTES, SHOES, BOOTS, SLIPPERS, SNEAKERS, MOCCASINS, AND SANDALS (U.S. CLS. 22 AND 39).

CAROLYN CATALDO, EXAMINING ATTORNEY

SN 78-253,387. SKYE HOPPUS AND SUZANNE MITCHELL, SAN DIEGO, CA. FILED 5-22-2003.

CHILDISH

FOR CLOTHING, HEADWEAR AND FOOTWEAR, NAMELY, PANTS, SHORTS, OVERALLS, SHORTALLS, LEGGINGS, ROMPERS, JACKETS, COATS, ANORAKS, SWEATSHIRTS, SWEATPANTS, SWEATERS, SHIRTS, TANK TOPS, VESTS, SKIRTS, DRESSES, WRAPS, SCARVES, GLOVES, MITTENS, CAPS, HATS, BONNETS, SOCKS, BELTS, SHOES, BOOTS, BOOTIES, SLIPPERS, TIGHTS, HOSIERY, BODYSUITS, ONE-PIECE GARMENTS, JUMPERS, SLEEPWEAR, APRONS, BEACHWEAR, SWIMWEAR, BATHROBES, UNDERWEAR, LINGERIE, LAYETTES, DIAPER COVERS, AND NEWBORN AND INFANT WEAR (U.S. CLS. 22 AND 39).

FIRST USE 9-15-2003; IN COMMERCE 12-6-2003.
MICHAEL WEBSTER, EXAMINING ATTORNEY

CLASS 25—(Continued).

SN 78-257,909. THUNDER INDUSTRIES, LOS ANGELES, CA. FILED 6-3-2003.

PIT GIRL

NO CLAIM IS MADE TO THE EXCLUSIVE RIGHT TO USE "GIRL", APART FROM THE MARK AS SHOWN.

FOR MENS', WOMENS' AND CHILDRENS' CLOTHING, FOOTWEAR AND HEADWEAR; NAMELY, SHIRTS, T-SHIRTS, TANK TOPS, SWEATSHIRTS, SWEATPANTS, SHORTS, PANTS, JACKETS, VESTS, HATS AND CAPS, THONGS, CASUAL SHOES AND GLOVES (U.S. CLS. 22 AND 39).

FIRST USE 4-20-1998; IN COMMERCE 4-20-1998.
MICHAEL KEATING, EXAMINING ATTORNEY

SN 78-261,972. FEDERATED BRANDS, INC., MANCHESTER, NH. FILED 6-13-2003.

CHARTER CLUB INTIMATES

OWNER OF U.S. REG. NOS. 1,390,871, 1,997,131 AND OTHERS.

NO CLAIM IS MADE TO THE EXCLUSIVE RIGHT TO USE "INTIMATES", APART FROM THE MARK AS SHOWN.

FOR WOMEN'S CLOTHING, APPAREL AND INTIMATE APPAREL, NAMELY, CAMISOLES, PAJAMAS, NIGHTSHIRTS, NIGHT GOWNS, UNDERWEAR AND LOUNGEWEAR, NAMELY PANTS, SHIRTS AND CARDIGANS, SOCKS, HOSIERY, TIGHTS, SLIPPERS (U.S. CLS. 22 AND 39).

FIRST USE 12-31-1994; IN COMMERCE 12-31-1994.
CAROL SPILS, EXAMINING ATTORNEY

SN 78-261,997. ADRIANNA PABELL L.L.C., NEW YORK, NY. FILED 6-13-2003.

SAFE SILK

NO CLAIM IS MADE TO THE EXCLUSIVE RIGHT TO USE "SILK", APART FROM THE MARK AS SHOWN.

FOR WOMEN'S CLOTHING, MADE IN WHOLE OR PART OF SILK, NAMELY, SKIRTS, SWEATERS, PANTS, BLOUSES, DRESSES, SHIRTS AND JACKETS (U.S. CLS. 22 AND 39).

CIMMERIAN COLEMAN, EXAMINING ATTORNEY

SN 78-262,373. NEW FRONTIER HOLDINGS, INC., WESTPORT, CT. FILED 6-13-2003.

CARPOOL COUTURE

NO CLAIM IS MADE TO THE EXCLUSIVE RIGHT TO USE "COUTURE", APART FROM THE MARK AS SHOWN.

FOR CLOTHING, NAMELY, PANTS, SKIRTS, SHIRTS, BLOUSES, HALTER TOPS, TANK TOPS, SWEATERS, DRESSES, JACKETS, VESTS, SHORTS, JEANS, COATS AND BLAZERS (U.S. CLS. 22 AND 39).

RICHARD A. STRASER, EXAMINING ATTORNEY

CLASS 25—(Continued).

SN 78-267,555. ANTONIO GUAL LIMITED, NEW YORK, NY. FILED 6-26-2003.

ANTONIO GUAL

THE NAME ANTONIO GUAL IDENTIFIES A LIVING INDIVIDUAL WHOSE CONSENT IS OF RECORD.

FOR CLOTHING FOR MEN, WOMEN AND CHILDREN, NAMELY, PANTS, JEANS, SHORTS, BLOUSES, SKIRTS, DRESSES, SWEATERS, VESTS, JACKETS, SWIMWEAR, CAPS, HEADBANDS, HATS, BELTS, UNDERWEAR, UNDERGARMENTS, SOCKS, SLEEPWEAR, STOCKINGS, PANTYHOSE, SCARVES, SUSPENDERS, NECKTIE, FOOTWEAR; RAINWEAR; SWEATERS, BELTS, T-SHIRTS, DRESS SHIRTS; VISORS (U.S. CLS. 22 AND 39).

FIRST USE 12-31-1980; IN COMMERCE 12-31-1980.
KELLY BOULTON, EXAMINING ATTORNEY

SN 78-274,966. CONVERSE INC., NORTH ANDOVER, MA. FILED 7-16-2003.

THE STARTING FIVE

FOR FOOTWEAR AND APPAREL, NAMELY, T-SHIRTS, SWEATSHIRTS, HATS, WARM-UPS TOPS AND BOTTOMS, OUTERWEAR, NAMELY, JACKETS, ATHLETIC SHORTS, AND SHOES (U.S. CLS. 22 AND 39).
MARLENE BELL, EXAMINING ATTORNEY

SN 78-280,021. PHIPES, INC., ORION TOWNSHIP, MI. FILED 7-29-2003.

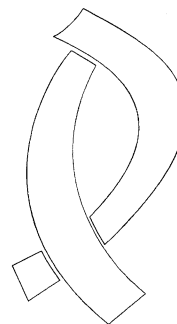

"THE MARK CONSISTS OF A STYLIZED REPRESENTATION OF THE LETTER "P".

FOR MEN'S, WOMEN'S AND CHILDREN'S CLOTHES, NAMELY, CAPS, SHIRTS, TEE-SHIRTS, SWEATERS, SWEATSHIRTS, PANTS, SOCKS, COATS, JACKETS, UNDERWEAR, NAMELY UNDERPANTS AND UNDER-SHIRTS, AND SHOES (U.S. CLS. 22 AND 39).

TRACY FLETCHER, EXAMINING ATTORNEY

CLASS 25—(Continued).

SN 78-281,198. COEY TANNING CO., INC., WARTRACE, TN. FILED 7-30-2003.

SKULL-EEZ

FOR LEATHER SKULL CAPS (U.S. CLS. 22 AND 39). FIRST USE 6-1-2003; IN COMMERCE 6-1-2003. LEIGH CAROLINE CASE, EXAMINING ATTORNEY

SN 78-285,370. WILD APACHE PRODUCTIONS, INC., BALDWIN, NY. FILED 8-9-2003.

WILD APACHE

FOR CLOTHING, NAMELY, HEADWEAR, FOOTWEAR, TOPS AND BOTTOMS, TANK TOPS, T-SHIRTS, SHIRTS, NECKTIES, ASCOTS, SWEATSHIRTS, SWEAT PANTS, SWEAT SUITS, ATHLETIC UNIFORMS, CARDIGANS, SWEATERS, JACKETS, COATS, ANORAKS, JERSEYS, VESTS, PULLOVERS, PANTS, BLOUSES, LEGGINGS, SHORTS, SKORTS, ROMPERS, TROUSERS, JUMPSUITS, OVERALLS, SKIRTS, DRESSES, JUMPERS, BATHING SUITS, UNITARDS, LEOTARDS, TIGHTS, UNDERWEAR, SLEEPWEAR, SLEEP SHIRTS, PAJAMAS, ROBES, NIGHTGOWNS, SLIPPERS SOCKS, SOCKS, HOSIERY, BANDANNAS, SCARVES, NECKERCHIEVES, MUFFLERS, HATS, CAPS, HEADBAND, WRIST BANDS, GLOVES, BELTS, SUSPENDERS, CLOTH BABY BIBS; AND MASQUERADE COSTUMES AND MASKS SOLD IN CONNECTION THEREWITH (U.S. CLS. 22 AND 39).

MICHAEL ENGEL, EXAMINING ATTORNEY

SN 78-285,914. CHARM STEP/EASY STREET SALES CORPORATION, SOMERSWORTH, NH. FILED 8-11-2003.

COMFORT WAVE

NO CLAIM IS MADE TO THE EXCLUSIVE RIGHT TO USE COMFORT, APART FROM THE MARK AS SHOWN. FOR SHOES (U.S. CLS. 22 AND 39). CAROL SPILS, EXAMINING ATTORNEY

SN 78-288,728. AEROGROUP INTERNATIONAL HOLDINGS, INC., EDISON, NJ. FILED 8-18-2003.

AEROSOLES
signature

OWNER OF U.S. REG. NOS. 1,756,927, 2,144,257 AND 2,648,060.

FOR SHOES, BOOTS, SANDALS, SNEAKERS, ESPADRILLES AND SLIPPERS; SCARVES, HATS, SHAWLS, GLOVES AND MITTENS (U.S. CLS. 22 AND 39). FIRST USE 12-0-2003; IN COMMERCE 2-7-2004. HOWARD SMIGA, EXAMINING ATTORNEY

CLASS 25—(Continued).

SN 78-291,575. GRAY MATTER HOLDINGS, LLC, BALTIMORE, MD. FILED 8-25-2003.

180S

OWNER OF U.S. REG. NOS. 2,143,509 AND 2,724,071. FOR CLOTHING, NAMELY, TOPS AND BOTTOMS, JACKETS, COATS, WARM-UP SUITS, SWEAT SUITS, SWEAT PANTS, SWEATSHIRTS, SWEATERS, BLAZERS, VESTS, PANTS, TROUSERS, SLACKS, SHORTS, UNDERWEAR, THERMAL UNDERWEAR, SWIMWEAR, LOUNGEWEAR, GLOVES, MITTENS, SCARVES, WRISTBANDS, SKIWEAR, TIGHTS, FOUL WEATHER GEAR, BEACH WEAR, UNITARDS, BODY SUITS, FISHING VESTS AND WADERS, SLEEPWEAR, ROBES, CAFTANS, NECKWEAR, OVERALLS, PANTSUITS, SUITS, SUIT COATS, RAINWEAR, SASHES, BELTS, SHAWLS, SOCKS; HEADWEAR, NAMELY, HEADBANDS AND HATS; AND FOOTWEAR, NAMELY, SHOES, BOOTS AND SANDALS, EXCLUDING DISTRIBUTION AND/OR SALE OF THE FOREGOING TO OR THROUGH RELIGIOUS ORGANIZATIONS OR RELIGIOUS YOUTH MINISTRIES (U.S. CLS. 22 AND 39).

ANDREA SAUNDERS, EXAMINING ATTORNEY

SN 78-292,746. KNIGHTS APPAREL LLC, OAK BROOK, IL. FILED 8-27-2003.



FOR CLOTHING, SPORTS CLOTHING AND ACTIVE WEAR, NAMELY, SHIRTS, GOLF SHIRTS, POLO SHIRTS, UNDERSHIRTS, SWEAT SHIRTS, KNIT SHIRTS, T-SHIRTS, PANTS, OUTERWEAR PANTS, SWEAT PANTS, SHORTS, GYM SHORTS, BOXER SHORTS, SWEATSHORTS, JACKETS AND JERSEYS (U.S. CLS. 22 AND 39).

FIRST USE 3-0-2002; IN COMMERCE 3-0-2002. KEVON CHISOLM, EXAMINING ATTORNEY

SN 78-293,207. ANGUIANO, JOSE, CHULA VISTA, CA. FILED 8-28-2003.

CODE OF SILENCE

FOR CLOTHING, NAMELY, SHIRTS JACKETS, PANTS, AND HEADGEAR, NAMELY, HATS AND CAPS (U.S. CLS. 22 AND 39).

CURTIS FRENCH, EXAMINING ATTORNEY

CLASS 25—(Continued).

SN 78-293,450. COLLINS, KEY, V., HOUSTON, TX. FILED 8-28-2003.

EVERYDAY SPORTS

NO CLAIM IS MADE TO THE EXCLUSIVE RIGHT TO USE SPORTS, APART FROM THE MARK AS SHOWN.
 FOR CLOTHING, NAMELY T-SHIRTS, HATS, HEADBANDS, SWEATSHIRTS, SWEATPANTS, AND SOCKS (U.S. CLS. 22 AND 39).
 LEIGH CAROLINE CASE, EXAMINING ATTORNEY

CLASS 25—(Continued).

SN 78-296,087. AMERICAN CLUB INTERNATIONAL CO., LTD., OSAKA, JAPAN, FILED 9-4-2003.

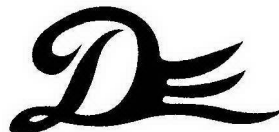

DRAGON BEARD

THE MARK CONSISTS OF THE WORDS "DRAGON BEARD" TOGETHER WITH A STYLIZED LETTER "D".
 FOR SHOES, LEATHER SHOES, TRACK AND FIELD ATHLETIC SHOES, BASKETBALL SHOES, TENNIS SHOES, SOCCER SHOES, MOUNTAIN-CLIMBING SHOES, SANDALS, BOXING SHOES, BOOTS, RUBBER SHOES, SPORTS SHOES, INSOLES, ANKLE-HIGH SHOES, SKI SHOES, SHOES FOR PROTECTION AGAINST THE COLD, GOLF SHOES, BASEBALL SHOES (U.S. CLS. 22 AND 39).
 APRIL L. RADEMACHER, EXAMINING ATTORNEY

SN 78-295,178. INDIGO GROUP USA, INC., GARDENA, CA. FILED 9-2-2003.

BUCKINGHAM DENIM & DUDS

NO CLAIM IS MADE TO THE EXCLUSIVE RIGHT TO USE "DENIM & DUDS", APART FROM THE MARK AS SHOWN.
 FOR JEANS, SWEATERS, JACKETS, COATS, SHIRTS, T-SHIRTS, SKIRTS, VESTS, AND TANK TOPS (U.S. CLS. 22 AND 39).
 FIRST USE 1-19-2003; IN COMMERCE 6-2-2003.
 CAROLYN GRAY, EXAMINING ATTORNEY

SN 78-296,095. OSHKOSH B'GOSH, INC., OSHKOSH, WI. FILED 9-4-2003.



OWNER OF U.S. REG. NOS. 511,479, 2,575,818 AND OTHERS.
 NO CLAIM IS MADE TO THE EXCLUSIVE RIGHT TO USE "1895", APART FROM THE MARK AS SHOWN.
 THE MARK CONSISTS OF THE WORDS AND NUMBERS OSHKOSH 1895 IN A CLOVERLEAF DESIGN.
 SEC. 2(F) AS TO "OSHKOSH".
 FOR CLOTHING, NAMELY BIB OVERALLS, JUMPERS, JEANS, SHORTALLS, SHORTS, SKIRTS, SKORTS, DRESSES, PANTS, SHIRTS, BLOUSES, SWEATERS, SWEATSHIRTS, HOSIERY, COVERALLS, JUMPSUITS, WARMUP SUITS, FLEECE PANTS, SLEEPWEAR, PAJAMAS, ROMPERS, BODY SUITS, CREEPERS, SOCKS, TIGHTS, LEGGINGS, UNDERWEAR, VESTS, COATS, JACKETS, HATS, CAPS, VISORS, HEADBANDS, BANDANAS, GLOVES, MITTENS, SCARVES, BELTS, SUSPENDERS, APRONS, SWIMWEAR, AND FOOTWEAR, NAMELY BOOTS, SHOES, SANDALS, BOOTIES, AND SLIPPERS (U.S. CLS. 22 AND 39).
 WANDA KAY PRICE, EXAMINING ATTORNEY

SN 78-295,236. WING, LAUREN LEE, CULVER CITY, CA. FILED 9-3-2003.

PILATES PACIFICA SWIMMING WITHOUT WATER

NO CLAIM IS MADE TO THE EXCLUSIVE RIGHT TO USE PILATES, APART FROM THE MARK AS SHOWN.
 "PACIFICA" IS THE LATIN POSSESSIVE FORM FOR THE TERM PACIFIC.
 FOR T-SHIRTS, SHORTS, EXERCISE PANTS, AND SWIMWEAR (U.S. CLS. 22 AND 39).
 BILL DAWE, EXAMINING ATTORNEY

CLASS 25—(Continued).

SN 78-296,523. OLD DOMINION FOOTWEAR, INC., LYNCHBURG, VA. FILED 9-5-2003.

SEDALIA

FOR SHOES (U.S. CLS. 22 AND 39).
H. M. FISHER, EXAMINING ATTORNEY

SN 78-300,400. PRO-PAC DISTRIBUTING COMPANY, LOS ANGELES, CA. FILED 9-15-2003.

PRO CLUB

FOR SHIRTS, NAMELY T-SHIRTS AND SWEAT SHIRTS (U.S. CLS. 22 AND 39).
FIRST USE 5-1-1996; IN COMMERCE 5-1-1996.
TONI HICKEY, EXAMINING ATTORNEY

SN 78-301,754. OZAN ÖRME TEKSTİL SANAYİ VE TİCARET LİMİTED SİRKETİ, EMINÖNÜ-İSTANBUL, TURKEY, FILED 9-17-2003.



FOR ANKLE GARTERS, ANKLETS, ANORAKS, APRONS, ATHLETIC FOOTWEAR, ATHLETIC SHOES, BABUSHKAS, BANDANNAS, BATH SLIPPERS, BATHING CAPS, BATHING SUITS, BATHROBES, BEACH SHOES, BEACHWEAR, BED JACKETS, BERETS, BERMUDA SHORTS, BIKINIS, BLAZERS, BLOUSES, BOAS, BODY SHAPERS, BODY SUITS, BOLEROS, BOLO TIES, BONNETS, BOOTS, BOW TIES, BOXER SHORTS, BRAS, BRASSIERES, BUSTIERS, CAFTANS, CAMP SHIRTS, CAPS, COATS, CORSELETS, CORSETS, CRAVATS, CULOTTES, DENIM JACKETS, DISPOSABLE UNDERWEAR, DRESSES, DRESSING GOWNS, ESPADRILLES, EVENING GOWNS, FOOTWEAR, FUR COATS, FUR JACKETS, GABERDINES, GARTER BELTS, GIRDLES, GLOVES, GOLF SHIRTS, GYM SHORTS, GYMNASTIC SHOES, HATS, HEAD BANDS, HEADWEAR, HOSE, INNER SOLES, JACKETS, JEANS, JUMPERS, JUMPSUITS, KERCHIEFS, KILTS, KIMONOS, KNEE HIGHS,

CLASS 25—(Continued).

KNIT SHIRTS, LAB COATS, LACE BOOTS, LEATHER COATS, LEATHER JACKETS, LEOTARDS, LINGERIE, LOUNGEWEAR, MINISKIRTS, MONEY BELTS, NECKTIES, NECKWEAR, NIGHT GOWNS, NIGHT SHIRTS, OVERALLS, OVERCOATS, OVERSHOES, PAJAMAS, PANTALOONS, PANTIES, PANTS, PANTSUITS, PANTYHOSE, PARKAS, PELERINES, POLO SHIRTS, PULLOVERS, RAIN BOOTS, RAIN COATS, RAIN JACKETS, RAIN SUITS, RAINWEAR, SHIRTS, SHOES, SHORTS, SLEEP SHIRTS, SLEEPWEAR, SLIPPERS, SLIPS, SOCKS, SPORT COATS, SPORT SHIRTS, STOCKINGS, SUSPENDERS, SWEAT BANDS, SWEAT PANTS, SWEAT SHIRTS, SWEAT SHORTS, SWEAT SUITS, SWEATERS, SWEATSOCKS, SWIM WEAR, SWIMMING CAPS, SWIMSUITS, TAILLEURS, TANGAS, TANK TOPS, TAP PANTS, TEDDIES, TENNIS WEAR, TIES, TIGHTS, TOE BOXES, TROUSERS, T-SHIRTS, TUNICS, TURBANS, UNDERCLOTHES, UNDERPANTS, UNDERSHIRTS, UNDERWEAR, WALKING SHORTS; CLOTHING, NAMELY, BELTS, CAPS, WRAP-AROUNDS; UNDERWEAR NAMELY BRIEFS, THONGS (U.S. CLS. 22 AND 39).
GEOFFREY FOSDICK, EXAMINING ATTORNEY

SN 78-301,993. L.C. LICENSING, INC., NEW YORK, NY. FILED 9-18-2003.

07

FOR CLOTHING, NAMELY, SKIRTS, SHIRTS, BLOUSES, PANTS, JACKETS, VESTS, SWEATERS, DRESSES, JUMPSUITS, SHORTS, JEANS, JERSEYS, CULOTTES, SCARVES, TUNICS, BLAZERS, NECKWEAR, BELTS, COATS, HATS, CAPS, HOODS, GLOVES, PANTYHOSE, DRESS HOSIERY, SPORT HOSIERY, SOCKS; UNDERWEAR, INTIMATE APPAREL, NAMELY, BRASSIERES, PANTIES, CAMISOLES, TEDDIES AND SLIPS; BODYWEAR, NAMELY, LEOTARDS AND TIGHTS; SHOES, SANDALS, SLIPPERS, SNEAKERS AND BOOTS; RAINWEAR; SWIMSUITS AND COVERUPS; BIKINI TOPS AND BOTTOMS; SLEEPWEAR, NAMELY, NIGHTGOWNS, PAJAMAS, SLEEP-SHIRTS, ROBES AND BEDJACKETS (U.S. CLS. 22 AND 39).
DAWN FELDMAN, EXAMINING ATTORNEY

SN 78-302,734. JB APPAREL, LLC, NEW YORK, NY. FILED 9-19-2003.



OWNER OF U.S. REG. NO. 1,587,912.
FOR CLOTHING AND CLOTHING ACCESSORIES, NAMELY, JEANS, SKIRTS, BLOUSES, PANTS, PULL-OVER SWEATERS, DRESSES, OVERCOATS, VESTS, SWEATERS, JACKETS, SHIRTS (U.S. CLS. 22 AND 39).
TONI HICKEY, EXAMINING ATTORNEY

CLASS 25—(Continued).

SN 78-303,276. DIRECT EXPORT, INC., BOCA RATON, FL. FILED 9-22-2003.



OWNER OF U.S. REG. NO. 2,556,060.
FOR FOOTWEAR, HEADWEAR, UNDERWEAR, UNDERSHIRTS, BRAS, PANTIES, STOCKINGS, SHIRTS, JACKETS, PANTS, SHORTS, GLOVES, MITTENS, DRESSES, PARKAS, SWEATERS AND SWEAT SHIRTS (U.S. CLS. 22 AND 39).
DOMINICK J. SALEMI, EXAMINING ATTORNEY

SN 78-303,360. DRY, LESLIE, LOS ANGELES, CA. FILED 9-22-2003.

SOULFUL SELF

FOR T-SHIRTS, TANK TOPS, SPORTS BRAS, SWEAT SUITS, AND SWEAT PANTS (U.S. CLS. 22 AND 39).
SUSAN LESLIE DUBOIS, EXAMINING ATTORNEY

SN 78-303,945. ORGANIZED GEAR ENTERTAINMENT, INC., DORCHESTER, MA. FILED 9-23-2003.

ORGANIZED GEAR

NO CLAIM IS MADE TO THE EXCLUSIVE RIGHT TO USE "GEAR", APART FROM THE MARK AS SHOWN.
FOR CASUAL CLOTHING, NAMELY, HATS, HEADBANDS, VISORS, SCARVES, SHORT SLEEVE T-SHIRTS, LONG SLEEVE T-SHIRTS, TANK TOPS, TUBE TOPS, RUGBY SHIRTS, POLO SHIRTS, SPORT SHIRTS, SWEAT SHIRTS, BELTS, SWEAT PANTS, DENIM PANTS, SHORT PANTS, SKIRTS, SOCKS, UNDERWEAR, UNDERSHIRTS, SWEAT SUITS, JOGGING SUITS, VELOUR SUITS, DENIM JACKETS, AND WIND RESISTANT JACKETS (U.S. CLS. 22 AND 39).
FIRST USE 9-12-1999; IN COMMERCE 9-18-1999.
CAROLYN GRAY, EXAMINING ATTORNEY

SN 78-304,168. THE SHOE SHOW, INC., CONCORD, NC. FILED 9-23-2003.

POLL PARROT

FOR FOOTWEAR (U.S. CLS. 22 AND 39).
MICHAEL WEBSTER, EXAMINING ATTORNEY

CLASS 25—(Continued).

SN 78-304,188. THE SHOE SHOW, INC., CONCORD, NC. FILED 9-23-2003.

PAUL PIRATE

FOR FOOTWEAR (U.S. CLS. 22 AND 39).
MICHAEL WEBSTER, EXAMINING ATTORNEY

SN 78-305,059. EL VAQUERITO 7, ONTARIO, CA. FILED 9-24-2003.

THE KING OF CARTEL

FOR CLOTHING, NAMELY HATS, T-SHIRTS, SWEATERS, AND BOOTS (U.S. CLS. 22 AND 39).
DAVID ELTON, EXAMINING ATTORNEY

SN 78-305,741. BOSTON 2004, INC., BOSTON, MA. FILED 9-26-2003.

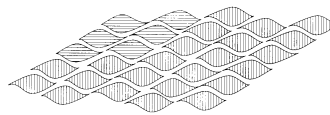

Boston ☆ 2004
Nothing conventional about it.

NO CLAIM IS MADE TO THE EXCLUSIVE RIGHT TO USE BOSTON AND 2004, APART FROM THE MARK AS SHOWN.
THE LINING SHOWN IN THE MARK IS TO INDICATE SHADING.
FOR NECKTIES; BANDANNAS; BATHROBES; NIGHT SHIRTS; JOGGING SUITS; SOCKS; SHORTS; PANTS; SLACKS; SHIRTS; JACKETS; SWEATERS; BOWTIES; HEADWEAR; RAIN WEAR, NAMELY, RAIN PONCHOS AND JACKETS; CLOTHING, NAMELY, NYLON SHELLS; HATS; CAPS; VISORS; APRONS; WIND RESISTANT JACKETS; GOLF SUITS AND HATS; BLAZERS; JEANS; WORKOUT AND SUPPORT APPAREL, NAMELY, SHORTS, JACKETS, SLACKS, AND SHIRTS; T-SHIRTS; SWEAT SHIRTS; SWEAT PANTS (U.S. CLS. 22 AND 39).
GINA FINK, EXAMINING ATTORNEY

CLASS 25—(Continued).

SN 78-305,812. BLAS, MATTHEW, CANOGA PARK, CA. FILED 9-26-2003.



FOR MEN'S, WOMEN'S AND CHILDREN'S CLOTHING, NAMELY, SWEATSHIRTS, SHIRTS, JEANS, JACKETS, COATS, SWEATPANTS, SLACKS, SUITS, HATS, HEADBANDS, VISORS, CAPS, DRESSES, SHOES, SNEAKERS, BOOTS, WRISTBANDS, SOCKS, T-SHIRTS, BELTS, UNDERGARMENTS, NECKTIES, DRESS (U.S. CLS. 22 AND 39).

GENE MACIOL, EXAMINING ATTORNEY

SN 78-305,813. LOLLYTOGS, LTD., NEW YORK, NY. FILED 9-26-2003.



OWNER OF U.S. REG. NOS. 1,813,815, 2,390,119 AND OTHERS.

FOR CLOTHING FOR BOYS AND GIRLS, NAMELY, SCHOOL UNIFORMS, WOVEN SHIRTS, KNITTED SHIRTS, SWEATERS, SWEATSHIRTS, SWEAT PANTS, PANTS, OVERALLS, SLACKS, SHORTS, JACKETS, COATS, VESTS, SOCKS, HOSIERY, BELTS, SUSPENDERS, BANDANNAS; FOR GIRLS, NAMELY, BLOUSES, SKIRTS, JUMPERS AND DRESSES; AND, FOR BOYS, NAMELY, NECKTIES (U.S. CLS. 22 AND 39).

FIRST USE 1-2-1999; IN COMMERCE 1-2-1999.
INGA ERVIN, EXAMINING ATTORNEY

CLASS 25—(Continued).

SN 78-306,286. JAS. D. EASTON, INC., VAN NUYS, CA. FILED 9-26-2003.

FRM

FOR CLOTHING AND FOOTWEAR FOR PLAYING SPORTS AND FOR CASUAL WEAR, NAMELY, JACKETS, JERSEYS, TEE SHIRTS, SHIRTS, PANTS, WIND-BREAKERS, SOCKS, UNDERWEAR, SWEAT SHIRTS, SWEAT PANTS, SWEAT SHORTS, SWEAT SUITS, CAPS, GLOVES AND WRISTBANDS (U.S. CLS. 22 AND 39).

JANICE L. MCMORROW, EXAMINING ATTORNEY

SN 78-306,403. PERRYMAN, VINCENT LEE, VALLEY CENTER, CA. FILED 9-28-2003.

ONNPOP

FOR HATS, SHIRTS, SHOES, BELTS, PANTS (U.S. CLS. 22 AND 39).

JANICE L. MCMORROW, EXAMINING ATTORNEY

SN 78-307,720. THE STEP COMPANY, MARIETTA, GA. FILED 9-30-2003.

BODYACTIVE

FOR CLOTHING, NAMELY, T-SHIRTS, SWEATSHIRTS, JACKETS AND HATS (U.S. CLS. 22 AND 39).

AMY ALFIERI, EXAMINING ATTORNEY

SN 78-308,306. KELLY, MICHAEL J., BEDFORD, TX. FILED 10-1-2003.

BIKED UP

FOR SHIRTS AND HATS (U.S. CLS. 22 AND 39).

JAMES GRIFFIN, EXAMINING ATTORNEY

SN 78-308,894. VANITY FAIR, INC., WILMINGTON, DE. FILED 10-2-2003.

REAL SEXY

OWNER OF U.S. REG. NO. 2,820,507.
FOR LINGERIE, SLEEPWEAR AND HOSIERY (U.S. CLS. 22 AND 39).

STACY WAHLBERG, EXAMINING ATTORNEY

CLASS 25—(Continued).

SN 78-309,159. BYSL, INC., NEW YORK, NY. FILED 10-3-2003.

HARRIMAN & FORD

FOR CLOTHING, NAMELY MEN'S, WOMEN'S AND CHILDREN'S PANTS, BLAZERS, BLOUSES, BODY-SUITS, CARDIGANS, SPORT COATS, DRESSES, JEANS, JUMPSUITS, KNIT SHIRTS, OVERALLS, PANTS, PANTSUITS, POLO SHIRTS, PULL-OVERS, SPORT SHIRTS, SWEATSHIRTS, SHORTS, SKIRTS, SLACKS, SWEAT-PANTS, SWEATSHORTS, SWEATSUITS, SWEATERS, T-SHIRTS, TOPS, TROUSERS AND VESTS (U.S. CLS. 22 AND 39).

NELSON SNYDER, EXAMINING ATTORNEY

SN 78-309,870. VANITY FAIR, INC., WILMINGTON, DE. FILED 10-6-2003.

SEXYCOTTON

FOR LINGERIE, SLEEPWEAR AND HOSIERY (U.S. CLS. 22 AND 39).

KHANH LE, EXAMINING ATTORNEY

SN 78-311,632. VANITY FAIR, INC., WILMINGTON, DE. FILED 10-9-2003.

BODY SLEEK

OWNER OF U.S. REG. NOS. 1,936,277 AND 1,936,848.
FOR LINGERIE, SLEEPWEAR AND HOSIERY (U.S. CLS. 22 AND 39).

DAWN HAN, EXAMINING ATTORNEY

SN 78-311,866. LIU, WAN-IHN, TAICHUNG CITY, TAIWAN, FILED 10-9-2003.

ohoh-mini

FOR CLOTHING, NAMELY, DRESSES, MATERNITY DRESSES, SWEATERS, SHIRTS, PANTS, LINGERIE, BRAS, PANTIES, NIGHT GOWNS, GIRDLES; CLOTHING FOR CHILDREN AND INFANTS, NAMELY, SHORTS, SHIRTS, T-SHIRTS, SWIMSUITS, PANTS, SWEATERS, JERSEYS, SOCKS, JACKETS, BELTS, SUSPENDERS, DRESSES, COATS, RAINCOATS, UNDERWEAR, PAJAMAS (U.S. CLS. 22 AND 39).

FIRST USE 9-0-2003; IN COMMERCE 9-0-2003.

JENNIFER KRISP, EXAMINING ATTORNEY

CLASS 25—(Continued).

SN 78-312,054. BROOKS SPORTS, INC., BOTHELL, WA. FILED 10-10-2003.

PDRB

FOR ATHLETIC FOOTWEAR (U.S. CLS. 22 AND 39).
FIRST USE 5-0-2002; IN COMMERCE 5-0-2002.
NELSON SNYDER, EXAMINING ATTORNEY

SN 78-312,102. VANITY FAIR, INC., WILMINGTON, DE. FILED 10-10-2003.

UNDER EXPOSED

FOR LINGERIE, SLEEPWEAR AND HOSIERY (U.S. CLS. 22 AND 39).
STACY WAHLBERG, EXAMINING ATTORNEY

SN 78-312,705. PGA TOUR, INC., PONTE VEDRA BEACH, FL. FILED 10-13-2003.

GOLF STARTS HERE

FOR CLOTHING – NAMELY MEN'S AND WOMEN'S SHIRTS, JACKETS, PANTS, SOCKS, NECKTIES AND HEADWEAR (U.S. CLS. 22 AND 39).
JOHN SCHUYLER YARD, EXAMINING ATTORNEY

SN 78-313,643. TEAR IT OFF INTERNATIONAL, SAN JUAN CAPISTRANO, CA. FILED 10-14-2003.

TEAR IT OFF

FOR WOMEN'S CLOTHING; NAMELY, T-SHIRTS, HATS, CAPS, VISORS, SWEATSHIRTS, JACKETS, VESTS, PANTS, LEGGINGS, SWEATPANTS, CAPRIS, SHORTS, WALKING SHORTS, JUMPERS, SKIRTS, DRESSES, PAJAMAS, ROBES, UNDERWEAR, SOCKS, GLOVES, SWIM TRUNKS, COVER-UPS, BATHING SUITS, BIKINIS, BELTS, BELT BUCKLES, TIES, SCARVES, BEANIES, SHIRTS, TANK TOPS, JERSEYS, SANDALS, SLIPPERS, BOOTS, AND SHOES (U.S. CLS. 22 AND 39).

RICHARD WHITE, EXAMINING ATTORNEY

SN 78-313,966. RED CARTER, LLC, MIAMI BEACH, FL. FILED 10-15-2003.

SANDY BOTTOMS

FOR SWIM WEAR, BEACHWEAR AND COVERUPS (U.S. CLS. 22 AND 39).

SHAUNIA WALLACE, EXAMINING ATTORNEY

CLASS 25—(Continued).

SN 78-314,085. REVAH HOLDINGS, INC., LOS ANGELES, CA. FILED 10-15-2003.



OWNER OF U.S. REG. NOS. 1,445,266, 2,391,333 AND OTHERS.

THE MARK CONSISTS OF A FOUR POINTED CROWN ABOVE THE REGISTERED MARK INCO.

FOR CLOTHING NAMELY, DRESSES, ATHLETIC WEAR NAMELY, JOGGING SUITS AND SWEATSHIRTS, PANTS, JEANS, OVERALLS, SLACKS, SHIRTS, TOPS, SHORTS, SKIRTS, SWEATERS, SWEAT SHIRTS, SWEAT PANTS, SWEAT SHORTS, COATS, PARKAS, VESTS, CAPS, HATS, BELTS, BOXER SHORTS, UNDERWEAR, SHOES, FOOTWEAR, BATHING SUITS, BATHING TRUNKS, SWIM WEAR, SWIM SUITS, BEACHWEAR, BEACH COVERUPS, GLOVES, PAJAMAS, SLEEPWEAR, ROBES, BATHROBES, SKI WEAR, SKI SUITS, SNOW PANTS, SNOWBOARD BOOTS, SNOWBOARD GLOVES, SOCKS, HOSIERY, RAIN WEAR, RAIN COATS, RAIN JACKETS, RAIN SUITS, AND RAIN BOOTS (U.S. CLS. 22 AND 39).

FIRST USE 2-18-2000; IN COMMERCE 2-18-2000.
SHAUNIA WALLACE, EXAMINING ATTORNEY

SN 78-314,450. FII FOOTWEAR MANAGEMENT LIMITED, NORTHAMPTON, UNITED KINGDOM, FILED 10-16-2003.



THE NAME FRANK WRIGHT DOES NOT IDENTIFY A LIVING INDIVIDUAL.

THE MARK CONSISTS OF A STYLIZED HEAD OF A BULLDOG NEXT TO THE WORDING.

FOR FOOTWEAR AND SHOES (U.S. CLS. 22 AND 39).
JOHN HWANG, EXAMINING ATTORNEY

SN 78-314,675. MCDERMOTT, PAMELA J., E. SANDWICH, MA. FILED 10-16-2003.

WIGGEE'S

FOR CHILDREN'S CLOTHING, NAMELY, TOPS AND BOTTOMS, FOOTWEAR, AND HATS (U.S. CLS. 22 AND 39).

DAVID TAYLOR, EXAMINING ATTORNEY

CLASS 25—(Continued).

SN 78-320,230. MAY DEPARTMENT STORES INTERNATIONAL, INC., ST. LOUIS, MO. FILED 10-29-2003.

WELCOME HOME

OWNER OF U.S. REG. NO. 1,827,554.
FOR INFANT'S CLOTHING, NAMELY, TWO-PIECE SLEEPER SETS, T-SHIRTS, PANTS, OVERALLS, COVERALLS AND SHAWLS (U.S. CLS. 22 AND 39).
FIRST USE 6-10-1993; IN COMMERCE 6-10-1993.
GINA HAYES, EXAMINING ATTORNEY

SN 78-320,732. CONOCOPHILLIPS COMPANY, HOUSTON, TX. FILED 10-30-2003.



FOR CAPS; SPORTS SHIRTS; DRESS SHIRTS; T-SHIRTS; SHORTS; JACKETS; PARKAS; WIND RESISTANT JACKETS; SWEATSHIRTS; VEST; APRONS; GLOVES (U.S. CLS. 22 AND 39).

CAROL SPILS, EXAMINING ATTORNEY

CLASS 26—FANCY GOODS

SN 76-489,413. H.C.T.V., INC., MONTGOMERYVILLE, PA. FILED 2-12-2003.

TONI TWIST

NO CLAIM IS MADE TO THE EXCLUSIVE RIGHT TO USE "TWIST", APART FROM THE MARK AS SHOWN.

FOR HAIR PIECES SOLD VIA TELEVISION AND PRESENTED BY TONI BRATTIN (U.S. CLS. 37, 39, 40, 42 AND 50).

NICHOLAS ALTREE, EXAMINING ATTORNEY

SN 78-302,335. LISA FRANK, INC., TUCSON, AZ. FILED 9-18-2003.

HAIR GLAM

NO CLAIM IS MADE TO THE EXCLUSIVE RIGHT TO USE "HAIR", APART FROM THE MARK AS SHOWN.

FOR HAIR ACCESSORIES, NAMELY HAIR CLIPS AND CLAW CLIPS, HAIR SCRUNCHIES, PONY TAIL HOLDERS, BOWS FOR HAIR, BEADS FOR HAIR, ELASTIC CORDING FOR HAIR, HAIR ACCESSORY KITS CONSISTING PRIMARILY OF HAIR CLIPS, HAIR SCRUNCHIES, HAIR BOWS, HAIR BEADS, OR ELASTIC CORDING FOR HAIR AND HAIR COMB, HAIR BRUSH, OR A COMPACT MIRROR (U.S. CLS. 37, 39, 40, 42 AND 50).

DAWN FELDMAN, EXAMINING ATTORNEY

CLASS 26—(Continued).

SN 78-307,123. JOSTENS, INC., MINNEAPOLIS, MN. FILED 9-30-2003.

STATUS TASSEL

NO CLAIM IS MADE TO THE EXCLUSIVE RIGHT TO USE "TASSEL", APART FROM THE MARK AS SHOWN. FOR DECORATIVE TASSELS (U.S. CLS. 37, 39, 40, 42 AND 50).
LANA PHAM, EXAMINING ATTORNEY

CLASS 28—(Continued).

SN 75-628,606. NATIONAL PAINTBALL SUPPLY, INC., MANTUA, NJ. FILED 1-27-1999.

DIABLO

THE ENGLISH TRANSLATION OF "DIABLO" IS "DEVIL".
FOR PAINTBALL GUNS AND GUN PARTS (U.S. CLS. 22, 23, 38 AND 50).
FIRST USE 12-14-1996; IN COMMERCE 12-14-1996.
GINNY ISAACSON, EXAMINING ATTORNEY

CLASS 27—FLOOR COVERINGS

SN 76-451,226. ECHO ADVISORY OF FLORIDA, LLC, FORT LAUDERDALE, FL. FILED 9-11-2002.

LIGHTSAVER

FOR PROTECTIVE SYSTEMS FOR AIRPORT RUNWAY AND TAXIWAY LIGHT FIXTURES, NAMELY, ANCHORED RUBBER MATS (U.S. CLS. 19, 20, 37, 42 AND 50).
FIRST USE 5-8-2001; IN COMMERCE 5-8-2001.
BRENDAN MCCAULEY, EXAMINING ATTORNEY

SN 78-226,018. R & L MCMAHAN ENTERPRISES INCORPORATED, CEDAR PARK, TX. FILED 3-15-2003.

LET'S GEL

FOR CARPETS, RUGS, MATS, NAMELY RESILIENT CARPETS, RUGS AND MATS. (U.S. CLS. 19, 20, 37, 42 AND 50).
M. E. BODSON, EXAMINING ATTORNEY

SN 75-743,823. PROPHET CORPORATION, THE, OWATONNA, MN. FILED 7-6-1999.

RAINBOW

FOR ATHLETIC EQUIPMENT AND SPORTING GOODS; NAMELY FOOTBALL EQUIPMENT NAMELY, YOUTH GUARDS AND SHOULDER PADS; VOLLEYBALL EQUIPMENT, NAMELY VOLLEYBALLS, NETS, AND KNEE PADS; BASKETBALL EQUIPMENT, NAMELY GOALS, BACKBOARDS, NETS AND BASKETBALLS; SOCCER EQUIPMENT, NAMELY SOCCER BALLS, GOALS, NETS, SHIN PADS; BASEBALL EQUIPMENT, NAMELY CATCHER'S MASKS AND PADS, BACK STOPS, BATS, BALLS, GLOVES, AND BASES; TRACK EQUIPMENT, NAMELY STARTING BLOCKS, HURDLES, RACE BATONS, SHOT PUTS, AND DISCUSSES; PHYSICAL EDUCATION EQUIPMENT AND RECREATION EQUIPMENT FOR PLAYING GAMES AND SPORTS, NAMELY PLAYGROUNDS BALLS, FLYING DISCS, PADDLE BALL GAMES, RACQUET BALL RACQUETS AND BALLS; TABLE TENNIS TABLES, TABLE TENNIS NETS AND TABLE TENNIS PADDLES; INFLATABLE FLOAT MATTRESSES OR PADS FOR RECREATIONAL USE; BADMINTON RACQUETS, BADMINTON NETS, AND BADMINTON SHUTTLE COCKS; HOCKEY EQUIPMENT, NAMELY SHIN PADS, GOALS, STICKS AND PUCKS; GOLF EQUIPMENT, NAMELY GOLF BALLS AND TEES; AND FITNESS EQUIPMENT, NAMELY EXERCISE WEIGHTS AND EXERCISE MACHINES (U.S. CLS. 22, 23, 38 AND 50).
FIRST USE 1-1-1992; IN COMMERCE 1-1-1992.
KEVON CHISOLM, EXAMINING ATTORNEY

SN 75-747,596. GOTCHA INTERNATIONAL, L.P., IRVINE, CA. FILED 6-29-1999.

GOTCHA

CLASS 28—TOYS AND SPORTING GOODS

SN 75-292,139. KAHN, KENNETH H., N. HOLLYWOOD, CA. FILED 6-30-1997.

COWBEARS

FOR DOLLS (U.S. CLS. 22, 23, 38 AND 50).
STEVEN BERK, EXAMINING ATTORNEY

OWNER OF U.S. REG. NOS. 1,222,521, 1,686,083 AND OTHERS.
FOR SPORTING GOODS, NAMELY SKATEBOARDS, SURF BOARDS, SNOWBOARDS, SNOWBOARD BINDINGS, PROTECTIVE GEAR CONSISTING OF KNEE AND ELBOW PADS (U.S. CLS. 22, 23, 38 AND 50).
DOUGLAS LEE, EXAMINING ATTORNEY

CLASS 28—(Continued).

SN 76-283,193. BASS PRO TRADEMARKS, L.L.C, SPRINGFIELD, MO. FILED 7-11-2001.

BASS PRO SHOPS FISH STIKS

OWNER OF U.S. REG. NOS. 1,950,067, 2,487,746 AND OTHERS.

NO CLAIM IS MADE TO THE EXCLUSIVE RIGHT TO USE "PRO SHOPS", APART FROM THE MARK AS SHOWN. FOR FISHING TACKLE FOR CHILDREN (U.S. CLS. 22, 23, 38 AND 50).

YONG KIM, EXAMINING ATTORNEY

SN 76-283,314. DAN-DEE INTERNATIONAL. LTD., JERSEY CITY, NJ. FILED 7-11-2001.

KOOL KIDS

FOR STUFFED TOY ANIMALS; DOLLS; POLYRESIN TOY FIGURINES (U.S. CLS. 22, 23, 38 AND 50).

YONG KIM, EXAMINING ATTORNEY

SN 76-435,744. HOLMES, RONEE C., NEW ORLEANS, LA. FILED 7-29-2002.

POMPOM-ETTES

FOR FINGER-HELD STREAMERS (U.S. CLS. 22, 23, 38 AND 50).

FIRST USE 3-8-2002; IN COMMERCE 3-8-2002.

JENNIFER DIXON, EXAMINING ATTORNEY

SN 76-436,989. HASBRO, INC., PAWTUCKET, RI. FILED 8-2-2002.

ZIP TRIMMER

NO CLAIM IS MADE TO THE EXCLUSIVE RIGHT TO USE TRIMMER, APART FROM THE MARK AS SHOWN.

FOR TOY LAWN TRIMMER (U.S. CLS. 22, 23, 38 AND 50).

FIRST USE 4-30-2001; IN COMMERCE 4-30-2001.

RONALD MCMORROW, EXAMINING ATTORNEY

SN 76-476,875. BASS ASSASSIN LURES, INC., MAYO, FL. FILED 12-16-2002.

TEXAS ASSASSIN

OWNER OF U.S. REG. NOS. 1,754,053, 1,994,156 AND 2,138,892.

NO CLAIM IS MADE TO THE EXCLUSIVE RIGHT TO USE "TEXAS", APART FROM THE MARK AS SHOWN.

FOR FISHING LURES (U.S. CLS. 22, 23, 38 AND 50).

FIRST USE 10-22-2002; IN COMMERCE 10-22-2002.

PAUL F. GAST, EXAMINING ATTORNEY

CLASS 28—(Continued).

SN 76-512,642. FOX, KATHLEEN, MT. PLEASANT, SC. FILED 5-8-2003.



NO CLAIM IS MADE TO THE EXCLUSIVE RIGHT TO USE "LIBRARY", APART FROM THE MARK AS SHOWN. THE MARK CONSISTS OF LIBRARYGAMES.COM, MAKING THE LIBRARY FUN! AND DESIGN.

FOR EDUCATIONAL GAMES CONSISTING OF GAME CARDS, GAME PIECES, AND INSTRUCTION AND TRACKING SHEETS IN THE FIELD OF LIBRARY SCIENCE, TERMINOLOGY, AND RESOURCES (U.S. CLS. 22, 23, 38 AND 50).

FIRST USE 2-2-2002; IN COMMERCE 2-2-2002.

RICHARD A. STRASER, EXAMINING ATTORNEY

SN 76-515,007. MAVERICK SKATEBOARDS, INC., BEVERLY HILLS, CA. FILED 5-16-2003.



THE MARK CONSISTS OF A FANCIFUL CARTOON DRAWING OF A CAT.

FOR SKATEBOARDS; SKATEBOARD ACCESSORIES, NAMELY, SKATEBOARD TRUCKS, SKATEBOARD WHEELS AND SKATEBOARD DECKS (U.S. CLS. 22, 23, 38 AND 50).

FIRST USE 6-0-1993; IN COMMERCE 6-0-1993.

FLORENTINA BLANDU, EXAMINING ATTORNEY

SN 76-515,113. LINDY LITTLE JOE, INC., BRAINERD, MN. FILED 5-19-2003.

MAX GAP

FOR FISHING TACKLE, FISHING LURES, FISHING JIGS, AND ARTIFICIAL FISHING BAIT (U.S. CLS. 22, 23, 38 AND 50).

GEORGIA CARTY, EXAMINING ATTORNEY

CLASS 28—(Continued).

SN 76-515,216. BEE UNLIMITED, INC., SEDONA, AZ. FILED 5-7-2003.

RUMPLEDINK RABBIT

NO CLAIM IS MADE TO THE EXCLUSIVE RIGHT TO USE "RABBIT", APART FROM THE MARK AS SHOWN. FOR PLUSH TOYS (U.S. CLS. 22, 23, 38 AND 50). CATHERINE FAINT, EXAMINING ATTORNEY

SN 76-515,514. ZERNOV, JEFFREY P., BRAINERD, MN. FILED 5-19-2003.

BUZZ STIX

FOR FISHING RODS, FISHING REELS, FISHING TACKLE, FISHING LURES AND FISHING FLOATS (U.S. CLS. 22, 23, 38 AND 50). FIRST USE 4-21-2003; IN COMMERCE 5-2-2003. KARLA PERKINS, EXAMINING ATTORNEY

SN 76-517,270. COSKER, LINDA S., STODDARD, NH. FILED 5-27-2003.

COSKER'S DOLLS

NO CLAIM IS MADE TO THE EXCLUSIVE RIGHT TO USE "DOLLS", APART FROM THE MARK AS SHOWN. FOR DOLLS (U.S. CLS. 22, 23, 38 AND 50). CHARLES L. JENKINS, EXAMINING ATTORNEY

SN 76-518,274. PRINCE SPORTS, INC., BORDENTOWN, NJ. FILED 5-30-2003.

POWERLINE

FOR STRINGED SPORTS RACKETS, NAMELY, TENNIS, RACQUETBALL, SQUASH, AND BADMINTON RACKETS (U.S. CLS. 22, 23, 38 AND 50). ROBERT COGGINS, EXAMINING ATTORNEY

SN 76-518,317. PRINCE SPORTS, INC., BORDENTOWN, NJ. FILED 5-30-2003.

FUSIONLITE

OWNER OF U.S. REG. NO. 2,257,578. FOR STRINGED SPORTS RACKETS, NAMELY, TENNIS, RACQUETBALL, SQUASH, AND BADMINTON RACKETS (U.S. CLS. 22, 23, 38 AND 50). ROBERT COGGINS, EXAMINING ATTORNEY

CLASS 28—(Continued).

SN 76-522,747. ATOLL HOLDINGS, INC., SAN LUIS OBISPO, CA. FILED 6-9-2003.

ROPE CHALLENGE

NO CLAIM IS MADE TO THE EXCLUSIVE RIGHT TO USE ROPE. APART FROM THE MARK AS SHOWN. FOR EXERCISE EQUIPMENT, NAMELY A COMBINATION OF A POLE TO WHICH A CLIMBING ROPE IS ATTACHED AS WELL AS AN AUTO-BELAY DEVICE (U.S. CLS. 22, 23, 38 AND 50). ERICA GLEMBOCKI, EXAMINING ATTORNEY

SN 76-522,748. ATOLL HOLDINGS, INC., SAN LUIS OBISPO, CA. FILED 6-9-2003.

POLE CHALLENGE

NO CLAIM IS MADE TO THE EXCLUSIVE RIGHT TO USE POLE. APART FROM THE MARK AS SHOWN. FOR EXERCISE EQUIPMENT, NAMELY A POLE CONFIGURED FOR CLIMBING AND INCORPORATING AN AUTO-BELAY DEVICE (U.S. CLS. 22, 23, 38 AND 50). ERICA GLEMBOCKI, EXAMINING ATTORNEY

SN 76-531,005. SPORTSPOWER, KOWLOON, HONG KONG, FILED 7-21-2003.

FLY SLAMA JAMA

THE MARK IS WORD ONLY AND CONSISTS OF THE TEXT FLY SLAMA JAMA. FOR TRAMPOLINES HAVING INFLATABLE SAFETY ENCLOSURES FOR USE IN BASKETBALL TRAMPOLINE GAMES (U.S. CLS. 22, 23, 38 AND 50). JANICE L. MCMORROW, EXAMINING ATTORNEY

CLASS 28—(Continued).

SN 76-532,358. BVS ENTERTAINMENT, INC., BURBANK, CA. FILED 7-25-2003.

THUNDERSAURUS MEGAZORD

FOR TOYS, GAMES, PLAYTHINGS, AND SPORTING GOODS, NAMELY, TOY SCOOTERS; BENDABLE PLAY FIGURES; TOY ACTION FIGURES AND ACCESSORIES THEREFORE; TOY BANKS; TOY WATCHES; BATH TUB TOYS; CHILDREN'S MULTIPLE ACTIVITY TOYS; TOY MAGIC TRICKS; WATER SQUIRTING TOYS; WIND-UP TOYS; SLING SHOTS; AUDIO AND VISUAL TOYS, NAMELY, TALKING DOLLS, TOY 3-D VIEWERS AND REELS; MECHANICAL ACTION TOYS; BATTERY-OPERATED ACTION TOYS; DOLLS, PUPPETS; PLAYSETS FOR DOLLS, DOLL CLOTHING AND COSTUMES; ROLE PLAYING GAMES; ACTION-TYPE TARGET SHOOTING GAME SETS COMPRISING TOY GUN, TOY SUCTION DARTS AND TARGET; TOY WEAPONS; SQUIRT GUNS; KITES; PLASTIC PARTY FAVORS IN THE NATURE OF SMALL TOYS AND NOISEMAKERS; BALLOONS; STUFFED AND PLUSH TOYS; LATEX SQUEEZE TOY FIGURES; MUSICAL TOYS; INFLATABLE BATH TOYS; SWIMMING AND RIDE-ON TOYS; TOY VEHICLES; RIDE-IN TOYS; MOBILES FOR CHILDREN; CHRISTMAS TREE ORNAMENTS; TOY CRAFT KITS COMPRISING MOLDS AND MOLDING COMPOUND FOR MAKING TOY FIGURES; PLASTIC ACTION FIGURE MODELS (U.S. CLS. 22, 23, 38 AND 50).
THEODORE MCBRIDE, EXAMINING ATTORNEY

SN 76-532,368. BVS ENTERTAINMENT, INC., BURBANK, CA. FILED 7-25-2003.

RED QUADRO BATTLIZED POWER RANGER

NO CLAIM IS MADE TO THE EXCLUSIVE RIGHT TO USE "RED", APART FROM THE MARK AS SHOWN.
FOR TOYS, GAMES, PLAYTHINGS, AND SPORTING GOODS, NAMELY, TOY SCOOTERS; BENDABLE PLAY FIGURES; TOY ACTION FIGURES AND ACCESSORIES THEREFORE; TOY BANKS; TOY WATCHES; BATH TUB TOYS; CHILDREN'S MULTIPLE ACTIVITY TOYS; TOY MAGIC TRICKS; WATER SQUIRTING TOYS; WIND-UP TOYS; SLING SHOTS; AUDIO AND VISUAL TOYS, NAMELY, TALKING DOLLS, TOY 3-D VIEWERS AND REELS; MECHANICAL ACTION TOYS; BATTERY-OPERATED ACTION TOYS; DOLLS, PUPPETS; PLAYSETS FOR DOLLS, DOLL CLOTHING AND COSTUMES; ROLE PLAYING GAMES; ACTION-TYPE TARGET SHOOTING GAME SETS COMPRISING TOY GUN, TOY SUCTION DARTS AND TARGET; TOY WEAPONS; SQUIRT GUNS; KITES; PLASTIC PARTY FAVORS IN THE NATURE OF SMALL TOYS AND NOISEMAKERS; BALLOONS; STUFFED AND PLUSH TOYS; LATEX SQUEEZE TOY FIGURES; MUSICAL TOYS; INFLATABLE BATH TOYS; SWIMMING AND RIDE-ON TOYS; TOY VEHICLES; RIDE-IN TOYS; MOBILES FOR CHILDREN; CHRISTMAS TREE ORNAMENTS; TOY CRAFT KITS COMPRISING MOLDS AND MOLDING COMPOUND FOR MAKING TOY FIGURES; PLASTIC ACTION FIGURE MODELS (U.S. CLS. 22, 23, 38 AND 50).
THEODORE MCBRIDE, EXAMINING ATTORNEY

CLASS 28—(Continued).

SN 76-532,444. HEASLET, JOEY, ATASCADERO, CA. FILED 7-25-2003.

LIQUID VISION INDUSTRIES

NO CLAIM IS MADE TO THE EXCLUSIVE RIGHT TO USE "INDUSTRIES", APART FROM THE MARK AS SHOWN.

FOR SPORTING GOODS FOR WATER SPORT ACTIVITIES, NAMELY, SAILBOARDS, WATER SKIS, SURFBOARDS AND ACCESSORIES THEREFOR, NAMELY, LEASHES AND WAX APPLICATORS (U.S. CLS. 22, 23, 38 AND 50).

LAURA KOVAISKY, EXAMINING ATTORNEY

SN 76-532,445. HEASLET, JOEY, ATASCADERO, CA. FILED 7-25-2003.

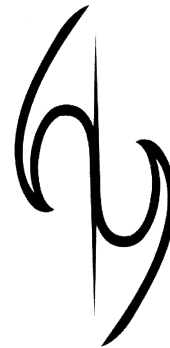

FOR SPORTING GOODS FOR WATER SPORT ACTIVITIES, NAMELY, SAILBOARDS, WATER SKIS, SURFBOARDS AND ACCESSORIES THEREFOR, NAMELY, LEASHES AND WAX APPLICATORS (U.S. CLS. 22, 23, 38 AND 50).

LAURA KOVAISKY, EXAMINING ATTORNEY

CLASS 28—(Continued).

SN 76-532,493. BVS ENTERTAINMENT, INC., BURBANK, CA. FILED 7-25-2003.

THUNDERSAURUS JUMBO MEGAZORD

FOR TOYS, GAMES, PLAYTHINGS, AND SPORTING GOODS, NAMELY, TOY SCOOTERS; BENDABLE PLAY FIGURES; TOY ACTION FIGURES AND ACCESSORIES THEREFORE; TOY BANKS; TOY WATCHES; BATH TUB TOYS; CHILDREN'S MULTIPLE ACTIVITY TOYS; TOY MAGIC TRICKS; WATER SQUIRTING TOYS; WIND-UP TOYS; SLING SHOTS; AUDIO AND VISUAL TOYS, NAMELY, TALKING DOLLS, TOY 3-D VIEWERS AND REELS; MECHANICAL ACTION TOYS; BATTERY-OPERATED ACTION TOYS; DOLLS, PUPPETS; PLAYSETS FOR DOLLS, DOLL CLOTHING AND COSTUMES; ROLE PLAYING GAMES; ACTION-TYPE TARGET SHOOTING GAME SETS COMPRISING TOY GUN, TOY SUCTION DARTS AND TARGET; TOY WEAPONS; SQUIRT GUNS; KITES; PLASTIC PARTY FAVORS IN THE NATURE OF SMALL TOYS AND NOISEMAKERS; BALLOONS; STUFFED AND PLUSH TOYS; LATEX SQUEEZE TOY FIGURES; MUSICAL TOYS; INFLATABLE BATH TOYS; SWIMMING AND RIDE-ON TOYS; TOY VEHICLES; RIDE-IN TOYS; MOBILES FOR CHILDREN; CHRISTMAS TREE ORNAMENTS; TOY CRAFT KITS COMPRISING MOLDS AND MOLDING COMPOUND FOR MAKING TOY FIGURES; PLASTIC ACTION FIGURE MODELS (U.S. CLS. 22, 23, 38 AND 50).
THEODORE MCBRIDE, EXAMINING ATTORNEY

SN 76-537,046. BCI BURKE COMPANY, LLC, FOND DU LAC, WI. FILED 8-13-2003.

LITTLE BUDDIES

FOR HEAVY DUTY PLAYGROUND EQUIPMENT FOR INDOOR AND OUTDOOR USE, NAMELY, PLAY STRUCTURES, CLIMBING UNITS, SLIDES, TUNNEL AND TUBE UNITS, PLAY PANELS, LADDERS, PLATFORMS, PLAY ROOFS, HANDRAILS, PLAY STAIRS AND STEPS, STEERING WHEELS, SHAPED SEATS, NON-PANED PLAY WINDOWS, BRIDGES, CLIMBING POSTS, FREE STANDING PAINT CENTERS, FREE STANDING PUPPET SHOW CENTERS, FREE STANDING SAND TABLES AND FREE STANDING WATER TABLES (U.S. CLS. 22, 23, 38 AND 50).
FIRST USE 11-13-2002; IN COMMERCE 1-1-2003.
JAMES GRIFFIN, EXAMINING ATTORNEY

SN 76-537,350. KOPECKY, DEREK M., PARK CITY, UT. FILED 8-1-2003.

EXTREME STANDZ

NO CLAIM IS MADE TO THE EXCLUSIVE RIGHT TO USE STAND, APART FROM THE MARK AS SHOWN.
FOR HOBBY CRAFT KIT COMPRISING PIECES OF DURABLE PLASTIC MATERIAL WHICH WHEN ASSEMBLED BECOMES A STAND FOR HOBBY WORK AND DISPLAY (U.S. CLS. 22, 23, 38 AND 50).
FIRST USE 1-2-2001; IN COMMERCE 1-2-2001.
LESLEY LAMOTHE, EXAMINING ATTORNEY

CLASS 28—(Continued).

SN 76-542,505. HASBRO, INC., PAWTUCKET, RI. FILED 9-4-2003.

JETFIRE

FOR TOY ACTION FIGURES, TOY VEHICLES AND TOY ROBOTS CONVERTIBLE INTO OTHER VISUAL TOY FORMS (U.S. CLS. 22, 23, 38 AND 50).
FIRST USE 4-4-2002; IN COMMERCE 4-4-2002.
CAROLINE WOOD, EXAMINING ATTORNEY

SN 76-542,506. HASBRO, INC., PAWTUCKET, RI. FILED 9-4-2003.

SUPER SCRABBLE

OWNER OF U.S. REG. NOS. 802,995, 1,136,336 AND OTHERS.
FOR BOARD GAMES (U.S. CLS. 22, 23, 38 AND 50).
CAROLINE WOOD, EXAMINING ATTORNEY

SN 76-542,623. ACKER, THOMAS W., LARGO, FL. FILED 8-25-2003.

TungSil

FOR FISHING LURES, JIGS AND SINKERS (U.S. CLS. 22, 23, 38 AND 50).
ROBIN CHOSID, EXAMINING ATTORNEY

CLASS 28—(Continued).

SN 76-543,146. LJC GOLF COMPANY, INC., VISTA, CA.
FILED 8-26-2003.

L·J·G O L F

NO CLAIM IS MADE TO THE EXCLUSIVE RIGHT TO USE "GOLF", APART FROM THE MARK AS SHOWN.

THE MARK CONSISTS OF LJC GOLF IN STYLIZED LETTERS WITH DOTS BETWEEN LJ AND JC. FOR GOLF CLUBS AND GOLF BAGS (U.S. CLS. 22, 23, 38 AND 50).

FIRST USE 11-3-2002; IN COMMERCE 12-3-2002.
DAVID C. REIHNER, EXAMINING ATTORNEY

SN 76-544,092. POLLOCK, ALEXANDER, DETROIT, MI.
FILED 8-25-2003.

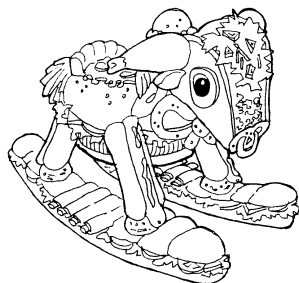

EDDIE-BULL

FOR RIDE-ON-TOY - CHILD'S ROCKING HORSE MADE IN THE SHAPE OF FAST FOODS, NAMELY, HAMBURGER, HOT-DOGS, TACO, FRIED CHICKEN, HOAGIE/SUB, PIZZA, FRIES/CHIPS, PRETZEL, ONION RINGS, AND OLIVES (U.S. CLS. 22, 23, 38 AND 50).

CURTIS FRENCH, EXAMINING ATTORNEY

SN 76-544,754. GOEBEN, ROBERT VON, SAN FRANCISCO, CA. FILED 9-15-2003.

SMASH PADS

NO CLAIM IS MADE TO THE EXCLUSIVE RIGHT TO USE PADS, APART FROM THE MARK AS SHOWN. FOR INTERACTIVE ELECTRONIC TAG GAMES (U.S. CLS. 22, 23, 38 AND 50).

BILL DAWE, EXAMINING ATTORNEY

CLASS 28—(Continued).

SN 76-545,791. LA JOLLA CLUB GOLF COMPANY, VISTA, CA. FILED 9-12-2003.

CHECK YOUR LIE BEFORE YOU BUY

NO CLAIM IS MADE TO THE EXCLUSIVE RIGHT TO USE LIE, APART FROM THE MARK AS SHOWN. FOR GOLF CLUBS (U.S. CLS. 22, 23, 38 AND 50).
CAROLYN GRAY, EXAMINING ATTORNEY

SN 76-546,419. HASBRO, INC., PAWTUCKET, RI. FILED 9-23-2003.

ACTION FORCE

NO CLAIM IS MADE TO THE EXCLUSIVE RIGHT TO USE ACTION, APART FROM THE MARK AS SHOWN.

FOR TOY ACTION FIGURES AND ACCESSORIES FOR USE THEREWITH; TOY VEHICLES AND ACCESSORIES FOR USE THEREWITH; TOY PLAYSETS FOR USE WITH TOY ACTION FIGURES AND TOY VEHICLES; DOLLS, DOLL CLOTHING AND DOLL ACCESSORIES; CHILDREN'S MULTIPLE ACTIVITY TOYS; PLUSH TOYS; STUFFED TOYS; BEAN BAG TOYS; TOY MODELING COMPOUNDS; TOY MOLDS AND TOY EXTRUDERS FOR USE WITH TOY MODELING COMPOUNDS; PLASTIC AND VINYL TOY CHARACTERS AND TOY ANIMALS; RIDE-ON TOYS; PULL TOYS; PUSH TOYS; RADIO CONTROLLED TOY VEHICLES; TOY ROBOTS CONVERTIBLE INTO OTHER VISUAL TOY FORMS; MECHANICAL TOYS; TOY CONSTRUCTION SETS; BUILDING TOYS; WIND-UP TOYS; WATER SQUIRTING TOYS; INFLATABLE TOYS; ROLE-PLAYING TOYS; TOY BALL AND DART SHOOTERS AND FOAM TOY BALLS AND DARTS FOR USE THEREWITH; BOARD GAMES; PARLOR GAMES; SKILL AND ACTION GAMES; CARD GAMES; PLAYING CARDS; TRADING CARD GAMES; ELECTRONIC HAND-HELD GAMES; JIGSAW PUZZLES; CHRISTMAS TREE DECORATIONS (U.S. CLS. 22, 23, 38 AND 50).

TARAH HARDY, EXAMINING ATTORNEY

SN 76-546,475. BERMUDA TRIANGLE GOLF, LLC, RAMONA, CA. FILED 9-24-2003.

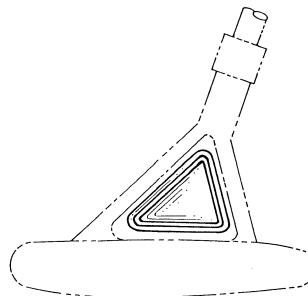

THE MARK CONSISTS OF A DISTINCTIVE NON-FUNCTIONAL TRIANGULAR PLATE AND PLAQUE WHERE THE PUTTER HEAD ATTACHES TO THE SHAFT.

SEC. 2(F).

FOR PUTTER HEAD (U.S. CLS. 22, 23, 38 AND 50).

FIRST USE 6-23-1997; IN COMMERCE 6-23-1997.

KEVON CHISOLM, EXAMINING ATTORNEY

CLASS 28—(Continued).

SN 76-550,361. VULCAN GOLF, L.L.C., ST. CHARLES, IL. FILED 9-22-2003.

CALDERA

FOR GOLF CLUBS (U.S. CLS. 22, 23, 38 AND 50).
KELLY BOULTON, EXAMINING ATTORNEY

CLASS 28—(Continued).

SN 76-553,524. MAJERIK, MATTHEW, EMPIRE, AL. FILED 10-3-2003.

Depth Charge

FOR NATURAL ANIMAL FOODSTUFFS, NAMELY, PACKAGED FREEZE-DRIED FISHING BAIT (U.S. CLS. 22, 23, 38 AND 50).
RON FAIRBANKS, EXAMINING ATTORNEY

SN 76-550,628. HASBRO, INC., PAWTUCKET, RI. FILED 10-9-2003.

TOMB WRAITH

FOR TOY ACTION FIGURES (U.S. CLS. 22, 23, 38 AND 50).
LINDA E. BLOHM, EXAMINING ATTORNEY

SN 76-556,216. RICE, MARK, CUMMING, GA. FILED 10-14-2003.

CATS HAVE A LIFE TOO!

SN 76-550,629. HASBRO, INC., PAWTUCKET, RI. FILED 10-9-2003.

TRANSCORCHER

FOR TOY ACTION FIGURES (U.S. CLS. 22, 23, 38 AND 50).
LINDA E. BLOHM, EXAMINING ATTORNEY

FOR PARLOR GAMES, MORE SPECIFICALLY A BOARD AND CARD GAME PLAYED WITH MOVABLE PIECES AND CARDS (U.S. CLS. 22, 23, 38 AND 50).
FIRST USE 9-15-2003; IN COMMERCE 9-15-2003.
GEORGE LORENZO, EXAMINING ATTORNEY

SN 76-551,365. LOVETT, JOE L., VERO BEACH, FL. FILED 9-24-2003.

WE SHALL OVERCOME

FOR BOARD GAMES (U.S. CLS. 22, 23, 38 AND 50).
MARGERY A. TIERNEY, EXAMINING ATTORNEY

SN 76-556,217. RICE, MARK, CUMMING, GA. FILED 10-14-2003.

PAWSITIVELY HISTORICAL

FOR PARLOR GAMES, MORE SPECIFICALLY A BOARD AND CARD GAME PLAYED WITH MOVABLE PIECES AND CARDS (U.S. CLS. 22, 23, 38 AND 50).
FIRST USE 7-1-2000; IN COMMERCE 11-1-2000.
GEORGE LORENZO, EXAMINING ATTORNEY

SN 76-553,518. HONDA GIKEN KOGYO KABUSHIKI KAISHA (HONDA MOTOR CO., LTD.), TOKYO 107-8556, JAPAN, FILED 10-3-2003.



SN 76-558,165. GLOBAL PROFILES, INC., DECATUR, GA. FILED 10-24-2003.

GABBY & GABE

OWNER OF U.S. REG. NO. 1,673,535.
FOR TOY VEHICLES, NAMELY DIECAST AUTOMOBILES AND RADIO-CONTROLLED AUTOMOBILES (U.S. CLS. 22, 23, 38 AND 50).
LAURA KOVAISKY, EXAMINING ATTORNEY

FOR STUFFED TOY ANIMALS (U.S. CLS. 22, 23, 38 AND 50).
DOUGLAS LEE, EXAMINING ATTORNEY

CLASS 28—(Continued).

SN 78-062,815. HARMON TROPHY HUNTING PRODUCTS, INC., ELLIJAY, GA. FILED 5-10-2001.

HARMON DEER SCENTS

NO CLAIM IS MADE TO THE EXCLUSIVE RIGHT TO USE "DEER SCENTS", APART FROM THE MARK AS SHOWN.

SEC. 2(F).

FOR HUNTERS' SCENT LURE, NAMELY, DEER RELATED LURES AND ATTRACTANTS (U.S. CLS. 22, 23, 38 AND 50).

FIRST USE 2-1-1999; IN COMMERCE 2-1-1999.

JOHN GARTNER, EXAMINING ATTORNEY

SN 78-154,526. FRANZ SCHNEIDER GMBH & CO. KG, NEUSTADT/COBURG, FED REP GERMANY, FILED 8-15-2002.

ROLLY TOYS

OWNER OF FED REP GERMANY REG. NO. 866495, DATED 2-24-1970, EXPIRES 3-31-2008.

OWNER OF U.S. REG. NO. 1,969,845.

NO CLAIM IS MADE TO THE EXCLUSIVE RIGHT TO USE "TOYS", APART FROM THE MARK AS SHOWN.

FOR ACTION SKILL GAMES; BOARD GAMES; CHILDREN'S TOYS, NAMELY WHEELED AND NON-WHEELED VEHICLES, PLAY AGRICULTURAL VEHICLES AND EQUIPMENT AND ACCESSORIES THEREFOR, PLAY CONSTRUCTION VEHICLES AND EQUIPMENT AND ACCESSORIES THEREFOR, WHEELED AND NON-WHEELED TOY ANIMALS, AND ROCKING AND WHEELED RIDING TOY ANIMALS; SNOW SLEDS AND TOBOGGANS FOR RECREATIONAL USE; TOY HAND CARTS, TOY TOOLS AND TOY TOOL ACCESSORIES THEREFOR; TOY MILK CHURNS (U.S. CLS. 22, 23, 38 AND 50).

FIRST USE 10-0-1987; IN COMMERCE 7-5-1988.

YONG KIM, EXAMINING ATTORNEY

SN 78-195,405. SHERWOOD-DROLET CORPORATION LTD., SHERBROOKE, QUEBEC, CANADA, FILED 12-17-2002.

ECLIPSE

FOR HOCKEY STICKS (U.S. CLS. 22, 23, 38 AND 50).

FIRST USE 9-11-2002; IN COMMERCE 9-11-2002.

LINDA E. BLOHM, EXAMINING ATTORNEY

SN 78-215,693. COMAL TACKLE COMPANY, BUDA, TX. FILED 2-17-2003.

COMAL

FOR FISHING EQUIPMENT, NAMELY, FLOATS, LEADERS, WEIGHTS, STRINGERS AND BOTTOM WALKERS (U.S. CLS. 22, 23, 38 AND 50).

FIRST USE 11-27-1964; IN COMMERCE 11-27-1964.

LINDA ESTRADA, EXAMINING ATTORNEY

CLASS 28—(Continued).

SN 78-215,697. COMAL TACKLE COMPANY, BUDA, TX. FILED 2-17-2003.



NO CLAIM IS MADE TO THE EXCLUSIVE RIGHT TO USE TACKLE, APART FROM THE MARK AS SHOWN.

FOR FISHING EQUIPMENT, NAMELY, FLOATS, LEADERS, WEIGHTS, STRINGERS AND BOTTOM WALKERS (U.S. CLS. 22, 23, 38 AND 50).

FIRST USE 0-0-1990; IN COMMERCE 0-0-1990.

LINDA ESTRADA, EXAMINING ATTORNEY

SN 78-226,646. URBAN, KEITH, NASHVILLE, TN. FILED 3-17-2003.

KEITH URBAN

THE NAME KEITH URBAN IDENTIFIES A LIVING INDIVIDUAL WHOSE CONSENT IS OF RECORD.

FOR TOYS, NAMELY STUFFED ANIMALS (U.S. CLS. 22, 23, 38 AND 50).

FIRST USE 0-0-2001; IN COMMERCE 0-0-2001.

WON TEAK OH, EXAMINING ATTORNEY

SN 78-227,798. FITMETRICS ASSOCIATES, LIMITED, HUDSON, OH. FILED 3-19-2003.

ISOCIZER

FOR EXERCISE EQUIPMENT, NAMELY INFLATABLE ISOMETRIC EXERCISE CUSHIONS (U.S. CLS. 22, 23, 38 AND 50).

ALEX KEAM, EXAMINING ATTORNEY

SN 78-228,400. LISA FRANK, INC., TUCSON, AZ. FILED 3-21-2003.

CANDLE CRAZE

NO CLAIM IS MADE TO THE EXCLUSIVE RIGHT TO USE "CANDLE", APART FROM THE MARK AS SHOWN.

FOR CHILDREN'S HOBBY CRAFT KIT FOR THE PURPOSE OF MAKING CANDLES (U.S. CLS. 22, 23, 38 AND 50).

FIRST USE 5-6-1999; IN COMMERCE 5-6-1999.

ROBERT LORENZO, EXAMINING ATTORNEY

CLASS 28—(Continued).

SN 78-230,943. PROFESSIONAL MOTORSPORTS MERCHANDISE COMPANY, INC., BLAINE, MN. FILED 3-27-2003.

PMC

FOR DIECAST VEHICLE MODELS (U.S. CLS. 22, 23, 38 AND 50).
MARC LEIPZIG, EXAMINING ATTORNEY

SN 78-230,953. PROFESSIONAL MOTORSPORTS MERCHANDISE COMPANY, INC., BLAINE, MN. FILED 3-27-2003.

**PROFESSIONAL
MOTORSPORTS
COLLECTIBLES**

NO CLAIM IS MADE TO THE EXCLUSIVE RIGHT TO USE "COLLECTIBLES", APART FROM THE MARK AS SHOWN.
FOR DIECAST SCALE MODEL VEHICLES (U.S. CLS. 22, 23, 38 AND 50).
MICHAEL SOUDERS, EXAMINING ATTORNEY

SN 78-231,101. PROFESSIONAL MOTORSPORTS MERCHANDISE COMPANY, INC., BLAINE, MN. FILED 3-28-2003.

FIBERCAST

FOR DIECAST SCALE MODEL VEHICLES (U.S. CLS. 22, 23, 38 AND 50).
TRACY FLETCHER, EXAMINING ATTORNEY

SN 78-232,726. LEAPFROG ENTERPRISES, INC., EMERYVILLE, CA. FILED 4-1-2003.

TURTLE PAD

FOR INTERACTIVE ELECTRONIC GAME MACHINES THAT TEACH USERS IN VARIOUS ACADEMIC SUBJECTS AND TRIVIA (U.S. CLS. 22, 23, 38 AND 50).
DAWN FELDMAN, EXAMINING ATTORNEY

SN 78-234,112. POLYDRON INTERNATIONAL LIMITED, GLOUCESTERSHIRE, UNITED KINGDOM, FILED 4-4-2003.

POLYDRON

FOR INTERLOCKING CONSTRUCTION TOYS (U.S. CLS. 22, 23, 38 AND 50).
FIRST USE 0-0-1983; IN COMMERCE 0-0-1983.
TRACY FLETCHER, EXAMINING ATTORNEY

CLASS 28—(Continued).

SN 78-234,122. POLYDRON INTERNATIONAL LIMITED, GLOUCESTERSHIRE, UNITED KINGDOM, FILED 4-4-2003.

FRAMEWORKS

FOR INTERLOCKING CONSTRUCTION TOYS (U.S. CLS. 22, 23, 38 AND 50).
FIRST USE 0-0-1983; IN COMMERCE 0-0-1983.
TRACY FLETCHER, EXAMINING ATTORNEY

SN 78-245,134. MATTEL, INC., EL SEGUNDO, CA. FILED 5-2-2003.

MAGIC RABBITS

NO CLAIM IS MADE TO THE EXCLUSIVE RIGHT TO USE RABBITS, APART FROM THE MARK AS SHOWN.
FOR TOYS, GAMES, AND PLAYTHINGS, NAMELY, DOLLS, DOLL CLOTHING, DOLL ACCESSORIES AND DOLL PLAYSETS AND ACCESSORIES FOR THE FOREGOING; TOY VEHICLES, TOY FIGURES AND PLAYSETS AND ACCESSORIES FOR THE FOREGOING (U.S. CLS. 22, 23, 38 AND 50).
SUELLEN HICKEY, EXAMINING ATTORNEY

SN 78-249,632. WURLEY-BIRD LIMITED, NOTTINGHAM, UNITED KINGDOM, FILED 5-14-2003.



THE STIPPLING SHOWN IN THE MARK IS A FEATURE OF THE MARK AND IS NOT INTENDED TO INDICATE COLOR.

FOR PLAY APPARATUS AND PLAYGROUND EQUIPMENT, NAMELY, MERRY-GO-ROUNDS AND RIDER PROPELLED MERRY-GO-ROUNDS (U.S. CLS. 22, 23, 38 AND 50).
MONIQUE MILLER, EXAMINING ATTORNEY

SN 78-250,951. MATTEL, INC., EL SEGUNDO, CA. FILED 5-16-2003.

HIP HOT CONVERTIBLE

NO CLAIM IS MADE TO THE EXCLUSIVE RIGHT TO USE "CONVERTIBLE", APART FROM THE MARK AS SHOWN.

FOR TOYS, GAMES AND PLAYTHINGS, NAMELY, DOLLS, DOLL CLOTHING, DOLL ACCESSORIES, DOLL PLAYSETS AND ACCESSORIES THEREFORE; TOY ANIMALS, TOY VEHICLES, TOY FIGURES AND ACCESSORIES AND PLAYSETS FOR THE FOREGOING (U.S. CLS. 22, 23, 38 AND 50).
SUELLEN HICKEY, EXAMINING ATTORNEY

CLASS 28—(Continued).

SN 78-254,575. MATTEL, INC., EL SEGUNDO, CA. FILED 5-27-2003.

SCHOOL BOX GAMES

NO CLAIM IS MADE TO THE EXCLUSIVE RIGHT TO USE "GAMES", APART FROM THE MARK AS SHOWN.
FOR TOYS, GAMES AND PLAYTHINGS, NAMELY A FULL LINE OF BOARD GAMES, CARD GAMES AND PLAYTHINGS (U.S. CLS. 22, 23, 38 AND 50).
SUELLEN HICKEY, EXAMINING ATTORNEY

SN 78-255,952. BVS ENTERTAINMENT, INC., BURBANK, CA. FILED 5-29-2003.

TRICERA ZORD

OWNER OF U.S. REG. NOS. 2,087,949, 2,666,612 AND OTHERS.

FOR TOYS, GAMES AND PLAYTHINGS, NAMELY, TOY SCOOTERS; BENDABLE PLAY FIGURES; TOY ACTION FIGURES AND ACCESSORIES THEREFORE; TOY BANKS; TOY WATCHES; BATH TUB TOYS; CHILDREN'S MULTIPLE ACTIVITY TOYS; TOY MAGIC TRICKS; WATER SQUIRTING TOYS; WIND-UP TOYS; SLING SHOTS; AUDIO AND VISUAL TOYS, NAMELY, TALKING DOLLS, TOY 3-D VIEWERS AND REELS; MECHANICAL ACTION TOYS; BATTERY-OPERATED ACTION TOYS; DOLLS, PUPPETS; PLAYSETS FOR DOLLS, DOLL CLOTHING AND COSTUMES; ROLE PLAYING GAMES; ACTION-TYPE TARGET SHOOTING GAME SETS COMPRISING TOY GUN, TOY SUCTION DARTS AND TARGET; TOY WEAPONS; SQUIRT GUNS; KITES; PLASTIC PARTY FAVORS IN THE NATURE OF SMALL TOYS AND NOISEMAKERS; BALLOONS; STUFFED AND PLUSH TOYS; LATEX SQUEEZE TOY FIGURES; MUSICAL TOYS; INFLATABLE BATH TOYS; SWIMMING AND RIDE-ON TOYS; TOY VEHICLES; RIDE-IN TOYS; MOBILES FOR CHILDREN; CHRISTMAS TREE ORNAMENTS; TOY CRAFT KITS COMPRISING MOLDS AND MOLDING COMPOUND FOR MAKING TOY FIGURES; PLASTIC ACTION FIGURE MODELS (U.S. CLS. 22, 23, 38 AND 50).
THEODORE MCBRIDE, EXAMINING ATTORNEY

CLASS 28—(Continued).

SN 78-255,954. BVS ENTERTAINMENT, INC., BURBANK, CA. FILED 5-29-2003.

DIMETRO ZORD

OWNER OF U.S. REG. NOS. 2,087,949, 2,666,612 AND OTHERS.

FOR TOYS, GAMES AND PLAYTHINGS, NAMELY, TOY SCOOTERS; BENDABLE PLAY FIGURES; TOY ACTION FIGURES AND ACCESSORIES THEREFORE; TOY BANKS; TOY WATCHES; BATH TUB TOYS; CHILDREN'S MULTIPLE ACTIVITY TOYS; TOY MAGIC TRICKS; WATER SQUIRTING TOYS; WIND-UP TOYS; SLING SHOTS; AUDIO AND VISUAL TOYS, NAMELY, TALKING DOLLS, TOY 3-D VIEWERS AND REELS; MECHANICAL ACTION TOYS; BATTERY-OPERATED ACTION TOYS; DOLLS, PUPPETS; PLAYSETS FOR DOLLS, DOLL CLOTHING AND COSTUMES; ROLE PLAYING GAMES; ACTION-TYPE TARGET SHOOTING GAME SETS COMPRISING TOY GUN, TOY SUCTION DARTS AND TARGET; TOY WEAPONS; SQUIRT GUNS; KITES; PLASTIC PARTY FAVORS IN THE NATURE OF SMALL TOYS AND NOISEMAKERS; BALLOONS; STUFFED AND PLUSH TOYS; LATEX SQUEEZE TOY FIGURES; MUSICAL TOYS; INFLATABLE BATH TOYS; SWIMMING AND RIDE-ON TOYS; TOY VEHICLES; RIDE-IN TOYS; MOBILES FOR CHILDREN; CHRISTMAS TREE ORNAMENTS; TOY CRAFT KITS COMPRISING MOLDS AND MOLDING COMPOUND FOR MAKING TOY FIGURES; PLASTIC ACTION FIGURE MODELS (U.S. CLS. 22, 23, 38 AND 50).

THEODORE MCBRIDE, EXAMINING ATTORNEY

SN 78-256,330. MATTEL, INC., EL SEGUNDO, CA. FILED 5-30-2003.

HOT WHEELS HOT 100

OWNER OF U.S. REG. NOS. 843,156 AND 884,563.

NO CLAIM IS MADE TO THE EXCLUSIVE RIGHT TO USE "100", APART FROM THE MARK AS SHOWN.

FOR TOYS, GAMES AND PLAYTHINGS, NAMELY, DOLLS, DOLL CLOTHING, DOLL ACCESSORIES; TOY VEHICLES, TOY FIGURES, TOY VEHICLE TRACK SETS, ACCESSORIES AND PLAYSETS FOR THE FOREGOING (U.S. CLS. 22, 23, 38 AND 50).

SUELLEN HICKEY, EXAMINING ATTORNEY

SN 78-265,237. FAHSEL, SUSAN, NORTH BEND, WA. FILED 6-20-2003.

EGG-CENTIVES

FOR EDUCATIONAL TOYS, NAMELY A MOTIVATIONAL KIT USED BY PARENTS WITH CHILDREN TO REINFORCE DESIRABLE BEHAVIOR IN A CHILD (U.S. CLS. 22, 23, 38 AND 50).

JOHN HWANG, EXAMINING ATTORNEY

CLASS 28—(Continued).

SN 78-266,679. 3 MUSES, LLC, STUDIO CITY, CA. FILED 6-24-2003.



FOR TOYS, NAMELY, DOLLS AND PLAY FIGURES, DOLL CLOTHING, DOLL ACCESSORIES, DOLL PLAYSETS, DOLL FURNITURE, TOY VEHICLES, PLUSH TOYS, BOARD GAMES, CARD GAMES, PARLOR GAMES, CHILDREN'S MULTIPLE ACTIVITY TOYS, HAND HELD UNIT FOR PLAYING ELECTRONIC GAMES, TOY NAIL SETS, TOY CAMERAS, TOY WATCHES, TOY JEWELRY AND SPINNING TOPS (U.S. CLS. 22, 23, 38 AND 50).

FIRST USE 10-23-2003; IN COMMERCE 10-23-2003.
 JOSETTE BEVERLY, EXAMINING ATTORNEY

SN 78-268,665. LOB-STER, INC., PLAINFIELD, NJ. FILED 6-30-2003.



OWNER OF U.S. REG. NO. 1,051,374.
 FOR TENNIS BALL THROWING MACHINES (U.S. CLS. 22, 23, 38 AND 50).
 FIRST USE 7-0-2001; IN COMMERCE 7-0-2001.
 ROBERT LORENZO, EXAMINING ATTORNEY

SN 78-274,468. SUNRISE INCORPORATED, TOKYO, JAPAN, FILED 7-15-2003.

COWBOY BEBOP

OWNER OF U.S. REG. NO. 2,669,348.
 NO CLAIM IS MADE TO THE EXCLUSIVE RIGHT TO USE "COWBOY", APART FROM THE MARK AS SHOWN.
 FOR TOY FIGURES, TOY ROBOTS, TOY VEHICLES, PLASTIC MODEL KITS, NAMELY TOY MODEL HOBBY CRAFT KITS FOR MAKING MODEL VEHICLES AND RELATED ACCESSORIES SOLD AS A UNIT (U.S. CLS. 22, 23, 38 AND 50).
 FIRST USE 9-25-1998; IN COMMERCE 1-9-2002.
 LAVERNE THOMPSON, EXAMINING ATTORNEY

CLASS 28—(Continued).

SN 78-281,692. HUGHES, JOHN, K., PHOENIX, AZ. FILED 7-31-2003.

BOWORKER

FOR PORTABLE EXERCISE GYMS (U.S. CLS. 22, 23, 38 AND 50).
 FIRST USE 3-13-2001; IN COMMERCE 3-13-2001.
 M. E. BODSON, EXAMINING ATTORNEY

SN 78-284,697. BVS ENTERTAINMENT, INC., BURBANK, CA. FILED 8-7-2003.

RED DINO ZORD MORPHIN POWER RANGERS

OWNER OF U.S. REG. NOS. 2,501,742, 2,553,614 AND OTHERS.
 FOR GAMES AND PLAYTHINGS, NAMELY, TOY SCOOTERS; BENDABLE PLAY FIGURES; TOY ACTION FIGURES AND ACCESSORIES THEREFORE; TOY BANKS; TOY WATCHES; BATH TUB TOYS; CHILDREN'S MULTIPLE ACTIVITY TOYS; TOY MAGIC TRICKS; WATER SQUIRTING TOYS; WIND-UP TOYS; SLING SHOTS; AUDIO AND VISUAL TOYS, NAMELY, TALKING DOLLS, TOY 3-D VIEWERS AND REELS; MECHANICAL ACTION TOYS; BATTERY-OPERATED ACTION TOYS; DOLLS, PUPPETS; PLAYSETS FOR DOLLS, DOLL CLOTHING AND COSTUMES; ROLE PLAYING GAMES; ACTION-TYPE TARGET SHOOTING GAME SETS COMPRISING TOY GUN, TOY SUCTION DARTS AND TARGET; TOY WEAPONS; SQUIRT GUNS; KITES; PLASTIC PARTY FAVORS IN THE NATURE OF SMALL TOYS AND NOISEMAKERS; BALLOONS; STUFFED AND PLUSH TOYS; LATEX SQUEEZE TOY FIGURES; MUSICAL TOYS; INFLATABLE BATH TOYS; SWIMMING AND RIDE-ON TOYS; TOY VEHICLES; RIDE-IN TOYS; MOBILES FOR CHILDREN; CHRISTMAS TREE ORNAMENTS; TOY CRAFT KITS COMPRISING MOLDS AND MOLDING COMPOUND FOR MAKING TOY FIGURES; PLASTIC ACTION FIGURE MODELS; HAND-HELD ELECTRONIC GAMES (U.S. CLS. 22, 23, 38 AND 50).
 THEODORE MCBRIDE, EXAMINING ATTORNEY

CLASS 28—(Continued).

SN 78-284,864. BVS ENTERTAINMENT, INC., BURBANK, CA. FILED 8-8-2003.

RED TALKING THUNDER POWER RANGER

OWNER OF U.S. REG. NOS. 2,501,742, 2,553,614 AND OTHERS.

NO CLAIM IS MADE TO THE EXCLUSIVE RIGHT TO USE "RED TALKING", APART FROM THE MARK AS SHOWN.

FOR GAMES AND PLAYTHINGS, NAMELY, TOY SCOOTERS; BENDABLE PLAY FIGURES; TOY ACTION FIGURES AND ACCESSORIES THEREFORE; TOY BANKS; TOY WATCHES; BATH TUB TOYS; CHILDREN'S MULTIPLE ACTIVITY TOYS; TOY MAGIC TRICKS; WATER SQUIRTING TOYS; WIND-UP TOYS; SLING SHOTS; AUDIO AND VISUAL TOYS, NAMELY, TALKING DOLLS, TOY 3-D VIEWERS AND REELS; MECHANICAL ACTION TOYS; BATTERY-OPERATED ACTION TOYS; DOLLS, PUPPETS; PLAYSETS FOR DOLLS, DOLL CLOTHING AND COSTUMES; ROLE PLAYING GAMES; ACTION-TYPE TARGET SHOOTING GAME SETS COMPRISING TOY GUN, TOY SUCTION DARTS AND TARGET; TOY WEAPONS; SQUIRT GUNS; KITES; PLASTIC PARTY FAVORS IN THE NATURE OF SMALL TOYS AND NOISEMAKERS; BALLOONS; STUFFED AND PLUSH TOYS; LATEX SQUEEZE TOY FIGURES; MUSICAL TOYS; INFLATABLE BATH TOYS; SWIMMING AND RIDE-ON TOYS; TOY VEHICLES; RIDE-IN TOYS; MOBILES FOR CHILDREN; CHRISTMAS TREE ORNAMENTS; TOY CRAFT KITS COMPRISING MOLDS AND MOLDING COMPOUND FOR MAKING TOY FIGURES; PLASTIC ACTION FIGURE MODELS; HAND-HELD ELECTRONIC GAMES (U.S. CLS. 22, 23, 38 AND 50).

THEODORE MCBRIDE, EXAMINING ATTORNEY

SN 78-285,991. VON DER SCHULENBURG, ERIK VINCENT, ARCADIA, CA. FILED 8-12-2003.

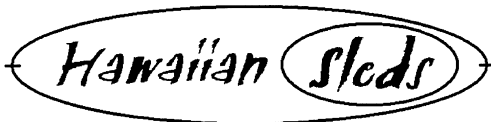

NO CLAIM IS MADE TO THE EXCLUSIVE RIGHT TO USE "HAWAIIAN", APART FROM THE MARK AS SHOWN. FOR SURFBOARDS, SURFBOARD BAGS, SURFBOARD WAX, SURFBOARD FINS AND SURFBOARD LEASHES (U.S. CLS. 22, 23, 38 AND 50).

DAVID ELTON, EXAMINING ATTORNEY

SN 78-288,533. MATTEL, INC., EL SEGUNDO, CA. FILED 8-18-2003.

POWER D-CRYPTOR

FOR TOYS, GAMES AND PLAYTHINGS, NAMELY, BOARD GAMES, CARD GAMES, ROLE-PLAYING GAMES AND ACCESSORIES SOLD IN CONNECTION THEREWITH (U.S. CLS. 22, 23, 38 AND 50).

SUELLEN HICKEY, EXAMINING ATTORNEY

CLASS 28—(Continued).

SN 78-289,699. MATTEL, INC., EL SEGUNDO, CA. FILED 8-20-2003.

MX HEDZ

NO CLAIM IS MADE TO THE EXCLUSIVE RIGHT TO USE "MX", APART FROM THE MARK AS SHOWN.

FOR TOYS, GAMES AND PLAYTHINGS, NAMELY, DOLLS, DOLL CLOTHING, DOLL ACCESSORIES; TOY VEHICLES, TOY FIGURES, ACCESSORIES AND PLAYSETS FOR THE FOREGOING (U.S. CLS. 22, 23, 38 AND 50).

SUELLEN HICKEY, EXAMINING ATTORNEY

SN 78-294,772. ABSOLUTE COMMUNICATIONS, INC., CANTON, MI. FILED 9-2-2003.



NO CLAIM IS MADE TO THE EXCLUSIVE RIGHT TO USE "CUP", APART FROM THE MARK AS SHOWN.

FOR ATHLETIC SUPPORTER TO BE USED AS A GAG GIFT (U.S. CLS. 22, 23, 38 AND 50).

FIRST USE 7-24-2003; IN COMMERCE 9-2-2003.

ROBIN CHOSID, EXAMINING ATTORNEY

SN 78-296,677. SHIMANO INC., SAKAI, JAPAN, FILED 9-5-2003.

TERAMAR

FOR FISHING TACKLE, REELS FOR FISHING, RODS FOR FISHING, LINES FOR FISHING, LINE GUIDES FOR USE ON FISHING RODS, HOOKS FOR FISHING, ARTIFICIAL LURES FOR FISHING, ARTIFICIAL BAITS, FISHING CREELS, FLOATS FOR FISHING; FISHING WEIGHTS NAMELY, SINKERS; LANDING NETS FOR ANGLERS, SPORTSMEN'S FISHING BAGS, FISHING GLOVES, FISHING ROD CASES AND FISHING TACKLE CONTAINERS; AND HIP-GUARDS SPECIALLY MADE FOR FISHING (U.S. CLS. 22, 23, 38 AND 50).

ELLEN B. AWRICH, EXAMINING ATTORNEY

CLASS 28—(Continued).

SN 78-300,606. POLYCONCEPT USA, INC., STAMFORD, CT. FILED 9-15-2003.



FOR CHILDREN'S ART ACTIVITY TOYS (U.S. CLS. 22, 23, 38 AND 50).
TONI HICKEY, EXAMINING ATTORNEY

CLASS 28—(Continued).

SN 78-301,601. CONG, LIN, ROHNERT PARK, CA. FILED 9-17-2003.



FOR TOY FOAM BUILDING BLOCKS (U.S. CLS. 22, 23, 38 AND 50).
FIRST USE 9-10-2003; IN COMMERCE 9-10-2003.
JOHN HWANG, EXAMINING ATTORNEY

SN 78-301,126. JUMP-AEROBICS, INC., DBA JUMP ROPE TECHNOLOGY, INC., WOODBRIDGE, VA. FILED 9-16-2003.

HYPERFORMANCE JUMP ROPE

NO CLAIM IS MADE TO THE EXCLUSIVE RIGHT TO USE "JUMP ROPE", APART FROM THE MARK AS SHOWN. FOR JUMP ROPE WITH PATENTED BALL BEARING SWIVEL SYSTEM (U.S. CLS. 22, 23, 38 AND 50).
FIRST USE 4-0-2001; IN COMMERCE 4-0-2001.
MARC LEIPZIG, EXAMINING ATTORNEY

SN 78-301,924. HUFFY CORPORATION, MIAMISBURG, OH. FILED 9-18-2003.



NO CLAIM IS MADE TO THE EXCLUSIVE RIGHT TO USE "GOLF", APART FROM THE MARK AS SHOWN. FOR GOLF PUTTING AND GOLF CLUB SWING AIDS, NAMELY, PRACTICE NETS, BALLS, TARGETS, MATS, AND PUTTING AND CHIPPING PADS; GOLF EQUIPMENT, NAMELY, GOLF BAGS, GOLF BALLS, GOLF TEES, GOLF ACCESSORY POUCHES, GOLF BAG COVERS, GOLF CLUB COVERS, GOLF BAG TAGS, GOLF BALL MARKERS, GOLF BALL SLEEVES, AND HAND-PULLED GOLF BAG CARTS (U.S. CLS. 22, 23, 38 AND 50).
FIRST USE 9-26-2003; IN COMMERCE 9-26-2003.
TRICIA SONNEBORN, EXAMINING ATTORNEY

SN 78-301,491. TOY STATE INDUSTRIAL LTD., KOWLOON, HONG KONG, FILED 9-17-2003.

REV & RUMBLE FOGGER

FOR TOY VEHICLES (U.S. CLS. 22, 23, 38 AND 50).
ERICA GLEMBOCKI, EXAMINING ATTORNEY

CLASS 28—(Continued).

SN 78-301,925. HUFFY CORPORATION, MIAMISBURG, OH. FILED 9-18-2003.

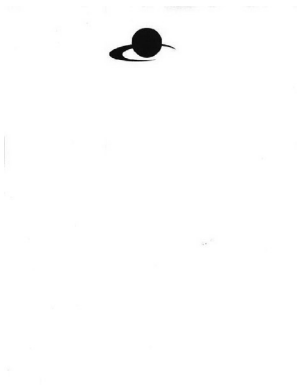

THE MARK CONSISTS OF A SILHOUETTE OF A BALL RESTING ON A STYLIZED PLANAR SURFACE.

FOR GOLF PUTTING AND GOLF CLUB SWING AIDS, NAMELY, PRACTICE NETS, BALLS, TARGETS, MATS, AND PUTTING AND CHIPPING PADS; GOLF EQUIPMENT, NAMELY, GOLF BAGS, GOLF BALLS, GOLF TEES, GOLF ACCESSORY POUCHES, GOLF BAG COVERS, GOLF CLUB COVERS, GOLF BAG TAGS, GOLF BALL MARKERS, GOLF BALL SLEEVES, AND HAND-PULLED GOLF BAG CARTS (U.S. CLS. 22, 23, 38 AND 50).

LINDA E. BLOHM, EXAMINING ATTORNEY

SN 78-302,249. KUHN, TODD A., NORTH EAST, MD. FILED 9-18-2003.

CRIMSON TUSKER

FOR ARCHERY, HUNTING ARROWHEAD (U.S. CLS. 22, 23, 38 AND 50).

STEVEN BERK, EXAMINING ATTORNEY

SN 78-302,254. KUHN, TODD A., NORTH EAST, MD. FILED 9-18-2003.

FERRULE-FLAGE

FOR BROADHEAD ARROWHEAD FOR ARCHERY ARROWS (U.S. CLS. 22, 23, 38 AND 50).

CHRISTOPHER BUONGIORNO, EXAMINING ATTORNEY

SN 78-302,261. KUHN, TODD A., NORTH EAST, MD. FILED 9-18-2003.

SPIRAL WOUND CHANNEL

FOR BROADHEAD ARROWHEAD FOR ARCHERY ARROWS (U.S. CLS. 22, 23, 38 AND 50).

CHRISTOPHER BUONGIORNO, EXAMINING ATTORNEY

CLASS 28—(Continued).

SN 78-302,443. IMM GROUP, MINNEAPOLIS, MN. FILED 9-18-2003.

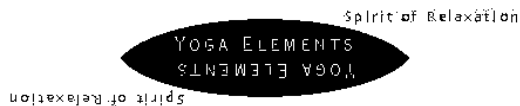

NO CLAIM IS MADE TO THE EXCLUSIVE RIGHT TO USE "YOGA", APART FROM THE MARK AS SHOWN.

THE MARK CONSISTS OF A RECTANGLE CONTAINING AN OVAL WITH THE WORDS "YOGA ELEMENTS" AND "SPIRIT OF RELAXATION" REPEATED TWICE.

FOR EXERCISE EQUIPMENT FOR YOGA, NAMELY, EXERCISE MATS, EXERCISE STRAPS, EXERCISE BRICKS, EXERCISE BLOCKS, AND EXERCISE BALLS (U.S. CLS. 22, 23, 38 AND 50).

DAVID C. REIHNER, EXAMINING ATTORNEY

SN 78-303,683. POLYCONCEPT USA, INC., STAMFORD, CT. FILED 9-22-2003.

REFLECTO ART

NO CLAIM IS MADE TO THE EXCLUSIVE RIGHT TO USE ART, APART FROM THE MARK AS SHOWN.

FOR CHILDREN'S ART ACTIVITY TOY (U.S. CLS. 22, 23, 38 AND 50).

JANICE L. MCMORROW, EXAMINING ATTORNEY

SN 78-306,337. LECLAIR, STEPHEN R., HOUSTON, TX. FILED 9-27-2003.

GIFTS FOR THOSE YOU APPRECIATE

FOR PLUSH TOYS, DOLLS (U.S. CLS. 22, 23, 38 AND 50).

MARK T. MULLEN, EXAMINING ATTORNEY

SN 78-310,243. BANDAI AMERICA INCORPORATED, CYPRESS, CA. FILED 10-7-2003.

T NEEZ

FOR DOLL ACCESSORIES; DOLL CASES; DOLL CLOTHING; DOLL FURNITURE; DOLL HOUSE FURNISHINGS; DOLLS; POSABLE DOLLS; TALKING DOLLS; DOLLS WITH LIGHTS, SOUNDS AND MOVEMENT; ACCESSORIES FOR DOLL CLOTHES; MUSICAL TOYS; PAPER DOLLS; PLAY SETS FOR DOLLS; TALKING TOYS; TOY BAKE WARE AND COOKWARE; TOY BANKS; TOY TOPS; TOY VEHICLES; TOY WATCHES (U.S. CLS. 22, 23, 38 AND 50).

RONALD AIKENS, EXAMINING ATTORNEY

CLASS 28—(Continued).

SN 78-311,150. ADAMS GOLF, LTD., PLANO, TX. FILED 10-8-2003.

CLASS 28—(Continued).

SN 78-314,393. RDH ENTERPRISES, LLC, LOGAN, UT. FILED 10-16-2003.

SPEEDLINE

FOR GOLF CLUBS (U.S. CLS. 22, 23, 38 AND 50).
STANLEY I. OSBORNE, EXAMINING ATTORNEY

**THERAPY WITHOUT THE
THERAPIST**

SN 78-311,538. I.S.A. CORPORATION, SALEM, OR. FILED 10-9-2003.

DEEKS

FOR RUBBER HUNTING DECOYS (U.S. CLS. 22, 23, 38 AND 50).
JENNIFER KRISP, EXAMINING ATTORNEY

FOR MANUALLY OPERABLE MUSCLE STRETCHING, FLEXIBILITY ENHANCING AND MUSCLE STRENGTHENING EXERCISE EQUIPMENT (U.S. CLS. 22, 23, 38 AND 50).
ELLEN PERKINS, EXAMINING ATTORNEY

SN 78-311,545. I.S.A. CORPORATION, SALEM, OR. FILED 10-9-2003.

DURADUCK

FOR RUBBER HUNTING DECOYS (U.S. CLS. 22, 23, 38 AND 50).
JENNIFER KRISP, EXAMINING ATTORNEY

SN 78-315,628. HUNTER'S SPECIALTIES, INC., CEDAR RAPIDS, IA. FILED 10-20-2003.

SN 78-312,667. ROSE ART INDUSTRIES, INC., LIVINGSTON, NJ. FILED 10-13-2003.

TALK N' WRITE

FOR TOY WALKIE-TALKIES (U.S. CLS. 22, 23, 38 AND 50).
LINDA E. BLOHM, EXAMINING ATTORNEY

BUSHWHACKER

SN 78-314,388. RDH ENTERPRISES, LLC, LOGAN, UT. FILED 10-16-2003.

GET YOUR LIFE BACK

FOR MANUALLY OPERABLE MUSCLE STRETCHING, FLEXIBILITY ENHANCING AND MUSCLE STRENGTHENING EXERCISE EQUIPMENT (U.S. CLS. 22, 23, 38 AND 50).
ELLEN PERKINS, EXAMINING ATTORNEY

FOR HUNTING GAME CALLS (U.S. CLS. 22, 23, 38 AND 50).
STEVEN R. FINE, EXAMINING ATTORNEY

CLASS 28—(Continued).

SN 78-318,295. NBA PROPERTIES, INC., NEW YORK, NY. FILED 10-24-2003.



OWNER OF U.S. REG. NOS. 1,768,251, 2,160,732 AND OTHERS.

FOR TOYS, GAMES AND SPORTING GOODS, NAMELY BASKETBALLS, GOLF BALLS, PLAY-GROUND BALLS, SPORTS BALLS, RUBBER ACTION BALLS AND FOAM ACTION BALLS, PLUSH BALLS, BASKETBALL NETS, BASKETBALL BACKBOARDS, PUMPS FOR INFLATING BASKETBALLS, AND NEEDLES THEREFOR, GOLF CLUBS, GOLF BAGS, GOLF PUTTERS, GOLF ACCESSORIES, NAMELY, DIVOT REPAIR TOOLS, TEES, BALL MARKERS, GOLF BAG COVERS, CLUB HEAD COVERS, GOLF GLOVES, GOLF BALL SLEEVES, ELECTRONIC BASKETBALL TABLE TOP GAMES, BASKETBALL TABLE TOP GAMES, BASKETBALL BOARD GAMES, ACTION SKILL GAMES, ADULT'S AND CHILDREN'S PARTY GAMES, TRIVIA INFORMATION GAMES AND ELECTRONIC VIDEO ARCADE GAME MACHINES, BASKETBALL KIT COMPRISED OF A NET AND WHISTLE, DOLLS, DECORATIVE DOLLS, COLLECTIBLE DOLLS, TOY ACTION FIGURES, BOBBLEHEAD ACTION FIGURES, STUFFED TOYS, JIGSAW PUZZLES AND CHRISTMAS TREE ORNAMENTS, CHRISTMAS STOCKINGS; TOY VEHICLES IN THE NATURE OF CARS, TRUCKS AND VANS, ALL CONTAINING BASKETBALL THEMES, TOY FINGERS, CARD GAMES, PLAYING CARDS, NOISE-MAKERS (U.S. CLS. 22, 23, 38 AND 50).

BRIAN PINO, EXAMINING ATTORNEY

SN 78-322,341. KUHN, TODD A., ELKTON, MD. FILED 11-3-2003.

Crimson Raptor

THE MARK CONSISTS OF STANDARD CHARACTERS WITHOUT CLAIM TO ANY PARTICULAR FONT, STYLE, SIZE, OR COLOR.

FOR ARCHERY PRODUCT, SPECIFICALLY AN ARROWHEAD (U.S. CLS. 22, 23, 38 AND 50).

STEVEN BERK, EXAMINING ATTORNEY

CLASS 28—(Continued).

SN 78-327,958. CONOCOPHILLIPS COMPANY, HOUSTON, TX. FILED 11-14-2003.



FOR TOYS, NAMELY, MECHANICAL ACTION TOYS, BATTER-OPERATED ACTION TOYS, BENDABLE TOYS, CONSTRUCTION TOYS, DRAWING TOYS, ELECTRIC ACTION TOYS, FANTASY CHARACTER TOYS, INFLATABLE TOYS, NON-RIDING TRANSPORTATION TOYS, PARTY FAVORS IN THE NATURE OF SMALL TOYS, PET TOYS, PLASTIC CHARACTER TOYS, PLUSH TOYS, POP UP TOYS, PULL TOYS, PUSH TOYS, RIDE-ONE TOYS, RUBBER CHARACTER TOYS, SAND TOYS, SOFT SCULPTURE TOYS, SQUEEZE TOYS, STUFFED TOYS, TALKING TOYS, YO-YOS, KITES, PLAY GASOLINE STATIONS AND PUMPS, TOY MODEL CARS, TOY MODEL AIRPLANES, TOY MODEL TRUCKS, TOY MODEL SHIPS, TOY MODEL TRAINS, AND TOY MODEL SPACECRAFT; BOARDS GAMES; CARD GAMES; SPORT BALLS; GOLF BALLS; RUBBER ACTION BALLS; BALLOONS; ARCADE-TYPE ELECTRONIC EDUCATION VIDEO GAMES; FLYING DISKS; PLAYING CARDS; TOY BANKS; GOLF CLUBS; HEAD COVERS FOR GOLF CLUBS; GOLF TEES; GOLF BALL MARKERS (U.S. CLS. 22, 23, 38 AND 50).

CAROL SPILS, EXAMINING ATTORNEY

SN 78-341,713. CONOCOPHILLIPS COMPANY, HOUSTON, TX. FILED 12-16-2003.



FOR TOYS, NAMELY, MECHANICAL ACTION TOYS, BATTER-OPERATED ACTION TOYS, BENDABLE TOYS, CONSTRUCTION TOYS, DRAWING TOYS, ELECTRIC ACTION TOYS, FANTASY CHARACTER TOYS, INFLATABLE TOYS, NON-RIDING TRANSPORTATION TOYS, PARTY FAVORS IN THE NATURE OF SMALL TOYS, PET TOYS, PLASTIC CHARACTER TOYS, PLUSH TOYS, POP UP TOYS, PULL TOYS, PUSH TOYS, RIDE-ON TOYS, RUBBER CHARACTER TOYS, SAND TOYS, SOFT SCULPTURE TOYS, SQUEEZE TOYS, STUFFED TOYS, TALKING TOYS, YO-YOS, KITES, PLAY GASOLINE STATIONS AND PUMPS, TOY MODEL CARS, TOY MODEL AIRPLANES, TOY MODEL TRUCKS, TOY MODEL SHIPS, TOY MODEL TRAINS, AND TOY MODEL SPACECRAFT; BOARD GAMES; CARD GAMES; SPORT BALLS; GOLF BALLS; RUBBER ACTION BALLS; BALLOONS; ARCADE-TYPE ELECTRONIC EDUCATION VIDEO GAMES; FLYING DISKS; PLAYING CARDS; TOY BANKS; GOLF CLUBS; HEAD COVERS FOR GOLF CLUBS; GOLF TEES; GOLF BALL MARKERS (U.S. CLS. 22, 23, 38 AND 50).

CAROL SPILS, EXAMINING ATTORNEY

CLASS 28—(Continued).

SN 78-364,509. TAYLOR MADE GOLF COMPANY, INC.,
DBA TAYLORMADE-ADIDAS GOLF COMPANY,
CARLSBAD, CA. FILED 2-8-2004.

CLASS 28—(Continued).

SN 78-364,514. TAYLOR MADE GOLF COMPANY, INC.,
DBA TAYLORMADE-ADIDAS GOLF COMPANY,
CARLSBAD, CA. FILED 2-8-2004.

AL DENTE NOODLE

THE MARK CONSISTS OF STANDARD CHARACTERS
WITHOUT CLAIM TO ANY PARTICULAR FONT, STYLE,
SIZE, OR COLOR.
FOR GOLF EQUIPMENT, NAMELY GOLF BALLS
(U.S. CLS. 22, 23, 38 AND 50).
RICHARD WHITE, EXAMINING ATTORNEY



SN 78-364,512. TAYLOR MADE GOLF COMPANY, INC.,
DBA TAYLORMADE-ADIDAS GOLF COMPANY,
CARLSBAD, CA. FILED 2-8-2004.

SPEEDMANTLE

THE MARK CONSISTS OF STANDARD CHARACTERS
WITHOUT CLAIM TO ANY PARTICULAR FONT, STYLE,
SIZE, OR COLOR.
FOR GOLF EQUIPMENT, NAMELY GOLF BALLS
(U.S. CLS. 22, 23, 38 AND 50).
RICHARD WHITE, EXAMINING ATTORNEY



ROTINI NOODLE

THE MARK CONSISTS OF STANDARD CHARACTERS
WITHOUT CLAIM TO ANY PARTICULAR FONT, STYLE,
SIZE, OR COLOR.
FOR GOLF EQUIPMENT, NAMELY GOLF BALLS
(U.S. CLS. 22, 23, 38 AND 50).
RICHARD WHITE, EXAMINING ATTORNEY



SN 78-364,513. TAYLOR MADE GOLF COMPANY, INC.,
DBA TAYLORMADE-ADIDAS GOLF COMPANY,
CARLSBAD, CA. FILED 2-8-2004.

CLASS 29—MEATS AND PROCESSED FOODS

SN 76-061,162. ZOTT GMBH & CO, D-86690 MERTINGEN,
FED REP GERMANY, FILED 6-1-2000.

ZOTT

OWNER OF U.S. REG. NO. 1,228,631.
FOR CHEESE (U.S. CL. 46).
FIRST USE 12-31-1976; IN COMMERCE 12-31-1984.
GEOFFREY FOSDICK, EXAMINING ATTORNEY



SN 76-443,916. POWER INSIGHTS INTERNATIONAL, INC.,
BREA, CA. FILED 8-21-2002.

SPEEDCORE

THE MARK CONSISTS OF STANDARD CHARACTERS
WITHOUT CLAIM TO ANY PARTICULAR FONT, STYLE,
SIZE, OR COLOR.
FOR GOLF EQUIPMENT, NAMELY GOLF BALLS
(U.S. CLS. 22, 23, 38 AND 50).
RICHARD WHITE, EXAMINING ATTORNEY

**LUNA ROSSA ARTICHOKE
CROWNS**

OWNER OF U.S. REG. NO. 2,258,126.
NO CLAIM IS MADE TO THE EXCLUSIVE RIGHT TO
USE ARTICHOKE CROWNS, APART FROM THE MARK AS
SHOWN.
THE ENGLISH TRANSLATION OF "LUNA ROSSA" IS
"PINK MOON".
FOR PROCESSED ARTICHOKES (U.S. CL. 46).
GEOFFREY FOSDICK, EXAMINING ATTORNEY

CLASS 29—(Continued).

SN 76-455,217. OCEAN FISHERIES LIMITED, VANCOUVER, BRITISH COLUMBIA, CANADA, FILED 9-30-2002.

SNACK'N LUNCH

NO CLAIM IS MADE TO THE EXCLUSIVE RIGHT TO USE "LUNCH", APART FROM THE MARK AS SHOWN.

FOR CANNED SEAFOOD; PACKAGED FOOD PRODUCT COMBINATION OF SEAFOOD AND CRACKERS; PACKAGED SEAFOOD; TUNA AND SALMON SOLD IN POUCHES OR CANS; PACKAGED MEALS CONTAINING SEAFOOD, VEGETABLES, DRESSING, PASTA, RICE AND/OR NOODLES (U.S. CL. 46).

SUSAN LESLIE DUBOIS, EXAMINING ATTORNEY

SN 76-458,760. FRANK BRUNCKHORST CO., L.L.C., BROOKLYN, NY. FILED 10-17-2002.

THE SANDWICH CHICKEN

NO CLAIM IS MADE TO THE EXCLUSIVE RIGHT TO USE "CHICKEN", APART FROM THE MARK AS SHOWN.

FOR PROCESSED MEATS (U.S. CL. 46).
INGRID C. EULIN, EXAMINING ATTORNEY

SN 76-508,280. ROYAL BALTIC, LTD., BROOKLYN, NY. FILED 4-10-2003.

BOYARIN

FOR CHEESE, SMOKED FISH, CANNED FISH; CANNED CUT VEGETABLES; PICKLED TOMATOES AND CUCUMBERS; MEAT; POULTRY; PROCESSED MEAT AND POULTRY, NAMELY, PORK, BEEF, CHICKEN, HAM, TURKEY, VEAL, SALAMI, BOLOGNA, AND SMOKED DUCK BREAST; JAMS AND FRUIT PRESERVES; MARINATED MUSHROOMS; CANNED SAUERKRAUT; DAIRY PRODUCTS EXCLUDING ICE CREAM, ICE MILK AND FROZEN YOGURT; AND COMPOTES (U.S. CL. 46).

SUSAN HAYASH, EXAMINING ATTORNEY

SN 76-508,281. ROYAL BALTIC, LTD., BROOKLYN, NY. FILED 4-10-2003.

BOYAR

FOR CHEESE, SMOKED FISH, CANNED FISH; CANNED CUT VEGETABLES; PICKLED TOMATOES AND CUCUMBERS; MEAT; POULTRY; PROCESSED MEAT AND POULTRY, NAMELY, PORK, BEEF, CHICKEN, HAM, TURKEY, VEAL, SALAMI, BOLOGNA, AND SMOKED DUCK BREAST; JAMS AND FRUIT PRESERVES; MARINATED MUSHROOMS; CANNED SAUERKRAUT; DAIRY PRODUCTS EXCLUDING ICE CREAM, ICE MILK AND FROZEN YOGURT; AND COMPOTES (U.S. CL. 46).

SUSAN HAYASH, EXAMINING ATTORNEY

CLASS 29—(Continued).

SN 76-510,867. ADVANCE FOOD COMPANY, INC., ENID, OK. FILED 4-30-2003.

THE COUNTRY FRIED STEAK EXPERTS

NO CLAIM IS MADE TO THE EXCLUSIVE RIGHT TO USE COUNTRY FRIED STEAK, APART FROM THE MARK AS SHOWN.

SEC. 2(F).
FOR BREADED BEEF, CHICKEN, PORK, VEAL AND TURKEY (U.S. CL. 46).

FIRST USE 12-31-1995; IN COMMERCE 12-31-1995.
CIMMERIAN COLEMAN, EXAMINING ATTORNEY

SN 76-511,445. NEWMAN, JOEL CLYDE, KILLEN, AL. FILED 5-6-2003.



NO CLAIM IS MADE TO THE EXCLUSIVE RIGHT TO USE SLAB, APART FROM THE MARK AS SHOWN.

FOR PREPARED MEATS, NAMELY PORK AND BEEF (U.S. CL. 46).

FIRST USE 5-24-2002; IN COMMERCE 5-24-2002.
BRENDAN MCCAULEY, EXAMINING ATTORNEY

SN 76-516,066. ZANE, PETER L., HINGHAM, MA. FILED 5-23-2003.

STOCK EXCHANGE

FOR BOUILLON; BROTHS; SOUP; CHICKEN, FISH MEAT AND VEAL SOCKS AND PREPARATIONS FOR MAKING BOUILLON, BROTHS, STOCKS AND SOUPS (U.S. CL. 46).

MARY CRAWFORD, EXAMINING ATTORNEY

CLASS 29—(Continued).

SN 76-520,234. BEST FOOD SERVICES, INC., CHICAGO, IL. FILED 5-20-2003.



THE LINING IS A FEATURE OF THE MARK AND DOES NOT INDICATE COLOR. THE STIPPLING IN THE DRAWING IS FOR SHADING PURPOSES ONLY.

THE ENGLISH TRANSLATION OF THE ASIAN CHARACTERS IN THE MARK IS "ETERNAL PEACE".

THE ENGLISH TRANSLITERATION OF THE FOREIGN WORDING IN THE MARK IS "HENG TAI".

FOR FOOD PRODUCTS, NAMELY, CANNED FRUITS (U.S. CL. 46).

FIRST USE 6-1-2002; IN COMMERCE 6-1-2002.
CATHERINE FAINT, EXAMINING ATTORNEY

CLASS 29—(Continued).

SN 76-540,942. LES VIANDES DU BRETON INC., RIVIERE-DU-LOUP (QUEBEC) G5R 5X8, CANADA, FILED 8-18-2003.

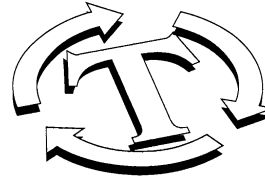

**GUARANTEED INTEGRITY
INTÉGRITÉ GARANTIE**

NO CLAIM IS MADE TO THE EXCLUSIVE RIGHT TO USE "INTEGRITY GUARANTEED", APART FROM THE MARK AS SHOWN.

THE ENGLISH TRANSLATION OF INTEGRITE GARANTIE IS GUARANTEED INTEGRITY.

FOR MEAT AND PROCESSED FOOD OBTAINED AND PRODUCED IN ACCORDANCE WITH A TRACEABILITY PROGRAM BY WHICH THE PRODUCT IS FOLLOWED AND IDENTIFIED FROM THE FARM THROUGH THE PRODUCTION CHAIN TO THE POINT OF PURCHASE, NAMELY- PORK (U.S. CL. 46).

DAWN FELDMAN, EXAMINING ATTORNEY

SN 76-526,246. ADM EDIBLE BEAN SPECIALITIES, INC., DECATUR, IL. FILED 6-27-2003.

MIDLAND HARVEST

FOR REFRIED BEANS (U.S. CL. 46).
BRETT J. GOLDEN, EXAMINING ATTORNEY

SN 76-546,481. VIENNA SAUSAGE MANUFACTURING CO., CHICAGO, IL. FILED 9-24-2003.

SN 76-530,137. CONNORS, WILLIAM, MANCHESTER, CT. FILED 7-7-2003.



BILLY'S TAVERN CHILI

NO CLAIM IS MADE TO THE EXCLUSIVE RIGHT TO USE "CHILI", APART FROM THE MARK AS SHOWN.

THE NAME BILLY IDENTIFIES A LIVING INDIVIDUAL WHOSE CONSENT IS OF RECORD.

FOR CHILI (U.S. CL. 46).
MARLENE BELL, EXAMINING ATTORNEY

NO CLAIM IS MADE TO THE EXCLUSIVE RIGHT TO USE "CHILI", APART FROM THE MARK AS SHOWN.

FOR FROZEN AND CANNED CHILI WITH BEEF AND BEANS (U.S. CL. 46).

RUDY R. SINGLETON, EXAMINING ATTORNEY

CLASS 29—(Continued).

SN 76-546,495. VIENNA SAUSAGE MANUFACTURING CO., CHICAGO, IL. FILED 9-24-2003.



NO CLAIM IS MADE TO THE EXCLUSIVE RIGHT TO USE "SOUP", APART FROM THE MARK AS SHOWN. FOR FROZEN AND CANNED FULL STRENGTH SOUPS (U.S. CL. 46).

RUDY R. SINGLETON, EXAMINING ATTORNEY

SN 76-547,113. KETO, L.L.C., NEPTUNE, NJ. FILED 9-10-2003.

KETO BUTTA

OWNER OF U.S. REG. NOS. 2,413,260, 2,662,280 AND 2,687,640.

NO CLAIM IS MADE TO THE EXCLUSIVE RIGHT TO USE BUTTER, APART FROM THE MARK AS SHOWN. SEC. 2(F) AS TO "KETO".

FOR LOW CARBOHYDRATE BUTTER FLAVORED OIL (U.S. CL. 46).

FIRST USE 12-1-2000; IN COMMERCE 12-1-2000. ESTHER BELENKER, EXAMINING ATTORNEY

SN 76-547,597. ICELAND SEAFOOD CORPORATION, NEWPORT NEWS, VA. FILED 9-30-2003.

TILAPIA TONIGHT

NO CLAIM IS MADE TO THE EXCLUSIVE RIGHT TO USE "TILAPIA", APART FROM THE MARK AS SHOWN. FOR FISH AND SEAFOOD (U.S. CL. 46).

FIRST USE 2-1-2001; IN COMMERCE 2-1-2001.

ELIZABETH HUGHITT, EXAMINING ATTORNEY

CLASS 29—(Continued).

SN 76-550,465. GIUSEPPE CITTERIO S. P. A., 20017 RITO MILANO, ITALY, FILED 10-9-2003.



OWNER OF U.S. REG. NOS. 988,024, 1,151,142 AND 2,614,168.

NO CLAIM IS MADE TO THE EXCLUSIVE RIGHT TO USE "1878", "MILANO" AND "FRESCO", APART FROM THE MARK AS SHOWN.

THE DRAWING IS LINED FOR THE COLOR(S) RED AND BLUE. COLOR IS A FEATURE OF THE MARK.

THE ENGLISH TRANSLATION OF FRESCO IS FRESH. FOR PROCESSED MEATS AND CHEESES (U.S. CL. 46).

FIRST USE 1-1-2002; IN COMMERCE 1-1-2002. MARY ROSSMAN, EXAMINING ATTORNEY

SN 76-560,187. NATURE SOY, INC., PHILADELPHIA, PA. FILED 10-27-2003.

PROTEIN-WISE

FOR VEGETARIAN MEAT SUBSTITUTE (U.S. CL. 46).

FIRST USE 3-14-2003; IN COMMERCE 3-14-2003.

EUGENIA MARTIN, EXAMINING ATTORNEY

SN 78-110,251. AURORA FOODS INC., ST. LOUIS, MO. FILED 2-21-2002.

LENDER'S

OWNER OF U.S. REG. NOS. 932,754, 1,172,496 AND OTHERS.

FOR CREAM CHEESE (U.S. CL. 46).

REBECCA SMITH, EXAMINING ATTORNEY

CLASS 29—(Continued).

SN 78-128,542. FATTORIA NOVELLI S.R.L., 05100 TERNI, ITALY, FILED 5-14-2002.



THE STIPLING IS FOR SHADING PURPOSES ONLY. FOR EGGS (U.S. CL. 46).
CIMMERIAN COLEMAN, EXAMINING ATTORNEY

SN 78-146,324. 99¢ ONLY STORES, CITY OF COMMERCE, CA. FILED 7-22-2002.

SANTA PAULA FANCY FOODS

NO CLAIM IS MADE TO THE EXCLUSIVE RIGHT TO USE "FANCY FOODS", APART FROM THE MARK AS SHOWN.
FOR JARRED VEGETABLES AND FRUITS (U.S. CL. 46).
FIRST USE 11-2-2002; IN COMMERCE 11-2-2002.
MICHELE SWAIN, EXAMINING ATTORNEY

SN 78-147,396. DCI CHEESE COMPANY, INC., MAYVILLE, WI. FILED 7-25-2002.

CHEESE MASTERS

NO CLAIM IS MADE TO THE EXCLUSIVE RIGHT TO USE "CHEESE", APART FROM THE MARK AS SHOWN.
FOR CHEESE (U.S. CL. 46).
DOMINIC J. FERRAIUOLO, EXAMINING ATTORNEY

SN 78-158,546. ELMHURST DAIRY, INC., JAMAICA, NY. FILED 8-28-2002.

ELMHURST DAIRY FAT FREE PLUS

NO CLAIM IS MADE TO THE EXCLUSIVE RIGHT TO USE "ELMHURST DAIRY FAT FREE", APART FROM THE MARK AS SHOWN.
FOR DAIRY PRODUCTS, NAMELY, FAT FREE MILK (U.S. CL. 46).
JOHN KELLY, EXAMINING ATTORNEY

CLASS 29—(Continued).

SN 78-179,034. E.A. SWEEN COMPANY, EDEN PRAIRIE, MN. FILED 10-28-2002.



OWNER OF U.S. REG. NOS. 1,220,359, 2,591,258 AND OTHERS.

NO CLAIM IS MADE TO THE EXCLUSIVE RIGHT TO USE "DELI", APART FROM THE MARK AS SHOWN.
THE LINING IS A FEATURE OF THE MARK.
FOR SNACK FOODS, NAMELY, MEAT (U.S. CL. 46).
FIRST USE 6-8-2001; IN COMMERCE 6-8-2001.
MARIA-VICTORIA SUAREZ, EXAMINING ATTORNEY

SN 78-217,505. CA MAU FROZEN SEAFOOD PROCESSING IMPORT EXPORT CORPORATION, TA CAMIMEX, CA MAU CITY, VIETNAM, FILED 2-21-2003.



OWNER OF VIETNAM REG. NO. 8278, DATED 5-19-1993, EXPIRES 2-6-2013.
FOR PROCESSED SEA PRODUCTS, NAMELY, SHRIMP, FISH, OCTOPUS, SQUID AND CUTTLE FISH (U.S. CL. 46).
BARNEY CHARLON, EXAMINING ATTORNEY

SN 78-222,676. TRANSPACIFIC FOODS, INC, IRVINE, CA. FILED 3-6-2003.

IDEAL CHOICE

FOR CANNED FRUITS, VEGETABLES, AND MUSH-ROOMS (U.S. CL. 46).
CHRISTOPHER BUONGIORNO, EXAMINING ATTORNEY

CLASS 29—(Continued).

SN 78-231,579. NORTH PACIFIC GROUP, INC., PORTLAND, OR. FILED 3-28-2003.



NO CLAIM IS MADE TO THE EXCLUSIVE RIGHT TO USE "PACIFIC'S FINEST", APART FROM THE MARK AS SHOWN.

THE STIPPLING IS FOR SHADING PURPOSES ONLY.

THE MARK CONSISTS OF THE WORD PACIFIC'S AT THE TOP WITH THE WORD FINEST BELOW ON A RIBBON WITH A BURST OF ALTERNATING STRIPES BEHIND THE WORDS.

FOR CANNED, FROZEN, POUCH, ASEPTIC, AND NON-PERISHABLE FOODS, NAMELY, PEANUT BUTTER, GRAPEFRUIT, MANDARINS, PEACHES, PEARS, PINEAPPLE, TROPICAL FRUIT, FRUIT BITS, POTATO FLAKES AND GRANULARS, ARTICHOKE, BABY CORN, CORN, BAMBOO, WATER CHESTNUTS, MUSHROOMS, OLIVES, PEPPERS, PIMENTOS, STIR-FRY VEGETABLES, BOILED CLAMS, CRAB, MACKEREL, SARDINES, SMOKED BABY CLAMS, SMOKED MUSSELS, SMOKED OYSTERS, AND TUNA (U.S. CL. 46).

FIRST USE 2-24-2003; IN COMMERCE 2-24-2003.

ALEX KEAM, EXAMINING ATTORNEY

SN 78-236,242. RESTAURANTES Y SERVICIOS, S.A., GUATEMALA CITY, GUATEMALA, FILED 4-10-2003.

EL TABLAZO

PRIORITY CLAIMED UNDER SEC. 44(D) ON GUATEMALA APPLICATION NO. 000549, FILED 2-4-2003, REG. NO. 124695, DATED 7-15-2003, EXPIRES 7-15-2013.

THE ENGLISH TRANSLATION OF THE WORD "EL TABLAZO" IN THE MARK IS "BIG TABLE".

FOR LINE OF PREPARED, FROZEN OR PACKAGED MEALS, MAINLY OF MEAT, POULTRY AND VEGETABLES, WITH DIFFERENT SAUCES (U.S. CL. 46).

GIANCARLO CASTRO, EXAMINING ATTORNEY

SN 78-236,250. RESTAURANTES Y SERVICIOS, S.A., GUATEMALA CITY, GUATEMALA, FILED 4-10-2003.

EL METRO

PRIORITY CLAIMED UNDER SEC. 44(D) ON GUATEMALA APPLICATION NO. 000548, FILED 2-4-2003, REG. NO. 124685, DATED 7-14-2003, EXPIRES 7-14-2013.

THE ENGLISH TRANSLATION OF THE WORD "EL METRO" IN THE MARK IS "THE METER".

FOR LINE OF PREPARED, FROZEN OR PACKAGED MEALS, MAINLY OF MEAT, POULTRY AND VEGETABLES, WITH DIFFERENT SAUCES (U.S. CL. 46).

GIANCARLO CASTRO, EXAMINING ATTORNEY

CLASS 29—(Continued).

SN 78-271,230. NATURAL SUPPLEMENT ASSOCIATION, INCORPORATED, DBA EXPERIMENTAL AND APPLIED SCIENCES, INC., GOLDEN, CO. FILED 7-7-2003.



OWNER OF U.S. REG. NO. 1,907,029.
FOR READY TO EAT FOOD BARS WITH A SOY OR WHEY PROTEIN BASE (U.S. CL. 46).
FIRST USE 2-27-2003; IN COMMERCE 2-27-2003.
RAUL CORDOVA, EXAMINING ATTORNEY

SN 78-280,413. THE DINEX GROUP, LLC, NEW YORK, NY. FILED 7-29-2003.

**DANIEL BOULUD
CONNOISSEUR**

OWNER OF U.S. REG. NO. 2,734,459.
THE NAME(S), PORTRAIT(S), AND/OR SIGNATURE(S) SHOWN IN THE MARK IDENTIFIES DANIEL BOULUD, WHOSE CONSENT(S) TO REGISTER IS SUBMITTED.
FOR FOOD PRODUCTS, NAMELY CAVIAR AND SMOKED SALMON (U.S. CL. 46).
FIRST USE 10-1-1997; IN COMMERCE 10-1-1997.
KHANH LE, EXAMINING ATTORNEY

SN 78-294,762. ALLIED INTERNATIONAL, CORP., ASHBURN, VA. FILED 9-2-2003.

SMITH & JOHNSON

FOR MEAT, FISH POULTRY, MEAT EXTRACTS, PRESERVED AND COOKED FRUITS AND VEGETABLES, JELLIES, JAMS, MILK PRODUCTS, EXCLUDING ICE CREAM, ICE MILK AND FROZEN YOGURT, PEANUT BUTTER, CHEESES, AND YOGURTS (U.S. CL. 46).
FIRST USE 2-1-2000; IN COMMERCE 2-1-2000.
ROBIN CHOSID, EXAMINING ATTORNEY

SN 78-295,252. INTERNATIONAL FOOD NETWORK, LLC, ATLANTA, GA. FILED 9-3-2003.

NATURES VALUE

FOR CANNED FRUITS AND VEGETABLES (U.S. CL. 46).
FIRST USE 10-18-2002; IN COMMERCE 10-18-2002.
MITCHELL FRONT, EXAMINING ATTORNEY

CLASS 29—(Continued).

SN 78-300,981. CHIQUITA BRANDS, INC., CINCINNATI, OH. FILED 9-16-2003.

FLAVOR SAVOR

FOR FROZEN, PREPARED AND/OR PACKAGED MEALS CONSISTING PRIMARILY OF MEAT, FISH, POULTRY, FRUITS AND/OR VEGETABLES (U.S. CL. 46).

KARANENDRA S. CHHINA, EXAMINING ATTORNEY

SN 78-305,630. JUANITA'S FOODS, WILMINGTON, CA. FILED 9-25-2003.

MENUDITO

OWNER OF U.S. REG. NO. 1,265,854. FOR CANNED BEEF AND HOMINY STEW (U.S. CL. 46).

FIRST USE 0-0-1966; IN COMMERCE 0-0-1966. JENNIFER CHICOSKI, EXAMINING ATTORNEY

SN 78-310,866. CCI FOODS, INC., NEW ROCHELLE, NY. FILED 10-8-2003.

VILLA TUNARI

FOR CANNED HEARTS OF PALM, CANNED FRUITS, CANNED VEGETABLES (U.S. CL. 46).

BARNEY CHARLON, EXAMINING ATTORNEY

SN 78-310,966. CARGILL, INCORPORATED, WAYZATA, MN. FILED 10-8-2003.

TORTIFINA

FOR SHORTENING (U.S. CL. 46). CHARLES L. JENKINS, EXAMINING ATTORNEY

SN 78-311,975. ALLIED OLD ENGLISH, INC., PORT READING, NJ. FILED 10-10-2003.

CARB LOGIC!

NO CLAIM IS MADE TO THE EXCLUSIVE RIGHT TO USE "CARB", APART FROM THE MARK AS SHOWN.

FOR JELLY, JAMS, FRUIT PRESERVES, FRUIT TOPPING (U.S. CL. 46).

CIMMERIAN COLEMAN, EXAMINING ATTORNEY

CLASS 30—STAPLE FOODS

SN 76-240,360. LIWAYWAY MARKETING CORPORATION, PASAY CITY, PHILIPPINES, FILED 4-11-2001.



OWNER OF U.S. REG. NOS. 1,407,783 AND 1,582,820. THE ENGLISH TRANSLATION OF "OISHI" IS BIG ROCK. FOR RICE FLOUR AND RICE STARCH BASED SNACK FOOD AND WHEAT FLOUR AND WHEAT STARCH BASE SNACK FOOD (U.S. CL. 46).

SAMUEL E. SHARPER JR., EXAMINING ATTORNEY

SN 76-257,951. PURE DE-LITE PRODUCTS, INC., PROVO, UT. FILED 5-16-2001.

CHEWY SENSATIONS

NO CLAIM IS MADE TO THE EXCLUSIVE RIGHT TO USE "CHEWY", APART FROM THE MARK AS SHOWN.

FOR LOW-CARB, SUGAR-FREE, BELGIAN CHOCOLATE BARS, SWEETENED WITH MALTITOL, IN DARK CHOCOLATE LICORICE, DARK CHOCOLATE MINT, MILK CHOCOLATE CARAMEL, AND MILK CHOCOLATE MOCHA (U.S. CL. 46).

LINDA M. KING, EXAMINING ATTORNEY

SN 76-382,719. SUGARCRAFT, INC., HAMILTON, OH. FILED 3-18-2002.

SUGARCRAFT

FOR INGREDIENTS FOR BAKERY GOODS, NAMELY ICING, FLAVORINGS, SPRINKLES, NON-PAREILS, MERINGUE POWDER, CHOCOLATE WAFERS, PRESSED SUGAR SHAPES, CHOCOLATE AND CUSTARD-BASED PASTRY FILLINGS, CARAMEL AND DRY FONDANT (U.S. CL. 46).

CHARLES JOYNER, EXAMINING ATTORNEY

CLASS 30—(Continued).

SN 76-414,213. MILAGRO FOOD INDUSTRIES LTD., GB LONDON, WC2B 6AW, UNITED KINGDOM, FILED 6-3-2002.

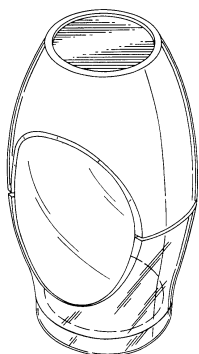

PRIORITY CLAIMED UNDER SEC. 44(D) ON ERP N CMNTY TM OFC APPLICATION NO. 002489086, FILED 12-4-2001, REG. NO. 002489086, DATED 11-27-2003, EXPIRES 12-4-2011.

THE MARK CONSISTS OF A THREE-DIMENSIONAL DESIGN OF AN OVAL-SHAPED CONTAINER AND OVAL-SHAPED LID FOR PACKAGING COFFEE, TEA, COCOA, RICE, TAPIOCA, SAGO, ARTIFICIAL COFFEE, FLOUR AND PREPARATIONS MADE FROM CEREALS, NAMELY, CEREAL DERIVED FOOD BARS AND CEREAL BASED SNACK FOOD; BREAD, PASTRY AND CONFECTIONERY, NAMELY, ICE-CREAM SWEETS, CHOCOLATE, HONEY, BAKING-POWDER, SALT, MUSTARD, VINEGAR, SAUCES (CONDIMENTS), SPICES AND ICE (FOR COOLING PURPOSES).

FOR COFFEE; TEA; COCOA; RICE; TAPIOCA; SAGO; ARTIFICIAL COFFEE; FLOUR AND PREPARATIONS MADE FROM CEREALS; NAMELY, READY TO EAT, CEREAL DERIVED FOOD BARS AND CEREAL BASED SNACK FOOD; BREAD; PASTRY AND CONFECTIONERY, NAMELY, ICE-CREAM, SWEETS, CHOCOLATE, HONEY, BAKING-POWDER; SALT, MUSTARD; VINEGAR, SAUCES; SPICES; ICE (U.S. CL. 46).

INGRID C. EULIN, EXAMINING ATTORNEY

SN 76-428,362. CONAGRA FROZEN FOODS, LTD., BOIS-BRAND, QUEBEC J7G 2A7, CANADA, FILED 7-9-2002.



OWNER OF U.S. REG. NOS. 870,562, 2,307,631 AND 2,311,996.

NO CLAIM IS MADE TO THE EXCLUSIVE RIGHT TO USE "MINI", APART FROM THE MARK AS SHOWN. FOR FRANKFURTERS ON A STICK, COVERED WITH DOUGH AND COOKED (U.S. CL. 46).

FIRST USE 9-19-2001; IN COMMERCE 9-19-2001.

SAMUEL E. SHARPER JR., EXAMINING ATTORNEY

CLASS 30—(Continued).

SN 76-449,203. PAULUCCI, JENO F., DULUTH, MN. FILED 9-9-2002.

MICHELINA'S HOT SUBS

OWNER OF U.S. REG. NO. 2,567,985.
NO CLAIM IS MADE TO THE EXCLUSIVE RIGHT TO USE "HOT SUBS", APART FROM THE MARK AS SHOWN. FOR FROZEN SANDWICHES COMPRISED OF BUNS WITH VARIOUS MEATS, CHEESES AND SAUCES (U.S. CL. 46).

TANYA AMOS, EXAMINING ATTORNEY

SN 76-502,424. BADIA SPICES, INC., MIAMI, FL. FILED 3-14-2003.

COMPLETE SEASONING

NO CLAIM IS MADE TO THE EXCLUSIVE RIGHT TO USE "SEASONING", APART FROM THE MARK AS SHOWN.

FOR BLEND OF SEVERAL SPICES FOR USE IN FOOD PREPARATION (U.S. CL. 46).

FIRST USE 0-0-1969; IN COMMERCE 0-0-1969.

KEVON CHISOLM, EXAMINING ATTORNEY

SN 76-505,984. BOSCO PRODUCTS, INC., TOWACO, NJ. FILED 4-14-2003.



FOR PAR-BAKED FROZEN PIZZAS AND BREAD STICKS SOLD PRIMARILY TO WHOLESALE FOOD DISTRIBUTORS (U.S. CL. 46).

DOMINIC J. FERRAIUOLO, EXAMINING ATTORNEY

SN 76-508,179. BOSCO PRODUCTS, INC., TOWACO, NJ. FILED 4-14-2003.

BOSCO STICKS

NO CLAIM IS MADE TO THE EXCLUSIVE RIGHT TO USE "STICKS", APART FROM THE MARK AS SHOWN.

FOR PAR-BAKED MOZZARELLA CHEESE FILLED BREAD STICKS SOLD PRIMARILY TO WHOLESALE DISTRIBUTORS (U.S. CL. 46).

FIRST USE 9-0-1998; IN COMMERCE 9-0-1998.

DOMINIC J. FERRAIUOLO, EXAMINING ATTORNEY

CLASS 30—(Continued).

SN 76-511,818. ISHIMURA, ZENOSUKE, FUKUOKA, JAPAN, AND ISHIMURA, SHINGO, FUKUOKA, JAPAN, FILED 4-16-2003.

CLASS 30—(Continued).

SN 76-520,888. MARS, INCORPORATED, MCLEAN, VA. FILED 6-5-2003.

14 March = π (Pi • Pie) Day
(3. 14)

PRIORITY CLAIMED UNDER SEC. 44(D) ON JAPAN APPLICATION NO. 2003-007314, FILED 2-3-2003, REG. NO. 4699238, DATED 8-8-2003, EXPIRES 8-8-2013.
FOR CONFECTIONARY, NAMELY PIES (U.S. CL. 46).
DAVID C. REIHNER, EXAMINING ATTORNEY

**BE GOOD TO YOUR HEART
EVERYDAY**

SN 76-515,911. LARRY WARD ENTERPRISES, INC., WESTERVILLE, OH. FILED 4-28-2003.

**MAIN STREET GOURMET
FOOD & GIFTS**

OWNER OF U.S. REG. NO. 2,771,177.
NO CLAIM IS MADE TO THE EXCLUSIVE RIGHT TO USE "GOURMET FOOD & GIFTS", APART FROM THE MARK AS SHOWN.
FOR SALSAS, BREAD MIXES, MUFFIN MIXES, GOURMET COFFEES, COCOA, INSTANT HOT CHOCOLATE AND SAUCES USED AS DIPS (U.S. CL. 46).
FIRST USE 7-24-1995; IN COMMERCE 7-24-1995.
ROBERT LORENZO, EXAMINING ATTORNEY

FOR BAKERY DESSERTS, BAKERY GOODS, BAKERY PRODUCTS, BASES FOR MAKING MILK SHAKES, BONBONS, BREAKFAST CEREALS, BROWNIES, BUBBLE GUM, CAKE MIXES, CAKES, CANDY, CANDY BARS, CANDY CAKE DECORATIONS, CANDY COATED APPLES, CANDY COATED POPCORN, CANDY DECORATIONS FOR CAKES, CANDY MINTS, CAPPUCINO, CARAMEL POPCORN, CARAMELS, CEREAL BASED SNACK FOOD, CHOCOLATE CHIPS, CHOCOLATE COVERED NUTS, CHOCOLATE FONDUE, CHOCOLATE FOOD BEVERAGES NOT BEING DAIRY-BASED OR VEGETABLE BASED, CHOCOLATE MOUSSE, CHOCOLATE POWDER, CHOCOLATE SYRUP, CHOCOLATE TOPPING, CHOCOLATE TRUFFLES, CHOCOLATE-BASED FILINGS FOR CAKES AND PIES, CHOCOLATE-BASED READY-TO-EAT FOOD BARS, COCOA, COCOA MIXES, COCOA-BASED INGREDIENT IN CONFECTIONERY PRODUCTS, COFFEE, COFFEE-BASED BEVERAGE CONTAINING MILK, CONES FOR ICE CREAM, CONFECTIONERY CHIPS FOR BAKING, COOKIES, CRACKERS, DESSERT MOUSSE, DESSERT SOUFFLES, DOUGH, DOUGHNUTS, DULCE DE LECHE, DUMPLINGS, ECLAIRS, EDIBLE CAKES DECORATIONS, EDIBLE DECORATIONS FOR CAKES, ESPRESSO, EXTRACTS USED AS FLAVORING, FLAVORED AND SWEETENED GELATINES, FLAVORED ICES, FLAVORED, SWEETENED GELATIN DESSERTS, FLAVORING SYRUP, FLOUR, FROSTING MIXES, FROSTINGS, FROZEN CONFECTIONS, FROZEN CUSTARDS, FROZEN YOGURT, GRANOLA, GRANOLA-SUBSTITUTE, ICING, ICING MIXES, MARSHMALLOW TOPPING, MARSHMALLOWS, MILK SHAKES, MIXES FOR BAKERY GOODS, MUESLI, MUFFINS, NATURAL SWEETENER, OATMEAL, PANCAKE MIXES, PANCAKE SYRUP, PANCAKES, PARFAITS, PASTIES, PASTRIES, PIES, POPPED POPCORN, PROCESSED CEREALS, PROCESSED GRAINS, PROCESSED OATS, PROCESSED POPCORN, PROCESSED UNPOPPED POPCORN, PROPOLIS FOR FOOD PURPOSES, PUDDINGS, PUFFED CORN SNACKS, READY TO EAT CEREAL DERIVED FOOD BARS, RICE CAKES, RICE-BASED SNACK FOODS, ROLLED OATS, ROLLS, BREAD, SAUCES, SEASONED COATING FOR MEAT, FISH, POULTRY, SEASONINGS, SHAKES, SHERBET, SNACK MIX CONSISTING PRIMARILY OF CRACKERS, PRETZELS, CANDIED NUTS AND/OR POPPED POPCORN, SORBET, SOY-BASED ICE CREAM SUBSTITUTE, SUGAR, SUGAR SUBSTITUTES, TABLE SYRUP, TAPIOCA, TARTS, TEA, TEA FOR INFUSIONS, TEA-BASED BEVERAGES WITH FRUIT FLAVORING, TOPPING SYRUP, WAFFLES, WHEAT-BASED SNACK FOODS (U.S. CL. 46).
SUELLEN HICKEY, EXAMINING ATTORNEY

SN 76-518,566. WU, JUI-LING, LA HABRA, CA. AND LEE, CHING SUI, LA HABRA, CA. FILED 6-2-2003.

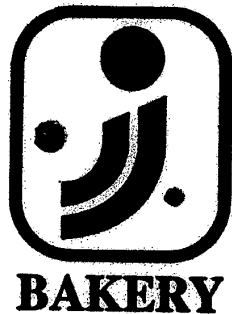

NO CLAIM IS MADE TO THE EXCLUSIVE RIGHT TO USE "BAKERY", APART FROM THE MARK AS SHOWN.
THE MARK CONSISTS OF A ROUND-CORNER SQUARE WITH IMAGE OF .JJ. INSIDE AND LETTERS OF BAKERY OUTSIDE.
FOR BAKERY PRODUCTS (U.S. CL. 46).
FIRST USE 5-0-1996; IN COMMERCE 5-0-1996.
MITCHELL FRONT, EXAMINING ATTORNEY

CLASS 30—(Continued).

SN 76-521,940. MARS, INCORPORATED, MCLEAN, VA.
FILED 6-11-2003.

COCOAVIA - BE GOOD TO YOUR HEART EVERYDAY

FOR BAKERY DESSERTS, BAKERY GOODS, BAKERY PRODUCTS, BASES FOR MAKING MILK SHAKES, BONBONS, BREAKFAST CEREALS, BROWNIES, BUBBLE GUM, CAKE MIXES, CAKES, CANDY, CANDY BARS, CANDY CAKE DECORATIONS, CANDY COATED APPLES, CANDY COATED POPCORN, CANDY DECORATIONS FOR CAKES, CANDY MINTS, CAPPUCINO, CARAMEL POPCORN, CARAMELS, CEREAL BASED SNACK FOOD, CHOCOLATE CHIPS, CHOCOLATE COVERED NUTS, CHOCOLATE FONDUE, CHOCOLATE FOOD BEVERAGES NOT BEING DAIRY-BASED OR VEGETABLE BASED, CHOCOLATE MOUSSE, CHOCOLATE POWDER, CHOCOLATE SYRUP, CHOCOLATE TOPPING, CHOCOLATE TRUFFLES, CHOCOLATE-BASED FILINGS FOR CAKES AND PIES, CHOCOLATE-BASED READY-TO-EAT FOOD BARS, COCOA, COCOA MIXES, COCOA-BASED INGREDIENT IN CONFECTIONERY PRODUCTS, COFFEE, COFFEE-BASED BEVERAGE CONTAINING MILK, CONES FOR ICE CREAM, CONFECTIONERY CHIPS FOR BAKING, COOKIES, CRACKERS, DESSERT MOUSSE, DESSERT SOUFFLES, DOUGH, DOUGHNUTS, DULCE DE LECHE, DUMPLINGS, ECLAIRS, EDIBLE CAKES DECORATIONS, EDIBLE DECORATIONS FOR CAKES, ESPRESSO, EXTRACTS USED AS FLAVORING, FLAVORED AND SWEETENED GELATINES, FLAVORED ICES, FLAVORED, SWEETENED GELATIN DESSERTS, FLAVORING SYRUP, FLOUR, FROSTING MIXES, FROSTINGS, FROZEN CONFECTIONS, FROZEN CUSTARDS, FROZEN YOGURT, GRANOLA, GRANOLA-SUBSTITUTE, ICING, ICING MIXES, MARSHMALLOW TOPPING, MARSHMALLOWS, MILK SHAKES, MIXES FOR BAKERY GOODS, MUESLI, MUFFINS, NATURAL SWEETENER, OATMEAL, PANCAKE MIXES, PANCAKE SYRUP, PANCAKES, PARFAITS, PASTIES, PASTRIES, PIES, POPPED POPCORN, PROCESSED CEREALS, PROCESSED GRAINS, PROCESSED OATS, PROCESSED POPCORN, PROCESSED UNPOPPED POPCORN, PROPOLIS FOR FOOD PURPOSES, PUDDINGS, PUFFED CORN SNACKS, READY TO EAT CEREAL DERIVED FOOD BARS, RICE CAKES, RICE-BASED SNACK FOODS, ROLLED OATS, ROLLS, BREAD, SAUCES, SEASONED COATING FOR MEAT, FISH, POULTRY, SEASONINGS, SHAKES, SHERBET, SNACK MIX CONSISTING PRIMARILY OF CRACKERS, PRETZELS, CANDIED NUTS AND/OR POPPED POPCORN, SORBET, SOY-BASED ICE CREAM SUBSTITUTE, SUGAR, SUGAR SUBSTITUTES, TABLE SYRUP, TAPIOCA, TARTS, TEA, TEA FOR INFUSIONS, TEA-BASED BEVERAGES WITH FRUIT FLAVORING, TOPPING SYRUP, WAFFLES, WHEAT-BASED SNACK FOODS (U.S. CL. 46).

SUELLEN HICKEY, EXAMINING ATTORNEY

CLASS 30—(Continued).

SN 76-524,164. MILLBROOK DISTRIBUTION SERVICES INC., LEICESTER, MA. FILED 6-20-2003.



OWNER OF U.S. REG. NO. 760,818 AND OTHERS.
FOR CHOCOLATE CARAMEL POPCORN, CHOCOLATE PEANUT BUTTER PRETZELS, CHOCOLATES, CHOCOLATE ALMOND BARK, AND CHOCOLATE NONPAREILS (U.S. CL. 46).

FIRST USE 6-0-2002. THE MARK WAS FIRST USED ANYWHERE IN A DIFFERENT FORM OTHER THAN THAT SOUGHT TO BE REGISTERED ON 10/08/1958.; IN COMMERCE 6-0-2002, THE MARK WAS FIRST USED IN COMMERCE IN A DIFFERENT FORM OTHER THAN THAT SOUGHT TO BE REGISTERED ON 10/08/1958..

SUELLEN HICKEY, EXAMINING ATTORNEY

SN 76-533,990. ZITO PREHRAMBENA INDUSTRIJA, D.D.,
SI-1000 LJUBLJANA, SLOVENIA, FILED 7-31-2003.



OWNER OF SLOVENIA REG. NO. 200370038, DATED 6-18-2003, EXPIRES 1-14-2013.

THE COLOR(S) NAVY BLUE, RED IS/ARE CLAIMED AS A FEATURE OF THE MARK.

THE LETTERS "KRE" ARE NAVY BLUE; THE LETTER "X" IS RED.

FOR FLOUR AND PREPARATIONS MADE OF CEREALS, NAMELY, BREAKFAST CEREALS, PROCESSED CEREALS; CEREAL BASED SNACK FOODS; BREAD; PASTRIES; BISCUITS; CRACKERS; WAFFLES; FINGER ROLLS SPRINKLED OVER WITH SALT (U.S. CL. 46).

APRIL L. RADEMACHER, EXAMINING ATTORNEY

CLASS 30—(Continued).

SN 76-534,592. TRUONG GIANG CORPORATION, DBA 3 BALLERINA COMPANY, SOUTH EL MONTE, CA. FILED 8-5-2003.

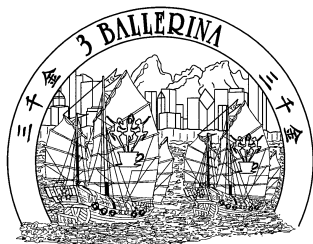

OWNER OF U.S. REG. NOS. 2,561,662, 2,570,889 AND OTHERS.

THE LINING AND STIPLING SHOWN IN THE MARK IS MERELY TO INDICATE SHADING.

THE NON-LATIN CHARACTERS IN THE MARK TRANSLITERATE TO SAN QIAN JING (MAINLAND CHINA'S (MANDARIN) PRONUNCIATION) AND THIS MEANS "THREE DAUGHTERS".

FOR TEA (U.S. CL. 46).

FIRST USE 6-25-2003; IN COMMERCE 6-5-2003.

CHRISTOPHER ADKINS, EXAMINING ATTORNEY

CLASS 30—(Continued).

THE RECTANGLE APPEARS ON TOP OF A CIRCLE WITH THE WORD PREMIUM IN THE COLOR GOLD APPEARING AT THE TOP HALF OF THE CIRCLE ABOVE THE WORD CALIFORNIA, AND THE WORD RICE IN THE COLOR GOLD APPEARING AT THE BOTTOM HALF OF THE CIRCLE BELOW THE WORD CALIFORNIA. THE BACKGROUND OF THE CIRCLE BENEATH THE WORDS PREMIUM AND RICE IS THE COLOR ROYAL BLUE, SURROUNDED BY AN OUTER BORDER IN THE COLOR GOLD AND AN OUTSIDE BORDER IN THE COLOR ROYAL BLUE. THE CIRCLE CONTAINS AN INNER BORDER IN THE COLOR GOLD AND AN INSIDE BORDER IN THE COLOR ROYAL BLUE. THE CENTER OF THE CIRCLE IS THE COLOR SILVER WITH A SUNBURST DESIGN IN THE COLOR DARK GREEN. THE CIRCLE APPEARS ATOP A REPRESENTATION OF THREE WHEAT SHEAVES IN THE COLOR GOLD.

FOR RICE (U.S. CL. 46).

ELIZABETH PIGNATELLO, EXAMINING ATTORNEY

SN 76-535,786. AN ORIGINAL SOFT PRETZEL FACTORY INC., PHILADELPHIA, PA. FILED 8-11-2003.

SOFT PRETZEL FACTORY

NO CLAIM IS MADE TO THE EXCLUSIVE RIGHT TO USE "SOFT PRETZEL", APART FROM THE MARK AS SHOWN.

FOR SOFT PRETZELS (U.S. CL. 46).

FIRST USE 10-12-1999; IN COMMERCE 10-12-1999.

APRIL L. RADEMACHER, EXAMINING ATTORNEY

SN 76-540,810. TRUSTEES OF THE COFFEE QUALITY INSTITUTE CHARITABLE TRUST, LONG BEACH, CA. FILED 7-28-2003.

Q COFFEE

NO CLAIM IS MADE TO THE EXCLUSIVE RIGHT TO USE COFFEE, APART FROM THE MARK AS SHOWN.

FOR COFFEE, ROASTED AND UNROASTED (U.S. CL. 46).

LEIGH CAROLINE CASE, EXAMINING ATTORNEY

SN 76-540,211. CALIFORNIA RICE COMMISSION, SACRAMENTO, CA. FILED 8-26-2003.



OWNER OF U.S. REG. NO. 2,501,426. NO CLAIM IS MADE TO THE EXCLUSIVE RIGHT TO USE "PREMIUM", "CALIFORNIA" OR "RICE", APART FROM THE MARK AS SHOWN.

THE MARK CONSISTS OF THE WORD CALIFORNIA IN THE COLOR WHITE, SURROUNDED BY THE COLOR SILVER, IN A RECTANGLE WITH THE COLOR DARK GREEN AS THE BACKGROUND SURROUNDED BY A GOLD BORDER AND A DARK GREEN OUTER BORDER.

SN 76-547,114. LIFE SERVICES SUPPLEMENTS, INC., NEPTUNE, NJ. FILED 9-10-2003.

KETO SWEET

OWNER OF U.S. REG. NOS. 2,413,260, 2,662,280 AND 2,687,640.

NO CLAIM IS MADE TO THE EXCLUSIVE RIGHT TO USE SWEET, APART FROM THE MARK AS SHOWN.

SEC. 2(F) AS TO "KETO".

FOR SUGAR FREE NATURAL SWEETENER (U.S. CL. 46).

FIRST USE 2-29-2000; IN COMMERCE 2-29-2000.

ESTHER BELENKER, EXAMINING ATTORNEY

CLASS 30—(Continued).

SN 76-550,419. LEGAL EAGLE, INC., GREENVILLE, SC. FILED 10-8-2003.



FOR CANDY (U.S. CL. 46).
FIRST USE 7-15-2002; IN COMMERCE 7-15-2002.
DARLENE BULLOCK, EXAMINING ATTORNEY

SN 76-550,451. ORE ENTERPRISES, LLC, HIGHLAND PARK, NJ. FILED 10-9-2003.

SMARTBLENDZ

FOR MIXES FOR BAKERY GOODS, PASTA, BREAD AND BATTER (U.S. CL. 46).
FIRST USE 10-1-2003; IN COMMERCE 10-1-2003.
DARLENE BULLOCK, EXAMINING ATTORNEY

SN 76-553,705. CAFES MARAGOS MEXICANOS, S.A. DE C.V., CO. PARQUES DEL PEDREGAL, MEXICO, FILED 10-6-2003.

MARAGY

FOR COFFEE (U.S. CL. 46).
RONALD MCMORROW, EXAMINING ATTORNEY

SN 76-557,310. TEXXSTAR RESOURCES (U.S.A.), INC., AUSTIN, TX. FILED 10-14-2003.

WILLIAMS FARM

FOR PEACH SALSA, FRUIT AND VEGETABLE BASED HOT (SPICY) SAUCES AND SALSA (U.S. CL. 46).
FIRST USE 3-10-2003; IN COMMERCE 3-10-2003.
JULIE WATSON, EXAMINING ATTORNEY

CLASS 30—(Continued).

SN 78-086,636. VILLAMONTE, STEVE L., SR., PAPILLION, NE. FILED 10-3-2001.



NO CLAIM IS MADE TO THE EXCLUSIVE RIGHT TO USE "CUISINE", "SIGNATURE QUALITY DINING", "THE ORIGINAL CLASSIC", AND "DRESSING", APART FROM THE MARK AS SHOWN.

FOR SALAD DRESSING (U.S. CL. 46).
BRETT J. GOLDEN, EXAMINING ATTORNEY

SN 78-129,511. HERSHEY CHOCOLATE & CONFECTIONERY CORPORATION, WHEAT RIDGE, CO. FILED 5-17-2002.

MINTENSITY

FOR CANDY, CANDY MINTS, CHEWING GUM (U.S. CL. 46).
MICHAEL WEBSTER, EXAMINING ATTORNEY

SN 78-138,683. KENCRAFT, INC., ALPINE, UT. FILED 6-25-2002.

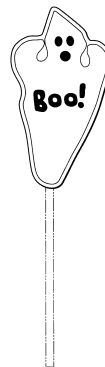

THE MARK CONSISTS OF A CONFIGURATION OF A CANDY SUCKER SHAPED IN THE FORM OF A GHOST WITH THE WORDING "BOO!" INSCRIBED.

SEC. 2(F).
FOR CANDY, NAMELY SUCKERS IN THE SHAPE OF A GHOST (U.S. CL. 46).
FIRST USE 6-0-2002; IN COMMERCE 6-0-2002.
INGRID C. EULIN, EXAMINING ATTORNEY

CLASS 30—(Continued).

SN 78-138,688. KENCRAFT, INC., ALPINE, UT. FILED 6-25-2002.

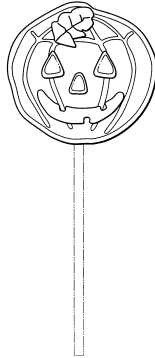

THE MARK CONSISTS OF A CONFIGURATION OF A CANDY SUCKER SHAPED IN THE FORM OF A PUMPKIN FACE WITH A LEAF TOPPING THE HEAD.
 SEC. 2(F).
 FOR CANDY, NAMELY SUCKERS IN THE SHAPE OF A PUMPKIN HAVING PLACED THEREON ICING (U.S. CL. 46).
 FIRST USE 6-0-2002; IN COMMERCE 6-0-2002.
 INGRID C. EULIN, EXAMINING ATTORNEY

CLASS 30—(Continued).

SN 78-138,711. KENCRAFT, INC., ALPINE, UT. FILED 6-25-2002.

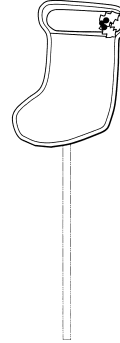

THE MARK CONSISTS OF A CONFIGURATION OF A CANDY SUCKER SHAPED IN THE FORM OF A HOLIDAY STOCKING.
 SEC. 2(F).
 FOR CANDY, NAMELY SUCKERS IN THE SHAPE OF A STOCKING HAVING PLACED THEREON ICING (U.S. CL. 46).
 FIRST USE 7-0-2000; IN COMMERCE 7-0-2000.
 INGRID C. EULIN, EXAMINING ATTORNEY

SN 78-155,956. MY FAVORITE COMPANY, INC., LOS ANGELES, CA. FILED 8-20-2002.

TREAT STREET

NO CLAIM IS MADE TO THE EXCLUSIVE RIGHT TO USE TREAT, APART FROM THE MARK AS SHOWN.
 FOR CANDY (U.S. CL. 46).
 LAVERNE THOMPSON, EXAMINING ATTORNEY

SN 78-138,697. KENCRAFT, INC., ALPINE, UT. FILED 6-25-2002.

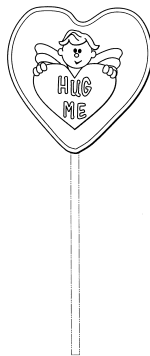

THE MARK CONSISTS OF A CONFIGURATION OF A CANDY SUCKER SHAPED IN THE FORM OF A HEART CONTAINING A CUPID HOLDING A HEART WITH THE WORDS "HUG ME" INSCRIBED.
 SEC. 2(F).
 FOR CANDY, NAMELY SUCKERS IN THE SHAPE OF A HEART HAVING PLACED THEREON ICING IN THE SHAPE OF CUPID HOLDING A HEART (U.S. CL. 46).
 FIRST USE 12-0-1999; IN COMMERCE 12-0-1999.
 INGRID C. EULIN, EXAMINING ATTORNEY

SN 78-160,584. PRODUCTOS DE TRIGO, S.A. DE C.V., GUADALAJARA JALISCO, MEXICO, FILED 9-4-2002.



OWNER OF MEXICO REG. NO. 368920, DATED 10-26-1989, EXPIRES 10-26-2009.
 NO CLAIM IS MADE TO THE EXCLUSIVE RIGHT TO USE DORADITAS, APART FROM THE MARK AS SHOWN.
 THE ENGLISH TRANSLATION OF DORADITAS IS "CRISP".
 FOR CRACKERS, COFFEE, TEA, COCOA, SUGAR, RICE, BREAD AND FLOUR (U.S. CL. 46).
 MARIA-VICTORIA SUAREZ, EXAMINING ATTORNEY

CLASS 30—(Continued).

SN 78-174,330. DYLAN LEE, INC., WOBURN, MA. FILED 10-15-2002.

PAGODA ICE CREAM

NO CLAIM IS MADE TO THE EXCLUSIVE RIGHT TO USE "ICE CREAM", APART FROM THE MARK AS SHOWN. FOR ICE CREAM AND ICE CREAM POPSICLES (U.S. CL. 46).

FIRST USE 6-24-2002; IN COMMERCE 6-24-2002.
KHANH LE, EXAMINING ATTORNEY

CLASS 30—(Continued).

SN 78-229,854. LA RANCHERA, INC., HOUSTON, TX. FILED 3-25-2003.



NO CLAIM IS MADE TO THE EXCLUSIVE RIGHT TO USE "ORIGINAL", APART FROM THE MARK AS SHOWN. THE NAME(S), PORTRAIT(S), AND/OR SIGNATURE(S) SHOWN IN THE MARK DOES NOT IDENTIFY A PARTICULAR LIVING INDIVIDUAL.

THE FOREIGN WORDING IN THE MARK TRANSLATES INTO ENGLISH AS MY RANCHER (FEMININE FORM). FOR CORN AND FLOUR TORTILLAS (U.S. CL. 46).
DAVID C. REIHNER, EXAMINING ATTORNEY

SN 78-223,575. WOLPA, MARK E., BERKELEY, CA. FILED 3-10-2003.



OWNER OF U.S. REG. NO. 2,205,885.
NO CLAIM IS MADE TO THE EXCLUSIVE RIGHT TO USE "A FOOT OF BUBBLEGUM" AND "CHOCOLATES & CANDY", APART FROM THE MARK AS SHOWN.
FOR CHEWING GUM, NAMELY BUBBLEGUM (U.S. CL. 46).
SONYA STEPHENS, EXAMINING ATTORNEY

SN 78-230,147. RICHLAND ENTERPRISES, INC., DESTIN, FL. FILED 3-26-2003.

SN 78-225,373. MENDOCINO BEVERAGE CORPORATION, MENDOCINO, CA. FILED 3-13-2003.

MENDO MATÉ

NO CLAIM IS MADE TO THE EXCLUSIVE RIGHT TO USE "MATE", APART FROM THE MARK AS SHOWN. THE TERM MATE IS TRANSLATED AS GREEN TEA FROM ARGENTINA.
FOR TEA-BASED BEVERAGES WITH FRUIT FLAVORING (U.S. CL. 46).
IRENE D. WILLIAMS, EXAMINING ATTORNEY

TEA FIT FOR THE QUEEN IN EVERYONE

NO CLAIM IS MADE TO THE EXCLUSIVE RIGHT TO USE TEA, APART FROM THE MARK AS SHOWN. FOR BULK LOOSE DRY TEA (U.S. CL. 46).
KATHERINE STOIDES, EXAMINING ATTORNEY

CLASS 30—(Continued).

SN 78-232,268. PF BRANDS, INC., NEWARK, DE. FILED 4-1-2003.

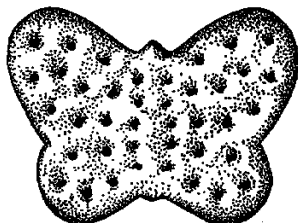

OWNER OF U.S. REG. NO. 1,630,220.
 THE STIPLING IS FOR SHADING PURPOSES ONLY.
 THE MARK CONSISTS OF THE CONFIGURATION OF
 THE GOODS WHICH ARE IN THE SHAPE OF A BUTTER-
 FLY.
 SEC. 2(F).
 FOR CRACKERS (U.S. CL. 46).
 FIRST USE 12-31-1979; IN COMMERCE 12-31-1979.
 JENNIFER CHICOSKI, EXAMINING ATTORNEY

SN 78-232,848. MISE EN PLACE CORP., LANSDALE, PA.
 FILED 4-2-2003.

THE BREAD DISTRICT

NO CLAIM IS MADE TO THE EXCLUSIVE RIGHT TO
 USE "BREAD", APART FROM THE MARK AS SHOWN.
 FOR BAGELS, BAKERY DESSERTS, BAKERY GOODS,
 BAKERY PRODUCTS, BARBECUE SAUCE, BISCUITS,
 BRAN, BREAD, BREAD STICKS, BREADCRUMBS,
 BRIOCHES, BUNS, CAKES, CALZONES, CAPPUCCINO,
 CHEESECAKE, CHOCOLATE, CINNAMON, CINNAMON
 ROLLS, COCOA, COCOA-BASED INGREDIENT IN CON-
 FECTIONERY PRODUCTS, COFFEE, COFFEE BEANS,
 COFFEE-BASED BEVERAGE CONTAINING MILK,
 COOKIES, CORN MEAL, CRACKERS, CROISSANTS,
 CROUTONS, CRYSTALLIZED GINGER, DANISH PAS-
 TRIES, DOUGH, DOUGHNUTS, ECLAIRS, ESPRESSO,
 FLOUR, FRITTERS, GINGERBREAD, GLUTEN, HON-
 EY, HOT CHOCOLATE, HUSHPUPPIES, ICED TEA,
 MARINADES, MATZO, MIXES FOR BAKERY GOODS,
 MUFFINS, PASTRIES, PIZZA, PIZZA CRUST, PIZZA
 DOUGH, PIZZA SAUCE, PRETZELS, ROLLS, SALAD
 DRESSINGS, SANDWICHES, SAUCES, TEA, TEA-BASED
 BEVERAGES WITH FRUIT FLAVORINGS, TOMATO
 SAUCE (U.S. CL. 46).
 DARRYL SPRUILL, EXAMINING ATTORNEY

SN 78-234,042. PROJECT RENEWAL, INC., NEW YORK, NY.
 FILED 4-4-2003.

HOME STREET HOME

FOR BAKERY PRODUCTS (U.S. CL. 46).
 TRACY FLETCHER, EXAMINING ATTORNEY

CLASS 30—(Continued).

SN 78-235,779. LIDL STIFTUNG & CO. KG, NECKARSULM,
 FED REP GERMANY, FILED 4-9-2003.

FIN CARRÉ

OWNER OF GREECE REG. NO. 130588, DATED 9-17-1998,
 EXPIRES 9-5-2006.
 THE FOREIGN WORDING IN THE MARK TRANSLATES
 INTO ENGLISH AS CHOICE SQUARE.
 FOR COFFEE, TEA, COCOA, SUGAR, RICE, TAPIO-
 CA, SAGO, ARTIFICIAL COFFEE; FLOUR AND PRE-
 PARATIONS MADE FROM CEREALS, NAMELY,
 CEREAL BASED SNACK FOOD, READY TO EAT
 CEREAL DERIVED FOOD BARS, BREAKFAST CER-
 EALS, MUESLI, CORN FLAKES, PROCESSED CEREALS;
 BREAD, PASTRY AND CONFECTIONERY, NAMELY,
 CANDY, MUFFINS, DOUGHNUTS, DANISH PASTRIES,
 PASTRIES, CAKES SWEETMEATS, CHEWING GUM,
 CHOCOLATE TRUFFLES, CHOCOLATE, CHOCOLATE-
 BASED READY-TO-EAT FOOD BARS, LICORICE, CAN-
 DY BARS, CANDY COATED POPCORN, CANDY
 MINTS, MARZIPAN, CHOCOLATE CANDY, COOKIES,
 CRACKERS, PIES, ARS, CINNAMON ROLLS, CROIS-
 SANTS, FROZEN CONFECTIONS, BAKERY GOODS;
 ICE; FLAVORED ICES, ICE-CREAM; HONEY; TREA-
 CLE; YEAST; BAKING POWDER; SALT; MUSTARD;
 VINEGAR; SAUCES; SPICES (U.S. CL. 46).
 DARLENE BULLOCK, EXAMINING ATTORNEY

SN 78-241,597. BARREL O'FUN SNACK FOODS CO., PER-
 HAM, MN. FILED 4-24-2003.

CRISPY DIGINS

OWNER OF U.S. REG. NO. 1,771,697.
 NO CLAIM IS MADE TO THE EXCLUSIVE RIGHT TO
 USE CRISPY, APART FROM THE MARK AS SHOWN.
 FOR SNACK FOOD MIX CONTAINING CEREAL
 BASED CRACKERS, PRETZELS, CHEESECRISPS AND
 OTHER CEREAL BASED PREPARATIONS (U.S. CL. 46).
 KEVON CHISOLM, EXAMINING ATTORNEY

SN 78-243,866. PASTIFICIO FRATELLI PAGANI S.P.A.,
 ROVATO (PROVINCE OF BRESCIA), ITALY, FILED 4-
 30-2003.



OWNER OF U.S. REG. NO. 1,806,292.
 THE ENGLISH TRANSLATION OF "GIULIA" IS "JULIA".
 FOR PASTA (U.S. CL. 46).
 TRACY FLETCHER, EXAMINING ATTORNEY

CLASS 30—(Continued).

SN 78-247,188. ANNIE'S ENTERPRISES, INC., NORTH CALAIS, VT. FILED 5-8-2003.

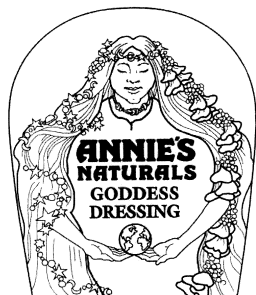

NO CLAIM IS MADE TO THE EXCLUSIVE RIGHT TO USE "NATURALS" AND "DRESSING", APART FROM THE MARK AS SHOWN.

FOR SAUCES; CONDIMENTS, NAMELY, SALAD DRESSINGS (U.S. CL. 46).

FIRST USE 0-0-1993; IN COMMERCE 0-0-1993.

STANLEY I. OSBORNE, EXAMINING ATTORNEY

SN 78-247,462. ANNIE'S ENTERPRISES, INC., NORTH CALAIS, VT. FILED 5-8-2003.

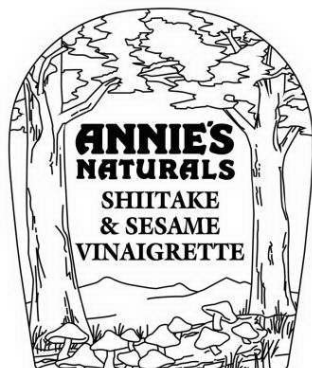

OWNER OF U.S. REG. NOS. 2,238,045 AND 2,296,416.
NO CLAIM IS MADE TO THE EXCLUSIVE RIGHT TO USE NATURALS SHIITAKE & SESAME VINAIGRETTE, APART FROM THE MARK AS SHOWN.

FOR SAUCES; CONDIMENTS, NAMELY, SALAD DRESSINGS (U.S. CL. 46).

FIRST USE 0-0-1991; IN COMMERCE 0-0-1991.

CIMMERIAN COLEMAN, EXAMINING ATTORNEY

CLASS 30—(Continued).

SN 78-249,092. GENERAL MILLS, INC., MINNEAPOLIS, MN. FILED 5-13-2003.

BETTY CROCKER COMPLETE DESSERTS

OWNER OF U.S. REG. NOS. 716,936, 1,198,117 AND OTHERS.

NO CLAIM IS MADE TO THE EXCLUSIVE RIGHT TO USE "COMPLETE DESSERTS", APART FROM THE MARK AS SHOWN.

THE NAME BETTY CROCKER DOES NOT IDENTIFY A LIVING INDIVIDUAL.

FOR DESSERT MIXES, NAMELY, PACKAGED KITS CONTAINING BAKING MIXES FOR COBBLERS, CRISPS, CAKES, PIES, AND OTHER BAKED DESSERTS, AS WELL AS ONE OR MORE OF THE FOLLOWING—PROCESSED FRUIT, CHOCOLATE, FUDGE, CARAMEL, NUTS AND CANDY PIECES (U.S. CL. 46).

ALICE SUE CARRUTHERS, EXAMINING ATTORNEY

SN 78-254,928. APIÁRIO POLENECTAR LTDA., SAN PAUL, BRAZIL, FILED 5-27-2003.



NO CLAIM IS MADE TO THE EXCLUSIVE RIGHT TO USE APIARIO, APART FROM THE MARK AS SHOWN.

THE FOREIGN WORDING IN THE MARK TRANSLATES INTO ENGLISH AS POLENECTAR BEE FARM.

FOR PROPOLIS FOR FOOD PURPOSES (U.S. CL. 46).

FIRST USE 10-31-1995; IN COMMERCE 5-22-2003.

ROBIN CHOSID, EXAMINING ATTORNEY

SN 78-267,867. HEINRICH LEUPOLDT KG, D-95163 WEISSENSTADT, FED REP GERMANY, FILED 6-27-2003.



PRIORITY CLAIMED UNDER SEC. 44(D) ON FED REP GERMANY APPLICATION NO. 30304104, FILED 1-27-2003, REG. NO. 30304104, DATED 4-10-2003, EXPIRES 1-31-2013.

OWNER OF U.S. REG. NOS. 1,480,967 AND 1,670,856.

FOR BREAD, PASTRY, WHOLEMEAL BREAD (U.S. CL. 46).

LAURA KOVAISKY, EXAMINING ATTORNEY

CLASS 30—(Continued).

SN 78-272,276. KRAFT FOODS HOLDINGS, INC., NORTH-FIELD, IL. FILED 7-9-2003.

MISTER SALTY

OWNER OF U.S. REG. NOS. 806,451, 2,602,837 AND OTHERS.

NO CLAIM IS MADE TO THE EXCLUSIVE RIGHT TO USE "SALTY", APART FROM THE MARK AS SHOWN.

FOR SNACK FOOD COMBINATION CONSISTING PRIMARILY OF PRETZELS AND CHEESE (U.S. CL. 46).
GINA FINK, EXAMINING ATTORNEY



SN 78-283,797. JUNGLE ENTERPRISES, LLC, SANTA MONICA, CA. FILED 8-6-2003.

THE JUNGLE

FOR RAW FOODS, NAMELY, GOURMET, UN-COOKED, VEGAN CRACKERS, COOKIES AND GRAIN-BASED CHIPS (U.S. CL. 46).

FIRST USE 6-1-2003; IN COMMERCE 6-1-2003.
TRACY FLETCHER, EXAMINING ATTORNEY



SN 78-286,341. BAKE ONE, INC., SMYRNA, GA. FILED 8-12-2003.

BAKE ONE

NO CLAIM IS MADE TO THE EXCLUSIVE RIGHT TO USE "BAKE", APART FROM THE MARK AS SHOWN.

FOR WHOLESALE BAKERY GOODS (U.S. CL. 46).
FIRST USE 12-27-2001; IN COMMERCE 12-27-2001.
CAROLYN CATALDO, EXAMINING ATTORNEY



SN 78-287,253. F.G.H. CONSULTING U.S.A., INC., BOYNTON BEACH, FL. FILED 8-14-2003.



NO CLAIM IS MADE TO THE EXCLUSIVE RIGHT TO USE "CARB", APART FROM THE MARK AS SHOWN.

FOR SUGARLESS CONFECTIONERY, NAMELY, CANDIES, BISCUITS AND CHOCOLATES (U.S. CL. 46).
YSA DEJESUS, EXAMINING ATTORNEY

CLASS 30—(Continued).

SN 78-290,924. S&S BRANDS, INC., WILMINGTON, DE. FILED 8-22-2003.

KEEP ON CRUNCHIN'

FOR CRACKERS (U.S. CL. 46).
FIRST USE 11-15-2003; IN COMMERCE 11-15-2003.
ELLEN B. AWRICH, EXAMINING ATTORNEY



SN 78-293,984. WHITLEY PEANUT FACTORY, INC., HAYES, VA. FILED 8-29-2003.



SEC. 2(F).
FOR SNACK FOODS, NAMELY, PEANUT FOOD BARS AND PEANUT BRITTLE, CANDY, CRACKERS AND CRACKER SANDWICHES, COOKIES AND COOKIE SANDWICHES, PRETZELS, BREAD STICKS, BROWNIES, CAKES, SNACK CAKES, PACKAGE COMBINATIONS CONSISTING PRIMARILY POPPED POPCORN; CHOCOLATE; BISCUITS; PROCESSED POPCORN; CHOCOLATE COVERED NUTS; CHOCOLATE TRUFFLES; PEANUT MARINADE (U.S. CL. 46).
FIRST USE 7-0-1986; IN COMMERCE 7-0-1986.
MARY ROSSMAN, EXAMINING ATTORNEY



SN 78-294,381. IMAGINATION CONFECTIONS LLC, BELLWOOD, IL. FILED 8-29-2003.

IMAGINATION CONFECTIONS

NO CLAIM IS MADE TO THE EXCLUSIVE RIGHT TO USE CONFECTIONS, APART FROM THE MARK AS SHOWN.

FOR CANDY (U.S. CL. 46).
LINDA ESTRADA, EXAMINING ATTORNEY



SN 78-294,900. KRAFT FOODS HOLDINGS, INC., NORTH-FIELD, IL. FILED 9-2-2003.

PUDDING POPPERS

NO CLAIM IS MADE TO THE EXCLUSIVE RIGHT TO USE PUDDING, APART FROM THE MARK AS SHOWN.
FOR PUDDING AND CANDY (U.S. CL. 46).
TRACY CROSS, EXAMINING ATTORNEY

CLASS 30—(Continued).

SN 78-296,089. IHA BEVERAGE, MONTEBELLO, CA. FILED 9-4-2003.



**Squeez
Me**

FOR FRUIT FLAVORED GELATIN (U.S. CL. 46).
GEORGIA CARTY, EXAMINING ATTORNEY

SN 78-298,269. HERBAL REPUBLIC INC, VANCOUVER,
BRITISH COLUMBIA, CANADA, FILED 9-10-2003.



Herbal Republic

NO CLAIM IS MADE TO THE EXCLUSIVE RIGHT TO
USE HERBAL, APART FROM THE MARK AS SHOWN.
FOR TEA AND HERBAL TEAS; ICED TEA BEV-
ERAGES; TEA-BASED BEVERAGES WITH FRUIT FLA-
VORING; TEA-BASED BEVERAGES WITH MILK;
LIQUID AND POWDERED TEA BEVERAGE MIXES;
BAKED GOODS, NAMELY, COOKIES, MUFFINS,
SCONES, BISCUITS, PASTRIES AND BREADS; CHOCO-
LATE, CANDY AND FROZEN CONFECTIONS (U.S. CL.
46).

FIRST USE 1-25-1999; IN COMMERCE 1-25-1999.
TRICIA SONNEBORN, EXAMINING ATTORNEY

SN 78-300,439. CHIPURNOI INCORPORATED, SHARON,
CT. FILED 9-15-2003.

SAN LORENZO

FOR CANDY AND CONFECTIONERY PRODUCTS,
NAMELY, COOKIES AND CAKES (U.S. CL. 46).
KARANENDRA S. CHHINA, EXAMINING ATTORNEY

SN 78-302,434. COLOMBINA, S.A., ZARZAL, VALLE, CO-
LOMBIA, FILED 9-18-2003.

COFFEE DELIGHT

NO CLAIM IS MADE TO THE EXCLUSIVE RIGHT TO
USE "COFFEE", APART FROM THE MARK AS SHOWN.
FOR CANDY (U.S. CL. 46).
FIRST USE 5-1-1974; IN COMMERCE 5-1-1974.
RICHARD A. STRASER, EXAMINING ATTORNEY

CLASS 30—(Continued).

SN 78-302,870. FRIEDRIKIS, RUSS, BESSEMER, AL. FILED 9-19-2003.

MOSQUITO BREATH

FOR NON-MEDICATED LOZENGES AND CHEWING
GUM (U.S. CL. 46).
SHAUNIA WALLACE, EXAMINING ATTORNEY

SN 78-303,040. WELLS' DAIRY, INC., LE MARS, IA. FILED 9-
19-2003.

CARB FREEDOM

NO CLAIM IS MADE TO THE EXCLUSIVE RIGHT TO
USE "CARB", APART FROM THE MARK AS SHOWN.
FOR NON-DAIRY FROZEN DESSERTS, NAMELY
SOY-BASED ICE CREAM SUBSTITUTES (U.S. CL. 46).
CHRISTOPHER BUONGIORNO, EXAMINING ATTOR-
NEY

SN 78-303,231. LAPIN, ADAM, HUNTINGDON VALLEY, PA.
FILED 9-21-2003.

CANARY VALLEY

FOR MUSTARD (U.S. CL. 46).
INGRID C. EULIN, EXAMINING ATTORNEY

SN 78-304,213. JENKINS FOODS, L.L.C., DETROIT, MI.
FILED 9-23-2003.



Dips to Go!

NO CLAIM IS MADE TO THE EXCLUSIVE RIGHT TO
USE DIPS, APART FROM THE MARK AS SHOWN.
FOR SALSA (U.S. CL. 46).
FIRST USE 11-1-2003; IN COMMERCE 11-1-2003.
AMY GEARIN, EXAMINING ATTORNEY

SN 78-304,700. LEA & PERRINS, INC., FAIR LAWN, NJ.
FILED 9-24-2003.

PURE BLEND

FOR SAUCES (U.S. CL. 46).
GEOFFREY FOSDICK, EXAMINING ATTORNEY

CLASS 30—(Continued).

SN 78-304,857. LASO SOCIEDAD ANONIMA, PROVINCIA DE BUENOS AIRES, ARGENTINA, FILED 9-24-2003.

ZUWIS

FOR BREAKFAST CEREALS, READY TO EAT CEREALS AND CEREAL BARS (U.S. CL. 46).
DAWN FELDMAN, EXAMINING ATTORNEY

SN 78-305,229. LIPTON INVESTMENTS, INC., WILMINGTON, DE. FILED 9-25-2003.

TV TAILGATING

FOR SAUCES, EXCLUDING APPLE SAUCE AND CRANBERRY SAUCE (U.S. CL. 46).
DAVID C. REIHNER, EXAMINING ATTORNEY

SN 78-306,079. HERNANDEZ, JEFFERY, MIAMI BEACH, FL. FILED 9-26-2003.

TEATOPIA

FOR TEA (U.S. CL. 46).
FIRST USE 10-28-2003; IN COMMERCE 10-28-2003.
LANA PHAM, EXAMINING ATTORNEY

SN 78-306,518. PASTAS CORA, S.A. DE C.V., 50070 TOLUCA, MEXICO, FILED 9-29-2003.

TRES ESTRELLAS

OWNER OF U.S. REG. NO. 1,773,101.
THE FOREIGN WORDING IN THE MARK TRANSLATES INTO ENGLISH AS THREE STARS.
FOR FOOD PRODUCTS AND INGREDIENTS, NAMELY, COOKIES, CAKE MIX, PREPARED CHURRO FLOUR, SWEETENED, FLAVORED GELATIN, COCOA, SUGAR, TAPIOCA, SAGO, CAKES, PASTRY, FLAVORED ICES, AND CRACKERS (U.S. CL. 46).
FIRST USE 5-25-1993; IN COMMERCE 5-25-1993.
JENNIFER CHICOSKI, EXAMINING ATTORNEY

CLASS 30—(Continued).

SN 78-306,657. PERFETTI VAN MELLE BENELUX B.V., BREDA, NETHERLANDS, FILED 9-29-2003.

MENTOS INSTANT FRESH BREATH

OWNER OF U.S. REG. NOS. 932,951, 2,528,946 AND OTHERS.
FOR COCOA, COCOA MIXES; COCOA-BASED INGREDIENT IN CONFECTIONERY PRODUCTS: CHOCOLATE, CHOCOLATE COVERED NUTS, CHOCOLATE FOOD BEVERAGES NOT BEING DAIRY BASED OR VEGETABLE BASED; CHOCOLATE SYRUP; CONFECTIONERY CHIPS FOR BAKING; FROZEN CONFECTIONS; PASTRIES; LICORICE; ICE; CARAMELS, CARAMEL POPCORN; SWEETS, NAMELY, CANDY; PEPPERMINT CANDY; PEPPERMINT CANDY MINTS; PUFFED CORN SNACKS; RICE BASED SNACK FOODS; CEREAL BASED SNACK FOOD (U.S. CL. 46).
AMY GEARIN, EXAMINING ATTORNEY

SN 78-306,682. BEN & JERRY'S HOMEMADE HOLDINGS, INC., BURLINGTON, VT. FILED 9-29-2003.

BERRY ROCK-US CAUCUS

NO CLAIM IS MADE TO THE EXCLUSIVE RIGHT TO USE BERRY, APART FROM THE MARK AS SHOWN.
FOR ICE CREAM, FROZEN YOGURT AND FROZEN CONFECTIONS (U.S. CL. 46).
LESLEY LAMOTHE, EXAMINING ATTORNEY

SN 78-306,803. NEENAN, MAURICE TIMOTHY, SANTA YNEZ, CA. FILED 9-29-2003.

CHEF TIM'S GRINGO SALSA

NO CLAIM IS MADE TO THE EXCLUSIVE RIGHT TO USE SALSA, APART FROM THE MARK AS SHOWN.
FOR SALSA (U.S. CL. 46).
JOHN HWANG, EXAMINING ATTORNEY

SN 78-307,009. BASHOUR, ERICA M, ROCKVILLE, MD. FILED 9-29-2003.

B.SWEETS

FOR FOOD PRODUCTS, NAMELY CHOCOLATE CANDY AND OTHER OTHER NON-CHOCOLATE CANDY (U.S. CL. 46).
JEFFREY S. MOLINOFF, EXAMINING ATTORNEY

CLASS 30—(Continued).

SN 78-308,994. TAMALES MOLLY, INC., SANTA FE, NM.
FILED 10-3-2003.

Tamale Molly

FOR FROZEN FOOD, NAMELY TAMALES, AND SAUCES (U.S. CL. 46).
FIRST USE 5-1-2000; IN COMMERCE 2-13-2001.
BRENDAN REGAN, EXAMINING ATTORNEY

SN 78-310,197. AUTOMATIC BREWERS AND COFFEE DEVICES, INC., WEST CONSHOHOCKEN, PA. FILED 10-7-2003.

CAFFE LATAZZA

NO CLAIM IS MADE TO THE EXCLUSIVE RIGHT TO USE "CAFFE", APART FROM THE MARK AS SHOWN. THE ENGLISH TRANSLATION OF "CAFFE LATAZZA" IS "COFFEE THE CUP".
FOR COFFEE (U.S. CL. 46).
RUDY R. SINGLETON, EXAMINING ATTORNEY

SN 78-312,328. IMAGINATION CONFECTIONS LLC, BELLWOOD, IL. FILED 10-10-2003.

BRINGING MAGIC TO CANDY

FOR CANDY (U.S. CL. 46).
JENNIFER KRISP, EXAMINING ATTORNEY

SN 78-312,928. THE KROGER CO. OF MICHIGAN, LIVONIA, MI. FILED 10-13-2003.

CORNITO EXCAVATORS

FOR CORN CHIPS (U.S. CL. 46).
DAWN HAN, EXAMINING ATTORNEY

CLASS 30—(Continued).

SN 78-313,227. IN PURSUIT OF TEA, INC., BROOKLYN, NY.
FILED 10-14-2003.

IN PURSUIT OF TEA

NO CLAIM IS MADE TO THE EXCLUSIVE RIGHT TO USE "TEA", APART FROM THE MARK AS SHOWN. FOR ALL NATURAL UNFLAVORED LOOSE TEA LEAVES (U.S. CL. 46).
FIRST USE 5-19-1999; IN COMMERCE 5-19-1999.
GINA HAYES, EXAMINING ATTORNEY

SN 78-313,569. HOLSUM BAKERY, INC., PHOENIX, AZ.
FILED 10-14-2003.

FIESTA FARMS

FOR BREADS (U.S. CL. 46).
LINDA E. BLOHM, EXAMINING ATTORNEY

SN 78-315,136. KLUM, HEIDI, NEW YORK, NY. FILED 10-17-2003.

HEIDI KLUM

THE NAME HEIDI KLUM IDENTIFIES A LIVING INDIVIDUAL WHOSE CONSENT IS OF RECORD. FOR CANDY (U.S. CL. 46).
PRISCILLA MILTON, EXAMINING ATTORNEY

SN 78-320,769. FRANKIE FLAMINGO & COMPANY, INC., ST. AUGUSTINE, FL. FILED 10-30-2003.

FLAMINGO FIRE

FOR HOT SAUCE (U.S. CL. 46).
FIRST USE 8-15-2003; IN COMMERCE 8-15-2003.
MATTHEW KLINE, EXAMINING ATTORNEY

SN 78-320,777. FRANKIE FLAMINGO & COMPANY, INC., ST. AUGUSTINE, FL. FILED 10-30-2003.

CHOMPIN' GATOR

FOR HOT SAUCE (U.S. CL. 46).
FIRST USE 10-26-2003; IN COMMERCE 10-26-2003.
MATTHEW KLINE, EXAMINING ATTORNEY

CLASS 31—NATURAL AGRICULTURAL PRODUCTS

SN 76-065,438. TING FONG LLC, BROOKLYN, NY. FILED 6-7-2000.



NO CLAIM IS MADE TO THE EXCLUSIVE RIGHT TO USE "CROWN CUT BROCCOLI" AND THE NON-LATIN CHARACTERS WHICH TRANSLITERATES TO "MO GING SAE LAN FA" WHICH MEANS "CROWN CUT WESTERN BROCCOLI", APART FROM THE MARK AS SHOWN.

THE DRAWING IS LINED FOR THE COLOR RED.

THE MARK CONSISTS OF THE VERTICALLY DISPOSED NON-LATIN CHARACTERS IN THE MARK TRANSLITERATES TO "MO GING SAE GAE LAN FA" WHICH MEANS "CROWN CUT WESTERN BROCCOLI". THE HORIZONTALLY DISPOSED NON-LATIN CHARACTERS ABOVE THE DRAGON TRANSLITERATES TO "SHAO LIN" WHICH IS THE NAME OF A TEMPLE BUT HAS NO OTHER MEANING.

FOR FRESH BROCCOLI, RAW BROCCOLI, AND OR UNPROCESSED BROCCOLI (U.S. CLS. 1 AND 46).
KAREN M. STRYZ, EXAMINING ATTORNEY

SN 76-331,801. SULLIVAN, MARY ELLEN, VALLEY CENTER, CA. AND BERNHARDY, B. PAUL, VALLEY CENTER, CA. FILED 10-30-2001.

THE LAVENDER FIELDS

NO CLAIM IS MADE TO THE EXCLUSIVE RIGHT TO USE "LAVENDER", APART FROM THE MARK AS SHOWN. FOR CUT FLOWERS, FLOWER BUDS, AND DRIED FLOWERS (U.S. CLS. 1 AND 46).

FIRST USE 11-10-2000; IN COMMERCE 11-10-2000.

JEFFREY S. MOLINOFF, EXAMINING ATTORNEY

CLASS 31—(Continued).

SN 76-476,385. KULL, AMELITA E., DRESHER, PA. FILED 12-17-2002.

E.B.LEGRICE

THE MARK CONSISTS OF STANDARD CHARACTERS WITHOUT CLAIM TO ANY PARTICULAR FONT, STYLE, SIZE, OR COLOR.

THE NAME(S), PORTRAIT(S), AND/OR SIGNATURE(S) SHOWN IN THE MARK DOES NOT IDENTIFY A PARTICULAR LIVING INDIVIDUAL.

FOR LIVE FLOWERING PLANTS, NAMELY, CLIMBING ROSES (U.S. CLS. 1 AND 46).

MARK T. MULLEN, EXAMINING ATTORNEY

SN 76-478,752. TRITON INTERNATIONAL FROZEN FOODS, INGLEWOOD, CA. FILED 12-24-2002.

TRITON FRESH

NO CLAIM IS MADE TO THE EXCLUSIVE RIGHT TO USE "FRESH", APART FROM THE MARK AS SHOWN.

FOR FRESH FRUITS AND VEGETABLES, NOT INCLUDING BARLEY FIELD CORN, SUGAR BEETS, CAULIFLOWER, GARDEN BEANS, LETTUCE, PEAS, PEPPERS, SPINACH AND WATERMELON (U.S. CLS. 1 AND 46).

FIRST USE 12-14-2002; IN COMMERCE 12-14-2002.

INGA ERVIN, EXAMINING ATTORNEY

SN 76-501,793. FERRY-MORSE SEED COMPANY, FULTON, KY. FILED 3-21-2003.

HEALTH SMART

FOR PACKET SEEDS, NAMELY, PLANT SEEDS (U.S. CLS. 1 AND 46).

FIRST USE 10-0-2002; IN COMMERCE 10-0-2002.

BRIAN PINO, EXAMINING ATTORNEY

CLASS 31—(Continued).

SN 76-502,941. JAC. TH. DE VROOMEN B.V., 2160 AA LISSE, NETHERLANDS, FILED 3-31-2003.

GARDEN JOY SELECT

OWNER OF U.S. REG. NO. 2,140,138.
NO CLAIM IS MADE TO THE EXCLUSIVE RIGHT TO USE "GARDEN", APART FROM THE MARK AS SHOWN.
FOR AGRICULTURAL, HORTICULTURAL AND FORESTRY PRODUCTS, NAMELY, LIVING PLANTS, LIVE FLOWERS AND FLOWER BULBS (U.S. CLS. 1 AND 46).

FIRST USE 8-31-2001; IN COMMERCE 8-31-2001.
BARBARA GAYNOR, EXAMINING ATTORNEY

SN 76-505,761. HOLYOAK, H.K., ALAPAHA, GA. FILED 4-11-2003.

HYTECH-SPECK

FOR LIVE HYBRID FISH (U.S. CLS. 1 AND 46).
TARAH HARDY, EXAMINING ATTORNEY

SN 76-527,973. RUTGERS, THE STATE UNIVERSITY, NEW BRUNSWICK, NJ. FILED 7-7-2003.

JERSEY STAR

NO CLAIM IS MADE TO THE EXCLUSIVE RIGHT TO USE JERSEY, APART FROM THE MARK AS SHOWN.
FOR LIVING PLANTS AND PARTS THEREOF, NAMELY DOGWOODS AND HOLLIES, AND SCIONS, BUDS, STEM CUTTINGS AND ROOT CUTTINGS THEREFROM (U.S. CLS. 1 AND 46).
DANIEL CAPSHAW, EXAMINING ATTORNEY

SN 76-531,435. SPECIALITES PET FOOD, 75008 PARIS, FRANCE, FILED 7-22-2003.

C'SENS

FOR ANIMAL FEED ADDITIVES FOR NON-NUTRITIONAL PURPOSES FOR USE AS A FLAVORING (U.S. CLS. 1 AND 46).
TONI HICKEY, EXAMINING ATTORNEY

CLASS 31—(Continued).

SN 76-548,941. RICHARD BAGDASARIAN, INC., MECCA, CA. FILED 9-11-2003.

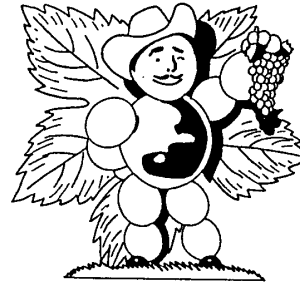

OWNER OF U.S. REG. NOS. 574,737 AND 578,835.
THE LINING IS A FEATURE OF THE MARK AND DOES NOT INDICATE COLOR.
FOR FRESH FRUITS (U.S. CLS. 1 AND 46).
FIRST USE 6-8-1952; IN COMMERCE 6-8-1952.
MICHAEL LEVY, EXAMINING ATTORNEY

SN 76-549,049. BUNCH, GENE W., FOREST GROVE, OR. FILED 10-6-2003.

MIRACLE KOI FOOD

NO CLAIM IS MADE TO THE EXCLUSIVE RIGHT TO USE "KOI" AND "FOOD", APART FROM THE MARK AS SHOWN.
FOR FISH FOOD (U.S. CLS. 1 AND 46).
FIRST USE 3-15-1995; IN COMMERCE 3-15-1995.
LESLEY LAMOTHE, EXAMINING ATTORNEY

SN 76-549,240. BALL HORTICULTURAL COMPANY, WEST CHICAGO, IL. FILED 10-6-2003.

MAGILLA

FOR HORTICULTURAL PLANTS (U.S. CLS. 1 AND 46).
FIRST USE 1-1-2002; IN COMMERCE 1-1-2002.
LESLEY LAMOTHE, EXAMINING ATTORNEY

SN 76-553,999. TURF-SEED, INC., HUBBARD, OR. FILED 10-6-2003.

WINTERPLEX

FOR GRASS SEED (U.S. CLS. 1 AND 46).
FIRST USE 9-0-1997; IN COMMERCE 9-0-1997.
MICHAEL KAZAZIAN, EXAMINING ATTORNEY

CLASS 31—(Continued).

SN 78-150,786. FERNLEA FLOWERS LIMITED, DELHI, CANADA, FILED 8-5-2002.

BIG SHOTS

FOR LIVE PLANTS, NAMELY PANSIES. (U.S. CLS. 1 AND 46).
BRETT J. GOLDEN, EXAMINING ATTORNEY

SN 78-206,921. MARS, INCORPORATED, MC LEAN, VA. FILED 1-24-2003.

FBMI

FOR PET FOOD (U.S. CLS. 1 AND 46).
DOMINICK J. SALEMI, EXAMINING ATTORNEY

SN 78-225,777. INTER-PLANT PATENT MARKETING INC., NIAGARA-ON-THE-LAKE, ONTARIO, CANADA, FILED 3-14-2003.

FULFORD GALA

OWNER OF CANADA REG. NO. TMA414168, DATED 7-2-1993, EXPIRES 7-2-2008.
NO CLAIM IS MADE TO THE EXCLUSIVE RIGHT TO USE "GALA", APART FROM THE MARK AS SHOWN.
FOR APPLE TREES (U.S. CLS. 1 AND 46).
FIRST USE 10-23-1989; IN COMMERCE 10-23-1989.
ROBERT LORENZO, EXAMINING ATTORNEY

SN 78-225,815. INTER-PLANT PATENT MARKETING INC., NIAGARA-ON-THE-LAKE, ONTARIO, CANADA, FILED 3-14-2003.

THOME EMPIRE

OWNER OF CANADA REG. NO. TMA413414, DATED 6-11-1993, EXPIRES 6-11-2008.
NO CLAIM IS MADE TO THE EXCLUSIVE RIGHT TO USE "EMPIRE", APART FROM THE MARK AS SHOWN.
FOR APPLE TREES (U.S. CLS. 1 AND 46).
FIRST USE 10-23-1989; IN COMMERCE 10-23-1989.
ROBERT LORENZO, EXAMINING ATTORNEY

CLASS 31—(Continued).

SN 78-230,821. NOURICHE NUTRITION LTD., LAKE SAINT LOUIS, MO. FILED 3-27-2003.

Dyna-Milk

FOR NON-MEDICATED ADDITIVES FOR ANIMAL FEED, NAMELY MILK REPLACER AND WHOLE MILK FORTIFIER CONSISTING OF VITAMINS, MINERALS AND OTHER NUTRIENTS TO BE FED TO LIVESTOCK (U.S. CLS. 1 AND 46).
WILLIAM VERHOSEK, EXAMINING ATTORNEY

SN 78-239,390. ADVANTA USA, INC., SLATER, IA. FILED 4-18-2003.

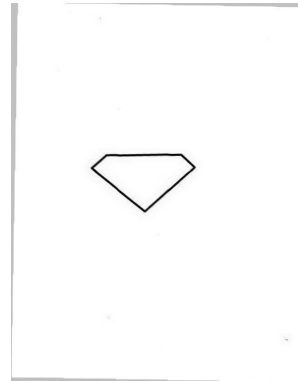

THE MARK CONSISTS OF DIAMOND DESIGN.
FOR AGRICULTURAL SEEDS (U.S. CLS. 1 AND 46).
FIRST USE 1-1-2000; IN COMMERCE 1-1-2000.
NANCY CLARKE, EXAMINING ATTORNEY

SN 78-251,129. AFFINITY PETCARE, S.A., BARCELONA, SPAIN, FILED 5-16-2003.

RUBADUB

PRIORITY CLAIMED UNDER SEC. 44(D) ON SPAIN APPLICATION NO. 2514408, FILED 11-25-2002, REG. NO. 2.514.408, DATED 10-20-2003, EXPIRES 11-25-2012.
FOR FOODSTUFF FOR ANIMALS; ANIMAL FEED ADDITIVES FOR NONNUTRITIONAL PURPOSES FOR USE AS FLAVOURING, INGREDIENT OR FILLER; NON-MEDICATED ADDITIVES FOR ANIMAL FEED; ANIMAL-LITTER; AROMATIC SAND LITTER FOR PETS; CAT LITTER; SANDED PAPER FOR PET LITTER (U.S. CLS. 1 AND 46).
PAULA MAYS, EXAMINING ATTORNEY

CLASS 31—(Continued).

SN 78-291,306. FLORISTS' TRANSWORLD DELIVERY, INC.,
DOWNERS GROVE, IL. FILED 8-22-2003.

ROSES WITH HUGS

NO CLAIM IS MADE TO THE EXCLUSIVE RIGHT TO
USE "ROSE", APART FROM THE MARK AS SHOWN.
FOR LIVE CUT FLORAL ARRANGEMENTS SOLD
TOGETHER WITH A GIFT ITEM (U.S. CLS. 1 AND 46).
ANN LINNEHAN, EXAMINING ATTORNEY

SN 78-297,796. SERGEANT'S PET CARE PRODUCTS, INC.,
OMAHA, NE. FILED 9-9-2003.

SAY "CHEEEZ DOGGIES"

NO CLAIM IS MADE TO THE EXCLUSIVE RIGHT TO
USE "CHEESE", APART FROM THE MARK AS SHOWN.
FOR EDIBLE PET TREATS AND PET FOOD (U.S. CLS.
1 AND 46).
FIRST USE 2-1-2003; IN COMMERCE 2-1-2003.
DORITT L. CARROLL, EXAMINING ATTORNEY

SN 78-300,913. LAND O'LAKES, INC., ARDEN HILLS, MN.
FILED 9-16-2003.

CHEESE FLAVOR BUILDER

FOR INGREDIENT FOR ANIMAL FEED (U.S. CLS. 1
AND 46).
FIRST USE 2-28-2003; IN COMMERCE 2-28-2003.
KENNETH D. BATTLE, EXAMINING ATTORNEY

SN 78-300,984. CHIQUITA BRANDS, INC., CINCINNATI,
OH. FILED 9-16-2003.

FLAVOR SAVOR

FOR FRESH FRUITS AND VEGETABLES (U.S. CLS. 1
AND 46).
KARANENDRA S. CHHINA, EXAMINING ATTORNEY

SN 78-302,262. THE CHEF'S GARDEN, INC., HURON, OH.
FILED 9-18-2003.

BEEET BLUSH

NO CLAIM IS MADE TO THE EXCLUSIVE RIGHT TO
USE "BEEET", APART FROM THE MARK AS SHOWN.
FOR FRESH VEGETABLES (U.S. CLS. 1 AND 46).
CHRISTOPHER BUONGIORNO, EXAMINING ATTORNEY

CLASS 31—(Continued).

SN 78-303,462. LAND O'LAKES FARMLAND FEED, LLC,
ARDEN HILLS, MN. FILED 9-22-2003.

PUSH

FOR AGRICULTURAL ANIMAL FEED (U.S. CLS. 1
AND 46).
SUSAN LESLIE DUBOIS, EXAMINING ATTORNEY

SN 78-313,874. MISSION PRODUCE, INC., OXNARD, CA.
FILED 10-15-2003.



NO CLAIM IS MADE TO THE EXCLUSIVE RIGHT TO
USE "AVOCADO", APART FROM THE MARK AS SHOWN.
FOR FRESH FRUITS AND FRESH VEGETABLES (U.S.
CLS. 1 AND 46).
FIRST USE 7-1-1985; IN COMMERCE 3-1-1992.
DARRYL SPRUILL, EXAMINING ATTORNEY

CLASS 32—LIGHT BEVERAGES

SN 76-445,150. CITIZENS BUSINESS CREDIT COMPANY,
NEW YORK, NY. FILED 8-26-2002.

NATURE'S OWN

FOR FRUIT JUICES (U.S. CLS. 45, 46 AND 48).
FIRST USE 0-0-1990; IN COMMERCE 0-0-1991.
CAROL SPILS, EXAMINING ATTORNEY

CLASS 32—(Continued).

SN 76-450,041. GUANGDONG JIANLIBAO GROUP CO., LTD., SANSHUI, GUANGDONG PROVINCE, P.R., CHINA, FILED 8-30-2002.



PRIORITY CLAIMED UNDER SEC. 44(D) ON CHINA APPLICATION NO. 3199171, FILED 6-4-2002, REG. NO. 3199171, DATED 1-7-2004, EXPIRES 1-6-2014.

THE ENGLISH TRANSLATION OF THE ORIENTAL CHARACTERS FORMING PART OF THE DESIGN ASPECTS OF THE MARK IS "THE FIFTH SEASON" AND THEIR TRANSLITERATION IS "DL WU JL".

FOR BEAN JUICES; TEA-BASED BEVERAGES, NAMELY, FRUIT-BASED SOFT DRINKS FLAVORED WITH TEA; NON-ALCOHOLIC BEAN EXTRACTS USED IN THE PREPARATION OF BEVERAGES (U.S. CLS. 45, 46 AND 48).

INGRID C. EULIN, EXAMINING ATTORNEY

SN 76-532,248. PERRON, LAURENT, BERGHEIM, TX. FILED 7-25-2003.

THE MARGARITA MAN

OWNER OF U.S. REG. NO. 2,253,686.
NO CLAIM IS MADE TO THE EXCLUSIVE RIGHT TO USE MARGARITA, APART FROM THE MARK AS SHOWN.
FOR NON-ALCOHOLIC COCKTAIL MIXES (U.S. CLS. 45, 46 AND 48).

FIRST USE 12-1-1985; IN COMMERCE 12-1-1985.
KATHRYN COWARD, EXAMINING ATTORNEY

CLASS 32—(Continued).

SN 76-534,496. THE SLEEMAN BREWING & MALTING CO. LTD., GUELPH, ONTARIO N1L 1E9, CANADA, FILED 8-4-2003.



OWNER OF U.S. REG. NOS. 2,345,180, 2,585,764 AND OTHERS.

NO CLAIM IS MADE TO THE EXCLUSIVE RIGHT TO USE "LAGER", APART FROM THE MARK AS SHOWN.
FOR BREWED ALCOHOLIC BEVERAGES, NAMELY, LAGER BEER (U.S. CLS. 45, 46 AND 48).

WILLIAM BRECKENFELD, EXAMINING ATTORNEY

SN 76-540,982. CERVECERIA MODELO, S.A. DE C.V., 11320 MEXICO, D.F., MEXICO, FILED 8-29-2003.

CORONA FROM THE PEOPLE WHO BROUGHT YOU CINCO DE MAYO

OWNER OF U.S. REG. NOS. 1,681,365, 1,729,694 AND OTHERS.

THE ENGLISH TRANSLATION OF "CORONA" IS "CROWN".

FOR BEER (U.S. CLS. 45, 46 AND 48).
JOHN DALIER, EXAMINING ATTORNEY

SN 76-544,455. THE PANTRY, INC., SANFORD, NC. FILED 9-3-2003.

RED CELESTE

OWNER OF U.S. REG. NO. 2,730,524.
FOR ENERGY DRINKS, NAMELY, NON-ALCOHOLIC BEVERAGES CONTAINING NIACIN, VITAMIN B6, VITAMIN B12, AND PANTOTHENIC ACID (U.S. CLS. 45, 46 AND 48).

MICHAEL KEATING, EXAMINING ATTORNEY

SN 76-555,056. HOANG, DAVID T., ST. PETERSBURG, FL. FILED 10-15-2003.

PRISTINE PEAKS

FOR BOTTLED WATER (U.S. CLS. 45, 46 AND 48).
FIRST USE 5-0-1999; IN COMMERCE 5-0-1999.
LINDA E. BLOHM, EXAMINING ATTORNEY

CLASS 32—(Continued).

SN 78-189,615. GORDON FOOD SERVICE, INC., GRAND RAPIDS, MI. FILED 11-27-2002.

NATURAL CHOICE

FOR FRUIT JUICE CONCENTRATE SOLD IN LARGE CONTAINERS EXCLUSIVELY THROUGH FOOD SERVICE TRADE CHANNELS FOR USE IN COMMERCIAL OR INSTITUTIONAL BEVERAGE DISPENSERS (U.S. CLS. 45, 46 AND 48).

FIRST USE 8-1-1988; IN COMMERCE 8-1-1988.
ROBIN CHOSID, EXAMINING ATTORNEY

SN 78-224,824. ANHEUSER-BUSCH INCORPORATED, SAINT LOUIS, MO. FILED 3-12-2003.

ANHEUSER 1896

OWNER OF U.S. REG. NOS. 28,866, 1,646,209 AND OTHERS.

NO CLAIM IS MADE TO THE EXCLUSIVE RIGHT TO USE 1896, APART FROM THE MARK AS SHOWN.

FOR BEER (U.S. CLS. 45, 46 AND 48).
MARY CRAWFORD, EXAMINING ATTORNEY

SN 78-242,294. ADAMS OUTDOOR ADVERTISING LIMITED PARTNERSHIP, NORTH CHARLESTON, SC. FILED 4-25-2003.

OUTHOUSE SPRINGS

NO CLAIM IS MADE TO THE EXCLUSIVE RIGHT TO USE SPRINGS, APART FROM THE MARK AS SHOWN.
FOR DRINKING WATER (U.S. CLS. 45, 46 AND 48).
CIMMERIAN COLEMAN, EXAMINING ATTORNEY

SN 78-266,866. CSC BRANDS LP, CAMDEN, NJ. FILED 6-25-2003.

INVIGOR8

FOR FRUIT AND VEGETABLE JUICE BEVERAGES (U.S. CLS. 45, 46 AND 48).
SCOTT BALDWIN, EXAMINING ATTORNEY

SN 78-274,156. CHOICE FIRST DISTRIBUTION, LLC, TEMPE, AZ. FILED 7-14-2003.

KRONIK

FOR ENERGY DRINKS, SPORTS DRINKS, SOFT DRINKS (U.S. CLS. 45, 46 AND 48).
FIRST USE 8-15-2003; IN COMMERCE 8-29-2003.
KAREN K. BUSH, EXAMINING ATTORNEY

CLASS 32—(Continued).

SN 78-285,939. SNOW VALLEY, INC., UPPER MARLBORO, MD. FILED 8-11-2003.



FOR BOTTLED WATER (U.S. CLS. 45, 46 AND 48).
LAURIEL DALIER, EXAMINING ATTORNEY

SN 78-297,666. HALSER, JOSEPH G., IV, MILWAUKEE, WI. FILED 9-9-2003.

III DACHSHUNDS BEER COMPANY

NO CLAIM IS MADE TO THE EXCLUSIVE RIGHT TO USE "BEER COMPANY", APART FROM THE MARK AS SHOWN.

THE FOREIGN WORDING IN THE MARK TRANSLATES INTO ENGLISH AS BADGER HOUND.
FOR BEER (U.S. CLS. 45, 46 AND 48).
DEZMONA MIZELLE, EXAMINING ATTORNEY

SN 78-314,440. OLD EUROPEAN BREWERY COMPANY, SAN DIEGO, CA. FILED 10-16-2003.

ZWOLLE

FOR BEER (U.S. CLS. 45, 46 AND 48).
STEVEN JACKSON, EXAMINING ATTORNEY

CLASS 33—WINES AND SPIRITS

SN 76-458,101. HARVEY FRESH (1994) LTD, WESTERN AUSTRALIA, 6005, AUSTRALIA, FILED 10-15-2002.

BILLY GOAT HILL ESTATE

PRIORITY CLAIMED UNDER SEC. 44(D) ON AUSTRALIA APPLICATION NO. 925687, FILED 9-3-2002, REG. NO. 925687, DATED 9-3-2002, EXPIRES 9-3-2012.

NO CLAIM IS MADE TO THE EXCLUSIVE RIGHT TO USE "ESTATE", APART FROM THE MARK AS SHOWN.
FOR WINE, NAMELY STILL WINE, SPARKLING WINE AND FORTIFIED WINE; SPIRITS; LIQUEURS (U.S. CLS. 47 AND 49).

ZACHARY BELLO, EXAMINING ATTORNEY

CLASS 33—(Continued).

SN 76-469,992. FERRARI F.LLI LUNELLI S.P.A., FRAZIONE RAVINA, 38040 TRENTO, ITALY, FILED 11-25-2002.

TERRE DI PIETRA

THE ENGLISH TRANSLATION OF "TERRE DI PIETRA" IS "STONE LAND".

FOR ALCOHOLIC BEVERAGES, NAMELY, WINES, SPARKLING WINES AND GRAPPA (U.S. CLS. 47 AND 49).

GEORGIA CARTY, EXAMINING ATTORNEY

SN 76-479,246. FINCA LA ANITA S.A., 1001 - BUENOS AIRES, ARGENTINA, FILED 12-30-2002.

FINCA LA ANITA

NO CLAIM IS MADE TO THE EXCLUSIVE RIGHT TO USE "FINCA", APART FROM THE MARK AS SHOWN.

THE ENGLISH TRANSLATION OF FINCA LA ANITA IS VINEYARD OF ANITA.

FOR WINES (U.S. CLS. 47 AND 49).

FIRST USE 5-0-1996; IN COMMERCE 0-0-1996.

WANDA KAY PRICE, EXAMINING ATTORNEY

SN 76-483,349. P.R. ARGENTINA S.A., PROV. OF BUENOS AIRES, ARGENTINA, FILED 1-15-2003.

ETCHART RIO DE PLATA

OWNER OF U.S. REG. NO. 2,562,714.

THE WORDS "RIO DE PLATA" MAY BE TRANSLATED INTO ENGLISH AS "RIVER OF SILVER".

FOR ALCOHOLIC BEVERAGES, NAMELY, WINES (U.S. CLS. 47 AND 49).

DAVID C. REIHNER, EXAMINING ATTORNEY

SN 76-487,548. STE DU VIGNOBLE WILLIAM FEVRE, 89800, CHABLIS, FRANCE, FILED 2-5-2003.

WILLIAM FEVRE

THE NAME WILLIAM FEVRE IDENTIFIES A LIVING INDIVIDUAL WHOSE CONSENT IS OF RECORD.

FOR WINES (U.S. CLS. 47 AND 49).

FIRST USE 1-9-1990; IN COMMERCE 1-9-1990.

TRACY WHITAKER-BOWN, EXAMINING ATTORNEY

CLASS 33—(Continued).

SN 76-489,078. SICHUAN TIANHAOCHEN LIQUOR CO., LTD, CHENGDU, SICHUAN, CHINA, FILED 2-10-2003.



NO CLAIM IS MADE TO THE EXCLUSIVE RIGHT TO USE "LIQUOR", APART FROM THE MARK AS SHOWN.

THE STIPPLING IS A FEATURE OF THE MARK.

THE NON-LATIN CHARACTER(S) IN THE MARK TRANSLITERATE INTO TIAN, HAO, CHEN, AND JIU, AND TRANSLATE INTO ENGLISH AS SKY, HORN, OLD/ LONG TIME AND LIQUOR, RESPECTIVELY.

FOR DISTILLED LIQUOR (U.S. CLS. 47 AND 49).

FIRST USE 9-1-2002; IN COMMERCE 9-1-2002.

INGA ERVIN, EXAMINING ATTORNEY

SN 76-501,276. CAVIT CANTINA VITICOLTORI CONSORZIO CANTINE SOCIALI DEL TRENTO SOC. COOP A.R.L., 38040 RAVINA (TRENTO), ITALY, FILED 3-25-2003.

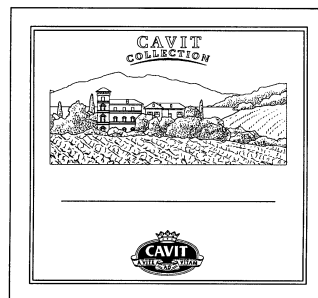

OWNER OF U.S. REG. NOS. 1,174,470, 2,046,921 AND 2,476,352.

NO CLAIM IS MADE TO THE EXCLUSIVE RIGHT TO USE COLLECTION, APART FROM THE MARK AS SHOWN.

FOR WINES (U.S. CLS. 47 AND 49).

FIRST USE 1-13-1998; IN COMMERCE 1-13-1998.

LEIGH CAROLINE CASE, EXAMINING ATTORNEY

SN 76-508,111. OLSEN BROTHERS FARMS, PROSSER, WA, FILED 4-21-2003.

Floating Rock Winery

THE MARK CONSISTS OF STANDARD CHARACTERS WITHOUT CLAIM TO ANY PARTICULAR FONT, STYLE, SIZE, OR COLOR.

NO CLAIM IS MADE TO THE EXCLUSIVE RIGHT TO USE "WINERY", APART FROM THE MARK AS SHOWN.

FOR WINE FOR DRINKING (U.S. CLS. 47 AND 49).

DAWN FELDMAN, EXAMINING ATTORNEY

CLASS 33—(Continued).

SN 76-508,860. JIM BEAM BRANDS CO., DEERFIELD, IL.
FILED 4-23-2003.

BEAM & COLA

OWNER OF U.S. REG. NOS. 544,365, 1,883,870 AND
OTHERS.

NO CLAIM IS MADE TO THE EXCLUSIVE RIGHT TO
USE "COLA", APART FROM THE MARK AS SHOWN.

FOR PREPARED ALCOHOLIC COCKTAILS (U.S. CLS.
47 AND 49).

FIRST USE 4-24-1985; IN COMMERCE 4-24-1985.
AMY GEARIN, EXAMINING ATTORNEY

SN 76-515,494. ALOIS LAGEDER S.P.A., 39040 MAGRE' (BZ),
ITALY, FILED 5-19-2003.

RIFF

FOR WINE (U.S. CLS. 47 AND 49).
KARLA PERKINS, EXAMINING ATTORNEY

SN 76-519,021. VISANT LIMITED, RU -394006, VORONEZH,
RUSSIAN FED., FILED 6-2-2003.

VISANT

OWNER OF RUSSIAN FED. REG. NO. 215807, DATED 10-
5-2002, EXPIRES 10-5-2010.

THE ENGLISH TRANSLATION OF THE WORD "VI-
SANT" IN THE MARK IS "WATCHING".

FOR VODKA (U.S. CLS. 47 AND 49).
ODESSA BIBBINS, EXAMINING ATTORNEY

SN 76-519,958. ZAO "GRUPPA PREDPRIYATIY OST", NO-
GINSKY RAYON, RUSSIAN FED., FILED 5-23-2003.



PRIORITY CLAIMED UNDER SEC. 44(D) ON RUSSIAN
FED. APPLICATION NO. 2002731063, FILED 12-11-2002,
REG. NO. 240948, DATED 11-12-2002, EXPIRES 11-12-2012.

THE LINING IS A FEATURE OF THE MARK AND DOES
NOT INDICATE COLOR.

FOR ALCOHOLIC BEVERAGES, NAMELY DISTILLED
SPIRITS, DISTILLED RICE SPIRITS, APERITIF WINES,
ALCOHOLIC APERITIF BITTERS, ALCOHOLIC HONEY
DRINK, PEPPERMINT SCHNAPPS; ALCOHOLIC FRUIT-
BASED BEVERAGES; SAKE; GIN; RUM; LIQUEURS,
WHISKEY; BRANDY; VODKA (U.S. CLS. 47 AND 49).
DOMINIC J. FERRAIUOLO, EXAMINING ATTORNEY

CLASS 33—(Continued).

SN 76-520,134. SARL JEAN-MARC BROCARD, 89800 CHA-
BLIS, FRANCE, FILED 5-12-2003.

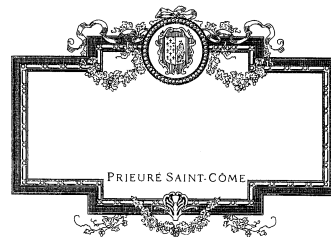

THE LINING AND STIPPLING IN THE DRAWING ARE
FEATURES OF THE MARK AND NOT INTENDED TO
INDICATE COLOR.

THE ENGLISH TRANSLATION OF "PRIEURE" IS "PRI-
ORY".

FOR WINE (U.S. CLS. 47 AND 49).

FIRST USE 6-0-1999; IN COMMERCE 1-0-2003.
LAVERNE THOMPSON, EXAMINING ATTORNEY

SN 76-523,099. CAVIT CANTINA VITICOLTORI CONSOR-
ZIO CANTINE SOCIALI DEL TRENTINO SOC. COOP. A
R.L., 38040 RAVINA (TRENTO), ITALY, FILED 6-13-2003.



OWNER OF U.S. REG. NOS. 1,174,470, 2,046,921 AND
2,476,352.

NO CLAIM IS MADE TO THE EXCLUSIVE RIGHT TO
USE COLLECTION, APART FROM THE MARK AS SHOWN.

FOR WINES (U.S. CLS. 47 AND 49).

FIRST USE 5-5-2003; IN COMMERCE 5-5-2003.
LEIGH CAROLINE CASE, EXAMINING ATTORNEY

SN 76-542,431. VIGNERONS DE LA MEDITERRANEE, 11100
NARBONNE, FRANCE, FILED 9-5-2003.

RESERVE ST. MARTIN

NO CLAIM IS MADE TO THE EXCLUSIVE RIGHT TO
USE "RESERVE", APART FROM THE MARK AS SHOWN.

FOR WINES (U.S. CLS. 47 AND 49).

FIRST USE 9-1-1994; IN COMMERCE 9-1-1994.
TANYA AMOS, EXAMINING ATTORNEY

CLASS 33—(Continued).

SN 76-547,491. NELSON AND SONS, INC, DBA HOPLAND HILLS WINERY, UKIAH, CA. FILED 9-24-2003.

HOPLAND HILLS WINERY

NO CLAIM IS MADE TO THE EXCLUSIVE RIGHT TO USE WINERY, APART FROM THE MARK AS SHOWN.
FOR WINE (U.S. CLS. 47 AND 49).
CURTIS FRENCH, EXAMINING ATTORNEY

SN 76-547,521. DARDEN CORPORATION, ORLANDO, FL. FILED 9-30-2003.

TWISTED TIMBER

FOR PREPARED ALCOHOLIC COCKTAIL (U.S. CLS. 47 AND 49).
FIRST USE 8-5-2003; IN COMMERCE 8-5-2003.
CHRIS WELLS, EXAMINING ATTORNEY

SN 76-549,373. INDEPENDENT LIQUOR (NZ) LIMITED, PAKAKURA, AUCKLAND, NEW ZEALAND, FILED 9-30-2003.

CRUISER

FOR PREPARED ALCOHOLIC COCKTAILS, WINE COOLERS AND ALCOHOLIC MALT COOLERS (U.S. CLS. 47 AND 49).
ELIZABETH HUGHITT, EXAMINING ATTORNEY

SN 76-549,460. VINE & SUN, L.L.C., TACOMA, WA. FILED 9-17-2003.

BARONS V

FOR WINE (U.S. CLS. 47 AND 49).
APRIL L. RADEMACHER, EXAMINING ATTORNEY

SN 76-550,152. INTERNATIONAL WINES & BEER, INC., BOCA RATON, FL. FILED 10-8-2003.

LEIDERSBURG

FOR WINE (U.S. CLS. 47 AND 49).
MARK T. MULLEN, EXAMINING ATTORNEY

CLASS 33—(Continued).

SN 76-552,089. AMANI VINEYARDS (PTY) LTD, STELLENBOSCH, 7600, SOUTH AFRICA, FILED 10-15-2003.

**AMANI**

OWNER OF SOUTH AFRICA REG. NO. 1998/01051, DATED 1-28-1998, EXPIRES 1-28-2008.
FOR ALCOHOLIC BEVERAGES, NAMELY WINES; SPIRITS DERIVED FROM GRAPES AND LIQUEURS (U.S. CLS. 47 AND 49).
RUDY R. SINGLETON, EXAMINING ATTORNEY

SN 76-553,596. STARR MILANO, INC., HOPLAND, CA. FILED 10-6-2003.

RECALL RED

NO CLAIM IS MADE TO THE EXCLUSIVE RIGHT TO USE "RED", APART FROM THE MARK AS SHOWN.
FOR WINE (U.S. CLS. 47 AND 49).
FIRST USE 9-3-2003; IN COMMERCE 9-11-2003.
ELLEN B. AWRICH, EXAMINING ATTORNEY

SN 78-146,828. WINERY EXCHANGE, INC., NOVATO, CA. FILED 7-23-2002.

PARKERS ESTATE OLD VINE STREET

NO CLAIM IS MADE TO THE EXCLUSIVE RIGHT TO USE "ESTATE", APART FROM THE MARK AS SHOWN.
FOR WINE (U.S. CLS. 47 AND 49).
CAROLINE WOOD, EXAMINING ATTORNEY

SN 78-149,423. S. FASSBIND AG, 6414 OBERARTH, SWITZERLAND, FILED 7-31-2002.

THE SECRET TREASURES

OWNER OF SWITZERLAND REG. NO. 469529, DATED 2-16-2000, EXPIRES 2-9-2010.
FOR DISTILLED SPIRITS AND WINES (U.S. CLS. 47 AND 49).
DEZMONA MIZELLE, EXAMINING ATTORNEY

CLASS 33—(Continued).

SN 78-152,440. KOMPANIA SPIRYTUSOWA "WRATISLAWIA" POLMOS WROCLAW SPOLKA AKCYJNA, 51-501 WROCLAW, POLAND, FILED 8-8-2002.

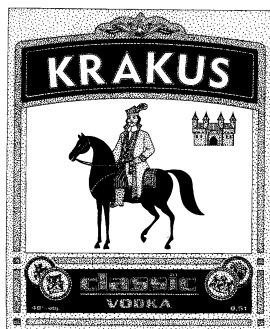

NO CLAIM IS MADE TO THE EXCLUSIVE RIGHT TO USE "CLASSIC VODKA", "40% ABJ", AND "0.51", APART FROM THE MARK AS SHOWN.

THE MARK CONSISTS OF THE COLORS BLUE, YELLOW, GOLD, RED, PURPLE, BROWN, WHITE, BLACK AND CAUCASIAN FLESH TONE. COLOR IS CLAIMED AS A FEATURE OF THE MARK. THE HORSEMAN IN THE CENTER OF THE DESIGN HAS BLACK HAIR, A BLACK MOUSTACHE, AND HIS FACE IS CAUCASIAN FLESH TONE. HE IS WEARING A YELLOW COAT WITH RED LINING. HIS PANTS ARE STRIPED RED AND WHITE, AND HE IS WEARING A BLUE AND RED INNER COAT ON TOP OF A WHITE SHIRT. HE IS WEARING A RED AND WHITE CAP WITH A RED AND BLUE FEATHER, A GOLD BELT, AND BROWN BOOTS. HE IS SITTING ON A BLACK HORSE THAT HAS RED REINS AND STIRRUPS, AND HIS SADDLE IS PURPLE WITH RED BORDERING. THE HORSEMAN IS SET ON A WHITE BACKGROUND, AND BEHIND HIM IS A YELLOW CASTLE. ABOVE THIS HORSEMAN DESIGN IS THE WORD "KRAKUS" IN WHITE LETTERING WITH A GOLD BORDER OF EACH LETTER ON A BLUE RECTANGULAR BACKGROUND. THE BLUE RECTANGLE HAS A THIN, GOLD BORDER. BELOW THE HORSEMAN DESIGN IS THE WORD "CLASSIC" IN RED LETTERING WITH A WHITE BORDER OF EACH LETTER ON A BLACK RECTANGULAR BACKGROUND. BELOW THE WORD "CLASSIC" IS A THIN GOLD LINE, AND BELOW THAT IS THE WORD "VODKA" IN GOLD. THERE ARE TWO GOLD COINS ON EACH SIDE OF THE WORD "CLASSIC". THE WORDS "40% ABJ." AND "0.51" APPEAR IN GOLD IN THE LOWER LEFT AND RIGHT HAND CORNERS OF THE DESIGN, RESPECTIVELY. THE ENTIRE DESIGN IS OUTLINED WITH A GOLD BORDER WITH A CREST DESIGN AT THE TOP WHICH IS OUTLINED IN WHITE. THE GOLD OUTLINE OF THE DESIGN IS SURROUNDED BY THE COLOR YELLOW.

THE ENGLISH TRANSLATION OF KRAKUS IS "MEMBER OF POLISH REGIMENT CREATED ABROAD".

FOR ALCOHOLIC BEVERAGES, NAMELY VODKA (U.S. CLS. 47 AND 49).

TARAH HARDY, EXAMINING ATTORNEY

SN 78-186,363. BICKFORD'S AUSTRALIA PTY LTD, NORTH PLYMPTON SOUTH AUSTRALIA, AUSTRALIA, FILED 11-19-2002.

KREMLIN

PRIORITY CLAIMED UNDER SEC. 44(D) ON AUSTRALIA APPLICATION NO. 913469, FILED 5-21-2002, REG. NO. 913469, DATED 5-21-2002, EXPIRES 5-21-2012.

FOR VODKA (U.S. CLS. 47 AND 49).

SUELLEN HICKEY, EXAMINING ATTORNEY

CLASS 33—(Continued).

SN 78-221,957. CONECUH RIDGE DISTILLERY, INC., TROY, AL. FILED 3-5-2003.

CONECUH RIDGE

NO CLAIM IS MADE TO THE EXCLUSIVE RIGHT TO USE "CONECUH", APART FROM THE MARK AS SHOWN. FOR WHISKEY (U.S. CLS. 47 AND 49). FIRST USE 12-6-2002; IN COMMERCE 12-18-2002. MATTHEW PAPPAS, EXAMINING ATTORNEY

SN 78-223,180. WIZARD ACADEMY PRESS, INC., BUDA, TX. FILED 3-7-2003.

WEDDING FEAST OF GALILEE

FOR WINE (U.S. CLS. 47 AND 49).
SONYA STEPHENS, EXAMINING ATTORNEY

SN 78-231,224. FREIXENET, S.A., BARCELONA, SPAIN, FILED 3-28-2003.



NO CLAIM IS MADE TO THE EXCLUSIVE RIGHT TO USE "ESTATE", APART FROM THE MARK AS SHOWN.

THE MARK CONSISTS OF THE TERMS "ASH TREE ESTATE" ABOVE WHICH IS A TREE DESIGN. THE WORDS "ASH TREE ESTATE" ARE GOLD, THE TREE DESIGN IS BLACK, THE BACKGROUND AGAINST WHICH THE TERMS "ASH TREE ESTATE" AND THE TREE DESIGN ARE SET IS CREAM AND THE BORDER LINE AROUND THE BACKGROUND IS GOLD. THESE COLORS ARE A DESIGNATED FEATURE OF THE MARK.

FOR WINES (U.S. CLS. 47 AND 49).

JOHN HWANG, EXAMINING ATTORNEY

CLASS 33—(Continued).

SN 78-233,293. CHENGDU JINYUMANTANG INDUSTRIAL CO., LIMITED, CHENGDU, CHINA, FILED 4-2-2003.



THE MARK CONSISTS OF 4 CHINESE CHARACTERS. THE NON-LATIN CHARACTER(S) IN THE MARK TRANSLITERATES INTO JIN YU MAN TANG , AND THIS MEANS GOLD JADE FULL HALL IN ENGLISH.

FOR SPIRITS, NAMELY, DISTILLED SPIRITS, POTABLE SPIRITS AND BRANDY SPIRITS MADE OF RICE, SORGHUM, GLUTINOUS RICE, WHEAT, MAIZE, BARLEY; DISTILLED LIQUORS; WINE IN GENERAL; RED WINE; WHITE WINE; LIQUEURS; APERITIFS WITH A DISTILLED ALCOHOLIC LIQUOR BASE; APERITIFS WITH A WINE BASE; FRUIT WINE. (U.S. CLS. 47 AND 49).

MARLENE BELL, EXAMINING ATTORNEY

CLASS 33—(Continued).

SN 78-236,306. WISDOM CREEK WINES PTY LTD, NORWOOD, SOUTH AUSTRALIA, AUSTRALIA, FILED 4-10-2003.



AUSTRALIAN WINE UNLEASHED

PRIORITY CLAIMED UNDER SEC. 44(D) ON AUSTRALIA APPLICATION NO. 949648, FILED 4-7-2003, REG. NO. 949648, DATED 4-7-2003, EXPIRES 4-7-2013.

NO CLAIM IS MADE TO THE EXCLUSIVE RIGHT TO USE AUSTRALIAN WINE, APART FROM THE MARK AS SHOWN.

THE STIPPLING IN THE DRAWING IS A FEATURE OF THE MARK AND IS NOT INTENDED TO INDICATE A COLOR.

FOR WINES, SPIRITS AND LIQUEURS (U.S. CLS. 47 AND 49).

SAMUEL E. SHARPER JR., EXAMINING ATTORNEY

SN 78-240,612. ZAO ODESSKY KONJATSCHNYI ZAWOD, 65005 ODESSA, UKRAINE, FILED 4-22-2003.

SHUSTOFF

FOR ALCOHOLIC BEVERAGES EXCEPT BEERS, NAMELY APERITIFS WITH A DISTILLED ALCOHOLIC LIQUOR BASE; DISTILLED LIQUORS; DISTILLED SPIRITS; WINES; WHISKY; VODKA; GIN; PREPARED ALCOHOLIC COCKTAILS; LIQUEURS; DISTILLED BEVERAGES; BITTERS, NAMELY SCHNAPPS AND LIQUEURS; RUM; LIQUEURS AND SPIRITS IN THE NATURE OF DIGESTIVES; SPIRITUOUS ALCOHOLIC EXTRACTS (U.S. CLS. 47 AND 49).

CHERYL CLAYTON, EXAMINING ATTORNEY

SN 78-235,483. TIA MARIA LIMITED, BRISTOL, UNITED KINGDOM, FILED 4-9-2003.



THE NAME(S), PORTRAIT(S), AND/OR SIGNATURE(S) SHOWN IN THE MARK DOES NOT IDENTIFY A PARTICULAR LIVING INDIVIDUAL.

THE FOREIGN WORDING IN THE MARK TRANSLATES INTO ENGLISH AS AUNT.

FOR DISTILLED SPIRITS AND LIQUEURS (U.S. CLS. 47 AND 49).

WILLIAM BRECKENFELD, EXAMINING ATTORNEY

SN 78-280,419. R. & A. BAILEY & CO., DUBLIN 12, IRELAND, FILED 7-29-2003.

BAILEYS

FOR ALCOHOLIC BEVERAGES, NAMELY, WINES, DISTILLED SPIRITS AND LIQUEURS (U.S. CLS. 47 AND 49).

FIRST USE 9-0-1979; IN COMMERCE 9-0-1979. CAROLINE WOOD, EXAMINING ATTORNEY

CLASS 33—(Continued).

SN 78-293,240. MEGALO PROPERTY HOLDINGS PTY LTD, RICHMOND, SOUTH AUSTRALIA 5033, AUSTRALIA, FILED 8-28-2003.

THE GOVERNOR

FOR WINES (U.S. CLS. 47 AND 49).
KIMBERLY PERRY, EXAMINING ATTORNEY

SN 78-294,652. WINEHAVEN, INC., CHISAGO CITY, MN. FILED 9-2-2003.

DEER GARDEN

FOR WINE (U.S. CLS. 47 AND 49).
FIRST USE 11-9-2002; IN COMMERCE 11-30-2002.
BILL DAWE, EXAMINING ATTORNEY

SN 78-295,986. RED HEAD, INC., DBA CABO WABO ENTERPRISES, NOVATO, CA. FILED 9-4-2003.

GOT TEQUILA?

NO CLAIM IS MADE TO THE EXCLUSIVE RIGHT TO USE "TEQUILA", APART FROM THE MARK AS SHOWN.
FOR TEQUILA (U.S. CLS. 47 AND 49).
REBECCA SMITH, EXAMINING ATTORNEY

SN 78-300,657. PURPLE WINE COMPANY LLC, GRATON, CA. FILED 9-15-2003.

ROCK RABBIT ROCKS

OWNER OF U.S. REG. NO. 2,348,506.
FOR WINE (U.S. CLS. 47 AND 49).
TONI HICKEY, EXAMINING ATTORNEY

SN 78-303,445. SCHRADER CELLARS, LLC, CALISTOGA, CA. FILED 9-22-2003.

VT

FOR WINE (U.S. CLS. 47 AND 49).
DORITT L. CARROLL, EXAMINING ATTORNEY

SN 78-307,368. CARLISLE WINERY & VINEYARDS, LLC, SANTA ROSA, CA. FILED 9-30-2003.

BLACK TONGUE

FOR WINE (U.S. CLS. 47 AND 49).
RONALD MCMORROW, EXAMINING ATTORNEY

CLASS 33—(Continued).

SN 78-307,719. ROBERT MONDAVI WINERY, NAPA, CA. FILED 9-30-2003.

CHATSWORTH LANE

FOR WINE (U.S. CLS. 47 AND 49).
REBECCA SMITH, EXAMINING ATTORNEY

SN 78-307,725. ROBERT MONDAVI WINERY, NAPA, CA. FILED 9-30-2003.

WYNK PYNK

NO CLAIM IS MADE TO THE EXCLUSIVE RIGHT TO USE "PINK", APART FROM THE MARK AS SHOWN.
FOR WINE (U.S. CLS. 47 AND 49).
REBECCA SMITH, EXAMINING ATTORNEY

SN 78-307,728. ROBERT MONDAVI WINERY, NAPA, CA. FILED 9-30-2003.

WYNK WHYTE

NO CLAIM IS MADE TO THE EXCLUSIVE RIGHT TO USE "WHITE", APART FROM THE MARK AS SHOWN.
FOR WINE (U.S. CLS. 47 AND 49).
REBECCA SMITH, EXAMINING ATTORNEY

SN 78-309,243. VALLE IMPORTERS CORP., SCHILLER PARK, IL. FILED 10-3-2003.



NO CLAIM IS MADE TO THE EXCLUSIVE RIGHT TO USE "TEQUILA AÑEJO 100% DE AGAVE", APART FROM THE MARK AS SHOWN.

THE FOREIGN WORDING IN THE MARK TRANSLATES INTO ENGLISH AS DISTINGUISHED. THE ENGLISH TRANSLATION OF "TEQUILA AÑEJO 100% DE AGAVE" IS "OLD TEQUILA 100% AGAVE PLANT".

FOR ALCOHOLIC BEVERAGES NAMELY TEQUILA (U.S. CLS. 47 AND 49).
KHANH LE, EXAMINING ATTORNEY

SN 78-309,265. VINCOR INTERNATIONAL IBC INC., BRIDGETOWN, BARBADOS, FILED 10-3-2003.

OFFSPRING

FOR WINE (U.S. CLS. 47 AND 49).
DAWN HAN, EXAMINING ATTORNEY

CLASS 33—(Continued).

SN 78-310,625. V & C, LLC, GOLDENDALE, WA. FILED 10-7-2003.

FORT ROCK RED

NO CLAIM IS MADE TO THE EXCLUSIVE RIGHT TO USE "RED", APART FROM THE MARK AS SHOWN.
FOR WINE (U.S. CLS. 47 AND 49).
FIRST USE 2-14-2003; IN COMMERCE 2-14-2003.
CATHERINE CAIN, EXAMINING ATTORNEY

SN 78-312,025. GREEN, ROBERT, DBA INDIAN HILL VINEYARDS, MT. AUKUM, CA. FILED 10-10-2003.

INDIAN HILL VINEYARDS

NO CLAIM IS MADE TO THE EXCLUSIVE RIGHT TO USE "VINEYARDS", APART FROM THE MARK AS SHOWN.
FOR WINES (U.S. CLS. 47 AND 49).
GIANCARLO CASTRO, EXAMINING ATTORNEY

SN 78-312,784. VINCOR INTERNATIONAL IBC INC., BRIDGETOWN, BARBADOS, FILED 10-13-2003.

SUCKER LAMBS

FOR WINE (U.S. CLS. 47 AND 49).
KIMBERLY FRYE, EXAMINING ATTORNEY

SN 78-312,786. VINCOR INTERNATIONAL IBC INC., BRIDGETOWN, BARBADOS, FILED 10-13-2003.

SAVAGE BEAUTY

FOR WINE (U.S. CLS. 47 AND 49).
KIMBERLY FRYE, EXAMINING ATTORNEY

SN 78-314,097. THE WINE GROUP LLC, LATHROP, CA. FILED 10-15-2003.

FRONT PORCH

FOR WINES (U.S. CLS. 47 AND 49).
RICHARD WHITE, EXAMINING ATTORNEY

CLASS 33—(Continued).

SN 78-314,339. DAN-KAY INTERNATIONAL INC., BELL-MORE, NY. FILED 10-16-2003.

MOLLY'S

FOR LIQUERS (U.S. CLS. 47 AND 49).
REBECCA SMITH, EXAMINING ATTORNEY

SN 78-318,485. THE WINE GROUP LLC, LATHROP, CA. FILED 10-24-2003.

FIRST CRUSH

FOR WINES (U.S. CLS. 47 AND 49).
RICHARD WHITE, EXAMINING ATTORNEY

SN 78-374,975. THE WINE GROUP LLC, LATHROP, CA. FILED 2-26-2004.

**WINE FOR A LOW
CARB WORLD**

THE MARK CONSISTS OF STANDARD CHARACTERS WITHOUT CLAIM TO ANY PARTICULAR FONT, STYLE, SIZE, OR COLOR.
FOR WINES (U.S. CLS. 47 AND 49).
RICHARD WHITE, EXAMINING ATTORNEY

CLASS 34—SMOKERS' ARTICLES

SN 76-363,787. INTERNATIONAL CRUISE LIQUOR & TOBACCO LLC, MIAMI, FL. FILED 1-28-2002.

BOSS

FOR CIGARETTES AND CIGARS (U.S. CLS. 2, 8, 9 AND 17).
IRA J. GOODSaid, EXAMINING ATTORNEY

CLASS 34—(Continued).

SN 76-453,037. JAPAN TOBACCO INC., TOKYO, JAPAN,
FILED 9-17-2002.

ICENE

OWNER OF SWITZERLAND REG. NO. 504854, DATED 8-12-2002, EXPIRES 8-12-2012.
FOR CIGARETTES (U.S. CLS. 2, 8, 9 AND 17).
BRIAN BROWN, EXAMINING ATTORNEY

SN 76-519,403. HOLT'S COMPANY, PHILADELPHIA, PA.
FILED 5-28-2003.

**A TASTE FROM ANOTHER
ERA**

FOR CIGARS (U.S. CLS. 2, 8, 9 AND 17).
FIRST USE 8-1-2002; IN COMMERCE 8-1-2002.
STEVEN R. FINE, EXAMINING ATTORNEY

SN 76-547,416. PENTON, JUAN J., HIALEAH, FL. FILED 9-3-2003.

CUBAN PARADISE

NO CLAIM IS MADE TO THE EXCLUSIVE RIGHT TO USE "CUBAN", APART FROM THE MARK AS SHOWN.
FOR CIGARS MADE FROM CUBAN SEED TOBACCO, CIGAR CUTTERS, CIGAR ASHTRAYS, AND LIGHTERS ALL NOT OF PRECIOUS METALS (U.S. CLS. 2, 8, 9 AND 17).
DAVID C. REIHNER, EXAMINING ATTORNEY

SN 76-549,947. CIGARROS DON GUILLERMO, C. POR A., ATLANTA, GA. FILED 9-15-2003.

GUILLERMITO PETITS

OWNER OF U.S. REG. NO. 2,085,901.
NO CLAIM IS MADE TO THE EXCLUSIVE RIGHT TO USE "PETITS", APART FROM THE MARK AS SHOWN.
THE NAME GUILLERMITO PETITS DOES NOT IDENTIFY A LIVING INDIVIDUAL.
FOR HAND-MADE CIGARS (U.S. CLS. 2, 8, 9 AND 17).
FIRST USE 6-1-1993; IN COMMERCE 6-1-1995.
MICHAEL HALL, EXAMINING ATTORNEY

CLASS 34—(Continued).

SN 78-234,696. GENERAL CIGAR CO., INC., NEW YORK, NY. FILED 4-7-2003.

**HOYO DE MONTERREY
CAMPO**

OWNER OF U.S. REG. NOS. 86,340, 1,407,903 AND OTHERS.
THE ENGLISH TRANSLATION OF THE WORD "HOYO DE MONTERREY" IS "VALLEY OF MONTERREY" AND "CAMPO" CAN BE TRANSLATED AS "FIELD", "COUNTRY", AND/OR "COUNTRYSIDE".
FOR CIGARS (U.S. CLS. 2, 8, 9 AND 17).
ALICE SUE CARRUTHERS, EXAMINING ATTORNEY

SN 78-276,165. TABACALERA LA CAYA, S.A., SANTIAGO, DOMINICAN REP. FILED 7-18-2003.

DON FANO

THE NAME(S), PORTRAIT(S), AND/OR SIGNATURE(S) SHOWN IN THE MARK DOES NOT IDENTIFY A PARTICULAR LIVING INDIVIDUAL.
FOR CIGARS (U.S. CLS. 2, 8, 9 AND 17).
FIRST USE 7-20-1997; IN COMMERCE 7-20-1997.
ODESSA BIBBINS, EXAMINING ATTORNEY

SN 78-298,420. SEACOI INVESTMENTS, INC., MIRAMAR, FL. FILED 9-10-2003.

CORSARIOS

THE ENGLISH TRANSLATION OF "CORSARIOS" IS "CORSAIR, PIRATE".
FOR CIGARS (U.S. CLS. 2, 8, 9 AND 17).
LAURIEL DALIER, EXAMINING ATTORNEY

SN 78-303,361. GOLDMAN, ALEX, ASTORIA, NY. FILED 9-22-2003.

LA SIMBOMBO

FOR CIGARS (U.S. CLS. 2, 8, 9 AND 17).
FIRST USE 2-1-1996; IN COMMERCE 2-1-1996.
CIMMERIAN COLEMAN, EXAMINING ATTORNEY

SN 78-305,676. JIAN FENG ZHAO, MONROVIA, CA. FILED 9-25-2003.

STATUE OF LIBERTY

FOR CIGARETTES (U.S. CLS. 2, 8, 9 AND 17).
GLENN CLARK, EXAMINING ATTORNEY

CLASS 34—(Continued).

SN 78-308,057. BWT BRANDS, INC., MACON, GA. FILED 10-1-2003.



OWNER OF CANADA REG. NO. TMA595086, DATED 11-19-2003, EXPIRES 11-19-2018.
FOR CIGARETTES (U.S. CLS. 2, 8, 9 AND 17).
JAMES GRIFFIN, EXAMINING ATTORNEY

CLASS 35—(Continued).

SN 75-613,228. ZEESMAN COMMUNICATIONS, INC., CULVER CITY, CA. FILED 12-29-1998.



FOR BUSINESS CONSULTATION, BUSINESS MANAGEMENT CONSULTATION, ADVERTISING CONSULTATION, PUBLIC RELATIONS CONSULTATION AND ADVERTISING AGENCIES (U.S. CLS. 100, 101 AND 102).
FIRST USE 6-0-1993; IN COMMERCE 6-0-1993.
KIM SAITO, EXAMINING ATTORNEY

SERVICE MARKS

SN 75-793,643. BASNIGHT, ROBERT W., DBA BASNIGHT ASSOCIATES, FUQUAY VARINA, NC. FILED 9-7-1999.

CLASS 35—ADVERTISING AND BUSINESS

SN 74-698,839. MSM ACQUISITION, L.L.C., BEVERLY HILLS, CA. FILED 7-10-1995.



MAIN STREET MEDIA

NO CLAIM IS MADE TO THE EXCLUSIVE RIGHT TO USE "MEDIA", APART FROM THE MARK AS SHOWN.
FOR ADVERTISING, MARKETING AND CONSULTING SERVICES, NAMELY, DEVELOPING, IMPLEMENTING AND MONITORING DIRECT RESPONSE MARKETING PROGRAMS FOR OTHERS, ARRANGING FOR AND PURCHASING TELEVISION, RADIO, PRINT AND INTERACTIVE TELECOMMUNICATIONS ADVERTISING FOR OTHERS, AND PRODUCTION AND DISTRIBUTION OF TELEVISION COMMERCIALS AND INFORMERCIALS (U.S. CLS. 100, 101 AND 102).
FIRST USE 2-18-1994; IN COMMERCE 2-18-1994.
HOWARD SMIGA, EXAMINING ATTORNEY

FOR DISTRIBUTORSHIPS FEATURING PLAYGROUND EQUIPMENT AND PARK EQUIPMENT, INCLUDING COMPONENTS AND HARDWARE; PARK SHELTERS; PARK FURNISHINGS; CUSHIONED PLAYGROUND SURFACES; AND BASKETBALL GOALS (U.S. CLS. 100, 101 AND 102).
FIRST USE 8-25-2003; IN COMMERCE 8-25-2003.
SOPHIA S. KIM, EXAMINING ATTORNEY

SN 75-861,798. CORPORATE PLANNED STAFFING, INC., CHERRY HILLS, NJ. FILED 12-2-1999.

CORPORATE PLANNED STAFFING

SN 75-400,630. PROGRESSIVE DISTRIBUTION SERVICES, INC., GRAND RAPIDS, MI. FILED 12-5-1997.

ORDERLINK

SEC. 2(F).
FOR ORDER FULFILLMENT SERVICES (U.S. CLS. 100, 101 AND 102).
FIRST USE 2-17-1996; IN COMMERCE 2-17-1996.
SHARI SHEFFIELD, EXAMINING ATTORNEY

NO CLAIM IS MADE TO THE EXCLUSIVE RIGHT TO USE "PLANNED STAFFING", APART FROM THE MARK AS SHOWN.
SEC. 2(F).
FOR PERSONNEL PLACEMENT SERVICES AND TEMPORARY PERSONNEL STAFFING (U.S. CLS. 100, 101 AND 102).
FIRST USE 2-2-1991; IN COMMERCE 2-2-1991.
CHARLES L. JENKINS, EXAMINING ATTORNEY

CLASS 35—(Continued).

SN 76-012,024. WORLD OMNI FINANCIAL CORP, DEERFIELD BEACH, FL. FILED 3-30-2000.

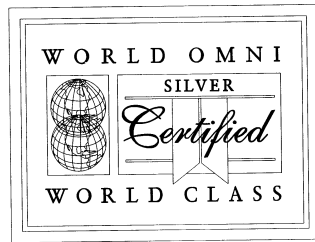

NO CLAIM IS MADE TO THE EXCLUSIVE RIGHT TO USE SILVER CERTIFIED OR WORLD CLASS, APART FROM THE MARK AS SHOWN.

FOR PROVIDING CUSTOMERS WITH ASSURANCE THAT INSPECTION AND CLEANING SERVICES WERE PERFORMED ON USED AND LEASED VEHICLES PRIOR TO THEIR SALE (U.S. CLS. 100, 101 AND 102). DANIEL CAPSHAW, EXAMINING ATTORNEY

SN 76-012,473. WORLD OMNI FINANCIAL CORP., DEERFIELD BEACH, FL. FILED 3-30-2000.

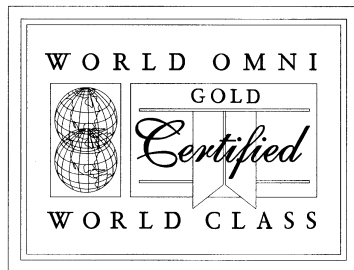

NO CLAIM IS MADE TO THE EXCLUSIVE RIGHT TO USE "GOLD CERTIFIED OR WORLD CLASS", APART FROM THE MARK AS SHOWN.

FOR PROVIDING CUSTOMERS WITH ASSURANCE THAT INSPECTION AND CLEANING SERVICES WERE PERFORMED ON USED AND LEASED VEHICLES PRIOR TO THEIR SALE (U.S. CLS. 100, 101 AND 102). DANIEL CAPSHAW, EXAMINING ATTORNEY

SN 76-053,426. DEALER MARKETING SERVICES, INC., ROCK ISLAND, IL. FILED 5-19-2000.

CAREXPRESS.COM

FOR PROVIDING INFORMATION ABOUT AUTOMOBILES AVAILABLE FOR SALE VIA A GLOBAL COMPUTER NETWORK (U.S. CLS. 100, 101 AND 102). FIRST USE 12-31-1996; IN COMMERCE 12-31-1996. MICHAEL BAIRD, EXAMINING ATTORNEY

CLASS 35—(Continued).

SN 76-165,707. ADVANTEX MARKETING INTERNATIONAL INC., TORONTO, ONTARIO, CANADA, FILED 11-15-2000.

MILEAGE METER

PRIORITY CLAIMED UNDER SEC. 44(D) ON CANADA APPLICATION NO. 1080783, FILED 10-31-2000, REG. NO. TMA606749, DATED 3-31-2004, EXPIRES 3-31-2019.

FOR PROMOTING THE GOODS AND SERVICES OF OTHERS BY PREPARING AND PLACING ADVERTISEMENTS ON THE GLOBAL COMPUTER NETWORK; PROMOTING THE GOODS AND SERVICES OF OTHERS BY AWARDING LOYALTY PROGRAM CREDITS AND POINTS; CONSULTING IN THE FIELD OF ADVERTISING VIA THE GLOBAL COMPUTER NETWORK AND ASSISTING OTHERS IN DEVELOPING PROMOTIONAL CAMPAIGNS OVER THE GLOBAL COMPUTER NETWORK (U.S. CLS. 100, 101 AND 102).

KEVON CHISOLM, EXAMINING ATTORNEY

SN 76-186,247. JOHN H. HARLAND COMPANY, DECATUR, GA. FILED 12-26-2000.

STRATICS

FOR DIRECT MAIL ADVERTISING SERVICES FOR BANKS, CREDIT UNIONS, AND OTHER FINANCIAL INSTITUTIONS, AND CONSULTATION IN THE FIELD OF DIRECT MAIL ADVERTISING FOR BANKS, CREDIT UNIONS, AND OTHER FINANCIAL INSTITUTIONS FEATURING DATABASE MODELING, MARKET ANALYSIS, MARKETING STRATEGY DEVELOPMENT AND IMPLEMENTATION, AND ADVERTISING AGENCY SERVICES FOR BANKS, CREDIT UNIONS, AND OTHER FINANCIAL INSTITUTIONS IN THE FIELD OF DESIGNING PROMOTIONAL AND MARKETING CAMPAIGNS AND MATERIAL (U.S. CLS. 100, 101 AND 102).

FIRST USE 10-20-2000; IN COMMERCE 11-8-2000. JASON TURNER, EXAMINING ATTORNEY

SN 76-196,922. COMSITE INTERNATIONAL, INC., SAN ANTONIO, TX. FILED 1-19-2001.

COMSITE

FOR WORLD WIDE WEB PAGE HOSTING FOR OTHERS AND TURKEY ELECTRONIC COMMERCE APPLICATION DEVELOPMENT FOR OTHERS (U.S. CLS. 100, 101 AND 102).

FIRST USE 5-9-1997; IN COMMERCE 5-9-1997. KELLEY WELLS, EXAMINING ATTORNEY

CLASS 35—(Continued).

SN 76-298,204. CBR INCORPORATED, ST. PAUL, MN. FILED 8-13-2001.

LUCKY GIRL

FOR RETAIL STORE SERVICES FEATURING BATH AND BODY PRODUCTS, BOOKS, CALENDARS, COLLECTIBLES, JEWELRY INCLUDING CUFF LINKS, EARRINGS, NECKLACES, PINS, RINGS, DESK ACCESSORIES, DECORATIVE ACCESSORIES, PICTURE FRAMES, GIFT BAGS, GOURMET GOODIES, HAIR ORNAMENTS, PAPER GIFT ITEMS SUCH AS STATIONERY, JOURNALS, STICKERS, GREETING CARDS, PHOTO ALBUMS, ORNAMENTS, DECORATIVE PILLOWS, THROWS, WALL ART, AND WOMEN'S AND GIRLS' ACCESSORIES EXCLUDING CLOTHING (U.S. CLS. 100, 101 AND 102).

MICHAEL SOUDERS, EXAMINING ATTORNEY

SN 76-314,659. ZAGNOLI MCEVOY FOLEY LTD., CHICAGO, IL. FILED 9-20-2001.

ZOPINION

FOR CONDUCTING BUSINESS AND MARKET RESEARCH SURVEYS, AND CONSULTING SERVICES RELATED THERETO (U.S. CLS. 100, 101 AND 102).

FIRST USE 8-6-2001; IN COMMERCE 8-6-2001.
KIM SAITO, EXAMINING ATTORNEY

SN 76-356,229. MONUMENTAL LIFE INSURANCE COMPANY, BALTIMORE, MD. FILED 1-9-2002.

**FAMILY HEALTH
ADVANTAGE**

NO CLAIM IS MADE TO THE EXCLUSIVE RIGHT TO USE "FAMILY HEALTH", APART FROM THE MARK AS SHOWN.

FOR ADMINISTRATION OF A DISCOUNT PROGRAM FOR ENABLING PARTICIPANTS TO OBTAIN DISCOUNTS ON GOODS AND SERVICES THROUGH USE OF A DISCOUNT MEMBERSHIP CARD FOR HEALTH CARE SERVICES (U.S. CLS. 100, 101 AND 102).

FIRST USE 3-1-1994; IN COMMERCE 6-0-1994.
MARK T. MULLEN, EXAMINING ATTORNEY

SN 76-361,759. BOHBOT, MARC, LOS ANGELES, CA. AND BOHBOT, MICHELLE, LOS ANGELES, CA. FILED 1-24-2002.

BISOU BISOU

OWNER OF U.S. REG. NOS. 1,806,214, 2,449,332 AND OTHERS.

THE ENGLISH TRANSLATION OF "BISOU BISOU" IS "KISS KISS".

FOR RETAIL STORE SERVICES IN THE FIELD OF CLOTHING (U.S. CLS. 100, 101 AND 102).

FIRST USE 3-20-1994; IN COMMERCE 3-20-1994.
ROBERT LORENZO, EXAMINING ATTORNEY

CLASS 35—(Continued).

SN 76-364,722. THE COUNCIL OF INSURANCE AGENTS AND BROKERS, WASHINGTON, DC. FILED 1-31-2002.

COUNCIL PREFI

FOR ASSOCIATION SERVICES, NAMELY, PROMOTING THE GOODS AND SERVICES OF INSURANCE AGENTS AND BROKERS BY PROVIDING A PREMIUM FINANCING PLAN (U.S. CLS. 100, 101 AND 102).

FIRST USE 12-28-1998; IN COMMERCE 12-28-1998.
GLENN CLARK, EXAMINING ATTORNEY

SN 76-376,622. CONSULTING SERVICES INTERNATIONAL INC., SMITHTOWN, NY. FILED 2-27-2002.

CRMS

FOR PROVIDING AN ON-LINE DATABASE IN THE FIELD OF OCEAN SHIPPING CONTRACT CARRIER RATES TO SUBSCRIBERS (U.S. CLS. 100, 101 AND 102).

FIRST USE 1-15-2002; IN COMMERCE 1-15-2002.
MARLENE BELL, EXAMINING ATTORNEY

SN 76-408,813. SITTHIDETH, VIKKI, SAN DIEGO, CA. FILED 5-8-2002.

LAO TAXMASTER

NO CLAIM IS MADE TO THE EXCLUSIVE RIGHT TO USE "LAO", APART FROM THE MARK AS SHOWN. FOR PREPARING INCOME TAX AND BOOKKEEPING SERVICES (U.S. CLS. 100, 101 AND 102).

FIRST USE 1-1-2002; IN COMMERCE 1-1-2002.
LINDA POWELL, EXAMINING ATTORNEY

SN 76-442,692. HARRISONGRAY, LLC, ATLANTA, GA. FILED 8-20-2002.

HARRISONGRAY



THE NAME HARRISON GRAY DOES NOT IDENTIFY A LIVING INDIVIDUAL.

THE MARK CONSISTS OF UPPER CASE LETTERS IN ARIAL FONT, COLORED LIGHT GRAY WITH A LARGER FONT SIZE FOR THE LETTER'S H AND G. FOUR ENCLOSED CIRCLES COLORED LIGHT BLUE UNDERLINES THE WORD PORTION OF THE MARK.

FOR CONSULTING SERVICES IN THE FIELD OF BUSINESS MANAGEMENT (U.S. CLS. 100, 101 AND 102).

FIRST USE 12-15-2001; IN COMMERCE 12-15-2001.
MARGERY A. TIERNEY, EXAMINING ATTORNEY

CLASS 35—(Continued).

SN 76-443,188. Y&R PROPERTIES, SAN FRANCISCO, CA. FILED 8-23-2002.

BRANDJUNCTION

FOR PROVIDING AN ONLINE COMPUTER DATABASE IN THE FIELD OF ADVERTISING, BRAND IDENTITY, BRAND DEVELOPMENT AND MARKETING (U.S. CLS. 100, 101 AND 102).
SCOTT OSLICK, EXAMINING ATTORNEY

SN 76-460,640. LEGENTA, INC., MORGAN HILL, CA. FILED 10-22-2002.

LEGENTA

FOR LICENSING AND BUSINESS MANAGEMENT OF TECHNOLOGY-BASED ASSETS IN THE NATURE OF COMPUTER SOFTWARE (U.S. CLS. 100, 101 AND 102).
FIRST USE 10-7-2002; IN COMMERCE 10-7-2002.
IRA J. GOODSID, EXAMINING ATTORNEY

SN 76-461,388. PROFESSIONAL STAFF GROUP, INC., BOSTON, MA. FILED 10-24-2002.

PSG CONSTRUCTION

NO CLAIM IS MADE TO THE EXCLUSIVE RIGHT TO USE "CONSTRUCTION", APART FROM THE MARK AS SHOWN.

FOR EMPLOYMENT STAFFING SERVICES, NAMELY, TEMPORARY AND PERMANENT STAFFING (U.S. CLS. 100, 101 AND 102).

FIRST USE 4-0-2002; IN COMMERCE 4-0-2002.
BILL DAWE, EXAMINING ATTORNEY

SN 76-461,832. TRO OF NC, INC., LAKEVIEW, NC. FILED 10-28-2002.



THE MARK CONSISTS OF A GOLDEN TOBACCO LEAF WITH THE CAPITAL LETTERS "TRO" WRITTEN ACROSS IT IN RED.

FOR RETAIL STORE SERVICES FEATURING TOBACCO, TOBACCO PRODUCTS AND TOBACCO ACCESSORIES (U.S. CLS. 100, 101 AND 102).

FIRST USE 6-1-2001; IN COMMERCE 6-1-2001.
BRIAN BROWN, EXAMINING ATTORNEY

CLASS 35—(Continued).

SN 76-463,652. AMERICAN MULTILINE CORPORATION, DALLAS, TX. FILED 11-1-2002.



NO CLAIM IS MADE TO THE EXCLUSIVE RIGHT TO USE "QUALITY", "SERVICE" OR "VALUE", APART FROM THE MARK AS SHOWN.

FOR PERSONNEL STAFFING SERVICES (U.S. CLS. 100, 101 AND 102).

FIRST USE 3-6-2002; IN COMMERCE 3-6-2002.
GINA FINK, EXAMINING ATTORNEY

SN 76-472,592. CHINA NORTH INDUSTRIES CORPORATION, BEIJING, 100053, CHINA, FILED 12-6-2002.



OWNER OF U.S. REG. NOS. 1,755,207 AND 2,000,209.

NO CLAIM IS MADE TO THE EXCLUSIVE RIGHT TO USE THE CHINESE CHARACTERS (WHICH TRANSLITERATE TO GONG YE WHICH MEANS "INDUSTRIES"), APART FROM THE MARK AS SHOWN.

COLOR IS CLAIMED AS PART OF THE MARK.

THE MARK CONSISTS IN PART OF A STYLIZED RED AND YELLOW LETTER "N" WHEREIN THE LETTER "N" BEGINS IN RED AND GRADUALLY CHANGES TO YELLOW. THE LETTER "N" IS INSIDE A BLUE CIRCLE. THE CHINESE CHARACTERS AND THE WORD NORINCO ARE ALSO BLUE.

THE CHINESE CHARACTERS IN THE MARK TRANSLITERATE TO BEI FANG GONG YE AND THIS MEANS NORTH INDUSTRIES IN ENGLISH.

FOR ADVERTISING AND COMMERCIAL INFORMATION AGENCIES, BUSINESS MANAGEMENT CONSULTING, MARKETING RESEARCH, PUBLIC RELATIONS, TRADING CONSULTATION, NAMELY, PROVIDING INFORMATION ABOUT TRADE WITH CHINA, ORGANIZING BUSINESS AND ADVERTISING EXHIBITIONS TO PROMOTE TRADE WITH CHINA, IMPORT-EXPORT AGENCIES, SALES PROMOTION ON BEHALF OF OTHERS, NAMELY, PROVIDING SALES AGENCY REPRESENTATION FOR BUSINESSES NEEDING ASSISTANCE IN TRADE WITH CHINA AND OFFICE MACHINE AND EQUIPMENT RENTAL (U.S. CLS. 100, 101 AND 102).

GLENN CLARK, EXAMINING ATTORNEY

CLASS 35—(Continued).

SN 76-472,997. ACCOUNTANTS INC. SERVICES, BURLINGAME, CA. FILED 12-9-2002.



OWNER OF U.S. REG. NO. 2,681,137.
NO CLAIM IS MADE TO THE EXCLUSIVE RIGHT TO USE EXECUTIVE, APART FROM THE MARK AS SHOWN.
FOR TEMPORARY AND PERMANENT PLACEMENT OF ACCOUNTING AND FINANCE PERSONNEL (U.S. CLS. 100, 101 AND 102).
FIRST USE 5-15-2000; IN COMMERCE 5-15-2000.
KATHLEEN M. VANSTON, EXAMINING ATTORNEY

SN 76-482,805. BRANDVIA ALLIANCE, INC., LOS GATOS, CA. FILED 1-16-2003.

BRANDVIA...

FOR PREPARATION OF CUSTOM PROMOTIONAL PRODUCTS, GIFTS AND MATERIALS FOR OTHERS; PREPARATION OF MERCHANDISING PRODUCTS, GIFTS AND MATERIALS FOR OTHERS; MAIL ORDER CATALOG SERVICES FEATURING PROMOTIONAL AND MERCHANDISING PRODUCTS, GIFTS AND MATERIALS; ONLINE RETAIL STORE AND ONLINE CATALOG SERVICES FEATURING PROMOTIONAL AND MERCHANDISING PRODUCTS, GIFTS AND MATERIALS; PROVIDING AN ONLINE DATABASE FEATURING PROMOTIONAL AND MERCHANDISING PRODUCTS, GIFTS AND MATERIALS; AND ONLINE ORDERING SERVICES FEATURING PROMOTIONAL AND MERCHANDISING PRODUCTS, GIFTS AND MATERIALS (U.S. CLS. 100, 101 AND 102).

FIRST USE 1-25-2003; IN COMMERCE 1-25-2003.
WANDA KAY PRICE, EXAMINING ATTORNEY

SN 76-484,364. LONDON DIAMOND JEWELLERY COMPANY LIMITED, LONDON EC1N 6RY, ENGLAND, FILED 1-22-2003.

ICECOOL

FOR COMPUTERIZED ON-LINE RETAIL ORDERING SERVICES AND MAIL ORDER CATALOGUE SERVICES IN THE FIELD OF JEWELLERY, MADE FROM PRECIOUS METALS AND/OR THEIR ALLOYS, OR COATED THEREWITH, AND PRECIOUS STONES (U.S. CLS. 100, 101 AND 102).

FIRST USE 12-0-1998; IN COMMERCE 12-0-1998.
LINDA M. KING, EXAMINING ATTORNEY

CLASS 35—(Continued).

SN 76-485,881. JMH PUBLISHING, INC., INVENTORS' DIGEST DIVISION, CONCORD, NH. AND ACADEMY OF APPLIED SCIENCE, INC., CONCORD, NH. FILED 1-24-2003.

NATIONAL INVENTORS' MONTH

OWNER OF U.S. REG. NO. 2,301,054.
NO CLAIM IS MADE TO THE EXCLUSIVE RIGHT TO USE "INVENTORS", APART FROM THE MARK AS SHOWN.

SEC. 2(F).
FOR SERVICES IN PROMOTING PUBLIC AWARENESS OF THE NEED TO RECOGNIZE AND PUBLICIZE THE ROLE OF INVENTION AND OF INVENTORS IN PROMOTING THE PROGRESS OF ARTS IN THE UNITED STATES AND ABROAD (U.S. CLS. 100, 101 AND 102).

FIRST USE 11-1-1997; IN COMMERCE 11-1-1997.
MONIQUE MILLER, EXAMINING ATTORNEY

SN 76-489,640. HANDS ON DEMAND, INC., WEST LINN, OR. FILED 2-14-2003.

YOUR NEIGHBORHOOD HELPING FAMILIES LIVE FOR LESS!

FOR DIRECT MAIL ADVERTISING (U.S. CLS. 100, 101 AND 102).

FIRST USE 10-15-2002; IN COMMERCE 10-15-2002.
LINDA E. BLOHM, EXAMINING ATTORNEY

SN 76-490,418. TIME INC., NEW YORK, NY. FILED 2-12-2003.

GET ORGANIZED AMERICA

FOR PROMOTING THE GOODS AND SERVICES OF OTHERS FOR RAISING THE AWARENESS OF THE NEED AND IMPORTANCE OF BEING ORGANIZED, NAMELY, ARRANGING FOR SPONSORS TO AFFILIATE THEIR GOODS AND SERVICES WITH COMMUNITY PROGRAMS (U.S. CLS. 100, 101 AND 102).

FIRST USE 8-1-2003; IN COMMERCE 8-1-2003.
BRIAN PINO, EXAMINING ATTORNEY

SN 76-491,382. ACE HARDWARE CORPORATION, OAK BROOK, IL. FILED 2-21-2003.

NSN

FOR WHOLESALE STORE SERVICES; NAMELY, PROVIDING WHOLESALE INDUSTRIAL SUPPLIES AND EQUIPMENT TO COMMERCIAL AND INDUSTRIAL CUSTOMERS (U.S. CLS. 100, 101 AND 102).

FIRST USE 5-16-2002; IN COMMERCE 5-16-2002.
IRENE D. WILLIAMS, EXAMINING ATTORNEY

CLASS 35—(Continued).

SN 76-498,655. GIORDANO, PEARL, VINELAND, NJ. FILED 3-19-2003.

JERSEY FIRST

NO CLAIM IS MADE TO THE EXCLUSIVE RIGHT TO USE JERSEY, APART FROM THE MARK AS SHOWN.

FOR PROMOTING BUSINESS IN NEW JERSEY THROUGH LICENSING OF NEW JERSEY-BASED GOODS AND SERVICES (U.S. CLS. 100, 101 AND 102).

STEVEN R. FINE, EXAMINING ATTORNEY

SN 76-502,198. NORTH COAST SEA-FOODS CORP., BOSTON, MA. FILED 3-28-2003.

DRYDOCK

FOR DISTRIBUTORSHIP SERVICES FEATURING LIVE, FRESH AND FROZEN SEAFOOD PROVIDED TO RESTAURANTS, HOTELS, CLUBS AND INSTITUTIONS (U.S. CLS. 100, 101 AND 102).

DAVID H. STINE, EXAMINING ATTORNEY

SN 76-502,521. RED ROCK ENTERPRISES, LLC, FRIENDSVILLE, MO. FILED 3-31-2003.

THE TIMBER EXPERTS

OWNER OF U.S. REG. NO. 2,346,230.

NO CLAIM IS MADE TO THE EXCLUSIVE RIGHT TO USE "TIMBER", APART FROM THE MARK AS SHOWN. SEC. 2(F).

FOR RETAIL AND WHOLESALE STORE SERVICES FEATURING LUMBER AND TIMBER (U.S. CLS. 100, 101 AND 102).

FIRST USE 1-1-1998; IN COMMERCE 1-1-1998.
LINDA E. BLOHM, EXAMINING ATTORNEY

SN 76-503,228. MAGELLAN HEALTH SERVICES, INC., COLUMBIA, MD. FILED 4-1-2003.

TRUSTED SOLUTIONS TO LIFE'S CHALLENGES

FOR EMPLOYEE ASSISTANCE PROGRAMS FOR EMPLOYERS AND EMPLOYEES CONSISTING OF (A) WORK-LIFE COUNSELING AND REFERRAL SERVICES TO ASSIST EMPLOYEES AND THEIR FAMILY MEMBERS WITH PERSONAL AND WORKPLACE PROBLEMS, AND (B) CONSULTATIONS REGARDING HANDLING ORGANIZATIONAL TRANSITIONS AND WORKPLACE SITUATIONS THAT INVOLVE EMPLOYEE PROBLEMS (U.S. CLS. 100, 101 AND 102).

FIRST USE 3-16-2001; IN COMMERCE 3-16-2001.
RON FAIRBANKS, EXAMINING ATTORNEY

CLASS 35—(Continued).

SN 76-508,258. COMPASS VIEW EVENTS, LLC, SUDBURY, MA. FILED 4-21-2003.



FOR BUSINESS MEETING PLANNING FOR CLIENTS SPECIALIZING IN EXECUTIVE EVENTS, SALES MEETING AND USER GROUP MEETINGS; BUSINESS MANAGEMENT CONSULTATION (U.S. CLS. 100, 101 AND 102).

FIRST USE 5-10-2002; IN COMMERCE 5-10-2002.
CHARLES L. JENKINS, EXAMINING ATTORNEY

SN 76-508,390. ABRISHAMI, MARGARITA PARDO, PALM BEACH GARDENS, FL. AND ABRISHAMI, BAHRAM A., PALM BEACH GARDENS, FL. FILED 4-18-2003.

**(VIEWS)VIVE
INTERNATIONAL
EXECUTIVE WOMEN
SOCIETY**

NO CLAIM IS MADE TO THE EXCLUSIVE RIGHT TO USE INTERNATIONAL EXECUTIVE WOMEN SOCIETY, APART FROM THE MARK AS SHOWN.

FOR ASSOCIATION SERVICES, NAMELY, PROMOTING THE INTEREST OF WOMEN EXECUTIVES BY PROVIDING BUSINESS INFORMATION, NETWORKING OPPORTUNITIES AND PERSONAL AND BUSINESS GROWTH ENHANCEMENTS (U.S. CLS. 100, 101 AND 102).

MARIA-VICTORIA SUAREZ, EXAMINING ATTORNEY

SN 76-508,424. INTERLOIRE, BP 1921, 37019 TOURS SEDEX, FRANCE, FILED 4-8-2003.

FINES BULLES

THE ENGLISH TRANSLATION OF THE WORDS FINES BULLES IS FINE BUBBLES.

FOR ASSOCIATION SERVICES, NAMELY PROMOTING THE INTERESTS OF THE WINE PRODUCERS IN THE LOIRE VALLEY REGION; PROMOTING THE SALE OF SPARKLING WINES OF OTHERS THROUGH THE DISTRIBUTION OF PRINTED MATERIAL; BY PROVIDING HYPERTEXT LINKS TO THE WEB SITES OF OTHERS AND BY PREPARING AND PLACING ADVERTISEMENTS IN AN ELECTRONIC MAGAZINE ACCESSED THROUGH A GLOBAL COMPUTER NETWORK (U.S. CLS. 100, 101 AND 102).

FIRST USE 1-1-2002; IN COMMERCE 1-1-2002.
ROBERT LORENZO, EXAMINING ATTORNEY

CLASS 35—(Continued).

SN 76-508,747. GRASSROOTS PROMOTIONS, LLC, DALLAS, TX. FILED 4-22-2003.

PROM ESSENTIALS TOUR

NO CLAIM IS MADE TO THE EXCLUSIVE RIGHT TO USE "PROM" AND "TOUR", APART FROM THE MARK AS SHOWN.

FOR PROMOTING THE GOODS AND SERVICES OF OTHERS BY ARRANGING FOR SPONSORS TO AFFILIATE THEIR GOODS AND SERVICES WITH A NATIONAL TOUR THEMED AROUND ASSISTING YOUNG GIRLS IN PREPARING FOR THEIR HIGH SCHOOL PROM, SUCH TOUR INCLUDING FASHION SHOWS AND MUSICAL PERFORMANCES (U.S. CLS. 100, 101 AND 102).

MONIQUE MILLER, EXAMINING ATTORNEY

CLASS 35—(Continued).

SN 76-511,076. LYN'S NEEDLEWORK, INC., BETHESDA, MD. FILED 5-2-2003.

KNIT AND STITCH

FOR RETAIL AND COMPUTERIZED ON-LINE STORE SERVICES FEATURING YARN, NEEDLEPOINT CANVASES AND FIBERS, NEEDLEWORK BOOKS, MAGAZINES, PATTERNS, FURNITURE, JEWELRY, AND NEEDLEWORK ACCESSORIES (U.S. CLS. 100, 101 AND 102).

FIRST USE 4-4-2003; IN COMMERCE 4-4-2003.
DAVID C. REIHNER, EXAMINING ATTORNEY

SN 76-508,995. AWE ENTERPRISES, INC., AUSTELL, GA. FILED 4-24-2003.

**MOTIVATED CAR SELLERS.
NO DEALERS.
THAT'S AUTOCRISIS.COM**

NO CLAIM IS MADE TO THE EXCLUSIVE RIGHT TO USE "CAR SELLERS" AND "NO DEALERS", APART FROM THE MARK AS SHOWN.

FOR OPERATING ON-LINE MARKETPLACES FOR SELLERS TO ADVERTISE THEIR NEW AND USED LAND, AIR AND WATER VEHICLES (U.S. CLS. 100, 101 AND 102).

MARY CRAWFORD, EXAMINING ATTORNEY

SN 76-511,560. MEDSITE, INC., NEW YORK, NY. FILED 4-18-2003.

MEDSITE IDETAILED

OWNER OF U.S. REG. NOS. 2,481,598, 2,581,424 AND 2,617,076.

FOR PROMOTING THE GOODS AND SERVICES OF PHARMACEUTICAL COMPANIES TO HEALTH CARE INDUSTRY PROFESSIONALS; BUSINESS MARKETING CONSULTING SERVICES (U.S. CLS. 100, 101 AND 102).

FIRST USE 4-7-2003; IN COMMERCE 4-7-2003.
JENNIFER KRISP, EXAMINING ATTORNEY

SN 76-510,570. AUTODOLLARS, INC., MANCHESTER, MI. FILED 5-1-2003.

AUTODOLLARS

FOR BUSINESS INFORMATION SERVICES, NAMELY PREPARING AND PROVIDING REPORTS TO DEALERSHIPS FOR THEIR CUSTOMERS, REGARDING AVAILABILITY OF MANUFACTURER INCENTIVE AND REBATE PROGRAMS BY LOCATION, EMPLOYMENT, AND AFFINITY PROGRAM STATUS (U.S. CLS. 100, 101 AND 102).

FIRST USE 8-1-2002; IN COMMERCE 8-1-2002.
STEVEN BERK, EXAMINING ATTORNEY

SN 76-512,583. CDW CORPORATION, VERNON HILLS, IL. FILED 5-8-2003.

CDW LOGISTICS

OWNER OF U.S. REG. NOS. 1,649,113, 2,614,744 AND OTHERS.

NO CLAIM IS MADE TO THE EXCLUSIVE RIGHT TO USE LOGISTICS, APART FROM THE MARK AS SHOWN.

FOR INVENTORY MANAGEMENT SERVICES IN THE FIELD OF ELECTRONIC EQUIPMENT, COMPUTER HARDWARE, COMPUTER SOFTWARE, AND RELATED PERIPHERAL DEVICES; BUSINESS MANAGEMENT SERVICES IN THE FIELD OF MATERIALS AND SERVICES MANAGEMENT AND PROCUREMENT FOR OTHERS, NAMELY, PURCHASING ELECTRONIC EQUIPMENT, COMPUTER HARDWARE, RELATED PERIPHERAL DEVICES, SOFTWARE AND TELEPHONY SERVICES FOR OTHERS, BUSINESS MANAGEMENT SERVICES, NAMELY, MANAGING LOGISTICS AND SUPPLY CHAIN SERVICES FOR OTHERS; INFORMATION MANAGEMENT SERVICES, NAMELY, MONITORING AND TRACKING PACKAGE AND PRODUCT SHIPMENTS, AND TRACKING SALES VOLUME (U.S. CLS. 100, 101 AND 102).

CAROL SPILS, EXAMINING ATTORNEY

CLASS 35—(Continued).

SN 76-514,335. BRUNSWICK BOWLING & BILLIARDS CORPORATION, MUSKEGON, MI. FILED 5-15-2003.

BRUNSWICK HOME & BILLIARD

OWNER OF U.S. REG. NOS. 807,079, 2,648,401 AND OTHERS.

NO CLAIM IS MADE TO THE EXCLUSIVE RIGHT TO USE "HOME & BILLIARD", APART FROM THE MARK AS SHOWN.

FOR RETAIL STORE SERVICES FEATURING BILLIARDS EQUIPMENT (U.S. CLS. 100, 101 AND 102).

KEVON CHISOLM, EXAMINING ATTORNEY

SN 76-514,422. AMERICASDOCTOR, INC., GURNEE, IL. FILED 5-15-2003.

ESSENTIAL PATIENT RECRUITMENT

NO CLAIM IS MADE TO THE EXCLUSIVE RIGHT TO USE PATIENT RECRUITMENT, APART FROM THE MARK AS SHOWN.

FOR PATIENT RECRUITMENT SERVICES, NAMELY, RECRUITING PATIENTS FOR PARTICIPATION IN CLINICAL DRUG TRIALS, CLINICAL RESEARCH, AND MEDICAL STUDIES (U.S. CLS. 100, 101 AND 102).

RUDY R. SINGLETON, EXAMINING ATTORNEY

SN 76-517,085. FL FOOD LION, INC., SALISBURY, NC. FILED 5-27-2003.



OWNER OF U.S. REG. NOS. 1,427,887, 1,558,705 AND OTHERS.

NO CLAIM IS MADE TO THE EXCLUSIVE RIGHT TO USE "FOOD" AND "SPECIAL ORDER SERVICE", APART FROM THE MARK AS SHOWN.

FOR ONLINE RETAIL GROCERY STORE SERVICES (U.S. CLS. 100, 101 AND 102).

ANN LINNEHAN, EXAMINING ATTORNEY

CLASS 35—(Continued).

SN 76-518,826. CHAD ALLISON DESIGNS, L.L.C., SCOTTSDALE, AZ. FILED 6-2-2003.

CHAD ALLISON DESIGNS

NO CLAIM IS MADE TO THE EXCLUSIVE RIGHT TO USE "DESIGNS", APART FROM THE MARK AS SHOWN.

THE NAME CHAD ALLISON DOES NOT IDENTIFY A LIVING INDIVIDUAL.

FOR RETAIL STORE SERVICES FEATURING JEWELRY AND COMPUTERIZED ON-LINE RETAIL SERVICES FEATURING JEWELRY (U.S. CLS. 100, 101 AND 102).

FIRST USE 9-21-1999; IN COMMERCE 3-6-2000.

KELLEY WELLS, EXAMINING ATTORNEY

SN 76-519,973. AWARDS.COM, LLC, FORT LEE, NJ. FILED 5-23-2003.

INSPIRE SOMEONE

OWNER OF U.S. REG. NO. 2,756,615.

FOR IMPLEMENTATION OF INCENTIVE PROGRAMS FOR THE EMPLOYEES OF OTHERS' BUSINESSES THROUGH THE CREATION AND DISTRIBUTION OF AWARDS AND INCENTIVE PRODUCTS; RETAIL STORE SERVICES AND COMPUTERIZED ONLINE RETAIL STORE SERVICES FEATURING PRODUCTS RELATED TO PROMOTIONS, TRAINING, MOTIVATION, LEADERSHIP, MANAGEMENT, INCENTIVES AND RECOGNITION; COUNSELING IN THE FIELDS OF AWARDS AND EMPLOYEE MOTIVATION; AND, PROVIDING INFORMATION IN THE FIELDS OF INCENTIVES AND EMPLOYEE RECOGNITION VIA WEBSITES ON A GLOBAL COMPUTER NETWORK (U.S. CLS. 100, 101 AND 102).

DOMINIC J. FERRAIUOLO, EXAMINING ATTORNEY

CLASS 35—(Continued).

SN 76-519,974. AWARDS.COM, LLC, FORT LEE, NJ. FILED 5-23-2003.

awards.com

NO CLAIM IS MADE TO THE EXCLUSIVE RIGHT TO USE "AWARDS" AND "COM", APART FROM THE MARK AS SHOWN.

FOR DEVELOPMENT AND IMPLEMENTATION OF PROMOTIONAL CAMPAIGNS AND INCENTIVE PROGRAMS FOR BUSINESS THROUGH THE CREATION AND DISTRIBUTION OF PROMOTIONAL MATERIALS, COMMENDATIONS, AND INCENTIVE PRODUCTS; RETAIL STORE SERVICES AND COMPUTERIZED ONLINE RETAIL STORE SERVICES FEATURING PUBLICATIONS, PROMOTIONAL PRODUCTS, PERSONAL GIFTS, BUSINESS GIFTS, CORPORATE GIFTS, ORGANIZATIONAL GIFTS, COMMENDATIONS, TROPHIES AND PRODUCTS RELATED TO PROMOTIONS, TRAINING, MOTIVATION, LEADERSHIP, MANAGEMENT, INCENTIVES AND RECOGNITION; COUNSELING IN THE FIELDS OF COMMENDATIONS, LEADERSHIP, MANAGEMENT, TRAINING, ADVERTISING, PROMOTION, MOTIVATION, INCENTIVES AND RECOGNITION; AND PROVIDING INFORMATION IN THE FIELDS OF MANAGEMENT, TRAINING, ADVERTISING, PROMOTION, MOTIVATION, INCENTIVES AND RECOGNITION VIA WEBSITES ON A GLOBAL COMPUTER NETWORK (U.S. CLS. 100, 101 AND 102).

FIRST USE 7-1-2002; IN COMMERCE 7-1-2002.
DOMINIC J. FERRAIUOLO, EXAMINING ATTORNEY

SN 76-520,922. AMERICASDOCTOR, INC., GURNEE, IL. FILED 6-9-2003.

**ASSURED PERFORMANCE
YOU CAN OWN**

FOR RECRUITMENT OF PATIENTS AND CONSUMERS FOR MEDICAL AND MARKET RESEARCH STUDIES AND/OR CLINICAL TRIALS (U.S. CLS. 100, 101 AND 102).

STEVEN BERK, EXAMINING ATTORNEY

SN 76-523,095. AMERICAN RIVERS, INC., WASHINGTON, DC. FILED 6-13-2003.

AMERICAN RIVERS

OWNER OF U.S. REG. NOS. 1,519,356 AND 1,531,238.
SEC. 2(F).
FOR ASSOCIATION SERVICES, NAMELY, PROMOTING THE INTERESTS OF PEOPLE INVOLVED IN PROTECTION AND RESTORATION OF RIVERS, STREAMS, WATERWAYS AND SOURCES OF FRESH WATER; AND PROMOTING PUBLIC AWARENESS OF AND INTEREST IN PROTECTING AND RESTORING SUCH WATER BODIES (U.S. CLS. 100, 101 AND 102).

FIRST USE 0-0-1986; IN COMMERCE 0-0-1986.
STANLEY I. OSBORNE, EXAMINING ATTORNEY

CLASS 35—(Continued).

SN 76-525,198. INTERNATIONAL YOUTH FOUNDATION, BALTIMORE, MD. FILED 6-24-2003.

**INTERNATIONAL YOUTH
FOUNDATION**

OWNER OF U.S. REG. NOS. 2,452,880, 2,452,881 AND 2,452,882.

NO CLAIM IS MADE TO THE EXCLUSIVE RIGHT TO USE FOUNDATION, APART FROM THE MARK AS SHOWN.

SEC. 2(F).

FOR ASSOCIATION SERVICES, NAMELY, PROMOTING THE INTERESTS OF HUMAN DEVELOPMENT FOR CHILDREN AND YOUTH; PROMOTING PUBLIC AWARENESS OF THE NEEDS OF CHILDREN AND YOUTH; PROVIDING ASSISTANCE TO CHILDREN AND YOUTH TO IDENTIFY AND ACCESS MARKET-PLACE RESOURCES FOR HUMAN DEVELOPMENT (U.S. CLS. 100, 101 AND 102).

FIRST USE 0-0-1997; IN COMMERCE 0-0-1997.

SUSAN LESLIE DUBOIS, EXAMINING ATTORNEY

SN 76-529,746. ICOM INFORMATION & COMMUNICATIONS INC., TORONTO, CANADA, FILED 7-15-2003.

VARISERT

OWNER OF CANADA REG. NO. TMA560734, DATED 4-24-2002, EXPIRES 4-24-2017.

OWNER OF U.S. REG. NO. 2,078,418.

FOR DIRECT MAIL ADVERTISING, NAMELY, DIRECT MAIL INSERTING SERVICES AND VARIABLE SELECTIVE DIRECT MAIL INSERTION SERVICES (U.S. CLS. 100, 101 AND 102).

GEOFFREY FOSDICK, EXAMINING ATTORNEY

SN 76-534,333. KIDS NEED US NOW, LLC, WOBURN, MA. FILED 7-22-2003.

ANTI-MOBILE

FOR MOBILE VENDOR SERVICES FEATURING FOOD (U.S. CLS. 100, 101 AND 102).

JAMES GRIFFIN, EXAMINING ATTORNEY

CLASS 35—(Continued).

SN 76-534,697. STREETMAKER, INC., DALLAS, TX. FILED 8-4-2003.

StreetMaker



FOR BUSINESS MARKETING CONSULTING SERVICES; BUSINESS CONSULTATION; BUSINESS DEVELOPMENT SERVICES, NAMELY PROVIDING START-UP SUPPORT FOR BUSINESSES OF OTHERS; BUSINESS PLANNING; CONDUCTING BUSINESS AND MARKET RESEARCH; AND PRODUCT MERCHANDISING (U.S. CLS. 100, 101 AND 102).

FIRST USE 3-0-2000; IN COMMERCE 3-0-2000.
ELLEN B. AWRICH, EXAMINING ATTORNEY

CLASS 35—(Continued).

SN 76-535,627. WESTCOAST EXCLUSIVE, LLC, CULVER CITY, CA. FILED 8-8-2003.

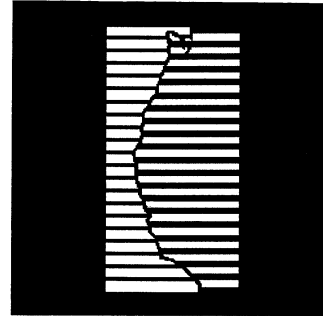

SN 76-535,099. RED ANGUS ASSOCIATION OF AMERICA, DENTON, TX. FILED 8-6-2003.

Pro-Cow

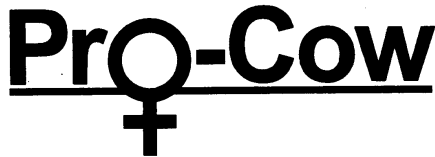

FOR ASSOCIATION SERVICES, NAMELY, PROMOTING THE INTERESTS OF CATTLE RAISERS AND THE CATTLE REPLACEMENT INDUSTRY; AND MARKETING SERVICES, NAMELY, DIRECT MARKET ADVERTISING FOR OTHERS IN THE FIELD OF CATTLE REPLACEMENT (U.S. CLS. 100, 101 AND 102).

FIRST USE 7-0-2003; IN COMMERCE 7-0-2003.
REBECCA SMITH, EXAMINING ATTORNEY

NO CLAIM IS MADE TO THE EXCLUSIVE RIGHT TO USE THE REPRESENTATION OF THE DESIGN OF THE WEST COAST OF THE UNITED STATES, APART FROM THE MARK AS SHOWN.

THE LINING SHOWN IN THE DRAWING IS A FEATURE OF THE MARK AND NOT INTENDED TO INDICATE COLOR.

THE MARK CONSISTS OF A DESIGN WHICH INCLUDES A REPRESENTATION OF THE WEST COAST OF THE UNITED STATES FORMED BY A COMBINATION OF TWO DIFFERENT HORIZONTAL LININGS, ALL WITHIN A RECTANGLE.

FOR ARRANGING AND CONDUCTING TRADE SHOWS IN THE FIELD OF APPAREL (U.S. CLS. 100, 101 AND 102).

FIRST USE 3-27-2002; IN COMMERCE 3-27-2002.
MARY ROSSMAN, EXAMINING ATTORNEY

SN 76-535,526. POWELL, MICHAEL BENJAMIN, CLARKSVILLE, AR. FILED 7-25-2003.

BIG BEN ROCKS

FOR WHOLESALE ORDERING SERVICES FEATURING STONE FOR RESIDENTIAL AND COMMERCIAL USE (U.S. CLS. 100, 101 AND 102).

FIRST USE 1-19-2002; IN COMMERCE 1-19-2002.
CAROLINE WEIMER, EXAMINING ATTORNEY

SN 76-537,145. EVERGREEN SPRINKLER SYSTEMS, INC., MIAMI, FL. FILED 8-13-2003.

EVERGREEN

SN 76-535,534. WILLOW TEX, INC., LONG ISLAND CITY, NY. FILED 7-24-2003.

IZIT

FOR DISTRIBUTORSHIP SERVICES IN THE FIELD OF TEXTILES (U.S. CLS. 100, 101 AND 102).

FIRST USE 0-0-1991; IN COMMERCE 0-0-1991.
SONYA STEPHENS, EXAMINING ATTORNEY

OWNER OF U.S. REG. NO. 2,408,695.
FOR WHOLESALE DISTRIBUTORSHIP SERVICES FEATURING LAWN SPRINKLERS AND IRRIGATION SYSTEMS AND ALL INDIVIDUAL COMPONENTS THEREOF AND ACCESSORIES THEREFORE (U.S. CLS. 100, 101 AND 102).

PAM WILLIS, EXAMINING ATTORNEY

CLASS 35—(Continued).

SN 76-538,623. BRAIN WAREHOUSE, LLC, SAN DIEGO, CA. FILED 8-20-2003.

LEADWAREHOUSE

FOR MARKETING SERVICES, NAMELY, PROVIDING QUALIFIED SALES LEADS TO OTHERS; ONLINE REFERRAL SERVICES TO PROFESSIONAL AND NON-PROFESSIONAL SERVICES PROVIDERS AND RETAILERS AND WHOLESALERS FEATURING A WIDE VARIETY OF GENERAL MERCHANDISE AND CONSUMER MERCHANDISE; COMPUTER SERVICES, NAMELY, PROVIDING A DIRECTORY OF PROFESSIONAL AND NON-PROFESSIONAL SERVICES PROVIDERS AND RETAILERS AND WHOLESALERS FEATURING A WIDE VARIETY OF GENERAL MERCHANDISE AND CONSUMER MERCHANDISE INFORMATION FOR OBTAINING DATA AND INFORMATION FROM OTHERS VIA THE INTERNET; ADVERTISING SERVICES, NAMELY, PROVIDING ONLINE MARKETING SERVICES IN THE NATURE OF BANNER ADVERTISING, DISPLAY ADVERTISING, LINK EXCHANGES AND SEARCH ENGINE PLACEMENT SERVICES IN THE FIELD OF PROFESSIONAL AND NON-PROFESSIONAL SERVICES PROVIDERS AND RETAILERS AND WHOLESALERS FEATURING A WIDE VARIETY OF GENERAL MERCHANDISE AND CONSUMER MERCHANDISE (U.S. CLS. 100, 101 AND 102).

FIRST USE 8-15-2003; IN COMMERCE 8-15-2003.
TRACY CROSS, EXAMINING ATTORNEY

SN 76-538,806. SHOWS INTERNATIONAL, INC., WESTLAKE VILLAGE, CA. FILED 8-20-2003.

KOSHER WORLD

NO CLAIM IS MADE TO THE EXCLUSIVE RIGHT TO USE "KOSHER", APART FROM THE MARK AS SHOWN.

FOR ARRANGING AND CONDUCTING TRADE SHOW EXHIBITIONS IN THE FIELD OF KOSHER PRODUCTS, SPECIALTY FOOD ITEMS, AND PRODUCTS RELATED TO SPECIFIC DEMOGRAPHICS OR RELIGIOUS GROUPS (U.S. CLS. 100, 101 AND 102).

FIRST USE 4-24-2003; IN COMMERCE 4-24-2003.
LINDA M. KING, EXAMINING ATTORNEY

SN 76-540,095. CANDIDATE RESOURCES, INC., GRAND PRAIRIE, TX. FILED 8-26-2003.

THE SCOREBOARD

FOR TESTING TO DETERMINE EMPLOYMENT SKILLS (U.S. CLS. 100, 101 AND 102).

FIRST USE 8-7-1990; IN COMMERCE 8-7-1990.
ELIZABETH PIGNATELLO, EXAMINING ATTORNEY

CLASS 35—(Continued).

SN 76-540,096. CANDIDATE RESOURCES, INC., GRAND PRAIRIE, TX. FILED 8-26-2003.

THE GUARDIAN

FOR TESTING TO DETERMINE EMPLOYMENT SKILLS (U.S. CLS. 100, 101 AND 102).

FIRST USE 6-1-1991; IN COMMERCE 7-29-1991.
ELIZABETH PIGNATELLO, EXAMINING ATTORNEY

SN 76-540,719. COPART, INC., FAIRFIELD, CA. FILED 8-15-2003.



THE MARK CONSISTS OF THE YELLOW LETTER V, A RED LETTER B, AND A BLUE NUMERIC 2, ON A GREEN OVAL BACKGROUND.

FOR AUCTIONEERING, NAMELY AUTOMOBILE AUCTIONS; INTERNET AUCTIONS FEATURING NEW, USED AND SALVAGE VEHICLES; AUTOMOBILE SALVAGE AGENTS; WHOLESALE DISTRIBUTORSHIPS AND RETAIL STORES FEATURING NEW, USED, AND SALVAGE VEHICLES VIA THE INTERNET (U.S. CLS. 100, 101 AND 102).

BARBARA RUTLAND, EXAMINING ATTORNEY

SN 76-541,840. RSC THE QUALITY MEASUREMENT COMPANY, EVANSVILLE, IN. FILED 8-29-2003.

STARBOARD

FOR RESEARCH AND CONSULTING SERVICES IN EVALUATING AND MEASURING CONSUMER REACTION TO AND THE EFFECTIVENESS OF ADVERTISING; PERFORMING CONSUMER RESEARCH ON TELEVISION ADVERTISING (U.S. CLS. 100, 101 AND 102).

FIRST USE 5-12-2003; IN COMMERCE 5-12-2003.
M. E. BODSON, EXAMINING ATTORNEY

SN 76-542,496. RECEPTASIGN, LLC, LONG ISLAND CITY, NY. FILED 9-4-2003.

SO CLEAN YOU CAN LEAN

FOR RENTAL OF ADVERTISING SPACE IN THE NATURE OF BILLBOARDS ON OUTDOOR TRASH RECEPTACLES (U.S. CLS. 100, 101 AND 102).

CAROLINE WOOD, EXAMINING ATTORNEY

CLASS 35—(Continued).

SN 76-542,719. ONSITE COMPANIES, INC., HANOVER, MD. FILED 9-8-2003.

AEROTEK AVIATION

OWNER OF U.S. REG. NOS. 1,557,200, 2,741,095 AND OTHERS.

NO CLAIM IS MADE TO THE EXCLUSIVE RIGHT TO USE AVIATION, APART FROM THE MARK AS SHOWN.

FOR EMPLOYMENT COUNSELING, PLACEMENT AND RECRUITING SERVICES RELATING TO THE TEMPORARY AND PERMANENT PLACEMENT OF PERSONNEL (U.S. CLS. 100, 101 AND 102).

INGA ERVIN, EXAMINING ATTORNEY

SN 76-543,601. WOMEN TAKING CARE OF BUSINESS, INC., ST. PETERSBURG, FL. FILED 9-10-2003.

WTCB WOMEN TAKING CARE OF BUSINESS INC.

NO CLAIM IS MADE TO THE EXCLUSIVE RIGHT TO USE WOMEN AND INC., APART FROM THE MARK AS SHOWN.

FOR SALES AND MARKETING CONSULTING FOR SMALL AND MID SIZED BUSINESSES (U.S. CLS. 100, 101 AND 102).

FIRST USE 9-1-2003; IN COMMERCE 9-1-2003.
SCOTT OSICK, EXAMINING ATTORNEY

SN 76-545,580. INTEGRATED HOUSEKEEPING MANAGEMENT, INC., FISHERS, IN. FILED 9-17-2003.

IHM FACILITY SERVICES

OWNER OF U.S. REG. NOS. 1,323,640 AND 1,526,308.
NO CLAIM IS MADE TO THE EXCLUSIVE RIGHT TO USE FACILITY SERVICES, APART FROM THE MARK AS SHOWN.

FOR MANAGEMENT CONSULTING SERVICES DIRECTED PARTICULARLY TO AID INDUSTRY AND MANAGING PLANT HOUSEKEEPING AND JANITORIAL WORKFORCES (U.S. CLS. 100, 101 AND 102).

FIRST USE 4-30-1998; IN COMMERCE 4-30-1998.
CAROLYN GRAY, EXAMINING ATTORNEY

SN 76-546,472. DEDICATED NET ACCESS, BEVERLY HILLS, CA. FILED 9-23-2003.

RATE

FOR CONDUCTING BUSINESS AND MARKETING RESEARCH SERVICES (U.S. CLS. 100, 101 AND 102).
PAM WILLIS, EXAMINING ATTORNEY

CLASS 35—(Continued).

SN 76-546,632. VALUE CITY OF MICHIGAN, INC., WESTLAND, MI. FILED 9-24-2003.

MALLBUSTERS!* *GET TONS MORE STUFF THAN YOU GET AT THE MALL!

FOR RETAIL DEPARTMENT STORE SERVICES (U.S. CLS. 100, 101 AND 102).

FIRST USE 7-20-2003; IN COMMERCE 7-20-2003.
RUDY R. SINGLETON, EXAMINING ATTORNEY

SN 76-547,776. PROFITLOGIC, INC., CAMBRIDGE, MA. FILED 9-29-2003.



FOR BUSINESS MANAGEMENT CONSULTING SERVICES FOR OTHERS IN THE FIELD OF REVENUE MANAGEMENT, YIELD MANAGEMENT, PROFIT OPTIMIZATION, MERCHANDIZING, INVENTORY OPTIMIZATION AND PRICING AND INVENTORY ANALYSES (U.S. CLS. 100, 101 AND 102).

FIRST USE 1-3-2000; IN COMMERCE 1-3-2000.
ALICIA COLLINS, EXAMINING ATTORNEY

SN 76-548,734. BRICK INDUSTRY ASSOCIATION, RESTON, VA. FILED 10-2-2003.

REAL HOMES ARE MADE OF BRICK

FOR PROMOTING THE INTERESTS OF THE CLAY BRICK PRODUCT INDUSTRY BY DISSEMINATING ADVERTISING AND PROMOTIONAL MATERIALS AND CONSUMER AND INDUSTRY INFORMATION ABOUT CLAY BRICK AND CLAY BRICK PRODUCTS (U.S. CLS. 100, 101 AND 102).

FIRST USE 3-1-2003; IN COMMERCE 3-1-2003.
KEVON CHISOLM, EXAMINING ATTORNEY

CLASS 35—(Continued).

SN 76-549,178. VIRTUAL MEETING STRATEGIES, INC., INDIANAPOLIS, IN. FILED 9-22-2003.

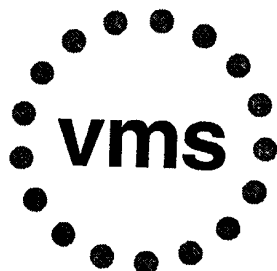

FOR BUSINESS SERVICES, NAMELY, ARRANGING AND CONDUCTING BUSINESS MEETINGS AND SEMINARS (U.S. CLS. 100, 101 AND 102).
FIRST USE 5-1-2003; IN COMMERCE 5-1-2003.
CIMMERIAN COLEMAN, EXAMINING ATTORNEY

SN 76-549,273. SAATCHI & SAATCHI NORTH AMERICA, INC., NEW YORK, NY. FILED 10-6-2003.

CONSUMEROLOGY

FOR CONSULTING SERVICES IN THE FIELDS OF MARKETING, ADVERTISING, AND CONSUMER RESEARCH; ADVERTISING AGENCY SERVICES (U.S. CLS. 100, 101 AND 102).
DORITT L. CARROLL, EXAMINING ATTORNEY

SN 76-550,227. HRM OUTSOURCING, INC., SAINT LOUIS, MO. FILED 10-9-2003.



NO CLAIM IS MADE TO THE EXCLUSIVE RIGHT TO USE "SENIOR", APART FROM THE MARK AS SHOWN.
THE MARK CONSISTS OF THE WORDS "SENIOR FORCE" IMPOSED ON AN OVAL.
FOR EMPLOYMENT CONSULTING, RECRUITING AND PLACEMENT SERVICES (U.S. CLS. 100, 101 AND 102).
LAURA KOVAISKY, EXAMINING ATTORNEY

CLASS 35—(Continued).

SN 76-550,383. PUPPY TOWN USA INC., PLYMOUTH MEETING, PA. FILED 9-22-2003.



FOR RETAIL STORE SERVICES FEATURING PETS, PET SUPPLIES, AND DECORATIVE ACCESSORIES (U.S. CLS. 100, 101 AND 102).
TONI HICKEY, EXAMINING ATTORNEY

SN 76-550,526. VERTICAL STORES, CORP., SAMMAMISH, WA. FILED 9-22-2003.

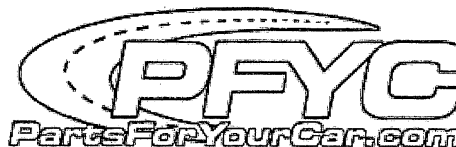

OWNER OF U.S. REG. NO. 2,771,407.
NO CLAIM IS MADE TO THE EXCLUSIVE RIGHT TO USE "PARTS FOR YOUR CAR.COM", APART FROM THE MARK AS SHOWN.
FOR ON-LINE RETAIL STORE SERVICES FEATURING AUTOMOBILE PARTS (U.S. CLS. 100, 101 AND 102).
FIRST USE 6-7-2002; IN COMMERCE 6-7-2002.
KELLY BOULTON, EXAMINING ATTORNEY

SN 76-551,049. MOORING TAX ASSET GROUP, LLC, VIENNA, VA. FILED 9-22-2003.

LIEN TAX BY MOORING

NO CLAIM IS MADE TO THE EXCLUSIVE RIGHT TO USE "LIEN TAX", APART FROM THE MARK AS SHOWN.
FOR TAX LIEN MANAGEMENT SERVICES (U.S. CLS. 100, 101 AND 102).
FIRST USE 6-1-2003; IN COMMERCE 6-1-2003.
DARRYL SPRUILL, EXAMINING ATTORNEY

CLASS 35—(Continued).

SN 76-551,756. ONSITE COMPANIES, INC., HANOVER, MD. FILED 10-14-2003.

THE SCIENCE OF EFFICIENT WORK

FOR EMPLOYMENT AGENCIES, EMPLOYMENT COUNSELING, AND RECRUITING SERVICES RELATING TO THE TEMPORARY AND PERMANENT PLACEMENT OF SCIENTIFIC, ENGINEERING, COMPUTER, DATA PROCESSING, MANUFACTURING, TECHNICAL, LIGHT INDUSTRIAL, COMPUTER, AND CLERICAL PERSONNEL (U.S. CLS. 100, 101 AND 102).
MARK T. MULLEN, EXAMINING ATTORNEY

SN 76-552,023. ORTHODONTIC CENTERS OF AMERICA, INC., METAIRIE, LA. FILED 10-15-2003.

OCA

FOR BUSINESS MANAGEMENT OF ORTHODONTIC OFFICES, BUSINESS MANAGEMENT CONSULTATION IN THE FIELD OF ORTHODONTIC OFFICES AND PROVIDING TECHNICAL ASSISTANCE IN CONNECTION WITH THE ESTABLISHMENT AND/OR OPERATION OF ORTHODONTIC OFFICES (U.S. CLS. 100, 101 AND 102).
FIRST USE 3-15-2003; IN COMMERCE 3-15-2003.
INGA ERVIN, EXAMINING ATTORNEY

SN 76-552,024. ORTHODONTIC CENTERS OF AMERICA, INC., METAIRIE, LA. FILED 10-15-2003.



FOR BUSINESS MANAGEMENT OF ORTHODONTIC OFFICES, BUSINESS MANAGEMENT CONSULTATION IN THE FIELD OF ORTHODONTIC OFFICES AND PROVIDING TECHNICAL ASSISTANCE IN CONNECTION WITH THE ESTABLISHMENT AND/OR OPERATION OF ORTHODONTIC OFFICES (U.S. CLS. 100, 101 AND 102).
FIRST USE 3-15-2003; IN COMMERCE 3-15-2003.
INGA ERVIN, EXAMINING ATTORNEY

CLASS 35—(Continued).

SN 76-552,257. HORIZON MANAGEMENT SERVICES, INC., ASHEVILLE, NC. FILED 10-17-2003.

ORIZON SEARCH SOLUTIONS

NO CLAIM IS MADE TO THE EXCLUSIVE RIGHT TO USE SEARCH, APART FROM THE MARK AS SHOWN.
FOR PERSONNEL RECRUITMENT AND PLACEMENT SERVICES (U.S. CLS. 100, 101 AND 102).
TARAH HARDY, EXAMINING ATTORNEY

SN 76-552,369. ROCAWEAR LICENSING, LLC, CLIFTON, NJ. FILED 9-26-2003.



OWNER OF U.S. REG. NOS. 2,434,124, 2,633,943 AND OTHERS.
NO CLAIM IS MADE TO THE EXCLUSIVE RIGHT TO USE "WEAR", APART FROM THE MARK AS SHOWN.
FOR RETAIL STORE SERVICES IN THE FIELD OF GENERAL MERCHANDISE; NAMELY, MEN'S, WOMEN'S AND CHILDREN'S CLOTHING AND FOOTWEAR (U.S. CLS. 100, 101 AND 102).
GIANCARLO CASTRO, EXAMINING ATTORNEY

SN 76-553,225. LANCO, INC., WILMINGTON, DE. FILED 10-21-2003.

STYLE POINTS

FOR ADMINISTRATION OF AN INCENTIVE PROGRAM WHEREBY PARTICIPANTS ACCUMULATE POINTS FOR PURCHASES WHICH MAY BE REDEEMED FOR A DISCOUNT TOWARDS THE PURCHASE OF CONSUMER GOODS (U.S. CLS. 100, 101 AND 102).
CHARLES JOYNER, EXAMINING ATTORNEY

SN 76-553,246. RETAIL STRATEGIC ALLIANCES, INC., CHESTER, NY. FILED 10-22-2003.

TAILGATEGUY.COM

FOR ON-LINE RETAIL STORE SERVICES IN THE FIELD OF OUTDOOR AND PICNIC PRODUCTS (U.S. CLS. 100, 101 AND 102).
FIRST USE 6-1-2002; IN COMMERCE 6-1-2002.
CAROLINE WOOD, EXAMINING ATTORNEY

CLASS 35—(Continued).

SN 76-553,384. KOHL'S ILLINOIS, INC., AURORA, IL. FILED 10-3-2003.

BEFORE THE RINGS, THE EVERYDAY THINGS

FOR GIFT REGISTRY SERVICES, NAMELY, A RETAIL DEPARTMENT STORE GIFT REGISTRY (U.S. CLS. 100, 101 AND 102).
KEVON CHISOLM, EXAMINING ATTORNEY

CLASS 35—(Continued).

SN 76-554,739. TECHNOMIC, INC., CHICAGO, IL. FILED 10-14-2003.

SmartSearch

FOR MARKET INTELLIGENCE RESEARCH SERVICES DIRECTED TO THE FOOD SERVICE INDUSTRY (U.S. CLS. 100, 101 AND 102).
FIRST USE 8-1-2003; IN COMMERCE 8-1-2003.
JULIE WATSON, EXAMINING ATTORNEY

SN 76-553,784. LUMENS, INC., SACRAMENTO, CA. FILED 10-23-2003.

LUMENS

FOR RETAIL STORE SERVICES, MAIL ORDER CATALOG SERVICES, AND ONLINE RETAIL STORE SERVICES FEATURING LIGHTING AND LIGHTING PRODUCTS AND ACCESSORIES (U.S. CLS. 100, 101 AND 102).
ANN E. SAPPENFIELD, EXAMINING ATTORNEY

SN 76-554,803. TOPCO ASSOCIATES, LLC, SKOKIE, IL. FILED 10-14-2003.

DOLLAR ISLE

FOR COOPERATIVE ADVERTISING AND MARKETING OF GROCERY STORE PRODUCTS (U.S. CLS. 100, 101 AND 102).
JULIE WATSON, EXAMINING ATTORNEY

SN 76-553,785. LUMENS, INC., SACRAMENTO, CA. FILED 10-23-2003.

LIGHT AND LIVING

NO CLAIM IS MADE TO THE EXCLUSIVE RIGHT TO USE "LIGHT", APART FROM THE MARK AS SHOWN.
FOR RETAIL STORE SERVICES, MAIL ORDER CATALOG SERVICES, AND ONLINE RETAIL STORE SERVICES FEATURING LIGHTING AND LIGHTING PRODUCTS AND ACCESSORIES (U.S. CLS. 100, 101 AND 102).
ANN E. SAPPENFIELD, EXAMINING ATTORNEY

SN 76-555,034. FEMINISTS FOR LIFE OF AMERICA, WASHINGTON, DC. FILED 10-29-2003.

IT'S TIME TO QUESTION ABORTION.

FOR ASSOCIATION SERVICES, NAMELY PROMOTING THE INTERESTS OF TRUE EQUALITY FOR ALL HUMAN BEINGS, PARTICULARLY WOMEN AND UNBORN CHILDREN (U.S. CLS. 100, 101 AND 102).
FIRST USE 4-30-2003; IN COMMERCE 4-30-2003.
MATTHEW KLINE, EXAMINING ATTORNEY

SN 76-554,022. SHOTWELL, JAY, SUNNYVALE, CA. FILED 10-6-2003.

DUPUBLIS

FOR PUBLIC RELATIONS SERVICES (U.S. CLS. 100, 101 AND 102).
ELISSA GARBER KON, EXAMINING ATTORNEY

SN 76-556,903. WINSTON-SALEM BUSINESS, INC., WINSTON-SALEM, NC. FILED 10-22-2003.

WHERE BUSINESS LIVES

FOR PROMOTING ECONOMIC DEVELOPMENT AND BUSINESS GROWTH IN WINSTON-SALEM, NORTH CAROLINA SPECIFICALLY, AND IN FORSYTH COUNTY, NORTH CAROLINA GENERALLY; AND BUSINESS RECRUITMENT SERVICES (U.S. CLS. 100, 101 AND 102).
FIRST USE 8-0-2003; IN COMMERCE 8-0-2003.
HENRY S. ZAK, EXAMINING ATTORNEY

CLASS 35—(Continued).

SN 76-557,248. MURRAY'S DISCOUNT AUTO STORES, INC., BELLEVILLE, MI. FILED 11-5-2003.

MURRAY'S AUTO PARTS

THE MARK CONSISTS OF STANDARD CHARACTERS WITHOUT CLAIM TO ANY PARTICULAR FONT, STYLE, SIZE, OR COLOR.

OWNER OF U.S. REG. NOS. 1,506,561 AND 1,601,501.

NO CLAIM IS MADE TO THE EXCLUSIVE RIGHT TO USE "AUTO PARTS", APART FROM THE MARK AS SHOWN.

FOR RETAIL AUTOMOTIVE PARTS STORE SERVICES (U.S. CLS. 100, 101 AND 102).

FIRST USE 1-1-2001; IN COMMERCE 1-1-2001.
DARRYL SPRUILL, EXAMINING ATTORNEY

SN 76-574,702. OFFICE OF 21ST CENTURY WORKFORCE, WASHINGTON, DC. FILED 2-9-2004.

WOMENENTREPRENEURSHIP IN THE 21ST CENTURY

FOR PROVIDING INFORMATION IN THE FIELD OF WORKING WOMEN (U.S. CLS. 100, 101 AND 102).
DARLENE BULLOCK, EXAMINING ATTORNEY

SN 78-014,910. PREMIER LIFESTYLES INTERNATIONAL CORPORATION, NEWHALL, CA. FILED 6-29-2000.

POWER MERCHANT PROGRAM

NO CLAIM IS MADE TO THE EXCLUSIVE RIGHT TO USE "MERCHANT PROGRAM", APART FROM THE MARK AS SHOWN.

FOR ELECTRONIC WHOLESALE DISTRIBUTORSHIP CATALOG SERVICES PROVIDED TO MERCHANTS FEATURING A WIDE RANGE OF CONSUMER GOODS (U.S. CLS. 100, 101 AND 102).

FIRST USE 7-8-1999; IN COMMERCE 7-8-1999.
DOMINIC J. FERRAIUOLO, EXAMINING ATTORNEY

CLASS 35—(Continued).

SN 78-019,906. TAMTAM, INC., LAKEWOOD, CO. FILED 8-7-2000.



FOR INTERNATIONAL MARKET ANALYSIS, BUSINESS RESEARCH, BUSINESS CONSULTATION, AND PROVIDING A WEB SITE ON GLOBAL COMPUTER NETWORKS FEATURING ADVERTISING SPACE AND INFORMATION IN THE FIELDS OF INTERNATIONAL BUSINESS MARKETING, BUSINESS RESEARCH AND BUSINESS CONSULTATION (U.S. CLS. 100, 101 AND 102).

FIRST USE 7-21-2000; IN COMMERCE 7-21-2000.
APRIL L. RADEMACHER, EXAMINING ATTORNEY

SN 78-067,909. GAGE MARKETING GROUP, LLC, MINNEAPOLIS, MN. FILED 6-7-2001.

WHAT MOVES YOU

FOR PROMOTING THE GOODS AND SERVICES OF OTHERS THROUGH THE DISTRIBUTION OF PRINTED MATERIAL, ONLINE MATERIAL AND SAMPLES, THROUGH PROMOTIONAL CONTESTS, AND THROUGH CONSUMER OFFERS; MARKETING SERVICES; NAMELY, PERFORMING MARKET RESEARCH AND ANALYSIS, MARKETING CONSULTING, DESIGN AND DEVELOPMENT OF PROMOTIONAL MARKETING COMMUNICATIONS AND COLLATERAL MATERIAL PACKAGING AND DISTRIBUTION, TELEMARKETING, MAILING LIST MANAGEMENT, AND PROMOTIONAL ORDER FULFILLMENT SERVICES WITH RESPECT TO COUPONS, REBATES, REFUNDS, SAMPLES, CHANCE PROMOTIONS, AND CONSUMER OFFERS (U.S. CLS. 100, 101 AND 102).
CATHERINE CAIN, EXAMINING ATTORNEY

SN 78-085,830. TRUSERV CORPORATION, CHICAGO, IL. FILED 9-27-2001.

INSPIRATION NOW AVAILABLE IN A GALLON CAN

FOR RETAIL HARDWARE STORE SERVICES (U.S. CLS. 100, 101 AND 102).

FIRST USE 4-1-2001; IN COMMERCE 4-1-2001.
MARIA-VICTORIA SUAREZ, EXAMINING ATTORNEY

CLASS 35—(Continued).

SN 78-125,785. 1-800 CONTACTS, INC., DRAPER, UT. FILED 5-2-2002.

THE WORLD'S LARGEST CONTACT LENS STORE.

NO CLAIM IS MADE TO THE EXCLUSIVE RIGHT TO USE "CONTACT LENS STORE", APART FROM THE MARK AS SHOWN.
SEC. 2(F).

FOR MAIL ORDER AND TELEPHONE ORDER SERVICES IN THE FIELD OF CONTACT LENSES AND RELATED PRODUCTS, AND ELECTRONIC RETAILING SERVICES VIA COMPUTER FEATURING CONTACT LENSES AND RELATED PRODUCTS (U.S. CLS. 100, 101 AND 102).

FIRST USE 6-1-1998; IN COMMERCE 6-1-1998.
BRETT J. GOLDEN, EXAMINING ATTORNEY

CLASS 35—(Continued).

SN 78-170,144. ROBINSON & ASSOCIATES ADVERTISING, INC., BETHESDA, MD. FILED 10-2-2002.



NO CLAIM IS MADE TO THE EXCLUSIVE RIGHT TO USE "DIRECT REWARDS", APART FROM THE MARK AS SHOWN.

FOR ADVERTISING SERVICES, NAMELY DIRECT MAIL (U.S. CLS. 100, 101 AND 102).

APRIL L. RADEMACHER, EXAMINING ATTORNEY

SN 78-135,349. BRILL, EDWARD N., NEW YORK, NY. FILED 6-13-2002.

GLOBAL HOSPITALITY SERVICES

NO CLAIM IS MADE TO THE EXCLUSIVE RIGHT TO USE HOSPITALITY SERVICES, APART FROM THE MARK AS SHOWN.

FOR BUSINESS CONSULTING SERVICES FOR HOTELS IN THE FIELD OF MAKING HOTEL RESERVATIONS AND PROVIDING OTHER HOTEL SERVICES (U.S. CLS. 100, 101 AND 102).

FIRST USE 5-31-2002; IN COMMERCE 6-10-2002.
JACQUELINE A. LAVINE, EXAMINING ATTORNEY

SN 78-195,487. PAPA JAZZ RECORD SHOPPE, INC., COLUMBIA, SC. FILED 12-17-2002.



SN 78-167,016. EMPLOYMENT CONDITIONS ABROAD LIMITED, LONDON, ENGLAND, FILED 9-23-2002.

ECA

FOR PROVIDING INFORMATION REGARDING EMPLOYMENT, PERSONNEL, BUSINESS MANAGEMENT AND BUSINESS ORGANIZATION VIA AN INTRANET (U.S. CLS. 100, 101 AND 102).

KARLA PERKINS, EXAMINING ATTORNEY

NO CLAIM IS MADE TO THE EXCLUSIVE RIGHT TO USE "BUY-SELL-TRADE", "NEW & USED RECORDS TAPES CDS", AND "JAZZ RECORD SHOPPE", APART FROM THE MARK AS SHOWN.

FOR RETAIL STORE SERVICES FEATURING NEW AND USED COMPACT DISCS, RECORDS, AND CASSETTES OF MUSICAL RECORDING (U.S. CLS. 100, 101 AND 102).

FIRST USE 7-1-1983; IN COMMERCE 7-1-1983.
KARLA PERKINS, EXAMINING ATTORNEY

CLASS 35—(Continued).

SN 78-214,142. MTS, INCORPORATED, WEST SACRAMENTO, CA. FILED 2-12-2003.

TOWER
MUSIC • MOVIES & MORE
Tower.com

OWNER OF U.S. REG. NOS. 1,469,471, 2,414,228 AND OTHERS.

NO CLAIM IS MADE TO THE EXCLUSIVE RIGHT TO USE "MUSIC" AND "MOVIES", APART FROM THE MARK AS SHOWN.

FOR ONLINE, TELEPHONE, CATALOG AND RETAIL STORE SERVICES IN THE FIELD OF RECORDS, CASSETTES, COMPACT DISCS, CD-ROM'S, COMPUTER SOFTWARE, LASER DISCS, DVD'S AND OTHER RECORDED MUSIC AND VIDEO, BLANK VIDEO AND AUDIO TAPES, BOOKS, MAGAZINES ON MUSIC AND ENTERTAINMENT, CLOTHING AND GIFT CERTIFICATES; PROVIDING A WEBSITE ON A GLOBAL COMPUTER NETWORK FEATURING CONSUMER INFORMATION IN THE FIELD OF ELECTRONICS GOODS (U.S. CLS. 100, 101 AND 102).

FIRST USE 2-10-2003; IN COMMERCE 2-10-2003.
 SUELLEN HICKEY, EXAMINING ATTORNEY

SN 78-218,125. HENNIGAN, TOM, GUTTENBERG, NJ. FILED 2-24-2003.

P.R.OMOTION!

NO CLAIM IS MADE TO THE EXCLUSIVE RIGHT TO USE P.R. AND PROMOTION, APART FROM THE MARK AS SHOWN.

FOR BUSINESS MARKETING CONSULTING SERVICES; CONDUCTING MARKETING STUDIES; DIRECT MARKETING ADVERTISING FOR OTHERS; PROMOTING THE GOODS AND SERVICES OF OTHERS BY PREPARING AND PLACING ADVERTISEMENTS IN AN ELECTRONIC MAGAZINE ACCESSED THROUGH A GLOBAL COMPUTER NETWORK; PROMOTING THE GOODS AND SERVICES OF OTHERS THROUGH THE DISTRIBUTION OF DISCOUNT CARDS; PROMOTING THE GOODS AND SERVICES OF OTHERS BY PROVIDING HYPERTEXT LINKS TO THE WEB SITES OF OTHERS; AND PUBLIC RELATIONS SERVICES FOR OTHERS (U.S. CLS. 100, 101 AND 102).

PRISCILLA MILTON, EXAMINING ATTORNEY

CLASS 35—(Continued).

SN 78-221,901. AMERICASPEAKS, WASHINGTON, DC. FILED 3-5-2003.

TAKING DEMOCRACY TO SCALE

FOR PUBLIC POLICY MEETING PLANNING SERVICES, NAMELY, ORGANIZING, ARRANGING, CONDUCTING AND FACILITATING MEETINGS OF CITIZENS ON PUBLIC POLICY AND PLANNING, AND UTILIZING COMPUTERS AND TECHNOLOGY TO MANAGE THE INTERACTION AND IDENTIFY THE PUBLIC'S PRIORITIES (U.S. CLS. 100, 101 AND 102).

FIRST USE 12-31-1998; IN COMMERCE 12-31-1998.
 KARLA PERKINS, EXAMINING ATTORNEY

SN 78-225,466. ACCESSIBILITY DOT NET, LLC, OMAHA, NE. FILED 3-14-2003.

Accessibility dot Net
accessibility driven, by demand.

FOR ONLINE RETAIL STORE SERVICES FEATURING EQUIPMENT FOR PERSONS WITH SPECIAL NEEDS, NAMELY VOICE RECOGNITION, SPEECH SYNTHESIS AND OPTICAL CHARACTER RECOGNITION EQUIPMENT AND COMPUTERS (U.S. CLS. 100, 101 AND 102).

FIRST USE 6-3-1999; IN COMMERCE 7-1-1999.
 DOMINIC J. FERRAIUOLO, EXAMINING ATTORNEY

SN 78-227,942. SF INTERACTIVE, SAN FRANCISCO, CA. FILED 3-20-2003.

Ad³

FOR DEVELOPING AND PREPARING ON-LINE ADVERTISING CAMPAIGNS AND ON-LINE ADVERTISEMENTS FOR OTHERS (U.S. CLS. 100, 101 AND 102).

CYNTHIA SLOAN, EXAMINING ATTORNEY

CLASS 35—(Continued).

SN 78-231,107. PROFESSIONAL MOTORSPORTS MERCHANTISE COMPANY, INC., BLAINE, MN. FILED 3-28-2003.

GO WITH THE PRO

FOR RETAIL STORE SERVICES, WHOLESALE DISTRIBUTION SERVICES, MAIL ORDER CATALOG SERVICES AND INTERNET BASED ORDERING SERVICES FEATURING AUTO RACING AND OTHER VEHICLE RACING MEMORABILIA, NOVELTIES, CLOTHING AND GIFTS (U.S. CLS. 100, 101 AND 102).
TRACY FLETCHER, EXAMINING ATTORNEY

SN 78-231,440. NAUTICAL NEEDS, INC., ST. PETERSBURG, FL. FILED 3-28-2003.

NAUTICAL NEEDS

NO CLAIM IS MADE TO THE EXCLUSIVE RIGHT TO USE "NAUTICAL", APART FROM THE MARK AS SHOWN. FOR PROVIDING A WEBSITE ON GLOBAL COMPUTER NETWORKS FEATURING ADVERTISING FOR OTHERS INTERESTED IN BUYING, SELLING, OR TRADING USED BOAT EQUIPMENT AND ACCESSORIES; PROVIDING AN ON-LINE DATA BASE ON THE INTERNET IN THE FIELD OF BUSINESSES DEALING IN THE SELLING AND BUYING OF USED BOATING EQUIPMENT AND ACCESSORIES (U.S. CLS. 100, 101 AND 102).
FIRST USE 3-26-2003; IN COMMERCE 3-28-2003.
WILLIAM VERHOSEK, EXAMINING ATTORNEY

SN 78-231,978. STAFFING CONCEPTS INTERNATIONAL, INC., TAMPA, FL. FILED 3-31-2003.

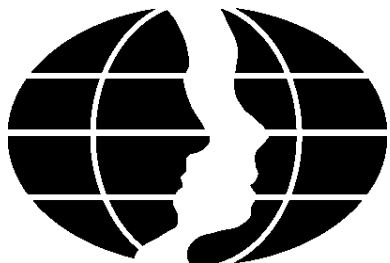

FOR EMPLOYEE LEASING SERVICES (U.S. CLS. 100, 101 AND 102).
FIRST USE 0-0-1985; IN COMMERCE 0-0-1985.
LINDA M. KING, EXAMINING ATTORNEY

SN 78-231,980. STAFFING CONCEPTS INTERNATIONAL, INC., TAMPA, FL. FILED 3-31-2003.

PLATFORMONE

FOR EMPLOYEE LEASING SERVICES (U.S. CLS. 100, 101 AND 102).
FIRST USE 1-24-2000; IN COMMERCE 1-24-2000.
DORITT L. CARROLL, EXAMINING ATTORNEY

CLASS 35—(Continued).

SN 78-231,984. STAFFING CONCEPTS INTERNATIONAL, INC., WASHINGTON, DC. FILED 3-31-2003.



FOR EMPLOYEE LEASING SERVICES (U.S. CLS. 100, 101 AND 102).
FIRST USE 3-16-2000; IN COMMERCE 3-16-2000.
KAREN BRACEY, EXAMINING ATTORNEY

SN 78-233,711. GENERAL CABLE TECHNOLOGIES CORPORATION, HIGHLAND HEIGHTS, KY. FILED 4-3-2003.



OWNER OF U.S. REG. NOS. 1,797,640, 2,706,461 AND OTHERS.
NO CLAIM IS MADE TO THE EXCLUSIVE RIGHT TO USE "CABLE" AND "IGNITION WIRE", APART FROM THE MARK AS SHOWN.
FOR WHOLESALE DISTRIBUTORSHIP AND ORDERING SERVICES FOR AUTOMOTIVE PRODUCTS FEATURING IGNITION WIRE, BOOSTER CABLES, PRIMARY WIRE, AND BATTERY STARTER CABLES (U.S. CLS. 100, 101 AND 102).
FIRST USE 11-5-2002; IN COMMERCE 11-5-2002.
ANDREA SAUNDERS, EXAMINING ATTORNEY

SN 78-234,184. PRODUCT TO MARKET, LLC, COKATO, MN. FILED 4-4-2003.

LINKING VALUE WITH SOLUTIONS

FOR BUSINESS CONSULTATION; BUSINESS MANAGEMENT CONSULTATION; BUSINESS ORGANIZATIONAL CONSULTATION; BUSINESS MANAGEMENT CONSULTING WITH BUSINESSES TO HELP SUCH BUSINESSES OPERATE MORE EFFICIENTLY AND EFFECTIVELY; BUSINESS MARKETING AND SALES CONSULTING SERVICES; BUSINESS DEVELOPMENT CONSULTING SERVICES; BUSINESS PLANNING SERVICES (U.S. CLS. 100, 101 AND 102).
MARC LEIPZIG, EXAMINING ATTORNEY

CLASS 35—(Continued).

SN 78-237,320. HAMDAN, MOHAMAD, BROOKLYN, NY.
FILED 4-14-2003.

SYSTEM LIQUIDATORS

NO CLAIM IS MADE TO THE EXCLUSIVE RIGHT TO USE LIQUIDATORS, APART FROM THE MARK AS SHOWN.

FOR INDUSTRIAL ASSET MANAGEMENT SERVICES, NAMELY, AUCTIONING, LIQUIDATING AND REMARKETING INDUSTRIAL ASSETS OF OTHERS (U.S. CLS. 100, 101 AND 102).

M. E. BODSON, EXAMINING ATTORNEY

SN 78-238,057. LINKS POINT, INC, NORWALK, CT. FILED 4-15-2003.

LOCATION POWERED SOLUTIONS

FOR BUSINESS MANAGEMENT SERVICES UTILIZING GLOBAL POSITIONING SYSTEM, GEOGRAPHIC INFORMATION SYSTEMS, AND LOCATION AND DIGITAL MAPPING TECHNOLOGIES FOR VEHICLE TRACKING, ASSET TRACKING, PERSONNEL TRACKING, MATERIAL TRACKING, ROUTING, ASSET LOCATION IDENTIFICATION, DATA COLLECTION, DATA VERIFICATION, NAVIGATION, INSPECTION, LOCATION VERIFICATION, FIELD SERVICE, DELIVERY, MAINTENANCE, EVIDENCE COLLECTION, AREA IDENTIFICATION, INVESTIGATION, DISTANCE DETERMINATION, CONSTRUCTION, RESOURCE MANAGEMENT, ACTIVITY VERIFICATION, ELECTRONIC COMMERCE, MAPPING, COMPLIANCE REPORTING, INCIDENT COMMAND AND CONTROL, AND SYSTEM OUTAGE MANAGEMENT VIA MOBILE COMPUTING DEVICES (U.S. CLS. 100, 101 AND 102).

FIRST USE 3-27-2003; IN COMMERCE 3-28-2003.

ALLISON HOLTZ, EXAMINING ATTORNEY

SN 78-238,180. BELIEVE MEDIA, INC., HOLLYWOOD, CA.
FILED 4-15-2003.

CONCEIVE MEDIA

NO CLAIM IS MADE TO THE EXCLUSIVE RIGHT TO USE "MEDIA", APART FROM THE MARK AS SHOWN.

FOR PRODUCTION OF FILM, VIDEO AND TELEVISION COMMERCIALS (U.S. CLS. 100, 101 AND 102).

HEATHER THOMPSON, EXAMINING ATTORNEY

SN 78-240,611. HUDSON HIGHLAND GROUP, INC., CHICAGO, IL. FILED 4-22-2003.

HIGHLAND PARTNERS

NO CLAIM IS MADE TO THE EXCLUSIVE RIGHT TO USE PARTNERS, APART FROM THE MARK AS SHOWN.

FOR EXECUTIVE SEARCH AND PLACEMENT SERVICES; PERSONNEL PLACEMENT AND RECRUITMENT SERVICES (U.S. CLS. 100, 101 AND 102).

FIRST USE 4-1-2003; IN COMMERCE 4-1-2003.

TARAH HARDY, EXAMINING ATTORNEY

CLASS 35—(Continued).

SN 78-241,870. R/M MANAGEMENT CO., INC., SCOTTSDALE, AZ. FILED 4-24-2003.

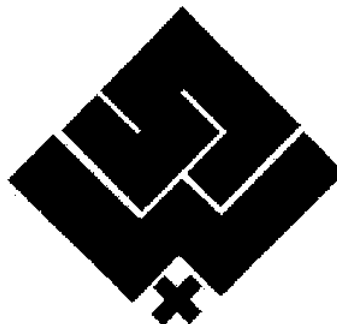

FOR BILLING SERVICES, OUTSOURCING IN THE FIELD OF BILLING SERVICES (U.S. CLS. 100, 101 AND 102).

LINDA E. BLOHM, EXAMINING ATTORNEY

SN 78-242,663. ABOT FRANCHISE INC., CONCORD, ONTARIO, CANADA, FILED 4-28-2003.



FOR RETAIL STORE SERVICES IN THE FIELD OF GENERAL MERCHANDISE, NAMELY, HOUSEWARES, LINENS, TOYS AND NOVELTIES, FOOD AND CONFECTIONERY, PARTY GOODS, HEALTH AND BEAUTY PRODUCTS, CLOTHING, PET PRODUCTS, GIFTWARE, SPORTING GOODS, BABY PRODUCTS, HARDWARE, MULTI-MEDIA PRODUCTS, JEWELRY, CRAFTS, CARDS, WRAP AND STATIONERY (U.S. CLS. 100, 101 AND 102).

KARLA PERKINS, EXAMINING ATTORNEY

CLASS 35—(Continued).

SN 78-242,802. CANON COMMUNICATIONS LLC, SANTA MONICA, CA. FILED 4-28-2003.

DESIGN & MANUFACTURING SOUTH

OWNER OF U.S. REG. NOS. 2,530,993 AND 2,535,092.
 NO CLAIM IS MADE TO THE EXCLUSIVE RIGHT TO USE DESIGN & MANUFACTURING, APART FROM THE MARK AS SHOWN.
 FOR ARRANGING AND CONDUCTING OF DESIGN AND MANUFACTURING TRADE SHOWS AND TRADE SHOWS AND EXHIBITIONS IN THE MEDIAL DEVICE, MICROELECTRONIC, PLASTICS PROCESSING, PACKAGING, AND GENERAL DESIGN ENGINEERING FIELDS (U.S. CLS. 100, 101 AND 102).
 KELLEY WELLS, EXAMINING ATTORNEY

SN 78-242,851. NATIONAL ASSOCIATION OF MORTGAGE BROKERS, MCCLEAN, VA. FILED 4-28-2003.

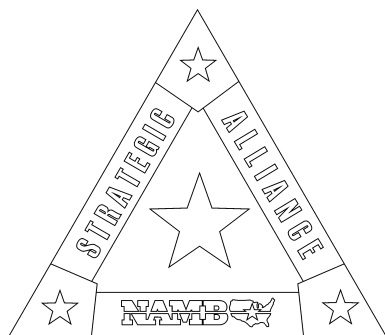

OWNER OF U.S. REG. NOS. 1,740,417 AND 1,820,229.
 NO CLAIM IS MADE TO THE EXCLUSIVE RIGHT TO USE "THE REPRESENTATION OF THE OUTLINE OF THE UNITED STATES OF AMERICA", APART FROM THE MARK AS SHOWN.
 FOR COOPERATIVE ADVERTISING AND MARKETING SERVICES, NAMELY, PROMOTING THE GOODS AND SERVICES OF MORTGAGE BROKERS; ESTABLISHING COOPERATIVE MARKETING ARRANGEMENTS TO PROMOTE MORTGAGE BROKERS AND THE MORTGAGE BROKERAGE PROFESSION, NAMELY, ARRANGING AND CONDUCTING TRADE SHOWS, CONFERENCES AND CONVENTIONS IN THE FIELD OF MORTGAGE BROKERAGE, AND ARRANGING AND ADMINISTERING DISCOUNT PROGRAMS FOR VENDORS OF GOODS AND SERVICES TO MORTGAGE BROKERS AND THE MORTGAGE BROKERAGE PROFESSION; BUSINESS NETWORKING OPPORTUNITIES, NAMELY, PROVIDING REFERRAL PROGRAMS FOR MORTGAGE BROKERS, AND BUSINESS NETWORKING AMONG MEMBERS OF THE MORTGAGE BROKERS ASSOCIATION TO DEVELOP COMMON BUSINESS INTERESTS; AND ASSOCIATION SERVICES, NAMELY, PROMOTING THE INTERESTS OF MORTGAGE BROKERS (U.S. CLS. 100, 101 AND 102).
 FIRST USE 8-0-2000; IN COMMERCE 8-0-2000.
 BRENDAN MCCAULEY, EXAMINING ATTORNEY

CLASS 35—(Continued).

SN 78-244,010. GERHART, DAVID, BAINBRIDGE ISLAND, WA. FILED 4-30-2003.

...HOW HARD CAN IT BE?

FOR BUSINESS MANAGEMENT AND BUSINESS MANAGEMENT CONSULTING SERVICES (U.S. CLS. 100, 101 AND 102).
 FIRST USE 4-0-2002; IN COMMERCE 6-0-2003.
 SOPHIA S. KIM, EXAMINING ATTORNEY

SN 78-245,130. WEEKLY READER CORPORATION, STAMFORD, CT. FILED 5-2-2003.

BUILD YOUR CLASSROOM PROGRAM

NO CLAIM IS MADE TO THE EXCLUSIVE RIGHT TO USE "PROGRAM", APART FROM THE MARK AS SHOWN.
 FOR CONDUCTING AN INCENTIVE AWARD PROGRAM FOR TEACHERS THROUGH AWARDED SCHOOL SUPPLIES TO FASTER MAGAZINE SUBSCRIPTION RENEWALS OF OTHERS (U.S. CLS. 100, 101 AND 102).
 JASON TURNER, EXAMINING ATTORNEY

SN 78-246,730. AVFUEL CORPORATION, ANN ARBOR, MI. FILED 5-7-2003.

TRIP

OWNER OF U.S. REG. NOS. 2,386,733 AND 2,811,973.
 FOR RETAIL AVIATION FUEL SUPPLY SERVICES; PROMOTING THE SALE OF AVIATION FUEL THROUGH THE ADMINISTRATION OF INCENTIVE AWARD PROGRAMS (U.S. CLS. 100, 101 AND 102).
 FIRST USE 0-0-1989; IN COMMERCE 0-0-1989.
 ROBIN CHOSID, EXAMINING ATTORNEY

SN 78-248,389. BROKERS' CHOICE OF AMERICA, INC., ENGLEWOOD, CO. FILED 5-12-2003.

LEADS AMERICA

NO CLAIM IS MADE TO THE EXCLUSIVE RIGHT TO USE "LEADS", APART FROM THE MARK AS SHOWN.
 FOR INSURANCE AGENT AND FINANCIAL PLANNER REFERRALS (U.S. CLS. 100, 101 AND 102).
 KATHLEEN M. VANSTON, EXAMINING ATTORNEY

CLASS 35—(Continued).

SN 78-254,621. DIVERSIFIED SERVICE OPTIONS, INC., JACKSONVILLE, FL. FILED 5-27-2003.

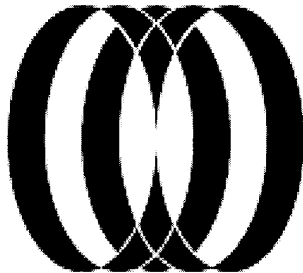

FOR ADVERTISING SERVICES, NAMELY, THE PREPARATION AND PRODUCTION OF PRINT ADVERTISING AND DIRECT MAIL SERVICES FOR OTHERS (U.S. CLS. 100, 101 AND 102).

FIRST USE 4-12-2003; IN COMMERCE 4-12-2003.
LINDA POWELL, EXAMINING ATTORNEY

SN 78-255,797. GRAND RAPIDS/KENT COUNTY CONVENTION & VISITORS BUREAU, GRAND RAPIDS, MI. FILED 5-29-2003.



NO CLAIM IS MADE TO THE EXCLUSIVE RIGHT TO USE "MICHIGAN'S WEST COAST", APART FROM THE MARK AS SHOWN.

FOR CONVENTION AND VISITOR'S BUREAU SERVICES, NAMELY PROMOTING BUSINESS, TOURISM AND CONVENTIONS IN THE AREA OF KENT, OTTAWA, MUSKEGON AND ALLEGAN COUNTIES, MICHIGAN (U.S. CLS. 100, 101 AND 102).

FIRST USE 2-28-2003; IN COMMERCE 2-28-2003.
JOANNA MATEJA, EXAMINING ATTORNEY

SN 78-261,832. RELOACTION, PLEASANTON, CA. FILED 6-12-2003.



OWNER OF U.S. REG. NOS. 1,788,967 AND 2,458,491.
FOR ASSISTING IN BUSINESS AND PERSONNEL RELOCATION AND PROVIDING INFORMATION RELATIVE THERETO (U.S. CLS. 100, 101 AND 102).
FIRST USE 10-1-2000; IN COMMERCE 10-1-2000.
JENNIFER DIXON, EXAMINING ATTORNEY

CLASS 35—(Continued).

SN 78-262,450. MILLER, ALLEN S., MEMPHIS, TN. FILED 6-13-2003.

SOUTHWIND COLLECTION

NO CLAIM IS MADE TO THE EXCLUSIVE RIGHT TO USE "COLLECTION", APART FROM THE MARK AS SHOWN.

FOR RETAIL DISTRIBUTORSHIP SERVICES FOR GIFTWARE AND BATH AND SKIN CARE PRODUCTS, FEATURING HOME ACCESSORIES AND GIFTS, HOME DECORATING ITEMS, BATH ACCESSORIES AND SKIN CARE ITEMS, AND JEWELRY, FOR THE PURPOSE OF CHARITABLE FUNDRAISING IN SCHOOLS (U.S. CLS. 100, 101 AND 102).

FIRST USE 6-12-2003; IN COMMERCE 6-12-2003.
KIMBERLY PERRY, EXAMINING ATTORNEY

SN 78-269,809. ACUHIRE, INC., VISTA, CA. FILED 7-2-2003.



NO CLAIM IS MADE TO THE EXCLUSIVE RIGHT TO USE "EMPLOYEE SCREENING SERVICES", APART FROM THE MARK AS SHOWN.

FOR BUSINESS SERVICES, NAMELY, PRE-EMPLOYMENT BACKGROUND SCREENING AND BACKGROUND CHECKS IN THE NATURE OF BACKGROUND INVESTIGATIONS OF EMPLOYEES FOR BUSINESSES AND/OR EMPLOYERS (U.S. CLS. 100, 101 AND 102).

FIRST USE 6-15-2002; IN COMMERCE 6-15-2003.
RUDY R. SINGLETON, EXAMINING ATTORNEY

SN 78-279,999. INTERNATIONAL MASTERS PUBLISHERS AB, MALMO, SWEDEN, FILED 7-29-2003.

IMP

FOR COMPUTERIZED ON-LINE RETAIL STORE SERVICES AND MAIL ORDER SERVICES FEATURING CULINARY PRODUCTS AND RELATED PUBLICATIONS; COMPUTERIZED ON-LINE RETAIL STORE SERVICES IN THE FIELDS OF PERIODICAL PUBLICATIONS, COOKING, CRAFTING, GARDENING, HOME DECORATING, HEALTH AND PERSONAL CARE, HOME REPAIR, ANIMAL LIFE, HISTORY AND LITERATURE, COMPACT DISCS AND CASSETTES FEATURING LITERARY WORKS, PERSONAL COMPUTER SOFTWARE APPLICATIONS, VITAMINS AND NUTRITIONAL SUPPLEMENTS, AND COSMETICS AND TOILET PREPARATIONS, NAMELY, BODY LOTIONS, SOAPS, HAND CREAMS, SHOWER GELS, BATH OILS, MUD MASKS, HAIR SHAMPOOS AND FRAGRANCE; DIRECT MARKETING ADVERTISING SERVICES FOR OTHERS; PROMOTING THE GOODS AND SERVICES OF OTHERS THROUGH THE DISTRIBUTION OF ON-LINE AND PRINTED MATERIALS; PROMOTING THE GOODS AND SERVICES OF OTHERS THROUGH ON-LINE AND MAIL ORDERING OF GOODS AND SERVICES FOR OTHERS (U.S. CLS. 100, 101 AND 102).

GEOFFREY FOSDICK, EXAMINING ATTORNEY

CLASS 35—(Continued).

SN 78-280,680. CYBER CITY SYSTEMS, INCORPORATED, PLEASANTON, CA. FILED 7-30-2003.

SOLUTIONS FOR GLOBAL ISSUES

NO CLAIM IS MADE TO THE EXCLUSIVE RIGHT TO USE GLOBAL ISSUES, APART FROM THE MARK AS SHOWN.

FOR BUSINESS CONSULTING SERVICES, NAMELY, STRATEGIC EMERGENCY AND DISASTER CONSEQUENCE MANAGEMENT AND MITIGATION FOR NATURAL AND MAN-MADE DISASTERS AND EMERGENCIES FOR BUSINESS AND GOVERNMENTAL ENTITIES, AND INSTRUCTIONAL MATERIALS DISTRIBUTED THEREWITH (U.S. CLS. 100, 101 AND 102).

BRIAN BROWN, EXAMINING ATTORNEY

SN 78-281,749. VARSITY GOLD, INC., GILBERT, AZ. FILED 7-31-2003.



FOR ADVERTISING SERVICES, NAMELY, CREATING CORPORATE AND BRAND IDENTITY SLOGANS FOR OTHERS; DIRECT MARKETING SLOGAN ADVERTISING FOR OTHERS (U.S. CLS. 100, 101 AND 102).

TANYA AMOS, EXAMINING ATTORNEY

SN 78-282,735. ALLDREDGE, JOE E., DBA JAN'S CARD SHOPS, ALBERTVILLE, AL. FILED 8-4-2003.



FOR RETAIL STORE SERVICES IN THE FIELDS OF HOME DECOR FURNITURE, FRAMED ART, PHOTO FRAMES, LAMPS, DECORATIVE ACCESSORIES (U.S. CLS. 100, 101 AND 102).

GWEN STOKOLS, EXAMINING ATTORNEY

CLASS 35—(Continued).

SN 78-283,208. IRON GATE HARDWARE LLC, KENNETT SQUARE, PA. FILED 8-5-2003.

IRON GATE

FOR RETAIL STORE SERVICES AND ON-LINE RETAIL STORE SERVICES VIA THE INTERNET FEATURING CONSTRUCTION HARDWARE (U.S. CLS. 100, 101 AND 102).

DAVID C. REIHNER, EXAMINING ATTORNEY

SN 78-284,639. BUZZTONE.COM, INC., LOS ANGELES, CA. FILED 8-7-2003.

BUZZTONE

FOR ADVERTISING AGENCY SERVICES; PUBLIC RELATIONS SERVICES; PUBLICITY AGENCY SERVICES; DIRECT MARKETING ADVERTISING SERVICES FOR OTHERS; BUSINESS MARKETING CONSULTING SERVICES; MARKET RESEARCH; SALES PROMOTION SERVICES, NAMELY PROMOTING THE GOODS AND SERVICES OF OTHERS THROUGH THE DISTRIBUTION OF PRINTED AND AUDIO PROMOTIONAL MATERIALS AND BY RENDERING SALES PROMOTIONAL ADVICE; AND PREPARING ADVERTISING OF OTHERS, PURCHASE AND PROCUREMENT OF MEDIA ADVERTISING TIME FOR OTHERS, MARKET RESEARCH, NAMELY, PLANNING AND RESEARCH OFF PRINT, RADIO, TELEVISION AND ELECTRONIC ADVERTISING MEDIA USE (U.S. CLS. 100, 101 AND 102).

FIRST USE 4-13-2000; IN COMMERCE 4-13-2000. THEODORE MCBRIDE, EXAMINING ATTORNEY

SN 78-284,701. COUNTRY CLUB PIZZA INC., CELEBRATION, FL. FILED 8-7-2003.

COUNTRY CLUB PIZZA

NO CLAIM IS MADE TO THE EXCLUSIVE RIGHT TO USE "PIZZA", APART FROM THE MARK AS SHOWN.

FOR FRANCHISING, NAMELY RENDERING TECHNICAL ASSISTANCE IN THE ESTABLISHMENT AND/OR OPERATION OF COUNTRY CLUBS ENGAGED IN THE BAKING AND DELIVERING OF HOT PIZZA PIES MADE TO ORDER BY CONSUMPTION OFF THE PREMISES (U.S. CLS. 100, 101 AND 102).

FIRST USE 2-1-2001; IN COMMERCE 7-2-2003. KAREN K. BUSH, EXAMINING ATTORNEY

CLASS 35—(Continued).

SN 78-284,844. MAJOR GIFTS IDENTIFICATION/CONSULTING, INC., ATLANTA, GA. FILED 8-8-2003.

PHILANTHROPIST NEXT DOOR

NO CLAIM IS MADE TO THE EXCLUSIVE RIGHT TO USE "PHILANTHROPIST", APART FROM THE MARK AS SHOWN.

FOR BUSINESS RESEARCH, NAMELY, A SERVICE TO IDENTIFY INDIVIDUALS WITHIN A NON PROFIT ORGANIZATION'S CONSTITUENCY WHO ARE PHILANTHROPIC BY COMPARING THE ORGANIZATION'S DATABASE OF CONSTITUENTS TO A DATABASE OF KNOWN FINANCIAL SUPPORTERS OF CHARITABLE ORGANIZATIONS (U.S. CLS. 100, 101 AND 102).

DAVID TAYLOR, EXAMINING ATTORNEY

SN 78-285,289. TUCKER, ARMSTEAD, HOLLOMAN AIRFORCE BASE, NM. FILED 8-8-2003.

M.O.B.

FOR DISTRIBUTORSHIPS IN THE FIELD OF CD'S, AUDIO TAPES, PRE RECORDED PHONOGRAPH RECORDS, PHONOGRAPH RECORDS, AUDIO AND VIDEO CASSETTES, AND DVD'S FEATURING MUSIC (U.S. CLS. 100, 101 AND 102).

CHRISTOPHER BUONGIORNO, EXAMINING ATTORNEY

SN 78-286,653. THOMAS R. FULCHER, SCOTTSDALE, AZ. FILED 8-13-2003.

THE IDEA GARDENER

FOR BUSINESS MARKETING CONSULTING SERVICES (U.S. CLS. 100, 101 AND 102).

FIRST USE 6-20-2003; IN COMMERCE 6-0-2003.
CATHERINE CAIN, EXAMINING ATTORNEY

SN 78-286,717. HELLO MOMMY, BOULDER, CO. FILED 8-13-2003.

HELLO MOMMY

FOR RETAIL STORE SERVICES, GIFT REGISTRY SERVICES, ONLINE RETAIL STORE SERVICES AND MAIL ORDER CATALOG SERVICES FEATURING CHILDREN'S/BABY CLOTHING AND SHOES, PRAMS AND STROLLERS, NURSERY FURNITURE AND BEDDING, TOYS AND BABY GIFTS, WOMEN'S MATERNITY CLOTHING AND ACCESSORIES, NAMELY SPORTSWEAR, LINGERIE AND UNDERWEAR, FITNESS AND SWIM APPAREL, SHOES, PERSONAL CARE PRODUCTS, BOOKS, VIDEOS AND OTHER RELATED ACCESSORIES (U.S. CLS. 100, 101 AND 102).

KATHERINE STOIDES, EXAMINING ATTORNEY

CLASS 35—(Continued).

SN 78-286,917. PENNSYLVANIA DUTCH TOURIST BUREAU, LANCASTER, PA. FILED 8-13-2003.

THE HEART OF PENNSYLVANIA DUTCH COUNTRY

NO CLAIM IS MADE TO THE EXCLUSIVE RIGHT TO USE "PENNSYLVANIA DUTCH COUNTRY", APART FROM THE MARK AS SHOWN.

FOR CONVENTION AND VISITOR BUREAU SERVICES, NAMELY, PROMOTING TOURISM AND TRADE CONVENTIONS IN LANCASTER COUNTY, PENNSYLVANIA (U.S. CLS. 100, 101 AND 102).

FIRST USE 1-30-2000; IN COMMERCE 1-30-2000.
GLENN CLARK, EXAMINING ATTORNEY

SN 78-287,740. CELEBRITY DOUBLES - LOOK-ALIKES & IMPERSONATORS, SALT LAKE CITY, UT. FILED 8-14-2003.



NO CLAIM IS MADE TO THE EXCLUSIVE RIGHT TO USE CELEBRITY DOUBLES LOOK-ALIKES & IMPERSONATORS, APART FROM THE MARK AS SHOWN.

TRADEMARK HAS A SILHOUETTE OF A BLACK STAR JUST TO THE LEFT OF THE WORDS: "CELEBRITY DOUBLES", UNDERLINED BY A BLACK HORIZONTAL LINE. UNDERNEATH THE BLACK LINE ARE THE WORDS: "LOOK-ALIKES & IMPERSONATORS".

FOR BOOKING AND PROMOTING CELEBRITY LOOK-ALIKES, DOUBLES, AND IMPERSONATORS THROUGHOUT THE UNITED STATES AND INTERNATIONALLY FOR CORPORATE AND PRIVATE EVENTS (U.S. CLS. 100, 101 AND 102).

FIRST USE 9-1-1996; IN COMMERCE 10-1-1996.
LEIGH CAROLINE CASE, EXAMINING ATTORNEY

SN 78-288,167. CLE CONTACT LENSES INC., NEW YORK, NY. FILED 8-15-2003.

CLE CONTACT LENSES

NO CLAIM IS MADE TO THE EXCLUSIVE RIGHT TO USE "CONTACT LENSES", APART FROM THE MARK AS SHOWN.

FOR ONLINE RETAIL SERVICES FEATURING CONTACT LENSES; MAIL ORDER AND PHONE ORDER SERVICES FEATURING CONTACT LENSES; AND RETAIL STORE SERVICES FEATURING CONTACT LENSES AND CONTACT LENS ACCESSORIES (U.S. CLS. 100, 101 AND 102).

ELIZABETH PIGNATELLO, EXAMINING ATTORNEY

CLASS 35—(Continued).

SN 78-293,614. COMBINENET, INC., PITTSBURGH, PA. FILED 8-28-2003.



FOR CONSULTING SERVICES AND HOSTED SOFTWARE SOLUTION SERVICES, NAMELY COLLECTING AND ANALYZING BUSINESS INFORMATION AND RESOLVING RESOURCE ALLOCATION, SOURCING, PROCUREMENT AND PRODUCTION PLANNING PROBLEMS FOR BUSINESSES (U.S. CLS. 100, 101 AND 102).
FIRST USE 3-31-2003; IN COMMERCE 3-31-2003.
CHARLES L. JENKINS, EXAMINING ATTORNEY

SN 78-297,275. BIOCAMP SYSTEMS, INC., BLOOMINGTON, MN. FILED 9-8-2003.

INTELLIDYNAMICS

FOR BUSINESS CONSULTING SERVICES IN THE FIELDS OF BUSINESS PERFORMANCE ENHANCEMENT, COMMERCIAL AND INDUSTRIAL PROCESS ANALYSIS, CONTROL AND OPTIMIZATION, BUSINESS ECONOMIC FORECASTING, MARKETING, AND E-COMMERCE (U.S. CLS. 100, 101 AND 102).
FIRST USE 9-6-2003; IN COMMERCE 9-6-2003.
TRACY CROSS, EXAMINING ATTORNEY

SN 78-297,595. GIVEASHARE LLC, PORTLAND, OR. FILED 9-8-2003.

GIVEASHARE

FOR COMPUTER ON-LINE ORDERING SERVICES FEATURING STOCK CERTIFICATES FRAMED OR UNFRAMED (U.S. CLS. 100, 101 AND 102).
FIRST USE 10-8-2002; IN COMMERCE 6-6-2003.
M. E. BODSON, EXAMINING ATTORNEY

CLASS 35—(Continued).

SN 78-297,601. JANGSOO INDUSTRY CO., LTD., SEOUL, REPUBLIC OF KOREA, FILED 9-8-2003.

JANGSOO

THE ENGLISH TRANSLATION OF "JANGSOO" IS "LONGEVITY".
FOR DISTRIBUTORSHIP SERVICES IN THE FIELD OF FURNITURE, BEDS, MATS, FOOD PRODUCTS AND PUBLICATIONS (U.S. CLS. 100, 101 AND 102).
IRA J. GOODSAD, EXAMINING ATTORNEY

SN 78-297,605. JANGSOO INDUSTRY CO., LTD., SEOUL, REPUBLIC OF KOREA, FILED 9-8-2003.

JANGSOO OK DOL

NO CLAIM IS MADE TO THE EXCLUSIVE RIGHT TO USE "OK DOL", APART FROM THE MARK AS SHOWN.
THE ENGLISH TRANSLATION OF "JANGSOO OK DOL" IS "LONGEVITY WARM STONE".
FOR DISTRIBUTORSHIP SERVICES IN THE FIELD OF FURNITURE, BEDS, MATS AND PUBLICATIONS (U.S. CLS. 100, 101 AND 102).
IRA J. GOODSAD, EXAMINING ATTORNEY

SN 78-298,641. IMAGINATION CONFECTIONS LLC, BELLWOOD, IL. FILED 9-10-2003.

IMAGINATION CONFECTIONS

NO CLAIM IS MADE TO THE EXCLUSIVE RIGHT TO USE CONFECTIONS, APART FROM THE MARK AS SHOWN.
FOR ASSOCIATION SERVICES, NAMELY PROMOTING THE INTERESTS OF CERTAIN CANDY MANUFACTURERS (U.S. CLS. 100, 101 AND 102).
LINDA ESTRADA, EXAMINING ATTORNEY

SN 78-303,170. TGR WORLDWIDE, LLC, KENOSHA, WI. FILED 9-20-2003.

TGR WORLDWIDE

NO CLAIM IS MADE TO THE EXCLUSIVE RIGHT TO USE "WORLDWIDE", APART FROM THE MARK AS SHOWN.
FOR BUSINESS MANAGEMENT AND CONSULTATION SERVICES (U.S. CLS. 100, 101 AND 102).
KELLY BOULTON, EXAMINING ATTORNEY

CLASS 35—(Continued).

SN 78-303,980. AMERICAN OPTOMETRIC ASSOCIATION, ST. LOUIS, MO. FILED 9-23-2003.

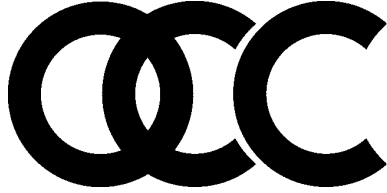

FOR PROVIDING ONLINE EMPLOYMENT PLACEMENT SERVICES NAMELY RESUME MATCHING SERVICES IN THE FIELD OF OPTOMETRY; PROVIDING ONLINE INFORMATION IN THE FIELD OF EMPLOYMENT, RECRUITMENT AND CAREERS IN THE FIELD OF OPTOMETRY (U.S. CLS. 100, 101 AND 102).
FIRST USE 9-16-2003; IN COMMERCE 9-16-2003.
MICHAEL WEBSTER, EXAMINING ATTORNEY

SN 78-304,862. LANE FURNITURE INDUSTRIES, INC., TUPELO, MS. FILED 9-24-2003.

AUTHENTICITY

FOR RETAIL STORE SERVICES FEATURING GIFT ITEMS, HOME FURNISHINGS, FURNITURE, FIREPLACES AND GRILLS (U.S. CLS. 100, 101 AND 102).
DAWN FELDMAN, EXAMINING ATTORNEY

SN 78-304,974. WRM TRAINING AND CONSULTING LLC, SALISBURY, CT. FILED 9-24-2003.

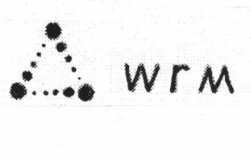

FOR CONSULTING SERVICES, NAMELY, BUSINESS AND EMPLOYEE MANAGEMENT TRAINING; EMPLOYEE DEVELOPMENT TRAINING; BUSINESS INTERPERSONAL COMMUNICATIONS TRAINING (U.S. CLS. 100, 101 AND 102).
FIRST USE 1-1-2002; IN COMMERCE 1-1-2002.
ALICE SUE CARRUTHERS, EXAMINING ATTORNEY

SN 78-305,657. 3PR CORPORATION, RENO, NV. FILED 9-25-2003.

CAVE CREED

FOR BUSINESS MANAGEMENT CONSULTATION AND PLANNING, BUSINESS RESEARCH AND MARKETING CONSULTING SERVICES, BUSINESS AUDITING AND BUSINESS EVALUATION OF HUMAN RESOURCES ISSUES (U.S. CLS. 100, 101 AND 102).
GLENN CLARK, EXAMINING ATTORNEY

CLASS 35—(Continued).

SN 78-306,302. NEWMAN, MICHAEL, HONOLULU, HI. FILED 9-26-2003.

NU SURF

NO CLAIM IS MADE TO THE EXCLUSIVE RIGHT TO USE SURF, APART FROM THE MARK AS SHOWN.
FOR RETAIL SHOP FEATURING SURF APPAREL AND ACCESSORIES (U.S. CLS. 100, 101 AND 102).
ANN LINNEHAN, EXAMINING ATTORNEY

SN 78-307,147. ECCA ENTERPRISES, INC., SAN ANTONIO, TX. FILED 9-30-2003.

DIRECT SOLUTIONS

FOR RETAIL STORE SERVICES AND MAIL ORDER SERVICES IN THE FIELD OF CONTACT LENSES AND RELATED PRODUCTS (U.S. CLS. 100, 101 AND 102).
CHRIS WELLS, EXAMINING ATTORNEY

SN 78-307,821. BAYLE, DAVID BISCO, FORT WAYNE, IN. FILED 10-1-2003.

BULLDOG TAX

NO CLAIM IS MADE TO THE EXCLUSIVE RIGHT TO USE "TAX", APART FROM THE MARK AS SHOWN.
FOR TAX PREPARATION SERVICE (U.S. CLS. 100, 101 AND 102).
KATHLEEN M. VANSTON, EXAMINING ATTORNEY

SN 78-308,162. CLAYTON-MARCUS COMPANY, INC., HICKORY, NC. FILED 10-1-2003.

COLOR STUDIO

FOR RETAIL FURNITURE STORE SERVICES (U.S. CLS. 100, 101 AND 102).
RONALD MCMORROW, EXAMINING ATTORNEY

CLASS 35—(Continued).

SN 78-308,211. HARRINGTON, LINDA J., HINESVILLE, GA.
FILED 10-1-2003.



NO CLAIM IS MADE TO THE EXCLUSIVE RIGHT TO USE ROSE, APART FROM THE MARK AS SHOWN.
FOR RETAIL SHOPS FEATURING FLOWERS AND GIFTS; ON-LINE RETAIL STORE SERVICES FEATURING FLOWERS AND GIFTS (U.S. CLS. 100, 101 AND 102).
AMY HELLA, EXAMINING ATTORNEY

SN 78-308,228. HARRINGTON, LINDA J., HINESVILLE, GA.
FILED 10-1-2003.

ROSE MASTERS

NO CLAIM IS MADE TO THE EXCLUSIVE RIGHT TO USE ROSE, APART FROM THE MARK AS SHOWN.
FOR RETAIL SHOPS FEATURING FLOWERS AND GIFTS; ON-LINE RETAIL STORE SERVICES FEATURING FLOWERS AND GIFTS (U.S. CLS. 100, 101 AND 102).
AMY HELLA, EXAMINING ATTORNEY

SN 78-308,324. LOMASNEY, MAUREEN, GRATON, CA.
FILED 10-1-2003.

ASHES TO ART

FOR CONDUCTING EXHIBITIONS IN NUMEROUS LOCATIONS AND THROUGH VARIOUS CHANNELS - INCLUDING ON-LINE - TO PROVIDE CONSUMER INFORMATION IN THE FIELD OF DEATH CARE AND MEMORIALIZATION AND TO PROMOTE AND SELL THE GOODS AND SERVICES OF OTHERS, PARTICULARLY ARTISTS, WHO COMPETE FOR THE OPPORTUNITY TO WIN AWARDS FOR HAVING CREATED FINELY CRAFTED MEMORIAL ART OBJECTS AS WELL AS OTHER CONSUMER GOODS RELATED TO MEMORIALIZATION THAT INCLUDE, BUT ARE NOT LIMITED TO, FUNERARY URNS AND VESSELS THAT MAY BE USED TO PERMANENTLY OR TEMPORARILY CONTAIN CREMATED REMAINS - THEREBY HONORING LIFE THROUGH ART (U.S. CLS. 100, 101 AND 102).
FIRST USE 12-11-2000; IN COMMERCE 2-20-2001.
RON FAIRBANKS, EXAMINING ATTORNEY

CLASS 35—(Continued).

SN 78-308,847. XOTIC MOTOVATION, INC., NAPA, CA.
FILED 10-2-2003.



THE MARK CONSISTS OF AN OUTLINE OF A CAR IN COLOR RED, WITH THE NAME XOTIC MOTOVATION IN FORTE FONT 80% GRAY SCALE COLOR.
FOR AUTOMOBILE DEALERSHIPS (U.S. CLS. 100, 101 AND 102).
MICHAEL HALL, EXAMINING ATTORNEY

SN 78-309,303. SEARS BRANDS, LLC, HOFFMAN ESTATES, IL. FILED 10-3-2003.

SEARS SALARY

OWNER OF U.S. REG. NOS. 642,438, 2,764,442 AND OTHERS.
FOR PROMOTING RETAIL STORE SERVICES THROUGH THE ADMINISTRATION OF AN INCENTIVE AWARD PROGRAM, NAMELY, REWARDING GIFT CERTIFICATES TO BE REDEEMED FOR MERCHANDISE PURCHASE (U.S. CLS. 100, 101 AND 102).
NORA BUCHANAN WILL, EXAMINING ATTORNEY

SN 78-309,356. XOTIC MOTOVATION, INC., NAPA, CA.
FILED 10-3-2003.

DRIVING YOUR DREAMS

FOR AUTOMOBILE DEALERSHIPS (U.S. CLS. 100, 101 AND 102).
RONALD MCMORROW, EXAMINING ATTORNEY

SN 78-310,093. BLARNEY CASTLE OIL CO., BEAR LAKE, MI. FILED 10-7-2003.

LOWCO

FOR RETAIL STORE SERVICES FEATURING CONVENIENCE STORE ITEMS AND GASOLINE (U.S. CLS. 100, 101 AND 102).
RONALD AIKENS, EXAMINING ATTORNEY

CLASS 35—(Continued).

SN 78-310,419. LM&B CATALOG, INC., GREENWICH, CT. FILED 10-7-2003.

RUNWAY FASHIONS AT RUNAWAY PRICES

FOR MAIL ORDER CATALOG SERVICES FEATURING GENERAL MERCHANDISE CLOTHING, CLOTHING ACCESSORIES, HEADWEAR, SWIMWEAR, JACKETS, COATS, FOOTWEAR, JEWELRY, BELTS AND LINGERIE (U.S. CLS. 100, 101 AND 102).
FIRST USE 2-28-2002; IN COMMERCE 2-28-2002.
DAWN FELDMAN, EXAMINING ATTORNEY

SN 78-310,719. C. GARBIN & ASSOCIATES, ROCHESTER, NY. FILED 10-8-2003.

EVERYONE PAYS THE SAME LOW PRICE

FOR AUTOMOBILE DEALERSHIP SERVICES (U.S. CLS. 100, 101 AND 102).
KELLEY WELLS, EXAMINING ATTORNEY

SN 78-310,745. AMERICAN AUTOMOBILE ASSOCIATION, INC., HEATHROW, FL. FILED 10-8-2003.

GET MORE FOR YOUR MONEY

FOR ARRANGING FOR DISCOUNT PURCHASES FOR MEMBER OF AN AUTOMOBILE CLUB (U.S. CLS. 100, 101 AND 102).
STANLEY I. OSBORNE, EXAMINING ATTORNEY

SN 78-311,871. HAIG, WILLIAM, L., HONOLULU, HI. FILED 10-9-2003.

CREDIBILITY BASED LOGO DESIGN

NO CLAIM IS MADE TO THE EXCLUSIVE RIGHT TO USE "LOGO DESIGN", APART FROM THE MARK AS SHOWN.
FOR CREATING TRADEMARKS FOR OTHERS (U.S. CLS. 100, 101 AND 102).
FIRST USE 3-1-2003; IN COMMERCE 3-1-2003.
TRICIA SONNEBORN, EXAMINING ATTORNEY

CLASS 35—(Continued).

SN 78-313,180. HEB GROCERY COMPANY, L.P., SAN ANTONIO, TX. FILED 10-14-2003.

HEB HEXELLENC

FOR RETAIL DELICATESSEN SERVICES (U.S. CLS. 100, 101 AND 102).
REBECCA SMITH, EXAMINING ATTORNEY

SN 78-313,200. HEB GROCERY COMPANY, L.P., SAN ANTONIO, TX. FILED 10-14-2003.

HEB HEXELENC

FOR RETAIL DELICATESSEN SERVICES (U.S. CLS. 100, 101 AND 102).
REBECCA SMITH, EXAMINING ATTORNEY

SN 78-313,581. RESOLUTION RESEARCH & MARKETING, INC., DENVER, CO. FILED 10-14-2003.

AMERIPULSE

FOR BUSINESS RESEARCH, ANALYSIS AND CONSULTING SERVICES, NAMELY, CONDUCTING BUSINESS AND MARKET RESEARCH SERVICES IN THE NATURE OF CUSTOM RESEARCH STUDIES WHICH PROVIDE QUESTIONNAIRE DESIGN, DATA COLLECTION VIA TELEPHONE, IN-PERSON FOCUS GROUPS, ONLINE SURVEYS OR FOCUS GROUPS AND FAXED INFORMATION, INCLUDING DATA TABULATION, STATISTICAL ANALYSIS AND REPORTING AND ARE PROVIDED TO CREATE A PANEL OF REGISTERED VOTERS TO PARTICIPATE IN STUDIES, AS THEY QUALIFY AND OCCUR, THROUGHOUT THE YEAR, EITHER ON THE TELEPHONE, THE INTERNET, OR VIA FOCUS GROUPS (U.S. CLS. 100, 101 AND 102).
CAROLINE WOOD, EXAMINING ATTORNEY

SN 78-313,588. ORCHARD COUNTRREE MARKET, INC., LA CRESCENT, MN. FILED 10-14-2003.

THE TWO WORLDS

FOR RETAIL STORES FEATURING FURNITURE AND HOME FURNISHINGS (U.S. CLS. 100, 101 AND 102).
JENNIFER KRISP, EXAMINING ATTORNEY

CLASS 35—(Continued).

SN 78-313,593. RESOLUTION RESEARCH & MARKETING, INC., DENVER, CO. FILED 10-14-2003.

CLASS 35—(Continued).

SN 78-331,107. RESOLUTION RESEARCH & MARKETING, INC., DENVER, CO. FILED 11-20-2003.

VOTERPULSE

FOR BUSINESS RESEARCH, ANALYSIS AND CONSULTING SERVICES, NAMELY, CONDUCTING BUSINESS AND MARKET RESEARCH SERVICES IN THE NATURE OF CUSTOM RESEARCH STUDIES WHICH PROVIDE QUESTIONNAIRE DESIGN, DATA COLLECTION VIA TELEPHONE, IN-PERSON FOCUS GROUPS, ONLINE SURVEYS OR FOCUS GROUPS AND FAXED INFORMATION, INCLUDING DATA TABULATION, STATISTICAL ANALYSIS AND REPORTING AND ARE PROVIDED TO CREATE A PANEL OF REGISTERED VOTERS TO PARTICIPATE IN STUDIES, AS THEY QUALIFY AND OCCUR, THROUGHOUT THE YEAR, EITHER ON THE TELEPHONE, THE INTERNET, OR VIA FOCUS GROUPS (U.S. CLS. 100, 101 AND 102).
CAROLINE WOOD, EXAMINING ATTORNEY

SN 78-314,590. LIL' DRUG STORE PRODUCTS, INC., CEDAR RAPIDS, IA. FILED 10-16-2003.

TAKE2

OWNER OF U.S. REG. NO. 1,993,921.
FOR PROMOTING THE MEDICINES AND PERSONAL HEALTH AND BEAUTY CARE PRODUCTS OF OTHERS THROUGH RETAIL DISPLAYS AND DISPENSERS (U.S. CLS. 100, 101 AND 102).
FIRST USE 11-8-1994; IN COMMERCE 11-8-1994.
JOSETTE BEVERLY, EXAMINING ATTORNEY

SN 78-318,914. AMDIAN ENTERPRISES LLC, ALEXANDRIA, VA. FILED 10-27-2003.

LEAVE NO TOWN BEHIND

FOR ASSOCIATION SERVICES, NAMELY, PROMOTING THE INTERESTS OF RURAL COMMUNITIES AND RURAL BROADBAND INTERNET SERVICE PROVIDERS (U.S. CLS. 100, 101 AND 102).
STANLEY I. OSBORNE, EXAMINING ATTORNEY

JuryPulse

THE MARK CONSISTS OF STANDARD CHARACTERS WITHOUT CLAIM TO ANY PARTICULAR FONT, STYLE, SIZE, OR COLOR.

FOR BUSINESS RESEARCH, ANALYSIS AND CONSULTING SERVICES, NAMELY, CONDUCTING BUSINESS AND MARKET RESEARCH SERVICES IN THE NATURE OF CUSTOM RESEARCH STUDIES WHICH PROVIDE QUESTIONNAIRE DESIGN, DATA COLLECTION VIA TELEPHONE, IN-PERSON FOCUS GROUPS, ONLINE SURVEYS OR FOCUS GROUPS AND FAXED INFORMATION, INCLUDING DATA TABULATION, STATISTICAL ANALYSIS AND REPORTING AND ARE PROVIDED TO CREATE A PANEL OF REGISTERED VOTERS TO PARTICIPATE IN STUDIES, AS THEY QUALIFY AND OCCUR, THROUGHOUT THE YEAR, EITHER ON THE TELEPHONE, THE INTERNET, OR VIA FOCUS GROUPS (U.S. CLS. 100, 101 AND 102).
CAROLINE WOOD, EXAMINING ATTORNEY

CLASS 36—INSURANCE AND FINANCIAL

SN 76-058,422. INSURED OG INSURANCE SERVICES, INC., PALO ALTO, CA. FILED 5-25-2000.

TURBOCOVERAGE

FOR INSURANCE BROKERAGE AND UNDERWRITING SERVICES IN THE FIELDS OF AUTO, MOTORCYCLE, RECREATIONAL VEHICLE, BOAT, PERSONAL WATERCRAFT AND HOMEOWNERS; VIRTUAL INSURANCE AGENCY SERVICES IN THE FIELDS OF AUTO, MOTORCYCLE, RECREATIONAL VEHICLE, BOAT, PERSONAL WATERCRAFT AND HOMEOWNERS; PROVIDING INFORMATION IN THE FIELDS OF INSURANCE AND RISK MANAGEMENT (U.S. CLS. 100, 101 AND 102).
KAREN K. BUSH, EXAMINING ATTORNEY

CLASS 36—(Continued).

SN 76-361,268. BHP BILLITON LIMITED, VICTORIA, AUSTRALIA, FILED 1-23-2002.

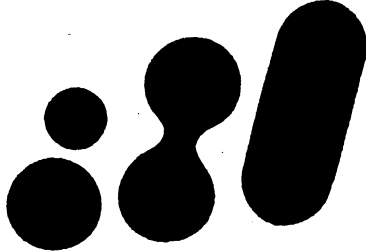

PRIORITY CLAIMED UNDER SEC. 44(D) ON AUSTRALIA APPLICATION NO. 883615, FILED 7-25-2001, REG. NO. 883615, DATED 7-25-2001, EXPIRES 7-25-2011.

FOR ACTUARIAL SERVICES; FINANCIAL ANALYSIS AND CONSULTATION; CAPITAL INVESTMENTS CONSULTATION; FINANCIAL CLEARING HOUSES; CUSTOMS BROKERAGE; FIDUCIARY REPRESENTATIVES; FINANCIAL EVALUATION OF PERSONAL PROPERTY AND REAL ESTATE FOR THE INSURANCE, BANKING, AND REAL ESTATE INDUSTRIES; FINANCIAL INFORMATION IN THE FIELD OF TRANSPORT, LOGISTICS, MANUFACTURING AND MINING; FINANCIAL MANAGEMENT; FINANCING SERVICES; FUNDS INVESTMENT; ELECTRONIC FUNDS TRANSFER; ON-LINE FINANCIAL TRANSACTIONS IN THE FIELDS OF TRANSPORT, LOGISTICS, MANUFACTURING, AND MINING; FINANCIAL GUARANTEES AND SURETIES; INSURANCE BROKERAGE AND INSURANCE UNDERWRITING IN THE FIELDS OF TRANSPORT, LOGISTICS, MANUFACTURING AND MINING; INSURANCE INFORMATION; LEASING OF REAL ESTATE; FINANCING LOANS; EXCHANGING MONEY; MUTUAL FUNDS BROKERAGE; SECURITIES BROKERAGE; STOCK AND BOND BROKERAGE, INCLUDING ELECTRONIC AND INTERNET SECURITIES; TRUSTEESHIP REPRESENTATIVES; PROVIDING ON-LINE INFORMATION RELATED TO INSURANCE, FINANCIAL AND MONETARY AFFAIRS IN THE FIELDS OF TRANSPORT, LOGISTICS, MANUFACTURING, AND MINING; VENTURE CAPITAL FINANCING; ARRANGING EXCHANGES BETWEEN BUYERS AND SELLERS, NAMELY, BROKERAGE IN THE FIELDS OF TRANSPORT, LOGISTICS, MANUFACTURING, AND MINING; OIL AND GAS LEASE ADMINISTRATION (U.S. CLS. 100, 101 AND 102).

KAREN K. BUSH, EXAMINING ATTORNEY

SN 76-368,879. WESTERN AND SOUTHERN LIFE INSURANCE COMPANY THE, DBA WESTERN-SOUTHERN LIFE, CINCINNATI, OH. FILED 2-11-2002.

OPTIMUS

THE ENGLISH TRANSLATION OF OPTIMUS IS BEST. FOR UNDERWRITING SERVICES FOR UNIVERSAL LIFE INSURANCE POLICIES (U.S. CLS. 100, 101 AND 102).

KIM SAITO, EXAMINING ATTORNEY

CLASS 36—(Continued).

SN 76-436,595. AMALGAMATED BANK, NEW YORK, NY. FILED 8-1-2002.

LONGVIEW QUANTITATIVE FUND

OWNER OF U.S. REG. NOS. 2,056,805, 2,491,659 AND OTHERS.

NO CLAIM IS MADE TO THE EXCLUSIVE RIGHT TO USE "QUANTITATIVE FUND", APART FROM THE MARK AS SHOWN.

FOR FINANCIAL SERVICES, NAMELY, INVESTMENT ADVISORY SERVICES, INVESTMENT MANAGEMENT SERVICES, ASSET MANAGEMENT SERVICES, AND THE COLLECTIVE INVESTMENT AND REINVESTMENT OF FUNDS (U.S. CLS. 100, 101 AND 102).

FIRST USE 3-1-1998; IN COMMERCE 3-1-1998.
CURTIS FRENCH, EXAMINING ATTORNEY

SN 76-467,936. AMERICAN PARTNERSHIP BOARD, SCOTTSDALE, AZ. FILED 11-18-2002.



FOR FINANCIAL MANAGEMENT AND FINANCIAL INVESTMENT SERVICES, NAMELY, THE TRADING, MATCHING, CLEARING, TRANSFER, SETTLEMENT AND OTHER BUSINESS ACTIVITIES RELATING OR PERTAINING TO SECONDARY MARKET SECURITIES AND ESCROW OF MONEYS (U.S. CLS. 100, 101 AND 102).

FIRST USE 12-0-1988; IN COMMERCE 12-0-1988.
CAROLYN CATALDO, EXAMINING ATTORNEY

SN 76-472,208. MUSÉE DU LOUVRE, PARIS, CEDEX 01, FRANCE, FILED 12-5-2002.

AMERICAN FRIENDS OF THE LOUVRE

FOR CHARITABLE FUNDRAISING SERVICES FOR A MUSEUM (U.S. CLS. 100, 101 AND 102).

INGRID C. EULIN, EXAMINING ATTORNEY

CLASS 36—(Continued).

SN 76-474,055. PERMANENT GENERAL ASSURANCE CORPORATION, NASHVILLE, TN. FILED 12-12-2002.

PGAC

FOR UNDERWRITING AUTOMOBILE INSURANCE; INSURANCE AGENCY AND INSURANCE BROKERAGE SERVICES IN THE FIELD OF AUTOMOBILE INSURANCE (U.S. CLS. 100, 101 AND 102).
FIRST USE 4-25-2002; IN COMMERCE 4-25-2002.
H. M. FISHER, EXAMINING ATTORNEY

SN 76-479,407. AMERIQUEST MORTGAGE COMPANY, ORANGE, CA. FILED 12-31-2002.



OWNER OF U.S. REG. NO. 2,608,552.
FOR MORTGAGE BANKING SERVICES; MORTGAGE BROKERAGE SERVICES; MORTGAGE LENDING SERVICES, NAMELY, LOAN PROCESSING, PURCHASING MORTGAGE LOANS FROM REAL ESTATE AND MORTGAGE BROKERS AND CORRESPONDENT LENDERS FOR OTHERS, BROKERING THE SALE AND SERVICING OF MORTGAGE LOANS TO SECONDARY MORTGAGE LENDERS, AND MAINTENANCE OF MORTGAGE ESCROW ACCOUNTS, AND EXCLUDING SERVICES FOR FINANCIAL RESTRUCTURING OF BUSINESS ENTITIES AND FINANCIAL MANAGEMENT FOR BUSINESSES (U.S. CLS. 100, 101 AND 102).
FIRST USE 4-0-1997; IN COMMERCE 4-0-1997.
CAROLINE WEIMER, EXAMINING ATTORNEY

CLASS 36—(Continued).

SN 76-488,620. BANK OF VERSAILLES, THE, VERSAILLES, MO. FILED 2-10-2003.

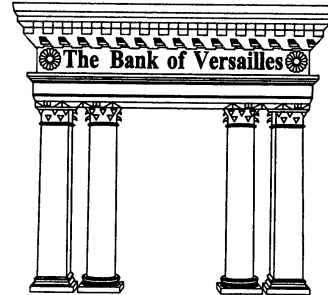

NO CLAIM IS MADE TO THE EXCLUSIVE RIGHT TO USE "BANK", APART FROM THE MARK AS SHOWN. SEC. 2(F) AS TO "THE BANK OF VERSAILLES".
FOR BANKING SERVICES (U.S. CLS. 100, 101 AND 102).
FIRST USE 6-0-1970; IN COMMERCE 6-0-1970.
BARNEY CHARLON, EXAMINING ATTORNEY

SN 76-499,279. BANK ONE CORPORATION, CHICAGO, IL. FILED 3-21-2003.

MAXIMUM STRENGTH BANKING

NO CLAIM IS MADE TO THE EXCLUSIVE RIGHT TO USE "BANKING", APART FROM THE MARK AS SHOWN.
FOR BANKING AND FINANCING SERVICES (U.S. CLS. 100, 101 AND 102).
CHRISIE B. KING, EXAMINING ATTORNEY

SN 76-501,044. FNIS INTELLECTUAL PROPERTY HOLDINGS, INC., SANTA BARBARA, CA. FILED 3-26-2003.

LOAN DIRECTOR

NO CLAIM IS MADE TO THE EXCLUSIVE RIGHT TO USE LOAN, APART FROM THE MARK AS SHOWN.
FOR REAL ESTATE SERVICES, NAMELY PROVIDING VALUATION AND APPRAISAL SERVICES AND RELATED REPORTS AND INFORMATION FOR USE BY THE REAL ESTATE LENDING INDUSTRY BY MEANS OF A DECISIONAL COMPUTER SYSTEM THAT AUTOMATICALLY SELECTS, RUNS AND EVALUATES SEARCHES ON AUTOMATED VALUATION MODELS (U.S. CLS. 100, 101 AND 102).
FIRST USE 3-1-2003; IN COMMERCE 3-1-2003.
WILLIAM VERHOSEK, EXAMINING ATTORNEY

CLASS 36—(Continued).

SN 76-502,080. CABRILLO CREDIT UNION, SAN DIEGO, CA. FILED 3-21-2003.

CABRILLO  PARTNERS

NO CLAIM IS MADE TO THE EXCLUSIVE RIGHT TO USE "PARTNERS", APART FROM THE MARK AS SHOWN. FOR CREDIT UNION SERVICES, CONSUMER AND COMMERCIAL LENDING SERVICES, AND DEPOSIT ACCOUNT SERVICES (U.S. CLS. 100, 101 AND 102). FIRST USE 11-0-2002; IN COMMERCE 11-0-2002. VERNA BETH RIRIE, EXAMINING ATTORNEY

SN 76-502,130. PACUL SERVICES INC., HARRISBURG, PA. FILED 3-28-2003.

CU BIZSOURCE

NO CLAIM IS MADE TO THE EXCLUSIVE RIGHT TO USE "CU", APART FROM THE MARK AS SHOWN. FOR BUSINESS LENDING SERVICES FOR CREDIT UNIONS; FINANCIAL ANALYSIS AND CONSULTATION IN THE FIELD OF COMMERCIAL LENDING SERVICES FOR CREDIT UNIONS; FINANCIAL SERVICES, NAMELY, CREDIT ANALYSIS; SECURITY SERVICES, NAMELY GUARANTEEING BUSINESS LOANS (U.S. CLS. 100, 101 AND 102). FIRST USE 8-1-2002; IN COMMERCE 8-1-2002. MICHAEL SOUDERS, EXAMINING ATTORNEY

SN 76-503,004. TRANSAMERICA LIFE INSURANCE AND ANNUITY COMPANY, LOS ANGELES, CA. FILED 4-1-2003.

**YOUR SIMPLE SOLUTIONS
WORKBOOK**

NO CLAIM IS MADE TO THE EXCLUSIVE RIGHT TO USE WORKBOOK, APART FROM THE MARK AS SHOWN. FOR RETIREMENT PLAN PARTICIPANT ENROLLMENT, CONSULTATION AND ADMINISTRATION SERVICES (U.S. CLS. 100, 101 AND 102). FIRST USE 9-9-2002; IN COMMERCE 9-9-2002. MELVIN AXILBUND, EXAMINING ATTORNEY

SN 76-504,120. TRC TECHNOLOGY, INC., OAKLAND, CA. FILED 4-4-2003.

RESERA

FOR CONSULTATION IN THE FIELD OF REAL ESTATE INVESTMENT AND REAL ESTATE BROKERAGE; PROVIDING INFORMATION IN THE FIELD OF REAL ESTATE BY MEANS OF LINKING THE WEB SITE TO OTHER WEB SITES FEATURING REAL ESTATE INFORMATION (U.S. CLS. 100, 101 AND 102). TANYA AMOS, EXAMINING ATTORNEY

CLASS 36—(Continued).

SN 76-504,726. GAINSCO SERVICE CORP., DALLAS, TX. FILED 4-7-2003.

**Fountain
Capital**
G R O U P

NO CLAIM IS MADE TO THE EXCLUSIVE RIGHT TO USE "CAPITAL GROUP", APART FROM THE MARK AS SHOWN.

THE MARK CONSISTS, IN PART, OF A STYLIZED WATER DESIGN.

FOR ACCIDENT INSURANCE UNDERWRITING; ACCOUNTS RECEIVABLE FINANCING; ASSUMING FINANCIAL RISK OF OTHERS BY ENTERING INTO OPTIONS AND SWAPS; AUTOMATED SECURITIES BROKERAGE; BANKING; BROKERAGE HOUSES IN THE FIELD OF STOCKS, COMMODITIES, AND FUTURES; ESTABLISHING MUTUAL FUNDS FOR OTHERS; FINANCIAL INVESTMENT IN THE FIELD OF MUTUAL FUNDS; FINANCIAL INVESTMENT IN THE FIELD OF BANKING; FINANCIAL MANAGEMENT; FINANCIAL PLANNING; FUND INVESTMENT CONSULTATION; INVESTMENT FUND MANAGEMENT SERVICES; INVESTMENT MANAGEMENT; MORTGAGE BANKING; MORTGAGE BROKERAGE SERVICES; MORTGAGE LENDING; MORTGAGE ORIGINATION SERVICES; MUTUAL FUND DISTRIBUTION; MUTUAL FUND INVESTMENT; SAVINGS AND LOAN ASSOCIATIONS; VENTURE CAPITAL FUNDING SERVICES TO EMERGING AND START-UP COMPANIES (U.S. CLS. 100, 101 AND 102).

M. E. BODSON, EXAMINING ATTORNEY

SN 76-507,269. E-LOAN, INC., DUBLIN, CA. FILED 4-15-2003.

E-LOAN

OWNER OF U.S. REG. NOS. 2,523,218 AND 2,579,051. SEC. 2(F).

FOR LENDING SERVICES NAMELY PROVIDING ON LINE APPLICATIONS FOR MORTGAGES AND CONSUMER LOANS; DIRECT FORWARDING OF ON-LINE MORTGAGE AND CONSUMER LOAN APPLICATIONS TO LENDING INSTITUTIONS; MORTGAGE BROKERAGE SERVICES, ALL RENDERED VIA A GLOBAL COMPUTER NETWORK (U.S. CLS. 100, 101 AND 102).

FIRST USE 12-24-1997; IN COMMERCE 12-24-1997.

TERESA M. RUPP, EXAMINING ATTORNEY

CLASS 36—(Continued).

SN 76-508,875. WORD & BROWN INSURANCE ADMINISTRATORS, INC., ORANGE, CA. FILED 4-23-2003.

HUMAN RESOURCEFUL

FOR ADMINISTRATION OF EMPLOYEE AND RETIREMENT BENEFIT PLANS AND SELF-DIRECTED EMPLOYEE AND RETIREMENT BENEFIT PLANS, NAMELY, ADMINISTRATION OF FEDERAL AND CALIFORNIA COBRA PLANS, SECTION 125 CAFETERIA PLANS, PREMIUM ONLY PLANS AND FLEXIBLE SPENDING ACCOUNT PLANS; ADMINISTRATION OF EMPLOYEE AND RETIREMENT BENEFIT PLAN SERVICES OFFERED OVER THE INTERNET (U.S. CLS. 100, 101 AND 102).

FIRST USE 9-27-2002; IN COMMERCE 10-16-2002.
SCOTT OSCLICK, EXAMINING ATTORNEY

SN 76-511,362. LEGACY MARKETING GROUP, SAN FRANCISCO, CA. FILED 5-2-2003.

SO ADVANCED IT'S SIMPLE

FOR ANNUITY UNDERWRITING SERVICES; AND FINANCIAL INVESTMENT SERVICES IN THE FIELD OF ANNUITIES (U.S. CLS. 100, 101 AND 102).

MITCHELL FRONT, EXAMINING ATTORNEY

SN 76-516,211. AMERICAN FAMILY LIFE ASSURANCE COMPANY OF COLUMBUS, COLUMBUS, GA. FILED 5-23-2003.

SERVICE ONE

NO CLAIM IS MADE TO THE EXCLUSIVE RIGHT TO USE "SERVICE", APART FROM THE MARK AS SHOWN.

FOR MULTIPLE LINE INSURANCE ADMINISTRATION SERVICES (U.S. CLS. 100, 101 AND 102).

MARY CRAWFORD, EXAMINING ATTORNEY

SN 76-519,949. ARMY AVIATION CENTER FEDERAL CREDIT UNION, DALEVILLE, AL. FILED 5-23-2003.

**ARMY AVIATION CENTER
FEDERAL CREDIT UNION**

NO CLAIM IS MADE TO THE EXCLUSIVE RIGHT TO USE "FEDERAL CREDIT UNION", APART FROM THE MARK AS SHOWN.

SEC. 2(F).
FOR CREDIT UNION SERVICES (U.S. CLS. 100, 101 AND 102).

FIRST USE 8-0-1967; IN COMMERCE 8-0-1967.
MARY CRAWFORD, EXAMINING ATTORNEY

CLASS 36—(Continued).

SN 76-523,693. E-LOAN, INC., DUBLIN, CA. FILED 6-19-2003.

E-LOAN

OWNER OF U.S. REG. NOS. 2,523,218 AND 2,579,051.
SEC. 2(F).

FOR LENDING SERVICES NAMELY PROVIDING ON LINE APPLICATIONS FOR MORTGAGES AND CONSUMER LOANS; DIRECT FORWARDING OF ON-LINE MORTGAGE AND CONSUMER LOAN APPLICATIONS TO LENDING INSTITUTIONS; MORTGAGE BROKERAGE SERVICES, ALL RENDERED VIA A GLOBAL COMPUTER NETWORK (U.S. CLS. 100, 101 AND 102).

FIRST USE 10-0-1996; IN COMMERCE 10-0-1996.
TERESA M. RUPP, EXAMINING ATTORNEY

SN 76-523,954. MERRILL LYNCH & CO., INC., NEW YORK, NY. FILED 6-19-2003.

STAYRS

FOR FINANCIAL SERVICES, NAMELY ISSUANCE OF AN INVESTMENT SECURITY (U.S. CLS. 100, 101 AND 102).

FIRST USE 6-10-2003; IN COMMERCE 6-10-2003.
KIMBERLY PERRY, EXAMINING ATTORNEY

SN 76-525,475. NUVEEN INVESTMENTS, INC., CHICAGO, IL. FILED 6-25-2003.

RITTENHOUSE

OWNER OF U.S. REG. NOS. 2,020,367 AND 2,627,791.
SEC. 2(F).

FOR FINANCIAL MANAGEMENT SERVICES, NAMELY, CASH MANAGEMENT, PORTFOLIO MANAGEMENT, MUTUAL FUND MANAGEMENT, AND ESTATE TRUST MANAGEMENT (U.S. CLS. 100, 101 AND 102).

FIRST USE 11-0-1979; IN COMMERCE 11-0-1979.
TONI HICKEY, EXAMINING ATTORNEY

SN 76-527,673. COMERICA INCORPORATED, DETROIT, MI. FILED 6-25-2003.

SILVER CIRCLE CHECKING

OWNER OF U.S. REG. NOS. 1,251,846, 2,747,735 AND OTHERS.

NO CLAIM IS MADE TO THE EXCLUSIVE RIGHT TO USE CHECKING, APART FROM THE MARK AS SHOWN.

FOR BANKING SERVICES, NAMELY, CHECKING ACCOUNT SERVICES (U.S. CLS. 100, 101 AND 102).

JOHN DALIER, EXAMINING ATTORNEY

CLASS 36—(Continued).

SN 76-532,126. TORREÓN CAPITAL, LP, AUSTIN, TX. FILED 7-14-2003.

TORREÓN CAPITAL

OWNER OF U.S. REG. NO. 2,348,752.

NO CLAIM IS MADE TO THE EXCLUSIVE RIGHT TO USE "CAPITAL", APART FROM THE MARK AS SHOWN. THE ENGLISH TRANSLATION OF "TORREON" IS "LARGE, FORTIFIED TOWER".

FOR CAPITAL INVESTMENT AND FINANCING SERVICES, NAMELY, LENDING OR PROVIDING DEBT, EQUITY AND MEZZANINE FINANCING AND EQUITY FUNDING, ARRANGING FOR DEBT, EQUITY AND MEZZANINE FINANCING AND EQUITY FUNDING, AND PROVIDING INVEST ADVICE, FINANCIAL MANAGEMENT SERVICES, AND ADMINISTRATIVE SERVICES RELATING TO DEBT, EQUITY AND MEZZANINE FINANCING AND EQUITY FUNDING (U.S. CLS. 100, 101 AND 102).

FIRST USE 8-30-2002; IN COMMERCE 8-30-2002.
JOHN LINCOSKI, EXAMINING ATTORNEY

SN 76-533,443. AVERY-HESS, INC., VIENNA, VA. FILED 7-30-2003.



NO CLAIM IS MADE TO THE EXCLUSIVE RIGHT TO USE "REALTORS", APART FROM THE MARK AS SHOWN. THE NAME AVERY HESS DOES NOT IDENTIFY A LIVING INDIVIDUAL.

FOR REAL ESTATE BROKERAGE SERVICES (U.S. CLS. 100, 101 AND 102).

FIRST USE 3-0-1992; IN COMMERCE 6-0-1992.
ERICA GLEMBOCKI, EXAMINING ATTORNEY

SN 76-533,889. BROOKE INSURANCE AGENCY, INC., BEEVILLE, TX. FILED 8-1-2003.

COMPCONTROL

FOR INSURANCE UNDERWRITING SERVICES IN THE FIELD OF WORKERS COMPENSATION; AND/OR INSURANCE BROKERAGE IN THE FIELD OF WORKERS COMPENSATION (U.S. CLS. 100, 101 AND 102).

FIRST USE 4-22-2003; IN COMMERCE 4-22-2003.
KEVON CHISOLM, EXAMINING ATTORNEY

CLASS 36—(Continued).

SN 76-534,332. HORACE MANN LIFE INSURANCE COMPANY, SPRINGFIELD, IL. FILED 8-4-2003.

FIXED SOLUTIONS

NO CLAIM IS MADE TO THE EXCLUSIVE RIGHT TO USE "SOLUTIONS", APART FROM THE MARK AS SHOWN.

FOR UNDERWRITING INSURANCE IN THE FIELD OF ANNUITIES AND FINANCIAL PLANNING SERVICES (U.S. CLS. 100, 101 AND 102).

GIANCARLO CASTRO, EXAMINING ATTORNEY

SN 76-537,287. MILLS LIMITED PARTNERSHIP, THE, ARLINGTON, VA. FILED 8-13-2003.

FOR SHOPPING CENTER SERVICES AND LEASING OF SHOPPING MALL SPACE (U.S. CLS. 100, 101 AND 102).

FIRST USE 9-12-1984; IN COMMERCE 9-12-1984.
CHRISTOPHER BUONGIORNO, EXAMINING ATTORNEY

SN 76-538,020. COMERICA INCORPORATED, DETROIT, MI. FILED 8-6-2003.

COMERICA SILVER CIRCLE CHECKING

OWNER OF U.S. REG. NOS. 1,251,846, 2,747,735 AND OTHERS.

NO CLAIM IS MADE TO THE EXCLUSIVE RIGHT TO USE CHECKING, APART FROM THE MARK AS SHOWN.

FOR BANKING SERVICES, NAMELY, CHECKING ACCOUNT SERVICES (U.S. CLS. 100, 101 AND 102).

JOHN DALIER, EXAMINING ATTORNEY

SN 76-538,631. NYC BIG APPLE DESIGNS, LLC, NEW YORK, NY. FILED 8-20-2003.

BUY A BIG APPLE TO HELP THE BIG APPLE

FOR CHARITABLE CIVIC AND COMMUNITY SERVICES FUNDRAISING (U.S. CLS. 100, 101 AND 102).

MATTHEW KLINE, EXAMINING ATTORNEY

CLASS 36—(Continued).

SN 76-539,310. MURCHISON, ROBERT W., SARASOTA, FL. FILED 8-11-2003.

DIVORCEOPTIONS

FOR FINANCIAL SERVICES, NAMELY, INVESTMENT ADVICE PROVIDED TO INDIVIDUALS INVOLVED IN A DIVORCE (U.S. CLS. 100, 101 AND 102).
FIRST USE 7-1-2003; IN COMMERCE 7-1-2003.
DAVID TAYLOR, EXAMINING ATTORNEY

SN 76-539,964. THE TORONTO DOMINION BANK, TORONTO, ONTARIO, CANADA, FILED 7-28-2003.

THE TORONTO-DOMINION BANK

OWNER OF U.S. REG. NO. 1,885,239.
NO CLAIM IS MADE TO THE EXCLUSIVE RIGHT TO USE "BANK", APART FROM THE MARK AS SHOWN.
FOR GENERAL BANKING SERVICES FOR WHOLESALE CLIENTS (U.S. CLS. 100, 101 AND 102).
FIRST USE 2-1-1955; IN COMMERCE 2-1-1955.
MICHAEL KAZAZIAN, EXAMINING ATTORNEY

SN 76-544,074. AMERICAN FIDELITY ASSURANCE COMPANY, OKLAHOMA CITY, OK. FILED 9-11-2003.

ACCIDENT PROTECTION PLUS

NO CLAIM IS MADE TO THE EXCLUSIVE RIGHT TO USE "ACCIDENT PROTECTION", APART FROM THE MARK AS SHOWN.
FOR INSURANCE SERVICES NAMELY, INSURANCE UNDERWRITING IN THE FIELD OF LIFE, HEALTH AND SUPPLEMENTAL DISABILITY INSURANCE (U.S. CLS. 100, 101 AND 102).
FIRST USE 8-1-2003; IN COMMERCE 8-1-2003.
ROBIN CHOSID, EXAMINING ATTORNEY

SN 76-544,162. BANDERSNATCH RESEARCH, L.L.C., BOZEMAN, MT. FILED 9-11-2003.



NO CLAIM IS MADE TO THE EXCLUSIVE RIGHT TO USE "RESEARCH LLC", APART FROM THE MARK AS SHOWN.
FOR PROVIDING FINANCIAL RESEARCH AND INFORMATION ABOUT PUBLICLY TRADED COMPANIES, NAMELY, INFORMATION ABOUT CORPORATE FINANCIALS, THE STOCK MARKET GENERALLY, SEC FILINGS, AND OTHER DATA IMPACTING STOCK PRICES (U.S. CLS. 100, 101 AND 102).
FIRST USE 5-0-2003; IN COMMERCE 5-0-2003.
TRACY CROSS, EXAMINING ATTORNEY

CLASS 36—(Continued).

SN 76-545,025. KUPCZYK, KURT E., CANOGA PARK, CA. AND CRAWFORD, GARLAND, CANOGA PARK, CA. FILED 9-2-2003.

E-VALUE8AMERICA

FOR REAL ESTATE APPRAISAL SERVICES (U.S. CLS. 100, 101 AND 102).
FIRST USE 7-6-2002; IN COMMERCE 7-6-2002.
LEIGH CAROLINE CASE, EXAMINING ATTORNEY

SN 76-545,423. THE PENSION BOARDS - UNITED CHURCH OF CHRIST, INC., NEW YORK, NY. FILED 9-17-2003.

WWW.PBUCC.ORG

FOR PROVIDING INFORMATION VIA A WEB SITE CONCERNING THE ADMINISTRATION OF PENSION PLANS AND LIFE, HEALTH, DISABILITY, DENTAL, AND SUPPLEMENTAL INSURANCE PLANS FOR RETIRED CLERGY, LAY EMPLOYEES, AND THEIR FAMILIES (U.S. CLS. 100, 101 AND 102).
FIRST USE 1-1-2003; IN COMMERCE 1-1-2003.
STEVEN BERK, EXAMINING ATTORNEY

SN 76-546,260. LENDINGTREE, INC., CHARLOTTE, NC. FILED 9-22-2003.

LENDINGTREE

OWNER OF U.S. REG. NO. 2,265,733.
FOR COMPUTER SERVICES, NAMELY, MATCHING CONSUMERS WITH REAL ESTATE PROFESSIONALS IN THE FIELD OF REAL ESTATE SERVICES VIA A GLOBAL COMPUTER NETWORK (U.S. CLS. 100, 101 AND 102).
FIRST USE 8-1-2000; IN COMMERCE 8-1-2000.
ESTHER BELENKER, EXAMINING ATTORNEY

SN 76-546,678. FCC SERVICES CO., INC., OKLAHOMA CITY, OK. FILED 9-24-2003.

FIRST CAPITAL BUSINESS CREDIT

OWNER OF U.S. REG. NO. 1,966,916.
NO CLAIM IS MADE TO THE EXCLUSIVE RIGHT TO USE "CAPITAL BUSINESS CREDIT", APART FROM THE MARK AS SHOWN.
FOR FINANCIAL SERVICES, NAMELY, PROVIDING ASSET BASED LENDING AND INVOICE PURCHASING SERVICES (U.S. CLS. 100, 101 AND 102).
RAUL CORDOVA, EXAMINING ATTORNEY

CLASS 36—(Continued).

SN 76-546,680. FCC SERVICES CO., INC., OKLAHOMA CITY, OK. FILED 9-24-2003.

FIRST CAPITAL TEMPFUNDS

OWNER OF U.S. REG. NO. 1,966,916.
NO CLAIM IS MADE TO THE EXCLUSIVE RIGHT TO USE "CAPITAL TEMP FUNDS", APART FROM THE MARK AS SHOWN.

FOR FINANCIAL SERVICES, NAMELY, PROVIDING LENDING AND INVOICE PURCHASING SERVICES TO EMPLOYMENT AGENCIES (U.S. CLS. 100, 101 AND 102).
RAUL CORDOVA, EXAMINING ATTORNEY

SN 76-547,719. VALUEREALTY, INC., CAMBRIDGE, MA. FILED 9-26-2003.

VALUEVENTURES

FOR REAL ESTATE INVESTMENT SERVICES (U.S. CLS. 100, 101 AND 102).
MICHAEL WEBSTER, EXAMINING ATTORNEY

SN 76-547,807. FIRST CITIZENS MORTGAGE CORP., FAIRFAX, VA. FILED 9-25-2003.

RILEY HOME MORTGAGE CORPORATION

NO CLAIM IS MADE TO THE EXCLUSIVE RIGHT TO USE "HOME MORTGAGE CORPORATION", APART FROM THE MARK AS SHOWN.

FOR MORTGAGE LENDING AND BROKERAGE SERVICES (U.S. CLS. 100, 101 AND 102).
FIRST USE 9-15-2003; IN COMMERCE 9-15-2003.
BRIAN NEVILLE, EXAMINING ATTORNEY

SN 76-550,228. FRANCORP, INC., OLYMPIA FIELDS, IL. FILED 10-9-2003.

THE FRANCORP CAPITAL REVENUE PARTICIPATION PROGRAM

NO CLAIM IS MADE TO THE EXCLUSIVE RIGHT TO USE "CAPITAL REVENUE PARTICIPATION PROGRAM", APART FROM THE MARK AS SHOWN.

FOR FINANCIAL INVESTMENT IN THE FIELD OF FRANCHISING (U.S. CLS. 100, 101 AND 102).
FIRST USE 3-7-2002; IN COMMERCE 3-7-2002.
ANN LINNEHAN, EXAMINING ATTORNEY

CLASS 36—(Continued).

SN 76-550,545. AMALGAMATED BANK, NEW YORK, NY. FILED 9-22-2003.

AMALGAMATED BANK LONGVIEW MUTUAL FUNDS

OWNER OF U.S. REG. NOS. 1,507,479, 2,056,805 AND OTHERS.

NO CLAIM IS MADE TO THE EXCLUSIVE RIGHT TO USE "BANK" AND "MUTUAL FUNDS", APART FROM THE MARK AS SHOWN.

SEC. 2(F) AS TO "AMALGAMATED".
FOR FINANCIAL SERVICES, NAMELY, MUTUAL FUND BROKERAGE, MUTUAL FUND DISTRIBUTION AND MUTUAL FUND INVESTMENT (U.S. CLS. 100, 101 AND 102).

APRIL L. RADEMACHER, EXAMINING ATTORNEY

SN 76-550,546. AMALGAMATED BANK, NEW YORK, NY. FILED 9-22-2003.

AB LONGVIEW FUNDS

OWNER OF U.S. REG. NOS. 1,233,893, 2,056,805 AND OTHERS.

NO CLAIM IS MADE TO THE EXCLUSIVE RIGHT TO USE "FUNDS", APART FROM THE MARK AS SHOWN.

FOR INVESTMENT ADVISORY SERVICES, INVESTMENT MANAGEMENT SERVICES, ASSET MANAGEMENT SERVICES, THE COLLECTIVE INVESTMENT AND REINVESTMENT OF FUNDS AND FINANCIAL INVESTMENT SERVICES IN THE FIELD OF MUTUAL FUNDS (U.S. CLS. 100, 101 AND 102).

APRIL L. RADEMACHER, EXAMINING ATTORNEY

SN 76-551,137. FORTUNA, MICHAEL, WOODLAND HILLS, CA. FILED 9-4-2003.

UNDERWRITING WIZARD

NO CLAIM IS MADE TO THE EXCLUSIVE RIGHT TO USE "UNDERWRITING", APART FROM THE MARK AS SHOWN.

FOR MORTGAGE BROKERAGE/MORTGAGE UNDERWRITING SERVICES (U.S. CLS. 100, 101 AND 102).
JILL C. ALT, EXAMINING ATTORNEY

CLASS 36—(Continued).

SN 76-551,996. AMALGAMATED BANK, NEW YORK, NY. FILED 10-14-2003.

LONGVIEW CORE BOND FUND

OWNER OF U.S. REG. NOS. 2,056,805, 2,491,659 AND OTHERS.

NO CLAIM IS MADE TO THE EXCLUSIVE RIGHT TO USE CORE BOND FUND, APART FROM THE MARK AS SHOWN.

FOR INVESTMENT ADVISORY SERVICES, INVESTMENT MANAGEMENT SERVICES, FINANCIAL ASSET MANAGEMENT SERVICES, THE COLLECTIVE INVESTMENT AND REINVESTMENT OF FUNDS AND FINANCIAL INVESTMENT SERVICES IN THE FIELD OF MUTUAL FUNDS (U.S. CLS. 100, 101 AND 102).

FIRST USE 3-0-1998; IN COMMERCE 3-0-1998.
STEVEN BERK, EXAMINING ATTORNEY

SN 76-552,002. OLD BRIDGE INSURANCE, INC., PONTE VEDRA BEACH, FL. FILED 10-15-2003.

OLD BRIDGE INSURANCE, INC.

NO CLAIM IS MADE TO THE EXCLUSIVE RIGHT TO USE "INSURANCE, INC.", APART FROM THE MARK AS SHOWN.

FOR INSURANCE UNDERWRITING IN THE FIELD OF PERSONAL PROPERTY, HOMEOWNERS, PERSONAL ARTICLES, DWELLING FIRE, PERSONAL LIABILITY, AND BUILDERS RISK PRODUCTS (U.S. CLS. 100, 101 AND 102).

INGA ERVIN, EXAMINING ATTORNEY

SN 76-552,737. HEALTH CARE SERVICE CORPORATION, DBA BLUE CROSS AND BLUE SHIELD OF TEXAS, RICHARDSON, TX. FILED 10-20-2003.

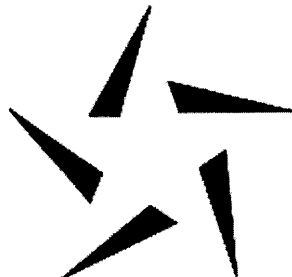

THE MARK CONSISTS OF FIVE TRIANGULAR SHAPED PIECES ARRANGED IN A STAR SHAPED DESIGN.

FOR INSURANCE ADMINISTRATION AND INSURANCE CLAIMS PROCESSING (U.S. CLS. 100, 101 AND 102).

FIRST USE 11-0-1994; IN COMMERCE 11-0-1994.
LINDA E. BLOHM, EXAMINING ATTORNEY

CLASS 36—(Continued).

SN 76-553,227. IPACQ, INC., AVON, CT. FILED 10-21-2003.



FOR ORGANIZATION, MANAGEMENT, AND ADMINISTRATION OF PREFERRED AND EXCLUSIVE PROVIDER PLANS IN THE FIELDS OF HEALTH CARE, WORKER'S COMPENSATION, DENTAL COVERAGE, AUTO INSURANCE, PHARMACY PLANS, MRIS, DISEASE MANAGEMENT, TRANSPLANTS, BEHAVIORAL HEALTH AND OTHER MANAGED CARE SERVICES (U.S. CLS. 100, 101 AND 102).

CHARLES JOYNER, EXAMINING ATTORNEY

SN 76-553,248. LONG BEACH ACCEPTANCE CORP., PARAMUS, NJ. FILED 10-22-2003.

DRIVEN BY PEOPLE

FOR FINANCIAL SERVICES, NAMELY, AUTOMOBILE LOAN ORIGINATION AND LOAN FINANCING SERVICES (U.S. CLS. 100, 101 AND 102).

CHARLES JOYNER, EXAMINING ATTORNEY

SN 76-553,578. AMERICAN LIBERTY BAIL BONDS, INC., DBA AMERICAN LIBERTY BAIL BONDS, WHITTIER, CA. FILED 10-20-2003.



FOR PROVIDING BAIL BONDING SERVICES (U.S. CLS. 100, 101 AND 102).

FIRST USE 11-2-2002; IN COMMERCE 11-2-2002.
NANCY CLARKE, EXAMINING ATTORNEY

CLASS 36—(Continued).

SN 76-553,940. ROBERT L. STARK ENTERPRISES, INC., WOODMERE, OH. FILED 10-22-2003.

THE BEAUTIFUL PEOPLE

FOR REAL ESTATE MANAGEMENT; LEASING OF REAL ESTATE (U.S. CLS. 100, 101 AND 102).
TRICIA SONNEBORN, EXAMINING ATTORNEY

SN 76-554,157. MINNESOTA BEARING COMPANY, MINNEAPOLIS, MN. FILED 10-27-2003.

PRODUCTIVITY EXCHANGE

NO CLAIM IS MADE TO THE EXCLUSIVE RIGHT TO USE "EXCHANGE", APART FROM THE MARK AS SHOWN.

FOR OPERATING A MARKETPLACE FOR SELLERS OF GOODS AND SERVICES (U.S. CLS. 100, 101 AND 102).

DARRYL SPRUILL, EXAMINING ATTORNEY

SN 76-554,439. NATIONWIDE MUTUAL INSURANCE COMPANY, COLUMBUS, OH. FILED 10-27-2003.



FOR INSURANCE AND FINANCIAL SERVICES, NAMELY, DESIGNING AND BROKERING SETTLEMENTS OF LEGAL CLAIMS UTILIZING ANNUITY CONTRACTS AND REINSURANCE CONTRACTS (U.S. CLS. 100, 101 AND 102).

FIRST USE 9-30-2002; IN COMMERCE 9-30-2002.
VIVIAN MICZNIK FIRST, EXAMINING ATTORNEY

CLASS 36—(Continued).

SN 76-554,837. THE NORTHWESTERN MUTUAL LIFE INSURANCE COMPANY, MILWAUKEE, WI. FILED 10-14-2003.

QUIET CONVERSATION

FOR UNDERWRITING OF LIFE, VARIABLE LIFE, DISABILITY, AND LONG-TERM CARE INSURANCE; BROKERAGE OF GROUP HEALTH INSURANCE; MUTUAL FUND INVESTMENT AND BROKERAGE; INVESTMENT ADVISING; ANNUITY UNDERWRITING; ESTATE AND FIDUCIARY TRUST MANAGEMENT, ESTATE PLANNING, FINANCIAL PLANNING, ESTATE AND TRUST DISTRIBUTION PLANNING, AND MUTUAL FUND ADMINISTRATION AND DISTRIBUTION (U.S. CLS. 100, 101 AND 102).

RICHARD WHITE, EXAMINING ATTORNEY

SN 76-554,838. THE NORTHWESTERN MUTUAL LIFE INSURANCE COMPANY, MILWAUKEE, WI. FILED 10-14-2003.

IT'S TIME FOR A QUIET CONVERSATION

FOR UNDERWRITING OF LIFE, VARIABLE LIFE, DISABILITY, AND LONG-TERM CARE INSURANCE; BROKERAGE OF GROUP HEALTH INSURANCE; MUTUAL FUND INVESTMENT AND BROKERAGE; INVESTMENT ADVISING; ANNUITY UNDERWRITING; ESTATE AND FIDUCIARY TRUST MANAGEMENT, ESTATE PLANNING, FINANCIAL PLANNING, ESTATE AND TRUST DISTRIBUTION PLANNING, AND MUTUAL FUND ADMINISTRATION AND DISTRIBUTION (U.S. CLS. 100, 101 AND 102).

RICHARD WHITE, EXAMINING ATTORNEY

SN 76-554,839. THE NORTHWESTERN MUTUAL LIFE INSURANCE COMPANY, MILWAUKEE, WI. FILED 10-14-2003.

QUIET CONVERSATIONS

FOR UNDERWRITING OF LIFE, VARIABLE LIFE, DISABILITY, AND LONG-TERM CARE INSURANCE; BROKERAGE OF GROUP HEALTH INSURANCE; MUTUAL FUND INVESTMENT AND BROKERAGE; INVESTMENT ADVISING; ANNUITY UNDERWRITING; ESTATE AND FIDUCIARY TRUST MANAGEMENT, ESTATE PLANNING, FINANCIAL PLANNING, ESTATE AND TRUST DISTRIBUTION PLANNING, AND MUTUAL FUND ADMINISTRATION AND DISTRIBUTION (U.S. CLS. 100, 101 AND 102).

RICHARD WHITE, EXAMINING ATTORNEY

CLASS 36—(Continued).

SN 76-554,994. ONLINE RESOURCES CORPORATION, MCLEAN, VA. FILED 10-24-2003.

QUOTIEN

FOR BANKING SERVICES RENDERED VIA THE INTERNET, BILL PAYMENT SERVICES RENDERED VIA THE INTERNET, AND CASH MANAGEMENT SERVICES FOR BUSINESS CUSTOMERS OF BANKS RENDERED VIA THE INTERNET (U.S. CLS. 100, 101 AND 102).

FIRST USE 0-0-2001; IN COMMERCE 0-0-2001.
JENNIFER KRISP, EXAMINING ATTORNEY

SN 76-555,475. NATIONWIDE ADVANTAGE MORTGAGE COMPANY, WEST DES MOINES, IA. FILED 10-30-2003.

EXPANSE

FOR MORTGAGE LENDING AND BROKERAGE SERVICES (U.S. CLS. 100, 101 AND 102).
K. MARGARET LE, EXAMINING ATTORNEY

SN 76-556,386. NORTH ISLAND FINANCIAL CREDIT UNION, CHULA VISTA, CA. FILED 10-31-2003.

WELCOME TO THE ISLAND

FOR BANKING SERVICES; FINANCIAL MANAGEMENT SERVICES; FINANCIAL SERVICES, NAMELY CONSUMER AND REAL ESTATE LOANS, SAVINGS, CHECKING, CERTIFICATES OF DEPOSIT AND IRA ACCOUNTS; ATM AND DEBIT CARD SERVICES; HOME BANKING (U.S. CLS. 100, 101 AND 102).

FIRST USE 5-1-2003; IN COMMERCE 5-1-2003.
DAVID H. STINE, EXAMINING ATTORNEY

SN 76-559,871. MARBRIDGE GROUP LLC, SAN FRANCISCO, CA. FILED 11-14-2003.

MARBRIDGE

THE MARK CONSISTS OF STANDARD CHARACTERS WITHOUT CLAIM TO ANY PARTICULAR FONT, STYLE, SIZE, OR COLOR.

FOR PROVIDING INFORMATION, ADVICE, RESEARCH AND CONSULTING IN THE FIELDS OF FINANCE AND INVESTMENT; FINANCIAL INVESTMENT SERVICES IN THE FIELDS OF SECURITIES, FUNDS, AND VENTURE CAPITAL BUSINESSES; INVESTMENT AND ASSET MANAGEMENT SERVICES; INVESTMENT OF FUNDS FOR OTHERS; AND INVESTMENT INTRODUCTION SERVICES, NAMELY, PROVIDING FINANCIAL ADVICE AND ASSISTANCE TO INTRODUCE INVESTORS WITH INVESTMENT OPPORTUNITIES (U.S. CLS. 100, 101 AND 102).

PATRICIA EVANKO, EXAMINING ATTORNEY

CLASS 36—(Continued).

SN 78-077,432. INSIGHT REALTY, INC, RICHMOND, VA. FILED 8-3-2001.

INSIGHT REALTY

NO CLAIM IS MADE TO THE EXCLUSIVE RIGHT TO USE "REALTY", APART FROM THE MARK AS SHOWN. FOR REAL ESTATE BROKERAGE SERVICES (U.S. CLS. 100, 101 AND 102).

FIRST USE 6-18-2001; IN COMMERCE 6-18-2001.
MARK T. MULLEN, EXAMINING ATTORNEY

SN 78-131,554. HORNE, DWIGHT R., BURLINGTON, ONTARIO, CANADA, FILED 5-28-2002.

SRUL

PRIORITY CLAIMED UNDER SEC. 44(D) ON CANADA APPLICATION NO. 1,127,867, FILED 1-18-2002, REG. NO. TMA605111, DATED 3-15-2004, EXPIRES 3-15-2019.

FOR INSURANCE AGENCY IN THE FIELD OF LIFE AND ACCIDENT INSURANCE (U.S. CLS. 100, 101 AND 102).

DARLENE BULLOCK, EXAMINING ATTORNEY

SN 78-137,544. THE SELLER'S AGENT, ST. LOUIS, MO. FILED 6-21-2002.



NO CLAIM IS MADE TO THE EXCLUSIVE RIGHT TO USE "THE SELLER'S AGENT", APART FROM THE MARK AS SHOWN.

FOR REAL ESTATE BROKERAGE SERVICES (U.S. CLS. 100, 101 AND 102).

FIRST USE 1-31-1997; IN COMMERCE 1-31-1997.
M. E. BODSON, EXAMINING ATTORNEY

SN 78-155,716. BOARDWALK APPRAISAL COMPANY, ROYAL OAK, MI. FILED 8-19-2002.

BOARDWALK APPRAISAL

NO CLAIM IS MADE TO THE EXCLUSIVE RIGHT TO USE "APPRAISAL", APART FROM THE MARK AS SHOWN. FOR US 100 101 102; G AND S- REAL ESTATE APPRAISAL SERVICES (U.S. CLS. 100, 101 AND 102).

FIRST USE 12-18-1997; IN COMMERCE 12-18-1997.
CURTIS FRENCH, EXAMINING ATTORNEY

CLASS 36—(Continued).

SN 78-161,693. WAITZ, ANTHONY, PALO ALTO, CA. AND BOKHARI, WASIQ, PALO ALTO, CA. FILED 9-6-2002.

QUANTUM INSIGHT

FOR CAPITAL INVESTMENT CONSULTATION; FINANCIAL ANALYSIS OF TECHNOLOGY BUSINESSES; VENTURE CAPITAL FUNDING SERVICES TO EMERGING AND START-UP COMPANIES (U.S. CLS. 100, 101 AND 102).

FIRST USE 8-30-2002; IN COMMERCE 8-30-2002.
MICHAEL BAIRD, EXAMINING ATTORNEY

SN 78-166,415. NCMIC GROUP, INC., WEST DES MOINES, IA. FILED 9-20-2002.

NCMIC FINANCIAL SOLUTIONS

OWNER OF U.S. REG. NOS. 1,694,844, 2,686,112 AND OTHERS.

NO CLAIM IS MADE TO THE EXCLUSIVE RIGHT TO USE "FINANCIAL SOLUTIONS", APART FROM THE MARK AS SHOWN.

FOR CREDIT CARD SERVICES, COMMERCIAL LENDING SERVICES, AND FINANCING SERVICES TO LICENSED PROFESSIONAL HEALTHCARE PROVIDERS (U.S. CLS. 100, 101 AND 102).

FIRST USE 7-25-2001; IN COMMERCE 7-25-2001.
JOHN GARTNER, EXAMINING ATTORNEY

SN 78-168,618. FIRST NIAGARA INSURANCE BROKERS, INC., NIAGARA FALLS ONTARIO, CANADA, FILED 9-27-2002.

FIRST NIAGARA INSURANCE BROKERS

PRIORITY CLAIMED UNDER SEC. 44(D) ON CANADA APPLICATION NO. 1135808, FILED 3-28-2002, REG. NO. TMA599,726, DATED 1-16-2004, EXPIRES 1-16-2019.

NO CLAIM IS MADE TO THE EXCLUSIVE RIGHT TO USE "NIAGARA INSURANCE BROKERS", APART FROM THE MARK AS SHOWN.

FOR INSURANCE AGENCY SERVICES, PROVIDING FINANCING FOR THE PURCHASE OF INSURANCE PRODUCTS, AND SELLING ANNUITIES, RRSP'S, RSP'S, GIC'S AND SEGREGATED FUNDS (U.S. CLS. 100, 101 AND 102).

FIRST USE 0-0-1984; IN COMMERCE 0-0-1984.
KIMBERLY PERRY, EXAMINING ATTORNEY

CLASS 36—(Continued).

SN 78-170,812. HENRY C. BECK COMPANY, DALLAS, TX. FILED 10-3-2002.

HENRY C. BECK COMPANY

NO CLAIM IS MADE TO THE EXCLUSIVE RIGHT TO USE "COMPANY", APART FROM THE MARK AS SHOWN. THE LIKENESS (OR, "PORTRAIT") IN THE MARK DOES NOT IDENTIFY A LIVING INDIVIDUAL.

FOR FINANCIAL SERVICES, NAMELY FINANCIAL LENDING SERVICES; FINANCIAL INVESTMENT SERVICES; REAL ESTATE SERVICES, NAMELY BUYING AND SELLING REAL ESTATE (U.S. CLS. 100, 101 AND 102).

DOMINIC J. FERRAIUOLO, EXAMINING ATTORNEY

SN 78-185,304. ALLIANZ LIFE INSURANCE COMPANY OF NORTH AMERICA, MINNEAPOLIS, MN. FILED 11-14-2002.

GENERATION PLANNER

NO CLAIM IS MADE TO THE EXCLUSIVE RIGHT TO USE "PLANNER", APART FROM THE MARK AS SHOWN.

FOR INSURANCE SERVICES, NAMELY, UNDERWRITING, CLAIMS PROCESSING, CLAIMS ADMINISTRATION, CONSULTATION AND BROKERAGE, IN THE FIELDS OF LIFE INSURANCE AND ANNUITIES (U.S. CLS. 100, 101 AND 102).

FIRST USE 1-17-2003; IN COMMERCE 1-17-2003.
MICHAEL WEBSTER, EXAMINING ATTORNEY

SN 78-187,963. ASSOCIATES FIRST CAPITAL CORPORATION, IRVING, TX. FILED 11-22-2002.

YESBROKER.COM

FOR FINANCIAL SERVICES, NAMELY, CONSUMER LENDING AND FINANCING SERVICES; CREDIT SERVICES AND CREDIT INSURANCE SERVICES, NAMELY, LOAN PRE-QUALIFICATION SERVICES AND BROKERAGE OF CREDIT INSURANCE TO OTHERS; INFORMATION SERVICES IN THE FIELD OF CONSUMER LENDING, FINANCING SERVICES, CREDIT SERVICES AND CREDIT INSURANCE SERVICES, FINANCIAL INFORMATION SERVICES, AND LOAN PRE-QUALIFICATION SERVICES, PROVIDED VIA A GLOBAL COMPUTER NETWORK (U.S. CLS. 100, 101 AND 102).

FIRST USE 6-24-2000; IN COMMERCE 6-24-2000.
JOHN GARTNER, EXAMINING ATTORNEY

CLASS 36—(Continued).

SN 78-188,663. CREDIT RESOURCES, INC., WEST PATERSON, NJ. FILED 11-25-2002.



Credit Resources, Inc.

NO CLAIM IS MADE TO THE EXCLUSIVE RIGHT TO USE CREDIT RESOURCES INC., APART FROM THE MARK AS SHOWN.

FOR CREDIT REPORTING SERVICES (U.S. CLS. 100, 101 AND 102).

FIRST USE 7-1-1983; IN COMMERCE 7-1-1983.
BRIDGETT SMITH, EXAMINING ATTORNEY

SN 78-203,663. PALMSOURCE, INC., SUNNYVALE, CA. FILED 1-15-2003.

PALMONE

OWNER OF U.S. REG. NOS. 2,613,597, 2,653,036 AND OTHERS.

FOR WARRANTY SERVICES, NAMELY, UNDERWRITING AND PROVIDING WARRANTY PROGRAMS IN THE FIELD OF CONSUMER ELECTRONIC PRODUCTS; PROVIDING EXTENDED REPAIR CONTRACT SERVICES AND EXTENDED WARRANTY SERVICES IN THE FIELD OF CONSUMER ELECTRONIC PRODUCTS; PROVIDING WEBSITES FEATURING INFORMATION AND LINKS TO OTHER WEBSITES IN THE FIELD OF FINANCE, INSURANCE AND INVESTING; FINANCIAL SERVICES, NAMELY, PROVIDING ONLINE BILL PAYMENT SERVICES; FINANCING SERVICES; VENTURE CAPITAL SERVICES, NAMELY, PROVIDING FINANCING TO EMERGING AND START-UP COMPANIES IN THE FIELD OF CONSUMER ELECTRONIC PRODUCTS (U.S. CLS. 100, 101 AND 102).

H. M. FISHER, EXAMINING ATTORNEY

SN 78-206,198. KEYCORP, CLEVELAND, OH. FILED 1-23-2003.

KEY INVENTORY MANAGEMENT

OWNER OF U.S. REG. NOS. 1,495,327, 2,631,102 AND OTHERS.

NO CLAIM IS MADE TO THE EXCLUSIVE RIGHT TO USE "INVENTORY MANAGEMENT", APART FROM THE MARK AS SHOWN.

FOR FINANCIAL SERVICES ACCESSED VIA A GLOBAL COMPUTER NETWORK, NAMELY ON-LINE MARINE, RECREATIONAL VEHICLE, AND AUTO DEALER WHOLESALE FLOOR PLAN LINES OF CREDIT. (U.S. CLS. 100, 101 AND 102).

PAULA MAYS, EXAMINING ATTORNEY

CLASS 36—(Continued).

SN 78-207,456. THESTREET.COM, INC., NEW YORK, NY. FILED 1-27-2003.

STREETINSIGHT

FOR PROVIDING COMMENTARY, ANALYSIS AND INFORMATION CONCERNING SECURITIES AND SECURITIES MARKETS, COMMENTARY AND ANALYSIS OF STOCK, BOND, COMMODITY AND FOREIGN EXCHANGE MARKETS, BROKERAGE FIRM RESEARCH INFORMATION AND RATINGS CHANGES, INDEPENDENT FINANCIAL RESEARCH AND RATINGS CHANGES, ECONOMIC REPORTS, FINANCIAL MARKET EVENTS, FOREIGN FINANCIAL MARKETS INFORMATION, ALL MADE AVAILABLE ON-LINE VIA A GLOBAL COMMUNICATIONS NETWORK; NEWS REPORTING SERVICES FEATURING FINANCIAL INFORMATION, NAMELY, STOCK, BOND, COMMODITY, FOREIGN EXCHANGE AND OTHER SECURITIES QUOTATIONS AND QUOTATION UPDATES, INFORMATION CONCERNING SECURITIES AND SECURITIES MARKETS, COMMENTARY AND ANALYSIS OF STOCK, BOND, COMMODITY AND FOREIGN EXCHANGE MARKETS, BROKERAGE FIRM RESEARCH INFORMATION AND RATINGS CHANGES, INDEPENDENT FINANCIAL RESEARCH AND RATINGS CHANGES, ECONOMIC REPORTS, FINANCIAL MARKET EVENTS, FOREIGN FINANCIAL MARKETS INFORMATION, ALL MADE AVAILABLE ON-LINE VIA A GLOBAL COMMUNICATIONS NETWORK (U.S. CLS. 100, 101 AND 102).

LAURA KOVAISKY, EXAMINING ATTORNEY

SN 78-207,894. NEUBERGER BERMAN MANAGEMENT INC., NEW YORK, NY. FILED 1-28-2003.

NEUBERGER BERMAN ADVISERS MANAGEMENT TRUST FOCUS PORTFOLIO

OWNER OF U.S. REG. NOS. 1,939,546, 2,651,905 AND OTHERS.

NO CLAIM IS MADE TO THE EXCLUSIVE RIGHT TO USE ADVISERS MANAGEMENT TRUST AND PORTFOLIO, APART FROM THE MARK AS SHOWN.

FOR INVESTMENT ADVISORY AND MUTUAL FUND SERVICES, NAMELY, SPONSORING MUTUAL FUNDS, PROVIDING ADMINISTRATION AND SHAREHOLDER SERVICES TO MUTUAL FUNDS, DISTRIBUTING MUTUAL FUND SHARES AND MANAGING FUNDS AND BONDS AND OTHER INVESTMENTS FOR INSTITUTIONS AND THE GENERAL PUBLIC (U.S. CLS. 100, 101 AND 102).

STEVEN BERK, EXAMINING ATTORNEY

CLASS 36—(Continued).

SN 78-207,899. NEUBERGER BERMAN MANAGEMENT INC., NEW YORK, NY. FILED 1-28-2003.

**NEUBERGER BERMAN
ADVISERS MANAGEMENT
TRUST REGENCY
PORTFOLIO**

OWNER OF U.S. REG. NOS. 1,939,546, 2,651,905 AND OTHERS.

NO CLAIM IS MADE TO THE EXCLUSIVE RIGHT TO USE ADVISERS MANAGEMENT TRUST AND PORTFOLIO, APART FROM THE MARK AS SHOWN.

FOR INVESTMENT ADVISORY AND MUTUAL FUND SERVICES, NAMELY, SPONSORING MUTUAL FUNDS, PROVIDING ADMINISTRATION AND SHAREHOLDER SERVICES TO MUTUAL FUNDS, DISTRIBUTING MUTUAL FUND SHARES AND MANAGING FUNDS AND BONDS AND OTHER INVESTMENTS FOR INSTITUTIONS AND THE GENERAL PUBLIC (U.S. CLS. 100, 101 AND 102).

STEVEN BERK, EXAMINING ATTORNEY

SN 78-218,197. CRITTSO FINANCIAL, L.L.C., ELKHART, IN. FILED 2-24-2003.

CMYBILL

FOR CREDIT CARD SERVICES; AND PROVIDING CREDIT CARD ACCOUNT INFORMATION VIA THE INTERNET (U.S. CLS. 100, 101 AND 102).

AISHA CLARKE, EXAMINING ATTORNEY

SN 78-219,112. WASHINGTON MUTUAL, INC., SEATTLE, WA. FILED 2-26-2003.

**COMMON SENSE.
UNCOMMON SOLUTIONS.**

FOR ESTABLISHING AND ADMINISTERING MUTUAL FUNDS FOR OTHERS; MUTUAL FUND BROKERAGE, MUTUAL FUND DISTRIBUTION AND INVESTMENT OF FUNDS FOR OTHERS; MAINTAINING MUTUAL FUND INVESTMENT AND FUND INVESTMENT ACCOUNTS; FUNDS INVESTMENT; FUNDS INVESTMENT CONSULTATION; INVESTMENT ADVICE; FINANCIAL PORTFOLIO MANAGEMENT; FINANCIAL PLANNING SERVICES; PROVIDING AN INTERNET WEBSITE CONTAINING INFORMATION RELATED TO THE FOREGOING SERVICES (U.S. CLS. 100, 101 AND 102).

FIRST USE 10-0-2001; IN COMMERCE 10-0-2001.

SAMUEL E. SHARPER JR., EXAMINING ATTORNEY

CLASS 36—(Continued).

SN 78-224,350. ING NORTH AMERICA INSURANCE CORPORATION, ATLANTA, GA. FILED 3-11-2003.

PORTFOLIO BLUEPRINT

NO CLAIM IS MADE TO THE EXCLUSIVE RIGHT TO USE "PORTFOLIO", APART FROM THE MARK AS SHOWN.

FOR FINANCIAL SERVICES, NAMELY, PROVIDING RETIREMENT PLAN FIDUCIARIES WITH PLAN INVESTMENT OPTION PORTFOLIO SELECTION AND MONITORING SERVICES (U.S. CLS. 100, 101 AND 102).
FIRST USE 2-28-2003; IN COMMERCE 2-28-2003.

ALLISON HOLTZ, EXAMINING ATTORNEY

SN 78-225,927. ROGERS, BRIAN KEITH, NORTH BEND, WA. FILED 3-14-2003.

**MULTIPLE MERCHANT
BOOTH RENTAL PAYMENT
TECHNOLOGY**

FOR CREDIT CARD SERVICES (U.S. CLS. 100, 101 AND 102).

GIANCARLO CASTRO, EXAMINING ATTORNEY

SN 78-230,169. WASHINGTON MUTUAL, INC., SEATTLE, WA. FILED 3-26-2003.

**CAN! (COMMITTED ACTIVE
NEIGHBORS)**

FOR CHARITABLE FUND RAISING; CHARITABLE FUNDRAISING SERVICES FOR GRANTS AND NON-PROFIT COMMUNITY EVENTS; FINANCIAL SPONSORSHIP OF NON-PROFIT CHARITABLE COMMUNITY EVENTS; CHARITABLE AND PHILANTHROPIC SERVICES CONCERNING MONETARY DONATIONS IN SUPPORT OF CHILD EDUCATION AND COMMUNITY NEEDS; BANKING SERVICES; BANKING SERVICES, NAMELY SAVINGS ACCOUNTS AND MORTGAGE LENDING FOR AFFORDABLE HOUSING (U.S. CLS. 100, 101 AND 102).

ANDREA SAUNDERS, EXAMINING ATTORNEY

SN 78-231,681. HARRIS, DOUGLAS S., GREENSBORO, NC. FILED 3-30-2003.

REBIT

FOR FINANCIAL SERVICES IN THE NATURE OF AN INVESTMENT SECURITY (U.S. CLS. 100, 101 AND 102).

FIRST USE 3-13-2003; IN COMMERCE 3-17-2003.

JENNIFER DIXON, EXAMINING ATTORNEY

CLASS 36—(Continued).

SN 78-233,108. AMERICAN MEDICAL SECURITY GROUP, INC., GREEN BAY, WI. FILED 4-2-2003.

WE'RE ALL ABOUT YOU

FOR INSURANCE SERVICES, NAMELY, DESIGN AND ADMINISTRATION OF HEALTH CARE INSURANCE PLANS FOR OTHERS (U.S. CLS. 100, 101 AND 102).

PAULA MAYS, EXAMINING ATTORNEY

SN 78-239,199. PENSON WORLDWIDE, INC., DALLAS, TX. FILED 4-17-2003.

PENSON FINANCIAL SERVICES

NO CLAIM IS MADE TO THE EXCLUSIVE RIGHT TO USE "FINANCIAL SERVICES", APART FROM THE MARK AS SHOWN.

SEC. 2(F).

FOR FINANCIAL SERVICES, NAMELY, FINANCIAL CLEARING HOUSES, FINANCIAL INFORMATION PROCESSING, INVESTMENT FUND TRANSFER AND TRANSACTION SERVICES, FINANCING SERVICES, INVESTMENT BROKERAGE, AND CURRENCY EXCHANGE (U.S. CLS. 100, 101 AND 102).

FIRST USE 0-0-1995; IN COMMERCE 0-0-1995.

JOHN SCHUYLER YARD, EXAMINING ATTORNEY

SN 78-239,212. PENSON WORLDWIDE, INC., DALLAS, TX. FILED 4-17-2003.

PENSON WORLDWIDE

NO CLAIM IS MADE TO THE EXCLUSIVE RIGHT TO USE WORLDWIDE, APART FROM THE MARK AS SHOWN.

FOR FINANCIAL SERVICES, NAMELY, FINANCIAL CLEARING HOUSES, FINANCIAL INFORMATION PROCESSING, INVESTMENT FUND TRANSFER AND TRANSACTION SERVICES, FINANCING SERVICES, INVESTMENT BROKERAGE, AND CURRENCY EXCHANGE (U.S. CLS. 100, 101 AND 102).

FIRST USE 0-0-1995; IN COMMERCE 0-0-1995.

JOHN SCHUYLER YARD, EXAMINING ATTORNEY

CLASS 36—(Continued).

SN 78-252,665. ACCREDITED INVESTOR SERVICES, INC., ST. CLOUD, MN. FILED 5-21-2003.



NO CLAIM IS MADE TO THE EXCLUSIVE RIGHT TO USE PLANNING, APART FROM THE MARK AS SHOWN. FOR FINANCIAL PLANNING (U.S. CLS. 100, 101 AND 102).

CIMMERIAN COLEMAN, EXAMINING ATTORNEY

SN 78-261,120. TULSA TEACHERS CREDIT UNION, TULSA, OK. FILED 6-11-2003.



NO CLAIM IS MADE TO THE EXCLUSIVE RIGHT TO USE "TULSA TEACHERS CREDIT UNION", APART FROM THE MARK AS SHOWN.

FOR FINANCIAL SERVICES TO MEMBERSHIP BODY NAMELY, CHECKING ACCOUNT SERVICES, CREDIT CARD SERVICES, LOANS SERVICES NAMELY, PROVIDING TEMPORARY LOANS, SAVINGS AND LOAN SERVICES, LOAN FINANCING SERVICES, LENDING SERVICES IN THE NATURE OF DEALER DIRECT MORTGAGE FINANCING SERVICES; ONLINE BANKING SERVICES NAMELY, SAVINGS AND LOAN SERVICES, ISSUING CERTIFICATES OF DEPOSITS; INSURANCE UNDERWRITING SERVICES IN THE FIELD OF AUTO, ACCIDENTAL DEATH AND DISABILITY, CANCER PROTECTION, DENTAL, HOMEOWNERS, AND LONG TERM CARE INSURANCE (U.S. CLS. 100, 101 AND 102).

FIRST USE 5-1-2001; IN COMMERCE 5-1-2001.

PAULA MAYS, EXAMINING ATTORNEY

SN 78-263,756. ALPHA FLYING, INC., MANCHESTER, NH. FILED 6-18-2003.

PLANESENSE

FOR FORMATION, BROKERAGE, AND MANAGEMENT OF TIME SHARING INTERESTS, NAMELY, FRACTIONAL INTERESTS, FOR AIRCRAFT (U.S. CLS. 100, 101 AND 102).

FIRST USE 9-17-1995; IN COMMERCE 9-17-1995.

BRETT J. GOLDEN, EXAMINING ATTORNEY

CLASS 36—(Continued).

SN 78-263,961. VENTURE DEVELOPMENT INC., EDINA, MN. FILED 6-18-2003.

VENTURE DEVELOPMENT INCORPORATED

NO CLAIM IS MADE TO THE EXCLUSIVE RIGHT TO USE "DEVELOPMENT, INC.", APART FROM THE MARK AS SHOWN.

FOR FINANCIAL SERVICES, NAMELY PROVIDING MORTGAGE BROKERAGE SERVICES AND/OR MORTGAGE LOAN SERVICING FOR INDIVIDUALS TRYING TO OBTAIN RESIDENTIAL, INVESTMENT, OR COMMERCIAL PROPERTY (U.S. CLS. 100, 101 AND 102).

FIRST USE 5-1-1995; IN COMMERCE 5-1-1995.
JOHN LINCOSKI, EXAMINING ATTORNEY

SN 78-269,608. FIRST NATIONAL BANK OF OMAHA, OMAHA, NE. FILED 7-2-2003.

VISION CARD

NO CLAIM IS MADE TO THE EXCLUSIVE RIGHT TO USE "CARD", APART FROM THE MARK AS SHOWN.

FOR CREDIT CARD SERVICES (U.S. CLS. 100, 101 AND 102).

JOHN HWANG, EXAMINING ATTORNEY

SN 78-270,000. SAN JOSE STATE UNIVERSITY FOUNDATION, SAN JOSE, CA. FILED 7-2-2003.

STEPWISE

FOR PROVIDING FINANCIAL ADVICE TO THE PUBLIC AND PUBLIC BENEFIT AGENCIES AND CORPORATIONS IN THE FIELD OF ADMINISTERING A MORTGAGE LOAN ASSISTANCE PROGRAM (U.S. CLS. 100, 101 AND 102).

ELLEN B. AWRICH, EXAMINING ATTORNEY

SN 78-274,417. AMERICAN OPTOMETRIC ASSOCIATION, ST. LOUIS, MO. FILED 7-15-2003.

AOAADVANTAGE PLUS

THE MARK CONSISTS OF STANDARD CHARACTERS WITHOUT CLAIM TO ANY PARTICULAR FONT, STYLE, SIZE, OR COLOR.

FOR FINANCIAL SERVICES, NAMELY EDUCATIONAL LENDING SERVICES AND FINANCIAL ANALYSIS AND CONSULTATION (U.S. CLS. 100, 101 AND 102).

FIRST USE 5-28-2003; IN COMMERCE 5-28-2003.
MARY CRAWFORD, EXAMINING ATTORNEY

CLASS 36—(Continued).

SN 78-275,560. ARIZONA MEDIA CREDIT UNION, PHOENIX, AZ. FILED 7-17-2003.

FIRST EDITION COMMUNITY CREDIT UNION

NO CLAIM IS MADE TO THE EXCLUSIVE RIGHT TO USE "COMMUNITY CREDIT UNION", APART FROM THE MARK AS SHOWN.

FOR FINANCIAL SERVICES, NAMELY, MONEY LENDING AND CREDIT UNION SERVICES FOR CREDIT UNION MEMBERS; SAVINGS ACCOUNT SERVICES INCLUDING CERTIFICATES OF DEPOSIT AND MONEY MARKET SAVINGS; CHECKING SERVICES; RETIREMENT ACCOUNT SERVICES; PERSONAL PROPERTY REAL ESTATE FINANCING SERVICES, AND UNSECURED LOAN SERVICES; CREDIT CARD SERVICES; ON-LINE BANKING SERVICES; SMALL BUSINESS FINANCIAL SERVICES, NAMELY LOAN SERVICES, DEPOSIT SERVICES, AND CREDIT CARD PROCESSING (U.S. CLS. 100, 101 AND 102).

KARLA PERKINS, EXAMINING ATTORNEY

SN 78-279,206. AMERICAN EMPIRE SURPLUS LINES INSURANCE COMPANY, CINCINNATI, OH. FILED 7-25-2003.

AMERICAN EMPIRE SURPLUS LINES INSURANCE COMPANY

OWNER OF U.S. REG. NOS. 1,580,538 AND 2,232,516.
NO CLAIM IS MADE TO THE EXCLUSIVE RIGHT TO USE AMERICAN AND SURPLUS LINES INSURANCE COMPANY, APART FROM THE MARK AS SHOWN.

FOR PROPERTY AND CASUALTY INSURANCE UNDERWRITING SERVICES (U.S. CLS. 100, 101 AND 102).

FIRST USE 12-31-1986; IN COMMERCE 12-31-1986.

PAULA MAYS, EXAMINING ATTORNEY

SN 78-281,948. UNITED NATIONS CHILDREN'S FUND, NEW YORK, NY. FILED 8-1-2003.

GLOBAL PARENT

FOR CHARITABLE FUND RAISING SERVICES (U.S. CLS. 100, 101 AND 102).

ANN LINNEHAN, EXAMINING ATTORNEY

SN 78-282,119. HERITAGE RESERVE HOLDINGS, LLC, MENOMONEE FALLS, WI. FILED 8-1-2003.

WOODLAND PRIME

FOR LEASING OF OFFICE AND COMMERCIAL REAL ESTATE AND COMMERCIAL REAL ESTATE MANAGEMENT (U.S. CLS. 100, 101 AND 102).

TRICIA SONNEBORN, EXAMINING ATTORNEY

CLASS 36—(Continued).

SN 78-283,251. BANANA REPUBLIC (APPAREL), LLC, SAN FRANCISCO, CA. FILED 8-5-2003.

LUXE

FOR CREDIT CARD SERVICES (U.S. CLS. 100, 101 AND 102).
FIRST USE 5-0-2000; IN COMMERCE 5-0-2000.
ANNE MADDEN, EXAMINING ATTORNEY

SN 78-283,692. LAVA TRADING INC., NEW YORK, NY. FILED 8-6-2003.

**SPEED. INTELLIGENCE.
RELIABILITY.**

FOR ELECTRONIC SECURITIES TRADING SERVICES (U.S. CLS. 100, 101 AND 102).
FIRST USE 10-16-2002; IN COMMERCE 10-16-2002.
INGRID C. EULIN, EXAMINING ATTORNEY

SN 78-283,693. LAVA TRADING INC., NEW YORK, NY. FILED 8-6-2003.

**IMPROVING SECURITIES
TRADING THROUGH
TECHNOLOGY LEADERSHIP**

FOR ELECTRONIC SECURITIES TRADING SERVICES (U.S. CLS. 100, 101 AND 102).
FIRST USE 10-16-2002; IN COMMERCE 10-16-2002.
INGRID C. EULIN, EXAMINING ATTORNEY

SN 78-284,550. BANKNORTH GROUP, INC., PORTLAND, ME. FILED 8-7-2003.

RETIREMENT ESSENTIALS

NO CLAIM IS MADE TO THE EXCLUSIVE RIGHT TO USE "RETIREMENT", APART FROM THE MARK AS SHOWN.
FOR BANKING SERVICES (U.S. CLS. 100, 101 AND 102).
CAROLYN CATALDO, EXAMINING ATTORNEY

SN 78-284,565. BANKNORTH GROUP, INC., PORTLAND, ME. FILED 8-7-2003.

COLLEGE ESSENTIALS

NO CLAIM IS MADE TO THE EXCLUSIVE RIGHT TO USE "COLLEGE", APART FROM THE MARK AS SHOWN.
FOR BANKING SERVICES (U.S. CLS. 100, 101 AND 102).
CAROLYN CATALDO, EXAMINING ATTORNEY

CLASS 36—(Continued).

SN 78-286,720. BARON MORTGAGE CORPORATION, SALEM, MA. FILED 8-13-2003.

**BARON MORTGAGE
CORPORATION YOUR
LENDER FOR LIFE**

OWNER OF U.S. REG. NO. 2,815,969.
NO CLAIM IS MADE TO THE EXCLUSIVE RIGHT TO USE "MORTGAGE CORPORATION", APART FROM THE MARK AS SHOWN.
FOR MORTGAGE LENDING, NAMELY, ORIGINATION OF MORTGAGE LOANS (U.S. CLS. 100, 101 AND 102).
FIRST USE 8-1-1994; IN COMMERCE 8-1-1994.
THEODORE MCBRIDE, EXAMINING ATTORNEY

SN 78-288,121. UNITED GUARANTY CORPORATION, GREENSBORO, NC. FILED 8-15-2003.

**UNITED GUARANTY'S
PAYMENT ADVANTAGE**

NO CLAIM IS MADE TO THE EXCLUSIVE RIGHT TO USE "PAYMENT ADVANTAGE", APART FROM THE MARK AS SHOWN.
FOR MORTGAGE GUARANTY UNDERWRITING INSURANCE SERVICES (U.S. CLS. 100, 101 AND 102).
FIRST USE 10-1-2003; IN COMMERCE 10-1-2003.
RICHARD A. STRASER, EXAMINING ATTORNEY

SN 78-289,293. CAMARDA FINANCIAL ADVISORS, INC., ORANGE PARK, FL. FILED 8-19-2003.

ISIS

FOR INVESTMENT ADVICE AND FINANCIAL PORTFOLIO MANAGEMENT (U.S. CLS. 100, 101 AND 102).
AISHA CLARKE, EXAMINING ATTORNEY

SN 78-290,854. THE ENTREPRENEUR AUTHORITY, PLANO, TX. FILED 8-22-2003.

EAUTH.COM

FOR FRANCHISE BROKERING SERVICES FOR OTHERS; PROVIDING INVESTMENT ADVICE IN THE FIELD OF FRANCHISES AND BUSINESS OPPORTUNITIES (U.S. CLS. 100, 101 AND 102).
FIRST USE 5-0-2002; IN COMMERCE 5-0-2002.
TANYA AMOS, EXAMINING ATTORNEY

CLASS 36—(Continued).

SN 78-293,078. INTERACTIVE BROKERS LLC, GREENWICH, CT. FILED 8-27-2003.

IB BANK

OWNER OF U.S. REG. NO. 2,724,295.
NO CLAIM IS MADE TO THE EXCLUSIVE RIGHT TO USE "BANK", APART FROM THE MARK AS SHOWN, FOR BANKING SERVICES (U.S. CLS. 100, 101 AND 102).

DARLENE BULLOCK, EXAMINING ATTORNEY

SN 78-295,964. TSAI CAPITAL CORPORATION, NEW YORK, NY. FILED 9-4-2003.

**BECAUSE YOU SHOULDN'T
HAVE TO WORRY**

FOR FINANCIAL INVESTMENT IN THE FIELD OF STOCKS, BONDS, SECURITIES AND FINANCIAL ASSET MANAGEMENT (U.S. CLS. 100, 101 AND 102).

FIRST USE 9-0-2003; IN COMMERCE 9-0-2003.
JOHN LINCOSKI, EXAMINING ATTORNEY

SN 78-297,172. INDEPENDENT FIDUCIARY SERVICES, INC., WASHINGTON, DC. FILED 9-8-2003.

**INDEPENDENT FIDUCIARY
SERVICES, INC.**

NO CLAIM IS MADE TO THE EXCLUSIVE RIGHT TO USE "FIDUCIARY SERVICES, INC.", APART FROM THE MARK AS SHOWN.
SEC. 2(F).

FOR FINANCIAL AND INVESTMENT CONSULTING, PLANNING, ANALYSIS, MANAGEMENT AND DECISIONMAKING FOR EMPLOYEE BENEFIT PLANS AND OTHER INSTITUTIONAL INVESTORS (U.S. CLS. 100, 101 AND 102).

FIRST USE 10-1-1996; IN COMMERCE 10-1-1996.
ROBERT LORENZO, EXAMINING ATTORNEY

SN 78-300,510. CHARTER ONE FINANCIAL, INC., CLEVELAND, OH. FILED 9-15-2003.

**NEVER FORGET EVENT
REMINDERS**

FOR BANKING SERVICES (U.S. CLS. 100, 101 AND 102).

KARANENDRA S. CHHINA, EXAMINING ATTORNEY

CLASS 36—(Continued).

SN 78-300,943. TJTW FINANCIAL SERVICES, LLC, KNOXVILLE, TN. FILED 9-16-2003.

ONE WAY CHECK ADVANCE

NO CLAIM IS MADE TO THE EXCLUSIVE RIGHT TO USE CHECK ADVANCE, APART FROM THE MARK AS SHOWN.

FOR CHECK CASHING AND TEMPORARY LOANS (U.S. CLS. 100, 101 AND 102).

CHRISTOPHER BUONGIORNO, EXAMINING ATTORNEY

SN 78-302,161. VISA INTERNATIONAL SERVICE ASSOCIATION, FOSTER CITY, CA. FILED 9-18-2003.



OWNER OF U.S. REG. NOS. 2,716,020, 2,830,741 AND OTHERS.

FOR BROAD BASED FINANCIAL SERVICES, NAMELY, BANKING, BILL PAYMENT AND PRESENTMENT SERVICES, CREDIT CARD SERVICES, DEBIT CARD SERVICES, CHARGE CARD SERVICES, PREPAID CARD SERVICES OFFERED THROUGH CARDS WITH STORED VALUE, ELECTRONIC CREDIT AND DEBIT TRANSACTIONS, CASH DISBURSEMENT, CASH REPLACEMENT RENDERED BY CREDIT CARD AND DEBIT CARDS, ELECTRONIC CASH TRANSACTIONS, CHECK VERIFICATION, CHECK CASHING, DEPOSIT ACCESS AND AUTOMATED TELLER MACHINE SERVICES, POINT OF SALE AND POINT OF TRANSACTION SERVICES, TRANSACTION AUTHORIZATION AND SETTLEMENT SERVICES, ELECTRONIC PAYMENT PROCESSING SERVICES, CREDIT CARD AND DEBIT CARD VERIFICATION, PAYMENT TRANSACTION AUTHENTICATION AND VERIFICATION SERVICES, FACILITATING PERSON-TO-PERSON PAYMENT SERVICES THROUGH ELECTRONIC MEANS VIA A GLOBAL COMPUTER NETWORK; VALUE EXCHANGE SERVICES, NAMELY, SECURE ELECTRONIC CASH TRANSACTIONS AND ELECTRONIC CASH TRANSMISSIONS, OVER PUBLIC COMPUTER NETWORKS TO FACILITATE ELECTRONIC COMMERCE; ELECTRONIC FUNDS TRANSFER, STORED VALUE SMART CARD SERVICES AND ELECTRONIC CASH SERVICES, NAMELY, CURRENCY EXCHANGE IN A SECURE ENVIRONMENT OVER GLOBAL ELECTRONIC COMMUNICATIONS NETWORKS, PROVIDING FINANCIAL INFORMATION, NAMELY CREDIT AND DEBIT CARD DATA AND REPORTS, TRAVEL INSURANCE UNDERWRITING SERVICES, FINANCIAL RECORDS MANAGEMENT, ELECTRONIC FUNDS TRANSFER AND CURRENCY EXCHANGE SERVICES, FINANCIAL ASSESSMENT AND RISK MANAGEMENT SERVICES FOR OTHERS IN THE FIELD OF CONSUMER CREDIT; CREDIT MANAGEMENT SERVICES, DISSEMINATION OF FINANCIAL INFORMATION VIA A GLOBAL COMPUTER NETWORK, FINANCIAL INFORMATION RENDERED BY COMPUTER BY MEANS OF A SECURE INFORMATION COMPUTER NETWORK AND ADVISORY SERVICES REGARDING ALL OF THE FOREGOING SERVICES (U.S. CLS. 100, 101 AND 102).

MICHAEL WEBSTER, EXAMINING ATTORNEY

CLASS 36—(Continued).

SN 78-302,173. VISA INTERNATIONAL SERVICE ASSOCIATION, FOSTER CITY, CA. FILED 9-18-2003.



OWNER OF U.S. REG. NOS. 2,145,312, 2,803,570 AND OTHERS.

FOR BROAD BASED FINANCIAL SERVICES, NAMELY, BANKING, BILL PAYMENT AND PRESENTMENT SERVICES, CREDIT CARD SERVICES, DEBIT CARD SERVICES, CHARGE CARD SERVICES, PREPAID CARD SERVICES OFFERED THROUGH CARDS WITH STORED VALUE, ELECTRONIC CREDIT AND DEBIT TRANSACTIONS, CASH DISBURSEMENT, CASH REPLACEMENT RENDERED BY CREDIT CARD AND DEBIT CARDS, ELECTRONIC CASH TRANSACTIONS, CHECK VERIFICATION, CHECK CASHING, DEPOSIT ACCESS AND AUTOMATED TELLER MACHINE SERVICES, POINT OF SALE AND POINT OF TRANSACTION SERVICES, TRANSACTION AUTHORIZATION AND SETTLEMENT SERVICES, ELECTRONIC PAYMENT PROCESSING SERVICES, CREDIT CARD AND DEBIT CARD VERIFICATION, PAYMENT TRANSACTION AUTHENTICATION AND VERIFICATION SERVICES, FACILITATING PERSON-TO-PERSON PAYMENT SERVICES THROUGH ELECTRONIC MEANS VIA A GLOBAL COMPUTER NETWORK; VALUE EXCHANGE SERVICES, NAMELY, SECURE ELECTRONIC CASH TRANSACTIONS AND ELECTRONIC CASH TRANSMISSIONS, OVER PUBLIC COMPUTER NETWORKS TO FACILITATE ELECTRONIC COMMERCE; ELECTRONIC FUNDS TRANSFER, STORED VALUE SMART CARD SERVICES AND ELECTRONIC CASH SERVICES, NAMELY, CURRENCY EXCHANGE IN A SECURE ENVIRONMENT OVER GLOBAL ELECTRONIC COMMUNICATIONS NETWORKS, PROVIDING FINANCIAL INFORMATION, NAMELY CREDIT AND DEBIT CARD DATA AND REPORTS, TRAVEL INSURANCE UNDERWRITING SERVICES, FINANCIAL RECORDS MANAGEMENT, ELECTRONIC FUNDS TRANSFER AND CURRENCY EXCHANGE SERVICES, FINANCIAL ASSESSMENT AND RISK MANAGEMENT SERVICES FOR OTHERS IN THE FIELD OF CONSUMER CREDIT; CREDIT MANAGEMENT SERVICES, DISSEMINATION OF FINANCIAL INFORMATION VIA A GLOBAL COMPUTER NETWORK, FINANCIAL INFORMATION RENDERED BY COMPUTER BY MEANS OF A SECURE INFORMATION COMPUTER NETWORK AND ADVISORY SERVICES REGARDING ALL OF THE FOREGOING SERVICES (U.S. CLS. 100, 101 AND 102).

MICHAEL WEBSTER, EXAMINING ATTORNEY

SN 78-306,519. BENTRON FINANCIAL GROUP LLC, NAPERVILLE, IL. FILED 9-29-2003.

ANNUITY DETECTIVE

NO CLAIM IS MADE TO THE EXCLUSIVE RIGHT TO USE "ANNUITY", APART FROM THE MARK AS SHOWN.

FOR PROVIDING A WIDE VARIETY OF INFORMATION VIA GLOBAL COMPUTER NETWORK ABOUT ANNUITIES AND LIFE INSURANCE PRODUCTS (U.S. CLS. 100, 101 AND 102).

FIRST USE 7-31-2002; IN COMMERCE 7-31-2002.

KATHLEEN M. VANSTON, EXAMINING ATTORNEY

CLASS 36—(Continued).

SN 78-307,108. BLUE CROSS AND BLUE SHIELD OF SOUTH CAROLINA, COLUMBIA, SC. FILED 9-30-2003.

CHECKMYHRA

FOR PROVIDING INFORMATION ABOUT HEALTH CARE REIMBURSEMENT PLANS (U.S. CLS. 100, 101 AND 102).

JEFFREY S. MOLINOFF, EXAMINING ATTORNEY

SN 78-307,558. CHICAGO MERCANTILE EXCHANGE INC., CHICAGO, IL. FILED 9-30-2003.

BUILDING FUTURES IN OUR COMMUNITY

FOR CHARITABLE FUND RAISING (U.S. CLS. 100, 101 AND 102).

FRED MANDIR, EXAMINING ATTORNEY

SN 78-307,951. LUXURY MORTGAGE CORP., STAMFORD, CT. FILED 10-1-2003.

LUXURY MORTGAGE CORPORATION

NO CLAIM IS MADE TO THE EXCLUSIVE RIGHT TO USE "MORTGAGE CORPORATION", APART FROM THE MARK AS SHOWN.

FOR FIRST AND SECOND MORTGAGE LENDING, HOME EQUITY LENDING, MORTGAGE REFINANCING, ASSET BASED LENDING, COMMERCIAL AND INVESTOR MORTGAGE FINANCING (U.S. CLS. 100, 101 AND 102).

H. M. FISHER, EXAMINING ATTORNEY

SN 78-308,215. ROMP RESPONSIBLE OWNERS OF MANERLY PETS, ST. PAUL, MN. FILED 10-1-2003.

ROMP REGISTRY

OWNER OF U.S. REG. NO. 2,437,001.
NO CLAIM IS MADE TO THE EXCLUSIVE RIGHT TO USE REGISTRY, APART FROM THE MARK AS SHOWN.

FOR PROVIDING INFORMATION REGARDING DOG FRIENDLY RENTAL PROPERTIES (U.S. CLS. 100, 101 AND 102).

AMY HELLA, EXAMINING ATTORNEY

CLASS 36—(Continued).

SN 78-309,990. VISA U.S.A. INC., FOSTER CITY, CA. FILED 10-6-2003.

FOR THINGS PEOPLE DO

FOR BROAD BASED FINANCIAL SERVICES, NAMELY, BANKING, BILL PAYMENT AND PRESENTMENT SERVICES, CREDIT CARD SERVICES, DEBIT CARD SERVICES, CHARGE CARD SERVICES, PREPAID CARD SERVICES OFFERED THROUGH CARDS WITH STORED VALUE, ELECTRONIC CREDIT AND DEBIT TRANSACTIONS, CASH DISBURSEMENT, CASH REPLACEMENT RENDERED BY CREDIT CARD AND DEBIT CARDS, ELECTRONIC CASH TRANSACTIONS, CHECK VERIFICATION, CHECK CASHING, DEPOSIT ACCESS AND AUTOMATED TELLER MACHINE SERVICES, POINT OF SALE AND POINT OF TRANSACTION SERVICES, TRANSACTION AUTHORIZATION AND SETTLEMENT SERVICES, ELECTRONIC PAYMENT PROCESSING SERVICES, CREDIT CARD AND DEBIT CARD VERIFICATION, PAYMENT TRANSACTION AUTHENTICATION AND VERIFICATION SERVICES, FACILITATING PERSON-TO-PERSON PAYMENT SERVICES THROUGH ELECTRONIC MEANS VIA A GLOBAL COMPUTER NETWORK; VALUE EXCHANGE SERVICES, NAMELY, SECURE ELECTRONIC CASH TRANSACTIONS AND ELECTRONIC CASH TRANSMISSIONS, OVER PUBLIC COMPUTER NETWORKS TO FACILITATE ELECTRONIC COMMERCE; ELECTRONIC FUNDS TRANSFER, STORED VALUE SMART CARD SERVICES AND ELECTRONIC CASH SERVICES, NAMELY, CURRENCY EXCHANGE IN A SECURE ENVIRONMENT OVER GLOBAL ELECTRONIC COMMUNICATIONS NETWORKS, PROVIDING FINANCIAL INFORMATION, NAMELY CREDIT AND DEBIT CARD DATA AND REPORTS, TRAVEL INSURANCE UNDERWRITING SERVICES, FINANCIAL RECORDS MANAGEMENT, ELECTRONIC FUNDS TRANSFER AND CURRENCY EXCHANGE SERVICES, FINANCIAL ASSESSMENT AND RISK MANAGEMENT SERVICES FOR OTHERS IN THE FIELD OF CONSUMER CREDIT; CREDIT MANAGEMENT SERVICES, DISSEMINATION OF FINANCIAL INFORMATION VIA A GLOBAL COMPUTER NETWORK, FINANCIAL INFORMATION RENDERED BY COMPUTER BY MEANS OF A SECURE INFORMATION COMPUTER NETWORK AND ADVISORY SERVICES REGARDING ALL OF THE FOREGOING SERVICES (U.S. CLS. 100, 101 AND 102).
REBECCA GILBERT, EXAMINING ATTORNEY

SN 78-310,783. CITY NATIONAL BANK & TRUST CO., GLOVERSVILLE, NY. FILED 10-8-2003.

BANKING FOR YOUR LIFESTYLE

FOR BANKING SERVICES (U.S. CLS. 100, 101 AND 102).
FIRST USE 9-29-2003; IN COMMERCE 9-29-2003.
BARNEY CHARLON, EXAMINING ATTORNEY

CLASS 36—(Continued).

SN 78-311,455. AMERICAN INTERNATIONAL GROUP, INC., NEW YORK, NY. FILED 10-9-2003.

CRIME ADVANTAGE

NO CLAIM IS MADE TO THE EXCLUSIVE RIGHT TO USE "CRIME", APART FROM THE MARK AS SHOWN.
FOR INSURANCE UNDERWRITING SERVICES, NAMELY EMPLOYEE FRAUD INSURANCE (U.S. CLS. 100, 101 AND 102).
FIRST USE 8-1-2000; IN COMMERCE 8-1-2000.
MARIA-VICTORIA SUAREZ, EXAMINING ATTORNEY

SN 78-312,220. VAN KAMPEN INVESTMENTS INC., OAKBROOK TERRACE, IL. FILED 10-10-2003.

VAN KAMPEN PRIVATE PORTFOLIOS

OWNER OF U.S. REG. NOS. 1,457,729, 2,679,980 AND OTHERS.
NO CLAIM IS MADE TO THE EXCLUSIVE RIGHT TO USE "PRIVATE PORTFOLIOS", APART FROM THE MARK AS SHOWN.
FOR FINANCIAL SERVICES, NAMELY, MUTUAL FUND BROKERAGE SERVICES, ADMINISTERING MUTUAL FUND INVESTMENTS, AND FINANCIAL ADVISORY SERVICES (U.S. CLS. 100, 101 AND 102).
TANYA AMOS, EXAMINING ATTORNEY

SN 78-312,503. VALLEY VIEW CONSULTANTS, INC., EDWARDSVILLE, IL. FILED 10-11-2003.

THE STAR PLAN

NO CLAIM IS MADE TO THE EXCLUSIVE RIGHT TO USE "PLAN", APART FROM THE MARK AS SHOWN.
FOR EMPLOYER SPONSORED ESTATE PLANNING AND LIFE INSURANCE CONSULTATION (U.S. CLS. 100, 101 AND 102).
RICHARD WHITE, EXAMINING ATTORNEY

SN 78-313,399. HAZEN, BRYAN A, WICHITA, KS. FILED 10-14-2003.

REALTY4LESS

FOR REAL ESTATE LISTING, REAL ESTATE BROKERAGE, REAL ESTATE AGENCIES (U.S. CLS. 100, 101 AND 102).
M. E. BODSON, EXAMINING ATTORNEY

CLASS 36—(Continued).

SN 78-313,693. THE FIDELITY BANK, FUQUAY-VARINA, NC. FILED 10-15-2003.

RIGHT BY YOU

FOR BANKING SERVICES (U.S. CLS. 100, 101 AND 102).
CATHERINE CAIN, EXAMINING ATTORNEY

SN 78-313,962. ASSURANCEAMERICA CORPORATION, ATLANTA, GA. FILED 10-15-2003.

TRUSTWAY INSURANCE

NO CLAIM IS MADE TO THE EXCLUSIVE RIGHT TO USE "INSURANCE", APART FROM THE MARK AS SHOWN.
FOR INSURANCE AGENCIES (U.S. CLS. 100, 101 AND 102).
STEVEN BERK, EXAMINING ATTORNEY

SN 78-314,125. REALVANTAGE REAL ESTATE CORPORATION, BOCA RATON, FL. FILED 10-15-2003.

REALVANTAGE

FOR REAL ESTATE BROKERAGE, RENTAL AND APPRAISAL SERVICES (U.S. CLS. 100, 101 AND 102).
FIRST USE 12-15-1998; IN COMMERCE 10-31-2000.
REBECCA SMITH, EXAMINING ATTORNEY

SN 78-315,231. AMERICAN INTERNATIONAL GROUP, INC., NEW YORK, NY. FILED 10-17-2003.

AG ULTRA MORTGAGE COMPLETE

FOR INSURANCE UNDERWRITING SERVICES, NAMELY TERM LIFE INSURANCE (U.S. CLS. 100, 101 AND 102).
CHERYL CLAYTON, EXAMINING ATTORNEY

CLASS 37—CONSTRUCTION AND REPAIR

SN 75-731,845. EURO INDUSTRIES, INC., OCEANSIDE, CA. FILED 6-18-1999.

VANISHING SCREENS

NO CLAIM IS MADE TO THE EXCLUSIVE RIGHT TO USE "SCREENS", APART FROM THE MARK AS SHOWN.
FOR INSTALLATION OF SLIDING DOORS AND WINDOW SCREEN SYSTEMS, BOTH METAL AND NON-METAL (U.S. CLS. 100, 103 AND 106).
FIRST USE 0-0-1998; IN COMMERCE 0-0-1998.
KHANH LE, EXAMINING ATTORNEY

SN 76-499,719. ALL PRO INDUSTRIES, INC., RINGOLD, GA. FILED 3-24-2003.

ALL PRO PUTTING GREENS

NO CLAIM IS MADE TO THE EXCLUSIVE RIGHT TO USE "PUTTING GREENS", APART FROM THE MARK AS SHOWN.
FOR INSTALLATION AND MAINTENANCE OF SYNTHETIC GOLF AND PUTTING GREENS (U.S. CLS. 100, 103 AND 106).
FIRST USE 1-1-2003; IN COMMERCE 1-1-2003.
STANLEY I. OSBORNE, EXAMINING ATTORNEY

SN 76-499,720. ALL PRO INDUSTRIES, INC., RINGOLD, GA. FILED 3-24-2003.

BUILD A PUTTING GREEN DAY

FOR INSTALLATION AND MAINTENANCE OF SYNTHETIC GOLF AND PUTTING GREENS (U.S. CLS. 100, 103 AND 106).
FIRST USE 1-1-2003; IN COMMERCE 1-1-2003.
STANLEY I. OSBORNE, EXAMINING ATTORNEY

CLASS 37—(Continued).

SN 76-501,601. UNIVERSAL CONSTRUCTION SERVICES, INC., WAKEFIELD, MA. FILED 3-28-2003.



FOR CONSTRUCTION SERVICES, NAMELY, TAKING APART AND REMOVING DISCARDED INTERIOR BUILDING PARTITIONS AND FLOORING OF A BUILDING, AND INTERIOR CLEAN-UP SERVICES AT BUILDING CONSTRUCTION SITES (U.S. CLS. 100, 103 AND 106).

FIRST USE 9-4-2001; IN COMMERCE 10-7-2002.
MATTHEW KLINE, EXAMINING ATTORNEY

SN 76-503,411. JOHNSON, JOHN V., WESTERVILLE, OH. FILED 4-1-2003.

FOUNDATIONS4ENERGY

FOR INSTALLATION OF BUILDING WATERPROOFING AND INSULATION (U.S. CLS. 100, 103 AND 106).
FIRST USE 2-15-2003; IN COMMERCE 2-15-2003.
JENNIFER CHICOSKI, EXAMINING ATTORNEY

SN 76-506,199. FLOOD PROFESSIONALS, INC., TRAVERSE CITY, MI. FILED 4-14-2003.



NO CLAIM IS MADE TO THE EXCLUSIVE RIGHT TO USE "ADVANCED CLEANING EXPERTS", APART FROM THE MARK AS SHOWN.

THE DRAWING COMPRISES A RECTANGLE WITH THE WORDS ADVANCED CLEANING EXPERTS IN WHITE; THE SPADE AND CLUB PLAYING CARD SYMBOLS ARE BLACK AND OUTLINED IN WHITE; AND THE DIAMOND AND HEART PLAYING CARD SYMBOLS ARE COLORED RED AND OUTLINED IN WHITE.

FOR REPAIRING DAMAGE CAUSED BY WATER, FIRE SMOKE AND/OR SOOT; MOLD REMEDIATION (U.S. CLS. 100, 103 AND 106).

FIRST USE 8-1-2001; IN COMMERCE 8-1-2001.
RICHARD A. STRASER, EXAMINING ATTORNEY

CLASS 37—(Continued).

SN 76-512,086. ANDEX COMPANY, ELMHURST, IL. FILED 4-21-2003.

**THE MOST TRUSTED NAME
IN PEST CONTROL**

NO CLAIM IS MADE TO THE EXCLUSIVE RIGHT TO USE PEST CONTROL, APART FROM THE MARK AS SHOWN.

SEC. 2(F).
FOR TERMITE AND PEST CONTROL; EXTERMINATING SERVICES, NAMELY, VERMIN EXTERMINATION OTHER THAN FOR AGRICULTURE (U.S. CLS. 100, 103 AND 106).

FIRST USE 1-0-1993; IN COMMERCE 1-0-1993.
MICHAEL WEBSTER, EXAMINING ATTORNEY

SN 76-516,992. JENNINGS, JOHN DAVID, BIRMINGHAM, AL. FILED 5-20-2003.

AIR-KING

FOR AIR DUCT AND DRYER VENT CLEANING WHICH INCLUDES MOLD REMEDIATION; CHIMNEY SWEEPING (U.S. CLS. 100, 103 AND 106).

FIRST USE 10-1-2000; IN COMMERCE 10-1-2000.
IRA J. GOODSAD, EXAMINING ATTORNEY

SN 76-522,807. BRZOSKA, ALLEN R., CHAMPAIGN, IL. FILED 6-16-2003.

TOTAL		T _{TC}
	TILE	
		CARE

NO CLAIM IS MADE TO THE EXCLUSIVE RIGHT TO USE TILE CARE, APART FROM THE MARK AS SHOWN.

FOR TILE CARE SERVICES FOR RESIDENTIAL AND COMMERCIAL FACILITIES (U.S. CLS. 100, 103 AND 106).

FIRST USE 6-8-1992; IN COMMERCE 6-8-1992.
KEVON CHISOLM, EXAMINING ATTORNEY

CLASS 37—(Continued).

SN 76-525,306. HAMMOND LUMBER COMPANY, BELGRADE, ME. FILED 6-17-2003.



NO CLAIM IS MADE TO THE EXCLUSIVE RIGHT TO USE "PINE LOG HOMES" AND "LUMBER COMPANY", APART FROM THE MARK AS SHOWN.

THE MARK CONSISTING OF THE WORDS "MAINE PINE LOG HOMES BY HAMMOND LUMBER COMPANY" WITH THE WORD "MAINE PINE" BEING ABOVE A SOLID RECTANGLE DESIGN THAT CONTAINS THE WORDS "LOG HOMES" AND "BY HAMMOND LUMBER COMPANY"

SEC. 2(F) AS TO "MAINE PINE LOG HOMES". FOR BUILDING CONSTRUCTION AND REPAIR (U.S. CLS. 100, 103 AND 106).

FIRST USE 3-4-1987; IN COMMERCE 3-4-1987. STEVEN BERK, EXAMINING ATTORNEY

CLASS 37—(Continued).

SN 76-541,159. LIBERTI, STEPHEN A., ROCHESTER, NY. FILED 8-18-2003.



NO CLAIM IS MADE TO THE EXCLUSIVE RIGHT TO USE GROUT, APART FROM THE MARK AS SHOWN.

MAN WITH TROWEL IN HAND FOLLOWED BY NAME "MR. GROUT" TO RIGHT OF MAN LEVEL WITH TOP OF HEAD ACROSS TO THE RIGHT.

FOR TILE AND GROUT RESTORATION AND REPAIR OF DAMAGED TILES AND REMOVAL OF OLD, DISCOLORED, MOLD, MILDEWED GROUT, STAINING AND SEALING FLOOR GROUT (U.S. CLS. 100, 103 AND 106).

FIRST USE 8-16-1986; IN COMMERCE 8-15-1991. DAWN FELDMAN, EXAMINING ATTORNEY

SN 76-544,713. GREENE, DENNIS KEITH, YORK, SC. FILED 9-15-2003.

GUN SLINGER GIRLS BIKE WASH

NO CLAIM IS MADE TO THE EXCLUSIVE RIGHT TO USE "GIRLS BIKE WASH", APART FROM THE MARK AS SHOWN.

FOR MOTORCYCLE WASHING (U.S. CLS. 100, 103 AND 106).

BILL DAWE, EXAMINING ATTORNEY

SN 76-534,457. JOE CURRY WELL DRILLING, HOLLY, MI. FILED 8-4-2003.

MAKING MICHIGAN A SAFER PLACE TO BE "ONE WELL AT A TIME"

NO CLAIM IS MADE TO THE EXCLUSIVE RIGHT TO USE "MICHIGAN", APART FROM THE MARK AS SHOWN.

FOR WATER WELL DRILLING (U.S. CLS. 100, 103 AND 106).

BARBARA GAYNOR, EXAMINING ATTORNEY

SN 76-552,317. TB PROPRIETARY CORP., WILMINGTON, DE. FILED 9-29-2003.

CITY LIVING

FOR CONSTRUCTION SERVICES, NAMELY, PLANNING, LAYING OUT AND CUSTOM CONSTRUCTION OF RESIDENTIAL COMMUNITIES; REAL ESTATE DEVELOPMENT AND THE CONSTRUCTION OF HOMES (U.S. CLS. 100, 103 AND 106).

PAULA MAYS, EXAMINING ATTORNEY

CLASS 37—(Continued).

SN 78-130,116. AERO ACCESSORIES, INC., GIBSONVILLE, NC. FILED 5-21-2002.



THE LETTERS "AIA" WITH A ZIGZAG LINE THROUGH THEM.
 FOR AIRCRAFT REPAIR AND MAINTENANCE (U.S. CLS. 100, 103 AND 106).
 FIRST USE 8-10-1984; IN COMMERCE 8-10-1984.
 JOHN SCHUYLER YARD, EXAMINING ATTORNEY

CLASS 37—(Continued).

SN 78-222,095. IMES GROUP LIMITED, ABERDEEN, AB23 8JX, SCOTLAND, FILED 3-5-2003.

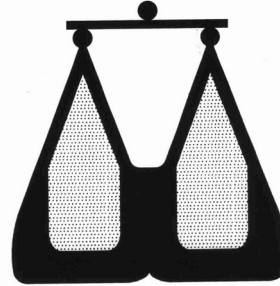

THE STIPLING IN THE DRAWING IS FOR SHADING PURPOSES ONLY.
 THE MARK CONSISTS OF A REPRESENTATION OF SCALES.
 FOR RENTAL OF INDUSTRIAL LOAD TESTING APPARATUS AND INSTRUMENTS; RENTAL OF INDUSTRIAL LIFTING EQUIPMENT; INSTALLATION, MAINTENANCE AND REPAIR OF INDUSTRIAL LOAD TESTING, LOAD BEARING AND LOAD LIFTING EQUIPMENT; MAINTENANCE AND REPAIR OF INDUSTRIAL PLANT, MACHINERY AND INSTRUMENTATION (U.S. CLS. 100, 103 AND 106).
 ALLISON HOLTZ, EXAMINING ATTORNEY

SN 78-189,634. SALTHOUSE BOATBUILDERS, LTD., GREENHITHE, NEW ZEALAND, FILED 11-27-2002.

SALTHOUSE

FOR BOAT BUILDING SERVICES (U.S. CLS. 100, 103 AND 106).
 FIRST USE 12-31-1957; IN COMMERCE 0-0-1972.
 FLORENTINA BLANDU, EXAMINING ATTORNEY

SN 78-231,453. XHAIL INCORPORATED, PLANO, TX. FILED 3-28-2003.

SN 78-190,751. ZOOM SEWER & DRAIN CLEANING SERVICE, INC., ORELAND, PA. FILED 12-3-2002.

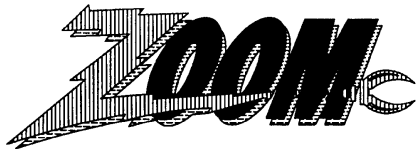

THE MARK CONSISTS OF THE TERM "ZOOM" IN STYLIZED FORM WITH THE "Z-" BEING RED, THE "OOM" BEING BLACK, AND THE LETTERS HAVING GRAY SHADOWS, AS REPRESENTED BY HATCHING IN THE DRAWING.
 FOR MUNICIPAL, COMMERCIAL, INDUSTRIAL AND RESIDENTIAL SEWER, DRAIN AND PIPE CLEANING SERVICES (U.S. CLS. 100, 103 AND 106).
 FIRST USE 8-1-1995; IN COMMERCE 8-1-1995.
 SHAUNIA WALLACE, EXAMINING ATTORNEY



NO CLAIM IS MADE TO THE EXCLUSIVE RIGHT TO USE "PAINTLESS DENT REMOVAL", APART FROM THE MARK AS SHOWN.
 FOR PAINTLESS DENT REMOVAL (U.S. CLS. 100, 103 AND 106).
 FIRST USE 10-23-2003; IN COMMERCE 10-23-2003.
 BRIAN BROWN, EXAMINING ATTORNEY

CLASS 37—(Continued).

SN 78-231,504. FRONTIER COMMUNITIES, LLC, EDWARDS, CO. FILED 3-28-2003.



THE MARK CONSISTS OF A STYLIZED, BLOCK, SANS SERIF, CAPITAL F WITH A THIN LINE RUNNING THE WIDTH OF THE LONG ARM OF THE F AND A THIN LINE RUNNING THE WIDTH OF THE STEM OF THE F.

FOR REAL ESTATE SITE SELECTION; REAL ESTATE DEVELOPMENT AND PLANNING OF RESIDENTIAL COMMUNITIES; CONSTRUCTION OF SINGLE FAMILY AND MULTI-FAMILY HOMES WITHIN RESIDENTIAL COMMUNITIES (U.S. CLS. 100, 103 AND 106).

ANN LINNEHAN, EXAMINING ATTORNEY

CLASS 37—(Continued).

SN 78-242,399. CLINE, ART, RENO, NV. FILED 4-25-2003.

MILES HOMES

NO CLAIM IS MADE TO THE EXCLUSIVE RIGHT TO USE "HOMES", APART FROM THE MARK AS SHOWN.

FOR HOME CONSTRUCTION CONTRACTING SERVICES FOR OTHERS (U.S. CLS. 100, 103 AND 106).

FIRST USE 9-1-2001; IN COMMERCE 4-1-2002.

APRIL L. RADEMACHER, EXAMINING ATTORNEY

SN 78-243,578. GROUTZILLA INCORPORATED, DOVE CANYON, CA. FILED 4-29-2003.



GROUTZILLA

FOR CLEANING OF GROUT USED WITH TILE; INTERIOR SEALING AND CAULKING SERVICES; NAMELY STAIN SEALING AND COLORING OF GROUT USED WITH TILE (U.S. CLS. 100, 103 AND 106).

SONYA STEPHENS, EXAMINING ATTORNEY

SN 78-231,729. WEBEMERGE, INC., NEW YORK, NY. FILED 3-30-2003.

COOLSPOT

FOR INSTALLATION, REPAIR, AND MAINTENANCE OF COMPUTER NETWORKS FOR OTHERS, NAMELY HIGH SPEED WIRED AND WIRELESS LOCAL AREA NETWORKS (LANS), LOCATED IN RESIDENTIAL AND COMMERCIAL BUILDINGS, USED TO TRANSMIT VOICE, AUDIO, CABLE AND DATA COMMUNICATIONS, ACCESS THE GLOBAL AND LOCAL COMPUTER NETWORK, AND MONITOR AND REPORT ON THE OPERATION OF MECHANICAL COMPONENTS AND MECHANICAL SYSTEMS WITHIN THE BUILDINGS (U.S. CLS. 100, 103 AND 106).

SONYA STEPHENS, EXAMINING ATTORNEY

SN 78-264,954. LOGIC LEVEL TECHNOLOGIES, POMPANO BEACH, FL. FILED 6-20-2003.

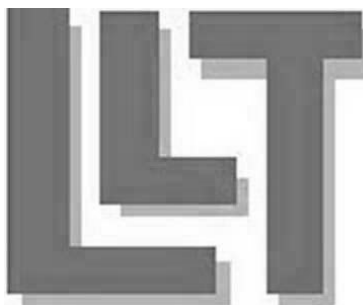

THE COLOR(S) BLUE AND GRAY IS/ARE CLAIMED AS A DISTINCTIVE FEATURE OF THE MARK.

BLUE IS THE BODY OF THE LETTERS, GRAY IS THE SHADING BEHIND THE LETTERS.

FOR REPAIR OF ELECTRONIC CONTROLS AND DRIVES FOR THE AUTOMATED MATERIAL HANDLING INDUSTRY (U.S. CLS. 100, 103 AND 106).

ALLISON HOLTZ, EXAMINING ATTORNEY

SN 78-236,886. ABSOLUTE CONCRETE CONSTRUCTION, INC., BOISE, ID. FILED 4-11-2003.

ABSOLUTE CONCRETE

NO CLAIM IS MADE TO THE EXCLUSIVE RIGHT TO USE "CONCRETE", APART FROM THE MARK AS SHOWN.

FOR CONSTRUCTION SERVICES, NAMELY, PLACEMENT OF PRE-FORMED CONCRETE WALLS, BLOCKS, BARRIERS; PLACEMENT OF CONCRETE MOLDS AND FORMS (U.S. CLS. 100, 103 AND 106).

FIRST USE 5-1-1996; IN COMMERCE 5-1-1996.

KELLY BOULTON, EXAMINING ATTORNEY

CLASS 37—(Continued).

SN 78-282,912. COHPS, L.L.C., METAIRIE, LA. FILED 8-4-2003.

COHPS

FOR MAINTENANCE OF, AND ADVICE REGARDING, BARRIER PARTITIONS IN BUILDINGS TO MINIMIZE THE SPREAD OF UNDERSIRABLES, NAMELY, SMOKE, FIRE, SOUND, BACTERIA AND OTHER CONTAMINANTS, BETWEEN WALLS, FLOORS AND CEILINGS (U.S. CLS. 100, 103 AND 106).

KAREN K. BUSH, EXAMINING ATTORNEY

SN 78-285,104. COFFMAN, PAUL, GRAND RAPIDS, MI. FILED 8-8-2003.

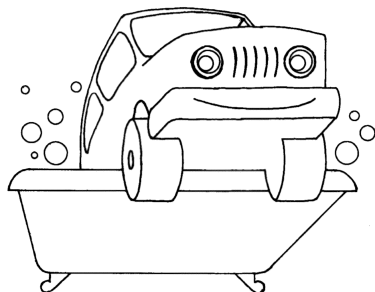

FOR AUTOMOBILE WASHING, CLEANING, POLISHING AND UNDERCOATING SERVICES (U.S. CLS. 100, 103 AND 106).

FIRST USE 2-15-1997; IN COMMERCE 2-15-1997.
CURTIS FRENCH, EXAMINING ATTORNEY

SN 78-292,547. BURT RICHARD TATE, SANTA ROSA, CA. FILED 8-26-2003.

EARTH FRIENDLY PEST CONTROL

NO CLAIM IS MADE TO THE EXCLUSIVE RIGHT TO USE "PEST CONTROL", APART FROM THE MARK AS SHOWN.

SEC. 2(F).
FOR PEST CONTROL SERVICES (U.S. CLS. 100, 103 AND 106).

FIRST USE 6-8-1995; IN COMMERCE 4-22-1996.
MELVIN AXILBUND, EXAMINING ATTORNEY

SN 78-300,301. BUCKSAR, DANIEL, MEDINA, OH. FILED 9-15-2003.

ONEBUILDER.COM

FOR CUSTOM CONSTRUCTION OF HOMES (U.S. CLS. 100, 103 AND 106).

FIRST USE 1-1-2004; IN COMMERCE 9-1-2004.
JEFFREY S. MOLINOFF, EXAMINING ATTORNEY

CLASS 37—(Continued).

SN 78-306,575. BROWN, JEFFREY J., HAYMARKET, VA. FILED 9-29-2003.

HONEY DO CREW

FOR RESIDENTIAL AND COMMERCIAL BUILDING MAINTENANCE REPAIR, REMODELING AND CONSTRUCTION (U.S. CLS. 100, 103 AND 106).

FIRST USE 6-1-2001; IN COMMERCE 7-1-2001.

JEFFREY S. MOLINOFF, EXAMINING ATTORNEY

SN 78-308,291. HOME SAVING TERMITE CONTROL, INC., SANTA CLARITA, CA. FILED 10-1-2003.

HOME PRESERVING DEHYDRATION SYSTEM

OWNER OF U.S. REG. NO. 1,940,903.

NO CLAIM IS MADE TO THE EXCLUSIVE RIGHT TO USE "DEHYDRATION SYSTEM", APART FROM THE MARK AS SHOWN.

FOR PEST CONTROL SERVICES IN THE NATURE OF IDENTIFYING, ELIMINATING, EXTERMINATING, CONTROLLING AND PREVENTING INFESTATIONS AND INFECTIONS OF WOOD DESTROYING PESTS OR ORGANISMS, AND IN CONNECTION THEREWITH TO MAKE INSPECTIONS AND INSPECTION REPORTS, RECOMMENDATIONS, ESTIMATES AND BIDS, EITHER ORAL OR WRITTEN; TO MAKE STRUCTURAL REPAIRS OR REPLACEMENTS; AND TO USE INSECTICIDES, PESTICIDES, FUMIGANTS AND ALLIED CHEMICAL AND SUBSTANCES AS REQUIRED TO FULLY PERFORM SAID SERVICES (U.S. CLS. 100, 103 AND 106).

ANDREA K. NADELMAN, EXAMINING ATTORNEY

SN 78-311,208. ALOUF, R. THOMAS JR., WIRTZ, VA. FILED 10-8-2003.

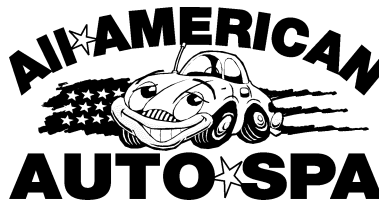

FOR AUTOMOBILE CLEANING AND CAR WASHING (U.S. CLS. 100, 103 AND 106).

FIRST USE 9-15-2003; IN COMMERCE 9-15-2003.
STANLEY I. OSBORNE, EXAMINING ATTORNEY

CLASS 37—(Continued).

SN 78-311,700. THE WEITZ COMPANY, LLC, DES MOINES, IA. FILED 10-9-2003.

WEITZ / NORRIS CUSTOM HOMES

NO CLAIM IS MADE TO THE EXCLUSIVE RIGHT TO USE CUSTOM HOMES, APART FROM THE MARK AS SHOWN.

FOR RESIDENTIAL CONSTRUCTION, GENERAL CONTRACTING FOR RESIDENTIAL CONSTRUCTION, CONSTRUCTION MANAGEMENT, DESIGN-BUILD CONSTRUCTION (U.S. CLS. 100, 103 AND 106).

MELVIN AXILBUND, EXAMINING ATTORNEY

CLASS 38—(Continued).

SN 76-450,515. METROCALL USA, INC., ALEXANDRIA, VA. FILED 9-16-2002.

METROCALL

OWNER OF U.S. REG. NO. 1,124,767.

FOR TELECOMMUNICATIONS SERVICES, NAMELY PROVIDING TELEPHONE COMMUNICATION SERVICES, CELLULAR TELEPHONE SERVICES AND WIRELESS TELEPHONE AND PERSONAL COMMUNICATION SERVICES TO THE PUBLIC AT LARGE; TELECOMMUNICATION SERVICES, NAMELY LOCAL AND LONG DISTANCE TRANSMISSION OF VOICE, DATA, GRAPHICS BY MEANS OF TELEPHONE, TELEGRAPHIC, CABLE OR SATELLITE TRANSMISSION (U.S. CLS. 100, 101 AND 104).

FIRST USE 5-4-1971; IN COMMERCE 5-4-1971.

INGRID C. EULIN, EXAMINING ATTORNEY

CLASS 38—COMMUNICATION

SN 76-100,679. AIR2LAN, INC., JACKSON, MS. FILED 8-1-2000.

AIR2LAN

FOR TELECOMMUNICATIONS SERVICES, NAMELY, PROVIDING HIGH-SPEED WIRELESS ACCESS TO A GLOBAL COMPUTER NETWORK; RELATED TELECOMMUNICATIONS SUPPORT SERVICES FOR BOTH END-USERS AND RESELLERS, NAMELY, VIRTUAL PRIVATE NETWORKING SERVICES, FIREWALL SERVICES, ELECTRONIC MAIL SERVICES, REMOTE DIAL ACCESS SERVICES, WIRELESS LOCAL AREA NETWORK SERVICES, SYSTEMS INTEGRATION AND WIRELESS CONSULTING SERVICES, AND PROVIDING MULTIPLE-USER ACCESS TO A GLOBAL COMPUTER NETWORK (U.S. CLS. 100, 101 AND 104).

FIRST USE 3-0-2000; IN COMMERCE 3-0-2000.

MARK T. MULLEN, EXAMINING ATTORNEY

SN 76-470,702. WIRELESS NETWORK SERVICES, INC., SALT LAKE CITY, UT. FILED 11-27-2002.

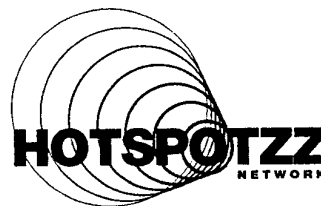

NO CLAIM IS MADE TO THE EXCLUSIVE RIGHT TO USE "HOT SPOTS NETWORK", APART FROM THE MARK AS SHOWN.

FOR COMMUNICATION SERVICES, NAMELY PROVIDING MULTIPLE USER WIRELESS INTERNET ACCESS THROUGH A COMMUNICATIONS NETWORK VIA PERSONAL AND LAPTOP COMPUTERS, CELLULAR PHONES, HANDHELD AND PERSONAL DIGITAL ASSISTANTS AND OTHER WIRELESS DEVICES USING VARIOUS AND DISPARATE WIRELESS COMMUNICATION AND COMPUTER NETWORKS (U.S. CLS. 100, 101 AND 104).

FIRST USE 9-22-2002; IN COMMERCE 9-22-2002.

AMY ALFIERI, EXAMINING ATTORNEY

SN 76-426,346. HEALTH CARE INVESTMENT VISIONS LLC, ALAMEDA, CA. FILED 6-28-2002.

VERTEX PROFESSIONAL COMMUNITY

NO CLAIM IS MADE TO THE EXCLUSIVE RIGHT TO USE "PROFESSIONAL COMMUNITY", APART FROM THE MARK AS SHOWN.

FOR PROVIDING ON-LINE CHAT ROOMS AND DISCUSSION FORUMS FOR TRANSMISSION OF MESSAGES AMONG HEALTH CARE INDUSTRY PROFESSIONALS CONCERNING HEALTH CARE INDUSTRY EMPLOYMENT INFORMATION AND INFORMATION ON HEALTH CARE PROVIDER RESOURCES (U.S. CLS. 100, 101 AND 104).

FIRST USE 4-4-2002; IN COMMERCE 4-4-2002.

CAROLINE WEIMER, EXAMINING ATTORNEY

SN 76-519,975. AWARDS.COM, LLC, FORT LEE, NJ. FILED 5-23-2003.

INSPIRE SOMEONE

OWNER OF U.S. REG. NO. 2,756,615.

FOR TRANSMISSION OF MESSAGES, DOCUMENTS, AUDIO AND AUDIOVISUAL MATERIALS, AND DATA VIA THE INTERNET (U.S. CLS. 100, 101 AND 104).

DOMINIC J. FERRAIUOLO, EXAMINING ATTORNEY

CLASS 38—(Continued).

SN 76-528,689. TRITON PCS OPERATING CO., L.L.C., BERWYN, PA. FILED 7-11-2003.

SEE FREE, CALL FREE

FOR PROVIDING WIRELESS TELECOMMUNICATION SERVICES, NAMELY, WIRELESS PERSONAL COMMUNICATION SERVICES (U.S. CLS. 100, 101 AND 104).

HOWARD SMIGA, EXAMINING ATTORNEY

SN 76-528,691. TRITON PCS OPERATING CO., L.L.C., BERWYN, PA. FILED 7-11-2003.

THE POWER OF UN

FOR PROVIDING WIRELESS TELECOMMUNICATION SERVICES, NAMELY, WIRELESS PERSONAL COMMUNICATION SERVICES (U.S. CLS. 100, 101 AND 104).

HOWARD SMIGA, EXAMINING ATTORNEY

SN 76-547,971. PACIFIC DATAVISION, INC., SAN DIEGO, CA. FILED 9-29-2003.

SELECT & SPEAK... IT'S THAT SIMPLE!

FOR TELECOMMUNICATIONS SERVICES, NAMELY, ELECTRONIC TRANSMISSION AND RECEPTION OF VOICE AND DATA MESSAGES FROM AND BETWEEN CELL PHONES, OTHER WIRELESS OR MOBILE COMMUNICATIONS DEVICES, AND OTHER DEVICES CONNECTED TO A GLOBAL COMPUTER NETWORK (U.S. CLS. 100, 101 AND 104).

FIRST USE 3-1-2003; IN COMMERCE 3-1-2003.

MICHAEL SOUDERS, EXAMINING ATTORNEY

SN 76-553,010. UNIFORM CODE COUNCIL, INC., WINCHESTER, VA. FILED 9-30-2003.

UCCNET INTELLIGENT ROUTER

OWNER OF U.S. REG. NOS. 2,382,573, 2,688,345 AND 2,703,640.

NO CLAIM IS MADE TO THE EXCLUSIVE RIGHT TO USE "INTELLIGENT ROUTER", APART FROM THE MARK AS SHOWN.

FOR ELECTRONIC FILE DELIVERY SERVICE FOR USERS IN SUPPLY CHAIN OF PRODUCTS AND SERVICES ON GLOBAL COMPUTER NETWORK (U.S. CLS. 100, 101 AND 104).

ALEX KEAM, EXAMINING ATTORNEY

CLASS 38—(Continued).

SN 78-167,065. LINE 1 COMMUNICATIONS, LLC, MARIETTA, GA. FILED 9-23-2002.

 Direct Line

NO CLAIM IS MADE TO THE EXCLUSIVE RIGHT TO USE "DIRECT LINE", APART FROM THE MARK AS SHOWN.

FOR TELECOMMUNICATIONS SERVICES, NAMELY, LONG DISTANCE, LOCAL DIALTONE, PROVIDING MULTIPLE-USER ACCESS TO A GLOBAL COMPUTER INFORMATION NETWORK, CONFERENCE CALLING, UNIFIED MESSAGING, AND WIRELESS SERVICES, NAMELY, CELLULAR TELEPHONE SERVICES (U.S. CLS. 100, 101 AND 104).

FIRST USE 6-1-2002; IN COMMERCE 6-1-2002.

MARIA-VICTORIA SUAREZ, EXAMINING ATTORNEY

SN 78-182,339. CELLCO PARTNERSHIP, DBA VERIZON WIRELESS, BEDMINSTER, NJ. FILED 11-6-2002.

CAN YOU HEAR ME NOW?

FOR TELECOMMUNICATIONS SERVICES, NAMELY TELEPHONE SERVICES (U.S. CLS. 100, 101 AND 104).

LAVERNE THOMPSON, EXAMINING ATTORNEY

SN 78-193,875. BELL, RANDALL, LAGUNA BEACH, CA. FILED 12-12-2002.

of **Master Disaster**

FOR TELEVISION BROADCASTING FEATURING GENERAL AND PROPERTY DAMAGE INFORMATION RELATED TO HIGH-PROFILE DISASTERS (U.S. CLS. 100, 101 AND 104).

FIRST USE 2-15-1995; IN COMMERCE 6-1-1997.

SUELLEN HICKEY, EXAMINING ATTORNEY

CLASS 38—(Continued).

SN 78-200,802. CORR WIRELESS COMMUNICATIONS, LLC, HUNTSVILLE, AL. FILED 1-7-2003.

**CORR WIRELESS HOW
PEOPLE CONNECT**

OWNER OF U.S. REG. NOS. 2,522,428, 2,648,515 AND OTHERS.

NO CLAIM IS MADE TO THE EXCLUSIVE RIGHT TO USE WIRELESS, APART FROM THE MARK AS SHOWN.

FOR TELEPHONE SERVICES, NAMELY, WIRELESS TELEPHONE AND PERSONAL COMMUNICATION SERVICES (U.S. CLS. 100, 101 AND 104).

FIRST USE 5-30-2001; IN COMMERCE 5-30-2001.
ALEX KEAM, EXAMINING ATTORNEY

CLASS 38—(Continued).

SN 78-272,693. THE BROADCAST TEAM, INC., ORMOND BEACH, FL. FILED 7-10-2003.



FOR VIDEO-ON-DEMAND TRANSMISSION SERVICES WHICH DISPLAY HIGHLIGHTS OF PRE-RECORDED WEDDING VIDEOS OVER THE INTERNET FOR SUBSCRIBERS (U.S. CLS. 100, 101 AND 104).

FIRST USE 3-6-2003; IN COMMERCE 3-6-2003.
CATHERINE CAIN, EXAMINING ATTORNEY

SN 78-222,684. HARRIS, DANIEL P., SANTA MONICA, CA. FILED 3-6-2003.

MEDIAPASS

FOR STREAMING OF VIDEO AND AUDIO RECORDINGS, MOTION PICTURES, ANIMATION, STILL IMAGES AND TEXT ON THE INTERNET; ELECTRONIC TRANSMISSION, VIA THE INTERNET, RADIO AND TELEVISION BROADCAST, CABLE AND SATELLITE, OF VIDEO AND AUDIO RECORDINGS, MOTION PICTURES, ANIMATION, STILL IMAGES AND TEXT (U.S. CLS. 100, 101 AND 104).

FIRST USE 10-15-2002; IN COMMERCE 10-15-2002.
STEVEN R. FINE, EXAMINING ATTORNEY

SN 78-283,830. CELLCO PARTNERSHIP, DBA VERIZON WIRELESS, BEDMINSTER, NJ. FILED 8-6-2003.



OWNER OF U.S. REG. NO. 2,792,586.
FOR TELECOMMUNICATIONS SERVICES, NAMELY, WIRELESS PHONE SERVICES (U.S. CLS. 100, 101 AND 104).

FIRST USE 10-0-2002; IN COMMERCE 10-0-2002.
BRIAN BROWN, EXAMINING ATTORNEY

SN 78-239,495. BIERMANN PRODUCTIONS L.L.C., WICHITA, KS. FILED 4-18-2003.

TCC

FOR TELEVISION BROADCASTING, RADIO BROADCASTING, AND INTERNET BROADCASTING (U.S. CLS. 100, 101 AND 104).

NELSON SNYDER, EXAMINING ATTORNEY

SN 78-296,182. ZOOM TELEPHONICS, INC., BOSTON, MA. FILED 9-4-2003.

ZOOMIT

OWNER OF U.S. REG. NOS. 1,892,967, 2,675,838 AND OTHERS.

FOR WEB ACCELERATION SERVICES, NAMELY, PROVIDING HIGHER SPEED ACCESS TO THE WORLD WIDE WEB (U.S. CLS. 100, 101 AND 104).

MARY CRAWFORD, EXAMINING ATTORNEY

SN 78-263,562. ARIZONA DIALTONE INC., CHANDLER, AZ. FILED 6-17-2003.

**TOUCH HOME PHONE
SERVICE**

NO CLAIM IS MADE TO THE EXCLUSIVE RIGHT TO USE "HOME PHONE SERVICE", APART FROM THE MARK AS SHOWN.

FOR RESIDENTIAL AND SMALL BUSINESS LOCAL TELEPHONE EXCHANGE SERVICE (U.S. CLS. 100, 101 AND 104).

CIMMERIAN COLEMAN, EXAMINING ATTORNEY

SN 78-297,742. AT&T CORP., NEW YORK, NY. FILED 9-9-2003.

AT&T CITY SAVINGS

OWNER OF U.S. REG. NOS. 1,298,084, 1,970,579 AND 2,110,288.

FOR TELECOMMUNICATIONS SERVICES, NAMELY, THE ELECTRONIC TRANSMISSION OF VOICE, DATA, FACSIMILE, VIDEO AND INFORMATION (U.S. CLS. 100, 101 AND 104).

ROBIN CHOSID, EXAMINING ATTORNEY

CLASS 38—(Continued).

SN 78-300,997. ASIAN SPIRIT IN AMERICA ENTERTAINMENT, LLC, NEW YORK, NY. FILED 9-16-2003.

IMAGINASIAN TELEVISION

NO CLAIM IS MADE TO THE EXCLUSIVE RIGHT TO USE "TELEVISION", APART FROM THE MARK AS SHOWN.

FOR TELECOMMUNICATIONS, NAMELY CABLE TELEVISION BROADCASTING, SUBSCRIPTION TELEVISION BROADCASTING, BROADCASTING VIA COMPUTER NETWORK, AUDIO AND VIDEO BROADCASTING (U.S. CLS. 100, 101 AND 104).

MICHAEL WEBSTER, EXAMINING ATTORNEY

CLASS 38—(Continued).

SN 78-303,775. VERIZON TRADEMARK SERVICES LLC, ARLINGTON, VA. FILED 9-22-2003.

VZACCESS

FOR WIRELESS TELECOMMUNICATION SERVICES, NAMELY, PROVIDING VOICE, TEXT, DATA, PICTURES, MUSIC AND VIDEO VIA WIRELESS NETWORKS BY MEANS OF WIRELESS DEVICES; ELECTRONIC MAIL SERVICES; INSTANT MESSAGING SERVICES; VOICE MAIL SERVICES; CALLER IDENTIFICATION SERVICES; PROVIDING ACCESS TO CALENDAR SERVICES AND PERSONALIZED ADDRESS BOOKS; AND PROVIDING ACCESS TO A GLOBAL COMMUNICATIONS NETWORK (U.S. CLS. 100, 101 AND 104).

DOMINIC J. FERRAIUOLO, EXAMINING ATTORNEY

SN 78-303,730. VERIZON TRADEMARK SERVICES LLC, ARLINGTON, VA. FILED 9-22-2003.

VZOFFICE

FOR WIRELESS TELECOMMUNICATION SERVICES, NAMELY, PROVIDING VOICE, TEXT, DATA, PICTURES, MUSIC AND VIDEO VIA WIRELESS NETWORKS BY MEANS OF WIRELESS DEVICES; ELECTRONIC MAIL SERVICES; INSTANT MESSAGING SERVICES; VOICE MAIL SERVICES; CALLER IDENTIFICATION SERVICES; PROVIDING ACCESS TO CALENDAR SERVICES AND PERSONALIZED ADDRESS BOOKS; AND PROVIDING ACCESS TO A GLOBAL COMMUNICATIONS NETWORK (U.S. CLS. 100, 101 AND 104).

DOMINIC J. FERRAIUOLO, EXAMINING ATTORNEY

SN 78-303,785. VERIZON TRADEMARK SERVICES LLC, ARLINGTON, VA. FILED 9-22-2003.

VZCUSTOM

FOR WIRELESS TELECOMMUNICATION SERVICES, NAMELY, PROVIDING VOICE, TEXT, DATA, PICTURES, MUSIC AND VIDEO VIA WIRELESS NETWORKS BY MEANS OF WIRELESS DEVICES; ELECTRONIC MAIL SERVICES; INSTANT MESSAGING SERVICES; VOICE MAIL SERVICES; CALLER IDENTIFICATION SERVICES; PROVIDING ACCESS TO CALENDAR SERVICES AND PERSONALIZED ADDRESS BOOKS; AND PROVIDING ACCESS TO A GLOBAL COMMUNICATIONS NETWORK (U.S. CLS. 100, 101 AND 104).

DOMINIC J. FERRAIUOLO, EXAMINING ATTORNEY

SN 78-303,738. VERIZON TRADEMARK SERVICES LLC, ARLINGTON, VA. FILED 9-22-2003.

VZVOICE

FOR WIRELESS TELECOMMUNICATION SERVICES, NAMELY, PROVIDING VOICE, TEXT, DATA, PICTURES, MUSIC AND VIDEO VIA WIRELESS NETWORKS BY MEANS OF WIRELESS DEVICES; ELECTRONIC MAIL SERVICES; INSTANT MESSAGING SERVICES; VOICE MAIL SERVICES; CALLER IDENTIFICATION SERVICES; PROVIDING ACCESS TO CALENDAR SERVICES AND PERSONALIZED ADDRESS BOOKS; AND PROVIDING ACCESS TO A GLOBAL COMMUNICATIONS NETWORK (U.S. CLS. 100, 101 AND 104).

DOMINIC J. FERRAIUOLO, EXAMINING ATTORNEY

SN 78-303,790. VERIZON TRADEMARK SERVICES LLC, ARLINGTON, VA. FILED 9-22-2003.

VZEMAIL

FOR WIRELESS TELECOMMUNICATION SERVICES, NAMELY, PROVIDING VOICE, TEXT, DATA, PICTURES, MUSIC AND VIDEO VIA WIRELESS NETWORKS BY MEANS OF WIRELESS DEVICES; ELECTRONIC MAIL SERVICES; INSTANT MESSAGING SERVICES; VOICE MAIL SERVICES; CALLER IDENTIFICATION SERVICES; PROVIDING ACCESS TO CALENDAR SERVICES AND PERSONALIZED ADDRESS BOOKS; AND PROVIDING ACCESS TO A GLOBAL COMMUNICATIONS NETWORK (U.S. CLS. 100, 101 AND 104).

DOMINIC J. FERRAIUOLO, EXAMINING ATTORNEY

CLASS 38—(Continued).

SN 78-306,238. INDIGO NETWORKS GMBH, DUESSEL-DORF 40233, FED REP GERMANY, FILED 9-26-2003.



FOR INTERNET TELEPHONY SERVICES (U.S. CLS. 100, 101 AND 104).
CAROLYN GRAY, EXAMINING ATTORNEY

SN 78-309,868. ANTOV, KROUM B., SANTA BARBARA, CA. FILED 10-6-2003.

VOICECHO

FOR VOICE MAIL SERVICES CONNECTED WITH TELEPHONE ANSWERING DEVICES (U.S. CLS. 100, 101 AND 104).
DOMINIC J. FERRAIUOLO, EXAMINING ATTORNEY

SN 78-310,185. REYNOLDS, TERI, ANNE, SAN JOSE, CA. FILED 10-7-2003.

RECALL

FOR ELECTRONIC SYSTEMATIC AND PERSONALIZED VOICE MESSAGING, NAMELY, THE RECORDING AND SUBSEQUENT TRANSMISSION OF PERSONALIZED VOICE AND TEXT MESSAGES TO AN INDIVIDUAL OR A LARGE GROUP BY TELEPHONE, COMPUTER, FAX AND E-MAIL AND WHEREIN THE CLIENT DATABASE CAN BE ACCESSED VIA TELEPHONE AND INTERNET (U.S. CLS. 100, 101 AND 104).
TRICIA SONNEBORN, EXAMINING ATTORNEY

SN 78-312,798. ZEUS MOBILE, LLC, POMPANO BEACH, FL. FILED 10-13-2003.

ZEUS MOBILE

NO CLAIM IS MADE TO THE EXCLUSIVE RIGHT TO USE "MOBILE", APART FROM THE MARK AS SHOWN.

FOR TELECOMMUNICATIONS AND INFORMATION TECHNOLOGY SERVICES, NAMELY ELECTRIC, DIGITAL, CELLULAR AND WIRELESS TRANSMISSION OF VOICE, DATA, INFORMATION, IMAGES, SIGNALS AND MESSAGES AND TRANSMISSION OF VOICE, DATA, IMAGES, AUDIO, VIDEO AND INFORMATION VIA TELEPHONE, TELEVISION AND GLOBAL COMMUNICATION NETWORKS; PROVIDING TELECOMMUNICATIONS CONNECTIONS OVER A GLOBAL COMMUNICATIONS NETWORK, ELECTRONIC MAIL, VOICE MAIL AND MESSAGING SERVICES, NAMELY, THE RECORDING AND STORAGE AND SUBSEQUENT TRANSMISSION OF VOICE MESSAGES BY TELEPHONE; RENTAL OF TELECOMMUNICATIONS EQUIPMENT, NAMELY, EQUIPMENT FOR ELECTRONIC ACCESS TO GLOBAL TELECOMMUNICATIONS NET-

CLASS 38—(Continued).

WORK, EQUIPMENT FOR TRANSMITTING, RECEIVING, RECORDING AND MONITORING VOICE, DATA, INFORMATION, IMAGES, SIGNALS, MESSAGES, COMPRISED OF DATA AND WORD PROCESSORS, AND TELECOMMUNICATIONS HARDWARE AND SOFTWARE AND COMPONENTS AND PERIPHERALS THEREOF FOR USE IN THE TELECOMMUNICATIONS INDUSTRY, AND RENTAL OF EQUIPMENT FOR TRANSMITTING, RECEIVING, RECORDING AND MONITORING COMPUTER PROGRAMS FOR USE IN OPERATING AND ACCESSING TELECOMMUNICATIONS SYSTEMS; PROVIDING MULTIPLE-USER DIAL-UP AND DEDICATED ACCESS TO THE INTERNET; PERSONAL COMMUNICATIONS SERVICES; PAGER SERVICES; ELECTRONIC MAIL SERVICES; TRANSMISSION AND BROADCAST OF AUDIO AND VIDEO PROGRAMMING; PROVIDING MULTIPLE-USER ACCESS TO A GLOBAL COMMUNICATION NETWORK; LEASING TELECOMMUNICATIONS EQUIPMENT, COMPONENTS, SYSTEMS AND SUPPLIES (U.S. CLS. 100, 101 AND 104).

DOMINIC J. FERRAIUOLO, EXAMINING ATTORNEY

SN 78-317,423. BLAISDELL, GRANT, CARMEL, IN. FILED 10-23-2003.

ANGELMOBILE

FOR TELECOMMUNICATIONS SERVICES, NAMELY, TRANSMISSION OF VOICE, DATA, IMAGES, AUDIO, VIDEO, AND INFORMATION VIA TELEPHONE OR THE INTERNET; PERSONAL COMMUNICATIONS SERVICES; PAGER SERVICES; ELECTRONIC MAIL SERVICES; TRANSMISSION OR BROADCAST OF NEWS AND NEWS SERVICES AND INFORMATION FOR OTHERS VIA TELEPHONE, INCLUDING THE INTERNET (U.S. CLS. 100, 101 AND 104).

MICHAEL ENGEL, EXAMINING ATTORNEY

CLASS 39—TRANSPORTATION AND STORAGE

SN 76-397,048. FRONTIER AIRLINES, INC., DENVER, CO. FILED 4-16-2002.

NO CLAIM IS MADE TO THE EXCLUSIVE RIGHT TO USE "JETEXPRESS", APART FROM THE MARK AS SHOWN.

FOR REGULARLY SCHEDULED COMMERCIAL TRANSPORTATION OF PASSENGERS AND/OR GOODS BY AIR (U.S. CLS. 100 AND 105).

FIRST USE 2-4-2002; IN COMMERCE 2-4-2002.
INGRID C. EULIN, EXAMINING ATTORNEY

CLASS 39—(Continued).

SN 76-490,498. EXECUTIVE DELIVERY SYSTEMS, INC., MIAMI, FL. FILED 2-19-2003.



NO CLAIM IS MADE TO THE EXCLUSIVE RIGHT TO USE "DELIVERY", APART FROM THE MARK AS SHOWN. THE STIPPLING IS A FEATURE OF THE MARK AND DOES NOT INDICATE COLOR.

FOR COURIER SERVICES AND DELIVERY SERVICES, NAMELY PARCEL DELIVERY, DOCUMENT DELIVERY AND DELIVERY OF GOODS BY MOTOR VEHICLE, BICYCLE AND FOOT MESSENGERS (U.S. CLS. 100 AND 105).

FIRST USE 1-0-2003; IN COMMERCE 1-0-2003.
JENNIFER DIXON, EXAMINING ATTORNEY

SN 76-499,648. NEW FRANKLIN GROUP, INC., MAPLE SHADE, NJ. FILED 3-21-2003.

RENTAL PLACE USA

NO CLAIM IS MADE TO THE EXCLUSIVE RIGHT TO USE RENTAL AND USA, APART FROM THE MARK AS SHOWN.

FOR VEHICLE RENTAL SERVICES (U.S. CLS. 100 AND 105).

JOHN HWANG, EXAMINING ATTORNEY

SN 76-505,340. ORIX KABUSHIKI KAISHA, DBA ORIX CORPORATION, TOKYO, JAPAN, FILED 4-9-2003.

オリックス レンタカー

NO CLAIM IS MADE TO THE EXCLUSIVE RIGHT TO USE RE-N-T-A-KA, THE transliteration for the JAPANESE WORDS RENT-A-CAR, APART FROM THE MARK AS SHOWN.

ORIX RENT-A-CAR
THE NON-ENGLISH CHARACTERS IN THE MARK transliterate to O-RI-KKU-SU RE-N-T-A-KA, AND THIS MEANS ORIX RENT-A-CAR IN ENGLISH.

FOR RENTAL AND LEASING OF MOTOR VEHICLES (U.S. CLS. 100 AND 105).

FIRST USE 6-1-2003; IN COMMERCE 6-1-2003.
MARGERY A. TIERNEY, EXAMINING ATTORNEY

CLASS 39—(Continued).

SN 76-505,587. ORIX KABUSHIKI KAISHA, DBA ORIX CORPORATION, MINATO-KU, TOKYO, JAPAN, FILED 4-9-2003.



NO CLAIM IS MADE TO THE EXCLUSIVE RIGHT TO USE RENT-A-CAR, APART FROM THE MARK AS SHOWN.

THE DIAMOND SHAPE IN THE MARK IS DEPICTED IN BLUE. THE WORD ORIX IS DEPICTED IN YELLOW WITH A RED LINE BELOW THE WORD ORIX. THE WORDS RENT-A-CAR ARE DEPICTED IN WHITE. THE SQUARE SHAPE BEHIND THE DIAMOND SHAPE IS DEPICTED IN YELLOW.

FOR RENTAL AND LEASING OF MOTOR VEHICLES (U.S. CLS. 100 AND 105).

FIRST USE 6-1-2003; IN COMMERCE 6-1-2003.
MARGERY A. TIERNEY, EXAMINING ATTORNEY

SN 76-518,437. ALL STAR MAINTENANCE, INC., SAN DIEGO, CA. FILED 5-19-2003.



FOR REFUSE COLLECTION AND DISPOSAL (U.S. CLS. 100 AND 105).

FIRST USE 0-0-1984; IN COMMERCE 0-0-1984.
NANCY CLARKE, EXAMINING ATTORNEY

CLASS 39—(Continued).

SN 76-524,786. ROLLERSON, THOMAS WARD, SANTA BARBARA, CA. FILED 6-16-2003.

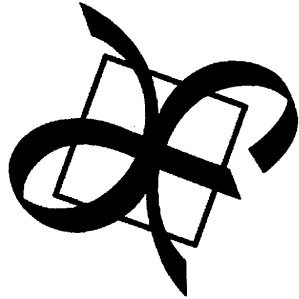

OWNER OF U.S. REG. NO. 2,307,917.
 FOR CHARITABLE SERVICES, NAMELY PROVIDING
 LAST WISH REQUESTS IN THE NATURE OF TRAVEL
 VACATIONS TO ADULTS WHO ARE LIVING THE
 FINAL YEAR OF THEIR LIFE (U.S. CLS. 100 AND 105).
 FIRST USE 10-1-1999; IN COMMERCE 10-1-1999.
 TARAH HARDY, EXAMINING ATTORNEY

SN 76-546,071. OCEAN DRIVE LIMOUSINES, INC., MIAMI, FL. FILED 9-22-2003.

OCEAN DRIVE LIMOUSINES

NO CLAIM IS MADE TO THE EXCLUSIVE RIGHT TO
 USE "LIMOUSINES", APART FROM THE MARK AS
 SHOWN.
 FOR LIMOUSINE SERVICES; TRANSPORTATION OF
 PASSENGERS BY CAR, VAN, BUS AND LIMOUSINE
 (U.S. CLS. 100 AND 105).
 FIRST USE 5-0-1997; IN COMMERCE 5-0-1997.
 DAWN FELDMAN, EXAMINING ATTORNEY

SN 76-547,036. PAPPAS & CO., MENDOTA, CA. FILED 9-25-2003.

PAPPAS COOLING

NO CLAIM IS MADE TO THE EXCLUSIVE RIGHT TO
 USE "COOLING", APART FROM THE MARK AS SHOWN.
 FOR REFRIGERATION STORAGE (U.S. CLS. 100 AND
 105).
 KATHRYN COWARD, EXAMINING ATTORNEY

CLASS 39—(Continued).

SN 76-547,550. NATIONAL RAILROAD PASSENGER CORPORATION, WASHINGTON, DC. FILED 9-30-2003.



OWNER OF U.S. REG. NOS. 2,602,178, 2,736,509 AND
 OTHERS.
 FOR RAILROAD TRANSPORTATION SERVICES (U.S.
 CLS. 100 AND 105).
 FIRST USE 9-11-2003; IN COMMERCE 9-11-2003.
 JENNIFER CHICOSKI, EXAMINING ATTORNEY

SN 78-229,224. SOFA CONNECTION, INC., MADISON, TN. FILED 3-24-2003.

SOFAST

OWNER OF U.S. REG. NO. 2,271,992.
 FOR DELIVERY OF SOFAS AND OTHER FURNI-
 TURE BY MEANS OF TRUCK (U.S. CLS. 100 AND 105).
 ELLEN B. AWRICH, EXAMINING ATTORNEY

SN 78-254,242. ALASKA DISCOVERY, INC., JUNEAU, AK. FILED 5-26-2003.

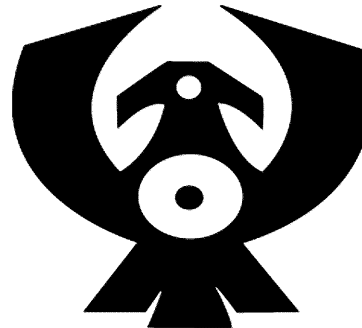

FOR TRAVEL GUIDE SERVICES; MAKING RESER-
 VATIONS AND BOOKINGS FOR TRANSPORTATION
 (U.S. CLS. 100 AND 105).
 FIRST USE 1-1-1990; IN COMMERCE 1-1-1990.
 NANCY CLARKE, EXAMINING ATTORNEY

SN 78-297,247. LANCASTER GROWERS, LLC, MILLERSVILLE, PA. FILED 9-8-2003.

PLANT TO PLATE

FOR FRESH PRODUCE DELIVERY BY TRUCK (U.S.
 CLS. 100 AND 105).
 FIRST USE 6-16-2003; IN COMMERCE 6-16-2003.
 ROBERT LORENZO, EXAMINING ATTORNEY

CLASS 39—(Continued).

SN 78-302,090. NORTHWEST AIRLINES, INC., EAGAN, MN. FILED 9-18-2003.

WORLDSMART

FOR AIR TRANSPORTATION SERVICES; TRANSPORTING PASSENGERS AND CARGO BY AIR; TRAVEL RELATED SERVICES, NAMELY, MAKING RESERVATIONS AND BOOKINGS FOR TRANSPORTATION, AIRPLANE CHARTERING, AND OFFERING A FREQUENT FLYER PROGRAM; ARRANGING TRAVEL TOURS; PROVIDING TRAVEL INFORMATION BY MEANS OF A GLOBAL COMPUTER NETWORK IN CONNECTION WITH THE TRANSPORTATION OF PEOPLE OR GOODS; AIRPORT TERMINAL SERVICES (U.S. CLS. 100 AND 105).

MATTHEW KLINE, EXAMINING ATTORNEY

SN 78-308,281. VACATION GETAWAYS, INCORPORATED, SEATTLE, WA. FILED 10-1-2003.

VACATION GETAWAYS

OWNER OF U.S. REG. NO. 2,179,723. SEC. 2(F). FOR TRAVEL INFORMATION SERVICES VIA AN ON-LINE GLOBAL COMPUTER NETWORK (U.S. CLS. 100 AND 105).

FIRST USE 10-16-1996; IN COMMERCE 10-16-1996. AMY ALFIERI, EXAMINING ATTORNEY

SN 78-311,694. RELIANT RESOURCES, INC., HOUSTON, TX. FILED 10-9-2003.

RELIANT

OWNER OF U.S. REG. NOS. 2,666,766, 2,681,501 AND 2,747,525. FOR DISTRIBUTION AND DELIVERY OF ENERGY (U.S. CLS. 100 AND 105).

FIRST USE 2-2-1999; IN COMMERCE 2-2-1999. CAROLINE WOOD, EXAMINING ATTORNEY

SN 78-320,391. U.S. LINES HOLDINGS LIMITED, HAMILTON HMCX, BERMUDA, FILED 10-29-2003.

USL

FOR TRANSPORTATION SERVICES, NAMELY TRANSPORTATION OF PASSENGERS AND CARGO BY SHIP, TRUCK AND RAIL (U.S. CLS. 100 AND 105). ALEX KEAM, EXAMINING ATTORNEY

CLASS 40—MATERIAL TREATMENT

SN 76-503,025. WAL-MART STORES, INC., BENTONVILLE, AR. FILED 4-1-2003.

DEVELOP YOUR BUSINESS

FOR FILM DEVELOPING SERVICES (U.S. CLS. 100, 103 AND 106). FIRST USE 6-2-2003; IN COMMERCE 6-2-2003. GINNY ISAACSON, EXAMINING ATTORNEY

SN 76-519,980. AWARDS.COM, LLC, FORT LEE, NJ. FILED 5-23-2003.

awards.com

NO CLAIM IS MADE TO THE EXCLUSIVE RIGHT TO USE "AWARDS" AND "COM", APART FROM THE MARK AS SHOWN.

FOR CUSTOMIZED PRINTING OF COMPANY NAMES AND LOGOS ON THE GOODS OF OTHERS FOR PROMOTIONAL AND ADVERTISING PURPOSES (U.S. CLS. 100, 103 AND 106).

FIRST USE 7-1-2002; IN COMMERCE 7-1-2002. DOMINIC J. FERRAIUOLO, EXAMINING ATTORNEY

SN 78-116,441. GENEVA LUCERNE, INC., BEVERLY HILLS, CA. FILED 3-21-2002.

GENEVA LUCERNE, INC.

NO CLAIM IS MADE TO THE EXCLUSIVE RIGHT TO USE "INC.", APART FROM THE MARK AS SHOWN.

FOR DENTAL LABORATORIES (U.S. CLS. 100, 103 AND 106).

JOHN LINCOSKI, EXAMINING ATTORNEY

SN 78-221,990. XTHINK, INC., ROUND ROCK, TX. FILED 3-5-2003.

XTHINK

FOR CUSTOM MANUFACTURE OF RECOGNITION SOFTWARE, INTELLIGENT SOFTWARE COMPONENTS AND ELECTRONIC PROBLEM SOLVING ENVIRONMENTS, NAMELY HANDWRITING AND VOICE RECOGNITION SOFTWARE FOR TABLET PCS (U.S. CLS. 100, 103 AND 106).

MATTHEW PAPPAS, EXAMINING ATTORNEY

CLASS 40—(Continued).

SN 78-271,374. WINOVIA LLC, ALBANY, NY. FILED 7-8-2003.



THE MARK CONSISTS OF WHITE LETTERS ON A BLUE BACKGROUND WITH A RED 3-DIMENSIONAL SPHERE IN THE CENTER OF THE LETTER O.

FOR CONSULTATION IN THE FIELD OF PLASTICS MANUFACTURING PROCESSES (U.S. CLS. 100, 103 AND 106).

FIRST USE 6-1-2003; IN COMMERCE 6-1-2003.
DORITT L. CARROLL, EXAMINING ATTORNEY

SN 78-306,946. INNOVA FINANCE, LLC, INCLINE VILLATE, NV. FILED 9-29-2003.

INNOVA

FOR MANUFACTURING SERVICES FOR OTHERS IN THE FIELD OF RUGGEDIZED HIGH TEMPERATURE ELECTRONIC DEVICES SOLD IN THE OIL AND GAS, MILITARY, MEDICAL AND AEROSPACE INDUSTRIES (U.S. CLS. 100, 103 AND 106).

FIRST USE 12-31-1989; IN COMMERCE 12-31-1989.
GEORGIA CARTY, EXAMINING ATTORNEY

SN 78-311,695. RELIANT RESOURCES, INC., HOUSTON, TX. FILED 10-9-2003.

RELIANT

OWNER OF U.S. REG. NOS. 2,666,766, 2,681,501 AND 2,747,525.

FOR PRODUCTION AND GENERATION OF ENERGY (U.S. CLS. 100, 103 AND 106).

FIRST USE 2-2-1999; IN COMMERCE 2-2-1999.
CAROLINE WOOD, EXAMINING ATTORNEY

CLASS 41—EDUCATION AND ENTERTAINMENT

SN 75-242,043. DUMBARTON CONCERTS, INC., WASHINGTON, DC. FILED 2-14-1997.

CELTIC CHRISTMAS

SEC. 2(F).
FOR ENTERTAINMENT SERVICES, NAMELY, PROVIDING LIVE MUSICAL PERFORMANCES (U.S. CLS. 100, 101 AND 107).

FIRST USE 12-5-1986; IN COMMERCE 12-5-1986.
STEVEN BERK, EXAMINING ATTORNEY

CLASS 41—(Continued).

SN 75-870,747. WILDBRAIN.COM, INC., SAN FRANCISCO, CA. FILED 12-10-1999.

DIGITAL DRIVE-IN

NO CLAIM IS MADE TO THE EXCLUSIVE RIGHT TO USE "DIGITAL", APART FROM THE MARK AS SHOWN.

FOR ENTERTAINMENT SERVICES, NAMELY MOTION PICTURE FILM PRODUCTION; PROVIDING A CONTINUING CARTOON SHOW DISTRIBUTED OVER BROADCAST TELEVISION, CABLE, RADIO AND GLOBAL COMPUTER INFORMATION NETWORKS (U.S. CLS. 100, 101 AND 107).

FIRST USE 11-19-1999; IN COMMERCE 11-19-1999.
ALEXANDER L. POWERS, EXAMINING ATTORNEY

SN 75-885,835. CW ANIMATION, LLC, STUDIO CITY, CA. FILED 12-30-1999.



FOR ENTERTAINMENT SERVICES IN THE NATURE OF AN ANIMATED TELEVISION SERIES (U.S. CLS. 100, 101 AND 107).

FIRST USE 10-6-1999; IN COMMERCE 10-6-1999.
STEVEN BERK, EXAMINING ATTORNEY

SN 75-899,912. RACING LOTTO LIMITED, AUCKLAND, NEW ZEALAND, FILED 1-21-2000.

RACE-O

OWNER OF NEW ZEALAND REG. NO. 229212, DATED 8-10-1993, EXPIRES 8-10-2014.

FOR ENTERTAINMENT SERVICES, NAMELY, PUBLIC GAMING ACTIVITIES IN CONNECTION WITH HORSE RACING, HARNESS RACING/TROTTING AND GREYHOUND RACING (U.S. CLS. 100, 101 AND 107).

BRIAN BROWN, EXAMINING ATTORNEY

SN 76-234,531. LAND ROVER, WARWICKSHIRE CV35 ORG, UNITED KINGDOM, FILED 4-3-2001.

A ROYAL WELCOME

FOR EDUCATIONAL SERVICES, NAMELY, CONDUCTING ORIENTATION SEMINARS AND ORIENTATION WORKSHOPS IN THE FIELD OF CAR OWNER CONSUMER ORIENTATION AS TO THE PURCHASED VEHICLE, ITS OPERATION, HOW TO USE THE OPERATION MANUAL AND WARRANTY SERVICES PROVIDED (U.S. CLS. 100, 101 AND 107).

FIRST USE 0-0-1990; IN COMMERCE 0-0-1990.
TANYA AMOS, EXAMINING ATTORNEY

CLASS 41—(Continued).

SN 76-371,595. MASTERMIND PREP LEARNING SOLUTIONS, INC., ROCKY MOUNT, NC. FILED 2-19-2002.



FOR EDUCATIONAL SERVICES, NAMELY, PROVIDING TUTORING AND EDUCATIONAL INSTRUCTION VIA ONE-ON-ONE SETTINGS, SMALL GROUPS, CLASSES, SEMINARS AND SUMMER CAMPS, TO STUDENTS IN KINDERGARTEN THROUGH ADULT, IN ALL ACADEMIC SUBJECTS, NAMELY, READING, WRITING, MATHEMATICS, SCIENCE, ENGLISH/LANGUAGE ARTS, FOREIGN LANGUAGES, STUDY SKILLS, AND PREPARATION FOR STANDARDIZED TESTS (U.S. CLS. 100, 101 AND 107).

FIRST USE 1-1-2002; IN COMMERCE 1-1-2002.
WANDA KAY PRICE, EXAMINING ATTORNEY

SN 76-374,261. CONCORD MOON, LLP, BOISE, ID. FILED 2-21-2002.



OWNER OF U.S. REG. NO. 2,194,786.
THE ENGLISH TRANSLATION OF THE CHINESE CHARACTERS IS "USING NO WAY AS WAY, HAVING NO LIMITATION AS LIMITATION".

THE NON-LATIN CHARACTERS IN THE MARK TRANSLITERATE TO "YI WU FA WEI YOU FA; YI WU XIAN WEI YOU XIAN" AND THIS MEANS "USING NO WAY AS WAY, HAVING NO LIMITATION AS LIMITATION" IN ENGLISH.

FOR EDUCATIONAL SERVICES IN THE NATURE OF MARTIAL ARTS INSTRUCTION AND PROVIDING MOTIVATION (U.S. CLS. 100, 101 AND 107).

FIRST USE 3-4-1964; IN COMMERCE 3-4-1964.
JASON TURNER, EXAMINING ATTORNEY

CLASS 41—(Continued).

SN 76-445,301. KABBALAH CENTRE INTERNATIONAL, INC., LOS ANGELES, CA. FILED 8-29-2002.



NO CLAIM IS MADE TO THE EXCLUSIVE RIGHT TO USE "CENTRE", APART FROM THE MARK AS SHOWN. SEC. 2(F) AS TO "THE KABBALAH CENTRE".

FOR EDUCATIONAL SERVICES, NAMELY, PROVIDING SEMINARS AND COURSES ON RELIGION AND SPIRITUALITY (U.S. CLS. 100, 101 AND 107).
FIRST USE 1-30-1991; IN COMMERCE 1-30-1991.
MIDGE BUTLER, EXAMINING ATTORNEY

SN 76-445,302. KABBALAH CENTRE INTERNATIONAL, INC., LOS ANGELES, CA. FILED 8-29-2002.

THE KABBALAH CENTRE

NO CLAIM IS MADE TO THE EXCLUSIVE RIGHT TO USE "CENTRE", APART FROM THE MARK AS SHOWN. SEC. 2(F).

FOR EDUCATIONAL SERVICES, NAMELY, PROVIDING SEMINARS AND COURSES ON RELIGION AND SPIRITUALITY (U.S. CLS. 100, 101 AND 107).
FIRST USE 1-30-1991; IN COMMERCE 1-30-1991.
MIDGE BUTLER, EXAMINING ATTORNEY

SN 76-452,253. BALLROOM BOXING, INC., GLEN BURNIE, MD. FILED 9-23-2002.

BOXING IN THE BALLROOM

OWNER OF U.S. REG. NO. 2,600,239.
NO CLAIM IS MADE TO THE EXCLUSIVE RIGHT TO USE "BOXING", APART FROM THE MARK AS SHOWN.

FOR ENTERTAINMENT SERVICES IN THE NATURE OF BOXING EVENTS AND TELEVISED SHOWS FEATURING BOXING TO BE BROADCAST ON TELEVISION, CABLE, SATELLITE, AND GLOBAL COMPUTER NETWORK (U.S. CLS. 100, 101 AND 107).

FIRST USE 1-7-1998; IN COMMERCE 1-7-1998.
ESTHER BELENKER, EXAMINING ATTORNEY

SN 76-461,412. FRONTIER MISSION FELLOWSHIP, PASADENA, CA. FILED 10-21-2002.

PERSPECTIVES

FOR EDUCATIONAL SERVICES, NAMELY, CONDUCTING CLASSES AND SEMINARS IN THE FIELD OF THE HISTORY AND EXPANSION OF THE WORLD-WIDE CHRISTIAN MOVEMENT AND TRAINING PEOPLE FOR THE INVOLVEMENT IN THAT CONTINUING MOVEMENT (U.S. CLS. 100, 101 AND 107).

FIRST USE 4-0-1984; IN COMMERCE 4-0-1984.
GEORGIA CARTY, EXAMINING ATTORNEY

CLASS 41—(Continued).

SN 76-464,433. FACE THE MUSIC, INC., NEW YORK, NY. FILED 11-5-2002.

FACE THE MUSIC

FOR PRODUCTION AND RECORDING OF MUSIC AND SOUND EFFECTS FOR TELEVISION AND RADIO COMMERCIALS, PROGRAMS, PROMOTIONS, FILMS, THEATRICAL PRODUCTIONS, MULTIMEDIA PRODUCTIONS AND VIDEO PROGRAMS; MUSIC COMPOSITION SERVICES FOR OTHERS, NAMELY, WRITING AND ARRANGING MUSIC FOR TELEVISION, RADIO COMMERCIALS, PROGRAMS, PROMOTIONS, FILMS, THEATRICAL PRODUCTIONS, MULTIMEDIA PRODUCTIONS AND VIDEO PROGRAMS (U.S. CLS. 100, 101 AND 107).

FIRST USE 11-0-1999; IN COMMERCE 11-0-1999.
ROBERT LORENZO, EXAMINING ATTORNEY

SN 76-488,402. NTN COMMUNICATIONS, INC., CARLSBAD, CA. FILED 2-10-2003.

SPEED

FOR PROVIDING AN INTERACTIVE GAME, NAMELY TRIVIA, BROADCAST VIA TELEVISION, CABLE, TELEPHONE, GLOBAL COMPUTER NETWORK AND OTHER ELECTRONIC MEDIA ENVIRONMENTS, NAMELY WIRELESS WEB AND SATELLITE, GLOBAL AND LOCAL TRANSMISSION NETWORKS SERVICING WIRELESS DEVICES, NAMELY CELLPHONES AND PDAS (U.S. CLS. 100, 101 AND 107).

FIRST USE 12-0-2002; IN COMMERCE 12-0-2002.
GEORGE LORENZO, EXAMINING ATTORNEY

SN 76-495,478. LATE NIGHT PRODUCTIONS, INC., NEW YORK, NY. FILED 3-5-2003.



NO CLAIM IS MADE TO THE EXCLUSIVE RIGHT TO USE "IN CONCERT", APART FROM THE MARK AS SHOWN.

FOR ENTERTAINMENT SERVICES, NAMELY PRESENTING A CONTINUING TELEVISION SERIES, FEATURING LIVE MUSICAL PERFORMANCES; SUPPLYING AND DISTRIBUTING PROGRAMS TO CABLE AND SATELLITE TELEVISION AND PREMIUM SALES, HOME VIDEO, CD ROMS AND/OR MASTER ANTENNA SYSTEMS SALES, IN CONNECTION THEREWITH; FILM VIDEO AND TELEVISION PRODUCTION AND DISTRIBUTION SERVICES (U.S. CLS. 100, 101 AND 107).

INGRID C. EULIN, EXAMINING ATTORNEY

CLASS 41—(Continued).

SN 76-497,554. JOHNSON PUBLISHING COMPANY, INC., CHICAGO, IL. FILED 12-5-2001.

EBONY BLACK FAMILY REUNION TOUR

OWNER OF U.S. REG. NOS. 1,179,532, 2,231,999 AND OTHERS.

NO CLAIM IS MADE TO THE EXCLUSIVE RIGHT TO USE "BLACK FAMILY REUNION TOUR", APART FROM THE MARK AS SHOWN.

FOR EDUCATIONAL AND ENTERTAINMENT SERVICES, NAMELY, CONDUCTING CULTURAL PROGRAMS FEATURING LIVE ENTERTAINMENT, FOOD, MUSIC, DANCE AND AUDIOVISUAL PRESENTATIONS, GAMES, SWEEPSTAKES, CONTESTS, AND FOOD PREPARATIONS DEMONSTRATIONS (U.S. CLS. 100, 101 AND 107).

ALICIA COLLINS, EXAMINING ATTORNEY

SN 76-498,677. SLEEPING GIANT SPORTS, INC., LAKE-LAND, FL. FILED 3-12-2003.

THUNDER BAY BORDER CATS

NO CLAIM IS MADE TO THE EXCLUSIVE RIGHT TO USE "THUNDER BAY", APART FROM THE MARK AS SHOWN.

FOR ENTERTAINMENT IN THE NATURE OF BASEBALL GAMES AND EXHIBITIONS (U.S. CLS. 100, 101 AND 107).

MICHELE SWAIN, EXAMINING ATTORNEY

SN 76-499,520. GOLDSTEIN, ROBERT N., DALLAS, TX. FILED 3-17-2003.



OWNER OF U.S. REG. NOS. 2,640,153 AND 2,716,167. THE MARK CONSISTS OF THE WORD CHEATERS WITH THE "C" OF THE WORD CHEATERS IS DEPICTED AS PART OF A MAGNIFYING GLASS. WITHIN THE "C" ASPECT IS A HEART WITH A BREAK DOWN ITS CENTER. THE "T" IN THE WORD CHEATERS IS EXTENDED BELOW THE REST OF THE ALL-CAPITALIZED LETTERS. COLOR IS NOT CLAIMED AS A FEATURE OF THE MARK.

FOR ENTERTAINMENT IN THE NATURE OF AN ONGOING TELEVISION SHOW IN THE FIELD OF NEWS AND DOCUMENTARY (U.S. CLS. 100, 101 AND 107).

FIRST USE 9-15-2001; IN COMMERCE 9-15-2001.
AMY HELLA, EXAMINING ATTORNEY

CLASS 41—(Continued).

SN 76-499,823. PENN NATIONAL GAMING, INC., WYOMISSING, PA. FILED 3-24-2003.

CHARLES TOWN RACES & SLOTS

NO CLAIM IS MADE TO THE EXCLUSIVE RIGHT TO USE "RACES & SLOTS", APART FROM THE MARK AS SHOWN.

SEC. 2(F).

FOR PROVIDING GAMING FACILITIES FOR PATRONS TO PLAY SLOT MACHINES AND VIDEO LOTTERY TERMINALS AND OTHER GAMES OF CHANCE; ENTERTAINMENT, NAMELY, CONDUCTING HORSE RACES (U.S. CLS. 100, 101 AND 107).

FIRST USE 1-0-1997; IN COMMERCE 1-0-1997.
CURTIS FRENCH, EXAMINING ATTORNEY

SN 76-502,178. AMERICAN ASSOCIATION OF CRITICAL CARE NURSES, INC., ALISO VIEJO, CA. FILED 3-28-2003.

NATIONAL TEACHING INSTITUTE & CRITICAL CARE EXPOSITION

NO CLAIM IS MADE TO THE EXCLUSIVE RIGHT TO USE "INSTITUTE" AND "EXPOSITION", APART FROM THE MARK AS SHOWN.

SEC. 2(F).

FOR CONDUCTING EDUCATIONAL CONFERENCES IN THE FIELD OF NURSING (U.S. CLS. 100, 101 AND 107).

FIRST USE 5-0-1991; IN COMMERCE 5-0-1991.
APRIL L. RADEMACHER, EXAMINING ATTORNEY

SN 76-502,969. J4 PROMOTIONS, INC., MEDINA, OH. FILED 3-10-2003.



FOR ENTERTAINMENT SERVICES, NAMELY, ARRANGING AND CONDUCTING SPORTS COMPETITIONS AND DOG JUMPING COMPETITIONS (U.S. CLS. 100, 101 AND 107).

FIRST USE 3-10-2003; IN COMMERCE 3-10-2003.
ALICIA COLLINS, EXAMINING ATTORNEY

CLASS 41—(Continued).

SN 76-503,092. PARGH, ANDREW L., BOCA RATON, FL. FILED 4-1-2003.

THE GADGET GURU

OWNER OF U.S. REG. NO. 2,223,036.

SEC. 2(F).

FOR ENTERTAINMENT SERVICES IN THE NATURE OF TELEVISION APPEARANCES FOR THE PURPOSE OF INTRODUCING AND/OR CRITIQUING NEW CONSUMER PRODUCTS (U.S. CLS. 100, 101 AND 107).

FIRST USE 6-1-1988; IN COMMERCE 4-24-1990.
CURTIS FRENCH, EXAMINING ATTORNEY

SN 76-504,119. TRC TECHNOLOGY, INC., OAKLAND, CA. FILED 4-4-2003.

RESERA

FOR EDUCATION AND TRAINING SERVICES, NAMELY CLASSES, SEMINARS, AND WORKSHOPS IN THE FIELD OF REAL ESTATE, TECHNOLOGY, AND MARKETING (U.S. CLS. 100, 101 AND 107).

TANYA AMOS, EXAMINING ATTORNEY

SN 76-504,676. ROBINSON, RONALDSON LEE, MEMPHIS, TN. FILED 4-7-2003.

RON-HOOD

THE NAME DOES NOT IDENTIFY A LIVING INDIVIDUAL.

FOR ENTERTAINMENT SERVICES, NAMELY, LIVE MUSICAL PERFORMANCES BY A RAP ARTIST (U.S. CLS. 100, 101 AND 107).

TARAH HARDY, EXAMINING ATTORNEY

SN 76-507,771. BH, JR., MOTORSPORTS, INC., WHITE HOUSE, TN. FILED 4-21-2003.

BOBBY HAMILTON, JR.

THE NAME BOBBY HAMILTON, JR. IDENTIFIES A LIVING INDIVIDUAL WHOSE CONSENT IS OF RECORD.

FOR ENTERTAINMENT SERVICES, NAMELY, IN THE NATURE OF PARTICIPATING IN PROFESSIONAL AUTOMOBILE RACES AND RELATED EXHIBITIONS (U.S. CLS. 100, 101 AND 107).

FIRST USE 3-1-1992; IN COMMERCE 3-1-1992.
KEVON CHISOLM, EXAMINING ATTORNEY

CLASS 41—(Continued).

SN 76-507,775. WELLSPRING LIFE RESOURCES, INC., PLYMOUTH, MN. FILED 4-21-2003.

CLASS 41—(Continued).

SN 76-510,400. BABYPROOFNY, INC., NEW YORK, NY. FILED 4-11-2003.

THE INTIMATE JOURNEY

FOR EDUCATIONAL SERVICES, NAMELY, CONDUCTING CLASSES, SEMINARS, CONFERENCES, AND RETREATS IN THE FIELD OF RELIGION, RELIGIOUS INSTRUCTION SERVICES, TRAINING SERVICES IN THE FIELD OF RELIGIOUS INSTRUCTION (U.S. CLS. 100, 101 AND 107).

FIRST USE 9-0-2001; IN COMMERCE 9-0-2001.
MONIQUE MILLER, EXAMINING ATTORNEY



SN 76-510,370. INTERNATIONAL SOCIETY OF ARBORICULTURE, INC., CHAMPAIGN, IL. FILED 4-11-2003.

NO CLAIM IS MADE TO THE EXCLUSIVE RIGHT TO USE BABY PROOF NEW YORK, APART FROM THE MARK AS SHOWN.

FOR TEACHING PARENTS AND EXPECTANT PARENTS HOW TO MAKE THEIR HOMES SAFE FOR INFANTS AND CPR (U.S. CLS. 100, 101 AND 107).

FIRST USE 3-8-2002; IN COMMERCE 12-3-2002.
KEVON CHISOLM, EXAMINING ATTORNEY



SN 76-511,602. BISK EDUCATION, INC., TAMPA, FL. FILED 5-5-2003.

OWNER OF U.S. REG. NOS. 1,786,035 AND 2,253,017.
NO CLAIM IS MADE TO THE EXCLUSIVE RIGHT TO USE "TREE CLIMBING CHAMPIONSHIP", APART FROM THE MARK AS SHOWN.

THE MARK CONSISTS OF THE WORDS "ISA TREE CLIMBING CHAMPIONSHIP" AND DESIGN INCLUDING A TREE CLIMBER WITHIN A CIRCLE.

FOR EDUCATIONAL AND ENTERTAINMENT SERVICES, AND SPORTING ACTIVITIES, NAMELY, ENTERTAINMENT IN THE NATURE OF COMPETITIONS IN THE FIELD OF TREE CLIMBING; CONDUCTING ENTERTAINMENT EXHIBITIONS IN THE NATURE OF TREE CLIMBING; ORGANIZING EXHIBITIONS FOR THE PURPOSE OF DEMONSTRATING SAFE TREE CLIMBING PRACTICES AND DEMONSTRATING IMPROVEMENTS AND INNOVATIONS IN TREE CLIMBING EQUIPMENT AND TECHNIQUES; AND PROVIDING INDUSTRY RECOGNITION AND EDUCATION TO THE PUBLIC RELATED TO TREE CLIMBING AND THE FIELD OF ARBORICULTURE (U.S. CLS. 100, 101 AND 107).

INGA ERVIN, EXAMINING ATTORNEY



University Alliance Online

OWNER OF U.S. REG. NO. 2,302,517.
NO CLAIM IS MADE TO THE EXCLUSIVE RIGHT TO USE ONLINE OR UNIVERSITY, APART FROM THE MARK AS SHOWN.

FOR ONLINE EDUCATIONAL SERVICES, NAMELY, OFFERING COURSES OF INSTRUCTION AT THE GRADUATE AND UNDERGRADUATE LEVEL, CERTIFICATE PROGRAMS, AND CONTINUING EDUCATION COURSES, VIA THE GLOBAL COMPUTER NETWORK (U.S. CLS. 100, 101 AND 107).

THEODORE MCBRIDE, EXAMINING ATTORNEY

CLASS 41—(Continued).

SN 76-511,950. BISK EDUCATION, INC., TAMPA, FL. FILED 5-5-2003.



OWNER OF U.S. REG. NOS. 2,302,517 AND 2,471,496.
NO CLAIM IS MADE TO THE EXCLUSIVE RIGHT TO USE ONLINE, UNIVERSITY OR EDUCATION NETWORK, APART FROM THE MARK AS SHOWN.

FOR ONLINE EDUCATIONAL SERVICES, NAMELY, OFFERING COURSES OF INSTRUCTION AT THE GRADUATE AND UNDERGRADUATE LEVEL, CERTIFICATE PROGRAMS, AND CONTINUING EDUCATION COURSES, VIA THE GLOBAL COMPUTER NETWORK (U.S. CLS. 100, 101 AND 107).

THEODORE MCBRIDE, EXAMINING ATTORNEY

SN 76-512,205. AMERICAN CHEER & DANCE ACADEMY, LLC, GAMBRILLS, MD. FILED 4-14-2003.

REACH THE BEACH

FOR CONDUCTING COMPETITIONS, CLINICS, SEMINARS AND CAMPS RELATING TO CHEERLEADING AND DANCE (U.S. CLS. 100, 101 AND 107).

FIRST USE 0-0-1997; IN COMMERCE 0-0-1998.

DOMINIC J. FERRAIUOLO, EXAMINING ATTORNEY

SN 76-512,244. LEARNING FOR LIFE, INC., IRVING, TX. FILED 5-7-2003.



OWNER OF U.S. REG. NO. 1,271,223.
FOR EDUCATION SERVICES NAMELY, MENTORING YOUNG MEN AND WOMEN IN THE FIELD OF CAREER DEVELOPMENT AND LIFE EXPERIENCE AND TO ASSIST YOUNG PEOPLE IN BECOMING MATURE, RESPONSIBLE ADULTS; CAREER COUNSELING (U.S. CLS. 100, 101 AND 107).

FIRST USE 2-28-1998; IN COMMERCE 2-28-1998.

ROBERT LORENZO, EXAMINING ATTORNEY

CLASS 41—(Continued).

SN 76-513,040. LEARNSOMETHING.COM, INC., TALLAHASSEE, FL. FILED 5-9-2003.



NO CLAIM IS MADE TO THE EXCLUSIVE RIGHT TO USE "HIPAA", APART FROM THE MARK AS SHOWN.

FOR TRAINING SERVICES IN THE FIELD OF HEALTH INSURANCE COMPLIANCE, NAMELY, COMPLIANCE WITH THE PROVISION OF THE HEALTH INSURANCE PORTABILITY AND ACCOUNTABILITY ACT (HIPAA) (U.S. CLS. 100, 101 AND 107).

FIRST USE 10-1-2002; IN COMMERCE 10-1-2002.

INGRID C. EULIN, EXAMINING ATTORNEY

SN 76-518,005. ZYE MUSIC, LLC, ATLANTA, GA. FILED 5-9-2003.

ZYE MUSIC

NO CLAIM IS MADE TO THE EXCLUSIVE RIGHT TO USE "MUSIC", APART FROM THE MARK AS SHOWN.

FOR ENTERTAINMENT SERVICES, NAMELY, MUSIC PRODUCTION, AUDIO RECORDING AND PRODUCTION, VIDEOTAPE PRODUCTION; PROVIDING PRE-RECORDED MUSIC AND PROVIDING INFORMATION RELATED TO SOLO RECORDING ARTISTS AND MUSICAL GROUPS ALL VIA THE INTERNET (U.S. CLS. 100, 101 AND 107).

MARY CRAWFORD, EXAMINING ATTORNEY

SN 76-518,202. COUDERT BROTHERS LLP, NEW YORK, NY. FILED 5-28-2003.

READY.TECH.GO

FOR PROVIDING ONLINE NEWSLETTERS IN THE FIELDS OF TELECOMMUNICATIONS, INFORMATION TECHNOLOGY AND MEDIA AND ENTERTAINMENT (U.S. CLS. 100, 101 AND 107).

FIRST USE 6-0-2000; IN COMMERCE 9-12-2000.

BARBARA RUTLAND, EXAMINING ATTORNEY

CLASS 41—(Continued).

SN 76-518,897. BLUE DIESEL, LLC, WESTERVILLE, OH.
FILED 5-8-2003.

smartED

FOR INTERACTIVE EMPLOYEE TRAINING PROVIDED VIA THE INTERNET FEATURING INSTRUCTION IN MARKETING TO CLIENT'S SALES FORCE PERSONNEL (U.S. CLS. 100, 101 AND 107).
FIRST USE 6-1-2003; IN COMMERCE 6-1-2003.
JAMES GRIFFIN, EXAMINING ATTORNEY

SN 76-519,978. AWARDS.COM, LLC, FORT LEE, NJ. FILED
5-23-2003.

awards.com

NO CLAIM IS MADE TO THE EXCLUSIVE RIGHT TO USE "AWARDS" AND "COM", APART FROM THE MARK AS SHOWN.
FOR COMPUTER SERVICES, NAMELY, PROVIDING ON-LINE NEWSLETTERS, MAGAZINE ARTICLES, PAMPHLETS AND NOTEBOOKS IN THE FIELDS OF COMMENDATIONS, LEADERSHIP, MANAGEMENT, TRAINING, ADVERTISING, PROMOTION, MOTIVATION, INCENTIVES AND RECOGNITION (U.S. CLS. 100, 101 AND 107).
DOMINIC J. FERRAIUOLO, EXAMINING ATTORNEY

SN 76-520,088. BEHRMAN, JONN, SALINE, MI. AND BEHRMAN, AIMEE, SALINE, MI. FILED 5-14-2003.

MOMMYFIT

FOR HEALTH CLUB SERVICES, NAMELY, PROVIDING INSTRUCTION AND EQUIPMENT IN THE FIELD OF PHYSICAL EXERCISE (U.S. CLS. 100, 101 AND 107).
CAROLYN CATALDO, EXAMINING ATTORNEY

SN 76-523,094. AMERICA ONLINE, INC., DULLES, VA.
FILED 6-13-2003.

LOVE.COM

FOR ENTERTAINMENT IN THE NATURE OF ONGOING TELEVISION PROGRAMS IN THE FIELD OF DATING, PERSONAL ADVICE, AND SOCIAL RELATIONSHIPS BROADCAST OVER COMPUTER NETWORKS AND TELEVISION (U.S. CLS. 100, 101 AND 107).
STANLEY I. OSBORNE, EXAMINING ATTORNEY

CLASS 41—(Continued).

SN 76-523,429. NATIONAL HERITAGE ACADEMIES, INC.,
GRAND RAPIDS, MI. FILED 6-18-2003.

**SCHOOLS FOR THE
AMERICAN DREAM**

NO CLAIM IS MADE TO THE EXCLUSIVE RIGHT TO USE SCHOOL, APART FROM THE MARK AS SHOWN.
FOR EDUCATIONAL SERVICES IN THE NATURE OF PRIMARY AND SECONDARY SCHOOLS; EDUCATIONAL SERVICES, NAMELY, CONDUCTING COURSES OF INSTRUCTION AT THE PRIMARY AND SECONDARY LEVELS (U.S. CLS. 100, 101 AND 107).
RAUL CORDOVA, EXAMINING ATTORNEY

SN 76-524,119. GEORGIA BIOMEDICAL PARTNERSHIP,
INC., ATLANTA, GA. FILED 6-13-2003.

**GEORGIA BIOMEDICAL
PARTNERSHIP**

NO CLAIM IS MADE TO THE EXCLUSIVE RIGHT TO USE "BIOMEDICAL PARTNERSHIP", APART FROM THE MARK AS SHOWN.
SEC. 2(F).
FOR EDUCATIONAL SERVICES, NAMELY, CONDUCTING EDUCATIONAL CONFERENCES IN THE FIELD OF LIFE SCIENCES (U.S. CLS. 100, 101 AND 107).
FIRST USE 9-1-1992; IN COMMERCE 9-1-1992.
SONYA STEPHENS, EXAMINING ATTORNEY

SN 76-525,476. FLATBED INDUSTRY FORUM LLC, ROCHESTER, PA. FILED 6-25-2003.



NO CLAIM IS MADE TO THE EXCLUSIVE RIGHT TO USE FLATBED INDUSTRY FORUM, APART FROM THE MARK AS SHOWN.
THE LINING IN THE DRAWING IS A FEATURE OF THE MARK AND DOES NOT INDICATE COLOR.
FOR EDUCATIONAL SEMINARS RELATING TO THE FLATBED TRANSPORTATION INDUSTRY (U.S. CLS. 100, 101 AND 107).
FIRST USE 3-11-2003; IN COMMERCE 3-11-2003.
TONI HICKEY, EXAMINING ATTORNEY

CLASS 41—(Continued).

SN 76-529,979. FEDERAL HOME LOAN MORTGAGE CORPORATION, MCLEAN, VA. FILED 7-14-2003.

DON'T BORROW TROUBLE

FOR PUBLICATION AND ON-LINE PUBLICATION OF EDUCATIONAL MATERIALS, NAMELY BOOKS, FOLIOS, PAMPHLETS AND WORKSHEETS RELATED TO ANTI-PREDATORY LENDING PRACTICES (U.S. CLS. 100, 101 AND 107).

FIRST USE 12-13-1999; IN COMMERCE 12-13-1999.
WILLIAM VERHOSEK, EXAMINING ATTORNEY

SN 76-532,532. THE CINCINNATI AREA CHAPTER OF THE AMERICAN RED CROSS, CINCINNATI, OH. FILED 7-28-2003.

BEPA

FOR TRAINING SERVICES, NAMELY, PROVIDING TRAINING TO BUSINESSES TO ENHANCE EMERGENCY PLANNING BY PREPARING FOR AND RESPONDING TO EMERGENCIES THROUGH MITIGATION, COMMUNICATION, RESPONSE AND RESTORATION OF SERVICES WITH MINIMAL RISK (U.S. CLS. 100, 101 AND 107).

FIRST USE 11-2-2002; IN COMMERCE 11-2-2002.
ODESSA BIBBINS, EXAMINING ATTORNEY

SN 76-533,313. ROBERT W. WOODRUFF ARTS CENTER, INC., ATLANTA, GA. FILED 7-17-2003.

ALLIANCE CHILDREN'S THEATRE

NO CLAIM IS MADE TO THE EXCLUSIVE RIGHT TO USE "CHILDREN'S THEATRE", APART FROM THE MARK AS SHOWN.

FOR ENTERTAINMENT SERVICES, NAMELY, THE PRODUCTION OF LIVE THEATRICAL PERFORMANCES FOR CHILDREN; EDUCATIONAL SERVICES, NAMELY, PROVIDING PRESCHOOL, KINDERGARTEN, AND ELEMENTARY SCHOOL STUDENTS INSTRUCTION IN ACTING, SCRIPTWRITING, AND THEATER APPRECIATION AND PROVIDING TEACHERS OF THE SAME IN-SERVICE PROGRAMS (U.S. CLS. 100, 101 AND 107).

FIRST USE 0-0-1987; IN COMMERCE 0-0-1987.
DANIEL CAPSHAW, EXAMINING ATTORNEY

CLASS 41—(Continued).

SN 76-536,401. AARP, WASHINGTON, DC. FILED 8-12-2003.

AARP BEST EMPLOYERS FOR WORKERS OVER 50

OWNER OF U.S. REG. NOS. 741,334, 2,461,155 AND OTHERS.

NO CLAIM IS MADE TO THE EXCLUSIVE RIGHT TO USE "BEST EMPLOYERS FOR WORKERS OVER 50", APART FROM THE MARK AS SHOWN.

FOR PROVIDING RECOGNITION AND INCENTIVES BY THE WAY OF AWARDS TO DEMONSTRATE EXCELLENCE IN THE FIELDS OF PUBLIC SERVICE, SIGNIFICANT ACHIEVEMENTS, MILESTONES AND CHARITABLE CONTRIBUTIONS IN THE FIELDS OF RETIREMENT, MATURE OR RETIRED LIFESTYLES, AGING, WORK RELATIONSHIPS, WORKFORCE ISSUES, ECONOMIC SECURITY, WORK, AND ELDER ISSUES; AND ENTERTAINMENT SERVICES, NAMELY, CONDUCTING CONTESTS IN MAGAZINES FOR RECOGNITION IN THE FIELDS OF PUBLIC SERVICE, SIGNIFICANT ACHIEVEMENTS, MILESTONES AND CHARITABLE CONTRIBUTIONS IN THE FIELDS OF RETIREMENT, MATURE OR RETIRED LIFESTYLES, AGING, WORK RELATIONSHIPS, WORKFORCE ISSUES, ECONOMIC SECURITY, WORK, AND ELDER ISSUES (U.S. CLS. 100, 101 AND 107).

FIRST USE 1-0-2003; IN COMMERCE 1-0-2003.
PAULA MAYS, EXAMINING ATTORNEY

SN 76-539,463. HORSESHOE GAMING HOLDING CORP., LAS VEGAS, NV. FILED 8-11-2003.

LEGENDARY JACKS

FOR CASINO SERVICES, NAMELY THE PROVISION OF GAMING MACHINES FOR USE BY CASINO CUSTOMERS (U.S. CLS. 100, 101 AND 107).

SHAUNIA WALLACE, EXAMINING ATTORNEY

SN 76-539,668. GINS, AMY DALE, EDGEWATER, NJ. FILED 8-25-2003.

GLOWS & GROWS

FOR EDUCATIONAL SERVICES, NAMELY CONDUCTING CLASSES, SEMINARS, CONFERENCES AND WORKSHOPS IN THE FIELDS OF SELF EVALUATION, MOTIVATION, AND BEHAVIOR MODIFICATION (U.S. CLS. 100, 101 AND 107).

SONYA STEPHENS, EXAMINING ATTORNEY

CLASS 41—(Continued).

SN 76-544,908. BNP MEDIA II, LLC, TROY, MI. FILED 9-8-2003.



NO CLAIM IS MADE TO THE EXCLUSIVE RIGHT TO USE "PACKAGE DESIGN", APART FROM THE MARK AS SHOWN.

THE MARK CONSISTS OF A DESIGN FORMED BY TWO QUADRILATERALS AND THE WORDS "PACKAGE DESIGN".

FOR EDUCATIONAL SERVICES, NAMELY, ARRANGING AND CONDUCTING CONFERENCES AND SEMINARS IN THE FIELD OF PACKAGING (U.S. CLS. 100, 101 AND 107).

DAVID C. REIHNER, EXAMINING ATTORNEY

SN 76-545,697. TECHTV, INC., SAN FRANCISCO, CA. FILED 9-22-2003.

NEW THINGS. TURN US ON.

FOR PRODUCTION AND DISTRIBUTION OF TELEVISION AND INTERNET PROGRAMS (U.S. CLS. 100, 101 AND 107).

FIRST USE 9-16-2002; IN COMMERCE 9-16-2002.

RUDY R. SINGLETON, EXAMINING ATTORNEY

SN 76-545,698. TECHTV, INC., SAN FRANCISCO, CA. FILED 9-22-2003.

NERD NATION

FOR PRODUCTION AND DISTRIBUTION OF TELEVISION AND INTERNET PROGRAMS (U.S. CLS. 100, 101 AND 107).

RUDY R. SINGLETON, EXAMINING ATTORNEY

SN 76-545,952. PETERS, PAUL J., II, MIDDLETON, MA. FILED 9-22-2003.

THE ELECTRIC GURUS

FOR ENTERTAINMENT IN THE NATURE OF A LIVE MUSICAL GROUP (U.S. CLS. 100, 101 AND 107).

CAROLINE WEIMER, EXAMINING ATTORNEY

CLASS 41—(Continued).

SN 76-546,090. I.S.Y. PRODUCTIONS, L.L.C., GREENWICH, CT. FILED 9-22-2003.

NANABANANA

OWNER OF U.S. REG. NO. 1,986,338.
FOR ENTERTAINMENT SERVICES, NAMELY, LIVE PERFORMANCES BY A STORYTELLER AND SINGER (U.S. CLS. 100, 101 AND 107).

FIRST USE 11-19-1997; IN COMMERCE 11-19-1997.

ELIZABETH HUGHITT, EXAMINING ATTORNEY

SN 76-546,421. HASBRO, INC., PAWTUCKET, RI. FILED 9-23-2003.

ACTION FORCE

FOR ENTERTAINMENT SERVICES, NAMELY, PRODUCTION AND DISTRIBUTION OF MOTION PICTURES, TELEVISION PROGRAMS, TELEVISION GAMES SHOWS AND CARTOON SERIES; TELEVISION PROGRAMS IN THE NATURE OF CHILDREN'S GAMES AND ENTERTAINMENT; PROVIDING INTERACTIVE COMPUTER GAMES BY MEANS OF A GLOBAL COMPUTER NETWORK (U.S. CLS. 100, 101 AND 107).

TARAH HARDY, EXAMINING ATTORNEY

SN 76-547,467. NEW YORK MAGPIES AUSTRALIAN RULES FOOTBALL CLUB INC., NEW YORK, NY. FILED 9-22-2003.

NEW YORK MAGPIES

NO CLAIM IS MADE TO THE EXCLUSIVE RIGHT TO USE "NEW YORK", APART FROM THE MARK AS SHOWN.

FOR ENTERTAINMENT SERVICES, NAMELY, ORGANIZING, CONDUCTING AND STAGING AUSTRALIAN RULES FOOTBALL GAMES, EXHIBITIONS AND CLINICS (U.S. CLS. 100, 101 AND 107).

FIRST USE 3-1-1998; IN COMMERCE 4-25-1998.

KATHRYN COWARD, EXAMINING ATTORNEY

SN 76-549,083. BONOMO, PATRICK, NEW YORK, NY. FILED 10-6-2003.

THE NEW BOHEMIA

FOR ENTERTAINMENT IN THE NATURE OF THEATER PRODUCTIONS/STAGE PERFORMANCES (U.S. CLS. 100, 101 AND 107).

FIRST USE 2-0-2002; IN COMMERCE 2-0-2002.

LESLEY LAMOTHE, EXAMINING ATTORNEY

CLASS 41—(Continued).

SN 76-549,647. OKLAHOMA DEPARTMENT OF LABOR, OKLAHOMA CITY, OK. FILED 9-15-2003.

SAFETY PAYS

FOR OUTREACH PROGRAM TO EDUCATE AND TRAIN OKLAHOMA EMPLOYERS IN WORKPLACE SAFETY AND HEALTH PROGRAMS DESIGNED TO REDUCE WORKPLACE INJURIES, MAKE HEALTHIER, HAPPIER EMPLOYEES, IMPROVE PRODUCTIVITY, DECREASE WORKERS' COMPENSATION INSURANCE PREMIUMS, AND ULTIMATELY IMPROVE THE EMPLOYERS' BOTTOM LINE (U.S. CLS. 100, 101 AND 107).

FIRST USE 6-30-1997; IN COMMERCE 6-30-1997.
DAWN FELDMAN, EXAMINING ATTORNEY

SN 76-550,647. OUTWARD BOUND, INC., GARRISON, NY. FILED 10-9-2003.

LIVE BIGGER.

FOR EDUCATIONAL SERVICES IN THE NATURE OF WILDERNESS SCHOOLS, COURSES, WORKSHOPS AND PROGRAMS (U.S. CLS. 100, 101 AND 107).

FIRST USE 2-0-2003; IN COMMERCE 2-0-2003.
SUSAN LESLIE DUBOIS, EXAMINING ATTORNEY

SN 76-552,188. GARDNER, TRISH, MOUNTAIN VIEW, CA. AND MADDEN, ANDREA, SAN FRANCISCO, CA. AND BERK, CARRIE, OAKLAND, CA. AND HEYMAN, JENNIFER, SAN FRANCISCO, CA. FILED 10-17-2003.

DMF

FOR ENTERTAINMENT SERVICES, NAMELY, CONDUCTING PARTIES FOR SINGLE ADULTS AT BARS, CLUBS AND OTHER FACILITIES (U.S. CLS. 100, 101 AND 107).

FIRST USE 3-7-2003; IN COMMERCE 3-7-2003.
TARAH HARDY, EXAMINING ATTORNEY

SN 76-553,244. OUTDOOR LIFE NETWORK, L.L.C., STAMFORD, CT. FILED 10-21-2003.

GLOBAL EXTREMES

FOR ENTERTAINMENT SERVICES, NAMELY, AN ONGOING TELEVISION SERIES IN THE FIELD OF OUTDOOR COMPETITIONS (U.S. CLS. 100, 101 AND 107).

JENNIFER KRISP, EXAMINING ATTORNEY

CLASS 41—(Continued).

SN 76-553,387. BAGDASARIAN PRODUCTIONS, LLC, MONTECITO, CA. FILED 10-3-2003.

LITTLE ALVIN AND THE MINI-MUNKS

FOR ENTERTAINMENT SERVICES— NAMELY-A LIVE ACTION PUPPET SHOW (U.S. CLS. 100, 101 AND 107).

KEVON CHISOLM, EXAMINING ATTORNEY

SN 76-555,124. IOWA WASTE REDUCTION CENTER, CEDAR FALLS, IA. FILED 10-29-2003.

STAR4D

OWNER OF U.S. REG. NO. 2,308,222.
FOR PAINT SPRAY TRAINING PROGRAM (U.S. CLS. 100, 101 AND 107).

FIRST USE 6-0-2003; IN COMMERCE 6-0-2003.
PATRICIA EVANKO, EXAMINING ATTORNEY

SN 76-555,522. NATIONAL SCHOOL BOARDS ASSOCIATION, ALEXANDRIA, VA. FILED 10-31-2003.

ELECTRONIC SCHOOL

OWNER OF U.S. REG. NO. 1,802,038.
SEC. 2(F).
FOR PROVIDING INFORMATION ON THE USE OF TECHNOLOGY IN PUBLIC EDUCATION VIA THE INTERNET (U.S. CLS. 100, 101 AND 107).

FIRST USE 3-30-1995; IN COMMERCE 3-30-1995.
YSA DEJESUS, EXAMINING ATTORNEY

SN 76-560,141. NEW ORLEANS BAPTIST THEOLOGICAL SEMINARY, NEW ORLEANS, LA. FILED 10-29-2003.

NOBTS

SEC. 2(F).
FOR EDUCATIONAL SERVICES, NAMELY, PROVIDING COURSES OF LIBERAL ARTS AND DIVINITY INSTRUCTION AT THE COLLEGE UNDERGRADUATE AND GRADUATE LEVELS (U.S. CLS. 100, 101 AND 107).

FIRST USE 5-19-1946; IN COMMERCE 5-19-1946.
JOHN HWANG, EXAMINING ATTORNEY

CLASS 41—(Continued).

SN 78-135,073. BROKERS' CHOICE OF AMERICA, INC., ENGLEWOOD, CO. FILED 6-12-2002.

SENIOR FINANCIAL SURVIVAL BOOTCAMP

NO CLAIM IS MADE TO THE EXCLUSIVE RIGHT TO USE SENIOR FINANCIAL, APART FROM THE MARK AS SHOWN.

FOR EDUCATIONAL SERVICES, NAMELY, CONDUCTING SEMINARS AND CONFERENCES IN THE FIELD OF EDUCATING FINANCIAL ADVISORS WITH REGARD TO FINANCIAL INFORMATION RELEVANT TO THE SENIOR CITIZEN'S MARKET, FOCUSING ON FIXED ANNUITIES, AND OTHER FINANCIAL NEEDS OF SENIOR CITIZENS (U.S. CLS. 100, 101 AND 107).
MITCHELL FRONT, EXAMINING ATTORNEY

SN 78-156,713. ALL HOURS FITNESS, INC., MANY, LA. FILED 8-22-2002.

ALL HOURS FITNESS, INC.

NO CLAIM IS MADE TO THE EXCLUSIVE RIGHT TO USE "FITNESS, INC.", APART FROM THE MARK AS SHOWN.

FOR HEALTH CLUB SERVICES, NAMELY PROVIDING INSTRUCTION AND EQUIPMENT IN THE FIELD OF PHYSICAL EXERCISE; GYMNASIUM (U.S. CLS. 100, 101 AND 107).
JOHN HWANG, EXAMINING ATTORNEY

SN 78-165,120. EDUSEED, WASHINGTON, DC. FILED 9-17-2002.

EDUSEED

FOR EDUCATIONAL SERVICES, NAMELY, MENTORING SERVICES AND COMMUNITY EDUCATION PROGRAMS IN THE FIELDS OF COMPUTER MENTORING, ACADEMIC MENTORING AND COMMUNITY HEALTH INFORMATION (U.S. CLS. 100, 101 AND 107).
FIRST USE 3-0-2000; IN COMMERCE 3-0-2000.
KELLY BOULTON, EXAMINING ATTORNEY

CLASS 41—(Continued).

SN 78-165,756. KING WORLD PRODUCTIONS, INC., NEW YORK, NY. FILED 9-19-2002.



OWNER OF U.S. REG. NOS. 1,448,954 AND 2,582,520.

THE MARK CONSISTS OF A STYLIZED THREE-DIMENSIONAL LETTER H WITH THE NUMBER 2 RAISED AND HOLLYWOOD SQUARES.

FOR ENTERTAINMENT SERVICES IN THE NATURE OF A TELEVISION GAME SHOW; PROVIDING INFORMATION IN THE FIELD OF ENTERTAINMENT VIA A GLOBAL COMPUTER NETWORK; AND PROVIDING INFORMATION ABOUT CELEBRITIES VIA A GLOBAL COMPUTER NETWORK (U.S. CLS. 100, 101 AND 107).
FIRST USE 9-16-2002; IN COMMERCE 9-16-2002.

KARLA PERKINS, EXAMINING ATTORNEY

SN 78-188,795. CHEW, CHERYL Y., BREA, CA. FILED 11-25-2002.

STARMAKER

FOR ENTERTAINMENT IN THE NATURE OF FASHION SHOWS AND THEATER PRODUCTIONS; CONDUCTING TALENT AND MODELING CONTESTS AT RECORDING STUDIOS AND ON-SITE LOCATIONS FOR CHILDREN, YOUTH, AND ADULTS; PROVIDING RADIO AND TELEVISION PROGRAMS IN THE FIELD OF TALENT AND MODEL SEARCHES (U.S. CLS. 100, 101 AND 107).

FIRST USE 10-19-2002; IN COMMERCE 10-19-2002.
BRETT J. GOLDEN, EXAMINING ATTORNEY

SN 78-190,640. APPALACHIAN STATE UNIVERSITY, BOONE, NC. FILED 12-3-2002.

APPALACHIAN SYMPHONY ORCHESTRA

OWNER OF U.S. REG. NOS. 2,444,195, 2,447,683 AND 2,469,189.

NO CLAIM IS MADE TO THE EXCLUSIVE RIGHT TO USE SYMPHONY ORCHESTRA, APART FROM THE MARK AS SHOWN.

SEC. 2(F).

FOR ENTERTAINMENT SERVICES, NAMELY, LIVE MUSICAL PERFORMANCES BY A SYMPHONY ORCHESTRA (U.S. CLS. 100, 101 AND 107).

FIRST USE 10-31-1979; IN COMMERCE 10-31-1979.
TRICIA SONNEBORN, EXAMINING ATTORNEY

CLASS 41—(Continued).

SN 78-209,700. SUNSET STUDIOS, COTTONWOOD, AZ. FILED 1-31-2003.

VIOLENT LITTLE BASTARD

FOR ENTERTAINMENT SERVICES, NAMELY, ENTERTAINMENT IN THE NATURE OF ON-GOING TELEVISION PROGRAMS, VIDEOTAPE PRODUCTION AND DISTRIBUTION, PRODUCTION AND DISTRIBUTION OF MOTION PICTURES, RADIO PROGRAMS AND PROGRAMS WEBCASTED OVER GLOBAL COMPUTER NETWORKS FEATURING A VARIETY OF ENTERTAINMENT (U.S. CLS. 100, 101 AND 107).

PAULA MAYS, EXAMINING ATTORNEY

SN 78-215,582. ALLENRYAN, NICOLE, PEMBROKE PINES, FL. FILED 2-17-2003.

GET CAUGHT THINKING

FOR CONDUCTING SEMINARS AND WORKSHOPS IN THE FIELD OF ACHIEVING AND IMPLEMENTING EFFICIENCY GOALS (U.S. CLS. 100, 101 AND 107).

WON TEAK OH, EXAMINING ATTORNEY

SN 78-222,462. HACHETTE FILIPACCHI MEDIA U.S., INC., NEW YORK, NY. FILED 3-6-2003.

POP PHOTO

OWNER OF U.S. REG. NOS. 511,952 AND 1,613,788. SEC. 2(F).
FOR PROVIDING AN ON-LINE MAGAZINE IN THE FIELD OF PHOTOGRAPHY AND IMAGING (U.S. CLS. 100, 101 AND 107).

REBECCA SMITH, EXAMINING ATTORNEY

SN 78-223,052. ST. NICHOLAS MUSIC INC., NEW YORK, NY. FILED 3-7-2003.

REINDEER GAMES

OWNER OF U.S. REG. NOS. 2,501,573 AND 2,691,362.
NO CLAIM IS MADE TO THE EXCLUSIVE RIGHT TO USE "GAMES" ONLY AS TO THE LOTTERY AND SWEEPSTAKES SERVICES, APART FROM THE MARK AS SHOWN.

FOR ENTERTAINMENT AND EDUCATIONAL SERVICES, NAMELY, PRODUCTION OF TELEVISION PROGRAMS AND MOTION PICTURE FILMS; ENTERTAINMENT SERVICES, NAMELY, A CHILDREN'S TELEVISION SERIES; ENTERTAINMENT AND EDUCATIONAL SERVICES, NAMELY, AMUSEMENT PARK SERVICES, AMUSEMENT PARK RIDES AND AMUSEMENT PARK SHOWS; THEATRICAL BOOKING AGENCIES; CONCERT BOOKING; ENTERTAINMENT SERVICES, NAMELY PROVIDING A WEB SITE FEATURING MUSICAL PERFORMANCES, MUSICAL VIDEOS, FILM CLIPS, PHOTOGRAPHS AND OTHER MULTIMEDIA OR INTERACTIVE MATERIALS; EDUCATION AND ENTERTAINMENT SERVICES, NAMELY, PROVIDING A WEB SITE FEATURING STORIES AND FUN ACTIVITIES FOR CHILDREN; MUSIC PUBLISHING; LOTTERY SERVICES; ENTERTAINMENT SER-

CLASS 41—(Continued).

VICES IN THE NATURE OF CONDUCTING A SWEEPSTAKES; ARRANGING AND CONDUCTING ATHLETIC COMPETITIONS; ENTERTAINMENT IN THE NATURE OF CIRCUSES; ENTERTAINMENT IN THE NATURE OF LIVE PERFORMANCES BY A MUSICAL BAND; ENTERTAINMENT IN THE NATURE OF LIGHT SHOWS OR LASER SHOWS; ENTERTAINMENT SERVICES, NAMELY, ORGANIZING AND CONDUCTING STAGE SHOWS, NIGHTCLUB SHOWS, FAN CLUBS; RECREATIONAL CAMPS; SUMMER CAMPS; SPORTS CAMPS; PROVIDING FACILITIES FOR RECREATIONAL AND EDUCATIONAL ACTIVITIES; PROVIDING RECOGNITION AND INCENTIVES BY THE WAY OF AWARDS TO DEMONSTRATE EXCELLENCE IN THE FIELDS OF ACADEMICS AND SPORTS, ENTERTAINMENT SERVICES, NAMELY, ORGANIZATION AND PROMOTION OF AN ANNUAL COMMUNITY CELEBRATION, ENTERTAINMENT SERVICES IN THE NATURE OF PROVIDING LIVE CHRISTMAS CONCERTS AND TELEVISED CHRISTMAS CONCERTS; ENTERTAINMENT SERVICES, NAMELY, CONDUCTING LIVE EXHIBITIONS IN THE NATURE OF BROADWAY OR STAGE THEATRICAL SHOWS, ICE SHOWS, LIVE PERFORMANCES BY COSTUMED HOLIDAY CHARACTERS, AND MAGIC SHOWS (U.S. CLS. 100, 101 AND 107).

DORITT L. CARROLL, EXAMINING ATTORNEY

SN 78-224,361. ARLUK TECHNOLOGIES LLC, NASHUA, NH. FILED 3-11-2003.

ROBOTECH CENTER

NO CLAIM IS MADE TO THE EXCLUSIVE RIGHT TO USE "CENTER", APART FROM THE MARK AS SHOWN.

FOR EDUCATIONAL SERVICES, NAMELY CONDUCTING CLASSES, COURSES AND WORKSHOPS IN THE FIELD OF TECHNOLOGY, TEAM BUILDING AND PROBLEM SOLVING SKILLS FOR CHILDREN AND DISTRIBUTING COURSE MATERIALS IN CONNECTION THEREWITH; PROVIDING EDUCATIONAL INFORMATION IN THE FIELD OF SCIENCE AND TECHNOLOGY IN A HANDS-ON FORMAT WITH EXPERIMENTATION (U.S. CLS. 100, 101 AND 107).

FIRST USE 11-15-2002; IN COMMERCE 11-15-2002.
PAULA MAYS, EXAMINING ATTORNEY

SN 78-226,260. KUSCHNIR, ARI, SUNNY ISLES, FL. AND THRIFT, SCOTT, SUNNY ISLES, FL. FILED 3-17-2003.

M S S N G P E C E S

FOR ENTERTAINMENT PROVIDED OVER A GLOBAL COMPUTER INFORMATION NETWORK AND OTHER ELECTRONIC COMPUTER NETWORKS, NAMELY, PROVIDING MULTIMEDIA INFORMATION AND ENTERTAINMENT PIECES IN THE NATURE OF MOTION PICTURES AND MOTION PICTURE CLIPS, STILLS AND SOUND EFFECTS; AND, PRODUCTION AND DISTRIBUTION OF ENTERTAINMENT AND EDUCATIONAL MOTION PICTURE FILMS ON A WIDE VARIETY OF THEMES; PRODUCTION AND DISTRIBUTION OF TELEVISION PROGRAMS TO OTHERS ON A WIDE VARIETY OF THEMES; PROVIDING AN INTERNET WEB SITE CONTAINING MATERIAL REGARDING THE FILM INDUSTRY, NAMELY ENTERTAINMENT RELATED MATERIAL AND ENTERTAINMENT NEWS; PRODUCTION OF AUDIO AND VIDEO RECORDINGS ON A WIDE VARIETY OF THEMES (U.S. CLS. 100, 101 AND 107).

LAURIEL DALIER, EXAMINING ATTORNEY

CLASS 41—(Continued).

SN 78-226,652. URBAN, KEITH, NASHVILLE, TN. FILED 3-17-2003.

KEITH URBAN

THE NAME KEITH URBAN IDENTIFIES A LIVING INDIVIDUAL WHOSE CONSENT IS OF RECORD.

FOR ENTERTAINMENT SERVICES, NAMELY, LIVE MUSICAL PERFORMANCES BY A SOLO RECORDING ARTIST; PROVIDING A WEB SITE FEATURING PRE-RECORDED MUSICAL AUDIO CLIPS, PHOTOGRAPHS, NEWS, REVIEWS AND OTHER MULTIMEDIA ARTICLES IN CONNECTION WITH A SOLO RECORDING ARTIST; AND FAN CLUB SERVICES (U.S. CLS. 100, 101 AND 107).

FIRST USE 0-0-2000; IN COMMERCE 0-0-2000.
WON TEAK OH, EXAMINING ATTORNEY

SN 78-227,800. FITMETRICS ASSOCIATES, LIMITED, HUDSON, OH. FILED 3-19-2003.

MOSTARDI METHOD

NO CLAIM IS MADE TO THE EXCLUSIVE RIGHT TO USE METHOD, APART FROM THE MARK AS SHOWN.

FOR EDUCATION SERVICES, NAMELY, PROVIDING TRAINING, INSTRUCTION, AND INFORMATION IN THE FIELDS OF AEROBIC AND ANAEROBIC EXERCISE AND PHYSICAL FITNESS; EDUCATION SERVICES, NAMELY TRAINING AND INSTRUCTION ABOUT HEALTH, DIETARY SUPPLEMENTS AND NUTRITION (U.S. CLS. 100, 101 AND 107).

ALEX KEAM, EXAMINING ATTORNEY

SN 78-231,882. FREMANTLE MEDIA NORTH AMERICA, INC., SANTA MONICA, CA. FILED 3-31-2003.

JUNIOR IDOLS

FOR ENTERTAINMENT SERVICES IN THE NATURE OF A TELEVISION TALENT SHOW (U.S. CLS. 100, 101 AND 107).

RAUL CORDOVA, EXAMINING ATTORNEY

SN 78-234,107. LOVE YOUR PATIENTS!, SCOTTSBLUFF, NE. FILED 4-4-2003.

LOVE YOUR PATIENTS!

FOR PUBLICATION OF BOOKS AND EDUCATIONAL SERVICES, NAMELY, CONDUCTING SEMINARS, CLASSES AND WORKSHOPS IN THE MEDICAL FIELD RELATING TO THE IMPROVEMENT OF PATIENT CAREGIVER RELATIONS, AND DISTRIBUTING COURSE MATERIALS IN CONNECTION THEREWITH (U.S. CLS. 100, 101 AND 107).

FIRST USE 3-2-2003; IN COMMERCE 3-2-2003.
GEORGIA CARTY, EXAMINING ATTORNEY

CLASS 41—(Continued).

SN 78-234,110. WALKER, ANDREW, LYNWOOD, IL. FILED 4-4-2003.



FOR MUSICAL COMPOSITIONS, RECORDINGS AND PERFORMANCES— ENTERTAINMENT NAMELY, LIVE PERFORMANCES BY A MUSICAL BAND; ENTERTAINMENT SERVICES IN THE NATURE OF A MUSICAL GROUP FEATURING LIVE PERFORMANCES OF MUSICAL COMPOSITIONS; SONG WRITING SERVICES (U.S. CLS. 100, 101 AND 107).

DOUGLAS LEE, EXAMINING ATTORNEY

SN 78-236,984. TADASANA YOGA, LLC, NEW YORK, NY. FILED 4-11-2003.

TADASANA YOGA

NO CLAIM IS MADE TO THE EXCLUSIVE RIGHT TO USE YOGA, APART FROM THE MARK AS SHOWN.

THE ENGLISH TRANSLATION OF THE WORD TADASANA IS "MOUNTAIN POSE".

FOR YOGA AND MEDITATION INSTRUCTION; PROVIDING YOGA AND MEDITATION STUDIO SERVICES (U.S. CLS. 100, 101 AND 107).

REBECCA GILBERT, EXAMINING ATTORNEY

SN 78-237,543. INTERNATIONAL CHILI SOCIETY OF LOS ANGELES, SAN JUAN CAPISTRANO, CA. FILED 4-14-2003.

WORLD'S CHAMPIONSHIP SALSA CONTEST

NO CLAIM IS MADE TO THE EXCLUSIVE RIGHT TO USE "SALSA CONTEST", APART FROM THE MARK AS SHOWN.

SEC. 2(F).

FOR ORGANIZING AND CONDUCTING SALSA MAKING CONTESTS (U.S. CLS. 100, 101 AND 107).

FIRST USE 10-1-1995; IN COMMERCE 10-1-1995.

ALLISON HOLTZ, EXAMINING ATTORNEY

CLASS 41—(Continued).

SN 78-247,582. WRZESINSKI, BRYAN, LOS ANGELES, CA. FILED 5-9-2003.

ANGEL'S HEART

FOR ENTERTAINMENT NAMELY, LIVE PERFORMANCES BY A MUSICAL BAND (U.S. CLS. 100, 101 AND 107).

TRACY CROSS, EXAMINING ATTORNEY

SN 78-248,055. AMGEN INC., THOUSAND OAKS, CA. FILED 5-9-2003.

HOPE RELAY

FOR EDUCATIONAL SERVICES, NAMELY, DEVELOPMENT AND DISSEMINATION OF EDUCATIONAL MATERIALS OF OTHERS IN THE FIELD OF AUTOIMMUNE AND INFLAMMATORY DISORDERS AND THE TREATMENT THEREOF; ORGANIZING AND CONDUCTING ATHLETIC EVENTS AND ACTIVITIES TO PROMOTE AWARENESS OF AUTOIMMUNE AND INFLAMMATORY DISORDERS AND THE TREATMENT THEREOF. (U.S. CLS. 100, 101 AND 107).

ROBIN CHOSID, EXAMINING ATTORNEY

SN 78-249,169. HARRY AND DELLA BURPEE MUSEUM ASSOCIATION, DBA BURPEE MUSEUM OF NATURAL HISTORY, ROCKFORD, IL. FILED 5-13-2003.

JANE

FOR EDUCATIONAL SERVICES, NAMELY, PROVIDING SEMINARS, LECTURES, DEMONSTRATIONS, CLASSES, WORKSHOPS, AND COURSES IN THE FIELD OF DINOSAUR FOSSILS; AND MUSEUM SERVICES FEATURING DINOSAUR RELATED EXHIBITS (U.S. CLS. 100, 101 AND 107).

GIANCARLO CASTRO, EXAMINING ATTORNEY

SN 78-250,518. R.A.W. EXPOSURE ENTERTAINMENT, INC., ST. PAUL, MN. FILED 5-15-2003.

RIGHT AND WRONG EXPOSURE

FOR EDUCATIONAL SERVICES, NAMELY, MENTORING AND TRAINING TEENAGERS BY CONDUCTING CLASSES, WORKSHOPS, AND SEMINARS IN THE PRODUCTION AND MARKETING OF MASS MEDIA SUCH AS PRINTED PUBLICATIONS, TELEVISION, RADIO AND ON-LINE WEBSITES (U.S. CLS. 100, 101 AND 107).

STEVEN R. FINE, EXAMINING ATTORNEY

CLASS 41—(Continued).

SN 78-251,061. BOWTIE, INC., LOS ANGELES, CA. FILED 5-16-2003.

RABBITS USA

SEC. 2(F).

FOR COMPUTER SERVICES, NAMELY, PROVIDING ONLINE PUBLICATIONS IN THE NATURE OF MAGAZINES, NEWSLETTERS AND JOURNALS, AND INFORMATION IN THE FIELDS OF ANIMALS AND FAMILY LEPORIDAE, VIA THE INTERNET (U.S. CLS. 100, 101 AND 107).

FIRST USE 4-2-1996; IN COMMERCE 4-2-1996.

SUSAN STIGLITZ, EXAMINING ATTORNEY

SN 78-255,848. PRODUCT PARTNERS, LLC, BEVERLY HILLS, CA. FILED 5-29-2003.



OWNER OF U.S. REG. NOS. 2,594,003 AND 2,630,688.

FOR EDUCATIONAL SERVICES, NAMELY INSTRUCTION IN THE USE OF EXERCISE EQUIPMENT AND DIET PROGRAMS (U.S. CLS. 100, 101 AND 107).

BARBARA GAYNOR, EXAMINING ATTORNEY

SN 78-256,420. MATTEL, INC., EL SEGUNDO, CA. FILED 5-30-2003.

THE ENCHANTED ADVENTURES GAME

NO CLAIM IS MADE TO THE EXCLUSIVE RIGHT TO USE GAME, APART FROM THE MARK AS SHOWN.

FOR ENTERTAINMENT AND EDUCATIONAL SERVICES, NAMELY, PROVIDING ONLINE GAMES AND ACTIVITIES FOR CHILDREN (U.S. CLS. 100, 101 AND 107).

SUELLEN HICKEY, EXAMINING ATTORNEY

SN 78-262,945. DAVIS, TOBY, MONCKS CORNER, SC. FILED 6-16-2003.



FOR PROVIDING NEWSLETTERS IN THE FIELD OF REAL ESTATE VIA EMAIL (U.S. CLS. 100, 101 AND 107).

FIRST USE 1-1-2003; IN COMMERCE 1-1-2003.

PAUL F. GAST, EXAMINING ATTORNEY

CLASS 41—(Continued).

SN 78-270,568. J. J. BURGARD & ASSOCIATES, KINGS BEACH, CA. FILED 7-3-2003.

GATEWAY TO MASTERY

FOR EDUCATIONAL SERVICES, NAMELY, CONDUCTING CLASSES, SEMINARS, WORKSHOPS, CONFERENCES AND CONVENTIONS IN THE FIELDS OF TEACHER TRAINING FOR CLASSROOM TEACHERS, LEARNING ASSESSMENT AND CLASSROOM MANAGEMENT, AND DISTRIBUTION OF PRINTED AND AUDIO-VISUAL COURSE MATERIALS IN CONNECTION THEREWITH; CONSULTATION SERVICES TO SCHOOL DISTRICTS AND BUSINESSES IN THE EDUCATION AND LEARNING ASSESSMENT FIELDS; DEVELOPMENT AND DISSEMINATION OF EDUCATIONAL MATERIALS OF OTHERS IN THE FIELDS OF TEACHING, LEARNING ASSESSMENT AND CLASSROOM MANAGEMENT; EDUCATIONAL SERVICES, NAMELY, CONDUCTING ON-LINE EXHIBITIONS AND DISPLAYS AND INTERACTIVE EXHIBITS IN THE FIELDS OF TEACHING, LEARNING ASSESSMENT AND CLASSROOM MANAGEMENT; ARRANGING AND CONDUCTING EDUCATIONAL SEMINARS, CONFERENCES, AND CONVENTIONS AND PROVIDING FACILITIES THEREFOR (U.S. CLS. 100, 101 AND 107).
YONG KIM, EXAMINING ATTORNEY

SN 78-272,484. CONNECTICUT CENTER FOR MASSAGE THERAPY, INC., NEWINGTON, CT. FILED 7-10-2003.



OWNER OF U.S. REG. NOS. 2,216,197 AND 2,329,690.
NO CLAIM IS MADE TO THE EXCLUSIVE RIGHT TO USE "CONNECTICUT CENTER FOR MASSAGE THERAPY", APART FROM THE MARK AS SHOWN.
FOR VOCATIONAL EDUCATION IN THE FIELD OF MASSAGE THERAPY; EDUCATIONAL SERVICES, NAMELY; CONDUCTING CLASSES, SEMINARS AND WORKSHOPS IN THE FIELD OF MASSAGE THERAPY (U.S. CLS. 100, 101 AND 107).
FIRST USE 7-1-2001; IN COMMERCE 7-1-2001.
JOHN E. MICHOS, EXAMINING ATTORNEY

CLASS 41—(Continued).

SN 78-272,688. THE INSTITUTE OF ELECTRICAL AND ELECTRONICS ENGINEERS, INC., PISCATAWAY, NJ. FILED 7-10-2003.

CSDP

FOR TRAINING SERVICES IN THE FIELD OF COMPUTER SOFTWARE DEVELOPMENT; EDUCATIONAL TESTING SERVICES TO DETERMINE THE PROFESSIONAL QUALIFICATIONS OF PERSONS IN THE COMPUTER SOFTWARE DEVELOPMENT FIELD (U.S. CLS. 100, 101 AND 107).
FIRST USE 1-25-2002; IN COMMERCE 1-25-2002.
CATHERINE CAIN, EXAMINING ATTORNEY

SN 78-275,847. FRIEDMAN, DARLENE, SPRINGFIELD, PA. FILED 7-18-2003.

CYRANO'S PROSE

FOR PERSONALIZED SPEECH AND TOAST WRITING SERVICES (U.S. CLS. 100, 101 AND 107).
FIRST USE 9-13-2003; IN COMMERCE 9-13-2003.
DAVID ELTON, EXAMINING ATTORNEY

SN 78-278,169. FIT IN THIRTY, LTD., FORT WORTH, TX. FILED 7-24-2003.

FIT IN THIRTY

FOR HEALTH CLUB SERVICES, NAMELY, PROVIDING INSTRUCTION AND EQUIPMENT IN THE FIELD OF PHYSICAL EXERCISE; AND PROVIDING FITNESS AND EXERCISE FACILITIES (U.S. CLS. 100, 101 AND 107).
BRIAN NEVILLE, EXAMINING ATTORNEY

SN 78-278,968. IMAGE PILOTS, INC., CHICAGO, IL. FILED 7-25-2003.

IMAGE PILOTS

FOR SPECIAL EVENT PLANNING AND CONSULTATION SERVICES (U.S. CLS. 100, 101 AND 107).
FIRST USE 11-30-1999; IN COMMERCE 6-30-2002.
MARGERY A. TIERNEY, EXAMINING ATTORNEY

CLASS 41—(Continued).

SN 78-278,972. IMAGE PILOTS, INC., CHICAGO, IL. FILED 7-25-2003.

PAINT ME A PARTY PRODUCTIONS

NO CLAIM IS MADE TO THE EXCLUSIVE RIGHT TO USE PRODUCTIONS, APART FROM THE MARK AS SHOWN.

FOR SPECIAL EVENT PLANNING AND CONSULTATION SERVICES (U.S. CLS. 100, 101 AND 107).

FIRST USE 11-30-1985; IN COMMERCE 12-31-1990.

MARGERY A. TIERNEY, EXAMINING ATTORNEY

CLASS 41—(Continued).

SN 78-284,100. HO CHUNK NATION, BLACK RIVER FALLS, WI. FILED 8-6-2003.

LIKE VEGAS. ONLY CLOSER.

FOR CASINO AND BINGO SERVICES (U.S. CLS. 100, 101 AND 107).

SHAUNIA WALLACE, EXAMINING ATTORNEY

SN 78-279,209. NORTHEAST FOUNDATION FOR CHILDREN, INC., GREENFIELD, MA. FILED 7-25-2003.

Responsive  Classroom

OWNER OF U.S. REG. NOS. 2,482,033 AND 2,515,613. SEC. 2(F).
FOR EDUCATIONAL SERVICES— NAMELY, PROVIDING COURSES OF INSTRUCTION AT THE POST-COLLEGE LEVEL FOR PROFESSIONALS IN THE FIELD OF CHILDREN'S EDUCATION (U.S. CLS. 100, 101 AND 107).
FIRST USE 6-0-2003; IN COMMERCE 6-0-2003.
BRIAN NEVILLE, EXAMINING ATTORNEY

SN 78-279,562. ALEXANDER, G. KEITH, NEW YORK, NY. FILED 7-28-2003.

VOICEOVER INFLUENCE AWARDS

NO CLAIM IS MADE TO THE EXCLUSIVE RIGHT TO USE "VOICEOVER" AND "AWARDS", APART FROM THE MARK AS SHOWN.

FOR ENTERTAINMENT SERVICES, NAMELY AN AWARD PROGRAM FOR THE PRESENTATION OF AWARDS IN RECOGNITION AND CELEBRATION OF THE DISTINGUISHED ACHIEVEMENT OF PERSONS IN THE VOICE-OVER INDUSTRY; EDUCATIONAL SERVICES, NAMELY PROVIDING ENCOURAGEMENT TO PERSONS TO DEMONSTRATE EXCELLENCE IN THE FIELD OF VOICE-OVERS THROUGH THE ISSUANCE OF AWARDS (U.S. CLS. 100, 101 AND 107).

PAULA MAYS, EXAMINING ATTORNEY

SN 78-284,089. HO CHUNK NATION, BLACK RIVER FALLS, WI. FILED 8-6-2003.

WHERE THE WINNERS ARE!

FOR CASINO AND BINGO SERVICES (U.S. CLS. 100, 101 AND 107).
SHAUNIA WALLACE, EXAMINING ATTORNEY

SN 78-285,739. NETWORK ENTERPRISES, INC., NEW YORK, NY. FILED 8-11-2003.

SPIKE TV ULTIMATE GUY VACATION

NO CLAIM IS MADE TO THE EXCLUSIVE RIGHT TO USE "TV", APART FROM THE MARK AS SHOWN.

FOR ENTERTAINMENT SERVICES IN THE NATURE OF AN ONGOING TELEVISION PROGRAM FEATURING LIVE ACTION; PROVIDING INFORMATION IN THE FIELD OF ENTERTAINMENT AND EDUCATION FEATURING LIVE ACTION RENDERED VIA COMPUTER BY MEANS OF A GLOBAL COMPUTER NETWORK (U.S. CLS. 100, 101 AND 107).

TRICIA THOMPSON, EXAMINING ATTORNEY

SN 78-287,049. BLACK, SCOTT V., FERNLEY, NV. FILED 8-13-2003.

EMPOWER
LEADERSHIP IN MOTION

THE STIPPLING IS FOR SHADING PURPOSES ONLY. THE MARK CONSISTS OF THE WORDS, "EMPOWER" AND "LEADERSHIP IN MOTION" SUPERIMPOSED OVER A STYLIZED LETTER U.

FOR EDUCATIONAL SERVICES, NAMELY, CONDUCTING CLASSES AND WORKSHOPS IN THE FIELD OF LEADERSHIP AND COMMUNICATION SKILLS AS WELL AS THE DISTRIBUTION OF COURSE MATERIALS IN CONNECTION THEREWITH (U.S. CLS. 100, 101 AND 107).

FIRST USE 3-1-1998; IN COMMERCE 3-1-1998.

TRACY CROSS, EXAMINING ATTORNEY

CLASS 41—(Continued).

SN 78-287,474. RYAN SEACREST PRODUCTIONS, INC., BURBANK, CA. FILED 8-14-2003.

RYAN SEACREST PRODUCTIONS

NO CLAIM IS MADE TO THE EXCLUSIVE RIGHT TO USE PRODUCTIONS, APART FROM THE MARK AS SHOWN.

THE NAME "RYAN SEACREST" IDENTIFIES A LIVING INDIVIDUAL WHOSE CONSENT IS OF RECORD.

FOR ENTERTAINMENT SERVICES, NAMELY, THE PRODUCTION OF RADIO AND TELEVISION PROGRAMMING (U.S. CLS. 100, 101 AND 107).

SUSAN HAYASH, EXAMINING ATTORNEY



SN 78-287,574. RYAN SEACREST PRODUCTIONS, INC., BURBANK, CA. FILED 8-14-2003.

RYAN SEACREST

THE NAME "RYAN SEACREST" IDENTIFIES A LIVING INDIVIDUAL WHOSE CONSENT IS OF RECORD.

FOR ENTERTAINMENT SERVICES, NAMELY, HOSTING RADIO AND TELEVISION PROGRAMS (U.S. CLS. 100, 101 AND 107).

SUSAN HAYASH, EXAMINING ATTORNEY



SN 78-288,385. JEFFREY WAYNE LEPINE AND CHARLES CUPANI PARTNERSHIP, THE, BAKERSFIELD, CA. FILED 8-17-2003.



NO CLAIM IS MADE TO THE EXCLUSIVE RIGHT TO USE "IMPROV", APART FROM THE MARK AS SHOWN.

FOR ACTING TROUPE PERFORMING IMPROVISATIONAL STYLE SHOWS (U.S. CLS. 100, 101 AND 107).

AISHA CLARKE, EXAMINING ATTORNEY

CLASS 41—(Continued).

SN 78-289,197. DC COMICS, NEW YORK, NY. FILED 8-19-2003.

THE FLASH

OWNER OF U.S. REG. NO. 1,078,898.

FOR ENTERTAINMENT SERVICES IN THE NATURE OF LIVE-ACTION, COMEDY, DRAMA AND ANIMATED TELEVISION SERIES; PRODUCTION OF LIVE-ACTION, COMEDY, DRAMA AND ANIMATED TELEVISION SERIES; DISTRIBUTION AND DISPLAY OF LIVE-ACTION, COMEDY, DRAMA AND ANIMATED MOTION PICTURE THEATRICAL FILMS; PRODUCTION OF LIVE-ACTION, COMEDY, DRAMA AND ANIMATED MOTION PICTURE THEATRICAL FILMS; THEATRICAL PERFORMANCES BOTH ANIMATED AND LIVE ACTION; INTERNET SERVICES PROVIDING INFORMATION VIA AN ELECTRONIC GLOBAL COMPUTER NETWORK IN THE FIELD OF ENTERTAINMENT RELATING SPECIFICALLY TO MUSIC, MOVIES, AND TELEVISION; PROVIDING GENERAL INTEREST NEWS, ENTERTAINMENT, AND EDUCATIONAL INFORMATION VIA A GLOBAL COMPUTER NETWORK; AND PROVIDING INFORMATION FOR AN ACTUAL ENTERTAINMENT VIA ELECTRONIC GLOBAL COMMUNICATIONS NETWORK IN THE NATURE OF LIVE-ACTION, COMEDY, DRAMA AND ANIMATED PROGRAMS AND PRODUCTION OF LIVE-ACTION COMEDY, ACTION AND ANIMATED MOTION FILMS FOR DISTRIBUTION VIA A GLOBAL COMPUTER NETWORK (U.S. CLS. 100, 101 AND 107).

LINDA MICKLEBURGH, EXAMINING ATTORNEY



SN 78-289,598. AMERICA ONLINE, INC., DULLES, VA. FILED 8-20-2003.

KOL JR

FOR EDUCATION AND ENTERTAINMENT SERVICES, NAMELY, PROVIDING INFORMATION IN THE FIELDS OF ENTERTAINMENT, MUSIC, MOVIES, SPORTS, AND EDUCATION VIA COMPUTER NETWORKS (U.S. CLS. 100, 101 AND 107).

HOWARD SMIGA, EXAMINING ATTORNEY



SN 78-290,145. BELL PRODUCTION SERVICES, INC., GRAND RAPIDS, MI. FILED 8-21-2003.

HEIRLOOM VIDEO

NO CLAIM IS MADE TO THE EXCLUSIVE RIGHT TO USE VIDEO, APART FROM THE MARK AS SHOWN.

FOR PRODUCING PERSONALIZED VIDEO TAPES (U.S. CLS. 100, 101 AND 107).

KEVON CHISOLM, EXAMINING ATTORNEY

CLASS 41—(Continued).

SN 78-291,477. HERRING, TANYA FAYE P., GREENSBORO, NC. FILED 8-23-2003.

HIGHWAYS TO SUCCESS

FOR EDUCATIONAL SERVICES, NAMELY, CONDUCTING CLASSES AND WORKSHOPS THROUGH A CONTEXTUALIZED AND SIMULTANEOUS MODE OF INSTRUCTION IN THE FIELDS OF BASIC WORK-FORCE DEVELOPMENT SKILLS WITH CONCENTRATIONS IN MEDICAL, LEGAL, FINANCIAL, COMPUTER AND CUSTOMER SERVICE, CLERICAL SUPPORT TASKS SUCH AS FILING AND RECORD KEEPING, EMPLOYABILITY SKILLS FOR RESUME AND APPLICATION PREPARATION, PROVIDING INBOUND AND OUTBOUND TELEPHONE SERVICES AND WORK-PLACE LITERACY IN ENGLISH, MATH, AND THE COMPUTER AND DISTRIBUTING COURSE MATERIAL IN CONNECTION THEREWITH (U.S. CLS. 100, 101 AND 107).

FIRST USE 11-15-1999; IN COMMERCE 11-15-1999.
CAROLINE WOOD, EXAMINING ATTORNEY

SN 78-291,573. HERRINGTON, STACEY, FORT WORTH, TX. FILED 8-25-2003.



FOR DANCE AND CHOREOGRAPHIC TRAINING, PERFORMANCE DIRECTION, AND CONSULTATION (U.S. CLS. 100, 101 AND 107).

FIRST USE 12-31-1998; IN COMMERCE 12-31-1998.
LAVERNE THOMPSON, EXAMINING ATTORNEY

SN 78-293,694. KABLER, SOPHIA M., MILL VALLEY, CA. FILED 8-28-2003.



FOR EDUCATIONAL SERVICES, NAMELY CONDUCTING WORKSHOPS AND TRAININGS DESIGNED TO HELP WOMEN DEVELOP STRATEGIES TO ACHIEVE THEIR LIFE GOALS - PERSONAL, PROFESSIONAL AND FINANCIAL (U.S. CLS. 100, 101 AND 107).

FIRST USE 6-1-2003; IN COMMERCE 7-11-2003.
CAROLYN CATALDO, EXAMINING ATTORNEY

CLASS 41—(Continued).

SN 78-295,189. ABSOLUTE BEST CARE INC, NEW YORK, NY. FILED 9-2-2003.

NANNY COACH

FOR CLASSES, SEMINARS, WORKSHOPS, LECTURES AND ONE-ON-ONE INSTRUCTION TO GUIDE AND TEACH PARENTS/FAMILIES HOW TO IMPROVE THEIR RELATIONSHIP WITH THEIR DOMESTIC HELP, NAMELY, CHILD CARE PROVIDERS, BABY NURSES, HOUSEKEEPERS AND CARE COMPANIONS, AND DISTRIBUTING WRITTEN AND ON-LINE COURSE MATERIALS IN CONNECTION THEREWITH (U.S. CLS. 100, 101 AND 107).

GWEN STOKOLS, EXAMINING ATTORNEY

SN 78-295,557. TIME INC., NEW YORK, NY. FILED 9-3-2003.

REAL SIMPLE

OWNER OF U.S. REG. NO. 2,470,211.
FOR TELEVISION PROGRAMMING SERVICES (U.S. CLS. 100, 101 AND 107).
JOHN LINCOSKI, EXAMINING ATTORNEY

SN 78-296,186. REACH MEDIA, INC., DALLAS, TX. FILED 9-4-2003.

THE TOM JOYNER MORNING SHOW

NO CLAIM IS MADE TO THE EXCLUSIVE RIGHT TO USE MORNING SHOW, APART FROM THE MARK AS SHOWN.

THE NAME(S), PORTRAIT(S), AND/OR SIGNATURE(S) SHOWN IN THE MARK IDENTIFIES TOM JOYNER, WHOSE CONSENT(S) TO REGISTER IS SUBMITTED.

FOR RADIO ENTERTAINMENT SERVICES, NAMELY, RADIO PROGRAMS FEATURING PERFORMANCES BY A RADIO PERSONALITY (U.S. CLS. 100, 101 AND 107).

FIRST USE 0-0-1993; IN COMMERCE 0-0-1993.
TARAH HARDY, EXAMINING ATTORNEY

CLASS 41—(Continued).

SN 78-296,532. INTERFAITH CAREPARTNERS, INC., HOUSTON, TX. FILED 9-5-2003.



NO CLAIM IS MADE TO THE EXCLUSIVE RIGHT TO USE "INTERFAITH", APART FROM THE MARK AS SHOWN.

THE MARK CONSISTS OF THE WORDS INTERFAITH CAREPARTNERS WITH TWO-PERSON DESIGN.

FOR EDUCATIONAL SERVICES, NAMELY, CONDUCTING CLASSES, SEMINARS, CONFERENCES, AND WORKSHOPS IN SUPPORT OF VOLUNTEERS PROVIDING RESPITE IN THE NATURE OF SUPPORTING FRAIL INDIVIDUALS REQUIRING ASSISTANCE WITH IN-HOME DAILY LIVING FUNCTIONS (U.S. CLS. 100, 101 AND 107).

FIRST USE 7-0-2000; IN COMMERCE 7-0-2000.

H. M. FISHER, EXAMINING ATTORNEY

SN 78-299,090. LEADERSHIP TRAINING INTERNATIONAL, INC., CHESAPEAKE, VA. FILED 9-11-2003.

LEADERSHIP TRAINING INTERNATIONAL

NO CLAIM IS MADE TO THE EXCLUSIVE RIGHT TO USE "TRAINING", APART FROM THE MARK AS SHOWN. SEC. 2(F) AS TO "LEADERSHIP INTERNATIONAL".

FOR LEADERSHIP DEVELOPMENT SERVICES IN THE FIELD OF MINISTRY FOR PROFESSIONAL MINISTERS AND TRAINERS WORLDWIDE, NAMELY THROUGH SPECIALIZED LEADERSHIP TRAINING CURRICULUMS, CONFERENCES AND SEMINARS; COACHING FOR RELIGIOUS LEADERS TO EFFECTIVELY USE LEADERSHIP TRAINING INTERNATIONAL MATERIALS AND TO START NEW LEADERSHIP TRAINING PROGRAMS WORLDWIDE; CONSULTING FOR CHURCHES AND ORGANIZATIONS SO THAT THEY MAY IMPLEMENT LEADERSHIP TRAINING PROJECTS AND PROGRAMS WORLDWIDE (U.S. CLS. 100, 101 AND 107).

FIRST USE 11-22-1992; IN COMMERCE 11-22-1992.

MARGERY A. TIERNEY, EXAMINING ATTORNEY

SN 78-299,203. REACH MEDIA, INC., DALLAS, TX. FILED 9-11-2003.

PARTY BEFORE THE PARTY

FOR ENTERTAINMENT SERVICES IN THE NATURE OF RADIO PROGRAMS FEATURING PERFORMANCES BY A RADIO PERSONALITY (U.S. CLS. 100, 101 AND 107).

SUSAN HAYASH, EXAMINING ATTORNEY

CLASS 41—(Continued).

SN 78-299,215. REACH MEDIA, INC., DALLAS, TX. FILED 9-11-2003.

THE BACK IN THE DAY BREAKFAST BUFFET

FOR ENTERTAINMENT SERVICES IN THE NATURE OF RADIO PROGRAMS FEATURING A RADIO PERSONALITY (U.S. CLS. 100, 101 AND 107).

SUSAN HAYASH, EXAMINING ATTORNEY

SN 78-299,578. AMERICAN MULTI-CINEMA, INC., KANSAS CITY, MO. FILED 9-12-2003.

AMC EMPIRE 25

OWNER OF U.S. REG. NOS. 1,253,982, 2,357,423 AND OTHERS.

NO CLAIM IS MADE TO THE EXCLUSIVE RIGHT TO USE "25", APART FROM THE MARK AS SHOWN.

FOR MOVIE THEATRE SERVICES (U.S. CLS. 100, 101 AND 107).

FIRST USE 4-21-2000; IN COMMERCE 4-21-2000.

STANLEY I. OSBORNE, EXAMINING ATTORNEY

SN 78-303,715. PTP SERVICES, LLC, WILMINGTON, DE. FILED 9-22-2003.

GAS TRANSMISSION NORTHWEST

NO CLAIM IS MADE TO THE EXCLUSIVE RIGHT TO USE GAS TRANSMISSION, APART FROM THE MARK AS SHOWN.

FOR EDUCATIONAL SERVICES, NAMELY, CONDUCTING CLASSES, WORKSHOPS, AND SEMINARS IN THE FIELDS OF ENERGY-RELATED AND ENVIRONMENTAL ISSUES AND DISTRIBUTING COURSE MATERIALS IN CONNECTION THEREWITH (U.S. CLS. 100, 101 AND 107).

TONI HICKEY, EXAMINING ATTORNEY

CLASS 41—(Continued).

SN 78-304,399. LEISURE TIME RESORTS OF AMERICA, INC., FRISCO, TX. FILED 9-23-2003.

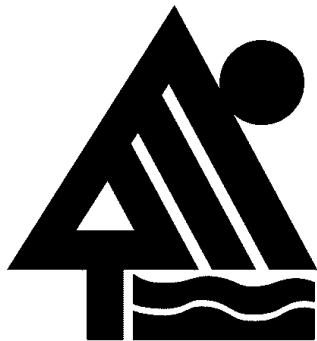

FOR PROVIDING FACILITIES FOR RECREATION ACTIVITIES (U.S. CLS. 100, 101 AND 107).
FIRST USE 4-0-1984; IN COMMERCE 4-0-1984.
GEOFFREY FOSDICK, EXAMINING ATTORNEY

SN 78-304,687. PLANET3 WIRELESS, INC., BREMEN, GA. FILED 9-24-2003.

CWSP

OWNER OF U.S. REG. NO. 2,806,634.
FOR EDUCATIONAL SERVICES, NAMELY, CONDUCTING CLASSES, WORKSHOPS AND SEMINARS, AND EDUCATIONAL TESTING SERVICES TO DEVELOP PROFESSIONAL SKILLS IN THE FIELD OF SECURITY MANAGEMENT OF WIRELESS COMPUTER HARDWARE AND SOFTWARE NETWORKING SYSTEMS, INCLUDING THE DESIGN AND INSTALLATION OF NETWORK SECURITY FOR COMPUTER HARDWARE AND SOFTWARE WIRELESS NETWORKING EQUIPMENT AND SYSTEMS (U.S. CLS. 100, 101 AND 107).

FIRST USE 9-1-2002; IN COMMERCE 9-1-2002.
LANA PHAM, EXAMINING ATTORNEY

SN 78-304,755. BRUNO, DANIEL J., UPPER MARLBORO, MD. FILED 9-24-2003.

THE CATS MEOW BAND

NO CLAIM IS MADE TO THE EXCLUSIVE RIGHT TO USE "BAND", APART FROM THE MARK AS SHOWN.
FOR ENTERTAINMENT IN THE NATURE OF LIVE PERFORMANCES BY A MUSIC ENSEMBLE AT PUBLIC ESTABLISHMENTS (U.S. CLS. 100, 101 AND 107).
CHRISIE B. KING, EXAMINING ATTORNEY

CLASS 41—(Continued).

SN 78-305,108. CALLAHAN, AUDREY, MARLO AGTAGMA, DBA FAMILYGENERATIONS, CHULA VISTA, CA. FILED 9-25-2003.

SILLY SNEAKERS

FOR ENTERTAINMENT SERVICES, NAMELY, PRODUCTION OF A LIVE ACTION SERIES WITH ANIMATED COMPONENTS FOR TELEVISION OR CABLE BROADCAST (U.S. CLS. 100, 101 AND 107).
BRIAN BROWN, EXAMINING ATTORNEY

SN 78-305,614. APPLIED DIGITAL IMAGING, RED BANK, NJ. FILED 9-25-2003.

ZEBO PHOTO

NO CLAIM IS MADE TO THE EXCLUSIVE RIGHT TO USE "PHOTO", APART FROM THE MARK AS SHOWN.
FOR PHOTOGRAPHY SERVICES (U.S. CLS. 100, 101 AND 107).
FIRST USE 10-2-2002; IN COMMERCE 10-2-2002.
BRETT J. GOLDEN, EXAMINING ATTORNEY

SN 78-306,170. JAMES DUBAN CONSULTING, LLC, LEWISVILLE, TX. FILED 9-26-2003.

BE A COLLEGE ACHIEVER

FOR EDUCATION SERVICES, NAMELY SEMINARS, IN THE FIELD OF COLLEGE SUCCESS AND ACADEMIC ACCOMPLISHMENT FOR HIGH SCHOOL, COLLEGE-BOUND AND COLLEGE STUDENTS; DISTRIBUTION OF COURSE MATERIALS IN CONNECTION THEREWITH; AND PROVIDING ON-LINE INFORMATION IN THE FIELD OF COLLEGE SUCCESS AND ACCOMPLISHMENT VIA A WEBSITE (U.S. CLS. 100, 101 AND 107).
JANICE L. MCMORROW, EXAMINING ATTORNEY

SN 78-307,536. IN HER SHOES, LLC, CHICAGO, IL. FILED 9-30-2003.

FOR HER INFORMATION

FOR ENTERTAINMENT SERVICES IN THE NATURE OF A TELEVISION TALK SHOW SERIES (U.S. CLS. 100, 101 AND 107).
SUSAN LESLIE DUBOIS, EXAMINING ATTORNEY

CLASS 41—(Continued).

SN 78-308,129. CARMEN MEDIA GROUP LIMITED, EURO-PORT, GIBRALTAR, FILED 10-1-2003.

SET2GO.COM

FOR ENTERTAINMENT SERVICES, NAMELY PROVIDING ON-LINE GAMES OF CHANCE, SPORTS BETTING AND CASINO STYLE GAMING (U.S. CLS. 100, 101 AND 107).

FRED MANDIR, EXAMINING ATTORNEY

SN 78-308,155. CARMEN MEDIA GROUP LIMITED, EURO-PORT, GIBRALTAR, FILED 10-1-2003.



FOR ENTERTAINMENT SERVICES, NAMELY PROVIDING ON-LINE GAMES OF CHANCE, SPORTS BETTING AND CASINO STYLE GAMING (U.S. CLS. 100, 101 AND 107).

RONALD MCMORROW, EXAMINING ATTORNEY

SN 78-308,590. BANDAI ENTERTAINMENT INC., CYPRESS, CA. FILED 10-2-2003.

DINOBREAKER

FOR ENTERTAINMENT SERVICES, NAMELY, PROVIDING ON-LINE MUSIC, MOVIES AND INFORMATION REGARDING GAMES, MUSIC AND THE TELEVISION SERIES; ENTERTAINMENT IN THE NATURE OF A TELEVISION ANIMATED CARTOON SERIES TO BE BROADCASTED VIA NETWORK, CABLE AND SATELLITE TRANSMISSION (U.S. CLS. 100, 101 AND 107).

LESLEY LAMOTHE, EXAMINING ATTORNEY

CLASS 41—(Continued).

SN 78-308,827. INTERVEN PARTNERS, INC., MANHATTAN BEACH, CA. FILED 10-2-2003.

A WOMAN'S WAY OF LEADERSHIP

FOR EDUCATIONAL SERVICES, NAMELY PROVIDING SPEAKERS AND CONDUCTING CONFERENCES, CLASSES, SEMINARS, WORKSHOPS AND INDIVIDUAL TRAINING, MENTORING AND COACHING IN PERSON, OR VIA TELEPHONE, COMPUTER NETWORK, OR OTHER ELECTRONIC MEANS IN THE FIELDS OF LEADERSHIP, PERSONAL AND CAREER DEVELOPMENT, RELATIONSHIPS, NETWORKING, COMMUNICATION, PRODUCTIVITY, EFFECTIVENESS, MANAGEMENT, AND SUPERVISORY AND INTERPERSONAL SKILLS FOR WOMEN, AND THE DISTRIBUTION OF EDUCATIONAL MATERIALS AND NEWSLETTERS PHYSICAL, ONLINE, AUDIO AND VIDEO USED IN CONNECTION THEREWITH (U.S. CLS. 100, 101 AND 107).

FIRST USE 8-30-1999; IN COMMERCE 8-30-1999. JOSETTE BEVERLY, EXAMINING ATTORNEY

SN 78-308,877. INTERVEN PARTNERS, INC., MANHATTAN BEACH, CA. FILED 10-2-2003.

MILLION DOLLAR MINDSET

FOR EDUCATIONAL SERVICES, NAMELY PROVIDING SPEAKERS AND CONDUCTING CONFERENCES, CLASSES, SEMINARS, WORKSHOPS AND INDIVIDUAL TRAINING MENTORING AND COACHING IN PERSON, OR VIA TELEPHONE, COMPUTER NETWORK OR OTHER ELECTRONIC MEANS IN THE FIELDS OF LEADERSHIP, PERSONAL AND CAREER DEVELOPMENT, RELATIONSHIPS, NETWORKING, COMMUNICATION, PRODUCTIVITY, EFFECTIVENESS, MANAGEMENT, AND SUPERVISORY AND INTERPERSONAL SKILLS, AND THE DISTRIBUTION OF EDUCATIONAL MATERIALS AND NEWSLETTERS PHYSICAL, ONLINE, AUDIO AND VIDEO USED IN CONNECTION THEREWITH (U.S. CLS. 100, 101 AND 107).

FIRST USE 4-8-2003; IN COMMERCE 4-8-2003. JOSETTE BEVERLY, EXAMINING ATTORNEY

SN 78-309,031. SPENCER, ROBERT, MANCHESTER, NH. FILED 10-3-2003.

JIHAD WATCH

NO CLAIM IS MADE TO THE EXCLUSIVE RIGHT TO USE "JIHAD", APART FROM THE MARK AS SHOWN. FOR EDUCATIONAL RESEARCH (U.S. CLS. 100, 101 AND 107).

ANDREA K. NADELMAN, EXAMINING ATTORNEY

CLASS 41—(Continued).

SN 78-309,282. TREASURE HD COMPANY LLC, BETHPAGE, NY. FILED 10-3-2003.

THE TREASURE SEEKERS

FOR ENTERTAINMENT SERVICES, NAMELY, AN ON-GOING TELEVISION PROGRAM IN THE FIELD OF ANTIQUES AND COLLECTIBLES (U.S. CLS. 100, 101 AND 107).

DAWN HAN, EXAMINING ATTORNEY

CLASS 41—(Continued).

SN 78-310,449. HILTON HOSPITALITY, INC., BEVERLY HILLS, CA. FILED 10-7-2003.

TEACHING KIDS TO CARE

FOR CONDUCTING EDUCATIONAL PROGRAMS FOR CHILDREN, ADOLESCENTS AND YOUNG ADULTS ON LOCAL COMMUNITY EVENTS AND PUBLIC SERVICE (U.S. CLS. 100, 101 AND 107).

FIRST USE 8-20-2002; IN COMMERCE 8-20-2002.
STEVEN R. FINE, EXAMINING ATTORNEY

SN 78-309,381. CIRQUE, INC., POMPAÑO BEACH, FL. FILED 10-3-2003.

DINNERACTIVE

FOR ENTERTAINMENT SERVICES IN THE NATURE OF THEATRICAL AND CIRCUS PERFORMANCES (U.S. CLS. 100, 101 AND 107).

FIRST USE 7-30-2003; IN COMMERCE 7-30-2003.
MICHAEL HALL, EXAMINING ATTORNEY

SN 78-310,688. HUMBLE ABODE MUSIC, WEST HURLEY, NY. FILED 10-8-2003.

THE MAMMALS

FOR ENTERTAINMENT IN THE NATURE OF LIVE MUSICAL GROUP (U.S. CLS. 100, 101 AND 107).

FIRST USE 2-14-2001; IN COMMERCE 3-22-2001.
SUSAN HAYASH, EXAMINING ATTORNEY

SN 78-309,704. PILIBOSIAN, GEORGE JAMES, MIAMI BEACH, FL. FILED 10-6-2003.

PROPER FORM

FOR PHYSICAL FITNESS INSTRUCTION (U.S. CLS. 100, 101 AND 107).

JENNIFER CHICOSKI, EXAMINING ATTORNEY

SN 78-311,831. POLLOCK, WILLIAM D., BURLINGAME, CA. FILED 10-9-2003.

**NO STARCH
PRESS**

NO CLAIM IS MADE TO THE EXCLUSIVE RIGHT TO USE "PRESS", APART FROM THE MARK AS SHOWN. FOR PUBLICATION OF BOOKS (U.S. CLS. 100, 101 AND 107).

FIRST USE 1-1-1995; IN COMMERCE 1-1-1995.
MARY ROSSMAN, EXAMINING ATTORNEY

SN 78-310,129. CITY OF ZION RECORDS, IRVING, TX. FILED 10-7-2003.

RRL

FOR ENTERTAINMENT IN THE NATURE OF A RADIO PROGRAM FEATURING RECORDED MUSIC ON REQUEST (U.S. CLS. 100, 101 AND 107).

CHARLES L. JENKINS, EXAMINING ATTORNEY

SN 78-310,324. HARPO, INC., CHICAGO, IL. FILED 10-7-2003.

INSIDE THE LIVES

FOR ENTERTAINMENT SERVICES IN THE NATURE OF A SERIES OF TELEVISION PROGRAMS AND SEGMENTS EXAMINING AND FEATURING DIFFERENT LIFESTYLES AND INDIVIDUALS; AND PROVIDING ON-LINE ENTERTAINMENT INFORMATION, VIA THE INTERNET, ON DIFFERENT INDIVIDUALS AND LIFESTYLES (U.S. CLS. 100, 101 AND 107).

TRICIA SONNEBORN, EXAMINING ATTORNEY

SN 78-312,239. TAKEOUT COMEDY LLC, NEW YORK, NY. FILED 10-10-2003.

TAKEOUT COMEDY

NO CLAIM IS MADE TO THE EXCLUSIVE RIGHT TO USE "COMEDY", APART FROM THE MARK AS SHOWN. FOR ENTERTAINMENT SERVICES IN THE NATURE OF ONGOING VARIETY SHOWS (U.S. CLS. 100, 101 AND 107).

FIRST USE 2-6-2003; IN COMMERCE 2-6-2003.
TANYA AMOS, EXAMINING ATTORNEY

CLASS 41—(Continued).

SN 78-312,656. VIACOM INTERNATIONAL INC., NEW YORK, NY. FILED 10-13-2003.

POSERS

FOR ENTERTAINMENT SERVICES, NAMELY ENTERTAINMENT IN THE NATURE OF AN ONGOING TELEVISION QUIZ/GAME SHOW, FEATURING LIVE ACTION, COMEDY AND DRAMA; PROVIDING INFORMATION IN THE FIELD OF ENTERTAINMENT RENDERED VIA COMPUTER BY MEANS OF A GLOBAL COMPUTER NETWORK (U.S. CLS. 100, 101 AND 107).
MELVIN AXILBUND, EXAMINING ATTORNEY

SN 78-313,348. LIFETIME ENTERTAINMENT SERVICES, NEW YORK, NY. FILED 10-14-2003.

WHAT MOM FORGOT TO TEACH ME

FOR ENTERTAINMENT SERVICES IN THE NATURE OF A TELEVISION SERIES FEATURING PRACTICAL ADVICE; ENTERTAINMENT SERVICES IN THE NATURE OF A RADIO SERIES FEATURING PRACTICAL ADVICE; ONLINE SERVICES, NAMELY, PROVIDING A WEBSITE FEATURING PRACTICAL ADVICE AND INFORMATION ABOUT TELEVISION AND RADIO PROGRAMS (U.S. CLS. 100, 101 AND 107).
ANN E. SAPPENFIELD, EXAMINING ATTORNEY

SN 78-313,440. HYDENTRA, L.P., PHILADELPHIA, PA. FILED 10-14-2003.

METGIRLS

FOR PROVIDING ADULT-ORIENTED ENTERTAINMENT VIA THE GLOBAL ONLINE COMPUTER NETWORK, NAMELY, PROVIDING WEBSITES FEATURING ADULT-ORIENTED INFORMATION AND IMAGES; PROVIDING ONLINE PUBLICATIONS VIA THE GLOBAL COMPUTER NETWORK, NAMELY ONLINE MAGAZINES WITH SUBJECT MATTER RELATED TO ADULT ENTERTAINMENT AND OTHER ADULT-THEMED TOPICS (U.S. CLS. 100, 101 AND 107).
FIRST USE 5-1-2002; IN COMMERCE 5-1-2002.
CAROLINE WOOD, EXAMINING ATTORNEY

CLASS 41—(Continued).

SN 78-315,255. REDWOOD CITY FRIENDS OF LITERACY, REDWOOD CITY, CA. FILED 10-17-2003.

FUELING THE FIRE OF HOPE

FOR EDUCATIONAL SERVICES, NAMELY, CONDUCTING CLASSES, SEMINARS AND WORKSHOPS IN THE FIELD OF LITERACY, LANGUAGE ARTS, OR REMEDIAL EDUCATION, AND DISTRIBUTION OF PRINTED MATERIALS IN CONNECTION THEREWITH; EDUCATIONAL SERVICES, NAMELY, PROVIDING CONSULTATION AND INSTRUCTION IN THE FIELD OF LITERACY, LANGUAGE ARTS, OR REMEDIAL EDUCATION; EDUCATIONAL SERVICES, NAMELY, CONDUCTING PROGRAMS IN THE FIELD OF LITERACY, LANGUAGE ARTS, OR REMEDIAL EDUCATION; EDUCATIONAL DEMONSTRATIONS; CHARITABLE SERVICES, NAMELY, PROVIDING TRAINING AND INSTRUCTION IN THE FIELD OF LITERACY, LANGUAGE ARTS, OR REMEDIAL EDUCATION (U.S. CLS. 100, 101 AND 107).

FIRST USE 5-31-1996; IN COMMERCE 10-31-1998.
PRISCILLA MILTON, EXAMINING ATTORNEY

SN 78-317,170. AMERICAN COLLEGE OF FORENSIC EXAMINERS, INC., SPRINGFIELD, MO. FILED 10-22-2003.

CERTIFIED FORENSIC NURSE, CFN

NO CLAIM IS MADE TO THE EXCLUSIVE RIGHT TO USE CERTIFIED FORENSIC NURSE, APART FROM THE MARK AS SHOWN.

FOR TESTING SERVICES, NAMELY, DEVELOPING, CONSTRUCTING AND ADMINISTERING TESTS AND TESTING PROGRAMS FOR CANDIDATES IN THE FIELD OF FORENSIC NURSING (U.S. CLS. 100, 101 AND 107).

MARY CRAWFORD, EXAMINING ATTORNEY

SN 78-318,753. FMR CORP., BOSTON, MA. FILED 10-27-2003.

FIDELITY E-NEWS

OWNER OF U.S. REG. NOS. 1,277,373, 1,481,037 AND OTHERS.

NO CLAIM IS MADE TO THE EXCLUSIVE RIGHT TO USE "E-NEWS", APART FROM THE MARK AS SHOWN.

FOR PROVIDING NEWSLETTERS BY E-MAIL IN THE FIELD OF INVESTMENTS AND FINANCIAL PLANNING (U.S. CLS. 100, 101 AND 107).

RICHARD A. STRASER, EXAMINING ATTORNEY

CLASS 41—(Continued).

SN 78-377,268. IGT, RENO, NV. FILED 3-2-2004.

WINTASTIK

THE MARK CONSISTS OF STANDARD CHARACTERS WITHOUT CLAIM TO ANY PARTICULAR FONT, STYLE, SIZE, OR COLOR.

FOR ENTERTAINMENT SERVICES, NAMELY, CONDUCTING A GAME OF CHANCE SIMULTANEOUSLY AT MULTIPLE, INDEPENDENT GAMING ESTABLISHMENTS (U.S. CLS. 100, 101 AND 107).

BRENDAN REGAN, EXAMINING ATTORNEY

CLASS 42—SCIENTIFIC, COMPUTER AND LEGAL SERVICES

SN 74-656,208. HELLMAN, DAVID W., WICHITA, KS. FILED 3-27-1995.

ProMed

FOR MEDICAL HEALTH CARE INFORMATION SERVICE, NAMELY THE PROVIDING OF LIVE MEDICAL CONSULTATION MADE AVAILABLE TO THE PUBLIC BY TELEPHONE (U.S. CLS. 100 AND 101).

JILL C. ALT, EXAMINING ATTORNEY

SN 75-860,908. MOORE NORTH AMERICA, INC., GRAND ISLAND, NY. FILED 12-1-1999.

INTELECHOICE

FOR COMPUTER SERVICES, NAMELY, PROVIDING FOR THE MERGING AND AUTOMATION OF DATA STREAMS FROM MULTIPLE DATABASES FOR USE IN DIGITAL PUBLISHING APPLICATIONS (U.S. CLS. 100 AND 101).

FIRST USE 9-0-1999; IN COMMERCE 9-0-1999. STEVEN BERK, EXAMINING ATTORNEY

CLASS 42—(Continued).

SN 76-020,088. SHANAHAN, JOHN M., NEWPORT BEACH, CA. FILED 4-6-2000.

THE OVAL OFFICE

OWNER OF IRELAND REG. NO. 226932, DATED 2-13-2003, EXPIRES 2-13-2010.

FOR RESTAURANTS, CARRY OUT RESTAURANTS, CATERING SERVICES, AND BAR SERVICES (U.S. CLS. 100 AND 101).

PAUL F. GAST, EXAMINING ATTORNEY

SN 76-025,831. CBC COMPANIES, INC., COLUMBUS, OH. FILED 4-7-2000.

BYTEONLINE

FOR PROVIDING TEMPORARY USE OF ONLINE NON-DOWNLOADABLE SOFTWARE FOR CREATION, UPDATING, PRINTING AND MANAGEMENT OF LOAN APPLICATION INFORMATION, LOAN APPLICATIONS AND FINANCING FORMS VIA ELECTRONIC COMPUTER NETWORKS AND FOR EXCHANGE OF INFORMATION BETWEEN LENDERS AND BORROWERS VIA ELECTRONIC COMPUTER NETWORKS REGARDING LOAN APPLICATIONS (U.S. CLS. 100 AND 101).

KIM SAITO, EXAMINING ATTORNEY

SN 76-034,515. KAYE, KATE MCGUIRE, JERSEY CITY, NJ. FILED 4-25-2000.

LOWBROW LOWDOWN

FOR ONLINE MAGAZINES FEATURING A WIDE RANGE OR GENERAL INTEREST NEWS, INFORMATION, COMMENTARY, AND OPINION (U.S. CLS. 100 AND 101).

FIRST USE 2-18-2000; IN COMMERCE 2-18-2000. BILL DAWE, EXAMINING ATTORNEY

SN 76-043,462. SHANAHAN, JOHN M., NEWPORT BEACH, CA. FILED 5-5-2000.

SHANAHAN'S ON THE GREEN

OWNER OF IRELAND REG. NO. 212637, DATED 3-8-1999, EXPIRES 3-8-2006.

FOR RESTAURANT, BAR, CATERING, RESTAURANT CARRY OUT SERVICES AND PROVIDING BANQUET AND SOCIAL FACILITIES FOR SPECIAL OCCASIONS (U.S. CLS. 100 AND 101).

PAUL F. GAST, EXAMINING ATTORNEY

CLASS 42—(Continued).

SN 76-085,594. CANAD CORPORATION OF MANITOBA LTD., WINNIPEG, MANITOBA, CANADA, FILED 7-7-2000.



OWNER OF CANADA REG. NO. TMA349147, DATED 12-16-1988, RENEWED AS REG. NO. TMA349147, DATED 12-16-2003, EXPIRES 12-16-2018.

NO CLAIM IS MADE TO THE EXCLUSIVE RIGHT TO USE "FAMILY DINING", APART FROM THE MARK AS SHOWN.

FOR RESTAURANT SERVICES (U.S. CLS. 100 AND 101).

AMY GEARIN, EXAMINING ATTORNEY

CLASS 42—(Continued).

SN 76-162,457. APPSTREAM, INC., PALO ALTO, CA. FILED 11-10-2000.



SEC. 2(F) AS TO "APPSTREAM".

FOR COMPUTER CONSULTATION SERVICES CONCERNING COMPUTER SOFTWARE AND DELIVERY, EXECUTION, MONITORING AND MANAGEMENT OF DATA CONTENT AND COMPUTER PROGRAMS (U.S. CLS. 100 AND 101).

FIRST USE 0-0-1998; IN COMMERCE 0-0-1998.

KAREN M. STRZYZ, EXAMINING ATTORNEY

SN 76-114,663. OUTDOORSCOUT LLC, GREENVILLE, SC. FILED 8-22-2000.

OUTDOORSCOUT

FOR CUSTOMIZED TOPOGRAPHIC MAPPING SERVICES FOR USE IN THE FIELDS OF CONSUMER-ORIENTED SPORTS AND RECREATION; PROVIDING A WEB SITE FEATURING TOPOGRAPHICAL INFORMATION, MAPS, EARTH IMAGES AND GPS TRACKING INFORMATION AND EARTH IMAGE INTERPRETATION SERVICES, FOR USE IN THE FIELDS OF CONSUMER-ORIENTED SPORTS AND RECREATION (U.S. CLS. 100 AND 101).

FIRST USE 8-1-2000; IN COMMERCE 8-1-2000.

KATHLEEN M. VANSTON, EXAMINING ATTORNEY

SN 76-288,473. CHAMPIONS FOR LIFE, DALLAS, TX. FILED 7-20-2001.

CHAMPIONS FOR LIFE

OWNER OF U.S. REG. NO. 2,043,139. FOR EVANGELISTIC AND MINISTERIAL SERVICES (U.S. CLS. 100 AND 101).

DAWN FELDMAN, EXAMINING ATTORNEY

SN 76-114,664. OUTDOORSCOUT LLC, GREENVILLE, SC. FILED 8-22-2000.

ROCKSCOUT

FOR CUSTOMIZED TOPOGRAPHIC MAPPING SERVICES FOR USE IN THE FIELDS OF CONSUMER-ORIENTED SPORTS AND RECREATION; PROVIDING A WEB SITE FEATURING TOPOGRAPHICAL INFORMATION, MAPS, EARTH IMAGES AND GPS TRACKING INFORMATION AND EARTH IMAGE INTERPRETATION SERVICES, FOR USE IN THE FIELDS OF CONSUMER-ORIENTED SPORTS AND RECREATION (U.S. CLS. 100 AND 101).

FIRST USE 8-1-2000; IN COMMERCE 8-1-2000.

KATHLEEN M. VANSTON, EXAMINING ATTORNEY

SN 76-320,516. H. D. KING, INC., ARDEN, NC. FILED 10-2-2001.



NO CLAIM IS MADE TO THE EXCLUSIVE RIGHT TO USE "HOT DOG", APART FROM THE MARK AS SHOWN. FOR RESTAURANT SERVICES (U.S. CLS. 100 AND 101).

FIRST USE 11-0-1981; IN COMMERCE 11-0-1981.

STEVEN R. FINE, EXAMINING ATTORNEY

CLASS 42—(Continued).

SN 76-345,956. COMSPEC COMMUNICATIONS, INC., TORONTO, ONTARIO, CANADA, FILED 12-7-2001.

MEDIACLAY

FOR COMPUTER PROGRAMMING SERVICES FOR OTHERS, NAMELY, PROVIDING A WEB-BASED ELECTRONIC CONTENT MANAGEMENT SYSTEM FOR OTHERS TO CREATE, DEVELOP, IMPLEMENT, EDIT, SECURE, MANAGE, AND PUBLISH WEBSITE CONTENT; INTERNET WEBSITE DESIGN AND DEVELOPMENT SERVICES FOR OTHERS, NAMELY, ELECTRONIC SYNDICATION SERVICES CONSISTING OF THE SUPPLYING OF CONTENT FOR THE WEBSITES OF OTHERS AND UPDATING OF SAID CONTENT FOR OTHERS; INTERNET WEBSITE DESIGN FOR OTHERS; COMPUTER CONSULTATION, NAMELY, INTERNET CONSULTING SERVICES AND INTERNET CONSULTING SERVICES RELATING TO WEBSITES (U.S. CLS. 100 AND 101).

FIRST USE 10-15-2000; IN COMMERCE 10-15-2000.
SONYA STEPHENS, EXAMINING ATTORNEY

SN 76-367,826. AWARE SYSTEMS, INC., EDINA, MN. FILED 2-7-2002.

AWARE WEB SOLUTIONS

NO CLAIM IS MADE TO THE EXCLUSIVE RIGHT TO USE "WEB SOLUTIONS", APART FROM THE MARK AS SHOWN.

FOR DESIGN AND DEVELOPMENT FOR OTHERS OF WEB SITES AND COMPUTER SOFTWARE IN THE FIELD OF WEB APPLICATIONS (U.S. CLS. 100 AND 101).

BRENDAN REGAN, EXAMINING ATTORNEY

SN 76-386,461. RABCO CORPORATION, THE, OCOEE, FL. FILED 3-20-2002.

**THE RABCO CORPORATION**

FOR DESIGN, ENGINEERING, AND CONSTRUCTION OF STORAGE FACILITIES (U.S. CLS. 100 AND 101).
FIRST USE 2-1-1996; IN COMMERCE 2-1-1996.

JOHN DALIER, EXAMINING ATTORNEY

SN 76-387,405. GA COMMUNICATIONS, INC., STONE MOUNTAIN, GA. FILED 3-25-2002.

DREAMSCAPES

FOR ENTERTAINMENT IN THE NATURE OF ONGOING TELEVISION PROGRAMS IN THE FIELD OF LANDSCAPE DESIGN (U.S. CLS. 100 AND 101).

FIRST USE 5-1-2001; IN COMMERCE 1-21-2002.
CATHERINE CAIN, EXAMINING ATTORNEY

CLASS 42—(Continued).

SN 76-411,911. BRITISH STANDARDS INSTITUTION, CHISWICK, LONDON W4 4AL, ENGLAND, FILED 5-24-2002.

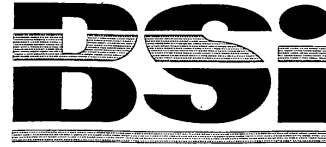

PRIORITY CLAIMED UNDER SEC. 44(D) ON UNITED KINGDOM APPLICATION NO. 2293131, FILED 2-18-2002, REG. NO. 2293131, DATED 11-15-2002, EXPIRES 2-18-2012.

THE STIPPLING SHOWN IN THE DRAWING IS A FEATURE OF THE MARK AND IS NOT INTENDED TO INDICATE COLOR.

FOR CERTIFICATION SERVICES, NAMELY, INSPECTION, TESTING, ANALYSIS, AND EVALUATION OF THE GOODS AND SERVICES OF OTHERS FOR THE PURPOSE OF CERTIFICATION, AND FOR COMPLIANCE WITH REQUIREMENTS OF QUALITY, PERFORMANCE AND SAFETY STANDARDS, NAMELY, PROVIDING, ESTABLISHING, ASSESSING, AND REGISTERING CONFORMITY TO SAFETY, PERFORMANCE, ENVIRONMENTAL MANAGEMENT, QUALITY MANAGEMENT, AND DIMENSIONAL STANDARDS FOR INDUSTRIAL, COMMERCIAL, AND DOMESTIC GOODS AND SERVICES; PROVIDING TESTING AND CONSULTING SERVICES, NAMELY, TESTING AND EVALUATING INDUSTRIAL, COMMERCIAL, AND CONSUMER GOODS AND SERVICES AND CONSULTING IN THE FIELD OF NEW PRODUCT TESTING, PRODUCT SAFETY AND PERFORMANCE, AND QUALITY TESTING, ASSURANCE, CONTROL AND MANAGEMENT SYSTEMS; PROVIDING AUDIT SERVICES TO ASSESS CONFORMANCE OF FACTORIES AND WORKPLACES TO QUALITY, PERFORMANCE, AND SAFETY STANDARDS AND TO ASSURE COMPLIANCE WITH GOVERNMENT LAWS AND REGULATIONS AND INDUSTRY PRACTICES; ADVISORY, NEGOTIATING, REPRESENTATION, AND INFORMATION SERVICES IN THE FIELDS OF SAFETY TESTING, PRODUCT EVALUATION, MANUFACTURING OF PRODUCTS, QUALITY ASSURANCE TESTING, PRODUCT DEVELOPMENT, STANDARDS DEVELOPMENT AND IMPLEMENTATION, EVALUATION TO THE STANDARDS OF OTHERS, AND QUALITY CONTROL SERVICES FOR OTHERS; NEW PRODUCT TESTING SERVICES, NAMELY, ELECTRICAL, PHYSICAL, CHEMICAL, METALLURGICAL, MECHANICAL AND OPTICAL TESTING; LABORATORY RESEARCH IN THE FIELDS OF ELECTRICAL, PHYSICAL, CHEMICAL, METALLURGICAL, MECHANICAL AND OPTICAL TESTING; PREPARING ENGINEERING AND CHEMICAL ANALYSIS AND RESEARCH AND REPORTS FOR OTHERS; REVIEWING STANDARDS AND PRACTICES TO ASSURE COMPLIANCE WITH SAFETY AND PERFORMANCE LAWS AND REGULATIONS AND OBTAINING CONSUMER AND INDUSTRIAL PRODUCT COMPLIANCE RECOGNITION AND LISTING; COMPUTER SERVICES, NAMELY, LEASING ACCESS TIME TO A COMPUTER DATABASE IN THE FIELDS OF SAFETY AND PERFORMANCE TESTING, PRODUCT TESTING AND EVALUATION, MANUFACTURING OF PRODUCTS, QUALITY ASSURANCE AND CONTROL TESTING, PRODUCT DEVELOPMENT, STANDARDS DEVELOPMENT AND IMPLEMENTATION, AND EVALUATION TO THE STANDARDS OF OTHERS; COMPUTER PROGRAMMING FOR OTHERS; RENTAL OF COMPUTERS; COMPUTER TIME SHARING SERVICES; PROVISION OF CONFERENCE, SEMINAR AND EXHIBITION FACILITIES, ALL RELATING TO PRODUCT AND MATERIAL DEVELOPMENT, TESTING, SAFETY, PERFORMANCE AND QUALITY TESTING AND CERTIFICATION MATTERS (U.S. CLS. 100 AND 101).

INGA ERVIN, EXAMINING ATTORNEY

CLASS 42—(Continued).

SN 76-438,261. NETWORK INFRASTRUCTURE CORPORATION, TEMPE, AZ. FILED 8-7-2002.

THE ONLY SOLUTION IS A TOTAL SOLUTION

FOR INFORMATION TECHNOLOGY SERVICES, NAMELY, COMPUTER CONSULTATION, COMPUTER DIAGNOSTIC SERVICES; SYSTEMS ANALYSIS AND TECHNICAL SUPPORT, NAMELY MONITORING OF NETWORK SYSTEMS FOR OTHERS (U.S. CLS. 100 AND 101).

FIRST USE 7-8-2002; IN COMMERCE 7-8-2002.
MARGERY A. TIERNEY, EXAMINING ATTORNEY

SN 76-447,873. DEMCO, INC., MADISON, WI. FILED 9-9-2002.

DEMCO

OWNER OF U.S. REG. NOS. 1,269,799, 2,455,455 AND OTHERS.

FOR PLANNING AND LAYOUT DESIGN SERVICES FOR LIBRARIES AND MEDIA CENTERS (U.S. CLS. 100 AND 101).

FIRST USE 3-1-1999; IN COMMERCE 3-1-1999.
SONYA STEPHENS, EXAMINING ATTORNEY

SN 76-479,814. BWIA WEST INDIES AIRWAYS LIMITED, PIARCO, WEST INDIES, TRINIDAD/TOBAGO, FILED 12-31-2002.



FOR ARRANGING AND BOOKING OF RESERVATIONS, NAMELY MAKING RESERVATIONS AND BOOKING FOR TEMPORARY LODGING AND MAKING RESERVATIONS AND BOOKINGS FOR RESTAURANTS AND MEALS (U.S. CLS. 100 AND 101).

FIRST USE 4-0-2000; IN COMMERCE 4-0-2000.
GEORGIA CARTY, EXAMINING ATTORNEY

CLASS 42—(Continued).

SN 76-485,280. BIOMETHODES, 75005 PARIS, FRANCE, FILED 1-27-2003.

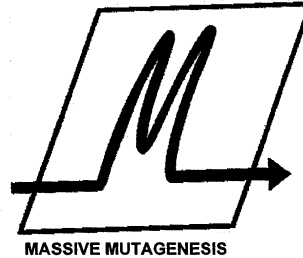

PRIORITY CLAIMED UNDER SEC. 44(D) ON FRANCE APPLICATION NO. 02/3179258, FILED 8-9-2002, REG. NO. 02/3179258, DATED 8-9-2002, EXPIRES 8-9-2012.

NO CLAIM IS MADE TO THE EXCLUSIVE RIGHT TO USE MUTAGENESIS, APART FROM THE MARK AS SHOWN.

FOR TECHNICAL CONSULTATION AND SCIENTIFIC RESEARCH IN THE FIELD OF MUTAGENESIS; CHEMICAL ANALYSIS SERVICES; CHEMICAL RESEARCH SERVICES; PRODUCT RESEARCH AND DEVELOPMENT; BIOLOGICAL RESEARCH; BACTERIOLOGICAL RESEARCH; TECHNICAL CONSULTATION IN THE FIELD OF MUTAGENESIS (U.S. CLS. 100 AND 101).

DAWN FELDMAN, EXAMINING ATTORNEY

SN 76-493,458. PRICEWATERHOUSECOOPERS LLP, NEW YORK, NY. FILED 2-26-2003.

PATHFINDER

FOR COMPUTER SERVICES OFFERED OVER A GLOBAL COMPUTER NETWORK, NAMELY, THE PROVISION OF TEMPORARY, NON-DOWNLOADABLE SOFTWARE FOR USE IN CONSULTING SERVICES RELATED TO FEDERAL, STATE AND LOCAL TAX LAWS AND REGULATIONS, ACCOUNTING PRINCIPLES AND AUDITING STANDARDS (U.S. CLS. 100 AND 101).

CURTIS FRENCH, EXAMINING ATTORNEY

SN 76-495,683. SVENSSON, EINAR, BEND, OR. FILED 3-7-2003.

SEMIMAGLEV URBANAUT

OWNER OF U.S. REG. NO. 1,050,385.
NO CLAIM IS MADE TO THE EXCLUSIVE RIGHT TO USE SEMIMAGLEV, APART FROM THE MARK AS SHOWN.

FOR ENGINEERING CONSULTATION AND DESIGN SERVICES IN THE FIELD OF RAPID TRANSIT SYSTEMS (U.S. CLS. 100 AND 101).

FIRST USE 7-15-2000; IN COMMERCE 7-15-2000.
LAURIEL DALIER, EXAMINING ATTORNEY

CLASS 42—(Continued).

SN 76-504,032. IGNITE DESIGN LLC, CHICAGO, IL. FILED 4-7-2003.

IGNITE USA

NO CLAIM IS MADE TO THE EXCLUSIVE RIGHT TO USE "USA", APART FROM THE MARK AS SHOWN. FOR ENGINEERING DESIGN SERVICES IN THE FIELDS OF HOUSEWARES, HARDWARE, FURNITURE, OFFICE SUPPLIES, ELECTRONICS AND MEDICAL DEVICES (U.S. CLS. 100 AND 101).

MARGERY A. TIERNEY, EXAMINING ATTORNEY

SN 76-508,028. FOX ROTHSCHILD LLP, PHILADELPHIA, PA. FILED 4-21-2003.

HIPAA-SAVER PAC

FOR LEGAL SERVICES (U.S. CLS. 100 AND 101). FIRST USE 1-24-2003; IN COMMERCE 1-24-2003. WILLIAM VERHOSEK, EXAMINING ATTORNEY

SN 76-511,198. AMERICA ONLINE, INC., DULLES, VA. FILED 5-2-2003.

KOL

FOR PROVIDING INFORMATION IN THE FIELD OF COMPUTERS VIA COMPUTER NETWORKS (U.S. CLS. 100 AND 101). HOWARD SMIGA, EXAMINING ATTORNEY

SN 76-514,687. CORETECH SYSTEM CO., LTD., HSINCHU, TAIWAN, FILED 5-15-2003.

MOLDEX3D

FOR COMPUTER SOFTWARE AND COMPUTER PROGRAM DESIGN, TESTING, AND ANALYSIS FOR OTHERS; COMPUTER SOFTWARE AND COMPUTER PROGRAM CONSULTATION; COMPUTER CALCULATION SERVICES IN THE NATURE OF COMPUTER DIAGNOSTIC SERVICES; RENTAL OF COMPUTER PROGRAMS FOR PLASTICS INJECTION MOLDING ANALYSIS, SIMULATION DESIGN, VERIFICATION, AND CONSULTING (U.S. CLS. 100 AND 101).

FIRST USE 2-21-2003; IN COMMERCE 2-21-2003. LEIGH CAROLINE CASE, EXAMINING ATTORNEY

SN 76-517,841. GEOTRACE TECHNOLOGIES, INC., DENVER, CO. FILED 5-29-2003.

ROCKRES

FOR COMPUTER GRAPHIC SERVICES AND COMPUTER SOFTWARE DEVELOPMENT IN THE GEOPHYSICAL FIELD (U.S. CLS. 100 AND 101).

SAMUEL E. SHARPER JR., EXAMINING ATTORNEY

CLASS 42—(Continued).

SN 76-519,923. NAPER SOLUTIONS, INC., NAPERVILLE, IL. FILED 5-22-2003.

NAPER SOLUTIONS

NO CLAIM IS MADE TO THE EXCLUSIVE RIGHT TO USE SOLUTIONS, APART FROM THE MARK AS SHOWN.

FOR COMPUTER SERVICES, NAMELY, DESIGNING AND IMPLEMENTING WEB SITES FOR ENTERPRISES CONDUCTING BUSINESS ON THE INTERNET; COMPUTER SERVICES, NAMELY, MANAGING WEB SITES FOR ENTERPRISES CONDUCTING BUSINESS ON THE INTERNET; COMPUTER CONSULTATION IN RELATION TO WEBSITE DESIGN AND MANAGEMENT SERVICES; COMPUTER SERVICES, NAMELY, PROVIDING SEARCH ENGINES FOR OBTAINING DATA ON A GLOBAL COMPUTER NETWORK (U.S. CLS. 100 AND 101).

FIRST USE 4-1-2003; IN COMMERCE 4-1-2003. ASMAT KHAN, EXAMINING ATTORNEY

SN 76-540,165. MANYONE NETWORKS, INC., SAN MATEO, CA. FILED 8-11-2003.

MANYONE
LINKING LIKE MINDS

FOR COMPUTER SERVICES, NAMELY PROVIDING SEARCH ENGINES FOR OBTAINING DATA ON A GLOBAL COMPUTER NETWORK, NAMELY, NETWORK INTERNET SERVICES WHEREBY USERS CAN SEARCH, ORGANIZE AND CATEGORIZE THE ENTIRE INTERNET VIA INDEPENDENTLY DEVELOPED PORTALS THAT ARE AUTOMATICALLY DOWNLOADED AND CACHED TO ENABLE THE UTILIZATION AND VIEWING THEREOF IN A RICH-MEDIA, BROADBAND LIKE AUDIO-VISUAL MANNER; COMPUTER SOFTWARE DATABASE AND WEB SITE MANAGEMENT ORGANIZATION; DATA MINING AND RELEVANCE TRACKING SERVICES WHEREBY USERS VISIT AND VIEW DIVERSE WEB SITES THROUGH A SINGLE, CONSISTENT AND VISUALLY DRIVEN DESKTOP; CREATION OF AN INTERNATIONAL INTERNET PORTAL; INTERNET-RELATED SERVICES, NAMELY WEB HOSTING, ORGANIZATION OF WEB SITES VIA PARAMETERS AND VARIABLES OF INDIVIDUAL USERS (U.S. CLS. 100 AND 101).

DAVID TAYLOR, EXAMINING ATTORNEY

CLASS 42—(Continued).

SN 76-540,368. MANYONE NETWORKS, INC., SAN MATEO, CA. FILED 8-11-2003.

EGALACTICA

FOR COMPUTER SERVICES, NAMELY PROVIDING SEARCH ENGINES FOR OBTAINING DATA ON A GLOBAL COMPUTER NETWORK, NAMELY, NETWORK INTERNET SERVICES WHEREBY USERS CAN SEARCH, ORGANIZE AND CATEGORIZE THE ENTIRE INTERNET VIA INDEPENDENTLY DEVELOPED PORTALS THAT ARE AUTOMATICALLY DOWNLOADED AND CACHED TO ENABLE THE UTILIZATION AND VIEWING THEREOF IN A RICH-MEDIA, BROADBAND LIKE AUDIO-VISUAL MANNER; COMPUTER SOFTWARE DATABASE AND WEB SITE MANAGEMENT ORGANIZATION, DATA MINING AND RELEVANCE TRACKING SERVICES WHEREBY USERS VISIT AND VIEW DIVERSE WEB SITES THROUGH A SINGLE, CONSISTENT AND VISUALLY DRIVEN DESKTOP; CREATION OF AN INTERNATIONAL INTERNET PORTAL; INTERNET-RELATED SERVICES, NAMELY WEB HOSTING, ORGANIZATION OF WEB SITES VIA PARAMETERS AND VARIABLES OF INDIVIDUAL USERS (U.S. CLS. 100 AND 101).

DAVID TAYLOR, EXAMINING ATTORNEY

SN 76-543,532. GASTERATOS, PAMELLA L, ALEXANDRIA, VA. FILED 8-27-2003.

PAMELLA
GASTERATOS DESIGN

NO CLAIM IS MADE TO THE EXCLUSIVE RIGHT TO USE DESIGN, APART FROM THE MARK AS SHOWN.

FOR GRAPHIC ART DESIGN (U.S. CLS. 100 AND 101).

FIRST USE 1-1-2003; IN COMMERCE 3-5-2003.

ROBERT C. CLARK JR., EXAMINING ATTORNEY

SN 76-544,395. L&P PROPERTY MANAGEMENT COMPANY, SOUTH GATE, CA. FILED 9-12-2003.

PLANT 2000

NO CLAIM IS MADE TO THE EXCLUSIVE RIGHT TO USE "PLANT", APART FROM THE MARK AS SHOWN.

FOR DESIGN FOR OTHERS OF BEDDING FOUNDATION AND MATTRESS MANUFACTURING FACILITIES (U.S. CLS. 100 AND 101).

FIRST USE 12-31-1995; IN COMMERCE 12-31-1995.

H. M. FISHER, EXAMINING ATTORNEY

SN 76-545,268. LEBENTAL, MIRIAM J., SAN PEDRO, CA. FILED 9-8-2003.

QUEEN OF TORTS

NO CLAIM IS MADE TO THE EXCLUSIVE RIGHT TO USE "TORTS", APART FROM THE MARK AS SHOWN.

FOR LEGAL SERVICES, NAMELY, PERFORMING LEGAL SERVICES IN THE AREA OF TORT LAW (U.S. CLS. 100 AND 101).

INGA ERVIN, EXAMINING ATTORNEY

CLASS 42—(Continued).

SN 76-545,838. REGULI, CONNIE, BRENTWOOD, TN. FILED 9-22-2003.



NO CLAIM IS MADE TO THE EXCLUSIVE RIGHT TO USE "LAW" AND "FAMILY LAW AND MEDIATION CENTER", APART FROM THE MARK AS SHOWN.

FOR PROVIDING LEGAL SERVICES AND MEDIATION TO FAMILIES, WHICH INCLUDES DIVORCE, CUSTODY, MEDIATION, CHILD SUPPORT, ALIMONY, NAME CHANGES, ADOPTION, DOMESTIC CRIMINAL OFFENSES, FAMILY BUSINESS SERVICES, PROBATE, AND ANY OTHER LEGAL OR MEDIATION SERVICES DIRECTLY RELATED TO A FAMILIES NEEDS (U.S. CLS. 100 AND 101).

FIRST USE 9-17-2003; IN COMMERCE 9-17-2003.

LINDA E. BLOHM, EXAMINING ATTORNEY

SN 76-547,775. PROFITLOGIC, INC., CAMBRIDGE, MA. FILED 9-29-2003.



FOR COMPUTER SERVICES, NAMELY, IMPLEMENTATION, CUSTOMIZATION AND UPDATING OF SOFTWARE IN THE FIELD OF REVENUE AND YIELD MANAGEMENT, PROFIT OPTIMIZATION, MERCHANDIZING, INVENTORY OPTIMIZATION AND PRICING AND INVENTORY ANALYSIS; COMPUTER CONSULTATION WITH REGARD TO OPERATION AND MANAGEMENT OF SOFTWARE AND DATA ENRICHMENT METHODOLOGIES IN THE FIELD OF REVENUE AND YIELD MANAGEMENT, PROFIT OPTIMIZATION, MERCHANDIZING, INVENTORY OPTIMIZATION AND PRICING AND INVENTORY ANALYSIS; DATA AUTOMATION, MANAGEMENT AND COLLECTION SERVICE USING PROPRIETARY SOFTWARE TO EVALUATE, ANALYZE AND COLLECT DATA IN THE FIELD OF REVENUE AND YIELD MANAGEMENT, PROFIT OPTIMIZATION, MERCHANDIZING, INVENTORY OPTIMIZATION AND PRICING AND INVENTORY ANALYSIS; SOFTWARE APPLICATION SERVICES, NAMELY, PROVIDING TEMPORARY USE OF ON-LINE NON-DOWNLOADABLE SOFTWARE IN THE FIELD OF REVENUE AND YIELD MANAGEMENT, PROFIT OPTIMIZATION, MERCHANDIZING, INVENTORY OPTIMIZATION AND PRICING AND INVENTORY ANALYSIS (U.S. CLS. 100 AND 101).

FIRST USE 1-3-2000; IN COMMERCE 1-3-2000.

ALICIA COLLINS, EXAMINING ATTORNEY

CLASS 42—(Continued).

SN 76-550,847. INDOOR ENVIRONMENTAL CONSULTANTS, INC., AUSTIN, TX. FILED 10-10-2003.

IEC

FOR MYCOLOGICAL, BACTERIOLOGICAL AND CHEMICAL AIR QUALITY CONTROL TECHNICAL SERVICES, NAMELY, CONSULTATION AND LABORATORY ANALYSIS, ALL IN THE FIELD OF INDOOR AIR QUALITY CONTROL (U.S. CLS. 100 AND 101).

FIRST USE 5-0-2001; IN COMMERCE 5-0-2001.
INGA ERVIN, EXAMINING ATTORNEY

SN 76-553,598. SARTAIN, JESSE, VALLEJO, CA. FILED 10-6-2003.

LIVINGSEARCH INTERNET ENGINE

NO CLAIM IS MADE TO THE EXCLUSIVE RIGHT TO USE "INTERNET ENGINE", APART FROM THE MARK AS SHOWN.

FOR COMPUTER SEARCH ENGINE SERVICES, NAMELY, EXTRACTION AND RETRIEVAL OF INFORMATION AND DATA MINING BY MEANS OF GLOBAL COMPUTER NETWORKS; CREATING INDEXES OF INFORMATION, INDEXES OF WEBSITES AND INDEXES OF OTHER INFORMATION SOURCES IN CONNECTION WITH A GLOBAL COMPUTER NETWORK (U.S. CLS. 100 AND 101).

FIRST USE 2-1-2003; IN COMMERCE 2-1-2003.
ELISSA GARBER KON, EXAMINING ATTORNEY

SN 76-556,743. NUNN, KENNETH L., BLOOMINGTON, IN. FILED 10-29-2003.

1-800-888-HURT

SEC. 2(F).
FOR LEGAL SERVICES (U.S. CLS. 100 AND 101).
FIRST USE 0-0-1990; IN COMMERCE 0-0-1990.
JOHN HWANG, EXAMINING ATTORNEY

CLASS 42—(Continued).

SN 76-580,533. INTERNATIONAL GEMMOLOGICAL INSTITUTE, INC., NEW YORK, NY. FILED 3-11-2004.



OWNER OF U.S. REG. NOS. 2,687,886 AND 2,700,221.
NO CLAIM IS MADE TO THE EXCLUSIVE RIGHT TO USE "GEM AUDIT", APART FROM THE MARK AS SHOWN.

FOR GEMOLOGICAL SERVICES, NAMELY, PROVIDING LABORATORY EXAMINATIONS AND ISSUING RE-EVALUATION CERTIFICATES FOR DIAMONDS AND COLORED STONES (U.S. CLS. 100 AND 101).

FIRST USE 8-1-1981; IN COMMERCE 8-1-1981.
H. M. FISHER, EXAMINING ATTORNEY

SN 78-006,819. RHYTHM NET DESIGN GROUP, SAN DIMAS, CA. FILED 5-4-2000.

RHYTHM NET

NO CLAIM IS MADE TO THE EXCLUSIVE RIGHT TO USE NET, APART FROM THE MARK AS SHOWN.

FOR COMPUTER SERVICES, NAMELY, DESIGNING AND DEVELOPING WEBSITES AND CD-ROM SOFTWARE FOR OTHERS, HOSTING THE WEB SITES OF OTHERS ON A COMPUTER SERVER FOR A GLOBAL COMPUTER NETWORK (U.S. CLS. 100 AND 101).

FIRST USE 0-0-1995; IN COMMERCE 0-0-1996.
STEVEN BERK, EXAMINING ATTORNEY

SN 78-099,949. WORLDCOM, INC., CLINTON, MS. FILED 12-26-2001.

DIGITAL SOURCE

NO CLAIM IS MADE TO THE EXCLUSIVE RIGHT TO USE "DIGITAL", APART FROM THE MARK AS SHOWN.

FOR PROVIDING AN ONLINE MAGAZINE IN THE FIELD OF TELECOMMUNICATIONS AND COMPUTER HARDWARE AND SOFTWARE (U.S. CLS. 100 AND 101).

FIRST USE 1-31-2001; IN COMMERCE 1-31-2001.
STEVEN BERK, EXAMINING ATTORNEY

CLASS 42—(Continued).

SN 78-202,716. WHITE OAK TECHNOLOGIES, INC., SILVER SPRING, MD. FILED 1-13-2003.

WAREMAN

FOR DATA MINING SERVICES, NAMELY, DATA MATCHING SERVICES USING PROPRIETARY SOFTWARE TO ANALYZE AND MATCH DATA RECORDS (U.S. CLS. 100 AND 101).

FIRST USE 11-10-2001; IN COMMERCE 11-10-2001.
JOHN KELLY, EXAMINING ATTORNEY

SN 78-223,833. 2ADVANCED STUDIOS, LLC, ALISO VIEJO, CA. FILED 3-10-2003.

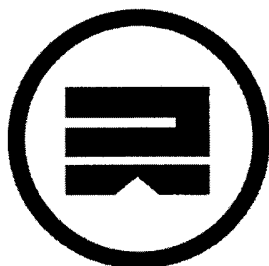

FOR HOSTING DIGITAL CONTENT ON THE INTERNET (U.S. CLS. 100 AND 101).
FIRST USE 3-1-2003; IN COMMERCE 3-1-2003.
MARIA-VICTORIA SUAREZ, EXAMINING ATTORNEY

SN 78-225,509. FNIS INTELLECTUAL PROPERTY HOLDINGS, INC., SANTA BARBARA, CA. FILED 3-14-2003.

THE 4TH REPOSITORY

NO CLAIM IS MADE TO THE EXCLUSIVE RIGHT TO USE "REPOSITORY", APART FROM THE MARK AS SHOWN.

FOR PROVIDING TEMPORARY USE OF ON-LINE NON-DOWNLOADABLE COMPUTER SOFTWARE THAT PROVIDES INFORMATION RELATING TO THE CREDIT WORTHINESS OF APPLICANTS SEEKING INSURANCE, CREDIT, AND MORTGAGE LOANS; PROVIDES CHAIN OF TITLE HISTORY OF REAL PROPERTY; AND PROVIDES ESTIMATES OF REAL PROPERTY VALUES FOR PURPOSES OF SEEKING INSURANCE, CREDIT, AND MORTGAGE LOANS (U.S. CLS. 100 AND 101).

FIRST USE 10-1-2002; IN COMMERCE 10-17-2002.
BRIAN PINO, EXAMINING ATTORNEY

CLASS 42—(Continued).

SN 78-226,529. AXAMAL, INC., COLLEGE STATION, TX. FILED 3-17-2003.

AXAMAL

FOR TECHNOLOGY COMMERCIALIZATION SERVICES, NAMELY, COMPUTER SERVICES, NAMELY, EXTRACTION AND RETRIEVAL BY MEANS OF GLOBAL COMPUTER NETWORKS, OF INFORMATION CONCERNING NEW TECHNOLOGIES AND TECHNOLOGICAL EXPERTISE DEVELOPED IN UNIVERSITY, GOVERNMENT AND INDUSTRIAL LABORATORIES, CONVERSION AND TRANSLATION OF SUCH INFORMATION INTO A UNIVERSALLY RECOGNIZED COMPUTER LANGUAGE AND CREATING ON-LINE, SEARCHABLE REPOSITORIES OF SUCH TRANSLATED INFORMATION FOR USE BY POTENTIAL LICENSEES (U.S. CLS. 100 AND 101).

STANLEY I. OSBORNE, EXAMINING ATTORNEY

SN 78-227,647. WINTRANS SOLUTIONS INC., CARSON CITY, NV. FILED 3-19-2003.

CLICKCONNECT

OWNER OF U.S. REG. NO. 2,523,094.
FOR APPLICATION SERVICE PROVIDER FEATURING BUSINESS MANAGEMENT SOFTWARE IN THE FIELD OF REAL ESTATE (U.S. CLS. 100 AND 101).
FIRST USE 3-1-1996; IN COMMERCE 3-1-1996.
DOUGLAS LEE, EXAMINING ATTORNEY

SN 78-228,260. ERVIN, HONORE MCDONOUGH, SPRINGFIELD, MA. FILED 3-20-2003.

ETIQUETTE GRRL

NO CLAIM IS MADE TO THE EXCLUSIVE RIGHT TO USE "ETIQUETTE", APART FROM THE MARK AS SHOWN.

FOR PROVIDING INTERIOR HOME DECORATING INFORMATION AND INFORMATION ABOUT ETIQUETTE AND STYLE (U.S. CLS. 100 AND 101).
GIANCARLO CASTRO, EXAMINING ATTORNEY

SN 78-242,629. ASSOCIATED BUILDERS AND CONTRACTORS, INC., ARLINGTON, VA. FILED 4-28-2003.

JOBINSITE

FOR PROVIDING TEMPORARY USE OF NON-DOWNLOADABLE COMPUTER SOFTWARE FOR CONDUCTING PERSONNEL ASSESSMENT TESTS MADE AVAILABLE VIA THE INTERNET (U.S. CLS. 100 AND 101).

FIRST USE 3-1-2003; IN COMMERCE 3-12-2003.
KARLA PERKINS, EXAMINING ATTORNEY

CLASS 42—(Continued).

SN 78-244,962. ADEPT DEVELOPER CONSULTING, INC., HOUSTON, TX. FILED 5-2-2003.



NO CLAIM IS MADE TO THE EXCLUSIVE RIGHT TO USE "DEVELOPER", APART FROM THE MARK AS SHOWN.

FOR COMPUTER SERVICES, NAMELY, DEVELOPING AND DESIGNING WEBSITES FOR OTHERS, COMPUTER PROGRAMMING OF WEBSITES FOR OTHERS, HOSTING THE WEBSITES OF OTHERS ON A COMPUTER SERVER FOR A GLOBAL COMPUTER NETWORK, AND DATABASE DEVELOPMENT SERVICES FOR OTHERS (U.S. CLS. 100 AND 101).

FIRST USE 6-19-2001; IN COMMERCE 6-20-2001.
MARY CRAWFORD, EXAMINING ATTORNEY

SN 78-248,325. HARRIS, WILTSHIRE & GRANNIS LLP, WASHINGTON, DC. FILED 5-12-2003.

BECAUSE SMART LAWYERING IS THE NEXT BEST THING TO DUMB LUCK

FOR LEGAL SERVICES (U.S. CLS. 100 AND 101).
FIRST USE 7-0-1998; IN COMMERCE 7-0-1998.
AMY HELLA, EXAMINING ATTORNEY

SN 78-248,478. RUDOLPH, FINE, PORTER & JOHNSON, LLP, EVANSVILLE, IN. FILED 5-12-2003.

A NEW GENERATION OF LAW

FOR LEGAL SERVICES (U.S. CLS. 100 AND 101).
FIRST USE 2-28-2003; IN COMMERCE 2-28-2003.
GIANCARLO CASTRO, EXAMINING ATTORNEY

SN 78-250,557. HOLGUIN, HECTOR, EL PASO, TX. FILED 5-15-2003.

SECUREORIGINS

FOR MONITORING THE COMPUTER SYSTEMS OF OTHERS FOR TECHNICAL PURPOSES; TECHNICAL SUPPORT, NAMELY MONITORING OF NETWORK SYSTEMS; TECHNICAL SUPPORT, NAMELY, PROVIDING BACK-UP COMPUTER PROGRAMS AND FACILITIES (U.S. CLS. 100 AND 101).

TARAH HARDY, EXAMINING ATTORNEY

CLASS 42—(Continued).

SN 78-263,054. ORATIVE CORPORATION, MENLO PARK, CA. FILED 6-16-2003.

ORATIVE

FOR MOBILE TELEPHONY COMMUNICATIONS SOFTWARE MAINTENANCE SERVICES (U.S. CLS. 100 AND 101).

MARK T. MULLEN, EXAMINING ATTORNEY

SN 78-270,364. PUBLIC INTEREST REGISTRY, RESTON, VA. FILED 7-3-2003.

SERVING THE PUBLIC INTEREST

FOR DOMAIN NAME REGISTRY SERVICES, NAMELY, COORDINATING THE REGISTRATION OF DOMAIN NAMES FOR IDENTIFICATION OF USERS AND INTERNET PROTOCOL ADDRESSES ON THE INTERNET; PROVIDING AN ONLINE COMPUTER DATABASE IN THE FIELD OF DOMAIN NAME REGISTRATION INFORMATION, AND DOMAIN NAME MONITORING SERVICES (U.S. CLS. 100 AND 101).

FIRST USE 2-28-2003; IN COMMERCE 2-28-2003.
CURTIS FRENCH, EXAMINING ATTORNEY

SN 78-272,409. FINANCIALCIRCUIT.COM, INC., CAMPBELL, CA. FILED 7-9-2003.

ENTERPRISE MONEYFIND

NO CLAIM IS MADE TO THE EXCLUSIVE RIGHT TO USE ENTERPRISE, APART FROM THE MARK AS SHOWN.

FOR PROVIDING TEMPORARY USE OF NON-DOWNLOADABLE SOFTWARE FOR LIABILITY-BASED FINANCIAL ANALYSIS, PLANNING AND EXECUTION (U.S. CLS. 100 AND 101).

FIRST USE 4-1-2003; IN COMMERCE 4-1-2003.
WON TEAK OH, EXAMINING ATTORNEY

SN 78-282,230. PROCOPIO CORY HARGREAVES & SAVITCH, LLP, SAN DIEGO, CA. FILED 8-1-2003.

INTRANACIONAL TRUST

NO CLAIM IS MADE TO THE EXCLUSIVE RIGHT TO USE "TRUST", APART FROM THE MARK AS SHOWN.

FOR LEGAL SERVICES (U.S. CLS. 100 AND 101).

CURTIS FRENCH, EXAMINING ATTORNEY

CLASS 42—(Continued).

SN 78-282,894. CARGILL, INCORPORATED, WAYZATA, MN. FILED 8-4-2003.

FERMENTATION SOLUTIONS

NO CLAIM IS MADE TO THE EXCLUSIVE RIGHT TO USE FERMENTATION, APART FROM THE MARK AS SHOWN.

FOR PRODUCT RESEARCH AND DEVELOPMENT; DEVELOPMENT OF NEW TECHNOLOGIES IN THE FIELD OF MICROBIAL BIOPROCESSING; DESIGN AND TESTING OF NEW PRODUCT DEVELOPMENT (U.S. CLS. 100 AND 101).

KAREN K. BUSH, EXAMINING ATTORNEY

SN 78-289,599. AMERICA ONLINE, INC., DULLES, VA. FILED 8-20-2003.

KOL JR

FOR PROVIDING INFORMATION IN THE FIELD OF COMPUTERS VIA COMPUTER NETWORKS (U.S. CLS. 100 AND 101).

HOWARD SMIGA, EXAMINING ATTORNEY

SN 78-294,450. HUTHEESING, VIVEK, AJIT, BERKELEY, CA. FILED 8-30-2003.

EBLOCK

FOR COMPUTER SERVICES, NAMELY, ACTING AS AN APPLICATION SERVICE PROVIDER IN THE FIELDS OF COLLABORATION AND KNOWLEDGE MANAGEMENT TO HOST COMPUTER APPLICATION SOFTWARE FOR THE CAPTURING, EXCHANGING, ORGANIZING, STORING, RETRIEVING, TRANSMITTING AND SHARING OF DATA AND INFORMATION. (U.S. CLS. 100 AND 101).

SHAUNIA WALLACE, EXAMINING ATTORNEY

SN 78-298,117. ZIEGLER, RON R., HOUSTON, TX. FILED 9-9-2003.

PAINOLOGY

FOR MEDICAL RESEARCH IN THE FIELD OF PAIN. (U.S. CLS. 100 AND 101).

MICHAEL WEBSTER, EXAMINING ATTORNEY

CLASS 42—(Continued).

SN 78-298,939. LAMM, BEN, WACO, TX. FILED 9-11-2003.



NO CLAIM IS MADE TO THE EXCLUSIVE RIGHT TO USE "INTERACTIVE", APART FROM THE MARK AS SHOWN.

FOR MULTIMEDIA DESIGN FOR OTHERS FOR THE PURPOSE OF CREATING ONLINE TRAINING COURSE, WEB SITES, PRESENTATIONS, ONLINE ADVERTISING, PROMOTIONAL CD BUSINESS CARDS, AND GAMES (U.S. CLS. 100 AND 101).

FIRST USE 8-1-2001; IN COMMERCE 5-1-2003.

RONALD AIKENS, EXAMINING ATTORNEY

SN 78-301,370. PROVENWEBSITES LLC, CHICAGO, IL. FILED 9-17-2003.

PROVENWEBHOSTING

FOR HOSTING THE WEB SITES OF OTHERS ON A COMPUTER SERVER FOR A GLOBAL COMPUTER NETWORK (U.S. CLS. 100 AND 101).

FIRST USE 3-1-2003; IN COMMERCE 3-1-2003.

TONI HICKEY, EXAMINING ATTORNEY

SN 78-302,359. CADCOM TELESYSTEMS, INC., ENID, OK. FILED 9-18-2003.

LET'S GO TENNIS

NO CLAIM IS MADE TO THE EXCLUSIVE RIGHT TO USE "TENNIS", APART FROM THE MARK AS SHOWN.

FOR APPLICATION SERVICE PROVIDER SERVICES, NAMELY, HOSTING WEB-BASED COMPUTER SOFTWARE APPLICATIONS FOR USE BY OTHERS; AND APPLICATION SERVICE PROVIDER SERVICES OFFERING REAL-TIME, INTERACTIVE WEB-BASED COMPUTER APPLICATIONS FOR USE BY ORGANIZATIONS AND THEIR CUSTOMERS, GUESTS OR MEMBERS IN THE FIELDS OF TIME MANAGEMENT, FACILITY ACCESS MANAGEMENT, ONLINE COMMERCIAL TRANSACTIONS, AND FINANCIAL AND BUSINESS MANAGEMENT; APPLICATION SERVICE PROVIDER SERVICES PROVIDING A SUITE OF REAL-TIME, WEB-BASED TENNIS FACILITY MANAGEMENT SOFTWARE TOOLS FOR USE BY THE TENNIS FACILITY STAFF AND ITS GUESTS (U.S. CLS. 100 AND 101).

RICHARD A. STRASER, EXAMINING ATTORNEY

CLASS 42—(Continued).

SN 78-303,159. JOSEPH, LAWRENCE J., MCLEAN, VA. FILED 9-20-2003.

ENSURING REGULATIONS FOLLOW THE LAW

FOR LEGAL SERVICES (U.S. CLS. 100 AND 101).
ESTHER BELENKER, EXAMINING ATTORNEY

SN 78-303,209. TRUTH TECHNOLOGIES INC, CONNECTICUT, CT. FILED 9-21-2003.

PocketIntranet

FOR COMPUTER SERVICES, NAMELY, DESIGNING AND IMPLEMENTING WEB SITES FOR OTHERS (U.S. CLS. 100 AND 101).
KELLY BOULTON, EXAMINING ATTORNEY

SN 78-303,726. TEV LAW GROUP PC, PITTSBURGH, PA. FILED 9-22-2003.

WE WILL APPRECIATE YOUR BUSINESS

FOR LEGAL SERVICES (U.S. CLS. 100 AND 101).
FIRST USE 9-22-2003; IN COMMERCE 9-22-2003.
DOMINIC J. FERRAIUOLO, EXAMINING ATTORNEY

SN 78-307,563. INTELSTAF HEALTHCARE MANAGEMENT, L.P., DALLAS, TX. FILED 9-30-2003.

IQ

FOR MEASUREMENT, EVALUATION, AND ANALYSIS OF CLINICAL OUTCOMES FOR HEALTHCARE AND HEALTHCARE-RELATED SERVICES (U.S. CLS. 100 AND 101).
SUSAN LESLIE DUBOIS, EXAMINING ATTORNEY

SN 78-309,696. RING, JESSEE B, FREMONT, CA. FILED 10-6-2003.

SOFTWARE QUALITY FIRST

NO CLAIM IS MADE TO THE EXCLUSIVE RIGHT TO USE "SOFTWARE", APART FROM THE MARK AS SHOWN.
FOR COMPUTER SOFTWARE CONSULTATION (U.S. CLS. 100 AND 101).
FIRST USE 8-11-1998; IN COMMERCE 5-1-1999.
LAURA KOVAISKY, EXAMINING ATTORNEY

CLASS 42—(Continued).

SN 78-309,697. REX CONSULTING, INC., BOULDER CREEK, CA. FILED 10-6-2003.

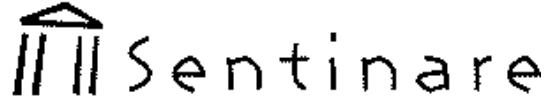

OWNER OF U.S. REG. NOS. 70,104, 70,903 AND 260,502.
FOR COMPUTER SERVICES, NAMELY FILTERING OF UNWANTED E-MAILS AND COMPUTER VIRUS PROTECTION SERVICES (U.S. CLS. 100 AND 101).
TRICIA SONNEBORN, EXAMINING ATTORNEY

SN 78-311,867. HAIG, WILLIAM, L., HONOLULU, HI. FILED 10-9-2003.

POWERLOGOS DESIGN

NO CLAIM IS MADE TO THE EXCLUSIVE RIGHT TO USE DESIGN, APART FROM THE MARK AS SHOWN.
FOR GRAPHIC ART DESIGN SERVICES, NAMELY, PROVIDING TRADEMARK DESIGN SERVICES (U.S. CLS. 100 AND 101).
FIRST USE 3-1-1998; IN COMMERCE 3-1-1998.
TRICIA SONNEBORN, EXAMINING ATTORNEY

SN 78-313,131. INVENTQJAYA SDN. BHD., KUALA LUMPUR, MEXICO, FILED 10-14-2003.

INVENTASIA

FOR RESEARCH AND DEVELOPMENT FOR NEW PRODUCTS AND TECHNOLOGIES FOR OTHERS (U.S. CLS. 100 AND 101).
GINA HAYES, EXAMINING ATTORNEY

SN 78-313,639. HOLMES, ROBERT P., RALEIGH, NC. FILED 10-14-2003.

WHEN YOU NEED A LAWYER, YOU NEED A FRIEND

FOR LEGAL SERVICES (U.S. CLS. 100 AND 101).
FIRST USE 3-1-2002; IN COMMERCE 3-1-2002.
CAROLINE WOOD, EXAMINING ATTORNEY

CLASS 42—(Continued).

SN 78-314,785. APANI NETWORKS, BREA, CA. FILED 10-16-2003.

APANI NETWORKS

NO CLAIM IS MADE TO THE EXCLUSIVE RIGHT TO USE "NETWORKS", APART FROM THE MARK AS SHOWN.

FOR COMPUTER SOFTWARE AND HARDWARE DEVELOPMENT (U.S. CLS. 100 AND 101).
DOMINIC J. FERRAIUOLO, EXAMINING ATTORNEY



SN 78-316,645. HAYES, THOMAS, JEROME, WESTMONT, IL. FILED 10-21-2003.

CODENTITY

FOR COMPUTER SOFTWARE DEVELOPMENT (U.S. CLS. 100 AND 101).
GEORGE LORENZO, EXAMINING ATTORNEY



CLASS 43—HOTEL AND RESTAURANT SERVICES

SN 76-287,594. GORSTEW LIMITED, KINGSTON, ST. ANDREW, JAMAICA, FILED 7-20-2001.

BEACHES HOLIDAYS

NO CLAIM IS MADE TO THE EXCLUSIVE RIGHT TO USE "HOLIDAYS", APART FROM THE MARK AS SHOWN. SEC. 2(F) AS TO "BEACHES".

FOR TRAVEL AGENCY SERVICES, NAMELY, MAKING RESERVATIONS AND BOOKING FOR TEMPORARY LODGING IN THE NATURE OF HOTEL ACCOMMODATIONS (U.S. CLS. 100 AND 101).
BRIAN NEVILLE, EXAMINING ATTORNEY



SN 76-401,704. CARMITA, INC., PARMA, OH. FILED 4-30-2002.

CHARACTERS

FOR RESTAURANT AND BAR SERVICES (U.S. CLS. 100 AND 101).
FIRST USE 0-0-1989; IN COMMERCE 9-0-1999.
CURTIS FRENCH, EXAMINING ATTORNEY

CLASS 43—(Continued).

SN 76-410,448. YAN CAN COOK, INC., DBA YAN CAN COOK, FOSTER CITY, CA. FILED 5-21-2002.



OWNER OF U.S. REG. NOS. 2,311,369, 2,367,762 AND 2,437,935.

NO CLAIM IS MADE TO THE EXCLUSIVE RIGHT TO USE "FRESH ASIAN COOKING", APART FROM THE MARK AS SHOWN.

THE NAME "YAN" AND THE IMAGE OF THE MAN IDENTIFY A LIVING INDIVIDUAL WHOSE CONSENT IS OF RECORD.

FOR RESTAURANTS, QUICK SERVICE RESTAURANTS, BAR SERVICES AND CATERING SERVICES; CONSULTING SERVICES IN THE FIELDS OF RESTAURANTS AND QUICK SERVICE RESTAURANTS (U.S. CLS. 100 AND 101).

WANDA KAY PRICE, EXAMINING ATTORNEY



SN 76-447,282. EINSTEIN AND NOAH CORP., GOLDEN, CO. FILED 9-6-2002.



OWNER OF U.S. REG. NO. 2,017,312.

THE MARK CONSISTS OF THE DESIGN OF A BAGEL WITH LIGHT RAYS SO THAT IT APPEARS TO BE SHINING.

FOR RESTAURANT SERVICES (U.S. CLS. 100 AND 101).

FIRST USE 8-29-1995; IN COMMERCE 11-13-1995.
DAVID C. REIHNER, EXAMINING ATTORNEY

CLASS 43—(Continued).

SN 76-447,370. BROADERICK MANAGEMENT CORPORATION, MADEIRA BEACH, FL. FILED 9-6-2002.

LEATHERBACKS STEAKHOUSE

NO CLAIM IS MADE TO THE EXCLUSIVE RIGHT TO USE STEAKHOUSE, APART FROM THE MARK AS SHOWN.

FOR RESTAURANT SERVICES (U.S. CLS. 100 AND 101).

BRENDAN MCCAULEY, EXAMINING ATTORNEY

SN 76-464,166. ENKI NY, INC., NEW YORK, NY. FILED 11-5-2002.

custom

FOR RESTAURANT (U.S. CLS. 100 AND 101).
FIRST USE 10-1-2002; IN COMMERCE 10-1-2002.
SHARI SHEFFIELD, EXAMINING ATTORNEY

SN 76-502,041. FRC NORTH-ITALIAN LLC, SCOTTSDALE, AZ. FILED 3-20-2003.

NORTH

FOR RESTAURANT SERVICES (U.S. CLS. 100 AND 101).

FIRST USE 5-21-2002; IN COMMERCE 5-21-2002.
TRICIA THOMPSON, EXAMINING ATTORNEY

SN 76-502,314. G & L ACQUISITION COMPANY, MUSKOGON, MI. FILED 3-28-2003.



The **amazing** Greek chili dog.

OWNER OF U.S. REG. NO. 1,997,026.
NO CLAIM IS MADE TO THE EXCLUSIVE RIGHT TO USE "GREEK CHILI DOG", APART FROM THE MARK AS SHOWN.

FOR RESTAURANT SERVICES (U.S. CLS. 100 AND 101).

FIRST USE 0-0-1999; IN COMMERCE 0-0-1999.
SONYA STEPHENS, EXAMINING ATTORNEY

CLASS 43—(Continued).

SN 76-505,531. HREC LICENSING, LLC, PARKER, CO. FILED 4-10-2003.

HREC INVESTMENT ADVISORS

OWNER OF U.S. REG. NOS. 2,011,247 AND 2,036,640.
NO CLAIM IS MADE TO THE EXCLUSIVE RIGHT TO USE INVESTMENT ADVISORS, APART FROM THE MARK AS SHOWN.

FOR CONSULTING SERVICES IN THE FIELD OF HOSPITALITY (U.S. CLS. 100 AND 101).

FIRST USE 7-16-2002; IN COMMERCE 7-16-2002.
TARAH HARDY, EXAMINING ATTORNEY

SN 76-507,361. FAST FRESH ITALIAN, LLC, NORTH BARRINGTON, IL. FILED 4-17-2003.

GO ROMA FRESH ITALIAN CIAO

NO CLAIM IS MADE TO THE EXCLUSIVE RIGHT TO USE "FRESH ITALIAN", APART FROM THE MARK AS SHOWN.

FOR RESTAURANT AND CATERING SERVICES (U.S. CLS. 100 AND 101).

JOHN HWANG, EXAMINING ATTORNEY

SN 76-508,068. M.J. PROPERTIES OF SOUTH CAROLINA, L.L.C., CHARLESTON, SC. FILED 4-21-2003.



THE LINING AND STIPLING ARE FEATURES OF THE MARK AND DO NOT INDICATE COLOR.

FOR BAR AND RESTAURANT SERVICES (U.S. CLS. 100 AND 101).

FIRST USE 9-15-1990; IN COMMERCE 9-15-1990.
KIMBERLY PERRY, EXAMINING ATTORNEY

CLASS 43—(Continued).

SN 76-517,833. ANGELO OF MULBERRY STREET, INC., NEW YORK, NY. FILED 5-29-2003.

ANGELO OF MULBERRY STREET

NO CLAIM IS MADE TO THE EXCLUSIVE RIGHT TO USE "OF MULBERRY STREET", APART FROM THE MARK AS SHOWN.
 SEC. 2(F).
 FOR RESTAURANTS (U.S. CLS. 100 AND 101).
 FIRST USE 0-0-1902; IN COMMERCE 0-0-1902.
 ROBIN CHOSID, EXAMINING ATTORNEY

CLASS 43—(Continued).

SN 76-532,264. CITY OF HAMPTON, VIRGINIA, HAMPTON, VA. FILED 7-18-2003.



NO CLAIM IS MADE TO THE EXCLUSIVE RIGHT TO USE THE HAMPTON ROADS CONVENTION CENTER, APART FROM THE MARK AS SHOWN.
 THE MARK CONSISTS OF A DESIGN OF A FOUR PEAK WAVE WITH A STAR LOCATED IN THE THIRD WAVE AND THE WORDS HAMPTON ROADS CONVENTION CENTER.
 FOR PROVIDING CONVENTION FACILITIES (U.S. CLS. 100 AND 101).
 FIRST USE 3-1-2002; IN COMMERCE 3-1-2002.
 LEIGH CAROLINE CASE, EXAMINING ATTORNEY

SN 76-522,899. CWH COMPANY, LLC, WESTMINSTER, CA. FILED 6-16-2003.



NO CLAIM IS MADE TO THE EXCLUSIVE RIGHT TO USE "CAFE", APART FROM THE MARK AS SHOWN.
 FOR RESTAURANT AND CAFE SERVICES (U.S. CLS. 100 AND 101).
 FIRST USE 1-1-2003; IN COMMERCE 1-1-2003.
 CAROL SPILS, EXAMINING ATTORNEY

SN 76-536,313. ADRICH INC., NEW YORK, NY. FILED 8-11-2003.



NO CLAIM IS MADE TO THE EXCLUSIVE RIGHT TO USE "BBQ" AND "USA", APART FROM THE MARK AS SHOWN.
 THE NAME IN THE MARK, "DAISY MAY" DOES NOT IDENTIFY A PARTICULAR LIVING INDIVIDUAL.
 FOR RESTAURANT SERVING FOOD AND BEVERAGES (U.S. CLS. 100 AND 101).
 FIRST USE 8-5-2003; IN COMMERCE 8-5-2003.
 PAULA MAYS, EXAMINING ATTORNEY

SN 76-529,825. RICE BOXX ENTERPRISES, LP, PLANO, TX. FILED 7-16-2003.

HAPPY EATERS!

FOR RESTAURANT SERVICES (U.S. CLS. 100 AND 101).
 FIRST USE 6-0-2000; IN COMMERCE 6-0-2000.
 AMY HELLA, EXAMINING ATTORNEY

SN 76-537,156. VEGAS.COM LLC, HENDERSON, NV. FILED 8-4-2003.

MR. V'S WILDCARD HOTELS

NO CLAIM IS MADE TO THE EXCLUSIVE RIGHT TO USE "HOTELS", APART FROM THE MARK AS SHOWN.
 FOR TRAVEL AGENCY SERVICES, NAMELY MAKING RESERVATIONS AND BOOKING FOR TEMPORARY LODGING (U.S. CLS. 100 AND 101).
 FIRST USE 6-9-2003; IN COMMERCE 6-9-2003.
 WILLIAM BRECKENFELD, EXAMINING ATTORNEY

CLASS 43—(Continued).

SN 76-540,971. G-MAR DEVELOPMENT CORP., DBA TULLY'S GOOD TIMES, EAST SYRACUSE, NY. FILED 8-29-2003.

TULLY'S GOOD TIMES

FOR RESTAURANT SERVICES (U.S. CLS. 100 AND 101).

FIRST USE 6-1-1991; IN COMMERCE 6-1-1991.
MONIQUE MILLER, EXAMINING ATTORNEY

SN 76-546,059. TK NYC LLC, WILMINGTON, DE. FILED 9-22-2003.

PER SE

FOR RESTAURANT, BAR AND CATERING SERVICES, AND PROVIDING BANQUET AND SOCIAL FUNCTION FACILITIES FOR SPECIAL OCCASIONS (U.S. CLS. 100 AND 101).

NANCY CLARKE, EXAMINING ATTORNEY

SN 76-547,830. LRM MANAGEMENT, INC., ATLANTA, GA. FILED 9-29-2003.

TOP OF THE GRAPE

FOR RESTAURANT AND BAR SERVICES (U.S. CLS. 100 AND 101).

FIRST USE 7-0-2001; IN COMMERCE 7-0-2001.
GEOFFREY FOSDICK, EXAMINING ATTORNEY

SN 76-547,832. LRM MANAGEMENT, INC., ATLANTA, GA. FILED 9-29-2003.

GRAPES BY THE BUNCH

FOR RESTAURANT AND BAR SERVICES (U.S. CLS. 100 AND 101).

FIRST USE 11-0-2000; IN COMMERCE 11-0-2000.
GEOFFREY FOSDICK, EXAMINING ATTORNEY

SN 76-548,659. TRAVEL PLANNERS, INC., NEW YORK, NY. FILED 9-16-2003.

**CONVENTION HOUSING.
UNCONVENTIONAL
SERVICE.**

FOR MAKING HOTEL RESERVATIONS FOR OTHERS (U.S. CLS. 100 AND 101).

APRIL L. RADEMACHER, EXAMINING ATTORNEY

CLASS 43—(Continued).

SN 76-552,818. GALINDO INDUSTRIES CORPORATION, HOLLYWOOD, CA. FILED 10-20-2003.

**THE MONTMARTRE
LOUNGE**

OWNER OF U.S. REG. NO. 2,807,195.
NO CLAIM IS MADE TO THE EXCLUSIVE RIGHT TO USE "LOUNGE", APART FROM THE MARK AS SHOWN.
FOR RESTAURANT SERVICES (U.S. CLS. 100 AND 101).

FIRST USE 6-3-2003; IN COMMERCE 9-1-2003.
SAMUEL E. SHARPER JR., EXAMINING ATTORNEY

SN 76-552,819. GALINDO INDUSTRIES CORPORATION, HOLLYWOOD, CA. FILED 10-20-2003.

DAY AFTER

OWNER OF U.S. REG. NO. 2,698,476.
FOR RESTAURANT SERVICES (U.S. CLS. 100 AND 101).

FIRST USE 6-3-2003; IN COMMERCE 9-1-2003.
SAMUEL E. SHARPER JR., EXAMINING ATTORNEY

SN 76-552,820. GALINDO INDUSTRIES CORPORATION, HOLLYWOOD, CA. FILED 10-20-2003.

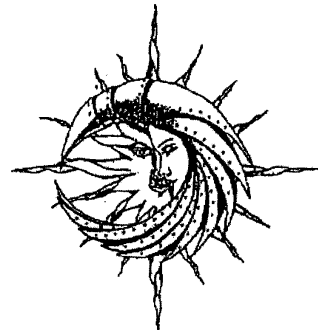

OWNER OF U.S. REG. NO. 2,702,145.
THE STIPPLING IS FOR SHADING PURPOSES ONLY AND DOES NOT INDICATE COLOR.

FOR RESTAURANT SERVICES (U.S. CLS. 100 AND 101).

FIRST USE 6-3-2003; IN COMMERCE 9-1-2003.
SAMUEL E. SHARPER JR., EXAMINING ATTORNEY

CLASS 43—(Continued).

SN 76-554,010. ROYAL MEATS, INC., WYANDOTTE, MI. FILED 10-6-2003.



FOR RESTAURANT SERVICES (U.S. CLS. 100 AND 101).
SHAUNIA WALLACE, EXAMINING ATTORNEY

SN 78-187,129. MEL-O-CREAM DONUTS INTERNATIONAL, INC., SPRINGFIELD, IL. FILED 11-20-2002.

MEL-O-CREAM SECRET FORMULA DONUTS

NO CLAIM IS MADE TO THE EXCLUSIVE RIGHT TO USE "DONUTS", APART FROM THE MARK AS SHOWN. FOR RESTAURANT SERVICES (U.S. CLS. 100 AND 101).
FIRST USE 0-0-1958; IN COMMERCE 0-0-1973.
DORITT L. CARROLL, EXAMINING ATTORNEY

SN 78-192,761. CARMA, LLC, HALLANDALE, FL. FILED 12-10-2002.



NO CLAIM IS MADE TO THE EXCLUSIVE RIGHT TO USE ARGENTINIAN STYLE STEAK HOUSE, APART FROM THE MARK AS SHOWN.
THE STIPPLING IS FOR SHADING PURPOSES ONLY. THE LINING SHOWN IN THE DRAWING IS A FEATURE OF THE MARK.
FOR RESTAURANT SERVICES (U.S. CLS. 100 AND 101).
KARLA PERKINS, EXAMINING ATTORNEY

CLASS 43—(Continued).

SN 78-206,256. AUTUMN TIME LLC, WILMINGTON, DE. FILED 1-23-2003.

ATLANTA BREAD

OWNER OF U.S. REG. NOS. 2,080,374, 2,524,665 AND OTHERS.
SEC. 2(F).
FOR RESTAURANT SERVICES (U.S. CLS. 100 AND 101).
FIRST USE 9-26-2001; IN COMMERCE 9-26-2001.
MARC LEIPZIG, EXAMINING ATTORNEY

SN 78-213,898. ARBY'S IP HOLDER TRUST, COMPRISING— THE CORPORATE TRUST ADMINISTRATOR, WILMINGTON TRUST COMPANY, A DELAWARE CORPORATION TRUST ORGANIZED UNDER THE LAWS OF DELAWARE, U.S.A., COMPRISING OF THE TRUSTEES OF THE ARBY'S IP HOLDER TRUST, A DELAWARE BUSINESS TRUST, COMPRISING— THE CORPORATE TRUST ADMINISTRATOR, WILMINGTON TRUST COMPANY, A DELAWARE CORPORATION, FT. LAUDERDALE, FL. FILED 2-12-2003.

KICKIN' RANCH DELUXE

FOR RESTAURANT SERVICES (U.S. CLS. 100 AND 101).
MARY CRAWFORD, EXAMINING ATTORNEY

SN 78-220,129. JEFFREY T. FYKES, HAMPTON, VA. AND GILDA D. FYKES, HAMPTON, VA. FILED 2-28-2003.



NO CLAIM IS MADE TO THE EXCLUSIVE RIGHT TO USE HEALTHY, APART FROM THE MARK AS SHOWN.
FOR JUICE BAR SERVICES (U.S. CLS. 100 AND 101).
FIRST USE 1-10-1998; IN COMMERCE 1-10-1998.
MARY ROSSMAN, EXAMINING ATTORNEY

CLASS 43—(Continued).

SN 78-243,450. MOTHERLODE INVESTORS LLC, STOCKTON, CA. FILED 4-29-2003.

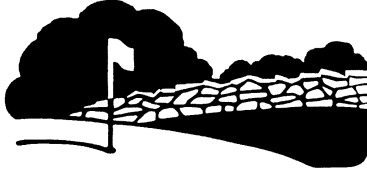

FOR RESORT HOTEL SERVICES; HEALTH RESORT SERVICE, NAMELY, PROVIDING FOOD AND LODGING THAT SPECIALIZE IN PROMOTING PATRONS' GENERAL HEALTH AND WELL-BEING; RESTAURANT AND CATERING SERVICES (U.S. CLS. 100 AND 101).

FIRST USE 4-0-1998; IN COMMERCE 4-0-1998.
DAVID TAYLOR, EXAMINING ATTORNEY

SN 78-244,695. ZC INVESTMENTS, LLC, TUCSON, AZ. FILED 5-1-2003.

SPA CLUB

OWNER OF U.S. REG. NOS. 2,498,670 AND 2,648,362. SEC. 2(F).

FOR HEALTH RESORT AND RESTAURANT SERVICES, NAMELY, PROVIDING FOOD AND LODGING THAT SPECIALIZE IN PROMOTING PATRONS' GENERAL HEALTH AND WELL-BEING (U.S. CLS. 100 AND 101).

FIRST USE 6-30-1999; IN COMMERCE 6-30-1999.
HOWARD SMIGA, EXAMINING ATTORNEY

SN 78-246,044. MAHC, INC., SACRAMENTO, CA. FILED 5-6-2003.

MANDANGO'S

FOR RESTAURANT AND LIQUOR BAR SERVICES (U.S. CLS. 100 AND 101).

FIRST USE 4-1-1996; IN COMMERCE 4-1-1996.
FLORENTINA BLANDU, EXAMINING ATTORNEY

SN 78-246,476. OLIVA ENTERPRISES, INC., LOS ANGELES, CA. FILED 5-7-2003.

CELESTINO

THE FOREIGN WORDING IN THE MARK TRANSLATES INTO ENGLISH AS LITTLE SKY BLUE.

FOR RESTAURANT SERVICES (U.S. CLS. 100 AND 101).

FIRST USE 7-1-1985; IN COMMERCE 7-1-1985.
ROBERT LORENZO, EXAMINING ATTORNEY

CLASS 43—(Continued).

SN 78-250,348. AGNEW, DENNIS, NEW YORK, NY. FILED 5-15-2003.

SMARTOTEL

FOR TRAVEL AGENCY SERVICES, NAMELY, MAKING RESERVATIONS AND BOOKING FOR TEMPORARY LODGING (U.S. CLS. 100 AND 101).
HOWARD SMIGA, EXAMINING ATTORNEY

SN 78-276,626. BMC - THE BENCHMARK MANAGEMENT COMPANY, THE WOODLANDS, TX. FILED 7-21-2003.



NO CLAIM IS MADE TO THE EXCLUSIVE RIGHT TO USE HOTEL, APART FROM THE MARK AS SHOWN. THE LINING IN THE DRAWING IS A FEATURE OF THE MARK.

FOR HOTEL SERVICES (U.S. CLS. 100 AND 101).
KEVON CHISOLM, EXAMINING ATTORNEY

SN 78-283,982. JOHNNY GARLIC'S, INC., SANTA ROSA, CA. FILED 8-6-2003.



NO CLAIM IS MADE TO THE EXCLUSIVE RIGHT TO USE ROCK-N-ROLL SUSHI-BBQ, APART FROM THE MARK AS SHOWN.

THE NAME(S), PORTRAIT(S), AND/OR SIGNATURE(S) SHOWN IN THE MARK DOES NOT IDENTIFY A PARTICULAR LIVING INDIVIDUAL.

FOR RESTAURANT SERVICES (U.S. CLS. 100 AND 101).

FIRST USE 4-30-2002; IN COMMERCE 5-15-2003.
TRACY FLETCHER, EXAMINING ATTORNEY

CLASS 43—(Continued).

SN 78-290,596. JESSIE SMALLS, INC., NEW YORK, NY. FILED 8-21-2003.



NO CLAIM IS MADE TO THE EXCLUSIVE RIGHT TO USE "RESTAURANT & BAR", APART FROM THE MARK AS SHOWN.

FOR RESTAURANT SERVICES FEATURING SOUTHERN AND CARIBBEAN STYLE COOKING (U.S. CLS. 100 AND 101).

FIRST USE 10-0-1997; IN COMMERCE 10-0-1997. JENNIFER CHICOSKI, EXAMINING ATTORNEY

SN 78-290,988. GRAHN, HARLEY, PORTLAND, OR. FILED 8-22-2003.



THE COLOR(S) RED, RED/ORANGE, WHITE AND ORANGE/YELLOW IS/ARE CLAIMED AS A FEATURE OF THE MARK.

THE FOLLOWING IS A DESCRIPTION OF WHERE THE COLORS APPEAR IN THE MARK. THE COFFEE CUP IS RED. THE BACKGROUND IS RED/ORANGE. THE STEAM-SHAPED V IS WHITE. THE TEXT IS ORANGE/YELLOW.

FOR MOBILE ESPRESSO BAR SERVICES (U.S. CLS. 100 AND 101).

FIRST USE 12-13-1992; IN COMMERCE 12-13-1992. DEZMONA MIZELLE, EXAMINING ATTORNEY

SN 78-292,108. ISLAND DREAMS, INC, KEY WEST, FL. FILED 8-26-2003.

MOST FUN INN KEY WEST

NO CLAIM IS MADE TO THE EXCLUSIVE RIGHT TO USE "INN KEY WEST", APART FROM THE MARK AS SHOWN.

FOR BED AND BREAKFAST INN (U.S. CLS. 100 AND 101).

FIRST USE 7-25-2003; IN COMMERCE 4-10-2003. INGRID C. EULIN, EXAMINING ATTORNEY

CLASS 43—(Continued).

SN 78-298,608. BANANA KING CORP., PASSAIC, NJ. FILED 9-10-2003.

BANANA KING

NO CLAIM IS MADE TO THE EXCLUSIVE RIGHT TO USE BANANA, APART FROM THE MARK AS SHOWN.

FOR FAST FOOD RESTAURANT SERVICES AND CARRY OUT RESTAURANT SERVICES (U.S. CLS. 100 AND 101).

FIRST USE 4-0-1993; IN COMMERCE 4-0-1993. TRACY CROSS, EXAMINING ATTORNEY

SN 78-298,647. MY GOODNESS INC, SCOTTSDALE, AZ. FILED 9-10-2003.

LIS DOON VARNA

THE FOREIGN WORDING IN THE MARK TRANSLATES INTO ENGLISH AS FORT OF FAIRY HILL.

FOR HOTEL, MOTEL, SNACK BAR SERVICES, RESTAURANT AND COCKTAIL LOUNGE SERVICES, CATERING SERVICES AND RENTAL OF ROOMS (U.S. CLS. 100 AND 101).

DAVID TAYLOR, EXAMINING ATTORNEY

SN 78-299,347. RUDY'S TEXAS BAR-B-Q, LLC, AUSTIN, TX. FILED 9-11-2003.

REAL TEXAS BAR-B-Q

NO CLAIM IS MADE TO THE EXCLUSIVE RIGHT TO USE "TEXAS BARBECUE", APART FROM THE MARK AS SHOWN.

FOR RESTAURANT, DELICATESSEN AND CATERING SERVICES (U.S. CLS. 100 AND 101).

FIRST USE 6-30-2000; IN COMMERCE 6-30-2000. DANIEL CAPSHAW, EXAMINING ATTORNEY

SN 78-299,869. LEE, TAESUK, CERRITOS, CA. FILED 9-12-2003.



NO CLAIM IS MADE TO THE EXCLUSIVE RIGHT TO USE TOKYO, APART FROM THE MARK AS SHOWN.

FOR JAPANESE RESTAURANT (U.S. CLS. 100 AND 101).

ESTHER BELENKER, EXAMINING ATTORNEY

CLASS 43—(Continued).

SN 78-302,550. WAKE ROBIN, LLC, LAKEVILLE, CT. FILED 9-17-2003.



OWNER OF U.S. REG. NO. 2,784,426.
NO CLAIM IS MADE TO THE EXCLUSIVE RIGHT TO USE "INN" AND "LAKEVILLE CONNECTICUT", APART FROM THE MARK AS SHOWN.

THE LINING AND STIPPLING IS A FEATURE OF THE MARK.

FOR HOTEL AND INN SERVICES, NAMELY, PROVIDING LODGING, RESTAURANT AND PUB SERVICES (U.S. CLS. 100 AND 101).

FIRST USE 2-0-2003; IN COMMERCE 2-0-2003.
MONIQUE MILLER, EXAMINING ATTORNEY

SN 78-305,124. GOODISON, MICHAEL, SHELTER ISLAND, NY. FILED 9-25-2003.

BAREFOOT CHARLIE'S

FOR RESTAURANT SERVICES (U.S. CLS. 100 AND 101).

FIRST USE 6-12-2003; IN COMMERCE 6-12-2003.
KIMBERLY PERRY, EXAMINING ATTORNEY

SN 78-305,162. CALI, PHILIP J., CHICAGO, IL. FILED 9-25-2003.

THE TILTED KILT

FOR RESTAURANT SERVICES; BAR SERVICES (U.S. CLS. 100 AND 101).
LANA PHAM, EXAMINING ATTORNEY

SN 78-306,594. SMOKE & SPICE, HOMESTEAD, FL. FILED 9-29-2003.

SMOKE & SPICE

FOR BARBEQUE RESTAURANT AND BARBEQUE CATERING SERVICES (U.S. CLS. 100 AND 101).
FIRST USE 9-15-2003; IN COMMERCE 9-25-2003.
ZHALEH DELANEY, EXAMINING ATTORNEY

CLASS 43—(Continued).

SN 78-306,651. JESIMO, INC, EAGAN, MN. FILED 9-29-2003.

STEAKBONES

FOR RESTAURANT SERVICES (U.S. CLS. 100 AND 101).

AMY GEARIN, EXAMINING ATTORNEY

SN 78-308,913. KIM, DONG CHUL, PASADENA, CA. FILED 10-3-2003.

KINTARO

THE FOREIGN WORDING IN THE MARK TRANSLATES INTO ENGLISH AS GOLDEN BOY.

FOR JAPANESE SEAFOOD RESTAURANT (U.S. CLS. 100 AND 101).

JEFFREY S. MOLINOFF, EXAMINING ATTORNEY

SN 78-309,035. KUZWIN, LTD., MIDDLETON, WI. FILED 10-3-2003.



SEC. 2(F) AS TO "PANCAKE CAFE".
FOR RESTAURANT SERVICES (U.S. CLS. 100 AND 101).

FIRST USE 3-0-1999; IN COMMERCE 3-0-1999.

JEFFREY S. MOLINOFF, EXAMINING ATTORNEY

SN 78-310,648. BLUMBERG, ROBERT, MENLO PARK, CA. FILED 10-7-2003.

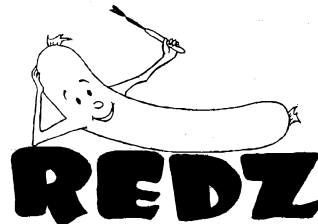

FOR RESTAURANT SERVICES (U.S. CLS. 100 AND 101).

SUSAN HAYASH, EXAMINING ATTORNEY

CLASS 43—(Continued).

SN 78-312,287. LUBCO, INC., SAN ANTONIO, TX. FILED 10-10-2003.

TASTES LIKE TEXAS FEELS LIKE HOME

FOR CAFETERIA AND RESTAURANT SERVICES (U.S. CLS. 100 AND 101).
FIRST USE 9-1-2003; IN COMMERCE 9-1-2003.
JENNIFER KRISP, EXAMINING ATTORNEY

SN 78-313,345. TSUNAMI RESTAURANTS, LLC, LAFAYETTE, LA. FILED 10-14-2003.



FOR RESTAURANT SERVICES (U.S. CLS. 100 AND 101).
FIRST USE 8-31-1999; IN COMMERCE 8-31-1999.
JULIE WATSON, EXAMINING ATTORNEY

SN 78-317,153. HILTON HOSPITALITY, INC., BEVERLY HILLS, CA. FILED 10-22-2003.

FIND THAT LOST WEEKEND

FOR HOTEL SERVICES (U.S. CLS. 100 AND 101).
FIRST USE 3-19-2003; IN COMMERCE 3-19-2003.
DANIEL CAPSHAW, EXAMINING ATTORNEY

SN 78-320,829. NATIONAL PATIENT ASSISTANT PRESCRIPTION GROUP, MORGAN, UT. FILED 10-30-2003.

.08 THE LEGAL LIMIT

FOR BAR AND RESTAURANT SERVICES (U.S. CLS. 100 AND 101).
MATTHEW KLINE, EXAMINING ATTORNEY

CLASS 44—MEDICAL, BEAUTY AND AGRICULTURAL SERVICES

SN 76-380,655. CLINTON, NAHOMA, PRINCETON, NJ. FILED 3-11-2002.

SEEMORG MATRIX WORK

NO CLAIM IS MADE TO THE EXCLUSIVE RIGHT TO USE "MATRIX WORK", APART FROM THE MARK AS SHOWN.

THE WORD "SEEMORG" IS AN ENGLISH PHONETIC SPELLING OF A FARSI WORD MEANING "THIRTY BIRDS".

FOR PSYCHOLOGICAL COUNSELING SERVICES (U.S. CLS. 100 AND 101).

FIRST USE 3-20-2001; IN COMMERCE 5-9-2001.
JULIA HARDY COFIELD, EXAMINING ATTORNEY

SN 76-412,830. A NEW YOU SKIN AND BODY CLINIC, LLC, WOODSTOCK, GA. FILED 5-22-2002.



NO CLAIM IS MADE TO THE EXCLUSIVE RIGHT TO USE "SKIN AND BODY CLINIC", APART FROM THE MARK AS SHOWN.

FOR MEDICAL SERVICES, NAMELY, MEDICAL AESTHETICS AND MEDICAL COSMETICS SERVICES (U.S. CLS. 100 AND 101).

FIRST USE 1-0-2002; IN COMMERCE 1-0-2002.
SUSAN STIGLITZ, EXAMINING ATTORNEY

SN 76-446,948. ONKEN, DEBORAH S., DBA FAMILY SYNTHESIS INSTITUTE, CLAYTON, MO. FILED S.R. 9-5-2002; AM. P.R. 2-19-2003.

FAMILY SYNTHESIS INSTITUTE

NO CLAIM IS MADE TO THE EXCLUSIVE RIGHT TO USE "FAMILY" AND "INSTITUTE", APART FROM THE MARK AS SHOWN.

FOR PSYCHOLOGICAL COUNSELING SERVICES (U.S. CLS. 100 AND 101).

FIRST USE 5-24-1988; IN COMMERCE 6-16-1992.
SAMUEL E. SHARPER JR., EXAMINING ATTORNEY

CLASS 44—(Continued).

SN 76-485,483. ASSOCIATION OF PROGRAM DIRECTORS IN ENDOCRINOLOGY, DIABETES & METABOLISM, AKA APDEM, BETHESDA, MD. FILED 1-28-2003.

APDEM

FOR INFORMATION SERVICES, NAMELY PROVIDING INFORMATION IN THE FIELDS OF ENDOCRINOLOGY, DIABETES AND METABOLISM (U.S. CLS. 100 AND 101).

FIRST USE 10-2-1996; IN COMMERCE 10-2-1996.
SUSAN STIGLITZ, EXAMINING ATTORNEY

CLASS 44—(Continued).

SN 76-501,052. NGUYEN, THAI, TACOMA, WA. AND NGUYEN, AUDREY, TACOMA, WA. FILED 3-26-2003.



NO CLAIM IS MADE TO THE EXCLUSIVE RIGHT TO USE "EXCELLENT DENTAL CARE CENTER", APART FROM THE MARK AS SHOWN.

A DESIGN OF A THUMB-UP IN LETTER "D" WITH SNOWING MOUNTAINS, TREES, AND LAKE WITH WORDS EXCELLENT DENTAL CARE CENTER.

FOR DENTAL SERVICES, NAMELY, DENTIST SERVICES, COSMETIC DENTISTRY AND ORTHODONTICS (U.S. CLS. 100 AND 101).

FIRST USE 12-31-2002; IN COMMERCE 12-31-2002.
WILLIAM VERHOSEK, EXAMINING ATTORNEY

SN 76-499,706. WASHINGTON BRAIN & SPINE INSTITUTE, P.C., BETHESDA, MD. FILED 3-24-2003.



NO CLAIM IS MADE TO THE EXCLUSIVE RIGHT TO USE "IMAGING", APART FROM THE MARK AS SHOWN.

FOR MEDICAL SERVICES AND MEDICAL TESTING, NAMELY, RADIOGRAPHIC IMAGING AND ENHANCEMENT SERVICES, NAMELY, CONVERSION OF IMAGES AND DATA FROM CAT SCANS, MRI, AND SIMILAR PROCEDURES INTO THREE-DIMENSIONAL IMAGES FOR MEDICAL DIAGNOSIS AND MEDICAL CONSULTATION (U.S. CLS. 100 AND 101).

FIRST USE 9-1-2002; IN COMMERCE 10-1-2002.
SAMUEL E. SHARPER JR., EXAMINING ATTORNEY

SN 76-507,431. THE MAGIC FOUNDATION, OAK PARK, IL. FILED 3-31-2003.

SN 76-500,263. BATCHELOR, LIN I., HAMPTON, VA. AND BATCHELOR, CARLA H., HAMPTON, VA. FILED 3-24-2003.

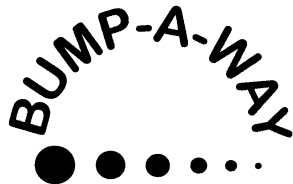

FOR PROVIDING FOR HYGIENIC AND BEAUTY CARE FOR HUMAN BEINGS OR ANIMALS (U.S. CLS. 100 AND 101).

FIRST USE 6-1-2001; IN COMMERCE 2-1-2003.
CAROLYN CATALDO, EXAMINING ATTORNEY



NO CLAIM IS MADE TO THE EXCLUSIVE RIGHT TO USE MEDICAL CLINIC, APART FROM THE MARK AS SHOWN.

FOR MEDICAL SERVICES, NAMELY, DIAGNOSIS AND TREATMENT OF GROWTH DEFICIENCIES ESPECIALLY RELATED TO CHILDREN (U.S. CLS. 100 AND 101).

MICHAEL KAZAZIAN, EXAMINING ATTORNEY

CLASS 44—(Continued).

SN 76-508,604. MALE REPRODUCTIVE CLINIC, P.A., HOUSTON, TX. FILED 4-22-2003.

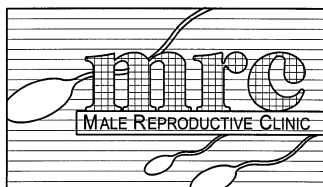

NO CLAIM IS MADE TO THE EXCLUSIVE RIGHT TO USE "MALE REPRODUCTIVE CLINIC", APART FROM THE MARK AS SHOWN.

THE DRAWING IS LINED FOR THE COLOR(S) BLUE AND YELLOW.

FOR MEDICAL SERVICES, NAMELY, MALE FERTILITY DIAGNOSTIC METHODS, MALE INFERTILITY MEDICAL TREATMENT OPTIONS, VASECTOMY, VASECTOMY REVERSAL, SEMEN ANALYSIS, SPERM PROCESSING FOR INTRAUTERINE INSEMINATION, CYROPRESERVATION OF SPERM AND SPERM BANKING (U.S. CLS. 100 AND 101).

FIRST USE 10-0-2000; IN COMMERCE 11-0-2000.
PATRICIA EVANKO, EXAMINING ATTORNEY

SN 76-535,853. ROTONDO, ROBERT, PROVIDENCE, RI. FILED 7-24-2003.

WHERE BEAUTY SPRINGS ETERNAL

FOR BEAUTY AND SKIN CARE SALONS; MASSAGE THERAPY SERVICES; AND DAY HEALTH SPA SERVICES, NAMELY, COSMETIC BODY CARE SERVICES FEATURING TREATMENTS FOR SKIN, SCALP AND BODY (U.S. CLS. 100 AND 101).

GIANCARLO CASTRO, EXAMINING ATTORNEY

SN 76-538,089. PHOENIX INTANGIBLES HOLDING COMPANY, GREENVILLE, DE. FILED 8-18-2003.

COMFORT CALL

NO CLAIM IS MADE TO THE EXCLUSIVE RIGHT TO USE "CALL", APART FROM THE MARK AS SHOWN.

FOR PHARMACY SERVICES, NAMELY, PHARMACEUTICAL ADVICE PROVIDED BY TELEPHONE TO CUSTOMERS PURCHASING PHARMACEUTICAL PRODUCTS (U.S. CLS. 100 AND 101).

BARBARA GAYNOR, EXAMINING ATTORNEY

CLASS 44—(Continued).

SN 76-539,143. TENET CHOICES, INC., NEW ORLEANS, LA. FILED 7-22-2003.

EXCELLENCE THROUGH EXPERIENCE

FOR HEALTH CARE IN THE NATURE OF HEALTH MAINTENANCE ORGANIZATION (U.S. CLS. 100 AND 101).

TANYA AMOS, EXAMINING ATTORNEY

SN 76-540,845. SHEIBANI-RAD, S. SHANE, LOS ANGELES, CA. FILED 8-15-2003.

NEW ME PRICE GUARANTEE WE BEAT ANY COMPETITOR'S PRICE ON IDENTICAL QUALITY PROCEDURE

OWNER OF U.S. REG. NOS. 2,595,297 AND 2,669,873.

NO CLAIM IS MADE TO THE EXCLUSIVE RIGHT TO USE PRICE GUARANTEE WE BEAT ANY COMPETITOR'S PRICE ON IDENTICAL QUALITY PROCEDURE, APART FROM THE MARK AS SHOWN.

FOR MEDICAL SERVICES, MEDICAL COUNSELING, AND PROVIDING MEDICAL INFORMATION, ALL RELATED TO COSMETIC SURGERY (U.S. CLS. 100 AND 101).

LINDA M. KING, EXAMINING ATTORNEY

SN 76-541,224. STEPHEN TASSONE, DDS, INC., TORRANCE, CA. FILED 8-19-2003.

NEW SMILES DENTISTRY

NO CLAIM IS MADE TO THE EXCLUSIVE RIGHT TO USE "DENTISTRY", APART FROM THE MARK AS SHOWN.

FOR DENTIST SERVICES (U.S. CLS. 100 AND 101).

FIRST USE 5-1-1990; IN COMMERCE 5-1-1990.

DORITT L. CARROLL, EXAMINING ATTORNEY

SN 76-546,404. IDENTITY SOLUTIONS, LLC, GREENSBORO, NC. FILED 9-23-2003.

IDENTITY SOLUTIONS

FOR PATERNITY TESTING AND OTHER DNA IDENTITY TESTING (U.S. CLS. 100 AND 101).

FIRST USE 8-1-2003; IN COMMERCE 8-1-2003.

MARGERY A. TIERNEY, EXAMINING ATTORNEY

CLASS 44—(Continued).

SN 76-549,467. THE SURROGACY CENTER LLC, MADISON, WI. FILED 9-17-2003.



NO CLAIM IS MADE TO THE EXCLUSIVE RIGHT TO USE "SURROGACY CENTER", APART FROM THE MARK AS SHOWN.

FOR PROVIDING COUNSELING, SCREENING AND MATCHING SERVICES FOR POTENTIAL GESTATIONAL CARRIERS, SURROGATES AND PEOPLE CREATING A FAMILY THROUGH ASSISTED REPRODUCTIVE TECHNOLOGY (U.S. CLS. 100 AND 101).

FIRST USE 12-1-2002; IN COMMERCE 12-1-2002.
KELLY BOULTON, EXAMINING ATTORNEY

SN 76-550,454. FAZZIO, FRANK J., JR., KUNA, ID. FILED 10-9-2003.

PERFECT LEGS

NO CLAIM IS MADE TO THE EXCLUSIVE RIGHT TO USE "LEGS", APART FROM THE MARK AS SHOWN.

FOR MEDICAL CLINIC FOR LEG VEIN CARE/SALON FOR LEG SKIN CARE (U.S. CLS. 100 AND 101).

ALEX KEAM, EXAMINING ATTORNEY

SN 76-552,235. TURF MANAGEMENT SYSTEMS INC., MISSISSAUGA, ONTARIO, CANADA, FILED 9-29-2003.

WEED MAN PROMISES KEPT

OWNER OF U.S. REG. NO. 1,125,439.
FOR LAWN CARE SERVICES, NAMELY, SPRAYING WEEDS, SOIL FERTILIZING AND CONDITIONING, MOTH CONTROL, AERATION AND POWER RAKING (U.S. CLS. 100 AND 101).

PAULA MAYS, EXAMINING ATTORNEY

CLASS 44—(Continued).

SN 76-557,456. UNIVERSITY HOSPITALS HEALTH SYSTEM, INC., CLEVELAND, OH. FILED 10-23-2003.



OWNER OF U.S. REG. NO. 1,388,649.
NO CLAIM IS MADE TO THE EXCLUSIVE RIGHT TO USE "SURGICAL SPECIALISTS", APART FROM THE MARK AS SHOWN.

THE STIPLING IN THE DRAWING IS FOR SHADING PURPOSES ONLY AND DOES NOT REPRESENT COLOR.

FOR SURGICAL SERVICES FOR INFANTS AND CHILDREN (U.S. CLS. 100 AND 101).

FIRST USE 9-0-2003; IN COMMERCE 9-0-2003.
DAVID H. STINE, EXAMINING ATTORNEY

SN 78-184,606. MRI MOBILE LIMITED PARTNERSHIP, BOISE, ID. FILED 11-13-2002.



SEC. 2(F).
FOR PROVIDING MAGNETIC RESONANCE IMAGING SERVICES (U.S. CLS. 100 AND 101).

FIRST USE 8-10-1988; IN COMMERCE 10-28-1988.
KAREN K. BUSH, EXAMINING ATTORNEY

SN 78-205,057. MEDTRONIC, INC., MINNEAPOLIS, MN. FILED 1-20-2003.



SPINE TRAUMA STUDY GROUP

NO CLAIM IS MADE TO THE EXCLUSIVE RIGHT TO USE "SPINE TRAUMA STUDY GROUP", APART FROM THE MARK AS SHOWN.

FOR PROVIDING MEDICAL INFORMATION IN THE FIELD OF SPINAL SURGERY TO SPINAL MEDICAL PROFESSIONALS (U.S. CLS. 100 AND 101).

STANLEY I. OSBORNE, EXAMINING ATTORNEY

CLASS 44—(Continued).

SN 78-230,420. HURWITZ, ROBERT, S., NEWPORT BEACH, CA. FILED 3-26-2003.



BabyScan

FOR MEDICAL IMAGING SERVICES IN THE NATURE OF 3-D ULTRASOUND IMAGES OF MOTHERS-TO-BE (U.S. CLS. 100 AND 101).
ANDREW BENZMILLER, EXAMINING ATTORNEY

SN 78-236,787. THE VEIN AND AESTHETIC CENTER OF BOSTON, INC., EAST WALPOLE, MA. FILED 4-11-2003.

THE BEAUTY OF MEDICAL TECHNOLOGY

FOR MEDICAL SERVICES, NAMELY LASER TREATMENT FOR VEINS AND FACIAL AESTHETIC TREATMENTS (U.S. CLS. 100 AND 101).
FIRST USE 2-15-2003; IN COMMERCE 2-15-2003.
CATHERINE CAIN, EXAMINING ATTORNEY

SN 78-266,340. LIPPSETT, STUART A., BRICK, NJ. FILED 6-24-2003.

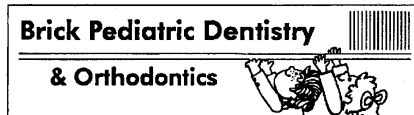

NO CLAIM IS MADE TO THE EXCLUSIVE RIGHT TO USE "BRICK PEDIATRIC DENTISTRY & ORTHODONTICS", APART FROM THE MARK AS SHOWN.
FOR DENTIST SERVICES (U.S. CLS. 100 AND 101).
FIRST USE 10-1-2002; IN COMMERCE 10-1-2002.
ELLEN B. AWRICH, EXAMINING ATTORNEY

CLASS 44—(Continued).

SN 78-290,677. SAM S. SIMOS, DDS, P.C., MARSEILLES, IL. FILED 8-21-2003.



FOR DENTIST SERVICES; COSMETIC DENTISTRY; RESTORATIVE DENTISTRY (U.S. CLS. 100 AND 101).
FIRST USE 9-1-2001; IN COMMERCE 9-1-2001.
ELLEN B. AWRICH, EXAMINING ATTORNEY

SN 78-300,665. DIVING MEDICAL SERVICES, LTD., NASSAU, BAHAMAS, FILED 9-15-2003.

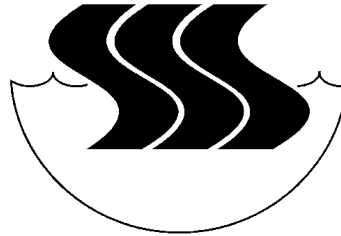

FOR RECOMPRESSION SERVICES, NAMELY, PROVIDING DIVERS WITH RECOMPRESSION TREATMENT IN A HYPERBARIC CHAMBER FOR TREATING PRESSURE RELATED INJURIES SUCH AS DECOMPRESSION SICKNESS AND ARTERIAL GAS EMBOLISMS (U.S. CLS. 100 AND 101).
PAUL F. GAST, EXAMINING ATTORNEY

SN 78-303,115. GOLDSTEIN, STEVEN, H, SCOTTSDALE, AZ. FILED 9-20-2003.

EVERYTHING MATTERS

FOR DENTIST SERVICES (U.S. CLS. 100 AND 101).
FIRST USE 9-1-2003; IN COMMERCE 9-1-2003.
JERI J. FICKES, EXAMINING ATTORNEY

CLASS 44—(Continued).

SN 78-304,548. INFLEXION, INC., NEWTON, MA. FILED 9-24-2003.

TECHNOLOGY ENHANCED ADHD MANAGEMENT

NO CLAIM IS MADE TO THE EXCLUSIVE RIGHT TO USE ADHD MANAGEMENT, APART FROM THE MARK AS SHOWN.

FOR PROVIDING AN INTERACTIVE WEB SITE ON THE GLOBAL COMPUTER NETWORK FEATURING MEDICAL INFORMATION IN THE FIELD OF ATTENTION DEFICIT HYPERACTIVITY DISORDER (ADHD), FOR HEALTH CARE CLINICIANS (U.S. CLS. 100 AND 101).

ESTHER BELENKER, EXAMINING ATTORNEY

SN 78-304,553. INFLEXION, INC., NEWTON, MA. FILED 9-24-2003.

PAINACTION

FOR PROVIDING A WEB SITE ON THE GLOBAL COMPUTER NETWORK IN THE FIELD OF PAIN MANAGEMENT (U.S. CLS. 100 AND 101).

ESTHER BELENKER, EXAMINING ATTORNEY

SN 78-306,071. HAZELDEN FOUNDATION, CENTER CITY, MN. FILED 9-26-2003.

UNMASK THE STIGMA

FOR REHABILITATION CARE OF CHEMICALLY DEPENDENT PEOPLE (U.S. CLS. 100 AND 101).

TRICIA SONNEBORN, EXAMINING ATTORNEY

SN 78-306,759. PIONEER HI-BRED INTERNATIONAL, INC., DES MOINES, IA. FILED 9-29-2003.

UPSHOT

FOR AGRICULTURAL CONSULTING SERVICES (U.S. CLS. 100 AND 101).

JENNIFER CHICOSKI, EXAMINING ATTORNEY

SN 78-309,217. VEDDER, THOMAS J, NEWBERRY, FL. FILED 10-3-2003.

FULL MOON ARABIANS

NO CLAIM IS MADE TO THE EXCLUSIVE RIGHT TO USE "ARABIANS", APART FROM THE MARK AS SHOWN. FOR BREEDING OF PUREBRED ARABIAN, HALF ARABIAN, AND ARABIAN SPORT HORSES (U.S. CLS. 100 AND 101).

KHANH LE, EXAMINING ATTORNEY

CLASS 44—(Continued).

SN 78-309,947. FREESPEECH, INC., FULLERTON, CA. FILED 10-6-2003.

FREESPEECH, INC. A GIFT TO OUR CHILDREN

NO CLAIM IS MADE TO THE EXCLUSIVE RIGHT TO USE "INC", APART FROM THE MARK AS SHOWN.

FOR SPEECH THERAPY SERVICES (U.S. CLS. 100 AND 101).

BRIAN NEVILLE, EXAMINING ATTORNEY

SN 78-313,363. VISICU, INC., BALTIMORE, MD. FILED 10-14-2003.

CULTURE OF QUALITY

FOR MEDICAL SERVICES, NAMELY, PROVIDING CLINICAL AND PATIENT CARE SERVICES IN INTENSIVE CARE UNITS AND OPERATING ROOM UNITS (U.S. CLS. 100 AND 101).

JULIE WATSON, EXAMINING ATTORNEY

CLASS 45—PERSONAL SERVICES

SN 76-502,570. POTOMAC RIDGE BEHAVIORAL HEALTH, INC., ROCKVILLE, MD. FILED 3-31-2003.

OPERATION RUNAWAY

NO CLAIM IS MADE TO THE EXCLUSIVE RIGHT TO USE "RUNAWAY", APART FROM THE MARK AS SHOWN. SEC. 2(F).

FOR TELEPHONE CONSULTING AND COUNSELING SERVICES FOR THOSE CHILDREN, OR TEENAGERS, WHO HAVE RUN AWAY FROM HOME, OR ARE CONSIDERING RUNNING AWAY FROM HOME (U.S. CLS. 100 AND 101).

FIRST USE 9-0-1991; IN COMMERCE 9-0-1991.

GLENN CLARK, EXAMINING ATTORNEY

SN 76-518,822. JON RANGLES EVANGELISTIC ASSOCIATION, MCKINNEY, TX. FILED 6-2-2003.

PARADIGM BIBLE STUDY

NO CLAIM IS MADE TO THE EXCLUSIVE RIGHT TO USE "BIBLE STUDY", APART FROM THE MARK AS SHOWN.

FOR EVANGELISTIC AND MINISTERIAL SERVICES (U.S. CLS. 100 AND 101).

FIRST USE 9-1-1997; IN COMMERCE 9-1-1997.

CURTIS FRENCH, EXAMINING ATTORNEY

CLASS 45—(Continued).

SN 76-530,616. COUNTY OF LOS ANGELES SHERIFF'S DEPARTMENT, MONTEREY PARK, CA. FILED 7-17-2003.

LOS ANGELES COUNTY SHERIFF'S DEPARTMENT

OWNER OF U.S. REG. NO. 2,627,597.
 NO CLAIM IS MADE TO THE EXCLUSIVE RIGHT TO USE "SHERIFF'S DEPARTMENT", APART FROM THE MARK AS SHOWN.
 SEC. 2(F).
 FOR POLICE AND CIVIL PROTECTION SERVICES (U.S. CLS. 100 AND 101).
 FIRST USE 0-0-1850; IN COMMERCE 0-0-1850.
 RONALD MCMORROW, EXAMINING ATTORNEY

SN 76-534,862. APPINTELL, INC., WELDON SPRINGS, MO. FILED 8-4-2003.

APPELL

FOR FRAUD DETECTION AND DATA INTEGRITY VERIFICATION SERVICES FOR THIRD PARTIES IN LOAN PROCESSING (U.S. CLS. 100 AND 101).
 GWEN STOKOLS, EXAMINING ATTORNEY

SN 76-551,319. CAHILL, TEENA L., PRINCETON, NJ. FILED 10-10-2003.

WISDOM...AND BEYOND

FOR PROVIDING INFORMATION IN THE FIELD OF SELF IMPROVEMENT (U.S. CLS. 100 AND 101).
 FIRST USE 2-1-2003; IN COMMERCE 9-30-2003.
 JOHN DALIER, EXAMINING ATTORNEY

SN 78-198,190. SAVE THE WORLD FOUNDATION, JOHANNESBURG, GAUTENG, SOUTH AFRICA, FILED 12-27-2002.



NO CLAIM IS MADE TO THE EXCLUSIVE RIGHT TO USE "FOUNDATION", APART FROM THE MARK AS SHOWN.
 FOR EVANGELISTIC AND MINISTERIAL SERVICES; MISSIONARY SERVICES; MINISTERIAL COUNSELING (U.S. CLS. 100 AND 101).
 MICHAEL KEATING, EXAMINING ATTORNEY

CLASS 45—(Continued).

SN 78-205,124. FULL SPECTRUM COMMUNICATIONS, INC., CLEARWATER, FL. FILED 1-20-2003.

DIAL-A-MATE "THE DISCREET WAY TO MEET"

FOR DATING, MATCHMAKING AND SOCIAL INTRODUCTION SERVICES OFFERED BY MEANS OF TELEPHONE AND THE GLOBAL COMPUTER NETWORK (U.S. CLS. 100 AND 101).
 KARLA PERKINS, EXAMINING ATTORNEY

SN 78-210,137. VIRTUAL SECURITY CORPORATION, WEST PALM BEACH, FL. FILED 2-3-2003.

VIRTUAL GUARD

NO CLAIM IS MADE TO THE EXCLUSIVE RIGHT TO USE "GUARD", APART FROM THE MARK AS SHOWN.
 FOR PROVIDING GATE AND PREMISE SECURITY MONITORING (U.S. CLS. 100 AND 101).
 KARLA PERKINS, EXAMINING ATTORNEY

SN 78-212,046. GATE SAFE, INC., COLLEGE PARK, GA. FILED 2-7-2003.

GATE SAFE, INC.

NO CLAIM IS MADE TO THE EXCLUSIVE RIGHT TO USE "INC.", APART FROM THE MARK AS SHOWN.
 FOR SECURITY GUARD SERVICES, SPECIFICALLY VALIDATION AND MONITORING OF AIRCRAFT CATERING SECURITY AND RAMP SECURITY IN AIRPORTS (U.S. CLS. 100 AND 101).
 FIRST USE 10-12-2001; IN COMMERCE 10-12-2001.
 ALICIA COLLINS, EXAMINING ATTORNEY

SN 78-236,095. HUNTLEIGH TECHNOLOGY PLC, LUTON, UNITED KINGDOM, FILED 4-10-2003.

INSIGHT

PRIORITY CLAIMED UNDER SEC. 44(D) ON UNITED KINGDOM APPLICATION NO. 2316583, FILED 11-23-2002, REG. NO. 2316583, DATED 9-5-2003, EXPIRES 11-23-2012.
 FOR ELECTRONIC MONITORING SERVICES THAT MONITOR THE PHYSICAL ENVIRONMENT OF AT-RISK PERSONS FOR HEALTH AND SOCIAL REASONS AND REACT TO SITUATIONS WITHIN THE ENVIRONMENT AND TO THE ACTIVITIES OF THE OCCUPANTS IN ORDER TO MINIMISE RISK TO THE OCCUPANTS AND TO THE ENVIRONMENT (U.S. CLS. 100 AND 101).
 AMY HELLA, EXAMINING ATTORNEY

CLASS 45—(Continued).

SN 78-264,989. TABLE FOR EIGHT, L.L.C., ROYAL OAK, MI. FILED 6-20-2003.

QUICK SPARK

NO CLAIM IS MADE TO THE EXCLUSIVE RIGHT TO USE QUICK, APART FROM THE MARK AS SHOWN.

FOR SOCIAL INTRODUCTION DATING SERVICES, NAMELY THOSE INVOLVING LARGE NUMBERS OF INDIVIDUALS MEETING IN COMPRESSED TIME SPANS (U.S. CLS. 100 AND 101).

FIRST USE 6-1-2001; IN COMMERCE 6-1-2001.
AMY ALFIERI, EXAMINING ATTORNEY

SN 78-284,678. THE NAVIGATORS, COLORADO SPRINGS, CO. FILED 8-7-2003.



FOR EVANGELISTIC MINISTERIAL SERVICES, NAMELY, PROMOTING THE CHRISTIAN RELIGION (U.S. CLS. 100 AND 101).

FIRST USE 2-1-2001; IN COMMERCE 2-1-2001.
STACY WAHLBERG, EXAMINING ATTORNEY

SN 78-298,790. IDEFENSE, INC., RESTON, VA. FILED 9-10-2003.

IDEFENSE 

OWNER OF U.S. REG. NOS. 2,589,336 AND 2,663,549.
FOR SECURITY SERVICES, NAMELY, SECURITY RISK AND THREAT MANAGEMENT IN THE FIELD OF THE SECURITY OF, AND VULNERABILITY TO BREACHES AND HACKING OF, COMPUTER AND ELECTRONIC INFORMATION INFRASTRUCTURE; AND PROVIDING INFORMATION IN THE FIELD OF THE SECURITY OF, AND VULNERABILITY TO BREACHES AND HACKING OF, COMPUTER AND ELECTRONIC INFORMATION INFRASTRUCTURE IN THE NATURE OF ELECTRONIC REPORTS AND THREAT ALERT NOTICES VIA A GLOBAL COMPUTER NETWORK (U.S. CLS. 100 AND 101).

ROBERT LORENZO, EXAMINING ATTORNEY

CLASS 45—(Continued).

SN 78-302,672. INVESTIGATION TECHNOLOGIES, LLC, MEMPHIS, TN. FILED 9-19-2003.

rapsheets 

NO CLAIM IS MADE TO THE EXCLUSIVE RIGHT TO USE RAPSHEETS, APART FROM THE MARK AS SHOWN, FOR CRIMINAL RECORDS DATA PROVIDED VIA THE INTERNET FOR INVESTIGATION AND EMPLOYMENT PURPOSES (U.S. CLS. 100 AND 101).

FIRST USE 6-16-2003; IN COMMERCE 8-1-2003.
MARGERY A. TIERNEY, EXAMINING ATTORNEY

SN 78-303,245. LIU, FANG-CHOU, AKA FANG-JOU, SAN JOSE, CA. FILED 9-21-2003.

LOOKS.TV

FOR ONLINE DATING SERVICES VIA A GLOBAL COMPUTER NETWORK (U.S. CLS. 100 AND 101).

INGRID C. EULIN, EXAMINING ATTORNEY

SN 78-303,296. INVESTIGATIVE CONSULTANTS, INC., WASHINGTON, DC. FILED 9-22-2003.

SONAR

FOR INVESTIGATIVE SERVICES, NAMELY, BACKGROUND SEARCHES AND OTHER PRIVATE INVESTIGATIONS VIA A GLOBAL COMPUTER NETWORK (U.S. CLS. 100 AND 101).

INGRID C. EULIN, EXAMINING ATTORNEY

SN 78-303,298. INVESTIGATIVE CONSULTANTS, INC., WASHINGTON, DC. FILED 9-22-2003.

INTENSE RAY

FOR INVESTIGATIVE SERVICES, NAMELY, BACKGROUND SEARCHES AND OTHER PRIVATE INVESTIGATIONS VIA A GLOBAL COMPUTER NETWORK (U.S. CLS. 100 AND 101).

INGRID C. EULIN, EXAMINING ATTORNEY

JUNE 29, 2004

U.S. PATENT AND TRADEMARK OFFICE

TM 489

CLASS 45—(Continued).

SN 78-304,156. TEMPLE OF FREEDOM, INC., SANTA ROSA,
CA. FILED 9-23-2003.

TOF

FOR PROVIDING AN ONLINE COMPUTER DATA-
BASE IN THE FIELD OF EVANGELISTIC AND MINIS-
TERIAL SERVICES, NAMELY INFORMATION
REGARDING RELIGIOUS OR SPIRITUAL PRACTICES
AND BELIEFS (U.S. CLS. 100 AND 101).
FIRST USE 7-23-2003; IN COMMERCE 7-23-2003.
MICHAEL WEBSTER, EXAMINING ATTORNE

* * * * *

SECTION 4.—PRIOR UNITED STATES CLASSIFICATION

APPLICATION IN ONE CLASS

COLLECTIVE MEMBERSHIP MARKS

CLASS 200—COLLECTIVE MEMBERSHIP
SN 76-529,350. JUNIOR CHAMBER INTERNATIONAL,
INC., CHESTERFIELD, MO. FILED 7-14-2003.



OWNER OF U.S. REG. NO. 865,535.
THE MARK CONSISTS OF THE TERM JCI AND A
SHIELD DEPICTING A STYLIZED REPRESENTATION OF
A GLOBE.

FOR INDICATING MEMBERSHIP IN APPLICANT
ORGANIZATION, WHICH IS AN ASSOCIATION OF
YOUNG LEADERS AND ENTREPRENEURS.

FIRST USE 4-1-2003; IN COMMERCE 4-1-2003.
TRACY FLETCHER, EXAMINING ATTORNEY

CERTIFICATION MARKS

CLASS A—GOODS

SN 76-485,331. CONSORZIO DEL CULATELLO DI ZIBELLO,
10 43010 ZIBELLO (PARMA), ITALY, FILED 1-27-2003.



OWNER OF ERPN CMNTY TM OFC REG. NO. 000813584,
DATED 11-14-2001, EXPIRES 4-9-2008.

THE ENGLISH TRANSLATION OF "DI ZIBELLO" IS "OF
ZIBELLO". THE ENGLISH TRANSLATION OF "CONSOR-
ZIO DEL CULATELLO OF ZIBELLO" IS "UNDER THE
CUSTODY OF THE CONSORTIUM FOR CULATELLO OF
ZIBELLO".

THE CERTIFICATION MARK, AS INTENDED TO BE
USED BY PERSONS AUTHORIZED BY APPLICANT, WILL
CERTIFY THAT THE GOODS ORIGINATE IN THE PARMA
PROVINCE OF ITALY, SPECIFICALLY THE ZONE COM-
PRISING OF THE TERRITORY OF THE COMMUNES OF
POLESINE, ZIBELLO BUSSETO, SORAGNA, ROCCABIAN-
CA, SAN SECONDO, SISSA AND COLORNO.
FOR CULATELLO HAM.
MARK T. MULLEN, EXAMINING ATTORNEY

CLASS B—SERVICES

SN 76-474,787. MICROBITEC CORPORATION, VANCOU-
VER BRITISH COLUMBIA, CANADA, FILED 12-9-2002.



PRIORITY CLAIMED UNDER SEC. 44(D) ON CANADA
APPLICATION NO. 1,147,872, FILED 7-24-2002, REG. NO.
TMA601268, DATED 2-3-2004, EXPIRES 2-3-2019.

NO CLAIM IS MADE TO THE EXCLUSIVE RIGHT TO
USE "CORPORATION" AND "BEVERAGE CERTIFICA-
TION PROGRAM", APART FROM THE MARK AS SHOWN.

THE SERVICES TO BE PERFORMED IN CONNECTION
WITH THE CERTIFICATION MARK, AS INTENDED TO BE
USED BY AUTHORIZED PERSONS, CERTIFIES THAT THE
SERVICES RENDERED IN CONNECTION WITH SANITIZ-
ING, DISINFECTING AND MAINTAINING BEVERAGE
DISPENSING EQUIPMENT INCLUDING, BUT NOT LIM-
ITED TO GLASS WASHERS, BEVERAGE LINES, AND ICE
MACHINES ARE IN COMPLIANCE WITH FEDERAL AND
LOCAL REGULATIONS AND OTHERWISE COMPORT
WITH HIGH STANDARDS OF HYGIENE.

FOR SANITIZING, DISINFECTING AND MAINTAIN-
ING BEVERAGE DISPENSING EQUIPMENT, INCLUD-
ING BUT NOT LIMITED TO GLASS WASHERS,
BEVERAGE LINES AND ICE MACHINES.

GEOFFREY FOSDICK, EXAMINING ATTORNEY

SN 76-505,214. AMERICAN ASSOCIATION OF PROFES-
SIONAL LANDMEN, FORT WORTH, TX. FILED 4-2-
2003.

RL

JUNE 29, 2004

U.S. PATENT AND TRADEMARK OFFICE

TM 491

THE CERTIFICATION MARK INTENDED TO BE USED
BY AUTHORIZED PERSONS, INTENDS TO CERTIFY
PETROLEUM LANDMEN WHO MEET CERTAIN RE-
QUIREMENTS FOR SAID CERTIFICATION.

STEVEN BERK, EXAMINING ATTORNE

FOR CERTIFICATION MARK USED TO IDENTIFY
PETROLEUM LANDMEN WHO MEET CERTAIN RE-
QUIREMENTS FOR SAID CERTIFICATION.

* * * * *

TRADEMARK REGISTRATIONS ISSUED

PRINCIPAL REGISTER

SECTION 1.— INTERNATIONAL CLASSIFICATION

The short titles associated below with the international class numbers are terms designed merely for quick identification and are not an official part of the international classification. The full names of international classes are given in section 6.1 of the trademark rules of practice.

The designation "U.S. Cl." appearing in this section refers to the U.S. class in effect prior to Sep. 1, 1973 rather than the international class which applies to applications filed on or after that date. For adoption of international classification see notice in the OFFICIAL GAZETTE of Jun. 26, 1973 (911 O.G. TM 210).

CLASS 1—CHEMICALS

- 2,857,116. **CO.DON AND DESIGN.** CO.DON GMBH, MULTIPLE CLASS, (INT. CLS. 1, 5 AND 9), (U.S. CLS. 1, 5, 6, 10, 18, 21, 23, 26, 36, 38, 44, 46, 51 AND 52). SN 75-367,523. PUB. 2-11-2003. FILED 10-3-1997.
- 2,857,152. **DOMINATOR.** BIO HUMA NETICS, INC., (U.S. CLS. 1, 5, 6, 10, 26 AND 46). SN 76-100,368. PUB. 4-6-2004. FILED 7-31-2000.
- 2,857,158. **VINYLOOP.** SOLVAY (SOCIETE ANONYME), MULTIPLE CLASS, (INT. CLS. 1, 40 AND 42), (U.S. CLS. 1, 5, 6, 10, 26, 46, 100, 101, 103 AND 106). SN 76-136,072. PUB. 4-6-2004. FILED 9-22-2000.
- 2,857,161. **STEMSIL.** CELLON S.A., MULTIPLE CLASS, (INT. CLS. 1, 5, 9 AND 10), (U.S. CLS. 1, 5, 6, 10, 18, 21, 23, 26, 36, 38, 39, 44, 46, 51 AND 52). SN 76-149,376. PUB. 4-6-2004. FILED 10-18-2000.
- 2,857,199. **IP PURE (STYLIZED).** NORTHLAND SEED & GRAIN CORP., MULTIPLE CLASS, (INT. CLS. 1, 5 AND 29), (U.S. CLS. 1, 5, 6, 10, 18, 26, 44, 46, 51 AND 52). SN 76-287,445. PUB. 4-6-2004. FILED 7-19-2001.
- 2,857,200. **IP PURE.** NORTHLAND SEED & GRAIN CORP., MULTIPLE CLASS, (INT. CLS. 1, 5 AND 29), (U.S. CLS. 1, 5, 6, 10, 18, 26, 44, 46, 51 AND 52). SN 76-287,651. PUB. 4-6-2004. FILED 7-19-2001.
- 2,857,207. **M AND DESIGN.** MERCK KGAA, MULTIPLE CLASS, (INT. CLS. 1, 2, 3, 5, 9, 10, 16, 29, 30, 35 AND 42), (U.S. CLS. 1, 2, 4, 5, 6, 10, 11, 16, 18, 21, 22, 23, 26, 29, 36, 37, 38, 39, 44, 46, 50, 51, 52, 100, 101 AND 102). SN 76-317,934. PUB. 10-29-2002. FILED 9-20-2001.
- 2,857,208. **DESIGNARRAY.** AZIGN BIOSCIENCE A/S, MULTIPLE CLASS, (INT. CLS. 1, 5 AND 42), (U.S. CLS. 1, 5, 6, 10, 18, 26, 44, 46, 51, 52, 100 AND 101). SN 76-318,921. PUB. 4-6-2004. FILED 9-28-2001.
- 2,857,210. **MISCELLANEOUS DESIGN.** SANKYO COMPANY, LIMITED, MULTIPLE CLASS, (INT. CLS. 1 AND 5), (U.S. CLS. 1, 5, 6, 10, 18, 26, 44, 46, 51 AND 52). SN 76-320,560. PUB. 4-6-2004. FILED 10-2-2001.
- 2,857,214. **KCS AND DESIGN.** KCS INDUSTRIE-HOLDING AG, MULTIPLE CLASS, (INT. CLS. 1, 3, 6, 7, 9, 11, 20, 35, 37, 40 AND 42), (U.S. CLS. 1, 2, 4, 5, 6, 10, 12, 13, 14, 19, 21, 22, 23, 25, 26, 31, 32, 34, 35, 36, 38, 46, 50, 51, 52, 100, 101, 102, 103 AND 106). SN 76-329,226. PUB. 4-6-2004. FILED 10-24-2001.
- 2,857,302. **CORROGARD.** ONDEO NALCO NETHERLANDS B.V., (U.S. CLS. 1, 5, 6, 10, 26 AND 46). SN 76-432,765. PUB. 4-6-2004. FILED 7-22-2002.
- 2,857,306. **SYNERGYLABS.** R.D.T. BUSINESS ENTERPRISES, INC., DBA SYNERGYLABS, MULTIPLE CLASS, (INT. CLS. 1, 3, 5, 31 AND 40), (U.S. CLS. 1, 4, 5, 6, 10, 18, 26, 44, 46, 50, 51, 52, 100, 103 AND 106). SN 76-434,418. PUB. 4-6-2004. FILED 7-24-2002.
- 2,857,313. **CAVATEX.** WACKER-CHEMIE, GMBH, MULTIPLE CLASS, (INT. CLS. 1, 3 AND 5), (U.S. CLS. 1, 4, 5, 6, 10, 18, 26, 44, 46, 50, 51 AND 52). SN 76-440,474. PUB. 4-6-2004. FILED 8-14-2002.
- 2,857,405. **DEBOND.** L & M CONSTRUCTION CHEMICAL, INC., (U.S. CLS. 1, 5, 6, 10, 26 AND 46). SN 76-478,845. PUB. 4-6-2004. FILED 12-27-2002.
- 2,857,470. **BIOCARB.** MIDWESTERN BIO-AG PRODUCTS & SERVICES, INC., (U.S. CLS. 1, 5, 6, 10, 26 AND 46). SN 76-498,125. PUB. 4-6-2004. FILED 2-19-2003.
- 2,857,482. **CADWELD.** ERICO INTERNATIONAL CORPORATION, (U.S. CLS. 1, 5, 6, 10, 26 AND 46). SN 76-502,326. PUB. 4-6-2004. FILED 3-31-2003.
- 2,857,495. **"GOURMET FOOD FOR YOUR GARDEN".** LONG ISLAND COMPOST CORP., MULTIPLE CLASS, (INT. CLS. 1 AND 31), (U.S. CLS. 1, 5, 6, 10, 26 AND 46). SN 76-507,430. PUB. 4-6-2004. FILED 3-31-2003.
- 2,857,509. **MIDWEST INDUSTRIAL SUPPLY, INC. AND DESIGN.** MIDWEST INDUSTRIAL SUPPLY, INC., MULTIPLE CLASS, (INT. CLS. 1 AND 4), (U.S. CLS. 1, 5, 6, 10, 15, 26 AND 46). SN 76-509,217. PUB. 4-6-2004. FILED 4-10-2003.
- 2,857,529. **INTERCHEM AND DESIGN.** INTERCHEM CORPORATION, (U.S. CLS. 1, 5, 6, 10, 26 AND 46). SN 76-512,823. PUB. 4-6-2004. FILED 5-8-2003.
- 2,857,724. **FLOMAG.** MARTIN MARIETTA MAGNESIA SPECIALTIES, LLC, (U.S. CLS. 1, 5, 6, 10, 26 AND 46). SN 76-537,258. PUB. 4-6-2004. FILED 8-13-2003.
- 2,857,725. **FLOMAG AND DESIGN.** MARTIN MARIETTA MAGNESIA SPECIALTIES, LLC, (U.S. CLS. 1, 5, 6, 10, 26 AND 46). SN 76-537,259. PUB. 4-6-2004. FILED 8-13-2003.
- 2,857,731. **C-335-P.** MAYCO CHEMICAL PRODUCTS, INC., (U.S. CLS. 1, 5, 6, 10, 26 AND 46). SN 76-538,467. PUB. 4-6-2004. FILED 8-19-2003.
- 2,857,795. **HP (STYLIZED).** HP-CHEMIE PELZER GMBH, MULTIPLE CLASS, (INT. CLS. 1, 12, 17 AND 27), (U.S. CLS. 1, 5, 6, 10, 12, 13, 19, 20, 21, 23, 26, 31, 35, 37, 42, 44, 46 AND 50). SN 78-138,114. PUB. 4-6-2004. FILED 6-24-2002.
- 2,857,839. **EKONERGY.** EKONERGY, INC., (U.S. CLS. 1, 5, 6, 10, 26 AND 46). SN 78-188,230. PUB. 4-6-2004. FILED 11-22-2002.
- 2,857,858. **FERTILIME.** AUMALE SYNERGIES, (U.S. CLS. 1, 5, 6, 10, 26 AND 46). SN 78-192,038. PUB. 4-6-2004. FILED 12-6-2002.
- 2,857,949. **PRIMEAGRA.** BARKALOW, RAYMOND W, (U.S. CLS. 1, 5, 6, 10, 26 AND 46). SN 78-219,500. PUB. 11-11-2003. FILED 2-27-2003.
- 2,858,053. **HORIZON PRODUCTS.** GRAIN PROCESSING CORPORATION, (U.S. CLS. 1, 5, 6, 10, 26 AND 46). SN 78-267,337. PUB. 4-6-2004. FILED 6-26-2003.
- 2,858,092. **FILTANIUM.** TECHNOLOGIES AVANCEES & MEMBRANES INDUSTRIELLES, MULTIPLE CLASS, (INT. CLS. 1, 7 AND 11), (U.S. CLS. 1, 5, 6, 10, 13, 19, 21, 23, 26, 31, 34, 35 AND 46). SN 78-274,278. PUB. 4-6-2004. FILED 7-15-2003.
- 2,858,105. **THE INVISIBLE ICE SCRAPER.** PENNZOIL-QUAKER STATE COMPANY, (U.S. CLS. 1, 5, 6, 10, 26 AND 46). SN 78-275,502. PUB. 4-6-2004. FILED 7-17-2003.
- 2,858,113. **RNAMATRIX.** QBIOGENE, INC., (U.S. CLS. 1, 5, 6, 10, 26 AND 46). SN 78-276,264. PUB. 4-6-2004. FILED 7-18-2003.
- 2,858,132. **POLARIN.** COGNIS DEUTSCHLAND GMBH & CO. KG, (U.S. CLS. 1, 5, 6, 10, 26 AND 46). SN 78-278,920. PUB. 4-6-2004. FILED 7-25-2003.
- 2,858,154. **DR. SMOOTH GROUT.** BERRY, MICHAEL V., (U.S. CLS. 1, 5, 6, 10, 26 AND 46). SN 78-288,442. PUB. 4-6-2004. FILED 8-18-2003.

CLASS 2—PAINTS

- 2,857,207 (*See Class 1 for this trademark*).
 2,857,213. **SENTINEL IMAGING AND DESIGN**. CONGRESS FINANCIAL CORPORATION (NEW ENGLAND), MULTIPLE CLASS, (INT. CLS. 2 AND 16), (U.S. CLS. 2, 5, 6, 11, 16, 22, 23, 29, 37, 38 AND 50). SN 76-329,180. PUB. 4-6-2004. FILED 10-24-2001.
 2,857,215. **SENTINEL**. CONGRESS FINANCIAL CORPORATION (NEW ENGLAND), MULTIPLE CLASS, (INT. CLS. 2 AND 16), (U.S. CLS. 2, 5, 6, 11, 16, 22, 23, 29, 37, 38 AND 50). SN 76-329,883. PUB. 4-6-2004. FILED 10-24-2001.
 2,857,334. **MOORCRAFT**. BENJAMIN MOORE & CO., (U.S. CLS. 6, 11 AND 16). SN 76-452,148. PUB. 4-6-2004. FILED 9-24-2002.
 2,857,371. **INTERNATIONAL PRODUCT**. INTERNATIONAL CHEMICAL COMPANY, MULTIPLE CLASS, (INT. CLS. 2, 3 AND 4), (U.S. CLS. 1, 4, 6, 11, 15, 16, 50, 51 AND 52). SN 76-467,389. PUB. 4-6-2004. FILED 11-15-2002.
 2,858,009. **CERAFUSE**. CCTI GROUP, INC., (U.S. CLS. 6, 11 AND 16). SN 78-250,113. PUB. 4-6-2004. FILED 5-15-2003.

CLASS 3—COSMETICS AND CLEANING PREPARATIONS

- 2,857,114. **SASA (STYLIZED)**. SA SA OVERSEAS LIMITED, MULTIPLE CLASS, (INT. CLS. 3 AND 21), (U.S. CLS. 1, 2, 4, 6, 13, 23, 29, 30, 33, 40, 50, 51 AND 52). SN 75-166,671. PUB. 8-5-2003. FILED 9-16-1996.
 2,857,129. **FLEUR DE SANTE (STYLIZED)**. INTERNATIONAL MASTERS PUBLISHERS AB, MULTIPLE CLASS, (INT. CLS. 3, 5, 9, 16, 21, 41 AND 42), (U.S. CLS. 1, 2, 4, 5, 6, 13, 18, 21, 22, 23, 26, 29, 30, 33, 36, 37, 38, 40, 44, 46, 50, 51, 52, 100, 101 AND 107). SN 75-793,568. PUB. 4-6-2004. FILED 9-7-1999.
 2,857,171. **EASYJET.COM THE WEB'S FAVOURITE AIRLINE**. EASYGROUP IP LICENSING LIMITED, MULTIPLE CLASS, (INT. CLS. 3, 9, 12, 14, 16, 18, 28, 29, 30, 32, 33, 34, 35, 38, 39, 41 AND 42), (U.S. CLS. 1, 2, 3, 4, 5, 6, 8, 9, 17, 19, 21, 22, 23, 26, 27, 28, 29, 31, 35, 36, 37, 38, 41, 44, 45, 46, 47, 48, 49, 50, 51, 52, 100, 101, 102, 104, 105 AND 107). SN 76-183,799. PUB. 4-6-2004. FILED 12-21-2000.
 2,857,207 (*See Class 1 for this trademark*).
 2,857,214 (*See Class 1 for this trademark*).
 2,857,230. **RICK OWENS (STYLIZED)**. EO BOCCI ASSOCIATI S.R.L., AND OWENS, RICK, MULTIPLE CLASS, (INT. CLS. 3, 9, 14, 18 AND 25), (U.S. CLS. 1, 2, 3, 4, 6, 21, 22, 23, 26, 27, 28, 36, 38, 39, 41, 50, 51 AND 52). SN 76-364,718. PUB. 4-6-2004. FILED 1-30-2002.
 2,857,248. **P PALMER SHAUN PALMER AND DESIGN**. SHAUN PALMER LTD., MULTIPLE CLASS, (INT. CLS. 3, 9, 14, 16, 18, 25 AND 28), (U.S. CLS. 1, 2, 3, 4, 5, 6, 21, 22, 23, 26, 27, 28, 29, 36, 37, 38, 39, 41, 50, 51 AND 52). SN 76-389,874. PUB. 6-24-2003. FILED 4-2-2002.
 2,857,274. **SWELL-X AND DESIGN**. EPIC HOLDING COMPANY, INC., (U.S. CLS. 1, 4, 6, 50, 51 AND 52). SN 76-410,062. PUB. 4-6-2004. FILED 5-21-2002.
 2,857,293. **NOBLERIME**. LG HOUSEHOLD & HEALTH CARE LTD., (U.S. CLS. 1, 4, 6, 50, 51 AND 52). SN 76-424,749. PUB. 4-6-2004. FILED 6-24-2002.
 2,857,306 (*See Class 1 for this trademark*).
 2,857,311. **FOOTHELPERS**. OTC CONNECTION, INC., DBA FOOTWORLD USA, MULTIPLE CLASS, (INT. CLS. 3 AND 10), (U.S. CLS. 1, 4, 6, 26, 39, 44, 50, 51 AND 52). SN 76-439,720. PUB. 4-6-2004. FILED 8-13-2002.
 2,857,313 (*See Class 1 for this trademark*).
 2,857,371 (*See Class 2 for this trademark*).
 2,857,410. **RETRO HAIR**. RETROHAIR, INC., (U.S. CLS. 1, 4, 6, 50, 51 AND 52). SN 76-480,787. PUB. 4-6-2004. FILED 12-26-2002.
 2,857,418. **MISCELLANEOUS DESIGN**. NEWAYS, INC., (U.S. CLS. 1, 4, 6, 50, 51 AND 52). SN 76-483,200. PUB. 4-6-2004. FILED 1-21-2003.
 2,857,419. **MISCELLANEOUS DESIGN**. NEWAYS, INC., (U.S. CLS. 1, 4, 6, 50, 51 AND 52). SN 76-483,201. PUB. 4-6-2004. FILED 1-21-2003.
 2,857,503. **NEUTROGENA 60 SECOND HAIR REPAIR**. NEUTROGENA CORPORATION, (U.S. CLS. 1, 4, 6, 50, 51 AND 52). SN 76-508,873. PUB. 4-6-2004. FILED 4-23-2003.
 2,857,518. **SOFT-TEX "SOFT AS A KITTEN" AND DESIGN**. SOFTEX FUR SUPPLIES INC., (U.S. CLS. 1, 4, 6, 50, 51 AND 52). SN 76-511,100. PUB. 4-6-2004. FILED 4-16-2003.
 2,857,530. **CRYSTALICIOUS! SHIMMER BRILLIANT AND DESIGN**. MILLER, THERESA, CARON, (U.S. CLS. 1, 4, 6, 50, 51 AND 52). SN 76-512,855. PUB. 4-6-2004. FILED 5-8-2003.
 2,857,567. **SOHO**. PRESTIGE COSMETICS, (U.S. CLS. 1, 4, 6, 50, 51 AND 52). SN 76-520,240. PUB. 4-6-2004. FILED 5-14-2003.
 2,857,578. **LUJO (STYLIZED)**. AVERY, DONALD RAY, (U.S. CLS. 1, 4, 6, 50, 51 AND 52). SN 76-521,928. PUB. 4-6-2004. FILED 6-11-2003.
 2,857,632. **SKIN WELLNESS AT ITS BEST!**. EPI SCIENCES, INC., MULTIPLE CLASS, (INT. CLS. 3 AND 5), (U.S. CLS. 1, 4, 6, 18, 44, 46, 50, 51 AND 52). SN 76-529,599. PUB. 4-6-2004. FILED 7-14-2003.
 2,857,641. **EPIB COMPLEX**. EPI SCIENCES, INC., MULTIPLE CLASS, (INT. CLS. 3 AND 5), (U.S. CLS. 1, 4, 6, 18, 44, 46, 50, 51 AND 52). SN 76-529,953. PUB. 4-6-2004. FILED 7-14-2003.
 2,857,642. **EPIA COMPLEX**. EPI SCIENCES, INC., MULTIPLE CLASS, (INT. CLS. 3 AND 5), (U.S. CLS. 1, 4, 6, 18, 44, 46, 50, 51 AND 52). SN 76-529,954. PUB. 4-6-2004. FILED 7-14-2003.
 2,857,657. **CAR WASH IN A BOTTLE**. STAR-BRITE DISTRIBUTING, INC., (U.S. CLS. 1, 4, 6, 50, 51 AND 52). SN 76-530,861. PUB. 4-6-2004. FILED 7-18-2003.
 2,857,667. **CROSSFOAM (STYLIZED)**. DOCTOR WAX PRODUCTS CORPORATION, (U.S. CLS. 1, 4, 6, 50, 51 AND 52). SN 76-531,360. PUB. 4-6-2004. FILED 7-14-2003.
 2,857,668. **ALWAYS FRESH**. DOCTOR WAX PRODUCTS CORPORATION, (U.S. CLS. 1, 4, 6, 50, 51 AND 52). SN 76-531,361. PUB. 4-6-2004. FILED 7-14-2003.
 2,857,730. **MEHRON**. MEHRON, (U.S. CLS. 1, 4, 6, 50, 51 AND 52). SN 76-538,451. PUB. 4-6-2004. FILED 8-19-2003.
 2,857,756. **VITAMINO COLOR AND DESIGN**. L'OREAL, (U.S. CLS. 1, 4, 6, 50, 51 AND 52). SN 76-543,926. PUB. 4-6-2004. FILED 8-29-2003.
 2,857,800. **NOSTRESS**. LABORATOIRES ROBERT SCHWARTZ, MULTIPLE CLASS, (INT. CLS. 3, 5, 29 AND 30), (U.S. CLS. 1, 4, 6, 18, 44, 46, 50, 51 AND 52). SN 78-148,142. PUB. 4-6-2004. FILED 7-26-2002.
 2,857,820. **NATIVE NATURALS AMERICAN INDIAN SPA LINE AND DESIGN**. DEHAAS MARY ELIZABETH, AND DEHAAS, KEITH BRADLAUGH, (U.S. CLS. 1, 4, 6, 50, 51 AND 52). SN 78-171,420. PUB. 4-6-2004. FILED 10-5-2002.
 2,857,830. **PASTE UP**. KAO KABUSHIKI KAISHA, AKA KAO CORPORATION, (U.S. CLS. 1, 4, 6, 50, 51 AND 52). SN 78-180,922. PUB. 4-6-2004. FILED 11-1-2002.
 2,857,854. **US KIDS AND DESIGN**. WELLA PERSONAL CARE OF NORTH AMERICA, INC., (U.S. CLS. 1, 4, 6, 50, 51 AND 52). SN 78-190,837. PUB. 4-6-2004. FILED 12-3-2002.
 2,857,881. **ODYSSEY NAIL SYSTEMS**. ODYSSEY NAIL SYSTEMS, INC., (U.S. CLS. 1, 4, 6, 50, 51 AND 52). SN 78-199,020. PUB. 4-6-2004. FILED 12-31-2002.
 2,857,884. **RAIN FOREST EXTRACT**. WORLD CLUB SUPPLY CORP., (U.S. CLS. 1, 4, 6, 50, 51 AND 52). SN 78-199,933. PUB. 4-6-2004. FILED 1-3-2003.
 2,857,972. **BASI HOMME ARMAND BASI**. MATMA, S.A., (U.S. CLS. 1, 4, 6, 50, 51 AND 52). SN 78-231,336. PUB. 4-6-2004. FILED 3-28-2003.
 2,857,992. **BIOTONE AND DESIGN**. NATURAL THOUGHTS, INC., (U.S. CLS. 1, 4, 6, 50, 51 AND 52). SN 78-244,690. PUB. 4-6-2004. FILED 5-1-2003.
 2,858,006. **ORANGE GLO**. ORANGE GLO INTERNATIONAL, INC., (U.S. CLS. 1, 4, 6, 50, 51 AND 52). SN 78-248,439. PUB. 4-6-2004. FILED 5-12-2003.
 2,858,007. **YVES SAINT LAURENT NU (STYLIZED)**. YVES SAINT LAURENT PARFUMS, (U.S. CLS. 1, 4, 6, 50, 51 AND 52). SN 78-248,639. PUB. 4-6-2004. FILED 5-12-2003.
 2,858,059. **DANIEL MCFADDEN**. DANIEL MCFADDEN, INC., (U.S. CLS. 1, 4, 6, 50, 51 AND 52). SN 78-269,144. PUB. 4-6-2004. FILED S.R. 7-1-2003; AM. P.R. 12-17-2003.
 2,858,063. **HOME AND DESIGN**. TARGET BRANDS, INC., (U.S. CLS. 1, 4, 6, 50, 51 AND 52). SN 78-269,797. PUB. 4-6-2004. FILED 7-2-2003.

2,858,100. **EUPHERO**. TOOBULAR INC. (U.S. CLS. 1, 4, 6, 50, 51 AND 52). SN 78-274,996. PUB. 4-6-2004. FILED 7-16-2003.
 2,858,114. **FRESH HAIR**. AMICO EDUCATIONAL CONCEPTS, INC. (U.S. CLS. 1, 4, 6, 50, 51 AND 52). SN 78-276,309. PUB. 4-6-2004. FILED 7-18-2003.
 2,858,126. **CAELUM**. ROBERTSON, FAY, DBA CASSOLETTE & CO (SALES & MARKETING) LTD. (U.S. CLS. 1, 4, 6, 50, 51 AND 52). SN 78-277,592. PUB. 4-6-2004. FILED 7-23-2003.
 2,858,127. **DREAM FAIRIES**. ROBERTSON, FAY, DBA CASSOLETTE & CO. (SALES & MARKETING) LTD. (U.S. CLS. 1, 4, 6, 50, 51 AND 52). SN 78-277,597. PUB. 4-6-2004. FILED 7-23-2003.
 2,858,157. **ORGANIMALS**. AUBREY ORGANICS, INC.. (U.S. CLS. 1, 4, 6, 50, 51 AND 52). SN 78-290,191. PUB. 4-6-2004. FILED 8-21-2003.
 2,858,160. **LENNOX**. RIVERA, ANGELICA. (U.S. CLS. 1, 4, 6, 50, 51 AND 52). SN 78-291,087. PUB. 4-6-2004. FILED 8-22-2003.

CLASS 4—LUBRICANTS AND FUELS

2,857,127. **FUELGAS**. FERRELLGAS, L.P., MULTIPLE CLASS, (INT. CLS. 4 AND 39), (U.S. CLS. 1, 6, 15, 100 AND 105). SN 75-738,326. PUB. 4-6-2004. FILED 6-28-1999.
 2,857,371 (*See Class 2 for this trademark*).
 2,857,509 (*See Class 1 for this trademark*).
 2,857,535. **HARVEST ACCENTS**. FOUR STAR INTERNATIONAL TRADING COMPANY, MULTIPLE CLASS, (INT. CLS. 4, 21, 24 AND 26), (U.S. CLS. 1, 2, 6, 13, 15, 23, 29, 30, 33, 37, 39, 40, 42 AND 50). SN 76-514,131. PUB. 4-6-2004. FILED 5-12-2003.
 2,857,708. **LIQUI-BEADS**. SUN DRILLING PRODUCTS CORPORATION, (U.S. CLS. 1, 6 AND 15). SN 76-533,586. PUB. 4-6-2004. FILED 7-18-2003.

CLASS 5—PHARMACEUTICALS

2,857,116 (*See Class 1 for this trademark*).
 2,857,129 (*See Class 3 for this trademark*).
 2,857,149. **MEDI-BEE**. BEE AND HERBAL NEW ZEALAND LIMITED, MULTIPLE CLASS, (INT. CLS. 5 AND 30), (U.S. CLS. 6, 18, 44, 46, 51 AND 52). SN 76-080,652. PUB. 4-6-2004. FILED 6-30-2000.
 2,857,161 (*See Class 1 for this trademark*).
 2,857,163. **HEARTSAVER**. CHOLESTEROL CONTROL LABORATORIES, INC.. (U.S. CLS. 6, 18, 44, 46, 51 AND 52). SN 76-153,158. PUB. 4-6-2004. FILED 2-17-2000.
 2,857,170. **RENOVO**. RENOVO LIMITED, MULTIPLE CLASS, (INT. CLS. 5, 41 AND 42), (U.S. CLS. 6, 18, 44, 46, 51, 52, 100, 101 AND 107). SN 76-173,450. PUB. 4-6-2004. FILED 11-30-2000.
 2,857,199 (*See Class 1 for this trademark*).
 2,857,200 (*See Class 1 for this trademark*).
 2,857,207 (*See Class 1 for this trademark*).
 2,857,208 (*See Class 1 for this trademark*).
 2,857,210 (*See Class 1 for this trademark*).
 2,857,219. **PERFETTI VAN MELLE**. PERFETTI VAN MELLE S.P.A., MULTIPLE CLASS, (INT. CLS. 5 AND 30), (U.S. CLS. 6, 18, 44, 46, 51 AND 52). SN 76-346,335. PUB. 4-6-2004. FILED 12-10-2001.
 2,857,220. **LECI-CHOLINE**. DEGUSSA BIOACTIVES DEUTSCHLAND GMBH & CO. KG, (U.S. CLS. 6, 18, 44, 46, 51 AND 52). SN 76-346,382. PUB. 4-6-2004. FILED 12-6-2001.
 2,857,221. **BREAST ASSURED**. NATURE'S SUNSHINE PRODUCTS, INC., (U.S. CLS. 6, 18, 44, 46, 51 AND 52). SN 76-350,848. PUB. 4-6-2004. FILED 12-13-2001.
 2,857,236. **TAKFIRE**. TAKEDA CHEMICAL INDUSTRIES, LTD., (U.S. CLS. 6, 18, 44, 46, 51 AND 52). SN 76-375,792. PUB. 4-15-2003. FILED 2-27-2002.
 2,857,250. **METABOLIC SOLUTIONS**. TFX INTERNATIONAL, INC., (U.S. CLS. 6, 18, 44, 46, 51 AND 52). SN 76-392,294. PUB. 4-6-2004. FILED 4-5-2002.
 2,857,306 (*See Class 1 for this trademark*).
 2,857,313 (*See Class 1 for this trademark*).
 2,857,398. **FLAMMACERIUM**. SOLVAY PHARMACEUTICALS B.V., (U.S. CLS. 6, 18, 44, 46, 51 AND 52). SN 76-476,181. PUB. 4-6-2004. FILED 12-16-2002.
 2,857,404. **PRASCO LABORATORIES**. PRASCO, LLC, (U.S. CLS. 6, 18, 44, 46, 51 AND 52). SN 76-478,818. PUB. 4-6-2004. FILED 12-27-2002.
 2,857,424. **MITO Q**. ANTIPODEAN BIOTECHNOLOGY LIMITED, (U.S. CLS. 6, 18, 44, 46, 51 AND 52). SN 76-484,733. PUB. 4-6-2004. FILED 1-24-2003.
 2,857,450. **ATLOX**. MERCKLE GMBH, (U.S. CLS. 6, 18, 44, 46, 51 AND 52). SN 76-490,317. PUB. 4-6-2004. FILED 2-19-2003.
 2,857,452. **MINDBLAST**. MINDFX SCIENCE, LLC, (U.S. CLS. 6, 18, 44, 46, 51 AND 52). SN 76-491,736. PUB. 4-6-2004. FILED 2-24-2003.
 2,857,469. **FUNGICIDE3**. UNITED INDUSTRIES CORPORATION, (U.S. CLS. 6, 18, 44, 46, 51 AND 52). SN 76-498,124. PUB. 4-6-2004. FILED 2-19-2003.
 2,857,479. **NYLEC**. ALTANA PHARMA AG, (U.S. CLS. 6, 18, 44, 46, 51 AND 52). SN 76-501,677. PUB. 4-6-2004. FILED 3-24-2003.
 2,857,504. **ENERGY ANSWERS**. NATURALLY SCIENTIFIC, INC., (U.S. CLS. 6, 18, 44, 46, 51 AND 52). SN 76-509,050. PUB. 4-6-2004. FILED 4-23-2003.
 2,857,505. **MEMORY ADVANTAGE**. NATURALLY SCIENTIFIC, INC., (U.S. CLS. 6, 18, 44, 46, 51 AND 52). SN 76-509,053. PUB. 4-6-2004. FILED 4-23-2003.
 2,857,506. **SLEEP SUPPORT**. NATURALLY SCIENTIFIC, INC., (U.S. CLS. 6, 18, 44, 46, 51 AND 52). SN 76-509,054. PUB. 4-6-2004. FILED 4-23-2003.
 2,857,507. **IMMUNE MENDER**. NATURALLY SCIENTIFIC, INC., (U.S. CLS. 6, 18, 44, 46, 51 AND 52). SN 76-509,059. PUB. 4-6-2004. FILED 4-23-2003.
 2,857,538. **MEGA CLA 1200**. NATURAL ORGANICS INC., (U.S. CLS. 6, 18, 44, 46, 51 AND 52). SN 76-514,629. PUB. 4-6-2004. FILED 5-14-2003.
 2,857,585. **ISIS PHARMACEUTICALS AND DESIGN**. ISIS PHARMACEUTICALS, INC., (U.S. CLS. 6, 18, 44, 46, 51 AND 52). SN 76-523,201. PUB. 4-6-2004. FILED 6-6-2003.
 2,857,632 (*See Class 3 for this trademark*).
 2,857,641 (*See Class 3 for this trademark*).
 2,857,642 (*See Class 3 for this trademark*).
 2,857,643. **FORTIUM**. KEMIN INDUSTRIES, INC., MULTIPLE CLASS, (INT. CLS. 5 AND 30), (U.S. CLS. 6, 18, 44, 46, 51 AND 52). SN 76-530,075. PUB. 4-6-2004. FILED 6-27-2003.
 2,857,644. **A AND DESIGN**. TAIKO PHARMACEUTICAL CO., LTD., (U.S. CLS. 6, 18, 44, 46, 51 AND 52). SN 76-530,123. PUB. 4-6-2004. FILED 7-15-2003.
 2,857,645. **SEIROGAN TOI A AND DESIGN**. TAIKO PHARMACEUTICAL CO., LTD., (U.S. CLS. 6, 18, 44, 46, 51 AND 52). SN 76-530,124. PUB. 4-6-2004. FILED 7-15-2003.
 2,857,648. **THE ULTIMATE BRAIN-BODY BOOST**. BIOTEST LABORATORIES, LLC, (U.S. CLS. 6, 18, 44, 46, 51 AND 52). SN 76-530,275. PUB. 4-6-2004. FILED 7-7-2003.
 2,857,655. **NO MOR**. PRODUCT CONCEPTS, INC., (U.S. CLS. 6, 18, 44, 46, 51 AND 52). SN 76-530,675. PUB. 4-6-2004. FILED 7-18-2003.
 2,857,698. **PROLEUKIN AND DESIGN**. CHIRON CORPORATION, (U.S. CLS. 6, 18, 44, 46, 51 AND 52). SN 76-532,544. PUB. 4-6-2004. FILED 7-25-2003.
 2,857,709. **OPTI-MASS**. OPTIMAL HEALTH SYSTEMS, (U.S. CLS. 6, 18, 44, 46, 51 AND 52). SN 76-533,634. PUB. 4-6-2004. FILED 7-31-2003.
 2,857,710. **COMPLETE PERFORMANCE**. OPTIMAL HEALTH SYSTEMS, (U.S. CLS. 6, 18, 44, 46, 51 AND 52). SN 76-533,635. PUB. 4-6-2004. FILED 7-31-2003.
 2,857,742. **SWISS VITAMINS**. DAILEY *E, INC., (U.S. CLS. 6, 18, 44, 46, 51 AND 52). SN 76-540,180. PUB. 4-6-2004. FILED 8-14-2003.
 2,857,764. **HEART CHECK**. MARCHIONI, ARTISTA J., (U.S. CLS. 6, 18, 44, 46, 51 AND 52). SN 76-547,654. PUB. 4-6-2004. FILED 9-12-2003.
 2,857,788. **KLEER-HEAD**. HAMIDA PHARMA, INC., (U.S. CLS. 6, 18, 44, 46, 51 AND 52). SN 78-116,386. PUB. 4-6-2004. FILED 3-20-2002.
 2,857,800 (*See Class 3 for this trademark*).
 2,857,828. **CILK**. ENVIRO CONSULTANT SERVICES, LLC,

- (U.S. CLS. 6, 18, 44, 46, 51 AND 52). SN 78-178,682. PUB. 4-6-2004. FILED 10-25-2002.
- 2,857,851. **CEPHASCREEN**. SOCIETE DIAGNOSTICA-STAGO. (U.S. CLS. 6, 18, 44, 46, 51 AND 52). SN 78-190,543. PUB. 4-6-2004. FILED 12-3-2002.
- 2,857,867. **HOLISTA**. HOLISTA HEALTH (CANADA) INC., (U.S. CLS. 6, 18, 44, 46, 51 AND 52). SN 78-193,932. PUB. 4-6-2004. FILED 12-12-2002.
- 2,857,871. **DEXASONE**. WALCO INTERNATIONAL, INC., (U.S. CLS. 6, 18, 44, 46, 51 AND 52). SN 78-196,897. PUB. 4-6-2004. FILED 12-20-2002.
- 2,857,914. **NUTRITION MADE SIMPLE**. BAXTER INTERNATIONAL INC., (U.S. CLS. 6, 18, 44, 46, 51 AND 52). SN 78-205,501. PUB. 4-6-2004. FILED 1-21-2003.
- 2,857,930. **MEVASEPT**. MÖLNLYCKE HEALTH CARE AB, (U.S. CLS. 6, 18, 44, 46, 51 AND 52). SN 78-213,084. PUB. 1-20-2004. FILED 2-10-2003.
- 2,857,978. **TIGHTEN UP YOUR PLEASURE**. BODYONICS, LTD., (U.S. CLS. 6, 18, 44, 46, 51 AND 52). SN 78-235,387. PUB. 4-6-2004. FILED 4-8-2003.
- 2,857,985. **NEY-ORO**. CERAMCO INC., (U.S. CLS. 6, 18, 44, 46, 51 AND 52). SN 78-242,607. PUB. 4-6-2004. FILED 4-28-2003.
- 2,858,003. **DURENTO**. BOEHRINGER INGELHEIM INTERNATIONAL GMBH, (U.S. CLS. 6, 18, 44, 46, 51 AND 52). SN 78-247,647. PUB. 4-6-2004. FILED 5-9-2003.
- 2,858,056. **CHINA TREASURES**. TEA GARDEN PRODUCTS, INC., (U.S. CLS. 6, 18, 44, 46, 51 AND 52). SN 78-268,162. PUB. 4-6-2004. FILED 6-27-2003.
- 2,858,081. **OOZE-CONTROL TIP**. DENTCO, INC., (U.S. CLS. 6, 18, 44, 46, 51 AND 52). SN 78-273,063. PUB. 4-6-2004. FILED 7-11-2003.
- 2,858,136. **METRA**. QUIDEL CORPORATION, (U.S. CLS. 6, 18, 44, 46, 51 AND 52). SN 78-279,893. PUB. 4-6-2004. FILED 7-28-2003.
- 2,858,147. **MEDIVATORS AND DESIGN**. MINNTECH CORPORATION, (U.S. CLS. 6, 18, 44, 46, 51 AND 52). SN 78-286,800. PUB. 4-6-2004. FILED 8-13-2003.
- 2,858,166. **FOLLINEX**. MONDIALMEDIA, (U.S. CLS. 6, 18, 44, 46, 51 AND 52). SN 78-292,287. PUB. 4-6-2004. FILED 8-26-2003.
- 2,858,170. **ZYMATEIN**. METABOLIC NUTRITION, INC., (U.S. CLS. 6, 18, 44, 46, 51 AND 52). SN 78-294,236. PUB. 4-6-2004. FILED 8-29-2003.

CLASS 6—METAL GOODS

- 2,857,214 (*See Class 1 for this trademark*).
- 2,857,269. **NEW ENGLAND POTTERY AND DESIGN**. NEW ENGLAND POTTERY CO., INC., MULTIPLE CLASS, (INT. CLS. 6, 17, 19, 20 AND 21), (U.S. CLS. 1, 2, 5, 12, 13, 14, 22, 23, 25, 29, 30, 32, 33, 35, 40 AND 50). SN 76-405,634. PUB. 4-6-2004. FILED 5-10-2002.
- 2,857,383. **UDDALLOY**. UDDEHOLM TOOLING AKTIEBOLAG, (U.S. CLS. 2, 12, 13, 14, 23, 25 AND 50). SN 76-472,649. PUB. 4-6-2004. FILED 12-4-2002.
- 2,857,401. **K AND DESIGN**. FISHER, KEITH, MULTIPLE CLASS, (INT. CLS. 6, 9, 12 AND 37), (U.S. CLS. 2, 12, 13, 14, 19, 21, 23, 25, 26, 31, 35, 36, 38, 44, 50, 100, 103 AND 106). SN 76-476,918. PUB. 4-6-2004. FILED 12-19-2002.
- 2,857,471. **SLIDE'N'HIDE**. 420820 ONTARIO LIMITED, DBA PREFERRED ENGINEERING PRODUCTS LTD., MULTIPLE CLASS, (INT. CLS. 6, 19 AND 20), (U.S. CLS. 1, 2, 12, 13, 14, 22, 23, 25, 32, 33 AND 50). SN 76-498,413. PUB. 4-6-2004. FILED 3-10-2003.
- 2,857,522. **EP (STYLIZED)**. ENGINEERED PRODUCTS, INC., (U.S. CLS. 2, 12, 13, 14, 23, 25 AND 50). SN 76-511,646. PUB. 4-6-2004. FILED 5-5-2003.
- 2,857,581. **FULL-WALL**. J & D HOME IMPROVEMENT, INC., (U.S. CLS. 2, 12, 13, 14, 23, 25 AND 50). SN 76-522,695. PUB. 4-6-2004. FILED 6-13-2003.
- 2,857,759. **LILY**. MAINE ORNAMENTAL WOODWORKERS, INC., (U.S. CLS. 2, 12, 13, 14, 23, 25 AND 50). SN 76-544,599. PUB. 4-6-2004. FILED 9-12-2003.
- 2,857,772. **WATERDREAM**. HANSGROHE AG, MULTIPLE CLASS, (INT. CLS. 6, 11, 17, 19, 20 AND 21), (U.S. CLS. 1, 2, 5, 12, 13, 14, 21, 22, 23, 25, 29, 30, 31, 32, 33, 34, 35, 40 AND 50).

- SN 78-038,872. PUB. 4-6-2004. FILED 12-12-2000.
- 2,858,020. **NO ACCESS**. H&M-AMH, INC., MULTIPLE CLASS, (INT. CLS. 6 AND 19), (U.S. CLS. 1, 2, 12, 13, 14, 23, 25, 33 AND 50). SN 78-255,727. PUB. 4-6-2004. FILED 5-29-2003.
- 2,858,115. **CHEMSTAR**. CHEMSTAR L.L.C., (U.S. CLS. 2, 12, 13, 14, 23, 25 AND 50). SN 78-276,696. PUB. 4-6-2004. FILED 7-21-2003.
- 2,858,151. **RB RELIABIL DOORS & WINDOWS AND DESIGN**. LF, LLC, MULTIPLE CLASS, (INT. CLS. 6 AND 19), (U.S. CLS. 1, 2, 12, 13, 14, 23, 25, 33 AND 50). SN 78-287,521. PUB. 4-6-2004. FILED 8-14-2003.

CLASS 7—MACHINERY

- 2,857,134. **H (STYLIZED)**. HINO JIDOSHA KABUSHIKI KAISHA, TA HINO MOTORS, LTD., (U.S. CLS. 13, 19, 21, 23, 31, 34 AND 35). SN 75-867,429. PUB. 4-6-2004. FILED 12-9-1999.
- 2,857,167. **PROCHARGER AND DESIGN**. ACCESSIBLE TECHNOLOGIES, INC., (U.S. CLS. 13, 19, 21, 23, 31, 34 AND 35). SN 76-163,343. PUB. 10-29-2002. FILED 11-10-2000.
- 2,857,214 (*See Class 1 for this trademark*).
- 2,857,282. **ROFIN**. ROFIN-SINAR LASER GMBH, MULTIPLE CLASS, (INT. CLS. 7, 9, 40, 41 AND 42), (U.S. CLS. 13, 19, 21, 23, 26, 31, 34, 35, 36, 38, 100, 101, 103, 106 AND 107). SN 76-417,018. PUB. 4-6-2004. FILED 6-4-2002.
- 2,857,329. **NEXWAY**. MITSUBISHI ELECTRIC CORPORATION, (U.S. CLS. 13, 19, 21, 23, 31, 34 AND 35). SN 76-450,772. PUB. 4-6-2004. FILED 9-18-2002.
- 2,857,415. **QUANTZ**. MACHINE DESIGN INCORPORATED, (U.S. CLS. 13, 19, 21, 23, 31, 34 AND 35). SN 76-481,670. PUB. 4-6-2004. FILED 1-13-2003.
- 2,857,447. **EAGLE**. WESTLAND CORPORATION, U.S.A., INC., (U.S. CLS. 13, 19, 21, 23, 31, 34 AND 35). SN 76-489,936. PUB. 4-6-2004. FILED 2-12-2003.
- 2,857,521. **DST-4**. TYMCO, INC., (U.S. CLS. 13, 19, 21, 23, 31, 34 AND 35). SN 76-511,484. PUB. 4-6-2004. FILED 5-6-2003.
- 2,857,555. **BREWWISE**. BUNN-O-MATIC CORPORATION, (U.S. CLS. 13, 19, 21, 23, 31, 34 AND 35). SN 76-517,573. PUB. 4-6-2004. FILED 5-27-2003.
- 2,857,575. **GLASS PRO**. GLASS PRO INCORPORATED, (U.S. CLS. 13, 19, 21, 23, 31, 34 AND 35). SN 76-521,486. PUB. 4-6-2004. FILED 6-9-2003.
- 2,857,617. **TECHPARTS FEEL THE POWER AND DESIGN**. HSIAO, HAO-YAO, AND LIU, CHIN-SHENG, (U.S. CLS. 13, 19, 21, 23, 31, 34 AND 35). SN 76-529,018. PUB. 4-6-2004. FILED 7-11-2003.
- 2,857,697. **SPIN-A-BATCH**. GARRISON, WILLIAM H., DBA AMERICAN SPIN-A-BATCH COMPANY, (U.S. CLS. 13, 19, 21, 23, 31, 34 AND 35). SN 76-532,540. PUB. 4-6-2004. FILED 7-25-2003.
- 2,857,810. **PLATOR AND DESIGN**. ALFRED KLET KG, (U.S. CLS. 13, 19, 21, 23, 31, 34 AND 35). SN 78-163,867. PUB. 12-2-2003. FILED 9-13-2002.
- 2,857,826. **STARLINE**. UNAXIS BALZERS AG, (U.S. CLS. 13, 19, 21, 23, 31, 34 AND 35). SN 78-178,093. PUB. 4-6-2004. FILED 10-24-2002.
- 2,857,862. **EXPRESS BLOWER**. EXPRESS BLOWER, INC., (U.S. CLS. 13, 19, 21, 23, 31, 34 AND 35). SN 78-192,390. PUB. 4-6-2004. FILED 12-9-2002.
- 2,857,940. **DUSTUP**. COLOVOS COMPANY, (U.S. CLS. 13, 19, 21, 23, 31, 34 AND 35). SN 78-217,346. PUB. 4-6-2004. FILED 2-21-2003.
- 2,857,952. **MILLBANKEXTRUSION**. BUHLER AG, MULTIPLE CLASS, (INT. CLS. 7, 9, 37, 39, 41 AND 42), (U.S. CLS. 13, 19, 21, 23, 26, 31, 34, 35, 36, 38, 100, 101, 103, 105, 106 AND 107). SN 78-220,056. PUB. 4-6-2004. FILED 2-28-2003.
- 2,858,008. **ROCK KING**. ABSOLUTE INNOVATIONS, INC., (U.S. CLS. 13, 19, 21, 23, 31, 34 AND 35). SN 78-249,489. PUB. 4-6-2004. FILED 5-14-2003.
- 2,858,015. **SNOWCHARGER**. K&N ENGINEERING, INC., (U.S. CLS. 13, 19, 21, 23, 31, 34 AND 35). SN 78-253,410. PUB. 4-6-2004. FILED 5-22-2003.
- 2,858,030. **KING MASTER**. YU, CHANG YUNG, (U.S. CLS. 13, 19, 21, 23, 31, 34 AND 35). SN 78-261,023. PUB. 4-6-2004.

FILED 6-11-2003.
2,858,066. **TRIANGLE**. TRIANGLE PACKAGE MACHINERY COMPANY, (U.S. CLS. 13, 19, 21, 23, 31, 34 AND 35). SN 78-270,156. PUB. 4-6-2004. FILED 7-3-2003.
2,858,092 (*See Class 1 for this trademark*).

CLASS 8—HAND TOOLS

2,857,395. **GO PARTY!**. INFINITY INDUSTRIES INC., (U.S. CLS. 23, 28 AND 44). SN 76-475,929. PUB. 4-6-2004. FILED 12-13-2002.
2,857,486. **MTECH USA**. MASTER CUTLERY, INC., (U.S. CLS. 23, 28 AND 44). SN 76-503,843. PUB. 4-6-2004. FILED 4-4-2003.
2,857,676. **AXEL**. KARECO INTERNATIONAL, INC., (U.S. CLS. 23, 28 AND 44). SN 76-531,797. PUB. 4-6-2004. FILED 7-23-2003.
2,858,164. **COMFORTGRIP**. ZINSSER BRANDS COMPANY, MULTIPLE CLASS, (INT. CLS. 8 AND 9), (U.S. CLS. 21, 23, 26, 28, 36, 38 AND 44). SN 78-292,132. PUB. 4-6-2004. FILED 8-26-2003.

CLASS 9—ELECTRICAL AND SCIENTIFIC APPARATUS

2,857,110. **BUSINESSWEB**. MANAGEMENT SCIENCE ASSOCIATES, INC., (U.S. CLS. 21, 23, 26, 36 AND 38). SN 74-696,130. PUB. 4-6-2004. FILED 7-3-1995.
2,857,116 (*See Class 1 for this trademark*).
2,857,121. **PIAGET (STYLIZED)**. S. A. ANCIENNE FABRIQUE GEORGES PIAGET ET CIE, (U.S. CLS. 21, 23, 26, 36 AND 38). SN 75-569,390. PUB. 4-6-2004. FILED 10-13-1998.
2,857,126. **INNOVATIVE PRODUCTS AND SERVICES OF BOSTON**. INNOVATIVE PRODUCTS AND SERVICES OF BOSTON, INC., (U.S. CLS. 21, 23, 26, 36 AND 38). SN 75-716,576. PUB. 4-6-2004. FILED 5-27-1999.
2,857,128. **INTEGO**. INTEGO, (U.S. CLS. 21, 23, 26, 36 AND 38). SN 75-738,404. PUB. 4-6-2004. FILED 6-28-1999.
2,857,129 (*See Class 3 for this trademark*).
2,857,133. **ULTRARF**. ULTRARF, INC., (U.S. CLS. 21, 23, 26, 36 AND 38). SN 75-866,232. PUB. 4-6-2004. FILED 12-6-1999.
2,857,138. **SMARTSTORE**. TRAX IP, LLC, (U.S. CLS. 21, 23, 26, 36 AND 38). SN 75-898,120. PUB. 4-6-2004. FILED S.R. 1-19-2000; AM. P.R. 1-16-2004.
2,857,140. **GAMECUBE**. NINTENDO CO., LTD., (U.S. CLS. 21, 23, 26, 36 AND 38). SN 75-981,370. PUB. 4-6-2004. FILED 1-24-2001.
2,857,151. **ESPORTA**. ESPORTA HEALTH & FITNESS LIMITED, MULTIPLE CLASS, (INT. CLS. 9, 16, 18, 24, 25, 28, 36, 38, 41 AND 42), (U.S. CLS. 1, 2, 3, 5, 21, 22, 23, 26, 29, 36, 37, 38, 39, 41, 42, 50, 100, 101, 102, 104 AND 107). SN 76-100,026. PUB. 1-21-2003. FILED 7-31-2000.
2,857,153. **FW W AND DESIGN**. W.W. FISCHER S.A., MULTIPLE CLASS, (INT. CLS. 9 AND 42), (U.S. CLS. 21, 23, 26, 36, 38, 100 AND 101). SN 76-115,650. PUB. 4-16-2002. FILED 8-24-2000.
2,857,159. **LEVELSEAS**. LEVELSEAS LIMITED, MULTIPLE CLASS, (INT. CLS. 9, 35, 36, 38, 39 AND 42), (U.S. CLS. 21, 23, 26, 36, 38, 100, 101, 102, 104 AND 105). SN 76-140,486. PUB. 10-29-2002. FILED 10-4-2000.
2,857,160. **CERTAPAY**. CERTAPAY INC., MULTIPLE CLASS, (INT. CLS. 9 AND 36), (U.S. CLS. 21, 23, 26, 36, 38, 100, 101 AND 102). SN 76-141,157. PUB. 4-6-2004. FILED 10-5-2000.
2,857,161 (*See Class 1 for this trademark*).
2,857,164. **TXT-POLYMEDIA**. TXT E-SOLUTIONS S.P.A., MULTIPLE CLASS, (INT. CLS. 9, 38 AND 42), (U.S. CLS. 21, 23, 26, 36, 38, 100, 101 AND 104). SN 76-154,522. PUB. 4-6-2004. FILED 10-25-2000.
2,857,165. **DOCTOON AND DESIGN**. NEUROMEDIA S.A., MULTIPLE CLASS, (INT. CLS. 9, 16, 18, 25, 28, 35, 38, 41 AND 42), (U.S. CLS. 1, 2, 3, 5, 21, 22, 23, 26, 29, 36, 37, 38, 39, 41, 50, 100, 101, 102, 104 AND 107). SN 76-157,442. PUB. 4-6-2004. FILED 11-1-2000.

2,857,166. **MISCELLANEOUS DESIGN**. SPEED-TRAP.COM LIMITED, MULTIPLE CLASS, (INT. CLS. 9, 35, 38 AND 42), (U.S. CLS. 21, 23, 26, 36, 38, 100, 101, 102 AND 104). SN 76-160,070. PUB. 4-6-2004. FILED 11-6-2000.
2,857,171 (*See Class 3 for this trademark*).
2,857,175. **INTEGRA-TR**. DATARADIO, INC., (U.S. CLS. 21, 23, 26, 36 AND 38). SN 76-197,474. PUB. 4-6-2004. FILED 1-12-2001.
2,857,178. **NORDEA AND DESIGN**. NORDEA AB, MULTIPLE CLASS, (INT. CLS. 9, 35, 36 AND 38), (U.S. CLS. 21, 23, 26, 36, 38, 100, 101, 102 AND 104). SN 76-205,651. PUB. 4-6-2004. FILED 2-6-2001.
2,857,181. **ANT**. ANT LIMITED, MULTIPLE CLASS, (INT. CLS. 9 AND 42), (U.S. CLS. 21, 23, 26, 36, 38, 100 AND 101). SN 76-220,729. PUB. 4-6-2004. FILED 3-6-2001.
2,857,182. **ANT AND DESIGN**. ANT LIMITED, MULTIPLE CLASS, (INT. CLS. 9 AND 42), (U.S. CLS. 21, 23, 26, 36, 38, 100 AND 101). SN 76-220,730. PUB. 4-6-2004. FILED 3-6-2001.
2,857,186. **WESPOT AND DESIGN**. WESPOT AB, (U.S. CLS. 21, 23, 26, 36 AND 38). SN 76-244,938. PUB. 4-6-2004. FILED 4-23-2001.
2,857,189. **GOLF RESORT TYCOON**. ACTIVISION VALUE PUBLISHING, INC., (U.S. CLS. 21, 23, 26, 36 AND 38). SN 76-253,014. PUB. 4-6-2004. FILED 5-7-2001.
2,857,190. **TREADVIEW (STYLIZED)**. AEA TECHNOLOGY PLC, (U.S. CLS. 21, 23, 26, 36 AND 38). SN 76-257,839. PUB. 4-6-2004. FILED 5-15-2001.
2,857,192. **PRETIUM**. WATSON WYATT PARTNERS, MULTIPLE CLASS, (INT. CLS. 9, 16, 35 AND 36), (U.S. CLS. 2, 5, 21, 22, 23, 26, 29, 36, 37, 38, 50, 100, 101 AND 102). SN 76-264,428. PUB. 4-6-2004. FILED 5-30-2001.
2,857,194. **AD-FICIENT**. QUEBECOR WORLD INC., (U.S. CLS. 21, 23, 26, 36 AND 38). SN 76-272,423. PUB. 4-6-2004. FILED 6-18-2001.
2,857,196. **BIG FISH (STYLIZED)**. BIG FISH COMMUNICATIONS, INC., MULTIPLE CLASS, (INT. CLS. 9 AND 38), (U.S. CLS. 21, 23, 26, 36, 38, 100, 101 AND 104). SN 76-275,613. PUB. 4-6-2004. FILED 6-22-2001.
2,857,197. **CLEANTOP (STYLIZED)**. TECHNICAL MANUFACTURING CORPORATION, (U.S. CLS. 21, 23, 26, 36 AND 38). SN 76-275,840. PUB. 4-6-2004. FILED 6-25-2001.
2,857,201. **SYS*ADMIRAL**. TIDAL SOFTWARE, INC., (U.S. CLS. 21, 23, 26, 36 AND 38). SN 76-293,452. PUB. 4-6-2004. FILED 7-31-2001.
2,857,203. **VECTOR**. TELECT, INC., (U.S. CLS. 21, 23, 26, 36 AND 38). SN 76-305,197. PUB. 4-6-2004. FILED 8-23-2001.
2,857,207 (*See Class 1 for this trademark*).
2,857,212. **NABERTHERM MORE THAN HEAT 30-3000 C AND DESIGN**. NABERTHERM GMBH, MULTIPLE CLASS, (INT. CLS. 9, 11 AND 42), (U.S. CLS. 13, 21, 23, 26, 31, 34, 36, 38, 100 AND 101). SN 76-329,149. PUB. 4-6-2004. FILED 10-24-2001.
2,857,214 (*See Class 1 for this trademark*).
2,857,216. **ONDVD**. SCM MICROSYSTEMS, INC., (U.S. CLS. 21, 23, 26, 36 AND 38). SN 76-331,147. PUB. 4-6-2004. FILED 10-29-2001.
2,857,217. **NRI AND DESIGN**. NRI DATA & BUSINESS PRODUCTS INC., MULTIPLE CLASS, (INT. CLS. 9, 35, 37 AND 42), (U.S. CLS. 21, 23, 26, 36, 38, 100, 101, 102, 103 AND 106). SN 76-345,479. PUB. 4-6-2004. FILED 12-6-2001.
2,857,230 (*See Class 3 for this trademark*).
2,857,244. **INTENSEPHOTONICS**. INTENSE PHOTONICS LTD, MULTIPLE CLASS, (INT. CLS. 9 AND 37), (U.S. CLS. 21, 23, 26, 36, 38, 100, 103 AND 106). SN 76-382,348. PUB. 4-6-2004. FILED 3-13-2002.
2,857,248 (*See Class 3 for this trademark*).
2,857,258. **TWISTED TALES**. NATURAL HISTORY NEW ZEALAND LIMITED, (U.S. CLS. 21, 23, 26, 36 AND 38). SN 76-397,730. PUB. 4-6-2004. FILED 4-18-2002.
2,857,259. **TWISTED TALES AND DESIGN**. NATURAL HISTORY NEW ZEALAND LIMITED, (U.S. CLS. 21, 23, 26, 36 AND 38). SN 76-397,731. PUB. 4-6-2004. FILED 4-18-2002.
2,857,264. **BUSINESS IMPROVEMENT PORTAL**. ACCESS INTERNATIONAL GROUP, MULTIPLE CLASS, (INT. CLS. 9, 41 AND 42), (U.S. CLS. 21, 23, 26, 36, 38, 100, 101 AND 107). SN 76-403,420. PUB. 4-6-2004. FILED 5-1-2002.
2,857,265. **BI-PORTAL**. ACCESS INTERNATIONAL GROUP, MULTIPLE CLASS, (INT. CLS. 9, 41 AND 42), (U.S. CLS. 21,

- 23, 26, 36, 38, 100, 101 AND 107). SN 76-403,421. PUB. 4-6-2004. FILED 5-1-2002.
- 2,857,279. **MISCELLANEOUS DESIGN**. NALGE NUNC INTERNATIONAL CORPORATION, (U.S. CLS. 21, 23, 26, 36 AND 38). SN 76-414,217. PUB. 4-6-2004. FILED 6-3-2002.
- 2,857,282 (*See Class 7 for this trademark*).
- 2,857,283. **MISCELLANEOUS DESIGN**. NALGE NUNC INTERNATIONAL CORPORATION, (U.S. CLS. 21, 23, 26, 36 AND 38). SN 76-417,531. PUB. 4-6-2004. FILED 6-3-2002.
- 2,857,289. **PRAXIS III**. EDUCATIONAL TESTING SERVICE, MULTIPLE CLASS, (INT. CLS. 9 AND 16), (U.S. CLS. 2, 5, 21, 22, 23, 26, 29, 36, 37, 38 AND 50). SN 76-421,441. PUB. 4-6-2004. FILED 6-14-2002.
- 2,857,295. **SIWAREX**. SIEMENS AKTIENGESELLSCHAFT, (U.S. CLS. 21, 23, 26, 36 AND 38). SN 76-427,896. PUB. 4-6-2004. FILED 7-1-2002.
- 2,857,300. **UTAC**. UNITED TEST AND ASSEMBLY CENTER LTD., MULTIPLE CLASS, (INT. CLS. 9, 40 AND 42), (U.S. CLS. 21, 23, 26, 36, 38, 100, 101, 103 AND 106). SN 76-430,869. PUB. 7-22-2003. FILED 7-15-2002.
- 2,857,305. **SIMPLEDVD**. PIXELTOOLS CORP., (U.S. CLS. 21, 23, 26, 36 AND 38). SN 76-434,128. PUB. 4-6-2004. FILED 7-25-2002.
- 2,857,308. **MASKMAN AND DESIGN**. BARUNSON CO., LTD., (U.S. CLS. 21, 23, 26, 36 AND 38). SN 76-437,237. PUB. 4-6-2004. FILED 7-31-2002.
- 2,857,309. **UNITED FINANCIAL GROUP**. UFG (UK) LIMITED, MULTIPLE CLASS, (INT. CLS. 9, 16, 35, 36 AND 41), (U.S. CLS. 2, 5, 21, 22, 23, 26, 29, 36, 37, 38, 50, 100, 101, 102 AND 107). SN 76-438,695. PUB. 4-6-2004. FILED 8-8-2002.
- 2,857,316. **CRACKED POT RECORDS INC. AND DESIGN**. CRACKED POT RECORDS INC, (U.S. CLS. 21, 23, 26, 36 AND 38). SN 76-443,226. PUB. 4-6-2004. FILED 8-19-2002.
- 2,857,335. **MOBE**. ABOMEM TECHNOLOGY CORPORATION, (U.S. CLS. 21, 23, 26, 36 AND 38). SN 76-454,899. PUB. 4-6-2004. FILED 9-27-2002.
- 2,857,343. **E LSG.SKYCHEFS AND DESIGN**. LSG LUFTHANSA SERVICE HOLDING AG, MULTIPLE CLASS, (INT. CLS. 9, 29, 30, 35, 41 AND 43), (U.S. CLS. 21, 23, 26, 36, 38, 46, 100, 101, 102 AND 107). SN 76-460,619. PUB. 12-30-2003. FILED 10-22-2002.
- 2,857,353. **WICKED WINNINGS**. ARISTOCRAT TECHNOLOGIES AUSTRALIA PTY LIMITED, (U.S. CLS. 21, 23, 26, 36 AND 38). SN 76-463,152. PUB. 4-6-2004. FILED 10-25-2002.
- 2,857,354. **ARGENT**. ARGENT SOFTWARE, INC., MULTIPLE CLASS, (INT. CLS. 9, 41 AND 42), (U.S. CLS. 21, 23, 26, 36, 38, 100, 101 AND 107). SN 76-463,458. PUB. 4-6-2004. FILED 10-30-2002.
- 2,857,358. **TUPPERWARE**. DART INDUSTRIES INC., (U.S. CLS. 21, 23, 26, 36 AND 38). SN 76-464,918. PUB. 4-6-2004. FILED 11-6-2002.
- 2,857,363. **DOT MED AND DESIGN**. DOTMED.COM, INC., MULTIPLE CLASS, (INT. CLS. 9, 10, 35 AND 42), (U.S. CLS. 21, 23, 26, 36, 38, 39, 44, 100, 101 AND 102). SN 76-465,667. PUB. 4-6-2004. FILED 11-12-2002.
- 2,857,376. **RPC**. ARCHVISION, INC., (U.S. CLS. 21, 23, 26, 36 AND 38). SN 76-470,007. PUB. 4-6-2004. FILED 11-25-2002.
- 2,857,389. **DAQMASTER**. YOKOGAWA ELECTRIC CORPORATION, (U.S. CLS. 21, 23, 26, 36 AND 38). SN 76-474,392. PUB. 4-6-2004. FILED 12-9-2002.
- 2,857,390. **CONNECTZONE**. KABUSHIKI KAISHA BSP, (U.S. CLS. 21, 23, 26, 36 AND 38). SN 76-474,534. PUB. 4-6-2004. FILED 11-29-2002.
- 2,857,400. **GTS RECORDS AND DESIGN**. BECKMORE MUSIC, INC., (U.S. CLS. 21, 23, 26, 36 AND 38). SN 76-476,775. PUB. 4-6-2004. FILED 12-19-2002.
- 2,857,401 (*See Class 6 for this trademark*).
- 2,857,403. **LIE DETECTOR**. BLACK BEAUTY CUSTOM STICKS, L.L.C., (U.S. CLS. 21, 23, 26, 36 AND 38). SN 76-478,741. PUB. 4-6-2004. FILED 12-16-2002.
- 2,857,412. **ASTRON (STYLIZED)**. ASTRON TECHNOLOGY CORP., (U.S. CLS. 21, 23, 26, 36 AND 38). SN 76-481,061. PUB. 4-6-2004. FILED 1-8-2003.
- 2,857,426. **ODYSSEY**. TYLER TECHNOLOGIES, INC., (U.S. CLS. 21, 23, 26, 36 AND 38). SN 76-484,897. PUB. 4-6-2004. FILED 1-24-2003.
- 2,857,434. **MINDREEF**. MINDREEF, INC., (U.S. CLS. 21, 23, 26, 36 AND 38). SN 76-485,822. PUB. 4-6-2004. FILED 1-29-2003.
- 2,857,435. **MICROCUP (STYLIZED)**. SIPIX GROUP LIMITED, (U.S. CLS. 21, 23, 26, 36 AND 38). SN 76-485,866. PUB. 4-6-2004. FILED 1-28-2003.
- 2,857,443. **MISCELLANEOUS DESIGN**. INSTRON CORPORATION, MULTIPLE CLASS, (INT. CLS. 9, 11 AND 41), (U.S. CLS. 13, 21, 23, 26, 31, 34, 36, 38, 100, 101 AND 107). SN 76-486,727. PUB. 4-6-2004. FILED 2-3-2003.
- 2,857,444. **INSTRON**. INSTRON CORPORATION, MULTIPLE CLASS, (INT. CLS. 9, 11 AND 41), (U.S. CLS. 13, 21, 23, 26, 31, 34, 36, 38, 100, 101 AND 107). SN 76-486,728. PUB. 4-6-2004. FILED 2-3-2003.
- 2,857,448. **WYNDGATE TECHNOLOGIES AND DESIGN**. GLOBAL MED TECHNOLOGIES, INC., DBA WYNDGATE TECHNOLOGIES, MULTIPLE CLASS, (INT. CLS. 9 AND 44), (U.S. CLS. 21, 23, 26, 36, 38, 100 AND 101). SN 76-490,056. PUB. 4-6-2004. FILED 2-14-2003.
- 2,857,460. **MISCELLANEOUS DESIGN**. MSS ELECTRONICS, INC., (U.S. CLS. 21, 23, 26, 36 AND 38). SN 76-494,592. PUB. 4-6-2004. FILED 3-3-2003.
- 2,857,461. **DECCA**. UMG RECORDINGS, INC., (U.S. CLS. 21, 23, 26, 36 AND 38). SN 76-495,838. PUB. 4-6-2004. FILED 3-10-2003.
- 2,857,462. **COMPARE2**. ROBERT MORRIS ASSOCIATES, (U.S. CLS. 21, 23, 26, 36 AND 38). SN 76-496,042. PUB. 4-6-2004. FILED 3-10-2003.
- 2,857,480. **DOD TECHNOLOGY**. MESATRONIC, S.A., (U.S. CLS. 21, 23, 26, 36 AND 38). SN 76-501,779. PUB. 4-6-2004. FILED 3-18-2003.
- 2,857,481. **MY FIRST SHADES**. MY FIRST SHADES, (U.S. CLS. 21, 23, 26, 36 AND 38). SN 76-501,819. PUB. 4-6-2004. FILED 3-27-2003.
- 2,857,490. **VITAL LINK (STYLIZED)**. COMPLIANCE AUTOMATION, INC., (U.S. CLS. 21, 23, 26, 36 AND 38). SN 76-505,651. PUB. 4-6-2004. FILED 4-9-2003.
- 2,857,500. **OZONE**. OUTDOOR OPTICS, INC., DBA OLYMPIC OPTICAL CO., (U.S. CLS. 21, 23, 26, 36 AND 38). SN 76-508,052. PUB. 4-6-2004. FILED 4-21-2003.
- 2,857,519. **BURNING SPEAR**. RODNEY, GODFREY WINSTON, MULTIPLE CLASS, (INT. CLS. 9 AND 41), (U.S. CLS. 21, 23, 26, 36, 38, 100, 101 AND 107). SN 76-511,355. PUB. 4-6-2004. FILED 5-2-2003.
- 2,857,520. **O (STYLIZED)**. OREGON SHAKESPEARE FESTIVAL ASSOCIATION, MULTIPLE CLASS, (INT. CLS. 9, 14, 16, 18, 21, 24, 25, 28, 30 AND 41), (U.S. CLS. 1, 2, 3, 5, 13, 21, 22, 23, 26, 27, 28, 29, 30, 33, 36, 37, 38, 39, 40, 41, 42, 46, 50, 100, 101 AND 107). SN 76-511,392. PUB. 4-6-2004. FILED 5-5-2003.
- 2,857,525. **O OREGON SHAKESPEARE FESTIVAL AND DESIGN**. OREGON SHAKESPEARE FESTIVAL ASSOCIATION, MULTIPLE CLASS, (INT. CLS. 9, 14, 16, 18, 21, 25, 28, 30 AND 41), (U.S. CLS. 1, 2, 3, 5, 13, 21, 22, 23, 26, 27, 28, 29, 30, 33, 36, 37, 38, 39, 40, 41, 46, 50, 100, 101 AND 107). SN 76-512,013. PUB. 4-6-2004. FILED 5-5-2003.
- 2,857,527. **FONT FOLIO**. ADOBE SYSTEMS INCORPORATED, (U.S. CLS. 21, 23, 26, 36 AND 38). SN 76-512,128. PUB. 4-6-2004. FILED 5-6-2003.
- 2,857,531. **LOGICALAPPS AND DESIGN**. LOGICAL APPS, INC., (U.S. CLS. 21, 23, 26, 36 AND 38). SN 76-513,385. PUB. 4-6-2004. FILED 5-1-2003.
- 2,857,532. **APPSCREATE**. LOGICAL APPS, INC., (U.S. CLS. 21, 23, 26, 36 AND 38). SN 76-513,386. PUB. 4-6-2004. FILED 5-1-2003.
- 2,857,534. **RUSH**. ERCOLANO, GREG, (U.S. CLS. 21, 23, 26, 36 AND 38). SN 76-513,905. PUB. 4-6-2004. FILED 5-14-2003.
- 2,857,539. **COOL BLUE**. LONG RANGE SYSTEMS, INC., (U.S. CLS. 21, 23, 26, 36 AND 38). SN 76-514,692. PUB. 4-6-2004. FILED 5-15-2003.
- 2,857,540. **SAFETY LEADER**. WALSH INTEGRATED ENVIRONMENTAL SYSTEMS INC., (U.S. CLS. 21, 23, 26, 36 AND 38). SN 76-514,856. PUB. 4-6-2004. FILED 5-16-2003.
- 2,857,541. **QC LEADER**. WALSH INTEGRATED ENVIRONMENTAL SYSTEMS INC., (U.S. CLS. 21, 23, 26, 36 AND 38). SN 76-514,857. PUB. 4-6-2004. FILED 5-16-2003.
- 2,857,561. **U RBANWORKS LATINO AND DESIGN**. VENTURA DISTRIBUTION, INC., (U.S. CLS. 21, 23, 26, 36 AND 38). SN 76-518,632. PUB. 4-6-2004. FILED 6-2-2003.
- 2,857,588. **PROJECT CODE RED**. ALASKA VILLAGE INITIATIVES, INC., (U.S. CLS. 21, 23, 26, 36 AND 38). SN 76-

- 523,553. PUB. 4-6-2004. FILED 5-30-2003.
- 2,857,590. **AMAZON**. AMAZON.COM, INC., (U.S. CLS. 21, 23, 26, 36 AND 38). SN 76-524,007. PUB. 4-6-2004. FILED 6-12-2003.
- 2,857,599. **MICENTER**. GLOBAL CLOUD, LTD., MULTIPLE CLASS, (INT. CLS. 9 AND 42), (U.S. CLS. 21, 23, 26, 36, 38, 100 AND 101). SN 76-525,572. PUB. 4-6-2004. FILED 6-26-2003.
- 2,857,615. **RENT-A-KRUZZER**. NELSON-WHITTAKER, LTD., DBA CENTRAL SPECIALTIES, (U.S. CLS. 21, 23, 26, 36 AND 38). SN 76-528,537. PUB. 4-6-2004. FILED 6-27-2003.
- 2,857,616. **VEND-A-KRUZZER**. NELSON-WHITTAKER, LTD., DBA CENTRAL SPECIALTIES, (U.S. CLS. 21, 23, 26, 36 AND 38). SN 76-528,538. PUB. 4-6-2004. FILED 6-27-2003.
- 2,857,619. **AERIELINK AND DESIGN**. SOYO COMPUTER INC., (U.S. CLS. 21, 23, 26, 36 AND 38). SN 76-529,184. PUB. 4-6-2004. FILED 7-14-2003.
- 2,857,628. **INTERLINK AND DESIGN**. INTERIM HEALTHCARE, INC., (U.S. CLS. 21, 23, 26, 36 AND 38). SN 76-529,416. PUB. 4-6-2004. FILED 7-14-2003.
- 2,857,629. **TABANYWARE**. INTEGRYS ASSETPOINT, LLC, (U.S. CLS. 21, 23, 26, 36 AND 38). SN 76-529,518. PUB. 4-6-2004. FILED 7-14-2003.
- 2,857,631. **IBEX PULSECHECK**. IBEX HEALTHDATA SYSTEMS, INC., MULTIPLE CLASS, (INT. CLS. 9 AND 42), (U.S. CLS. 21, 23, 26, 36, 38, 100 AND 101). SN 76-529,584. PUB. 4-6-2004. FILED 7-14-2003.
- 2,857,658. **LAGHU EYEWEAR (STYLIZED)**. CAC OPTICAL, INC., (U.S. CLS. 21, 23, 26, 36 AND 38). SN 76-530,996. PUB. 4-6-2004. FILED 7-21-2003.
- 2,857,678. **WEBOPUS**. CONTINUUM HEALTHCARE, INC., (U.S. CLS. 21, 23, 26, 36 AND 38). SN 76-531,882. PUB. 4-6-2004. FILED 7-24-2003.
- 2,857,702. **VENDWARE**. VENDING MANAGEMENT SERVICES LTD., (U.S. CLS. 21, 23, 26, 36 AND 38). SN 76-532,838. PUB. 4-6-2004. FILED 7-15-2003.
- 2,857,706. **E ECLIPSE AND DESIGN**. CAM SYSTEMS, LLC, (U.S. CLS. 21, 23, 26, 36 AND 38). SN 76-533,377. PUB. 4-6-2004. FILED 7-17-2003.
- 2,857,717. **MISCELLANEOUS DESIGN**. CYBERSOFT, INC., MULTIPLE CLASS, (INT. CLS. 9 AND 42), (U.S. CLS. 21, 23, 26, 36, 38, 100 AND 101). SN 76-535,306. PUB. 4-6-2004. FILED 8-6-2003.
- 2,857,748. **POPUP BEGONE**. MICROSMARTS ENTERPRISE, (U.S. CLS. 21, 23, 26, 36 AND 38). SN 76-541,632. PUB. 4-6-2004. FILED 8-21-2003.
- 2,857,757. **GET AND DESIGN**. MIAMI AUDIO MUSIC, (U.S. CLS. 21, 23, 26, 36 AND 38). SN 76-543,940. PUB. 4-6-2004. FILED 9-9-2003.
- 2,857,770. **STEPMIND PERFORMING WIRELESS WAYS AND DESIGN**. STEPMIND, MULTIPLE CLASS, (INT. CLS. 9 AND 38), (U.S. CLS. 21, 23, 26, 36, 38, 100, 101 AND 104). SN 76-976,746. PUB. 8-12-2003. FILED 12-12-2000.
- 2,857,778. **PREMIERACCESS**. SECURE COMPUTING CORPORATION, (U.S. CLS. 21, 23, 26, 36 AND 38). SN 78-078,232. PUB. 4-6-2004. FILED 8-8-2001.
- 2,857,779. **MACRAFT**. MACRAFT, INC., (U.S. CLS. 21, 23, 26, 36 AND 38). SN 78-078,958. PUB. 4-6-2004. FILED 8-13-2001.
- 2,857,787. **NETALYTICS**. NETALYTICS DSI GP, MULTIPLE CLASS, (INT. CLS. 9, 16 AND 42), (U.S. CLS. 2, 5, 21, 22, 23, 26, 29, 36, 37, 38, 50, 100 AND 101). SN 78-112,329. PUB. 2-10-2004. FILED 3-4-2002.
- 2,857,790. **VBUILD**. RED BEND LTD., (U.S. CLS. 21, 23, 26, 36 AND 38). SN 78-126,715. PUB. 4-6-2004. FILED 5-7-2002.
- 2,857,792. **SONIC**. SONIC SOLUTIONS, MULTIPLE CLASS, (INT. CLS. 9, 41 AND 42), (U.S. CLS. 21, 23, 26, 36, 38, 100, 101 AND 107). SN 78-134,620. PUB. 4-6-2004. FILED 6-11-2002.
- 2,857,794. **SPACE WEATHER AND DESIGN**. SPACE UPDATE, INC, (U.S. CLS. 21, 23, 26, 36 AND 38). SN 78-137,930. PUB. 4-6-2004. FILED 6-22-2002.
- 2,857,802. **CONDUIT RECORDS AND DESIGN**. CONDUIT RECORDS, (U.S. CLS. 21, 23, 26, 36 AND 38). SN 78-156,111. PUB. 4-6-2004. FILED 8-20-2002.
- 2,857,805. **UTCSP**. ULTRATERA CORPORATION, (U.S. CLS. 21, 23, 26, 36 AND 38). SN 78-157,741. PUB. 4-6-2004. FILED 8-26-2002.
- 2,857,808. **RF-232**. AEROCOMM, INC., (U.S. CLS. 21, 23, 26, 36 AND 38). SN 78-160,085. PUB. 4-6-2004. FILED 9-3-2002.
- 2,857,812. **NT OBJECTIVES, INC.**. NT OBJECTIVES, INC., (U.S. CLS. 21, 23, 26, 36 AND 38). SN 78-166,267. PUB. 4-6-2004. FILED 9-20-2002.
- 2,857,814. **EA BY ETIENNE AIGNER (STYLIZED)**, ETIENNE AIGNER INC., MULTIPLE CLASS, (INT. CLS. 9, 14 AND 25), (U.S. CLS. 2, 21, 22, 23, 26, 27, 28, 36, 38, 39 AND 50). SN 78-167,328. PUB. 4-6-2004. FILED 9-24-2002.
- 2,857,824. **THE VBIRDS**. STAR COMPANY LIMITED, MULTIPLE CLASS, (INT. CLS. 9, 38 AND 41), (U.S. CLS. 21, 23, 26, 36, 38, 100, 101, 104 AND 107). SN 78-176,131. PUB. 4-6-2004. FILED 10-18-2002.
- 2,857,847. **APPLAUNCHER**. TWISTED TECHNOLOGIES, INC., (U.S. CLS. 21, 23, 26, 36 AND 38). SN 78-189,862. PUB. 4-6-2004. FILED 11-29-2002.
- 2,857,852. **MOMS IN TOUCH INTERNATIONAL**. MOMS IN TOUCH INTERNATIONAL, MULTIPLE CLASS, (INT. CLS. 9, 16 AND 41), (U.S. CLS. 2, 5, 21, 22, 23, 26, 29, 36, 37, 38, 50, 100, 101 AND 107). SN 78-190,566. PUB. 4-6-2004. FILED 12-3-2002.
- 2,857,859. **SPELVIN**. SKUNK STUDIOS, LLC, (U.S. CLS. 21, 23, 26, 36 AND 38). SN 78-192,107. PUB. 4-6-2004. FILED 12-6-2002.
- 2,857,865. **XTIME**. XTIME, INC., MULTIPLE CLASS, (INT. CLS. 9, 41 AND 42), (U.S. CLS. 21, 23, 26, 36, 38, 100, 101 AND 107). SN 78-192,691. PUB. 4-6-2004. FILED 12-9-2002.
- 2,857,878. **RYAN AND DESIGN**. RYAN INTERNATIONAL CORPORATION, (U.S. CLS. 21, 23, 26, 36 AND 38). SN 78-197,997. PUB. 4-6-2004. FILED 12-26-2002.
- 2,857,882. **DPA MICROPHONES**. DPA MICROPHONES A/S, (U.S. CLS. 21, 23, 26, 36 AND 38). SN 78-199,455. PUB. 4-6-2004. FILED 1-2-2003.
- 2,857,883. **INFOWISE**. INFOWISE SOLUTIONS, INC., MULTIPLE CLASS, (INT. CLS. 9 AND 42), (U.S. CLS. 21, 23, 26, 36, 38, 100 AND 101). SN 78-199,882. PUB. 4-6-2004. FILED 1-3-2003.
- 2,857,890. **HARRIS MULTILINK**. HARRIS TRUST AND SAVINGS BANK, MULTIPLE CLASS, (INT. CLS. 9 AND 36), (U.S. CLS. 21, 23, 26, 36, 38, 100, 101 AND 102). SN 78-200,938. PUB. 4-6-2004. FILED 1-7-2003.
- 2,857,909. **WINTLEY PHIPPS**. PHIPPS, WINTLEY, MULTIPLE CLASS, (INT. CLS. 9 AND 41), (U.S. CLS. 21, 23, 26, 36, 38, 100, 101 AND 107). SN 78-203,274. PUB. 4-6-2004. FILED 1-14-2003.
- 2,857,910. **ARTRAC (STYLIZED)**. L.W. HANCOCK CORPORATION, (U.S. CLS. 21, 23, 26, 36 AND 38). SN 78-204,181. PUB. 4-6-2004. FILED 1-16-2003.
- 2,857,913. **UGLI FRUIT PRODUCTIONS AND DESIGN**. FAULK, DANIEL M., (U.S. CLS. 21, 23, 26, 36 AND 38). SN 78-205,286. PUB. 4-6-2004. FILED 1-21-2003.
- 2,857,916. **PRONOVA**. TDE THONHAUSER DATA ENGINEERING GMBH, MULTIPLE CLASS, (INT. CLS. 9, 35 AND 42), (U.S. CLS. 21, 23, 26, 36, 38, 100, 101 AND 102). SN 78-206,746. PUB. 4-6-2004. FILED 1-24-2003.
- 2,857,932. **MICROPEL**. CITY TECHNOLOGY LIMITED, (U.S. CLS. 21, 23, 26, 36 AND 38). SN 78-213,473. PUB. 4-6-2004. FILED 2-11-2003.
- 2,857,952 (*See Class 7 for this trademark*).
- 2,857,956. **MELODISTIK**. Q-TEK INTERNATIONAL, LLC, (U.S. CLS. 21, 23, 26, 36 AND 38). SN 78-221,045. PUB. 4-6-2004. FILED 3-3-2003.
- 2,857,967. **SYMON VISTA AND DESIGN**. SYMON COMMUNICATIONS, INC., (U.S. CLS. 21, 23, 26, 36 AND 38). SN 78-229,515. PUB. 4-6-2004. FILED 3-25-2003.
- 2,857,968. **ADOAM**. CENTRALYTICS, INC., MULTIPLE CLASS, (INT. CLS. 9 AND 35), (U.S. CLS. 21, 23, 26, 36, 38, 100, 101 AND 102). SN 78-229,575. PUB. 4-6-2004. FILED 3-25-2003.
- 2,857,976. **MORNING EDGE**. WIDEORBIT, (U.S. CLS. 21, 23, 26, 36 AND 38). SN 78-233,944. PUB. 4-6-2004. FILED 4-4-2003.
- 2,857,977. **MANTARAY**. WHEATON USA INC., (U.S. CLS. 21, 23, 26, 36 AND 38). SN 78-234,675. PUB. 4-6-2004. FILED 4-7-2003.
- 2,857,982. **ENVOKE**. ASYNCHRONY SOLUTIONS, INC., (U.S. CLS. 21, 23, 26, 36 AND 38). SN 78-236,950. PUB. 4-6-2004. FILED 4-11-2003.

- 2,858,040. **UNCLE MILTON**. UNCLE MILTON INDUSTRIES, INC., MULTIPLE CLASS, (INT. CLS. 9, 16 AND 28), (U.S. CLS. 2, 5, 21, 22, 23, 26, 29, 36, 37, 38 AND 50). SN 78-265,317. PUB. 4-6-2004. FILED 6-20-2003.
- 2,858,044. **MAD DOG MULTIMEDIA**. MAD DOG MULTIMEDIA, INC., (U.S. CLS. 21, 23, 26, 36 AND 38). SN 78-266,131. PUB. 4-6-2004. FILED 6-23-2003.
- 2,858,072. **WORLD OF QUILTS**. TANSTAAFL MEDIA, INC., (U.S. CLS. 21, 23, 26, 36 AND 38). SN 78-270,763. PUB. 4-6-2004. FILED 7-5-2003.
- 2,858,073. **VAGUE MOON RECORDS**. GILL, CHRISTOPHER B., (U.S. CLS. 21, 23, 26, 36 AND 38). SN 78-270,792. PUB. 4-6-2004. FILED 7-6-2003.
- 2,858,093. **COUNSELOR**. SUNBEAM PRODUCTS, INC., (U.S. CLS. 21, 23, 26, 36 AND 38). SN 78-274,438. PUB. 4-6-2004. FILED 7-15-2003.
- 2,858,094. **INDUCOMP**. INDUCOMP CORPORATION, (U.S. CLS. 21, 23, 26, 36 AND 38). SN 78-274,497. PUB. 4-6-2004. FILED 7-15-2003.
- 2,858,101. **TASCO**. BUSHNELL PERFORMANCE OPTICS, (U.S. CLS. 21, 23, 26, 36 AND 38). SN 78-275,041. PUB. 4-6-2004. FILED 7-16-2003.
- 2,858,103. **ETHERRAID**. ETRUNK TECHNOLOGIES INC., (U.S. CLS. 21, 23, 26, 36 AND 38). SN 78-275,106. PUB. 4-6-2004. FILED 7-16-2003.
- 2,858,108. **SOFTGENETICS**. SOFTGENETICS, LLC, (U.S. CLS. 21, 23, 26, 36 AND 38). SN 78-275,868. PUB. 4-6-2004. FILED 7-18-2003.
- 2,858,112. **PS-6261**. GEMINI SOUND PRODUCTS CORP., (U.S. CLS. 21, 23, 26, 36 AND 38). SN 78-276,171. PUB. 4-6-2004. FILED 7-18-2003.
- 2,858,121. **THE VITAL LIFE FORCE AND THE EMPOWERMENT OF THE BODY, MIND AND SOUL**. GLOBAL COLLEGE OF GAYATRI, (U.S. CLS. 21, 23, 26, 36 AND 38). SN 78-277,015. PUB. 4-6-2004. FILED 7-21-2003.
- 2,858,133. **CONNECTSHIP**. UNITED PARCEL SERVICE OF AMERICA, INC., (U.S. CLS. 21, 23, 26, 36 AND 38). SN 78-279,194. PUB. 4-6-2004. FILED 7-25-2003.
- 2,858,145. **PCIXHSD**. APPLIED DATA SCIENCES, INC., (U.S. CLS. 21, 23, 26, 36 AND 38). SN 78-286,335. PUB. 4-6-2004. FILED 8-12-2003.
- 2,858,146. **OMNITOWER**. MEDIA SUPPLY, INC., (U.S. CLS. 21, 23, 26, 36 AND 38). SN 78-286,413. PUB. 4-6-2004. FILED 8-12-2003.
- 2,858,156. **FIRECHEK**. MEMRY CORPORATION, (U.S. CLS. 21, 23, 26, 36 AND 38). SN 78-290,188. PUB. 4-6-2004. FILED 8-21-2003.
- 2,858,163. **READIVIEW**. MEADE INSTRUMENTS CORPORATION, (U.S. CLS. 21, 23, 26, 36 AND 38). SN 78-292,022. PUB. 4-6-2004. FILED 8-25-2003.
- 2,858,164 (*See Class 8 for this trademark*).
- 76-465,169. PUB. 4-6-2004. FILED 11-1-2002.
- 2,857,363 (*See Class 9 for this trademark*).
- 2,857,377. **MOISTURE-GUARD**. TUSCARORA INCORPORATED, MULTIPLE CLASS, (INT. CLS. 10 AND 21), (U.S. CLS. 2, 13, 23, 26, 29, 30, 33, 39, 40, 44 AND 50). SN 76-470,228. PUB. 4-6-2004. FILED 11-25-2002.
- 2,857,429. **JIMMIE HATZ AND DESIGN**. COMMON GROUND USA, INC., (U.S. CLS. 26, 39 AND 44). SN 76-485,143. PUB. 4-6-2004. FILED 1-27-2003.
- 2,857,691. **MEDIVIEW**. CASE MEDICAL, INC., (U.S. CLS. 26, 39 AND 44). SN 76-532,394. PUB. 4-6-2004. FILED 7-18-2003.
- 2,857,723. **PERFECT EAR**. MAGNATONE, (U.S. CLS. 26, 39 AND 44). SN 76-536,796. PUB. 4-6-2004. FILED 7-24-2003.
- 2,857,729. **ULTRAMAX**. MARLEN MANUFACTURING AND DEVELOPMENT CO., (U.S. CLS. 26, 39 AND 44). SN 76-538,412. PUB. 4-6-2004. FILED 8-19-2003.
- 2,857,766. **MEKANIKA**. MEKANIKA, INC., (U.S. CLS. 26, 39 AND 44). SN 76-548,751. PUB. 4-6-2004. FILED 9-15-2003.
- 2,857,789. **MICROVENA**. EV3 INC., (U.S. CLS. 26, 39 AND 44). SN 78-118,145. PUB. 4-6-2004. FILED 3-28-2002.
- 2,857,797. **PARADIGM**. GENERATION II ORTHOTICS INC., (U.S. CLS. 26, 39 AND 44). SN 78-139,206. PUB. 4-6-2004. FILED 6-26-2002.
- 2,857,801. **WHOLEY HI-TORQUE PLUS**. WHOLEY, MARK H., (U.S. CLS. 26, 39 AND 44). SN 78-155,564. PUB. 4-6-2004. FILED 8-19-2002.
- 2,857,836. **BANANA SCRUBS**. BANANA SCRUBS, INCORPORATED, (U.S. CLS. 26, 39 AND 44). SN 78-187,057. PUB. 4-6-2004. FILED 11-20-2002.
- 2,857,922. **PROSTHOCAD**. CADENT LTD., (U.S. CLS. 26, 39 AND 44). SN 78-209,981. PUB. 12-2-2003. FILED 2-3-2003.
- 2,857,973. **ENDOTINE**. COAPT SYSTEMS, INC., (U.S. CLS. 26, 39 AND 44). SN 78-231,487. PUB. 4-6-2004. FILED 3-28-2003.
- 2,858,037. **NICE AND COMFY AND DESIGN**. WERNER, APRIL DAWN, (U.S. CLS. 26, 39 AND 44). SN 78-262,684. PUB. 4-6-2004. FILED 6-16-2003.
- 2,858,038. **BD VACUTAINER AND DESIGN**. BECTON, DICKINSON AND COMPANY, (U.S. CLS. 26, 39 AND 44). SN 78-264,506. PUB. 4-6-2004. FILED 6-19-2003.
- 2,858,076. **TRILLIUM**. MEDTRONIC, INC., (U.S. CLS. 26, 39 AND 44). SN 78-272,047. PUB. 4-6-2004. FILED 7-9-2003.
- 2,858,090. **MALE ATTITUDES**. SPICE ENTERTAINMENT, INC., (U.S. CLS. 26, 39 AND 44). SN 78-274,203. PUB. 4-6-2004. FILED 7-15-2003.
- 2,858,137. **IT'S HARD TO BELIEVE SOMETHING SO SIMPLE CAN FEEL SO GOOD**. JUAREZ, MARK, MULTIPLE CLASS, (INT. CLS. 10 AND 20), (U.S. CLS. 2, 13, 22, 25, 26, 32, 39, 44 AND 50). SN 78-280,091. PUB. 4-6-2004. FILED 7-29-2003.
- 2,858,140. **FLEXIMATIC**. GENERAL PHYSIOTHERAPY, INC., (U.S. CLS. 26, 39 AND 44). SN 78-280,999. PUB. 4-6-2004. FILED 7-30-2003.

CLASS 10—MEDICAL APPARATUS

- 2,857,122. **MBST**. MUNTERMANN, AXEL, MULTIPLE CLASS, (INT. CLS. 10 AND 42), (U.S. CLS. 26, 39, 44, 100 AND 101). SN 75-585,753. PUB. 10-9-2001. FILED 11-9-1998.
- 2,857,161 (*See Class 1 for this trademark*).
- 2,857,207 (*See Class 1 for this trademark*).
- 2,857,222. **P.L.U.S. PIVOT LINK UNIVERSAL SYSTEM**. SPINEVISION S.A., (U.S. CLS. 26, 39 AND 44). SN 76-353,525. PUB. 9-30-2003. FILED 12-26-2001.
- 2,857,273. **MULTIJECT AND DESIGN**. EXELINT INTERNATIONAL CO., DBA EXEL INTERNATIONAL, (U.S. CLS. 26, 39 AND 44). SN 76-409,617. PUB. 4-6-2004. FILED 5-16-2002.
- 2,857,311 (*See Class 3 for this trademark*).
- 2,857,320. **DERMOBELLA**. MEI YIN CHANG FOR MEI BEAUTY PRODUCTS INC., (U.S. CLS. 26, 39 AND 44). SN 76-447,689. PUB. 4-6-2004. FILED 9-6-2002.
- 2,857,348. **ORIA AND DESIGN**. SOCIETE EUROSURGICAL S.A., MULTIPLE CLASS, (INT. CLS. 10 AND 44), (U.S. CLS. 26, 39, 44, 100 AND 101). SN 76-462,298. PUB. 4-6-2004. FILED 10-24-2002.
- 2,857,360. **SIXP.AG**. SIXP.AG, MULTIPLE CLASS, (INT. CLS. 10, 35 AND 42), (U.S. CLS. 26, 39, 44, 100, 101 AND 102). SN

CLASS 11—ENVIRONMENTAL CONTROL APPARATUS

- 2,857,119. **M METRO AND DESIGN**. METRO THEBE, INC., MULTIPLE CLASS, (INT. CLS. 11, 20 AND 21), (U.S. CLS. 2, 13, 21, 22, 23, 25, 29, 30, 31, 32, 33, 34, 40 AND 50). SN 75-553,097. PUB. 4-6-2004. FILED 9-14-1998.
- 2,857,146. **UNIVERSAL UNIVERSEL AND DESIGN**. FIESTA BARBEQUES LIMITED, (U.S. CLS. 13, 21, 23, 31 AND 34). SN 76-075,071. PUB. 4-6-2004. FILED 6-21-2000.
- 2,857,169. **ASPEN**. LYTRON INCORPORATED, (U.S. CLS. 13, 21, 23, 31 AND 34). SN 76-170,386. PUB. 4-6-2004. FILED 11-22-2000.
- 2,857,212 (*See Class 9 for this trademark*).
- 2,857,214 (*See Class 1 for this trademark*).
- 2,857,229. **PINGUINO DELONGHI AND DESIGN**. DE' LONGHI S.P.A., (U.S. CLS. 13, 21, 23, 31 AND 34). SN 76-364,245. PUB. 4-6-2004. FILED 1-22-2002.
- 2,857,411. **MOORE**. MOORE FANS, LLC, (U.S. CLS. 13, 21, 23, 31 AND 34). SN 76-480,982. PUB. 4-6-2004. FILED 1-8-2003.
- 2,857,416. **Z.PLEX**. GE OSMONICS, INC., (U.S. CLS. 13, 21, 23, 31 AND 34). SN 76-482,708. PUB. 4-6-2004. FILED 1-16-2003.
- 2,857,417. **XPLEAT**. GE OSMONICS, INC., (U.S. CLS. 13, 21,

- 23, 31 AND 34). SN 76-482,711. PUB. 4-6-2004. FILED 1-16-2003.
- 2,857,438. **LIGHTING ALTERNATIVES**. LIGHTING ALTERNATIVES, INC., MULTIPLE CLASS, (INT. CLS. 11 AND 42), (U.S. CLS. 13, 21, 23, 31, 34, 100 AND 101). SN 76-486,364. PUB. 4-6-2004. FILED 1-29-2003.
- 2,857,443 (*See Class 9 for this trademark*).
- 2,857,444 (*See Class 9 for this trademark*).
- 2,857,542. **USABIDET AND DESIGN**. LINDHEIMER ASSOCIATES, INC., (U.S. CLS. 13, 21, 23, 31 AND 34). SN 76-514,862. PUB. 4-6-2004. FILED 5-16-2003.
- 2,857,565. **THRU-AIR**. METSO PAPER USA, INC., (U.S. CLS. 13, 21, 23, 31 AND 34). SN 76-519,424. PUB. 4-6-2004. FILED 5-14-2003.
- 2,857,753. **LAMONTAGE**. M G K GROUP INC., MULTIPLE CLASS, (INT. CLS. 11 AND 18), (U.S. CLS. 1, 2, 3, 13, 21, 22, 23, 31, 34 AND 41). SN 76-543,479. PUB. 4-6-2004. FILED 9-8-2003.
- 2,857,772 (*See Class 6 for this trademark*).
- 2,857,832. **SUNSCAPE**. SMI HOME PRODUCTS, INC., (U.S. CLS. 13, 21, 23, 31 AND 34). SN 78-184,908. PUB. 4-6-2004. FILED 11-14-2002.
- 2,857,907. **MISCELLANEOUS DESIGN**. MORTON INTERNATIONAL, INC., (U.S. CLS. 13, 21, 23, 31 AND 34). SN 78-203,065. PUB. 4-6-2004. FILED 1-14-2003.
- 2,857,926. **HERBEAU**. HERBEAU CREATIONS OF AMERICA, INC., MULTIPLE CLASS, (INT. CLS. 11, 20 AND 21), (U.S. CLS. 2, 13, 21, 22, 23, 25, 29, 30, 31, 32, 33, 34, 40 AND 50). SN 78-211,892. PUB. 4-6-2004. FILED 2-6-2003.
- 2,857,996. **JENTLE PED**. MTI WHIRLPOOLS, INC., (U.S. CLS. 13, 21, 23, 31 AND 34). SN 78-245,148. PUB. 4-6-2004. FILED 5-2-2003.
- 2,858,092 (*See Class 1 for this trademark*).
- 2,858,120. **MAX-EMITTER**. R.M. WADE & CO., MULTIPLE CLASS, (INT. CLS. 11 AND 17), (U.S. CLS. 1, 5, 12, 13, 21, 23, 31, 34, 35 AND 50). SN 78-277,000. PUB. 4-6-2004. FILED 7-21-2003.

CLASS 12—VEHICLES

- 2,857,115. **TERRANO**. NISSAN JIDOSHA KABUSHIKI KAISHA, TA NISSON MOTOR CO., LTD., (U.S. CLS. 19, 21, 23, 31, 35 AND 44). SN 75-303,503. PUB. 6-15-1999. FILED 6-5-1997.
- 2,857,148. **F AND DESIGN**. FORMULA S.R.L., (U.S. CLS. 19, 21, 23, 31, 35 AND 44). SN 76-077,358. PUB. 9-2-2003. FILED 6-22-2000.
- 2,857,171 (*See Class 3 for this trademark*).
- 2,857,280. **MISCELLANEOUS DESIGN**. COMPAGNIE PLASTIC OMNIUM, (U.S. CLS. 19, 21, 23, 31, 35 AND 44). SN 76-416,204. PUB. 9-16-2003. FILED 5-31-2002.
- 2,857,385. **QUADGRIP**. AMERICAN SUZUKI MOTOR CORPORATION, (U.S. CLS. 19, 21, 23, 31, 35 AND 44). SN 76-473,183. PUB. 4-6-2004. FILED 11-26-2002.
- 2,857,401 (*See Class 6 for this trademark*).
- 2,857,484. **AIRLORD AND DESIGN**. KEITH HUBER, INC., (U.S. CLS. 19, 21, 23, 31, 35 AND 44). SN 76-502,861. PUB. 4-6-2004. FILED 3-31-2003.
- 2,857,491. **BURNCO**. PETERS, RONALD, (U.S. CLS. 19, 21, 23, 31, 35 AND 44). SN 76-505,813. PUB. 4-6-2004. FILED 4-11-2003.
- 2,857,557. **SPIRIT OF ECSTASY**. BAYERISCHE MOTORENWERKE AKTIENGESELLSCHAFT, (U.S. CLS. 19, 21, 23, 31, 35 AND 44). SN 76-518,228. PUB. 4-6-2004. FILED 5-29-2003.
- 2,857,762. **GO & PLAY (STYLIZED)**. MTS PRODUCTS, (U.S. CLS. 19, 21, 23, 31, 35 AND 44). SN 76-546,604. PUB. 4-6-2004. FILED 9-8-2003.
- 2,857,795 (*See Class 1 for this trademark*).
- 2,858,005. **WERNER PADDLES**. WERNER PADDLES, INC., (U.S. CLS. 19, 21, 23, 31, 35 AND 44). SN 78-248,073. PUB. 4-6-2004. FILED 5-9-2003.
- 2,858,013. **HTSPC**. BRIDGESTONE CORPORATION, (U.S. CLS. 19, 21, 23, 31, 35 AND 44). SN 78-252,044. PUB. 4-6-2004. FILED 5-20-2003.
- 2,858,048. **GRILLE-TECH (STYLIZED)**. GRILLE-TECH,

L.L.C., (U.S. CLS. 19, 21, 23, 31, 35 AND 44). SN 78-266,957. PUB. 4-6-2004. FILED 6-25-2003.

CLASS 13—FIREARMS

- 2,857,294. **CABALLER**. PIROTECNIA CABALLER, S.A., MULTIPLE CLASS, (INT. CLS. 13 AND 41), (U.S. CLS. 2, 9, 100, 101 AND 107). SN 76-427,126. PUB. 4-6-2004. FILED 7-3-2002.
- 2,857,365. **ANRUB**. WINDHOVER TECHNOLOGY MANAGEMENT PTY LIMITED, (U.S. CLS. 2 AND 9). SN 76-465,877. PUB. 4-6-2004. FILED 10-31-2002.
- 2,857,516. **HI VIZ XCOIL**. NORTH PASS, LTD., (U.S. CLS. 2 AND 9). SN 76-510,585. PUB. 4-6-2004. FILED 5-1-2003.
- 2,857,960. **HOT-COR AND DESIGN**. ALLIANT TECHSYSTEMS INC., (U.S. CLS. 2 AND 9). SN 78-224,195. PUB. 4-6-2004. FILED 3-11-2003.
- 2,858,031. **L.E.M. GUN SPECIALTIES**. BROWNELLS, INC., (U.S. CLS. 2 AND 9). SN 78-261,680. PUB. 4-6-2004. FILED 6-12-2003.

CLASS 14—JEWELRY

- 2,857,171 (*See Class 3 for this trademark*).
- 2,857,224. **MID-STATES RECYCLING & REFINING**. MID-STATES RECYCLING, INC., MULTIPLE CLASS, (INT. CLS. 14 AND 40), (U.S. CLS. 2, 27, 28, 50, 100, 103 AND 106). SN 76-355,282. PUB. 4-6-2004. FILED 1-7-2002.
- 2,857,230 (*See Class 3 for this trademark*).
- 2,857,248 (*See Class 3 for this trademark*).
- 2,857,257. **101**. VAN CLEEF & ARPELS LOGISTICS S. A., (U.S. CLS. 2, 27, 28 AND 50). SN 76-397,509. PUB. 5-20-2003. FILED 4-19-2002.
- 2,857,297. **P P (STYLIZED)**. ELLAGEM, INC., (U.S. CLS. 2, 27, 28 AND 50). SN 76-428,813. PUB. 4-6-2004. FILED 7-5-2002.
- 2,857,340. **LOCJEWELS**. LOCWEAR, L.L.C., MULTIPLE CLASS, (INT. CLS. 14 AND 26), (U.S. CLS. 2, 27, 28, 37, 39, 40, 42 AND 50). SN 76-459,554. PUB. 4-6-2004. FILED 10-21-2002.
- 2,857,341. **T AND DESIGN**. TOM TAILOR AG, (U.S. CLS. 2, 27, 28 AND 50). SN 76-459,593. PUB. 4-6-2004. FILED 10-8-2002.
- 2,857,520 (*See Class 9 for this trademark*).
- 2,857,525 (*See Class 9 for this trademark*).
- 2,857,651. **HATANI**. JEWELS CONNECTION, INC., (U.S. CLS. 2, 27, 28 AND 50). SN 76-530,601. PUB. 4-6-2004. FILED 7-17-2003.
- 2,857,807. **ZINO PLATINUM LOW RIDER**. DAVIDOFF & CIE SA, MULTIPLE CLASS, (INT. CLS. 14 AND 34), (U.S. CLS. 2, 8, 9, 17, 27, 28 AND 50). SN 78-158,242. PUB. 4-6-2004. FILED 8-27-2002.
- 2,857,814 (*See Class 9 for this trademark*).
- 2,857,819. **SIMPLE LEGACY**. SUTTERER, S. TERI, (U.S. CLS. 2, 27, 28 AND 50). SN 78-170,924. PUB. 4-6-2004. FILED 10-4-2002.
- 2,857,823. **HOT GOLD**. HISTORIC ORIGINALS LIMITED, (U.S. CLS. 2, 27, 28 AND 50). SN 78-175,850. PUB. 2-17-2004. FILED 10-18-2002.
- 2,857,885. **SIMPLY DESIRABLE**. MARC LAZAR INC., (U.S. CLS. 2, 27, 28 AND 50). SN 78-200,309. PUB. 4-6-2004. FILED 1-6-2003.
- 2,857,954. **LOVE + PEACE + HOPE**. BEHR, EHUD, (U.S. CLS. 2, 27, 28 AND 50). SN 78-220,564. PUB. 4-6-2004. FILED 3-1-2003.
- 2,857,981. **YANOVA**. YANOVA LIMITED, (U.S. CLS. 2, 27, 28 AND 50). SN 78-236,215. PUB. 4-6-2004. FILED 4-10-2003.
- 2,858,131. **MISCELLANEOUS DESIGN**. MEDIA MAVERICK INCORPORATED, (U.S. CLS. 2, 27, 28 AND 50). SN 78-278,724. PUB. 4-6-2004. FILED 7-24-2003.
- 2,858,135. **GDM**. GOLDIAM INTERNATIONAL LIMITED, (U.S. CLS. 2, 27, 28 AND 50). SN 78-279,774. PUB. 4-6-2004. FILED 7-28-2003.
- 2,858,168. **YBOA HOOPSTERS**. YOUTH BASKETBALL OF AMERICA, INC., MULTIPLE CLASS, (INT. CLS. 14 AND

25), (U.S. CLS. 2, 22, 27, 28, 39 AND 50). SN 78-293,221. PUB. 4-6-2004. FILED 8-28-2003.

CLASS 15—MUSICAL INSTRUMENTS

2,857,422. **JANUS AND DESIGN**. K. H. S. MUSICAL INSTRUMENT CO., LTD., (U.S. CLS. 2, 21 AND 36). SN 76-484,128. PUB. 4-6-2004. FILED 1-22-2003.

2,857,436. **LOST TIMBRE**. TONY PASS BANJO RIMS, LLC, (U.S. CLS. 2, 21 AND 36). SN 76-486,092. PUB. 4-6-2004. FILED 1-27-2003.

2,857,437. **LOST TIMBRE (STYLIZED)**. TONY PASS BANJO RIMS, LLC, (U.S. CLS. 2, 21 AND 36). SN 76-486,093. PUB. 4-6-2004. FILED 1-27-2003.

2,857,849. **ZZ VANDOREN PARIS AND DESIGN**. VARLEPIC PARTICIPATIONS, (U.S. CLS. 2, 21 AND 36). SN 78-190,391. PUB. 4-6-2004. FILED 12-2-2002.

2,858,029. **SHARK TOOTH AND DESIGN**. ATKIN, GREG M., (U.S. CLS. 2, 21 AND 36). SN 78-260,688. PUB. 4-6-2004. FILED 6-10-2003.

CLASS 16—PAPER GOODS AND PRINTED MATTER

2,857,129 (*See Class 3 for this trademark*).

2,857,142. **3GPP**. EUROPEAN TELECOMMUNICATIONS STANDARDS INSTITUTE, MULTIPLE CLASS, (INT. CLS. 16, 35, 38 AND 42), (U.S. CLS. 2, 5, 22, 23, 29, 37, 38, 50, 100, 101, 102 AND 104). SN 75-983,452. PUB. 4-6-2004. FILED 11-16-1998.

2,857,144. **PCPHOTO**. WERNER PUBLISHING CORPORATION, MULTIPLE CLASS, (INT. CLS. 16 AND 42), (U.S. CLS. 2, 5, 22, 23, 29, 37, 38, 50, 100 AND 101). SN 76-024,972. PUB. 4-6-2004. FILED 4-13-2000.

2,857,151 (*See Class 9 for this trademark*).

2,857,162. **PROFESSIONAL CONTRACTOR**. DEGUSSA CORPORATION, (U.S. CLS. 2, 5, 22, 23, 29, 37, 38 AND 50). SN 76-150,347. PUB. 4-6-2004. FILED 10-19-2000.

2,857,165 (*See Class 9 for this trademark*).

2,857,171 (*See Class 3 for this trademark*).

2,857,191. **FOUNDATIONS TAKE TWO**. MACMILLAN PUBLISHERS (AUST.) PTY. LTD., MULTIPLE CLASS, (INT. CLS. 16 AND 41), (U.S. CLS. 2, 5, 22, 23, 29, 37, 38, 50, 100, 101 AND 107). SN 76-258,007. PUB. 4-6-2004. FILED 5-16-2001.

2,857,192 (*See Class 9 for this trademark*).

2,857,206. **REFLEXION**. BLUE RIDGE PAPER PRODUCTS, INC., (U.S. CLS. 2, 5, 22, 23, 29, 37, 38 AND 50). SN 76-316,840. PUB. 4-6-2004. FILED 9-24-2001.

2,857,207 (*See Class 1 for this trademark*).

2,857,213 (*See Class 2 for this trademark*).

2,857,215 (*See Class 2 for this trademark*).

2,857,248 (*See Class 3 for this trademark*).

2,857,249. **THE CREDIT UNION JOURNAL**. GLOBAL INFORMATION LICENSING CORPORATION, (U.S. CLS. 2, 5, 22, 23, 29, 37, 38 AND 50). SN 76-391,776. PUB. 4-6-2004. FILED 4-9-2002.

2,857,253. **ALL HANDS AND DESIGN**. UNITED STATES OF AMERICA, THE DEPT OF THE NAVY, (U.S. CLS. 2, 5, 22, 23, 29, 37, 38 AND 50). SN 76-396,276. PUB. 4-6-2004. FILED 4-17-2002.

2,857,261. **MY RD TO GO AND DESIGN**. MYRDTOGO, INC., MULTIPLE CLASS, (INT. CLS. 16, 35 AND 44), (U.S. CLS. 2, 5, 22, 23, 29, 37, 38, 50, 100, 101 AND 102). SN 76-398,730. PUB. 4-6-2004. FILED 4-22-2002.

2,857,266. **SCHINDLER**. SCHINDLER AUFZUGE AG, (U.S. CLS. 2, 5, 22, 23, 29, 37, 38 AND 50). SN 76-404,248. PUB. 4-6-2004. FILED 5-6-2002.

2,857,267. **CAMBRIDGE CITY**. MEADWESTVACO CORPORATION, (U.S. CLS. 2, 5, 22, 23, 29, 37, 38 AND 50). SN 76-404,898. PUB. 4-6-2004. FILED 5-9-2002.

2,857,268. **CAMBRIDGE CITY AND DESIGN**. MEADWESTVACO CORPORATION, (U.S. CLS. 2, 5, 22, 23, 29, 37, 38 AND 50). SN 76-405,156. PUB. 4-6-2004. FILED 5-9-2002.

2,857,286. **THE OFFICIAL BLUE BOOK**. WHITMAN PUBLISHING, LLC, (U.S. CLS. 2, 5, 22, 23, 29, 37, 38 AND 50). SN 76-419,284. PUB. 4-6-2004. FILED 6-11-2002.

2,857,289 (*See Class 9 for this trademark*).

2,857,299. **INFINITY WALK**. SUNBECK, DEBORAH T., (U.S. CLS. 2, 5, 22, 23, 29, 37, 38 AND 50). SN 76-430,468. PUB. 4-6-2004. FILED 7-11-2002.

2,857,307. **MISCELLANEOUS DESIGN**. HENZO B.V., (U.S. CLS. 2, 5, 22, 23, 29, 37, 38 AND 50). SN 76-434,992. PUB. 4-6-2004. FILED 7-26-2002.

2,857,309 (*See Class 9 for this trademark*).

2,857,327. **DREAM COACH**. WIEDER, MARCIA, (U.S. CLS. 2, 5, 22, 23, 29, 37, 38 AND 50). SN 76-449,945. PUB. 4-6-2004. FILED 9-16-2002.

2,857,330. **DIRECTIONS FOR HOME & GARDEN**. GOOD DIRECTIONS, INC., (U.S. CLS. 2, 5, 22, 23, 29, 37, 38 AND 50). SN 76-451,347. PUB. 4-6-2004. FILED 9-17-2002.

2,857,345. **JUST START ANYWHERE**. KENNEDY CARLISLE PUBLISHING CO., MULTIPLE CLASS, (INT. CLS. 16, 41 AND 44), (U.S. CLS. 2, 5, 22, 23, 29, 37, 38, 50, 100, 101 AND 107). SN 76-461,188. PUB. 4-6-2004. FILED 10-24-2002.

2,857,397. **RIGHTPATHING YOUR FUTURE PASSION GOALS VALUES PURPOSE BEHAVIOR SKILLS AND DESIGN**. RIGHTPATH RESOURCES, INC., (U.S. CLS. 2, 5, 22, 23, 29, 37, 38 AND 50). SN 76-476,161. PUB. 11-18-2003. FILED 12-16-2002.

2,857,459. **DELETREE CONMIGO**. OLDEMARK, MULTIPLE CLASS, (INT. CLS. 16 AND 41), (U.S. CLS. 2, 5, 22, 23, 29, 37, 38, 50, 100, 101 AND 107). SN 76-494,152. PUB. 4-6-2004. FILED 3-3-2003.

2,857,520 (*See Class 9 for this trademark*).

2,857,525 (*See Class 9 for this trademark*).

2,857,528. **TATTOO JOHNNY**. NELSON, MARK, (U.S. CLS. 2, 5, 22, 23, 29, 37, 38 AND 50). SN 76-512,436. PUB. 4-6-2004. FILED 4-16-2003.

2,857,545. **DOLLAR PET AND DESIGN**. WOLVERTON PET SUPPLY CO., (U.S. CLS. 2, 5, 22, 23, 29, 37, 38 AND 50). SN 76-515,029. PUB. 4-6-2004. FILED 5-16-2003.

2,857,569. **KINGDOM ADVANCE PARTNERS IN A NEW VISION AND DESIGN**. VIRGINIA BAPTIST MISSION BOARD, MULTIPLE CLASS, (INT. CLS. 16 AND 45), (U.S. CLS. 2, 5, 22, 23, 29, 37, 38, 50, 100 AND 101). SN 76-520,970. PUB. 4-6-2004. FILED 5-29-2003.

2,857,571. **PRO-MAX**. LA-CO INDUSTRIES, INC., (U.S. CLS. 2, 5, 22, 23, 29, 37, 38 AND 50). SN 76-521,073. PUB. 4-6-2004. FILED 6-6-2003.

2,857,618. **NO FEAR SHAKESPEARE**. SPARKNOTES LLC, (U.S. CLS. 2, 5, 22, 23, 29, 37, 38 AND 50). SN 76-529,125. PUB. 4-6-2004. FILED 7-3-2003.

2,857,630. **THE FOUNTAIN**. THE LIGHT INC., (U.S. CLS. 2, 5, 22, 23, 29, 37, 38 AND 50). SN 76-529,527. PUB. 4-6-2004. FILED 7-14-2003.

2,857,654. **ATTIVO**. GHENT MANUFACTURING, INC., (U.S. CLS. 2, 5, 22, 23, 29, 37, 38 AND 50). SN 76-530,666. PUB. 4-6-2004. FILED 7-18-2003.

2,857,656. **MIND MUNCHIES**. GOALSGUY LEARNING SYSTEMS, INC., (U.S. CLS. 2, 5, 22, 23, 29, 37, 38 AND 50). SN 76-530,853. PUB. 4-6-2004. FILED 7-18-2003.

2,857,688. **ODYSSEY COULEUR**. IDAMAR ENTERPRISES, INC., MULTIPLE CLASS, (INT. CLS. 16 AND 35), (U.S. CLS. 2, 5, 22, 23, 29, 37, 38, 50, 100, 101 AND 102). SN 76-532,316. PUB. 4-6-2004. FILED 7-25-2003.

2,857,690. **TRANQUILITY**. ECKHOLM, CHERYL L., (U.S. CLS. 2, 5, 22, 23, 29, 37, 38 AND 50). SN 76-532,337. PUB. 4-6-2004. FILED 7-17-2003.

2,857,694. **TRANSCAD**. CALIPER CORPORATION, (U.S. CLS. 2, 5, 22, 23, 29, 37, 38 AND 50). SN 76-532,450. PUB. 4-6-2004. FILED 7-25-2003.

2,857,711. **KJVER AND DESIGN**. GLOBAL EVANGELISM, (U.S. CLS. 2, 5, 22, 23, 29, 37, 38 AND 50). SN 76-534,041. PUB. 4-6-2004. FILED 8-1-2003.

2,857,722. **WE'VE RAISED THE BAR ON SALADS**. OLDEMARK LLC, MULTIPLE CLASS, (INT. CLS. 16, 35 AND 43), (U.S. CLS. 2, 5, 22, 23, 29, 37, 38, 50, 100, 101 AND 102). SN 76-536,664. PUB. 4-6-2004. FILED 7-7-2003.

2,857,732. **FOTOS 2 GO (STYLIZED)**. MJ ZOOM, (U.S. CLS. 2, 5, 22, 23, 29, 37, 38 AND 50). SN 76-538,518. PUB. 4-6-2004. FILED 8-15-2003.

2,857,739. **PHARMACY STUDENT**. AMERICAN PHARMACISTS ASSOCIATION (APHA), FORMERLY THE AMERICAN PHARMACEUTICAL ASSOCIATION, (U.S. CLS. 2, 5, 22, 23, 29, 37, 38 AND 50). SN 76-539,946. PUB. 4-6-2004. FILED 8-12-2003.

2,857,749. **ASTROJET**. MONADNOCK PAPER MILLS, INC., (U.S. CLS. 2, 5, 22, 23, 29, 37, 38 AND 50). SN 76-542,753. PUB. 4-6-2004. FILED 9-8-2003.

2,857,758. **DESTINATION ALASKA BEST BUYS**. MCC MAGAZINES, LLC, MULTIPLE CLASS, (INT. CLS. 16, 35 AND 41), (U.S. CLS. 2, 5, 22, 23, 29, 37, 38, 50, 100, 101, 102 AND 107). SN 76-544,181. PUB. 4-6-2004. FILED 8-26-2003.

2,857,760. **WESTERN HORSEMAN**. MCC MAGAZINES, LLC, MULTIPLE CLASS, (INT. CLS. 16 AND 41), (U.S. CLS. 2, 5, 22, 23, 29, 37, 38, 50, 100, 101 AND 107). SN 76-544,871. PUB. 4-6-2004. FILED 9-4-2003.

2,857,786. **ABOUT YOU AND DESIGN**. WESTERN HOLDINGS, L.L.C., MULTIPLE CLASS, (INT. CLS. 16 AND 35), (U.S. CLS. 2, 5, 22, 23, 29, 37, 38, 50, 100, 101 AND 102). SN 78-109,470. PUB. 4-6-2004. FILED 2-18-2002.

2,857,787 (*See Class 9 for this trademark*).

2,857,793. **CLEAR VIEW**. GENERAL BINDING CORPORATION, (U.S. CLS. 2, 5, 22, 23, 29, 37, 38 AND 50). SN 78-136,790. PUB. 4-6-2004. FILED 6-18-2002.

2,857,817. **PAPER SOURCE**. PAPER SOURCE, INC., MULTIPLE CLASS, (INT. CLS. 16, 26 AND 35), (U.S. CLS. 2, 5, 22, 23, 29, 37, 38, 39, 40, 42, 50, 100, 101 AND 102). SN 78-170,168. PUB. 4-6-2004. FILED 10-2-2002.

2,857,827. **POINT OF ENTRY**. RAISING MORE MONEY, INC., (U.S. CLS. 2, 5, 22, 23, 29, 37, 38 AND 50). SN 78-178,128. PUB. 4-6-2004. FILED 10-24-2002.

2,857,842. **SA (STYLIZED)**. AARON, LA SHAUN M., MULTIPLE CLASS, (INT. CLS. 16, 35 AND 42), (U.S. CLS. 2, 5, 22, 23, 29, 37, 38, 50, 100, 101 AND 102). SN 78-188,910. PUB. 4-6-2004. FILED 11-26-2002.

2,857,852 (*See Class 9 for this trademark*).

2,857,869. **RAUANTIQUES.COM**. M.S. RAU, INC., (U.S. CLS. 2, 5, 22, 23, 29, 37, 38 AND 50). SN 78-194,440. PUB. 4-6-2004. FILED 12-13-2002.

2,857,911. **MISCELLANEOUS DESIGN**. SEMICONDUCTOR EQUIPMENT AND MATERIALS INTERNATIONAL, MULTIPLE CLASS, (INT. CLS. 16, 35, 36 AND 41), (U.S. CLS. 2, 5, 22, 23, 29, 37, 38, 50, 100, 101, 102 AND 107). SN 78-204,195. PUB. 4-6-2004. FILED 1-16-2003.

2,857,927. **REAL FOOD**. FRESH MARKET COMPANY LLC, (U.S. CLS. 2, 5, 22, 23, 29, 37, 38 AND 50). SN 78-211,895. PUB. 4-6-2004. FILED 2-6-2003.

2,857,938. **GALERIE IMAGE**. M-REAL CORPORATION, (U.S. CLS. 2, 5, 22, 23, 29, 37, 38 AND 50). SN 78-215,937. PUB. 4-6-2004. FILED 2-18-2003.

2,857,947. **PRO FRAME**. INTEGRATED IDEAS AND TECHNOLOGY, INC., (U.S. CLS. 2, 5, 22, 23, 29, 37, 38 AND 50). SN 78-218,706. PUB. 4-6-2004. FILED 2-25-2003.

2,857,948. **PRO PLATE**. INTEGRATED IDEAS AND TECHNOLOGY, INC., (U.S. CLS. 2, 5, 22, 23, 29, 37, 38 AND 50). SN 78-218,724. PUB. 4-6-2004. FILED 2-25-2003.

2,857,991. **YANKEE MAGAZINE SEASONS**. YANKEE PUBLISHING INCORPORATED, (U.S. CLS. 2, 5, 22, 23, 29, 37, 38 AND 50). SN 78-244,494. PUB. 4-6-2004. FILED 5-1-2003.

2,857,993. **LAVENDER**. LAVENDER LIFESTYLES MARKETING, INC., MULTIPLE CLASS, (INT. CLS. 16 AND 35), (U.S. CLS. 2, 5, 22, 23, 29, 37, 38, 50, 100, 101 AND 102). SN 78-244,907. PUB. 4-6-2004. FILED 5-2-2003.

2,857,994. **LAVENDER (STYLIZED)**. LAVENDER LIFESTYLES MARKETING, INC., MULTIPLE CLASS, (INT. CLS. 16 AND 35), (U.S. CLS. 2, 5, 22, 23, 29, 37, 38, 50, 100, 101 AND 102). SN 78-244,945. PUB. 4-6-2004. FILED 5-2-2003.

2,857,999. **CTA AND DESIGN**. CTA INC., DBA CLIFTON TELECARD ALLIANCE, (U.S. CLS. 2, 5, 22, 23, 29, 37, 38 AND 50). SN 78-246,585. PUB. 4-6-2004. FILED 5-7-2003.

2,858,033. **CIVIC VENTURES**. CIVIC VENTURES, MULTIPLE CLASS, (INT. CLS. 16, 35, 41 AND 42), (U.S. CLS. 2, 5, 22, 23, 29, 37, 38, 50, 100, 101, 102 AND 107). SN 78-262,097. PUB. 4-6-2004. FILED 6-13-2003.

2,858,040 (*See Class 9 for this trademark*).

2,858,068. **HOME AND DESIGN**. TARGET BRANDS, INC., (U.S. CLS. 2, 5, 22, 23, 29, 37, 38 AND 50). SN 78-270,476. PUB. 4-6-2004. FILED 7-3-2003.

2,858,071. **COTTON GROWER**. MEISTER MEDIA WORLD-WIDE INC., (U.S. CLS. 2, 5, 22, 23, 29, 37, 38 AND 50). SN 78-270,530. PUB. 4-6-2004. FILED 7-3-2003.

2,858,085. **SSX**. STARLINE PUBLICATIONS, INC., (U.S. CLS. 2, 5, 22, 23, 29, 37, 38 AND 50). SN 78-273,523. PUB. 4-6-2004. FILED 7-11-2003.

2,858,096. **...WHERE MOLECULES BECOME REAL**. 3D MOLECULAR DESIGNS, LLC, (U.S. CLS. 2, 5, 22, 23, 29, 37, 38 AND 50). SN 78-274,566. PUB. 4-6-2004. FILED 7-15-2003.

2,858,107. **PANTRY PRO**. GAUDET, MICHAEL, (U.S. CLS. 2, 5, 22, 23, 29, 37, 38 AND 50). SN 78-275,865. PUB. 4-6-2004. FILED 7-18-2003.

2,858,122. **SAF-T-BIN (STYLIZED)**. WEYERHAEUSER COMPANY, (U.S. CLS. 2, 5, 22, 23, 29, 37, 38 AND 50). SN 78-277,082. PUB. 4-6-2004. FILED 7-22-2003.

2,858,176. **MISCELLANEOUS DESIGN**. EAST CAROLINA UNIVERSITY, MULTIPLE CLASS, (INT. CLS. 16 AND 25), (U.S. CLS. 2, 5, 22, 23, 29, 37, 38, 39 AND 50). SN 78-975,139. PUB. 4-6-2004. FILED 1-30-2003.

CLASS 17—RUBBER GOODS

2,857,252. **ULTRA-SEAL**. DOCK PRODUCTS CANADA INC., (U.S. CLS. 1, 5, 12, 13, 35 AND 50). SN 76-395,518. PUB. 4-6-2004. FILED 4-12-2002.

2,857,269 (*See Class 6 for this trademark*).

2,857,468. **HPP PACKING**. CDI SEALS, INC., (U.S. CLS. 1, 5, 12, 13, 35 AND 50). SN 76-497,936. PUB. 4-6-2004. FILED 3-17-2003.

2,857,633. **GARDEN MATE**. TEKNOR APEX COMPANY, (U.S. CLS. 1, 5, 12, 13, 35 AND 50). SN 76-529,604. PUB. 4-6-2004. FILED 7-16-2003.

2,857,670. **LIQUI-TITE LINER**. WES PAK, INC., (U.S. CLS. 1, 5, 12, 13, 35 AND 50). SN 76-531,397. PUB. 4-6-2004. FILED 7-22-2003.

2,857,772 (*See Class 6 for this trademark*).

2,857,795 (*See Class 1 for this trademark*).

2,857,811. **TIMPUR**. CARCOUSTICS TECH CENTER GMBH, MULTIPLE CLASS, (INT. CLS. 17 AND 27), (U.S. CLS. 1, 5, 12, 13, 19, 20, 35, 37, 42 AND 50). SN 78-164,858. PUB. 4-6-2004. FILED 9-17-2002.

2,857,915. **TRADITIONAL BAKING AND DESIGN**. TRADITIONAL BAKING, (U.S. CLS. 1, 5, 12, 13, 35 AND 50). SN 78-205,568. PUB. 4-6-2004. FILED 1-21-2003.

2,858,120 (*See Class 11 for this trademark*).

CLASS 18—LEATHER GOODS

2,857,151 (*See Class 9 for this trademark*).

2,857,165 (*See Class 9 for this trademark*).

2,857,171 (*See Class 3 for this trademark*).

2,857,230 (*See Class 3 for this trademark*).

2,857,248 (*See Class 3 for this trademark*).

2,857,333. **KILLERSPIN**. KILLERSPIN, LLC, (U.S. CLS. 1, 2, 3, 22 AND 41). SN 76-451,678. PUB. 4-6-2004. FILED 9-18-2002.

2,857,352. **BARRY CORD**. CORD, BARRY KIESELSTEIN, (U.S. CLS. 1, 2, 3, 22 AND 41). SN 76-462,977. PUB. 4-6-2004. FILED 10-24-2002.

2,857,520 (*See Class 9 for this trademark*).

2,857,525 (*See Class 9 for this trademark*).

2,857,566. **MR AND DESIGN**. MODELLREPRO INGE EK-LUND AKTIEBOLAG, (U.S. CLS. 1, 2, 3, 22 AND 41). SN 76-519,845. PUB. 2-10-2004. FILED 6-5-2003.

2,857,595. **FASHION DOLL AND DESIGN**. FASHION DOLL, INC., MULTIPLE CLASS, (INT. CLS. 18 AND 25), (U.S. CLS. 1, 2, 3, 22, 39 AND 41). SN 76-524,941. PUB. 4-6-2004. FILED 6-24-2003.

2,857,753 (*See Class 11 for this trademark*).

2,857,837. **POLO SPORT**. PRL USA HOLDINGS, INC., (U.S. CLS. 1, 2, 3, 22 AND 41). SN 78-187,389. PUB. 4-6-2004. FILED 11-21-2002.

2,857,898. **MATTHEW SHEPARD FOUNDATION EMBRA-**

- CING DIVERSITY AND DESIGN.** MATTHEW SHEPARD FOUNDATION, MULTIPLE CLASS, (INT. CLS. 18, 36 AND 41), (U.S. CLS. 1, 2, 3, 22, 41, 100, 101, 102 AND 107). SN 78-202,767. PUB. 4-6-2004. FILED 1-13-2003.
- 2,857,980. **ELLA-BAGS.** AIMEE LARSEN AND ANDREA WIREN PARTNERSHIP, THE, (U.S. CLS. 1, 2, 3, 22 AND 41). SN 78-236,055. PUB. 4-6-2004. FILED 4-10-2003.
- 2,858,075. **ARC ACTIVE AND DESIGN.** K-2 CORPORATION, (U.S. CLS. 1, 2, 3, 22 AND 41). SN 78-271,476. PUB. 4-6-2004. FILED 7-8-2003.
- 2,858,110. **MANE-STAY.** JT INTERNATIONAL DISTRIBUTORS, INC., (U.S. CLS. 1, 2, 3, 22 AND 41). SN 78-275,983. PUB. 4-6-2004. FILED 7-18-2003.
- 2,858,116. **THE FILER.** KENNETH COLE PRODUCTIONS (LIC), INC., (U.S. CLS. 1, 2, 3, 22 AND 41). SN 78-276,707. PUB. 4-6-2004. FILED 7-21-2003.

CLASS 19—NON-METALLIC BUILDING MATERIALS

- 2,857,269 (*See Class 6 for this trademark.*)
- 2,857,271. **YOUR IDEAS BECOME REALITY.** ARMSTRONG WORLD INDUSTRIES, INC., MULTIPLE CLASS, (INT. CLS. 19 AND 27), (U.S. CLS. 1, 12, 19, 20, 33, 37, 42 AND 50). SN 76-408,492. PUB. 1-13-2004. FILED 5-15-2002.
- 2,857,396. **NATURGRESS.** IRIS CERAMICA - SOCIETA' PER AZIONI, (U.S. CLS. 1, 12, 33 AND 50). SN 76-475,938. PUB. 4-6-2004. FILED 12-17-2002.
- 2,857,454. **DI LEGNO AND DESIGN.** DI LEGNO INTERIORS NV, (U.S. CLS. 1, 12, 33 AND 50). SN 76-492,229. PUB. 4-6-2004. FILED 2-19-2003.
- 2,857,456. **ELMS AND DESIGN.** GREEN PRODUCTS, INC., (U.S. CLS. 1, 12, 33 AND 50). SN 76-492,526. PUB. 4-6-2004. FILED 2-26-2003.
- 2,857,471 (*See Class 6 for this trademark.*)
- 2,857,485. **CHROMASHIELD.** CESAR, CLAUDIO, (U.S. CLS. 1, 12, 33 AND 50). SN 76-503,815. PUB. 4-6-2004. FILED 4-3-2003.
- 2,857,772 (*See Class 6 for this trademark.*)
- 2,857,834. **EMULVIA TAC.** EUROVIA, (U.S. CLS. 1, 12, 33 AND 50). SN 78-186,543. PUB. 4-6-2004. FILED 11-19-2002.
- 2,857,969. **HOBBY GROWER.** SPECIALTY PRODUCTS & SERVICES, INC., (U.S. CLS. 1, 12, 33 AND 50). SN 78-230,643. PUB. 4-6-2004. FILED 3-27-2003.
- 2,857,984. **PANDA PLY AND DESIGN.** IPMG, INC., (U.S. CLS. 1, 12, 33 AND 50). SN 78-239,695. PUB. 4-6-2004. FILED 4-18-2003.
- 2,858,020 (*See Class 6 for this trademark.*)
- 2,858,102. **UNDERBRUSH.** SHELTER-PRO, LLC, (U.S. CLS. 1, 12, 33 AND 50). SN 78-275,064. PUB. 4-6-2004. FILED 7-16-2003.
- 2,858,124. **EXTENDA-LIFE.** BROOKS MANUFACTURING CO., (U.S. CLS. 1, 12, 33 AND 50). SN 78-277,204. PUB. 4-6-2004. FILED 7-22-2003.
- 2,858,151 (*See Class 6 for this trademark.*)

CLASS 20—FURNITURE AND ARTICLES NOT OTHERWISE CLASSIFIED

- 2,857,119 (*See Class 11 for this trademark.*)
- 2,857,214 (*See Class 1 for this trademark.*)
- 2,857,269 (*See Class 6 for this trademark.*)
- 2,857,471 (*See Class 6 for this trademark.*)
- 2,857,474. **MISCELLANEOUS DESIGN.** CUSTOM MARBLE DESIGN, INC., (U.S. CLS. 2, 13, 22, 25, 32 AND 50). SN 76-498,668. PUB. 4-6-2004. FILED 3-19-2003.
- 2,857,549. **GARDEN CULTURE.** CHERISON ENTERPRISES INC., MULTIPLE CLASS, (INT. CLS. 20, 21 AND 28), (U.S. CLS. 2, 13, 22, 23, 25, 29, 30, 32, 33, 38, 40 AND 50). SN 76-516,042. PUB. 4-6-2004. FILED 5-23-2003.
- 2,857,675. **W WOW AND DESIGN.** WOW PLASTICS, INC., (U.S. CLS. 2, 13, 22, 25, 32 AND 50). SN 76-531,726. PUB. 4-6-2004. FILED 7-23-2003.

- 2,857,701. **GRAND LUX.** CARPENTER CO., (U.S. CLS. 2, 13, 22, 25, 32 AND 50). SN 76-532,806. PUB. 4-6-2004. FILED 7-10-2003.
- 2,857,747. **ADMART.** ADMART ATTRACTIONS, INC., (U.S. CLS. 2, 13, 22, 25, 32 AND 50). SN 76-541,574. PUB. 4-6-2004. FILED 8-19-2003.
- 2,857,772 (*See Class 6 for this trademark.*)
- 2,857,773. **EASYRIDER.** EXGLOBE INC., (U.S. CLS. 2, 13, 22, 25, 32 AND 50). SN 78-042,506. PUB. 7-29-2003. FILED 1-10-2001.
- 2,857,785. **AMMIQUE.** MAINSTAY DESIGNS LIMITED, MULTIPLE CLASS, (INT. CLS. 20 AND 24), (U.S. CLS. 2, 13, 22, 25, 32, 42 AND 50). SN 78-101,802. PUB. 4-6-2004. FILED 1-9-2002.
- 2,857,829. **SHUR-LOC.** ELLIOTT, GORDON W., (U.S. CLS. 2, 13, 22, 25, 32 AND 50). SN 78-180,384. PUB. 4-6-2004. FILED 10-31-2002.
- 2,857,850. **SECURETOTE.** BUCKHORN, INC., (U.S. CLS. 2, 13, 22, 25, 32 AND 50). SN 78-190,530. PUB. 4-6-2004. FILED 12-3-2002.
- 2,857,926 (*See Class 11 for this trademark.*)
- 2,858,049. **CRYOTAGS.** DIVERSIFIED BIOTECH, INC., (U.S. CLS. 2, 13, 22, 25, 32 AND 50). SN 78-267,065. PUB. 4-6-2004. FILED 6-25-2003.
- 2,858,050. **CRYO-BABIES.** DIVERSIFIED BIOTECH, INC., (U.S. CLS. 2, 13, 22, 25, 32 AND 50). SN 78-267,086. PUB. 4-6-2004. FILED 6-25-2003.
- 2,858,095. **VALUBILT AND DESIGN.** NASHVILLE DESK INC, (U.S. CLS. 2, 13, 22, 25, 32 AND 50). SN 78-274,557. PUB. 4-6-2004. FILED 7-15-2003.
- 2,858,137 (*See Class 10 for this trademark.*)

CLASS 21—HOUSEWARES AND GLASS

- 2,857,114 (*See Class 3 for this trademark.*)
- 2,857,118. **DIRTBAG.** ARCOA INDUSTRIES, (U.S. CLS. 2, 13, 29, 30, 33, 40 AND 50). SN 75-533,876. PUB. 4-6-2004. FILED 8-10-1998.
- 2,857,119 (*See Class 11 for this trademark.*)
- 2,857,129 (*See Class 3 for this trademark.*)
- 2,857,183. **EV AND DESIGN.** KABUSHIKI KAISHA EVER NEW, MULTIPLE CLASS, (INT. CLS. 21 AND 28), (U.S. CLS. 2, 13, 22, 23, 29, 30, 33, 38, 40 AND 50). SN 76-240,431. PUB. 4-6-2004. FILED 4-13-2001.
- 2,857,263. **THE PANTRY PEST.** SAFER, INC., (U.S. CLS. 2, 13, 23, 29, 30, 33, 40 AND 50). SN 76-401,550. PUB. 4-15-2003. FILED 4-29-2002.
- 2,857,269 (*See Class 6 for this trademark.*)
- 2,857,317. **FRATERNAL ORDER OF POLICE AND DESIGN.** FRATERNAL ORDER OF POLICE, (U.S. CLS. 2, 13, 23, 29, 30, 33, 40 AND 50). SN 76-446,108. PUB. 4-6-2004. FILED 8-29-2002.
- 2,857,377 (*See Class 10 for this trademark.*)
- 2,857,445. **COUNTESS.** SPORNETTE INTERNATIONAL, INC., (U.S. CLS. 2, 13, 23, 29, 30, 33, 40 AND 50). SN 76-488,195. PUB. 4-6-2004. FILED 2-5-2003.
- 2,857,457. **MISCELLANEOUS DESIGN.** JOSIAH WEDGWOOD & SONS LIMITED, (U.S. CLS. 2, 13, 23, 29, 30, 33, 40 AND 50). SN 76-492,823. PUB. 4-6-2004. FILED 2-26-2003.
- 2,857,520 (*See Class 9 for this trademark.*)
- 2,857,525 (*See Class 9 for this trademark.*)
- 2,857,535 (*See Class 4 for this trademark.*)
- 2,857,549 (*See Class 20 for this trademark.*)
- 2,857,772 (*See Class 6 for this trademark.*)
- 2,857,846. **SALUTE CERAMICS AND DESIGN.** TIENSHAN, INC., (U.S. CLS. 2, 13, 23, 29, 30, 33, 40 AND 50). SN 78-189,572. PUB. 4-6-2004. FILED 11-27-2002.
- 2,857,918. **RUSH.** RUSH UNIVERSITY MEDICAL CENTER, MULTIPLE CLASS, (INT. CLS. 21 AND 24), (U.S. CLS. 2, 13, 23, 29, 30, 33, 40, 42 AND 50). SN 78-208,973. PUB. 4-6-2004. FILED 1-30-2003.
- 2,857,923. **HEIRLOOM BASKETS (STYLIZED).** DYER, ROBERT E., (U.S. CLS. 2, 13, 23, 29, 30, 33, 40 AND 50). SN 78-209,989. PUB. 4-6-2004. FILED 2-3-2003.
- 2,857,926 (*See Class 11 for this trademark.*)
- 2,857,989. **BLACK DIAMOND.** CORONA HAIR NET CORP.,

(U.S. CLS. 2, 13, 23, 29, 30, 33, 40 AND 50). SN 78-244,077. PUB. 4-6-2004. FILED 4-30-2003.
 2,858,023. **EYE WHERE**. QSL CORPORATION, (U.S. CLS. 2, 13, 23, 29, 30, 33, 40 AND 50). SN 78-256,911. PUB. 4-6-2004. FILED 6-2-2003.
 2,858,074. **THIRSTKEY**. THIRSTKEY, LLC, (U.S. CLS. 2, 13, 23, 29, 30, 33, 40 AND 50). SN 78-271,181. PUB. 4-6-2004. FILED 7-7-2003.

CLASS 23—YARNS AND THREADS

2,857,550. **JAMIE CLASSIC**. ORCHARD YARN AND THREAD COMPANY, INC., DBA LION BRAND YARN COMPANY, (U.S. CL. 43). SN 76-516,090. PUB. 4-6-2004. FILED 5-23-2003.

CLASS 24—FABRICS

2,857,151 (*See Class 9 for this trademark*).
 2,857,288. **KOLORON**. THE BIG FUN TOYS & SUNSHINE CO LIMITED, (U.S. CLS. 42 AND 50). SN 76-421,107. PUB. 4-6-2004. FILED 6-17-2002.
 2,857,487. **WRAP-IT**. LODESTAR TRADING INTERNATIONAL, INC., (U.S. CLS. 42 AND 50). SN 76-504,156. PUB. 4-6-2004. FILED 4-4-2003.
 2,857,520 (*See Class 9 for this trademark*).
 2,857,535 (*See Class 4 for this trademark*).
 2,857,605. **ASTRALA**. MOEHRKE, RONELLE J., (U.S. CLS. 42 AND 50). SN 76-526,877. PUB. 4-6-2004. FILED 6-23-2003.
 2,857,614. **SIT'N SECURE**. LEACHCO, INC., (U.S. CLS. 42 AND 50). SN 76-528,518. PUB. 4-6-2004. FILED 7-1-2003.
 2,857,785 (*See Class 20 for this trademark*).
 2,857,918 (*See Class 21 for this trademark*).
 2,858,016. **GOOD KARMA FLAGS**. FRIEDLANDER, ROBERT, (U.S. CLS. 42 AND 50). SN 78-253,624. PUB. 4-6-2004. FILED 5-23-2003.
 2,858,069. **HOME AND DESIGN**. TARGET BRANDS, INC., (U.S. CLS. 42 AND 50). SN 78-270,485. PUB. 4-6-2004. FILED 7-3-2003.

CLASS 25—CLOTHING

2,857,120. **ROCK ISLAND**. CALLAWAY, CHARLES, MULTIPLE CLASS, (INT. CLS. 25 AND 42), (U.S. CLS. 22, 39, 100 AND 101). SN 75-561,235. PUB. 4-6-2004. FILED 9-29-1998.
 2,857,151 (*See Class 9 for this trademark*).
 2,857,165 (*See Class 9 for this trademark*).
 2,857,177. **EU: HOMME**. GUEON, JEE-YONG, (U.S. CLS. 22 AND 39). SN 76-204,531. PUB. 4-6-2004. FILED 2-5-2001.
 2,857,185. **BIRKO-FLOR (STYLIZED)**. BIRKENSROCK ORTHOPAEDIE GMBH & CO. KG, (U.S. CLS. 22 AND 39). SN 76-244,044. PUB. 10-15-2002. FILED 4-20-2001.
 2,857,193. **JESSE JAMES**. JAMES, JESSE, (U.S. CLS. 22 AND 39). SN 76-269,628. PUB. 4-6-2004. FILED 6-11-2001.
 2,857,195. **JASMINE**. JASMINE ENTERPRISES, INC., (U.S. CLS. 22 AND 39). SN 76-274,593. PUB. 4-6-2004. FILED 6-21-2001.
 2,857,198. **FLOSPORT**. SLANT-SIX CLOTHING INC., (U.S. CLS. 22 AND 39). SN 76-285,282. PUB. 4-6-2004. FILED 7-13-2001.
 2,857,230 (*See Class 3 for this trademark*).
 2,857,242. **BODYZEN AND DESIGN**. BODYZEN ENTERPRISES, INC., (U.S. CLS. 22 AND 39). SN 76-380,550. PUB. 4-6-2004. FILED 3-8-2002.
 2,857,246. **N9NE**. CANAL GROUP, INC., (U.S. CLS. 22 AND 39). SN 76-385,589. PUB. 4-6-2004. FILED 3-21-2002.
 2,857,247. **AFRIKAN SPIRIT AND DESIGN**. AFARIOGUN, MOSHOOD, MULTIPLE CLASS, (INT. CLS. 25 AND 35), (U.S. CLS. 22, 39, 100, 101 AND 102). SN 76-389,749. PUB. 4-6-2004. FILED 4-1-2002.
 2,857,248 (*See Class 3 for this trademark*).

2,857,254. **PHOENIX SUNS AND DESIGN**. PHOENIX SUNS LIMITED PARTNERSHIP, (U.S. CLS. 22 AND 39). SN 76-396,639. PUB. 4-6-2004. FILED 4-16-2002.
 2,857,337. **AUTOMATIC SLIM'S**. THE DREAM TEAM, LLC, (U.S. CLS. 22 AND 39). SN 76-458,052. PUB. 4-6-2004. FILED 10-15-2002.
 2,857,359. **THE BOW PLACE**. SHALOM INTERNATIONAL CORPORATION, MULTIPLE CLASS, (INT. CLS. 25 AND 26), (U.S. CLS. 22, 37, 39, 40, 42 AND 50). SN 76-465,012. PUB. 4-6-2004. FILED 11-1-2002.
 2,857,391. **MISCELLANEOUS DESIGN**. BORDEN, RANDOLPH, (U.S. CLS. 22 AND 39). SN 76-475,187. PUB. 4-6-2004. FILED 12-3-2002.
 2,857,409. **PERFECTION BY JUMPING JACKS AND DESIGN**. MUNRO & COMPANY, INC., (U.S. CLS. 22 AND 39). SN 76-480,599. PUB. 4-6-2004. FILED 1-3-2003.
 2,857,421. **THROX**. HEAVEN, EDWIN, AND TRAGER, JEFFREY, (U.S. CLS. 22 AND 39). SN 76-483,911. PUB. 4-6-2004. FILED 1-17-2003.
 2,857,520 (*See Class 9 for this trademark*).
 2,857,525 (*See Class 9 for this trademark*).
 2,857,547. **QUEENIE 4EVER**. WONG, VENICE ANTOINETTE, (U.S. CLS. 22 AND 39). SN 76-515,666. PUB. 4-6-2004. FILED 5-20-2003.
 2,857,548. **FROZEN ROPES**. FROZEN ROPES LLC, MULTIPLE CLASS, (INT. CLS. 25 AND 41), (U.S. CLS. 22, 39, 100, 101 AND 107). SN 76-515,964. PUB. 4-6-2004. FILED 5-21-2003.
 2,857,574. **MISCELLANEOUS DESIGN**. MINICOZZI, SALVATORE J., (U.S. CLS. 22 AND 39). SN 76-521,436. PUB. 4-6-2004. FILED 6-6-2003.
 2,857,595 (*See Class 18 for this trademark*).
 2,857,635. **RICHARD DAYHOFF**. DAYHOFF, RICHARD, (U.S. CLS. 22 AND 39). SN 76-529,688. PUB. 4-6-2004. FILED 7-8-2003.
 2,857,646. **FRIENDSOFSE**. KLEEGER, JEFFREY KENNETH, (U.S. CLS. 22 AND 39). SN 76-530,212. PUB. 4-6-2004. FILED 7-7-2003.
 2,857,662. **HELLS ANGLERS AND DESIGN**. WOJAHN, RAYMOND, (U.S. CLS. 22 AND 39). SN 76-531,174. PUB. 4-6-2004. FILED 7-22-2003.
 2,857,672. **ANNIQUE**. O'BRYAN BROS., INC., (U.S. CLS. 22 AND 39). SN 76-531,571. PUB. 4-6-2004. FILED 7-16-2003.
 2,857,707. **TURNCOAT AND DESIGN**. BRASSEY, THERESA A. (U.S. CLS. 22 AND 39). SN 76-533,488. PUB. 4-6-2004. FILED 7-10-2003.
 2,857,713. **WHAT SEPARATES YOU**. SHARRON, LOWELL, (U.S. CLS. 22 AND 39). SN 76-534,270. PUB. 4-6-2004. FILED 7-21-2003.
 2,857,719. **HCASTRONEVES**. CASTRONEVES RACING, (U.S. CLS. 22 AND 39). SN 76-535,680. PUB. 4-6-2004. FILED 8-8-2003.
 2,857,761. **STREET PROFILE**. M & S TRADING, INC., (U.S. CLS. 22 AND 39). SN 76-545,243. PUB. 4-6-2004. FILED 9-5-2003.
 2,857,763. **MUNDO AND DESIGN**. MUNDO MARKETING AND SALES GROUP, LLC, (U.S. CLS. 22 AND 39). SN 76-546,761. PUB. 4-6-2004. FILED 9-8-2003.
 2,857,803. **CHILD OF MINE**. WILLIAM CARTER COMPANY, THE, (U.S. CLS. 22 AND 39). SN 78-156,541. PUB. 4-6-2004. FILED 8-21-2002.
 2,857,809. **ACADIA**. DANNER, INC., (U.S. CLS. 22 AND 39). SN 78-160,659. PUB. 4-6-2004. FILED 9-4-2002.
 2,857,814 (*See Class 9 for this trademark*).
 2,857,833. **GENRE STYLE**. GENRE STYLE, INC., (U.S. CLS. 22 AND 39). SN 78-184,965. PUB. 4-6-2004. FILED 11-14-2002.
 2,857,841. **YOUTHANDASIA**. CHRISTENSEN, NICKOLAS, G. (U.S. CLS. 22 AND 39). SN 78-188,814. PUB. 4-6-2004. FILED 11-26-2002.
 2,857,848. **CAMPANOLOGIST**. ECLECTIC INVESTMENTS, INC., (U.S. CLS. 22 AND 39). SN 78-190,357. PUB. 4-6-2004. FILED 12-2-2002.
 2,857,863. **SUBFREAKIE**. NAPOLEONE BV, (U.S. CLS. 22 AND 39). SN 78-192,496. PUB. 4-6-2004. FILED 12-9-2002.
 2,857,937. **HDC (STYLIZED)**. MCDAVID KNEE GUARD, INC., (U.S. CLS. 22 AND 39). SN 78-215,840. PUB. 4-6-2004. FILED 2-18-2003.
 2,857,944. **"JNCO" (STYLIZED)**. REVAH HOLDINGS, INC.,

(U.S. CLS. 22 AND 39). SN 78-218,191. PUB. 4-6-2004. FILED 2-24-2003.

2,857,958. **NICOLE VAN DYKE AND DESIGN**. CORBINEAU, NICOLE, (U.S. CLS. 22 AND 39). SN 78-222,019. PUB. 4-6-2004. FILED 3-5-2003.

2,857,997. **INSPIRA**. OFFLINE, INC., (U.S. CLS. 22 AND 39). SN 78-245,947. PUB. 4-6-2004. FILED 5-5-2003.

2,858,034. **PRO V2**. TSA CORPORATE SERVICES, INC., (U.S. CLS. 22 AND 39). SN 78-262,236. PUB. 4-6-2004. FILED 6-13-2003.

2,858,043. **NEWPORT BLUE**. FLAG SPORTSWEAR, INC., (U.S. CLS. 22 AND 39). SN 78-266,101. PUB. 4-6-2004. FILED 6-23-2003.

2,858,062. **MYSTICAL FRIENDS**. RMR DISTRIBUTORS, INC., (U.S. CLS. 22 AND 39). SN 78-269,777. PUB. 4-6-2004. FILED 7-2-2003.

2,858,083. **MAKE 'EM SWEAT**. HAMMOND, JEFF, (U.S. CLS. 22 AND 39). SN 78-273,242. PUB. 4-6-2004. FILED 7-11-2003.

2,858,086. **CITY SPA**. LERNER NEW YORK, INC., (U.S. CLS. 22 AND 39). SN 78-273,779. PUB. 4-6-2004. FILED 7-14-2003.

2,858,091. **HANES HER WAY AT HOME**. SARA LEE CORPORATION, (U.S. CLS. 22 AND 39). SN 78-274,208. PUB. 4-6-2004. FILED 7-15-2003.

2,858,097. **EXIT**. E.M.S. TRADING, INC., (U.S. CLS. 22 AND 39). SN 78-274,597. PUB. 4-6-2004. FILED 7-15-2003.

2,858,099. **MARK & STEVEN**. SMS PARTNERS, LLC, (U.S. CLS. 22 AND 39). SN 78-274,925. PUB. 4-6-2004. FILED 7-16-2003.

2,858,106. **BO2SY**. COSGRIFF, THOMAS, JR., (U.S. CLS. 22 AND 39). SN 78-275,682. PUB. 4-6-2004. FILED 7-17-2003.

2,858,129. **PJ PAINTBALL JUNKIES**. ROMAN DESIGNS, INC., MULTIPLE CLASS, (INT. CLS. 25 AND 28), (U.S. CLS. 22, 23, 38, 39 AND 50). SN 78-277,906. PUB. 4-6-2004. FILED 7-23-2003.

2,858,130. **JUNKIES**. ROMAN DESIGNS, INC., MULTIPLE CLASS, (INT. CLS. 25 AND 28), (U.S. CLS. 22, 23, 38, 39 AND 50). SN 78-277,979. PUB. 4-6-2004. FILED 7-23-2003.

2,858,148. **MY MOM IS MY HERO**. ALWAYS POSITIVE, INC., (U.S. CLS. 22 AND 39). SN 78-287,148. PUB. 4-6-2004. FILED 8-13-2003.

2,858,159. **MOOTS**. MUCHA BROTHERS, INC., (U.S. CLS. 22 AND 39). SN 78-291,081. PUB. 4-6-2004. FILED 8-22-2003.

2,858,168 (*See Class 14 for this trademark*).

2,858,176 (*See Class 16 for this trademark*).

CLASS 26—FANCY GOODS

2,857,145. **SHOES24**. KEUTER, STEFAN, (U.S. CLS. 37, 39, 40, 42 AND 50). SN 76-046,411. PUB. 4-6-2004. FILED 5-10-2000.

2,857,340 (*See Class 14 for this trademark*).

2,857,359 (*See Class 25 for this trademark*).

2,857,535 (*See Class 4 for this trademark*).

2,857,817 (*See Class 16 for this trademark*).

CLASS 27—FLOOR COVERINGS

2,857,271 (*See Class 19 for this trademark*).

2,857,576. **HOLDOVER**. L & P PROPERTY MANAGEMENT COMPANY, (U.S. CLS. 19, 20, 37, 42 AND 50). SN 76-521,768. PUB. 4-6-2004. FILED 6-10-2003.

2,857,795 (*See Class 1 for this trademark*).

2,857,811 (*See Class 17 for this trademark*).

2,857,943. **TAKE-OUT-TIME-OUT**. TOTO PRODUCTS, LLC, (U.S. CLS. 19, 20, 37, 42 AND 50). SN 78-217,932. PUB. 4-6-2004. FILED 2-23-2003.

2,858,144. **CASUAL CONCEPTS**. MOHAWK BRANDS, INC., (U.S. CLS. 19, 20, 37, 42 AND 50). SN 78-284,224. PUB. 4-6-2004. FILED 8-7-2003.

CLASS 28—TOYS AND SPORTING GOODS

2,857,125. **PREMIER PET PRODUCTS**. PREMIER PET PRODUCTS, L.L.C., MULTIPLE CLASS, (INT. CLS. 28 AND 35), (U.S. CLS. 22, 23, 38, 50, 100, 101 AND 102). SN 75-713,374. PUB. 4-6-2004. FILED 5-25-1999.

2,857,151 (*See Class 9 for this trademark*).

2,857,165 (*See Class 9 for this trademark*).

2,857,171 (*See Class 3 for this trademark*).

2,857,176. **RUGBYTECH R AND DESIGN**. RUGBYTECH LIMITED, (U.S. CLS. 22, 23, 38 AND 50). SN 76-199,702. PUB. 4-6-2004. FILED 1-25-2001.

2,857,183 (*See Class 21 for this trademark*).

2,857,241. **MARKET MANIA**. SCLAFANI, PAUL, (U.S. CLS. 22, 23, 38 AND 50). SN 76-378,919. PUB. 4-6-2004. FILED 3-6-2002.

2,857,248 (*See Class 3 for this trademark*).

2,857,272. **AMERICA'S FINEST 21ST CENTURY AUTHENTIC DETAIL AND DESIGN**. 21ST CENTURY TOYS, INC., (U.S. CLS. 22, 23, 38 AND 50). SN 76-409,503. PUB. 4-6-2004. FILED 5-8-2002.

2,857,331. **SHALLOWRAIDER**. BUCHER, JOE, (U.S. CLS. 22, 23, 38 AND 50). SN 76-451,619. PUB. 4-6-2004. FILED 9-23-2002.

2,857,332. **TOPRAIDER**. BUCHER, JOE, (U.S. CLS. 22, 23, 38 AND 50). SN 76-451,622. PUB. 4-6-2004. FILED 9-23-2002.

2,857,428. **BOBBIN' BOB**. THE UPPER DECK COMPANY, LLC, (U.S. CLS. 22, 23, 38 AND 50). SN 76-485,039. PUB. 4-6-2004. FILED 1-27-2003.

2,857,449. **DINGER AND DESIGN**. DINGER BATS, LLC., (U.S. CLS. 22, 23, 38 AND 50). SN 76-490,182. PUB. 4-6-2004. FILED 2-13-2003.

2,857,520 (*See Class 9 for this trademark*).

2,857,525 (*See Class 9 for this trademark*).

2,857,544. **CODY**. CODY TURKEY CALLS, LLC, (U.S. CLS. 22, 23, 38 AND 50). SN 76-515,001. PUB. 4-6-2004. FILED 5-16-2003.

2,857,549 (*See Class 20 for this trademark*).

2,857,556. **STRETCHABLE AND DESIGN**. IMPERIAL TOY CORPORATION, (U.S. CLS. 22, 23, 38 AND 50). SN 76-517,857. PUB. 4-6-2004. FILED 5-9-2003.

2,857,579. **SPRING VOLLEY**. MILLERSPORT, INC., (U.S. CLS. 22, 23, 38 AND 50). SN 76-522,082. PUB. 4-6-2004. FILED 6-2-2003.

2,857,689. **C CHILDREN'S HOSPITAL OF PITTSBURGH AND DESIGN**. CHILDREN'S HOSPITAL OF PITTSBURGH OF UPMC HEALTH SYSTEM, (U.S. CLS. 22, 23, 38 AND 50). SN 76-532,319. PUB. 4-6-2004. FILED 7-25-2003.

2,857,726. **CHANGING THE WAY YOU PLAY**. MARCOTT SPORTS, LLC, (U.S. CLS. 22, 23, 38 AND 50). SN 76-538,104. PUB. 4-6-2004. FILED 8-18-2003.

2,857,782. **NXT**. PRO SELECT, INC., (U.S. CLS. 22, 23, 38 AND 50). SN 78-083,560. PUB. 4-6-2004. FILED 9-12-2001.

2,857,868. **MISCELLANEOUS DESIGN**. KARSTEN MANUFACTURING CORPORATION, (U.S. CLS. 22, 23, 38 AND 50). SN 78-194,172. PUB. 4-6-2004. FILED 12-13-2002.

2,857,876. **SPECULIZER**. MARTIN, ROBERT A., JR., DBA ROB REDBONE MARTIN FISHING & ACCESSORIES, (U.S. CLS. 22, 23, 38 AND 50). SN 78-197,387. PUB. 4-6-2004. FILED 12-23-2002.

2,857,933. **CONNELLY**. CONNELLY BILLIARD MANUFACTURING, INC., (U.S. CLS. 22, 23, 38 AND 50). SN 78-214,740. PUB. 4-6-2004. FILED 2-13-2003.

2,857,939. **CONNELLY BILLIARDS**. CONNELLY BILLIARD MANUFACTURING, INC., (U.S. CLS. 22, 23, 38 AND 50). SN 78-216,669. PUB. 4-6-2004. FILED 2-19-2003.

2,857,986. **CANADA HAMMER**. GARDNER, MERLE F., (U.S. CLS. 22, 23, 38 AND 50). SN 78-242,813. PUB. 4-6-2004. FILED 4-28-2003.

2,858,040 (*See Class 9 for this trademark*).

2,858,041. **TANTRIX**. MCMANAWAY, MICHAEL PATRICK, (U.S. CLS. 22, 23, 38 AND 50). SN 78-266,044. PUB. 4-6-2004. FILED 6-23-2003.

2,858,047. **BIG WHEEL AND DESIGN**. ALPHA INTERNATIONAL, INC., (U.S. CLS. 22, 23, 38 AND 50). SN 78-266,650. PUB. 4-6-2004. FILED 6-24-2003.

2,858,082. **KING MASTER**. EXCALIBUR ELECTRONICS, INC., (U.S. CLS. 22, 23, 38 AND 50). SN 78-273,185. PUB. 4-6-2004. FILED 7-11-2003.

2,858,129 (*See Class 25 for this trademark.*)
 2,858,130 (*See Class 25 for this trademark.*)

CLASS 29—MEATS AND PROCESSED FOODS

2,857,137. **MISCELLANEOUS DESIGN.** ODWALLA, INC., MULTIPLE CLASS, (INT. CLS. 29 AND 32), (U.S. CLS. 45, 46 AND 48). SN 75-891,053. PUB. 4-6-2004. FILED 1-7-2000.
 2,857,171 (*See Class 3 for this trademark.*)
 2,857,179. **SWISSCENO AND DESIGN.** CENOVIS SA (CENOVIS AG) (CENOVIS LTD), MULTIPLE CLASS, (INT. CLS. 29 AND 30), (U.S. CL. 46). SN 76-207,832. PUB. 4-6-2004. FILED 2-9-2001.
 2,857,199 (*See Class 1 for this trademark.*)
 2,857,200 (*See Class 1 for this trademark.*)
 2,857,207 (*See Class 1 for this trademark.*)
 2,857,291. **PIONEER BRAND AND DESIGN.** PIONEER SNACKS, INC., (U.S. CL. 46). SN 76-424,248. PUB. 4-6-2004. FILED 6-24-2002.
 2,857,343 (*See Class 9 for this trademark.*)
 2,857,423. **HARBOR GOURMET.** OCEAN TECHNOLOGY, INC., (U.S. CL. 46). SN 76-484,716. PUB. 4-6-2004. FILED 1-24-2003.
 2,857,433. **ARDEN KITCHENS AND DESIGN.** ARDEN INTERNATIONAL, LLC, MULTIPLE CLASS, (INT. CLS. 29 AND 30), (U.S. CL. 46). SN 76-485,659. PUB. 4-6-2004. FILED 1-28-2003.
 2,857,476. **BERTOZZI PARMA PARMA BITES AND DESIGN.** ABELE BERTOZZI S.P.A., (U.S. CL. 46). SN 76-499,606. PUB. 4-6-2004. FILED 3-21-2003.
 2,857,604. **PASTURE PROPER.** ADAMS CREEK ENTERPRISES, (U.S. CL. 46). SN 76-526,556. PUB. 4-6-2004. FILED 6-23-2003.
 2,857,735. **TOPCATCH AND DESIGN.** TOP CATCH, INC., (U.S. CL. 46). SN 76-539,371. PUB. 4-6-2004. FILED 7-15-2003.
 2,857,741. **BRIX.** YOUNTVILLE PARTNERS, INC., DBA BRIX RESTAURANT, (U.S. CL. 46). SN 76-540,085. PUB. 4-6-2004. FILED 8-26-2003.
 2,857,745. **MON CUISINE (STYLIZED).** MEAL MART, INC., (U.S. CL. 46). SN 76-541,200. PUB. 4-6-2004. FILED 8-20-2003.
 2,857,800 (*See Class 3 for this trademark.*)
 2,857,906. **GREAT TASTE IN NO TIME.** TOPCO HOLDINGS, INC., MULTIPLE CLASS, (INT. CLS. 29 AND 30), (U.S. CL. 46). SN 78-202,933. PUB. 4-6-2004. FILED 1-14-2003.
 2,857,928. **ARCOR FRUIT SNACKS STRAWBERRY AND DESIGN.** ARCOR S.A.I.C., (U.S. CL. 46). SN 78-212,277. PUB. 4-6-2004. FILED 2-7-2003.
 2,857,946. **MASTER CHOICE.** GREAT ATLANTIC & PACIFIC TEA COMPANY, INC., THE, MULTIPLE CLASS, (INT. CLS. 29, 30, 31 AND 32), (U.S. CLS. 1, 45, 46 AND 48). SN 78-218,673. PUB. 4-6-2004. FILED 2-25-2003.
 2,858,032. **NOR-EAST FEAST.** WHITES COVE CORPORATION, (U.S. CL. 46). SN 78-261,693. PUB. 4-6-2004. FILED 6-12-2003.
 2,858,128. **HARRINGTON'S.** HARRINGTON'S IN VERMONT, INC., (U.S. CL. 46). SN 78-277,598. PUB. 4-6-2004. FILED 7-23-2003.
 2,858,153. **REGAL.** CARGILL, INCORPORATED, (U.S. CL. 46). SN 78-288,045. PUB. 4-6-2004. FILED 8-15-2003.

CLASS 30—STAPLE FOODS

2,857,136. **MAPLE HOUSE.** SHADY MAPLE FARM, LTD., (U.S. CL. 46). SN 75-869,674. PUB. 9-12-2000. FILED 12-13-1999.
 2,857,149 (*See Class 5 for this trademark.*)
 2,857,171 (*See Class 3 for this trademark.*)
 2,857,179 (*See Class 29 for this trademark.*)
 2,857,180. **CHOCOLATE BOWL.** BROOKSIDE FOODS LTD., (U.S. CL. 46). SN 76-217,757. PUB. 4-6-2004. FILED 3-1-2001.
 2,857,202. **LIMONCELLO DI CAPRI AND DESIGN.** LIMONCELLO DI CAPRI S.R.L., MULTIPLE CLASS, (INT. CLS. 30 AND 33), (U.S. CLS. 46, 47 AND 49). SN 76-301,970. PUB. 4-6-

2004. FILED 8-13-2001.
 2,857,207 (*See Class 1 for this trademark.*)
 2,857,219 (*See Class 5 for this trademark.*)
 2,857,233. **COSMIC BLASTERS.** PARMALAT DAIRY & BAKERY INC., (U.S. CL. 46). SN 76-366,556. PUB. 4-6-2004. FILED 2-1-2002.
 2,857,238. **ROYAL CUP DINE MOR.** ROYAL CUP, INC., (U.S. CL. 46). SN 76-378,465. PUB. 4-6-2004. FILED 3-6-2002.
 2,857,343 (*See Class 9 for this trademark.*)
 2,857,364. **GOLDEN CRISP.** WARNOCK FOOD PRODUCTS, INC., (U.S. CL. 46). SN 76-465,682. PUB. 4-6-2004. FILED 11-12-2002.
 2,857,431. **CANNERY AND DESIGN.** CANNERY CASINO RESORTS, LLC, (U.S. CL. 46). SN 76-485,593. PUB. 4-6-2004. FILED 1-28-2003.
 2,857,433 (*See Class 29 for this trademark.*)
 2,857,520 (*See Class 9 for this trademark.*)
 2,857,525 (*See Class 9 for this trademark.*)
 2,857,553. **LEROY HILL "REALLY GOOD".** LEROY HILL COFFEE COMPANY, INC., (U.S. CL. 46). SN 76-516,843. PUB. 4-6-2004. FILED 5-1-2003.
 2,857,593. **TEASWEET.** H & H PRODUCTS CO., (U.S. CL. 46). SN 76-524,162. PUB. 4-6-2004. FILED 6-20-2003.
 2,857,597. **MAMMA GEMELLI'S AND DESIGN.** MAMMA GEMELLI, INC., (U.S. CL. 46). SN 76-525,419. PUB. 4-6-2004. FILED 6-25-2003.
 2,857,613. **COWBOY BLEND AND DESIGN.** FULTON, BETTY J., DBA THE HOME RANCH COMPANY, (U.S. CL. 46). SN 76-528,323. PUB. 4-6-2004. FILED 6-30-2003.
 2,857,643 (*See Class 5 for this trademark.*)
 2,857,647. **BISTRO JACK.** JACK IN THE BOX INC., (U.S. CL. 46). SN 76-530,238. PUB. 4-6-2004. FILED 7-16-2003.
 2,857,653. **MAYA GOLD.** SUNRISE COFFEE COMPANY, INC., (U.S. CL. 46). SN 76-530,644. PUB. 4-6-2004. FILED 7-17-2003.
 2,857,677. **BARISTA BRAVA.** QUARTERMAINE COFFEE ROASTERS LLC, MULTIPLE CLASS, (INT. CLS. 30 AND 43), (U.S. CLS. 46, 100 AND 101). SN 76-531,851. PUB. 4-6-2004. FILED 7-24-2003.
 2,857,720. **TEA TIME THE TEA LOVER'S SHOP AND DESIGN.** CHOLLAMPAT, AZEEZ, (U.S. CL. 46). SN 76-535,915. PUB. 4-6-2004. FILED 8-11-2003.
 2,857,738. **UPGRADE TO THE BEST.** MILLER, WAYNE L., AND MILLER, REGINA S., (U.S. CL. 46). SN 76-539,765. PUB. 4-6-2004. FILED 8-25-2003.
 2,857,746. **MAD RIVER.** MAD RIVER COMPANY, LLC, MULTIPLE CLASS, (INT. CLS. 30 AND 32), (U.S. CLS. 45, 46 AND 48). SN 76-541,360. PUB. 4-6-2004. FILED 8-25-2003.
 2,857,752. **GOOD 'N HEARTY.** AMERICAN CEREAL CORPORATION, (U.S. CL. 46). SN 76-543,156. PUB. 4-6-2004. FILED 8-25-2003.
 2,857,775. **BEARTOOTH KITCHENS.** WEST FORK CREATIONS, INC., (U.S. CL. 46). SN 78-060,267. PUB. 4-6-2004. FILED 4-25-2001.
 2,857,800 (*See Class 3 for this trademark.*)
 2,857,822. **PRONEKTAR.** SCIAGE DU BERRY, MULTIPLE CLASS, (INT. CLS. 30 AND 31), (U.S. CLS. 1 AND 46). SN 78-173,595. PUB. 4-6-2004. FILED 10-11-2002.
 2,857,906 (*See Class 29 for this trademark.*)
 2,857,946 (*See Class 29 for this trademark.*)
 2,857,964. **FESTINGOS.** AHOLD RETAIL SERVICES AG, (U.S. CL. 46). SN 78-226,743. PUB. 4-6-2004. FILED 3-18-2003.
 2,857,965. **GUSTADOS.** AHOLD RETAIL SERVICES AG, (U.S. CL. 46). SN 78-226,745. PUB. 4-6-2004. FILED 3-18-2003.
 2,858,028. **LA PALOMA AND DESIGN.** C. H. GUENTHER & SON, INC., (U.S. CL. 46). SN 78-260,120. PUB. 4-6-2004. FILED 6-9-2003.
 2,858,058. **ANDES.** CHARMS MARKETING COMPANY, (U.S. CL. 46). SN 78-269,091. PUB. 4-6-2004. FILED 7-1-2003.
 2,858,061. **TIMPONE'S SALSA MUY RICA.** FISCHER & WIESER SPECIALTY FOODS, INC., (U.S. CL. 46). SN 78-269,299. PUB. 4-6-2004. FILED 7-1-2003.
 2,858,134. **MARY AND LOU'S.** MARY AND LOU'S LLC, (U.S. CL. 46). SN 78-279,361. PUB. 4-6-2004. FILED 7-27-2003.

CLASS 31—NATURAL AGRICULTURAL PRODUCTS

- 2,857,260. **BEEFWURST**. UNIVERSITY AND COMMUNITY COLLEGE SYSTEM OF NEVADA, (U.S. CLS. 1 AND 46). SN 76-397,983. PUB. 4-6-2004. FILED 4-18-2002.
- 2,857,306 (*See Class 1 for this trademark*).
- 2,857,399. **ALM AND DESIGN**. SMITH, ELIZABETH F., MULTIPLE CLASS, (INT. CLS. 31 AND 40), (U.S. CLS. 1, 46, 100, 103 AND 106). SN 76-476,649. PUB. 4-6-2004. FILED 12-18-2002.
- 2,857,495 (*See Class 1 for this trademark*).
- 2,857,497. **MISS ALICE**. DAVID AUSTIN ROSES LIMITED, (U.S. CLS. 1 AND 46). SN 76-507,932. PUB. 4-6-2004. FILED 4-21-2003.
- 2,857,822 (*See Class 30 for this trademark*).
- 2,857,896. **MISCELLANEOUS DESIGN**. J&J DISTRIBUTING CO., (U.S. CLS. 1 AND 46). SN 78-202,320. PUB. 4-6-2004. FILED 1-11-2003.
- 2,857,946 (*See Class 29 for this trademark*).
- 2,857,979. **EASY FLUSH**. CHURCH & DWIGHT COMPANY, (U.S. CLS. 1 AND 46). SN 78-236,042. PUB. 4-6-2004. FILED 4-10-2003.
- 2,858,064. **COACHELLA SEEDLESS**. SUN WORLD INTERNATIONAL, INC., (U.S. CLS. 1 AND 46). SN 78-270,012. PUB. 4-6-2004. FILED 7-2-2003.
- 2,858,174. **SUNKIST**. SUNKIST GROWERS, INC., (U.S. CLS. 1 AND 46). SN 78-302,322. PUB. 4-6-2004. FILED 9-18-2003.

CLASS 32—LIGHT BEVERAGES

- 2,857,112. **GULDEN DRAAK ALE AND DESIGN**. BROUWERIJ VAN STEENBERGE NAAMLOZE VENNOOTSCHAP, (U.S. CLS. 45, 46 AND 48). SN 75-098,928. PUB. 6-3-1997. FILED 5-6-1996.
- 2,857,117. **GULDEN DRAAK**. BROUWERIJ VAN STEENBERGE NAAMLOZE VENNOOTSCHAP, (U.S. CLS. 45, 46 AND 48). SN 75-454,108. PUB. 12-8-1998. FILED 3-20-1998.
- 2,857,137 (*See Class 29 for this trademark*).
- 2,857,155. **GUNG HO GRAPE**. DESERT HOLDINGS, INC., (U.S. CLS. 45, 46 AND 48). SN 76-125,184. PUB. 4-6-2004. FILED 9-8-2000.
- 2,857,171 (*See Class 3 for this trademark*).
- 2,857,204. **ARIA**. MAPLE LEAF DISTILLERS, INC., (U.S. CLS. 45, 46 AND 48). SN 76-306,407. PUB. 4-6-2004. FILED 8-29-2001.
- 2,857,325. **MCEWAN'S**. SCOTTISH & NEWCASTLE PLC, (U.S. CLS. 45, 46 AND 48). SN 76-449,487. PUB. 4-6-2004. FILED 9-11-2002.
- 2,857,432. **CERVEZA PILSENER AND DESIGN**. COMPANIA DE CERVAZES NACIONALES C.A., (U.S. CLS. 45, 46 AND 48). SN 76-485,615. PUB. 4-6-2004. FILED 1-28-2003.
- 2,857,492. **SCHLAFLY BEER BREWED IN SAINT LOUIS AND DESIGN**. THE SAINT LOUIS BREWERY, INC., (U.S. CLS. 45, 46 AND 48). SN 76-505,989. PUB. 4-6-2004. FILED 4-14-2003.
- 2,857,680. **SCHNUCKS DR. PHIZZ**. SCHNUCK MARKETS, INC., (U.S. CLS. 45, 46 AND 48). SN 76-532,059. PUB. 4-6-2004. FILED 7-9-2003.
- 2,857,695. **ICEFIELD (STYLIZED)**. LEE, TZONG LONG, (U.S. CLS. 45, 46 AND 48). SN 76-532,530. PUB. 4-6-2004. FILED 7-28-2003.
- 2,857,728. **CARMEL**. AGUDAT HAKORMIM HACOOPERATIVIT SHEL YEKVEI RICHON LE ZION V'ZICHRON YAAKOV B.M., DBA CARMEL WINE GROWERS COOPERATIVE, (U.S. CLS. 45, 46 AND 48). SN 76-538,404. PUB. 4-6-2004. FILED 8-19-2003.
- 2,857,746 (*See Class 30 for this trademark*).
- 2,857,934. **ORVAL**. BRASSERIE D'ORVAL, S.A., (U.S. CLS. 45, 46 AND 48). SN 78-215,250. PUB. 4-6-2004. FILED 2-14-2003.
- 2,857,946 (*See Class 29 for this trademark*).
- 2,858,142. **SIPPER SWEETS**. MCSTEVENS, INC., (U.S. CLS. 45, 46 AND 48). SN 78-283,215. PUB. 4-6-2004. FILED 8-5-2003.

CLASS 33—WINES AND SPIRITS

- 2,857,139. **STOLICHNAYA VANIL**. PEPSICO, INC., (U.S. CLS. 47 AND 49). SN 75-914,959. PUB. 4-6-2004. FILED 2-11-2000.
- 2,857,171 (*See Class 3 for this trademark*).
- 2,857,172. **LA JOTA VINEYARD CO.** LA JOTA VINEYARD & WINERY LLC, (U.S. CLS. 47 AND 49). SN 76-187,946. PUB. 4-6-2004. FILED 12-29-2000.
- 2,857,202 (*See Class 30 for this trademark*).
- 2,857,324. **HOT IRISHMAN SUPERIOR IRISH COFFEE AND DESIGN**. HOT IRISHMAN LIMITED, (U.S. CLS. 47 AND 49). SN 76-449,206. PUB. 9-30-2003. FILED 9-9-2002.
- 2,857,326. **WILLIAM RANDELL**. BAROSSA VINTAGE LIMITED, (U.S. CLS. 47 AND 49). SN 76-449,675. PUB. 4-6-2004. FILED 9-10-2002.
- 2,857,598. **HOLLYWOOD AND VINE CELLARS**. HOLLYWOOD AND VINE CELLARS, INC., (U.S. CLS. 47 AND 49). SN 76-525,505. PUB. 4-6-2004. FILED 6-24-2003.
- 2,857,875. **TRES ALEGRES COMPADRES**. LA COFRADIA S.A. DE C.V., (U.S. CLS. 47 AND 49). SN 78-197,253. PUB. 4-6-2004. FILED 12-23-2002.
- 2,858,065. **IMPORTED CANADIAN MIST AND DESIGN**. BROWN-FORMAN CORPORATION, (U.S. CLS. 47 AND 49). SN 78-270,037. PUB. 4-6-2004. FILED 7-2-2003.
- 2,858,070. **FINCA EL PORTILLO**. BODEGAS SALENTEIN S.A., (U.S. CLS. 47 AND 49). SN 78-270,507. PUB. 4-6-2004. FILED 7-3-2003.

CLASS 34—SMOKERS' ARTICLES

- 2,857,171 (*See Class 3 for this trademark*).
- 2,857,807 (*See Class 14 for this trademark*).
- 2,858,036. **BELCORP**. BELCORP OF AMERICA, INC., (U.S. CLS. 2, 8, 9 AND 17). SN 78-262,606. PUB. 4-6-2004. FILED 6-15-2003.

SERVICE MARKS**CLASS 35—ADVERTISING AND BUSINESS**

- 2,857,111. **TIN INDIAN**. ROCCA, JOHN H., MULTIPLE CLASS, (INT. CLS. 35 AND 41), (U.S. CLS. 100, 101, 102 AND 107). SN 75-005,658. PUB. 4-6-2004. FILED 10-13-1995.
- 2,857,123. **CUSTOMER MOSAIC**. BADERTSCHER COMMUNICATIONS, INC., (U.S. CLS. 100, 101 AND 102). SN 75-637,866. PUB. 4-6-2004. FILED 2-5-1999.
- 2,857,125 (*See Class 28 for this trademark*).
- 2,857,132. **INTERVENTURE**. INTERVENTURE, LLC, MULTIPLE CLASS, (INT. CLS. 35 AND 41), (U.S. CLS. 100, 101, 102 AND 107). SN 75-849,676. PUB. 4-6-2004. FILED 11-15-1999.
- 2,857,135. **ISPORTSTODAY.COM AND DESIGN**. COLLECTIBLES TODAY NETWORK, INC., (U.S. CLS. 100, 101 AND 102). SN 75-868,910. PUB. 4-6-2004. FILED 12-13-1999.
- 2,857,142 (*See Class 16 for this trademark*).
- 2,857,143. **INTERVENTURE CONSULTING**. INTERVENTURE, LLC, MULTIPLE CLASS, (INT. CLS. 35 AND 41), (U.S. CLS. 100, 101, 102 AND 107). SN 76-022,742. PUB. 4-6-2004. FILED 4-11-2000.
- 2,857,147. **GROUNDSWELL**. GROUNDSWELL COMMUNICATIONS, INC., (U.S. CLS. 100, 101 AND 102). SN 76-076,953. PUB. 4-6-2004. FILED 6-26-2000.
- 2,857,150. **RTEMP.COM**. R.T. TEMPS, INC., P.C., (U.S. CLS. 100, 101 AND 102). SN 76-092,696. PUB. 4-6-2004. FILED 7-20-2000.
- 2,857,156. **FLYINGCARPETS**. MEHDI DILMAGHANI & CO., INC., MULTIPLE CLASS, (INT. CLS. 35, 37 AND 42), (U.S. CLS. 100, 101, 102, 103 AND 106). SN 76-125,246. PUB. 5-21-2002. FILED 9-8-2000.
- 2,857,159 (*See Class 9 for this trademark*).
- 2,857,165 (*See Class 9 for this trademark*).
- 2,857,166 (*See Class 9 for this trademark*).
- 2,857,171 (*See Class 3 for this trademark*).
- 2,857,173. **THE CUSTOM SHOP**. MICHAEL SMITH CUSTOM

- CLOTHIERS, INC., (U.S. CLS. 100, 101 AND 102). SN 76-194,639. PUB. 4-6-2004. FILED 1-17-2001.
- 2,857,174. **THE CUSTOM SHOP.** MICHAEL SMITH CUSTOM CLOTHIERS, INC., (U.S. CLS. 100, 101 AND 102). SN 76-194,640. PUB. 4-6-2004. FILED 1-17-2001.
- 2,857,178 (*See Class 9 for this trademark.*).
- 2,857,184. **THE WARFIGHTERS ONE STOP LOGISTICS SHOP.** ENGINEERED SUPPORT SYSTEMS, INC., MULTIPLE CLASS, (INT. CLS. 35 AND 42), (U.S. CLS. 100, 101 AND 102). SN 76-241,849. PUB. 4-6-2004. FILED 4-17-2001.
- 2,857,192 (*See Class 9 for this trademark.*).
- 2,857,207 (*See Class 1 for this trademark.*).
- 2,857,214 (*See Class 1 for this trademark.*).
- 2,857,217 (*See Class 9 for this trademark.*).
- 2,857,228. **NEC.** NATIONAL EXTENDED CARE, LLC, (U.S. CLS. 100, 101 AND 102). SN 76-361,251. PUB. 4-6-2004. FILED 1-22-2002.
- 2,857,231. **PRINTFINDERS AND DESIGN.** BAREWALLS INTERACTIVE ART, INC., (U.S. CLS. 100, 101 AND 102). SN 76-365,764. PUB. 4-6-2004. FILED 2-4-2002.
- 2,857,234. **POWER-GEN MIDDLE EAST FOCUSING ON POWER GENERATION, TRANSMISSION & DISTRIBUTION AND DESIGN.** PENNWELL CORPORATION, (U.S. CLS. 100, 101 AND 102). SN 76-369,590. PUB. 4-6-2004. FILED 2-12-2002.
- 2,857,245. **DARK FIRE.** BND ENTERPRISES, LLC, (U.S. CLS. 100, 101 AND 102). SN 76-383,719. PUB. 4-6-2004. FILED 3-19-2002.
- 2,857,247 (*See Class 25 for this trademark.*).
- 2,857,255. **CHILD ABUSE STOPS HERE.** OLIVE CREST TREATMENT CENTERS, INC., DBA OLIVE CREST, MULTIPLE CLASS, (INT. CLS. 35, 36, 41, 43, 44 AND 45), (U.S. CLS. 100, 101, 102 AND 107). SN 76-396,651. PUB. 4-6-2004. FILED 4-16-2002.
- 2,857,256. **OLIVE CREST.** OLIVE CREST TREATMENT CENTERS, INC., DBA OLIVE CREST, MULTIPLE CLASS, (INT. CLS. 35, 36, 41, 43, 44 AND 45), (U.S. CLS. 100, 101, 102 AND 107). SN 76-396,657. PUB. 4-6-2004. FILED 4-16-2002.
- 2,857,261 (*See Class 16 for this trademark.*).
- 2,857,270. **LEGAL GATEWAY.** CYBERLAW NETWORK, INC., MULTIPLE CLASS, (INT. CLS. 35 AND 42), (U.S. CLS. 100, 101 AND 102). SN 76-405,794. PUB. 4-6-2004. FILED 5-6-2002.
- 2,857,276. **TOPDOCS.COM.** TOPDOCS, INC., MULTIPLE CLASS, (INT. CLS. 35 AND 44), (U.S. CLS. 100, 101 AND 102). SN 76-410,829. PUB. 4-6-2004. FILED 5-16-2002.
- 2,857,277. **TOPDOCS.** TOPDOCS, INC., MULTIPLE CLASS, (INT. CLS. 35 AND 44), (U.S. CLS. 100, 101 AND 102). SN 76-410,831. PUB. 4-6-2004. FILED 5-16-2002.
- 2,857,287. **HOUSE OF BLUES CONCERTS.** HOUSE OF BLUES BRANDS CORP., (U.S. CLS. 100, 101 AND 102). SN 76-420,401. PUB. 4-6-2004. FILED 6-11-2002.
- 2,857,290. **WE MAKE COOL STUFF.** IDAHO TECHNOLOGY, INC., MULTIPLE CLASS, (INT. CLS. 35, 41 AND 42), (U.S. CLS. 100, 101, 102 AND 107). SN 76-424,131. PUB. 4-6-2004. FILED 6-24-2002.
- 2,857,309 (*See Class 9 for this trademark.*).
- 2,857,310. **FIND-A-SUITE.** MAGDAR INDUSTRIES, INC., MULTIPLE CLASS, (INT. CLS. 35 AND 36), (U.S. CLS. 100, 101 AND 102). SN 76-439,716. PUB. 4-6-2004. FILED 8-13-2002.
- 2,857,318. **STEINBRANDING.** STEIN, GUILLERMO ALBERTO, MULTIPLE CLASS, (INT. CLS. 35 AND 42), (U.S. CLS. 100, 101 AND 102). SN 76-446,581. PUB. 4-6-2004. FILED 9-3-2002.
- 2,857,322. **HR AND DESIGN.** HIRE RETURN, LLC, (U.S. CLS. 100, 101 AND 102). SN 76-448,530. PUB. 4-6-2004. FILED 9-11-2002.
- 2,857,336. **COMPASS LOGO (STYLIZED).** PICTOMETRY INTERNATIONAL CORP., (U.S. CLS. 100, 101 AND 102). SN 76-457,582. PUB. 4-6-2004. FILED 10-7-2002.
- 2,857,343 (*See Class 9 for this trademark.*).
- 2,857,347. **JUPITEREVENTS.** JUPITERMEDIA CORPORATION, MULTIPLE CLASS, (INT. CLS. 35 AND 41), (U.S. CLS. 100, 101, 102 AND 107). SN 76-462,091. PUB. 4-6-2004. FILED 10-28-2002.
- 2,857,360 (*See Class 10 for this trademark.*).
- 2,857,362. **JOB 1 USA.** THE RUMPF CORPORATION, (U.S. CLS. 100, 101 AND 102). SN 76-465,596. PUB. 4-6-2004. FILED 11-8-2002.
- 2,857,363 (*See Class 9 for this trademark.*).
- 2,857,373. **NOENVELOPE.COM.** ALAMO DIRECT MAIL SERVICES, INC., (U.S. CLS. 100, 101 AND 102). SN 76-468,862. PUB. 4-6-2004. FILED 11-21-2002.
- 2,857,374. **THELEAPFROGGROUP FOR PATIENT SAFETY REWARDING HIGHER STANDARDS AND DESIGN.** THE LEAPFROG GROUP, MULTIPLE CLASS, (INT. CLS. 35, 41, 42 AND 44), (U.S. CLS. 100, 101, 102 AND 107). SN 76-469,163. PUB. 4-6-2004. FILED 11-22-2002.
- 2,857,382. **MISCELLANEOUS DESIGN.** LANDAMERICA FINANCIAL GROUP, INC., MULTIPLE CLASS, (INT. CLS. 35, 36 AND 42), (U.S. CLS. 100, 101 AND 102). SN 76-472,589. PUB. 4-6-2004. FILED 12-6-2002.
- 2,857,386. **THE HEART OF COLLECTING.** THE BRADFORD EXCHANGE, LTD., (U.S. CLS. 100, 101 AND 102). SN 76-473,272. PUB. 4-6-2004. FILED 11-26-2002.
- 2,857,407. **CULINARY TEAM USA.** AMERICAN CULINARY FEDERATION, INC., (U.S. CLS. 100, 101 AND 102). SN 76-480,179. PUB. 4-6-2004. FILED 12-30-2002.
- 2,857,413. **MISCELLANEOUS DESIGN.** GLASTONBURY HARTWELL SOCCER CLUB, INC., (U.S. CLS. 100, 101 AND 102). SN 76-481,156. PUB. 4-6-2004. FILED 1-9-2003.
- 2,857,420. **MISCELLANEOUS DESIGN.** GANDER MOUNTAIN COMPANY, (U.S. CLS. 100, 101 AND 102). SN 76-483,463. PUB. 4-6-2004. FILED 1-21-2003.
- 2,857,430. **DYNAMIC HEALTH LABORATORIES INC.** DYNAMIC HEALTH LABS, INC., (U.S. CLS. 100, 101 AND 102). SN 76-485,205. PUB. 4-6-2004. FILED 1-27-2003.
- 2,857,451. **CHAMBER OF COMMERCE OF THE UNITED STATES OF AMERICA.** CHAMBER OF COMMERCE OF THE UNITED STATES, (U.S. CLS. 100, 101 AND 102). SN 76-491,066. PUB. 4-6-2004. FILED 2-20-2003.
- 2,857,464. **LUCKYBRANDJEANS.COM.** LUCKY BRAND DUNGAREES, INC., (U.S. CLS. 100, 101 AND 102). SN 76-496,530. PUB. 4-6-2004. FILED 3-10-2003.
- 2,857,477. **ORDER SONS OF ITALY IN AMERICA LIBERTY EQUALITY FRATERNITY AND DESIGN.** ORDER SONS OF ITALY IN AMERICA, (U.S. CLS. 100, 101 AND 102). SN 76-500,132. PUB. 4-6-2004. FILED 3-25-2003.
- 2,857,493. **AAS.** MIDWEST DIAGNOSTIC MANAGEMENT, LLC, (U.S. CLS. 100, 101 AND 102). SN 76-506,131. PUB. 4-6-2004. FILED 4-14-2003.
- 2,857,494. **THE SUBSCRIBER'S HOME.** BREAKTHROUGH VENTURES INC., (U.S. CLS. 100, 101 AND 102). SN 76-507,397. PUB. 4-6-2004. FILED 4-17-2003.
- 2,857,515. **POSITIVE THINKING.** GUIDEPOSTS, A CHURCH CORPORATION, (U.S. CLS. 100, 101 AND 102). SN 76-510,282. PUB. 4-6-2004. FILED 4-29-2003.
- 2,857,523. **IKON DOCUMENT EFFICIENCY AT WORK.** IKON OFFICE SOLUTIONS WEST, INC., MULTIPLE CLASS, (INT. CLS. 35, 37, 39, 40 AND 42), (U.S. CLS. 100, 101, 102, 103, 105 AND 106). SN 76-511,917. PUB. 4-6-2004. FILED 5-5-2003.
- 2,857,524. **IKON DOCUMENT EFFICIENCY AT WORK AND DESIGN.** IKON OFFICE SOLUTIONS WEST, INC., MULTIPLE CLASS, (INT. CLS. 35, 37, 39, 40 AND 42), (U.S. CLS. 100, 101, 102, 103, 105 AND 106). SN 76-511,918. PUB. 4-6-2004. FILED 5-2-2003.
- 2,857,562. **CLASSIC RESTAURANT SUPPLY AND DESIGN.** CLASSIC RESTAURANT SUPPLY, L.L.C., (U.S. CLS. 100, 101 AND 102). SN 76-518,917. PUB. 4-6-2004. FILED 6-2-2003.
- 2,857,583. **MISCELLANEOUS DESIGN.** KELLY, LEWIS A., (U.S. CLS. 100, 101 AND 102). SN 76-523,106. PUB. 4-6-2004. FILED 6-16-2003.
- 2,857,586. **WIFE WOMEN INVOLVED IN FARM ECONOMICS AND DESIGN.** WOMEN INVOLVED IN FARM ECONOMICS (WIFE), (U.S. CLS. 100, 101 AND 102). SN 76-523,275. PUB. 4-6-2004. FILED 6-10-2003.
- 2,857,591. **SAN DIEGO COUNTY TAXPAYERS ASSOCIATION.** SAN DIEGO COUNTY TAXPAYERS ASSOCIATION, (U.S. CLS. 100, 101 AND 102). SN 76-524,079. PUB. 4-6-2004. FILED 6-9-2003.
- 2,857,601. **YOUR GLOBAL COMPLIANCE SPECIALISTS.** DUQUESNE UNIVERSITY OF THE HOLY GHOST, MULTIPLE CLASS, (INT. CLS. 35 AND 41), (U.S. CLS. 100, 101, 102 AND 107). SN 76-526,287. PUB. 4-6-2004. FILED 6-27-

- 2003.
- 2,857,602. **CITRA**. DUQUESNE UNIVERSITY OF THE HOLY GHOST, MULTIPLE CLASS, (INT. CLS. 35 AND 41), (U.S. CLS. 100, 101, 102 AND 107). SN 76-526,288. PUB. 4-6-2004. FILED 6-27-2003.
- 2,857,682. **LAZBOY THE NEW LOOK OF COMFORT AND DESIGN**. LZB PROPERTIES, INC., (U.S. CLS. 100, 101 AND 102). SN 76-532,141. PUB. 4-6-2004. FILED 7-14-2003.
- 2,857,688 (*See Class 16 for this trademark*).
- 2,857,693. **FIGHT FOR CHILDREN AND DESIGN**. FIGHT FOR CHILDREN, INC., MULTIPLE CLASS, (INT. CLS. 35, 36 AND 41), (U.S. CLS. 100, 101, 102 AND 107). SN 76-532,447. PUB. 4-6-2004. FILED 7-25-2003.
- 2,857,703. **OLTRA AND DESIGN**. OLTRA, INC., (U.S. CLS. 100, 101 AND 102). SN 76-532,889. PUB. 4-6-2004. FILED 7-28-2003.
- 2,857,704. **PATHFELLOW**. INSIGHT STRATEGIC CONCEPTS, INC., MULTIPLE CLASS, (INT. CLS. 35 AND 41), (U.S. CLS. 100, 101, 102 AND 107). SN 76-533,102. PUB. 4-6-2004. FILED 7-28-2003.
- 2,857,716. **COTH**. ASSOCIATION OF AMERICAN MEDICAL COLLEGES, (U.S. CLS. 100, 101 AND 102). SN 76-535,300. PUB. 4-6-2004. FILED 8-6-2003.
- 2,857,722 (*See Class 16 for this trademark*).
- 2,857,737. **CHOOSE WELL, USE WELL**. MERCER HUMAN RESOURCE CONSULTING, INC., (U.S. CLS. 100, 101 AND 102). SN 76-539,764. PUB. 4-6-2004. FILED 8-25-2003.
- 2,857,743. **AAMPP**. AMERICAN ASSOCIATION OF MINORITY PATENT PRACTITIONERS, (U.S. CLS. 100, 101 AND 102). SN 76-540,236. PUB. 4-6-2004. FILED 8-26-2003.
- 2,857,758 (*See Class 16 for this trademark*).
- 2,857,769. **LAIRD + PARTNERS**. LAIRD + PARTNERS LLC., (U.S. CLS. 100, 101 AND 102). SN 76-976,289. PUB. 4-6-2004. FILED 10-22-2002.
- 2,857,776. **VFINANCE**. VFINANCE HOLDINGS, INC., DBA VFINANCE.COM, (U.S. CLS. 100, 101 AND 102). SN 78-065,216. PUB. 4-6-2004. FILED 5-23-2001.
- 2,857,781. **FAST TRACK**. VON DUPRIN, INC., (U.S. CLS. 100, 101 AND 102). SN 78-083,051. PUB. 4-6-2004. FILED 9-7-2001.
- 2,857,784. **BRIGHTSTAR GROUP**. MARKETING ADVANTAGE GROUP LLC, (U.S. CLS. 100, 101 AND 102). SN 78-098,788. PUB. 4-6-2004. FILED 12-17-2001.
- 2,857,786 (*See Class 16 for this trademark*).
- 2,857,798. **UV COUNTRY**. TRACY EQUIPMENT, INC., (U.S. CLS. 100, 101 AND 102). SN 78-145,632. PUB. 4-6-2004. FILED 7-19-2002.
- 2,857,817 (*See Class 16 for this trademark*).
- 2,857,821. **METRIS COMPANIES**. METRIS DIRECT, INC., MULTIPLE CLASS, (INT. CLS. 35 AND 36), (U.S. CLS. 100, 101 AND 102). SN 78-171,680. PUB. 4-6-2004. FILED 10-7-2002.
- 2,857,831. **MOUNT NEBO MARKETING STRATEGIC MARKETING WITH AN APOSTOLIC VIEW AND DESIGN**. MURPHY, KEVIN G., (U.S. CLS. 100, 101 AND 102). SN 78-182,796. PUB. 4-6-2004. FILED 11-7-2002.
- 2,857,835. **ANIMA DOMUS**. ANIMA DOMUS INC., (U.S. CLS. 100, 101 AND 102). SN 78-187,012. PUB. 4-6-2004. FILED 11-20-2002.
- 2,857,842 (*See Class 16 for this trademark*).
- 2,857,843. **ORX ASSOCIATION**. OPERATIONAL RISKDATA EXCHANGE ASSOCIATION (ORX), MULTIPLE CLASS, (INT. CLS. 35, 36, 38, 41 AND 42), (U.S. CLS. 100, 101, 102, 104 AND 107). SN 78-188,930. PUB. 4-6-2004. FILED 11-26-2002.
- 2,857,855. **BEAN-STREAM**. BEAN-STREAM, INC., MULTIPLE CLASS, (INT. CLS. 35 AND 42), (U.S. CLS. 100, 101 AND 102). SN 78-190,847. PUB. 4-6-2004. FILED 12-3-2002.
- 2,857,857. **EXPRESS EVENT CENTER AND DESIGN**. EXPRESS FRANCHISE SERVICES, L.P., MULTIPLE CLASS, (INT. CLS. 35, 41 AND 43), (U.S. CLS. 100, 101, 102 AND 107). SN 78-191,980. PUB. 4-6-2004. FILED 12-6-2002.
- 2,857,860. **VALUE PARTNERS AND DESIGN**. V.P. HOLDING S.P.A., MULTIPLE CLASS, (INT. CLS. 35, 36 AND 42), (U.S. CLS. 100, 101 AND 102). SN 78-192,346. PUB. 4-6-2004. FILED 12-9-2002.
- 2,857,874. **BLUEGREEN COMMUNITIES**. BLUEGREEN CORPORATION, MULTIPLE CLASS, (INT. CLS. 35, 36, 37 AND 41), (U.S. CLS. 100, 101, 102, 103, 106 AND 107). SN 78-196,939. PUB. 4-6-2004. FILED 12-20-2002.
- 2,857,879. **HOLIDAY GLORIES**. THE NEIMAN MARCUS GROUP, INC., (U.S. CLS. 100, 101 AND 102). SN 78-198,064. PUB. 4-6-2004. FILED 12-26-2002.
- 2,857,880. **CLF**. CHILDREN'S LEUKEMIA FOUNDATION OF MICHIGAN, MULTIPLE CLASS, (INT. CLS. 35, 36 AND 45), (U.S. CLS. 100, 101 AND 102). SN 78-198,988. PUB. 4-6-2004. FILED 12-31-2002.
- 2,857,888. **MEDSOURCE**. MCKESSON CORPORATION, (U.S. CLS. 100, 101 AND 102). SN 78-200,680. PUB. 4-6-2004. FILED 1-7-2003.
- 2,857,892. **VOUCHEREDGE**. INFOMEDICS, INC., (U.S. CLS. 100, 101 AND 102). SN 78-201,597. PUB. 4-6-2004. FILED 1-9-2003.
- 2,857,894. **THE INVISIBLE RECEPTIONIST**. INTELLIGENT OFFICE SYSTEM, LLC, THE, (U.S. CLS. 100, 101 AND 102). SN 78-202,151. PUB. 4-6-2004. FILED 1-10-2003.
- 2,857,899. **LAS CRUCES (STYLIZED)**. CITY OF LAS CRUCES, (U.S. CLS. 100, 101 AND 102). SN 78-202,779. PUB. 4-6-2004. FILED 1-13-2003.
- 2,857,900. **LAS CRUCES AND DESIGN**. CITY OF LAS CRUCES, (U.S. CLS. 100, 101 AND 102). SN 78-202,790. PUB. 4-6-2004. FILED 1-13-2003.
- 2,857,901. **CUSTOM COBBLER AND DESIGN**. KCIN, INC., (U.S. CLS. 100, 101 AND 102). SN 78-202,820. PUB. 4-6-2004. FILED 1-13-2003.
- 2,857,911 (*See Class 16 for this trademark*).
- 2,857,916 (*See Class 9 for this trademark*).
- 2,857,917. **BADDOG**. BADDOG SERVICES & MERCHANDISE, LLC, (U.S. CLS. 100, 101 AND 102). SN 78-208,835. PUB. 4-6-2004. FILED 1-30-2003.
- 2,857,919. **DRAW A NEW BOTTOM LINE**. ORBIS ONLINE, INC., (U.S. CLS. 100, 101 AND 102). SN 78-209,201. PUB. 4-6-2004. FILED 1-30-2003.
- 2,857,921. **HORTON INTERNATIONAL, LLC**. HORTON INTERNATIONAL, LLC, (U.S. CLS. 100, 101 AND 102). SN 78-209,956. PUB. 4-6-2004. FILED 2-3-2003.
- 2,857,929. **IMAGINGAMERICA**. MISSION SEARCH CORPORATION, (U.S. CLS. 100, 101 AND 102). SN 78-212,284. PUB. 4-6-2004. FILED 2-7-2003.
- 2,857,935. **RIDERS READY AND DESIGN**. RIDERS READY, INC., (U.S. CLS. 100, 101 AND 102). SN 78-215,546. PUB. 4-6-2004. FILED 2-17-2003.
- 2,857,957. **HALO CANDLE COMPANY AND DESIGN**. THE TRUSTEES OF THE WILLIAM LESTER LEWIS JR. TRUST, A MISSOURI TRUST, THE TRUSTEES COMPRISING WILLIAM LESTER LEWIS JR. , U.S. CITIZEN & THE TRUSTEES OF THE RAQUEL MARIE LEWIS TRUST, A MISSOURI TRUST, THE TRUSTEES COMPRISING RAQUEL MARIE LEWIS, U.S. CITIZEN., (U.S. CLS. 100, 101 AND 102). SN 78-221,316. PUB. 4-6-2004. FILED 3-4-2003.
- 2,857,961. **VIA CAROLINA WHOLESALE AND DESIGN**. CAROLINA WHOLESALE MACHINE COMPANY, INC., (U.S. CLS. 100, 101 AND 102). SN 78-224,671. PUB. 4-6-2004. FILED 3-12-2003.
- 2,857,963. **CLIMAX ENTERTAINMENT**. STILL, DAVID M., JR., (U.S. CLS. 100, 101 AND 102). SN 78-225,393. PUB. 4-6-2004. FILED 3-13-2003.
- 2,857,968 (*See Class 9 for this trademark*).
- 2,857,983. **SCREENVISION DIRECT**. TECHNICOLOR SCREEN ADVERTISING, INC., (U.S. CLS. 100, 101 AND 102). SN 78-237,698. PUB. 4-6-2004. FILED 4-14-2003.
- 2,857,988. **AERO SUPPLIES & EXPRESS, INC. AND DESIGN**. AERO SUPPLIES & EXPRESS, INC., (U.S. CLS. 100, 101 AND 102). SN 78-244,062. PUB. 4-6-2004. FILED 4-30-2003.
- 2,857,990. **BENERX ADVANTAGE**. BENECARD SERVICES, INC., (U.S. CLS. 100, 101 AND 102). SN 78-244,214. PUB. 4-6-2004. FILED 5-1-2003.
- 2,857,993 (*See Class 16 for this trademark*).
- 2,857,994 (*See Class 16 for this trademark*).
- 2,858,002. **BETTERLIFE AND DESIGN**. BETTERLIFE TRADING, INC., (U.S. CLS. 100, 101 AND 102). SN 78-247,265. PUB. 4-6-2004. FILED 5-8-2003.
- 2,858,004. **GERTENS**. GERTEN GREENHOUSE AND GARDEN CENTER, INC., (U.S. CLS. 100, 101 AND 102). SN 78-247,739. PUB. 4-6-2004. FILED 5-9-2003.
- 2,858,012. **ROA HUTTON, L.L.C.**. THE HUTTON GROUP, INC., MULTIPLE CLASS, (INT. CLS. 35 AND 36), (U.S.

CLS. 100, 101 AND 102). SN 78-251,974. PUB. 4-6-2004. FILED 5-20-2003.

2,858,014. **TVC. TECHNOLOGY VENTURES CORPORATION**, (U.S. CLS. 100, 101 AND 102). SN 78-253,099. PUB. 4-6-2004. FILED 5-22-2003.

2,858,021. **BEST BRANDS. BASEMENT PRICES.. THE SPORTS BASEMENT, INC.**, (U.S. CLS. 100, 101 AND 102). SN 78-256,047. PUB. 4-6-2004. FILED 5-29-2003.

2,858,024. **MSU MENSUNDERWEARSTORE AND DESIGN. RUSSINA, BEVERLY**, (U.S. CLS. 100, 101 AND 102). SN 78-258,285. PUB. 4-6-2004. FILED 6-4-2003.

2,858,025. **CARMAXAUCTIONS.COM. CARMAX AUTO SUPERSTORES WEST COAST, INC.**, (U.S. CLS. 100, 101 AND 102). SN 78-259,085. PUB. 4-6-2004. FILED 6-5-2003.

2,858,026. **ULTIMATE PARTY NETWORK. MORANTE, JANET, H.**, (U.S. CLS. 100, 101 AND 102). SN 78-259,600. PUB. 4-6-2004. FILED 6-6-2003.

2,858,033 (*See Class 16 for this trademark*).

2,858,039. **COLISEUM BOOKS. COLISEUM BOOKS, INC.**, (U.S. CLS. 100, 101 AND 102). SN 78-265,000. PUB. 4-6-2004. FILED 6-20-2003.

2,858,051. **NORTH AMERICAN VERSATILE HUNTING DOG ASSOCIATION AND DESIGN. NORTH AMERICAN VERSATILE HUNTING DOG ASSOCIATION, MULTIPLE CLASS, (INT. CLS. 35 AND 41), (U.S. CLS. 100, 101, 102 AND 107).** SN 78-267,305. PUB. 4-6-2004. FILED 6-26-2003.

2,858,052. **NAVHDA. NORTH AMERICAN VERSATILE HUNTING DOG ASSOCIATION, MULTIPLE CLASS, (INT. CLS. 35 AND 41), (U.S. CLS. 100, 101, 102 AND 107).** SN 78-267,311. PUB. 4-6-2004. FILED 6-26-2003.

2,858,060. **THE COMEBACK COACH. THE COMEBACK INSTITUTE LLC, MULTIPLE CLASS, (INT. CLS. 35 AND 41), (U.S. CLS. 100, 101, 102 AND 107).** SN 78-269,176. PUB. 4-6-2004. FILED 7-1-2003.

2,858,077. **PLUSH. PILLOW TALK INTERNATIONAL, INC.**, (U.S. CLS. 100, 101 AND 102). SN 78-272,281. PUB. 4-6-2004. FILED 7-9-2003.

2,858,078. **MD&M. CANON COMMUNICATIONS INC.**, (U.S. CLS. 100, 101 AND 102). SN 78-272,447. PUB. 4-6-2004. FILED 7-10-2003.

2,858,111. **INTELLIGENT BUSINESS INTELLIGENCE. CHAMPIONSHIP SPORTS MARKETING, INC.**, (U.S. CLS. 100, 101 AND 102). SN 78-276,050. PUB. 4-6-2004. FILED 7-18-2003.

2,858,117. **BRINGING SMART MARKETERS TO MARKET. CORPORATE PROJECT RESOURCES, INC.**, (U.S. CLS. 100, 101 AND 102). SN 78-276,717. PUB. 4-6-2004. FILED 7-21-2003.

2,858,138. **POSEIDON AQUATICS. QUALITY PETS OF CALIFORNIA, INC.**, (U.S. CLS. 100, 101 AND 102). SN 78-280,322. PUB. 4-6-2004. FILED 7-29-2003.

2,858,139. **WIAA. WESTERN INSURANCE AGENTS ASSOCIATION, INC., A CALIFORNIA NON-PROFIT CORPORATION**, (U.S. CLS. 100, 101 AND 102). SN 78-280,832. PUB. 4-6-2004. FILED 7-30-2003.

2,858,155. **TEMPT DESTINY. MAVERIC INC.**, (U.S. CLS. 100, 101 AND 102). SN 78-289,603. PUB. 4-6-2004. FILED 8-20-2003.

2,858,158. **LOWERPOWERBILL. MRDB HOLDINGS, MULTIPLE CLASS, (INT. CLS. 35 AND 36), (U.S. CLS. 100, 101 AND 102).** SN 78-290,980. PUB. 4-6-2004. FILED 8-22-2003.

2,858,161. **SUNKIST NUTRITION BUREAU. SUNKIST GROWERS, INC.**, (U.S. CLS. 100, 101 AND 102). SN 78-291,378. PUB. 4-6-2004. FILED 8-22-2003.

2,858,162. **CLICKONDAYTON. MILLER, WAYNE, E.**, (U.S. CLS. 100, 101 AND 102). SN 78-291,413. PUB. 4-6-2004. FILED 8-23-2003.

2,858,165. **WHERE LAWYERS LOOK FOR LAWYERS. AMERICAN LEGAL SEARCH, LLC**, (U.S. CLS. 100, 101 AND 102). SN 78-292,160. PUB. 4-6-2004. FILED 8-26-2003.

2,858,167. **DOCUMENT FILINGS...IT'S WHAT WE DO.. MY CORPORATION BUSINESS SERVICES, INC.**, MULTIPLE CLASS, (INT. CLS. 35 AND 42), (U.S. CLS. 100, 101 AND 102). SN 78-293,179. PUB. 4-6-2004. FILED 8-27-2003.

2,858,171. **MCTEIGUE & MCCLELLAND. MCTEIGUE & MCCLELLAND, INC.**, (U.S. CLS. 100, 101 AND 102). SN 78-294,787. PUB. 4-6-2004. FILED 9-2-2003.

CLASS 36—INSURANCE AND FINANCIAL

2,857,108. **PCN. CORESOURCE, INC.**, (U.S. CL. 102). SN 74-348,526. PUB. 9-5-1995. FILED 1-14-1993.

2,857,109. **PCN PRIMARY CARE NETWORK. CORESOURCE, INC.**, (U.S. CLS. 101 AND 102). SN 74-357,381. PUB. 8-15-1995. FILED 2-9-1993.

2,857,124. **INTERNATIONAL HEALTH INSURANCE DANMARK AND DESIGN. INTERNATIONAL HEALTH INSURANCE DANMARK FORSIKRINGSAKTIESELSKAB**, (U.S. CLS. 100, 101 AND 102). SN 75-707,973. PUB. 4-6-2004. FILED 5-18-1999.

2,857,141. **CENTERPOINT ENERGY AND DESIGN. CENTERPOINT ENERGY, INC.**, (U.S. CLS. 100, 101 AND 102). SN 75-982,596. PUB. 4-6-2004. FILED 6-27-2001.

2,857,151 (*See Class 9 for this trademark*).

2,857,159 (*See Class 9 for this trademark*).

2,857,160 (*See Class 9 for this trademark*).

2,857,168. **FOLIO ADVISOR. FOLIOFN, INC.**, (U.S. CLS. 100, 101 AND 102). SN 76-166,223. PUB. 4-6-2004. FILED 11-16-2000.

2,857,178 (*See Class 9 for this trademark*).

2,857,192 (*See Class 9 for this trademark*).

2,857,205. **UNITED COMMUNITY INVESTMENT SERVICES. UNITED INTELLECTUAL PROPERTY HOLDINGS, INC.**, (U.S. CLS. 100, 101 AND 102). SN 76-315,385. PUB. 4-6-2004. FILED 9-20-2001.

2,857,218. **CRESTSTREET. CRESTSTREET CAPITAL CORPORATION**, (U.S. CLS. 100, 101 AND 102). SN 76-345,527. PUB. 4-6-2004. FILED 12-5-2001.

2,857,226. **DCA ACCESS. NCCI HOLDINGS INCORPORATED**, (U.S. CLS. 100, 101 AND 102). SN 76-358,388. PUB. 4-6-2004. FILED 1-14-2002.

2,857,227. **BENEFITRX. CAREGAIN, INC.**, (U.S. CLS. 100, 101 AND 102). SN 76-359,554. PUB. 4-6-2004. FILED 1-16-2002.

2,857,239. **CHEXCARD (STYLIZED). MERCHANT BANKCARD SERVICES CORPORATION**, (U.S. CLS. 100, 101 AND 102). SN 76-378,591. PUB. 4-6-2004. FILED 3-5-2002.

2,857,240. **DATASTAR. DIALOG CORPORATION, THE**, MULTIPLE CLASS, (INT. CLS. 36, 42 AND 44), (U.S. CLS. 100, 101 AND 102). SN 76-378,620. PUB. 4-6-2004. FILED 3-5-2002.

2,857,243. **MUNICH-AMERICAN RISKPARTNERS. AMERICAN RE-INSURANCE COMPANY**, (U.S. CLS. 100, 101 AND 102). SN 76-380,696. PUB. 4-6-2004. FILED 3-8-2002.

2,857,255 (*See Class 35 for this trademark*).

2,857,256 (*See Class 35 for this trademark*).

2,857,296. **TEACHERS' INSURANCE PLAN OF NJ SPECIAL RATES FOR A SPECIAL CLASS OF PEOPLE AND DESIGN. LANCER MANAGEMENT COMPANY, INC.**, (U.S. CLS. 100, 101 AND 102). SN 76-428,186. PUB. 4-6-2004. FILED 7-9-2002.

2,857,301. **HONOR OUR HEROES. HONOR OUR HEROES FOUNDATION**, (U.S. CLS. 100, 101 AND 102). SN 76-431,797. PUB. 11-25-2003. FILED 7-18-2002.

2,857,309 (*See Class 9 for this trademark*).

2,857,310 (*See Class 35 for this trademark*).

2,857,312. **INTERNATIONAL STUDENT LOAN PROGRAM. INTERNATIONAL EDUCATION FINANCE CORPORATION**, (U.S. CLS. 100, 101 AND 102). SN 76-440,278. PUB. 4-6-2004. FILED 8-12-2002.

2,857,349. **PATRIOT COMPUTERS. MARCO INVESTMENTS, INC.**, (U.S. CLS. 100, 101 AND 102). SN 76-462,611. PUB. 4-6-2004. FILED 10-28-2002.

2,857,378. **MISCELLANEOUS DESIGN. DESTINY HEALTH, INC.**, (U.S. CLS. 100, 101 AND 102). SN 76-470,381. PUB. 4-6-2004. FILED 11-29-2002.

2,857,382 (*See Class 35 for this trademark*).

2,857,384. **INVESTOR QUERY AND DESIGN. GMAC COMMERCIAL MORTGAGE CORPORATION**, (U.S. CLS. 100, 101 AND 102). SN 76-472,989. PUB. 4-6-2004. FILED 12-9-2002.

2,857,388. **SMITH GRAY BUILDING. KAY 138 BROADWAY REALTY ASSOCIATES, LLC**, (U.S. CLS. 100, 101 AND 102). SN 76-473,964. PUB. 4-6-2004. FILED 10-18-2002.

2,857,408. **N COMMERICAL BORROWER CONNECTION AND DESIGN. NORTHLAND NETWORKS, INC.**, (U.S. CLS. 100, 101 AND 102). SN 76-480,204. PUB. 4-6-2004. FILED 1-3-2003.

- 2,857,446. **KNOW MORE. GUIDE RESPONSIBLY. INVEST WISELY.** PHOENIX INVESTMENT PARTNERS, LTD., (U.S. CLS. 100, 101 AND 102). SN 76-489,221. PUB. 4-6-2004. FILED 2-11-2003.
- 2,857,458. **CHRISTOPHER COMMUNITY.** CHRISTOPHER COMMUNITY, INC., MULTIPLE CLASS, (INT. CLS. 36 AND 37), (U.S. CLS. 100, 101, 102, 103 AND 106). SN 76-493,179. PUB. 4-6-2004. FILED 2-25-2003.
- 2,857,465. **CACHET (STYLIZED).** CACHET BANQ, (U.S. CLS. 100, 101 AND 102). SN 76-497,514. PUB. 4-6-2004. FILED 3-10-2003.
- 2,857,478. **RACHEL THOMAS. O'GRADY, MAUREEN WILT-SIE, AND O'GRADY, JOHN,** (U.S. CLS. 100, 101 AND 102). SN 76-501,160. PUB. 4-6-2004. FILED 3-27-2003.
- 2,857,510. **THINK COLLATERAL.** COLLATERAL MORTGAGE CAPITAL, LLC, (U.S. CLS. 100, 101 AND 102). SN 76-509,534. PUB. 4-6-2004. FILED 4-25-2003.
- 2,857,546. **SUBURBAN REALTY AND DESIGN.** SUBURBAN REALTY, (U.S. CLS. 100, 101 AND 102). SN 76-515,134. PUB. 4-6-2004. FILED 5-19-2003.
- 2,857,551. **IDEA PARTNERSHIPS.** IDEA PARTNERSHIPS, LLC, MULTIPLE CLASS, (INT. CLS. 36 AND 37), (U.S. CLS. 100, 101, 102, 103 AND 106). SN 76-516,130. PUB. 4-6-2004. FILED 4-25-2003.
- 2,857,552. **SLEEP IN FOR THE CURE.** THE SUSAN G. KOMEN BREAST CANCER FOUNDATION, (U.S. CLS. 100, 101 AND 102). SN 76-516,417. PUB. 4-6-2004. FILED 5-23-2003.
- 2,857,580. **NATIONAL PLANNING HOLDINGS.** JACKSON NATIONAL LIFE INSURANCE COMPANY, (U.S. CLS. 100, 101 AND 102). SN 76-522,283. PUB. 4-6-2004. FILED 6-12-2003.
- 2,857,587. **FAMILY FOUNDATION PLUS.** THE DAYTON FOUNDATION PLUS, INC., (U.S. CLS. 100, 101 AND 102). SN 76-523,382. PUB. 4-6-2004. FILED 6-11-2003.
- 2,857,594. **MISCELLANEOUS DESIGN.** UNDERWOOD INSURANCE AGENCY, INC., THE, (U.S. CLS. 100, 101 AND 102). SN 76-524,450. PUB. 4-6-2004. FILED 6-23-2003.
- 2,857,606. **D DOMAINGROUP CHANGING FUNDRAISING. CHANGING THE WORLD. AND DESIGN.** THE DOMAIN GROUP, INC., (U.S. CLS. 100, 101 AND 102). SN 76-527,391. PUB. 4-6-2004. FILED 7-2-2003.
- 2,857,609. **FAMILY LENDING.** STANDARD PACIFIC CORP., (U.S. CLS. 100, 101 AND 102). SN 76-527,978. PUB. 4-6-2004. FILED 7-8-2003.
- 2,857,623. **NCN AND DESIGN.** ELECTRONIC CLEARING HOUSE, INC., (U.S. CLS. 100, 101 AND 102). SN 76-529,322. PUB. 4-6-2004. FILED 7-14-2003.
- 2,857,624. **NCN.** ELECTRONIC CLEARING HOUSE, INC., (U.S. CLS. 100, 101 AND 102). SN 76-529,323. PUB. 4-6-2004. FILED 7-14-2003.
- 2,857,625. **HOMES2DREAMS.** DINGEMAN, MARK J., (U.S. CLS. 100, 101 AND 102). SN 76-529,329. PUB. 4-6-2004. FILED 7-14-2003.
- 2,857,681. **OMNIUM.** OMNIUM WORLDWIDE, INC., (U.S. CLS. 100, 101 AND 102). SN 76-532,114. PUB. 4-6-2004. FILED 7-14-2003.
- 2,857,693 (*See Class 35 for this trademark*).
- 2,857,696. **IT REALLY DOES PAY TO DISCOVER.** NOVUS CREDIT SERVICES INC., (U.S. CLS. 100, 101 AND 102). SN 76-532,534. PUB. 4-6-2004. FILED 7-28-2003.
- 2,857,699. **CARING FOR CLASSROOMS AND DESIGN.** LIBERTY SCHOOL SERVICES, LLC, (U.S. CLS. 100, 101 AND 102). SN 76-532,763. PUB. 4-6-2004. FILED 7-15-2003.
- 2,857,700. **QUEST FOR VICTORY.** LIBERTY SCHOOL SERVICES, LLC, (U.S. CLS. 100, 101 AND 102). SN 76-532,764. PUB. 4-6-2004. FILED 7-15-2003.
- 2,857,734. **MEDEX.** ASSOCIATION OF AMERICAN MEDICAL COLLEGES, (U.S. CLS. 100, 101 AND 102). SN 76-539,223. PUB. 4-6-2004. FILED 8-20-2003.
- 2,857,740. **CONVERT PERQS.** MORGAN STANLEY, (U.S. CLS. 100, 101 AND 102). SN 76-540,084. PUB. 4-6-2004. FILED 8-26-2003.
- 2,857,744. **METRO/RISK.** METRO/RISK INC., (U.S. CLS. 100, 101 AND 102). SN 76-540,596. PUB. 4-6-2004. FILED 8-11-2003.
- 2,857,791. **GALE AND DESIGN.** THE GALE COMPANY, MULTIPLE CLASS, (INT. CLS. 36 AND 37), (U.S. CLS. 100, 101, 102, 103 AND 106). SN 78-127,544. PUB. 4-6-2004. FILED 5-9-2002.
- 2,857,799. **BCF BANK OF CENTRAL FLORIDA AND DESIGN.** F.N.B. CORPORATION, (U.S. CLS. 100, 101 AND 102). SN 78-148,138. PUB. 4-6-2004. FILED 7-26-2002.
- 2,857,821 (*See Class 35 for this trademark*).
- 2,857,843 (*See Class 35 for this trademark*).
- 2,857,860 (*See Class 35 for this trademark*).
- 2,857,872. **PHILLIPS 66 AND DESIGN.** PHILLIPS PETROLEUM COMPANY, (U.S. CLS. 100, 101 AND 102). SN 78-196,918. PUB. 4-6-2004. FILED 12-20-2002.
- 2,857,873. **PHILLIPS 66.** PHILLIPS PETROLEUM COMPANY, (U.S. CLS. 100, 101 AND 102). SN 78-196,920. PUB. 4-6-2004. FILED 12-20-2002.
- 2,857,874 (*See Class 35 for this trademark*).
- 2,857,880 (*See Class 35 for this trademark*).
- 2,857,890 (*See Class 9 for this trademark*).
- 2,857,898 (*See Class 18 for this trademark*).
- 2,857,902. **EXCLUSIVE ILLINOIS.** IDT NETHERLANDS, B.V. (PUERTO RICO BRANCH), (U.S. CLS. 100, 101 AND 102). SN 78-202,911. PUB. 4-6-2004. FILED 1-14-2003.
- 2,857,903. **EXCLUSIVE GEORGIA.** IDT NETHERLANDS, B.V. (PUERTO RICO BRANCH), (U.S. CLS. 100, 101 AND 102). SN 78-202,915. PUB. 4-6-2004. FILED 1-14-2003.
- 2,857,904. **EXCLUSIVE MASSACHUSETTS.** IDT NETHERLANDS, B.V. (PUERTO RICO BRANCH), (U.S. CLS. 100, 101 AND 102). SN 78-202,919. PUB. 4-6-2004. FILED 1-14-2003.
- 2,857,905. **EXCLUSIVE PENNSYLVANIA.** IDT NETHERLANDS, B.V. (PUERTO RICO BRANCH), (U.S. CLS. 100, 101 AND 102). SN 78-202,922. PUB. 4-6-2004. FILED 1-14-2003.
- 2,857,911 (*See Class 16 for this trademark*).
- 2,857,924. **THE RICHDAL GROUP AND DESIGN.** RICHDAL DEVELOPMENT COMPANY, MULTIPLE CLASS, (INT. CLS. 36 AND 37), (U.S. CLS. 100, 101, 102, 103 AND 106). SN 78-210,021. PUB. 4-6-2004. FILED 2-3-2003.
- 2,857,931. **RHYTHM AND HOPE.** AMERICAN LEBANESE SYRIAN ASSOCIATED CHARITIES, INC., (U.S. CLS. 100, 101 AND 102). SN 78-213,170. PUB. 4-6-2004. FILED 2-11-2003.
- 2,857,953. **FRANKLIN TEMPLETON INVESTMENTS AND DESIGN.** FRANKLIN RESOURCES, INC., (U.S. CLS. 100, 101 AND 102). SN 78-220,427. PUB. 11-11-2003. FILED 2-28-2003.
- 2,858,012 (*See Class 35 for this trademark*).
- 2,858,042. **MISCELLANEOUS DESIGN.** NORTHWEST MULTIPLE LISTING SERVICE, (U.S. CLS. 100, 101 AND 102). SN 78-266,055. PUB. 4-6-2004. FILED 6-23-2003.
- 2,858,045. **SECURITY BENEFIT ADVISOR 403(B)(7) PROGRAM.** SECURITY BENEFIT LIFE INSURANCE COMPANY, (U.S. CLS. 100, 101 AND 102). SN 78-266,304. PUB. 4-6-2004. FILED 6-24-2003.
- 2,858,080. **SMITH BARNEY ON-SITE.** CITIGROUP GLOBAL MARKETS INC., (U.S. CLS. 100, 101 AND 102). SN 78-272,512. PUB. 4-6-2004. FILED 7-10-2003.
- 2,858,088. **ONE CALL PROMISE.** COLLEGE LOAN CORPORATION, (U.S. CLS. 100, 101 AND 102). SN 78-274,089. PUB. 4-6-2004. FILED 7-14-2003.
- 2,858,104. **GAPEXPRESS.** WNC INSURANCE SERVICES, INC., (U.S. CLS. 100, 101 AND 102). SN 78-275,457. PUB. 4-6-2004. FILED 7-17-2003.
- 2,858,109. **METPREMIER.** METROPOLITAN LIFE INSURANCE COMPANY, (U.S. CLS. 100, 101 AND 102). SN 78-275,919. PUB. 4-6-2004. FILED 7-18-2003.
- 2,858,118. **WE GIVE YOU CREDIT FOR YOUR GOOD CREDIT.** AAXA DISCOUNT MORTGAGE, INC., (U.S. CLS. 100, 101 AND 102). SN 78-276,829. PUB. 4-6-2004. FILED 7-21-2003.
- 2,858,149. **MANHATTAN CONNECTION.** MANHATTAN CONNECTION, (U.S. CLS. 100, 101 AND 102). SN 78-287,385. PUB. 4-6-2004. FILED 8-14-2003.
- 2,858,152. **MR. DREAM HOME.** MR. DREAM HOME, INC., (U.S. CLS. 100, 101 AND 102). SN 78-287,684. PUB. 4-6-2004. FILED 8-14-2003.
- 2,858,158 (*See Class 35 for this trademark*).

CLASS 37—CONSTRUCTION AND REPAIR

- 2,857,156 (*See Class 35 for this trademark.*)
 2,857,214 (*See Class 1 for this trademark.*)
 2,857,217 (*See Class 9 for this trademark.*)
 2,857,244 (*See Class 9 for this trademark.*)
 2,857,379. **BUILD HISTORY.** PEARSON, LARRY, (U.S. CLS. 100, 103 AND 106). SN 76-470,824. PUB. 4-6-2004. FILED 11-27-2002.
 2,857,401 (*See Class 6 for this trademark.*)
 2,857,406. **VAIL VALLEY JET CENTER AND DESIGN.** VAIL VALLEY JET CENTER, MULTIPLE CLASS, (INT. CLS. 37 AND 39), (U.S. CLS. 100, 103, 105 AND 106). SN 76-478,946. PUB. 4-6-2004. FILED 12-30-2002.
 2,857,414. **ASSISTANCE ROADWATCH 24/7 EMERGENCY ROAD SERVICE AND DESIGN.** XTRA CORPORATION, (U.S. CLS. 100, 103 AND 106). SN 76-481,164. PUB. 4-6-2004. FILED 1-9-2003.
 2,857,458 (*See Class 36 for this trademark.*)
 2,857,475. **CATSPPEED WIRING LLC.** CATSPPEED WIRING, LLC, (U.S. CLS. 100, 103 AND 106). SN 76-499,274. PUB. 4-6-2004. FILED 2-28-2003.
 2,857,523 (*See Class 35 for this trademark.*)
 2,857,524 (*See Class 35 for this trademark.*)
 2,857,551 (*See Class 36 for this trademark.*)
 2,857,564. **MISCELLANEOUS DESIGN.** CARLISLE INTANGIBLE COMPANY, (U.S. CLS. 100, 103 AND 106). SN 76-519,188. PUB. 4-6-2004. FILED 6-3-2003.
 2,857,650. **MCDERMOTT M AND DESIGN.** MCDERMOTT INTERNATIONAL, INC., MULTIPLE CLASS, (INT. CLS. 37, 40 AND 42), (U.S. CLS. 100, 101, 103 AND 106). SN 76-530,471. PUB. 4-6-2004. FILED 7-8-2003.
 2,857,750. **MAGIC MARCITE.** MAGIC MARCITE, INC., (U.S. CLS. 100, 103 AND 106). SN 76-543,037. PUB. 4-6-2004. FILED 8-22-2003.
 2,857,791 (*See Class 36 for this trademark.*)
 2,857,796. **ADT AND DESIGN.** ADT SERVICES AG, MULTIPLE CLASS, (INT. CLS. 37 AND 45), (U.S. CLS. 100, 101, 103 AND 106). SN 78-138,611. PUB. 4-6-2004. FILED 6-25-2002.
 2,857,853. **SPARKS EXHIBITS & ENVIRONMENTS.** SPARKS EXHIBITS & ENVIRONMENTS CORP., MULTIPLE CLASS, (INT. CLS. 37 AND 42), (U.S. CLS. 100, 101, 103 AND 106). SN 78-190,575. PUB. 4-6-2004. FILED 12-3-2002.
 2,857,874 (*See Class 35 for this trademark.*)
 2,857,908. **DOYON AND DESIGN.** DOYON, LIMITED, (U.S. CLS. 100, 103 AND 106). SN 78-203,156. PUB. 4-6-2004. FILED 1-14-2003.
 2,857,924 (*See Class 36 for this trademark.*)
 2,857,945. **BRINGING BASEMENTS BACK TO LIFE.** BASEMENT SYSTEMS OF OHIO, INC., (U.S. CLS. 100, 103 AND 106). SN 78-218,343. PUB. 4-6-2004. FILED 2-24-2003.
 2,857,951. **DIRECT AND DESIGN.** INGERSOLL-RAND COMPANY, (U.S. CLS. 100, 103 AND 106). SN 78-219,995. PUB. 4-6-2004. FILED 2-28-2003.
 2,857,952 (*See Class 7 for this trademark.*)
 2,857,966. **CHARITYADVANTAGE.** NET CRUISER TECHNOLOGIES, INC., MULTIPLE CLASS, (INT. CLS. 37 AND 42), (U.S. CLS. 100, 101, 103 AND 106). SN 78-227,573. PUB. 4-6-2004. FILED 3-19-2003.
 2,858,057. **CASTLE KEEPERS AND DESIGN.** CASTLE KEEPERS OF CHARLESTON, INC., (U.S. CLS. 100, 103 AND 106). SN 78-269,050. PUB. 4-6-2004. FILED 7-1-2003.
 2,858,123. **COMET CLEANERS.** GODFREY FRANCHISE, INC., (U.S. CLS. 100, 103 AND 106). SN 78-277,116. PUB. 4-6-2004. FILED 7-22-2003.

CLASS 38—COMMUNICATION

- 2,857,142 (*See Class 16 for this trademark.*)
 2,857,151 (*See Class 9 for this trademark.*)
 2,857,159 (*See Class 9 for this trademark.*)
 2,857,164 (*See Class 9 for this trademark.*)
 2,857,165 (*See Class 9 for this trademark.*)
 2,857,166 (*See Class 9 for this trademark.*)
 2,857,171 (*See Class 3 for this trademark.*)
 2,857,178 (*See Class 9 for this trademark.*)

- 2,857,187. **WORRY FREE GUARANTEE.** CELLCO PARTNERSHIP, DBA VERIZON WIRELESS, (U.S. CLS. 100, 101 AND 104). SN 76-251,734. PUB. 4-6-2004. FILED 5-4-2001.
 2,857,196 (*See Class 9 for this trademark.*)
 2,857,225. **AMERICA'S CHOICE.** CELLCO PARTNERSHIP, DBA VERIZON WIRELESS, (U.S. CLS. 100, 101 AND 104). SN 76-356,566. PUB. 4-6-2004. FILED 1-9-2002.
 2,857,251. **FAMILY LINK.** TRZ BUSINESS SERVICES, INC., (U.S. CLS. 100, 101 AND 104). SN 76-394,143. PUB. 4-6-2004. FILED 4-11-2002.
 2,857,284. **ACCESS ROAD.** HAPPY MEDIA INCORPORATED, MULTIPLE CLASS, (INT. CLS. 38 AND 42), (U.S. CLS. 100, 101 AND 104). SN 76-418,082. PUB. 4-6-2004. FILED 6-7-2002.
 2,857,370. **WEB VIEW.** CONFERENCE-CALL USA, INC., DBA CITIZENS CONFERENCING, (U.S. CLS. 100, 101 AND 104). SN 76-466,664. PUB. 4-6-2004. FILED 11-13-2002.
 2,857,402. **FEDLINE.** JOINT VENTURE OF FEDERAL RESERVE BANKS, (U.S. CLS. 100, 101 AND 104). SN 76-478,630. PUB. 4-6-2004. FILED 12-27-2002.
 2,857,508. **STREAMING WORLD.** MAKING HISTORY, LTD., DBA STREAMING WORLD, MULTIPLE CLASS, (INT. CLS. 38 AND 42), (U.S. CLS. 100, 101 AND 104). SN 76-509,129. PUB. 4-6-2004. FILED 4-24-2003.
 2,857,543. **CRAZY CALL.** WORLDXCHANGE CORP., DBA ACCERIS COMMUNICATIONS PARTNERS D.B.A. ACCERIS COMMUNICATIONS SOLUTIONS, (U.S. CLS. 100, 101 AND 104). SN 76-514,918. PUB. 4-6-2004. FILED 5-16-2003.
 2,857,563. **K12 EDU.COM KIDS COUNT AND DESIGN.** K12EDU.COM CORPORATION, (U.S. CLS. 100, 101 AND 104). SN 76-519,155. PUB. 4-6-2004. FILED 6-3-2003.
 2,857,589. **GORGE.NET.** GORGE NETWORKS, INC., (U.S. CLS. 100, 101 AND 104). SN 76-523,687. PUB. 4-6-2004. FILED 6-19-2003.
 2,857,592. **V.I.S.T.A. EDC.** SCIENTIFIC SOFTWARE TOOLS, INC., (U.S. CLS. 100, 101 AND 104). SN 76-524,102. PUB. 4-6-2004. FILED 6-13-2003.
 2,857,634. **IWIFI.US.** IMPERIAL WIRELESS, (U.S. CLS. 100, 101 AND 104). SN 76-529,622. PUB. 4-6-2004. FILED 6-25-2003.
 2,857,767. **IWIFI (BLOCK FORM).** IMPERIAL WIRELESS, (U.S. CLS. 100, 101 AND 104). SN 76-560,068. PUB. 4-6-2004. FILED 11-3-2003.
 2,857,770 (*See Class 9 for this trademark.*)
 2,857,824 (*See Class 9 for this trademark.*)
 2,857,843 (*See Class 35 for this trademark.*)
 2,857,925. **UNION COMMUNICATIONS.** UNION TELEPHONE COMPANY, (U.S. CLS. 100, 101 AND 104). SN 78-211,514. PUB. 4-6-2004. FILED 2-6-2003.

CLASS 39—TRANSPORTATION AND STORAGE

- 2,857,113. **INTERNET TRAVEL NETWORK AND DESIGN.** INTERNET TRAVEL NETWORK, (U.S. CLS. 100 AND 105). SN 75-147,847. PUB. 4-6-2004. FILED 8-9-1996.
 2,857,127 (*See Class 4 for this trademark.*)
 2,857,157. **SAFESHIP IT!.** SAFESHIP INTERNATIONAL, INC., (U.S. CLS. 100 AND 105). SN 76-128,022. PUB. 4-6-2004. FILED 9-14-2000.
 2,857,159 (*See Class 9 for this trademark.*)
 2,857,171 (*See Class 3 for this trademark.*)
 2,857,406 (*See Class 37 for this trademark.*)
 2,857,427. **VEGAS.COM IT'S WHO YOU KNOW. AND DESIGN.** VEGAS.COM, LLC, MULTIPLE CLASS, (INT. CLS. 39, 41 AND 43), (U.S. CLS. 100, 101, 105 AND 107). SN 76-485,032. PUB. 4-6-2004. FILED 1-27-2003.
 2,857,473. **CGV SINCE 1983 CLASSIC GOLF VACATIONS YOUR PASSPORT TO THE BEST OF TIMES (STYLIZED).** PAR EMPRIZES, INC, (U.S. CLS. 100 AND 105). SN 76-498,636. PUB. 4-6-2004. FILED 3-19-2003.
 2,857,523 (*See Class 35 for this trademark.*)
 2,857,524 (*See Class 35 for this trademark.*)
 2,857,596. **SIMPLY EXCEPTIONAL.** LIBERTY TRAVEL, INC., (U.S. CLS. 100 AND 105). SN 76-524,950. PUB. 4-6-

2004. FILED 6-23-2003.
 2,857,687. **TRANSCAD**. CALIPER CORPORATION, (U.S. CLS. 100 AND 105). SN 76-532,312. PUB. 4-6-2004. FILED 7-25-2003.
 2,857,950. **BACHELORBLOWOUT.COM AND DESIGN**. BACHELORBLOWOUT, LLC, (U.S. CLS. 100 AND 105). SN 78-219,647. PUB. 4-6-2004. FILED 2-27-2003.
 2,857,952 (*See Class 7 for this trademark*).
 2,857,962. **KWIKTRAC**. KWIKTRAC ALERTING SYSTEMS, LLC, (U.S. CLS. 100 AND 105). SN 78-225,109. PUB. 4-6-2004. FILED 3-13-2003.
 2,858,087. **ARCDISC**. SANCO SYSTEMS, LLC, (U.S. CLS. 100 AND 105). SN 78-273,789. PUB. 4-6-2004. FILED 7-14-2003.
 2,858,150. **OMNI TRAILER SALES AND RENTALS**. MOBILE STORAGE GROUP, INC., MULTIPLE CLASS, (INT. CLS. 39 AND 43), (U.S. CLS. 100, 101 AND 105). SN 78-287,443. PUB. 4-6-2004. FILED 8-14-2003.

CLASS 40—MATERIAL TREATMENT

2,857,154. **SNAPSHOT**. WESTERN CORPORATE FEDERAL CREDIT UNION, (U.S. CLS. 100, 103 AND 106). SN 76-117,223. PUB. 4-6-2004. FILED 8-25-2000.
 2,857,158 (*See Class 1 for this trademark*).
 2,857,214 (*See Class 1 for this trademark*).
 2,857,224 (*See Class 14 for this trademark*).
 2,857,282 (*See Class 7 for this trademark*).
 2,857,300 (*See Class 9 for this trademark*).
 2,857,306 (*See Class 1 for this trademark*).
 2,857,355. **POLARFAB**. POLARFAB LLC, MULTIPLE CLASS, (INT. CLS. 40 AND 42), (U.S. CLS. 100, 101, 103 AND 106). SN 76-463,660. PUB. 4-6-2004. FILED 11-1-2002.
 2,857,356. **THE FLEXIBLE FOUNDRY**. POLARFAB LLC, MULTIPLE CLASS, (INT. CLS. 40 AND 42), (U.S. CLS. 100, 101, 103 AND 106). SN 76-463,661. PUB. 4-6-2004. FILED 11-1-2002.
 2,857,387. **DUROPLAS**. DUROPLAS CORPORATION, MULTIPLE CLASS, (INT. CLS. 40 AND 42), (U.S. CLS. 100, 101, 103 AND 106). SN 76-473,394. PUB. 4-6-2004. FILED 11-26-2002.
 2,857,399 (*See Class 31 for this trademark*).
 2,857,523 (*See Class 35 for this trademark*).
 2,857,524 (*See Class 35 for this trademark*).
 2,857,636. **ALL ABOUT PROMOTIONS**. UNDERKOFLE, REENA, AND UNDERKOFLE, ALAN, (U.S. CLS. 100, 103 AND 106). SN 76-529,727. PUB. 4-6-2004. FILED 7-15-2003.
 2,857,650 (*See Class 37 for this trademark*).
 2,857,806. **PROTEUS WORKSHOP AND DESIGN**. BROWN, STEPHEN CRAIG, (U.S. CLS. 100, 103 AND 106). SN 78-157,831. PUB. 4-6-2004. FILED 8-26-2002.
 2,857,816. **ENGAGE!**. THE PRINTER, INC., (U.S. CLS. 100, 103 AND 106). SN 78-168,634. PUB. 4-6-2004. FILED 9-27-2002.
 2,857,818. **PAPER SOURCE**. PAPER SOURCE, INC., MULTIPLE CLASS, (INT. CLS. 40 AND 42), (U.S. CLS. 100, 101, 103 AND 106). SN 78-170,171. PUB. 4-6-2004. FILED 10-2-2002.
 2,858,079. **HZZERO**. HALLIBURTON ENERGY SERVICES, INC., (U.S. CLS. 100, 103 AND 106). SN 78-272,505. PUB. 4-6-2004. FILED 7-10-2003.

CLASS 41—EDUCATION AND ENTERTAINMENT

2,857,111 (*See Class 35 for this trademark*).
 2,857,129 (*See Class 3 for this trademark*).
 2,857,131. **DESTINY UNLIMITED**. PATTERSON, DANITA, (U.S. CLS. 100, 101 AND 107). SN 75-848,850. PUB. 4-6-2004. FILED 11-15-1999.
 2,857,132 (*See Class 35 for this trademark*).
 2,857,143 (*See Class 35 for this trademark*).
 2,857,151 (*See Class 9 for this trademark*).
 2,857,165 (*See Class 9 for this trademark*).
 2,857,170 (*See Class 5 for this trademark*).
 2,857,171 (*See Class 3 for this trademark*).

2,857,188. **SCRIPTURE FROM SCRATCH**. SCRIPTURE FROM SCRATCH, (U.S. CLS. 100, 101 AND 107). SN 76-251,977. PUB. 4-6-2004. FILED 5-7-2001.
 2,857,191 (*See Class 16 for this trademark*).
 2,857,209. **THE RAID**. R.G. INTERNATIONAL S.A., (U.S. CLS. 100, 101 AND 107). SN 76-319,152. PUB. 4-6-2004. FILED 9-28-2001.
 2,857,211. **UNDERWATER ADVENTURES AND DESIGN**. MINNESOTA AQUARIUM, LLC, THE, (U.S. CLS. 100, 101 AND 107). SN 76-321,487. PUB. 10-14-2003. FILED 10-4-2001.
 2,857,232. **BIGHORN**. BIGHORN DEVELOPMENT, L.L.C., (U.S. CLS. 100, 101 AND 107). SN 76-366,170. PUB. 4-6-2004. FILED 1-31-2002.
 2,857,235. **OC VIVE.COM**. FREEDOM COMMUNICATIONS, INC., (U.S. CLS. 100, 101 AND 107). SN 76-374,021. PUB. 4-6-2004. FILED 2-22-2002.
 2,857,237. **OCVIVE!COM AND DESIGN**. FREEDOM COMMUNICATIONS, INC., (U.S. CLS. 100, 101 AND 107). SN 76-376,919. PUB. 4-6-2004. FILED 2-28-2002.
 2,857,255 (*See Class 35 for this trademark*).
 2,857,256 (*See Class 35 for this trademark*).
 2,857,262. **COKINETIC SYSTEMS**. COKINETIC SYSTEMS, CORP., MULTIPLE CLASS, (INT. CLS. 41 AND 42), (U.S. CLS. 100, 101 AND 107). SN 76-398,903. PUB. 4-6-2004. FILED 4-23-2002.
 2,857,264 (*See Class 9 for this trademark*).
 2,857,265 (*See Class 9 for this trademark*).
 2,857,278. **BRIDGE DAY**. FAYETTE COUNTY NEW RIVER GORGE BRIDGE DAY COMMISSION, (U.S. CLS. 100, 101 AND 107). SN 76-410,945. PUB. 4-6-2004. FILED 5-20-2002.
 2,857,281. **ADAYANA**. ADAYANA, INC., (U.S. CLS. 100, 101 AND 107). SN 76-416,906. PUB. 4-6-2004. FILED 6-4-2002.
 2,857,282 (*See Class 7 for this trademark*).
 2,857,285. **NEVERLAND FILMS**. NEVERLAND FILMS, INC., (U.S. CLS. 100, 101 AND 107). SN 76-418,949. PUB. 4-6-2004. FILED 6-10-2002.
 2,857,290 (*See Class 35 for this trademark*).
 2,857,292. **FRIENDS OF STRAYS**. FRIENDS OF STRAYS, INC., MULTIPLE CLASS, (INT. CLS. 41, 43 AND 44), (U.S. CLS. 100, 101 AND 107). SN 76-424,719. PUB. 4-6-2004. FILED 6-18-2002.
 2,857,294 (*See Class 13 for this trademark*).
 2,857,298. **RELATED RECORDS**. DELAWARE LICENSING CORPORATION, (U.S. CLS. 100, 101 AND 107). SN 76-430,093. PUB. 4-6-2004. FILED 7-12-2002.
 2,857,309 (*See Class 9 for this trademark*).
 2,857,315. **EVOLVE**. ELSEVIER INC., (U.S. CLS. 100, 101 AND 107). SN 76-442,919. PUB. 4-6-2004. FILED 8-16-2002.
 2,857,319. **GLOW**. E! ENTERTAINMENT TELEVISION, INC., (U.S. CLS. 100, 101 AND 107). SN 76-447,677. PUB. 3-25-2003. FILED 9-6-2002.
 2,857,328. **WICHITA RIVER FESTIVAL AND DESIGN**. WICHITA FESTIVALS, INC., (U.S. CLS. 100, 101 AND 107). SN 76-450,749. PUB. 4-6-2004. FILED 9-18-2002.
 2,857,339. **MISCELLANEOUS DESIGN**. PUPPETRONICS CORPORATION, (U.S. CLS. 100, 101 AND 107). SN 76-458,913. PUB. 4-6-2004. FILED 10-17-2002.
 2,857,342. **AAOMFP**. AMERICAN ACADEMY OF ORIENTAL MEDICINE FAMILY PRACTICE, (U.S. CLS. 100, 101 AND 107). SN 76-459,824. PUB. 4-6-2004. FILED 10-10-2002.
 2,857,343 (*See Class 9 for this trademark*).
 2,857,345 (*See Class 16 for this trademark*).
 2,857,346. **BASEMENT BHANGRA**. MALHOTRA, REKHA, (U.S. CLS. 100, 101 AND 107). SN 76-461,649. PUB. 4-6-2004. FILED 10-25-2002.
 2,857,347 (*See Class 35 for this trademark*).
 2,857,350. **PROFILES IN CARING**. DREAMWEAVER MEDICAL FOUNDATION, (U.S. CLS. 100, 101 AND 107). SN 76-462,729. PUB. 4-6-2004. FILED 10-28-2002.
 2,857,351. **MT. SHASTA BOARD & SKI PARK AND DESIGN**. WINTUN DEVELOPMENT COMPANY, INC., DBA MT. SHASTA SKI PARK, (U.S. CLS. 100, 101 AND 107). SN 76-462,928. PUB. 4-6-2004. FILED 10-24-2002.
 2,857,354 (*See Class 9 for this trademark*).
 2,857,357. **CLOUD 10**. HOOPER, ZACK JATHAN, (U.S. CLS. 100, 101 AND 107). SN 76-464,537. PUB. 4-6-2004. FILED 10-28-2002.
 2,857,361. **WARRIORS BOXING**. WARRIOR BOXING GYM,

- INC., (U.S. CLS. 100, 101 AND 107), SN 76-465,464. PUB. 4-6-2004. FILED 11-8-2002.
- 2,857,366. **VOYAGE AND DESIGN**. BAUMEL, SUSAN BENAY, (U.S. CLS. 100, 101 AND 107), SN 76-466,027. PUB. 4-6-2004. FILED 11-8-2002.
- 2,857,372. **STAMP OF APPROVAL A+ AND DESIGN**. AFRICAN-AMERICAN POSTAL LEAGUE UNITED FOR SUCCESS (APLUS), (U.S. CLS. 100, 101 AND 107), SN 76-468,410. PUB. 4-6-2004. FILED 11-19-2002.
- 2,857,374 (*See Class 35 for this trademark*).
- 2,857,375. **NEW YORK FESTIVALS**. INTERNATIONAL AWARDS GROUP, LLC, (U.S. CLS. 100, 101 AND 107), SN 76-469,710. PUB. 4-6-2004. FILED 11-15-2002.
- 2,857,381. **STATIC SHOCK**. DC COMICS, (U.S. CLS. 100, 101 AND 107), SN 76-472,339. PUB. 4-6-2004. FILED 12-4-2002.
- 2,857,425. **BECAUSE NO ONE IS ABOVE THE LAW!**. JUDICIAL WATCH, INC., (U.S. CLS. 100, 101 AND 107), SN 76-484,857. PUB. 4-6-2004. FILED 1-24-2003.
- 2,857,427 (*See Class 39 for this trademark*).
- 2,857,439. **BOOGER BARTER**. EQUIBRAND ENTERTAINMENT GROUP LP, (U.S. CLS. 100, 101 AND 107), SN 76-486,456. PUB. 4-6-2004. FILED 1-27-2003.
- 2,857,442. **P AND DESIGN**. PROVIDENCE SYSTEMS, INC., (U.S. CLS. 100, 101 AND 107), SN 76-486,579. PUB. 4-6-2004. FILED 1-24-2003.
- 2,857,443 (*See Class 9 for this trademark*).
- 2,857,444 (*See Class 9 for this trademark*).
- 2,857,459 (*See Class 16 for this trademark*).
- 2,857,463. **MENTOR ONLINE**. ROBERT MORRIS ASSOCIATES, (U.S. CLS. 100, 101 AND 107), SN 76-496,043. PUB. 4-6-2004. FILED 3-10-2003.
- 2,857,511. **LEARNMK**. MARY KAY INC., (U.S. CLS. 100, 101 AND 107), SN 76-509,926. PUB. 4-6-2004. FILED 4-29-2003.
- 2,857,512. **GUIDEPOSTS ONLINE**. GUIDEPOSTS, A CHURCH CORPORATION, (U.S. CLS. 100, 101 AND 107), SN 76-510,278. PUB. 4-6-2004. FILED 4-29-2003.
- 2,857,513. **THIS SITE IS POWERED BY POSITIVE THINKING**. GUIDEPOSTS, A CHURCH CORPORATION, (U.S. CLS. 100, 101 AND 107), SN 76-510,279. PUB. 4-6-2004. FILED 4-29-2003.
- 2,857,514. **QUIZ CENTRAL**. GUIDEPOSTS, A CHURCH CORPORATION, (U.S. CLS. 100, 101 AND 107), SN 76-510,281. PUB. 4-6-2004. FILED 4-29-2003.
- 2,857,517. **CME CAFE AND DESIGN**. HEALTHOLOGY, INC., (U.S. CLS. 100, 101 AND 107), SN 76-510,719. PUB. 4-6-2004. FILED 5-1-2003.
- 2,857,519 (*See Class 9 for this trademark*).
- 2,857,520 (*See Class 9 for this trademark*).
- 2,857,525 (*See Class 9 for this trademark*).
- 2,857,526. **CATALOOCHEE RANCH**. CATALOOCHEE RESORT, INC., (U.S. CLS. 100, 101 AND 107), SN 76-512,019. PUB. 4-6-2004. FILED 5-5-2003.
- 2,857,537. **MISCELLANEOUS DESIGN**. NATIONAL INSTITUTES OF HEALTH, (U.S. CLS. 100, 101 AND 107), SN 76-514,530. PUB. 4-6-2004. FILED 5-14-2003.
- 2,857,548 (*See Class 25 for this trademark*).
- 2,857,554. **GEORGIA ADAIR**. US MODEL, INC., (U.S. CLS. 100, 101 AND 107), SN 76-517,201. PUB. 4-6-2004. FILED 5-27-2003.
- 2,857,560. **1 LESSON ONE AND DESIGN**. OLIVER, JON, (U.S. CLS. 100, 101 AND 107), SN 76-518,345. PUB. 4-6-2004. FILED 6-2-2003.
- 2,857,573. **WHAT IF YOU HAD ALL THE TOOLS?**. LTB ENTERPRISES, INC., (U.S. CLS. 100, 101 AND 107), SN 76-521,408. PUB. 4-6-2004. FILED 6-9-2003.
- 2,857,577. **PRESTIGE PORTRAITS**. LIFETOUCH INC., (U.S. CLS. 100, 101 AND 107), SN 76-521,829. PUB. 4-6-2004. FILED 6-11-2003.
- 2,857,600. **QUESTIONS FOR LIFE**. PERFORMANCE LEARNING SYSTEMS, INC., (U.S. CLS. 100, 101 AND 107), SN 76-525,848. PUB. 4-6-2004. FILED 6-5-2003.
- 2,857,601 (*See Class 35 for this trademark*).
- 2,857,602 (*See Class 35 for this trademark*).
- 2,857,638. **THE DICKIE GROUP**. THE DICKIE GROUP, LLC, MULTIPLE CLASS, (INT. CLS. 41 AND 42), (U.S. CLS. 100, 101 AND 107), SN 76-529,816. PUB. 4-6-2004. FILED 7-8-2003.
- 2,857,649. **OSPREY POINT**. KIAWAH ISLAND INN COMPANY, LLC, (U.S. CLS. 100, 101 AND 107), SN 76-530,429. PUB. 4-6-2004. FILED 7-17-2003.
- 2,857,673. **BURNING FAT ONE BEAT AT A TIME**. SEGEL, MARVIN L., (U.S. CLS. 100, 101 AND 107), SN 76-531,637. PUB. 4-6-2004. FILED 7-23-2003.
- 2,857,674. **MESSAGE TIME PLUS**. CHILDREN'S LITERACY INITIATIVE, (U.S. CLS. 100, 101 AND 107), SN 76-531,666. PUB. 4-6-2004. FILED 7-23-2003.
- 2,857,683. **OAK POINT**. KIAWAH ISLAND INN COMPANY, LLC, (U.S. CLS. 100, 101 AND 107), SN 76-532,153. PUB. 4-6-2004. FILED 7-24-2003.
- 2,857,684. **IMAX THINK BIG**. IMAX CORPORATION, (U.S. CLS. 100, 101 AND 107), SN 76-532,206. PUB. 4-6-2004. FILED 7-21-2003.
- 2,857,685. **IMAX DMR**. IMAX CORPORATION, (U.S. CLS. 100, 101 AND 107), SN 76-532,215. PUB. 4-6-2004. FILED 7-21-2003.
- 2,857,686. **GRUPO DESTINO**. OMEGA SAFETY INTERNATIONAL, CORP., DBA ROYAL SALES ON LINE, (U.S. CLS. 100, 101 AND 107), SN 76-532,243. PUB. 4-6-2004. FILED 7-25-2003.
- 2,857,693 (*See Class 35 for this trademark*).
- 2,857,704 (*See Class 35 for this trademark*).
- 2,857,733. **MEDIA MINDS**. YOUNG WOMEN'S CHRISTIAN ASSOCIATION OF BOSTON, INC., (U.S. CLS. 100, 101 AND 107), SN 76-538,845. PUB. 4-6-2004. FILED 8-20-2003.
- 2,857,758 (*See Class 16 for this trademark*).
- 2,857,760 (*See Class 16 for this trademark*).
- 2,857,765. **MAINE COLLEGE OF ART**. MAINE COLLEGE OF ART, (U.S. CLS. 100, 101 AND 107), SN 76-548,159. PUB. 4-6-2004. FILED 8-11-2003.
- 2,857,768. **KEYS TO VICTORIOUS LIVING**. CANTON CHRISTIAN FELLOWSHIP, INC., (U.S. CLS. 100, 101 AND 107), SN 76-976,108. PUB. 4-6-2004. FILED 8-22-2002.
- 2,857,771. **PCCW**. PCCW-HKT DATACOM SERVICES LIMITED, (U.S. CLS. 100, 101 AND 107), SN 78-037,069. PUB. 4-6-2004. FILED 11-29-2000.
- 2,857,774. **RETIREMENT ASSET MANAGEMENT ACCUMULATION DISTRIBUTION TRANSFERENCE AND DESIGN**. SCUDDER TRUST COMPANY, (U.S. CLS. 100, 101 AND 107), SN 78-043,839. PUB. 4-6-2004. FILED 1-18-2001.
- 2,857,783. **THE LEADERSHIP TRUST**. LEADERSHIP TRUST, INC., THE, (U.S. CLS. 100, 101 AND 107), SN 78-096,205. PUB. 4-6-2004. FILED 12-3-2001.
- 2,857,792 (*See Class 9 for this trademark*).
- 2,857,824 (*See Class 9 for this trademark*).
- 2,857,843 (*See Class 35 for this trademark*).
- 2,857,845. **DOG B.O.N.E.S.**. DOG B.O.N.E.S. THERAPY DOGS OF MASSACHUSETTS, MULTIPLE CLASS, (INT. CLS. 41 AND 44), (U.S. CLS. 100, 101 AND 107), SN 78-189,029. PUB. 4-6-2004. FILED 11-26-2002.
- 2,857,852 (*See Class 9 for this trademark*).
- 2,857,857 (*See Class 35 for this trademark*).
- 2,857,861. **CINDY**. PLAMONDON, LUC, (U.S. CLS. 100, 101 AND 107), SN 78-192,347. PUB. 4-6-2004. FILED 12-9-2002.
- 2,857,865 (*See Class 9 for this trademark*).
- 2,857,866. **QUALITY NEW MEXICO**. QUALITY NEW MEXICO, (U.S. CLS. 100, 101 AND 107), SN 78-193,919. PUB. 4-6-2004. FILED 12-12-2002.
- 2,857,874 (*See Class 35 for this trademark*).
- 2,857,877. **A FREEZERBURNT CHRISTMAS**. BANNON ENTERPRISES, LLC, (U.S. CLS. 100, 101 AND 107), SN 78-197,428. PUB. 4-6-2004. FILED 12-23-2002.
- 2,857,893. **MIXX WORLD FOOD WORLD BEATS SUSHI BAR AND DESIGN**. MARINA DISTRICT DEVELOPMENT COMPANY, LLC, DBA BORGATA HOTEL, CASINO & SPA, MULTIPLE CLASS, (INT. CLS. 41 AND 43), (U.S. CLS. 100, 101 AND 107), SN 78-202,049. PUB. 4-6-2004. FILED 1-10-2003.
- 2,857,897. **LEADINGEDGE AND DESIGN**. ELMAR SUPPLY COMPANY, INC., (U.S. CLS. 100, 101 AND 107), SN 78-202,484. PUB. 4-6-2004. FILED 1-13-2003.
- 2,857,898 (*See Class 18 for this trademark*).
- 2,857,909 (*See Class 9 for this trademark*).
- 2,857,911 (*See Class 16 for this trademark*).
- 2,857,920. **LOST ELEMENT (STYLIZED)**. LOST ELEMENT, (U.S. CLS. 100, 101 AND 107), SN 78-209,924. PUB. 4-6-2004. FILED 2-2-2003.
- 2,857,941. **CLARK ATLANTA UNIVERSITY**. CLARK ATLAN-

- TA UNIVERSITY, INC., (U.S. CLS. 100, 101 AND 107). SN 78-217,717. PUB. 4-6-2004. FILED 2-21-2003.
- 2,857,942. **MISCELLANEOUS DESIGN. TRAIL BLAZERS, INC.**, (U.S. CLS. 100, 101 AND 107). SN 78-217,727. PUB. 4-6-2004. FILED 2-21-2003.
- 2,857,952 (*See Class 7 for this trademark.*).
- 2,857,955. **THE VELMAS. MINNICK, TODD R., AND GROSSHANDLER, MICHAEL S., AND BRUCE, MICHAEL J.**, (U.S. CLS. 100, 101 AND 107). SN 78-220,605. PUB. 4-6-2004. FILED 3-2-2003.
- 2,857,970. **ARTIST ON DEMAND. MUSICMATCH, INC.**, (U.S. CLS. 100, 101 AND 107). SN 78-230,969. PUB. 4-6-2004. FILED 3-27-2003.
- 2,857,971. **ARTIST MATCH. MUSICMATCH, INC.**, (U.S. CLS. 100, 101 AND 107). SN 78-230,977. PUB. 4-6-2004. FILED 3-27-2003.
- 2,857,975. **SYKART. SYKART INDOOR RACING CENTER, LLC**, (U.S. CLS. 100, 101 AND 107). SN 78-233,275. PUB. 4-6-2004. FILED 4-2-2003.
- 2,857,998. **LITTLE CAESARS AMATEUR HOCKEY LEAGUE AND DESIGN. LITTLE CAESAR ENTERPRISES, INC.**, (U.S. CLS. 100, 101 AND 107). SN 78-246,187. PUB. 4-6-2004. FILED 5-6-2003.
- 2,858,010. **ADVOCACY WATCH. VITAL OPTIONS INTERNATIONAL, INC.**, (U.S. CLS. 100, 101 AND 107). SN 78-250,447. PUB. 4-6-2004. FILED 5-15-2003.
- 2,858,011. **HEEB. BLEYER, JENNIFER S.**, (U.S. CLS. 100, 101 AND 107). SN 78-250,619. PUB. 12-23-2003. FILED 5-15-2003.
- 2,858,019. **KEROSENE BROTHERS. WHEELER, JOHN**, (U.S. CLS. 100, 101 AND 107). SN 78-255,353. PUB. 4-6-2004. FILED 5-28-2003.
- 2,858,027. **SOUP, SOAP & SALVATION. THE SALVATION ARMY, MULTIPLE CLASS, (INT. CLS. 41, 43 AND 45)**, (U.S. CLS. 100, 101 AND 107). SN 78-259,899. PUB. 4-6-2004. FILED 6-9-2003.
- 2,858,033 (*See Class 16 for this trademark.*).
- 2,858,046. **DVD EXPRESS (STYLIZED). VIDEO VENDING NEW YORK, INC.**, (U.S. CLS. 100, 101 AND 107). SN 78-266,319. PUB. 4-6-2004. FILED 6-24-2003.
- 2,858,051 (*See Class 35 for this trademark.*).
- 2,858,052 (*See Class 35 for this trademark.*).
- 2,858,054. **PROGRESS EMPOWERMENT CENTER. PROGRESS SOFTWARE CORPORATION**, (U.S. CLS. 100, 101 AND 107). SN 78-267,528. PUB. 4-6-2004. FILED 6-26-2003.
- 2,858,055. **MISS GALAXY. CORONATION, INC.**, (U.S. CLS. 100, 101 AND 107). SN 78-267,766. PUB. 4-6-2004. FILED 6-27-2003.
- 2,858,060 (*See Class 35 for this trademark.*).
- 2,858,084. **ANGELS WORKIN' OVERTIME. DUGAN, CASEY**, (U.S. CLS. 100, 101 AND 107). SN 78-273,328. PUB. 4-6-2004. FILED 7-11-2003.
- 2,858,098. **LONETTE MCKEE. MCKEE, LONETTE, RITA.**, (U.S. CLS. 100, 101 AND 107). SN 78-274,640. PUB. 4-6-2004. FILED 7-15-2003.
- 2,858,143. **SUNKIST KIDS. SUNKIST GROWERS, INC.**, (U.S. CLS. 100, 101 AND 107). SN 78-283,860. PUB. 4-6-2004. FILED 8-6-2003.
- 2,858,169. **DJ COMEBACK. MONTEAGUDO, LAZARO JR.**, (U.S. CLS. 100, 101 AND 107). SN 78-294,191. PUB. 4-6-2004. FILED 8-29-2003.
- 2,858,175. **THE IRRITANTS. KENDRICK, DEAN ARTHUR**, (U.S. CLS. 100, 101 AND 107). SN 78-303,428. PUB. 4-6-2004. FILED 9-22-2003.
- 2,857,159 (*See Class 9 for this trademark.*).
- 2,857,164 (*See Class 9 for this trademark.*).
- 2,857,165 (*See Class 9 for this trademark.*).
- 2,857,166 (*See Class 9 for this trademark.*).
- 2,857,170 (*See Class 5 for this trademark.*).
- 2,857,171 (*See Class 3 for this trademark.*).
- 2,857,181 (*See Class 9 for this trademark.*).
- 2,857,182 (*See Class 9 for this trademark.*).
- 2,857,184 (*See Class 35 for this trademark.*).
- 2,857,207 (*See Class 1 for this trademark.*).
- 2,857,208 (*See Class 1 for this trademark.*).
- 2,857,212 (*See Class 9 for this trademark.*).
- 2,857,214 (*See Class 1 for this trademark.*).
- 2,857,217 (*See Class 9 for this trademark.*).
- 2,857,223. **CAM ON PUBMED. THE NATIONAL LIBRARY OF MEDICINE, MULTIPLE CLASS, (INT. CLS. 42 AND 44)**, (U.S. CLS. 100 AND 101). SN 76-353,786. PUB. 4-6-2004. FILED 1-2-2002.
- 2,857,240 (*See Class 36 for this trademark.*).
- 2,857,262 (*See Class 41 for this trademark.*).
- 2,857,264 (*See Class 9 for this trademark.*).
- 2,857,265 (*See Class 9 for this trademark.*).
- 2,857,270 (*See Class 35 for this trademark.*).
- 2,857,275. **MWARE AND DESIGN. IRAD NV**, (U.S. CLS. 100 AND 101). SN 76-410,548. PUB. 4-6-2004. FILED 5-21-2002.
- 2,857,282 (*See Class 7 for this trademark.*).
- 2,857,284 (*See Class 38 for this trademark.*).
- 2,857,290 (*See Class 35 for this trademark.*).
- 2,857,300 (*See Class 9 for this trademark.*).
- 2,857,314. **EVOLVE. ELSEVIER INC.**, (U.S. CLS. 100 AND 101). SN 76-442,918. PUB. 4-6-2004. FILED 8-16-2002.
- 2,857,318 (*See Class 35 for this trademark.*).
- 2,857,323. **MOLDPRO INTERNATIONAL AND DESIGN. MOLDPRO INTERNATIONAL, LLC**, (U.S. CLS. 100 AND 101). SN 76-449,075. PUB. 4-6-2004. FILED 9-9-2002.
- 2,857,338. **LIVE WIRELESS. LANDPORT SYSTEM, INC.**, (U.S. CLS. 100 AND 101). SN 76-458,785. PUB. 4-6-2004. FILED 10-11-2002.
- 2,857,354 (*See Class 9 for this trademark.*).
- 2,857,355 (*See Class 40 for this trademark.*).
- 2,857,356 (*See Class 40 for this trademark.*).
- 2,857,360 (*See Class 10 for this trademark.*).
- 2,857,363 (*See Class 9 for this trademark.*).
- 2,857,367. **STAT. SEED DYNAMICS INCORPORATED**, (U.S. CLS. 100 AND 101). SN 76-466,581. PUB. 4-6-2004. FILED 11-7-2002.
- 2,857,368. **BATCHTRAK. SEED DYNAMICS INCORPORATED**, (U.S. CLS. 100 AND 101). SN 76-466,582. PUB. 4-6-2004. FILED 11-7-2002.
- 2,857,369. **EPA. SEED DYNAMICS INCORPORATED**, (U.S. CLS. 100 AND 101). SN 76-466,583. PUB. 4-6-2004. FILED 11-7-2002.
- 2,857,374 (*See Class 35 for this trademark.*).
- 2,857,382 (*See Class 35 for this trademark.*).
- 2,857,387 (*See Class 40 for this trademark.*).
- 2,857,394. **A DESKTOP ON EVERY WIRELESS DEVICE. VIAIR, INC.**, (U.S. CLS. 100 AND 101). SN 76-475,734. PUB. 4-6-2004. FILED 12-16-2002.
- 2,857,438 (*See Class 11 for this trademark.*).
- 2,857,455. **MYGEMOLOGIST. CANARY INVESTMENTS INC.**, (U.S. CLS. 100 AND 101). SN 76-492,486. PUB. 4-6-2004. FILED 2-26-2003.
- 2,857,466. **CRYPTYC SEARCH. CALLE, H. MARTIN, JR.**, (U.S. CLS. 100 AND 101). SN 76-497,700. PUB. 4-6-2004. FILED 3-17-2003.
- 2,857,467. **SEARCH-FOR-SYMMETRY. CALLE, H. MARTIN, JR.**, (U.S. CLS. 100 AND 101). SN 76-497,701. PUB. 4-6-2004. FILED 3-17-2003.
- 2,857,472. **SKS WESELECT. SIRS PUBLISHING, INC.**, (U.S. CLS. 100 AND 101). SN 76-498,459. PUB. 4-6-2004. FILED 3-19-2003.
- 2,857,498. **EVERYDAYPRINT. EVERYDAYOFFICE, INC.**, (U.S. CLS. 100 AND 101). SN 76-507,989. PUB. 4-6-2004. FILED 4-21-2003.
- 2,857,499. **EVERYDAYOFFICE. EVERYDAYOFFICE, INC.**, (U.S. CLS. 100 AND 101). SN 76-507,991. PUB. 4-6-2004. FILED 4-21-2003.
- 2,857,508 (*See Class 38 for this trademark.*).

CLASS 42—SCIENTIFIC, COMPUTER AND LEGAL SERVICES

- 2,857,120 (*See Class 25 for this trademark.*).
- 2,857,122 (*See Class 10 for this trademark.*).
- 2,857,129 (*See Class 3 for this trademark.*).
- 2,857,142 (*See Class 16 for this trademark.*).
- 2,857,144 (*See Class 16 for this trademark.*).
- 2,857,151 (*See Class 9 for this trademark.*).
- 2,857,153 (*See Class 9 for this trademark.*).
- 2,857,156 (*See Class 35 for this trademark.*).
- 2,857,158 (*See Class 1 for this trademark.*).

2,857,523 (*See Class 35 for this trademark.*)
 2,857,524 (*See Class 35 for this trademark.*)
 2,857,570. **FANLIB**. MY2CENTENCES LLC, (U.S. CLS. 100 AND 101). SN 76-521,061. PUB. 4-6-2004. FILED 6-6-2003.
 2,857,572. **ARE YOUR IMAGES FLUID?**. LIQUIDPIXELS, INCORPORATED, (U.S. CLS. 100 AND 101). SN 76-521,296. PUB. 4-6-2004. FILED 6-6-2003.
 2,857,582. **ISIS PHARMACEUTICALS AND DESIGN**. ISIS PHARMACEUTICALS, INC., (U.S. CLS. 100 AND 101). SN 76-523,064. PUB. 4-6-2004. FILED 6-6-2003.
 2,857,599 (*See Class 9 for this trademark.*)
 2,857,603. **DIVX CERTIFIED**. DIVXNETWORKS, INC., (U.S. CLS. 100 AND 101). SN 76-526,453. PUB. 4-6-2004. FILED 6-20-2003.
 2,857,607. **MOVE SMART HOME INSPECTIONS**. MOVE SMART, INC., (U.S. CLS. 100 AND 101). SN 76-527,494. PUB. 4-6-2004. FILED 7-3-2003.
 2,857,610. **THE FIRST CALL THE ONLY CALL**. MOUNTAIN MARKETING GROUP, LLC, (U.S. CLS. 100 AND 101). SN 76-528,145. PUB. 4-6-2004. FILED 7-7-2003.
 2,857,611. **1-800-2 MOVE IT**. MOUNTAIN MARKETING GROUP, LLC, (U.S. CLS. 100 AND 101). SN 76-528,146. PUB. 4-6-2004. FILED 7-7-2003.
 2,857,620. **PROTECTING YOUR IDEAS**. JAGTIANI, AJAY A., (U.S. CLS. 100 AND 101). SN 76-529,188. PUB. 4-6-2004. FILED 7-14-2003.
 2,857,621. **PROTECTING GREAT IDEAS**. JAGTIANI, AJAY A., (U.S. CLS. 100 AND 101). SN 76-529,189. PUB. 4-6-2004. FILED 7-14-2003.
 2,857,622. **E (STYLIZED)**. ENVIRON ELECTRONIC LABORATORIES, INC., (U.S. CLS. 100 AND 101). SN 76-529,315. PUB. 4-6-2004. FILED 7-14-2003.
 2,857,631 (*See Class 9 for this trademark.*)
 2,857,637. **B & P (STYLIZED)**. BRACEWELL & PATTERSON, L.L.P., (U.S. CLS. 100 AND 101). SN 76-529,741. PUB. 4-6-2004. FILED 7-15-2003.
 2,857,638 (*See Class 41 for this trademark.*)
 2,857,639. **EXYM**. EXYM CORPORATION, (U.S. CLS. 100 AND 101). SN 76-529,822. PUB. 4-6-2004. FILED 7-17-2003.
 2,857,650 (*See Class 37 for this trademark.*)
 2,857,652. **IMPROVING SOCIETY THROUGH INNOVATION**. GRAVIC, INC., (U.S. CLS. 100 AND 101). SN 76-530,613. PUB. 4-6-2004. FILED 7-17-2003.
 2,857,664. **1-800-LEE-FREE**. LEE B. STEINBERG, P.C., (U.S. CLS. 100 AND 101). SN 76-531,226. PUB. 4-6-2004. FILED 7-11-2003.
 2,857,665. **CALL LEE FREE**. LEE B. STEINBERG, P.C., (U.S. CLS. 100 AND 101). SN 76-531,273. PUB. 4-6-2004. FILED 7-11-2003.
 2,857,712. **CONSULIER**. CONSULIER ENGINEERING, INC., (U.S. CLS. 100 AND 101). SN 76-534,075. PUB. 4-6-2004. FILED 7-21-2003.
 2,857,717 (*See Class 9 for this trademark.*)
 2,857,721. **WISDOMATION**. WISDOMATION, INC., (U.S. CLS. 100 AND 101). SN 76-536,153. PUB. 4-6-2004. FILED 7-28-2003.
 2,857,777. **NEXTESTAGE AND DESIGN**. TAK INDUSTRIAL CORPORATION, (U.S. CLS. 100 AND 101). SN 78-075,731. PUB. 4-6-2004. FILED 7-25-2001.
 2,857,780. **DATATRAIL SYSTEMS**. DATATRAIL SYSTEMS INC., (U.S. CLS. 100 AND 101). SN 78-081,420. PUB. 4-6-2004. FILED 8-28-2001.
 2,857,787 (*See Class 9 for this trademark.*)
 2,857,792 (*See Class 9 for this trademark.*)
 2,857,813. **UPLIFT**. BOEHRINGER INGELHEIM INTERNATIONAL GMBH, (U.S. CLS. 100 AND 101). SN 78-167,242. PUB. 4-6-2004. FILED 9-24-2002.
 2,857,818 (*See Class 40 for this trademark.*)
 2,857,840. **PERFORMANCE PLUS**. G & T INDUSTRIES, INC., (U.S. CLS. 100 AND 101). SN 78-188,280. PUB. 4-6-2004. FILED 11-23-2002.
 2,857,842 (*See Class 16 for this trademark.*)
 2,857,843 (*See Class 35 for this trademark.*)
 2,857,844. **INNOZEN (STYLIZED)**. ZENGEN, INC., (U.S. CLS. 100 AND 101). SN 78-188,979. PUB. 4-6-2004. FILED 11-26-2002.
 2,857,853 (*See Class 37 for this trademark.*)
 2,857,855 (*See Class 35 for this trademark.*)

2,857,860 (*See Class 35 for this trademark.*)
 2,857,865 (*See Class 9 for this trademark.*)
 2,857,883 (*See Class 9 for this trademark.*)
 2,857,887. **CITYWIDE**. PASSKEY.COM, INC., (U.S. CLS. 100 AND 101). SN 78-200,359. PUB. 4-6-2004. FILED 1-6-2003.
 2,857,889. **UPLIFT AND DESIGN**. BOEHRINGER INGELHEIM INTERNATIONAL GMBH, (U.S. CLS. 100 AND 101). SN 78-200,686. PUB. 4-6-2004. FILED 1-7-2003.
 2,857,916 (*See Class 9 for this trademark.*)
 2,857,952 (*See Class 7 for this trademark.*)
 2,857,959. **SOUTHERN ESCROW AND TITLE, L.L.C. AND DESIGN**. SOUTHERN ESCROW & TITLE, LLC, (U.S. CLS. 100 AND 101). SN 78-223,988. PUB. 4-6-2004. FILED 3-11-2003.
 2,857,966 (*See Class 37 for this trademark.*)
 2,857,974. **OPENSILLS**. BADGER, BRUCE, (U.S. CLS. 100 AND 101). SN 78-231,590. PUB. 4-6-2004. FILED 3-28-2003.
 2,857,995. **ECLATA**. ECLATA, INC., (U.S. CLS. 100 AND 101). SN 78-245,022. PUB. 4-6-2004. FILED 5-2-2003.
 2,858,000. **RCAT**. MOLECULAR STAGING, INC., (U.S. CLS. 100 AND 101). SN 78-246,597. PUB. 4-6-2004. FILED 5-7-2003.
 2,858,018. **GET**. NETOPSYSTEMS AG, (U.S. CLS. 100 AND 101). SN 78-254,444. PUB. 4-6-2004. FILED 5-27-2003.
 2,858,022. **T.A.G. - WE ARE I.T.**. THE AURI GROUP, LLC, (U.S. CLS. 100 AND 101). SN 78-256,102. PUB. 4-6-2004. FILED 5-30-2003.
 2,858,033 (*See Class 16 for this trademark.*)
 2,858,035. **SCIOMICS AND DESIGN**. SCIOMICS, LLC, (U.S. CLS. 100 AND 101). SN 78-262,587. PUB. 4-6-2004. FILED 6-15-2003.
 2,858,125. **STRATEGYMAP**. STRATEGYMAP.COM, INC., (U.S. CLS. 100 AND 101). SN 78-277,293. PUB. 4-6-2004. FILED 7-22-2003.
 2,858,167 (*See Class 35 for this trademark.*)
 2,858,172. **VIA**. YOUTHFRIENDS, (U.S. CLS. 100 AND 101). SN 78-297,171. PUB. 4-6-2004. FILED 9-8-2003.
 2,858,173. **VIA AND DESIGN**. YOUTHFRIENDS, (U.S. CLS. 100 AND 101). SN 78-297,177. PUB. 4-6-2004. FILED 9-8-2003.

CLASS 43—HOTEL AND RESTAURANT SERVICES

2,857,255 (*See Class 35 for this trademark.*)
 2,857,256 (*See Class 35 for this trademark.*)
 2,857,292 (*See Class 41 for this trademark.*)
 2,857,321. **NERV RESTAURANT & LOUNGE**. DAVIES, KENDALL R., (U.S. CLS. 100 AND 101). SN 76-448,481. PUB. 4-6-2004. FILED 9-11-2002.
 2,857,343 (*See Class 9 for this trademark.*)
 2,857,392. **SIDELINES SPORTS BAR AND DESIGN**. FIESTA PALMS, LLC, (U.S. CLS. 100 AND 101). SN 76-475,483. PUB. 4-6-2004. FILED 12-13-2002.
 2,857,393. **ROLLER LOUNGE AND DESIGN**. FIESTA PALMS, LLC, (U.S. CLS. 100 AND 101). SN 76-475,485. PUB. 4-6-2004. FILED 12-13-2002.
 2,857,427 (*See Class 39 for this trademark.*)
 2,857,440. **JUICE IT UP**. JUICE IT UP FRANCHISE CORP., (U.S. CLS. 100 AND 101). SN 76-486,490. PUB. 4-6-2004. FILED 1-31-2003.
 2,857,441. **JUICE IT UP!**. JUICE IT UP FRANCHISE CORP., (U.S. CLS. 100 AND 101). SN 76-486,525. PUB. 4-6-2004. FILED 1-31-2003.
 2,857,488. **MAXFIELD PET RESORT, INC. TREAT YOUR PET TO THE MAX AND DESIGN**. MAXFIELD PET RESORT, INC., (U.S. CLS. 100 AND 101). SN 76-504,505. PUB. 4-6-2004. FILED 4-7-2003.
 2,857,501. **TBONZ**. M.J. PROPERTIES OF SOUTH CAROLINA, L.L.C., (U.S. CLS. 100 AND 101). SN 76-508,067. PUB. 4-6-2004. FILED 4-21-2003.
 2,857,536. **MISCELLANEOUS DESIGN**. LEGAL SEA FOODS, INC., (U.S. CLS. 100 AND 101). SN 76-514,419. PUB. 4-6-2004. FILED 5-15-2003.
 2,857,640. **EGGMAN'S**. EGGMAN'S RESTAURANT, INC., (U.S. CLS. 100 AND 101). SN 76-529,836. PUB. 4-6-2004. FILED 7-16-2003.
 2,857,659. **OBERWEIS (STYLIZED)**. OBERWEIS DAIRY,

- INC., (U.S. CLS. 100 AND 101). SN 76-531,058. PUB. 4-6-2004. FILED 7-21-2003.
- 2,857,660. **OBERWEIS**. OBERWEIS DAIRY, INC., (U.S. CLS. 100 AND 101). SN 76-531,059. PUB. 4-6-2004. FILED 7-21-2003.
- 2,857,661. **OBERWEIS DAIRY**. OBERWEIS DAIRY, INC., (U.S. CLS. 100 AND 101). SN 76-531,060. PUB. 4-6-2004. FILED 7-21-2003.
- 2,857,669. **SENROR BLUES (STYLIZED)**. WATSON, ALFRED H., (U.S. CLS. 100 AND 101). SN 76-531,393. PUB. 4-6-2004. FILED 7-22-2003.
- 2,857,671. **"THE BEST LITTLE ROADHOUSE IN VIRGINIA." ON THE PLANET AND DESIGN**. TIME FOR GOOD FOOD, INC., (U.S. CLS. 100 AND 101). SN 76-531,568. PUB. 4-6-2004. FILED 7-16-2003.
- 2,857,677 (*See Class 30 for this trademark*).
- 2,857,679. **GRASS**. GRASS LOUNGE, L.L.C., (U.S. CLS. 100 AND 101). SN 76-531,935. PUB. 4-6-2004. FILED 7-24-2003.
- 2,857,715. **GIORGIONE**. SPRING LEOPARD, LLC, (U.S. CLS. 100 AND 101). SN 76-535,049. PUB. 4-6-2004. FILED 7-21-2003.
- 2,857,718. **CRISPERS**. CRISPERS LLC, (U.S. CLS. 100 AND 101). SN 76-535,565. PUB. 4-6-2004. FILED 8-7-2003.
- 2,857,722 (*See Class 16 for this trademark*).
- 2,857,736. **LITTLE JOEY'S**. MMM ENTERPRISES, INC., (U.S. CLS. 100 AND 101). SN 76-539,642. PUB. 4-6-2004. FILED 8-25-2003.
- 2,857,751. **MEADOWGLEN AND DESIGN**. MG IP HOLDINGS, LLC, (U.S. CLS. 100 AND 101). SN 76-543,048. PUB. 4-6-2004. FILED 8-25-2003.
- 2,857,754. **MGM GRAND**. METRO-GOLDWYN-MAYER LION CORP, (U.S. CLS. 100 AND 101). SN 76-543,908. PUB. 4-6-2004. FILED 8-29-2003.
- 2,857,815. **CHICKEN CHEF**. CHICKEN CHEF CANADA LTD., (U.S. CLS. 100 AND 101). SN 78-167,686. PUB. 10-21-2003. FILED 9-25-2002.
- 2,857,856. **AUSSIE BUSH BURGERS**. SENN, J. MICHAEL, (U.S. CLS. 100 AND 101). SN 78-191,852. PUB. 4-6-2004. FILED 12-6-2002.
- 2,857,857 (*See Class 35 for this trademark*).
- 2,857,886. **MERLINS PIZZA AND DESIGN**. MERLINS PIZZA COMPANY, (U.S. CLS. 100 AND 101). SN 78-200,310. PUB. 4-6-2004. FILED 1-6-2003.
- 2,857,891. **EVERYBODY EATS WHEN THEY COME TO OUR HOUSE**. BERTUCCI'S, INC., (U.S. CLS. 100 AND 101). SN 78-201,449. PUB. 4-6-2004. FILED 1-9-2003.
- 2,857,893 (*See Class 41 for this trademark*).
- 2,857,895. **VINNY'S ITALIAN GRILL & PIZZERIA AND DESIGN**. VINNY'S ITALIAN GRILL & PIZZERIA, INC., (U.S. CLS. 100 AND 101). SN 78-202,293. PUB. 4-6-2004. FILED 1-11-2003.
- 2,857,987. **CREPE EXPRESS AND DESIGN**. JOUAULT'S CREPE MACHINE, INC., (U.S. CLS. 100 AND 101). SN 78-243,687. PUB. 4-6-2004. FILED 4-30-2003.
- 2,858,027 (*See Class 41 for this trademark*).
- 2,858,067. **GLOBAL GROUNDS**. ILLINOIS INSTITUTE OF TECHNOLOGY, (U.S. CLS. 100 AND 101). SN 78-270,354. PUB. 4-6-2004. FILED 7-3-2003.
- 2,858,089. **CHAPPS**. CHAPPS HAMBURGERS, INC., (U.S. CLS. 100 AND 101). SN 78-274,137. PUB. 4-6-2004. FILED 7-14-2003.
- 2,858,150 (*See Class 39 for this trademark*).
- PUB. 4-6-2004. FILED 10-21-2002.
- 2,857,345 (*See Class 16 for this trademark*).
- 2,857,348 (*See Class 10 for this trademark*).
- 2,857,374 (*See Class 35 for this trademark*).
- 2,857,380. **HENRY SHAW OZARK CORRIDOR AND DESIGN**. THE HENRY SHAW OZARK CORRIDOR FOUNDATION, (U.S. CLS. 100 AND 101). SN 76-471,150. PUB. 4-6-2004. FILED 11-19-2002.
- 2,857,448 (*See Class 9 for this trademark*).
- 2,857,489. **DOT PALM, INC.**. DOT PALM LANDSCAPING, INC., (U.S. CLS. 100 AND 101). SN 76-504,675. PUB. 4-6-2004. FILED 3-31-2003.
- 2,857,496. **EXPANDING AND ENHANCING SLEEP MEDICINE**. SLEEPTECH, LLC, (U.S. CLS. 100 AND 101). SN 76-507,693. PUB. 4-6-2004. FILED 4-18-2003.
- 2,857,608. **LOCKWORKS**. NEILL CORPORATION, (U.S. CLS. 100 AND 101). SN 76-527,709. PUB. 4-6-2004. FILED 7-3-2003.
- 2,857,612. **DESIGNED AROUND YOU**. OAKWOOD HEALTHCARE, INC., (U.S. CLS. 100 AND 101). SN 76-528,314. PUB. 4-6-2004. FILED 6-30-2003.
- 2,857,626. **LET OUR FAMILY TAKE CARE OF YOURS**. CIMARRON HEALTH PLAN, INC., (U.S. CLS. 100 AND 101). SN 76-529,357. PUB. 4-6-2004. FILED 7-14-2003.
- 2,857,627. **SIEGAL WEIGHT MANAGEMENT AND DESIGN**. U.S. MEDICAL CARE HOLDINGS LLC., (U.S. CLS. 100 AND 101). SN 76-529,372. PUB. 4-6-2004. FILED 7-14-2003.
- 2,857,663. **WE MAKE IT A HOME**. WELTY HOME FOR THE AGED, INC., (U.S. CLS. 100 AND 101). SN 76-531,199. PUB. 4-6-2004. FILED 7-22-2003.
- 2,857,705. **GREATER HAZLETON HEALTH ALLIANCE**. GREATER HAZLETON HEALTH ALLIANCE, (U.S. CLS. 100 AND 101). SN 76-533,323. PUB. 4-6-2004. FILED 7-17-2003.
- 2,857,714. **LEMME KILL YOUR WEEDS**. HERBI-SYSTEMS, INC., (U.S. CLS. 100 AND 101). SN 76-534,798. PUB. 4-6-2004. FILED 7-22-2003.
- 2,857,755. **MGM GRAND**. METRO-GOLDWYN-MAYER LION CORP, (U.S. CLS. 100 AND 101). SN 76-543,909. PUB. 4-6-2004. FILED 8-29-2003.
- 2,857,825. **VETERINARY VISION, INC. ANIMAL EYE SPECIALISTS AND DESIGN**. VETERINARY VISION, INC., (U.S. CLS. 100 AND 101). SN 78-176,779. PUB. 4-6-2004. FILED 10-21-2002.
- 2,857,845 (*See Class 41 for this trademark*).
- 2,857,864. **ROTECH HEALTHCARE INC.**. ROTECH HEALTHCARE INC., (U.S. CLS. 100 AND 101). SN 78-192,508. PUB. 4-6-2004. FILED 12-9-2002.
- 2,857,870. **IB INSTITUTE BEAUTE AND DESIGN**. MARIN-LEVINE, SUZANNE, AND MARC LAUTIN, EVERETT, (U.S. CLS. 100 AND 101). SN 78-195,473. PUB. 4-6-2004. FILED 12-17-2002.
- 2,857,912. **CENTRAL PLAINS LABORATORIES**. LABONE, INC., (U.S. CLS. 100 AND 101). SN 78-204,683. PUB. 4-6-2004. FILED 1-17-2003.
- 2,857,936. **G-SHOT**. MATLOCK, DAVID, L, (U.S. CLS. 100 AND 101). SN 78-215,760. PUB. 4-6-2004. FILED 2-17-2003.
- 2,858,017. **GO TO YOUR HAPPY PLACE**. MARINA DISTRICT DEVELOPMENT COMPANY, LLC, DBA BORGATA HOTEL, CASINO & SPA, (U.S. CLS. 100 AND 101). SN 78-253,865. PUB. 4-6-2004. FILED 5-23-2003.
- 2,858,119. **MISCELLANEOUS DESIGN**. SMILE ACUPUNCTURE CLINIC, INC., (U.S. CLS. 100 AND 101). SN 78-276,961. PUB. 4-6-2004. FILED 7-21-2003.

CLASS 44—MEDICAL, BEAUTY AND AGRICULTURAL SERVICES

- 2,857,223 (*See Class 42 for this trademark*).
- 2,857,240 (*See Class 36 for this trademark*).
- 2,857,255 (*See Class 35 for this trademark*).
- 2,857,256 (*See Class 35 for this trademark*).
- 2,857,261 (*See Class 16 for this trademark*).
- 2,857,276 (*See Class 35 for this trademark*).
- 2,857,277 (*See Class 35 for this trademark*).
- 2,857,292 (*See Class 41 for this trademark*).
- 2,857,344. **TAKE SHAPE FOR LIFE**. JASON PHARMACEUTICALS, INC., (U.S. CLS. 100 AND 101). SN 76-461,058.

CLASS 45—PERSONAL SERVICES

- 2,857,255 (*See Class 35 for this trademark*).
- 2,857,256 (*See Class 35 for this trademark*).
- 2,857,303. **CATHOLICCAFE.COM**. REALCAFES.COM INC., (U.S. CLS. 100 AND 101). SN 76-432,767. PUB. 4-6-2004. FILED 7-22-2002.
- 2,857,533. **IEM**. INNOVATIVE EMERGENCY MANAGEMENT INCORPORATED, (U.S. CLS. 100 AND 101). SN 76-513,762. PUB. 4-6-2004. FILED 5-12-2003.
- 2,857,558. **OUR LADY OF THE ROSES AND DESIGN**. OUR LADY OF THE ROSES, CORP., (U.S. CLS. 100 AND 101).

SN 76-518,328. PUB. 4-6-2004. FILED 6-2-2003.
2,857,559. **OUR LADY OF THE ROSES**. OUR LADY OF THE ROSES, CORP., (U.S. CLS. 100 AND 101). SN 76-518,329. PUB. 4-6-2004. FILED 6-2-2003.
2,857,568. **MINGLING MOMS**. MINGLING MOMS, LLC, (U.S. CLS. 100 AND 101). SN 76-520,460. PUB. 4-6-2004. FILED 5-27-2003.
2,857,569 (*See Class 16 for this trademark*).
2,857,584. **CHRISTMAS ANGEL**. THE SALVATION ARMY, (U.S. CLS. 100 AND 101). SN 76-523,169. PUB. 4-6-2004. FILED 6-16-2003.
2,857,666. **DR. LINDA**. LOVE DOCTOR ENTERPRISES LLC, (U.S. CLS. 100 AND 101). SN 76-531,326. PUB. 4-6-2004. FILED 7-11-2003.
2,857,692. **DAWN**. INDIANA BEHAVIORAL HEALTH CHOICES, INC., (U.S. CLS. 100 AND 101). SN 76-532,414. PUB. 4-6-2004. FILED 7-25-2003.
2,857,727. **HEART & SOUL**. MIDPOINTS MULTIMEDIA GROUP, INC., (U.S. CLS. 100 AND 101). SN 76-538,295. PUB. 4-6-2004. FILED 8-19-2003.
2,857,796 (*See Class 37 for this trademark*).
2,857,838. **THE PRINCESS PROJECT AND DESIGN**. THE PRINCESS PROJECT, (U.S. CLS. 100 AND 101). SN 78-187,576. PUB. 4-6-2004. FILED 11-21-2002.
2,857,880 (*See Class 35 for this trademark*).
2,858,001. **HEARTFELT MEMORIALS**. SOUTHLAND NATIONAL INSURANCE CORPORATION, (U.S. CLS. 100 AND 101). SN 78-246,613. PUB. 4-6-2004. FILED 5-7-2003.
2,858,027 (*See Class 41 for this trademark*).

* * * * *

SECTION 2.—PRIOR UNITED STATES CLASSIFICATION

COLLECTIVE MEMBERSHIP MARKS

CONTRACT TEXTILES, INC., SN 78-281,575. PUB. 4-6-2004. FILED 7-31-2003.

CLASS 200—COLLECTIVE MEMBERSHIP

2,857,483. **SONS OF ITALY.** ORDER SONS OF ITALY IN AMERICA, SN 76-502,859. PUB. 4-6-2004. FILED 3-31-2003.

CLASS B—SERVICES
2,857,304. **CERTIFIED COMMERCIAL COLLECTION AGENCY ASSOCIATION AND DESIGN.** COMMERCIAL LAW LEAGUE OF AMERICA, SN 76-433,322. PUB. 4-6-2004. FILED 7-22-2002.

CERTIFICATION MARKS

CLASS A—GOODS

2,858,141. **MISCELLANEOUS DESIGN.** ASSOCIATION OF

2,857,453. **CF CERTIFIED FORESTER AND DESIGN.** SOCIETY OF AMERICAN FORESTERS, SN 76-491,782. PUB. 4-6-2004. FILED 2-13-2003.

* * * * *

TRADEMARK REGISTRATIONS ISSUED UNDER SECTION 1(d)

The following marks have registered on the Principal Register pursuant to the intent-to-use provisions of Section 1(d) of the Trademark Act of 1946, as amended.

SECTION 1.— INTERNATIONAL CLASSIFICATION

The short titles associated below with the international class numbers are terms designed merely for quick identification and are not an official part of the international classification. The full names of international classes are given in section 6.1 of the trademark rules of practice.

The designation "U.S. Cl." appearing in this section refers to the U.S. class in effect prior to Sep. 1, 1973 rather than the international class which applies to applications filed on or after that date. For adoption of international classification see notice in the OFFICIAL GAZETTE of Jun. 26, 1973 (911 O.G. TM 210).

Application in more than one class

2,858,177. LINTEC KABUSHIKI KAISHA, TOKYO, JAPAN.
SN 74-058,155. PUB. 8-20-1996, FILED 5-11-1990.

2,858,182. ANDRITZ AG, A-8045 GRAZ, AUSTRIA. SN 75-
356,308. PUB. 5-22-2001, FILED 9-10-1997.



CLASS 6—METAL GOODS

FOR METALLIC FOIL SOLD IN SHEET FORM FOR INDUSTRIAL PRODUCT MANUFACTURE, NAMELY, PRESSURE SENSITIVE ADHESIVE SHEETS (U.S. CLS. 2, 12, 13, 14, 23, 25 AND 50).

FIRST USE 4-0-1990; IN COMMERCE 8-21-2003.

CLASS 9—ELECTRICAL AND SCIENTIFIC APPARATUS

FOR THERMAL PRINTERS FOR PRINTING LABELS AND PACKAGES (U.S. CLS. 21, 23, 26, 36 AND 38).

FIRST USE 0-0-1997; IN COMMERCE 3-14-2003.

CLASS 16—PAPER GOODS AND PRINTED MATTER

FOR PAPERS FOR INDUSTRIAL PURPOSES, NAMELY, RELEASE PAPERS WHICH ARE USED IN THE CASTING PROCESS OF ARTIFICIAL LEATHER AND OTHER MANUFACTURING PROCESSES; PLASTIC SHEETS AND LABELS FOR WRITING, PRINTING AND MARKING; PAPER SOLD IN SHEET FORM FOR INDUSTRIAL PRODUCT MANUFACTURE, NAMELY, SHEETS FOR MANUFACTURING SEMI-CONDUCTORS AND PRESSURE SENSITIVE ADHESIVE SHEETS; METALLIC FOIL SHEETS AND LABELS FOR WRITING, PRINTING AND MARKING (U.S. CLS. 2, 5, 22, 23, 29, 37, 38 AND 50).

FIRST USE 4-0-1990; IN COMMERCE 5-1-2003.



CLASS 6—METAL GOODS

FOR METAL SILOS AND PICKLING LINES, NAMELY, A SERIES OF METAL TANKS CONTAINING PICKLING ACID FOR PICKLING STRIPS OF METAL (U.S. CLS. 2, 12, 13, 14, 23, 25 AND 50).

FIRST USE 10-0-1997; IN COMMERCE 10-0-1997.

CLASS 7—MACHINERY

FOR WOODYARD EQUIPMENT, NAMELY, CRANES, DEBARKING DRUMS AND CHIPPERS; AUTOMATIC LOG SORTERS; MECHANICAL PULPING EQUIPMENT, NAMELY, REFINERS; REFINER PLATES; PULP BLEACHING MACHINES, MIXERS, BLEACH TOWER DISCHARGE SYSTEMS CONSISTING PRIMARILY OF BLEACH TOWERS, SCRAPER ARMS, DISCHARGE PIPES, DILUTION SCREWS, AND DRIVE MOTORS; MACHINES FOR WASHING PULP AND FIBER; DEWATERING EQUIPMENT FOR PULP, FIBROUS MATERIAL AND SLUDGE, NAMELY, DOUBLE WIRE PRESSES, HEAVY-DUTY PRESSES, SCREW PRESSES, DEWATERING MACHINES, AND DISC FILTERS; STOCK PREPARATION MACHINES FOR PAPER AND PAPERBOARD; MACHINES FOR THE MANUFACTURE OF PAPER TISSUE; HIGH EFFICIENCY HOODS FOR PAPER MACHINES; MACHINE VENTILATION EQUIPMENT, NAMELY, VENTILATING HOODS, WEB STABILIZERS AND BLOW BOXES INSTALLED IN MULTICYLINDER PAPER MACHINES; METAL ROLLING MILLS; MULTIPLE ROLL SETS, NAMELY, A PAIR OF ROLLS FORMING A NIP THROUGH WHICH METAL STRIPS PASS; HOT-ROLLING AND COLD-ROLLING MILLS OF METAL; MACHINES FOR SURFACE TREATMENT AND FINISHING OF STEEL STRIP; CENTRIFUGAL PUMPS; ROTARY PUMPS, NAMELY, STOCK PUMPS, MEDIUM-CONSISTENCY PUMPS, REACTOR PUMPS, AND MAIN COOLANT PUMPS; MECHANICAL SCREENS; THICKENING MACHINES FOR DEWATERING SLUDGE; BELT PRESSES; HIGH INTENSITY PRESSES; DISC FILTER, DRUM FILTER, AND PRESSURE FILTER MACHINES FOR DEWATERING SLUDGE AND PULP; POWER-OPERATED GRAIN PROCESSING EQUIPMENT; FEED MILLS; PELLETIZING MACHINES; MACHINES FOR EXTRUDING PELLETS FOR ANIMAL FEED AND DEBARKING PROCESS OPTIMIZATION SYSTEMS CONSISTING PRIMARILY OF DEBARKING DRUMS, SENSOR UNITS, MACHINES FOR SPLITTING THE FLOW OF TREES OR LOGS INTO STREAMS TO BE FURTHER PROCESSED OR FURTHER DEBARKED, AND MACHINES FOR DETERMINING THE AMOUNT OF BARK AND CONTROL THE TREES OR LOGS TO BE RECYCLED FOR FURTHER DEBARKING (U.S. CLS. 13, 19, 21, 23, 31, 34 AND 35).

FIRST USE 0-0-1997; IN COMMERCE 0-0-1997.

CLASS 9—ELECTRICAL AND SCIENTIFIC APPARATUS

FOR OPTIMIZING EQUIPMENT FOR FLOCCULENT ADDITION TO DEWATERING PLANTS CONSISTING OF ELECTRONIC SENSORS, CONTROLS TO CALCULATE RESIDUAL MOISTURE IN THE SLUDGE TO BE DEWATERED, AND UNITS FOR MIXING IN THE NECESSARY AMOUNT OF FLOCCULENT TO OBTAIN THE OPTIMUM VALUE OF RESIDUAL MOISTURE; AND ELECTROLYTIC COATING MACHINES (U.S. CLS. 21, 23, 26, 36 AND 38).

FIRST USE 0-0-1997; IN COMMERCE 0-0-1997.

CLASS 11—ENVIRONMENTAL CONTROL APPARATUS

FOR WASTE WATER TREATMENT SYSTEMS CONSISTING PRIMARILY OF MECHANICAL SCREENS, RAKES, PRESSES FOR SCREENINGS AND SAND FILTERING UNITS FOR THE TREATMENT OF EFFLUENTS; DRYING SYSTEMS FOR WASTE WATER SLUDGE CONSISTING PRIMARILY OF DRUMS, FLUIDIZED BED DRIERS, CYCLONES, CRUSHERS, STORAGE SILOS, TRANSPORTATION AND MIXING SCREWS, BURNERS, PIPES, AIR BLOWERS AND COOLERS; INCINERATORS FOR SEWAGE SLUDGE; AND SAND FILTERING UNITS FOR THE TREATMENT OF EFFLUENTS (U.S. CLS. 13, 21, 23, 31 AND 34).

FIRST USE 0-0-1997; IN COMMERCE 0-0-1997.

CLASS 20—FURNITURE AND ARTICLES NOT OTHERWISE CLASSIFIED

FOR PICKLING LINES, NAMELY, A SERIES OF NON-METAL TANKS CONTAINING PICKLING ACID FOR PICKLING STRIPS OF METAL (U.S. CLS. 2, 13, 22, 25, 32 AND 50).

FIRST USE 0-0-1997; IN COMMERCE 0-0-1997.

2,858,186. LUDWIG DEMMELER GMBH & CO., D-87751 HEIMERTINGEN, FED REP GERMANY. SN 75-497,540. PUB. 5-22-2001, FILED 6-4-1998.

DEMMELER

OWNER OF FED REP GERMANY REG. NO. 39740809, DATED 11-27-1997, EXPIRES 8-31-2007.

CLASS 6—METAL GOODS

FOR METAL CLAMPS; METAL CLAMPING AND FASTENING DEVICES FOR THE FIXTURE OF WORKPIECES ON WORKBENCHES AND PARTS THEREFOR, NAMELY GROUND CONNECTORS, CLAMPING AND ADAPTOR PLATES, LOCATING BUSHINGS, SPACER FRAMES, BASE RAILS, CLAMPING AND LOCATING ANGLES, SUPPORT AND FIXTURING FRAMES, CORNER MODULES, CONNECTING ANGLES, CONNECTING SYSTEM COMPONENTS, NAMELY UNIVERSAL STOPS, STOP BARS, FLAT ANGLES, V-BLOCKS FOR THE FASTENING OF TUBES, POSITIONING AND CLAMPING BOLTS, CONNECTION BOLTS, AND CLAMPING PADS (U.S. CLS. 2, 12, 13, 14, 23, 25 AND 50).

FIRST USE 3-0-1992; IN COMMERCE 8-0-1994.

CLASS 7—MACHINERY

FOR (BASED ON 44(E)) MACHINE TOOLS, NAMELY MULTIAXIAL MILLING AND DRILLING MACHINES, STRUCTURAL PARTS THEREFOR; AUTOMATIC TOOL CHANGING EQUIPMENT FOR MULTIAXIAL MILLING AND DRILLING MACHINES, NAMELY TURRET HEADS; AUTOMATIC WORKPIECE CHANGING EQUIPMENT FOR MULTIAXIAL MILLING AND DRILLING MACHINES, NAMELY GRIPPING DEVICES, HOLDING DEVICES, TURNING ARRANGEMENTS, CONVEYORS AND STRUCTURAL PARTS THEREFOR; POWER-OPERATED WELDING BENCHES AND STRUCTURAL PARTS THEREFOR (U.S. CLS. 13, 19, 21, 23, 31, 34 AND 35).

CLASS 9—ELECTRICAL AND SCIENTIFIC APPARATUS

FOR (BASED ON 44(E)) DATA PROCESSORS; COMPUTERS; COMPUTER SCANNERS; COMPUTER PRINTERS; COMPUTER MONITORS; AND COMPUTER PROGRAMS FOR CONTROLLING MACHINE TOOLS AND DATABASE MANAGEMENT (U.S. CLS. 21, 23, 26, 36 AND 38).

CLASS 20—FURNITURE AND ARTICLES NOT OTHERWISE CLASSIFIED

FOR WELDING SETS COMPRISING WELDING BENCHES, WELDING TABLES, AND FASTENING DEVICES FOR THE FIXTURE OF WORKPIECES ON WORKBENCHES, ALL SOLD AS A UNIT; WORKBENCHES; WORK TABLES; NON-METALLIC CLAMPS AND PARTS THEREFOR (U.S. CLS. 2, 13, 22, 25, 32 AND 50).

FIRST USE 3-0-1992; IN COMMERCE 8-0-1994.

CLASS 40—MATERIAL TREATMENT

FOR (BASED ON 44(E)) METAL WORKING, NAMELY, DRILLING, MILLING, SAWING, CASTING, POLISHING, GRINDING, TEMPERING, PLATING, SHAPING AND BANDING OF METAL; WELDING; MANUFACTURE OF WELDING MACHINES TO THE ORDER AND/OR SPECIFICATIONS OF OTHERS (U.S. CLS. 100, 103 AND 106).

CLASS 42—SCIENTIFIC, COMPUTER AND LEGAL SERVICES

FOR (BASED ON 44(E)) MECHANICAL ENGINEERING; LOCKSMITHING; TECHNOLOGICAL ENGINEERING; DESIGN OF AUTOMATION SYSTEMS TECHNOLOGY FOR OTHERS; ELECTRICAL ENGINEERING; AND DESIGN OF DATA PROCESSING SOFTWARE FOR OTHERS (U.S. CLS. 100 AND 101).

2,858,187. POSADAS DE MEXICO, S.A. DE C.V., C.P. 11000, MEXICO, MEXICO. SN 75-546,762. PUB. 9-17-2002, FILED 9-2-1998.

FIESTA KIDS

NO CLAIM IS MADE TO THE EXCLUSIVE RIGHT TO USE "KIDS", APART FROM THE MARK AS SHOWN.

CLASS 41—EDUCATION AND ENTERTAINMENT

FOR PROVIDING GOLF CLUB SERVICES, TENNIS COURT FACILITIES AND HEALTH CLUB SERVICES (U.S. CLS. 100, 101 AND 107).
FIRST USE 8-11-1997; IN COMMERCE 10-18-2001.

CLASS 42—SCIENTIFIC, COMPUTER AND LEGAL SERVICES

FOR HOTEL AND RESORT HOTEL SERVICES, NOT INCLUDING CASINO SERVICES (U.S. CLS. 100 AND 101).
FIRST USE 8-11-1997; IN COMMERCE 10-18-2001.

2,858,189. HONDA GIKEN KOGYO KABUSHIKI KAISHA (HONDA MOTOR CO., LTD.), MINATO-KU, TOKYO 107, JAPAN. SN 75-591,667. PUB. 12-14-1999, FILED 11-19-1998.

**CLASS 25—CLOTHING**

FOR SHIRTS AND HATS (U.S. CLS. 22 AND 39).
FIRST USE 3-22-1999; IN COMMERCE 3-22-1999.

CLASS 28—TOYS AND SPORTING GOODS

FOR TOYS, NAMELY MINIATURE TOY REPLICAS OF MOTORCYCLES (U.S. CLS. 22, 23, 38 AND 50).
FIRST USE 12-0-2002; IN COMMERCE 12-0-2002.

2,858,192. JATCO KABUSHIKI KAISHA, TA JATCO LTD, SHIZUOKA-KEN, JAPAN. SN 75-637,601. PUB. 4-16-2002, FILED 2-8-1999.

JATCO

OWNER OF JAPAN REG. NO. 3173662, DATED 7-31-1996, EXPIRES 7-31-2006.

OWNER OF JAPAN REG. NO. 3106762, DATED 12-26-1995, EXPIRES 12-26-2005.

CLASS 7—MACHINERY

FOR (BASED ON USE IN COMMERCE) MACHINE PARTS, NAMELY BELTS, CLUTCHES, UNIVERSAL JOINTS, POWER TRANSMISSION CHAINS, TRANSMISSION SHAFTS, TRANSMISSIONS AND TORQUE CONVERTERS; AND ENGINES AND MOTORS FOR MACHINES (U.S. CLS. 13, 19, 21, 23, 31, 34 AND 35).
FIRST USE 1-0-1971; IN COMMERCE 1-0-1977.

CLASS 9—ELECTRICAL AND SCIENTIFIC APPARATUS

FOR (BASED ON USE IN COMMERCE) ELECTRICAL CONTROLLERS FOR METAL WORKING MACHINES, CARGO HANDLING MACHINES, TURBINES, SHAFTS, SPINDLES, AXLES, BEARINGS AND SHAFT COUPLINGS; ELECTRICAL CONTROLLERS FOR ENGINES AND MOTORS; AND ELECTRICAL CONTROLLERS FOR TRANSMISSIONS (U.S. CLS. 21, 23, 26, 36 AND 38).
FIRST USE 1-0-1971; IN COMMERCE 1-0-1977.

CLASS 37—CONSTRUCTION AND REPAIR

FOR (BASED ON USE IN COMMERCE) INSTALLATION, MAINTENANCE AND REPAIR OF COMPUTER HARDWARE, AUTOMATIC ASSEMBLY MACHINES AND MACHINE TOOLS; VEHICLE MAINTENANCE AND REPAIR; (BASED ON 44(E) AND BASED ON USE IN COMMERCE) TRANSMISSION MAINTENANCE AND REPAIR; REBUILDING ENGINES THAT HAVE BEEN WORN OR PARTIALLY DESTROYED; REBUILDING MACHINES THAT HAVE BEEN WORN OR PARTIALLY DESTROYED; AND PROVIDING VEHICLE AND VEHICLE TRANSMISSION REPAIR INFORMATION (U.S. CLS. 100, 103 AND 106).
FIRST USE 1-0-1971; IN COMMERCE 1-0-1977.

CLASS 42—SCIENTIFIC, COMPUTER AND LEGAL SERVICES

FOR (BASED ON 44(E) AND BASED ON USE IN COMMERCE) DESIGN FOR OTHERS IN THE FIELD OF TRANSMISSIONS AND PARTS THEREOF; INDUSTRIAL DESIGN CONSULTATION; TRANSMISSION CONSULTATION; (BASED ON USE IN COMMERCE) DESIGN OF AUTOMATIC ASSEMBLY MACHINES AND MACHINE TOOLS, AND PARTS THEREOF FOR OTHERS; COMPUTER SOFTWARE DESIGN AND MAINTENANCE FOR OTHERS; MECHANICAL TESTING; CONSULTATION IN THE FIELD OF ELECTRICAL COMMUNICATIONS; DESIGN OF ELECTRICAL COMMUNICATIONS MACHINES AND PARTS THEREOF FOR OTHERS; PROVIDING AUTOMOBILE INFORMATION; AND PROVIDING AUTOMATIC ASSEMBLY MACHINE AND MACHINE TOOL INFORMATION (U.S. CLS. 100 AND 101).

FIRST USE 1-0-1971; IN COMMERCE 1-0-1977.

2,858,197. ROBERTSON, STEVEN C., KENT, WA. SN 75-695,506. PUB. 6-26-2001, FILED 5-26-1999.

GIVE THEIR WISH AS A GIFT**CLASS 35—ADVERTISING AND BUSINESS**

FOR ONLINE GIFT REGISTRY SERVICES, NAMELY, PROVIDING FOR ON-LINE GIFT REGISTRATION RELATING TO A SPECIFIC EVENT SUCH AS A WEDDING EVENT OR BABY SHOWER BUT ALSO ALLOWING FOR THE OPEN-ENDED REGISTRATION OF GIFT DESIRES; PROVIDING ON-LINE SHOPPING SERVICES OF PARTICIPATING MERCHANTS IN THE FIELD OF GENERAL MERCHANDISE FOR GIFT GIVERS (U.S. CLS. 100, 101 AND 102).

FIRST USE 6-1-2001; IN COMMERCE 6-1-2001.

CLASS 41—EDUCATION AND ENTERTAINMENT

FOR ONLINE EVENT PLANNING SERVICES FOR OTHERS (U.S. CLS. 100, 101 AND 107).

FIRST USE 6-1-2001; IN COMMERCE 6-1-2001.

CLASS 42—SCIENTIFIC, COMPUTER AND LEGAL SERVICES

FOR PROVIDING AN ON-LINE REMINDER SERVICES THAT REMINDS USERS ABOUT TIME-SPECIFIC EVENT OR DATE INFORMATION (U.S. CLS. 100 AND 101).

FIRST USE 6-1-2001; IN COMMERCE 6-1-2001.

2,858,195. MOTIENT CORPORATION, RESTON, VA. SN 75-688,691. PUB. 7-29-2003, FILED 4-22-1999.



NO CLAIM IS MADE TO THE EXCLUSIVE RIGHT TO USE "ELINK", AND "WIRELESS E-MAIL SERVICE", APART FROM THE MARK AS SHOWN.

CLASS 9—ELECTRICAL AND SCIENTIFIC APPARATUS

FOR TELECOMMUNICATIONS EQUIPMENT, NAMELY, A COMBINATION PAGE AND EMAIL DEVICE (U.S. CLS. 21, 23, 26, 36 AND 38).

FIRST USE 5-4-1999; IN COMMERCE 5-4-1999.

CLASS 16—PAPER GOODS AND PRINTED MATTER

FOR PUBLICATIONS, NAMELY PAMPHLETS, BOOKLETS, PRINTED INSTRUCTIONAL MATERIALS, PRINTED INSTRUCTION SHEETS, BROCHURES, MANUALS, LEAFLETS, FLYERS, BOOKS AND NEWSLETTERS REGARDING TELECOMMUNICATIONS AND RELATED SUBJECTS (U.S. CLS. 2, 5, 22, 23, 29, 37, 38 AND 50).

FIRST USE 5-4-1999; IN COMMERCE 5-4-1999.

CLASS 38—COMMUNICATION

FOR TELECOMMUNICATIONS SERVICES, NAMELY, EMAIL AND PAGING SERVICES (U.S. CLS. 100, 101 AND 104).

FIRST USE 5-4-1999; IN COMMERCE 5-4-1999.

2,858,198. LF, LLC, WILMINGTON, DE. SN 75-707,637. PUB. 11-7-2000, FILED 5-14-1999.

DESIGNABLES**CLASS 19—NON-METALLIC BUILDING MATERIALS**

FOR NON-METAL WINDOW CORNICES, NON-METAL WINDOW SHUTTERS, NON-METAL WINDOW VALANCES, NON-METAL VERTICAL BLIND VALANCES (U.S. CLS. 1, 12, 33 AND 50).

FIRST USE 6-1-1998; IN COMMERCE 6-1-1998.

CLASS 21—HOUSEWARES AND GLASS

FOR BATHROOM ACCESSORIES, NAMELY, WASTE-PAPER BASKETS, TOOTHBRUSH HOLDERS, TOOTH-PASTE DISPENSERS, SOAP DISPENSERS, AND SOAP DISHES, BOTTLES AND JARS SOLD EMPTY, TUMBLERS, BOUTIQUE TISSUE HOLDERS (U.S. CLS. 2, 13, 23, 29, 30, 33, 40 AND 50).

FIRST USE 6-1-1998; IN COMMERCE 6-1-1998.

CLASS 24—FABRICS

FOR DRAPERIES AND CURTAINS FOR WINDOWS AND DOORS, NAMELY, PANELS, SWAGS, TIEBACKS, PRISCILLAS, TOPPERS, VALANCES, AND TAB TOPS, TABLECLOTHS, SHOWER CURTAINS, SHOWER CURTAIN LINERS, BATH MATS, BATH RUGS (U.S. CLS. 42 AND 50).

FIRST USE 6-1-1998; IN COMMERCE 6-1-1998.

2,858,204. JOHN HILL GROUP B.V., DBA DOOR INTERNATIONAL B.V., ZEIST, NETHERLANDS. SN 75-758,877. PUB. 10-30-2001, FILED 7-23-1999.

2,858,206. HANWOOD INTERNATIONAL LTD., HONG KONG, HONG KONG. SN 75-775,048. PUB. 5-27-2003, FILED 9-3-1999.

DOOR
TRAINING

NO CLAIM IS MADE TO THE EXCLUSIVE RIGHT TO USE "TRAINING", APART FROM THE MARK AS SHOWN.

CLASS 16—PAPER GOODS AND PRINTED MATTER

FOR PRINTED INSTRUCTIONAL MANUALS, TRAINING MATERIALS AND DOCUMENTS FOR USE IN CONJUNCTION WITH THE PREPARATION AND DISSEMINATION OF ADVERTISING AND MARKETING MATTER AND MATERIALS FOR OTHERS, PROVIDING STATISTICAL INFORMATION, CONDUCTING BUSINESS AND MARKET RESEARCH AND SURVEYS, AND CONSULTATION IN THE FIELDS OF EMPLOYMENT, STAFF MANAGEMENT AND INDUSTRIAL ORGANIZATION AND MANAGEMENT; AND PRINTED INSTRUCTIONAL MANUALS, TRAINING MATERIALS AND DOCUMENTS FOR USE IN CONJUNCTION WITH EDUCATIONAL SERVICES, NAMELY, PROVIDING BUSINESS TRAINING, SEMINARS AND CONFERENCES IN A WIDE RANGE OF TOPICS RELATING TO TEAM BUILDING, BUSINESS PROCESSES AND KNOWLEDGE MANAGEMENT, AND CONSULTATION SERVICES, NAMELY, ADVICE IN CONNECTION WITH EMPLOYMENT, STAFF MANAGEMENT, AND INDUSTRIAL ORGANIZATION AND MANAGEMENT (U.S. CLS. 2, 5, 22, 23, 29, 37, 38 AND 50).

FIRST USE 1-5-2001; IN COMMERCE 1-5-2001.

CLASS 35—ADVERTISING AND BUSINESS

FOR PREPARATION AND DISSEMINATION OF ADVERTISING AND MARKETING MATTER AND MATERIALS FOR OTHERS; PROVIDING STATISTICAL INFORMATION; CONDUCTING BUSINESS AND MARKET RESEARCH AND SURVEYS; CONSULTATION IN THE FIELDS OF EMPLOYMENT, STAFF MANAGEMENT AND INDUSTRIAL ORGANIZATION AND MANAGEMENT (U.S. CLS. 100, 101 AND 102).

FIRST USE 1-5-2001; IN COMMERCE 1-5-2001.

CLASS 41—EDUCATION AND ENTERTAINMENT

FOR EDUCATIONAL SERVICES, NAMELY, PROVIDING BUSINESS TRAINING, SEMINARS AND CONFERENCES IN A WIDE RANGE OF TOPICS RELATING TO TEAM BUILDING, BUSINESS PROCESSES AND KNOWLEDGE MANAGEMENT, AND DISTRIBUTING PRINTED MATTER AND TRAINING MATERIALS IN CONNECTION THEREWITH (U.S. CLS. 100, 101 AND 107).

FIRST USE 1-5-2001; IN COMMERCE 1-5-2001.

iBooms

CLASS 9—ELECTRICAL AND SCIENTIFIC APPARATUS

FOR RADIO; RADIO CASSETTE RECORDER; RADIO CASSETTE PLAYER; HI FIDELITY COMPACT DISC PLAYER; HI FIDELITY COMPACT DISC RECORDER; TELEVISIONS; VIDEO GAME MACHINES FOR USE WITH TELEVISIONS; DIGITAL CAMERA; MP3 PLAYER; COMPUTER PARTS AND ACCESSORIES, NAMELY COMPUTER MOUSE; AUDIO SPEAKERS; MULTI DISC PLAYER FOR COMPACT DISCS AND DIGITAL VIDEO DISCS; SURVEYING, ELECTRIC, PHOTOGRAPHIC, SCIENTIFIC, NAUTICAL, LIFESAVING AND TEACHING APPARATUS AND INSTRUMENTS, NAMELY, PHOTOGRAPHIC CAMERAS, SCALES, OPTICAL SCANNER; APPARATUS FOR RECORDING, TRANSMISSION OR REPRODUCTION OF SOUND OR IMAGES, NAMELY, VIDEO CASSETTE PLAYER, DIGITAL VIDEO DISC PLAYER, VIDEO CAMERA; BLANK MAGNETIC DATA CARRIERS; RECORDING DISCS, NAMELY, AUDIO-TAPE CASSETTES FEATURING MUSIC; AUTOMATIC VENDING MACHINES; CALCULATORS; DATA PROCESSORS AND COMPUTERS; CABLE AND WIRELESS TELEPHONE SETS COMPRISING TELEPHONE AND HANDS FREE HEADSET; ACCESSORIES FOR CABLE AND WIRELESS TELEPHONE SETS, NAMELY, BATTERY CHARGER AND BATTERIES (U.S. CLS. 21, 23, 26, 36 AND 38).

FIRST USE 12-15-2002; IN COMMERCE 12-15-2002.

CLASS 28—TOYS AND SPORTING GOODS

FOR GAMES AND PLAYTHINGS, NAMELY, BOARD GAMES, CARD GAMES, DOLLS; GYMNAS TIC AND SPORTING ARTICLES, NAMELY BASEBALL BATS, BOWLING BALLS, EXERCISE TRAMPOLINES; CHRISTMAS TREE DECORATIONS, INFLATABLE TOYS; INFLATABLE TOY RADIO (U.S. CLS. 22, 23, 38 AND 50).

FIRST USE 11-18-2002; IN COMMERCE 11-18-2002.

2,858,212. BODYLOGIX.COM HOLDINGS, LLC, COSTA MESA, CA. SN 75-786,677. PUB. 6-17-2003, FILED 8-27-1999.

BODYLOGIX.COM

CLASS 5—PHARMACEUTICALS

FOR FITNESS PRODUCTS, NAMELY HEALTH AND NUTRITIONAL SUPPLEMENTS, VITAMINS, PROTEIN POWDERS (U.S. CLS. 6, 18, 44, 46, 51 AND 52).

FIRST USE 1-1-2000; IN COMMERCE 1-1-2000.

CLASS 25—CLOTHING

FOR CLOTHING, NAMELY T-SHIRTS, SHORTS, AND HATS (U.S. CLS. 22 AND 39).

FIRST USE 1-1-2000; IN COMMERCE 1-1-2000.

2,858,217. DIGIDEAL CORPORATION, SPOKANE, WA. SN 75-822,829. PUB. 2-20-2001, FILED 10-14-1999.

2,858,226. PERRY, NICK, NEW YORK, NY. SN 75-890,079. PUB. 8-20-2002, FILED 1-8-2000.

BACCARITO



CLASS 9—ELECTRICAL AND SCIENTIFIC APPARATUS

THE MARK CONSISTS, IN PART, OF A SPEAKER EMITTING SOUND WAVES.

FOR GAMING EQUIPMENT NAMELY, ELECTRONIC GAMING APPARATUS WITH CHANGEABLE ELECTRONICALLY CONTROLLED VISUAL DISPLAYS FOR PLAYING A CASINO CARD GAME (U.S. CLS. 21, 23, 26, 36 AND 38).
FIRST USE 9-12-2003; IN COMMERCE 9-12-2003.

CLASS 38—COMMUNICATION

FOR BROADCASTING PROGRAMS VIA A GLOBAL COMPUTER NETWORK; AUDIO BROADCASTING; CABLE RADIO BROADCASTING; CABLE TELEVISION BROADCASTING; RADIO BROADCASTING; SUBSCRIPTION TELEVISION BROADCASTING; TELEVISION BROADCASTING; VIDEO BROADCASTING; CABLE CASTING SERVICES; CABLE RADIO TRANSMISSION; CABLE TELEVISION TRANSMISSION (U.S. CLS. 100, 101 AND 104).
FIRST USE 1-8-2000; IN COMMERCE 1-1-2001.

CLASS 41—EDUCATION AND ENTERTAINMENT

FOR LEASING OF GAMING EQUIPMENT (U.S. CLS. 100, 101 AND 107).
FIRST USE 9-12-2003; IN COMMERCE 9-12-2003.

CLASS 41—EDUCATION AND ENTERTAINMENT

FOR AUDIO RECORDING AND REPRODUCTION; MUSIC COMPOSITION FOR OTHERS; MUSIC PUBLISHING SERVICES; RECORD MASTER PRODUCTION; AUDIO RECORDING AND PRODUCTION; SOUND RECORDINGS STUDIOS; DUPLICATION OF TAPE RECORDINGS; CINEMA STUDIOS; DANCE STUDIOS; RECORDING STUDIOS; SOUND RECORDING STUDIOS; ENTERTAINMENT IN THE NATURE OF A LIVE MUSICAL BAND; ENTERTAINMENT IN THE NATURE OF SYMPHONY ORCHESTRA PERFORMANCES; PRODUCTION AND DISTRIBUTION OF MOTION PICTURES; DISTRIBUTION OF RADIO PROGRAMS FOR OTHERS; DISTRIBUTION OF TELEVISION PROGRAMMING TO CABLE TELEVISION SYSTEMS; DISTRIBUTION OF TELEVISION PROGRAMS FOR OTHERS; ENTERTAINMENT SERVICES, NAMELY, PROVIDING AN ON-GOING RADIO PROGRAM IN THE FIELD OF MUSIC, DANCE, THEATER, NEWS, SPORTS, COMEDY AND COMMENTARY VIA A GLOBAL COMPUTER NETWORK; ENTERTAINMENT SERVICES, NAMELY, PROVIDING AN ON-GOING TELEVISION PROGRAM IN THE FIELD OF MUSIC, DANCE, THEATER, NEWS, SPORTS, COMEDY AND COMMENTARY VIA A GLOBAL COMPUTER NETWORK; ENTERTAINMENT, NAMELY, PROVIDING AN ON-GOING TELEVISION PROGRAM IN THE FIELD OF MUSIC, DANCE, THEATER, NEWS, SPORTS, COMEDY AND COMMENTARY DISTRIBUTED OVER TELEVISION, SATELLITE SYSTEMS AND THE GLOBAL COMPUTER NETWORK; ENTERTAINMENT, NAMELY, A CONTINUING VARIETY AND COMEDY SHOW DISTRIBUTED OVER TELEVISION AND SATELLITE; MOTION PICTURE FILM PRODUCTION, PRODUCTION OF RADIO AND TELEVISION PROGRAMS; DISTRIBUTION OF RADIO AND TELEVISION PROGRAMS FOR OTHERS (U.S. CLS. 100, 101 AND 107).
FIRST USE 1-8-2000; IN COMMERCE 1-1-2001.

2,858,222. ZUELLIG PHARMA HOLDINGS LTD, 87011 LABUAN F.T., MALAYSIA. SN 75-872,439. PUB. 1-8-2002, FILED 12-15-1999.

ZBASE

CLASS 35—ADVERTISING AND BUSINESS

FOR RETAIL STORE SERVICES, WHOLESALE STORE SERVICES, AND WHOLESALE DISTRIBUTORSHIPS, ALL FEATURING THE PHARMACEUTICAL GOODS OF OTHERS; PROFESSIONAL BUSINESS CONSULTANCY FOR PHARMACEUTICAL COMPANIES; PROVIDING STATISTICAL INFORMATION RELEVANT TO THE PHARMACEUTICAL INDUSTRY; BUSINESS RESEARCH ON PHARMACEUTICAL GOODS; DISSEMINATION OF ADVERTISING FOR OTHERS VIA AN ON-LINE ELECTRONIC COMMUNICATIONS NETWORK AND DISTRIBUTION OF PRINTED MARKETING MATERIALS IN THE FIELD OF PHARMACEUTICALS (U.S. CLS. 100, 101 AND 102).
FIRST USE 5-1-1998; IN COMMERCE 5-1-1998.

CLASS 39—TRANSPORTATION AND STORAGE

FOR DELIVERY OF PHARMACEUTICAL GOODS TO HOSPITALS AND PHARMACIES BY MEANS OF LAND, AIR OR SEA TRANSPORTATION; ELECTRONIC STORAGE FOR OTHERS OF PHARMACEUTICAL DATA; WAREHOUSE STORAGE OF PHARMACEUTICAL GOODS (U.S. CLS. 100 AND 105).
FIRST USE 5-1-1998; IN COMMERCE 5-1-1998.

2,858,237. NEW YORK YANKEES PARTNERSHIP, BRONX, NY. SN 75-981,715. PUB. 1-16-2001, FILED 6-17-1998.

CLASS 42—SCIENTIFIC, COMPUTER AND LEGAL SERVICES

FOR PROVIDING AN ON-LINE COMPUTER DATABASE IN THE FIELD OF PHARMACEUTICAL AND THE PHARMACEUTICALS INDUSTRY; COMPUTER PROGRAMMING FOR OTHERS; UPDATING OF COMPUTER SOFTWARE FOR OTHERS; COMPUTER SOFTWARE DESIGN FOR OTHERS; COMPUTER TIME-SHARING SERVICES AND PROVIDING AN ON-LINE DATABASE ON GLOBAL COMPUTER NETWORKS IN THE FIELD OF PHARMACOLOGY; RENTAL OF COMPUTER SOFTWARE (U.S. CLS. 100 AND 101).
FIRST USE 5-1-1998; IN COMMERCE 5-1-1998.

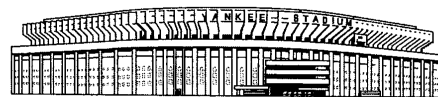

OWNER OF U.S. REG. NOS. 1,032,767 AND 1,727,655.
NO CLAIM IS MADE TO THE EXCLUSIVE RIGHT TO

USE "YANKEE STADIUM", APART FROM THE MARK AS SHOWN.

THE LINING IN THE DRAWING IS FOR SHADING PURPOSES ONLY AND DOES NOT INDICATE COLOR.

THE MARK CONSISTS, THE MARK IS A THREE-DIMENSIONAL REPRESENTATION OF YANKEE STADIUM BALLPARK

SEC. 2(F).

2,858,249. THAT'S MY AMERICA, L.L.C., CHICAGO, IL. SN 76-025,594. PUB. 9-17-2002, FILED 4-13-2000.

CLASS 6—METAL GOODS

FOR DECORATIVE TIN CANS SOLD EMPTY (U.S. CLS. 2, 12, 13, 14, 23, 25 AND 50).

FIRST USE 9-25-1997; IN COMMERCE 9-25-1997.

CLASS 20—FURNITURE AND ARTICLES NOT OTHERWISE CLASSIFIED

FOR FIGURINES MADE OF PLASTIC, WOOD, RESIN (U.S. CLS. 2, 13, 22, 25, 32 AND 50).

FIRST USE 0-0-1996; IN COMMERCE 0-0-1996.

CLASS 21—HOUSEWARES AND GLASS

FOR BEVERAGE CONTAINERS, NAMELY, CUPS AND MUGS (U.S. CLS. 2, 13, 23, 29, 30, 33, 40 AND 50).

FIRST USE 0-0-1996; IN COMMERCE 0-0-1996.

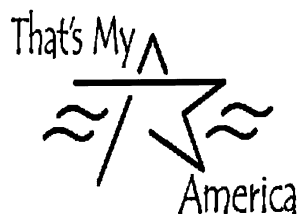

2,858,240. LES COLLECTIONS SHAN INC., LAVAL, QUEBEC, CANADA. SN 76-000,053. PUB. 7-30-2002, FILED 3-14-2000.

SHAN

PRIORITY CLAIMED UNDER SEC. 44(D) ON BENELUX APPLICATION NO. 956161, FILED 2-3-2000.

CLASS 14—JEWELRY

FOR JEWELRY AND ORNAMENTAL PINS (U.S. CLS. 2, 27, 28 AND 50).

FIRST USE 7-0-1997; IN COMMERCE 7-0-1997.

CLASS 24—FABRICS

FOR BATH LINEN (U.S. CLS. 42 AND 50).

FIRST USE 7-0-1996; IN COMMERCE 7-0-1996.

CLASS 25—CLOTHING

FOR CLOTHING FOR CHILDREN, NAMELY, PANTS, LEGGINGS; AND, CLOTHING FOR ADULTS AND CHILDREN, NAMELY, SWEATSHIRTS AND BELTS; NIGHT-GOWNS, FOOTWEAR, AND HEAD WEAR (U.S. CLS. 22 AND 39).

FIRST USE 7-0-1999; IN COMMERCE 7-0-1999.

CLASS 9—ELECTRICAL AND SCIENTIFIC APPARATUS

FOR PRE-RECORDED AUDIO AND VIDEO CASSETTE TAPES, COMPACT DISCS AND DIGITAL VIDEO DISCS, ALL FEATURING INFORMATION IN THE FIELD OF MUSIC AND MUSIC APPRECIATION, MUSIC COMPOSITION AND MUSIC PERFORMANCE (U.S. CLS. 21, 23, 26, 36 AND 38).

FIRST USE 12-10-2000; IN COMMERCE 12-10-2000.

CLASS 41—EDUCATION AND ENTERTAINMENT

FOR EDUCATIONAL AND ENTERTAINMENT SERVICES, NAMELY, PRODUCTION AND PERFORMANCE OF MULTI-MEDIA LIVE THEATRICAL MUSICAL PRODUCTIONS; AUDIO RECORDING AND PRODUCTION; DIGITAL VIDEO DISC AND VIDEO TAPE RECORDING AND PRODUCTION, PROVIDING EDUCATIONAL AND ENTERTAINMENT INFORMATION IN THE FIELDS OF MUSIC AND MUSIC APPRECIATION, MUSIC COMPOSITION, AND MUSIC PERFORMANCE, VIA A GLOBAL COMPUTER NETWORK (U.S. CLS. 100, 101 AND 107).

FIRST USE 12-10-2000; IN COMMERCE 12-10-2000.

2,858,254. MAGIQ TECHNOLOGIES, INC., NEW YORK, NY.
SN 76-037,103. PUB. 11-4-2003, FILED 4-28-2000.

MAGIQ

CLASS 9—ELECTRICAL AND SCIENTIFIC APPARATUS

FOR ELECTRICAL AND SCIENTIFIC APPARATUS, NAMELY, INTEGRATED OPTICAL SYSTEMS COMPRISING LASERS, DETECTORS AND MODULATORS FOR USE WITH QUANTUM COMPUTERS, QUANTUM CRYPTOGRAPHY AND INFORMATION PROCESSING; OPTOELECTRONIC SEMICONDUCTOR DEVICES, NAMELY, LASERS, DETECTORS AND MODULATORS FOR USE WITH QUANTUM COMPUTERS, QUANTUM CRYPTOGRAPHY AND INFORMATION PROCESSING; QUANTUM-TECHNOLOGY BASED TELECOMMUNICATIONS DEVICES, NAMELY, ROUTERS, BRIDGES, AMPLIFIERS, REGENERATORS AND REPEATERS; COMPUTER FIRMWARE FOR QUANTUM INFORMATION PROCESSING; COMPUTER PERIPHERALS; COMPUTER MICROPROCESSORS; COMPUTER CENTRAL PROCESSING UNITS; COMPUTER MEMORIES; COMPUTER HARDWARE FOR THE DEVELOPMENT, MAINTENANCE, AND USE OF LOCAL AND WIDE AREA COMPUTER NETWORKS; COMPUTER HARDWARE FOR INTERCONNECTING COMPUTER NETWORKS; COMPUTER HARDWARE AND SOFTWARE FOR INTERFACING COMPUTER PERIPHERALS TO A COMPUTER NETWORK, NAMELY ALGORITHMS; COMPUTER SOFTWARE FOR QUANTUM INFORMATION PROCESSING IN THE FIELDS OF TELECOMMUNICATIONS, QUANTUM COMPUTING, QUANTUM NETWORKING, QUANTUM CRYPTOGRAPHY, QUANTUM TELEPORTATION, QUANTUM SENSING AND QUANTUM MEASUREMENTS, AND PRINTED MANUALS SOLD TOGETHER WITH THE SOFTWARE IN CONNECTION THEREWITH; QUANTUM-COMPUTER BASED HARDWARE DESIGNED TO ENHANCE THE UTILITY OF SEMICONDUCTOR DEVICES; MEASUREMENT DEVICES BASED ON QUANTUM TECHNOLOGY, NAMELY, LASERS FOR MEASURING PURPOSES (U.S. CLS. 21, 23, 26, 36 AND 38).
FIRST USE 1-1-2002; IN COMMERCE 10-2-2003.

CLASS 41—EDUCATION AND ENTERTAINMENT

FOR EDUCATIONAL SERVICES, NAMELY, SEMINARS, WORKSHOPS, AND CLASSES IN THE FIELD OF QUANTUM COMPUTING, QUANTUM NETWORKING, QUANTUM CRYPTOGRAPHY, QUANTUM TELEPORTATION, QUANTUM SENSING, AND QUANTUM MEASUREMENT AND DISTRIBUTING COURSE MATERIALS IN CONNECTION THEREWITH; EDUCATIONAL RESEARCH; TRAINING IN THE USE QUANTUM COMPUTING, QUANTUM NETWORKING, QUANTUM CRYPTOGRAPHY, QUANTUM TELEPORTATION, QUANTUM SENSING AND QUANTUM MEASUREMENT; AND EDUCATIONAL SERVICES, NAMELY, PROVIDING INCENTIVES TO PEOPLE AND COMPANIES TO DEMONSTRATE EXCELLENCE IN THE FIELD OF QUANTUM COMPUTING, QUANTUM NETWORKING, QUANTUM CRYPTOGRAPHY, QUANTUM TELEPORTATION, QUANTUM SENSING AND QUANTUM MEASUREMENT (U.S. CLS. 100, 101 AND 107).
FIRST USE 1-1-2002; IN COMMERCE 4-21-2003.

CLASS 42—SCIENTIFIC, COMPUTER AND LEGAL SERVICES

FOR INSTALLATION OF QUANTUM COMPUTER HARDWARE; QUANTUM COMPUTER SOFTWARE DESIGN FOR OTHERS; QUANTUM COMPUTER DESIGN FOR OTHERS; COMPUTER CONSULTING SERVICES IN THE FIELD OF QUANTUM COMPUTING INCLUDING HARDWARE AND SOFTWARE; COMPUTER SITE DESIGN; COMPUTER SYSTEMS ANALYSIS; INSTALLATION OF COMPUTER SOFTWARE; UP-DATING OF COMPUTER SOFTWARE (U.S. CLS. 100 AND 101).
FIRST USE 1-1-2002; IN COMMERCE 10-2-2003.

2,858,259. BEYOND RETIREMENT, INC., ASHTABULA, OH.
SN 76-055,866. PUB. 11-13-2001, FILED 5-24-2000.

POSITIVE RETIREMENT

NO CLAIM IS MADE TO THE EXCLUSIVE RIGHT TO USE "RETIREMENT", APART FROM THE MARK AS SHOWN.

CLASS 16—PAPER GOODS AND PRINTED MATTER

FOR PRINTED MATERIALS IN THE FIELDS OF HEALTH AND WELLNESS, NAMELY, BOOKLETS, BROCHURES; INFORMATIONAL FLIERS IN THE FIELD OF EDUCATION; PAMPHLETS IN THE FIELD OF MOTIVATION, FUTURE PLANNING AND SETTING GOALS, EDUCATION, ACTIVITIES, AND EXERCISE; WORKBOOKS IN THE FIELD OF EDUCATION; QUESTIONNAIRES IN THE FIELD OF EDUCATION; PRINTED INSTRUCTIONAL, EDUCATIONAL, AND TEACHING MATERIALS IN THE FIELD OF MOTIVATION, FUTURE PLANNING AND SETTING GOALS, EDUCATION, ACTIVITIES, AND EXERCISE (U.S. CLS. 2, 5, 22, 23, 29, 37, 38 AND 50).
FIRST USE 6-28-2003; IN COMMERCE 6-28-2003.

CLASS 28—TOYS AND SPORTING GOODS

FOR EXERCISE EQUIPMENT, NAMELY EXERCISE BARS (U.S. CLS. 22, 23, 38 AND 50).
FIRST USE 6-30-2003; IN COMMERCE 6-30-2003.

CLASS 42—SCIENTIFIC, COMPUTER AND LEGAL SERVICES

FOR PROVIDING INFORMATION AND CONSULTATION IN THE FIELD OF HEALTH, EXERCISE, WELLNESS AND FITNESS FOR SENIOR CITIZENS (U.S. CLS. 100 AND 101).
FIRST USE 6-30-2003; IN COMMERCE 6-30-2003.

2,858,262. WISH YOU WERE HERE FILM & VIDEO, INC.,
BURBANK, CA. SN 76-081,197. PUB. 6-4-2002, FILED 6-30-2000.

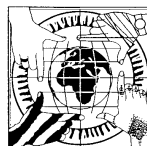

THE
PASSPORT
ROYALTY FREE COLLECTION

NO CLAIM IS MADE TO THE EXCLUSIVE RIGHT TO USE "THE ROYALTY FREE COLLECTION", APART FROM THE MARK AS SHOWN.

CLASS 9—ELECTRICAL AND SCIENTIFIC APPARATUS

FOR PRE-RECORDED COMPACT DISKS FEATURING STOCK FOOTAGE AND STOCK PHOTOGRAPHS RELATING TO NATURE AND TRAVEL (U.S. CLS. 21, 23, 26, 36 AND 38).
FIRST USE 6-0-2002; IN COMMERCE 12-0-2002.

CLASS 41—EDUCATION AND ENTERTAINMENT

FOR STOCK FOOTAGE LIBRARY SERVICES (U.S. CLS. 100, 101 AND 107).
FIRST USE 6-0-2002; IN COMMERCE 2-26-2004.

2,858,277. BUXTON COMPANY, THE, FORT WORTH, TX.
SN 76-135,571. PUB. 7-10-2001, FILED 9-26-2000.

MAPID**CLASS 16—PAPER GOODS AND PRINTED MATTER**

FOR MAPS (U.S. CLS. 2, 5, 22, 23, 29, 37, 38 AND 50).
FIRST USE 10-2-2003; IN COMMERCE 10-2-2003.

CLASS 35—ADVERTISING AND BUSINESS

FOR MARKET RESEARCH SERVICES IN THE FIELD OF GEOGRAPHIC INFORMATION (U.S. CLS. 100, 101 AND 102).
FIRST USE 2-18-2004; IN COMMERCE 2-18-2004.

2,858,278. GENERAL ELECTRIC COMPANY, SCHENECTADY, NY. SN 76-135,996. PUB. 6-4-2002, FILED 9-22-2000.

ENERVISTA**CLASS 35—ADVERTISING AND BUSINESS**

FOR BUSINESS SERVICES, NAMELY, BUSINESS CONSULTING SERVICES REGARDING ELECTRIC UTILITY ENTERPRISE MANAGEMENT; BUSINESS CONSULTING SERVICES REGARDING STRATEGIC PLANNING OF INFORMATION MANAGEMENT FOR ELECTRIC UTILITY ENTERPRISES (U.S. CLS. 100, 101 AND 102).
FIRST USE 8-31-2000; IN COMMERCE 8-31-2000.

CLASS 38—COMMUNICATION

FOR TRANSMISSION OF DATA AND DOCUMENTS BY MEANS OF A GLOBAL COMPUTER NETWORK AND BY ELECTRONIC MEANS FOR ELECTRICAL UTILITY ENTERPRISE MANAGEMENT (U.S. CLS. 100, 101 AND 104).
FIRST USE 8-31-2000; IN COMMERCE 8-31-2000.

CLASS 39—TRANSPORTATION AND STORAGE

FOR UTILITY SERVICES, NAMELY PROVISION OF SERVICES ENABLING ELECTRICAL UTILITY ENTERPRISE MANAGEMENT FOR OTHERS; ELECTRONIC STORAGE SERVICES, NAMELY PROVIDING THE STORAGE AND RETRIEVAL OF DATA FILES WITHIN A NETWORK ENVIRONMENT FOR ELECTRICAL UTILITY ENTERPRISE MANAGEMENT (U.S. CLS. 100 AND 105).
FIRST USE 8-31-2000; IN COMMERCE 8-31-2000.

CLASS 42—SCIENTIFIC, COMPUTER AND LEGAL SERVICES

FOR REMOTE AND ON-SITE MONITORING OF COMPUTER SYSTEMS, MONITORS AND RELAYS FOR ELECTRICAL UTILITY ENTERPRISE MANAGEMENT; APPLICATION SERVICE PROVIDER SERVICES, NAMELY, HOSTING COMPUTER APPLICATION SOFTWARE ON A COMPUTER SERVER FOR OTHERS FOR ELECTRICAL UTILITY ENTERPRISE MANAGEMENT (U.S. CLS. 100 AND 101).
FIRST USE 8-31-2000; IN COMMERCE 8-31-2000.

2,858,283. VETESSENTIAL LLC, HINGHAM, MA. SN 76-142,101. PUB. 7-16-2002, FILED 10-6-2000.

VETESSENTIAL**CLASS 35—ADVERTISING AND BUSINESS**

FOR CONSULTING SERVICES IN THE AREAS OF MARKETING AND HUMAN RESOURCES, AND BUSINESS AUDITING SERVICES FOR MARKETING, HEALTH AND SAFETY, FINANCE, INFORMATION AND TELECOMMUNICATION TECHNOLOGY, OPERATIONS, HUMAN RESOURCES, VALUATION, CLINICAL REVIEW AND WELLNESS PLANS, ALL SPECIFICALLY DESIGNED FOR VETERINARIANS, VETERINARY HOSPITALS AND VETERINARY CLINICS (U.S. CLS. 100, 101 AND 102).
FIRST USE 1-1-2002; IN COMMERCE 1-1-2002.

CLASS 42—SCIENTIFIC, COMPUTER AND LEGAL SERVICES

FOR CONSULTING SERVICES IN THE AREA OF HEALTH AND SAFETY, INFORMATION AND TELECOMMUNICATIONS TECHNOLOGY, OPERATIONS, CLINICAL REVIEW AND WELLNESS PLANS, ALL SPECIFICALLY DESIGNED FOR VETERINARIANS, VETERINARY HOSPITALS AND VETERINARY CLINICS (U.S. CLS. 100 AND 101).
FIRST USE 1-1-2002; IN COMMERCE 1-1-2002.

2,858,307. COMPUTER ASSOCIATES THINK, INC., ISLANDIA, NY. SN 76-190,528. PUB. 12-3-2002, FILED 1-5-2001.

**Computer Associates**

OWNER OF U.S. REG. NOS. 1,480,506, 2,396,840, AND OTHERS.

THE MARK CONSISTS, IN PART, OF A COMBINATION OF THE STYLIZED LETTER "C" AND THE STYLIZED LETTER "A". THE STYLIZED LETTER "C" IS DISSECTED BY A BLACK CIRCLE WITH THE PORTION OF THE STYLIZED LETTER "C" OUTSIDE OF THE CIRCLE BEING DISPLAYED IN A LIGHT BLUE AND THE PORTION OF THE STYLIZED LETTER "C" INSIDE THE CIRCLE BEING DISPLAYED IN A DARK BLUE. THE STYLIZED LETTER "A" IS INCLUDED ENTIRELY WITHIN THE SAME CIRCLE AND IS DISPLAYED IN THE COLOR GREEN. THE AFOREMENTIONED STYLIZED "CA" AND CIRCLE ARE DISPLAYED ABOVE THE STYLIZED WORDING "COMPUTER ASSOCIATES". COLOR IS A FEATURE OF THE

MARK.
SEC. 2(F).

CLASS 9—ELECTRICAL AND SCIENTIFIC APPARATUS

FOR HOUSE MARK OF COMPUTER SOFTWARE PRODUCTS NAMELY ENTERPRISE MANAGEMENT SOFTWARE, INFORMATION MANAGEMENT AND APPLICATION DEVELOPMENT SOFTWARE, BUSINESS APPLICATION SOFTWARE AND SOFTWARE FOR GLOBAL COMPUTER NETWORKS (U.S. CLS. 21, 23, 26, 36 AND 38).
FIRST USE 1-3-2001; IN COMMERCE 1-3-2001.

CLASS 42—SCIENTIFIC, COMPUTER AND LEGAL SERVICES

FOR COMPUTER CONSULTING SERVICES FOR GLOBAL COMPUTER NETWORKS (U.S. CLS. 100 AND 101).
FIRST USE 1-3-2001; IN COMMERCE 1-3-2001.

CLASS 12—VEHICLES

FOR AUTOMOBILE AND TRUCK BUMPERS, MADE OF ALUMINUM AND OTHER MATERIALS; AUTOMOBILES AND STRUCTURAL PARTS THEREFOR; AUTOMOBILE BODIES; FITTED LINERS FOR THE CARGO AREA VEHICLES; STRUCTURAL PARTS FOR TRUCKS (U.S. CLS. 19, 21, 23, 31, 35 AND 44).
FIRST USE 1-30-2001; IN COMMERCE 1-30-2001.

CLASS 35—ADVERTISING AND BUSINESS

FOR AUTOMOBILE DEALERSHIPS; WHOLESALE AND RETAIL STORE SERVICES FEATURING AUTOMOBILE AND TRUCK PARTS AND ACCESSORIES; WHOLESALE DISTRIBUTORSHIP SERVICES IN THE FIELD OF AUTOMOTIVE TRUCK, PARTS AND ACCESSORIES; IMPORT AGENCY SERVICES RELATED TO AUTOMOTIVE AND TRUCK, PARTS AND ACCESSORIES (U.S. CLS. 100, 101 AND 102).
FIRST USE 1-30-2001; IN COMMERCE 1-30-2001.

2,858,310. GLORY DAYS, INC., FAIRFAX, VA. SN 76-201,146. PUB. 12-10-2002, FILED 1-26-2001.

GLORY DAYS SPORTS

OWNER OF U.S. REG. NOS. 2,080,016 AND 2,080,017.
NO CLAIM IS MADE TO THE EXCLUSIVE RIGHT TO USE "SPORTS", APART FROM THE MARK AS SHOWN.

CLASS 41—EDUCATION AND ENTERTAINMENT

FOR ARRANGING, SPONSORING AND CONDUCTING ATHLETIC COMPETITIONS AND SPORTING EVENTS (U.S. CLS. 100, 101 AND 107).
FIRST USE 4-12-2001; IN COMMERCE 1-14-2002.

CLASS 43—HOTEL AND RESTAURANT SERVICES

FOR RESTAURANT SERVICES; BAR SERVICES; AND CATERING SERVICES (U.S. CLS. 100 AND 101).
FIRST USE 4-12-2001; IN COMMERCE 1-14-2002.

2,858,320. VINCITI NETWORKS, INC., SANTA CLARA, CA. SN 76-225,705. PUB. 7-16-2002, FILED 3-16-2001.

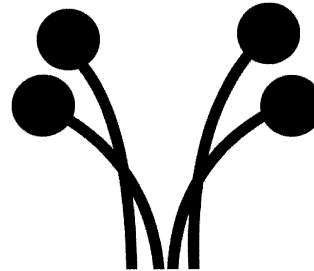

2,858,311. UTE LTD, SEATTLE, WA. SN 76-202,300. PUB. 6-11-2002, FILED 1-30-2001.



NO CLAIM IS MADE TO THE EXCLUSIVE RIGHT TO USE "LTD", APART FROM THE MARK AS SHOWN.

CLASS 37—CONSTRUCTION AND REPAIR

FOR MAINTENANCE OF COMMUNICATIONS AND COMPUTER SYSTEM NETWORKS AND COMPUTER HARDWARE (U.S. CLS. 100, 103 AND 106).
FIRST USE 3-19-2001; IN COMMERCE 2-4-2002.

CLASS 42—SCIENTIFIC, COMPUTER AND LEGAL SERVICES

FOR COMPUTER AND COMMUNICATION NETWORK SECURITY MANAGEMENT, NAMELY, MONITORING OF NETWORK SYSTEMS, PROVIDING BACKUP COMPUTER PROGRAMS AND FACILITIES AND TROUBLESHOOTING OF COMPUTER HARDWARE AND SOFTWARE PROBLEMS VIA TELEPHONE, E-MAIL AND/OR IN PERSON AND TECHNICAL DESIGNING, PLANNING AND IMPLEMENTATION OF COMPUTER HARDWARE, COMPUTER SYSTEMS, COMPUTER NETWORKS AND COMMUNICATION NETWORKS (U.S. CLS. 100 AND 101).
FIRST USE 4-1-2001; IN COMMERCE 1-1-2002.

2,858,327. PROMEDICA COMMUNICATIONS INC., NEW YORK, NY. SN 76-245,937. PUB. 12-31-2002, FILED 4-24-2001.



THE STIPPLING IS FOR SHADING PURPOSES.

CLASS 16—PAPER GOODS AND PRINTED MATTER

FOR (BASED ON USE IN COMMERCE) PRINTED REPORTS IN THE FIELD OF MEDICINE AND CONTINUING MEDICAL EDUCATION (U.S. CLS. 2, 5, 22, 23, 29, 37, 38 AND 50).

FIRST USE 1-0-1998; IN COMMERCE 1-0-1998.

CLASS 42—SCIENTIFIC, COMPUTER AND LEGAL SERVICES

FOR CONSULTING SERVICES IN THE FIELD OF MEDICINE AND CONTINUING MEDICAL EDUCATION (U.S. CLS. 100 AND 101).

FIRST USE 6-0-1998; IN COMMERCE 6-0-1998.

2,858,333. WATLOW POLYMER TECHNOLOGIES, INC., WINONA, MN. SN 76-250,204. PUB. 12-31-2002, FILED 5-2-2001.



CLASS 19—NON-METALLIC BUILDING MATERIALS

FOR PLASTIC BIRD BATHS BEING STRUCTURES; NON-METAL GUTTERS (U.S. CLS. 1, 12, 33 AND 50).

FIRST USE 9-1-2002; IN COMMERCE 9-1-2002.

CLASS 20—FURNITURE AND ARTICLES NOT OTHERWISE CLASSIFIED

FOR PET CARE PRODUCTS, NAMELY, PET CUSHIONS AND MATS, AND PORTABLE BEDS FOR PETS (U.S. CLS. 2, 13, 22, 25, 32 AND 50).

FIRST USE 9-1-2002; IN COMMERCE 9-1-2002.

2,858,343. MICROGROUP, INC., MEDWAY, MA. SN 76-267,658. PUB. 12-31-2002, FILED 6-7-2001.

MODULUER

CLASS 6—METAL GOODS

FOR SMALL ITEMS OF METAL HARDWARE, NAMELY, FITTINGS, CONNECTORS AND VALVES (U.S. CLS. 2, 12, 13, 14, 23, 25 AND 50).

FIRST USE 1-1-1995; IN COMMERCE 1-1-1995.

CLASS 7—MACHINERY

FOR MACHINE COUPLING COMPONENTS, NAMELY, FITTINGS, CONNECTORS AND VALVES (U.S. CLS. 13, 19, 21, 23, 31, 34 AND 35).

FIRST USE 1-1-1995; IN COMMERCE 1-1-1995.

CLASS 10—MEDICAL APPARATUS

FOR SURGICAL, MEDICAL, DENTAL AND VETERINARY INSTRUMENTS, NAMELY, CONNECTORS (U.S. CLS. 26, 39 AND 44).

FIRST USE 1-1-1995; IN COMMERCE 1-1-1995.

2,858,350. SPACESAVER CORPORATION, FORT ATKINSON, WI. SN 76-282,503. PUB. 12-9-2003, FILED 7-9-2001.

STORAGE CAN BE A MOVING EXPERIENCE

CLASS 9—ELECTRICAL AND SCIENTIFIC APPARATUS

FOR SAFETY AND SECURITY SYSTEMS COMPRISING INFRA-RED OPTICAL SENSORS USED ON A PLURALITY OF SPACED-APART MOVABLE CARRIAGES TO DETECT AN OBJECT OR A PERSON IN THE OPEN AISLE OF THE SHELVING SYSTEM; ELECTRONIC CONTROL FOR MOBILE STORAGE UNITS (U.S. CLS. 21, 23, 26, 36 AND 38).

FIRST USE 2-6-2003; IN COMMERCE 2-6-2003.

CLASS 20—FURNITURE AND ARTICLES NOT OTHERWISE CLASSIFIED

FOR FURNITURE, NAMELY, FILE CABINETS, STORAGE CABINETS AND SHELVING UNITS; MOBILE FILE, STORAGE AND SHELVING UNITS, AND PARTS AND ACCESSORIES THEREFORE, NAMELY, SHELVES, CARRIAGES CONSISTING OF METAL STRUCTURAL ELEMENTS ON WHICH STORAGE DEVICES ARE MOUNTED OR MOVE UPON, MOBILE STORAGE AND FILING SYSTEMS COMPRISED OF A PLURALITY OF MOBILE TRACK-GUIDED STORAGE CARRIAGES WHICH ARE MOVABLE TOGETHER AND APART TO OPEN-UP AND CLOSE ACCESS AISLES BETWEEN THE STORAGE CARRIAGES AND PARTS AND ACCESSORIES THEREFORE, NAMELY, HANGING FILE BARS, SHELVES, ANTI-TIP DEVICES, CARD HOLDERS, DIVIDERS, SERVICE TOOLS, INSTALLATION TOOLS, DRAWERS, DRAWER BRACKETS, HANGING FOLDER FRAMES, DRAWER LOCKS, TRIM STRIPS, BACK PANELS; COMPONENTS FOR ASSEMBLING DRAWERS SOLD AS AN INTEGRAL COMPONENT OF FILE CABINETS, STORAGE CABINETS, SHELVING UNITS AND MOBILE FILE UNITS, NAMELY, DRAWER FRONTS, DRAWER BACKS, DRAWER SIDES, KICK PLATES, LABEL HOLDERS, SLIDING SHELVES AND FILE DIVIDERS; COMPONENTS FOR ASSEMBLING FILE DIVIDERS SOLD AS AN INTEGRAL COMPONENT OF FILE CABINETS, STORAGE CABINETS, SHELVING UNITS AND MOBILE FILE UNITS, NAMELY, SLIDE BRACKETS, CROSS BRACKETS, SLOTTED OR PLAIN CENTER STOP BRACKETS; BIN DIVIDERS; COMPONENTS FOR ASSEMBLING BINS SOLD AS AN INTEGRAL COMPONENT OF FILE CABINETS, STORAGE CABINETS, SHELVING UNITS AND MOBILE FILE UNITS, NAMELY, BIN FRONTS, BIN BACKS, AND CARD HOLDERS; NON-METAL COMPUTER REEL HANGERS, REEL RACKS FOR FILM, MICROFICHE, MICROFILM, CARTRIDGES AND COMPUTER REELS; MOBILE STORAGE CARRIAGES EQUIPPED WITH SHELVES, FILE CABINETS, STORAGE CABINETS, SHELVING UNITS, MOBILE FILE AND STORAGE UNITS (U.S. CLS. 2, 13, 22, 25, 32 AND 50).

FIRST USE 2-6-2003; IN COMMERCE 2-6-2003.

2,858,355. MARTYNEC, ANDREA M., DOYLESTOWN, PA. SN 76-286,788. PUB. 6-24-2003, FILED 7-17-2001.



NO CLAIM IS MADE TO THE EXCLUSIVE RIGHT TO USE THE REPRESENTATION OF INTERNATIONAL RECYCLING SYMBOL WITH THE ROTATING ARROW, APART FROM THE MARK AS SHOWN.

THE STIPLING IS A FEATURE OF THE MARK AND IS NOT INTENDED TO INDICATE COLOR.

CLASS 35—ADVERTISING AND BUSINESS

FOR CONSERVATION SERVICES, NAMELY, PROMOTING PUBLIC AWARENESS IN THE NEED TO MAINTAIN AND CONSERVE LAND AND RESOURCES AND PARTICULARLY THE PRISTINE CONDITION OF NATURAL OUTDOOR SPACES (U.S. CLS. 100, 101 AND 102).

FIRST USE 8-0-2003; IN COMMERCE 8-0-2003.

CLASS 40—MATERIAL TREATMENT

FOR RECYCLING SERVICES (U.S. CLS. 100, 103 AND 106).

FIRST USE 8-0-2003; IN COMMERCE 8-0-2003.

2,858,359. DILLARD'S, INC., LITTLE ROCK, AR. SN 76-290,688. PUB. 5-20-2003, FILED 7-26-2001.

WINTER GLEN**CLASS 6—METAL GOODS**

FOR CHRISTMAS DECORATIONS AND ORNAMENTS, NAMELY, CHRISTMAS FIGURINES MADE OF METAL (U.S. CLS. 2, 12, 13, 14, 23, 25 AND 50).

FIRST USE 9-0-2000; IN COMMERCE 9-0-2000.

CLASS 20—FURNITURE AND ARTICLES NOT OTHERWISE CLASSIFIED

FOR CHRISTMAS DECORATIONS AND ORNAMENTS, NAMELY, FIGURINES AND OTHER CHRISTMAS VILLAGE PIECES MADE OF POLYRESIN, PVC AND PLASTIC (U.S. CLS. 2, 13, 22, 25, 32 AND 50).

FIRST USE 9-0-2000; IN COMMERCE 9-0-2000.

CLASS 21—HOUSEWARES AND GLASS

FOR CHRISTMAS DECORATIONS AND ORNAMENTS, NAMELY, CHRISTMAS VILLAGES AND NATIVITY SCENES COMPRISING HOUSES, FIGURINES AND OTHER CHRISTMAS VILLAGE PIECES MADE OF PORCELAIN (U.S. CLS. 2, 13, 23, 29, 30, 33, 40 AND 50).

FIRST USE 9-0-2000; IN COMMERCE 9-0-2000.

2,858,367. UNIMERCO GROUP AS, DK-7451 SUNDS, DENMARK. SN 76-302,853. PUB. 4-8-2003, FILED 8-17-2001.

**CLASS 8—HAND TOOLS**

FOR CUTTING HAND TOOLS NAMELY BORDERS, SCISSORS, KNIVES, MILLING CUTTERS, DIES, DRILL HOLDERS, BITS, PLANES, MOULDING IRONS, DIGGERS, PICKAXES, CHISELS, AXES, PINNERS; GRINDING TOOLS AND INSTRUMENTS; GRINDING STONES; BLADES FOR HAND TOOLS (U.S. CLS. 23, 28 AND 44).

FIRST USE 2-1-1996; IN COMMERCE 2-1-1996.

CLASS 40—MATERIAL TREATMENT

FOR POLISHING, GRINDING OFF, INFORMATION ABOUT TREATMENT OF METAL, METAL TREATING, METAL TEMPERING, FULLERING WITH LASER BEAM, GRINDING, FORGE ACTIVITIES (U.S. CLS. 100, 103 AND 106).

FIRST USE 8-19-1996; IN COMMERCE 8-19-1996.

CLASS 42—SCIENTIFIC, COMPUTER AND LEGAL SERVICES

FOR SCIENTIFIC AND INDUSTRIAL RESEARCH; COMPUTER PROGRAMMING; TESTING OF MATERIALS, NAMELY TESTING OF TOOLS AND MATERIALS USED IN THE PRODUCTION OF TOOLS; ADJUSTING AND CALIBRATION OF TOOLS; CONSULTATION AND ADVISING ON THE CHOICE OF CORRECT TOOLS AND THE CORRECT USE THEREOF (U.S. CLS. 100 AND 101).
FIRST USE 2-1-1996; IN COMMERCE 2-1-1996.

2,858,374. TGC, INC., ORLANDO, FL. SN 76-316,760. PUB. 5-7-2002, FILED 9-24-2001.



2,858,370. OREGON HEALTH AND SCIENCE UNIVERSITY, PORTLAND, OR. SN 76-308,763. PUB. 6-24-2003, FILED 9-4-2001.

OWNER OF U.S. REG. NOS. 1,826,651 AND 2,117,545. SEC. 2(F) AS TO "THE GOLF CHANNEL".

DANGEROUS DECIBELS**CLASS 9—ELECTRICAL AND SCIENTIFIC APPARATUS**

FOR EAR PLUGS NOT FOR MEDICAL PURPOSES; INTERACTIVE MULTIMEDIA COMPUTER GAME PROGRAMS; ELECTRONIC TEACHING APPARATUS AND INSTRUMENTS, NAMELY TESTING AND DISPLAY EQUIPMENT NAMELY SOUND LEVEL METERS (U.S. CLS. 21, 23, 26, 36 AND 38).

FIRST USE 6-0-2002; IN COMMERCE 6-0-2002.

CLASS 16—PAPER GOODS AND PRINTED MATTER

FOR PRINTED INSTRUCTIONAL, EDUCATIONAL, AND TEACHING MATERIALS IN THE FIELD OF PREVENTION AND TREATMENT OF HEARING LOSS AND TINNITUS (U.S. CLS. 2, 5, 22, 23, 29, 37, 38 AND 50).

FIRST USE 4-0-2000; IN COMMERCE 4-0-2000.

CLASS 41—EDUCATION AND ENTERTAINMENT

FOR EDUCATIONAL SERVICES, NAMELY PROVIDING INTERACTIVE MUSEUM EXHIBITS IN THE FIELD OF HEARING HEALTH AND PREVENTION AND TREATMENT OF HEARING LOSS; CONDUCTING EDUCATIONAL CLASSES, SEMINARS, CONFERENCES AND WORKSHOPS, AND ORGANIZING LIVE EVENTS TO EDUCATE THE PUBLIC ABOUT HEARING HEALTH AND THE PREVENTION AND TREATMENT OF HEARING LOSS, AND DISTRIBUTING EDUCATIONAL AND COURSE MATERIALS IN CONNECTION THEREWITH (U.S. CLS. 100, 101 AND 107).

FIRST USE 4-0-2000; IN COMMERCE 4-0-2000.

CLASS 42—SCIENTIFIC, COMPUTER AND LEGAL SERVICES

FOR PROMOTING PUBLIC AWARENESS OF HEARING HEALTH AND THE PREVENTION AND TREATMENT OF HEARING LOSS THROUGH PUBLIC SERVICE ANNOUNCEMENTS; PROVIDING A WEBSITE FEATURING INFORMATION ABOUT THE FIELD OF HEARING HEALTH AND THE PREVENTION AND TREATMENT OF HEARING LOSS (U.S. CLS. 100 AND 101).

FIRST USE 9-0-2001; IN COMMERCE 9-0-2001.

CLASS 25—CLOTHING

FOR LEISURE, CASUAL AND ATHLETIC CLOTHING, NAMELY, SWEATERS AND SWEATER VEST, SHORTS, TROUSERS, SHORTS, SWEAT SUITS, JACKETS, GOLF SHIRTS, HATS, CAPS AND VISORS, SOCKS (U.S. CLS. 22 AND 39).

FIRST USE 10-0-2002; IN COMMERCE 10-0-2002.

CLASS 35—ADVERTISING AND BUSINESS

FOR ADVERTISING SERVICES, NAMELY, PROMOTING THE GOODS AND SERVICES OF OTHERS BY ARRANGING FOR SPONSORS TO AFFILIATE THEIR GOODS AND SERVICES WITH GOLF-RELATED PROGRAMMING SUBJECT MATTER (U.S. CLS. 100, 101 AND 102).

FIRST USE 3-0-2000; IN COMMERCE 3-0-2000.

CLASS 41—EDUCATION AND ENTERTAINMENT

FOR PRODUCTION AND DISTRIBUTION OF ENTERTAINMENT AND EDUCATIONAL PROGRAMMING TO CABLE, WIRELESS CABLE AND/OR SATELLITE TELEVISION BROADCASTING SYSTEMS FEATURING GOLF-RELATED SUBJECT MATTER, INCLUDING GOLF-RELATED NEWS, INTERVIEWS AND HIGHLIGHTS FROM GOLF TOURNAMENTS AND GOLF-RELATED EVENTS (U.S. CLS. 100, 101 AND 107).

FIRST USE 3-0-2000; IN COMMERCE 3-0-2000.

2,858,376. PHOBOS ENTERTAINMENT HOLDINGS, INC., NEW YORK, NY. SN 76-317,466. PUB. 10-29-2002, FILED 9-25-2001.

PHOBOS**CLASS 16—PAPER GOODS AND PRINTED MATTER**

FOR PRINTS AND PUBLICATIONS IN THE NATURE OF BOOKS OF AND ON SCIENCE FICTION (U.S. CLS. 2, 5, 22, 23, 29, 37, 38 AND 50).

FIRST USE 5-1-2002; IN COMMERCE 5-1-2002.

CLASS 41—EDUCATION AND ENTERTAINMENT

FOR ENTERTAINMENT SERVICES, NAMELY, PROVIDING A WEB SITE FEATURING ON-LINE COMPUTER SCIENCE FICTION GAMES, STORIES, IMAGES, AND MOVIE, BOOK, AND COMPUTER AND VIDEO GAME REVIEWS IN THE FIELD OF SCIENCE FICTION VIA A GLOBAL COMPUTER NETWORK; ENTERTAINMENT SERVICES, NAMELY, TELEVISION SHOW PRODUCTION AND MOTION PICTURE FILM PRODUCTION; ENTERTAINMENT SERVICES, NAMELY, WRITING CONTESTS (U.S. CLS. 100, 101 AND 107).

FIRST USE 4-1-2001; IN COMMERCE 4-1-2001.

2,858,404. TRUMP, DONALD J., NEW YORK, NY. SN 76-349,615. PUB. 6-18-2002, FILED 12-12-2001.

TRUMP PALACE

OWNER OF U.S. REG. NOS. 1,557,303, 2,468,153, AND OTHERS.

CLASS 36—INSURANCE AND FINANCIAL

FOR REAL ESTATE SERVICES, NAMELY LISTING, LEASING AND MANAGING RESIDENTIAL CONDOMINIUMS (U.S. CLS. 100, 101 AND 102).

FIRST USE 12-5-2001; IN COMMERCE 12-5-2001.

2,858,391. BMG MUSIC, NEW YORK, NY. SN 76-334,651. PUB. 10-1-2002, FILED 11-6-2001.

BMG HERITAGE**CLASS 9—ELECTRICAL AND SCIENTIFIC APPARATUS**

FOR MUSICAL SOUND RECORDINGS (U.S. CLS. 21, 23, 26, 36 AND 38).

FIRST USE 2-0-2002; IN COMMERCE 2-0-2002.

CLASS 37—CONSTRUCTION AND REPAIR

FOR REAL ESTATE DEVELOPMENT AND CONSTRUCTION OF RESIDENTIAL CONDOMINIUMS (U.S. CLS. 100, 103 AND 106).

FIRST USE 12-5-2001; IN COMMERCE 12-5-2001.

CLASS 41—EDUCATION AND ENTERTAINMENT

FOR PROVIDING INFORMATION REGARDING MUSICAL ARTISTS AND PROVIDING RECORDED PERFORMANCES OF MUSICAL ARTISTS BY MEANS OF A GLOBAL COMPUTER NETWORK (U.S. CLS. 100, 101 AND 107).

FIRST USE 3-0-2004; IN COMMERCE 3-0-2004.

2,858,405. HEIMANN SYSTEMS, 94150 RUNGIS, FRANCE. SN 76-349,800. PUB. 6-24-2003, FILED 12-18-2001.

HCV**CLASS 9—ELECTRICAL AND SCIENTIFIC APPARATUS**

FOR ELECTRIC AND ELECTRONIC APPARATUS AND INSTRUMENTS FOR SECURITY AND MONITORING, NAMELY, SCANNERS FOR LETTERS, PARCELS, LUGGAGE, FREIGHT, CARGO; SCANNERS FOR DETECTING EXPLOSIVES, METALS, WEAPONS AND ORGANIC MATTER; IMAGE AMPLIFIERS, NAMELY, ELECTRONIC ZOOM LENSES; INFRARED AND ULTRAVIOLET IMAGE CONVERTERS; DETECTORS USING INFRARED RAYS FOR DETECTING HIDDEN GOODS IN PARCELS, LUGGAGE, FREIGHT CARGO; SCANNERS NOT FOR MEDICAL USE; X-RAY SCANNERS FOR INSPECTING TRUCKS AND TRANSPORT CONTAINERS; SURVEILLANCE SYSTEMS COMPRISED OF THE AFOREMENTIONED SCANNERS (U.S. CLS. 21, 23, 26, 36 AND 38).

FIRST USE 10-0-1999; IN COMMERCE 10-0-1999.

2,858,403. LG ELECTRONICS INC., SEOUL, REPUBLIC OF KOREA. SN 76-348,134. PUB. 12-31-2002, FILED 12-13-2001.

**CLASS 9—ELECTRICAL AND SCIENTIFIC APPARATUS**

FOR REFRIGERATOR THERMOSTATS (U.S. CLS. 21, 23, 26, 36 AND 38).

FIRST USE 3-0-2002; IN COMMERCE 3-0-2002.

CLASS 37—CONSTRUCTION AND REPAIR

FOR INSTALLATION, MAINTENANCE AND REPAIR OF INSPECTION, SURVEILLANCE AND SECURITY SYSTEMS COMPRISED OF SCANNERS, IMAGE AMPLIFIERS, NAMELY, ELECTRONIC ZOOM LENSES, INFRARED AND ULTRAVIOLET IMAGE CONVERTERS, DETECTORS USING INFRARED RAYS FOR DETECTING HIDDEN GOODS IN PARCELS, LUGGAGE, FREIGHT CARGO, SCANNERS NOT FOR MEDICAL USE, AND X-RAY SCANNERS FOR INSPECTING TRUCKS AND TRANSPORT CONTAINERS (U.S. CLS. 100, 103 AND 106).

FIRST USE 10-0-1999; IN COMMERCE 10-0-1999.

CLASS 11—ENVIRONMENTAL CONTROL APPARATUS

FOR REFRIGERATORS (U.S. CLS. 13, 21, 23, 31 AND 34).

FIRST USE 3-0-2002; IN COMMERCE 3-0-2002.

CLASS 42—SCIENTIFIC, COMPUTER AND LEGAL SERVICES

FOR PRODUCT DEVELOPMENT, NAMELY, DEVELOPMENT OF INSPECTION, SURVEILLANCE AND SECURITY SYSTEMS FOR OTHERS (U.S. CLS. 100 AND 101).

FIRST USE 10-0-1999; IN COMMERCE 10-0-1999.

2,858,406. HEIMANN SYSTEMS, 94150 RUNGIS, FRANCE.
SN 76-349,807. PUB. 6-24-2003, FILED 12-18-2001.

HEIMANN CARGO VISION

OWNER OF U.S. REG. NO. 1,330,617.
NO CLAIM IS MADE TO THE EXCLUSIVE RIGHT TO USE "CARGO" OR "VISION", APART FROM THE MARK AS SHOWN.

CLASS 9—ELECTRICAL AND SCIENTIFIC APPARATUS

FOR ELECTRIC AND ELECTRONIC APPARATUS AND INSTRUMENTS FOR SECURITY AND MONITORING, NAMELY, SCANNERS FOR LETTERS, PARCELS, LUGGAGE, FREIGHT, CARGO; SCANNERS FOR DETECTING EXPLOSIVES, METALS, WEAPONS AND ORGANIC MATTER; IMAGE AMPLIFIERS, NAMELY, ELECTRONIC ZOOM LENSES; INFRARED AND ULTRAVIOLET IMAGE CONVERTERS; DETECTORS USING INFRARED RAYS FOR DETECTING HIDDEN GOODS IN PARCELS, LUGGAGE, FREIGHT CARGO; SCANNERS NOT FOR MEDICAL USE; X-RAY SCANNERS FOR INSPECTING TRUCKS AND TRANSPORT CONTAINERS; SURVEILLANCE SYSTEMS COMPRISED OF THE AFOREMENTIONED SCANNERS (U.S. CLS. 21, 23, 26, 36 AND 38).

FIRST USE 10-0-1999; IN COMMERCE 10-0-1999.

CLASS 37—CONSTRUCTION AND REPAIR

FOR INSTALLATION, MAINTENANCE AND REPAIR OF INSPECTION, SURVEILLANCE AND SECURITY SYSTEMS COMPRISED OF SCANNERS, IMAGE AMPLIFIERS, NAMELY, ELECTRONIC ZOOM LENSES, INFRARED AND ULTRAVIOLET IMAGE CONVERTERS, DETECTORS USING INFRARED RAYS FOR DETECTING HIDDEN GOODS IN PARCELS, LUGGAGE, FREIGHT CARGO, SCANNERS NOT FOR MEDICAL USE, AND X-RAY SCANNERS FOR INSPECTING TRUCKS AND TRANSPORT CONTAINERS (U.S. CLS. 100, 103 AND 106).

FIRST USE 10-0-1999; IN COMMERCE 10-0-1999.

CLASS 42—SCIENTIFIC, COMPUTER AND LEGAL SERVICES

FOR PRODUCT DEVELOPMENT, NAMELY, DEVELOPMENT OF INSPECTION, SURVEILLANCE AND SECURITY SYSTEMS FOR OTHERS (U.S. CLS. 100 AND 101).

FIRST USE 10-0-1999; IN COMMERCE 10-0-1999.

2,858,407. COLUMBIAN MUTAL LIFE INSURANCE COMPANY, BINGHAMTON, NY. SN 76-351,210. PUB. 5-27-2003, FILED 12-13-2001.

UNIQ
benefit solutions

NO CLAIM IS MADE TO THE EXCLUSIVE RIGHT TO USE "BENEFIT SOLUTIONS", APART FROM THE MARK AS SHOWN.

CLASS 35—ADVERTISING AND BUSINESS

FOR BUSINESS MARKETING CONSULTING SERVICES IN THE INSURANCE INDUSTRY (U.S. CLS. 100, 101 AND 102).

FIRST USE 3-12-2002; IN COMMERCE 3-12-2002.

CLASS 36—INSURANCE AND FINANCIAL

FOR INSURANCE SERVICES, NAMELY, UNDERWRITING LIFE, HEALTH, ACCIDENT AND DISABILITY INSURANCE (U.S. CLS. 100, 101 AND 102).

FIRST USE 3-12-2002; IN COMMERCE 3-12-2002.

2,858,409. URBAN SCIENCE APPLICATIONS, INC., DETROIT, MI. SN 76-351,843. PUB. 8-5-2003, FILED 12-21-2001.

KNOWLEDGE TO EMPOWER YOU

CLASS 9—ELECTRICAL AND SCIENTIFIC APPARATUS

FOR COMPUTER SOFTWARE AND INSTRUCTIONAL MANUALS SOLD AS A UNIT FOR MARKET RESEARCH AND ANALYSIS (U.S. CLS. 21, 23, 26, 36 AND 38).

FIRST USE 2-0-2002; IN COMMERCE 2-0-2002.

CLASS 35—ADVERTISING AND BUSINESS

FOR BUSINESS CONSULTATION SERVICES, NAMELY, MARKET RESEARCH AND ANALYSIS, STATISTICAL AND QUANTITATIVE ANALYSIS IN THE NATURE OF PROVIDING STATISTICAL INFORMATION FOR BUSINESS OR COMMERCIAL PURPOSES, COMPUTERIZED DATABASE MANAGEMENT, AND BUSINESS CONSULTATION IN THE FIELD OF DIRECT MARKETING (U.S. CLS. 100, 101 AND 102).

FIRST USE 2-0-2002; IN COMMERCE 2-0-2002.

CLASS 42—SCIENTIFIC, COMPUTER AND LEGAL SERVICES

FOR COMPUTER NETWORK CONSULTATION SERVICES, DATA AND TECHNICAL CONSULTATION SERVICES FOR SOFTWARE APPLICATIONS, COMPUTER SOFTWARE PROGRAMMING AND DESIGN FOR OTHERS, GRAPHIC ART DESIGN FOR DIRECT MARKETING, AND ARBITRATION SUPPORT SERVICES (U.S. CLS. 100 AND 101).

FIRST USE 2-0-2002; IN COMMERCE 2-0-2002.

2,858,410. NATIONAL PETCARE CENTERS, INC., FORT COLLINS, CO. SN 76-352,373. PUB. 6-24-2003, FILED 12-26-2001.

2,858,415. BEBE DU JOUR., NORTH HOLLYWOOD, CA. SN 76-355,069. PUB. 12-3-2002, FILED 1-3-2002.



CLASS 35—ADVERTISING AND BUSINESS

FOR RETAIL VETERINARY PHARMACY SERVICES; RETAIL STORE SERVICES FEATURING PET PRODUCTS AND VETERINARY PHARMACEUTICAL PRODUCTS; BUSINESS MANAGEMENT SERVICES, BUSINESS OPERATIONS MANAGEMENT SERVICES, MARKETING AND ACCOUNTING SERVICES, ALL IN THE FIELD OF VETERINARY MANAGEMENT SERVICES (U.S. CLS. 100, 101 AND 102).
FIRST USE 1-31-2002; IN COMMERCE 4-15-2002.

CLASS 41—EDUCATION AND ENTERTAINMENT

FOR TRAINING SERVICES IN THE FIELD OF PET OBEDIENCE AND BEHAVIOR (U.S. CLS. 100, 101 AND 107).
FIRST USE 1-31-2002; IN COMMERCE 4-15-2002.

CLASS 44—MEDICAL, BEAUTY AND AGRICULTURAL SERVICES

FOR VETERINARY SERVICES; PET GROOMING AND PET BOARDING SERVICES; CONSULTING SERVICES IN THE FIELD OF PET CARE; INFORMATION SERVICES IN THE FIELD OF PET CARE (U.S. CLS. 100 AND 101).
FIRST USE 1-31-2002; IN COMMERCE 4-15-2002.

2,858,412. FUJI PHOTO FILM CO., LTD., KANAGAWA, JAPAN. SN 76-353,833. PUB. 2-4-2003, FILED 12-28-2001.

PRINTPIX

CLASS 9—ELECTRICAL AND SCIENTIFIC APPARATUS

FOR SELF-OPERATED PRINTING MACHINES, NAMELY, DIGITAL PRINTERS (U.S. CLS. 21, 23, 26, 36 AND 38).
FIRST USE 12-0-2002; IN COMMERCE 12-0-2002.

CLASS 16—PAPER GOODS AND PRINTED MATTER

FOR THERMAL PRINTING PAPERS (U.S. CLS. 2, 5, 22, 23, 29, 37, 38 AND 50).
FIRST USE 12-0-2002; IN COMMERCE 12-0-2002.

bebedujour

THE MARK MEANS "BABY OF THE DAY" IN THE FRENCH LANGUAGE.

CLASS 8—HAND TOOLS

FOR SPOONS (U.S. CLS. 23, 28 AND 44).
FIRST USE 8-22-2003; IN COMMERCE 8-22-2003.

CLASS 14—JEWELRY

FOR BABY JEWELRY (U.S. CLS. 2, 27, 28 AND 50).
FIRST USE 8-22-2003; IN COMMERCE 8-22-2003.

CLASS 25—CLOTHING

FOR CLOTHING, NAMELY, BABY BIBS NOT OUT OF PAPER (U.S. CLS. 22 AND 39).
FIRST USE 8-22-2003; IN COMMERCE 8-22-2003.

2,858,425. FASHION 21, INC., LOS ANGELES, CA. SN 76-359,489. PUB. 7-30-2002, FILED 1-16-2002.



CLASS 3—COSMETICS AND CLEANING PREPARATIONS

FOR COSMETICS (U.S. CLS. 1, 4, 6, 50, 51 AND 52).
FIRST USE 8-3-2001; IN COMMERCE 8-3-2001.

CLASS 9—ELECTRICAL AND SCIENTIFIC APPARATUS

FOR EYEWEAR, NAMELY, SUNGLASSES (U.S. CLS. 21, 23, 26, 36 AND 38).
FIRST USE 8-3-2001; IN COMMERCE 8-3-2001.

CLASS 14—JEWELRY

FOR JEWELRY, NAMELY, BRACELETS, EARRINGS, NECKLACES, RINGS AND WATCHES (U.S. CLS. 2, 27, 28 AND 50).
FIRST USE 8-3-2001; IN COMMERCE 8-3-2001.

CLASS 18—LEATHER GOODS

FOR HANDBAGS (U.S. CLS. 1, 2, 3, 22 AND 41).
FIRST USE 8-3-2001; IN COMMERCE 8-3-2001.

CLASS 25—CLOTHING

FOR CLOTHING, NAMELY, PANTS, SHIRTS, JACKETS, SKIRTS, DRESSES, GOWNS, SCARFS, BELTS, ROBES, PAJAMAS, VESTS AND HATS; TUBE TOPS, TANK TOPS, CORSETS, BRAS, UNDERWEAR, SHOES, AND SHAWLS (U.S. CLS. 22 AND 39).

FIRST USE 8-3-2001; IN COMMERCE 8-3-2001.

CLASS 35—ADVERTISING AND BUSINESS

FOR RETAIL STORE SERVICES FEATURING COSMETICS; EYEWEAR, NAMELY, SUNGLASSES; JEWELRY, NAMELY, BRACELETS, EARRINGS, NECKLACES, RINGS AND WATCHES; ACCESSORIES, SHOES, HANDBAGS; AND CLOTHING, NAMELY, PANTS, SHIRTS, JACKETS, SKIRTS, DRESSES, GOWNS, SCARFS, BELTS, ROBES, PAJAMAS, VESTS AND HATS; TUBE TOPS, TANK TOPS, CORSETS, BRAS, UNDERWEAR AND SHAWLS (U.S. CLS. 100, 101 AND 102).

FIRST USE 8-3-2001; IN COMMERCE 8-3-2001.

2,858,427. TRANSACTIS, INC., GREAT FALLS, VA. SN 76-365,116. PUB. 4-1-2003, FILED 2-1-2002.

TRANSACTMAIL**CLASS 35—ADVERTISING AND BUSINESS**

FOR ELECTRONIC ORDER FULFILLMENT SERVICES VIA ELECTRONIC MAIL AND GLOBAL COMPUTER NETWORK; MARKETING SERVICES, NAMELY CONDUCTING TARGETED MARKETING CAMPAIGNS FOR OTHERS IN THE NATURE OF CONTACTING CURRENT AND FORMER CUSTOMERS VIA ELECTRONIC MAIL; BUSINESS CONSULTING SERVICES IN THE FIELD OF ELECTRONIC COMMERCE AND DIRECT MARKETING ADVERTISING; CONTENT DEVELOPMENT FOR ELECTRONIC COMMERCE AND DIRECT MARKETING ADVERTISING, NAMELY DESIGNING AND DEVELOPING ELECTRONIC MAIL ADVERTISING CAMPAIGNS (U.S. CLS. 100, 101 AND 102).

FIRST USE 9-12-2003; IN COMMERCE 9-12-2003.

CLASS 42—SCIENTIFIC, COMPUTER AND LEGAL SERVICES

FOR PROVIDING TEMPORARY USE OF NON-DOWNLOADABLE SOFTWARE FOR CONDUCTING TRANSACTIONS IN THE NATURE OF ELECTRONIC MAIL MESSAGES WHICH ALLOW CONSUMERS TO PLACE ORDERS FOR GOODS AND SERVICES DIRECTLY THROUGH THE ELECTRONIC MAIL (U.S. CLS. 100 AND 101).

FIRST USE 9-12-2003; IN COMMERCE 9-12-2003.

2,858,430. ALLIED VAN LINES INC., NAPERVILLE, IL. SN 76-367,543. PUB. 11-4-2003, FILED 2-6-2002.

SIRVA**CLASS 35—ADVERTISING AND BUSINESS**

FOR BUSINESS AND PERSONNEL RELOCATION SERVICES FOR OTHERS; TRANSPORTATION MANAGEMENT SERVICES FOR OTHERS IN THE FIELD OF TRANSPORTATION AND INVENTORY LOGISTIC SERVICES, NAMELY, COORDINATING THE HANDLING; TRANSPORT, WAREHOUSING, STORAGE, AND TRACKING OF GOODS, TRANSPORTATION AND INVENTORY LOGISTIC SERVICES FOR OTHERS, NAMELY, CONSULTATION SERVICES ABOUT THE TRACKING OF PACKAGE SHIPMENTS (U.S. CLS. 100, 101 AND 102).

FIRST USE 2-11-2002; IN COMMERCE 2-11-2002.

CLASS 36—INSURANCE AND FINANCIAL

FOR INSURANCE SALES AND SERVICES FOR OTHERS, NAMELY, INSURANCE BROKERAGE; REAL ESTATE BROKERAGE AND APPRAISAL FOR OTHERS; FINANCIAL LENDING PRODUCTS AND SERVICES FOR OTHERS, NAMELY COMMERCIAL LENDING AND MORTGAGE BROKERAGE SERVICES (U.S. CLS. 100, 101 AND 102).

FIRST USE 2-11-2002; IN COMMERCE 2-11-2002.

CLASS 39—TRANSPORTATION AND STORAGE

FOR TRANSPORTATION AND MOVING SERVICES FOR OTHERS, NAMELY, THE TRANSPORTATION OF HOUSEHOLD AND COMMERCIAL GOODS AND SPECIALIZED TRANSPORT OF FRAGILE GOODS BY TRUCK, VAN, RAIL, AIR, AND OCEAN CARRIER; PACKING AND PACKAGING OF GOODS FOR TRANSPORTATION FOR OTHERS; TRANSPORTATION OF EXHIBITS AND DISPLAYS BY TRUCK, VAN, RAIL, AIR, AND OCEAN CARRIER FOR OTHERS; DELIVERY OF COMMERCIAL FREIGHT BY TRUCK, VAN, RAIL, AIR AND OCEAN CARRIER FOR OTHERS; TRANSPORTATION AND INVENTORY LOGISTIC CONSULTATION SERVICES FOR OTHERS ABOUT THE PACKING, TRANSPORT, WAREHOUSING AND STORAGE OF GOODS; WAREHOUSING AND STORAGE OF GOODS; STORAGE OF EXHIBITS AND DISPLAYS FOR OTHERS; FREIGHT FORWARDING AND FREIGHT BROKERAGE SERVICES FOR OTHERS (U.S. CLS. 100 AND 105).

FIRST USE 2-11-2002; IN COMMERCE 2-11-2002.

2,858,432. TRANSPORTES CONTINUOS INTERIORES S.A., EL PAPIOL, SPAIN. SN 76-369,490. PUB. 6-25-2002, FILED 2-12-2002.

TRACOINSA**CLASS 37—CONSTRUCTION AND REPAIR**

FOR INSTALLATION, REPAIR AND MAINTENANCE OF INDUSTRIAL MACHINES AND MACHINE TOOLS; INSTALLATION, REPAIR AND MAINTENANCE OF MOTORS AND ENGINES; AND INSTALLATION, REPAIR AND MAINTENANCE OF MACHINE COUPLINGS AND DRIVE BELTS (U.S. CLS. 100, 103 AND 106).

FIRST USE 5-7-2003; IN COMMERCE 5-7-2003.

CLASS 42—SCIENTIFIC, COMPUTER AND LEGAL SERVICES

FOR ENGINEERING IN THE FIELD OF ASSEMBLY LINES AND OTHER INDUSTRIAL APPLICATIONS (U.S. CLS. 100 AND 101).

FIRST USE 5-7-2003; IN COMMERCE 5-7-2003.

CLASS 39—TRANSPORTATION AND STORAGE

FOR TRANSPORTATION, GATHERING, STORAGE, AND TERMINALLING OF CRUDE OIL, SALTWATER AND DRILLING FLUIDS FOR OTHERS (U.S. CLS. 100 AND 105).

FIRST USE 0-0-2003; IN COMMERCE 0-0-2003.

2,858,435. GIFFARINE SKYLINE UNITY CO., LTD., PHAYATHAI, BANGKOK, 10400, THAILAND. SN 76-371,218. PUB. 1-21-2003, FILED 2-14-2002.

CLASS 3—COSMETICS AND CLEANING PREPARATIONS

FOR SOAPS, PERFUMERY, ESSENTIAL OILS FOR PERSONAL USE, COSMETICS, HAIR LOTIONS, SHAMPOOS, AND CONDITIONERS; SKIN AND FACE LOTIONS, CREAMS AND MOISTURIZERS, SUNSCREENS, FACIAL CLEANSERS, LIP CREAMS, BODY LOTIONS AND CREAMS, MOUTHWASHES, HAND AND NAIL CREAMS, FACIAL MASKS, MASSAGE OILS, BATH OILS, TALCUM POWDER, SHOWER GELS, TOOTH-PASTE, KITS CONTAINING ALL OF THE ABOVE, DEODORANTS AND ANTIPERSPIRANTS, FABRIC SOFTENER, LAUNDRY DETERGENT, DISHWASHING SOAP, JEWELRY CLEANER (U.S. CLS. 1, 4, 6, 50, 51 AND 52).

FIRST USE 3-17-2003; IN COMMERCE 3-17-2003.

CLASS 5—PHARMACEUTICALS

FOR DIETARY AND HERBAL SUPPLEMENTS, VITAMINS, MINERALS, INSECTICIDES, DISINFECTANTS, MOSQUITO REPELLENTS (U.S. CLS. 6, 18, 44, 46, 51 AND 52).

FIRST USE 3-17-2003; IN COMMERCE 3-17-2003.

CLASS 30—STAPLE FOODS

FOR COFFEE, NON-DAIRY CREAMERS, COOKIES, PROCESSED CEREAL, SEASONING SPICES, NOODLES, FLOUR, CORN SNACKS, RICE, PASTA, TEA, HONEY (U.S. CL. 46).

FIRST USE 3-17-2003; IN COMMERCE 3-17-2003.

2,858,442. PLAINS ALL AMERICAN PIPELINE, L.P., HOUSTON, TX. SN 76-377,946. PUB. 12-3-2002, FILED 3-4-2002.

PLAINS ALL AMERICAN

CLASS 35—ADVERTISING AND BUSINESS

FOR WHOLESALE DISTRIBUTORSHIP SERVICES FEATURING GATHERING AND MARKETING OF CRUDE OIL, LIQUID PETROLEUM GAS, NATURAL GAS LIQUIDS AND NATURAL GAS CONDENSATES FOR OTHERS (U.S. CLS. 100, 101 AND 102).

FIRST USE 0-0-2003; IN COMMERCE 0-0-2003.

2,858,449. TRILEGIANT CORPORATION, NORWALK, CT. SN 76-386,462. PUB. 1-21-2003, FILED 3-22-2002.

CLEVERCLUBHOUSE.COM

CLASS 35—ADVERTISING AND BUSINESS

FOR CONSUMER MEMBERSHIP PROGRAM FOR CHILDREN ENTITLING THE PARTICIPANT TO RECEIVE DISCOUNTS ON CONSUMER MERCHANDISE AND TRAVEL; PROVIDING THE FOREGOING PROGRAM BY MEANS OF A ON-LINE WEBSITE (U.S. CLS. 100, 101 AND 102).

FIRST USE 2-0-2003; IN COMMERCE 2-0-2003.

CLASS 41—EDUCATION AND ENTERTAINMENT

FOR EDUCATIONAL AND ENTERTAINMENT SERVICES, NAMELY PROVIDING GAMES AND EDUCATIONAL ACTIVITIES FOR CHILDREN VIA AN ON-LINE WEBSITE; PROVIDING AN INTERACTIVE WEBSITE FOR CHILDREN AND PROVIDING LINKS TO WEBSITES OF OTHERS, ALL FEATURING CHILDREN'S GAMES AND EDUCATIONAL ACTIVITIES (U.S. CLS. 100, 101 AND 107).

FIRST USE 2-0-2003; IN COMMERCE 2-0-2003.

2,858,453. AEROCARE HOME MEDICAL, INC., HOUSTON, TX. SN 76-395,629. PUB. 6-10-2003, FILED 4-15-2002.

BREATHE A LITTLE EASIER

CLASS 35—ADVERTISING AND BUSINESS

FOR RETAIL PHARMACY SERVICES (U.S. CLS. 100, 101 AND 102).

FIRST USE 4-10-2001; IN COMMERCE 4-10-2001.

CLASS 44—MEDICAL, BEAUTY AND AGRICULTURAL SERVICES

FOR HEALTH CARE SERVICES, NURSING CARE, PHARMACEUTICAL ADVICE, AND RENTAL OF MEDICAL EQUIPMENT (U.S. CLS. 100 AND 101).

FIRST USE 4-10-2001; IN COMMERCE 4-10-2001.

2,858,456. CELLPATH PLC, MID WALES, UNITED KINGDOM. SN 76-398,350. PUB. 4-8-2003, FILED 4-22-2002.

CELLPATH

OWNER OF UNITED KINGDOM REG. NO. 1539604, DATED 10-28-1994, EXPIRES 6-23-2010.

OWNER OF U.S. REG. NO. 1,936,392.

CLASS 9—ELECTRICAL AND SCIENTIFIC APPARATUS

FOR PATHOLOGY RESEARCH LABORATORY SUPPLIES, NAMELY, MICROSCOPE SLIDE MAILERS MADE FROM PLASTIC, COMPUTER SOFTWARE FOR INTERACTIVE CYTOLOGY TRAINING, MOUNTING MEDIUM FOR SLIDES, HISTOLOGY KNIVES FOR CYTOLOGY USES, BIOPSY SPECIMEN HOLDERS, SLIDE TRAYS FOR IMMUNOSTAINING, MICROSCOPE SLIDE STORAGE BOXES ORGANIZERS AND TRAYS (U.S. CLS. 21, 23, 26, 36 AND 38).

FIRST USE 1-1-1990; IN COMMERCE 1-1-1990.

CLASS 10—MEDICAL APPARATUS

FOR APPARATUS AND INSTRUMENTS FOR USE IN THE TREATMENT OR DIAGNOSIS OF A CONDITION IN A HUMAN OR AN ANIMAL IN THE FIELDS OF PATHOLOGY, AUTOPSY, MEDICAL OR VETERINARY CYTOLOGY AND MEDICAL OR VETERINARY HISTOLOGY ALL FOR USE IN TRANSPORTING OR PROCESSING SAMPLES FROM THE HUMAN OR ANIMAL BODY AND ALL FOR USE IN TAKING SAMPLES FROM THE HUMAN OR ANIMAL BODY, NAMELY, CONTAINERS FOR MEDICAL WASTE, SUPPORTS FOR MEDICAL USE, KNIVES, SCISSORS, DISSECTION BOARDS, CUT-UP BOARDS, DISSECTION TABLES, CUT-UP TABLES, PLASTIC BAGS FOR TRANSMITTING MEDICAL SPECIMENS, MICROTOMES, MICROTOME BLADES, MICROTOME BLADE HOLDERS, MICROTOME KNIVES, MICROSCOPE SLIDES, CERVICAL SPATULAS, SAMPLING BRUSHES FOR CLEANING BODY CAVITIES, SPECULUMS, FORCEPS FOR MEDICAL USE, SCALPELS, SCALPEL BLADES (U.S. CLS. 26, 39 AND 44).

FIRST USE 1-1-1990; IN COMMERCE 1-1-1990.

2,858,465. LOCKMASTERS, INC., NICHOLASVILLE, KY. SN 76-404,160. PUB. 6-17-2003, FILED 5-7-2002.

LOCKONE**CLASS 6—METAL GOODS**

FOR METAL LOCKS; METAL LOCKING MECHANISMS FOR USE WITH OR ON CLASSIFIED OR SENSITIVE CONTAINERS, VAULT DOORS AND DOORS FOR SENSITIVE OR CLASSIFIED AREAS; COMBINATION LOCKS PRIMARILY MADE OF METAL (U.S. CLS. 2, 12, 13, 14, 23, 25 AND 50).

FIRST USE 7-12-2002; IN COMMERCE 7-12-2002.

CLASS 9—ELECTRICAL AND SCIENTIFIC APPARATUS

FOR ELECTROMECHANICAL LOCKING MECHANISMS (U.S. CLS. 21, 23, 26, 36 AND 38).

FIRST USE 7-12-2002; IN COMMERCE 7-12-2002.

2,858,468. GARY D. NELSON ASSOCIATES, INC., SONOMA, CA. SN 76-405,854. PUB. 1-14-2003, FILED 5-3-2002.

HRHOME**CLASS 35—ADVERTISING AND BUSINESS**

FOR PROVIDING INFORMATION VIA A WEBSITE ON THE INTERNET IN THE FIELD OF PERSONNEL RECRUITMENT AND PLACEMENT, CONTINGENCY WORK FORCE SOLUTIONS, HUMAN RESOURCE EXPERT ANSWERS, HUMAN RESOURCE NEWS AND TRENDS, HUMAN RESOURCE POLICIES AND COMPLIANCE, JOB DESCRIPTIONS, SALARY (U.S. CLS. 100, 101 AND 102).

FIRST USE 1-2-2003; IN COMMERCE 1-2-2003.

CLASS 36—INSURANCE AND FINANCIAL

FOR PROVIDING INFORMATION VIA A WEBSITE ON THE INTERNET IN THE FIELD OF ADMINISTRATION OF EMPLOYEE BENEFITS (U.S. CLS. 100, 101 AND 102).

FIRST USE 1-2-2003; IN COMMERCE 1-2-2003.

CLASS 45—PERSONAL SERVICES

FOR PROVIDING INFORMATION VIA A WEBSITE ON THE INTERNET IN THE FIELD OF PRE-EMPLOYMENT BACKGROUND SCREENING AND CHECKS (U.S. CLS. 100 AND 101).

FIRST USE 1-2-2003; IN COMMERCE 1-2-2003.

2,858,472. MIDWEST OF CANNON FALLS, INC., CANNON FALLS, MN. SN 76-408,658. PUB. 7-15-2003, FILED 5-9-2002.

SEASONS OF CANNON FALLS

OWNER OF U.S. REG. NOS. 1,954,072, 1,954,988, AND 1,954,990.

SEC. 2(F) AS TO "CANNON FALLS".

CLASS 15—MUSICAL INSTRUMENTS

FOR MUSIC BOXES (U.S. CLS. 2, 21 AND 36).

FIRST USE 12-1-2002; IN COMMERCE 12-1-2002.

CLASS 16—PAPER GOODS AND PRINTED MATTER

FOR PAPER AND PRINTED MATTER, NAMELY POST CARDS, PAPER BAGS, LUMINARIA BAGS, SHREDDED PAPER GRASS, PAPER CHINESE LANTERNS, AND PAPER MACHE FIGURINES (U.S. CLS. 2, 5, 22, 23, 29, 37, 38 AND 50).

FIRST USE 12-1-2002; IN COMMERCE 12-1-2002.

CLASS 20—FURNITURE AND ARTICLES NOT OTHERWISE CLASSIFIED

FOR FURNITURE, PICTURE FRAMES, PILLOWS, ORNAMENTS, INCLUDING HOLIDAY ORNAMENTS MADE OF RESINS FOR DECORATIVE PURPOSES, NATIVITIES, PYRAMIDS, FIGURES AND FIGURINES, INCLUDING SANTAS, MADE OF PLASTIC, RESINS AND WOOD (U.S. CLS. 2, 13, 22, 25, 32 AND 50).

FIRST USE 12-1-2002; IN COMMERCE 12-1-2002.

CLASS 21—HOUSEWARES AND GLASS

FOR FIGURES AND FIGURINES, INCLUDING SANTAS AND NATIVITIES, MADE OF EARTHENWARE, PORCELAIN, AND TERRA COTTA, TEAPOTS NOT OF PRECIOUS METAL, NATIVITIES, TEA SETS, EASTER BASKETS, PICNIC BASKETS AND FLOWER BASKETS MADE OF METAL, RATTAN AND COGAN GRASS, STOCKING HOLDERS, AND ORNAMENTS, INCLUDING HOLIDAY ORNAMENTS, MADE OF CHINA, CRYSTAL, GLASS, PORCELAIN AND TERRA COTTA FOR DECORATIVE PURPOSES (U.S. CLS. 2, 13, 23, 29, 30, 33, 40 AND 50).

FIRST USE 12-1-2002; IN COMMERCE 12-1-2002.

CLASS 24—FABRICS

FOR TEXTILES AND TEXTILE GOODS, NAMELY WALL HANGINGS, BANNERS, TABLE RUNNERS, AND TABLE COVERS (U.S. CLS. 42 AND 50).

FIRST USE 12-1-2002; IN COMMERCE 12-1-2002.

CLASS 26—FANCY GOODS

FOR ARTIFICIAL PAPER, FABRIC AND BEADED GARLAND, BRAIDS, ARTIFICIAL FLOWERS, STEMS, AND LEAF SPRAYS (U.S. CLS. 37, 39, 40, 42 AND 50).

FIRST USE 12-1-2002; IN COMMERCE 12-1-2002.

CLASS 28—TOYS AND SPORTING GOODS

FOR GAMES AND PLAYTHINGS, NAMELY, STUFFED ANIMALS, JUMP ROPES, MARIONETTES, CHRISTMAS GARLANDS, CHRISTMAS TREE ORNAMENTS, AND TREE SKIRTS (U.S. CLS. 22, 23, 38 AND 50).

FIRST USE 12-1-2002; IN COMMERCE 12-1-2002.

CLASS 35—ADVERTISING AND BUSINESS

FOR WHOLESALE DISTRIBUTORSHIP SERVICES AND WHOLESALE SHOWROOM STORES FEATURING DECORATIVE GIFT AND ART ITEMS, TABLETOP GIFT AND ART ITEMS, COLLECTIBLES, FIGURES AND FIGURINES, MUSIC BOXES, DECORATIONS; LOCAL AND INTERNATIONAL FOLK ART; CHRISTMAS TREE ORNAMENTS, LIGHTS AND ACCESSORIES; NUT-CRACKERS, NATIVITIES, GARLANDS; CHRISTMAS, EASTER, THANKSGIVING, HALLOWEEN AND OTHER HOLIDAY OR SEASONAL DECORATIONS; BASKETS, DECORATIVE CONTAINERS, STUFFED TOY ANIMALS, JEWELRY, TEA SETS AND DISHES, ADVENT CALENDARS, CHOCOLATE CANDY, AND TABLETOP AND DISPLAY ACCESSORIES FOR THE HOME (U.S. CLS. 100, 101 AND 102).

FIRST USE 12-1-2002; IN COMMERCE 12-1-2002.

2,858,475. MEDICA HEALTH PLANS, MINNETONKA, MN. SN 76-409,448. PUB. 6-24-2003, FILED 5-17-2002.

MEDICA

OWNER OF U.S. REG. NOS. 1,761,828, 2,392,584, AND OTHERS.

THE MARK CONSISTS OF THE WORD "MEDICA" WITH ALL THE LETTERS IN THE COLOR BLUE.

CLASS 35—ADVERTISING AND BUSINESS

FOR PHYSICIAN, DENTAL, HOSPITAL, CLINIC AND PHARMACY REFERRAL SERVICES PROVIDED VIA A GLOBAL COMPUTER NETWORK (U.S. CLS. 100, 101 AND 102).

FIRST USE 10-31-2003; IN COMMERCE 10-31-2003.

CLASS 36—INSURANCE AND FINANCIAL

FOR ADMINISTRATION OF PREPAID HEALTHCARE PLANS, HEALTHCARE PLAN INSURANCE ADMINISTRATION SERVICES, UNDERWRITING HEALTHCARE PLANS; UNDERWRITING INSURANCE FOR PREPAID HEALTHCARE; DENTAL HEALTH INSURANCE UNDERWRITING AND ADMINISTRATION (U.S. CLS. 100, 101 AND 102).

FIRST USE 3-27-2002; IN COMMERCE 3-27-2002.

CLASS 38—COMMUNICATION

FOR PROVIDING ON-LINE MESSAGING AMONG COMPUTER USERS CONCERNING HEALTH AND MEDICAL INFORMATION; TRANSMISSION OF SECURE ELECTRONIC MESSAGING BETWEEN DOCTORS, NURSES, MEDICAL STAFF AND PATIENTS; PROVIDING ON-LINE TRANSMISSION OF MEDICAL AND INSURANCE RECORDS (U.S. CLS. 100, 101 AND 104).

FIRST USE 4-28-2003; IN COMMERCE 4-28-2003.

CLASS 44—MEDICAL, BEAUTY AND AGRICULTURAL SERVICES

FOR HEALTHCARE IN THE NATURE OF HEALTH MAINTENANCE ORGANIZATIONS; MEDICAL CONSULTING SERVICES, MEDICAL INFORMATION SERVICES AND MEDICAL DIAGNOSIS AND TREATMENT RESOURCES SERVICES AVAILABLE VIA TELEPHONE; TELEPHONIC ASSESSMENT AND REFERRAL SERVICES FOR MENTAL HEALTH, SUBSTANCE ABUSE AND DAILY LIVING MEDICAL PROBLEMS; PROVIDING A WEB SITE ON A GLOBAL COMPUTER NETWORK FEATURING MEDICAL, DRUG AND HEALTH INFORMATION, NAMELY, DIAGNOSTIC ADVICE, SYMPTOMS, CONDITIONS, TREATMENT, PREVENTION, MEDICAL NEWS, TIPS AND ADVICE ON HEALTH TOPICS, HEALTH RISKS, FITNESS EXERCISES, NUTRITION AND IMMUNIZATION; PROVIDING DENTAL HEALTH CARE BY DENTISTS; DENTIST SERVICES; CHIROPRACTIC SERVICES (U.S. CLS. 100 AND 101).

FIRST USE 4-28-2003; IN COMMERCE 4-28-2003.

2,858,476. ART HOLDINGS, INC., ST. MICHAEL, BARBADOS. SN 76-409,693. PUB. 6-24-2003, FILED 5-17-2002.



NO CLAIM IS MADE TO THE EXCLUSIVE RIGHT TO USE "AUTOMOTIVE ART", APART FROM THE MARK AS SHOWN.

CLASS 2—PAINTS

FOR PAINTS FOR AUTOMOBILES, PAINT SEALERS AND COATINGS IN THE NATURE OF AUTOMOBILE FINISHING (U.S. CLS. 6, 11 AND 16).

FIRST USE 3-16-2004; IN COMMERCE 3-16-2004.

CLASS 35—ADVERTISING AND BUSINESS

FOR FRANCHISING, NAMELY, OFFERING TECHNICAL ASSISTANCE IN THE ESTABLISHMENT AND/OR OPERATION OF AUTOMOBILE ACCESSORY AND PARTS STORES (U.S. CLS. 100, 101 AND 102).
FIRST USE 3-16-2004; IN COMMERCE 3-16-2004.

2,858,477. WESTVACO PACKAGING GROUP, INC., NEW YORK, NY. SN 76-410,324. PUB. 11-12-2002, FILED 5-21-2002.

DIGISTAK**CLASS 16—PAPER GOODS AND PRINTED MATTER**

FOR PAPERBOARD PACKAGING FOR COMPACT DISCS AND OTHER ELECTRONIC MEDIA (U.S. CLS. 2, 5, 22, 23, 29, 37, 38 AND 50).
FIRST USE 12-15-2003; IN COMMERCE 12-15-2003.

CLASS 20—FURNITURE AND ARTICLES NOT OTHERWISE CLASSIFIED

FOR PLASTIC PACKAGING CONTAINERS FOR COMPACT DISCS AND OTHER ELECTRONIC MEDIA (U.S. CLS. 2, 13, 22, 25, 32 AND 50).
FIRST USE 12-15-2003; IN COMMERCE 12-15-2003.

2,858,478. WESTVACO PACKAGING GROUP, INC., NEW YORK, NY. SN 76-410,750. PUB. 11-12-2002, FILED 5-20-2002.

DVDIGISTAK**CLASS 16—PAPER GOODS AND PRINTED MATTER**

FOR PAPERBOARD PACKAGING FOR COMPACT DISCS AND OTHER ELECTRONIC MEDIA (U.S. CLS. 2, 5, 22, 23, 29, 37, 38 AND 50).
FIRST USE 12-15-2003; IN COMMERCE 12-15-2003.

CLASS 20—FURNITURE AND ARTICLES NOT OTHERWISE CLASSIFIED

FOR PLASTIC PACKAGING CONTAINERS FOR COMPACT DISCS AND OTHER ELECTRONIC MEDIA (U.S. CLS. 2, 13, 22, 25, 32 AND 50).
FIRST USE 12-15-2003; IN COMMERCE 12-15-2003.

2,858,485. IDEABOX, LLC, BRONXVILLE, NY. SN 76-413,995. PUB. 7-1-2003, FILED 5-24-2002.

IDEABOX**CLASS 37—CONSTRUCTION AND REPAIR**

FOR INSTALLATION, MAINTENANCE AND REPAIR OF COMPUTER HARDWARE (U.S. CLS. 100, 103 AND 106).
FIRST USE 11-18-2003; IN COMMERCE 11-18-2003.

CLASS 42—SCIENTIFIC, COMPUTER AND LEGAL SERVICES

FOR INSTALLATION, MAINTENANCE AND REPAIR OF COMPUTER SOFTWARE; COMPUTER CONSULTING SERVICES; AND INTEGRATION OF COMPUTER SYSTEMS AND NETWORKS (U.S. CLS. 100 AND 101).
FIRST USE 11-18-2003; IN COMMERCE 11-18-2003.

2,858,497. MIDWEST OF CANNON FALLS, INC., CANNON FALLS, MN. SN 76-419,705. PUB. 7-15-2003, FILED 6-12-2002.

s e a s o n s
o f c a n n o n f a l l s



OWNER OF U.S. REG. NOS. 1,954,072, 1,954,988, AND 1,954,990.
SEC. 2(F) AS TO "CANNON FALLS".

CLASS 15—MUSICAL INSTRUMENTS

FOR MUSIC BOXES (U.S. CLS. 2, 21 AND 36).
FIRST USE 12-1-2002; IN COMMERCE 12-1-2002.

CLASS 16—PAPER GOODS AND PRINTED MATTER

FOR PAPER AND PRINTED MATTER, NAMELY POST CARDS, PAPER BAGS, LUMINARIA BAGS, SHREDDED PAPER GRASS, PAPER CHINESE LANTERNS, AND PAPER MACHE FIGURINES (U.S. CLS. 2, 5, 22, 23, 29, 37, 38 AND 50).
FIRST USE 12-1-2002; IN COMMERCE 12-1-2002.

CLASS 20—FURNITURE AND ARTICLES NOT OTHERWISE CLASSIFIED

FOR FURNITURE, PICTURE FRAMES, PILLOWS, ORNAMENTS, INCLUDING HOLIDAY ORNAMENTS MADE OF RESINS FOR DECORATIVE PURPOSES; NATIVITIES, PYRAMIDS, FIGURES AND FIGURINES, INCLUDING SANTAS, MADE OF PLASTIC, RESINS AND WOOD (U.S. CLS. 2, 13, 22, 25, 32 AND 50).
FIRST USE 12-1-2002; IN COMMERCE 12-1-2002.

CLASS 21—HOUSEWARES AND GLASS

FOR FIGURES AND FIGURINES, INCLUDING SANTAS AND NATIVITIES, MADE OF EARTHENWARE, PORCELAIN, AND TERRA COTTA; TEAPOTS NOT OF PRECIOUS METAL; NATIVITIES, TEA SETS, EASTER BASKETS, PICNIC BASKETS AND FLOWER BASKETS MADE OF RATTAN AND COGAN GRASS, STOCKING HOLDERS, PYRAMIDS AND ORNAMENTS, INCLUDING HOLIDAY ORNAMENTS, MADE OF CHINA, CRYSTAL, GLASS, PORCELAIN AND TERRA COTTA FOR DECORATIVE PURPOSES (U.S. CLS. 2, 13, 23, 29, 30, 33, 40 AND 50).
FIRST USE 12-1-2002; IN COMMERCE 12-1-2002.

CLASS 24—FABRICS

FOR TEXTILES AND TEXTILE GOODS, NAMELY WALL HANGINGS, BANNERS, TABLE RUNNERS, AND TABLE COVERS (U.S. CLS. 42 AND 50).
FIRST USE 12-1-2002; IN COMMERCE 12-1-2002.

CLASS 26—FANCY GOODS

FOR ARTIFICIAL PAPER, FABRIC AND BEADED GARLAND, BRAIDS, ARTIFICIAL FLOWERS, STEMS, AND LEAF SPRAYS (U.S. CLS. 37, 39, 40, 42 AND 50).
FIRST USE 12-1-2002; IN COMMERCE 12-1-2002.

CLASS 28—TOYS AND SPORTING GOODS

FOR GAMES AND PLAYTHINGS, NAMELY, STUFFED ANIMALS, JUMP ROPES, MARIONETTES, NATIVITIES, CHRISTMAS GARLANDS, CHRISTMAS TREE ORNAMENTS, AND TREE SKIRTS (U.S. CLS. 22, 23, 38 AND 50).
FIRST USE 12-1-2002; IN COMMERCE 12-1-2002.

CLASS 35—ADVERTISING AND BUSINESS

FOR WHOLESALE DISTRIBUTORSHIP SERVICES AND WHOLESALE SHOWROOM STORES FEATURING DECORATIVE GIFT AND ART ITEMS, TABLETOP GIFT AND ART ITEMS, COLLECTIBLES, FIGURES AND FIGURINES, MUSIC BOXES, DECORATIONS; LOCAL AND INTERNATIONAL FOLK ART; CHRISTMAS TREE ORNAMENTS, LIGHTS AND ACCESSORIES; NUT-CRACKERS, NATIVITIES, GARLANDS; CHRISTMAS, EASTER, THANKSGIVING, HALLOWEEN AND OTHER HOLIDAY OR SEASONAL DECORATIONS; BASKETS, DECORATIVE CONTAINERS, STUFFED TOY ANIMALS, JEWELRY, TEA SETS AND DISHES, ADVENT CALENDARS, CHOCOLATE CANDY, AND TABLETOP AND DISPLAY ACCESSORIES FOR THE HOME (U.S. CLS. 100, 101 AND 102).
FIRST USE 12-1-2002; IN COMMERCE 12-1-2002.

2,858,505. SME ASSOCIATES, LLC, FENTON, MO. SN 76-423,710. PUB. 11-11-2003, FILED 6-20-2002.

SME ASSOCIATES

NO CLAIM IS MADE TO THE EXCLUSIVE RIGHT TO USE "ASSOCIATES", APART FROM THE MARK AS SHOWN.

CLASS 35—ADVERTISING AND BUSINESS

FOR LOGISTICS MANAGEMENT FOR OTHERS IN THE FIELD OF SPORTING AND ENTERTAINMENT EVENTS; MARKETING SERVICES, NAMELY, PROMOTING THE SPORTING AND ENTERTAINMENT EVENTS OF OTHERS; PROMOTING THE GOODS AND SERVICES OF OTHERS BY ARRANGING FOR SPONSORS TO AFFILIATE THEIR GOODS AND SERVICES WITH SPORTING AND OTHER ENTERTAINMENT EVENTS; ARRANGING AND CONDUCTING BUSINESS CONFERENCES (U.S. CLS. 100, 101 AND 102).
FIRST USE 7-0-2002; IN COMMERCE 7-0-2002.

CLASS 43—HOTEL AND RESTAURANT SERVICES

FOR CONSULTING SERVICES IN THE FIELD OF HOSPITALITY; TRAVEL AGENCY SERVICES, NAMELY, MAKING RESERVATIONS AND BOOKINGS FOR TEMPORARY LODGING; HOSPITALITY SERVICES, NAMELY, ARRANGING A HOSPITALITY AREA WITH FOOD AND BEVERAGES AT SPORTING AND OTHER ENTERTAINMENT EVENTS (U.S. CLS. 100 AND 101).
FIRST USE 7-0-2002; IN COMMERCE 7-0-2002.

2,858,509. ABS SMOOTHIES USA, LLC, MARSHALL, MI. SN 76-425,172. PUB. 6-24-2003, FILED 6-26-2002.

YA-MAKIN SMOOTHIES

NO CLAIM IS MADE TO THE EXCLUSIVE RIGHT TO USE "SMOOTHIES", APART FROM THE MARK AS SHOWN.

CLASS 29—MEATS AND PROCESSED FOODS

FOR FRUIT PUREE BASES FOR USE IN FRUIT TOPPINGS AND FRUIT SAUCES (U.S. CL. 46).
FIRST USE 5-18-2002; IN COMMERCE 5-18-2002.

CLASS 32—LIGHT BEVERAGES

FOR FRUIT PUREE BASES FOR USE IN SMOOTHIES (U.S. CLS. 45, 46 AND 48).
FIRST USE 5-18-2002; IN COMMERCE 5-18-2002.

2,858,515. SING, DAVID, FRANKLIN, TN. SN 76-427,636. PUB. 6-17-2003, FILED 7-5-2002.

SING**CLASS 15—MUSICAL INSTRUMENTS**

FOR METAL KNOBS AND PICK GUARDS FOR GUITARS (U.S. CLS. 2, 21 AND 36).
FIRST USE 2-27-2004; IN COMMERCE 2-27-2004.

CLASS 40—MATERIAL TREATMENT

FOR CUSTOM MANUFACTURE OF GUITARS; CUSTOM IMPRINTING OF GUITARS WITH DECORATIVE DESIGNS (U.S. CLS. 100, 103 AND 106).
FIRST USE 2-27-2004; IN COMMERCE 2-27-2004.

2,858,518. HONEYVILLE GRAIN, INC., RANCHO CUCAMONGA, CA. SN 76-428,346. PUB. 9-30-2003, FILED 7-5-2002.

LA SUPREMA

THE ENGLISH TRANSLATION OF "LA" IS "THE".

CLASS 1—CHEMICALS

FOR FOOD PRESERVATIVE COMPOSITIONS (U.S. CLS. 1, 5, 6, 10, 26 AND 46).
FIRST USE 6-7-2003; IN COMMERCE 1-12-2004.

CLASS 32—LIGHT BEVERAGES

FOR BEVERAGE MIXES, NAMELY, NON-ALCOHOLIC COCKTAIL MIXES (U.S. CLS. 45, 46 AND 48).
FIRST USE 6-7-2003; IN COMMERCE 1-12-2004.

2,858,526. TEVA PHARMACEUTICALS USA, INC., NORTH WALES, PA. SN 76-430,245. PUB. 12-2-2003, FILED 2-11-2002.

TEVA UNIVERSITY

NO CLAIM IS MADE TO THE EXCLUSIVE RIGHT TO USE "UNIVERSITY", APART FROM THE MARK AS SHOWN.

THE ENGLISH TRANSLATION OF THE HEBREW WORD "TEVA" IS "NATURE".

CLASS 35—ADVERTISING AND BUSINESS

FOR PROVIDING INFORMATION IN THE FIELDS OF SALES AND MARKETING, BUSINESS OPERATIONS AND BUSINESS STRATEGY VIA THE INTERNET (U.S. CLS. 100, 101 AND 102).

FIRST USE 4-0-2002; IN COMMERCE 4-0-2002.

CLASS 41—EDUCATION AND ENTERTAINMENT

FOR EDUCATIONAL SERVICES, NAMELY, CONDUCTING CLASSES, SEMINARS, CONFERENCES AND WORKSHOPS, AND CONDUCTING PROGRAMS, ALL IN THE FIELDS OF PHARMACOLOGY, PHARMACY, HEALTH CARE; SALES AND MARKETING; BUSINESS OPERATIONS AND BUSINESS STRATEGY; PROVIDING INFORMATION IN THE FIELDS OF PHARMACOLOGY, PHARMACY, HEALTH CARE VIA THE INTERNET; PROVIDING CONTINUING MEDICAL, NURSING AND PHARMACY EDUCATION COURSES (U.S. CLS. 100, 101 AND 107).

FIRST USE 4-0-2002; IN COMMERCE 4-0-2002.

2,858,529. MUNICIPAL ART SOCIETY, NEW YORK, NY. AND CREATIVE TIME, INC., NEW YORK, NY. SN 76-430,685. PUB. 8-5-2003, FILED 7-12-2002.

TRIBUTE IN LIGHT

CLASS 16—PAPER GOODS AND PRINTED MATTER

FOR PUBLICATIONS, NAMELY, BOOKS, PAMPHLETS, AND NEWSLETTERS IN THE FIELD OF ARCHITECTURE, CHARITABLE FUND RAISING, AND MATTERS RELATED TO THE VICTIMS OF THE TERRORIST ATTACKS OF SEPTEMBER 11, 2001; PHOTOGRAPHS, PRINTS, PAINTINGS, AND POSTERS (U.S. CLS. 2, 5, 22, 23, 29, 37, 38 AND 50).

FIRST USE 3-11-2002; IN COMMERCE 3-11-2002.

CLASS 36—INSURANCE AND FINANCIAL

FOR CHARITABLE FUND RAISING; PROVIDING INFORMATION REGARDING CHARITABLE FUND RAISING TO BENEFIT AND HONOR THE VICTIMS OF SEPTEMBER 11, 2001 VIA A GLOBAL COMPUTER NETWORK (U.S. CLS. 100, 101 AND 102).

FIRST USE 3-11-2002; IN COMMERCE 3-11-2002.

CLASS 41—EDUCATION AND ENTERTAINMENT

FOR HONORING THE MEMORY OF THE VICTIMS OF THE TERRORIST ATTACKS OF SEPTEMBER 11, 2001 BY MAINTAINING A MEMORIAL TO HONOR THOSE VICTIMS; ORGANIZING ACTIVITIES, NAMELY, CONDUCTING MEETING AND MEMORIAL GATHERINGS, ORGANIZING, SPONSORING, AND COMMISSIONING WORKS OF ART AND OTHER MEMORIALS TO BENEFIT BY PROVIDING RECOGNITION AND HONOR THE VICTIMS OF SEPTEMBER 11, 2001 VIA A GLOBAL COMPUTER NETWORK (U.S. CLS. 100, 101 AND 107).

FIRST USE 3-11-2002; IN COMMERCE 3-11-2002.

2,858,543. DILLARD'S INC., LITTLE ROCK, AR. SN 76-435,727. PUB. 3-18-2003, FILED 7-29-2002.

ANTONIO MELANI

OWNER OF U.S. REG. NO. 2,657,191.

THE NAME "ANTONIO MELANI" DOES NOT IDENTIFY A LIVING INDIVIDUAL.

CLASS 18—LEATHER GOODS

FOR HANDBAGS (U.S. CLS. 1, 2, 3, 22 AND 41).

FIRST USE 9-18-2003; IN COMMERCE 9-18-2003.

CLASS 25—CLOTHING

FOR WOMEN'S SPORTSWEAR, NAMELY SHIRTS, PANTS, BLOUSES, SWEATERS, SKIRTS, BLAZERS, JACKETS, DRESSES AND TOPS (U.S. CLS. 22 AND 39).

FIRST USE 9-18-2003; IN COMMERCE 9-18-2003.

2,858,546. PELLA CORPORATION, PELLA, IA. SN 76-436,452. PUB. 4-1-2003, FILED 7-31-2002.

IMPERVIA

CLASS 6—METAL GOODS

FOR METAL WINDOWS AND DOORS (U.S. CLS. 2, 12, 13, 14, 23, 25 AND 50).

FIRST USE 1-1-2003; IN COMMERCE 1-1-2003.

CLASS 19—NON-METALLIC BUILDING MATERIALS

FOR NON-METAL WINDOWS AND DOORS (U.S. CLS. 1, 12, 33 AND 50).

FIRST USE 1-1-2003; IN COMMERCE 1-1-2003.

CLASS 40—MATERIAL TREATMENT

FOR CUSTOM MANUFACTURE OF WINDOWS AND DOORS (U.S. CLS. 100, 103 AND 106).

FIRST USE 1-1-2003; IN COMMERCE 1-1-2003.

2,858,577. INSURANCE BENEFIT SPOT CHECK, INC., SACRAMENTO, CA. SN 76-453,358. PUB. 4-15-2003, FILED 9-27-2002.

MDSOS

CLASS 36—INSURANCE AND FINANCIAL

FOR INSURANCE BENEFIT VERIFICATION SERVICES (U.S. CLS. 100, 101 AND 102).
FIRST USE 2-1-2003; IN COMMERCE 5-20-2003.

CLASS 38—COMMUNICATION

FOR INTERNET-BASED ELECTRONIC STORE AND FORWARD MESSAGING SERVICES (U.S. CLS. 100, 101 AND 104).
FIRST USE 2-1-2003; IN COMMERCE 5-20-2003.

CLASS 39—TRANSPORTATION AND STORAGE

FOR ELECTRONIC STORAGE OF MESSAGES AND DATA (U.S. CLS. 100 AND 105).
FIRST USE 2-1-2003; IN COMMERCE 5-20-2003.

CLASS 42—SCIENTIFIC, COMPUTER AND LEGAL SERVICES

FOR APPLICATION SERVICE PROVIDER (ASP) FEATURING SOFTWARE IN THE FIELD OF ELECTRONIC MESSAGING AND INSURANCE BENEFIT VERIFICATION (U.S. CLS. 100 AND 101).
FIRST USE 2-1-2003; IN COMMERCE 5-20-2003.

CLASS 44—MEDICAL, BEAUTY AND AGRICULTURAL SERVICES

FOR MAINTAINING PERSONAL MEDICAL HISTORY RECORDS AND FILES (U.S. CLS. 100 AND 101).
FIRST USE 2-1-2003; IN COMMERCE 5-20-2003.

2,858,595. ANDROGEN EXCESS SOCIETY, LOS ANGELES, CA. SN 76-464,771. PUB. 11-4-2003, FILED 11-6-2002.



NO CLAIM IS MADE TO THE EXCLUSIVE RIGHT TO USE "ANDROGEN EXCESS SOCIETY" OR "2002", APART FROM THE MARK AS SHOWN.

THE STIPPLING IS FOR SHADING PURPOSES ONLY.

THE MARK CONSISTS OF A STEROID MOLECULAR MODEL AND THE INITIALS: "A E S" CONNECTED WITH ARROWS, EMBEDDED IN A CIRCLE. OUTSIDE SUCH CIRCLE ARE THE TERMS: "ANDROGEN EXCESS SOCIETY" AND "2002". OUTSIDE SUCH TERMS IS ANOTHER CIRCLE.

CLASS 16—PAPER GOODS AND PRINTED MATTER

FOR PUBLICATIONS, NAMELY JOURNALS, BROCHURES, PAMPHLETS, AND NEWSLETTERS, CONTAINING EDUCATIONAL INFORMATION PRIMARILY IN THE FIELD OF THE ETIOLOGY, DIAGNOSIS, TREATMENT, AND PREVENTION OF ANDROGEN EXCESS DISORDERS (U.S. CLS. 2, 5, 22, 23, 29, 37, 38 AND 50).
FIRST USE 6-15-2003; IN COMMERCE 6-15-2003.

CLASS 35—ADVERTISING AND BUSINESS

FOR PROMOTING PUBLIC AWARENESS WITH RESPECT TO ANDROGEN EXCESS DISORDERS (U.S. CLS. 100, 101 AND 102).
FIRST USE 4-13-2002; IN COMMERCE 4-13-2002.

CLASS 36—INSURANCE AND FINANCIAL

FOR CHARITABLE FUNDRAISING (U.S. CLS. 100, 101 AND 102).
FIRST USE 3-19-2003; IN COMMERCE 3-19-2003.

CLASS 41—EDUCATION AND ENTERTAINMENT

FOR DEVELOPMENT AND DISSEMINATION OF EDUCATIONAL MATERIALS OF OTHERS IN THE FIELD OF STUDIES RELATIVE TO THE ETIOLOGY, DIAGNOSIS, TREATMENT, AND PREVENTION OF ANDROGEN EXCESS DISORDERS, AND THE IMPORTANCE, PRIORITIES, AND NEED FOR FUNDING OF STUDIES WITH RESPECT THEREOF; EDUCATIONAL SERVICES, NAMELY, CONDUCTING SEMINARS AND SYMPOSIUMS IN THE FIELD OF ANDROGEN EXCESS DISORDERS; PROVIDING CONTINUING MEDICAL EDUCATION COURSES (U.S. CLS. 100, 101 AND 107).
FIRST USE 6-18-2003; IN COMMERCE 6-18-2003.

CLASS 42—SCIENTIFIC, COMPUTER AND LEGAL SERVICES

FOR MEDICAL AND SCIENTIFIC RESEARCH, NAMELY, CONDUCTING CLINICAL TRIALS; MEDICAL AND SCIENTIFIC RESEARCH IN THE FIELD OF ANDROGEN EXCESS DISORDERS; PROVIDING ON-LINE INFORMATION WITH RESPECT TO RESEARCH IN THE FIELD OF ANDROGEN EXCESS DISORDERS VIA A GLOBAL COMPUTER INFORMATION NETWORK; PROVIDING AN ON-LINE DATABASE, ACCESSIBLE TO USERS OF A GLOBAL COMPUTER NETWORK, FEATURING INFORMATION WITH RESPECT TO RESEARCH IN THE FIELD OF ANDROGEN EXCESS DISORDERS (U.S. CLS. 100 AND 101).
FIRST USE 10-20-2003; IN COMMERCE 10-20-2003.

CLASS 44—MEDICAL, BEAUTY AND AGRICULTURAL SERVICES

FOR PROVIDING MEDICAL INFORMATION, NAMELY, ON THE ETIOLOGY, DIAGNOSIS, TREATMENT, AND PREVENTION OF ANDROGEN EXCESS DISORDERS, AND THE IMPORTANCE, PRIORITIES, AND NEED FOR STUDIES WITH RESPECT THEREOF; PROVIDING AN ON-LINE WEB-SITE AND DATABASE FEATURING RECENT FINDINGS WITH RESPECT TO ANDROGEN EXCESS DISORDERS (U.S. CLS. 100 AND 101).
FIRST USE 4-13-2002; IN COMMERCE 4-13-2002.

2,858,598. USA PRODUCTS GROUP INC., LODI, CA. SN 76-465,563. PUB. 11-18-2003, FILED 11-8-2002.

PRO GRIP
CARGO CONTROL

NO CLAIM IS MADE TO THE EXCLUSIVE RIGHT TO USE "CARGO CONTROL", APART FROM THE MARK AS SHOWN.

CLASS 12—VEHICLES

FOR CARGO AND CARRIER EQUIPMENT FOR VEHICLES, NAMELY , CARGO ANCHORS (U.S. CLS. 19, 21, 23, 31, 35 AND 44).
FIRST USE 1-31-2003; IN COMMERCE 1-31-2003.

CLASS 22—CORDAGE AND FIBERS

FOR CARGO AND CARRIER EQUIPMENT FOR VEHICLES, NAMELY RATCHET TIE-DOWNS AND HOOKS, AUTO TOW ROPES AND AUTO TOW STRAPS (U.S. CLS. 1, 2, 7, 19, 22, 42 AND 50).
FIRST USE 1-31-2003; IN COMMERCE 1-31-2003.

2,858,634. PRYM-DRITZ CORPORATION, SPARTANBURG, SC. SN 76-477,868. PUB. 12-9-2003, FILED 12-24-2002.

Dritz

OWNER OF U.S. REG. NOS. 776,241, 789,679, AND OTHERS.

CLASS 3—COSMETICS AND CLEANING PREPARATIONS

FOR ANTI-FRAYING COMPOUND FOR USE IN TAILORING CLOTHING (U.S. CLS. 1, 4, 6, 50, 51 AND 52).
FIRST USE 5-31-2003; IN COMMERCE 5-31-2003.

CLASS 8—HAND TOOLS

FOR HAND TOOLS FOR USE IN TAILORING CLOTHING, NAMELY, AWLS, DRESSMAKER'S HAND OPERATED SHEARS, TAILOR TACKERS, HAND TOOL FOR RIPPING SEAMS IN CLOTHING, FOLDING SCISSORS (U.S. CLS. 23, 28 AND 44).
FIRST USE 5-31-2003; IN COMMERCE 5-31-2003.

CLASS 9—ELECTRICAL AND SCIENTIFIC APPARATUS

FOR TAPE MEASURES; YARD STICKS; DRESSMAKERS' GRADUATED RULERS; SEWING AND CRAFT GRADUATED RULERS; TRANSPARENT GRADUATED RULERS; MEASURING GUIDES IN THE NATURE OF BEVELS; BUTTON GAUGES; HEM MARKERS; SEWING GAUGES (U.S. CLS. 21, 23, 26, 36 AND 38).
FIRST USE 5-31-2003; IN COMMERCE 5-31-2003.

CLASS 16—PAPER GOODS AND PRINTED MATTER

FOR MAGNETIC PIN HOLDERS IN THE NATURE OF PAPER CLIP HOLDERS; PATTERN FILE BOXES; SKIRT MARKERS; TRACING PAPERS FOR TRANSFERRING PATTERN MARKINGS USING HEAT OR PRESSURE; TRANSFER PAPER; TAILORS' CHALK; TAILORS' CHALK AND HOLDERS; TAILORS' CHALK PENCILS; SEWING CRAFT GLUE STICKS FOR HOUSEHOLD USE; SEWING CRAFT LIQUID GLUE FOR HOUSEHOLD USE; CRAFT SPRAY ADHESIVE FOR HOUSEHOLD USE; TACK REMOVER IN THE NATURE OF A STAPLE REMOVER; MARKING PENS; HEM MARKERS; DISAPPEARING INK PENS; IRON-ON TRANSFER PENCILS; TAILORS' CHALK WHEELS (U.S. CLS. 2, 5, 22, 23, 29, 37, 38 AND 50).
FIRST USE 5-31-2003; IN COMMERCE 5-31-2003.

CLASS 21—HOUSEWARES AND GLASS

FOR TWIST, DRESSMAKER, POINT, PLEATING, SILK, QUILTING, BUTTON, DIAPER, AND GLASS HEAD PINS IN THE NATURE OF CLOTHES PINS; PLASTIC RINGS IN THE NATURE OF TOWEL RINGS; SLEEVE BOARDS IN THE NATURE OF IRONING BOARDS AND SHAPED SLEEVE BOARD COVERS (U.S. CLS. 2, 13, 23, 29, 30, 33, 40 AND 50).
FIRST USE 5-31-2003; IN COMMERCE 5-31-2003.

CLASS 23—YARNS AND THREADS

FOR THREAD (U.S. CL. 43).
FIRST USE 5-31-2003; IN COMMERCE 5-31-2003.

CLASS 25—CLOTHING

FOR SHOULDER PADS FOR CLOTHING; DRESS SHIELDS; BRA CUPS; GARTERS; KNITTED CUFFS; KNITTED COLLARS; WAIST BANDS FOR CLOTHING; POCKET SQUARES, NAMELY IRON-ON AND SEW-ON POCKET SQUARES (U.S. CLS. 22 AND 39).
FIRST USE 5-31-2003; IN COMMERCE 5-31-2003.

CLASS 26—FANCY GOODS

FOR TRACING WHEELS, CLOTHING BUCKLES; CLOTHING BUTTONS; BUTTON COVERS NOT OF PRECIOUS METAL; GROMMETS IN THE NATURE OF EYELETS; SNAP FASTENERS; EYELETS; HOOKS AND EYES; SEWING BOXES; THIMBLES; SAFETY PINS; QUILTING SAFETY PINS; CURVED SAFETY PINS; PIN CUSHIONS; NEEDLES; HAND NEEDLES; SELF-THREADING HAND NEEDLES; QUILTING NEEDLES; NEEDLES FOR BEADING; NEEDLES FOR CREWEL; NEEDLES FOR DARNING; NEEDLES FOR EMBROIDERY; NEEDLES FOR TAPESTRY; NEEDLES FOR CHENILLE; DOLL NEEDLES; COMPACT NEEDLES; RIBBON EMBROIDERY NEEDLES; SEWING MACHINE NEEDLES; MACHINE NEEDLES FOR DENIM; PLASTIC CHILDREN'S NEEDLES, NEEDLE CUSHIONS; NEEDLE THREADERS; LOOP TURNERS; BRAIDS; HORSEHAIR BRAIDS; COLLAR STAYS; THIMBLES OF METAL, PLASTIC, AND LEATHER; ZIPPER GUIDES; IRON-ON PATCHES FOR CLOTHING; NYLON, DENIM, COTTON, AND TWILL ORNAMENTAL PATCHES (U.S. CLS. 37, 39, 40, 42 AND 50).
FIRST USE 5-31-2003; IN COMMERCE 5-31-2003.

2,858,653. PIONEER MANUFACTURING CO., CLEVELAND, OH. SN 76-490,965. PUB. 7-22-2003, FILED 2-12-2003.

THE STRIPING PEOPLE

OWNER OF U.S. REG. NOS. 2,603,457 AND 2,603,458.
NO CLAIM IS MADE TO THE EXCLUSIVE RIGHT TO USE "STRIPING", APART FROM THE MARK AS SHOWN.

CLASS 2—PAINTS

FOR PAINTS USED FOR MARKING LINES ON ATHLETIC FIELDS, ROADS, PARKING LOTS, DRIVEWAYS, AND WALKWAYS (U.S. CLS. 6, 11 AND 16).
FIRST USE 4-28-2003; IN COMMERCE 9-8-2003.

CLASS 7—MACHINERY

FOR STRIPING MACHINES FOR MARKING LINES ON ATHLETIC FIELDS, ROADS, PARKING LOTS, DRIVEWAYS, AND WALKWAYS (U.S. CLS. 13, 19, 21, 23, 31, 34 AND 35).
FIRST USE 8-31-2003; IN COMMERCE 8-31-2003.

CLASS 42—SCIENTIFIC, COMPUTER AND LEGAL SERVICES

FOR TRAVEL AGENCY SERVICES, NAMELY, MAKING RESERVATIONS AND BOOKING FOR TEMPORARY LODGING (U.S. CLS. 100 AND 101).
FIRST USE 6-4-2001; IN COMMERCE 6-4-2001.

2,858,677. WORLD'S FARE, LLC, CARLSBAD, CA. SN 76-508,976. PUB. 12-30-2003, FILED 4-24-2003.

BRINGING HOME THE FLAVORS OF THE WORLD

CLASS 29—MEATS AND PROCESSED FOODS

FOR FROZEN ENTREES CONSISTING PRIMARILY OF POULTRY OR VEGETABLES (U.S. CL. 46).
FIRST USE 8-0-2003; IN COMMERCE 8-0-2003.

CLASS 30—STAPLE FOODS

FOR FROZEN ENTREES CONSISTING PRIMARILY OF PASTA OR RICE (U.S. CL. 46).
FIRST USE 8-0-2003; IN COMMERCE 8-0-2003.

2,858,685. ORBITZ, LLC, CHICAGO, IL. SN 76-975,902. PUB. 4-30-2002, FILED 4-18-2000.

ORBITZ

CLASS 38—COMMUNICATION

FOR PROVIDING ON-LINE CHAT ROOMS AND ON-LINE BULLETIN BOARDS FOR TRANSMISSION OF MESSAGES AMONG COMPUTER USERS CONCERNING TRAVEL; PROVIDING ACCESS TO AN INTERACTIVE COMPUTER DATABASE IN THE FIELD OF TRAVEL INFORMATION, TRANSPORTATION BY AIR, TRAIN, BUS OR BOAT, MUSICAL EVENTS, THEATRICAL EVENTS, LIVE DRAMATIC EVENTS, FILMS, SPORTING EVENTS, DINING, ART EXHIBITIONS, GROUND TRAFFIC, PARKING, SHOPPING AND DESTINATION INFORMATION (U.S. CLS. 100, 101 AND 104).
FIRST USE 6-4-2001; IN COMMERCE 6-4-2001.

CLASS 39—TRANSPORTATION AND STORAGE

FOR TRAVEL AGENCY SERVICES, NAMELY, MAKING RESERVATIONS AND BOOKINGS FOR TRANSPORTATION; PROVIDING INFORMATION CONCERNING TRAVEL, TRAVEL NEWS AND TRAVEL-RELATED TOPICS VIA ELECTRONIC COMMUNICATIONS NETWORKS (U.S. CLS. 100 AND 105).
FIRST USE 6-4-2001; IN COMMERCE 6-4-2001.

2,858,687. PHILD CO., LTD., KAMIGYO-KU, KYOTO CITY 602-0023, JAPAN. SN 76-976,516. PUB. 2-11-2003, FILED 5-17-2001.

RAKU

THE ENGLISH TRANSLATION OF THE JAPANESE WORD "RAKU" IS "COMFORT" OR "EASE".

CLASS 24—FABRICS

FOR PILLOW SHAMS (U.S. CLS. 42 AND 50).
FIRST USE 5-17-2001; IN COMMERCE 5-17-2001.

CLASS 25—CLOTHING

FOR ANKLETS, BELTS, SHIRTS, SWEATSHIRTS, SWEATPANTS, UNDER SHIRTS, SINGLETs, T-SHIRTS, TANKTOPS, UNDERCLOTHES, UNDERGARMENTS, UNDERPANTS, UNDERSHIRTS AND UNDERWEAR (U.S. CLS. 22 AND 39).
FIRST USE 5-17-2001; IN COMMERCE 5-17-2001.

2,858,688. PENNSYLVANIA ROUTE 6 TOURIST ASSOCIATION, GALETON, PA. SN 76-976,564. PUB. 6-10-2003, FILED 1-16-2002.

DO 6

NO CLAIM IS MADE TO THE EXCLUSIVE RIGHT TO USE "6", APART FROM THE MARK AS SHOWN.

CLASS 14—JEWELRY

FOR CIGARETTE LIGHTERS OF PRECIOUS METAL; FLASHLIGHTS OF PRECIOUS METAL (U.S. CLS. 2, 27, 28 AND 50).
FIRST USE 5-20-2001; IN COMMERCE 5-20-2001.

CLASS 16—PAPER GOODS AND PRINTED MATTER

FOR PRINTED TRAVEL GUIDEBOOKS; PROMOTIONAL VISITORS' GUIDE BOOKS FEATURING INFORMATION ON LOCAL RESTAURANTS, RETAIL ESTABLISHMENTS, ZOOS, PARKS, HOSPITALS, AND INFORMATION CENTERS (U.S. CLS. 2, 5, 22, 23, 29, 37, 38 AND 50).
FIRST USE 10-1-2001; IN COMMERCE 10-1-2001.

CLASS 25—CLOTHING

FOR SHIRTS AND T-SHIRTS (U.S. CLS. 22 AND 39).
FIRST USE 11-15-1997; IN COMMERCE 11-15-1997.

CLASS 39—TRANSPORTATION AND STORAGE

FOR TRAVEL INFORMATION SERVICES (U.S. CLS. 100 AND 105).
FIRST USE 5-1-2001; IN COMMERCE 4-1-2003.

2,858,689. INTERDESIGN, INC., SOLON, OH. SN 76-976,567.
 PUB. 9-30-2003, FILED 6-20-2002.

IDESIGN

CLASS 6—METAL GOODS

FOR METAL GOODS, NAMELY, METAL CLOTHING HOOKS, ADHESIVE-MOUNTED METAL HOOKS, SCREW-MOUNTED METAL HOOKS, SUCTION-MOUNTED METAL HOOKS, METAL HOOKS, METAL BOTTLES SOLD EMPTY; METAL BOTTLES FOR LOTIONS, SHAMPOOS, LIQUID SOAP, HAIR SPRAY, COLOGNE, LIQUID FRAGRANCES, LIQUID COSMETICS, LIQUID ANTISEPTICS, LIQUID SKIN MEDICINE, OINTMENTS; METAL BOTTLE CAPS, METAL BATHROOM BASKETS OF COMMON METALS, NON-PRECIOUS METAL SCULPTURES, MAGNETIC METAL HOOKS, METAL RACKS FOR CLOTHING, HATS, APRONS, COATS, JACKETS, SCARVES, BROOMS, MOPS, DUSTPANS, UMBRELLAS, BAGS, LADDERS, AND RAKES; METAL OVER THE DOOR RACKS, METAL OR PRIMARILY METAL OVER THE DOOR HOOKS, METAL OR PRIMARILY METAL OVER PANEL HOOKS AND DOUBLE HOOKS, METAL PANEL PIN ON HOOK, METAL PANEL PIN ON CLIPS, METAL KNOBS, METAL HOUSE NUMBERS, METAL MAGNETIC SQUEEZE CLIP CLOSURES, METAL TRIVETS, MAGNETIC HOLDERS FOR METAL SQUEEZE CLIP CLOSURES AND METAL HOOKS, METAL CARD HOLDERS FOR HOUSEHOLD USE, NAMELY, PLACE CARDS, NAME PLATES (U.S. CLS. 2, 12, 13, 14, 23, 25 AND 50).
 FIRST USE 2-4-2004; IN COMMERCE 2-4-2004.

CLASS 20—FURNITURE AND ARTICLES NOT OTHERWISE CLASSIFIED

FOR MAGNETIC PHOTO FRAMES, METAL PICTURE HOLDERS, METAL CORNER SHELVES, NAMELY, METAL LEDGE TRAYS, NON-METAL HOUSEWARES, NAMELY, NON-METAL CLOTHING HOOKS, NON-METAL ADHESIVE MOUNTED HOOKS, NON-METAL SCREW-MOUNTED HOOKS, NON-METAL SUCTION-MOUNTED HOOKS, NON-METAL OVER THE DOOR HOOKS, NON-METAL BOTTLE CAPS, NON-METAL BOTTLE CLOSURES, NON-METAL MAGNETIC SQUEEZE CLIP CLOSURES, PLASTIC BOXES, NON-METAL CLOSURES FOR BOTTLES AND CONTAINERS FOR PERSONAL HYGIENIC AND COSMETIC ARTICLES, PLASTIC CONTAINER CLOSURES, PICTURE FRAMES, FURNITURE MIRRORS, FOG FREE MIRRORS, NON-METAL PEGS, STORAGE RACKS, WOOD AND CERAMIC RACKS FOR CLOTHING, COATS, HATS, JACKETS, AND SCARVES, STORAGE RACKS FOR GLASSES, WOOD RACKS, GLASS RACKS, PLASTIC LUGGAGE TAGS, NON-METAL KNOBS, NON-METAL BOXES, PLASTIC BOX CONTAINING A MAGNET FOR STORAGE OF COUPONS, MAGNETIC PHOTO FRAMES, DRAWER ORGANIZER TRAYS, DRAWER ORGANIZER DIVIDERS; NON-METAL SELF-ADHESIVE HOOKS, CHROME FINIAL HOOKS, CERAMIC FINIAL HOOKS, NON-METAL HOOKS, SINGLE HOOKS OF CHROME AND GLASS, SINGLE HOOKS OF CHROME AND CERAMIC, NON-METAL DOUBLE HOOKS, DOUBLE HOOKS OF CHROME AND GLASS, DOUBLE HOOKS OF CHROME AND CERAMIC, WALL-MOUNTED SINGLE HOOKS, RACKS, SINGLE HOOK RACKS OF CHROME AND GLASS, DOUBLE RACKS, DOUBLE RACKS OF CHROME AND GLASS, WALL-MOUNTED RACKS, WALLMOUNTED RACKS OF CHROME AND GLASS, SCREW-MOUNTED CHROME HOOKS, SELF-ADHESIVE HOOKS, SELF-ADHESIVE TRIPLE HOOKS, MAGNETIC HOOKS, CHROME KNOBS, CHROME DRAWER PULLS (U.S. CLS. 2, 13, 22, 25, 32 AND 50).
 FIRST USE 2-4-2004; IN COMMERCE 2-4-2004.

CLASS 21—HOUSEWARES AND GLASS

FOR HOUSEHOLD ACCESSORIES, NAMELY, METAL RACKS FOR DRYING DISHES, SQUEEGEES, SINK GRID/MATS, SPONGE TRAYS, FLATWARE HOLDERS, SHOWER CADDIES, METAL RAZOR HOLDERS, METAL TOOTHBRUSH HOLDERS, METAL TOILET TISSUE ROLL STANDS, METAL TOILET BRUSHES, METAL SOAP DISHES, METAL WASTEBASKETS, MAGNETIC BROOM HOLDERS, METAL TOWEL RINGS, METAL TOWEL BARS, METAL PAPER TOWEL HOLDERS, MAGNETIC CUPS, METAL CUPS, HAND PUMPED FLAVOR SPRAYERS FOR FOOD, PERFUME ATOMIZERS SOLD EMPTY, BOTTLES SOLD EMPTY, HOUSEWARES, NAMELY, BASKETS MADE OF PLASTIC, WASTE PAPER BASKETS, PLASTIC BATH RACKS, PLASTIC DRYING RACKS, BEVERAGEWARE, PLASTIC COASTERS, COASTERS NOT OF PAPER OR TABLE LINEN, BOWLS, SOAP BOXES, BOXES FOR DISPENSING PAPER TOWELS, CANDLE HOLDERS NOT OF PRECIOUS METAL, ALL PURPOSE PORTABLE CONTAINERS, SOAP CONTAINERS, CONTAINERS FOR FOOD OR BEVERAGE, CONTAINERS FOR HOUSEHOLD OR KITCHEN USE, CONTAINERS IN THE NATURE OF MAGNETIC CUPS AND HOLDERS FOR HOUSEHOLD OR KITCHEN USE, TUMBLERS, CUPS, PLASTIC CUPS, DRINKING VESSELS, GARBAGE CANS, TOTES AND LINERS; BATH ACCESSORIES, NAMELY, SOAP HOLDERS, SPONGE HOLDERS, TOOTHBRUSH CENTERS, RAZOR HOLDERS, SHOWER CADDIES, TOILET TISSUE HOLDERS; HOUSEHOLD UTENSILS, NAMELY DRAINERS, DRAIN BOARD MATS, SINK MATS, SINK SADDLES, SCRUBBER AND SPONGE HOLDERS, COMPOST CONTAINER FOR SINKS, SINK TRAYS, MUG RACKS, RECIPE BOXES, ARCH CLIPS, BROOM HOLDERS, MUGS, PAILS, SALAD BOWLS, SQUEEGEES, CORNER SHELVES FOR SINKS, SOAP CRADLES, SPONGE CRADLES, SCRUB PAD HOLDERS, COMPOST CONTAINERS FOR COUNTERTOPS, SINK PROTECTION MATS, DRAINBOARD MATS, DISH DRAINERS, SINK TRAYS, HANGING BASKETS FOR STRADDLING A DOUBLE SINK, BASKETS SECURABLE TO SINKS FOR DRAINING SCRUBBERS AND TOWEL BARS, SOAP DISHES, TOOTHBRUSH STANDS, TOOTHBRUSH HOLDERS, CANISTER SETS, CANS, NAMELY, WASTEPAPER BASKETS; TOILET TISSUE ROLL RESERVE HOLDERS, TOWEL HOLDERS, TISSUE STANDS, NON-METAL PAPER TOWEL HOLDERS, NON-METAL PAPER TOWEL HOLDER STANDS, TOILET BRUSHES, SELF-ADHESIVE RAZOR HOLDERS, SELF-ADHESIVE TOOTHBRUSH HOLDERS, SELF-ADHESIVE DOUBLE TOOTHBRUSH HOLDERS, CHROME TOILET TISSUE HOLDERS, CERAMIC TOILET TISSUE HOLDERS, CHROME FINIAL TOWEL RINGS, CERAMIC FINIAL TOWEL RINGS, CHROME FINIAL TOWEL BARS, CERAMIC FINIAL TOWEL BARS, BATH ACCESSORIES, NAMELY, VALETS, VALETS OF CHROME AND GLASS; COOKBOOK HOLDERS, NAPKIN HOLDERS, SPOON RESTS, SPOON STANDS, SOAP SAVERS, SINK PUMPS FOR DISPENSING SOAP, DISPENSERS FOR LIQUID SOAP (U.S. CLS. 2, 13, 23, 29, 30, 33, 40 AND 50).
 FIRST USE 2-4-2004; IN COMMERCE 2-4-2004.

2,858,694. MICHIELSENS, LOUISE, LONDON, SW8 4AJ, UNITED KINGDOM. AND MAZZILLI, TIZIANO, LONDON, SW8 4AJ, UNITED KINGDOM. TA VOYAGE, SN 76-976,644. PUB. 6-25-2002, FILED 4-17-2000.

VOYAGE

OWNER OF UNITED KINGDOM REG. NO. 2183982,
 DATED 12-24-1999, EXPIRES 12-9-2008.

CLASS 18—LEATHER GOODS

FOR ARTICLES OF LEATHER AND IMITATION LEATHER, NAMELY, LUGGAGE, TRAVELING BAGS, SPORTS BAGS, HANDBAGS, SHOPPING BAGS, SHOULDER BAGS, SATCHELS, PURSES, KEY FOBs, KEY CASES; UMBRELLAS AND PARASOLS (U.S. CLS. 1, 2, 3, 22 AND 41).
 FIRST USE 0-0-1987; IN COMMERCE 0-0-1991.

CLASS 25—CLOTHING

FOR (BASED ON 44(E)) CLOTHING, NAMELY, DRESSES, CARDIGANS, SWEATERS, SKIRTS, BLOUSES, TOPS, COATS, JACKETS, TROUSERS, SHORTS, PANTS, SUITS, SHIRTS, TEE-SHIRTS, WAIST-COATS, NECKTIES, CRAVATS, SCARVES, GLOVES, BELTS, LEATHER GLOVES AND LEATHER BELTS; HEADGEAR, NAMELY, HATS, VISORS, AND CAPS (U.S. CLS. 22 AND 39).

FIRST USE 0-0-1987; IN COMMERCE 0-0-1991.

2,858,713. PROFESSIONAL SKIN CARE, INC., VALENCIA, CA. SN 78-040,466. PUB. 8-21-2001, FILED 12-22-2000.

ONLY YOURX**CLASS 3—COSMETICS AND CLEANING PREPARATIONS**

FOR PERFUME, COLOGNE, ESSENTIAL OILS FOR PERSONAL USE, MASSAGE OILS AND LOTIONS AND CREAMS, SHAVING BALM, AFTER SHAVE LOTION, FOUNDATION MAKEUP, FACE POWDER, CONCEALER CREAM FOR THE FACE, SKIN AND BODY, EYELINER, EYE SHADOW, MASCARA, BLUSHER, CUTICLE CREAM, FACIAL, SKIN AND BODY BRONZING CREAMS AND GELS AND LOTIONS, FACE AND SKIN MOISTURIZERS AND CONDITIONERS, SUNSCREENS, SUNTANNING LOTIONS AND CREAMS AND GELS, MAKEUP REMOVER, SKIN AND FACIAL CLEANSERS AND TONERS, FACE AND SKIN SOAP, FACIAL, BODY AND SKIN CREAMS AND LOTIONS TO SMOOTH WRINKLES AND REDUCE THE APPEARANCE OF FINE LINES AND WRINKLES, HAND CREAM, PH BALANCING CREAMS AND LOTIONS FOR THE FACE, SKIN AND BODY, BATH OIL, SKIN FIRING CREAMS AND LOTIONS, SKIN EXFOLIATING CREAMS AND LOTIONS AND GELS, FACE AND BODY MASKS, HAIR AND BODY SHAMPOO, HAIR CONDITIONERS, HAIR CARE MOISTURIZING PREPARATIONS, NONMEDICATED, TOPICALLY APPLIED PREPARATIONS TO PROTECT THE SKIN FROM THE EFFECTS OF WIND, SUN AND ENVIRONMENTAL POLLUTION, ANTIPERSPIRANTS AND DEODORANTS (U.S. CLS. 1, 4, 6, 50, 51 AND 52).

FIRST USE 11-0-2001; IN COMMERCE 11-0-2001.

CLASS 35—ADVERTISING AND BUSINESS

FOR MAIL ORDER, RETAIL SERVICES VIA THE INTERNET AND RETAIL STORE SERVICES FEATURING COSMETICS, SKIN AND HAIR AND BODY AND NAIL CARE PREPARATIONS, FRAGRANCES AND PERSONAL CARE PRODUCTS (U.S. CLS. 100, 101 AND 102).

FIRST USE 11-0-2001; IN COMMERCE 11-0-2001.

CLASS 42—SCIENTIFIC, COMPUTER AND LEGAL SERVICES

FOR PROVIDING INFORMATION ABOUT THE BEAUTY INDUSTRY AND SELECTION AND USE OF PERSONAL CARE PRODUCTS VIA THE INTERNET AND WEBSITE; CONSULTATION SERVICES IN THE FIELDS OF SELECTION AND USE OF COSMETICS, PERSONAL CARE PRODUCTS, FRAGRANCES AND BEAUTY TREATMENTS (U.S. CLS. 100 AND 101).

FIRST USE 11-0-2001; IN COMMERCE 11-0-2001.

2,858,709. MARYE W JIANG, NEW YORK, NY. SN 78-031,638. PUB. 9-17-2002, FILED 10-20-2000.

AMERICAN HOMELIFE

NO CLAIM IS MADE TO THE EXCLUSIVE RIGHT TO USE "AMERICAN", APART FROM THE MARK AS SHOWN.

CLASS 41—EDUCATION AND ENTERTAINMENT

FOR PROVIDING ONLINE BOOKS IN THE FIELD OF AMERICAN HERITAGE AND DEMOCRACY; EDUCATIONAL SERVICES, NAMELY, VOLUNTEERS CONDUCTING SEMINARS PROMOTING BUSINESS OPPORTUNITIES IN THE FIELD OF AMERICAN HERITAGE AND DEMOCRACY (U.S. CLS. 100, 101 AND 107).

FIRST USE 11-30-2003; IN COMMERCE 11-30-2003.

CLASS 42—SCIENTIFIC, COMPUTER AND LEGAL SERVICES

FOR PROVIDING A WEBSITE OVER GLOBAL COMMUNICATIONS NETWORKS FEATURING INFORMATION PROMOTING AMERICAN HERITAGE AND DEMOCRACY (U.S. CLS. 100 AND 101).

FIRST USE 11-30-2003; IN COMMERCE 11-30-2003.

2,858,714. CARTER, SCOTT CHARLES, SAN DIEGO, CA. SN 78-043,134. PUB. 2-5-2002, FILED 1-14-2001.

THE NEW BREED BAND

NO CLAIM IS MADE TO THE EXCLUSIVE RIGHT TO USE "BAND", APART FROM THE MARK AS SHOWN.

CLASS 9—ELECTRICAL AND SCIENTIFIC APPARATUS

FOR PRE-RECORDED AUDIO AND VIDEO TAPES, CASSETTES AND COMPACT DISCS FEATURING MUSIC (U.S. CLS. 21, 23, 26, 36 AND 38).

FIRST USE 0-0-1999; IN COMMERCE 0-0-1999.

CLASS 41—EDUCATION AND ENTERTAINMENT

FOR ENTERTAINMENT, NAMELY LIVE PERFORMANCES BY A MUSICAL BAND (U.S. CLS. 100, 101 AND 107).

FIRST USE 0-0-1999; IN COMMERCE 0-0-1999.

CLASS 41—EDUCATION AND ENTERTAINMENT

FOR ENTERTAINMENT SERVICES IN THE NATURE OF AMUSEMENT PARK RIDES (U.S. CLS. 100, 101 AND 107).

FIRST USE 6-0-2001; IN COMMERCE 6-0-2001.

2,858,716. DC COMICS, NEW YORK, NY. SN 78-046,079. PUB. 1-8-2002, FILED 2-1-2001.

2,858,718. NUMEREX SOLUTIONS, LLC, ATLANTA, GA. SN 78-047,504. PUB. 7-9-2002, FILED 2-9-2001.

FASTTRACK WIRELESS

NO CLAIM IS MADE TO THE EXCLUSIVE RIGHT TO USE "WIRELESS", APART FROM THE MARK AS SHOWN.

**CLASS 16—PAPER GOODS AND PRINTED MATTER**

FOR PRINTED MATTER AND PAPER GOODS, NAMELY, BOOKS FEATURING CHARACTERS FROM ANIMATED, ACTION ADVENTURE, COMEDY AND/OR DRAMA FEATURES, COMIC BOOKS, CHILDREN'S BOOKS, MAGAZINES FEATURING CHARACTERS FROM ANIMATED, ACTION ADVENTURE, COMEDY AND/OR DRAMA FEATURES, COLORING BOOKS, CHILDREN'S ACTIVITY BOOKS; NOTE CARDS, GREETING CARDS, TRADING CARDS; PENS, PENCILS, CASES THEREFOR, DECALS, HEAT TRANSFERS; POSTERS; BOOK COVERS, BOOK MARKS, CALENDARS, PAPER PARTY FAVORS AND PAPER PARTY DECORATIONS, NAMELY, PAPER NAPKINS, PAPER HATS, INVITATIONS, PAPER TABLE CLOTHS, PRINTED TRANSFERS FOR EMBROIDERY OR FABRIC APPLIQUES; PAPER PHOTO FRAMES (U.S. CLS. 2, 5, 22, 23, 29, 37, 38 AND 50).

FIRST USE 11-0-2001; IN COMMERCE 11-0-2001.

CLASS 21—HOUSEWARES AND GLASS

FOR GLASS, CERAMIC AND EARTHENWARE GOODS, NAMELY, COFFEE MUGS, MUGS, COFFEE CUPS, AND CUPS; BEVERAGE GLASSWARE, NAMELY, MUGS AND DRINKING GLASSES; CERAMIC, GLASS AND CHINA FIGURINES; WASTEPAPER BASKETS; PLASTIC BUCKETS; CANTEENS; PLASTIC COASTERS; THERMAL INSULATED CONTAINERS FOR FOOD OR BEVERAGES; CORK SCREWS; CORN COB HOLDERS; WATER BOTTLES SOLD EMPTY; VACUUM BOTTLES; DECANTERS; RUBBER HOUSEHOLD GLOVES; AND DINNERWARE, NAMELY, PAPER PLATES AND PAPER CUPS (U.S. CLS. 2, 13, 23, 29, 30, 33, 40 AND 50).

FIRST USE 6-0-2001; IN COMMERCE 6-0-2001.

CLASS 25—CLOTHING

FOR CLOTHING FOR MEN, WOMEN AND CHILDREN - NAMELY, SHIRTS, T-SHIRTS, SWEATSHIRTS, TANK TOPS, BLOUSES, SUSPENDERS, SWEATERS, JACKETS, HATS, CAPS, SUNVISORS, BELTS, AND MASQUERADE AND HALLOWEEN COSTUMES AND MASKS SOLD IN CONNECTION THEREWITH (U.S. CLS. 22 AND 39).

FIRST USE 6-0-2001; IN COMMERCE 6-0-2001.

CLASS 9—ELECTRICAL AND SCIENTIFIC APPARATUS

FOR WEB TELEMETRY DEVICES WHICH MONITOR AND CONTROL GEOGRAPHICALLY REMOTE APPLICATIONS, NAMELY, COMPUTER SOFTWARE AND HARDWARE WHICH ENABLES ACCESS TO A COMPUTER NETWORK PLATFORM FOR TRANSMISSION OF WIRELESS DATA TELEMETRY; MODEMS; RADIO TRANSMITTERS; COMPUTERS FOR RECEIVING WIRELESS DATA TELEMETRY SIGNALS (U.S. CLS. 21, 23, 26, 36 AND 38).

FIRST USE 1-1-2004; IN COMMERCE 1-1-2004.

CLASS 38—COMMUNICATION

FOR TELECOMMUNICATIONS SERVICES, NAMELY, A SERVICE THAT ENABLES DATA TO BE TRANSMITTED ELECTRONICALLY OVER A WIRELESS INTERFACE (U.S. CLS. 100, 101 AND 104).

FIRST USE 1-1-2004; IN COMMERCE 1-1-2004.

2,858,720. QUEST DIAGNOSTICS INCORPORATED, TERBORO, NJ. SN 78-050,015. PUB. 10-15-2002, FILED 2-23-2001.

QUESTEST**CLASS 5—PHARMACEUTICALS**

FOR HOME TEST KITS FOR HUMAN IMMUNODEFICIENCY VIRUS AND OTHER INFECTIOUS DISEASES, NAMELY SEXUALLY TRANSMITTED DISEASE, HEPATITIS, BACTERIAL INFECTIONS, VIRAL INFECTIONS, MENINGITIS, LYME DISEASE, PARASITIC INFECTIONS, SHINGLES, FUNGAL INFECTIONS, MONONUCLEOSIS, PNEUMONIA, BRONCHITIS, INFLUENZA, TUBERCULOSIS, MICROBIAL INFECTIONS; MEDICAL DIAGNOSTIC PREPARATIONS, NAMELY, DIAGNOSTIC PREPARATIONS FOR LABORATORY, CLINICAL AND MEDICAL USE, REAGENTS FOR THE TREATMENT, MONITORING AND DIAGNOSIS OF DISEASE, PHARMACEUTICAL PREPARATIONS FOR THE TREATMENT, MONITORING AND DIAGNOSIS OF DISEASE (U.S. CLS. 6, 18, 44, 46, 51 AND 52).

FIRST USE 5-0-2001; IN COMMERCE 5-0-2001.

CLASS 42—SCIENTIFIC, COMPUTER AND LEGAL SERVICES

FOR PROVIDING CLINICAL DIAGNOSTIC LABORATORY TESTING AND DIAGNOSTIC INFORMATION SERVICES DIRECTLY TO CONSUMERS TO SCREEN FOR COMMON HEALTH CONDITIONS, NAMELY, LIPID TESTS FOR HEART DISEASE, PROSTATE SPECIFIC ANTIGEN FOR PROSTATE DISEASE, ANTIBODY TESTING FOR HUMAN IMMUNODEFICIENCY VIRUS, BONE MINERAL DENSITOMETRY FOR OSTEOPOROSIS, AND BLOOD PRESSURE FOR STROKE RISK; MEDICAL SERVICES, NAMELY, PROVIDING DIAGNOSTIC HEALTH SCREENS IN THE FIELDS OF INFECTIOUS DISEASE, ALLERGIES, MICROBIAL DISEASE, PREGNANCY-RELATED DISEASE, BACTERIAL DISEASE, HEART DISEASE, VIRAL DISEASE, HISTOLOGICAL DISEASE, GENETIC DISEASE, BLOOD-RELATED DISEASE, FUNGAL DISEASE, ADRENAL DISEASE, CANCER, LIVER DISEASE, AUTO-IMMUNE DISEASE, SEXUALLY TRANSMITTED DISEASE, KIDNEY DISEASE, PARASITIC DISEASE, BONE DISEASE, GROWTH DISORDER, DIABETES, BLOOD TYPING, PRE-NATAL CONDITIONS, THYROID CONDITIONS, ELECTROLYTE TESTING, HEMATOLOGY, PREVENTIVE HEALTH, NUTRITION, PREGNANCY TESTING, DRUG SCREENING, PROSTATE CONDITION TESTING, GENETIC TESTING AND URINE TESTING (U.S. CLS. 100 AND 101).

FIRST USE 5-0-2001; IN COMMERCE 5-0-2001.

2,858,724. MASTERWIN INTERNATIONAL HOLDINGS LIMITED, TSUEN WAN, NEW TERRITORIES, HONG KONG. SN 78-056,280. PUB. 6-24-2003, FILED 4-2-2001.

**CLASS 6—METAL GOODS**

FOR NON-ELECTRIC CABLES AND WIRES OF COMMON METAL; PIPES AND TUBES OF METAL; METAL SAFES; GOODS OF COMMON METAL NOT INCLUDED IN OTHER CLASSES, NAMELY KEY RINGS AND TOOL BOXES (U.S. CLS. 2, 12, 13, 14, 23, 25 AND 50).

FIRST USE 12-0-2003; IN COMMERCE 12-0-2003.

CLASS 14—JEWELRY

FOR PRECIOUS METALS AND THEIR ALLOYS; GOODS IN PRECIOUS METAL OR COATED THEREWITH NOT INCLUDED IN OTHER CLASSES NAMELY, JEWELRY; PRECIOUS STONE; HOROLOGICAL AND CHRONOMETRIC INSTRUMENTS, NAMELY, DESK CLOCKS AND WALL CLOCKS; PEN HOLDERS OF PRECIOUS METAL; NAME CARD HOLDERS OF PRECIOUS METAL; PAPER CLIPS HOLDERS OF PRECIOUS METAL; ASHTRAYS MADE OF PRECIOUS METAL; TIE CLIPS, CUFFLINKS, BELT-BUCKLES OF PRECIOUS METAL; PILL CASES MADE OF PRECIOUS METAL; AND CIGARETTE CASES OF PRECIOUS METAL (U.S. CLS. 2, 27, 28 AND 50).

FIRST USE 12-0-2003; IN COMMERCE 12-0-2003.

CLASS 16—PAPER GOODS AND PRINTED MATTER

FOR PAPER, CARDBOARD AND GOODS MADE FROM THESE MATERIALS NOT INCLUDED IN OTHER CLASSES, NAMELY, PACKAGING BOXES OF PAPER AND CARDBOARD; BOOKBINDING MATERIAL; PHOTOGRAPHS, STATIONERY; ADHESIVES FOR STATIONERY OR HOUSEHOLD PURPOSES; ARTISTS' MATERIALS, NAMELY, PENCILS, PAINTS; PAINT BRUSHES; TYPEWRITERS AND OFFICE REQUISITES NOT INCLUDING FURNITURE, NAMELY, STAPLES, RUBBER BANDS; PLASTIC MATERIALS FOR PACKAGING, NAMELY WRAPPERS, BAGS; PLAYING CARDS; PRINTERS' TYPE; PRINTING BLOCKS; BUSINESS CARD HOLDERS, LETTER OPENERS, TAPE DISPENSERS, PENS, PEN STANDS, BOOKMARKS, MEMO PAD HOLDERS, PEN HOLDERS NOT OF PRECIOUS METAL (U.S. CLS. 2, 5, 22, 23, 29, 37, 38 AND 50).

FIRST USE 12-0-2003; IN COMMERCE 12-0-2003.

CLASS 40—MATERIAL TREATMENT

FOR MANUFACTURE OF DESKTOPS, DESKTOP SETS, NAME CARD HOLDERS, MEMO PAD HOLDERS, NAME CARD CASES, MONEY CLIPS, BOOKMARKS, PHOTO FRAMES, CLOCKS, KEY HOLDERS, LETTER OPENERS, WINE AND CIGAR ACCESSORIES, MEN'S WEAR ACCESSORIES, ORGANIZERS AND WALLETS TO THE ORDER AND SPECIFICATION OF OTHERS (U.S. CLS. 100, 103 AND 106).

FIRST USE 12-0-2003; IN COMMERCE 12-0-2003.

CLASS 42—SCIENTIFIC, COMPUTER AND LEGAL SERVICES

FOR DESIGN OF DESKTOP PRODUCTS, DESKTOP SETS, GOLF SERIES, NAME CARD HOLDERS, HOLDERS FOR DESK ACCESSORIES, NAME CARD CASES, MONEY CLIPS, BOOKMARKS, PHOTO FRAMES, CLOCKS, KEY HOLDERS, LETTER OPENERS, WINE AND CIGAR ACCESSORIES, MEN'S WEAR ACCESSORIES, ORGANIZERS AND WALLETS; JEWELRY DESIGNING IN THE NATURE OF TRINKET DESIGN, PACKAGING DESIGN SERVICES (U.S. CLS. 100 AND 101).

FIRST USE 12-0-2003; IN COMMERCE 12-0-2003.

2,858,728. WATLOW POLYMER TECHNOLOGIES, INC., WINONA, MN. SN 78-061,438. PUB. 4-15-2003, FILED 5-1-2001.



NuWarmth

CLASS 19—NON-METALLIC BUILDING MATERIALS

FOR PLASTIC BIRD BATHS BEING STRUCTURES (U.S. CLS. 1, 12, 33 AND 50).

FIRST USE 9-1-2001; IN COMMERCE 9-1-2001.

CLASS 20—FURNITURE AND ARTICLES NOT OTHERWISE CLASSIFIED

FOR PET CARE PRODUCTS, NAMELY, MATS NOT FOR FEEDING PURPOSES (U.S. CLS. 2, 13, 22, 25, 32 AND 50).

FIRST USE 9-1-2001; IN COMMERCE 9-1-2001.

2,858,741. CEILINGS PLUS, LOS ANGELES, CA. SN 78-084,818. PUB. 7-9-2002, FILED 9-20-2001.

CORNICHE

CLASS 6—METAL GOODS

FOR BUILDING MATERIALS, NAMELY PANELS AND TILES MADE OF METAL FOR CEILINGS AND WALLS (U.S. CLS. 2, 12, 13, 14, 23, 25 AND 50).
FIRST USE 6-15-2001; IN COMMERCE 11-25-2002.

CLASS 11—ENVIRONMENTAL CONTROL APPARATUS

FOR ELECTRIC LIGHTING FIXTURES (U.S. CLS. 13, 21, 23, 31 AND 34).
FIRST USE 6-15-2001; IN COMMERCE 11-25-2002.

2,858,745. "ZIAJA" LTD ZAKLAD PRODUKCJI LEKOW SPOLKA Z O.O., GDANSK-MATARNIA, POLAND. SN 78-087,396. PUB. 8-19-2003, FILED 10-8-2001.

ARETINOL Q

NO CLAIM IS MADE TO THE EXCLUSIVE RIGHT TO USE "ARETINOL", APART FROM THE MARK AS SHOWN.

CLASS 3—COSMETICS AND CLEANING PREPARATIONS

FOR HAIR CARE PREPARATIONS, NAMELY, HAIR SHAMPOOS, HAIR SHAMPOO WITH CONDITIONERS, BABY SHAMPOO; HAIR GEL, HAIR LOTIONS, HAIR POMADES, HAIR CONDITIONERS; STYLING GELS, STYLING LOTIONS, HAIR DYES; COSMETIC PRODUCTS FOR THE CARE OF THE SKIN, NAMELY, SKIN CREAMS, NON-MEDICATED LIP BALM, SHAVING BALMS, SKIN CLEANSER, FACIAL CLEANSER, TONIC LOTIONS, FACIAL MASK, BEAUTY MASK, FACIAL MOISTURIZER MASK, BATH OIL, PERFUME OIL, NON-MEDICATED BATH MILKS, BABY POWDER, BATH POWDER, BODY POWDER, BATH SOAP; TOILET SOAP, HAIR SPRAY, NON-MEDICATED FOOT POWDER, NON-MEDICATED FOOT CARE BALMS, FOOT DEODORANT SPRAY; EYE CREAM, EYE GELS, EYE MAKE UP REMOVER; FACE CREAMS, FACE POWDER, FACIAL EMULSIONS; FACIAL MASKS, FACIAL SCRUBS, HAND CREAMS, NON-MEDICATED HAND BALMS, NON-MEDICATED BABY CREAMS; SKIN CREAM FOR THE CARE OF INFANTS; CLEANING PREPARATIONS, NAMELY, BATH FOAM, SHOWER GELS, BODY SOAPS, LIQUID BODY SOAPS, DEODORANT SOAPS, DISINFECTANT SOAPS, DEODORANTS FOR PERSONAL USE; ESSENTIAL OILS FOR PERSONAL USE, BABY OIL, BATH OIL, MASSAGE OIL; PERFUME; EAU DE PERFUME; COLOGNE; TOILET WATER, DENTRIFRICES, TOOTH GEL, TOOTH PASTE, MOUTH WASH; PRE-MOISTENED COSMETIC WIPES; PRE-MOISTENED COSMETIC TOWELETES; PRE-MOISTENED COSMETIC TISSUES (U.S. CLS. 1, 4, 6, 50, 51 AND 52).
FIRST USE 1-15-2002; IN COMMERCE 1-15-2002.

CLASS 5—PHARMACEUTICALS

FOR MEDICATED CREAM FOR THE PREVENTION AND TREATMENT OF DIAPER RASH AND FEMININE HYGIENE WASHES; MEDICATED HAIR CARE PREPARATIONS, NAMELY, MEDICATED SHAMPOOS, DANDRUFF SHAMPOOS, CONDITIONERS, LOTIONS; MEDICATED SKIN CARE PREPARATIONS, NAMELY MEDICATED CREAMS, BALMS, CLEANSERS, TONIC LOTIONS, MASKS, MILKS, GELS, POWDERS, SOAPS, AND SPRAYS; FUNGICIDAL AND BACTERICIDAL MEDICAL PREPARATIONS FOR THE FEET, NAMELY, FOOT BALMS, FOOT SPRAYS, FOOT LOTIONS, MEDICATED PRE-MOISTENED WIPES, MEDICATED PRE-MOISTENED TOWELETES, MEDICATED PRE-MOISTENED TISSUES (U.S. CLS. 6, 18, 44, 46, 51 AND 52).
FIRST USE 1-15-2002; IN COMMERCE 1-15-2002.

2,858,753. ALTICOR INC., ADA, MI. SN 78-098,422. PUB. 5-27-2003, FILED 12-14-2001.

ESOLIS

CLASS 3—COSMETICS AND CLEANING PREPARATIONS

FOR COSMETICS; SKIN CARE PRODUCTS, NAMELY, NON-MEDICATED SKIN CARE PREPARATIONS, NON-MEDICATED SKIN SERUM, WRINKLE REMOVING SKIN CARE PREPARATIONS, SKIN CLEANSERS AND SOAPS, SKIN CLARIFIERS, SKIN CREAMS, SKIN LOTIONS, SKIN MASKS, SKIN TEXTURIZERS, SKIN TONERS, SKIN OILS AND GELS, NAMELY, SKIN EMOLLIENTS AND SKIN GEL FOR ACCELERATING, ENHANCING OR EXTENDING TANS, SKIN MOISTURIZERS, SKIN LIGHTENERS AND SKIN POWDERS (U.S. CLS. 1, 4, 6, 50, 51 AND 52).
FIRST USE 9-16-2002; IN COMMERCE 9-16-2002.

CLASS 5—PHARMACEUTICALS

FOR MEDICATED SKIN CARE PREPARATIONS (U.S. CLS. 6, 18, 44, 46, 51 AND 52).
FIRST USE 9-16-2002; IN COMMERCE 9-16-2002.

2,858,764. MATERIALS SCIENCES CORPORATION, FT. WASHINGTON, PA. SN 78-106,888. PUB. 2-25-2003, FILED 2-5-2002.

ENGINEERING THE FUTURE OF MATERIALS

CLASS 9—ELECTRICAL AND SCIENTIFIC APPARATUS

FOR ENGINEERING PRODUCTS, NAMELY SOFTWARE USED TO DESIGN AND CHARACTERIZE MATERIALS AND STRUCTURES, IN THE FIELD OF MATERIAL PROPERTIES, PRODUCT PERFORMANCE, AND DESIGN AND ANALYSIS OF STRUCTURES (U.S. CLS. 21, 23, 26, 36 AND 38).
FIRST USE 3-1-2002; IN COMMERCE 5-1-2002.

CLASS 42—SCIENTIFIC, COMPUTER AND LEGAL SERVICES

FOR ENGINEERING SERVICES IN THE FIELD OF MATERIAL PROPERTIES, PRODUCT PERFORMANCE, AND DESIGN AND ANALYSIS OF STRUCTURES (U.S. CLS. 100 AND 101).
FIRST USE 3-1-2002; IN COMMERCE 8-1-2002.

2,858,767. LESSLIE, JAMES, HOWARD BEACH, NY. SN 78-107,361. PUB. 1-14-2003, FILED 2-7-2002.

COWABUNGA

OWNER OF U.S. REG. NOS. 2,538,118 AND 2,560,930.

CLASS 29—MEATS AND PROCESSED FOODS

FOR SNACK FOODS, NAMELY, PROCESSED NUTS AND SEEDS, CANDIED NUTS, BEEF JERKY MEAT SNACKS, FRUIT-BASED SNACKS AND SNACK MIXES CONSISTING PRIMARILY OF PROCESSED FRUITS, PROCESSED NUTS AND/OR RAISINS (U.S. CL. 46).

FIRST USE 6-21-1999; IN COMMERCE 10-16-2003.

CLASS 30—STAPLE FOODS

FOR SNACK FOODS, NAMELY BUBBLE GUM, CANDY, CANDY-COATED POPCORN, CARAMEL POPCORN, CEREAL-BASED SNACK FOODS, CHEESE-FLAVORED PUFFED CORN SNACKS, CHEESE-FLAVORED CHEESE BALLS, CHOCOLATE COVERED NUTS, CORN CHIPS, CRACKERS, GRAIN-BASED CHIPS, MARSHMALLOWS, POPPED POPCORN SNACKS, RICE-BASED SNACK FOODS, SNACK MIX CONSISTING PRIMARILY OF CRACKERS, PRETZELS, CANDIED NUTS AND/OR POPPED CORN, TOASTED CORN KERNELS, AND WHEAT-BASED SNACK FOODS (U.S. CL. 46).

FIRST USE 6-21-1999; IN COMMERCE 10-16-2003.

2,858,786. MORNINGSTAR SERVICES INC., WILMINGTON, DE. SN 78-121,804. PUB. 3-11-2003, FILED 4-15-2002.

XPOSE THE CODE

CLASS 29—MEATS AND PROCESSED FOODS

FOR MILK (U.S. CL. 46).
FIRST USE 5-0-2002; IN COMMERCE 5-0-2002.

CLASS 30—STAPLE FOODS

FOR MILKSHAKES (U.S. CL. 46).
FIRST USE 5-0-2002; IN COMMERCE 5-0-2002.

2,858,807. CARVER INDUSTRIES, L.L.C., MINNEAPOLIS, MN. SN 78-136,931. PUB. 9-30-2003, FILED 6-19-2002.

NUVARI

CLASS 12—VEHICLES

FOR BOATS AND STRUCTURAL PARTS THEREFOR (U.S. CLS. 19, 21, 23, 31, 35 AND 44).
FIRST USE 10-0-2002; IN COMMERCE 10-0-2002.

CLASS 25—CLOTHING

FOR CLOTHING ITEMS, NAMELY, HATS, JACKETS, SHIRTS AND T-SHIRTS, FOR PROMOTIONAL PURPOSES IN CONNECTION WITH BOATS (U.S. CLS. 22 AND 39).
FIRST USE 12-0-2002; IN COMMERCE 12-0-2002.

2,858,812. AUTOBYTEL INC., IRVINE, CA. SN 78-138,805. PUB. 7-8-2003, FILED 6-25-2002.

TAKE THE PLEDGE TO SLOW DOWN

CLASS 35—ADVERTISING AND BUSINESS

FOR PUBLIC RELATION SERVICES RELATING TO TRAFFIC SAFETY, DRIVING HABITS AND NEIGHBORHOOD SAFETY CONCERNS, AND PROMOTING PUBLIC AWARENESS OF THE NEED FOR TRAFFIC SAFETY, DRIVING HABITS AND NEIGHBORHOOD SAFETY CONCERNS, AND PRINTED MATERIALS, DECALS, STICKERS, VIDEO TAPES AND SIGNAGE DISTRIBUTED IN CONNECTION THEREWITH (U.S. CLS. 100, 101 AND 102).

FIRST USE 4-29-2002; IN COMMERCE 4-29-2002.

CLASS 41—EDUCATION AND ENTERTAINMENT

FOR EDUCATIONAL SERVICES, NAMELY CONDUCTING PROGRAMS IN THE FIELD OF TRAFFIC SAFETY, DRIVING HABITS AND NEIGHBORHOOD SAFETY CONCERNS, AND PRINTED MATERIALS, DECALS, STICKERS, VIDEO TAPES AND SIGNAGE DISTRIBUTED IN CONNECTION THEREWITH (U.S. CLS. 100, 101 AND 107).

FIRST USE 4-29-2002; IN COMMERCE 4-29-2002.

2,858,813. WALTRIP, DARRELL LEE, HARRISBURG, NC. SN 78-138,865. PUB. 6-24-2003, FILED 6-26-2002.

BOOGITY! BOOGITY! BOOGITY!

CLASS 9—ELECTRICAL AND SCIENTIFIC APPARATUS

FOR SUNGLASSES, DECORATIVE MAGNETS, AND MOUSE PADS (U.S. CLS. 21, 23, 26, 36 AND 38).
FIRST USE 9-9-2002; IN COMMERCE 9-9-2002.

CLASS 14—JEWELRY

FOR JEWELRY, NAMELY, PINS, PENDANTS, CHAINS, NECKLACES, RINGS, AND EARRINGS (U.S. CLS. 2, 27, 28 AND 50).
FIRST USE 1-14-2003; IN COMMERCE 4-14-2003.

CLASS 16—PAPER GOODS AND PRINTED MATTER

FOR PRINTED MATTER, NAMELY, BROCHURES PERTAINING TO AUTO RACING, POSTERS, FLYERS, PROMO CARDS, POSTER PAPER DESIGNED FOR USE AS BILLBOARDS, CD COVERS, STICKERS, DECALS, CALENDARS AND TRADING CARDS (U.S. CLS. 2, 5, 22, 23, 29, 37, 38 AND 50).
FIRST USE 3-5-2003; IN COMMERCE 3-5-2003.

CLASS 24—FABRICS

FOR TEXTILES, NAMELY, TOWELS, BED BLANKETS, PICNIC BLANKETS, BANNERS, PENNANTS, AND FLAGS (U.S. CLS. 42 AND 50).
FIRST USE 6-10-2003; IN COMMERCE 6-10-2003.

CLASS 28—TOYS AND SPORTING GOODS

FOR TOYS AND SPORTING GOODS, NAMELY, MINATURE CARS AND TRUCKS (U.S. CLS. 22, 23, 38 AND 50).

FIRST USE 2-24-2003; IN COMMERCE 2-24-2003.

2,858,829. THE OTIS CONNER COMPANIES, INC., DALLAS, TX. SN 78-150,166. PUB. 2-11-2003, FILED 8-2-2002.

NO LIMITS**CLASS 35—ADVERTISING AND BUSINESS**

FOR RETAIL STORE SERVICES AND AUTOMOBILE DEALERSHIPS FEATURING NEW AND USED AUTOMOBILES, TRUCKS, AUTOMOBILE PARTS AND TRUCK PARTS (U.S. CLS. 100, 101 AND 102).

FIRST USE 5-13-2002; IN COMMERCE 6-17-2002.

CLASS 36—INSURANCE AND FINANCIAL

FOR CONSUMER FINANCIAL SERVICES IN THE FIELD OF AUTOMOBILE AND TRUCK FINANCING (U.S. CLS. 100, 101 AND 102).

FIRST USE 5-13-2002; IN COMMERCE 6-17-2002.

2,858,836. REALTOPIA, INC., RENO, NV. SN 78-154,204. PUB. 7-29-2003, FILED 8-14-2002.

REALTOPIA**CLASS 35—ADVERTISING AND BUSINESS**

FOR FRANCHISING SERVICES, NAMELY, OFFERING TECHNICAL ASSISTANCE IN THE ESTABLISHMENT AND OPERATION OF REAL ESTATE INVESTMENT, MANAGEMENT AND ACQUISITION CORPORATION (U.S. CLS. 100, 101 AND 102).

FIRST USE 8-0-2002; IN COMMERCE 8-0-2002.

CLASS 36—INSURANCE AND FINANCIAL

FOR REAL ESTATE INVESTMENT AND ACQUISITION SERVICES; REAL ESTATE MANAGEMENT SERVICES (U.S. CLS. 100, 101 AND 102).

FIRST USE 8-0-2002; IN COMMERCE 8-0-2002.

2,858,842. ETERNIT AG, 8867 NIEDERURNEN, SWITZERLAND. SN 78-157,533. PUB. 9-23-2003, FILED 8-24-2002.

SWISSPEARL**CLASS 17—RUBBER GOODS**

FOR INSULATING AND SOUND ABSORBING PLATES AND SLABS; PREFABRICATED WALLS AND FACADES CONTAINING INTEGRATED HEAT AND SOUND ABSORBING PLATES AND SLABS; ALL THE AFORESAID GOODS OF SWISS ORIGIN (U.S. CLS. 1, 5, 12, 13, 35 AND 50).

FIRST USE 7-31-2002; IN COMMERCE 7-31-2002.

CLASS 19—NON-METALLIC BUILDING MATERIALS

FOR NON-METAL BUILDING MATERIALS, NAMELY, PANELS, PLATES, SLABS AND SHAPED PARTS OF FIBRO CEMENT AND OTHER RAW MATERIALS COMBINED WITH BINDER, CEMENT, GYPSUM OR SYNTHETIC MATERIALS, FOR THE PRODUCTION OF COVERINGS AND LININGS FOR WALLS, PARTITION WALLS, CEILINGS, PIPES AND FACADES AND FOR THE PRODUCTION OF FINISHED ELEMENTS; READY-TO ASSEMBLE, SELF-SUPPORTING WALLS AND FACADES; ALL THE AFORESAID GOODS OF SWISS ORIGIN (U.S. CLS. 1, 12, 33 AND 50).

FIRST USE 7-31-2002; IN COMMERCE 7-31-2002.

CLASS 20—FURNITURE AND ARTICLES NOT OTHERWISE CLASSIFIED

FOR PANELS, PLATES, SLABS AND SHAPED PARTS OF FIBRO CEMENT AND OTHER MINERAL RAW MATERIAL COMBINED WITH BINDER, CEMENT, GYPSUM OR SYNTHETIC MATERIALS, FOR THE PRODUCTION OF FURNITURE; ALL THE AFORESAID GOODS OF SWISS ORIGIN (U.S. CLS. 2, 13, 22, 25, 32 AND 50).

FIRST USE 7-31-2002; IN COMMERCE 7-31-2002.

2,858,846. OCM, INC., VERNON HILLS, IL. SN 78-159,140. PUB. 7-8-2003, FILED 8-29-2002.



THE MARK CONSISTS OF OUR COMPANY LOGO AND THE NAME OF THE COMPANY TO THE RIGHT OF THE LOGO. THE LETTERS "OCM" ARE IN BOLD AND BLACK. THE LOGO HAS THE COLOR RED FROM THE INSIDE OF THE DIAMOND SHAPE TO THE EDGE OF THE FIGURE INSIDE, AND IN THE SMALL OVAL SHAPE IN THE CURVE OF THE FIGURE. THE "O" FIGURE IS WHITE.

THE NON-LATIN CHARACTER(S) IN THE MARK TRANSLITERATE INTO THE LETTER "O", AND THIS MEANS THE LETTER "O".

CLASS 6—METAL GOODS

FOR METAL ACCESSORIES AND STRUCTURAL HARDWARE FOR CONCRETE CONSTRUCTION, NAMELY, ANCHORS, BRACKETS, BRIDGING, BRACES, HE AND SHE BOLTS, CAPS, CAST INSERTS, CLAMPS, COUPLINGS, CONES, COLUMN CLAMPS, COIL RODS, CLIPS, CHAIRS, SPACERS, STRAPPING, STUDS, WALL ENFORCEMENTS, WASHERS, WEDGES, WATERSTOPS, EYE BOLTS AND NUTS, FERRULE INSERTS, FORM ALIGNERS, FORM PATCHES, FORM TIES, COIL FRAMES, ROD FRAMES, HANGERS AND HANGER INSERTS, HINGES, JOINT SEALS, LIFT INSERTS, LIFTING PLATES AND BOLTS, LOOP INSERTS, BASE PACK, SCAFFOLDING AND WALL FORMERS (U.S. CLS. 2, 12, 13, 14, 23, 25 AND 50).

FIRST USE 9-3-2002; IN COMMERCE 9-3-2002.

CLASS 19—NON-METALLIC BUILDING MATERIALS

FOR NON-METAL SCAFFOLDING (U.S. CLS. 1, 12, 33 AND 50).

FIRST USE 9-3-2002; IN COMMERCE 9-3-2002.

CLASS 20—FURNITURE AND ARTICLES NOT OTHERWISE CLASSIFIED

FOR NON-METAL ACCESSORIES AND STRUCTURAL HARDWARE FOR CONCRETE CONSTRUCTION, NAMELY, ANCHORS, BRACKETS, BRIDGING, BRACES, HE AND SHE BOLTS, CAPS, CAST INSERTS, CLAMPS, COUPLINGS, CONES, COLUMN CLAMPS, COIL RODS, CLIPS, CHAIRS, SPACERS, STRAPPING, STUDS, WALL ENFORCEMENTS, WASHERS, WEDGES, WATERSTOPS, EYE BOLTS AND NUTS, FERRULE INSERTS, FORM ALIGNERS, FORM PATCHES, FORM TIES, COIL FRAMES, ROD FRAMES, HANGERS AND HANGER INSERTS, HINGES, JOINT SEALS, LIFT INSERTS, LIFTING PLATES AND BOLTS, LOOP INSERTS, BASE PACK, AND WALL FORMERS (U.S. CLS. 2, 13, 22, 25, 32 AND 50).

FIRST USE 9-3-2002; IN COMMERCE 9-3-2002.

2,858,849. PHILADELPHIA GEAR CORPORATION, NORRISTOWN, PA. SN 78-161,557. PUB. 12-23-2003, FILED 9-6-2002.

PHILADELPHIA GEAR CORPORATION

OWNER OF U.S. REG. NOS. 997,278 AND 1,000,489. NO CLAIM IS MADE TO THE EXCLUSIVE RIGHT TO USE "CORPORATION", APART FROM THE MARK AS SHOWN.

SEC. 2(F) AS TO PHILADELPHIA GEAR.

CLASS 7—MACHINERY

FOR TRANSMISSION GEARS FOR MACHINES; MACHINERY BRAKES; MACHINE PARTS, NAMELY, VARIABLE SPEED DRIVES; SYNCHRONIZING CLUTCHES FOR MACHINES; CLUTCH AND BRAKE UNITS FOR MACHINERY; SELF-ALIGNING GEAR COUPLINGS FOR MACHINES; POWER DRIVEN REDUCTION GEAR UNITS FOR REDUCING THE SPEED OF MOTORS; MOTOR DRIVES FOR MIXERS AND AGITATORS; MECHANICAL ACTUATORS FOR CONVERTING ROTARY MOTION INTO LINEAR MOTION; PORTABLE MIXERS FOR COMMERCIAL AND INDUSTRIAL USES; SHAFT MOUNTED GEAR SYSTEM FOR DRIVING PAPER MACHINE DRYERS; PRIMARY MOTOR DRIVEN PARALLEL SHAFT REDUCERS; SPROCKETS, AND TRANSMISSIONS FOR SHIPS, BOATS AND MARINE VESSELS; PROPULSION GEAR DRIVES, CLUTCHES AND COUPLINGS, AND REDUCTION GEARING FOR MARINE DRIVES; HYDRO VISCOUS DRIVE USED AS WET CLUTCHES, WET BRAKES, TORQUE CONTROL DEVICES OR VARIABLE SPEED DRIVES FOR MACHINES; MACHINERY AND PARTS OF MACHINES, NAMELY, GENERAL PURPOSE MIXERS, AGITATORS, AERATORS, GEAR MOTORS NOT FOR LAND MOTOR VEHICLES, GEAR DRIVES, AND REPLACEMENT PARTS THEREFORE FOR ALL THE ABOVE; MACHINERY AND PARTS OF MACHINES, NAMELY, COAL HANDLING AND CRUSHING MACHINES FOR USE IN MINES AND COAL-FIRED POWER PLANTS, AND REPLACEMENT PARTS THEREFORE; INDUSTRIAL AND LIGHT COMMERCIAL MECHANICAL DRIVERS FOR MACHINES; BEVEL-HELICAL AND BEVEL-EPICYCLIC ROLLER MILL DRIVES; CONDENSATE FEED AND COOLING WATER PUMP DRIVES; INDUCED DRAFT, FORCED DRAFT, AND AIR-PREHEATER FAN DRIVES FOR MACHINES; POWER TRANSMISSION EQUIPMENT IS USED TO DRIVE HORIZONTAL OR VERTICAL PUMPS FOR THE TRANSPORTATION, STORAGE, OR CONDITIONING OF TREATED OR UNTREATED WATER; PUMPS AND DRIVES FOR NATURAL GAS PIPELINE PUMPING; GAS TURBINE ELECTRICAL POWER-GENERATION, ACCESSORY PUMP AND STARTER DRIVES; HIGH SPEED DRIVES AND TRANSMISSION EQUIPMENT TO POWER MACHINERY USED IN GAS AND OIL GATHERING AND COMPRESSION; SHELL PINION GEARING, ROLLING MILL DRIVES, AND REDUCERS

ENGINEERED FOR LARGE LOADS USED IN THE STEEL AND METAL PROCESSING INDUSTRY; WIND AND HYDRO-TURBINE DRIVES AND SYNCHRONOUS CONDENSER AND COOLING TOWER DRIVES; REPLACEMENT PARTS AND ACCESSORIES THEREFORE FOR ALL THE ABOVE (U.S. CLS. 13, 19, 21, 23, 31, 34 AND 35).
FIRST USE 0-0-1939; IN COMMERCE 0-0-1939.

CLASS 37—CONSTRUCTION AND REPAIR

FOR INSTALLATION, REPAIR, OVERHAUL, AND MODIFICATION SERVICES FOR INDUSTRIAL GEARS, GEAR BOXES, DRIVERS, PUMPS, SPEED REDUCERS, SPEED INCREASES, TRANSMISSION EQUIPMENT, AND RELATED GOODS (U.S. CLS. 100, 103 AND 106).
FIRST USE 0-0-1939; IN COMMERCE 0-0-1939.

CLASS 42—SCIENTIFIC, COMPUTER AND LEGAL SERVICES

FOR ENGINEERING AND DESIGN SERVICES INVOLVING INDUSTRIAL GEARS, GEAR BOXES, DRIVERS, PUMPS, SPEED REDUCERS, SPEED INCREASES, TRANSMISSION EQUIPMENT, AND RELATED GOODS; COMPUTER-AIDED DESIGN (CAD) INVOLVING INDUSTRIAL GEARS, GEAR BOXES, DRIVERS, PUMPS, SPEED REDUCERS, SPEED INCREASES, TRANSMISSION EQUIPMENT, AND RELATED GOODS (U.S. CLS. 100 AND 101).
FIRST USE 0-0-1939; IN COMMERCE 0-0-1939.

2,858,850. SODEXHO OPERATIONS, LLC, GAITHERSBURG, MD. SN 78-161,933. PUB. 6-10-2003, FILED 9-9-2002.

VILLAGE MERCHANT

CLASS 35—ADVERTISING AND BUSINESS

FOR BUSINESS MARKETING CONSULTING SERVICES RENDERED TO RETIREMENT COMMUNITIES, FEATURING ANALYSES OF THE TASTES, PREFERENCES, AND SPENDING HABITS OF THE RESIDENTS OF SUCH COMMUNITIES (U.S. CLS. 100, 101 AND 102).
FIRST USE 0-0-2003; IN COMMERCE 0-0-2003.

CLASS 36—INSURANCE AND FINANCIAL

FOR CHARGE CARD SERVICES RENDERED TO RESIDENTS OF RETIREMENT COMMUNITIES (U.S. CLS. 100, 101 AND 102).
FIRST USE 0-0-2003; IN COMMERCE 0-0-2003.

CLASS 43—HOTEL AND RESTAURANT SERVICES

FOR CONTRACT FOOD SERVICES RENDERED TO RETIREMENT COMMUNITIES FEATURING CUSTOMIZED DINING PROGRAMS BASED ON ANALYSES OF THE TASTES, PREFERENCES, AND SPENDING HABITS OF THE RESIDENTS OF SUCH COMMUNITIES (U.S. CLS. 100 AND 101).
FIRST USE 0-0-2003; IN COMMERCE 0-0-2003.

2,858,853. RICHLAND PARTNERS, LLC, RICHLAND, PA. SN 78-162,970. PUB. 7-1-2003, FILED 9-11-2002.

LEFFLER ENERGY

NO CLAIM IS MADE TO THE EXCLUSIVE RIGHT TO USE "ENERGY", APART FROM THE MARK AS SHOWN.

CLASS 35—ADVERTISING AND BUSINESS

FOR WHOLESALE DISTRIBUTORSHIPS AND RETAIL SERVICES FEATURING OIL, GASOLINE AND OTHER PETROLEUM PRODUCTS (U.S. CLS. 100, 101 AND 102).
FIRST USE 8-31-2002; IN COMMERCE 8-31-2002.

CLASS 37—CONSTRUCTION AND REPAIR

FOR MAINTENANCE AND REPAIR OF EQUIPMENT UTILIZING OIL, GASOLINE AND OTHER PETROLEUM PRODUCTS, NAMELY FURNACES, BOILERS, HOT WATER HEATERS AND LIKE EQUIPMENT (U.S. CLS. 100, 103 AND 106).
FIRST USE 8-31-2002; IN COMMERCE 8-31-2002.

2,858,855. SODEXHO OPERATIONS, LLC, GAITHERSBURG, MD. SN 78-163,758. PUB. 6-24-2003, FILED 9-13-2002.

PREFERENCE MADE SIMPLE

CLASS 35—ADVERTISING AND BUSINESS

FOR BUSINESS MARKETING CONSULTING SERVICES RENDERED TO RETIREMENT COMMUNITIES, FEATURING ANALYSES OF THE TASTES, PREFERENCES, AND SPENDING HABITS OF THE RESIDENTS OF SUCH COMMUNITIES (U.S. CLS. 100, 101 AND 102).
FIRST USE 0-0-2003; IN COMMERCE 0-0-2003.

CLASS 36—INSURANCE AND FINANCIAL

FOR CHARGE CARD SERVICES RENDERED TO RESIDENTS OF RETIREMENT COMMUNITIES (U.S. CLS. 100, 101 AND 102).
FIRST USE 0-0-2003; IN COMMERCE 0-0-2003.

CLASS 43—HOTEL AND RESTAURANT SERVICES

FOR CONTRACT FOOD SERVICES RENDERED TO RETIREMENT COMMUNITIES FEATURING CUSTOMIZED DINING PROGRAMS BASED ON ANALYSES OF THE TASTES, PREFERENCES, AND SPENDING HABITS OF THE RESIDENTS OF SUCH COMMUNITIES (U.S. CLS. 100 AND 101).
FIRST USE 0-0-2003; IN COMMERCE 0-0-2003.

2,858,856. HOTSET HEIZPATRONEN U. ZUBEHOR GMBH, LUDENSCHIED, FED REP GERMANY. SN 78-163,896. PUB. 7-22-2003, FILED 9-13-2002.

HOTSLIGHT

PRIORITY CLAIMED UNDER SEC. 44(D) ON FED REP GERMANY APPLICATION NO. 30235914109, FILED 7-24-2002, REG. NO. 30235914, DATED 8-20-2002, EXPIRES 7-31-2012.

OWNER OF U.S. REG. NOS. 1,449,355 AND 2,514,206.

CLASS 9—ELECTRICAL AND SCIENTIFIC APPARATUS

FOR ELECTRICAL CONNECTORS AND PARTS THEREOF; THERMO ELEMENTS, NAMELY, ELECTRICAL TEMPERATURE MEASURING DEVICES (U.S. CLS. 21, 23, 26, 36 AND 38).
FIRST USE 9-30-2002; IN COMMERCE 1-31-2003.

CLASS 11—ENVIRONMENTAL CONTROL APPARATUS

FOR ELECTRICAL HEATERS FOR INDUSTRIAL PURPOSES AND PARTS THEREFOR, NAMELY, ELECTRICAL HEATING CARTRIDGES; AND TEMPERATURE CONTROL DEVICES SOLD ONLY AS A COMPONENT OF ELECTRICAL HEATERS (U.S. CLS. 13, 21, 23, 31 AND 34).
FIRST USE 9-30-2002; IN COMMERCE 1-31-2003.

2,858,857. LITIGATION SYSTEMS, INC., WASHINGTON, DC. SN 78-164,291. PUB. 7-1-2003, FILED 9-16-2002.

ELECTRONICODE

CLASS 9—ELECTRICAL AND SCIENTIFIC APPARATUS

FOR COMPUTER SOFTWARE FOR USE IN INDEXING AND ORGANIZING ELECTRONIC FILES, INCLUDING EMAIL; DECOMPRESSION OF ELECTRONIC FILES; EXTRACTION, ORGANIZATION, IDENTIFICATION AND TRANSFER OF DATA, TEXT AND IMAGES FROM ELECTRONIC FILES (U.S. CLS. 21, 23, 26, 36 AND 38).
FIRST USE 9-19-2002; IN COMMERCE 9-19-2002.

CLASS 35—ADVERTISING AND BUSINESS

FOR RECORDS MANAGEMENT SERVICES, NAMELY, INDEXING AND ORGANIZING ELECTRONIC FILES, INCLUDING EMAIL; AND EXTRACTING, ORGANIZING AND IDENTIFYING DATA, TEXT AND IMAGES FROM ELECTRONIC FILES (U.S. CLS. 100, 101 AND 102).
FIRST USE 10-0-1998; IN COMMERCE 10-0-1998.

CLASS 38—COMMUNICATION

FOR ELECTRONIC TRANSMISSION OF DATA, TEXT AND IMAGES FROM ELECTRONIC FILES (U.S. CLS. 100, 101 AND 104).
FIRST USE 10-0-1998; IN COMMERCE 10-0-1998.

CLASS 40—MATERIAL TREATMENT

FOR DIGITAL DECOMPRESSION OF ELECTRONIC FILES (U.S. CLS. 100, 103 AND 106).
FIRST USE 10-0-1998; IN COMMERCE 10-0-1998.

2,858,859. ECLECTIC PRODUCTS, INC., EUGENE, OR. SN 78-165,043. PUB. 11-11-2003, FILED 9-17-2002.

RV GOOP

NO CLAIM IS MADE TO THE EXCLUSIVE RIGHT TO USE "RV", APART FROM THE MARK AS SHOWN.

CLASS 1—CHEMICALS

FOR ADHESIVES FOR THE REPAIR OF RECREATIONAL VEHICLES (U.S. CLS. 1, 5, 6, 10, 26 AND 46).
FIRST USE 1-1-2003; IN COMMERCE 1-1-2003.

CLASS 17—RUBBER GOODS

FOR SEALANTS FOR THE REPAIR OF RECREATIONAL VEHICLES (U.S. CLS. 1, 5, 12, 13, 35 AND 50).
FIRST USE 1-1-2003; IN COMMERCE 1-1-2003.

2,858,879. DIOTALEVI, DAVID A., MILFORD, MA. SN 78-170,922. PUB. 7-15-2003, FILED 10-4-2002.

FACEGRACES

CLASS 3—COSMETICS AND CLEANING PREPARATIONS

FOR COSMETICS (U.S. CLS. 1, 4, 6, 50, 51 AND 52).
FIRST USE 11-1-2002; IN COMMERCE 11-1-2002.

CLASS 16—PAPER GOODS AND PRINTED MATTER

FOR PRINTED PRODUCTS, NAMELY, PRODUCT GUIDES FEATURING TEMPORARY TATTOOS AND INSTRUCTIONS DESCRIBING A SYSTEM FOR THEIR USE SOLD AS A UNIT (U.S. CLS. 2, 5, 22, 23, 29, 37, 38 AND 50).

FIRST USE 11-1-2002; IN COMMERCE 11-1-2002.

2,858,882. FIOS, INC., PORTLAND, OR. SN 78-171,868. PUB. 5-27-2003, FILED 10-7-2002.

ELECTRONIC DISCOVERY SIMPLIFIED

NO CLAIM IS MADE TO THE EXCLUSIVE RIGHT TO USE "ELECTRONIC DISCOVERY", APART FROM THE MARK AS SHOWN.

CLASS 35—ADVERTISING AND BUSINESS

FOR COMPUTERIZED DATABASE MANAGEMENT; BUSINESS INFORMATION AUDITING; DATA AUDITING; BUSINESS MANAGEMENT CONSULTATION (U.S. CLS. 100, 101 AND 102).

FIRST USE 11-19-2002; IN COMMERCE 1-27-2003.

CLASS 42—SCIENTIFIC, COMPUTER AND LEGAL SERVICES

FOR PROVIDING TEMPORARY USE OF ONLINE NON-DOWNLOADABLE SOFTWARE FOR USE IN DATABASE AND INFORMATION MANAGEMENT, COMPUTER-BASED LITIGATION SUPPORT, AND ELECTRONIC DISCOVERY; COMPUTER-BASED LITIGATION SUPPORT SERVICES; ELECTRONIC DISCOVERY SERVICES; CONSULTATION IN THE FIELD OF INFORMATION MANAGEMENT; ELECTRONIC DATA COLLECTION AS AN ELEMENT OF COMPUTER-BASED LITIGATION SUPPORT SERVICES (U.S. CLS. 100 AND 101).

FIRST USE 3-22-2003; IN COMMERCE 3-22-2003.

2,858,909. CLIO DESIGNS INCORPORATED, WATERTOWN, MA. SN 78-182,969. PUB. 9-16-2003, FILED 11-7-2002.

CLIO DESIGNS

NO CLAIM IS MADE TO THE EXCLUSIVE RIGHT TO USE "DESIGNS", APART FROM THE MARK AS SHOWN.

CLASS 8—HAND TOOLS

FOR GOOD FOR PERSONAL CARE, NAMELY, NON-ELECTRIC RAZORS, SHAVERS, BATTERY-OPERATED SHAVERS, NOSE AND EAR HAIR TRIMMERS AND EYEBROW TRIMMERS (U.S. CLS. 23, 28 AND 44).
FIRST USE 11-11-2002; IN COMMERCE 5-29-2003.

CLASS 9—ELECTRICAL AND SCIENTIFIC APPARATUS

FOR BODY FAT ANALYZERS (U.S. CLS. 21, 23, 26, 36 AND 38).

FIRST USE 11-11-2002; IN COMMERCE 10-15-2003.

CLASS 21—HOUSEWARES AND GLASS

FOR GOODS FOR PERSONAL CARE, NAMELY, TOOTHBRUSHES, AND HAIR BRUSHES AND COMBS (U.S. CLS. 2, 13, 23, 29, 30, 33, 40 AND 50).

FIRST USE 12-10-2002; IN COMMERCE 7-28-2003.

2,858,923. P.K. FOOD CORP., SAN LEANDRO, CA. SN 78-186,338. PUB. 7-1-2003, FILED 11-18-2002.

MR. TOON

CLASS 29—MEATS AND PROCESSED FOODS

FOR CANNED FRUIT; CANNED SEAFOOD AND FISH; AND IMITATION SEAFOOD (U.S. CL. 46).

FIRST USE 1-1-2003; IN COMMERCE 1-1-2003.

CLASS 30—STAPLE FOODS

FOR RICE (U.S. CL. 46).

FIRST USE 4-15-2002; IN COMMERCE 4-15-2002.

CLASS 32—LIGHT BEVERAGES

FOR CANNED FRUIT JUICE (U.S. CLS. 45, 46 AND 48).

FIRST USE 1-1-2003; IN COMMERCE 1-1-2003.

2,858,924. NEOPETS, INC., GLENDALE, CA. SN 78-186,650. PUB. 12-16-2003, FILED 11-19-2002.

KADOATIE

CLASS 16—PAPER GOODS AND PRINTED MATTER

FOR PAPER GOODS AND PRINTED MATTER, NAMELY, TRADING CARDS, POSTERS, STICKERS, PAPER PARTY DECORATIONS; STATIONERY ITEMS, NAMELY, ENVELOPES, GREETING CARDS, ANNOUNCEMENT CARDS, NOTEBOOKS AND PADS, NOTE PAPER, NOTE CARDS, AND LABELS; PAINTINGS AND CALLIGRAPHIC WORKS; PHOTOGRAPHS; BOOKS AND PAMPHLETS FEATURING ANIMATED CHARACTERS (U.S. CLS. 2, 5, 22, 23, 29, 37, 38 AND 50).

FIRST USE 11-20-2002; IN COMMERCE 11-20-2002.

CLASS 28—TOYS AND SPORTING GOODS

FOR TOYS, GAMES AND PLAYTHINGS, NAMELY, TOY VEHICLES, TOY ACTION FIGURES AND ACCESSORIES FOR USE THEREWITH; DOLLS, DOLL CLOTHING AND DOLL ACCESSORIES; CHILDREN'S MULTIPLE ACTIVITY TOYS; PLUSH TOYS; STUFFED TOYS; PLASTIC AND VINYL TOY CHARACTERS AND TOY ANIMALS; TOY FIGURES; RADIO-CONTROLLED TOY VEHICLES; MECHANICAL TOYS; WIND-UP TOYS; WATER SQUIRTING TOYS; MUSICAL TOYS; INFLATABLE TOYS; JIGSAW PUZZLES; EQUIPMENT SOLD AS A UNIT FOR PLAYING BOARD, PARLOR, SKILL AND ACTION, CARD, ROLE-PLAYING, AND ELECTRONIC HAND-HELD UNIT FOR PLAYING GAMES (U.S. CLS. 22, 23, 38 AND 50).

FIRST USE 11-10-2002; IN COMMERCE 11-10-2002.

2,858,956. WOMBLE CARLYLE SANDRIDGE & RICE, PLLC, WINSTON-SALEM, NC. SN 78-197,356. PUB. 8-26-2003, FILED 12-23-2002.

COVERGARD**CLASS 36—INSURANCE AND FINANCIAL**

FOR INSURANCE CONSULTING SERVICES (U.S. CLS. 100, 101 AND 102).

FIRST USE 5-0-2003; IN COMMERCE 5-0-2003.

CLASS 42—SCIENTIFIC, COMPUTER AND LEGAL SERVICES

FOR LEGAL SERVICES, NAMELY, PROVIDING ADVICE TO BUSINESSES WITH RESPECT TO THE ADEQUACY OF THEIR INSURANCE COVERAGE (U.S. CLS. 100 AND 101).

FIRST USE 5-0-2003; IN COMMERCE 5-0-2003.

2,858,926. KONICA MINOLTA GRAPHIC IMAGING U.S.A., INC., MAHWAH, NJ. SN 78-187,342. PUB. 10-14-2003, FILED 11-21-2002.

REPLICA NEWS

NO CLAIM IS MADE TO THE EXCLUSIVE RIGHT TO USE "NEWS", APART FROM THE MARK AS SHOWN.

CLASS 1—CHEMICALS

FOR CHEMICALS FOR DEVELOPING PRINTING PLATES (U.S. CLS. 1, 5, 6, 10, 26 AND 46).

FIRST USE 10-1-2003; IN COMMERCE 10-1-2003.

CLASS 7—MACHINERY

FOR PRINTING PLATES (U.S. CLS. 13, 19, 21, 23, 31, 34 AND 35).

FIRST USE 10-1-2003; IN COMMERCE 10-1-2003.

2,858,976. NAVIGANT INTERNATIONAL, INC., ENGLEWOOD, CO. SN 78-206,642. PUB. 11-4-2003, FILED 1-23-2003.

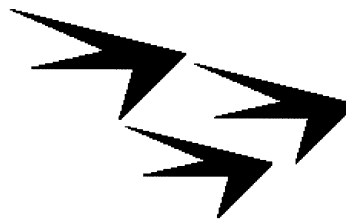

OWNER OF U.S. REG. NO. 2,340,447.
THE MARK CONSISTS OF AN ABSTRACT DEPICTION OF THREE FLYING BIRDS.

2,858,951. BAKER HUGHES INCORPORATED, HOUSTON, TX. SN 78-195,638. PUB. 8-19-2003, FILED 12-18-2002.

ISAP**CLASS 7—MACHINERY**

FOR DOWNHOLE OIL FIELD EQUIPMENT, NAMELY PACKERS AND BRIDGE PLUGS, USED IN OIL AND GAS WELLS TO ISOLATE THE FLOW OF FLUIDS TO OR FROM GEOLOGIC FORMATIONS (U.S. CLS. 13, 19, 21, 23, 31, 34 AND 35).

FIRST USE 4-1-1997; IN COMMERCE 6-1-1997.

CLASS 9—ELECTRICAL AND SCIENTIFIC APPARATUS

FOR DOWNHOLE OIL FIELD EQUIPMENT, NAMELY FLOW REGULATORS USED IN OIL AND GAS WELLS (U.S. CLS. 21, 23, 26, 36 AND 38).

FIRST USE 4-1-1997; IN COMMERCE 6-1-1997.

CLASS 35—ADVERTISING AND BUSINESS

FOR TRAVEL AGENCY SERVICES, NAMELY, MAKING RESERVATIONS AND BOOKING CONFERENCE FACILITIES; ARRANGING AND CONDUCTING BUSINESS CONFERENCES; BUSINESS TRAVEL AND CONFERENCE PLANNING SERVICES, NAMELY, ARRANGING AND CONDUCTING BUSINESS MEETINGS FOR OTHERS; TRAVEL MANAGEMENT SERVICES, NAMELY, ASSISTING OTHERS IN MONITORING AND REPORTING TRAVEL EXPENSES AND TRAVEL PROGRAMS (U.S. CLS. 100, 101 AND 102).

FIRST USE 2-1-2004; IN COMMERCE 2-1-2004.

CLASS 39—TRANSPORTATION AND STORAGE

FOR TRAVEL AGENCY SERVICES, NAMELY, MAKING RESERVATIONS AND BOOKING GROUND AND AIR TRANSPORTATION AND TEMPORARY LODGING; PROVIDING TRAVEL INFORMATION, AND ARRANGING TRAVEL TOURS; PROVIDING TRAVEL GUIDE SERVICES; BOOKING CRUISES AND SIGHT-SEEING TOURS FOR OTHERS (U.S. CLS. 100 AND 105).

FIRST USE 2-1-2004; IN COMMERCE 2-1-2004.

2,858,993. NAVITAIRE INC., MINNEAPOLIS, MN. SN 78-216,703. PUB. 10-7-2003, FILED 2-19-2003.

2,859,022. URBAN SCIENCE APPLICATIONS, INC., DETROIT, MI. SN 78-240,673. PUB. 12-16-2003, FILED 4-22-2003.

POWERED BY NAVITAIRE

CLASS 9—ELECTRICAL AND SCIENTIFIC APPARATUS

FOR COMPUTER SOFTWARE, HARDWARE, AND COMPUTER-OPERATED KIOSKS COMPRISED OF A COMPUTER, A TOUCH SCREEN, AND PROPRIETARY SOFTWARE FOR CONTROLLING THE KIOSKS, FOR MAKING RESERVATIONS, FOR ENABLING PASSENGER BOARDING, REGISTRATION, AND CHECK-IN, AND CUSTOMER LOYALTY SERVICES, IN THE FIELDS OF TRAVEL, TRANSPORTATION AND TEMPORARY LODGING; COMPUTER SOFTWARE AND HARDWARE FOR ACCOUNTING AND FINANCIAL MANAGEMENT FOR USE IN THE TRAVEL, TRANSPORTATION AND LODGING INDUSTRIES (U.S. CLS. 21, 23, 26, 36 AND 38).

FIRST USE 2-23-2004; IN COMMERCE 2-23-2004.

CLASS 39—TRANSPORTATION AND STORAGE

FOR ONLINE DATA AND DOCUMENT MANAGEMENT SERVICES IN THE FIELDS OF AIRLINE RESERVATIONS, CUSTOMER INFORMATION, AND FLIGHT SCHEDULES, NAMELY, TRANSPORTATION RESERVATION SERVICES (U.S. CLS. 100 AND 105).

FIRST USE 5-5-2003; IN COMMERCE 5-5-2003.

2,859,011. PATERNO, MARIA K., SANTA CLARA, CA. SN 78-233,544. PUB. 12-16-2003, FILED 4-3-2003.

MARISAN GROUP

NO CLAIM IS MADE TO THE EXCLUSIVE RIGHT TO USE "GROUP", APART FROM THE MARK AS SHOWN.

CLASS 35—ADVERTISING AND BUSINESS

FOR PROVIDING BUSINESS AND BUSINESS MARKETING CONSULTING SERVICES TO THE HIGH TECHNOLOGY INDUSTRY (U.S. CLS. 100, 101 AND 102).

FIRST USE 6-1-1990; IN COMMERCE 6-1-1990.

CLASS 42—SCIENTIFIC, COMPUTER AND LEGAL SERVICES

FOR TECHNICAL CONSULTING SERVICES IN THE FIELD OF COMPUTER SOFTWARE AND HARDWARE DEVELOPMENT (U.S. CLS. 100 AND 101).

FIRST USE 6-1-1990; IN COMMERCE 6-1-1990.

POTENTIAL DELIVERED

CLASS 9—ELECTRICAL AND SCIENTIFIC APPARATUS

FOR COMPUTER SOFTWARE AND INSTRUCTIONAL MANUALS SOLD AS A UNIT FOR MARKET RESEARCH AND ANALYSIS (U.S. CLS. 21, 23, 26, 36 AND 38).

FIRST USE 6-0-2003; IN COMMERCE 6-0-2003.

CLASS 35—ADVERTISING AND BUSINESS

FOR BUSINESS CONSULTATION SERVICES, NAMELY, MARKET RESEARCH AND ANALYSIS, STATISTICAL AND QUANTITATIVE ANALYSIS IN THE NATURE OF PROVIDING STATISTICAL INFORMATION FOR BUSINESS OR COMMERCIAL PURPOSES, COMPUTERIZED DATABASE MANAGEMENT, AND BUSINESS CONSULTATION IN THE FIELD OF DIRECT MARKETING (U.S. CLS. 100, 101 AND 102).

FIRST USE 6-0-2003; IN COMMERCE 6-0-2003.

CLASS 42—SCIENTIFIC, COMPUTER AND LEGAL SERVICES

FOR COMPUTER NETWORK CONSULTATION SERVICES, DATA AND TECHNICAL CONSULTATION SERVICES FOR SOFTWARE APPLICATIONS, COMPUTER SOFTWARE PROGRAMMING AND DESIGN FOR OTHERS, GRAPHIC ART DESIGN FOR DIRECT MARKETING, AND ARBITRATION SUPPORT SERVICES (U.S. CLS. 100 AND 101).

FIRST USE 6-0-2003; IN COMMERCE 6-0-2003.

2,859,045. BRIGHT PROSPECT SCHOLAR SUPPORT PROGRAM, POMONA, CA. SN 78-975,361. PUB. 5-27-2003, FILED 12-18-2001.

BRIGHT PROSPECT

CLASS 16—PAPER GOODS AND PRINTED MATTER

FOR PUBLICATIONS, NAMELY, MAGAZINES, NEWSLETTERS, BOOKS, PAMPHLETS, BROCHURES, CATALOGS FLYERS AND LEAFLETS IN THE FIELD OF EDUCATION, STUDY SKILLS, COLLEGE COUNSELING, SCHOLARSHIP GUIDANCE, COLLEGE ENTRANCE EXAMINATION PREPARATION, CAREER COUNSELING AND COLLEGE FINANCING; PENS; PENCILS; NOTEBOOKS; CALENDARS; PAPER WEIGHTS; PAPER COASTERS; PAPER BANNERS; PAPER FLAGS; DATE BOOKS; POSTERS; PHOTO ALBUMS; DRAFTING, DRAWING AND UNGRADUATED RULERS; PAPER PENNANTS (U.S. CLS. 2, 5, 22, 23, 29, 37, 38 AND 50).

FIRST USE 6-11-2002; IN COMMERCE 6-11-2002.

CLASS 36—INSURANCE AND FINANCIAL

FOR CHARITABLE FUND RAISING SERVICES; PROVIDING EDUCATIONAL SCHOLARSHIPS (U.S. CLS. 100, 101 AND 102).

FIRST USE 6-11-2002; IN COMMERCE 6-11-2002.

CLASS 41—EDUCATION AND ENTERTAINMENT

FOR EDUCATIONAL SERVICES, NAMELY, PROVIDING COURSES, WORKSHOPS, SEMINARS, AND DISTANCE LEARNING PROGRAMS IN THE FIELD OF EDUCATION, STUDY SKILLS, COLLEGE COUNSELING, SCHOLARSHIP GUIDANCE, COLLEGE ENTRANCE EXAMINATION PREPARATION, CAREER COUNSELING AND COLLEGE FINANCING (U.S. CLS. 100, 101 AND 107).

FIRST USE 6-11-2002; IN COMMERCE 6-11-2002.

* * * * *

SECTION 2.— INTERNATIONAL CLASSIFICATION

The short titles associated below with the international class numbers are terms designed merely for quick identification and are not an official part of the international classification. The full names of international classes are given in section 6.1 of the trademark rules of practice.

The designation "U.S. Cl." appearing in this section refers to the U.S. class in effect prior to Sep. 1, 1973 rather than the international class which applies to applications filed on or after that date. For adoption of international classification see notice in the OFFICIAL GAZETTE of Jun. 26, 1973 (911 O.G. TM 210).

Application in one class

CLASS 1—CHEMICALS

2,858,210. SHELL OIL COMPANY, HOUSTON, TX. SN 75-783,329. PUB. 10-7-2003, FILED 8-24-1999.

CLASS 1—(Continued).

2,858,380. DDB CORPORATION, HIALEAH, FL. SN 76-319,131. PUB. 8-5-2003, FILED 9-28-2001.

NEW GEN

FOR EXPOXY RESIN DISPERSION FOR THE PREPARATION OF CLEAR COATS, ENAMELS AND PRIMERS; CURING AGENT DISPERSION FOR THE PREPARATION OF CLEAR COATS, ENAMELS AND PRIMERS (U.S. CLS. 1, 5, 6, 10, 26 AND 46).

FIRST USE 11-1-2001; IN COMMERCE 11-1-2001.



NO CLAIM IS MADE TO THE EXCLUSIVE RIGHT TO USE "SWEET AMERICA", APART FROM THE MARK AS SHOWN.

FOR ARTIFICIAL SWEETENERS, NAMELY, A LOW CALORIE SUGAR SUBSTITUTE (U.S. CLS. 1, 5, 6, 10, 26 AND 46).

FIRST USE 10-1-2003; IN COMMERCE 1-14-2004.

2,858,336. SAXE, CHARLES C., CAMARILLO, CA. SN 76-259,302. PUB. 5-7-2002, FILED 5-18-2001.

FERTERRA

FOR SOIL CONDITIONERS FOR AGRICULTURAL, DOMESTIC, AND HORTICULTURAL USE, NAMELY, SOIL AMENDMENTS COMPOSED OF MINERALS, RICE HULLS, ORGANIC HUMUS, HUMATE SOIL CONDITIONERS; SOIL GOODS, NAMELY, PLANTING MIX, POTTING MIX FOR AGRICULTURAL, DOMESTIC, AND HORTICULTURAL USE AND FERTILIZERS, NAMELY, ORGANIC FERTILIZERS FOR AGRICULTURAL, DOMESTIC, AND HORTICULTURAL USE (U.S. CLS. 1, 5, 6, 10, 26 AND 46).

FIRST USE 3-9-2000; IN COMMERCE 11-24-2003.

2,858,387. SERVICIOS CORPORATIVOS DE ADMINISTRACION G.M.Z., S.A. DE C.V., COL. DEL VALLE, C.P. 03100, MEXICO, D.F., MEXICO. SN 76-328,872. PUB. 7-29-2003, FILED 10-23-2001.

OMNI INSTANT GLUE

NO CLAIM IS MADE TO THE EXCLUSIVE RIGHT TO USE "INSTANT GLUE", APART FROM THE MARK AS SHOWN.

FOR GLUES AND ADHESIVES FOR USE IN THE AUTOMOTIVE INDUSTRY, AUTOMOBILE REPAIR INDUSTRY, FOOTWEAR INDUSTRY, PLASTICS INDUSTRY, TOY INDUSTRY AND FURNITURE INDUSTRY, BUT EXCLUDING ADHESIVES FOR USE IN THE CONSTRUCTION INDUSTRY (U.S. CLS. 1, 5, 6, 10, 26 AND 46).

FIRST USE 4-26-2002; IN COMMERCE 4-30-2002.

CLASS 1—(Continued).

2,858,399. SERVICIOS CORPORATIVOS DE ADMINISTRACION G.M.Z., S.A. DE C.V. COL. DEL VALLE, C.P. 03100, MEXICO. SN 76-346,282. PUB. 7-29-2003, FILED 12-10-2001.

OMNI

FOR GLUES AND ADHESIVES FOR USE IN THE AUTOMOTIVE INDUSTRY, AUTOMOBILE REPAIR INDUSTRY, FOOTWEAR INDUSTRY, PLASTICS INDUSTRY, TOY INDUSTRY AND FURNITURE INDUSTRY, BUT EXCLUDING ADHESIVES FOR USE IN THE CONSTRUCTION INDUSTRY (U.S. CLS. 1, 5, 6, 10, 26 AND 46).

FIRST USE 4-26-2002; IN COMMERCE 4-30-2002.

2,858,439. POWER SERVICE PRODUCTS, INC., WEATHERFORD, TX. SN 76-377,001. PUB. 4-15-2003, FILED 3-1-2002.

SLICK DIESEL

NO CLAIM IS MADE TO THE EXCLUSIVE RIGHT TO USE "DIESEL", APART FROM THE MARK AS SHOWN.

FOR CHEMICAL ADDITIVES FOR USE IN COMBINATION WITH ENGINE FUELS (U.S. CLS. 1, 5, 6, 10, 26 AND 46).

FIRST USE 11-0-2003; IN COMMERCE 11-0-2003.

2,858,482. DRY PAK INDUSTRIES, INC., STUDIO CITY, CA. SN 76-412,074. PUB. 12-31-2002, FILED 5-24-2002.

PERFORMANCE DRY

NO CLAIM IS MADE TO THE EXCLUSIVE RIGHT TO USE "DRY", APART FROM THE MARK AS SHOWN.

FOR CHEMICAL, NAMELY, DESICCANTS FOR USE IN THE PACKAGING (U.S. CLS. 1, 5, 6, 10, 26 AND 46).

FIRST USE 1-28-2004; IN COMMERCE 12-22-2003.

2,858,489. HUMEX, S.A., 43110 LA CANONJA (TARRAGONA), SPAIN. SN 76-416,510. PUB. 6-17-2003, FILED 6-3-2002.



NO CLAIM IS MADE TO THE EXCLUSIVE RIGHT TO USE "S.A.", APART FROM THE MARK AS SHOWN.

THE BLACK IN THE DRAWING IS BLUE AND THE REMAINDER OF THE LOGO IS YELLOW.

FOR CHEMICAL PRODUCTS, NAMELY CALCIUM CHLORIDE USED FOR THE ABSORPTION OF HUMIDITY IN AIR (U.S. CLS. 1, 5, 6, 10, 26 AND 46).

FIRST USE 2-4-2003; IN COMMERCE 2-4-2003.

CLASS 1—(Continued).

2,858,522. UMG ABS, LTD., TOKYO, JAPAN. SN 76-429,365. PUB. 6-10-2003, FILED 7-11-2002.

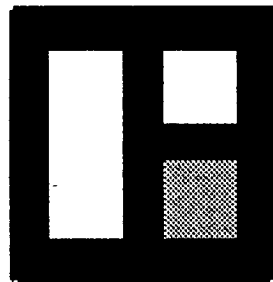

THE STIPLING IN THE DRAWING INDICATES SHADING.

FOR UNPROCESSED SYNTHETIC RESINS AND RESIN MOLDING COMPOUNDS FOR USE IN A WIDE VARIETY OF FIELDS; UNPROCESSED PLASTICS FOR USE IN A WIDE VARIETY OF FIELDS; CHEMICALS FOR USE IN THE MANUFACTURE OF A WIDE VARIETY OF GOODS (U.S. CLS. 1, 5, 6, 10, 26 AND 46).

FIRST USE 4-1-2002; IN COMMERCE 4-1-2002.

2,858,556. REMEDIATION PRODUCTS, INC., ARVADA, CO. SN 76-439,089. PUB. 6-17-2003, FILED 8-9-2002.

TRAP & TREAT

FOR ENVIRONMENTAL REMEDIATION PRODUCTS, NAMELY ON ADSORBENT CHEMICAL MATRIX USED TO SUPPORT A CATALYST OR MICROBE FOR USE IN SITU REMEDIATION OF SOIL AND GROUND WATER CONTAMINATION (U.S. CLS. 1, 5, 6, 10, 26 AND 46).

FIRST USE 11-13-2003; IN COMMERCE 11-13-2003.

2,858,633. WELLMAN, INC., SHREWSBURY, NJ. SN 76-477,330. PUB. 12-2-2003, FILED 12-20-2002.

THERMACLEAR TI

NO CLAIM IS MADE TO THE EXCLUSIVE RIGHT TO USE "TI", APART FROM THE MARK AS SHOWN.

FOR UNPROCESSED SYNTHETIC RESINS, NAMELY, POLYETHYLENE TEREPHTHALATE (PET) RESIN (U.S. CLS. 1, 5, 6, 10, 26 AND 46).

FIRST USE 2-1-2004; IN COMMERCE 2-1-2004.

CLASS 1—(Continued).

2,859,033. J.M. HUBER CORPORATION, EDISON, NJ. SN 78-253,766. PUB. 1-6-2004, FILED 5-23-2003.

RXCIPIENTS

FOR CHEMICAL ADDITIVES FOR USE IN THE MANUFACTURE OF PHARMACEUTICALS (U.S. CLS. 1, 5, 6, 10, 26 AND 46).

FIRST USE 1-30-2004; IN COMMERCE 1-30-2004.

CLASS 2—PAINTS

2,858,457. DIAMON-FUSION INTERNATIONAL, INC., SAN JUAN CAPISTRANO, CA. SN 76-398,685. PUB. 12-17-2002, FILED 4-22-2002.

**INNOVATION THAT
IGNITES BUSINESS**

FOR PROTECTIVE COATINGS FOR GLASS, CERAMIC TILE, PORCELAIN, GRANITE, AND OTHER SUBSTRATES (U.S. CLS. 6, 11 AND 16).

FIRST USE 4-10-2002; IN COMMERCE 4-10-2002.

2,858,487. TERMA-RUST INC., NEWARK, COUNTY OF NEW CASTLE, DE. SN 76-415,491. PUB. 6-10-2003, FILED 6-3-2002.

TERMARUST

FOR HIGH PERFORMANCE, ANTICORROSIVE, VOLATILE ORGANIC COMPOUND COMPLIANT COATINGS INCLUDING RUST INHIBITORS, PENETRANTS, SURFACE TOLERANT PRIMERS, AND SURFACE TOP COATS (U.S. CLS. 6, 11 AND 16).

FIRST USE 3-0-2003; IN COMMERCE 3-0-2003.

CLASS 3—COSMETICS AND CLEANING PREPARATIONS**CLASS 3—(Continued).**

2,858,193. BIOCARE LABS, INC., BEDFORD PARK, IL. SN 75-640,162. PUB. 1-16-2001, FILED 2-10-1999.



NO CLAIM IS MADE TO THE EXCLUSIVE RIGHT TO USE "NATURAL", APART FROM THE MARK AS SHOWN. BELLEZA" IS SPANISH FOR "BEAUTY".

FOR NON-MEDICATION HAIR CARE PREPARATIONS, HAIR SHAMPOOS AND HAIR CONDITIONERS, AND SKIN CARE PRODUCTS, NAMELY, SKIN CLARIFIERS, SKIN CLEANSERS, SKIN CLEANSING CREAM, SKIN CLEANSING LOTION, SKIN CREAM, SKIN EMOLLIENTS, SKIN LIGHTENERS, SKIN LOTION, SKIN MASKS AND SKIN MOISTURIZER MASKS (U.S. CLS. 1, 4, 6, 50, 51 AND 52).

FIRST USE 9-0-2003; IN COMMERCE 10-0-2003.

2,858,349. TRANZONIC COMPANIES, THE, DBA HOSPITAL SPECIALTY COMPANY, HIGHLAND HEIGHTS, OH. SN 76-276,766. PUB. 12-23-2003, FILED 6-26-2001.

PRECIOUS

OWNER OF U.S. REG. NO. 1,659,713. FOR PREMOISTENED BABY WIPES (U.S. CLS. 1, 4, 6, 50, 51 AND 52).

FIRST USE 1-2-2003; IN COMMERCE 1-2-2003.

2,858,408. ALDI INC., BATAVIA, IL. SN 76-351,428. PUB. 6-25-2002, FILED 12-21-2001.

NANNY'S

OWNER OF U.S. REG. NOS. 1,678,501 AND 1,765,494. FOR BABY WIPES (U.S. CLS. 1, 4, 6, 50, 51 AND 52).

FIRST USE 3-3-2004; IN COMMERCE 3-3-2004.

2,858,520. MIGLIORE, INC., CHICAGO, IL. SN 76-428,984. PUB. 3-4-2003, FILED 7-9-2002.

11TH COMMANDMENT

FOR PERFUME AND FRAGRANCES FOR PERSONAL USE (U.S. CLS. 1, 4, 6, 50, 51 AND 52).

FIRST USE 7-25-2003; IN COMMERCE 7-25-2003.

CLASS 3—(Continued).

2,858,605. NEUTROGENA CORPORATION, LOS ANGELES, CA. SN 76-466,928. PUB. 8-5-2003, FILED 11-5-2002.

NEUTROGENA HYDRATING FACIAL

OWNER OF U.S. REG. NOS. 590,385, 2,019,977, AND OTHERS.

NO CLAIM IS MADE TO THE EXCLUSIVE RIGHT TO USE "HYDRATING FACIAL", APART FROM THE MARK AS SHOWN.

FOR FACIAL SKIN CARE PRODUCTS, NAMELY, FACIAL CLEANSER, FACIAL WIPES AND FACIAL STRIPS, EYE CREAM, EYE GEL, EYE LOTION, FACIAL TREATMENT CREAM, FACIAL TREATMENT GEL, FACIAL TREATMENT LOTION, ANTI-AGING CREAM, ANTI-AGING GEL, ANTI-AGING LOTION, MOISTURIZER CREAM, MOISTURIZER GEL, MOISTURIZER LOTION, FACIAL MASKS; COSMETICS, NAMELY, FOUNDATION, MAKE-UP, LOOSE FACIAL POWDER, PRESSED FACIAL POWDER, CONCEALER, EYE SHADOW AND LIP COLOR; BODY CARE PRODUCTS, NAMELY, BODY LOTION, BODY CREAM, BODY WASH, BODY SHAVE GEL, ANTI-PER SPIRANT, HAND CREAM AND HAND LOTION (U.S. CLS. 1, 4, 6, 50, 51 AND 52).

FIRST USE 2-28-2003; IN COMMERCE 2-28-2003.

2,858,645. THOMPSON, ANDY, AUSTIN, TX. SN 76-483,298. PUB. 7-22-2003, FILED 1-17-2003.

ANTI MONKEY BUTT

FOR POWDER FOR THE PREVENTION AND TREATMENT OF RASHES (U.S. CLS. 1, 4, 6, 50, 51 AND 52).
FIRST USE 1-28-2004; IN COMMERCE 1-28-2004.

2,858,676. GOLDEN CROWN CORPORATION, POST FALLS, ID. SN 76-508,321. PUB. 12-2-2003, FILED 4-7-2003.

GLIDE EASE

FOR NON-MEDICATED GROOMING PREPARATION, NAMELY, D-MATting HAIR SPRAY FOR CATS AND DOGS (U.S. CLS. 1, 4, 6, 50, 51 AND 52).
FIRST USE 3-1-2003; IN COMMERCE 3-1-2003.

2,858,682. ADVANCED TECHNOLOGY SYSTEMS, INC., INDIANAPOLIS, IN. SN 76-517,992. PUB. 12-2-2003, FILED 5-29-2003.

BONFIRE

FOR SUNTANNING PREPARATIONS (U.S. CLS. 1, 4, 6, 50, 51 AND 52).
FIRST USE 11-9-2003; IN COMMERCE 11-9-2003.

CLASS 3—(Continued).

2,858,692. WAL-MART STORES, INC., BENTONVILLE, AR. SN 76-976,605. PUB. 9-2-2003, FILED 1-28-2003.

KID CONNECTION

NO CLAIM IS MADE TO THE EXCLUSIVE RIGHT TO USE "KID", APART FROM THE MARK AS SHOWN.
FOR BUBBLE BATH (U.S. CLS. 1, 4, 6, 50, 51 AND 52).
FIRST USE 6-30-2003; IN COMMERCE 6-30-2003.

2,858,693. WAL-MART STORES, INC., BENTONVILLE, AR. SN 76-976,606. PUB. 10-14-2003, FILED 1-28-2003.



NO CLAIM IS MADE TO THE EXCLUSIVE RIGHT TO USE "KID", APART FROM THE MARK AS SHOWN.
THE MARK CONSISTS OF MULTIPLE STICK FIGURES IN A CIRCLE WITH AN OVAL AROUND THE FIGURES AND WORDS "KID CONNECTION".
FOR BUBBLE BATH (U.S. CLS. 1, 4, 6, 50, 51 AND 52).
FIRST USE 6-30-2003; IN COMMERCE 6-30-2003.

2,858,740. HAIRMARKER LLC, SANTA FE, NM. SN 78-082,232. PUB. 1-8-2002, FILED 8-31-2001.

GOOD BYE GRAY

FOR HAIR CARE PRODUCTS, NAMELY, HAIR COLORING PREPARATIONS (U.S. CLS. 1, 4, 6, 50, 51 AND 52).
FIRST USE 2-10-2004; IN COMMERCE 2-10-2004.

2,858,781. HANNA'S CANDLE COMPANY, FAYETTEVILLE, AR. SN 78-118,878. PUB. 8-12-2003, FILED 4-2-2002.

MY SPACE

FOR HYGIENE ITEMS FOR PERSONAL USE, NAMELY HAND SOAPS, BODY SOAPS, LOTIONS, CONDITIONERS, FRAGRANCES (U.S. CLS. 1, 4, 6, 50, 51 AND 52).
FIRST USE 1-1-2004; IN COMMERCE 1-1-2004.

CLASS 3—(Continued).

2,858,782. HANNA'S CANDLE COMPANY, FAYETTEVILLE, AR. SN 78-118,883. PUB. 3-18-2003, FILED 4-2-2002.

MY SPA

NO CLAIM IS MADE TO THE EXCLUSIVE RIGHT TO USE "SPA", APART FROM THE MARK AS SHOWN.

FOR HYGIENE ITEMS FOR PERSONAL USE, NAMELY, HAND SOAPS, BODY SOAPS, LOTIONS, CONDITIONERS, FRAGRANCES (U.S. CLS. 1, 4, 6, 50, 51 AND 52).

FIRST USE 1-1-2004; IN COMMERCE 1-1-2004.

2,858,808. L'OREAL USA CREATIVE, INC., NEW YORK, NY. SN 78-137,604. PUB. 4-8-2003, FILED 6-21-2002.

SOLID WATER

FOR HAIR STYLING PREPARATIONS (U.S. CLS. 1, 4, 6, 50, 51 AND 52).

FIRST USE 12-0-2003; IN COMMERCE 12-0-2003.

2,858,818. MEI SHUAL COSMETICS CO., LTD., TAINAN, TAIWAN. SN 78-141,341. PUB. 7-15-2003, FILED 7-3-2002.

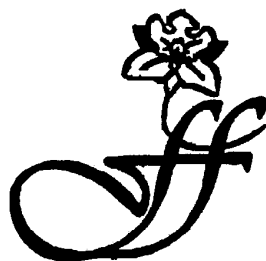

FOR COSMETICS, NAMELY, LIPSTICKS, CREAM MAKEUP FOUNDATION, NAIL ENAMEL, LIQUID EYE-LINER, EYEBROW PENCILS, SKIN MILK, FACE CREAM, FACIAL CLEANSING CREAMS AND FACIAL CLEANSING FOAM, GLITTER HAIR CREAM, FACIAL TONER, SKIN LOTION, VANISHING CREAM, MOISTURIZING SKIN CREAM, SUNBLOCK OIL, COMPACTS CONTAINING FACE POWDER, LIQUID TALCS, EYE SHADOW CREAM, ROUGE, ROUGE CREAM, PERFUMES, AND NON-MEDICATED LANOLIN OINTMENT AND COSMETICS FOR THE SKIN (U.S. CLS. 1, 4, 6, 50, 51 AND 52).

FIRST USE 5-0-2002; IN COMMERCE 8-20-2002.

CLASS 3—(Continued).

2,858,898. TRANZONIC COMPANIES, THE, HIGHLAND HEIGHTS, OH. SN 78-178,533. PUB. 10-14-2003, FILED 10-25-2002.

WET 'N WASH

FOR DRY CLOTHS IMPREGNATED WITH SKIN CLEANSER FOR PERSONAL CLEANSING; DRY CLOTHS IMPREGNATED WITH ALL PURPOSE CLEANSER FOR SURFACE CLEANSING (U.S. CLS. 1, 4, 6, 50, 51 AND 52).

FIRST USE 5-9-2003; IN COMMERCE 5-9-2003.

2,858,972. PHILLIPS, ROSEMARY E., DBA ROSEMARY'S POTPOURRI, NEW WINDSOR, IL. SN 78-205,117. PUB. 10-21-2003, FILED 1-20-2003.

SCENT OF A NAME

NO CLAIM IS MADE TO THE EXCLUSIVE RIGHT TO USE "SCENT", APART FROM THE MARK AS SHOWN.

FOR BODY OIL, POTPOURRI, POT POURRI REFRESHER OILS, MASSAGE OIL, LOTIONS, NAMELY SKIN LOTIONS AND MASSAGE LOTIONS, BODY GEL, AND LIP GLOSS (U.S. CLS. 1, 4, 6, 50, 51 AND 52).

FIRST USE 11-14-2002; IN COMMERCE 11-14-2002.

2,858,973. VARGAS MARCAS E PARTICIPACOES LTDA, RIO DE JANEIRO, BRAZIL. SN 78-205,140. PUB. 9-2-2003, FILED 1-20-2003.

NATUCOR

FOR HAIR PRODUCTS, NAMELY, SHAMPOOS, CONDITIONERS, STYLING GELS, HAIR SPRAYS, HAIR BLEACHING PREPARATIONS, HAIR COLORING PREPARATIONS, DEPILATORY PREPARATIONS; DEODORANTS FOR PERSONAL USE; COSMETICS, NAMELY, LIPSTICK, FOUNDATION, BLUSH, EYE SHADOW, MASCARA, EYELINER, LIPSTICK LINER; SKIN TREATMENT PRODUCTS, NAMELY, CLEANSER, TONER, MOISTURIZER, EYE CREAM, MAKEUP REMOVER, BEAUTY MASKS; FRAGRANCE PRODUCTS, NAMELY, COLOGNE, EAU DE TOILETTE, PERFUME; SHAVING PRODUCTS, NAMELY, AFTER SHAVE, SHAVING CREAM, SHAVING GEL, SHAVING LOTION (U.S. CLS. 1, 4, 6, 50, 51 AND 52).

FIRST USE 0-0-2003; IN COMMERCE 0-0-2003.

2,858,996. NOODLEMAN, F. RICHARD, CAMPBELL, CA. SN 78-217,993. PUB. 10-7-2003, FILED 2-24-2003.

REVERCEL MD

OWNER OF U.S. REG. NO. 2,530,682.
FOR PERSONAL SKIN CARE CREAMS, LOTIONS, CLEANERS, TONERS AND GELS (U.S. CLS. 1, 4, 6, 50, 51 AND 52).

FIRST USE 8-0-2003; IN COMMERCE 8-0-2003.

CLASS 3—(Continued).

2,859,020. ALTERNASFERA, LLC, STANFORDVILLE, NY. SN 78-237,654. PUB. 11-4-2003, FILED 4-14-2003.

THE BIOLOGY OF SENSUAL SKIN

NO CLAIM IS MADE TO THE EXCLUSIVE RIGHT TO USE "SKIN", APART FROM THE MARK AS SHOWN.

FOR NON-MEDICATED SKIN CARE AND CLEANING PREPARATIONS, NAMELY, CREAM, GEL, FLUID, AND OIL; MOISTURIZING AND ANTI-AGING CREAM; ANTI-WRINKLE CREAM FOR EYES AND FACE; MASSAGE OIL AND SKIN EMULSIFYING PREPARATIONS; SUN SCREEN; SUN BLOCK; MAKE-UP REMOVER, MAKE-UP REMOVER; LIP AND EYE MAKE-UP REMOVER (U.S. CLS. 1, 4, 6, 50, 51 AND 52).
FIRST USE 8-22-2003; IN COMMERCE 8-22-2003.

2,859,031. MYKYTYN ENTERPRISES, INC., HOUSTON, TX. SN 78-251,218. PUB. 12-2-2003, FILED 5-17-2003.

ONE MINUTE NAIL STRENGTHENER

OWNER OF U.S. REG. NO. 2,500,082.
NO CLAIM IS MADE TO THE EXCLUSIVE RIGHT TO USE "NAIL STRENGTHENER", APART FROM THE MARK AS SHOWN.

FOR NAIL CARE PREPARATION, NAIL CREAM, NAIL HARDENERS, NAIL STRENGTHENERS (U.S. CLS. 1, 4, 6, 50, 51 AND 52).
FIRST USE 7-1-2003; IN COMMERCE 8-1-2003.

2,859,035. PACIFIC WORLD CORPORATION, LAKE FOREST, CA. SN 78-254,397. PUB. 1-6-2004, FILED 5-27-2003.

CRYSTAL HARD

FOR NAIL STRENGTHENER (U.S. CLS. 1, 4, 6, 50, 51 AND 52).
FIRST USE 1-1-2004; IN COMMERCE 1-1-2004.

2,859,040. AMAZING CONCEALER COSMETICS, INC, LIBERTYVILLE, IL. SN 78-262,055. PUB. 12-23-2003, FILED 6-13-2003.

AMAZINGCOSMETICS

OWNER OF U.S. REG. NOS. 2,602,733 AND 2,670,062.
FOR COSMETICS, NAMELY, FACE MAKEUP, CONCEALER, FACE POWDER, EYE MAKEUP, MASCARA, EYESHADOW, EYELINER, EYESHADOW BASE, LIP TREATMENT CREAM, LIPSTICK, BRONZER, LIPLINER, BLUSH, LIP GLOSS, FACE LOTIONS, FACIAL CLEANSERS, EYE MAKEUP REMOVER, EYE CREAM, EYE TREATMENT CREAM, BODY CLEANSERS, BODY LOTIONS, BODY SCRUBS, FRAGRANCE FOR PERSONAL USE, AND MAKEUP KITS COMPRISING ONE OR MORE OF THE FOREGOING (U.S. CLS. 1, 4, 6, 50, 51 AND 52).
FIRST USE 9-0-2003; IN COMMERCE 9-0-2003.

CLASS 4—LUBRICANTS AND FUELS

2,858,544. IMPORTADORA LA PLAZA, C. POR A., SANTIAGO, DOMINICAN REP. SN 76-435,817. PUB. 1-21-2003, FILED 7-30-2002.

JAYACO

FOR GREASES AND LUBRICANTS FOR CAR AND MOTORCYCLE DIESEL AND GASOLINE ENGINES (U.S. CLS. 1, 6 AND 15).

FIRST USE 7-28-2003; IN COMMERCE 7-28-2003.

2,858,700. A H J MARKETING, INC., DBA DOWNEAST MARKETING, AUBURN, ME. SN 78-010,432. PUB. 6-4-2002, FILED 5-30-2000.

DOWNEAST HOME WARMERS

NO CLAIM IS MADE TO THE EXCLUSIVE RIGHT TO USE "DOWNEAST", APART FROM THE MARK AS SHOWN.

FOR CANDLES (U.S. CLS. 1, 6 AND 15).
FIRST USE 2-4-2004; IN COMMERCE 2-27-2004.

2,858,815. DIAL BRANDS, INC., SCOTTSDALE, AZ. SN 78-139,395. PUB. 1-7-2003, FILED 6-27-2002.

MOON BLOSSOM

OWNER OF U.S. REG. NO. 2,496,655.
FOR CANDLES (U.S. CLS. 1, 6 AND 15).
FIRST USE 12-6-2002; IN COMMERCE 12-6-2002.

CLASS 5—PHARMACEUTICALS

2,858,243. GENZYME CORPORATION, FRAMINGHAM, MA. SN 76-009,147. PUB. 9-25-2001, FILED 3-24-2000.

LIPOBRIDGE

FOR PHARMACEUTICAL PRODUCTS, NAMELY A LIPID FOR USE IN DELIVERING DRUGS INTO THE BRAIN (U.S. CLS. 6, 18, 44, 46, 51 AND 52).
FIRST USE 6-1-2001; IN COMMERCE 6-1-2001.

2,858,251. RECAPS, LLC, BELLEVUE, WA. SN 76-033,156. PUB. 4-17-2001, FILED 4-24-2000.

REVERIFY

FOR DIETARY SUPPLEMENTS (U.S. CLS. 6, 18, 44, 46, 51 AND 52).
FIRST USE 8-0-2000; IN COMMERCE 8-0-2000.

CLASS 5—(Continued).

2,858,289. TECHNINFO S.A.M, CEDEX, MONACO. SN 76-155,549. PUB. 3-26-2002, FILED 10-27-2000.

EDUCTYL

FOR PHARMACEUTICAL PREPARATIONS FOR THE TREATMENT OF CONSTIPATION (U.S. CLS. 6, 18, 44, 46, 51 AND 52).

FIRST USE 12-8-2003; IN COMMERCE 12-8-2003.

2,858,309. MERCK & CO., INC., WHITEHOUSE STATION, NJ. SN 76-198,436. PUB. 8-21-2001, FILED 1-24-2001.

ARCOXIA

FOR ANTI-INFLAMMATORY ANALGESICS AND PHARMACEUTICAL PREPARATIONS FOR THE TREATMENT OF ARTHRITIS (U.S. CLS. 6, 18, 44, 46, 51 AND 52).

FIRST USE 3-19-2004; IN COMMERCE 3-19-2004.

2,858,332. CELGENE CORPORATION, WARREN, NJ. SN 76-250,132. PUB. 10-9-2001, FILED 5-2-2001.

IMIDS

FOR PHARMACEUTICAL PREPARATIONS, NAMELY, CYTOKINE INHIBITORY DRUGS; PHARMACEUTICAL PREPARATIONS THAT MODULATE THE IMMUNE SYSTEM (U.S. CLS. 6, 18, 44, 46, 51 AND 52).

FIRST USE 4-0-1997; IN COMMERCE 4-0-1997.

2,858,348. TECHLAB, INC., BLACKSBURG, VA. SN 76-276,403. PUB. 12-31-2002, FILED 6-25-2001.

IBD-SCAN

FOR IN VITRO DIAGNOSTIC TEST KIT CONSISTING OF MICROTITER WELLS COATED WITH LACTOFERRIN ANTIBODIES, A CONJUGATE CONSISTING OF ANTIBODIES TO LACTOFERRIN TAGGED WITH PEROXIDASE, LACTOFERRIN STANDARDS, DILUENT, SUBSTRATE, INTENSIFIER, AND WASH SOLUTION FOR USE IN THE DETECTION OF ELEVATED LEVELS OF LACTOFERRIN IN HUMANS FOR CLINICAL OR LABORATORY USE (U.S. CLS. 6, 18, 44, 46, 51 AND 52).

FIRST USE 1-25-2001; IN COMMERCE 2-14-2003.

CLASS 5—(Continued).

2,858,463. UNITED INDUSTRIES CORPORATION, ST. LOUIS, MO. SN 76-402,171. PUB. 12-3-2002, FILED 5-1-2002.

TICK DEFENSE

NO CLAIM IS MADE TO THE EXCLUSIVE RIGHT TO USE "TICK", APART FROM THE MARK AS SHOWN, FOR INSECT REPELLENT FOR HUMANS (U.S. CLS. 6, 18, 44, 46, 51 AND 52).

FIRST USE 3-15-2003; IN COMMERCE 3-15-2003.

2,858,469. MA, VAN, LOS ANGELES, CA. SN 76-407,159. PUB. 7-29-2003, FILED 5-10-2002.

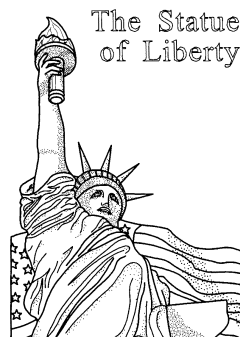

THE LINING AND STIPPLING SHOWN IN THE DRAWING ARE FEATURES OF THE MARK AND ARE NOT INTENDED TO INDICATE COLOR.

FOR MEDICATED OIL, NAMELY, TOPICAL ANALGESIC (U.S. CLS. 6, 18, 44, 46, 51 AND 52).

FIRST USE 12-26-2003; IN COMMERCE 12-26-2003.

2,858,499. ISAGENIX INTERNATIONAL, INC., PHOENIX, AZ. SN 76-420,065. PUB. 6-24-2003, FILED 6-13-2002.

HAVE YOUR CAKE & EAT IT TOO

FOR NUTRITIONAL SUPPLEMENT IN THE FORM OF SNACK BARS FOR WEIGHT LOSS (U.S. CLS. 6, 18, 44, 46, 51 AND 52).

FIRST USE 7-25-2003; IN COMMERCE 7-25-2003.

CLASS 5—(Continued).

2,858,501. JML MARKETING, INC., DALLAS, TX. SN 76-422,309. PUB. 1-14-2003, FILED 6-18-2002.

TRUWELL

FOR NUTRITIONAL, VITAMIN MINERAL AND HEALTH FOOD SUPPLEMENTS; DIETARY SUPPLEMENTS FOR STIMULATION OF THE PRODUCTION OF HUMAN GROWTH HORMONE; DIETARY SUPPLEMENTS FOR USE IN TREATING AILMENTS OF THE JOINTS; DIETARY SUPPLEMENTS FOR USE IN TREATING OSTEOPOROSIS AND OTHER BONE DISORDERS; MEAL REPLACEMENT DRINKS AND DIETARY SUPPLEMENTS IN THE FORM OF ENERGY DRINK POWDERS; AND DIETARY SUPPLEMENTS FOR USE IN WEIGHT MANAGEMENT (U.S. CLS. 6, 18, 44, 46, 51 AND 52).

FIRST USE 10-8-2002; IN COMMERCE 5-1-2003.

2,858,532. TELIK, INC., PALO ALTO, CA. SN 76-431,080. PUB. 12-17-2002, FILED 7-16-2002.

TELIK

OWNER OF U.S. REG. NO. 2,416,187.
FOR PHARMACEUTICAL PREPARATIONS FOR THE TREATMENT OF ONCOLOGICAL DISORDERS, DIABETES AND INFLAMMATION DISORDERS (U.S. CLS. 6, 18, 44, 46, 51 AND 52).

FIRST USE 2-23-2004; IN COMMERCE 2-23-2004.

2,858,551. WEIDER NUTRITION INTERNATIONAL, INC., SALT LAKE CITY, UT. SN 76-438,450. PUB. 7-15-2003, FILED 8-1-2002.

OB3

FOR DIETARY SUPPLEMENTS (U.S. CLS. 6, 18, 44, 46, 51 AND 52).

FIRST USE 3-11-2003; IN COMMERCE 3-11-2003.

2,858,599. UPSHER-SMITH LABORATORIES, INC., MAPLE GROVE, MN. SN 76-465,738. PUB. 4-29-2003, FILED 11-12-2002.

JANTOVEN

FOR PHARMACEUTICAL PREPARATIONS, NAMELY ANTICOAGULANTS; PHARMACEUTICAL PREPARATIONS FOR THE TREATMENT OF HEART CONDITIONS AND CORONARY ARTERY DISEASE (U.S. CLS. 6, 18, 44, 46, 51 AND 52).

FIRST USE 10-14-2003; IN COMMERCE 10-14-2003.

CLASS 5—(Continued).

2,858,619. ASPEN VETERINARY RESOURCES, LTD., GREELEY, CO. SN 76-472,813. PUB. 5-20-2003, FILED 12-6-2002.

INSTAVAC

OWNER OF U.S. REG. NOS. 2,493,557 AND 2,513,254.
FOR VETERINARY PREPARATIONS, NAMELY, INTRANASAL VACCINES FOR PREVENTION OF INFECTIOUS BOVINE RHINOTRACHEITIS AND PARAINFLUENZA-3 IN LIVESTOCK (U.S. CLS. 6, 18, 44, 46, 51 AND 52).

FIRST USE 10-15-2003; IN COMMERCE 10-15-2003.

2,858,631. RIDLEY BLOCK OPERATIONS, INC., MANKATO, MN. SN 76-476,241. PUB. 12-9-2003, FILED 12-12-2002.

EQUINEHP

FOR FEED SUPPLEMENTS FOR HORSES (U.S. CLS. 6, 18, 44, 46, 51 AND 52).

FIRST USE 9-19-2003; IN COMMERCE 9-19-2003.

2,858,665. PHOENIX INTANGIBLES HOLDING COMPANY, GREENVILLE, DE. SN 76-496,486. PUB. 11-11-2003, FILED 3-12-2003.



THE DRAWING IS LINED FOR THE COLOR RED.
FOR MEAL REPLACEMENT BARS (U.S. CLS. 6, 18, 44, 46, 51 AND 52).

FIRST USE 11-10-2003; IN COMMERCE 11-10-2003.

2,858,667. SPECTRALFUSION, INC., FEASTERVILLE, PA. SN 76-499,917. PUB. 11-18-2003, FILED 3-21-2003.

THE COLORS YELLOW AND ORANGE ARE CLAIMED AS FEATURES OF THE MARK.

THE COLOR ORANGE APPEARS AT THE TOPS AND BOTTOMS OF THE LETTERS, AND THE COLOR YELLOW RUNS THROUGH THE MIDDLE OF THE LETTERS.

FOR PET SUPPLEMENTS AND/OR VITAMINS FOR PET HEALTH AND VITALITY (U.S. CLS. 6, 18, 44, 46, 51 AND 52).

FIRST USE 1-15-2003; IN COMMERCE 4-1-2003.

CLASS 5—(Continued).

2,858,739. ARVESTA CORPORATION, SAN FRANCISCO, CA. SN 78-080,832. PUB. 1-21-2003, FILED 8-23-2001.

CAPTEVATE

FOR PESTICIDES, INSECTICIDES, HERBICIDES AND FUNGICIDES ALL FOR USE IN AGRICULTURE, HORTICULTURE AND SILVICULTURE (U.S. CLS. 6, 18, 44, 46, 51 AND 52).
FIRST USE 8-0-2003; IN COMMERCE 8-0-2003.

2,858,809. MONSANTO TECHNOLOGY LLC, ST. LOUIS, MO. SN 78-137,778. PUB. 12-17-2002, FILED 6-21-2002.

ROUNDUP ULTRAMAX II

OWNER OF U.S. REG. NOS. 847,249 AND 2,502,825. FOR HERBICIDES FOR DOMESTIC AND AGRICULTURAL USE (U.S. CLS. 6, 18, 44, 46, 51 AND 52).
FIRST USE 8-28-2003; IN COMMERCE 8-28-2003.

2,858,811. I.V. HOUSE, INC., HAZELWOOD, MO. SN 78-138,705. PUB. 9-2-2003, FILED 6-25-2002.

**I.V. HOUSE
ULTRADRESSING**

OWNER OF U.S. REG. NO. 1,688,925. NO CLAIM IS MADE TO THE EXCLUSIVE RIGHT TO USE "I.V." OR "ULTRADRESSING", APART FROM THE MARK AS SHOWN.
FOR PROTECTIVE DRESSING FOR INTRAVENOUS SITES AND OTHER SENSITIVE AREAS (U.S. CLS. 6, 18, 44, 46, 51 AND 52).
FIRST USE 3-26-2002; IN COMMERCE 9-13-2002.

2,858,822. SMITHKLINE BEECHAM CORPORATION, PHILADELPHIA, PA. SN 78-145,721. PUB. 7-15-2003, FILED 7-19-2002.

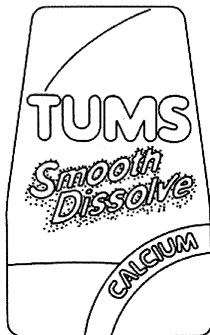

OWNER OF U.S. REG. NOS. 268,593, 2,076,469, AND

CLASS 5—(Continued).

OTHERS.

NO CLAIM IS MADE TO THE EXCLUSIVE RIGHT TO USE "CALCIUM" AND "DISSOLVE", APART FROM THE MARK AS SHOWN.

THE STIPPLING IS FOR SHADING PURPOSES ONLY. THE MARK CONSISTS OF THE STYLIZED WORD "TUMS" AND THE STYLIZED WORDS "SMOOTH DISSOLVE" WITH A HALF CIRCLE IN TOP LEFT-HAND CORNER OF THE LABEL AND A QUARTER CIRCLE IN THE RIGHT-HAND BOTTOM CORNER WITH THE WORD "CALCIUM".

FOR ANTACIDS AND CALCIUM SUPPLEMENTS (U.S. CLS. 6, 18, 44, 46, 51 AND 52).
FIRST USE 9-16-2002; IN COMMERCE 9-16-2002.

2,858,823. SMITHKLINE BEECHAM CORPORATION, PHILADELPHIA, PA. SN 78-145,734. PUB. 7-22-2003, FILED 7-19-2002.

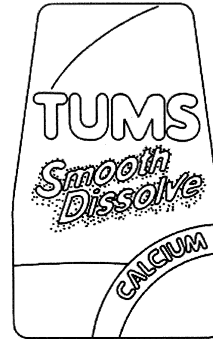

OWNER OF U.S. REG. NOS. 268,593, 2,076,469, AND OTHERS.

NO CLAIM IS MADE TO THE EXCLUSIVE RIGHT TO USE "CALCIUM" AND "DISSOLVE", APART FROM THE MARK AS SHOWN.

THE STIPPLING IS A FEATURE OF THE MARK. THE MARK CONSISTS OF THE STYLIZED WORD "TUMS" IN THE COLOR WHITE AND THE STYLIZED WORDS "SMOOTH DISSOLVE" IN THE COLOR WHITE OUTLINED WITH STIPPLING IN THE COLOR BLUE WITH A HALF CIRCLE IN TOP LEFT-HAND CORNER OF THE LABEL TO DESIGNATE A VARIATION OF THE BACKGROUND COLOR BLUE FROM DARK AT TOP TO LIGHT BLUE AND A PORTION OF THE LOWER LEFT-HAND CORNER IN THE COLOR LIGHT BLUE AND A QUARTER CIRCLE IN THE RIGHT-HAND BOTTOM CORNER IN THE COLOR LIGHT BLUE WITH THE WORD "CALCIUM" IN A DARKER SHADE OF THE COLOR BLUE; COLOR IS CLAIMED AS A FEATURE OF THE MARK.

FOR ANTACIDS AND CALCIUM SUPPLEMENTS (U.S. CLS. 6, 18, 44, 46, 51 AND 52).
FIRST USE 9-16-2002; IN COMMERCE 9-16-2002.

2,858,826. JOHNSON DIVERSEY, INC., STURTEVANT, WI. SN 78-148,691. PUB. 6-17-2003, FILED 7-30-2002.

SOFT CARE NEUTRA-GERM

FOR ANTIBACTERIAL HAND SOAPS AND ANTISEPTIC HAND SOAPS FOR COMMERCIAL, INDUSTRIAL AND INSTITUTIONAL USE (U.S. CLS. 6, 18, 44, 46, 51 AND 52).
FIRST USE 3-17-2003; IN COMMERCE 3-17-2003.

CLASS 5—(Continued).

2,858,837. VDF FUTURECEUTICALS, INC., MOMENCE, IL. SN 78-155,086. PUB. 6-24-2003, FILED 8-16-2002.



FOR DIETARY SUPPLEMENT (U.S. CLS. 6, 18, 44, 46, 51 AND 52).
FIRST USE 11-20-2001; IN COMMERCE 11-20-2001.

2,858,840. DOCTORS' PREFERRED, INC., POTOMAC, MD. SN 78-156,337. PUB. 10-21-2003, FILED 8-21-2002.

BP ESSENTIALS

NO CLAIM IS MADE TO THE EXCLUSIVE RIGHT TO USE "BP", APART FROM THE MARK AS SHOWN. FOR VITAMINS AND NUTRITIONAL FOOD SUPPLEMENTS (U.S. CLS. 6, 18, 44, 46, 51 AND 52).
FIRST USE 8-0-2002; IN COMMERCE 8-0-2002.

2,858,894. GAMBRO PATHOGEN REDUCTION TECHNOLOGY, INC., LAKEWOOD, CO. SN 78-177,066. PUB. 7-29-2003, FILED 10-22-2002.

NAVIGANT BIOTECHNOLOGIES

NO CLAIM IS MADE TO THE EXCLUSIVE RIGHT TO USE "BIOTECHNOLOGIES", APART FROM THE MARK AS SHOWN. FOR PATHOGEN REDUCTION COMPOSITION FOR TREATING COLLECTED BLOOD AND BLOOD COMPONENTS (U.S. CLS. 6, 18, 44, 46, 51 AND 52).
FIRST USE 10-8-2003; IN COMMERCE 10-8-2003.

2,858,900. PURDUE PRODUCTS, LP, STAMFORD, CT. SN 78-178,935. PUB. 6-17-2003, FILED 10-28-2002.

GENTLAX WAKE TO RELIEF

OWNER OF U.S. REG. NO. 698,463. FOR LAXATIVES (U.S. CLS. 6, 18, 44, 46, 51 AND 52).
FIRST USE 11-4-2002; IN COMMERCE 11-4-2002.

CLASS 5—(Continued).

2,858,911. ALBAUGH, INC., ANKENY, IA. SN 78-183,346. PUB. 7-1-2003, FILED 11-8-2002.

OUTLAW

FOR HERBICIDES FOR COMMERCIAL, INDUSTRIAL AND AGRICULTURAL USE (U.S. CLS. 6, 18, 44, 46, 51 AND 52).
FIRST USE 3-13-2003; IN COMMERCE 3-13-2003.

2,858,945. BIO-CIDE INTERNATIONAL, INC., NORMAN, OK. SN 78-193,726. PUB. 7-29-2003, FILED 12-12-2002.

RESPICIDE

FOR MEDICAL DISINFECTANT SOLUTIONS COMPRISED OF CHLORINE DIOXIDE/SODIUM CHLORITE FOR USE WITH MEDICAL INSTRUMENTS AND/OR RUBBER OR PLASTIC MEDICAL APPLIANCES NAMELY CPAP MASKS AND ACCESSORIES (U.S. CLS. 6, 18, 44, 46, 51 AND 52).
FIRST USE 11-1-2003; IN COMMERCE 11-1-2003.

2,858,965. GARNETT MCKEEN LABORATORIES, INC., EAST ISLIP, NY. SN 78-201,205. PUB. 9-9-2003, FILED 1-8-2003.



FOR DIETARY SUPPLEMENTS (U.S. CLS. 6, 18, 44, 46, 51 AND 52).
FIRST USE 12-1-2001; IN COMMERCE 12-1-2001.

2,858,977. OMNII PRODUCTS OF PALM BEACH, DBA OMNII ORAL PHARMACEUTICALS, WEST PALM BEACH, FL. SN 78-207,877. PUB. 12-2-2003, FILED 1-28-2003.

BASED IN EVIDENCE

FOR DENTAL PREVENTIVE CARE PRODUCTS, NAMELY, DENTAL RINSES (U.S. CLS. 6, 18, 44, 46, 51 AND 52).
FIRST USE 7-17-2003; IN COMMERCE 3-18-2004.

CLASS 5—(Continued).

2,858,995. NATROL, INC., CHATSWORTH, CA. SN 78-217,814. PUB. 10-7-2003, FILED 2-22-2003.

FEELANEW

FOR DIETARY SUPPLEMENTS (U.S. CLS. 6, 18, 44, 46, 51 AND 52).
FIRST USE 4-28-2003; IN COMMERCE 4-28-2003.

2,858,997. LABRADA BODYBUILDING NUTRITION, INC., HOUSTON, TX. SN 78-218,713. PUB. 12-2-2003, FILED 2-25-2003.

EFA LEAN

NO CLAIM IS MADE TO THE EXCLUSIVE RIGHT TO USE "EFA", APART FROM THE MARK AS SHOWN.
FOR NUTRITIONAL SUPPLEMENT, NAMELY, LIQUID ESSENTIAL FATTY ACID BLEND SUPPLEMENT (U.S. CLS. 6, 18, 44, 46, 51 AND 52).
FIRST USE 6-20-2003; IN COMMERCE 6-20-2003.

2,858,998. LANE LABS - USA, INC. ALLENDALE, NJ. SN 78-220,152. PUB. 11-4-2003, FILED 2-28-2003.

NATURE'S LINING

FOR DIETARY SUPPLEMENT TO SUPPORT THE STOMACH (U.S. CLS. 6, 18, 44, 46, 51 AND 52).
FIRST USE 5-1-2003; IN COMMERCE 5-1-2003.

2,859,019. NATURE'S WAY PRODUCTS, INC., SPRINGVILLE, UT. SN 78-236,970. PUB. 12-30-2003, FILED 4-11-2003.

UMCKA

FOR VITAMINS, MINERAL SUPPLEMENTS, DIETARY SUPPLEMENTS AND PHARMACEUTICAL PREPARATIONS FOR THE TREATMENT OF COLDS AND OTHER DISEASES OF THE RESPIRATORY TRACT (U.S. CLS. 6, 18, 44, 46, 51 AND 52).
FIRST USE 8-1-2003; IN COMMERCE 8-1-2003.

2,859,036. APICAL PHARMACEUTICAL, INC., FT. LAUDERDALE, FL. SN 78-254,443. PUB. 12-16-2003, FILED 5-27-2003.

PROPANION

FOR ANIMAL FEED ADDITIVE INCLUDING MICROBIAL CULTURE FOR USE AS A NUTRITIONAL SUPPLEMENT (U.S. CLS. 6, 18, 44, 46, 51 AND 52).
FIRST USE 6-20-2003; IN COMMERCE 6-20-2003.

CLASS 5—(Continued).

2,859,039. ALAVEN PHARMACEUTICAL LLC, ALPHARETTA, GA. SN 78-260,232. PUB. 12-23-2003, FILED 6-10-2003.

HEXAFED

FOR PHARMACEUTICAL PRODUCT CONTAINING ANTIHISTAMINE AND DECONGESTANT (U.S. CLS. 6, 18, 44, 46, 51 AND 52).
FIRST USE 3-25-2004; IN COMMERCE 3-31-2004.

2,859,043. ALAVEN PHARMACEUTICAL LLC, ALPHARETTA, GA. SN 78-281,221. PUB. 12-23-2003, FILED 7-30-2003.

HEXAFLU

FOR PHARMACEUTICAL PREPARATIONS, NAMELY A TABLET USED TO TREAT THE SYMPTOMS OF FLU, WHICH CONSIST OF FEVER, ACHE AND PAINS, RUNNY NOSE AND CONGESTION (U.S. CLS. 6, 18, 44, 46, 51 AND 52).
FIRST USE 1-15-2004; IN COMMERCE 1-31-2004.

CLASS 6—METAL GOODS

2,858,183. H. PAULIN & CO. LIMITED, SCARBOROUGH, ONTARIO M1L 4N3, CANADA. SN 75-362,266. PUB. 6-25-2002, FILED 9-24-1997.



THE MARK CONSISTS OF THE STYLIZED REPRESENTATION OF THE LETTER "P".
FOR METAL FASTENERS, NAMELY, SCREWS, BOLTS, NUTS, WASHERS, STUDS, PLUGS, AND RIVETS (U.S. CLS. 2, 12, 13, 14, 23, 25 AND 50).
FIRST USE 5-30-2003; IN COMMERCE 5-30-2003.

CLASS 6—(Continued).

2,858,250. J&L SPECIALTY STEEL, INC., PITTSBURGH, PA. SN 76-032,635. PUB. 5-22-2001, FILED 4-24-2000.

SANI GRAIN

NO CLAIM IS MADE TO THE EXCLUSIVE RIGHT TO USE "GRAIN", APART FROM THE MARK AS SHOWN.
FOR STAINLESS STEEL WITH A DECORATIVE ROLLED ON FINISH IN SHEET AND STRIP FORM (U.S. CLS. 2, 12, 13, 14, 23, 25 AND 50).
FIRST USE 5-18-2003; IN COMMERCE 5-18-2003.

2,858,275. AMES ELECTRO MATERIALS CORP., GLENS FALLS, NY. SN 76-132,120. PUB. 7-17-2001, FILED 9-20-2000.

CONSSERT

FOR CLAD METALS AND METAL TAPES USED IN MANUFACTURING CONTACT POINTS TO CONDUCT ELECTRICITY FOR THE ELECTRICAL CONTACT INDUSTRY (U.S. CLS. 2, 12, 13, 14, 23, 25 AND 50).
FIRST USE 1-5-2004; IN COMMERCE 1-5-2004.

2,858,319. J&L SPECIALTY STEEL, INC., PITTSBURGH, PA. SN 76-219,349. PUB. 8-21-2001, FILED 3-2-2001.

ASTROTEX

FOR STAINLESS STEEL SHEET AND STRIP FOR ARCHITECTURAL AND APPLIANCE PANELS (U.S. CLS. 2, 12, 13, 14, 23, 25 AND 50).
FIRST USE 5-18-2003; IN COMMERCE 5-18-2003.

2,858,371. CHUCKHOUSE, INC., SANTA ROSA, CA. SN 76-313,008. PUB. 1-28-2003, FILED 9-17-2001.

CHUCKHOUSE

FOR PORTABLE BUILDINGS MADE PRIMARILY OF METAL (U.S. CLS. 2, 12, 13, 14, 23, 25 AND 50).
FIRST USE 7-1-2003; IN COMMERCE 9-1-2003.

2,858,424. RUUD LIGHTING, INC., RACINE, WI. SN 76-357,977. PUB. 10-1-2002, FILED 1-10-2002.

CROWN-WELD

FOR METAL LIGHT-POLE STRUCTURES AND LIGHT-POLE BASES (U.S. CLS. 2, 12, 13, 14, 23, 25 AND 50).
FIRST USE 1-0-2002; IN COMMERCE 1-0-2002.

CLASS 6—(Continued).

2,858,428. J&L SPECIALTY STEEL, INC., CORAOPOLIS, PA. SN 76-365,957. PUB. 7-30-2002, FILED 2-1-2002.

NEUKOTE

FOR COATED STAINLESS STEEL STRIP OR SHEET (U.S. CLS. 2, 12, 13, 14, 23, 25 AND 50).
FIRST USE 5-18-2003; IN COMMERCE 5-18-2003.

2,858,466. ENERGY ABSORPTION SYSTEMS, INC., CHICAGO, IL. SN 76-404,192. PUB. 1-14-2003, FILED 5-6-2002.

STOPGATE

FOR VEHICLE ARRESTING DEVICES, NAMELY METAL CRASH BARRIERS (U.S. CLS. 2, 12, 13, 14, 23, 25 AND 50).
FIRST USE 6-0-2003; IN COMMERCE 6-0-2003.

2,858,572. QUALITY EDGE, INC., WALKER, MI. SN 76-450,662. PUB. 5-27-2003, FILED 9-18-2002.

TRU-GUARD

FOR METAL GUTTER GUARDS (U.S. CLS. 2, 12, 13, 14, 23, 25 AND 50).
FIRST USE 2-0-2003; IN COMMERCE 2-0-2003.

2,858,584. VITO, ROBERT, BERWYN, PA. SN 76-458,595. PUB. 7-22-2003, FILED 10-16-2002.

DEUCE

FOR BICYCLE LOCKS (U.S. CLS. 2, 12, 13, 14, 23, 25 AND 50).
FIRST USE 10-15-2003; IN COMMERCE 10-15-2003.

2,858,600. VITO, ROBERT, BERWYN, PA. SN 76-466,219. PUB. 7-8-2003, FILED 11-12-2002.

ARMORLITE

FOR METAL ANTI-THEFT LOCKS (U.S. CLS. 2, 12, 13, 14, 23, 25 AND 50).
FIRST USE 10-15-2003; IN COMMERCE 10-15-2003.

CLASS 6—(Continued).

2,858,620. DIXON VALVE & COUPLING COMPANY, CHES-
TERTOWN, MD. SN 76-473,047. PUB. 11-18-2003, FILED 11-
25-2002.

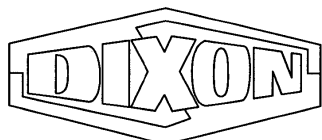

The Right Connection

OWNER OF U.S. REG. NO. 1.383.010.
FOR METAL HOSE FITTINGS, CONNECTORS AND
CONDUITS FOR THE TRANSFER AND CONTROL OF
FLUIDS, GASES AND DRY MATERIALS (U.S. CLS. 2, 12,
13, 14, 23, 25 AND 50).
FIRST USE 12-0-2002; IN COMMERCE 12-0-2002.

2,858,750. LANGLOTZ, BENNET K., PORTLAND, OR. SN 78-
091,120. PUB. 7-16-2002, FILED 10-31-2001.

UNITED WE STAND

FOR METAL LICENSE PLATES (U.S. CLS. 2, 12, 13, 14,
23, 25 AND 50).
FIRST USE 4-5-2004; IN COMMERCE 4-5-2004.

2,858,790. STADLER, DAVID M., LATHRUP VILLAGE, MI.
SN 78-127,126. PUB. 12-10-2002, FILED 5-8-2002.

STABILOC

FOR METAL LOCKS FOR STORM DRAIN GRATINGS
(U.S. CLS. 2, 12, 13, 14, 23, 25 AND 50).
FIRST USE 3-2-2004; IN COMMERCE 3-2-2004.

2,858,803. PRESSED STEEL TANK CO., INC., WEST ALLIS,
WI. SN 78-133,002. PUB. 12-3-2002, FILED 6-4-2002.

ECOMOLD

FOR COPPER ALLOYS IN THE FORM OF INGOTS,
RODS, BARS AND PLATES FOR USE BY MACHINE
SHOPS, FOUNDRIES AND MOLDBAKERS (U.S. CLS. 2,
12, 13, 14, 23, 25 AND 50).
FIRST USE 11-15-2002; IN COMMERCE 12-16-2002.

CLASS 6—(Continued).

2,858,810. TIFFIN SCENIC STUDIOS, INC., TIFFIN, OH. SN
78-138,538. PUB. 1-28-2003, FILED 6-25-2002.

THE RESTRICTOR

FOR MANUALLY OPERATED METAL ROPE LOCKS
USED IN CONNECTION WITH STAGE RIGGINGS (U.S.
CLS. 2, 12, 13, 14, 23, 25 AND 50).
FIRST USE 7-22-2002; IN COMMERCE 3-19-2004.

2,858,889. MET-COIL SYSTEMS CORPORATION, WEST-
FIELD, MA. SN 78-174,648. PUB. 8-26-2003, FILED 10-15-
2002.

FAST SEAM

NO CLAIM IS MADE TO THE EXCLUSIVE RIGHT TO
USE "SEAM", APART FROM THE MARK AS SHOWN.
FOR HEATING, COOLING AND VENTILATING
DUCTS OF METAL (U.S. CLS. 2, 12, 13, 14, 23, 25 AND
50).
FIRST USE 2-10-2003; IN COMMERCE 2-10-2003.

2,858,937. CAMPBELL FITTINGS INC., BOYERTOWN, PA.
SN 78-191,455. PUB. 7-29-2003, FILED 12-5-2002.

COBRA

FOR METAL COUPLINGS AND PIPE FITTINGS USED
IN THE PETROLEUM TRANSFER INDUSTRY,
NAMELY, ON FUEL TRUCKS (U.S. CLS. 2, 12, 13, 14,
23, 25 AND 50).
FIRST USE 6-15-2003; IN COMMERCE 6-15-2003.

2,859,008. PRIMESOURCE BUILDING PRODUCTS, INC.,
CARROLLTON, TX. SN 78-230,130. PUB. 12-2-2003, FILED
3-26-2003.



NO CLAIM IS MADE TO THE EXCLUSIVE RIGHT TO
USE "FASTENERS", APART FROM THE MARK AS
SHOWN.

FOR METAL FASTENERS, NAMELY COLLATED
NAILS AND SCREWS (U.S. CLS. 2, 12, 13, 14, 23, 25
AND 50).
FIRST USE 6-1-2002; IN COMMERCE 6-1-2002.

CLASS 7—MACHINERY

CLASS 7—(Continued).

2,858,248. DRESSER-RAND CO., OLEAN, NY. SN 76-022,415.
PUB. 7-10-2001, FILED 4-10-2000.

MAGNUM

FOR MACHINE PARTS, NAMELY, VALVES FOR INDUSTRIAL FLUID COMPRESSORS (U.S. CLS. 13, 19, 21, 23, 31, 34 AND 35).
FIRST USE 9-9-1998; IN COMMERCE 12-0-1998.

2,858,379. OMEGA GARDEN, INC., VANCOUVER, BRITISH COLUMBIA, CANADA. SN 76-318,979. PUB. 9-9-2003, FILED 9-28-2001.



NO CLAIM IS MADE TO THE EXCLUSIVE RIGHT TO USE "GARDEN", APART FROM THE MARK AS SHOWN.
THE MARK CONSISTS OF A STYLIZED GREEK LETTER "OMEGA" WITH THE WORDING "OMEGA GARDEN" APPEARING THEREIN.

FOR ROTARY HYDROPONIC GARDENING MACHINE (U.S. CLS. 13, 19, 21, 23, 31, 34 AND 35).
FIRST USE 8-0-2000; IN COMMERCE 10-0-2000.

2,858,433. DEMAG CRANES & COMPONENTS CORP., SOLON, OH. SN 76-369,754. PUB. 7-23-2002, FILED 2-12-2002.

CASTMASTER

FOR CRANES; OVERHEAD CRANES; PARTS AND FITTINGS THEREOF (U.S. CLS. 13, 19, 21, 23, 31, 34 AND 35).
FIRST USE 1-1-2004; IN COMMERCE 1-1-2004.

CLASS 7—(Continued).

2,858,486. DELTA INTERNATIONAL MACHINERY CORP., JACKSON, TN. SN 76-414,109. PUB. 7-15-2003, FILED 5-28-2002.

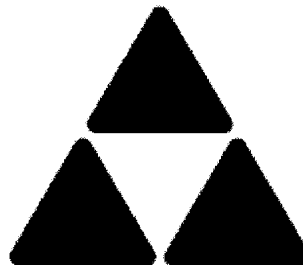

FOR MACHINES AND MACHINE ACCESSORIES, NAMELY BITS FOR MACHINES; BITS FOR POWER DRILLS; MACHINE PARTS, NAMELY BLADES; BLADES FOR POWER SAWS; BLOWERS; BORING MACHINES; BRUSHES BEING PARTS OF MOTORS; CHUCKS FOR POWER DRILLS; POWER DRILL BITS; DRILLS; AIR COMPRESSORS, ELECTRIC GENERATORS, FILTERS FOR MACHINES; GLUE GUNS, GRINDERS, POWER PNEUMATIC TOOLS NAMELY NAILERS, STAPLERS, ANGLE ROTARY TOOL, CUT-OFF TOOL FOR CUTTING SHEET METAL, BOLTS AND FIBERGLASS, GRINDERS, RECIPROCATING SAWS, SHEARS, IMPACT WRENCHES, HAMMERS, SANDERS, DRILLS, WRENCHES, RATCHETS; POWER TOOLS NAMELY ROUTERS, SAWS, PRESSES; SANDERS; POWER SCREWDRIVERS; SPRAYERS; POWER STAPLERS; WHEELS; POWER DRIVEN WRENCHES (U.S. CLS. 13, 19, 21, 23, 31, 34 AND 35).

FIRST USE 10-1-2002; IN COMMERCE 10-1-2002.

2,858,490. HENSLEY INDUSTRIES, INC., DALLAS, TX. SN 76-417,069. PUB. 9-16-2003, FILED 6-6-2002.



FOR MACHINE PARTS, NAMELY, WEAR PARTS, ATTACHMENTS AND GROUND ENGAGING TOOLS, ALL FOR EARTH MOVING EQUIPMENT; BUCKETS, REPLACEMENT LIPS FOR BUCKETS, TEETH, ADAPTERS, CHEEK PLATES, BASE PLATES, AND ASSEMBLIES OF THESE PARTS FOR POWER OPERATED BUCKETS, EXCAVATORS, SCOOPS, SHOVELS, AND LOADERS (U.S. CLS. 13, 19, 21, 23, 31, 34 AND 35).
FIRST USE 8-0-2002; IN COMMERCE 8-0-2002.

CLASS 7—(Continued).

2,858,493. PERRY, LENORE E., LEO, IN. SN 76-418,262. PUB. 12-31-2002, FILED 6-10-2002.



FOR INSERTS, CUTTING, GROOVING AND PARTING TOOLS, BORING BARS AND HOLDERS THEREFOR FOR METAL-WORKING MACHINE TOOLS (U.S. CLS. 13, 19, 21, 23, 31, 34 AND 35).
FIRST USE 9-4-2002; IN COMMERCE 9-4-2002.

CLASS 7—(Continued).

2,858,554. INTERAMERICAN MOTOR CORPORATION, CANOGA PARK, CA. SN 76-438,943. PUB. 4-8-2003, FILED 8-5-2002.



FOR AIR-INTAKE TUBES AND FILTERS FOR AFTER-MARKET INSTALLATION OF AUTOMOTIVE ENGINES, AUTOMOTIVE ENGINE BLOCKS, EXHAUST PIPE, INTAKE MANIFOLDS, ENGINE BLOCKS, ENGINE BEARINGS, ENGINE OR MOTOR MUFFLERS, ENGINE RODS, INTERNAL COMBUSTION ENGINE PARTS NAMELY, PISTON RINGS, PISTONS, CONNECTING RODS, MECHANICAL ENGINE PARTS FOR LAND VEHICLES, MOTORCYCLE ENGINE PARTS, NAMELY, AIR CLEANERS, VEHICLE ENGINE PARTS, NAMELY AIR CLEANERS, OIL TANK PLUGS AND CAPS, CRANKCASE BREATHERS, OIL COOLERS, PUSH RODS, ROCKER ARMS, ENGINE CASES, ENGINE CAM PROTECTORS, CAMSHAFTS FOR VEHICLE ENGINES, CONNECTING HOSES FOR VEHICLE RADIATORS, DIESEL ENGINES, HEADERS AS PART OF VEHICLE EXHAUST SYSTEM, INTERNAL COMBUSTION LAND VEHICLE ENGINE PARTS NAMELY, CONNECTING RODS, INTERNAL COMBUSTION ENGINES LAND VEHICLE PARTS, NAMELY, COILS, DISTRIBUTOR CAPS, DISTRIBUTOR ROTORS, LAND VEHICLE PARTS, NAMELY SPARK PLUG WIRES, LAND VEHICLE SUSPENSION PARTS, NAMELY TORSION/SWAY BARS, MECHANICAL ENGINE PARTS FOR LAND VEHICLES, SILENCERS AS PART OF VEHICLE EXHAUST SYSTEMS, VEHICLE PARTS, NAMELY CARBURETORS, ENGINE CASES, ENGINE CAM PROTECTORS INTAKE MANIFOLDS, CAM COVERS, POWER VALVE FOR CARBURETORS, VEHICLE WASHING MACHINES (U.S. CLS. 13, 19, 21, 23, 31, 34 AND 35).
FIRST USE 3-13-2002; IN COMMERCE 3-13-2002.

2,858,530. IRWIN INDUSTRIAL TOOL COMPANY, FREEPORT, IL. SN 76-430,752. PUB. 4-8-2003, FILED 7-12-2002.

LENOX SST CARBIDE

OWNER OF U.S. REG. NOS. 2,592,314, 2,642,826, AND OTHERS.
NO CLAIM IS MADE TO THE EXCLUSIVE RIGHT TO USE "CARBIDE", APART FROM THE MARK AS SHOWN.
FOR CARBIDE TIP POWER BAND SAW BLADES (U.S. CLS. 13, 19, 21, 23, 31, 34 AND 35).
FIRST USE 8-1-2002; IN COMMERCE 8-1-2002.

2,858,542. DELTA INTERNATIONAL MACHINERY CORP., NORTH JACKSON, TN. SN 76-434,171. PUB. 8-26-2003, FILED 7-25-2002.



FOR POWER SAWS (U.S. CLS. 13, 19, 21, 23, 31, 34 AND 35).
FIRST USE 8-0-2002; IN COMMERCE 8-0-2002.

2,858,592. PENTAIR POOL PRODUCTS, INC., MOORPARK, CA. SN 76-462,923. PUB. 11-4-2003, FILED 10-30-2002.



FOR AQUARIUM PUMPS (U.S. CLS. 13, 19, 21, 23, 31, 34 AND 35).
FIRST USE 6-10-2003; IN COMMERCE 6-10-2003.

CLASS 7—(Continued).

2,858,601. RICH PALM ENTERPRISE CORP. LTD., TAIPEI, TAIWAN. SN 76-466,693. PUB. 8-5-2003, FILED 11-4-2002.

RICH PALM GEAR

NO CLAIM IS MADE TO THE EXCLUSIVE RIGHT TO USE "GEAR", APART FROM THE MARK AS SHOWN.

FOR MACHINE PARTS, NAMELY, ROLLER CHAINS; ENGINES NOT FOR LAND VEHICLES; PULLEYS BEING PARTS OF MACHINES; HYDRAULIC DOOR OPENERS; ELECTRIC PUMPS; METAL CLAMPS USED FOR HOLDING PIECE PARTS ON MACHINE TOOL TABLES; HYDRAULIC CLAMPS; HYDRAULIC PUMPS; VACUUM PUMPS; BEARINGS FOR TRANSMISSION SHAFTS, BEING PARTS OF MACHINES; ENGINE BEARINGS; MACHINE PARTS, NAMELY, BEARINGS AND BUSHINGS; MACHINE PARTS, NAMELY, ROLLER BEARINGS; SHAFT BEARINGS FOR VACUUM PUMPS; WORM GEAR REDUCERS AND GEAR REDUCERS FOR MACHINES; ELECTRIC MOTORS FOR MACHINES; GEAR BOXES FOR MACHINES; CONVEYER CHAINS FOR MACHINES; POWER-OPERATED CHAIN SAWS; WOOD WORKING MACHINES, NAMELY, BAND SAWING MACHINES, CROSS-CUT CIRCULAR SAWS, SAW BLAZING CLAMPS USED FOR HOLDING PIECE PARTS ON MACHINE TOOL TABLES, POWER-OPERATED STRAIGHT SAW SHARPENERS, VENEER REELING AND UNREELING MACHINES, POWER-OPERATED VENEER CLIPPERS, POWER-OPERATED DOUBLE SIZERS, ELECTRIC SANDERS FOR PLYWOOD, POWER-OPERATED LUMBER CORE COMPOSERS, INDUSTRIAL COLD PRESSES, DEHUMIDIFICATION WOOD DRYERS, POWER-OPERATED BAND SCROLL SAWS, CIRCULAR SAW BENCHES, POWER-OPERATED TRIMMING SAWS, PANEL SIZING CIRCULAR SAWS, HAND OPERATED TRIMMING MACHINES, DOUBLE SAWS, GANG RIP SAWS, RADIAL ARM SAWS, MULTI-BLADE CIRCULAR SAWS FOR PANEL SIZING, JIG SAWS, DOUBLE END SAWS FOR ROUND BAR, PLANERS, MILLING MACHINES, POWER-OPERATED SINGLE-HEAD WOOD BORERS, WOOD LATHE MACHINES, AUTOMATIC WOOD LATHES, WOOD COPYING LATHES, ROUND BAR MAKING MACHINES, DOWEL MAKING MACHINES, DOWEL CUTTING MACHINES, POLISHING MACHINES FOR USE IN GRINDING AND POLISHING WOOD, MECHANICAL GLUE SPREADERS, POWER-OPERATED HOT PRESS LUMBER COMPOSERS, EDGE BANDING MACHINES, DRILLING AND TAPPING MACHINES (U.S. CLS. 13, 19, 21, 23, 31, 34 AND 35).

FIRST USE 8-26-2003; IN COMMERCE 8-26-2003.

2,858,647. SKYJACK INC., GUELPH, ONTARIO N1H 1B9, CANADA. SN 76-486,338. PUB. 12-2-2003, FILED 1-29-2003.



OWNER OF U.S. REG. NOS. 1,866,750 AND 2,069,859. THE MARK CONSISTS OF "SKYJACK". FOR MOBILE ELEVATING WORK PLATFORMS (U.S. CLS. 13, 19, 21, 23, 31, 34 AND 35). FIRST USE 2-5-2003; IN COMMERCE 2-5-2003.

CLASS 7—(Continued).

2,858,722. AMERICAN TOOL COMPANIES A/S, HVIDORE, DENMARK. SN 78-052,172. PUB. 2-25-2003, FILED 3-9-2001.

SPEEDHAMMER

FOR POWER TOOL ACCESSORIES, NAMELY, MASONRY DRILL BITS (U.S. CLS. 13, 19, 21, 23, 31, 34 AND 35).

FIRST USE 8-1-2003; IN COMMERCE 8-1-2003.

2,858,868. ALLFAST FASTENING SYSTEMS, INC., CITY OF INDUSTRY, CA. SN 78-167,946. PUB. 7-15-2003, FILED 9-25-2002.

ALLFAST

OWNER OF U.S. REG. NO. 1,180,834. FOR POWER-OPERATED RIVET GUNS AND POWER-OPERATED RIVET SETTING TOOLS (U.S. CLS. 13, 19, 21, 23, 31, 34 AND 35).

FIRST USE 0-0-1990; IN COMMERCE 0-0-1990.

2,858,895. LIN ENGINEERING, INC., SANTA CLARA, CA. SN 78-177,593. PUB. 6-3-2003, FILED 10-23-2002.

SILVERPAK

FOR ELECTRIC MOTORS FOR MACHINES AND DRIVE CONTROLLERS THEREFOR (U.S. CLS. 13, 19, 21, 23, 31, 34 AND 35).

FIRST USE 3-13-2003; IN COMMERCE 3-13-2003.

2,858,907. CHAPEAU, INC., GRANITE BAY, CA. SN 78-182,223. PUB. 6-17-2003, FILED 11-6-2002.

BPE

FOR ELECTRIC POWER GENERATION EQUIPMENT, NAMELY, INTERNAL COMBUSTION ENGINE DRIVEN POWER GENERATORS, AND PARTS THEREFORE (U.S. CLS. 13, 19, 21, 23, 31, 34 AND 35).

FIRST USE 6-27-2003; IN COMMERCE 6-27-2003.

2,859,006. HERRAMIENTAS DE AMOREBIETA, S.A.L., AMOREBIETA, BIZKAIA, SPAIN. SN 78-228,005. PUB. 11-25-2003, FILED 3-20-2003.

IZARTOOL

FOR TOOLS FOR USE IN POWER-OPERATED MACHINES, NAMELY, DRILL BITS, REAMERS, COUNTERSINKS AND MILLING CUTTERS (U.S. CLS. 13, 19, 21, 23, 31, 34 AND 35).

FIRST USE 1-0-2000; IN COMMERCE 3-0-2003.

CLASS 8—HAND TOOLS

2,858,365. JONES, LINDA M., RENO, NV. SN 76-298,740. PUB. 10-29-2002, FILED 8-13-2001.



NO CLAIM IS MADE TO THE EXCLUSIVE RIGHT TO USE "BARBEQUE GRILL CLEANER", APART FROM THE MARK AS SHOWN.

FOR HAND-OPERATED TOOL, NAMELY, A CLEANER FOR BARBEQUE GRILLS (U.S. CLS. 23, 28 AND 44).

FIRST USE 11-27-2002; IN COMMERCE 6-30-2003.

2,858,483. DELTA INTERNATIONAL MACHINERY CORP., NORTH JACKSON, TN. SN 76-412,502. PUB. 7-15-2003, FILED 5-28-2002.

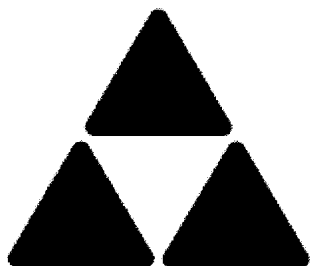

FOR HAND TOOLS AND HAND TOOL ACCESSORIES NAMELY TOOL BELTS; BITS FOR HAND DRILLS, BLADES FOR HAND SAWS, CLAMPS, CAULKING GUNS, CHISELS, CHOPPERS, CLAMPS; DIES; DRILL BITS FOR HAND DRILLS; FILES; FORKS; GREASE GUNS; GRINDING STONES; HAND TOOLS NAMELY HAMMERS, PLANERS, SHOVELS, KNIVES, MALLETS, MITRE BOXES, PICKS, PUNCHES, RASPS, RATCHET WRENCHES, RAZORS, REAMERS, SAWS, SCRAPERS, SCREWDRIVERS, SHEARS, SLICERS, SOCKET SETS, SPRAYERS FOR USE IN PAINTING, SQUARES, TONGS, TROWELS, VICES, WRENCHES, WOODWORKING TOOLS AND METAL WORKING TOOLS NAMELY CUTTING BAN SAWS, DRILL PRESSES, LATHES, GRINDERS; PALETTE KNIVES; PEN KNIVES; AND HAND JACKS (U.S. CLS. 23, 28 AND 44).

FIRST USE 10-1-2002; IN COMMERCE 10-1-2002.

CLASS 8—(Continued).

2,858,640. INDIAN VALLEY INDUSTRIES, INC., JOHNSON CITY, NY. SN 76-480,071. PUB. 9-2-2003, FILED 1-3-2003.

THE TRAPPER

OWNER OF U.S. REG. NO. 2,624,423. FOR GOLF BUNKER RAKES (U.S. CLS. 23, 28 AND 44). FIRST USE 2-9-2003; IN COMMERCE 2-16-2004.

2,858,791. ARCMATE MANUFACTURING CORPORATION, ESCONDIDO, CA. SN 78-127,899. PUB. 11-5-2002, FILED 5-10-2002.

ORANG-U-TONGS

FOR HAND TOOL FOR LITTER PICK-UP, REACHER (U.S. CLS. 23, 28 AND 44). FIRST USE 12-1-2002; IN COMMERCE 3-1-2003.

2,858,963. FORT JAMES OPERATING COMPANY, ATLANTA, GA. SN 78-200,170. PUB. 7-15-2003, FILED 1-6-2003.

DIXIE KRAZY CRITTERS

OWNER OF U.S. REG. NOS. 120,264, 2,421,949, AND OTHERS. FOR DISPOSABLE CUTLERY, NAMELY, KNIVES, FORKS AND SPOONS (U.S. CLS. 23, 28 AND 44). FIRST USE 3-1-2004; IN COMMERCE 3-1-2004.

2,858,964. DEMON INTERNATIONAL, OREM, UT. SN 78-200,940. PUB. 9-16-2003, FILED 1-7-2003.



FOR HAND TOOLS, NAMELY, SCREWDRIVERS, WRENCHES, SCRAPERS, IRONS FOR MELTING WAX, PLIERS FOR SERVICING SNOWBOARDS AND SNOWBOARDING EQUIPMENT; SNOWBOARD BINDING TOOLS, NAMELY SCREWDRIVERS, WRENCHES AND PLIERS, POCKET DRIVERS, RATCHETING DRIVERS AND BITS FOR DRIVERS (U.S. CLS. 23, 28 AND 44). FIRST USE 7-1-2002; IN COMMERCE 9-1-2002.

CLASS 9—ELECTRICAL AND SCIENTIFIC APPARATUS

CLASS 9—(Continued).

2,858,178. AVAYA INC., BASKING RIDGE, NJ. SN 74-410,846. PUB. 2-1-1994, FILED 7-8-1993.

INTUITY

FOR TELECOMMUNICATIONS PRODUCTS, NAMELY TELECOMMUNICATIONS COMPUTER PROGRAMS AND HARDWARE FOR USE WITH A TELECOMMUNICATIONS SWITCH OR TELECOMMUNICATIONS CLIENT SERVER, TO PROVIDE VOICE MAIL, VOICE MESSAGING AND RESPONSE, FACSIMILE MESSAGING AND RESPONSE, IMAGE MESSAGING AND RESPONSE, AND AN ELECTRONIC MAIL INTERFACE (U.S. CLS. 21, 23, 26, 36 AND 38).

FIRST USE 3-31-1994; IN COMMERCE 3-31-1994.

2,858,200. HEADSPROUT, INC., SEATTLE, WA. SN 75-729,073. PUB. 10-24-2000, FILED 6-16-1999.

HEADSPROUT

FOR EDUCATIONAL SOFTWARE FOR CHILDREN; EDUCATIONAL SOFTWARE FOR ADULTS FEATURING INSTRUCTION IN READING, WRITING, LITERATURE, MATHEMATICS, SCIENCE, SOCIAL SCIENCES, LANGUAGES, HEALTH, COMPUTERS, BASIC LIVING SKILLS, TRADE SKILLS, STUDY HABITS AND COLLEGE PREPARATION SKILLS; SOFTWARE AND PRE-RECORDED VIDEO TAPES, AUDIO TAPES, CD'S AND CD-ROM'S FEATURING INSTRUCTION IN READING, WRITING, LITERATURE, MATHEMATICS, SCIENCE, SOCIAL SCIENCES, LANGUAGES, HEALTH, COMPUTERS, BASIC LIVING SKILLS, TRADE SKILLS, STUDY HABITS AND COLLEGE PREPARATION SKILLS, AND INSTRUCTION MANUALS AND WORKBOOKS SOLD AS A UNIT WITH THE AFORESAID GOODS (U.S. CLS. 21, 23, 26, 36 AND 38).

FIRST USE 9-1-2003; IN COMMERCE 9-1-2003.

2,858,203. CBC (AMERICA) CORP., COMMACK, NY. SN 75-749,013. PUB. 9-12-2000, FILED 6-15-1999.

CBC

OWNER OF U.S. REG. NO. 2,155,602. FOR CLOSED CIRCUIT TELEVISION (CCTV) EQUIPMENT; NAMELY, TELEVISION CAMERAS, MONITORS, VCBS AND MULTIPLEXERS, ALL FOR USE IN THE FIELDS OF SECURITY AND SURVEILLANCE, AND MACHINE VISION (U.S. CLS. 21, 23, 26, 36 AND 38).

FIRST USE 1-1-2000; IN COMMERCE 1-1-2000.

CLASS 9—(Continued).

2,858,205. PERCEPTUAL ENGINEERING, INC., MINNEAPOLIS, MN. SN 75-769,354. PUB. 5-22-2001, FILED 8-6-1999.

PERCEPTUAL PROSPECTOR

FOR SUITE OF COMPUTER SOFTWARE APPLICATIONS DESIGNED TO TRANSFORM, STANDARDIZE, ENHANCE AND EXTRACT INFORMATION FROM COMPUTER AIDED DESIGN (CAD) DRAWINGS (U.S. CLS. 21, 23, 26, 36 AND 38).

FIRST USE 8-6-2003; IN COMMERCE 8-6-2003.

2,858,211. GENERAL MOTORS CORPORATION, DETROIT, MI. SN 75-786,415. PUB. 7-11-2000, FILED 8-27-1999.

WEB INTEGRATED SERVICE ENVIRONMENT (WISE)

NO CLAIM IS MADE TO THE EXCLUSIVE RIGHT TO USE "WEB INTEGRATED SERVICE", APART FROM THE MARK AS SHOWN.

FOR COMPUTER SOFTWARE FOR USE IN THE SERVICE, REPAIR AND MAINTENANCE OF AUTOMOBILES AND THE IDENTIFICATION AND ORDERING OF AUTOMOBILE PARTS (U.S. CLS. 21, 23, 26, 36 AND 38).

FIRST USE 8-0-2000; IN COMMERCE 8-0-2000.

2,858,218. ITT INDUSTRIES, INC., WHITE PLAINS, NY. SN 75-823,856. PUB. 9-23-2003, FILED 10-15-1999.

ESAT

FOR COMPUTER SOFTWARE FOR MONITORING, ANALYZING, AND GEOGRAPHICALLY MAPPING NEWS REPORTS ON SELECTED TOPICS OF INTEREST IN THE FIELDS OF DEFENSE, ELECTRONICS AND GENERAL INDUSTRIAL (U.S. CLS. 21, 23, 26, 36 AND 38).

FIRST USE 0-0-1999; IN COMMERCE 0-0-1999.

CLASS 9—(Continued).

2,858,223. VISIBLE INVENTORY, INC., SALEM, NH. SN 75-877,113. PUB. 9-11-2001, FILED 12-21-1999.

iShelf

FOR APPARATUS FOR INVENTORY CONTROL NAMELY SUPPORT PLATFORMS FEATURING WEIGHT SENSORS FOR MEASURING, GENERATING AND TRANSMITTING ELECTRONIC DATA ABOUT THE INVENTORY LEVELS OF GOODS LOCATED THERE-UPON (U.S. CLS. 21, 23, 26, 36 AND 38).
FIRST USE 10-5-2003; IN COMMERCE 10-5-2003.

2,858,233. INFINEON TECHNOLOGIES NORTH AMERICA CORP., SAN JOSE, CA. SN 75-932,679. PUB. 7-29-2003, FILED 3-1-2000.

SEROCCO

FOR DATACOMMUNICATION INTEGRATED CIRCUITS (U.S. CLS. 21, 23, 26, 36 AND 38).
FIRST USE 2-28-2004; IN COMMERCE 2-28-2004.

2,858,234. GREENWAY MEDICAL TECHNOLOGIES, CARROLLTON, GA. SN 75-934,319. PUB. 1-2-2001, FILED 3-2-2000.

PRIMEEXCHANGE

FOR COMPUTER SOFTWARE FOR USE IN THE MEDICAL FIELD, TO BE USED BY PHYSICIANS, CLINICS, AND HOSPITALS TO SECURE, TRANSCRIBE AND MAINTAIN MEDICAL RECORDS OF PATIENTS (U.S. CLS. 21, 23, 26, 36 AND 38).
FIRST USE 12-16-2003; IN COMMERCE 12-16-2003.

2,858,235. HARMAN INTERNATIONAL INDUSTRIES, INCORPORATED, NORTHRIDGE, CA. SN 75-937,174. PUB. 3-12-2002, FILED 3-6-2000.

LOGIC 7

FOR VEHICLE MULTIMEDIA AND AUDIO SYSTEMS AND COMPONENTS, NAMELY, LOUDSPEAKERS, AMPLIFIERS, RADIOS, ELECTRONIC MICRO-PROCESSORS, ELECTRONIC SIGNAL PROCESSORS, VIDEO MONITORS, AND NAVIGATIONAL EQUIPMENT COMPOSED OF GLOBAL POSITIONING SATELLITE BASED NAVIGATION RECEIVERS WITH WIRELESS CONNECTIVITY (U.S. CLS. 21, 23, 26, 36 AND 38).
FIRST USE 7-0-1996; IN COMMERCE 7-0-1996.

CLASS 9—(Continued).

2,858,244. LUCASFILM ENTERTAINMENT COMPANY LTD., NICASIO, CA. SN 76-010,999. PUB. 6-5-2001, FILED 3-24-2000.

JEDI

FOR INTERACTIVE ENTERTAINMENT SOFTWARE, NAMELY, INTERACTIVE VIDEO GAME PROGRAMS AND INTERACTIVE MULTIMEDIA COMPUTER GAME PROGRAMS; AND COMPACT DISCS AND CD-ROMS FEATURING SCIENCE FICTION GAMES AND MUSIC (U.S. CLS. 21, 23, 26, 36 AND 38).
FIRST USE 3-19-2002; IN COMMERCE 3-19-2002.

2,858,246. UNBOUND MEDICINE, INC., CHARLOTTESVILLE, VA. SN 76-019,939. PUB. 7-24-2001, FILED 4-7-2000.

UNBOUND MEDICINE

NO CLAIM IS MADE TO THE EXCLUSIVE RIGHT TO USE "MEDICINE", APART FROM THE MARK AS SHOWN. FOR COMPUTER SOFTWARE AND MIDDLEWARE USED TO BACKUP, ARCHIVE, SEARCH, RETRIEVE AND DISPLAY DATA RELATING TO MEDICAL TOPICS AND MEDICAL INFORMATION (U.S. CLS. 21, 23, 26, 36 AND 38).
FIRST USE 10-0-2002; IN COMMERCE 10-0-2002.

2,858,280. COMMATCH LTD., LOD 75100, ISRAEL. SN 76-138,758. PUB. 12-17-2002, FILED 10-2-2000.



PRIORITY CLAIMED UNDER SEC. 44(D) ON ISRAEL APPLICATION NO. 136,663, FILED 4-6-2000, REG. NO. 136663, DATED 4-6-2000, EXPIRES 4-6-2007.

THE MARK CONSISTS OF A DISTINCTIVE GEOMETRIC DESIGN.

FOR INSTRUMENTS FOR USE IN TELEPHONY AND TELECOMMUNICATION SYSTEMS, NAMELY, VOICE-OVER-IP CARRIER ACCESS GATEWAYS, CONNECTING IP ACCESS TO LEGACY PUBLIC TELEPHONY LOCAL EXCHANGES, GATEWAYS THAT INTERCONNECT IP CORE TO LEGACY PUBLIC TELEPHONY ACCESS EQUIPMENT, IP-TO-IP NEXT GENERATION SIGNALING GATEWAYS, COMPUTER HARDWARE NAMELY, IP MEDIA COMMUNICATIONS SERVERS AND APPLICATION PLATFORMS, AND IP APPLICATION ENABLING PLATFORMS (U.S. CLS. 21, 23, 26, 36 AND 38).

FIRST USE 3-0-2000; IN COMMERCE 6-0-2001.

CLASS 9—(Continued).

2,858,285. KABUSHIKI KAISHA HITACHI SEISAKUSHO, DBA HITACHI, LTD., TOKYO 101-8010, JAPAN. SN 76-152,028. PUB. 5-29-2001, FILED 10-23-2000.

NXAUTO

FOR COMPUTER SOFTWARE FOR USE IN CONNECTION WITH AUTOMOBILE ASSEMBLY PLANT PRODUCTION CONTROL (U.S. CLS. 21, 23, 26, 36 AND 38). FIRST USE 10-0-1998; IN COMMERCE 12-0-2000.

2,858,286. MARKEM CORPORATION, KEENE, NH. SN 76-152,476. PUB. 8-19-2003, FILED 10-24-2000.

SMARTLASE

FOR LASER MARKING SYSTEM FOR MARKING PRODUCTS AND PRODUCT PACKAGING, NAMELY, LASER CODER (U.S. CLS. 21, 23, 26, 36 AND 38). FIRST USE 4-23-2001; IN COMMERCE 4-23-2001.

2,858,292. MIPS TECHNOLOGIES, INC., MOUNTAIN VIEW, CA. SN 76-163,142. PUB. 9-3-2002, FILED 11-10-2000.

5KF

FOR COMPUTER SOFTWARE FOR USE IN, AND FOR USE IN THE DESIGN, DEVELOPMENT, DESCRIPTION AND TESTING OF, COMPUTING DEVICES, COMPUTER HARDWARE AND CODE; COMPUTER SOFTWARE FOR DESCRIBING, DESIGNING, TESTING, MODELING, SIMULATING, DEBUGGING, DEVELOPING AND VERIFYING COMPUTING DEVICES, COMPONENT PARTS THEREFOR, COMPUTER HARDWARE AND CODE; MICROPROCESSOR CORES; MANUALS, DATA SHEETS, AND LITERATURE SOLD AS A UNIT WITH ALL THE AFORESAID GOODS (U.S. CLS. 21, 23, 26, 36 AND 38). FIRST USE 9-0-2001; IN COMMERCE 9-0-2001.

2,858,294. PAION CO. LTD., SEOUL, REPUBLIC OF KOREA. SN 76-166,821. PUB. 1-15-2002, FILED 11-16-2000.

PAION

FOR SEMICONDUCTORS AND COMPUTER CHIPS (U.S. CLS. 21, 23, 26, 36 AND 38). FIRST USE 9-1-2000; IN COMMERCE 12-15-2000.

CLASS 9—(Continued).

2,858,295. BASF AKTIENGESELLSCHAFT, LUDWIGSHAFEN AM RHEIN, FED REP GERMANY. SN 76-167,883. PUB. 4-30-2002, FILED 11-17-2000.

LUCOLOR

FOR COMPUTER PROGRAMS FOR USE IN DATABASE MANAGEMENT (U.S. CLS. 21, 23, 26, 36 AND 38). FIRST USE 12-11-2001; IN COMMERCE 12-11-2001.

2,858,299. SONY KABUSHIKI KAISHA, TA SONY CORPORATION, TOKYO 141, JAPAN. SN 76-177,693. PUB. 1-28-2003, FILED 12-7-2000.

Game SYNC

NO CLAIM IS MADE TO THE EXCLUSIVE RIGHT TO USE "GAME", APART FROM THE MARK AS SHOWN. FOR AUDIO TAPE PLAYERS AND RECORDERS, AUDIO DISC PLAYERS AND RECORDERS, AMPLIFIERS, RADIOS, LOUDSPEAKERS AND REMOTE CONTROLLERS THEREFOR, VIDEO GAME MACHINES FOR USE WITH TELEVISIONS AND PERIPHERALS THEREFOR, NAMELY, VIDEO GAME CONTROLLERS; IC MEMORY CARDS; AND PRE-RECORDED VIDEO GAME DISCS (U.S. CLS. 21, 23, 26, 36 AND 38). FIRST USE 2-28-2001; IN COMMERCE 2-28-2001.

2,858,335. AMAZE ENTERTAINMENT, INC., KIRKLAND, WA. SN 76-256,982. PUB. 12-18-2001, FILED 5-14-2001.

AMAZE ENTERTAINMENT

NO CLAIM IS MADE TO THE EXCLUSIVE RIGHT TO USE "ENTERTAINMENT", APART FROM THE MARK AS SHOWN. FOR COMPUTER GAME SOFTWARE, VIDEO GAME SOFTWARE, PROGRAMS AND CARTRIDGES; ELECTRONIC GAME PROGRAMS (U.S. CLS. 21, 23, 26, 36 AND 38). FIRST USE 8-0-2001; IN COMMERCE 8-0-2001.

2,858,341. SILICON LABORATORIES, INC., AUSTIN, TX. SN 76-263,322. PUB. 9-18-2001, FILED 5-25-2001.

AERO

FOR INTEGRATED CIRCUITS SOLD TO OEMS FOR INCORPORATION INTO WIRELESS COMMUNICATION DEVICES (U.S. CLS. 21, 23, 26, 36 AND 38). FIRST USE 3-5-2001; IN COMMERCE 3-5-2001.

CLASS 9—(Continued).

2,858,344. PEREG GMBH, 84478 WALDKRAIBURG, FED REP GERMANY. SN 76-267,739. PUB. 1-7-2003, FILED 6-6-2001.

TOSI

FOR PRE-SOILED TEST OBJECTS IN THE NATURE OF A METAL STRIP, COVERED BY A PLASTIC COVER, CONTAINING A SIMULATION OF BLOOD COAGULATION, FOR CHECKING THE WASHING PERFORMANCE, DISINFECTING PERFORMANCE, RINSING PERFORMANCE AND STERILIZATION PERFORMANCE OF MACHINES FOR WASHING, CLEANING, DISINFECTING AND STERILIZING MEDICAL INSTRUMENTS, MEDICAL EQUIPMENT AND CLOTHING (U.S. CLS. 21, 23, 26, 36 AND 38).

FIRST USE 6-6-2001; IN COMMERCE 6-6-2001.

CLASS 9—(Continued).

2,858,373. CIRCADIANT SYSTEMS, INC., ALLENTOWN, PA. SN 76-316,687. PUB. 1-21-2003, FILED 9-25-2001.

**INTELLIGENT
FAULTFINDER**

NO CLAIM IS MADE TO THE EXCLUSIVE RIGHT TO USE "INTELLIGENT", APART FROM THE MARK AS SHOWN.

FOR COMPUTER HARDWARE AND SOFTWARE PROGRAMS FOR PERFORMING ANALYSIS AND DIAGNOSIS OF CAUSES FOR OPTICAL DEVICE FAILURES, SOLD AS AN INTEGRAL COMPONENT OF COMPUTER SOFTWARE FOR TESTING AND DIAGNOSTIC ANALYSIS OF OPTICAL NETWORK EQUIPMENT, NAMELY, OPTICAL COMPONENTS, OPTICAL SUBSYSTEMS, OPTICAL SYSTEMS, OPTICAL TRANSMITTERS, OPTICAL RECEIVERS, OPTICAL TRANSCEIVERS, OPTICAL TRANSPONDERS, AND OPTICAL LINE CARDS, FOR USE IN THE FIELD OF OPTICAL NETWORK COMMUNICATIONS (U.S. CLS. 21, 23, 26, 36 AND 38).

FIRST USE 6-20-2003; IN COMMERCE 6-20-2003.

2,858,417. TEMPO RESEARCH CORPORATION, VISTA, CA. SN 76-356,689. PUB. 1-14-2003, FILED 1-9-2002.

DISCRIMINATOR

FOR TELECOMMUNICATIONS DIAGNOSTICS EQUIPMENT, NAMELY, EQUIPMENT FOR DETECTING A LINE TONE ON A METALLIC WIRE (U.S. CLS. 21, 23, 26, 36 AND 38).

FIRST USE 8-28-2001; IN COMMERCE 8-28-2001.

2,858,372. PFIZER HEALTH SOLUTIONS INC., NEW YORK, NY. SN 76-316,263. PUB. 7-2-2002, FILED 9-24-2001.

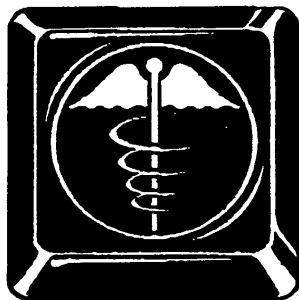

NO CLAIM IS MADE TO THE EXCLUSIVE RIGHT TO USE "THE REPRESENTATION OF THE CADUCEUS SYMBOL", APART FROM THE MARK AS SHOWN.

FOR COMPUTER SOFTWARE FOR USE IN MONITORING PATIENTS WITH A VARIETY OF DISEASES AND CHRONIC CONDITIONS; HEALTH EDUCATIONAL SOFTWARE FEATURING INSTRUCTION IN PREVENTIVE HEALTH AND WELLNESS PROGRAMS (U.S. CLS. 21, 23, 26, 36 AND 38).

FIRST USE 10-31-2001; IN COMMERCE 10-31-2001.

2,858,418. INTELLIGENT CONTENT CORPORATION, WESTON, FL. SN 76-357,218. PUB. 3-4-2003, FILED 1-11-2002.

1-CLICK CONSULT

NO CLAIM IS MADE TO THE EXCLUSIVE RIGHT TO USE "CONSULT", APART FROM THE MARK AS SHOWN.

FOR PRERECORDED VIDEOTAPES, DVDS, COMPACT DISCS, INTERACTIVE MULTIMEDIA COMPUTER PROGRAMS, IN THE FIELD OF HEALTH SCIENCES (U.S. CLS. 21, 23, 26, 36 AND 38).

FIRST USE 1-18-2004; IN COMMERCE 1-18-2004.

2,858,436. MICROFOUR, INC., AMARILLO, TX. SN 76-372,207. PUB. 8-6-2002, FILED 2-19-2002.

POCKETPAL

FOR COMPUTER SOFTWARE FOR USE TO MANAGE MEDICAL RECORDS AND MEDICAL OFFICES, AND INSTRUCTIONAL MANUALS THEREFOR (U.S. CLS. 21, 23, 26, 36 AND 38).

FIRST USE 3-1-2004; IN COMMERCE 3-1-2004.

CLASS 9—(Continued).

2,858,437. NORTH SAFETY PRODUCTS INC., CRANSTON, RI. SN 76-373,747. PUB. 7-22-2003, FILED 2-20-2002.

CFR-1

FOR RESPIRATORY MASKS FOR NON-MEDICAL PURPOSES; RESPIRATORY MASK FILTERS (U.S. CLS. 21, 23, 26, 36 AND 38).

FIRST USE 9-30-2002; IN COMMERCE 9-30-2002.

2,858,440. COMMON VOICES, LLC, CAMBRIDGE, MA. SN 76-377,297. PUB. 11-25-2003, FILED 3-1-2002.

COMMON VOICES

FOR COMPUTER SOFTWARE, NAMELY, VOICE AND DATA APPLICATIONS FOR MESSAGING, CALL PROCESSING AND MANAGEMENT AND INTERACTIVE VOICE RESPONSE FOR USE IN THE TELECOMMUNICATIONS INDUSTRY (U.S. CLS. 21, 23, 26, 36 AND 38).

FIRST USE 2-13-2004; IN COMMERCE 2-13-2004.

2,858,462. DATAMAX CORPORATION, ORLANDO, FL. SN 76-401,842. PUB. 11-19-2002, FILED 4-30-2002.

A CLASS

OWNER OF U.S. REG. NOS. 2,440,942, 2,453,083, AND 2,453,084.

FOR LASER PRINTERS, ACCESSORIES, NAMELY, ELECTRONIC SENSORS, ADAPTORS AND PARTS THEREFORE FOR USE IN PRODUCING AND PRINTING BAR CODES AND BAR CODE LABELS (U.S. CLS. 21, 23, 26, 36 AND 38).

FIRST USE 2-0-2003; IN COMMERCE 2-0-2003.

2,858,464. GLOBAL INFORMATION LICENSING CORPORATION, CLAYMONT, DE. SN 76-402,424. PUB. 7-15-2003, FILED 4-29-2002.

CREATIVE SOLUTIONS ACCOUNTING

OWNER OF U.S. REG. NO. 1,255,162.

NO CLAIM IS MADE TO THE EXCLUSIVE RIGHT TO USE "SOLUTIONS ACCOUNTING", APART FROM THE MARK AS SHOWN.

FOR COMPUTER SOFTWARE FOR USE BY ACCOUNTING AND TAX PROFESSIONALS TO ASSIST THEM WITH WORKFLOW MANAGEMENT (U.S. CLS. 21, 23, 26, 36 AND 38).

FIRST USE 9-1-1998; IN COMMERCE 9-1-1998.

CLASS 9—(Continued).

2,858,467. HUBBARD SYSTEMS, INC., BIRMINGHAM, AL. SN 76-405,236. PUB. 12-16-2003, FILED 5-8-2002.

COLIPSO

FOR COMPUTER SOFTWARE FOR USE IN DATABASE MANAGEMENT FOR USE IN THE FIELD OF DEBT COLLECTION FOR THE LEGAL, BANKING, FINANCIAL AND COLLECTION AGENCY INDUSTRIES (U.S. CLS. 21, 23, 26, 36 AND 38).

FIRST USE 7-0-2003; IN COMMERCE 7-0-2003.

2,858,470. LEGAL RESEARCH CENTER, INC., MINNEAPOLIS, MN. SN 76-408,136. PUB. 7-1-2003, FILED 5-15-2002.

ASKFIRST

FOR COMPUTER SOFTWARE, NAMELY, DATABASE RESEARCH SOFTWARE FOR USE IN EXTRACTING, CLASSIFYING, CONTROLLING ACCESS AND RETRIEVING META-DATA INFORMATION FROM LEGAL-RELATED DATA FILES, AND INSTRUCTION MANUALS, GUIDES AND REFERENCE CARDS SOLD AS A UNIT, SPECIFICALLY EXCLUDING USE FOR PHYSICIAN REFERRAL SERVICES (U.S. CLS. 21, 23, 26, 36 AND 38).

FIRST USE 5-31-2003; IN COMMERCE 5-31-2003.

2,858,494. KONAMI CORPORATION, TOKYO, JAPAN. SN 76-418,959. PUB. 8-26-2003, FILED 6-7-2002.



THE MARK CONSISTS OF THE WORD "GOLDEN SALOON" WITH THE LETTER "S" IN THE SHAPE OF A DOLLAR SIGN IN THE COLOR YELLOW WITH ORANGE AND BLACK SHADING.

FOR SLOT MACHINES; OPERATING SOFTWARE FOR USE IN SLOT MACHINES; VIDEO GAME MACHINES FOR USE WITH TELEVISIONS; COMPUTER GAME CARTRIDGES; VIDEO GAME CARTRIDGES; COMPUTER GAME PROGRAMS; VIDEO GAME PROGRAMS; VIDEO GAME PROGRAMS FOR USE WITH TELEVISION SETS; COMPUTER GAME SOFTWARE; VIDEO GAME SOFTWARE; COMPUTER GAME CD-ROMS; VIDEO GAME CD-ROMS; COMPUTER GAME JOYSTICKS; VIDEO GAME JOYSTICKS (U.S. CLS. 21, 23, 26, 36 AND 38).

FIRST USE 9-17-2001; IN COMMERCE 9-17-2001.

CLASS 9—(Continued).

2,858,539. FINANCIAL TECHNOLOGIES INTERNATIONAL CORP., ISELIN, NJ. SN 76-433,706. PUB. 2-4-2003, FILED 7-24-2002.

STREETMODEL

FOR COMPUTER SOFTWARE FOR ENABLING THE MANAGEMENT OF GLOBAL FINANCIAL DATA, WITH AN INDUSTRY RECOGNIZED DATA MODEL, FOR USE BY FINANCIAL COMPANIES (U.S. CLS. 21, 23, 26, 36 AND 38).

FIRST USE 6-0-2002; IN COMMERCE 6-0-2002.

2,858,540. FINANCIAL TECHNOLOGIES INTERNATIONAL CORP., ISELIN, NJ. SN 76-433,708. PUB. 2-4-2003, FILED 7-24-2002.

STREETACTIONS

FOR COMPUTER SOFTWARE FOR ENABLING THE WORKFLOW BASED PROCESSING OF GLOBAL CORPORATE MESSAGING, NAMELY ELECTION, NOTIFICATION, ENTITLEMENT TRACKING AND PROCESSING OF CORPORATE ACTION TRANSACTIONS, FOR USE BY FINANCIAL COMPANIES (U.S. CLS. 21, 23, 26, 36 AND 38).

FIRST USE 6-0-2002; IN COMMERCE 6-0-2002.

2,858,541. FINANCIAL TECHNOLOGIES INTERNATIONAL CORP., ISELIN, NJ. SN 76-433,789. PUB. 2-4-2003, FILED 7-24-2002.

STREETDIRECTOR

FOR COMPUTER SOFTWARE FOR ENABLING THE MANAGEMENT AND TRACKING OF FINANCIAL TRANSACTIONS THROUGHOUT THEIR LIFE CYCLE, FOR USE BY FINANCIAL COMPANIES (U.S. CLS. 21, 23, 26, 36 AND 38).

FIRST USE 9-0-2003; IN COMMERCE 9-0-2003.

2,858,549. SYSTEMAX INC., PORT WASHINGTON, NY. SN 76-437,597. PUB. 8-26-2003, FILED 8-5-2002.

PROFIT CENTER

FOR COMPUTER SOFTWARE, NAMELY, ENTERPRISE APPLICATION SOFTWARE THAT INTEGRATES ALL ASPECTS OF SALES FORCE AUTOMATION, ORDER PROCESSING AND PRODUCT MANAGEMENT (U.S. CLS. 21, 23, 26, 36 AND 38).

FIRST USE 6-1-2003; IN COMMERCE 12-12-2003.

CLASS 9—(Continued).

2,858,550. OAKLEY, INC., FOOTHILL RANCH, CA. SN 76-437,842. PUB. 7-29-2003, FILED 8-5-2002.

HALF PINT

FOR PROTECTIVE EYEWEAR, NAMELY SPECTACLES, PRESCRIPTION EYEWEAR, NAMELY EYEGLASS FRAMES AND LENSES; ANTI-GLARE EYEGLASSES AND SUNGLASSES AND THEIR PARTS AND ACCESSORIES, NAMELY REPLACEMENT LENSES, FRAMES, EAR STEMS, AND NOSE PIECES; CASES SPECIALLY ADAPTED FOR SPECTACLES AND SUNGLASSES AND THEIR PARTS AND ACCESSORIES (U.S. CLS. 21, 23, 26, 36 AND 38).

FIRST USE 9-19-2002; IN COMMERCE 9-19-2002.

2,858,553. DIGIGRAM, 38330 MONTBONNOT, FRANCE. SN 76-438,836. PUB. 11-4-2003, FILED 8-7-2002.

Ether
IES
Sound

PRIORITY CLAIMED UNDER SEC. 44(D) ON FRANCE APPLICATION NO. 023149000, FILED 2-20-2002, REG. NO. 023149000, DATED 2-20-2002, EXPIRES 2-20-2012.

NO CLAIM IS MADE TO THE EXCLUSIVE RIGHT TO USE "SOUND", APART FROM THE MARK AS SHOWN.

FOR APPARATUS AND INSTRUMENTS FOR NETWORK CONNECTION SOCKETS FOR RECORDING, TRANSMISSION, REPRODUCTION AND MIXING OF DIGITAL SOUND, NAMELY MICROPHONES, AUDIO SPEAKERS, COMPUTER HARDWARE AND SOFTWARE FOR MANIPULATING, EDITING, RECORDING, MIXING, STORING, PLAYING AND CREATING DIGITAL AUDIO DATA AND FOR FILE MANAGEMENT; APPARATUS AND INSTRUMENTS FOR TELECOMMUNICATIONS, NAMELY TELEPHONE AND RADIOTELEPHONE RECEIVERS AND TRANSMITTERS (U.S. CLS. 21, 23, 26, 36 AND 38).

FIRST USE 1-6-2003; IN COMMERCE 1-6-2003.

CLASS 9—(Continued).

2,858,555. INFITRON, INC., SEOUL, 152- 887, REPUBLIC OF KOREA. SN 76-439,038. PUB. 6-10-2003, FILED 8-9-2002.



FOR PORTABLE POISONOUS-COMPOUND PERSONAL ALARMS AND PERSONAL SIZE DETECTORS OF POISONOUS FUMES AND GASES (U.S. CLS. 21, 23, 26, 36 AND 38).

FIRST USE 1-19-2000; IN COMMERCE 1-19-2000.

2,858,564. TSUBASA SYSTEM CO., LTD., TOKYO, JAPAN. SN 76-446,126. PUB. 11-25-2003, FILED 9-3-2002.

DR. SUM

FOR COMPUTER SOFTWARE FOR CALCULATING AND TOTALING DATA AND CREATING REPORTS (U.S. CLS. 21, 23, 26, 36 AND 38).

FIRST USE 2-22-2003; IN COMMERCE 2-22-2003.

2,858,566. SAMSUNG ELECTRONICS CO., LTD., KYUNGKI-DO, REPUBLIC OF KOREA. SN 76-446,958. PUB. 6-24-2003, FILED 9-5-2002.

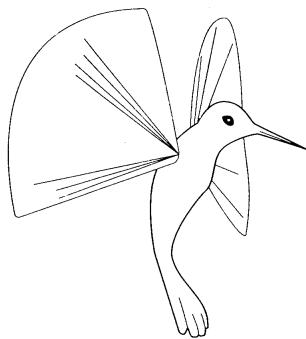

THE DESIGN CONSISTS OF A HUMMINGBIRD IN FLIGHT, WHEREIN THE BODY OF THE HUMMINGBIRD IS SUBSTANTIALLY YELLOW; THE HEAD, BEAK, BACK AND TAIL OF THE HUMMINGBIRD ARE ORANGE-RED; AND THE WINGS OF THE HUMMINGBIRD CONSIST OF A GRADATION OF COLORS, NAMELY YELLOW, ORANGE, RED, VIOLET, INDIGO, BLUE, GREEN, YELLOW AND ORANGE.

FOR MOBILE PHONES AND ACCESSORIES, NAMELY, BATTERIES; BATTERY CHARGERS; HEADPHONES, AND MOBILE PHONE CARRYING CASES FOR CONSUMERS (U.S. CLS. 21, 23, 26, 36 AND 38).

FIRST USE 12-0-2002; IN COMMERCE 12-0-2002.

CLASS 9—(Continued).

2,858,573. ALPHA SECURITY PRODUCTS, INC., NORTH CANTON, OH. SN 76-450,854. PUB. 1-7-2003, FILED 9-16-2002.

MEDIALOK

FOR STORAGE CONTAINERS FOR RECORDED MEDIA; NAMELY, AUDIO CASSETTES, VIDEO CASSETTES, COMPACT DISCS, GAME CARTRIDGES, MINI DISKS, LASER DISKS, VIDEO DISKS, AND CASSETTE TAPES (U.S. CLS. 21, 23, 26, 36 AND 38).

FIRST USE 1-15-2003; IN COMMERCE 1-15-2003.

2,858,589. DH LABS, INC., JUPITER, FL. SN 76-460,860. PUB. 7-29-2003, FILED 10-21-2002.

SILVER SONIC

FOR INSULATED WIRE FOR STEREO AND HI-FI USE (U.S. CLS. 21, 23, 26, 36 AND 38).

FIRST USE 11-6-1992; IN COMMERCE 12-1-1992.

2,858,594. AVIVA BIOSCIENCES CORPORATION, SAN DIEGO, CA. SN 76-464,662. PUB. 9-9-2003, FILED 11-5-2002.



FOR MICROCHIPS AND BIO CHIPS FOR BIOLOGICAL TESTS IN THE FIELD OF CELL MANIPULATION, SAMPLE PREPARATION AND DRUG DISCOVERY (U.S. CLS. 21, 23, 26, 36 AND 38).

FIRST USE 1-31-2003; IN COMMERCE 1-31-2003.

2,858,629. CMC ENERGY SERVICES, BETHESDA, MD. SN 76-475,102. PUB. 11-11-2003, FILED 12-13-2002.

Home Energy Tune-up

NO CLAIM IS MADE TO THE EXCLUSIVE RIGHT TO USE "HOME ENERGY", APART FROM THE MARK AS SHOWN.

FOR COMPUTER SOFTWARE FOR USE BY HOME INSPECTORS TO ANALYZE THE ENERGY EFFICIENCY OF RESIDENCES WHICH HAVE BEEN PURCHASED OR ARE TO BE SOLD (U.S. CLS. 21, 23, 26, 36 AND 38).

FIRST USE 8-0-2002; IN COMMERCE 8-0-2002.

CLASS 9—(Continued).

2,858,638. HITACHI AMERICA, LTD., FARMINGTON HILLS, MI. SN 76-478,210. PUB. 12-16-2003, FILED 12-23-2002.

ZERO HAND CODING

NO CLAIM IS MADE TO THE EXCLUSIVE RIGHT TO USE "CODING", APART FROM THE MARK AS SHOWN.

FOR COMPUTER SOFTWARE, NAMELY COMPUTER SOFTWARE FOR GENERATING OBJECT CODE FOR MICROCOMPUTERS OR MICROCONTROLLERS DIRECTLY FROM GRAPHIC EXPRESSIONS OF CONTROL ALGORITHMS, WITHOUT MANUALLY WRITING TEXT-BASED CONTROL PROGRAMS (U.S. CLS. 21, 23, 26, 36 AND 38).

FIRST USE 2-23-2004; IN COMMERCE 2-23-2004.

2,858,644. HAGEMeyer NORTH AMERICA, INC., ALPHARETTA, GA. SN 76-482,680. PUB. 11-25-2003, FILED 1-16-2003.

CAMBAR

OWNER OF U.S. REG. NO. 2,549,696.
FOR PROTECTIVE GLOVES FOR INDUSTRIAL USE; PROTECTIVE HELMETS FOR INDUSTRIAL USE; TEST KIT FOR MEASURING BACTERIA AND FUNGUS LEVELS FOR MANAGING COOLANT SYSTEMS; REFRACTOMETER FOR MEASURING CONCENTRATION OF METAL WORKING FLUIDS; BACK SUPPORT BELTS FOR SAFETY PURPOSES; SAFETY MARKERS, NAMELY, BARRICADE TAPE; MAGNETIC LEVELS; AND ELECTRONICS CLEANERS AND WIPES, NAMELY, CLEANERS AND DEGREASERS FOR REMOVING DIRT, DUST, RESIDUE, AND CHEMICALS FROM ELECTRICAL AND ELECTRONIC DEVICES AND EQUIPMENT (U.S. CLS. 21, 23, 26, 36 AND 38).

FIRST USE 3-1-2003; IN COMMERCE 3-1-2003.

2,858,646. PREMIER INTERNATIONAL ENTERPRISES, INC., CHICAGO, IL. SN 76-484,411. PUB. 9-9-2003, FILED 1-22-2003.

**RAPID APPLICATION
DEVELOPMENT FOR A
RAPIDLY CHANGING
WORLD**

FOR SOFTWARE FOR BUILDING BUSINESS ADMINISTRATION AND DATA MANAGEMENT SYSTEMS (U.S. CLS. 21, 23, 26, 36 AND 38).

FIRST USE 3-1-2003; IN COMMERCE 3-1-2003.

CLASS 9—(Continued).

2,858,658. WETYPE4U.COM, INC., DEERFIELD BEACH, FL. SN 76-493,596. PUB. 10-21-2003, FILED 2-27-2003.

TALK N SEND

FOR COMPUTER SOFTWARE, NAMELY, AUDIO ENCODING AND RECORDING SOFTWARE (U.S. CLS. 21, 23, 26, 36 AND 38).

FIRST USE 3-3-2003; IN COMMERCE 3-28-2003.

2,858,662. YAMAHA CORPORATION, SHIZUOKA, JAPAN. SN 76-495,184. PUB. 9-30-2003, FILED 3-6-2003.

01X

FOR AUDIO MIXERS; DIGITAL AUDIO MIXERS THAT ALSO FUNCTION AS DIGITAL AUDIO INPUT/OUTPUT INTERFACES AND REMOTE CONTROLLERS OF COMPUTER SOFTWARE IN THE FIELD OF MUSIC PRODUCTION; REMOTE CONTROLLERS THAT CONTROL COMPUTER SOFTWARE IN THE FIELD OF MUSIC PRODUCTION; DIGITAL AUDIO INPUT/OUTPUT INTERFACES; MIDI INTERFACES; AUDIO SIGNAL PROCESSORS (U.S. CLS. 21, 23, 26, 36 AND 38).

FIRST USE 12-16-2003; IN COMMERCE 12-16-2003.

2,858,664. AMPLIFIER RESEARCH CORPORATION, SOUTHERTON, PA. SN 76-495,929. PUB. 11-18-2003, FILED 3-11-2003.

ARNELLAB

FOR RADIO RECEIVERS, RECEIVER CALIBRATORS, LEAK DETECTORS FOR TESTING RADIO FREQUENCY SHIELDS, ANTENNAS, RADIO FREQUENCY TESTERS, AND RADIO FREQUENCY COUPLERS (U.S. CLS. 21, 23, 26, 36 AND 38).

FIRST USE 9-12-2003; IN COMMERCE 9-12-2003.

2,858,679. FABLEVISION, INC., WATERTOWN, MA. SN 76-511,028. PUB. 12-9-2003, FILED 4-15-2003.

STATIONERY STUDIO

NO CLAIM IS MADE TO THE EXCLUSIVE RIGHT TO USE "STATIONERY", APART FROM THE MARK AS SHOWN.

FOR COMPUTER SOFTWARE THAT ALLOWS USERS TO CREATE CUSTOMIZED STATIONERY TEMPLATES (U.S. CLS. 21, 23, 26, 36 AND 38).

FIRST USE 6-15-2003; IN COMMERCE 6-15-2003.

CLASS 9—(Continued).

2,858,690. FUJITSU LIMITED, KAWASAKI-SHI, KANAGAWA-KEN, JAPAN. SN 76-976,568. PUB. 10-22-2002, FILED 9-6-2001.



FOR MAGNETO-OPTICAL BLANK DISCS (U.S. CLS. 21, 23, 26, 36 AND 38).
FIRST USE 11-1-2001; IN COMMERCE 6-6-2003.

2,858,708. ONSPEC ELECTRONIC, INC., SANTA CLARA, CA. SN 78-031,284. PUB. 8-5-2003, FILED 10-18-2000.

OMNIFLASH

FOR FLASH MEMORY CARD READERS (U.S. CLS. 21, 23, 26, 36 AND 38).
FIRST USE 11-15-2001; IN COMMERCE 11-15-2001.

2,858,710. MATTEL, INC., EL SEGUNDO, CA. SN 78-035,768. PUB. 8-14-2001, FILED 11-17-2000.

UNO

OWNER OF U.S. REG. NOS. 1,005,397, 2,157,927, AND OTHERS.
THE ENGLISH TRANSLATION OF "UNO" IS ONE FOR GAMING MACHINES (U.S. CLS. 21, 23, 26, 36 AND 38).
FIRST USE 5-19-2003; IN COMMERCE 5-19-2003.

CLASS 9—(Continued).

2,858,717. IPWIRELESS, INC., SAN BRUNO, CA. SN 78-046,124. PUB. 10-8-2002, FILED 2-1-2001.



SEC. 2(F).
FOR TELECOMMUNICATIONS EQUIPMENT FOR WIRELESS CONNECTIONS TO COMPUTER NETWORKS, NAMELY, BASE STATIONS, PORTABLE AND MOBILE SUBSCRIBER UNITS, MODEMS, COMMUNICATIONS NETWORK CONTROLLERS AND COMPUTER SOFTWARE FOR WIRELESS CONNECTIONS TO COMPUTER NETWORKS (U.S. CLS. 21, 23, 26, 36 AND 38).
FIRST USE 6-0-2001; IN COMMERCE 6-0-2001.

2,858,721. AVANTES BV, EERBEEK, NETHERLANDS. SN 78-051,334. PUB. 7-30-2002, FILED 3-5-2001.



PRIORITY CLAIMED UNDER SEC. 44(D) ON NETHERLANDS APPLICATION NO. 0976510, FILED 10-27-2000, REG. NO. 0976510, DATED 10-27-2000, EXPIRES 10-27-2010.

THE MARK CONSISTS OF THE STYLIZED WORD "AVANTES", IN WHICH THE CHARACTER "V" IS BRIGHT RED, THE OTHER CHARACTERS DEEP BLUE, AND THE BACKGROUND WHITE.

FOR SPECTROMETERS WITH THE FOLLOWING ACCESSORIES, NAMELY, FIBER OPTIC CABLES, SENSORS AND PROBES; LIGHT SOURCES, NAMELY, DEUTERIUM LAMPS, TUNGSTEN HALOGEN LAMPS, MERCURY CALIBRATION LAMPS AND LOW POWER XENON LAMPS; DATA ACQUISITION AND ANALYSIS COMPUTER SOFTWARE (U.S. CLS. 21, 23, 26, 36 AND 38).
FIRST USE 12-1-2000; IN COMMERCE 1-1-2001.

CLASS 9—(Continued).

2,858,725. HUMAN DEVELOPMENT RESOURCE COUNCIL, INC., NORCROSS, GA. SN 78-058,547. PUB. 3-19-2002, FILED 4-16-2001.

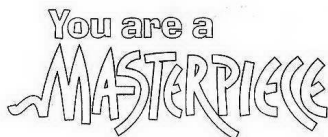

THE MARK CONSISTS OF THE WORDS OF THE MARK IN STYLIZED FORM.

FOR PRERECORDED VIDEOTAPES AND DIGITAL VIDEO DISCS FEATURING A SERIES OF EDUCATIONAL PROGRAMS REGARDING FETAL DEVELOPMENT, SEXUALLY TRANSMITTED DISEASES, AND THE PHYSICAL AND EMOTIONAL EFFECTS OF PREMATURE SEXUAL INVOLVEMENT (U.S. CLS. 21, 23, 26, 36 AND 38).

FIRST USE 7-1-2001; IN COMMERCE 7-1-2001.

2,858,726. AMX CORPORATION, RICHARDSON, TX. SN 78-060,334. PUB. 12-31-2002, FILED 4-25-2001.



FOR INTEGRATED COMPUTERIZED, ELECTRONIC SYSTEM COMPRISED OF CARDFRAMES, CONTROL CARDS, FLOPPY DISK DRIVES, SLIDE CONTROLLER, TELEVISION CONTROL MANAGER, MASTER-POST EXPANDER, WIRELESS RECEIVERS, WIRED CONTROL PANELS, SOFTWARE PANELS, DATA SIGNAL MODULATOR, INFARED ENMITTED CABLE, POWER CONTROLLER, DUAL POWER CONTROLLER, RELAY CONTROLLER, RECEIVER MODULE, EXTENDED RANGE ANTENNA, RELAY RECEIVER, INCANDESCENT DIMMER MODULE, WIRELESS SINGLE PROJECTOR CONTROL, WIRELESS DUAL PROJECTOR CONTROL AND RELATED SOFTWARE FOR USE IN ACCESSING AND CONTROLLING SLIDE PROJECTORS, VIDEO PROJECTORS, COMPACT DISC PLAYERS, PROJECTION SCREENS, LIGHTING SYSTEMS AND OTHER RELATED AUDIO/VIDEO EQUIPMENT (U.S. CLS. 21, 23, 26, 36 AND 38).

FIRST USE 6-0-2001; IN COMMERCE 6-0-2001.

CLASS 9—(Continued).

2,858,756. MELLANOX TECHNOLOGIES, INC., SANTA CLARA, CA. SN 78-103,251. PUB. 2-4-2003, FILED 1-17-2002.

INFINIHOST

FOR COMPUTER HARDWARE AND PERIPHERALS; EMBEDDED PROCESSORS; SEMICONDUCTORS; SOFTWARE DRIVERS; HOST CHANNEL ADAPTERS; TARGET CHANNEL ADAPTERS; SWITCHES; ROUTERS; BACKPLANES; TELECOM EQUIPMENT AND SOFTWARE FOR SERVER TO SERVER COMMUNICATIONS, TRANSMITTING DATA ACROSS A CONNECTION BETWEEN COMPUTERS, AND ENABLING A COMPUTER TO ACCESS DATA FROM A STORAGE DEVICE, ALL FOR THE SERVER, COMMUNICATION AND DATA STORAGE MARKETS (U.S. CLS. 21, 23, 26, 36 AND 38).
FIRST USE 5-0-2002; IN COMMERCE 5-0-2002.

2,858,760. INNOSTREAM INC., KYONGKI-DO, REPUBLIC OF KOREA. SN 78-105,931. PUB. 1-7-2003, FILED 1-31-2002.



FOR TELEPHONES (U.S. CLS. 21, 23, 26, 36 AND 38).
FIRST USE 7-20-2003; IN COMMERCE 7-20-2003.

2,858,762. NCAST CORPORATION, SUNNYVALE, CA. SN 78-105,996. PUB. 1-21-2003, FILED 1-31-2002.

N-WAY

FOR COMPUTER HARDWARE AND SOFTWARE USED TO BROADCAST AND PROVIDE ACCESS TO SIMULTANEOUS USERS TO DIGITAL VIDEO, AUDIO AND GRAPHIC INFORMATION AND OVER THE GLOBAL COMPUTER INFORMATION NETWORK (U.S. CLS. 21, 23, 26, 36 AND 38).
FIRST USE 8-0-2003; IN COMMERCE 9-0-2003.

2,858,765. NETEZZA CORPORATION, FRAMINGHAM, MA. SN 78-107,138. PUB. 4-8-2003, FILED 2-6-2002.

NPS

FOR DATABASE APPLIANCES, NAMELY, COMPUTERS, MEMORY MODULES AND COMPUTER PROGRAMS FOR USE IN STORING CONTENT, DOCUMENTS, DATA AND MEDIA (U.S. CLS. 21, 23, 26, 36 AND 38).
FIRST USE 9-22-2003; IN COMMERCE 10-24-2003.

CLASS 9—(Continued).

2,858,776. 3COM CORPORATION, SANTA CLARA, CA. SN 78-114,110. PUB. 9-24-2002, FILED 3-11-2002.

XRN

FOR EXPANDABLE AND REDUNDANT MODULES AND SWITCHES FOR USE IN CONNECTION WITH COMPUTERS AND COMPUTER NETWORKS AND INSTRUCTION MANUALS SOLD AS A UNIT THEREWITH (U.S. CLS. 21, 23, 26, 36 AND 38).

FIRST USE 6-1-2002; IN COMMERCE 6-1-2002.

2,858,783. ON TIME SYSTEMS, INC., EUGENE, OR. SN 78-119,254. PUB. 7-15-2003, FILED 4-3-2002.

ON TIME SYSTEMS

NO CLAIM IS MADE TO THE EXCLUSIVE RIGHT TO USE "SYSTEMS", APART FROM THE MARK AS SHOWN.

FOR COMPUTER SOFTWARE FOR USE IN MILITARY AND INDUSTRIAL APPLICATIONS FOR TRANSPORTATION ROUTE PLANNING AND FOR SCHEDULING MANUFACTURING PROCESSES (U.S. CLS. 21, 23, 26, 36 AND 38).

FIRST USE 7-26-1999; IN COMMERCE 9-12-2003.

2,858,787. LIKE FATHER LIKE SON, RECORDS, INC., ATLANTA, GA. SN 78-121,863. PUB. 6-24-2003, FILED 4-15-2002.

**LIKE FATHER LIKE SON
RECORDS**

NO CLAIM IS MADE TO THE EXCLUSIVE RIGHT TO USE "RECORDS", APART FROM THE MARK AS SHOWN.

FOR MUSICAL SOUND RECORDINGS AND VIDEOS FEATURING MUSICAL ARTIST (U.S. CLS. 21, 23, 26, 36 AND 38).

FIRST USE 1-1-2001; IN COMMERCE 12-1-2002.

2,858,788. IMAGING AUTOMATION, INC., BEDFORD, NH. SN 78-122,556. PUB. 5-27-2003, FILED 4-18-2002.

IA-THENTICATE

FOR SYSTEMS FOR CAPTURING, ANALYZING AND PROCESSING TRAVEL AND IDENTITY DOCUMENTS, NAMELY, COMPUTER HARDWARE AND SOFTWARE AND INSTRUCTION MANUALS SOLD AS A UNIT FOR CAPTURING, ANALYZING AND PROCESSING TRAVEL AND IDENTITY DOCUMENTS; COMPUTER SOFTWARE AND INSTRUCTION MANUALS SOLD AS A UNIT FOR IMAGE AND TEXT ACQUISITION, VERIFICATION, STORAGE, GENERATION OF DATABASES AND TRANSMISSION OF RECORDS OF PERSONS, CLIENTS, PASSENGERS AND GUESTS (U.S. CLS. 21, 23, 26, 36 AND 38).

FIRST USE 9-30-2002; IN COMMERCE 9-30-2002.

CLASS 9—(Continued).

2,858,792. INTERNATIONAL REMOTE IMAGING SYSTEMS, INC., CHATSWORTH, CA. SN 78-127,977. PUB. 1-14-2003, FILED 5-10-2002.



OWNER OF U.S. REG. NOS. 1,422,605, 2,032,041, AND OTHERS.

FOR LABORATORY URINALYSIS SYSTEM, NAMELY, A FLUID HANDLING RECEPTACLE, A FLOW CELL, A MICROSCOPE, AN ELECTRONIC CAMERA, AN ELECTRONIC CIRCUIT, A COMPUTER HAVING MEMORY AND DISK AUXILIARY STORAGE, COMPUTER PROGRAMS, A DISPLAY MONITOR, A CHEMICAL ANALYZER AND REAGENTS AND CHEMICALS USED IN THE LABORATORY URINALYSIS SYSTEM (U.S. CLS. 21, 23, 26, 36 AND 38).

FIRST USE 10-0-2001; IN COMMERCE 2-0-2002.

2,858,801. JOHNSON, LAHNIE, TAMPA, FL. SN 78-132,385. PUB. 12-31-2002, FILED 5-31-2002.

MEMORYCAM

FOR VIDEO CAMERA LENS, NAMELY, A VERY SMALL VIDEO CAMERA LENS, LOCATED ON THE END OF A CABLE SENDING SIGNALS TO A PORTABLE CAMCORDER, THAT MAY BE CLIPPED ON A USERS HAT, GLASSES, OR HEAD SET ENABLING HANDS FREE RECORDING OF THE DESIRED SUBJECT MATERIAL (U.S. CLS. 21, 23, 26, 36 AND 38).

FIRST USE 6-30-2002; IN COMMERCE 9-4-2003.

2,858,816. SIEMENS MEDICAL SOLUTIONS USA, INC., MALVERN, PA. SN 78-140,896. PUB. 9-9-2003, FILED 7-2-2002.

COHERENCE

FOR COMPUTER SOFTWARE FOR USE IN ONCOLOGY CARE TO COMPILE, INDEX, STORE, ACCESS, RETRIEVE, DOWNLOAD AND REVIEW DATA RELATING TO ONCOLOGY CARE AND ONCOLOGY PATIENTS (U.S. CLS. 21, 23, 26, 36 AND 38).

FIRST USE 5-12-2003; IN COMMERCE 5-12-2003.

CLASS 9—(Continued).

2,858,828. CUBICLE DECOR, LLC, LOUISVILLE, KY. SN 78-150,086. PUB. 9-16-2003, FILED 8-2-2002.

CUBE BUCKS

NO CLAIM IS MADE TO THE EXCLUSIVE RIGHT TO USE "BUCKS", APART FROM THE MARK AS SHOWN.

FOR COUPONS WHICH ARE USED ELECTRONICALLY THAT ACT AS MARKETING DEVICES USED AS AN INCENTIVE FOR INDIVIDUALS TO PURCHASE RETAIL GOODS, NAMELY ITEMS SUITABLE FOR BUSINESS CUBICLES, OFFICES AND OTHER BUSINESS ENVIRONMENTS; COUPONS WHICH ARE USED ELECTRONICALLY THAT CAN BE USED TO RECEIVE DISCOUNTS ON DECOR FOR CUBICLES AND OFFICES, NAMELY, STATUTES, GLASSWARE, DOLLS, HOLIDAY DECORATIONS, GENERAL OFFICE SUPPLIES, FLOWER STANDS, HERITAGE DECORATIONS, LAMPS, FANS, PICTURES, PICTURE FRAMES, POSTERS, AND THE LIKE (U.S. CLS. 21, 23, 26, 36 AND 38).
FIRST USE 2-1-2003; IN COMMERCE 2-1-2003.

2,858,835. EXIDE TECHNOLOGIES, ALPHARETTA, GA. SN 78-153,900. PUB. 3-18-2003, FILED 8-13-2002.

XLT

FOR BATTERIES AND BATTERY ACCESSORIES RELATED THERETO, NAMELY, BATTERY BOOSTER CABLES, TERMINALS, CABLES, BOLTS AND TRAYS, PRIMARY WIRE, TERMINAL KITS AND CHARGERS (U.S. CLS. 21, 23, 26, 36 AND 38).
FIRST USE 8-0-2003; IN COMMERCE 8-0-2003.

2,858,873. AFFILIATED PATHOLOGISTS MEDICAL GROUP, INC., TORRANCE, CA. SN 78-170,306. PUB. 5-6-2003, FILED 10-2-2002.

EPATHCOMPOSER

FOR COMPUTER SOFTWARE FOR IMPORTING MICROSCOPIC IMAGES INTO PATHOLOGY REPORTS (U.S. CLS. 21, 23, 26, 36 AND 38).
FIRST USE 4-0-2002; IN COMMERCE 4-0-2002.

2,858,876. CURIO, LTD., FORT WORTH, TX. SN 78-170,661. PUB. 7-29-2003, FILED 10-3-2002.

PERSON-TO-PERSON

FOR TELEPHONE ANSWERING MACHINE CAPABLE OF ROUTING CALLS TO VARIOUS EXTENSIONS (U.S. CLS. 21, 23, 26, 36 AND 38).
FIRST USE 1-8-2004; IN COMMERCE 2-16-2004.

CLASS 9—(Continued).

2,858,881. INTERNATIONAL FUND ADMINISTRATION, INC., NEW YORK, NY. SN 78-171,860. PUB. 6-24-2003, FILED 10-7-2002.

PRAEEO

THE FOREIGN WORDING IN THE MARK TRANSLATES INTO ENGLISH AS "TO LEAD THE WAY".

FOR COMPUTER SOFTWARE FOR USE BY HEDGE FUND MANAGERS AND OTHER INVESTMENT MANAGERS TO SUPPORT ADMINISTRATIVE AND ACCOUNTING REQUIREMENTS, NAMELY CAPITAL AND SHARE BASED ACCOUNTING, FULLY INTEGRATED WEBSITES FOR CLIENTS, INVESTORS AND SERVICE PROVIDERS, INTEGRATED COMPLIANCE MODULES, CALCULATION AND REPORTING OF INVESTOR CAPITAL/SHARE VALUES, RECORDKEEPING AND REPORTING OF INVESTOR ACTIVITY, AND ELECTRONIC DOCUMENT STORAGE AND RETRIEVAL (U.S. CLS. 21, 23, 26, 36 AND 38).
FIRST USE 7-1-2001; IN COMMERCE 7-1-2001.

2,858,893. PAGEUP WEB SERVICES, LLC, WILLOUGHBY HILLS, OH. SN 78-176,947. PUB. 7-29-2003, FILED 10-22-2002.

WEB-REDI SOLUTIONS

NO CLAIM IS MADE TO THE EXCLUSIVE RIGHT TO USE "WEB-READY", APART FROM THE MARK AS SHOWN.

FOR COMPUTER SOFTWARE FOR WEB SITE AND DATABASE INTEGRATION (U.S. CLS. 21, 23, 26, 36 AND 38).
FIRST USE 2-1-2004; IN COMMERCE 2-1-2004.

2,858,927. CAPCOM CO., LTD., CHUO-KU, OSAKA, JAPAN. SN 78-187,789. PUB. 7-15-2003, FILED 11-22-2002.

DRAGON QUARTER

FOR COMPUTER GAME SOFTWARE, COMPUTER GAME CARTRIDGES, COMPUTER GAME CASSETTES, COMPUTER GAME DISCS, COMPUTER GAME TAPES, VIDEO GAME CARTRIDGES, VIDEO GAME MACHINES FOR USE WITH TELEVISION RECEIVERS (U.S. CLS. 21, 23, 26, 36 AND 38).
FIRST USE 11-14-2002; IN COMMERCE 2-18-2003.

2,858,928. LINDE, STEPHANIE, NEW YORK, NY. SN 78-187,933. PUB. 7-8-2003, FILED 11-22-2002.

GOTCHA GIRLS

FOR SERIES OF ADULT PRACTICAL JOKE VIDEOS (U.S. CLS. 21, 23, 26, 36 AND 38).
FIRST USE 5-31-2003; IN COMMERCE 5-31-2003.

CLASS 9—(Continued).

2,858,930. CAPCOM CO., LTD., CHUO-KU, OSAKA, JAPAN.
SN 78-188,407. PUB. 7-29-2003, FILED 11-25-2002.

P.N.03

FOR COMPUTER GAME SOFTWARE, COMPUTER GAME CARTRIDGES, COMPUTER GAME CASSETTES, COMPUTER GAME DISCS, COMPUTER GAME TAPES, VIDEO GAME CARTRIDGES, VIDEO GAME MACHINES FOR USE WITH TELEVISION RECEIVERS (U.S. CLS. 21, 23, 26, 36 AND 38).
FIRST USE 3-27-2003; IN COMMERCE 9-9-2003.

2,858,931. CAPCOM CO., LTD., CHUO-KU, OSAKA, JAPAN.
SN 78-188,408. PUB. 7-29-2003, FILED 11-25-2002.

VIEWTIFUL JOE

FOR COMPUTER GAME SOFTWARE, COMPUTER GAME CARTRIDGES, COMPUTER GAME CASSETTES, COMPUTER GAME DISCS, COMPUTER GAME TAPES, VIDEO GAME CARTRIDGES, VIDEO GAME MACHINES FOR USE WITH TELEVISION RECEIVERS (U.S. CLS. 21, 23, 26, 36 AND 38).
FIRST USE 6-26-2003; IN COMMERCE 10-7-2003.

2,858,954. SUMMIT PUBLISHING COMPANY, CHICAGO, IL. SN 78-196,088. PUB. 7-22-2003, FILED 12-19-2002.

AUTOMATION WORLD

OWNER OF U.S. REG. NOS. 1,860,390 AND 1,860,391.
NO CLAIM IS MADE TO THE EXCLUSIVE RIGHT TO USE "AUTOMATION", APART FROM THE MARK AS SHOWN.

FOR DOWNLOADABLE ELECTRONIC PUBLICATIONS IN THE NATURE OF MAGAZINES RELATING TO AUTOMATED FACTORY AND/OR BUSINESS PROCESSES, PRODUCTS AND INFORMATION (U.S. CLS. 21, 23, 26, 36 AND 38).
FIRST USE 6-30-2003; IN COMMERCE 6-30-2003.

2,858,983. ADVANCED DIGITAL OPTICS, INC., WESTLAKE, CA. SN 78-208,817. PUB. 12-16-2003, FILED 1-30-2003.

CHROMIX

FOR DEVICES FOR PROJECTING AN IMAGE ONTO A DISPLAY, NAMELY IMAGE DISPLAY PROJECTORS, VIDEO DISPLAY PROJECTORS, AND LIQUID CRYSTAL DISPLAY PROJECTORS (U.S. CLS. 21, 23, 26, 36 AND 38).
FIRST USE 1-0-2003; IN COMMERCE 1-0-2003.

CLASS 9—(Continued).

2,858,984. MULTILING CORPORATION, PROVO, UT. SN 78-209,209. PUB. 9-16-2003, FILED 1-30-2003.

SEMANTIS

FOR COMPUTER SOFTWARE FOR LANGUAGE TRANSLATION PURPOSES (U.S. CLS. 21, 23, 26, 36 AND 38).
FIRST USE 3-20-2003; IN COMMERCE 3-31-2003.

2,858,986. ANABELL INC., LOS ANGELES, CA. SN 78-210,844.
PUB. 9-30-2003, FILED 2-4-2003.

ANABELL

FOR TELEPHONE RINGERS (U.S. CLS. 21, 23, 26, 36 AND 38).
FIRST USE 1-7-2003; IN COMMERCE 9-1-2003.

2,858,992. PHONEBITES, INC., SAN FRANCISCO, CA. SN 78-216,647. PUB. 1-20-2004, FILED 2-19-2003.



FOR WIRELESS COMMUNICATION ACCESSORY PRODUCTS, NAMELY, COVERS FOR CELLULAR PHONES, AND HANDS-FREE HEADSETS FOR CELLULAR PHONES (U.S. CLS. 21, 23, 26, 36 AND 38).
FIRST USE 12-1-2002; IN COMMERCE 11-1-2003.

2,859,005. KONAMI GAMING, INC., LAS VEGAS, NV. SN 78-227,469. PUB. 11-11-2003, FILED 3-19-2003.

CASH CROSSING

FOR GAMING EQUIPMENT, NAMELY, SLOT MACHINES, GAMING MACHINES AND GAME SOFTWARE USED THEREWITH (U.S. CLS. 21, 23, 26, 36 AND 38).
FIRST USE 10-6-2003; IN COMMERCE 10-6-2003.

CLASS 9—(Continued).

2,859,009. ANCHOR EDUCATIONAL FOUNDATION, INC., PROVIDENCE, RI. SN 78-233,076. PUB. 10-21-2003, FILED 4-2-2003.

TILLY: A MESSAGE OF HOPE

FOR PRERECORDED VIDEO TAPES, VIDEO CASSETTES, AND VIDEO DISKS FEATURING A MOTION PICTURE AND DISCUSSION GROUP CONCERNING FAMILY-ORIENTED, LIFE-AFFIRMING THEMES (U.S. CLS. 21, 23, 26, 36 AND 38).
FIRST USE 2-15-2003; IN COMMERCE 8-18-2003.

2,859,012. MEMOREX INTERNATIONAL INC., KOWLOON, HONG KONG. SN 78-234,153. PUB. 11-4-2003, FILED 4-4-2003.

ACTION X

FOR BLANK OPTICAL RECORDING MEDIA, NAMELY RECORDABLE AND REWRITEABLE CDS (U.S. CLS. 21, 23, 26, 36 AND 38).
FIRST USE 7-31-2003; IN COMMERCE 7-31-2003.

2,859,018. PROPPER MANUFACTURING COMPANY, INC., LONG ISLAND CITY, NY. SN 78-236,664. PUB. 11-25-2003, FILED 4-11-2003.

POWERALL

FOR BATTERIES FOR OPHTHALMOSCOPES; BATTERY CHARGERS FOR OPHTHALMOSCOPES (U.S. CLS. 21, 23, 26, 36 AND 38).
FIRST USE 12-0-2003; IN COMMERCE 12-0-2003.

2,859,025. PR TRADING COMPANY, INC., HOUSTON, TX. SN 78-242,115. PUB. 12-16-2003, FILED 4-25-2003.



FOR SUNGLASSES HAVING PLASTIC OR METAL FRAMES (U.S. CLS. 21, 23, 26, 36 AND 38).
FIRST USE 12-9-2003; IN COMMERCE 12-9-2003.

CLASS 9—(Continued).

2,859,027. NUBRIDGE COMPANY LIMITED, CENTRAL, HONG KONG. SN 78-245,984. PUB. 12-16-2003, FILED 5-5-2003.

Animal Friends

FOR COMPUTER MOUSE (U.S. CLS. 21, 23, 26, 36 AND 38).
FIRST USE 11-1-2001; IN COMMERCE 1-15-2002.

2,859,032. KONAMI GAMING, INC., LAS VEGAS, NV. SN 78-252,333. PUB. 1-20-2004, FILED 5-20-2003.

CASH INFERNO

NO CLAIM IS MADE TO THE EXCLUSIVE RIGHT TO USE "CASH", APART FROM THE MARK AS SHOWN.
FOR GAMING EQUIPMENT, NAMELY, SLOT MACHINES, GAMING MACHINES AND GAME SOFTWARE USED THEREWITH (U.S. CLS. 21, 23, 26, 36 AND 38).
FIRST USE 1-28-2004; IN COMMERCE 1-28-2004.

2,859,041. ZYLOWARE CORPORATION, LONG ISLAND CITY, NY. SN 78-262,099. PUB. 12-23-2003, FILED 6-13-2003.

INVINCILITES

OWNER OF U.S. REG. NO. 859,275.
FOR EYEGLASS FRAMES, EYEGLASSES, SUNGLASSES AND PARTS THEREOF (U.S. CLS. 21, 23, 26, 36 AND 38).
FIRST USE 12-1-2003; IN COMMERCE 12-1-2003.

CLASS 10—MEDICAL APPARATUS

2,858,181. MOI CORP., PITTSBURGH, PA. SN 75-273,275. PUB. 1-20-1998, FILED 4-11-1997.

LIFECHEK

FOR MEDICAL DEVICES, NAMELY, CALORIE SENSORS AND HEART RATE MONITORS (U.S. CLS. 26, 39 AND 44).
FIRST USE 6-19-2003; IN COMMERCE 8-22-2003.

2,858,190. ALSIUS CORPORATION, IRVINE, CA. SN 75-604,187. PUB. 7-30-2002, FILED 12-9-1998.

COOL LINE

FOR SURGICAL DEVICES, NAMELY, CATHETERS (U.S. CLS. 26, 39 AND 44).
FIRST USE 7-22-1999; IN COMMERCE 7-22-1999.

CLASS 10—(Continued).

2,858,196. KARL STORZ GMBH & CO. KG., D-78532 TUTTLINGEN, FED REP GERMANY. SN 75-693,816. PUB. 5-27-2003, FILED 4-29-1999.

ENDOVISION

PRIORITY CLAIMED UNDER SEC. 44(D) ON FED REP GERMANY APPLICATION NO. 39862930.7, FILED 10-31-1998, REG. NO. 39862930, DATED 2-25-1999, EXPIRES 10-31-2008.

OWNER OF U.S. REG. NO. 1,443,905.

FOR LINE OF MEDICAL, SURGICAL, DENTAL AND VETERINARY INSTRUMENTS USED IN ENDOSCOPIC SURGICAL PROCEDURES RELATING TO THE RESPECTIVE FIELDS; IMPLANTABLE ORTHOPEDIC ARTICLES; SUTURE MATERIALS; ILLUMINATING, LIGHTING, INSTALLATIONS AND APPARATUS FOR USE WITH ENDOSCOPES; MEDICAL MICROSCOPES FOR USE IN CONNECTION WITH ENDOSCOPES; DATA PROCESSING APPARATUS, DATA MEDIA AND DOCUMENTATION INSTALLATIONS ALL FOR USE WITH ENDOSCOPES; SUCTION AND RINSING APPARATUS FOR MEDICAL AND SURGICAL PROCEDURES; HIGH FREQUENCY APPARATUS AND INSTRUMENTS FOR USE IN ELECTROSURGERY; HIGH FREQUENCY VOLTAGE GENERATORS FOR USE WITH ENDOSCOPIC INSTRUMENTS USED IN ELECTROSURGERY; ULTRASONIC APPARATUS AND INSTRUMENTS FOR DIAGNOSTIC MEDICAL APPLICATIONS; TRAINING, TEACHING AND INSTRUCTING INSTALLATIONS TO INSTRUCT SURGICAL AND MEDICAL AND SURGICAL PERSONNEL IN THE USE OF THESE PRODUCTS IN THE ENDOSCOPIC FIELD; TEST AND CHECKING INSTALLATIONS AND SAFEKEEPING AND TRANSPORT RECEPTACLES SPECIFICALLY FOR USE WITH SAID APPARATUS AND INSTRUMENTS, ALL FOR USE IN THE ENDOSCOPIC FIELD FOR MEDICAL USE (U.S. CLS. 26, 39 AND 44).

FIRST USE 5-0-1982; IN COMMERCE 5-0-1982.

2,858,215. ABILITY ONE CORPORATION, BOLINGBROOK, IL. SN 75-804,810. PUB. 1-8-2002, FILED 9-22-1999.

ROLYAN

OWNER OF U.S. REG. NO. 1,331,554.

FOR MEDICAL AND REHABILITATIVE EQUIPMENT, NAMELY PUZZLE BOARDS, STACKING CONES, BALLS, BOARD GAMES, EXERCISE EQUIPMENT, LOWER EXTREMITY EXERCISE EQUIPMENT, UPPER EXTREMITY EXERCISE EQUIPMENT, EXERCISE BALLS, EXERCISE ROLLS CONSISTING OF CYLINDRICAL ROLLERS FOR MUSCLE REEDUCATION AND BALANCE TRAINING, EXERCISE WEDGES, EXERCISE BANDS, GYMNASTIC APPARATUS USED FOR BALANCE TRAINING, EXERCISE MATS MASSAGE MATS, EXERCISE TABLES, MASSAGE TABLES, DUMBBELLS, ABDOMEN PROTECTORS FOR GYMNASTIC AND ATHLETIC USE AND GLOVES FOR EXERCISE AND GYMNASTIC PURPOSES (U.S. CLS. 26, 39 AND 44).

FIRST USE 1-0-2001; IN COMMERCE 1-0-2001.

CLASS 10—(Continued).

2,858,227. SMITH & NEPHEW, INC., MEMPHIS, TN. SN 75-891,916. PUB. 7-15-2003, FILED 1-7-2000.

TRIVEX

FOR MEDICAL DEVICE, NAMELY INSTRUMENT FOR USE IN VARICOSE VEIN SURGERY (U.S. CLS. 26, 39 AND 44).

FIRST USE 6-15-2000; IN COMMERCE 6-15-2000.

2,858,363. CORDIS CORPORATION, MIAMI LAKES, FL. SN 76-296,421. PUB. 12-10-2002, FILED 8-9-2001.

QWIKPATCH

OWNER OF U.S. REG. NO. 2,314,270.

FOR PATCH USED IN CONNECTION WITH MEDICAL CATHETERS (U.S. CLS. 26, 39 AND 44).

FIRST USE 9-26-2000; IN COMMERCE 9-26-2000.

2,858,447. CYTYC CORPORATION, BOXBOROUGH, MA. SN 76-383,992. PUB. 6-17-2003, FILED 3-19-2002.

THINPREP

FOR MEDICAL APPARATUS, NAMELY, MICROSCOPIC SLIDE PROCESSING AND IMAGING APPARATUS COMPRISING COMPUTER HARDWARE, COMPUTER SOFTWARE, AND MICROSCOPES FOR USE IN THE DETECTION, DIAGNOSIS, AND TREATMENT OF CANCER; ELECTRONIC MEDICAL IMAGING AND IMAGE PROCESSING APPARATUS FOR USE IN THE DETECTION, DIAGNOSIS, AND TREATMENT OF CANCER AND PARTS AND ATTACHMENTS THEREFOR (U.S. CLS. 26, 39 AND 44).

FIRST USE 6-16-2003; IN COMMERCE 6-16-2003.

2,858,552. DIAGNOSTIC PRODUCTS CORPORATION, LOS ANGELES, CA. SN 76-438,528. PUB. 5-6-2003, FILED 8-5-2002.

SPERMALITE

FOR MEDICAL DEVICE IN THE NATURE OF A LIGHT DEVICE FOR ANALYZING SEMEN IN MEDICAL DIAGNOSIS (U.S. CLS. 26, 39 AND 44).

FIRST USE 11-11-2002; IN COMMERCE 11-11-2002.

CLASS 10—(Continued).

2,858,636. UNITRON INDUSTRIES LTD., KITCHENER, ONTARIO, CANADA. SN 76-477,922. PUB. 7-15-2003, FILED 12-23-2002.

CONVERSA

FOR HEARING AIDS AND HEARING AID PARTS (U.S. CLS. 26, 39 AND 44).
FIRST USE 4-0-2003; IN COMMERCE 4-0-2003.

2,858,705. KARASIC, BRIAN LEE, HOUSTON, TX. SN 78-024,274. PUB. 7-31-2001, FILED 9-2-2000.

INTUPRO

FOR MEDICAL APPARATUS, NAMELY AN INTUBATION PROTECTION AND VISUALIZATION DEVICE FOR THE PURPOSE OF WIDENING THE PHARYNX USED DURING ENDOTRACHEAL INTUBATION IN THE OPERATING ROOM OF A HOSPITAL (U.S. CLS. 26, 39 AND 44).
FIRST USE 12-0-2003; IN COMMERCE 12-0-2003.

2,858,729. DEPUY, INC., WARSAW, IN. SN 78-062,089. PUB. 7-2-2002, FILED 5-4-2001.

PLIF-SG

FOR MEDICAL DEVICES AND ORTHOPEDIC ARTICLES, NAMELY, INSTRUMENTS USED IN SPINAL IMPLANT SURGERY (U.S. CLS. 26, 39 AND 44).
FIRST USE 0-0-2001; IN COMMERCE 0-0-2001.

2,858,743. SURGRX, PALO ALTO, CA. SN 78-086,796. PUB. 7-16-2002, FILED 10-3-2001.

SURGRX

FOR TISSUE SEALING AND HEMOSTASIS DEVICE USED IN SURGICAL PROCEDURES, NAMELY, A LAPAROSCOPIC DEVICE AND REUSABLE EXTENSION CABLE AND ADAPTOR WHICH ADAPTS TO ELECTRO-SURGICAL GENERATORS (U.S. CLS. 26, 39 AND 44).
FIRST USE 10-0-1999; IN COMMERCE 12-0-2000.

2,858,966. ALLEGIANCE CORPORATION, MCGAW PARK, IL. SN 78-202,112. PUB. 12-16-2003, FILED 1-10-2003.

TEMNO EVOLUTION

OWNER OF U.S. REG. NOS. 1,827,355 AND 2,538,383.
FOR SOFT TISSUE BIOPSY NEEDLES (U.S. CLS. 26, 39 AND 44).
FIRST USE 5-2-2003; IN COMMERCE 5-2-2003.

CLASS 11—ENVIRONMENTAL CONTROL APPARATUS

2,858,180. UNITED STATES FILTER CORPORATION, PALM DESERT, CA. SN 74-722,542. PUB. 7-31-2001, FILED 8-28-1995.

PM KIT

NO CLAIM IS MADE TO THE EXCLUSIVE RIGHT TO USE "KIT", APART FROM THE MARK AS SHOWN.
FOR REPLACEMENT PARTS FOR WATER TREATMENT PUMPS AND CHLORINATORS, NAMELY VALVES, SEALS, DIAPHRAGMS, AND BALLS FOR VALVES (U.S. CLS. 13, 21, 23, 31 AND 34).
FIRST USE 6-1-2003; IN COMMERCE 6-1-2003.

2,858,207. BARBER, JACK A., LEESBURG, FL. SN 75-777,828. PUB. 12-26-2000, FILED 8-17-1999.

PUREWISE

OWNER OF U.S. REG. NOS. 2,228,068 AND 2,238,728.
FOR AIR AND WATER PURIFICATION AND FILTERING UNITS FOR COMMERCIAL AND DOMESTIC USE (U.S. CLS. 13, 21, 23, 31 AND 34).
FIRST USE 8-17-1999; IN COMMERCE 8-17-1999.

2,858,253. PDH INTERNATIONAL INCORPORATED, DECATUR, GA. SN 76-036,096. PUB. 3-6-2001, FILED 4-27-2000.

DEXWET

FOR DEODORIZING EXHAUST WET FILTERS AND PARTS THEREFOR (U.S. CLS. 13, 21, 23, 31 AND 34).
FIRST USE 6-0-2002; IN COMMERCE 6-0-2002.

2,858,272. WILBUR CURTIS COMPANY, MONTEBELLO, CA. SN 76-104,413. PUB. 9-11-2001, FILED 8-7-2000.

THE GOLD CUP SERIES

NO CLAIM IS MADE TO THE EXCLUSIVE RIGHT TO USE "SERIES", APART FROM THE MARK AS SHOWN.
FOR COMMERCIAL COFFEE BREWERS AND PARTS THEREOF (U.S. CLS. 13, 21, 23, 31 AND 34).
FIRST USE 7-15-2003; IN COMMERCE 7-15-2003.

CLASS 11—(Continued).

2,858,381. INAX CORPORATION, AICHI, JAPAN. SN 76-319,299. PUB. 6-24-2003, FILED 10-1-2001.

LUSCENCE

FOR SHOWER TOILETS AND STRUCTURAL PARTS THEREFOR; TOILET SEATS; TOILET BOWLS; TOILET SEATS FOR HEATING, WASHING AND DRYING BODY PARTS; BIDETS AND REMOTE CONTROLS, SOLD TOGETHER AS A UNIT; WATER CLOSETS, AND REMOTE CONTROLS, SOLD TOGETHER AS A UNIT; TOILET TANKS AND STRUCTURAL PARTS THEREFOR; TOILET TANK ASSEMBLIES COMPRISED OF TOILET TANK BOWLS FOR FLUSHING TOILET TANKS; TOILETS AND REMOTE CONTROLS, SOLD TOGETHER AS A UNIT; TANKS, NAMELY, CISTERN TANKS; TANK BALLS; WATER FAUCETS; FIXED SPOUTS USED DIRECTLY IN BIDETS AND TOILETS; PLUMBING FIXTURES, NAMELY, SHOWER SPRAYERS FOR USE WITH TOILETS AND BIDETS; AND BIDET NOZZLES (U.S. CLS. 13, 21, 23, 31 AND 34).
FIRST USE 3-1-2002; IN COMMERCE 3-1-2002.

2,858,454. MODULAR INTERNATIONAL, INC., PITTSBURGH, PA. SN 76-395,783. PUB. 10-1-2002, FILED 4-15-2002.

APERTURES

FOR ELECTRIC LIGHTING FIXTURES (U.S. CLS. 13, 21, 23, 31 AND 34).
FIRST USE 7-27-2001; IN COMMERCE 7-27-2001.

2,858,498. DISCOVAIR, L.L.C., ZEELAND, MI. SN 76-419,990. PUB. 10-29-2002, FILED 6-13-2002.

DISCOVAIR

FOR COLD AIR RETURN BOXES AND GRILLES (U.S. CLS. 13, 21, 23, 31 AND 34).
FIRST USE 3-28-2003; IN COMMERCE 3-15-2004.

2,858,575. BASCO MANUFACTURING COMPANY, MASON, OH. SN 76-451,659. PUB. 5-27-2003, FILED 9-20-2002.

CELESTA

FOR SHOWER AND BATH SURROUNDS MANUFACTURED PRIMARILY OF GLASS (U.S. CLS. 13, 21, 23, 31 AND 34).
FIRST USE 11-1-2002; IN COMMERCE 11-1-2002.

CLASS 11—(Continued).

2,858,603. MINKA LIGHTING, INC., CORONA, CA. SN 76-466,908. PUB. 7-8-2003, FILED 11-14-2002.

SIDEWINDER

FOR CEILING FANS AND ELECTRIC LIGHTING FIXTURES (U.S. CLS. 13, 21, 23, 31 AND 34).
FIRST USE 3-15-2003; IN COMMERCE 3-15-2003.

2,858,604. MINKA LIGHTING, INC., CORONA, CA. SN 76-466,909. PUB. 7-8-2003, FILED 11-14-2002.

REGATTA

FOR CEILING FANS AND ELECTRIC LIGHTING FIXTURES (U.S. CLS. 13, 21, 23, 31 AND 34).
FIRST USE 3-20-2003; IN COMMERCE 3-20-2003.

2,858,606. T2T, INC., EVERETT, WA. SN 76-467,057. PUB. 9-16-2003, FILED 11-14-2002.

ASTRO ARM

OWNER OF U.S. REG. NO. 2,691,268.
FOR FLASHLIGHT ACCESSORIES, NAMELY, FLASHLIGHT HOLDERS (U.S. CLS. 13, 21, 23, 31 AND 34).
FIRST USE 9-25-2003; IN COMMERCE 9-25-2003.

2,858,615. ILCAR, 06510 CARROS, FRANCE. SN 76-471,230. PUB. 8-5-2003, FILED 11-18-2002.

ILCAR

FOR ELECTRIC LIGHTING FIXTURES, LAMPS, STREET LAMPS (U.S. CLS. 13, 21, 23, 31 AND 34).
FIRST USE 0-0-1985; IN COMMERCE 7-0-2002.

2,858,635. LAKEWOOD ENGINEERING & MFG. CO., CHICAGO, IL. SN 76-477,870. PUB. 8-26-2003, FILED 12-24-2002.

RAINGUARD

FOR ELECTRIC FANS, ELECTRIC WINDOW FANS, AND PORTABLE ELECTRIC FANS (U.S. CLS. 13, 21, 23, 31 AND 34).
FIRST USE 2-4-2004; IN COMMERCE 2-4-2004.

CLASS 11—(Continued).

2,858,652. ACUITY BRANDS, INC., ATLANTA, GA. SN 76-490,110. PUB. 9-30-2003, FILED 2-20-2003.

BRITWAY

FOR ELECTRIC LIGHTING FIXTURES (U.S. CLS. 13, 21, 23, 31 AND 34).
FIRST USE 12-16-2003; IN COMMERCE 12-16-2003.

2,858,656. HARSCO TECHNOLOGIES CORPORATION, FAIRMONT, MN. SN 76-492,697. PUB. 10-7-2003, FILED 2-26-2003.

MACH

FOR INDUSTRIAL BOILERS (U.S. CLS. 13, 21, 23, 31 AND 34).
FIRST USE 5-29-2003; IN COMMERCE 5-29-2003.

2,858,691. SHARP KABUSHIKI KAISHA, TA SHARP CORPORATION, OSAKA 545-8522, JAPAN. SN 76-976,580. PUB. 6-17-2003, FILED 5-15-2002.

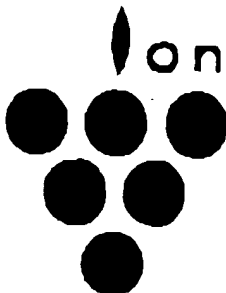

NO CLAIM IS MADE TO THE EXCLUSIVE RIGHT TO USE "ION", APART FROM THE MARK AS SHOWN.

THE MARK CONSISTS OF A STYLIZED DEPICTION OF A CLUSTER OF GRAPES AND A STYLIZED VERSION OF THE WORD "ION".

FOR AIR CONDITIONERS AND AIR PURIFIERS (U.S. CLS. 13, 21, 23, 31 AND 34).
FIRST USE 2-1-2002; IN COMMERCE 3-1-2002.

2,858,771. WHIRLPOOL PROPERTIES, INC., ST. JOSEPH, MI. SN 78-109,898. PUB. 7-23-2002, FILED 2-20-2002.

FREEZERATOR

FOR REFRIGERATORS, FREEZERS AND COMBINATION REFRIGERATOR/FREEZERS (U.S. CLS. 13, 21, 23, 31 AND 34).
FIRST USE 11-25-2003; IN COMMERCE 11-25-2003.

CLASS 11—(Continued).

2,858,799. ROSSTECH SIGNALS, INC., ELLIOT LAKE, ONTARIO, CANADA. SN 78-130,509. PUB. 9-16-2003, FILED 5-22-2002.

ANTHELION

FOR LIGHTING, NAMELY, COLOURED UNDERWATER LIGHTING UNITS AND FILTERS FOR USE WITH LIGHTING UNITS FOR THE INTERIOR OF HOT TUBS, COLOURED AND WHITE DECORATIVE AND SAFETY LIGHTING FIXTURES FOR EXTERIOR HOT TUB USE; INDOOR AND OUTDOOR LOW VOLTAGE ACCENT LIGHTING UNITS AND FIXTURES FOR DECKS, WALKWAYS, STEPS, SOFFITS, WINDOWS AND WALLS; LIGHTING FIXTURES FOR USE AS FEATURE LIGHTING ACCENTS; ELECTRIC NIGHT-LIGHTS; ELECTRIC LIGHTING FIXTURES AND UNITS FOR ILLUMINATING MARINE INSTRUMENTATION; LOW VOLTAGE ELECTRIC OR BATTERY OPERATED ACCENT LIGHTING FIXTURES FOR USE IN MARINE APPLICATIONS; BATTERY AND ELECTRICALLY OPERATED REMOTE LIGHTING (LED) FLASHLIGHTS, AUTOMOTIVE AND NAUTICAL HEADLAMPS; LIGHTING FIXTURES FOR USE IN SURVEILLANCE USING INFRA-RED AND VISIBLE LIGHT; PHOTO-STUDIO LIGHTING FIXTURES (U.S. CLS. 13, 21, 23, 31 AND 34).
FIRST USE 9-12-2003; IN COMMERCE 9-12-2003.

2,858,940. GENLYTE THOMAS GROUP LLC, LOUISVILLE, KY. SN 78-192,642. PUB. 8-12-2003, FILED 12-9-2002.

FLOODPAK

FOR ELECTRICAL LIGHTING FIXTURES (U.S. CLS. 13, 21, 23, 31 AND 34).
FIRST USE 10-29-2003; IN COMMERCE 10-29-2003.

2,858,959. KING OF FANS, INC., FT. LAUDERDALE, FL. SN 78-199,055. PUB. 9-9-2003, FILED 12-31-2002.

PLAZA

FOR ENVIRONMENTAL CONTROL APPARATUS, NAMELY ELECTRIC CIRCULATING FANS FOR DOMESTIC AND COMMERCIAL USE; CEILING AND WALL SURFACE MOUNTED FANS AND REPLACEMENT PARTS THEREFOR; PORTABLE ELECTRIC FANS AND REPLACEMENT PARTS THEREFOR; FREE-STANDING ELECTRIC FANS AND REPLACEMENT PARTS THEREFOR; ELECTRIC DESK FANS AND REPLACEMENT PARTS THEREFOR; HIGH VELOCITY ELECTRIC FLOOR FANS AND REPLACEMENT PARTS THEREFOR; AND ELECTRIC LIGHTING FIXTURES AND STRUCTURAL PARTS THEREFOR (U.S. CLS. 13, 21, 23, 31 AND 34).
FIRST USE 4-1-2003; IN COMMERCE 4-1-2003.

CLASS 11—(Continued).

2,858,970. MOEN INCORPORATED, NORTH OLMSTED, OH. SN 78-205,015. PUB. 9-2-2003, FILED 1-20-2003.

INDIAN SUMMER

FOR FAUCETS FOR USE IN KITCHENS, LAVATORIES, AND ROMAN TUBS; TUB SPOUTS; SHOWER/TUB CONTROL VALVES; TUB WASTES AND OVERFLOWS; BIDETS; SHOWER HEADS AND BODY SPRAYS; HAND-HELD SHOWERS AND SLIDE BARS AND MOUNTING BRACKETS THEREFOR (U.S. CLS. 13, 21, 23, 31 AND 34).

FIRST USE 4-1-2003; IN COMMERCE 5-1-2003.

2,858,978. WESTINGHOUSE LIGHTING CORPORATION, PHILADELPHIA, PA. SN 78-208,262. PUB. 9-16-2003, FILED 1-29-2003.

ECOMAX

FOR FLUORESCENT LIGHT BULBS (U.S. CLS. 13, 21, 23, 31 AND 34).

FIRST USE 5-21-2003; IN COMMERCE 5-21-2003.

2,858,990. INTUITIVE CONTROL SYSTEMS, LLC, STATE COLLEGE, PA. SN 78-213,754. PUB. 10-28-2003, FILED 2-12-2003.

SPEEDSENTRY

FOR RADAR OR LASER BASED SPEED DETECTORS IN THE NATURE OF DYNAMIC VEHICLE SPEED MONITORING DISPLAYS (U.S. CLS. 13, 21, 23, 31 AND 34).

FIRST USE 1-1-2003; IN COMMERCE 1-1-2003.

2,859,010. BE AEROSPACE, INC., WELLINGTON, FL. SN 78-233,381. PUB. 11-11-2003, FILED 4-3-2003.

ENDURA

FOR AIRPLANE GALLEY EQUIPMENT, NAMELY, ELECTRIC HOT BEVERAGE MAKERS (U.S. CLS. 13, 21, 23, 31 AND 34).

FIRST USE 2-19-2003; IN COMMERCE 2-19-2003.

2,859,014. SERA GMBH, HEINSBERG, FED REP GERMANY. SN 78-235,538. PUB. 12-2-2003, FILED 4-9-2003.

SIPORAX

FOR WATER FILTERS, ESPECIALLY FOR AQUARIA, TERRARIA AND GARDEN PONDS, AND MADE OF OPEN-PORED SINTER GLASS OR OPEN-PORED SINTER GLASS CERAMICS (U.S. CLS. 13, 21, 23, 31 AND 34).

FIRST USE 4-30-2001; IN COMMERCE 4-30-2001.

CLASS 12—VEHICLES

2,858,229. TRIPGRIP, INC., HENDERSONVILLE, TN. SN 75-911,369. PUB. 10-24-2000, FILED 2-7-2000.

TRIPGRIPS

FOR HAND EXERCISING AND STRESS RELIEF APPARATUS FOR ATTACHMENT TO A VEHICLE STEERING WHEEL (U.S. CLS. 19, 21, 23, 31, 35 AND 44).

FIRST USE 11-5-2002; IN COMMERCE 11-5-2002.

2,858,238. CAMPAGNOLO SRL, 36100 VICENZA, ITALY. SN 75-982,586. PUB. 11-5-2002, FILED 5-24-2000.

CAMPY

FOR BICYCLES; BICYCLE PARTS, COMPONENTS AND ACCESSORIES, NAMELY, BICYCLE FRAMES, TUBES AND CONNECTORS FOR BICYCLE FRAMES, BICYCLE WHEELS, RIMS AND SPOKES FOR BICYCLE WHEELS, PEDALS, HUBS, WHEEL HUBS, WHEEL HUBS, NAMELY, QUICK-RELEASE SKEWERS CONTROLLED BY CAM LEVERS FOR FAST LOCKING SAME, CHANGE-SPEED GEARS AND FRONT CHANGERS, CRANKS, SIMPLE AND MULTIPLE GEAR WHEELS, CRANKS WITH GEAR WHEELS, GEARS, FREE WHEELS, DRIVE CHAINS, BRAKES, CABLE GUIDES, KNOBS, CONTROLS AND LEVERS, PILLARS AND SADDLES, PUMPS AND PUMP BEARINGS, PINS AND BEARINGS FOR CRANKS AND PEDALS, STEERING KNUCKLES AND BEARINGS AND BUSHINGS THEREOF, FRONT AND BACK FORKS, CABLES AND SHEATHES, PEDAL CLIPS, HANDLE-BARS AND HANDLE-BAR CONNECTIONS, TIRES AND TUBULAR TIRES, ALL THE AFORECIDED GOODS FOR BICYCLES (U.S. CLS. 19, 21, 23, 31, 35 AND 44).

FIRST USE 1-21-2004; IN COMMERCE 1-21-2004.

2,858,282. KUMHO TIRE CO., INC., SEOUL, REPUBLIC OF KOREA. SN 76-141,171. PUB. 4-9-2002, FILED 10-5-2000.



OWNER OF U.S. REG. NOS. 1,465,352, 1,878,573, AND OTHERS.

NO CLAIM IS MADE TO THE EXCLUSIVE RIGHT TO USE "DESIGN TECHNOLOGY" AND "TIRES", APART FROM THE MARK AS SHOWN.

THE MARK CONSISTS OF A FANCIFUL REPRESENTATION OF THE LETTER "K" AND THE WORDS "KUMHO TIRES" BOTH IN WHITE LETTERING ON A SOLID RED RECTANGLE AND THE WORDS "DESIGN TECHNOLOGY" IN BLACK LETTERING ABOVE THE RED RECTANGLE.

FOR AUTOMOBILE TIRES AND STRUCTURAL PARTS THEREOF (U.S. CLS. 19, 21, 23, 31, 35 AND 44).

FIRST USE 1-1-2001; IN COMMERCE 1-1-2001.

CLASS 12—(Continued).

2,858,312. WHEELED COACH INDUSTRIES, INC., HUTCHINSON, KS. SN 76-203,280. PUB. 1-1-2002, FILED 1-31-2001.

CRUSADER

FOR AMBULANCES (U.S. CLS. 19, 21, 23, 31, 35 AND 44).
FIRST USE 3-31-2001; IN COMMERCE 3-31-2001.

2,858,361. OCEANEERING INTERNATIONAL, INC., HOUSTON, TX. SN 76-294,037. PUB. 6-11-2002, FILED 8-2-2001.

SPECTRUM

FOR REMOTELY-OPERATED UNDERWATER VEHICLE FOR CONSTRUCTION, MAINTENANCE, AND SALVAGE (U.S. CLS. 19, 21, 23, 31, 35 AND 44).
FIRST USE 7-9-2001; IN COMMERCE 7-9-2001.

2,858,495. CARLISLE INTANGIBLE COMPANY, SYRACUSE, NY. SN 76-419,078. PUB. 12-24-2002, FILED 6-10-2002.

MUD LITE

FOR LAND VEHICLE TIRES, INCLUDING ALL-TERRAIN VEHICLE TIRES (U.S. CLS. 19, 21, 23, 31, 35 AND 44).
FIRST USE 6-0-2002; IN COMMERCE 6-0-2002.

2,858,496. CARLISLE INTANGIBLE COMPANY, SYRACUSE, NY. SN 76-419,079. PUB. 12-24-2002, FILED 6-10-2002.



FOR DRIVE BELTS AND TRACKS FOR SNOWMOBILES (U.S. CLS. 19, 21, 23, 31, 35 AND 44).
FIRST USE 7-1-1974; IN COMMERCE 7-1-1974.

CLASS 12—(Continued).

2,858,511. CIA WHEEL GROUP, LOS ANGELES, CA. SN 76-426,960. PUB. 1-28-2003, FILED 7-2-2002.

BACCARAT

FOR AUTOMOTIVE WHEELS AND RELATED ACCESSORIES, NAMELY, LUG NUTS, LUG BOLTS, CENTER CAPS, HUB COVERS, WHEEL COVERS, WHEEL LOCKS, WHEEL STUDS, WASHERS, CENTERING RINGS AND VALVE STEMS (U.S. CLS. 19, 21, 23, 31, 35 AND 44).
FIRST USE 7-1-2002; IN COMMERCE 7-1-2002.

2,858,513. BRITAX CHILD SAFETY INC., CHARLOTTE, NC. SN 76-427,164. PUB. 10-7-2003, FILED 7-3-2002.

PRESTIGE

FOR BABY STROLLERS, PUSHCHAIRS AND PRAMS; REPLACEMENT PARTS AND FITTINGS FOR ALL THE AFOREMENTIONED GOODS, BUT NOT INCLUDING TIRES (U.S. CLS. 19, 21, 23, 31, 35 AND 44).
FIRST USE 8-31-1995; IN COMMERCE 2-26-2003.

2,858,517. CARY MARINE, INC., HALLANDALE BEACH, FL. SN 76-428,336. PUB. 4-8-2003, FILED 7-1-2002.



FOR BOATS, YACHTS (U.S. CLS. 19, 21, 23, 31, 35 AND 44).
FIRST USE 9-0-2003; IN COMMERCE 9-0-2003.

2,858,527. CWD, LLC, DBA CENTRIC PARTS, TORRANCE, CA. SN 76-430,413. PUB. 4-22-2003, FILED 7-15-2002.

POSI QUIET

NO CLAIM IS MADE TO THE EXCLUSIVE RIGHT TO USE "QUIET", APART FROM THE MARK AS SHOWN. FOR POSITIVE MOLDED BRAKE PAD FOR LAND VEHICLES (U.S. CLS. 19, 21, 23, 31, 35 AND 44).
FIRST USE 11-1-2002; IN COMMERCE 11-1-2002.

CLASS 12—(Continued).

2,858,547. ERA POWER COMPANY, TOPTON, PA. SN 76-437,505. PUB. 10-14-2003, FILED 8-5-2002.

POWER PARK

NO CLAIM IS MADE TO THE EXCLUSIVE RIGHT TO USE "POWER", APART FROM THE MARK AS SHOWN.

FOR VEHICLES, NAMELY, AUTOMOBILES, VANS, TRUCKS, BOATS, TRAINS AND AIRPLANES, HAVING A POWER GENERATION SYSTEM FOR SUPPLYING POWER TO A VEHICLE AND TO OFF-BOARD POWER USES OR LOADS (U.S. CLS. 19, 21, 23, 31, 35 AND 44).
FIRST USE 5-0-2003; IN COMMERCE 5-0-2003.

2,858,548. ERA POWER COMPANY, TOPTON, PA. SN 76-437,506. PUB. 11-4-2003, FILED 8-5-2002.



NO CLAIM IS MADE TO THE EXCLUSIVE RIGHT TO USE "POWER", APART FROM THE MARK AS SHOWN.

FOR VEHICLES, NAMELY, AUTOMOBILES, VANS, TRUCKS, BOATS, TRAINS AND AIRPLANES, HAVING A POWER GENERATION SYSTEM FOR SUPPLYING POWER TO A VEHICLE AND TO OFF-BOARD POWER USES OR LOADS (U.S. CLS. 19, 21, 23, 31, 35 AND 44).
FIRST USE 5-0-2003; IN COMMERCE 5-0-2003.

2,858,583. NETWORK INDUSTRIES INC., CHULA VISTA, CA. SN 76-458,272. PUB. 9-30-2003, FILED 10-7-2002.

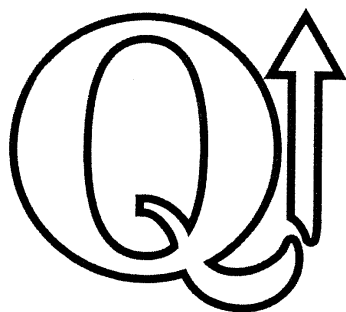

FOR MATERIAL HANDLING DEVICES, NAMELY FORKLIFTS, TELESCOPING MAST LIFTS, ARTICULATED ARM/SELF PROPELLED BOOMS, BOOM SUPPORTED LIFTS, TRAILER MOUNTED LIFTS, PORTABLE PERSONNEL LIFTS; REPLACEMENT PARTS FOR MATERIAL HANDLING VEHICLES, NAMELY TIRES, WHEELS AND AXLE BEARINGS; HAND TRUCKS; AND ROLLER CARTS (U.S. CLS. 19, 21, 23, 31, 35 AND 44).

FIRST USE 8-27-2003; IN COMMERCE 8-27-2003.

CLASS 12—(Continued).

2,858,585. FATE SOCIEDAD ANONIMA INDUSTRIAL COMERCIAL E INMOBILIARIA, (1058) BUENOS AIRES, ARGENTINA. SN 76-458,820. PUB. 7-15-2003, FILED 10-9-2002.

AR-550 ADVANCE

OWNER OF U.S. REG. NOS. 1,495,035, 2,330,858, AND OTHERS.

FOR TIRES (U.S. CLS. 19, 21, 23, 31, 35 AND 44).
FIRST USE 3-0-2003; IN COMMERCE 5-0-2003.

2,858,749. AMTECH CORPORATION, YELM, WA. SN 78-091,104. PUB. 12-24-2002, FILED 10-31-2001.



OWNER OF U.S. REG. NO. 2,492,598.

NO CLAIM IS MADE TO THE EXCLUSIVE RIGHT TO USE "HARDTOPS", APART FROM THE MARK AS SHOWN. THE LINING IN THE DRAWING IS A FEATURE OF THE MARK AND IS NOT INTENDED TO INDICATE COLOR.

THE MARK CONSISTS OF THE WORDS "HELMET HARDTOP" AND THE DESIGN OF AN ENCIRCLED LETTER "H".

FOR HARDTOPS FOR MILITARY AND UTILITY VEHICLES AND TRAILERS FOR HAULING CARGO AND EQUIPMENT (U.S. CLS. 19, 21, 23, 31, 35 AND 44).
FIRST USE 12-0-2001; IN COMMERCE 4-0-2002.

2,858,825. GATOR CITY RIMS, DETROIT, MI. SN 78-147,674. PUB. 9-16-2003, FILED 7-25-2002.



NO CLAIM IS MADE TO THE EXCLUSIVE RIGHT TO USE "RIMS", APART FROM THE MARK AS SHOWN.

THE STIPPLING IS A FEATURE OF THE MARK. FOR AUTOMOTIVE CHROME WHEEL RIMS (U.S. CLS. 19, 21, 23, 31, 35 AND 44).

FIRST USE 9-1-2002; IN COMMERCE 8-1-2003.

CLASS 12—(Continued).

2,858,847. HAYES LEMMERZ INTERNATIONAL, INC., NORTHVILLE, MI. SN 78-159,240. PUB. 4-22-2003, FILED 8-29-2002.

GEMTECH

FOR WHEEL RIMS FOR LAND VEHICLES (U.S. CLS. 19, 21, 23, 31, 35 AND 44).
FIRST USE 1-9-2004; IN COMMERCE 1-9-2004.

2,858,952. SHIMANO INC., SAKAI, OSAKA, JAPAN. SN 78-195,860. PUB. 7-22-2003, FILED 12-18-2002.



FOR BICYCLES, PARTS AND FITTINGS FOR BICYCLES, NAMELY, HUBS, HUB QUICK RELEASE LEVERS, GEAR RELEASE LEVERS, GEAR SHIFT LEVERS, FRONT DERAILLEURS, REAR DERAILLEURS, PULLEYS, CRANKS, CRANK SETS, CHAIN WHEELS, BRAKE LEVERS, FRONT BRAKES, REAR BRAKES, BOTTOM BRACKETS, DERAILLEURS CONTROLLED BY COMPUTER (U.S. CLS. 19, 21, 23, 31, 35 AND 44).
FIRST USE 3-3-2003; IN COMMERCE 9-16-2003.

CLASS 13—FIREARMS

2,858,684. INGRAM ENTERPRISES, INC., SPRINGFIELD, MO. SN 76-531,412. PUB. 11-18-2003, FILED 7-21-2003.

BARREL OF FUN

FOR FIREWORKS (U.S. CLS. 2 AND 9).
FIRST USE 3-1-2004; IN COMMERCE 3-1-2004.

2,858,896. BRUGGER + THOMET AG, THUN, SWITZERLAND. SN 78-177,606. PUB. 6-17-2003, FILED 10-23-2002.

IMPULS II-A

FOR ACCESSORIES FOR FIREARMS, NAMELY, SILENCERS (U.S. CLS. 2 AND 9).
FIRST USE 12-31-1997; IN COMMERCE 12-31-1997.

CLASS 14—JEWELRY

CLASS 14—(Continued).

2,858,480. SOPHIE HONG FASHION CO., LTD., TAIPEI, TAIWAN. SN 76-411,521. PUB. 7-8-2003, FILED 5-28-2002.



OWNER OF U.S. REG. NO. 2,426,569.
THE NAME "SOPHIE HONG" IDENTIFIES A LIVING INDIVIDUAL WHOSE CONSENT IS OF RECORD.
FOR PRECIOUS METALS, NAMELY, GOLD AND SILVER; EMERALDS, PEARLS; DIAMONDS; PINS BEING JEWELRY, NECKLACES, BRACELETS, RINGS, EARRINGS (U.S. CLS. 2, 27, 28 AND 50).
FIRST USE 2-0-1985; IN COMMERCE 9-0-1996.

2,858,627. CASIO KEISANKI KABUSHIKI KAISHA, DBA CASIO COMPUTER CO., LTD., SHIBUYA-KU, TOKYO, JAPAN. SN 76-474,896. PUB. 7-29-2003, FILED 12-12-2002.



FOR ELECTRONIC WATCHES, CLOCKS; WRIST WATCHES HAVING A FUNCTION OF TRANSMITTING AND RECEIVING DATA TO AND FROM AN ELECTRONIC PERSONAL ORGANIZER OR A PERSONAL COMPUTER; AUTONOMOUS RADIO CONTROLLED WATCHES (U.S. CLS. 2, 27, 28 AND 50).
FIRST USE 3-0-2002; IN COMMERCE 4-0-2002.

2,858,680. NEWTON IMPORT EXPORT, INC., TAMPA, FL. SN 76-515,137. PUB. 1-13-2004, FILED 5-19-2003.



NO CLAIM IS MADE TO THE EXCLUSIVE RIGHT TO USE "925", APART FROM THE MARK AS SHOWN.
FOR JEWELRY— NAMELY—STERLING SILVER BRACELETS, EARRINGS, PENDANTS, RINGS (U.S. CLS. 2, 27, 28 AND 50).
FIRST USE 10-1-2003; IN COMMERCE 10-1-2003.

CLASS 14—(Continued).

2,858,738. ALTARATIONS, LLC, FAYETTEVILLE, NC. SN 78-079,501. PUB. 12-18-2001, FILED 8-16-2001.

HIS PRESENCE, NOT OUR PRESENTS

OWNER OF U.S. REG. NOS. 2,437,353, 2,453,438, AND OTHERS.

FOR JEWELRY, NAMELY, ANKLE BRACELETS, BRACELETS, BROOCHES, CHAINS, CHARMS, CUFF LINKS, EARRINGS, NECKLACES, PENDANTS, PINS, RINGS, TIE CLIPS AND WATCHES (U.S. CLS. 2, 27, 28 AND 50).

FIRST USE 2-27-2004; IN COMMERCE 2-27-2004.

2,858,869. CATHEDRAL ART METAL CO., INC., PROVIDENCE, RI. SN 78-168,377. PUB. 12-9-2003, FILED 9-26-2002.

GOD ANSWERS KNEE MAIL

FOR JEWELRY, MEDALLIONS, AND ORNAMENTS OF PRECIOUS METAL (U.S. CLS. 2, 27, 28 AND 50).

FIRST USE 12-30-2002; IN COMMERCE 12-30-2002.

2,859,047. BLUM, LAURA, BEVERLY HILLS, CA. SN 78-975,386. PUB. 7-8-2003, FILED 11-20-2002.

ULLR

FOR JEWELRY NAMELY PINS, PENDANTS AND NECKLACES (U.S. CLS. 2, 27, 28 AND 50).

FIRST USE 11-19-2002; IN COMMERCE 11-19-2002.

CLASS 15—MUSICAL INSTRUMENTS

2,858,208. DEAN MARKLEY STRINGS, INC., SANTA CLARA, CA. SN 75-779,268. PUB. 1-23-2001, FILED 8-17-1999.

EXTREME

FOR STRINGS FOR MUSICAL INSTRUMENTS (U.S. CLS. 2, 21 AND 36).

FIRST USE 3-30-2004; IN COMMERCE 3-30-2004.

2,858,209. DEAN MARKLEY STRINGS, INC., SANTA CLARA, CA. SN 75-779,588. PUB. 1-30-2001, FILED 8-17-1999.

XTREME

FOR STRINGS FOR MUSICAL INSTRUMENTS (U.S. CLS. 2, 21 AND 36).

FIRST USE 3-30-2004; IN COMMERCE 3-30-2004.

CLASS 16—PAPER GOODS AND PRINTED MATTER

2,858,185. GNASS, STEPHEN PAUL, BEVERLY HILLS, CA. SN 75-446,113. PUB. 9-21-1999, FILED 3-6-1998.

KIDVENTOR

FOR INSTRUCTIONAL AND TEACHING MATERIALS, NAMELY, POSTERS, STATIONARY, CALENDARS, PENS, AND PENCILS FEATURING SUBJECTS ON NEW TECHNOLOGIES, INVENTIONS, AND DISCOVERIES (U.S. CLS. 2, 5, 22, 23, 29, 37, 38 AND 50).

FIRST USE 9-20-2002; IN COMMERCE 9-20-2002.

2,858,242. SMEDLEY FINANCIAL SERVICES, INC., SALT LAKE CITY, UT. SN 76-003,642. PUB. 12-19-2000, FILED 3-17-2000.

THE TREND IS YOUR FRIEND EXPERT

FOR PUBLICATIONS, NAMELY, NEWSLETTERS, BROCHURES AND BOOKS PROVIDING FINANCIAL PLANNING, FINANCIAL MANAGEMENT, AND COMMERCIAL MARKET INFORMATION (U.S. CLS. 2, 5, 22, 23, 29, 37, 38 AND 50).

FIRST USE 5-31-2001; IN COMMERCE 5-31-2001.

2,858,264. H.M. PUBLISHERS HOLDINGS LIMITED, HAMPSHIRE, UNITED KINGDOM. SN 76-086,128. PUB. 4-23-2002, FILED 7-10-2000.

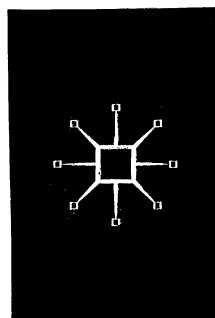

FOR HOUSE MARK FOR ACADEMIC, EDUCATIONAL, INSTRUCTIONAL AND TEACHING MATERIALS COVERING ALL SUBJECTS IN THE FORM OF PRINTED PUBLICATIONS, NAMELY, BOOKS, TEXTBOOKS, PAMPHLETS, BROCHURES, NEWSLETTERS, JOURNALS, MAGAZINES, GUIDES, DICTIONARIES AND REFERENCES MANUALS; HOUSE MARK FOR CATALOGUES FEATURING ACADEMIC, EDUCATIONAL, INSTRUCTIONAL AND TEACHING MATERIALS COVERING ALL SUBJECTS; STATIONARY; WRITING INSTRUMENTS; AND CALENDARS (U.S. CLS. 2, 5, 22, 23, 29, 37, 38 AND 50).

FIRST USE 6-0-2000; IN COMMERCE 8-0-2000.

CLASS 16—(Continued).

2,858,271. GROWING FAMILY, INC., EARTH CITY, MO. SN 76-104,373. PUB. 4-24-2001, FILED 8-7-2000.

LICENSE TO CHARM

FOR PORTRAIT PHOTOGRAPHS; BIRTH ANNOUNCEMENT CARDS; PAPER AND CARDBOARD PHOTO HOLDERS; PRESENTATION FOLDERS; POSTERS; THANK YOU CARDS; MAGAZINES, NEWSLETTERS, AND BROCHURES IN THE FIELD OF CHILD AND INFANT CARE; BABY BOOKS; PICTURE BOOKS; PHOTOGRAPH ALBUMS; EDUCATIONAL AND REFERENCE BOOKS IN THE FIELD OF CHILD AND INFANT CARE; MOUNTED AND UNMOUNTED PHOTOGRAPHS; PRINTED AWARD CERTIFICATES (U.S. CLS. 2, 5, 22, 23, 29, 37, 38 AND 50).

FIRST USE 5-0-2000; IN COMMERCE 5-0-2000.

2,858,313. MICHAELS OF OREGON CO., OREGON CITY, OR. SN 76-204,722. PUB. 1-1-2002, FILED 2-1-2001.

HUNT BETTER/SHOOT BETTER

FOR PRINTED MATERIALS CONCERNING FIREARMS ACCESSORIES AND RELATED PRODUCTS, NAMELY, CATALOGS, PRICE LISTS, PRODUCT SELECTION GUIDES, PRODUCT REQUEST CARDS, DISTRIBUTOR LISTINGS, AND FOLDERS FOR CONTAINING PROMOTIONAL MATERIALS WITHIN THE GUN ACCESSORY TRADE (U.S. CLS. 2, 5, 22, 23, 29, 37, 38 AND 50).

FIRST USE 10-6-2003; IN COMMERCE 10-6-2003.

2,858,317. POULIN, ANNEMARIE B., DBA ENERGENESIS, SLIVER CITY, NM. SN 76-214,970. PUB. 7-2-2002, FILED 2-23-2001.

ENERGENESIS

FOR PRINTED MATERIALS, NAMELY, PAMPHLETS AND BROCHURES IN THE FIELD OF NATURAL HEALING THERAPIES, NAMELY BIOENERGETICS USING TECHNIQUES OF BIOFEEDBACK AND SPIRITUAL COUNSELING (U.S. CLS. 2, 5, 22, 23, 29, 37, 38 AND 50).

FIRST USE 10-28-1996; IN COMMERCE 10-28-1996.

2,858,323. CREDIT SUISSE FIRST BOSTON LLC, NEW YORK, NY. SN 76-229,902. PUB. 2-19-2002, FILED 3-22-2001.

CREDIT COMPASS

NO CLAIM IS MADE TO THE EXCLUSIVE RIGHT TO USE CREDIT, APART FROM THE MARK AS SHOWN.

FOR PRINTED PUBLICATIONS, NAMELY NEWSLETTERS, REPORTS AND PAMPHLETS REGARDING THE SELECTION, ANALYSIS, AND MANAGEMENT OF FINANCIAL PORTFOLIOS (U.S. CLS. 2, 5, 22, 23, 29, 37, 38 AND 50).

FIRST USE 1-0-2002; IN COMMERCE 1-0-2002.

CLASS 16—(Continued).

2,858,347. TIME INC., NEW YORK, NY. SN 76-272,681. PUB. 11-13-2001, FILED 6-15-2001.

TEEN PEOPLE

OWNER OF U.S. REG. NOS. 2,227,491, 2,405,958, AND OTHERS.

FOR STUDENT PLANNER, STUDENT ASSIGNMENT BOOK, 3-RING BINDER, JOURNALS, MEMORY BOOKS AND WALL CALENDARS (U.S. CLS. 2, 5, 22, 23, 29, 37, 38 AND 50).

FIRST USE 6-0-2003; IN COMMERCE 6-0-2003.

2,858,385. MAGIED, NIZAR AWAD, FALLS CHURCH, VA. SN 76-326,220. PUB. 10-8-2002, FILED 10-18-2001.

JAMBOO

"JAMBOO" MEANS IN KENYA (AFRICA) "HALLOW". FOR CHILDREN'S BOOKS, COLORING BOOKS, PRINTED INSTRUCTIONAL AND TEACHING MATERIALS IN THE AREA OF EARLY CHILDHOOD LEARNING, GREETING CARDS, POSTERS (U.S. CLS. 2, 5, 22, 23, 29, 37, 38 AND 50).

FIRST USE 0-0-1986; IN COMMERCE 0-0-1986.

2,858,388. SERVICIOS CORPORATIVOS DE ADMINISTRACION G.M.Z., S.A. DE C.V., MEXICO, D.F., MEXICO. SN 76-328,875. PUB. 7-22-2003, FILED 10-23-2001.

OMNI INSTANT GLUE

NO CLAIM IS MADE TO THE EXCLUSIVE RIGHT TO USE "INSTANT GLUE", APART FROM THE MARK AS SHOWN.

FOR GLUES AND ADHESIVES FOR USE WITH STATIONERY AND OTHER PAPER MATTER, GENERAL HOUSEHOLD USES, AND GENERAL OFFICE USES, BUT EXCLUDING ADHESIVES FOR USE IN THE CONSTRUCTION INDUSTRY (U.S. CLS. 2, 5, 22, 23, 29, 37, 38 AND 50).

FIRST USE 5-3-2002; IN COMMERCE 5-13-2002.

CLASS 16—(Continued).

2,858,389. POSTMARK PRESS, INC., WATERTOWN, MA. SN 76-333,022. PUB. 7-8-2003, FILED 11-2-2001.



NO CLAIM IS MADE TO THE EXCLUSIVE RIGHT TO USE "POST MARK PRESS" AND "WATERTOWN MAY 3 1-30P 106 M.A.", APART FROM THE MARK AS SHOWN.

THE STIPLING IS A FEATURE OF THE MARK.

THE MARK CONSISTS OF A TURN OF THE CENTURY POSTMARK DESIGN WITH THE WORDS "POSTMARK PRESS".

FOR GREETING CARDS BEARING TURN OF THE CENTURY IMAGES (U.S. CLS. 2, 5, 22, 23, 29, 37, 38 AND 50).

FIRST USE 10-1-2001; IN COMMERCE 10-1-2001.

2,858,400. SERVICIOS CORPORATIVOS DE ADMINISTRACION G.M.Z., S.A. DE C.V., COL. DEL VALLE, C.P. 03100, MEXICO, D.F., MEXICO. SN 76-346,607. PUB. 7-29-2003, FILED 12-10-2001.

OMNI

FOR GLUES AND ADHESIVES FOR USE WITH STATIONERY AND OTHER PAPER MATTER, GENERAL HOUSEHOLD USES, AND GENERAL OFFICE USES, BUT EXCLUDING ADHESIVES FOR USE IN THE CONSTRUCTION INDUSTRY (U.S. CLS. 2, 5, 22, 23, 29, 37, 38 AND 50).

FIRST USE 5-3-2002; IN COMMERCE 5-13-2002.

2,858,458. MOVIE FILM FEST, INC., FULLERTON, CA. SN 76-398,739. PUB. 6-17-2003, FILED 4-22-2002.

FOLD-VELOPE

FOR REUSABLE PAPER MAIL CONTAINERS (U.S. CLS. 2, 5, 22, 23, 29, 37, 38 AND 50).

FIRST USE 3-18-2002; IN COMMERCE 3-18-2002.

2,858,460. DEYOUNG, JOSEPHINE B., CORRALES, NM. AND BUCHAN, SUZETTE, CALEDONIA, MI. SN 76-401,708. PUB. 12-24-2002, FILED 4-30-2002.

BRING A BOOK TO LIFE

FOR HOBBY CRAFT KITS USED TO MAKE CHARACTERS AND OBJECTS FROM CHILDREN'S LITERATURE OUT OF ITEMS SUCH AS POM-POMS, FEATHERS, WOOD, PAPER, PLASTIC, SEQUINS, STONES, MARBLES, BUTTONS, AND BEADS AND INSTRUCTIONS THEREFORE (U.S. CLS. 2, 5, 22, 23, 29, 37, 38 AND 50).

FIRST USE 1-1-2003; IN COMMERCE 1-1-2003.

CLASS 16—(Continued).

2,858,508. TATTOO MANUFACTURING, INC., TUCSON, AZ. SN 76-424,966. PUB. 7-15-2003, FILED 6-25-2002.

TATTOOTLES

FOR PRINTED MATERIALS, NAMELY STORY BOOKS FOR CHILDREN (U.S. CLS. 2, 5, 22, 23, 29, 37, 38 AND 50).

FIRST USE 1-1-1997; IN COMMERCE 1-1-1997.

2,858,565. TOP FLIGHT, INC., CHATTANOOGA, TN. SN 76-446,844. PUB. 7-15-2003, FILED 9-4-2002.



THE MARK CONSISTS OF THE WORDING "GIRLS ONLY" AND THE LETTERS "G" AND "O". ALL LETTERS ARE LOWER CASE WITH THE EXCEPTION OF THE TWO LETTERS "O" WHICH ARE REPRESENTED AS A DAISY TYPE FLOWER.

FOR STATIONERY GOODS, NAMELY, STATIONERY PORTFOLIOS, NOTEBOOKS, COMPOSITION BOOKS, BINDERS, PENCIL POUCHES WITH ZIPPER CLOSURES, MEMO BOOKS, PERSONAL PLANNERS, NOTEPADS, AND ORGANIZERS FOR STATIONERY USE (U.S. CLS. 2, 5, 22, 23, 29, 37, 38 AND 50).

FIRST USE 6-11-2003; IN COMMERCE 6-11-2003.

2,858,612. PAPELES VENEZOLANOS, C.A., EDIFICIO FORUM, EL ROSAL, CARACAS, VENEZUELA. SN 76-469,531. PUB. 6-17-2003, FILED 11-22-2002.

CAFETERIA

FOR TOILET PAPER, PAPER NAPKINS FOR HOUSEHOLD AND KITCHEN USE (U.S. CLS. 2, 5, 22, 23, 29, 37, 38 AND 50).

FIRST USE 2-23-1990; IN COMMERCE 5-26-2003.

CLASS 16—(Continued).

2,858,668. FISCH, ELLEN, HEWLETT, NY. SN 76-500,989. PUB. 11-11-2003, FILED 3-24-2003.

ELLEN FISCH PAINTS VACATIONS THAT LAST FOREVER

FOR PRINTS, PAINTINGS (U.S. CLS. 2, 5, 22, 23, 29, 37, 38 AND 50).
FIRST USE 11-11-2003; IN COMMERCE 11-11-2003.

2,858,670. WALDMAN PUBLISHING CORP., NEW YORK, NY. AND PLAYMORE INC., PUBLISHERS, NEW YORK, NY. SN 76-503,319. PUB. 12-23-2003, FILED 4-2-2003.

A WONDER-VIEW BOOK

NO CLAIM IS MADE TO THE EXCLUSIVE RIGHT TO USE "BOOK", APART FROM THE MARK AS SHOWN.
FOR SERIES OF CHILDREN'S BOOKS (U.S. CLS. 2, 5, 22, 23, 29, 37, 38 AND 50).
FIRST USE 9-0-2003; IN COMMERCE 9-0-2003.

2,858,752. MCNENY, LARRY R., GARLAND, TX. AND PARKS, MICHAEL, GARLAND, TX. AND PARKS, MARIA SEDOFF, GARLAND, TX. SN 78-098,104. PUB. 11-25-2003, FILED 12-13-2001.

MICHAEL PARKES

MICHAEL PARKES IS A PSEUDONYM OF MICHAEL PARKS WHO IS THE ARTIST WHO CONCEIVES, DESIGNS, CREATES AND SIGNS THE ARTWORKS SOLD UNDER THE NAME MICHAEL PARKES.

FOR ORIGINAL OIL PAINTINGS, ORIGINAL SIGNED AND NUMBERED LIMITED EDITION STONE LITHOGRAPH PRINTS, ORIGINAL GICLEE PRINTS, AND ORIGINAL HAND DRAWN SKETCHES (U.S. CLS. 2, 5, 22, 23, 29, 37, 38 AND 50).
FIRST USE 1-1-1980; IN COMMERCE 1-12-1980.

2,858,870. DOBSON, NATASHA D., AURORA, CO. SN 78-168,605. PUB. 8-19-2003, FILED 9-27-2002.



NO CLAIM IS MADE TO THE EXCLUSIVE RIGHT TO USE "BEAUTY", APART FROM THE MARK AS SHOWN.
FOR BOOKS FOR AFRICAN-AMERICAN FEMALES ON THE SUBJECTS OF HEALTH, BEAUTY, AND FASHION (U.S. CLS. 2, 5, 22, 23, 29, 37, 38 AND 50).
FIRST USE 3-1-2002; IN COMMERCE 11-11-2003.

CLASS 16—(Continued).

2,858,918. THINK FAST, LLC, GLENS FALLS, NY. SN 78-185,868. PUB. 7-1-2003, FILED 11-16-2002.

PROMOSQUAD HITPREDICTOR

FOR PRINTED REPORTS FEATURING MARKET RESEARCH IN THE FIELD OF MUSIC (U.S. CLS. 2, 5, 22, 23, 29, 37, 38 AND 50).
FIRST USE 2-0-2003; IN COMMERCE 2-0-2003.

2,858,925. TYLER, VICTOR, PAUL, PALMDALE, CA. AND TYLER, NANCY, JANE, PALMDALE, CA. SN 78-187,290. PUB. 7-22-2003, FILED 11-20-2002.

DOODLE SMART

FOR BLACK AND WHITE, 20 INCHES BY 24 INCHES, COLORABLE EDUCATIONAL POSTERS (U.S. CLS. 2, 5, 22, 23, 29, 37, 38 AND 50).
FIRST USE 8-25-2003; IN COMMERCE 9-2-2003.

2,858,933. NEOPETS, INC., GLENDALE, CA. SN 78-188,733. PUB. 7-22-2003, FILED 11-25-2002.

BRUCE

FOR PAPER GOODS AND PRINTED MATTER, NAMELY, TRADING CARDS, POSTERS, STICKERS, PAPER PARTY DECORATIONS; STATIONERY ITEMS, NAMELY, ENVELOPES, GREETING CARDS, ANNOUNCEMENT CARDS, NOTEBOOKS AND PADS, NOTE PAPER, NOTE CARDS, AND LABELS; BOOKS AND PAMPHLETS FEATURING ANIMATED CHARACTERS (U.S. CLS. 2, 5, 22, 23, 29, 37, 38 AND 50).
FIRST USE 10-4-2002; IN COMMERCE 10-4-2002.

2,858,953. SUMMIT PUBLISHING COMPANY, CHICAGO, IL. SN 78-196,082. PUB. 7-22-2003, FILED 12-19-2002.

AUTOMATION WORLD

OWNER OF U.S. REG. NO. 1,860,390.
NO CLAIM IS MADE TO THE EXCLUSIVE RIGHT TO USE "AUTOMATION", APART FROM THE MARK AS SHOWN.
FOR PRINTED PUBLICATIONS, NAMELY MAGAZINES RELATING TO AUTOMATED FACTORY AND/OR BUSINESS PROCESSES, PRODUCTS AND INFORMATION (U.S. CLS. 2, 5, 22, 23, 29, 37, 38 AND 50).
FIRST USE 6-30-2003; IN COMMERCE 6-30-2003.

CLASS 16—(Continued).

2,858,958. MOSELEY, BRIAN KEITH, EL CAJON, CA. SN 78-198,047. PUB. 11-18-2003, FILED 12-26-2002.

MASTERWORK MAPS

NO CLAIM IS MADE TO THE EXCLUSIVE RIGHT TO USE "MAPS", APART FROM THE MARK AS SHOWN.

FOR PRINTED BOOKS OF FLOOR PLANS, VEHICLE DESIGNS, AND MAPS FOR ROLE-PLAYING GAMES (U.S. CLS. 2, 5, 22, 23, 29, 37, 38 AND 50).

FIRST USE 6-25-2003; IN COMMERCE 6-25-2003.

2,858,960. THE PSYCHOLOGICAL CORPORATION, SAN ANTONIO, TX. SN 78-199,926. PUB. 9-2-2003, FILED 1-3-2003.

DELV

FOR PRINTED MATERIALS, NAMELY TEST BOOKLETS, TEST FORMS, ANSWER BOOKLETS AND ANSWER FORMS, SCORE REPORTS, BOOKS, WORKBOOKS FOR TESTING AND EVALUATING SPEECH (U.S. CLS. 2, 5, 22, 23, 29, 37, 38 AND 50).

FIRST USE 3-0-2003; IN COMMERCE 3-0-2003.

2,859,003. GERMAN MARSHALL FUND OF THE UNITED STATES, THE, WASHINGTON, DC. SN 78-226,067. PUB. 11-25-2003, FILED 3-15-2003.

TRANSATLANTIC TRENDS

FOR PRINTED MATERIAL, NAMELY BOOKS, BOOKLETS, PAMPHLETS, POLICY BRIEFS, RESEARCH REPORTS, AND SURVEYS ON ATTITUDES OF THE AMERICAN AND EUROPEAN PUBLIC ON A RANGE OF FOREIGN POLICY ISSUES (U.S. CLS. 2, 5, 22, 23, 29, 37, 38 AND 50).

FIRST USE 8-19-2003; IN COMMERCE 9-3-2003.

2,859,028. MEN'S JOURNAL LLC, NEW YORK, NY. SN 78-247,989. PUB. 12-9-2003, FILED 5-9-2003.

LIVE THE INTERESTING LIFE

FOR GENERAL INTEREST MAGAZINE FOR MEN (U.S. CLS. 2, 5, 22, 23, 29, 37, 38 AND 50).

FIRST USE 6-23-2003; IN COMMERCE 6-23-2003.

CLASS 17—RUBBER GOODS**CLASS 17—(Continued).**

2,858,557. PRABHAT INDUSTRIES, MUMBAI 400 009, INDIA. SN 76-440,201. PUB. 7-15-2003, FILED 8-12-2002.

INLUBE

FOR GASKETS COMPRISED OF A RUBBER COMPOUND CONTAINING A LUBRICANT FOR USE IN CONNECTING PIPES (U.S. CLS. 1, 5, 12, 13, 35 AND 50).

FIRST USE 9-1-2003; IN COMMERCE 9-1-2003.

2,858,622. SCHNEE-MOREHEAD BUSINESS TRUST, IRVING, TX. SN 76-473,684. PUB. 11-18-2003, FILED 12-10-2002.

RS 220

FOR SEALANTS, NAMELY, SEALANTS IN TAPE FORM FOR USE IN VACUUM BAG MOLDING PROCESSES IN THE MANUFACTURE OF COMPOSITE PARTS FOR THE AEROSPACE INDUSTRY (U.S. CLS. 1, 5, 12, 13, 35 AND 50).

FIRST USE 10-0-2002; IN COMMERCE 10-0-2002.

2,858,854. GLOBAMATRIX HOLDINGS, PTE. LTD., SINGAPORE, SINGAPORE. SN 78-163,524. PUB. 11-25-2003, FILED 9-12-2002.

Goldust

FOR WINDOW FILMS, NAMELY, SOLAR AND HEAT RESISTANT FILMS, INSULATING FILMS, AND SCRATCH RESISTANT AND SAFETY FILMS (U.S. CLS. 1, 5, 12, 13, 35 AND 50).

FIRST USE 12-2-2003; IN COMMERCE 12-2-2003.

2,858,938. FORMICA CORPORATION, CINCINNATI, OH. SN 78-191,603. PUB. 7-1-2003, FILED 12-5-2002.

LOCK & DROP

FOR INTERLOCKING GROOVED PLANKS COMPRISED PREDOMINANTLY OF LAMINATE AND SOLD AS AN INTEGRAL COMPONENT OF LAMINATE FLOORING PROVIDING FOR EASY INSTALLATION (U.S. CLS. 1, 5, 12, 13, 35 AND 50).

FIRST USE 11-6-2002; IN COMMERCE 11-13-2002.

CLASS 18—LEATHER GOODS

CLASS 18—(Continued).

2,858,194. CHAMAA, FEHMI, DBA FEHMI CHAMAA, ASCHHEIM-DORNACH, FED REP GERMANY. SN 75-654,459. PUB. 6-27-2000, FILED 3-5-1999.

MONDI

PRIORITY CLAIMED UNDER SEC. 44(D) ON FED REP GERMANY APPLICATION NO. 39851987.0, FILED 9-10-1998. OWNER OF U.S. REG. NOS. 1,110,564, 1,954,185, AND OTHERS. SEC. 2(F). FOR TRAVELING AND LUGGAGE, HANDBAGS, DRESSING CASES, PURSES, BRIEFCASES, KEY CASES (U.S. CLS. 1, 2, 3, 22 AND 41). FIRST USE 2-28-2003; IN COMMERCE 2-28-2003.

2,858,302. HARBRO, LLC, BRIGHTON, MI. SN 76-185,879. PUB. 8-21-2001, FILED 12-22-2000.

RAINSTIK

OWNER OF U.S. REG. NO. 2,402,927. FOR UMBRELLAS (U.S. CLS. 1, 2, 3, 22 AND 41). FIRST USE 4-17-2003; IN COMMERCE 4-17-2003.

2,858,369. GIRL MANIA, INC., LOS ANGELES, CA. SN 76-305,038. PUB. 12-17-2002, FILED 8-24-2001.

GIRL MANIA

FOR BAGS, NAMELY HAND BAGS, SHOULDER BAGS, BOOK BAGS, OVERNIGHT BAGS, DUFFEL BAGS, TRAVEL BAGS, GARMENT BAGS FOR TRAVEL, ALL PURPOSE SPORT BAGS, BEACH BAGS AND COSMETIC BAGS SOLD EMPTY; BACKPACKS, PURSES, WALLETS, COIN PURSES, LEATHER KEY CHAINS, AND TOTES, NAMELY TOTE BAGS (U.S. CLS. 1, 2, 3, 22 AND 41). FIRST USE 11-9-2001; IN COMMERCE 12-15-2001.

2,858,459. WING HOP FUNG GINSENG, INC., LOS ANGELES, CA. SN 76-400,341. PUB. 7-8-2003, FILED 4-25-2002.

THE WORD "LAN O" IS AN ABBREVIATION OF THE NAME OF A LIVING INDIVIDUAL, NAMELY DESIGNER LAN ONG. A WRITTEN CONSENT AUTHORIZING THE APPLICANT TO REGISTER THE NAME, IS SUBMITTED HEREWITH. THE MARK CONSISTS OF THE STYLIZED REPRESENTATION OF THE WORDS "LAN O". THE WORD "LAN" IS THE FIRST NAME OF THE

CLASS 18—(Continued).

DESIGNER LAN ONG, AND IT IS THE TRANSLITERATION OF THE CHINESE CHARACTER WHICH GENERALLY MEANS "ORCHID". FOR PURSES AND HANDBAGS (U.S. CLS. 1, 2, 3, 22 AND 41). FIRST USE 12-1-2003; IN COMMERCE 12-1-2003.

2,858,697. FFPE, LLC, SAN DIEGO, CA. SN 76-976,676. PUB. 7-16-2002, FILED 4-4-2001.



FOR WALLETS AND BRIEFCASES (U.S. CLS. 1, 2, 3, 22 AND 41). FIRST USE 3-29-2004; IN COMMERCE 3-29-2004.

2,858,748. PER-LEE, MYRA S., ESCONDIDO, CA. SN 78-089,556. PUB. 3-26-2002, FILED 10-22-2001.

HOUNDSACROSSAMERICA

FOR DOG APPAREL, AS IN LEASHES, COLLARS, AND JACKETS (U.S. CLS. 1, 2, 3, 22 AND 41). FIRST USE 1-1-2002; IN COMMERCE 3-1-2002.

CLASS 19—NON-METALLIC BUILDING MATERIALS

2,858,279. ANLIN INDUSTRIES, INC., CLOVIS, CA. SN 76-136,167. PUB. 5-22-2001, FILED 9-27-2000.

LAGUNA

FOR VINYL WINDOWS, NAMELY WINDOWS WITH FRAMES MADE OF VINYL (U.S. CLS. 1, 12, 33 AND 50). FIRST USE 2-1-2004; IN COMMERCE 2-1-2004.

CLASS 19—(Continued).

2,858,305. STYLE-MARK, INC., ARCHBOLD, OH. SN 76-188,614. PUB. 11-27-2001, FILED 1-2-2001.

STYLE SOLUTIONS

OWNER OF U.S. REG. NO. 2,176,741.
FOR NON-METAL MOLDINGS, TRIMS, HANDRAILS, BANNISTERS, BALUSTRADES AND ARCHITECTURAL FINISHING COMPONENTS, NAMELY, CEILING MEDALLIONS AND TRIMS, FOR USE IN THE BUILDING INDUSTRY (U.S. CLS. 1, 12, 33 AND 50).
FIRST USE 2-0-2001; IN COMMERCE 2-0-2001.

2,858,318. PALTOUGH INDUSTRIES (1998) LTD., RAMAT YOCHANAN 30035, ISRAEL. SN 76-218,650. PUB. 2-12-2002, FILED 3-5-2001.

SUNLITE

FOR THERMOPLASTIC SHEETS FOR USE IN THE BUILDING AND CONSTRUCTION INDUSTRY; NON-LUMINOUS, NON-MECHANICAL SIGNS NOT OF METAL (U.S. CLS. 1, 12, 33 AND 50).
FIRST USE 0-0-2000; IN COMMERCE 0-0-2000.

2,858,402. SOLENO TEXTILES TECHNIQUES, INC., LAVAL, PROVINCE OF QUEBEC, H7L 3Z1, CANADA. SN 76-347,628. PUB. 1-7-2003, FILED 12-12-2001.

AQUAMAT THE WATER CONSERVATION SYSTEM

NO CLAIM IS MADE TO THE EXCLUSIVE RIGHT TO USE "THE WATER CONSERVATION SYSTEM", APART FROM THE MARK AS SHOWN.

FOR NON-WOVEN TEXTILE, NAMELY, FABRIC FOR EVEN DISTRIBUTION AND CONSERVATION OF IRRIGATION WATER IN NURSERIES, GREENHOUSES, LANDSCAPING AND GENERAL HORTICULTURAL AND AGRICULTURAL MARKET (U.S. CLS. 1, 12, 33 AND 50).
FIRST USE 0-0-2002; IN COMMERCE 0-0-2002.

2,858,558. BLITZ U.S.A., INC., MIAMI, OK. SN 76-441,023. PUB. 9-9-2003, FILED 8-16-2002.

OUT-POST

FOR PREFABRICATED DOGHOUSES (U.S. CLS. 1, 12, 33 AND 50).
FIRST USE 9-0-2002; IN COMMERCE 9-0-2002.

CLASS 19—(Continued).

2,858,574. MITTEN INC., PARIS, ONTARIO. SN 76-451,531. PUB. 7-15-2003, FILED 9-17-2002.

SIDING THE WORLD SINCE 1959

PRIORITY CLAIMED UNDER SEC. 44(D) ON CANADA APPLICATION NO. 1152115, FILED 9-9-2002.
FOR VINYL SIDING PROFILES (U.S. CLS. 1, 12, 33 AND 50).
FIRST USE 11-0-2002; IN COMMERCE 11-0-2002.

2,858,735. EPPINK, DIXIE I., YORBA LINDA, CA. SN 78-070,306. PUB. 12-17-2002, FILED 6-21-2001.

STABLE BLEND

NO CLAIM IS MADE TO THE EXCLUSIVE RIGHT TO USE "STABLE", APART FROM THE MARK AS SHOWN.
FOR WOOD FIBER FOR USE IN ANIMAL BEDDING (U.S. CLS. 1, 12, 33 AND 50).
FIRST USE 7-9-2001; IN COMMERCE 12-5-2001.

2,858,754. ANCHOR WALL SYSTEMS, INC., MINNETONKA, MN. SN 78-099,763. PUB. 6-25-2002, FILED 12-21-2001.

ZNL

FOR RETAINING WALL SYSTEM COMPOSED OF CONCRETE BLOCKS, NON-METALLIC CONNECTOR BARS, NAMELY, LOCK BARS SUITABLE FOR RETAINING WALL SYSTEMS, EARTH REINFORCEMENT MATERIALS, NAMELY, SYNTHETIC REINFORCEMENT FABRIC AND GRIDS, DRAINAGE TILES, AND MASONRY ADHESIVE SUITABLE FOR USE IN RETAINING WALL SYSTEMS; CONCRETE BLOCKS; NON-METALLIC CONNECTOR BARS, NAMELY, LOCK BARS SUITABLE FOR RETAINING WALL SYSTEMS (U.S. CLS. 1, 12, 33 AND 50).

FIRST USE 6-0-2003; IN COMMERCE 6-0-2003.

2,858,759. TEASDALE, BRADFORD, A. CALIFON, NJ. SN 78-104,339. PUB. 10-15-2002, FILED 1-23-2002.

*** MYSTICAL MOSAICS ***

NO CLAIM IS MADE TO THE EXCLUSIVE RIGHT TO USE "MOAICS", APART FROM THE MARK AS SHOWN.
FOR MOSAIC TILE SURFACES FOR HOME DECORATING (U.S. CLS. 1, 12, 33 AND 50).
FIRST USE 1-0-2003; IN COMMERCE 1-1-2003.

CLASS 19—(Continued).

2,858,948. HARMON, INC., GOLDEN VALLEY, MN. SN 78-195,180. PUB. 8-26-2003, FILED 12-17-2002.

HI-5000

FOR GLASS CURTAIN WALLS FOR BUILDING EXTERIORS (U.S. CLS. 1, 12, 33 AND 50).
FIRST USE 2-24-2004; IN COMMERCE 2-24-2004.

2,858,949. HARMON, INC., GOLDEN VALLEY, MN. SN 78-195,182. PUB. 8-26-2003, FILED 12-17-2002.

HI-7000

FOR GLASS CURTAIN WALLS FOR BUILDING EXTERIORS (U.S. CLS. 1, 12, 33 AND 50).
FIRST USE 2-24-2004; IN COMMERCE 2-24-2004.

2,859,030. MATES, MATTHEW, ORLANDO, FL. SN 78-251,197. PUB. 11-25-2003, FILED 5-17-2003.



NO CLAIM IS MADE TO THE EXCLUSIVE RIGHT TO USE "POOL BARRIERS", APART FROM THE MARK AS SHOWN.

FOR NON-METAL FENCE PANELS FOR BUILDING POOL FENCES (U.S. CLS. 1, 12, 33 AND 50).
FIRST USE 6-27-2003; IN COMMERCE 10-20-2003.

CLASS 20—FURNITURE AND ARTICLES NOT OTHERWISE CLASSIFIED

2,858,419. MERILLAT INDUSTRIES, INC., ADRIAN, MI. SN 76-357,505. PUB. 9-10-2002, FILED 1-11-2002.

SAVONA

FOR CABINETRY, NAMELY, KITCHEN AND BATHROOM CABINETS AND DOORS FOR CABINETS (U.S. CLS. 2, 13, 22, 25, 32 AND 50).
FIRST USE 8-2-2002; IN COMMERCE 8-2-2002.

CLASS 20—(Continued).

2,858,420. MERILLAT INDUSTRIES, INC., ADRIAN, MI. SN 76-357,506. PUB. 9-10-2002, FILED 1-11-2002.

ACERRA

FOR CABINETRY, NAMELY, KITCHEN AND BATHROOM CABINETS AND DOORS FOR CABINETS (U.S. CLS. 2, 13, 22, 25, 32 AND 50).
FIRST USE 8-2-2002; IN COMMERCE 8-2-2002.

2,858,421. MERILLAT INDUSTRIES, INC., ADRIAN, MI. SN 76-357,507. PUB. 12-3-2002, FILED 1-11-2002.

CAPRI

FOR CABINETRY, NAMELY, KITCHEN AND BATHROOM CABINETS AND CABINET DOORS (U.S. CLS. 2, 13, 22, 25, 32 AND 50).
FIRST USE 11-15-2002; IN COMMERCE 11-15-2002.

2,858,422. MERILLAT INDUSTRIES, INC., ADRIAN, MI. SN 76-357,512. PUB. 12-3-2002, FILED 1-11-2002.

CALAIS

FOR CABINETRY, NAMELY, KITCHEN AND BATHROOM CABINETS AND CABINET DOORS (U.S. CLS. 2, 13, 22, 25, 32 AND 50).
FIRST USE 11-17-2002; IN COMMERCE 11-17-2002.

2,858,423. MERILLAT INDUSTRIES, INC., ADRIAN, MI. SN 76-357,516. PUB. 12-24-2002, FILED 1-11-2002.

EPIC

FOR CABINETRY, NAMELY, KITCHEN AND BATHROOM CABINETS AND CABINET DOORS (U.S. CLS. 2, 13, 22, 25, 32 AND 50).
FIRST USE 8-2-2002; IN COMMERCE 8-2-2002.

2,858,503. MANU COMM ENTERPRISES, PITTSBURGH, PA. SN 76-422,909. PUB. 8-5-2003, FILED 6-19-2002.

CHOICE TAG

NO CLAIM IS MADE TO THE EXCLUSIVE RIGHT TO USE "TAG", APART FROM THE MARK AS SHOWN.

FOR PLASTIC KEY TAG THAT CAN BE ATTACHED TO KEY CHAINS, WITH ADVERTISING AND COUPONS FOR MERCHANTS AND RESTAURANTS AND INFORMATION ABOUT FUNDRAISING ORGANIZATIONS (U.S. CLS. 2, 13, 22, 25, 32 AND 50).
FIRST USE 9-1-2002; IN COMMERCE 9-1-2002.

CLASS 20—(Continued).

2,858,642. HAGEMEYER NORTH AMERICA, INC., ALPHARETTA, GA. SN 76-482,669. PUB. 12-2-2003, FILED 1-16-2003.

CAMBAR

FOR NON-METAL LADDERS; NON-METAL BROOM HANDLES; AND NON-METAL CASTERS AND PLASTIC CASTERS (U.S. CLS. 2, 13, 22, 25, 32 AND 50).
FIRST USE 3-1-2003; IN COMMERCE 3-1-2003.

2,858,860. ATICO INTERNATIONAL USA, INC., FORT LAUDERDALE, FL. SN 78-165,414. PUB. 7-22-2003, FILED 9-18-2002.

CASUAL POINTE

NO CLAIM IS MADE TO THE EXCLUSIVE RIGHT TO USE "CASUAL", APART FROM THE MARK AS SHOWN.
FOR CHAIRS AND LOUNGE CHAIRS (U.S. CLS. 2, 13, 22, 25, 32 AND 50).
FIRST USE 10-10-2002; IN COMMERCE 12-14-2003.

2,858,897. CPFILMS INC., FIELDALE, VA. SN 78-177,946. PUB. 11-11-2003, FILED 10-24-2002.

HALCYON

FOR INTERIOR WINDOW SHADE PRINCIPALLY OF POLYESTER FILM FOR USE IN CONTROLLING GLARE OR HEAT (U.S. CLS. 2, 13, 22, 25, 32 AND 50).
FIRST USE 3-15-2003; IN COMMERCE 3-15-2003.

2,858,921. HALLMARK LICENSING, INC., KANSAS CITY, MO. SN 78-186,193. PUB. 7-15-2003, FILED 11-18-2002.

THERE'S A STORY IN EVERY MOMENT

FOR PICTURE FRAMES (U.S. CLS. 2, 13, 22, 25, 32 AND 50).
FIRST USE 12-17-2002; IN COMMERCE 12-17-2002.

2,858,922. HALLMARK LICENSING, INC., KANSAS CITY, MO. SN 78-186,198. PUB. 7-15-2003, FILED 11-18-2002.

FOR ALL OF LIFE'S SHINING MOMENTS

FOR PICTURE FRAMES, PILLOWS (U.S. CLS. 2, 13, 22, 25, 32 AND 50).
FIRST USE 12-17-2002; IN COMMERCE 12-17-2002.

CLASS 20—(Continued).

2,858,929. DEBARROS, CATHIA Q., HUNTINGTON BEACH, CA. AND WRIGHT, CARLA S., HUNTINGTON BEACH, CA. SN 78-188,333. PUB. 7-29-2003, FILED 11-24-2002.



NO CLAIM IS MADE TO THE EXCLUSIVE RIGHT TO USE "PET", APART FROM THE MARK AS SHOWN.
FOR POLYRESIN FIGURINES (U.S. CLS. 2, 13, 22, 25, 32 AND 50).
FIRST USE 6-30-2003; IN COMMERCE 11-3-2003.

2,858,946. BABE EASE, LLC, PELHAM, NH. SN 78-193,849. PUB. 7-1-2003, FILED 12-12-2002.

CLEAN DINER

FOR FITTED FABRIC COVERS; FURNITURE COVERS; SEAT COVERS; AND HIGHCHAIR COVERS, NAMELY, ONE PIECE SLIP COVERS FOR RESTAURANT HIGHCHAIRS, WHICH COVER ENTIRE SEATING AREA INCLUDING FRONT, BACK, SIDES, AND SEAT THEREOF SO AS TO PROVIDE SANITARY PROTECTION TO BABIES AND TODDLERS (U.S. CLS. 2, 13, 22, 25, 32 AND 50).
FIRST USE 4-19-2003; IN COMMERCE 4-19-2003.

2,858,957. FIBERTECH POLYMERS, INC., NEWPORT BEACH, CA. SN 78-197,568. PUB. 7-29-2003, FILED 12-23-2002.

SMART SHIM

NO CLAIM IS MADE TO THE EXCLUSIVE RIGHT TO USE "SHIM", APART FROM THE MARK AS SHOWN.
FOR NON-METAL SHIMS MADE OF POLYMER AND CELLULOSE MATERIALS (U.S. CLS. 2, 13, 22, 25, 32 AND 50).
FIRST USE 11-20-2003; IN COMMERCE 11-20-2003.

2,859,015. FIBERTECH POLYMERS, INC., NEWPORT BEACH, CA. SN 78-235,617. PUB. 11-18-2003, FILED 4-9-2003.

SMARTSTAKE

FOR LANDSCAPING PRODUCTS, NAMELY NON-METAL STAKES THAT SUPPORT LANDSCAPE EDGING BOARDS; LANDSCAPING PRODUCTS, NAMELY PLASTIC STAKES THAT SUPPORT LANDSCAPE EDGING BOARDS (U.S. CLS. 2, 13, 22, 25, 32 AND 50).
FIRST USE 9-30-2003; IN COMMERCE 11-24-2003.

CLASS 20—(Continued).

2,859,021. L.C. INDUSTRIES, LLC, CHICAGO, IL. SN 78-238,729. PUB. 1-20-2004, FILED 4-17-2003.

1803 COLLECTION

NO CLAIM IS MADE TO THE EXCLUSIVE RIGHT TO USE "COLLECTION", APART FROM THE MARK AS SHOWN.

FOR NON-METAL MONEY CLIPS (U.S. CLS. 2, 13, 22, 25, 32 AND 50).

FIRST USE 7-1-2003; IN COMMERCE 7-1-2003.

CLASS 21—HOUSEWARES AND GLASS

2,858,316. KARL GRUNEWALD VERWALTUNGS GMBH, 55595 SPABRUCKEN, FED REP GERMANY. SN 76-211,281. PUB. 12-25-2001, FILED 2-16-2001.



FOR COOKWARE, NAMELY, POTS, PANS, NON-ELECTRIC PRESSURE COOKERS, DOUBLE BOILERS AND DUTCH OVENS (U.S. CLS. 2, 13, 23, 29, 30, 33, 40 AND 50).

FIRST USE 3-1-2001; IN COMMERCE 3-1-2001.

2,858,438. FELISSIMO CORPORATION, KOBE 650, JAPAN. SN 76-375,543. PUB. 2-4-2003, FILED 2-26-2002.

MUNIDEE

FOR BOTTLE HOLDERS FOR SOFT DRINKS AND DRINKING WATER (U.S. CLS. 2, 13, 23, 29, 30, 33, 40 AND 50).

FIRST USE 9-26-2001; IN COMMERCE 10-1-2001.

2,858,507. L'OREAL, PARIS, FRANCE. SN 76-424,795. PUB. 9-30-2003, FILED 6-26-2002.

MAKEUP ARTISTE

FOR MAKEUP BRUSHES (U.S. CLS. 2, 13, 23, 29, 30, 33, 40 AND 50).

FIRST USE 1-1-2003; IN COMMERCE 1-1-2003.

CLASS 21—(Continued).

2,858,582. UNITED WAY SERVICES, CLEVELAND, OH. SN 76-457,937. PUB. 5-27-2003, FILED 10-4-2002.

GUITAR MANIA

NO CLAIM IS MADE TO THE EXCLUSIVE RIGHT TO USE GUITAR, APART FROM THE MARK AS SHOWN.

FOR COLLECTIBLE SCULPTURES, NAMELY, MINIATURE GUITARS MADE OF CERAMIC PORCELAIN (U.S. CLS. 2, 13, 23, 29, 30, 33, 40 AND 50).

FIRST USE 6-0-2003; IN COMMERCE 7-0-2003.

2,858,618. ALLIED MARKETING GROUP, INC., DALLAS, TX. SN 76-472,378. PUB. 6-17-2003, FILED 12-4-2002.

FREEDOM

FOR COOKWARE SOLD AS A SET CONSISTING OF SAUCEPANS WITH LIDS, DUTCH OVENS WITH LIDS, SKILLETS, FRY PANS, MIXING BOWL SETS, MEASURING SPOONS AND CUPS, AND CUTLERY SETS (U.S. CLS. 2, 13, 23, 29, 30, 33, 40 AND 50).

FIRST USE 3-0-2003; IN COMMERCE 3-0-2003.

2,858,678. MARKETING AND CREATIVE SALES, INC., CHESTERFIELD, MO. SN 76-509,722. PUB. 11-18-2003, FILED 4-28-2003.

CHILL-A-BOWL

FOR WATER BOWLS FOR PETS (U.S. CLS. 2, 13, 23, 29, 30, 33, 40 AND 50).

FIRST USE 11-3-2003; IN COMMERCE 11-3-2003.

2,858,913. CARRUTH STUDIO, INC., WATERVILLE, OH. SN 78-184,683. PUB. 7-8-2003, FILED 11-13-2002.

CANDLELIGHT CREATURES

NO CLAIM IS MADE TO THE EXCLUSIVE RIGHT TO USE "CANDLELIGHT", APART FROM THE MARK AS SHOWN.

FOR CANDLE HOLDERS NOT OF PRECIOUS METAL (U.S. CLS. 2, 13, 23, 29, 30, 33, 40 AND 50).

FIRST USE 3-17-2004; IN COMMERCE 3-17-2004.

2,858,936. KAT-BOX KING, INC., GLEN CARBON, IL. SN 78-191,438. PUB. 7-29-2003, FILED 12-5-2002.

LITTER TO GO!

FOR DISPOSABLE CAT LITTER CONTAINER (U.S. CLS. 2, 13, 23, 29, 30, 33, 40 AND 50).

FIRST USE 10-0-2003; IN COMMERCE 10-0-2003.

CLASS 21—(Continued).

2,858,939. AMCOR LIMITED, ABBOTSFORD, AUSTRALIA.
SN 78-191,611. PUB. 7-15-2003, FILED 12-5-2002.

AMGUARD

FOR PLASTIC CONTAINERS FOR FOOD OR BEV-
ERAGES (U.S. CLS. 2, 13, 23, 29, 30, 33, 40 AND 50).
FIRST USE 2-13-2002; IN COMMERCE 3-4-2004.

CLASS 22—CORDAGE AND FIBERS

2,858,643. HAGEMEYER NORTH AMERICA, INC., AL-
PHARETTA, GA. SN 76-482,678. PUB. 11-25-2003, FILED
1-16-2003.

CAMBAR

OWNER OF U.S. REG. NO. 2,549,696.
FOR TARPAULINS FOR GENERAL USE; AND TIES
FOR FASTENING OR BUNDLING CABLES OR HOSES
(U.S. CLS. 1, 2, 7, 19, 22, 42 AND 50).
FIRST USE 3-1-2003; IN COMMERCE 3-1-2003.

CLASS 23—YARNS AND THREADS

2,858,473. RADICI POLIESTERE ITALIA S.P.A., 24122 BER-
GAMO, ITALY. SN 76-409,389. PUB. 7-8-2003, FILED 5-20-
2002.



THE MARK CONSISTS OF AN ARBITRARY DESIGN OF
LINES.
FOR YARNS AND THREADS FOR TEXTILE USE (U.S.
CL. 43).
FIRST USE 0-0-2002; IN COMMERCE 0-0-2002.

CLASS 24—FABRICS**CLASS 24—(Continued).**

2,858,390. TRANZONIC COMPANIES, THE, HIGHLAND
HEIGHTS, OH. SN 76-334,261. PUB. 10-8-2002, FILED 11-5-
2001.

COTTON CREATIONS

NO CLAIM IS MADE TO THE EXCLUSIVE RIGHT TO
USE "COTTON", APART FROM THE MARK AS SHOWN.
FOR WASH CLOTHS, BIRD'S EYE CLOTHS, FIN-
ISHED BULK TEXTILE FOR THE MANUFACTURE OF
SHOP TOWELS, GLASS TOWELS, POLISHING CLOTHS,
WIPING CLOTHS, DUST CLOTHS, CAR WASH TOWELS,
BATH TOWELS AND HAND TOWELS; AND TOWELS,
NAMELY, SHOP TOWELS, HAND TOWELS, BATH
TOWELS, MASSAGE/SALON HAND TOWELS, DISH
TOWELS, HUCK TOWELS AND INSTITUTIONAL TO-
WELS, ALL MADE IN WHOLE OR IN SIGNIFICANT
PART OF COTTON (U.S. CLS. 42 AND 50).
FIRST USE 12-17-2003; IN COMMERCE 12-17-2003.

2,858,772. MANDELL, PHYLLIS, WILLIAMSVILLE, VT.
AND MANDELL, JOSEPH I., WILLIAMSVILLE, VT.
AND MANDELL, ELISABETH, WILLIAMSVILLE, VT.
SN 78-110,329. PUB. 9-17-2002, FILED 2-21-2002.

PARISH HILL

FOR DECORATIVE DECORATOR ROOM PILLOW
COVERS STUFFED WITH PILLOWS OR PILLOW MA-
TERIALS, WITH AND WITHOUT ADDED FRAGRANCE
(U.S. CLS. 42 AND 50).
FIRST USE 9-7-2002; IN COMMERCE 9-7-2002.

2,858,830. SAYRE ENTERPRISES, INC., BUENA VISTA, VA.
SN 78-150,684. PUB. 8-5-2003, FILED 8-5-2002.

FLAG TALES

NO CLAIM IS MADE TO THE EXCLUSIVE RIGHT TO
USE "FLAG", APART FROM THE MARK AS SHOWN.
FOR CLOTH FLAGS AND BANNERS, TABLE LINEN,
NAMELY, NAPKINS, PLACE MATS AND TABLE-
CLOTHS, TOWELS, GOLF TOWELS (U.S. CLS. 42 AND
50).
FIRST USE 1-0-2002; IN COMMERCE 1-0-2002.

CLASS 25—CLOTHING

2,858,214. MISTRAL PICTURES, LLC, LOS ANGELES, CA.
SN 75-796,494. PUB. 5-8-2001, FILED 9-8-1999.

TRUE VINYL

FOR CLOTHING, NAMELY, T-SHIRTS, SWEAT-
SHIRTS, CAPS, JACKETS, PANTS, SCARVES, UNDER-
WEAR, JOGGING OUTFITS, SNEAKERS, AND SHOES
(U.S. CLS. 22 AND 39).
FIRST USE 4-2-2004; IN COMMERCE 4-2-2004.

CLASS 25—(Continued).

2,858,252. WE MEDIA, INC., NEW YORK, NY. SN 76-034,101.
PUB. 12-26-2000, FILED 4-25-2000.

WEMEDIA

FOR CLOTHING, NAMELY HATS, CAPS, TEE-SHIRTS, SHIRTS, SWEATSHIRTS, SWEAT PANTS, SHORTS, PANTS, SOCKS, BOXER SHORTS, UNDERWEAR, JACKETS, COATS, HEADBANDS, NECK WARMERS, SCARVES (U.S. CLS. 22 AND 39).
FIRST USE 7-0-2000; IN COMMERCE 7-0-2000.

2,858,284. CHEN, YI FEI, NEW YORK, NY. SN 76-146,511.
PUB. 10-8-2002, FILED 10-16-2000.

LAYEFE

FOR CLOTHING, AND FOOTWEAR, NAMELY COATS, DRESSING GOWNS, JACKETS, OVERCOATS, PAJAMAS, PANTS, SHIRTS, SKIRTS, SUITS, SWEATERS, SWIMSUITS, TOPCOATS, UNDERPANTS, UNDERWEAR, SHOES, BOOTS, HALF-BOOTS, SLIPPERS, SOCKS, CLOTHING COMBINATIONS, GLOVES, MITTENS, NECKTIES, SCARVES, HATS, TOP HATS, CLOTHING BELTS, CLOTHING DRAWERS; LINEN GARMENTS, NAMELY SHIRTS, TIES, SKIRTS, DRESSES, PANTS, SUITS; KNITWEAR CLOTHING, NAMELY SHIRTS, TIES, SKIRTS, DRESSES, SWEATERS, COATS, PANTS, SUITS (U.S. CLS. 22 AND 39).
FIRST USE 10-5-2002; IN COMMERCE 10-5-2002.

2,858,296. LIFE LINE, BRONX, NY. SN 76-169,777. PUB. 4-23-2002, FILED 11-20-2000.

LIFE LINE

FOR CLOTHING, NAMELY, SHIRTS, PANTS, JACKETS, FOOTWEAR AND HEADWEAR (U.S. CLS. 22 AND 39).
FIRST USE 11-17-2001; IN COMMERCE 12-28-2002.

CLASS 25—(Continued).

2,858,314. DOMINION RACING VENTURES, LLC, VIRGINIA BEACH, VA. SN 76-205,256. PUB. 5-7-2002, FILED 2-6-2001.



FOR BABY CLOTHES, NAMELY, BABY BUNTING, TOPS, BOTTOMS, JUMPERS, SOCKS, HEADWEAR, FOOTWEAR, JACKETS, LAYETTES, CLOTH BIBS, AND SWEATERS; CHILDREN'S CLOTHING, NAMELY, HEADWEAR, SWEATSHIRTS, T-SHIRTS, SOCKS JACKETS, PANTS, SWEATERS AND FOOTWEAR; ADULT'S CLOTHING, NAMELY, HEADWEAR, SWEATSHIRTS, T-SHIRTS, SOCKS JACKETS, PANTS, SWEATERS AND FOOTWEAR (U.S. CLS. 22 AND 39).
FIRST USE 1-15-2001; IN COMMERCE 1-15-2001.

2,858,330. LEGENDARY HOLDINGS, INC., CHULA VISTA, CA. SN 76-247,217. PUB. 1-1-2002, FILED 4-26-2001.

LEGENDARY SPORT

NO CLAIM IS MADE TO THE EXCLUSIVE RIGHT TO USE "SPORT", APART FROM THE MARK AS SHOWN.
FOR CLOTHING, NAMELY, HATS, CAPS (U.S. CLS. 22 AND 39).
FIRST USE 3-26-2004; IN COMMERCE 3-26-2004.

2,858,346. WMS ENTERPRISES, INC., PLYMOUTH, MI. SN 76-270,801. PUB. 7-22-2003, FILED 6-13-2001.

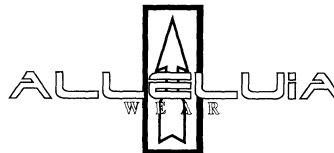

PRIORITY CLAIMED UNDER SEC. 44(D) ON CANADA APPLICATION NO. 1086140, FILED 12-19-2000.
NO CLAIM IS MADE TO THE EXCLUSIVE RIGHT TO USE "WEAR", APART FROM THE MARK AS SHOWN.
FOR MALE AND FEMALE GARMENTS, SPECIFICALLY T-SHIRTS, SWEATSHIRTS, SWEATERS, SKIRTS, PANTS, HEADWEAR, SOCKS, OUTERWEAR, NAMELY JACKETS AND SCARVES, CHOIR ROBES, UNDERGARMENTS, AND FOOTWEAR (U.S. CLS. 22 AND 39).
FIRST USE 7-27-2001; IN COMMERCE 8-10-2001.

CLASS 25—(Continued).

2,858,382. PRIVA INC., ANJOU, QUEBEC, CANADA. SN 76-320,638. PUB. 10-28-2003, FILED 10-3-2001.

TIDY TURTLE

PRIORITY CLAIMED UNDER SEC. 44(D) ON CANADA APPLICATION NO. 1117317, FILED 10-2-2001.

FOR BIBS, NAMELY, CLOTH BABY BIBS; INFANT AND BABY CARE PRODUCTS, NAMELY, SMOCKS (U.S. CLS. 22 AND 39).

FIRST USE 12-16-2002; IN COMMERCE 12-16-2002.

2,858,383. BROWN, NYJGEL A., EAST ORANGE, NJ. SN 76-322,380. PUB. 9-24-2002, FILED 10-3-2001.



NO CLAIM IS MADE TO THE EXCLUSIVE RIGHT TO USE "WEAR", APART FROM THE MARK AS SHOWN.

FOR CLOTHING, NAMELY, SHIRTS, HATS, SWEATERS, JACKETS (U.S. CLS. 22 AND 39).

FIRST USE 5-23-2000; IN COMMERCE 6-0-2000.

2,858,397. AEIOU, INC., WESTFIELD, NJ. SN 76-345,262. PUB. 10-29-2002, FILED 12-3-2001.

AEIOU

FOR CLOTHING, NAMELY SHIRTS, SKORTS, JUMP-SUITS, SHORTS, PANTS, SWEATERS, HEADWEAR, BONNETS, HATS, BASEBALL CAPS, EAR MUFFS, SCARVES, JERSEYS, DRESSES, COATS, JEANS, CARDIGANS, JACKETS, BLAZERS, SOCKS, BOOTIES, SHOES, BELTS, SUSPENDERS, BLOUSES, BATHING SUITS, MITTENS, GLOVES, BOOTS, SLEEPERS, PAJAMAS, NIGHTGOWNS, ROMPERS, CREEPERS, CRAWLERS, SUNSUITS, PLAYSUITS, UNITARDS, LEGGINGS, DIAPER COVERS, UNDERWEAR, CLOTH BIBS, SWEAT-SHIRTS, SWEATPANTS, SWEATSHORTS, JOGGING SUITS, BODYSHIRTS, FLEECE TOPS, VESTS, SUITS, T-SHIRTS, SIDE TIE T-SHIRTS, SIDE SNAP T-SHIRTS, CROP TOPS, SWIMSUITS, COVER-UPS, KIMONOS, SACQUE SETS, LAYETTES, OVERALLS, JEANS, SNOW SUITS, SHORTALLS, COVERALLS, ROBES, PONCHOS (U.S. CLS. 22 AND 39).

FIRST USE 4-27-2002; IN COMMERCE 4-27-2002.

CLASS 25—(Continued).

2,858,398. MIDWEST QUALITY GLOVES, INC., CHILLICOTHE, MO. SN 76-345,405. PUB. 11-5-2002, FILED 12-5-2001.

PRO POWER

FOR HOUSEHOLD AND YARD WORK ACCESSORIES, NAMELY GLOVES, APRONS AND VESTS (U.S. CLS. 22 AND 39).

FIRST USE 4-16-2002; IN COMMERCE 7-2-2002.

2,858,401. MISSISSIPPI STATE UNIVERSITY, MISSISSIPPI STATE, MS. SN 76-347,413. PUB. 12-17-2002, FILED 12-12-2001.

MISSISSIPPI



HORSE PARK

NO CLAIM IS MADE TO THE EXCLUSIVE RIGHT TO USE "MISSISSIPPI HORSE PARK", APART FROM THE MARK AS SHOWN.

THE DRAWING IS LINED FOR COLORS AND IS NOT A FEATURE OF THE MARK.

THE MARK CONTAINS A HORSE AND VEGETATION IN COLORS. THE MARK IS MAINLY IN BLACK. THERE IS BROWN ON THE EAR, BACK, FACE AND NOSE PORTIONS OF THE HORSE. THE GRAIN-TYPE VEGETATION IS BROWN. THE THREE LEAF SLIVERS ON EITHER SIDE OF THE GRAIN-TYPE VEGETATION ARE IN GREEN.

FOR T-SHIRTS (U.S. CLS. 22 AND 39).

FIRST USE 8-1-2001; IN COMMERCE 8-29-2001.

2,858,444. BARNES, ANN, TORONTO, ONTARIO, CANADA. SN 76-381,549. PUB. 5-20-2003, FILED 3-12-2002.

PATTERNS OF BEHAVIOR

FOR SHIRTS (U.S. CLS. 22 AND 39).

FIRST USE 6-30-2002; IN COMMERCE 6-30-2002.

CLASS 25—(Continued).

2,858,481. GFW GROUP, INC., NEW YORK, NY. SN 76-411,666. PUB. 7-8-2003, FILED 5-23-2002.

MARINA DEL FORTE

THE WORD "FORTE" MEANS "STRONG" IN ITALIAN. FOR SHOES (U.S. CLS. 22 AND 39).
FIRST USE 8-26-2003; IN COMMERCE 8-26-2003.

2,858,516. DOBRANSKY, MICHAEL T., CARDIFF BY THE SEA, CA. SN 76-427,809. PUB. 1-28-2003, FILED 6-28-2002.



OWNER OF U.S. REG. NOS. 2,093,572 AND 2,344,019.
FOR CLOTHING, NAMELY, SHIRTS, T-SHIRTS, TANK TOPS, UNDERSHIRTS, NIGHT SHIRTS, SWEATERS, SWEATSHIRTS, VESTS, JACKETS, COATS, TIES, BELTS FOR CLOTHING, PANTS, TROUSERS, SHORTS, BOXER SHORTS, UNDERWEAR, BRIEFS, PAJAMA TOPS, PAJAMA BOTTOMS, SWEATPANTS, DRESSES, SKIRTS, SWIMWEAR, BOARD SHORTS, HOSIERY, SOCKS, JOGGING SUITS, BANDANNAS, NECKERCHIEFS, SCARVES, RAIN COATS, WIND-RESISTANT JACKETS, APRONS, BATH ROBES, CLOTH BABY BIBS, WET SUITS, GLOVES, MITTENS AND HEADWEAR, NAMELY, HATS, CAPS AND VISORS AND HEAD BANDS; AND FOOTWEAR, NAMELY, ATHLETIC FOOTWEAR, CASUAL FOOTWEAR, BOOTS, SANDALS AND BEACH FOOTWEAR (U.S. CLS. 22 AND 39).
FIRST USE 7-24-2001; IN COMMERCE 6-6-2003.

2,858,525. LAWRENCE STEVENS FASHIONS, LTD., NEW YORK, NY. SN 76-430,089. PUB. 1-28-2003, FILED 7-12-2002.

CAFE PARADISE

FOR MEN'S AND WOMEN'S CLOTHING, NAMELY BATHING SUITS, BEACH COVERUPS, BEACHWEAR, BLAZERS, BLOUSES, BOXER SHORTS, COATS, COVERALLS, COVERUPS, DRESSES, HALTER TOPS, JACKETS, JEANS, OVERALLS, OVERCOATS, PANTS, RAINCOATS, ROBES, SARONGS, SHIRTS, SHORTS, SKIRTS, SLACKS, SLEEPWEAR, SUITS, SWEAT SHIRTS, SWEAT PANTS, SWEAT SUITS, SWEATERS, SWIM WEAR, T-SHIRTS, TANK TOPS, TROUSERS, TUNICS, UNDERWEAR, VESTS; CAPS, HATS, HOSIERY, KERCHIEFS, SCARVES, SOCKS; FOOTWEAR (U.S. CLS. 22 AND 39).
FIRST USE 2-28-2003; IN COMMERCE 2-28-2003.

CLASS 25—(Continued).

2,858,588. ZAPPA FAMILY TRUST, THE, STUDIO CITY, CA. SN 76-459,926. PUB. 11-11-2003, FILED 10-18-2002.

ZAPPA INSTITUTE OF TECHNOLOGY

OWNER OF U.S. REG. NOS. 1,840,602 AND 1,847,743. FOR CLOTHING, NAMELY, MEN'S, WOMEN'S AND CHILDREN'S TOPS AND BOTTOMS (U.S. CLS. 22 AND 39).
FIRST USE 6-10-2003; IN COMMERCE 6-10-2003.

2,858,610. DILLARD'S INC., LITTLE ROCK, AR. SN 76-469,449. PUB. 9-2-2003, FILED 11-14-2002.

CHELSEA & VIOLET

FOR CLOTHING, NAMELY: JACKETS, VEST, PANTS, SKIRTS, SKORTS, JUMPERS, DRESSES, SHIRTS, BLOUSES, KNIT TOPS, SWEATERS AND COATS (U.S. CLS. 22 AND 39).
FIRST USE 2-0-2003; IN COMMERCE 2-0-2003.

2,858,628. MAGIC FOOT, LLC, SPRING LAKE, MI. SN 76-474,980. PUB. 8-19-2003, FILED 12-9-2002.

ULTRAFOOT

FOR INSOLES (U.S. CLS. 22 AND 39).
FIRST USE 7-31-2003; IN COMMERCE 7-31-2003.

2,858,648. MAGO LTD., NEW YORK, NY. SN 76-487,473. PUB. 9-16-2003, FILED 1-29-2003.

MAGO

THE WORD "MAGO" MEANS "WIZARD" OR "MAGICIAN" IN THE ITALIAN LANGUAGE.
FOR WOMEN'S WEARING APPAREL, NAMELY, SWEATERS, JACKETS, PANTS, COATS AND SKIRTS (U.S. CLS. 22 AND 39).
FIRST USE 8-14-2003; IN COMMERCE 8-14-2003.

2,858,650. HALF PINTS CLOTHING COMPANY, WILLMAR, MN. SN 76-488,209. PUB. 11-11-2003, FILED 2-7-2003.

HALF PINTS

FOR CHILDREN'S CLOTHING, NAMELY, INFANTWEAR (U.S. CLS. 22 AND 39).
FIRST USE 2-22-2003; IN COMMERCE 2-22-2003.

CLASS 25—(Continued).

2,858,654. LEGAL MUSCLE PUBLISHING, INC., CARLE PLACE, NY. SN 76-491,397. PUB. 11-4-2003, FILED 2-21-2003.

LEGAL MUSCLE

FOR CLOTHING, NAMELY TOPS, PANTS, SHIRTS AND SWEAT SHIRTS (U.S. CLS. 22 AND 39).
FIRST USE 4-30-2003; IN COMMERCE 4-30-2003.

2,858,660. CROQUIS LOS ANGELES, ENCINO, CA. SN 76-494,792. PUB. 12-9-2003, FILED 3-6-2003.

RAN★TEES

NO CLAIM IS MADE TO THE EXCLUSIVE RIGHT TO USE "TEES", APART FROM THE MARK AS SHOWN.

THE MARK CONSISTS OF THE LETTERS "RAN" FOLLOWED BY A FIVE POINT STAR AND THEN FOLLOWED BY THE LETTERS "TEES".

FOR CLOTHES, NAMELY, T-SHIRTS (U.S. CLS. 22 AND 39).

FIRST USE 4-23-2003; IN COMMERCE 5-27-2003.

2,858,695. KAYSER-ROTH CORPORATION, GREENSBORO, NC. SN 76-976,649. PUB. 12-24-2002, FILED 12-22-2000.

HUE

OWNER OF U.S. REG. NO. 1,250,432.
FOR BRAS (U.S. CLS. 22 AND 39).
FIRST USE 1-25-2004; IN COMMERCE 1-25-2004.

CLASS 25—(Continued).

2,858,751. TRAIL BLAZERS, INC., PORTLAND, OR. SN 78-097,489. PUB. 6-24-2003, FILED 12-10-2001.



OWNER OF U.S. REG. NOS. 1,774,223, 1,892,082, AND OTHERS.

SEC. 2(F) AS TO "PORTLAND".

FOR CLOTHING, NAMELY HOSIERY, FOOTWEAR, BASKETBALL SHOES, BASKETBALL SNEAKERS, T-SHIRTS, SHIRTS, SWEATSHIRTS, SWEAT PANTS, PANTS, TANK TOPS, JERSEYS, SHORTS, PAJAMAS, SPORT SHIRTS, RUGBY SHIRTS, SWEATERS, BELTS, TIES, NIGHTSHIRTS, HATS, WARM-UP SUITS, WARM-UP PANTS, WARM-UP TOPS, JACKETS, PARKAS, COATS, CLOTH BIBS, HEAD BANDS, WRIST BANDS, APRONS, BOXER SHORTS, SLACKS, CAPS, EAR MUFFS, GLOVES, MITTENS, WOVEN AND KNIT SHIRTS (U.S. CLS. 22 AND 39).

FIRST USE 7-10-2002; IN COMMERCE 7-10-2002.

2,858,768. RZ DESIGN, L.L.C., SOUTH FREEPORT, ME. SN 78-108,794. PUB. 11-26-2002, FILED 2-14-2002.

SOUTHWEST MOCCASIN CO.

NO CLAIM IS MADE TO THE EXCLUSIVE RIGHT TO USE "MOCCASIN CO.", APART FROM THE MARK AS SHOWN.

FOR FOOTWEAR (U.S. CLS. 22 AND 39).

FIRST USE 7-17-2002; IN COMMERCE 7-17-2002.

2,858,769. FORD MOTOR COMPANY, DEARBORN, MI. SN 78-108,939. PUB. 10-15-2002, FILED 2-15-2002.

FORD FIELD

FOR CLOTHING, NAMELY, T-SHIRTS, SWEAT SHIRTS, POLO SHIRTS, GOLF SHIRTS, DRESS SHIRTS, SWEATERS, VESTS, JACKETS, RAINWEAR, WORK COATS, OVERALLS, SHORTS, SKIRTS, PANTS, SWEAT PANTS, SCARVES, SLEEP WEAR, NECKTIES, WRISTBANDS, SWIMWEAR, HEADWEAR, NAMELY, CAPS, HATS, SUNVISORS, HEADBANDS, BANDANNAS; FOOTWEAR, NAMELY, ATHLETIC SHOES, SLIPPERS AND MOCCASINS (U.S. CLS. 22 AND 39).

FIRST USE 9-22-2002; IN COMMERCE 9-22-2002.

CLASS 25—(Continued).

2,858,775. GREGORY R. FORTE, FULLERTON, CA. SN 78-113,430. PUB. 11-5-2002, FILED 3-8-2002.

BLAINT INDUSTRIES

NO CLAIM IS MADE TO THE EXCLUSIVE RIGHT TO USE "INDUSTRIES", APART FROM THE MARK AS SHOWN.

FOR MEN'S AND WOMEN'S CLOTHING AND APPAREL, NAMELY, SHIRTS; SWEATSHIRTS; SHORTS; PANTS; CAPS; BELTS; JACKETS; SHOES; SOCKS; UNDERWEAR (U.S. CLS. 22 AND 39).

FIRST USE 3-2-2002; IN COMMERCE 3-25-2003.

2,858,844. PINAR, LEVENT, WETHERILL PARK, AUSTRALIA. AND PINAR, EMEL SARIKAYA, WETHERILL PARK, AUSTRALIA. SN 78-158,459. PUB. 10-21-2003, FILED 8-28-2002.



PRIORITY CLAIMED UNDER SEC. 44(D) ON AUSTRALIA APPLICATION NO. 924586, FILED 8-26-2002.

THE LIKENESS IN THE MARK DOES NOT IDENTIFY A LIVING INDIVIDUAL.

THE MARK CONSISTS OF A GOLFER STANDING WITH ONE LEG CROSSED OVER THE OTHER, LEANING ON A PUTTER WITH ONE HAND AND THE OTHER HAND ON WAIST.

FOR CLOTHING, NAMELY, SHIRTS, PANTS, VESTS, JACKETS, SHORTS, SOCKS, JUMPERS; FOOTWEAR; SHOES; HEADGEAR, NAMELY, HATS, CAPS (U.S. CLS. 22 AND 39).

FIRST USE 8-26-2002; IN COMMERCE 11-20-2002.

2,858,848. GALLARDO, LARA, KATERINA, NEW YORK, NY. SN 78-159,979. PUB. 8-12-2003, FILED 9-1-2002.

LARADIVA

FOR SWIM WEAR; CLOTHING, NAMELY, SKIRTS, SHIRTS, CROPS TOPS, HALTER TOPS, TANK TOPS, BATHING SUITS, PANTS, DRESSES (U.S. CLS. 22 AND 39).

FIRST USE 7-3-2002; IN COMMERCE 10-1-2002.

CLASS 25—(Continued).

2,858,867. RETAIL BRAND ALLIANCE, INC., ENFIELD, CT. SN 78-167,919. PUB. 12-9-2003, FILED 9-25-2002.

BROOKSCOOL

FOR CLOTHING, NAMELY, SHIRTS, JACKETS, PANTS, SUITS, BOTTOMS, TOPS, COATS, SKIRTS, DRESSES, TROUSERS, OUTER SHIRTS, NAMELY EVENING, DRESS, POLO, AND SPORTS SHIRTS; BEACHWEAR, SWIMWEAR, AND FORMAL WEAR, NAMELY JACKETS, PANTS, SUITS, SHIRTS, SHOES, CUMMERBUNDS, TIES, SUSPENDERS AND GOWNS (U.S. CLS. 22 AND 39).

FIRST USE 3-0-2003; IN COMMERCE 3-0-2003.

2,858,880. CHARLOTTE CHECKERS PROFESSIONAL ICE HOCKEY LLC, CHARLOTTE, NC. SN 78-170,944. PUB. 7-15-2003, FILED 10-4-2002.



OWNER OF U.S. REG. NOS. 1,860,549 AND 2,090,707. NO CLAIM IS MADE TO THE EXCLUSIVE RIGHT TO USE "CHARLOTTE", APART FROM THE MARK AS SHOWN.

FOR CLOTHING, NAMELY, JERSEYS, JACKETS, COATS, SWEAT PANTS, WARM-UP SUITS, HATS, CAPS, SWEATERS, SHIRTS, T-SHIRTS, SWEATSHIRTS; AND CLOTHING FOR INFANTS AND TODDLERS, NAMELY, JUMPERS, T-SHIRTS, BABY CLOTH BIBS, AND FLEECE SETS, NAMELY, TOPS AND BOTTOMS (U.S. CLS. 22 AND 39).

FIRST USE 10-0-2002; IN COMMERCE 10-0-2002.

CLASS 25—(Continued).

2,858,883. THE NAT NAST COMPANY, SOUTH NORWALK, CT. SN 78-172,022. PUB. 7-22-2003, FILED 10-8-2002.



FOR MEN'S, WOMEN'S, AND CHILDREN'S CLOTHING, NAMELY, BANDANAS, BATHING SUITS, BASEBALL CAPS, BATHROBES, BEACHWEAR, BELTS, CLOTH BABY BIBS, BIKINIS, BLAZER, BLOUSES, BODY SUITS, CAMISOLES, CARDIGANS, COATS, DRESSES, EVENING WEAR, NAMELY, TUXEDOS, GOWNS, CUMMERBUNDS, TIES, DINNER JACKETS, AND VESTS, GLOVES, HATS, INFANT WEAR, JACKETS, JEANS, LEGGINS, LEOTARDS, LINGERIE, LOUNGE WEAR, NECKBANDS, NECKTIES, PAJAMAS, PANTS, POLO SHIRTS, PULLOVERS, RAINWEAR, SCARVES, SHIRTS, SMOKING JACKETS, SPORTS SHIRTS, SHORTS, SKIRTS, SLACKS, SLEEP WEAR, SUITS, SWEATERS, SWIM WEAR, SWEATBANDS, SWEATSHIRTS, SWEAT PANTS, SWEAT SUITS, T-SHIRTS, TANK TOPS, TOPS, TROUSERS, TURTLENECKS, UNDERWEAR, UNIFORMS, VESTS, WRAPS, WRISTBANDS, HOSIERY, SOCKS, ATHLETIC FOOTWEAR, BOOTS, FOOTWEAR, SHOES, SLIPPERS, AND SNEAKERS (U.S. CLS. 22 AND 39).

FIRST USE 4-1-2000; IN COMMERCE 4-1-2000.

2,858,886. HUNTER, DORIEN DION, RENTON, WA. SN 78-172,590. PUB. 6-3-2003, FILED 10-9-2002.



FOR (BASED ON USE IN COMMERCE) SHIRTS, PANTS, SWEAT SUITS, SWEAT PANTS, SWEATSHIRTS, JACKETS, SWEATERS, AND HATS (U.S. CLS. 22 AND 39).

FIRST USE 12-1-2001; IN COMMERCE 1-15-2002.

CLASS 25—(Continued).

2,858,888. INNOVATIVE FASHION GROUP CORP., NEW YORK, NY. SN 78-174,111. PUB. 8-5-2003, FILED 10-14-2002.

LAYER 8

FOR CLOTHING, NAMELY SHIRTS, SHORTS AND PANTS (U.S. CLS. 22 AND 39).

FIRST USE 10-5-2003; IN COMMERCE 10-5-2003.

2,858,932. O'BRYAN BROS., INC., CHICAGO, IL. SN 78-188,684. PUB. 10-14-2003, FILED 11-25-2002.

CUDDL JOHNS

OWNER OF U.S. REG. NOS. 1,151,788 AND 1,876,003. FOR WOMEN'S CLOTHING, NAMELY, UNDERWEAR, LINGERIE, LOUNGEWEAR AND SLEEPWEAR (U.S. CLS. 22 AND 39).

FIRST USE 8-0-2003; IN COMMERCE 8-0-2003.

2,858,974. LITTLE RAPIDS CORPORATION, GREEN BAY, WI. SN 78-205,869. PUB. 9-2-2003, FILED 1-22-2003.

SCAMPERS

FOR PEDICURE SLIPPERS (U.S. CLS. 22 AND 39).

FIRST USE 1-16-2003; IN COMMERCE 4-23-2003.

2,858,988. RICHARD LEEDS INTERNATIONAL, INC., NEW YORK, NY. SN 78-212,128. PUB. 9-23-2003, FILED 2-7-2003.

LONG JAMMY JOHNS

FOR WOMEN'S, GIRL'S AND INFANT'S INTIMATE APPAREL, NAMELY, SLEEPWEAR, ROBES, LOUNGEWEAR, LONG UNDERWEAR, PANTIES AND LINGERIE (U.S. CLS. 22 AND 39).

FIRST USE 9-0-2003; IN COMMERCE 9-0-2003.

2,859,017. OH TRADING CO., INC., LONG ISLAND CITY, NY. SN 78-236,239. PUB. 12-16-2003, FILED 4-10-2003.

SAMUEL & GRACE

FOR WOMEN'S, MEN'S AND CHILDREN'S CLOTHING, NAMELY, JACKETS, JOGGING SUITS, PANTS, JEANS, SHORTS, SHIRTS, T-SHIRTS, DRESSES, SKIRTS, HEADWEAR, SOCKS AND FOOTWEAR (U.S. CLS. 22 AND 39).

FIRST USE 2-0-2004; IN COMMERCE 2-0-2004.

CLASS 27—FLOOR COVERINGS

CLASS 27—(Continued).

2,858,339. LAMINATING SERVICES, INC., LOUISVILLE, KY. SN 76-261,951. PUB. 4-9-2002, FILED 5-25-2001.



FOR WALLPAPER FROM ENVIRONMENTALLY FRIENDLY OR RECYCLED MATERIAL (U.S. CLS. 19, 20, 37, 42 AND 50).
FIRST USE 6-1-2001; IN COMMERCE 6-1-2001.

2,859,024. FAN MATS, LLC, ALPHARETTA, GA. SN 78-241,915. PUB. 12-2-2003, FILED 4-25-2003.

FANMATS

FOR DOOR MATS (U.S. CLS. 19, 20, 37, 42 AND 50).
FIRST USE 8-1-2003; IN COMMERCE 8-1-2003.

CLASS 28—TOYS AND SPORTING GOODS

2,858,258. ARMADILLO SPORTS DESIGN LIMITED, KNUTSFORD, WA16 8UG, UNITED KINGDOM. SN 76-051,498. PUB. 7-29-2003, FILED 5-18-2000.

ARMADILLO

FOR PROTECTIVE SPORTS EQUIPMENT, NAMELY ELBOW, KNEE, SHOULDER AND SHIN PADS, PROTECTIVE WRIST AND ANKLE CUFFS, BODY PADS AND PROTECTIVE GLOVES (U.S. CLS. 22, 23, 38 AND 50).
FIRST USE 12-12-2003; IN COMMERCE 12-12-2003.

2,858,266. KABUSHIKI KAISHA SHUEISHA, TA SHUEISHA INC., CHIYODA-KU, TOKYO 101-8050, JAPAN. SN 76-088,513. PUB. 5-20-2003, FILED 7-13-2000.

BULMA

FOR GAMES, PLAYTHINGS AND SPORTING GOODS, NAMELY, COLLECTIBLE TOY FIGURES AND ACTION FIGURES AND ACTION FIGURE ACCESSORIES, TALKING TOY FIGURES, PLUSH TOYS, TOY VEHICLES, DOLLS AND ROLE-PLAYING GAME EQUIPMENT IN THE NAME OF MALE ACTION TOYS AND MODELS, ACTIVITY SETS AND PLAYSET ENVIRONMENTS COMPRISED OF MINI FIGURES/SCENE DISPLAYS, TOY FIGURES (U.S. CLS. 22, 23, 38 AND 50).
FIRST USE 12-0-2002; IN COMMERCE 12-0-2002.

CLASS 28—(Continued).

2,858,300. BRASS EAGLE, INC., BENTONVILLE, AR. SN 76-180,251. PUB. 7-9-2002, FILED 12-13-2000.

XSHIELD

FOR PAINTBALL MASKS (U.S. CLS. 22, 23, 38 AND 50).
FIRST USE 10-0-2003; IN COMMERCE 10-0-2003.

2,858,308. KOSZALINSKI, TONY C., DBA DAK PRODUCTS COMPANY, APPLETON, WI. SN 76-194,594. PUB. 10-23-2001, FILED 1-12-2001.

PAR POWER

OWNER OF U.S. REG. NO. 2,425,709.
FOR GOLF CLUBS (U.S. CLS. 22, 23, 38 AND 50).
FIRST USE 8-0-2001; IN COMMERCE 10-0-2002.

2,858,360. DANIEL BARTAL LTD., TEL AVIV 62154, ISRAEL. SN 76-292,580. PUB. 6-18-2002, FILED 7-31-2001.

**DANIEL BARTAL**

DANIEL BARTAL DOES NOT IDENTIFY A LIVING INDIVIDUAL.

THE MARK CONSISTS OF A STYLIZED HEAD OF A PERSON WITH ARMS UPRAISED IN A CIRCULAR CONFIGURATION SYMBOLICALLY REPRESENTING A PERSON EXERCISING ALONG WITH THE PRINTED NAME "DANIEL BARTAL".

FOR EXERCISE AND FITNESS ACCESSORIES, NAMELY, WEIGHT LIFTING MACHINES AND PARTS THEREFORE; FREE WEIGHTS AND PARTS THEREFORE; UPPER AND LOWER BODY, TORSO AND TRUNK, AND CARDIOVASCULAR CONDITIONING MACHINES (U.S. CLS. 22, 23, 38 AND 50).
FIRST USE 9-0-2003; IN COMMERCE 9-0-2003.

2,858,431. HASBRO, INC., PAWTUCKET, RI. SN 76-367,745. PUB. 2-18-2003, FILED 2-6-2002.

FURREAL FRIENDS

FOR INTERACTIVE ELECTRONIC PLUSH TOY ANIMALS AND ACCESSORIES FOR USE THEREWITH, NAMELY, TOY BRUSHES (U.S. CLS. 22, 23, 38 AND 50).
FIRST USE 6-1-2002; IN COMMERCE 6-1-2002.

CLASS 28—(Continued).

2,858,452. GRAPHITE DESIGN INTERNATIONAL, INC., SAN DIEGO, CA. SN 76-395,547. PUB. 11-12-2002, FILED 4-12-2002.

PURPLE ICE

NO CLAIM IS MADE TO THE EXCLUSIVE RIGHT TO USE PURPLE, APART FROM THE MARK AS SHOWN. FOR GOLF CLUB SHAFTS (U.S. CLS. 22, 23, 38 AND 50).

FIRST USE 4-30-2002; IN COMMERCE 4-30-2002.

2,858,537. ACUSHNET COMPANY, FAIRHAVEN, MA. SN 76-433,321. PUB. 6-17-2003, FILED 7-22-2002.

980F

FOR GOLF EQUIPMENT, NAMELY GOLF CLUBS (U.S. CLS. 22, 23, 38 AND 50).

FIRST USE 5-1-2003; IN COMMERCE 5-1-2003.

2,858,608. ROSKOPF GOLF L.L.C., PORTLAND, OR. SN 76-467,580. PUB. 6-24-2003, FILED 11-15-2002.

ROSKOPF CUE STICK

FOR GOLF PUTTERS (U.S. CLS. 22, 23, 38 AND 50).

FIRST USE 9-12-2003; IN COMMERCE 10-0-2003.

2,858,621. JADA TOYS, INC., LOS ANGELES, CA. SN 76-473,504. PUB. 7-29-2003, FILED 12-9-2002.

DUB SHOP

OWNER OF U.S. REG. NO. 2,684,629. FOR DIECAST TOY CARS, TOY TRUCKS AND TOY VEHICLES; AND, KITS FOR ASSEMBLING DIECAST TOY CARS, TOY TRUCKS AND TOY VEHICLES (U.S. CLS. 22, 23, 38 AND 50).

FIRST USE 8-9-2002; IN COMMERCE 8-9-2002.

2,858,637. TUPPER, SHARON DEE, SEDONA, AZ. AND TUPPER, SCOTT IRVIN, SEDONA, AZ. SN 76-478,096. PUB. 8-12-2003, FILED 12-24-2002.

RV PETS

NO CLAIM IS MADE TO THE EXCLUSIVE RIGHT TO USE "PETS", APART FROM THE MARK AS SHOWN. FOR PLUSH TOYS (U.S. CLS. 22, 23, 38 AND 50).

FIRST USE 12-2-2003; IN COMMERCE 1-9-2004.

CLASS 28—(Continued).

2,858,651. ROGER CLEVELAND GOLF COMPANY, INC., CYPRESS, CA. SN 76-489,344. PUB. 9-30-2003, FILED 2-11-2003.

TA6

FOR GOLF CLUBS, GOLF CLUB HEADS, GOLF CLUB SHAFTS, GOLF CLUB GRIPS, GOLF BAGS, GOLF BAG COVERS, GOLF CLUB HEAD COVERS AND GOLF BALLS (U.S. CLS. 22, 23, 38 AND 50).

FIRST USE 1-29-2004; IN COMMERCE 1-29-2004.

2,858,659. HEDSTROM CORPORATION, BEDFORD, PA. SN 76-494,760. PUB. 12-30-2003, FILED 3-5-2003.

GO BIGGER

FOR EQUIPMENT FOR SKATEBOARDING AND IN-LINE SKATING, NAMELY, RAMPS, GRIND RAILS, AND JUMP STANDS (U.S. CLS. 22, 23, 38 AND 50).

FIRST USE 4-28-2003; IN COMMERCE 4-28-2003.

2,858,698. VERDUCCI U.S.A., LLC., WESTMINSTER, CA. SN 76-976,678. PUB. 5-13-2003, FILED 3-15-2002.

VOLANDO

THE ITALIAN WORDING IN THE MARK "VOLANDO" TRANSLATES IN ENGLISH TO "FLYING".

FOR IN-LINE ROLLER SKATES; ACCESSORIES AND PARTS FOR IN-LINE ROLLER SKATES, NAMELY WHEELS, BEARINGS, FRAMES, BOOTS, AND BREAKS; PROTECTIVE GEAR USED IN CONNECTION WITH IN-LINE SKATING, NAMELY KNEE-PADS, ELBOW PADS AND WRIST GUARDS (U.S. CLS. 22, 23, 38 AND 50).

FIRST USE 1-1-2001; IN COMMERCE 1-1-2001.

2,858,701. MATTEL, INC., EL SEGUNDO, CA. SN 78-011,499. PUB. 1-21-2003, FILED 6-6-2000.

HOOLIGAN

FOR TOY VEHICLES AND ACCESSORIES THEREFOR (U.S. CLS. 22, 23, 38 AND 50).

FIRST USE 12-0-2000; IN COMMERCE 12-0-2000.

CLASS 28—(Continued).

2,858,704. MATTEL, INC., EL SEGUNDO, CA. SN 78-014,583.
PUB. 7-16-2002, FILED 6-27-2000.

STACK 'N POP

OWNER OF U.S. REG. NOS. 2,067,906, 2,290,611, AND 2,291,634.

NO CLAIM IS MADE TO THE EXCLUSIVE RIGHT TO USE "STACK", APART FROM THE MARK AS SHOWN.

FOR MULTIPLE ACTIVITY TOYS FOR INFANTS AND CHILDREN, NAMELY, STACKABLE TOY CUPS (U.S. CLS. 22, 23, 38 AND 50).

FIRST USE 3-0-2001; IN COMMERCE 3-0-2001.

2,858,707. SIGNITZER, PAUL ALLEN, BRISBANE, QUEENSLAND, AUSTRALIA. AND FOGARTY, MICHAEL ROBERT, BRAY PARK, QUEENSLAND, AUSTRALIA. AND FOGARTY, ANDREW MARK, INNISFAIL, QUEENSLAND, AUSTRALIA. SN 78-030,731. PUB. 11-20-2001, FILED 10-16-2000.

FOR FISHING EQUIPMENT, NAMELY, FISHING TACKLE, FISHING LURES, ARTIFICIAL FISHING BAITS, FISHING SINKERS (U.S. CLS. 22, 23, 38 AND 50).
FIRST USE 8-15-2000; IN COMMERCE 7-15-2003.

2,858,719. MATTEL, INC., EL SEGUNDO, CA. SN 78-048,773.
PUB. 8-28-2001, FILED 2-16-2001.

AMAZON BLASTER

FOR TOY ACTION FIGURES AND ACCESSORIES THEREFOR (U.S. CLS. 22, 23, 38 AND 50).
FIRST USE 5-21-2001; IN COMMERCE 5-21-2001.

2,858,723. MATTEL, INC., EL SEGUNDO, CA. SN 78-054,472.
PUB. 7-16-2002, FILED 3-22-2001.

SPINNIN' RIM

FOR TOYS, NAMELY, TOY VEHICLE TRACK SETS AND ACCESSORIES THEREFOR (U.S. CLS. 22, 23, 38 AND 50).
FIRST USE 11-0-2002; IN COMMERCE 11-0-2002.

CLASS 28—(Continued).

2,858,730. MATTEL, INC., EL SEGUNDO, CA. SN 78-062,900.
PUB. 7-15-2003, FILED 5-10-2001.

WAVE FLIER

FOR TOYS, GAMES AND PLAYTHINGS, NAMELY, TOY ACTION FIGURES AND ACCESSORIES THEREFOR (U.S. CLS. 22, 23, 38 AND 50).

FIRST USE 12-13-2001; IN COMMERCE 12-13-2001.

2,858,731. MATTEL, INC., EL SEGUNDO, CA. SN 78-065,246.
PUB. 6-25-2002, FILED 5-23-2001.

DAYLA

FOR TOYS, GAMES, AND PLAYTHINGS, NAMELY, DOLLS, DOLL CLOTHING AND DOLL ACCESSORIES (U.S. CLS. 22, 23, 38 AND 50).

FIRST USE 6-0-2002; IN COMMERCE 6-0-2002.

2,858,736. GONZALES, DAVID, EMERYVILLE, CA. SN 78-071,321. PUB. 1-8-2002, FILED 6-27-2001.

HOMIEROLLERZ

FOR TOY LOW RIDER CARS AND TOY LOW RIDER BICYCLES MADE PRIMARILY OF PLASTIC RESIN AND DIE CAST METAL (U.S. CLS. 22, 23, 38 AND 50).
FIRST USE 9-1-2003; IN COMMERCE 9-1-2003.

2,858,747. MATTEL, INC., EL SEGUNDO, CA. SN 78-088,901.
PUB. 9-2-2003, FILED 10-17-2001.

HAPPENIN' PET SALON

NO CLAIM IS MADE TO THE EXCLUSIVE RIGHT TO USE "PET SALON", APART FROM THE MARK AS SHOWN.
FOR TOYS, NAMELY, DOLLS, DOLL CLOTHING, DOLL ACCESSORIES, TOY ANIMAL FIGURES AND TOY ANIMAL FIGURE ACCESSORIES; SOLD TOGETHER AS A UNIT (U.S. CLS. 22, 23, 38 AND 50).
FIRST USE 5-23-2002; IN COMMERCE 5-23-2002.

2,858,770. MATTEL, INC., EL SEGUNDO, CA. SN 78-109,660.
PUB. 10-7-2003, FILED 2-19-2002.

GLAMOUROUS EVENING

FOR TOYS, GAMES AND PLAYTHINGS, NAMELY, DOLLS, DOLL CLOTHING AND DOLL ACCESSORIES (U.S. CLS. 22, 23, 38 AND 50).
FIRST USE 9-12-2002; IN COMMERCE 9-12-2002.

CLASS 28—(Continued).

2,858,778. MATTEL, INC., EL SEGUNDO, CA. SN 78-115,972.
PUB. 4-1-2003, FILED 3-19-2002.

24/SEVEN

FOR TOYS, GAMES AND PLAYTHINGS, NAMELY, TOY VEHICLES AND ACCESSORIES THEREFOR (U.S. CLS. 22, 23, 38 AND 50).
FIRST USE 12-18-2003; IN COMMERCE 12-18-2003.

2,858,779. KUIPER, JERALD W., POWAY, CA. SN 78-116,997.
PUB. 11-19-2002, FILED 3-22-2002.

KOOK-EE JAR

FOR DICE GAME (U.S. CLS. 22, 23, 38 AND 50).
FIRST USE 2-14-2003; IN COMMERCE 2-15-2003.

2,858,789. CRANIUM, INC., SEATTLE, WA. SN 78-127,009.
PUB. 6-24-2003, FILED 5-7-2002.

SOUNDSTAGE

FOR BOARD GAMES; EQUIPMENT SOLD AS A UNIT FOR PLAYING A BOARD GAME; QUESTION SETS FOR BOARD GAME; DOLLS; ACTION FIGURES; JIGSAW PUZZLES; MANIPULATIVE PUZZLES; THREE DIMENSIONAL PUZZLES; CARD GAMES; EQUIPMENT SOLD AS A UNIT FOR PLAYING CARD GAMES (U.S. CLS. 22, 23, 38 AND 50).
FIRST USE 8-0-2002; IN COMMERCE 8-0-2002.

2,858,793. MATTEL, INC., EL SEGUNDO, CA. SN 78-128,184.
PUB. 6-24-2003, FILED 5-13-2002.

SWOOP COUPE

NO CLAIM IS MADE TO THE EXCLUSIVE RIGHT TO USE "COUPE", APART FROM THE MARK AS SHOWN.
FOR TOYS, GAMES AND PLAYTHINGS, NAMELY, TOY VEHICLES AND ACCESSORIES THEREFOR (U.S. CLS. 22, 23, 38 AND 50).
FIRST USE 10-0-2003; IN COMMERCE 10-0-2003.

2,858,794. MATTEL, INC., EL SEGUNDO, CA. SN 78-128,215.
PUB. 7-15-2003, FILED 5-13-2002.

COPTER CHASE

FOR TOYS, GAMES AND PLAYTHINGS, NAMELY, TOY VEHICLES AND ACCESSORIES THEREFOR, TOY VEHICLE PLAYSETS AND ACCESSORIES (U.S. CLS. 22, 23, 38 AND 50).
FIRST USE 9-0-2002; IN COMMERCE 9-0-2002.

CLASS 28—(Continued).

2,858,795. DUDAR, JULIE K., ESCONDIDO, CA. SN 78-128,604. PUB. 11-26-2002, FILED 5-14-2002.

TURN 'N' LEARN

FOR EDUCATIONAL GAMES COMPRISED OF FLASH CARDS AND STAND-UP GAME BOARDS (U.S. CLS. 22, 23, 38 AND 50).
FIRST USE 5-18-2003; IN COMMERCE 5-18-2003.

2,858,796. MATTEL, INC., EL SEGUNDO, CA. SN 78-128,910.
PUB. 7-15-2003, FILED 5-15-2002.

DRAGONWAGON

FOR TOYS, NAMELY, TOY VEHICLES AND ACCESSORIES THEREFOR (U.S. CLS. 22, 23, 38 AND 50).
FIRST USE 11-0-2002; IN COMMERCE 11-0-2002.

2,858,797. MATTEL, INC., EL SEGUNDO, CA. SN 78-128,914.
PUB. 7-15-2003, FILED 5-15-2002.

NEUTROID

FOR TOYS, NAMELY, TOY VEHICLES AND ACCESSORIES THEREFOR (U.S. CLS. 22, 23, 38 AND 50).
FIRST USE 1-0-2003; IN COMMERCE 1-0-2003.

2,858,798. BURROWS GOLF, INC., VALENCIA, CA. SN 78-129,985. PUB. 11-19-2002, FILED 5-20-2002.

ION

FOR GOLF CLUBS AND COMPONENT PARTS THEREOF, NAMELY, HEADS, SHAFTS AND GRIPS (U.S. CLS. 22, 23, 38 AND 50).
FIRST USE 1-1-2004; IN COMMERCE 1-1-2004.

2,858,805. BRINE, INC., MILFORD, MA. SN 78-134,455. PUB. 11-19-2002, FILED 6-10-2002.

PROPHECY

FOR LACROSSE STICKS, LACROSSE STICK HEADS AND PARTS THEREOF, SOCCER BALLS, SOCCER SHIN GUARDS, FIELD HOCKEY GLOVES (U.S. CLS. 22, 23, 38 AND 50).
FIRST USE 11-25-2002; IN COMMERCE 11-25-2002.

CLASS 28—(Continued).

2,858,806. QUIKSILVER, INC., HUNTINGTON BEACH, CA. SN 78-136,536. PUB. 1-21-2003, FILED 6-18-2002.

ROXY

OWNER OF U.S. REG. NO. 2,083,400.
FOR SNOWBOARDS AND SPECIAL BAGS TO STORE AND TRANSPORT SPORTING EQUIPMENT, NAMELY, BAGS FOR SNOWBOARDS (U.S. CLS. 22, 23, 38 AND 50).
FIRST USE 9-25-2002; IN COMMERCE 9-25-2002.

2,858,817. MARTHA STEWART LIVING OMNIMEDIA, INC., NEW YORK, NY. SN 78-141,166. PUB. 12-2-2003, FILED 7-3-2002.

**MARTHA STEWART
EVERYDAY**

OWNER OF U.S. REG. NOS. 2,182,768, 2,628,567, AND OTHERS.

FOR ARTIFICIAL CHRISTMAS TREES, ARTIFICIAL CHRISTMAS WREATHS, ARTIFICIAL CHRISTMAS GARLANDS, CHRISTMAS TREE DECORATIONS, NAMELY, ORNAMENTS, SKIRTS, STANDS, AND STAND COVERS; CHRISTMAS WREATH HANGERS AND STANDS, CHRISTMAS STOCKING AND STOCKING HOLDERS, AND SNOW GLOBES (U.S. CLS. 22, 23, 38 AND 50).
FIRST USE 9-0-2002; IN COMMERCE 9-0-2002.

2,858,819. MATTEL, INC., EL SEGUNDO, CA. SN 78-141,958. PUB. 9-2-2003, FILED 7-8-2002.

MINI DIVA STARZ

NO CLAIM IS MADE TO THE EXCLUSIVE RIGHT TO USE "MINI", APART FROM THE MARK AS SHOWN.

FOR TOYS, GAMES AND PLAYTHINGS, NAMELY, DOLLS, DOLL CLOTHING AND DOLL ACCESSORIES (U.S. CLS. 22, 23, 38 AND 50).

FIRST USE 12-20-2002; IN COMMERCE 12-20-2002.

2,858,832. MATTEL, INC., EL SEGUNDO, CA. SN 78-151,484. PUB. 9-23-2003, FILED 8-6-2002.

SWAMPSTER

FOR TOYS, GAMES AND PLAYTHINGS, NAMELY, TOY VEHICLES AND ACCESSORIES THEREFOR (U.S. CLS. 22, 23, 38 AND 50).

FIRST USE 11-14-2002; IN COMMERCE 11-14-2002.

CLASS 28—(Continued).

2,858,905. MY FAVORITE COMPANY, INC., LOS ANGELES, CA. SN 78-181,599. PUB. 12-23-2003, FILED 11-5-2002.

POLAR PACK

NO CLAIM IS MADE TO THE EXCLUSIVE RIGHT TO USE "PACK", APART FROM THE MARK AS SHOWN.
FOR PLUSH TOYS (U.S. CLS. 22, 23, 38 AND 50).
FIRST USE 8-1-2003; IN COMMERCE 8-1-2003.

2,858,912. MEARTHANE PRODUCTS CORPORATION, CRANSTON, RI. SN 78-184,513. PUB. 9-2-2003, FILED 11-13-2002.



THE STIPPLING IS FOR SHADING PURPOSES.

THE MARK CONSISTS OF A STYLIZED REPRESENTATION OF THE UPPER TORSO OF A RAT WEARING A PROTECTIVE HELMET AND CARRYING A HOCKEY STICK. THE SWIRLING DESIGN ON THE LEFT HAND SIDE AND LOWER PERIMETER OF THE RAT'S TORSO INDICATES MOVEMENT.

FOR WHEELS FOR IN-LINE SKATES (U.S. CLS. 22, 23, 38 AND 50).

FIRST USE 2-28-2003; IN COMMERCE 2-28-2003.

2,858,955. KNOTT, JAMES, J, SAN DIEGO, CA. SN 78-196,425. PUB. 7-29-2003, FILED 12-19-2002.

COOL POOL TOOL

FOR BILLIARD CUE TOOL TO SHAPE THE TIP (U.S. CLS. 22, 23, 38 AND 50).

FIRST USE 12-19-2002; IN COMMERCE 12-19-2002.

2,859,007. JAKKS PACIFIC, INC., MALIBU, CA. SN 78-228,736. PUB. 11-25-2003, FILED 3-21-2003.

FISH TANK FUN

NO CLAIM IS MADE TO THE EXCLUSIVE RIGHT TO USE "FISH TANK", APART FROM THE MARK AS SHOWN.
FOR TOY AQUARIUM (U.S. CLS. 22, 23, 38 AND 50).
FIRST USE 4-22-2003; IN COMMERCE 4-22-2003.

CLASS 28—(Continued).

2,859,026. MIKEN COMPOSITES, LLC, CALEDONIA, MN. SN 78-244,880. PUB. 11-25-2003, FILED 5-2-2003.

M-PULSE

FOR SOFTBALL BATS (U.S. CLS. 22, 23, 38 AND 50).
FIRST USE 5-21-2003; IN COMMERCE 5-21-2003.

2,859,029. FOODSOURCE LURE CORPORATION, BIRMINGHAM, AL. SN 78-248,446. PUB. 1-13-2004, FILED 5-12-2003.

FOODSOURCE

FOR FISHING LURES; BIODEGRADABLE FISHING LURES (U.S. CLS. 22, 23, 38 AND 50).
FIRST USE 5-7-2003; IN COMMERCE 7-11-2003.

CLASS 29—MEATS AND PROCESSED FOODS

2,858,201. JACKSON, FITZ A., BELLEROSE, NY. SN 75-735,151. PUB. 8-6-2002, FILED 7-16-1999.

TROPICAL CHOICE

NO CLAIM IS MADE TO THE EXCLUSIVE RIGHT TO USE "CHOICE", APART FROM THE MARK AS SHOWN.
FOR MEAT, NAMELY, JAMAICAN JERK BEEF AND CHICKEN (U.S. CL. 46).
FIRST USE 6-0-2000; IN COMMERCE 4-7-2004.

2,858,245. CHOMARAT, JEAN BERNARD, B-1040 BRUXELLES, BELGIUM. AND TAPIERO, YVES, LONDON W8 7BL, UNITED KINGDOM. SN 76-016,088. PUB. 9-3-2002, FILED 4-3-2000.

BOROMEO

PRIORITY CLAIMED UNDER SEC. 44(D) ON ERP N CMNTY TM OFC APPLICATION NO. 1369222, FILED 11-3-1999, REG. NO. 1369222, DATED 1-30-2001, EXPIRES 1-30-2011.
FOR EDIBLE OILS AND FATS (U.S. CL. 46).
FIRST USE 2-16-2000; IN COMMERCE 2-20-2000.

CLASS 29—(Continued).

2,858,563. ALEXIA FOODS, INC., BROOKLYN, NY. SN 76-444,371. PUB. 4-22-2003, FILED 8-28-2002.

OVEN REDS

NO CLAIM IS MADE TO THE EXCLUSIVE RIGHT TO USE "REDS", APART FROM THE MARK AS SHOWN.
FOR POTATO PRODUCTS, NAMELY, FRENCH FRIED POTATOES, INSTANT POTATOES, AND PROCESSED POTATOES; POTATO-BASED SNACK FOODS (U.S. CL. 46).
FIRST USE 11-15-2002; IN COMMERCE 11-15-2002.

2,858,581. HORMEL FOODS, LLC, AUSTIN, MN. SN 76-457,454. PUB. 7-15-2003, FILED 10-10-2002.

CRAZY TASTY

NO CLAIM IS MADE TO THE EXCLUSIVE RIGHT TO USE "TASTY", APART FROM THE MARK AS SHOWN.
FOR PROCESSED MEAT, POULTRY (U.S. CL. 46).
FIRST USE 3-20-2003; IN COMMERCE 3-20-2003.

2,858,597. LION ROCK HOLDINGS L.L.C., GRAND RAPIDS, MI. SN 76-465,505. PUB. 5-20-2003, FILED 11-1-2002.

YOU'LL NEVER GO BACK TO STICK

FOR BUTTER AND MARGARINE (U.S. CL. 46).
FIRST USE 2-1-2002; IN COMMERCE 2-1-2002.

2,858,673. ALEXIA FOODS, INC., BROOKLYN, NY. SN 76-503,520. PUB. 11-18-2003, FILED 4-2-2003.

COUNTRY REDS

NO CLAIM IS MADE TO THE EXCLUSIVE RIGHT TO USE "REDS", APART FROM THE MARK AS SHOWN.
FOR PROCESSED POTATOES (U.S. CL. 46).
FIRST USE 9-0-2003; IN COMMERCE 9-0-2003.

CLASS 29—(Continued).

2,858,711. GLOBAL ORGANIC BRANDS, INC., KATONAH, NY. SN 78-038,833. PUB. 8-6-2002, FILED 12-11-2000.



NO CLAIM IS MADE TO THE EXCLUSIVE RIGHT TO USE "MEDITERRANEAN ORGANIC", APART FROM THE MARK AS SHOWN.

FOR CUT AND SLICED CANNED ORGANIC VEGETABLES (U.S. CL. 46).
FIRST USE 3-23-2001; IN COMMERCE 3-23-2001.



2,858,800. WACHLER, NORMAN, BLOOMFIELD HILLS, MI. SN 78-132,372. PUB. 12-31-2002, FILED 5-31-2002.

ULTRASCHMALZ

FOR BUTTER SUBSTITUTE FOR USE AS A SPREAD OR FOR COOKING (U.S. CL. 46).
FIRST USE 3-19-2004; IN COMMERCE 3-19-2004.



2,858,821. ACH FOOD COMPANIES, INC., MEMPHIS, TN. SN 78-145,598. PUB. 9-9-2003, FILED 7-19-2002.

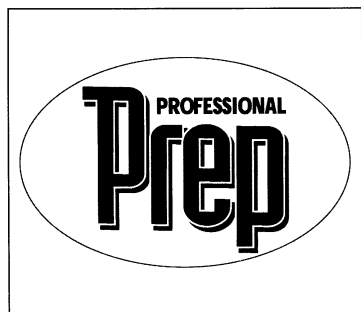

NO CLAIM IS MADE TO THE EXCLUSIVE RIGHT TO USE "PROFESSIONAL", APART FROM THE MARK AS SHOWN.

THE MARK CONSISTS OF THE WORD "PREP" APPEARING IN RED AND THE WORD "PROFESSIONAL" APPEARING IN BLUE. THE WORDS APPEAR WITHIN A WHITE OVAL WITH A DIFFUSE EDGE WHICH FADES FROM WHITE TO BLUE, ALL ON A FIELD OF SOLID BLUE.

FOR EDIBLE VEGETABLE OIL (U.S. CL. 46).
FIRST USE 7-0-2002; IN COMMERCE 7-0-2002.

CLASS 29—(Continued).

2,858,841. FRESH EXPRESS INCORPORATED, SALINAS, CA. SN 78-156,595. PUB. 3-25-2003, FILED 8-21-2002.

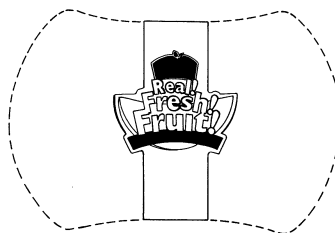

NO CLAIM IS MADE TO THE EXCLUSIVE RIGHT TO USE "REAL FRESH FRUIT", APART FROM THE MARK AS SHOWN.

THE MARK CONSISTS OF THE WORDS "REAL! FRESH! FRUIT!" AND THE LABEL DESIGN SHOWN IN THE DRAWING. THE BROKEN LINES SHOWN IN THE DRAWING INDICATE THE OUTLINE OF THE PACKAGE FOR THE GOODS AND ARE NOT A FEATURE OF THE MARK. FOR PRECUT FRESH PACKAGED FRUITS (U.S. CL. 46).

FIRST USE 8-31-2002; IN COMMERCE 8-31-2002.



2,858,864. ICICLE SEAFOODS, INC., SEATTLE, WA. SN 78-166,751. PUB. 5-27-2003, FILED 9-23-2002.

ARCTIC DRAGON

FOR SEAFOOD (U.S. CL. 46).
FIRST USE 2-14-2003; IN COMMERCE 2-14-2003.



2,858,899. WAYMOUTH FARMS, NEW HOPE, MN. SN 78-178,817. PUB. 7-22-2003, FILED 10-27-2002.

SALAD PIZAZZ!

NO CLAIM IS MADE TO THE EXCLUSIVE RIGHT TO USE "SALAD", APART FROM THE MARK AS SHOWN.

FOR DRIED OR ROASTED AND SALTED NUTS, DRIED FRUITS, TEXTURED SOY PROTEIN, DRIED VEGETABLES AND COMBINATIONS OF THE ABOVE, SOLD AS A UNIT (U.S. CL. 46).

FIRST USE 3-10-2003; IN COMMERCE 3-10-2003.



2,858,906. WESTERN FAMILY FOODS, INC., TIGARD, OR. SN 78-182,046. PUB. 12-9-2003, FILED 11-5-2002.

FRUIT ON THE GO

NO CLAIM IS MADE TO THE EXCLUSIVE RIGHT TO USE "FRUIT", APART FROM THE MARK AS SHOWN.

FOR PROCESSED FRUIT PACKED IN A CONTAINER (U.S. CL. 46).

FIRST USE 8-31-2003; IN COMMERCE 8-31-2003.

CLASS 29—(Continued).

2,858,962. PEARSALL, MATTHEW J., MORETOWN, VT. SN 78-200,003. PUB. 8-5-2003, FILED 1-3-2003.

HEY JERKY

NO CLAIM IS MADE TO THE EXCLUSIVE RIGHT TO USE "JERKY", APART FROM THE MARK AS SHOWN. FOR BEEF JERKY AND JERKY (U.S. CL. 46). FIRST USE 3-1-2004; IN COMMERCE 3-1-2004.

2,859,000. FRESH EXPRESS INCORPORATED, SALINAS, CA. SN 78-222,163. PUB. 10-28-2003, FILED 3-5-2003.

CAFE FRESH

OWNER OF U.S. REG. NO. 1,989,800. NO CLAIM IS MADE TO THE EXCLUSIVE RIGHT TO USE "FRESH", APART FROM THE MARK AS SHOWN. FOR PREPACKAGED FRESH CUT SALADS, FRUITS AND VEGETABLES (U.S. CL. 46). FIRST USE 10-14-2003; IN COMMERCE 10-14-2003.

2,859,004. OBIM FRESH-CUT FRUIT CO., LLC, FORT WORTH, TX. SN 78-226,574. PUB. 12-16-2003, FILED 3-17-2003.

STRAWBERRY BLUES

OWNER OF U.S. REG. NO. 2,703,250. NO CLAIM IS MADE TO THE EXCLUSIVE RIGHT TO USE "STRAWBERRY", APART FROM THE MARK AS SHOWN. FOR PACKAGED FRESH FRUIT (U.S. CL. 46). FIRST USE 4-5-2003; IN COMMERCE 4-5-2003.

CLASS 30—STAPLE FOODS

2,858,216. LEVY, DONNA, SHERMAN OAKS, CA. SN 75-822,763. PUB. 6-11-2002, FILED 10-14-1999.

FIBER HEALTH

NO CLAIM IS MADE TO THE EXCLUSIVE RIGHT TO USE "FIBER", APART FROM THE MARK AS SHOWN. FOR PROCESSED FOODS CONTAINING FIBER, NAMELY, COOKIES, BREAD, CRACKERS AND READY TO EAT GRANOLA-BASED AND CEREAL DERIVED NUTRITIONAL SNACK BARS (U.S. CL. 46). FIRST USE 4-29-2000; IN COMMERCE 4-29-2000.

CLASS 30—(Continued).

2,858,239. CORPORATIVO INTERNACIONAL MEXICANO, S. DE R.L. DE C.V., MEXICO, MEXICO. SN 75-983,163. PUB. 7-25-2000, FILED 12-1-1999.

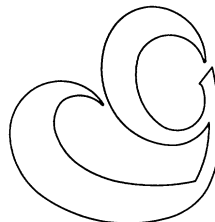

THE MARK CONSISTS OF A STYLIZED REPRESENTATION OF THE LETTER "G". FOR CRACKERS; PASTAS; PASTRIES (U.S. CL. 46). FIRST USE 2-0-1987; IN COMMERCE 2-0-1987.

2,858,263. CALVILLO, JESUS E., SAN ANTONIO, TX. SN 76-085,291. PUB. 6-24-2003, FILED 7-10-2000.

EL MIRASOL

THE ENGLISH TRANSLATION OF THE SPANISH WORD "EL MIRASOL" IS "SUNFLOWER". FOR SALSA (U.S. CL. 46). FIRST USE 9-30-2000; IN COMMERCE 9-30-2000.

2,858,269. ALDI INC., BATAVIA, IL. SN 76-099,987. PUB. 8-5-2003, FILED 8-1-2000.

TUSCAN GARDEN

FOR SPOONABLE AND PORTABLE SALAD DRESSINGS (U.S. CL. 46). FIRST USE 11-22-2000; IN COMMERCE 11-22-2000.

2,858,290. WHITE, TRICIA L., ONTARIO, CA. SN 76-157,505. PUB. 6-11-2002, FILED 10-31-2000.

PRETTY HOT AND ALWAYS TEMPTING

FOR FOODSTUFF, NAMELY, COOKIES, PASTRIES, CONFECTIONERY CHIPS AND CONFECTIONERY BITS FOR BAKING, AND BAKED GOODS, NAMELY, CAKES AND BREAD STICKS (U.S. CL. 46). FIRST USE 12-1-2003; IN COMMERCE 12-1-2003.

CLASS 30—(Continued).

2,858,297. PH, S.A.R.L. 75005 PARIS, FRANCE. SN 76-171,314.
PUB. 2-19-2002, FILED 11-27-2000.

PIERRE HERMÉ

THE NAME "PIERRE HERME" IDENTIFIES A LIVING INDIVIDUAL WHOSE CONSENT IS OF RECORD.
FOR COOKIES, TEA, COFFEE, CHOCOLATE, CROISSANTS, BISCUITS, CANDY, CAKES, PASTRIES, PIES AND CHOCOLATE TRUFFLES (U.S. CL. 46).
FIRST USE 0-0-2000; IN COMMERCE 0-0-2000.

CLASS 30—(Continued).

2,858,324. INDUSTRIALIZADORA DE KAFFEE ANDES, S.A. DE C.V., C.P. 09820, MEXICO, D.F., MEXICO. SN 76-234,823. PUB. 7-16-2002, FILED 4-2-2001.

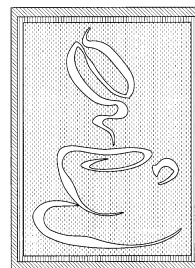

Café
La Fortuna

NO CLAIM IS MADE TO THE EXCLUSIVE RIGHT TO USE "CAFE", APART FROM THE MARK AS SHOWN.

THE DRAWING IS LINED FOR THE COLORS RED, GREEN AND PURPLE.

THE ENGLISH TRANSLATION OF "CAFE" IS "COFFEE", AND THE ENGLISH TRANSLATION OF "LA FORTUNA" IS "THE FORTUNE".

FOR COFFEE (U.S. CL. 46).

FIRST USE 12-10-2002; IN COMMERCE 12-10-2002.

2,858,321. NATURE'S PATH FOODS INC., DELTA, BRITISH COLUMBIA V4G 1E8, CANADA. SN 76-228,087. PUB. 9-30-2003, FILED 3-20-2001.

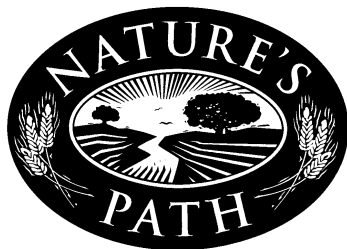

PRIORITY CLAIMED UNDER SEC. 44(D) ON CANADA APPLICATION NO. 1,091,571, FILED 2-5-2001, REG. NO. TMA579700, DATED 4-16-2003, EXPIRES 4-16-2018.

OWNER OF U.S. REG. NOS. 1,848,671 AND 2,069,075.

THE LINING SHOWN IN THE DRAWING IS A FEATURE OF THE MARK.

FOR CEREAL-BASED READY TO EAT FOOD BARS; CEREAL GRANOLA (U.S. CL. 46).

FIRST USE 10-5-1999; IN COMMERCE 10-5-1999.

2,858,334. MARS, INCORPORATED, MCLEAN, VA. SN 76-254,045. PUB. 6-11-2002, FILED 5-7-2001.

ONE STOP CANDY SHOP

NO CLAIM IS MADE TO THE EXCLUSIVE RIGHT TO USE "CANDY SHOP", APART FROM THE MARK AS SHOWN.

FOR CONFECTIONERY, NAMELY, CANDY (U.S. CL. 46).

FIRST USE 3-0-2003; IN COMMERCE 3-0-2003.

2,858,337. MARS, INCORPORATED, MCLEAN, VA. SN 76-259,480. PUB. 12-18-2001, FILED 5-21-2001.

WHAT IS IT ABOUT THE GREEN ONES?

OWNER OF U.S. REG. NO. 1,876,053.
FOR CONFECTIONERY, NAMELY, CANDY (U.S. CL. 46).

FIRST USE 1-6-2004; IN COMMERCE 1-6-2004.

CLASS 30—(Continued).

2,858,411. ROCKMAN CO. (U.S.A.), INC., COMMERCE, CA. SN 76-352,505. PUB. 8-19-2003, FILED 12-26-2001.

**BUN ẮN RẤT DẸO VÀ KHÔNG BỊ ĐỨT
CÁCH ĐỀM NẤU LẠI VẪN NGON NHƯ THƯỜNG**

NO CLAIM IS MADE TO THE EXCLUSIVE RIGHT TO USE "NOODLE", APART FROM THE MARK AS SHOWN.

THE MARK CONSISTS OF THE VIETNAMESE PHRASE "BUN AN RAT DEO VA KHONG BI DUT CACH DEM NAU LAI VAN NGON NHU THUONG" WHICH GENERALLY MEANS "NOODLE. VERY ELASTIC WILL NOT BREAK. STILL GREAT IF LEFT OVERNIGHT AND COOKED AGAIN".

THE DIRECT TRANSLATION OF THE VIETNAMESE PHRASE OF THE MARK, NAMELY "BUN AN RAT DEO VA KHONG BI DUT CACH DEM NAU LAI VAN NGON NHU THUONG" IS "NOODLE EAT VERY SMOOTH AND NOT BE BROKEN OVERNIGHT COOKED AGAIN STILL GOOD AS USUAL".

FOR STAPLE FOODS, NAMELY, RICE, RICE NOODLES, RICE STICKS, RICE VERMICELLI, VERMICELLI NOODLES AND PASTA (U.S. CL. 46).

FIRST USE 4-16-2002; IN COMMERCE 4-16-2002.

2,858,413. JUST BORN, INC., BETHLEHEM, PA. SN 76-353,961. PUB. 10-7-2003, FILED 1-2-2002.

**TEENEE BEANEE ISLAND
BREEZE**

OWNER OF U.S. REG. NO. 1,261,851.
SEC. 2(F) AS TO "TEENEE".
FOR CANDY (U.S. CL. 46).
FIRST USE 11-30-2001; IN COMMERCE 11-30-2001.

2,858,416. MILO'S TEA COMPANY, INC., BESSEMER, AL. SN 76-356,583. PUB. 7-30-2002, FILED 1-8-2002.

**"THE GREAT SOUTHERN
TEA COMPANY"**

OWNER OF U.S. REG. NO. 1,643,771.
NO CLAIM IS MADE TO THE EXCLUSIVE RIGHT TO USE "TEA COMPANY", APART FROM THE MARK AS SHOWN.

FOR PREMIXED SWEETENED TEA (U.S. CL. 46).
FIRST USE 4-1-2002; IN COMMERCE 2-1-2003.

CLASS 30—(Continued).

2,858,455. KKBL NO. 257 VENTURES LTD., DELTA, B.C. V3M 6Y9, CANADA. SN 76-396,412. PUB. 6-3-2003, FILED 4-16-2002.

HEALTHY WAY

PRIORITY CLAIMED UNDER SEC. 44(D) ON CANADA APPLICATION NO. 1,118,618, FILED 10-16-2001.

FOR BAKERY PRODUCTS, NAMELY, FRESH BREADS, ROLLS, TORTILLAS, TORTILLA WRAPS, DOUGH WRAPS FOR PASTRY, PITA BREAD, BAGELS AND BREAD STICKS (U.S. CL. 46).

FIRST USE 11-0-2000; IN COMMERCE 1-15-2003.

2,858,484. ALL KITCHENS, INC., RICHMOND, VA. SN 76-412,517. PUB. 2-11-2003, FILED 5-20-2002.

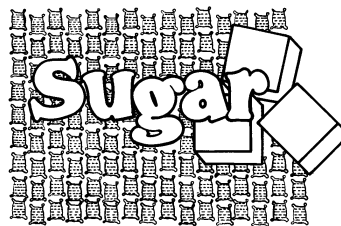

OWNER OF U.S. REG. NOS. 2,379,450 AND 2,439,523.
NO CLAIM IS MADE TO THE EXCLUSIVE RIGHT TO USE "SUGAR", APART FROM THE MARK AS SHOWN.

THE STIPPLING IN THE DRAWING IS FOR SHADING PURPOSES ONLY.

FOR PREPACKAGED, PORTION CONTROLLED SERVINGS OF SUGAR (U.S. CL. 46).

FIRST USE 6-0-2002; IN COMMERCE 6-0-2002.

2,858,488. JINJIANG FUJIAN YASHIDA FOOD CO., LTD., FUJIAN, CHINA. SN 76-415,709. PUB. 7-22-2003, FILED 5-29-2002.



FOR WHITE SUGAR; LOTUS ROOT STARCH; HONEY; SOY SAUCE; CONDIMENTS, NAMELY, RELISH; MEAT TENDERIZING POWDER; TEA; BREAD; MINT FOR CONFECTIONERY; COOKING SALT; COCOA PRODUCTS, NAMELY, COCOA MIXES; MALT SWEETS; SWEETMEATS, NAMELY, CANDY; CHOCOLATE; PASTA; MOON CAKES; CORN MEAL; ICE CREAM; PIES (U.S. CL. 46).

FIRST USE 10-0-2002; IN COMMERCE 10-0-2002.

CLASS 30—(Continued).

2,858,502. COCOA PETE'S CHOCOLATE ADVENTURES COMPANY, CAMPBELL, CA. SN 76-422,876. PUB. 7-29-2003, FILED 6-19-2002.

HALLOWED GROUNDS

FOR CANDIES, CHOCOLATE AND CONFECTIONS, NAMELY, CANDIES AND CHOCOLATE (U.S. CL. 46).
FIRST USE 8-31-2002; IN COMMERCE 8-31-2002.

2,858,524. THE COCO TREE, INC., SPARTA, NJ. SN 76-429,932. PUB. 6-24-2003, FILED 7-11-2002.

THE COCO TREE

NO CLAIM IS MADE TO THE EXCLUSIVE RIGHT TO USE "COCO", APART FROM THE MARK AS SHOWN.

FOR CANDY, NAMELY, MILK CHOCOLATE, WHITE CHOCOLATE AND DARK CHOCOLATE WITH OR WITHOUT INCLUSIONS SUCH AS NUTS, FRUIT, MARZIPAN, CARAMELS AND OTHER FILLINGS (U.S. CL. 46).

FIRST USE 9-2-2002; IN COMMERCE 9-2-2002.

2,858,576. FIRST CATERING, INC., LA GRANGE, GA. SN 76-451,827. PUB. 7-15-2003, FILED 9-23-2002.

YAM GOOD PIE

NO CLAIM IS MADE TO THE EXCLUSIVE RIGHT TO USE "PIE", APART FROM THE MARK AS SHOWN.

FOR PIES (U.S. CL. 46).
FIRST USE 11-0-1998; IN COMMERCE 1-0-2004.

2,858,657. ALDI INC., BATAVIA, IL. SN 76-493,106. PUB. 10-7-2003, FILED 2-27-2003.

CHEF'S CUPBOARD

OWNER OF U.S. REG. NO. 1,493,355.
FOR STUFFING MIXES CONTAINING BREAD (U.S. CL. 46).

FIRST USE 8-21-2003; IN COMMERCE 8-21-2003.

2,858,674. FARAGHER FAMILY FARM, LLC, NEWPORT, KY. SN 76-505,562. PUB. 12-2-2003, FILED 4-10-2003.

FIELD FRIENDS

FOR BAKED SNACKS GOODS, NAMELY COOKIES AND CRACKERS (U.S. CL. 46).
FIRST USE 9-5-2003; IN COMMERCE 9-5-2003.

CLASS 30—(Continued).

2,858,696. BARILLA ALIMENTARE S.P.A., PARMA, ITALY. SN 76-976,674. PUB. 7-15-2003, FILED 6-19-2002.

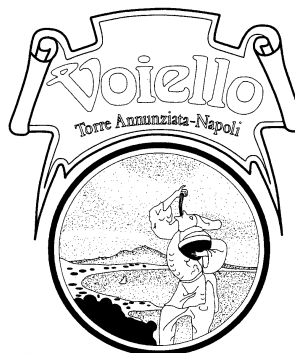

OWNER OF ITALY REG. NO. 727,517, DATED 9-26-1997, EXPIRES 6-17-2005.

OWNER OF U.S. REG. NO. 1,847,802.

NO CLAIM IS MADE TO THE EXCLUSIVE RIGHT TO USE "TORRE ANNUNZIATA" AND "NAPOLI", APART FROM THE MARK AS SHOWN.

THE STIPPLING SHOWN IN THE DRAWING IS A FEATURE OF THE MARK AND NOT INTENDED TO INDICATE COLOR.

FOR PASTA (U.S. CL. 46).

FIRST USE 0-0-1980; IN COMMERCE 1-0-2004.

2,858,757. OUT OF THE BLUE LIMITED, PALO ALTO, CA. SN 78-103,411. PUB. 11-19-2002, FILED 1-17-2002.

BLOOMSBERRY

FOR CHOCOLATE, CHOCOLATES, NON-MEDICATED CANDY (U.S. CL. 46).

FIRST USE 1-1-2000; IN COMMERCE 5-1-2000.

2,858,777. DORNBUSCH, RAYMOND PETER, TRAVERSE CITY, MI. SN 78-114,813. PUB. 7-8-2003, FILED 3-14-2002.

ESPRESSO BAY

NO CLAIM IS MADE TO THE EXCLUSIVE RIGHT TO USE "ESPRESSO", APART FROM THE MARK AS SHOWN.

FOR GROUND AND WHOLE BEAN COFFEE; HOT AND FROZEN COFFEE; ESPRESSO COFFEE-BASED BEVERAGE CONTAINING MILK, NAMELY, CAFE LATTE; HERBAL TEA, CHAI TEA, AND TEA BASED BEVERAGES; HOT CHOCOLATE; BAKERY GOODS, NAMELY, BISCOTTI, BREAD, BROWNIES, CAKES, COOKIES, MUFFINS, CROISSANTS, DOUGHNUTS, CINNAMON ROLLS AND PECAN ROLLS, PASTRIES, AND SCONES; CHOCOLATE; CANDY (U.S. CL. 46).

FIRST USE 5-28-2003; IN COMMERCE 5-28-2003.

CLASS 30—(Continued).

2,858,824. HARVEST RICE, INC., HOUSTON, TX. SN 78-147,551. PUB. 7-15-2003, FILED 7-25-2002.



NO CLAIM IS MADE TO THE EXCLUSIVE RIGHT TO USE "RICE", APART FROM THE MARK AS SHOWN. FOR RICE (U.S. CL. 46). FIRST USE 3-8-2004; IN COMMERCE 3-8-2004.

2,858,866. TARGET BRANDS, INC., MINNEAPOLIS, MN. SN 78-167,836. PUB. 7-15-2003, FILED 9-25-2002.

FRUITY FABLES

NO CLAIM IS MADE TO THE EXCLUSIVE RIGHT TO USE "FRUITY", APART FROM THE MARK AS SHOWN. FOR BREAKFAST CEREALS (U.S. CL. 46). FIRST USE 12-0-2001; IN COMMERCE 12-0-2001.

2,858,891. DISHAKA GOURMET IMPORTS, L.L.C., HOUSTON, TX. SN 78-176,128. PUB. 7-29-2003, FILED 10-18-2002.

INDICA

FOR RICE (U.S. CL. 46). FIRST USE 2-0-2004; IN COMMERCE 2-0-2004.

CLASS 30—(Continued).

2,858,901. QUINN, ROBERT, CATHEDRAL CITY, CA. AND QUINN, DEBORAH, CATHEDRAL CITY, CA. SN 78-179,806. PUB. 8-26-2003, FILED 10-29-2002.



FOR PACKAGED BAKERY GOODS, NAMELY PASTRIES, CRACKERS AND COOKIES SOLD THROUGH GOLF SHOPS AND OTHER GOLF-RELATED BUSINESSES (U.S. CL. 46). FIRST USE 2-5-2004; IN COMMERCE 2-5-2004.

2,858,943. JARET INTERNATIONAL (CS), INC., ISELIN, NJ. SN 78-193,215. PUB. 8-19-2003, FILED 12-11-2002.

DREAM MATES

FOR CONFECTIONERY, NAMELY CANDY, CHOCOLATE AND MINTS (U.S. CL. 46). FIRST USE 4-30-2003; IN COMMERCE 4-30-2003.

2,858,947. COLD STONE CREAMERY, INC., SCOTTSDALE, AZ. SN 78-194,407. PUB. 7-29-2003, FILED 12-13-2002.

**NIGHTS IN WHITE
CHOCOLATE**

FOR ICE CREAM AND FROZEN YOGURT (U.S. CL. 46). FIRST USE 4-14-2003; IN COMMERCE 4-14-2003.

2,858,985. TASTE CONNECTIONS, TORRANCE, CA. SN 78-209,867. PUB. 9-30-2003, FILED 2-1-2003.

TASTE CONNECTIONS

FOR LOW PROTEIN DRY MIXES; NAMELY, BREAD MIXES, COOKIE MIXES, CAKE MIXES, AND ALL PURPOSE BAKING MIXES (U.S. CL. 46). FIRST USE 6-21-2003; IN COMMERCE 7-29-2003.

CLASS 30—(Continued).

2,859,001. UNILEVER N.V., ROTTERDAM, NETHERLANDS.
SN 78-223,521. PUB. 10-21-2003, FILED 3-10-2003.

BREYERS

OWNER OF U.S. REG. NOS. 144,708, 2,601,005, AND
OTHERS.
SEC. 2(F).
FOR FROZEN CONFECTIONS (U.S. CL. 46).
FIRST USE 5-31-2002; IN COMMERCE 5-31-2002.

2,859,016. FLYING COLORS TOYS, INC, MALIBU, CA. SN
78-235,627. PUB. 12-2-2003, FILED 4-9-2003.

WOO-CHOW CHERRY

NO CLAIM IS MADE TO THE EXCLUSIVE RIGHT TO
USE "CHERRY", APART FROM THE MARK AS SHOWN.
FOR CHEWING GUM AND CANDY (U.S. CL. 46).
FIRST USE 7-24-2003; IN COMMERCE 7-24-2003.

CLASS 31—NATURAL AGRICULTURAL PRODUCTS

2,858,384. KRB SEED COMPANY, LLC, WINSTON-SALEM,
NC. SN 76-322,586. PUB. 11-18-2003, FILED 10-5-2001.



NO CLAIM IS MADE TO THE EXCLUSIVE RIGHT TO
USE "REBEL IV", APART FROM THE MARK AS SHOWN.
THE MARK IS LINED FOR THE COLOR RED.
FOR GRASS SEED (U.S. CLS. 1 AND 46).
FIRST USE 2-1-2004; IN COMMERCE 2-1-2004.

2,858,578. R. D. BISCUIT COMPANY, INC., HOUSTON, TX.
SN 76-453,656. PUB. 7-15-2003, FILED 9-27-2002.

RED DOG

NO CLAIM IS MADE TO THE EXCLUSIVE RIGHT TO
USE "DOG", APART FROM THE MARK AS SHOWN.
FOR PET FOOD (U.S. CLS. 1 AND 46).
FIRST USE 9-0-2002; IN COMMERCE 12-0-2002.

2,858,602. NEWMAN, MATTHEW, NEW ROADS, LA. SN 76-
466,864. PUB. 12-23-2003, FILED 11-14-2002.

BAIT STATION**CLASS 31—(Continued).**

NO CLAIM IS MADE TO THE EXCLUSIVE RIGHT TO
USE "BAIT", APART FROM THE MARK AS SHOWN.
FOR IDENTIFY EDIBLE ATTRACTANT GEL USED
TO BAIT TRAPS FOR WILDLIFE (U.S. CLS. 1 AND 46).
FIRST USE 3-21-2003; IN COMMERCE 3-21-2003.

2,858,632. RIDLEY BLOCK OPERATIONS, INC., MANKATO,
MN. SN 76-476,243. PUB. 12-9-2003, FILED 12-12-2002.

EQUINEHP

FOR EDIBLE HORSE TREATS (U.S. CLS. 1 AND 46).
FIRST USE 9-19-2003; IN COMMERCE 9-19-2003.

2,858,671. NDSU RESEARCH FOUNDATION, FARGO, ND.
SN 76-503,502. PUB. 11-11-2003, FILED 4-2-2003.

PRAIRIE TORCH

FOR LIVE PLANTS— NAMELY, HYBRID BUCKEYE,
SPECIFICALLY— AESCULUS X 'BERGESON' (U.S. CLS. 1
AND 46).
FIRST USE 6-1-2003; IN COMMERCE 6-1-2003.

2,858,672. NDSU RESEARCH FOUNDATION, FARGO, ND.
SN 76-503,503. PUB. 11-11-2003, FILED 4-2-2003.

PRAIRIE HORIZON

FOR LIVE PLANTS— NAMELY, MANCHURIAN AL-
DER, SPECIFICALLY— ALNUS HIRSUTA 'HARBIN'
(U.S. CLS. 1 AND 46).
FIRST USE 2-19-2004; IN COMMERCE 2-19-2004.

CLASS 32—LIGHT BEVERAGES

2,858,232. KHAWAM MARKETING GROUP SARL, BEIRUT,
LEBANON. SN 75-921,158. PUB. 11-28-2000, FILED 2-16-
2000.

LAZIZA

FOR BEER, NON-ALCOHOLIC BEER AND NON-AL-
COHOLIC MALT BEVERAGES (U.S. CLS. 45, 46 AND 48).
FIRST USE 0-0-1931; IN COMMERCE 3-0-2001.

CLASS 32—(Continued).

2,858,315. BLEU WATER COMPANY, INC., RICHMOND, VA. SN 76-205,776. PUB. 11-13-2001, FILED 2-6-2001.

DEEP BLEU CHRISTAL

NO CLAIM IS MADE TO THE EXCLUSIVE RIGHT TO USE "BLEU", APART FROM THE MARK AS SHOWN.
THE ENGLISH TRANSLATION OF "BLEU" IS "BLUE".
FOR BOTTLED DRINKING WATER (U.S. CLS. 45, 46 AND 48).
FIRST USE 3-15-2004; IN COMMERCE 3-15-2004.

2,858,338. CUDDY, GERALD M., STONEHAM, MA. SN 76-259,879. PUB. 12-11-2001, FILED 5-22-2001.

LEMON APE

NO CLAIM IS MADE TO THE EXCLUSIVE RIGHT TO USE "LEMON", APART FROM THE MARK AS SHOWN.
FOR GRAPÉ FLAVORED LEMONADE (U.S. CLS. 45, 46 AND 48).
FIRST USE 3-4-2004; IN COMMERCE 3-4-2004.

2,858,429. SOUTH BEACH BEVERAGE COMPANY, INC., NORWALK, CT. SN 76-366,146. PUB. 9-24-2002, FILED 1-31-2002.

LIZARDADE

FOR NON-ALCOHOLIC BEVERAGES, NAMELY, CARBONATED SOFT DRINKS; AND SYRUPS, CONCENTRATES AND POWDERS FOR MAKING SOFT DRINKS (U.S. CLS. 45, 46 AND 48).
FIRST USE 8-1-2002; IN COMMERCE 8-1-2002.

2,858,875. DOLCE, GREGORY L. HAVRE DE GRACE, MD. SN 78-170,426. PUB. 9-2-2003, FILED 10-2-2002.

DOLCE AQUA BOTTLED WATER

NO CLAIM IS MADE TO THE EXCLUSIVE RIGHT TO USE "AQUA BOTTLED WATER", APART FROM THE MARK AS SHOWN.
"DOLCE AQUA" MEANS "SWEET WATER" IN THE ITALIAN AND SPANISH LANGUAGE.
FOR BOTTLED DRINKING WATER (U.S. CLS. 45, 46 AND 48).
FIRST USE 8-31-2003; IN COMMERCE 8-31-2003.

CLASS 32—(Continued).

2,859,023. UTMOST BRANDS, INC., NEW YORK, NY. SN 78-241,863. PUB. 12-2-2003, FILED 4-24-2003.

GUS

FOR CARBONATED SOFT DRINKS (U.S. CLS. 45, 46 AND 48).
FIRST USE 6-29-2003; IN COMMERCE 6-29-2003.

CLASS 33—WINES AND SPIRITS

2,858,179. PRZEDSIĘBIORSTWO POLMOS BIAŁYSTOK S.A., BIAŁYSTOK, POLAND. SN 74-711,421. PUB. 6-24-1997, FILED 8-4-1995.



NO CLAIM IS MADE TO THE EXCLUSIVE RIGHT TO USE "ZUBROWKA" AND "VODKA", APART FROM THE MARK AS SHOWN.
THE ENGLISH TRANSLATION OF "ZUBROWKA" IS "SWEET-SCENTED GRASS HIERCHLOE" AND/OR "A VODKA FLAVORED WITH THE SWEET-SCENT GRASS HIERCHLOE".
FOR VODKA (U.S. CLS. 47 AND 49).
FIRST USE 8-7-2003; IN COMMERCE 8-7-2003.

2,858,345. TEQUILA SAN MATIAS DE JALISCO, S.A. DE C.V., JALISCO, MEXICO. SN 76-268,000. PUB. 1-15-2002, FILED 6-7-2001.

PISTO LISTO

THE ENGLISH TRANSLATION OF "LISTO" IS "READY".
FOR MIXED ALCOHOLIC COCKTAILS CONTAINING TEQUILA (U.S. CLS. 47 AND 49).
FIRST USE 10-22-1999; IN COMMERCE 2-2-2004.

CLASS 33—(Continued).

2,858,352. VINA QUEBRADA DE MACUL S.A., SANTIAGO, CHILE. SN 76-283,410. PUB. 2-12-2002, FILED 7-11-2001.

STELLA AUREA

OWNER OF U.S. REG. NO. 2,406,609.
THE ENGLISH TRANSLATION OF "STELLA AUREA" IS "GOLDEN STAR".
FOR WINES (U.S. CLS. 47 AND 49).
FIRST USE 3-30-2004; IN COMMERCE 3-30-2004.

2,858,353. CARIBBEAN DISTILLERS CORPORATION INTERNATIONAL LIMITED, ROAD BAY, ANGUILLA. SN 76-283,968. PUB. 8-27-2002, FILED 7-12-2001.



THE NON-LATIN CHARACTER IN THE MARK IS A REPRESENTATION OF A DAGGER, BUT RESEMBLES A CHARACTER THAT TRANSLITERATES TO "JIN" IN CHINESE AND "I" IN JAPANESE, BOTH OF WHICH MEAN "WELL" OR "SOURCE OF WATER" IN ENGLISH.
FOR DISTILLED SPIRITS (U.S. CLS. 47 AND 49).
FIRST USE 7-28-2003; IN COMMERCE 7-28-2003.

2,858,414. TWISTED OAK WINERY, LLC, MURPHYS, CA. SN 76-355,054. PUB. 10-7-2003, FILED 12-12-2001.

TWISTED OAK

NO CLAIM IS MADE TO THE EXCLUSIVE RIGHT TO USE "WINERY", APART FROM THE MARK AS SHOWN.
FOR WINE (U.S. CLS. 47 AND 49).
FIRST USE 8-11-2003; IN COMMERCE 7-4-2003.

2,858,545. BRONCO WINE COMPANY, CERES, CA. SN 76-436,191. PUB. 1-21-2003, FILED 7-31-2002.

SEA RIDGE

OWNER OF U.S. REG. NOS. 2,198,682 AND 2,254,439.
FOR WINES (U.S. CLS. 47 AND 49).
FIRST USE 11-11-2002; IN COMMERCE 4-29-2003.

CLASS 33—(Continued).

2,858,559. ZUCCARDI, JOSE ALBERTO, MENDOZA, ARGENTINA. SN 76-441,180. PUB. 7-29-2003, FILED 8-14-2002.

ZUCCARDI

FOR WINES (U.S. CLS. 47 AND 49).
FIRST USE 1-1-1998; IN COMMERCE 1-1-2000.

2,858,596. GAVIDIA, ARMANDO A., CAPITAL FEDERAL, ARGENTINA. SN 76-465,046. PUB. 5-20-2003, FILED 11-1-2002.

LUXOS

FOR WINES (U.S. CLS. 47 AND 49).
FIRST USE 9-1-2003; IN COMMERCE 9-1-2003.

2,858,613. ALVAREZ, ALBERTO JUAN, PROVINCIA DE RIO NEGRO - ARGENTINA, ARGENTINA. SN 76-469,738. PUB. 8-12-2003, FILED 11-25-2002.



THE FOREIGN WORDING IN THE MARK TRANSLATES INTO ENGLISH AS "HILLS OF THE WIND".
FOR ALCOHOLIC BEVERAGES, NAMELY, TEQUILA, AGAVE DISTILLED, BRANDY, VODKA, GIN, RUM, WHISKEY, LIQUORS, COGNAC, WINE, SPARKLING WINE, AND CHAMPAGNE (U.S. CLS. 47 AND 49).
FIRST USE 12-18-2002; IN COMMERCE 12-18-2002.

2,858,630. STAR INDUSTRIES, INC., SYOSSET, NY. SN 76-475,907. PUB. 7-15-2003, FILED 12-18-2002.

WEEPING ROCK

FOR WINE (U.S. CLS. 47 AND 49).
FIRST USE 6-0-2003; IN COMMERCE 6-30-2003.

CLASS 33—(Continued).

2,858,675. LAIL VINEYARDS, LLC, DBA LAIL VINEYARDS, ST. HELENA, CA. SN 76-508,237. PUB. 1-6-2004, FILED 4-21-2003.

BLUEPRINT

FOR WINE (U.S. CLS. 47 AND 49).
FIRST USE 3-3-2004; IN COMMERCE 3-3-2004.

2,858,683. MANOUSAKIS, THEODORE, ALEXANDRIA, VA. SN 76-524,576. PUB. 1-13-2004, FILED 6-11-2003.

NOSTOS

FOR WINE (U.S. CLS. 47 AND 49).
FIRST USE 6-1-1998; IN COMMERCE 6-1-1998.

2,858,737. BREW KING LIMITED, PORT COQUITLAM, BRITISH COLUMBIA, CANADA. SN 78-079,137. PUB. 5-27-2003, FILED 8-14-2001.

PASSPORT SERIES

PRIORITY CLAIMED UNDER SEC. 44(D) ON CANADA APPLICATION NO. 1112000, FILED 8-8-2001.

NO CLAIM IS MADE TO THE EXCLUSIVE RIGHT TO USE "SERIES", APART FROM THE MARK AS SHOWN.

FOR WINE MAKING KITS COMPRISED OF FRUIT JUICE AND CONCENTRATES, DRIED FLOWERS AND HERBS, WOOD CHIPS, ACTIVE DRY WINE YEAST, CLARIFYING AGENTS, FINING AGENTS, STABILIZERS, WINE MAKING CHEMICAL ADDITIVES (U.S. CLS. 47 AND 49).

FIRST USE 8-1-2001; IN COMMERCE 9-1-2001.

2,858,820. ASAHI BREWERIES, LTD., TOKYO, JAPAN. SN 78-145,548. PUB. 8-12-2003, FILED 7-19-2002.



OWNER OF U.S. REG. NOS. 686,984, 1,516,598, AND 2,398,046.

NO CLAIM IS MADE TO THE EXCLUSIVE RIGHT TO USE "DRAFT", "DRAFT BEER", "SUPER DRY" AND "NET

CLASS 33—(Continued).

CONTENTS 12 FL OZ. 355 ML", APART FROM THE MARK AS SHOWN.

THE MARK CONSISTS OF THE COLORS BLACK, GRAY AND RED AND CONTAINS, IN PART, THE FOLLOWING WORDING "ASAHI BEER IS BREWED FROM SELECTED INGREDIENTS USING OUR PURE CULTURED YEAST AND OUR ADVANCED BREWING TECHNIQUES ASAHI BEER HAS EXCELLENT RICHNESS TRULY REFRESHING DRINKABILITY AND SATIN SMOOTHNESS".

THE FOREIGN WORDING IN THE MARK TRANSLATES INTO ENGLISH AS "DRAFT" "SUPER DRY" AND "DRAFT BEER." THE ENGLISH TRANSLATION OF WORD "ASAHI" IS "RISING SUN".

FOR BEER (U.S. CLS. 47 AND 49).
FIRST USE 9-14-2002; IN COMMERCE 9-14-2002.

2,858,861. VICENTE GANDIA PLA, S.A., CHIVA-VALENCIA, SPAIN. SN 78-166,025. PUB. 5-27-2003, FILED 9-19-2002.

HERENCIA ANTICA

THE ENGLISH TRANSLATION OF "HERENCIA ANTICA" IS "ANCIENT INHERITANCE".

FOR WINE (U.S. CLS. 47 AND 49).
FIRST USE 1-1-1997; IN COMMERCE 3-3-2003.

2,858,885. JUMPING J INVESTMENTS, INC., PASO ROBLES, CA. SN 78-172,348. PUB. 5-13-2003, FILED 10-8-2002.

OAK MEADOW

FOR WINE (U.S. CLS. 47 AND 49).
FIRST USE 11-12-2003; IN COMMERCE 11-12-2003.

2,858,915. PIERCE, LEON W., STOCKTON, CA. SN 78-185,318. PUB. 6-24-2003, FILED 11-14-2002.

LE CASK

NO CLAIM IS MADE TO THE EXCLUSIVE RIGHT TO USE "CASK", APART FROM THE MARK AS SHOWN.

FOR ALCOHOLIC BEVERAGES, NAMELY, WINES AND WINE COOLERS (U.S. CLS. 47 AND 49).

FIRST USE 1-24-2003; IN COMMERCE 3-15-2003.

2,858,934. TARGET BRANDS, INC., MINNEAPOLIS, MN. SN 78-190,578. PUB. 8-5-2003, FILED 12-3-2002.

VIVID

FOR SPARKLING WINE (U.S. CLS. 47 AND 49).
FIRST USE 4-30-2003; IN COMMERCE 4-30-2003.

CLASS 33—(Continued).

2,858,981. COTCHETT, JOSEPH W., HALF MOON BAY, CA. SN 78-208,600. PUB. 9-9-2003, FILED 1-29-2003.

MAIN STREET MERLOT

NO CLAIM IS MADE TO THE EXCLUSIVE RIGHT TO USE "MERLOT", APART FROM THE MARK AS SHOWN. FOR WINES (U.S. CLS. 47 AND 49). FIRST USE 5-30-2002; IN COMMERCE 5-30-2002.

2,858,982. COTCHETT, JOSEPH W., HALF MOON BAY, CA. SN 78-208,771. PUB. 9-9-2003, FILED 1-30-2003.

FISHERMAN'S RED

NO CLAIM IS MADE TO THE EXCLUSIVE RIGHT TO USE "RED", APART FROM THE MARK AS SHOWN. FOR WINES (U.S. CLS. 47 AND 49). FIRST USE 5-30-2002; IN COMMERCE 5-30-2002.

2,859,002. TRINITAS CELLARS, LLC, IRVINE, CA. SN 78-225,957. PUB. 11-25-2003, FILED 3-14-2003.

TRINITAS

FOR WINES (U.S. CLS. 47 AND 49). FIRST USE 4-1-2003; IN COMMERCE 4-1-2003.

CLASS 34—SMOKERS' ARTICLES

2,858,225. GUANGZHOU NO. 1 CIGARETTE FACTORY, GUANGZHOU, CHINA. SN 75-888,102. PUB. 7-1-2003, FILED 1-6-2000.



THE CHINESE CHARACTERS IN THE MARK TRANSLITERATE TO "JINF FENG" AND THIS MEANS "GOLD HILL" IN ENGLISH. FOR CIGARETTES (U.S. CLS. 2, 8, 9 AND 17). FIRST USE 1-22-2004; IN COMMERCE 1-22-2004.

CLASS 34—(Continued).

2,858,304. PINKERTON TOBACCO CO. LP, OWENSBORO, KY. SN 76-186,444. PUB. 6-11-2002, FILED 12-27-2000.

LONGHORN

FOR SNUFF (U.S. CLS. 2, 8, 9 AND 17). FIRST USE 7-1-2003; IN COMMERCE 7-1-2003.

2,858,328. ETOBACCO LLC, PALO ALTO, CA. SN 76-246,432. PUB. 9-11-2001, FILED 4-25-2001.

SMOKE WITH E'S

FOR SMOKING TOBACCO, CIGARETTES, CIGARS, AND SMOKELESS TOBACCO (U.S. CLS. 2, 8, 9 AND 17). FIRST USE 1-14-2004; IN COMMERCE 1-14-2004.

2,858,329. ETOBACCO LLC, PALO ALTO, CA. SN 76-246,433. PUB. 8-13-2002, FILED 4-25-2001.

E

FOR SMOKING TOBACCO, CIGARETTES AND SMOKELESS TOBACCO (U.S. CLS. 2, 8, 9 AND 17). FIRST USE 1-14-2004; IN COMMERCE 1-14-2004.

2,858,686. I.T.C. LIMITED, KOLKATA 700071, INDIA. SN 76-976,303. PUB. 2-5-2002, FILED 3-23-2000.



OWNER OF U.S. REG. NOS. 2,366,879 AND 2,373,506. FOR CIGARETTES, LOOSE CIGARETTE TOBACCO AND CIGARETTE PAPER (U.S. CLS. 2, 8, 9 AND 17). FIRST USE 9-0-1998; IN COMMERCE 9-0-1998.

CLASS 34—(Continued).

2,858,950. VECTOR TOBACCO LTD., HAMILTON, BERMUDA. SN 78-195,555. PUB. 12-2-2003, FILED 12-17-2002.

Quest

FOR CIGARETTES (U.S. CLS. 2, 8, 9 AND 17).
FIRST USE 7-0-2002; IN COMMERCE 9-9-2002.

2,858,991. MORINE, MARCUS DANIEL, CHICO, CA. SN 78-214,116. PUB. 9-23-2003, FILED 2-12-2003.

OFF THE CUFF SNUFF

FOR SNUFF (U.S. CLS. 2, 8, 9 AND 17).
FIRST USE 2-1-2003; IN COMMERCE 9-1-2003.

2,859,046. WIND RIVER TOBACCO COMPANY, LLC, JACKSON, WY. SN 78-975,378. PUB. 1-7-2003, FILED 6-26-2002.

TETON

FOR SMOKING TOBACCO, ROLLING TOBACCO (U.S. CLS. 2, 8, 9 AND 17).
FIRST USE 12-15-2003; IN COMMERCE 12-17-2003.

SERVICE MARKS

CLASS 35—ADVERTISING AND BUSINESS

2,858,184. DIRECT-JOBS LLC, COCKEYSVILLE, MD. SN 75-439,022. PUB. 10-26-1999, FILED 2-23-1998.

directJobs
.com

NO CLAIM IS MADE TO THE EXCLUSIVE RIGHT TO USE "COM", APART FROM THE MARK AS SHOWN.
THE MARK IS LINED FOR THE COLORS BLUE AND RED.

FOR EMPLOYMENT RELATED INFORMATION SERVICES PROVIDED ONLINE, THROUGH ELECTRONIC MAIL, BY FACSIMILE AND TELEPHONE, NAMELY JOB PLACEMENT, JOB POSTING, EMPLOYEE SEARCHING AND SCREENING, AND PROVIDING INFORMATION ABOUT EMPLOYERS (U.S. CLS. 100, 101 AND 102).
FIRST USE 1-1-1998; IN COMMERCE 1-1-1998.

CLASS 35—(Continued).

2,858,199. HERMAN, RON, LOS ANGELES, CA. SN 75-717,182. PUB. 1-18-2000, FILED 5-28-1999.

R.H. VINTAGE

NO CLAIM IS MADE TO THE EXCLUSIVE RIGHT TO USE "VINTAGE", APART FROM THE MARK AS SHOWN.
FOR RETAIL STORE SERVICES FEATURING CLOTHING AND ACCESSORIES (U.S. CLS. 100, 101 AND 102).
FIRST USE 1-23-2000; IN COMMERCE 2-16-2000.

2,858,202. RKS PLASTICS INC, NEW BRUNSWICK, NJ. SN 75-737,731. PUB. 2-27-2001, FILED 6-28-1999.

everydayneeds

FOR ON-LINE STORE SERVICES FEATURING JANITORIAL SUPPLIES FOR HOME AND COMMERCIAL USE (U.S. CLS. 100, 101 AND 102).
FIRST USE 2-9-2004; IN COMMERCE 2-9-2004.

2,858,213. PROSPECTIV DIRECT, INC., WOBURN, MA. SN 75-788,353. PUB. 8-8-2000, FILED 8-30-1999.

TEENSAVE

FOR PROVIDING PRODUCT DISCOUNT INFORMATION ABOUT A WIDE RANGE OF GENERAL MERCHANDISE AND CONSUMER PRODUCTS AND SERVICES OF OTHERS BY MEANS OF A GLOBAL COMMUNICATIONS NETWORK (U.S. CLS. 100, 101 AND 102).
FIRST USE 4-0-2003; IN COMMERCE 4-0-2003.

2,858,219. ADVERTISING.COM, INC., BALTIMORE, MD. SN 75-859,504. PUB. 6-25-2002, FILED 11-30-1999.

**THE DOT COM OF
INTERNET ADVERTISING**

FOR COMPUTER SERVICES, NAMELY, PROVIDING AN INTERACTIVE ONLINE COMPUTER DATABASE IN THE FIELD OF MARKETING; COMPUTER SERVICES, NAMELY, PROVIDING REPORTING SERVICES VIA AN ON-LINE GLOBAL COMPUTER INFORMATION NETWORK RELATING TO COMPUTER NETWORK USE AND USERS FOR BUSINESS PURPOSES (U.S. CLS. 100, 101 AND 102).
FIRST USE 8-28-2003; IN COMMERCE 8-28-2003.

CLASS 35—(Continued).

2,858,220. PUBLISHERS CLEARING HOUSE LLC, PORT WASHINGTON, NY. SN 75-871,697. PUB. 10-10-2000, FILED 12-15-1999.

IT'S ALL ABOUT WINNING

FOR ON-LINE RETAIL SERVICES FEATURING GENERAL MERCHANDISE; OFFERING MAGAZINES ON A SUBSCRIPTION BASIS FOR OTHERS VIA A GLOBAL COMPUTER NETWORK; PROMOTING THE GOODS OF OTHERS THROUGH PROMOTIONAL CONTESTS ON A GLOBAL COMPUTER NETWORK (U.S. CLS. 100, 101 AND 102).

FIRST USE 1-0-2000; IN COMMERCE 1-0-2000.

2,858,224. PIAGGIO & C. S.P.A., PONTEDERA, PISA, ITALY. SN 75-879,473. PUB. 8-20-2002, FILED 12-22-1999.

VESPA BOUTIQUE

OWNER OF U.S. REG. NOS. 1,929,118, 2,156,150, AND OTHERS.

NO CLAIM IS MADE TO THE EXCLUSIVE RIGHT TO USE "BOUTIQUE", APART FROM THE MARK AS SHOWN. "VESPA" IS AN ITALIAN WORD MEANING "WASP" IN ENGLISH.

FOR RETAIL STORE SERVICES FEATURING SCOOTERS, PARTS AND ACCESSORIES THEREFORE, AND BRANDED OR LOGO MERCHANDISE AND APPAREL (U.S. CLS. 100, 101 AND 102).

FIRST USE 11-15-2000; IN COMMERCE 11-15-2000.

2,858,236. THE ALLIANCE GROUP INTERNATIONAL, ARLINGTON, VA. SN 75-955,940. PUB. 2-4-2003, FILED 3-10-2000.



The Alliance Group

NO CLAIM IS MADE TO THE EXCLUSIVE RIGHT TO USE "GROUP", APART FROM THE MARK AS SHOWN.

FOR BUSINESS MANAGEMENT CONSULTATION, NAMELY ORGANIZATIONAL CONSULTING SERVICES FOR THE FINANCIAL, OPERATIONAL AND ADMINISTRATIVE ACTIVITIES OF BUSINESS (U.S. CLS. 100, 101 AND 102).

FIRST USE 12-6-1999; IN COMMERCE 1-12-2000.

CLASS 35—(Continued).

2,858,255. QUAM (HK) LIMITED, KOWLOON TONG, KOWLOON, HONG KONG. SN 76-040,055. PUB. 8-19-2003, FILED 5-3-2000.

PRIORITY CLAIMED UNDER SEC. 44(D) ON HONG KONG APPLICATION NO. 06057, FILED 3-21-2000, REG. NO. 13952, DATED 3-21-2000, EXPIRES 3-21-2007.

FOR PREPARING AND DISSEMINATING ADVERTISEMENTS FOR THE MERCHANDISE OF OTHERS AND DEVELOPING PROMOTIONAL CAMPAIGNS FOR THE BUSINESSES OF OTHERS (U.S. CLS. 100, 101 AND 102).

FIRST USE 7-11-2003; IN COMMERCE 7-11-2003.

2,858,291. RADSTRAT.COM, LLC, HANOVER, NH. SN 76-163,115. PUB. 7-2-2002, FILED 11-10-2000.

VISIONARY VISUALS

NO CLAIM IS MADE TO THE EXCLUSIVE RIGHT TO USE "VISUALS", APART FROM THE MARK AS SHOWN.

FOR BUSINESS MARKETING CONSULTING SERVICES SPECIFICALLY RELATED TO THE CREATION OF CHARTS, GRAPHS AND OTHER VISUALS FOR USE IN BUSINESS PRESENTATIONS (U.S. CLS. 100, 101 AND 102).

FIRST USE 2-26-2004; IN COMMERCE 2-26-2004.

2,858,362. VETINSITE.COM, INC., SILVER SPRING, MD. SN 76-295,659. PUB. 8-6-2002, FILED 8-3-2001.

PET PORTAL

NO CLAIM IS MADE TO THE EXCLUSIVE RIGHT TO USE "PET", APART FROM THE MARK AS SHOWN.

FOR PROVIDING CUSTOMIZED INFORMATIONAL SERVICES VIA THE INTERNET IN THE FIELD OF VETERINARY MEDICINE, NAMELY, APPOINTMENT SCHEDULING, REVIEW OF CUSTOMER RECORDS, AND COMMUNICATION BETWEEN BUSINESS AND CUSTOMER (U.S. CLS. 100, 101 AND 102).

FIRST USE 4-4-2003; IN COMMERCE 4-4-2003.

CLASS 35—(Continued).

2,858,386. POWERPLAY RINKS, INC., EXTON, PA. SN 76-327,730. PUB. 9-24-2002, FILED 10-19-2001.

POWER PLAY RINKS

NO CLAIM IS MADE TO THE EXCLUSIVE RIGHT TO USE "RINKS", APART FROM THE MARK AS SHOWN.
FOR BUSINESS MANAGEMENT AND CONSULTATION FOR RECREATIONAL FACILITIES, NAMELY, SKATING RINKS (U.S. CLS. 100, 101 AND 102).
FIRST USE 7-19-2001; IN COMMERCE 7-19-2001.

2,858,443. MANNING, SELVAGE & LEE, INC., NEW YORK, NY. SN 76-379,642. PUB. 7-29-2003, FILED 3-7-2002.



FOR PUBLIC RELATIONS SERVICES; MARKET RESEARCH SERVICES; AND CONDUCTING PUBLIC ATTITUDE SURVEYS AND STUDIES (U.S. CLS. 100, 101 AND 102).
FIRST USE 6-1-2002; IN COMMERCE 6-1-2002.

2,858,450. LIGGETT VECTOR BRANDS, INC., RESEARCH TRIANGLE PARK, NC. SN 76-387,108. PUB. 11-11-2003, FILED 3-26-2002.

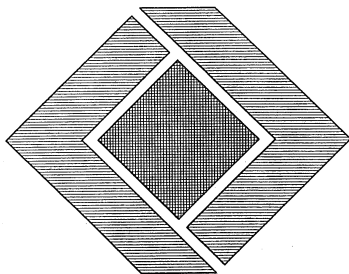

THE MARK CONSISTS OF A DIAMOND DESIGN SURROUNDED BY BRACKETS. THE DIAMOND DESIGN IS GOLD AND THE BRACKETS ARE BLUE. COLOR IS CLAIMED AS A FEATURE OF THE MARK.

FOR ADVERTISING SERVICES FOR OTHERS, NAMELY, MARKETING AND PROMOTING THE PURCHASE OF CIGARETTES FOR OTHERS; DISTRIBUTORSHIPS IN THE FIELD OF CIGARETTES (U.S. CLS. 100, 101 AND 102).
FIRST USE 5-1-2003; IN COMMERCE 5-1-2003.

CLASS 35—(Continued).

2,858,451. LIGGETT VECTOR BRANDS INC., RESEARCH TRIANGLE PARK, NC. SN 76-390,558. PUB. 4-22-2003, FILED 4-1-2002.

LIGGETT VECTOR BRANDS

NO CLAIM IS MADE TO THE EXCLUSIVE RIGHT TO USE "BRANDS", APART FROM THE MARK AS SHOWN.
FOR ADVERTISING SERVICES, NAMELY PROVIDING MARKETING AND PROMOTIONAL ACTIVITIES ASSOCIATED WITH THE COMMERCIALIZATION OF CIGARETTES (U.S. CLS. 100, 101 AND 102).
FIRST USE 7-31-2002; IN COMMERCE 7-31-2002.

2,858,474. HALLOWES, JAMES M., LOS ANGELES, CA. SN 76-409,436. PUB. 6-10-2003, FILED 5-17-2002.

HIGHLY SENSITIVE PEOPLE

FOR RETAIL GIFT STORE SERVICES AND ONLINE RETAIL GIFT STORE SERVICES AVAILABLE VIA A GLOBAL COMPUTER NETWORK (U.S. CLS. 100, 101 AND 102).
FIRST USE 5-27-2003; IN COMMERCE 5-27-2003.

2,858,492. INFO PARTNERS CORP., VENTNOR, NJ. SN 76-417,929. PUB. 6-3-2003, FILED 6-5-2002.

EZ*INFO

FOR PROVIDING ON-LINE DIRECTORY INFORMATION SERVICES (U.S. CLS. 100, 101 AND 102).
FIRST USE 9-9-2002; IN COMMERCE 9-9-2002.

CLASS 35—(Continued).

2,858,531. MOTOR AND EQUIPMENT MANUFACTURERS ASSOCIATION, RESEARCH TRIANGLE PARK, NC. SN 76-430,951. PUB. 4-1-2003, FILED 7-2-2002.



Automotive Aftermarket Suppliers Association

NO CLAIM IS MADE TO THE EXCLUSIVE RIGHT TO USE "AUTOMOTIVE AFTERMARKET SUPPLIERS ASSOCIATION", APART FROM THE MARK AS SHOWN.

FOR ASSOCIATION SERVICES, NAMELY, PROMOTING THE INTERESTS OF THE AUTOMOTIVE AFTERMARKET INDUSTRY (U.S. CLS. 100, 101 AND 102).
FIRST USE 11-5-2002; IN COMMERCE 11-5-2002.

CLASS 35—(Continued).

2,858,568. HEALTHPLAN HOLDINGS, INC., TAMPA, FL. SN 76-448,597. PUB. 7-1-2003, FILED 9-11-2002.

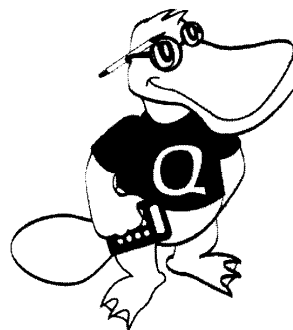

THE MARK CONSISTS OF THE DESIGN OF AN ANTHROPOMORPHIC PLATYPUS WEARING BOTH A SWEATER FEATURING THE LETTER "Q" AND EYEGLASSES AND HOLDING A PENCIL AND A CALCULATOR.

FOR INSURANCE AGENCY REFERRAL SERVICES, NAMELY ONLINE MATCHING OF INSURANCE AGENTS WITH POTENTIAL CUSTOMERS AND PRESENTING POTENTIAL CUSTOMERS WITH A VARIETY OF INSURANCE PLANS AND AGENTS VIA THE INTERNET (U.S. CLS. 100, 101 AND 102).
FIRST USE 1-14-2004; IN COMMERCE 1-14-2004.

2,858,536. MOTOR AND EQUIPMENT MANUFACTURERS ASSOCIATION, RESEARCH TRIANGLE PARK, NC. SN 76-432,445. PUB. 4-1-2003, FILED 7-17-2002.



Automotive Aftermarket Suppliers Association

NO CLAIM IS MADE TO THE EXCLUSIVE RIGHT TO USE "AUTOMOTIVE AFTERMARKET SUPPLIERS ASSOCIATION", APART FROM THE MARK AS SHOWN.

THE COLOR RED IS CLAIMED FOR THE BACKGROUND OF THE FANCIFUL LETTER "M".
FOR ASSOCIATION SERVICES, NAMELY, PROMOTING THE INTERESTS OF THE AUTOMOTIVE AFTERMARKET INDUSTRY (U.S. CLS. 100, 101 AND 102).
FIRST USE 11-5-2002; IN COMMERCE 11-5-2002.

2,858,569. MARKET MEASURES/COZINT L.P., EAST HANOVER, NJ. SN 76-450,114. PUB. 9-23-2003, FILED 9-16-2002.

SCRIPDRIVER

FOR CONDUCTING MARKET RESEARCH IN THE FIELD OF PHARMACEUTICALS; BUSINESS SERVICES, NAMELY, PROVIDING DATABASES REGARDING THE PURCHASE AND SALE OF PHARMACEUTICAL PRODUCTS OF OTHERS (U.S. CLS. 100, 101 AND 102).
FIRST USE 10-0-2002; IN COMMERCE 10-0-2002.

2,858,570. MARKET MEASURES/COZINT L.P., EAST HANOVER, NJ. SN 76-450,122. PUB. 9-2-2003, FILED 9-16-2002.

RX DECISION FUNNEL

NO CLAIM IS MADE TO THE EXCLUSIVE RIGHT TO USE "RX", APART FROM THE MARK AS SHOWN.

FOR CONDUCTING MARKET RESEARCH IN THE FIELD OF PHARMACEUTICAL; BUSINESS SERVICES, NAMELY, PROVIDING DATABASES REGARDING THE PURCHASE AND SALE OF PHARMACEUTICAL PRODUCTS OF OTHERS (U.S. CLS. 100, 101 AND 102).
FIRST USE 5-2-2003; IN COMMERCE 5-2-2003.

CLASS 35—(Continued).

2,858,571. AUBREY DANIELS INTERNATIONAL, INC., ATLANTA, GA. SN 76-450,165. PUB. 9-9-2003, FILED 9-16-2002.

PIC/NIC ANALYSIS

NO CLAIM IS MADE TO THE EXCLUSIVE RIGHT TO USE "ANALYSIS", APART FROM THE MARK AS SHOWN. FOR CONSULTING SERVICES IN THE FIELD OF BEHAVIOR-BASED ORGANIZATIONAL PERFORMANCE STRATEGIES, NAMELY, USING BEHAVIOR ANALYSIS TO SOLVE VARIOUS PROBLEMS FACED BY ORGANIZATIONS (U.S. CLS. 100, 101 AND 102).
FIRST USE 9-0-1981; IN COMMERCE 9-0-1981.

2,858,580. R & R OPERATING PARTNERSHIP, L.P., DBA CHERRYDALE FARMS, ALLENTOWN, PA. SN 76-455,912. PUB. 6-10-2003, FILED 10-4-2002.

C & D DISTRIBUTING

NO CLAIM IS MADE TO THE EXCLUSIVE RIGHT TO USE "DISTRIBUTING", APART FROM THE MARK AS SHOWN. FOR DISTRIBUTORSHIP SERVICES IN THE FIELD OF CANDIES AND CONFECTIONARY (U.S. CLS. 100, 101 AND 102).
FIRST USE 1-0-2003; IN COMMERCE 1-0-2003.

2,858,609. OCEAN GROUP, INC., DBA OCEAN FRESH FISH & SEAFOOD MARKETING CO., INC., LOS ANGELES, CA. SN 76-469,211. PUB. 12-2-2003, FILED 11-21-2002.



TWO FISH IN THE WATER JUMPING UP IN THE AIR. FOR WHOLESALE STORES FEATURING SEAFOOD (U.S. CLS. 100, 101 AND 102).
FIRST USE 8-22-2003; IN COMMERCE 8-22-2003.

CLASS 35—(Continued).

2,858,617. ALAMO GROUP INC., SEGUIN, TX. SN 76-472,217. PUB. 7-22-2003, FILED 12-5-2002.

MEMBER OF THE ALAMO GROUP ALWAYS ON THE CUTTING EDGE

FOR DISTRIBUTORSHIP SERVICES IN THE FIELD OF MACHINERY; NAMELY, HITCH-MOUNTED, TRACTOR-MOUNTED, AND BOOM-MOUNTED FLAIL, ROTARY, AND SICKLEBAR MOVERS (U.S. CLS. 100, 101 AND 102).
FIRST USE 1-1-2003; IN COMMERCE 1-1-2003.

2,858,639. WESTERVELT, DEBORAH R.G., NORTH HAVEN, CT. SN 76-479,673. PUB. 9-23-2003, FILED 1-2-2003.

OCTOPUS' ISLAND

FOR RETAIL AND ON-LINE GIFT SHOP SERVICES FEATURING HANDCRAFTS, GIFTS, TOYS, ORNAMENTS, SOUVENIRS, JEWELRY, NAUTICAL AND HOME DECOR, SHELLS, ROCKS AND MINERALS, AND FASHION BEACHWEAR (U.S. CLS. 100, 101 AND 102).
FIRST USE 3-31-2003; IN COMMERCE 3-31-2003.

2,858,663. ILOVENAPA, LLC, ST. HELENA, CA. SN 76-495,580. PUB. 11-18-2003, FILED 2-20-2003.

ILOVENAPA

FOR ON-LINE ORDERING SERVICES FEATURING PRODUCTS OF AND SERVICES AVAILABLE IN NAPA COUNTY, CALIFORNIA (U.S. CLS. 100, 101 AND 102).
FIRST USE 3-1-2003; IN COMMERCE 3-1-2003.

2,858,699. SKYMARK INCORPORATED, SILVER SPRINGS, FL. SN 78-003,106. PUB. 1-30-2001, FILED 4-7-2000.

COUPONBASKET.COM

FOR PROMOTING THE GOODS AND SERVICES OF OTHERS ON-LINE THROUGH THE DISTRIBUTION OF COUPONS (U.S. CLS. 100, 101 AND 102).
FIRST USE 3-26-1999; IN COMMERCE 4-10-2003.

CLASS 35—(Continued).

2,858,706. CORPORATE APPAREL UNLIMITED, GWINN, MI. SN 78-025,774. PUB. 12-11-2001, FILED 9-13-2000.

NO CLAIM IS MADE TO THE EXCLUSIVE RIGHT TO USE "CORPORATE APPAREL", APART FROM THE MARK AS SHOWN.

FOR COMPUTERIZED ONLINE WHOLESALE SERVICES IN THE FIELD OF CASUAL APPAREL, NAMELY SPORT SHIRTS, POLO SHIRTS, DENIM SHIRTS, T-SHIRTS, SWEATSHIRTS, JACKETS, FLEECE OUTERWEAR, CAPS, HATS SWEATERS AND WINDSHIRTS (U.S. CLS. 100, 101 AND 102).

FIRST USE 10-25-2000; IN COMMERCE 10-25-2000.

2,858,712. SMITHKLINE BEECHAM CORPORATION, PHILADELPHIA, PA. SN 78-039,986. PUB. 10-16-2001, FILED 12-20-2000.

WORKSET

FOR BUSINESS INFORMATION SERVICES, NAMELY, PROVIDING HEALTH INFORMATION TO HEALTHCARE ORGANIZATIONS AND EMPLOYERS PERTAINING TO COST AND PRODUCTIVITY IMPACT OF DISEASES AND LIFESTYLE THREATS (U.S. CLS. 100, 101 AND 102).

FIRST USE 1-31-2002; IN COMMERCE 1-31-2002.

2,858,715. CAMPBELL MITHUN ESTY LLC, MINNEAPOLIS, MN. SN 78-045,124. PUB. 4-22-2003, FILED 1-26-2001.

BR&ND INNOVATORS

FOR NEW PRODUCT IDEA DEVELOPMENT, NAMELY, PRODUCT DEVELOPMENT AND PRODUCT DEVELOPMENT CONSULTATION FOR OTHERS (U.S. CLS. 100, 101 AND 102).

FIRST USE 7-31-2003; IN COMMERCE 7-31-2003.

CLASS 35—(Continued).

2,858,732. VENNERS RETAIL SYSTEMS (HOLDINGS) LIMITED, BUCKINGHAMSHIRE, MK9 1DS, UNITED KINGDOM. SN 78-065,585. PUB. 7-16-2002, FILED 5-24-2001.

VCSTIMELESS

FOR BUSINESS MANAGEMENT; ADMINISTRATION OF BUSINESS PAYROLL FOR OTHERS; OFFICE FUNCTIONS, NAMELY SECRETARIAL AND CLERICAL SERVICES; COMPUTERIZED DATABASE MANAGEMENT; COMPUTERIZED FILE MANAGEMENT; CONDUCTING MARKETING STUDIES AND RESEARCH; PERSONNEL MANAGEMENT CONSULTANCY; PROVIDING STATISTICAL INFORMATION; INFORMATION AND ADVISORY SERVICES FOR ALL OF THE FOREGOING (U.S. CLS. 100, 101 AND 102).

FIRST USE 11-0-2000; IN COMMERCE 3-0-2002.

2,858,733. RAINMAKING OASIS, INC., MADISON, CT. SN 78-066,152. PUB. 12-18-2001, FILED 5-29-2001.

RAINMINDER

FOR BUSINESS MARKETING CONSULTING SERVICES FOR PROFESSIONALS; BUSINESS MARKETING CONSULTING SERVICES OFFERED ON-LINE VIA A GLOBAL COMPUTER NETWORK; PROVIDING INFORMATION CONCERNING BUSINESS MARKETING VIA A GLOBAL COMPUTER NETWORK (U.S. CLS. 100, 101 AND 102).

FIRST USE 1-1-2004; IN COMMERCE 2-26-2004.

2,858,744. HOWES ENTERPRISE INTERNATIONAL, INC., LOMPOC, CA. SN 78-087,020. PUB. 9-24-2002, FILED 10-4-2001.

HOT ROD CENTRAL

NO CLAIM IS MADE TO THE EXCLUSIVE RIGHT TO USE "HOT ROD", APART FROM THE MARK AS SHOWN.

FOR ON LINE RETAIL SERVICES FEATURING AUTOMOBILES, AUTOMOBILE PARTS AND ACCESSORIES VIA THE INTERNET AND ON-LINE TRADING SERVICES IN WHICH SELLER POSTS PRODUCTS TO BE AUCTIONED AND BIDDING IS DONE VIA THE INTERNET (U.S. CLS. 100, 101 AND 102).

FIRST USE 7-17-2002; IN COMMERCE 4-15-2003.

2,858,766. FOOTSTAR CORPORATION, WEST NYACK, NY. SN 78-107,268. PUB. 10-1-2002, FILED 2-6-2002.

THE STREET STARTS HERE

FOR RETAIL STORE SERVICES FEATURING FOOTWEAR, CLOTHING AND RELATED ACCESSORIES (U.S. CLS. 100, 101 AND 102).

FIRST USE 3-1-2002; IN COMMERCE 3-1-2002.

CLASS 35—(Continued).

2,858,780. MONTALIER INTERNATIONAL LTD., TORONTO ONTARIO, CANADA. SN 78-117,464. PUB. 1-14-2003, FILED 3-26-2002.

PHARLEX

FOR BUSINESS MANAGEMENT AND CONSULTATION IN THE FIELDS OF BUSINESS DEVELOPMENT FOR THE PHARMACEUTICAL, BIOTECHNOLOGY, DIAGNOSTICS, MEDICAL DEVICES, LIFE SCIENCES AND HEALTH CARE INDUSTRIES; ORGANIZING BUSINESS MEETINGS FOR THE PROMOTION OF BUSINESS DEVELOPMENT AND LICENSING OPPORTUNITIES FOR THE PHARMACEUTICAL, BIOTECHNOLOGY, DIAGNOSTIC, MEDICAL DEVICES, LIFE SCIENCES AND HEALTH CARE INDUSTRIES (U.S. CLS. 100, 101 AND 102).

FIRST USE 3-18-2004; IN COMMERCE 3-18-2004.

2,858,785. UNITY FOUNDATION, THE, UNITY, ME. SN 78-121,321. PUB. 3-4-2003, FILED 4-12-2002.

CQ

FOR MANAGEMENT SURVEY SERVICES, NAMELY, CONSULTATION IN THE FIELD OF BUSINESS MANAGEMENT AND BUSINESS ORGANIZATION FOR NON-PROFIT COMPANIES THROUGH THE PROVISION, REVIEW, AND ANALYSIS OF MANAGEMENT SURVEYS (U.S. CLS. 100, 101 AND 102).

FIRST USE 7-9-2003; IN COMMERCE 7-9-2003.

2,858,802. PSI ENERGY, INC., PLAINFIELD, IN. SN 78-132,982. PUB. 1-14-2003, FILED 6-4-2002.

SAVER MAN

FOR ENERGY USAGE MANAGEMENT; PROMOTING PUBLIC AWARENESS OF THE NEED FOR REDUCING ENERGY CONSUMPTION AND WASTE (U.S. CLS. 100, 101 AND 102).

FIRST USE 3-1-2001; IN COMMERCE 3-1-2001.

2,858,852. EASTBAY, INC., WAUSAU, WI. SN 78-162,584. PUB. 5-6-2003, FILED 9-10-2002.

**YOUR MILLION - S Q U A
R E - F O O T C Y B E R
W A R E H O U S E**

FOR RETAIL AND MAIL ORDER SERVICES RELATING TO ATHLETIC FOOTWEAR AND APPAREL (U.S. CLS. 100, 101 AND 102).

FIRST USE 4-0-2002; IN COMMERCE 4-0-2002.

CLASS 35—(Continued).

2,858,863. ROYAL ORTHODONTIC LABORATORIES INC., INDEPENDENCE, MO. SN 78-166,620. PUB. 8-12-2003, FILED 9-21-2002.

**ROYAL ORTHODONTIC
LABORATORIES INC.**

NO CLAIM IS MADE TO THE EXCLUSIVE RIGHT TO USE "ORTHODONTIC LABORATORIES, INC.", APART FROM THE MARK AS SHOWN.

FOR MAIL ORDER SERVICES FEATURING ORTHODONTIC AND PERIODONTIC SUPPLIES AND EQUIPMENT (U.S. CLS. 100, 101 AND 102).

FIRST USE 1-0-2004; IN COMMERCE 1-0-2004.

2,858,878. PATLAK, DAN, WHEELING, IL. SN 78-170,895. PUB. 7-22-2003, FILED 10-3-2002.

LANDSLIDE GROUP

NO CLAIM IS MADE TO THE EXCLUSIVE RIGHT TO USE "GROUP", APART FROM THE MARK AS SHOWN.

FOR CONSULTATION IN THE FIELD OF PUBLIC RELATIONS AND GOVERNMENT RELATIONS; DEVELOPING PROMOTIONAL CAMPAIGNS FOR POLITICAL CANDIDATES (U.S. CLS. 100, 101 AND 102).

FIRST USE 1-1-2001; IN COMMERCE 1-1-2001.

2,858,887. DISCOUNT NUTRITION CENTER, INC., HOUSTON, TX. SN 78-173,814. PUB. 7-15-2003, FILED 10-11-2002.

**SIGNATURE NUTRITION W
W . S I G N A T U R E N U T
R I T I O N . C O M**

NO CLAIM IS MADE TO THE EXCLUSIVE RIGHT TO USE "NUTRITION", APART FROM THE MARK AS SHOWN.

FOR RETAIL STORES AND ON-LINE RETAIL SERVICES IN THE FIELD OF NUTRITIONAL SUPPLEMENTS (U.S. CLS. 100, 101 AND 102).

FIRST USE 6-26-2003; IN COMMERCE 6-26-2003.

2,858,904. GRUEN & SELLS, LTD., CHICAGO, IL. SN 78-181,492. PUB. 12-30-2003, FILED 11-4-2002.

HOMEPOINTS

FOR PROMOTING THE SALE OF CREDIT CARD ACCOUNTS THROUGH THE ADMINISTRATION OF INCENTIVE AWARD PROGRAMS; PROMOTING THE SALE OF GOODS AND SERVICES OF OTHERS BY GRANTING POINTS FOR CREDIT CARD USE; ISSUING GIFT CERTIFICATES THAT MAY BE REDEEMED FOR GOODS AND SERVICES; ISSUING STORED VALUE CARDS (U.S. CLS. 100, 101 AND 102).

FIRST USE 1-31-2003; IN COMMERCE 1-31-2003.

CLASS 35—(Continued).

2,858,910. TICKETLEAP.COM LLC, PHILADELPHIA, PA. SN 78-183,321. PUB. 7-15-2003, FILED 11-8-2002.



FOR TICKET AGENCY SERVICES, NAMELY, ADVERTISING AND MARKETING TICKETS FOR MUSIC, SPORTS, ART-RELATED, BUSINESS, ACADEMIC-RELATED, TOURISM-RELATED AND OTHER ENTERTAINMENT EVENTS (U.S. CLS. 100, 101 AND 102).
FIRST USE 9-15-2003; IN COMMERCE 9-15-2003.

CLASS 35—(Continued).

2,858,941. STRUCTURETEK LLC, STEAMBOAT SPRINGS, CO. SN 78-192,655. PUB. 11-4-2003, FILED 12-9-2002.



NO CLAIM IS MADE TO THE EXCLUSIVE RIGHT TO USE "PROPERTY DOCUMENT MANAGEMENT", APART FROM THE MARK AS SHOWN.

FOR PROPERTY DOCUMENT MANAGEMENT SERVICES FOR THE CONSTRUCTION INDUSTRY, NAMELY, DOCUMENT SCANNING, STORAGE, INDEXING, RETRIEVAL, IMAGING, REPRODUCTION, TRACKING AND MANAGEMENT SERVICES (U.S. CLS. 100, 101 AND 102).
FIRST USE 3-12-2002; IN COMMERCE 3-12-2002.

2,858,916. THINK FAST, LLC, GLENS FALLS, NY. SN 78-185,866. PUB. 7-1-2003, FILED 11-16-2002.

HITPREDICTOR

FOR MARKET RESEARCH SERVICES IN THE FIELD OF MUSIC (U.S. CLS. 100, 101 AND 102).
FIRST USE 8-0-2002; IN COMMERCE 8-0-2002.

2,858,961. HILDRETH ENTERPRISES LLC, VERMILLION, SD. SN 78-199,963. PUB. 10-14-2003, FILED 1-3-2003.

NOTHING BUT (MAC) PRICES

FOR GOODS OR SERVICES PRICE QUOTATIONS AND PROVIDING INFORMATION REGARDING AVAILABILITY FOR COMPUTERS AND OTHER ELECTRONICS FROM COMPUTER RESELLERS AND COMPUTER/ELECTRONIC DEALERS (U.S. CLS. 100, 101 AND 102).
FIRST USE 11-18-2003; IN COMMERCE 11-18-2003.

2,858,919. THINK FAST, LLC, GLENS FALLS, NY. SN 78-185,870. PUB. 7-1-2003, FILED 11-16-2002.

PROMOSQUAD HITPREDICTOR

FOR MARKET RESEARCH SERVICES IN THE FIELD OF MUSIC (U.S. CLS. 100, 101 AND 102).
FIRST USE 8-0-2002; IN COMMERCE 8-0-2002.

2,858,969. BIGBADTOYSTORE, INC., SOMERSET, WI. SN 78-203,889. PUB. 9-2-2003, FILED 1-16-2003.

BBTS

FOR ON-LINE RETAIL STORE SERVICES FEATURING TOYS (U.S. CLS. 100, 101 AND 102).
FIRST USE 6-1-2003; IN COMMERCE 6-1-2003.

2,858,971. SEARS BRANDS, LLC, HOFFMAN ESTATES, IL. SN 78-205,115. PUB. 9-30-2003, FILED 1-20-2003.

SEARS GRAND

OWNER OF U.S. REG. NOS. 1,529,006, 2,321,954, AND 2,377,059.
FOR RETAIL DEPARTMENT STORE SERVICES (U.S. CLS. 100, 101 AND 102).
FIRST USE 9-0-2003; IN COMMERCE 9-0-2003.

CLASS 35—(Continued).

2,858,979. TOPSAIL GROUP, L.L.C., WESTON, CT. SN 78-208,373. PUB. 9-16-2003, FILED 1-29-2003.

TOPSAIL

FOR BUSINESS MARKETING CONSULTING SERVICES (U.S. CLS. 100, 101 AND 102).
FIRST USE 1-15-2003; IN COMMERCE 11-20-2003.

CLASS 36—INSURANCE AND FINANCIAL

2,858,188. KBC BANKVERZEKERINGSHOLDING N.V., 1080, BRUSSELS, BELGIUM. SN 75-591,011. PUB. 1-21-2003, FILED 11-23-1998.

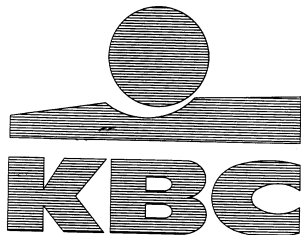

PRIORITY CLAIMED UNDER SEC. 44(D) ON BENELUX APPLICATION NO. 916770, FILED 5-28-1998, REG. NO. 632501, DATED 5-25-1998, EXPIRES 5-28-2008.

THE DRAWING IS LINED FOR THE COLOR BLUE.

FOR BANK AND INSURANCE SERVICES, NAMELY, FINANCIAL, MONETARY AND BANKING MATTERS, TRANSACTIONS AND OPERATIONS, SUCH AS TRANSACTIONS AND OPERATIONS IN CONNECTION WITH DEPOSITS, DEMAND ACCOUNTS, TIME DEPOSIT ACCOUNTS, SAVING ACCOUNTS, CURRENT ACCOUNTS, FOREIGN EXCHANGE, BILLS OF EXCHANGE AND PROMISSORY NOTES, CHECKS, SECURITIES AND COUPONS, LINES OF CREDIT, ADVANCES AND CREDIT TRANSACTIONS INCLUDING DOCUMENTARY AND ACCEPTANCE CREDITS, FINANCING, LOANS, GUARANTEES, DEAL CAREERED AND SURETYSHIP TRANSACTIONS, DISCOUNT AND REDISCOUNT TRANSACTIONS; ISSUE OF BONDS AND SAVINGS CERTIFICATES; TRADING IN PRECIOUS METALS, COINS AND MEDALS; ADVICE AND INTER MEDIATION WITH REGARD TO BANKING MATTERS AND FINANCIAL TRANSACTIONS, FINANCIAL ADVICE AND INTER MEDIATION; ISSUE, TRADING AND CUSTODY OF NEGOTIABLE AND OTHER SECURITIES; INVESTMENT MANAGEMENT AND ADVICE, INVESTMENT AND TRUST TRANSACTIONS; PROVISION OF FINANCIAL SERVICES FOR THE BENEFIT OF CUSTOMERS; INVESTMENT IN SHARES, BONDS, SAVINGS CERTIFICATES AND OTHER SECURITIES, RENDERING ON-LINE BANKING, INVESTMENT AND FINANCIAL SERVICES, UN CODED AND CODED INFORMATION VIA COMPUTER REGARDING FINAN-

CLASS 36—(Continued).

CIAL TRANSACTIONS; FINANCIAL APPRAISAL SERVICES, PROVISION OF INFORMATION DATABASES RELATING TO FINANCIAL DATA, RESEARCH AND REPORTS IN THAT REGARD, RENDERING FINANCIAL CONSULTATION SERVICES, INSURANCE BROKERAGE SERVICES; INSURANCE SERVICES, SUCH AS THE CONCLUSION OF LIFE ASSURANCE, PROPERTY INSURANCE, MOTOR VEHICLE INSURANCE, FIRE INSURANCE, THEFT INSURANCE, LEGAL AID INSURANCE, PROFESSIONAL INSURANCE, MARINE AND AVIATION INSURANCE, TRANSPORT INSURANCE, SICKNESS INSURANCE, GUARANTEED INCOME INSURANCE, INSURANCE AGAINST NATURAL DISASTERS, KEY MAN INSURANCE, FAMILY LIABILITY INSURANCE, TRAVEL INSURANCE, INSURANCE AGAINST POLITICAL RISKS, EXPORT RISK INSURANCE, CREDIT RISK AND EXCHANGE RISK INSURANCE (HEDGING), REINSURANCE, LOAN BALANCE INSURANCE, GROUP ASSURANCE, ACCIDENT INSURANCE, COMPANY INSURANCE POLICIES (U.S. CLS. 100, 101 AND 102).

FIRST USE 0-0-1998; IN COMMERCE 0-0-1998.

2,858,230. FRANK RUSSELL COMPANY, TACOMA, WA. SN 75-919,367. PUB. 10-3-2000, FILED 2-15-2000.

**RUSSELL SMALL CAP
COMPLETENESS INDEX**

OWNER OF U.S. REG. NOS. 1,885,501, 1,945,514, AND OTHERS.

NO CLAIM IS MADE TO THE EXCLUSIVE RIGHT TO USE "SMALL CAP" AND "INDEX", APART FROM THE MARK AS SHOWN.

FOR PROVIDING AND UPDATING AN INDEX OF SECURITIES VALUES FOR OTHERS AND PROVIDING RULES AS TO THE MAKE UP OF THE INDEX; AND FINANCIAL SERVICES IN THE NATURE OF AN INVESTMENT SECURITY (U.S. CLS. 100, 101 AND 102).

FIRST USE 5-1-2000; IN COMMERCE 5-1-2000.

2,858,241. LEAN INVESTMENTS, LLC, MUSCATINE, IA. SN 76-000,466. PUB. 6-26-2001, FILED 3-15-2000.

LEAN INVESTMENTS

NO CLAIM IS MADE TO THE EXCLUSIVE RIGHT TO USE "INVESTMENTS", APART FROM THE MARK AS SHOWN.

FOR INVESTMENT FUND MANAGEMENT SERVICES (U.S. CLS. 100, 101 AND 102).

FIRST USE 2-1-2000; IN COMMERCE 4-1-2000.

2,858,270. BISON CAPITAL, L.L.C., VENICE, FL. SN 76-101,776. PUB. 11-19-2002, FILED 8-2-2000.

BISON CAPITAL

NO CLAIM IS MADE TO THE EXCLUSIVE RIGHT TO USE "CAPITAL", APART FROM THE MARK AS SHOWN.

FOR INVESTMENT IN THE FIELD OF VENTURE CAPITAL (U.S. CLS. 100, 101 AND 102).

FIRST USE 10-7-2003; IN COMMERCE 10-7-2003.

CLASS 36—(Continued).

2,858,276. AMERICAN TRUCKSOURCE, INC., IRVING, TX. SN 76-132,891. PUB. 12-17-2002, FILED 9-21-2000.

AMERICAN PARTSSOURCE

OWNER OF U.S. REG. NOS. 2,375,928, 2,375,931, AND OTHERS.

NO CLAIM IS MADE TO THE EXCLUSIVE RIGHT TO USE "AMERICAN", APART FROM THE MARK AS SHOWN. FOR FINANCIAL SERVICES, NAMELY, FINANCING FOR OTHERS IN CONNECTION WITH THE ACQUISITION OF NEW AND USED MOTOR VEHICLES; AND INSURANCE SERVICES, NAMELY, UNDERWRITING EXTENDED WARRANTY CONTRACTS IN THE FIELD OF NEW AND USED MOTOR VEHICLES (U.S. CLS. 100, 101 AND 102).

FIRST USE 9-27-2002; IN COMMERCE 9-27-2002.

2,858,322. GLOBAL CASH ACCESS, LLC, SUNNYVALE, CA. SN 76-229,366. PUB. 6-17-2003, FILED 3-22-2001.

QUIKCREDIT

FOR FINANCIAL SERVICES, NAMELY, PROVIDING CREDIT AND CASH ADVANCES (U.S. CLS. 100, 101 AND 102).

FIRST USE 9-10-2001; IN COMMERCE 9-10-2001.

2,858,325. SWAN INC., ENGLEWOOD, CO. SN 76-236,039. PUB. 12-18-2001, FILED 3-28-2001.

SHIELD - A SWAN SOLUTION

FOR INSURANCE PROCUREMENT AND ADMINISTRATION SERVICES PROVIDED FOR HOTELS (U.S. CLS. 100, 101 AND 102).

FIRST USE 6-30-2001; IN COMMERCE 6-30-2001.

2,858,340. UBS FINANCIAL SERVICES INC., WEEHAWKEN, NJ. SN 76-262,992. PUB. 1-8-2002, FILED 5-25-2001.

ASAP

THE MARK CONSISTS OF STANDARD CHARACTERS WITHOUT CLAIM TO ANY PARTICULAR FONT, STYLE, SIZE, OR COLOR.

FOR FINANCIAL SERVICES, NAMELY, THE BROKERAGE OF SECURITIES (U.S. CLS. 100, 101 AND 102).

FIRST USE 3-14-2001; IN COMMERCE 3-14-2001.

CLASS 36—(Continued).

2,858,368. AMERICAN CAPITAL ACCESS HOLDINGS (ARIZONA), INCORPORATED, NEW YORK, NY. SN 76-305,000. PUB. 6-25-2002, FILED 8-27-2001.



FOR UNDERWRITING, REINSURANCE, GUARANTY INSURANCE, SURETY INSURANCE, AND INSURANCE FOR TRANSACTIONS FOR NEW ISSUE AND SECONDARY MARKET ISSUERS OF MUNICIPAL, INTERNATIONAL, AND SPECIALTY BONDS, COLLATERALIZED BOND OBLIGATIONS, COLLATERALIZED DEBT OBLIGATIONS, CORPORATE AND CONSUMER DEBT, INTEREST RATE SWAPS, CURRENCY SWAPS, CREDIT DEFAULT SWAPS AND OTHER FINANCIAL DERIVATIVES; INVESTMENT AND SECURITIES BROKERAGE SERVICES; FINANCIAL MANAGEMENT SERVICES, NAMELY, PORTFOLIO INVESTMENT MANAGEMENT AND CREDIT RISK MANAGEMENT; INSTITUTIONAL STRUCTURED FINANCE TRANSACTION ADVISORY SERVICES, NAMELY, THE CREATION AND ISSUANCE OF COLLATERALIZED BOND OBLIGATIONS, COLLATERALIZED DEBT OBLIGATIONS, INTEREST RATE SWAPS, CURRENCY SWAPS, CREDIT DEFAULT SWAPS AND OTHER FINANCIAL DERIVATIVES (U.S. CLS. 100, 101 AND 102).

FIRST USE 10-29-2002; IN COMMERCE 10-29-2002.

2,858,394. FIRST AMERICAN REAL ESTATE SOLUTIONS, L.P., ANAHEIM, CA. SN 76-341,044. PUB. 6-4-2002, FILED 11-21-2001.

REISOURCE

FOR REAL PROPERTY INFORMATION SERVICES, NAMELY, OWNERSHIP AND PROPERTY INFORMATION DATA ON COMPARABLES, MAPS, VALUATION AND PRICING DATA, MORTGAGE MARKETING, LOAN RECORDING INFORMATION AND LENDER MARKET SHARE INFORMATION; PROVIDING AN ON-LINE ELECTRONIC DATABASE ON GLOBAL COMPUTER NETWORKS IN THE FIELD OF REAL PROPERTY INFORMATION, NAMELY, OWNERSHIP AND PROPERTY INFORMATION AND DATA ON COMPARABLES, MAPS, VALUATION AND PRICING DATA, MORTGAGE MARKETING, LOAN RECORDING INFORMATION AND LENDER MARKET SHARE INFORMATION (U.S. CLS. 100, 101 AND 102).

FIRST USE 6-1-2003; IN COMMERCE 6-1-2003.

CLASS 36—(Continued).

2,858,395. HIGHBRIDGE CAPITAL MANAGEMENT, LLC, NEW YORK, NY. SN 76-341,594. PUB. 7-29-2003, FILED 11-26-2001.

**HIGHBRIDGE CAPITAL
MANAGEMENT, LLC**

OWNER OF U.S. REG. NOS. 2,417,249, 2,454,647, AND OTHERS.

NO CLAIM IS MADE TO THE EXCLUSIVE RIGHT TO USE "CAPITAL MANAGEMENT, LLC", APART FROM THE MARK AS SHOWN.

FOR FINANCIAL SERVICES, NAMELY, INVESTMENT ADVISORY SERVICES, INVESTMENT MANAGEMENT SERVICES AND ASSET MANAGEMENT SERVICES (U.S. CLS. 100, 101 AND 102).

FIRST USE 1-0-2003; IN COMMERCE 1-0-2003.

2,858,396. HIGHBRIDGE CAPITAL MANAGEMENT, LLC, NEW YORK, NY. SN 76-342,403. PUB. 6-24-2003, FILED 11-28-2001.



OWNER OF U.S. REG. NOS. 2,417,249, 2,417,250, AND 2,454,647.

NO CLAIM IS MADE TO THE EXCLUSIVE RIGHT TO USE "CAPITAL MANAGEMENT, LLC", APART FROM THE MARK AS SHOWN.

THE STRIPING IS A FEATURE OF THE MARK AND IS DISPLAYED IN THE COLOR GREEN. THE SOLID BLOCK IN THE MARK IS A FEATURE OF THE MARK AND IS DISPLAYED IN THE COLOR BLUE.

FOR FINANCIAL SERVICES, NAMELY, INVESTMENT ADVISORY SERVICES, INVESTMENT MANAGEMENT SERVICES AND ASSET MANAGEMENT SERVICES (U.S. CLS. 100, 101 AND 102).

FIRST USE 1-0-2003; IN COMMERCE 1-0-2003.

CLASS 36—(Continued).

2,858,445. ROYAL BANK OF CANADA, NEW YORK, NY. SN 76-382,151. PUB. 11-5-2002, FILED 3-12-2002.



NO CLAIM IS MADE TO THE EXCLUSIVE RIGHT TO USE "ALTERNATIVE ASSETS GROUP", APART FROM THE MARK AS SHOWN.

THE STIPPLING IS A FEATURE OF THE MARK.

THE MARK CONSISTS OF TRIANGLE WITH TWO LETTERS "A" AND WORDS.

FOR FINANCIAL SERVICES, NAMELY ALTERNATIVE INVESTMENT SERVICES AND INVESTMENT RELATED SERVICES IN THE FIELD OF PRIVATE CAPITAL VEHICLES (U.S. CLS. 100, 101 AND 102).

FIRST USE 3-8-2000; IN COMMERCE 3-8-2000.

2,858,461. JOHNSON FINANCIAL GROUP, INC., RACINE, WI. SN 76-401,838. PUB. 11-25-2003, FILED 4-30-2002.

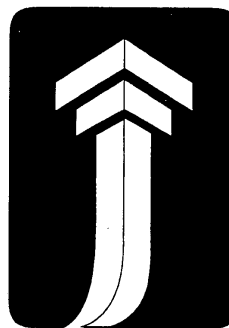

THE MARK CONSISTS, IN PART, OF A "J" DESIGN.

FOR FINANCIAL SERVICES, NAMELY, FINANCIAL ANALYSIS SERVICES, FINANCIAL ADVISORY SERVICES, FINANCIAL MANAGEMENT SERVICES, FINANCIAL RESEARCH SERVICES, AND FINANCIAL PORTFOLIO MANAGEMENT SERVICES; INVESTMENT SERVICES, NAMELY, INVESTMENT CONSULTATION SERVICES, INVESTMENT ADVISORY SERVICES, AND INVESTMENT MANAGEMENT SERVICES; FUNDS INVESTMENT SERVICES; INVESTING THE FUNDS OF OTHERS; MUTUAL FUND INVESTMENT SERVICES; ESTABLISHING MUTUAL FUNDS AND MODEL FINANCIAL PORTFOLIOS FOR OTHERS; EVALUATING ASSET ALLOCATION, RISK TOLERANCE, FINANCIAL ALTERNATIVE PLANS AND INVESTMENT TIME FRAMES; PROVIDING INFORMATION AND ANALYSIS IN THE FIELDS OF FINANCE, ECONOMICS, INVESTMENT, FINANCIAL PLANNING, AND INVESTMENT STRATEGY; PROVIDING FINANCIAL INFORMATION IN THE NATURE OF RATES OF EXCHANGE (U.S. CLS. 100, 101 AND 102).

FIRST USE 4-1-1998; IN COMMERCE 4-1-1998.

CLASS 36—(Continued).

2,858,491. SCATTERDAY, RICK, PLACENTIA, CA. AND HARVEY, ANDREW, PLACENTIA, CA. SN 76-417,477. PUB. 5-20-2003, FILED 6-3-2002.

CIO

FOR BOND AGENCY SERVICES; FINANCIAL SERVICES IN THE NATURE OF AN INVESTMENT SECURITY, NAMELY, BONDS BACKED BY INSURANCE POLICIES (U.S. CLS. 100, 101 AND 102).
FIRST USE 2-6-2004; IN COMMERCE 2-6-2004.

2,858,504. LOANSTAR FUNDING GROUP, INC., BRYAN, TX. SN 76-423,704. PUB. 1-7-2003, FILED 6-20-2002.

EDGEUCATIONAL LOANS

NO CLAIM IS MADE TO THE EXCLUSIVE RIGHT TO USE "LOANS", APART FROM THE MARK AS SHOWN.
FOR LOAN FINANCING, NAMELY, PROVIDING NON-FEDERALLY GUARANTEED STUDENT LOANS (U.S. CLS. 100, 101 AND 102).
FIRST USE 3-31-2004; IN COMMERCE 3-31-2004.

2,858,528. JOHN ELLISON ADVISORY GROUP, LTD., ELM GROVE, WI. SN 76-430,642. PUB. 10-21-2003, FILED 7-15-2002.



OWNER OF U.S. REG. NO. 1,986,426.
NO CLAIM IS MADE TO THE EXCLUSIVE RIGHT TO USE "INSURANCE", "FINANCIAL & ESTATE PLANNING", "INVESTMENTS", "EMPLOYEE BENEFITS" AND "ADVISORY GROUP, LTD.", APART FROM THE MARK AS SHOWN.
THE LINING SHOWN IN THE DRAWING IS A FEATURE OF THE MARK.
FOR CONSULTATION IN THE FIELD OF FINANCIAL AND ESTATE PLANNING, EMPLOYEE BENEFITS, INSURANCE AND INVESTMENTS (U.S. CLS. 100, 101 AND 102).
FIRST USE 4-30-2001; IN COMMERCE 10-28-2002.

CLASS 36—(Continued).

2,858,533. GENERAL RE CORPORATION, STAMFORD, CT. SN 76-431,349. PUB. 2-18-2003, FILED 7-15-2002.

Gen Re

OWNER OF U.S. REG. NOS. 2,534,813, 2,584,384, AND OTHERS.
FOR INSURANCE AND REINSURANCE SERVICES, NAMELY, UNDERWRITING AND BROKERAGE OF ALL TYPES OF PROPERTY, CASUALTY, LIFE INSURANCE, AND REINSURANCE; RISK MANAGEMENT SERVICES, CLAIMS SERVICES, ACTUARIAL SCIENCE SERVICES AND CONSULTATION SERVICES, FINANCIAL ANALYSIS SERVICES; INVESTMENT ADVICE, ANALYSIS AND MANAGEMENT SERVICES; CAPITAL MANAGEMENT; ASSET AND LIABILITY MANAGEMENT; SECURITIES BROKERAGE SERVICES; FINANCIAL PLANNING AND INVESTMENT SERVICES; PROVIDING INFORMATION VIA THE INTERNET IN THE FIELD OF FINANCIAL INVESTMENTS (U.S. CLS. 100, 101 AND 102).
FIRST USE 12-30-2000; IN COMMERCE 12-30-2000.

2,858,534. SIERRA CLUB, SAN FRANCISCO, CA. SN 76-431,686. PUB. 11-11-2003, FILED 7-18-2002.

SIERRA CLUB

NO CLAIM IS MADE TO THE EXCLUSIVE RIGHT TO USE "CLUB", APART FROM THE MARK AS SHOWN.
FOR FINANCIAL SERVICES, NAMELY— FINANCIAL INVESTMENT SERVICES IN THE FIELD OF SECURITIES, MUTUAL FUNDS, STOCKS, BONDS, ANNUITIES AND OTHER FINANCIAL INSTRUMENTS; FINANCIAL INVESTMENT SERVICES IN THE FIELD OF INSURANCE PRODUCTS, AND FINANCIAL INVESTMENT ADVICE AND CONSULTATION SERVICES (U.S. CLS. 100, 101 AND 102).
FIRST USE 1-0-2003; IN COMMERCE 1-0-2003.

2,858,535. 24/7 REAL ESTATE, INC., WOODRIDGE, IL. SN 76-432,113. PUB. 6-3-2003, FILED 7-18-2002.



NO CLAIM IS MADE TO THE EXCLUSIVE RIGHT TO USE "REAL ESTATE", APART FROM THE MARK AS SHOWN.
FOR REAL ESTATE AGENCY SERVICES (U.S. CLS. 100, 101 AND 102).
FIRST USE 4-0-2002; IN COMMERCE 4-0-2002.

CLASS 36—(Continued).

2,858,567. DOLEX DOLLAR EXPRESS, INC., ARLINGTON, TX. SN 76-448,562. PUB. 8-5-2003, FILED 9-11-2002.

CARTERA EXPRESS

NO CLAIM IS MADE TO THE EXCLUSIVE RIGHT TO USE "EXPRESS", APART FROM THE MARK AS SHOWN. THE ENGLISH TRANSLATION OF THE WORD "CARTERA" IN THE MARK IS "PORTFOLIO".

FOR FINANCIAL SERVICES, NAMELY, MONEY TRANSFER AND BANKING SERVICES AND DEBIT, CREDIT, CHECK AND PREPAID CARD SERVICES (U.S. CLS. 100, 101 AND 102).

FIRST USE 7-0-2003; IN COMMERCE 7-0-2003.

2,858,591. LINCOLN HERITAGE LIFE INSURANCE COMPANY, PHOENIX, AZ. SN 76-461,866. PUB. 7-29-2003, FILED 10-28-2002.

PRELIANT

FOR INSURANCE BROKERAGE IN THE FIELD OF LIFE AND HEALTH (U.S. CLS. 100, 101 AND 102).

FIRST USE 3-15-2004; IN COMMERCE 3-15-2004.

2,858,611. JIM MORAN & ASSOCIATES, INC., DEERFIELD BEACH, FL. SN 76-469,485. PUB. 9-2-2003, FILED 11-15-2002.

JM&A CONNECT

FOR PROVIDING INFORMATION TO AUTOMOBILE DEALERSHIPS REGARDING FINANCE AND INSURANCE PRODUCTS VIA A SECURE WEB SITE (U.S. CLS. 100, 101 AND 102).

FIRST USE 8-16-2002; IN COMMERCE 8-16-2002.

2,858,616. INTEGRITY LIFE INSURANCE COMPANY, CINCINNATI, OH. SN 76-472,013. PUB. 11-18-2003, FILED 11-20-2002.

INCOME  SOURCE

FOR SINGLE PREMIUM IMMEDIATE ANNUITY BROKERAGE SERVICES (U.S. CLS. 100, 101 AND 102).

FIRST USE 1-21-2003; IN COMMERCE 1-21-2003.

CLASS 36—(Continued).

2,858,661. CENDANT PUBLISHING, INC., LAS VEGAS, NV. SN 76-495,087. PUB. 11-4-2003, FILED 3-6-2003.

BUYERS ADVANTAGE

OWNER OF U.S. REG. NOS. 1,531,245, 1,614,237, AND 2,484,963.

FOR PROVIDING TO CONSUMERS A COMPREHENSIVE PACKAGE WHICH ENTITLES THEM TO EXTENDED WARRANTIES, FULL AND PARTIAL PURCHASE PRICE REIMBURSEMENT, REIMBURSEMENT FOR POST-PURCHASE PRICE REDUCTIONS, AND REIMBURSEMENT FOR PRODUCT REPAIR AND REPLACEMENT, IN CONNECTION WITH A WIDE RANGE OF CONSUMER MERCHANDISE; AND, COMPUTER ON-LINE SERVICES, PROVIDED BY MEANS OF A GLOBAL COMPUTER NETWORK, NAMELY, ARRANGING FOR CONSUMERS TO RECEIVE EXTENDED WARRANTIES, FULL AND PARTIAL PRICE REIMBURSEMENT, REIMBURSEMENT FOR POST-PURCHASE PRICE REDUCTIONS, AND REIMBURSEMENT FOR PRODUCT REPAIR AND REPLACEMENT IN CONNECTION WITH THEIR PURCHASE OF A WIDE RANGE OF CONSUMER MERCHANDISE (U.S. CLS. 100, 101 AND 102).

FIRST USE 2-0-2003; IN COMMERCE 2-0-2003.

2,858,681. MORRISON, TAMMY J., HERMOSA BEACH, CA. SN 76-515,630. PUB. 11-11-2003, FILED 4-25-2003.

STAND YOUR GROUND

OWNER OF U.S. REG. NO. 2,120,291. FOR CHARITABLE FUND RAISING SERVICES (U.S. CLS. 100, 101 AND 102).

FIRST USE 9-1-2003; IN COMMERCE 9-1-2003.

2,858,742. REAL TIME BOSS, INC., CANAL FULTON, OH. SN 78-085,897. PUB. 7-22-2003, FILED 9-27-2001.

MORTGAGE BOSS

NO CLAIM IS MADE TO THE EXCLUSIVE RIGHT TO USE "MORTGAGE", APART FROM THE MARK AS SHOWN.

FOR COMPUTER E-COMMERCE SERVICE THAT ALLOWS USERS TO PREFORM MORTGAGE MANAGEMENT VIA A GLOBAL COMPUTER NETWORK (U.S. CLS. 100, 101 AND 102).

FIRST USE 11-19-2003; IN COMMERCE 11-19-2003.

CLASS 36—(Continued).

2,858,758. IDT NETHERLANDS, B.V. (PUERTO RICO BRANCH), SAN JUAN, PUERTO RICO. SN 78-103,627. PUB. 1-21-2003, FILED 1-18-2002.

ARTZEINU

THE ENGLISH TRANSLATION OF THE WORD "ARTZEINU" IN THE MARK IS "OUR LAND".
FOR TELEPHONE CALLING CARD AND DEBIT CARD SERVICES (U.S. CLS. 100, 101 AND 102).
FIRST USE 1-0-2002; IN COMMERCE 1-0-2002.

2,858,774. POPULAR, INC., SAN JUAN, PUERTO RICO. SN 78-112,888. PUB. 6-3-2003, FILED 3-6-2002.

POPULAR E-CHECK

OWNER OF U.S. REG. NOS. 2,363,673, 2,592,967, AND OTHERS.

FOR FINANCIAL SERVICES, NAMELY ELECTRONIC CHECK CONVERSION SERVICES PROVIDING FOR ELECTRONIC CHECK PROCESSING (U.S. CLS. 100, 101 AND 102).

FIRST USE 3-1-2002; IN COMMERCE 3-1-2002.

2,858,833. EXTRACO CORPORATION, WACO, TX. SN 78-153,830. PUB. 4-8-2003, FILED 8-13-2002.



THE MARK CONSISTS OF THE STYLIZED WORD "EXTRACO" AND "THE IMAGE OF A BIRD IN FLIGHT".

FOR BANKING SERVICES; FINANCIAL ANALYSIS AND CONSULTATION; FINANCIAL MANAGEMENT; FINANCIAL PLANNING; FINANCIAL INVESTMENT IN THE FIELDS OF SECURITIES, BONDS, PERSONALTY, AND REAL ESTATE; INSURANCE BROKERAGE; INSURANCE ANALYSIS, CONSULTATION AND PLANNING; INSURANCE UNDERWRITING IN THE FIELDS OF HEALTH, FIRE, LIFE, CASUALTY, PROPERTY, HOME AND FLOOD; INVESTMENT BROKERAGE; MORTGAGE BROKERAGE, BANKING AND LENDING SERVICES; MORTGAGE ADMINISTRATIVE SERVICES, NAMELY MAINTAINING ESCROW ACCOUNTS; TRUST SERVICES, NAMELY INVESTMENT AND TRUST COMPANY SERVICES (U.S. CLS. 100, 101 AND 102).

FIRST USE 1-2-2002; IN COMMERCE 1-2-2002.

CLASS 36—(Continued).

2,858,834. EXTRACO CORPORATION, WACO, TX. SN 78-153,839. PUB. 4-8-2003, FILED 8-13-2002.



OWNER OF U.S. REG. NOS. 2,318,570, 2,419,900, AND OTHERS.

FOR BANKING SERVICES; FINANCIAL ANALYSIS AND CONSULTATION; FINANCIAL MANAGEMENT; FINANCIAL PLANNING; FINANCIAL INVESTMENT IN THE FIELDS OF SECURITIES, BONDS, PERSONALTY, AND REAL ESTATE; INSURANCE BROKERAGE; INSURANCE ANALYSIS, CONSULTATION AND PLANNING; INSURANCE UNDERWRITING IN THE FIELDS OF HEALTH, FIRE, LIFE, CASUALTY, PROPERTY, HOME AND FLOOD; INVESTMENT BROKERAGE; MORTGAGE BROKERAGE, BANKING AND LENDING SERVICES; MORTGAGE ADMINISTRATIVE SERVICES, NAMELY MAINTAINING ESCROW ACCOUNTS; TRUST SERVICES, NAMELY INVESTMENT AND TRUST COMPANY SERVICES (U.S. CLS. 100, 101 AND 102).

FIRST USE 1-2-2002; IN COMMERCE 1-2-2002.

2,858,872. CUMBRIA TRADING VENTURES, ALBUQUERQUE, NM. SN 78-169,048. PUB. 12-9-2003, FILED 9-29-2002.



FOR FORMATION, BROKERAGE AND MANAGEMENT OF TIME SHARE INTERESTS IN SAILBOATS (U.S. CLS. 100, 101 AND 102).

FIRST USE 1-1-2003; IN COMMERCE 1-1-2003.

2,858,877. THE GRAHAM & DODD VALUE FUND, LLC, NEW YORK, NY. SN 78-170,746. PUB. 7-29-2003, FILED 10-3-2002.

**THE GRAHAM & DODD
VALUE FUND**

NO CLAIM IS MADE TO THE EXCLUSIVE RIGHT TO USE "VALUE FUND", APART FROM THE MARK AS SHOWN.

FOR FINANCIAL PORTFOLIO MANAGEMENT AND FINANCIAL INVESTMENT IN THE FIELD OF SECURITIES (U.S. CLS. 100, 101 AND 102).

FIRST USE 1-1-2001; IN COMMERCE 10-15-2003.

CLASS 36—(Continued).

2,858,884. AMERICAN EXPRESS COMPANY, NEW YORK, NY. SN 78-172,064. PUB. 8-26-2003, FILED 10-8-2002.

THE OFFICIAL CARD OF THE GLOBAL VILLAGE

NO CLAIM IS MADE TO THE EXCLUSIVE RIGHT TO USE "CARD", APART FROM THE MARK AS SHOWN.

FOR FINANCIAL SERVICES, NAMELY, CHARGE AND CREDIT CARD SERVICES (U.S. CLS. 100, 101 AND 102).

FIRST USE 3-1-2003; IN COMMERCE 3-1-2003.

2,858,890. WACHOVIA CORPORATION, CHARLOTTE, NC. SN 78-175,858. PUB. 7-1-2003, FILED 10-18-2002.

CROWN ACCESS BANKING

OWNER OF U.S. REG. NOS. 1,444,442, 1,522,073, AND 1,983,532.

NO CLAIM IS MADE TO THE EXCLUSIVE RIGHT TO USE "ACCESS BANKING", APART FROM THE MARK AS SHOWN.

FOR BANKING SERVICES (U.S. CLS. 100, 101 AND 102).

FIRST USE 8-5-2002; IN COMMERCE 8-5-2002.

2,858,892. BSD, INC., WATERBURY, CT. SN 78-176,552. PUB. 11-11-2003, FILED 10-21-2002.

WORKSITE PLUS

FOR ADMINISTRATION OF EMPLOYEE BENEFIT PLANS (U.S. CLS. 100, 101 AND 102).

FIRST USE 11-8-2002; IN COMMERCE 11-8-2002.

2,858,935. MONEY NOW, INC., FORT COLLINS, CO. SN 78-191,198. PUB. 7-1-2003, FILED 12-4-2002.

MONEY NOW

NO CLAIM IS MADE TO THE EXCLUSIVE RIGHT TO USE "MONEY", APART FROM THE MARK AS SHOWN.

FOR SHORT TERM LOANS (U.S. CLS. 100, 101 AND 102).

FIRST USE 9-28-2000; IN COMMERCE 9-28-2000.

CLASS 36—(Continued).

2,858,987. GREENLIGHT FINANCIAL SERVICES, IRVINE, CA. SN 78-211,060. PUB. 10-21-2003, FILED 2-5-2003.

GREAT IDEAS START WITH A SWITCH...

FOR FINANCIAL SERVICES, NAMELY, MORTGAGE LENDING SERVICES FOR HOME BUYERS (U.S. CLS. 100, 101 AND 102).

FIRST USE 7-0-2003; IN COMMERCE 7-0-2003.

2,859,042. ADVENTURE INCORPORATED, GLOUCESTER, MA. SN 78-263,777. PUB. 1-20-2004, FILED 6-18-2003.

ADVENTURE MANAGEMENT SYSTEMS

NO CLAIM IS MADE TO THE EXCLUSIVE RIGHT TO USE "MANAGEMENT SYSTEMS", APART FROM THE MARK AS SHOWN.

FOR RISK MANAGEMENT (U.S. CLS. 100, 101 AND 102).

FIRST USE 1-22-2004; IN COMMERCE 1-22-2004.

CLASS 37—CONSTRUCTION AND REPAIR

2,858,273. SYNERGY TECHNICAL SOLUTIONS CORP., FREDERICKSBURG, VA. SN 76-116,252. PUB. 5-14-2002, FILED 8-24-2000.

SYNERGY TECHNICAL SOLUTIONS

NO CLAIM IS MADE TO THE EXCLUSIVE RIGHT TO USE "TECHNICAL SOLUTIONS", APART FROM THE MARK AS SHOWN.

FOR INSTALLATION, MAINTENANCE, AND REPAIR OF COMPUTERS, COMPUTER HARDWARE, COMPUTER SYSTEMS, COMPUTER NETWORKS AND NETWORK COMPONENTS, NAMELY, CABLES, WIRES, SWITCHES, NETWORK LINKING DEVICES, COMPUTER PERIPHERALS AND OTHER COMPUTER COMPONENTS (U.S. CLS. 100, 103 AND 106).

FIRST USE 12-17-2003; IN COMMERCE 12-17-2003.

2,858,331. SUPERSTRUCTURES, NEW YORK, NY. SN 76-249,692. PUB. 5-13-2003, FILED 5-2-2001.

SUPERSTRUCTURES

OWNER OF U.S. REG. NO. 1,678,827. SEC. 2(F).

FOR RESIDENTIAL AND COMMERCIAL BUILDING CONSTRUCTION SERVICES, NAMELY, CONSTRUCTION CONTRACTING, PLANNING, AND MANAGEMENT (U.S. CLS. 100, 103 AND 106).

FIRST USE 0-0-1993; IN COMMERCE 8-20-2003.

CLASS 37—(Continued).

2,858,366. RODENHISER EXCAVATING INC., ASHLAND, MA. SN 76-300,967. PUB. 7-15-2003, FILED 8-16-2001.

EXPERIENCE IS THE DIFFERENCE

FOR MUNICIPAL, COMMERCIAL AND RESIDENTIAL SEWER AND DRAIN CLEANING; MUNICIPAL, COMMERCIAL AND RESIDENTIAL EXCAVATION, NAMELY LAND CLEARING, WATER AND SEWER DRAINAGE, SEPTIC SYSTEM DRAINAGE, UTILITY LINE EXCAVATION, FOUNDATION EXCAVATION, HYDRO EXCAVATION, FOUNDATION INSTALLATION, TERRAIN GRADING; ROAD CONSTRUCTION; INSTALLATION, MAINTENANCE AND REPAIR OF MUNICIPAL, COMMERCIAL OR RESIDENTIAL SEPTIC TANKS, SEWERS, DRAINAGE SYSTEMS, HYDRAULIC SEWERS, MECHANICAL SEWERS, GREASE TRAPS AND GREASE TANKS, AND SUBSURFACE DISPOSAL SYSTEMS; MAINTENANCE OF SANITARY FACILITIES, NAMELY PORTABLE TOILETS; AND COMMERCIAL AND RESIDENTIAL GENERAL CONTRACTING IN THE FIELD OF CONSTRUCTION AND REMODELING (U.S. CLS. 100, 103 AND 106).

FIRST USE 3-5-2003; IN COMMERCE 3-5-2003.

2,858,510. HALL, LEONARD *DEWAYNE, EDMOND, OK. SN 76-426,589. PUB. 4-15-2003, FILED 7-1-2002.



NO CLAIM IS MADE TO THE EXCLUSIVE RIGHT TO USE "AMERICA'S", APART FROM THE MARK AS SHOWN. FOR AUTOMOTIVE SERVICES, NAMELY, FULL SERVICE CAR WASH, DETAIL, OIL CHANGE, AND LIGHT MAINTENANCE SERVICES (U.S. CLS. 100, 103 AND 106).

FIRST USE 6-30-1997; IN COMMERCE 11-30-2002.

2,858,593. GALLAGHER'S HEATING AND AIR CONDITIONING, INC., LOS MOLINOS, CA. SN 76-463,274. PUB. 10-7-2003, FILED 10-31-2002.

**CLASS 37—(Continued).**

NO CLAIM IS MADE TO THE EXCLUSIVE RIGHT TO USE "HEATING" AND "AIR CONDITIONING", APART FROM THE MARK AS SHOWN.

FOR HEATING AND AIR CONDITIONING UNIT INSTALLATION AND REPAIR SERVICES (U.S. CLS. 100, 103 AND 106).

FIRST USE 3-15-2003; IN COMMERCE 3-15-2003.

2,858,734. ALCO FENCE COMPANY OF CENTRAL WEST VIRGINIA, FAIRMONT, WV. SN 78-066,764. PUB. 3-5-2002, FILED 5-31-2001.

ALCO FENCE PAINTERS

NO CLAIM IS MADE TO THE EXCLUSIVE RIGHT TO USE "FENCE PAINTERS", APART FROM THE MARK AS SHOWN.

FOR FENCE PAINTING SERVICES (U.S. CLS. 100, 103 AND 106).

FIRST USE 11-7-1996; IN COMMERCE 11-7-1996.

CLASS 38—COMMUNICATION

2,858,655. ILD TELECOMMUNICATIONS, INC., PONTE VEDRA BEACH, FL. SN 76-491,891. PUB. 11-4-2003, FILED 2-21-2003.

1-888-TEN-HUTT

FOR TELECOMMUNICATIONS SERVICES, NAMELY ELECTRONIC TRANSMISSION OF VOICE, DATA AND INFORMATION (U.S. CLS. 100, 101 AND 104).

FIRST USE 6-1-2003; IN COMMERCE 6-1-2003.

2,858,761. NCAST CORPORATION, SUNNYVALE, CA. SN 78-105,986. PUB. 12-31-2002, FILED 1-31-2002.

N-WAY

FOR COMMUNICATION SERVICES, NAMELY, ELECTRONIC TRANSMISSION AND BROADCASTING OF VIDEO, AUDIO AND DATA; TELEVISION BROADCASTING SERVICES (U.S. CLS. 100, 101 AND 104).

FIRST USE 8-0-2003; IN COMMERCE 8-0-2003.

CLASS 39—TRANSPORTATION AND STORAGE

CLASS 39—(Continued).

2,858,257. AUTOMOTIVE RENTALS, INC., MT. LAUREL, NJ.
SN 76-043,253. PUB. 1-1-2002, FILED 5-8-2000.

DATA X

NO CLAIM IS MADE TO THE EXCLUSIVE RIGHT TO USE "DATA", APART FROM THE MARK AS SHOWN.

FOR PROVIDING VEHICLE FLEET MANAGEMENT INFORMATION TO CUSTOMERS BY ELECTRONIC TRANSMISSION VIA THE GLOBAL COMMUNICATIONS NETWORK (U.S. CLS. 100 AND 105).

FIRST USE 4-0-2000; IN COMMERCE 4-0-2000.

2,858,326. TRAVELFAST INTERNATIONAL, INC., SAN FRANCISCO, CA. SN 76-238,144. PUB. 4-30-2002, FILED 4-11-2001.

IFLYPAL

FOR PROVIDING TRAVEL INFORMATION AND FLIGHT TRAVEL BOOKING VIA AN INTERACTIVE WEBSITE ON A GLOBAL COMPUTER NETWORK (U.S. CLS. 100 AND 105).

FIRST USE 1-1-1980; IN COMMERCE 9-1-2002.

2,858,351. TOTAL WAREHOUSING, INC., PHOENIX, AZ. SN 76-282,756. PUB. 7-16-2002, FILED 7-9-2001.

TOTAL DISTRIBUTION

NO CLAIM IS MADE TO THE EXCLUSIVE RIGHT TO USE "DISTRIBUTION", APART FROM THE MARK AS SHOWN.

FOR FREIGHT TRANSPORTATION AND DELIVERY OF GOODS BY TRUCK; PACKING AND HANDLING OF CARGO FOR TRANSPORT AND STORAGE; WAREHOUSE STORAGE SERVICES (U.S. CLS. 100 AND 105).

FIRST USE 3-31-2003; IN COMMERCE 3-31-2003.

2,858,357. SC FULFIL LIMITED, CENTRAL, HONG KONG.
SN 76-290,210. PUB. 9-2-2003, FILED 7-26-2001.

Multi PL

FOR FREIGHT TRANSPORTATION AND LOGISTICS SERVICES, NAMELY, TRANSPORTATION AND DELIVERING THE GOODS OF OTHERS VIA TRAINS, AIRPLANES AND/OR SHIPS; ARRANGING FOR THE STORAGE OF THE GOODS OF OTHERS; FREIGHT MANAGEMENT SERVICES; COMPUTERIZED FREIGHT MANAGEMENT SERVICES; PROVIDING ELECTRONIC TRACKING OF FREIGHT INFORMATION TO OTHERS; PROVIDING TRANSPORTATION DOCUMENTATION FOR OTHERS (U.S. CLS. 100 AND 105).

FIRST USE 6-0-2000; IN COMMERCE 6-0-2000.

CLASS 39—(Continued).

2,858,358. SC FULFIL LIMITED, CENTRAL, HONG KONG.
SN 76-290,614. PUB. 9-2-2003, FILED 7-26-2001.

MPL

FOR FREIGHT TRANSPORTATION AND LOGISTICS SERVICES, NAMELY, TRANSPORTATION AND DELIVERING THE GOODS OF OTHERS VIA TRAINS, AIRPLANES AND/OR SHIPS; ARRANGING FOR THE STORAGE OF THE GOODS AND OTHERS; FREIGHT MANAGEMENT SERVICES; PROVIDING ELECTRONIC TRACKING OF FREIGHT INFORMATION TO OTHERS; PROVIDING TRANSPORTATION DOCUMENTATION FOR OTHERS (U.S. CLS. 100 AND 105).

FIRST USE 6-0-2000; IN COMMERCE 6-0-2000.

2,858,393. WASHINGTON EXPRESS LLC, BELTSVILLE, MD.
SN 76-337,854. PUB. 6-24-2003, FILED 11-14-2001.



OWNER OF U.S. REG. NO. 1,880,085,
SEC. 2(F) "WASHINGTON EXPRESS".
FOR COURIER SERVICES (U.S. CLS. 100 AND 105).
FIRST USE 11-8-2001; IN COMMERCE 11-8-2001.

2,858,746. EAST KENTUCKY POWER COOPERATIVE, INC.,
WINCHESTER, KY. SN 78-087,659. PUB. 5-13-2003, FILED
10-10-2001.

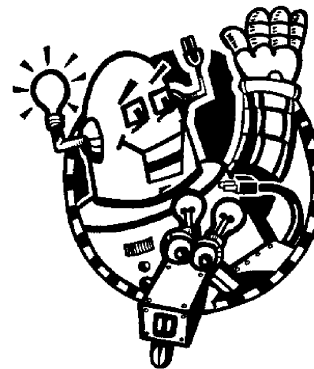

FOR PUBLIC UTILITY SERVICES IN THE NATURE OF ELECTRICITY DISTRIBUTION (U.S. CLS. 100 AND 105).

FIRST USE 5-28-1998; IN COMMERCE 5-28-1998.

CLASS 39—(Continued).

2,858,845. COLLEGE BUTLER, LLC, EVANSTON, IL. SN 78-158,469. PUB. 12-9-2003, FILED 8-28-2002.



FOR MESSENGER SERVICES, PICKUP AND DELIVERY OF LAUNDRY, DRY CLEANING, GROCERIES AND TEXTBOOKS (U.S. CLS. 100 AND 105).
FIRST USE 8-0-2002; IN COMMERCE 8-0-2002.

2,858,908. SEMPRA ENERGY, SAN DIEGO, CA. SN 78-182,871. PUB. 12-30-2003, FILED 11-7-2002.



OWNER OF U.S. REG. NOS. 2,437,361, 2,457,642, AND OTHERS.

NO CLAIM IS MADE TO THE EXCLUSIVE RIGHT TO USE "THE GAS COMPANY" AND "ENERGY" AND "UTILITY", APART FROM THE MARK AS SHOWN.

THE MARK CONSISTS OF TWO COLORS, BLUE AND RED – WITH THE CRESCENT AND FIGURE (BUT NOT THE FLAME IN THE FIGURE'S HANDS) IN RED. ALL OTHER ELEMENTS, INCLUDING THE PRINTING ARE BLUE.

FOR PUBLIC UTILITY SERVICES IN THE NATURE OF THE DISTRIBUTION OF ENERGY AND NATURAL GAS (U.S. CLS. 100 AND 105).

FIRST USE 1-1-2000; IN COMMERCE 1-1-2000.

2,859,037. INFONE LLC, BEAVERTON, OR. SN 78-254,859. PUB. 12-9-2003, FILED 5-27-2003.

HOW CAN WE HELP YOU?

FOR MAKING RESERVATIONS AND BOOKINGS FOR TRANSPORTATION (U.S. CLS. 100 AND 105).
FIRST USE 5-24-2003; IN COMMERCE 5-24-2003.

CLASS 40—MATERIAL TREATMENT

CLASS 40—(Continued).

2,858,354. BIORIGINAL FOOD & SCIENCE CORP., SASKATOON, SASKATCHEWAN, CANADA. SN 76-285,224. PUB. 12-18-2001, FILED 7-13-2001.

BIOELITE

FOR CUSTOM PROCESSING NUTRITIONAL SUPPLEMENTAL TO THE ORDER AND SPECIFICATION OF OTHERS (U.S. CLS. 100, 103 AND 106).
FIRST USE 3-8-2004; IN COMMERCE 3-8-2004.

2,858,364. HALLIBURTON ENERGY SERVICES, INC., CARROLLTON, TX. SN 76-296,647. PUB. 7-2-2002, FILED 8-8-2001.

TRANSIENT GEL

NO CLAIM IS MADE TO THE EXCLUSIVE RIGHT TO USE "GEL", APART FROM THE MARK AS SHOWN.
FOR FRACTURING AND STIMULATION SERVICES FOR OIL AND GAS WELLS (U.S. CLS. 100, 103 AND 106).
FIRST USE 11-30-2001; IN COMMERCE 11-30-2001.

2,858,514. HALLIBURTON ENERGY SERVICES, INC., CARROLLTON, TX. SN 76-427,618. PUB. 3-4-2003, FILED 7-5-2002.

HMP

FOR FRACTURING AND STIMULATION SERVICES FOR OIL AND GAS WELLS (U.S. CLS. 100, 103 AND 106).
FIRST USE 1-31-2002; IN COMMERCE 1-31-2002.

2,858,975. TUGBOAT, INC., NAPA, CA. SN 78-206,064. PUB. 9-16-2003, FILED 1-22-2003.

TUGBOAT

FOR CUSTOMIZED PRINTING OF COMPANY NAMES AND LOGOS FOR PROMOTIONAL AND ADVERTISING PURPOSES; CUSTOM EMBROIDERY OF CORPORATE NAMES AND LOGOS FOR OTHERS (U.S. CLS. 100, 103 AND 106).
FIRST USE 11-7-2002; IN COMMERCE 4-7-2003.

CLASS 41—EDUCATION AND ENTERTAINMENT

CLASS 41—(Continued).

2,858,221. TRIBUNE MEDIA SERVICES, INC., CHICAGO, IL. SN 75-871,894. PUB. 3-27-2001, FILED 12-14-1999.

THE PUZZLE PALACE

NO CLAIM IS MADE TO THE EXCLUSIVE RIGHT TO USE "PUZZLE", APART FROM THE MARK AS SHOWN. FOR ENTERTAINMENT SERVICES, NAMELY, PROVIDING ON-LINE PUZZLES AND GAMES VIA A GLOBAL COMPUTER NETWORK (U.S. CLS. 100, 101 AND 107).

FIRST USE 4-1-2004; IN COMMERCE 4-1-2004.

2,858,261. MILLER, VALERIE JOY, DUBLIN, CA. SN 76-075,533. PUB. 1-15-2002, FILED 6-19-2000.

TO SEE OR NOT TO SEE

FOR PROVIDING ENTERTAINMENT INFORMATION IN THE NATURE OF PROVIDING WEB SITE ON A GLOBAL INFORMATION NETWORK FEATURING INFORMATION ON THE FILM INDUSTRY (U.S. CLS. 100, 101 AND 107).

FIRST USE 3-30-2004; IN COMMERCE 3-30-2004.

2,858,274. B.F.C. INTERNATIONAL, INC., EL PASO, TX. SN 76-130,729. PUB. 11-20-2001, FILED 9-19-2000.

CHAMPIONS OF CHANGE INITIATIVE

FOR EDUCATIONAL SERVICES, NAMELY, PROVIDING SEMINARS, LECTURES AND CONFERENCES IN THE FIELD OF LEADERSHIP TRAINING (U.S. CLS. 100, 101 AND 107).

FIRST USE 7-1-1997; IN COMMERCE 7-1-1997.

2,858,281. BLUE HORSESHOE PRODUCTIONS, INC., CHICAGO, IL. SN 76-138,777. PUB. 3-12-2002, FILED 10-2-2000.

BLUEHORSESHOE PRODUCTIONS

NO CLAIM IS MADE TO THE EXCLUSIVE RIGHT TO USE "PRODUCTIONS", APART FROM THE MARK AS SHOWN.

FOR ENTERTAINMENT SERVICES, NAMELY, MOTION PICTURE, FILM, TELEVISION AND THEATER PRODUCTION SERVICES (U.S. CLS. 100, 101 AND 107).

FIRST USE 11-26-2003; IN COMMERCE 11-26-2003.

CLASS 41—(Continued).

2,858,287. MADSEN, A. SHARON, CLANCY, MT. SN 76-155,371. PUB. 12-18-2001, FILED 10-26-2000.

LIVE LITERATE

FOR EDUCATIONAL SERVICES, NAMELY, CONDUCTING CLASSES, SEMINARS, CONFERENCES AND WORKSHOPS IN THE FIELD OF THE ENGLISH LANGUAGE AND DISTRIBUTING COURSE MATERIALS IN CONNECTION THEREWITH; AND EDUCATIONAL SERVICES, NAMELY, PROVIDING COURSES OF INSTRUCTION AT THE PRIMARY, SECONDARY AND COLLEGE LEVEL AND DISTRIBUTING COURSE MATERIAL IN CONNECTION THEREWITH (U.S. CLS. 100, 101 AND 107).

FIRST USE 6-12-2003; IN COMMERCE 6-12-2003.

2,858,288. MADSEN, A. SHARON, CLANCY, MT. SN 76-155,372. PUB. 12-18-2001, FILED 10-26-2000.

IMPENETRABLE LITERACY SHIELD

FOR EDUCATIONAL SERVICES, NAMELY, CONDUCTING CLASSES, SEMINARS, CONFERENCES AND WORKSHOPS IN THE FIELD OF THE ENGLISH LANGUAGE AND DISTRIBUTING COURSE MATERIALS IN CONNECTION THEREWITH; AND EDUCATIONAL SERVICES, NAMELY, PROVIDING COURSES OF INSTRUCTION AT THE PRIMARY, SECONDARY AND COLLEGE LEVEL AND DISTRIBUTING COURSE MATERIAL IN CONNECTION THEREWITH (U.S. CLS. 100, 101 AND 107).

FIRST USE 6-12-2003; IN COMMERCE 6-12-2003.

2,858,306. GLORY DAYS, INC., FAIRFAX, VA. SN 76-189,466. PUB. 10-29-2002, FILED 12-26-2000.

GLORY DAYS

OWNER OF U.S. REG. NOS. 2,080,016 AND 2,080,017. FOR ARRANGING, SPONSORING AND CONDUCTING ATHLETIC COMPETITIONS AND SPORTING EVENTS (U.S. CLS. 100, 101 AND 107).

FIRST USE 4-12-2001; IN COMMERCE 1-14-2002.

2,858,342. SCHIEFFELIN, LINDSAY, IRVING, TX. SN 76-267,550. PUB. 1-21-2003, FILED 6-6-2001.

FITNESS BRIGADE

NO CLAIM IS MADE TO THE EXCLUSIVE RIGHT TO USE "FITNESS", APART FROM THE MARK AS SHOWN.

FOR PROVIDING INSTRUCTION IN THE FIELD OF EXERCISE AND FUN ACTIVITIES FOR EXERCISE (U.S. CLS. 100, 101 AND 107).

FIRST USE 9-0-2001; IN COMMERCE 9-0-2001.

CLASS 41—(Continued).

2,858,356. FIVE STAR PRODUCTIONS, LLC, STAMFORD, CT. SN 76-288,121. PUB. 4-29-2003, FILED 7-20-2001.

DIGIPLEX

FOR ENTERTAINMENT SERVICES, NAMELY, MOBILE DRIVE IN THEATERS FEATURING MOVIES AND LIVE ENTERTAINMENT; PRODUCTION OF VIDEOTAPES FOR USE DURING MOBILE DRIVE-IN THEATER EVENTS (U.S. CLS. 100, 101 AND 107).

FIRST USE 2-1-2004; IN COMMERCE 2-1-2004.

2,858,375. RANDOMWORLD, LTD., BLUEFIELD, WV. SN 76-316,812. PUB. 9-3-2002, FILED 9-25-2001.

RANDOMWORLD

FOR LEASING OF ELECTRONIC GAMING MACHINES (U.S. CLS. 100, 101 AND 107).

FIRST USE 4-16-2003; IN COMMERCE 4-16-2003.

2,858,377. ADVANCED RESEARCH AND TECHNOLOGY INSTITUTE, INC., BLOOMINGTON, IN. SN 76-317,620. PUB. 9-24-2002, FILED 9-26-2001.

INGEN

FOR EDUCATIONAL RESEARCH SERVICES, NAMELY, CONDUCTING AND SPONSORING RESEARCH PROGRAMS IN THE FIELDS OF GENOMICS, NAMELY, INFORMATION TECHNOLOGY, PROTEOMICS, GENOTYPING, PHENOTYPING, BIOETHICS, BIOLOGY, CHEMISTRY, BIOINFORMATICS, MEDICAL INFORMATICS AND SUPERCOMPUTING (U.S. CLS. 100, 101 AND 107).

FIRST USE 3-0-2002; IN COMMERCE 3-0-2002.

2,858,448. SHAY, JANET, GLENDALE, AZ. SN 76-385,345. PUB. 12-10-2002, FILED 3-20-2002.

SABLE CREEK PRESS

OWNER OF U.S. REG. NO. 1,964,098.

NO CLAIM IS MADE TO THE EXCLUSIVE RIGHT TO USE "PRESS", APART FROM THE MARK AS SHOWN.

FOR PUBLICATION OF PRINTED MATTER, NAMELY MAGAZINES, NEWSLETTERS, NEWSPAPERS, PRINTED MUSIC, POSTERS, BOOKS, BROCHURES AND WORKBOOKS (U.S. CLS. 100, 101 AND 107).

FIRST USE 7-16-2002; IN COMMERCE 7-16-2002.

CLASS 41—(Continued).

2,858,506. VOSS, MATTHEW SCOTT, ROYAL OAK, MI. SN 76-423,713. PUB. 7-15-2003, FILED 6-20-2002.

THAT 80's BAND

NO CLAIM IS MADE TO THE EXCLUSIVE RIGHT TO USE "80'S BAND", APART FROM THE MARK AS SHOWN. FOR ENTERTAINMENT SERVICES, NAMELY A LIVE MUSICAL PERFORMANCE GROUP (U.S. CLS. 100, 101 AND 107).

FIRST USE 8-28-2002; IN COMMERCE 8-28-2002.

2,858,512. COGNITIVE LEARNING SYSTEMS, INC., NORTHFIELD, IL. SN 76-427,043. PUB. 8-12-2003, FILED 7-2-2002.

THE SCIENCE OF LEARNING

NO CLAIM IS MADE TO THE EXCLUSIVE RIGHT TO USE "LEARNING", APART FROM THE MARK AS SHOWN.

FOR EDUCATIONAL SERVICES, NAMELY, DEVELOPMENT AND IMPLEMENTATION OF CUSTOMIZED LEARNING MODULES COMPRISED OF SOFTWARE, BOOKS, AND EQUIPMENT (U.S. CLS. 100, 101 AND 107).

FIRST USE 8-0-2002; IN COMMERCE 8-0-2002.

2,858,519. MINYANVILLE PUBLISHING AND MULTIMEDIA, INC., NEW YORK, NY. SN 76-428,876. PUB. 4-1-2003, FILED 7-2-2002.

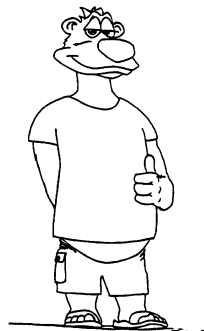

FOR ENTERTAINMENT SERVICES, NAMELY, PROVIDING ONLINE COMIC STRIPS, CARTOONS AND COLUMNS IN THE FIELD OF STOCK MARKET, FINANCE AND INVESTMENT VIA A GLOBAL COMPUTER NETWORK (U.S. CLS. 100, 101 AND 107).

FIRST USE 7-1-2002; IN COMMERCE 10-1-2002.

CLASS 41—(Continued).

2,858,521. BROWN & WILLIAMSON TOBACCO CORPORATION, LOUISVILLE, KY. SN 76-429,149. PUB. 9-16-2003, FILED 7-11-2002.

PLAY ON THE HOUSE

NO CLAIM IS MADE TO THE EXCLUSIVE RIGHT TO USE "PLAY", APART FROM THE MARK AS SHOWN.

FOR ENTERTAINMENT IN THE NATURE OF PLAYING CARD TOURNAMENTS (U.S. CLS. 100, 101 AND 107).

FIRST USE 9-0-2002; IN COMMERCE 9-0-2002.

2,858,560. MEDISEM, INC., ATTLEBORO, MA. SN 76-442,302. PUB. 7-1-2003, FILED 8-21-2002.

MEDISEM

FOR TRAINING SERVICES IN THE MEDICAL FIELD; CONSULTATION SERVICES IN THE MEDICAL TRAINING FIELD (U.S. CLS. 100, 101 AND 107).

FIRST USE 8-29-2002; IN COMMERCE 8-29-2002.

2,858,562. ILLINOIS PRIMARY HEALTH CARE ASSOCIATION, CHICAGO, IL. SN 76-444,058. PUB. 6-17-2003, FILED 8-27-2002.

HIPAAITIZE

FOR EDUCATIONAL SERVICES, NAMELY, CONDUCTING CLASSES, WEB SEMINARS, WORKSHOPS, AND CONFERENCES IN THE FIELDS OF COMPLIANCE ISSUES AND FINANCIAL IMPACT ISSUES RELATING TO THE FEDERAL HEALTH INSURANCE PORTABILITY AND ACCOUNTABILITY ACT (U.S. CLS. 100, 101 AND 107).

FIRST USE 11-14-2002; IN COMMERCE 11-19-2002.

2,858,579. O2 HOLDINGS, LLC, NEW YORK, NY. SN 76-454,173. PUB. 9-16-2003, FILED 10-1-2002.

OH! OXYGEN

OWNER OF U.S. REG. NO. 2,684,295.
FOR PRODUCTION OF TELEVISION PROGRAMS IN THE NATURE OF COMEDY, DRAMA, ANIMATED PROGRAMMING, TALK SHOWS, MUSICAL PERFORMANCES, NEWS AND INFORMATION ON TOPICS OF INTEREST TO WOMEN; EDUCATIONAL AND ENTERTAINMENT SERVICES, NAMELY, TELEVISION PROGRAMMING IN THE NATURE OF COMEDY, DRAMA, ANIMATED PROGRAMMING, TALK SHOWS, MUSICAL PERFORMANCES, NEWS AND INFORMATION ON TOPICS OF INTEREST TO WOMEN PROVIDED BY MEANS OF THE INTERNET, CABLE, BROADCAST AND SATELLITE TELEVISION AND AUDIO AND VISUAL MEDIA (U.S. CLS. 100, 101 AND 107).

FIRST USE 10-15-2002; IN COMMERCE 10-15-2002.

CLASS 41—(Continued).

2,858,590. GET PSYCH'D, INC., HUNTINGTON, NY. SN 76-461,217. PUB. 7-22-2003, FILED 10-21-2002.

**COMMUNICATE
APPRECIATE VALIDATE**

FOR EDUCATIONAL AND ENTERTAINMENT SERVICES, NAMELY, PRODUCING AND BROADCASTING TELEVISION PROGRAMS AND CONDUCTING SEMINARS FEATURING INSPIRATIONAL, MOTIVATIONAL AND SPIRITUAL MESSAGES AND INFORMATION RELATING TO EXTRASENSORY PERCEPTION, AFTER-LIFE EXPERIENCES, AND PSYCHIC PHENOMENA, CONSULTATIONS AND FORECASTING (U.S. CLS. 100, 101 AND 107).

FIRST USE 10-1-2001; IN COMMERCE 10-1-2001.

2,858,607. BOY SCOUTS OF AMERICA, IRVING, TX. SN 76-467,565. PUB. 7-8-2003, FILED 11-18-2002.

CHARACTER QUEST

OWNER OF U.S. REG. NOS. 1,852,681, 2,342,444, AND OTHERS.

FOR EDUCATIONAL SERVICES, NAMELY A PROGRAM THAT IS UTILIZED BY SCHOOLS AT THE ELEMENTARY LEVEL, AS A PART OF AN AFTER-SCHOOL PROGRAM THAT FOCUSES ON CHARACTER BUILDING, MORALS AND SELF-ESTEEM (U.S. CLS. 100, 101 AND 107).

FIRST USE 8-31-2003; IN COMMERCE 8-31-2003.

2,858,614. TEACHING MATTERS, INC., NEW YORK, NY. SN 76-470,319. PUB. 9-30-2003, FILED 11-26-2002.



OWNER OF U.S. REG. NO. 2,321,787.
FOR EDUCATIONAL SERVICES, NAMELY CONSULTING TO TEACHERS, PRINCIPALS, EDUCATORS AND COMMUNITY MEMBERS REGARDING THE USE OF TECHNOLOGY IN THE CLASSROOM AND THE ROLE OF TECHNOLOGY IN THE EDUCATIONAL PROCESS (U.S. CLS. 100, 101 AND 107).

FIRST USE 3-1-2003; IN COMMERCE 3-1-2003.

CLASS 41—(Continued).

2,858,649. MATFUSION, L.L.C., PLANO, TX. SN 76-487,645. PUB. 9-23-2003, FILED 2-5-2003.

MATFUSION

FOR PHYSICAL FITNESS INSTRUCTION SERVICES (U.S. CLS. 100, 101 AND 107).
FIRST USE 1-1-2003; IN COMMERCE 1-1-2003.

2,858,669. ESPN, INC., BRISTOL, CT. SN 76-501,647. PUB. 11-11-2003, FILED 3-28-2003.

COLD PIZZA

FOR ENTERTAINMENT SERVICES, NAMELY, AN ONGOING TELEVISION PROGRAM FEATURING SPORTS, NEWS REPORTING AND ENTERTAINMENT FEATURES (U.S. CLS. 100, 101 AND 107).
FIRST USE 10-20-2003; IN COMMERCE 10-20-2003.

2,858,703. CHILDREN OF DESTINY INTERNATIONAL, PASADENA, CA. SN 78-014,374. PUB. 7-2-2002, FILED 6-26-2000.



FOR EDUCATIONAL SERVICES FOR CHILDREN, PARENTS AND FAMILIES, NAMELY, CONDUCTING CLASSES, SEMINARS, AND WORKSHOPS IN THE FIELD OF CHARACTER ENRICHMENT PROGRAMS, SERVICES LEARNING PROGRAMS TO PROMOTE SELF-ESTEEM, GOAL-DEVELOPMENT AND GOAL-ACHIEVEMENT; ENTERTAINMENT IN THE INTEREST OF CHILDREN PROVIDED VIA ON-GOING RADIO PROGRAMS, ON-GOING TELEVISION PROGRAMS, LIVE MUSICAL AND LIVE THEATRICAL PERFORMANCES, FILM PRESENTATIONS AND COMPUTER VIA A GLOBAL COMPUTER NETWORK FEATURING PRESENTATIONS THAT PROMOTE THE PHYSICAL, MENTAL AND SPIRITUAL DEVELOPMENT OF CHILDREN; ENTERTAINMENT IN THE NATURE OF ONGOING TELEVISION PROGRAMS IN THE FIELD OF EDUCATIONAL AND ENTERTAINING TOPICS OF INTEREST TO CHILDREN, PARENTS, AND FAMILIES; ENTERTAINMENT SERVICES IN THE NATURE OF ONGOING LIVE-ACTION, COMEDY, DRAMA, AND/OR ANIMATED TELEVISION PROGRAMS; ENTERTAINMENT, NAMELY, PRODUCTION OF TELEVISION SHOWS, THEATER PRODUCTIONS, AND FILM PRODUCTIONS FEATURING LIVE-ACTION, COMEDY, DRAMA AND ANIMATION; PROVIDING A WEB SITE FEATURING INFORMATION ABOUT MOVIES, CARTOONS, AND RELATED ENTERTAINMENT INDUSTRY INFORMATION (U.S. CLS. 100, 101 AND 107).
FIRST USE 9-24-2002; IN COMMERCE 9-24-2002.

CLASS 41—(Continued).

2,858,755. WORLD WRESTLING FEDERATION ENTERTAINMENT, INC., STAMFORD, CT. SN 78-101,426. PUB. 8-26-2003, FILED 1-8-2002.

THE GAME

THE NAME SHOWN IN THE MARK IDENTIFIES PAUL LEVESQUE, WHOSE CONSENT IS OF RECORD.
FOR WRESTLING EXHIBITIONS AND PERFORMANCES BY A PROFESSIONAL WRESTLER (U.S. CLS. 100, 101 AND 107).
FIRST USE 7-26-1999; IN COMMERCE 7-26-1999.

2,858,773. HISTORY FACTORY, THE, CHANTILLY, VA. SN 78-111,453. PUB. 10-21-2003, FILED 2-27-2002.

CENTER FOR HERITAGE IN MANAGEMENT

NO CLAIM IS MADE TO THE EXCLUSIVE RIGHT TO USE "CENTER" AND "MANAGEMENT", APART FROM THE MARK AS SHOWN.

FOR EDUCATIONAL SERVICES, NAMELY, CONDUCTING ON-SITE WORKSHOPS AND TRAINING SEMINARS IN THE FIELD OF DISCOVERING, PRESERVING AND LEVERAGING AN ORGANIZATION'S HISTORY IN ORDER TO ADDRESS A WIDE VARIETY OF ONGOING BUSINESS CHALLENGES (U.S. CLS. 100, 101 AND 107).
FIRST USE 9-1-2002; IN COMMERCE 9-1-2002.

2,858,831. NEGOTIATION SKILLS COMPANY, INC., THE, PRIDE'S CROSSING, MA. SN 78-151,245. PUB. 3-11-2003, FILED 8-6-2002.

AGREEING TO AGREE

FOR NEGOTIATION TRAINING SERVICES, NAMELY WORKSHOPS IN THE FIELD OF NEGOTIATION SKILLS AND STRATEGIES (U.S. CLS. 100, 101 AND 107).
FIRST USE 3-30-2004; IN COMMERCE 3-30-2004.

2,858,838. MEDICAL SIMULATION CORPORATION, ENGLEWOOD, CO. SN 78-155,723. PUB. 4-1-2003, FILED 8-19-2002.

PATHWAY TO PRACTICE

FOR EDUCATIONAL SERVICES, NAMELY, CONDUCTING CLASSES, SEMINARS, CONFERENCES, AND WORKSHOPS IN THE FIELD OF MEDICINE AND DISTRIBUTION OF COURSE MATERIALS IN CONNECTION THEREWITH (U.S. CLS. 100, 101 AND 107).
FIRST USE 2-0-2003; IN COMMERCE 2-0-2003.

CLASS 41—(Continued).

2,858,839. THE DOLLYWOOD COMPANY, PIGEON FORGE, TN. SN 78-156,207. PUB. 9-23-2003, FILED 8-21-2002.

RED, WHITE & BLUE GRASS BLAST

FOR ENTERTAINMENT IN THE NATURE OF COMPETITIONS IN THE FIELD OF DANCE AND MUSIC HELD PERIODICALLY AT A THEME PARK OPERATED BY APPLICANT; ORGANIZING AND CONDUCTING FESTIVALS FEATURING A VARIETY OF ACTIVITIES, NAMELY SPORTING, ATHLETIC, AND ENTERTAINMENT EVENTS, ART EXHIBITIONS, ETHNIC DANCES, AND THE LIKE HELD PERIODICALLY AT A THEME PARK OPERATED BY APPLICANT (U.S. CLS. 100, 101 AND 107).

FIRST USE 1-0-2002; IN COMMERCE 1-0-2002.

2,858,858. GAMEFLY, INC., SANTA MONICA, CA. SN 78-165,013. PUB. 4-22-2003, FILED 9-17-2002.

GAMEFLY

FOR RENTAL OF VIDEO GAMES (U.S. CLS. 100, 101 AND 107).

FIRST USE 10-7-2002; IN COMMERCE 10-7-2002.

2,858,862. PANTANO, JOSEPH A, DOWNERS GROVE, IL. SN 78-166,083. PUB. 12-16-2003, FILED 9-19-2002.

THE KNOWLEDGE FOUNDATION

NO CLAIM IS MADE TO THE EXCLUSIVE RIGHT TO USE "FOUNDATION", APART FROM THE MARK AS SHOWN.

FOR EDUCATIONAL DEMONSTRATIONS IN THE FIELD OF HAIR CUTTING, COLORING AND DESIGN; EDUCATIONAL SERVICES, NAMELY, CONDUCTING CLASSES, SEMINARS, CONFERENCES, AND WORKSHOPS IN THE FIELD OF HAIR CUTTING, AND COLORINGS AND DESIGN AND DISTRIBUTING COURSE MATERIALS IN CONNECTION THEREWITH; VOCATIONAL EDUCATION IN THE FIELD OF BEAUTY (U.S. CLS. 100, 101 AND 107).

FIRST USE 12-0-1993; IN COMMERCE 4-0-1997.

2,858,903. BROWNING, MICHAEL G., TAMPA, FL. SN 78-181,375. PUB. 7-1-2003, FILED 11-4-2002.

AFTER DEATH

FOR ENTERTAINMENT, NAMELY, LIVE PERFORMANCES BY A ROCK BAND (U.S. CLS. 100, 101 AND 107).

FIRST USE 9-1-1999; IN COMMERCE 10-29-2000.

CLASS 41—(Continued).

2,858,917. THINK FAST, LLC, GLENS FALLS, NY. SN 78-185,867. PUB. 8-19-2003, FILED 11-16-2002.

HITPREDICTOR

THE MARK CONSISTS OF STANDARD CHARACTERS WITHOUT CLAIM TO ANY PARTICULAR FONT, STYLE, SIZE, OR COLOR.

FOR ONLINE PUBLICATION OF MARKET RESEARCH IN THE FIELD OF MUSIC (U.S. CLS. 100, 101 AND 107).

FIRST USE 8-0-2002; IN COMMERCE 8-0-2002.

2,858,920. THINK FAST, LLC, GLENS FALLS, NY. SN 78-185,871. PUB. 7-1-2003, FILED 11-16-2002.

PROMOSQUAD HITPREDICTOR

THE MARK CONSISTS OF STANDARD CHARACTERS WITHOUT CLAIM TO ANY PARTICULAR FONT, STYLE, SIZE, OR COLOR.

FOR ONLINE PUBLICATION OF MARKET RESEARCH IN THE FIELD OF MUSIC (U.S. CLS. 100, 101 AND 107).

FIRST USE 8-0-2002; IN COMMERCE 8-0-2002.

2,858,942. VIACOM INTERNATIONAL INC., NEW YORK, NY. SN 78-193,036. PUB. 6-17-2003, FILED 12-10-2002.

JIMMY NEUTRON'S NICKTOONS BLAST

OWNER OF U.S. REG. NOS. 2,594,583, 2,635,670, AND OTHERS.

THE NAME "JIMMY NEUTRON" DOES NOT IDENTIFY A LIVING INDIVIDUAL.

FOR ENTERTAINMENT SERVICES IN THE NATURE OF AN AMUSEMENT PARK RIDE AND ATTRACTION (U.S. CLS. 100, 101 AND 107).

FIRST USE 4-1-2003; IN COMMERCE 4-1-2003.

CLASS 41—(Continued).

2,858,967. SINGH, HARTEJ, LIVINGSTON, NJ. SN 78-202,875. PUB. 8-26-2003, FILED 1-14-2003.

ENTCENT

FOR EDUCATIONAL SERVICES, NAMELY CONDUCTING CLASSES AND SEMINARS IN THE FIELD OF SPECIALIZED NEEDS OF ENTREPRENEURS (U.S. CLS. 100, 101 AND 107).

FIRST USE 1-29-2004; IN COMMERCE 3-1-2004.

2,858,968. RAMBO, ANNA C., NEW YORK, NY. SN 78-203,193. PUB. 7-1-2003, FILED 1-14-2003.

XYGON ENTERTAINMENT

NO CLAIM IS MADE TO THE EXCLUSIVE RIGHT TO USE "ENTERTAINMENT", APART FROM THE MARK AS SHOWN.

FOR ENTERTAINMENT SERVICES, NAMELY, PRODUCTION AND DISTRIBUTION OF VIDEO AND AUDIO RECORDINGS FEATURING MUSIC AND ENTERTAINMENT; PRODUCTION AND DISTRIBUTION OF MOTION PICTURES; PRODUCTION AND DISTRIBUTION OF TELEVISION COMMERCIALS AND PROGRAMS; MULTIMEDIA ENTERTAINMENT SOFTWARE PRODUCTION SERVICES; DISTRIBUTION SERVICES FOR OTHERS OF VIDEO AND AUDIO RECORDINGS FEATURING MUSIC AND ENTERTAINMENT (U.S. CLS. 100, 101 AND 107).

FIRST USE 3-15-2004; IN COMMERCE 3-15-2004.

2,858,989. INNOVATIVE AFTERMARKET SYSTEMS, INC., AUSTIN, TX. SN 78-212,665. PUB. 9-30-2003, FILED 2-9-2003.

THE INSTITUTE OF HIGHER EARNING

FOR EDUCATIONAL SERVICES - NAMELY, CONDUCTING WORKSHOPS, COURSES, SEMINARS, LECTURES AND OTHER TRAINING CLASSES ON SUBJECTS RELATED TO VEHICLE DEALERSHIP SALES, ADMINISTRATION, FINANCING PROGRAMS, CUSTOMER RELATIONS, AND RELATED TOPICS (U.S. CLS. 100, 101 AND 107).

FIRST USE 2-23-2004; IN COMMERCE 2-23-2004.

CLASS 41—(Continued).

2,858,999. VIACOM INTERNATIONAL INC., NEW YORK, NY. SN 78-220,272. PUB. 7-22-2003, FILED 2-28-2003.

MTV BASH

OWNER OF U.S. REG. NOS. 1,580,650, 2,540,212, AND OTHERS.

FOR ENTERTAINMENT SERVICES IN THE NATURE OF AN ON-GOING TELEVISION PROGRAM FEATURING LIVE ACTION, COMEDY, MUSIC AND CELEBRITIES; PROVIDING INFORMATION IN THE FIELD OF ENTERTAINMENT FEATURING LIVE ACTION, COMEDY, MUSIC AND CELEBRITIES VIA COMPUTER BY MEANS OF A GLOBAL COMPUTER NETWORK (U.S. CLS. 100, 101 AND 107).

FIRST USE 7-13-2003; IN COMMERCE 7-13-2003.

2,859,038. INFONE LLC, BEAVERTON, OR. SN 78-254,861. PUB. 12-9-2003, FILED 5-27-2003.

HOW CAN WE HELP YOU?

FOR ARRANGING FOR TICKETS AND/OR RESERVATIONS FOR ARTS AND ENTERTAINMENT EVENTS, PUBLIC EVENTS, ATTRACTIONS, CONFERENCES, LECTURES, CLASSES, FESTIVALS, EXHIBITS, AND SPORTS EVENTS (U.S. CLS. 100, 101 AND 107).

FIRST USE 5-24-2003; IN COMMERCE 5-24-2003.

CLASS 42—SCIENTIFIC, COMPUTER AND LEGAL SERVICES

2,858,191. FLORES, LEO, BONSALE, CA. SN 75-626,393. PUB. 12-7-1999, FILED 1-25-1999.

JOE BURRITO

NO CLAIM IS MADE TO THE EXCLUSIVE RIGHT TO USE "BURRITO", APART FROM THE MARK AS SHOWN.

FOR RESTAURANT SERVICES (U.S. CLS. 100 AND 101).

FIRST USE 3-17-2004; IN COMMERCE 3-17-2004.

2,858,228. AMERICATT.COM, LLC, LAS VEGAS, NV. SN 75-907,327. PUB. 12-12-2000, FILED 1-26-2000.

DOCTORAT.COM

FOR PROVIDING ONLINE MEDICAL INFORMATION, NAMELY, NEWS, REFERENCE MATERIALS, AND CURRENT EVENTS PERTAINING TO DOCTORS AND THE MEDICAL COMMUNITY (U.S. CLS. 100 AND 101).

FIRST USE 3-6-2004; IN COMMERCE 3-6-2004.

CLASS 42—(Continued).

2,858,231. RUBY'S DINER, INC., NEWPORT BEACH, CA. SN 75-919,925. PUB. 12-26-2000, FILED 2-14-2000.

RUBY'S DINETTE

OWNER OF U.S. REG. NOS. 1,315,104 AND 1,631,936. NO CLAIM IS MADE TO THE EXCLUSIVE RIGHT TO USE "DINETTE", APART FROM THE MARK AS SHOWN. FOR RESTAURANT SERVICES (U.S. CLS. 100 AND 101).

FIRST USE 6-25-1995; IN COMMERCE 6-29-1995.

2,858,247. SPARK NETWORK SERVICES, INC., EVANSTON, IL. SN 76-022,045. PUB. 5-22-2001, FILED 4-10-2000.

MATCHLINK

OWNER OF U.S. REG. NO. 2,015,891. FOR COMPUTERIZED DATING AND INTRODUCTION SERVICES PROVIDED BY TELEPHONE OR THROUGH A GLOBAL COMPUTER NETWORK, NAMELY, THE MATCHING OF COMPATIBLE PERSONALITIES BASED ON INFORMATION STORED IN A COMPUTER DATABASE DERIVED FROM USER SUPPLIED ANSWERS TO PERSONALITY PROFILE QUESTIONS (U.S. CLS. 100 AND 101).

FIRST USE 2-14-2000; IN COMMERCE 2-14-2000.

2,858,256. RIVER OF FIRE MINISTRIES INTERNATIONAL, INC., VANCOUVER, WA. SN 76-040,289. PUB. 9-11-2001, FILED 5-3-2000.

RIVER OF FIRE MINISTRIES INTERNATIONAL

NO CLAIM IS MADE TO THE EXCLUSIVE RIGHT TO USE "MINISTRIES INTERNATIONAL", APART FROM THE MARK AS SHOWN.

FOR EVANGELISTIC AND MINISTERIAL SERVICES PROMOTING THE GOSPEL OF JESUS CHRIST; COUNSELING IN THE FIELD OF RELIGION (U.S. CLS. 100 AND 101).

FIRST USE 1-15-2000; IN COMMERCE 3-3-2003.

2,858,260. BINGO PLAYERS, INC., RESEDA, CA. SN 76-062,418. PUB. 4-23-2002, FILED 6-5-2000.

CAFÉ BINGO

FOR RESTAURANT SERVICES, AND BAR AND LOUNGE SERVICES (U.S. CLS. 100 AND 101).

FIRST USE 1-17-2002; IN COMMERCE 1-17-2002.

CLASS 42—(Continued).

2,858,265. RICE BOXX ENTERPRISES, LP, PLANO, TX. SN 76-087,366. PUB. 4-10-2001, FILED 7-11-2000.



FOR RESTAURANT SERVICES (U.S. CLS. 100 AND 101).

FIRST USE 6-0-2000; IN COMMERCE 6-0-2000.

2,858,268. 3E COMPANY, ENVIRONMENTAL, ECOLOGICAL AND ENGINEERING, CARLSBAD, CA. SN 76-095,580. PUB. 3-5-2002, FILED 7-24-2000.

ONE CLICK COMPLIANCE

OWNER OF U.S. REG. NO. 2,129,812. NO CLAIM IS MADE TO THE EXCLUSIVE RIGHT TO USE "COMPLIANCE", APART FROM THE MARK AS SHOWN.

FOR COMPUTER SERVICES, NAMELY, PROVIDING AN ON-LINE COMPUTER DATABASE FEATURING INFORMATION ON THE HANDLING, STORAGE AND REGULATION OF HAZARDOUS WASTE MATERIAL (U.S. CLS. 100 AND 101).

FIRST USE 2-8-2000; IN COMMERCE 2-8-2000.

2,858,293. BREHM, NANCY, BOSTON, MA. SN 76-163,891. PUB. 11-13-2001, FILED 11-13-2000.

BODY AS GARDEN

FOR PROVIDING CLINICAL SERVICES IN THE NATURE OF PSYCHOLOGICAL AND REHABILITATION THERAPIES FOR THE TREATMENT OF WEIGHT LOSS (U.S. CLS. 100 AND 101).

FIRST USE 12-26-2003; IN COMMERCE 12-26-2003.

2,858,298. CORRELAGEN, INC., NEWTON, MA. SN 76-175,342. PUB. 8-28-2001, FILED 12-4-2000.

CORRELAGEN

FOR PROVIDE GENOMIC DIAGNOSTIC AND ANALYTIC SERVICES TO HEALTHCARE ORGANIZATIONS AND THEIR PATIENTS (U.S. CLS. 100 AND 101).

FIRST USE 10-31-2003; IN COMMERCE 10-31-2003.

CLASS 42—(Continued).

2,858,301. ORALECT, L.P., PLANO, TX. SN 76-184,373. PUB. 7-15-2003, FILED 12-20-2000.

FASTBRACES.COM

FOR ORTHODONTIC AND DENTAL SERVICES (U.S. CLS. 100 AND 101).
FIRST USE 12-1-1999; IN COMMERCE 12-1-1999.

2,858,303. RUSTEN MARKETING GROUP, INC., MINNEAPOLIS, MN. SN 76-186,226. PUB. 11-20-2001, FILED 12-22-2000.

WHAT'S THE TERM FOR CLAIMING YOUR HOME'S EQUITY FOR YOURSELF? SMART.

FOR CONSULTING SERVICES, NAMELY, PROVIDING ADVICE, INFORMATION AND SALES MATERIAL REGARDING; BROKERAGE, MORTGAGE AND LENDING SERVICES, REAL ESTATE TITLE, HOMEOWNERS, PROPERTY AND CASUALTY INSURANCE, TO ASSIST OTHERS IN MARKETING AND SELLING THEIR OWN REAL ESTATE (U.S. CLS. 100 AND 101).
FIRST USE 1-21-2001; IN COMMERCE 7-18-2001.

2,858,378. BARMEDIA, INC., WASHINGTON, MO. SN 76-317,638. PUB. 7-8-2003, FILED 9-26-2001.

ETAB

FOR DEVELOPMENT AND TESTING OF COMPUTER SYSTEMS FOR OTHERS, NAMELY, INTERACTIVE RESTAURANT COMMUNICATION, ADVERTISING, ACCOUNTING, FINANCIAL, INVENTORY MANAGEMENT AND PURCHASING COMPUTER SYSTEMS; LEASING OF COMPUTER SYSTEMS, NAMELY, INTERACTIVE RESTAURANT COMMUNICATION, ADVERTISING, ACCOUNTING, FINANCIAL, INVENTORY MANAGEMENT AND PURCHASING COMPUTER SYSTEMS (U.S. CLS. 100 AND 101).
FIRST USE 12-1-2001; IN COMMERCE 12-1-2001.

2,858,426. BLUE GRAVITY COMMUNICATIONS, INC., PENNSAUKEN, NJ. SN 76-361,783. PUB. 4-8-2003, FILED 1-22-2002.

SITE DEFENDER

NO CLAIM IS MADE TO THE EXCLUSIVE RIGHT TO USE "SITE", APART FROM THE MARK AS SHOWN.
FOR MAINTAINING WEB SITES FOR OTHERS; REGISTRATION OF DOMAIN NAMES FOR THE IDENTIFICATION OF USERS ON A GLOBAL COMPUTER NETWORK (U.S. CLS. 100 AND 101).
FIRST USE 10-0-1999; IN COMMERCE 1-0-2000.

CLASS 42—(Continued).

2,858,441. DELTA PACIFIC, INC., NEW ORLEANS, LA. SN 76-377,761. PUB. 10-22-2002, FILED 3-5-2002.

AESCULAPIUS RESEARCH GROUP

NO CLAIM IS MADE TO THE EXCLUSIVE RIGHT TO USE "RESEARCH GROUP", APART FROM THE MARK AS SHOWN.

FOR CONSULTING SERVICES IN THE FIELD OF DESIGN, SELECTION, IMPLEMENTATION AND USE OF COMPUTER HARDWARE AND SOFTWARE SYSTEMS FOR OTHERS (U.S. CLS. 100 AND 101).
FIRST USE 10-18-2002; IN COMMERCE 10-18-2002.

2,858,446. ICLOPS, LLC, CHICAGO, IL. SN 76-382,585. PUB. 1-7-2003, FILED 3-18-2002.

ICLOPS

FOR PROVIDING TEMPORARY USE OF ON-LINE NON DOWNLOADABLE SOFTWARE FOR USE IN ACCESSING AND SEARCHING DATABASES IN THE HEALTH CARE FIELD TO HELP PROVIDE INFORMATION TO HEALTH CARE PROFESSIONALS; COMPUTER CONSULTATION SERVICES FOR HEALTH CARE PROFESSIONALS; CREATING CUSTOM SOFTWARE AND DATABASES TO HELP PROVIDE INFORMATION TO HEALTH CARE PROFESSIONALS (U.S. CLS. 100 AND 101).

FIRST USE 12-1-2002; IN COMMERCE 12-1-2002.

2,858,471. AMERICAN SOCIETY OF COMPOSERS, AUTHORS & PUBLISHERS, NEW YORK, NY. SN 76-408,459. PUB. 11-26-2002, FILED 5-15-2002.

THE POWER OF IDEAS

FOR PERFORMING RIGHTS LICENSING SERVICES (U.S. CLS. 100 AND 101).
FIRST USE 7-1-2002; IN COMMERCE 7-1-2002.

2,858,523. TRI-DYNE INDUSTRIES LLC, METAIRIE, LA. SN 76-429,639. PUB. 2-25-2003, FILED 7-11-2002.

TRI-DYNE INDUSTRIES

NO CLAIM IS MADE TO THE EXCLUSIVE RIGHT TO USE "INDUSTRIES", APART FROM THE MARK AS SHOWN.

FOR PRODUCT RESEARCH, PRODUCT DEVELOPMENT, AND LICENSING OF INTELLECTUAL PROPERTY (U.S. CLS. 100 AND 101).
FIRST USE 11-3-2003; IN COMMERCE 11-3-2003.

CLASS 42—(Continued).

2,858,702. GLEASON, ROBERT E., MECHANICSVILLE, VA. SN 78-014,232. PUB. 10-9-2001, FILED 6-25-2000.

rivierarental.com

THE WORD "RENTAL" AND THE UNDERLINING BENEATH THIS WORD "RENTAL" ARE IN THE COLOR RED. THE DOTS OVER THE "I" S IN "RIVIERA" ARE IN THE COLOR RED.

SEC. 2(F).

FOR TRAVEL AGENCY SERVICES, NAMELY MAKING RESERVATIONS AND BOOKINGS FOR TEMPORARY LODGING FOR VACATION RENTAL PROPERTIES, VIA GLOBAL COMPUTER NETWORKS (U.S. CLS. 100 AND 101).

FIRST USE 1-1-1999; IN COMMERCE 1-1-1999.

2,858,727. TELEGEN SERVICES INC., NEWBURGH, NY. SN 78-061,181. PUB. 10-2-2001, FILED 4-30-2001.

SILENTPARTNER

FOR QUALITY CONTROL FOR OTHERS, NAMELY, MONITORING QUALITY OF TELEMARKETING INTERACTIONS USING CONFERENCE BRIDGES TO SILENTLY MONITOR OR DIGITALLY RECORD INBOUND OR OUTBOUND TELEMARKETING INTERACTIONS (U.S. CLS. 100 AND 101).

FIRST USE 1-1-2002; IN COMMERCE 9-10-2002.

2,858,763. RESCH, LYNNE, BROOKLYN, NY. SN 78-106,375. PUB. 3-11-2003, FILED 2-1-2002.

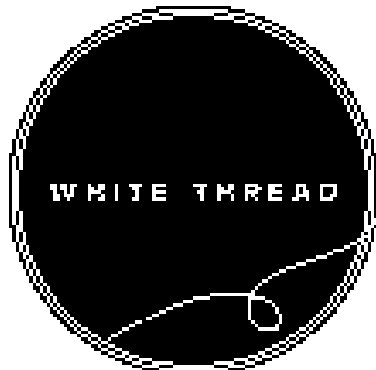

FOR GRAPHIC ART DESIGN; WEBSITE DESIGN (U.S. CLS. 100 AND 101).

FIRST USE 2-8-2002; IN COMMERCE 2-8-2002.

CLASS 42—(Continued).

2,858,804. KEYONUS INCORPORATED, SAN DIEGO, CA. SN 78-134,281. PUB. 12-31-2002, FILED 6-9-2002.

KEYONUS

FOR COMPUTER PROJECT MANAGEMENT SERVICES (U.S. CLS. 100 AND 101).

FIRST USE 4-7-2003; IN COMMERCE 4-7-2003.

2,858,814. ANGLE, JONATHAN, C., SAN PEDRO, CA. SN 78-139,373. PUB. 8-19-2003, FILED 6-27-2002.

CIO PARTNERS

NO CLAIM IS MADE TO THE EXCLUSIVE RIGHT TO USE "CIO", APART FROM THE MARK AS SHOWN.

FOR COMPUTER CONSULTATION, COMPUTER MANAGEMENT, COMPUTER PROJECT MANAGEMENT SERVICES, MANAGING COMPUTER WEB SITES FOR OTHERS, MONITORING THE COMPUTER SYSTEMS OF OTHERS FOR TECHNICAL PURPOSES AND PROVIDING BACK-UP COMPUTER PROGRAMS (U.S. CLS. 100 AND 101).

FIRST USE 1-4-2002; IN COMMERCE 6-20-2002.

2,858,843. ULTICOM, INC, MT. LAUREL, NJ. SN 78-158,189. PUB. 4-22-2003, FILED 8-27-2002.

SIGNALCARE

FOR SOFTWARE DEVELOPMENT AND CONSULTING FOR OTHERS; TECHNICAL SUPPORT SERVICES, NAMELY, TROUBLESHOOTING OF COMPUTER HARDWARE AND SOFTWARE PROBLEMS; MAINTENANCE OF COMPUTER SOFTWARE; UPDATING COMPUTER SOFTWARE FOR OTHERS (U.S. CLS. 100 AND 101).

FIRST USE 11-24-2003; IN COMMERCE 11-24-2003.

2,858,874. PCTFILER HOLDINGS PTY LTD, WILLOUGHBY, AUSTRALIA. SN 78-170,409. PUB. 9-2-2003, FILED 10-2-2002.

PCTFILER

PRIORITY CLAIMED UNDER SEC. 44(D) ON AUSTRALIA APPLICATION NO. 908547, FILED 4-6-2002, REG. NO. 908547, DATED 4-6-2002, EXPIRES 4-6-2012.

FOR PATENT ATTORNEY SERVICES INCLUDING SUCH SERVICES OFFERED VIA A GLOBAL COMPUTER NETWORK; LEGAL SERVICES INCLUDING SUCH SERVICES OFFERED VIA A GLOBAL COMPUTER NETWORK (U.S. CLS. 100 AND 101).

FIRST USE 4-16-2002; IN COMMERCE 2-17-2003.

CLASS 42—(Continued).

2,859,013. NATIONAL STUDY OF SCHOOL EVALUATION, SCHAUMBURG, IL. SN 78-234,225. PUB. 12-2-2003, FILED 4-4-2003.

NSSE-SURVEY

FOR PROVIDING TEMPORARY USE OF ON-LINE, NON-DOWNLOADABLE SOFTWARE FOR USE IN CREATING, UPDATING AND MAINTAINING SURVEYS ON A WEBSITE (U.S. CLS. 100 AND 101).
FIRST USE 8-1-2003; IN COMMERCE 9-11-2003.

CLASS 43—HOTEL AND RESTAURANT SERVICES

2,858,434. KAT & CATS, INC., LEXINGTON, KY. SN 76-371,023. PUB. 8-20-2002, FILED 2-15-2002.

HOT MOON

FOR PREPARATION OF HOT DISHES TO BE PROVIDED AT FAST-FOOD TYPE RESTAURANT (U.S. CLS. 100 AND 101).
FIRST USE 8-1-2002; IN COMMERCE 8-1-2002.

2,858,500. GROUND ROUND, INC., THE, BRAINTREE, MA. SN 76-421,869. PUB. 8-26-2003, FILED 6-17-2002.

GROUND ROUND HOUND

OWNER OF U.S. REG. NOS. 2,621,535, 2,635,442, AND OTHERS.
FOR RESTAURANT AND BAR SERVICES (U.S. CLS. 100 AND 101).
FIRST USE 9-30-2002; IN COMMERCE 9-30-2002.

2,858,784. SODEXHO OPERATIONS, LLC, GAITHERSBURG, MD. SN 78-120,567. PUB. 10-15-2002, FILED 4-9-2002.

THE GARDEN TOSS

THE MARK CONSISTS OF STANDARD CHARACTERS WITHOUT CLAIM TO ANY PARTICULAR FONT, STYLE, SIZE, OR COLOR.
FOR CONTRACT FOOD SERVICES; PREPARING AND SERVING FOODS IN INSTITUTIONAL DINING FACILITIES (U.S. CLS. 100 AND 101).
FIRST USE 8-0-2002; IN COMMERCE 8-0-2002.

CLASS 43—(Continued).

2,858,827. GILLETTE COMPANY, THE, BOSTON, MA. SN 78-150,010. PUB. 12-23-2003, FILED 8-1-2002.



NO CLAIM IS MADE TO THE EXCLUSIVE RIGHT TO USE "STADIUM", APART FROM THE MARK AS SHOWN, FOR PROVIDING BANQUET AND SOCIAL FUNCTION FACILITIES FOR SPECIAL OCCASION (U.S. CLS. 100 AND 101).
FIRST USE 9-9-2002; IN COMMERCE 9-9-2002.

2,858,851. REEVES, DAVID S., ROSEVILLE, CA. AND LYNCH, MONICA, ROSEVILLE, CA. SN 78-162,211. PUB. 9-9-2003, FILED 9-9-2002.



NO CLAIM IS MADE TO THE EXCLUSIVE RIGHT TO USE DELI, APART FROM THE MARK AS SHOWN, FOR RESTAURANT SERVICES (U.S. CLS. 100 AND 101).
FIRST USE 8-0-2002; IN COMMERCE 8-0-2002.

2,858,865. MOONDANCE, INC., AUSTIN, TX. SN 78-167,485. PUB. 8-19-2003, FILED 9-24-2002.

ELITE CIRCLE GRILLE

NO CLAIM IS MADE TO THE EXCLUSIVE RIGHT TO USE "GRILLE", APART FROM THE MARK AS SHOWN, FOR RESTAURANT SERVICES (U.S. CLS. 100 AND 101).
FIRST USE 9-11-2003; IN COMMERCE 9-11-2003.

CLASS 43—(Continued).

2,858,871. BURRITO BEACH, LLC, CHICAGO, IL. SN 78-168,773. PUB. 8-26-2003, FILED 9-27-2002.



OWNER OF U.S. REG. NOS. 2,095,659 AND 2,127,616. NO CLAIM IS MADE TO THE EXCLUSIVE RIGHT TO USE "BURRITO", APART FROM THE MARK AS SHOWN. FOR RESTAURANT SERVICES (U.S. CLS. 100 AND 101).
FIRST USE 1-4-1998; IN COMMERCE 1-4-1998.

2,858,902. MCDONALD'S CORPORATION, OAK BROOK, IL. SN 78-180,574. PUB. 5-27-2003, FILED 10-31-2002.

GOT A BUCK? YOU'RE IN LUCK.

FOR RESTAURANT SERVICES (U.S. CLS. 100 AND 101).
FIRST USE 10-3-2002; IN COMMERCE 10-3-2002.

2,858,980. PRETZELMAKER, INC., SALT LAKE CITY, UT. SN 78-208,543. PUB. 9-16-2003, FILED 1-29-2003.

SERVING THE WORLD A PRETZEL AND A SMILE

FOR RESTAURANT SERVICES (U.S. CLS. 100 AND 101).
FIRST USE 4-30-2002; IN COMMERCE 7-31-2002.

CLASS 43—(Continued).

2,859,034. MARINA DISTRICT DEVELOPMENT COMPANY, LLC, DBA BORGATA HOTEL, CASINO & SPA, ATLANTIC CITY, NJ. SN 78-253,867. PUB. 12-23-2003, FILED 5-23-2003.

GO TO YOUR HAPPY PLACE

FOR RESORT HOTEL, RESTAURANT, BAR, AND COCKTAIL LOUNGE SERVICES; PROVIDING CONVENTION FACILITIES; BANQUET AND CATERING SERVICES; RESORT HOTEL, RESTAURANT, BAR, COCKTAIL LOUNGE, CONVENTION FACILITIES AND BANQUET AND CATERING SERVICES, ALL FEATURING FREQUENT CUSTOMER LOYALTY AND PROMOTION PROGRAMS; PROVIDING ON-LINE INFORMATION IN THE FIELDS OF RESORT HOTELS, RESTAURANTS, BARS, COCKTAIL LOUNGES, CONVENTION FACILITIES AND BANQUET AND CATERING SERVICES; PROVIDING ON-LINE INFORMATION IN THE FIELD OF RESORT HOTELS, RESTAURANTS, BARS, COCKTAIL LOUNGES, CONVENTION FACILITIES AND CATERING SERVICES ALL FEATURING FREQUENT CUSTOMER LOYALTY AND PROMOTION PROGRAMS (U.S. CLS. 100 AND 101).
FIRST USE 7-2-2003; IN COMMERCE 7-2-2003.

CLASS 44—MEDICAL, BEAUTY AND AGRICULTURAL SERVICES

2,858,479. COUNTRY GREEN LAWN & LANDSCAPE MAINTENANCE, INC., ROCHESTER, MN. SN 76-411,107. PUB. 6-24-2003, FILED 5-23-2002.

NO CLAIM IS MADE TO THE EXCLUSIVE RIGHT TO USE "LAWNCARE & LANDSCAPE MAINTENANCE", APART FROM THE MARK AS SHOWN.
FOR LAWN CARE (U.S. CLS. 100 AND 101).
FIRST USE 6-1-2002; IN COMMERCE 6-1-2002.

CLASS 44—(Continued).

2,858,561. MERCK & CO., INC., WHITEHOUSE STATION, NJ. SN 76-442,601. PUB. 3-11-2003, FILED 8-19-2002.



Stronger Together

FOR DISEASE MANAGEMENT SERVICES WHICH PROVIDE INFORMATION ABOUT HIV TO HEALTH CARE PROVIDERS, PATIENTS AND OTHERS INVOLVED IN THE CARE OF THOSE WITH HIV, INCLUDING INFORMATION ABOUT THE DISEASE, ITS TREATMENT, AND SUGGESTIONS FOR PATIENT MANAGEMENT (U.S. CLS. 100 AND 101).

FIRST USE 1-31-2003; IN COMMERCE 1-31-2003.

2,858,586. THE TAN FACTORY, L.L.C., NORTHVILLE, MI. SN 76-459,910. PUB. 7-15-2003, FILED 10-15-2002.

THE SMARTER WAY TO TAN

FOR TANNING SALON SERVICES (U.S. CLS. 100 AND 101).

FIRST USE 2-1-2001; IN COMMERCE 2-1-2001.

2,858,587. THE TAN FACTORY, L.L.C., NORTHVILLE, MI. SN 76-459,911. PUB. 7-15-2003, FILED 10-15-2002.

THE TAN FACTORY

NO CLAIM IS MADE TO THE EXCLUSIVE RIGHT TO USE "TAN", APART FROM THE MARK AS SHOWN.

FOR TANNING SALON SERVICES (U.S. CLS. 100 AND 101).

FIRST USE 2-1-2001; IN COMMERCE 2-1-2001.

2,858,623. MIRACLE-EAR, INC., PLYMOUTH, MN. SN 76-474,595. PUB. 7-8-2003, FILED 12-6-2002.

ME-3 SOLUTION

FOR AUDIOLOGICAL SERVICE PACKAGE WHICH PROVIDES A COMPREHENSIVE PROGRAM TO ASSIST A HEARING AID USER IN THE SELECTION, MAINTENANCE AND WARRANTY OF HEARING AIDS (U.S. CLS. 100 AND 101).

FIRST USE 1-1-2002; IN COMMERCE 1-1-2002.

CLASS 44—(Continued).

2,858,624. MIRACLE-EAR, INC., PLYMOUTH, MN. SN 76-474,596. PUB. 7-8-2003, FILED 12-6-2002.

ME-2 SOLUTION

FOR AUDIOLOGICAL SERVICE PACKAGE WHICH PROVIDES A COMPREHENSIVE PROGRAM TO ASSIST A HEARING AID USER IN THE SELECTION, MAINTENANCE AND WARRANTY OF HEARING AIDS (U.S. CLS. 100 AND 101).

FIRST USE 1-1-2002; IN COMMERCE 1-1-2002.

2,858,625. MIRACLE-EAR, INC., PLYMOUTH, MN. SN 76-474,597. PUB. 7-8-2003, FILED 12-6-2002.

ME-1 SOLUTION

FOR AUDIOLOGICAL SERVICE PACKAGE WHICH PROVIDES A COMPREHENSIVE PROGRAM TO ASSIST A HEARING AID USER IN THE SELECTION, MAINTENANCE AND WARRANTY OF HEARING AIDS (U.S. CLS. 100 AND 101).

FIRST USE 1-1-2002; IN COMMERCE 1-1-2002.

2,858,626. MIRACLE-EAR, INC., PLYMOUTH, MN. SN 76-474,598. PUB. 7-8-2003, FILED 12-6-2002.

ME-4 SOLUTION

FOR AUDIOLOGICAL SERVICE PACKAGE WHICH PROVIDES A COMPREHENSIVE PROGRAM TO ASSIST A HEARING AID USER IN THE SELECTION, MAINTENANCE AND WARRANTY OF HEARING AIDS (U.S. CLS. 100 AND 101).

FIRST USE 1-1-2002; IN COMMERCE 1-1-2002.

2,858,666. BJC HEALTHCARE, ST. LOUIS, MO. SN 76-498,145. PUB. 1-6-2004, FILED 2-14-2003.

EMEDCENTER

FOR MEDICAL CONSULTING SERVICES, NAMELY, PROVIDING SECURED PHYSICIAN-TO-PHYSICIAN CONSULTATIONS VIA THE INTERNET, FACSIMILE, AND TELEPHONE (U.S. CLS. 100 AND 101).

FIRST USE 3-1-2003; IN COMMERCE 3-1-2003.

2,858,914. LIFESTYLE IMPROVEMENT CENTERS, LLC, LEXINGTON, VA. SN 78-184,931. PUB. 6-24-2003, FILED 11-14-2002.

SLENDERIFIC

FOR COUNSELING IN THE FIELD OF WEIGHT LOSS, NUTRITION AND WELLNESS (U.S. CLS. 100 AND 101).

FIRST USE 12-15-2001; IN COMMERCE 5-1-2002.

CLASS 44—(Continued).

2,858,944. THE PILLHELP COMPANY, LLC, FT. MYERS, FL.
SN 78-193,254. PUB. 8-19-2003, FILED 12-11-2002.

PILLHELP

FOR PHARMACEUTICAL ADVICE (U.S. CLS. 100
AND 101).
FIRST USE 5-25-2001; IN COMMERCE 5-25-2001.

CLASS 44—(Continued).

2,859,044. ALTHEA TECHNOLOGIES, INC., SAN DIEGO,
CA. SN 78-975,322. PUB. 6-24-2003, FILED 8-5-2002.

eXpress Profiling

2,858,994. HELPING HAND REHABILITATION CENTER,
COUNTRYSIDE, IL. SN 78-217,584. PUB. 11-18-2003, FILED
2-21-2003.

SERVICE FOR LIFE

FOR PROVIDING COMMUNITY-BASED PHYSICAL
THERAPY, SPEECH THERAPY, OCCUPATIONAL
THERAPY, VOCATIONAL THERAPY, AND PHYSICAL
REHABILITATION SERVICES FOR CHILDREN AND
ADULTS WITH PHYSICAL AND/OR COGNITIVE DIS-
ABILITIES (U.S. CLS. 100 AND 101).
FIRST USE 10-0-2003; IN COMMERCE 10-0-2003.

NO CLAIM IS MADE TO THE EXCLUSIVE RIGHT TO
USE "PROFILING", APART FROM THE MARK AS SHOWN.
FOR MEDICAL TESTING AND ANALYTICAL SER-
VICES IN THE FIELD OF GENES (U.S. CLS. 100 AND
101).
FIRST USE 6-0-2002; IN COMMERCE 6-0-2002.

* * * * *

PRIOR UNITED STATES CLASSIFICATION

APPLICATION IN ONE CLASS

CERTIFICATION MARKS

CLASS A—GOODS

2,858,267. BAY AREA COMPLIANCE LAB CORP., SUNNYVALE, CA. SN 76-090,646. PUB. 3-12-2002, FILED 7-17-2000.



THE CERTIFICATION MARK, INTENDED TO BE USED BY AUTHORIZED PERSONS, IS INTENDED TO CERTIFY THE ABOVE-IDENTIFIED GOODS IN COMPLIANCE WITH THE UNITED STATES, CANADIAN AND INTERNATIONAL REQUIREMENTS BY CONDUCTING ELECTROMAGNETIC COMPATIBILITY (EMC) TESTING, CS03 TESTING, JATE, CCIB, BSMI, TAS AND OFHA TESTING.

FOR DIGITAL AND ANALOG TELECOMMUNICATIONS EQUIPMENT, NAMELY, T1/E1 EQUIPMENT, ISDN EQUIPMENT, PUBLIC SWITCH DIGITAL SERVICES DEVICES, MODEM, TELEPHONE, PRIVATE BRANCH EXCHANGER, ROUTER AND FAX MACHINE; INFORMATION TECHNOLOGIES EQUIPMENT, NAMELY, COMPUTER SYSTEM, PC SERVER, VIDEO CARD, MOTHERBOARD, I/O CARD, POWER SUPPLY, SCANNER, PRINTER AND PC STORAGE; INDUSTRY, SCIENCE AND MEDICAL EQUIPMENT, NAMELY, UNIVERSAL PORT TESTER, USB PORT VERIFICATION SYSTEM; HOUSEHOLD DEVICES, NAMELY, WASHING MACHINE, DRYER, FAN, MICROWAVE OVEN, RADIO AND LUMINOUS LAMPS (U.S. CL. A).

FIRST USE 9-15-2003; IN COMMERCE 9-15-2003.

2,858,641. UNIFORM CODE COUNCIL, INC., LAWRENCEVILLE, NJ. SN 76-482,509. PUB. 8-5-2003, FILED 1-15-2003.



NO CLAIM IS MADE TO THE EXCLUSIVE RIGHT TO USE "INTEROPERABILITY TESTED", APART FROM THE MARK AS SHOWN.

THE CERTIFICATION MARK IS INTENDED TO BE USED BY AUTHORIZED ENTITIES OR PERSONS AND IS INTENDED TO CERTIFY THAT A SOFTWARE CONFORMS TO STANDARDS DESIGNATED BY THE UNIFORM CODE COUNCIL.

FOR COMPUTER SOFTWARE (U.S. CL. A).
FIRST USE 2-21-2003; IN COMMERCE 2-21-2003.

CERTIFICATION MARKS

CLASS B—SERVICES

2,858,538. BRIDG'S COMMITTEE LLC, WHEATON, IL. SN 76-433,393. PUB. 7-15-2003, FILED 7-23-2002.



NO CLAIM IS MADE TO THE EXCLUSIVE RIGHT TO USE "QUALITY", APART FROM THE MARK AS SHOWN.

THE CERTIFICATION MARK AS INTENDED TO BE USED BY AUTHORIZED PERSONS IS INTENDED TO CERTIFY COMPLIANCE WITH APPLICANT'S PROGRAM FOR THE BASIC REQUIREMENTS FOR INTERNATIONAL DESIGN AND GRAPHIC SOLUTIONS.

FOR GRAPHIC ART DESIGN SERVICES (U.S. CL. B).
FIRST USE 1-1-2004; IN COMMERCE 1-1-2004.

* * * * *

SUPPLEMENTAL REGISTER

These registrations are not subject to opposition.

SECTION 1.— INTERNATIONAL CLASSIFICATION

The short titles associated below with the international class numbers are terms designed merely for quick identification and are not an official part of the international classification. The full names of international classes are given in section 6.1 of the trademark rules of practice.

The designation "U.S. Cl." appearing in this section refers to the U.S. class in effect prior to Sep. 1, 1973 rather than the international class which applies to applications filed on or after that date. For adoption of international classification see notice in the OFFICIAL GAZETTE of Jun. 26, 1973 (911 O.G. TM 210).

Application in more than one class

2,859,060. THE TRUSTEE OF THE SOUND RECORDING SPECIAL PAYMENTS FUND, A NEW YORK TRUST, THE TRUSTEE COMPRISING ENEX STEELE, A U.S. CITIZEN, NEW YORK, NY. SN 76-415,383. FILED P.R. 5-29-2002; AM. S.R. 2-2-2004.

SOUND RECORDING SPECIAL PAYMENTS FUND

NO CLAIM IS MADE TO THE EXCLUSIVE RIGHT TO USE "SPECIAL PAYMENTS FUND", APART FROM THE MARK AS SHOWN.

CLASS 35—ADVERTISING AND BUSINESS

FOR ACCOUNTING, BILLING AND BOOKKEEPING SERVICES PERTAINING TO MUSIC LICENSING FUNDS; ASSOCIATION SERVICES, NAMELY, PROMOTING THE INTERESTS OF MUSICIANS; AND PUBLIC RELATIONS SERVICES IN THE FIELD OF MUSIC (U.S. CLS. 100, 101 AND 102).

FIRST USE 2-0-2002; IN COMMERCE 2-0-2002.

CLASS 36—INSURANCE AND FINANCIAL

FOR ADMINISTRATION OF MUSIC LICENSING FUNDS, NAMELY, COLLECTION AND DISTRIBUTION OF ROYALTIES TO MUSICIANS (U.S. CLS. 100, 101 AND 102).

FIRST USE 2-0-2002; IN COMMERCE 2-0-2002.

2,859,071. FUNDUS HOTELENTWICKLUNGS- UND VERWALTUNGSGESELLSCHAFT MBH, 50674 KOLN, FED REP GERMANY. SN 76-483,962. FILED P.R. 1-21-2003; AM. S.R. 4-5-2004.

ADLON

PRIORITY CLAIMED UNDER SEC. 44(D) ON FED REP GERMANY APPLICATION NO. 30235086.1/4, FILED 7-19-2002, REG. NO. 30235086, DATED 9-5-2002, EXPIRES 7-31-2012.

OWNER OF U.S. REG. NO. 2,694,206.

CLASS 42—SCIENTIFIC, COMPUTER AND LEGAL SERVICES

FOR INTERIOR DECORATING SERVICES (U.S. CLS. 100 AND 101).

CLASS 43—HOTEL AND RESTAURANT SERVICES

FOR CONSULTING SERVICES IN THE FIELD OF HOSPITALITY; MAKING RESERVATIONS AND BOOKINGS FOR TEMPORARY LODGING FOR OTHERS; HOTELS; RESTAURANTS; CAFETERIAS, AND SELF-SERVE RESTAURANTS AND RESTAURANTS FEATURING HOME DELIVERY; BAR SERVICES; CATERING AND PARTY SERVICES; AND PROVIDING GENERAL PURPOSE FACILITIES FOR EXHIBITION (U.S. CLS. 100 AND 101).

2,859,072. ELEVEN ELEVEN CORPORATION, GUAYNABO, PUERTO RICO. SN 76-487,084. FILED P.R. 1-31-2003; AM. S.R. 3-26-2004.

INFANTI

THE ENGLISH TRANSLATION OF INFANTI IS INFANT.

CLASS 10—MEDICAL APPARATUS

FOR BABY PRODUCTS, NAMELY, BOTTLES, NIPPLES FOR BABY BOTTLES, BOTTLENECK SPOUTS FOR BABY BOTTLES, FEEDING BOTTLE TEATS, BREAST SHIELDS, ASPIRATORS AND PACIFIERS (U.S. CLS. 26, 39 AND 44).

FIRST USE 9-4-2003; IN COMMERCE 9-4-2003.

CLASS 12—VEHICLES

FOR CAR SEATS FOR BABIES AND CHILDREN, STROLLERS AND BABY CARRIAGES (U.S. CLS. 19, 21, 23, 31, 35 AND 44).

FIRST USE 8-12-2003; IN COMMERCE 8-12-2003.

CLASS 20—FURNITURE AND ARTICLES NOT OTHERWISE CLASSIFIED

FOR HIGH CHAIRS FOR BABIES, PLAYPENS, WALKERS FOR BABIES AND JUMPERS FOR BABIES (U.S. CLS. 2, 13, 22, 25, 32 AND 50).
FIRST USE 2-9-2004; IN COMMERCE 2-9-2004.

CLASS 21—HOUSEWARES AND GLASS

FOR BOTTLE BRUSHES, MILK POWDER CONTAINERS, BRUSH AND COMB SETS, BOWLS AND SPILL-PROOF CUPS (U.S. CLS. 2, 13, 23, 29, 30, 33, 40 AND 50).
FIRST USE 9-4-2003; IN COMMERCE 9-4-2003.

CLASS 28—TOYS AND SPORTING GOODS

FOR SWINGS FOR BABIES (U.S. CLS. 22, 23, 38 AND 50).
FIRST USE 2-9-2004; IN COMMERCE 2-9-2004.

2,859,083. HREC LICENSING, LLC, PARKER, CO. SN 76-505,549. FILED P.R. 4-10-2003; AM. S.R. 4-7-2004.

HOSPITALITY REAL ESTATE COUNSELORS

OWNER OF U.S. REG. NOS. 2,011,247 AND 2,036,640.

CLASS 36—INSURANCE AND FINANCIAL

FOR REAL ESTATE APPRAISAL SERVICES TO THE HOSPITALITY INDUSTRY (U.S. CLS. 100, 101 AND 102).
FIRST USE 1-1-1995; IN COMMERCE 1-1-1995.

CLASS 43—HOTEL AND RESTAURANT SERVICES

FOR CONSULTING SERVICES IN THE FIELD OF HOSPITALITY (U.S. CLS. 100 AND 101).
FIRST USE 1-1-1995; IN COMMERCE 1-1-1995.

2,859,097. CAREGAIN, INC., MONROE, NJ. SN 78-065,925. FILED P.R. 5-25-2001; AM. S.R. 12-22-2003.

HEALTHCAREIRA**CLASS 36—INSURANCE AND FINANCIAL**

FOR ADMINISTRATION AND MANAGEMENT OF HEALTHCARE BENEFITS FOR EMPLOYEES, INDIVIDUALS AND PATIENTS UNDER A PERSONAL ACCOUNT SYSTEM; CONSULTING IN THE AREA OF HEALTHCARE NEEDS AND BENEFIT ELIGIBILITY BASED ON INDIVIDUAL HEALTH DATA; FINANCIAL SERVICES, NAMELY, SAVINGS ACCOUNT TO PROVIDE FUNDS FOR HEALTHCARE EXPENSES (U.S. CLS. 100, 101 AND 102).
FIRST USE 5-10-2001; IN COMMERCE 5-10-2001.

CLASS 42—SCIENTIFIC, COMPUTER AND LEGAL SERVICES

FOR MANAGING INDIVIDUAL HEALTHCARE DATA FOR OTHERS, HEALTH PLANNING SERVICES FOR AN INDIVIDUAL'S LIFETIME (U.S. CLS. 100 AND 101).
FIRST USE 5-10-2001; IN COMMERCE 5-10-2001.

2,859,099. MAKE-UP CHANNEL, INC., SIGNAL HILL, CA. SN 78-166,813. FILED P.R. 9-23-2002; AM. S.R. 9-9-2003.

MAKE-UP CHANNEL

NO CLAIM IS MADE TO THE EXCLUSIVE RIGHT TO USE CHANNEL, APART FROM THE MARK AS SHOWN.

CLASS 35—ADVERTISING AND BUSINESS

FOR PROVIDING CAREER INFORMATION IN THE FIELDS OF MAKE-UP, BEAUTY, AND COSMETICS (U.S. CLS. 100, 101 AND 102).
FIRST USE 3-15-2003; IN COMMERCE 3-15-2003.

CLASS 41—EDUCATION AND ENTERTAINMENT

FOR EDUCATIONAL SERVICES, NAMELY PROVIDING CLASSES, WORKSHOPS, AND SEMINARS IN THE FIELD OF MAKE-UP, BEAUTY, AND COSMETICS (U.S. CLS. 100, 101 AND 107).
FIRST USE 3-15-2003; IN COMMERCE 3-15-2003.

2,859,107. MISCO PRODUCTS CORPORATION, READING, PA. SN 78-217,566. FILED P.R. 2-21-2003; AM. S.R. 2-20-2004.

LOCK & FILL**CLASS 3—COSMETICS AND CLEANING PREPARATIONS**

FOR INDUSTRIAL AND INSTITUTIONAL CLEANING AND MAINTENANCE PRODUCTS, NAMELY GLASS, FLOOR, CARPET, AND ALL-PURPOSE CLEANING PRODUCTS (U.S. CLS. 1, 4, 6, 50, 51 AND 52).
FIRST USE 9-1-2002; IN COMMERCE 9-1-2002.

CLASS 7—MACHINERY

FOR UNIT FOR DILUTING AND DISPENSING CONCENTRATED LIQUID INDUSTRIAL AND INSTITUTIONAL CLEANING AND MAINTENANCE PRODUCTS (U.S. CLS. 13, 19, 21, 23, 31, 34 AND 35).
FIRST USE 9-1-2002; IN COMMERCE 9-1-2002.
2,859,113. EDGARIAN & JENKS, SAN FRANCISCO, CA. SN 78-235,639. FILED P.R. 4-9-2003; AM. S.R. 4-12-2004.

NARRATIVE PRESS

NO CLAIM IS MADE TO THE EXCLUSIVE RIGHT TO USE "PRESS", APART FROM THE MARK AS SHOWN.

CLASS 40—MATERIAL TREATMENT

FOR PRINTING AND DESKTOP PUBLISHING FOR
OTHERS (U.S. CLS. 100, 103 AND 106).
FIRST USE 8-15-2003; IN COMMERCE 8-15-2003.

**CLASS 41—EDUCATION AND ENTERTAIN-
MENT**

FOR ELECTRONIC PUBLISHING, NAMELY PUBLI-
CATION OF TEXT AND GRAPHIC WORKS OF OTHERS
FEATURING FICTION AND NONFICTION (U.S. CLS.
100, 101 AND 107).
FIRST USE 8-15-2003; IN COMMERCE 8-15-2003.

* * * * *

SECTION 2.— INTERNATIONAL CLASSIFICATION

The short titles associated below with the international class numbers are terms designed merely for quick identification and are not an official part of the international classification. The full names of international classes are given in section 6.1 of the trademark rules of practice.

The designation "U.S. Cl." appearing in this section refers to the U.S. class in effect prior to Sep. 1, 1973 rather than the international class which applies to applications filed on or after that date. For adoption of international classification see notice in the OFFICIAL GAZETTE of Jun. 26, 1973 (911 O.G. TM 210).

Application in one class

CLASS 3—COSMETICS AND CLEANING PREPARATIONS

2,859,064. ORALABS, INC., ENGLEWOOD, CO. SN 76-439,847.
FILED P.R. 8-8-2002; AM. S.R. 3-24-2004.

LIP NATURALS

NO CLAIM IS MADE TO THE EXCLUSIVE RIGHT TO USE "LIP", APART FROM THE MARK AS SHOWN.
FOR NON-MEDICATED LIP BALM (U.S. CLS. 1, 4, 6, 50, 51 AND 52).
FIRST USE 3-15-1999; IN COMMERCE 3-15-1999.

CLASS 4—LUBRICANTS AND FUELS

2,859,063. TAYLOR, HENRY MICHAEL, BIGLERVILLE, PA.
SN 76-438,571. FILED 8-7-2002.

READY-MADE FIRE

NO CLAIM IS MADE TO THE EXCLUSIVE RIGHT TO USE FIRE, APART FROM THE MARK AS SHOWN.
FOR PORTABLE INCENDIARY KIT CONSISTING PRIMARILY OF A COMBUSTIBLE CONTAINER HOUSING COMBUSTIBLE MATERIAL, NAMELY, NATURAL AND ARTIFICIAL FIREPLACE LOGS (U.S. CLS. 1, 6 AND 15).
FIRST USE 5-24-2002; IN COMMERCE 5-24-2002.

CLASS 7—MACHINERY

2,859,132. NUTOOL, INC., MILPITAS, CA. SN 78-319,851.
FILED 10-28-2003.

ECMP

FOR SEMICONDUCTOR MANUFACTURING MACHINES; SEMICONDUCTOR SUBSTRATES MANUFACTURING MACHINES; AND SEMICONDUCTOR WAFER PROCESSING MACHINES (U.S. CLS. 13, 19, 21, 23, 31, 34 AND 35).
FIRST USE 10-24-2003; IN COMMERCE 10-24-2003.

CLASS 9—ELECTRICAL AND SCIENTIFIC APPARATUS

CLASS 9—(Continued).

2,859,052. ROCHESTER INSTITUTE OF TECHNOLOGY, ROCHESTER, NY. SN 76-352,799. FILED P.R. 12-26-2001; AM. S.R. 3-12-2003.

PRESERVATION ENVIRONMENT MONITOR

NO CLAIM IS MADE TO THE EXCLUSIVE RIGHT TO USE MONITOR, APART FROM THE MARK AS SHOWN.
FOR ELECTRONIC DATALOGGER WHICH MEASURES, STORES AND DISPLAYS TEMPERATURE AND RELATIVE HUMIDITY DATA, AND ANALYZES THE IMPACT ON MATERIAL DECAY RATES (U.S. CLS. 21, 23, 26, 36 AND 38).
FIRST USE 8-0-1995; IN COMMERCE 9-0-1995.

2,859,053. ROCHESTER INSTITUTE OF TECHNOLOGY, ROCHESTER, NY. SN 76-353,116. FILED P.R. 12-26-2001; AM. S.R. 3-12-2003.

Preservation Environment Monitor



NO CLAIM IS MADE TO THE EXCLUSIVE RIGHT TO USE MONITOR, APART FROM THE MARK AS SHOWN.
FOR ELECTRONIC DATALOGGER WHICH MEASURES, STORES AND DISPLAYS TEMPERATURE AND RELATIVE HUMIDITY DATA, AND ANALYZES THE IMPACT ON MATERIAL DECAY RATES (U.S. CLS. 21, 23, 26, 36 AND 38).
FIRST USE 8-0-1995; IN COMMERCE 9-0-1995.

CLASS 9—(Continued).

2,859,054. GEBHARDT, LINDA, CHICAGO, IL. AND KRAUS, KEITH, CHICAGO, IL. SN 76-356,025. FILED P.R. 1-4-2002; AM. S.R. 4-9-2004.

STATE TRACKER

FOR COMPUTER SOFTWARE FOR USE IN DATABASE MANAGEMENT IN THE FIELD OF TRAVEL AND GEOGRAPHICAL INFORMATION (U.S. CLS. 21, 23, 26, 36 AND 38).

FIRST USE 10-3-2001; IN COMMERCE 10-3-2001.

2,859,056. CHANEY INSTRUMENT COMPANY, LAKE GEN-EVA, WI. SN 76-399,185. FILED P.R. 4-23-2002; AM. S.R. 11-3-2003.

CHANEY INSTRUMENT

NO CLAIM IS MADE TO THE EXCLUSIVE RIGHT TO USE "INSTRUMENT", APART FROM THE MARK AS SHOWN.

FOR THERMOMETERS (U.S. CLS. 21, 23, 26, 36 AND 38).

FIRST USE 10-1-2001; IN COMMERCE 10-1-2001.

2,859,058. VENVEST, INC., ST. LOUIS, MO. SN 76-412,657. FILED P.R. 5-28-2002; AM. S.R. 3-11-2004.

"THE TALKING THERMOSTAT"

NO CLAIM IS MADE TO THE EXCLUSIVE RIGHT TO USE "THERMOSTAT", APART FROM THE MARK AS SHOWN.

FOR THERMOSTATS (U.S. CLS. 21, 23, 26, 36 AND 38).

FIRST USE 8-1-2002; IN COMMERCE 8-1-2002.

2,859,095. NEXANT, INC., SAN FRANCISCO, CA. SN 76-976,611. FILED P.R. 5-20-2002; AM. S.R. 1-27-2004.

HEDGE

FOR COMPUTER APPLICATION SOFTWARE FOR USE IN THE ELECTRIC ENERGY INDUSTRY, FOR FINANCIAL TRANSMISSION RIGHT (FTR) AND CONGESTION REVENUE RIGHT (CRR) CALCULATIONS, AUCTIONS AND ALLOCATIONS, AND FOR THE BUYING, SELLING AND ALLOCATION OF SINGLE AND MULTI-PERIOD WHOLESALE ELECTRICITY OPTIONS AND OBLIGATIONS (U.S. CLS. 21, 23, 26, 36 AND 38).

FIRST USE 7-1-2002; IN COMMERCE 7-1-2002.

CLASS 9—(Continued).

2,859,100. DAVIS INSTRUMENTS CORPORATION, HAYWARD, CA. SN 78-176,707. FILED P.R. 10-21-2002; AM. S.R. 4-13-2004.



THE MARK CONSISTS OF STANDARD CHARACTERS WITHOUT CLAIM TO ANY PARTICULAR FONT, STYLE, SIZE, OR COLOR.

FOR ELECTRONIC APPARATUS, NAMELY, DATA LOGGER, FIRMWARE, CABLE, POWER ADAPTER, AND SOFTWARE, FOR MONITORING AND RECORDING VEHICLE SPEED, ACCELERATION, DISTANCE, TIME VARIABLES, AUTOMOTIVE SYSTEM PARAMETERS, ENGINE LOGGING, AND RESETTING TROUBLE CODES (U.S. CLS. 21, 23, 26, 36 AND 38).

FIRST USE 11-0-2002; IN COMMERCE 2-0-2003.

2,859,104. TERACRUZ, INC., MADISON, AL. SN 78-202,620. FILED P.R. 1-13-2003; AM. S.R. 1-12-2004.

DBAPPLIANCE

FOR COMPUTER SYSTEMS COMPRISING HARDWARE AND SOFTWARE FOR INCREASING THE SPEED AND EFFICIENCY OF DATA QUERIES AND RETRIEVAL FROM ELECTRONIC DATABASES (U.S. CLS. 21, 23, 26, 36 AND 38).

FIRST USE 4-30-2003; IN COMMERCE 5-12-2003.

2,859,105. AMERICAN MEDIA PARTNERS, INC., WESTBROOK, ME. SN 78-209,398. FILED P.R. 1-31-2003; AM. S.R. 4-13-2004.

RAPID RECALL

FOR PRE-RECORDED INSTRUCTIONAL VIDEO TAPES, AUDIO TAPES, CD-ROM'S, ALL IN THE FIELD OF MEMORY IMPROVEMENT SKILLS, AND PAMPHLETS DISTRIBUTED AS A UNIT THEREWITH (U.S. CLS. 21, 23, 26, 36 AND 38).

FIRST USE 8-16-2002; IN COMMERCE 8-16-2002.

CLASS 9—(Continued).

2,859,106. TELEFONIX TECHNOLOGY, INC., SAN DIEGO, CA. SN 78-215,338. FILED P.R. 2-14-2003; AM. S.R. 2-17-2004.

HUMBUCKER

FOR MOBILE ELECTROMAGNETIC PICKUPS USED TO LOCATE FAULTS IN BURIED OR OVERHEAD ELECTRICALLY-CONDUCTIVE CABLES FOR TELEPHONE, CABLE TELEVISION OR ELECTRIC UTILITY TRANSMISSION APPLICATIONS (U.S. CLS. 21, 23, 26, 36 AND 38).

FIRST USE 6-11-2002; IN COMMERCE 6-11-2002.

2,859,109. IMPACT LABS, INC., COLUMBIA, MD. SN 78-225,688. FILED P.R. 3-14-2003; AM. S.R. 3-11-2004.

MASTER ARCHIVE

FOR COMPUTER SOFTWARE USED IN THE ENCODING, ENCRYPTION, MANIPULATION, TRANSMISSION, AND STORAGE OF IMAGES (U.S. CLS. 21, 23, 26, 36 AND 38).

FIRST USE 11-1-2001; IN COMMERCE 11-1-2001.

2,859,111. GROTE INDUSTRIES, LLC, MADISON, IN. SN 78-229,751. FILED P.R. 3-25-2003; AM. S.R. 3-22-2004.

THE INTELLIGENT BACK-UP SYSTEM

FOR A SENSOR FOR DETECTING OBSTACLES THAT MAY BE IN THE PATH OF A VEHICLE WHEN IT IS IN A BACKING SITUATION (U.S. CLS. 21, 23, 26, 36 AND 38).

FIRST USE 3-9-2003; IN COMMERCE 3-9-2003.

2,859,121. GLOBAL SOFTWARE CONSULTING, INC., HUNTSVILLE, AL. SN 78-249,943. FILED P.R. 5-14-2003; AM. S.R. 11-3-2003.



THE COLOR(S) RED AND TURQUOISE IS/ARE CLAIMED AS A FEATURE OF THE MARK.
THE LETTERS OF OFFICELAW USE RED TEXT WITH A TURQUOISE BACKGROUND.

THE MARK CONSISTS OF THE CHARACTERS OFFICE-LAW.

FOR PRERECORDED CD ROM DISK CONTAINING LEGAL INFORMATION AND FORMS FOR USE BY BUSINESSES (U.S. CLS. 21, 23, 26, 36 AND 38).

FIRST USE 6-2-2002; IN COMMERCE 6-2-2002.

CLASS 9—(Continued).

2,859,126. WIRELESS XCESSORIES GROUP, INC., HUNTINGDON VALLEY, PA. SN 78-285,773. FILED P.R. 8-11-2003; AM. S.R. 3-11-2004.

INDUSTRIAL STRENGTH

FOR ACCESSORIES FOR CELLULAR TELEPHONES, NAMELY CASES FOR CELLULAR TELEPHONES, CHARGING UNITS ADAPTED TO PLUG INTO CIGARETTE LIGHTERS OF VEHICLES FOR USE WITH CELLULAR TELEPHONES, HOLSTERS FOR CELLULAR TELEPHONES, EARPHONES AND HEADSETS FOR USE WITH CELLULAR TELEPHONES (U.S. CLS. 21, 23, 26, 36 AND 38).

FIRST USE 3-6-2003; IN COMMERCE 3-6-2003.

CLASS 12—VEHICLES

2,859,122. ROCKY MOUNTAIN ATV, PAYSON, UT. SN 78-254,748. FILED P.R. 5-27-2003; AM. S.R. 1-12-2004.

PRIMARY DRIVE

FOR EXTERNAL DRIVE SPROCKETS FOR OFF-ROAD VEHICLES (U.S. CLS. 19, 21, 23, 31, 35 AND 44).

FIRST USE 12-1-1997; IN COMMERCE 12-1-1997.

CLASS 16—PAPER GOODS AND PRINTED MATTER

2,859,061. SMALLEY RELATIONSHIP CENTER, BRANSON, MO. SN 76-434,642. FILED P.R. 7-26-2002; AM. S.R. 1-23-2004.

COUPLES INTENSIVE

FOR NON-FICTION BOOKS AND WORKBOOKS FOCUSING ON USING BIBLICAL TEACHINGS TO HELP BUILD RELATIONSHIPS (U.S. CLS. 2, 5, 22, 23, 29, 37, 38 AND 50).

FIRST USE 1-21-2004; IN COMMERCE 1-21-2004.

2,859,074. AMOS PRESS INC., SIDNEY, OH. SN 76-492,214. FILED P.R. 2-19-2003; AM. S.R. 9-25-2003.

MUSCLECAR ENTHUSIAST

FOR MAGAZINES ON THE SUBJECT OF AUTOMOBILES (U.S. CLS. 2, 5, 22, 23, 29, 37, 38 AND 50).

FIRST USE 4-1-2003; IN COMMERCE 4-1-2003.

CLASS 16—(Continued).

2,859,078. ADVANSTAR COMMUNICATIONS, INC., DULUTH, MN. SN 76-500,290. FILED P.R. 3-25-2003; AM. S.R. 3-10-2004.

VETGUIDE

FOR PRINTED PUBLICATION, NAMELY, A MAGAZINE DEVOTED TO VETERINARY EQUIPMENT AND SALES (U.S. CLS. 2, 5, 22, 23, 29, 37, 38 AND 50).
FIRST USE 11-0-1999; IN COMMERCE 11-0-1999.

2,859,082. PENTON MEDIA, INC., CLEVELAND, OH. SN 76-505,131. FILED P.R. 4-9-2003; AM. S.R. 4-6-2004.

CONNECTED HOME

FOR PUBLICATIONS, NAMELY, MAGAZINES, NEWSPAPERS, NEWSLETTERS, BROCHURES, PAMPHLETS, PRINTED EXHIBITION PROGRAMS, BOOKS AND DIRECTORIES IN THE FIELD OF INFORMATION TECHNOLOGY (U.S. CLS. 2, 5, 22, 23, 29, 37, 38 AND 50).
FIRST USE 1-1-2001; IN COMMERCE 1-1-2001.

2,859,116. BULMAN, RICHARD L., PORTLAND, ME. SN 78-238,272. FILED P.R. 4-16-2003; AM. S.R. 4-16-2004.

HEALTHY FAMILY

THE MARK CONSISTS OF STANDARD CHARACTERS WITHOUT CLAIM TO ANY PARTICULAR FONT, STYLE, SIZE, OR COLOR.

FOR CONSUMER MAGAZINE PROVIDING FAMILIES WITH INFORMATION RELATED TO HEALTHFUL LIVING (U.S. CLS. 2, 5, 22, 23, 29, 37, 38 AND 50).
FIRST USE 9-0-2003; IN COMMERCE 4-12-2004.

CLASS 17—RUBBER GOODS**CLASS 17—(Continued).**

2,859,119. CRANE PLASTICS SIDING LLC, COLUMBUS, OH. SN 78-242,652. FILED P.R. 4-28-2003; AM. S.R. 3-15-2004.

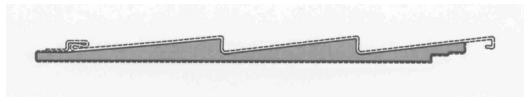

THE COLOR PURPLE IS CLAIMED AS A DISTINCTIVE FEATURE OF THE MARK.

THE COLOR PURPLE APPEARS ON THE FOAM THAT IS ON THE UNDERNEATH SIDE OF THE SIDING.

THE DOTTED OUTLINE OF THE GOODS IS INTENDED TO SHOW THE POSITION OF THE MARK AND IS NOT A PART OF OR THE SHAPE OF THE MARK.

FOR BUILDING MATERIALS, NAMELY, FOAM INSULATION APPLIED TO VINYL OR VINYL COMPOSITE BUILDING MATERIALS (U.S. CLS. 1, 5, 12, 13, 35 AND 50).

FIRST USE 1-1-2003; IN COMMERCE 1-1-2003.

CLASS 19—NON-METALLIC BUILDING MATERIALS

2,859,098. GARDNER ASPHALT CORPORATION, TAMPA, FL. SN 78-114,746. FILED P.R. 3-13-2002; AM. S.R. 3-8-2004.

ARIZONA

FOR ASPHALT AND ELASTOMERIC COATINGS AND CEMENTS, FOR USE ON ROOFS, DRIVEWAYS, FOUNDATIONS AND BUILDING EXTERIORS (U.S. CLS. 1, 12, 33 AND 50).

FIRST USE 6-1-1999; IN COMMERCE 6-1-1999.

CLASS 21—HOUSEWARES AND GLASS

2,859,055. MODERN CLASSIC ARTWORKS, LEXINGTON, KY. SN 76-377,795. FILED P.R. 3-4-2002; AM. S.R. 4-16-2004.

MODERN CLASSIC ARTWORKS

FOR COFFEE MUGS (U.S. CLS. 2, 13, 23, 29, 30, 33, 40 AND 50).

FIRST USE 7-15-2003; IN COMMERCE 7-15-2003.

2,859,110. CONERTY, JAMES, T., LITTLETON, CO. SN 78-229,657. FILED P.R. 3-25-2003; AM. S.R. 3-31-2004.

COVER CATCHER

FOR METAL WIRE RACK TO HOLD BEDDING AT THE END OF A BED (U.S. CLS. 2, 13, 23, 29, 30, 33, 40 AND 50).

FIRST USE 1-7-2003; IN COMMERCE 1-7-2003.

CLASS 21—(Continued).

2,859,112. FOAMEX ASIA CO., LTD., CARLSBAD, CA. SN 78-229,909. FILED P.R. 3-25-2003; AM. S.R. 3-8-2004.

SCRUBCLEAN

FOR MICRODENIER POLYESTER WIPER FOR USE IN HIGH-TECH CLEANING PROCEDURES IN THE MANUFACTURE OF SEMICONDUCTORS, HIGH DISK DRIVES, MEDICAL DEVICES, AND SIMILAR PRODUCTS (U.S. CLS. 2, 13, 23, 29, 30, 33, 40 AND 50).

FIRST USE 6-1-2003; IN COMMERCE 6-1-2003.

CLASS 25—CLOTHING

2,859,081. PIPE DREAM PRODUCTS, INC., CHATSWORTH, CA. SN 76-504,387. FILED P.R. 4-8-2003; AM. S.R. 3-10-2004.

**EDIBLE CROTCHLESS
GUMMY PANTIES**

NO CLAIM IS MADE TO THE EXCLUSIVE RIGHT TO USE "PANTIES", APART FROM THE MARK AS SHOWN. FOR PANTIES, LINGERIE AND UNDEWEAR (U.S. CLS. 22 AND 39).

FIRST USE 2-1-2001; IN COMMERCE 2-1-2001.

2,859,131. MOSHER PHOTO, INC., VINEYARD HAVEN, MA. SN 78-318,676. FILED P.R. 10-26-2003; AM. S.R. 4-15-2004.

got film?

FOR T-SHIRTS, SWEAT SHIRTS, HATS, SHORTS, SWEAT PANTS AND LONG SLEEVED SHIRTS (U.S. CLS. 22 AND 39).

FIRST USE 7-0-2003; IN COMMERCE 7-0-2003.

CLASS 26—FANCY GOODS**CLASS 26—(Continued).**

2,859,048. SONIA DI MARIA, PHOENIX, AZ. AND SANDRO DI MARIA, VIA MALASPINNA 3/MILANO, ITALY. AND SERGIO DI MARIA, VIA MALASPINNA 3/MILANO, ITALY. SN 75-621,117. FILED P.R. 1-15-1999; AM. S.R. 9-2-2003.

HAIRDIAMONDS

NO CLAIM IS MADE TO THE EXCLUSIVE RIGHT TO USE "HAIR", APART FROM THE MARK AS SHOWN.

FOR SYNTHETIC HAIR PIECES; SYNTHETIC, METAL, METALLIC, AND RHINESTONE HAIR ACCESSORIES, NAMELY BARRETTES AND SNAP AND CLAW CLIPS (U.S. CLS. 37, 39, 40, 42 AND 50).

FIRST USE 12-0-1998; IN COMMERCE 12-0-1998.

CLASS 29—MEATS AND PROCESSED FOODS

2,859,067. E.W. GROBBEL SONS, INC., DETROIT, MI. SN 76-461,411. FILED P.R. 10-21-2002; AM. S.R. 5-9-2003.

GUNSBERG

FOR MEAT (U.S. CL. 46).

FIRST USE 5-1-2003; IN COMMERCE 5-1-2003.

2,859,101. SAEZ, JOSE, MIAMI, FL. SN 78-184,319. FILED P.R. 11-12-2002; AM. S.R. 2-3-2004.



THE MARK CONSISTS OF THE LETTERS TEX-MEX BRAND IN BOLD CAPITAL GREEN LETTERS.

FOR FRESH CURED AND COOKED SAUSAGE (U.S. CL. 46).

FIRST USE 1-14-2003; IN COMMERCE 1-14-2003.

2,859,114. POTEET SEAFOOD CO., INC., BRUNSWICK, GA. SN 78-236,346. FILED P.R. 4-10-2003; AM. S.R. 3-23-2004.

**SWEET GEORGIA WHITE
SHRIMP**

NO CLAIM IS MADE TO THE EXCLUSIVE RIGHT TO USE GEORGIA WHITE SHRIMP, APART FROM THE MARK AS SHOWN.

FOR SEAFOOD, NAMELY SHRIMP (U.S. CL. 46).

FIRST USE 1-1-2003; IN COMMERCE 1-1-2003.

CLASS 30—STAPLE FOODS

CLASS 30—(Continued).

2,859,070. VAN WYK CONFECTIONS, LLC, HIGHLANDS RANCH, CO. SN 76-479,544. FILED P.R. 12-27-2002; AM. S.R. 3-8-2004.

**THE ORIGINAL FUND
RAISING BELGIAN
CHOCOLATE DONATION
BAR**

OWNER OF U.S. REG. NO. 2,554,352.
NO CLAIM IS MADE TO THE EXCLUSIVE RIGHT TO USE "BELGIAN CHOCOLATE" OR "BAR", APART FROM THE MARK AS SHOWN.
FOR CHOCOLATE BAR (U.S. CL. 46).
FIRST USE 8-0-2003; IN COMMERCE 8-0-2003.

CLASS 32—LIGHT BEVERAGES

2,859,068. ULTIMATE JUICE COMPANY, BASKING RIDGE, NJ. SN 76-476,353. FILED P.R. 12-12-2002; AM. S.R. 11-14-2003.

SUPERFOOD

FOR FRUIT AND VEGETABLE JUICES AND COMBINATIONS, THEREOF, AND FRUIT BASED BEVERAGES, WHETHER PASTEURIZED AND UNPASTEURIZED (U.S. CLS. 45, 46 AND 48).
FIRST USE 1-1-1982; IN COMMERCE 1-1-1982.

CLASS 33—WINES AND SPIRITS

2,859,062. SOFTWARE TESTING GROUP INC., DBA TRADITIONAL SPIRIT PRODUCTS, REDMOND, WA. SN 76-437,618. FILED P.R. 8-2-2002; AM. S.R. 3-29-2004.

SIBERIA

FOR VODKA (U.S. CLS. 47 AND 49).
FIRST USE 3-3-2004; IN COMMERCE 3-3-2004.

2,859,093. ROYAL WINE CORPORATION, BAYONNE, NJ. SN 76-545,712. FILED P.R. 9-22-2003; AM. S.R. 4-8-2004.

ALTOONA HILLS

FOR WINES (U.S. CLS. 47 AND 49).
FIRST USE 6-0-2003; IN COMMERCE 6-0-2003.

SERVICE MARKS

CLASS 35—ADVERTISING AND BUSINESS**CLASS 35—(Continued).**

2,859,057. PRICE MODERN, LLC, DBA LINK, HERNDON, VA. SN 76-399,880. FILED P.R. 4-24-2002; AM. S.R. 7-7-2003.

**THE NATION'S LEADING
FACILITIES ENGINE**

NO CLAIM IS MADE TO THE EXCLUSIVE RIGHT TO USE "FACILITIES ENGINE", APART FROM THE MARK AS SHOWN.
FOR BUSINESS CONSULTATION SERVICES IN THE FIELD OF OFFICE SPACE (U.S. CLS. 100, 101 AND 102).
FIRST USE 3-4-2002; IN COMMERCE 4-8-2002.

2,859,059. INTERNATIONAL CLOTHIERS INC., DOWNSVIEW, ONTARIO M6A 1M4, CANADA. SN 76-412,889. FILED P.R. 5-28-2002; AM. S.R. 3-18-2004.

**INTERNATIONAL
CLOTHIERS**

NO CLAIM IS MADE TO THE EXCLUSIVE RIGHT TO USE CLOTHIERS, APART FROM THE MARK AS SHOWN.
FOR RETAIL CLOTHING STORE SERVICES (U.S. CLS. 100, 101 AND 102).
FIRST USE 1-2-1988; IN COMMERCE 3-21-1998.

2,859,069. U.S. PHYSICAL THERAPY, INC., HOUSTON, TX. SN 76-479,252. FILED P.R. 12-30-2002; AM. S.R. 11-26-2003.

U.S. PHYSICAL THERAPY

NO CLAIM IS MADE TO THE EXCLUSIVE RIGHT TO USE "PHYSICAL THERAPY", APART FROM THE MARK AS SHOWN.
FOR MANAGEMENT SERVICES FOR OUTPATIENT PHYSICAL AND/OR OCCUPATIONAL THERAPY CLINICS (U.S. CLS. 100, 101 AND 102).
FIRST USE 4-1-1992; IN COMMERCE 4-1-1992.

2,859,076. LA PREFERIDA, INC., CHICAGO, IL. SN 76-494,738. FILED P.R. 2-22-2003; AM. S.R. 2-27-2004.

WORLD WIDE PRODUCE

NO CLAIM IS MADE TO THE EXCLUSIVE RIGHT TO USE "PRODUCE", APART FROM THE MARK AS SHOWN.
FOR WHOLESALE DISTRIBUTORSHIP AND/OR WHOLESALE STORE FEATURING FRESH FRUITS AND VEGETABLES (U.S. CLS. 100, 101 AND 102).
FIRST USE 4-22-1992; IN COMMERCE 4-22-1992.

CLASS 35—(Continued).

2,859,077. REPLY! INC., ALAMO, CA. SN 76-500,270. FILED P.R. 3-24-2003; AM. S.R. 3-15-2004.

IMOTORS.COM

FOR ONLINE REFERRAL SERVICES TO VEHICLE DEALERS FEATURING ONLINE INFORMATION REGARDING SALES, HISTORY, MODEL, VALUE, PERFORMANCE, INSURANCE, FINANCING AND MAINTENANCE CONCERNING THE AUTOMOTIVE INDUSTRY, MOTOR VEHICLES AND MOTOR VEHICLES' SALES, PRICES AND RATINGS; PROVIDING REFERRALS AND BUSINESS LEADS TO VEHICLE DEALERS (U.S. CLS. 100, 101 AND 102).

FIRST USE 7-0-2001; IN COMMERCE 7-0-2001.

2,859,085. IVFONLINE.COM, LLC, GUILFORD, CT. SN 76-516,638. FILED P.R. 4-30-2003; AM. S.R. 4-12-2004.

WWW.IVFONLINE.COM

FOR ELECTRONIC RETAILING SERVICES VIA COMPUTER FEATURING SPECIALTY PRODUCTS FOR USE IN THE FIELD OF IN VITRO FERTILIZATION (U.S. CLS. 100, 101 AND 102).

FIRST USE 6-15-1999; IN COMMERCE 6-15-1999.

2,859,086. GREEN INDUSTRY YELLOW PAGES, INC., WOODBINE, MD. SN 76-518,764. FILED 5-12-2003.

**WWW.GREENINDUSTRY
YELLOWPAGES.COM**

FOR ONLINE ADVERTISING SERVICES FEATURING AN ONLINE DIRECTORY WITH BANNER ADS OF SUPPLIERS OF GOODS AND SERVICES IN THE GREEN INDUSTRY TRADE INCLUDING THOSE USED BY LANDSCAPERS, GARDEN CENTERS, NURSERIES, AND BUSINESSES IN IRRIGATION, HYDROPONICS, HORTICULTURE, AND ENVIRONMENTAL MANAGEMENT, AND GENERALLY IN AGRICULTURE (U.S. CLS. 100, 101 AND 102).

FIRST USE 11-1-2001; IN COMMERCE 11-1-2001.

2,859,088. BURNS & MCDONNELL ENGINEERING COMPANY, KANSAS CITY, MO. SN 76-519,501. FILED P.R. 5-27-2003; AM. S.R. 4-1-2004.

DATA CONSERVATION

FOR DATABASE MANAGEMENT AS IT RELATES TO GEOGRAPHIC INFORMATION SYSTEMS AND INTERNET TECHNOLOGY (U.S. CLS. 100, 101 AND 102).

FIRST USE 4-0-2003; IN COMMERCE 4-0-2003.

CLASS 35—(Continued).

2,859,103. HAL, JON, HEWLETT, NY. SN 78-201,424. FILED P.R. 1-9-2003; AM. S.R. 4-9-2004.

WRESTLINGFIGURES.COM

FOR ONLINE RETAIL STORE SERVICES FEATURING WRESTLING ACTION FIGURES, AUTOGRAPHED MEMORABILIA, COLLECTIBLES, BOOKS, VIDEO-TAPES, AUDIOCASSETTES, COMPACT DISCS, GAMES AND PLAYTHINGS, AND TRADING CARDS (U.S. CLS. 100, 101 AND 102).

FIRST USE 7-4-1995; IN COMMERCE 7-4-1995.

2,859,108. GATELYS GROUP, LLC, ENGLEWOOD, CO. SN 78-222,823. FILED P.R. 3-7-2003; AM. S.R. 2-26-2004.

GATELYS

FOR ON-LINE RETAIL DEPARTMENT STORE SERVICES FEATURING PRODUCTS THAT DO NOT REQUIRE STORAGE OR SHIPMENT FROM COMPANY OWNED OR LEASED WAREHOUSE FACILITIES, EG HOME FURNISHINGS, ELECTRONICS, CHILDREN'S TOYS, FITNESS EQUIPMENT, KITCHEN AND GOURMET FOOD PRODUCTS, CLOTHING, JEWELRY, COLLECTIBLES, TOOLS, OUTDOOR PRODUCTS AND RECREATIONAL EQUIPMENT (U.S. CLS. 100, 101 AND 102).

FIRST USE 7-7-2002; IN COMMERCE 7-19-2002.

2,859,124. SUN INNOVATIONS INC, PLANO, TX. SN 78-273,418. FILED P.R. 7-11-2003; AM. S.R. 3-15-2004.

FLOWER GALLERY

FOR MAIL ORDER AND MAIL ORDER CATALOG SERVICES, RETAIL STORE SERVICES FEATURING PHONE-IN ORDERS, COMPUTERIZED ON-LINE ORDERING SERVICES, IMPORT AND EXPORT SERVICES, ALL FEATURING ARTIFICIAL FLOWERS, FRESH CUT FLOWERS, DRIED FLOWERS, FLORAL BOUQUETS AND ARRANGEMENTS, PLANTS, TREES, GIFTS, GIFT BASKETS, FOODS, GOURMET FOODS, PRODUCE, CANDY, CHOCOLATE, BAKERY ITEMS, HOME DECORATING ITEMS AND ACCESSORIES, KITCHEN WARE AND ACCESSORIES, GIFT WINES, COLLECTIBLES, AROMATHERAPY GIFT ITEMS, CANDLES AND ACCESSORIES, TOYS, PLUSH TOYS; AUTOMOBILE AND DELIVERY VAN TRANSPORTATION OF GOODS IN THE NATURE OF ARTIFICIAL FLOWERS, FRESH CUT FLOWERS, DRIED FLOWERS, FLORAL BOUQUETS AND ARRANGEMENTS, PLANTS, TREES, GIFTS, GIFT BASKETS, FOODS, GOURMET FOODS, PRODUCE, CANDY, CHOCOLATE, BAKERY ITEMS, HOME DECORATING ITEMS AND ACCESSORIES, KITCHEN WARE AND ACCESSORIES, GIFT WINES, COLLECTIBLES, AROMA THERAPY GIFT ITEMS, CANDLES AND ACCESSORIES, TOYS AND PLUSH TOYS (U.S. CLS. 100, 101 AND 102).

FIRST USE 2-0-1999; IN COMMERCE 2-0-1999.

CLASS 35—(Continued).

2,859,128. AMERICAN OPTOMETRIC ASSOCIATION, ST. LOUIS, MO. SN 78-303,984. FILED P.R. 9-23-2003; AM. S.R. 3-17-2004.

OPTOMETRY'S CAREER CENTER

NO CLAIM IS MADE TO THE EXCLUSIVE RIGHT TO USE "OPTOMETRY'S CAREER", APART FROM THE MARK AS SHOWN.

FOR PROVIDING ONLINE EMPLOYMENT PLACE-
MENT SERVICES NAMELY RESUME MATCHING SER-
VICES IN THE FIELD OF OPTOMETRY; PROVIDING
ONLINE INFORMATION IN THE FIELD OF EMPLOY-
MENT, RECRUITMENT AND CAREERS IN THE FIELD
OF OPTOMETRY (U.S. CLS. 100, 101 AND 102).

FIRST USE 9-16-2003; IN COMMERCE 9-16-2003.

CLASS 36—INSURANCE AND FINANCIAL

2,859,079. ELECTRONIC STORED VALUE SERVICES, INC., MERRIMACK, NH. SN 76-501,831. FILED P.R. 3-27-2003; AM. S.R. 3-23-2004.

IPREPAY

FOR TELEPHONE CALLING CARD SERVICES (U.S. CLS. 100, 101 AND 102).

FIRST USE 5-5-2003; IN COMMERCE 5-5-2003.

2,859,092. PROFILE NETWORK, INC., DBA SPORTS PRO-
FILES, SKOKIE, IL. SN 76-543,062. FILED P.R. 8-25-2003;
AM. S.R. 4-6-2004.

CELEBRITY FLAG FOOTBALL CHALLENGE

NO CLAIM IS MADE TO THE EXCLUSIVE RIGHT TO USE "CHALLENGE", APART FROM THE MARK AS SHOWN.

FOR CHARITABLE FUNDRAISING SERVICES (U.S. CLS. 100, 101 AND 102).

FIRST USE 1-10-2003; IN COMMERCE 1-10-2003.

2,859,094. PDC PRESS, INC., WILLIAMSVILLE, NY. SN 76-
551,265. FILED P.R. 8-8-2003; AM. S.R. 3-25-2004.

GINGERBREAD VILLAGE STROLL

FOR CHARITABLE FUND RAISING SERVICES (U.S. CLS. 100, 101 AND 102).

FIRST USE 5-31-2001; IN COMMERCE 5-31-2003.

CLASS 36—(Continued).

2,859,096. CHILDREN OF PROMISE INTERNATIONAL, ALMA, MO. SN 78-033,557. FILED P.R. 11-2-2000; AM. S.R. 3-30-2004.

ORPHAN INC.

NO CLAIM IS MADE TO THE EXCLUSIVE RIGHT TO USE "INC.", APART FROM THE MARK AS SHOWN.

FOR CHARITABLE FUNDRAISING, NAMELY, PRO-
VIDING FINANCIAL ASSISTANCE FOR ORPHANS,
WIDOWS AND NEEDY CHILDREN; SOLICITING
CHARITABLE AND PHILANTHROPIC CONTRIBU-
TIONS FROM THE BUSINESS COMMUNITY; FACIL-
ITATING AND ARRANGING PARTNERSHIPS
BETWEEN BUSINESS ORGANIZATIONS AND OR-
PHANS, WIDOWS AND NEEDY CHILDREN TO PRO-
VIDE FINANCIAL ASSISTANCE (U.S. CLS. 100, 101 AND
102).

FIRST USE 3-0-2001; IN COMMERCE 3-0-2001.

2,859,117. WINKLEVOSS, LLC, GREENWICH, CT. SN 78-
241,918. FILED P.R. 4-25-2003; AM. S.R. 1-28-2004.

CHARITABLE GIVING'S NEW GROWTH OPPORTUNITY

FOR FINANCIAL SERVICES, NAMELY PROVIDING
AN INVESTMENT ACCOUNT THAT ALLOWS THE
CUSTOMER TO DIRECT INVESTMENT OF THE FUNDS
CONTRIBUTED TO NONPROFIT ORGANIZATIONS
(U.S. CLS. 100, 101 AND 102).

FIRST USE 3-26-2003; IN COMMERCE 3-26-2003.

2,859,118. PUTNAM RETAIL MANAGEMENT, LP, BOSTON,
MA. SN 78-242,518. FILED P.R. 4-27-2003; AM. S.R. 3-16-
2004.

PREDIVERSIFIED OPTIONS

FOR MUTUAL FUND INVESTMENT, BROKERAGE
AND DISTRIBUTION SERVICES; MUTUAL FUND AD-
MINISTRATION SERVICES AND INVESTMENT AD-
VICE AND CONSULTATION SERVICES; FINANCIAL
SERVICES, NAMELY, INVESTMENT MANAGEMENT,
FINANCIAL ANALYSIS, CONSULTATION, MANAGE-
MENT AND PLANNING SERVICES; PROVIDING FI-
NANCIAL NEWS AND INFORMATION, INFORMATION
ABOUT RETIREMENT PLANNING, INVESTMENT AC-
COUNT INFORMATION, RESEARCH IN THE FIELDS
OF INVESTMENT AND FINANCE, AND INFORMAT-
ION ABOUT MUTUAL FUND PERFORMANCE (U.S.
CLS. 100, 101 AND 102).

FIRST USE 5-0-2003; IN COMMERCE 5-0-2003.

CLASS 36—(Continued).

2,859,127. MID AMERICA BANK, FSB, CLARENDON HILLS, IL. SN 78-295,050. FILED P.R. 9-2-2003; AM. S.R. 2-17-2004.

ULTIMATE CHECKING

NO CLAIM IS MADE TO THE EXCLUSIVE RIGHT TO USE "CHECKING", APART FROM THE MARK AS SHOWN. FOR BANKING SERVICES (U.S. CLS. 100, 101 AND 102).

FIRST USE 1-19-2004; IN COMMERCE 1-19-2004.

2,859,130. GENE RICHARD HITCHCOCK, JR., BIRMINGHAM, AL. SN 78-307,922. FILED P.R. 10-1-2003; AM. S.R. 3-25-2004.

401PLAN

FOR FINANCIAL PLANNING (U.S. CLS. 100, 101 AND 102).

FIRST USE 1-10-2003; IN COMMERCE 1-10-2003.

CLASS 41—EDUCATION AND ENTERTAINMENT

2,859,049. JOHNNY LINDY COMPANY, DBA VIN DI BONA PRODUCTIONS, WEST LOS ANGELES, CA. SN 75-919,046. FILED P.R. 2-15-2000; AM. S.R. 1-10-2002.

COMEDY REALITY TELEVISION NETWORK

NO CLAIM IS MADE TO THE EXCLUSIVE RIGHT TO USE REALITY TELEVISION NETWORK, APART FROM THE MARK AS SHOWN.

FOR ENTERTAINMENT SERVICES, NAMELY, PRODUCTION OF MOTION PICTURE FILMS AND TELEVISION PROGRAMS; DISTRIBUTION FOR OTHERS OF MOTION PICTURE FILMS, TELEVISION PROGRAMS, PRE-RECORDED VIDEO TAPES, DIGITAL VIDEO DISCS AND COMPACT DISCS; PROVIDING INFORMATION IN THE FIELD OF ENTERTAINMENT VIA A GLOBAL COMPUTER NETWORK (U.S. CLS. 100, 101 AND 107).

FIRST USE 9-1-1999; IN COMMERCE 9-1-1999.

CLASS 41—(Continued).

2,859,051. NORTECH INVESTMENTS LTD, ST. JOHNS, ANTIGUA & BARBUDA. SN 76-330,667. FILED P.R. 10-25-2001; AM. S.R. 3-2-2004.

RACEBOOK INFO

FOR PROVISION OF CASINO GAMES ON AND THROUGH A GLOBAL COMPUTER NETWORK WHEREIN THERE ARE NO ACTUAL MONETARY WAGERS; PROVISION OF CONTESTS AND SWEEPSTAKES ON AND THROUGH A GLOBAL COMPUTER NETWORK; PROVIDING A WEB SITE ON AND THROUGH A GLOBAL COMPUTER NETWORK FEATURING INFORMATION IN THE FIELDS OF GAMING, ATHLETIC COMPETITION AND ENTERTAINMENT (U.S. CLS. 100, 101 AND 107).

FIRST USE 2-1-2001; IN COMMERCE 2-1-2001.

2,859,073. M.W.L.L.C., INC., SHERMAN OAKS, CA. SN 76-487,115. FILED P.R. 2-3-2003; AM. S.R. 1-23-2004.

THE MORTGAGE MINUTE

NO CLAIM IS MADE TO THE EXCLUSIVE RIGHT TO USE "MORTGAGE", APART FROM THE MARK AS SHOWN.

FOR ENTERTAINMENT IN THE NATURE OF A CONTINUING SERIES OF RADIO AND TELEVISION PROGRAMS FEATURING INFORMATION REGARDING MORTGAGE BANKING SERVICES (U.S. CLS. 100, 101 AND 107).

FIRST USE 4-30-1998; IN COMMERCE 2-24-2003.

2,859,075. LATINA MEDIA VENTURES LLC, NEW YORK, NY. SN 76-493,143. FILED P.R. 2-20-2003; AM. S.R. 3-1-2004.

LATINA NIGHTS

THE ENGLISH TRANSLATION OF THE TERM "LATINA" RELATES TO WOMEN OF HISPANIC ORIGIN.

FOR ENTERTAINMENT, NAMELY LIVE MUSICAL PERFORMANCE (U.S. CLS. 100, 101 AND 107).

FIRST USE 7-25-2002; IN COMMERCE 7-25-2002.

CLASS 41—(Continued).

2,859,084. ACT, INC., IOWA CITY, IA. SN 76-508,041. FILED P.R. 4-21-2003; AM. S.R. 3-12-2004.

CAREERskills

FOR EDUCATIONAL AND TRAINING SERVICES, NAMELY, CONDUCTING, PROVIDING AND DISTRIBUTING COURSES, CLASSES, SEMINARS, WORKSHOPS, LECTURES AND TUTORIALS IN THE FIELD OF INFORMATION TECHNOLOGY, AND DISTRIBUTION OF COURSE MATERIALS AND TEACHING AIDS IN CONNECTION THEREWITH, NAMELY, PAMPHLETS, BROCHURES, TEXTBOOKS, INSTRUCTIONAL SOFTWARE, COMPUTER HARDWARE, LAB MANUALS, AUDIOVISUAL RECORDINGS, PRACTICE EXAMINATIONS, INSTRUCTION KITS, AND ON-LINE COURSEWARE (U.S. CLS. 100, 101 AND 107).
FIRST USE 3-26-2003; IN COMMERCE 3-26-2003.

2,859,090. GEORGIA BIOMEDICAL PARTNERSHIP, INC., ATLANTA, GA. SN 76-524,118. FILED P.R. 6-13-2003; AM. S.R. 3-2-2004.

GEORGIA LIFE SCIENCES SUMMIT

NO CLAIM IS MADE TO THE EXCLUSIVE RIGHT TO USE "LIFE SCIENCES SUMMIT", APART FROM THE MARK AS SHOWN.
FOR EDUCATIONAL SERVICES, NAMELY, CONDUCTING EDUCATIONAL CONFERENCES IN THE FIELD OF BIOMEDICINE (U.S. CLS. 100, 101 AND 107).
FIRST USE 9-1-2001; IN COMMERCE 9-1-2001.

2,859,091. FLATBED INDUSTRY FORUM LLC, ROCHESTER, PA. SN 76-525,477. FILED P.R. 6-25-2003; AM. S.R. 3-15-2004.

FLATBED INDUSTRY FORUM

NO CLAIM IS MADE TO THE EXCLUSIVE RIGHT TO USE "FORUM", APART FROM THE MARK AS SHOWN.
FOR EDUCATIONAL SEMINARS RELATING TO THE FLATBED TRANSPORTATION INDUSTRY (U.S. CLS. 100, 101 AND 107).
FIRST USE 3-11-2003; IN COMMERCE 3-11-2003.

2,859,102. GRAND STAFF, INC., PRAIRIE VILLAGE, KS. SN 78-187,124. FILED P.R. 11-20-2002; AM. S.R. 7-18-2003.

PIANOS4RENT

FOR MUSICAL INSTRUMENT RENTAL SERVICES (U.S. CLS. 100, 101 AND 107).
FIRST USE 11-1-2002; IN COMMERCE 11-1-2002.

CLASS 41—(Continued).

2,859,123. THE INSTITUTE OF ELECTRICAL AND ELECTRONICS ENGINEERS, INC., PISCATAWAY, NJ. SN 78-272,698. FILED P.R. 7-10-2003; AM. S.R. 4-2-2004.

CERTIFIED SOFTWARE DEVELOPMENT PROFESSIONAL

FOR TRAINING SERVICES IN THE FIELD OF COMPUTER SOFTWARE DEVELOPMENT; EDUCATIONAL TESTING SERVICES TO DETERMINE THE PROFESSIONAL QUALIFICATIONS OF PERSONS IN THE COMPUTER SOFTWARE DEVELOPMENT FIELD (U.S. CLS. 100, 101 AND 107).
FIRST USE 1-25-2002; IN COMMERCE 1-25-2002.

2,859,129. HOPPE, FRED J., MALCOLM, NE. AND HOPPE, DONNA, MALCOLM, NE. SN 78-306,772. FILED P.R. 9-29-2003; AM. S.R. 10-2-2003.

DINOSAUR WALK MUSEUM

NO CLAIM IS MADE TO THE EXCLUSIVE RIGHT TO USE "DINOSAUR" AND "MUSEUM", APART FROM THE MARK AS SHOWN.
FOR MUSEUM SERVICES FEATURING EXHIBITS, EDUCATIONAL INFORMATION AND TOURIST ATTRACTIONS CONCERNING THE WORLD'S LARGEST EXHIBIT OF LIFE-SIZED, REALISTIC LOOKING DINOSAURS (U.S. CLS. 100, 101 AND 107).
FIRST USE 1-31-2003; IN COMMERCE 1-31-2003.

CLASS 42—SCIENTIFIC, COMPUTER AND LEGAL SERVICES

2,859,050. AMERICAN PSYCHOLOGICAL ASSOCIATION, WASHINGTON, DC. SN 76-140,885. FILED P.R. 10-5-2000; AM. S.R. 2-11-2004.

PsycARTICLES

OWNER OF U.S. REG. NOS. 1,398,486, 2,376,753, AND OTHERS.
FOR PROVIDING AND MAINTAINING AN ON-LINE COMPUTER DATABASE IN THE FIELD OF PSYCHOLOGICAL AND SOCIAL SCIENCES, NAMELY, A DATABASE CONTAINING FULL TEXT ARTICLES FROM PUBLISHED PSYCHOLOGICAL AND SOCIAL SCIENCE JOURNALS (U.S. CLS. 100 AND 101).
FIRST USE 9-28-2000; IN COMMERCE 10-15-2000.

CLASS 42—(Continued).

2,859,065. MELVIN H. WOLOVITS, P.C., DALLAS, TX. SN 76-455,798. FILED P.R. 9-30-2002; AM. S.R. 3-19-2004.

BABY BIRTH INJURIE S.COM

FOR LEGAL SERVICES INVOLVING ISSUES CONCERNING BIRTH INJURIES (U.S. CLS. 100 AND 101).
FIRST USE 12-0-2002; IN COMMERCE 12-0-2002.

2,859,080. THE DORIS DILLON CENTER, NEW YORK, NY. SN 76-501,886. FILED P.R. 3-28-2003; AM. S.R. 3-24-2004.

LESSON LAUNCHER

NO CLAIM IS MADE TO THE EXCLUSIVE RIGHT TO USE LESSON, APART FROM THE MARK AS SHOWN.
FOR COMPUTER SERVICES, NAMELY, AN INTERACTIVE WEB-BASED SERVICE THAT ALLOWS TEACHERS TO CREATE AND STORE LESSON PLANS ELECTRONICALLY (U.S. CLS. 100 AND 101).
FIRST USE 11-1-2002; IN COMMERCE 11-1-2002.

2,859,115. WAVBANK, INC., LANGLEY, WA. SN 78-236,708. FILED P.R. 4-11-2003; AM. S.R. 3-25-2004.

MOLECULAR INTERROGATION AND DATA SYSTEMS

FOR BIOTECHNOLOGICAL AND CHEMICAL RESEARCH, DEVELOPMENT AND ANALYSIS FOR SCIENTIFIC AND/OR MEDICAL USE, NAMELY RESEARCH AND DEVELOPMENT OF BIOTECHNOLOGY DEVICES, TOOLS AND REAGENTS, MOLECULAR SIGNAL DETECTION TECHNOLOGY, AND BIOACTIVATION TECHNOLOGY; PASSIVE SIGNAL DETECTION, RECORDING AND PROCESSING; MAPPING AND ANALYSIS OF DETECTED SIGNALS; GENETIC ENGINEERING; DEVELOPMENT OF COMPUTER HARDWARE AND SOFTWARE RELATED TO ALL OF THE ABOVE; DEVELOPMENT AND ANALYSIS OF ELECTRONIC DATABASES AND LIBRARIES OF DIGITAL DATASETS AND SIGNALS RELATED TO ALL OF THE ABOVE; PROVIDING TEMPORARY USE OF ON-LINE NON-DOWNLOADABLE COMPUTER SOFTWARE AND DATA FOR SCIENTIFIC AND/OR MEDICAL USE, NAMELY FOR THE IDENTIFICATION AND ANALYSIS OF MOLECULAR SIGNALS AND SUBSTANCES; PROVIDING ONLINE USERS' MANUALS ASSOCIATED THEREWITH; PROVIDING TEMPORARY USE OF ON-LINE NON-DOWNLOADABLE ELECTRONIC DATABASES AND LIBRARIES OF DIGITAL DATASETS AND SIGNALS RELATED TO ALL OF THE ABOVE (U.S. CLS. 100 AND 101).
FIRST USE 1-15-2004; IN COMMERCE 1-15-2004.

CLASS 42—(Continued).

2,859,120. APATITE TO ZIRCON, INC., VIOLA, ID. SN 78-249,269. FILED P.R. 5-13-2003; AM. S.R. 3-20-2004.

ZHE

FOR TECHNICAL CONSULTATION IN THE FIELD OF GEOLOGY FEATURING SAMPLE PROCESSING OF EARTH AND SPACE MINERALS AND MATERIALS AND AGE DATING OF EARTH AND SPACE MINERALS AND MATERIALS (U.S. CLS. 100 AND 101).
FIRST USE 10-20-1998; IN COMMERCE 10-20-1998.

2,859,125. PRO QC INTERNATIONAL NORTH AMERICA, MCHENRY, IL. SN 78-277,382. FILED P.R. 7-22-2003; AM. S.R. 2-11-2004.



FOR ENGINEERING; TECHNICAL CONSULTATION AND RESEARCH IN THE FIELD OF ENGINEERING AND QUALITY ASSURANCE; PROVIDING QUALITY ASSURANCE SERVICES IN THE FIELD OF MANUFACTURING; QUALITY CONTROL FOR OTHERS; TECHNICAL SUPERVISION AND INSPECTION IN THE FIELD OF PRODUCT QUALITY CONTROL (U.S. CLS. 100 AND 101).
FIRST USE 10-30-2002; IN COMMERCE 10-30-2002.

CLASS 45—PERSONAL SERVICES

2,859,087. ZENCON TECHNOLOGIES, LLC, MESA, AZ. SN 76-519,054. FILED P.R. 5-13-2003; AM. S.R. 3-22-2004.

PEOPLE MEET

NO CLAIM IS MADE TO THE EXCLUSIVE RIGHT TO USE "MEET", APART FROM THE MARK AS SHOWN.
FOR ON-LINE DATING SERVICE (U.S. CLS. 100 AND 101).
FIRST USE 1-15-2002; IN COMMERCE 1-15-2002.

CLASS 45—(Continued).

2,859,089. ZENCON TECHNOLOGIES, LLC, MESA, AZ. SN
76-522,443. FILED P.R. 6-13-2003; AM. S.R. 3-22-2004.

JPEOPLEmeet

FOR ON-LINE DATING SERVICE (U.S. CLS. 100 AND
101).
FIRST USE 1-15-2002; IN COMMERCE 1-15-2002.

* * * * *

PRIOR UNITED STATES CLASSIFICATION

APPLICATION IN ONE CLASS

CERTIFICATION MARKS

CLASS A—GOODS

2,859,066. URECKI, VICTOR H., CHARLESTON, WV. SN 76-461,366. FILED P.R. 10-23-2002; AM. S.R. 2-24-2004.



THE MARK CONTAINS HEBREW CHARACTERS WHICH TRANSLITERATE TO REYSH, SHIN AND CHAF. THESE HEBREW LETTERS TRANSLATE TO KASHRUT, OR KOSHER, AND ARE RECOGNIZED TO SIGNIFY THAT A PRODUCT MEETS THE HEBREW KOSHER STANDARDS.

THE CERTIFICATION MARK, AS USED BY AUTHORIZED PERSONS, CERTIFIES THAT THE FOODS OR FOOD PRODUCTS ARE PRODUCED OR MANUFACTURED IN COMPLIANCE WITH KOSHER STANDARDS AND THE TRADITIONAL DIETARY LAWS, OR KASHRUT, OF THE JEWISH PEOPLE.

FOR FOODS AND PREPARED FOODS, NAMELY, DAIRY AND BAKERY GOODS (U.S. CL. A).
FIRST USE 7-0-2001; IN COMMERCE 7-0-2001.

NO CLAIM IS MADE TO THE EXCLUSIVE RIGHT TO USE "DAIRY", APART FROM THE MARK AS SHOWN.

* * * * *

TRADEMARK REGISTRATIONS RENEWED

The designation "U.S. Cl." appearing in this section refers to the U.S. class in effect prior to Sep. 1, 1973 rather than the international class which applies to applications filed on or after that date. For adoption of international classification see notice in the OFFICIAL GAZETTE of Jun. 26, 1973 (911 O.G. TM 210).

41,324.	STATE EXPRESS. U.S. CL. 17. (INT. CL. 34). REG. 10-20-1903.	769,386.	TURN-TITE. U.S. CL. 13. (INT. CL. 6). REG. 5-12-1964.
90,977.	POWER AND DESIGN. U.S. CL. 46. (INT. CL. 30). REG. 4-8-1913.	769,509.	BENNETT. U.S. CL. 27. (INT. CL. 14). REG. 5-12-1964.
170,857.	EXCALIBUR AND DESIGN. U.S. CL. 46. (INT. CL. 30). REG. 7-24-1923.	769,819.	INSTANT AND DESIGN. U.S. CL. 15. (INT. CL. 1). REG. 5-19-1964.
181,329.	THE STETSONIAN AND DESIGN. U.S. CL. 39. (INT. CL. 25). REG. 3-18-1924.	773,193.	INDUCTO. U.S. CL. 34. (INT. CL. 11). REG. 7-14-1964.
313,927.	SABRETT. U.S. CL. 46. (INT. CL. 30). REG. 6-12-1934.	776,716.	STAGE COACH. U.S. CL. 46. (INT. CL. 29). REG. 9-8-1964.
314,825.	GM (STYLIZED). U.S. CL. 23. (INT. CL. 12). REG. 7-10-1934.	776,725.	GRAVY MASTER AND DESIGN. U.S. CL. 46. (INT. CLS. 29 AND 30). REG. 9-8-1964.
323,153.	MISCELLANEOUS DESIGN. U.S. CL. 52. (INT. CL. 3). REG. 4-2-1935.	777,161.	INTERACT. U.S. CL. 107. (INT. CL. 41). REG. 9-15-1964.
403,521.	ANDREW AND DESIGN. U.S. CL. 21. (INT. CLS. 7, 9, 11, 12 AND 15). REG. 9-28-1943.	779,770.	FLO-LITE. U.S. CL. 19. (INT. CL. 12). REG. 11-10-1964.
406,115.	VYCOR. U.S. CL. 1. (INT. CL. 21). REG. 3-14-1944.	780,141.	TRANS-X (STYLIZED). U.S. CL. 15. (INT. CL. 4). REG. 11-17-1964.
406,515.	LUMBERJACK (STYLIZED). U.S. CL. 39. (INT. CL. 25). REG. 4-11-1944.	946,237.	SEALTITE. U.S. CL. 21. (INT. CLS. 7, 9, 11, 12 AND 15). REG. 10-31-1972.
407,245.	OBSESSION. U.S. CL. 6. (INT. CL. 3). REG. 5-23-1944.	962,581.	BRAND-REX. U.S. CL. 21. (INT. CL. 9). REG. 7-3-1973.
582,766.	LAPP (STYLIZED). U.S. CL. 21. (INT. CLS. 9 AND 17). REG. 11-24-1953.	971,128.	DEEP CRYSTAL. U.S. CL. 6. (INT. CL. 1). REG. 10-23-1973.
587,536.	VISI-FLO. U.S. CL. 26. (INT. CL. 9). REG. 3-30-1954.	972,092.	DAILY EXPRESS AND DESIGN. U.S. CL. 105. (INT. CL. 39). REG. 10-30-1973.
587,665.	FUL-AIRE. U.S. CL. 6. (INT. CL. 5). REG. 3-30-1954.	974,050.	FILA (STYLIZED). U.S. CL. 42. (INT. CL. 24). REG. 11-27-1973.
588,107.	KADY (STYLIZED). U.S. CL. 23. (INT. CL. 7). REG. 4-13-1954.	975,325.	TURF-FLOW. U.S. CL. 13. (INT. CL. 17). REG. 12-25-1973.
588,496.	STRONGHOLD. U.S. CL. 13. (INT. CL. 6). REG. 4-20-1954.	977,599.	PICNIC. U.S. CL. 1. (INT. CL. 4). REG. 1-29-1974.
589,326.	GILFILLAN (STYLIZED). U.S. CL. 26. (INT. CL. 9). REG. 5-4-1954.	979,279.	MACDONALD. U.S. CL. 17. (INT. CL. 34). REG. 2-26-1974.
591,736.	Q-TIPS (STYLIZED). U.S. CL. 44. (INT. CL. 5). REG. 6-22-1954.	979,893.	STANDARD. U.S. CL. 23. (INT. CL. 12). REG. 3-5-1974.
594,041.	TIPTREE MARMALADE WILKIN & SONS LTD. ESSEX, ENGLAND AND DESIGN. U.S. CL. 46. (INT. CL. 29). REG. 8-17-1954.	980,477.	ETOILE ROSE AND DESIGN. U.S. CL. 47. (INT. CL. 33). REG. 3-12-1974.
595,630.	JOTA (STYLIZED). U.S. CL. 44. (INT. CL. 10). REG. 9-21-1954.	980,875.	4X4 AND DESIGN. U.S. CLS. 18 AND 46. (INT. CLS. 5 AND 31). REG. 3-26-1974.
598,641.	HOUSWEET (STYLIZED). U.S. CL. 6. (INT. CL. 5). REG. 11-30-1954.	980,937.	BEAD AND DESIGN. U.S. CL. 22. (INT. CL. 28). REG. 3-26-1974.
599,437.	SUNKIST (STYLIZED). U.S. CL. 46. (INT. CLS. 1, 5, 29, 30, 31 AND 32). REG. 12-14-1954.	981,542.	VOTRAX. U.S. CL. 21. (INT. CL. 9). REG. 4-2-1974.
720,533.	RADEX (STYLIZED). U.S. CL. 6. (INT. CL. 3). REG. 8-29-1961.	982,100.	KNOEDLER (STYLIZED). U.S. CL. 101. (INT. CL. 35). REG. 4-9-1974.
721,168.	W AND DESIGN.	982,461.	10BENZAGEL (STYLIZED). U.S. CL. 18. (INT. CL. 5). REG. 4-23-1974.
732,431.	PULLMAN. U.S. CL. 23. (INT. CL. 16). REG. 6-5-1962.	982,594.	OETKER AND DESIGN. U.S. CL. 46. (INT. CLS. 3 AND 30). REG. 4-23-1974.
738,553.	MISCELLANEOUS DESIGN. U.S. CL. 23. (INT. CL. 7). REG. 10-2-1962.	982,708.	BIG CHUNK. U.S. CL. 46. (INT. CL. 29). REG. 4-23-1974.
748,216.	P PILOT INTERNATIONAL AND DESIGN. U.S. CL. 200. REG. 4-16-1963.	982,957.	MANDALAY. U.S. CL. 46. (INT. CL. 30). REG. 4-30-1974.
755,523.	MANNITHERM. U.S. CL. 37. (INT. CL. 16). REG. 8-27-1963.	983,590.	SHADEMASTER. U.S. CL. 1. (INT. CL. 31). REG. 5-14-1974.
757,827.	MISCELLANEOUS DESIGN. U.S. CL. 42. (INT. CLS. 22, 24, 26 AND 27). REG. 10-1-1963.	983,591.	GREENSPIRE. U.S. CL. 1. (INT. CL. 31). REG. 5-14-1974.
758,551.	PHILLIPS 66 AND DESIGN. U.S. CL. 52. (INT. CL. 3). REG. 10-15-1963.	984,437.	Y M A AND DESIGN. U.S. CL. 23. (INT. CLS. 7 AND 8). REG. 5-21-1974.
762,753.	ARPEGGIO. U.S. CL. 36. (INT. CL. 15). REG. 1-7-1964.	984,521.	TASCAM. U.S. CL. 36. (INT. CL. 9). REG. 5-21-1974.
767,262.	H HI-BRAND AND DESIGN. U.S. CL. 46. (INT. CL. 29). REG. 3-24-1964.	986,081.	FAMOUS OLD TIME. U.S. CL. 46. (INT. CL. 30). REG. 6-11-1974.
767,384.	INTERPOOL. U.S. CL. 12. (INT. CL. 19). REG. 3-31-1964.	986,980.	REMINGTON. U.S. CL. 44. (INT. CL. 10). REG. 6-25-1974.
767,494.	TURBO-CLEAN. U.S. CL. 23. (INT. CL. 7). REG. 3-31-1964.	988,234.	TRACKWALL. U.S. CL. 12. (INT. CL. 19). REG. 7-16-1974.
767,865.	GILLETTE. U.S. CL. 23. (INT. CL. 8). REG. 4-7-1964.	988,743.	BOX-MOUNT (STYLIZED). U.S. CL. 13. (INT. CL. 6). REG. 7-23-1974.
		989,449.	REOFOS. U.S. CL. 6. (INT. CL. 1). REG. 7-30-1974.

- 989,674. REMINGTON. U.S. CL. 44. (INT. CL. 11). REG. 7-30-1974.
- 989,754. BILL JOHNSON'S BIG APPLE AND DESIGN. U.S. CL. 100. (INT. CL. 42). REG. 7-30-1974.
- 989,978. EI (STYLIZED). U.S. CLS. 32, 37, 38, 39 AND 101 ONLY. (INT. CLS. 10, 16, 20, 25, 26 AND 35). REG. 8-6-1974.
- 990,773. KICE. U.S. CL. 23. (INT. CL. 7). REG. 8-13-1974.
- 990,879. ANEMOSTAT. U.S. CL. 34. (INT. CL. 11). REG. 8-13-1974.
- 992,185. FIRST PLACE. U.S. CL. 102. (INT. CL. 36). REG. 8-27-1974.
- 992,393. SOLITECH. U.S. CL. 21. (INT. CL. 9). REG. 9-3-1974.
- 993,855. TURNER. U.S. CL. 26. (INT. CL. 9). REG. 9-24-1974.
- 994,552. LUBOIL. U.S. CL. 15. (INT. CL. 4). REG. 10-1-1974.
- 996,398. MAXI MIX. U.S. CL. 26. (INT. CL. 9). REG. 10-22-1974.
- 997,190. 5. INT. CL. 1. (U.S. CL. 12). REG. 11-5-1974.
- 997,278. PHILADELPHIA. INT. CL. 7. (U.S. CLS. 13, 19, 21, 23, 31, 34 AND 35). REG. 11-5-1974.
- 999,163. TRU AND DESIGN. U.S. CL. 21. (INT. CL. 9). REG. 11-26-1974.
- 999,713. HALSTON. INT. CL. 25. (U.S. CL. 39). REG. 12-17-1974.
- 1,000,040. LAWN DOCTOR. U.S. CL. 100. (INT. CL. 42). REG. 12-17-1974.
- 1,226,634. WEST'S. INT. CL. 16. (U.S. CL. 38). REG. 2-8-1983.
- 1,230,956. CUSR. INT. CL. 9. (U.S. CLS. 21 AND 26). REG. 3-15-1983.
- 1,232,664. U.S.C.A.. INT. CL. 16. (U.S. CL. 38). REG. 3-29-1983.
- 1,232,669. BLUE DEMONS. INT. CLS. 20, 21, 24 AND 41 ONLY. (U.S. CLS. 2, 33, 42, 50 AND 107). REG. 3-29-1983.
- 1,233,095. THE LEARNING ANNEX. INT. CL. 41. (U.S. CL. 107). REG. 3-29-1983.
- 1,233,504. NATIONAL PEN AND DESIGN. INT. CL. 16 ONLY. (U.S. CL. 37). REG. 4-5-1983.
- 1,239,995. PAINT CREW. INT. CL. 7. (U.S. CL. 23). REG. 5-31-1983.
- 1,250,471. EURO-STAR AND DESIGN. INT. CL. 25. (U.S. CL. 39). REG. 9-6-1983.
- 1,251,846. COMERICA. INT. CL. 36. (U.S. CL. 102). REG. 9-20-1983.
- 1,253,441. UNITED STATES FLAG FOUNDATION. INT. CL. 42. (U.S. CL. 100). REG. 10-4-1983.
- 1,254,211. HERBALIFE. INT. CLS. 3 AND 5. (U.S. CLS. 18, 51 AND 52). REG. 10-18-1983.
- 1,255,109. LANE. INT. CL. 7. (U.S. CL. 23). REG. 10-25-1983.
- 1,263,461. THE ELECTRIC BLACKBOARD. INT. CL. 9. (U.S. CLS. 21, 23, 26, 36 AND 38). REG. 1-10-1984.
- 1,264,470. GROWMASTER. INT. CLS. 37 AND 42. (U.S. CLS. 100 AND 103). REG. 1-17-1984.
- 1,264,578. MURATA (STYLIZED). INT. CL. 9 ONLY. (U.S. CLS. 21, 23, 26, 36 AND 38 ONLY). REG. 1-24-1984.
- 1,265,025. VITRON. INT. CL. 21. (U.S. CLS. 1 AND 42). REG. 1-24-1984.
- 1,265,496. HYDRISINOL. INT. CL. 3. (U.S. CL. 51). REG. 1-31-1984.
- 1,266,905. CHAMPION. INT. CL. 7. (U.S. CL. 23). REG. 2-14-1984.
- 1,269,601. INTRON. INT. CL. 5. (U.S. CL. 18). REG. 3-13-1984.
- 1,269,675. COURSEMASTER. INT. CL. 9. (U.S. CL. 26). REG. 3-13-1984.
- 1,270,367. ANNIE'S BOOK SWAP THE GREAT AMERICAN BOOK EXCHANGE A NOVEL IDEA AND DESIGN. INT. CL. 42. (U.S. CL. 101). REG. 3-13-1984.
- 1,270,394. MT MIDWEST TRADING AND DESIGN. INT. CL. 42. (U.S. CL. 101). REG. 3-13-1984.
- 1,270,448. OXITARDANT. INT. CL. 1. (U.S. CL. 6). REG. 3-20-1984.
- 1,270,992. DELAS. INT. CL. 33. (U.S. CL. 47). REG. 3-20-1984.
- 1,271,520. HOSOKAWA MICRON. INT. CL. 7. (U.S. CL. 23). REG. 3-27-1984.
- 1,271,526. ZIPPY. INT. CL. 7. (U.S. CLS. 23 AND 50). REG. 3-27-1984.
- 1,271,619. G-31. INT. CL. 9. (U.S. CL. 26). REG. 3-27-1984.
- 1,271,773. MICROWAVES & RF. INT. CL. 16. (U.S. CL. 38). REG. 3-27-1984.
- 1,271,794. CUMULUS. INT. CL. 17. (U.S. CL. 1). REG. 3-27-1984.
- 1,271,989. BLUE DIAMOND AND DESIGN. INT. CLS. 29, 30 AND 31. (U.S. CLS. 1 AND 46). REG. 3-27-1984.
- 1,272,000. RENSHENFENGWANGJIANG AND DESIGN. INT. CL. 30. (U.S. CL. 46). REG. 3-27-1984.
- 1,272,045. LOLLIPALS. INT. CL. 30. (U.S. CL. 46). REG. 3-27-1984.
- 1,272,226. VINYL SIDING INSTITUTE VSI THE SOCIETY OF THE PLASTICS INDUSTRY, INC. (STYLIZED). INT. CL. 42. (U.S. CL. 100). REG. 3-27-1984.
- 1,272,247. MEMBER VINYL SIDING INSTITUTE VSI THE SOCIETY OF THE PLASTICS INDUSTRY, INC. (STYLIZED). U.S. CL. 200. REG. 3-27-1984.
- 1,272,283. NUCREL. INT. CL. 1. (U.S. CL. 6). REG. 4-3-1984.
- 1,272,312. DARTH VADER. INT. CL. 25 ONLY. (U.S. CL. 39). REG. 4-3-1984.
- 1,272,407. DETROIT DIESEL AND DESIGN. INT. CL. 7. (U.S. CL. 23). REG. 4-3-1984.
- 1,272,484. UNIVERSAL. INT. CL. 9. (U.S. CL. 21). REG. 4-3-1984.
- 1,272,555. FASTIGHT. INT. CL. 10. (U.S. CL. 44). REG. 4-3-1984.
- 1,272,676. THE SWAP SHEET. INT. CL. 16. (U.S. CL. 38). REG. 4-3-1984.
- 1,272,714. UNION JACKS. INT. CLS. 18 AND 28. (U.S. CLS. 3 AND 22). REG. 4-3-1984.
- 1,272,719. MR. SANDMAN. INT. CL. 19. (U.S. CL. 50). REG. 4-3-1984.
- 1,272,782. SANDALO (STYLIZED). INT. CL. 25. (U.S. CL. 39). REG. 4-3-1984.
- 1,272,977. TASTYKAKE (STYLIZED). INT. CL. 30. (U.S. CL. 46). REG. 4-3-1984.
- 1,273,022. ROZES (STYLIZED). INT. CL. 33. (U.S. CL. 47). REG. 4-3-1984.
- 1,273,102. LUX ET VERITAS AND DESIGN. INT. CL. 41. (U.S. CL. 107). REG. 4-3-1984.
- 1,273,187. ONE KEY PLAY. INT. CL. 15. (U.S. CL. 36). REG. 4-3-1984.
- 1,273,320. RIMLOCK. INT. CL. 7. (U.S. CL. 23). REG. 4-10-1984.
- 1,273,363. MOCON. INT. CL. 9. (U.S. CL. 26). REG. 4-10-1984.
- 1,273,516. MISCELLANEOUS DESIGN. INT. CL. 18. (U.S. CL. 3). REG. 4-10-1984.
- 1,273,615. MISCELLANEOUS DESIGN. INT. CL. 25. (U.S. CLS. 22 AND 39). REG. 4-10-1984.
- 1,273,654. FORMTHOTICS. INT. CL. 25. (U.S. CL. 39). REG. 4-10-1984.
- 1,273,726. BLUE DIAMOND AND DESIGN. INT. CLS. 29, 30 AND 31. (U.S. CL. 46). REG. 4-10-1984.
- 1,273,825. ELITE. INT. CL. 35. (U.S. CL. 101). REG. 4-10-1984.
- 1,273,888. BREAK THE LANGUAGE BARRIER. INT. CLS. 41 AND 42 ONLY. (U.S. CLS. 100 AND 107). REG. 4-10-1984.
- 1,273,954. STRIDE RITE. INT. CL. 42. (U.S. CL. 101). REG. 4-10-1984.
- 1,274,035. BELSPERSE. INT. CL. 1. (U.S. CL. 6). REG. 4-17-1984.
- 1,274,773. MISCELLANEOUS DESIGN. INT. CL. 6. (U.S. CL. 13). REG. 4-24-1984.
- 1,274,944. BLUE SABRE AND DESIGN. INT. CL. 25. (U.S. CL. 39). REG. 4-24-1984.
- 1,275,031. KENMORE. INT. CL. 11. (U.S. CLS. 13, 21, 23, 31 AND 34). REG. 4-24-1984.
- 1,275,057. MONTERO. INT. CL. 12. (U.S. CL. 19). REG. 4-24-1984.
- 1,275,107. CHAUTAUQUA. INT. CLS. 16, 18 AND 25. (U.S. CLS. 3, 37 AND 39). REG. 4-24-1984.
- 1,275,171. E AND DESIGN. INT. CL. 17. (U.S. CLS. 1, 12, 21 AND 35). REG. 4-24-1984.
- 1,275,371. PATAK'S. INT. CLS. 29 AND 30. (U.S. CL. 46). REG. 4-24-1984.
- 1,275,841. MANNY G. INT. CL. 7. (U.S. CL. 23). REG. 5-1-1984.
- 1,275,931. PADL-PET. INT. CL. 9. (U.S. CL. 26). REG. 5-1-1984.
- 1,276,243. CAMARO (STYLIZED). INT. CL. 25. (U.S. CLS. 22 AND 39). REG. 5-1-1984.
- 1,276,401. LOUISVILLE. INT. CL. 28. (U.S. CL. 22). REG. 5-1-1984.
- 1,276,456. TROPIC ISLE AND DESIGN. INT. CL. 31. (U.S. CL. 46). REG. 5-1-1984.
- 1,276,675. MISCELLANEOUS DESIGN. INT. CL. 5. (U.S. CL. 44). REG. 5-8-1984.

- 1,276,737. SPATOURS. INT. CL. 8. (U.S. CL. 23). REG. 5-8-1984.
- 1,277,037. GOLF-BUOY. INT. CL. 21. (U.S. CL. 2). REG. 5-8-1984.
- 1,277,275. T AND DESIGN. INT. CL. 30. (U.S. CL. 46). REG. 5-8-1984.
- 1,277,662. MAJIBLOND. INT. CL. 3. (U.S. CL. 51). REG. 5-15-1984.
- 1,277,702. GRIME AWAY. INT. CL. 3. (U.S. CL. 52). REG. 5-15-1984.
- 1,277,719. DUBOIS. INT. CL. 3. (U.S. CL. 52). REG. 5-15-1984.
- 1,277,732. DI-FOAM. INT. CL. 3. (U.S. CL. 52). REG. 5-15-1984.
- 1,277,936. INFORMIX. INT. CL. 9. (U.S. CL. 38). REG. 5-15-1984.
- 1,278,850. DURA-LINE. INT. CL. 11. (U.S. CL. 34). REG. 5-22-1984.
- 1,278,885. PANARACER (STYLIZED). INT. CL. 12. (U.S. CL. 35). REG. 5-22-1984.
- 1,279,935. STEFANEL AND DESIGN. INT. CL. 25. (U.S. CL. 39). REG. 5-29-1984.
- 1,280,332. H AND DESIGN. INT. CLS. 1 AND 4. (U.S. CLS. 6 AND 15). REG. 6-5-1984.
- 1,280,642. POLY-FINE. INT. CL. 11. (U.S. CL. 31). REG. 6-5-1984.
- 1,280,664. EQUA-TRAC. INT. CL. 12. (U.S. CLS. 19 AND 23). REG. 6-5-1984.
- 1,280,728. THE THING. INT. CL. 16. (U.S. CL. 38). REG. 6-5-1984.
- 1,281,770. SWISS VILLAGE (STYLIZED). INT. CL. 29. (U.S. CL. 46). REG. 6-12-1984.
- 1,281,847. LE DOMAINE. INT. CL. 33. (U.S. CL. 47). REG. 6-12-1984.
- 1,284,061. REGISIL. INT. CL. 5. (U.S. CL. 44). REG. 7-3-1984.
- 1,284,241. NATIONAL WILDLIFE. INT. CL. 16. (U.S. CL. 38). REG. 7-3-1984.
- 1,284,295. POST-IT. INT. CL. 16. (U.S. CL. 5). REG. 7-3-1984.
- 1,285,831. TWINCONE. INT. CL. 7. (U.S. CLS. 4 AND 23). REG. 7-17-1984.
- 1,286,158. PRAIRIE FARMS AND DESIGN. INT. CLS. 29 AND 30. (U.S. CL. 46). REG. 7-17-1984.
- 1,286,313. CD. INT. CL. 33. (U.S. CL. 47). REG. 7-17-1984.
- 1,287,111. BRUCE. INT. CL. 20. (U.S. CL. 32). REG. 7-24-1984.
- 1,287,504. ABKA (STYLIZED). U.S. CL. 200. REG. 7-24-1984.
- 1,287,661. SILENT PACK. INT. CLS. 7 AND 12. (U.S. CLS. 19 AND 23). REG. 7-31-1984.
- 1,288,419. A.W.O.L.. INT. CL. 42. (U.S. CL. 101). REG. 7-31-1984.
- 1,290,930. ULTRA. INT. CL. 15. (U.S. CL. 36). REG. 8-21-1984.
- 1,291,749. AIR THERAPY AND DESIGN. INT. CL. 5. (U.S. CL. 6). REG. 8-28-1984.
- 1,295,408. SALLY HANSEN (STYLIZED). INT. CL. 3 ONLY. (U.S. CLS. 4, 6 AND 51). REG. 9-18-1984.
- 1,295,829. MISCELLANEOUS DESIGN. INT. CL. 9. (U.S. CLS. 21 AND 36). REG. 9-18-1984.
- 1,296,009. MMM AND DESIGN. INT. CLS. 14, 24 AND 25. (U.S. CLS. 28, 39 AND 42). REG. 9-18-1984.
- 1,298,257. MARKSCOPE AND DESIGN. INT. CL. 42. (U.S. CLS. 100 AND 101). REG. 9-25-1984.
- 1,298,425. ROTO WITCH. INT. CL. 7. (U.S. CL. 23). REG. 10-2-1984.
- 1,299,674. LAMB'S SUPREME SKILLET BROWNS. INT. CL. 29. (U.S. CL. 46). REG. 10-9-1984.
- 1,300,287. FLEXFLO. INT. CL. 9. (U.S. CL. 26). REG. 10-16-1984.
- 1,301,050. HELLS ANGELS MC AND DESIGN. U.S. CL. 200. REG. 10-16-1984.
- 1,301,253. CHAMP AND DESIGN. INT. CL. 7. (U.S. CL. 23). REG. 10-23-1984.
- 1,302,361. RITE-ON. INT. CL. 4. (U.S. CL. 15). REG. 10-30-1984.
- 1,302,779. TWEETY. INT. CL. 25. (U.S. CL. 39). REG. 10-30-1984.
- 1,302,815. MISCELLANEOUS DESIGN. INT. CL. 28. (U.S. CL. 22). REG. 10-30-1984.
- 1,308,028. PRIME TIME. INT. CL. 19. (U.S. CL. 12). REG. 12-4-1984.
- 1,317,841. BIOSONICS. INT. CL. 9. (U.S. CLS. 21 AND 26). REG. 2-5-1985.
- 1,320,729. BAY SPRINGS. INT. CL. 19. (U.S. CL. 12). REG. 2-19-1985.
- 1,321,770. KING RANCH. INT. CL. 6. (U.S. CL. 12). REG. 2-26-1985.
- 1,323,102. ROCKHOPPER. INT. CL. 12. (U.S. CL. 19). REG. 3-5-1985.
- 1,323,691. FLIGHT GUARD. INT. CL. 36. (U.S. CL. 102). REG. 3-5-1985.
- 1,600,876. TUBEX. INT. CL. 20. (U.S. CL. 32). REG. 6-12-1990.
- 1,634,291. MEDALLA LIGHT PUERTO RICO AND DESIGN. INT. CL. 32. (U.S. CL. 48). REG. 2-5-1991.
- 1,661,224. MISCELLANEOUS DESIGN. INT. CL. 42. (U.S. CL. 100). REG. 10-15-1993.
- 1,685,170. SECRET EAR (STYLIZED). INT. CL. 10. (U.S. CL. 44). REG. 5-5-1992.
- 1,688,217. KIDDIECORP AND DESIGN. INT. CL. 42. (U.S. CLS. 100 AND 101). REG. 5-19-1992.
- 1,692,814. VTDP. INT. CL. 12. (U.S. CLS. 19, 21, 23, 31, 35 AND 44). REG. 6-9-1992.
- 1,698,051. MCCLOUD AND DESIGN. INT. CLS. 37 AND 42. (U.S. CLS. 100, 101, 103 AND 106). REG. 6-30-1992.
- 1,698,494. CENTURA. INT. CL. 36. (U.S. CL. 102). REG. 6-30-1992.
- 1,700,903. SOCIAL DISTORTION. INT. CL. 41. (U.S. CL. 107). REG. 7-14-1992.
- 1,753,371. ALASKAN FALLS (STYLIZED). INT. CL. 32. (U.S. CL. 45). REG. 2-16-1993.
- 1,755,761. 800-CANDIES. INT. CL. 39. (U.S. CL. 105). REG. 3-2-1993.
- 1,755,967. GINSENG BOARD OF WISCONSIN, INC. WISCONSIN GINSENG AND DESIGN. U.S. CL. A. REG. 3-2-1993.
- 1,757,759. DARK REIGN. INT. CL. 41. (U.S. CL. 107). REG. 3-9-1993.
- 1,765,747. TROCADERO. INT. CL. 11 ONLY. (U.S. CLS. 13, 21, 23, 31 AND 34). REG. 4-20-1993.
- 1,766,653. CORTINA. INT. CL. 11. (U.S. CL. 13). REG. 4-20-1993.
- 1,767,330. EARLY WARNING. INT. CL. 9. (U.S. CL. 38). REG. 4-27-1993.
- 1,767,438. C. O'LAUGHLIN READING GUIDELINE (STYLIZED). INT. CL. 16. (U.S. CL. 38). REG. 4-27-1993.
- 1,767,686. LEXICON. INT. CL. 41. (U.S. CL. 107). REG. 4-27-1993.
- 1,768,179. PALETON. INT. CL. 30. (U.S. CL. 46). REG. 4-27-1993.
- 1,772,322. J'S (STYLIZED). INT. CL. 14. (U.S. CLS. 1 AND 28). REG. 5-18-1993.
- 1,775,042. OCEAN TECHNOLOGY SYSTEMS OTS "TECHNOLOGY IN DEPTH" AND DESIGN. INT. CL. 9. (U.S. CLS. 21 AND 26). REG. 6-8-1993.
- 1,775,680. SUN AND SPORT. INT. CL. 3. (U.S. CL. 51). REG. 6-8-1993.
- 1,776,469. MISCELLANEOUS DESIGN. INT. CLS. 16 AND 41. (U.S. CLS. 38 AND 107). REG. 6-15-1993.
- 1,777,613. TYLENOL PM. INT. CL. 5. (U.S. CL. 18). REG. 6-22-1993.
- 1,779,400. PRAIRIE STONE. INT. CLS. 36 AND 37. (U.S. CLS. 100, 101, 102 AND 103). REG. 6-29-1993.
- 1,781,931. C.O.P.S. MONITORING AND DESIGN. INT. CL. 42. (U.S. CLS. 100 AND 101). REG. 7-13-1993.
- 1,783,492. MISCELLANEOUS DESIGN. INT. CL. 25. (U.S. CL. 39). REG. 7-20-1993.
- 1,785,133. TILEX. INT. CLS. 3 AND 5. (U.S. CLS. 6, 18 AND 52). REG. 8-3-1993.
- 1,785,554. MARBLED ELEGANCE. INT. CL. 19. (U.S. CL. 12). REG. 8-3-1993.
- 1,785,608. COTTON A R T AND DESIGN. INT. CL. 24. (U.S. CL. 42). REG. 8-3-1993.
- 1,789,490. NYU. INT. CL. 25. (U.S. CL. 39). REG. 8-24-1993.
- 1,791,381. DATCON. INT. CL. 9. (U.S. CL. 26). REG. 9-7-1993.
- 1,792,265. REFRESH-A-CAR. INT. CL. 1. (U.S. CL. 1). REG. 9-14-1993.
- 1,793,312. ATLANTIS. INT. CL. 42. (U.S. CL. 101). REG. 9-21-1993.
- 1,794,114. PEDESTAL. INT. CL. 9. (U.S. CL. 38). REG. 9-21-1993.
- 1,795,214. ENK PRODUCTIONS (STYLIZED). INT. CL. 35. (U.S. CL. 101). REG. 9-28-1993.
- 1,795,346. ANN WIGMORE FOUNDATION. INT. CL. 41. (U.S. CL. 107). REG. 9-28-1993.
- 1,795,392. DON SHERWOOD GOLF & TENNIS WORLD AND DESIGN. INT. CL. 42. (U.S. CL. 100). REG. 9-28-1993.
- 1,795,873. HEALTHY PLANET PRODUCTS AND DESIGN. INT. CL. 16. (U.S. CLS. 37 AND 38). REG. 9-28-1993.

- 1,796,056. LOS STATOS DELUXE. INT. CL. 34. (U.S. CL. 17). REG. 9-28-1993.
- 1,797,303. MULTIPOINTE. INT. CL. 38. (U.S. CL. 104). REG. 10-5-1993.
- 1,797,496. THE PERFECT BLEND. INT. CL. 5. (U.S. CL. 18). REG. 10-12-1993.
- 1,797,890. CSC. INT. CL. 24 ONLY. (U.S. CL. 42). REG. 10-12-1993.
- 1,798,221. EA EXPRESS AIR FREIGHT UNLIMITED INC. AND DESIGN. INT. CL. 39. (U.S. CL. 105). REG. 10-12-1993.
- 1,799,689. CRUISEONE. INT. CL. 39. (U.S. CL. 105). REG. 10-19-1993.
- 1,801,323. VERANDA. INT. CL. 3 ONLY. (U.S. CLS. 51 AND 52). REG. 10-26-1993.
- 1,803,047. AUTOPOLE. INT. CLS. 6 AND 9. (U.S. CLS. 12 AND 26). REG. 11-9-1993.
- 1,803,181. HUBCAP HEAVEN. INT. CL. 12. (U.S. CL. 19). REG. 11-9-1993.
- 1,804,051. BLACK THANG. INT. CLS. 3 AND 25. (U.S. CLS. 39, 51 AND 52). REG. 11-16-1993.
- 1,806,453. KINGSMILL. INT. CL. 39. (U.S. CLS. 100 AND 105). REG. 11-23-1993.
- 1,806,723. MF MASTERFORM (STYLIZED). INT. CL. 16. (U.S. CLS. 37 AND 38). REG. 11-23-1993.
- 1,807,354. INTEGRABLOK. INT. CL. 12. (U.S. CLS. 19, 21, 23, 31, 35 AND 44). REG. 11-30-1993.
- 1,808,085. MISCELLANEOUS DESIGN. INT. CL. 41. (U.S. CL. 107). REG. 11-30-1993.
- 1,808,191. THE CHATTANOOGA HEART INSTITUTE AND DESIGN. INT. CL. 42. (U.S. CL. 100). REG. 11-30-1993.
- 1,811,179. SEA AIR SPACE AND DESIGN. INT. CL. 41. (U.S. CL. 107). REG. 12-14-1993.
- 1,811,780. HERBALIFE AND DESIGN. INT. CLS. 3, 5, 16 AND 30. (U.S. CLS. 18, 38, 45, 46 AND 51). REG. 12-21-1993.
- 1,811,894. STECAL. INT. CL. 9. (U.S. CL. 38). REG. 12-21-1993.
- 1,812,858. TEMP-GARD. INT. CL. 11. (U.S. CL. 13). REG. 12-21-1993.
- 1,814,123. HOLLYWOOD VIDEO SUPERSTORE. INT. CL. 41. (U.S. CLS. 101 AND 107). REG. 12-28-1993.
- 1,815,141. OUR LOAN IS YOUR HOME. INT. CL. 36. (U.S. CL. 102). REG. 1-4-1994.
- 1,817,131. TASTE OF THE NATION. INT. CL. 36. (U.S. CL. 102). REG. 1-18-1994.
- 1,818,109. COUNTRYWILD. INT. CL. 30. (U.S. CL. 46). REG. 1-25-1994.
- 1,818,397. SUN SOLUTIONS. INT. CL. 9. (U.S. CLS. 21, 26 AND 38). REG. 1-25-1994.
- 1,819,446. HEMATO-CLAD. INT. CL. 10. (U.S. CL. 44). REG. 2-1-1994.
- 1,819,772. Q (STYLIZED). INT. CL. 9. (U.S. CL. 38). REG. 2-8-1994.
- 1,820,654. MULTIFUSER. INT. CL. 21. (U.S. CL. 13). REG. 2-8-1994.
- 1,821,206. MULTICELL COMPOUND AND DESIGN. INT. CL. 12. (U.S. CL. 35). REG. 2-15-1994.
- 1,821,965. THERMIC-WELD. INT. CL. 7. (U.S. CLS. 23 AND 50). REG. 2-15-1994.
- 1,822,617. CYROX. INT. CL. 12. (U.S. CL. 35). REG. 2-22-1994.
- 1,822,618. MOLAS. INT. CL. 12. (U.S. CL. 35). REG. 2-22-1994.
- 1,822,619. MAG.MOPUS. INT. CL. 12. (U.S. CL. 19). REG. 2-22-1994.
- 1,824,318. SPRAY SENSATIONS. INT. CL. 11. (U.S. CLS. 13 AND 35). REG. 3-1-1994.
- 1,825,127. CHEMI-MAT. INT. CL. 16. (U.S. CL. 31). REG. 3-8-1994.
- 1,826,202. METASONICS. INT. CL. 9. (U.S. CL. 36). REG. 3-15-1994.
- 1,826,285. BEETLE CAT. INT. CL. 12. (U.S. CL. 19). REG. 3-15-1994.
- 1,826,359. FLEXSHIELD. INT. CL. 17. (U.S. CLS. 5 AND 12). REG. 3-15-1994.
- 1,826,399. AEGIS. INT. CL. 24. (U.S. CL. 42). REG. 3-15-1994.
- 1,827,317. MARY ANN. INT. CL. 9. (U.S. CLS. 23 AND 26). REG. 3-22-1994.
- 1,827,408. EXPRESSIONS. INT. CL. 14. (U.S. CL. 28). REG. 3-22-1994.
- 1,827,952. CABOT (STYLIZED). INT. CL. 1. (U.S. CL. 6). REG. 3-29-1994.
- 1,827,956. CRYSTAL DEEP SEAL. INT. CL. 1. (U.S. CL. 6). REG. 3-29-1994.
- 1,828,019. DERMAGRAN. INT. CL. 5. (U.S. CLS. 18 AND 44). REG. 3-29-1994.
- 1,828,250. NAPOLEON HILL. INT. CL. 16. (U.S. CL. 38). REG. 3-29-1994.
- 1,828,341. HOTLICKS. INT. CLS. 25, 30, 35 AND 42. (U.S. CLS. 39, 46, 100 AND 101). REG. 3-29-1994.
- 1,828,552. NEIGHBOR'S FINANCIAL CORPORATION. INT. CL. 36. (U.S. CL. 102). REG. 3-29-1994.
- 1,828,569. PENNIES BY THE INCH. INT. CL. 36. (U.S. CL. 102). REG. 3-29-1994.
- 1,828,591. MISCELLANEOUS DESIGN. INT. CL. 39. (U.S. CL. 105). REG. 3-29-1994.
- 1,828,631. THE RECYCLE CYCLE THE RECYCLE CYCLE AND DESIGN. INT. CL. 41. (U.S. CL. 107). REG. 3-29-1994.
- 1,828,706. TRACK LINE. INT. CL. 42. (U.S. CL. 100). REG. 3-29-1994.
- 1,828,837. CLIPPER. INT. CL. 10. (U.S. CL. 44). REG. 3-29-1994.
- 1,828,840. MEDNEXT. INT. CL. 10. (U.S. CL. 44). REG. 3-29-1994.
- 1,829,121. GEMINI. INT. CL. 2. (U.S. CLS. 6 AND 16). REG. 4-5-1994.
- 1,829,122. RAINBOW AND DESIGN. INT. CLS. 2, 3, 5 AND 21. (U.S. CLS. 6, 16, 29 AND 52). REG. 4-5-1994.
- 1,829,151. GRIOT'S GARAGE AND DESIGN. INT. CLS. 3, 6, 12, 16, 18, 20, 21, 24 AND 42. (U.S. CLS. 2, 3, 4, 13, 19, 32, 38, 42, 51, 52 AND 101). REG. 4-5-1994.
- 1,829,162. TETRA HERMIT CRAB MEAL. INT. CL. 5. (U.S. CL. 18). REG. 4-5-1994.
- 1,829,177. PLP AND DESIGN. INT. CLS. 6, 8 AND 9. (U.S. CLS. 12, 13, 21, 23 AND 26). REG. 4-5-1994.
- 1,829,178. PLP. INT. CLS. 6, 8 AND 9. (U.S. CLS. 12, 13, 23 AND 26). REG. 4-5-1994.
- 1,829,181. ALL-GRIP (STYLIZED). INT. CLS. 6 AND 22. (U.S. CLS. 7 AND 13). REG. 4-5-1994.
- 1,829,183. FLUXTAC. INT. CL. 6. (U.S. CL. 13). REG. 4-5-1994.
- 1,829,197. DERCO QDR AND DESIGN. INT. CL. 7. (U.S. CLS. 23 AND 35). REG. 4-5-1994.
- 1,829,198. METAULLICS. INT. CL. 7. (U.S. CL. 23). REG. 4-5-1994.
- 1,829,211. MOKI. INT. CL. 8. (U.S. CLS. 23, 28 AND 44). REG. 4-5-1994.
- 1,829,246. UPS-32. INT. CL. 9. (U.S. CL. 38). REG. 4-5-1994.
- 1,829,254. CASANOVA AND DESIGN. INT. CL. 9. (U.S. CL. 26). REG. 4-5-1994.
- 1,829,358. MOTHER'S JOY. INT. CL. 14. (U.S. CL. 28). REG. 4-5-1994.
- 1,829,359. SKB AND DESIGN. INT. CLS. 15 AND 18. (U.S. CLS. 2, 3 AND 36). REG. 4-5-1994.
- 1,829,385. SUPER ARCOFLEX. INT. CL. 16. (U.S. CLS. 37 AND 38). REG. 4-5-1994.
- 1,829,392. MACHINE AGE. INT. CL. 16. (U.S. CL. 38). REG. 4-5-1994.
- 1,829,394. PERSONNELLY YOURS. INT. CL. 16. (U.S. CL. 38). REG. 4-5-1994.
- 1,829,411. FIVE STAR AND DESIGN. INT. CL. 16. (U.S. CLS. 37 AND 38). REG. 4-5-1994.
- 1,829,431. REFRACTIONS. INT. CL. 19. (U.S. CL. 12). REG. 4-5-1994.
- 1,829,483. PORTOLANO. INT. CL. 25. (U.S. CL. 39). REG. 4-5-1994.
- 1,829,553. MEHARI'S MILD & LIGHT AGIO AND DESIGN. INT. CL. 34. (U.S. CL. 17). REG. 4-5-1994.
- 1,829,574. A PEOPLE BUSINESS. INT. CL. 35. (U.S. CL. 101). REG. 4-5-1994.
- 1,829,660. HOLLYWOOD STARS AND DESIGN. INT. CL. 41. (U.S. CL. 107). REG. 4-5-1994.
- 1,829,690. FELL'S POINT FUN FESTIVAL AND DESIGN. INT. CL. 42. (U.S. CL. 100). REG. 4-5-1994.
- 1,829,757. STONE MOUNTAIN. INT. CLS. 27 AND 42. (U.S. CLS. 42, 100 AND 101). REG. 4-5-1994.
- 1,829,770. SCREWGRADE. INT. CL. 1. (U.S. CL. 5). REG. 4-5-1994.
- 1,829,779. PRISCO ENVIROKLENE. INT. CL. 3. (U.S. CLS. 6 AND 51). REG. 4-5-1994.
- 1,829,798. MERCATOR. INT. CL. 9. (U.S. CL. 38). REG. 4-5-1994.
- 1,829,828. A CLOSER LOOK. INT. CL. 16. (U.S. CL. 38). REG. 4-5-1994.
- 1,829,834. NOUR. INT. CL. 16. (U.S. CL. 29). REG. 4-5-1994.
- 1,829,903. ALLTMOR. INT. CL. 28. (U.S. CL. 22). REG. 4-5-1994.

- 1,829,920. BELIEVE. INT. CL. 29. (U.S. CL. 46). REG. 4-5-1994.
- 1,829,959. CAREZZA. INT. CL. 33. (U.S. CL. 47). REG. 4-5-1994.
- 1,830,037. NINE BEAN LOAF. INT. CL. 29. (U.S. CL. 46). REG. 4-5-1994.
- 1,830,170. SYSLOAD. INT. CLS. 9 AND 16 ONLY. (U.S. CLS. 26 AND 38). REG. 4-12-1994.
- 1,830,180. OPTIKA. INT. CL. 9. (U.S. CL. 38). REG. 4-12-1994.
- 1,830,272. MOTOCROSS-M22. INT. CL. 12. (U.S. CL. 35). REG. 4-12-1994.
- 1,830,294. MISCELLANEOUS DESIGN. INT. CL. 14. (U.S. CL. 28). REG. 4-12-1994.
- 1,830,468. MISCELLANEOUS DESIGN. INT. CL. 30. (U.S. CL. 46). REG. 4-12-1994.
- 1,830,495. MR FLAVOR AND DESIGN. INT. CL. 31. (U.S. CL. 46). REG. 4-12-1994.
- 1,830,605. 9 KCRG - TV NEWS AND DESIGN. INT. CL. 38. (U.S. CL. 104). REG. 4-12-1994.
- 1,830,619. FORWARD AIR, INC. AND DESIGN. INT. CL. 39. (U.S. CL. 105). REG. 4-12-1994.
- 1,830,620. PIZZA BOLI'S AND DESIGN. INT. CLS. 39 AND 42. (U.S. CLS. 100 AND 105). REG. 4-12-1994.
- 1,830,621. PIZZA BOLI'S. INT. CLS. 39 AND 42. (U.S. CLS. 100 AND 105). REG. 4-12-1994.
- 1,830,642. CAROLINA LEAGUE. INT. CL. 41. (U.S. CLS. 101 AND 107). REG. 4-12-1994.
- 1,830,654. KNOWING AWARENESS THINKING. INT. CL. 41. (U.S. CL. 107). REG. 4-12-1994.
- 1,830,750. ECO PRODUCTS. INT. CL. 1. (U.S. CL. 1). REG. 4-12-1994.
- 1,830,785. LIFE TRACE AND DESIGN. INT. CL. 10. (U.S. CL. 44). REG. 4-12-1994.
- 1,830,786. INVISATRACE. INT. CL. 10. (U.S. CL. 44). REG. 4-12-1994.
- 1,830,836. CARTER'S. INT. CL. 28. (U.S. CLS. 22, 23, 38 AND 50). REG. 4-12-1994.
- 1,830,877. GYM RAT. INT. CL. 35. (U.S. CL. 101). REG. 4-12-1994.
- 1,831,074. STANDARD. INT. CL. 7. (U.S. CLS. 13, 19, 21, 23, 31, 34 AND 35). REG. 4-19-1994.
- 1,831,093. ULTRA (STYLIZED). INT. CL. 7. (U.S. CL. 23). REG. 4-19-1994.
- 1,831,094. SATURN. INT. CL. 7. (U.S. CL. 23). REG. 4-19-1994.
- 1,831,303. FOOT & ANKLE. INT. CL. 16. (U.S. CL. 38). REG. 4-19-1994.
- 1,831,446. ANNALEE MOBILITEE DOLLS. INT. CL. 28. (U.S. CL. 22). REG. 4-19-1994.
- 1,831,511. ODWALLA. INT. CL. 32. (U.S. CL. 46). REG. 4-19-1994.
- 1,831,576. DIVERSIFIED DESIGN & CONSTRUCTION, INC. AND DESIGN. INT. CL. 37. (U.S. CL. 103). REG. 4-19-1994.
- 1,831,587. HOPELINE. INT. CL. 38. (U.S. CL. 104). REG. 4-19-1994.
- 1,831,860. AQUASITE. INT. CL. 5. (U.S. CL. 18). REG. 4-19-1994.
- 1,831,888. STRAINPRESS AND DESIGN. INT. CL. 7. (U.S. CL. 23). REG. 4-19-1994.
- 1,832,042. ACCUSTAIR. INT. CL. 9. (U.S. CL. 38). REG. 4-19-1994.
- 1,832,125. PERSHING ROCKET. INT. CL. 13. (U.S. CL. 9). REG. 4-19-1994.
- 1,832,211. UNIGRANITE. INT. CL. 19. (U.S. CL. 12). REG. 4-19-1994.
- 1,832,350. EL'S. INT. CL. 29. (U.S. CL. 46). REG. 4-19-1994.
- 1,832,438. TAKEBACK AND TRANSFER. INT. CL. 38. (U.S. CL. 104). REG. 4-19-1994.
- 1,832,525. AUTOMATIC BUILDING MACHINE. INT. CL. 7. (U.S. CL. 23). REG. 4-19-1994.
- 1,832,529. SWIVELLOK. INT. CL. 9. (U.S. CL. 21). REG. 4-19-1994.
- 1,832,655. WORLD CITIZEN. INT. CL. 9. (U.S. CLS. 14 AND 26). REG. 4-26-1994.
- 1,832,749. POLYSHEATH. INT. CL. 17. (U.S. CLS. 1 AND 12). REG. 4-26-1994.
- 1,832,754. THE SHERPA BAG. INT. CL. 18. (U.S. CLS. 2 AND 3). REG. 4-26-1994.
- 1,832,796. MISCELLANEOUS DESIGN. INT. CL. 25. (U.S. CL. 39). REG. 4-26-1994.
- 1,832,844. MISCELLANEOUS DESIGN. INT. CL. 30. (U.S. CL. 46). REG. 4-26-1994.
- 1,832,879. LINC AND DESIGN. INT. CL. 35. (U.S. CL. 101). REG. 4-26-1994.
- 1,832,883. STRICTLY LEGAL. INT. CL. 35. (U.S. CL. 101). REG. 4-26-1994.
- 1,832,980. BURGER CHEF AND DESIGN. INT. CL. 42. (U.S. CL. 100). REG. 4-26-1994.
- 1,833,033. SCRUMBLITS. INT. CLS. 9 AND 28. (U.S. CLS. 21 AND 22). REG. 4-26-1994.
- 1,833,155. QSC. INT. CL. 9. (U.S. CLS. 21 AND 36). REG. 4-26-1994.
- 1,833,266. MISCELLANEOUS DESIGN. INT. CL. 11. (U.S. CL. 13). REG. 4-26-1994.
- 1,833,561. FERMENTZYME. INT. CL. 1. (U.S. CLS. 1 AND 6). REG. 5-3-1994.
- 1,833,658. COMMANDER AND DESIGN. INT. CL. 7. (U.S. CL. 23). REG. 5-3-1994.
- 1,833,761. LUXUS AND DESIGN. INT. CL. 11. (U.S. CL. 13). REG. 5-3-1994.
- 1,833,818. FRENCH LACE. INT. CL. 16. (U.S. CL. 1). REG. 5-3-1994.
- 1,833,944. RUDY'S. INT. CL. 29. (U.S. CL. 46). REG. 5-3-1994.
- 1,833,973. VITA. INT. CL. 30. (U.S. CL. 46). REG. 5-3-1994.
- 1,834,050. TRAVEL WORLDWIDE NETWORK. INT. CL. 39. (U.S. CL. 105). REG. 5-3-1994.
- 1,834,128. PARTNER PROGRAM. INT. CL. 42. (U.S. CL. 100). REG. 5-3-1994.
- 1,834,140. BP EXPRESS. INT. CL. 42. (U.S. CL. 101). REG. 5-3-1994.
- 1,834,201. ORANGE JULIUS AND DESIGN. INT. CLS. 29, 30, 32, 35 AND 42. (U.S. CLS. 45, 46, 100 AND 101). REG. 5-3-1994.
- 1,834,288. ORTHOVISC. INT. CL. 5. (U.S. CL. 18). REG. 5-3-1994.
- 1,834,543. CHAR-BROIL H2O SMOKER AND DESIGN. INT. CL. 11. (U.S. CL. 34). REG. 5-3-1994.
- 1,834,666. NOMEX THERMACOLOR. INT. CL. 22. (U.S. CL. 1). REG. 5-3-1994.
- 1,834,815. JAYSHREE'S AND DESIGN. INT. CL. 30. (U.S. CL. 46). REG. 5-3-1994.
- 1,834,827. AZZURRO. INT. CL. 30. (U.S. CL. 46). REG. 5-3-1994.
- 1,834,908. PACIFIC HIGHLANDS RANCH. INT. CL. 37. (U.S. CL. 103). REG. 5-3-1994.
- 1,835,437. NBA. INT. CL. 16. (U.S. CLS. 37 AND 38). REG. 5-10-1994.
- 1,835,599. MASSIMA. INT. CL. 30. (U.S. CL. 46). REG. 5-10-1994.
- 1,835,828. MALONE'S GRILL & BAR. INT. CL. 42. (U.S. CL. 100). REG. 5-10-1994.
- 1,836,058. EXECONTROL. INT. CL. 9. (U.S. CL. 38). REG. 5-10-1994.
- 1,836,143. P PRINT-RITE (STYLIZED). INT. CL. 16. (U.S. CLS. 11, 23, 26, 37 AND 38). REG. 5-10-1994.
- 1,836,573. NU-CHECK. INT. CL. 7. (U.S. CL. 23). REG. 5-17-1994.
- 1,836,855. C AND DESIGN. INT. CL. 25. (U.S. CL. 39). REG. 5-17-1994.
- 1,836,994. CPD. INT. CL. 35. (U.S. CL. 101). REG. 5-17-1994.
- 1,837,175. LAWYERS' AND MERCHANTS' TRANSLATION BUREAU. INT. CL. 42. (U.S. CLS. 100 AND 101). REG. 5-17-1994.
- 1,837,274. MISCELLANEOUS DESIGN. INT. CL. 3. (U.S. CL. 51). REG. 5-17-1994.
- 1,837,293. G-7 DAILY BRIEFING. INT. CL. 16. (U.S. CL. 38). REG. 5-17-1994.
- 1,837,512. WHIRLPOOL. INT. CL. 11. (U.S. CLS. 13, 21, 23, 31 AND 34). REG. 5-24-1994.
- 1,837,771. SMOKE GUARD (STYLIZED). INT. CL. 9. (U.S. CL. 21). REG. 5-31-1994.
- 1,837,899. FIXIT. INT. CL. 19. (U.S. CL. 12). REG. 5-31-1994.
- 1,838,046. IVORY SILK. INT. CL. 31. (U.S. CL. 1). REG. 5-31-1994.
- 1,838,395. ENDOBUTTON. INT. CL. 10. (U.S. CL. 44). REG. 5-31-1994.
- 1,839,108. AMERICAN BIG BUSINESSES DIRECTORY. INT. CL. 16. (U.S. CL. 38). REG. 6-7-1994.
- 1,839,233. KDS (STYLIZED). INT. CL. 8. (U.S. CL. 23). REG. 6-14-1994.
- 1,839,320. MISCELLANEOUS DESIGN. INT. CL. 11. (U.S. CLS. 13 AND 34). REG. 6-14-1994.
- 1,839,593. CRONOS. INT. CLS. 36 AND 39. (U.S. CLS. 101, 102 AND 105). REG. 6-14-1994.
- 1,839,850. MOEN AND DESIGN. INT. CL. 8. (U.S. CL. 23). REG. 6-14-1994.
- 1,840,537. KING STARLITE. INT. CL. 17. (U.S. CL. 1). REG. 6-21-1994.

- 1,840,738. FLOR DE APANAS AND DESIGN. INT. CL. 30. (U.S. CL. 46). REG. 6-21-1994.
- 1,840,748. MAIN STREET MUFFINS AND DESIGN. INT. CL. 30. (U.S. CL. 46). REG. 6-21-1994.
- 1,840,996. AMERICAN FILM MARKETING ASSOCIATION. INT. CL. 42. (U.S. CL. 100). REG. 6-21-1994.
- 1,841,055. INTEGRITY IN TRAVEL. INT. CL. 42. (U.S. CL. 100). REG. 6-21-1994.
- 1,841,088. NOVOLIN 70/30 PREFILLED. INT. CL. 10 ONLY. (U.S. CL. 44). REG. 6-21-1994.
- 1,841,558. BEAUTY FLASH. INT. CL. 16. (U.S. CL. 38). REG. 6-21-1994.
- 1,841,814. A-V BLUEBOOK. INT. CL. 16. (U.S. CL. 38). REG. 6-28-1994.
- 1,842,644. MISCELLANEOUS DESIGN. INT. CL. 6. (U.S. CL. 13). REG. 7-5-1994.
- 1,842,789. NIRVANA. INT. CL. 9. (U.S. CLS. 21 AND 36). REG. 7-5-1994.
- 1,843,124. DUTCH HENRY WINERY. INT. CL. 33. (U.S. CL. 47). REG. 7-5-1994.
- 1,843,892. 4 DELTA FOUR AND DESIGN. INT. CL. 40. (U.S. CL. 106). REG. 7-5-1994.
- 1,844,798. THE ECONOMIST CONFERENCES AND DESIGN. INT. CL. 41. (U.S. CLS. 100, 101 AND 107). REG. 7-12-1994.
- 1,845,078. TRUE MOTION. INT. CL. 9. (U.S. CL. 38). REG. 7-12-1994.
- 1,845,216. GLENBROOK. INT. CL. 33. (U.S. CL. 47). REG. 7-12-1994.
- 1,845,343. AQUAMIX. INT. CL. 7. (U.S. CL. 23). REG. 7-19-1994.
- 1,846,102. DEFLECT. INT. CL. 3. (U.S. CL. 51). REG. 7-19-1994.
- 1,846,313. YOGLOO. INT. CL. 32. (U.S. CLS. 45 AND 46). REG. 7-19-1994.
- 1,846,413. HOMEBEST. INT. CLS. 3, 4, 5, 8, 10, 11, 16 AND 21 ONLY. (U.S. CLS. 1, 2, 4, 6, 13, 15, 18, 21, 23, 29, 30, 33, 37, 40, 44, 46, 50, 51 AND 52 ONLY). REG. 7-26-1994.
- 1,847,240. VIA MILANO. INT. CL. 9. (U.S. CL. 26). REG. 7-26-1994.
- 1,847,472. VACATION MATRIX. INT. CL. 41. (U.S. CLS. 100 AND 107). REG. 7-26-1994.
- 1,847,806. ASCORBALOX. INT. CL. 30. (U.S. CL. 46). REG. 8-2-1994.
- 1,848,229. MISCELLANEOUS DESIGN. INT. CL. 25. (U.S. CL. 39). REG. 8-2-1994.
- 1,848,404. PUBLIC SECTOR JOB BULLETIN. INT. CL. 16. (U.S. CL. 38). REG. 8-2-1994.
- 1,848,483. BIOKIT. INT. CL. 5. (U.S. CL. 6). REG. 8-9-1994.
- 1,848,732. 1-800-SEND-FTD. INT. CL. 38. (U.S. CL. 104). REG. 8-9-1994.
- 1,848,810. SHAMROCK AND DESIGN. INT. CLS. 2, 29 AND 30. (U.S. CLS. 6, 44 AND 46). REG. 8-9-1994.
- 1,849,101. PHOTO WATCH. INT. CL. 9. (U.S. CL. 38). REG. 8-9-1994.
- 1,851,450. MEDICAL UPDATE. INT. CL. 16. (U.S. CL. 38). REG. 8-30-1994.
- 1,853,330. MISCELLANEOUS DESIGN. INT. CL. 41. (U.S. CL. 107). REG. 9-6-1994.
- 1,853,580. GULFSTREAM. INT. CL. 11. (U.S. CL. 31). REG. 9-13-1994.
- 1,853,881. HALLOWEEN SPOOKTACULAR. INT. CL. 41. (U.S. CL. 107). REG. 9-13-1994.
- 1,854,431. DIAMEDIX (STYLIZED). INT. CL. 5. (U.S. CL. 18). REG. 9-20-1994.
- 1,854,436. COMAL. INT. CL. 5. (U.S. CL. 18). REG. 9-20-1994.
- 1,854,729. AMERICAN ATHLETIC, INC.. INT. CL. 28. (U.S. CL. 22). REG. 9-20-1994.
- 1,854,859. MERIDIAN FUND, INC.. INT. CL. 36. (U.S. CLS. 101 AND 102). REG. 9-20-1994.
- 1,855,599. COMMANDER. INT. CL. 9. (U.S. CLS. 21 AND 26). REG. 9-27-1994.
- 1,855,801. MISCELLANEOUS DESIGN. INT. CL. 21. (U.S. CLS. 21 AND 29). REG. 9-27-1994.
- 1,857,021. ONLY A GAME. INT. CL. 41. (U.S. CL. 107). REG. 10-4-1994.
- 1,857,258. MEDALIST. INT. CL. 16. (U.S. CLS. 2, 23 AND 37). REG. 10-4-1994.
- 1,858,375. NAPA SILVER. INT. CL. 7. (U.S. CLS. 19, 23 AND 31). REG. 10-18-1994.
- 1,858,889. WESTERN UNION. INT. CL. 38. (U.S. CLS. 100, 101 AND 104). REG. 10-18-1994.
- 1,859,293. HANDYMAN CLUB OF AMERICA. INT. CLS. 37 AND 42. (U.S. CL. 101). REG. 10-18-1994.
- 1,859,456. FLOWTRON ELECTRIC LEAF EATER AND DESIGN. INT. CL. 7. (U.S. CL. 23). REG. 10-25-1994.
- 1,861,799. T PLUS 2. INT. CL. 17. (U.S. CLS. 6 AND 12). REG. 11-8-1994.
- 1,862,016. WESTERN UNION AND DESIGN. INT. CL. 38. (U.S. CLS. 100, 101 AND 104). REG. 11-8-1994.
- 1,862,956. MORDILLO (STYLIZED). INT. CLS. 16 AND 28. (U.S. CLS. 2, 5, 22, 23, 29, 37, 38 AND 50). REG. 11-15-1994.
- 1,863,606. AQUAMOD. INT. CL. 9. (U.S. CLS. 21 AND 26). REG. 11-22-1994.
- 1,863,805. PRIMETIME AND DESIGN. INT. CL. 28. (U.S. CL. 22). REG. 11-22-1994.
- 1,863,899. RETEX. INT. CL. 35. (U.S. CL. 101). REG. 11-22-1994.
- 1,867,117. RANCHO DEL SOL. INT. CL. 30. (U.S. CL. 46). REG. 12-13-1994.
- 1,867,429. TETRA-BAC. INT. CL. 5. (U.S. CL. 18). REG. 12-13-1994.
- 1,872,150. PH LIQUID EXTRACT AND DESIGN. INT. CL. 1. (U.S. CL. 6). REG. 1-10-1995.
- 1,874,015. FRANKIE AND DESIGN. INT. CL. 29. (U.S. CL. 46). REG. 1-17-1995.
- 1,874,150. SHARK TV. INT. CL. 35. (U.S. CL. 101). REG. 1-17-1995.
- 1,875,710. SAM TAYLOR'S BAR-B-Q AND DESIGN. INT. CL. 42. (U.S. CL. 100). REG. 1-24-1995.
- 1,875,922. THE T.I.M.E.. INT. CL. 16. (U.S. CL. 38). REG. 1-24-1995.
- 1,876,853. TWH BEA AND DESIGN. INT. CL. 35. (U.S. CLS. 100 AND 101). REG. 1-31-1995.
- 1,876,996. OVATIONS AND DESIGN. INT. CL. 41. (U.S. CL. 107). REG. 1-31-1995.
- 1,877,009. THE BIG BAD WOLF. INT. CL. 41. (U.S. CL. 107). REG. 1-31-1995.
- 1,882,121. THINKING MAPS. INT. CL. 16. (U.S. CL. 38). REG. 3-7-1995.
- 1,882,171. W. INT. CL. 16. (U.S. CL. 38). REG. 3-7-1995.
- 1,882,454. THE JEFFREY GROUP AND DESIGN. INT. CL. 35. (U.S. CL. 101). REG. 3-7-1995.
- 1,883,844. OLDE ENGLISH 800. INT. CL. 32. (U.S. CL. 48). REG. 3-14-1995.
- 1,885,828. F.A.S.T. TECHNOLOGY AND DESIGN. INT. CL. 7. (U.S. CL. 23). REG. 3-28-1995.
- 1,886,694. MISTY. INT. CL. 32. (U.S. CL. 45). REG. 3-28-1995.

* * * * *

TRADEMARK REGISTRATIONS CANCELED

The designation "U.S. Cl." appearing in this section refers to the U.S. class in effect prior to Sep. 1, 1973 rather than the international class which applies to applications filed on or after that date. For adoption of international classification see notice in the OFFICIAL GAZETTE of Jun. 26, 1973 (911 O.G. TM 210).

SECTION 7(D)

1,916,325. LASCO. INT. CL. 19 ONLY. REG. 9-5-1995.

SECTION 8

171,735. DURA AND DESIGN. U.S. CL. 13. REG. 8-14-1923.
171,801. DIXISTEEL. U.S. CL. 13. REG. 8-14-1923.
171,868. HARPIC. U.S. CL. 4. REG. 8-14-1923.
171,877. KWIKLEEN (STYLIZED). U.S. CL. 4. REG. 8-14-1923.
402,692. BRYLFOAM. U.S. CL. 52. REG. 8-10-1943.
402,715. GLAMORTEX. U.S. CL. 16. REG. 8-10-1943.
402,720. COLONAIID. U.S. CL. 18. REG. 8-10-1943.
402,745. AMBASSADOR. U.S. CL. 50. REG. 8-10-1943.
402,746. ARISTOCRAT. U.S. CL. 50. REG. 8-10-1943.
402,747. MONARCH. U.S. CL. 50. REG. 8-10-1943.
402,748. PREMIER. U.S. CL. 50. REG. 8-10-1943.
402,777. MOOR MAN'S (STYLIZED). U.S. CL. 50. REG. 8-10-1943.
402,781. PHOBOTEX. U.S. CL. 6. REG. 8-10-1943.
754,379. CAMEL-BLACK. U.S. CL. 1. REG. 8-13-1963.
754,393. VELVET. U.S. CL. 2. REG. 8-13-1963.
754,397. DELCAN. U.S. CL. 2. REG. 8-13-1963.
754,399. ARGOS. U.S. CL. 2. REG. 8-13-1963.
754,400. DEAL-AR-PAK. U.S. CL. 2. REG. 8-13-1963.
754,403. STAMPEDE. U.S. CL. 4. REG. 8-13-1963.
754,407. AHS AND DESIGN. U.S. CL. 5. REG. 8-13-1963.
754,408. LADCO. U.S. CL. 5. REG. 8-13-1963.
754,423. STA-PUT. U.S. CL. 8. REG. 8-13-1963.
754,425. GREEN GARDE. U.S. CL. 10. REG. 8-13-1963.
754,432. TYSULITE. U.S. CL. 12. REG. 8-13-1963.
754,439. BAKENAMEL. U.S. CL. 13. REG. 8-13-1963.
754,442. FED. U.S. CL. 13. REG. 8-13-1963.
754,460. FLEXOMATIC. U.S. CL. 14. REG. 8-13-1963.
754,461. CORROSTAN. U.S. CL. 14. REG. 8-13-1963.
754,473. YORK. U.S. CL. 17. REG. 8-13-1963.
754,474. YORK AND DESIGN. U.S. CL. 17. REG. 8-13-1963.
754,475. LA PRIMADORA FALCON. U.S. CL. 17. REG. 8-13-1963.
754,481. VELASQUES (STYLIZED). U.S. CL. 17. REG. 8-13-1963.
754,482. PIPE MAJOR. U.S. CL. 17. REG. 8-13-1963.
754,483. MISCELLANEOUS DESIGN. U.S. CL. 17. REG. 8-13-1963.
754,485. ALLPYRAL. U.S. CL. 18. REG. 8-13-1963.
754,486. B FAMILY AND DESIGN. U.S. CL. 18. REG. 8-13-1963.
754,487. AQUA SOLVA. U.S. CL. 18. REG. 8-13-1963.
754,488. CARI-TAB. U.S. CL. 18. REG. 8-13-1963.
754,492. B-NUTRON. U.S. CL. 18. REG. 8-13-1963.
754,501. AMTICO PROMENADE AND DESIGN. U.S. CL. 20. REG. 8-13-1963.
754,505. VINYLBEST. U.S. CL. 20. REG. 8-13-1963.
754,506. 4J (STYLIZED). U.S. CL. 21. REG. 8-13-1963.
754,508. MEDALLION. U.S. CL. 21. REG. 8-13-1963.
754,512. JEWEL. U.S. CL. 21. REG. 8-13-1963.

754,526. VAPOR (STYLIZED). U.S. CLS. 21 AND 23. REG. 8-13-1963.
754,528. HUSTLER. U.S. CL. 21. REG. 8-13-1963.
754,530. VACULATOR. U.S. CL. 21. REG. 8-13-1963.
754,546. SELECTOMATIC. U.S. CL. 23. REG. 8-13-1963.
754,557. PNEUMAFILTER. U.S. CL. 23. REG. 8-13-1963.
754,562. IMPERIAL TRIPLE CROWN. U.S. CL. 23. REG. 8-13-1963.
754,563. MISCELLANEOUS DESIGN. U.S. CL. 23. REG. 8-13-1963.
754,572. RAPIDRESS. U.S. CL. 23. REG. 8-13-1963.
754,573. THERMOCON-DEVELO. U.S. CL. 23. REG. 8-13-1963.
754,574. HAWK BILT. U.S. CL. 23. REG. 8-13-1963.
754,578. ESCAL-AIRE. U.S. CL. 23. REG. 8-13-1963.
754,598. PLASTUF. U.S. CL. 26. REG. 8-13-1963.
754,599. NATIONAL AND DESIGN. U.S. CL. 27. REG. 8-13-1963.
754,618. AEROFORM. U.S. CL. 32. REG. 8-13-1963.
754,623. CIRCULATIC. U.S. CL. 34. REG. 8-13-1963.
754,626. SLYDE-OUT. U.S. CL. 34. REG. 8-13-1963.
754,639. AUTOGRAPHIC BUSINESS FORMS. U.S. CL. 37. REG. 8-13-1963.
754,640. QUICK. U.S. CL. 37. REG. 8-13-1963.
754,649. THE OFFICIAL GUIDE. U.S. CL. 38. REG. 8-13-1963.
754,658. PADDY O'MALLARD. U.S. CL. 38. REG. 8-13-1963.
754,670. QUEEN CASUALS AND DESIGN. U.S. CL. 39. REG. 8-13-1963.
754,674. RUN AWAY. U.S. CL. 39. REG. 8-13-1963.
754,702. AMWAY. U.S. CL. 39. REG. 8-13-1963.
754,710. ILLUSION. U.S. CL. 42. REG. 8-13-1963.
754,713. VYNDURA (STYLIZED). U.S. CL. 42. REG. 8-13-1963.
754,726. NATIONAL AND DESIGN. U.S. CL. 44. REG. 8-13-1963.
754,727. GRIPTIGHT (STYLIZED). U.S. CL. 44. REG. 8-13-1963.
754,737. BALL-O-FOOT. U.S. CL. 44. REG. 8-13-1963.
754,740. AEROTROL. U.S. CL. 44. REG. 8-13-1963.
754,742. AT AND DESIGN. U.S. CL. 44. REG. 8-13-1963.
754,749. TAC. U.S. CL. 46. REG. 8-13-1963.
754,754. CLASSIQUE. U.S. CL. 46. REG. 8-13-1963.
754,760. WHIP DEELITE. U.S. CL. 46. REG. 8-13-1963.
754,774. PLAN IT - KIT AND DESIGN. U.S. CL. 50. REG. 8-13-1963.
754,780. SUN/STOP. U.S. CL. 51. REG. 8-13-1963.
754,784. BRIGHT IDEA. U.S. CL. 51. REG. 8-13-1963.
754,806. LOUVERBORD. U.S. CL. 12. REG. 8-13-1963.
754,807. WICKERBORD. U.S. CL. 12. REG. 8-13-1963.
754,808. AIRHEART. U.S. CL. 19. REG. 8-13-1963.
954,843. TECHNEQUIP LIMITED T AND DESIGN. U.S. CL. 13. REG. 3-13-1973.
989,978. EI (STYLIZED). U.S. CLS. 8, 22, 42 AND 50, ONLY. REG. 8-6-1974.
1,216,803. NO NAME. INT. CL. 25. REG. 11-16-1982.
1,232,669. BLUE DEMONS. INT. CL. 16 ONLY. REG. 3-29-1983.
1,233,504. NATIONAL PEN AND DESIGN. INT. CL. 20 ONLY. REG. 4-5-1983.
1,247,465. PRO-STIK. INT. CL. 1. REG. 8-9-1983.
1,247,469. MONAL. INT. CL. 1. REG. 8-9-1983.
1,247,473. TOUGH ONE. INT. CL. 2. REG. 8-9-1983.

- 1,247,474. THERMOCHROME. INT. CL. 2. REG. 8-9-1983.
1,247,476. MACAP. INT. CL. 2. REG. 8-9-1983.
1,247,483. ULTRIANCE. INT. CL. 3. REG. 8-9-1983.
1,247,485. FANTASTIK FIBERGLASS. INT. CL. 3. REG. 8-9-1983.
1,247,487. ROYAL SHIELD AND DESIGN. INT. CL. 3. REG. 8-9-1983.
1,247,488. REDKEN AND DESIGN. INT. CL. 3. REG. 8-9-1983.
1,247,492. HUNTING WORLD. INT. CL. 3. REG. 8-9-1983.
1,247,496. PAUL MITCHELL HAIR SCULPTING LOTION AND DESIGN. INT. CL. 3. REG. 8-9-1983.
1,247,499. EMPEROR. INT. CL. 3. REG. 8-9-1983.
1,247,502. NAIL TODAY AND DESIGN. INT. CL. 3. REG. 8-9-1983.
1,247,503. MIRACLE LASH. INT. CL. 3. REG. 8-9-1983.
1,247,506. EYE SYMETRICS. INT. CL. 3. REG. 8-9-1983.
1,247,509. LTD PLUS. INT. CL. 3. REG. 8-9-1983.
1,247,515. SPOTAMIN. INT. CL. 5. REG. 8-9-1983.
1,247,517. TERMIDE. INT. CL. 5. REG. 8-9-1983.
1,247,523. CHLORACHEL 250-SWINE. INT. CL. 5. REG. 8-9-1983.
1,247,526. BORDITECH. INT. CL. 5. REG. 8-9-1983.
1,247,527. RHINITECH. INT. CL. 5. REG. 8-9-1983.
1,247,535. OXY-QUENCHERS. INT. CL. 5. REG. 8-9-1983.
1,247,543. POP'EMS (STYLIZED). INT. CL. 5. REG. 8-9-1983.
1,247,544. THORO. INT. CL. 5. REG. 8-9-1983.
1,247,549. VISIDRESS. INT. CL. 5. REG. 8-9-1983.
1,247,550. CHC AND DESIGN. INT. CLS. 6, 16, 28 AND 34. REG. 8-9-1983.
1,247,551. BROWNING. INT. CLS. 6 AND 11. REG. 8-9-1983.
1,247,553. C G C. INT. CLS. 6, 9 AND 40. REG. 8-9-1983.
1,247,557. TRISEAL. INT. CL. 6. REG. 8-9-1983.
1,247,558. ISOCAP. INT. CLS. 6 AND 17. REG. 8-9-1983.
1,247,559. MR-9. INT. CL. 6. REG. 8-9-1983.
1,247,562. THERMCORE. INT. CL. 6. REG. 8-9-1983.
1,247,565. AUTO HOME FARM INDUSTRY AND DESIGN. INT. CLS. 7, 9, 12 AND 17. REG. 8-9-1983.
1,247,566. MISCELLANEOUS DESIGN. INT. CLS. 7 AND 9. REG. 8-9-1983.
1,247,573. S AND DESIGN. INT. CL. 7. REG. 8-9-1983.
1,247,574. MSC AND DESIGN. INT. CLS. 7 AND 42. REG. 8-9-1983.
1,247,587. TONAL AND DESIGN. INT. CL. 8. REG. 8-9-1983.
1,247,592. ELESTA. INT. CL. 9. REG. 8-9-1983.
1,247,598. VENTGARD. INT. CL. 9. REG. 8-9-1983.
1,247,608. ACCUTOME INC.. INT. CL. 10. REG. 8-9-1983.
1,247,610. AIR FROHLICH (STYLIZED). INT. CL. 11. REG. 8-9-1983.
1,247,612. THERMATEC. INT. CL. 11. REG. 8-9-1983.
1,247,615. BOUTIQUE. INT. CL. 11. REG. 8-9-1983.
1,247,618. POLYNESIAN. INT. CL. 11. REG. 8-9-1983.
1,247,619. HILO. INT. CL. 11. REG. 8-9-1983.
1,247,620. MAUI. INT. CL. 11. REG. 8-9-1983.
1,247,621. LANAI. INT. CL. 11. REG. 8-9-1983.
1,247,622. KONA. INT. CL. 11. REG. 8-9-1983.
1,247,623. WAIKIKI. INT. CL. 11. REG. 8-9-1983.
1,247,627. 555 (STYLIZED). INT. CL. 11. REG. 8-9-1983.
1,247,628. CITRAJET. INT. CL. 11. REG. 8-9-1983.
1,247,634. R AND DESIGN. INT. CL. 12. REG. 8-9-1983.
1,247,635. STRUT MASTER. INT. CL. 12. REG. 8-9-1983.
1,247,643. N NATIONAL FINDINGS INC. AND DESIGN. INT. CL. 14. REG. 8-9-1983.
1,247,647. MARLA. INT. CL. 14. REG. 8-9-1983.
1,247,653. MISCELLANEOUS DESIGN. INT. CL. 16. REG. 8-9-1983.
1,247,670. POLYBOARD. INT. CL. 16. REG. 8-9-1983.
1,247,674. THE COLOR GRID. INT. CL. 16. REG. 8-9-1983.
1,247,679. FABRI-GRAPHICS. INT. CL. 16. REG. 8-9-1983.
1,247,681. BICYCLING MAGAZINE'S MARKETING & MERCHANDISING NEWSLETTER (STYLIZED). INT. CL. 16. REG. 8-9-1983.
1,247,682. TOMORROW'S BUSINESS LEADER. INT. CL. 16. REG. 8-9-1983.
1,247,683. IMPRESS. INT. CL. 16. REG. 8-9-1983.
1,247,687. CHINA TIMES MAGAZINE AND DESIGN. INT. CL. 16. REG. 8-9-1983.
1,247,689. ITC CASLON HEADLINE. INT. CL. 16. REG. 8-9-1983.
1,247,690. THE OSCEOLA TIMES RECORDING PROGRESS IN MISSISSIPPI COUNTY OVER A CENTURY SINCE AND DESIGN. INT. CL. 16. REG. 8-9-1983.
1,247,701. LUSTR-METL. INT. CL. 19. REG. 8-9-1983.
1,247,708. SCOTPRINTS. INT. CL. 20. REG. 8-9-1983.
1,247,710. SLUMBER AIR. INT. CL. 20. REG. 8-9-1983.
1,247,717. ATHENA. INT. CL. 20. REG. 8-9-1983.
1,247,719. FAT CATS (STYLIZED). INT. CL. 21. REG. 8-9-1983.
1,247,723. IDEAL. INT. CL. 21. REG. 8-9-1983.
1,247,724. BRUSHTIQUES (STYLIZED). INT. CL. 21. REG. 8-9-1983.
1,247,726. TEXTAPE. INT. CL. 21. REG. 8-9-1983.
1,247,730. LO-MAN OUTDOOR STORE, LTD AND DESIGN. INT. CL. 22. REG. 8-9-1983.
1,247,732. WIMBLEDON. INT. CL. 24. REG. 8-9-1983.
1,247,738. RECHERCHE (STYLIZED). INT. CL. 24. REG. 8-9-1983.
1,247,744. MISCELLANEOUS DESIGN. INT. CL. 25. REG. 8-9-1983.
1,247,749. SNOW PATROL. INT. CL. 25. REG. 8-9-1983.
1,247,755. JONATHAN MICHAEL. INT. CL. 25. REG. 8-9-1983.
1,247,756. THE MEMBERSHIP. INT. CL. 25. REG. 8-9-1983.
1,247,765. VESTRIS. INT. CL. 25. REG. 8-9-1983.
1,247,769. SPECTATOR II (STYLIZED). INT. CL. 25. REG. 8-9-1983.
1,247,773. EWE & EYE. INT. CL. 26. REG. 8-9-1983.
1,247,778. CHALLENGE SERIES STRATEGY BOXING. INT. CL. 28. REG. 8-9-1983.
1,247,779. WHERE IT'S YOU IN THE RING. INT. CL. 28. REG. 8-9-1983.
1,247,780. T.W. CUSTOM. INT. CL. 28. REG. 8-9-1983.
1,247,784. SIDEWINDER AND DESIGN. INT. CL. 28. REG. 8-9-1983.
1,247,792. STRIKE FORCE. INT. CL. 28. REG. 8-9-1983.
1,247,796. SELCHOW & RIGHTER AND DESIGN. INT. CL. 28. REG. 8-9-1983.
1,247,803. CLAY TIME. INT. CL. 28. REG. 8-9-1983.
1,247,812. ROYALHEART. INT. CL. 29. REG. 8-9-1983.
1,247,816. THE DESSERT MAKER. INT. CL. 29. REG. 8-9-1983.
1,247,817. PIMA (STYLIZED). INT. CL. 29. REG. 8-9-1983.
1,247,821. MURRAY ALLEN AND DESIGN. INT. CL. 30. REG. 8-9-1983.
1,247,822. WE MAKE THE WORLD TASTE GOOD. INT. CL. 30. REG. 8-9-1983.
1,247,824. CHASE & SANBORN AND DESIGN. INT. CL. 30. REG. 8-9-1983.
1,247,826. VENDMARK. INT. CL. 30. REG. 8-9-1983.
1,247,829. SODA STRAWS. INT. CL. 30. REG. 8-9-1983.
1,247,830. GUMSUCKERS. INT. CL. 30. REG. 8-9-1983.
1,247,832. REJUVENATION. INT. CL. 31. REG. 8-9-1983.
1,247,833. PIC AND DESIGN. INT. CL. 31. REG. 8-9-1983.
1,247,835. FIREFALL AND DESIGN. INT. CL. 31. REG. 8-9-1983.
1,247,841. MISCELLANEOUS DESIGN. INT. CL. 31. REG. 8-9-1983.
1,247,843. MISCELLANEOUS DESIGN. INT. CL. 31. REG. 8-9-1983.
1,247,844. GLACIER. INT. CL. 31. REG. 8-9-1983.
1,247,849. BARBICAN. INT. CL. 32. REG. 8-9-1983.
1,247,851. CAJUN PLAY DE DO COCKTAIL. INT. CL. 33. REG. 8-9-1983.
1,247,852. TAYLOR, FLADGATE & YEATMAN. INT. CL. 33. REG. 8-9-1983.
1,247,854. CARIBE-ROYALE. INT. CL. 33. REG. 8-9-1983.
1,247,857. RICHLAND. INT. CL. 34. REG. 8-9-1983.
1,247,860. CHINA CONNECTION. INT. CL. 35. REG. 8-9-1983.
1,247,863. MISCELLANEOUS DESIGN. INT. CL. 35. REG. 8-9-1983.
1,247,864. THE LIFESTYLE MONITOR. INT. CL. 35. REG. 8-9-1983.

- 1,247,867. AYER INTERNATIONAL. INT. CL. 35. REG. 8-9-1983.
- 1,247,868. AYER. INT. CL. 35. REG. 8-9-1983.
- 1,247,869. N W AYER. INT. CL. 35. REG. 8-9-1983.
- 1,247,871. M AND DESIGN. INT. CLS. 35, 40, 41 AND 42. REG. 8-9-1983.
- 1,247,872. MARSDEN. INT. CLS. 35, 40, 41 AND 42. REG. 8-9-1983.
- 1,247,875. S AND DESIGN. INT. CL. 35. REG. 8-9-1983.
- 1,247,881. T.M.S. ASSISTANCE. INT. CLS. 36 AND 42. REG. 8-9-1983.
- 1,247,883. AMERICAN CITIZENS AND DESIGN. INT. CL. 36. REG. 8-9-1983.
- 1,247,885. PAYMASTER CASHBOX. INT. CL. 36. REG. 8-9-1983.
- 1,247,886. PAYMASTER CASHBOX KEY. INT. CL. 36. REG. 8-9-1983.
- 1,247,888. MINIMIZER. INT. CL. 36. REG. 8-9-1983.
- 1,247,890. PETROSURANCE (STYLIZED). INT. CL. 36. REG. 8-9-1983.
- 1,247,891. CONTEMPORARY LIFE. INT. CL. 36. REG. 8-9-1983.
- 1,247,894. NEBS NATIONAL EMPLOYEE BENEFIT SPECIALISTS. INT. CL. 36. REG. 8-9-1983.
- 1,247,896. OVERSEAL BANDING. INT. CL. 37. REG. 8-9-1983.
- 1,247,897. MISCELLANEOUS DESIGN. INT. CLS. 37 AND 42. REG. 8-9-1983.
- 1,247,899. WYOMING INTERIOR SYSTEMS, INC.. INT. CLS. 37 AND 42. REG. 8-9-1983.
- 1,247,902. CCC AND DESIGN. INT. CL. 37. REG. 8-9-1983.
- 1,247,910. RESISTANE. INT. CL. 40. REG. 8-9-1983.
- 1,247,911. MISCELLANEOUS DESIGN. INT. CL. 40. REG. 8-9-1983.
- 1,247,912. GRAPHIKOTE. INT. CL. 40. REG. 8-9-1983.
- 1,247,914. PRESTO FOTO AND DESIGN. INT. CL. 40. REG. 8-9-1983.
- 1,247,917. GAMES PEOPLE PLAY. INT. CL. 41. REG. 8-9-1983.
- 1,247,919. MISCELLANEOUS DESIGN. INT. CL. 41. REG. 8-9-1983.
- 1,247,921. FINANCIAL PLANNING SERVICES OF AMERICA & DESIGN AND DESIGN. INT. CL. 41. REG. 8-9-1983.
- 1,247,924. COUNTRY MUSIC WAX MUSEUM. INT. CL. 41. REG. 8-9-1983.
- 1,247,925. FROM WASHINGTON...CITIZEN ALERT. INT. CL. 41. REG. 8-9-1983.
- 1,247,935. FF AND DESIGN. INT. CLS. 41 AND 42. REG. 8-9-1983.
- 1,247,938. LONESOME PINE INTERNATIONAL RACEWAY AND DESIGN. INT. CL. 41. REG. 8-9-1983.
- 1,247,940. MISCELLANEOUS DESIGN. INT. CL. 41. REG. 8-9-1983.
- 1,247,942. THE FASHION FACTORY AND DESIGN. INT. CL. 42. REG. 8-9-1983.
- 1,247,951. JACK'S BARGAIN STORES. INT. CL. 42. REG. 8-9-1983.
- 1,247,956. MISCELLANEOUS DESIGN. INT. CL. 42. REG. 8-9-1983.
- 1,247,957. RESLABS. INT. CL. 42. REG. 8-9-1983.
- 1,247,958. TUNE.UP MANUFACTURERS INSTITUTE AND DESIGN. INT. CL. 42. REG. 8-9-1983.
- 1,247,960. SCARBOROUGH AND COMPANY. INT. CL. 42. REG. 8-9-1983.
- 1,247,968. PENNY ANNIE STUDIOS AND DESIGN. INT. CL. 42. REG. 8-9-1983.
- 1,247,969. TOPS APPLIANCE CITY. INT. CL. 42. REG. 8-9-1983.
- 1,247,970. TOPS APPLIANCE CITY IS #1 AND DESIGN. INT. CL. 42. REG. 8-9-1983.
- 1,247,973. PELA (STYLIZED). INT. CL. 42. REG. 8-9-1983.
- 1,247,974. GULLIVER'S FISH & CHIPS AND DESIGN. INT. CL. 42. REG. 8-9-1983.
- 1,247,996. SALON WRAPS. INT. CL. 3. REG. 8-9-1983.
- 1,248,001. 108V. INT. CL. 12. REG. 8-9-1983.
- 1,248,003. 207V. INT. CL. 12. REG. 8-9-1983.
- 1,248,011. LITE MAID. INT. CL. 30. REG. 8-9-1983.
- 1,264,578. MURATA (STYLIZED). INT. CL. 1 ONLY. REG. 1-24-1984.
- 1,273,888. BREAK THE LANGUAGE BARRIER. INT. CL. 39 ONLY. REG. 4-10-1984.
- 1,295,408. SALLY HANSEN (STYLIZED). INT. CL. 5 ONLY. REG. 9-18-1984.
- 1,715,325. ACCUTEK AND DESIGN. INT. CL. 9. REG. 9-15-1992.
- 1,724,472. TRENDS. INT. CL. 42. REG. 10-13-1992.
- 1,761,085. COMPU-FLOW. INT. CL. 9. REG. 3-30-1993.
- 1,765,747. TROCADERO. INT. CLS. 20 AND 21 ONLY. REG. 4-20-1993.
- 1,786,374. CYTO FE AND DESIGN. INT. CL. 1. REG. 8-10-1993.
- 1,786,381. RAYCASALT. INT. CL. 1. REG. 8-10-1993.
- 1,786,388. WE DON'T MAKE A LOT OF THE PRODUCTS YOU BUY. WE MAKE A LOT OF THE PRODUCTS YOU BUY BETTER.. INT. CL. 1. REG. 8-10-1993.
- 1,786,394. PUTT-PUTT. INT. CL. 2. REG. 8-10-1993.
- 1,786,397. WE DON'T MAKE A LOT OF THE PRODUCTS YOU BUY. WE MAKE A LOT OF THE PRODUCTS YOU BUY BETTER.. INT. CL. 2. REG. 8-10-1993.
- 1,786,402. MR. CHRISTAL'S. INT. CL. 3. REG. 8-10-1993.
- 1,786,404. CARLA CORCINI (STYLIZED). INT. CLS. 3, 21 AND 26. REG. 8-10-1993.
- 1,786,405. PAUL MITCHELL THE SUPER STRENGTHENER. INT. CL. 3. REG. 8-10-1993.
- 1,786,408. AVEDA AND DESIGN. INT. CL. 3. REG. 8-10-1993.
- 1,786,421. SHINE-EASE FLOOR FINISH. INT. CL. 3. REG. 8-10-1993.
- 1,786,424. THERMOFINISH. INT. CL. 3. REG. 8-10-1993.
- 1,786,432. YOUR ENGINE'S LIFE DEPENDS ON IT. INT. CL. 4. REG. 8-10-1993.
- 1,786,433. A CANDLE IN THE WINDOW. INT. CL. 4. REG. 8-10-1993.
- 1,786,434. ECOGREEN. INT. CL. 4. REG. 8-10-1993.
- 1,786,439. LUMPULSE (STYLIZED). INT. CL. 5. REG. 8-10-1993.
- 1,786,440. SATURN (STYLIZED). INT. CL. 5. REG. 8-10-1993.
- 1,786,451. FORMULA 1447. INT. CL. 5. REG. 8-10-1993.
- 1,786,469. ZIP SCROLLS. INT. CL. 6. REG. 8-10-1993.
- 1,786,482. TURBOTRON AND DESIGN. INT. CL. 7. REG. 8-10-1993.
- 1,786,486. LAZY BOY. INT. CL. 7. REG. 8-10-1993.
- 1,786,492. GMQ (STYLIZED). INT. CL. 7. REG. 8-10-1993.
- 1,786,498. SARCO. INT. CL. 8. REG. 8-10-1993.
- 1,786,506. MISCELLANEOUS DESIGN. INT. CLS. 9 AND 16. REG. 8-10-1993.
- 1,786,523. THE MODEL APPROACH. INT. CLS. 9 AND 41. REG. 8-10-1993.
- 1,786,526. WEST BOND. INT. CL. 9. REG. 8-10-1993.
- 1,786,533. TRAIN OF THOUGHT. INT. CL. 9. REG. 8-10-1993.
- 1,786,555. SYSFLOW. INT. CL. 9. REG. 8-10-1993.
- 1,786,556. CALENDAR MANAGER. INT. CL. 9. REG. 8-10-1993.
- 1,786,559. VACUPETTE. INT. CL. 9. REG. 8-10-1993.
- 1,786,561. SAF. INT. CLS. 9, 37 AND 42. REG. 8-10-1993.
- 1,786,568. SHELFSPACE. INT. CL. 9. REG. 8-10-1993.
- 1,786,569. EXPANDING THE POWER OF YOUR MIND. INT. CLS. 9 AND 41. REG. 8-10-1993.
- 1,786,573. QUANTITATIVE MEDICINE. INT. CL. 9. REG. 8-10-1993.
- 1,786,590. MAGNA-TIES. INT. CL. 9. REG. 8-10-1993.
- 1,786,596. EXACPAC. INT. CL. 9. REG. 8-10-1993.
- 1,786,600. HME PRO AND DESIGN. INT. CL. 9. REG. 8-10-1993.
- 1,786,611. DESKWRITER. INT. CL. 9. REG. 8-10-1993.
- 1,786,630. ACCUPLUS (STYLIZED). INT. CL. 9. REG. 8-10-1993.
- 1,786,631. NICE. INT. CL. 9. REG. 8-10-1993.
- 1,786,634. DIRECT-DOOR. INT. CL. 9. REG. 8-10-1993.
- 1,786,639. ECOPRINT. INT. CL. 9. REG. 8-10-1993.
- 1,786,643. SUPRVISION. INT. CL. 9. REG. 8-10-1993.
- 1,786,647. PRIMEGARD. INT. CL. 10. REG. 8-10-1993.

- 1,786,661. AUTOVAP. INT. CL. 11. REG. 8-10-1993.
 1,786,664. MISCELLANEOUS DESIGN. INT. CLS. 11 AND 20. REG. 8-10-1993.
 1,786,671. US GEAR AND DESIGN. INT. CL. 12. REG. 8-10-1993.
 1,786,673. W WINKEL WINKEL WHEEL TRIED AND TRUE AND DESIGN. INT. CL. 12. REG. 8-10-1993.
 1,786,681. PUTS YOUR GUN IN ITS PLACE. INT. CL. 13. REG. 8-10-1993.
 1,786,685. MISCELLANEOUS DESIGN. INT. CL. 14. REG. 8-10-1993.
 1,786,688. ENDURO. INT. CL. 15. REG. 8-10-1993.
 1,786,690. SMALL WORLD OF MUSIC. INT. CL. 15. REG. 8-10-1993.
 1,786,696. THE GREEN PENCIL THE ENVIRONMENTALLY FRIENDLY PENCIL. INT. CL. 16. REG. 8-10-1993.
 1,786,712. HORTENSIA. INT. CL. 16. REG. 8-10-1993.
 1,786,722. MISCELLANEOUS DESIGN. INT. CL. 16. REG. 8-10-1993.
 1,786,727. SECTORPLEX-UTILITIES. INT. CLS. 16 AND 36. REG. 8-10-1993.
 1,786,728. KNOWLEDGE MINING CENTER. INT. CLS. 16 AND 42. REG. 8-10-1993.
 1,786,733. WILD STARS. INT. CL. 16. REG. 8-10-1993.
 1,786,735. LITTLE BOOK OF PAPER MILL EQUIPMENT (STYLIZED). INT. CL. 16. REG. 8-10-1993.
 1,786,738. ALEENE'S. FLEXIBLE STRETCHABLE FABRIC GLUE. INT. CL. 16. REG. 8-10-1993.
 1,786,739. VICTORIAN CHARMS. INT. CL. 16. REG. 8-10-1993.
 1,786,740. ZIPPY CARVE (STYLIZED). INT. CL. 16. REG. 8-10-1993.
 1,786,741. WCCN AND DESIGN. INT. CL. 16. REG. 8-10-1993.
 1,786,749. THE CONFIDENT COLLECTOR KNOWS THE FACTS. INT. CL. 16. REG. 8-10-1993.
 1,786,753. WHERE'S WALDO?. INT. CL. 16. REG. 8-10-1993.
 1,786,760. SPILLBLOCKER AND DESIGN. INT. CL. 17. REG. 8-10-1993.
 1,786,761. GULLIVER AND DESIGN. INT. CL. 18. REG. 8-10-1993.
 1,786,763. COLISEUM STONE. INT. CL. 19. REG. 8-10-1993.
 1,786,767. BLOK-LAYERS. INT. CL. 19. REG. 8-10-1993.
 1,786,774. PROJECT PLANNER. INT. CL. 20. REG. 8-10-1993.
 1,786,776. TROPITONE. INT. CL. 20. REG. 8-10-1993.
 1,786,777. TROPITONE AND DESIGN. INT. CL. 20. REG. 8-10-1993.
 1,786,780. STRONGBOX. INT. CL. 20. REG. 8-10-1993.
 1,786,788. MISCELLANEOUS DESIGN. INT. CLS. 21, 41 AND 42. REG. 8-10-1993.
 1,786,789. MISCELLANEOUS DESIGN. INT. CL. 21. REG. 8-10-1993.
 1,786,791. READYBRUSH. INT. CL. 21. REG. 8-10-1993.
 1,786,795. WE DON'T MAKE A LOT OF THE PRODUCTS YOU BUY. WE MAKE A LOT OF THE PRODUCTS YOU BUY BETTER.. INT. CL. 22. REG. 8-10-1993.
 1,786,798. THE BANNER SOURCE. INT. CL. 24. REG. 8-10-1993.
 1,786,805. MALIBU YACHT CLUB. INT. CLS. 25 AND 41. REG. 8-10-1993.
 1,786,813. LETHERLUX. INT. CL. 25. REG. 8-10-1993.
 1,786,814. ENON & ZOE AND DESIGN. INT. CL. 25. REG. 8-10-1993.
 1,786,817. POWER 50 PLUS. INT. CL. 25. REG. 8-10-1993.
 1,786,824. TUFF KIKS AND DESIGN. INT. CL. 25. REG. 8-10-1993.
 1,786,852. CREATIVE CORRIDORS. INT. CL. 27. REG. 8-10-1993.
 1,786,853. DESIGN SOLUTIONS. INT. CL. 27. REG. 8-10-1993.
 1,786,854. CREATIVE INTERIORS. INT. CL. 27. REG. 8-10-1993.
 1,786,855. UNITED CARPET NETWORK AND DESIGN. INT. CL. 27. REG. 8-10-1993.
 1,786,865. FIGHTING PURR. INT. CL. 28. REG. 8-10-1993.
 1,786,871. WHEATIES. INT. CL. 28. REG. 8-10-1993.
 1,786,876. GREAT WAR PLANES. INT. CL. 28. REG. 8-10-1993.
 1,786,893. MARYLAND MIX. INT. CL. 29. REG. 8-10-1993.
 1,786,911. BA LE AND DESIGN. INT. CL. 30. REG. 8-10-1993.
 1,786,912. PARTITION. INT. CL. 30. REG. 8-10-1993.
 1,786,919. BONS TEMPS COCHON. INT. CL. 30. REG. 8-10-1993.
 1,786,933. CAKE STA. INT. CL. 30. REG. 8-10-1993.
 1,786,934. V-V ARTIFICIAL VANILLA. INT. CL. 30. REG. 8-10-1993.
 1,786,935. YOSHIDA'S FINE SAUCES AND DESIGN. INT. CL. 30. REG. 8-10-1993.
 1,786,944. RESTAURANT READY. INT. CL. 31. REG. 8-10-1993.
 1,786,956. CALIFORNIA CELLARS (STYLIZED). INT. CL. 33. REG. 8-10-1993.
 1,786,958. HEUBLEIN PREMIUM CLASSICS. INT. CL. 33. REG. 8-10-1993.
 1,786,968. VIRTUAL LOGISTICS. INT. CL. 35. REG. 8-10-1993.
 1,786,976. MARKETING NAVIGATORS. INT. CL. 35. REG. 8-10-1993.
 1,786,977. DIRECT ACCESS. INT. CL. 35. REG. 8-10-1993.
 1,786,978. NEW IN TOWN AND DESIGN. INT. CL. 35. REG. 8-10-1993.
 1,786,988. O MEDCHECK AND DESIGN. INT. CL. 35. REG. 8-10-1993.
 1,786,992. SMART STRATEGIC MARKETING AND RESEARCH TECHNIQUES. INT. CL. 35. REG. 8-10-1993.
 1,786,995. CASH PLUS CARD. INT. CL. 35. REG. 8-10-1993.
 1,786,997. C-H-I A NON-PROFIT EDUCATIONAL EXCHANGEPROGRAM AND DESIGN. INT. CL. 35. REG. 8-10-1993.
 1,787,018. THE ALTERNATE EQUIVALENT PLAN. INT. CL. 36. REG. 8-10-1993.
 1,787,020. FISHNET MINISTRIES. INT. CLS. 36, 41 AND 42. REG. 8-10-1993.
 1,787,025. MANAGEDCARE MUTUAL. INT. CL. 36. REG. 8-10-1993.
 1,787,029. LP PLUS. INT. CL. 36. REG. 8-10-1993.
 1,787,032. THE OUTDOORSMAN AGENCY. INT. CL. 36. REG. 8-10-1993.
 1,787,035. BUSINESS LOAN CENTER AND DESIGN. INT. CL. 36. REG. 8-10-1993.
 1,787,038. AMERICAN BUYING. INT. CL. 36. REG. 8-10-1993.
 1,787,055. PHONE-LIFT. INT. CL. 36. REG. 8-10-1993.
 1,787,060. CITGO THE TOUGH GUYS AND DESIGN. INT. CL. 37. REG. 8-10-1993.
 1,787,063. PARTS LOCATOR. INT. CL. 38. REG. 8-10-1993.
 1,787,069. VNC. INT. CL. 38. REG. 8-10-1993.
 1,787,074. MARINER TRAVEL. INT. CL. 39. REG. 8-10-1993.
 1,787,100. LIBERACE. INT. CL. 41. REG. 8-10-1993.
 1,787,101. LIBERACE AND DESIGN. INT. CL. 41. REG. 8-10-1993.
 1,787,102. ORBIS MEDICAL NEWS AND DESIGN. INT. CLS. 41 AND 42. REG. 8-10-1993.
 1,787,104. NEURO-ASSOCIATIVE CONDITIONING. INT. CL. 41. REG. 8-10-1993.
 1,787,106. KIDS 'N MUSIC. INT. CL. 41. REG. 8-10-1993.
 1,787,112. MATHMANIA. INT. CL. 41. REG. 8-10-1993.
 1,787,115. BRAIN BUSTER (STYLIZED). INT. CL. 41. REG. 8-10-1993.
 1,787,118. CREATING A CUSTOMER-CENTERED CULTURE. INT. CL. 41. REG. 8-10-1993.
 1,787,120. BOOKS BY USERS SAS INSTITUTE'S AUTHOR SERVICE AND DESIGN. INT. CL. 41. REG. 8-10-1993.
 1,787,121. UNCA THE UNIVERSITY OF NORTH CAROLINA AT ASHEVILLE UNIVERSITY OF NORTH CAROLINA AND DESIGN. INT. CL. 41. REG. 8-10-1993.
 1,787,122. WOMEN WITH A CALL INTERNATIONAL. INT. CL. 41. REG. 8-10-1993.
 1,787,136. WORLD FABRIC FORUM. INT. CL. 41. REG. 8-10-1993.

- 1,787,140. KILLER HAYSEEDS. INT. CL. 41. REG. 8-10-1993.
 1,787,142. FUTURE UNIVERSITY. INT. CL. 41. REG. 8-10-1993.
 1,787,143. SOBER PROM. INT. CL. 41. REG. 8-10-1993.
 1,787,149. MISCELLANEOUS DESIGN. INT. CL. 41. REG. 8-10-1993.
 1,787,157. B&B BAR-B-Q AND DESIGN. INT. CL. 41. REG. 8-10-1993.
 1,787,166. SB SMITHKLINE BEECHAM (STYLIZED). INT. CL. 42. REG. 8-10-1993.
 1,787,167. FASHION VICTIM. INT. CL. 42. REG. 8-10-1993.
 1,787,173. VIDEO IMAGE AND DESIGN. INT. CL. 42. REG. 8-10-1993.
 1,787,189. BARKERS RED HOTS WORTH THE WAIT CHARCOAL-BROILED WORTH THE WAIT WORLD FAMOUS AND DESIGN. INT. CL. 42. REG. 8-10-1993.
 1,787,193. ALPINE LABORATORIES. INT. CL. 42. REG. 8-10-1993.
 1,787,199. EXPANDING THE HORIZONS OF BIOTECHNOLOGY. INT. CL. 42. REG. 8-10-1993.
 1,787,203. KONA'S (STYLIZED). INT. CL. 42. REG. 8-10-1993.
 1,787,207. QUICK-QUOTE. INT. CL. 42. REG. 8-10-1993.
 1,787,208. BORVIN WINES INTERNATIONAL. INT. CL. 42. REG. 8-10-1993.
 1,787,223. "WE DIG DIAMONDS". INT. CL. 42. REG. 8-10-1993.
 1,787,233. SPD AND DESIGN. INT. CL. 42. REG. 8-10-1993.
 1,787,235. CAFE 66 AND DESIGN. INT. CL. 42. REG. 8-10-1993.
 1,787,255. MISCELLANEOUS DESIGN. INT. CL. 42. REG. 8-10-1993.
 1,787,258. DETECTERS. INT. CLS. 9 AND 10. REG. 8-10-1993.
 1,787,267. ALMAX. INT. CLS. 17, 22 AND 23. REG. 8-10-1993.
 1,787,270. SITESENTRY. INT. CLS. 9 AND 42. REG. 8-10-1993.
 1,787,274. ENVIROPLASTIC. INT. CLS. 1, 20 AND 21. REG. 8-10-1993.
 1,787,278. FAIR LANES AND DESIGN. INT. CLS. 41 AND 42. REG. 8-10-1993.
 1,787,285. ALOA AND DESIGN. INT. CLS. 16 AND 42. REG. 8-10-1993.
 1,787,288. TROLLIES. INT. CLS. 9, 21, 25 AND 28. REG. 8-10-1993.
 1,787,299. SNOW 'N SLEET. INT. CL. 1. REG. 8-10-1993.
 1,787,300. UNICARB. INT. CL. 2. REG. 8-10-1993.
 1,787,305. POLYPLUS. INT. CL. 3. REG. 8-10-1993.
 1,787,313. KEY WEST ALOE CAT AND DESIGN. INT. CL. 3. REG. 8-10-1993.
 1,787,315. SMOOTH START. INT. CL. 3. REG. 8-10-1993.
 1,787,317. INSTACOVER. INT. CL. 3. REG. 8-10-1993.
 1,787,318. HYDRASILK. INT. CL. 3. REG. 8-10-1993.
 1,787,322. IRVING ADVANT AND DESIGN. INT. CL. 4. REG. 8-10-1993.
 1,787,327. SWORD. INT. CL. 5. REG. 8-10-1993.
 1,787,342. EARTHNET (STYLIZED). INT. CL. 5. REG. 8-10-1993.
 1,787,350. TTT AND DESIGN. INT. CL. 6. REG. 8-10-1993.
 1,787,352. T.E.S. INT. CL. 6. REG. 8-10-1993.
 1,787,359. TERRAMASTER. INT. CL. 7. REG. 8-10-1993.
 1,787,360. E-Z DIG. INT. CL. 7. REG. 8-10-1993.
 1,787,361. WEARRING. INT. CL. 7. REG. 8-10-1993.
 1,787,362. WALLABY. INT. CL. 7. REG. 8-10-1993.
 1,787,363. TRIVANTAGE. INT. CL. 7. REG. 8-10-1993.
 1,787,366. TRUCRAFT TOOLS YOU CAN USE FOR LIFE. INT. CL. 8. REG. 8-10-1993.
 1,787,382. KNEEL-RITE (STYLIZED). INT. CL. 9. REG. 8-10-1993.
 1,787,393. THE WORKS. INT. CL. 9. REG. 8-10-1993.
 1,787,394. ESRIG. INT. CL. 9. REG. 8-10-1993.
 1,787,401. GG GERALD GENTA (STYLIZED). INT. CL. 9. REG. 8-10-1993.
 1,787,403. COMET/CG. INT. CL. 9. REG. 8-10-1993.
 1,787,406. BEYOND TECHNOLOGY. INT. CL. 9. REG. 8-10-1993.
 1,787,415. DRIP STOP. INT. CL. 9. REG. 8-10-1993.
 1,787,418. MEGA:MAX. INT. CL. 9. REG. 8-10-1993.
 1,787,420. 4MATION LESSON BANK AND DESIGN. INT. CL. 9. REG. 8-10-1993.
 1,787,421. GOLD MEDALIST. INT. CL. 9. REG. 8-10-1993.
 1,787,429. WORLD VAC. INT. CL. 9. REG. 8-10-1993.
 1,787,430. POWERSHIP 3. INT. CL. 9. REG. 8-10-1993.
 1,787,431. NETCHECK. INT. CL. 9. REG. 8-10-1993.
 1,787,436. MULTI MINI-FLEX. INT. CL. 10. REG. 8-10-1993.
 1,787,449. CONSOLIDATED INDUSTRIES CI AND DESIGN. INT. CL. 11. REG. 8-10-1993.
 1,787,453. MINOFF LAMP AND DESIGN. INT. CL. 11. REG. 8-10-1993.
 1,787,454. AQUAHUT AND DESIGN. INT. CL. 11. REG. 8-10-1993.
 1,787,455. VERTIHEAT. INT. CL. 11. REG. 8-10-1993.
 1,787,457. AIRGEL. INT. CL. 12. REG. 8-10-1993.
 1,787,458. WIPERS EXPRESS. INT. CL. 12. REG. 8-10-1993.
 1,787,459. QL10. INT. CL. 12. REG. 8-10-1993.
 1,787,468. TIME CHAIN. INT. CL. 14. REG. 8-10-1993.
 1,787,475. WHAT SHALL WE DO TOMORROW?. INT. CL. 16. REG. 8-10-1993.
 1,787,477. BEAN TALK. INT. CL. 16. REG. 8-10-1993.
 1,787,484. AN OUNCE OF PREVENTION TIPS THE SCALES IN YOUR FAVOR AND DESIGN. INT. CL. 16. REG. 8-10-1993.
 1,787,498. FUTEC. INT. CL. 18. REG. 8-10-1993.
 1,787,500. VECOR V (STYLIZED). INT. CL. 19. REG. 8-10-1993.
 1,787,504. IN-SOL EDGE. INT. CL. 19. REG. 8-10-1993.
 1,787,509. KRUISE. INT. CL. 20. REG. 8-10-1993.
 1,787,511. RACKWARE. INT. CL. 20. REG. 8-10-1993.
 1,787,514. CRATE-MATE. INT. CL. 20. REG. 8-10-1993.
 1,787,519. DIMWOK "DOING IT MY WAY! OK!" AND DESIGN. INT. CL. 25. REG. 8-10-1993.
 1,787,520. FUN CLUB BY SOUTHERN CLASSICS AND DESIGN. INT. CL. 25. REG. 8-10-1993.
 1,787,525. SOCK MOP. INT. CL. 25. REG. 8-10-1993.
 1,787,530. BURNING SAND. INT. CL. 25. REG. 8-10-1993.
 1,787,531. BURNIN' SAND. INT. CL. 25. REG. 8-10-1993.
 1,787,532. BURNING BEACH. INT. CL. 25. REG. 8-10-1993.
 1,787,533. BURNING WATER. INT. CL. 25. REG. 8-10-1993.
 1,787,534. BURNING SURF. INT. CL. 25. REG. 8-10-1993.
 1,787,559. FFG AND DESIGN. INT. CL. 28. REG. 8-10-1993.
 1,787,565. ROCK ISLAND (STYLIZED). INT. CL. 29. REG. 8-10-1993.
 1,787,570. FANCY SUPREME. INT. CL. 29. REG. 8-10-1993.
 1,787,572. NATHAN'S AND DESIGN. INT. CL. 29. REG. 8-10-1993.
 1,787,579. MINI O'S (STYLIZED). INT. CL. 30. REG. 8-10-1993.
 1,787,581. CBC (STYLIZED). INT. CL. 30. REG. 8-10-1993.
 1,787,587. VIVA PACIFIC. INT. CL. 31. REG. 8-10-1993.
 1,787,593. FLYING DRAGON ORCHIDS. INT. CL. 31. REG. 8-10-1993.
 1,787,594. PASTURE-MATE. INT. CL. 31. REG. 8-10-1993.
 1,787,595. LARVETS. INT. CL. 31. REG. 8-10-1993.
 1,787,605. WESTERN INTERACTIVE MEDIA. INT. CL. 35. REG. 8-10-1993.
 1,787,606. BELIEVE IT!. INT. CL. 35. REG. 8-10-1993.
 1,787,616. PARKS AS CLASSROOMS. INT. CL. 36. REG. 8-10-1993.
 1,787,618. THE NATIONAL DEAN'S LIST ALUMNI ASSOCIATION. INT. CL. 36. REG. 8-10-1993.
 1,787,620. CRITICALCARE. INT. CL. 37. REG. 8-10-1993.
 1,787,621. T.R.E.E. HOME. INT. CL. 37. REG. 8-10-1993.
 1,787,622. OPTI-TRANS. INT. CL. 39. REG. 8-10-1993.
 1,787,624. STUDENT BODY AND DESIGN. INT. CL. 41. REG. 8-10-1993.
 1,787,626. DOS PUEBLOS. INT. CL. 41. REG. 8-10-1993.
 1,787,627. SLAMM DUNK. INT. CL. 41. REG. 8-10-1993.
 1,787,635. UNCOMMON SENSE (STYLIZED). INT. CL. 41. REG. 8-10-1993.
 1,787,636. THE BOX AND DESIGN. INT. CL. 41. REG. 8-10-1993.
 1,787,637. VISTAZOOM. INT. CL. 41. REG. 8-10-1993.
 1,787,646. 1-800-PC FLOWERS. INT. CL. 42. REG. 8-10-1993.
 1,787,649. PATRIOT. INT. CL. 42. REG. 8-10-1993.
 1,787,658. THAT'S AMORE. INT. CL. 42. REG. 8-10-1993.

- 1,787,675. POS/2. INT. CL. 9. REG. 8-10-1993.
 1,787,679. BLISTER VENT. INT. CL. 9. REG. 8-10-1993.
 1,787,680. INSTRUCTIONAL STM. INT. CL. 9. REG. 8-10-1993.
 1,787,683. EXCLUSIVE SPORTS JEWELRY. INT. CL. 14. REG. 8-10-1993.
 1,787,684. SPORT BANDS. INT. CL. 14. REG. 8-10-1993.
 1,787,686. THE CONSUMER CHASE. INT. CL. 16. REG. 8-10-1993.
 1,787,687. HEALTH TALK (STYLIZED). INT. CL. 16. REG. 8-10-1993.
 1,787,690. GENETIC TRENDS. INT. CL. 16. REG. 8-10-1993.
 1,787,691. BOARD MEMBER. INT. CL. 16. REG. 8-10-1993.
 1,787,699. MISCELLANEOUS DESIGN. INT. CL. 30. REG. 8-10-1993.
 1,787,700. MISCELLANEOUS DESIGN. INT. CL. 31. REG. 8-10-1993.
 1,787,708. NATIONAL SPORTS CENTER FOR THE DISABLED. INT. CL. 41. REG. 8-10-1993.
 1,797,890. CSC. INT. CL. 26 ONLY. REG. 10-12-1993.
 1,801,323. VERANDA. INT. CLS. 4, 5 AND 20 ONLY. REG. 10-26-1993.
 1,846,413. HOMEBEST. INT. CLS. 1 AND 9 ONLY. REG. 7-26-1994.
 1,997,987. PAY 'N TALK. INT. CL. 38. REG. 9-3-1996.
 2,032,969. BAD MOJO. INT. CL. 28. REG. 1-21-1997.
 2,068,238. EUROPICLON (STYLIZED). INT. CL. 20 ONLY. REG. 6-10-1997.
 2,086,678. ALASKA SEAS. INT. CL. 29. REG. 8-12-1997.
 2,086,680. GROUP 4 SECURITAS AND DESIGN. INT. CLS. 6, 9, 14 AND 42. REG. 8-12-1997.
 2,086,683. PEACH PASSION EVERCLEAR AND DESIGN. INT. CL. 33. REG. 8-12-1997.
 2,086,684. GRUNO LTD. INT. CL. 25. REG. 8-12-1997.
 2,086,686. ENERGION. INT. CL. 1. REG. 8-12-1997.
 2,086,689. ROBERTOS BURRITOS AND DESIGN. INT. CL. 30. REG. 8-12-1997.
 2,086,695. ALLIANCE USA GOOD PEOPLE...GOOD PRODUCTS... AND DESIGN. INT. CL. 35. REG. 8-12-1997.
 2,086,698. PORTLAND'S OWN REAL ALE. INT. CLS. 32 AND 42. REG. 8-12-1997.
 2,086,700. DIAL-A-CLAIM. INT. CL. 36. REG. 8-12-1997.
 2,086,702. TEAMTALK. INT. CL. 9. REG. 8-12-1997.
 2,086,705. DITRONIC (STYLIZED). INT. CL. 12. REG. 8-12-1997.
 2,086,706. ECOSYSTEM POWER (STYLIZED). INT. CL. 12. REG. 8-12-1997.
 2,086,709. R/3 CLIENT/SERVER ABAP/4 SD MM PP QM PM HR FI CO AM PS OC IS AND DESIGN. INT. CLS. 9, 16, 41 AND 42. REG. 8-12-1997.
 2,086,714. MISCELLANEOUS DESIGN. INT. CLS. 8, 9 AND 16. REG. 8-12-1997.
 2,086,715. RYSER. INT. CLS. 29 AND 30. REG. 8-12-1997.
 2,086,716. CYCLOCELL. INT. CL. 7. REG. 8-12-1997.
 2,086,717. PRESTIGE (STYLIZED). INT. CL. 21. REG. 8-12-1997.
 2,086,719. NATURES' DELITES. INT. CLS. 29 AND 30. REG. 8-12-1997.
 2,086,723. ADMIRAL FAIRWEATHER. INT. CLS. 9 AND 41. REG. 8-12-1997.
 2,086,725. FOOD & FABLES FROM THE HEART OF THE SOUTH. INT. CLS. 29 AND 30. REG. 8-12-1997.
 2,086,726. INTERNATIONAL CHALLENGE DAY AND DESIGN. INT. CLS. 9, 14, 16, 18, 25, 28, 38, 39 AND 41. REG. 8-12-1997.
 2,086,727. TREKER. INT. CL. 28. REG. 8-12-1997.
 2,086,728. PHOTOMARK. INT. CL. 16. REG. 8-12-1997.
 2,086,729. BRAINSTORM. INT. CL. 41. REG. 8-12-1997.
 2,086,731. SPORTS DOMINATOR SD AND DESIGN. INT. CL. 42. REG. 8-12-1997.
 2,086,736. KIDS LIBRIS. INT. CL. 41. REG. 8-12-1997.
 2,086,737. PERFECT HAIR. INT. CLS. 3 AND 26. REG. 8-12-1997.
 2,086,739. ASCENSION YOGA AND DESIGN. INT. CL. 41. REG. 8-12-1997.
 2,086,740. PROFESSIONAL SABRE. INT. CLS. 9, 39 AND 42. REG. 8-12-1997.
 2,086,743. CARMEN AND DESIGN. INT. CL. 14. REG. 8-12-1997.
 2,086,744. THE NEXT STEP. INT. CL. 42. REG. 8-12-1997.
 2,086,745. THE STORK LINE INC (STYLIZED). INT. CL. 42. REG. 8-12-1997.
 2,086,752. KNOXVILLE SMOKIES. INT. CL. 41. REG. 8-12-1997.
 2,086,753. GLACIER WHITES. INT. CL. 2. REG. 8-12-1997.
 2,086,758. SNAKELIGHT AND DESIGN. INT. CL. 11. REG. 8-12-1997.
 2,086,760. RETRO Q. INT. CLS. 6 AND 9. REG. 8-12-1997.
 2,086,762. PHILADELPHIA BAR & GRILL AND DESIGN. INT. CL. 42. REG. 8-12-1997.
 2,086,764. SILHOUETTE. INT. CL. 11. REG. 8-12-1997.
 2,086,766. TACO FIESTA. INT. CL. 42. REG. 8-12-1997.
 2,086,767. TOBY. INT. CL. 32. REG. 8-12-1997.
 2,086,768. MICRO-PUR. INT. CL. 21. REG. 8-12-1997.
 2,086,769. MISCELLANEOUS DESIGN. INT. CLS. 25 AND 42. REG. 8-12-1997.
 2,086,771. TTT (STYLIZED). INT. CL. 42. REG. 8-12-1997.
 2,086,774. MISCELLANEOUS DESIGN. INT. CLS. 9 AND 16. REG. 8-12-1997.
 2,086,775. MICRO PHONO DRIVE. INT. CL. 9. REG. 8-12-1997.
 2,086,777. GOLDEN SPIKE. INT. CL. 32. REG. 8-12-1997.
 2,086,781. D AND DESIGN. INT. CL. 12. REG. 8-12-1997.
 2,086,782. ELFILE. INT. CLS. 35, 38 AND 39. REG. 8-12-1997.
 2,086,783. PEGASOS AND DESIGN. INT. CLS. 9, 37, 38 AND 42. REG. 8-12-1997.
 2,086,784. DEUTSCHE FINANCIAL SERVICES. INT. CL. 36. REG. 8-12-1997.
 2,086,786. MISCELLANEOUS DESIGN. INT. CLS. 9, 35, 41 AND 42. REG. 8-12-1997.
 2,086,794. MICROBREW FESTIVAL IN A BOX. INT. CL. 32. REG. 8-12-1997.
 2,086,795. ALVISE ZANROSSO. INT. CL. 7. REG. 8-12-1997.
 2,086,796. NEW YORK FISH HOUSE AND DESIGN. INT. CL. 42. REG. 8-12-1997.
 2,086,798. SMONMASTER. INT. CL. 9. REG. 8-12-1997.
 2,086,799. AVANTI. INT. CL. 12. REG. 8-12-1997.
 2,086,800. EVENING MULTI. INT. CL. 5. REG. 8-12-1997.
 2,086,802. BUKAMARANGA AND DESIGN. INT. CL. 42. REG. 8-12-1997.
 2,086,805. CANADIAN WIGGLER RATTLER. INT. CL. 28. REG. 8-12-1997.
 2,086,806. GREAT PERENNIAL DIVIDE. INT. CL. 42. REG. 8-12-1997.
 2,086,809. VF WORKS INC. AND DESIGN. INT. CL. 42. REG. 8-12-1997.
 2,086,812. FYBOSYSTEM. INT. CLS. 5 AND 30. REG. 8-12-1997.
 2,086,813. FYBOCARE. INT. CLS. 5 AND 30. REG. 8-12-1997.
 2,086,814. FYBOZEST. INT. CLS. 5 AND 30. REG. 8-12-1997.
 2,086,815. GROUPE GASCOGNE AND DESIGN. INT. CLS. 6, 16, 17, 19, 20, 35 AND 40. REG. 8-12-1997.
 2,086,817. "MAAC". INT. CLS. 25 AND 41. REG. 8-12-1997.
 2,086,818. GUT CHECK. INT. CL. 25. REG. 8-12-1997.
 2,086,819. SILVERLINE PICTURES. INT. CL. 41. REG. 8-12-1997.
 2,086,820. L. I. F. E. (LEARNING IT FROM EXPERIENCE). INT. CL. 25. REG. 8-12-1997.
 2,086,821. MISCELLANEOUS DESIGN. INT. CL. 38. REG. 8-12-1997.
 2,086,822. SILVERLINE PICTURES AND DESIGN. INT. CL. 41. REG. 8-12-1997.
 2,086,825. DOROTHY SCHOELN THE SILVER CONNECTION AND DESIGN. INT. CL. 25. REG. 8-12-1997.
 2,086,830. HYPERLEADS. INT. CL. 35. REG. 8-12-1997.
 2,086,831. SCHULSTAD ROYAL DANISH PASTRY AND DESIGN. INT. CL. 30. REG. 8-12-1997.
 2,086,833. TRANSFRESH (STYLIZED). INT. CL. 39. REG. 8-12-1997.
 2,086,834. PD AND DESIGN. INT. CL. 30. REG. 8-12-1997.
 2,086,836. NEOGLYPHICS AND DESIGN. INT. CLS. 35 AND 42. REG. 8-12-1997.
 2,086,838. GUESS HOME COLLECTION. INT. CLS. 3, 4, 20, 21, 24, 25, 27 AND 42. REG. 8-12-1997.

- 2,086,841. HIGH PRODUCTIVITY SYSTEMS (STYLIZED). INT. CL. 9. REG. 8-12-1997.
- 2,086,843. THE EXHIBIT CONNECTION. INT. CL. 35. REG. 8-12-1997.
- 2,086,844. HEARTH BAKED BENNY'S BAGELS AND DESIGN. INT. CL. 42. REG. 8-12-1997.
- 2,086,845. THUNDERBIRD RECORDING. INT. CL. 41. REG. 8-12-1997.
- 2,086,848. MONEY & INVESTING UPDATE. INT. CL. 42. REG. 8-12-1997.
- 2,086,850. EASY FOR YOU. SAFE FOR NATURE.. INT. CL. 19. REG. 8-12-1997.
- 2,086,852. MARKET CONCEPTS. INT. CL. 9. REG. 8-12-1997.
- 2,086,853. CELFORT AND DESIGN. INT. CL. 17. REG. 8-12-1997.
- 2,086,855. ST. CLAIR ENTERTAINMENT GROUP INC. AND DESIGN. INT. CL. 9. REG. 8-12-1997.
- 2,086,858. SECURITY FIRST GROUP AND DESIGN. INT. CL. 36. REG. 8-12-1997.
- 2,086,862. BIT BARBECUE. INT. CL. 21. REG. 8-12-1997.
- 2,086,864. MATTRESS MILL AND DESIGN. INT. CL. 20. REG. 8-12-1997.
- 2,086,865. VIVA MEXICO! (STYLIZED). INT. CLS. 29 AND 30. REG. 8-12-1997.
- 2,086,866. PRESTO! AND DESIGN. INT. CL. 9. REG. 8-12-1997.
- 2,086,870. GAME MAKER. INT. CL. 9. REG. 8-12-1997.
- 2,086,871. ALFA 156. INT. CL. 12. REG. 8-12-1997.
- 2,086,873. M AND DESIGN. INT. CLS. 25 AND 28. REG. 8-12-1997.
- 2,086,874. ISOLUTE. INT. CL. 1. REG. 8-12-1997.
- 2,086,876. DIAL ANYWHERE. INT. CL. 36. REG. 8-12-1997.
- 2,086,877. REGENCY. INT. CL. 14. REG. 8-12-1997.
- 2,086,880. GRUMBACHER ARTIST PEN. INT. CL. 16. REG. 8-12-1997.
- 2,086,884. ON-HOLD INTERNATIONAL. INT. CL. 35. REG. 8-12-1997.
- 2,086,885. OC OCEAN CITY GOLF AND YACHT CLUB AND DESIGN. INT. CL. 41. REG. 8-12-1997.
- 2,086,886. DELIVERING RESULTS. INT. CL. 39. REG. 8-12-1997.
- 2,086,890. POWRCM. INT. CL. 9. REG. 8-12-1997.
- 2,086,892. THE SUMMIT SOLUTION. INT. CL. 42. REG. 8-12-1997.
- 2,086,893. STEREO. INT. CLS. 9 AND 42. REG. 8-12-1997.
- 2,086,894. RADIANT SHREDS. INT. CL. 16. REG. 8-12-1997.
- 2,086,897. LIFEWISE A LOAN FOR LIFE. INT. CL. 36. REG. 8-12-1997.
- 2,086,899. BOBEETZA'S KITCHEN HEALTH CONSCIOUS GOURMET FOOD ZACUSCA A GRILLED VEGETABLE SAUCE AND DESIGN. INT. CL. 30. REG. 8-12-1997.
- 2,086,900. E EXCELLENCE AND DESIGN. INT. CL. 30. REG. 8-12-1997.
- 2,086,906. FIELDUAL. INT. CL. 9. REG. 8-12-1997.
- 2,086,907. COUNTRY CLUB. INT. CL. 32. REG. 8-12-1997.
- 2,086,910. AIRSPUR. INT. CL. 7. REG. 8-12-1997.
- 2,086,911. MISCELLANEOUS DESIGN. INT. CLS. 13, 18, 21 AND 25. REG. 8-12-1997.
- 2,086,914. MISCELLANEOUS DESIGN. INT. CLS. 13, 18, 21 AND 25. REG. 8-12-1997.
- 2,086,915. LEGAL THERAPY. INT. CL. 42. REG. 8-12-1997.
- 2,086,916. FOLIOMAG. INT. CLS. 1 AND 31. REG. 8-12-1997.
- 2,086,917. ISOREL. INT. CL. 17. REG. 8-12-1997.
- 2,086,920. OREGON CHAI AND DESIGN. INT. CL. 30. REG. 8-12-1997.
- 2,086,922. AMSTAR. INT. CL. 1. REG. 8-12-1997.
- 2,086,923. THE LOOP AND DESIGN. INT. CL. 38. REG. 8-12-1997.
- 2,086,924. NEW HEALTH VENTURES. INT. CLS. 35, 36 AND 42. REG. 8-12-1997.
- 2,086,926. EXECU SEARCH. INT. CL. 35. REG. 8-12-1997.
- 2,086,929. COLLECTION TEATRO. INT. CL. 31. REG. 8-12-1997.
- 2,086,931. SALIENT CORPORATION (STYLIZED). INT. CL. 42. REG. 8-12-1997.
- 2,086,933. CHICKEN REQUESTS. INT. CL. 29. REG. 8-12-1997.
- 2,086,936. PHYCARON. INT. CL. 1. REG. 8-12-1997.
- 2,086,937. CLEMEX. INT. CL. 42. REG. 8-12-1997.
- 2,086,941. NHV NEW HEALTH VENTURES AND DESIGN. INT. CLS. 35, 36 AND 42. REG. 8-12-1997.
- 2,086,942. EVERGRO AND DESIGN. INT. CL. 1. REG. 8-12-1997.
- 2,086,943. MICROLUBE. INT. CL. 18. REG. 8-12-1997.
- 2,086,944. RICE MAGIC AND DESIGN. INT. CL. 29. REG. 8-12-1997.
- 2,086,947. THE OFFICIAL AIRPORT OF SANTA CLAUS ROVANIEMI AND DESIGN. INT. CL. 39. REG. 8-12-1997.
- 2,086,948. EMPLOYEE ADVANTAGE. INT. CLS. 16 AND 35. REG. 8-12-1997.
- 2,086,951. MISCELLANEOUS DESIGN. INT. CL. 30. REG. 8-12-1997.
- 2,086,952. I.ON AND DESIGN. INT. CLS. 35 AND 42. REG. 8-12-1997.
- 2,086,954. AIR-TECH LTD (STYLIZED). INT. CL. 39. REG. 8-12-1997.
- 2,086,962. MISCELLANEOUS DESIGN. INT. CL. 37. REG. 8-12-1997.
- 2,086,970. THE MAGAZINE OF LA CUCINA ITALIANA GOOD FOOD FOR GOOD LIVING AND DESIGN. INT. CL. 16. REG. 8-12-1997.
- 2,086,971. OSTEONOVA. INT. CLS. 5 AND 29. REG. 8-12-1997.
- 2,086,972. I.Q. INDEX. INT. CL. 36. REG. 8-12-1997.
- 2,086,975. CLINICAL CONNECTION. INT. CL. 9. REG. 8-12-1997.
- 2,086,978. GRAND REALE GANCIA. INT. CL. 33. REG. 8-12-1997.
- 2,086,982. EASY GOLF. INT. CL. 28. REG. 8-12-1997.
- 2,086,983. CHEFS ONLINE AND DESIGN. INT. CL. 42. REG. 8-12-1997.
- 2,086,987. HOME SCOUT. INT. CL. 42. REG. 8-12-1997.
- 2,086,990. SLOWBLEND. INT. CL. 2. REG. 8-12-1997.
- 2,086,991. TWELVE STARS AND DESIGN. INT. CLS. 35 AND 38. REG. 8-12-1997.
- 2,086,992. PEACE OF MIND SERVICE. INT. CL. 37. REG. 8-12-1997.
- 2,086,993. DAKOTAH AND DESIGN. INT. CLS. 18, 20, 24 AND 28. REG. 8-12-1997.
- 2,086,994. MISCELLANEOUS DESIGN. INT. CLS. 36 AND 42. REG. 8-12-1997.
- 2,086,996. DOWNTOWN PLAZA AND DESIGN. INT. CL. 36. REG. 8-12-1997.
- 2,087,002. DUMMIES 101. INT. CL. 9. REG. 8-12-1997.
- 2,087,004. COMPUTER TRAINING MICROTEACH AND DESIGN. INT. CL. 41. REG. 8-12-1997.
- 2,087,005. PHOENIX POWER AND DESIGN. INT. CLS. 6 AND 14. REG. 8-12-1997.
- 2,087,006. AEC GROUP. INT. CL. 37. REG. 8-12-1997.
- 2,087,009. HOLD 'N TIE. INT. CL. 16. REG. 8-12-1997.
- 2,087,011. CRIMSON HILL. INT. CL. 33. REG. 8-12-1997.
- 2,087,012. MAPS AND DESIGN. INT. CLS. 9 AND 16. REG. 8-12-1997.
- 2,087,015. WALK-IN HEALTH CARE OF OLATHE AND DESIGN. INT. CL. 42. REG. 8-12-1997.
- 2,087,019. SIR SPEEDY ONLINE. INT. CLS. 35 AND 42. REG. 8-12-1997.
- 2,087,021. ATLANTA WOODWRIGHT. INT. CL. 37. REG. 8-12-1997.
- 2,087,022. IAMC MAPA ESTRATEGICO. INT. CLS. 16 AND 35. REG. 8-12-1997.
- 2,087,023. PATHWINDER. INT. CL. 7. REG. 8-12-1997.
- 2,087,024. SYSTEME O2S AND DESIGN. INT. CL. 8. REG. 8-12-1997.
- 2,087,025. LONGS DRUGS FOR A HEALTHY COMMUNITY. INT. CLS. 16 AND 42. REG. 8-12-1997.
- 2,087,026. HOPFEST. INT. CL. 32. REG. 8-12-1997.
- 2,087,028. BOTTOM LINE WINE. INT. CL. 35. REG. 8-12-1997.
- 2,087,036. EQUINE MEDICAL REVIEW. INT. CL. 16. REG. 8-12-1997.
- 2,087,037. SAFETYSHIELD. INT. CL. 9. REG. 8-12-1997.

- 2,087,040. BASEBALL HALL OF FAME COOPERSTOWN OFFICIAL LEAGUE BALL MUSEUM SHOP AND DESIGN. INT. CL. 42. REG. 8-12-1997.
- 2,087,046. MACROSPERSE. INT. CL. 1. REG. 8-12-1997.
- 2,087,049. GIGGLE BALL. INT. CL. 28. REG. 8-12-1997.
- 2,087,051. ROBOTIX AND DESIGN. INT. CL. 28. REG. 8-12-1997.
- 2,087,053. O-ZONE. INT. CL. 42. REG. 8-12-1997.
- 2,087,060. ALL THESE BRAND NAMES AND DESIGN. INT. CL. 42. REG. 8-12-1997.
- 2,087,061. OBJECTSHARE SYSTEMS, INC.. INT. CL. 9. REG. 8-12-1997.
- 2,087,065. DESIGNER MARBLE. INT. CL. 37. REG. 8-12-1997.
- 2,087,066. EDUVENTURES. INT. CL. 36. REG. 8-12-1997.
- 2,087,069. CYBERASSURANCE. INT. CL. 36. REG. 8-12-1997.
- 2,087,070. AGENTEXERCISER. INT. CL. 9. REG. 8-12-1997.
- 2,087,071. GENAGENT. INT. CL. 9. REG. 8-12-1997.
- 2,087,072. GENMANAGER. INT. CL. 9. REG. 8-12-1997.
- 2,087,073. PRINCENET. INT. CL. 9. REG. 8-12-1997.
- 2,087,076. ATLANTIC SUMMER. INT. CL. 25. REG. 8-12-1997.
- 2,087,077. LUCY'S COOKIES AND DESIGN. INT. CL. 30. REG. 8-12-1997.
- 2,087,078. DO THE WRITE THING. INT. CL. 41. REG. 8-12-1997.
- 2,087,080. U.S. CLEARING. INT. CL. 36. REG. 8-12-1997.
- 2,087,081. TREND AND DESIGN. INT. CL. 35. REG. 8-12-1997.
- 2,087,083. PAN COMPANION. INT. CL. 21. REG. 8-12-1997.
- 2,087,086. FLORIDA RIVER. INT. CL. 31. REG. 8-12-1997.
- 2,087,088. MISCELLANEOUS DESIGN. INT. CL. 25. REG. 8-12-1997.
- 2,087,089. COMTDOPA. INT. CL. 5. REG. 8-12-1997.
- 2,087,090. PEELEX. INT. CL. 16. REG. 8-12-1997.
- 2,087,091. NEIGHBOR TO NEIGHBOR. INT. CL. 42. REG. 8-12-1997.
- 2,087,093. MISCELLANEOUS DESIGN. INT. CL. 14. REG. 8-12-1997.
- 2,087,096. TONIGHT'S IDEA. INT. CLS. 29 AND 30. REG. 8-12-1997.
- 2,087,098. VITREOLENS HANDLE. INT. CL. 10. REG. 8-12-1997.
- 2,087,101. GRANNY NANNY'S QUILTING GADGETS. INT. CL. 16. REG. 8-12-1997.
- 2,087,102. WOOLWEAVE. INT. CL. 27. REG. 8-12-1997.
- 2,087,103. WHAT-A-SAW AND DESIGN. INT. CL. 8. REG. 8-12-1997.
- 2,087,104. SERVICE CORPS USA. INT. CL. 41. REG. 8-12-1997.
- 2,087,106. LEMSIP. INT. CL. 5. REG. 8-12-1997.
- 2,087,110. KLYMAX. INT. CL. 12. REG. 8-12-1997.
- 2,087,111. ACTPROMOTE. INT. CL. 35. REG. 8-12-1997.
- 2,087,113. ERASOFT. INT. CL. 7. REG. 8-12-1997.
- 2,087,114. MIGUEL I. INT. CL. 33. REG. 8-12-1997.
- 2,087,117. ST. LOUIS COUNTY DEPARTMENT OF HIGHWAYS & TRAFFIC AND DESIGN. INT. CL. 37. REG. 8-12-1997.
- 2,087,118. MISCELLANEOUS DESIGN. INT. CL. 25. REG. 8-12-1997.
- 2,087,119. FIRST POINTS. INT. CL. 42. REG. 8-12-1997.
- 2,087,121. COMPUTER GEEKS. INT. CL. 42. REG. 8-12-1997.
- 2,087,122. MISCELLANEOUS DESIGN. INT. CL. 25. REG. 8-12-1997.
- 2,087,123. SIP & DIP. INT. CL. 42. REG. 8-12-1997.
- 2,087,124. LABO LIFE. INT. CL. 5. REG. 8-12-1997.
- 2,087,126. 911. INT. CL. 41. REG. 8-12-1997.
- 2,087,127. BUSY! BUDDY. INT. CL. 16. REG. 8-12-1997.
- 2,087,128. PERSONAS. INT. CL. 35. REG. 8-12-1997.
- 2,087,133. SENTRY. INT. CL. 36. REG. 8-12-1997.
- 2,087,136. LEADING EDGE BOOMERANGS AND DESIGN. INT. CL. 28. REG. 8-12-1997.
- 2,087,137. LA MORE AND DESIGN. INT. CL. 9. REG. 8-12-1997.
- 2,087,141. DYNA-COAT. INT. CL. 17. REG. 8-12-1997.
- 2,087,143. E.CENTRAL BIG CITY. SMALL PLANET. INT. CLS. 38 AND 42. REG. 8-12-1997.
- 2,087,144. SKINSAVVY. INT. CL. 42. REG. 8-12-1997.
- 2,087,145. BIT JOCKEY. INT. CL. 38. REG. 8-12-1997.
- 2,087,146. DIESEL. INT. CL. 41. REG. 8-12-1997.
- 2,087,147. PACER. INT. CL. 10. REG. 8-12-1997.
- 2,087,150. VYNAL-PLUS. INT. CL. 19. REG. 8-12-1997.
- 2,087,153. MILEAGE BANKING. INT. CL. 36. REG. 8-12-1997.
- 2,087,158. ELASTOBASE. INT. CL. 19. REG. 8-12-1997.
- 2,087,160. MISCELLANEOUS DESIGN. INT. CL. 9. REG. 8-12-1997.
- 2,087,161. QWIKTRANS (STYLIZED). INT. CL. 38. REG. 8-12-1997.
- 2,087,162. DOW. INT. CL. 42. REG. 8-12-1997.
- 2,087,165. STARRCADE. INT. CL. 9. REG. 8-12-1997.
- 2,087,169. XTREME MEDIA AND DESIGN. INT. CL. 9. REG. 8-12-1997.
- 2,087,170. BONITA PREMIUM BANANAS AND DESIGN. INT. CL. 31. REG. 8-12-1997.
- 2,087,171. MISCELLANEOUS DESIGN. INT. CL. 15. REG. 8-12-1997.
- 2,087,173. IT'S EASY! IT'S FUN! COLLECT EVERY ONE!. INT. CL. 16. REG. 8-12-1997.
- 2,087,174. JUST FOR THE GUYS. INT. CL. 3. REG. 8-12-1997.
- 2,087,179. INTERACTION. INT. CL. 36. REG. 8-12-1997.
- 2,087,183. OVER 1,500! AND DESIGN. INT. CL. 42. REG. 8-12-1997.
- 2,087,185. COMMUNITY BANKSHARES AND DESIGN. INT. CL. 36. REG. 8-12-1997.
- 2,087,188. COOL BEGINNINGS. INT. CL. 25. REG. 8-12-1997.
- 2,087,189. PULSE AND DESIGN. INT. CL. 25. REG. 8-12-1997.
- 2,087,191. DURAWEAVE. INT. CL. 25. REG. 8-12-1997.
- 2,087,193. PASSPORT TO EUROPE. INT. CL. 39. REG. 8-12-1997.
- 2,087,195. FREE RIDE. INT. CL. 35. REG. 8-12-1997.
- 2,087,198. BORDER PORTER. INT. CL. 32. REG. 8-12-1997.
- 2,087,200. STA-DOWN. INT. CL. 25. REG. 8-12-1997.
- 2,087,203. THE ENCHANTED GARDEN. INT. CL. 41. REG. 8-12-1997.
- 2,087,205. WATCH TV AND DESIGN. INT. CLS. 38 AND 41. REG. 8-12-1997.
- 2,087,206. WEBSHARE. INT. CL. 9. REG. 8-12-1997.
- 2,087,207. ORIGINAL V-RING AND DESIGN. INT. CL. 17. REG. 8-12-1997.
- 2,087,208. BITSOURCE AND DESIGN. INT. CL. 42. REG. 8-12-1997.
- 2,087,209. MAXJET AND DESIGN. INT. CL. 7. REG. 8-12-1997.
- 2,087,213. GIBBS SFP. INT. CL. 9. REG. 8-12-1997.
- 2,087,214. TIMELESS TERRECOTTE ONE WORLD CONCEPTS IN PLANTERWARE AND DESIGN. INT. CL. 21. REG. 8-12-1997.
- 2,087,215. BOXCAR PROPHETS. INT. CL. 41. REG. 8-12-1997.
- 2,087,216. NICK NEWS. INT. CL. 9. REG. 8-12-1997.
- 2,087,218. STERLING AND DESIGN. INT. CL. 38. REG. 8-12-1997.
- 2,087,219. CLASSIC ADVANTAGE. INT. CL. 36. REG. 8-12-1997.
- 2,087,220. THE ELITE BY NEPTUNE AND DESIGN. INT. CL. 25. REG. 8-12-1997.
- 2,087,221. HOW ARTISTS GET BY. INT. CL. 41. REG. 8-12-1997.
- 2,087,223. YOUR NEIGHBORHOOD HARDWARE STORE. INT. CL. 42. REG. 8-12-1997.
- 2,087,225. ROSEBUD. INT. CL. 16. REG. 8-12-1997.
- 2,087,226. IPARK. INT. CL. 42. REG. 8-12-1997.
- 2,087,227. OLD DOUBLE B BRAND AND DESIGN. INT. CL. 29. REG. 8-12-1997.
- 2,087,233. CLEARANCE ZONE. INT. CL. 42. REG. 8-12-1997.
- 2,087,236. WOLF TRACKS. INT. CL. 32. REG. 8-12-1997.
- 2,087,237. CLERGYTAX (STYLIZED). INT. CL. 9. REG. 8-12-1997.
- 2,087,238. SMARTCITE. INT. CL. 9. REG. 8-12-1997.
- 2,087,242. SUPER VICKY. INT. CL. 9. REG. 8-12-1997.
- 2,087,245. STENCIL IT! (STYLIZED). INT. CL. 9. REG. 8-12-1997.
- 2,087,246. TATTERS. INT. CL. 25. REG. 8-12-1997.
- 2,087,248. CARE CASE. INT. CL. 24. REG. 8-12-1997.

- 2,087,253. HOW'S MY WRITING? 1-800-2-2-JAMIE TRUCK TALK TIME AND DESIGN. INT. CL. 16. REG. 8-12-1997.
- 2,087,254. PUTTING RULES. INT. CL. 28. REG. 8-12-1997.
- 2,087,257. LAKO. INT. CL. 7. REG. 8-12-1997.
- 2,087,259. SPORT ICE AND DESIGN. INT. CLS. 12, 16, 19, 24 AND 27. REG. 8-12-1997.
- 2,087,262. MAC. INT. CL. 42. REG. 8-12-1997.
- 2,087,263. MAC AND DESIGN. INT. CL. 42. REG. 8-12-1997.
- 2,087,264. DESTINET AND DESIGN. INT. CL. 35. REG. 8-12-1997.
- 2,087,265. DESTINET AND DESIGN. INT. CL. 42. REG. 8-12-1997.
- 2,087,266. CORPORATE ALERT AND DESIGN. INT. CL. 42. REG. 8-12-1997.
- 2,087,267. CATIONIC TECHNOLOGIES SYMPOSIUM PAPER INDUSTRY AND DESIGN. INT. CL. 41. REG. 8-12-1997.
- 2,087,269. DESTINET. INT. CL. 41. REG. 8-12-1997.
- 2,087,270. MISCELLANEOUS DESIGN. INT. CL. 14. REG. 8-12-1997.
- 2,087,271. CHEZZIE BEE. INT. CL. 28. REG. 8-12-1997.
- 2,087,272. OLD WORLD FINANCIAL SERVICES. INT. CL. 36. REG. 8-12-1997.
- 2,087,274. MISCELLANEOUS DESIGN. INT. CL. 42. REG. 8-12-1997.
- 2,087,275. ORIGAMI IN SPACE. INT. CL. 28. REG. 8-12-1997.
- 2,087,276. GAFSOLVER TMP. INT. CL. 3. REG. 8-12-1997.
- 2,087,279. KANE SERVICE (STYLIZED). INT. CL. 42. REG. 8-12-1997.
- 2,087,280. BLOODY BOLD WORLD CLASS BLOODY MARY MIX DELICIOUSLY RICH AND TASTY AND DESIGN. INT. CL. 32. REG. 8-12-1997.
- 2,087,282. MAW CHANG OPTICAL AND DESIGN. INT. CL. 42. REG. 8-12-1997.
- 2,087,283. AMS APPALACHIAN MEDICAL SUPPLY AND DESIGN. INT. CL. 42. REG. 8-12-1997.
- 2,087,285. KAPLOAN. INT. CLS. 9 AND 41. REG. 8-12-1997.
- 2,087,286. COLLIER'S. INT. CLS. 9, 16 AND 28. REG. 8-12-1997.
- 2,087,289. THE PEOPLES FOUNDATION AND DESIGN. INT. CL. 41. REG. 8-12-1997.
- 2,087,290. ACCENT SERVICE COMPANY, INC. AND DESIGN. INT. CLS. 35 AND 36. REG. 8-12-1997.
- 2,087,297. COLLEGE CREDIT. INT. CL. 36. REG. 8-12-1997.
- 2,087,298. BIOTHERM EAU VITAMINEE. INT. CL. 3. REG. 8-12-1997.
- 2,087,299. IN SCALE ILLUSTRATED. INT. CL. 16. REG. 8-12-1997.
- 2,087,301. PROGRAMMING RESOURCES COMPANY AND DESIGN. INT. CL. 9. REG. 8-12-1997.
- 2,087,302. BODY MANAGEMENT. INT. CLS. 3 AND 5. REG. 8-12-1997.
- 2,087,303. GOLD'N PLUMP SIGNATURE GOLD. INT. CL. 29. REG. 8-12-1997.
- 2,087,304. WIRELESS TOGO. INT. CL. 42. REG. 8-12-1997.
- 2,087,306. FRIEND LINKS AND DESIGN. INT. CL. 42. REG. 8-12-1997.
- 2,087,307. 940/941 SOLUTION. INT. CL. 9. REG. 8-12-1997.
- 2,087,309. MINDWORKS. INT. CL. 9. REG. 8-12-1997.
- 2,087,310. FUN FLIGHT. INT. CL. 41. REG. 8-12-1997.
- 2,087,313. VISUAL NAVIGATOR. INT. CL. 9. REG. 8-12-1997.
- 2,087,315. FRESH AGAIN ... WHAT THE WORLD OF FRESH IS COMING TO. INT. CL. 29. REG. 8-12-1997.
- 2,087,318. SS STREET SCENE EQUIPMENT AND DESIGN. INT. CL. 12. REG. 8-12-1997.
- 2,087,319. "I CARE". INT. CL. 41. REG. 8-12-1997.
- 2,087,320. HOME PRO FLOORING SYSTEMS AND DESIGN. INT. CL. 19. REG. 8-12-1997.
- 2,087,322. TROPIC. INT. CL. 19. REG. 8-12-1997.
- 2,087,324. SOHNLEIN (STYLIZED). INT. CLS. 32 AND 33. REG. 8-12-1997.
- 2,087,325. TIPROKAR. INT. CL. 5. REG. 8-12-1997.
- 2,087,326. MICRO MACRO. INT. CL. 10. REG. 8-12-1997.
- 2,087,328. PORTS AND DESIGN. INT. CLS. 16 AND 25. REG. 8-12-1997.
- 2,087,331. GAYPACK. INT. CL. 35. REG. 8-12-1997.
- 2,087,335. CREDIT EQUITY. INT. CL. 36. REG. 8-12-1997.
- 2,087,337. ACXIOM RM-TOOLS. INT. CL. 35. REG. 8-12-1997.
- 2,087,338. PTCB PHARMACY TECHNICIAN CERTIFICATION BOARD AND DESIGN. INT. CL. 42. REG. 8-12-1997.
- 2,087,340. ISCP AND DESIGN. INT. CL. 42. REG. 8-12-1997.
- 2,087,342. PALATEMP. INT. CL. 5. REG. 8-12-1997.
- 2,087,343. CYBERMAGIC (STYLIZED). INT. CL. 40. REG. 8-12-1997.
- 2,087,344. TTS INC. AND DESIGN. INT. CL. 38. REG. 8-12-1997.
- 2,087,345. TRAPP. INT. CL. 3. REG. 8-12-1997.
- 2,087,346. NATIONAL EMERGENCY MEDICINE ASSOCIATION AND DESIGN. INT. CL. 42. REG. 8-12-1997.
- 2,087,348. RUDOLFO LONGEVITY INSTITUTE. INT. CL. 3. REG. 8-12-1997.
- 2,087,350. AVANT WATER WORKS AND DESIGN. INT. CL. 32. REG. 8-12-1997.
- 2,087,351. E-Z PACK. INT. CL. 9. REG. 8-12-1997.
- 2,087,352. CTI AND DESIGN. INT. CL. 11. REG. 8-12-1997.
- 2,087,356. SISTEMALUX. INT. CL. 11. REG. 8-12-1997.
- 2,087,358. FAT ATTRACTION. INT. CL. 5. REG. 8-12-1997.
- 2,087,359. PATIENT ASSISTANCE PARTNERS. INT. CL. 35. REG. 8-12-1997.
- 2,087,365. REAL FOOD DAILY AND DESIGN. INT. CL. 42. REG. 8-12-1997.
- 2,087,368. POWERDOCTORX (STYLIZED). INT. CL. 9. REG. 8-12-1997.
- 2,087,369. CHAOS. INT. CL. 28. REG. 8-12-1997.
- 2,087,370. EXTREMELY CUSTOMIZED FOODS. INT. CLS. 40 AND 42. REG. 8-12-1997.
- 2,087,372. ANS. INT. CL. 42. REG. 8-12-1997.
- 2,087,375. LUXUREE AND DESIGN. INT. CL. 3. REG. 8-12-1997.
- 2,087,376. TWISTIR. INT. CL. 7. REG. 8-12-1997.
- 2,087,378. SELF LABEL. INT. CL. 16. REG. 8-12-1997.
- 2,087,379. SMART SHELF. INT. CL. 35. REG. 8-12-1997.
- 2,087,380. ZUKEN REDAC AND DESIGN. INT. CL. 42. REG. 8-12-1997.
- 2,087,385. MPM AND DESIGN. INT. CL. 40. REG. 8-12-1997.
- 2,087,386. HERO NET AND DESIGN. INT. CL. 42. REG. 8-12-1997.
- 2,087,388. ATUN 100% NATURAL MARATUN AND DESIGN. INT. CL. 29. REG. 8-12-1997.
- 2,087,390. A TECHNOLOGY COMPANY IN THE PEOPLE BUSINESS. INT. CL. 42. REG. 8-12-1997.
- 2,087,394. AMERICA'S TOP JOBS. INT. CL. 16. REG. 8-12-1997.
- 2,087,400. MISCELLANEOUS DESIGN. INT. CL. 37. REG. 8-12-1997.
- 2,087,401. DINO TOTS. INT. CL. 29. REG. 8-12-1997.
- 2,087,402. NEBRASKA CELLULAR. INT. CL. 38. REG. 8-12-1997.
- 2,087,403. MX-RAY. INT. CL. 12. REG. 8-12-1997.
- 2,087,406. BENEDETTI. INT. CL. 37. REG. 8-12-1997.
- 2,087,407. CAFE PARIS AND DESIGN. INT. CL. 21. REG. 8-12-1997.
- 2,087,408. POWERDEX. INT. CL. 9. REG. 8-12-1997.
- 2,087,409. COLORSENTRY. INT. CL. 9. REG. 8-12-1997.
- 2,087,410. BODIOLOGY. INT. CL. 41. REG. 8-12-1997.
- 2,087,411. BIG BORDER. INT. CL. 30. REG. 8-12-1997.
- 2,087,412. E AND DESIGN. INT. CL. 39. REG. 8-12-1997.
- 2,087,413. DRINK WITH A PURPOSE. INT. CL. 32. REG. 8-12-1997.
- 2,087,414. FRIENDS & FAMILY MAIL. INT. CL. 9. REG. 8-12-1997.
- 2,087,417. SCREAMIN' DEMON (STYLIZED). INT. CL. 7. REG. 8-12-1997.
- 2,087,418. DYNA MOD AND DESIGN. INT. CL. 7. REG. 8-12-1997.
- 2,087,419. OUR COMMITMENT IS GUARANTEED. INT. CL. 42. REG. 8-12-1997.
- 2,087,420. HARTLINE. INT. CL. 36. REG. 8-12-1997.
- 2,087,424. COPON. INT. CL. 2. REG. 8-12-1997.

- 2,087,427. EQUAL FOR BAKING. INT. CL. 30. REG. 8-12-1997.
- 2,087,430. \$ FINANCIAL MATTERS AND DESIGN. INT. CL. 41. REG. 8-12-1997.
- 2,087,434. MISCELLANEOUS DESIGN. INT. CL. 9. REG. 8-12-1997.
- 2,087,437. SAM (STYLIZED). INT. CL. 9. REG. 8-12-1997.
- 2,087,438. WHERE IN THE WORLD IS CARMEN SANDIEGO?. INT. CL. 16. REG. 8-12-1997.
- 2,087,439. IAAA INTERNATIONAL ADULT ATHLETIC ASSOCIATION AND DESIGN. INT. CL. 42. REG. 8-12-1997.
- 2,087,440. BU AND DESIGN. INT. CL. 36. REG. 8-12-1997.
- 2,087,441. INTERX TECHNOLOGIES AND DESIGN. INT. CL. 38. REG. 8-12-1997.
- 2,087,443. MASS RISK MANAGEMENT. INT. CL. 35. REG. 8-12-1997.
- 2,087,444. M MACADAMIA DE COSTA RICA AND DESIGN. INT. CLS. 29 AND 30. REG. 8-12-1997.
- 2,087,445. CLUSTER RISK MANAGEMENT. INT. CL. 42. REG. 8-12-1997.
- 2,087,446. LA CLASSE GLOBALE FRANCOPHONE (STYLIZED). INT. CL. 42. REG. 8-12-1997.
- 2,087,448. PYRAMID PORTER AND DESIGN. INT. CL. 32. REG. 8-12-1997.
- 2,087,449. KADO. INT. CL. 30. REG. 8-12-1997.
- 2,087,450. DO IT YOURSELF EASY! AND DESIGN. INT. CL. 27. REG. 8-12-1997.
- 2,087,454. LA SOURCE. INT. CL. 21. REG. 8-12-1997.
- 2,087,456. MISCELLANEOUS DESIGN. INT. CL. 35. REG. 8-12-1997.
- 2,087,459. CONNECT-IT. INT. CL. 38. REG. 8-12-1997.
- 2,087,462. MAXIM. INT. CL. 9. REG. 8-12-1997.
- 2,087,467. ABMAX. INT. CL. 28. REG. 8-12-1997.
- 2,087,468. VALUE-BASED REINVENTION. INT. CL. 35. REG. 8-12-1997.
- 2,087,471. SLICE. INT. CL. 16. REG. 8-12-1997.
- 2,087,472. TELEMOTION. INT. CL. 16. REG. 8-12-1997.
- 2,087,474. NET HEALTHCARE NATIONAL EXPLORERS AND TRAVELERS AND DESIGN. INT. CL. 35. REG. 8-12-1997.
- 2,087,475. IRON CITY DARK PITTSBURGH BREWING CO. AND DESIGN. INT. CL. 32. REG. 8-12-1997.
- 2,087,477. SHAWS INK. INT. CL. 42. REG. 8-12-1997.
- 2,087,479. PUTTING KNOWLEDGE TO WORK. INT. CL. 16. REG. 8-12-1997.
- 2,087,481. YAMAZEN (STYLIZED). INT. CLS. 35, 36, 41 AND 42. REG. 8-12-1997.
- 2,087,482. CAFE TODAY. INT. CL. 30. REG. 8-12-1997.
- 2,087,487. THE ARLENE VALVE. INT. CL. 9. REG. 8-12-1997.
- 2,087,490. RESELLER MANAGEMENT. INT. CL. 16. REG. 8-12-1997.
- 2,087,491. TENEMOS MILLER LITE. VIVIMOS EN TEXAS. QUE VIDA TAN BUENA!. INT. CL. 32. REG. 8-12-1997.
- 2,087,497. PC/DESKTOP EXPRESS. INT. CL. 38. REG. 8-12-1997.
- 2,087,498. BLANC DES COLLINES ROUGES. INT. CL. 33. REG. 8-12-1997.
- 2,087,499. MAJA TRADING COMPANY, INC. IMPORT EXPORT AND DESIGN. INT. CL. 35. REG. 8-12-1997.
- 2,087,501. GENENCOR INTERNATIONAL AND DESIGN. INT. CL. 1. REG. 8-12-1997.
- 2,087,503. RENTA FRUT. INT. CL. 31. REG. 8-12-1997.
- 2,087,504. BURNING PASSION. INT. CL. 30. REG. 8-12-1997.
- 2,087,505. GOURMET GOODIES. INT. CL. 30. REG. 8-12-1997.
- 2,087,507. JESSICA B. INT. CL. 25. REG. 8-12-1997.
- 2,087,508. HARTPLUS (STYLIZED). INT. CL. 16. REG. 8-12-1997.
- 2,087,509. VANGUARD PERSONAL ADVISORY SERVICE. INT. CL. 36. REG. 8-12-1997.
- 2,087,511. ALISEA. INT. CL. 32. REG. 8-12-1997.
- 2,087,517. OGLETHORPE TEA AND DESIGN. INT. CL. 30. REG. 8-12-1997.
- 2,087,518. NIKIDESS. INT. CL. 5. REG. 8-12-1997.
- 2,087,519. FAT FREE YOGA. INT. CL. 9. REG. 8-12-1997.
- 2,087,527. DR. RIFFIC. INT. CL. 32. REG. 8-12-1997.
- 2,087,529. MISCELLANEOUS DESIGN. INT. CL. 12. REG. 8-12-1997.
- 2,087,536. COUNTRY COLLECTION. INT. CL. 3. REG. 8-12-1997.
- 2,087,537. RAT BASTARD ROOT BEER. INT. CL. 32. REG. 8-12-1997.
- 2,087,539. FPI AND DESIGN. INT. CL. 37. REG. 8-12-1997.
- 2,087,540. GENIJET AND DESIGN. INT. CL. 11. REG. 8-12-1997.
- 2,087,548. QUICK STAFF HEALTHCARE STAFFING SOLUTIONS, INC. AND DESIGN. INT. CL. 35. REG. 8-12-1997.
- 2,087,552. GUARANTEED IMPRESSIONS AND DESIGN. INT. CL. 35. REG. 8-12-1997.
- 2,087,553. DEL CAMBIO. INT. CL. 42. REG. 8-12-1997.
- 2,087,558. PAGE 1 RACING (STYLIZED). INT. CLS. 35 AND 41. REG. 8-12-1997.
- 2,087,559. RAVIOLITA. INT. CL. 30. REG. 8-12-1997.
- 2,087,563. WEST STREET GRILL. INT. CL. 30. REG. 8-12-1997.
- 2,087,564. NEXCLAIM TECHNOLOGIES. INT. CLS. 36 AND 42. REG. 8-12-1997.
- 2,087,565. THE NANNA. INT. CL. 20. REG. 8-12-1997.
- 2,087,571. CRAFTS UNLIMITED. INT. CL. 35. REG. 8-12-1997.
- 2,087,573. DETEKTYW AND DESIGN. INT. CL. 16. REG. 8-12-1997.
- 2,087,576. THE BURRS. INT. CL. 41. REG. 8-12-1997.
- 2,087,577. PURETEK MINX. INT. CL. 3. REG. 8-12-1997.
- 2,087,578. USISL. INT. CL. 41. REG. 8-12-1997.
- 2,087,581. FPP (STYLIZED). INT. CL. 16. REG. 8-12-1997.
- 2,087,583. REVERSE WRAP. INT. CL. 28. REG. 8-12-1997.
- 2,087,584. THE RESEARCH CENTER TIME INC. (STYLIZED). INT. CLS. 35, 36 AND 42. REG. 8-12-1997.
- 2,087,589. LA TWEEZZE - "EASY" (STYLIZED). INT. CL. 8. REG. 8-12-1997.
- 2,087,593. ORGANIC ADRENALINE AND DESIGN. INT. CL. 25. REG. 8-12-1997.
- 2,087,597. TURBOPPP. INT. CL. 9. REG. 8-12-1997.
- 2,087,599. OUTLOOK. INT. CL. 9. REG. 8-12-1997.
- 2,087,600. CHEVY CHASE DIRECT TOUCH. INT. CL. 36. REG. 8-12-1997.
- 2,087,601. CHEVY CHASE DIRECT TOUCH BANKING. INT. CL. 36. REG. 8-12-1997.
- 2,087,602. CHEVY CHASE FINANCIAL MANAGER. INT. CL. 36. REG. 8-12-1997.
- 2,087,603. LUCKY CLOVER GIVEAWAY. INT. CL. 42. REG. 8-12-1997.
- 2,087,605. DON LEO. INT. CL. 34. REG. 8-12-1997.
- 2,087,607. MISCELLANEOUS DESIGN. INT. CL. 25. REG. 8-12-1997.
- 2,087,608. LAZERMARK. INT. CL. 16. REG. 8-12-1997.
- 2,087,610. COTTA AND DESIGN. INT. CL. 7. REG. 8-12-1997.
- 2,087,611. ONE TO ONE. INT. CLS. 16 AND 35. REG. 8-12-1997.
- 2,087,612. RX AND DESIGN. INT. CL. 16. REG. 8-12-1997.
- 2,087,613. HOUSE VIEW AND DESIGN. INT. CLS. 36 AND 41. REG. 8-12-1997.
- 2,087,614. ALBUM WORKS BY THOMPSON. INT. CL. 16. REG. 8-12-1997.
- 2,087,615. AZTEX AND DESIGN. INT. CL. 11. REG. 8-12-1997.
- 2,087,617. THE CAR SHOW AND DESIGN. INT. CL. 41. REG. 8-12-1997.
- 2,087,619. WE GET IT. INT. CL. 37. REG. 8-12-1997.
- 2,087,629. FUTURE GENERATIONS AND DESIGN. INT. CLS. 16, 25 AND 41. REG. 8-12-1997.
- 2,087,630. MEMBER ACCESS 2K. INT. CL. 16. REG. 8-12-1997.
- 2,087,632. ASTRO*SCAN. INT. CL. 16. REG. 8-12-1997.
- 2,087,634. SERV-SELL AND DESIGN. INT. CL. 41. REG. 8-12-1997.
- 2,087,637. VEGA. INT. CL. 9. REG. 8-12-1997.
- 2,087,638. FRUIT HAPPENS ...LIGHTEN UP!. INT. CL. 32. REG. 8-12-1997.

- 2,087,639. SOBIK'S SUBS AND DESIGN. INT. CL. 42. REG. 8-12-1997.
- 2,087,645. NAIL BASICS. INT. CL. 3. REG. 8-12-1997.
- 2,087,648. ULYSSES. INT. CL. 9. REG. 8-12-1997.
- 2,087,651. ZIPPY CODER. INT. CL. 16. REG. 8-12-1997.
- 2,087,652. HEALTHMAX. INT. CL. 16. REG. 8-12-1997.
- 2,087,654. SNEAKY SWEET AND DESIGN. INT. CL. 5. REG. 8-12-1997.
- 2,087,655. SNEAKY WHITE AND DESIGN. INT. CL. 3. REG. 8-12-1997.
- 2,087,657. CRICKET CORRAL AND DESIGN. INT. CL. 21. REG. 8-12-1997.
- 2,087,658. POWERSTAT. INT. CL. 9. REG. 8-12-1997.
- 2,087,659. INSTACOLOR. INT. CL. 42. REG. 8-12-1997.
- 2,087,667. EAGLE VALET EXPRESS. INT. CL. 37. REG. 8-12-1997.
- 2,087,671. TRINKETS & TRASH. INT. CL. 41. REG. 8-12-1997.
- 2,087,673. UTILIMAG. INT. CL. 1. REG. 8-12-1997.
- 2,087,674. REST & REBUILD. INT. CL. 5. REG. 8-12-1997.
- 2,087,675. BUST. INT. CL. 16. REG. 8-12-1997.
- 2,087,676. SKATE 2000 AND DESIGN. INT. CL. 35. REG. 8-12-1997.
- 2,087,678. WING STATION AND DESIGN. INT. CL. 42. REG. 8-12-1997.
- 2,087,679. TURBOTEARS. INT. CL. 5. REG. 8-12-1997.
- 2,087,680. BRUTUS. INT. CL. 28. REG. 8-12-1997.
- 2,087,681. CONSUMERS-ON-DEMAND. INT. CL. 35. REG. 8-12-1997.
- 2,087,684. SUPREME AND DESIGN. INT. CL. 36. REG. 8-12-1997.
- 2,087,686. DAMOA. INT. CL. 35. REG. 8-12-1997.
- 2,087,688. DMA DANCE. INT. CL. 9. REG. 8-12-1997.
- 2,087,689. STRUERS AND DESIGN. INT. CL. 7. REG. 8-12-1997.
- 2,087,691. SUNSKINS AND DESIGN. INT. CL. 25. REG. 8-12-1997.
- 2,087,692. MISCELLANEOUS DESIGN. INT. CL. 39. REG. 8-12-1997.
- 2,087,694. HOME HEALTH CHOICE. INT. CL. 36. REG. 8-12-1997.
- 2,087,697. BODYSTRIDER. INT. CL. 28. REG. 8-12-1997.
- 2,087,699. STICKERPOINT U.S.A. INC. AND DESIGN. INT. CL. 16. REG. 8-12-1997.
- 2,087,700. CREDIT CARE. INT. CL. 36. REG. 8-12-1997.
- 2,087,703. RUNNING MATE. INT. CL. 1. REG. 8-12-1997.
- 2,087,704. STEMPRO (STYLIZED). INT. CL. 1. REG. 8-12-1997.
- 2,087,705. PSYSPIN. INT. CL. 11. REG. 8-12-1997.
- 2,087,707. WOW IT'S WEDNESDAY. INT. CL. 42. REG. 8-12-1997.
- 2,087,709. NORTHSTAR. INT. CL. 37. REG. 8-12-1997.
- 2,087,711. MASTERLAMINATE DIE. INT. CL. 7. REG. 8-12-1997.
- 2,087,713. NATIONSLINK. INT. CL. 36. REG. 8-12-1997.
- 2,087,720. THOROWET. INT. CL. 1. REG. 8-12-1997.
- 2,087,722. WHAT THE FOLK?. INT. CL. 41. REG. 8-12-1997.
- 2,087,723. DYANSEN. INT. CLS. 6, 16 AND 42. REG. 8-12-1997.
- 2,087,724. ICFA AND DESIGN. INT. CLS. 9, 16 AND 41. REG. 8-12-1997.
- 2,087,727. BYE FLY AND DESIGN. INT. CL. 5. REG. 8-12-1997.
- 2,087,729. AUDIBLOX. INT. CL. 16. REG. 8-12-1997.
- 2,087,730. PART TECHNOLOGY . . . TOTALLY HUMAN. INT. CL. 38. REG. 8-12-1997.
- 2,087,732. KEM-O-KLEEN. INT. CL. 7. REG. 8-12-1997.
- 2,087,734. COLL/AG-40. INT. CL. 5. REG. 8-12-1997.
- 2,087,735. SMILE MILES. INT. CL. 42. REG. 8-12-1997.
- 2,087,737. CENTURION. INT. CL. 6. REG. 8-12-1997.
- 2,087,738. GARDENS & LANDSCAPES. INT. CL. 16. REG. 8-12-1997.
- 2,087,739. MERCHANT OF CHOICE. INT. CL. 35. REG. 8-12-1997.
- 2,087,741. MISCELLANEOUS DESIGN. INT. CL. 42. REG. 8-12-1997.
- 2,087,742. STAY CONNECTED!. INT. CL. 42. REG. 8-12-1997.
- 2,087,746. ALCA 5. INT. CL. 6. REG. 8-12-1997.
- 2,087,748. MISCELLANEOUS DESIGN. INT. CL. 35. REG. 8-12-1997.
- 2,087,750. AQUA-FORM. INT. CL. 1. REG. 8-12-1997.
- 2,087,751. METALOGIC. INT. CL. 6. REG. 8-12-1997.
- 2,087,752. SUPEROCK (STYLIZED). INT. CL. 19. REG. 8-12-1997.
- 2,087,753. TUNING BOARD. INT. CL. 28. REG. 8-12-1997.
- 2,087,754. NATURAL TIES AND DESIGN. INT. CL. 42. REG. 8-12-1997.
- 2,087,755. NATURAL TIES. INT. CL. 42. REG. 8-12-1997.
- 2,087,758. MAGNETOUCH. INT. CL. 10. REG. 8-12-1997.
- 2,087,759. DOGTOOTH. INT. CL. 6. REG. 8-12-1997.
- 2,087,760. RB AND DESIGN. INT. CLS. 3 AND 31. REG. 8-12-1997.
- 2,087,761. MISCELLANEOUS DESIGN. INT. CL. 42. REG. 8-12-1997.
- 2,087,762. ROLL THRU THE ZOO. INT. CL. 35. REG. 8-12-1997.
- 2,087,763. SIMPLY WELL ADVISED. INT. CL. 36. REG. 8-12-1997.
- 2,087,766. ALEX AUTOMOTIVE. INT. CLS. 35 AND 37. REG. 8-12-1997.
- 2,087,767. BADGER HACKLE AND DESIGN. INT. CL. 25. REG. 8-12-1997.
- 2,087,768. NATURAL GARDEN PRESS. INT. CL. 16. REG. 8-12-1997.
- 2,087,769. THE POETRY GUILD. INT. CL. 16. REG. 8-12-1997.
- 2,087,773. CONQUEST AND DESIGN. INT. CL. 37. REG. 8-12-1997.
- 2,087,776. CAVEAT EMPTOR. INT. CL. 34. REG. 8-12-1997.
- 2,087,778. NO 1 IN PARTS FOR IMPORTED CARS AND DESIGN. INT. CL. 35. REG. 8-12-1997.
- 2,087,779. CLIP-IN CLIMBING INSURANCE. INT. CL. 36. REG. 8-12-1997.
- 2,087,780. VIE. INT. CL. 16. REG. 8-12-1997.
- 2,087,781. FOTOFACORY PRESS. INT. CL. 16. REG. 8-12-1997.
- 2,087,782. MELAPHARM. INT. CL. 5. REG. 8-12-1997.
- 2,087,783. METRO CALIFORNIA MEDIA. INT. CL. 16. REG. 8-12-1997.
- 2,087,785. HEARTLAND WIRELESS COMMUNICATIONS, INC.. INT. CL. 38. REG. 8-12-1997.
- 2,087,786. SEXPOSE (STYLIZED). INT. CL. 16. REG. 8-12-1997.
- 2,087,790. EC/EDI INSIDER. INT. CL. 16. REG. 8-12-1997.
- 2,087,793. BACH (STYLIZED). INT. CL. 14. REG. 8-12-1997.
- 2,087,794. MALLAPALOOZA. INT. CL. 35. REG. 8-12-1997.
- 2,087,795. PANDORAMONIUM. INT. CL. 16. REG. 8-12-1997.
- 2,087,796. JUST BEAUTIFUL. INT. CL. 3. REG. 8-12-1997.
- 2,087,799. TELESELECT. INT. CL. 38. REG. 8-12-1997.
- 2,087,800. SURVIVAL STRATEGIES. INT. CLS. 16 AND 41. REG. 8-12-1997.
- 2,087,805. E EUROCREDIT AND DESIGN. INT. CLS. 35 AND 36. REG. 8-12-1997.
- 2,087,806. BEYOND AROMATHERAPY. INT. CL. 3. REG. 8-12-1997.
- 2,087,808. HOUSE HOLDS. INT. CL. 16. REG. 8-12-1997.
- 2,087,809. CLEAN WRAP. INT. CL. 16. REG. 8-12-1997.
- 2,087,812. COAST WATCHERS. INT. CL. 16. REG. 8-12-1997.
- 2,087,814. WE TALK BUSINESS. INT. CL. 42. REG. 8-12-1997.
- 2,087,815. I AND DESIGN. INT. CL. 25. REG. 8-12-1997.
- 2,087,820. BECAUSE...A CHILD CAN TELL THE DIFFERENCE. INT. CL. 3. REG. 8-12-1997.
- 2,087,821. BOULDER CANYON AND DESIGN. INT. CL. 18. REG. 8-12-1997.
- 2,087,823. ASL. INT. CL. 28. REG. 8-12-1997.
- 2,087,825. PICKER-UPPER. INT. CL. 21. REG. 8-12-1997.
- 2,087,827. KL & ASSOCIATES. INT. CL. 35. REG. 8-12-1997.
- 2,087,829. SUNSHINE CREATIONS SPINNING BLISS. INT. CL. 28. REG. 8-12-1997.
- 2,087,830. EXOTISPORTZ AND DESIGN. INT. CL. 35. REG. 8-12-1997.
- 2,087,833. CROWNING ACHIEVEMENTS. INT. CL. 16. REG. 8-12-1997.
- 2,087,836. BRYANT PARK. INT. CLS. 24 AND 27. REG. 8-12-1997.

- 2,087,838. PATTI. INT. CL. 28. REG. 8-12-1997.
2,087,840. YOUNG AMERICA VOTES. INT. CL. 16. REG. 8-12-1997.
2,087,846. TUESDAY MARTES AND DESIGN. INT. CL. 16. REG. 8-12-1997.
2,087,847. SATURDAY SABADO AND DESIGN. INT. CL. 16. REG. 8-12-1997.
2,087,848. TALL ORDER. INT. CL. 16. REG. 8-12-1997.
2,087,850. LIFEART. INT. CL. 9. REG. 8-12-1997.
2,087,851. LIFEART. INT. CL. 16. REG. 8-12-1997.
2,087,852. MISTAYA. INT. CL. 25. REG. 8-12-1997.
2,087,853. PLUGGED IN TO THE COMMUNITY. INT. CL. 39. REG. 8-12-1997.
2,087,855. TOURNEAU AND DESIGN. INT. CL. 35. REG. 8-12-1997.
2,087,858. VAMPIRUS. INT. CL. 28. REG. 8-12-1997.
2,087,861. PCI AND DESIGN. INT. CL. 42. REG. 8-12-1997.
2,087,863. EL PASO ENERGY CORPORATION. INT. CL. 40. REG. 8-12-1997.
2,087,865. EL PASO ENERGY INTERNATIONAL. INT. CL. 40. REG. 8-12-1997.
2,087,867. THE DIGESTIVE WELLNESS CENTER DIGESTIVE SOLUTIONS, COMPASSIONATE CARE. INT. CL. 42. REG. 8-12-1997.
2,087,869. INTRANET BOOTCAMP. INT. CL. 41. REG. 8-12-1997.
2,087,870. MIRAGE (STYLIZED). INT. CL. 11. REG. 8-12-1997.
2,087,872. WISH UPON A STAR AND DESIGN. INT. CL. 20. REG. 8-12-1997.
2,087,877. LEGEND DAIRY FARMS. INT. CL. 42. REG. 8-12-1997.
2,087,880. PACIFIC RESPONSE INCORPORATED AND DESIGN. INT. CL. 42. REG. 8-12-1997.
2,087,882. SHYLA. INT. CL. 25. REG. 8-12-1997.
2,087,883. ETERNAL LOVE. INT. CL. 25. REG. 8-12-1997.
2,087,885. SHYLA N.Y.. INT. CL. 25. REG. 8-12-1997.
2,087,889. AQUAFRESH AND DESIGN. INT. CL. 21. REG. 8-12-1997.
2,087,890. MAGNA-FLAG AND DESIGN. INT. CL. 9. REG. 8-12-1997.
2,087,891. GRAPHASEAL. INT. CL. 17. REG. 8-12-1997.
2,087,897. LUVLITES. INT. CL. 25. REG. 8-12-1997.
2,087,898. TOOTHPICS AND DESIGN. INT. CL. 14. REG. 8-12-1997.
2,087,900. FRUCK. INT. CL. 25. REG. 8-12-1997.
2,087,902. BELGIAN CLUB. INT. CL. 30. REG. 8-12-1997.
2,087,903. VICTORIAN MANOR. INT. CL. 24. REG. 8-12-1997.
2,087,904. ART N SOUL. INT. CL. 35. REG. 8-12-1997.
2,087,905. DRU HILL. INT. CL. 41. REG. 8-12-1997.
2,087,906. PAM AND DESIGN. INT. CL. 36. REG. 8-12-1997.
2,087,908. DISHES. INT. CL. 36. REG. 8-12-1997.
2,087,909. DISHES. INT. CL. 25. REG. 8-12-1997.
2,087,910. DARLENE'S. INT. CL. 35. REG. 8-12-1997.
2,087,911. MUTUAL EDGE. INT. CL. 36. REG. 8-12-1997.
2,087,913. MDX. INT. CL. 42. REG. 8-12-1997.
2,087,915. WILD ORCHARD AND DESIGN. INT. CL. 32. REG. 8-12-1997.
2,087,917. FORD AND DESIGN. INT. CL. 20. REG. 8-12-1997.
2,087,918. TROPICAL ICE AND DESIGN. INT. CL. 25. REG. 8-12-1997.
2,087,919. REPUBLIC FINANCIAL SERVICES. INT. CL. 36. REG. 8-12-1997.
2,087,925. IAWQ INTERNATIONAL ASSOCIATION ON WATER QUALITY AND DESIGN. INT. CLS. 16, 41 AND 42. REG. 8-12-1997.
2,087,928. KIDS PLUS. INT. CL. 25. REG. 8-12-1997.
2,087,929. STONE PROTECTORS AND DESIGN. INT. CLS. 28 AND 41. REG. 8-12-1997.
2,087,930. BANRIE COSMOS AND DESIGN. INT. CL. 42. REG. 8-12-1997.
2,087,931. INFLATABAND. INT. CL. 12. REG. 8-12-1997.
2,087,932. MISCELLANEOUS DESIGN. INT. CLS. 9, 16, 25 AND 41. REG. 8-12-1997.
2,087,933. VALUE WISE. INT. CL. 29. REG. 8-12-1997.
2,087,934. SESAME STREET PEP. INT. CLS. 9, 16 AND 18. REG. 8-12-1997.
2,087,935. WB AND DESIGN. INT. CL. 25. REG. 8-12-1997.
2,087,942. GREAT COMBINATIONS. INT. CL. 30. REG. 8-12-1997.
2,087,945. MOSBY LIFELINE AND DESIGN. INT. CL. 9. REG. 8-12-1997.
2,087,951. SUMMITECH AND DESIGN. INT. CLS. 9, 10 AND 21. REG. 8-12-1997.
2,087,952. UNPLUGGED. INT. CLS. 35 AND 41. REG. 8-12-1997.
2,087,953. REALLY "WILD" ANIMALS (STYLIZED). INT. CL. 41. REG. 8-12-1997.
2,087,955. CALLAWAY BIG BERTHA WAR BIRD SOLE PLATE S H AND DESIGN. INT. CL. 28. REG. 8-12-1997.
2,087,956. MACH I. INT. CL. 21. REG. 8-12-1997.
2,087,958. COAXIOM. INT. CL. 9. REG. 8-12-1997.
2,087,959. ENVIROCLEAN. INT. CL. 11. REG. 8-12-1997.
2,087,961. ALR REVOLUTION AND DESIGN. INT. CL. 9. REG. 8-12-1997.
2,087,963. VERSATABLE. INT. CL. 7. REG. 8-12-1997.
2,087,965. OFFICIAL UNIVERSAL STUDIOS MONSTERS AND DESIGN. INT. CL. 25. REG. 8-12-1997.
2,087,966. OMNIO. INT. CLS. 41 AND 42. REG. 8-12-1997.
2,087,967. OUCH!. INT. CLS. 10 AND 16. REG. 8-12-1997.
2,087,968. OMNIO. INT. CL. 38. REG. 8-12-1997.
2,087,969. LIVE LONG. LIVE WELL.. INT. CL. 36. REG. 8-12-1997.
2,087,970. ADD SOFT. INT. CL. 9. REG. 8-12-1997.
2,087,973. WHISPERS ON WINGS. INT. CL. 21. REG. 8-12-1997.
2,087,974. ANDE. INT. CL. 9. REG. 8-12-1997.
2,087,977. ASSISTED CARE PARTNERS. INT. CLS. 35 AND 36. REG. 8-12-1997.
2,087,978. MAGNETEL. INT. CL. 9. REG. 8-12-1997.
2,087,979. LITTLE EMILIE. INT. CL. 28. REG. 8-12-1997.
2,087,980. HUSKY. INT. CL. 21. REG. 8-12-1997.
2,087,981. LIVE LOGIC. INT. CL. 9. REG. 8-12-1997.
2,087,982. WFA. INT. CL. 6. REG. 8-12-1997.
2,087,983. IVS. INT. CL. 9. REG. 8-12-1997.
2,087,987. P.S. I LOVE YOU. INT. CL. 16. REG. 8-12-1997.
2,087,988. WEST-100 AND DESIGN. INT. CL. 36. REG. 8-12-1997.
2,087,990. SURESAFE. INT. CL. 5. REG. 8-12-1997.
2,087,992. GLOBAL OUTSIDE DIRECTOR. INT. CL. 35. REG. 8-12-1997.
2,087,993. SABU AND DESIGN. INT. CL. 25. REG. 8-12-1997.
2,087,994. STI SEQUIM TECHNOLOGIES INCORPORATED (STYLIZED). INT. CL. 10. REG. 8-12-1997.
2,087,997. SILENTLITE. INT. CL. 9. REG. 8-12-1997.
2,088,000. PAIN AWAY. INT. CL. 9. REG. 8-12-1997.
2,088,002. TIMOTHY'S WORLD COFFEE AND DESIGN. INT. CLS. 21, 30 AND 42. REG. 8-12-1997.
2,088,005. BUSINESS ANALYST. INT. CL. 42. REG. 8-12-1997.
2,088,006. MAUVILLA!. INT. CLS. 35 AND 42. REG. 8-12-1997.
2,088,007. SCIENCE RULES. INT. CL. 41. REG. 8-12-1997.
2,088,009. ORDINARY MARY AND DESIGN. INT. CL. 25. REG. 8-12-1997.
2,088,012. SMART AND DESIGN. INT. CL. 9. REG. 8-12-1997.
2,088,013. THE FUTURE OF WIRELESS COMMUNICATIONS. INT. CL. 9. REG. 8-12-1997.
2,088,014. CREDITWORKS. INT. CL. 9. REG. 8-12-1997.
2,088,015. CAM GRAMS AND DESIGN. INT. CL. 9. REG. 8-12-1997.
2,088,016. DANGEROUS. INT. CL. 9. REG. 8-12-1997.
2,088,018. STONEFLASH AND DESIGN. INT. CL. 7. REG. 8-12-1997.
2,088,020. BNOX (STYLIZED). INT. CL. 9. REG. 8-12-1997.
2,088,021. SH SPORTS HEALTH (STYLIZED). INT. CL. 42. REG. 8-12-1997.
2,088,022. WARNER'S JUST YOUR LENGTH. INT. CL. 25. REG. 8-12-1997.
2,088,023. SOFT IMPRESSIONS. INT. CL. 16. REG. 8-12-1997.
2,088,024. REAL ANIMALS. INT. CLS. 9 AND 28. REG. 8-12-1997.
2,088,025. FIX-KIT. INT. CL. 9. REG. 8-12-1997.

- 2,088,026. PAD DRIVER PLUS. INT. CL. 9. REG. 8-12-1997.
 2,088,029. PORTABOARD. INT. CL. 20. REG. 8-12-1997.
 2,088,031. WATERMARK ENTERPRISE. INT. CL. 9. REG. 8-12-1997.
 2,088,033. MAGNASTEER. INT. CL. 12. REG. 8-12-1997.
 2,088,035. DISCPORT TOWER. INT. CL. 9. REG. 8-12-1997.
 2,088,037. MUSICAL ZOO. INT. CL. 28. REG. 8-12-1997.
 2,088,040. SCD CONCEPT AND DESIGN. INT. CL. 25. REG. 8-12-1997.
 2,088,041. BUD LIGHT AND DESIGN. INT. CL. 32. REG. 8-12-1997.
 2,088,043. TENKO AND THE GUARDIANS OF THE MAGIC. INT. CL. 25. REG. 8-12-1997.
 2,088,044. FORE ... THE FUN OF IT!. INT. CL. 16. REG. 8-12-1997.
 2,088,046. MICROPLANET. INT. CL. 9. REG. 8-12-1997.
 2,088,047. ONEITA COLORWEAR. INT. CL. 25. REG. 8-12-1997.
 2,088,049. WONDERFIT. INT. CL. 14. REG. 8-12-1997.
 2,088,056. PALATTE-TIME. INT. CL. 16. REG. 8-12-1997.
 2,088,058. MED E CART AND DESIGN. INT. CL. 12. REG. 8-12-1997.
 2,088,059. GENTLE-LET. INT. CL. 10. REG. 8-12-1997.
 2,088,060. DON TOMAS. INT. CL. 29. REG. 8-12-1997.
 2,088,061. BRELLA-BRERO. INT. CL. 42. REG. 8-12-1997.
 2,088,062. PAPA BEAR RECORDS AND DESIGN. INT. CLS. 9, 16 AND 25. REG. 8-12-1997.
 2,088,063. STIR CRAZY CAFE. INT. CL. 42. REG. 8-12-1997.
 2,088,064. VISUAL SIGNAL CODE. INT. CL. 14. REG. 8-12-1997.
 2,088,065. SPORTRIDER. INT. CL. 28. REG. 8-12-1997.
 2,088,067. MCACHE. INT. CL. 9. REG. 8-12-1997.
 2,088,068. TOYRAK. INT. CL. 12. REG. 8-12-1997.
 2,088,072. SPIRO TORR (STYLIZED). INT. CL. 9. REG. 8-12-1997.
 2,088,075. LITTLE CADET. INT. CL. 25. REG. 8-12-1997.
 2,088,076. SELECT EDITION. INT. CL. 25. REG. 8-12-1997.
 2,088,077. PROCESSVISION. INT. CL. 9. REG. 8-12-1997.
 2,088,081. VELVASOFT. INT. CL. 21. REG. 8-12-1997.
 2,088,082. KIDS LAB AND DESIGN. INT. CLS. 9 AND 42. REG. 8-12-1997.
 2,088,083. PERFORMANCE PLUS AND DESIGN. INT. CLS. 9 AND 11. REG. 8-12-1997.
 2,088,084. DE-LINK AND DESIGN. INT. CL. 17. REG. 8-12-1997.
 2,088,085. DREAM SLEEPER. INT. CL. 20. REG. 8-12-1997.
 2,088,087. IMTS TOIL-FREE NUMBER. INT. CL. 35. REG. 8-12-1997.
 2,088,088. ARMADILLO. INT. CL. 16. REG. 8-12-1997.
 2,088,089. FARAD. INT. CL. 9. REG. 8-12-1997.
 2,088,090. WAVES. INT. CL. 9. REG. 8-12-1997.
 2,088,091. MISCELLANEOUS DESIGN. INT. CL. 25. REG. 8-12-1997.
 2,088,092. AMERITECH EDUCATION AVENUE. INT. CL. 42. REG. 8-12-1997.
 2,088,093. P THE PANTRY AND DESIGN. INT. CL. 42. REG. 8-12-1997.
 2,088,094. WAVE VISION LOOKING TO TOMORROW AND DESIGN. INT. CL. 41. REG. 8-12-1997.
 2,088,095. FILE-IT. INT. CLS. 16 AND 18. REG. 8-12-1997.
 2,088,097. LITEX. INT. CL. 9. REG. 8-12-1997.
 2,088,099. ESSENTIAL (STYLIZED). INT. CL. 10. REG. 8-12-1997.
 2,088,102. DRUG MONSTER. INT. CLS. 9, 16, 25 AND 28. REG. 8-12-1997.
 2,088,103. V VANELLI AND DESIGN. INT. CL. 24. REG. 8-12-1997.
 2,088,104. NORTH PENN. INT. CL. 28. REG. 8-12-1997.
 2,088,105. RADIO CITY. INT. CL. 42. REG. 8-12-1997.
 2,088,106. TRIPLE FUN. INT. CL. 28. REG. 8-12-1997.
 2,088,111. KIT & CABOODLE. INT. CL. 28. REG. 8-12-1997.
 2,088,119. ILLUMINATER. INT. CL. 9. REG. 8-12-1997.
 2,088,121. VISUALMEDIA. INT. CL. 9. REG. 8-12-1997.
 2,088,122. TYLOK. INT. CL. 10. REG. 8-12-1997.
 2,088,123. SAMS. INT. CL. 9. REG. 8-12-1997.
 2,088,127. TRUE-BOND. INT. CL. 3. REG. 8-12-1997.
 2,088,128. DECIDERIGHT. INT. CL. 9. REG. 8-12-1997.
 2,088,130. COASTLINE. INT. CL. 19. REG. 8-12-1997.
 2,088,132. INTRINSA. INT. CL. 9. REG. 8-12-1997.
 2,088,134. LANSDOWNE COLLECTION. INT. CL. 11. REG. 8-12-1997.
 2,088,137. RADIANT. INT. CLS. 3 AND 21. REG. 8-12-1997.
 2,088,138. CRAFTWORKS. INT. CL. 9. REG. 8-12-1997.
 2,088,139. SHOWBUILDER. INT. CL. 9. REG. 8-12-1997.
 2,088,141. GREAT EYES. INT. CL. 3. REG. 8-12-1997.
 2,088,142. RISKOPTICS. INT. CL. 9. REG. 8-12-1997.
 2,088,143. DIGITAL CIRCUIT RIDERS. INT. CLS. 9 AND 16. REG. 8-12-1997.
 2,088,145. GIFT WITH HEART. INT. CL. 6. REG. 8-12-1997.
 2,088,146. READIPREP. INT. CL. 9. REG. 8-12-1997.
 2,088,149. LUNATIK. INT. CL. 16. REG. 8-12-1997.
 2,088,150. A AND DESIGN. INT. CL. 32. REG. 8-12-1997.
 2,088,151. INTEGRA HEALTH AND DESIGN. INT. CL. 42. REG. 8-12-1997.
 2,088,154. PREMEVIEW. INT. CL. 9. REG. 8-12-1997.
 2,088,155. ROCKIN' WHEELIN' KIDS. INT. CL. 28. REG. 8-12-1997.
 2,088,156. MAGICWORLD. INT. CLS. 41 AND 42. REG. 8-12-1997.
 2,088,161. BENEFIT INNOVATIONS. INT. CL. 35. REG. 8-12-1997.
 2,088,163. DUAL ROLL. INT. CL. 7. REG. 8-12-1997.
 2,088,164. MAGIC DUST. INT. CL. 14. REG. 8-12-1997.
 2,088,165. PSYCHINTERACTIVE. INT. CL. 9. REG. 8-12-1997.
 2,088,168. PURESANITATION AND DESIGN. INT. CL. 37. REG. 8-12-1997.
 2,088,169. MODERN DIGITAL POST. INT. CLS. 9 AND 40. REG. 8-12-1997.
 2,088,171. TRED-TIES. INT. CL. 19. REG. 8-12-1997.
 2,088,173. CANDY EUPHORIUM. INT. CL. 42. REG. 8-12-1997.
 2,088,174. PHASER. INT. CL. 7. REG. 8-12-1997.
 2,088,175. COPIS. INT. CL. 9. REG. 8-12-1997.
 2,088,176. CARINE AND DESIGN. INT. CL. 25. REG. 8-12-1997.
 2,088,177. CALCIBOR. INT. CL. 1. REG. 8-12-1997.
 2,088,178. THE VISION. INT. CL. 16. REG. 8-12-1997.
 2,088,179. COPPERTONE KIDS. INT. CL. 9. REG. 8-12-1997.
 2,088,181. FOOT NOOK. INT. CL. 42. REG. 8-12-1997.
 2,088,183. PHOTO ESSENTIALS. INT. CL. 9. REG. 8-12-1997.
 2,088,185. TSE. INT. CL. 21. REG. 8-12-1997.
 2,088,187. STRATTON AND DESIGN. INT. CL. 41. REG. 8-12-1997.
 2,088,188. YOUR CAROLINAS CONNECTION. INT. CL. 38. REG. 8-12-1997.
 2,088,189. REVISOR DTS. INT. CL. 9. REG. 8-12-1997.
 2,088,190. APOTHEUS. INT. CL. 10. REG. 8-12-1997.
 2,088,193. BEAMER. INT. CL. 9. REG. 8-12-1997.
 2,088,194. POLYTRAC. INT. CL. 10. REG. 8-12-1997.
 2,088,196. GOODBABY. INT. CL. 12. REG. 8-12-1997.
 2,088,200. NATURE'S FLEECE. INT. CL. 23. REG. 8-12-1997.
 2,088,201. POCKETPROBE. INT. CL. 9. REG. 8-12-1997.
 2,088,203. ICODE96. INT. CL. 9. REG. 8-12-1997.
 2,088,205. VOYAGER. INT. CL. 20. REG. 8-12-1997.
 2,088,209. KUDOS ETC.. INT. CL. 35. REG. 8-12-1997.
 2,088,211. PURE COUNTRY. INT. CL. 25. REG. 8-12-1997.
 2,088,212. FLOWKEEPER. INT. CL. 9. REG. 8-12-1997.
 2,088,216. WINDBORNE. INT. CL. 20. REG. 8-12-1997.
 2,088,217. X-FILES. INT. CLS. 20 AND 26. REG. 8-12-1997.
 2,088,218. L C J MINISTRIES, INC. AND DESIGN. INT. CL. 42. REG. 8-12-1997.
 2,088,219. CNG ENERGY INDEX. INT. CL. 42. REG. 8-12-1997.
 2,088,220. MERLOT. INT. CL. 36. REG. 8-12-1997.
 2,088,221. CLEANIN' HOUSE. INT. CL. 28. REG. 8-12-1997.
 2,088,222. SURF N' FUN. INT. CL. 28. REG. 8-12-1997.
 2,088,223. GRABNET. INT. CL. 9. REG. 8-12-1997.
 2,088,225. ROLLERBLADE. INT. CL. 16. REG. 8-12-1997.
 2,088,226. TENTH PLANET. INT. CL. 16. REG. 8-12-1997.
 2,088,229. MONTU. INT. CL. 21. REG. 8-12-1997.
 2,088,231. COMFORTECH. INT. CL. 20. REG. 8-12-1997.
 2,088,233. PALA (STYLIZED). INT. CL. 21. REG. 8-12-1997.
 2,088,234. TENTH PLANET. INT. CL. 9. REG. 8-12-1997.
 2,088,236. A SOLID DECISION. INT. CL. 42. REG. 8-12-1997.
 2,088,237. INNOSCAN. INT. CL. 9. REG. 8-12-1997.

- 2,088,240. R5000. INT. CL. 9. REG. 8-12-1997.
 2,088,241. DACNET. INT. CL. 9. REG. 8-12-1997.
 2,088,242. SOLUTIONS ON THE SPOT. INT. CL. 42. REG. 8-12-1997.
 2,088,243. ORIGINAL HARVEST. INT. CL. 30. REG. 8-12-1997.
 2,088,245. TO GO GUARD AND DESIGN. INT. CL. 16. REG. 8-12-1997.
 2,088,246. GEOFILL AND DESIGN. INT. CL. 19. REG. 8-12-1997.
 2,088,247. BABY'S FIRST AND ONLY. INT. CL. 28. REG. 8-12-1997.
 2,088,248. GREAT SPACE. INT. CL. 42. REG. 8-12-1997.
 2,088,250. REVOLUTIONARY MEMORY TECHNOLOGY THAT USES A DIFFERENT PART OF THE BRAIN TO MEMORIZE. INT. CL. 9. REG. 8-12-1997.
 2,088,251. THE FAT INSTINCT. INT. CL. 41. REG. 8-12-1997.
 2,088,253. ORBITZ AND DESIGN. INT. CL. 32. REG. 8-12-1997.
 2,088,255. COMPUJOB. INT. CL. 9. REG. 8-12-1997.
 2,088,256. COOL COMFORT. INT. CL. 25. REG. 8-12-1997.
 2,088,257. IMAGETERM (STYLIZED). INT. CL. 9. REG. 8-12-1997.
 2,088,258. 1790. INT. CL. 42. REG. 8-12-1997.
 2,088,259. NEMASOFT. INT. CL. 9. REG. 8-12-1997.
 2,088,260. PFX-3000. INT. CL. 11. REG. 8-12-1997.
 2,088,261. PLEASANT SURPRISES. INT. CL. 42. REG. 8-12-1997.
 2,088,262. UNS. INT. CL. 14. REG. 8-12-1997.
 2,088,266. EAGLE AND DESIGN. INT. CL. 9. REG. 8-12-1997.
 2,088,267. GLOBAL ADAPTER. INT. CL. 9. REG. 8-12-1997.
 2,088,268. MARIA ISABELLA. INT. CL. 25. REG. 8-12-1997.
 2,088,270. ALBARELLA AND DESIGN. INT. CL. 25. REG. 8-12-1997.
 2,088,272. PALM PRESS AND DESIGN. INT. CL. 16. REG. 8-12-1997.
 2,088,273. MINSTREL. INT. CL. 9. REG. 8-12-1997.
 2,088,275. WHO'S IN CHARGE. INT. CL. 41. REG. 8-12-1997.
 2,088,276. WASHINGTON UNWRAPPED. INT. CL. 41. REG. 8-12-1997.
 2,088,278. ELYSIAN FIELDS. INT. CL. 41. REG. 8-12-1997.
 2,088,279. MISCELLANEOUS DESIGN. INT. CL. 6. REG. 8-12-1997.
 2,088,280. HPN WORLDWIDE. INT. CLS. 35 AND 42. REG. 8-12-1997.
 2,088,281. BOLD IMAGE GOLF. INT. CL. 25. REG. 8-12-1997.
 2,088,282. HEALTH DESIGN CONSULTANTS (STYLIZED). INT. CL. 35. REG. 8-12-1997.
 2,088,283. SKYDOC. INT. CLS. 35 AND 38. REG. 8-12-1997.
 2,088,285. AN ATM IN EVERY HOME. INT. CL. 42. REG. 8-12-1997.
 2,088,286. MPI CLEARANCE SERVICES. INT. CL. 35. REG. 8-12-1997.
 2,088,287. IN THE GAME. INT. CL. 41. REG. 8-12-1997.
 2,088,288. INSTED. INT. CL. 41. REG. 8-12-1997.
 2,088,289. FLEXCERAM. INT. CL. 9. REG. 8-12-1997.
 2,088,292. AIR-COM 2000. INT. CL. 11. REG. 8-12-1997.
 2,088,294. EMERALD. INT. CL. 12. REG. 8-12-1997.
 2,088,297. UNITRAP. INT. CL. 9. REG. 8-12-1997.
 2,088,298. UNISTEEP. INT. CL. 9. REG. 8-12-1997.
 2,088,301. A WORLD OF DIFFERENCE. INT. CL. 42. REG. 8-12-1997.
 2,088,302. MEANSTREETS. INT. CL. 6. REG. 8-12-1997.
 2,088,305. EAGLE. INT. CL. 9. REG. 8-12-1997.
 2,088,306. POWER WIPE. INT. CL. 9. REG. 8-12-1997.
 2,088,307. COPPER HILLS. INT. CL. 41. REG. 8-12-1997.
 2,088,309. CONCORDIA RECORDINGS AND DESIGN. INT. CL. 9. REG. 8-12-1997.
 2,088,314. EARTH'S MOST ABSORBENT NATURAL FIBERS AND DESIGN. INT. CL. 5. REG. 8-12-1997.
 2,088,316. GROUND ZERO. INT. CL. 41. REG. 8-12-1997.
 2,088,318. GO FIGURE. INT. CL. 25. REG. 8-12-1997.
 2,088,321. PURCHASEDIRECT. INT. CLS. 9 AND 35. REG. 8-12-1997.
 2,088,325. CGR. INT. CL. 1. REG. 8-12-1997.
 2,088,326. AR2. INT. CL. 1. REG. 8-12-1997.
 2,088,327. MOVING YOUR BUSINESS AHEAD, ONE SQUARE FOOT AT A TIME. INT. CL. 36. REG. 8-12-1997.
 2,088,328. POW-R-LAM. INT. CL. 19. REG. 8-12-1997.
 2,088,329. RAILSTAR. INT. CL. 4. REG. 8-12-1997.
 2,088,330. LIFE'S MOMENTS. INT. CL. 20. REG. 8-12-1997.
 2,088,333. CARBANA. INT. CL. 12. REG. 8-12-1997.
 2,088,336. RAGS TO RAINBOWS. INT. CL. 28. REG. 8-12-1997.
 2,088,339. INCENTIVE FLOW MANUFACTURING. INT. CL. 40. REG. 8-12-1997.
 2,088,340. METANOVA. INT. CL. 9. REG. 8-12-1997.
 2,088,341. GOOD TO THE LAST DROP AND DESIGN. INT. CL. 30. REG. 8-12-1997.
 2,088,342. DR MANAGER. INT. CLS. 9 AND 36. REG. 8-12-1997.
 2,088,343. VOODU VALVE. INT. CL. 9. REG. 8-12-1997.
 2,088,344. REDUX (STYLIZED). INT. CL. 5. REG. 8-12-1997.
 2,088,346. BEETLE BATTLER. INT. CL. 28. REG. 8-12-1997.
 2,088,350. BENEFACTOR SELECT. INT. CL. 36. REG. 8-12-1997.
 2,088,351. MEMBER SELECT. INT. CL. 36. REG. 8-12-1997.
 2,088,352. EXPERIENCE GOD'S CHRISTMAS PRESENCE. INT. CLS. 4, 14, 16 AND 21. REG. 8-12-1997.
 2,088,353. HANG UPS. INT. CL. 9. REG. 8-12-1997.
 2,088,355. S AND DESIGN. INT. CL. 42. REG. 8-12-1997.
 2,088,356. PRO-E-SENTIAL. INT. CL. 5. REG. 8-12-1997.
 2,088,357. TEL-A-HEART. INT. CL. 16. REG. 8-12-1997.
 2,088,358. PROTEIN. INT. CL. 9. REG. 8-12-1997.
 2,088,359. XL. INT. CL. 9. REG. 8-12-1997.
 2,088,360. DESIGNSECURE. INT. CL. 16. REG. 8-12-1997.
 2,088,361. SLAM TIME. INT. CL. 14. REG. 8-12-1997.
 2,088,363. ATHLITE. INT. CL. 14. REG. 8-12-1997.
 2,088,365. BEYOND THE BEYOND. INT. CL. 28. REG. 8-12-1997.
 2,088,368. FIRST DOWN. INT. CL. 25. REG. 8-12-1997.
 2,088,369. FIRST DOWN AND DESIGN. INT. CL. 25. REG. 8-12-1997.
 2,088,370. MISCELLANEOUS DESIGN. INT. CL. 42. REG. 8-12-1997.
 2,088,373. U-DO BLOCK. INT. CL. 19. REG. 8-12-1997.
 2,088,374. KITSCH KASSEROLE. INT. CL. 9. REG. 8-12-1997.
 2,088,376. INSTAFRESH. INT. CL. 5. REG. 8-12-1997.
 2,088,377. RUNAWAY MOUNTAIN. INT. CL. 21. REG. 8-12-1997.
 2,088,381. DUAL-CLENS. INT. CL. 3. REG. 8-12-1997.
 2,088,382. DOGSAVER. INT. CL. 9. REG. 8-12-1997.
 2,088,384. PHOSPHAMASS. INT. CL. 5. REG. 8-12-1997.
 2,088,385. OUR DREAM IS TO HELP YOU REALIZE YOURS. INT. CL. 41. REG. 8-12-1997.
 2,088,386. 1-800-ALL-LOAN THE ONLY NUMBER YOU NEED. AND DESIGN. INT. CL. 36. REG. 8-12-1997.
 2,088,390. HAL HOOKWELL AND DESIGN. INT. CL. 28. REG. 8-12-1997.
 2,088,391. S.W.A.T.. INT. CL. 42. REG. 8-12-1997.
 2,088,392. GLOBAL CONEXTIONS. INT. CL. 42. REG. 8-12-1997.
 2,088,393. MIRAM AND DESIGN. INT. CL. 9. REG. 8-12-1997.
 2,088,395. OUTLAW. INT. CL. 30. REG. 8-12-1997.
 2,088,397. BAKU BAKU. INT. CL. 28. REG. 8-12-1997.
 2,088,399. FORM-KRAFT. INT. CLS. 6 AND 40. REG. 8-12-1997.
 2,088,400. OSCAR DE LA RENTA AND DESIGN. INT. CL. 25. REG. 8-12-1997.
 2,088,402. ROTO TRACK. INT. CL. 28. REG. 8-12-1997.
 2,088,403. ATRC. INT. CL. 28. REG. 8-12-1997.
 2,088,404. RALLY CROSS. INT. CL. 28. REG. 8-12-1997.
 2,088,405. FOOTBALL GAMEBREAKER. INT. CL. 28. REG. 8-12-1997.
 2,088,407. STINK AWAY (STYLIZED). INT. CL. 5. REG. 8-12-1997.
 2,088,410. THROWBACK. INT. CL. 28. REG. 8-12-1997.
 2,088,411. SLAMMERFOAM. INT. CL. 17. REG. 8-12-1997.
 2,088,416. ASSET GUARD. INT. CL. 36. REG. 8-12-1997.
 2,088,417. NEXSERV. INT. CL. 9. REG. 8-12-1997.
 2,088,418. SIBC AND DESIGN. INT. CL. 9. REG. 8-12-1997.

- 2,088,419. N NORTHWEST REGIONAL CENTER AND DESIGN. INT. CL. 42. REG. 8-12-1997.
- 2,088,424. SCREEN TO SCREEN. INT. CL. 9. REG. 8-12-1997.
- 2,088,427. WHITE MOUNTAINS INSURANCE COMPANY AND DESIGN. INT. CL. 36. REG. 8-12-1997.
- 2,088,428. TAKE COMMAND OF YOUR FLEET. INT. CL. 36. REG. 8-12-1997.
- 2,088,431. ANYTIME, ANYDAY...ANYWEAR. INT. CL. 25. REG. 8-12-1997.
- 2,088,433. GLASSCHALK. INT. CL. 2. REG. 8-12-1997.
- 2,088,434. ADVENTURE CARE. INT. CL. 5. REG. 8-12-1997.
- 2,088,436. HYLOFT AND DESIGN. INT. CL. 28. REG. 8-12-1997.
- 2,088,437. PRUDENTIAL - FOR HEALTH. INT. CL. 16. REG. 8-12-1997.
- 2,088,438. R-ZONE. INT. CL. 28. REG. 8-12-1997.
- 2,088,439. GALLAVANTER. INT. CL. 25. REG. 8-12-1997.
- 2,088,440. TEAM AJ. INT. CL. 41. REG. 8-12-1997.
- 2,088,441. WHITE BUFFALO COLOGNE. INT. CL. 3. REG. 8-12-1997.
- 2,088,442. BLOWSDRIER. INT. CL. 22. REG. 8-12-1997.
- 2,088,443. PUNCH A BUNCH. INT. CL. 28. REG. 8-12-1997.
- 2,088,444. BIANCA. INT. CL. 14. REG. 8-12-1997.
- 2,088,445. SIMOWICZ AT AVENTURA. INT. CL. 25. REG. 8-12-1997.
- 2,088,447. PET TEAM. INT. CLS. 3 AND 5. REG. 8-12-1997.
- 2,088,449. MORE MILK LESS COCOA. INT. CL. 30. REG. 8-12-1997.
- 2,088,450. CHILDREN'S COMMUNITY CARE. INT. CL. 42. REG. 8-12-1997.
- 2,088,452. ARKIN. INT. CL. 5. REG. 8-12-1997.
- 2,088,453. VALUE AUDITING. INT. CL. 35. REG. 8-12-1997.
- 2,088,454. SHOW SOME LOVE. INT. CL. 25. REG. 8-12-1997.
- 2,099,683. PAGAN. INT. CLS. 14 AND 26. REG. 9-23-1997.
- 2,099,856. FABERGE. INT. CLS. 20 AND 24 ONLY. REG. 9-23-1997.
- 2,106,084. AGRA. INT. CL. 40 ONLY. REG. 10-21-1997.
- 2,108,544. ALTUS. INT. CL. 33. REG. 10-28-1997.
- 2,128,579. GRI-GLYCALC. INT. CL. 16 ONLY. REG. 1-13-1998.
- 2,129,439. WATER BLOSSOM. INT. CLS. 29 AND 30 ONLY. REG. 1-13-1998.
- 2,144,226. MISCELLANEOUS DESIGN. INT. CLS. 16, 29 AND 32 ONLY. REG. 3-17-1998.
- 2,144,971. TRILLIUM U.S.A.. INT. CLS. 36 AND 41 ONLY. REG. 3-17-1998.
- 2,145,743. THE ROOSEVELT GROUP. INT. CLS. 35 AND 36 ONLY. REG. 3-24-1998.
- 2,148,681. SUBPLAY. INT. CL. 25 ONLY. REG. 4-7-1998.
- 2,148,763. TENAGRA. INT. CL. 42 ONLY. REG. 4-7-1998.
- 2,150,722. THE BLACK BOOK AND DESIGN. INT. CL. 9 ONLY. REG. 4-14-1998.
- 2,151,359. THE FAITH CONNECTION. INT. CL. 9 ONLY. REG. 4-14-1998.
- 2,152,332. A AND DESIGN. INT. CLS. 3 AND 16 ONLY. REG. 4-21-1998.
- 2,157,247. MISCELLANEOUS DESIGN. INT. CL. 42 ONLY. REG. 5-12-1998.
- 2,172,104. BEST BAGELS IN TOWN. INT. CL. 30 ONLY. REG. 7-14-1998.
- 2,178,068. WRONZ. INT. CL. 24 ONLY. REG. 8-4-1998.
- 2,183,419. NHFA NATIONAL HOME FURNISHINGS ASSOCIATION AND DESIGN. INT. CL. 42 ONLY. REG. 8-25-1998.
- 2,202,229. MCCORMICK MEAL IDEA CENTER (STYLIZED). INT. CL. 29 ONLY. REG. 11-3-1998.
- 2,212,101. LUBE USA AND DESIGN. INT. CL. 9 ONLY. REG. 12-22-1998.

SECTION 18

- 1,329,753. CHRISTINE (STYLIZED). INT. CL. 25. REG. 4-9-1985.

- 1,637,826. CAN. INT. CL. 36. REG. 3-12-1991.

INADVERTENTLY ISSUED REGISTRATION NUMBERS

- 2,407,629. CEGETEL AND DESIGN. INT. CLS. 9, 16, 38 AND 42. REG. 11-28-2000. RESTORED TO SN 75-494,738.
- 2,649,268. LAKE WINNIE. INT. CL. 41. REG. 11-12-2002. RESTORED TO SN 76-360,412.
- 2,649,269. LAKE WINNEPESAUKAH. INT. CL. 41. REG. 11-12-2002. RESTORED TO SN 76-360,414.
- 2,649,270. LAKE WINNIE AND DESIGN. INT. CL. 41. REG. 11-12-2002. RESTORED TO SN 76-360,415.
- 2,731,222. TEXAS STAMPEDE COWBOYS CONCERTS KIDS AND DESIGN. INT. CL. 36. REG. 7-1-2003. RESTORED TO SN 76-256,691.
- 2,760,580. MOHA AND DESIGN. INT. CLS. 8 AND 21. REG. 9-9-2003. RESTORED TO SN 75-854,175.
- 2,800,917. SUIDEN (STYLIZED). INT. CLS. 11 AND 12. REG. 12-30-2003. RESTORED TO SN 76-321,627.
- 2,834,707. MISCELLANEOUS DESIGN. INT. CL. 29. REG. 4-20-2004. RESTORED TO SN 75-336,318.
- 2,834,708. C.P.L. SLITTER. INT. CL. 7. REG. 4-20-2004. RESTORED TO SN 75-412,839.
- 2,834,714. ROCK N ROYAL. INT. CL. 14. REG. 4-20-2004. RESTORED TO SN 75-550,624.
- 2,834,719. 30-DAY RENEWAL SYSTEM. INT. CL. 5. REG. 4-20-2004. RESTORED TO SN 75-640,563.
- 2,834,735. IC-CHART. INT. CL. 9. REG. 4-20-2004. RESTORED TO SN 75-735,002.
- 2,834,737. IEXCHANGE. INT. CL. 35. REG. 4-20-2004. RESTORED TO SN 75-744,439.
- 2,834,738. TODAY'S PLASTICS. INT. CL. 20. REG. 4-20-2004. RESTORED TO SN 75-752,742.
- 2,834,740. QUICK STIX. INT. CL. 30. REG. 4-20-2004. RESTORED TO SN 75-762,280.
- 2,834,743. CORFLEX AND DESIGN. INT. CL. 10. REG. 4-20-2004. RESTORED TO SN 75-791,606.
- 2,834,744. POST AND PLAY. INT. CL. 41. REG. 4-20-2004. RESTORED TO SN 75-792,077.
- 2,834,745. CH@WEAR. INT. CL. 25. REG. 4-20-2004. RESTORED TO SN 75-794,686.
- 2,834,747. PRECISIONCRAFT. INT. CL. 8. REG. 4-20-2004.
- 2,834,751. FACEFINITY. INT. CL. 3. REG. 4-20-2004. RESTORED TO SN 75-800,506.
- 2,834,754. HYDROBELT. INT. CL. 7. REG. 4-20-2004. RESTORED TO SN 75-811,498.
- 2,834,763. PROSOFTTRAINING.COM. INT. CL. 9. REG. 4-20-2004. RESTORED TO SN 75-877,484.
- 2,834,770. FLUXFILL. INT. CL. 2. REG. 4-20-2004. RESTORED TO SN 75-902,437.
- 2,834,778. PORO-TEX. INT. CL. 17. REG. 4-20-2004. RESTORED TO SN 75-955,265.
- 2,834,814. SYNTECHS. INT. CL. 37. REG. 4-20-2004. RESTORED TO SN 76-075,277.
- 2,834,824. ONE GOOD INVESTMENT IS WORTH A LIFETIME OF LABOR. INT. CL. 36. REG. 4-20-2004. RESTORED TO SN 76-092,869.
- 2,834,826. MOVENET.COM AND DESIGN. INT. CL. 35. REG. 4-20-2004. RESTORED TO SN 76-096,027.
- 2,834,830. DRAGON O P T I C A L AND DESIGN. INT. CL. 25. REG. 4-20-2004. RESTORED TO SN 76-104,436.
- 2,834,835. MISCELLANEOUS DESIGN. INT. CL. 16. REG. 4-20-2004. RESTORED TO SN 76-112,490.
- 2,834,836. ONIMUSHA. INT. CL. 28. REG. 4-20-2004. RESTORED TO SN 76-113,328.
- 2,835,120. MEGA TREADMILLS. INT. CL. 28. REG. 4-20-2004. RESTORED TO SN 76-391,212.
- 2,835,124. QCSE. INT. CL. 11. REG. 4-20-2004. RESTORED TO SN 76-394,501.

- 2,835,128. HYPERBLANK. INT. CL. 9. REG. 4-20-2004. RESTORED TO SN 76-397,148.
- 2,835,423. NO STRIPPING ALLOWED. INT. CL. 3. REG. 4-20-2004. RESTORED TO SN 78-158,982.
- 2,835,424. TAMING OF THE FRIZZ. INT. CL. 3. REG. 4-20-2004. RESTORED TO SN 78-158,984.
- 2,835,425. HYDRANT-DEFENDER. INT. CL. 6. REG. 4-20-2004. RESTORED TO SN 78-159,331.
- 2,835,515. ACHIEVE. INT. CL. 14. REG. 4-20-2004. RESTORED TO SN 78-232,812.
- 2,835,516. FHLBANK ATLANTA AND DESIGN. INT. CL. 36. REG. 4-20-2004. RESTORED TO SN 78-234,131.
- 2,835,520. TOMMY BAHAMA. INT. CL. 11. REG. 4-20-2004. RESTORED TO SN 78-975,254.
- 2,835,521. TARARI. INT. CL. 9. REG. 4-20-2004. RESTORED TO SN 78-975,256.
- 2,835,528. LOANTRADE. INT. CL. 36. REG. 4-20-2004. RESTORED TO SN 75-870,573.
- 2,835,529. PORNSTAR.COM. INT. CL. 35. REG. 4-20-2004. RESTORED TO SN 75-983,156.
- 2,835,531. INETAP. INT. CL. 9. REG. 4-20-2004. RESTORED TO SN 76-121,827.
- 2,835,637. TWINTURBO IONIC. INT. CL. 11. REG. 4-20-2004. RESTORED TO SN 78-226,390.
- 2,835,641. USDOCUMENTS. INT. CL. 35. REG. 4-20-2004. RESTORED TO SN 78-249,183.
- 2,835,643. PANORAMABUILDER. INT. CL. 9. REG. 4-20-2004. RESTORED TO SN 78-260,516.
- 2,835,644. SUPER KITCHEN & BATH CLEANER. INT. CL. 3. REG. 4-20-2004. RESTORED TO SN 78-261,762.

* * * * *

TRADEMARK REGISTRATIONS AMENDED, CORRECTED, ETC.

The designation "U.S. Cl." appearing in this section refers to the U.S. class in effect prior to Sep. 1, 1973 rather than the international class which applies to applications filed on or after that date. For adoption of international classification see notice in the OFFICIAL GAZETTE of Jun. 26, 1973 (911 O.G. TM 210).

Any change to the registration will be indicated at the bottom of each entry under ELEMENTS AMENDED, CORRECTED OR RESTRICTED. With the exception of changes to the goods and services, additions to the registration will appear in asterisks and deletions of the registration will appear in brackets. Elements which are only changed will be listed with no punctuation. As to the goods/services statement, amendments to the goods/services will appear in asterisks and deletions will appear in brackets. In addition if any change to the goods/services occurs, the element "Goods/Services" will be listed under ELEMENTS AMENDED, CORRECTED OR RESTRICTED.

582,470. REG. 11-17-1953. DEAN INTELLECTUAL PROPERTY SERVICES, L.P. (DELAWARE LIMITED PARTNERSHIP) 2515 MCKINNEY AVENUE, SUITE 1200, DALLAS, TX, 75201, SN 71-636,582. FILED 10-14-1952. PRINCIPAL REGISTER.

The logo for Meadow Gold features the word "Meadow" in a white, serif font above the word "Gold" in a white, serif font. Both words are set against a black rectangular background.

OWNER OF U.S. REG. NOS. 56,820, 394,672 AND OTHERS.
INT. CLS. 29, 30 AND 32/U.S. CL. 46

FOR BUTTER; [OLEO-MARGARINE; EGGS: FRESH, FROZEN, AND POWDERED;] CHEESE; [((MAYONNAISE DRESSING,)) FRENCH DRESSING, ((SANDWICH SPREAD:))] CITRUS JUICES: FRESH FROZEN, RECONSTITUTED, AND CANNED; ICE CREAM, ICE MILK, ICES AND SHERBERTS OF VARIOUS FLAVORINGS, FROZEN CONFECTIONS SOLD IN CUPS AND ON STICKS, [ICE CREAM PIES, ICE CREAM TARTS, ICE CREAM CAKES; ((IMITATION ICE CREAM MADE FROM VEGETABLE FAT:)) MILK AND MILK PRODUCTS—NAMESLY, FLUID MILKS, FLUID CREAMS, FLAVORED MILK DRINKS, BUTTERMILK, SKIM MILK, COTTAGE CHEESE, MODIFIED AND/OR FORTIFIED MILK, CONCENTRATED AND/OR FROZEN MILK, SOUR OR SALAD CREAM, YOGURT, EVAPORATED, POWDERED, AND CONDENSED MILKS [NON-FAT DRY MILK SOLID; DESSERT TOPPINGS, CONSISTING OF CREAM OR VEGETABLE FAT PRODUCT, WHIPPED, AND EXPELLED FROM CONTAINER BY GAS].

FIRST USE 9-1-1901; IN COMMERCE 9-1-1901.

ELEMENTS AMENDED
ASSIGNMENT/NAME CHANGE
MARK

1,262,903. REG. 1-3-1984. ACTIVEAID, INC. (MINNESOTA CORPORATION) 101 ACTIVEAID ROAD, REDWOOD FALLS, MN, 56283, SN 73-389,104. FILED 9-27-1982. PRINCIPAL REGISTER.

ACTIVEAID

OWNER OF U.S. REG. NOS. 808,160 AND 808,887.
INT. CL. 10/U.S. CLS. 26, 39 AND 44

TM 702

FOR PATIENT HANDLING AND TREATMENT APPARATUS—NAMESLY, TREATMENT TABLES, TILT [TABLETS] *TABLES*, EMERGENCY SPINE BOARDS, BATH TUB CHAIRS AND BATH TUB TRANSFER BENCHES.

FIRST USE 9-9-1965; IN COMMERCE 5-5-1966.

ELEMENTS CORRECTED
GOODS/SERVICES

1,338,756. REG. 6-4-1985. NATURAL ORGANICS, INC. (NEW YORK CORPORATION) 548 BROADHOLLOW ROAD, MELVILLE, NY, 117473708, SN 73-504,772. FILED 10-22-1984. PRINCIPAL REGISTER.

VITA SWEET

NO CLAIM IS MADE TO THE EXCLUSIVE RIGHT TO USE "SWEET", APART FROM THE MARK AS SHOWN.

INT. CL. 5/U.S. CL. 18

FOR A DIETARY SUPPLEMENT—NAMESLY, A SWEETENER CONTAINING NATURAL SUGARS.

FIRST USE 9-4-1984; IN COMMERCE 9-4-1984.

ELEMENTS AMENDED
OWNER ADDRESS
MARK

1,791,875. REG. 9-7-1993. EPS SETTLEMENTS GROUP, INC. (CALIFORNIA CORPORATION) 7100 E. BELLEVIEW AVENUE, SUITE 300, GREENWOOD VILLAGE, CO, 80111, SN 74-313,504. FILED 9-14-1992. PRINCIPAL REGISTER.

The logo for LifeLine features the word "LifeLine" in a white, serif font. The "i" in "Life" has a dot that is a small circle, and the "l" in "Line" is a simple vertical bar.

INT. CL. 36/U.S. CLS. 101 AND 102

FOR PROVIDING FINANCIAL, RATING AND SECURITY INFORMATION ABOUT VARIOUS LIFE INSURANCE COMPANIES.
FIRST USE 7-15-1992; IN COMMERCE 7-15-1992.

2,068,391. REG. 6-10-1997. KENDLE RESEARCH ASSOCIATES, INC. (OHIO CORPORATION) 441 VINE STREET, SUITE 700, CINCINNATI, OH, 452022816, SN 74-687,621. FILED 6-13-1995. PRINCIPAL REGISTER.

ELEMENTS AMENDED
OWNER NAME
OWNER ADDRESS
CITIZENSHIP
ENTITY
MARK

TRIALINE

INT. CL. 35/U.S. CLS. 100, 101 AND 102
FOR COMPUTER INFORMATION STORAGE AND RETRIEVAL SERVICES IN THE FIELD OF INFORMATION PROVIDED BY PHYSICIANS TO PHARMACEUTICAL COMPANIES CONCERNING CLINICAL TRIAL DATA ON DRUGS.
FIRST USE 12-22-1982; IN COMMERCE 12-22-1982.

1,797,292. REG. 10-5-1993. CHEVRON USA INC. (PENNSYLVANIA CORPORATION) 6001 BOLLINGER CANYON ROAD, SAN RAMON, CA, 94583, SN 74-005,664. FILED 11-28-1989. PRINCIPAL REGISTER.

ELEMENTS CORRECTED
OWNER NAME



OWNER OF U.S. REG. NO. 1,506,381.
NO CLAIM IS MADE TO THE EXCLUSIVE RIGHT TO USE "EXPRESS LUBE", APART FROM THE MARK AS SHOWN.
THE LINING SHOWN IN THE DRAWING IS A FEATURE OF THE MARK AND IS NOT INTENDED TO INDICATE COLOR.
INT. CL. 37/U.S. CL. 103
FOR AUTOMOTIVE LUBRICATION AND OIL CHANGE SERVICES.
FIRST USE 1-2-1993; IN COMMERCE 1-2-1993.

2,100,528. REG. 9-23-1997. GARLINGHOUSE, INC. (VIRGINIA CORPORATION) WEST SHORE III, 301 CONCOURSE BLVD, SUITE 240, VA, 23060, SN 75-137,949. FILED P.R. 7-22-1996; AM. S.R. 6-19-1997. SUPPLEMENTAL REGISTER.



ELEMENTS CORRECTED
DISCLAIMER

NO CLAIM IS MADE TO THE EXCLUSIVE RIGHT TO USE "LOG HOMES", APART FROM THE MARK AS SHOWN.
INT. CL. 16/U.S. CLS. 2, 5, 22, 23, 29, 37, 38 AND 50
FOR MAGAZINES IN THE FIELD OF MANUFACTURING AND DECORATING OF LOG HOMES.
FIRST USE 9-27-1994; IN COMMERCE 9-27-1994.

1,914,833. REG. 8-29-1995. WATT PUBLISHING COMPANY (ILLINOIS CORPORATION) 122 S. WESLEY AVENUE, MOUNT MORRIS, IL, 610541497, SN 74-404,404. FILED 6-22-1993. PRINCIPAL REGISTER.

ELEMENTS AMENDED
OWNER NAME
OWNER ADDRESS
CITIZENSHIP
ENTITY
MARK



OWNER OF U.S. REG. NO. 906,210.
SEC. 2(F).
INT. CL. 16/U.S. CLS. 2, 5, 22, 23, 29, 37, 38 AND 50
FOR MAGAZINES DIRECTED TO MEAT, POULTRY AND SEAFOOD PROCESSORS AND DISTRIBUTORS.
FIRST USE 3-19-1993; IN COMMERCE 3-19-1993.

2,106,819. REG. 10-21-1997. DEAN INTELLECTUAL PROPERTY SERVICES I.L.P. (DELAWARE LIMITED PARTNERSHIP) SUITE 1200, 2515 MCKINNEY AVENUE, DALLAS, TX, 75201, SN 75-153,086. FILED 8-20-1996. PRINCIPAL REGISTER.

MCARTHUR

ELEMENTS AMENDED
MARK

SEC. 2(F).
INT. CL. 29/U.S. CL. 46
FOR DAIRY PRODUCTS, NAMELY, MILK, HALF AND HALF, WHIPPING CREAM, COTTAGE CHEESE, SOUR CREAM, NON-DAIRY COFFEE CREAMER, YOGURT.
FIRST USE 0-0-1970; IN COMMERCE 0-0-1990.
INT. CL. 30/U.S. CL. 46
FOR FROZEN YOGURT, ICE CREAM, FROZEN CONFECTIONS AND SHERBET.
FIRST USE 0-0-1970; IN COMMERCE 0-0-1990.
INT. CL. 32/U.S. CLS. 45, 46 AND 48

FOR ORANGE JUICE AND LEMON DRINK.
FIRST USE 0-0-1970; IN COMMERCE 0-0-1990.

ELEMENTS CORRECTED
OWNER NAME
OWNER ADDRESS
ENTITY
CITIZENSHIP

2,120,965. REG. 12-16-1997. SERVICEMASTER BRANDS, L.L.C. (VERMONT LTD LIAB CO) 100 BANK STREET, BURLINGTON, VT, 05401, SN 75-103,181. FILED 5-13-1996. PRINCIPAL REGISTER.



AMERICAN RESIDENTIAL SERVICES

NO CLAIM IS MADE TO THE EXCLUSIVE RIGHT TO USE "AMERICAN RESIDENTIAL SERVICES, INC.", APART FROM THE MARK AS SHOWN.

THE LINING IS A FEATURE OF THE MARK AND IS NOT INTENDED TO DESIGNATE COLOR.
INT. CL. 37/U.S. CLS. 100, 103 AND 106

FOR INSTALLATION, MAINTENANCE, REPAIR AND REPLACEMENT OF AIR CONDITIONING AND HEATING EQUIPMENT, PLUMBING, AND ELECTRICAL SYSTEMS.

FIRST USE 9-27-1996; IN COMMERCE 9-27-1996.

ELEMENTS AMENDED
OWNER NAME
OWNER ADDRESS
CITIZENSHIP
ENTITY
MARK

2,124,616. REG. 12-30-1997. ACOME SOCIETE COOPERATIVE DE PRODUCTION, SOCIETE ANONYME A CAPITAL VARIABLE (FRANCE CORPORATION) 14, RUE DE MARGNAN, PARIS, FRANCE, 75008, SN 74-545,356. FILED 7-5-1994. PRINCIPAL REGISTER.



OWNER OF FRANCE REG. NO. 1315230, DATED 7-5-1985, EXPIRES 7-5-2005.

OWNER OF U.S. REG. NO. 1,574,464.

THE LINING SHOWN IN THE DRAWING IS A FEATURE OF THE MARK AND DOES NOT INDICATE COLOR.

INT. CL. 9/U.S. CLS. 21, 23, 26, 36 AND 38

FOR ELECTRICAL MATERIAL, NAMELY, ELECTRICAL CONNECTIONS FOR CONDUCTORS AND/OR CABLES AND/OR OTHER WIRES, ELECTRICAL CONDUCTORS, ELECTRICAL HEATING CABLES, THERMOSTATS; ELECTRICAL WIRES AND CABLES, FIBRE OPTIC CABLES OR OTHER WIRES NOT OF METAL.
INT. CL. 11/U.S. CLS. 13, 21, 23, 31 AND 34

FOR INSTALLATIONS FOR HEATING, REFRIGERATING, WATER SUPPLY AND SANITARY PURPOSES, NAMELY, (1) REGULATORS FOR PIPES AND OR TUBES FOR THE DISTRIBUTION OF HOT WATER, COLD WATER, AND OR LOW TEMPERATURE WATER, WATER FOR SANITARY PURPOSES, FOR SUPPLYING RADIATORS, (2) HIGH VERTICAL PIPING SYSTEMS NOT OF METAL, NAMELY, TUBE COLUMN, RISER PIPES, RISING MAIN, SUPPLY PIPES.
INT. CL. 17/U.S. CLS. 1, 5, 12, 13, 35 AND 50

FOR INSTALLATIONS FOR HEATING, REFRIGERATING, WATER SUPPLY AND SANITARY PURPOSES, NAMELY, (1) PIPING SYSTEMS NOT OF METAL, NAMELY, TUBES, PIPES, PRE ASSEMBLED MAINFOLDS, MANIFOLDS AND TAPES, (2) POLYETHYLENE TUBES AND PIPES; PIPES FOR HEATING NOT OF METAL, PIPES FOR WATER SUPPLY NOT OF METAL; PACKING, STOPPING AND INSULATING MATERIALS, NAMELY, INSULATORS FOR CABLE, DIELECTRIC INSULATORS, INSULATORS FOR ELECTRIC DUCTS, SEAL PACKINGS, POLYSTYRENE THERMAL INSULATING AND SOUNDPROOFING SLABS, PERIPHERAL THERMAL INSULATING AND SOUNDPROOFING STRIPS OF POLYETHYLENE FOAM OR OF POLYURETHANE FOAM.

ELEMENTS CORRECTED
OWNER NAME

2,305,254. REG. 1-4-2000. ACSYS, INC. (GEORGIA CORPORATION) 2000 PENNSYLVANIA AVENUE, N.W. SUITE 7650, WASHINGTON, DC, 20006, SN 75-404,683. FILED 12-12-1997. PRINCIPAL REGISTER.

**STAFFING.SERVICE.
SOLUTIONS**

INT. CL. 35/U.S. CLS. 100, 101 AND 102

FOR PROVIDING TEMPORARY STAFFING AND PERMANENT JOB RECRUITMENT OPPORTUNITIES IN THE AREAS OF ACCOUNTING, BANKING, HUMAN RESOURCES, LEGAL, INFORMATION TECHNOLOGY, FINANCE, ADMINISTRATION, SALES, GRAPHICS AND DESIGN, AND PROFESSIONAL SERVICES.

FIRST USE 11-0-1997; IN COMMERCE 11-0-1997.

ELEMENTS CORRECTED
OWNER NAME

2,317,697. REG. 2-15-2000. ACSYS, INC. (GEORGIA CORPORATION) 2000 PENNSYLVANIA AVENUE, N.W. SUITE 7650, WASHINGTON, DC, 20006, SN 75-404,682. FILED 12-12-1997. PRINCIPAL REGISTER.



THE STIPLING ON THE DRAWING INDICATES SHADING ONLY AND DOES NOT INDICATE COLOR.
INT. CL. 35/U.S. CLS. 100, 101 AND 102

FOR PROVIDING TEMPORARY STAFFING AND PERMANENT JOB RECRUITMENT OPPORTUNITIES IN THE AREAS OF ACCOUNTING, BANKING, HUMAN RESOURCES, LEGAL, INFORMATION TECHNOLOGY, FINANCE, ADMINISTRATION, SALES, GRAPHICS AND DESIGN, AND PROFESSIONAL SERVICES.

FIRST USE 11-0-1997; IN COMMERCE 11-0-1997.

ELEMENTS CORRECTED
OWNER NAME



2,471,956. REG. 7-24-2001. ACBEL POLYTECH INC. (TAIWAN CORPORATION) 10F., NO. 145, SEC. 2, CHUNG SHAN N. RD., TAIPEI, TAIWAN., SN 75-546,104. FILED 9-1-1998. PRINCIPAL REGISTER.

ACBEL

INT. CL. 9/U.S. CLS. 21, 23, 26, 36 AND 38

FOR ELECTRICAL REGULATORS; RELAYS; CIRCUIT BREAKERS; ELECTRONIC BALLAST FOR ELECTRIC LIGHTING; ELECTRICAL CONNECTORS; MAGNETIC CHOKES; AC POWER PROTECTORS; VOLTAGE SURGE PROTECTORS; VOLTAGE CONVERTERS; AC/DC CONVERTERS; DC/DC CONVERTERS; VOLTAGE REGULATORS; POWER SUPPLIES; UNINTERRUPTED POWER SUPPLIES; BATTERY CHARGERS; POWER LINE FILTERS; ELECTRICAL FILTERS; HIGH EFFICIENCY FLUORESCENT LAMP BALLAST; MODEMS; COMPUTER TERMINALS; COMPUTER DISC DRIVES; ELECTRIC PRINTERS; [TELEPHONES;] FACSIMILE MACHINES; AND MAGNETIC CODED/IC CARD READERS.

FIRST USE 12-12-2000; IN COMMERCE 12-12-2000.

ELEMENTS AMENDED
GOODS/SERVICES



2,495,665. REG. 10-9-2001. VELTEK ASSOCIATES, INC. (PENNSYLVANIA CORPORATION) 1039 WEST BRIDGE STREET, PHOENIXVILLE, PA, 194604218, SN 75-886,611. FILED 12-13-1999. PRINCIPAL REGISTER.

DECON-AHOL WFI

OWNER OF U.S. REG. NO. 2,369,869.
NO CLAIM IS MADE TO THE EXCLUSIVE RIGHT TO USE "WFI", APART FROM THE MARK AS SHOWN.
INT. CL. 5/U.S. CLS. 6, 18, 44, 46, 51 AND 52

FOR GENERAL PURPOSE GERMICIDE, NAMELY, STERILE ISOPROPYL ALCOHOL FOR USE AS A DECONTAMINATE .
FIRST USE 12-0-1998; IN COMMERCE 12-0-1998.

ELEMENTS CORRECTED
DATE OF FIRST USE
DATE OF FIRST USE IN COMMERCE



2,512,647. REG. 11-27-2001. K.L.M. (H.K.) LTD (HONG KONG CORPORATION) UNIT 7, 12/F, FU HANG IND. BLDG., 1 HOK YUEN ST., E., HUNGHORN KOWLOON, HONG KONG., SN 76-226,592. FILED 3-19-2001. PRINCIPAL REGISTER.

KLM

INT. CL. 14/U.S. CLS. 2, 27, 28 AND 50
FOR JEWELRY.
FIRST USE 12-0-2000; IN COMMERCE 12-0-2000.

ELEMENTS CORRECTED
OWNER NAME



2,537,874. REG. 2-12-2002. G DATA SOFTWARE GMBH (FED REP GERMANY LIMITED LIABILITY COMPANY) SIEMENSSTRASSE 16, D-44793 BOCHUM, FED REP GERMANY., SN 76-078,544. FILED 6-27-2000. PRINCIPAL REGISTER.



PRIORITY CLAIMED UNDER SEC. 44(D) ON FED REP GERMANY APPLICATION NO. 30004489, FILED 1-24-2000, REG. NO. 30004489, DATED 5-17-2000, EXPIRES 1-31-2010.

NO CLAIM IS MADE TO THE EXCLUSIVE RIGHT TO USE "DATA", APART FROM THE MARK AS SHOWN.

THE MARK CONSISTS OF THE WORDS G DATA IN A UNIQUE BLOCK PRINT STYLE. THE SMALL SQUARE IN THE MIDDLE ON THE LEFT SIDE OF THE LETTER "D" IS RED, AND COLOR IS CLAIMED AS A FEATURE OF THE MARK

INT. CL. 9/U.S. CLS. 21, 23, 26, 36 AND 38

FOR COMPUTER SOFTWARE PROGRAMS FOR ACCESSING GLOBAL COMPUTER NETWORKS AND INTRA-OFFICE NETWORKS FOR GENERAL USE; COMPUTER SOFTWARE IN THE NATURE OF CD-ROM'S CONTAINING PRE-RECORDED TELEPHONE NUMBERS AND ADDRESSES, ROUTE PLANNERS CONSISTING OF DIGITAL MAPS AND TRAFFIC INFORMATION USED TO PLAN TRAVEL ROUTES, ADDRESS MANAGERS WHICH HELP USERS ENTER AND MANAGE ADDRESSES IN COMPUTER DATABASES, HOTEL GUIDES CONTAINING INFORMATION ABOUT HOTELS, LANGUAGE TECHNOLOGY IN THE NATURE OF COMPUTER SOFTWARE USED FOR SPEECH SYNTHESIS (TEXT-TO-SPEECH), VOICE RECOGNITION (SPEECH-TO-TEXT), PRE-RECORDED SOFTWARE CONTAINING DICTIONARIES IN NUMEROUS LANGUAGES AND TRANSLATIONS FROM ONE LANGUAGE TO ANOTHER, DATA SAFETY IN THE NATURE OF SECURITY SOFTWARE USED TO PREVENT THEFT OF DATA BY OTHER PARTIES, PROTECTION AGAINST VIRUSES, AND SOFTWARE FOR CODING AND ENCODING; AND OFFICE SYSTEMS COMPRISED OF ALL OF THE ABOVE.
FIRST USE ; IN COMMERCE .

ELEMENTS CORRECTED
FOREIGN REG. NO.

2,566,512. REG. 5-7-2002. LANG, PHILIP S. (UNITED STATES INDIVIDUAL) 2420 - 223RD PL. NE, REDMOND, WA, 98053, SN 75-897,409. FILED 1-7-2000. PRINCIPAL REGISTER.

THE WINE STEWARD

NO CLAIM IS MADE TO THE EXCLUSIVE RIGHT TO USE "WINE", APART FROM THE MARK AS SHOWN.
INT. CL. 35/U.S. CLS. 100, 101 AND 102
FOR ADVERTISING AND MARKETING, NAMELY, CREATING AND PLACING ADVERTISING AND INFORMATIONAL MATERIAL FOR WINE INDUSTRY MEMBERS, FEATURING WINE AND WINE PRODUCTS.
FIRST USE 6-1-1993; IN COMMERCE 6-1-1993.

ELEMENTS CORRECTED
OWNER NAME

2,602,330. REG. 7-30-2002. KOIKE ARONSON, INC. (DELAWARE CORPORATION) 635 MAIN STREET, ARCADE, NY, 14009, SN 76-121,355. FILED 9-1-2000. PRINCIPAL REGISTER.

PLATE-PRO

INT. CL. 7/U.S. CLS. 13, 19, 21, 23, 31, 34 AND 35
FOR COMPUTER NUMERICALLY CONTROLLED (CNC) CUTTING MACHINES, NAMELY, CNC MACHINES FOR CUTTING AND SHAPING METAL.
FIRST USE 8-11-2000; IN COMMERCE 8-11-2000.

ELEMENTS CORRECTED
OWNER ADDRESS

2,632,145. REG. 10-8-2002. ADVANCED K, LLC (DELAWARE LIMITED LIABILITY COMPANY) 515 FLAGLER DRIVE, SUITE 300P, WEST PALM BEACH, FL, 33401, SN 75-640,434. FILED 2-11-1999. PRINCIPAL REGISTER.

DAILY 15

INT. CL. 3/U.S. CLS. 1, 4, 6, 50, 51 AND 52
FOR COSMETICS; NAMELY, SKIN CREAMS, SKIN LOTIONS, SKIN CLEANSERS; SKIN MAKEUP REMOVERS, SKIN MASKS, SKIN MOISTURIZERS AND EYE CREAMS.
FIRST USE 12-1-2000; IN COMMERCE 4-23-2001.

ELEMENTS CORRECTED
CITIZENSHIP

2,637,135. REG. 10-15-2002. LOVELAND INDUSTRIES, INC. (COLORADO CORPORATION) 14520 WELD COUNTY ROAD 64, GREELEY, CO, 80632, SN 76-266,136. FILED 6-5-2001. PRINCIPAL REGISTER.

VINEAGRA

INT. CL. 1/U.S. CLS. 1
FOR FERTILIZER FOR AGRICULTURAL USE.
FIRST USE 6-6-2002; IN COMMERCE 6-6-2002.

ELEMENTS CORRECTED
MARK

2,667,976. REG. 12-31-2002. SKILLSOFT CORPORATION (DELAWARE CORPORATION) 20 INDUSTRIAL PARK DRIVE, NASHUA, NH, 03062, SN 76-178,686. FILED 12-10-2000. PRINCIPAL REGISTER.

SKILLSOFT

OWNER OF U.S. REG. NO. 2,469,531.
INT. CL. 42/U.S. CLS. 100 AND 101
FOR COMPUTER SERVICES, NAMELY, TEMPORARY USE OF NON-DOWNLOADABLE EDUCATION COMPUTER SOFTWARE FOR PROVIDING, CREATING, AND DEPLOYING COMPUTER-BASED COURSES OF STUDY IN THE FIELDS OF BUSINESS SKILLS EDUCATION AND PROFESSIONAL DEVELOPMENT, AND FOR TRACKING AND REPORTING LEARNING RESULTS RELATED TO THE COURSES OF STUDY; EDUCATIONAL CONSULTING SERVICES, NAMELY, PLANNING, DEVELOPMENT, IMPLEMENTATION, AND ADMINISTRATION OF COMPUTER BASED EDUCATIONAL PROGRAMS IN THE FIELDS OF BUSINESS SKILLS EDUCATION AND PROFESSIONAL DEVELOPMENT.
FIRST USE 2-1-1999; IN COMMERCE 3-15-1999.

ELEMENTS CORRECTED
DATE OF FIRST USE
DATE OF FIRST USE IN COMMERCE

2,684,301. REG. 2-4-2003. WETSUITS SOUTH AFRICA (PTY) LIMITED (SOUTH AFRICA CORPORATION) 6 SPENCER ROAD SALT RIVER, 7926, CAPE TOWN, SOUTH AFRICA., SN 76-102,835. FILED 8-4-2000. PRINCIPAL REGISTER.

2,705,250. REG. 4-8-2003. ANGELETTA, JOSEPH G. (UNITED STATES INDIVIDUAL) 418 5TH STREET, MAMARONECK, NY, 10543, SN 76-231,164. FILED 3-27-2001. PRINCIPAL REGISTER.

FRONTLINE



INT. CL. 25/U.S. CLS. 22 AND 39
FOR WETSUITS.
FIRST USE 0-0-1987; IN COMMERCE 0-0-1999.

ELEMENTS CORRECTED
ENTITY

OWNER OF U.S. REG. NOS. 1,546,470, 1,897,554 AND 1,902,828.

NO CLAIM IS MADE TO THE EXCLUSIVE RIGHT TO USE FUN UNDER THE SUN, APART FROM THE MARK AS SHOWN.

INT. CL. 3/U.S. CLS. 1, 4, 6, 50, 51 AND 52.

FOR LOTIONS, NAMELY, SUNSCREEN; SUN BLOCK; SUNTAN OIL; SUN BLOCK PREPARATIONS; SUNSCREEN PREPARATIONS; SUNTAN PREPARATIONS.

FIRST USE 7-0-2002; IN COMMERCE 7-0-2002.

ELEMENTS AMENDED
DISCLAIMER

2,697,417. REG. 3-18-2003. AMRO BIOTECH PLC (UNITED KINGDOM CORPORATION) 123 GOLDSWORTH ROAD, WOKING, SURREY, GU21 1LR, UNITED KINGDOM., SN 76-350,394. FILED 12-18-2001. PRINCIPAL REGISTER.

2,707,652. REG. 4-15-2003. INTERSPORT, INC. (MARYLAND CORPORATION) 3220 RODERICK ROAD, FREDERICK, MD, 21704, SN 76-186,083. FILED 12-22-2000. PRINCIPAL REGISTER.

AMRO

ZUBAT

INT. CL. 25/U.S. CLS. 22 AND 39

FOR SPORTS CLOTHING FOR SURF, WAKE AND SKATEBOARD WEAR, NAMELY, SNOWBOARD JACKETS, PANTS, BOOTS, SURF AND [WAKE BOARD WETSUITS] * WAKEBOARD WETSUITS * ,RASH GUARDS, AND BOARD SHORTS.

FIRST USE 3-0-2002; IN COMMERCE 3-0-2002.

ELEMENTS CORRECTED
GOODS/SERVICES

PRIORITY CLAIMED UNDER SEC. 44(D) ON UNITED KINGDOM APPLICATION NO. 2273314, FILED 6-21-2001, REG. NO. 2273314, DATED 6-21-2001, EXPIRES 6-21-2011.

INT. CL. 5/U.S. CLS. 6, 18, 44, 46, 51 AND 52

FOR PHARMACEUTICAL AND VETERINARY PREPARATIONS FOR USE IN PROPHYLAXIS AND TREATMENT OF AUTOIMMUNE DISEASES AND DISEASES RELATED TO GLUCOSE INTOLERANCE OR IMPAIRED GLUCOSE TOLERANCE; CLINICAL, MEDICAL AND VETERINARY REAGENTS; MEDICAL DIAGNOSTIC REAGENTS; CHEMICAL REAGENTS FOR THE DIAGNOSIS OF AUTOIMMUNE DISEASE AND OTHER DISEASES RELATED TO GLUCOSE INTOLERANCE OR IMPAIRED GLUCOSE TOLERANCE.

FIRST USE : IN COMMERCE .

INT. CL. 42/U.S. CLS. 100 AND 101

FOR CHEMICAL RESEARCH; BIOTECHNOLOGY RESEARCH; CONTRACT RESEARCH IN THE FIELD OF MEDICINE; SCIENTIFIC RESEARCH; LABORATORY RESEARCH AND TESTING IN THE [FILED] * FIELD * OF PHARMACEUTICALS; CHEMICAL ANALYSIS; TECHNOLOGICAL RESEARCH IN THE FIELD OF MEDICINE; ADVISORY AND CONSULTANCY SERVICES IN CONNECTION WITH THE AFORESAID SERVICES.

FIRST USE : IN COMMERCE .

ELEMENTS CORRECTED
GOODS/SERVICES

2,713,427. REG. 5-6-2003. RUSSELL ASSET MANAGEMENT, INC. (DELAWARE CORPORATION) 300 DELAWARE AVE., STE 900, WILMINGTON, DE, 19801, SN 76-434,336. FILED 7-22-2002. PRINCIPAL REGISTER.

DRILAYER

INT. CL. 25/U.S. CLS. 22 AND 39

FOR ACTIVEWEAR, NAMELY TOPS, SHORTS, PANTS, SWEATSHIRTS, JACKETS, SOCKS, GLOVES, HATS, TIGHTS AND UNDERWEAR INCLUDING SPORTS BRAS, CAMISOLES, BRIEFS AND UNDERPANTS.

FIRST USE 6-30-2000; IN COMMERCE 1-1-2001.

ELEMENTS CORRECTED
OWNER NAME

2,717,335. REG. 5-20-2003. SL ENVIRONETICS GROUP INCORPORATED (CALIFORNIA CORPORATION) 8530 VENICE BOULEVARD, LOS ANGELES, CA, 90034, SN 76-414,394. FILED 5-29-2002. PRINCIPAL REGISTER.

ENVIRONETICS

INT. CL. 42/U.S. CLS. 100 AND 101
FOR ARCHITECTURAL DESIGN SERVICES; INTERIOR DESIGN AND DECORATION CONSULTATION.
FIRST USE 2-1-1963; IN COMMERCE 2-1-1963.

ELEMENTS AMENDED
DATE OF FIRST USE

2,730,300. REG. 6-24-2003. NEUENHAUSER MASCHINENBAU GMBH (FED REP GERMANY CORPORATION) LADESTASSE 5, 49828 NEUENHAUS, FED REP GERMANY., SN 76-321,772. FILED 10-5-2001. PRINCIPAL REGISTER.

TWISTER

INT. CL. 7/U.S. CLS. 13, 19, 21, 23, 31, 34 AND 35
FOR SOIL PREPARATION DEVICES, MACHINES AND SOIL PREPARATION SYSTEMS NAMELY, SCREENING AND SCREEN-CRUSHING MACHINES, SOIL SEPARATING AND SOIL CONDITIONING MACHINES, CONVEYERS, BUCKET SEPARATORS, SCREEN WALLED BUCKETS, BUCKETS FOR BACKHOES AND BACKHOE LOADERS, EARTH MOVING MACHINES, STATIONARY AND FIXED SCREENS FOR SOIL PREPARATION, CRUSHING MILLS, CRUSHERS AND CRUSHING DEVICES, COMMINUTION MACHINES AND REPLACEMENT PARTS THEREFOR.
FIRST USE 12-31-1997; IN COMMERCE 1-1-2000.

ELEMENTS CORRECTED
OWNER NAME

2,738,300. REG. 7-15-2003. KONINKLIJKE VAN ZANTEN B.V. (NETHERLANDS CORPORATION) LE LOOSTERWEG LA, 2182 BL HILLEGOM, NETHERLANDS., SN 76-307,477. FILED 8-29-2001. PRINCIPAL REGISTER.

ROYAL VAN ZANTEN

INT. CL. 31/U.S. CLS. 1 AND 46
FOR ORNAMENTAL CULTIVATION PRODUCTS, NAMELY SEEDS, CUTTINGS, PARTS OF LIVE PLANTS, LIVE PLANTS AND FLOWERS.
FIRST USE 11-1-2001; IN COMMERCE 11-0-2001.
INT. CL. 35/U.S. CLS. 100, 101 AND 102
FOR RETAIL STORE SERVICES; WHOLESALE STORE SERVICES; IMPORT AND EXPORT SERVICES IN THE AREA OF ORNAMENTAL CULTIVATION PRODUCTS, NAMELY SEEDS, CUTTINGS, PARTS OF LIVE PLANTS, LIVE PLANTS AND FLOWERS.
FIRST USE 11-1-2001; IN COMMERCE 11-1-2001.
INT. CL. 42/U.S. CLS. 100 AND 101

FOR PROVIDING PROFESSIONAL ADVISE IN THE AREA OF GROWING ORNAMENTAL CULTIVATION PRODUCTS IN THE AREA OF REPRODUCTION, PLANT IMPROVEMENTS, CULTIVATION, CULTIVATION USING TECHNIQUES SUCH AS SOILLESS GROWING OF PLANTS, EXPLANT GROWING AND HYDROPONICS GROWING .
FIRST USE 11-1-2001; IN COMMERCE 11-1-2001.

ELEMENTS CORRECTED
OWNER NAME

2,739,609. REG. 7-22-2003. SAGE, GIGI TOMASEK (UNITED STATES INDIVIDUAL) 100 CONGRESS AVE., AUSTIN, TX, 78701, SN 76-297,416. FILED 8-9-2001. PRINCIPAL REGISTER.

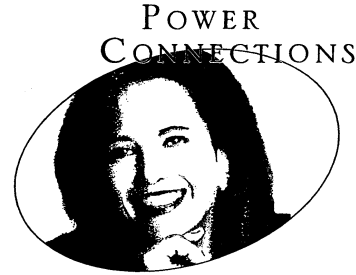

PRIORITY CLAIMED UNDER SEC. 44(D) ON ERP N CMNTY TM OFC APPLICATION NO. 002086171, FILED 2-12-2001, REG. NO. 002086171, DATED 4-18-2002, EXPIRES 2-12-2011.
THE STIPPLING IN THE MARK IS FOR SHADING PURPOSES ONLY AND IS A FEATURE OF THE MARK AND IS NOT INTENDED TO INDICATE COLOR.
THE PERSON SHOWN IN THE MARK IDENTIFIES A LIVING INDIVIDUAL WHOSE CONSENT IS OF RECORD.
INT. CL. 35/U.S. CLS. 100, 101 AND 102
FOR RESTAURANT SERVICES, NAMELY, PROVIDING FOOD AND DRINK.
FIRST USE ; IN COMMERCE .
INT. CL. 42/U.S. CLS. 100 AND 101
FOR PROVIDING TEMPORARY HOUSING ACCOMMODATIONS AND BEAUTY SALONS AND SPA SERVICES.
FIRST USE ; IN COMMERCE .

ELEMENTS CORRECTED
OWNER NAME
OWNER ADDRESS
CITIZENSHIP
ENTITY

2,745,031. REG. 7-29-2003. WILLITTS DESIGNS INTERNATIONAL, INC. (CALIFORNIA CORPORATION) 1129 INDUSTRIAL AVE., PETALUMA, CA, 94952, AND COUNTRY ARTISTS LTD. (UNITED KINGDOM LIMITED COMPANY) LOXLEY ROAD, WELLESBOURNE, STRATFORD-UPON-AVON, WARWICKSHIRE, ENGLAND, CV35 9JY, SN 78-079,915. FILED 8-17-2001. PRINCIPAL REGISTER.

A BREED APART

INT. CL. 20/U.S. CLS. 2, 13, 22, 25, 32 AND 50

FOR FIGURINES MADE OF PLASTIC RESIN.
FIRST USE 12-20-2001; IN COMMERCE 5-15-2002.

2,749,392. REG. 8-12-2003. COMITE INTERNATIONAL DE
LA CROIX-ROUGE (SWITZERLAND COMPANY) 19,
AVENUE DE LA PAIX, 1202, GENEVA,, SWITZERLAND.,
SN 76-304,266. FILED 8-23-2001. PRINCIPAL REGISTER.

ELEMENTS CORRECTED
OWNER NAME

2,745,918. REG. 8-5-2003. KINGDREAM PUBLIC LIMITED
COMPANY (CHINA CORPORATION) NO. 456 LUOYU
ROAD, HONGSHAN DISTRICT, WUHAN CITY, HUBEI
PROVINCE, P.R., CHINA,, SN 76-235,107. FILED 4-4-2001.
PRINCIPAL REGISTER.

CRISTAL ROUGE



OWNER OF CHINA REG. NO. 1400184, DATED 5-21-2000,
EXPIRES 5-20-2010.

OWNER OF CHINA REG. NO. 1381931, DATED 4-7-2000,
EXPIRES 4-6-2010.

INT. CL. 6/U.S. CLS. 2, 12, 13, 14, 23, 25 AND 50

FOR METALS, NAMELY, STEEL ALLOYS, METAL
POWDERS, ANTI-FRICTION METALS, AND COMMON
METAL ALLOYS IN BARS, SHEETS, AND BILLETS.

FIRST USE ; IN COMMERCE .

INT. CL. 7/U.S. CLS. 13, 19, 21, 23, 31, 34 AND 35

FOR MACHINERY, NAMELY, DRILLING MACHINES
FOR GEOLOGICAL EXPLORATION, MACHINES FOR
MINING AND MINE ORE SEPARATION, OIL AND GAS
DRILLING MACHINES, AND MACHINES FOR PETRO-
LEUM REFINING.

FIRST USE ; IN COMMERCE .

ELEMENTS CORRECTED

FOREIGN COUNTRY OF ORIGIN

FOREIGN REG. NO.

FOREIGN REG. DATE

FOREIGN REG. EXPIRATION DATE

2,747,422. REG. 8-5-2003. WRENCHHEAD, INC. (DELAWARE
CORPORATION) 108 CORPORATE DRIVE, WHITE
PLAINS, NY, 10604, SN 78-171,757. FILED 10-7-2002.
PRINCIPAL REGISTER.

WRENCHHEAD PRO MANAGER

OWNER OF U.S. REG. NOS. 2,332,262, 2,332,995 AND
2,335,748.

NO CLAIM IS MADE TO THE EXCLUSIVE RIGHT TO
USE "PRO MANAGER", APART FROM THE MARK AS
SHOWN.

INT. CL. 9/U.S. CLS. 21, 23, 26, 36 AND 38

FOR COMPUTER SOFTWARE THAT ENABLES BUSI-
NESSES TO ORDER AUTOMOTIVE PARTS AND AUTO-
MOTIVE PRODUCTS FROM SUPPLIERS OVER A
GLOBAL COMPUTER NETWORK; COMPUTER SOFT-
WARE FOR MANAGING AUTOMOTIVE SERVICE BUSI-
NESSES.

FIRST USE 9-1-2000; IN COMMERCE 9-1-2000.

ELEMENTS AMENDED
OWNER ADDRESS

PRIORITY CLAIMED UNDER SEC. 44(D) ON SWITZER-
LAND APPLICATION NO. 02402/2001, FILED 3-7-2001, REG.
NO. 485829, DATED 6-14-2001.

ENGLISH TRANSLATION OF "CRISTAL ROUGE" IS
"RED CRYSTAL".

INT. CL. 39/U.S. CLS. 100 AND 105

FOR FREIGHT TRANSPORTATION BY PLANE, BY
TRUCK, BY TRAIN OR BY BOAT; TRANSPORT OF
PERSONS BY PLANE, RAIL, BOAT, TRUCKS, BUSES
AND AMBULANCES; PACKAGING AND STORAGE OF
GOODS * BUT NOT INCLUDING CRUISE SHIP SER-
VICES, AND NOT INCLUDING ANY SERVICES SIMI-
LAR OR RELATED TO CRUISE SHIP SERVICES *.

FIRST USE ; IN COMMERCE .

INT. CL. 41/U.S. CLS. 100, 101 AND 107

FOR EDUCATION, NAMELY, CONDUCTING WORK-
SHOPS AND PROVIDING COURSES OF INSTRUCTION
AT PRIMARY, SECONDARY AND COLLEGE LEVEL IN
THE FIELD OF INTERNATIONAL LAW, HUMANITARI-
AN LAW, MEDICINE, HOSPITAL ADMINISTRATION
AND ARCHITECTURE, AGRICULTURAL METHODS,
VETERINARY CARE AND SANITATION METHODS,
AND DISTRIBUTING COURSE MATERIAL IN CON-
NECTION THEREWITH; ENTERTAINMENT IN THE
NATURE OF VISUAL AND AUDIO PERFORMANCES,
NAMELY, LIVE MUSICAL BAND, GYMNASTIC,
DANCE, OPERA AND BALLET PERFORMANCES; EN-
TERTAINMENT SERVICES, NAMELY, PROVIDING A
WEB SITE FEATURING MUSICAL PERFORMANCES,
MUSICAL VIDEOS, RELATED FILM CLIPS, PHOTO-
GRAPHS, AND OTHER MULTIMEDIA MATERIALS;
ENTERTAINMENT SERVICES, NAMELY, PROVIDING
RADIO AND TELEVISION PROGRAMS IN THE FIELD
OF VARIETY, NEWS, INTERNATIONAL AND HUMA-
NITARIAN LAW VIA A GLOBAL COMPUTER NET-
WORK OR DISTRIBUTED OVER TELEVISION,
SATELLITE, AUDIO, AND VIDEO MEDIA; ORGANIZ-
ING COMMUNITY AND CHARITY FESTIVALS AND
EXHIBITIONS FEATURING SPORTING EVENTS, ART
EXHIBITIONS, FLEA MARKETS, ETHNIC DANCES.

FIRST USE ; IN COMMERCE .

INT. CL. 42/U.S. CLS. 100 AND 101

FOR MEDICAL ASSISTANCE SERVICES, NAMELY,
FIRST AID SERVICES, MEDICAL AND SURGICAL
TREATMENTS; ORTHOPEDIC TREATMENTS AND
PROSTHETIC IMPLANTATION; FOOD NUTRITION
CONSULTATION; LEGAL ASSISTANCE SERVICES; RELI-
EF ASSISTANCE SERVICES IN THE AGRICULTURAL,
VETERINARY AND SANITATION FIELD; RELIEF
SERVICES TO DISPLACED AND DISASTER STRICKEN
POPULATIONS IN RELATION TO DISASTER, HEALTH
AND HUNGER; CHARITABLE SERVICES, NAMELY,
PROVIDING FOOD, CLOTHING, AND MEDICINE;
MISSING PERSONS TRACING AND INVESTIGATION
SERVICES.

FIRST USE ; IN COMMERCE .

ELEMENTS AMENDED
GOODS/SERVICES

2,754,680. REG. 8-26-2003. OMEGATREND INTERNATIONAL PTY. LTD. (AUSTRALIA COMPANY) 216 STIRLING HIGHWAY, CLAREMONT, AUSTRALIA., SN 75-289,176. FILED 5-9-1997. PRINCIPAL REGISTER.



OMEGATREND

OWNER OF AUSTRALIA REG. NO. A634045, DATED 7-5-1994, EXPIRES 7-5-2004.

OWNER OF AUSTRALIA REG. NO. A634046, DATED 7-5-1994, EXPIRES 7-5-2004.

INT. CL. 16/U.S. CLS. 2, 5, 22, 23, 29, 37, 38 AND 50

FOR PRINTED PUBLICATIONS, NAMELY, BROCHURES AND CATALOGUES IN RELATION TO PRODUCTS, NAMELY, COSMETICS, PERSONAL CARE PRODUCTS, TOILETRIES, HOUSEHOLD CLEANING PRODUCTS, KITCHEN UTENSILS AND CONTAINERS, COOKWARE, FOOD PRODUCTS AND CLOTHING; PRINTED FLIP CHARTS; PRINTED FORMS AND PRINTED STATIONERY, NAMELY, ORDER FORMS, DIRECT DEBIT FORMS, APPLICATION FORMS, INVITATIONS AND WRITING PADS; PRINTED BUSINESS INFORMATION BROCHURES IN RELATION TO PRODUCTS, NAMELY, COSMETIC, PERSONAL CARE PRODUCTS, TOILETRIES, HOUSEHOLD CLEANING PRODUCTS, KITCHEN UTENSILS AND CONTAINERS, COOKWARE, FOOD PRODUCTS AND CLOTHING; PERSONAL BUSINESS PLANNERS AND REFILLS THEREFOR; DIARIES AND REFILLS FOR DIARIES; CALENDARS; MEMO PADS AND REFILLS FOR MEMO PADS; PRINTED INSTRUCTIONAL AND TRAINING MANUALS AND PRINTED INFORMATION SHEETS IN [RELATING] * RELATION * TO MARKETING AND SELLING OF PRODUCTS, NAMELY, COSMETICS, PERSONAL CARE PRODUCTS, TOILETRIES, HOUSEHOLD CLEANING PRODUCTS, KITCHEN UTENSILS AND CONTAINERS, COOKWARE, FOOD PRODUCTS AND CLOTHING; PLASTIC BAGS AND PLASTIC WRAP FOR WRAPPING MERCHANDISE .

FIRST USE ; IN COMMERCE .

INT. CL. 41/U.S. CLS. 100, 101 AND 107

FOR EDUCATIONAL SERVICES, NAMELY, CONDUCTING CLASSES, SEMINARS, LECTURES, CONFERENCES AND WORKSHOPS IN THE FIELDS OF DIRECT SELLING COSMETICS, LIFESTYLE, GROOMING AND BEAUTY CARE.

FIRST USE ; IN COMMERCE .

ELEMENTS CORRECTED
GOODS/SERVICES

2,755,159. REG. 8-26-2003. I432 (CALIFORNIA GENERAL PARTNERSHIP) 23161 VENTURA BOULEVARD, WOODLAND HILLS, CA, 91364, SN 76-317,650. FILED 9-25-2001. PRINCIPAL REGISTER.

I432

INT. CL. 14/U.S. CLS. 2, 27, 28 AND 50

FOR JEWELRY.

FIRST USE 9-0-2001; IN COMMERCE 9-0-2001.

ELEMENTS CORRECTED
ASSIGNMENT/NAME CHANGE
ENTITY

2,757,388. REG. 8-26-2003. DELONGHI AMERICA, INC. (DELAWARE CORPORATION) PARK 80 WEST, PLAZA ONE, 4TH FLOOR, SADDLE BROOK, NJ, 07663, SN 76-975,524. FILED 3-9-2001. PRINCIPAL REGISTER.

DÈLONGHI LIVING INNOVATION

OWNER OF U.S. REG. NOS. 1,200,965, 2,417,071 AND OTHERS.

INT. CL. 7/U.S. CLS. 13, 19, 21, 23, 31, 34 AND 35

FOR HOUSE MARK FOR A FULL LINE OF HOUSEHOLD ELECTRIC APPLIANCES, NAMELY, FOOD PROCESSORS, JUICE EXTRACTORS, HAND-HELD MIXERS, BLENDERS, MINCING MACHINES AND REPLACEMENT PARTS THEREFOR; AND FLOOR CARE APPLIANCES, NAMELY, ELECTRIC SWEEPERS, EXTRACTOR CLEANERS, VACUUM CLEANERS, AND HAND HELD STEAM CLEANERS, AND REPLACEMENT PARTS THEREFOR.

FIRST USE 3-1-2000; IN COMMERCE 3-1-2000.

INT. CL. 11/U.S. CLS. 13, 21, 23, 31 AND 34

FOR HOUSE MARK FOR A FULL LINE OF DOMESTIC HEATING APPLIANCES, NAMELY, FAN HEATERS, CONVECTORS, OIL FILLED ELECTRIC RADIATORS, WOOD AND COAL BURNING STOVES, KEROSENE HEATERS, CATALYTIC GAS HEATERS, NATURAL GAS HEATERS, INFRA-RED GAS HEATERS, AND INFRA-RED QUARTZ HEATERS, ELECTRIC CONTACT GRILLS, ELECTRIC BARBECUES, ELECTRIC DEEP FRYERS, ELECTRIC OVENS, MICROWAVE OVENS FOR COOKING, ELECTRIC TOASTER OVENS, ESPRESSO, CAPPUCINO AND FILTER COFFEE MACHINES, ELECTRIC PERCOLATORS, ELECTRIC TOASTERS, HAND HELD ELECTRIC HAIR DRYERS, AND REPLACEMENT PARTS THEREFOR; ELECTRIC ICE CREAM MAKERS AND REPLACEMENT PARTS THEREFOR AND AIR TREATMENT APPLIANCES, NAMELY, HUMIDIFIERS, DEHUMIDIFIERS, AIR PURIFIERS, ELECTRIC FANS, AND AIR CONDITIONERS, AND REPLACEMENT PARTS THEREOF.

FIRST USE 3-1-2000; IN COMMERCE 3-1-2000.

ELEMENTS CORRECTED

GOODS/SERVICES

INTERNATIONAL CLASS(ES)

DATE OF FIRST USE

DATE OF FIRST USE IN COMMERCE

2,757,788. REG. 9-2-2003. C.I.T. S.P.A. CONFEZIONI ITALIANE TESSILI COMMERCIO INDUSTRIA TESSUTI (ITALY CORPORATION) VIA DELL'ANNUNCIATA 27, 20121 MILANO, ITALY., SN 75-669,327. FILED 3-26-1999. PRINCIPAL REGISTER.

BAGUTTA

PRIORITY CLAIMED UNDER SEC. 44(D) ON ERPNTY TM OFC APPLICATION NO. 1057496, FILED 12-3-1998, REG. NO. 1057496, DATED 11-27-2002, EXPIRES 12-3-2008.

INT. CL. 9/U.S. CLS. 21, 23, 26, 36 AND 38

FOR SPECTACLES; SPECTACLE LENSES; SPECTACLE FRAMES; STRINGS AND SMALL CHAINS FOR SPECTACLES; SPECTACLE CASES.

ELEMENTS CORRECTED
OWNER NAME
OWNER ADDRESS

2,759,287. REG. 9-2-2003. TRUE SOURCE, INC. (ILLINOIS CORPORATION) 25 TRI-STATE INTERNATIONAL, SUITE 100, LINCOLNSHIRE, IL, 60069, SN 75-937,818. FILED 3-7-2000. PRINCIPAL REGISTER.

2,768,590. REG. 9-30-2003. LA NUOVA ADELCHI S.R.L. (ITALY LIMITED LIABILITY COMPANY) VIA PROVINCIALE MONTESANO - TRICASE, TRICASE (LECCE), ITALY., SN 76-085,885. FILED 7-10-2000. PRINCIPAL REGISTER.

PRACTICITY

INT. CL. 9/U.S. CLS. 21, 23, 26, 36 AND 38
FOR COMPUTER SOFTWARE, NAMELY, COMPUTER SOFTWARE FOR KNOWLEDGE MANAGEMENT AND ELECTRONIC COLLABORATION.
FIRST USE 6-3-2001; IN COMMERCE 6-3-2001.
INT. CL. 35/U.S. CLS. 100, 101 AND 102
FOR CONSULTING SERVICES IN THE FIELD OF ANALYZING AND IMPLEMENTING BUSINESS PROCESSES.
FIRST USE 6-3-2001; IN COMMERCE 6-3-2001.
INT. CL. 42/U.S. CLS. 100 AND 101
FOR CONSULTING SERVICES IN THE FIELD OF COMPUTER SOFTWARE.
FIRST USE 6-3-2001; IN COMMERCE 6-3-2001.

ELEMENTS CORRECTED
OWNER NAME
OWNER ADDRESS



PRIORITY CLAIMED UNDER SEC. 44(D) ON ITALY APPLICATION NO. MI2000C00641, FILED 5-31-2000, REG. NO. 00869092, DATED 6-10-2002, EXPIRES 5-31-2010.
THE STIPPLING IS A FEATURE OF THE MARK.
INT. CL. 25/U.S. CLS. 22 AND 39
FOR FOOTWEAR; RUBBER SOLES, LEATHER SOLES, PVC SOLES ALL FOR FOOTWEAR; SHOE INSERTS AND NON-ORTHOPEDIC INNER SOLES FOR FOOTWEAR.
FIRST USE ; IN COMMERCE .

ELEMENTS CORRECTED
FOREIGN REG. NO.

2,762,632. REG. 9-9-2003. PERSISTENCE SOFTWARE, INC. (DELAWARE CORPORATION) 1720 SOUTH AMPHLETT BLVD, SUITE 300, SAN MATEO, CA, 94402, SN 76-377,632. FILED 2-28-2002. PRINCIPAL REGISTER.

2,768,983. REG. 9-30-2003. HCC HOLDING, INC. (DELAWARE CORPORATION) SUITE 1300 1105 N. MARKET STREET, WILMINGTON, DE, 19801, SN 76-439,883. FILED 8-13-2002. PRINCIPAL REGISTER.

EDGEXTEND

INT. CL. 9/U.S. CLS. 21, 23, 26, 36 AND 38
FOR COMPUTER SOFTWARE TO ENHANCE DISTRIBUTED CACHING OF APPLICATION SERVERS.
FIRST USE 6-30-2002; IN COMMERCE 6-30-2002.

ELEMENTS CORRECTED
CITIZENSHIP



INT. CL. 19/U.S. CLS. 1, 12, 33 AND 50
FOR CEMENT, PORTLAND CEMENT, MASONRY CEMENT AND CEMENT BASED CONSTRUCTION MATERIALS.
FIRST USE 12-1-1916; IN COMMERCE 12-1-1916.

ELEMENTS CORRECTED
OWNER ADDRESS

2,767,222. REG. 9-23-2003. DISPORT DO BRASIL LTDA. (PARTNERSHIP), AV 20 DE SETEMBRO, Nº 4411, BAIRRO CENTRO EM SAPIRANGA (RS) 93800-00, BRAZIL., SN 76-075,623. FILED 6-22-2000. PRINCIPAL REGISTER.

DUMOND

OWNER OF U.S. REG. NOS. 1,797,084 AND 1,797,085.
INT. CL. 25/U.S. CLS. 22 AND 39
FOR FOOTWEAR, NAMELY SHOES, BOOTS, SANDALS, SLIPPERS[AND BELTS].
FIRST USE 11-29-2002; IN COMMERCE 11-29-2002.

ELEMENTS CORRECTED
GOODS/SERVICES
OWNER ADDRESS

2,771,919. REG. 10-7-2003. KISS A ME PRODUCTIONS, INC. (NEW YORK CORPORATION) 90 GARFIELD AVENUE, SAYVILLE, NY, 11782, SN 75-550,229. FILED 6-15-1998. PRINCIPAL REGISTER.

'KISS A' ME'

INT. CL. 28/U.S. CLS. 22, 23, 38 AND 50

FOR STUFFED TOY ANIMALS [AND ACCESSORIES THEREOF, CHILDREN'S GAMES, NAMELY, BOARD GAMES, CARD GAMES, CHILDREN'S PARTY GAMES, HAND HELD UNITS FOR PLAYING VIDEO GAMES].
FIRST USE 11-0-2000; IN COMMERCE 11-0-2000.

ELEMENTS CORRECTED
GOODS/SERVICES

FOR FINANCIAL SERVICES IN THE FIELD OF BANKING AND INVESTMENT BANKING, NAMELY, ACCEPTANCE OF DEPOSITS INCLUDING SUBSTITUTE BOND ISSUANCE, ACCEPTANCE OF FIXED INTERVAL INSTALLMENT DEPOSITS, LOANS, DISCOUNT OF BILLS AND NOTES, DOMESTIC REMITTANCE, LIABILITY GUARANTEE, ACCEPTANCE OF BILLS, LENDING SECURITIES, ACQUISITION OR TRANSFER OF MONETARY CLAIMS, SAFETY DEPOSIT BOX SERVICES, MONEY EXCHANGE, TRUSTEESHIP REPRESENTATIVE SERVICES, FIDUCIARY OF INVESTMENT TRUST, FOREIGN EXCHANGE TRANSACTIONS, LETTER OF CREDIT RELATED BUSINESS, INSTALLMENT PURCHASING AGENCY SERVICES, ISSUANCE OF TOKENS OF VALUE AND PRE-PAID CARDS, AGENCIES AND BROKERAGE FOR COLLECTION OF GAS CHARGES AND ELECTRICITY FEES, AGENCIES OR BROKERAGE FOR PAYMENT OF GAS CHARGES AND ELECTRICITY FEES, CREDIT CARD SERVICES; CONSULTANCY BASED ON CONTRACT ON INVESTMENT ADVICE FOR SECURITIES, INVESTMENT BASED ON CONTRACTS OF ENTRUSTING INVESTMENT, ISSUES AND SUBSCRIPTION OF BENEFICIARY CERTIFICATES, OPERATION OR ORDERS OF OPERATION FOR TRUST ASSETS ON SECURITIES INVESTMENT TRUSTS, CONSULTANCY ON SECURITIES, PROVIDING INFORMATION ON SECURITIES, SECURITIES TRADING, TRANSACTIONS OF SECURITIES INDEX FUTURES, SECURITIES OPTIONS OR OVERSEAS MARKET SECURITIES FUTURES, AGENCIES OR BROKERAGE FOR SECURITIES TRADING AND FOR TRANSACTIONS ON COMMISSION OF SECURITIES INDEX FUTURES, SECURITIES, OPTIONS OR OVERSEAS MARKET SECURITIES FUTURES, AGENCIES FOR BROKERAGE OF SECURITIES TRADING IN DOMESTIC SECURITIES MARKETS AND OF TRANSACTIONS ON COMMISSION OF SECURITIES INDEX FUTURES OR SECURITIES OPTIONS, AGENCIES FOR BROKERAGE OF SECURITIES TRADING IN OVERSEAS SECURITIES MARKETS AND OF TRANSACTIONS ON COMMISSION OF OVERSEAS MARKET SECURITIES FUTURES, UNDERWRITING SECURITIES, SELLING SECURITIES, HANDLING SUBSCRIPTIONS AND OFFERING OF SECURITIES, PROVIDING STOCK MARKET INFORMATION, TRUSTEESHIP OF FUTURES TRANSACTION IN A COMMODITY MARKET; LIFE INSURANCE BROKERAGE, LIFE INSURANCE UNDERWRITING, AGENCIES FOR NON-LIFE INSURANCE, CLAIM ADJUSTMENT FOR NON-LIFE INSURANCE, NON-LIFE INSURANCE UNDERWRITING, INSURANCE ACTUARIAL SERVICES; REAL ESTATE BROKERAGE, MANAGEMENT AND CONSULTATION, REAL ESTATE AGENCIES, REAL ESTATE APPRAISAL AND VALUATION; PROVIDING DETAILED FINANCIAL OR REAL ESTATE INFORMATION ON BUILDINGS OR LAND VIA A GLOBAL COMPUTER NETWORK; ANTIQUE APPRAISAL, ART APPRAISAL, JEWELRY APPRAISAL AND USED CAR APPRAISAL; COMPANY CREDIT INVESTIGATIONS; PROVIDING TAX INFORMATION AND CONSULTATION; CHARITABLE FUND RAISING.
FIRST USE 6-5-2000; IN COMMERCE 6-5-2000.

2,772,021. REG. 10-7-2003. KABUSHIKI KAISHA SHINSEI GINKO A/T/A SHINSEI BANK, LIMITED (JAPAN CORPORATION) 1-8 UCHISAIWAI-CHO, 2-CHOME, CHIYODA-KU, TOKYO, JAPAN., SN 76-011,413. FILED 3-28-2000. PRINCIPAL REGISTER.



ELEMENTS CORRECTED
ASSIGNMENT/NAME CHANGE
DESCRIPTION OF MARK
OWNER NAME
MARK

PRIORITY CLAIMED UNDER SEC. 44(D) ON JAPAN APPLICATION NO. 2000-16080, FILED 2-24-2000, REG. NO. 4493726, DATED 7-27-2001, EXPIRES 7-27-2011.
THE MARK APPEARS IN BLUE AND COLOR IS CLAIMED AS A FEATURE OF THE MARK.
INT. CL. 36/U.S. CLS. 100, 101 AND 102

2,779,885. REG. 11-4-2003. IMATION CORP. (DELAWARE CORPORATION) ONE IMATION PLACE, OAKDALE, MN, 55128, SN 76-022,597. FILED 4-11-2000. PRINCIPAL REGISTER.

2,783,527. REG. 11-18-2003. AQUANOVA GERMAN SOLUBILISATE TECHNOLOGIES (AGT) GMBH (FED REP GERMANY CORPORATION) HELMERTSTRASSE 4-6, MANNHEIM, FED REP GERMANY, D-68219, SN 76-045,365. FILED 5-10-2000. PRINCIPAL REGISTER.



OWNER OF U.S. REG. NO. 2,282,195.
 INT. CL. 9/U.S. CLS. 21, 23, 26, 36 AND 38
 FOR BLANK AND FORMATTED COMPUTER [FLOPPY] * FLOPPY * DISKS; COMPUTER DISK DRIVES; BLANK AND FORMATTED COMPUTER TAPES; BLANK AND FORMATTED COMPUTER TAPE CARTRIDGES; BLANK AND FORMATTED COMPUTER TAPE REELS; COMPUTER TAPE REEL COLLARS FOR ALLOWING SELF-THREADING OF THE TAPE INTO A TAPE DRIVE; RE-WRITABLE OPTICAL DISKS AND DRIVES; HEAD CLEANING TAPES FOR COMPUTER TAPE DRIVES; HOLDERS FOR COMPUTER DISKS, TAPES, AND TAPE CARTRIDGES; ; DUPLICATORS; ; PRINTERS, INCLUDING COMPUTER PRINTERS AND READER PRINTERS; [:] COMPUTER * SOFTWARE FOR USE IN DATA STORAGE, DATA TRANSPORT AND * COMMUNICATIONS, * AND * DATA ARCHIVING. [IMAGERY]

FIRST USE 4-1-2000; IN COMMERCE 4-1-2000.
 INT. CL. 16/U.S. CLS. 2, 5, 22, 23, 29, 37, 38 AND 50
 FOR PAPER, INCLUDING COMPUTER PAPER; INKLESS FINGERPRINT/FOOTPRINT KITS; PRINTED LABELS NOT OF TEXTILE; PRINTED LABELS FOR COMPUTER TAPE CARTRIDGES AND COMPUTER DISKS; PRINTED INSTRUCTIONAL, EDUCATIONAL AND TEACHING MATERIALS IN THE FIELD OF COMPUTER DATA STORAGE GOODS AND SERVICES, AND TAPE USED ON COMPUTER DISKS TO PREVENT ERASING AND WRITING INFORMATION CONTAINED THEREIN; ; MULTI-SHEET CARBONLESS COPY FORMS; INK RIBBONS FOR PRINTERS.

FIRST USE 4-1-2000; IN COMMERCE 4-1-2000.
 INT. CL. 39/U.S. CLS. 100 AND 105
 FOR ELECTRONIC STORAGE OF DATA, NAMELY, LABELING AND INITIALIZING DATA STORAGE MEDIA; DATA MIGRATION SERVICES, INCLUDING COPYING AND CONVERTING DATA; SECURE DATA DESTRUCTION, LIBRARY/CURRENT SYSTEM CONFIGURATION ASSESSMENT AND RECOMMENDATIONS.

FIRST USE 4-1-2000; IN COMMERCE 4-1-2000.
 INT. CL. 42/U.S. CLS. 100 AND 101
 FOR COMPUTER SOFTWARE DESIGN FOR OTHERS; COMPUTER SERVICES, NAMELY, DATA STORAGE RECOVERY SERVICES FOR OTHERS; INSTALLATION AND MAINTENANCE OF COMPUTER SOFTWARE; COMPUTER SYSTEM INTEGRATION SERVICES; AND APPLICATION HOSTING.

FIRST USE 4-1-2000; IN COMMERCE 4-1-2000.

ELEMENTS CORRECTED
 GOODS/SERVICES

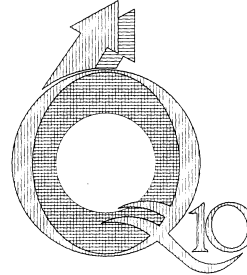

OWNER OF GERMAN DEM REP REG. NO. 30020767, DATED 3-17-2000, EXPIRES 3-31-2010.
 NO CLAIM IS MADE TO THE EXCLUSIVE RIGHT TO USE "Q10", APART FROM THE MARK AS SHOWN.
 THE DRAWING IS LINED FOR THE COLORS RED, BLUE AND YELLOW.

INT. CL. 32/U.S. CLS. 45, 46 AND 48
 FOR MEDICINAL MINERAL WATERS, VITAMIN AND/OR OXYGEN SUPPLEMENTED DRINKING WATER AND MINERAL WATERS CONTAINING COENZYME Q10, ALL FOR USE IN THE TREATMENT OF HUMAN ENERGY DEFICIENCY.
 FIRST USE ; IN COMMERCE .

ELEMENTS CORRECTED
 OWNER NAME
 OWNER ADDRESS
 CITIZENSHIP
 ENTITY

2,785,199. REG. 11-25-2003. INTERNATIONAL SPEEDWAY CORPORATION (FLORIDA CORPORATION) 1801 W. INTERNATIONAL SPEEDWAY BOULEVARD, DAYTONA BEACH, FL, 321141243, SN 75-562,250. FILED 9-30-1998. PRINCIPAL REGISTER.

CHICAGOLAND SPEEDWAY

SEC. 2(F).
 INT. CL. 6/U.S. CLS. 2, 12, 13, 14, 23, 25 AND 50
 FOR NON-LUMINOUS AND NON-MECHANICAL METAL SIGNS.
 FIRST USE 7-14-2001; IN COMMERCE 7-14-2001.
 INT. CL. 12/U.S. CLS. 19, 21, 23, 31, 35 AND 44
 FOR LICENSE PLATE HOLDERS .
 FIRST USE 7-14-2001; IN COMMERCE 7-14-2001.
 INT. CL. 14/U.S. CLS. 2, 27, 28 AND 50
 FOR JEWELRY, NAMELY PINS.
 FIRST USE 7-14-2001; IN COMMERCE 7-14-2001.
 INT. CL. 16/U.S. CLS. 2, 5, 22, 23, 29, 37, 38 AND 50
 FOR SOUVENIR PROGRAMS FEATURING AUTO RACING, STICKERS, BUMPER STICKERS, DECALS, AND POSTERS.
 FIRST USE 7-14-2001; IN COMMERCE 7-14-2001.
 INT. CL. 20/U.S. CLS. 2, 13, 22, 25, 32 AND 50
 FOR PLASTIC BADGE HOLDERS, SEAT CUSHIONS, PLASTIC NOVELTY ITEMS, NAMELY LICENSE PLATES AND NON-METAL KEY CHAINS.
 FIRST USE 7-14-2001; IN COMMERCE 7-14-2001.
 INT. CL. 21/U.S. CLS. 2, 13, 23, 29, 30, 33, 40 AND 50
 FOR BEVERAGE GLASSWARE.
 FIRST USE 7-14-2001; IN COMMERCE 7-14-2001.
 INT. CL. 24/U.S. CLS. 42 AND 50

FOR TEXTILE GOODS, NAMELY CLOTH FLAGS AND CLOTH PENNANTS.

FIRST USE 7-14-2001; IN COMMERCE 7-14-2001.

INT. CL. 25/U.S. CLS. 22 AND 39

FOR MEN'S, WOMEN'S, CHILDREN'S AND INFANTS' CLOTHING AND CLOTHING ACCESSORIES, NAMELY, CAPS, HATS, LEATHER JACKETS, T-SHIRTS, GOLF SHIRTS, AND SWEATSHIRTS.

FIRST USE 7-14-2001; IN COMMERCE 7-14-2001.

INT. CL. 28/U.S. CLS. 22, 23, 38 AND 50

FOR GAMES AND PLAYTHINGS, NAMELY, PLUSH TOYS AND DIE CAST MINIATURE CARS AND TRUCKS.

FIRST USE 7-14-2001; IN COMMERCE 7-14-2001.

INT. CL. 34/U.S. CLS. 2, 8, 9 AND 17

FOR SMOKERS' ARTICLES, NAMELY, ASHTRAYS AND CIGARETTE LIGHTERS NOT OF PRECIOUS METAL.

FIRST USE 7-14-2001; IN COMMERCE 7-14-2001.

ELEMENTS CORRECTED
DATE OF FIRST USE
DATE OF FIRST USE IN COMMERCE
[GOODS/SERVICES]
[INTERNATIONAL CLASS(ES)]

2,789,267. REG. 12-2-2003. FIRST CLERMONT BANK (OHIO CORPORATION) 400 TECHECENTER DRIVE, MILFORD, OH, 45150, SN 76-238,308. FILED 4-10-2001. PRINCIPAL REGISTER.



INT. CL. 36/U.S. CLS. 100, 101 AND 102
FOR BANKING; FINANCIAL ANALYSIS AND CONSULTATION; AND MORTGAGE LENDING SERVICES.
FIRST USE 4-26-2001; IN COMMERCE 4-26-2001.

ELEMENTS CORRECTED
OWNER NAME
OWNER ADDRESS
CITIZENSHIP
ENTITY
ASSIGNMENT/NAME CHANGE

2,789,615. REG. 12-2-2003. PN II, INC. (NEVADA CORPORATION) 1635 VILLAGE CENTER CIRCLE, SUITE 250, LAS VEGAS, NV, 89134, SN 76-415,243. FILED 6-5-2002. PRINCIPAL REGISTER.

PULTRIM

INT. CL. 19/U.S. CLS. 1, 12, 33 AND 50

FOR PRE-FABRICATED SYNTHETIC BOARD FOR USE IN THE BUILDING CONSTRUCTION FIELD.
FIRST USE 7-0-2002; IN COMMERCE 7-0-2002.

ELEMENTS CORRECTED
FILING DATE

2,790,571. REG. 12-9-2003. NEURIM PHARMACEUTICALS (1991) LTD. (ISRAEL CORPORATION) 8 HANECHOSHET STREET, TEL AVIV, ISRAEL, 69710, SN 76-435,551. FILED 7-29-2002. PRINCIPAL REGISTER.

CIRCADIN

OWNER OF ISRAEL REG. NO. 88580, DATED 10-5-1995, EXPIRES 8-12-2014.
INT. CL. 5/U.S. CLS. 6, 18, 44, 46, 51 AND 52
FOR PHARMACEUTICAL PREPARATION FOR THE TREATMENT OF SLEEPING PROBLEMS.

ELEMENTS CORRECTED
FOREIGN REG. EXPIRATION DATE

2,793,099. REG. 12-9-2003. THE MCMILLIN COMPANIES, LLC (CALIFORNIA LIMITED LIABILITY COMPANY) 2727 HOOVER AVENUE, NATIONAL CITY, CA, 91950, SN 78-145,462. FILED 7-18-2002. PRINCIPAL REGISTER.

STONEBRIDGE ESTATES

NO CLAIM IS MADE TO THE EXCLUSIVE RIGHT TO USE "ESTATES", APART FROM THE MARK AS SHOWN.
INT. CL. 37/U.S. CLS. 100, 103 AND 106
FOR RESIDENTIAL REAL ESTATE DEVELOPMENT AND CONSTRUCTION SERVICES.
FIRST USE 1-1-2003; IN COMMERCE 1-1-2003.

ELEMENTS CORRECTED
OWNER ADDRESS

2,794,915. REG. 12-16-2003. LEBEDOVYCH, OREST, W (UNITED STATES INDIVIDUAL) 210 LEE BOULEVARD, SAVANNAH, GA, 31405, SN 78-205,241. FILED 1-21-2003. PRINCIPAL REGISTER.

QUICKSTARS

INT. CL. 9/U.S. CLS. 21, 23, 26, 36 AND 38
FOR COMPUTER SOFTWARE FOR RISK MANAGEMENT; COMPUTER SOFTWARE FOR RISK MANAGEMENT THAT MAY BE DOWNLOADED FROM A GLOBAL COMPUTER NETWORK.
FIRST USE 9-23-1999; IN COMMERCE 9-23-1999.

ELEMENTS CORRECTED
OWNER NAME
CITIZENSHIP
ENTITY

2,794,916. REG. 12-16-2003. QUICKSTARS, L.L.C. (GEORGIA LTD LIAB CO) 210 LEE BOULEVARD, SAVANNAH, GA, 31405, SN 78-205,247. FILED 1-21-2003. PRINCIPAL REGISTER.

QUICKSTARS

INT. CL. 36/U.S. CLS. 100, 101 AND 102
FOR RISK MANAGEMENT.
FIRST USE 9-23-1999; IN COMMERCE 9-23-1999.

ELEMENTS CORRECTED
OWNER NAME
CITIZENSHIP
ENTITY

FOR BATTERIES; ALKALINE BATTERIES; LITHIUM BATTERIES [; SILVER OXIDE CELLS; AIR CELLS; BATTERY CHARGERS; RECHARGEABLE BATTERIES; DRY CELLS].
FIRST USE 10-0-1999; IN COMMERCE 10-0-1999.

ELEMENTS CORRECTED
GOODS/SERVICES

2,795,614. REG. 12-16-2003. HORIZON COSMETICS, INC. (DELAWARE CORPORATION) C/O UNITED CORPORATE SERVICES, INC., 15 EAST NORTH STREET, DOVER, DE, 19901, SN 76-349,491. FILED 12-17-2001. PRINCIPAL REGISTER.

CRAVE

INT. CL. 3/U.S. CLS. 1, 4, 6, 50, 51 AND 52
FOR EAU DE TOILETTE; HAIR AND BODY WASH; PERSONAL DEODORANTS; AFTER SHAVE BALM.
FIRST USE 9-6-2002; IN COMMERCE 9-6-2002.

ELEMENTS CORRECTED
OWNER NAME
OWNER ADDRESS

2,798,874. REG. 12-23-2003. FIDELITY NATIONAL INFORMATION SOLUTIONS INC. (CALIFORNIA CORPORATION) 4050 CALLE REAL, SANTA BARBARA, CA, 93110, SN 76-414,801. FILED 5-30-2002. PRINCIPAL REGISTER.

TRANSACTIONPOINT

INT. CL. 36/U.S. CLS. 100, 101 AND 102
FOR PROVIDING AN ON-LINE COMPUTER DATABASE IN THE FIELD OF REAL ESTATE FOR USE IN FACILITATING REAL ESTATE TRANSACTIONS.
FIRST USE 1-31-2002; IN COMMERCE 1-31-2002.
INT. CL. 42/U.S. CLS. 100 AND 101
FOR INTEGRATION OF COMPUTER SYSTEMS AND NETWORKS FOR SUPPORTING, MANAGING, AND FACILITATING REAL ESTATE TRANSACTIONS.
FIRST USE 1-31-2002; IN COMMERCE 1-31-2002.

ELEMENTS AMENDED
MARK

2,798,366. REG. 12-23-2003. MATSUSHITA ELECTRIC INDUSTRIAL CO., LTD. (JAPAN CORPORATION) 1006, OAZA KADOMA, KADOMA-SHI, OSAKA-FU, JAPAN., SN 76-215,455. FILED 2-23-2001. PRINCIPAL REGISTER.



NO CLAIM IS MADE TO THE EXCLUSIVE RIGHT TO USE "DIGITAL", APART FROM THE MARK AS SHOWN.
THE STIPPLING SHOWN IN THE MARK IS FOR SHADING PURPOSES ONLY AND DOES NOT INDICATE COLOR. THE LINING SHOWN IN THE MARK IS A FEATURE OF THE MARK AND IS NOT INTENDED TO INDICATE COLOR.
INT. CL. 9/U.S. CLS. 21, 23, 26, 36 AND 38

2,799,114. REG. 12-23-2003. LORI DAVIS PRODUCTS, INC. (CALIFORNIA CORPORATION) P. O. BOX 7659, THOUSAND OAKS, CA, 91359, SN 78-072,066. FILED 7-2-2001. PRINCIPAL REGISTER.

LORI

OWNER OF U.S. REG. NOS. 1,826,785, 2,024,980 AND OTHERS.
INT. CL. 3/U.S. CLS. 1, 4, 6, 50, 51 AND 52
FOR HAIR CARE PRODUCTS; NAMELY, SHAMPOO, CONDITIONER [INCLUDING ENZYME-BASED AND NEUTRALIZING CONDITIONERS], STYLING GEL, [HAIR REJUVENATORS,] SHINE ENHANCERS, [HAIR SHEEN,] HAIR SPRAY [INCLUDING HAIR FINISHING AND HAIR STYLING SPRAYS], HAIR GEL, SPRAY GEL, [STRAIGHTENING GEL, HAIR LOTIONS,] COSMETIC HAIR SEALER AND ENHANCER, *AND* CONDITIONING TREATMENTS [, AND PEROXIDE ACCELERATORS; COSMETICS; TOILETRIES, NAMELY, SKIN LOTIONS, PERFUMES, BATH GELS, BATH LOTIONS, AND BATH PERFUMES].
FIRST USE 12-31-2001; IN COMMERCE 12-31-2001.

ELEMENTS CORRECTED
GOODS/SERVICES

2,800,551. REG. 12-30-2003. SHARP KABUSHIKI KAISHA (JAPAN CORPORATION), TA SHARP CORPORATION, 22-22, NAGAIKE-CHO, ABENO-KU, OSAKA 545-8522, JAPAN., SN 75-481,770. FILED 5-8-1998. PRINCIPAL REGISTER.

DDMP

INT. CL. 9/U.S. CLS. 21, 23, 26, 36 AND 38
FOR MICRO-PROCESSORS AND INTEGRATED CIRCUITS.
FIRST USE 8-1-2002; IN COMMERCE 8-1-2002.

ELEMENTS CORRECTED
DATE OF FIRST USE

2,801,941. REG. 1-6-2004. TAG HEUER S.A. (SWITZERLAND CORPORATION) 14A, AVENUE DES CHAMPS-MONTANTS, CH - 2074 MARIN, SWITZERLAND., SN 76-458,290. FILED 10-15-2002. PRINCIPAL REGISTER.

AQUAGRAPH

PRIORITY CLAIMED UNDER SEC. 44(D) ON SWITZERLAND APPLICATION NO. 06308/2002, FILED 7-18-2002, REG. NO. 502154, DATED 8-19-2002, EXPIRES 7-18-2012.
INT. CL. 14/U.S. CLS. 2, 27, 28 AND 50
FOR HOROLOGICAL AND CHRONOMETRIC INSTRUMENTS, NAMELY WATCHES, WRIST WATCHES, STRAPS FOR WRIST WATCHES AND WATCH CASES, TRAVEL CLOCKS, CLOCKS, CHRONOMETERS AND CHRONOGRAPHS FOR USE AS WATCHES.
FIRST USE ; IN COMMERCE .

ELEMENTS CORRECTED
FOREIGN REG. DATE

2,802,611. REG. 1-6-2004. PACIFIC AND ARCTIC RAILWAY AND NAVIGATION COMPANY (ALASKA CORPORATION) P.O. BOX 435, SKAGWAY, AK, 99840, SN 75-605,038. FILED 12-14-1998. PRINCIPAL REGISTER.

WHITE PASS

OWNER OF U.S. REG. NO. 1,038,956.
INT. CL. 35/U.S. CLS. 100, 101 AND 102
FOR RETAIL GIFT SHOP SERVICES.
FIRST USE 5-0-1997; IN COMMERCE 5-0-1997.
INT. CL. 39/U.S. CLS. 100 AND 105
FOR TOUR GUIDE SERVICES, AND TRANSPORTATION OF PASSENGERS BY TRAIN SERVICES.
FIRST USE 0-0-1898; IN COMMERCE 0-0-1898.

ELEMENTS CORRECTED
GOODS/SERVICES
INTERNATIONAL CLASS(ES)
DATE OF FIRST USE
DATE OF FIRST USE IN COMMERCE

2,803,900. REG. 1-13-2004. LAUREUS WORLD SPORTS AWARDS LIMITED (UNITED KINGDOM COMPANY) 15 HILL ST, LONDON, UNITED KINGDOM, W1X 7FB, SN 75-881,656. FILED 12-27-1999. PRINCIPAL REGISTER.

LAUREUS

OWNER OF SWITZERLAND REG. NO. 464963, DATED 9-13-1999, EXPIRES 7-7-2009.

INT. CL. 9/U.S. CLS. 21, 23, 26, 36 AND 38
FOR COMPACT DISCS FEATURING MUSIC, SPEECHES, DOCUMENTARIES, FILMS; EYEGLASSES AND SUNGLASSES; CASES FOR EYEGLASSES AND SUNGLASSES.

FIRST USE ; IN COMMERCE .
INT. CL. 12/U.S. CLS. 19, 21, 23, 31, 35 AND 44
FOR CARS, SPORTS CARS, BICYCLES, BOATS.
FIRST USE ; IN COMMERCE .

INT. CL. 14/U.S. CLS. 2, 27, 28 AND 50
FOR WATCHES, CLOCKS, TABLE CLOCKS, CHRONOMETERS; JEWELLERY ARTICLES NAMELY- CLIPS, BROOCHES, PINS, EARRINGS, RINGS, BRACELETS, CHAINS, NECKLACES, TIARA; STATUETTES OF PRECIOUS METAL; CUFF LINKS; TIE CLIPS; PRECIOUS GEMSTONES.

FIRST USE ; IN COMMERCE .
INT. CL. 16/U.S. CLS. 2, 5, 22, 23, 29, 37, 38 AND 50
FOR DIARIES, NOTEBOOKS, CALENDARS, POSTERS, POSTCARDS, GREETING CARDS, PHOTOGRAPHIC PRINTS, PRINTED MATERIAL, NAMELY, BOOKS, MAGAZINES, CATALOGS, PAMPHLETS AND BROCHURES IN THE FIELD OF SPORTS AND AWARD PROGRAMS.
FIRST USE ; IN COMMERCE .

INT. CL. 18/U.S. CLS. 1, 2, 3, 22 AND 41
FOR TRUNKS, OVERNIGHT CASES AND SUITCASES; TRAVELING BAGS, ALL-PURPOSE SPORTS BAGS, HANDBAGS; BACKPACKS; BRIEFCASES; WALLETS, CREDIT CARD CASES, BUSINESS CARD CASES, PURSES, NOT OF PRECIOUS METAL; KEY CASES; [UMBRELLA] * UMBRELLAS *.

FIRST USE ; IN COMMERCE .
INT. CL. 25/U.S. CLS. 22 AND 39
FOR SHIRTS, T-SHIRTS, SHORTS, TROUSERS, SHIRTS, SPORTS JERSEYS, SWEATERS, * FOOTWEAR, HEADWEAR *.

FIRST USE ; IN COMMERCE .
INT. CL. 35/U.S. CLS. 100, 101 AND 102
FOR COMPUTERIZED RETAIL STORE SERVICES VIA A WEB SITE ON A GLOBAL COMPUTER NETWORK FEATURING TICKETS TO SPORTING AND ENTERTAINMENT EVENTS, SOUVENIRS, TRAVEL TOUR PACKAGES.

FIRST USE ; IN COMMERCE .
INT. CL. 41/U.S. CLS. 100, 101 AND 107

FOR ARRANGING AND CONDUCTING SPORTING EVENTS AND ATHLETIC COMPETITIONS; ARRANGING AND CONDUCTING AN AWARDS PROGRAMME AND CEREMONY TO RECOGNIZE EXCELLENCE IN THE FIELD OF SPORTS; EDUCATION SERVICES, NAMELY, PROVIDING INCENTIVES TO PEOPLE AND ORGANIZATIONS TO DEMONSTRATE EXCELLENCE IN THE FIELD OF SPORTS AND ATHLETICS THROUGH THE ISSUANCE OF AWARDS; ENTERTAINMENT SERVICES, NAMELY, PROVIDING TELEVISION AND RADIO PROGRAMS FEATURING SPORTING EVENTS, SPORTS AND ATHLETIC COMPETITIONS, AWARDS SHOWS, THE HISTORY OF SPORTS AND ATHLETICS, HISTORICAL FIGURES, AND FAMOUS PERSONS IN THE ATHLETIC AND SPORTING FIELDS; PROVIDING FACILITIES FOR SPORTS AND ATHLETIC EVENTS AND COMPETITIONS, AND FOR SPORTS AND ATHLETIC AWARDS CEREMONIES; PROVIDING SPORTS INFORMATION BY MEANS OF TELEPHONE AND A WEB SITE VIA A GLOBAL COMPUTER NETWORK; MUSEUMS; PROVIDING INFORMATION ON HISTORICAL AND CURRENT SPORTS AND ATHLETIC FIGURES, THE HISTORY OF SPORTS, A SPORTS AWARD PROGRAM, VARIOUS SPORTING AND ATHLETIC EVENTS VIA A WEB SITE BY MEANS OF A GLOBAL COMPUTER NETWORK.

FIRST USE ; IN COMMERCE .
INT. CL. 42/U.S. CLS. 100 AND 101

FOR PROMOTING PUBLIC AWARENESS AMONG THE YOUTH OF THE WORLD OF THE NEED AND IMPORTANCE OF SPORTSMANSHIP AND ACHIEVEMENT IN THE FIELDS OF SPORTS AND ATHLETICS; RESTAURANT AND BAR SERVICES; PROVIDING TEMPORARY HOUSING ACCOMMODATION; LEGAL SERVICES.

FIRST USE ; IN COMMERCE .

ELEMENTS CORRECTED

OWNER NAME
 OWNER ADDRESS
 CITIZENSHIP
 ENTITY
 GOODS/SERVICES

2,806,860. REG. 1-20-2004. KONAMI CORPORATION (JAPAN CORPORATION) 4-3-1 TORANOMON, MINATO-KU, TOKYO 105-6021, JAPAN., SN 76-008,448. FILED 3-23-2000. PRINCIPAL REGISTER.

DUNGEON DICE MONSTERS

INT. CL. 9/U.S. CLS. 21, 23, 26, 36 AND 38

FOR COMPUTER PRODUCTS, NAMELY, COMPUTER GAME PROGRAMS; VIDEO GAME CARTRIDGES; VIDEO GAME CD-ROMS; VIDEO OUTPUT GAME UNITS; COMPUTER GAME CD-ROMS; VIDEO GAME PROGRAMS; VIDEO GAME PROGRAMS FOR USE WITH TELEVISION SETS; AND VIDEO GAME MACHINES FOR USE WITH TELEVISION SETS.

FIRST USE 2-13-2003; IN COMMERCE 2-13-2003.

ELEMENTS CORRECTED
 OWNER ADDRESS

2,806,781. REG. 1-20-2004. MIKRON HOLDING AG (SWITZERLAND CORPORATION) MUHLEBRUCKE 2, CH-2505 BIEL, SWITZERLAND., SN 75-392,144. FILED 11-18-1997. PRINCIPAL REGISTER.



OWNER OF U.S. REG. NOS. 102,397, 2,169,988 AND OTHERS.

INT. CL. 7/U.S. CLS. 13, 19, 21, 23, 31, 34 AND 35

FOR TRANSFER MACHINES FOR THE PROCESSING OF PRODUCTION PARTS; MACHINING CENTERS; AUTOMATIC ASSEMBLY MACHINES; INDUSTRIAL ROBOTS; TRANSPORT AND FEEDING CONVEYORS; GEARS AS PARTS FOR MACHINES AND MOTOR DRIVEN TOOLS; TRANSMISSION GEARS FOR MACHINES; DRIVE GEARS FOR ELECTRIC MOTORS FOR MACHINES.

FIRST USE 1-31-1998; IN COMMERCE 1-31-1998.

INT. CL. 12/U.S. CLS. 19, 21, 23, 31, 35 AND 44

FOR LAND VEHICLES PARTS, NAMELY, GEARS FOR WINDSHIELD WIPERS, WINDOW FILTERS, DOOR LOCKING CONTROLS, ROOF OPENERS, POWER STEERING, SEAT ADJUSTMENT, MIRROR ADJUSTMENT, TRUNK OPENERS, GEARS FOR USE IN LAND VEHICLE PARTS, NAMELY, AIRBAGS, SEAT BELTS, AND ANTI-SLIDE DEVICES; LAND VEHICLE PARTS, NAMELY DRIVE GEARS.

FIRST USE 1-31-1998; IN COMMERCE 1-31-1998.

INT. CL. 42/U.S. CLS. 100 AND 101

FOR PROJECT PLANNING AND DESIGN SERVICES FOR ASSEMBLING AND PROCESSING PLANTS; DESIGNING CONTROLS FOR MACHINES AND AUTOMATIC MACHINERY; DESIGNING COMPUTER SOFTWARE PROGRAMS TO THE ORDER AND SPECIFICATION OF OTHERS.

FIRST USE 1-31-1998; IN COMMERCE 1-31-1998.

ELEMENTS CORRECTED
 GOODS/SERVICES
 DATE OF FIRST USE
 DATE OF FIRST USE IN COMMERCE

2,807,229. REG. 1-20-2004. SHAW INDUSTRIES GROUP, INC. (GEORGIA CORPORATION) 616 EAST WALNUT AVENUE, P.O. DRAWER 2128, DALTON, GA, 307222128, SN 76-396,394. FILED 4-18-2002. PRINCIPAL REGISTER.

XAMPLE

INT. CL. 9/U.S. CLS. 21, 23, 26, 36 AND 38

FOR COMPUTER SOFTWARE USED IN CONNECTION WITH PREPARING CARPET [DESIGN] *DESIGNS*.

FIRST USE 4-30-2002; IN COMMERCE 4-30-2002.

ELEMENTS CORRECTED
 GOODS/SERVICES

2,809,902. REG. 2-3-2004. AMERICAN COLLEGE OF VETERINARY OPHTHALMOLOGISTS, INC. (ILLINOIS NON-PROFIT, TAX EXEMPT CORPORATION) P.O. BOX 1311, MERIDIAN, ID, 83680, SN 76-435,510. FILED 7-29-2002. PRINCIPAL REGISTER.



THE DESIGN OF THE STATUE OF HOURS OF EDFU INCLUDED WITHIN A FIELD OF BLACK WITHIN A PYRAMID.

INT. CL. 16/U.S. CLS. 2, 5, 22, 23, 29, 37, 38 AND 50

FOR PRINTED MATTER, NAMELY INFORMATIONAL AND EDUCATIONAL PUBLICATIONS, NAMELY, PRINTED CERTIFICATES, BOOKS, JOURNALS, MAGAZINES, REPORTS, NEWSLETTERS, BULLETINS, HANDOUTS AND BROCHURES RELATED TO THE ADVANCEMENT OF OPHTHALMOLOGY AND ALL PHASES OF VETERINARY MEDICINE.

FIRST USE 11-2-1980; IN COMMERCE 11-2-1980.
INT. CL. 35/U.S. CLS. 100, 101 AND 102

FOR ASSOCIATION SERVICES, NAMELY PROMOTING THE INTERESTS OF VETERINARY OPHTHALMOLOGISTS; COMPUTERIZED DATABASE MANAGEMENT OF CERTIFICANT AND MEMBER PROFILES; PROVIDING TRADE INFORMATION TO VETERINARY SPECIALISTS.

FIRST USE 11-2-1980; IN COMMERCE 11-2-1980.
INT. CL. 41/U.S. CLS. 100, 101 AND 107

FOR EDUCATIONAL SERVICES, NAMELY EDUCATIONAL TESTING SERVICES IN THE FIELD OF VETERINARY OPHTHALMOLOGY; ESTABLISHING EDUCATIONAL, TESTING, COMPETENCY AND ACCREDITATION STANDARDS FOR OTHERS IN THE FIELD OF VETERINARY OPHTHALMOLOGY; ORGANIZING RESIDENCY PROGRAMS IN THE FIELD OF VETERINARY OPHTHALMOLOGY FOR OTHERS; ARRANGING AND CONDUCTING CLASSES, SEMINARS, SYMPOSIA, CONFERENCES AND WORKSHOPS IN THE FIELD OF VETERINARY OPHTHALMOLOGY AND DISTRIBUTING COURSE AND EDUCATIONAL MATERIALS IN CONNECTION THEREWITH.

FIRST USE 11-2-1980; IN COMMERCE 11-2-1980.

ELEMENTS CORRECTED
DESCRIPTION OF MARK

2,810,844. REG. 2-3-2004. LUCASFILM LTD. (CALIFORNIA CORPORATION) 5858 LUCAS VALLEY ROAD, NICASIO, CA, 94946. SN 75-553,132. FILED 9-15-1998. PRINCIPAL REGISTER.

ILM

INT. CL. 41/U.S. CLS. 100, 101 AND 107

FOR ENTERTAINMENT SERVICES, NAMELY, [MOTION PICTURE FILM SERIES, AND GLOBAL COMPUTER NETWORK OR AND MOTION PICTURE] * PRODUCTION AND DISTRIBUTION OF MOTION PICTURE FILM SERIES, PROVIDING AUDIOVISUAL ENTERTAINMENT IN THE FIELD OF SCIENCE FICTION VIA A GLOBAL COMPUTER NETWORK, PROVIDING MOTION PICTURE SPECIAL EFFECTS FOR OTHERS, AND PROVIDING NEWS IN THE FIELD OF EDUCATION VIA GLOBAL COMPUTER INFORMATION NETWORK *.

FIRST USE 3-31-1980; IN COMMERCE 3-31-1980.

ELEMENTS CORRECTED
GOODS/SERVICES

2,810,960. REG. 2-3-2004. HERKUPLAST KUBERN GMBH (FED REP GERMANY CORPORATION) AM STEINHUEGEL 1, 94140 ERING, FED REP GERMANY., SN 76-007,740. FILED 3-23-2000. PRINCIPAL REGISTER.



INT. CL. 20/U.S. CLS. 2, 13, 22, 25, 32 AND 50

FOR PLANT POTS, NAMELY, VESSELS MADE OF POLYSTYRENE, ACRYL POLYETHYLENE [TEREPHTHALAT,] * TEREPHTHALAT * POLYPROPYLENE, AND POLYETHYLENE, FOR USE IN THE CULTIVATION OF PLANTS.

FIRST USE 0-0-1972; IN COMMERCE 12-0-1998.

ELEMENTS CORRECTED
GOODS/SERVICES

2,811,863. REG. 2-3-2004. MARINA DISTRICT DEVELOPMENT COMPANY, LLC (NEW JERSEY LTD LIAB CO), DBA BORGATA HOTEL, CASINO & SPA, ONE BORGATA WAY, ATLANTIC CITY, NJ, 08401, SN 78-183,959. FILED 11-12-2002. PRINCIPAL REGISTER.

BORGATA HOTEL CASINO & SPA

NO CLAIM IS MADE TO THE EXCLUSIVE RIGHT TO USE "HOTEL CASINO AND SPA", APART FROM THE MARK AS SHOWN.

THE FOREIGN WORDING IN THE MARK TRANSLATES INTO ENGLISH AS VILLAGE.

INT. CL. 44/U.S. CLS. 100 AND 101

FOR BEAUTY SALON SERVICES; BARBER SHOP SERVICES; HEALTH SPA SERVICES; AND PROVIDING ON-LINE INFORMATION IN THE FIELDS OF BEAUTY SALON SERVICES, BARBER SHOP SERVICES, AND HEALTH SPA SERVICES VIA A GLOBAL COMPUTER NETWORK.

FIRST USE 7-10-2003; IN COMMERCE 7-10-2003.

ELEMENTS CORRECTED
ENTITY

2,811,975. REG. 2-10-2004. PROEL KG (FED REP GERMANY LIMITED PARTNERSHIP) TREUCHTLINGER STRASSE 29, D-91781 WEISSENBURG I BAY, FED REP GERMANY., SN 75-343,815. FILED 8-20-1997. PRINCIPAL REGISTER.

NORIPHAN

PRIORITY CLAIMED UNDER SEC. 44(D) ON ERPNCMNTY TM OFC APPLICATION NO. 608315. FILED 7-29-1997. REG. NO. 608315, DATED 1-20-1999, EXPIRES 7-29-2007.
INT. CL. 1/U.S. CLS. 1

FOR SCREEN PRINTING AIDS, NAMELY, CHEMICALS FOR PREPARING A PRINTING SCREEN, ADHESIVE FOR USE ON FRAMES, DEGREASING AGENTS, MESH DEGREASING AND PREPARING MEDIUM; CHEMICALS FOR DE-COATING A PRINTING SCREEN, NAMELY, DE-COATING GEL, DE-COATING EMULSIONS, FILLERS FOR SPOTTING OUT AND COVERING THE EDGES OF SCREEN STENCILS; POLYMER EMULSIONS FOR STENCIL PREPARATIONS FOR SCREEN PRINTING.

FIRST USE ; IN COMMERCE .
INT. CL. 2/U.S. CLS. 6, 11 AND 16

FOR INK JET PRINTER'S INK] * INK JET PRINTER INK, PRINTER'S INK *, NAMELY, SCREEN PRINTING INKS; TAMPON PRINTING INKS; AND LACQUERS IN THE NATURE OF COATINGS.

FIRST USE ; IN COMMERCE .
INT. CL. 3/U.S. CLS. 1, 4, 6, 50, 51 AND 52

FOR CLEANING PREPARATIONS FOR USE IN CLEANING PRINTING SCREENS, NAMELY, LIQUID CLEANER, CLEANING PASTE AND CLEANING CONCENTRATE.

FIRST USE ; IN COMMERCE .

ELEMENTS CORRECTED
ASSIGNMENT/NAME CHANGE
GOODS/SERVICES
OWNER NAME

2,812,359. REG. 2-10-2004. WW AUTOMOBILES, INC. (MISSISSIPPI CORPORATION), DBA TOM WADLER KIA AND TOM WADLER NISSAN, 3064 HIGHWAY 82 EAST, GREENVILLE, MS, 38703, AND WWD AUTOMOBILE, INC. (MISSISSIPPI CORPORATION), DBA TOM WADLER TOYOTA AND TOM WADLER LINCOLN-MERCURY, 3064 HIGHWAY 82 EAST, GREENVILLE, MS, 38703, SN 76-446,765. FILED 8-5-2002. PRINCIPAL REGISTER.

"IF TOM WADLER'S NAME IS NOT ON THE BACK OF YOUR VEHICLE . . . YOU PAID TOOOOOOOO MUCH"

THE NAME "TOM WADLER" IDENTIFIES A LIVING INDIVIDUAL WHOSE CONSENT IS OF RECORD.

INT. CL. 35/U.S. CLS. 100, 101 AND 102
FOR AUTOMOBILE DEALERSHIP SERVICES.
FIRST USE 8-30-2000; IN COMMERCE 8-30-2000.

ELEMENTS CORRECTED
OWNER NAME
MARK

2,812,205. REG. 2-10-2004. LEMANS CORPORATION (WISCONSIN CORPORATION) 3501 KENNEDY ROAD, BOX 5222, JANESVILLE, WI, 535475222, SN 76-387,047. FILED 3-27-2002. PRINCIPAL REGISTER.

2,812,974. REG. 2-10-2004. G & N REFRESHMENTS, LLC (CONNECTICUT LIMITED LIABILITY JOINT STOCK COMPANY) 399 LEDYARD STREET, SUITE 9, HARTFORD, CT, 06114, SN 78-196,395. FILED 12-19-2002. PRINCIPAL REGISTER.



THE MARK CONSISTS IN PART OF THE STYLIZED LETTER "M".

INT. CL. 25/U.S. CLS. 22 AND 39

FOR CLOTHING AND APPAREL FOR USE IN HUNTING, WITH ALL TERRAIN VEHICLES, MOTORCYCLES AND SNOWMOBILES, NAMELY JACKETS, PANTS, JERSEYS, TEE-SHIRTS, LONG SLEEVE SHIRTS, SWEATSHIRTS, HELMET SKINS, IN THE NATURE OF TIGHT FITTING CAPS FOR WEARING UNDER HELMETS, LEG SKINS, HATS, IN THE NATURE OF TIGHT [FILLING] * FITTING * PANTS FOR DRIVING, HATS, SOCKS, GLOVES, VESTS, TURTLENECK SWEATERS, PULLOVERS, BEANIES.

FIRST USE 10-0-2000; IN COMMERCE 10-0-2000.

ELEMENTS CORRECTED
GOODS/SERVICES

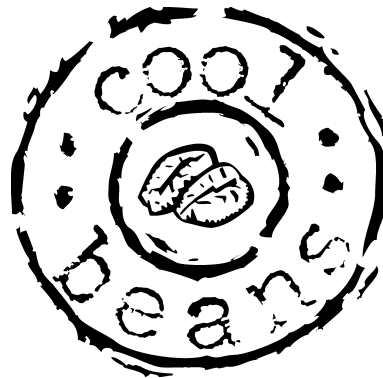

INT. CL. 43/U.S. CLS. 100 AND 101

FOR CATERING SERVICES FOR OFFICES, NAMELY, SUPPLYING BEVERAGES, SNACKS, PAPER, FOAM, PLASTIC UTENSILS AND TABLEWARE, AND CLEANING SUPPLIES; AND RENTAL OF FOOD AND BEVERAGE SERVICES EQUIPMENT.

FIRST USE 7-31-2000; IN COMMERCE 7-31-2000.

ELEMENTS CORRECTED
ENTITY

2,813,415. REG. 2-10-2004. HTE AKTIENGESELLSCHAFT THE HIGH THROUGHPUT EXPERIMENTATION COMPANY (FED REP GERMANY LTD LIAB CO) KURPFALZRING 104, 69123 HEIDELBERG, FED REP GERMANY., SN 76-169,818. FILED 11-20-2000. PRINCIPAL REGISTER.



OWNER OF FED REP GERMANY REG. NO. 39952129, DATED 3-23-2000, EXPIRES 8-31-2009.

INT. CL. 1/U.S. CLS. 1

FOR CHEMICALS USED IN INDUSTRY AND SCIENCE, NAMELY, CHEMICALS USED IN MATERIAL SCIENCE AND CATALYSIS RESEARCH; CATALYSTS FOR USE IN THE MANUFACTURE OF INDUSTRIAL CHEMICALS, NAMELY, BASIS CHEMICALS, INTERMEDIATES, FINE CHEMICALS, AND POLYMERS; CATALYSTS FOR USE IN THE OIL AND GAS PROCESSING INDUSTRY; CATALYSTS FOR USE IN THE FIELD OF ENVIRONMENTAL CONTROL.

FIRST USE 8-0-1995; IN COMMERCE 8-1-1995.

INT. CL. 9/U.S. CLS. 21, 23, 26, 36 AND 38

FOR SCIENTIFIC, ELECTRICAL, ELECTRONIC, MEASURING, CHECKING, PHYSICAL AND CHEMICAL APPARATUS, INSTRUMENTS AND DEVICES USED FOR SCIENTIFIC RESEARCH, NAMELY, TEST REACTORS, TUBE REACTORS, AND PARTS FOR TEST REACTORS AND TUBE REACTORS, FOR USE IN THE MANUFACTURE AND TESTING OF MATERIALS; SOFTWARE USED TO CONTROL APPARATUS, INSTRUMENTS AND DEVICES USED FOR SCIENTIFIC RESEARCH; COMPUTER PROGRAMS FOR PROCESSING DATA STORED ON DATA CARRIERS IN THE FIELD OF CHEMISTRY; AND DATA PROCESSORS, BLANK MAGNETIC DATA CARRIERS, AND COMPUTERS.

FIRST USE 8-0-1995; IN COMMERCE 8-0-1995.

INT. CL. 37/U.S. CLS. 100, 103 AND 106

FOR DEVELOPING CONSTRUCTION, INSTALLATION AND MAINTENANCE OF CHEMICAL PLANTS AND PARTS AND COMPONENTS FOR CHEMICAL PLANTS.

FIRST USE 8-0-1995; IN COMMERCE 8-0-1995.

INT. CL. 42/U.S. CLS. 100 AND 101

FOR RESEARCH IN THE FIELD OF CHEMISTRY; CARRY OUT, PERFORMING AND EVALUATING CHEMICAL ANALYSIS; CARRY OUT, PERFORMING AND EVALUATING CHEMICAL SYNTHESIS; CARRY OUT, PERFORMING AND EVALUATING PHYSICAL ANALYSIS; DRAFTING, TESTING AND EVALUATION OF CHEMICAL SUBSTANCE LIBRARIES; DEVELOPMENT OF CHEMICAL SYNTHESIS AND ANALYSIS; DEVELOPMENT OF MICRO-TECHNICAL APPARATUS AND DEVICES, NAMELY, ROBOTS USED FOR MICRO-TECHNICAL PURPOSES; TESTING MATERIALS AND PROPERTIES OF SUBSTANCES; COMPUTER PROGRAMMING FOR OTHERS; DATA BASE DEVELOPMENT SERVICES; PROVIDING AND ON-LINE COMPUTER DATABASE IN THE FIELD OF MATERIAL AND CATALYSTS RESEARCH AND DEVELOPMENT; AND CONSULTATION IN THE FIELDS OF COMBINATORIAL MATERIAL RESEARCH, CATALYSIS, AND REACTION AND PROCESS TECHNOLOGY.

FIRST USE 8-8-1995; IN COMMERCE 8-0-1995.

ELEMENTS CORRECTED
OWNER NAME

2,813,542. REG. 2-10-2004. HENRY BUTCHER INTERNATIONAL LIMITED (UNITED KINGDOM COMPANY) BROWNLOW HOUSE, 50/51 HIGH HOLBORN, LONDON, UNITED KINGDOM, WC1V 6EG, SN 76-284,490. FILED 11-20-2001. PRINCIPAL REGISTER.

HENRY BUTCHER

OWNER OF UNITED KINGDOM REG. NO. 2183234, DATED 11-27-1998, EXPIRES 11-27-2008.

THE NAME "HENRY BUTCHER" DOES NOT IDENTIFY A LIVING INDIVIDUAL.

INT. CL. 35/U.S. CLS. 100, 101 AND 102

FOR BUSINESS CONSULTING SERVICES FOR COMMERCIAL AND INDUSTRIAL BUSINESSES; BUSINESS ACQUISITIONS AND BUSINESS MERGER CONSULTATION; [AUCTIONEER] *AUCTIONEERING* ; BUSINESS APPRAISALS; BUSINESS MANAGEMENT; PROVIDING BUSINESS INFORMATION RELATING TO THE ACQUISITION, AUCTIONING AND DISPOSAL OF PROPERTY, BUSINESS AND COMMODITIES, NAMELY INDUSTRIAL PLANT, MACHINERY, EQUIPMENT AND OTHER ASSETS.

FIRST USE 10-20-2001; IN COMMERCE 10-20-2001.

INT. CL. 36/U.S. CLS. 100, 101 AND 102

FOR BUSINESS LIQUIDATION SERVICES; REAL ESTATE ACQUISITION SERVICES; FINANCIAL VALUATION OF PERSONAL PROPERTY AND REAL ESTATE; COMMODITY BROKERAGE SERVICES; BUSINESS BROKERAGE SERVICES; FINANCIAL INVESTMENT ADVICE IN THE FIELD OF THE VALUATION OF PROPERTY, BUSINESS AND COMMODITIES, NAMELY, INDUSTRIAL PLANT, MACHINERY, EQUIPMENT AND OTHER ASSETS; VALUATION, FINANCIAL APPRAISAL AND DEPRECIATION APPRAISAL SERVICES IN RELATION TO SUCH ASSETS, LOAN FINANCING; LEASE-PURCHASE LOANS; REAL ESTATE MANAGEMENT SERVICES; REAL ESTATE TRUSTEE SERVICES; REAL ESTATE SETTLEMENT SERVICES.

FIRST USE 10-20-2001; IN COMMERCE 10-20-2001.

ELEMENTS CORRECTED
GOODS/SERVICES

2,813,623. REG. 2-10-2004. INFONYTE GMBH (FED REP GERMANY CORPORATION) JULIUS-REIBER-STRASSE 15, D-64293 DARMSTADT, FED REP GERMANY., SN 76-335,413. FILED 11-7-2001. PRINCIPAL REGISTER.

INFONYTE

PRIORITY CLAIMED UNDER SEC. 44(D) ON FED REP GERMANY APPLICATION NO. 30153003.3/9, FILED 9-4-2001, REG. NO. 30153003, DATED 10-30-2001, EXPIRES 9-30-2011.

INT. CL. 9/U.S. CLS. 21, 23, 26, 36 AND 38

FOR SOFTWARE STORED ON DATA CARRIERS FOR STORAGE, RETRIEVAL AND PROCESSING OF DATA ENCODED IN [ML] * XML * (EXTENSIBLE MARKUP LANGUAGE).

FIRST USE 3-28-2001; IN COMMERCE 12-0-2002.

INT. CL. 35/U.S. CLS. 100, 101 AND 102

FOR LICENSING OF SOFTWARE.

FIRST USE 3-28-2001; IN COMMERCE 12-12-2001.

INT. CL. 42/U.S. CLS. 100 AND 101

FOR DEVELOPMENT OF SOFTWARE; COMPUTER SOFTWARE DESIGN FOR OTHERS, NAMELY, PROVIDING CUSTOMER-SPECIFIC ADAPT IONS OF SOFTWARE FOR STORAGE, RETRIEVAL AND PROCESSING OF DATA ENCLOSED IN [ML] * XML *.

FIRST USE 3-28-2001; IN COMMERCE 12-12-2001.

ELEMENTS CORRECTED
GOODS/SERVICES

2,813,768. REG. 2-10-2004. DIGZ LLC (NEW JERSEY LIMITED LIABILITY CORPORATION) P.O. BOX 1520, WALL, NJ, 07719, SN 76-395,823. FILED 4-15-2002. PRINCIPAL REGISTER.

2,817,485. REG. 2-24-2004. SUBCREWS.COM, INC. (NORTH CAROLINA CORPORATION) P.O. BOX 1667, CORNELIUS, NC, 28031, SN 78-234,310. FILED 4-5-2003. PRINCIPAL REGISTER.

DIGZ

SUBCREWS.COM

INT. CL. 37/U.S. CLS. 100, 103 AND 106
 FOR CONSTRUCTION SERVICES, NAMELY, GENERAL CONTRACTING AND SITE WORK FOR COMMERCIAL AND RESIDENTIAL PROJECTS; EXCAVATION; RETAINING WALL INSTALLATION AND REPAIR; WATER MAIN INSTALLATION AND REPAIR; PIPE INSTALLATION AND REPAIR; TRENCHING; DRAIN INSTALLATION AND REPAIR; SEPTIC INSTALLATION AND REPAIR; SEWER AND SEPTIC ABANDONMENT; [BUILDING, DEMOLITION] * BUILDING DEMOLITION *.
 FIRST USE 1-1-2002; IN COMMERCE 1-1-2002.

INT. CL. 35/U.S. CLS. 100, 101 AND 102
 FOR ON-LINE REFERRAL SERVICES FOR GENERAL BUILDING CONTRACTORS AND SUB-CONTRACTORS.
 FIRST USE 1-1-2003; IN COMMERCE 1-1-2003.

ELEMENTS CORRECTED
 OWNER NAME

ELEMENTS CORRECTED
 GOODS/SERVICES

2,814,980. REG. 2-17-2004. LARIOS PERNOD RICARD, S.A. (SPAIN SPAIN-SOCIEDAD ANONIMA) POLIGONO INDUSTRIAL GUADALHORCE, CESAR VALLEJO 24, 29004 MALAGA, SPAIN., SN 78-170,772. FILED 10-3-2002. PRINCIPAL REGISTER.

2,818,708. REG. 3-2-2004. LIDL STIFTUNG & CO. KG (FED REP GERMANY CORPORATION) STIFTSBERGSTRASSE 1, D-74167 NECKARSULM, FED REP GERMANY., SN 76-226,448. FILED 3-19-2001. PRINCIPAL REGISTER.

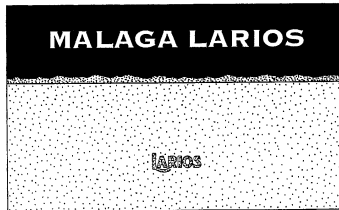

Marlene

PRIORITY CLAIMED UNDER SEC. 44(D) ON SPAIN APPLICATION NO. 2489691, FILED 7-15-2002, REG. NO. 2489691, DATED 12-5-2002, EXPIRES 12-5-2012.
 OWNER OF U.S. REG. NOS. 2,012,264 AND 2,033,227.
 NO CLAIM IS MADE TO THE EXCLUSIVE RIGHT TO USE "MALAGA" OR "NATURAL" , APART FROM THE MARK AS SHOWN.
 THE STIPPLING SHOWS THE PLACEMENT OF COLOR AND SHADING IN THE MARK, BUT THE MARK IS NOT LINED FOR COLOR.
 THE MARK CONSISTS OF THE COLORS YELLOW, RED, WHITE, AND BLACK. THE TOP THIRD OF THE RECTANGLE IS BLACK WITH WHITE LETTERING. THE BOTTOM TWO-THIRDS OF THE RECTANGLE IS YELLOW. A RED LINE SEPARATES THE BLACK AND YELLOW PORTIONS OF THE RECTANGLE. THE CIRCLE ABOVE THE RECTANGLE IS YELLOW. COLOR IS CLAIMED AS A FEATURE OF THE MARK.
 THE TRANSLATION OF "ASOLEADO" IN THE MARK IS "SUNNY".
 INT. CL. 33/U.S. CLS. 47 AND 49
 FOR ALCOHOLIC BEVERAGES, NAMELY, WINE.
 FIRST USE ; IN COMMERCE .

OWNER OF FED REP GERMANY REG. NO. 39402762, DATED 5-11-1995, EXPIRES 11-22-2004.
 INT. CL. 29/U.S. CL. 46
 FOR JAMS, MARMALADES, FRUIT JELLIES, FRUIT PASTES, FRUIT PULP, FRUIT PRODUCTS, NAMELY SAUCES, DRIED FRUIT, FRUIT JELLIES, FRUIT JAMS AND FRUIT-BASED SPREADS; FRUIT AND VEGETABLE PRESERVES, MILK AND MILK PRODUCTS, NAMELY KEFIR, SOUR MILK, CHEESE, FRESH CHEESE, YOGURT, SWEET CREAM AND SOUR CREAM, ROTE CRUTZE (KIND OF FRUIT JELLY WITH THE ADDITION OF RED FRUITS), BUTTER, ALL AFOREMENTIONED GOODS ALSO WITH THE ADDITION OF YOGURT, FRUIT AND FRUIT EXTRACTS, NATURAL AND ARTIFICIAL FLAVORS, HERBS, SPICES, SPIRITS, COCOA, COFFEE AND COFFEE EXTRACT, MALT, SUGAR OR ARTIFICIAL SWEETENERS AS TASTE INGREDIENTS, ALL AFOREMENTIONED GOODS FRESH OR PRESERVED .
 FIRST USE ; IN COMMERCE .
 INT. CL. 30/U.S. CL. 46
 FOR FLAVORED AND SWEETENED GELATIN DESERTS AND DESSERTS MADE WITH CREAM, YOGURT AND CURD.
 FIRST USE ; IN COMMERCE .
 INT. CL. 32/U.S. CLS. 45, 46 AND 48
 FOR FRUIT JUICES AND FRUIT FLAVORED DRINKS, SYRUPS [AND] * FOR * MAKING FRUIT DRINKS AND SOFT DRINKS, NON-ALCOHOLIC BEVERAGES, NAMELY MALT BEVERAGES, SOFT DRINKS; FRUIT JUICE CONCENTRATES.
 FIRST USE ; IN COMMERCE .

ELEMENTS CORRECTED
 FOREIGN REG. DATE
 FOREIGN REG. EXPIRATION DATE

ELEMENTS CORRECTED
 GOODS/SERVICES
 OWNER ADDRESS

2,819,080. REG. 3-2-2004. BURROWING OWL VINEYARDS LTD. (CANADA CORPORATION) RR#1, S-52, C-20, OLIVER, BRITISH COLUMBIA, CANADA, V0H 1T0, SN 76-464,421. FILED 10-31-2002. PRINCIPAL REGISTER.



OWNER OF CANADA REG. NO. 570851, DATED 11-19-2002, EXPIRES 11-19-2017.
 THE STIPPLING IS A FEATURE OF THE MARK AND DOES NOT INDICATE COLOR.
 INT. CL. 33/U.S. CLS. 47 AND 49
 FOR WINE.
 FIRST USE 3-0-1998; IN COMMERCE 5-0-2003.

ELEMENTS CORRECTED
 DATE OF FIRST USE IN COMMERCE

2,819,384. REG. 3-2-2004. STYLE TREND STUDIOS, INC. (FLORIDA CORPORATION) 12807 LAKE DRIVE EXTENSION, DELRAY BEACH, FL. 33444, SN 76-505,694. FILED 4-11-2003. PRINCIPAL REGISTER.

POTTER'S STONE

NO CLAIM IS MADE TO THE EXCLUSIVE RIGHT TO USE "STONE", APART FROM THE MARK AS SHOWN.
 INT. CL. 21/U.S. CLS. 2, 13, 23, 29, 30, 33, 40 AND 50
 FOR PLANTERS AND FLOWER POTS.
 FIRST USE 4-0-2002; IN COMMERCE 4-0-2002.

ELEMENTS CORRECTED
 OWNER ADDRESS

2,819,392. REG. 3-2-2004. AVAIL MEDICAL PRODUCTS, INC. (DELAWARE CORPORATION) 1660 CHASE TEXAS TOWER, 201 MAIN STREET, FORT WORTH, TX, 76102, SN 76-506,528. FILED 4-14-2003. PRINCIPAL REGISTER.



OWNER OF U.S. REG. NO. 2,326,238.
 INT. CL. 40/U.S. CLS. 100, 103 AND 106

FOR MANUFACTURE OF GENERAL PRODUCT LINES IN THE FIELD OF MEDICAL DISPOSABLES TO THE ORDER AND SPECIFICATION OF OTHERS.
 FIRST USE 1-27-2003; IN COMMERCE 1-27-2003.
 INT. CL. 42/U.S. CLS. 100 AND 101
 FOR PRODUCT RESEARCH AND DEVELOPMENT.
 FIRST USE 1-27-2003; IN COMMERCE 1-27-2003.

ELEMENTS CORRECTED
 OWNER ADDRESS

2,819,751. REG. 3-2-2004. DOLLAR CASTLE, INC. (MICHIGAN CORPORATION) 23832 DEQUINDRE, HAZEL PARK, MI, 48030, SN 78-186,809. FILED 11-20-2002. PRINCIPAL REGISTER.



NO CLAIM IS MADE TO THE EXCLUSIVE RIGHT TO USE "DOLLAR" AND "WHERE EVERYTHING IS A DOLLAR", APART FROM THE MARK AS SHOWN.
 INT. CL. 35/U.S. CLS. 100, 101 AND 102
 FOR RETAIL STORE SERVICES FEATURING GENERAL MERCHANDISE.
 FIRST USE 8-15-1999; IN COMMERCE 8-15-1999.

ELEMENTS CORRECTED
 [PRIOR U.S. REGS.]

2,819,979. REG. 3-2-2004. HUDSON CITY SAVINGS BANK (NEW JERSEY CORPORATION) 80 WEST CENTURY ROAD, PARAMUS, NJ, 07652, SN 78-234,215. FILED 4-4-2003. PRINCIPAL REGISTER.

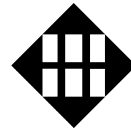

HUDSON CITY
 SAVINGS BANK

OWNER OF U.S. REG. NOS. 2,604,907, 2,695,692 AND OTHERS.
 NO CLAIM IS MADE TO THE EXCLUSIVE RIGHT TO USE "SAVINGS BANK", APART FROM THE MARK AS SHOWN.
 THE LINING IN THE SQUARE DESIGN OF THE MARK FORMS AN "H".
 INT. CL. 36/U.S. CLS. 100, 101 AND 102

FOR BANKING SERVICES, NAMELY RETAIL BANKING SERVICES; FINANCIAL TRANSACTION, NAMELY INTERNET BANKING, TELEPHONE BANKING, ATM AND DEBIT CARD SERVICES, DIRECT DEPOSIT AND AUTOMATED CLEARING HOUSE TRANSACTIONS, CREDIT CARDS SERVICES, WIRING OF FUNDS, SALE AND REDEMPTION OF U.S. SAVINGS BONDS, SALE OF MONEY ORDERS, CASHIER'S CHECKS AND TRAVELER'S CHECKS; LOAN SERVICES, NAMELY LOAN FINANCING, OVERDRAFT CHECKING, MORTGAGE LENDING, HOME EQUITY LOANS, COMMERCIAL LOANS AND HOME IMPROVEMENT EQUITY LOANS; CONSUMER FINANCIAL SERVICES, NAMELY CHECKING ACCOUNTS, SAVINGS ACCOUNTS, CERTIFICATES OF DEPOSIT, HOLIDAY AND VACATION CLUB ACCOUNTS, INDIVIDUAL RETIREMENT ACCOUNTS AND SELF-EMPLOYED QUALIFIED RETIREMENT PLANS, RENT SECURITY ACCOUNTS AND SAFETY DEPOSIT BOX SERVICES.

FIRST USE 3-13-2002; IN COMMERCE 3-13-2002.

ELEMENTS CORRECTED
DESCRIPTION OF MARK

2,820,142. REG. 3-2-2004. ZTE CORPORATION (CHINA CORPORATION) N/F., A WING, ZTE PLAZA, HI-TECH ROAD S., HI-TECH INDUSTRIAL PARK, SHENZHEN, P.R., CHINA., SN 76-036,173. FILED 4-27-2000. PRINCIPAL REGISTER.

ZTE

INT. CL. 9/U.S. CLS. 21, 23, 26, 36 AND 38

FOR LOW VOLTAGE ELECTRICAL POWER SUPPLIERS; BATTERIES; BATTERY CHARGERS; TELECOMMUNICATIONS MODEMS; ELECTRICAL CABLES; ELECTRIC APPARATUS FOR COMMUNICATION, NAMELY, RECTIFIERS; RECORDED COMPUTER PERIPHERALS FOR COMPUTERS; SEMICONDUCTORS; INTEGRATED CIRCUITS; VIDEO TELEPHONES; ELECTRICAL WIRE AND CABLES; ELECTRICAL WIRE FOR USE WITH TELEPHONES; OPTICAL DATA MEDIA, NAMELY, COMPACT DISKS; COMPUTER MEMORIES; SMOKE DETECTORS, METAL DETECTORS, AND RADAR DETECTORS; MEASURING APPARATUS, NAMELY, GRADUATED RULERS; STORED PROGRAM-CONTROLLED SWITCHING SYSTEMS, NAMELY, STORED PROGRAM CONTROLLED TELEPHONE SWITCHES CONSISTING OF SWITCHING NETWORK MODULE, OPERATION AND MAINTENANCE MODULE, REMOTE SWITCHING MODULE, PACKET HANDLING MODULE, REMOTE SUBSCRIBER UNIT, PERIPHERAL SWITCHING MODULE AND COMPUTER PROGRAMS FOR TELECOMMUNICATION SWITCHES AND VOICE MAIL AND MESSAGE AND COMPUTER PROGRAMS TO MANAGE, OPERATE AND MAINTAIN TELECOMMUNICATION SYSTEMS AND TELECOMMUNICATION NETWORKS; PRE-RECORDED LASER DISCS FEATURING TELEPHONE NUMBER LISTINGS, SOFTWARE FOR CONNECTING COMPUTERS TO THE INTERNET AND SOFTWARE FEATURING INSTRUCTION IN INSTALLING, USING AND OPERATING COMPUTER HARDWARE AND COMMUNICATION DEVICES; ELECTRONIC APPARATUS FOR EDUCATIONAL PURPOSE, NAMELY, COMPUTER HARDWARE AND EDUCATIONAL SOFTWARE TO INSTRUCT THE INSTALLATIONS AND USAGE OF THOSE APPARATUS; BURGLAR ALARM, FIRE ALARMS, ENVIRONMENTAL ALARMS THAT ARE COLLECTING EQUIPMENT FOR MONITORING TEMPERATURE, HUMIDITY AND WATERLOGGING AND PERSONAL SECURITY ALARMS; OPTICAL COMMUNICATION EQUIPMENT, NAMELY, SYNCHRONOUS DIGITAL HIERARCHY OPTICAL TRANSPORT SYSTEMS, NAMELY, TERMINAL MULTIPLEXERS, ADD/DROP MULTIPLEXERS, REGENERATORS AND MANAGEMENT PROGRAMS, AND DENSE WAVELENGTH DIVISION MULTIPLEXING TRANSPORT SYSTEMS, NAMELY, FIBER OPTICAL CABLES, FIBER OPTICAL CONNECTORS, OPTICAL MULTIPLEXERS AND DEMULTIPLEXERS, OPTICAL TERMINALS, OPTICAL

LINE AMPLIFIERS, OPTICAL ADD/DROP MULTIPLEXERS, AND OPTICAL CROSS CONNECTS AND MANAGEMENT SYSTEMS COMPRISED OF COMPUTER HARDWARE AND SOFTWARE FOR PERFORMANCE, CONFIGURATION, FAULT, AND SECURITY OF OPTICAL TRANSPORT NETWORKS; DEVICES FOR AUTOMATION, NAMELY, COMPUTER HARDWARE, COMPUTER SOFTWARE FOR INSTRUCTING INSTALLATION, USAGE, AND OPERATION OF THE ASSOCIATED COMPUTER HARDWARE; ELECTRODYNAMIC APPARATUS FOR THE REMOTE CONTROL OF SIGNALS, CONSISTING OF REMOTE CONTROLS FOR COMPUTER HARDWARE; COMPUTER MONITORS; ELECTRICAL MEASUREMENT INSTRUMENTS FOR ELECTRICAL SIGNALS AND PARAMETERS USING MICROWAVE, RADIO FREQUENCY OR LASER; ELECTRIC VERIFYING UNITS COMPRISED OF COMPUTER HARDWARE AND SOFTWARE FOR INSTRUCTING INSTALLATION, USAGE, AND OPERATION OF THE UNITS; REMOTE-CONTROL ELECTRICAL EQUIPMENT FOR OPERATION, WHICH HAS DATA COMMUNICATION INTERFACE THAT CAN REALIZE COLLECTING OF ANALOG QUANTITY AND DIGITAL QUANTITY, AND CONTROL THE PERIPHERAL ELECTRICAL EQUIPMENT ACCORDING TO COMPUTER INSTRUCTIONS, INCLUDING COMPUTER HARDWARE, CONTROL SOFTWARE AND OTHER FILES ABOUT EQUIPMENT INSTALLATION AND USAGE; ELECTRICAL SWITCHES; ELECTRICITY INVERTERS; TRANSMITTERS OF ELECTRONIC SIGNALS, NAMELY, RADIO TRANSMITTERS; TELECOMMUNICATION TRANSMITTERS, NAMELY, TRANSMISSION APPARATUS FOR COMMUNICATION PURPOSES; RADIOTELEPHONE SETS COMPRISED OF CORDLESS TELEPHONES, TELEPHONE ANSWERING MACHINES; RECORDED COMPUTER SOFTWARE FOR USE IN DATABASE MANAGEMENT, FOR USE AS A SPREADSHEET, FOR CONTROL PROCESS IN THE FIELD OF TELECOMMUNICATION FOR PROTOCOL PROCESSING; TELEPHONE SETS, NAMELY, TELEPHONES, CELLULAR PHONES, MOBILE PHONES, CORDLESS TELEPHONES, PERSONAL COMMUNICATION SERVICE HANDSETS AND ACCESSORIES THEREFOR, NAMELY, AC ADAPTERS, DATA CABLES, BELT CLIPS, BATTERY CHARGERS, BATTERIES; COMPUTER HARDWARE AND PERIPHERAL DEVICES; CONNECTORS FOR COMMUNICATION PURPOSES; INFORMATION PROCESSING ENGINE AND CENTRAL PROCESSING DEVICE, NAMELY, COMPUTER HARDWARE, AND CENTRAL PROCESSING UNITS; ELECTRONIC SENSORS FOR ELECTRICITY; MAGNETIC DATA MEDIA, NAMELY, BLANK MAGNETIC DISKS AND PRERECORDED MAGNETIC DISKS FEATURING COMMUNICATION AND TELECOMMUNICATION EDUCATIONAL CONTENTS; BLANK SMART CARDS; DATA PROCESSING APPARATUS, NAMELY, DATA PROCESSORS; VIDEOCONFERENCING SYSTEMS CONSISTING OF INTELLIGENT VIDEO SERVERS, VIDEOCONFERENCING TERMINALS, NAMELY, VIDEO I/O APPARATUS, AUDIO I/O APPARATUS, VIDEO ENCODERS AND DECODERS, AUDIO ENCODERS AND DECODERS, TRANSPORT NETWORKS AND MANAGEMENT SYSTEMS FOR MANAGING MCU AND MONITORING ALL OTHER VIDEOCONFERENCING DEVICES; MULTIPOINT CONTROL DEVICES FOR VIDEO CONFERENCE, NAMELY, DEVICES TO CONNECT AND CONTROL AT LEAST TWO VIDEOCONFERENCING TERMINALS; MOBILE COMMUNICATION SYSTEMS, NAMELY GSM SYSTEMS, AND CD MA SYSTEMS, NAMELY, BASE STATION SYSTEM COMPRISING OF BASE STATION CONTROLLERS AND BASE TRANSCEIVER STATIONS; MOBILE SWITCH SYSTEM, NAMELY, MOBILE SWITCHING CENTER/VISITOR LOCATION REGISTER, HOME LOCATION REGISTER/AUTHENTICATION CENTER, AND SHORT MESSAGE SERVICE CENTER; MOBILE STATIONS THAT INCLUDE MOBILE PHONES AND A VARIETY OF WIRELESS TERMINALS, MOBILE PHONES, HANDSETS; HOME LOCATION REGISTER THAT IS A CENTRAL PROCESSING UNIT IN MOBILE COMMUNICATION SYSTEMS FOR STORING THE VISITOR'S DATA INTEGRATED BY COMPUTER HARDWARE AND SOFTWARE FOR INSTRUCTING INSTALLATION, USAGE, AND OPERATION OF THE REGISTER; BASE STATION CONTROLLER CONSISTING OF SWITCHING, EMBEDDING COMPUTER AND PERIPHERAL HARDWARE AND SOFTWARE FOR SYSTEM OPERATION, DATABASE AND SERVICE PROCESSING; BASE TRANSCEIVER STATION CON-

SISTING OF CARRIER PROCESSING MODULE, COMMON CONTROLLING MODULE HARDWARE AND SOFTWARE FOR SIGNAL PROCESSING, SYSTEM OPERATION AND APPLICATION; CENTRALIZED MONITORING SYSTEM FOR DYNAMIC EQUIPMENT AND ENVIRONMENT COMPRISED OF COMPUTER HARDWARE AND COMPUTER SOFTWARE FOR INSTRUCTING INSTALLATION, USAGE, AND OPERATION OF THE REGISTER; ELECTRICAL ENVIRONMENT MONITORING APPARATUS INTEGRATED BY COMPUTER HARDWARE AND SOFTWARE FOR INSTRUCTING INSTALLATION, USAGE, AND OPERATION OF THE REGISTER; ACCESS DEVICES, NAMELY, ACCESS SERVERS, WIRELESS ACCESS SERVERS, NETWORK MANAGEMENT SYSTEMS, NAMELY, SOFTWARE SYSTEMS THAT IMPLEMENT MANAGEMENT AND MAINTENANCE SUCH AS CONFIGURATION, PERFORMANCE, FAILURE, SECURITY AND ACCOUNTING FOR NETWORK ACCESS PRODUCTS; IP TELEPHONY GATEWAY, NAMELY, ACCESS APPARATUS CONSISTING OF MEDIA GATEWAY, MEDIA GATEWAY CONTROLLER, AND GATE KEEPER USED FOR VOICE AND FACSIMILE BETWEEN PUBLIC SWITCHED TELEPHONE NETWORK AND INTERNET.
FIRST USE 12-0-1996; IN COMMERCE 8-0-2003.

ELEMENTS CORRECTED
OWNER ADDRESS

2,821,512. REG. 3-9-2004. JACK DANIEL'S PROPERTIES, INC. (DELAWARE CORPORATION) 4040 CIVIC CENTER DRIVE, SUITE 528, SAN RAFAEL, CA. 94903, SN 76-241,487. FILED 4-16-2001. PRINCIPAL REGISTER.

LYNCHBURG LIVE

INT. CL. 42/U.S. CLS. 100 AND 101

FOR [RESTAURANT AND] BAR SERVICES.
FIRST USE 5-31-2001; IN COMMERCE 5-31-2001.

ELEMENTS CORRECTED
GOODS/SERVICES

2,821,536. REG. 3-9-2004. DECADE SYSTEMS CORPORATION (FLORIDA CORPORATION) 13901 SUTTON PARK DR SOUTH, STE 320, JACKSONVILLE, FL, 32224, SN 76-304,020. FILED 8-24-2001. PRINCIPAL REGISTER.



THE STIPPLING AND LINING DEPICTED IN THE MARK ARE FEATURES OF THE MARK.
INT. CL. 9/U.S. CLS. 21, 23, 26, 36 AND 38
FOR COMPUTER SOFTWARE, NAMELY, COMPUTER SOFTWARE DESIGNED FOR USE IN THE FIELD OF INFORMATION LOGISTICS FOR DATA INTEGRATION AGGREGATION, TRANSLATION, TRANSMISSION AND PROCESSING FOR THE TRANSFER OF INFORMATION BETWEEN INTERNAL SYSTEMS, DATABASES, AND [SERVICES] *SERVICE* PROVIDERS.
FIRST USE 8-0-1998; IN COMMERCE 8-0-1998.

ELEMENTS CORRECTED
GOODS/SERVICES

* * * * *

TRADEMARK REGISTRATIONS—NEW CERTIFICATES

New Certificates issued under section 7(e) of the Trademark Act of 1946 for the unexpired term of the original registrations.

1,533,745. OFFICE TOWN. INT. CL. 42. OFFICE DEPOT, INC., DELRAY BEACH, FL. REG. 4-4-1989. NEW CERT. SEC. 7(C) TO REGISTRANT.

2,228,780. SHALOM AND DESIGN. INT. CL. 25. KRAMER, BARBARA, NEW YORK, NY. REG. 3-2-1999. NEW CERT. SEC. 7(C) TO REGISTRANT.

1,939,705. OFFICE DEPOT. INT. CL. 16. OFFICE DEPOT, INC., DELRAY BEACH, FL. REG. 12-5-1995. NEW CERT. SEC. 7(C) TO OFFICE CLUB, INC., THE, DELRAY BEACH, FL.

2,465,376. ETO'N (STYLIZED). INT. CL. 9. WIDEWORLD-WAVE, INC., NOVATO, CA. REG. 7-3-2001. NEW CERT. SEC. 7(C) TO REGISTRANT.

1,999,700. GLYCOLACTIC. INT. CL. 3. ABBE COSMETIC GROUP INTERNATIONAL, INC. DBA ABBE COSMETICS, FARMINGDALE, NY. REG. 9-10-1996. NEW CERT. SEC. 7(C) TO REGISTRANT.

2,468,168. LUCIPAC. INT. CLS. 1 AND 5. KIKKOMAN CORPORATION, CHIBA, JAPAN. REG. 7-10-2001. NEW CERT. SEC. 7(C) TO REGISTRANT.

2,005,974. GLYCOLIGHTEN. INT. CL. 3. ABBE COSMETIC GROUP INTERNATIONAL, INC. DBA ABBE COSMETICS, FARMINGDALE, NY. REG. 10-8-1996. NEW CERT. SEC. 7(C) TO REGISTRANT.

2,500,872. INCREDIBLE PIZZA COMPANY GREAT FOOD, FUN, FAMILY & FRIENDS AND DESIGN. INT. CL. 42. BARSNESS, RICK, ROGERSVILLE, MO. REG. 10-23-2001. NEW CERT. SEC. 7(C) TO REGISTRANT.

2,075,744. END-ZIT. INT. CL. 5. ABBE COSMETIC GROUP INTERNATIONAL, INC. DBA ABBE COSMETICS, FARMINGDALE, NY. REG. 7-1-1997. NEW CERT. SEC. 7(C) TO REGISTRANT.

2,605,349. IAN'S NATURAL FOODS. INT. CLS. 29 AND 30. GELERMAN, STEVEN, NORTH ANDOVER, MA. REG. 8-6-2002. NEW CERT. SEC. 7(C) TO REGISTRANT.

2,150,371. CERA-STEROL. INT. CL. 3. ABBE COSMETIC GROUP INTERNATIONAL, INC. DBA ABBE COSMETICS, FARMINGDALE, NY. REG. 4-14-1998. NEW CERT. SEC. 7(C) TO ABBE LABORATORIES, INC., FARMINGDALE, NY.

2,697,729. METAL ONE. INT. CL. 35. METAL ONE, INC., CHICAGO, IL. REG. 3-18-2003. NEW CERT. SEC. 7(C) TO REGISTRANT.

2,735,505. PRO-MED. INT. CL. 3. ABBE COSMETICS GROUP INTERNATIONAL, INC. DBA ABBE COSMETICS, FARMINGDALE, NY. REG. 7-8-2003. NEW CERT. SEC. 7(C) TO REGISTRANT.

* * * * *

This page is intentionally blank

INDEX OF REGISTRANTS

JUNE 29, 2004

(Registered; Renewed; Canceled; Amended, Corrected, etc.; New Certificates; 12c Publications.)

The designation "U.S. Cl." appearing in this section refers to the U.S. class in effect prior to Sep. 1, 1973 rather than the international class which applies to applications filed on or after that date. For adoption of international classification see notice in the OFFICIAL GAZETTE of Jun. 26, 1973 (911 O.G. TM 210).

- "EURO-STAR" REITMODEN GMBH & CO. KG, SPEZIAL-FABRIK FUR REITBEKLEIDUNG, MONCHENGLABACH 1, FED REP GERMANY:
1,250,471. REN. 5-19-04. INT. CL. 25.
- "ZIAJA" LTD ZAKLAD PRODUKCJI LEKOW SPOLKA Z O.O., GDANSK-MATARNIA, POLAND:
2,858,745, MULTIPLE CLASS, INT. CLS. 3 AND 5.
- A & A MANUFACTURING CO., INC., NEW BERLIN, WI, MILWAUKEE SLIDE & SPINDLE, INC., MILWAUKEE, WI:
1,821,965. REN. 5-19-04. INT. CL. 7.
- A & V, INC., MILWAUKEE, WI:
2,835,644, CANC. IIRN. RESTORED TO S.N. 78-261,762.
- A CANDLE IN THE WINDOW, INC., NEW YORK, NY:
1,786,433, CANC. INT. CL. 4.
- A H J MARKETING, INC., AUBURN, ME, DBA DOWNEAST MARKETING:
2,858,700, INT. CL. 4.
- A. COLISH, INC., MT. VERNON, NY:
1,247,912, CANC. INT. CL. 40.
- A. E. ARTHUR LIMITED, KING'S LYNN, NORFOLK, ENGLAND:
1,247,717, CANC. INT. CL. 20.
- A. T. SURGICAL MFG. CO., INC., HOLYOKE, MA:
754,742, CANC. U.S. CL. 44.
- A.T.X. INTERNATIONAL, INC., LINCOLN, RI, A.T. CROSS COMPANY, LINCOLN, RI:
1,857,258. REN. 5-19-04. INT. CL. 16.
- A-Z ANICOM, INC., NORTHBROOK, IL TO ANICOM INC, MOUNT PROSPECT, IL:
1,786,596, CANC. INT. CL. 9.
- AARON, LA SHAUN M., FT. LAUDERDALE, FL:
2,857,842, PUB. 4-6-2004. MULTIPLE CLASS, INT. CLS. 16, 35 AND 42.
- AAXA DISCOUNT MORTGAGE, INC., WILMINGTON, NC:
2,858,118, PUB. 4-6-2004. INT. CL. 36.
- ABBA ACCESSORIES, INC., EAST PROVIDENCE, RI:
1,786,685, CANC. INT. CL. 14.
- ABBE COSMETIC GROUP INTERNATIONAL, INC., FARMINGDALE, NY, DBA ABBE COSMETICS TO ABBE LABORATORIES, INC., FARMINGDALE, NY:
2,150,371 NEW CERT. 6-29-2004. INT. CL. 3.
- ABBE LABORATORIES, INC., FARMINGDALE, NY:
1,999,700 NEW CERT. 6-29-2004. INT. CL. 3.
2,005,974 NEW CERT. 6-29-2004. INT. CL. 3.
2,075,744 NEW CERT. 6-29-2004. INT. CL. 5.
2,735,505 NEW CERT. 6-29-2004. INT. CL. 3.
- ABBOTT LABORATORIES, NORTH CHICAGO, IL:
754,740, CANC. U.S. CL. 44.
- ABBOTT LABORATORIES, ABBOTT PARK, IL:
2,088,340, CANC. INT. CL. 9.
- ABELE BERTOZZI S.P.A., 43100 PARMA, ITALY:
2,857,476, PUB. 4-6-2004. INT. CL. 29.
- ABILITY ONE CORPORATION, BOLINGBROOK, IL FROM SMITH & NEPHEW, INC., MEMPHIS, TN:
2,858,215, INT. CL. 10.
- ABOMEM TECHNOLOGY CORPORATION, MIAO-LIH HSIEN, TAIWAN:
2,857,335, PUB. 4-6-2004. INT. CL. 9.
- ABS SMOOTHIES USA, LLC, MARSHALL, MI:
2,858,509, MULTIPLE CLASS, INT. CLS. 29 AND 32.
- ABSOLUTE INNOVATIONS, INC., OSCEOLA, IN:
2,858,008, PUB. 4-6-2004. INT. CL. 7.
- ACBEL POLYTECH INC., TAIPEI, TAIWAN:
2,471,956, AM. INT. CL. 9.
- ACCENT SERVICE COMPANY, INC., OMAHA, NE:
2,087,290, CANC. MULTIPLE CLASS, INT. CLS. 35 AND 36.
- ACCESS INTERNATIONAL GROUP, FLORHAM PARK, NJ:
2,857,264, PUB. 4-6-2004. MULTIPLE CLASS, INT. CLS. 9, 41 AND 42.
2,857,265, PUB. 4-6-2004. MULTIPLE CLASS, INT. CLS. 9, 41 AND 42.
- ACCESSIBLE TECHNOLOGIES, INC., LENEXA, KS:
2,857,167, PUB. 10-29-2002. INT. CL. 7.
- ACCUTOME, INC., FRAZER, PA:
1,247,608, CANC. INT. CL. 10.
- ACE*COMM CORPORATION, GAITHERSBURG, MD, AMERICAN COMPUTER AND ELECTRONICS CORPORATION, GAITHERSBURG, MD:
1,829,246. REN. 5-20-04. INT. CL. 9.
- ACH FOOD COMPANIES, INC., MEMPHIS, TN:
2,858,821, INT. CL. 29.
- ACOME SOCIETE COOPERATIVE DE TRAVAILLEURS, 75008 PARIS, FRANCE:
2,124,616, COR. MULTIPLE CLASS, INT. CLS. 9, 11 AND 17.
- ACSYS, INC., WASHINGTON, DC:
2,305,254, COR. INT. CL. 35.
2,317,697, COR. INT. CL. 35.
- ACT, INC., IOWA CITY, IA:
2,859,084, INT. CL. 41.
- ACTIVEAID, INC., REDWOOD FALLS, MN:
1,262,903, COR. INT. CL. 10.
- ACTIVISION VALUE PUBLISHING, INC., EDEN PRAIRIE, MN:
2,857,189, PUB. 4-6-2004. INT. CL. 9.
- ACTMEDIA, INC., NORWALK, CT:
2,087,111, CANC. INT. CL. 35.
- ACUITY BRANDS, INC., ATLANTA, GA:
2,858,652, INT. CL. 11.
- ACUSHNET COMPANY, FAIRHAVEN, MA:
2,858,537, INT. CL. 28.
- ACXIOM CORPORATION, CONWAY, AR:
2,087,337, CANC. INT. CL. 35.
- ADAMS CREEK ENTERPRISES, YONCALLA, OR:
2,857,604, PUB. 4-6-2004. INT. CL. 29.
- ADAMS HEATING AND AIR CONDITIONING, INC., CHARLOTTE, NC:
1,787,454, CANC. INT. CL. 11.
- ADAYANA, INC., MINNEAPOLIS, MN:
2,857,281, PUB. 4-6-2004. INT. CL. 41.
- ADD SOFT, INC., OMAHA, NE:
2,087,970, CANC. INT. CL. 9.
- ADDESIGN, INC., BOCA RATON, FL:
2,086,952, CANC. MULTIPLE CLASS, INT. CLS. 35 AND 42.
- ADDISON-WESLEY EDUCATIONAL PUBLISHERS INC, READING, MA:
2,088,165, CANC. INT. CL. 9.
- ADHESIVES RESEARCH, INC., GLEN ROCK, PA:
1,826,359, REN. 5-18-04. INT. CL. 17.

- ADMART ATTRACTIONS, INC., DANVILLE, KY:
2,857,747, PUB. 4-6-2004. INT. CL. 20.
- ADMINISTRATORS NETWORK, INC.:
See— CORESOURCE, INC..
- ADMINISTRATORS NETWORK, INC.:
See— CORESOURCE, INC..
- ADOBE SYSTEMS INCORPORATED, SAN JOSE, CA:
2,857,527, PUB. 4-6-2004. INT. CL. 9.
- ADT SERVICES AG, SCHAFFHAUSEN, SWITZERLAND:
2,857,796, PUB. 4-6-2004. MULTIPLE CLASS, INT. CLS. 37 AND 45.
- ADVANCE MAGAZINE PUBLISHERS INC., NEW YORK, NY:
1,841,558. REN. 5-17-04. INT. CL. 16.
- ADVANCED DIGITAL OPTICS, INC., WESTLAKE, CA:
2,858,983, INT. CL. 9.
- ADVANCED ENVIROTECH SYSTEMS, INC., DALLAS, TX:
2,087,959, CANC. INT. CL. 11.
- ADVANCED LOGIC RESEARCH, INC., IRVINE, CA:
2,087,961, CANC. INT. CL. 9.
- ADVANCED POLYMER SCIENCES, INC., AVON, OH:
2,086,686, CANC. INT. CL. 1.
- ADVANCED RESEARCH AND TECHNOLOGY INSTITUTE, INC., BLOOMINGTON, IN:
2,858,377, INT. CL. 41.
- ADVANCED TECHNOLOGY SYSTEMS, INC., INDIANAPOLIS, IN:
2,858,682, INT. CL. 3.
- ADVANSTAR COMMUNICATIONS, INC., DULUTH, MN:
2,859,078, INT. CL. 16.
- ADVENTURE INCORPORATED, GLOUCESTER, MA:
2,859,042, INT. CL. 36.
- ADVERTISING.COM, INC., BALTIMORE, MD FROM TEKNOSURF.COM, INC., BALTIMORE, MD:
2,858,219, INT. CL. 35.
- AEA TECHNOLOGY PLC, OXFORDSHIRE, OX11 0QJ, UNITED KINGDOM:
2,857,190, PUB. 4-6-2004. INT. CL. 9.
- AEC GROUP, INC., BRIDGEVILLE, PA:
2,087,006, CANC. INT. CL. 37.
- AEIOU, INC., WESTFIELD, NJ:
2,858,397, INT. CL. 25.
- AERO SUPPLIES & EXPRESS, INC., DAYTONA BEACH, FL:
2,857,988, PUB. 4-6-2004. INT. CL. 35.
- AEROCARE HOME MEDICAL, INC., HOUSTON, TX:
2,858,453, MULTIPLE CLASS, INT. CLS. 35 AND 44.
- AEROCOMM, INC., LENEXA, KS:
2,857,808, PUB. 4-6-2004. INT. CL. 9.
- AFARIOGUN, MOSHOOD, BROOKLYN, NY:
2,857,247, PUB. 4-6-2004. MULTIPLE CLASS, INT. CLS. 25 AND 35.
- AFFILIATED PATHOLOGISTS MEDICAL GROUP, INC., TORRANCE, CA:
2,858,873, INT. CL. 9.
- AFMA, LOS ANGELES, CA, AMERICAN FILM MARKETING ASSOCIATION, LOS ANGELES, CA:
1,840,996. REN. 5-19-04. INT. CL. 42.
- AFRICAN-AMERICAN POSTAL LEAGUE UNITED FOR SUCCESS (APLUS), ATLANTA, GA:
2,857,372, PUB. 4-6-2004. INT. CL. 41.
- AGC, INC., CLEVELAND, OH:
2,088,247, CANC. INT. CL. 28.
- AGIO SIGARENFABRIEKEN N.V., 5525 AR DUIZEL, NETHERLANDS:
1,829,553. REN. 5-20-04. INT. CL. 34.
- AGRA, INC., CALGARY, ALBERTA, CANADA TO AMEC INC., TORONTO ONTARIO, CANADA:
2,106,084, CANC. INT. CL. 40.
- AGRI LABORATORIES, LTD., ST. JOSEPH, MO:
1,867,429. REN. 5-17-04. INT. CL. 5.
- AGUDAT HAKORMIM HACOOPERATIVIT SHEL YEKVEI RICHON LE ZION V'ZICHRON YAAKOV B.M., RICHON LE ZION 75100, ISRAEL, DBA CARMEL WINE GROWERS COOPERATIVE:
2,857,728, PUB. 4-6-2004. INT. CL. 32.
- AHOLD RETAIL SERVICES AG, KLOSTER, SWITZERLAND:
2,857,964, PUB. 4-6-2004. INT. CL. 30.
- AHOLD RETAIL SERVICES AG, KLOSTERS, SWITZERLAND:
2,857,965, PUB. 4-6-2004. INT. CL. 30.
- AIMEE LARSEN AND ANDREA WIREN PARTNERSHIP, THE, RINGGOLD, GA:
2,857,980, PUB. 4-6-2004. INT. CL. 18.
- AIR-FROHLICH AG. FUR ENERGIERUCKGEWINNUNG, ARBON, SWITZERLAND:
1,247,610, CANC. INT. CL. 11.
- AIXTRON SEMICONDUCTOR TECHNOLOGIES GMBH, D-5100 AACHEN, FED REP GERMANY:
2,088,097, CANC. INT. CL. 9.
- ALADDIN ENGINEERING & MFG., INC., WAUKESHA, WI, DBA ALADCO:
1,836,573. REN. 5-16-04. INT. CL. 7.
- ALAMO DIRECT MAIL SERVICES, INC., HAUPPAUGE, NY:
2,857,373, PUB. 4-6-2004. INT. CL. 35.
- ALAMO GROUP INC., SEGUIN, TX:
2,858,617, INT. CL. 35.
- ALASKA VILLAGE INITIATIVES, INC., ANCHORAGE, AK:
2,857,588, PUB. 4-6-2004. INT. CL. 9.
- ALAVEN PHARMACEUTICAL LLC, ALPHARETTA, GA:
2,859,039, INT. CL. 5.
2,859,043, INT. CL. 5.
- ALBAUGH, INC., ANKENY, IA:
2,858,911, INT. CL. 5.
- ALCHEMY CARTA LIMITED, THE, LEICESTER LE2 7BU, ENGLAND:
2,099,683, CANC. MULTIPLE CLASS, INT. CLS. 14 AND 26.
- ALCO FENCE COMPANY OF CENTRAL WEST VIRGINIA, FAIRMONT, WV:
2,858,734, INT. CL. 37.
- ALDI INC., BATAVIA, IL:
2,858,269, INT. CL. 30.
2,858,408, INT. CL. 3.
2,858,657, INT. CL. 30.
- ALDO E IVO PORTOLANO-GUANTI SRL, MELITO, NAPLES, ITALY:
1,829,483. REN. 5-20-04. INT. CL. 25.
- ALEXANDER'S, INC., NEW YORK, NY:
1,247,756, CANC. INT. CL. 25.
- ALEXIA FOODS, INC., BROOKLYN, NY:
2,858,563, INT. CL. 29.
2,858,673, INT. CL. 29.
- ALFRED KLET KG, REMSCHEID, FED REP GERMANY:
2,857,810, PUB. 12-2-2003. INT. CL. 7.
- ALIANTE CELLULAR INC., LINCOLN, NE:
2,087,402, CANC. INT. CL. 38.
- ALL ENGLAND LAWN TENNIS CLUB (WIMBLEDON) LIMITED, THE, WIMBLEDON, ENGLAND:
1,247,732, CANC. INT. CL. 24.
- ALL KITCHENS, INC., RICHMOND, VA:
2,858,484, INT. CL. 30.
- ALL THESE BRAND NAMES, WHITE PLAINS, NY:
2,087,060, CANC. INT. CL. 42.
- ALLEGIANCE CORPORATION, MCGAW PARK, IL:
2,858,966, INT. CL. 10.
- ALLFAST FASTENING SYSTEMS, INC., CITY OF INDUSTRY, CA:
2,858,868, INT. CL. 7.
- ALLIANCE USA, INC., RICHARDSON, TX:
2,086,695, CANC. INT. CL. 35.
- ALLIANT FOODSERVICE, INC., DEERFIELD, IL:
2,088,150, CANC. INT. CL. 32.
- ALLIANT TECHSYSTEMS INC., EDINA, MN:
1,277,037. REN. 5-21-04. INT. CL. 21.
2,857,960, PUB. 4-6-2004. INT. CL. 13.
- ALLIED MARKETING GROUP, INC., DALLAS, TX:
2,858,618, INT. CL. 21.
- ALLIED VAN LINES INC., NAPERVILLE, IL:
2,858,430, MULTIPLE CLASS, INT. CLS. 35, 36 AND 39.
- ALMAR SALES CO., INC., NEW YORK, NY:
1,827,408. REN. 5-17-04. INT. CL. 14.
- ALPHA INTERNATIONAL, INC., CEDAR RAPIDS, IA:
2,858,047, PUB. 4-6-2004. INT. CL. 28.

- ALPHA SECURITY PRODUCTS, INC., NORTH CANTON, OH:
2,858,573, INT. CL. 9.
- ALSIUS CORPORATION, IRVINE, CA FROM NEUROPERFUSION, INC., IRVINE, CA:
2,858,190, INT. CL. 10.
- ALTAIR COMPUTING, INC., TROY, MI:
2,087,160, CANC. INT. CL. 9.
- ALTAIR ENGINEERING, INC., TROY, MI:
2,835,128, CANC. IIRN. RESTORED TO S.N. 76-397,148.
- ALTANA PHARMA AG, 78467 KONSTANZ, FED REP GERMANY:
2,857,479, PUB. 4-6-2004. INT. CL. 5.
- ALTARATIONS, LLC, FAYETTEVILLE, NC:
2,858,738, INT. CL. 14.
- ALTERNASFERA, LLC, STANFORDVILLE, NY:
2,859,020, INT. CL. 3.
- ALTHEA TECHNOLOGIES, INC., SAN DIEGO, CA:
2,859,044, INT. CL. 44.
- ALTICOR INC., ADA, MI:
2,858,753, MULTIPLE CLASS, INT. CLS. 3 AND 5.
- ALUMINUM COMPANY OF AMERICA, PITTSBURGH, PA:
1,247,469, CANC. INT. CL. 1.
2,087,746, CANC. INT. CL. 6.
- ALVAREZ, ALBERTO JUAN, PROVINCIA DE RIO NEGRO - ARGENTINA, ARGENTINA:
2,858,613, INT. CL. 33.
- ALVISE ZANROSSO, 36015 - SCHIO (VICENZA), ITALY:
2,086,795, CANC. INT. CL. 7.
- ALWAYS POSITIVE, INC., ESCONDIDO, CA:
2,858,148, PUB. 4-6-2004. INT. CL. 25.
- AM-GOLD PRODUCTS, INC., NEW YORK, NY:
2,088,049, CANC. INT. CL. 14.
- AMAZE ENTERTAINMENT, INC., KIRKLAND, WA FROM KNOWWONDER, INC., KIRKLAND, WA:
2,858,335, INT. CL. 9.
- AMAZING CONCEALER COSMETICS, INC, LIBERTYVILLE, IL:
2,859,040, INT. CL. 3.
- AMAZON.COM, INC., SEATTLE, WA:
2,857,590, PUB. 4-6-2004. INT. CL. 9.
- AMCOR LIMITED, ABBOTSFORD, AUSTRALIA:
2,858,939, INT. CL. 21.
- AMERICA ONLINE, INC., DULLES, VA:
2,087,372, CANC. INT. CL. 42.
- AMERICAN ACADEMY OF DERMATOLOGY, SCHAUMBURG, IL:
2,087,144, CANC. INT. CL. 42.
- AMERICAN ACADEMY OF OPHTHALMOLOGY, INC., SAN FRANCISCO, CA:
2,088,203, CANC. INT. CL. 9.
- AMERICAN ACADEMY OF ORIENTAL MEDICINE FAMILY PRACTICE, TEXARKANA, AR:
2,857,342, PUB. 4-6-2004. INT. CL. 41.
- AMERICAN AIRLINES, INC., DALLAS/FORT WORTH AIRPORT, TX:
2,086,740, CANC. MULTIPLE CLASS, INT. CLS. 9, 39 AND 42.
- AMERICAN ASSOCIATION OF MINORITY PATENT PRACTITIONERS, SILVER SPRING, MD:
2,857,743, PUB. 4-6-2004. INT. CL. 35.
- AMERICAN BILTRITE INC., CAMBRIDGE, MA:
754,501, CANC. U.S. CL. 20.
- AMERICAN BOARDING KENNELS ASSOCIATION, COLORADO SPRINGS, CO:
1,287,504, REN. 5-17-04. U.S. CL. 200.
- AMERICAN BUYING CORPORATION, CHICAGO, IL TO AMERICAN BUYING RETIREMENT SERVICES, INC., BAY HARBOR, FL:
1,787,038, CANC. INT. CL. 36.
- AMERICAN CAPITAL ACCESS HOLDINGS (ARIZONA), INCORPORATED, NEW YORK, NY:
2,858,368, INT. CL. 36.
- AMERICAN CEREAL CORPORATION, EDEN PRAIRIE, MN:
2,857,752, PUB. 4-6-2004. INT. CL. 30.
- AMERICAN CITIZENS LIFE INSURANCE CORPORATION, WASHINGTON, DC:
1,247,883, CANC. INT. CL. 36.
- AMERICAN COLLEGE OF VETERINARY OPHTHALMOLOGISTS, INC., MERIDIAN, ID:
2,809,902, COR. MULTIPLE CLASS, INT. CLS. 16, 35 AND 41.
- AMERICAN CULINARY FEDERATION, INC., ST. AUGUSTINE, FL:
2,857,407, PUB. 4-6-2004. INT. CL. 35.
- AMERICAN CYANAMID COMPANY, MADISON, NJ:
2,088,344, CANC. INT. CL. 5.
- AMERICAN DAIRY QUEEN CORPORATION, EDINA, MN:
1,886,694, REN. 5-18-04. INT. CL. 32.
- AMERICAN EQUINE PRODUCTS, INC., WILTON, CT:
1,247,544, CANC. INT. CL. 5.
- AMERICAN EXPRESS COMPANY, NEW YORK, NY:
2,858,884, INT. CL. 36.
- AMERICAN HEAT-SEAL, INC., MILWAUKEE, WI:
754,407, CANC. U.S. CL. 5.
- AMERICAN INDUSTRIAL DIRECT LLC, CARY, IL:
1,301,253, REN. 5-17-04. INT. CL. 7.
- AMERICAN LEBANESE SYRIAN ASSOCIATED CHARITIES, INC., MEMPHIS, TN:
2,857,931, PUB. 4-6-2004. INT. CL. 36.
- AMERICAN LEGAL SEARCH, LLC, BIRMINGHAM, AL:
2,858,165, PUB. 4-6-2004. INT. CL. 35.
- AMERICAN MEDIA PARTNERS, INC., WESTBROOK, ME:
2,859,105, INT. CL. 9.
- AMERICAN OPTOMETRIC ASSOCIATION, ST. LOUIS, MO:
2,859,128, INT. CL. 35.
- AMERICAN ORTHOPAEDIC FOOT AND ANKLE SOCIETY, INC., SEATTLE, WA:
1,831,303, REN. 5-21-04. INT. CL. 16.
- AMERICAN PHARMACISTS ASSOCIATION (APHA), WASHINGTON, DC, FORMERLY THE AMERICAN PHARMACEUTICAL ASSOCIATION:
2,857,739, PUB. 4-6-2004. INT. CL. 16.
- AMERICAN POWER CONVERSION CORPORATION, WEST KINGSTOWN, RI:
2,087,368, CANC. INT. CL. 9.
- AMERICAN PROMOTIONAL EVENTS, INC., FLORENCE, AL, CHINA PYROTECHNICS, INC., FLORENCE, AL:
1,832,125, REN. 5-20-04. INT. CL. 13.
- AMERICAN PSYCHOLOGICAL ASSOCIATION, WASHINGTON, DC:
2,859,050, INT. CL. 42.
- AMERICAN RE-INSURANCE COMPANY, PRINCETON, NJ:
2,857,243, PUB. 4-6-2004. INT. CL. 36.
- AMERICAN SAVINGS BANK, F.A., IRVINE, CA:
2,087,153, CANC. INT. CL. 36.
- AMERICAN SOCIETY OF COMPOSERS, AUTHORS & PUBLISHERS, NEW YORK, NY:
2,858,471, INT. CL. 42.
- AMERICAN SOCIETY OF TRAVEL AGENTS, INC., ALEXANDRIA, VA:
1,841,055, REN. 5-19-04. INT. CL. 42.
- AMERICAN SPORTS INTERNATIONAL, LTD., JEFFERSON, IA, AKA AMERICAN ATHLETIC, INC.:
1,854,729, REN. 5-20-04. INT. CL. 28.
- AMERICAN STANDARD INC., PISCATAWAY, NJ:
2,086,764, CANC. INT. CL. 11.
- AMERICAN STATES INSURANCE COMPANY, INDIANAPOLIS, IN:
2,087,179, CANC. INT. CL. 36.
- AMERICAN SUZUKI MOTOR CORPORATION, BREA, CA:
2,857,385, PUB. 4-6-2004. INT. CL. 12.
- AMERICAN TELEPHONE AND TELEGRAPH COMPANY, NEW YORK, NY TO MROBERTS SOFTWARE, INC., INDIANAPOLIS, IN:
1,787,403, CANC. INT. CL. 9.
- AMERICAN TOOL COMPANIES A/S, HVIDORE, DENMARK:
2,858,722, INT. CL. 7.
- AMERICAN TRUCKSOURCE, INC., IRVING, TX:
2,858,276, INT. CL. 36.
- AMERICATT.COM, LLC, LAS VEGAS, NV:
2,858,228, INT. CL. 42.

- AMERITECH CORPORATION, CHICAGO, IL:
2,087,974, CANC. INT. CL. 9.
2,088,092, CANC. INT. CL. 42.
- AMES ELECTRO MATERIALS CORP., GLENS FALLS, NY
FROM HANDY & HARMAN, RYE NEW YORK, NY:
2,858,275, INT. CL. 6.
- AMETEK, INC., NEW YORK, NY:
754,598, CANC. U.S. CL. 26.
- AMICO EDUCATIONAL CONCEPTS, INC, CRESTWOOD,
IL:
2,858,114, PUB. 4-6-2004. INT. CL. 3.
- AMOS PRESS INC., SIDNEY, OH:
2,859,074, INT. CL. 16.
- AMPLIFIER RESEARCH CORPORATION, SOUDERTON,
PA:
2,858,664, INT. CL. 9.
- AMRO BIOTECH PLC, WOKING, SURREY, GU21 1LR,
UNITED KINGDOM:
2,697,417, COR. MULTIPLE CLASS, INT. CLS. 5 AND 42.
- AMSPEC CHEMICAL CORPORATION, GLOUCESTR CITY,
NJ:
2,086,922, CANC. INT. CL. 1.
- AMT - THE ASSOCIATION FOR MANUFACTURING
TECHNOLOGY, MCLEAN, VA:
2,088,087, CANC. INT. CL. 35.
- AMTECH CORPORATION, YELM, WA:
2,858,749, INT. CL. 12.
- AMWAY CORPORATION, ADA, MI:
754,702, CANC. U.S. CL. 39.
- AMX CORPORATION, RICHARDSON, TX FROM PANJA,
INC., RICHARDSON, TX:
2,858,726, INT. CL. 9.
- ANABELL INC., LOS ANGELES, CA:
2,858,986, INT. CL. 9.
- ANAHEIM MANUFACTURING COMPANY, ANAHEIM,
CA, WHITE CONSOLIDATED INDUSTRIES, INC., CLE-
VELAND, OH:
1,833,658, REN. 5-20-04. INT. CL. 7.
- ANALYTICAL BIO-CHEMISTRY LABORATORIES, INC.,
COLUMBIA, MO TO OL ANALYTICAL, COLUMBIA, MO:
1,786,661, CANC. INT. CL. 11.
- ANAMET INC., LAKEVILLE, CT, ANACONDA AMERICAN
BRASS COMPANY, WATERBURY, CT:
946,237, REN. 5-20-04. U.S. CL. 21 (INT. CLS. 7, 9, 11, 12
AND 15).
- ANCHOR EDUCATIONAL FOUNDATION, INC., PROVID-
ENCE, RI:
2,859,009, INT. CL. 9.
- ANCHOR WALL SYSTEMS, INC., MINNETONKA, MN:
2,858,754, INT. CL. 19.
- ANDERSON'S CAJUN'S WHARF, INC., LITTLE ROCK, AR,
DBA CAJUN'S WHARF:
1,247,851, CANC. INT. CL. 33.
- ANDREW CORPORATION, ORLAND PARK, IL:
403,521, REN. 5-17-04. U.S. CL. 21 (INT. CLS. 7, 9, 11, 12
AND 15).
- ANDREWS, MARK, NEW YORK, NY AND ANTHONY,
LARRY, JR., NEW YORK, NY AND GREEN, JAMES,
NEW YORK, NY AND RUFFIN, TAMIR, NEW YORK, NY
AND PECK, KEVIN, NEW YORK, NY:
2,087,905, CANC. INT. CL. 41.
- ANDRITZ AG, A-8045 GRAZ, AUSTRIA:
2,858,182, MULTIPLE CLASS, INT. CLS. 6, 7, 9, 11 AND
20.
- ANDROGEN EXCESS SOCIETY, LOS ANGELES, CA:
2,858,595, MULTIPLE CLASS, INT. CLS. 16, 35, 36, 41, 42
AND 44.
- ANGELETTA, JOSEPH G., MAMARONECK, NY:
2,705,250, AM. INT. CL. 3.
- ANGELICA CORPORATION, ST. LOUIS, MO:
1,787,233, CANC. INT. CL. 42.
- ANGELO BENEDETTI, INCORPORATED, BEDFORD, OH:
2,087,406, CANC. INT. CL. 37.
- ANGLE, JONATHAN, C., SAN PEDRO, CA:
2,858,814, INT. CL. 42.
- ANHEUSER-BUSCH, INCORPORATED, ST. LOUIS, MO:
2,087,236, CANC. INT. CL. 32.
2,088,041, CANC. INT. CL. 32.
- ANIKA THERAPEUTICS, IHC., WOBURN, MA, ANIKA
RESEARCH, INC., WOBURN, MA:
1,834,288, REN. 5-16-04. INT. CL. 5.
- ANIMA DOMUS INC., CORAL GABLES, FL:
2,857,835, PUB. 4-6-2004. INT. CL. 35.
- ANLIN INDUSTRIES, INC., CLOVIS, CA:
2,858,279, INT. CL. 19.
- ANN WIGMORE FOUNDATION, INC., SAN FIDEL, MA:
1,795,346, REN. 5-16-04. INT. CL. 41.
- ANNALEE MOBILITEE DOLLS, INC., MEREDITH, NH:
1,831,446, REN. 5-17-04. INT. CL. 28.
- ANNIES BOOK STOP ASSOCIATION, INC., NASHUA, NH,
ANNIE'S BOOK SWAP, INC., WESTBOROUGH, MA:
1,270,367, REN. 5-19-04. INT. CL. 42.
- ANT LIMITED, CAMBRIDGE, CB4 0WZ, UNITED KING-
DOM:
2,857,181, PUB. 4-6-2004. MULTIPLE CLASS, INT. CLS. 9
AND 42.
2,857,182, PUB. 4-6-2004. MULTIPLE CLASS, INT. CLS. 9
AND 42.
- ANTIPODEAN BIOTECHNOLOGY LIMITED, AUCKLAND,
NEW ZEALAND:
2,857,424, PUB. 4-6-2004. INT. CL. 5.
- APATITE TO ZIRCON, INC., VIOLA, ID:
2,859,120, INT. CL. 42.
- APDC, INC., ARLINGTON, TX:
2,088,407, CANC. INT. CL. 5.
- APICAL PHARMACEUTICAL, INC., FT. LAUDERDALE,
FL:
2,859,036, INT. CL. 5.
- APOTHEUS LABORATORIES, LTD., LUBBOCK, TX:
2,088,190, CANC. INT. CL. 10.
- APPALACHIAN MEDICAL SUPPLY, INC., ASHEVILLE, NC:
2,087,283, CANC. INT. CL. 42.
- APPLIED DATA SCIENCES, INC., CARROLLTON, TX:
2,858,145, PUB. 4-6-2004. INT. CL. 9.
- APTAKER CO., INC., CARROLLTON, TX:
1,847,240, REN. 5-20-04. INT. CL. 9.
- AQUA METER INSTRUMENTS CORP., ROSELAND, NJ:
754,423, CANC. U.S. CL. 8.
- AQUANOVA GETRANKETECHNOLOGIE GMBH, D-68219
MANNHEIM, FED REP GERMANY:
2,783,527, COR. INT. CL. 32.
- AQUARIUS WETSUITS (PTY) LIMITED, CAPE TOWN,
SOUTH AFRICA TO AQUARIUS WETSUITS (PTY) LIM-
ITED, CAPE TOWN, SOUTH AFRICA:
2,684,301, COR. INT. CL. 25.
- ARCHER DANIELS MIDLAND COMPANY, DECATUR, IL:
1,786,933, CANC. INT. CL. 30.
1,786,934, CANC. INT. CL. 30.
- ARCHVISION, INC., LEXINGTON, KY:
2,857,376, PUB. 4-6-2004. INT. CL. 9.
- ARCIMATE MANUFACTURING CORPORATION, ESCON-
DIDO, CA:
2,858,791, INT. CL. 8.
- ARCOA INDUSTRIES, ESCONDIDO, CA:
2,857,118, PUB. 4-6-2004. INT. CL. 21.
- ARCOR S.A.I.C., BUENOS AIRES, ARGENTINA:
2,857,928, PUB. 4-6-2004. INT. CL. 29.
- ARDATH TOBACCO COMPANY LIMITED, LONDON
WC2R 2PG, ENGLAND, LEVY, ALBERT, LONDON,
ENGLAND, TA ARDATH TOBACCO COMPANY:
41,324, REN. 5-21-04. U.S. CL. 17 (INT. CL. 34).
- ARDEN INTERNATIONAL, LLC, LAKEVILLE, MN:
2,857,433, PUB. 4-6-2004. MULTIPLE CLASS, INT. CLS. 29
AND 30.
- ARGENT SOFTWARE, INC., LONDONDERRY, NH:
2,857,354, PUB. 4-6-2004. MULTIPLE CLASS, INT. CLS. 9,
41 AND 42.
- ARGOS PRODUCTS COMPANY, GENOA, IL:
754,399, CANC. U.S. CL. 2.
- ARINC, INC., ANNAPOLIS, MD:
2,088,283, CANC. MULTIPLE CLASS, INT. CLS. 35 AND
38.
- ARISTOCRAT TECHNOLOGIES AUSTRALIA PTY LIM-
ITED, LANE COVE, NEW SOUTH WALES 2066, AUSTRALIA:
2,857,353, PUB. 4-6-2004. INT. CL. 9.

ARMADILLO SPORTS DESIGN LIMITED, KNUTSFORD, WA16 8UG, UNITED KINGDOM:
2,858,258, INT. CL. 28.

ARMATRON INTERNATIONAL, INC., MELROSE, MA:
1,859,456, REN. 5-21-04, INT. CL. 7.

ARMSTRONG WOOD PRODUCTS, INC., ADDISON, TX:
1,287,111, REN. 5-17-04, INT. CL. 20.

ARMSTRONG WORLD INDUSTRIES, INC., LANCASTER, PA:
2,857,271, PUB. 1-13-2004, MULTIPLE CLASS, INT. CLS. 19 AND 27.

ART HOLDINGS, INC., ST. MICHAEL, BARBADOS:
2,858,476, MULTIPLE CLASS, INT. CLS. 2 AND 35.

ART RENAISSANCE INCORPORATED, DETROIT, MI:
2,087,723, CANC. MULTIPLE CLASS, INT. CLS. 6, 16 AND 42.

ARTEMIS KAUSCHUK- UND KUNSTSTOFFTECHNIK GMBH & CIE., HANNOVER, FED REP GERMANY:
2,834,754, CANC. IIRN. RESTORED TO S.N. 75-811,498.

ARTIS, INC., BUELLTON, CA:
1,786,738, CANC. INT. CL. 16.

ARVESTA CORPORATION, SAN FRANCISCO, CA FROM TOMEN AGRO, INC., SAN FRANCISCO, CA:
2,858,739, INT. CL. 5.

AS IS ENTERTAINMENT, INC., NEW YORK, NY:
2,148,681, CANC. INT. CL. 25.

ASAHI BREWERIES, LTD., TOKYO, JAPAN:
2,858,820, INT. CL. 33.

ASICS CORPORATION, KOBE CITY, HYOGO PREFECTURE, JAPAN:
1,273,516, REN. 5-20-04, INT. CL. 18.
1,273,615, REN. 5-20-04, INT. CL. 25.

ASPEN VETERINARY RESOURCES, LTD., GREELEY, CO:
2,858,619, INT. CL. 5.

ASPHALTIC FUTURES CORPORATION, RIO PIEDRAS, PUERTO RICO:
2,087,322, CANC. INT. CL. 19.

ASSEMBLED PRODUCTS CORPORATION, ROGERS, AR:
2,088,058, CANC. INT. CL. 12.

ASSOCIATED CITRUS PACKERS, YUMA, AZ:
1,247,841, CANC. INT. CL. 31.
1,247,843, CANC. INT. CL. 31.

ASSOCIATION OF AMERICAN MEDICAL COLLEGES, WASHINGTON, DC:
2,857,716, PUB. 4-6-2004, INT. CL. 35.
2,857,734, PUB. 4-6-2004, INT. CL. 36.

ASSOCIATION OF CONTRACT TEXTILES, INC., FORT WORTH, TX:
2,858,141, PUB. 4-6-2004, U.S. CL. A.

ASSOCIATION OF LUTHERAN OLDER ADULTS, INC., VALPARAISO, IN:
1,787,285, CANC. MULTIPLE CLASS, INT. CLS. 16 AND 42.

ASTRON TECHNOLOGY CORP., HSIN CHUANG CITY, TAIPEI HSIEN, TAIWAN:
2,857,412, PUB. 4-6-2004, INT. CL. 9.

ASYNCHRONY SOLUTIONS, INC., ST. LOUIS, MO:
2,857,982, PUB. 4-6-2004, INT. CL. 9.

ATICO INTERNATIONAL USA, INC., FORT LAUDERDALE, FL:
2,835,515, CANC. IIRN. RESTORED TO S.N. 78-232,812.
2,858,860, INT. CL. 20.

ATKIN, GREG M., ANAHEIM, CA:
2,858,029, PUB. 4-6-2004, INT. CL. 15.

ATLANTA WOODWRIGHT, INC., TUCKER, GA:
2,087,021, CANC. INT. CL. 37.

ATLANTIC FILTER CORPORATION, WEST PALM BEACH, FL:
1,853,580, REN. 5-18-04, INT. CL. 11.

ATLANTIC RICHFIELD COMPANY, LOS ANGELES, CA TO CPH DOS PUEBLOS ASSOCIATES, NEWPORT BEACH, CA:
1,787,626, CANC. INT. CL. 41.

ATLANTIC STEEL COMPANY, ATLANTA, GA:
171,801, CANC. U.S. CL. 13.

AUBREY DANIELS INTERNATIONAL, INC., ATLANTA, GA:
2,858,571, INT. CL. 35.

AUBREY ORGANICS, INC., TAMPA, FL:
2,858,157, PUB. 4-6-2004, INT. CL. 3.

AUDIO-TECHNICA U.S., INC., STOW, OH:
2,088,297, CANC. INT. CL. 9.
2,088,298, CANC. INT. CL. 9.

AUDIT SYSTEMS COMPANY, TIMONIUM, MD:
2,088,201, CANC. INT. CL. 9.

AUMALE SYNERGIES, PARIS, FRANCE:
2,857,858, PUB. 4-6-2004, INT. CL. 1.

AURORA PUBLISHERS, INC., NASHVILLE, TN:
1,247,924, CANC. INT. CL. 41.

AUTO BODY EXPRESS, INC., SANTA FE, NM:
2,088,441, CANC. INT. CL. 3.

AUTO-SHADE, L.L.C., MOORPARK, CA:
2,088,333, CANC. INT. CL. 12.

AUTOBYTEL INC., IRVINE, CA:
2,858,812, MULTIPLE CLASS, INT. CLS. 35 AND 41.

AUTOGRAPHIC BUSINESS FORMS, INC., MOHAWK, NJ:
754,639, CANC. U.S. CL. 37.

AUTOMATIC LIQUID PACKAGING, INC., WOODSTOCK, IL:
2,088,381, CANC. INT. CL. 3.

AUTOMOTIVE RENTALS, INC., MT. LAUREL, NJ:
2,858,257, INT. CL. 39.

AVAIL MEDICAL PRODUCTS, INC., FORT WORTH, TX:
2,819,392, COR. MULTIPLE CLASS, INT. CLS. 40 AND 42.

AVANTES BV, EERBEEK, NETHERLANDS:
2,858,721, INT. CL. 9.

AVANTOS PERFORMANCE SYSTEMS, INC., EMERYVILLE, CA:
2,088,128, CANC. INT. CL. 9.

AVAYA INC., BASKING RIDGE, NJ FROM AMERICAN TELEPHONE AND TELEGRAPH COMPANY, NEW YORK, NY:
2,858,178, INT. CL. 9.

AVEDA CORPORATION, BLAINE, MN:
1,786,408, CANC. INT. CL. 3.

AVENTIS PHARMACEUTICALS PRODUCTS INC., BRIDGEWATER, NJ:
982,461, REN. 5-18-04, U.S. CL. 18 (INT. CL. 5).

AVERY, DONALD RAY, FAYETTEVILLE, NC:
2,857,578, PUB. 4-6-2004, INT. CL. 3.

AVIVA BIOSCIENCES CORPORATION, SAN DIEGO, CA:
2,858,594, INT. CL. 9.

AVOCET, INC., NEWARK, CA:
1,787,457, CANC. INT. CL. 12.

AVON BOOKS, INC., NEW YORK, NY:
1,786,749, CANC. INT. CL. 16.

AVT, INC., LITTLETON, CO:
2,088,418, CANC. INT. CL. 9.

AZIGN BIOSCIENCE A/S, 2450 KOBENHAVN SV, DENMARK:
2,857,208, PUB. 4-6-2004, MULTIPLE CLASS, INT. CLS. 1, 5 AND 42.

AZROCK INDUSTRIES INC., SAN ANTONIO, TX TO DOMCO INC., FARNHAM, QUEBEC:
1,786,421, CANC. INT. CL. 3.

AZTEX PRODUCTS, INC., RENO, NV:
2,087,615, CANC. INT. CL. 11.

B & B BAR-B-Q, INC., FAYETTEVILLE, AR:
1,787,157, CANC. INT. CL. 41.

B.C. SEKHAR SDN. BHD., 50200 KUALA LUMPUR, MALAYSIA:
2,088,084, CANC. INT. CL. 17.

B.F.C. INTERNATIONAL, INC., EL PASO, TX:
2,858,274, INT. CL. 41.

B.V. KONINKLIJKE TABAKFABRIEK KOFFIEBRANDERIJ THEEHANDEL J. & A. C. VAN ROSSEM, NIJKERK, NETHERLANDS:
754,483, CANC. U.S. CL. 17.

B&G MANUFACTURING CO., INC., HATFIELD, PA:
2,088,279, CANC. INT. CL. 6.

B&J MANUFACTURING CO., INC., GLENWOOD, IL, DBA B&J:
1,831,094, REN. 5-16-04, INT. CL. 7.

B&S UNDERWRITERS, INC., ALEXANDRIA, LA:
1,787,018, CANC. INT. CL. 36.

- BABE EASE, LLC, PELHAM, NH:
2,858,946, INT. CL. 20.
- BACHELORBLOWOUT, LLC, NEW ORLEANS, LA:
2,857,950, PUB. 4-6-2004. INT. CL. 39.
- BADDOG SERVICES & MERCHANDISE, LLC, GAHANNA, OH:
2,857,917, PUB. 4-6-2004. INT. CL. 35.
- BADERTSCHER COMMUNICATIONS, INC., MARION, OH:
2,857,123, PUB. 4-6-2004. INT. CL. 35.
- BADGER, BRUCE, SYDNEY NEW SOUTH WALES, AUSTRALIA:
2,857,974, PUB. 4-6-2004. INT. CL. 42.
- BAG CONCEPTS INC., ROSWELL, GA:
2,087,821, CANC. INT. CL. 18.
- BAILEY, COVERT, TIGARD, OR:
1,787,149, CANC. INT. CL. 41.
- BAKER HUGHES INCORPORATED, HOUSTON, TX:
2,858,951, MULTIPLE CLASS, INT. CLS. 7 AND 9.
- BALAGUERA, HERVERT WILSON, MARACAY, VENEZUELA:
2,087,935, CANC. INT. CL. 25.
- BALLY GAMING INTERNATIONAL, INC., LAS VEGAS, NV:
2,086,870, CANC. INT. CL. 9.
- BANANA SCRUBS, INCORPORATED, WACO, TX:
2,857,836, PUB. 4-6-2004. INT. CL. 10.
- BANKS, FREDERICK, JR., HUDSON, MA:
1,806,723, REN. 5-17-04. INT. CL. 16.
- BANNON ENTERPRISES, LLC, EAST GRANBY, CT:
2,857,877, PUB. 4-6-2004. INT. CL. 41.
- BARACUDA INTERNATIONAL CORPORATION, FT. LAUDERDALE, FL:
2,088,212, CANC. INT. CL. 9.
- BARBER, JACK A., LEESBURG, FL:
2,858,207, INT. CL. 11.
- BAREWALLS INTERACTIVE ART, INC., SHARON, MA:
2,857,231, PUB. 4-6-2004. INT. CL. 35.
- BARILLA ALIMENTARE S.P.A., PARMA, ITALY:
2,858,696, INT. CL. 30.
- BARKALOW, RAYMOND W, DOYLESTOWN, PA:
2,857,949, PUB. 11-11-2003. INT. CL. 1.
- BARKERS CHARCOAL BROILED HOTS, INC., MARIETTA, GA:
1,787,189, CANC. INT. CL. 42.
- BARMEDIA, INC., WASHINGTON, MO:
2,858,378, INT. CL. 42.
- BARNES, ANN, TORONTO, ONTARIO, CANADA:
2,858,444, INT. CL. 25.
- BARNHART INDUSTRIES, INC., BARNHART, MO:
2,087,825, CANC. INT. CL. 21.
- BARNSTEAD THERMOLYNE CORPORATION, DUBUQUE, IA, G. K. TURNER ASSOCIATES, PALO ALTO, CA:
993,855, REN. 5-18-04. U.S. CL. 26 (INT. CL. 9).
- BARNSTEAD THERMOLYNE CORPORATION, DUBUQUE, IA, THERMOLYNE CORPORATION, DUBUQUE, IA:
996,398, REN. 5-18-04. U.S. CL. 26 (INT. CL. 9).
- BAROSSA VINTAGE LIMITED, ANGASTON, SOUTH AUSTRALIA 5353, AUSTRALIA:
2,857,326, PUB. 4-6-2004. INT. CL. 33.
- BARTO, ROBERT, NEW YORK, NY, DBA DESIGN MODE INTERNATIONAL:
1,786,814, CANC. INT. CL. 25.
- BARUNSON CO., LTD., SEOUL, REPUBLIC OF KOREA:
2,857,308, PUB. 4-6-2004. INT. CL. 9.
- BASCO MANUFACTURING COMPANY, MASON, OH:
2,858,575, INT. CL. 11.
- BASEMENT SYSTEMS OF OHIO, INC., TWINSBURG, OH:
2,857,945, PUB. 4-6-2004. INT. CL. 37.
- BASF AKTIENGESSELLSCHAFT, LUDWIGSHAFEN AM RHEIN, FED REP GERMANY:
2,858,295, INT. CL. 9.
- BASF CORPORATION, MOUNT OLIVE, NJ:
1,786,388, CANC. INT. CL. 1.
- BASF CORPORATION, NEW JERSEY, VA:
1,786,397, CANC. INT. CL. 2.
- BASF CORPORATION, MOUNT OLIVE, NJ:
1,786,795, CANC. INT. CL. 22.
- BASS PUBLIC LIMITED COMPANY, BURTON-ON-TRENT, ENGLAND:
1,247,849, CANC. INT. CL. 32.
- BASS PUBLIC LIMITED COMPANY, LONDON, W1Y 1WE, ENGLAND:
2,086,767, CANC. INT. CL. 32.
- BAT INTERNATIONAL, INC., WHITTIER, CA:
2,087,318, CANC. INT. CL. 12.
- BAUMEL, SUSAN BENAY, FALLS CHURCH, VA:
2,857,366, PUB. 4-6-2004. INT. CL. 41.
- BAUSCH & LOMB INCORPORATED, ROCHESTER, NY:
1,787,421, CANC. INT. CL. 9.
- BAXTER INTERNATIONAL INC., DEERFIELD, IL:
2,857,914, PUB. 4-6-2004. INT. CL. 5.
- BAY AREA COMPLIANCE LAB CORP., SUNNYVALE, CA:
2,858,267, U.S. CL. A.
- BAYERISCHE MOTOREN WERKE AKTIENGESSELLSCHAFT, 80809 MUNICH, FED REP GERMANY:
2,857,557, PUB. 4-6-2004. INT. CL. 12.
- BAYLINER MARINE CORPORATION, EVERETT, WA:
2,086,799, CANC. INT. CL. 12.
- BAYLOR UNIVERSITY, WACO, TX:
2,087,440, CANC. INT. CL. 36.
- BCB BEVERAGES LIMITED, COUNTY CORK, IRELAND:
2,087,527, CANC. INT. CL. 32.
- BE AEROSPACE, INC., WELLINGTON, FL:
2,859,010, INT. CL. 11.
- BEAN-STREAM, INC., WILMINGTON, DE:
2,857,855, PUB. 4-6-2004. MULTIPLE CLASS, INT. CLS. 35 AND 42.
- BEATRICE FOODS CO., CHICAGO, IL TO DEAN INTELLECTUAL PROPERTY SERVICES, L.P., DALLAS, TX:
582,470, AM. U.S. CL. 46.
- BEBE DU JOUR, NORTH HOLLYWOOD, CA:
2,858,415, MULTIPLE CLASS, INT. CLS. 8, 14 AND 25.
- BECKMAN INSTRUMENTS, INC., FULLERTON, CA:
2,088,012, CANC. INT. CL. 9.
- BECKMORE MUSIC, INC., BROOKLYN, NY:
2,857,400, PUB. 4-6-2004. INT. CL. 9.
- BECTON, DICKINSON AND COMPANY, FRANKLIN LAKES, NJ:
2,858,038, PUB. 4-6-2004. INT. CL. 10.
- BEE AND HERBAL NEW ZEALAND LIMITED, CAMBRIDGE, NEW ZEALAND:
2,857,149, PUB. 4-6-2004. MULTIPLE CLASS, INT. CLS. 5 AND 30.
- BEECHAM INC., BRISTOL, TN:
402,692, CANC. U.S. CL. 52.
- BETLE, INC., SOUTH DARTMOUTH, MA, CONCORDIA COMPANY, INC., SOUTH DARTMOUTH, MA:
1,826,285, REN. 5-20-04. INT. CL. 12.
- BEHR PROCESS CORPORATION, SANTA ANA, CA:
2,086,753, CANC. INT. CL. 2.
- BEHR, EHUD, NEW YORK, NY:
2,857,954, PUB. 4-6-2004. INT. CL. 14.
- BELCORP OF AMERICA, INC., MIAMI, FL:
2,858,036, PUB. 4-6-2004. INT. CL. 34.
- BELGIAN VILLAGE INN, MOLINE, IL:
2,087,902, CANC. INT. CL. 30.
- BELL COMMUNICATIONS RESEARCH, INC., MORRISTOWN, NJ:
2,087,340, CANC. INT. CL. 42.
- BENECARD SERVICES, INC., LAWRENCEVILLE, NJ:
2,857,990, PUB. 4-6-2004. INT. CL. 35.
- BENJAMIN FRANKLIN LITERARY & MEDICAL SOCIETY, INC., THE, INDIANAPOLIS, IN, DBA CHILDREN'S BETTER HEALTH INSTITUTE:
1,851,450, REN. 5-20-04. INT. CL. 16.
- BENJAMIN MOORE & CO., MONTVALE, NJ:
2,857,334, PUB. 4-6-2004. INT. CL. 2.
- BENNETT BROTHERS, INC., CHICAGO, IL:
769,509, REN. 5-20-04. U.S. CL. 27 (INT. CL. 14).
- BENNY'S BAGELS, INC., DALLAS, TX:
2,086,844, CANC. INT. CL. 42.
- BERG TECHNOLOGY, INC., RENO, NV:
2,088,175, CANC. INT. CL. 9.
- BERG, JOSEPH A., BAKERSFIELD, CA:
1,787,509, CANC. INT. CL. 20.

BERNARDAUD PORCELAINES DE LIMOGES, S.A., 87000 LIMOGES, FRANCE:
2,087,407, CANC. INT. CL. 21.

BERRY, MICHAEL V., CANTON, GA:
2,858,154, PUB. 4-6-2004. INT. CL. 1.

BERTUCCI'S, INC., NORTHBOROUGH, MA:
2,857,891, PUB. 4-6-2004. INT. CL. 43.

BESCO USA, ORANGE, CA:
2,086,982, CANC. INT. CL. 28.

BEST BAGELS IN TOWN, ROCKY POINT, NY:
2,172,104, CANC. INT. CL. 30.

BETTERLIFE TRADING, INC., SCOTTSDALE, AZ:
2,858,002, PUB. 4-6-2004. INT. CL. 35.

BEYOND RETIREMENT, INC., ASHTABULA, OH:
2,858,259, MULTIPLE CLASS, INT. CLS. 16, 28 AND 42.

BEYOND TECHNOLOGY, INC., UPPER SADDLE RIVER, NJ:
1,787,406, CANC. INT. CL. 9.

BIG BARGAIN WORLD, INC., ORLANDO, FL, DBA BARGAIN WORLD:
2,086,731, CANC. INT. CL. 42.

BIG FISH COMMUNICATIONS, INC., MARINA DEL REY, CA:
2,857,196, PUB. 4-6-2004. MULTIPLE CLASS, INT. CLS. 9 AND 38.

BIGBADTOYSTORE, INC., SOMERSET, WI:
2,858,969, INT. CL. 35.

BIGHORN DEVELOPMENT, L.L.C., PALM DESERT, CA:
2,857,232, PUB. 4-6-2004. INT. CL. 41.

BILL COMMUNICATIONS, INC., NEW YORK, NY:
2,087,471, CANC. INT. CL. 16.

BILL JOHNSON'S RESTAURANTS, PHOENIX, AZ:
989,754, REN. 5-20-04. U.S. CL. 100 (INT. CL. 42).

BINGO PLAYERS, INC., RESEDA, CA:
2,858,260, INT. CL. 42.

BINNEY & SMITH INC., EASTON, PA:
1,247,803, CANC. INT. CL. 28.

BIO HUMA NETICS, INC., CHANDLER, AZ:
2,857,152, PUB. 4-6-2004. INT. CL. 1.

BIO-CIDE INTERNATIONAL, INC., NORMAN, OK:
2,858,945, INT. CL. 5.

BIO-ENERGY SYSTEMS, INC., KALISPELL, MT:
2,088,356, CANC. INT. CL. 5.

BIOCARE LABS, INC., BEDFORD PARK, IL:
2,858,193, INT. CL. 3.

BIOKIT, S.A., 08186-LLICA D'AMUNT (BARCELONA), SPAIN:
1,848,483, REN. 5-20-04. INT. CL. 5.

BIOLAB SERVICES, INC., WILMINGTON, DE:
1,274,035, REN. 5-17-04. INT. CL. 1.

BIORIGINAL FOOD & SCIENCE CORP., SASKATOON, SASKATCHEWAN, CANADA:
2,858,354, INT. CL. 40.

BIOSONICS, INC., SEATTLE, WA:
1,317,841, REN. 5-18-04. INT. CL. 9.

BIOTEST LABORATORIES, LLC, COLORADO SPRINGS, CO:
2,857,648, PUB. 4-6-2004. INT. CL. 5.

BIO THERM, ALBERT, MONACO:
2,087,298, CANC. INT. CL. 3.

BIRKENSROCK ORTHOPAEDIE GMBH & CO. KG, DEX, FED REP GERMANY:
2,857,185, PUB. 10-15-2002. INT. CL. 25.

BISON CAPITAL, L.L.C., VENICE, FL:
2,858,270, INT. CL. 36.

BITSOURCE, INC., MOUNTAIN VIEW, CA:
2,087,208, CANC. INT. CL. 42.
2,087,379, CANC. INT. CL. 35.

BJC HEALTHCARE, ST. LOUIS, MO:
2,858,666, INT. CL. 44.

BLACK & DECKER CORPORATION, THE, TOWSON, MD:
2,086,758, CANC. INT. CL. 11.

BLACK & VEATCH, KANSAS CITY, MO:
2,086,890, CANC. INT. CL. 9.

BLACK BEAUTY CUSTOM STICKS, L.L.C., BIRMINGHAM, MI:
2,857,403, PUB. 4-6-2004. INT. CL. 9.

BLACK HILLS GOLD DESIGNS & CREATIONS, RAPID CITY, SD:
2,087,270, CANC. INT. CL. 14.

BLACK ROSE, LTD., BEAVERTON, OR:
2,088,014, CANC. INT. CL. 9.

BLACKBOARD, INC., WASHINGTON, DC:
1,263,461, REN. 5-20-04. INT. CL. 9.

BLACKBOOK PHOTOGRAPHY, INC., KEW GARDENS, NY:
2,150,722, CANC. INT. CL. 9.

BLEU WATER COMPANY, INC., RICHMOND, VA:
2,858,315, INT. CL. 32.

BLEYER, JENNIFER S., BROOKLYN, NY:
2,858,011, PUB. 12-23-2003. INT. CL. 41.

BLITZ U.S.A., INC., MIAMI, OK:
2,858,558, INT. CL. 19.

BLOODY GOOD PRODUCTS, INC., GUILFORD, CT:
2,087,280, CANC. INT. CL. 32.

BLOOME, DAVID ADAM, LOS ANGELES, CA:
2,087,386, CANC. INT. CL. 42.

BLUE BELL, INC., GREENSBORO, NC:
1,247,744, CANC. INT. CL. 25.

BLUE CROSS AND BLUE SHIELD ASSOCIATION, CHICAGO, IL:
2,087,969, CANC. INT. CL. 36.

BLUE CROSS AND BLUE SHIELD OF MASSACHUSETTS, INC., BOSTON, MA:
2,086,924, CANC. MULTIPLE CLASS, INT. CLS. 35, 36 AND 42.
2,086,941, CANC. MULTIPLE CLASS, INT. CLS. 35, 36 AND 42.

BLUE GRAVITY COMMUNICATIONS, INC., PENNSAUKEN, NJ:
2,858,426, INT. CL. 42.

BLUE HORSESHOE PRODUCTIONS, INC., CHICAGO, IL FROM VINCENT, JENNIFER, CHICAGO, IL:
2,858,281, INT. CL. 41.

BLUE RIDGE PAPER PRODUCTS, INC., ASHEVILLE, NC:
2,857,206, PUB. 4-6-2004. INT. CL. 16.

BLUEGREEN CORPORATION, BOCA RATON, FL:
2,857,874, PUB. 4-6-2004. MULTIPLE CLASS, INT. CLS. 35, 36, 37 AND 41.

BLUM, LAURA, BEVERLY HILLS, CA:
2,859,047, INT. CL. 14.

BMG MUSIC, NEW YORK, NY:
2,858,391, MULTIPLE CLASS, INT. CLS. 9 AND 41.

BND ENTERPRISES, LLC, SAN ANTONIO, TX:
2,857,245, PUB. 4-6-2004. INT. CL. 35.

BNOX, INC., NEW YORK, NY:
2,088,020, CANC. INT. CL. 9.

BOC GROUP PLC, THE, SURREY GU20 6HJ, ENGLAND:
1,247,653, CANC. INT. CL. 16.

BODEGAS SALENTEIN S.A., BUENOS AIRES, ARGENTINA:
2,858,070, PUB. 4-6-2004. INT. CL. 33.

BODIOLOGY CONSULTING, INC., GLENVIEW, IL:
2,087,410, CANC. INT. CL. 41.

BODYLOGIX.COM HOLDINGS, LLC, COSTA MESA, CA:
2,858,212, MULTIPLE CLASS, INT. CLS. 5 AND 25.

BODYONICS, LTD., HICKSVILLE, NY:
2,857,978, PUB. 4-6-2004. INT. CL. 5.

BODYZEN ENTERPRISES, INC., MIAMI, FL:
2,857,242, PUB. 4-6-2004. INT. CL. 25.

BOEHME FILATX, INC., REIDSVILLE, NC:
2,087,720, CANC. INT. CL. 1.

BOEHRINGER INGELHEIM INTERNATIONAL GMBH, INGELHEIM AM RHEIN, FED REP GERMANY:
2,857,813, PUB. 4-6-2004. INT. CL. 42.
2,857,889, PUB. 4-6-2004. INT. CL. 42.
2,858,003, PUB. 4-6-2004. INT. CL. 5.

BOHMER, MARY ANTHONY, FAIRLAWN, OH:
2,087,630, CANC. INT. CL. 16.

BOLD IMAGE, INC., LITTLE RIVER, SC:
2,088,281, CANC. INT. CL. 25.

BORAL BRICKS, INC., ATLANTA, GA:
2,088,236, CANC. INT. CL. 42.

BORDEN, INC., COLUMBUS, OH:
1,247,816, CANC. INT. CL. 29.

- BORDEN, RANDOLPH, BOSTON, MA:
2,857,391, PUB. 4-6-2004. INT. CL. 25.
- BORDWIN, MILTON, BOSTON, MA, DBA OUNCE OF PREVENTION, INC.:
1,787,484, CANC. INT. CL. 16.
- BORG-WARNER PROTECTIVE SERVICES CORPORATION, PARSIPPANY, NJ:
2,087,279, CANC. INT. CL. 42.
- BORVIN WINES INTERNATIONAL INC., ALEXANDRIA, VA:
1,787,208, CANC. INT. CL. 42.
- BOTTOM LINE WINE COMPANY, WASHINGTON, DC:
2,087,028, CANC. INT. CL. 35.
- BOY SCOUTS OF AMERICA, IRVING, TX:
2,858,607, INT. CL. 41.
- BOYAJIAN ENTERPRISES, INC., BROOKLINE, MA:
2,087,083, CANC. INT. CL. 21.
- BP P.L.C., LONDON SW1Y 4PD, ENGLAND, BRITISH PETROLEUM COMPANY P.L.C., THE, LONDON EC2M 7BA, ENGLAND:
1,834,140, REN. 5-21-04. INT. CL. 42.
- BRACEWELL & PATTERSON, L.L.P., HOUSTON, TX:
2,857,637, PUB. 4-6-2004. INT. CL. 42.
- BRAKE PRO., LTD., CONCORD, ONTARIO, CANADA, TENNECO HEAVY DUTY BRAKE LTD., CONCORD - ONTARIO, CANADA:
1,807,354, REN. 5-15-04. INT. CL. 12.
- BRAND-REX LIMITED, WEYBRIDGE, SURREY, UNITED KINGDOM, AKZONA INCORPORATED, ASHEVILLE, NC:
962,581, REN. 5-18-04. U.S. CL. 21 (INT. CL. 9).
- BRASS EAGLE, INC., BENTONVILLE, AR:
2,858,300, INT. CL. 28.
- BRASSERIE D'ORVAL, S.A., VILLERS-DEVANT-ORVAL, BELGIUM:
2,857,934, PUB. 4-6-2004. INT. CL. 32.
- BRASSEY, THERESA A, MANTECA, CA:
2,857,707, PUB. 4-6-2004. INT. CL. 25.
- BREAKTHROUGH VENTURES INC., CHAPPAQUA, NY:
2,857,494, PUB. 4-6-2004. INT. CL. 35.
- BREHM, NANCY, BOSTON, MA:
2,858,293, INT. CL. 42.
- BRETH, NEWTON R., BOULDER, CO:
2,087,487, CANC. INT. CL. 9.
- BREW KING LIMITED, PORT COQUITLAM, BRITISH COLUMBIA, CANADA:
2,858,737, INT. CL. 33.
- BRIDG'S COMMITTEE LLC, WHEATON, IL:
2,858,538, U.S. CL. B.
- BRIDGEPORT BREWING COMPANY, BEAVERTON, OR:
2,086,698, CANC. MULTIPLE CLASS, INT. CLS. 32 AND 42.
- BRIDGESTONE CORPORATION, CHUO-KU, TOKYO, JAPAN:
1,248,001, CANC. INT. CL. 12.
1,248,003, CANC. INT. CL. 12.
1,787,459, CANC. INT. CL. 12.
- BRIDGESTONE CORPORATION, TOKYO, JAPAN:
1,821,206, REN. 5-16-04. INT. CL. 12.
1,822,617, REN. 5-16-04. INT. CL. 12.
1,822,618, REN. 5-16-04. INT. CL. 12.
1,822,619, REN. 5-16-04. INT. CL. 12.
1,830,272, REN. 5-16-04. INT. CL. 12.
2,858,013, PUB. 4-6-2004. INT. CL. 12.
- BRIGHT PROSPECT SCHOLAR SUPPORT PROGRAM, POMONA, CA:
2,859,045, MULTIPLE CLASS, INT. CLS. 16, 36 AND 41.
- BRINE, INC., MILFORD, MA:
2,858,805, INT. CL. 28.
- BRITAX CHILD SAFETY INC., CHARLOTTE, NC:
2,858,513, INT. CL. 12.
- BRODERBUND SOFTWARE, INC., NOVATO, CA:
2,087,438, CANC. INT. CL. 16.
- BRONCO WINE COMPANY, CERES, CA:
2,858,545, INT. CL. 33.
- BROOKS MANUFACTURING CO., BELLINGHAM, WA:
2,858,124, PUB. 4-6-2004. INT. CL. 19.
- BROOKSIDE FOODS LTD., ABBOTSFORD, BRITISH COLUMBIA V2T 6G2, CANADA:
2,857,180, PUB. 4-6-2004. INT. CL. 30.
- BROUGHTON, AMOS W., TEMPLE CITY, CA:
2,088,171, CANC. INT. CL. 19.
- BROUWERIJ VAN STEENBERGE NAAMLOZE VENNOOTSCHAP, 9940 ERTVELDE, BELGIUM:
2,857,112, PUB. 6-3-1997. INT. CL. 32.
2,857,117, PUB. 12-8-1998. INT. CL. 32.
- BROWN & WILLIAMSON TOBACCO CORPORATION, LOUISVILLE, KY:
754,482, CANC. U.S. CL. 17.
1,247,857, CANC. INT. CL. 34.
2,858,521, INT. CL. 41.
- BROWN GROUP, INC., ST. LOUIS, MO:
2,087,233, CANC. INT. CL. 42.
- BROWN-FORMAN CORPORATION, LYNCHBURG, TN:
1,247,854, CANC. INT. CL. 33.
- BROWN-FORMAN CORPORATION, LOUISVILLE, KY:
2,858,065, PUB. 4-6-2004. INT. CL. 33.
- BROWN, NYJGEL A., EAST ORANGE, NJ:
2,858,383, INT. CL. 25.
- BROWN, STEPHEN CRAIG, SONOMA, CA:
2,857,806, PUB. 4-6-2004. INT. CL. 40.
- BROWNELLS, INC., MONTEZUMA, IA:
2,858,031, PUB. 4-6-2004. INT. CL. 13.
- BROWNING & CO., INC., SOUTHGATE, CA:
1,247,551, CANC. MULTIPLE CLASS, INT. CLS. 6 AND 11.
- BROWNING, MICHAEL G., TAMPA, FL:
2,858,903, INT. CL. 41.
- BROYHILL COMPANY, THE, DAKOTA CITY, NE:
1,787,359, CANC. INT. CL. 7.
- BRUCE FOODS CORPORATION, ST. MARTINVILLE, LA:
2,086,865, CANC. MULTIPLE CLASS, INT. CLS. 29 AND 30.
- BRUGGER + THOMET AG, THUN, SWITZERLAND:
2,858,896, INT. CL. 13.
- BRUMMEL, DAVID G., RIVER FALLS, WI, DBA AVES INC:
1,837,899, REN. 5-17-04. INT. CL. 19.
- BRUNO POGGI E FIGLI S.R.L., ROME, ITALY:
1,786,763, CANC. INT. CL. 19.
- BSD, INC., WATERBURY, CT:
2,858,892, INT. CL. 36.
- BUCHER, JOE, EAGLE RIVER, WI:
2,857,331, PUB. 4-6-2004. INT. CL. 28.
2,857,332, PUB. 4-6-2004. INT. CL. 28.
- BUCKHORN, INC., MILFORD, OH:
2,857,850, PUB. 4-6-2004. INT. CL. 20.
- BUHLER AG, UZWIL, SWITZERLAND:
2,857,952, PUB. 4-6-2004. MULTIPLE CLASS, INT. CLS. 7, 9, 37, 39, 41 AND 42.
- BUKAMARANGA BEAN COMPANY INC., THE, KINGSTON, ONTARIO, CANADA:
2,086,802, CANC. INT. CL. 42.
- BULMAN, RICHARD L., PORTLAND, ME:
2,859,116, INT. CL. 16.
- BUNN-O-MATIC CORPORATION, SPRINGFIELD, IL:
2,857,555, PUB. 4-6-2004. INT. CL. 7.
- BUREAU OF NATIONAL AFFAIRS, INC., WASHINGTON, DC:
2,087,238, CANC. INT. CL. 9.
- BURGER TYME OF AMERICA, INC., LAFAYETTE, LA:
1,786,919, CANC. INT. CL. 30.
- BURLEIGH INSTRUMENTS INC., FISHERS, NY:
1,787,680, CANC. INT. CL. 9.
- BURNS & MCDONNELL ENGINEERING COMPANY, KANSAS CITY, MO:
2,859,088, INT. CL. 35.
- BURRITO BEACH, LLC, CHICAGO, IL:
2,858,871, INT. CL. 43.
- BURROWING OWL VINEYARDS LTD., OLIVER, BRITISH COLUMBIA, CANADA:
2,819,080, COR. INT. CL. 33.
- BURROWS GOLF, INC., VALENCIA, CA:
2,858,798, INT. CL. 28.
- BURROWS, RONNI K., PITTSBURGH, PA:
2,086,915, CANC. INT. CL. 42.

BURRS, THE, CAMBRIDGE, MA:
2,087,576, CANC. INT. CL. 41.

BURTON CORPORATION, THE, BURLINGTON, VT:
2,087,191, CANC. INT. CL. 25.

BUSCH ENTERTAINMENT CORPORATION, ST. LOUIS, MO:
1,877,009, REN. 5-17-04, INT. CL. 41.
2,088,229, CANC. INT. CL. 21.

BUSCH PROPERTIES, INC., ST. LOUIS, MO:
1,806,453, REN. 5-20-04, INT. CL. 39.

BUSHNELL PERFORMANCE OPTICS, OVERLAND PARK, KS:
2,858,101, PUB. 4-6-2004, INT. CL. 9.

BUSINESS LOAN CENTER, NEW YORK, NY:
1,787,035, CANC. INT. CL. 36.

BUST, LOS ANGELES, CA:
2,087,675, CANC. INT. CL. 16.

BUTTERWORTH VENTURES, INC., GRAND RAPIDS, MI:
2,087,987, CANC. INT. CL. 16.

BUXTON COMPANY, THE, FORT WORTH, TX:
2,858,277, MULTIPLE CLASS, INT. CLS. 16 AND 35.

BUY THE WEIGH, INC., CHICAGO, IL:
2,087,505, CANC. INT. CL. 30.

C C POLLEN COMPANY, PHOENIX, AZ:
1,247,832, CANC. INT. CL. 31.

C. H. GUENTHER & SON, INC., SAN ANTONIO, TX:
2,858,028, PUB. 4-6-2004, INT. CL. 30.

C.I.T. S.P.A. CONFEZIONI ITALIANE TESSILI COMMERCIO INDUSTRIA TESSUTI, 20121 MILANO, ITALY:
2,757,788, COR. INT. CL. 9.

CABLE ELECTRIC PRODUCTS, INC., PROVIDENCE, RI:
1,247,615, CANC. INT. CL. 11.

CABLE NEWS NETWORK, INC., ATLANTA, GA:
2,088,275, CANC. INT. CL. 41.
2,088,276, CANC. INT. CL. 41.
2,088,287, CANC. INT. CL. 41.

CABOT CORPORATION, BOSTON, MA:
1,827,952, REN. 5-16-04, INT. CL. 1.

CAC OPTICAL, INC., LONG ISLAND CITY, NY:
2,857,658, PUB. 4-6-2004, INT. CL. 9.

CACHET BANQ, PASADENA, CA:
2,857,465, PUB. 4-6-2004, INT. CL. 36.

CADENT LTD., OR YEHUDA, ISRAEL:
2,857,922, PUB. 12-2-2003, INT. CL. 10.

CALCADOS SANDALO S/A, FRANCA - SAO PAULO - SP, BRAZIL:
1,272,782, REN. 5-21-04, INT. CL. 25.

CALDWELL, ROBERT BRIAN, COTTONWOOD, AZ, DBA METASONICS:
1,826,202, REN. 5-17-04, INT. CL. 9.

CALIFORNIA ALMOND GROWERS EXCHANGE, SACRAMENTO, CA:
1,271,989, REN. 5-21-04, MULTIPLE CLASS, INT. CLS. 29, 30 AND 31.
1,273,726, REN. 5-21-04, MULTIPLE CLASS, INT. CLS. 29, 30 AND 31.

CALIFORNIA SUNCARE, INC., LOS ANGELES, CA:
1,786,402, CANC. INT. CL. 3.

CALIPER CORPORATION, NEWTON, MA:
2,857,687, PUB. 4-6-2004, INT. CL. 39.
2,857,694, PUB. 4-6-2004, INT. CL. 16.

CALL HOME, INC., MISSISSAUGA, ONTARIO, L4Z 3K3, CANADA:
2,087,264, CANC. INT. CL. 35.
2,087,265, CANC. INT. CL. 42.
2,087,269, CANC. INT. CL. 41.

CALLAWAY GOLF COMPANY, CARLSBAD, CA:
2,087,955, CANC. INT. CL. 28.

CALLAWAY, CHARLES, DENVER, CO:
2,857,120, PUB. 4-6-2004, MULTIPLE CLASS, INT. CLS. 25 AND 42.

CALLE, H. MARTIN, JR. GREENWICH, CT:
2,857,466, PUB. 4-6-2004, INT. CL. 42.

CALLE, H. MARTIN, JR., GREENWICH, CT:
2,857,467, PUB. 4-6-2004, INT. CL. 42.

CALVILLO, JESUS E., SAN ANTONIO, TX:
2,858,263, INT. CL. 30.

CALVIN KLEIN COSMETIC CORPORATION, WILMINGTON, DE:
407,245, REN. 5-17-04, U.S. CL. 6 (INT. CL. 3).

CAM SYSTEMS, LLC, SARATOGA, CA:
2,857,706, PUB. 4-6-2004, INT. CL. 9.

CAMPAGNOLO SRL, 36100 VICENZA, ITALY:
2,858,238, INT. CL. 12.

CAMPANIA HOLDING COMPANY, VIENNA, VA:
2,087,694, CANC. INT. CL. 36.

CAMPBELL FITTINGS INC., BOYERTOWN, PA:
2,858,937, INT. CL. 6.

CAMPBELL MITHUN ESTY LLC, MINNEAPOLIS, MN:
2,858,715, INT. CL. 35.

CAN-DO BRICK COMPANY, SIOUX FALLS, SD:
2,088,373, CANC. INT. CL. 19.

CANAL GROUP, INC., CHICAGO, IL:
2,857,246, PUB. 4-6-2004, INT. CL. 25.

CANARY INVESTMENTS INC., HOUSTON, TX:
2,857,455, PUB. 4-6-2004, INT. CL. 42.

CANDLE CORPORATION OF AMERICA, DES PLAINES, IL:
2,152,332, CANC. MULTIPLE CLASS, INT. CLS. 3 AND 16.

CANNERY CASINO RESORTS, LLC, LAS VEGAS, NV:
2,857,431, PUB. 4-6-2004, INT. CL. 30.

CANNIZZARO, CARL C., BOCA RATON, FL:
2,087,540, CANC. INT. CL. 11.

CANON COMMUNICATIONS INC, SANTA MONICA, CA:
2,858,078, PUB. 4-6-2004, INT. CL. 35.

CANON KABUSHIKI KAISHA, TOKYO, JAPAN:
2,088,183, CANC. INT. CL. 9.

CANTON CHRISTIAN FELLOWSHIP, INC., CANTON, OH:
2,857,768, PUB. 4-6-2004, INT. CL. 41.

CAPCOM CO., LTD., CHUO-KU, OSAKA, JAPAN:
2,834,836, CANC. IIRN. RESTORED TO S.N. 76-113,328.
2,858,927, INT. CL. 9.
2,858,930, INT. CL. 9.
2,858,931, INT. CL. 9.

CAPITAL DISTRIBUTION, INC., SAN JUAN CAPISTRANO, CA:
2,087,118, CANC. INT. CL. 25.

CAPSTONE INTERNATIONAL, INC., ST. PETERSBURG, FL:
1,829,959, REN. 5-20-04, INT. CL. 33.

CAPSULATED SYSTEMS, INC., YELLOW SPRINGS, OH:
1,247,476, CANC. INT. CL. 2.

CARCOUSTICS TECH CENTER GMBH, LEVERKUSEN, FED REP GERMANY:
2,857,811, PUB. 4-6-2004, MULTIPLE CLASS, INT. CLS. 17 AND 27.

CARDIOMETRICS, INC., MOUNTAIN VIEW, CA:
2,088,194, CANC. INT. CL. 10.

CAREGAIN, INC., MONROE, NJ:
2,857,227, PUB. 4-6-2004, INT. CL. 36.
2,859,097, MULTIPLE CLASS, INT. CLS. 36 AND 42.

CARGILL, INCORPORATED, WAYZATA, MN, W. R. GRACE & CO., NEW YORK, NY:
980,875, REN. 5-21-04, MULTIPLE CLASS, U.S. CLS. 18 (INT. CL. 5) AND 46 (INT. CL. 31).

CARGILL, INCORPORATED, WAYZATA, MN:
1,787,594, CANC. INT. CL. 31.
2,858,153, PUB. 4-6-2004, INT. CL. 29.

CARIBBEAN DISTILLERS CORPORATION INTERNATIONAL LIMITED, ROAD BAY, ANGUILLA:
2,858,353, INT. CL. 33.

CARLA CORCINI, INC., BROCKTON, MA:
1,786,404, CANC. MULTIPLE CLASS, INT. CLS. 3, 21 AND 26.

CARLISLE INTANGIBLE COMPANY, SYRACUSE, NY:
2,857,564, PUB. 4-6-2004, INT. CL. 37.

CARLISLE INTANGIBLE COMPANY, SYRACUSE, NY FROM CARLISLE MANAGEMENT COMPANY, SYRACUSE, NY:
2,858,495, INT. CL. 12.
2,858,496, INT. CL. 12.

CARMAX AUTO SUPERSTORES WEST COAST, INC., WALNUT, CA:
2,858,025, PUB. 4-6-2004, INT. CL. 35.

- CARMAX AUTO SUPERSTORES, INC., GLEN ALLEN, VA:
2,087,183, CANC. INT. CL. 42.
- CAROLINA GALVANIZING CORPORATION, ABERDEEN, NC:
1,247,553, CANC. MULTIPLE CLASS, INT. CLS. 6, 9 AND 40.
- CAROLINA LEAGUE, INC., GREENSBORO, NC:
1,830,642, REN. 5-16-04. INT. CL. 41.
- CAROLINA WHOLESALE MACHINE COMPANY, INC., CHARLOTTE, NC:
2,857,961, PUB. 4-6-2004. INT. CL. 35.
- CARPENTER CO., RICHMOND, VA, E.R. CARPENTER COMPANY, INC., RICHMOND, VA:
1,832,749, REN. 5-16-04. INT. CL. 17.
- CARPENTER CO., RICHMOND, VA:
2,857,701, PUB. 4-6-2004. INT. CL. 20.
- CARPENTER MANUFACTURING COMPANY, INC., MANLIUS, NY:
1,285,831, REN. 5-18-04. INT. CL. 7.
- CARRUTH STUDIO, INC., WATERVILLE, OH:
2,858,913, INT. CL. 21.
- CARSON PIRIE SCOTT & CO., MILWAUKEE, WI:
2,088,261, CANC. INT. CL. 42.
- CARTER-WALLACE, INC., NEW YORK, NY:
402,720, CANC. U.S. CL. 18.
- CARTER, SCOTT CHARLES, SAN DIEGO, CA:
2,858,714, MULTIPLE CLASS, INT. CLS. 9 AND 41.
- CARVER INDUSTRIES, L.L.C., MINNEAPOLIS, MN FROM CARVER BOAT CORPORATION, L.L.C., MINNEAPOLIS, MN:
2,858,807, MULTIPLE CLASS, INT. CLS. 12 AND 25.
- CARY MARINE, INC., HALLANDALE BEACH, FL:
2,858,517, INT. CL. 12.
- CASE MEDICAL, INC., RIDGEFIELD, NJ:
2,857,691, PUB. 4-6-2004. INT. CL. 10.
- CASE-HOYT CORPORATION, THE, ROCHESTER, NY:
1,247,679, CANC. INT. CL. 16.
- CASHMERE HOUSE, INC., SANTA ANA, CA:
2,088,185, CANC. INT. CL. 21.
- CASIO KEISANKI KABUSHIKI KAISHA, SHINJUKU-KU, TOKYO, JAPAN, DBA CASIO COMPUTER CO:
1,273,187, REN. 5-16-04. INT. CL. 15.
- CASIO KEISANKI KABUSHIKI KAISHA, SHIBUYA-KU, TOKYO, JAPAN, DBA CASIO COMPUTER CO., LTD.:
2,858,627, INT. CL. 14.
- CASSEL, DONALD, MARINA DEL REY, CA:
2,087,122, CANC. INT. CL. 25.
- CASSIDY, VICTOR, CHICAGO, IL:
2,087,221, CANC. INT. CL. 41.
- CASTLE KEEPERS OF CHARLESTON, INC., NORTH CHARLESTON, SC:
2,858,057, PUB. 4-6-2004. INT. CL. 37.
- CASTLE, MICHAEL, GLENVIEW, IL:
1,848,229, REN. 5-16-04. INT. CL. 25.
- CASTRONEVES RACING, MIAMI, FL:
2,857,719, PUB. 4-6-2004. INT. CL. 25.
- CATALOOCHEE RESORT, INC., MAGGIE VALLEY, NC:
2,857,526, PUB. 4-6-2004. INT. CL. 41.
- CATHEDRAL ART METAL CO., INC., PROVIDENCE, RI:
2,858,869, INT. CL. 14.
- CATSPED WIRING, LLC, LAKE LUZERNE, NY:
2,857,475, PUB. 4-6-2004. INT. CL. 37.
- CB COMMERCIAL REAL ESTATE SERVICES GROUP, INC., LOS ANGELES, CA:
2,088,327, CANC. INT. CL. 36.
- CBC (AMERICA) CORP., COMMACK, NY:
2,858,203, INT. CL. 9.
- CCTI GROUP, INC., PALM CITY, FL:
2,858,009, PUB. 4-6-2004. INT. CL. 2.
- CCTV CORPORATION, SOUTH HACKENSACK, NJ:
2,087,409, CANC. INT. CL. 9.
- CDI SEALS, INC., HUMBLE, TX:
2,857,468, PUB. 4-6-2004. INT. CL. 17.
- CECIL SAYDAH COMPANY, LOS ANGELES, CA:
1,797,890, REN. 5-18-04. INT. CL. 24.
1,797,890, CANC. INT. CL. 26.
- CEDAR RAPIDS TELEVISION COMPANY, CEDAR RAPIDS, IA:
1,830,605, REN. 5-18-04. INT. CL. 38.
- CEGELEC, 92300 LEVALLOIS-PERRET, FRANCE:
2,086,906, CANC. INT. CL. 9.
- CEGETEL, 75008 PARIS, FRANCE:
2,407,629, CANC. IIRN. RESTORED TO S.N. 75-494,738.
- CEILINGS PLUS, LOS ANGELES, CA:
2,858,741, MULTIPLE CLASS, INT. CLS. 6 AND 11.
- CELEBRITY ENTERPRISES, INC., TIJERAS, NM:
2,086,845, CANC. INT. CL. 41.
- CELEBRITY INTERNATIONAL INC., NEW YORK, NY:
1,247,749, CANC. INT. CL. 25.
- CELFORT CONSTRUCTION MATERIALS INC., VALLEY-FIELD, QUEBEC, CANADA:
2,086,853, CANC. INT. CL. 17.
- CELGENE CORPORATION, WARREN, NJ:
2,858,332, INT. CL. 5.
- CELLCO PARTNERSHIP, BEDMINSTER, NJ, DBA VERIZON WIRELESS:
2,857,187, PUB. 4-6-2004. INT. CL. 38.
2,857,225, PUB. 4-6-2004. INT. CL. 38.
- CELLO PARTNERSHIP, BEDMINSTER, NJ, DBA VERIZON WIRELESS:
1,831,587, REN. 5-18-04. INT. CL. 38.
- CELLON S.A., BERELDAGE, LUXEMBOURG:
2,857,161, PUB. 4-6-2004. MULTIPLE CLASS, INT. CLS. 1, 5, 9 AND 10.
- CELLPATH PLC, MID WALES, UNITED KINGDOM:
2,858,456, MULTIPLE CLASS, INT. CLS. 9 AND 10.
- CELLULAR, USA, LAS VEGAS, NV:
2,087,304, CANC. INT. CL. 42.
- CEM ENTERPRISES, INC., DECATUR, GA:
1,247,724, CANC. INT. CL. 21.
- CENDANT PUBLISHING, INC., LAS VEGAS, NV:
2,858,661, INT. CL. 36.
- CENOVIS SA (CENOVIS AG) (CENOVIS LTD), 1204 GENEVA, SWITZERLAND:
2,857,179, PUB. 4-6-2004. MULTIPLE CLASS, INT. CLS. 29 AND 30.
- CENTERPOINT ENERGY, INC., HOUSTON, TX:
2,857,141, PUB. 4-6-2004. INT. CL. 36.
- CENTRAL FREIGHT LINES, INC., WACO, TX:
2,086,886, CANC. INT. CL. 39.
- CENTRAL GARDEN & PET COMPANY, AUBURN, WA:
2,087,214, CANC. INT. CL. 21.
- CENTRALYTICS, INC., GLEN ELLYN, IL:
2,857,968, PUB. 4-6-2004. MULTIPLE CLASS, INT. CLS. 9 AND 35.
- CERAMCO INC., BURLINGTON, NJ:
2,857,985, PUB. 4-6-2004. INT. CL. 5.
- CERG PLUS, 94000 CRETEIL, FRANCE TO LOAN SYSTEM, CRETEIL, FRANCE:
1,786,555, CANC. INT. CL. 9.
- CERTAPAY INC., TORONTO, ONTARIO, CANADA:
2,857,160, PUB. 4-6-2004. MULTIPLE CLASS, INT. CLS. 9 AND 36.
- CERVECERIA INDIA, INC., MAYAQUEZ, PUERTO RICO:
1,634,291, REN. 5-21-04. INT. CL. 32.
- CESAR, CLAUDIO, HILLSBOROUGH, CA:
2,857,485, PUB. 4-6-2004. INT. CL. 19.
- CHAIN CONSTRUCTION CORP., CHESTNUT HILL, MA:
1,247,902, CANC. INT. CL. 37.
- CHAIR-A-PEUTICS INC., RED BANK, NJ:
2,088,000, CANC. INT. CL. 9.
- CHAMAA, FEHMI, ASCHHEIM-DORNACH, FED REP GERMANY, DBA FEHMI CHAMAA FROM MONDI TEXTILE GMBH, 81735 MUNCHEN, FED REP GERMANY:
2,858,194, INT. CL. 18.
- CHAMBER OF COMMERCE OF THE UNITED STATES, WASHINGTON, DC:
2,857,451, PUB. 4-6-2004. INT. CL. 35.
- CHAMBERLAIN GROUP, INC., THE, ELMHURST, IL:
1,247,562, CANC. INT. CL. 6.
- CHAMPAGNE DEUTZ, 51160 AY, MARNE, FRANCE:
1,270,992, REN. 5-17-04. INT. CL. 33.

- CHAMPION INTERNATIONAL CORPORATION, STAMFORD, CT:
754,806, CANC. U.S. CL. 12.
754,807, CANC. U.S. CL. 12.
- CHAMPION INTERNATIONAL CORPORATION*, STAMFORD, CT:
2,087,739, CANC. INT. CL. 35.
- CHAMPIONSHIP SPORTS MARKETING, INC., ATLANTA, GA:
2,858,111, PUB. 4-6-2004. INT. CL. 35.
- CHANEY INSTRUMENT COMPANY, LAKE GENEVA, WI:
2,859,056, INT. CL. 9.
- CHAOS SNOWBOARDS, LTD., EL CAJON, CA:
2,087,369, CANC. INT. CL. 28.
- CHAPEAU, INC., GRANITE BAY, CA:
2,858,907, INT. CL. 7.
- CHAPPS HAMBURGERS, INC., ARLINGTON, TX:
2,858,089, PUB. 4-6-2004. INT. CL. 43.
- CHARLES D. WHITMER, AVON LAKE, OH:
767,384. REN. 5-17-04. U.S. CL. 12 (INT. CL. 19).
- CHARLES MACHINE WORKS, INC., THE, PERRY, OK:
1,298,425. REN. 5-18-04. INT. CL. 7.
- CHARLES, JENNIFER, BROOKLYN, NY:
2,088,278, CANC. INT. CL. 41.
- CHARLOTTE CHECKERS PROFESSIONAL ICE HOCKEY LLC, CHARLOTTE, NC:
2,858,880, INT. CL. 25.
- CHARMS MARKETING COMPANY, CHICAGO, IL:
2,858,058, PUB. 4-6-2004. INT. CL. 30.
- CHAUTAUQUA HARDWARE CORPORATION, JAMESTOWN, NY:
1,247,550, CANC. MULTIPLE CLASS, INT. CLS. 6, 16, 28 AND 34.
- CHAUTAUQUA INSTITUTION, CHAUTAUQUA, NY:
1,275,107. REN. 5-20-04. MULTIPLE CLASS, INT. CLS. 16, 18 AND 25.
- CHEMCUT CORPORATION:
1,247,566, CANC. MULTIPLE CLASS, INT. CLS. 7 AND 9.
- CHEMSTAR L.L.C., ST. CLAIR, MO:
2,858,115, PUB. 4-6-2004. INT. CL. 6.
- CHEN, YI FEL, NEW YORK, NY:
2,858,284, INT. CL. 25.
- CHERISON ENTERPRISES INC., CONCORD, ONTARIO, CANADA:
2,857,549, PUB. 4-6-2004. MULTIPLE CLASS, INT. CLS. 20, 21 AND 28.
- CHESEBROUGH-POND'S INC., WILMINGTON, DE:
2,099,856, CANC. MULTIPLE CLASS, INT. CLS. 20 AND 24.
- CHESEBROUGH-POND'S, INC., WILMINGTON, DE, Q-TIPS, INC., LONG ISLAND CITY, NY:
591,736. REN. 5-21-04. U.S. CL. 44 (INT. CL. 5).
- CHEVY CHASE BANK, F.S.B., CHEVY CHASE, MD:
2,087,600, CANC. INT. CL. 36.
2,087,601, CANC. INT. CL. 36.
2,087,602, CANC. INT. CL. 36.
- CHICKEN CHEF CANADA LTD., WINNIPEG, MANITOBA, CANADA:
2,857,815, PUB. 10-21-2003. INT. CL. 43.
- CHILDREN OF DESTINY INTERNATIONAL, PASADENA, CA:
2,858,703, INT. CL. 41.
- CHILDREN OF PROMISE INTERNATIONAL, ALMA, MO:
2,859,096, INT. CL. 36.
- CHILDREN'S A.I.D.S. NETWORK, INC., THE, NEW YORK, NY:
1,637,826, CANC. INT. CL. 36.
- CHILDREN'S HOSPITAL OF PITTSBURGH, PITTSBURGH, PA:
2,088,450, CANC. INT. CL. 42.
- CHILDREN'S HOSPITAL OF PITTSBURGH OF UPMC HEALTH SYSTEM, PITTSBURGH, PA:
2,857,689, PUB. 4-6-2004. INT. CL. 28.
- CHILDREN'S LEUKEMIA FOUNDATION OF MICHIGAN, SOUTHFIELD, MI:
2,857,880, PUB. 4-6-2004. MULTIPLE CLASS, INT. CLS. 35, 36 AND 45.
- CHILDREN'S LITERACY INITIATIVE, PHILADELPHIA, PA:
2,857,674, PUB. 4-6-2004. INT. CL. 41.
- CHILDREN'S TELEVISION WORKSHOP, NEW YORK, NY:
2,087,934, CANC. MULTIPLE CLASS, INT. CLS. 9, 16 AND 18.
- CHINA NATIONAL LIGHT INDUSTRIAL PRODUCTSIMPORT & EXPORT CORPORATION, GUANGDONG (GROUP) CO., GUANGZHOU, CHINA:
1,247,627, CANC. INT. CL. 11.
- CHINA TIMES, INC., WASHINGTON, DC:
1,247,687, CANC. INT. CL. 16.
- CHIRON CORPORATION, EMERYVILLE, CA:
2,857,698, PUB. 4-6-2004. INT. CL. 5.
- CHLOE SOCIETE ANONYME, 75008 PARIS, FRANCE:
1,837,274. REN. 5-21-04. INT. CL. 3.
- CHOCOLATERIE DU COTEAU SOCIETE EN NOM COLLECTIF, 42120 LE COTEAU, FRANCE:
1,786,912, CANC. INT. CL. 30.
- CHOLESTEROL CONTROL LABORATORIES, INC., FT LAUDERDALE, FL:
2,857,163, PUB. 4-6-2004. INT. CL. 5.
- CHOLLAMPAT, AZEEZ, PALO ALTO, CA:
2,857,720, PUB. 4-6-2004. INT. CL. 30.
- CHOMARAT, JEAN BERNARD, B-1040 BRUXELLES, BELGIUM AND TAPIERO, YVES, LONDON W8 7BL, UNITED KINGDOM:
2,858,245, INT. CL. 29.
- CHRIS-CRAFT INDUSTRIES, INC., NEW YORK, NY:
754,573, CANC. U.S. CL. 23.
- CHRISTENSEN, NICKOLAS, G, LODI, CA:
2,857,841, PUB. 4-6-2004. INT. CL. 25.
- CHRISTOPHER COMMUNITY, INC., SYRACUSE, NY:
2,857,458, PUB. 4-6-2004. MULTIPLE CLASS, INT. CLS. 36 AND 37.
- CHUCKHOUSE, INC., SANTA ROSA, CA:
2,858,371, INT. CL. 6.
- CHURCH & DWIGHT COMPANY, GREEN RIVER, WY:
2,857,979, PUB. 4-6-2004. INT. CL. 31.
- CIA WHEEL GROUP, LOS ANGELES, CA:
2,858,511, INT. CL. 12.
- CIBA-GEIGY CORPORATION, ARDSLEY, NY:
402,781, CANC. U.S. CL. 6.
- CIMARRON HEALTH PLAN, INC., ALBUQUERQUE, NM:
2,857,626, PUB. 4-6-2004. INT. CL. 44.
- CINNAMUFFS, INC., BOCA RATON, FL:
1,833,033. REN. 5-21-04. MULTIPLE CLASS, INT. CLS. 9 AND 28.
- CIRCADIANT SYSTEMS, INC., ALLENTOWN, PA:
2,858,373, INT. CL. 9.
- CIRRUS LOGIC, INC., FREMONT, CA:
2,088,121, CANC. INT. CL. 9.
- CITGO PETROLEUM CORPORATION, TULSA, OK:
1,787,060, CANC. INT. CL. 37.
- CITIGROUP GLOBAL MARKETS INC., NEW YORK, NY:
2,858,080, PUB. 4-6-2004. INT. CL. 36.
- CITIZEN TOKEI KABUSHIKI KAISHA, SHINJUKU-KU, TOKYO, JAPAN, TA CITIZEN WATCH CO., LTD.:
2,088,064, CANC. INT. CL. 14.
- CITY OF LAS CRUCES, LAS CRUCES, NM:
2,857,899, PUB. 4-6-2004. INT. CL. 35.
2,857,900, PUB. 4-6-2004. INT. CL. 35.
- CITY TECHNOLOGY LIMITED, PORTSMOUTH, HAMPSHIRE, ENGLAND:
2,857,932, PUB. 4-6-2004. INT. CL. 9.
- CITYSEARCH, INC., LA CRESCENTA, CA:
2,087,748, CANC. INT. CL. 35.
- CIVIC VENTURES, SAN FRANCISCO, CA:
2,858,033, PUB. 4-6-2004. MULTIPLE CLASS, INT. CLS. 16, 35, 41 AND 42.
- CLARK ATLANTA UNIVERSITY, INC., ATLANTA, GA:
2,857,941, PUB. 4-6-2004. INT. CL. 41.
- CLASSIC ADVANTAGE FRANCHISE SYSTEMS, INC., LAS VEGAS, NV:
2,087,219, CANC. INT. CL. 36.
- CLASSIC RESTAURANT SUPPLY, L.L.C., HARTFORD, CT:
2,857,562, PUB. 4-6-2004. INT. CL. 35.

- CLEARLY CANADIAN BEVERAGE CORPORATION, VANCOUVER, B.C., CANADA:
2,088,253, CANC. INT. CL. 32.
- CLERGYTAX INC., CARMEL, IN:
2,087,237, CANC. INT. CL. 9.
- CLIO DESIGNS INCORPORATED, WATERTOWN, MA:
2,858,909, MULTIPLE CLASS, INT. CLS. 8, 9 AND 21.
- CLOROX COMPANY, THE, OAKLAND, CA:
1,785,133, REN. 5-21-04, MULTIPLE CLASS, INT. CLS. 3 AND 5.
- CMC ENERGY SERVICES, BETHESDA, MD:
2,858,629, INT. CL. 9.
- CO.DON GMBH, 14513 TELTOW, FED REP GERMANY:
2,857,116, PUB. 2-11-2003, MULTIPLE CLASS, INT. CLS. 1, 5 AND 9.
- COAPT SYSTEMS, INC., PALO ALTO, CA:
2,857,973, PUB. 4-6-2004, INT. CL. 10.
- COATINGS INCORPORATED AND COMPANY, BAYAMON, PUERTO RICO:
1,271,526, REN. 5-20-04, INT. CL. 7.
1,275,841, REN. 5-21-04, INT. CL. 7.
- COBALT GROUP, INC., THE, SEATTLE, WA:
2,086,987, CANC. INT. CL. 42.
- COBE LABORATORIES, INC., LAKEWOOD, CO TO COBE CARDIOVASCULAR OPERATING CO., INC., ARVADA, CO:
1,786,647, CANC. INT. CL. 10.
- COCOA PETE'S CHOCOLATE ADVENTURES COMPANY, CAMPBELL, CA:
2,858,502, INT. CL. 30.
- COCOAS Y CHOCOLATES LA CORONA, S.A. DE C.V., MEXICO D.F., MEXICO:
1,768,179, REN. 5-20-04, INT. CL. 30.
- CODY TURKEY CALLS, LLC, HALIFAX, PA:
2,857,544, PUB. 4-6-2004, INT. CL. 28.
- COFFEE BEANERY, LTD., THE, FLUSHING, MI:
1,787,581, CANC. INT. CL. 30.
- COFFEES OF THE WORLD CORP., NORTH YORK, ONTARIO, CANADA:
2,088,002, CANC. MULTIPLE CLASS, INT. CLS. 21, 30 AND 42.
- COFFIELD UNGARETTI & HARRIS, CHICAGO, IL:
2,087,419, CANC. INT. CL. 42.
- COGENT LIGHT TECHNOLOGIES, INC., SANTA CLARITA, CA:
2,088,359, CANC. INT. CL. 9.
- COGNIS DEUTSCHLAND GMBH & CO. KG, DUESSELDORF, FED REP GERMANY:
2,858,132, PUB. 4-6-2004, INT. CL. 1.
- COGNITIVE LEARNING SYSTEMS, INC., NORTHFIELD, IL:
2,858,512, INT. CL. 41.
- COKINETIC SYSTEMS, CORP., GREENWICH, CT:
2,857,262, PUB. 4-6-2004, MULTIPLE CLASS, INT. CLS. 41 AND 42.
- COLD STONE CREAMERY, INC., SCOTTSDALE, AZ:
2,858,947, INT. CL. 30.
- COLGATE-PALMOLIVE COMPANY, NEW YORK, NY:
171,877, CANC. U.S. CL. 4.
- COLISEUM BOOKS, INC., NEW YORK, NY:
2,858,039, PUB. 4-6-2004, INT. CL. 35.
- COLLATERAL MORTGAGE CAPITAL, LLC, BIRMINGHAM, AL:
2,857,510, PUB. 4-6-2004, INT. CL. 36.
- COLLECTIBLES TODAY NETWORK, INC., NILES, IL:
2,857,135, PUB. 4-6-2004, INT. CL. 35.
- COLLEGE ENTRANCE EXAMINATION BOARD, NEW YORK, NY:
2,087,297, CANC. INT. CL. 36.
- COLLEGE LOAN CORPORATION, SAN DIEGO, CA:
2,858,088, PUB. 4-6-2004, INT. CL. 36.
- COLLEGEBÜTLER, LLC, EVANSTON, IL:
2,858,845, INT. CL. 39.
- COLLINS & AIKMAN CORPORATION, NEW YORK, NY:
754,710, CANC. U.S. CL. 42.
- COLMAR INDUSTRIES, INC., LANCASTER, PA:
2,087,450, CANC. INT. CL. 27.
- COLOVOS COMPANY, CHICAGO, IL:
2,857,940, PUB. 4-6-2004, INT. CL. 7.
- COLUMBIA HOUSE COMPANY, THE, NEW YORK, NY:
2,157,247, CANC. INT. CL. 42.
- COLUMBIA INSURANCE COMPANY, OMAHA, NE:
986,081, REN. 5-17-04, U.S. CL. 46 (INT. CL. 30).
- COLUMBIAN MUTAL LIFE INSURANCE COMPANY, BINGHAMTON, NY:
2,858,407, MULTIPLE CLASS, INT. CLS. 35 AND 36.
- COM AUDIO INC., CORONA DEL MAR, CA:
1,786,533, CANC. INT. CL. 9.
- COMBUSTION TEC, INC., APOPKA, FL:
2,087,352, CANC. INT. CL. 11.
- COMDALE TECHNOLOGIES (CANADA) INC., TORONTO, ONTARIO M9C 1A3, CANADA:
2,088,077, CANC. INT. CL. 9.
- COMERICA INCORPORATED, DETROIT, MI:
1,251,846, REN. 5-18-04, INT. CL. 36.
- COMITE INTERNATIONAL DE LA CROIX-ROUGE, SWITZERLAND:
2,749,392, AM. MULTIPLE CLASS, INT. CLS. 39, 41 AND 42.
- COMMATCH LTD., LOD 75100, ISRAEL:
2,858,280, INT. CL. 9.
- COMMERCIAL LAW LEAGUE OF AMERICA, CHICAGO, IL:
2,857,304, PUB. 4-6-2004, U.S. CL. B.
- COMMERCIAL LOGIC, INC., LYME, NH:
2,087,408, CANC. INT. CL. 9.
- COMMON GROUND USA, INC., OAKLAND, CA:
2,857,429, PUB. 4-6-2004, INT. CL. 10.
- COMMON VOICES, LLC, CAMBRIDGE, MA:
2,858,440, INT. CL. 9.
- COMMUNICATION INDUSTRIES CORP., GRAFTON, VT, COMMUNICATION INDUSTRIES CORP., EAST RUTHERFORD, NJ:
1,841,814, REN. 5-21-04, INT. CL. 16.
- COMMUNICATIONS/TODAY, LTD., HIGH POINT, NC:
1,787,686, CANC. INT. CL. 16.
- COMMUNITY BANKSHARES, INC., CONCORD, NH:
2,087,185, CANC. INT. CL. 36.
- COMPAGNIE PLASTIC OMNIUM, 69007 LYON, FRANCE:
2,857,280, PUB. 9-16-2003, INT. CL. 12.
- COMPANIA DE CERVAZES NACIONALES C.A., GUAYAQUIL, ECUADOR:
2,857,432, PUB. 4-6-2004, INT. CL. 32.
- COMPETITION CAMS, INC., MEMPHIS, TN:
2,087,209, CANC. INT. CL. 7.
- COMPGEEKS.COM, OCEANSIDE, CA:
2,087,121, CANC. INT. CL. 42.
- COMPLIANCE AUTOMATION, INC., BOERNE, TX:
2,857,490, PUB. 4-6-2004, INT. CL. 9.
- COMPUTER ASSOCIATES THINK, INC., ISLANDIA, NY:
2,858,307, MULTIPLE CLASS, INT. CLS. 9 AND 42.
- COMPUTER LANGUAGE RESEARCH, INC., CARROLLTON, TX:
2,088,146, CANC. INT. CL. 9.
- CONAGRA, INC., OMAHA, NE:
1,247,812, CANC. INT. CL. 29.
2,086,678, CANC. INT. CL. 29.
2,086,933, CANC. INT. CL. 29.
- CONCEPTS 2000, INC., BELLEVUE, NE:
2,086,762, CANC. INT. CL. 42.
- CONCORDIA COLLEGE CORPORATION, MOORHEAD, MN:
2,088,309, CANC. INT. CL. 9.
- CONDUIT RECORDS, SEATTLE, WA:
2,857,802, PUB. 4-6-2004, INT. CL. 9.
- CONERTY, JAMES, T, LITTLETON, CO:
2,859,110, INT. CL. 21.
- CONFERENCE-CALL USA, INC., CHICAGO, IL, DBA CITIZENS CONFERENCEING:
2,857,370, PUB. 4-6-2004, INT. CL. 38.
- CONGOLEUM CORPORATION, KEARNY, NJ:
754,505, CANC. U.S. CL. 20.
- CONGRESS FINANCIAL CORPORATION (NEW ENGLAND), BOSTON, MA:
2,857,215, PUB. 4-6-2004, MULTIPLE CLASS, INT. CLS. 2

- AND 16.
CONGRESS FINANCIAL CORPORATION (NEW ENGLAND), BOSTON, MA:
2,857,213, PUB. 4-6-2004. MULTIPLE CLASS, INT. CLS. 2 AND 16.
- CONKLIN COMPANY, INC., SHAKOPEE, MN:
994,552, REN. 5-20-04. U.S. CL. 15 (INT. CL. 4).
1,302,361, REN. 5-20-04. INT. CL. 4.
1,308,028, REN. 5-20-04. INT. CL. 19.
- CONLEY PRODUCTS, INC., BUFFALO, NY:
1,787,511, CANC. INT. CL. 20.
- CONMED ANDOVER MEDICAL, INC., UTICA, NY, AND-
OVER MEDICAL INCORPORATED, HAVERHILL, MA:
1,830,786, REN. 5-21-04. INT. CL. 10.
- CONNELLY BILLIARD MANUFACTURING, INC., TUC-
SON, AZ:
2,857,933, PUB. 4-6-2004. INT. CL. 28.
2,857,939, PUB. 4-6-2004. INT. CL. 28.
- CONOCO INC., PONCA CITY, OK:
2,088,428, CANC. INT. CL. 36.
- CONOCOPHILLIPS COMPANY, HOUSTON, TX:
758,551, REN. 5-20-04. U.S. CL. 52 (INT. CL. 3).
- CONQUEST PEST CONTROL, INC., WASHINGTON, DC:
2,087,773, CANC. INT. CL. 37.
- CONSOLIDATED INDUSTRIES CORP., LAFAYETTE, IN:
1,787,449, CANC. INT. CL. 11.
- CONSOLIDATED NATURAL GAS COMPANY, PITTS-
BURGH, PA:
2,088,219, CANC. INT. CL. 42.
- CONSTELLATION BRANDS, INC., FAIRPORT, NY, ALMA-
DEN VINEYARDS, INC., SAN JOSE, CA, DBA CAVES DU
DOMAINE:
1,281,847, REN. 5-21-04. INT. CL. 33.
- CONSULIER ENGINEERING, INC., RIVIERA BEACH, FL:
2,857,712, PUB. 4-6-2004. INT. CL. 42.
- CONTAINER CORPORATION OF AMERICA, CHICAGO,
IL:
754,397, CANC. U.S. CL. 2.
- CONTEMPORARY ARTISTS ENTERPRISES, INC., LOS
ANGELES, CA:
1,787,627, CANC. INT. CL. 41.
- CONTINENTAL BAKING COMPANY, ST. LOUIS, MO TO
INTERSTATE BRANDS WEST CORPORATION, KANSAS
CITY, MO:
1,787,579, CANC. INT. CL. 30.
- CONTINENTAL CABLEVISION OF MASSACHUSETTS,
INC., ANDOVER, MA:
2,087,730, CANC. INT. CL. 38.
- CONTINENTAL CORPORATION, THE, NEW YORK, NY:
2,086,700, CANC. INT. CL. 36.
- CONTINUUM HEALTHCARE, INC., WILTON, CT:
2,857,678, PUB. 4-6-2004. INT. CL. 9.
- CONTRACTOR SUCCESS GROUP, INC., CHESTERFIELD,
MO, DBA FUTURE UNIVERSITY:
1,787,142, CANC. INT. CL. 41.
- COOL CARRIERS (USA), INC., HUENEME, CA:
2,087,692, CANC. INT. CL. 39.
- COR-A-VENT, INC., MISHAWAKA, IN:
1,787,679, CANC. INT. CL. 9.
- CORBINEAU, NICOLE, PARIS, FRANCE:
2,857,958, PUB. 4-6-2004. INT. CL. 25.
- CORD, BARRY KIESELSTEIN, NEW YORK, NY:
2,857,352, PUB. 4-6-2004. INT. CL. 18.
- CORDIS CORPORATION, MIAMI LAKES, FL:
2,858,363, INT. CL. 10.
- CORESOURCING, INC., NORTHBROOK, IL FROM ADMINIS-
TRATORS NETWORK, INC., FORT WAYNE, IN:
2,857,108, PUB. 9-5-1995. INT. CL. 36.
2,857,109, PUB. 8-15-1995. INT. CL. 36.
- CORESTATES BANK, NATIONAL ASSOCIATION, PHILA-
DELPHIA, PA:
2,088,220, CANC. INT. CL. 36.
- CORFLEX, INC., MANCHESTER, NH:
2,834,743, CANC. IIRN. RESTORED TO S.N. 75-781,606.
- CORNING INCORPORATED, CORNING, NY:
406,115, REN. 5-17-04. U.S. CL. 1 (INT. CL. 21).
- COROMETRICS MEDICAL SYSTEMS, INC., WALLING-
FORD, CT TO GE MARQUETTE MEDICAL SYSTEMS
INC, MILWAUKEE, WI:
1,786,573, CANC. INT. CL. 9.
- CORONA HAIR NET CORP., SAN DIEGO, CA:
2,857,989, PUB. 4-6-2004. INT. CL. 21.
- CORONATION, INC., CANTON, OH:
2,858,055, PUB. 4-6-2004. INT. CL. 41.
- CORPORATE APPAREL UNLIMITED, GWINN, MI:
2,858,706, INT. CL. 35.
- CORPORATE PROJECT RESOURCES, INC., CHICAGO, IL:
2,858,117, PUB. 4-6-2004. INT. CL. 35.
- CORPORATION FOR ECONOMIC EDUCATION, THE, SAN
ANSELMO, CA:
1,786,997, CANC. INT. CL. 35.
- CORPORATIVO INTERNACIONAL MEXICANO, S. DE R.L.
DE C.V., MEXICO, MEXICO:
2,858,239, INT. CL. 30.
- CORRELAGEN, INC., NEWTON, MA:
2,858,298, INT. CL. 42.
- CORVEL CORPORATION, IRVINE, CA:
1,786,988, CANC. INT. CL. 35.
- COSCO INDUSTRIES INC, CHESTNUT RIDGE, NY:
732,431, REN. 5-18-04. U.S. CL. 23 (INT. CL. 16).
- COSGRIFF, THOMAS, JR., WESTWOOD, NJ:
2,858,106, PUB. 4-6-2004. INT. CL. 25.
- COSMIC ENERGY RESEARCH CENTER, INC., HONOLU-
LU, HI:
2,087,005, CANC. MULTIPLE CLASS, INT. CLS. 6 AND
14.
- COSMOS TRADING CO., LTD., TAIPEI, TAIWAN:
2,087,930, CANC. INT. CL. 42.
- COTCHETT, JOSEPH W., HALF MOON BAY, CA:
2,858,981, INT. CL. 33.
2,858,982, INT. CL. 33.
- COTTA TRANSMISSION COMPANY, ROCKFORD, IL:
2,087,610, CANC. INT. CL. 7.
- COUNTRY GREEN LAWN & LANDSCAPE MAINTEN-
NANCE, INC., ROCHESTER, MN:
2,858,479, INT. CL. 44.
- COURSEMASTER AUTOPILOTS PTY. LIMITED, CHATS-
WOOD N.S.W., AUSTRALIA:
1,269,675, REN. 5-16-04. INT. CL. 9.
- CPFILMS INC., FIELDALE, VA:
2,858,897, INT. CL. 20.
- CRABTREE & EVELYN, LTD., WALTHAM, MA:
1,801,323, REN. 5-21-04. INT. CL. 3.
1,801,323, CANC. MULTIPLE CLASS, INT. CLS. 4, 5 AND
20.
- CRACKED POT RECORDS INC, OLATHE, KS:
2,857,316, PUB. 4-6-2004. INT. CL. 9.
- CRAFTWORK SOLUTIONS, INC., SAN JOSE, CA:
2,088,138, CANC. INT. CL. 9.
- CRAIN INDUSTRIES, INC., ST. LOUIS, MO:
2,088,085, CANC. INT. CL. 20.
- CRANE PLASTICS SIDING LLC, COLUMBUS, OH:
2,859,119, INT. CL. 17.
- CRANIUM, INC., SEATTLE, WA:
2,858,789, INT. CL. 28.
- CRC INDUSTRIES, INC., WARMINSTER, PA:
780,141, REN. 5-20-04. U.S. CL. 15 (INT. CL. 4).
- CREATIVE NAIL DESIGN, INC., VISTA, CA:
2,087,645, CANC. INT. CL. 3.
- CREATIVE SOLUTIONS, INC., DEXTER, MI:
2,087,307, CANC. INT. CL. 9.
- CREDIT SUISSE FIRST BOSTON LLC, NEW YORK, NY:
2,858,323, INT. CL. 16.
- CRESTSTREET CAPITAL CORPORATION, TORONTO, ON-
TARIO M5H 3P5, CANADA:
2,857,218, PUB. 4-6-2004. INT. CL. 36.
- CRIBARI VINEYARDS, INC., FRESNO, CA, DBA GLEN-
BROOK VINEYARD:
1,845,216, REN. 5-20-04. INT. CL. 33.
- CRISPERS LLC, LAKE LAND, FL:
2,857,718, PUB. 4-6-2004. INT. CL. 43.
- CRONOS GROUP SA, THE, L-2120 LUXEMBOURG, LUX-
EMBOURG, C.G. HOLDING S.A., L-1126, LUXEMBOURG:
1,839,593, REN. 5-16-04. MULTIPLE CLASS, INT. CLS. 36

- AND 39.
CROQUIS LOS ANGELES, ENCINO, CA:
2,858,660, INT. CL. 25.
- CRUISEONE, INC., FT. LAUDERDALE, FL:
1,799,689, REN. 5-15-04. INT. CL. 39.
- CRYSTAL DEEP SEAL CORPORATION, EAST SETAUKET, NY:
1,827,956, REN. 5-20-04. INT. CL. 1.
- CRYSTAL TISSUE COMPANY, THE, MIDDLETOWN, OH:
2,086,894, CANC. INT. CL. 16.
- CS CONCEPTS, INC., ATLANTA, GA:
2,088,248, CANC. INT. CL. 42.
- CSA, INC., SOUTH EASTON, MA:
2,087,467, CANC. INT. CL. 28.
- CSSI, THE SUPPORT GROUP, INC., LAS COLINAS, TX:
2,087,390, CANC. INT. CL. 42.
- CTA INC., NORTH BERGEN, NJ, DBA CLIFTON TELECARD ALLIANCE:
2,857,999, PUB. 4-6-2004. INT. CL. 16.
- CUBICLE DECOR, LLC, LOUISVILLE, KY:
2,858,828, INT. CL. 9.
- CUC PUBLISHING, INC., AURORA, CO:
2,086,948, CANC. MULTIPLE CLASS, INT. CLS. 16 AND 35.
- CUDDY, GERALD M., STONEHAM, MA:
2,858,338, INT. CL. 32.
- CUMBERLAND MEMORIAL HOSPITAL AND EXTENDED CARE UNIT, INC., THE, CUMBERLAND, WI:
2,088,419, CANC. INT. CL. 42.
- CUMBRIA TRADING VENTURES, ALBUQUERQUE, NM:
2,858,872, INT. CL. 36.
- CURIO, LTD., FORT WORTH, TX:
2,858,876, INT. CL. 9.
- CUSTOM MARBLE DESIGN, INC., AGAWAM, MA:
2,857,474, PUB. 4-6-2004. INT. CL. 20.
- CWD, LLC, TORRANCE, CA, DBA CENTRIC PARTS:
2,858,527, INT. CL. 12.
- CYBERLAW NETWORK, INC., ST. PAUL, MN:
2,857,270, PUB. 4-6-2004. MULTIPLE CLASS, INT. CLS. 35 AND 42.
- CYBERMAGIC, INC, SAN RAMON, CA:
2,087,343, CANC. INT. CL. 40.
- CYBERSOFT, INC., CONSHOHOCKEN, PA:
2,857,717, PUB. 4-6-2004. MULTIPLE CLASS, INT. CLS. 9 AND 42.
- CYTYC CORPORATION, BOXBOROUGH, MA:
2,858,447, INT. CL. 10.
- DAIDO CORPORATION, SOMERSET, NJ:
1,787,366, CANC. INT. CL. 8.
- DAILEY *E, INC., WEST PALM BEACH, FL:
2,857,742, PUB. 4-6-2004. INT. CL. 5.
- DAILY EXPRESS, INC., CARLISLE, PA:
972,092, REN. 5-20-04. U.S. CL. 105 (INT. CL. 39).
- DAILY RACING FORM LLC, NEW YORK, NY, DRF FINANCE, INC., NEW YORK, NY:
1,828,706, REN. 5-21-04. INT. CL. 42.
- DAIMARU CALIFORNIA, INC., THE, TORRANCE, CA:
2,087,767, CANC. INT. CL. 25.
- DAIWA SEIKO, INC., HIGASHIKURUME-CITY, TOKYO, JAPAN:
1,829,903, REN. 5-20-04. INT. CL. 28.
- DAKOTAH, INCORPORATED, WEBSTER, SD:
2,086,993, CANC. MULTIPLE CLASS, INT. CLS. 18, 20, 24 AND 28.
- DALLOZ SAFETY AB, 260 50 BILLESOLM, SWEDEN:
1,787,258, CANC. MULTIPLE CLASS, INT. CLS. 9 AND 10.
- DAMON INDUSTRIES, INC., ALLIANCE, OH:
720,533, REN. 5-20-04. U.S. CL. 6 (INT. CL. 3).
- DANIEL BARTAL LTD., TEL AVIV 62154, ISRAEL:
2,858,360, INT. CL. 28.
- DANIEL MCFADDEN, INC., WEST HOLLYWOOD, CA:
2,858,059, PUB. 4-6-2004. INT. CL. 3.
- DANIEL, JOSEPH EDWARD, HOUSTON, TX:
2,088,433, CANC. INT. CL. 2.
- DANNER, INC., PORTLAND, OR:
2,857,809, PUB. 4-6-2004. INT. CL. 25.
- DANSK TRANSFERTRYK HOLDING A/S, DK-7430 IKAST, DENMARK:
1,785,608, REN. 5-19-04. INT. CL. 24.
- DARLENE'S PRODUCTION COMPANY, CUPERTINO, CA:
2,087,910, CANC. INT. CL. 35.
- DART INDUSTRIES INC., ORLANDO, FL:
2,857,358, PUB. 4-6-2004. INT. CL. 9.
- DATAMAX CORPORATION, ORLANDO, FL:
2,858,462, INT. CL. 9.
- DATARADIO, INC., TOWN OF MOUNT ROYAL, QUEBEC, CANADA:
2,857,175, PUB. 4-6-2004. INT. CL. 9.
- DATATIMES CORPORATION, OKLAHOMA CITY, OK:
2,088,005, CANC. INT. CL. 42.
- DATATRIL SYSTEMS INC., TORONTO, ONTARIO, CANADA:
2,857,780, PUB. 4-6-2004. INT. CL. 42.
- DATREK PROFESSIONAL BAGS, INC., SPRINGFIELD, TN:
2,086,727, CANC. INT. CL. 28.
- DAVID AUSTIN ROSES LIMITED, ALBRIGHTON, WOLVERHAMPTON, ENGLAND:
2,857,497, PUB. 4-6-2004. INT. CL. 31.
- DAVID SHERMAN CORPORATION, ST. LOUIS, MO:
2,086,683, CANC. INT. CL. 33.
- DAVIDOFF & CIE SA, 1200 GENEVE, SWITZERLAND:
2,857,807, PUB. 4-6-2004. MULTIPLE CLASS, INT. CLS. 14 AND 34.
- DAVIES, KENDALL R., VIRGINIA BEACH, VA:
2,857,321, PUB. 4-6-2004. INT. CL. 43.
- DAVIS INSTRUMENTS CORPORATION, HAYWARD, CA:
2,859,100, INT. CL. 9.
- DAVIS, ARTHUR H., BEVERLY HILLS, CA:
2,834,714, CANC. IIRN. RESTORED TO S.N. 75-550,624.
- DAVIS, STEVEN MEARL, MEMPHIS, TN, DBA PERFORMANCE DISTRIBUTORS INC.:
2,087,417, CANC. INT. CL. 7.
2,087,418, CANC. INT. CL. 7.
- DAYHOFF, RICHARD, CHICAGO, IL:
2,857,635, PUB. 4-6-2004. INT. CL. 25.
- DAYTON HUDSON CORPORATION, MINNEAPOLIS, MN:
1,787,255, CANC. INT. CL. 42.
2,088,330, CANC. INT. CL. 20.
- DC COMICS, NEW YORK, NY:
2,857,381, PUB. 4-6-2004. INT. CL. 41.
2,858,716, MULTIPLE CLASS, INT. CLS. 16, 21, 25 AND 41.
- DDB CORPORATION, HIALEAH, FL:
2,858,380, INT. CL. 1.
- DE PAUL UNIVERSITY, CHICAGO, IL:
1,232,669, REN. 5-17-04. MULTIPLE CLASS, INT. CLS. 20, 21, 24 AND 41.
1,232,669, CANC. INT. CL. 16.
- DE' LONGHI S.P.A., 31100 TREVISO, ITALY:
2,857,229, PUB. 4-6-2004. INT. CL. 11.
- DEAN FOODS COMPANY, FRANKLIN PARK, IL:
2,106,819, COR. MULTIPLE CLASS, INT. CLS. 29, 30 AND 32.
- DEAN INTELLECTUAL PROPERTY SERVICES, L.P., DALLAS, TX:
2,834,707, CANC. IIRN. RESTORED TO S.N. 75-336,318.
- DEAN MARKLEY STRINGS, INC., SANTA CLARA, CA:
2,858,208, INT. CL. 15.
2,858,209, INT. CL. 15.
- DEB SBS INC., STANLEY, NC, SBS PRODUCTS, INC., SAGINAW, MI:
1,846,102, REN. 5-21-04. INT. CL. 3.
- DEBARROS, CATHIA Q., HUNTINGTON BEACH, CA AND WRIGHT, CARLA S., HUNTINGTON BEACH, CA:
2,858,929, INT. CL. 20.
- DECADE SYSTEMS CORPORATION, JACKSONVILLE, FL:
2,821,536, COR. INT. CL. 9.
- DEGUSSA BIOACTIVES DEUTSCHLAND GMBH & CO. KG, D-85354 FREISING, FED REP GERMANY:
2,857,220, PUB. 4-6-2004. INT. CL. 5.
- DEGUSSA CORPORATION, PARSIPPANY, NJ:
2,857,162, PUB. 4-6-2004. INT. CL. 16.

DEHAAS MARY ELIZABETH, NORMAN, OK AND DEHAAS, KEITH BRADLAUGH, NORMAN, OK:
2,857,820, PUB. 4-6-2004. INT. CL. 3.

DEL LABORATORIES, INC., UNIONDALE, NY:
1,295,408. REN. 5-21-04. INT. CL. 3.
1,295,408, CANC. INT. CL. 5.

DELAWARE CAPITAL FORMATION, INC., WILMINGTON, DE, O P W CORPORATION, CINCINNATI, OH:
587,536. REN. 5-18-04. U.S. CL. 26 (INT. CL. 9).

DELAWARE LICENSING CORP., WILMINGTON, DE:
2,087,266, CANC. INT. CL. 42.

DELAWARE LICENSING CORPORATION, CLAYMONT, DE:
2,857,298, PUB. 4-6-2004. INT. CL. 41.

DELEON, EUGENE, HOUSTON, TX:
1,828,631. REN. 5-16-04. INT. CL. 41.

DELL COMPUTER CORPORATION, ROUND ROCK, TX:
1,787,620, CANC. INT. CL. 37.

DELONGHI AMERICA, INC., SADDLE BROOK, NJ:
2,757,388, COR. MULTIPLE CLASS, INT. CLS. 7 AND 11.

DELTA DALLAS, INC., DALLAS, TX, DONLYN, INC., DALLAS, TX, DBA DELTA DALLAS PERMANENT & TEMPORARY PERSONNEL SERVICES:
1,829,574. REN. 5-18-04. INT. CL. 35.
1,832,883. REN. 5-17-04. INT. CL. 35.

DELTA INTERNATIONAL MACHINERY CORP., NORTH JACKSON, TN:
2,858,483, INT. CL. 8.

DELTA INTERNATIONAL MACHINERY CORP., JACKSON, TN:
2,858,486, INT. CL. 7.

DELTA INTERNATIONAL MACHINERY CORP., NORTH JACKSON, TN:
2,858,542, INT. CL. 7.

DELTA PACIFIC, INC., NEW ORLEANS, LA:
2,858,441, INT. CL. 42.

DELTA SIGMA CHI, SAN BERNARDINO, CA:
1,661,224. REN. 5-17-04. INT. CL. 42.

DEMAG CRANES & COMPONENTS CORP., SOLON, OH:
2,858,433, INT. CL. 7.

DEMON INTERNATIONAL, OREM, UT:
2,858,964, INT. CL. 8.

DENTCO, INC., HUMACAO, PUERTO RICO:
2,858,081, PUB. 4-6-2004. INT. CL. 5.

DENTSPLY RESEARCH & DEVELOPMENT CORP., LOS ANGELES, CA, DENTSPLY INTERNATIONAL INC., YORK, PA:
1,284,061. REN. 5-20-04. INT. CL. 5.

DEPUY, INC., WARSAW, IN:
2,858,729, INT. CL. 10.

DERCO B.V., 1821 BE ALKMAAR, NETHERLANDS:
1,829,197. REN. 5-20-04. INT. CL. 7.

DERMA SCIENCES, INC., PRINCETON, NJ:
1,828,019. REN. 5-16-04. INT. CL. 5.

DEROMA S.P.A., MALO - VICENZA, ITALY:
1,786,789, CANC. INT. CL. 21.

DESERT HOLDINGS, INC, ALPHARETTA, GA:
2,857,155, PUB. 4-6-2004. INT. CL. 32.

DESTINY HEALTH, INC., BETHESDA, MD:
2,857,378, PUB. 4-6-2004. INT. CL. 36.

DESTRON FEARING CORPORATION, SOUTH SAINT PAUL, MN:
2,087,727, CANC. INT. CL. 5.

DETEMOBIL DEUTSCHE TELEKOM MOBILNET GMBH, BONN, FED REP GERMANY:
2,086,783, CANC. MULTIPLE CLASS, INT. CLS. 9, 37, 38 AND 42.

DETROIT DIESEL CORPORATION, DETROIT, MI, GENERAL MOTORS CORPORATION, DETROIT, MI:
1,272,407. REN. 5-17-04. INT. CL. 7.

DEUTSCHE FINANCIAL SERVICES CORPORATION, ST. LOUIS, MO:
2,086,784, CANC. INT. CL. 36.

DEWAL INDUSTRIES, INC., SAUNDERSTOWN, RI:
2,834,778, CANC. IIRN. RESTORED TO S.N. 75-955,265.

DEYOUNG, JOSEPHINE B., CORRALES, NM AND BUCHAN, SUZETTE, CALEDONIA, MI:
2,858,460, INT. CL. 16.

DH LABS, INC., JUPITER, FL:
2,858,589, INT. CL. 9.

DI LEGNO INTERIORS NV, B-3580 BERINGEN, BELGIUM:
2,857,454, PUB. 4-6-2004. INT. CL. 19.

DIAGNOSTIC PRODUCTS CORPORATION, LOS ANGELES, CA:
2,858,552, INT. CL. 10.

DIAL BRANDS, INC., SCOTTSDALE, AZ:
2,858,815, INT. CL. 4.

DIALOG CORPORATION, THE, CARY, NC:
2,857,240, PUB. 4-6-2004. MULTIPLE CLASS, INT. CLS. 36, 42 AND 44.

DIAMEDIX CORPORATION, MIAMI, FL:
1,854,431. REN. 5-18-04. INT. CL. 5.

DIAMON-FUSION INTERNATIONAL, INC., SAN JUAN CAPISTRANO, CA:
2,858,457, INT. CL. 2.

DIANA, RICHARD, KINGSTON, WA:
1,830,654. REN. 5-16-04. INT. CL. 41.

DIEDRICH COFFEE, IRVINE, CA:
1,840,738. REN. 5-18-04. INT. CL. 30.

DIGIDEAL CORPORATION, SPOKANE, WA:
2,858,217, MULTIPLE CLASS, INT. CLS. 9 AND 41.

DIGIGRAM, 38330 MONTBONNOT, FRANCE:
2,858,553, INT. CL. 9.

DIGZ LLC, WALL, NJ:
2,813,768, COR. INT. CL. 37.

DILLARD'S INC., LITTLE ROCK, AR:
2,858,543, MULTIPLE CLASS, INT. CLS. 18 AND 25.
2,858,610, INT. CL. 25.

DILLARD'S, INC., LITTLE ROCK, AR:
2,858,359, MULTIPLE CLASS, INT. CLS. 6, 20 AND 21.

DILORENZO, JAMES C., SCARSDALE, NY:
2,087,867, CANC. INT. CL. 42.

DINERS CLUB INTERNATIONAL LTD., CHICAGO, IL:
2,088,321, CANC. MULTIPLE CLASS, INT. CLS. 9 AND 35.

DINGEMAN, MARK J., COSTA MESA, CA:
2,857,625, PUB. 4-6-2004. INT. CL. 36.

DINGER BATS, LLC., RIDGWAY, IL:
2,857,449, PUB. 4-6-2004. INT. CL. 28.

DIOTALEVI, DAVID A., MILFORD, MA:
2,858,879, MULTIPLE CLASS, INT. CLS. 3 AND 16.

DIRECT-DOOR, INC., AKRON, OH:
1,786,634, CANC. INT. CL. 9.

DIRECT-JOBS LLC, COCKEYSVILLE, MD:
2,858,184, INT. CL. 35.

DISCOUNT NUTRITION CENTER, INC., HOUSTON, TX:
2,858,887, INT. CL. 35.

DISCOVAIR, L.L.C., ZEELAND, MI:
2,858,498, INT. CL. 11.

DISHAKA GOURMET IMPORTS, L.L.C., HOUSTON, TX:
2,858,891, INT. CL. 30.

DISHES PROJECT INC., EAST HAMPTON, NY:
2,087,908, CANC. INT. CL. 36.
2,087,909, CANC. INT. CL. 25.

DISNEY ENTERPRISES INC, BURBANK, CA, WALT DISNEY COMPANY, THE, BURBANK, CA:
1,832,796. REN. 5-21-04. INT. CL. 25.

DISNEY ENTERPRISES, INC., BURBANK, CA, WALT DISNEY COMPANY, THE, BURBANK, CA:
1,853,330. REN. 5-21-04. INT. CL. 41.

DISPORT DO BRASIL LTDA., BAIRRO CENTRO EM SAPIRANGA (RS), BRAZIL:
2,767,222, COR. INT. CL. 25.

DIVERSIFIED BIOTECH, INC., BOSTON, MA:
2,858,049, PUB. 4-6-2004. INT. CL. 20.
2,858,050, PUB. 4-6-2004. INT. CL. 20.

DIVERSIFIED DESIGN & CONSTRUCTION, INC., TUCSON, AZ:
1,831,576. REN. 5-20-04. INT. CL. 37.

DIVERSIFIED PRODUCTS CORPORATION, OPELIKA, AL:
2,087,697, CANC. INT. CL. 28.

DIVXNETWORKS, INC., SAN DIEGO, CA:
2,857,603, PUB. 4-6-2004. INT. CL. 42.

DIXON VALVE & COUPLING COMPANY, CHESTER-TOWN, MD:
2,858,620, INT. CL. 6.

- DIXON, DANNY, ELK CITY, OK AND DIXON, DALANA, ELK CITY, OK:
2,087,375, CANC. INT. CL. 3.
- DOBRAŃSKY, MICHAEL T., CARDIFF BY THE SEA, CA:
2,858,516, INT. CL. 25.
- DOBSON, NATASHA D., AURORA, CO:
2,858,870, INT. CL. 16.
- DOCK PRODUCTS CANADA INC., LONDON, ONTARIO N6M 1A3, CANADA:
2,857,252, PUB. 4-6-2004. INT. CL. 17.
- DOCTOR WAX PRODUCTS CORPORATION, SUDBURY, MA:
2,857,667, PUB. 4-6-2004. INT. CL. 3.
2,857,668, PUB. 4-6-2004. INT. CL. 3.
- DOCTORS' PREFERRED, INC., POTOMAC, MD:
2,858,840, INT. CL. 5.
- DOG B.O.N.E.S. THERAPY DOGS OF MASSACHUSETTS, MEDFORD, MA:
2,857,845, PUB. 4-6-2004. MULTIPLE CLASS, INT. CLS. 41 AND 44.
- DOLCE, GREGORY L, HAVRE DE GRACE, MD:
2,858,875, INT. CL. 32.
- DOLEX DOLLAR EXPRESS, INC., ARLINGTON, TX:
2,858,567, INT. CL. 36.
- DOLLAR CASTLE, INC., HAZEL PARK, MI:
2,819,751, COR. INT. CL. 35.
- DOMAINE LA CHEVALIERE, LIEUDIT "PECH DU CAYROU" - 34500 BEZIERS, FRANCE:
2,108,544, CANC. INT. CL. 33.
- DOMINGUEZ-COWLES, TERESA M., LINCOLN, NE:
2,087,400, CANC. INT. CL. 37.
- DOMINION RACING VENTURES, LLC, VIRGINIA BEACH, VA:
2,858,314, INT. CL. 25.
- DON FRANCISCO FOODS, INC., RIVERBANK, CA:
2,088,060, CANC. INT. CL. 29.
- DONALD BRUCE & CO., CHICAGO, IL:
1,829,358, REN. 5-17-04. INT. CL. 14.
- DONOVAN DATA SYSTEMS, INC., NEW YORK, NY:
2,086,893, CANC. MULTIPLE CLASS, INT. CLS. 9 AND 42.
- DONOVAN, JOHN W., IVYLAND, PA, DBA JACK DONOVAN AND COMPANY:
2,087,456, CANC. INT. CL. 35.
- DORNBUSCH, RAYMOND PETER, TRAVERSE CITY, MI:
2,858,777, INT. CL. 30.
- DOT PALM LANDSCAPING, INC., MARATHON, FL:
2,857,489, PUB. 4-6-2004. INT. CL. 44.
- DOTMED.COM, INC., NEW YORK, NY:
2,857,363, PUB. 4-6-2004. MULTIPLE CLASS, INT. CLS. 9, 10, 35 AND 42.
- DOUBLE B FOODS, INC., WEIMAR, TX:
2,087,227, CANC. INT. CL. 29.
- DOW JONES & COMPANY, INC., NEW YORK, NY:
2,086,848, CANC. INT. CL. 42.
- DOW STEREO/VIDEO, INC., SAN DIEGO, CA:
2,087,162, CANC. INT. CL. 42.
- DOWBRANDS INC., GREENVILLE, SC:
1,247,485, CANC. INT. CL. 3.
- DOYON, LIMITED, FAIRBANKS, AK:
2,857,908, PUB. 4-6-2004. INT. CL. 37.
- DPA MICROPHONES A/S, 3450 ALLEROD, DENMARK:
2,857,882, PUB. 4-6-2004. INT. CL. 9.
- DPA, L.P., SAN DIEGO, CA:
2,086,996, CANC. INT. CL. 36.
- DR. AUGUST OETKER NAHRUNGSMITTEL KG, D - 4800 BIELEFELD 1, FED REP GERMANY:
982,594, REN. 5-18-04. U.S. CL. 46 (INT. CLS. 3 AND 30).
- DRAGON OPTICAL, INC., CARLSBAD, CA:
2,834,830, CANC. IIRN. RESTORED TO S.N. 76-104,436.
- DREAMWEAVER MEDICAL FOUNDATION, PARK CITY, UT:
2,857,350, PUB. 4-6-2004. INT. CL. 41.
- DRESSER-RAND CO., OLEAN, NY:
2,858,248, INT. CL. 7.
- DRESSER, INC., ADDISON, TX:
1,300,287, REN. 5-21-04. INT. CL. 9.
- DREW PICTURES, SAN FRANCISCO, CA:
2,032,969, CANC. INT. CL. 28.
- DRM, INC, CHARLOTTE, NC:
2,087,302, CANC. MULTIPLE CLASS, INT. CLS. 3 AND 5.
- DRUMMOND SCIENTIFIC COMPANY, BROOMALL, PA:
1,819,446, REN. 5-20-04. INT. CL. 10.
- DRY PAK INDUSTRIES, INC., STUDIO CITY, CA:
2,858,482, INT. CL. 1.
- DSC COMMUNICATIONS CORPORATION, PLANO, TX:
2,088,288, CANC. INT. CL. 41.
- DTS SOFTWARE INC., PLANTATION, FL:
2,088,189, CANC. INT. CL. 9.
- DUCK CORPORATION, THE, CLIFTON, NY:
1,845,078, REN. 5-16-04. INT. CL. 9.
- DUDAR, JULIE K., ESCONDIDO, CA:
2,858,795, INT. CL. 28.
- DUGAN, CASEY, EDINA, MN:
2,858,084, PUB. 4-6-2004. INT. CL. 41.
- DUKENET COMMUNICATIONS, INC., CHARLOTTE, NC:
2,088,188, CANC. INT. CL. 38.
- DUQUESNE UNIVERSITY OF THE HOLY GHOST, PITTSBURGH, PA:
2,857,601, PUB. 4-6-2004. MULTIPLE CLASS, INT. CLS. 35 AND 41.
2,857,602, PUB. 4-6-2004. MULTIPLE CLASS, INT. CLS. 35 AND 41.
- DURA CORPORATION, SOUTHFIELD, MI:
171,735, CANC. U.S. CL. 13.
- DURAWALL, INC., KENILWORTH, NJ:
754,713, CANC. U.S. CL. 42.
- DUROPLAS CORPORATION, NORTH EAST, MD:
2,857,387, PUB. 4-6-2004. MULTIPLE CLASS, INT. CLS. 40 AND 42.
- DUYKA, DEBORAH, CARLSBAD, CA:
2,087,904, CANC. INT. CL. 35.
- DYER, ROBERT E., ORLAND, ME:
2,857,923, PUB. 4-6-2004. INT. CL. 21.
- DYNAMIC FASTENER SERVICE, INC., RAYTOWN, MO:
2,087,141, CANC. INT. CL. 17.
- DYNAMIC HEALTH LABS, INC., BROOKLYN, NY:
2,857,430, PUB. 4-6-2004. INT. CL. 35.
- DYNAMIX, INC., EUGENE, OR:
1,786,876, CANC. INT. CL. 28.
- E. I. DU PONT DE NEMOURS AND COMPANY, WILMINGTON, DE:
1,272,283, REN. 5-15-04. INT. CL. 1.
1,834,666, REN. 5-21-04. INT. CL. 22.
- E. WOOD LIMITED, NORTH YORKSHIRE DL6 2XA, ENGLAND:
2,087,424, CANC. INT. CL. 2.
- E.CENTRAL, DENVER, CO:
2,087,143, CANC. MULTIPLE CLASS, INT. CLS. 38 AND 42.
- E.M.S. TRADING, INC., CITY OF INDUSTRY, CA:
2,858,097, PUB. 4-6-2004. INT. CL. 25.
- E.N.K. PRODUCTIONS, LTD., NEW YORK, NY:
1,795,214, REN. 5-17-04. INT. CL. 35.
- E.W. GROBBEL SONS, INC., DETROIT, MI:
2,859,067, INT. CL. 29.
- E! ENTERTAINMENT TELEVISION, INC., LOS ANGELES, CA:
2,857,319, PUB. 3-25-2003. INT. CL. 41.
- EAGLE CREEK, INC., SAN MARCOS, CA:
2,088,434, CANC. INT. CL. 5.
- EARTHRISE TRADING COMPANY, SAN RAFAEL, CA, DBA EARTHNET COMPANY:
1,787,342, CANC. INT. CL. 5.
- EAST CAROLINA UNIVERSITY, GREENVILLE, NC:
2,858,176, PUB. 4-6-2004. MULTIPLE CLASS, INT. CLS. 16 AND 25.
- EAST KENTUCKY POWER COOPERATIVE, INC., WINCHESTER, KY:
2,858,746, INT. CL. 39.
- EASTBAY, INC., WAUSAU, WI:
2,858,852, INT. CL. 35.
- EASTERN MASSACHUSETTS REAL ESTATE INC., WAKEFIELD, MA:
2,087,613, CANC. MULTIPLE CLASS, INT. CLS. 36 AND

41.
EASTERN STEEL RACK CO., BOSTON, MA:
754,618, CANC. U.S. CL. 32.
- EASYGROUP IP LICENSING LIMITED, CAMDEN, LONDON, NW1 7DL, UNITED KINGDOM:
2,857,171, PUB. 4-6-2004. MULTIPLE CLASS, INT. CLS. 3, 9, 12, 14, 16, 18, 28, 29, 30, 32, 33, 34, 35, 38, 39, 41 AND 42.
- EASYTEL, BEVERLY HILLS, CA:
2,087,218, CANC. INT. CL. 38.
- EATON CORPORATION, CLEVELAND, OH:
2,087,583, CANC. INT. CL. 28.
2,088,119, CANC. INT. CL. 9.
- EBELING ASSOCIATES, INC., CLIFTON PARK, NY, HARTLEY, GEORGE M., NEW CANAAN, CT:
1,836,058, REN. 5-21-04. INT. CL. 9.
- EBSCO INDUSTRIES, INC., BIRMINGHAM, AL:
989,978, REN. 5-20-04. MULTIPLE CLASS, U.S. CLS. 32 (INT. CL. 20), 37 (INT. CL. 16), 38 (INT. CL. 16), 39 (INT. CLS. 10, 25 AND 26) AND 101 (INT. CL. 35).
989,978, CANC. MULTIPLE CLASS, U.S. CLS. 8, 22, 42 AND 50.
1,786,865, CANC. INT. CL. 28.
- ECKHOLM, CHERYL L., AUSTIN, TX:
2,857,690, PUB. 4-6-2004. INT. CL. 16.
- ECLATA, INC., BROOMFIELD, CO:
2,857,995, PUB. 4-6-2004. INT. CL. 42.
- ECLECTIC INVESTMENTS, INC., NEWPORT BEACH, CA:
2,857,848, PUB. 4-6-2004. INT. CL. 25.
- ECLECTIC PRODUCTS, INC., EUGENE, OR:
2,858,859, MULTIPLE CLASS, INT. CLS. 1 AND 17.
- ECOLAB INC., ST. PAUL, MN:
1,247,509, CANC. INT. CL. 3.
- ECOLOGIC CORPORATION, WASHINGTON, DC:
2,086,786, CANC. MULTIPLE CLASS, INT. CLS. 9, 35, 41 AND 42.
- ECONO CHINA SUPPLIES, INC., CARSON, CA:
2,087,809, CANC. INT. CL. 16.
- ECONOMIST NEWSPAPER LIMITED, THE, LONDON SWIA IHG, ENGLAND:
1,844,798, REN. 5-17-04. INT. CL. 41.
- ED. GEISTLICH SOHNE AG FUR CHEMISCHE INDUSTRIE, WOLHUSEN, SWITZERLAND:
1,247,549, CANC. INT. CL. 5.
- EDELBROCK CORP., TORRANCE, CA TO EDELBROCK CORPORATION, TORRANCE, CA:
1,787,352, CANC. INT. CL. 6.
- EDGARIAN & JENKS, SAN FRANCISCO, CA:
2,859,113, MULTIPLE CLASS, INT. CLS. 40 AND 41.
- EDUCATIONAL COMMUNICATIONS, INC., LAKE FOREST, IL:
1,787,618, CANC. INT. CL. 36.
- EDUCATIONAL TESTING SERVICE, PRINCETON, NJ:
2,857,289, PUB. 4-6-2004. MULTIPLE CLASS, INT. CLS. 9 AND 16.
- EDUVENTURES, INC., BOSTON, MA:
2,087,066, CANC. INT. CL. 36.
- EG&G ASTROPHYSICS, LONG BEACH, CA:
2,087,632, CANC. INT. CL. 16.
- EGGMAN'S RESTAURANT, INC., ALSIP, IL:
2,857,640, PUB. 4-6-2004. INT. CL. 43.
- EKONERGY, INC., MIAMI, FL:
2,857,839, PUB. 4-6-2004. INT. CL. 1.
- EL PASO ENERGY CORPORATION, EL PASO, TX:
2,087,863, CANC. INT. CL. 40.
2,087,865, CANC. INT. CL. 40.
- ELBINGER LABORATORIES, INC., EAST LANSING, MI:
1,247,911, CANC. INT. CL. 40.
- ELECTRONIC CLEARING HOUSE, INC., CAMARILLO, CA:
2,857,623, PUB. 4-6-2004. INT. CL. 36.
2,857,624, PUB. 4-6-2004. INT. CL. 36.
- ELECTRONIC STORED VALUE SERVICES, INC., MERRIMACK, NH:
2,859,079, INT. CL. 36.
- ELESTA AG, ELEKTRONIK, BAD RAGAZ, BAD RAGAZ, SWITZERLAND:
1,247,592, CANC. INT. CL. 9.
- ELEVEN ELEVEN CORPORATION, GUAYNABO, PUERTO RICO:
2,859,072, MULTIPLE CLASS, INT. CLS. 10, 12, 20, 21 AND 28.
- ELF TECHNOLOGIES, INC., MERCER ISLAND, WA:
2,086,782, CANC. MULTIPLE CLASS, INT. CLS. 35, 38 AND 39.
- ELITE MODEL MANAGEMENT CORPORATION, NEW YORK, NY, ELITE MODEL MANAGEMENT CORPORATION, NEW YORK, NY:
1,273,825, REN. 5-16-04. INT. CL. 35.
- ELLAGEM, INC., NEW YORK, NY:
2,857,297, PUB. 4-6-2004. INT. CL. 14.
- ELLINGTON, RICHARD J., ANGIER, NC:
2,087,565, CANC. INT. CL. 20.
- ELLIOTT, GORDON W., FOREST, VA:
2,857,829, PUB. 4-6-2004. INT. CL. 20.
- ELLIS CONSULTING, INC., LENEXA, KS:
2,087,319, CANC. INT. CL. 41.
- ELMAR SUPPLY COMPANY, INC., WILLOW GROVE, PA:
2,857,897, PUB. 4-6-2004. INT. CL. 41.
- ELSEVIER INC., NEW YORK, NY FROM ELSEVIER SCIENCE INC., NEW YORK, NY:
2,857,314, PUB. 4-6-2004. INT. CL. 42.
2,857,315, PUB. 4-6-2004. INT. CL. 41.
- ELSEVIER SCIENCE INC.:
See—ELSEVIER INC..
- ELSEVIER SCIENCE INC.:
See—ELSEVIER INC..
- EMC CORPORATION, ST. PAUL, MN:
1,295,829, REN. 5-21-04. INT. CL. 9.
- EMERSON ELECTRIC CO., ST. LOUIS, MO:
1,275,171, REN. 5-15-04. INT. CL. 17.
- ENCAP PRODUCTS COMPANY, MT. PROSPECT, IL:
754,425, CANC. U.S. CL. 10.
- ENCHANTED GARDEN, LLC, THE, RIDGEFIELD, CT:
2,087,203, CANC. INT. CL. 41.
- ENERGY ABSORPTION SYSTEMS, INC., CHICAGO, IL:
2,858,466, INT. CL. 6.
- ENERGY SAVING TECHNOLOGY, INC., SAUK CITY, WI:
2,087,274, CANC. INT. CL. 42.
- ENERGY UNLIMITED PARTNERS, LOS ANGELES, CA:
2,088,233, CANC. INT. CL. 21.
- ENESCO CORPORATION, ELK GROVE VILLAGE, IL:
1,786,690, CANC. INT. CL. 15.
- ENGINEERED PRODUCTS, INC., GREENVILLE, SC:
2,857,522, PUB. 4-6-2004. INT. CL. 6.
- ENGINEERED SUPPORT SYSTEMS, INC., ST. LOUIS, MO:
2,857,184, PUB. 4-6-2004. MULTIPLE CLASS, INT. CLS. 35 AND 42.
- ENNIS BUSINESS FORMS, INC., ENNIS, TX:
2,087,659, CANC. INT. CL. 42.
- ENTRE PURE INDUSTRIES, LLC, LASALLE, CO:
2,087,350, CANC. INT. CL. 32.
- ENVIRO CONSULTANT SERVICES, LLC, LAKEWOOD, CO:
2,857,828, PUB. 4-6-2004. INT. CL. 5.
- ENVIRO-DYNAMICS INC., DALLAS, TX:
1,792,265, REN. 5-17-04. INT. CL. 1.
- ENVIRON ELECTRONIC LABORATORIES, INC., MINNEAPOLIS, MN:
2,857,622, PUB. 4-6-2004. INT. CL. 42.
- ENVISIONS SOLUTIONS TECHNOLOGY, INC., BURLINGAME, CA:
2,086,866, CANC. INT. CL. 9.
- EO BOCCI ASSOCIATI S.R.L., I - TORINO, ITALY AND OWENS, RICK, LOS ANGELES, CA:
2,857,230, PUB. 4-6-2004. MULTIPLE CLASS, INT. CLS. 3, 9, 14, 18 AND 25.
- EPI SCIENCES, INC., FRUITLAND, ID:
2,857,632, PUB. 4-6-2004. MULTIPLE CLASS, INT. CLS. 3 AND 5.
2,857,641, PUB. 4-6-2004. MULTIPLE CLASS, INT. CLS. 3 AND 5.
2,857,642, PUB. 4-6-2004. MULTIPLE CLASS, INT. CLS. 3 AND 5.
- EPIC HOLDING COMPANY, INC., NEW BRUNSWICK, NJ:
2,857,274, PUB. 4-6-2004. INT. CL. 3.

- EPPINK, DIXIE I., YORBA LINDA, CA:
2,858,735, INT. CL. 19.
- EPS SETTLEMENTS GROUP, INC., GREENWOOD VIL-
LAGE, CO:
1,791,875, AM. INT. CL. 36.
- EQUIBRAND ENTERTAINMENT GROUP LP, GRANBURY,
TX:
2,857,439, PUB. 4-6-2004. INT. CL. 41.
- EQUIFAX SERVICES INC., ATLANTA, GA:
2,087,301, CANC. INT. CL. 9.
- EQUITABLE LIFE INSURANCE COMPANY OF IOWA, DES
MOINES, IA:
1,247,891, CANC. INT. CL. 36.
- ERA AVIATION, INC., ANCHORAGE, AK:
2,087,412, CANC. INT. CL. 39.
- ERA POWER COMPANY, TOPTON, PA:
2,858,547, INT. CL. 12.
2,858,548, INT. CL. 12.
- ERCOLANO, GREG, ALTADENA, CA:
2,857,534, PUB. 4-6-2004. INT. CL. 9.
- ERICO INTERNATIONAL CORPORATION, SOLON, OH:
2,857,482, PUB. 4-6-2004. INT. CL. 1.
- ESAB CUTTING SYSTEMS, FLORENCE, SC:
2,088,174, CANC. INT. CL. 7.
- ESPN, INC., BRISTOL, CT:
2,858,669, INT. CL. 41.
- ESPORTA HEALTH & FITNESS LIMITED, WOKINGHAM,
BERKSHIRE, UNITED KINGDOM:
2,857,151, PUB. 1-21-2003. MULTIPLE CLASS, INT. CLS.
9, 16, 18, 24, 25, 28, 36, 38, 41 AND 42.
- ETÓN CORPORATION, PALO ALTO, CA:
2,465,376 NEW CERT. 6-29-2004. INT. CL. 9.
- ETABLISSEMENTS JOSEPH OPINEL & CIE., 73160 COGNIN,
FRANCE:
2,087,024, CANC. INT. CL. 8.
- ETERNIT AG, 8867 NIEDERURNEN, SWITZERLAND:
2,858,842, MULTIPLE CLASS, INT. CLS. 17, 19 AND 20.
- ETIENNE AIGNER INC., NEW YORK, NY:
2,857,814, PUB. 4-6-2004. MULTIPLE CLASS, INT. CLS. 9,
14 AND 25.
- ETOBACCO LLC, PALO ALTO, CA:
2,858,328, INT. CL. 34.
2,858,329, INT. CL. 34.
- ETRUNK TECHNOLOGIES INC., TAIPEI, TAIWAN:
2,858,103, PUB. 4-6-2004. INT. CL. 9.
- EUROCREDIT S.R.L., NAPLES, ITALY:
2,087,805, CANC. MULTIPLE CLASS, INT. CLS. 35 AND
36.
- EUROPEAN TELECOMMUNICATIONS STANDARDS IN-
STITUTE, VALBONNE, FRANCE:
2,857,142, PUB. 4-6-2004. MULTIPLE CLASS, INT. CLS.
16, 35, 38 AND 42.
- EUROVIA, RUEIL MALMAISON, FRANCE:
2,857,834, PUB. 4-6-2004. INT. CL. 19.
- EVANS & SUTHERLAND COMPUTER CORPORATION,
SALT LAKE CITY, UT:
1,787,394, CANC. INT. CL. 9.
- EVERGRO PRODUCTS INC., DELTA, BRITISH COLUM-
BIA, CANADA:
2,086,942, CANC. INT. CL. 1.
- EVERYDAYOFFICE, INC., NEW YORK, NY:
2,857,498, PUB. 4-6-2004. INT. CL. 42.
2,857,499, PUB. 4-6-2004. INT. CL. 42.
- EV3 INC., PLYMOUTH, MN:
2,857,789, PUB. 4-6-2004. INT. CL. 10.
- EX LIBRIS - POLISH BOOK GALLERY, INC., CHICAGO, IL:
2,087,573, CANC. INT. CL. 16.
- EXABYTE CORPORATION, BOULDER, CO:
2,088,266, CANC. INT. CL. 9.
- EXCALIBUR ELECTRONICS, INC., MIAMI, FL:
2,858,082, PUB. 4-6-2004. INT. CL. 28.
- EXCEL, INC., BARRINGTON, IL:
1,787,420, CANC. INT. CL. 9.
- EXECU SEARCH, INC., PHILADELPHIA, PA:
2,086,926, CANC. INT. CL. 35.
- EXECUTIVE BUSINESS GROUP, INC., TAMPA, FL:
2,086,884, CANC. INT. CL. 35.
- EXECUTIVE NETWORK CONSULTANTS, INC., WES-
TLAKE, OH, DBA CARDWELL GROUP:
1,786,977, CANC. INT. CL. 35.
- EXELINT INTERNATIONAL CO., LOS ANGELES, CA, DBA
EXEL INTERNATIONAL:
2,857,273, PUB. 4-6-2004. INT. CL. 10.
- EXGLOBE INC., VILLE ST-LAURENT, QUEBEC:
2,857,773, PUB. 7-29-2003. INT. CL. 20.
- EXIDE TECHNOLOGIES, ALPHARETTA, GA:
2,858,835, INT. CL. 9.
- EXMARK MANUFACTURING COMPANY INCORPO-
RATED, BEATRICE, NE:
1,787,363, CANC. INT. CL. 7.
- EXPRESS AIR FREIGHT UNLIMITED, INC., JAMAICA, NY:
1,798,221, REN. 5-20-04. INT. CL. 39.
- EXPRESS BLOWER, INC., FAIRFIELD, OH:
2,857,862, PUB. 4-6-2004. INT. CL. 7.
- EXPRESS FRANCHISE SERVICES, L.P., OKLAHOMA CITY,
OK:
2,857,857, PUB. 4-6-2004. MULTIPLE CLASS, INT. CLS.
35, 41 AND 43.
- EXTRACO CORPORATION, WACO, TX:
2,858,833, INT. CL. 36.
2,858,834, INT. CL. 36.
- EXYM CORPORATION, WESTMINSTER, CA:
2,857,639, PUB. 4-6-2004. INT. CL. 42.
- EZ DOCK, INC., WINONA, MN:
2,086,850, CANC. INT. CL. 19.
- F. L. SMITHE MACHINE COMPANY, INC., DUNCANS-
VILLE, PA:
1,266,905, REN. 5-21-04. INT. CL. 7.
- F. SCHUMACHER & CO., NEW YORK, NY:
2,087,836, CANC. MULTIPLE CLASS, INT. CLS. 24 AND
27.
- F. VON LANGSDORFF LICENSING LIMITED, MISSISSAU-
GA, ONTARIO, CANADA:
1,832,211, REN. 5-21-04. INT. CL. 19.
- F.N.B. CORPORATION, HERMITAGE, PA:
2,857,799, PUB. 4-6-2004. INT. CL. 36.
- FABLEVISION, INC., WATERTOWN, MA:
2,858,679, INT. CL. 9.
- FABRICA DE PAPEL SAN FRANCISCO, S.A. DE C.D., BAJA
CALIFORNIA, MEXICO:
1,786,712, CANC. INT. CL. 16.
- FABRIKANT, MARVIN, WASHINGTON, DC AND FABRI-
KANT, PATRICIA A., WASHINGTON, DC:
2,086,862, CANC. INT. CL. 21.
- FAIR LANES, INC., HUNT VALLEY, MD TO AMF BOWL-
ING WORLDWIDE, INC., MECHANICSVILLE, VA:
1,787,278, CANC. MULTIPLE CLASS, INT. CLS. 41 AND
42.
- FAIRCHILD PUBLICATIONS, INC., NEW YORK, NY,
CAPITAL CITIES MEDIA, INC., NEW YORK, NY:
1,882,171, REN. 5-16-04. INT. CL. 16.
- FAIRVIEW FARMS, INCORPORATED, LANDRUM, SC:
1,247,935, CANC. MULTIPLE CLASS, INT. CLS. 41 AND
42.
- FAN MATS, LLC, ALPHARETTA, GA:
2,859,024, INT. CL. 27.
- FAN-FUN GAMES, INC., GROVE CITY, OH:
1,787,559, CANC. INT. CL. 28.
- FAR WEST INDUSTRIES INC., VERNON, BRITISH CO-
LUMBIA, CANADA:
2,087,852, CANC. INT. CL. 25.
- FARAGHER FAMILY FARM, LLC, NEWPORT, KY:
2,858,674, INT. CL. 30.
- FARBER, M. PAUL, KINGWOOD, TX:
2,087,734, CANC. INT. CL. 5.
- FARMHAND, INC., HOPKINS, MN:
754,574, CANC. U.S. CL. 23.
- FASHION DOLL, INC., NEW YORK, NY:
2,857,595, PUB. 4-6-2004. MULTIPLE CLASS, INT. CLS. 18
AND 25.
- FASHION VICTIM, CHICAGO, IL:
1,787,167, CANC. INT. CL. 42.
- FASHION 21, INC., LOS ANGELES, CA:
2,858,425, MULTIPLE CLASS, INT. CLS. 3, 9, 14, 18, 25
AND 35.

FASHIONS POWER INC., NORTH MIAMI, FL:
2,087,507, CANC. INT. CL. 25.

FATE SOCIEDAD ANONIMA INDUSTRIAL COMERCIAL E INMOBILIARIA, (1058) BUENOS AIRES, ARGENTINA:
2,858,585, INT. CL. 12.

FAULK, DANIEL M., HOLLIS, NY:
2,857,913, PUB. 4-6-2004. INT. CL. 9.

FAULTLESS STARCH/BON AMI COMPANY, KANSAS CITY, MO:
2,087,345, CANC. INT. CL. 3.

FAYETTE COUNTY NEW RIVER GORGE BRIDGE DAY COMMISSION, OAK HILL, WV:
2,857,278, PUB. 4-6-2004. INT. CL. 41.

FEATURE FOODS, INC., CUYAHOGA FALLS, OH, MAIN STREET MUFFINS, INC., AKRON, OH:
1,840,748, REN. 5-20-04. INT. CL. 30.

FECHTER, AARON, ORLANDO, FL:
1,247,919, CANC. INT. CL. 41.

FEDERAL CHAIN COMPANY, PROVIDENCE, RI:
754,442, CANC. U.S. CL. 13.

FEDERAL EXPRESS CORPORATION, MEMPHIS, TN:
1,787,430, CANC. INT. CL. 9.

FEDERAL HOME LOAN BANK OF ATLANTA, ATLANTA, GA:
2,835,516, CANC. IIRN. RESTORED TO S.N. 78-234,131.

FEDERAL SIGNAL CORPORATION, OAK BROOK, IL:
1,855,599, REN. 5-20-04. INT. CL. 9.

FEDERAL TRADE CORPORATION, PLACENTIA, CA:
2,087,472, CANC. INT. CL. 16.

FELISSIMO CORPORATION, KOBE 650, JAPAN:
2,858,438, INT. CL. 21.

FERMENTA ANIMAL HEALTH COMPANY:
1,247,526, CANC. INT. CL. 5.
1,247,527, CANC. INT. CL. 5.

FERRELLGAS, L.P., LIBERTY, MO FROM THERMOGAS COMPANY, TULSA, OK:
2,857,127, PUB. 4-6-2004. MULTIPLE CLASS, INT. CLS. 4 AND 39.

FERRERO S.P.A., CUNEO, ITALY:
2,088,449, CANC. INT. CL. 30.

FFPE, LLC, SAN DIEGO, CA:
2,858,697, INT. CL. 18.

FIAT AUTO S.P.A., TORINO, CORSO G.AGNELLI 200, ITALY:
2,086,871, CANC. INT. CL. 12.

FIBERMARK, INC., BRATTLEBORO, VT, ARCON COATING MILLS, INC., OCEANSIDE, NY:
1,829,385, REN. 5-16-04. INT. CL. 16.

FIBERTECH POLYMERS, INC., NEWPORT BEACH, CA:
2,858,957, INT. CL. 20.
2,859,015, INT. CL. 20.

FIDELITY NATIONAL INFORMATION SOLUTIONS INC., SANTA BARBARA, CA:
2,798,874, AM. MULTIPLE CLASS, INT. CLS. 36 AND 42.

FIESTA BARBEQUES LIMITED, BRAMPTON, ONTARIO, CANADA:
2,857,146, PUB. 4-6-2004. INT. CL. 11.

FIESTA PALMS, LLC, LAS VEGAS, NV:
2,857,392, PUB. 4-6-2004. INT. CL. 43.
2,857,393, PUB. 4-6-2004. INT. CL. 43.

FIGHT FOR CHILDREN, INC., VIENNA, VA:
2,857,693, PUB. 4-6-2004. MULTIPLE CLASS, INT. CLS. 35, 36 AND 41.

FILA LUXEMBOURG S.A.R.L., L-1855 LUXEMBOURG, LUXEMBOURG, FRATELLI FILA S.P.A., 3 MILAN, ITALY:
974,050, REN. 5-15-04. U.S. CL. 42 (INT. CL. 24).

FILENET CORPORATION, COSTA MESA, CA:
2,088,031, CANC. INT. CL. 9.

FINANCIAL INDUSTRY COMPUTER SYSTEMS, INC., ADDISON, TX:
2,835,531, CANC. IIRN. RESTORED TO S.N. 76-121,827.

FINANCIAL TECHNOLOGIES INTERNATIONAL CORP., ISELIN, NJ:
2,858,539, INT. CL. 9.
2,858,540, INT. CL. 9.
2,858,541, INT. CL. 9.

FIOS, INC., PORTLAND, OR:
2,858,882, MULTIPLE CLASS, INT. CLS. 35 AND 42.

FIRESTONE TIRE & RUBBER COMPANY, THE, AKRON, OH:
1,247,635, CANC. INT. CL. 12.

FIRST AMERICAN REAL ESTATE SOLUTIONS, L.P., ANAHEIM, CA:
2,858,394, INT. CL. 36.

FIRST BRANDS PROPERTIES INC., WILMINGTON, DE:
2,087,009, CANC. INT. CL. 16.

FIRST CATERING, INC., LA GRANGE, GA:
2,858,576, INT. CL. 30.

FIRST CLERMONT BANK, MILFORD, OH TO CLERMONT SAVINGS BANK, FSB, MILFORD, OH:
2,789,267, COR. INT. CL. 36.

FIRST OPTIONS OF CHICAGO, INC., CHICAGO, IL:
2,088,142, CANC. INT. CL. 9.

FIRST PLACE FINANCIAL CORP., WARREN, OH, FIRST NATIONAL BANK OF MEMPHIS, THE, MEMPHIS, TN:
992,185, REN. 5-20-04. U.S. CL. 102 (INT. CL. 36).

FISCH, ELLEN, HEWLETT, NY:
2,858,668, INT. CL. 16.

FISCHER & WIESER SPECIALTY FOODS, INC., FREDERICKSBURG, TX:
2,858,061, PUB. 4-6-2004. INT. CL. 30.

FISHER, KEITH, HIGHLAND PARK, IL:
2,857,401, PUB. 4-6-2004. MULTIPLE CLASS, INT. CLS. 6, 9, 12 AND 37.

FISHNET MINISTRIES, INC., FRONT ROYAL, VA:
1,787,020, CANC. MULTIPLE CLASS, INT. CLS. 36, 41 AND 42.

FIVE STAR PRODUCTIONS, LLC, STAMFORD, CT:
2,858,356, INT. CL. 41.

FIXTURE PERFECT INSTALLATIONS, DALLAS, TX:
2,087,539, CANC. INT. CL. 37.

FLAG SPORTSWEAR, INC., SAN DIEGO, CA:
2,858,043, PUB. 4-6-2004. INT. CL. 25.

FLATBED INDUSTRY FORUM LLC, ROCHESTER, PA:
2,859,091, INT. CL. 41.

FLEXICORE SYSTEMS, INC., HUBER HEIGHTS, OH:
1,786,780, CANC. INT. CL. 20.

FLINTKOTE COMPANY, THE, STAMFORD, CT:
754,379, CANC. U.S. CL. 1.

FLORENCE MACARONI MFG. CO., INC., CHICAGO, IL:
2,086,834, CANC. INT. CL. 30.

FLORES, LEO, BONSALE, CA:
2,858,191, INT. CL. 42.

FLORET, EVELYN, NEW YORK, NY:
1,787,525, CANC. INT. CL. 25.

FLORIDA PANTHERS HOCKEY CLUB, LTD., FORT LAUDERDALE, FL:
2,087,918, CANC. INT. CL. 25.

FLORISTS' TRANSWORLD DELIVERY, INC., DOWNERS GROVE, IL, FLORISTS' TRANSWORLD DELIVERY ASSOCIATION, SOUTHFIELD, MI:
1,848,732, REN. 5-21-04. INT. CL. 38.

FLUIDRIVE, INC., BROOKSTON, IN, MUD HOG CORPORATION, BROOKSTON, IN:
1,280,664, REN. 5-21-04. INT. CL. 12.

FLUOROWARE, INC., CHASKA, MN:
1,715,325, CANC. INT. CL. 9.
2,088,205, CANC. INT. CL. 20.

FLYING COLORS TOYS, INC, MALIBU, CA:
2,859,016, INT. CL. 30.

FMALI HERB, INC., SANTA CRUZ, CA:
1,272,000, REN. 5-16-04. INT. CL. 30.

FOAMEX ASIA CO., LTD., CARLSBAD, CA:
2,859,112, INT. CL. 21.

FOLIOFN, INC., VIENNA, VA:
2,857,168, PUB. 4-6-2004. INT. CL. 36.

FOODSOURCE LURE CORPORATION, BIRMINGHAM, AL:
2,859,029, INT. CL. 28.

FOOT SCIENCE INTERNATIONAL LIMITED, SOCKBURN, CHRISTCHURCH, NEW ZEALAND:
1,273,654, REN. 5-16-04. INT. CL. 25.

- FOOTSTAR CORPORATION, WEST NYACK, NY FROM APACHE MINNESOTA THOM MCAN, INC., WEST NYACK, NY:
2,858,766, INT. CL. 35.
- FORD MOTOR COMPANY, DEARBORN, MI:
2,087,917, CANC. INT. CL. 20.
2,087,956, CANC. INT. CL. 21.
2,858,769, INT. CL. 25.
- FOREFRONT GROUP, INC., THE, HOUSTON, TX:
2,088,223, CANC. INT. CL. 9.
- FORMICA CORPORATION, WAYNE, NJ:
1,247,674, CANC. INT. CL. 16.
- FORMICA CORPORATION, CINCINNATI, OH:
1,829,431, REN. 5-16-04, INT. CL. 19.
2,858,938, INT. CL. 17.
- FORMULA DI FRATI DANIELA & C. S.A.S.:
See— FORMULA S.R.L.
- FORMULA S.R.L., 59100 PRATO, ITALY FROM FORMULA DI FRATI DANIELA & C. S.A.S., 59100 PRATO(PO), ITALY:
2,857,148, PUB. 9-2-2003, INT. CL. 12.
- FORSHEDA SHAFT SEAL CORPORATION, TWINSBURG, OH:
2,087,207, CANC. INT. CL. 17.
- FORT JAMES OPERATING COMPANY, ATLANTA, GA:
2,858,963, INT. CL. 8.
- FORTIS BENEFITS INSURANCE COMPANY, ST. PAUL, MN:
2,087,799, CANC. INT. CL. 38.
- FORWARD AIR ROYALTY COMPANY, WILMINGTON, DE, FORWARD AIR, INC., COLUMBUS, OH:
1,830,619, REN. 5-20-04, INT. CL. 39.
- FOUR STAR INTERNATIONAL TRADING COMPANY, TAIPEI, TAIWAN:
2,857,535, PUB. 4-6-2004, MULTIPLE CLASS, INT. CLS. 4, 21, 24 AND 26.
- FOURJAY INDUSTRIES, INC., DAYTON, OH:
754,506, CANC. U.S. CL. 21.
- FRANCHI MENOTTI S.R.L., MILAN, ITALY:
2,087,093, CANC. INT. CL. 14.
- FRANK RUSSELL COMPANY, TACOMA, WA:
2,858,230, INT. CL. 36.
- FRANKLIN RESOURCES, INC., SAN MATEO, CA:
2,857,953, PUB. 11-11-2003, INT. CL. 36.
- FRATERNAL ORDER OF POLICE, NASHVILLE, TN:
2,857,317, PUB. 4-6-2004, INT. CL. 21.
- FRAUSTO, KEVIN, RENO, NV:
2,087,593, CANC. INT. CL. 25.
- FREDERICK BREWING CO., FREDERICK, MD:
2,087,026, CANC. INT. CL. 32.
- FREE RIDE MEDIA L.L.C., NEW YORK, NY:
2,087,195, CANC. INT. CL. 35.
- FREEDOM COMMUNICATIONS, INC., IRVINE, CA:
2,857,235, PUB. 4-6-2004, INT. CL. 41.
2,857,237, PUB. 4-6-2004, INT. CL. 41.
- FREESTYLE PUBLICATIONS, INC., ARVADA, CO:
2,088,282, CANC. INT. CL. 35.
- FRESH EXPRESS INCORPORATED, SALINAS, CA:
2,858,841, INT. CL. 29.
2,859,000, INT. CL. 29.
- FRESH INTELLECTUAL PROPERTIES, INC, WILMINGTON, DE:
1,755,761, REN. 5-18-04, INT. CL. 39.
- FRESH MARK, INC., MASSILLON, OH:
1,874,015, REN. 5-21-04, INT. CL. 29.
- FRESH MARKET COMPANY LLC, BOULDER, CO:
2,857,927, PUB. 4-6-2004, INT. CL. 16.
- FRIEDLANDER, ROBERT, PAIA, HI:
2,858,016, PUB. 4-6-2004, INT. CL. 24.
- FRIENDS OF STRAYS, INC., ST. PETERSBURG, FL:
2,857,292, PUB. 4-6-2004, MULTIPLE CLASS, INT. CLS. 41, 43 AND 44.
- FRONTIER PLASTICS CORP, ABILENE, TX, DBA EMERALD BOAT COMPANY:
2,088,294, CANC. INT. CL. 12.
- FROZEN ROPES LLC, CHESTER, NY:
2,857,548, PUB. 4-6-2004, MULTIPLE CLASS, INT. CLS. 25 AND 41.
- FTA INTERNATIONAL, INC., PORTLAND, OR:
2,087,814, CANC. INT. CL. 42.
- FU TAI UMBRELLA WORKS, TAIPEI HSIEN, TAIWAN:
1,787,498, CANC. INT. CL. 18.
- FUJI PHOTO FILM CO., LTD., KANAGAWA, JAPAN:
2,858,412, MULTIPLE CLASS, INT. CLS. 9 AND 16.
- FUJIREBIO INC., CHUO-KU, TOKYO, JAPAN:
1,786,439, CANC. INT. CL. 5.
- FUJITSU BUSINESS COMMUNICATION SYSTEMS, INC., ANAHEIM, CA:
2,087,983, CANC. INT. CL. 9.
- FUJITSU LIMITED, KAWASAKI-SHI, KANAGAWA-KEN, JAPAN:
2,858,690, INT. CL. 9.
- FULCRUM BRANDS L.P., RIO RANCHO, NM:
2,087,691, CANC. INT. CL. 25.
- FULLER BRUSH COMPANY, THE, GREAT BEND, KS, FULLER BRUSH COMPANY, THE, HARTFORD, CT:
587,665, REN. 5-17-04, U.S. CL. 6 (INT. CL. 5).
- FULTON, BETTY J., EUREKA, CA, DBA THE HOME RANCH COMPANY:
2,857,613, PUB. 4-6-2004, INT. CL. 30.
- FUN FLIGHT, INCORPORATED, ALEXANDRIA, VA:
2,087,310, CANC. INT. CL. 41.
- FUNDUS HOTELENTWICKLUNGS- UND VERWALTUNGSGESELLSCHAFT MBH, 50674 KOLN, FED REP GERMANY:
2,859,071, MULTIPLE CLASS, INT. CLS. 42 AND 43.
- FURLO ENTERPRISES, INC., SAGINAW, MI, DBA SURSAFE COMPANY:
2,087,990, CANC. INT. CL. 5.
- FURNITURE COMFORT CORPORATION, NEW ALBANY, MS:
2,088,231, CANC. INT. CL. 20.
- FUTURE BUSINESS LEADERS OF AMERICA-PHI BETA LAMBDA, INC., WASHINGTON, DC:
1,247,682, CANC. INT. CL. 16.
- FUTURE GENERATIONS FOUNDATION, MILL VALLEY, CA:
2,087,629, CANC. MULTIPLE CLASS, INT. CLS. 16, 25 AND 41.
- FUTUREKIDS, INC., LOS ANGELES, CA TO HIGHLIGHTS FOR CHILDREN, INC., COLUMBUS, OH:
1,787,112, CANC. INT. CL. 41.
- G & N REFRESHMENTS, LLC, HARTFORD, CT:
2,812,974, COR. INT. CL. 43.
- G & T INDUSTRIES, INC., GRAND RAPIDS, MI:
2,857,840, PUB. 4-6-2004, INT. CL. 42.
- G DATA SOFTWARE GMBH, D-44793 BOCHUM, FED REP GERMANY:
2,537,874, COR. INT. CL. 9.
- G. NEIL CORPORATION, NORTH MANKATO, MN:
1,829,394, REN. 5-17-04, INT. CL. 16.
- G+H MONTAGE GMBH, LUDWIGSHAFEN, FED REP GERMANY:
1,247,558, CANC. MULTIPLE CLASS, INT. CLS. 6 AND 17.
- G-7 GROUP, INC., NEW YORK, NY, G-7 DAILY BRIEFING, INC., NEW YORK, NY:
1,837,293, REN. 5-20-04, INT. CL. 16.
- GAF CHEMICALS CORPORATION, WAYNE, NJ:
2,087,276, CANC. INT. CL. 3.
- GALLAGHER, RICHARD N., SCOTTSDALE, AZ:
2,086,911, CANC. MULTIPLE CLASS, INT. CLS. 13, 18, 21 AND 25.
2,086,914, CANC. MULTIPLE CLASS, INT. CLS. 13, 18, 21 AND 25.
- GALLAGHER'S HEATING AND AIR CONDITIONING, INC., LOS MOLINOS, CA:
2,858,593, INT. CL. 37.
- GALLANT INTERNATIONAL, INC., NEW YORK, NY:
2,088,439, CANC. INT. CL. 25.
- GALLARDO, LARA, KATERINA, NEW YORK, NY:
2,858,848, INT. CL. 25.
- GAMBRO PATHOGEN REDUCTION TECHNOLOGY, INC., LAKEWOOD, CO:
2,858,894, INT. CL. 5.

- GAMEFLY, INC., SANTA MONICA, CA:
2,858,858, INT. CL. 41.
- GAMEWRIGHT, INC., BOSTON, MA:
2,088,111, CANC. INT. CL. 28.
- GANCIA S.P.A., PROVINCE OF ASTI, ITALY:
2,086,978, CANC. INT. CL. 33.
- GANDER MOUNTAIN COMPANY, BLOOMINGTON, MN:
2,857,420, PUB. 4-6-2004. INT. CL. 35.
- GARDNER ASPHALT CORPORATION, TAMPA, FL:
2,859,098, INT. CL. 19.
- GARDNER, MERLE F., MEMPHIS, TN:
2,857,986, PUB. 4-6-2004. INT. CL. 28.
- GARLINGHOUSE, INC., VA:
2,100,528, AM. INT. CL. 16.
- GARNETT MCKEEN LABORATORIES, INC., EAST ISLIP, NY:
2,858,965, INT. CL. 5.
- GARRISON, WILLIAM H., ASHLAND, VA, DBA AMERICAN SPIN-A-BATCH COMPANY:
2,857,697, PUB. 4-6-2004. INT. CL. 7.
- GARY D. NELSON ASSOCIATES, INC., SONOMA, CA:
2,858,468, MULTIPLE CLASS, INT. CLS. 35, 36 AND 45.
- GARZA, SAMUEL A., LAREDO, TX:
2,086,820, CANC. INT. CL. 25.
- GAS RESEARCH INSTITUTE, DES PLAINES, IL:
2,128,579, CANC. INT. CL. 16.
- GASCOGNE S.A., 40100 DAX, FRANCE:
2,086,815, CANC. MULTIPLE CLASS, INT. CLS. 6, 16, 17, 19, 20, 35 AND 40.
- GASTRO-GNOMES, INC., WEST HARTFORD, CT:
2,088,056, CANC. INT. CL. 16.
- GATELYS GROUP, LLC, ENGLEWOOD, CO:
2,859,108, INT. CL. 35.
- GATES RUBBER COMPANY, THE, DENVER, CO:
1,247,565, CANC. MULTIPLE CLASS, INT. CLS. 7, 9, 12 AND 17.
- GATOR CITY RIMS, DETROIT, MI:
2,858,825, INT. CL. 12.
- GAUDET, MICHAEL, TORONTO, ONTARIO, CANADA:
2,858,107, PUB. 4-6-2004. INT. CL. 16.
- GAVIDIA, ARMANDO A., CAPITAL FEDERAL, ARGENTINA:
2,858,596, INT. CL. 33.
- GAYLE MARTZ, INC., NEW YORK, NY:
1,832,754, REN. 5-20-04. INT. CL. 18.
- GE CAPITAL MORTGAGE CORPORATION, RALEIGH, NC:
2,086,972, CANC. INT. CL. 36.
- GE OSMONICS, INC., MINNETONKA, MN:
2,857,416, PUB. 4-6-2004. INT. CL. 11.
2,857,417, PUB. 4-6-2004. INT. CL. 11.
- GEBHARDT, LINDA, CHICAGO, IL AND KRAUS, KEITH, CHICAGO, IL:
2,859,054, INT. CL. 9.
- GEMINI COATINGS, INC., EL RENO, OK:
1,829,121, REN. 5-18-04. INT. CL. 2.
- GEMINI SOUND PRODUCTS CORP., EDISON, NJ:
2,858,112, PUB. 4-6-2004. INT. CL. 9.
- GENE RICHARD HITCHCOCK, JR., BIRMINGHAM, AL:
2,859,130, INT. CL. 36.
- GENENCOR INTERNATIONAL, INC., PALO ALTO, CA, SOLVAY ENZYMES, INC., ELKHART, IN:
1,833,561, REN. 5-17-04. INT. CL. 1.
- GENENCOR INTERNATIONAL, INC., ROCHESTER, NY:
2,087,501, CANC. INT. CL. 1.
- GENERAL BINDING CORPORATION, SKOKIE, IL:
2,857,793, PUB. 4-6-2004. INT. CL. 16.
- GENERAL ELECTRIC COMPANY, SCHENECTADY, NY:
2,858,278, MULTIPLE CLASS, INT. CLS. 35, 38, 39 AND 42.
- GENERAL MILLS, INC., MINNEAPOLIS, MN:
1,786,871, CANC. INT. CL. 28.
- GENERAL MOTORS CORPORATION, DETROIT, MI:
314,825, REN. 5-18-04. U.S. CL. 23 (INT. CL. 12).
779,770, REN. 5-16-04. U.S. CL. 19 (INT. CL. 12).
2,088,033, CANC. INT. CL. 12.
2,858,211, INT. CL. 9.
- GENERAL NUTRITION INVESTMENT COMPANY, PITTSBURGH, PA:
2,088,384, CANC. INT. CL. 5.
- GENERAL PHYSIOTHERAPY, INC., ST. LOUIS, MO:
2,858,140, PUB. 4-6-2004. INT. CL. 10.
- GENERAL RE CORPORATION, STAMFORD, CT:
2,086,994, CANC. MULTIPLE CLASS, INT. CLS. 36 AND 42.
2,858,533, INT. CL. 36.
- GENERATION II ORTHOTICS INC., RICHMOND, BRITISH COLUMBIA V6W 1L5, CANADA:
2,857,797, PUB. 4-6-2004. INT. CL. 10.
- GENFOOT INC., MONTREAL, QUEBEC, CANADA:
1,786,824, CANC. INT. CL. 25.
- GENLYTE THOMAS GROUP LLC, LOUISVILLE, KY:
2,858,940, INT. CL. 11.
- GENOVESE DRUG STORES, INC., MELVILLE, NY:
2,087,735, CANC. INT. CL. 42.
- GENRE STYLE, INC., SCOTTSDALE, AZ:
2,857,833, PUB. 4-6-2004. INT. CL. 25.
- GENTA, GERALD, MONACO, MONACO:
1,787,401, CANC. INT. CL. 9.
- GENZYME CORPORATION, FRAMINGHAM, MA:
2,858,243, INT. CL. 5.
- GEORGETTE KLINGER, INC., NEW YORK, NY:
2,632,145, COR. INT. CL. 3.
- GEORGIA BIOMEDICAL PARTNERSHIP, INC., ATLANTA, GA:
2,859,090, INT. CL. 41.
- GERMAN MARSHALL FUND OF THE UNITED STATES, THE, WASHINGTON, DC:
2,859,003, INT. CL. 16.
- GERTEN GREENHOUSE AND GARDEN CENTER, INC., INVER GROVE HEIGHTS, MN:
2,858,004, PUB. 4-6-2004. INT. CL. 35.
- GESSNER PRODUCTS COMPANY, INC., AMBLER, PA:
1,247,719, CANC. INT. CL. 21.
- GET PSYCH'D, INC., HUNTINGTON, NY:
2,858,590, INT. CL. 41.
- GFW GROUP, INC., NEW YORK, NY:
2,858,481, INT. CL. 25.
- GH SENSORS, INC.:
See—SAFESHIP INTERNATIONAL, INC..
- GHENT MANUFACTURING, INC., LEBANON, OH:
2,857,654, PUB. 4-6-2004. INT. CL. 16.
- GIBBS SYSTEM, INC., MOORPARK, CA:
2,087,213, CANC. INT. CL. 9.
- GIBSON; BARBARA U., SULPHUR, LA, DBA PENNY ANNIE STUDIOS:
1,247,968, CANC. INT. CL. 42.
- GIFFARINE SKYLINE UNITY CO., LTD., PHAYATHAI, BANGKOK, 10400, THAILAND:
2,858,435, MULTIPLE CLASS, INT. CLS. 3, 5 AND 30.
- GILL, CHRISTOPHER B., GROTON, MA:
2,858,073, PUB. 4-6-2004. INT. CL. 9.
- GILLERT, LESLIE, YARMOUTH, ME:
1,786,798, CANC. INT. CL. 24.
- GILLETTE COMPANY, THE, BOSTON, MA:
767,865, REN. 5-20-04. U.S. CL. 23 (INT. CL. 8).
2,858,827, INT. CL. 43.
- GILMAR S.P.A., 47048 SAN GIOVANNI IN MARIGNANO, RIMINI, ITALY:
2,087,259, CANC. MULTIPLE CLASS, INT. CLS. 12, 16, 19, 24 AND 27.
- GINSENG BOARD OF WISCONSIN, INC., WAUSAU, WI:
1,755,967, REN. 5-21-04. U.S. CL. A.
- GIRL MANIA, INC., LOS ANGELES, CA:
2,858,369, INT. CL. 18.
- GLASS PRO INCORPORATED, LAKE IN THE HILLS, IL:
2,857,575, PUB. 4-6-2004. INT. CL. 7.
- GLASTONBURY HARTWELL SOCCER CLUB, INC., GLASTONBURY, CT:
2,857,413, PUB. 4-6-2004. INT. CL. 35.
- GLEASON, ROBERT E., MECHANICSVILLE, VA:
2,858,702, INT. CL. 42.
- GLOBAL CASH ACCESS, LLC, SUNNYVALE, CA:
2,858,322, INT. CL. 36.

- GLOBAL CLOUD, LTD., CINCINNATI, OH:
2,857,599, PUB. 4-6-2004. MULTIPLE CLASS, INT. CLS. 9 AND 42.
- GLOBAL COLLEGE OF GAYATRI, CHATSWORTH, CA:
2,858,121, PUB. 4-6-2004. INT. CL. 9.
- GLOBAL CROSSING HOLDINGS LIMITED, HAMILTON HM12, BM, BERMUDA, ALLNET COMMUNICATION SERVICES, INC., BINGHAM FARMS, MI:
1,797,303, REN. 5-20-04. INT. CL. 38.
- GLOBAL EVANGELISM, GOODYEAR, AZ:
2,857,711, PUB. 4-6-2004. INT. CL. 16.
- GLOBAL INFORMATION LICENSING CORPORATION, CLAYMONT, DE:
2,857,249, PUB. 4-6-2004. INT. CL. 16.
2,858,464, INT. CL. 9.
- GLOBAL MED TECHNOLOGIES, INC., DENVER, CO, DBA WYNDGATE TECHNOLOGIES:
2,857,448, PUB. 4-6-2004. MULTIPLE CLASS, INT. CLS. 9 AND 44.
- GLOBAL ORGANIC BRANDS, INC., KATONAH, NY:
2,858,711, INT. CL. 29.
- GLOBAL PREPCORP., INC., SALINAS, CA TO GLOBAL PREPCORP., INC., SALINAS, CA:
1,786,944, CANC. INT. CL. 31.
- GLOBAL SOFTWARE CONSULTING, INC., HUNTSVILLE, AL:
2,859,121, INT. CL. 9.
- GLOBAMATRIX HOLDINGS, PTE. LTD., SINGAPORE, SINGAPORE:
2,858,854, INT. CL. 17.
- GLORY DAYS, INC., FAIRFAX, VA:
2,858,306, INT. CL. 41.
2,858,310, MULTIPLE CLASS, INT. CLS. 41 AND 43.
- GMAC COMMERCIAL MORTGAGE CORPORATION, HORSHAM, PA:
2,857,384, PUB. 4-6-2004. INT. CL. 36.
- GNASS, STEPHEN PAUL, BEVERLY HILLS, CA:
2,858,185, INT. CL. 16.
- GOALSGUY LEARNING SYSTEMS, INC., PALM HARBOR, FL:
2,857,656, PUB. 4-6-2004. INT. CL. 16.
- GODFREY FRANCHISE, INC., ARLINGTON, TX:
2,858,123, PUB. 4-6-2004. INT. CL. 37.
- GOLD'N PLUMP POULTRY, INC., ST. CLOUD, MN:
2,087,303, CANC. INT. CL. 29.
- GOLDEN CROWN CORPORATION, POST FALLS, ID:
2,858,676, INT. CL. 3.
- GOLDIAM INTERNATIONAL LIMITED, MUMBAI, INDIA:
2,858,135, PUB. 4-6-2004. INT. CL. 14.
- GOLF TRAINING SYSTEMS, INC., DULUTH, GA:
2,087,254, CANC. INT. CL. 28.
- GOLFSMITH INTERNATIONAL, INC., AUSTIN, TX:
1,795,392, REN. 5-17-04. INT. CL. 42.
- GONZALES, DAVID, EMERYVILLE, CA:
2,858,736, INT. CL. 28.
- GOOD DIRECTIONS, INC., DANBURY, CT:
2,857,330, PUB. 4-6-2004. INT. CL. 16.
- GOOD LAD CO., PHILADELPHIA, PA:
2,087,188, CANC. INT. CL. 25.
- GOODYEAR TIRE & RUBBER COMPANY, THE, AKRON, OH:
402,745, CANC. U.S. CL. 50.
402,746, CANC. U.S. CL. 50.
402,747, CANC. U.S. CL. 50.
402,748, CANC. U.S. CL. 50.
- GORDON, GIANNETTI & ASSOCIATES, OAKLEY, CA TO SMART STRATEGIC MARKETING AND RESEARCH TECHNIQUES, WALNUT CREEK, CA:
1,786,992, CANC. INT. CL. 35.
- GORGE NETWORKS, INC., HOOD RIVER, OR:
2,857,589, PUB. 4-6-2004. INT. CL. 38.
- GOSPO CENTRIC, INGLEWOOD, CA:
2,087,137, CANC. INT. CL. 9.
- GRAHAM STAMPING COMPANY, WHEATLAND, PA:
1,842,644, REN. 5-16-04. INT. CL. 6.
- GRAIN PROCESSING CORPORATION, MUSCATINE, IA:
2,858,053, PUB. 4-6-2004. INT. CL. 1.
- GRAND STAFF, INC., PRAIRIE VILLAGE, KS:
2,859,102, INT. CL. 41.
- GRAPHIC CONTROLS CORPORATION, BUFFALO, NY:
1,830,785, REN. 5-20-04. INT. CL. 10.
- GRAPHITE DESIGN INTERNATIONAL, INC., SAN DIEGO, CA:
2,858,452, INT. CL. 28.
- GRASS LOUNGE, L.L.C., MIAMI, FL:
2,857,679, PUB. 4-6-2004. INT. CL. 43.
- GRAVIC, INC., PAOLI, PA:
2,857,652, PUB. 4-6-2004. INT. CL. 42.
- GRAVYMASTER, INC., BRANFORD, CT, GRAVYMASTER COMPANY, INC., LONG ISLAND CITY, NY:
776,725, REN. 5-17-04. U.S. CL. 46 (INT. CLS. 29 AND 30).
- GRAYHILL, INC., LAGRANGE, IL:
2,088,241, CANC. INT. CL. 9.
- GREAT AMERICAN CLEANERS, INC., CORAL SPRINGS, FL:
2,087,667, CANC. INT. CL. 37.
- GREAT ATLANTIC & PACIFIC TEA COMPANY, INC., THE, MONTVALE, NJ:
2,857,946, PUB. 4-6-2004. MULTIPLE CLASS, INT. CLS. 29, 30, 31 AND 32.
- GREAT CRAFTS, INC., SONORA, CA:
2,087,571, CANC. INT. CL. 35.
- GREATER HAZLETON HEALTH ALLIANCE, HAZLETON, PA:
2,857,705, PUB. 4-6-2004. INT. CL. 44.
- GREEN INDUSTRY YELLOW PAGES, INC., WOODBINE, MD:
2,859,086, INT. CL. 35.
- GREEN PRODUCTS, INC., ROMEOVILLE, IL:
2,857,456, PUB. 4-6-2004. INT. CL. 19.
- GREENLIGHT FINANCIAL SERVICES, IRVINE, CA:
2,858,987, INT. CL. 36.
- GREENWAY MEDICAL TECHNOLOGIES, CARROLLTON, GA:
2,858,234, INT. CL. 9.
- GREGORY R. FORTE, FULLERTON, CA:
2,858,775, INT. CL. 25.
- GRIDNET INTERNATIONAL, L.L.C., ROSWELL, GA:
2,087,161, CANC. INT. CL. 38.
- GRILLE-TECH, L.L.C., LYNCHBURG, VA:
2,858,048, PUB. 4-6-2004. INT. CL. 12.
- GRIOT, RICHARD L., TACOMA, WA, DBA GRIOT'S GARAGE:
1,829,151, REN. 5-18-04. MULTIPLE CLASS, INT. CLS. 3, 6, 12, 16, 18, 20, 21, 24 AND 42.
- GROTE INDUSTRIES, LLC, MADISON, IN:
2,859,111, INT. CL. 9.
- GROUND ROUND, INC., THE, BRAINTREE, MA:
2,858,500, INT. CL. 43.
- GROUNDSWELL COMMUNICATIONS, INC., ALEXANDRIA, VA:
2,857,147, PUB. 4-6-2004. INT. CL. 35.
- GROUP ITALGLASS USA, CORP., FORT LAUDERDALE, FL:
2,087,454, CANC. INT. CL. 21.
- GROUP 4 SECURITAS (INTERNATIONAL) B.V., 2585 HJ THE HAGUE, NETHERLANDS:
2,086,680, CANC. MULTIPLE CLASS, INT. CLS. 6, 9, 14 AND 42.
- GROUP, LLC, THE, PORTLAND, OR:
2,088,156, CANC. MULTIPLE CLASS, INT. CLS. 41 AND 42.
- GROWING FAMILY, INC., EARTH CITY, MO:
2,858,271, INT. CL. 16.
- GRUEN & SELLS, LTD., CHICAGO, IL:
2,858,904, INT. CL. 35.
- GRUNO ET CHARDIN, 1440 WAUTHIER-BRAINE, BELGIUM:
2,086,684, CANC. INT. CL. 25.
- GT MERCHANDISING & LICENSING CORP., NEW YORK, NY:
2,087,652, CANC. INT. CL. 16.
- GUALTIERI, GREGORY F., SYRACUSE, NY, DBA FINANCIAL PLANNING SERVICES OF AMERICA:
1,247,921, CANC. INT. CL. 41.

GUANGZHOU NO. 1 CIGARETTE FACTORY, GUANGZHOU, CHINA:
2,858,225, INT. CL. 34.

GUARANTEED IMPRESSIONS, PORTLAND, OR:
2,087,552, CANC. INT. CL. 35.

GUEON, JEE-YONG, LOS ANGELES, CA:
2,857,177, PUB. 4-6-2004. INT. CL. 25.

GUERRA, MARIA TERESA, LAREDO, TX:
2,088,268, CANC. INT. CL. 25.

GUESS?, INC., LOS ANGELES, CA:
2,086,838, CANC. MULTIPLE CLASS, INT. CLS. 3, 4, 20,
21, 24, 25, 27 AND 42.

GUEST MEDICAL & DENTAL PRODUCTS AG, CH-6305
ZUG, SWITZERLAND TO GUEST ELCHROM SCIENTI-
FIC AG, CHAM, SWITZERLAND:
1,786,559, CANC. INT. CL. 9.

GUIDEPOSTS, A CHURCH CORPORATION, CARMEL, NY:
2,857,512, PUB. 4-6-2004. INT. CL. 41.
2,857,513, PUB. 4-6-2004. INT. CL. 41.
2,857,514, PUB. 4-6-2004. INT. CL. 41.
2,857,515, PUB. 4-6-2004. INT. CL. 35.

GULLIVER'S INC., MILLER PLACE, NY:
1,247,974, CANC. INT. CL. 42.

GULTON INDUSTRIES, INC., PLANO, TX TO LUMINATOR
HOLDING, LLC, PLANO, TX:
1,787,418, CANC. INT. CL. 9.

GUNVAULT, INC., ALBUQUERQUE, NM TO ADVANCED
SECURITY PRODUCTS, L.L.C., SCOTTSDALE, AZ:
1,786,681, CANC. INT. CL. 13.

H & H PRODUCTS CO., ORLANDO, FL:
2,857,593, PUB. 4-6-2004. INT. CL. 30.

H H G CORP., SCARSDALE, NY:
2,087,126, CANC. INT. CL. 41.

H. PAULIN & CO. LIMITED, SCARBOROUGH, ONTARIO
M1L 4N3, CANADA:
2,858,183, INT. CL. 6.

H.M. PUBLISHERS HOLDINGS LIMITED, HAMPSHIRE,
UNITED KINGDOM:
2,858,264, INT. CL. 16.

H&M-AMH, INC., WILMINGTON, DE:
2,858,020, PUB. 4-6-2004. MULTIPLE CLASS, INT. CLS. 6
AND 19.

HADER HARDWARE, INC., CINCINNATI, OH:
2,087,223, CANC. INT. CL. 42.

HAGEMEYER NORTH AMERICA, INC., ALPHARETTA,
GA:
2,858,642, INT. CL. 20.
2,858,643, INT. CL. 22.
2,858,644, INT. CL. 9.

HAIRMARKER LLC, SANTA FE, NM:
2,858,740, INT. CL. 3.

HAL HOOKWELL, INC., EDINA, MN:
2,088,390, CANC. INT. CL. 28.

HAL, JON, HEWLETT, NY:
2,859,103, INT. CL. 35.

HALE, CLIVE, SAVANNAH, GA, DBA HALE TEA COM-
PANY:
2,087,517, CANC. INT. CL. 30.

HALF PINTS CLOTHING COMPANY, WILLMAR, MN:
2,858,650, INT. CL. 25.

HALL, LEONARD *DEWAYNE, EDMOND, OK:
2,858,510, INT. CL. 37.

HALLIBURTON ENERGY SERVICES, INC., CARROLL-
TON, TX, DRESSER INDUSTRIES, INC., DALLAS, TX:
1,885,828, REN. 5-17-04. INT. CL. 7.

HALLIBURTON ENERGY SERVICES, INC., CARROLL-
TON, TX:
2,858,079, PUB. 4-6-2004. INT. CL. 40.
2,858,364, INT. CL. 40.
2,858,514, INT. CL. 40.

HALLMARK LICENSING, INC., KANSAS CITY, MO:
2,858,921, INT. CL. 20.
2,858,922, INT. CL. 20.

HALLOWES, JAMES M., LOS ANGELES, CA:
2,858,474, INT. CL. 35.

HALSTON LLC, NEW YORK, NY, HALSTON ENTER-
PRISES, INC., NEW YORK, NY:
999,713, REN. 5-21-04. INT. CL. 25.

HAMIDA PHARMA, INC., IRVINE, CA:
2,857,788, PUB. 4-6-2004. INT. CL. 5.

HAMMOND, JEFF, SANDUSKY, OH:
2,858,083, PUB. 4-6-2004. INT. CL. 25.

HAN, HYUK K., NEW YORK, NY:
2,087,686, CANC. INT. CL. 35.

HANA COMPANY LIMITED, CHAI-WAN, HONG KONG,
CARDIC LIMITED, HAPPY VALLEY, HONG KONG:
1,836,143, REN. 5-17-04. INT. CL. 16.

HANAN PRODUCTS COMPANY, INC., HICKSVILLE, NY:
754,760, CANC. U.S. CL. 46.

HANCOR, INC., FINDLAY, OH:
975,325, REN. 5-20-04. U.S. CL. 13 (INT. CL. 17).

HAND HELD PRODUCTS, INC., CHARLOTTE, NC:
2,088,193, CANC. INT. CL. 9.

HANDFORD, MARTIN, ROMFORD, ESSEX, ENGLAND:
1,786,753, CANC. INT. CL. 16.

HANEY, TRENA, BIG RAPIDS, MI AND HANEY, ROLA,
BIG RAPIDS, MI:
2,087,973, CANC. INT. CL. 21.

HANNA'S CANDLE COMPANY, FAYETTEVILLE, AR:
2,858,781, INT. CL. 3.
2,858,782, INT. CL. 3.

HANSA-PACIFIC ASSOCIATES, INC., GILROY, CA:
1,787,587, CANC. INT. CL. 31.

HANSGRÖHE AG, D-77761 SCHILTACH, FED REP GER-
MANY:
2,857,772, PUB. 4-6-2004. MULTIPLE CLASS, INT. CLS. 6,
11, 17, 19, 20 AND 21.

HANWOOD INTERNATIONAL LTD., HONG KONG, HONG
KONG:
2,858,206, MULTIPLE CLASS, INT. CLS. 9 AND 28.

HAPPI HOUSE RESTAURANTS, INC., SAN JOSE, CA:
2,087,741, CANC. INT. CL. 42.

HAPPY MEDIA INCORPORATED, ASTORIA, NY:
2,857,284, PUB. 4-6-2004. MULTIPLE CLASS, INT. CLS. 38
AND 42.

HARBRO, LLC, BRIGHTON, MI:
2,858,302, INT. CL. 18.

HARDEE'S FOOD SYSTEMS, INC., ST. LOUIS, MO:
1,832,980, REN. 5-17-04. INT. CL. 42.

HARMAN INTERNATIONAL INDUSTRIES, INCORPO-
RATED, NORTHRIDGE, CA:
2,858,235, INT. CL. 9.

HARMON, INC., GOLDEN VALLEY, MN:
2,858,948, INT. CL. 19.
2,858,949, INT. CL. 19.

HARPER; SHIRLEY J., GLEN ELLYN, IL:
1,247,773, CANC. INT. CL. 26.

HARRINGTON'S IN VERMONT, INC., RICHMOND, VT:
2,858,128, PUB. 4-6-2004. INT. CL. 29.

HARRIS TRUST AND SAVINGS BANK, CHICAGO, IL:
2,857,890, PUB. 4-6-2004. MULTIPLE CLASS, INT. CLS. 9
AND 36.

HARSCO TECHNOLOGIES CORPORATION, FAIRMONT,
MN:
2,858,656, INT. CL. 11.

HART BREWING, INC., SEATTLE, WA:
2,086,794, CANC. INT. CL. 32.

HARTFORD LIFE INSURANCE COMPANY, HARTFORD,
CT:
2,087,420, CANC. INT. CL. 36.

HARTMAN PLASTICS, INC., HONEY BROOK, PA:
2,087,508, CANC. INT. CL. 16.

HARTWIG, CARL C., SR., PRINCETON, TX:
2,086,910, CANC. INT. CL. 7.

HARVEST RICE, INC., HOUSTON, TX:
2,858,824, INT. CL. 30.

HASBRO, INC., PAWTUCKET, RI:
2,088,402, CANC. INT. CL. 28.
2,088,403, CANC. INT. CL. 28.
2,858,431, INT. CL. 28.

HAUSER FOODS INC., BETHEL, CT:
2,087,504, CANC. INT. CL. 30.

HAYES LEMMERZ INTERNATIONAL, INC., NORTH-
VILLE, MI:
2,858,847, INT. CL. 12.

- HAYSLETT, GARY, TINELY PARK, IL:
2,087,688, CANC. INT. CL. 9.
- HCC HOLDING, INC., WILMINGTON, DE:
2,768,983, COR. INT. CL. 19.
- HEADSPROUT, INC., SEATTLE, WA:
2,858,200, INT. CL. 9.
- HEALTH PROMOTION NETWORK, INC., ELMHURST, IL:
2,087,434, CANC. INT. CL. 9.
2,087,443, CANC. INT. CL. 35.
2,087,445, CANC. INT. CL. 42.
2,088,280, CANC. MULTIPLE CLASS, INT. CLS. 35 AND 42.
- HEALTHCARE STAFFING SOLUTIONS, INC., LOWELL, MA:
2,087,548, CANC. INT. CL. 35.
- HEALTHOLOGY, INC., NEW YORK, NY:
2,857,517, PUB. 4-6-2004, INT. CL. 41.
- HEALTHPLAN HOLDINGS, INC., TAMPA, FL:
2,858,568, INT. CL. 35.
- HEALTHRIDER CORP, LOGAN, UT:
2,088,065, CANC. INT. CL. 28.
- HEALTHWATCH, INC., VISTA, CA:
2,087,147, CANC. INT. CL. 10.
- HEALTHWORKS ALLIANCE, INC., WAYNE, PA:
2,086,975, CANC. INT. CL. 9.
- HEALTHY PLANET, INC., ORINDA, CA, CAROLYN BEAN PUBLISHING, LTD., PETALUMA, CA:
1,795,873, REN. 5-16-04, INT. CL. 16.
- HEARTLAND WIRELESS COMMUNICATIONS, INC., PLANO, TX:
2,087,785, CANC. INT. CL. 38.
- HEAVEN, EDWIN, SAN FRANCISCO, CA AND TRAGER, JEFFREY, SUISUN, CA:
2,857,421, PUB. 4-6-2004, INT. CL. 25.
- HEDSTROM CORPORATION, BEDFORD, PA:
2,858,659, INT. CL. 28.
- HEEP TUNG MANUFACTORY LTD, FO TAN, N.T., HONG KONG:
2,088,106, CANC. INT. CL. 28.
- HEIDRICK & STRUGGLES, INC., CHICAGO, IL:
2,087,992, CANC. INT. CL. 35.
- HEIMANN SYSTEMS, 94150 RUNGIS, FRANCE:
2,858,405, MULTIPLE CLASS, INT. CLS. 9, 37 AND 42.
2,858,406, MULTIPLE CLASS, INT. CLS. 9, 37 AND 42.
- HELENE CURTIS INDUSTRIES, INC., CHICAGO, IL:
754,784, CANC. U.S. CL. 51.
- HELL SURVIVORS INC., PINCKNEY, MI:
2,087,830, CANC. INT. CL. 35.
- HELL'S ANGELS MOTORCYCLE CORPORATION, RENO, NV, HELLS ANGELS MOTORCYCLE CLUB, OAKLAND, CA, AKA HELLS ANGELS:
1,301,050, REN. 5-18-04, U.S. CL. 200.
- HELPING HAND REHABILITATION CENTER, COUNTRY-SIDE, IL:
2,858,994, INT. CL. 44.
- HENKEL KOMMANDITGESELLSCHAFT AUF AKTIEN (HENKEL KGAA), D-40191 DUESSELDORF, FED REP GERMANY:
2,087,046, CANC. INT. CL. 1.
- HENRY BUTCHER INTERNATIONAL LIMITED, LONDON, UNITED KINGDOM:
2,813,542, COR. MULTIPLE CLASS, INT. CLS. 35 AND 36.
- HENSLEY INDUSTRIES, INC., DALLAS, TX:
2,858,490, INT. CL. 7.
- HENZO B.V., 6045GL ROERMOND, NETHERLANDS:
2,857,307, PUB. 4-6-2004, INT. CL. 16.
- HERAEUS KULZER GMBH, 63450 HANAU, FED REP GERMANY:
2,087,342, CANC. INT. CL. 5.
- HERBALIFE INTERNATIONAL, INC., LOS ANGELES, CA:
1,254,211, REN. 5-21-04, MULTIPLE CLASS, INT. CLS. 3 AND 5.
1,811,780, REN. 5-21-04, MULTIPLE CLASS, INT. CLS. 3, 5, 16 AND 30.
- HERBEAU CREATIONS OF AMERICA, INC., NAPLES, FL:
2,857,926, PUB. 4-6-2004, MULTIPLE CLASS, INT. CLS. 11, 20 AND 21.
- HERBI-SYSTEMS, INC., BARTLETT, TN:
2,857,714, PUB. 4-6-2004, INT. CL. 44.
- HERITAGE PRESERVATION CORPORATION, SPARTANBURG, SC:
2,087,459, CANC. INT. CL. 38.
- HERKUPLAST KUBERN GMBH, 94140 ERING, FED REP GERMANY:
2,810,960, COR. INT. CL. 20.
- HERMAN, RON, LOS ANGELES, CA:
2,858,199, INT. CL. 35.
- HERRAMIENTAS DE AMOREBIETA, S.A.L., AMOREBIETA, BIZKAIA, SPAIN:
2,859,006, INT. CL. 7.
- HERSHEY THE TIN MAN, CORVALLIS, MT:
2,088,145, CANC. INT. CL. 6.
- HEUBLEIN, INC., FARMINGTON, CT TO UDV NORTH AMERICA, INC., STAMFORD, CT:
1,786,958, CANC. INT. CL. 33.
- HEWITT, STEVE, OJAI, CA:
2,087,608, CANC. INT. CL. 16.
- HEWLETT-PACKARD COMPANY, PALO ALTO, CA:
1,786,611, CANC. INT. CL. 9.
- HFI FOODS, INC., REDMOND, WA:
2,087,315, CANC. INT. CL. 29.
- HI-40 CORPORATION, KANSAS CITY, MO:
2,088,370, CANC. INT. CL. 42.
- HIATT, CAROL J., HARRISON, OH:
2,087,678, CANC. INT. CL. 42.
- HIGH END SYSTEMS, INC., AUSTIN, TX:
2,087,705, CANC. INT. CL. 11.
- HIGHBRIDGE CAPITAL MANAGEMENT, LLC, NEW YORK, NY:
2,858,395, INT. CL. 36.
2,858,396, INT. CL. 36.
- HIGHLAND SUPPLY CORPORATION, HIGHLAND, IL:
1,833,818, REN. 5-16-04, INT. CL. 16.
- HILDRETH ENTERPRISES LLC, VERMILLION, SD:
2,858,961, INT. CL. 35.
- HILL-SHAW COMPANY, CHICAGO, IL:
754,530, CANC. U.S. CL. 21.
- HILLERICH & BRADSBY CO., LOUISVILLE, KY:
1,276,401, REN. 5-18-04, INT. CL. 28.
- HINKLE, JACKSON HERBERT, III, NORTH HOLLYWOOD, CA:
1,757,759, REN. 5-20-04, INT. CL. 41.
- HINO JIDOSHA KABUSHIKI KAISHA, TOKYO, JAPAN, TA HINO MOTORS, LTD.:
2,857,134, PUB. 4-6-2004, INT. CL. 7.
- HIRE RETURN, LLC, MCLEAN, VA:
2,857,322, PUB. 4-6-2004, INT. CL. 35.
- HIRSCH SPEIDEL, INC., PROVIDENCE, RI:
1,787,684, CANC. INT. CL. 14.
- HISTORIC ORIGINALS LIMITED, READING, UNITED KINGDOM:
2,857,823, PUB. 2-17-2004, INT. CL. 14.
- HISTORY FACTORY, THE, CHANTILLY, VA:
2,858,773, INT. CL. 41.
- HITACHI AMERICA, LTD., FARMINGTON HILLS, MI:
2,858,638, INT. CL. 9.
- HLG FRANCHISE MARKETING COMPANY, CLINTON, PA, HOTLICKS FRANCHISE MARKETING, INC., PITTSBURGH, PA:
1,828,341, REN. 5-21-04, MULTIPLE CLASS, INT. CLS. 25, 30, 35 AND 42.
- HNILICA, JOHN L., NEW PORT RICHEY, FL:
2,087,654, CANC. INT. CL. 5.
2,087,655, CANC. INT. CL. 3.
- HOGAN, CHRISTOPHER J., JR., MORTON GROVE, IL:
2,086,843, CANC. INT. CL. 35.
- HOLISTA HEALTH (CANADA) INC., BURNABY, BRITISH COLUMBIA, CANADA:
2,857,867, PUB. 4-6-2004, INT. CL. 5.
- HOLLAND AMERICA LINE INC., SEATTLE, WA:
1,787,637, CANC. INT. CL. 41.
- HOLLINGSEAD INTERNATIONAL, INC., GOLETA, CA, HOLLINGSEAD-PRYOR, ENTERPRISES, INC., SANTA FE SPRINGS, CA:
988,743, REN. 5-18-04, U.S. CL. 13 (INT. CL. 6).

HOLLOWAY, JOHN, PORTLAND, OR, DBA MANLEY DESIGN:
2,087,529, CANC. INT. CL. 12.

HOLLYWOOD AND VINE CELLARS, INC., HELENA, CA:
2,857,598, PUB. 4-6-2004. INT. CL. 33.

HOLLYWOOD MANGEMENT COMPANY, WILSONVILLE, OR:
1,814,123. REN. 5-15-04. INT. CL. 41.

HOLLYWOOD STARS II, INC., NEW YORK, NY:
1,829,660. REN. 5-20-04. INT. CL. 41.

HOLMAN COOKING EQUIPMENT, INC., SACO, ME:
2,835,124, CANC. IIRN. RESTORED TO S.N. 76-394,501.

HOLMES, JOHN F., WHITING, IA, DBA JOHN HOLMES PUBLISHING COMPANY:
1,787,063, CANC. INT. CL. 38.

HOME FINANCIAL NETWORK, INC., WESTPORT, CT:
2,088,285, CANC. INT. CL. 42.

HONDA GIKEN KOGYO KABUSHIKI KAISHA (HONDA MOTOR CO., LTD.), MINATO-KU, TOKYO 107, JAPAN:
2,858,189, MULTIPLE CLASS, INT. CLS. 25 AND 28.

HONEYVILLE GRAIN, INC., RANCHO CUCAMONGA, CA:
2,858,518, MULTIPLE CLASS, INT. CLS. 1 AND 32.

HONOR OUR HEROES FOUNDATION, WASHINGTON, DC:
2,857,301, PUB. 11-25-2003. INT. CL. 36.

HOOPER, ZACK JATHAN, ENTERPRISE, AL:
2,857,357, PUB. 4-6-2004. INT. CL. 41.

HOPPE, FRED J., MALCOLM, NE AND HOPPE, DONNA, MALCOLM, NE:
2,859,129, INT. CL. 41.

HORMEL FOODS, LLC, AUSTIN, MN:
2,858,581, INT. CL. 29.

HORTON INTERNATIONAL, LLC, WEST HARTFORD, CT:
2,857,921, PUB. 4-6-2004. INT. CL. 35.

HOSOKAWA MICRON CORPORATION, CHUO-KU, OSAKA, JAPAN:
1,271,520. REN. 5-17-04. INT. CL. 7.

HOSPIRA, INC., LAKE FOREST, IL:
2,087,326, CANC. INT. CL. 10.

HOT IRISHMAN LIMITED, URGLIN CARLOW, IRELAND:
2,857,324, PUB. 9-30-2003. INT. CL. 33.

HOTSET HEIZPATRONEN U. ZUBEHOR GMBH, LUDENSCHIED, FED REP GERMANY:
2,858,856, MULTIPLE CLASS, INT. CLS. 9 AND 11.

HOUSE OF BLUES BRANDS CORP., HOLLYWOOD, CA:
2,857,287, PUB. 4-6-2004. INT. CL. 35.

HOWES ENTERPRISE INTERNATIONAL, INC., LOMPOC, CA:
2,858,744, INT. CL. 35.

HP-CHEMIE PELZER GMBH, WITTEN, FED REP GERMANY:
2,857,795, PUB. 4-6-2004. MULTIPLE CLASS, INT. CLS. 1, 12, 17 AND 27.

HREC LICENSING, LLC, PARKER, CO:
2,859,083, MULTIPLE CLASS, INT. CLS. 36 AND 43.

HSIAO, HAO-YAO, TANZIH HSIANG, TAICHUNG HSIEN, TAIWAN AND LIU, CHIN-SHENG, TANZIH HSIANG, TAICHUNG HSIEN, TAIWAN:
2,857,617, PUB. 4-6-2004. INT. CL. 7.

HTE AKTIENGESELLSCHAFT THE HIGH THROUGHPUT EXPERIMENTATION COMPANY, 69123 HEIDELBERG, FED REP GERMANY:
2,813,415, COR. MULTIPLE CLASS, INT. CLS. 1, 9, 37 AND 42.

HUBBARD SYSTEMS, INC., BIRMINGHAM, AL:
2,858,467, INT. CL. 9.

HUBBELL INCORPORATED, ORANGE, CT:
1,832,529. REN. 5-15-04. INT. CL. 9.

HUBCAP HEAVEN, LLC, ANNAPOLIS, MD, HUBCAP HEAVEN, SUITLAND, MD:
1,803,181. REN. 5-15-04. INT. CL. 12.

HUDSON CITY SAVINGS BANK, PARAMUS, NJ:
2,819,979, COR. INT. CL. 36.

HUGGINS, ELEANOR M., TRUCKEE, CA:
1,787,475, CANC. INT. CL. 16.

HUGHES AIRCRAFT EMPLOYEES FEDERAL CREDIT UNION, EL SEGUNDO, CA:
1,247,885, CANC. INT. CL. 36.
1,247,886, CANC. INT. CL. 36.

HULL HOUSE ASSOCIATION, CHICAGO, IL:
2,087,091, CANC. INT. CL. 42.

HULME, RONALD A., CASTOR VALLEY, CA:
2,087,928, CANC. INT. CL. 25.

HUMAN DEVELOPMENT RESOURCE COUNCIL, INC., NORCROSS, GA:
2,858,725, INT. CL. 9.

HUMES & BERG MANUFACTURING CO., INC., EAST CHICAGO, IN:
1,786,688, CANC. INT. CL. 15.

HUMEX, S.A., 43110 LA CANONJA (TARRAGONA), SPAIN:
2,858,489, INT. CL. 1.

HUNTER FAN COMPANY, MEMPHIS, TN:
2,088,134, CANC. INT. CL. 11.

HUNTER-ZIGMAN, INC., MILWAUKEE, WI:
2,087,762, CANC. INT. CL. 35.

HUNTER, DORIEN DION, RENTON, WA:
2,858,886, INT. CL. 25.

HUNTER'S SPECIALTIES, INC., CEDAR RAPIDS, IA:
1,863,805. REN. 5-18-04. INT. CL. 28.

HUNTING WORLD INCORPORATED, NEW YORK, NY:
1,247,492, CANC. INT. CL. 3.

HUNTING WORLD, INCORPORATED, SPARKS, NV TO HUNTING WORLD LLC, SPARKS, NV:
1,786,813, CANC. INT. CL. 25.

HURD MILLWORK COMPANY, INC., MEDFORD, WI:
1,787,504, CANC. INT. CL. 19.

HURST PERFORMANCE, INC., WARMINSTER, PA:
754,808, CANC. U.S. CL. 19.

HUSTLER, INC., KISSIMMEE, FL:
754,528, CANC. U.S. CL. 21.

HWB INCORPORATED, WEST PALM BEACH, FL:
2,834,708, CANC. IIRN. RESTORED TO S.N. 75-412,839.

HYDROTEX PARTNERS, LTD., CARROLLTON, TX:
1,280,332. REN. 5-21-04. MULTIPLE CLASS, INT. CLS. 1 AND 4.

I.C.E.D. MANAGEMENT, INC., WILMINGTON, DE:
1,787,393, CANC. INT. CL. 9.

I.T.C. LIMITED, KOLKATA 700071, INDIA:
2,858,686, INT. CL. 34.

I.V. HOUSE, INC., HAZELWOOD, MO:
2,858,811, INT. CL. 5.

I'VE GOT BETTER THINGS TO DO WITH MY TIME, INC., ST. CLOUD, MN:
2,087,651, CANC. INT. CL. 16.

IAN'S NATURAL FOODS, INC., REVERE, MA:
2,605,349 NEW CERT. 6-29-2004. MULTIPLE CLASS, INT. CLS. 29 AND 30.

IBEX HEALTHDATA SYSTEMS, INC., ROSEMONT, IL:
2,857,631, PUB. 4-6-2004. MULTIPLE CLASS, INT. CLS. 9 AND 42.

ICI AMERICAS INC., WILMINGTON, DE:
754,488, CANC. U.S. CL. 18.

ICI AMERICAS INC., WILMINGTON, DE TO HODGSON PROCESS CHEMICALS INC., ROCK HILL, SC:
1,786,381, CANC. INT. CL. 1.

ICICLE SEAFOODS, INC., SEATTLE, WA:
2,858,864, INT. CL. 29.

ICLOPS, LLC, CHICAGO, IL:
2,858,446, INT. CL. 42.

IDAHO TECHNOLOGY, INC., SALT LAKE CITY, UT:
2,857,290, PUB. 4-6-2004. MULTIPLE CLASS, INT. CLS. 35, 41 AND 42.

IDAMAR ENTERPRISES, INC., NEWARK, NJ:
2,857,688, PUB. 4-6-2004. MULTIPLE CLASS, INT. CLS. 16 AND 35.

IDEA PARTNERSHIPS, LLC, PHILADELPHIA, PA:
2,857,551, PUB. 4-6-2004. MULTIPLE CLASS, INT. CLS. 36 AND 37.

IDEABOX, LLC, BRONXVILLE, NY:
2,858,485, MULTIPLE CLASS, INT. CLS. 37 AND 42.

- IDT NETHERLANDS, B.V. (PUERTO RICO BRANCH), SAN JUAN, PUERTO RICO:
2,857,902, PUB. 4-6-2004. INT. CL. 36.
2,857,903, PUB. 4-6-2004. INT. CL. 36.
2,857,904, PUB. 4-6-2004. INT. CL. 36.
2,857,905, PUB. 4-6-2004. INT. CL. 36.
2,858,758, INT. CL. 36.
- IKON OFFICE SOLUTIONS WEST, INC., PORTLAND, OR:
2,857,523, PUB. 4-6-2004. MULTIPLE CLASS, INT. CLS. 35, 37, 39, 40 AND 42.
2,857,524, PUB. 4-6-2004. MULTIPLE CLASS, INT. CLS. 35, 37, 39, 40 AND 42.
- ILCAR, 06510 CARROS, FRANCE:
2,858,615, INT. CL. 11.
- ILCO UNICAN CORP., ROCKY MOUNT, NC:
2,087,737, CANC. INT. CL. 6.
- ILD TELECOMMUNICATIONS, INC., PONTE VEDRA BEACH, FL:
2,858,655, INT. CL. 38.
- ILLINOIS INSTITUTE OF TECHNOLOGY, CHICAGO, IL:
2,858,067, PUB. 4-6-2004. INT. CL. 43.
- ILLINOIS PRIMARY HEALTH CARE ASSOCIATION, CHICAGO, IL:
2,858,562, INT. CL. 41.
- ILMAILULAITOS, 01530 VANTAA, FINLAND:
2,086,947, CANC. INT. CL. 39.
- ILOVENAPA, LLC, ST. HELENA, CA:
2,858,663, INT. CL. 35.
- IMAGING AUTOMATION, INC., BEDFORD, NH:
2,858,788, INT. CL. 9.
- IMATION CORP., OAKDALE, MN:
2,779,885, COR. MULTIPLE CLASS, INT. CLS. 9, 16, 39 AND 42.
- IMAX CORPORATION, MISSISSAUGA, ONTARIO L5K 1B1, CANADA:
2,857,684, PUB. 4-6-2004. INT. CL. 41.
2,857,685, PUB. 4-6-2004. INT. CL. 41.
- IMPACT GESELLSCHAFT FUR SPORTMARKETING MBH, D-63263 NEU-ISENBURG, FED REP GERMANY:
2,086,726, CANC. MULTIPLE CLASS, INT. CLS. 9, 14, 16, 18, 25, 28, 38, 39 AND 41.
- IMPACT LABS, INC., COLUMBIA, MD:
2,859,109, INT. CL. 9.
- IMPERIAL KNIFE ASSOCIATED COMPANIES, INC., PROVIDENCE, RI:
754,562, CANC. U.S. CL. 23.
754,563, CANC. U.S. CL. 23.
- IMPERIAL TOY CORPORATION, LOS ANGELES, CA:
2,857,556, PUB. 4-6-2004. INT. CL. 28.
- IMPERIAL WIRELESS, BOISE, ID:
2,857,634, PUB. 4-6-2004. INT. CL. 38.
2,857,767, PUB. 4-6-2004. INT. CL. 38.
- IMPORTADORA LA PLAZA, C. POR A., SANTIAGO, DOMINICAN REP:
2,858,544, INT. CL. 4.
- INAX CORPORATION, AICHI, JAPAN:
2,858,381, INT. CL. 11.
- INCREDIBLE PIZZA CO., INC., ROGERSVILLE, MO:
2,500,872 NEW CERT. 6-29-2004. INT. CL. 42.
- INDIAN VALLEY INDUSTRIES, INC., JOHNSON CITY, NY:
2,858,640, INT. CL. 8.
- INDIANA BEHAVIORAL HEALTH CHOICES, INC., INDIANAPOLIS, IN:
2,857,692, PUB. 4-6-2004. INT. CL. 45.
- INDUCOMP CORPORATION, PACIFIC, MO:
2,858,094, PUB. 4-6-2004. INT. CL. 9.
- INDUCTOTHERM CORP., RANOCAS, NJ:
773,193, REN. 5-17-04. U.S. CL. 34 (INT. CL. 11).
- INDUCTOTHERM CORPORATION, RANOCAS, NJ:
1,278,850, REN. 5-16-04. INT. CL. 11.
- INDUSTRIAL ACOUSTICS COMPANY, INC., BRONX, NY:
988,234, REN. 5-17-04. U.S. CL. 12 (INT. CL. 19).
- INDUSTRIAL ENGINEERING AND EQUIPMENT COMPANY, INCORPORATED, ST. LOUIS, MO, SOLITECH INCORPORATED, SAINT LOUIS, MO:
992,393, REN. 5-17-04. U.S. CL. 21 (INT. CL. 9).
- INDUSTRIAL EXCHANGE CORPORATION, RICHMOND, VA:
1,786,735, CANC. INT. CL. 16.
- INDUSTRIALIZADORA DE KAFFEE ANDES, S.A. DE C.V., C.P. 09820, MEXICO, D.F., MEXICO:
2,858,324, INT. CL. 30.
- INFINEON TECHNOLOGIES NORTH AMERICA CORP., SAN JOSE, CA:
2,858,233, INT. CL. 9.
- INFINITY INDUSTRIES INC., SAN DIEGO, CA:
2,857,395, PUB. 4-6-2004. INT. CL. 8.
- INFITRON, INC., SEOUL, 152- 887, REPUBLIC OF KOREA:
2,858,555, INT. CL. 9.
- INFO PARTNERS CORP., VENTNOR, NJ:
2,858,492, INT. CL. 35.
- INFODATA SYSTEMS, INC., FALLS CHURCH, VA:
1,786,568, CANC. INT. CL. 9.
- INFOMEDICS, INC., WOBURN, MA:
2,857,892, PUB. 4-6-2004. INT. CL. 35.
- INFONE LLC, BEAVERTON, OR:
2,859,037, INT. CL. 39.
2,859,038, INT. CL. 41.
- INFONYTE GMBH, D-64293 DARMSTADT, FED REP GERMANY:
2,813,623, COR. MULTIPLE CLASS, INT. CLS. 9, 35 AND 42.
- INFORMIX SOFTWARE, INC.:
1,277,936, REN. 5-15-04. INT. CL. 9.
- INFOUSA INC., OMAHA, NE, AMERICAN BUSINESS INFORMATION, INC., OMAHA, NE:
1,839,108, REN. 5-16-04. INT. CL. 16.
- INFOWISE SOLUTIONS, INC., IRVING, TX:
2,857,883, PUB. 4-6-2004. MULTIPLE CLASS, INT. CLS. 9 AND 42.
- INGE, JENNIFER, CREEDE, CO, DBA RARE THINGS:
1,830,294, REN. 5-21-04. INT. CL. 14.
- INGERSOLL-RAND COMPANY, WOODCLIFF LAKE, NJ:
2,857,951, PUB. 4-6-2004. INT. CL. 37.
- INGRAM ENTERPRISES, INC., SPRINGFIELD, MO:
2,858,684, INT. CL. 13.
- INNOSTREAM INC., KYONGKI-DO, REPUBLIC OF KOREA:
2,858,760, INT. CL. 9.
- INNOVATIVE AFTERMARKET SYSTEMS, INC., AUSTIN, TX:
2,858,989, INT. CL. 41.
- INNOVATIVE EMERGENCY MANAGEMENT INCORPORATED, BATON ROUGE, LA:
2,857,533, PUB. 4-6-2004. INT. CL. 45.
- INNOVATIVE FASHION GROUP CORP., NEW YORK, NY:
2,858,888, INT. CL. 25.
- INNOVATIVE MANAGEMENT TECHNOLOGIES INC., MINNEAPOLIS, MN TO INTERNATIONAL MANAGEMENT TECHNOLOGIES, INC., BURNSVILLE, MN:
1,787,118, CANC. INT. CL. 41.
- INNOVATIVE PRODUCTS AND SERVICES OF BOSTON, INC., BRAINTREE, MA:
2,857,126, PUB. 4-6-2004. INT. CL. 9.
- INNOVATIVE SCIENCES, INC., RALEIGH, NC:
1,882,121, REN. 5-18-04. INT. CL. 16.
- INNOVATOR CORPORATION, BROWNS POINT, WA:
2,088,258, CANC. INT. CL. 42.
- INOREX, INC., KENT, WA:
2,086,719, CANC. MULTIPLE CLASS, INT. CLS. 29 AND 30.
- INSIGHT STRATEGIC CONCEPTS, INC., GOSHEN, IN:
2,857,704, PUB. 4-6-2004. MULTIPLE CLASS, INT. CLS. 35 AND 41.
- INSITE VISION INCORPORATED, ALAMEDA, CA:
1,831,860, REN. 5-17-04. INT. CL. 5.
- INSTRON CORPORATION, CANTON, MA:
2,857,443, PUB. 4-6-2004. MULTIPLE CLASS, INT. CLS. 9, 11 AND 41.
2,857,444, PUB. 4-6-2004. MULTIPLE CLASS, INT. CLS. 9, 11 AND 41.
- INSURANCE BENEFIT SPOT CHECK, INC., SACRAMENTO, CA:
2,858,577, MULTIPLE CLASS, INT. CLS. 36, 38, 39, 42

- AND 44.
 INTAPP GROUP, INC., NEW YORK, NY:
 2,088,318, CANC. INT. CL. 25.
 INTEGO, PARIS, FRANCE:
 2,857,128, PUB. 4-6-2004. INT. CL. 9.
 INTEGRATED IDEAS AND TECHNOLOGY, INC., COEUR
 D'ALENE, ID:
 2,857,947, PUB. 4-6-2004. INT. CL. 16.
 2,857,948, PUB. 4-6-2004. INT. CL. 16.
 INTEGRATIONWARE, INC., BUFFALO GROVE, IL:
 2,759,287, COR. MULTIPLE CLASS, INT. CLS. 9, 35 AND
 42.
 INTEGREAT CONCEPTS, INC., PHOENIX, AZ:
 2,834,735, CANC. IIRN. RESTORED TO S.N. 75-735,002.
 INTEGRITY LIFE INSURANCE COMPANY, CINCINNATI,
 OH:
 2,858,616, INT. CL. 36.
 INTEGRYS ASSETPOINT, LLC, GREENVILLE, SC:
 2,857,629, PUB. 4-6-2004. INT. CL. 9.
 INTELLIGENT CONTENT CORPORATION, WESTON, FL:
 2,858,418, INT. CL. 9.
 INTELLIGENT OFFICE SYSTEM, LLC, THE, BOULDER,
 CO:
 2,857,894, PUB. 4-6-2004. INT. CL. 35.
 INTENSE PHOTONICS LTD, HIGH BLANTYRE, GLAS-
 GOW, UNITED KINGDOM:
 2,857,244, PUB. 4-6-2004. MULTIPLE CLASS, INT. CLS. 9
 AND 37.
 INTERACTIVE SHOPPING, INC., HOUSTON, TX:
 2,087,313, CANC. INT. CL. 9.
 INTERAMERICAN MOTOR CORPORATION, CANOGA
 PARK, CA:
 2,858,554, INT. CL. 7.
 INTERCHEM CORPORATION, PARAMUS, NJ:
 2,857,529, PUB. 4-6-2004. INT. CL. 1.
 INTERDESIGN, INC., SOLON, OH:
 2,858,689, MULTIPLE CLASS, INT. CLS. 6, 20 AND 21.
 INTERIM HEALTHCARE, INC., SUNRISE, FL:
 2,857,628, PUB. 4-6-2004. INT. CL. 9.
 INTERLAKE COMPANIES, INC., THE, LISLE, IL TO
 INTERLAKE MATERIAL HANDLING, INC., LISLE, IL:
 1,787,362, CANC. INT. CL. 7.
 INTERMATCH SWEDEN AB, STOCKHOLM, SWEDEN, P.
 CERLIS CORPORATION, MIAMI, FL:
 1,796,056, REN. 5-16-04. INT. CL. 34.
 INTERNATIONAL ADULT ATHLETIC ASSOCIATION, INC.
 (IAAA), ELK GROVE, CA:
 2,087,439, CANC. INT. CL. 42.
 INTERNATIONAL ASSOCIATION ON WATER QUALITY,
 LONDON, SW1H 9BT, ENGLAND:
 2,087,925, CANC. MULTIPLE CLASS, INT. CLS. 16, 41
 AND 42.
 INTERNATIONAL AWARDS GROUP, LLC, CHARLOTTE
 AMALIE ST. THOMAS, US VIRGIN ISLANDS:
 2,857,375, PUB. 4-6-2004. INT. CL. 41.
 INTERNATIONAL BRASS BOOKMARK, LTD., GARDEN
 CITY PARK, NY:
 2,086,728, CANC. INT. CL. 16.
 INTERNATIONAL BUSINESS MACHINES CORPORATION,
 ARMONK, NY:
 1,786,728, CANC. MULTIPLE CLASS, INT. CLS. 16 AND
 42.
 INTERNATIONAL CHEMICAL COMPANY, PHILADEL-
 PHIA, PA:
 2,857,371, PUB. 4-6-2004. MULTIPLE CLASS, INT. CLS. 2,
 3 AND 4.
 INTERNATIONAL CLOTHIERS INC., DOWNSVIEW, ON-
 TARIO M6A 1M4, CANADA:
 2,859,059, INT. CL. 35.
 INTERNATIONAL DATA GROUP, INC., FRAMINGHAM,
 MA:
 2,086,830, CANC. INT. CL. 35.
 2,087,952, CANC. MULTIPLE CLASS, INT. CLS. 35 AND
 41.
 INTERNATIONAL EDUCATION FINANCE CORPORA-
 TION, BRAINTREE, MA:
 2,857,312, PUB. 4-6-2004. INT. CL. 36.
 INTERNATIONAL FUND ADMINISTRATION, INC., NEW
 YORK, NY:
 2,858,881, INT. CL. 9.
 INTERNATIONAL HEALTH INSURANCE DANMARK
 FORSIKRINGSAKTIESELSKAB, DK-1261 KOBENHAVN
 K, DENMARK:
 2,857,124, PUB. 4-6-2004. INT. CL. 36.
 INTERNATIONAL MASTERS PUBLISHERS AB, 201 80
 MALMO, SWEDEN:
 2,857,129, PUB. 4-6-2004. MULTIPLE CLASS, INT. CLS. 3,
 5, 9, 16, 21, 41 AND 42.
 INTERNATIONAL PAPER COMPANY:
 1,247,683, CANC. INT. CL. 16.
 INTERNATIONAL PRODUCTS DISTRIBUTING INCORPO-
 RATED, ROSWELL, NM TO IMPACT CONFECTIONS,
 INC., ROSWELL, NM:
 1,787,699, CANC. INT. CL. 30.
 INTERNATIONAL REMOTE IMAGING SYSTEMS, INC.,
 CHATSWORTH, CA:
 2,858,792, INT. CL. 9.
 INTERNATIONAL SORBENT TECHNOLOGY LTD., TUC-
 SON, AZ:
 2,086,874, CANC. INT. CL. 1.
 INTERNATIONAL SPEEDWAY CORPORATION, DAYTO-
 NA BEACH, FL:
 2,785,199, COR. MULTIPLE CLASS, INT. CLS. 6, 12, 14,
 16, 20, 21, 24, 25, 28 AND 34.
 INTERNATIONAL TYPEFACE CORPORATION, NEW
 YORK, NY:
 1,247,689, CANC. INT. CL. 16.
 INTERNET TRAVEL NETWORK, PALO ALTO, CA:
 2,857,113, PUB. 4-6-2004. INT. CL. 39.
 INTERSPORT, INC., FREDERICK, MD:
 2,707,652, COR. INT. CL. 25.
 INTERVENTURE, LLC, SAN LUIS OBISPO, CA:
 2,857,132, PUB. 4-6-2004. MULTIPLE CLASS, INT. CLS. 35
 AND 41.
 2,857,143, PUB. 4-6-2004. MULTIPLE CLASS, INT. CLS. 35
 AND 41.
 INTERX TECHNOLOGIES, SACRAMENTO, CA:
 2,087,441, CANC. INT. CL. 38.
 INTEX PRODUCTS, INC., GREENVILLE, SC:
 754,403, CANC. U.S. CL. 4.
 INTRINSA CORPORATION, PALO ALTO, CA:
 2,088,132, CANC. INT. CL. 9.
 INTUITIVE CONTROL SYSTEMS, LLC, STATE COLLEGE,
 PA:
 2,858,990, INT. CL. 11.
 IOWA PHYSICIANS CLINIC MEDICAL FOUNDATION, A
 SUBSIDIARY OF IOWA HEALTH SYSTEM, DES MOINES,
 IA:
 2,088,151, CANC. INT. CL. 42.
 IPMG, INC, OROVILLE, CA:
 2,857,984, PUB. 4-6-2004. INT. CL. 19.
 IPWIRELESS, INC., SAN BRUNO, CA:
 2,858,717, INT. CL. 9.
 IRAD NV, LEUVEN, BELGIUM:
 2,857,275, PUB. 4-6-2004. INT. CL. 42.
 IRIS CERAMICA - SOCIETA' PER AZIONI, 41042 FIORANO
 MODENESE (MODENA), ITALY:
 2,857,396, PUB. 4-6-2004. INT. CL. 19.
 IRVING OIL CORPORATION, ELLSWORTH, ME:
 1,787,322, CANC. INT. CL. 4.
 IRWIN INDUSTRIAL TOOL COMPANY, FREEPORT, IL:
 2,858,530, INT. CL. 7.
 ISAAC MIZRAHI & CO., L.P., NEW YORK, NY:
 2,087,815, CANC. INT. CL. 25.
 ISAGENIX INTERNATIONAL, INC., PHOENIX, AZ:
 2,858,499, INT. CL. 5.
 ISIS PHARMACEUTICALS, INC., CARLSBAD, CA:
 2,857,582, PUB. 4-6-2004. INT. CL. 42.
 2,857,585, PUB. 4-6-2004. INT. CL. 5.
 ISOROY S.A., 14100 LISIEUX, FRANCE:
 2,086,917, CANC. INT. CL. 17.
 ITALGRANI U.S.A., INC., ST. LOUIS, MO:
 1,835,599, REN. 5-17-04. INT. CL. 30.

- ITT INDUSTRIES, INC., WHITE PLAINS, NY, GILFILLAN BROS. INCORPORATED, LOS ANGELES, CA:
589,326. REN. 5-18-04. U.S. CL. 26 (INT. CL. 9).
- ITT INDUSTRIES, INC., WHITE PLAINS, NY:
2,858,218, INT. CL. 9.
- ITT SHERATON CORPORATION, BOSTON, MA:
2,088,392, CANC. INT. CL. 42.
- IVFONLINE.COM, LLC, GUILFORD, CT:
2,859,085, INT. CL. 35.
- IVY HALL, INC., BIRMINGHAM, AL:
2,088,353, CANC. INT. CL. 9.
- IWATANI SANGYO KABUSHIKI KAISHA, HOMMACHI HIGASHIKU, OSAKA, JAPAN:
1,247,515, CANC. INT. CL. 5.
- 1432, WOODLAND HILLS, CA TO CLAPPER, JOE T., LOS ANGELES, CA:
2,755,159, COR. INT. CL. 14.
- J & D HOME IMPROVEMENT, INC., CANONSBURG, PA:
2,857,581, PUB. 4-6-2004. INT. CL. 6.
- J. C. PENNEY COMPANY, INC., NEW YORK, NY:
1,247,755, CANC. INT. CL. 25.
- J. STRICKLAND & CO., MEMPHIS, TN:
1,247,487, CANC. INT. CL. 3.
- J. TERZI & SONS, INC., NEWARK, NJ:
1,247,951, CANC. INT. CL. 42.
- J.A. SEXAUER, INC., JACKSONVILLE, FL, J.A. SEXAUER MFG. CO., INC., NEW YORK, NY:
323,153. REN. 5-17-04. U.S. CL. 52 (INT. CL. 3).
- J.B. GOODHOUSE, INC., BLOOMINGTON, MN TO MINNESOTA AMERICAN, INC., BLOOMINGTON, MN:
1,787,514, CANC. INT. CL. 20.
- J.M. HUBER CORPORATION, EDISON, NJ:
2,859,033, INT. CL. 1.
- J&H FOOD AND BEVERAGE, INC., PASADENA, CA:
2,087,537, CANC. INT. CL. 32.
- J&J DISTRIBUTING CO., ST. PAUL, MN:
2,857,896, PUB. 4-6-2004. INT. CL. 31.
- J&L SPECIALTY STEEL, INC., PITTSBURGH, PA:
2,858,250, INT. CL. 6.
2,858,319, INT. CL. 6.
- J&L SPECIALTY STEEL, INC., CORAOPOLIS, PA:
2,858,428, INT. CL. 6.
- J'S CONCEPTS LIMITED, HUNGHOM, KOWLOON, HONG KONG:
1,772,322. REN. 5-17-04. INT. CL. 14.
- JACK DANIEL'S PROPERTIES, INC., SAN RAFAEL, CA:
2,821,512, COR. INT. CL. 42.
- JACK IN THE BOX INC., SAN DIEGO, CA:
2,857,647, PUB. 4-6-2004. INT. CL. 30.
- JACKSON NATIONAL LIFE INSURANCE COMPANY, LANSING, MI:
2,857,580, PUB. 4-6-2004. INT. CL. 36.
- JACKSON, FITZ A., BELLEROSE, NY:
2,858,201, INT. CL. 29.
- JACOB DELAFON, 75003 PARIS, FRANCE:
1,765,747. REN. 5-17-04. INT. CL. 11.
1,765,747, CANC. MULTIPLE CLASS, INT. CLS. 20 AND 21.
- JACUZZI INC., WALNUT CREEK, CA:
1,766,653. REN. 5-17-04. INT. CL. 11.
- JADA TOYS, INC., LOS ANGELES, CA:
2,858,621, INT. CL. 28.
- JAGTIANI, AJAY A., CLIFTON, VA:
2,857,620, PUB. 4-6-2004. INT. CL. 42.
2,857,621, PUB. 4-6-2004. INT. CL. 42.
- JAK PAK, INC., MILWAUKEE, WI:
1,247,792, CANC. INT. CL. 28.
- JAKKS PACIFIC, INC., MALIBU, CA:
2,859,007, INT. CL. 28.
- JAMES, JESSE, LONG BEACH, CA:
2,857,193, PUB. 4-6-2004. INT. CL. 25.
- JARET INTERNATIONAL (CS), INC., ISELIN, NJ:
2,858,943, INT. CL. 30.
- JASMINE ENTERPRISES, INC., HANOVER PARK, IL:
2,857,195, PUB. 4-6-2004. INT. CL. 25.
- JASON INDUSTRIAL, INC., FAIRFIELD, NJ:
2,088,163, CANC. INT. CL. 7.
- JASON PHARMACEUTICALS, INC., OWINGS MILLS, MD:
2,857,344, PUB. 4-6-2004. INT. CL. 44.
- JATCO KABUSHIKI KAISHA, SHIZUOKA-KEN, JAPAN, TA JATCO LTD FROM JATCO KABUSHIKI KAISHA, SHIZUOKA-KEN, JAPAN, TA JATCO CORPORATION:
2,858,192, MULTIPLE CLASS, INT. CLS. 7, 9, 37 AND 42.
- JAYSHREE HOLDINGS, INC., GROVELAND, FL:
1,834,815. REN. 5-15-04. INT. CL. 30.
- JBL, INCORPORATED, NORTHRIDGE, CA:
2,088,273, CANC. INT. CL. 9.
- JE DI ASSOCIATES, INC., HARRISONVILLE, PA:
2,087,306, CANC. INT. CL. 42.
- JEFFUS, STANLEY E., GARLAND, TX:
1,786,590, CANC. INT. CL. 9.
- JENKINS & GOURNOE, INC., CHICAGO, IL:
2,086,944, CANC. INT. CL. 29.
- JERUSALEM PENCILS LTD., JERUSALEM 91 001, ISRAEL:
1,786,696, CANC. INT. CL. 16.
- JET SPRAY CORP., NORWOOD, MA:
1,247,628, CANC. INT. CL. 11.
- JEWELS CONNECTION, INC., LOS ANGELES, CA:
2,857,651, PUB. 4-6-2004. INT. CL. 14.
- JIANGSU GOODBABY GROUP, INC., JIANGSU, CHINA:
2,088,196, CANC. INT. CL. 12.
- JIM MORAN & ASSOCIATES, INC., DEERFIELD BEACH, FL:
2,858,611, INT. CL. 36.
- JINJIANG FUJIAN YASHIDA FOOD CO., LTD., FUJIAN, CHINA:
2,858,488, INT. CL. 30.
- JIST WORKS, INC., INDIANAPOLIS, IN:
2,087,394, CANC. INT. CL. 16.
- JLBC GOLF ENTERPRISES, LTD. CO., ERLANGER, KY:
2,088,044, CANC. INT. CL. 16.
- JML MARKETING, INC., DALLAS, TX:
2,858,501, INT. CL. 5.
- JOHN B. STETSON COMPANY, MT. KISCO, NY:
181,329. REN. 5-21-04. U.S. CL. 39 (INT. CL. 25).
- JOHN ELLISON ADVISORY GROUP, LTD., ELM GROVE, WI FROM BENEFIT DESIGN CONSULTANTS, LTD., ELM GROVE, WI:
2,858,528, INT. CL. 36.
- JOHN GIRVAN COMPANY, INC., THE, JACKSONVILLE, FL:
2,088,177, CANC. INT. CL. 1.
- JOHN GROSSMAN, INC., POINT RICHMOND, CA, DBA THE GIFTED LINE TO WEE GOOD, INC., CULVER CITY, CA:
1,786,739, CANC. INT. CL. 16.
- JOHN H. HARLAND COMPANY, DECATUR, GA, FORMATION TECHNOLOGIES, INC., DENVER, CO:
1,794,114. REN. 5-18-04. INT. CL. 9.
- JOHN HILL GROUP B.V., ZEIST, NETHERLANDS, DBA DOOR INTERNATIONAL B.V.:
2,858,204, MULTIPLE CLASS, INT. CLS. 16, 35 AND 41.
- JOHN O. BUTLER COMPANY, CHICAGO, IL:
1,276,675. REN. 5-15-04. INT. CL. 5.
1,855,801. REN. 5-15-04. INT. CL. 21.
- JOHN PAUL MITCHELL SYSTEMS, UNIVERSAL CITY, CA:
1,247,496, CANC. INT. CL. 3.
- JOHN PAUL MITCHELL SYSTEMS, SANTA CLARITA, CA:
1,786,405, CANC. INT. CL. 3.
- JOHNNY LINDY COMPANY, WEST LOS ANGELES, CA, DBA VIN DI BONA PRODUCTIONS:
2,859,049, INT. CL. 41.
- JOHNS MANVILLE INTERNATIONAL, INC., DENVER, CO, JOHNS-MANVILLE CORPORATION, DENVER, CO:
1,265,025. REN. 5-21-04. INT. CL. 21.
- JOHNSON & JOHNSON, NEW BRUNSWICK, NJ:
2,088,314, CANC. INT. CL. 5.
- JOHNSON FINANCIAL GROUP, INC., RACINE, WI FROM JOHNSON INTERNATIONAL, INC., RACINE, WI:
2,858,461, INT. CL. 36.
- JOHNSON, LAHNIE, TAMPA, FL:
2,858,801, INT. CL. 9.
- JOHNSON, LANNY L., EAST LANSING, MI:
2,087,967, CANC. MULTIPLE CLASS, INT. CLS. 10 AND 16.

- JOHNSON, PAUL M., NEWPORT BEACH, CA:
2,088,342, CANC. MULTIPLE CLASS, INT. CLS. 9 AND 36.
- JOHNSON DIVERSEY, INC., STURTEVANT, WI, CHEMED CORPORATION, CINCINNATI, OH:
971,128, REN. 5-20-04. U.S. CL. 6 (INT. CL. 1).
1,277,719, REN. 5-20-04. INT. CL. 3.
- JOHNSON DIVERSEY, INC., STURTEVANT, WI:
1,277,732, REN. 5-20-04. INT. CL. 3.
2,858,826, INT. CL. 5.
- JOINT VENTURE OF FEDERAL RESERVE BANKS, CHICAGO, IL:
2,857,402, PUB. 4-6-2004. INT. CL. 38.
- JONES, ATANEE, SAN DIEGO, CA:
2,087,271, CANC. INT. CL. 28.
- JONES, LINDA M., RENO, NV:
2,858,365, INT. CL. 8.
- JONMOR INVESTMENTS, INC., WILMINGTON, DE:
776,716, REN. 5-20-04. U.S. CL. 46 (INT. CL. 29).
- JORDAN CONCEPTS, INC., ROSWELL, GA:
1,247,710, CANC. INT. CL. 20.
- JOSIAH WEDGWOOD & SONS LIMITED, STOKES-ON-TRENT ST12 9ES, UNITED KINGDOM:
2,857,457, PUB. 4-6-2004. INT. CL. 21.
- JOTA GMBH HERSTELLUNG UND VERTRIEB ROTIERENDER INSTRUMENTE, 40025 DÜSSELDORF, FED REP GERMANY, JOTA-WERK GEBR. FUNKE A. G., DUESSELDORF, FED REP GERMANY:
595,630, REN. 5-20-04. U.S. CL. 44 (INT. CL. 10).
- JOUAULT'S CREPE MACHINE, INC., MIAMI, FL:
2,857,987, PUB. 4-6-2004. INT. CL. 43.
- JOY IN MUDVILLE, INC., STOCKTON, CA:
2,087,328, CANC. MULTIPLE CLASS, INT. CLS. 16 AND 25.
- JP PRODUCTIONS, UPPER MONTCLAIR, NJ:
2,088,061, CANC. INT. CL. 42.
- JSR HEALTHBRED LTD., EAST YORKSHIRE Y025 9ED, ENGLAND:
1,787,700, CANC. INT. CL. 31.
- JT INTERNATIONAL DISTRIBUTORS, INC., INDIANAPOLIS, IN:
2,858,110, PUB. 4-6-2004. INT. CL. 18.
- JTI-MACDONALD TM CORP., MONTREAL, QUEBEC, CANADA, MACDONALD TOBACCO INC., MONTREAL, QUEBEC, CANADA:
979,279, REN. 5-16-04. U.S. CL. 17 (INT. CL. 34).
- JUAREZ, MARK, SAN LEANDRO, CA:
2,858,137, PUB. 4-6-2004. MULTIPLE CLASS, INT. CLS. 10 AND 20.
- JUDICIAL WATCH, INC., WASHINGTON, DC:
2,857,425, PUB. 4-6-2004. INT. CL. 41.
- JUICE IT UP FRANCHISE CORP., IRVINE, CA:
2,857,440, PUB. 4-6-2004. INT. CL. 43.
2,857,441, PUB. 4-6-2004. INT. CL. 43.
- JULIUS SAMANN LTD., HAMILTON HM12, BERMUDA, SAMAN, JULES, WATERTOWN, NY, DBA CAR-FRESHER COMPANY:
598,641, REN. 5-17-04. U.S. CL. 6 (INT. CL. 5).
- JUMPING J INVESTMENTS, INC., PASO ROBLES, CA:
2,858,885, INT. CL. 33.
- JUPITER MEDIA CORPORATION, DARIEN, CT:
2,857,347, PUB. 4-6-2004. MULTIPLE CLASS, INT. CLS. 35 AND 41.
- JUST BORN, INC., BETHLEHEM, PA:
2,858,413, INT. CL. 30.
- K. H. S. MUSICAL INSTRUMENT CO., LTD., TAIPEI HSIEN, TAIWAN:
2,857,422, PUB. 4-6-2004. INT. CL. 15.
- K.L.M. (H.K.) LTD, HUNG HORN KOWLOON, HONG KONG:
2,512,647, COR. INT. CL. 14.
- K.M.A. SUNBELT TRADING CORPORATION, CLEARWATER, FL, DBA INTERNATIONAL DIAMOND CENTER:
1,787,223, CANC. INT. CL. 42.
- K&N ENGINEERING, INC., RIVERSIDE, CA:
2,858,015, PUB. 4-6-2004. INT. CL. 7.
- K-2 CORPORATION, VASHON, WA:
2,858,075, PUB. 4-6-2004. INT. CL. 18.
- KABUSHIKI KAISHA BSP, TOKYO, JAPAN:
2,857,390, PUB. 4-6-2004. INT. CL. 9.
- KABUSHIKI KAISHA EVER NEW, KOTO-KU, TOKYO, JAPAN:
2,857,183, PUB. 4-6-2004. MULTIPLE CLASS, INT. CLS. 21 AND 28.
- KABUSHIKI KAISHA HITACHI SEISAKUSHO, TOKYO 101-8010, JAPAN, DBA HITACHI LTD.:
2,858,285, INT. CL. 9.
- KABUSHIKI KAISHA SEGA ENTERPRISES, TOKYO, JAPAN, DBA SEGA ENTERPRISES, LTD.:
2,088,397, CANC. INT. CL. 28.
- KABUSHIKI KAISHA SHINSEI GINKO A/T/A SHINSEI BANK, LIMITED, TOKYO, JAPAN TO KABUSHIKI KAISHA SHINSEI GINKO, TOKYO, JAPAN, AKA SHINSEI BANK, LIMITED:
2,772,021, COR. INT. CL. 36.
- KABUSHIKI KAISHA SHUEISHA, CHIYODA-KU, TOKYO 101-8050, JAPAN, TA SHUEISHA INC.:
2,858,266, INT. CL. 28.
- KABUSHIKI KAISHA ZUKEN, YOKOHAMA-SHI, KANAGAWA-KEN, JAPAN:
2,087,380, CANC. INT. CL. 42.
- KADY INTERNATIONAL INC., SCARBOROUGH, ME, KINETIC DISPERSION CORPORATION, BUFFALO, NY:
588,107, REN. 5-18-04. U.S. CL. 23 (INT. CL. 7).
- KAETRON SOFTWARE CORPORATION, THE WOODLANDS, TX:
2,087,245, CANC. INT. CL. 9.
- KALSEC, INC., KALAMAZOO, MI:
1,847,806, REN. 5-16-04. INT. CL. 30.
- KAM TOYS & NOVELTY MFG. LTD., HUNGHOM, KOWLOON, HONG KONG:
2,087,929, CANC. MULTIPLE CLASS, INT. CLS. 28 AND 41.
- KAMAN MUSIC CORPORATION, BLOOMFIELD, CT, OVATION INSTRUMENTS, INC., BLOOMFIELD, CT:
1,290,930, REN. 5-18-04. INT. CL. 15.
- KAO KABUSHIKI KAISHA, CHUO-KU, TOKYO 103-8210, JAPAN, AKA KAO CORPORATION:
2,857,830, PUB. 4-6-2004. INT. CL. 3.
- KAPCOA CORPORATION, GLENVIEW, IL:
754,572, CANC. U.S. CL. 23.
- KARASIC, BRIAN LEE, HOUSTON, TX:
2,858,705, INT. CL. 10.
- KARECO INTERNATIONAL, INC., CHATSWORTH, CA:
2,857,676, PUB. 4-6-2004. INT. CL. 8.
- KARL GRÜNEWALD VERWALTUNGS GMBH, 55595 SPABRUCKEN, FED REP GERMANY:
2,858,316, INT. CL. 21.
- KARL STORZ GMBH & CO. KG., D-78532 TUTTLINGEN, FED REP GERMANY FROM KARL STORZ GMBH, & CO., D-78532 TUTTLINGEN, FED REP GERMANY:
2,858,196, INT. CL. 10.
- KARMAN, INC., DENVER, CO:
2,088,211, CANC. INT. CL. 25.
- KARSTEN MANUFACTURING CORPORATION, PHOENIX, AZ:
2,857,868, PUB. 4-6-2004. INT. CL. 28.
- KARWAYHO, INC., OREM, UT, DBA DESIGNER MARBLE:
2,087,065, CANC. INT. CL. 37.
- KAT & CATS, INC., LEXINGTON, KY:
2,858,434, INT. CL. 43.
- KAT-BOX KING, INC., GLEN CARBON, IL:
2,858,936, INT. CL. 21.
- KAY 138 BROADWAY REALTY ASSOCIATES, LLC, ELMONT, NY:
2,857,388, PUB. 4-6-2004. INT. CL. 36.
- KAYLIEN, INC., SANTEE, CA:
1,247,701, CANC. INT. CL. 19.
- KAYSER-ROTH CORPORATION, NEW YORK, NY:
754,674, CANC. U.S. CL. 39.
- KAYSER-ROTH CORPORATION, GREENSBORO, NC:
2,858,695, INT. CL. 25.

- KBC BANKVERZEKERINGSHELDING N.V., 1080, BRUSSELS, BELGIUM:
2,858,188, INT. CL. 36.
- KCIN, INC., WATERVILLE, ME:
2,857,901, PUB. 4-6-2004. INT. CL. 35.
- KCS INDUSTRIE-HOLDING AG, A-1060 VIENNA, AUSTRIA:
2,857,214, PUB. 4-6-2004. MULTIPLE CLASS, INT. CLS. 1, 3, 6, 7, 9, 11, 20, 35, 37, 40 AND 42.
- KDS CORPORATION, KYOTO-SHI, JAPAN, KYOTO MEASURING INSTRUMENTS CORP., KYOTO, JAPAN:
1,839,233, REN. 5-20-04. INT. CL. 8.
- KEITH HUBER, INC., GULFPORT, MS:
2,857,484, PUB. 4-6-2004. INT. CL. 12.
- KELLOGG NORTH AMERICA COMPANY, BATTLE CREEK, MI:
1,830,037, REN. 5-21-04. INT. CL. 29.
- KELLY, LEWIS A., LEXINGTON, KY:
2,857,583, PUB. 4-6-2004. INT. CL. 35.
- KEMIN INDUSTRIES, INC., DES MOINES, IA:
2,857,643, PUB. 4-6-2004. MULTIPLE CLASS, INT. CLS. 5 AND 30.
- KENCRAFT, INC., ALPINE, UT:
1,272,045, REN. 5-16-04. INT. CL. 30.
- KENDLE RESEARCH ASSOCIATES, INC., CINCINNATI, OH:
2,068,391, COR. INT. CL. 35.
- KENDRICK, DEAN ARTHUR, CINCINNATI, OH:
2,858,175, PUB. 4-6-2004. INT. CL. 41.
- KENNEDY CARLISLE PUBLISHING CO., LOS ANGELES, CA:
2,857,345, PUB. 4-6-2004. MULTIPLE CLASS, INT. CLS. 16, 41 AND 44.
- KENNETH COLE PRODUCTIONS (LIC), INC., NASSAU, BAHAMAS:
2,858,116, PUB. 4-6-2004. INT. CL. 18.
- KERRY'S BROMELIAD NURSERY, INC., HOMESTEAD, FL:
1,787,593, CANC. INT. CL. 31.
- KEUTER, STEFAN, FED REP GERMANY:
2,857,145, PUB. 4-6-2004. INT. CL. 26.
- KEY WEST FRAGRANCE & COSMETIC FACTORY, INC., KEY WEST, FL:
1,787,313, CANC. INT. CL. 3.
- KEYONUS INCORPORATED, SAN DIEGO, CA:
2,858,804, INT. CL. 42.
- KEYSTONE AREA REALTY, INC., TAMPA, FL:
2,088,386, CANC. INT. CL. 36.
- KEYSTONE BREWERS HOLDING COMPANY, WILMINGTON, DE:
2,087,475, CANC. INT. CL. 32.
- KEYSTONE CONSOLIDATED INDUSTRIES, INC., DALLAS, TX:
754,460, CANC. U.S. CL. 14.
1,321,770, REN. 5-17-04. INT. CL. 6.
- KHAWAM MARKETING GROUP SARL, BEIRUT, LEBANON:
2,858,232, INT. CL. 32.
- KIAWAH ISLAND INN COMPANY, LLC, KIAWAH ISLAND, SC:
2,857,649, PUB. 4-6-2004. INT. CL. 41.
2,857,683, PUB. 4-6-2004. INT. CL. 41.
- KICE INDUSTRIES, INC., WICHITA, KS, KICE METAL PRODUCTS COMPANY, INC., WICHITA, KS:
990,773, REN. 5-21-04. U.S. CL. 23 (INT. CL. 7).
- KIDDIECORP, INC., SAN DIEGO, CA:
1,688,217, REN. 5-17-04. INT. CL. 42.
- KIKKOMAN CORPORATION, CHIBA, JAPAN:
2,468,168 NEW CERT. 6-29-2004. MULTIPLE CLASS, INT. CLS. 1 AND 5.
- KILLER HAYSEEDS, MINNEAPOLIS, MN:
1,787,140, CANC. INT. CL. 41.
- KILLERSPIN, LLC, CHICAGO, IL:
2,857,333, PUB. 4-6-2004. INT. CL. 18.
- KINCO INTERNATIONAL, INC., PORTLAND, OR:
1,274,944, REN. 5-17-04. INT. CL. 25.
- KING ARTHUR FLOUR COMPANY, THE, NORWICH, VT:
170,857, REN. 5-18-04. U.S. CL. 46 (INT. CL. 30).
- KING OF FANS, INC., FT. LAUDERDALE, FL:
2,858,959, INT. CL. 11.
- KING PLASTIC CORPORATION, NORTH PORT, FL:
1,840,537, REN. 5-21-04. INT. CL. 17.
- KING WORLD PRODUCTIONS, INC., NEW YORK, NY:
2,088,440, CANC. INT. CL. 41.
- KINGDREAM PUBLIC LIMITED COMPANY, WUHAN CITY, HUBEI PROVINCE, P.R., CHINA:
2,745,918, COR. MULTIPLE CLASS, INT. CLS. 6 AND 7.
- KINGPORT INTERNATIONAL CORPORATION, EVANSTON, IL:
2,088,095, CANC. MULTIPLE CLASS, INT. CLS. 16 AND 18.
- KIRK'S FOLLY, INC., PROVIDENCE, RI:
2,088,164, CANC. INT. CL. 14.
- KISS A ME PRODUCTIONS, INC., SAYVILLE, NY:
2,771,919, COR. INT. CL. 28.
- KKBL NO. 257 VENTURES LTD., DELTA, B.C. V3M 6Y9, CANADA:
2,858,455, INT. CL. 30.
- KL & ASSOCIATES, CHICAGO, IL:
2,087,827, CANC. INT. CL. 35.
- KLEEGER, JEFFREY KENNETH, LOS ANGELES, CA:
2,857,646, PUB. 4-6-2004. INT. CL. 25.
- KLOPP, MARK CHRISTIAN, NEW YORK, NY:
2,086,954, CANC. INT. CL. 39.
- KLYMAX, INC., BURNSVILLE, MN:
2,087,110, CANC. INT. CL. 12.
- KNIGHT, MARGARET A., DEALE, MD:
2,086,899, CANC. INT. CL. 30.
- KNOEDLER GALLERY, LLC, NEW YORK, NY, M. KNOEDLER & CO., INC., NEW YORK, NY:
982,100, REN. 5-17-04. U.S. CL. 101 (INT. CL. 35).
- KNOGO NORTH AMERICA, INC., HAUPPAUGE, NY:
1,272,484, REN. 5-17-04. INT. CL. 9.
- KNOTT, JAMES, J, SAN DIEGO, CA:
2,858,955, INT. CL. 28.
- KNOXVILLE SMOKIES BASEBALL, INCORPORATED, KNOXVILLE, TN:
2,086,752, CANC. INT. CL. 41.
- KOIKE ARONSON, INC., ARCADE, NY:
2,602,330, COR. INT. CL. 7.
- KONAMI CORPORATION, TOKYO, JAPAN:
2,806,860, COR. INT. CL. 9.
2,858,494, INT. CL. 9.
- KONAMI GAMING, INC., LAS VEGAS, NV:
2,859,005, INT. CL. 9.
2,859,032, INT. CL. 9.
- KONICA MINOLTA GRAPHIC IMAGING U.S.A., INC., MAHWAH, NJ:
2,858,926, MULTIPLE CLASS, INT. CLS. 1 AND 7.
- KONINKLIJKE LUCHTVAART MAATSCHAPPIJ N.V., AMSTELVEEN, NETHERLANDS, AKA KLM:
2,087,193, CANC. INT. CL. 39.
- KONINKLIJKE VAN ZANTEN B.V., 2182 BL HILLEGOM, NETHERLANDS:
2,738,300, COR. MULTIPLE CLASS, INT. CLS. 31, 35 AND 42.
- KOOKA WINES, INC., SEATTLE, WA, DBA CLICK IMPORTS:
2,087,011, CANC. INT. CL. 33.
- KOOS, INC., KENOSHA, WI TO IMC SALT INC., NORTHBROOK, IL:
1,787,299, CANC. INT. CL. 1.
- KOPPERS COMPANY, INC., PITTSBURGH, PA:
402,715, CANC. U.S. CL. 16.
- KOSZALINSKI, TONY C., APPLETON, WI, DBA DAK PRODUCTS COMPANY:
2,858,308, INT. CL. 28.
- KRAFT FOODS, INC., NORTHFIELD, IL:
2,088,341, CANC. INT. CL. 30.
- KRAFT PIZZA COMPANY, NORTHFIELD, IL:
2,087,942, CANC. INT. CL. 30.
- KRANSON INDUSTRIES, INC., ST. LOUIS, MO:
2,088,081, CANC. INT. CL. 21.
- KRB SEED COMPANY, LLC, WINSTON-SALEM, NC:
2,858,384, INT. CL. 31.

KRYPTONITE CORPORATION, CANTON, MA:
2,088,302, CANC. INT. CL. 6.

KUIPER, JERALD W., POWAY, CA:
2,858,779, INT. CL. 28.

KUMHO TIRE CO., INC., SEOUL, REPUBLIC OF KOREA:
2,858,282, INT. CL. 12.

KUMIAI CHEMICAL INDUSTRY CO., LTD., TAITO-KU,
TOKYO, JAPAN:
1,786,440, CANC. INT. CL. 5.

KWIKTRAC ALERTING SYSTEMS, LLC, ROWAYTON, CT:
2,857,962, PUB. 4-6-2004. INT. CL. 39.

K12EDU.COM CORPORATION, NORTH QUINCY, MA:
2,857,563, PUB. 4-6-2004. INT. CL. 38.

L & L CONCESSION COMPANY, TROY, MI:
1,272,714, REN. 5-18-04. MULTIPLE CLASS, INT. CLS. 18
AND 28.

L & L WINGS, INC., NEW YORK, NY:
1,787,530, CANC. INT. CL. 25.
1,787,531, CANC. INT. CL. 25.
1,787,532, CANC. INT. CL. 25.
1,787,533, CANC. INT. CL. 25.
1,787,534, CANC. INT. CL. 25.

L & M CONSTRUCTION CHEMICAL, INC., OMAHA, NE:
2,857,405, PUB. 4-6-2004. INT. CL. 1.

L & P PROPERTY MANAGEMENT COMPANY, SOUTH
GATE, CA:
2,857,576, PUB. 4-6-2004. INT. CL. 27.

L. A. DREYFUS COMPANY, SOUTH PLAINFIELD, NJ:
754,408, CANC. U.S. CL. 5.

L. J. SMITH CO., INC., BOWERSTON, OH:
1,832,042, REN. 5-21-04. INT. CL. 9.

L.C. INDUSTRIES, LLC, CHICAGO, IL:
2,859,021, INT. CL. 20.

L.D. KICHLER CO., THE, CLEVELAND, OH:
1,787,453, CANC. INT. CL. 11.

L.W. HANCOCK CORPORATION, LAS VEGAS, NV:
2,857,910, PUB. 4-6-2004. INT. CL. 9.

L&P PROPERTY MANAGEMENT COMPANY, SOUTH
GATE, CA:
1,271,794, REN. 5-20-04. INT. CL. 17.

L'OREAL, 75381 PARIS CEDEX, FRANCE:
1,277,662, REN. 5-20-04. INT. CL. 3.

L'OREAL, PARIS, FRANCE:
2,857,756, PUB. 4-6-2004. INT. CL. 3.
2,858,507, INT. CL. 21.

L'OREAL USA CREATIVE, INC., NEW YORK, NY:
2,858,808, INT. CL. 3.

LA COFRADIA S.A. DE C.V., TEQUILA, MEXICO:
2,857,875, PUB. 4-6-2004. INT. CL. 33.

LA JOTA VINEYARD & WINERY LLC, ANGWIN, CA
FROM SMITH, WILLIAM H., ANGWIN, CA:
2,857,172, PUB. 4-6-2004. INT. CL. 33.

LA NUOVA ADELCHI S.R.L., TRICASE (LECCE), ITALY:
2,768,590, COR. INT. CL. 25.

LA PREFERIDA, INC., CHICAGO, IL:
2,859,076, INT. CL. 35.

LA-CO INDUSTRIES, INC., ELK GROVE VILLAGE, IL:
2,857,571, PUB. 4-6-2004. INT. CL. 16.

LABO'LIFE, 79160 LA CHAPELLE THIREUIL, FRANCE:
2,087,124, CANC. INT. CL. 5.

LABONE, INC., LENEXA, KS:
2,087,497, CANC. INT. CL. 38.
2,857,912, PUB. 4-6-2004. INT. CL. 44.

LABORATOIRES GOEMAR, 35400 SAINT MALO, FRANCE:
2,086,936, CANC. INT. CL. 1.

LABORATOIRES ROBERT SCHWARTZ, GRAFFENSTA-
DEN, FRANCE:
2,857,800, PUB. 4-6-2004. MULTIPLE CLASS, INT. CLS. 3,
5, 29 AND 30.

LABRADA BODYBUILDING NUTRITION, INC., HOUS-
TON, TX:
2,858,997, INT. CL. 5.

LACK, FRED S., III, TORRANCE, CA, DBA ATLANTIS
ENTERPRISES:
1,793,312, REN. 5-21-04. INT. CL. 42.

LAIL VINEYARDS, LLC, ST. HELENA, CA, DBA LAIL
VINEYARDS:
2,858,675, INT. CL. 33.

LAIRD + PARTNERS LLC., NEW YORK, NY:
2,857,769, PUB. 4-6-2004. INT. CL. 35.

LAKE WINNEPESAUCAH, INC., ROSSVILLE, GA:
2,649,268, CANC. IIRN. RESTORED TO S.N. 76-360,412.
2,649,269, CANC. IIRN. RESTORED TO S.N. 76-360,414.
2,649,270, CANC. IIRN. RESTORED TO S.N. 76-360,415.

LAKEWOOD ENGINEERING & MFG. CO., CHICAGO, IL:
2,858,635, INT. CL. 11.

LAKO FOREST OY LTD, FIN-21160 MERIMASKU, FIN-
LAND:
2,087,257, CANC. INT. CL. 7.

LAMB-WESTON, INC., KENNEWICK, WA:
1,299,674, REN. 5-16-04. INT. CL. 29.

LAMBERT, ELMER J., BELLEVILLE, IL:
1,832,350, REN. 5-18-04. INT. CL. 29.

LAMINATING SERVICES, INC., LOUISVILLE, KY:
2,858,339, INT. CL. 27.

LAMSON CORPORATION, SYRACUSE, NY:
1,786,482, CANC. INT. CL. 7.

LANCER MANAGEMENT COMPANY, INC., LONG
BEACH, NY:
2,857,296, PUB. 4-6-2004. INT. CL. 36.

LANCETTI COSMETICS CORPORATION, DEERFIELD
BEACH, FL:
2,086,717, CANC. INT. CL. 21.

LANDAMERICA FINANCIAL GROUP, INC., RICHMOND,
VA:
2,857,382, PUB. 4-6-2004. MULTIPLE CLASS, INT. CLS.
35, 36 AND 42.

LANDPORT SYSTEM, INC., SANTA CLARA, CA:
2,857,338, PUB. 4-6-2004. INT. CL. 42.

LANE LABS - USA, INC, ALLENDALE, NJ:
2,858,998, INT. CL. 5.

LANE PUNCH CORPORATION, SALISBURY, NC:
1,255,109, REN. 5-16-04. INT. CL. 7.

LANG, PHILIP S., REDMOND, WA:
2,566,512, COR. INT. CL. 35.

LANGLOTZ, BENNET K., PORTLAND, OR:
2,858,750, INT. CL. 6.

LANNET DATA COMMUNICATIONS, LTD., TEL-AVIV
61131, ISRAEL:
2,086,798, CANC. INT. CL. 9.

LAPORTE CONSTRUCTION CHEMICALS NORTH AMER-
ICA, INC., MENTOR, OH:
2,087,750, CANC. INT. CL. 1.

LAPP INSULATOR COMPANY LLC, LEROY, NY, LAPP
INSULATOR COMPANY, INC., LE ROY, NY:
582,766, REN. 5-15-04. U.S. CL. 21 (INT. CLS. 9 AND 17).

LARCOTEX INTERNATIONAL INC., INGLEWOOD, CA:
1,329,753, CANC. INT. CL. 25.

LARIOS PERNOD RICARD, S.A., 29004 MALAGA, SPAIN:
2,814,980, COR. INT. CL. 33.

LATINA MEDIA VENTURES LLC, NEW YORK, NY:
2,859,075, INT. CL. 41.

LAUREUS SPORTS AWARD INC., 6300 ZUG, SWITZER-
LAND:
2,803,900, COR. MULTIPLE CLASS, INT. CLS. 9, 12, 14,
16, 18, 25, 35, 41 AND 42.

LAVENDER LIFESTYLES MARKETING, INC., MINNEA-
POLIS, MN:
2,857,993, PUB. 4-6-2004. MULTIPLE CLASS, INT. CLS. 16
AND 35.
2,857,994, PUB. 4-6-2004. MULTIPLE CLASS, INT. CLS. 16
AND 35.

LAVERNE, DAVID, REDDING, CA AND PAGE, TERRI
CORENE, REDDING, CA:
2,087,558, CANC. MULTIPLE CLASS, INT. CLS. 35 AND
41.

LAWN DOCTOR, INC., HOLMDEL, NJ, LAWN DOCTOR,
INC., HOLMDEL, NJ:
1,000,040, REN. 5-17-04. U.S. CL. 100 (INT. CL. 42).

LAWRENCE STEVENS FASHIONS, LTD., NEW YORK, NY:
2,858,525, INT. CL. 25.

LAWYER INTERNATIONAL, INC., NORTHBROOK, IL:
1,247,474, CANC. INT. CL. 2.

LAWYERS' AND MERCHANTS' TRANSLATION BUREAU
INC., NEW YORK, NY:
1,837,175, REN. 5-16-04. INT. CL. 42.

- LCJ MINISTRIES, INC., BROOKLYN, NY:
2,088,218, CANC. INT. CL. 42.
- LDS, INC., LENEXA, KS:
1,786,630, CANC. INT. CL. 9.
- LEACHCO, INC., ADA, OK:
2,857,614, PUB. 4-6-2004. INT. CL. 24.
- LEADERSHIP TRUST, INC., THE, RESEARCH TRIANGLE PARK, NC:
2,857,783, PUB. 4-6-2004. INT. CL. 41.
- LEAN INVESTMENTS, LLC, MUSCATINE, IA:
2,858,241, INT. CL. 36.
- LEARNING CURVE TOYS, L.L.C., CHICAGO, IL:
2,087,051, CANC. INT. CL. 28.
- LEE B. STEINBERG, P.C., SOUTHFIELD, MI:
2,857,664, PUB. 4-6-2004. INT. CL. 42.
2,857,665, PUB. 4-6-2004. INT. CL. 42.
- LEE, TZONG LONG, HUNTINGTON BEACH, CA:
2,857,695, PUB. 4-6-2004. INT. CL. 32.
- LEGAL MUSCLE PUBLISHING, INC., CARLE PLACE, NY:
2,858,654, INT. CL. 25.
- LEGAL RESEARCH CENTER, INC., MINNEAPOLIS, MN:
2,858,470, INT. CL. 9.
- LEGAL SEA FOODS, INC., ALLSTON, MA:
2,857,536, PUB. 4-6-2004. INT. CL. 43.
- LEGENDARY HOLDINGS, INC., CHULA VISTA, CA:
2,858,330, INT. CL. 25.
- LEMANS CORPORATION, JANESVILLE, WI:
2,812,205, COR. INT. CL. 25.
- LERNER NEW YORK, INC., NEW YORK, NY:
2,858,086, PUB. 4-6-2004. INT. CL. 25.
- LEROY HILL COFFEE COMPANY, INC., MOBILE, AL:
2,857,553, PUB. 4-6-2004. INT. CL. 30.
- LES COLLECTIONS SHAN INC., LAVAL, QUEBEC, CANADA:
2,858,240, MULTIPLE CLASS, INT. CLS. 14, 24 AND 25.
- LES ENTREPRISES VECOR INC., ST-HUBERT, QUEBEC, CANADA:
1,787,500, CANC. INT. CL. 19.
- LES TECHNOLOGIES CLEMEX INC./CLEMEX TECHNOLOGIES INC., LONGUEUIL, QUEBEC, CANADA:
2,086,937, CANC. INT. CL. 42.
- LESSLIE, JAMES, HOWARD BEACH, NY:
2,858,767, MULTIPLE CLASS, INT. CLS. 29 AND 30.
- LETTIERI'S INC., BURNSVILLE, MN:
2,834,740, CANC. IIRN. RESTORED TO S.N. 75-762,280.
- LEVELSEAS LIMITED, LONDON WC1B 3ST, ENGLAND:
2,857,159, PUB. 10-29-2002. MULTIPLE CLASS, INT. CLS. 9, 35, 36, 38, 39 AND 42.
- LEVY, DONNA, SHERMAN OAKS, CA:
2,858,216, INT. CL. 30.
- LEWIS WOOLF GRIPTIGHT LIMITED, BIRMINGHAM, ENGLAND:
754,727, CANC. U.S. CL. 44.
- LEXICON MARKETING OPERATING LIMITED, SAN FRANCISCO, CA:
1,767,686, REN. 5-15-04. INT. CL. 41.
- LF, LLC, WILMINGTON, DE:
2,858,151, PUB. 4-6-2004. MULTIPLE CLASS, INT. CLS. 6 AND 19.
- LF, LLC, WILMINGTON, DE FROM LF CORPORATION, WILMINGTON, DE:
2,858,198, MULTIPLE CLASS, INT. CLS. 19, 21 AND 24.
- LG ELECTRONICS INC., SEOUL, REPUBLIC OF KOREA:
2,858,403, MULTIPLE CLASS, INT. CLS. 9 AND 11.
- LG HOUSEHOLD & HEALTH CARE LTD., SEOUL 150-721, REPUBLIC OF KOREA:
2,857,293, PUB. 4-6-2004. INT. CL. 3.
- LIBERTY SCHOOL SERVICES, LLC, MURFREESBORO, TN:
2,857,699, PUB. 4-6-2004. INT. CL. 36.
2,857,700, PUB. 4-6-2004. INT. CL. 36.
- LIBERTY TRAVEL, INC., RAMSEY, NJ:
2,857,596, PUB. 4-6-2004. INT. CL. 39.
- LICENSING INTERNATIONAL, INC., GLENVIEW, IL:
1,832,879, REN. 5-20-04. INT. CL. 35.
- LIDL STIFTUNG & CO. KG, 74172 NECKARSULM, FED REP GERMANY:
2,818,708, COR. MULTIPLE CLASS, INT. CLS. 29, 30 AND 32.
- LIFE EXTENSION INTERNATIONAL, INC., DALLAS, TX:
2,087,482, CANC. INT. CL. 30.
- LIFE LINE, BRONX, NY:
2,858,296, INT. CL. 25.
- LIFE TECHNOLOGIES, INC., GAITHERSBURG, MD:
2,087,703, CANC. INT. CL. 1.
2,087,704, CANC. INT. CL. 1.
- LIFELINE AMPLIFICATION SYSTEMS, INC., PLATTEVILLE, WI:
2,088,025, CANC. INT. CL. 9.
- LIFESTYLE IMPROVEMENT CENTERS, LLC, LEXINGTON, VA:
2,858,914, INT. CL. 44.
- LIFETOUCH INC., EDEN PRAIRIE, MN:
2,857,577, PUB. 4-6-2004. INT. CL. 41.
- LIGGETT VECTOR BRANDS INC., RESEARCH TRIANGLE PARK, NC:
2,858,451, INT. CL. 35.
- LIGGETT VECTOR BRANDS, INC., RESEARCH TRIANGLE PARK, NC:
2,858,450, INT. CL. 35.
- LIGHTBRIDGE, INC., WALTHAM, MA:
2,088,123, CANC. INT. CL. 9.
- LIGHTING ALTERNATIVES, INC., CHERRY HILL, NJ:
2,857,438, PUB. 4-6-2004. MULTIPLE CLASS, INT. CLS. 11 AND 42.
- LIGUORI, LISA A., POWAY, CA AND LIGUORI, CATHERINE E., POWAY, CA AND LIGUORI, DANIEL T., POWAY, CA:
1,233,504, REN. 5-19-04. INT. CL. 16.
1,233,504, CANC. INT. CL. 20.
- LIKE FATHER LIKE SON, RECORDS, INC, ATLANTA, GA:
2,858,787, INT. CL. 9.
- LILYBLAD PETROLEUM, INC., TACOMA, WA:
1,786,434, CANC. INT. CL. 4.
- LIMONCELLO DI CAPRI S.R.L., CAPRI (NA), ITALY:
2,857,202, PUB. 4-6-2004. MULTIPLE CLASS, INT. CLS. 30 AND 33.
- LIN ENGINEERING, INC., SANTA CLARA, CA:
2,858,895, INT. CL. 7.
- LINC ACCEPTANCE COMPANY, LLC, NORWALK, CT:
2,087,700, CANC. INT. CL. 36.
- LINCOLN ELECTRIC COMPANY, THE, CLEVELAND, OH:
2,088,339, CANC. INT. CL. 40.
2,088,391, CANC. INT. CL. 42.
- LINCOLN HERITAGE LIFE INSURANCE COMPANY, PHOENIX, AZ:
2,858,591, INT. CL. 36.
- LINDE, STEPHANIE, NEW YORK, NY:
2,858,928, INT. CL. 9.
- LINDEN OAK CORPORATION, WILMINGTON, DE, CONVENIENT PRODUCTS SALES CORPORATION, MONTEZUMA, GA:
1,276,456, REN. 5-20-04. INT. CL. 31.
- LINDEN OAKS CORPORATION, WILMINTON, DE, W. R. GRACE & CO., NEW YORK, NY:
982,708, REN. 5-20-04. U.S. CL. 46 (INT. CL. 29).
- LINDHEIMER ASSOCIATES, INC., LEWISVILLE, NC:
2,857,542, PUB. 4-6-2004. INT. CL. 11.
- LINDQUIST BROS. BAIT CO. LTD., WINDSOR, ONTARIO, CANADA:
2,086,805, CANC. INT. CL. 28.
- LINEAR DYNAMICS INC., PARSIPPANY, NJ:
1,247,896, CANC. INT. CL. 37.
- LINO MANFROTTO & CO. S.P.A., 36061 BASSANO DEL GRAPPA (VI), ITALY:
1,803,047, REN. 5-19-04. MULTIPLE CLASS, INT. CLS. 6 AND 9.
- LINSON, LESLIE J., WORCESTER, MA:
2,087,848, CANC. INT. CL. 16.
- LINTEC KABUSHIKI KAISHA, TOKYO, JAPAN:
2,858,177, MULTIPLE CLASS, INT. CLS. 6, 9 AND 16.
- LINWORTH PUBLISHING, INC., WORTHINGTON, OH:
1,786,722, CANC. INT. CL. 16.
- LION ROCK HOLDINGS L.L.C., GRAND RAPIDS, MI:
2,858,597, INT. CL. 29.
- LIPOSOME COMPANY, INC., THE, PRINCETON, NJ:
1,787,199, CANC. INT. CL. 42.

LIQUIDPIXELS, INCORPORATED, FAIRPORT, NY:
2,857,572, PUB. 4-6-2004. INT. CL. 42.

LISA FRANK, INC., TUCSON, AZ:
2,087,127, CANC. INT. CL. 16.
2,087,173, CANC. INT. CL. 16.
2,088,336, CANC. INT. CL. 28.

LITIGATION SYSTEMS, INC., WASHINGTON, DC:
2,858,857, MULTIPLE CLASS, INT. CLS. 9, 35, 38 AND 40.

LITTLE CAESAR ENTERPRISES, INC., DETROIT, MI:
2,087,707, CANC. INT. CL. 42.
2,857,998, PUB. 4-6-2004. INT. CL. 41.

LITTLE RAPIDS CORPORATION, GREEN BAY, WI:
2,858,974, INT. CL. 25.

LITTON INDUSTRIAL PRODUCTS, INC., EAST HARTFORD, CT:
1,247,557, CANC. INT. CL. 6.

LIVENT INC., TORONTO, ONTARIO, CANADA:
2,087,932, CANC. MULTIPLE CLASS, INT. CLS. 9, 16, 25 AND 41.

LIVING ROOM OF MADISON, INC., THE, MADISON, WI:
2,087,088, CANC. INT. CL. 25.

LO-MAN OUTDOOR STORE, LTD., BABYLON, NY:
1,247,730, CANC. INT. CL. 22.

LOANSTAR FUNDING GROUP, INC., BRYAN, TX:
2,858,504, INT. CL. 36.

LOANTRADE INC., BOCA RATON, FL:
2,835,528, CANC. IIRN. RESTORED TO S.N. 75-870,573.

LOCKE, LARRY, LONG BEACH, CA AND LOCKE, TERESA M., LONG BEACH, CA:
2,088,015, CANC. INT. CL. 9.

LOCKMASTERS, INC., NICHOLASVILLE, KY:
2,858,465, MULTIPLE CLASS, INT. CLS. 6 AND 9.

LOCWEAR, L.L.C., BATON ROUGE, LA:
2,857,340, PUB. 4-6-2004. MULTIPLE CLASS, INT. CLS. 14 AND 26.

LODESTAR TRADING INTERNATIONAL, INC., LONGMONT, CO:
2,857,487, PUB. 4-6-2004. INT. CL. 24.

LOEW'S THEATRES, INC., NEW YORK, NY:
754,473, CANC. U.S. CL. 17.
754,474, CANC. U.S. CL. 17.

LOEWEN GROUP INTERNATIONAL, INC., BURNABY, B.C., CANADA:
2,088,178, CANC. INT. CL. 16.

LOGICAL APPS, INC., IRVINE, CA:
2,857,531, PUB. 4-6-2004. INT. CL. 9.
2,857,532, PUB. 4-6-2004. INT. CL. 9.

LONE WOLF PROPERTIES, LLC, CHATTANOOGA, TN, CHATTANOOGA HEART INSTITUTE, INC., CHATTANOOGA, TN:
1,808,191, REN. 5-20-04. INT. CL. 42.

LONESOME PINE INTERNATIONAL RACEWAY, INC., COEBURN, VA:
1,247,938, CANC. INT. CL. 41.

LONG ISLAND COMPOST CORP., WESTBURY, NY:
2,857,495, PUB. 4-6-2004. MULTIPLE CLASS, INT. CLS. 1 AND 31.

LONG RANGE SYSTEMS, INC., DALLAS, TX:
2,857,539, PUB. 4-6-2004. INT. CL. 9.

LONGS DRUG STORES CALIFORNIA, INC., WALNUT CREEK, CA:
2,087,025, CANC. MULTIPLE CLASS, INT. CLS. 16 AND 42.

LONGTON CROWN COLLECTIONS, LTD., NILES, IL:
2,087,833, CANC. INT. CL. 16.

LOOP INTERNET SWITCH COMPANY, LLC, THE, LOS ANGELES, CA:
2,086,923, CANC. INT. CL. 38.

LORI DAVIS PRODUCTS, INC., THOUSAND OAKS, CA:
2,799,114, COR. INT. CL. 3.

LOST ELEMENT, HOUSTON, TX:
2,857,920, PUB. 4-6-2004. INT. CL. 41.

LOU TESS FOOD SERVICE, INC., LITCHFIELD, CT, DBA WEST STREET GRILL:
2,087,563, CANC. INT. CL. 30.

LOUIS GARNEAU SPORTS INC., QUEBEC, CANADA:
2,088,040, CANC. INT. CL. 25.

LOUISIANA-PACIFIC CORPORATION, PORTLAND, OR:
2,087,150, CANC. INT. CL. 19.

LOVE DOCTOR ENTERPRISES LLC, NEW CANAAN, CT:
2,857,666, PUB. 4-6-2004. INT. CL. 45.

LOVELAND INDUSTRIES, INC., GREELEY, CO:
2,637,135, COR. INT. CL. 1.

LSG LUFTHANSA SERVICE HOLDING AG, 63263 NEU-ISENBURG, FED REP GERMANY:
2,857,343, PUB. 12-30-2003. MULTIPLE CLASS, INT. CLS. 9, 29, 30, 35, 41 AND 43.

LT DESIGNS, INC., NEW YORK, NY:
2,087,189, CANC. INT. CL. 25.

LTB ENTERPRISES, INC., WESTLAKE VILLAGE, CA:
2,857,573, PUB. 4-6-2004. INT. CL. 41.

LUBE, U.S.A., INC., GREENVILLE, SC:
2,212,101, CANC. INT. CL. 9.

LUCASFILM ENTERTAINMENT COMPANY LTD., NICASIO, CA:
2,858,244, INT. CL. 9.

LUCASFILM LTD., NICASIO, CA:
2,810,844, COR. INT. CL. 41.

LUCASFILM LTD., SAN RAFAEL, CA:
1,272,312, REN. 5-18-04. INT. CL. 25.

LUCKY BRAND DUNGAREES, INC., VERNON, CA:
2,857,464, PUB. 4-6-2004. INT. CL. 35.

LUCKY STORES, INC., DUBLIN, CA:
2,087,933, CANC. INT. CL. 29.

LUDWIG DEMMELER GMBH & CO., D-87751 HEIMERTINGEN, FED REP GERMANY:
2,858,186, MULTIPLE CLASS, INT. CLS. 6, 7, 9, 20, 40 AND 42.

LUSKINS, INC., COLUMBIA, MD:
2,086,992, CANC. INT. CL. 37.

LUXOTTICA LEASING S.P.A., AGORDO (BELLUNO) 32021, ITALY:
1,271,619, REN. 5-17-04. INT. CL. 9.

LYDALL, INC., MANCHESTER, CT:
755,523, REN. 5-20-04. U.S. CL. 37 (INT. CL. 16).

LYDIA SECURITY MONITORING, INC., F WILLIAMSTOWN, NJ:
1,781,931, REN. 5-18-04. INT. CL. 42.

LYNCH LABORATORIES, INC., MINNEAPOLIS, MN:
2,088,376, CANC. INT. CL. 5.

LYTRON INCORPORATED, WOBURN, MA:
2,857,169, PUB. 4-6-2004. INT. CL. 11.

LZB PROPERTIES, INC., MONROE, MI:
2,857,682, PUB. 4-6-2004. INT. CL. 35.

M & S TRADING, INC., SANTA ANA, CA:
2,857,761, PUB. 4-6-2004. INT. CL. 25.

M G K GROUP INC., NEW YORK, NY:
2,857,753, PUB. 4-6-2004. MULTIPLE CLASS, INT. CLS. 11 AND 18.

M. GRUMBACHER INC., CRANBURY, NJ:
2,086,990, CANC. INT. CL. 2.

M. GRUMBACHER, INC., CRANBURY, NJ:
2,086,880, CANC. INT. CL. 16.

M. H. GREENEBAUM, INC., NEW YORK, NY:
754,754, CANC. U.S. CL. 46.

M.I.C. INDUSTRIES, INC., RESTON, VA:
1,832,525, REN. 5-18-04. INT. CL. 7.

M.J. MRVICA ASSOCIATES, INC., BERLIN, NJ:
2,087,738, CANC. INT. CL. 16.

M.J. PROPERTIES OF SOUTH CAROLINA, L.L.C., CHARLESTON, SC:
2,857,501, PUB. 4-6-2004. INT. CL. 43.

M.S. RAU, INC., NEW ORLEANS, LA:
2,857,869, PUB. 4-6-2004. INT. CL. 16.

M.W.L.L.C., INC., SHERMAN OAKS, CA:
2,859,073, INT. CL. 41.

M&R COMMUNICATIONS, INC., SMITHTOWN, NY:
2,086,876, CANC. INT. CL. 36.

M-REAL CORPORATION, ESPOO, FINLAND:
2,857,938, PUB. 4-6-2004. INT. CL. 16.

M-YACHTS, INC., WESTPORT PT., MA:
2,087,403, CANC. INT. CL. 12.

MA, VAN, LOS ANGELES, CA:
2,858,469, INT. CL. 5.

- MAAT, MARGARET MORGAN, CRANFORD, NJ:
2,087,800, CANC. MULTIPLE CLASS, INT. CLS. 16 AND 41.
- MACADAMIA DE COSTA RICA S.A., ATIRRO TURRIALBA, COSTA RICA:
2,087,444, CANC. MULTIPLE CLASS, INT. CLS. 29 AND 30.
- MACH 1, INC., CHICO, CA:
2,087,793, CANC. INT. CL. 14.
2,087,812, CANC. INT. CL. 16.
- MACHINE AGE, INC., SHERMAN OAKS, CA:
1,829,392, REN. 5-20-04, INT. CL. 16.
- MACHINE DESIGN INCORPORATED, WEST COLUMBIA, SC:
2,857,415, PUB. 4-6-2004, INT. CL. 7.
- MACIE VIDEO SERVICE, INC., DEDHAM, MA:
2,086,962, CANC. INT. CL. 37.
- MACMILLAN PUBLISHERS (AUST.) PTY. LTD., VICTORIA 3141, AUSTRALIA:
2,857,191, PUB. 4-6-2004, MULTIPLE CLASS, INT. CLS. 16 AND 41.
- MACRAFT, INC., PAGE, AZ:
2,857,779, PUB. 4-6-2004, INT. CL. 9.
- MAD DOG MULTIMEDIA, INC., SAN DIEGO, CA:
2,858,044, PUB. 4-6-2004, INT. CL. 9.
- MAD RIVER COMPANY, LLC, ATLANTA, GA:
2,857,746, PUB. 4-6-2004, MULTIPLE CLASS, INT. CLS. 30 AND 32.
- MADSEN, A. SHARON, CLANCY, MT:
2,858,287, INT. CL. 41.
2,858,288, INT. CL. 41.
- MAG TECHNOLOGY CO., LTD., TAIPEI, TAIWAN:
2,088,237, CANC. INT. CL. 9.
- MAGDAR INDUSTRIES, INC., MARIETTA, GA:
2,857,310, PUB. 4-6-2004, MULTIPLE CLASS, INT. CLS. 35 AND 36.
- MAGIC FOOT, LLC, SPRING LAKE, MI:
2,858,628, INT. CL. 25.
- MAGIC MARCITE, INC., ORLANDO, FL:
2,857,750, PUB. 4-6-2004, INT. CL. 37.
- MAGIED, NIZAR AWAD, FALLS CHURCH, VA:
2,858,385, INT. CL. 16.
- MAGIQ TECHNOLOGIES, INC., NEW YORK, NY:
2,858,254, MULTIPLE CLASS, INT. CLS. 9, 41 AND 42.
- MAGNATONE, CASSELBERRY, FL:
2,857,723, PUB. 4-6-2004, INT. CL. 10.
- MAGNETROL INTERNATIONAL, INCORPORATED, DOWNERS GROVE, IL:
2,087,978, CANC. INT. CL. 9.
- MAGO LTD., NEW YORK, NY:
2,858,648, INT. CL. 25.
- MAHAKALA INC., NEW YORK, NY:
2,087,883, CANC. INT. CL. 25.
- MAILBOX INSTALLERS, INC., THE, MIAMIVILLE, OH:
1,786,469, CANC. INT. CL. 6.
- MAIN LINE HEALTH, INC., RADNOR, PA:
2,087,795, CANC. INT. CL. 16.
- MAINE COLLEGE OF ART, PORTLAND, ME:
2,857,765, PUB. 4-6-2004, INT. CL. 41.
- MAINE ORNAMENTAL WOODWORKERS, INC., BAINBRIDGE ISLAND, WA:
2,857,759, PUB. 4-6-2004, INT. CL. 6.
- MAINSTAY DESIGNS LIMITED, BRISTOL, UNITED KINGDOM:
2,857,785, PUB. 4-6-2004, MULTIPLE CLASS, INT. CLS. 20 AND 24.
- MAISON CASANOVA S.R.L., SCHIO (VICENZA), ITALY:
1,829,254, REN. 5-20-04, INT. CL. 9.
- MAKE-UP CHANNEL, INC., SIGNAL HILL, CA:
2,859,099, MULTIPLE CLASS, INT. CLS. 35 AND 41.
- MAKING HISTORY, LTD., CHICAGO, IL, DBA STREAMING WORLD:
2,857,508, PUB. 4-6-2004, MULTIPLE CLASS, INT. CLS. 38 AND 42.
- MALHOTRA, REKHA, WESTBURY, NY:
2,857,346, PUB. 4-6-2004, INT. CL. 41.
- MALJACK PRODUCTIONS, INC., ORLAND PARK, IL:
2,088,286, CANC. INT. CL. 35.
- MALLINCKRODT, INC., ST. LOUIS, MO:
754,400, CANC. U.S. CL. 2.
754,749, CANC. U.S. CL. 46.
- MAMMA GEMELLI, INC., BABYLON, NY:
2,857,597, PUB. 4-6-2004, INT. CL. 30.
- MANAGEDCARE MUTUAL CAPTIVE INSURANCE COMPANY, ATLANTA, GA:
1,787,025, CANC. INT. CL. 36.
- MANAGEMENT SCIENCE ASSOCIATES, INC., PITTSBURGH, PA:
2,857,110, PUB. 4-6-2004, INT. CL. 9.
- MANDELL, PHYLLIS, WILLIAMSVILLE, VT AND MANDELL, JOSEPH I., WILLIAMSVILLE, VT AND MANDELL, ELISABETH, WILLIAMSVILLE, VT:
2,858,772, INT. CL. 24.
- MANHATTAN CONNECTION, NEW YORK, NY:
2,858,149, PUB. 4-6-2004, INT. CL. 36.
- MANLEY, INC., KANSAS CITY, MO:
754,512, CANC. U.S. CL. 21.
- MANN + HUMMEL GMBH, 71638 LUDWIGSBURG, FED REP GERMANY:
2,068,238, CANC. INT. CL. 20.
- MANNING, SELVAGE & LEE, INC., NEW YORK, NY:
2,858,443, INT. CL. 35.
- MANOUSAKIS, THEODORE, ALEXANDRIA, VA:
2,858,683, INT. CL. 33.
- MANU COMM ENTERPRISES, PITTSBURGH, PA:
2,858,503, INT. CL. 20.
- MANUFACTURERS SUPPLIES COMPANY, ST. LOUIS, MO:
1,247,574, CANC. MULTIPLE CLASS, INT. CLS. 7 AND 42.
- MAPLE LEAF DISTILLERS, INC., WINNIPEG, MANITOBA R3E 2K3, CANADA:
2,857,204, PUB. 4-6-2004, INT. CL. 32.
- MARATHON ENTERPRISES, INC., EAST RUTHERFORD, NJ, SABRETT FOOD COMPANY, INC., NEW YORK, NY:
313,927, REN. 5-20-04, U.S. CL. 46 (INT. CL. 30).
- MARATUN, S.A. DE C.V., 22800 ENSENADA, BAJA CALIFORNIA, MEXICO:
2,087,388, CANC. INT. CL. 29.
- MARBERGA MANAGEMENT, INC., KENSINGTON, MD:
1,787,658, CANC. INT. CL. 42.
- MARbled ELEGANCE, INC., SANTA CLARA, CA:
1,785,554, REN. 5-19-04, INT. CL. 19.
- MARC LAZAR INC., NEW YORK, NY:
2,857,885, PUB. 4-6-2004, INT. CL. 14.
- MARCHIONI, ARTISTA J., SAN PEDRO, CA:
2,857,764, PUB. 4-6-2004, INT. CL. 5.
- MARCO INVESTMENTS, INC., NORFOLK, VA:
2,857,349, PUB. 4-6-2004, INT. CL. 36.
- MARCOTT SPORTS, LLC, CHICAGO, IL:
2,857,726, PUB. 4-6-2004, INT. CL. 28.
- MARIN-LEVINE, SUZANNE, NEW YORK, NY AND MARC LAUTIN, EVERETT, NEW YORK, NY:
2,857,870, PUB. 4-6-2004, INT. CL. 44.
- MARINA DISTRICT DEVELOPMENT COMPANY, LLC, ATLANTIC CITY, NJ, DBA BORGATA HOTEL, CASINO & SPA:
2,811,863, COR. INT. CL. 44.
2,857,893, PUB. 4-6-2004, MULTIPLE CLASS, INT. CLS. 41 AND 43.
2,858,017, PUB. 4-6-2004, INT. CL. 44.
2,859,034, INT. CL. 43.
- MARINER TRAVEL, INC., NARRAGANSETT, RI:
1,787,074, CANC. INT. CL. 39.
- MARK CONTROLS CORP., EVANSTON, IL:
754,546, CANC. U.S. CL. 23.
- MARKEM CORPORATION, KEENE, NH:
2,858,286, INT. CL. 9.
- MARKET MEASURES/COZINT L.P., EAST HANOVER, NJ:
2,858,569, INT. CL. 35.
2,858,570, INT. CL. 35.
- MARKETING ADVANTAGE GROUP LLC, EVANSTON, IL:
2,857,784, PUB. 4-6-2004, INT. CL. 35.
- MARKETING AND CREATIVE SALES, INC., CHESTERFIELD, MO:
2,858,678, INT. CL. 21.

- MARKETING AND MANAGEMENT GROUP, INC., SO. DENNIS, MA:
2,088,161, CANC. INT. CL. 35.
- MARKETING NAVIGATORS, INC., HARTLAND, WI:
1,786,976, CANC. INT. CL. 35.
- MARKETPLACE SYSTEMS GROUP, INC., MIDLOTHIAN, VA TO UNLIMITED SOLUTIONS, INC., LEWIS CENTER, OH:
1,787,675, CANC. INT. CL. 9.
- MARKSCOPE INCORPORATED, NEW YORK, NY:
1,298,257, REN. 5-17-04, INT. CL. 42.
- MARLA JEWELRY COMPANY, INC., NEW YORK, NY:
1,247,647, CANC. INT. CL. 14.
- MARLEN MANUFACTURING AND DEVELOPMENT CO., BEDFORD, OH:
2,857,729, PUB. 4-6-2004, INT. CL. 10.
- MARLO FURNITURE COMPANY, INC., ALEXANDRIA, VA:
1,288,419, REN. 5-19-04, INT. CL. 42.
- MARS, INCORPORATED, MCLEAN, VA:
2,858,334, INT. CL. 30.
2,858,337, INT. CL. 30.
- MARSDEN REPRODUCTIONS, INC., NEW YORK, NY:
1,247,871, CANC. MULTIPLE CLASS, INT. CLS. 35, 40, 41 AND 42.
1,247,872, CANC. MULTIPLE CLASS, INT. CLS. 35, 40, 41 AND 42.
- MARTHA STEWART LIVING OMNIMEDIA, INC., NEW YORK, NY:
2,858,817, INT. CL. 28.
- MARTIN MARIETTA MAGNESIA SPECIALTIES INC., BALTIMORE, MD:
2,087,673, CANC. INT. CL. 1.
- MARTIN MARIETTA MAGNESIA SPECIALTIES, LLC, RALEIGH, NC:
2,857,724, PUB. 4-6-2004, INT. CL. 1.
2,857,725, PUB. 4-6-2004, INT. CL. 1.
- MARTIN YALE INDUSTRIES, INC., CHICAGO, IL:
1,247,670, CANC. INT. CL. 16.
- MARTIN, ROBERT A., JR., METAIRIE, LA, DBA ROB REDBONE MARTIN FISHING & ACCESSORIES:
2,857,876, PUB. 4-6-2004, INT. CL. 28.
- MARTYNEC, ANDREA M., DOYLESTOWN, PA:
2,858,355, MULTIPLE CLASS, INT. CLS. 35 AND 40.
- MARVEL CHARACTERS, INC., LOS ANGELES, CA, CADENCE INDUSTRIES CORPORATION, NEW YORK, NY, DBA MARVEL COMICS GROUP:
1,280,728, REN. 5-18-04, INT. CL. 16.
- MARVEL CHARACTERS, INC., CALABASAS, CA:
2,088,149, CANC. INT. CL. 16.
- MARY AND LOU'S LLC, WAUCONDA, IL:
2,858,134, PUB. 4-6-2004, INT. CL. 30.
- MARY KAY INC., DALLAS, TX:
2,857,511, PUB. 4-6-2004, INT. CL. 41.
- MARYE W JIANG, NEW YORK, NY:
2,858,709, MULTIPLE CLASS, INT. CLS. 41 AND 42.
- MASQUERADE BOOKS, INC., NEW YORK, NY:
2,087,225, CANC. INT. CL. 16.
- MASTER CRAFT PRODUCTS, INC., CLEVELAND, OH:
2,087,711, CANC. INT. CL. 7.
- MASTER CUTLERY, INC., SECAUCUS, NJ:
2,857,486, PUB. 4-6-2004, INT. CL. 8.
- MASTER PRECISION PRODUCTS, INC., GREENVILLE, MI:
2,087,385, CANC. INT. CL. 40.
- MASTERWIN INTERNATIONAL HOLDINGS LIMITED, TSUEN WAN, NEW TERRITORIES, HONG KONG:
2,858,724, MULTIPLE CLASS, INT. CLS. 6, 14, 16, 40 AND 42.
- MATERIALS SCIENCES CORPORATION, FT. WASHINGTON, PA:
2,858,764, MULTIPLE CLASS, INT. CLS. 9 AND 42.
- MATES, MATTHEW, ORLANDO, FL:
2,859,030, INT. CL. 19.
- MATFUSION, L.L.C., PLANO, TX:
2,858,649, INT. CL. 41.
- MATLOCK, DAVID, L, LOS ANGELES, CA:
2,857,936, PUB. 4-6-2004, INT. CL. 44.
- MATMA, S.A., BARCELONA, SPAIN:
2,857,972, PUB. 4-6-2004, INT. CL. 3.
- MATRIX ESSENTIALS, INC., SOLON, OH:
1,787,317, CANC. INT. CL. 3.
1,787,318, CANC. INT. CL. 3.
- MATSUSHITA ELECTRIC INDUSTRIAL CO. LTD., OSAKA, JAPAN:
754,599, CANC. U.S. CL. 27.
- MATSUSHITA ELECTRIC INDUSTRIAL CO., LTD., OSAKA, JAPAN:
754,726, CANC. U.S. CL. 44.
- MATSUSHITA ELECTRIC INDUSTRIAL CO., LTD., KADOMA-SHI, OSAKA PREFECTURE, JAPAN:
1,278,885, REN. 5-16-04, INT. CL. 12.
- MATSUSHITA ELECTRIC INDUSTRIAL CO., LTD., KADOMA-SHI, OSAKA-FU, JAPAN:
2,798,366, COR. INT. CL. 9.
- MATTEL, INC., EL SEGUNDO, CA:
2,087,979, CANC. INT. CL. 28.
2,088,221, CANC. INT. CL. 28.
2,088,222, CANC. INT. CL. 28.
2,858,701, INT. CL. 28.
2,858,704, INT. CL. 28.
2,858,710, INT. CL. 9.
2,858,719, INT. CL. 28.
2,858,723, INT. CL. 28.
2,858,730, INT. CL. 28.
2,858,747, INT. CL. 28.
2,858,770, INT. CL. 28.
2,858,778, INT. CL. 28.
2,858,793, INT. CL. 28.
2,858,794, INT. CL. 28.
2,858,796, INT. CL. 28.
2,858,797, INT. CL. 28.
2,858,819, INT. CL. 28.
2,858,832, INT. CL. 28.
- MATTEL, INC., EL SEGUNDO, CA:
2,858,731, INT. CL. 28.
- MATTHEW SHEPARD FOUNDATION, CASPER, WY:
2,857,898, PUB. 4-6-2004, MULTIPLE CLASS, INT. CLS. 18, 36 AND 41.
- MAVERIC INC., POMPTON PLAINS, NJ:
2,858,155, PUB. 4-6-2004, INT. CL. 35.
- MAW CHANG OPTICIANS INC., MONTEREY PARK, CA:
2,087,282, CANC. INT. CL. 42.
- MAX FACTOR & CO., LOS ANGELES, CA:
1,247,503, CANC. INT. CL. 3.
1,247,506, CANC. INT. CL. 3.
- MAXCELL BIOSCIENCE, BROOMFIELD, CO:
2,834,719, CANC. IIRN. RESTORED TO S.N. 75-640,563.
- MAXFIELD PET RESORT, INC., MEADVILLE, PA:
2,857,488, PUB. 4-6-2004, INT. CL. 43.
- MAXIMA TECHNOLOGIES & SYSTEMS, INC., LANCASTER, PA:
1,791,381, REN. 5-21-04, INT. CL. 9.
- MAXXAR CORPORATION, THE, WIXOM, MI, FEDERAL SCREW WORKS, DETROIT, MI:
981,542, REN. 5-21-04, U.S. CL. 21 (INT. CL. 9).
- MAYBELLINE INTERMEDIATE CO., WILMINGTON, DE:
2,088,141, CANC. INT. CL. 3.
- MAYCO CHEMICAL PRODUCTS, INC., EL RENO, OK:
2,857,731, PUB. 4-6-2004, INT. CL. 1.
- MAYEUX, JERRY V., CORRALES, NM:
1,786,374, CANC. INT. CL. 1.
- MCC MAGAZINES, LLC, AUGUSTA, GA:
2,857,758, PUB. 4-6-2004, MULTIPLE CLASS, INT. CLS. 16, 35 AND 41.
2,857,760, PUB. 4-6-2004, MULTIPLE CLASS, INT. CLS. 16 AND 41.
- MCCORMACK AUDIO CORPORATION, LEUCADIA, CA:
2,086,775, CANC. INT. CL. 9.
- MCCORMICK DELAWARE, INC., WILMINGTON, DE:
2,202,229, CANC. INT. CL. 29.
- MCCOY, EDWARD A., WALKERSVILLE, MD:
2,087,900, CANC. INT. CL. 25.
- MCDavid KNEE GUARD, INC., WOODRIDGE, IL:
2,857,937, PUB. 4-6-2004, INT. CL. 25.

- MCDERMOTT INTERNATIONAL, INC., NEW ORLEANS, LA:
2,857,650, PUB. 4-6-2004. MULTIPLE CLASS, INT. CLS. 37, 40 AND 42.
- MCDONALD'S CORPORATION, OAK BROOK, IL:
1,296,009, REN. 5-20-04. MULTIPLE CLASS, INT. CLS. 14, 24 AND 25.
2,858,902, INT. CL. 43.
- MCELROY, PHILIP, LONDON, ONTARIO, CANADA, DBA K-R INDUSTRIES:
1,787,382, CANC. INT. CL. 9.
- MCI COMMUNICATIONS CORPORATION, WASHINGTON, DC:
1,787,069, CANC. INT. CL. 38.
1,832,438, REN. 5-18-04. INT. CL. 38.
2,087,414, CANC. INT. CL. 9.
- MCKEE, LONETTE, RITA., ALLAMUCHY, NJ:
2,858,098, PUB. 4-6-2004. INT. CL. 41.
- MCKESSON CORPORATION, SAN FRANCISCO, CA:
2,857,888, PUB. 4-6-2004. INT. CL. 35.
- MCM FOOTWEAR ENTERPRISES, INC., MIAMI, FL:
2,088,181, CANC. INT. CL. 42.
- MCMANAWAY, MICHAEL PATRICK, NELSON, NEW ZEALAND:
2,858,041, PUB. 4-6-2004. INT. CL. 28.
- MCNELIS, JAMES N., WILMINGTON, DE:
2,088,382, CANC. INT. CL. 9.
- MCNENY, LARRY R., GARLAND, TX AND PARKS, MICHAEL, GARLAND, TX AND PARKS, MARIA SED-OFF, GARLAND, TX:
2,858,752, INT. CL. 16.
- MCSTEVENS, INC., VANCOUVER, WA:
2,858,142, PUB. 4-6-2004. INT. CL. 32.
- MCTEIGUE & MCCLELLAND, INC., GREAT BARRINGTON, MA:
2,858,171, PUB. 4-6-2004. INT. CL. 35.
- MEADE INSTRUMENTS CORPORATION, IRVINE, CA:
2,858,163, PUB. 4-6-2004. INT. CL. 9.
- MEADWESTVACO COPORATION, STAMFORD, CT:
2,857,267, PUB. 4-6-2004. INT. CL. 16.
- MEADWESTVACO CORPORATION, STAMFORD, CT:
1,829,411, REN. 5-17-04. INT. CL. 16.
2,857,268, PUB. 4-6-2004. INT. CL. 16.
- MEAL MART, INC., MASPETH, NY:
2,857,745, PUB. 4-6-2004. INT. CL. 29.
- MEARTHANE PRODUCTS CORPORATION, CRANSTON, RI:
2,858,912, INT. CL. 28.
- MEDECISION INC., WAYNE, PA:
2,834,737, CANC. IIRN. RESTORED TO S.N. 75-744,439.
- MEDIA MAVERICK INCORPORATED, SAN LUIS OBISPO, CA:
2,858,131, PUB. 4-6-2004. INT. CL. 14.
- MEDIA SUPPLY, INC., EXTON, PA:
2,858,146, PUB. 4-6-2004. INT. CL. 9.
- MEDICA HEALTH PLANS, MINNETONKA, MN:
2,858,475, MULTIPLE CLASS, INT. CLS. 35, 36, 38 AND 44.
- MEDICAL MEDIA INFORMATION (NETHERLANDS) BV, 1411 DD NAARDEN, NETHERLANDS:
2,087,036, CANC. INT. CL. 16.
- MEDICAL SIMULATION CORPORATION, ENGLEWOOD, CO:
2,858,838, INT. CL. 41.
- MEDISEM, INC., ATTLEBORO, MA:
2,858,560, INT. CL. 41.
- MEDTRONIC, INC., MINNEAPOLIS, MN:
1,828,840, REN. 5-15-04. INT. CL. 10.
2,858,076, PUB. 4-6-2004. INT. CL. 10.
- MEHDI DILMAGHANI & CO., INC., SCARSDALE, NY:
2,857,156, PUB. 5-21-2002. MULTIPLE CLASS, INT. CLS. 35, 37 AND 42.
- MEHRON, CHESTNUT RIDGE, NY:
2,857,730, PUB. 4-6-2004. INT. CL. 3.
- MEI SHUAL COSMETICS CO., LTD., TAINAN, TAIWAN:
2,858,818, INT. CL. 3.
- MEI YIN CHANG FOR MEI BEAUTY PRODUCTS INC., POMONA, CA:
2,857,320, PUB. 4-6-2004. INT. CL. 10.
- MEISTER MEDIA WORLDWIDE INC., WILLOUGHBY, OH:
2,858,071, PUB. 4-6-2004. INT. CL. 16.
- MEKANIKA, INC., BOCA RATON, FL:
2,857,766, PUB. 4-6-2004. INT. CL. 10.
- MELLANOX TECHNOLOGIES, INC., SANTA CLARA, CA:
2,858,756, INT. CL. 9.
- MELVIN H. WOLOVITS, P.C., DALLAS, TX:
2,859,065, INT. CL. 42.
- MEMOREX INTERNATIONAL INC., KOWLOON, HONG KONG:
2,859,012, INT. CL. 9.
- MEMRY CORPORATION, BETHEL, CT:
2,858,156, PUB. 4-6-2004. INT. CL. 9.
- MEN'S JOURNAL LLC, NEW YORK, NY:
2,859,028, INT. CL. 16.
- MENNEN COMPANY, THE, NEW YORK, NY:
2,087,174, CANC. INT. CL. 3.
2,087,820, CANC. INT. CL. 3.
- MERCATOR SOFTWARE, LLC, WESTBORO, MA, TSI INTERNATIONAL LTD., WILTON, CT:
1,829,798, REN. 5-16-04. INT. CL. 9.
- MERCER HUMAN RESOURCE CONSULTING, INC., NEW YORK, NY:
2,857,737, PUB. 4-6-2004. INT. CL. 35.
- MERCHANT BANKCARD SERVICES CORPORATION, FORT WORTH, TX:
2,857,239, PUB. 4-6-2004. INT. CL. 36.
- MERCK & CO., INC., WHITEHOUSE STATION, NJ:
2,858,309, INT. CL. 5.
2,858,561, INT. CL. 44.
- MERCK KGAA, D-64293 DARMSTADT, FED REP GERMANY:
2,857,207, PUB. 10-29-2002. MULTIPLE CLASS, INT. CLS. 1, 2, 3, 5, 9, 10, 16, 29, 30, 35 AND 42.
- MERCKLE GMBH, D-89079 ULM, FED REP GERMANY:
2,857,450, PUB. 4-6-2004. INT. CL. 5.
- MERIDIAN FUND, INC., LARKSPUR, CA:
1,854,859, REN. 5-16-04. INT. CL. 36.
- MERILLAT INDUSTRIES, INC., ADRIAN, MI:
2,858,419, INT. CL. 20.
2,858,420, INT. CL. 20.
2,858,421, INT. CL. 20.
2,858,422, INT. CL. 20.
2,858,423, INT. CL. 20.
- MERIT MEDICAL SYSTEMS INC, SOUTH JORDAN, UT:
1,828,837, REN. 5-21-04. INT. CL. 10.
- MERLINS PIZZA COMPANY, NICEVILLE, FL:
2,857,886, PUB. 4-6-2004. INT. CL. 43.
- MESATRONIC, S.A., VOIRON, FRANCE:
2,857,480, PUB. 4-6-2004. INT. CL. 9.
- MESTEK, INC., WESTFIELD, MA:
990,879, REN. 5-20-04. U.S. CL. 34 (INT. CL. 11).
- MET-COIL SYSTEMS CORPORATION, WESTFIELD, MA:
2,858,889, INT. CL. 6.
- METABOLIC NUTRITION, INC., NORTH MIAMI BEACH, FL:
2,858,170, PUB. 4-6-2004. INT. CL. 5.
- METAL ONE CORPORATION, TOKYO, 105-9914, JAPAN:
2,697,729 NEW CERT. 6-29-2004. INT. CL. 35.
- METALOGIC, INC., BUCKNER, KY:
2,087,751, CANC. INT. CL. 6.
- METALURGICA DUQUE S/A, SANTA CATARINA, BRAZIL:
2,086,781, CANC. INT. CL. 12.
- METAULICS SYSTEMS CO., L.P., SOLON, OH, METAULICS SYSTEMS CO., L.P., SOLON, OH:
1,829,198, REN. 5-20-04. INT. CL. 7.
- METRIS DIRECT, INC., MINNETONKA, MN:
2,857,821, PUB. 4-6-2004. MULTIPLE CLASS, INT. CLS. 35 AND 36.
- METRO ATLANTIC ATHLETIC CONFERENCE, EDISON, NJ:
2,086,817, CANC. MULTIPLE CLASS, INT. CLS. 25 AND 41.

METRO BEVERAGE CO., INC., COLUMBUS, OH:
1,753,371. REN. 5-18-04. INT. CL. 32.

METRO THEBE, INC., RANCHO DOMINGUEZ, CA:
2,857,119. PUB. 4-6-2004. MULTIPLE CLASS, INT. CLS. 11, 20 AND 21.

METRO-GOLDWYN-MAYER LION CORP, LOS ANGELES, CA:
2,857,754. PUB. 4-6-2004. INT. CL. 43.
2,857,755. PUB. 4-6-2004. INT. CL. 44.

METRO/RISK INC., SAN FRANCISCO, CA:
2,857,744. PUB. 4-6-2004. INT. CL. 36.

METROPOLITAN LIFE INSURANCE COMPANY, NEW YORK, NY:
2,858,109. PUB. 4-6-2004. INT. CL. 36.

METSO PAPER USA, INC., BIDDEFORD, ME:
2,857,565. PUB. 4-6-2004. INT. CL. 11.

MG IP HOLDINGS, LLC, DULLES, VA:
2,857,751. PUB. 4-6-2004. INT. CL. 43.

MGRDICHIAN, LAUREEN, BURBANK, CA:
2,087,077. CANC. INT. CL. 30.

MIA ROSE PRODUCTS, INCORPORATED, NEWPORT BEACH, CA, PALENCAR; MIA, NEWPORT BEACH, CA, DBA MIA ROSE PRODUCTS:
1,291,749. REN. 5-17-04. INT. CL. 5.

MIAMI AUDIO MUSIC, MIAMI, FL:
2,857,757. PUB. 4-6-2004. INT. CL. 9.

MICHAEL SMITH CUSTOM CLOTHIERS, INC., SYLVANIA, OH:
2,857,173. PUB. 4-6-2004. INT. CL. 35.
2,857,174. PUB. 4-6-2004. INT. CL. 35.

MICHAELS OF OREGON CO., OREGON CITY, OR:
2,858,313. INT. CL. 16.

MICHELSENS, LOUISE, LONDON, SW8 4AJ, UNITED KINGDOM AND MAZZILLI, TIZIANO, LONDON, SW8 4AJ, UNITED KINGDOM, TA VOYAGE:
2,858,694. MULTIPLE CLASS, INT. CLS. 18 AND 25.

MICROCAL SOFTWARE, INC., NORTHAMPTON, MA:
2,087,658. CANC. INT. CL. 9.

MICROFOUR, INC., AMARILLO, TX:
2,858,436. INT. CL. 9.

MICROGROUP, INC., MEDWAY, MA:
2,858,343. MULTIPLE CLASS, INT. CLS. 6, 7 AND 10.

MICROPLANET, INC., RALEIGH, NC:
2,088,046. CANC. INT. CL. 9.

MICROSMARTS ENTERPRISE, OLYMPIA FIELDS, IL:
2,857,748. PUB. 4-6-2004. INT. CL. 9.

MICROTEACH, INC., CINCINNATI, OH:
2,087,004. CANC. INT. CL. 41.

MICROTEST, INC., PHOENIX, AZ:
2,088,035. CANC. INT. CL. 9.

MID AMERICA BANK, FSB, CLARENDON HILLS, IL:
2,859,127. INT. CL. 36.

MID-ATLANTIC CARDIOLOGY, P.A., SPRINGFIELD, NJ:
2,087,262. CANC. INT. CL. 42.
2,087,263. CANC. INT. CL. 42.

MID-STATES RECYCLING, INC., DES PLAINES, IL:
2,857,224. PUB. 4-6-2004. MULTIPLE CLASS, INT. CLS. 14 AND 40.

MIDLAND NATIONAL LIFE INSURANCE COMPANY, SIOUX FALLS, SD:
1,247,888. CANC. INT. CL. 36.

MIDPOINTS MULTIMEDIA GROUP, INC., FORT LAUDERDALE, FL:
2,857,727. PUB. 4-6-2004. INT. CL. 45.

MIDWEST DIAGNOSTIC MANAGEMENT, LLC, MOLENA, IL:
2,857,493. PUB. 4-6-2004. INT. CL. 35.

MIDWEST INDUSTRIAL SUPPLY, INC., CANTON, OH:
2,857,509. PUB. 4-6-2004. MULTIPLE CLASS, INT. CLS. 1 AND 4.

MIDWEST OF CANNON FALLS, INC., CANNON FALLS, MN:
2,858,472. MULTIPLE CLASS, INT. CLS. 15, 16, 20, 21, 24, 26, 28 AND 35.
2,858,497. MULTIPLE CLASS, INT. CLS. 15, 16, 20, 21, 24, 26, 28 AND 35.

MIDWEST QUALITY GLOVES, INC., CHILLICOTHE, MO:
2,858,398. INT. CL. 25.

MIDWESTERN BIO-AG PRODUCTS & SERVICES, INC., BLUE MOUNDS, WI:
2,857,470. PUB. 4-6-2004. INT. CL. 1.

MIGLIORE, INC., CHICAGO, IL:
2,858,520. INT. CL. 3.

MIGUEL TORRES, S.A., DEL PENEDES (BARCELONA), SPAIN:
2,087,114. CANC. INT. CL. 33.

MIKEN COMPOSITES, LLC, CALEDONIA, MN:
2,859,026. INT. CL. 28.

MIKRON HOLDING AG, CH-2505 BIEL, SWITZERLAND:
2,806,781. COR. MULTIPLE CLASS, INT. CLS. 7, 12 AND 42.

MILES LABORATORIES, INC., ELKHART, IN:
754,485. CANC. U.S. CL. 18.

MILLER BREWING COMPANY, MILWAUKEE, WI, PABST BREWING COMPANY, SAN ANTONIO, TX:
1,883,844. REN. 5-20-04. INT. CL. 32.

MILLER BREWING COMPANY, MILWAUKEE, WI:
2,087,491. CANC. INT. CL. 32.

MILLER, THERESA, CARON, SOUTH SAN FRANCISCO, CA:
2,857,530. PUB. 4-6-2004. INT. CL. 3.

MILLER, VALERIE JOY, DUBLIN, CA:
2,858,261. INT. CL. 41.

MILLER, WAYNE L., SANTA MONICA, CA AND MILLER, REGINA S., SANTA MONICA, CA:
2,857,738. PUB. 4-6-2004. INT. CL. 30.

MILLER, WAYNE, E, CENTERVILLE, OH:
2,858,162. PUB. 4-6-2004. INT. CL. 35.

MILLERSPORT, INC., PLAINVIEW, NY:
2,857,579. PUB. 4-6-2004. INT. CL. 28.

MILLIKEN & COMPANY, NEW YORK, NY:
1,786,852. CANC. INT. CL. 27.
1,786,853. CANC. INT. CL. 27.
1,786,854. CANC. INT. CL. 27.

MILO'S TEA COMPANY, INC., BESSEMER, AL:
2,858,416. INT. CL. 30.

MINDFX SCIENCE, LLC, LAREDO, CA:
2,857,452. PUB. 4-6-2004. INT. CL. 5.

MINDREEF, INC., HILL, NH:
2,857,434. PUB. 4-6-2004. INT. CL. 9.

MINDWORKS CORPORATION, SUNNYVALE, CA:
2,087,309. CANC. INT. CL. 9.

MINERVA CORPORATION, TORRANCE, CA:
2,087,113. CANC. INT. CL. 7.

MINGLING MOMS, LLC, MUTTONTOWN, NY:
2,857,568. PUB. 4-6-2004. INT. CL. 45.

MINICOZZI, SALVATORE J., ATLANTA, GA:
2,857,574. PUB. 4-6-2004. INT. CL. 25.

MINKA LIGHTING, INC., CORONA, CA:
2,858,603. INT. CL. 11.
2,858,604. INT. CL. 11.

MINNESOTA AQUARIUM, LLC, THE, BLOOMINGTON, MN:
2,857,211. PUB. 10-14-2003. INT. CL. 41.

MINNICK, TODD R., CLIFTON PARK, NY AND GROSSHANDLER, MICHAEL S., WATERVLIET, NY AND BRUCE, MICHAEL J., GLOVERSVILLE, NY:
2,857,955. PUB. 4-6-2004. INT. CL. 41.

MINNTECH CORPORATION, MINNEAPOLIS, MN:
2,858,147. PUB. 4-6-2004. INT. CL. 5.

MINYANVILLE PUBLISHING AND MULTIMEDIA, INC., NEW YORK, NY:
2,858,519. INT. CL. 41.

MIPS TECHNOLOGIES, INC., MOUNTAIN VIEW, CA:
2,088,240. CANC. INT. CL. 9.
2,858,292. INT. CL. 9.

MIRACLE-EAR, INC., PLYMOUTH, MN:
2,858,623. INT. CL. 44.
2,858,624. INT. CL. 44.
2,858,625. INT. CL. 44.
2,858,626. INT. CL. 44.

MIRAGE OVERSEAS, LTD., COLD SPRING HARBOR, NY:
2,087,870. CANC. INT. CL. 11.

MIRAM INTERNATIONAL, INC., MINNEAPOLIS, MN:
2,088,393. CANC. INT. CL. 9.

- MISCO PRODUCTS CORPORATION, READING, PA:
2,859,107, MULTIPLE CLASS, INT. CLS. 3 AND 7.
- MISSION SEARCH CORPORATION, TAMPA, FL:
2,857,929, PUB. 4-6-2004. INT. CL. 35.
- MISSISSIPPI MADNESS, INC., CLARKSDALE, MS:
2,086,725, CANC. MULTIPLE CLASS, INT. CLS. 29 AND 30.
- MISSISSIPPI STATE UNIVERSITY, MISSISSIPPI STATE, MS:
2,858,401, INT. CL. 25.
- MISTRAL PICTURES, LLC, LOS ANGELES, CA:
2,858,214, INT. CL. 25.
- MITCHELL, MARIO, HAWTHORNE, CA:
2,086,818, CANC. INT. CL. 25.
- MITSUBISHI ELECTRIC CORPORATION, CHIYODA-KU, TOKYO, JAPAN:
2,857,329, PUB. 4-6-2004. INT. CL. 7.
- MITSUBISHI ELECTRIC SALES AMERICA INC., COMPTON, CA:
754,508, CANC. U.S. CL. 21.
- MITSUBISHI JIDOSHA KOGYO KABUSHIKI KAISHA, MINATO-KU, TOKYO, JAPAN:
1,275,057, REN. 5-16-04. INT. CL. 12.
- MITSUI MINING COMPANY, LIMITED, CHUO-KU, TOKYO, JAPAN:
1,787,267, CANC. MULTIPLE CLASS, INT. CLS. 17, 22 AND 23.
- MITTEN INC., PARIS, ONTARIO:
2,858,574, INT. CL. 19.
- MIURA, HIROYUKI, GRANADA HILLS, CA:
2,087,171, CANC. INT. CL. 15.
- MJ ZOOM, SAN FRANCISCO, CA:
2,857,732, PUB. 4-6-2004. INT. CL. 16.
- MMM ENTERPRISES, INC., LAKE BARRINGTON, IL:
2,857,736, PUB. 4-6-2004. INT. CL. 43.
- MOBILE STORAGE GROUP, INC., BURBANK, CA:
2,858,150, PUB. 4-6-2004. MULTIPLE CLASS, INT. CLS. 39 AND 43.
- MOCON, INC., MINNEAPOLIS, MN:
1,273,363, REN. 5-17-04. INT. CL. 9.
- MODELLREPRO INGE EKLUND AKTIEBOLAG, 430 63 HINDAS, SWEDEN:
2,857,566, PUB. 2-10-2004. INT. CL. 18.
- MODERN CLASSIC ARTWORKS, LEXINGTON, KY:
2,859,055, INT. CL. 21.
- MODERN PRODUCTS, INC., MILWAUKEE, WI:
754,486, CANC. U.S. CL. 18.
- MODULAR INTERNATIONAL, INC., PITTSBURGH, PA:
2,858,454, INT. CL. 11.
- MOEHRKE, RONELLE J., FT. LAUDERDALE, FL:
2,857,605, PUB. 4-6-2004. INT. CL. 24.
- MOEN INCORPORATED, NORTH OLMSTED, OH:
1,839,850, REN. 5-20-04. INT. CL. 8.
2,858,970, INT. CL. 11.
- MOHA MODERNE HAUSHALTWAREN AG, CH-3052 ZOLLIKOFEN, SWITZERLAND:
2,760,580, CANC. IIRN. RESTORED TO S.N. 75-854,175.
- MOHAN EXPORTS (INDIA) LTD., NEW DELHI - 110 048, INDIA:
2,088,009, CANC. INT. CL. 25.
- MOHAWK BRANDS, INC., WILMINGTON, DE:
2,858,144, PUB. 4-6-2004. INT. CL. 27.
- MOHAWK CARPET CORPORATION, ATLANTA, GA:
2,087,133, CANC. INT. CL. 36.
- MOI CORP., PITTSBURGH, PA:
2,858,181, INT. CL. 10.
- MOKI KNIFE CO., LTD., GIFU-KEN 501-32, JAPAN:
1,829,211, REN. 5-16-04. INT. CL. 8.
- MOLDPRO INTERNATIONAL, LLC, KAILUA, HI:
2,857,323, PUB. 4-6-2004. INT. CL. 42.
- MOLECULAR STAGING, INC., NEW HAVEN, CT:
2,858,000, PUB. 4-6-2004. INT. CL. 42.
- MOMS IN TOUCH INTERNATIONAL, POWAY, CA:
2,857,852, PUB. 4-6-2004. MULTIPLE CLASS, INT. CLS. 9, 16 AND 41.
- MONADNOCK PAPER MILLS, INC., BENNINGTON, NH:
2,857,749, PUB. 4-6-2004. INT. CL. 16.
- MONARCH AVALON, INC., BALTIMORE, MD:
2,087,823, CANC. INT. CL. 28.
- MONDIALMEDIA, COLONIAL HEIGHTS, VA:
2,858,166, PUB. 4-6-2004. INT. CL. 5.
- MONEY NOW, INC., FORT COLLINS, CO:
2,858,935, INT. CL. 36.
- MONOLITHIC SYSTEM TECHNOLOGY, INC., SAN JOSE, CA:
2,088,067, CANC. INT. CL. 9.
- MONSANTO TECHNOLOGY LLC, ST. LOUIS, MO:
2,858,809, INT. CL. 5.
- MONTALIER INTERNATIONAL LTD., TORONTO ONTARIO, CANADA:
2,858,780, INT. CL. 35.
- MONTEAGUDO, LAZARO JR., NEW YORK, NY:
2,858,169, PUB. 4-6-2004. INT. CL. 41.
- MOONDANCE, INC., AUSTIN, TX:
2,858,865, INT. CL. 43.
- MOORE COMPANY, THE, WESTERLY, RI:
769,386, REN. 5-17-04. U.S. CL. 13 (INT. CL. 6).
- MOORE FANS, LLC, MARCELINE, MO:
2,857,411, PUB. 4-6-2004. INT. CL. 11.
- MOORMAN MANUFACTURING COMPANY, QUINCY, IL:
402,777, CANC. U.S. CL. 50.
- MORANTE, JANET, H., HUNTINGTON BEACH, CA:
2,858,026, PUB. 4-6-2004. INT. CL. 35.
- MORGAN INCORPORATED, PRAIRIE VILLAGE, KS, GYM RAT, INC., PRAIRIE VILLAGE, KS:
1,830,877, REN. 5-16-04. INT. CL. 35.
- MORGAN STANLEY, NEW YORK, NY:
2,857,740, PUB. 4-6-2004. INT. CL. 36.
- MORINE, MARCUS DANIEL, CHICO, CA:
2,858,991, INT. CL. 34.
- MORNINGSTAR SERVICES INC., WILMINGTON, DE, PRESTO FOOD PRODUCTS, INC., CITY OF INDUSTRY, CA:
1,830,468, REN. 5-16-04. INT. CL. 30.
- MORNINGSTAR SERVICES INC., WILMINGTON, DE:
2,858,786, MULTIPLE CLASS, INT. CLS. 29 AND 30.
- MORRISON, TAMMY J., HERMOSA BEACH, CA:
2,858,681, INT. CL. 36.
- MORROW SNOWBOARDS, INC., SALEM, OR:
2,086,873, CANC. MULTIPLE CLASS, INT. CLS. 25 AND 28.
- MORTON INTERNATIONAL, INC., CHICAGO, IL:
2,088,289, CANC. INT. CL. 2.
2,857,907, PUB. 4-6-2004. INT. CL. 11.
- MOSBY-YEAR BOOK, INC., ST. LOUIS, MO:
2,087,945, CANC. INT. CL. 9.
- MOSELEY, BRIAN KEITH, EL CAJON, CA:
2,858,958, INT. CL. 16.
- MOSHER PHOTO, INC., VINEYARD HAVEN, MA:
2,859,131, INT. CL. 25.
- MOTHERS AGAINST DRUNK DRIVING, ORANGE COUNTY CHAPTER, ORANGE, CA:
1,787,143, CANC. INT. CL. 41.
- MOTIENT CORPORATION, RESTON, VA FROM ARDIS COMPANY, LINCOLNSHIRE, IL:
2,858,195, MULTIPLE CLASS, INT. CLS. 9, 16 AND 38.
- MOTOR AND EQUIPMENT MANUFACTURERS ASSOCIATION, RESEARCH TRIANGLE PARK, NC:
2,858,531, INT. CL. 35.
2,858,536, INT. CL. 35.
- MOTORENFABRIK HATZ GMBH & CO. KG, RUHSTORF/ROTT, FED REP GERMANY:
1,287,661, REN. 5-15-04. MULTIPLE CLASS, INT. CLS. 7 AND 12.
- MOTOROLA, INC., SCHAUMBURG, IL:
1,787,270, CANC. MULTIPLE CLASS, INT. CLS. 9 AND 42.
- MOUNTAIN MARKETING GROUP, LLC, PARADISE VALLEY, AZ:
2,857,610, PUB. 4-6-2004. INT. CL. 42.
2,857,611, PUB. 4-6-2004. INT. CL. 42.
- MOVE SMART, INC., COVINGTON, WA:
2,857,607, PUB. 4-6-2004. INT. CL. 42.
- MOVENET.COM, INC., NEW YORK, NY:
2,834,826, CANC. IIRN. RESTORED TO S.N. 76-096,027.
- MOVIE FILM FEST, INC., FULLERTON, CA:
2,858,458, INT. CL. 16.

MOVING COMFORT, INC., CHANTILLY, VA:
2,713,427, COR. INT. CL. 25.

MQH INVESTMENTS LTD., TORONTO, ONTARIO, CANADA:
1,272,719, REN. 5-17-04, INT. CL. 19.

MR. BUILD INTERNATIONAL, WINDSOR, CT:
1,247,863, CANC. INT. CL. 35.

MR. DREAM HOME, INC., AUSTIN, TX:
2,858,152, PUB. 4-6-2004, INT. CL. 36.

MR. SHOWER DOOR, INC., NORWALK, CT:
1,833,761, REN. 5-20-04, INT. CL. 11.

MR. TRAVEL, INC., CHICAGO, IL:
1,787,207, CANC. INT. CL. 42.

MRDB HOLDINGS, DALLAS, TX:
2,858,158, PUB. 4-6-2004, MULTIPLE CLASS, INT. CLS. 35 AND 36.

MSS ELECTRONICS, INC., WHITE PLAINS, NY:
2,857,460, PUB. 4-6-2004, INT. CL. 9.

MTI WHIRLPOOLS, INC., SUGAR HILL, GA:
2,857,996, PUB. 4-6-2004, INT. CL. 11.

MTS PRODUCTS, SUN VALLEY, CA:
2,857,762, PUB. 4-6-2004, INT. CL. 12.

MUCHA BROTHERS, INC., STEAMBOAT SPRINGS, CO:
2,858,159, PUB. 4-6-2004, INT. CL. 25.

MUELLER INTERNATIONAL, INC., PORTSMOUTH, NH:
2,835,425, CANC. IIRN, RESTORED TO S.N. 78-159,331.

MULTILING CORPORATION, PROVO, UT:
2,858,984, INT. CL. 9.

MUNDO MARKETING AND SALES GROUP, LLC, PLEASANT RIDGE, MI:
2,857,763, PUB. 4-6-2004, INT. CL. 25.

MUNICIPAL ART SOCIETY, NEW YORK, NY AND CREATIVE TIME, INC., NEW YORK, NY:
2,858,529, MULTIPLE CLASS, INT. CLS. 16, 36 AND 41.

MUNRO & COMPANY, INC., HOT SPRINGS, AR:
2,857,409, PUB. 4-6-2004, INT. CL. 25.

MUNTERMANN, AXEL, D-35578 WETZLAR, FED REP GERMANY:
2,857,122, PUB. 10-9-2001, MULTIPLE CLASS, INT. CLS. 10 AND 42.

MURATA MANUFACTURING CO., LTD., NAGAOKAKYOSHI, KYOTO, JAPAN:
1,264,578, REN. 5-21-04, INT. CL. 9.
1,264,578, CANC. INT. CL. 1.

MURPHY, KEVIN G., LEE'S SUMMIT, MO:
2,857,831, PUB. 4-6-2004, INT. CL. 35.

MURRAY-ALLEN INTERNATIONAL, INC., NEW YORK, NY:
1,247,821, CANC. INT. CL. 30.

MURRAY-ALLEN INTERNATIONAL, INC., CARLSTADT, NJ:
1,247,822, CANC. INT. CL. 30.

MUSICMATCH, INC., SAN DIEGO, CA:
2,857,970, PUB. 4-6-2004, INT. CL. 41.
2,857,971, PUB. 4-6-2004, INT. CL. 41.

MY CORPORATION BUSINESS SERVICES, INC., AGOURA HILLS, CA:
2,858,167, PUB. 4-6-2004, MULTIPLE CLASS, INT. CLS. 35 AND 42.

MY FAVORITE COMPANY, INC., LOS ANGELES, CA:
2,858,905, INT. CL. 28.

MY FIRST SHADES, GREAT NECK, NY:
2,857,481, PUB. 4-6-2004, INT. CL. 9.

MYKYTYN ENTERPRISES, INC., HOUSTON, TX:
2,859,031, INT. CL. 3.

MYRDTOGO, INC., CORAL SPRINGS, FL:
2,857,261, PUB. 4-6-2004, MULTIPLE CLASS, INT. CLS. 16, 35 AND 44.

MY2CENTENCES LLC, NEW YORK, NY:
2,857,570, PUB. 4-6-2004, INT. CL. 42.

MÖLNLYCKE HEALTH CARE AB, GÖTEBORG, SWEDEN:
2,857,930, PUB. 1-20-2004, INT. CL. 5.

N. W. AYER & SON, INC., NEW YORK, NY:
1,247,867, CANC. INT. CL. 35.
1,247,868, CANC. INT. CL. 35.
1,247,869, CANC. INT. CL. 35.

N.V. FOOD CHEMICALS, B 9910 KNESSELARE, BELGIUM:
1,872,150, REN. 5-15-04, INT. CL. 1.

NABERTHERM GMBH, 28865 LILIENTHAL, FED REP GERMANY:
2,857,212, PUB. 4-6-2004, MULTIPLE CLASS, INT. CLS. 9, 11 AND 42.

NALGE NUNC INTERNATIONAL CORPORATION, ROCHESTER, NY:
2,857,279, PUB. 4-6-2004, INT. CL. 9.
2,857,283, PUB. 4-6-2004, INT. CL. 9.

NAMKUNG PROMOTIONS INC., COSTA MESA, CA:
2,088,155, CANC. INT. CL. 28.

NAPOLEON HILL FOUNDATION, WISE, VA:
1,828,250, REN. 5-21-04, INT. CL. 16.

NAPOLEONE BV, 1183 A T AMSTELVEEN, NETHERLANDS:
2,857,863, PUB. 4-6-2004, INT. CL. 25.

NASHVILLE DESK INC, NASHVILLE, TN:
2,858,095, PUB. 4-6-2004, INT. CL. 20.

NATHAN'S FAMOUS SYSTEMS, INC., WESTBURY, NY:
1,787,572, CANC. INT. CL. 29.

NATIONAL ASSOCIATION OF CEMETERIES, RESTON, VA:
2,087,724, CANC. MULTIPLE CLASS, INT. CLS. 9, 16 AND 41.

NATIONAL AUTOMOTIVE PARTS ASSOCIATION, ATLANTA, GA:
1,858,375, REN. 5-18-04, INT. CL. 7.

NATIONAL BASEBALL HALL OF FAME AND MUSEUM, INC., COOPERSTOWN, NY:
2,087,040, CANC. INT. CL. 42.

NATIONAL CENTER FOR NONPROFIT BOARDS, WASHINGTON, DC:
1,787,691, CANC. INT. CL. 16.

NATIONAL DEMOGRAPHICS & LIFESTYLES INC., DENVER, CO:
1,247,864, CANC. INT. CL. 35.

NATIONAL DISPATCH CENTER, INC., THE, SAN DIEGO, CA:
2,086,821, CANC. INT. CL. 38.

NATIONAL EMERGENCY MEDICINE ASSOCIATION, BALTIMORE, MD:
2,087,346, CANC. INT. CL. 42.

NATIONAL EXPLORERS AND TRAVELERS HEALTHCARE, INC., FORT LAUDERDALE, FL:
2,087,474, CANC. INT. CL. 35.

NATIONAL EXTENDED CARE, LLC, SAN ANTONIO, TX:
2,857,228, PUB. 4-6-2004, INT. CL. 35.

NATIONAL FINDINGS, INC., MIAMI, FL:
1,247,643, CANC. INT. CL. 14.

NATIONAL FLAG FOUNDATION, PITTSBURGH, PA:
1,253,441, REN. 5-17-04, INT. CL. 42.

NATIONAL GEOGRAPHIC SOCIETY, WASHINGTON, DC:
2,087,953, CANC. INT. CL. 41.

NATIONAL HOME FURNISHINGS ASSOCIATION, HIGH POINT, NC:
2,183,419, CANC. INT. CL. 42.

NATIONAL INSTITUTE OF NUTRITION INCORPORATED, EL MONTE, CA:
754,492, CANC. U.S. CL. 18.

NATIONAL INSTITUTES OF HEALTH, BETHESDA, MD:
2,857,537, PUB. 4-6-2004, INT. CL. 41.

NATIONAL LIFE INSURANCE COMPANY, MONTPELIER, VT, DBA NATIONAL LIFE OF VERMONT:
1,787,029, CANC. INT. CL. 36.

NATIONAL MANUFACTURING CO., STERLING, IL:
754,439, CANC. U.S. CL. 13.
2,834,747, CANC. IIRN.

NATIONAL PARK FOUNDATION, WASHINGTON, DC:
1,787,616, CANC. INT. CL. 36.

NATIONAL PETCARE CENTERS, INC., FORT COLLINS, CO:
2,858,410, MULTIPLE CLASS, INT. CLS. 35, 41 AND 44.

NATIONAL RAILWAY PUBLICATION COMPANY, NEW YORK, NY:
754,649, CANC. U.S. CL. 38.

NATIONAL SPECIALTY SERVICES, INC., DUBLIN, OH:
2,087,977, CANC. MULTIPLE CLASS, INT. CLS. 35 AND 36.

- NATIONAL SPORTS CENTER FOR THE DISABLED, INC., WINTER PARK, CO:
1,787,708, CANC. INT. CL. 41.
- NATIONAL STUDY OF SCHOOL EVALUATION, SCHAUMBURG, IL:
2,859,013, INT. CL. 42.
- NATIONAL WESTERN LIFE INSURANCE COMPANY, AUSTIN, TX:
2,088,350, CANC. INT. CL. 36.
- NATIONAL WILDLIFE FEDERATION, RESTON, VA:
1,284,241, REN. 5-21-04, INT. CL. 16.
- NATIONAL-STANDARD COMPANY, NILES, MI:
754,461, CANC. U.S. CL. 14.
- NATIONSBANK CORPORATION, CHARLOTTE, NC:
2,087,713, CANC. INT. CL. 36.
- NATROL, INC., CHATSWORTH, CA:
2,858,995, INT. CL. 5.
- NATURAL HISTORY NEW ZEALAND LIMITED, DUNEDIN, NEW ZEALAND:
2,857,258, PUB. 4-6-2004, INT. CL. 9.
2,857,259, PUB. 4-6-2004, INT. CL. 9.
- NATURAL ORGANICS INC., MELVILLE, NY:
2,857,538, PUB. 4-6-2004, INT. CL. 5.
- NATURAL ORGANICS, INC., MELVILLE, NY:
1,338,756, AM. INT. CL. 5.
- NATURAL THOUGHTS, INC., SAN DIEGO, CA:
2,857,992, PUB. 4-6-2004, INT. CL. 3.
- NATURAL TIES, INC., EVANSTON, IL:
2,087,754, CANC. INT. CL. 42.
2,087,755, CANC. INT. CL. 42.
2,087,761, CANC. INT. CL. 42.
- NATURALLY SCIENTIFIC, INC., WEST CALDWELL, NJ:
2,857,504, PUB. 4-6-2004, INT. CL. 5.
2,857,505, PUB. 4-6-2004, INT. CL. 5.
2,857,506, PUB. 4-6-2004, INT. CL. 5.
2,857,507, PUB. 4-6-2004, INT. CL. 5.
- NATURE'S PATH FOODS INC., DELTA, BRITISH COLUMBIA V4G 1E8, CANADA:
2,858,321, INT. CL. 30.
- NATURE'S SUNSHINE PRODUCTS, INC., PROVO, UT:
2,857,221, PUB. 4-6-2004, INT. CL. 5.
- NATURE'S WAY PRODUCTS, INC., SPRINGVILLE, UT:
2,859,019, INT. CL. 5.
- NAUTICA APPAREL, INC., NEW YORK, NY:
2,834,835, CANC. IIRN. RESTORED TO S.N. 76-112,490.
- NAVIGANT INTERNATIONAL, INC., ENGLEWOOD, CO:
2,858,976, MULTIPLE CLASS, INT. CLS. 35 AND 39.
- NAVITAIRE INC., MINNEAPOLIS, MN:
2,858,993, MULTIPLE CLASS, INT. CLS. 9 AND 39.
- NAVY LEAGUE OF THE UNITED STATES, ARLINGTON, VA:
1,811,179, REN. 5-18-04, INT. CL. 41.
- NBA PROPERTIES, INC., NEW YORK, NY:
1,835,437, REN. 5-20-04, INT. CL. 16.
- NCST CORPORATION, SUNNYVALE, CA:
2,858,761, INT. CL. 38.
2,858,762, INT. CL. 9.
- NCCI HOLDINGS INCORPORATED, BOCA RATON, FL:
2,857,226, PUB. 4-6-2004, INT. CL. 36.
- NCR CORPORATION, DAYTON, OH TO NCR CORPORATION, DAYTON, OH:
1,786,631, CANC. INT. CL. 9.
- ND INDUSTRIES, INC., CLAWSON, MI, OAKLAND CORPORATION, THE, TROY, MI, DBA ND INDUSTRIES:
1,829,770, REN. 5-21-04, INT. CL. 1.
- NDSU RESEARCH FOUNDATION, FARGO, ND:
2,858,671, INT. CL. 31.
2,858,672, INT. CL. 31.
- NEAT MANAGEMENT GROUP, INC., AUSTIN, TX, DBA NATIONAL EMPLOYEE BENEFIT SPECIALISTS:
1,247,894, CANC. INT. CL. 36.
- NEBRASKA FURNITURE MART, INC., OMAHA, NE:
1,724,472, CANC. INT. CL. 42.
- NEGOTIATION SKILLS COMPANY, INC. THE, PRIDE'S CROSSING, MA:
2,858,831, INT. CL. 41.
- NEIGHBOR'S FINANCIAL CORPORATION, SACRAMENTO, CA:
1,815,141, REN. 5-20-04, INT. CL. 36.
1,828,552, REN. 5-20-04, INT. CL. 36.
- NEILL CORPORATION, HAMMOND, LA:
2,857,608, PUB. 4-6-2004, INT. CL. 44.
- NELSON-WHITTAKER, LTD., CRYSTAL LAKE, IL, DBA CENTRAL SPECIALTIES:
2,857,615, PUB. 4-6-2004, INT. CL. 9.
2,857,616, PUB. 4-6-2004, INT. CL. 9.
- NELSON, MARK, STATEN ISLAND, NY:
2,857,528, PUB. 4-6-2004, INT. CL. 16.
- NEMASOFT, INC., ANN ARBOR, MI:
2,088,259, CANC. INT. CL. 9.
- NEOGLYPHICS MEDIA CORPORATION, CHICAGO, IL:
2,086,836, CANC. MULTIPLE CLASS, INT. CLS. 35 AND 42.
- NEOMETAL OPTIK INTERNATIONAL S.R.L., 32040 DO-MEGGE DI CADORE (BELLUNO), ITALY:
2,087,242, CANC. INT. CL. 9.
- NEOPETS, INC., GLENDALE, CA:
2,858,924, MULTIPLE CLASS, INT. CLS. 16 AND 28.
2,858,933, INT. CL. 16.
- NEPTUNE HOME FURNISHINGS, INC., HAVERHILL, MA:
2,087,220, CANC. INT. CL. 25.
- NET CRUISER TECHNOLOGIES, INC., PAOLI, PA:
2,857,966, PUB. 4-6-2004, MULTIPLE CLASS, INT. CLS. 37 AND 42.
- NETALYTICS DSI GP, NEW YORK, NY:
2,857,787, PUB. 2-10-2004, MULTIPLE CLASS, INT. CLS. 9, 16 AND 42.
- NETCAST COMMUNICATIONS CORP., NEW YORK, NY:
2,087,145, CANC. INT. CL. 38.
- NETEZZA CORPORATION, FRAMINGHAM, MA:
2,858,765, INT. CL. 9.
- NETFRAME SYSTEMS INCORPORATED, MILPITAS, CA:
2,087,981, CANC. INT. CL. 9.
- NETOPSYSTEMS AG, BERLIN, FED REP GERMANY:
2,858,018, PUB. 4-6-2004, INT. CL. 42.
- NETWORK INDUSTRIES INC., CHULA VISTA, CA:
2,858,583, INT. CL. 12.
- NEUENHAUSER MASCHINENBAU GMBH, 49828 NEUENHAUS, FED REP GERMANY:
2,730,300, COR. INT. CL. 7.
- NEURIM PHARMACEUTICALS (1991) LTD., TEL AVIV, ISRAEL:
2,790,571, COR. INT. CL. 5.
- NEUROMEDIA S.A., B-7000 MONS, BELGIUM FROM NEUROPLANET SA, B-4000 LIEGE, BELGIUM:
2,857,165, PUB. 4-6-2004, MULTIPLE CLASS, INT. CLS. 9, 16, 18, 25, 28, 35, 38, 41 AND 42.
- NEUROPLANET SA:
See— NEUROMEDIA S.A..
- NEUTROGENA CORPORATION, LOS ANGELES, CA:
2,857,503, PUB. 4-6-2004, INT. CL. 3.
2,858,605, INT. CL. 3.
- NEVERLAND FILMS, INC., LOS ANGELES, CA:
2,857,285, PUB. 4-6-2004, INT. CL. 41.
- NEW ENGLAND MUTUAL LIFE INSURANCE COMPANY, BOSTON, MA:
2,086,852, CANC. INT. CL. 9.
- NEW ENGLAND POTTERY CO., INC., FOXBORO, MA:
2,857,269, PUB. 4-6-2004, MULTIPLE CLASS, INT. CLS. 6, 17, 19, 20 AND 21.
- NEW IN TOWN, INC., HUNTINGTON STATION, NY:
1,786,978, CANC. INT. CL. 35.
- NEW PENDULUM CORP., WILMINGTON, DE:
1,786,760, CANC. INT. CL. 17.
- NEW SOLUTIONS, INC., CHARLOTTE, NC:
1,830,750, REN. 5-16-04, INT. CL. 1.
- NEW TECHNOLOGY SOLUTIONS INC., NORTH HAVEN, CT:
2,087,869, CANC. INT. CL. 41.
- NEW YORK CENTER FOR ART AND AWARENESS, NEW YORK, NY:
2,087,519, CANC. INT. CL. 9.
- NEW YORK FISH HOUSE, INC., ELIZABETH, NJ:
2,086,796, CANC. INT. CL. 42.

NEW YORK TIMES COMPANY, THE, NEW YORK, NY:
 2,087,053, CANC. INT. CL. 42.
 NEW YORK UNIVERSITY, NEW YORK, NY:
 1,789,490. REN. 5-18-04. INT. CL. 25.
 NEW YORK YANKEES PARTNERSHIP, BRONX, NY:
 2,858,237, MULTIPLE CLASS, INT. CLS. 6, 20 AND 21.
 NEWAYS, INC., SALEM, UT:
 2,857,418, PUB. 4-6-2004. INT. CL. 3.
 2,857,419, PUB. 4-6-2004. INT. CL. 3.
 NEWBURN, JESSIE, COLUMBIA, MD, DBA DO THE WRITE
 THING:
 2,087,078, CANC. INT. CL. 41.
 NEWCO, INC., JANESVILLE, WI TO PLAYCORE WISCON-
 SIN, INC., JANESVILLE, WI:
 1,786,774, CANC. INT. CL. 20.
 NEWMAN, MATTHEW, NEW ROADS, LA:
 2,858,602, INT. CL. 31.
 NEWPORT TOOL & FASTNER CO., INC., NORCO, CA:
 1,274,773. REN. 5-17-04. INT. CL. 6.
 NEWTON IMPORT EXPORT, INC., TAMPA, FL:
 2,858,680, INT. CL. 14.
 NEXANT, INC., SAN FRANCISCO, CA:
 2,859,095, INT. CL. 9.
 NEXCLAIM TECHNOLOGIES, INC., HARTFORD, CT:
 2,087,564, CANC. MULTIPLE CLASS, INT. CLS. 36 AND
 42.
 NINTENDO CO., LTD., MINAMI-KU, KYOTO, JAPAN:
 2,857,140, PUB. 4-6-2004. INT. CL. 9.
 NIRO-PLAN AG, 6302 ZUG, SWITZERLAND, EMCO LIM-
 ITED, WOODBRIDGE, ONTARIO L4L 3P6, CANADA,
 DBA KINDRED INDUSTRIES:
 1,833,266. REN. 5-21-04. INT. CL. 11.
 NIRVANA, L.L.C., LOS ANGELES, CA, NIRVANA, BELLE-
 VUE, WA:
 1,842,789. REN. 5-16-04. INT. CL. 9.
 NISSAN JIDOSHA KABUSHIKI KAISHA, KANAGAWA-
 KEN, JAPAN, TA NISSON MOTOR CO., LTD.:
 2,857,115, PUB. 6-15-1999. INT. CL. 12.
 NOODLEMAN, F. RICHARD, CAMPBELL, CA:
 2,858,996, INT. CL. 3.
 NORD KAOLIN COMPANY, JEFFERSONVILLE, GA:
 2,087,267, CANC. INT. CL. 41.
 NORDEA AB, S-105 71 STOCKHOLM, SWEDEN:
 2,857,178, PUB. 4-6-2004. MULTIPLE CLASS, INT. CLS. 9,
 35, 36 AND 38.
 NORIX GROUP, INC., WEST CHICAGO, IL:
 2,088,411, CANC. INT. CL. 17.
 NORTECH INVESTMENTS LTD, ST. JOHNS, ANTIGUA &
 BARBUDA:
 2,859,051, INT. CL. 41.
 NORTH AMERICAN MEMBERSHIP GROUP INC., MINNE-
 TONKA, MN:
 1,859,293. REN. 5-16-04. MULTIPLE CLASS, INT. CLS. 37
 AND 42.
 NORTH AMERICAN PHILIPS CORPORATION, NEW
 YORK, NY TO PHILIPS ELECTRONICS NORTH AMER-
 ICA CORPORATION, NEW YORK, NY:
 1,787,415, CANC. INT. CL. 9.
 NORTH AMERICAN VERSATILE HUNTING DOG ASSO-
 CIATION, ARLINGTON HEIGHTS, IL:
 2,858,051, PUB. 4-6-2004. MULTIPLE CLASS, INT. CLS. 35
 AND 41.
 2,858,052, PUB. 4-6-2004. MULTIPLE CLASS, INT. CLS. 35
 AND 41.
 NORTH PASS, LTD., FT. COLLINS, CO:
 2,857,516, PUB. 4-6-2004. INT. CL. 13.
 NORTH SAFETY PRODUCTS INC., CRANSTON, RI:
 2,858,437, INT. CL. 9.
 NORTHERN STATES POWER COMPANY, MINNEAPOLIS,
 MN:
 2,087,853, CANC. INT. CL. 39.
 NORTHLAND NETWORKS, INC., MINNEAPOLIS, MN:
 2,857,408, PUB. 4-6-2004. INT. CL. 36.
 NORTHLAND SEED & GRAIN CORP., ST. PAUL, MN:
 2,857,199, PUB. 4-6-2004. MULTIPLE CLASS, INT. CLS. 1,
 5 AND 29.
 2,857,200, PUB. 4-6-2004. MULTIPLE CLASS, INT. CLS. 1,
 5 AND 29.
 NORTHSTAR COMPUSERV, INC., NEW HOPE, MN:
 2,087,709, CANC. INT. CL. 37.
 NORTHWEST COMMUNICATIONS INC., TIGARD, OR:
 1,997,987, CANC. INT. CL. 38.
 NORTHWEST MULTIPLE LISTING SERVICE, KIRKLAND,
 WA:
 2,858,042, PUB. 4-6-2004. INT. CL. 36.
 NOUR TRADING HOUSE INC., WATERLOO, ONTARIO,
 CANADA:
 1,829,834. REN. 5-20-04. INT. CL. 16.
 NOVO NORDISK A/S, DK-2880 BAGSVAERD, DENMARK:
 1,841,088. REN. 5-15-04. INT. CL. 10.
 NOVUS CREDIT SERVICES INC., RIVERWOODS, IL:
 2,857,696, PUB. 4-6-2004. INT. CL. 36.
 NOXELL CORPORATION, HUNT VALLEY, MD:
 2,834,751, CANC. IIRN. RESTORED TO S.N. 75-800,506.
 NRI DATA & BUSINESS PRODUCTS INC., MORRISVILLE,
 PA:
 2,857,217, PUB. 4-6-2004. MULTIPLE CLASS, INT. CLS. 9,
 35, 37 AND 42.
 NT OBJECTIVES, INC., RANCHO SANTA MARGARITA,
 CA:
 2,857,812, PUB. 4-6-2004. INT. CL. 9.
 NTN COMMUNICATIONS, INC., CARLSBAD, CA:
 1,787,115, CANC. INT. CL. 41.
 NUBRIDGE COMPANY LIMITED, CENTRAL, HONG
 KONG:
 2,859,027, INT. CL. 9.
 NUMA CORPORATION, AKRON, OH:
 2,087,768, CANC. INT. CL. 16.
 2,087,769, CANC. INT. CL. 16.
 NUMBER ONE PARTS, INC., FOREST PARK, GA:
 2,087,778, CANC. INT. CL. 35.
 NUMEREX SOLUTIONS, LLC, ATLANTA, GA:
 2,858,718, MULTIPLE CLASS, INT. CLS. 9 AND 38.
 NUTOOL, INC., MILPITAS, CA:
 2,859,132, INT. CL. 7.
 NUTRAMAX LABORATORIES, INC., EDGEWOOD, MD:
 1,854,436. REN. 5-20-04. INT. CL. 5.
 NUTRASWEET COMPANY, THE, DEERFIELD, IL:
 2,087,427, CANC. INT. CL. 30.
 NUTRIFIT INTERNATIONAL CORP., MIAMI, FL:
 2,087,358, CANC. INT. CL. 5.
 O.R.A. CORPORATION, SAN DIEGO, CA:
 2,087,096, CANC. MULTIPLE CLASS, INT. CLS. 29 AND
 30.
 O'BRYAN BROS., INC., CHICAGO, IL:
 2,857,672, PUB. 4-6-2004. INT. CL. 25.
 2,858,932, INT. CL. 25.
 O'CONNELL, ALETA MINEO, LOLO, MT:
 2,087,253, CANC. INT. CL. 16.
 O'GRADY, MAUREEN WILTSIE, LYME, CT AND O'GRA-
 DY, JOHN, LYME, CT:
 2,857,478, PUB. 4-6-2004. INT. CL. 36.
 O'LAUGHLIN, CAROLINE, MEDINAH, IL, DBA C.
 O'LAUGHLIN CO.:
 1,767,438. REN. 5-20-04. INT. CL. 16.
 OAKLEY, INC., FOOTHILL RANCH, CA:
 2,858,550, INT. CL. 9.
 OAKWOOD HEALTHCARE, INC., DEARBORN, MI:
 2,857,612, PUB. 4-6-2004. INT. CL. 44.
 OAT HILL CORPORATION, CALISTOGA, CA:
 1,843,124. REN. 5-21-04. INT. CL. 33.
 OBERWEIS DAIRY, INC., NORTH AURORA, IL:
 2,857,659, PUB. 4-6-2004. INT. CL. 43.
 2,857,660, PUB. 4-6-2004. INT. CL. 43.
 2,857,661, PUB. 4-6-2004. INT. CL. 43.
 OBIM FRESH-CUT FRUIT CO., LLC, FORT WORTH, TX:
 2,859,004, INT. CL. 29.
 OCEAN CITY GOLF & YACHT CLUB, INC., BERLIN, MD:
 2,086,885, CANC. INT. CL. 41.
 OCEAN GROUP, INC., LOS ANGELES, CA, DBA OCEAN
 FRESH FISH & SEAFOOD MARKETING CO., INC.:
 2,858,609, INT. CL. 35.
 OCEAN TECHNOLOGY, INC., ARNOLD, MD:
 2,857,423, PUB. 4-6-2004. INT. CL. 29.
 OCEANEERING INTERNATIONAL, INC., HOUSTON, TX:
 2,858,361, INT. CL. 12.

- OCM, INC., VERNON HILLS, IL:
2,858,846, MULTIPLE CLASS, INT. CLS. 6, 19 AND 20.
- ODWALLA, INC., HALF MOON BAY, CA:
2,857,137, PUB. 4-6-2004. MULTIPLE CLASS, INT. CLS. 29 AND 32.
- ODWALLA, INC., DAVENPORT, CA:
1,831,511. REN. 5-16-04. INT. CL. 32.
- ODYSSEY NAIL SYSTEMS, INC., ORLANDO, FL:
2,857,881, PUB. 4-6-2004. INT. CL. 3.
- OFFICE CLUB, INC., THE, DELRAY BEACH, FL:
1,533,745 NEW CERT. 6-29-2004. INT. CL. 42.
- OFFICE DEPOT, INC., DELRAY BEACH, FL TO OFFICE CLUB, INC., THE, DELRAY BEACH, FL:
1,939,705 NEW CERT. 6-29-2004. INT. CL. 16.
- OFFLINE, INC., CERRITOS, CA:
2,857,997, PUB. 4-6-2004. INT. CL. 25.
- OGLEVEE, LTD., CONNELLEVILLE, PA:
1,247,844, CANC. INT. CL. 31.
- OH TRADING CO., INC., LONG ISLAND CITY, NY:
2,859,017, INT. CL. 25.
- OHLMEYER, DONALD JR., LOS ANGELES, CA:
1,247,917, CANC. INT. CL. 41.
- OIL FILTER DISMANTLING SYSTEMS, INC., SYLMAR, CA:
1,843,892. REN. 5-20-04. INT. CL. 40.
- OKAMOTO KABUSHIKI KAISHA, BUNKYO-KU, TOKYO, JAPAN, DBA OKAMOTO INDUSTRIES, INC.:
1,247,634, CANC. INT. CL. 12.
- OKLAHOMA STATE UNIVERSITY, STILLWATER, OK, DBA FIRE PROTECTION PUBLICATIONS, AKA FPP:
2,087,581, CANC. INT. CL. 16.
- OLATHE MEDICAL SERVICES, INC., OLATHE, KS:
2,087,015, CANC. INT. CL. 42.
- OLD WORLD FINANCIAL SERVICES, INC., ADEL, GA:
2,087,272, CANC. INT. CL. 36.
- OLDCASTLE, INC., LOS ANGELES, CA:
1,786,767, CANC. INT. CL. 19.
- OLDEMARK, BURLINGTON, VT:
2,857,459, PUB. 4-6-2004. MULTIPLE CLASS, INT. CLS. 16 AND 41.
- OLDEMARK LLC, BURLINGTON, VT:
2,857,722, PUB. 4-6-2004. MULTIPLE CLASS, INT. CLS. 16, 35 AND 43.
- OLI-VERLAG N.V., CURACAO, NETHERLD ANTILLES:
1,862,956. REN. 5-17-04. MULTIPLE CLASS, INT. CLS. 16 AND 28.
- OLIVE CREST TREATMENT CENTERS, INC., SANTA ANA, CA, DBA OLIVE CREST:
2,857,255, PUB. 4-6-2004. MULTIPLE CLASS, INT. CLS. 35, 36, 41, 43, 44 AND 45.
2,857,256, PUB. 4-6-2004. MULTIPLE CLASS, INT. CLS. 35, 36, 41, 43, 44 AND 45.
- OLIVER, JON, BOSTON, MA:
2,857,560, PUB. 4-6-2004. INT. CL. 41.
- OLSON; KENT NORMAN, LAKEWOOD, CO:
754,658, CANC. U.S. CL. 38.
- OLTRA, INC., RESTON, VA:
2,857,703, PUB. 4-6-2004. INT. CL. 35.
- OMAHA ROYALS L.P., OMAHA, NE:
2,087,607, CANC. INT. CL. 25.
- OMEGA GARDEN, INC., VANCOUVER, BRITISH COLUMBIA, CANADA FROM BACK TO GARDENING INC., VANCOUVER, BRITISH COLUMBIA, CANADA:
2,858,379, INT. CL. 7.
- OMEGA SAFETY INTERNATIONAL, CORP., MCALLEN, TX, DBA ROYAL SALES ON LINE:
2,857,686, PUB. 4-6-2004. INT. CL. 41.
- OMEGATREND INTERNATIONAL PTY. LTD., CLAREMONT, AUSTRALIA:
2,754,680, COR. MULTIPLE CLASS, INT. CLS. 16 AND 41.
- OMNII PRODUCTS OF PALM BEACH, WEST PALM BEACH, FL, DBA OMNII ORAL PHARMACEUTICALS:
2,858,977, INT. CL. 5.
- OMNIPPOINT CORPORATION, COLORADO SPRINGS, CO:
2,088,013, CANC. INT. CL. 9.
- OMNIUM WORLDWIDE, INC., OMAHA, NE:
2,857,681, PUB. 4-6-2004. INT. CL. 36.
- ON TIME SYSTEMS, INC., EUGENE, OR:
2,858,783, INT. CL. 9.
- ONDEO NALCO NETHERLANDS B.V., TILBURG 5048AV, NETHERLANDS:
2,857,302, PUB. 4-6-2004. INT. CL. 1.
- ONEITA INDUSTRIES, INC., CHARLESTON, SC:
1,786,817, CANC. INT. CL. 25.
2,088,047, CANC. INT. CL. 25.
- ONSPEC ELECTRONIC, INC., SANTA CLARA, CA:
2,858,708, INT. CL. 9.
- OPENLANDS PROJECT, CHICAGO, IL:
2,086,806, CANC. INT. CL. 42.
- OPERATIONAL RISKDATA EXCHANGE ASSOCIATION (ORX), CH-8027 ZURICH, SWITZERLAND:
2,857,843, PUB. 4-6-2004. MULTIPLE CLASS, INT. CLS. 35, 36, 38, 41 AND 42.
- OPTI-TRANS, INC., CHARLESTON, SC:
1,787,622, CANC. INT. CL. 39.
- OPTIKA INC., COLORADO SPRING, CO:
1,830,180. REN. 5-20-04. INT. CL. 9.
- OPTIMAL HEALTH SYSTEMS, MESA, AZ:
2,857,709, PUB. 4-6-2004. INT. CL. 5.
2,857,710, PUB. 4-6-2004. INT. CL. 5.
- ORALABS, INC., ENGLEWOOD, CO:
2,859,064, INT. CL. 3.
- ORALECT, L.P., PLANO, TX:
2,858,301, INT. CL. 42.
- ORANGE GLO INTERNATIONAL, INC., GREENWOOD VILLAGE, CO:
2,858,006, PUB. 4-6-2004. INT. CL. 3.
- ORANGE JULIUS OF AMERICA, MINNEAPOLIS, MN:
1,834,201. REN. 5-18-04. MULTIPLE CLASS, INT. CLS. 29, 30, 32, 35 AND 42.
- ORBIS BROADCAST, L. P., CHICAGO, IL TO ORBIS BROADCAST GROUP, INC., AUSTIN, TX:
1,787,102, CANC. MULTIPLE CLASS, INT. CLS. 41 AND 42.
- ORBIS ONLINE, INC., SAN ANTONIO, TX:
2,857,919, PUB. 4-6-2004. INT. CL. 35.
- ORBITZ, LLC, CHICAGO, IL FROM DUNC, LLC, CHICAGO, IL:
2,858,685, MULTIPLE CLASS, INT. CLS. 38, 39 AND 42.
- ORCA BAY SEAFOODS, INC., SEATTLE, WA:
2,087,559, CANC. INT. CL. 30.
- ORCHARD YARN AND THREAD COMPANY, INC., NEW YORK, NY, DBA LION BRAND YARN COMPANY:
2,857,550, PUB. 4-6-2004. INT. CL. 23.
- ORDER SONS OF ITALY IN AMERICA, WASHINGTON, DC:
2,857,477, PUB. 4-6-2004. INT. CL. 35.
2,857,483, PUB. 4-6-2004. U.S. CL. 200.
- OREGON CHAI, INC., PORTLAND, OR:
2,086,920, CANC. INT. CL. 30.
- OREGON HEALTH AND SCIENCE UNIVERSITY, PORTLAND, OR:
2,858,370, MULTIPLE CLASS, INT. CLS. 9, 16, 41 AND 42.
- OREGON SHAKESPEARE FESTIVAL ASSOCIATION, ASHLAND, OR:
2,857,520, PUB. 4-6-2004. MULTIPLE CLASS, INT. CLS. 9, 14, 16, 18, 21, 24, 25, 28, 30 AND 41.
2,857,525, PUB. 4-6-2004. MULTIPLE CLASS, INT. CLS. 9, 14, 16, 18, 21, 25, 28, 30 AND 41.
- ORFEVRERIE CHRISTOFLE, PARIS (SEINE), FRANCE:
1,276,737. REN. 5-16-04. INT. CL. 8.
- ORIGI-NAIIS, INC., ARLINGTON, TX:
2,088,127, CANC. INT. CL. 3.
- ORION CORPORATION, 02200 ESPOO, FINLAND:
2,087,089, CANC. INT. CL. 5.
- ORUM, PETER, ST. CHARLES, IL:
1,270,394. REN. 5-21-04. INT. CL. 42.
- OSCAR DE LA RENTA, LTD., NEW YORK, NY:
2,088,400, CANC. INT. CL. 25.
- OTC CONNECTION, INC., SUFFERN, NY, DBA FOOT-WORLD USA:
2,857,311, PUB. 4-6-2004. MULTIPLE CLASS, INT. CLS. 3 AND 10.
- OTIS ELEVATOR COMPANY:
754,578, CANC. U.S. CL. 23.

OTSUKA PHARMACEUTICAL CO., LTD., CHIYODA-KU, TOKYO, JAPAN:
2,088,452, CANC. INT. CL. 5.

OUR LADY OF THE ROSES, CORP., BAYSIDE, NY:
2,857,558, PUB. 4-6-2004. INT. CL. 45.
2,857,559, PUB. 4-6-2004. INT. CL. 45.

OUT OF THE BLUE LIMITED, PALO ALTO, CA:
2,858,757, INT. CL. 30.

OUTDOOR OPTICS, INC., MEMPHIS, TN, DBA OLYMPIC OPTICAL CO.:
2,857,500, PUB. 4-6-2004. INT. CL. 9.

OUTDOORSMAN AGENCY, INC., THE, BISHOPVILLE, SC:
1,787,032, CANC. INT. CL. 36.

OUTLAW PRODUCTIONS INC., JACKSON, WY:
2,088,395, CANC. INT. CL. 30.

OVARD; JOHN C., SANTA ROSA, CA, DBA THERMATEC:
1,247,612, CANC. INT. CL. 11.

OVERLOOKED OPINIONS, INC., CHICAGO, IL:
2,087,331, CANC. INT. CL. 35.

OWEN, A. JAMES, JR., IPSWICH, MA:
2,087,076, CANC. INT. CL. 25.

O2 HOLDINGS, LLC, NEW YORK, NY:
2,858,579, INT. CL. 41.

P. E. LAMOREAUX AND ASSOCIATES, INC., TUSCALOOSA, AL:
1,247,973, CANC. INT. CL. 42.

P.F. COLLIER L.P., NEW YORK, NY:
2,087,286, CANC. MULTIPLE CLASS, INT. CLS. 9, 16 AND 28.

P.K. FOOD CORP., SAN LEANDRO, CA:
2,858,923, MULTIPLE CLASS, INT. CLS. 29, 30 AND 32.

PABU SERVICES, INC., WILMINGTON, DE, CIBA-GEIGY CORPORATION, ARDSLEY, NY:
989,449. REN. 5-17-04. U.S. CL. 6 (INT. CL. 1).

PACCAR INC, BELLEVUE, WA, DBA KENWORTH TRUCK COMPANY:
1,787,606, CANC. INT. CL. 35.

PACIFIC AND ARCTIC RAILWAY AND NAVIGATION COMPANY, SKAGWAY, AK:
2,802,611, COR. MULTIPLE CLASS, INT. CLS. 35 AND 39.

PACIFIC FARM COMPANY, FIREBAUGH, CA:
1,247,835, CANC. INT. CL. 31.

PACIFIC FRUIT INC., NEW YORK, NY:
2,087,170, CANC. INT. CL. 31.

PACIFIC RESPONSE, INC., GOLD RIVER, CA:
2,087,880, CANC. INT. CL. 42.

PACIFIC WORLD CORPORATION, LAKE FOREST, CA:
2,859,035, INT. CL. 3.

PACIFICA FOUNDATION, THE, BERKELEY, CA:
2,086,729, CANC. INT. CL. 41.

PACKAGING SERVICE COMPANY, INC., PEARLAND, TX:
977,599. REN. 5-17-04. U.S. CL. 1 (INT. CL. 4).

PAGEUP WEB SERVICES, LLC, WILLOUGHBY HILLS, OH:
2,858,893, INT. CL. 9.

PAION CO. LTD., SEOUL, REPUBLIC OF KOREA:
2,858,294, INT. CL. 9.

PALL CORPORATION, EAST HILLS, NY, BRUNSWICK CORPORATION, SKOKIE, IL:
1,280,642. REN. 5-20-04. INT. CL. 11.

PALM PRESS, INCORPORATED, BERKELEY, CA:
2,088,272, CANC. INT. CL. 16.

PALTOUGH INDUSTRIES (1998) LTD., RAMAT YOCHANAN 30035, ISRAEL:
2,858,318, INT. CL. 19.

PANLINE U.S.A., INC., ENGLWOOD, NJ:
2,087,275, CANC. INT. CL. 28.

PANTANO, JOSEPH A, DOWNERS GROVE, IL:
2,858,862, INT. CL. 41.

PAOLO VILLORESI, NEW YORK, NY:
2,086,970, CANC. INT. CL. 16.

PAPA BEAR RECORDS, INC., WOODSTOCK, NY:
2,088,062, CANC. MULTIPLE CLASS, INT. CLS. 9, 16 AND 25.

PAPELES VENEZOLANOS, C.A., EDIFICIO FORUM, EL ROSAL, CARACAS, VENEZUELA:
2,858,612, INT. CL. 16.

PAPER SOURCE, INC., CHICAGO, IL:
2,857,817, PUB. 4-6-2004. MULTIPLE CLASS, INT. CLS. 16, 26 AND 35.
2,857,818, PUB. 4-6-2004. MULTIPLE CLASS, INT. CLS. 40 AND 42.

PAR EMPRIZES, INC, SALINAS, CA:
2,857,473, PUB. 4-6-2004. INT. CL. 39.

PARCPLACE-DIGITALK, INC., SUNNYVALE, CA:
2,087,061, CANC. INT. CL. 9.

PARDEE HOMES, LOS ANGELES, CA:
1,834,908. REN. 5-19-04. INT. CL. 37.

PARK NEWSPAPERS OF BLYTHEVILLE, INC., BLYTHEVILLE, AR:
1,247,690, CANC. INT. CL. 16.

PARMALAT DAIRY & BAKERY INC., ETOBICOKE ONTARIO M9C 5J1, CANADA:
2,857,233, PUB. 4-6-2004. INT. CL. 30.

PARMI TOOL CO., INC., LYNN, IN TO GARDEN WAY INCORPORATED, TROY, NY:
1,786,486, CANC. INT. CL. 7.

PARTNERS IN SUCCESS, INC., CHARLOTTE, NC:
2,088,385, CANC. INT. CL. 41.

PARY, THEODORE, LAUREL, MD:
2,086,983, CANC. INT. CL. 42.

PASSAGE CONSTRUCTION CO., INC., CORRALES, NM:
1,787,621, CANC. INT. CL. 37.

PASSKEY.COM, INC., QUINCY, MA:
2,857,887, PUB. 4-6-2004. INT. CL. 42.

PASTABILITIES, LLC, GREENSBORO, NC:
2,086,769, CANC. MULTIPLE CLASS, INT. CLS. 25 AND 42.

PATAK (SPICES) LTD., LANCASHIRE WA11 9UZ, UNITED KINGDOM:
1,275,371. REN. 5-20-04. MULTIPLE CLASS, INT. CLS. 29 AND 30.

PATERNO, MARIA K., SANTA CLARA, CA:
2,859,011, MULTIPLE CLASS, INT. CLS. 35 AND 42.

PATLAK, DAN, WHEELING, IL:
2,858,878, INT. CL. 35.

PATONS & BALDWIN'S LIMITED, DARLINGTON, COUNTY DURHAM, ENGLAND:
2,088,200, CANC. INT. CL. 23.

PATRICK J BUTLER, AURORA, CO:
1,847,472. REN. 5-21-04. INT. CL. 41.

PATRIOT PRODUCTS, INC., OWOSSO, MI:
1,787,649, CANC. INT. CL. 42.

PATTERSON, DANITA, CHICAGO, IL:
2,857,131, PUB. 4-6-2004. INT. CL. 41.

PATTON ELECTRIC COMPANY, INC., NEW HAVEN, IN TO RIVAL COMPANY, THE, KANSAS CITY, MO:
1,787,455, CANC. INT. CL. 11.

PAUL AND BILL'S SERVICE CENTER, INC., AURORA, IL:
1,247,897, CANC. MULTIPLE CLASS, INT. CLS. 37 AND 42.

PC FLOWERS, INC., VIENNA, VA:
1,787,646, CANC. INT. CL. 42.

PCCW-HKT DATACOM SERVICES LIMITED, QUARRY BAY, HONG KONG:
2,857,771, PUB. 4-6-2004. INT. CL. 41.

PCTFILER HOLDINGS PTY LTD, WILLOUGHBY, AUSTRALIA:
2,858,874, INT. CL. 42.

PDC PRESS, INC., WILLIAMSVILLE, NY:
2,859,094, INT. CL. 36.

PDG ASSOCIATES, INC., BATAVIA, OH:
2,088,328, CANC. INT. CL. 19.

PDH INTERNATIONAL INCORPORATED, DECATUR, GA:
2,858,253, INT. CL. 11.

PEARSALL, MATTHEW J., MORETOWN, VT:
2,858,962, INT. CL. 29.

PEARSON, LARRY, BOZEMAN, MT:
2,857,379, PUB. 4-6-2004. INT. CL. 37.

PECINOVSKY, GERALD, NEWTON, IA:
1,848,404. REN. 5-15-04. INT. CL. 16.

PEDINOL PHARMACAL, INC., FARMINGDALE, NY:
1,265,496. REN. 5-20-04. INT. CL. 3.

PELLA CORPORATION, PELLA, IA:
2,858,546, MULTIPLE CLASS, INT. CLS. 6, 19 AND 40.

- PENDLETON FLOUR MILLS, LLC, PENDLETON, OR,
FISHER FLOURING MILLS COMPANY, SEATTLE, WA:
90,977. REN. 5-18-04. U.S. CL. 46 (INT. CL. 30).
- PENNSYLVANIA FASHIONS, INC., WARRENDALE, PA:
1,247,942, CANC. INT. CL. 42.
- PENNSYLVANIA ROUTE 6 TOURIST ASSOCIATION, GA-
LETON, PA:
2,858,688, MULTIPLE CLASS, INT. CLS. 14, 16, 25 AND
39.
- PENNWELL CORPORATION, TULSA, OK:
2,857,234, PUB. 4-6-2004. INT. CL. 35.
- PENNZOIL-QUAKER STATE COMPANY, HOUSTON, TX:
2,858,105, PUB. 4-6-2004. INT. CL. 1.
- PENTAIR POOL PRODUCTS, INC., MOORPARK, CA:
2,858,592, INT. CL. 7.
- PENTON MEDIA, INC., CLEVELAND, OH, HAYDEN PUB-
LISHING COMPANY, INC., ROCHELLE PARK, NJ:
1,271,773. REN. 5-21-04. INT. CL. 16.
- PENTON MEDIA, INC., CLEVELAND, OH:
2,859,082, INT. CL. 16.
- PEOPLES FOUNDATION, THE, IRVING, TX:
2,087,289, CANC. INT. CL. 41.
- PEPSICO, INC., PURCHASE, NY:
2,087,638, CANC. INT. CL. 32.
2,857,139, PUB. 4-6-2004. INT. CL. 33.
- PER-LEE, MYRA S., ESCONDIDO, CA:
2,858,748, INT. CL. 18.
- PERCEPTUAL ENGINEERING, INC., MINNEAPOLIS, MN:
2,858,205, INT. CL. 9.
- PEREG GMBH, 84478 WALDKRAIBURG, FED REP GER-
MANY:
2,858,344, INT. CL. 9.
- PERFETTI VAN MELLE S.P.A., 7 - 20020 LAINATE (MI),
ITALY:
2,857,219, PUB. 4-6-2004. MULTIPLE CLASS, INT. CLS. 5
AND 30.
- PERFORMANCE LEARNING SYSTEMS, INC., ARLING-
TON, TX:
2,857,600, PUB. 4-6-2004. INT. CL. 41.
- PERRY, LENORE E., LEO, IN:
2,858,493, INT. CL. 7.
- PERRY, NICK, NEW YORK, NY:
2,858,226, MULTIPLE CLASS, INT. CLS. 38 AND 41.
- PERSISTENCE SOFTWARE, INC., SAN MATEO, CA:
2,762,632, COR. INT. CL. 9.
- PERSONAL SELLING POWER, INC., FREDERICKSBURG,
VA:
2,086,736, CANC. INT. CL. 41.
- PETCAVICH, ROBERT J., SAN DIEGO, CA TO PLANET
POLYMER TECHNOLOGIES, INC., SAN DIEGO, CA:
1,787,274, CANC. MULTIPLE CLASS, INT. CLS. 1, 20
AND 21.
- PETER & BARBARA SHEARER, SOUTH AMBOY, NY:
762,753. REN. 5-17-04. U.S. CL. 36 (INT. CL. 15).
- PETER PAN INDUSTRIES, NEWARK, NJ:
1,787,288, CANC. MULTIPLE CLASS, INT. CLS. 9, 21, 25
AND 28.
2,088,374, CANC. INT. CL. 9.
- PETERMAN, LARRY, PISMO BEACH, CA, DBA S.S. LOLLI-
POP:
1,787,595, CANC. INT. CL. 31.
- PETERS, RONALD, LONG BEACH, CA:
2,857,491, PUB. 4-6-2004. INT. CL. 12.
- PETROSURANCE INCORPORATED, COLUMBUS, OH:
1,247,890, CANC. INT. CL. 36.
- PETTEAM, INC., COLUMBUS, OH:
2,088,447, CANC. MULTIPLE CLASS, INT. CLS. 3 AND 5.
- PETTIT, SUE ANN L., ASHLAND, MO, DBA PETTIT
ORIGINALS:
2,088,102, CANC. MULTIPLE CLASS, INT. CLS. 9, 16, 25
AND 28.
- PFIZER HEALTH SOLUTIONS INC., NEW YORK, NY:
2,858,372, INT. CL. 9.
- PFIZER INC., NEW YORK, NY:
1,247,523, CANC. INT. CL. 5.
- PH, S.A.R.L, 75005 PARIS, FRANCE:
2,858,297, INT. CL. 30.
- PHARMACIA S.P.A., MILAN, ITALY:
2,087,518, CANC. INT. CL. 5.
- PHARMACY TECHNICIAN CERTIFICATION BOARD,
INC., WASHINGTON, DC:
2,087,338, CANC. INT. CL. 42.
- PHARMADIL, INC., GUILDERLAND, NY:
2,087,782, CANC. INT. CL. 5.
- PHELAN, JEFFREY P., PASADENA, CA:
2,087,913, CANC. INT. CL. 42.
- PHILADELPHIA CHEWING GUM CORPORATION, HA-
VERTOWN, PA:
1,247,829, CANC. INT. CL. 30.
1,247,830, CANC. INT. CL. 30.
- PHILADELPHIA GEAR CORPORATION, NORRISTOWN,
PA:
997,278. REN. 5-20-04. INT. CL. 7.
2,858,849, MULTIPLE CLASS, INT. CLS. 7, 37 AND 42.
- PHILD CO., LTD., KAMIGYO-KU, KYOTO CITY 602-0023,
JAPAN:
2,858,687, MULTIPLE CLASS, INT. CLS. 24 AND 25.
- PHILIPPE CAUSSE DE MONREDON, 92200 NEUILLY-SUR-
SEINE, FRANCE:
2,086,774, CANC. MULTIPLE CLASS, INT. CLS. 9 AND
16.
- PHILIPS MEDIA, INC., NEW YORK, NY:
2,088,139, CANC. INT. CL. 9.
- PHILLIPS PETROLEUM COMPANY, BARTLESVILLE, OK:
1,787,235, CANC. INT. CL. 42.
2,857,872, PUB. 4-6-2004. INT. CL. 36.
2,857,873, PUB. 4-6-2004. INT. CL. 36.
- PHILLIPS, ROSEMARY E., NEW WINDSOR, IL, DBA
ROSEMARY'S POTPOURRI:
2,858,972, INT. CL. 3.
- PHIPPS, WINTLEY, VERO BEACH, FL:
2,857,909, PUB. 4-6-2004. MULTIPLE CLASS, INT. CLS. 9
AND 41.
- PHOBOS ENTERTAINMENT HOLDINGS, INC., NEW
YORK, NY:
2,858,376, MULTIPLE CLASS, INT. CLS. 16 AND 41.
- PHOENIX INTANGIBLES HOLDING COMPANY, GREEN-
VILLE, DE:
2,858,665, INT. CL. 5.
- PHOENIX INVESTMENT PARTNERS, LTD., HARTFORD,
CT:
2,857,446, PUB. 4-6-2004. INT. CL. 36.
- PHOENIX SUNS LIMITED PARTNERSHIP, PHOENIX, AZ:
2,857,254, PUB. 4-6-2004. INT. CL. 25.
- PHONEBITES, INC., SAN FRANCISCO, CA:
2,858,992, INT. CL. 9.
- PIAGGIO & C. S.P.A., PONTEDERA, PISA, ITALY:
2,858,224, INT. CL. 35.
- PIASECKI AIRCRAFT CORPORATION, ESSINGTON, PA:
1,692,814. REN. 5-18-04. INT. CL. 12.
- PICATECH HUBER AG, KRIENS, SWITZERLAND, PICA-
TECH AG., CH-6010 KRIENS, SWITZERLAND:
1,831,888. REN. 5-20-04. INT. CL. 7.
- PICTOMETRY INTERNATIONAL CORP., ROCHESTER,
NY:
2,857,336, PUB. 4-6-2004. INT. CL. 35.
- PIERCE, LEON W., STOCKTON, CA:
2,858,915, INT. CL. 33.
- PIETERSMA, RONALD C., CHINO, CA:
2,087,877, CANC. INT. CL. 42.
- PIG IMPROVEMENT COMPANY, INC., SPRING GREEN,
WI:
1,247,833, CANC. INT. CL. 31.
- PILLOW TALK INTERNATIONAL, INC., FT. LAUDER-
DALE, FL:
2,858,077, PUB. 4-6-2004. INT. CL. 35.
- PILOT CLUB INTERNATIONAL, THE, MACON, GA:
748,216. REN. 5-15-04. U.S. CL. 200.
- PIMA WESTERN, INC., TUCSON, AZ:
1,247,817, CANC. INT. CL. 29.
- PINAR, LEVENT, WETHERILL PARK, AUSTRALIA AND
PINAR, EMEL SARIKAYA, WETHERILL PARK, AUS-
TRALIA:
2,858,844, INT. CL. 25.

- PINE RIDGE ASSOCIATES, L.P., DAYTON, OR, DBA ARCHERY SUMMIT WINERY:
2,087,498, CANC. INT. CL. 33.
- PINKERTON TOBACCO CO. LP, OWENSBORO, KY:
2,858,304, INT. CL. 34.
- PIONEER MANUFACTURING CO., CLEVELAND, OH:
2,858,653, MULTIPLE CLASS, INT. CLS. 2 AND 7.
- PIONEER SNACKS, INC., FARMINGTON HILLS, MI:
2,857,291, PUB. 4-6-2004. INT. CL. 29.
- PIPEDREAM PRODUCTS, INC., CHATSWORTH, CA:
2,859,081, INT. CL. 25.
- PIROTECNIA CABALLER, S.A., S/N -46160 LIRIA -VALENCIA, SPAIN:
2,857,294, PUB. 4-6-2004. MULTIPLE CLASS, INT. CLS. 13 AND 41.
- PIXELTOOLS CORP., CUPERTINO, CA:
2,857,305, PUB. 4-6-2004. INT. CL. 9.
- PLAID ENTERPRISES, INC., NORCROSS, GA:
2,088,023, CANC. INT. CL. 16.
- PLAINS ALL AMERICAN PIPELINE, L.P., HOUSTON, TX:
2,858,442, MULTIPLE CLASS, INT. CLS. 35 AND 39.
- PLAMONDON, LUC, DUBLIN 4, IRELAND:
2,857,861, PUB. 4-6-2004. INT. CL. 41.
- PLAN-IT-KIT, INC., WESTPORT, CT:
754,774, CANC. U.S. CL. 50.
- PLATINUM CLOTHING COMPANY, THE, LOS ANGELES, CA:
2,086,825, CANC. INT. CL. 25.
- PLATTE CHEMICAL CO., FREMONT, NE:
1,787,327, CANC. INT. CL. 5.
- PN II, INC., LAS VEGAS, NV:
2,789,615, COR. INT. CL. 19.
- PNC BANK CORP., PITTSBURGH, PA:
2,088,351, CANC. INT. CL. 36.
- PNEUMAFIL CORPORATION, CHARLOTTE, NC:
754,557, CANC. U.S. CL. 23.
- POKKA USA, INC., AMERICAN CANYON, CA:
1,846,313, REN. 5-21-04. INT. CL. 32.
- POLARFAB LLC, BLOOMINGTON, MN:
2,857,355, PUB. 4-6-2004. MULTIPLE CLASS, INT. CLS. 40 AND 42.
2,857,356, PUB. 4-6-2004. MULTIPLE CLASS, INT. CLS. 40 AND 42.
- POLIZZI, THOMAS A., PONTE VEDRA BEACH, FL AND POLIZZI, BERNADETTE C., PONTE VEDRA BEACH, FL, DBA WCCN PUBLISHING:
1,786,741, CANC. INT. CL. 16.
- POLYGLASS S.P.A., TREVISO, ITALY:
2,087,158, CANC. INT. CL. 19.
- POLYNESIAN SPAS LTD. OF WESTERN MICHIGAN, KENTWOOD, MI:
1,247,618, CANC. INT. CL. 11.
1,247,619, CANC. INT. CL. 11.
1,247,620, CANC. INT. CL. 11.
1,247,621, CANC. INT. CL. 11.
1,247,622, CANC. INT. CL. 11.
1,247,623, CANC. INT. CL. 11.
- POPULAR, INC., SAN JUAN, PUERTO RICO:
2,858,774, INT. CL. 36.
- POSADAS DE MEXICO, S.A. DE C.V., C.P. 11000, MEXICO, MEXICO:
2,858,187, MULTIPLE CLASS, INT. CLS. 41 AND 42.
- POSITIVE RESPONSE TELEVISION, INC., SHERMAN OAKS, CA:
2,086,737, CANC. MULTIPLE CLASS, INT. CLS. 3 AND 26.
- POSTMARK PRESS, INC., WATERTOWN, MA:
2,858,389, INT. CL. 16.
- POTEET SEAFOOD CO., INC., BRUNSWICK, GA:
2,859,114, INT. CL. 29.
- POULIN, ANNEMARIE B., SLIVER CITY, NM, DBA EN-ERGENESIS:
2,858,317, INT. CL. 16.
- POWER ON SOFTWARE, INC., SHERRODSVILLE, OH:
2,088,424, CANC. INT. CL. 9.
- POWER SERVICE PRODUCTS, INC., WEATHERFORD, TX:
2,858,439, INT. CL. 1.
- POWERPLAY RINKS, INC., EXTON, PA:
2,858,386, INT. CL. 35.
- PR TRADING COMPANY, INC., HOUSTON, TX:
2,859,025, INT. CL. 9.
- PRABHAT INDUSTRIES, MUMBAI 400 009, INDIA:
2,858,557, INT. CL. 17.
- PRACTICE PERFORMANCE PUBLISHING, INC., LONG BEACH, CA:
1,787,635, CANC. INT. CL. 41.
- PRAIRIE FARMS DAIRY, INC., CARLINVILLE, IL:
1,286,158, REN. 5-20-04. MULTIPLE CLASS, INT. CLS. 29 AND 30.
- PRASCO, LLC, CINCINNATI, OH:
2,857,404, PUB. 4-6-2004. INT. CL. 5.
- PRECISION FABRICS GROUP, INC., GREENSBORO, NC:
1,826,399, REN. 5-15-04. INT. CL. 24.
- PREFORMED LINE PRODUCTS COMPANY, MAYFIELD VILLAGE, OH:
1,829,177, REN. 5-20-04. MULTIPLE CLASS, INT. CLS. 6, 8 AND 9.
1,829,178, REN. 5-20-04. MULTIPLE CLASS, INT. CLS. 6, 8 AND 9.
- PREMENOS CORP., CONCORD, CA:
2,088,154, CANC. INT. CL. 9.
- PREMIER INTERNATIONAL ENTERPRISES, INC., CHICAGO, IL:
2,858,646, INT. CL. 9.
- PREMIER PET PRODUCTS, L.L.C., RICHMOND, VA:
2,857,125, PUB. 4-6-2004. MULTIPLE CLASS, INT. CLS. 28 AND 35.
- PREMIUM TOBACCO STORES, INC., BENICIA, CA, DBA CIGARETTES CHEAPER!
2,087,776, CANC. INT. CL. 34.
- PRESSED STEEL TANK CO., INC., WEST ALLIS, WI:
2,858,803, INT. CL. 6.
- PRESTIGE COSMETICS, POMPANO BEACH, FL:
2,857,567, PUB. 4-6-2004. INT. CL. 3.
- PRESTOFOTO, INC., ANNAPOLIS, MD:
1,247,914, CANC. INT. CL. 40.
- PRETZELMAKER, INC., SALT LAKE CITY, UT:
2,858,980, INT. CL. 43.
- PRICE MODERN, LLC, HERNDON, VA, DBA LINK:
2,859,057, INT. CL. 35.
- PRIMARY CHILDREN'S MEDICAL CENTER, SALT LAKE CITY, UT:
1,828,569, REN. 5-21-04. INT. CL. 36.
- PRIMARY PAYMENT SYSTEMS, INC., SCOTTSDALE, AZ, WALLY INDUSTRIES, PETALUMA, CA:
1,767,330, REN. 5-20-04. INT. CL. 9.
- PRIMESOURCE BUILDING PRODUCTS, INC., CARROLLTON, TX:
2,859,008, INT. CL. 6.
- PRINCENET, INC., SOMERSET, NJ:
2,087,070, CANC. INT. CL. 9.
2,087,071, CANC. INT. CL. 9.
2,087,072, CANC. INT. CL. 9.
2,087,073, CANC. INT. CL. 9.
- PRINCETON NURSERYMEN'S RESEARCH ASSOCIATES, ALLENTOWN, NJ, DBA PRINCETON NURSERIES:
983,590, REN. 5-17-04. U.S. CL. 1 (INT. CL. 31).
983,591, REN. 5-17-04. U.S. CL. 1 (INT. CL. 31).
- PRINCIPAL MUTUAL LIFE INSURANCE COMPANY, DES MOINES, IA:
2,087,911, CANC. INT. CL. 36.
- PRINTERS' SERVICE, INC., NEWARK, NJ:
1,829,779, REN. 5-16-04. INT. CL. 3.
1,845,343, REN. 5-16-04. INT. CL. 7.
1,863,606, REN. 5-16-04. INT. CL. 9.
- PRINTZ, MICHAEL M., WESTPORT, CT:
2,087,742, CANC. INT. CL. 42.
- PRISM, INC., EAST GREENWICH, RI, BEAD CHAIN MANUFACTURING COMPANY, THE, BRIDGEPORT, CT:
980,937, REN. 5-17-04. U.S. CL. 22 (INT. CL. 28).
- PRITIKIN, ROBERT, PACIFIC PALISADES, CA:
2,088,251, CANC. INT. CL. 41.
- PRIVA INC., ANJOU, QUEBEC, CANADA:
2,858,382, INT. CL. 25.

- PRL USA HOLDINGS, INC., WILMINGTON, DE:
2,857,837, PUB. 4-6-2004. INT. CL. 18.
- PRO QC INTERNATIONAL NORTH AMERICA,
MCHENRY, IL:
2,859,125, INT. CL. 42.
- PRO SELECT, INC., ELMHURST, IL:
2,857,782, PUB. 4-6-2004. INT. CL. 28.
- PROCTER & GAMBLE COMPANY, THE, CINCINNATI, OH:
2,144,226, CANC. MULTIPLE CLASS, INT. CLS. 16, 29
AND 32.
- PRODUCERS RICE MILL, INC., STUTTGART, AR, PIONEER
FOOD INDUSTRIES, INC., DE WITT, AR:
982,957. REN. 5-16-04. U.S. CL. 46 (INT. CL. 30).
- PRODUCT CONCEPTS, INC., RIO RICO, AZ:
2,857,655, PUB. 4-6-2004. INT. CL. 5.
- PROEL KG, D-91781 WEISSENBURG I BAY, FED REP
GERMANY TO FARBENFABRIK PROLL GMBH & CO.
KG, D-91781 WEISSENBURG I. BAY., FED REP GER-
MANY:
2,811,975, COR. MULTIPLE CLASS, INT. CLS. 1, 2 AND
3.
- PROFESSIONAL APARTMENT MANAGEMENT, INC.,
LODI, CA:
2,087,906, CANC. INT. CL. 36.
- PROFESSIONAL SKIN CARE, INC., VALENCIA, CA:
2,858,713, MULTIPLE CLASS, INT. CLS. 3, 35 AND 42.
- PROFILE NETWORK, INC., SKOKIE, IL, DBA SPORTS
PROFILES:
2,859,092, INT. CL. 36.
- PROGRESS SOFTWARE CORPORATION, BEDFORD, MA:
2,858,054, PUB. 4-6-2004. INT. CL. 41.
- PROGRESSIVE VISION, INC., BEDFORD, TX:
2,088,143, CANC. MULTIPLE CLASS, INT. CLS. 9 AND
16.
- PROMARK INTERNATIONAL, INC., BOISE, ID:
2,087,401, CANC. INT. CL. 29.
- PROMEDICA COMMUNICATIONS INC., NEW YORK, NY:
2,858,327, MULTIPLE CLASS, INT. CLS. 16 AND 42.
- PROPPER MANUFACTURING COMPANY, INC., LONG
ISLAND CITY, NY:
2,859,018, INT. CL. 9.
- PROSOFTTRAINING.COM, AUSTIN, TX:
2,834,763, CANC. IIRN. RESTORED TO S.N. 75-877,484.
- PROSPECTIV DIRECT, INC., WOBURN, MA:
2,858,213, INT. CL. 35.
- PROSPERITY SYSTEM, INC., BALTIMORE, MD, PIZZA
BOLI'S SYSTEM, INC., BALTIMORE, MD:
1,830,620. REN. 5-17-04. MULTIPLE CLASS, INT. CLS. 39
AND 42.
- PROSPERITY SYSTEM, INC., BALTIMORE, MD, PIZZA
BOLI'S SYSTEM, INC., BALTIMORE, MD:
1,830,621. REN. 5-17-04. MULTIPLE CLASS, INT. CLS. 39
AND 42.
- PROSPERITY TREE INTERNATIONAL, TORRANCE, CA:
2,087,872, CANC. INT. CL. 20.
- PROTECTIVE TECHNOLOGIES INTERNATIONAL MAR-
KETING, L.L.C., SALT LAKE CITY, UT:
2,087,674, CANC. INT. CL. 5.
- PROVIDENCE SYSTEMS, INC., CARLSBAD, CA:
2,857,442, PUB. 4-6-2004. INT. CL. 41.
- PROVIDENT LIFE AND ACCIDENT INSURANCE COM-
PANY, CHATTANOOGA, TN:
2,088,416, CANC. INT. CL. 36.
- PRUDENTIAL INSURANCE COMPANY OF AMERICA,
THE, NEWARK, NJ:
2,088,437, CANC. INT. CL. 16.
- PRYM-DRITZ CORPORATION, SPARTANBURG, SC:
2,858,634, MULTIPLE CLASS, INT. CLS. 3, 8, 9, 16, 21, 23,
25 AND 26.
- PRZEDSIĘBIORSTWO POLMOS BIALYSTOK S.A., BIALYS-
TOK, POLAND FROM AGROS HOLDING S.A., 00-613
WARSAW, POLAND:
2,858,179, INT. CL. 33.
- PSI ENERGY, INC., PLAINFIELD, IN:
2,858,802, INT. CL. 35.
- PSYCHOLOGICAL CORPORATION, SAN ANTONIO, TX,
PSYCHOLOGICAL CORPORATION, SAN ANTONIO, TX:
1,875,922. REN. 5-20-04. INT. CL. 16.
- PUBLIC RELATIONS PLUS, INC., NEW MILFORD, CT:
2,087,783, CANC. INT. CL. 16.
- PUBLICATION MARKETING CORP., NASHVILLE, TN,
PUBLICATION MARKETING CORP., NASHVILLE, TN:
1,829,828. REN. 5-20-04. INT. CL. 16.
- PUBLISHERS CLEARING HOUSE LLC, PORT WASHING-
TON, NY:
2,858,220, INT. CL. 35.
- PUBLISHING CONNECTIONS INC., BETHESDA, MD:
2,087,861, CANC. INT. CL. 42.
- PUGH, DAVID K., MIRAMAR, FL:
2,088,006, CANC. MULTIPLE CLASS, INT. CLS. 35 AND
42.
- PULLMAN COMPANY, THE, ROLLING MEADOWS, IL:
1,247,559, CANC. INT. CL. 6.
- PUMPKIN LTD., DENVER, CO TO PUMPKIN LTD., DEN-
VER, CO, DBA PUMPKIN MASTERS, INC.:
1,786,740, CANC. INT. CL. 16.
- PUPPETRONICS CORPORATION, SANDPOINT, ID:
2,857,339, PUB. 4-6-2004. INT. CL. 41.
- PURDUE PRODUCTS, LP, STAMFORD, CT:
2,858,900, INT. CL. 5.
- PURESERVICE CORPORATION, OKLAHOMA CITY, OK:
2,088,168, CANC. INT. CL. 37.
- PURETEK CORPORATION, SAN FERNANDO, CA:
2,087,577, CANC. INT. CL. 3.
- PURKEY, ROBERT JR, KNOXVILLE, TN:
2,087,069, CANC. INT. CL. 36.
- PUROS DE VILLA GONZALEZ, S.A., SANTIAGO, DOMIN-
ICAN REP:
2,087,605, CANC. INT. CL. 34.
- PUTNAM RETAIL MANAGEMENT, LP, BOSTON, MA:
2,859,118, INT. CL. 36.
- PUTT-PUTT GOLF COURSES OF AMERICA, INC., FAYET-
TEVILLE, NC:
1,786,394, CANC. INT. CL. 2.
- PYCCO CORPORATION, EDEN PRAIRIE, MN:
2,087,128, CANC. INT. CL. 35.
- PYRAMID BREWERIES INCORPORATED, SEATTLE, WA:
2,087,448, CANC. INT. CL. 32.
- Q-MATIC CORPORATION, LISLE, IL:
1,819,772. REN. 5-20-04. INT. CL. 9.
- Q-TEK INTERNATIONAL, LLC, KENT, WA:
2,857,956, PUB. 4-6-2004. INT. CL. 9.
- QBIOGENE, INC., CARLSBAD, CA:
2,858,113, PUB. 4-6-2004. INT. CL. 1.
- QSC AUDIO PRODUCTS, INC., COSTA MESA, CA:
1,833,155. REN. 5-20-04. INT. CL. 9.
- QSL CORPORATION, DRACUT, MA:
2,858,023, PUB. 4-6-2004. INT. CL. 21.
- QUALITY EDGE, INC., WALKER, MI:
2,858,572, INT. CL. 6.
- QUALITY JUICE & BEVERAGE CORPORATION, TROY,
MI:
2,087,915, CANC. INT. CL. 32.
- QUALITY MILLS, INC., MT. AIRY, NC:
1,247,738, CANC. INT. CL. 24.
- QUALITY NEW MEXICO, ALBUQUERQUE, NM:
2,857,866, PUB. 4-6-2004. INT. CL. 41.
- QUALITY PETS OF CALIFORNIA, INC., GARDENA, CA:
2,858,138, PUB. 4-6-2004. INT. CL. 35.
- QUAM (HK) LIMITED, KOWLOON TONG, KOWLOON,
HONG KONG:
2,858,255, INT. CL. 35.
- QUARTERMAINE COFFEE ROASTERS LLC, ROCKVILLE,
MD:
2,857,677, PUB. 4-6-2004. MULTIPLE CLASS, INT. CLS. 30
AND 43.
- QUEBECOR WORLD INC., MONTREAL, CANADA:
2,857,194, PUB. 4-6-2004. INT. CL. 9.
- QUEEN CASUALS, INC., PHILADELPHIA, PA:
754,670, CANC. U.S. CL. 39.
- QUEST DIAGNOSTICS INCORPORATED, TETERBORO, NJ:
2,858,720, MULTIPLE CLASS, INT. CLS. 5 AND 42.
- QUICKSTARS, L.L.C., SAVANNAH, GA:
2,794,915, COR. INT. CL. 9.
2,794,916, COR. INT. CL. 36.

- QUIDEL CORPORATION, SAN DIEGO, CA:
2,858,136, PUB. 4-6-2004. INT. CL. 5.
- QUIKSILVER, INC., COSTA MESA, CA:
1,783,492. REN. 5-19-04. INT. CL. 25.
- QUIKSILVER, INC., HUNTINGTON BEACH, CA:
2,858,806, INT. CL. 28.
- QUINN, ROBERT, CATHEDRAL CITY, CA AND QUINN,
DEBORAH, CATHEDRAL CITY, CA:
2,858,901, INT. CL. 30.
- R & R OPERATING PARTNERSHIP, L.P., ALLENTOWN,
PA, DBA CHERRYDALE FARMS:
2,858,580, INT. CL. 35.
- R. D. BISCUIT COMPANY, INC., HOUSTON, TX:
2,858,578, INT. CL. 31.
- R.A. INVESTMENT PROPERTIES, INC., MIAMI, FL:
2,087,022, CANC. MULTIPLE CLASS, INT. CLS. 16 AND
35.
- R.D.T. BUSINESS ENTERPRISES, INC., FORT LAUDER-
DALE, FL, DBA SYNERGYLABS:
2,857,306, PUB. 4-6-2004. MULTIPLE CLASS, INT. CLS. 1,
3, 5, 31 AND 40.
- R.G. INTERNATONAL S.A., 060 BRUSSELS, BELGIUM
FROM RAID GAULOISES ORGANISATION, 92170
VANVES, FRANCE:
2,857,209, PUB. 4-6-2004. INT. CL. 41.
- R.M. WADE & CO., TUALATIN, OR:
2,858,120, PUB. 4-6-2004. MULTIPLE CLASS, INT. CLS. 11
AND 17.
- R.T. TEMPS, INC., P.C., WAYNE, PA:
2,857,150, PUB. 4-6-2004. INT. CL. 35.
- RADIANT PRODUCTS, LTD., LOS ANGELES, CA:
2,088,137, CANC. MULTIPLE CLASS, INT. CLS. 3 AND
21.
- RADIATOR SPECIALTY COMPANY, CHARLOTTE, NC:
769,819. REN. 5-17-04. U.S. CL. 15 (INT. CL. 1).
- RADICI POLIESTERE ITALIA S.P.A., 24122 BERGAMO,
ITALY:
2,858,473, INT. CL. 23.
- RADNET, INC., CAMBRIDGE, MA:
2,087,206, CANC. INT. CL. 9.
- RADSTRAT.COM, LLC, HANOVER, NH:
2,858,291, INT. CL. 35.
- RAID GAULOISES ORGANISATION:
See— R.G. INTERNATONAL S.A.
- RAINBOW TECHNOLOGY CORPORATION, BIRMING-
HAM, AL:
1,829,122. REN. 5-20-04. MULTIPLE CLASS, INT. CLS. 2,
3, 5 AND 21.
- RAINHART CO., AUSTIN, TX:
1,827,317. REN. 5-17-04. INT. CL. 9.
- RAINMAKING OASIS, INC., MADISON, CT:
2,858,733, INT. CL. 35.
- RAISING MORE MONEY, INC., SEATTLE, WA:
2,857,827, PUB. 4-6-2004. INT. CL. 16.
- RAM GOLF CORPORATION, MELROSE PARK, IL:
1,247,780, CANC. INT. CL. 28.
- RAMBO, ANNA C., NEW YORK, NY:
2,858,968, INT. CL. 41.
- RAMCO-USA, INC., LAKELAND, FL:
1,786,432, CANC. INT. CL. 4.
- RAMONDETTI, AMATO, 116/12, 10133 TORINO, ITALY:
2,087,553, CANC. INT. CL. 42.
- RANDOMWORLD, LTD., BLUEFIELD, WV:
2,858,375, INT. CL. 41.
- RAPID DISPLAYS, INC., CHICAGO, IL:
2,087,049, CANC. INT. CL. 28.
- RBC CENTURA BANKS, INC., ROCKY MOUNT, NC,
CENTURA BANKS, INC., ROCK MOUNT, NC:
1,698,494. REN. 5-18-04. INT. CL. 36.
- RCL ENTERPRISES, INC., ALLEN, TX:
2,151,359, CANC. INT. CL. 9.
- READY PRODUCTS, INC., ORANGE, CT:
1,786,791, CANC. INT. CL. 21.
- REAL TIME BOSS, INC., CANAL FULTON, OH:
2,858,742, INT. CL. 36.
- REAL TORINO, INC., MENDHAM, NJ:
1,834,827. REN. 5-18-04. INT. CL. 30.
- REALCAFES.COM INC., TORONTO, ONTARIO, CANADA:
2,857,303, PUB. 4-6-2004. INT. CL. 45.
- REALTOPIA, INC., RENO, NV:
2,858,836, MULTIPLE CLASS, INT. CLS. 35 AND 36.
- REBY, LAURE, 76420 BIHOREL-LES-ROUEN, FRANCE:
2,088,176, CANC. INT. CL. 25.
- RECAPS, LLC, BELLEVUE, WA:
2,858,251, INT. CL. 5.
- RECKETT & COLMAN INC., WAYNE, NJ:
1,247,543, CANC. INT. CL. 5.
- RECKITT & COLMAN (OVERSEAS) LIMITED, HULL,
ENGLAND:
171,868, CANC. U.S. CL. 4.
- RECKITT & COLMAN (OVERSEAS) LIMITED, HULL HU8
7DS, ENGLAND:
2,086,812, CANC. MULTIPLE CLASS, INT. CLS. 5 AND
30.
2,086,813, CANC. MULTIPLE CLASS, INT. CLS. 5 AND
30.
2,086,814, CANC. MULTIPLE CLASS, INT. CLS. 5 AND
30.
2,087,106, CANC. INT. CL. 5.
- RECTORSEAL CORPORATION, THE, HOUSTON, TX, REC-
TORSEAL CORPORATION, THE, HOUSTON, TX:
997,190. REN. 5-16-04. INT. CL. 1.
- RECTORSEAL CORPORATION, THE, HOUSTON, TX:
1,861,799. REN. 5-16-04. INT. CL. 17.
- RED BEND LTD., ROSH HA'AYIN, ISRAEL:
2,857,790, PUB. 4-6-2004. INT. CL. 9.
- RED KAP APPAREL CORP., WILMINGTON, DE:
2,087,200, CANC. INT. CL. 25.
- RED RIVER NET, INC., FARGO, ND:
2,087,226, CANC. INT. CL. 42.
- REDKEN LABORATORIES, INC., CANOGA PARK, CA:
1,247,483, CANC. INT. CL. 3.
1,247,488, CANC. INT. CL. 3.
- REEBOK INTERNATIONAL LTD., STOUGHTON, MA:
2,088,363, CANC. INT. CL. 14.
- REED ELSEVIER INC., NEWTON, MA:
2,087,490, CANC. INT. CL. 16.
- REED HOLDINGS, INC., ATLANTA, GA:
754,640, CANC. U.S. CL. 37.
- REEVES, DAVID S., ROSEVILLE, CA AND LYNCH, MON-
ICA, ROSEVILLE, CA:
2,858,851, INT. CL. 43.
- REFRESCOS NACIONALES, C. POR A., SANTO DOMINGO,
DOMINICAN REP:
2,086,907, CANC. INT. CL. 32.
- REHAU INCORPORATED, LEESBURG, VA:
1,787,305, CANC. INT. CL. 3.
- REL-EEZE/JDM ENTERPRISES, IRWINDALE, CA:
1,786,451, CANC. INT. CL. 5.
- REMEDIATION PRODUCTS, INC., ARVADA, CO:
2,858,556, INT. CL. 1.
- REMEDIUM, CC, TOTIUSDAL 0134, SOUTH AFRICA:
2,087,729, CANC. INT. CL. 16.
- REMINGTON CORPORATION, L.L.C., BRIDGEPORT, CT,
SPERRY RAND CORPORATION, NEW YORK, NY:
986,980. REN. 5-17-04. U.S. CL. 44 (INT. CL. 10).
989,674. REN. 5-17-04. U.S. CL. 44 (INT. CL. 11).
- RENOVO LIMITED, MANCHESTER, UNITED KINGDOM:
2,857,170, PUB. 4-6-2004. MULTIPLE CLASS, INT. CLS. 5,
41 AND 42.
- RENTA FRUT, INC., PRINCETON, MA:
2,087,503, CANC. INT. CL. 31.
- REPLY! INC., ALAMO, CA:
2,859,077, INT. CL. 35.
- REPUBLIC NEW YORK CORPORATION, NEW YORK, NY:
2,087,919, CANC. INT. CL. 36.
- RESCH, LYNNE, BROOKLYN, NY:
2,858,763, INT. CL. 42.
- RESLABS, INC., SKOKIE, IL:
1,247,957, CANC. INT. CL. 42.
- RESTAURANT MANAGEMENT GROUP, INC., NOR-
CROSS, GA:
1,835,828. REN. 5-17-04. INT. CL. 42.

- RETAIL BRAND ALLIANCE, INC., ENFIELD, CT FROM
BROOKS BROTHERS, INC., NEW YORK, NY:
2,858,867, INT. CL. 25.
- RETEX COOPERATIVE, INC., NEW YORK, NY:
1,863,899. REN. 5-20-04. INT. CL. 35.
- RETROHAIR, INC., CARNEGIE, PA:
2,857,410, PUB. 4-6-2004. INT. CL. 3.
- REVAH HOLDINGS, INC., LOS ANGELES, CA:
2,857,944, PUB. 4-6-2004. INT. CL. 25.
- RFD PARTNERS, L.P., SANTA MONICA, CA, DBA REAL
FOOD DAILY:
2,087,365, CANC. INT. CL. 42.
- RICE BOXX ENTERPRISES, LP, PLANO, TX:
2,858,265, INT. CL. 42.
- RICE FOOD MARKETS, INC., HOUSTON, TX:
2,088,301, CANC. INT. CL. 42.
- RICE LAKE WEIGHING SYSTEMS, INC., RICE LAKE, WI:
2,087,462, CANC. INT. CL. 9.
- RICH PALM ENTERPRISE CORP. LTD., TAIPEI, TAIWAN:
2,858,601, INT. CL. 7.
- RICHARD A. BEAN, SANTEE, CA, DBA PRIDE METAL
FINISHING:
2,087,680, CANC. INT. CL. 28.
- RICHARD BOYD ENTERPRISES, INC., MIAMI, FL:
1,825,127. REN. 5-21-04. INT. CL. 16.
- RICHARD LEEDS INTERNATIONAL, INC., NEW YORK,
NY:
2,858,988, INT. CL. 25.
- RICHDALE DEVELOPMENT COMPANY, OMAHA, NE:
2,857,924, PUB. 4-6-2004. MULTIPLE CLASS, INT. CLS. 36
AND 37.
- RICHLAND PARTNERS, LLC, RICHLAND, PA:
2,858,853, MULTIPLE CLASS, INT. CLS. 35 AND 37.
- RIDERS READY, INC., FORT WAYNE, IN:
2,857,935, PUB. 4-6-2004. INT. CL. 35.
- RIDLEY BLOCK OPERATIONS, INC., MANKATO, MN:
2,858,631, INT. CL. 5.
2,858,632, INT. CL. 31.
- RIGHTPATH RESOURCES, INC., ATLANTA, GA:
2,857,397, PUB. 11-18-2003. INT. CL. 16.
- RIMOLDI NECCHI S.R.L., LODI, ITALY, ROCKWELL-
RIMOLDI S.P.A., OPERA, MILANO, ITALY:
1,273,320. REN. 5-20-04. INT. CL. 7.
- RISER FOODS INC., BEDFORD ROAD, OH:
1,248,011, CANC. INT. CL. 30.
- RIVER OF FIRE MINISTRIES INTERNATIONAL, INC.,
VANCOUVER, WA:
2,858,256, INT. CL. 42.
- RIVERA, ANGELICA, LOS ANGELES, CA:
2,858,160, PUB. 4-6-2004. INT. CL. 3.
- RIVERSIDE BREWING CO., RIVERSIDE, CA:
2,086,777, CANC. INT. CL. 32.
- RIVERSIDE FRUIT SALES, INC., FORT PIERCE, FL:
2,087,086, CANC. INT. CL. 31.
- RKS PLASTICS INC, NEW BRUNSWICK, NJ:
2,858,202, INT. CL. 35.
- RMR DISTRIBUTORS, INC., TAMPA, FL:
2,858,062, PUB. 4-6-2004. INT. CL. 25.
- ROADWAY EXPRESS, INC., AKRON, OH:
2,087,351, CANC. INT. CL. 9.
- ROBBINS, ANTHONY J., SAN DIEGO, CA TO ROBBINS
RESEARCH INTERNATIONAL, INC., SAN DIEGO, CA:
1,787,104, CANC. INT. CL. 41.
- ROBERT BURTON ASSOCIATES, LTD., NEW YORK, NY:
1,247,996, CANC. INT. CL. 3.
- ROBERT IAN PRODUCTIONS, INC., MONROE, WI:
1,786,569, CANC. MULTIPLE CLASS, INT. CLS. 9 AND
41.
- ROBERT MORRIS ASSOCIATES, PHILADELPHIA, PA:
2,857,462, PUB. 4-6-2004. INT. CL. 9.
2,857,463, PUB. 4-6-2004. INT. CL. 41.
- ROBERTSON, FAY, POOLE DORSET, UNITED KINGDOM,
DBA CASOLETTE & CO (SALES & MARKETING) LTD:
2,858,126, PUB. 4-6-2004. INT. CL. 3.
- ROBERTOS PARTNERSHIP, FORT COLLINS, CO, DBA
ROBERTOS BURRITOS:
2,086,689, CANC. INT. CL. 30.
- ROBERTSON, FAY, POOLE DORSET, UNITED KINGDOM,
DBA CASOLETTE & CO. (SALES & MARKETING) LTD:
2,858,127, PUB. 4-6-2004. INT. CL. 3.
- ROBERTSON, STEVEN C., KENT, WA:
2,858,197, MULTIPLE CLASS, INT. CLS. 35, 41 AND 42.
- ROCCA, JOHN H., LEESBURG, VA:
2,857,111, PUB. 4-6-2004. MULTIPLE CLASS, INT. CLS. 35
AND 41.
- ROCHESTER INSTITUTE OF TECHNOLOGY, ROCHE-
STER, NY:
2,859,052, INT. CL. 9.
2,859,053, INT. CL. 9.
- ROCK ISLAND FOODS INC., IGNACIO, CA:
1,787,565, CANC. INT. CL. 29.
- ROCKEFELLER GROUP, INC., NEW YORK, NY:
2,088,105, CANC. INT. CL. 42.
- ROCKET SPEED INC., DOVER, DE:
2,795,614, COR. INT. CL. 3.
- ROCKMAN CO. (U.S.A.), INC., COMMERCE, CA:
2,858,411, INT. CL. 30.
- ROCKTRON CORPORATION, ROCHESTER HILLS, MI:
2,088,343, CANC. INT. CL. 9.
- ROCKY MOUNTAIN ATV, PAYSON, UT:
2,859,122, INT. CL. 12.
- RODALE PRESS, INC., EMMAUS, PA:
1,247,681, CANC. INT. CL. 16.
- RODEKUH, KELLIE, ENGLEWOOD, CO:
2,088,209, CANC. INT. CL. 35.
- RODENHISER EXCAVATING INC., ASHLAND, MA:
2,858,366, INT. CL. 37.
- RODNEY, GODFREY WINSTON, LAURELTON, NY:
2,857,519, PUB. 4-6-2004. MULTIPLE CLASS, INT. CLS. 9
AND 41.
- ROFIN-SINAR LASER GMBH, D-22113 HAMBURG, FED
REP GERMANY:
2,857,282, PUB. 4-6-2004. MULTIPLE CLASS, INT. CLS. 7,
9, 40, 41 AND 42.
- ROGER CLEVELAND GOLF COMPANY, INC., CYPRESS,
CA:
2,858,651, INT. CL. 28.
- ROISER, ERICH, MONDSEE, AUSTRIA, DBA CAMARO
SPORTSWEAR:
1,276,243. REN. 5-21-04. INT. CL. 25.
- ROLAND CORPORATION U.S., LOS ANGELES, CA:
1,787,106, CANC. INT. CL. 41.
- ROLL-KRAFT, INC., WILLOUGHBY, OH:
2,088,399, CANC. MULTIPLE CLASS, INT. CLS. 6 AND
40.
- ROLLERBLADE, INC., MINNETONKA, MN:
2,088,225, CANC. INT. CL. 16.
- ROMAN DESIGNS, INC., ANAHEIM, CA:
2,858,129, PUB. 4-6-2004. MULTIPLE CLASS, INT. CLS. 25
AND 28.
2,858,130, PUB. 4-6-2004. MULTIPLE CLASS, INT. CLS. 25
AND 28.
- ROMAN, RICHARD, CANTON, OH:
2,088,316, CANC. INT. CL. 41.
- ROOSEVELT GROUP, INC., THE, QUEENSTOWN, MD:
2,145,743, CANC. MULTIPLE CLASS, INT. CLS. 35 AND
36.
- ROSE OF SHARON MINISTRIES, INC., MIAMI, FL:
1,787,122, CANC. INT. CL. 41.
- ROSE, DAVID D., VAN NUYS, CA, DBA PET-TECH
PRODUCTS:
2,087,657, CANC. INT. CL. 21.
- ROSE'S STORES, INC., HENDERSON, NC:
1,787,520, CANC. INT. CL. 25.
- ROSEBRIER, INC., ALBANY, OR:
2,087,760, CANC. MULTIPLE CLASS, INT. CLS. 3 AND
31.
- ROSKOPF GOLF L.L.C., PORTLAND, OR:
2,858,608, INT. CL. 28.
- ROSSTECH SIGNALS, INC., ELLIOT LAKE, ONTARIO,
CANADA:
2,858,799, INT. CL. 11.
- ROTARY INTERNATIONAL, EVANSTON, IL:
777,161. REN. 5-17-04. U.S. CL. 107 (INT. CL. 41).

- ROTECH HEALTHCARE INC., ORLANDO, FL:
2,857,864, PUB. 4-6-2004. INT. CL. 44.
- ROYAL BANK OF CANADA, NEW YORK, NY:
2,858,445, INT. CL. 36.
- ROYAL CATHAY TRADING COMPANY, SOUTH SAN FRANCISCO, CA:
1,247,860, CANC. INT. CL. 35.
- ROYAL CUP, INC., BIRMINGHAM, AL:
2,857,238, PUB. 4-6-2004. INT. CL. 30.
- ROYAL GORGE COMPANY OF COLORADO, CANON CITY, CO:
1,786,788, CANC. MULTIPLE CLASS, INT. CLS. 21, 41 AND 42.
- ROYAL ORTHODONTIC LABORATORIES INC., INDEPENDENCE, MO:
2,858,863, INT. CL. 35.
- ROYAL WINE CORPORATION, BAYONNE, NJ:
2,859,093, INT. CL. 33.
- RPM USA INC., CLINTON TOWNSHIP, MI:
2,087,897, CANC. INT. CL. 25.
- RUBY'S DINER, INC., NEWPORT BEACH, CA:
2,858,231, INT. CL. 42.
- RUDOLFO INCORPORATED, LAS VEGAS, NV:
2,087,348, CANC. INT. CL. 3.
- RUDOLPH FOODS COMPANY, INC., LIMA, OH:
1,833,944, REN. 5-21-04. INT. CL. 29.
- RUGBYTECH LIMITED, LIMERICK, IRELAND:
2,857,176, PUB. 4-6-2004. INT. CL. 28.
- RUSH UNIVERSITY MEDICAL CENTER, CHICAGO, IL:
2,857,918, PUB. 4-6-2004. MULTIPLE CLASS, INT. CLS. 21 AND 24.
- RUSSELL INFORMATION SCIENCES, INC., ALISO VIEJO, CA:
1,786,556, CANC. INT. CL. 9.
- RUSSELL T. GILMAN, INC., GRAFTON, WI:
1,786,492, CANC. INT. CL. 7.
- RUSSINA, BEVERLY, ST. LOUIS, MO:
2,858,024, PUB. 4-6-2004. INT. CL. 35.
- RUSTEN MARKETING GROUP, INC., MINNEAPOLIS, MN:
2,858,303, INT. CL. 42.
- RUUD LIGHTING, INC., RACINE, WI:
2,858,424, INT. CL. 6.
- RUYGROK, ELLYNN JOYCE, LA CRESCENTA, CA:
2,088,245, CANC. INT. CL. 16.
- RXPROVISIONS, INC., LINCOLN PARK, NJ:
2,087,611, CANC. MULTIPLE CLASS, INT. CLS. 16 AND 35.
2,087,612, CANC. INT. CL. 16.
- RYAN INTERNATIONAL CORPORATION, COLUMBUS, OH:
2,857,878, PUB. 4-6-2004. INT. CL. 9.
- RYBCZYNSKI, TERESA Z., DEARBORN HEIGHTS, MI:
2,087,248, CANC. INT. CL. 24.
- RYOBI AMERICA CORPORATION, ANDERSON, SC:
2,087,963, CANC. INT. CL. 7.
- RZ DESIGN, L.L.C., SOUTH FREEPORT, ME:
2,858,768, INT. CL. 25.
- S. A. ANCIENNE FABRIQUE GEORGES PIAGET ET CIE, 2117 LA COTE-AUX-FEES, SWITZERLAND:
2,857,121, PUB. 4-6-2004. INT. CL. 9.
- S. C. CHANG INC., SOUTH EL MONTE, CA:
2,087,376, CANC. INT. CL. 7.
- S.E.A. UTENSILI DIAMANTATI S.P.A., I-42023 CADELBOSSO SOPRA (REGGIO EMILIA), ITALY:
2,088,018, CANC. INT. CL. 7.
- S.H. LEGGITT, SAN MARCOS, TX:
2,086,760, CANC. MULTIPLE CLASS, INT. CLS. 6 AND 9.
- S.I.L.O. S.P.A. SOCIETA ITALIANA LAVORAZIONE ORO, CASTIGLION FIBOCCHI (AREZZO), ITALY:
2,086,743, CANC. INT. CL. 14.
- S&A RESTAURANT CORP., DALLAS, TX:
2,087,603, CANC. INT. CL. 42.
- SA SA OVERSEAS LIMITED, ROAD TOWN, TORTOLA, BR. VIRGIN ISLANDS:
2,857,114, PUB. 8-5-2003. MULTIPLE CLASS, INT. CLS. 3 AND 21.
- SABAN ENTERTAINMENT, INC., LOS ANGELES, CA:
2,087,858, CANC. INT. CL. 28.
- SABAN ENTERTAINMENT, INC., BURBANK, CA:
2,088,043, CANC. INT. CL. 25.
- SABAN ENTERTAINMENT, INC., LOS ANGELES, CA:
2,088,346, CANC. INT. CL. 28.
2,088,443, CANC. INT. CL. 28.
- SAES GETTERS, S.P.A. 20020 LAINATE(MI), ITALY:
2,088,072, CANC. INT. CL. 9.
- SAEZ, JOSE, MIAMI, FL:
2,859,101, INT. CL. 29.
- SAF DRIVE SYSTEMS LTD., KITCHENER, ONTARIO, CANADA:
1,786,561, CANC. MULTIPLE CLASS, INT. CLS. 9, 37 AND 42.
- SAFER, INC., NEWTON, MA:
1,247,465, CANC. INT. CL. 1.
- SAFER, INC., LITITZ, PA:
2,857,263, PUB. 4-15-2003. INT. CL. 21.
- SAFESHIP INTERNATIONAL, INC., GRAPEVINE, TX
FROM GH SENSORS, INC., LANSING, MI:
2,857,157, PUB. 4-6-2004. INT. CL. 39.
- SAGE INNOVATIONS GMBH, 80538 MUNICH, FED REP GERMANY:
2,739,609, COR. MULTIPLE CLASS, INT. CLS. 35 AND 42.
- SAKS & COMPANY, NEW YORK, NY:
2,087,119, CANC. INT. CL. 42.
- SALES/SERVICES, INC., CINCINNATI, OH:
1,247,910, CANC. INT. CL. 40.
- SALIENT CORPORATION, LONG BEACH, CA:
2,086,931, CANC. INT. CL. 42.
- SALLY BEAUTY COMPANY, DENTON, TX:
2,087,796, CANC. INT. CL. 3.
- SALON SCIENCES, INC., CORAL SPRINGS, FL TO SALON SCIENCES, CORPORATION, FT. LAUDERDALE, FL:
1,787,315, CANC. INT. CL. 3.
- SAMCO SCIENTIFIC CORPORATION, SAN FERNANDO, CA:
1,275,931, REN. 5-21-04. INT. CL. 9.
- SAMSON INFORMATION TECHNOLOGIES LLC, REGO PARK, NY:
2,088,257, CANC. INT. CL. 9.
- SAMSUNG ELECTRONICS CO., LTD., KYUNGKI-DO, REPUBLIC OF KOREA:
2,858,566, INT. CL. 9.
- SAN DIEGO COUNTY TAXPAYERS ASSOCIATION, SAN DIEGO, CA:
2,857,591, PUB. 4-6-2004. INT. CL. 35.
- SAN GEMINIANO ITALIA - S.C. A R.L., CAMPOGALLIANO (MODENA), ITALY:
2,087,511, CANC. INT. CL. 32.
- SANCHEZ, DARRELL, BOULDER, CO:
2,087,753, CANC. INT. CL. 28.
- SANCO SYSTEMS, LLC, OVIEDO, FL:
2,858,087, PUB. 4-6-2004. INT. CL. 39.
- SANDATA, INC., PORT WASHINGTON, NY:
1,786,600, CANC. INT. CL. 9.
- SANDHILLS, INC., WILMINGTON, DE:
2,088,093, CANC. INT. CL. 42.
- SANDY HAGEN'S JAZZ DANCE CENTER, INC., BOSTON, MA, DBA SANDY HAGEN'S JAZZ DANCE CENTER:
1,247,940, CANC. INT. CL. 41.
- SANKYO COMPANY, LIMITED, CHUO-KU, TOKYO, JAPAN:
2,857,210, PUB. 4-6-2004. MULTIPLE CLASS, INT. CLS. 1 AND 5.
- SANOFI, 75008 PARIS, FRANCE:
2,087,325, CANC. INT. CL. 5.
- SAP AKTIENGESELLSCHAFT, D-69190 WALLDORF, FED REP GERMANY:
2,086,709, CANC. MULTIPLE CLASS, INT. CLS. 9, 16, 41 AND 42.
- SAPLING CORPORATION, MISSISSAUGA, ONTARIO, CANADA:
1,786,523, CANC. MULTIPLE CLASS, INT. CLS. 9 AND 41.

- SARA LEE CORPORATION, WINSTON-SALEM, NC:
2,088,091, CANC. INT. CL. 25.
2,088,256, CANC. INT. CL. 25.
2,858,091, PUB. 4-6-2004. INT. CL. 25.
- SARAMAR CORPORATION, WILMINGTON, DE:
1,247,499, CANC. INT. CL. 3.
- SARAMAR CORPORATION, DOVER, DE TO SARAMAR LLC, CHICAGO, IL:
1,787,477, CANC. INT. CL. 16.
- SARATOGA PROPERTIES, INC., NORFOLK, VA:
2,088,173, CANC. INT. CL. 42.
- SARGENT, JIM W. III, FLORENCE, AL, DBA SARGENT COMPANY/SARCO:
1,786,498, CANC. INT. CL. 8.
- SARGENTO FOODS INC., PLYMOUTH, WI:
2,087,370, CANC. MULTIPLE CLASS, INT. CLS. 40 AND 42.
- SARGENTO INCORPORATED, PLYMOUTH, WI:
1,787,570, CANC. INT. CL. 29.
- SAS INSTITUTE INC., CARY, NC:
1,787,120, CANC. INT. CL. 41.
- SAVE THE CHILDREN FEDERATION, INC., WESTPORT, CT:
1,787,055, CANC. INT. CL. 36.
- SAVE-A-LOT FOOD STORES, INC., EARTH CITY, MO, MORAN FOODS, INC., ST. LOUIS, MO:
1,829,920, REN. 5-20-04. INT. CL. 29.
- SAXE, CHARLES C., CAMARILLO, CA:
2,858,336, INT. CL. 1.
- SAYRE ENTERPRISES, INC., BUENA VISTA, VA:
2,858,830, INT. CL. 24.
- SC FULFIL LIMITED, CENTRAL, HONG KONG:
2,858,357, INT. CL. 39.
2,858,358, INT. CL. 39.
- SCANLON PLAN ASSOCIATES, LANSING, MI:
1,247,875, CANC. INT. CL. 35.
- SCARBOROUGH AND COMPANY, INC., MILFORD, NH:
1,247,960, CANC. INT. CL. 42.
- SCATTERDAY, RICK, PLACENTIA, CA AND HARVEY, ANDREW, PLACENTIA, CA:
2,858,491, INT. CL. 36.
- SCHERING CORPORATION, KENILWORTH, NJ:
1,269,601, REN. 5-15-04. INT. CL. 5.
- SCHERING-PLOUGH HEALTHCARE PRODUCTS, INC., MEMPHIS, TN:
2,088,179, CANC. INT. CL. 9.
- SCHIEFFELIN & CO., NEW YORK, NY:
980,477, REN. 5-19-04. U.S. CL. 47 (INT. CL. 33).
- SCHIEFFELIN, LINDSAY, IRVING, TX:
2,858,342, INT. CL. 41.
- SCHINDLER AUFZUGE AG, 6030 EBIKON, SWITZERLAND:
2,857,266, PUB. 4-6-2004. INT. CL. 16.
- SCHLASINGER, ANNETTE, MINNETONKA, MN, DBA MAGNETIC GOODIES:
1,832,655, REN. 5-18-04. INT. CL. 9.
- SCHLUMBERGER INDUSTRIES, INC., NORCROSS, GA:
2,087,012, CANC. MULTIPLE CLASS, INT. CLS. 9 AND 16.
- SCHNEE-MOREHEAD BUSINESS TRUST, IRVING, TX:
2,858,622, INT. CL. 17.
- SCHNUCK MARKETS, INC., ST. LOUIS, MO:
2,857,680, PUB. 4-6-2004. INT. CL. 32.
- SCHOLL, INC., MEMPHIS, TN:
754,737, CANC. U.S. CL. 44.
- SCHOOL HEALTH CORPORATION, HANOVER PARK, IL:
2,088,021, CANC. INT. CL. 42.
- SCHROEDER & TREMAYNE, INC., ST. LOUIS, MO, GARDEN BOTANIK A, INC., REDMOND, WA:
1,775,680, REN. 5-21-04. INT. CL. 3.
- SCHULSTAD FROST A/S, 7500 HOLSTEBRO, DENMARK:
2,086,831, CANC. INT. CL. 30.
- SCHWAN, BRAD, SAN LUIS OBISPO, CA:
1,787,203, CANC. INT. CL. 42.
- SCHWARTZ, AMY MILLER, DAVENPORT, IA:
2,086,723, CANC. MULTIPLE CLASS, INT. CLS. 9 AND 41.
- SCIAGE DU BERRY, 36290 MEZIERES EN BRENNE, FRANCE:
2,857,822, PUB. 4-6-2004. MULTIPLE CLASS, INT. CLS. 30 AND 31.
- SCIENTIFIC COMPONENTS CORP., BROOKLYN, NY:
1,834,128, REN. 5-20-04. INT. CL. 42.
- SCIENTIFIC SOFTWARE TOOLS, INC., MEDIA, PA:
2,857,592, PUB. 4-6-2004. INT. CL. 38.
- SCIENTIFIC-ATLANTA, INC., NORCROSS, GA:
2,087,958, CANC. INT. CL. 9.
- SCIOMICS, LLC, FORT WORTH, TX:
2,858,035, PUB. 4-6-2004. INT. CL. 42.
- SCLAFANI, PAUL, WESTON, FL:
2,857,241, PUB. 4-6-2004. INT. CL. 28.
- SCM MICROSYSTEMS, INC., FREMONT, CA:
2,857,216, PUB. 4-6-2004. INT. CL. 9.
- SCOTT PLASTICS CO., SARASOTA, FL:
1,247,708, CANC. INT. CL. 20.
- SCOTTISH & NEWCASTLE PLC, EDINBURGH EH12 6HX, SCOTLAND:
2,857,325, PUB. 4-6-2004. INT. CL. 32.
- SCRIPTURE FROM SCRATCH, BILLINGS, MT:
2,857,188, PUB. 4-6-2004. INT. CL. 41.
- SCT CORPORATION, BALTIMORE, MD, TA JEPPI NUT CO.:
1,786,893, CANC. INT. CL. 29.
- SCUDDER TRUST COMPANY, SALEM, NH:
2,857,774, PUB. 4-6-2004. INT. CL. 41.
- SEA WORLD, INC., ST. LOUIS, MO:
1,853,881, REN. 5-21-04. INT. CL. 41.
- SEARS BRANDS, LLC, HOFFMAN ESTATES, IL:
1,275,031, REN. 5-17-04. INT. CL. 11.
1,779,400, REN. 5-21-04. MULTIPLE CLASS, INT. CLS. 36 AND 37.
2,858,971, INT. CL. 35.
- SECURE COMPUTING CORPORATION, ROSEVILLE, MN:
2,857,778, PUB. 4-6-2004. INT. CL. 9.
- SECURITY BENEFIT LIFE INSURANCE COMPANY, TOPEKA, KS:
2,858,045, PUB. 4-6-2004. INT. CL. 36.
- SECURITY FIRST GROUP, INC., LOS ANGELES, CA:
2,086,858, CANC. INT. CL. 36.
- SEED DYNAMICS INCORPORATED, SALINAS, CA:
2,857,367, PUB. 4-6-2004. INT. CL. 42.
2,857,368, PUB. 4-6-2004. INT. CL. 42.
2,857,369, PUB. 4-6-2004. INT. CL. 42.
- SEEDMAN, JACOB, GARDEN GROVE, CA:
2,228,780, NEW CERT. 6-29-2004. INT. CL. 25.
- SEELEY, LARRY E., NEW PORT RICHEY, FL:
2,088,292, CANC. INT. CL. 11.
- SEER TECHNOLOGIES, INC., CARY, NC:
2,086,841, CANC. INT. CL. 9.
- SEGA OF AMERICA, INC., REDWOOD CITY, CA:
2,088,037, CANC. INT. CL. 28.
- SEGEL, MARVIN L., KING OF PRUSSIA, PA:
2,857,673, PUB. 4-6-2004. INT. CL. 41.
- SELCHOW & RIGHTER COMPANY, AVON, CT:
1,247,796, CANC. INT. CL. 28.
- SEMICONDUCTOR EQUIPMENT AND MATERIALS INTERNATIONAL, SAN JOSE, CA:
2,857,911, PUB. 4-6-2004. MULTIPLE CLASS, INT. CLS. 16, 35, 36 AND 41.
- SEMPRA ENERGY, SAN DIEGO, CA:
2,858,908, INT. CL. 39.
- SENN, J. MICHAEL, GREER, SC:
2,857,856, PUB. 4-6-2004. INT. CL. 43.
- SEQUIM TECHNOLOGIES INCORPORATED, SEQUIM, WA:
2,087,994, CANC. INT. CL. 10.
- SERA GMBH, HEINSBERG, FED REP GERMANY:
2,859,014, INT. CL. 11.
- SERPENTIX CONVEYOR CORPORATION, WESTMINSTER, CO:
2,087,023, CANC. INT. CL. 7.
- SERVICE LIFE & CASUALTY INSURANCE CO., AUSTIN, TX:
2,087,634, CANC. INT. CL. 41.

- SERVICE MERCHANDISE COMPANY, INC., BRENTWOOD, TN:
2,086,877, CANC. INT. CL. 14.
- SERVICEMASTER BRANDS, L.L.C., BURLINGTON, VT:
2,120,965, AM. INT. CL. 37.
- SERVICIOS CORPORATIVOS DE ADMINISTRACION G.M.Z., S.A. DE C.V., COL. DEL VALLE, C.P. 03100, MEXICO, D.F. MEXICO:
2,858,387, INT. CL. 1.
- SERVICIOS CORPORATIVOS DE ADMINISTRACION G.M.Z., S.A. DE C.V., MEXICO, D.F. MEXICO:
2,858,388, INT. CL. 16.
- SERVICIOS CORPORATIVOS DE ADMINISTRACION G.M.Z., S.A. DE C.V., COL. DEL VALLE, C.P. 03100, MEXICO:
2,858,399, INT. CL. 1.
- SERVICIOS CORPORATIVOS DE ADMINISTRACION G.M.Z., S.A. DE C.V., COL. DEL VALLE, C.P. 03100, MEXICO, D.F. MEXICO:
2,858,400, INT. CL. 16.
- SERVPRO INDUSTRIES, INC., GALLATIN, TN:
2,087,437, CANC. INT. CL. 9.
- SGC COMMUNICATION RESOURCES, LLC, SAN FRANCISCO, CA, AMERICAN SCHOOL OF SKILLS, INC., NEW YORK, NY, DBA THE LEARNING ANNEX:
1,233,095, REN. 5-20-04. INT. CL. 41.
- SGL CARBON, LLC, CHARLOTTE, NC:
1,270,448, REN. 5-17-04. INT. CL. 1.
- SHADY MAPLE FARM, LTD., MISSISSAUGA, ONTARIO, CANADA:
2,857,136, PUB. 9-12-2000. INT. CL. 30.
- SHAHINIAN, LEE, JR., LOS ALTOS, CA:
2,087,679, CANC. INT. CL. 5.
- SHAKE, SABU, JR., MONTEREY, CA:
2,087,993, CANC. INT. CL. 25.
- SHAKLEE CORPORATION, SAN FRANCISCO, CA:
1,787,193, CANC. INT. CL. 42.
- SHALOM INTERNATIONAL CORPORATION, CARTERETTE, NJ:
2,857,359, PUB. 4-6-2004. MULTIPLE CLASS, INT. CLS. 25 AND 26.
- SHAMROCK FOODS COMPANY, PHOENIX, AZ:
1,848,810, REN. 5-20-04. MULTIPLE CLASS, INT. CLS. 2, 29 AND 30.
- SHANDAGGAN FARM, INC., JACKSON CENTER, PA:
2,129,439, CANC. MULTIPLE CLASS, INT. CLS. 29 AND 30.
- SHARE OUR STRENGTH, WASHINGTON, DC:
1,817,131, REN. 5-15-04. INT. CL. 36.
- SHARK TV, INC., SAN ANTONIO, TX:
1,874,150, REN. 5-20-04. INT. CL. 35.
- SHARLACH, JEFFREY R., MIAMI BEACH, FL:
1,882,454, REN. 5-20-04. INT. CL. 35.
- SHARP KABUSHIKI KAISHA, OSAKA 545-8522, JAPAN, TA SHARP CORPORATION:
2,800,551, COR. INT. CL. 9.
2,858,691, INT. CL. 11.
- SHARRON, LOWELL, LOS ANGELES, CA:
2,857,713, PUB. 4-6-2004. INT. CL. 25.
- SHAUN PALMER LTD., CH-8865- BILTEN, SWITZERLAND:
2,857,248, PUB. 6-24-2003. MULTIPLE CLASS, INT. CLS. 3, 9, 14, 16, 18, 25 AND 28.
- SHAVERS, MARY JAYE, MILLERSVILLE, MD:
2,087,499, CANC. INT. CL. 35.
- SHAW INDUSTRIES GROUP, INC., DALTON, GA:
2,807,229, COR. INT. CL. 9.
- SHAW INDUSTRIES, INC., DALTON, GA:
2,087,102, CANC. INT. CL. 27.
- SHAW, JAMES G., BEND, OR, DBA SHAW RESOURCES:
1,836,994, REN. 5-20-04. INT. CL. 35.
- SHAW, ROBERT, CHINESE CAMP, CA AND SHAW, KATHERINE, CHINESE CAMP, CA:
2,087,477, CANC. INT. CL. 42.
- SHAY, JANET, GLENDALE, AZ:
2,858,448, INT. CL. 41.
- SHELL OIL COMPANY, HOUSTON, TX:
2,858,210, INT. CL. 1.
- SHELTER-PRO, LLC, STEARNS, KY:
2,858,102, PUB. 4-6-2004. INT. CL. 19.
- SHEPARD NILES, INC., LATROBE, PA:
738,553, REN. 5-21-04. U.S. CL. 23 (INT. CL. 7).
- SHERIDAN NURSERIES LIMITED, GEORGETOWN, ONTARIO, CANADA:
1,838,046, REN. 5-19-04. INT. CL. 31.
- SHERWIN-WILLIAMS COMPANY, THE, CLEVELAND, OH:
1,247,473, CANC. INT. CL. 2.
- SHIMANO INC., SAKAI, OSAKA, JAPAN:
2,858,952, INT. CL. 12.
- SHINSEI CORPORATION, CERRITOS, CA:
1,247,784, CANC. INT. CL. 28.
- SHIPE, SUSAN, FRAMINGHAM, MA:
1,787,683, CANC. INT. CL. 14.
- SHIPLEY COMPANY, L.L.C., MARLBOROUGH, MA:
2,088,325, CANC. INT. CL. 1.
2,088,326, CANC. INT. CL. 1.
- SHYLA INC., CROTON FALLS, NY:
2,087,882, CANC. INT. CL. 25.
2,087,885, CANC. INT. CL. 25.
- SIEMENS AKTIENGESSELLSCHAFT, MUNCHEN, FED REP GERMANY:
2,857,295, PUB. 4-6-2004. INT. CL. 9.
- SIEMENS MEDICAL SOLUTIONS USA, INC., MALVERN, PA:
2,858,816, INT. CL. 9.
- SIERRA CLUB, SAN FRANCISCO, CA:
2,858,534, INT. CL. 36.
- SIGALLO LTD., NEW YORK, NY:
1,247,765, CANC. INT. CL. 25.
- SIGNITZER, PAUL ALLEN, BRISBANE, QUEENSLAND, AUSTRALIA AND FOGARTY, MICHAEL ROBERT, BRAY PARK, QUEENSLAND, AUSTRALIA AND FOGARTY, ANDREW MARK, INNISFAIL, QUEENSLAND, AUSTRALIA:
2,858,707, INT. CL. 28.
- SILICON LABORATORIES, INC., AUSTIN, TX:
2,858,341, INT. CL. 9.
- SILVERLINE PICTURES, INC., STUDIO CITY, CA:
2,086,819, CANC. INT. CL. 41.
2,086,822, CANC. INT. CL. 41.
- SIMMONS, HENRY JR., SAN JOSE, CA, DBA KIDS LAB:
2,088,082, CANC. MULTIPLE CLASS, INT. CLS. 9 AND 42.
- SIMMONS, WALTER, CHICAGO, IL:
2,087,684, CANC. INT. CL. 36.
- SIMOWICZ ENTERPRISES, INC., AVENTURA, FL:
2,088,445, CANC. INT. CL. 25.
- SIMPSON PAPER COMPANY, SEATTLE, WA:
2,088,360, CANC. INT. CL. 16.
- SING, DAVID, FRANKLIN, TN:
2,858,515, MULTIPLE CLASS, INT. CLS. 15 AND 40.
- SINGH, HARTEJ, LIVINGSTON, NJ:
2,858,967, INT. CL. 41.
- SIPCO PUBLICATIONS, INC., BRIARCLIFF MANOR, NY:
1,787,136, CANC. INT. CL. 41.
- SIPIX GROUP LIMITED, BRITISH A. CENTRE, GRAND CAYMAN, CAYMAN ISLANDS:
2,857,435, PUB. 4-6-2004. INT. CL. 9.
- SIR SPEEDY, INC., MISSION VIEJO, CA:
2,087,019, CANC. MULTIPLE CLASS, INT. CLS. 35 AND 42.
- SIRS PUBLISHING, INC., BOCA RATON, FL:
2,857,472, PUB. 4-6-2004. INT. CL. 42.
- SISTEMALUX INC., QUEBEC, CANADA:
2,087,356, CANC. INT. CL. 11.
- SIX FLAGS THEME PARKS INC., PARSIPPANY, NJ:
2,088,377, CANC. INT. CL. 21.
- SIXP.AG, D-73525 SCHWAEBISCH GMUEND, FED REP GERMANY:
2,857,360, PUB. 4-6-2004. MULTIPLE CLASS, INT. CLS. 10, 35 AND 42.
- SKANDIA FOODS, INC., ARLINGTON HEIGHTS, IL:
2,086,715, CANC. MULTIPLE CLASS, INT. CLS. 29 AND 30.
- SKATE 2000 (U.S.A.) INC., MIAMI BEACH, FL:
2,087,676, CANC. INT. CL. 35.

- SKB CORPORATION, ORANGE, CA:
1,829,359. REN. 5-18-04. MULTIPLE CLASS, INT. CLS. 15 AND 18.
- SKILLSOFT CORPORATION, NASHUA, NH:
2,667,976. COR. INT. CL. 42.
- SKLAROFF BROTHERS, INC., PHILADELPHIA, PA TO SKLAROFF COMPANY, HE, PHILADELPHIA, PA:
1,216,803. CANC. INT. CL. 25.
- SKUNK STUDIOS, LLC, REDWOOD CITY, CA:
2,857,859. PUB. 4-6-2004. INT. CL. 9.
- SKYJACK INC., GUELPH, ONTARIO N1H 1B9, CANADA:
2,858,647. INT. CL. 7.
- SKYLINE CORPORATION, ELKHART, IN:
1,320,729. REN. 5-20-04. INT. CL. 19.
- SKYMARK INCORPORATED, SILVER SPRINGS, FL:
2,858,699. INT. CL. 35.
- SL ENVIRONETICS GROUP INCORPORATED, LOS ANGELES, CA:
2,717,335. AM. INT. CL. 42.
- SLADE, JOHN, METUCHEN, NJ:
2,087,671. CANC. INT. CL. 41.
- SLANT-SIX CLOTHING INC., RICHMOND BRITISH COLUMBIA, CANADA:
2,857,198. PUB. 4-6-2004. INT. CL. 25.
- SLEEP OPTIONS, INC., CINCINNATI, OH:
2,088,216. CANC. INT. CL. 20.
- SLEEPTech, LLC, KINNELON, NJ:
2,857,496. PUB. 4-6-2004. INT. CL. 44.
- SMALLEY RELATIONSHIP CENTER, BRANSON, MO:
2,859,061. INT. CL. 16.
- SME ASSOCIATES, LLC, FENTON, MO:
2,858,505. MULTIPLE CLASS, INT. CLS. 35 AND 43.
- SMEDLEY FINANCIAL SERVICES, INC., SALT LAKE CITY, UT:
2,858,242. INT. CL. 16.
- SMERIK, RANDY, POWAY, CA:
2,835,521. CANC. IIRN. RESTORED TO S.N. 78-975,256.
- SMI HOME PRODUCTS, INC., GLEN GARDNER, NJ:
2,857,832. PUB. 4-6-2004. INT. CL. 11.
- SMILE ACUPUNCTURE CLINIC, INC., LOS ANGELES, CA:
2,858,119. PUB. 4-6-2004. INT. CL. 44.
- SMITH & LOVELESS, INC., LENEXA, KS:
1,820,654. REN. 5-21-04. INT. CL. 21.
- SMITH & NEPHEW RICHARDS, INC., MEMPHIS, TN:
2,088,099. CANC. INT. CL. 10.
- SMITH & NEPHEW, INC., MEMPHIS, TN, ACUFEX MICRO-SURGICAL, INC., MANSFIELD, MA:
1,838,395. REN. 5-16-04. INT. CL. 10.
- SMITH & NEPHEW, INC., MEMPHIS, TN:
2,858,227. INT. CL. 10.
- SMITH & VANDIVER, INC., WATSONVILLE, CA:
2,087,806. CANC. INT. CL. 3.
- SMITH, ELIZABETH F., BETHEL, CT:
2,857,399. PUB. 4-6-2004. MULTIPLE CLASS, INT. CLS. 31 AND 40.
- SMITH, WILLIAM H.:
See—LA JOTA VINEYARD & WINERY LLC.
- SMITHKLINE BEECHAM CORPORATION, PHILADELPHIA, PA:
2,087,889. CANC. INT. CL. 21.
2,858,712. INT. CL. 35.
2,858,822. INT. CL. 5.
2,858,823. INT. CL. 5.
- SMITHKLINE BEECHAM PLC, BRENTFORD MIDDLESEX TW8 9EP, ENGLAND:
1,787,166. CANC. INT. CL. 42.
- SMOKE GUARD CORPORATION, BOISE, ID:
1,837,771. REN. 5-16-04. INT. CL. 9.
- SMOOTH SAILING BEVERAGE COMPANY, BELLINGHAM, WA:
2,087,413. CANC. INT. CL. 32.
- SMS PARTNERS, LLC, TAMPA, FL:
2,858,099. PUB. 4-6-2004. INT. CL. 25.
- SNIDER, TODD, NASHVILLE, TN:
2,087,722. CANC. INT. CL. 41.
- SNOUFFER, CHET A., DELAWARE, OH:
2,087,136. CANC. INT. CL. 28.
- SOARING HELMET CORPORATION, TUKWILA, WA:
2,087,637. CANC. INT. CL. 9.
- SOBIK'S SANDWICH SHOPS, INC., LONGWOOD, FL:
2,087,639. CANC. INT. CL. 42.
- SOCIAL DISTORTION II, LAGUNA BEACH, CA:
1,700,903. REN. 5-21-04. INT. CL. 41.
- SOCIETA COMMERCIALE MISTERE S.R.L., 21051 ARCI-SATE, ITALY:
2,088,270. CANC. INT. CL. 25.
- SOCIETA' APOSTOLATO SAN PAOLO S.R.L., 12051 ALBA (CUNEO), ITALY:
1,776,469. REN. 5-20-04. MULTIPLE CLASS, INT. CLS. 16 AND 41.
- SOCIETE DES FOURS A CHAUX D'AUMAILE, 75001 PARIS, FRANCE:
2,086,916. CANC. MULTIPLE CLASS, INT. CLS. 1 AND 31.
- SOCIETE DES PRODUITS NESTLE, S.A., 1800 VEVEY, SWITZERLAND:
1,247,824. CANC. INT. CL. 30.
- SOCIETE DIAGNOSTICA-STAGO, ASNIERES, FRANCE:
2,857,851. PUB. 4-6-2004. INT. CL. 5.
- SOCIETE EUROSURGICAL S.A., 62217 BEAURAINS, FRANCE:
2,857,348. PUB. 4-6-2004. MULTIPLE CLASS, INT. CLS. 10 AND 44.
- SOCIETY FOR THE PRESERVATION OF FEDERAL HILL AND FELS POINT, INC., THE, BALTIMORE, MD:
1,829,690. REN. 5-16-04. INT. CL. 42.
- SOCIETY OF AMERICAN FORESTERS, BETHESDA, MD:
2,857,453. PUB. 4-6-2004. U.S. CL. B.
- SOCIETY OF THE PLASTICS INDUSTRY, INC.; , THE, WASHINGTON, DC:
1,272,226. REN. 5-20-04. INT. CL. 42.
1,272,247. REN. 5-15-04. U.S. CL. 200.
- SODEXHO OPERATIONS, LLC, GAITHERSBURG, MD:
2,858,784. INT. CL. 43.
2,858,850. MULTIPLE CLASS, INT. CLS. 35, 36 AND 43.
2,858,855. MULTIPLE CLASS, INT. CLS. 35, 36 AND 43.
- SOFTEX FUR SUPPLIES INC., NEW YORK, NY:
2,857,518. PUB. 4-6-2004. INT. CL. 3.
- SOFTGENETICS, LLC, STATE COLLEGE, PA:
2,858,108. PUB. 4-6-2004. INT. CL. 9.
- SOFTWARE TESTING GROUP INC., REDMOND, WA, DBA TRADITIONAL SPIRIT PRODUCTS:
2,859,062. INT. CL. 33.
- SOHNLEIN RHEINGOLD KG, D-65187 WIESBADEN, FED REP GERMANY:
2,087,324. CANC. MULTIPLE CLASS, INT. CLS. 32 AND 33.
- SOLENO TEXTILES TECHNIQUES, INC., LAVAL, PROVINCE OF QUEBEC, H7L 3Z1, CANADA:
2,858,402. INT. CL. 19.
- SOLVAY (SOCIETE ANONYME), BRUSSELS, BELGIUM:
2,857,158. PUB. 4-6-2004. MULTIPLE CLASS, INT. CLS. 1, 40 AND 42.
- SOLVAY PHARMACEUTICALS B.V., WEESP, NETHERLANDS:
2,857,398. PUB. 4-6-2004. INT. CL. 5.
- SONIA DI MARIA, PHOENIX, AZ AND SANDRO DI MARIA, VIA MALASPINNA 3/MILANO, ITALY AND SERGIO DI MARIA, VIA MALASPINNA 3/MILANO, ITALY:
2,859,048. INT. CL. 26.
- SONIC SOLUTIONS, NOVATO, CA:
2,857,792. PUB. 4-6-2004. MULTIPLE CLASS, INT. CLS. 9, 41 AND 42.
- SONOCO PRODUCTS COMPANY, HARTSVILLE, SC:
754,393. CANC. U.S. CL. 2.
- SONY INTERACTIVE ENTERTAINMENT INC., NEW YORK, NY:
2,088,365. CANC. INT. CL. 28.
2,088,404. CANC. INT. CL. 28.
2,088,405. CANC. INT. CL. 28.
- SONY KABUSHIKI KAISHA, TOKYO, JAPAN, TA SONY CORPORATION:
2,088,089. CANC. INT. CL. 9.

- SONY KABUSHIKI KAISHA, TOKYO 141, JAPAN, TA SONY CORPORATION:
2,858,299, INT. CL. 9.
- SOPHIE HONG FASHION CO., LTD., TAIPEI, TAIWAN:
2,858,480, INT. CL. 14.
- SORENSEN ASSOCIATES INC, TROUTDALE, OR:
2,087,681, CANC. INT. CL. 35.
- SORENSEN BIOSCIENCE, INC., SALT LAKE CITY, UT:
1,787,436, CANC. INT. CL. 10.
- SOUTH BEACH BEVERAGE COMPANY, INC., NORWALK, CT:
2,858,429, INT. CL. 32.
- SOUTHERN ESCROW & TITLE, LLC, DESTIN, FL:
2,857,959, PUB. 4-6-2004. INT. CL. 42.
- SOUTHERN SCRAP MATERIAL COMPANY, INC., BATON ROUGE, LA TO SXX, L.C., NEW ORLEANS, LA:
1,786,995, CANC. INT. CL. 35.
- SOUTHERN STATES COOPERATIVE, INCORPORATED, RICHMOND, VA:
1,264,470. REN. 5-20-04. MULTIPLE CLASS, INT. CLS. 37 AND 42.
- SOUTHLAND NATIONAL INSURANCE CORPORATION, TUSCALOOSA, AL:
2,858,001, PUB. 4-6-2004. INT. CL. 45.
- SOYO COMPUTER INC., HSING CHUANG CITY, TAIPEI HSIEN, TAIWAN:
2,857,619, PUB. 4-6-2004. INT. CL. 9.
- SPACE UPDATE, INC, HOUSTON, TX:
2,857,794, PUB. 4-6-2004. INT. CL. 9.
- SPACESAVER CORPORATION, FORT ATKINSON, WI:
2,858,350, MULTIPLE CLASS, INT. CLS. 9 AND 20.
- SPANG & COMPANY, BUTLER, PA:
2,834,738, CANC. IIRN. RESTORED TO S.N. 75-752,742.
- SPARK NETWORK SERVICES, INC., EVANSTON, IL:
2,858,247, INT. CL. 42.
- SPARKNOTES LLC, NEW YORK, NY:
2,857,618, PUB. 4-6-2004. INT. CL. 16.
- SPARKS EXHIBITS & ENVIRONMENTS CORP., PHILADELPHIA, PA:
2,857,853, PUB. 4-6-2004. MULTIPLE CLASS, INT. CLS. 37 AND 42.
- SPECIAL LIBRARIES ASSOCIATION, WASHINGTON, DC:
2,087,479, CANC. INT. CL. 16.
- SPECIALITY HOSPITALS OF AMERICA, INC., LA MIRADA, CA:
2,088,355, CANC. INT. CL. 42.
- SPECIALIZED BICYCLE COMPONENTS, INC., MORGAN HILL, CA:
1,323,102. REN. 5-21-04. INT. CL. 12.
- SPECIALTY PRODUCTS & SERVICES, INC., SAN JOSE, CA:
2,857,969, PUB. 4-6-2004. INT. CL. 19.
- SPECTRA-PHYSICS LASERS, INC., MOUNTAIN VIEW, CA:
2,087,997, CANC. INT. CL. 9.
- SPECTRALFUSION, INC., FEASTERVILLE, PA:
2,858,667, INT. CL. 5.
- SPECTRIAN CORPORATION:
See—ULTRARF, INC.
- SPEED-TRAP.COM LIMITED, NEWBURY, BERKSHIRE, UNITED KINGDOM:
2,857,166, PUB. 4-6-2004. MULTIPLE CLASS, INT. CLS. 9, 35, 38 AND 42.
- SPENCE, SEILA MORGAN, BLACKSTONE, VA:
2,088,357, CANC. INT. CL. 16.
- SPICE ENTERTAINMENT, INC., CHICAGO, IL:
2,858,090, PUB. 4-6-2004. INT. CL. 10.
- SPICE MARKET, INC., BROOKLYN, NY:
2,087,536, CANC. INT. CL. 3.
- SPINEVISION S.A., 75012 PARIS, FRANCE:
2,857,222, PUB. 9-30-2003. INT. CL. 10.
- SPORNETTE INTERNATIONAL, INC., HOMEWOOD, IL:
2,857,445, PUB. 4-6-2004. INT. CL. 21.
- SPORTFOLIO LIMITED, RUGBY CV21 3BD, ENGLAND:
1,787,431, CANC. INT. CL. 9.
- SPORTMART INC., NILES, IL:
2,086,744, CANC. INT. CL. 42.
- SPORTSMEDIA TECHNOLOGY CORPORATION, DURHAM, NC:
2,088,007, CANC. INT. CL. 41.
- SPR-VINHOS, S.A., CAMBRES, LAMEGO, PORTUGAL, ED. ROZES, GUY ET YVES ROZES SUCCESSIONS, EPERNAY (MARNE), FRANCE:
1,273,022. REN. 5-17-04. INT. CL. 33.
- SPRIGLE, DAVID, SANTA MONICA, CA:
2,087,781, CANC. INT. CL. 16.
- SPRING LEOPARD, LLC, NEW YORK, NY:
2,857,715, PUB. 4-6-2004. INT. CL. 43.
- ST. CLAIR ENTERTAINMENT GROUP INC., THE, ST. LAURENT, QUEBEC, CANADA:
2,086,855, CANC. INT. CL. 9.
- ST. LOUIS COUNTY DEPARTMENT OF HIGHWAYS AND TRAFFIC, ST. LOUIS, MO:
2,087,117, CANC. INT. CL. 37.
- STA-RITE INDUSTRIES, INC., MILWAUKEE, WI:
767,494. REN. 5-18-04. U.S. CL. 23 (INT. CL. 7).
- STADLER, DAVID M., LATHRUP VILLAGE, MI:
2,858,790, INT. CL. 6.
- STANDARD MOTOR PRODUCTS, INC., LONG ISLAND CITY, NY:
979,893. REN. 5-16-04. U.S. CL. 23 (INT. CL. 12).
1,831,074. REN. 5-19-04. INT. CL. 7.
- STANDARD PACIFIC CORP., IRVINE, CA:
2,857,609, PUB. 4-6-2004. INT. CL. 36.
- STANLEY H. KAPLAN EDUCATIONAL CENTER LTD., NEW YORK, NY:
2,087,285, CANC. MULTIPLE CLASS, INT. CLS. 9 AND 41.
- STANLEY WORKS, THE, NEW BRITAIN, CT:
2,086,714, CANC. MULTIPLE CLASS, INT. CLS. 8, 9 AND 16.
- STAR COMPANY LIMITED, BIRMINGHAM, UNITED KINGDOM:
2,857,824, PUB. 4-6-2004. MULTIPLE CLASS, INT. CLS. 9, 38 AND 41.
- STAR INDUSTRIES, INC., SYOSSET, NY:
2,858,630, INT. CL. 33.
- STAR-BRITE DISTRIBUTING, INC., FORT LAUDERDALE, FL:
2,857,657, PUB. 4-6-2004. INT. CL. 3.
- STAR-TELEGRAM OPERATING, LTD., FORT WORTH, TX:
1,787,687, CANC. INT. CL. 16.
- STAR, SONIA, CUPERTINO, CA:
2,086,739, CANC. INT. CL. 41.
- STARKEY LABORATORIES, INC., EDEN PRAIRIE, MN:
1,685,170. REN. 5-18-04. INT. CL. 10.
- STARLINE PUBLICATIONS, INC., POUGHKEEPSIE, NY:
2,858,085, PUB. 4-6-2004. INT. CL. 16.
- STATE AND FEDERAL ASSOCIATES, INC., ALEXANDRIA, VA:
2,087,359, CANC. INT. CL. 35.
- STEBCO PRODUCTS CORPORATION, CHICAGO, IL:
1,786,761, CANC. INT. CL. 18.
- STEFANEL S.P.A., TREVISO, ITALY, MAGLIFICIO PIAVE S.P.A., PONTE DI PIAVE, ITALY:
1,279,935. REN. 5-20-04. INT. CL. 25.
- STEIN, GUILLERMO ALBERTO, NORTH BAY VILLAGE, FL:
2,857,318, PUB. 4-6-2004. MULTIPLE CLASS, INT. CLS. 35 AND 42.
- STEINER COMPANY, INC., CHICAGO, IL:
1,786,664, CANC. MULTIPLE CLASS, INT. CLS. 11 AND 20.
- STEPMIND, 92130 ISSY LES MOULINEAUX, FRANCE:
2,857,770, PUB. 8-12-2003. MULTIPLE CLASS, INT. CLS. 9 AND 38.
- STERLING PLASTICS CO., MADISON, WI:
2,087,808, CANC. INT. CL. 16.
- STEVENSON, ROBERT W., GLENDALE, CA:
2,834,824, CANC. IIRN. RESTORED TO S.N. 76-092,869.
- STICKERPOINT U.S.A., INC., PLAINVIEW, NY:
2,087,699, CANC. INT. CL. 16.
- STILL, DAVID M., JR., CAMDEN, NJ:
2,857,963, PUB. 4-6-2004. INT. CL. 35.
- STIR CRAZY ENTERPRISES, L.L.C., CHICAGO, IL:
2,088,063, CANC. INT. CL. 42.

- STONE MOUNTAIN CARPET MILLS INC., EARTH CITY, MO, LEADING EDGE MARKETING, INC., ST. LOUIS, MO:
1,829,757. REN. 5-16-04. MULTIPLE CLASS, INT. CLS. 27 AND 42.
- STORK LINE, INC., THE, ALTAMONTE SPRINGS, FL:
2,086,745, CANC. INT. CL. 42.
- STRATEGYMAP.COM, INC., CHICAGO, IL:
2,858,125, PUB. 4-6-2004. INT. CL. 42.
- STRATTON CORPORATION, STRATTON MOUNTAIN, VT:
2,088,187, CANC. INT. CL. 41.
- STRIDE RITE CORPORATION, THE, LEXINGTON, MA:
1,273,954. REN. 5-21-04. INT. CL. 42.
- STRIPPER BAGS, INC, LAGUNA BEACH, CA:
2,087,846, CANC. INT. CL. 16.
- STRIPPER BAGS, INC., LAGUNA BEACH, CA:
2,087,847, CANC. INT. CL. 16.
- STROTE, JOEL R., LOS ANGELES, CA, DBA TRUSTEE OF THE LIBERACE REVOCABLE TRUST, A TRUST OF CALIFORNIA:
1,787,100, CANC. INT. CL. 41.
1,787,101, CANC. INT. CL. 41.
- STROUSE, ADLER COMPANY, THE, NEW HAVEN, CT:
2,088,431, CANC. INT. CL. 25.
- STRUCTURETEK LLC, STEAMBOAT SPRINGS, CO:
2,858,941, INT. CL. 35.
- STRUERS A/S, DENMARK, WESTLAKE, OH:
2,087,689, CANC. INT. CL. 7.
- STYLE TREND STUDIOS, INC., DELRAY BEACH, FL:
2,819,384, COR. INT. CL. 21.
- STYLE-MARK, INC., ARCHBOLD, OH:
2,858,305, INT. CL. 19.
- SUBCREWS.COM, INC., CORNELIUS, NC:
2,817,485, COR. INT. CL. 35.
- SUBURBAN REALTY, MIDLOTHIAN, IL:
2,857,546, PUB. 4-6-2004. INT. CL. 36.
- SUGGS GROUP, INC., ATLANTA, GA:
2,087,891, CANC. INT. CL. 17.
- SUIDEN CO., LTD., TEN'NOJI-KU, OSAKA, JAPAN:
2,800,917, CANC. IIRN. RESTORED TO S.N. 76-321,627.
- SUMITOMO RUBBER INDUSTRIES, LTD., CHUO-KU, KOBE, JAPAN:
2,087,951, CANC. MULTIPLE CLASS, INT. CLS. 9, 10 AND 21.
- SUMMIT MEDICAL SYSTEMS, INC., MINNEAPOLIS, MN:
2,086,892, CANC. INT. CL. 42.
- SUMMIT PUBLISHING COMPANY, CHICAGO, IL:
2,858,953, INT. CL. 16.
2,858,954, INT. CL. 9.
- SUN DRILLING PRODUCTS CORPORATION, BELLE CHASSE, LA:
2,857,708, PUB. 4-6-2004. INT. CL. 4.
- SUN INNOVATIONS INC, PLANO, TX:
2,859,124, INT. CL. 35.
- SUN MICROSYSTEMS, INC., SANTA CLARA, CA:
1,818,397. REN. 5-20-04. INT. CL. 9.
- SUN WORLD INTERNATIONAL, INC., BAKERSFIELD, CA:
2,858,064, PUB. 4-6-2004. INT. CL. 31.
- SUN 99 LIMITED, LONDON WIN 5AD, ENGLAND:
1,787,468, CANC. INT. CL. 14.
- SUN'N FUN EAA FLY-IN, INC., LAKELAND, FL:
1,247,956, CANC. INT. CL. 42.
- SUNBEAM PRODUCTS, INC., BOCA RATON, FL:
2,858,093, PUB. 4-6-2004. INT. CL. 9.
- SUNBECK, DEBORAH T., ROCHESTER, NY:
2,857,299, PUB. 4-6-2004. INT. CL. 16.
- SUNKIST GROWERS, INC., SHERMAN OAKS, CA:
599,437. REN. 5-20-04. U.S. CL. 46 (INT. CLS. 1, 5, 29, 30, 31 AND 32).
2,858,143, PUB. 4-6-2004. INT. CL. 41.
2,858,161, PUB. 4-6-2004. INT. CL. 35.
2,858,174, PUB. 4-6-2004. INT. CL. 31.
- SUNRISE COFFEE COMPANY, INC., LAGUNA NIGUEL, CA:
2,857,653, PUB. 4-6-2004. INT. CL. 30.
- SUNSHINE CREATIONS, BELFAST, ME:
2,087,829, CANC. INT. CL. 28.
- SUPER STORE INDUSTRIES, STOCKTON, CA, MEXPRO FOODS, INC., SACRAMENTO, CA:
1,867,117. REN. 5-15-04. INT. CL. 30.
- SUPERIOR ABRASIVES, INC., DAYTON, OH:
1,247,573, CANC. INT. CL. 7.
- SUPERNUTRITION LIFE-EXTENSION RESEARCH, INC., PACIFICA, CA:
1,797,496. REN. 5-21-04. INT. CL. 5.
- SUPEROCK BLOCK COMPANY, INC., BIRMINGHAM, AL:
2,087,752, CANC. INT. CL. 19.
- SUPERSTRUCTURES, NEW YORK, NY FROM SUPERSTRUCTURES INC., NEW YORK, NY:
2,858,331, INT. CL. 37.
- SUPERVALU HOLDINGS, INC., EDEN PRARIE, MN, WETERAU INCORPORATED, HAZELWOOD, MO:
1,846,413. REN. 5-20-04. MULTIPLE CLASS, INT. CLS. 3, 4, 5, 8, 10, 11, 16 AND 21.
- SURGRX, PALO ALTO, CA:
2,858,743, INT. CL. 10.
- SUTTERER, S. TERI, RAMSEY, MN:
2,857,819, PUB. 4-6-2004. INT. CL. 14.
- SVR, INC., ALEXANDRIA, VA:
1,247,925, CANC. INT. CL. 41.
- SWAN INC., ENGLEWOOD, CO:
2,858,325, INT. CL. 36.
- SWARTWOUT INDUSTRIES, INC., MIDLAND, TX:
754,626, CANC. U.S. CL. 34.
- SWIRL, INC., EASLEY, SC:
1,247,769, CANC. INT. CL. 25.
- SWISS VILLAGE CHEESE, INC., NAMPA, ID:
1,281,770. REN. 5-17-04. INT. CL. 29.
- SYKART INDOOR RACING CENTER, LLC, TUKWILA, WA:
2,857,975, PUB. 4-6-2004. INT. CL. 41.
- SYMON COMMUNICATIONS, INC., PLANO, TX:
2,857,967, PUB. 4-6-2004. INT. CL. 9.
- SYNERGIST, LLC, LOUISVILLE, KY:
2,088,442, CANC. INT. CL. 22.
- SYNERGY INC., NEWARK, NJ:
2,087,903, CANC. INT. CL. 24.
- SYNERGY TECHNICAL SOLUTIONS CORP., FREDERICKSBURG, VA:
2,834,814, CANC. IIRN. RESTORED TO S.N. 76-075,277.
2,858,273, INT. CL. 37.
- SYNTHES (U.S.A.), PAOLI, PA, SYNTHES LTD. (U.S.A.), WAYNE, PA:
1,272,555. REN. 5-20-04. INT. CL. 10.
- SYSLOAD SOFTWARE, CRETEIL, FRANCE:
1,830,170. REN. 5-20-04. MULTIPLE CLASS, INT. CLS. 9 AND 16.
- SYSTEMAX INC., PORT WASHINGTON, NY:
2,858,549, INT. CL. 9.
- T H AGRICULTURE & NUTRITION COMPANY, INC., KANSAS CITY, KS:
754,487, CANC. U.S. CL. 18.
- TABOR, AARON THOMAS, WINSTON SALEM, NC:
2,088,250, CANC. INT. CL. 9.
- TACO BELL CORP., IRVINE, CA:
2,087,411, CANC. INT. CL. 30.
- TADMIS, INC., FARMINGDALE, NY:
1,786,968, CANC. INT. CL. 35.
- TAG HEUER S.A., CH - 2074 MARIN, SWITZERLAND:
2,801,941, COR. INT. CL. 14.
- TAI HAU IRON AND STEEL CO., LTD., PING TUNG, TAIWAN:
2,087,759, CANC. INT. CL. 6.
- TAIKO PHARMACEUTICAL CO., LTD., OSAKA, 564-0032, JAPAN:
2,857,644, PUB. 4-6-2004. INT. CL. 5.
2,857,645, PUB. 4-6-2004. INT. CL. 5.
- TAK INDUSTRIAL CORPORATION, PORTLAND, OR:
2,857,777, PUB. 4-6-2004. INT. CL. 42.
- TAKATA INC., AUBURN HILLS, MI:
2,087,037, CANC. INT. CL. 9.
- TAKECOVER, INC., ATLANTA, GA:
2,086,943, CANC. INT. CL. 18.

TAKEDA CHEMICAL INDUSTRIES, LTD., CHUO-KU, OSAKA, JAPAN:
2,857,236, PUB. 4-15-2003. INT. CL. 5.

TAKING CHARGE, INC., MINNEAPOLIS, MN:
1,808,085. REN. 5-20-04. INT. CL. 41.

TANDY CORPORATION, FORT WORTH, TX, DBA COMPUTER CITY:
2,088,242, CANC. INT. CL. 42.

TANSTAAFL MEDIA, INC., BOTHELL, WA:
2,858,072, PUB. 4-6-2004. INT. CL. 9.

TAREN HOLDINGS, INC., LOS ANGELES, CA TO CCC ACQUISITION CORP., LOS ANGELES, CA:
1,786,805, CANC. MULTIPLE CLASS, INT. CLS. 25 AND 41.

TARGET BRANDS, INC., MINNEAPOLIS, MN:
2,858,063, PUB. 4-6-2004. INT. CL. 3.
2,858,068, PUB. 4-6-2004. INT. CL. 16.
2,858,069, PUB. 4-6-2004. INT. CL. 24.
2,858,866, INT. CL. 30.
2,858,934, INT. CL. 33.

TARIN-REMOHI, PASCUAL, 28040 MADRID, SPAIN, TARIN-REMOHI, PASCUAL, 28040 MADRID, SPAIN:
1,811,894. REN. 5-17-04. INT. CL. 9.

TASTE CONNECTIONS, TORRANCE, CA:
2,858,985, INT. CL. 30.

TASTYKAKE INVESTMENT COMPANY, WILMINGTON, DE, TASTYKAKE, INC., PHILADELPHIA, PA:
1,272,977. REN. 5-21-04. INT. CL. 30.
1,277,275. REN. 5-21-04. INT. CL. 30.

TATTOO MANUFACTURING, INC., TUCSON, AZ:
2,858,508, INT. CL. 16.

TAYLOR FLADGATE & YEATMAN LIMITED, ST. HELIER, JERSEY, CHANNEL ISLANDS:
1,247,852, CANC. INT. CL. 33.

TAYLOR GROUP INC., THE, DENVER, CO, DBA THE LINKS AT CITY PARK:
1,875,710. REN. 5-16-04. INT. CL. 42.

TAYLOR, HENRY MICHAEL, BIGLERVILLE, PA:
2,859,063, INT. CL. 4.

TAYLOR, LESLIE H., FAIRFAX STATION, VA:
1,876,996. REN. 5-21-04. INT. CL. 41.

TAYLOR, VINCE, CASPAR, CA TO VINCENT D. TAYLOR CHARITABLE REMAINDER UNITRUST, CASPAR, CA:
1,786,639, CANC. INT. CL. 9.

TDE THONHAUSER DATA ENGINEERING GMBH, LEOBEN, AUSTRIA:
2,857,916, PUB. 4-6-2004. MULTIPLE CLASS, INT. CLS. 9, 35 AND 42.

TEA GARDEN PRODUCTS, INC., WEST HOLLYWOOD, CA:
2,858,056, PUB. 4-6-2004. INT. CL. 5.

TEAC CORPORATION, MUSASHINO-SHI, TOKYO, JAPAN, TASCAM CORPORATION, LOS ANGELES, CA:
984,521. REN. 5-20-04. U.S. CL. 36 (INT. CL. 9).

TEACHING MATTERS, INC., NEW YORK, NY:
2,858,614, INT. CL. 41.

TEASDALE, BRADFORD, A, CALIFON, NJ:
2,858,759, INT. CL. 19.

TECHLAB, INC., BLACKSBURG, VA:
2,858,348, INT. CL. 5.

TECHNEQUIP LIMITED, WESTON, ONTARIO, M9L 1P2, CANADA:
954,843, CANC. U.S. CL. 13.

TECHNICAL MANUFACTURING CORPORATION, PEABODY, MA:
2,857,197, PUB. 4-6-2004. INT. CL. 9.

TECHNICOLOR SCREEN ADVERTISING, INC., NEW YORK, NY:
2,857,983, PUB. 4-6-2004. INT. CL. 35.

TECHNINFO S.A.M, CEDEX, MONACO:
2,858,289, INT. CL. 5.

TECHNOLOGIES AVANCEES & MEMBRANES INDUSTRIELLES, 26110 NYONS, FRANCE:
2,858,092, PUB. 4-6-2004. MULTIPLE CLASS, INT. CLS. 1, 7 AND 11.

TECHNOLOGY VENTURES CORPORATION, ALBUQUERQUE, NM:
2,858,014, PUB. 4-6-2004. INT. CL. 35.

TECHPOOL STUDIOS, INC., CLEVELAND, OH:
2,087,850, CANC. INT. CL. 9.
2,087,851, CANC. INT. CL. 16.

TEICHMANN, CYNTHIA ANN, TOLUCA, CA:
2,087,758, CANC. INT. CL. 10.

TEKNOR APEX COMPANY, PAWTUCKET, RI:
2,857,633, PUB. 4-6-2004. INT. CL. 17.

TEKRA CORPORATION, NEW BERLIN, WI:
2,088,088, CANC. INT. CL. 16.

TELECT, INC., LIBERTY LAKE, WA:
2,857,203, PUB. 4-6-2004. INT. CL. 9.

TELEFONIX TECHNOLOGY, INC., SAN DIEGO, CA:
2,859,106, INT. CL. 9.

TELEGEN SERVICES INC., NEWBURGH, NY:
2,858,727, INT. CL. 42.

TELESOFT DESIGN LTD., MILTON ABBAS, DORSET, DT11 0BD, UNITED KINGDOM:
2,087,648, CANC. INT. CL. 9.

TELESPHERE CORPORATION, NEW YORK, NY:
2,088,267, CANC. INT. CL. 9.

TELIK, INC., PALO ALTO, CA:
2,858,532, INT. CL. 5.

TEMPCRAFT, INC., CLEVELAND, OH TO HOWMET RESEARCH CORPORATION, WHITEHALL, MI:
1,761,085, CANC. INT. CL. 9.

TEMPO RESEARCH CORPORATION, VISTA, CA:
2,858,417, INT. CL. 9.

TENAGRA CORPORATION, THE, HOUSTON, TX:
2,148,763, CANC. INT. CL. 42.

TENNESSEE WALKING HORSE BREEDERS' & EXHIBITORS' ASSOCIATION, THE, LEWISBURG, TN:
1,876,853. REN. 5-20-04. INT. CL. 35.

TENTH PLANET EXPLORATIONS, INC., HALF MOON BAY, CA:
2,088,226, CANC. INT. CL. 16.
2,088,234, CANC. INT. CL. 9.

TEQUILA SAN MATIAS DE JALISCO, S.A. DE C.V., JALISCO, MEXICO:
2,858,345, INT. CL. 33.

TERACRUZ, INC., MADISON, AL:
2,859,104, INT. CL. 9.

TERMA-RUST INC., NEWARK, COUNTY OF NEW CASTLE, DE:
2,858,487, INT. CL. 2.

TERRAMITE CORPORATION, THE, CHARLESTON, WV:
1,787,360, CANC. INT. CL. 7.

TETRA GMBH, MELLE, FED REP GERMANY:
1,829,162. REN. 5-17-04. INT. CL. 5.

TETRA LIMITED, MAIDENHEAD, BERKSHIRE, ENGLAND TO TETRA INTERNATIONAL LIMITED, MAIDENHEAD BERKSHIRE, UNITED KINGDOM:
1,786,506, CANC. MULTIPLE CLASS, INT. CLS. 9 AND 16.

TETRAFLUOR, INC., EL SEGUNDO, CA TO COORS CERAMICON DESIGNS, LTD., GOLDEN, CO:
1,787,361, CANC. INT. CL. 7.

TEVA PHARMACEUTICALS USA, INC., NORTH WALES, PA:
2,858,526, MULTIPLE CLASS, INT. CLS. 35 AND 41.

TEXACO INC., WHITE PLAINS, NY:
1,797,292, COR. INT. CL. 37.
2,088,329, CANC. INT. CL. 4.

TEXAS STAMPEDE, INC., DALLAS, TX:
2,731,222, CANC. IIRN. RESTORED TO S.N. 76-256,691.

TEXWIPE COMPANY, THE, UPPER SADDLE RIVER, NJ:
1,247,726, CANC. INT. CL. 21.

TFX INTERNATIONAL, INC., PALM DESERT, CA:
2,857,250, PUB. 4-6-2004. INT. CL. 5.

TGC, INC., ORLANDO, FL:
2,858,374, MULTIPLE CLASS, INT. CLS. 25, 35 AND 41.

THANEOHNS CORP., BOZEMAN, MT:
2,086,864, CANC. INT. CL. 20.

THAT'S MY AMERICA, L.L.C., CHICAGO, IL:
2,858,249, MULTIPLE CLASS, INT. CLS. 9 AND 41.

THE ALLIANCE GROUP INTERNATIONAL, ARLINGTON, VA:
2,858,236, INT. CL. 35.

- THE AURI GROUP, LLC, INDIANAPOLIS, IN:
2,858,022, PUB. 4-6-2004. INT. CL. 42.
- THE BIG FUN TOYS & SUNSHINE CO LIMITED, OAKHAM, RUTLAND LE15 7ZN, UNITED KINGDOM:
2,857,288, PUB. 4-6-2004. INT. CL. 24.
- THE BRADFORD EXCHANGE, LTD., NILES, IL:
2,857,386, PUB. 4-6-2004. INT. CL. 35.
- THE COCO TREE, INC., SPARTA, NJ:
2,858,524, INT. CL. 30.
- THE COMEBACK INSTITUTE LLC, PALM BEACH GARDENS, FL:
2,858,060, PUB. 4-6-2004. MULTIPLE CLASS, INT. CLS. 35 AND 41.
- THE DAYTON FOUNDATION PLUS, INC., DAYTON, OH:
2,857,587, PUB. 4-6-2004. INT. CL. 36.
- THE DICKIE GROUP, LLC, WALTHAM, MA:
2,857,638, PUB. 4-6-2004. MULTIPLE CLASS, INT. CLS. 41 AND 42.
- THE DOLLYWOOD COMPANY, PIGEON FORGE, TN:
2,858,839, INT. CL. 41.
- THE DOMAIN GROUP, INC., SEATTLE, WA:
2,857,606, PUB. 4-6-2004. INT. CL. 36.
- THE DORIS DILLON CENTER, NEW YORK, NY:
2,859,080, INT. CL. 42.
- THE DREAM TEAM, LLC, MIAMI, FL:
2,857,337, PUB. 4-6-2004. INT. CL. 25.
- THE GALE COMPANY, FLORHAM PARK, NJ:
2,857,791, PUB. 4-6-2004. MULTIPLE CLASS, INT. CLS. 36 AND 37.
- THE GRAHAM & DODD VALUE FUND, LLC, NEW YORK, NY:
2,858,877, INT. CL. 36.
- THE HENRY SHAW OZARK CORRIDOR FOUNDATION, EUREKA, MO:
2,857,380, PUB. 4-6-2004. INT. CL. 44.
- THE HUTTON GROUP, INC., BLOOMFIELD, NJ:
2,858,012, PUB. 4-6-2004. MULTIPLE CLASS, INT. CLS. 35 AND 36.
- THE INSTITUTE OF ELECTRICAL AND ELECTRONICS ENGINEERS, INC., PISCATAWAY, NJ:
2,859,123, INT. CL. 41.
- THE LEAPFROG GROUP, WASHINGTON, DC:
2,857,374, PUB. 4-6-2004. MULTIPLE CLASS, INT. CLS. 35, 41, 42 AND 44.
- THE LIGHT INC., RUTHERFORD, NJ:
2,857,630, PUB. 4-6-2004. INT. CL. 16.
- THE MCMILLIN COMPANIES, LLC, NATIONAL CITY, CA:
2,793,099, COR. INT. CL. 37.
- THE NAT NAST COMPANY, SOUTH NORWALK, CT:
2,858,883, INT. CL. 25.
- THE NATIONAL LIBRARY OF MEDICINE, BETHESDA, MD:
2,857,223, PUB. 4-6-2004. MULTIPLE CLASS, INT. CLS. 42 AND 44.
- THE NEIMAN MARCUS GROUP, INC., DALLAS, TX:
2,857,879, PUB. 4-6-2004. INT. CL. 35.
- THE OTIS CONNER COMPANIES, INC., DALLAS, TX:
2,858,829, MULTIPLE CLASS, INT. CLS. 35 AND 36.
- THE PILLHELP COMPANY, LLC, FT. MYERS, FL:
2,858,944, INT. CL. 44.
- THE PRINCESS PROJECT, SAN FRANCISCO, CA:
2,857,838, PUB. 4-6-2004. INT. CL. 45.
- THE PRINTER, INC., DES MOINES, IA:
2,857,816, PUB. 4-6-2004. INT. CL. 40.
- THE PSYCHOLOGICAL CORPORATION, SAN ANTONIO, TX:
2,858,960, INT. CL. 16.
- THE RUMPF CORPORATION, TOLEDO, OH:
2,857,362, PUB. 4-6-2004. INT. CL. 35.
- THE SAINT LOUIS BREWERY, INC., ST. LOUIS, MO:
2,857,492, PUB. 4-6-2004. INT. CL. 32.
- THE SALVATION ARMY, LONG BEACH, CA:
2,857,584, PUB. 4-6-2004. INT. CL. 45.
- THE SALVATION ARMY, WEST NYACK, NY:
2,858,027, PUB. 4-6-2004. MULTIPLE CLASS, INT. CLS. 41, 43 AND 45.
- THE SPORTS BASEMENT, INC., SAN FRANCISCO, CA:
2,858,021, PUB. 4-6-2004. INT. CL. 35.
- THE SUSAN G. KOMEN BREAST CANCER FOUNDATION, DALLAS, TX:
2,857,552, PUB. 4-6-2004. INT. CL. 36.
- THE TAN FACTORY, L.L.C., NORTHVILLE, MI:
2,858,586, INT. CL. 44.
2,858,587, INT. CL. 44.
- THE TRUSTEE OF THE SOUND RECORDING SPECIAL PAYMENTS FUND, A NEW YORK TRUST, THE TRUSTEE COMPRISING ENEX STEELE, A U.S. CITIZEN, NEW YORK, NY:
2,859,060, MULTIPLE CLASS, INT. CLS. 35 AND 36.
- THE TRUSTEES OF THE WILLIAM LESTER LEWIS JR. TRUST, A MISSOURI TRUST, THE TRUSTEES COMPRISING WILLIAM LESTER LEWIS JR., U.S. CITIZEN & THE TRUSTEES OF THE RAQUEL MARIE LEWIS TRUST, A MISSOURI TRUST, THE TRUSTEES COMPRISING RAQUEL MARIE LEWIS, U.S. CITIZEN., SAINT JAMES, MO:
2,857,957, PUB. 4-6-2004. INT. CL. 35.
- THE UPPER DECK COMPANY, LLC, CARLSBAD, CA:
2,857,428, PUB. 4-6-2004. INT. CL. 28.
- THERMOGAS COMPANY:
See—*FERRELLGAS, L.P.*
- THIGHMASTER WORLD CORPORATION, CALABASAS, CA:
2,835,423, CANC. IIRN. RESTORED TO S.N. 78-158,982.
2,835,424, CANC. IIRN. RESTORED TO S.N. 78-158,984.
- THINK FAST, LLC, GLENS FALLS, NY:
2,858,916, INT. CL. 35.
2,858,917, INT. CL. 41.
2,858,918, INT. CL. 16.
2,858,919, INT. CL. 35.
2,858,920, INT. CL. 41.
- THIRSTKEY, LLC, RICHMOND, VA:
2,858,074, PUB. 4-6-2004. INT. CL. 21.
- THOMAS INDUSTRIES INC., LOUISVILLE, KY:
1,831,093, REN. 5-16-04. INT. CL. 7.
- THOMAS REGIONAL DIRECTORY COMPANY, NEW YORK, NY:
2,087,081, CANC. INT. CL. 35.
- THOMPSON PAPER BOX, INC., LAKEVILLE, MA:
2,087,614, CANC. INT. CL. 16.
- THOMPSON, ANDY, AUSTIN, TX:
2,858,645, INT. CL. 3.
- THOMPSON, CHRISTOPHER S., MILWAUKEE, WI:
2,088,454, CANC. INT. CL. 25.
- THOMPSON, KENNETH, VENTURAL, CA:
2,087,090, CANC. INT. CL. 16.
- TICKETLEAP.COM LLC, PHILADELPHIA, PA:
2,858,910, INT. CL. 35.
- TIDAL SOFTWARE, INC., MOUNTAIN VIEW, CA:
2,857,201, PUB. 4-6-2004. INT. CL. 9.
- TIENSHAN, INC., SOUTH NORWALK, CT:
2,857,846, PUB. 4-6-2004. INT. CL. 21.
- TIERNEY, MICHAEL E., MAVMELLE, AR, DBA COLLECTOR'S EDITIONS:
1,786,733, CANC. INT. CL. 16.
- TIFFIN SCENIC STUDIOS, INC., TIFFIN, OH:
2,858,810, INT. CL. 6.
- TIGER ELECTRONICS, INC., VERNON HILLS, IL:
2,088,438, CANC. INT. CL. 28.
- TILLAMOOK COUNTY CREAMERY ASSOCIATION, TILLAMOOK, OR:
1,832,844, REN. 5-20-04. INT. CL. 30.
- TIME FOR GOOD FOOD, INC., ALEXANDRIA, VA:
2,857,671, PUB. 4-6-2004. INT. CL. 43.
- TIME INC., NEW YORK, NY:
2,087,584, CANC. MULTIPLE CLASS, INT. CLS. 35, 36 AND 42.
2,858,347, INT. CL. 16.
- TIMON, KARLA, HONOLULU, HI:
2,088,436, CANC. INT. CL. 28.
- TITANSports, INC., STAMFORD, CT:
2,087,146, CANC. INT. CL. 41.
- TMS ASSISTANCE, PARIS, FRANCE:
1,247,881, CANC. MULTIPLE CLASS, INT. CLS. 36 AND 42.
- TOG SHOP, INC., THE, AMERICUS, GA:
757,827, REN. 5-19-04. U.S. CL. 42 (INT. CLS. 22, 24, 26

- AND 27).
TOM TAILOR AG, 22453 HAMBURG, FED REP GERMANY:
2,857,341, PUB. 4-6-2004. INT. CL. 14.
TOMKINS INDUSTRIES, INC., DAYTON, OH TO LASCO
BATHWARE, INC., ANAHEIM, CA:
1,916,325, CANC. INT. CL. 19.
TONAL S.R.L., LISSONE (MILANO), ITALY:
1,247,587, CANC. INT. CL. 8.
TONY PASS BANJO RIMS, LLC, LOUANN, AR:
2,857,436, PUB. 4-6-2004. INT. CL. 15.
2,857,437, PUB. 4-6-2004. INT. CL. 15.
TOOBULAR INC, MIAMI BEACH, FL:
2,858,100, PUB. 4-6-2004. INT. CL. 3.
TOP BILLING, INC., HOLLYWOOD, FL:
2,087,589, CANC. INT. CL. 8.
TOP CATCH, INC., BROOKLYN, NY:
2,857,735, PUB. 4-6-2004. INT. CL. 29.
TOP FLIGHT, INC., CHATTANOOGA, TN:
2,858,565, INT. CL. 16.
TOP VALVE CO., LTD., TAIPEI, TAIWAN:
1,839,320. REN. 5-18-04. INT. CL. 11.
TOPCO HOLDINGS, INC., SKOKIE, IL:
2,857,906, PUB. 4-6-2004. MULTIPLE CLASS, INT. CLS. 29
AND 30.
TOPDOCS, INC., BETHESDA, MD:
2,857,276, PUB. 4-6-2004. MULTIPLE CLASS, INT. CLS. 35
AND 44.
2,857,277, PUB. 4-6-2004. MULTIPLE CLASS, INT. CLS. 35
AND 44.
TOPS APPLIANCE CITY, INC., EDISON, NJ:
1,247,969, CANC. INT. CL. 42.
1,247,970, CANC. INT. CL. 42.
TOPSAIL GROUP, L.L.C., WESTON, CT:
2,858,979, INT. CL. 35.
TORBJORNSEN, THOMAS M., FREWSBURG, NY:
2,087,617, CANC. INT. CL. 41.
TOTAL TELECOMMUNICATIONS SERVICES, INC., OKLA-
HOMA CITY, OK:
2,087,344, CANC. INT. CL. 38.
TOTAL WAREHOUSING, INC., PHOENIX, AZ:
2,858,351, INT. CL. 39.
TOTO PRODUCTS, LLC, ROCKVILLE, MD:
2,857,943, PUB. 4-6-2004. INT. CL. 27.
TOURNEAU, INC., NEW YORK, NY:
2,087,855, CANC. INT. CL. 35.
TOWERS, PERRIN, FORSTER & CROSBY, INC., PHILA-
DELPHIA, PA:
2,087,599, CANC. INT. CL. 9.
TOY TRUCK LINES, INC., FT. PIERCE, FL:
2,088,104, CANC. INT. CL. 28.
TOYRAK ENTERPRISES, INC., SANDY, OR:
2,088,068, CANC. INT. CL. 12.
TPL, INC., HIGHLAND PARK, IL:
2,086,951, CANC. INT. CL. 30.
TPS PUBLISHING, INC., VAN NUYS, CA:
2,087,786, CANC. INT. CL. 16.
TRACY EQUIPMENT, INC., HOUSTON, TX:
2,857,798, PUB. 4-6-2004. INT. CL. 35.
TRADER PUBLISHING COMPANY, NORFOLK, VA, UNI-
CON PUBLICATIONS, INC., AKRON, NY:
1,272,676. REN. 5-21-04. INT. CL. 16.
TRADITIONAL BAKING, BLOOMINGTON, CA:
2,857,915, PUB. 4-6-2004. INT. CL. 17.
TRAIL BLAZERS, INC., PORTLAND, OR:
2,857,942, PUB. 4-6-2004. INT. CL. 41.
2,858,751, INT. CL. 25.
TRANSACTIS, INC., GREAT FALLS, VA:
2,858,427, MULTIPLE CLASS, INT. CLS. 35 AND 42.
TRANSFRESH CORPORATION, SALINAS, CA:
2,086,833, CANC. INT. CL. 39.
TRANSKRIT CORPORATION, ROANOKE, VA:
2,087,378, CANC. INT. CL. 16.
TRANSPORTES CONTINUOS INTERIORES S.A., EL PA-
PIOL, SPAIN:
2,858,432, MULTIPLE CLASS, INT. CLS. 37 AND 42.
TRANZONIC COMPANIES, THE, HIGHLAND HEIGHTS,
OH, DBA HOSPITAL SPECIALTY COMPANY:
2,858,349, INT. CL. 3.
TRANZONIC COMPANIES, THE, HIGHLAND HEIGHTS,
OH:
2,858,390, INT. CL. 24.
2,858,898, INT. CL. 3.
TRAVEL GUARD GROUP, INC., STEVEN POINT, WI,
SENTRY INSURANCE A MUTUAL COMPANY, STEVENS
POINT, WI:
1,323,691. REN. 5-21-04. INT. CL. 36.
TRAVEL WORLDWIDE NETWORK, MARIETTA, GA:
1,834,050. REN. 5-20-04. INT. CL. 39.
TRAVELFAST INTERNATIONAL, INC., SAN FRANCISCO,
CA:
2,858,326, INT. CL. 39.
TRAX IP, LLC, SCOTTSDALE, AZ:
2,857,138, PUB. 4-6-2004. INT. CL. 9.
TRAX SOFTWARES, INC., CULVER CITY, CA:
2,086,702, CANC. INT. CL. 9.
TRI-DYNE INDUSTRIES LLC, METAIRIE, LA:
2,858,523, INT. CL. 42.
TRI-MAG, INC., VISALIA, CA:
1,230,956. REN. 5-19-04. INT. CL. 9.
TRI-STATE BREEDERS COOPERATIVE, BARABOO, WI:
1,787,690, CANC. INT. CL. 16.
TRI-WHEAT DISTRIBUTING, INC., COLONIAL HEIGHTS,
VA:
2,088,243, CANC. INT. CL. 30.
TRIANGLE PACKAGE MACHINERY COMPANY, CHICA-
GO, IL:
2,858,066, PUB. 4-6-2004. INT. CL. 7.
TRIBUNE MEDIA SERVICES, INC., CHICAGO, IL:
2,858,221, INT. CL. 41.
TRILEGIANT CORPORATION, NORWALK, CT:
2,858,449, MULTIPLE CLASS, INT. CLS. 35 AND 41.
TRILLIUM USA INC, MILAND, TX:
2,144,971, CANC. MULTIPLE CLASS, INT. CLS. 36 AND
41.
TRINITAS CELLARS, LLC, IRVINE, CA:
2,859,002, INT. CL. 33.
TRINITY INVESTMENT MANAGEMENT CORPORATION,
BELLEFONTE, PA:
1,786,727, CANC. MULTIPLE CLASS, INT. CLS. 16 AND
36.
TRINTEC INDUSTRIES, INC., AJAX, ONTARIO, CANADA:
2,088,361, CANC. INT. CL. 14.
TRIPGRIP, INC., HENDERSONVILLE, TN:
2,858,229, INT. CL. 12.
TROPITONE FURNITURE COMPANY, INC., SARASOTA,
FL:
1,786,776, CANC. INT. CL. 20.
1,786,777, CANC. INT. CL. 20.
TRU CORPORATION, PEABODY, MA:
999,163. REN. 5-17-04. U.S. CL. 21 (INT. CL. 9).
TRUMP, DONALD J., NEW YORK, NY:
2,858,404, MULTIPLE CLASS, INT. CLS. 36 AND 37.
TRUSTEES OF BOSTON UNIVERSITY, BOSTON, MA:
1,857,021. REN. 5-16-04. INT. CL. 41.
TRUSTEES OF THE CALIFORNIA STAT UNIVERSITY,
THE, LONG BEACH, CA, CALIFORNIA STATE UNIVER-
SITY, CHICO, CHICO, CA:
1,836,855. REN. 5-16-04. INT. CL. 25.
TRZ BUSINESS SERVICES, INC., KENT, OH:
2,857,251, PUB. 4-6-2004. INT. CL. 38.
TSA CORPORATE SERVICES, INC., ENGLEWOOD, CO:
2,858,034, PUB. 4-6-2004. INT. CL. 25.
TSUBASA SYSTEM CO., LTD., TOKYO, JAPAN:
2,858,564, INT. CL. 9.
TUBE TURNS TECHNOLOGIES, INC., LOUISVILLE, KY:
1,787,350, CANC. INT. CL. 6.
TUBEX LIMITED, MID GLAORGAN, WALES, UNITED
KINGDOM:
1,600,876. REN. 5-19-04. INT. CL. 20.
TUCKER, ROGER, MUNCIE, IN:
2,086,766, CANC. INT. CL. 42.
TUGBOAT, INC., NAPA, CA:
2,858,975, INT. CL. 40.
TUNE-UP MANUFACTURERS INSTITUTE, TEANECK, NJ:
1,247,958, CANC. INT. CL. 42.

- TUPPER, SHARON DEE, SEDONA, AZ AND TUPPER, SCOTT IRVIN, SEDONA, AZ:
2,858,637, INT. CL. 28.
- TURBO POWER, INC., FLUSHING, NY:
2,835,637, CANC. IIRN. RESTORED TO S.N. 78-226,390.
- TURBO SPORTSWEAR, INC., PERTH AMBOY, NJ:
2,088,368, CANC. INT. CL. 25.
2,088,369, CANC. INT. CL. 25.
- TURTLE WAX, INC., CHICAGO, IL:
1,277,702, REN. 5-17-04, INT. CL. 3.
- TUSCARORA INCORPORATED, WHEELING, IL:
2,857,377, PUB. 4-6-2004. MULTIPLE CLASS, INT. CLS. 10 AND 21.
- TUTHILL CORPORATION, HINSDALE, IL:
2,088,260, CANC. INT. CL. 11.
- TWELVE STARS COMMUNICATIONS LIMITED, LONDON W1, ENGLAND:
2,086,991, CANC. MULTIPLE CLASS, INT. CLS. 35 AND 38.
- TWENTIETH CENTURY FOX FILM CORPORATION, LOS ANGELES, CA:
2,088,217, CANC. MULTIPLE CLASS, INT. CLS. 20 AND 26.
- TWIN LABORATORIES, INC., RONKONKOMA, NY:
1,247,535, CANC. INT. CL. 5.
- TWISTED OAK WINERY, LLC, MURPHYS, CA:
2,858,414, INT. CL. 33.
- TWISTED TECHNOLOGIES, INC., ACWORTH, GA:
2,857,847, PUB. 4-6-2004. INT. CL. 9.
- TXT E-SOLUTIONS S.P.A., 20128 MILANO, ITALY:
2,857,164, PUB. 4-6-2004. MULTIPLE CLASS, INT. CLS. 9, 38 AND 42.
- TY, INC., WESTMONT, IL:
2,087,838, CANC. INT. CL. 28.
- TYLENOL COMPANY, THE, RARITAN, NJ:
1,777,613, REN. 5-18-04, INT. CL. 5.
- TYLER PRODUCTS COMPANY, WESTLAND, MI:
2,087,320, CANC. INT. CL. 19.
- TYLER REFRIGERATION CORPORATION, NILES, MI:
754,432, CANC. U.S. CL. 12.
- TYLER TECHNOLOGIES, INC., DALLAS, TX:
2,857,426, PUB. 4-6-2004. INT. CL. 9.
- TYLER, VICTOR, PAUL, PALMDALE, CA AND TYLER, NANCY, JANE, PALMDALE, CA:
2,858,925, INT. CL. 16.
- TYMCO, INC., WACO, TX:
2,857,521, PUB. 4-6-2004. INT. CL. 7.
- T2T, INC., EVERETT, WA:
2,858,606, INT. CL. 11.
- U. S. PRODUCTS, INC., HAYDEN LAKE, ID TO PALHOUSE HOLDINGS, L.L.C., HAYDEN LAKE, ID:
1,786,424, CANC. INT. CL. 3.
- U.S. CLEARING CORPORATION, NEW YORK, NY:
2,087,080, CANC. INT. CL. 36.
- U.S. MEDICAL CARE HOLDINGS LLC., BOCA RATON, FL:
2,857,627, PUB. 4-6-2004. INT. CL. 44.
- U.S. PHYSICAL THERAPY, INC., HOUSTON, TX:
2,859,069, INT. CL. 35.
- U.S. ROBOTICS ACCESS CORP., SKOKIE, IL:
2,087,597, CANC. INT. CL. 9.
- U.S. TAPE COMPANY, PATCHOGUE, NY:
2,088,305, CANC. INT. CL. 9.
2,088,306, CANC. INT. CL. 9.
- U.S.A. MARKETING ASSOCIATES, INC., INDIALANTIC, FL:
2,835,120, CANC. IIRN. RESTORED TO S.N. 76-391,212.
- U-N-US, INC., NEW YORK, NY:
2,088,262, CANC. INT. CL. 14.
- UBS FINANCIAL SERVICES INC., WEEHAWKEN, NJ:
2,858,340, INT. CL. 36.
- UDDEHOLM TOOLING AKTIEBOLAG, S-683 85 HAGFORS, SWEDEN:
2,857,383, PUB. 4-6-2004. INT. CL. 6.
- UFG (UK) LIMITED, EC4R 1EB LONDON, UNITED KINGDOM:
2,857,309, PUB. 4-6-2004. MULTIPLE CLASS, INT. CLS. 9, 16, 35, 36 AND 41.
- UGS PLM SOLUTIONS INC., PLANO, TX:
2,086,971, CANC. MULTIPLE CLASS, INT. CLS. 5 AND 29.
- ULSTER SCIENTIFIC, INC., NEW PALTZ, NY:
2,088,059, CANC. INT. CL. 10.
- ULTICOM, INC., MT. LAUREL, NJ:
2,858,843, INT. CL. 42.
- ULTIMATE JUICE COMPANY, BASKING RIDGE, NJ:
2,859,068, INT. CL. 32.
- ULTRA-OPTIX, INC., EAST HAVEN, CT:
1,786,643, CANC. INT. CL. 9.
- ULTRARF, INC., DURHAM, NC FROM SPECTRIAN CORPORATION, SUNNYVALE, CA:
2,857,133, PUB. 4-6-2004. INT. CL. 9.
- ULTRATERA CORPORATION, HSIN CHU, TAIWAN:
2,857,805, PUB. 4-6-2004. INT. CL. 9.
- UMG ABS, LTD., TOKYO, JAPAN:
2,858,522, INT. CL. 1.
- UMG RECORDINGS, INC., UNIVERSAL CITY, CA:
2,857,461, PUB. 4-6-2004. INT. CL. 9.
- UNAXIS BALZERS AG, 9496 BALZERS, LIECHTENSTEIN:
2,857,826, PUB. 4-6-2004. INT. CL. 7.
- UNBOUND MEDICINE, INC., CHARLOTTESVILLE, VA:
2,858,246, INT. CL. 9.
- UNCLE MILTON INDUSTRIES, INC., WESTLAKE VILLAGE, CA:
2,858,040, PUB. 4-6-2004. MULTIPLE CLASS, INT. CLS. 9, 16 AND 28.
- UNDERKOFER, REENA, POWAY, CA AND UNDERKOFER, ALAN, POWAY, CA:
2,857,636, PUB. 4-6-2004. INT. CL. 40.
- UNDERSEA SYSTEMS INTERNATIONAL, INC., SANTA ANA, CA, DBA OCEAN TECHNOLOGY SYSTEMS:
1,775,042, REN. 5-17-04, INT. CL. 9.
- UNDERWOOD INSURANCE AGENCY, INC., THE, LAFAYETTE, IN:
2,857,594, PUB. 4-6-2004. INT. CL. 36.
- UNGER ENTERPRISES, INC., GLENDALE, CA:
2,088,029, CANC. INT. CL. 20.
- UNIFORM CODE COUNCIL, INC., LAWRENCEVILLE, NJ:
2,858,641, U.S. CL. A.
- UNILEVER N.V., ROTTERDAM, NETHERLANDS:
2,859,001, INT. CL. 30.
- UNIMERCO GROUP AS, DK-7451 SUNDS, DENMARK:
2,858,367, MULTIPLE CLASS, INT. CLS. 8, 40 AND 42.
- UNION CARBIDE CORPORATION, DANBURY, CT:
1,787,300, CANC. INT. CL. 2.
- UNION DES VIGNERONS DES COTES DU RHONE, TULLETTE, FRANCE:
1,286,313, REN. 5-17-04, INT. CL. 33.
- UNION OIL COMPANY OF CALIFORNIA, EL SEGUNDO, CA, DBA UNOCAL:
2,087,619, CANC. INT. CL. 37.
- UNION TELEPHONE COMPANY, FARMINGTON, NH:
2,857,925, PUB. 4-6-2004. INT. CL. 38.
- UNIQUE INDUSTRIES, INC., DENVER, CO:
2,087,732, CANC. INT. CL. 7.
- UNITED CARPET NETWORK, LTD., INC., GRAND ISLAND, NE:
1,786,855, CANC. INT. CL. 27.
- UNITED INDUSTRIES CORPORATION, ST. LOUIS, MO:
2,857,469, PUB. 4-6-2004. INT. CL. 5.
2,858,463, INT. CL. 5.
- UNITED INTELLECTUAL PROPERTY HOLDINGS, INC., LAS VEGAS, NV:
2,857,205, PUB. 4-6-2004. INT. CL. 36.
- UNITED PARCEL SERVICE OF AMERICA, INC., ATLANTA, GA:
2,858,133, PUB. 4-6-2004. INT. CL. 9.
- UNITED STATES FILTER CORPORATION, PALM DESERT, CA FROM WALLACE & TIERNAN, INC., BELLEVILLE, NJ:
2,858,180, INT. CL. 11.
- UNITED STATES GEAR CORPORATION, CHICAGO, IL:
1,786,671, CANC. INT. CL. 12.
- UNITED STATES OF AMERICA, THE DEPT OF THE NAVY, ANACOSTIA ANNEX, DC:
2,857,253, PUB. 4-6-2004. INT. CL. 16.

- UNITED TEST AND ASSEMBLY CENTER LTD., SINGAPORE, SINGAPORE:
2,857,300, PUB. 7-22-2003. MULTIPLE CLASS, INT. CLS. 9, 40 AND 42.
- UNITED WAY SERVICES, CLEVELAND, OH:
2,858,582, INT. CL. 21.
- UNITRON INDUSTRIES LTD., KITCHENER, ONTARIO, CANADA:
2,858,636, INT. CL. 10.
- UNITY FOUNDATION, THE, UNITY, ME:
2,858,785, INT. CL. 35.
- UNIVERSAL CIGAR CORPORATION, NEW YORK, NY:
754,475, CANC. U.S. CL. 17.
- UNIVERSAL CITY STUDIOS, INC., UNIVERSAL CITY, CA:
2,087,965, CANC. INT. CL. 25.
- UNIVERSAL PROPULSION COMPANY, INC., PHOENIX, AZ:
2,087,931, CANC. INT. CL. 12.
- UNIVERSITY AND COMMUNITY COLLEGE SYSTEM OF NEVADA, RENO, NV:
2,857,260, PUB. 4-6-2004. INT. CL. 31.
- UNIVERSITY OF NORTH CAROLINA AT ASHEVILLE, THE, ASHEVILLE, NC:
1,787,121, CANC. INT. CL. 41.
- UPSHER-SMITH LABORATORIES, INC., MAPLE GROVE, MN:
2,858,599, INT. CL. 5.
- URBAN SCIENCE APPLICATIONS, INC., DETROIT, MI:
2,858,409, MULTIPLE CLASS, INT. CLS. 9, 35 AND 42.
2,859,022, MULTIPLE CLASS, INT. CLS. 9, 35 AND 42.
- URBANA CORPORATION, TAMARAC, FL:
2,087,246, CANC. INT. CL. 25.
- URECKI, VICTOR H., CHARLESTON, WV:
2,859,066, U.S. CL. A.
- URU PRODUCTIONS, PITTSBURGH, PA:
1,247,778, CANC. INT. CL. 28.
1,247,779, CANC. INT. CL. 28.
- US MODEL, INC., MILWAUKEE, WI:
2,857,554, PUB. 4-6-2004. INT. CL. 41.
- USA PRODUCTS GROUP INC., LODI, CA:
2,858,598, MULTIPLE CLASS, INT. CLS. 12 AND 22.
- USDOCUMENTS, INC., LAFAYETTE, CA:
2,835,641, CANC. IIRN. RESTORED TO S.N. 78-249,183.
- USISL, INC., TAMPA, FL:
2,087,578, CANC. INT. CL. 41.
- USX CORPORATION, PITTSBURGH, PA:
1,829,183. REN. 5-21-04. INT. CL. 6.
- UTE LTD, SEATTLE, WA:
2,858,311, MULTIPLE CLASS, INT. CLS. 12 AND 35.
- UTMOST BRANDS, INC., NEW YORK, NY:
2,859,023, INT. CL. 32.
- V.P. HOLDING S.P.A., MILANO, ITALY:
2,857,860, PUB. 4-6-2004. MULTIPLE CLASS, INT. CLS. 35, 36 AND 42.
- VAIL VALLEY JET CENTER, GYPSUM, CO:
2,857,406, PUB. 4-6-2004. MULTIPLE CLASS, INT. CLS. 37 AND 39.
- VAN CLEEF & ARPELS LOGISTICS S. A., 1752 VILLARS-SUR-GLANE, SWITZERLAND:
2,857,257, PUB. 5-20-2003. INT. CL. 14.
- VAN WAVEREN B.V., 2182 BX HILLEGOM, NETHERLANDS:
2,086,929, CANC. INT. CL. 31.
- VAN WINKLE ASSOCIATES, TINTON FALLS, NJ:
2,087,430, CANC. INT. CL. 41.
- VAN WYK CONFECTIONS, LLC, HIGHLANDS RANCH, CO:
2,859,070, INT. CL. 30.
- VANELLI TEXTILE INDUSTRY AND COMMERCE ANONYM COMPANY, 80220 NISANTASI, ISTANBUL, TURKEY:
2,088,103, CANC. INT. CL. 24.
- VANGUARD GROUP, INC., THE, MALVERN, PA:
2,087,509, CANC. INT. CL. 36.
- VANH; MY-HANH TRAN, SAN FRANCISCO, CA, DBA NAIL TODAY:
1,247,502, CANC. INT. CL. 3.
- VAPOR CORPORATION, CHICAGO, IL:
754,526, CANC. MULTIPLE CLASS, U.S. CLS. 21 AND 23.
754,623, CANC. U.S. CL. 34.
- VARGAS MARCAS E PARTICIPACOES LTDA, RIO DE JANEIRO, BRAZIL:
2,858,973, INT. CL. 3.
- VARLEPIC PARTICIPATIONS, 75018 PARIS, FRANCE:
2,857,849, PUB. 4-6-2004. INT. CL. 15.
- VARNER TECHNOLOGIES, INC., CHESTERFIELD, MO:
2,088,255, CANC. INT. CL. 9.
- VBS, INC., FORT LAUDERDALE, FL:
2,834,745, CANC. IIRN. RESTORED TO S.N. 75-794,686.
- VDF FUTURECEUTICALS, INC., MOMENCE, IL:
2,858,837, INT. CL. 5.
- VDK INTERNATIONAL SARL, 75116 PARIS, FRANCE:
2,087,449, CANC. INT. CL. 30.
- VECTOR TOBACCO LTD., HAMILTON, BERMUDA:
2,858,950, INT. CL. 34.
- VEGAS.COM, LLC, HENDERSON, NV:
2,857,427, PUB. 4-6-2004. MULTIPLE CLASS, INT. CLS. 39, 41 AND 43.
- VELASQUES SIGARENFABRIEKEN N.V., GEEL, BELGIUM:
754,481, CANC. U.S. CL. 17.
- VELSICOL CHEMICAL CORPORATION, CHICAGO, IL:
1,247,517, CANC. INT. CL. 5.
- VELTEK ASSOCIATES, INC., PHOENIXVILLE, PA:
2,495,665, COR. INT. CL. 5.
- VENDING MANAGEMENT SERVICES LTD., MASTERTON, NEW ZEALAND:
2,857,702, PUB. 4-6-2004. INT. CL. 9.
- VENDMARK, INC., EAGAN, MN:
1,247,826, CANC. INT. CL. 30.
- VENETIAN BLIND & FLOOR COVERING SHOP, INC., HOUSTON, TX, DBA GULF COAST WINDOW COVERING:
2,088,130, CANC. INT. CL. 19.
- VENNERS RETAIL SYSTEMS (HOLDINGS) LIMITED, BUCKINGHAMSHIRE, MK9 1DS, UNITED KINGDOM:
2,858,732, INT. CL. 35.
- VENTURA DISTRIBUTION, INC., THOUSAND OAKS, CA:
2,857,561, PUB. 4-6-2004. INT. CL. 9.
- VENTURE INTERNATIONAL, LTD., ROSWELL, GA:
2,087,104, CANC. INT. CL. 41.
- VENVEST, INC., ST. LOUIS, MO:
2,859,058, INT. CL. 9.
- VERDUCCI U.S.A., LLC., WESTMINSTER, CA:
2,858,698, INT. CL. 28.
- VESSEY AND COMPANY, INC., EL CENTRO, CA:
1,830,495. REN. 5-20-04. INT. CL. 31.
- VETERINARY VISION, INC., SAN MATEO, CA:
2,857,825, PUB. 4-6-2004. INT. CL. 44.
- VETESSENTIAL LLC, HINGHAM, MA:
2,858,283, MULTIPLE CLASS, INT. CLS. 35 AND 42.
- VETINSITE.COM, INC., SILVER SPRING, MD:
2,858,362, INT. CL. 35.
- VF WORKS, INC., PALM HARBOR, FL:
2,086,809, CANC. INT. CL. 42.
- VFINANCE HOLDINGS, INC., BOCA RATON, FL, DBA VFINANCE.COM:
2,857,776, PUB. 4-6-2004. INT. CL. 35.
- VIACOM INTERNATIONAL INC., NEW YORK, NY:
2,087,216, CANC. INT. CL. 9.
2,858,942, INT. CL. 41.
2,858,999, INT. CL. 41.
- VIAIR, INC., SEATTLE, WA:
2,857,394, PUB. 4-6-2004. INT. CL. 42.
- VIATICUM FUND, L.C., THE, SALT LAKE CITY, UT:
2,086,897, CANC. INT. CL. 36.
- VICENTE GANDIA PLA, S.A., CHIVA-VALENCIA, SPAIN:
2,858,861, INT. CL. 33.
- VIDEO IMAGE ASSOCIATES, LOS ANGELES, CA TO VERY IMAGINATIVE PICTURES INC, LOS ANGELES, CA:
1,787,173, CANC. INT. CL. 42.
- VIDEO JUKEBOX NETWORKS, INC., MIAMI, FL TO BOX WORLDWIDE, INC., THE, MIAMI BEACH, FL:
1,787,636, CANC. INT. CL. 41.

- VIDEO VENDING NEW YORK, INC., NEW YORK, NY:
2,858,046, PUB. 4-6-2004. INT. CL. 41.
- VIE FITNESS, INC., ST. PETERSBURG, FL:
2,087,780, CANC. INT. CL. 16.
- VIEWPOINT INTERNATIONAL, INC., NEW YORK, NY:
2,835,520, CANC. IIRN. RESTORED TO S.N. 78-975,254.
- VILEDA GMBH, D-69469 WEINHEIM, FED REP GER-
MANY:
2,086,768, CANC. INT. CL. 21.
- VINA QUEBRADA DE MACUL S.A., SANTIAGO, CHILE:
2,858,352, INT. CL. 33.
- VINCITI NETWORKS, INC., SANTA CLARA, CA:
2,858,320, MULTIPLE CLASS, INT. CLS. 37 AND 42.
- VINNY'S ITALIAN GRILL & PIZZERIA, INC., FOREST, VA:
2,857,895, PUB. 4-6-2004. INT. CL. 43.
- VINTNERS INTERNATIONAL COMPANY, INC., GON-
ZALES, CA TO CANANDAIGUA BRANDS, INC., FAIR-
PORT, NY:
1,786,956, CANC. INT. CL. 33.
- VIRGINIA BAPTIST MISSION BOARD, RICHMOND, VA:
2,857,569, PUB. 4-6-2004. MULTIPLE CLASS, INT. CLS. 16
AND 45.
- VIRGINIA READY-MIXED CONCRETE ASSOCIATION,
CHARLOTTEVILLE, VA:
2,088,246, CANC. INT. CL. 19.
- VIRSUN, INC., SEATTLE, WA:
2,088,169, CANC. MULTIPLE CLASS, INT. CLS. 9 AND
40.
- VISIBLE INVENTORY, INC., SALEM, NH:
2,858,223, INT. CL. 9.
- VITAL OPTIONS INTERNATIONAL, INC., ENCINO, CA:
2,858,010, PUB. 4-6-2004. INT. CL. 41.
- VITASOY INTERNATIONAL HOLDINGS LIMITED, NEW
TERRITORIES, HONG KONG:
1,833,973. REN. 5-17-04. INT. CL. 30.
- VITO, ROBERT, BERWYN, PA:
2,858,584, INT. CL. 6.
2,858,600, INT. CL. 6.
- VM MOTORI S.P.A., 44042 CENTO (FE), ITALY:
2,086,705, CANC. INT. CL. 12.
2,086,706, CANC. INT. CL. 12.
- VO, LE VAN, CHICAGO, IL:
1,786,911, CANC. INT. CL. 30.
- VOLK OPTICAL, INC., MENTOR, OH:
2,087,098, CANC. INT. CL. 10.
- VON DUPRIN, INC., INDIANAPOLIS, IN:
2,857,781, PUB. 4-6-2004. INT. CL. 35.
- VOSS, MATTHEW SCOTT, ROYAL OAK, MI:
2,858,506, INT. CL. 41.
- VRL INTERNATIONAL LIMITED, GRAND CAYMAN,
CAYMAN ISLANDS:
2,087,123, CANC. INT. CL. 42.
- W. C. BRADLEY COMPANY, COLUMBUS, GA:
1,834,543. REN. 5-18-04. INT. CL. 11.
- W. J. DENNIS & COMPANY, ELGIN, IL:
1,247,723, CANC. INT. CL. 21.
- W.B. MCCLLOUD & COMPANY, HOFFMAN ESTATES, IL:
1,698,051. REN. 5-18-04. MULTIPLE CLASS, INT. CLS. 37
AND 42.
- W.H. MAZE CO., PERU, IL, INDEPENDENT NAIL AND
PACKING COMPANY INC., THE, BRIDGEWATER, MA:
588,496. REN. 5-17-04. U.S. CL. 13 (INT. CL. 6).
- W.W. FISCHER S.A., CH- 1143 APPLES, SWITZERLAND:
2,857,153, PUB. 4-16-2002. MULTIPLE CLASS, INT. CLS. 9
AND 42.
- WA DESIGN, INC., EMERYVILLE, CA:
2,087,982, CANC. INT. CL. 6.
- WACHLER, NORMAN, BLOOMFIELD HILLS, MI:
2,858,800, INT. CL. 29.
- WACHOVIA CORPORATION, CHARLOTTE, NC:
2,858,890, INT. CL. 36.
- WACKER-CHEMIE, GMBH, D-81737, MUNICH, FED REP
GERMANY:
2,857,313, PUB. 4-6-2004. MULTIPLE CLASS, INT. CLS. 1,
3 AND 5.
- WAGNER SPRAY TECH CORPORATION, MINNEAPOLIS,
MN:
1,239,995. REN. 5-19-04. INT. CL. 7.
- WAL-MART STORES, INC., BENTONVILLE, AR:
2,088,075, CANC. INT. CL. 25.
2,088,076, CANC. INT. CL. 25.
2,858,692, INT. CL. 3.
2,858,693, INT. CL. 3.
- WALBERT LABORATORIES, INC., CITY OF INDUSTRY,
CA, DBA WLI INTERNATIONAL:
1,804,051. REN. 5-17-04. MULTIPLE CLASS, INT. CLS. 3
AND 25.
- WALCO INTERNATIONAL, INC., GRAPEVINE, TX:
2,857,871, PUB. 4-6-2004. INT. CL. 5.
- WALDMAN PUBLISHING CORP., NEW YORK, NY AND
PLAYMORE INC., PUBLISHERS, NEW YORK, NY:
2,858,670, INT. CL. 16.
- WALKER P. STEPHENS & COMPANY PUBLISHERS, KING-
STON, PA:
2,087,299, CANC. INT. CL. 16.
- WALL STREET LANGUAGES, LTD., NEW YORK, NY:
1,273,888. REN. 5-17-04. MULTIPLE CLASS, INT. CLS. 41
AND 42.
1,273,888, CANC. INT. CL. 39.
- WALSH INTEGRATED ENVIRONMENTAL SYSTEMS INC.,
MONTREAL, QUEBEC, CANADA:
2,857,540, PUB. 4-6-2004. INT. CL. 9.
2,857,541, PUB. 4-6-2004. INT. CL. 9.
- WALTRIP, DARRELL LEE, HARRISBURG, NC:
2,858,813, MULTIPLE CLASS, INT. CLS. 9, 14, 16, 24 AND
28.
- WAMPOLE INCORPORATED, PERTH, ONTARIO, CANA-
DA:
754,780, CANC. U.S. CL. 51.
- WARMAN INTERNATIONAL LIMITED, ARTARMON,
2064, NEW SOUTH WALES, AUSTRALIA:
2,086,716, CANC. INT. CL. 7.
- WARNACO INC., NEW YORK, NY:
2,088,022, CANC. INT. CL. 25.
- WARNER BROS. ENTERTAINMENT INC., BURBANK, CA:
1,302,779. REN. 5-18-04. INT. CL. 25.
1,302,815. REN. 5-18-04. INT. CL. 28.
- WARNER COMMUNICATIONS INC., NEW YORK, NY:
2,087,966, CANC. MULTIPLE CLASS, INT. CLS. 41 AND
42.
2,087,968, CANC. INT. CL. 38.
- WARNERVISION ENTERTAINMENT INC., NEW YORK,
NY:
2,088,024, CANC. MULTIPLE CLASS, INT. CLS. 9 AND
28.
- WARNOCK FOOD PRODUCTS, INC., MADERA, CA:
2,857,364, PUB. 4-6-2004. INT. CL. 30.
- WARRIOR BOXING GYM, INC., HOLLYWOOD, FL:
2,857,361, PUB. 4-6-2004. INT. CL. 41.
- WASHINGTON EXPRESS LLC, BELTSVILLE, MD FROM
WASHINGTON EXPRESS SERVICES, INC., BELTSVILLE,
MD:
2,858,393, INT. CL. 39.
- WASHINGTON PUBLISHING COMPANY, GAITHERS-
BURG, MD:
2,087,790, CANC. INT. CL. 16.
- WATCHTV, INC., PORTLAND, OR:
2,087,205, CANC. MULTIPLE CLASS, INT. CLS. 38 AND
41.
- WATLOW POLYMER TECHNOLOGIES, INC., WINONA,
MN:
2,858,333, MULTIPLE CLASS, INT. CLS. 19 AND 20.
2,858,728, MULTIPLE CLASS, INT. CLS. 19 AND 20.
- WATSON WYATT & COMPANY, WASHINGTON, DC:
2,088,453, CANC. INT. CL. 35.
- WATSON WYATT PARTNERS, REIGATE, SURREY, UNI-
TED KINGDOM:
2,857,192, PUB. 4-6-2004. MULTIPLE CLASS, INT. CLS. 9,
16, 35 AND 36.
- WATSON, ALFRED H., LOS ANGELES, CA:
2,857,669, PUB. 4-6-2004. INT. CL. 43.
- WATT PUBLISHING COMPANY, MOUNT MORRIS, IL:
1,914,833, AM. INT. CL. 16.
- WAVBANK, INC., LANGLEY, WA:
2,859,115, INT. CL. 42.

WAXMAN CONSUMER PRODUCTS GROUP INC., BEDFORD HEIGHTS, OH, WAXMAN INDUSTRIES, INC., BEDFORD HEIGHTS, OH:
1,824,318. REN. 5-20-04. INT. CL. 11.

WAYMOUTH FARMS, NEW HOPE, MN:
2,858,899. INT. CL. 29.

WE MEDIA, INC., NEW YORK, NY:
2,858,252. INT. CL. 25.

WEBB, YONA, CLEVELAND, OH:
2,087,446. CANC. INT. CL. 42.

WEEKLY READER CORPORATION, MIDDLETOWN, CT:
2,087,840. CANC. INT. CL. 16.

WEHAH FARM, INC., RICHVALE, CA, DBA LUNDBERG FAMILY FARMS:
1,818,109. REN. 5-17-04. INT. CL. 30.

WEIDER NUTRITION INTERNATIONAL, INC., SALT LAKE CITY, UT:
2,858,551. INT. CL. 5.

WELLA PERSONAL CARE OF NORTH AMERICA, INC., HACKENSACK, NJ:
2,857,854. PUB. 4-6-2004. INT. CL. 3.

WELLMAN, INC., SHREWSBURY, NJ:
2,858,633. INT. CL. 1.

WELLS LAMONT CORPORATION, NILES, IL:
406,515. REN. 5-20-04. U.S. CL. 39 (INT. CL. 25).

WELLSPARK GROUP LIMITED PARTNERSHIP, NEWTON, MA:
2,087,794. CANC. INT. CL. 35.

WELTON SOUND SYSTEMS USA LTD., CARROLLTON, TX:
2,088,016. CANC. INT. CL. 9.

WELTY HOME FOR THE AGED, INC., WHEELING, WV:
2,857,663. PUB. 4-6-2004. INT. CL. 44.

WERNER PADDLES, INC., SULTAN, WA:
2,858,005. PUB. 4-6-2004. INT. CL. 12.

WERNER PUBLISHING CORPORATION, LOS ANGELES, CA:
2,857,144. PUB. 4-6-2004. MULTIPLE CLASS, INT. CLS. 16 AND 42.

WERNER, APRIL DAWN, ROLLA, MO:
2,858,037. PUB. 4-6-2004. INT. CL. 10.

WES PAK, INC., LITTLE ROCK, AR:
2,857,670. PUB. 4-6-2004. INT. CL. 17.

WESPOT AB, SE-223 70 LUND, SWEDEN:
2,857,186. PUB. 4-6-2004. INT. CL. 9.

WEST BOND INC., ANAHEIM, CA:
1,786,526. CANC. INT. CL. 9.

WEST FORK CREATIONS, INC., RED LODGE, MT:
2,857,775. PUB. 4-6-2004. INT. CL. 30.

WEST PUBLISHING CORPORATION, EAGAN, MN:
1,226,634. REN. 5-18-04. INT. CL. 16.
1,232,664. REN. 5-18-04. INT. CL. 16.

WEST-100 INTERNATIONAL, INC., DOVER, DE:
2,087,988. CANC. INT. CL. 36.

WESTERN CORPORATE FEDERAL CREDIT UNION, SAN DIMAS, CA:
2,857,154. PUB. 4-6-2004. INT. CL. 40.

WESTERN FAMILY FOODS, INC., TIGARD, OR:
2,086,900. CANC. INT. CL. 30.
2,858,906. INT. CL. 29.

WESTERN HOLDINGS, L.L.C., CASPER, WY:
2,857,786. PUB. 4-6-2004. MULTIPLE CLASS, INT. CLS. 16 AND 35.

WESTERN INSURANCE AGENTS ASSOCIATION, INC., A CALIFORNIA NON-PROFIT CORPORATION, RANCHO CORDOVA, CA:
2,858,139. PUB. 4-6-2004. INT. CL. 35.

WESTERN INTERNATIONAL MEDIA CORPORATION, LOS ANGELES, CA:
1,787,605. CANC. INT. CL. 35.

WESTERN NATIONAL WARRANTY CORPORATION, SCOTTSDALE, AZ:
2,087,335. CANC. INT. CL. 36.

WESTERN SLING COMPANY, SEDALIA, CO:
1,829,181. REN. 5-16-04. MULTIPLE CLASS, INT. CLS. 6 AND 22.

WESTERN UNION HOLDINGS, INC., ENGLEWOOD, CO, NEW VALLEY CORPORATION, PARAMUS, NJ:
1,858,889. REN. 5-20-04. INT. CL. 38.
1,862,016. REN. 5-20-04. INT. CL. 38.

WESTERVELT, DEBORAH R.G., NORTH HAVEN, CT:
2,858,639. INT. CL. 35.

WESTGATE SOFTWARE, INC., DRAPER, UT:
1,849,101. REN. 5-20-04. INT. CL. 9.

WESTINGHOUSE ELECTRIC CORPORATION, NEW YORK, NY:
721,168. REN. 5-18-04. MULTIPLE CLASS, U.S. CLS. 1 (INT. CLS. 1, 3, 4, 17, 18, 19, 22 AND 31), 14 (INT. CL. 6), 15 (INT. CL. 4), 21 (INT. CL. 7), 23 (INT. CL. 17), 26 (INT. CL. 9) AND 34 (INT. CL. 11).

WESTINGHOUSE LIGHTING CORPORATION, PHILADELPHIA, PA:
2,858,978. INT. CL. 11.

WESTLAND CORPORATION, U.S.A., INC., WICHITA, KS:
2,857,447. PUB. 4-6-2004. INT. CL. 7.

WESTVACO PACKAGING GROUP, INC., NEW YORK, NY:
2,858,477. MULTIPLE CLASS, INT. CLS. 16 AND 20.
2,858,478. MULTIPLE CLASS, INT. CLS. 16 AND 20.

WETTERAU INCORPORATED, HAZELWOOD, MO TO SUPERVALU HOLDINGS, INC., EDEN PRARIE, MN:
1,846,413. CANC. MULTIPLE CLASS, INT. CLS. 1 AND 9.

WETYPE4U.COM, INC., DEERFIELD BEACH, FL:
2,858,658. INT. CL. 9.

WEYERHAEUSER COMPANY, FEDERAL WAY, WA:
2,858,122. PUB. 4-6-2004. INT. CL. 16.

WHAT-A-PRODUCT, INC., SCOTTSDALE, AZ:
2,087,103. CANC. INT. CL. 8.

WHEATON USA INC., MILLVILLE, NJ:
2,857,977. PUB. 4-6-2004. INT. CL. 9.

WHEELED COACH INDUSTRIES, INC., HUTCHINSON, KS:
2,858,312. INT. CL. 12.

WHEELER, JOHN, NASHVILLE, TN:
2,858,019. PUB. 4-6-2004. INT. CL. 41.

WHIRLPOOL PROPERTIES, INC., ST. JOSEPH, MI, WHIRLPOOL CORPORATION, BENTON HARBOR, MI:
1,837,512. REN. 5-20-04. INT. CL. 11.

WHIRLPOOL PROPERTIES, INC., BENTON HARBOR, MI:
2,086,771. CANC. INT. CL. 42.

WHIRLPOOL PROPERTIES, INC., ST. JOSEPH, MI:
2,858,771. INT. CL. 11.

WHITE CONSOLIDATED INDUSTRIES, INC., CLEVELAND, OH:
1,787,429. CANC. INT. CL. 9.

WHITE DENTAL STUDIO, INC., OLATHE, KS:
2,087,898. CANC. INT. CL. 14.

WHITE MOUNTAINS HOLDINGS, INC., MANCHESTER, NH:
2,088,427. CANC. INT. CL. 36.

WHITE, TRICIA L., ONTARIO, CA:
2,858,290. INT. CL. 30.

WHITES COVE CORPORATION, YARMOUTH, ME:
2,858,032. PUB. 4-6-2004. INT. CL. 29.

WHITMAN PUBLISHING, LLC, ATLANTA, GA:
2,857,286. PUB. 4-6-2004. INT. CL. 16.

WHITNEY, F. ALEXANDER, SR., DULUTH, GA:
2,087,766. CANC. MULTIPLE CLASS, INT. CLS. 35 AND 37.

WHOLEY, MARK H., OAKMONT, PA:
2,857,801. PUB. 4-6-2004. INT. CL. 10.

WICHITA FESTIVALS, INC., WICHITA, KS:
2,857,328. PUB. 4-6-2004. INT. CL. 41.

WIDEORBIT, SAN FRANCISCO, CA:
2,857,976. PUB. 4-6-2004. INT. CL. 9.

WIEDER, MARCIA, SAN FRANCISCO, CA:
2,857,327. PUB. 4-6-2004. INT. CL. 16.

WILBUR CURTIS COMPANY, MONTEBELLO, CA:
2,858,272. INT. CL. 11.

WILEN COMPANIES, INCORPORATED, THE, ATLANTA, GA:
2,088,026. CANC. INT. CL. 9.

WILEN MANUFACTURING COMPANY, INCORPORATED, ATLANTA, GA:
2,087,980. CANC. INT. CL. 21.

- WILEY PUBLISHING, INC., INDIANAPOLIS, IN:
2,087,002, CANC. INT. CL. 9.
- WILKIN & SONS LIMITED, COLCHESTER, ESSEX CO
S, ENGLAND:
594,041, REN. 5-16-04. U.S. CL. 46 (INT. CL. 29).
- WILLIAM CARTER COMPANY, THE, ATLANTA, GA:
1,830,836, REN. 5-20-04. INT. CL. 28.
2,857,803, PUB. 4-6-2004. INT. CL. 25.
- WILLIAM M. MERCER, INCORPORATED, NEW YORK,
NY:
2,087,468, CANC. INT. CL. 35.
- WILLIAM PENROD, ODESSA, FL, DBA PENROD & SON'S
MARKETING & ADVERTISING:
2,087,890, CANC. INT. CL. 9.
- WILLIAMSBURG SOAP AND CANDLE COMPANY, WIL-
LIAMSBURG, VA, DBA GRANNY NANNY'S QUILTING
GADGETS:
2,087,101, CANC. INT. CL. 16.
- WILLIAMSVILLE BREWERY LTD., ASHLAND, VA:
2,087,198, CANC. INT. CL. 32.
- WILLITTS DESIGNS INTERNATIONAL, INC., PETALUMA,
CA:
2,745,031, COR. INT. CL. 20.
- WIND RIVER TOBACCO COMPANY, LLC, JACKSON, WY:
2,859,046, INT. CL. 34.
- WINDHOVER TECHNOLOGY MANAGEMENT PTY LIM-
ITED, VICTORIA, AUSTRALIA:
2,857,365, PUB. 4-6-2004. INT. CL. 13.
- WING HOP FUNG GINSENG, INC., LOS ANGELES, CA:
2,858,459, INT. CL. 18.
- WING-IT INC., NUTLEY, NJ:
2,088,410, CANC. INT. CL. 28.
- WINKEL WHEEL, INC., KENT, WA:
1,786,673, CANC. INT. CL. 12.
- WINKLEVOSS, LLC, GREENWICH, CT:
2,859,117, INT. CL. 36.
- WINTER, JEFFREY M., AUSTIN, TX:
2,087,215, CANC. INT. CL. 41.
- WINTUN DEVELOPMENT COMPANY, INC., MT. SHASTA,
CA, DBA MT. SHASTA SKI PARK:
2,857,351, PUB. 4-6-2004. INT. CL. 41.
- WIPERS EXPRESS, INC., PATERSON, NJ:
1,787,458, CANC. INT. CL. 12.
- WIRELESS TELECOMMUNICATIONS, INC., YORK, PA:
2,088,094, CANC. INT. CL. 41.
- WIRELESS XCESSORIES GROUP, INC., HUNTINGDON
VALLEY, PA:
2,859,126, INT. CL. 9.
- WISDOMATION, INC., BOISE, ID:
2,857,721, PUB. 4-6-2004. INT. CL. 42.
- WISH YOU WERE HERE FILM & VIDEO, INC., BURBANK,
CA:
2,858,262, MULTIPLE CLASS, INT. CLS. 9 AND 41.
- WMS ENTERPRISES, INC., PLYMOUTH, MI:
2,858,346, INT. CL. 25.
- WNC INSURANCE SERVICES, INC., SIMI VALLEY, CA:
2,858,104, PUB. 4-6-2004. INT. CL. 36.
- WOJAHN, RAYMOND, PHOENIX, AZ:
2,857,662, PUB. 4-6-2004. INT. CL. 25.
- WOLVERTON PET SUPPLY CO., LANSING, MI:
2,857,545, PUB. 4-6-2004. INT. CL. 16.
- WOMBLE CARLYLE SANDRIDGE & RICE, PLLC, WIN-
STON-SALEM, NC:
2,858,956, MULTIPLE CLASS, INT. CLS. 36 AND 42.
- WOMEN INVOLVED IN FARM ECONOMICS (WIFE),
COTTAGE GROVE, MN:
2,857,586, PUB. 4-6-2004. INT. CL. 35.
- WONG, VENICE ANTOINETTE, WOODLAND HILLS, CA:
2,857,547, PUB. 4-6-2004. INT. CL. 25.
- WOOL RESEARCH ORGANISATION OF NEW ZEALAND,
INC., LINCOLN, NEW ZEALAND:
2,178,068, CANC. INT. CL. 24.
- WORLD CHAMPIONSHIP WRESTLING, INC., ATLANTA,
GA:
2,087,165, CANC. INT. CL. 9.
- WORLD CLIMBING ASSOCIATION, SACRAMENTO, CA:
2,087,779, CANC. INT. CL. 36.
- WORLD CLUB SUPPLY CORP., ORANGE, CA:
2,857,884, PUB. 4-6-2004. INT. CL. 3.
- WORLD WRESTLING FEDERATION ENTERTAINMENT,
INC., STAMFORD, CT:
2,858,755, INT. CL. 41.
- WORLD'S FARE, LLC, CARLSBAD, CA:
2,858,677, MULTIPLE CLASS, INT. CLS. 29 AND 30.
- WORLDSPAN, L.P., ATLANTA, GA:
1,828,591, REN. 5-18-04. INT. CL. 39.
- WORLDXCHANGE CORP., SAN DIEGO, CA, DBA ACCERIS
COMMUNICATIONS PARTNERS D.B.A. ACCERIS COM-
MUNICATIONS SOLUTIONS:
2,857,543, PUB. 4-6-2004. INT. CL. 38.
- WOW PLASTICS, INC., RICHMOND, TX:
2,857,675, PUB. 4-6-2004. INT. CL. 20.
- WRC P.L.C., WILTSHIRE SN5 8YF, UNITED KINGDOM:
2,088,090, CANC. INT. CL. 9.
- WRENCHHEAD, INC., WHITE PLAINS, NY:
2,747,422, AM. INT. CL. 9.
- WRIGHT CONTRACTING INC., OXFORD, MI:
2,088,307, CANC. INT. CL. 41.
- WRIGHT MEDICAL TECHNOLOGY, INC., ARLINGTON,
TN:
2,088,122, CANC. INT. CL. 10.
- WW AUTOMOBILES, INC., GREENVILLE, MS, DBA TOM
WADLER KIA AND TOM WADLER NISSAN AND WWD
AUTOMOBILE, INC., GREENVILLE, MS, DBA TOM
WADLER TOYOTA AND TOM WADLER LINCOLN-
MERCURY:
2,812,359, COR. INT. CL. 35.
- WYATT COMPANY, THE, WASHINGTON, DC:
2,088,417, CANC. INT. CL. 9.
- WYOMING INTERIOR SYSTEMS, INC., CASPER, WY:
1,247,899, CANC. MULTIPLE CLASS, INT. CLS. 37 AND
42.
- XPAYS LLC, SAN FRANCISCO, CA:
2,835,529, CANC. IIRN. RESTORED TO S.N. 75-983,156.
- XTIME, INC., BURLINGAME, CA:
2,857,865, PUB. 4-6-2004. MULTIPLE CLASS, INT. CLS. 9,
41 AND 42.
- XTRA CORPORATION, WESTPORT, CT:
2,857,414, PUB. 4-6-2004. INT. CL. 37.
- XTREME MEDIA, BURBANK, CA:
2,087,169, CANC. INT. CL. 9.
- YALE UNIVERSITY, NEW HAVEN, CT:
1,273,102, REN. 5-21-04. INT. CL. 41.
- YAMAHA CORPORATION, SHIZUOKA, JAPAN:
2,858,662, INT. CL. 9.
- YAMAWA MFG. CO., LTD., MINATO-KU, TOKYO, JAPAN:
984,437, REN. 5-16-04. U.S. CL. 23 (INT. CLS. 7 AND 8).
- YAMAZEN CORPORATION, OSAKA 550, JAPAN:
2,087,481, CANC. MULTIPLE CLASS, INT. CLS. 35, 36, 41
AND 42.
- YANKEE PUBLISHING INCORPORATED, DUBLIN, NH:
2,857,991, PUB. 4-6-2004. INT. CL. 16.
- YANOVA LIMITED, KOWLOON, HONG KONG:
2,857,981, PUB. 4-6-2004. INT. CL. 14.
- YAROS COMMUNICATIONS, INC., ST. LOUIS, MO:
1,787,624, CANC. INT. CL. 41.
- YOKOGAWA ELECTRIC CORPORATION, TOKYO, JAPAN:
2,857,389, PUB. 4-6-2004. INT. CL. 9.
- YORK INTERNATIONAL CORPORATION, YORK, PA:
2,088,083, CANC. MULTIPLE CLASS, INT. CLS. 9 AND
11.
- YOSHIDA'S INC., PORTLAND, OR, DBA YOSHIDA FOOD
PRODUCTS COMPANY TO YOSHIDA FOOD PRODUCTS
COMPANY LIMITED PARTNERSHIP, PORTLAND, OR:
1,786,935, CANC. INT. CL. 30.
- YOUNG REGULATOR COMPANY, CLEVELAND, OH:
1,247,598, CANC. INT. CL. 9.
- YOUNG WOMEN'S CHRISTIAN ASSOCIATION OF BOS-
TON, INC., BOSTON, MA:
2,857,733, PUB. 4-6-2004. INT. CL. 41.
- YOUNTVILLE PARTNERS, INC., NAPA, CA, DBA BRX
RESTAURANT:
2,857,741, PUB. 4-6-2004. INT. CL. 29.
- YOUTH BASKETBALL OF AMERICA, INC., ORLANDO, FL:
2,858,168, PUB. 4-6-2004. MULTIPLE CLASS, INT. CLS. 14

AND 25.
YOUTHFRIENDS, KANSAS CITY, MO:
2,858,172, PUB. 4-6-2004. INT. CL. 42.
2,858,173, PUB. 4-6-2004. INT. CL. 42.
YU, CHANG YUNG, TAINAN HSIEN, TAIWAN:
2,858,030, PUB. 4-6-2004. INT. CL. 7.
YVES SAINT LAURENT PARFUMS, NEUILLY SUR SEINE,
FRANCE:
2,858,007, PUB. 4-6-2004. INT. CL. 3.
ZALE DELAWARE, INC., IRVING, TX:
2,088,444, CANC. INT. CL. 14.
ZAPPA FAMILY TRUST, THE, STUDIO CITY, CA:
2,858,588, INT. CL. 25.
ZARTIC, INC., ROME, GA:
767,262, REN. 5-21-04. U.S. CL. 46 (INT. CL. 29).
ZEE, JOSH, LOS ANGELES, CA:
2,088,358, CANC. INT. CL. 9.
ZENCON TECHNOLOGIES, LLC, MESA, AZ:
2,859,087, INT. CL. 45.
2,859,089, INT. CL. 45.
ZENGEN, INC., WOODLAND HILLS, CA:
2,857,844, PUB. 4-6-2004. INT. CL. 42.
ZIDELL, AMY L., BURBANK, CA:
1,787,519, CANC. INT. CL. 25.
ZINSSER BRANDS COMPANY, MEDINA, OH:
2,858,164, PUB. 4-6-2004. MULTIPLE CLASS, INT. CLS. 8
AND 9.
ZONDERVAN CORPORATION, THE, GRAND RAPIDS, MI:
2,088,352, CANC. MULTIPLE CLASS, INT. CLS. 4, 14, 16
AND 21.
ZTE CORPORATION, SHENZHEN, P.R., CHINA:
2,820,142, COR. INT. CL. 9.
ZUCCARDI, JOSE ALBERTO, MENDOZA, ARGENTINA:
2,858,559, INT. CL. 33.
ZUELLIG PHARMA HOLDINGS LTD, 87011 LABUAN F.T.,
MALAYSIA:
2,858,222, MULTIPLE CLASS, INT. CLS. 35, 39 AND 42.
ZURN INDUSTRIES, INC., DALLAS, TX:
1,812,858, REN. 5-19-04. INT. CL. 11.
ZYLOWARE CORPORATION, LONG ISLAND CITY, NY:
2,859,041, INT. CL. 9.
21ST CENTURY TOYS, INC., SAN LORENZO, CA:
2,857,272, PUB. 4-6-2004. INT. CL. 28.
24/7 REAL ESTATE, INC., WOODRIDGE, IL:
2,858,535, INT. CL. 36.
3CIM, INC., FREMONT, CA:
2,835,643, CANC. IIRN. RESTORED TO S.N. 78-260,516.
3COM CORPORATION, SANTA CLARA, CA:
2,858,776, INT. CL. 9.
3D MOLECULAR DESIGNS, LLC, WAUWATOSA, WI:
2,858,096, PUB. 4-6-2004. INT. CL. 16.
3E COMPANY, ENVIRONMENTAL, ECOLOGICAL AND
ENGINEERING, CARLSBAD, CA:
2,858,268, INT. CL. 42.
3M, ST. PAUL, MN:
1,284,295, REN. 5-17-04. INT. CL. 16.
4HEALTH, INC., BOULDER, CO:
2,086,800, CANC. INT. CL. 5.
401K FORUM, INC., SAN FRANCISCO, CA:
2,087,763, CANC. INT. CL. 36.
420820 ONTARIO LIMITED, VAUGHAN, ONTARIO, CANA-
DA, DBA PREFERRED ENGINEERING PRODUCTS
LTD.:
2,857,471, PUB. 4-6-2004. MULTIPLE CLASS, INT. CLS. 6,
19 AND 20.

* * * * *