

# MARKS PUBLISHED FOR OPPOSITION

The following marks are published in compliance with section 12(a) of the Trademark Act of 1946. Applications for the registration of marks in more than one class have been filed as provided in section 30 of said act as amended by Public Law 772, 87th Congress, approved Oct. 9, 1962, 76 Stat. 769. Opposition under section 13 may be filed within thirty days of the date of this publication. See rules 2.101 to 2.105.

A separate fee of two hundred dollars for opposing each mark in each class must accompany the opposition.

## SECTION 1.— INTERNATIONAL CLASSIFICATION

The short titles associated below with the international class numbers are terms designed merely for quick identification and are not an official part of the international classification. The full names of international classes are given in section 6.1 of the trademark rules of practice.

The designation "U.S. Cl." appearing in this section refers to the U.S. class in effect prior to Sep. 1, 1973 rather than the international class which applies to applications filed on or after that date. For adoption of international classification see notice in the OFFICIAL GAZETTE of Jun. 26, 1973 (911 O.G. TM 210).

### Application in more than one class

SN 75-071,665. BASIC TRADEMARK S.A., L-1150 LUXEMBOURG, LUXEMBOURG, FILED 3-12-1996.



OWNER OF BENELUX REG. NO. 592203, DATED 5-15-1996, EXPIRES 5-15-2006.

OWNER OF U.S. REG. NOS. 1,535,394 AND 1,537,872.

#### CLASS 3—COSMETICS AND CLEANING PREPARATIONS

FOR PERFUMES, ESSENTIAL OILS FOR PERSONAL USE, COSMETICS, NAMELY AFTERSHAVE LOTION, AFTERSHAVE BALM (U.S. CLS. 1, 4, 6, 50, 51 AND 52).

#### CLASS 9—ELECTRICAL AND SCIENTIFIC APPARATUS

FOR SPECTACLES, EYE GLASSES AND SUN GLASSES (U.S. CLS. 21, 23, 26, 36 AND 38).  
TERESA M. RUPP, EXAMINING ATTORNEY

SN 75-463,066. FRENCH CONNECTION LIMITED, LONDON, ENGLAND, FILED 4-6-1998.

**FCUK**

OWNER OF ERPN CMNTY TM OFC REG. NO. 743112, DATED 9-3-1999, EXPIRES 2-4-2008.

#### CLASS 18—LEATHER GOODS

FOR ARTICLES MADE WHOLLY OR PRINCIPALLY OF LEATHER OR OF IMITATION LEATHER, NAMELY, TRUNKS, TRAVELING BAGS, LUGGAGE, HANDBAGS, PURSES, KEY-CASES, WALLETS, BRIEFCASES, GARMENT BAGS FOR TRAVEL, ATTACHE' CASES, CHECKBOOK HOLDERS, PASSPORT HOLDERS, CREDIT CARD HOLDERS, UMBRELLAS, PARASOLS, HOLLERS, SHOULDER BAGS AND SECURING STRAPS (U.S. CLS. 1, 2, 3, 22 AND 41).

#### CLASS 25—CLOTHING

FOR ARTICLES OF CLOTHING, NAMELY, SUITS, JACKETS, TROUSERS, OVERCOATS, SOCKS, HOSIERY, SLEEPWEAR, RAINWEAR, SHORTS, SHIRTS, FROCKS, DRESSES, BLOUSES, JERSEYS, PARKAS, SWEATERS, WAISTCOATS, SKIRTS, HEADWEAR, GLOVES, FOOTWEAR, T-SHIRTS, SWEATSHIRTS, SCARVES, TIES, CLOTHING BELTS, CRAVATS, SHAWLS, BATH ROBES, SWIMWEAR, JEANS AND TUXEDOS (U.S. CLS. 22 AND 39).

LESLEY LAMOTHE, EXAMINING ATTORNEY

SN 75-471,972. WILKINSON, BRIGITTE FRANCES, LEEDS, LS19 6JL, UNITED KINGDOM, FILED 4-22-1998.

**SNAPFAX**

#### CLASS 16—PAPER GOODS AND PRINTED MATTER

FOR PRINTED MATTER, NAMELY, MAGAZINES, NEWSLETTERS, PRINTED REPORTS AND PAMPHLETS IN THE FIELDS OF SALES, ADVERTISING, MARKETING AND PROMOTION OF GOODS AND SERVICES (U.S. CLS. 2, 5, 22, 23, 29, 37, 38 AND 50).

#### CLASS 35—ADVERTISING AND BUSINESS

FOR ADVERTISING AGENCIES, PREPARING AND PLACING ADVERTISEMENTS FOR OTHERS, DISSEMINATION OF ADVERTISING FOR OTHERS, BUSINESS MARKETING CONSULTING SERVICES, CONDUCTING MARKETING STUDIES, CONDUCTING BUSINESS AND MARKET RESEARCH SURVEYS, AND MARKET RESEARCH (U.S. CLS. 100, 101 AND 102).

ANDREA K. NADELMAN, EXAMINING ATTORNEY

SN 75-491,049. LAMM, STEVEN, NEW YORK, NY. FILED 5-26-1998.

SN 75-787,311. H.C. ANDERSEN INTERNATIONAL APS, DK-2100 COPENHAGEN Ø, DENMARK, FILED 8-30-1999.

## VITALITY MEDICINE

NO CLAIM IS MADE TO THE EXCLUSIVE RIGHT TO USE "MEDICINE", APART FROM THE MARK AS SHOWN.

### CLASS 5—PHARMACEUTICALS

FOR VITAMINS AND HERBAL SUPPLEMENTS (U.S. CLS. 6, 18, 44, 46, 51 AND 52).

### CLASS 16—PAPER GOODS AND PRINTED MATTER

FOR SERIES OF NONFICTION BOOKS IN THE FIELD OF PREVENTIVE HEALTH SERVICES, NAMELY, WELLNESS ENHANCEMENT, SEXUAL ENHANCEMENT AND FITNESS ENHANCEMENT (U.S. CLS. 2, 5, 22, 23, 29, 37, 38 AND 50).

HOWARD B. LEVINE, EXAMINING ATTORNEY



OWNER OF ERPN CMNTY TM OFC REG. NO. 1287655, DATED 10-3-2000, EXPIRES 8-24-2009.

THE NAME IN THE MARK IS NOT A LIVING INDIVIDUAL.

### CLASS 3—COSMETICS AND CLEANING PREPARATIONS

FOR FULL LINE OF COSMETICS (U.S. CLS. 1, 4, 6, 50, 51 AND 52).

### CLASS 9—ELECTRICAL AND SCIENTIFIC APPARATUS

FOR SPECTACLES AND SUN GLASSES (U.S. CLS. 21, 23, 26, 36 AND 38).

### CLASS 14—JEWELRY

FOR JEWELRY, PRECIOUS GEMSTONES, CLOCKS AND WATCHES (U.S. CLS. 2, 27, 28 AND 50).

### CLASS 16—PAPER GOODS AND PRINTED MATTER

FOR CARDBOARD; COPYING PAPER; PRINTING PAPER AND WRITING PAPER; PACKAGING BAGS, ENVELOPES AND POUCHES OF PAPER; GARBAGE BAGS OF PAPER; TOWELS OF PAPER; TABLE NAPKINS OF PAPER; HAND TOWELS OF PAPER; HANDKERCHIEFS OF PAPER; DRESSMAKING PATTERNS; TABLE CLOTHES OF PAPER; BLINDS OF PAPER; PAPER BANNERS; FLAGS OF PAPER; BABIES DIAPERS OF PAPER; BABIES NAPKINS OF PAPERS; BLANK AND PRINTED BAGGAGE LABELS; ART PRINTS IN THE NATURE OF CALLIGRAPHY; PAINTINGS DONE ON PAPER AND CARDBOARD; MOUNTED AND UNMOUNTED PHOTOGRAPHS; PLAYING CARDS AND STATIONERY (U.S. CLS. 2, 5, 22, 23, 29, 37, 38 AND 50).

### CLASS 18—LEATHER GOODS

FOR LEATHER SOLD IN BULK, IMITATION LEATHER SOLD IN BULK; LEATHER TOTE BAGS; LEATHER POUCHES AND BAGS FOR MERCHANDISE PACKAGING; LEATHER AND IMITATION LEATHER VANITY CASES SOLD EMPTY; LEATHER HARNESSES AND SADDLERY; LEATHER ANIMAL LEASHES AND COLLARS (U.S. CLS. 1, 2, 3, 22 AND 41).

### CLASS 21—HOUSEWARES AND GLASS

FOR FULL LINE OF HOUSEHOLD AND KITCHEN UTENSILS, TABLEWARE AND CONTAINERS, ALL OF GLASSWARE, PORCELAIN OR EARTHENWARE (U.S. CLS. 2, 13, 23, 29, 30, 33, 40 AND 50).

### CLASS 25—CLOTHING

FOR FULL LINE OF APPAREL (U.S. CLS. 22 AND 39).

### CLASS 28—TOYS AND SPORTING GOODS

FOR FULL LINE OF CHILDREN'S TOYS; A FULL LINE OF SPORTS AND ATHLETIC EQUIPMENT (U.S. CLS. 22, 23, 38 AND 50).

SN 75-629,548. ONEX CORPORATION, TORONTO, ONTARIO, M5J 2S1, CANADA, FILED 1-28-1999.

## ONEX

### CLASS 35—ADVERTISING AND BUSINESS

FOR BUSINESS PLANNING; BUSINESS MANAGEMENT; STRATEGIC PLANNING; BUSINESS REORGANIZATION CONSULTATION AND PROVIDING BUSINESS INFORMATION IN THE AREAS OF BUSINESS STRATEGIES, INFORMATION RELATING TO CAPITAL EXPENDITURE, CORPORATE REORGANIZATION, BUSINESS ACQUISITION ALL FOR THE AIRLINE CATERING, CALL CENTRE, CUSTOMER CARE, ELECTRONICS MANUFACTURING, AUTOMOTIVE AND TRUCK COMPONENTS, FILMED ENTERTAINMENT AND SUGAR REFINING INDUSTRIES (U.S. CLS. 100, 101 AND 102).

FIRST USE 6-0-1983; IN COMMERCE 6-0-1983.

### CLASS 36—INSURANCE AND FINANCIAL

FOR FINANCIAL PLANNING; FINANCIAL MANAGEMENT, INCLUDING FINANCIAL MANAGEMENT REGARDING CAPITALIZATION, CAPITAL EXPENDITURES, AND REVENUE DIVERSIFICATION; FINANCIAL ANALYSIS AND CONSULTATION; FINANCIAL FORECASTING AND FINANCIAL RESEARCH AND PROVIDING FINANCIAL INFORMATION ALL FOR THE AIRLINE CATERING, CALL CENTRE, CUSTOMER CARE, ELECTRONICS MANUFACTURING, AUTOMOTIVE AND TRUCK COMPONENTS, FILMED ENTERTAINMENT AND SUGAR REFINING INDUSTRIES (U.S. CLS. 100, 101 AND 102).

FIRST USE 6-0-1983; IN COMMERCE 6-0-1983.  
ZHALEH DELANEY, EXAMINING ATTORNEY

**CLASS 30—STAPLE FOODS**

FOR CAKES; BISCUITS; COOKIES; PASTRIES AND CONFECTIONERY, NAMELY, CANDY, CHOCOLATE, CARAMELS, CHEWING GUM, LIQUORICE, ICE CREAM, PRALINES, PEPPERMINT CANDIES, CONFECTIONERY PASTILLES, MARZIPAN, AND CANDY LOZENGES (U.S. CL. 46).

**CLASS 32—LIGHT BEVERAGES**

FOR BEERS; MINERAL AND AERATED WATERS; FRUIT DRINKS AND FRUIT JUICES, VEGETABLE DRINKS AND VEGETABLE JUICES (U.S. CLS. 45, 46 AND 48).

MARTHA FROMM, EXAMINING ATTORNEY

SN 75-910,975. SUBAFILMS LIMITED, LONDON, UNITED KINGDOM, FILED 2-7-2000.

**YELLOW SUBMARINE**

OWNER OF ERPN CMNTY TM OFC REG. NO. 773051, DATED 4-29-1999, EXPIRES 3-5-2008.

**CLASS 11—ENVIRONMENTAL CONTROL APPARATUS**

FOR (BASED ON INTENT TO USE) TABLE LAMPS, WALL MOUNTED LAMPS, STANDARD LAMPS, ELECTRIC LANTERNS, ELECTRIC NIGHT-LIGHTS, LAMP BASES, LAMP SHADES ELECTRIC PARTY LIGHTS, ELECTRIC FAIRY LIGHTS, ELECTRIC LIGHTS FOR CHRISTMAS TREES, FLASHLIGHTS, CYCLE LIGHTS, SCOOTER LIGHTS, ORNAMENTAL WATER FOUNTAINS, JETS AND STREAMS, ARTIFICIAL WATERFALLS, ELECTRIC COFFEE MACHINES, ELECTRIC KETTLES, WAFFLE IRONS AND TOASTED SANDWICH MAKERS; ORNAMENTAL FOUNTAINS, JETS AND STREAMS (U.S. CLS. 13, 21, 23, 31 AND 34).

**CLASS 12—VEHICLES**

FOR (BASED ON INTENT TO USE) LAND VEHICLE AND WATER VEHICLES, NAMELY AUTOMOBILES; TRUCKS; BOATS; CANOES; KAYAKS; BICYCLES, TRICYCLES; SCOOTERS; MOTORCYCLES; MOTOR SCOOTERS, ELECTRICALLY POWERED VEHICLES, NAMELY AUTOMOBILES, GOLF CARTS, AND CARTS FOR PERSONAL TRANSPORT; ELECTRIC CARTS; ELECTRIC CYCLES; ELECTRIC SCOOTERS; BELLS AND HORNS FOR CYCLES AND SCOOTERS; PARTS AND FITTINGS FOR ALL THE AFORESAID GOODS, NAMELY BATTERIES (U.S. CLS. 19, 21, 23, 31, 35 AND 44).

**CLASS 28—TOYS AND SPORTING GOODS**

FOR (BASED ON 44(E)) TOYS, GAMES AND PLAYTHINGS; GYMNASTIC AND SPORTING ARTICLES NOT INCLUDED IN OTHER CLASSES; DECORATIONS FOR CHRISTMAS TREES; CHRISTMAS CRACKERS, DOLLS; TOY AND NOVELTY FACE MASKS; NOVELTIES IN THE FORM OF SOUVENIRS, INCLUDING MINIATURE SUBMARINES; TOY MUSICAL BOXES; TOY MUSICAL INSTRUMENTS; TOY MODELS, NAMELY TOY SUBMARINES; CUBE-TYPE PUZZLES; GOLF EQUIPMENT, INCLUDING GOLF CLUBS AND GOLF BALLS; SNOW GLASS BALLS; KITES; PLAY BALLS AND PLAY BALLOONS; FLIPPERS FOR SWIMMING; ARM FOAM AND SWIM FLOATS FOR RECREATIONAL USE; INFLATABLE BATH TOY; INFLATABLE FLOAT MATTRESSES OR PADS FOR RECREATIONAL USE; INFLATABLE INNER TUBES FOR AQUATIC RECREATIONAL USE; INFLATABLE MATTRESSES FOR RECREATIONAL USE; INFLATABLE POOLS FOR RECREATIONAL USE; INFLATABLE RIDE-ON-TOYS; INFLATABLE PLAY ARTICLES FOR SWIMMING POOLS; AND INFLATABLE TOYS; ARCADE-TYPE

ELECTRONIC EDUCATION VIDEO GAMES; COIN-OPERATED VIDEO GAMES; ELECTRONIC DART GAMES; NOT INCLUDED IN OTHER CLASSES; AMUSEMENT APPARATUS NAMELY HAND HELD ELECTRONIC GAMES, NOT BEING COIN FED; VIRTUAL REALITY APPARATUS AND MOTION SIMULATORS FOR AMUSEMENT AND ENTERTAINMENT PURPOSES; FAIR GROUND RIDES; BOARD GAMES; PARLOR GAMES; THROWING GAMES; SKITTLES; BOULE GAMES, QUIZ GAMES; CARD GAMES; DICE GAMES; TOY FIGURINES; TOY ACTION FIGURES; TOY BENDABLE FIGURES; PLUSH TOYS; STUFFED TOYS; BEAN FILLED TOYS; HAND PUPPETS, FINGER PUPPETS; STRING PUPPETS; WINDUP TOYS; MUSICAL TOYS; TOY MUSICAL SNOW GLOBES; TOY MODEL VEHICLES, SHIPS AND SUBMARINES; SCALE MODEL VEHICLES, SHIPS AND SUBMARINES; WIND-UP AND PULL ALONG TOY FIGURES, VEHICLES, SHIPS AND SUBMARINES; TOY MODEL HOBBY CRAFT KITS; TOY MODEL KITS FOR MAKING UP INTO VEHICLES, SHIPS, SUBMARINES AND FIGURES; TOY MOBILES; JIGSAW PUZZLES; MANIPULATIVE PUZZLES; GOLF BAGS; GOLF GLOVES; GOLF PUTTER COVERS; GOLF BALL MARKETS; GOLF TEES; TOY KITS COMPRISED OF TOY SUBMARINES AND TOY SUBMARINES AND TOY PASSENGERS; FLYING DISCS; CRIB MOBILES; MOBILES FOR CHILDREN; SPINNING TOYS; YO-YOS; CHILDREN PLAYHOUSES; PLAY TENTS; CHARACTER COSTUMES, BEING PLAYTHINGS; SKIPPING ROPES; CROQUET SETS; BEACH BALLS; FOOTBALLS; BOWLING BALLS; BOUNCING BALLS; NAMELY GENERAL PURPOSE PLAY BALLS; JUGGLING BALLS; BASEBALLS; SOFTBALLS; BASEBALL BATS; BASEBALL GLOVES; PLAY SNORKELS; PLAY GOGGLES AND PLAY MASKS FOR SWIMMING; AIR MATTRESSES FOR SUPPORTING A PERSON FLOATING ON WATER; TOY BUCKETS AND SHOVELS; SURF BOARDS; BATH TOYS; WATER PISTOLS; TOY PERISCOPES; PADDLING POOLS AND PLAY SWIMMING POOLS; TENNIS RACQUETS; TENNIS BALLS; STAND ALONE ELECTRONIC AND VIDEO GAME MACHINES; HAND HELD UNITS FOR PLAYING ELECTRONIC AND VIDEO GAMES; COMPUTER ASSISTED GAME, NOT BEING COIN FED AND NOT BEING FOR USE WITH AN EXTERNAL DISPLAY; AMUSEMENT APPARATUS INCORPORATING IMAGE PROJECTION SCREENS, TELEVISION SCREENS, ELECTRONIC DISPLAY EQUIPMENT, VIDEO DISPLAY EQUIPMENT, VIRTUAL REALITY DISPLAY EQUIPMENT OR COMPUTER ASSISTED IMAGE GENERATION EQUIPMENT, ALL FOR USE IN ARCADES, AMUSEMENT PARKS OR URBAN ENTERTAINMENT ENVIRONMENT; AMUSEMENT PARK RIDES; VIRTUAL REALITY RIDES; ARCADE GAMES; NOT BEING COIN OPERATED; AMUSEMENT APPARATUS, NAMELY HELMETS, HEADSETS, VISORS, SCREENS BOOTHS, CABINS AND CINEMAS FOR DISPLAYING CARTOONS, ANIMATION, AND VIRTUAL REALITY IMAGES; NOT BEING COIN FED; AMUSEMENT APPARATUS, NAMELY, SIT-IN RIDES AND RIDE-ON MACHINES WHICH SIMULATE THE MOTION OF A VEHICLE, SHIP OR SUBMARINE, NOT BEING COIN FED; VIRTUAL REALITY RIDES WHICH COMBINE THE DISPLAY OF IMAGES WITH SIMULATING THE EFFECTS OF MOTIONS; ELECTRONIC REMOTE CONTROLLED TOYS; SNOWBOARDS; SNOWBOARD BINDINGS; SKIS; SKI POLES; SKI BINDINGS; SKATEBOARDS; SKATEBOARD DECKS; ROLLER SKATES; IN-LINE SKATES; PROTECTIVE ARM AND KNEE PADS FOR SKATEBOARDERS AND ROLLER SKATERS; BAGS SPECIALLY ADAPTED FOR CARRYING SURFBOARDS, SNOWBOARDS AND SKI EQUIPMENT; SNOW SLEDS FOR RECREATIONAL USE; TOY RIDE-ON VEHICLES, SHIPS AND SUBMARINES; BICYCLES, TRICYCLE AND SCOOTERS, ALL BEING FOR PLAY OR RECREATIONAL PURPOSES; PLAYMATS; PLAYTHINGS FOR INFANTS, NAMELY, ACTIVITY SETS AND MATS WITH MULTIPLE ACTIVITY TOYS; ACTIVITY BOOKS AND ACTIVITY CHARTS, ALL FEATURING DETACHABLE TOYS; BABIES' RATTLES; PLAY EQUIPMENT, NAMELY, SWINGS, SLIDES, CLIMBING STRUCTURES, TUNNELS, PLATFORMS AND PANELS; SEE-SAWS; PLAYTHINGS IN THE NATURE OF INFLATABLE OR AIR-FILLED HOPPERS; PLAY TABLES AND PLAY CHAIRS; TRAMPOLINES; AND OTHER GOODS (U.S. CLS. 22, 23, 38 AND 50).

JEFF DEFORD, EXAMINING ATTORNEY

SN 75-979,761. ABB DAIMLER-BENZ TRANSPORTATION GMBH, 13627 BERLIN, FED REP GERMANY, FILED 7-24-1998.

## INNOVIA

PRIORITY CLAIMED UNDER SEC. 44(D) ON FED REP GERMANY APPLICATION NO. 39805028, FILED 2-2-1998, REG. NO. 39805028, DATED 3-20-1998, EXPIRES 2-29-2008.

### CLASS 12—VEHICLES

FOR VEHICLES FOR CONVEYANCE OVER LAND, NAMELY, LOCOMOTIVES; TRAINS, NAMELY, COACHES AND TRUCKS HAULED BY LOCOMOTIVES OR POWERHEADS; COACHES, NAMELY, PASSENGER COACHES; RESTAURANT CARS OR SLEEPING CARS; RAILCARS; MASS TRANSIT VEHICLES, NAMELY, METRO CARS OVER- OR UNDERGROUND; LIGHT RAIL VEHICLES, NAMELY, TRAMS; FREIGHT WAGONS FOR CARRYING CONTAINERS, PIGGY BACK TRANSPORT, BULK TRANSPORT OF COAL, ORE, OIL, AND THE LIKE; RAILBOUND BUSES, NAMELY, RAILCARS FOR PASSENGER SERVICE POWERED EITHER BY AN ELECTRICAL MOTOR OR A DIESEL ENGINE, TROLLEY BUSES; RACK, FUNICULAR, AND ROPE RAILWAYS AND CABLE CARS, NAMELY, RAILED TRANSPORT SYSTEMS COMPRISED OF CARS AND RAILS WHEREIN THE CARS ARE MOVED BY AN EXTERNAL FORCE APPLIED VIA CABLE OR THE LIKE; TRACTION AND ELECTRIC MOTORS AND LAND VEHICLES, NAMELY, LOCOMOTIVES, TRAINS, COACHES, MASS TRANSIT VEHICLES, LIGHT RAIL VEHICLES, FREIGHT WAGONS, RAILBOUND BUSES, TROLLEY BUSES, RACK, FUNICULAR, AND ROPE RAILWAYS AND CABLECARS, RAILCARS AND TROLLEYS; MECHANICAL PARTS FOR SAID LAND VEHICLES, NAMELY, DRIVES, GEARS, COUPLERS, BOGIES, BRAKES AND WHEELS; STRUCTURAL PARTS AND BODY SHELLS FOR SAID LAND VEHICLES (U.S. CLS. 19, 21, 23, 31, 35 AND 44).

### CLASS 37—CONSTRUCTION AND REPAIR

FOR MAINTENANCE, CLEANING AND REPAIR OF MACHINERY, RAILROAD VEHICLES, TROLLEYS AND BUSES (U.S. CLS. 100, 103 AND 106).

JENNIFER KRISP, EXAMINING ATTORNEY

SN 76-005,183. QUICKSILVER LIMITED, HONG KONG, HONG KONG, FILED 3-20-2000.

## THINKING LEARNING COMMUNICATING

PRIORITY CLAIMED UNDER SEC. 44(D) ON HONG KONG APPLICATION NO. 99/11345, FILED 9-23-1999.

PRIORITY CLAIMED UNDER SEC. 44(D) ON HONG KONG APPLICATION NO. 99/11344, FILED 9-23-1999.

PRIORITY CLAIMED UNDER SEC. 44(D) ON HONG KONG APPLICATION NO. 99/11343, FILED 9-23-1999.

### CLASS 16—PAPER GOODS AND PRINTED MATTER

FOR PRINTED MATTER, NAMELY, NEWSPAPERS, PERIODICALS, BOOKS AND MAGAZINES FEATURING EDUCATION, ENTERTAINMENT, INTER-PERSONAL COMMUNICATION, INTEREST, SPORTS, TRAVEL, LIFESTYLE, COMPUTERS, SCIENCE, FASHION BUSINESS AND CULTURES, STATIONARY, PRINTED INSTRUCTIONAL AND TEACHING MATERIALS FEATURING EDUCATION, ENTERTAINMENT, INTER-PERSONAL COMMUNICATION, INTEREST, SPORTS, TRAVEL, LIFESTYLE, COMPUTERS, SCIENCE, FASHION BUSINESS AND CULTURES, PLAYING CARDS, SHIPPING, ADDRESS, AND PRINTED ADHESIVE LABELS FOR PACKAGING AND EDUCATION PURPOSES, STICKERS, DOCUMENT FOLDERS, PENS, FOUNTAIN PENS, PENCILS, WRITING PADS, MEMO PADS AND WRITING PAPER (U.S. CLS. 2, 5, 22, 23, 29, 37, 38 AND 50).

FIRST USE 11-1-2000; IN COMMERCE 11-1-2000.

### CLASS 35—ADVERTISING AND BUSINESS

FOR PUBLICITY AGENT SERVICES AND ADVERTISING AGENCY SERVICES; BUSINESS ADVISORY SERVICES RELATING TO MANAGEMENT OPERATION; BUSINESS MANAGEMENT AND CONSULTATION, PROVIDING BUSINESS ADVICE RELATING TO MARKETING; BUSINESS RESEARCH AND ANALYSIS RELATING TO BUSINESS FUNCTIONS AND PERFORMANCE; PERSONNEL MANAGEMENT SERVICES; BUSINESS INFORMATION STORAGE AND RETRIEVAL SERVICES IN THE FIELD OF COMPUTER SCIENCE, EDUCATION, ENTERTAINMENT, INTER-PERSONAL COMMUNICATION AND COMMERCE; PUBLIC RELATIONS SERVICES; AND BUSINESS MANAGEMENT CONSULTATION SERVICES, NAMELY, PERFORMANCE MANAGEMENT (U.S. CLS. 100, 101 AND 102).

FIRST USE 11-1-2000; IN COMMERCE 11-1-2000.

### CLASS 41—EDUCATION AND ENTERTAINMENT

FOR ARRANGING AND CONDUCTING COURSES OF INSTRUCTION, WORKSHOPS AND SEMINARS RELATING TO ENTERTAINMENT, CULTURE, EDUCATION, BUSINESS OPERATIONS AND FUNCTIONS; STRATEGIC TRAINING AND DEVELOPMENT SERVICES IN THE FIELD OF BUSINESS MANAGEMENT, EDUCATION, COMPUTERS AND INTER-PERSONAL COMMUNICATION; AND PRODUCTION OF MOTION PICTURE FILMS, AND OF AUDIO AND VISUAL RECORDINGS FOR ALL THE AFORESAID SERVICES (U.S. CLS. 100, 101 AND 107).

FIRST USE 11-1-2000; IN COMMERCE 11-1-2000.

DEZMONA MIZELLE, EXAMINING ATTORNEY

SN 76-012,780. BOOMERANG TRACKING INC., MONTREAL, QUEBEC, CANADA, FILED 3-29-2000.



OWNER OF U.S. REG. NO. 2,121,175.

### CLASS 9—ELECTRICAL AND SCIENTIFIC APPARATUS

FOR ELECTRONIC APPARATUS AND INSTRUMENTS FOR TRACKING VEHICLES, OBJECTS, AND PEOPLE, NAMELY, COMPUTERS, RADIO-FREQUENCY TRANSMITTERS, TRANSPONDERS AND TRACKERS DELIVERED PRIMARILY VIA ELECTRONIC WIRELESS TECHNOLOGY (U.S. CLS. 21, 23, 26, 36 AND 38).

**CLASS 42—SCIENTIFIC, COMPUTER AND LEGAL SERVICES**

FOR TRACKING AND RECOVERY OF VEHICLES, OBJECTS, AND PEOPLE PRIMARILY VIA ELECTRONIC WIRELESS TECHNOLOGY (U.S. CLS. 100 AND 101).  
MITCHELL FRONT, EXAMINING ATTORNEY

SN 76-015,212. UFI LIMITED, SHEFFIELD, ENGLAND,  
FILED 3-31-2000.

# LearnDirect

PRIORITY CLAIMED UNDER SEC. 44(D) ON ERPN CMNTY TM OFC APPLICATION NO. 1353374, FILED 10-18-1999, REG. NO. 1353374, DATED 8-3-2001, EXPIRES 10-18-2009.

**CLASS 9—ELECTRICAL AND SCIENTIFIC APPARATUS**

FOR COMPUTER SOFTWARE FOR EDUCATION TRAINING, TEACHING ONLINE AND DISTANCE LEARNING IN THE FIELD OF EDUCATION, TRAINING AND TEACHING SERVICES RECORDED ON TAPES AND DISCS; PRERECORDED COMPACT DISCS, CD ROMS, VIDEO DISCS, VIDEO CASSETTES, MOTION PICTURE FILMS, AND AUDIO TAPES FEATURING EDUCATION, TEACHING, TRAINING, ONLINE AND LEARNING MATERIAL IN THE FIELD OF VOCATIONAL TRAINING, BUSINESS SKILLS, INFORMATION TECHNOLOGY AND BASIC SKILLS; APPARATUS AND INSTRUMENTS, NAMELY, TAPE CASSETTE PLAYERS, CD PLAYERS, DVD PLAYERS, MINI-DISC PLAYERS AND ANY OTHER APPARATUS NAMELY, TAPE PLAYERS, MP3 PLAYERS AND COMPUTER MEMORY HARDWARE FOR RECORDING TRANSMISSION, RECEPTION, PROCESSING RETRIEVAL, REPRODUCTION, DISPLAY AND PRINTING OF SOUND, IMAGES AND DATA IN THE FIELD OF EDUCATION, TRAINING AND TEACHING SERVICES; ELECTRONIC DEVICES AND INSTRUMENTS, NAMELY, COMPUTER HARDWARE, MODEMS, ELECTRONIC INFORMATION DELIVERY DEVICES AND INSTRUMENTS, NAMELY, COMPUTERS, PAGERS, TELEPHONES, INTERACTIVE CABLE TV, INTERACTIVE CABLE TV, INTERACTIVE SATELLITE TV, PDAS AND UNITS FOR SENDING AND RECEIVING ELECTRONIC MAIL AND ENABLING REMOTE ACCESS TO ON-LINE INFORMATION IN THE FIELD OF EDUCATION, TRAINING AND TEACHING SERVICES, POCKET CALCULATORS; COMPUTER SOFTWARE FOR EDUCATION, TRAINING, TEACHING ONLINE AND DISTANCE LEARNING IN THE FIELD OF EDUCATION, TRAINING AND TEACHING SERVICES THAT MAY BE DOWNLOADED FROM A GLOBAL COMPUTER NETWORK; DOWNLOADABLE ELECTRONIC PUBLICATIONS IN THE NATURE OF BOOKS, TEXT BOOKS, LEARNING MATERIALS, ARTICLES, BULLETINS, JOURNALS AND PERIODICALS, QUESTIONNAIRES IN THE FIELD OF EDUCATION, TRAINING AND TEACHING SERVICES; MOUSE MATS (U.S. CLS. 21, 23, 26, 36 AND 38).

**CLASS 14—JEWELRY**

FOR BADGES OF PRECIOUS METAL (U.S. CLS. 2, 27, 28 AND 50).

**CLASS 16—PAPER GOODS AND PRINTED MATTER**

FOR PRINTED PUBLICATIONS, NAMELY, BOOKS, MAGAZINES, NEWSLETTERS, BULLETINS FEATURING EDUCATION, TEACHING TRAINING ON-LINE AND DISTANCE LEARNING MATERIAL; PAPER CERTIFICATES; POSTERS, CALENDARS AND DIARIES; WRITING AND DRAWING INSTRUMENTS, NAMELY, PENS, PENCILS, ERASERS, DRAWING RULERS, DRAWING COMPASSES, CURVES, TRIANGLES, PEN HOLDERS; NOTEPAPER; STATIONERY; PAPER BADGES, PAPER PLACE MATS AND PLASTIC PLACE MATS (U.S. CLS. 2, 5, 22, 23, 29, 37, 38 AND 50).

**CLASS 20—FURNITURE AND ARTICLES NOT OTHERWISE CLASSIFIED**

FOR NON-METAL TROPHIES; PLASTIC BADGES (U.S. CLS. 2, 13, 22, 25, 32 AND 50).

**CLASS 25—CLOTHING**

FOR CLOTHING, NAMELY, JACKETS, COATS, SWEATSHIRTS, SHIRTS, T-SHIRTS, BASEBALL CAPS, SCARVES AND GLOVES, JACKETS, PULLOVERS, SOCKS, TIES, CRAVATS, TROUSERS, TRACK SUITS, SHORTS, SWIMMING COSTUMES, SHOES, FOOTWEAR, APRONS (U.S. CLS. 22 AND 39).

**CLASS 41—EDUCATION AND ENTERTAINMENT**

FOR EDUCATIONAL SERVICES, NAMELY, PROVIDING AND CONDUCTING CLASSES, SEMINARS, CONFERENCES, WORKSHOPS AND LECTURES VIA DISTANCE LEARNING VIA A GLOBAL COMPUTER NETWORK AND ELECTRONIC NETWORKS AND VIA ALL FORMS OF TELEVISION IN ALL FIELDS OF FURTHER AND HIGHER EDUCATION, NAMELY, THE AREAS OF AUTOMOTIVE, BASICS SKILLS NAMELY, LITERACY AND MATH, ENVIRONMENTAL SERVICES AND TECHNOLOGY, INFORMATION TECHNOLOGY AND COMPUTING LANGUAGES AND COOKING AND DISTRIBUTING COURSE MATERIALS IN CONNECTION THEREWITH, ORGANIZING AND CONDUCTING SEMINARS, CONFERENCES AND LECTURES IN ALL FIELDS OF FURTHER AND HIGHER EDUCATION, NAMELY, THE AREAS OF AUTOMOTIVE, BASIC SKILLS NAMELY, LITERACY AND MATH, ENVIRONMENTAL SERVICES AND TECHNOLOGY, INFORMATION TECHNOLOGY AND COMPUTING LANGUAGES AND COOKING; PUBLICATION OF BOOKS, MAGAZINES, JOURNALS, BULLETINS, LEAFLETS, ARTICLES, PERIODICALS AND ELECTRONIC PUBLICATIONS ON-LINE (U.S. CLS. 100, 101 AND 107).  
TRACY CROSS, EXAMINING ATTORNEY

SN 76-025,422. RUSS, WILLIAM F, STEVENSON RANCH,  
CA. FILED 4-14-2000.

**RETRO BILL****CLASS 9—ELECTRICAL AND SCIENTIFIC APPARATUS**

FOR SERIES OF COMPACT DISCS, RECORDS, AUDIOCASSETTES, VIDEOCASSETTES, CD-ROM DISCS, VIDEO DISCS, AND DVD DISCS FEATURING MUSIC AND SAFETY AND SELF-ESTEEM PROMOTION MATERIAL AND COMEDY MATERIAL; ELECTRONIC GAME SOFTWARE, COMPUTER GAME SOFTWARE, SCREEN SAVERS (U.S. CLS. 21, 23, 26, 36 AND 38).

**CLASS 16—PAPER GOODS AND PRINTED MATTER**

FOR STICKERS, RUBBER STAMPS, NOTEBOOKS, COLORING BOOKS, COMIC BOOKS, PAPER BAGS, WRAPPING PAPER, GREETING CARDS, SERIES OF COMIC BOOKS, SERIES OF CHILDREN'S ACTIVITY BOOKS, SERIES OF BOOKS IN THE FIELD OF SAFETY AND SELF-ESTEEM PROMOTION, NOTE PADS, PAPER PARTY DECORATIONS, PENCILS, PEN, POSTCARDS, STATIONERY, BULLETIN BOARDS, CALENDARS, INSTRUCTIONAL AND TEACHING MATERIALS IN THE FIELD OF SAFETY AND SELF-ESTEEM PROMOTION (U.S. CLS. 2, 5, 22, 23, 29, 37, 38 AND 50).

**CLASS 25—CLOTHING**

FOR SHIRTS, PANTS, CAPS, HATS, VISORS, FOOTWEAR, JACKETS, UNDERWEAR, BELTS AND PAJAMAS, AND SPORTSWEAR, NAMELY BOWLING SHIRTS (U.S. CLS. 22 AND 39).

**CLASS 28—TOYS AND SPORTING GOODS**

FOR BOARD GAMES, CHILDREN'S TOY PLAY HOUSES, HANDICRAFT KITS CONTAINING ADHESIVE BOARD, GLITTER AND SAND FOR USE IN CHILDREN'S ART ACTIVITIES, CHRISTMAS TREE DECORATIONS, INFLATABLE TOYS, STUFFED TOYS, TOY ACTION FIGURES, TOY BALLOONS, TETHER BALLS, TOY DOLLS, TOY PUPPETS, PLUSH TOYS, HAND HELD UNIT FOR PLAYING ELECTRONIC GAMES, JIGSAW PUZZLES, BOWLING BALLS (U.S. CLS. 22, 23, 38 AND 50).

**CLASS 41—EDUCATION AND ENTERTAINMENT**

FOR ENTERTAINMENT SERVICES, NAMELY, PROVIDING A SERIES OF ON-GOING TELEVISION SHOWS, MOTION PICTURES AND LIVE PERFORMANCES IN THE FIELD OF COMEDY AND EDUCATION (U.S. CLS. 100, 101 AND 107).

ELLEN B. AWRICH, EXAMINING ATTORNEY

**CLASS 41—EDUCATION AND ENTERTAINMENT**

FOR EDUCATIONAL SERVICES, NAMELY, ARRANGING AND CONDUCTING CLASSES IN THE FIELDS OF SPEECH, HEARING, DEAFNESS AND COMMUNICATION; COMMUNITY SERVICES, NAMELY, ORGANIZING EDUCATIONAL PROGRAMS IN THE FIELDS OF SPEECH, HEARING, DEAFNESS AND COMMUNICATION; EDUCATIONAL WORKSHOPS FEATURING LIP READING INSTRUCTION; EDUCATIONAL RESEARCH IN THE FIELDS OF AUDIOLOGY, DEAF EDUCATION, SPEECH AND HEARING SCIENCES AND SOCIAL SERVICES; EDUCATIONAL SERVICES, NAMELY, ARRANGING AND CONDUCTING COURSES OF INSTRUCTION AT THE UNDERGRADUATE, GRADUATE, POSTDOCTORAL AND CONTINUING EDUCATION LEVELS FOR STUDENTS AND PROFESSIONALS IN THE FIELDS OF AUDIOLOGY, DEAF EDUCATION AND SPEECH AND HEARING SCIENCES (U.S. CLS. 100, 101 AND 107).

FIRST USE 9-0-1998; IN COMMERCE 9-0-1998.

**CLASS 42—SCIENTIFIC, COMPUTER AND LEGAL SERVICES**

FOR CLINICAL AUDIOLOGICAL SERVICES, NAMELY, HEARING ASSESSMENT, HEARING AID, COCHLEAR IMPLANT AND OTHER HEARING DEVICE EVALUATION, CONSULTATION, FITTING, PROGRAMMING AND FOLLOW UPS; PROVIDING SIGN LANGUAGE AND LIP READING INTERPRETING SERVICES FOR OTHERS (U.S. CLS. 100 AND 101).

FIRST USE 9-0-1998; IN COMMERCE 9-0-1998.

ALICIA COLLINS, EXAMINING ATTORNEY

SN 76-165,665. MANIFATTURA TESSUTI SPUGNA BESANA S.P.A., PROVINCE OF MILANO, ITALY, FILED 11-15-2000.

**CARRARA**

PRIORITY CLAIMED UNDER SEC. 44(D) ON ITALY APPLICATION NO. 009371, FILED 8-10-2000, REG. NO. 00924784, DATED 1-14-2004, EXPIRES 8-10-2010.

**CLASS 3—COSMETICS AND CLEANING PREPARATIONS**

FOR PERFUMES AND ROOM FRAGRANCES (U.S. CLS. 1, 4, 6, 50, 51 AND 52).

**CLASS 21—HOUSEWARES AND GLASS**

FOR FITTED PICNIC BASKETS; FLOWER BASKETS; BASKETS MADE OF CLOTH, WOOD, WICKER AND STRAW; BOTTLES SOLD EMPTY; GLASS BOWLS; SOAP BOXES; BOXES OF GLASS; DISH WASHING BRUSHES; BRUSHES FOR CLEANING TANKS AND CONTAINERS; PERFUME BURNERS; SERVING TRAYS, NOT OF PRECIOUS METAL; CANDLESTICKS, NOT OF PRECIOUS METAL; COMB CASES; PLATES; DISHES; CUPS; OVEN-PROOF DISHES; BAKING-PANS; DESSERT BOWLS; POTS; CONTAINERS FOR HOUSEHOLD OR KITCHEN USE, NOT OF PRECIOUS METAL; DISHES FOR SOAP; SOAP DISPENSERS; METAL BOXES FOR DISPENSING PAPER TOWELS; FLOWER POTS; FRUIT CUPS; HOLDERS FOR FLOWERS AND PLANTS; PERFUME SPRAYERS AND PERFUME VAPORIZERS SOLD EMPTY; SOAP HOLDERS; SPONGE HOLDERS; STATUES OF PORCELAIN, TERRA-COTTA OR GLASS; STATUETTES OF PORCELAIN, TERRA-COTTA OR GLASS; TOILET BRUSHES; TOILET PAPER HOLDERS; BATH SPONGES FOR PERSONAL USE AND TOILET SCOURING SPONGES; TOOTHBRUSHES; VASES NOT OF PRECIOUS METAL (U.S. CLS. 2, 13, 23, 29, 30, 33, 40 AND 50).

SN 76-057,725. CENTRAL INSTITUTE FOR THE DEAF, ST. LOUIS, MO. FILED 5-26-2000.



THE STIPPLING IN THE DRAWING IS FOR SHADING PURPOSES ONLY AND IS NOT INDICATIVE OF COLORING.

**CLASS 35—ADVERTISING AND BUSINESS**

FOR MAIL ORDER, RETAIL STORE, AND COMPUTERIZED ON-LINE RETAIL SERVICES FEATURING SPEECH, LANGUAGE, HEARING AND EDUCATIONAL ASSESSMENT TOOLS, ASSISTIVE LISTENING TECHNOLOGY, BOOKS AND OTHER PRODUCTS RELATED TO HEARING, DEAFNESS AND HEARING IMPAIRMENT (U.S. CLS. 100, 101 AND 102).

FIRST USE 9-0-1998; IN COMMERCE 9-0-1998.

**CLASS 24—FABRICS**

FOR TOWELS; TABLE LINEN; BED LINEN; AND BATH LINEN (U.S. CLS. 42 AND 50).

**CLASS 27—FLOOR COVERINGS**

FOR CARPETS AND RUGS (U.S. CLS. 19, 20, 37, 42 AND 50).

G. MAYERSCHOFF, EXAMINING ATTORNEY

SN 76-176,993. DEUTSCHE TELEKOM AG, 53113 BONN, FED REP GERMANY, FILED 12-7-2000.



PRIORITY CLAIMED UNDER SEC. 44(D) ON FED REP GERMANY APPLICATION NO. 30043206.62, FILED 6-7-2000, REG. NO. 30043206.2, DATED 10-25-2000, EXPIRES 6-30-2010.

**CLASS 9—ELECTRICAL AND SCIENTIFIC APPARATUS**

FOR ELECTRIC, ELECTRONIC, OPTICAL, MEASURING, SIGNALING, CONTROLLING AND TEACHING APPARATUS AND INSTRUMENTS, ALL FOR USE WITH TELECOMMUNICATIONS, NAMELY, APPARATUS FOR PRODUCING SOUND, IMAGES OR DATA, NAMELY, MAGNETIC AND OPTICAL DATA CARRIERS, DATA PROCESSORS AND COMPUTERS, NAMELY, MICROCOMPUTERS, MINICOMPUTERS, COMPUTER CENTRAL PROCESSORS, COMPUTER MONITORS, COMPUTER KEYBOARDS, COMPUTER TERMINALS, COMPUTER INTERFACE BOARDS, COMPUTER MEMORIES, COMPUTER LASER PRINTERS, COMPUTER IMPACT PRINTERS, COMPUTER DOT MATRIX PRINTERS, COMPUTER OPERATING SYSTEMS, COMPUTERS AND INSTRUCTIONAL MANUALS SOLD AS A UNIT, COMPUTER INTERFACE APPARATUS, NAMELY, COMPUTER MODEMS, COMPUTER MOUSE AND MOUSE PAD, COMPUTER PERIPHERALS AND PARTS THEREOF; COMPUTER PROGRAMS AND DATABASES FOR USE IN OPERATING TELECOMMUNICATIONS AND BUSINESS MANAGEMENT SYSTEMS AND RELATED INSTRUCTION MANUALS SOLD AS A UNIT; COMPUTER PROGRAMS, NAMELY, FINANCIAL ACCOUNTING SYSTEM SOFTWARE, SOFTWARE USED FOR THE PROVISION OF ONLINE INFORMATION SERVICES, NETWORK MANAGEMENT SOFTWARE, COMPUTER PROXY SOFTWARE FOR USE WITH OTHER SOFTWARE PROGRAMS, COMPUTER PROGRAMS AND SOFTWARE FOR CONTROLLING ACCESS AND ALARM MONITORING OF HOMES, APARTMENTS, BUILDINGS AND OTHER PROPERTIES, BILLING ANALYSIS SOFTWARE, AND SOFTWARE FOR NETWORK ACCESS CONTROL AND FOR CREATING AND MAINTAINING FIREWALLS; COMPUTER PROGRAMS FOR ACCESSING A GLOBAL COMPUTER NETWORK AND INTERACTIVE COMPUTER COMMUNICATIONS NETWORK; OPTICAL CABLES, OPTIC FILTERS, OPTICAL SCANNERS, OPTICAL CHARACTER READERS, OPTICAL DISCS, OPTICAL FIBERS, OPTICAL GLASS FOR SIGNAL TRANSMISSION, OPTIC TRANSMITTERS, OPTIC RECEIVERS, OPTICAL SIGNAL PROCESSING APPARATUS, OPTIC SWITCHES, OPTICAL ATTENUATORS, OPTICAL AMPLIFIERS, OPTICAL CHARACTER RECOGNITION APPARATUS, AND PARTS THEREOF; AUDIO, VIDEO AND DATA COMMUNICATIONS SYSTEMS, NAMELY, DIGITAL AND ANALOGUE SIGNAL TRANSMITTERS, RECEIVERS AND CONVERTERS, RADIO AND TELEPHONE TRANSMITTERS, RECEIVERS AND SERVERS, ANSWERING MACHINES, TELECOMMUNICATION TRANSMISSION, RECEIVING AND STORAGE APPA-

RATUS, NAMELY, TELECOMMUNICATIONS TRANSMITTING SETS, DATA TRANSMITTERS, FACSIMILE MACHINES, ELECTRONIC MAIL APPARATUS FOR ELECTRONIC EXCHANGE OF DATA IMAGES AND MESSAGES, REMOTE CONTROLS AND SET-TOP UNITS FOR TELEVISION, CINEMATOGRAPHIC TELEVISION AND AMUSEMENT EQUIPMENT, NAMELY, SIGNAL DECODERS, ELECTRICAL WIRE, ELECTRICAL WIRE CONNECTORS, INTEGRATED CIRCUITS, PRINTED CIRCUITS, ELECTRIC CIRCUITS, CIRCUIT BREAKERS, PRINTED CIRCUIT BOARDS, ELECTRIC CIRCUIT BOARDS, CIRCUIT CONNECTORS, ELECTRICAL CONTROLLERS, ELECTRICAL CONVERTERS, ELECTRICAL FUSES, ELECTRIC LUMINESCENT DISPLAY PANELS, ELECTRICAL SWITCH PLATES, ELECTRIC PLUGS, ANTENNAS, ELECTRICAL CABLES, COMPUTER CABLES, COMPUTER CHIPS, SILICON CHIPS, CHRONOGRAPHS FOR USE AS SPECIALIZED TIME RECORDING APPARATUS, ELECTRIC COILS, COMPUTER BUFFERS, BLANK COMPUTER DISCS, BLANK COMPUTER FLOPPY DISKS, COMPUTER HARD DISCS, ELECTRICAL CONDUCTORS, ACOUSTIC CONDUITS, ELECTRICAL CONDUITS, FIBER OPTIC CONDUITS AND PARTS THEREOF; COMPACT DISC PLAYERS, AUDIO AND VIDEO TAPE RECORDERS, AUDIO AND VIDEO TAPE PLAYERS, AUDIO AND VIDEO CASSETTE RECORDERS, AUDIO AND VIDEO CASSETTE PLAYERS, BLANK AUDIO AND VIDEO TAPES, CASSETTES, DISCS AND MICROFICHE; AUDIO AND VIDEO TAPES, CASSETTES, DISCS AND MICROFICHE FEATURING INFORMATION CONCERNING TELECOMMUNICATIONS, AND CONCERNING PERSONAL AND BUSINESS MANAGEMENT SYSTEMS; AUDIO AND VIDEO RECORDINGS IN THE FIELD OF TELECOMMUNICATIONS, INFORMATION TECHNOLOGY, SAFETY; TELEVISION AND TELEVISION PERIPHERAL EQUIPMENT, NAMELY CAMERAS, SET BOXES, REMOTE CONTROL UNITS FOR INTERACTIVE AND NON-INTERACTIVE USE; COMPUTER MEMORY, COMPUTER PERIPHERALS AND MODEMS; VIDEO MONITORS, AUTOMATIC VENDING MACHINES AND TIMING MECHANISMS THEREFOR, AND PARTS THEREOF; MACHINE READABLE, MAGNETICALLY ENCODED CARDS, NAMELY, PREPAID TELEPHONE CALLING CARDS AND CREDIT CARDS; SMART CARDS; DATA PROCESSORS AND READERS, WORD PROCESSORS, MAGNETIC CODED CARD READERS, MAGNETIC CODED CARDS, NAMELY, FIDELITY CARDS, ELECTRONIC ENCRYPTION UNITS, LASERS NOT FOR MEDICAL USE, LIGHT EMITTING DIODES, LIGHT EMITTING DIODE DISPLAYS, MICROPROCESSORS, BLANK MAGNETIC DATA CARRIERS, DEMAGNETIZERS FOR MAGNETIC TAPES, AND PARTS THEREOF; COMPUTER, DATA AND VIDEO NETWORKING AND CONFERENCING EQUIPMENT, NAMELY, TELECONFERENCING EQUIPMENT AND AUDIOVISUAL TEACHING EQUIPMENT IN THE NATURE OF OVERHEAD FILM, PHOTOGRAPHIC AND SLIDE PROJECTORS, PROJECTION SCREENS, COMPUTER BASED INFORMATION DISPLAY EQUIPMENT, NAMELY, COMPUTERS WHICH DISPLAY INFORMATION ON AN OVERHEAD SCREEN, INTERCOMS; TELEPHONES, TELEPHONE ANSWERING MACHINES, TELEPHONE TRANSMITTERS, TELEPHONE NETWORKS, TELEPHONE WIRES, TELEPRINTERS, TELETYPEWRITERS, AND PARTS THEREOF, NAMELY, CALLER IDENTIFICATION BOXES, DIALING ASSEMBLIES, TELEPHONE UNITS, AUDIO OPERATED RELAYS, AUDIO OPERATED RELAYS, AUDIO/VIDEO SIGNAL AND OPTICAL FILTERS, PROTECTORS AND AUTOMATIC SIGNALING AND CONTROL EQUIPMENT, TELEMETERS, WIRELESS AND CELLULAR TELEPHONES, RADIO PAGERS, PORTABLE COMPUTER DEVICES, NAMELY LAPTOPS, HANDHELD AND POCKET COMPUTERS, FACSIMILE TRANSMITTERS AND RECEIVERS, WIRELESS FAX MACHINES, PERSONAL COMMUNICATIONS EQUIPMENT, NAMELY, PERSONAL DIGITAL ASSISTANTS, CALCULATORS AND RELATED PERIPHERALS; SATELLITE PROCESSORS, SATELLITES AND SATELLITE COMMUNICATION EARTH STATIONS BOTH STATIONARY AND MOVEABLE; AUDIO AND VIDEO RECORDINGS IN THE FIELD OF NEWS, SPORTS, ENTERTAINMENT, CULTURE, BUSINESS AND FINANCE, WEATHER AND TRAVEL; PRERECORDED COMPACT DISCS, AUDIO CASSETTE TAPES, VIDEO CASSETTE TAPES, DIGITAL AUDIO TAPES AND DIGITAL VIDEO DISCS FEATURING MUSICAL, VARIETY, NEWS AND COME-

DY SHOWS; COMPUTER GAME PROGRAMS FOR CHILDREN AND ADULTS; VIDEO AND COMPUTER GAME CARTRIDGES (U.S. CLS. 21, 23, 26, 36 AND 38).

#### **CLASS 16—PAPER GOODS AND PRINTED MATTER**

FOR PRINTED MATTER, NAMELY, TELEPHONE DIRECTORIES, BOOKS, NEWSLETTERS, PAMPHLETS, BROCHURES, MAGAZINES AND PAPERBACKS ALL IN THE FIELD OF TELECOMMUNICATIONS, PRINTED AND STAMPED PLASTIC AND CARDBOARD GREETING, BLANK, NOTE, AND INDEX CARDS; NOTE PAPER AND ENVELOPES, RUBBER STAMPS, NAME TAGS AND LABELS MADE FROM PAPER OR CARDBOARD, NOTEBOOKS, DIARIES, NOTE PAPERS, NOTE PADS, ADDRESS BOOKS, FOLDERS FOR LETTERS AND LOOSE PAPERS, CLEAR HOLE REINFORCEMENTS, STUDENT CALENDARS, STAMP ALBUMS AND PHOTO-ALBUMS; PAPER WEIGHTS, LETTER OPENERS, BLOTTER PADS; DESK TRAYS, DESK STANDS AND HOLDERS FOR HOLDING STATIONERY AND OFFICE IMPLEMENTS; PRINTED INSTRUCTIONAL AND TEACHING MATERIALS ALL IN THE FIELDS OF TELECOMMUNICATIONS, INFORMATION TECHNOLOGY, SAFETY, NEWS, SPORTS, ENTERTAINMENT, CULTURE, BUSINESS AND FINANCE, WEATHER AND TRAVEL; STATIONERY, DRAWING AND UNGRADUATED RULERS, ERASERS, STAPLERS, STAPLES, PAPER CLIPS, BOOK MARKERS, CUTOUT SAMPLES AND STENCILS; SCRATCH PICTURES, PAPER, NAMELY, BOND PAPER AND ART PAPER, PVC STICKERS, GIFT WRAP PAPER; BLACKBOARDS, CHALK STICKS, ADHESIVES FOR STATIONERY OR HOUSEHOLD PURPOSES; DRAWING AND PAINTING MATERIALS, NAMELY, PENCILS, DRAWING PENCILS, PENS, DRAWING PENS, PAINT TRAYS, PAINTING SETS FOR ARTISTS, PAINTING SETS FOR CHILDREN, CRAFT PAINT KITS, AND PENCIL CASES; NON-MAGNETICALLY ENCODED, PREPAID TELEPHONE CALLING CARDS (U.S. CLS. 2, 5, 22, 23, 29, 37, 38 AND 50).

#### **CLASS 35—ADVERTISING AND BUSINESS**

FOR ADVERTISING AND BUSINESS MANAGEMENT, PROFESSIONAL CONSULTANCY IN THE FIELD OF DATA PROCESSING (U.S. CLS. 100, 101 AND 102).

#### **CLASS 36—INSURANCE AND FINANCIAL**

FOR INSURANCE SERVICES, NAMELY, INSURANCE BROKERAGE, INSURANCE CLAIMS PROCESSING; FINANCIAL SERVICES, NAMELY, CLEARING OF SECURE FINANCIAL TRANSACTIONS THROUGH ONLINE SERVICES; FINANCIAL ANALYSIS AND CONSULTATION, PROVIDING FINANCIAL INFORMATION, ISSUANCE OF SECURITIES, COMMERCIAL LENDING SERVICES, FINANCIAL PORTFOLIO MANAGEMENT, DISCOUNT BROKERAGE SERVICES, BROKERAGE OF SHARES AND BUSINESS VENTURES, BROKERAGE OF FUND SHARES, SECURITIES CONSULTING AND SAFE KEEPING, BROKERAGE OF PRODUCTIVE INVESTMENTS AND FUNDS; FINANCIAL SPONSORSHIP OF SPORTS, EDUCATIONAL AND ENTERTAINMENT PROGRAMS AND EVENTS; REAL ESTATE SERVICES, NAMELY BROKERAGE, MANAGEMENT, LEASING, APPRAISAL OF REAL PROPERTY; CUSTOMS BROKERAGE FOR THIRD PARTIES; MONETARY EXCHANGE; CREDIT CARD SERVICES; TELEPHONE CALLING CARD SERVICES; ELECTRONIC COMMERCE SERVICES, NAMELY, ELECTRONIC DEBIT AND CREDIT CARD PROCESSING SERVICES, FUNDS TRANSFER AND PAYMENT PROCESSING SERVICES; PROVIDING INFORMATION VIA THE TELEPHONE AND THE GLOBAL COMMUNICATIONS INFORMATION NETWORK IN THE FIELD OF BUSINESS AND FINANCE (U.S. CLS. 100, 101 AND 102).

#### **CLASS 38—COMMUNICATION**

FOR TELECOMMUNICATIONS AND INFORMATION TECHNOLOGY SERVICES, NAMELY, ELECTRIC, DIGITAL, CELLULAR AND WIRELESS TRANSMISSION OF VOICE, DATA, INFORMATION, IMAGES, SIGNALS AND MESSAGES AND TRANSMISSION OF VOICE, DATA, IMAGES, AUDIO, VIDEO AND INFORMATION VIA TELEPHONE, TELEVISION AND GLOBAL COMMUNICATIONS INFORMATION NETWORKS; PROVIDING TELECOMMUNICATIONS CONNECTIONS OVER A GLOBAL COMMUNICATIONS INFORMATION NETWORK, ELECTRONIC MAIL, VOICE MAIL AND MESSAGING SERVICES, NAMELY, THE RECORDING AND STORAGE AND SUBSEQUENT TRANSMISSION OF VOICE MESSAGES BY TELEPHONE; RENTAL OF TELECOMMUNICATIONS EQUIPMENT, NAMELY, EQUIPMENT FOR ELECTRONIC ACCESS TO GLOBAL TELECOMMUNICATIONS NETWORK, EQUIPMENT FOR TRANSMITTING, RECEIVING, RECORDING AND MONITORING VOICE, DATA, INFORMATION, IMAGES, SIGNALS, MESSAGES, COMPRISED OF DATA AND WORD PROCESSORS, AND TELECOMMUNICATIONS HARDWARE AND SOFTWARE AND COMPONENTS AND PERIPHERALS THEREOF FOR USE IN THE TELECOMMUNICATIONS INDUSTRY, AND RENTAL OF EQUIPMENT FOR TRANSMITTING, RECEIVING, RECORDING AND MONITORING COMPUTER PROGRAMS FOR USE IN OPERATING AND ACCESSING TELECOMMUNICATIONS SYSTEMS; AUDIO AND VIDEO BROADCASTING FEATURING ENTERTAINMENT IN THE NATURE OF LIVE VISUAL AND AUDIO PERFORMANCES, AND MUSICAL, VARIETY, NEWS AND COMEDY SHOWS; PROVIDING MULTIPLE-USER DIAL-UP AND DEDICATED ACCESS TO THE INTERNET; PERSONAL COMMUNICATIONS SERVICES; PAGER SERVICES; ELECTRONIC MAIL SERVICES; TRANSMISSION AND BROADCAST OF AUDIO AND VIDEO PROGRAMMING; PROVIDING MULTIPLE-USER ACCESS TO A GLOBAL COMMUNICATION INFORMATION NETWORK; LEASING TELECOMMUNICATIONS EQUIPMENT, COMPONENTS, SYSTEMS AND SUPPLIES (U.S. CLS. 100, 101 AND 104).

#### **CLASS 39—TRANSPORTATION AND STORAGE**

FOR WAREHOUSE STORAGE OF GOODS; STORAGE OF GOODS RELATING TO TELECOMMUNICATIONS COMPUTERS AND OTHER INFORMATION TECHNOLOGY DEVICES; TRANSPORTATION OF GOODS BY TRUCK, SHIP, RAILWAY AND PLANE (U.S. CLS. 100 AND 105).

#### **CLASS 41—EDUCATION AND ENTERTAINMENT**

FOR EDUCATION AND INSTRUCTION, NAMELY, EDUCATIONAL SERVICES IN THE NATURE OF CLASSES AND SEMINARS IN THE FIELDS OF BUSINESS, TELECOMMUNICATIONS AND COMPUTERS, AND THE DISTRIBUTION OF COURSE MATERIALS THEREWITH; ENTERTAINMENT IN THE NATURE OF LIVE VISUAL AND AUDIO PERFORMANCES, NAMELY, MUSICAL BANDS, GYMNASIAC, DANCE, AND BALLET PERFORMANCES; ENTERTAINMENT SERVICES, NAMELY, PROVIDING MUSICAL, VARIETY, NEWS AND COMEDY SHOWS VIA A GLOBAL COMPUTER INFORMATION NETWORK; ENTERTAINMENT SERVICES, NAMELY, PROVIDING ON-LINE COMPUTER GAMES FOR CHILDREN AND ADULTS; PROVIDING ENTERTAINMENT INFORMATION AND GENERAL INFORMATION AT THE SPECIFIC REQUEST OF END-USERS BY MEANS OF TELEPHONE OR GLOBAL COMMUNICATIONS NETWORKS; ORGANIZING COMMUNITY SPORTING AND CULTURAL EVENTS; PUBLICATION OF BOOKS, MAGAZINES, JOURNALS, MANUALS, BROCHURES AND LEAFLETS ON THE SUBJECT OF TELECOMMUNICATIONS; ELECTRONIC PUBLISHING SERVICES, NAMELY, PUBLICATION OF TEXT AND GRAPHIC WORKS OF OTHERS ON TELECOMMUNICATIONS RECORDED ON CD-RIN AND CD-I; ORGANIZING FAIRS AND EXHIBITIONS IN THE FIELD OF VISUAL AND AUDIO PERFORMANCES, NAMELY, ROCK GROUP, GYMNASIAC, DANCE, AND BALLET PERFORMANCES (U.S. CLS. 100, 101 AND 107).



**CLASS 42—SCIENTIFIC, COMPUTER AND LEGAL SERVICES**

FOR COMPUTER PROGRAMMING SERVICES FOR OTHERS; CONSULTING IN THE FIELD OF TELECOMMUNICATION, RENTAL OF SOFTWARE AND HARDWARE FOR ONLINE ACCESS; SERVICES OF AN INTERNET TRUST CENTER, NAMELY, ASSURANCE AND ADMINISTRATION OF DIGITAL KEYS AND/OR DIGITAL CERTIFICATES; WEB PAGE HOSTING SERVICES; COMPUTER SERVICES, NAMELY, CREATING INDEXES OF INFORMATION AVAILABLE ON COMPUTER NETWORKS; CONSULTING AND DESIGN SERVICES IN THE FIELD OF INFORMATION TECHNOLOGY, COMPUTER PROGRAMMING, TELECOMMUNICATIONS AND GLOBAL COMMUNICATION NETWORKS; INSTALLATION, MAINTENANCE AND REPAIR OF COMPUTER SOFTWARE (U.S. CLS. 100 AND 101).

HOWARD B. LEVINE, EXAMINING ATTORNEY

SN 76-197,112. BP P.L.C., LONDON, ENGLAND, FILED 1-16-2001.

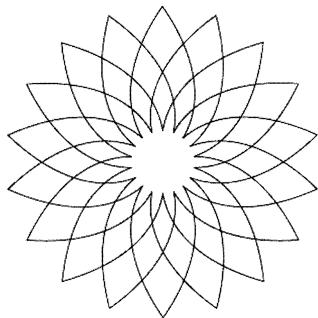

PRIORITY CLAIMED UNDER SEC. 44(D) ON UNITED KINGDOM APPLICATION NO. 2240389, FILED 7-21-2000, REG. NO. 2240389, DATED 7-21-2000, EXPIRES 7-21-2012.

THE COLOR(S) GREEN AND YELLOW IS/ARE CLAIMED AS A FEATURE OF THE MARK.

THE MARK CONSISTS OF A GEOMETRIC DESIGN HAVING FOUR DISTINCT ELEMENTS AS FOLLOWS: AN INNER ELEMENT THAT IS OPAQUE WHITE; MULTIPLE LOBES RADIATING FROM THE WHITE INTERIOR WHICH ARE PANTONE YELLOW #109; MULTIPLE LOBES RADIATING FROM THE YELLOW LOBES WHICH ARE PANTONE LIGHT GREEN #368; AND MULTIPLE LOBES RADIATING FROM THE LIGHT GREEN LOBES WHICH ARE PANTONE DARK GREEN #355.

**CLASS 1—CHEMICALS**

FOR CHEMICALS, NAMELY, CHEMICALS FOR USE IN THE MANUFACTURE OF PHARMACEUTICALS, COSMETICS, DETERGENTS, PACKAGING, WIRE AND CABLE INSTALLATION, CASSETTE TAPES, SYNTHETIC RUBBER, PAINTS AND COATINGS, ADHESIVES, FUEL ADDITIVES, LUBRICANTS, TEXTILES, AGRICULTURE, ELECTRICAL AND ELECTRONIC COMPONENTS, AUTOMOTIVE PARTS, BUILDING AND CONSTRUCTION, PLASTICS, FOODS AND DIAGNOSTIC EQUIPMENT; UNPROCESSED ARTIFICIAL AND SYNTHETIC RESINS FOR USE IN THE MANUFACTURE OF FIBERS, POLYMERS AND COATINGS; PLASTIC MOLDING COMPOUNDS FOR USE IN THE MANUFACTURE OF MOLDED PLASTIC ARTICLES, PLASTIC SHEETS AND PLASTIC FILMS; CHEMICAL PRODUCTS FOR USE IN MACHINING AND METAL WORKING OPERATIONS AND IN THE TREATMENT OF COOLING SYSTEMS, NAMELY, COOLANTS FOR VEHICLE ENGINES AND CUTTING TOOLS; SOLVENTS AS ADDITIVES FOR USE IN THE MANUFACTURE OF A WIDE VARIETY OF GOODS; SOLVENT TYPE PROCESSING COMPOSITIONS FOR USE IN THE ELECTRONICS INDUSTRY; CHEMICAL SOLVENTS FOR USE IN HEAVY INDUSTRIAL AND MARINE VESSEL CLEAN-

ING, WAX AND PLUGGING SOLVENTS FOR USE IN THE MANUFACTURE OF PETROLEUM AND HEAT TRANSFER FLUIDS; HYDRAULIC FLUIDS FOR GENERAL USE; DETERGENTS AND DEGREASING PREPARATIONS FOR USE IN INDUSTRY AND MANUFACTURING PROCESSES, NAMELY, INDUSTRIAL DETERGENT PREPARATIONS FOR USE IN CLEANING MACHINES DURING MANUFACTURE OF GOODS AND DEGREASING PREPARATIONS USED ON MACHINES AND PARTS THEREOF DURING THE MANUFACTURE OF GOODS; DETERGENT ADDITIVE FOR USE WITH MOTOR OIL; SURFACTANTS FOR USE IN THE MANUFACTURE OF SYNTHETIC DETERGENTS; RELEASING AGENTS, NAMELY, MOLD RELEASE COMPOUNDS FOR USE IN A WIDE VARIETY OF INDUSTRIES; CHEMICAL PREPARATIONS FOR USE IN THE REMOVAL OF LIME, SCUM, SCALE, MORTAR, OIL, GREASE, WAX, INK, CARBON, DIRT, MILDEW, MOLD, GRIME AND STAINS; EMULSIFIERS FOR USE IN THE MANUFACTURE OF FOODS, LEATHER, TEXTILES, COATINGS, OILS AND COOLANTS; CHEMICAL PREPARATIONS FOR INHIBITING RUST ON METALS; BRAKE FLUID; CHEMICAL PREPARATIONS FOR USE IN THE DETECTION OF SURFACE BLEMISHES, FLAWS AND CRACKS IN RELATION TO METAL; DIAGNOSTIC AND ANALYTICAL PREPARATIONS, NAMELY, DIAGNOSTIC PREPARATIONS FOR SCIENTIFIC OR RESEARCH USE; CHEMICAL PREPARATIONS, NAMELY, DISPERSANTS FOR THE DISPERSAL OF OIL, GREASE AND PETROLEUM; CHEMICAL PREPARATIONS FOR PREVENTING SCALE FOR NON-HOUSEHOLD PURPOSES; CHEMICAL PRODUCTS FOR PRESERVING FOODSTUFFS; CATALYSTS FOR USE IN THE MANUFACTURE OF INDUSTRIAL CHEMICALS, PETROLEUM RACK, AND FOR USE IN THE OIL PROCESSING INDUSTRIES; DRILLING MUDS FOR USE IN OIL WELL DRILLING; ANTI-FREEZING AND DE-ICING PREPARATIONS FOR MELTING SNOW AND ICE, AND TO PREVENT ENGINES AND ENGINE PARTS FROM FREEZING; CHEMICAL ADDITIVES FOR FUELS AND LUBRICANTS, NAMELY CHEMICAL ADDITIVES FOR MOTOR OIL, CHEMICAL GASOLINE ADDITIVES; CHEMICAL ADDITIVES FOR FUEL TREATMENT, CHEMICAL ADDITIVES FOR USE WITH INTERNAL COMBUSTION ENGINE FUELS, FUEL INJECTION CLEANER CHEMICAL ADDITIVES, OCTANE BOOSTER FUEL CHEMICAL ADDITIVES; MOLDING COMPOUNDS, NAMELY, PLASTIC MOLDING COMPOUNDS FOR USE IN PLASTIC EXTRUSION OPERATIONS; PLASTIC MOLDING COMPOUNDS FOR USE IN THE MANUFACTURE OF MOLDED PLASTIC ARTICLES; PLASTIC MOLDING COMPOUNDS FOR USE IN THE MANUFACTURE OF PLASTIC SHEETS AND FILMS; POLYMER BEADS FOR USE IN MANUFACTURING; LIQUID POLYMERS FOR USE IN THE MANUFACTURE OF SEALING AND CAULKING PRODUCTS; ENGINEERING THERMOPLASTICS IN THE NATURE OF RECYCLABLE OLEFIN POLYMERS FOR GENERAL USE IN THE MANUFACTURE OF GOODS; SILICON AND SILICATES FOR USE IN THE MANUFACTURE OF BUILDING MATERIALS, ELECTRONICS, AND ALLOYS; AGGLUTINANTS FOR CEMENTS; PHOTOGRAPHIC FILM, NAMELY, SENSITIZED AND UNEXPOSED; CHEMICAL ADDITIVES FOR OIL WELL DRILLING FLUIDS; TRANSMISSION FLUID. (U.S. CLS. 1, 5, 6, 10, 26 AND 46).

**CLASS 2—PAINTS**

FOR ANTI-CORROSIVE PREPARATIONS AND SUBSTANCES, NAMELY, CORROSION INHIBITING PAINT TYPE COATINGS FOR USE IN THE OIL AND GAS DRILLING INDUSTRY; ANTI-RUST OILS AND GREASES; RUST PRESERVATIVES IN THE NATURE OF A COATING; AGGLUTINANTS FOR PAINTS AND FOR PUTTY; INTERIOR AND EXTERIOR PAINTS; VARNISHES, LACQUERS IN THE NATURE OF A COATING, COATINGS IN THE NATURE OF PAINTS, SPRAYS OR OILS FOR DECORATING USE, PRESERVING AGAINST RUST, PREVENTING STAINING, PROTECTION AGAINST CORROSION, WATERPROOFING AND WEATHERPROOFING, AND SEALANTS, NAMELY, SEALER COATINGS FOR USE IN THE MANUFACTURE OF PRODUCTS; COLORANTS FOR USE IN THE MAN-

UFACTURE OF BEVERAGES, COSMETICS, FOOD, PAINT, PAPER, PLASTIC MOLDING COMPOUNDS, PRINTING INK AND SOAP; ENAMELS FOR PAINTING; MORDANTS FOR LEATHER AND WOOD; COLOR PIGMENTS; PREPARATIONS FOR UNDERCOATING AND UNDERSEALING VEHICLE CHASSIS; METALS IN POWDER FORM FOR PAINTERS, DECORATORS, AND ARTISTS; NATURAL RESINS FOR USE IN THE COATING AND MANUFACTURE OF PLASTICS; THICKENERS, THINNERS AND COLOR PIGMENTS ALL FOR PAINTS, VARNISHES AND LACQUERS; WOOD PRESERVING OILS. (U.S. CLS. 6, 11 AND 16).

### **CLASS 3—COSMETICS AND CLEANING PREPARATIONS**

FOR PAINT, LACQUER AND VARNISH REMOVING PREPARATIONS; DETERGENTS AND DE-GREASING LIQUIDS AND PREPARATIONS, EXCLUDING USE IN INDUSTRIAL AND MANUFACTURING PROCESSES OR FOR MEDICAL PURPOSES, NAMELY, AUTOMATIC DISHWASHING, DISH AND LAUNDRY DETERGENTS; CLEANING, POLISHING, SCOURING AND ABRASIVE PREPARATIONS, NAMELY, ALL PURPOSE CLEANING PREPARATIONS, FLOOR POLISH, CHROME POLISH AND GENERAL PURPOSE SCOURING POWDER; SOAPS, NAMELY DISINFECTANT SOAPS AND LIQUID SOAPS FOR HANDS, FACE AND BODY; HAIR LOTIONS; PERFUME; HAIR GELS AND EYE GELS AND HAIRSPRAYS; SHAMPOOS, NAMELY BABY, CARPET AND HAIR; ESSENTIAL OILS FOR PERSONAL USE; COSMETICS; DENTIFRICES; TOOTHPASTE; SHOE POLISH; ESSENTIAL OILS FOR FOOD FLAVORINGS; DEPILATORIES; DEODORANTS FOR PERSONAL USE; SKIN WHITENING CREAMS; COTTON BALLS FOR COSMETIC PURPOSES; CLEANSING MOISTURIZING MILK; FALSE NAILS; FALSE EYELASHES; ADHESIVES FOR FALSE EYELASHES, HAIR AND NAILS; HAIR WAVING PREPARATIONS IN THE NATURE OF HAIR WAVING LOTIONS; COSMETIC KITS CONSISTING PRIMARILY OF MAKEUP, EYEBROW PENCILS; LIPSTICKS; SACHETS FOR PERFUMING CLOTHING AND LINEN; MOUTHWASHES, NOT FOR MEDICAL PURPOSES; SHAVING PREPARATIONS; SCALE REMOVING PREPARATIONS FOR HOUSEHOLD PURPOSES; STAIN REMOVERS; SUN TANNING PREPARATIONS; SUNSCREEN PREPARATIONS; TALCUM POWDER; WINDSCREEN CLEANING PREPARATIONS; WAXES, NAMELY, FLOOR WAX AND AUTOMOBILE WAX; PETROLEUM JELLY FOR COSMETIC PURPOSES; SANDPAPER; ABRASIVE CLOTH; CHEMICAL PREPARATIONS FOR INHIBITING RUST, NAMELY, RUST REMOVING PREPARATIONS. (U.S. CLS. 1, 4, 6, 50, 51 AND 52).

### **CLASS 4—LUBRICANTS AND FUELS**

FOR INDUSTRIAL OILS; GREASES, NAMELY AUTOMOTIVE GREASE, GREASE FOR MACHINES AND GENERAL PURPOSE GREASE; FUELS, NAMELY, GASOLINE, DIESEL, NATURAL GAS AND LIQUID GAS, OIL USED AS A FUEL FOR INDUSTRIAL OR DOMESTIC USE; CANDLES AND ILLUMINATING GREASE FOR MACHINES; NON-CHEMICAL ADDITIVES FOR GASOLINE, DIESEL AND OILS; LUBRICANTS AND LUBRICATING GREASES; NAMELY, ALL PURPOSE LUBRICANTS, LUBRICANTS FOR INDUSTRIAL MACHINERY AND AUTOMOTIVE ENGINE LUBRICANTS; METAL WORKING PRODUCTS HAVING LUBRICATING PROPERTIES, NAMELY, CUTTING OIL FOR INDUSTRIAL METAL WORKING; ENGINE OILS, GEAR OILS, AUTOMOTIVE FINAL DRIVE OILS; CARNAUBA WAX; PETROLEUM JELLY FOR INDUSTRIAL PURPOSES; PREPARATIONS, FLUIDS AND OILS FOR MACHINING AND/OR METAL WORKING OPERATIONS, NAMELY, CUTTING OIL FOR INDUSTRIAL METAL WORKING, MINERAL OIL FOR USE IN THE MANUFACTURE OF METAL CUTTING FLUIDS. (U.S. CLS. 1, 6 AND 15).

### **CLASS 5—PHARMACEUTICALS**

FOR DISINFECTANTS, NAMELY, ALL PURPOSE, FOR CHEMICAL TOILETS, CONTACT LENSES, MEDICAL INSTRUMENTS AND HYGIENE PURPOSES; ANTI-SEPTICS; PREPARATIONS FOR KILLING WEEDS AND DESTROYING VERMIN; INSECTICIDES FOR AGRICULTURAL AND DOMESTIC USE; GENERAL PURPOSE GERMICIDES; ADDITIVES TO FODDER OR DRINKING WATER FOR MEDICAL PURPOSES, NAMELY, MEDICATED ANIMAL FEED AND MEDICATED ANIMAL DRINKING WATER; BANDAGES, NAMELY, ADHESIVE, SURGICAL AND SKIN WOUND; MEDICAL STICKING PLASTERS; OVER THE COUNTER MEDICINES, NAMELY, MEDICINES FOR TREATING HEADACHES, STOMACH UPSETS, INDIGESTION, SORE THROATS, DIARRHEA, STRESS, INSOMNIA, MOUTH ULCERS, TOOTHACHE, SKIN IRRITATION, COLDS AND FLU; DISINFECTING DETERGENTS FOR MEDICAL PURPOSES; GREASES AND PETROLEUM JELLY FOR MEDICAL OR VETERINARY PURPOSES; NON-ELECTRIC INSECT REPELLANTS; AIR FRESHENERS FOR MOTOR VEHICLES AND ROOMS; DIAGNOSTIC AND ANALYTICAL PREPARATIONS, NAMELY, DIAGNOSTIC PREPARATIONS FOR CLINICAL OR MEDICAL LABORATORY USE; MEDICATED SHAMPOOS. (U.S. CLS. 6, 18, 44, 46, 51 AND 52).

### **CLASS 6—METAL GOODS**

FOR ARRAY FRAMES FOR SOLAR CELLS AND MODULES MADE WHOLLY OR PRINCIPALLY OF METAL; CONTAINERS OF METAL FOR LUBRICANTS, OILS, GREASES, CHEMICALS, COMPRESSED GASES AND LIQUID FUEL; METAL PIPES; MANUALLY OPERATED METAL VALVES NOT BEING PARTS OF MACHINES; METAL KEY RINGS AND KEY RINGS WITH FOBS; ALUMINUM FOIL; OIL CANS AND DRUMS FOR HOUSEHOLD AND KITCHEN PURPOSES SOLD EMPTY MADE WHOLLY OR PRINCIPALLY OF METAL; METAL BARRELS; FLUID STORAGE TANKS MADE WHOLLY OR PRINCIPALLY OF METAL; METAL GAS STORAGE TANKS. (U.S. CLS. 2, 12, 13, 14, 23, 25 AND 50).

### **CLASS 7—MACHINERY**

FOR PUMPS, NAMELY, GASOLINE, OIL OR WATER PUMPS FOR USE IN MOTORS AND ENGINES, SUMP PUMPS, CENTRAL FUGAL PUMPS, POSITIVE DISPLACEMENT PUMPS, ROTARY PUMPS, SUCTION PUMPS AND VACUUM PUMPS; COMPRESSORS, NAMELY, AIR COMPRESSORS, REFRIGERATORS AND COMPRESSORS FOR MACHINES; IGNITION PARTS FOR INTERNAL COMBUSTION ENGINES; NAMELY, CONDENSERS; GENERATORS, NAMELY, ELECTRONIC AND FOR LAND VEHICLES; DRILLING MACHINES, NAMELY, DRILLING RIGS; FILTERS, NAMELY, OIL, GAS OR AIR FILTERS FOR MOTORS, ENGINES AND MACHINES; MACHINES FOR EXHAUSTION, TRANSPORTATION, GENERATION AND PREPARATION OF GASES; ORE TREATING MACHINES; PUMP DIAPHRAGMS; SPEED GOVERNORS FOR MACHINE ENGINES AND MOTORS; TURBINES OTHER THAN FOR LAND VEHICLES, NAMELY, HYDRAULIC AND WIND TURBINES; VEHICLE WASHING MACHINES; TIRE VULCANISERS; BOOMS USED IN THE RECOVERY AND TOWING OF DISABLED LAND VEHICLES; DERRICKS; MECHANICAL LOADING RAMPS; FUEL ECONOMIZERS FOR MOTORS AND ENGINES; RADIATOR CAPS; RADIATORS FOR MOTORS AND ENGINES; DYNAMOS; FAN BELTS FOR MOTORS AND ENGINES; PHOTOVOLTAIC APPARATUS AND INSTALLATIONS FOR GENERATING SOLAR ELECTRICITY, NAMELY, ELECTRIC GENERATORS; STEAM RADIATORS FOR VEHICLES. (U.S. CLS. 13, 19, 21, 23, 31, 34 AND 35).

**CLASS 9—ELECTRICAL AND SCIENTIFIC APPARATUS**

FOR SURVEYING APPARATUS AND INSTRUMENTS, NAMELY, SURVEYORS LEVELS, SURVEYORS CHAINS, MEASURING APPARATUS AND INSTRUMENTS USED BY SURVEYORS TO SURVEY LAND; MEASURING APPARATUS AND INSTRUMENTS, NAMELY, OHM-METERS, WAVE METERS, ALTIMETERS, ALCOHOL-METERS, AMMETERS, DYNAMOMETERS, ERGOMETERS, FREQUENCY METERS, GALVANOMETERS, GASOMETERS, HYDROMETERS, INCLINOMETERS, LACTOMETERS, MANOMETERS, PLANIMETERS, POLARIMETERS, PRESSURE GAUGES, PROTRACTORS, PYROMETERS, REFRACTOMETERS, SACCHAROMETERS, SALINOMETERS, SCALES, SPEED INDICATORS, SPHEROMETERS, TACHOMETERS, TELEMETERS, VARIOMETERS, VOLIMETERS; PHOTOGRAPHIC APPARATUS AND INSTRUMENTS, NAMELY, PHOTOGRAPHIC CAMERAS; FIRE EXTINGUISHERS; POWER CABLES; ELECTRICAL PHOTOVOLTAIC CELLS AND BATTERIES; BATTERY CHARGER AND ELECTRIC ACCUMULATORS; ACID HYDROMETERS; ACID METERS FOR BATTERIES; ANODE BATTERIES; ANODES; CAPACITORS; CIRCUIT BREAKERS AND CIRCUIT CLOSERS; CLOTHING FOR PROTECTION AGAINST ACCIDENTS AND/OR FIRE, NAMELY, PROTECTIVE GLOVES, HELMETS AND COATS; COIN OPERATED ELECTRIC GATES FOR CAR PARKS OR PARKING LOTS; COMPUTERS; BLANK MAGNETIC AND OPTICAL DISKS; GALVANIC BATTERIES; MAGNETICALLY ENCODED IDENTITY CARDS; MAGNETICALLY ENCODED CARDS FOR ELECTRONIC, OPTICAL OR MAGNETIC STORAGE OF DATA FOR USE AS CUSTOMER LOYALTY CARDS; SMART CARDS, NAMELY, BLANK, ENCODED, ELECTRONIC, CHIPPED OR INTEGRATED CIRCUIT SMART CARDS; MAGNETICALLY ENCODED CARD READERS AND ENCODERS, AUTOMATED TELLER AND CARD READING MACHINES; AUTHORIZATION CARDS, CHARGE CARDS AND PERSONAL IDENTIFICATION CARDS, NAMELY, MAGNETICALLY ENCODED AUTHORIZATION CARDS, CHARGE CARDS AND PERSONAL IDENTIFICATION CARDS; ELECTRIC CONTROLLERS FOR REMOTE IGNITION OF FURNACES AND OTHER FUEL BURNING APPLIANCES; INTEGRATED CIRCUITS; LIFEJACKETS; LIFE SAVING RAFTS; CHILDREN'S FLOATATION AIDS, NAMELY, LIFE BUOYS; OSCILLOGRAPHS; PRINTED CIRCUITS; PYROMETERS; SOLAR BATTERIES; TELEMETERS; TEMPERATURE INDICATORS, NAMELY, THERMOMETERS, TEMPERATURE INDICATORS FOR USE WITH ENGINES AND MACHINES; ELECTRIC THEFT PREVENTION BURGLAR ALARMS; SILICON WAFERS; WATER LEVEL INDICATORS FOR SCIENTIFIC MEASURING AND SWIMMING POOLS; COMPUTER SOFTWARE FOR DATA PROCESSING, FOR DYNAMIC SIMULATION OF OIL WELL DRILLING, FOR ESTABLISHING PUMP OPERATING SCHEDULES, FOR FINANCIAL REPORTING, FOR MANAGING CONFERENCES, FOR USE AS A SPREADSHEET, FOR WORD PROCESSING; DOWNLOADABLE ELECTRONIC PUBLICATIONS IN THE NATURE OF NEWSLETTERS AND MAGAZINES IN THE FIELDS OF CHEMICALS, PETROLEUM, GAS, ENGINEERING, SOLAR ENERGY AND EXPLORATION; AUTOMATIC AND COIN OPERATED AMUSEMENT MACHINES, NAMELY, SLOT MACHINES; SUNGLASSES; SPECTACLE CHAINS; DISPOSABLE PHOTOGRAPHIC CAMERAS; FUEL DISPENSING PUMPS FOR SERVICE STATIONS; BLANK AUDIO TAPES; BLANK MAGNETIC COMPUTER TAPES; ELECTRIC LIGHT EMITTING SIGNS; TIRE PRESSURE MEASURING GAUGE; RADIOS; ELECTRIC PLUGS; PLUG ADAPTERS; SPEED INDICATORS, NAMELY, SPEEDOMETERS; VEHICLE BREAKDOWN WARNING TRIANGLES; PUMPS, NAMELY, METERED GASOLINE PUMPS; CENTRIFUGAL METERING PUMPS; FUEL PUMPS FOR SERVICE STATIONS; CONDENSERS; PHOTOVOLTAIC SOLAR ELECTRIC INSTALLATIONS, NAMELY, ELECTRIC GENERATORS AND SOLAR COLLECTORS FOR USE IN TELECOMMUNICATIONS, NAVIGATIONAL AIDS, CATHODIC PROTECTION, LIGHTING AND RURAL ELECTRIFICATION; EXPOSED PHOTOGRAPHIC FILM. (U.S. CLS. 21, 23, 26, 36 AND 38).

**CLASS 11—ENVIRONMENTAL CONTROL APPARATUS**

FOR INSTALLATIONS AND APPARATUS FOR LIGHTING, HEATING, COOKING, REFRIGERATING, DRYING, VENTILATING, AIR CONDITIONING, WATER SUPPLY, SANITARY PURPOSES, GAS SEPARATION, GAS STORAGE, WASTE DESTRUCTION OR DISPOSAL, NAMELY, WATER FILTERING APPARATUS, WATER FLUSHING INSTALLATIONS, WATER HEATERS, WATER PURIFICATION APPARATUS FOR MACHINES, WATER SOFTENING APPARATUS AND INSTALLATIONS, SANITARY FIXTURES, NAMELY, URINAL FIXTURES, TOILETS, CEILING LIGHTS, ELECTRIC LAMPS, GAS LAMPS, LIGHT BULBS, LIGHTS FOR VEHICLES, ELECTRIC SOLAR AND GAS HEATING INSTALLATIONS AND APPARATUS, DOMESTIC OVENS AND MICROWAVE OVENS FOR COOKING, REFRIGERATORS, FREEZERS, INDUSTRIAL DRYERS FOR HEATING AND DEHUMIDIFYING AND CLOTHES DRYERS, AIR CONDITIONERS; SEPARATORS FOR THE CLEANING AND PURIFICATION OF GASES; INCINERATORS; HEAT ACCUMULATORS, NAMELY, SOLAR HEATING COLLECTION PANELS; COOLING AND FREEZING APPARATUS, NAMELY, EVAPORATIVE AIR COOLING UNITS FOR DOMESTIC USE, FREEZERS FOR DOMESTIC OR INDUSTRIAL USE; ELECTRICAL AND STEAM CENTRAL HEATING RADIATORS; ELECTRIC LIGHT BULBS; LAMPS AND DISCHARGE TUBES FOR LIGHTING; ELECTRICALLY OPERATED INSECT REPELLANTS; DISTILLATION APPARATUS AND COLUMNS, NAMELY, WATER DISTILLATION UNITS; DUST EXHAUSTING AND REMOVING INSTALLATIONS, NAMELY AIR PURIFYING UNITS FOR INDUSTRIAL PURPOSES; FLARE STACKS FOR USE IN RELEASE OF GASES; FLUES FOR USE IN CARRYING OFF SMOKE AND GASES; FUEL ECONOMIZERS, NAMELY, APPARATUS FOR MEASURING AND REGULATING THE CONSUMPTION OF FUEL IN HOME, FACTORIES AND OFFICES; GAS BURNERS FOR INDUSTRIAL, COMMERCIAL AND DOMESTIC USE; GERMICIDAL GAS BURNERS; HEAT EXCHANGERS; HEAT PUMPS; PETROL BURNERS; RADIATORS, NAMELY, ELECTRIC AND STEAM RADIATORS FOR HEATING BUILDINGS; SOLAR COLLECTORS FOR HEATING; SOLAR FURNACES; ELECTRIC TORCH LIGHTS; PLUMBING FITTINGS, NAMELY, LEVEL CONTROLLING VALVES FOR USE IN TANKS; AIR-FRESHENING DISPENSING UNITS FOR AUTOMOBILES, AIRCRAFT AND BOATS; PUMPS, NAMELY, HEAT PUMPS; STEAM GENERATORS; EXHAUSTS OTHER THAN FOR LAND VEHICLES, NAMELY, EXHAUST HOODS FOR KITCHENS; FILTERING MACHINES, NAMELY, FILTERING UNITS FOR WATER FILTERING UNITS FOR PRODUCING POTABLE WATER FOR DOMESTIC USE AND FILTERING UNITS FOR ENGINES AND MACHINES; HEAT EXCHANGERS; PHOTOVOLTAIC SOLAR ELECTRIC INSTALLATIONS, NAMELY, SOLAR COLLECTORS FOR USE IN TELECOMMUNICATIONS, NAVIGATIONAL AIDS, CATHODIC PROTECTION, LIGHTING AND FOR RURAL ELECTRIFICATION; FILAMENTS FOR ELECTRIC LAMPS. (U.S. CLS. 13, 21, 23, 31 AND 34).

**CLASS 12—VEHICLES**

FOR LAND VEHICLE PARTS AND ACCESSORIES THEREOF, NAMELY, WHEELS, HUB CAPS, TIRES, INNER TUBES, TIRE VALVES, AIR BRAKE HOSES, EXHAUST PIPES, ENGINE OR MOTOR SILENCERS, ELECTRIC STARTER MOTORS, BRAKE LININGS, REAR VIEW MIRRORS, BUMPER, MUDGUARDS, BODY PANELS, HOODS, CLUTCHES, SEATS AND SEAT COVERS, STEERING WHEELS AND STEERING WHEEL COVERS, GEAR LEVER KNOBS, HORNS, HYDRAULIC CIRCUITS, SHOCK ABSORBERS AND SPRINGS; WINDSHIELDS, WINDSHIELD WIPERS, ANTI-DAZZLE DEVICES AND ANTI-GLARE VISORS FOR AUTOMOBILES, NAMELY, AUTOMOBILE WINDSHIELD SUNSHADES. (U.S. CLS. 19, 21, 23, 31, 35 AND 44).

**CLASS 14—JEWELRY**

FOR JEWELRY; ASHTRAYS OF PRECIOUS METAL, BADGES AND BROOCHES ALL OF PRECIOUS METAL OR PLATED THEREWITH; WATCHES; CLOCKS; CUFF LINKS; EARRINGS; MEDALS; TIE CLIPS; TIE PINS. (U.S. CLS. 2, 27, 28 AND 50).

**CLASS 16—PAPER GOODS AND PRINTED MATTER**

FOR ADHESIVES AND ADHESIVE TAPES FOR STATIONERY OR HOUSEHOLD USE; ATLASES; MAPS; PAPER OR PLASTIC BAGS FOR PACKAGING; FICTION AND NON-FICTION BOOKS ON A VARIETY OF TOPICS; CHRISTMAS AND GIFT CARDS; PRINTED CHARTS; PLASTIC BUBBLE PACK FOR WRAPPING OR PACKAGING; CALENDARS; DIARIES; PAPER TAPES; BLANK CARDS AND BLANK COMPUTER DISKS FOR RECORDING COMPUTER PROGRAMMES; PAPER MATS FOR USE WITH TYPEWRITERS AND COMPUTERS; COASTERS OF PAPER; PLACE MATS OF PAPER; PRINTED PAPER CONTROL TOKENS FOR USE AS TICKETS; FILTER PAPER; FOLDERS; PAPER FLAGS; INSTRUCTION MANUALS IN THE FIELD OF VEHICLE MAINTENANCE, GENERAL FEATURE MAGAZINES, AND NEWSPAPERS FEATURING NATIONAL, WORLD EVENTS AND BUSINESS NEWS; WRITING, DRAWING, TYPING, ART, NOTEBOOK AND COPIER PAPER; CARDBOARD; PAPERWEIGHTS; DRAWING BOARD PINS; MAPPING PINS; CORKBOARD PINS; PINS FOR STATIONERY USE, NAMELY, PUSH PINS; PENS; PENCILS; PEN AND PENCIL HOLDERS; PENCIL SHARPENERS; MOUNTED AND UNMOUNTED PHOTOGRAPHS; PICTURES; PAPER AND PLASTIC HANDKERCHIEFS; FACIAL TISSUES AND PAPER TOWELS; POSTCARDS; GREETING CARDS; POSTERS; PRINTED PROSPECTUSES; PAPER RIBBONS; RUBBER ERASERS; DRAWING AND DRAFTING RULERS; STANDS FOR PENS AND PENCILS; PAPER TABLE CLOTHS; PAPER TABLE LINEN, MATS AND NAPKINS, ALL OF PAPER; STATIONERY WRITING CASES; BOOKMARKS; PAINT BRUSHES; PAINT APPLICATOR ROLLERS; VOUCHER BOOKS; STATIONERY; HAND HELD PRINTING APPLIANCES AND IMPRINTERS FOR OFFICE USE, NAMELY, LABEL PRINTING MACHINES; DOCUMENT FILES; TRAVELER'S CHEQUES; PAYMENT, PRE-PAYMENT, AND DEFERRED PAYMENT CARDS, AUTHORIZATION CARDS, CHARGE CARDS AND PERSONAL IDENTIFICATION CARDS, NAMELY, DEBIT AND CREDIT CARDS WITHOUT MAGNETIC CODING; PRINTED PAPER ADVERTISING SIGNS; BIRTHDAY AND CAKE DECORATIONS, NAMELY, PAPER CAKE DECORATIONS. (U.S. CLS. 2, 5, 22, 23, 29, 37, 38 AND 50).

**CLASS 17—RUBBER GOODS**

FOR NON-METALLIC HOSES AND PIPES FOR USE IN BUILDING AND CONSTRUCTION; INSULATING OILS FOR TRANSFORMERS; SEMI-PROCESSED PLASTICS PRODUCTS, NAMELY PLASTICS IN EXTRUDED FORM FOR GENERAL INDUSTRIAL USE; PLASTICS FILM OTHER THAN FOR WRAPPING, NAMELY, FOR INDUSTRIAL AND COMMERCIAL PACKING USE, FOR USE AS A LAMINATE, FOR USE PACKAGING FOOD IN PRESERVING SEEDS; CLUTCH LININGS; PLASTICS IN EXTRUDED FORM FOR GENERAL INDUSTRIAL USE; COMPONENTS AND ASSEMBLIES IN MOLDED FORM FOR USE IN MANUFACTURE, NAMELY, EXTRUDED PLASTIC IN THE FORM OF BARS, BLOCKS, PELLETS, RODS, SHEETS AND TUBES FOR USE IN MANUFACTURING. (U.S. CLS. 1, 5, 12, 13, 35 AND 50).

**CLASS 18—LEATHER GOODS**

FOR LEATHER AND IMITATION LEATHER AND GOODS MADE THEREOF, NAMELY, SHOPPING BAGS, ATHLETIC BAGS, SHOULDER BAGS, TRAVEL BAGS, TOOL BAGS, PURSES, WALLETS, BRIEFCASES, SUITCASES AND HOLDALLS IN THE NATURE OF DUFFLE BAGS; STRAPS FOR SUITCASES, BRIEFCASES AND HANDBAGS; UMBRELLAS, PARASOLS AND WALKING STICKS. (U.S. CLS. 1, 2, 3, 22 AND 41).

**CLASS 19—NON-METALLIC BUILDING MATERIALS**

FOR ASPHALT, PITCH, BITUMEN, NAMELY, BITUMEN BASED ASPHALT SEALANTS AND BITUMINOUS ROOF COATINGS; ASPHALTIC BITUMEN COMPOUND, SOLUTIONS AND EMULSIONS OF ASPHALTIC BITUMEN, NONE BEING IN THE NATURE OF PAINT; ASPHALT PAVING; BITUMINOUS COATINGS FOR ROOFING; BITUMINOUS PRODUCTS FOR BUILDING AND ROAD CONSTRUCTION, NAMELY, BITUMEN BASED ASPHALT SEALANT; FRAMEWORKS AND CLADDINGS FOR USE IN BUILDING AND CIVIL ENGINEERING, NOT OF METAL; NON-METAL CHIMNEYS; FLOOR BOARDS AND FLOOR TILES, NOT OF METAL; HUTS, JOISTS, LATHS, LATTICE WORK AND LINTELS, NONE BEING OF METAL; MACADAM, BUILDING PANELS, NONE BEING OF METAL; PREFABRICATED PLATFORMS AND BOOMS, NONE BEING OF METAL; ASPHALT AND BITUMINOUS MATERIALS FOR MAKING AND COATING ROADS, PAVING STONES, PAVING BLOCKS, CONCRETE PATCHING COMPOUNDS, TAR AND CONCRETE; DAMP COURSES AND ROOF FLASHING, NOT OF METAL; TAR, NAMELY FOR ASPHALT AND CONCRETE PATCHING, SEALANTS FOR ASPHALT DRIVEWAYS AND ROOFING; TARRIED STRINGS FOR BUILDING; WALL LININGS, NOT OF METAL, FOR BUILDING; NON-METALLIC TILES; NON-METAL LATTICE STRUCTURES ALL FOR USE IN BUILDING AND CIVIL ENGINEERING; NON-METALLIC GEOTEXTILES, NAMELY, EROSION-CONTROL SHEETING AND FABRICS FOR CONSTRUCTION USE. (U.S. CLS. 1, 12, 33 AND 50).

**CLASS 20—FURNITURE AND ARTICLES NOT OTHERWISE CLASSIFIED**

FOR CONTAINERS NOT OF METAL FOR COMMERCIAL TRANSPORT USE; WOOD BARRELS; PLASTIC BOXES, NON-METAL PALLETS; DRINKING STRAWS; NON-METALLIC CONTAINERS FOR CHEMICAL OR PETROLEUM PRODUCTS AND PETROLEUM DERIVATIVES FOR COMMERCIAL USE; NON-ELECTRIC FANS FOR PERSONAL USE; NOVELTY IDENTITY LICENSE PLATES, NOT OF METAL; CONTAINERS AND CONTAINER CLOSURES OF NON-METALLIC MATERIAL OR IN WHICH NON-METALLIC MATERIALS PREDOMINATE FOR COMMERCIAL USE; DECORATIVE WALL PLAQUES; PICTURE FRAMES; NON-METAL KEY RINGS AND KEY RINGS WITH FOBS; BIRTHDAY AND CAKE DECORATIONS, NAMELY, PLASTIC CAKE DECORATIONS; FITTED FABRIC FURNITURE COVERS; INTERIOR WINDOW BLINDS; FIXED CABINETS NOT OF METAL FOR DISPENSING TOWELS. (U.S. CLS. 2, 13, 22, 25, 32 AND 50).

**CLASS 21—HOUSEWARES AND GLASS**

FOR NON-METAL OIL CANS AND DRUMS FOR HOUSEHOLD AND KITCHEN PURPOSES SOLD EMPTY; NON-METALLIC CONTAINERS FOR HOUSEHOLD AND KITCHEN PURPOSES; NON-METAL ABRASIVE PADS FOR KITCHEN PURPOSES; NAMELY, PADS FOR CLEANING; TANKARDS NOT OF PRECIOUS METAL; SMALL DOMESTIC UTENSILS FOR DISPENSING DOSES OF HOUSEHOLD LIQUID, NAMELY, DISPENSERS FOR LIQUID SOAP OR SIMILAR HOUSEHOLD OR COMMERCIAL PRODUCTS, SOAP BOXES; CLEANSING INSTRUMENTS, NAMELY, SPONGES, BRUSHES AND FLANNELS CLOTHS FOR CLEANING; IMPREGNATED CLOTHS FOR CLEANING, DUSTING AND POLISHING; POLISHING CLOTHS; PORTABLE COLD BOXES AND COOLERS SOLD AS A UNIT WITH SACHETS FOR USE THEREWITH; DEODORIZING APPARATUS FOR PERSONAL USE, NAMELY AEROSOL DISPENSERS NOT FOR MEDICAL USE; BOXES FOR DISPENSING TOWELS; PADS OF METAL, NAMELY STEEL WOOL FOR CLEANING; BURNERS FOR PERFUME AND DOMESTIC INCENSE BURNERS; POWDER PUFFS; GRASS SPRINKLERS; TOILET ARTICLES, NAMELY, HAIR BRUSHES AND BRUSHES TO APPLY

MAKEUP, COSMETIC COMBS AND COMBS FOR THE HAIR, AND FACIAL SPONGES FOR APPLYING MAKEUP; TOOTHBRUSHES, BOTH ELECTRIC AND NON-ELECTRIC; INSECT TRAPS; MEAL TRAYS; SERVING TRAYS FOR DOMESTIC PURPOSES NOT OF PRECIOUS METAL; AND BOWLS, BUTTER DISHES, COFFEE POTS NOT OF PRECIOUS METAL, CRYSTAL GLASSWARE, CUPS, DISHES, DRINKING GLASSES AND GLASS BEVERAGeware, VASES, BUSTS AND FIGURINES OF GLASS, PORCELAIN OR EARTHENWARE; EYEBROW BRUSHES; CLEANING OR DUSTING CLOTHS. (U.S. CLS. 2, 13, 23, 29, 30, 33, 40 AND 50).

#### **CLASS 22—CORDAGE AND FIBERS**

FOR TOW ROPES FOR AUTOMOBILES; ROPE, TWINE, COMMERCIAL NETS, TENTS, CANVAS TARPULINS, SAILS SACKS FOR THE TRANSPORTATION OR STORAGE OF MATERIALS IN BULK; GEOTEXTILE CONTAINERS AND BAGS MADE OF TEXTILE FOR MERCHANDISE PACKAGING; COMMERCIAL NETTING FOR AGRICULTURAL USE; POLYOLEFIN FIBERS NOT FOR TEXTILE USE; TEXTILE FIBERS; NON-WOVEN FABRICS AND FELT, NAMELY, ACRYLIC AND POLYESTER FIBERS; CARBON FIBERS FOR TEXTILE USE. (U.S. CLS. 1, 2, 7, 19, 22, 42 AND 50).

#### **CLASS 23—YARNS AND THREADS**

FOR YARN AND THREAD FOR TEXTILE PURPOSES; NON-WOVEN FABRICS AND FELT, NAMELY, YARN. (U.S. CL. 43).

#### **CLASS 24—FABRICS**

FOR FABRIC FOR USE IN PRODUCING FURNITURE COVERS, CLOTHING AND CURTAINS; TEXTILE GOODS, NAMELY NAPKINS, PLACE MATS, WALL HANGINGS, CURTAINS AND TOWELS; BED BLANKETS AND TABLE LINEN; HANDKERCHIEFS; UNFITTED FABRIC FURNITURE COVERS. (U.S. CLS. 42 AND 50).

#### **CLASS 25—CLOTHING**

FOR CLOTHING, NAMELY TIES, JERSEYS, SHIRTS, TROUSERS, UNDERWEAR, T-SHIRTS, JACKETS, POLO SHIRTS, BELTS, SKIRTS, DRESSES, BLOUSES, BOILER SUITS, SCARVES, SPORTS SHIRTS, SPORTS SHORTS, BELTS, GLOVES AND SUITS; FOOTWEAR; HEADGEAR, NAMELY, ANTI-GLARE SUN VISORS, HEAD BANDS, BASEBALL CAPS AND HATS; UNIFORMS; WATERPROOF CLOTHING, NAMELY, RAINWEAR; WET SUITS FOR WATER-SKIING AND SUB-AQUA. (U.S. CLS. 22 AND 39).

#### **CLASS 26—FANCY GOODS**

FOR LACE TRIMMINGS USED IN THE MANUFACTURE OF CLOTHING, TABLE LINENS AND BED LINENS; BOBBIN LACE, EMBROIDERY, RIBBON AND SHOELACES; BUTTONS FOR CLOTHING; HOOKS AND EYES; STRAIGHT PINS FOR SEWING AND SAFETY PINS AND NEEDLES; ZIPPER FASTENERS; ARTIFICIAL FLOWERS. (U.S. CLS. 37, 39, 40, 42 AND 50).

#### **CLASS 27—FLOOR COVERINGS**

FOR CARPETS, DOOR MATS, RUGS, LINOLEUM FOR USE ON FLOORS AND OTHER HARD SURFACE FLOOR COVERINGS; WALLPAPER, EXCLUDING THOSE MADE FROM TEXTILE MATERIAL; BATH MATS. (U.S. CLS. 19, 20, 37, 42 AND 50).

#### **CLASS 28—TOYS AND SPORTING GOODS**

FOR GAMES, NAMELY, BOARD GAMES, AND CARD GAMES; TOYS, NAMELY, STUFFED TOYS, WIND UP TOYS, ACTION FIGURES, VEHICLES, RIDE ON TOYS, INFLATABLE TOYS, ELECTRONICALLY OPERATED TOY MOTOR VEHICLES; MUSICAL TOYS AND MECHANICAL TOYS; SCALE MODEL TOY VEHICLES; TOY MODEL HOBBYCRAFT CONSTRUCTION KITS FOR MAKING TOYS AND MODELS; GYMNASIAC AND SPORTING GOODS, NAMELY, HORIZONTAL BARS, PARALLEL BARS, VAULTING HORSES, ATHLETIC WRIST JOINT SUPPORTS, TRAINING STOOLS, SPORTS BALLS, SPORTS BASEBALL BATS, GOLF CLUBS, TENNIS RAQUETS, RACQUETBALL AND SQUASH RACKETS, HOCKEY STICKS, BADMINTON SHUTTLECOCK, SKIS; CHRISTMAS TREE DECORATIONS; SKI WAX; AUTOMATIC AND COIN OPERATED AMUSEMENT GAME MACHINES; PLAYING CARDS. (U.S. CLS. 22, 23, 38 AND 50).

#### **CLASS 29—MEATS AND PROCESSED FOODS**

FOR MEAT, FISH FOR FOOD PURPOSES, POULTRY IN GENERAL AND GAME FOOD; MEAT EXTRACTS; PRESERVED, DRIED AND COOKED FRUITS AND VEGETABLES; JELLIES, JAMS, FRUIT SAUCES; EGGS, MILK AND MILK PRODUCTS, NAMELY, DAIRY PRODUCTS EXCLUDING ICE CREAM, AND FROZEN YOGURT; EDIBLE OILS AND FATS; FRUIT PRESERVES; SHELLFISH FOR HUMAN CONSUMPTION IN GENERAL; SOUPS; POTATO CRISPS AND CHIPS. (U.S. CL. 46).

#### **CLASS 30—STAPLE FOODS**

FOR COFFEE, TEA, COCOA, SUGAR, RICE, TAPIOCA, SAGO; FLOUR AND PREPARATIONS MADE FROM CEREALS, NAMELY, CEREAL BASED SNACK FOOD AND BREAKFAST CEREALS; BREAD AND PASTRY; FLAVORED ICES AND ICE CREAMS; HONEY, TREATLE; YEAST, BAKING POWDER; SALT, MUSTARD; VINEGAR, SAUCES; SPICES; ICE; MAYONNAISE; PIES; HOT DOG SANDWICHES AND HAMBURGER SANDWICHES; SWEETS, NAMELY, CANDY; CHEWING GUM; CHOCOLATE; SANDWICHES; BIRTHDAY AND CAKE DECORATIONS; NAMELY, EDIBLE CAKE DECORATIONS; SALAD DRESSINGS; FROZEN YOGURT. (U.S. CL. 46).

#### **CLASS 31—NATURAL AGRICULTURAL PRODUCTS**

FOR FRESH FRUITS, FRESH VEGETABLES, HERBS; LIVING PLANTS AND FLOWERS, AND SEEDS THEREOF; FLOWER BULBS AND CORMS; ANIMAL FOODSTUFFS FOR ANIMALS, BIRDS, FISH AND GAME, NONE BEING FOR MEDICAL PURPOSES; ANIMAL LITTER; CUT CHRISTMAS TREES; DRIED FLOWERS FOR DECORATION; AGRICULTURAL, HORTICULTURAL AND FORESTRY PRODUCTS AND GRAINS NOT INCLUDED IN OTHER CLASSES, NAMELY, AGRICULTURAL GRAIN FOR PLANTING, AGRICULTURAL SEEDS, FLOWER BULBS, RAW MAIZE, FRESH OATS, RYE SEED, CHOPPED STRAW FOR ANIMAL BEDDING AND RAW WHEAT. (U.S. CLS. 1 AND 46).

#### **CLASS 32—LIGHT BEVERAGES**

FOR BEERS; MINERAL AND AERATED WATERS AND OTHER NON-ALCOHOLIC DRINKS, NAMELY, FRUIT DRINKS, FRUIT JUICES, COFFEE FLAVOURED SOFT DRINKS, TEA FLAVOURED SOFT DRINKS, COLAS, TOMATO JUICE BEVERAGES, SMOOTHIES, SOFT DRINKS, ENERGY DRINKS, SOFT DRINKS; NAMELY FLAVORED SODAS CARBONATED SOFT DRINKS AND SYRUPS FOR MAKING SOFT DRINKS; SWEET CIDER. (U.S. CLS. 45, 46 AND 48).

**CLASS 33—WINES AND SPIRITS**

FOR WINE; HARD CIDER AND PERRY; ALCOHOLIC BEVERAGES EXCEPT BEERS, NAMELY GIN, VODKA, BRANDY, WHISKEY, RUM, ALCOHOLIC TEA BASED BEVERAGES, APERITIFS WITH A DISTILLED ALCOHOLIC LIQUEUR BASE. (U.S. CLS. 47 AND 49).

**CLASS 34—SMOKERS' ARTICLES**

FOR TOBACCO; CIGARS; CIGARETTES; SMOKER'S ARTICLES, NAMELY, TOBACCO SMOKING PIPES, MATCHES, CIGARETTE PAPERS, ASHTRAYS, NOT OF PRECIOUS METAL, CIGARETTE LIGHTERS, NOT OF PRECIOUS METAL AND CIGARETTE CASES, NOT OF PRECIOUS METAL. (U.S. CLS. 2, 8, 9 AND 17).

**CLASS 35—ADVERTISING AND BUSINESS**

FOR DIRECT MAIL ADVERTISING; SHOW WINDOW DISPLAY ARRANGEMENT SERVICES; MARKET RESEARCH; CONDUCTING MARKETING STUDIES; PUBLIC RELATIONS; MANAGEMENT OF PROCUREMENT IN THE NATURE OF PURCHASING FUEL AND PRODUCTS FOR SALE IN A CONVENIENCE STORE SITUATED ON A SERVICE STATION; BUSINESS MANAGEMENT SERVICES; BOOKKEEPING AND FINANCIAL STATEMENT PREPARATION AND ANALYSIS FOR BUSINESSES ALL RELATING TO THE PURCHASE OF AND PAYMENT FOR AVIATION AND AUTOMOTIVE FUEL AND RELATED SERVICES; ACCOUNTING; AND FINANCIAL STATEMENT PREPARATION AND ANALYSIS FOR BUSINESSES; BUSINESS APPRAISALS; BOOKKEEPING; OFFICE MACHINE AND EQUIPMENT RENTAL; DATA PROCESSING SERVICES; COMPUTERIZED DATABASE MANAGEMENT; REGISTRATION SERVICES CREDIT CARDS USED FOR FINANCIAL TRANSACTIONS; PROVIDING BUSINESS INFORMATION RELATING TO OIL AND ITS DERIVATIVES, GAS, PETROLEUM, EXPLORATION, ENGINEERING, CHEMICALS, SOLAR ENERGY, RETAILING OF OIL AND ITS DERIVATIVES, RETAILING OF GENERAL MERCHANDISE THROUGH RETAIL OUTLETS; BUSINESS MANAGEMENT CONSULTANCY; PROVIDING A WEB SITE WHICH FEATURES ADVERTISEMENTS FOR THE GOODS AND SERVICES OF OTHERS ON A GLOBAL COMPUTER NETWORK; PROVISION OF INFORMATION FOR BUSINESS PURPOSES ON THE INTERNET RELATING TO OIL AND ITS DERIVATIVES, GAS, PETROLEUM, EXPLORATION, SOLAR ENERGY, ENGINEERING, CHEMICALS, RETAIL OUTLETS FEATURING OIL AND ITS DERIVATIVES AND GENERAL MERCHANDISE; ON-LINE TRADING SERVICES IN WHICH SELLER POSTS PRODUCTS TO BE AUCTIONED AND BIDDING IS DONE VIA THE INTERNET WITH GOODS IDENTIFIED AS OIL, OIL DERIVATIVES, GAS, GOODS IN CONNECTION WITH THE PRODUCTION OF SOLAR ENERGY, CHEMICALS; PROVISION OF ON-LINE PROCUREMENT FACILITIES, NAMELY, PURCHASING OF OIL, OIL DERIVATIVES, GAS, GOODS FOR USE IN PRODUCTION OF SOLAR ENERGY, GOODS FOR USE IN CONNECTION WITH EXPLORATION, CHEMICALS, GENERAL MERCHANDISE SOLD THROUGH RETAIL OUTLETS SITUATED ON SERVICE STATIONS SITES FOR OTHERS VIA A GLOBAL COMPUTER NETWORK; PHOTOCOPYING SERVICES; BUSINESS ADVICE ON THE PURCHASE OF GOODS FOR SALE THROUGH CONVENIENCE STORES, SERVICE STATIONS, TAKE-AWAY FOOD COUNTERS, BAKERIES, CAFES, RESTAURANTS, AND VENDING MACHINES; BUSINESS MANAGEMENT, NAMELY, MANAGEMENT OF CUSTOMER LOYALTY, INCENTIVE OR PROMOTIONAL SCHEMES; BUSINESS MANAGEMENT AND CONSULTATION, NAMELY, PROVIDING ADVICE ON THE OPERATION OF BAKERIES, TAKE-AWAY FOOD COUNTERS, CAFES, RESTAURANTS, SERVICE STATIONS AND CONVENIENCE STORES, PROCUREMENT OF STOCK FOR RETAIL STORES; RETAILING SERVICES RELATING TO FILLING STATIONS AND SHOPS LOCATED ON FILLING STATIONS, NAMELY, RETAIL STORE SERVICES FEATURING CONVENIENCE STORE ITEMS AND GASOLINE; RETAIL CONVENIENCE STORE SERVICES; DISCOUNT CARD SERVICES, NAMELY, PROMOTING THE GOODS AND SERVICES OF OTHERS THROUGH THE DISTRIBUTION OF DISCOUNT CARDS; SERVICES COMPRISING ORGANIZING THE SCHEDULING OF PRODUCT TRANSPORT,

INCLUDING ON LINE SERVICES FOR SAME, NAMELY, SCHEDULING SERVICES FOR TRANSPORTATION OF GOODS FROM MANUFACTURERS TO CUSTOMERS; RETAIL GASOLINE SUPPLY SERVICES; MANAGEMENT OF CAMPGROUND ACCOMMODATION FOR OTHERS; RETAIL BAKERY OUTLET SHOPS WITHIN GENERAL CONVENIENCE STORES; RENTAL OF VENDING MACHINES; RETAIL FRANCHISING SERVICES IN THE ESTABLISHMENT OR OPERATION OF SERVICE STATIONS, RETAIL CONVENIENCE STORES SITUATED ON SERVICE STATION SITES, RESTAURANTS, HOTELS/MOTELS AND CAR WASHES; OPERATION OF A BUSINESS FOR OTHERS; NAMELY, AUTOMOBILE SERVICE STATIONS; TRANSPORTATION LOGISTICS SERVICES, NAMELY, ARRANGING FOR THE TRANSPORTATION OF GOODS, NAMELY, CHEMICALS, CHEMICAL PRODUCTS, OIL, OIL DERIVATIVES, GAS, GOODS FOR USE IN PRODUCING SOLAR ENERGY GOODS FOR USE IN EXPLORATION, AND GOODS FOR USE IN CONVENIENCE STORES; ONLINE TRANSPORTATION LOGISTICS SERVICES, NAMELY, PLANNING AND SCHEDULING SHIPMENTS OF GOODS VIA AIR, SEA, RAIL AND LAND (U.S. CLS. 100, 101 AND 102).

**CLASS 36—INSURANCE AND FINANCIAL**

FOR FINANCIAL MANAGEMENT AND CONSULTANCY; FINANCING SERVICES; LOAN FINANCING; PROMOTING THE SALE OF ITEMS BY OFFERING THE SALE OF SAME ON CREDIT TERMS; CREDIT CARD SERVICES, NAMELY, ISSUING OF PAYMENT, PREPAYMENT AND DEFERRED PAYMENT CREDIT CARDS; CREDIT CARD SERVICES USING TRANSPONDER-BASED SYSTEMS PROVIDING PREPAYMENT AND DEFERRED PAYMENT FOR GOODS OR SERVICES; PURCHASING MANAGEMENT CONSULTANCY IN THE NATURE OF PROVIDING ADVICE CONCERNING FINANCIAL ASPECTS OF PURCHASING FUELS AND GOODS FOR SALE IN CONVENIENCE STORES SITUATED ON A SERVICE STATION; FINANCIAL CLEARING HOUSE SERVICES; PAYMENT PROCESSING, NAMELY, ELECTRONIC PROCESSING AND TRANSMISSION OF BILL PAYMENT DATA; RENTAL AND LEASING OF REAL ESTATE; CREDIT CARD SERVICES IN THE NATURE OF ISSUING PAYMENT CARD, PRE-PAYMENT CARD, DEFERRED PAYMENT CARDS, AND AUTHORIZATION OF PURCHASES FOR CREDIT CARD TRANSACTIONS; CASH CARD SERVICES, NAMELY, CASH REPLACEMENT RENDERED BY CREDIT CARD; FINANCING OF PURCHASES, NAMELY CHEMICALS, GOODS FOR USE IN PRODUCING SOLAR ENERGY, OIL, OIL DERIVATIVES, GAS, GOODS SOLD THROUGH CONVENIENCE STORES SITUATED ON SERVICE STATION SITES, GOODS FOR USE IN THE EXPLORATION FOR OIL AND GAS; ELECTRONIC FUNDS-TRANSFER AND CASH DISPENSING SERVICES, NAMELY, ELECTRONIC CASH TRANSACTIONS; FINANCIAL ANALYSIS AND CONSULTATION RELATING TO THE ISSUE OF STATEMENTS OF ACCOUNT; BILL PAYMENT PROCESSING SERVICES; FINANCIAL SERVICES IN THE NATURE OF AN INVESTMENT SECURITY; INSURANCE CONSULTATION AND INSURANCE BROKERAGE SERVICES; GUARANTEE SERVICES, NAMELY FINANCIAL GUARANTEE AND SURETY AND GUARANTEE INSURANCE UNDERWRITING; ADMINISTRATION AND MANAGEMENT OF EMPLOYEE PENSION FUNDS; ON-LINE EMPLOYEE PENSION FUND INFORMATION AND ADMINISTRATION SERVICES; CHARITABLE FUND RAISING; FINANCIAL SPONSORSHIP OF EDUCATIONAL AND CHARITABLE EVENTS; ON-LINE TRADING OF STOCKS, BONDS AND OTHER SECURITIES; OFFICE SERVICES, NAMELY, LEASING AND RENTAL OF OFFICE SPACE. (U.S. CLS. 100, 101 AND 102).

**CLASS 37—CONSTRUCTION AND REPAIR**

FOR ANTI-RUST TREATMENT FOR VEHICLES; ASPHALTING; AIRCRAFT, LAND VEHICLE AND TRAILER CLEANING, POLISHING, GREASING, LUBRICATION, MAINTENANCE AND REPAIR; MOTOR VEHICLE WASHING; FURNACE INSTALLATION AND REPAIRS; VEHICLE TIRE RE-FITTING AND REPAIR; HEATING EQUIPMENT INSTALLATION AND REPAIR; LAUNDRY SERVICES; LEATHER CARE, CLEANING AND REPAIR; CONSTRUCTION OF POWER GENERATING PLANTS; INSTALLATION, MAINTENANCE, REPAIR AND SERVICING OF GAS SUPPLY AND DISTRIBUTION APPARATUS AND INSTRUMENTS; REPAIR, MAINTENANCE AND SERVICING OF GAS APPARATUS AND INSTRUMENTS; MACHINERY INSTALLATION, MAINTENANCE AND REPAIR; PIPELINE CONSTRUCTION AND MAINTENANCE; PUMP REPAIR AND MAINTENANCE; VEHICLE SERVICE STATIONS AND VEHICLE FUELLING STATION SERVICES; PAINTING OR REPAIR OF SIGNS; MAINTENANCE, REPAIR AND CARE OF SHIPS, OIL RIGS AND AIRCRAFT; OFFICE SERVICES, NAMELY, INSTALLATION AND REPAIR OF BUSINESS OFFICE MACHINERY AND EQUIPMENT; REFUELING SERVICES FOR SHIPS, BOATS, AIRCRAFT AND LAND VEHICLES; REFUELING SERVICES FOR LAND VEHICLES, SHIPS, BOATS AND AIRCRAFT. (U.S. CLS. 100, 103 AND 106).

**CLASS 38—COMMUNICATION**

FOR FACSIMILE TRANSMISSION SERVICES, TELEX AND TELEPHONE TRANSMISSION SERVICES; MESSAGE SENDING SERVICES BY ELECTRONIC TRANSMISSION; TELECOMMUNICATIONS, NAMELY, FACSIMILE TRANSMISSION SERVICES, TELEPHONE SERVICES, INTERNET AND EXTRANET TRANSMISSION SERVICES AND ISTN TRANSMISSION SERVICES; PROVIDING ACCESS TO THE INTERNET, NAMELY, PROVIDING TELECOMMUNICATIONS CONNECTIONS TO A GLOBAL COMPUTER NETWORK; INTERNET CAFE SERVICES, NAMELY, PROVIDING ON-LINE CHAT ROOMS FOR TRANSMISSION OF MESSAGES AMONG COMPUTER USERS CONCERNING TOPICS OF GENERAL INTEREST. (U.S. CLS. 100, 101 AND 104).

**CLASS 39—TRANSPORTATION AND STORAGE**

FOR VEHICLE RENTAL, NAMELY, CAR, TRUCK AND TRAILER RENTAL; VEHICLE TOWING; VEHICLE PARKING; TRANSPORTATION OF FREIGHT BY AIR, SEA, RAIL OR LAND; PACKAGING OF ARTICLES FOR TRANSPORT, SALE AND STORAGE, STORAGE OF SHIPS; TRANSPORTATION BY AIR, LAND, SEA AND RAIL; AND STORAGE OF FUEL, OIL, PETROLEUM, GAS AND LUBRICANTS; PUBLIC UTILITY SERVICES IN THE NATURE OF TRANSMISSION, SUPPLY AND DISTRIBUTION OF ELECTRICITY; TRANSMISSION OF OIL AND GAS BY PIPELINE; MARINE TRANSPORT SERVICES; CHARTERING OF SHIPS OR SPACE ON SHIPS FOR TRANSPORT OF FREIGHT. (U.S. CLS. 100 AND 105).

**CLASS 40—MATERIAL TREATMENT**

FOR FUEL OIL, USED LUBRICANTS AND GAS TREATMENT SERVICES; RECYCLING OF PLASTICS; GENERATION OF GAS AND ELECTRICITY; OIL AND GAS REFINERY SERVICES; PROVIDING INFORMATION ON TREATMENT OF MATERIALS, NAMELY, ON-LINE PROVISION OF INFORMATION ON TREATMENT OF MATERIALS, NAMELY, GAS, OIL, WATER AND OTHER FORMS OF ENERGY. (U.S. CLS. 100, 103 AND 106).

**CLASS 41—EDUCATION AND ENTERTAINMENT**

FOR EDUCATIONAL SERVICES TAKING PLACE OFF THE PREMISES OF A SCHOOL OR OTHER EDUCATIONAL ESTABLISHMENT IN THE FIELDS OF OIL, GAS AND PETROCHEMICALS, SCIENCE, HEALTH, SAFETY AND ENVIRONMENT, NAMELY, CONDUCTING CLASSES, SEMINARS, CONFERENCES, WORKSHOPS AND ON THE JOB TRAINING IN THE FIELDS OF OIL, GAS AND PETROCHEMICAL INDUSTRIES, SCIENCE, HEALTH, SAFETY AND ENVIRONMENT; ARRANGING AND CONDUCTING INTERNATIONAL EDUCATIONAL CONFERENCES BETWEEN SCHOOLS IN DIFFERENT COUNTRIES, AND PROVIDING MULTI-LINGUAL SCIENCE TEACHING UNITS FOR THAT PURPOSE; PUBLICATION OF BOOKS; ORGANIZATION OF COMPETITIONS, NAMELY, ENTERTAINMENT IN THE NATURE OF COMPETITIONS IN THE FIELD OF SPORTS AND BUSINESS; PROVIDING NON-DOWNLOADABLE ELECTRONIC PUBLICATIONS, NAMELY NEWSLETTERS AND MAGAZINES IN THE FIELDS OF CHEMICALS, GAS, OIL, SOLAR ENERGY AND EXPLORATION, RETAILING AND ENGINEERING; ELECTRONIC GAMES SERVICES ON THE INTERNET, NAMELY PROVIDING AND ON-LINE COMPUTER GAME; COMPUTER EDUCATION TRAINING SERVICES IN THE USE AND OPERATION OF COMPUTER SOFTWARE FOR ORGANIZING THE SCHEDULING OF PRODUCT TRANSPORT, MONITORING PERFORMANCE AND REPORTING THEREON; TRAINING IN THE USE AND OPERATION OF PETROCHEMICALS PRODUCTION FACILITIES; RECREATIONAL SERVICES IN THE NATURE OF CHILDREN'S PLAYGROUNDS AT SERVICE STATIONS; ENTERTAINMENT SERVICES, NAMELY, ORGANIZATION OF COMPETITIONS FOR OTHERS FOR COMMERCIAL OR ADVERTISING PURPOSES. (U.S. CLS. 100, 101 AND 107).

**CLASS 42—SCIENTIFIC, COMPUTER AND LEGAL SERVICES**

FOR PROVISION OF FACILITIES FOR CONFERENCES, NAMELY, PROVIDING CONVENTION FACILITIES; COMPUTER PROGRAMMING FOR OTHERS; RENTAL OF COMPUTERS; DESIGN OF COMPUTER SOFTWARE FOR OTHERS; DESIGN AND MAINTENANCE OF COMPUTER PROGRAMMES FOR ORGANIZING THE SCHEDULING OF PRODUCT TRANSPORT, AND REPORTING THEREON VIA ON-LINE, TELEPHONE, E-MAIL AND IN PERSON; ARCHITECTURAL AND INTERIOR DESIGN SERVICES FOR RETAIL AND WHOLESALE OUTLETS; RENTAL OF UNIFORMS; CHEMICAL ANALYSIS SERVICES FOR OIL FIELD EXPLORATION; OIL-WELL TESTING; OIL PROSPECTING; CONDUCTING ENGINEERING SERVICES OF OIL-FIELDS; TESTS AND INSPECTION FOR EARLY DAMAGE DIAGNOSIS IN OIL-FIELD AND OIL CONDUCTING PLANT, EQUIPMENT AND SYSTEMS; MARINE, AERIAL AND LAND SURVEYING; DESIGN OF EQUIPMENT FOR USE IN INDUSTRIAL PROCESSES; HORTICULTURAL SERVICES; MANAGEMENT ANALYSIS AND TESTING OF OIL AND GAS FIELDS, NAMELY, OIL AND GAS FIELD EXPLORATION; LIAISON SERVICES TO FACILITATE THE EXCHANGE OF TECHNICAL AND TECHNOLOGICAL INFORMATION, NAMELY, TECHNICAL CONSULTATION AND RESEARCH IN THE FIELDS OF GEOLOGY, ENGINEERING, EXPLORATION, SOLAR ENERGY, CHEMICALS, OIL AND OIL DERIVATIVES, GAS AND THE PRODUCTION OF ENERGY; COMMISSIONING AND INSPECTION OF PLANT, MACHINERY AND APPARATUS IN THE FIELDS OF GEOLOGY, ENGINEERING, EXPLORATION, SOLAR ENERGY, CHEMICALS, OIL AND OIL DERIVATIVES, GAS AND THE PRODUCTION OF ENERGY; NON-MEDICAL TECHNOLOGICAL ANALYSIS SERVICES IN THE FIELDS OF EXPLORATION, CHEMICALS, OIL AND OIL DERIVATIVES, SOLAR ENERGY PRODUCTION, GAS AND ENGINEERING; LEGAL REPRESENTATION; EXPLOITATION OF INDUSTRIAL AND INTELLECTUAL PROPERTY, NAMELY, INTELLECTUAL PROPERTY CONSULTATION AND THE LICENSING OF INTELLECTUAL PROPERTY; RENTAL OF ROOMS; TRAVEL AGENCY SERVICES, NAMELY, BOOKING OF CAMPGROUND ACCOMMODATIONS; ARCHITECTURAL ADVICE AND CONSULTANCY SERVICES; COMPUTER SOFT-

WARE CONSULTANCY; WEATHER INFORMATION SERVICES; NAMELY, WEATHER FORECASTING AND WEATHER REPORTING; PREPARATION OF ENGINEERING DRAWINGS, TECHNICAL DOCUMENTATION AND REPORTS FOR OTHERS; PROFESSIONAL ADVISORY SERVICES RELATING TO LUBRICATION AND MAINTENANCE OF ENGINES AND MACHINERY; CONSULTANCY, ADVISORY, SURVEY, TECHNICAL CONSULTATION, SCIENTIFIC RESEARCH, PRODUCT RESEARCH AND DESIGN SERVICES, ALL IN THE FIELDS OF ENGINEERING, CHEMICALS, GAS, OIL AND OIL DERIVATIVES, SOLAR ENERGY, EXPLORATION AND ENVIRONMENTAL ISSUES INDUSTRIES, ENGINEERING, COMPUTERS, OIL, CHEMICALS, PLASTICS, RETAIL STORE DESIGN, ENVIRONMENTAL IMPACT OF PROCESS PLANT; LEGAL ADVICE; CONSULTANCY SERVICES RELATING TO THE FILING AND PROSECUTION OF APPLICATIONS FOR REGISTRATION OF INTELLECTUAL PROPERTY VIA ONLINE, TELEPHONE, E-MAIL AND IN PERSON; OFFICE SERVICES, NAMELY, OFFICE COFFEE SUPPLY SERVICES; PERSONAL IDENTIFICATION CARD, NAMELY, PREPARATION OF IDENTIFICATION CARDS; PROVIDING MULTILINGUAL SCIENCE TEACHING UNITS, NAMELY, LANGUAGE INTERPRETING FOR INTERNATIONAL CONFERENCES BETWEEN SCHOOLS IN DIFFERENT COUNTRIES; COMPUTER SERVICES, NAMELY PROVIDING ON-LINE NEWSLETTERS AND MAGAZINES IN THE FIELDS OF CHEMICALS, PETROLEUM, GAS, ENGINEERING, SOLAR ENERGY AND EXPLORATION; PATENT EXPLOITATION AND LICENSING OF INTELLECTUAL PROPERTY IN THE CHEMICALS, OIL AND OIL DERIVATIVES, SOLAR ENERGY, ENGINEERING, EXPLORATION AND NATURAL ENERGY FIELDS (U.S. CLS. 100 AND 101).

#### **CLASS 43—HOTEL AND RESTAURANT SERVICES**

FOR HOTEL SERVICES; CAFE, CAFETERIA; CANTEN, CATERING, RESTAURANT AND SNACK BAR SERVICES; TAKE-AWAY FOOD SERVICES, NAMELY, CARRY-OUT RESTAURANTS; PROVISION OF FOOD AND DRINK, NAMELY, BAR SERVICES AND CONTRACT FOOD SERVICES. (U.S. CLS. 100 AND 101).

#### **CLASS 44—MEDICAL, BEAUTY AND AGRICULTURAL SERVICES**

FOR PROVIDING PUBLIC BATH, SHOWER, SAUNA AND TOILET FACILITIES; HEALTH AND BEAUTY CARE; HAIRDRESSING SALONS AND BARBERSHOPS; MASSAGE SERVICES. (U.S. CLS. 100 AND 101).

#### **CLASS 45—PERSONAL SERVICES**

FOR SECURITY SERVICES, NAMELY, SECURITY GUARD SERVICES AND MONITORING SECURITY SYSTEMS AND CONSULTATION SERVICES RELATED THERETO. (U.S. CLS. 100 AND 101).  
BRIDGETT SMITH, EXAMINING ATTORNEY

---

SN 76-241,207. LOCANIS TECHNOLOGIES GMBH, 85774 UNTERFOHRING, FED REP GERMANY, FILED 4-13-2001.

## **LOCANIS**

PRIORITY CLAIMED UNDER SEC. 44(D) ON FED REP GERMANY APPLICATION NO. 30086483.335, FILED 11-24-2000, REG. NO. 30086483.3, DATED 11-24-2000, EXPIRES 11-24-2010.

PRIORITY CLAIMED UNDER SEC. 44(D) ON FED REP GERMANY APPLICATION NO. 30076446.409, FILED 10-16-2000, REG. NO. 30076446.4, DATED 10-16-2000, EXPIRES 10-16-2010.

#### **CLASS 7—MACHINERY**

FOR WAREHOUSE MANAGEMENT SYSTEMS, NAMELY INTEGRATED WAREHOUSE MANAGEMENT SYSTEMS COMPRISED OF INTERCHANGEABLE MACHINE AND MECHANICAL COMPONENTS THAT PERFORM THE FUNCTIONS OF PICKING, TRACKING, SORTING, MOVING, CONTROLLING, AND LOADING WAREHOUSE INVENTORY, PROCESSING RETURNED GOODS, GUIDING FORKLIFTS, AND TRACKING ARRIVAL AND DEPARTURE OF DELIVERY TRUCKS; AND WAREHOUSE MANAGEMENT INSTALLATIONS AND STRUCTURAL PARTS THEREOF, NAMELY MACHINES AND MECHANICAL COMPONENTS THAT PERFORM THE FUNCTIONS OF PICKING, TRACKING, SORTING, MOVING, CONTROLLING, AND LOADING WAREHOUSE INVENTORY, PROCESSING RETURNED GOODS, GUIDING FORKLIFTS, AND TRACKING ARRIVAL AND DEPARTURE OF DELIVERY TRUCKS (U.S. CLS. 13, 19, 21, 23, 31, 34 AND 35).

#### **CLASS 9—ELECTRICAL AND SCIENTIFIC APPARATUS**

FOR PROGRAMS FOR DATA PROCESSING APPLICATIONS IN THE FIELD OF WAREHOUSE MANAGEMENT AND LOGISTICS, NAMELY RECORDING, CONTROLLING, AND TRACKING WAREHOUSE INVENTORY; DATA PROCESSING SYSTEMS FOR WAREHOUSE MANAGEMENT SYSTEMS, NAMELY DATA PROCESSING SYSTEMS FOR RECORDING, CONTROLLING, AND TRACKING WAREHOUSE INVENTORY; REMOTE-CONTROL DEVICES FOR WAREHOUSE MANAGEMENT SYSTEMS, NAMELY NAVIGATION AND POSITION REFERENCE DEVICES THAT REMOTELY CONTROL FORKLIFTS, LIFTERS, STACKERS, AND CONVEYORS FOR THE PURPOSE OF PICKING, TRACKING, SORTING, MOVING, CONTROLLING, AND LOADING WAREHOUSE INVENTORY; WAREHOUSE MANAGEMENT CONTROLLERS, NAMELY NAVIGATION CONTROLLERS AND POSITION REFERENCE DEVICES THAT DIRECT MACHINES AND MECHANICAL COMPONENTS IN THE FUNCTIONS OF PICKING, TRACKING, SORTING, MOVING, CONTROLLING, AND LOADING WAREHOUSE INVENTORY; WAREHOUSE INVENTORY; AND ELECTRONIC POSITION LOCATING AND MEASURING DEVICES, NAMELY NAVIGATION AND POSITION REFERENCE DEVICES THAT LOCATE WAREHOUSE INVENTORY, AND MACHINES AND MECHANICAL COMPONENTS, IN THE FUNCTIONS OF PICKING, TRACKING, SORTING, MOVING, CONTROLLING, AND LOADING WAREHOUSE INVENTORY (U.S. CLS. 21, 23, 26, 36 AND 38).

#### **CLASS 35—ADVERTISING AND BUSINESS**

FOR BUSINESS ADMINISTRATION CONSULTING; ONLINE SERVICES OF AN E-COMMERCE MANAGER, SPECIFICALLY AN E-LOGISTICS MANAGER, NAMELY ONLINE PRESENTATION OF GOODS AND SERVICES; ORDER RECEIVING SERVICES AND DELIVERY ORDERING SERVICES, NAMELY ORDER FULFILLMENT TRACKING, ACCOUNTING, MEDIATION, AND CONTRACTING OF COMMERCIAL TRANSACTIONS FOR THIRD PARTIES VIA ONLINE SHOPS OR ONLINE FORUMS IN THE FIELD OF ORDER RECEIVING, DELIVERY ORDERING, ORDER FULFILLMENT, AND PRODUCT TRACEABILITY; AND CONSULTING IN ORGANIZATION MATTERS, NAMELY PRODUCT TRACEABILITY (U.S. CLS. 100, 101 AND 102).

#### **CLASS 37—CONSTRUCTION AND REPAIR**

FOR MAINTENANCE, SERVICING, AND REPAIR OF DATA PROCESSING EQUIPMENT, CONTROLS SYSTEMS, AND CONTROLLERS (U.S. CLS. 100, 103 AND 106).



**CLASS 42—SCIENTIFIC, COMPUTER AND LEGAL SERVICES**

FOR DEVELOPMENT, DESIGN AND MAINTENANCE OF PROGRAMS FOR DATA PROCESSING; PROGRAMMING AND PROGRAM MAINTENANCE FOR DATA PROCESSING; ENGINEERING CONSULTING SERVICES FOR THIRD PARTIES IN THE FIELDS OF EDP HARDWARE AND SOFTWARE, WAREHOUSE MANAGEMENT, WAREHOUSE MANAGEMENT SYSTEMS, LOGISTICS, AND WAREHOUSE CONTROL SYSTEMS; AND MAINTENANCE, SERVICING, AND REPAIR OF COMPUTER SOFTWARE PROGRAMS (U.S. CLS. 100 AND 101).

EUGENIA MARTIN, EXAMINING ATTORNEY

SN 76-249,533. MARATHON ANIMATION, 75006 PARIS, FRANCE, FILED 5-2-2001.

**TOTALLY SPIES!**

PRIORITY CLAIMED UNDER SEC. 44(D) ON FRANCE APPLICATION NO. 003063971, FILED 11-2-2000, REG. NO. 003063971, DATED 11-2-2000, EXPIRES 11-2-2010.

**CLASS 3—COSMETICS AND CLEANING PREPARATIONS**

FOR HAND AND BODY SOAPS; PERFUMERY, ESSENTIAL OILS FOR PERSONAL USE, COSMETICS, HAIR LOTIONS; DENTIFRICES; SACHETS (U.S. CLS. 1, 4, 6, 50, 51 AND 52).

**CLASS 9—ELECTRICAL AND SCIENTIFIC APPARATUS**

FOR AUDIO TAPE PLAYERS, TELEVISIONS, COMPUTERS, VIDEO TAPE RECORDERS, PHOTOGRAPHIC CAMERAS AND VIDEO TAPE CAMERAS; BLANK MAGNETIC DATA CARRIERS; BLANK DIGITAL VIDEO DISCS, BLANK COMPACT DISCS, BLANK COMPUTER DISCS; DATA PROCESSORS (U.S. CLS. 21, 23, 26, 36 AND 38).

**CLASS 16—PAPER GOODS AND PRINTED MATTER**

FOR WRITING PAPER, BOND PAPER, WRAPPING PAPER; CARDBOARD; PAPER COVERS FOR DISKS, VIDEO DISKS AND VIDEO CASSETTES; STATIONERY PADS; SIGNBOARDS OF PAPER OR CARDBOARD; PAPER BAGS, PAPER OR PLASTIC BAGS FOR HOUSEHOLD USE, GROCERY BAGS, LUNCH BAGS, SMALL BAGS FOR PAPER PACKAGING; WRITING PAPER, POSTCARDS; ENVELOPES; POSTAGE STAMPS; VISITING CARDS; CALENDARS; PRINTED LABELS; PAPER FLAGS; POSTERS; GRAPHIC PRINTS; PAINTINGS AND PICTURES FRAMED OR UNFRAMED; LEAFLETS IN THE FIELD OF MUSIC AND TELEVISION SERIES; PROSPECTUSES FEATURING INFORMATION ON MUSIC AND ABOUT TELEVISION SERIES; PRINTED PUBLICATIONS, NAMELY, JOURNALS, PAMPHLETS, BROCHURES, MANUALS, MAGAZINES IN THE FIELD OF MUSIC AND TELEVISION SERIES; PLAYING CARDS, PAINTBRUSHES, PRINTED MATTER, NAMELY, YOUTH AND TEENAGER MAGAZINES, BOOKS AND JOURNALS FEATURING INFORMATION ON MUSIC AND ABOUT TELEVISION SERIES; TYPEWRITERS; OFFICE REQUISITES, NAMELY, CORRECTING FLUID FOR TYPE, RUBBER BANDS, STAPLERS, PENS, PENCILS; BOOKBINDING MATERIAL, NAMELY, BOOKBINDINGS, BOOKBINDING WIRE, BOOKBINDING TAPE; STATIONERY, GLUES FOR STATIONERY PURPOSES; WRAPPING SHEETS OF PLASTICS; PHOTOGRAPHS; NEGATIVES; MATERIAL FOR ARTISTS, NAMELY, ARTISTS' BRUSHES, ARTISTS' PASTELS, ARTISTS' PENS, ARTISTS' PENCILS (U.S. CLS. 2, 5, 22, 23, 29, 37, 38 AND 50).

**CLASS 18—LEATHER GOODS**

FOR LEATHER AND IMITATIONS OF LEATHER SOLD IN BULK; HANDBAGS; BACKPACKS; TRUNKS AND VALISES; UMBRELLAS AND PARASOLS (U.S. CLS. 1, 2, 3, 22 AND 41).

**CLASS 28—TOYS AND SPORTING GOODS**

FOR GAMES AND PLAYTHINGS, NAMELY, ACTION SKILL GAMES, BOARD GAMES, CARD GAMES, MANIPULATIVE GAMES, PARLOR GAMES, PINBALL GAMES, DOLLS, MECHANICAL TOYS, PLUSH TOYS, POSITIONAL TOY FIGURES; GYMNASTIC APPARATUS; SPORTING ARTICLES, NAMELY, SKATEBOARDS, SOCCER BALLS, BASKET BALLS, BEACH BALLS, TENNIS RACKETS, TABLE TENNIS RACKETS, BEACH RACKETS, SKIS; DECORATIONS FOR CHRISTMAS TREES (U.S. CLS. 22, 23, 38 AND 50).

**CLASS 35—ADVERTISING AND BUSINESS**

FOR DIRECT MAIL ADVERTISING; ARRANGING FOR NEWSPAPER SUBSCRIPTIONS FOR OTHERS; BUSINESS INQUIRIES AND INVESTIGATIONS; DOCUMENT REPRODUCTION; COMPUTERIZED FILE MANAGEMENT; REMOTE DATA PROCESSING SERVICES; ARRANGING MUSICAL WORKS, AUDIOVISUAL WORKS, AND MAGAZINE SUBSCRIPTIONS FOR OTHERS (U.S. CLS. 100, 101 AND 102).

**CLASS 41—EDUCATION AND ENTERTAINMENT**

FOR SERIES OF CARTOONS FOR YOUTH AND CHILDREN BROADCAST AS ENTERTAINMENT VIA THE INTERNET; PUBLICATION OF BOOKS; ENTERTAINMENT IN THE NATURE OF FASHION SHOWS; RADIO AND TELEVISION ENTERTAINMENT IN THE NATURE OF ONGOING ANIMATED YOUTH AND CHILDREN'S SHOWS; PRODUCTION OF RADIO AND TELEVISION PROGRAMS FOR YOUTH AND CHILDREN; PRODUCTION AND SCREENING OF FILMS; MODELING FOR ARTISTS; ORGANIZATION OF COMPETITIONS OF EDUCATION OR ENTERTAINMENT; PROVIDING AN ON-LINE COMPUTER DATABASE IN THE FIELD OF EDUCATION AND OF ENTERTAINMENT AND GAMES (U.S. CLS. 100, 101 AND 107).

STACY WAHLBERG, EXAMINING ATTORNEY

SN 76-250,550. MOMMY & ME COMPANY, THE, BURBANK, CA. FILED 5-3-2001.

**DADDY AND ME**

OWNER OF U.S. REG. NO. 2,693,584 AND OTHERS.

**CLASS 1—CHEMICALS**

FOR UNEXPOSED CAMERA FILM (U.S. CLS. 1, 5, 6, 10, 26 AND 46).

**CLASS 9—ELECTRICAL AND SCIENTIFIC APPARATUS**

FOR DISPOSABLE CAMERAS (U.S. CLS. 21, 23, 26, 36 AND 38).

**CLASS 16—PAPER GOODS AND PRINTED MATTER**

FOR PHOTO ALBUMS, SCRAP BOOKS, AND PUBLICATIONS, NAMELY, BOOKS IN THE FIELD OF PARENTING AND CHILDREN'S BOOKS, ARTS AND CRAFTS PAINT KIT SETS, GREETING CARDS, AND PAPER BABY BIBS (U.S. CLS. 2, 5, 22, 23, 29, 37, 38 AND 50).

**CLASS 20—FURNITURE AND ARTICLES NOT OTHERWISE CLASSIFIED**

FOR PICTURE FRAMES (U.S. CLS. 2, 13, 22, 25, 32 AND 50).

**CLASS 24—FABRICS**

FOR TOWELS (U.S. CLS. 42 AND 50).

**CLASS 25—CLOTHING**

FOR CLOTHING, NAMELY, PLASTIC BABY BIBS, SLEEPWEAR, JACKETS, SWIMWEAR, CHILDREN'S CLOTH EATING BIBS, AND BABY LAYETTES (U.S. CLS. 22 AND 39).

**CLASS 28—TOYS AND SPORTING GOODS**

FOR BALLOONS; CHILDREN'S MULTIPLE ACTIVITY TOYS; ARTS AND CRAFTS KIT COMPRISED OF MINI-FRAMES, PUNCHOUT SHEETS, GLITTER GLUE, STICKERS, STARS, AND COLORING IMPLEMENTS TO CREATE PERSONALIZED FRAMES; ROLE-PLAY TOYS; INTERACTIVE ELECTRONIC TOYS WITH VOICE RECORDING, PLAYBACK, AND VOICE ALTERING FUNCTIONS; INFANT PRESCHOOL TOYS, NAMELY, ACTION CRIB TOYS, MUSICAL TOYS, STACKING AND NESTING TOYS; SOFT INFANT TOYS; BATH TOYS; AND PUZZLES (U.S. CLS. 22, 23, 38 AND 50).

**CLASS 31—NATURAL AGRICULTURAL PRODUCTS**

FOR DRIED AND LIVE FLOWER ARRANGEMENTS (U.S. CLS. 1 AND 46).  
TINA L. SNAPP, EXAMINING ATTORNEY

SN 76-250,887. SUNMARKS, INC., CLAYMONT, DE. FILED 5-3-2001.



NO CLAIM IS MADE TO THE EXCLUSIVE RIGHT TO USE "COFFEE COMPANY", APART FROM THE MARK AS SHOWN.

**CLASS 21—HOUSEWARES AND GLASS**

FOR CUPS, MUGS, THERMAL INSULATED COFFEE AND BEVERAGE CUPS AND MUGS MADE OF PLASTIC AND/OR CERAMICS, CUPHOLDERS AND MUGHOLDERS FOR USE ON CAR DASHBOARDS (U.S. CLS. 2, 13, 23, 29, 30, 33, 40 AND 50).  
FIRST USE 7-31-1998; IN COMMERCE 7-31-1998.

**CLASS 30—STAPLE FOODS**

FOR COFFEE, TEA, COCOA, ESPRESSO, COFFEE-BASED BEVERAGES, ESPRESSO-BASED BEVERAGES; POWDERED COFFEE, TEA, COCOA AND ESPRESSO-BASED BEVERAGES; GROUND AND WHOLE BEAN COFFEE (U.S. CL. 46).  
FIRST USE 7-31-1998; IN COMMERCE 7-31-1998.

**CLASS 35—ADVERTISING AND BUSINESS**

FOR RETAIL STORE SERVICES, FEATURING COFFEE, TEA, COCOA, ESPRESSO, COFFEE-BASED BEVERAGES AND ESPRESSO-BASED BEVERAGES; POWDERED COFFEE, TEA, COCOA AND ESPRESSO-BASED BEVERAGES; GROUND AND WHOLE BEAN COFFEE; RELATED ITEMS, NAMELY, CUPS, MUGS, THERMAL INSULATED COFFEE AND BEVERAGE CUPS AND MUGS MADE OF PLASTIC AND/OR CERAMICS, CUPHOLDERS AND MUGHOLDERS FOR USE ON CAR DASHBOARDS (U.S. CLS. 100, 101 AND 102).  
FIRST USE 7-31-1998; IN COMMERCE 7-31-1998.  
MARK T. MULLEN, EXAMINING ATTORNEY

SN 76-265,091. EXEL LOGISTICS LIMITED, MILTON KEYNES, BUCKS, MK9 1EQ, UNITED KINGDOM, FILED 6-1-2001.



OWNER OF U.S. REG. NOS. 1,786,055 AND 2,043,905.

**CLASS 35—ADVERTISING AND BUSINESS**

FOR BUSINESS AND COMMERCIAL MANAGEMENT ASSISTANCE AND CONSULTANCY SERVICES RELATING TO FREIGHT MANAGEMENT, CONTRACT LOGISTICS, CUSTOM BROKERING, WAREHOUSING, ROUTE PLANNING, SUPPLY CHAIN MANAGEMENT AND DISTRIBUTION; PERSONNEL RECRUITMENT AND PLACEMENT SERVICES; ESTIMATION OF CONSTRUCTION WORK; BUSINESS ADMINISTRATION; COMPUTERIZED ON-LINE ORDERING SERVICES RELATING TO FREIGHT MANAGEMENT, CONTRACT LOGISTICS, CUSTOMS BROKING, WAREHOUSING, ROUTE PLANNING, SUPPLY CHAIN MANAGEMENT AND DISTRIBUTION; DISSEMINATION OF ADVERTISING FOR OTHERS VIA THE INTERNET; CONSULTING SERVICES RELATING TO FREIGHT MANAGEMENT; PROVIDING INFORMATION RELATING TO FREIGHT MANAGEMENT BY MEANS OF A COMPUTER (U.S. CLS. 100, 101 AND 102).

**CLASS 39—TRANSPORTATION AND STORAGE**

FOR PROVIDING INFORMATION RELATING TO WAREHOUSING BY MEANS OF A COMPUTER; CONSULTING SERVICES RELATING TO WAREHOUSING (U.S. CLS. 100 AND 105).

**CLASS 42—SCIENTIFIC, COMPUTER AND LEGAL SERVICES**

FOR COMPUTER PROJECT MANAGEMENT SERVICES RELATING TO FREIGHT MANAGEMENT, CONTRACT LOGISTICS, CUSTOMS BROKING, WAREHOUSING, ROUTE PLANNING, SUPPLY CHAIN MANAGEMENT AND DISTRIBUTION; COMPUTER PROGRAMMING FOR OTHERS AND COMPUTER RENTAL SERVICES; INDUSTRIAL DESIGN SERVICES; COMPUTER SERVICES, NAMELY DESIGNING AND IMPLEMENTING NETWORK WEB PAGES FOR OTHERS; PROVIDING CUSTOMIZED ON-LINE WEB PAGES FEATURING USER-DEFINED INFORMATION WHICH INCLUDES SEARCH ENGINES AND ON-LINE WEB LINKS TO OTHER WEBSITES (U.S. CLS. 100 AND 101).

STEVEN R. FOSTER, EXAMINING ATTORNEY

SN 76-298,553. ASSOCIATED ELECTRIC & GAS INSURANCE SERVICES LIMITED, HAMILTON, BERMUDA, FILED 8-10-2001.

## AEGISPORTAL

OWNER OF U.S. REG. NOS. 1,896,440 AND 1,925,826.

### CLASS 36—INSURANCE AND FINANCIAL

FOR RISK MANAGEMENT SERVICES, NAMELY, BENCHMARKING, UNDERWRITING, CLAIMS, AND LOSS CONTROL SERVICES FOR ENTITIES ACTIVE IN THE TELECOMMUNICATIONS, UTILITY, AND ENERGY INDUSTRIES, AND TELECOMMUNICATIONS, UTILITY AND ENERGY-RELATED INDUSTRIES, AS WELL AS THOSE INVOLVED IN INSURING OR PROCURING INSURANCE FOR SAID INDUSTRIES; PROVIDING INFORMATION, INCLUDING THROUGH LINKS TO THE WEB SITES OF OTHERS, ABOUT RISK, UNDERWRITING, CLAIMS, LOSS CONTROL, BENCHMARKING, RISK MANAGEMENT SERVICES AND INSURANCE COVERING RISKS ENCOUNTERED BY ENTITIES ACTIVE IN THE TELECOMMUNICATIONS, UTILITY AND ENERGY INDUSTRIES, AND TELECOMMUNICATIONS, UTILITY AND ENERGY-RELATED INDUSTRIES (U.S. CLS. 100, 101 AND 102).

### CLASS 38—COMMUNICATION

FOR FACILITATING THE EXCHANGE OF INFORMATION BETWEEN AND AMONG BROKERS, CONSULTANTS, RISK MANAGERS, UNDERWRITERS, INSURED AND OTHERS REGARDING INSURANCE COVERING RISKS ENCOUNTERED BY ENTITIES ACTIVE IN THE TELECOMMUNICATIONS, UTILITY, ENERGY AND TELECOMMUNICATIONS, UTILITY AND ENERGY-RELATED INDUSTRIES, AND THOSE INVOLVED IN INSURING OR IN PROCURING INSURANCE SERVICES FOR SAID INDUSTRIES BY PROVIDING INTERACTIVE INTERNET WEB SITES FEATURING CHAT ROOMS AND ELECTRONIC MAIL SERVICES (U.S. CLS. 100, 101 AND 104).

ELIZABETH HUGHITT, EXAMINING ATTORNEY

SN 76-298,554. ASSOCIATED ELECTRIC & GAS INSURANCE SERVICES LIMITED, HAMILTON, BERMUDA, FILED 8-10-2001.

## AEGISLINK

OWNER OF U.S. REG. NOS. 1,896,440 AND 1,925,826.

### CLASS 36—INSURANCE AND FINANCIAL

FOR RISK MANAGEMENT SERVICES, NAMELY, BENCHMARKING, UNDERWRITING, CLAIMS, AND LOSS CONTROL SERVICES FOR ENTITIES ACTIVE IN THE TELECOMMUNICATIONS, UTILITY, AND ENERGY INDUSTRIES, AND TELECOMMUNICATIONS, UTILITY AND ENERGY-RELATED INDUSTRIES, AS WELL AS THOSE INVOLVED IN INSURING OR PROCURING INSURANCE FOR SAID INDUSTRIES; PROVIDING INFORMATION, INCLUDING THROUGH LINKS TO THE WEB SITES OF OTHERS, ABOUT RISK, UNDERWRITING, CLAIMS, LOSS CONTROL, BENCHMARKING, RISK MANAGEMENT SERVICES AND INSURANCE COVERING RISKS ENCOUNTERED BY ENTITIES ACTIVE IN THE TELECOMMUNICATIONS, UTILITY AND ENERGY INDUSTRIES, AND TELECOMMUNICATIONS, UTILITY AND ENERGY-RELATED INDUSTRIES (U.S. CLS. 100, 101 AND 102).

### CLASS 38—COMMUNICATION

FOR FACILITATING THE EXCHANGE OF INFORMATION BETWEEN AND AMONG BROKERS, CONSULTANTS, RISK MANAGERS, UNDERWRITERS, INSURED AND OTHERS REGARDING INSURANCE COVERING RISKS ENCOUNTERED BY ENTITIES ACTIVE IN THE TELECOMMUNICATIONS, UTILITY, ENERGY AND TELECOMMUNICATIONS, UTILITY AND ENERGY-RELATED INDUSTRIES, AND THOSE INVOLVED IN INSURING OR IN PROCURING INSURANCE SERVICES FOR SAID INDUSTRIES BY PROVIDING INTERACTIVE INTERNET WEB SITES FEATURING CHAT ROOMS AND ELECTRONIC MAIL SERVICES (U.S. CLS. 100, 101 AND 104).

ELIZABETH HUGHITT, EXAMINING ATTORNEY

SN 76-303,156. KABUSHIKI KAISHA NTT DOCOMO, DBA NTT DOCOMO, INC., TOKYO, JAPAN, FILED 8-22-2001.

## FOMA

### CLASS 9—ELECTRICAL AND SCIENTIFIC APPARATUS

FOR VIDEO OUTPUT GAME MACHINES FOR USE WITH TELEVISIONS AND OVER THE GLOBAL COMMUNICATION NETWORK; ROBOTS FOR PERSONAL OR ENTERTAINMENT USE; ELECTRONIC GAMES ADAPTED FOR USE WITH TELEVISION RECEIVERS ONLY ENABLING THE USERS TO COMMUNICATE WITH EACH OTHER VIA TELECOMMUNICATION NETWORK (U.S. CLS. 21, 23, 26, 36 AND 38).

### CLASS 16—PAPER GOODS AND PRINTED MATTER

FOR ATLASES, BLUE PRINTS, BOOKLETS, HANDBOOKS, AND PROSPECTUSES ALL IN THE FIELDS OF TELECOMMUNICATION EQUIPMENT, PDA-RELATED EQUIPMENT, TELECOMMUNICATION SERVICES, COMPUTER-RELATED EQUIPMENT, COMPUTER SOFTWARE, COMPUTER SERVICES AND TELECOMMUNICATION ENGINEERING; CARDBOARD ARTICLES, NAMELY, CARDBOARD AND CARDBOARD BOXES, CHAPLETS, COMIC BOOKS, PAPER CONTROL TOKENS, GRAPHIC PRINTS, INSTRUCTION MANUALS FOR CELLULAR TELEPHONES, HANDHELD COMPUTERS, TELECOMMUNICATION EQUIPMENT, PDA-RELATED EQUIPMENT, COMPUTER SOFTWARE, COMPUTER SERVICES AND TELECOMMUNICATION ENGINEERING; PERIODICALS IN THE FIELD OF TELECOMMUNICATION EQUIPMENT, PDA-RELATED EQUIPMENT, COMPUTER SOFTWARE, COMPUTER SERVICES AND TELECOMMUNICATION ENGINEERING; PRINTED PLANS, POSTCARDS, POSTERS, PRINTED PUBLICATIONS, PRINTED TIMETABLES, PRINTED INSTRUCTIONAL TEACHING MATERIALS, TEAR-OFF CALENDARS (U.S. CLS. 2, 5, 22, 23, 29, 37, 38 AND 50).

### CLASS 28—TOYS AND SPORTING GOODS

FOR GAMES, NAMELY, COIN-OPERATED VIDEO GAMES, ELECTRONIC DART GAMES AND HANDHELD UNITS FOR PLAYING ELECTRONIC GAMES; DECORATIONS FOR CHRISTMAS TREES, TOYS, NAMELY, INFANT DEVELOPMENT TOYS, MECHANICAL TOYS AND PET TOYS, BACKGAMMON GAMES; DOLLS; DOMINOS; BILLIARD MARKERS; TOY MOBILES; PARLOR GAMES; PLAY BALLOONS (U.S. CLS. 22, 23, 38 AND 50).

**CLASS 35—ADVERTISING AND BUSINESS**

FOR PROVIDING BUSINESS DIRECTORY INFORMATION RELATING TO ADVERTISEMENTS, TO THE SALE OF GOODS, AND TO SHOPS CLASSIFIED BY THE TYPE OF BUSINESS VIA WIRELESS COMMUNICATION SERVICES; PROVIDING BUSINESS INFORMATION RELATING TO SALES VOLUME TRACKING AND COMMERCIAL INFORMATION VIA WIRELESS COMMUNICATION SERVICES; ADVERTISING AGENCIES; DISSEMINATION OF ADVERTISING MATTER; PREPARING ADVERTISEMENTS FOR OTHERS; THE BRINGING TOGETHER, PROMOTING THE GOODS AND SERVICES OF OTHERS BY MEANS OF OPERATING A SHOPPING MALL WITH LINKS TO THE RETAIL WEB SITES OF OTHERS VIA WIRELESS COMMUNICATION SERVICES; COMPUTERIZED ORDERING SERVICES IN THE FIELD OF FOOD, DAILY NECESSITIES AND ENTERTAINMENT, VIA TELEPHONE, COMPUTER TERMINALS, CELLULAR TELEPHONES, PDA AND WIRELESS COMMUNICATION SERVICES; MANAGEMENT OF TRADE SHOW AND BUSINESS EXHIBITIONS FOR ADVERTISING PURPOSES IN THE FIELD OF TELECOMMUNICATIONS AND COMPUTERS; RENTAL OF ADVERTISING SPACE; TELEPHONE ANSWERING SERVICES; SECRETARIAL AGENCY SERVICES FOR RECEIVING TELEPHONE CALLS; MARKET RESEARCH VIA A COMPUTER DATA BASE; BUSINESS MANAGEMENT AND CONSULTATION; PLANNING OF SALES PROMOTION AND ADVERTISING FOR COMMUNICATION TERMINALS AND TELECOMMUNICATION SERVICES; BUSINESS MANAGEMENT; BUSINESS ADMINISTRATION; BUSINESS MANAGEMENT CONSULTANCY, BUSINESS ORGANIZATION CONSULTANCY, BUSINESS MANAGEMENT ASSISTANCE, BUSINESS APPRAISALS; BUSINESS RESEARCH; BUSINESS ENTERPRISE RESOURCE PLANNING; EFFICIENCY EXPERTS; ADVISORY SERVICES FOR BUSINESS MANAGEMENT; RELOCATION SERVICES FOR BUSINESSES; PROMOTING THE GOODS AND SERVICES OF OTHERS BY PREPARING AND PLACING ADVERTISEMENTS IN AN ELECTRONIC MAGAZINE ACCESSED THROUGH A GLOBAL COMPUTER NETWORK AND INFORMATION SERVICES RELATING THERETO; BUSINESS ADMINISTRATION SERVICES FOR THE PROCESSING OF SALES MADE ON A GLOBAL COMPUTER NETWORK; PROVIDING AUCTION SERVICES VIA A GLOBAL COMPUTER NETWORK; WORLDWIDE BILLING SERVICES; MONITORING SERVICES INVOLVING THE USE OF TWO-WAY WIRELESS COMMUNICATION SYSTEMS, GLOBAL POSITIONING SYSTEMS, AND COMPUTER INTEGRATION SYSTEMS TO ASCERTAIN THE GEOGRAPHIC LOCATIONS OF MOVABLE OBJECTS, NAMELY, MOTOR VEHICLES AND INDIVIDUALS; PROVIDING FACILITIES FOR EXHIBITIONS FOR ADVERTISING PURPOSES (U.S. CLS. 100, 101 AND 102).

**CLASS 36—INSURANCE AND FINANCIAL**

FOR RENTAL OF OFFICE SPACE FOR ADVERTISING PURPOSES; CREDIT CARD SERVICES; PROVIDING INFORMATION RELATING TO STOCK, FINANCE AND FOREIGN EXCHANGE MARKET CONDITIONS, REAL ESTATE, AND INSURANCE; REAL ESTATE MANAGEMENT SERVICES; BANKING SERVICES CONDUCTED VIA A GLOBAL COMPUTER NETWORK LINKED BY COMMON PROTOCOLS; ELECTRONIC MONEY TRANSFER; FINANCIAL SERVICES RELATING TO ELECTRONIC COMMERCE, NAMELY, PROVIDING ELECTRONIC COMMERCE SERVICES, NAMELY, TELECOMMUNICATION PREPAID DEBIT CARD SERVICES, ON-LINE FINANCIAL PLANNING RESEARCH AND ANALYSIS SERVICES; FINANCIAL SERVICES, NAMELY, AGENCIES FOR COLLECTING CHARGES FOR INFORMATION PROVIDERS RENDERED BY TELECOMMUNICATION FEE COLLECTING SYSTEM; PREPAID STORED VALUE CARD SERVICES FOR PAYMENT OF TELEPHONE CALLS, SUBWAY, BUS AND RAIL ROAD FARES, BRIDGE AND TUNNEL TOLLS, MERCHANDISE COSTS AND LOW VALUE ELECTRONIC DEBIT TRANSACTIONS; COLLECTION

AGENCY SERVICES FOR OTHERS IN THE FIELD OF ELECTRONIC COMMERCE VIA WIRELESS COMMUNICATION SERVICES; ONLINE COLLECTION AGENCY SERVICES, NAMELY, COLLECTING LIABILITIES FOR OTHERS FOR PROVIDING INFORMATION OVER COMPUTERS; ELECTRONIC FUNDS TRANSFERS AND TRANSACTIONS; PROVIDING ELECTRONIC BANKING SERVICES; COMPUTERIZED FINANCIAL AND INSURANCE INFORMATION PROVIDED VIA WIRELESS COMMUNICATION SERVICES; HOME BANKING SERVICES; INTERNET HOME BANKING (U.S. CLS. 100, 101 AND 102).

**CLASS 37—CONSTRUCTION AND REPAIR**

FOR INSTALLATION OF TELECOMMUNICATION NETWORKS, INSTALLATION OF COMMUNICATION EQUIPMENT, MAINTENANCE AND REPAIR OF TELECOMMUNICATION NETWORKS, MAINTENANCE AND REPAIR OF COMMUNICATION EQUIPMENT; INSTALLATION AND REPAIR OF TELECOMMUNICATION APPARATUS; INSTALLATION AND REPAIR OF COMPUTER HARDWARE; REPAIR AND MAINTENANCE OF TELECOMMUNICATION APPARATUS AND INSTRUMENTS; REPAIR AND MAINTENANCE OF COMPUTERS; INSTALLATION, REPAIR AND MAINTENANCE OF SUBMARINE CABLES, AERIAL POWER TRANSMISSION WIRE, COMMUNICATION EQUIPMENT FOR CONTROL IN BUILDINGS, TELECOMMUNICATION SYSTEMS, TELECOMMUNICATION FOR CONTROL IN BUILDING, TELECOMMUNICATION FACILITIES, DATA COMMUNICATION FACILITIES, COMPUTER SYSTEMS; BUILDING CONSTRUCTION; CONSTRUCTION OF COMMUNICATION PLANTS; INSTALLATION AND REPAIR OF TELEPHONE SETS AND TELEPHONE WIRE; RENTAL AND LEASING OF CONSTRUCTION EQUIPMENT, CIVIL ENGINEERING MACHINERY, EARTH MOVING EQUIPMENT AND EXCAVATORS; PROVIDING INFORMATION RELATING TO BUILDING CONSTRUCTION AND REPAIR; CONSULTATION AND SUPERVISION IN THE FIELD OF CONSTRUCTION AND CIVIL ENGINEERING WORKS; MAINTENANCE OF ELECTRICAL FACILITIES INSTALLED IN BUILDINGS, AND OF BUILDING FACILITIES; DISINFECTING TELEPHONE SETS (U.S. CLS. 100, 103 AND 106).

**CLASS 38—COMMUNICATION**

FOR PROVIDING CHAT ROOMS FOR TRANSMISSION OF MESSAGES AMONG COMPUTER USERS CONCERNING ENTERTAINMENT, EDUCATION, TECHNOLOGY, CULTURE, MUSIC, SPORTS, FASHION, LANGUAGE, IMAGES, LIVING INFORMATION, PERSONAL COMPUTERS, IT RELATED MATTER, CURRENT EVENTS AND LIFESTYLES; STREAMING OF AUDIO MATERIAL ON THE INTERNET (U.S. CLS. 100, 101 AND 104).

**CLASS 39—TRANSPORTATION AND STORAGE**

FOR TRANSPORTATION OF PASSENGERS AND/OR GOODS BY AIR, RAIL, BOATS AND VEHICLES; MERCHANDISE PACKAGING FOR TRANSPORTATION AND WAREHOUSE STORAGE OF GOODS; TRAVEL AGENCY SERVICES, NAMELY; MAKING RESERVATIONS AND BOOKINGS FOR TRANSPORTATION ARRANGEMENT; PROVIDING TRAVEL AND TRANSPORTATION INFORMATION (U.S. CLS. 100 AND 105).

**CLASS 40—MATERIAL TREATMENT**

FOR CHEMICAL TREATMENT FOR CLOTHING, LEATHER STAINING, PAPER FINISHING, ELECTROPLATING FOR METALS, CERAMIC GLAZING, GOLD-PLATING, GLASS ETCHING; INFORMATION SERVICES RELATING TO TREATMENT OF CLOTHING, LEATHER STAINING, PAPER FINISHING, ELECTROPLATING FOR METALS, FOOD TREATMENT FOR STORAGE, CERAMIC BURNING, GOLD-PLATING, FOR DYEING, GLASS ETCHING, PROVIDED VIA WIRELESS COMMUNICATION SERVICES FROM A COMPUTER DATABASE OR A GLOBAL COMPUTER NETWORK (U.S. CLS. 100, 103 AND 106).

**CLASS 41—EDUCATION AND ENTERTAINMENT**

FOR PRODUCTION OF TELEVISION PROGRAMS BY USING COMPUTER GRAPHICS; DEVELOPMENT AND DISSEMINATION OF EDUCATIONAL MATERIALS OF OTHERS IN THE FIELD OF COMPUTERS; PROVIDING INFORMATION RELATING TO EDUCATION AND ENTERTAINMENT, MOVIES, SPORTS, SCENIC SPOTS, PLACES OF HISTORIC INTEREST, AND RECREATION; THEATRICAL BOOKING AGENCIES; TRAINING IN THE USE AND OPERATION OF A WIDE VARIETY OF EQUIPMENT, NAMELY, COMPUTERS, CAMERAS, COMMUNICATION APPARATUS AND AUDIO-VIDEO EQUIPMENT; PUBLICATION OF BOOKS, MAGAZINES; PROVIDING A COMPUTER GAME PLAYED BY USING COMPUTER TERMINAL TELECOMMUNICATION; RENTAL AND LEASING OF TELEVISION GAME TOYS; RENTAL OF AMUSEMENT FACILITIES EQUIPPED WITH GAME MACHINES; ELECTRONIC LIBRARIES PROVIDING ELECTRONICALLY RECORDED NEWSPAPERS, MAGAZINES, PHOTOGRAPHS, PICTURES, MUSIC, ANIMATED CARTOONS, COMPUTER PROGRAMS TO COMPUTERS LINKED TO A NETWORK; EDUCATION, PROVIDED BY TELEPHONE, IN THE FIELD OF SALES TECHNIQUE; ORGANIZATION, BY TELEPHONE, OF SEMINARS RELATING TO SALES TECHNIQUE; EDUCATIONAL SERVICES, NAMELY, CONDUCTING SEMINARS IN THE FIELD OF INFORMATION PROCESSING; ARRANGING AND CONDUCTING EDUCATIONAL SEMINARS, SYMPOSIA AND CONFERENCES IN THE FIELD OF ENTERTAINMENT, EDUCATION, TECHNOLOGY, CULTURE, IMAGES, FASHION, NEWS, SPORTS AND LIVING INFORMATION; ORGANIZING EXHIBITIONS FOR CULTURAL AND EDUCATIONAL PURPOSES IN THE FIELDS OF ENTERTAINMENT, EDUCATION, TECHNOLOGY, CULTURE, IMAGES, FASHION, NEWS, SPORTS AND LIVING INFORMATION; RENTAL OF RECORDED MAGNETIC TAPES, GAME CARTRIDGES, MAGNETIC DISKS AND OPTICAL RECORDING MEDIA IN WHICH GAME PROGRAMS ARE RECORDED, VIDEOTAPES, SOUND RECORDINGS, RADIOS AND TELEVISIONS; LENDING LIBRARIES; PROVIDING MUSEUM FACILITIES; RENTAL OF EXHIBITION HALLS AND STADIUM FACILITIES; INFORMATION RELATING TO ENTERTAINMENT OR EDUCATION, PROVIDED VIA WIRELESS COMMUNICATION SERVICES FROM A COMPUTER DATABASE OR A GLOBAL COMPUTER NETWORK; ELECTRONIC GAMES SERVICES PROVIDED BY MEANS OF A GLOBAL COMPUTER NETWORK; ELECTRONIC LIBRARY SERVICES, NAMELY, SERVICES WHICH FEATURE NEWSPAPERS, MAGAZINES, PHOTOGRAPHS AND PICTURES VIA COMPUTER NETWORK; PROVIDING DIGITAL MUSIC NOT DOWNLOADABLE FROM A GLOBAL COMPUTER NETWORK; PROVIDING ON-LINE PUBLICATIONS, NAMELY, NEWSPAPERS, BOOKS, MAGAZINES IN THE FIELD OF ENTERTAINMENT, EDUCATION, TECHNOLOGY AND CULTURE VIA WIRELESS TELECOMMUNICATION SERVICES (U.S. CLS. 100, 101 AND 107).

**CLASS 42—SCIENTIFIC, COMPUTER AND LEGAL SERVICES**

FOR COMPUTER SERVICES, NAMELY PROVIDING ON-LINE PUBLICATIONS AND MAGAZINES IN THE FIELD OF ENTERTAINMENT, EDUCATION, TECHNOLOGY AND CULTURE VIA WIRELESS COMMUNICATION SERVICES; ELECTRONIC MONITORING SERVICES, NAMELY, TWO WAY WIRELESS COMMUNICATION SYSTEMS MONITORING, GLOBAL POSITIONING SYSTEMS MONITORING, AND COMPUTER INTEGRATION SERVICES TO ASCERTAIN THE GEOGRAPHIC LOCATIONS OF MOVABLE OBJECTS (U.S. CLS. 100 AND 101).

J. TINGLEY, EXAMINING ATTORNEY

SN 76-305,818. SYSTEM ACCESS PTE LTD, SINGAPORE, FILED 8-28-2001.

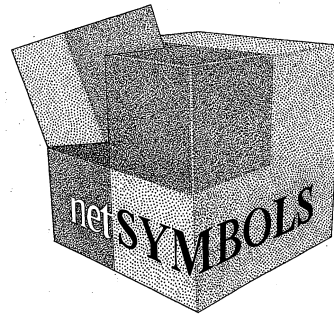

THE STIPPLING IS FOR SHADING PURPOSES ONLY.

**CLASS 9—ELECTRICAL AND SCIENTIFIC APPARATUS**

FOR TRANSACTION PROCESSING COMPUTER SOFTWARE FOR THE FINANCE AND BANKING INDUSTRIES; COMPUTER SOFTWARE PLATFORM FOR FACILITATING AND ADMINISTERING THE USE OF WEB-BASED AND SERVER-BASED COMPUTER SOFTWARE APPLICATIONS FOR THE PROCESSING OF ELECTRONIC BANKING TRANSACTION AND INTERACTIVE CUSTOMER RELATIONSHIP MANAGEMENT; BLANK FLOPPY DISKS AND BLANK COMPUTER DISKS; COMPUTER SOFTWARE FOR USE IN ELECTRONIC BANKING; INSTRUCTIONAL MATERIAL, NAMELY, SYSTEM DOCUMENTATION, USER MANUALS AND TRAINING MANUALS RELATING TO COMPUTERS AND TO DATA, ALL RECORDED ON MAGNETIC COMPUTER TAPES, FLOPPY DISKS AND COMPUTER DISKS; ALL FOR USE BY RETAIL AND WHOLESALE FINANCIAL SERVICES INSTITUTIONS (U.S. CLS. 21, 23, 26, 36 AND 38).

FIRST USE 1-15-2001; IN COMMERCE 1-15-2001.

**CLASS 35—ADVERTISING AND BUSINESS**

FOR COMPUTERIZED DATABASE MANAGEMENT SERVICES, NAMELY, MIGRATION OF EXISTING LEGACY SYSTEMS OF BANKS OR FINANCE INSTITUTIONS TO READABLE DATABASES—DEVELOPMENT OF PROCESSES, NAMELY, BUSINESS PROCESS REENGINEERING (BPR) FOR ELECTRONIC INFORMATION AND COMMUNICATION SERVICES RELATING TO ALL ASPECTS OF FINANCIAL SERVICES (U.S. CLS. 100, 101 AND 102).

FIRST USE 1-15-2001; IN COMMERCE 1-15-2001.

**CLASS 42—SCIENTIFIC, COMPUTER AND LEGAL SERVICES**

FOR COMPUTER SERVICES, NAMELY, SYSTEM IMPLEMENTATION SERVICES AND SYSTEM MAINTENANCE SERVICES NAMELY, DEVELOPMENT, INSTALLATION, CUSTOMIZATION AND TESTING OF SOFTWARE SOLUTIONS FOR THE BANKING AND FINANCIAL INDUSTRIES; WEBSITE DESIGN SERVICES; COMPUTER PROGRAMMING SERVICES FOR OTHERS; COMPUTER SYSTEMS ANALYSIS; DEVELOPMENT, DESIGN AND CUSTOMIZATION OF COMPUTER HARDWARE AND SOFTWARE; TECHNICAL SUPPORT SERVICES, NAMELY, TROUBLESHOOTING OF COMPUTER HARDWARE AND SOFTWARE PROBLEMS, MONITORING OF NETWORK SYSTEMS AND PROVIDING BACK-UP COMPUTER PROGRAMS AND FACILITIES; INTEGRATION OF COMPUTER SYSTEMS AND NETWORKS; MAINTENANCE AND UPDATING OF COMPUTER SOFTWARE SERVICES FOR OTHERS; COMPUTER SYSTEMS ANALYSIS OF DATA AND INFORMATION, NAMELY, GAP ANALYSIS; COMPUTER CONSULTING SERVICES IN RELATION TO INFORMATION SYSTEMS AND NETWORKS FOR IMPLEMENTATION, INTEGRATION AND CUSTOMIZATION OF SOFTWARE SOLUTIONS TO FIT THE SPECIFIC NEEDS OF THE BANKING AND FINANCIAL INDUSTRIES (U.S. CLS. 100 AND 101).

FIRST USE 1-15-2001; IN COMMERCE 1-15-2001.  
LESLEY LAMOTHE, EXAMINING ATTORNEY

**CLASS 42—SCIENTIFIC, COMPUTER AND LEGAL SERVICES**

FOR COMPUTER SERVICES, NAMELY, SYSTEM IMPLEMENTATION SERVICES AND SYSTEM MAINTENANCE SERVICES NAMELY, DEVELOPMENT, INSTALLATION, CUSTOMIZATION AND TESTING OF SOFTWARE SOLUTIONS FOR THE BANKING AND FINANCIAL INDUSTRIES; WEBSITE DESIGN SERVICES; COMPUTER PROGRAMMING SERVICES FOR OTHERS; COMPUTER SYSTEMS ANALYSIS; DEVELOPMENT, DESIGN AND CUSTOMIZATION OF COMPUTER HARDWARE AND SOFTWARE; TECHNICAL SUPPORT SERVICES, NAMELY, TROUBLESHOOTING OF COMPUTER HARDWARE AND SOFTWARE PROBLEMS, MONITORING OF NETWORK SYSTEMS AND PROVIDING BACK-UP COMPUTER PROGRAMS AND FACILITIES; INTEGRATION OF COMPUTER SYSTEMS AND NETWORKS; MAINTENANCE AND UPDATING OF COMPUTER SOFTWARE SERVICES FOR OTHERS; COMPUTER SYSTEMS ANALYSIS OF DATA AND INFORMATION, NAMELY, GAP ANALYSIS; COMPUTER CONSULTING SERVICES IN RELATION TO INFORMATION SYSTEMS AND NETWORKS FOR IMPLEMENTATION, INTEGRATION AND CUSTOMIZATION OF SOFTWARE SOLUTIONS TO FIT THE SPECIFIC NEEDS OF THE BANKING AND FINANCIAL INDUSTRIES (U.S. CLS. 100 AND 101).

FIRST USE 1-15-2001; IN COMMERCE 1-15-2001.  
LESLEY LAMOTHE, EXAMINING ATTORNEY

SN 76-305,819. SYSTEM ACCESS PTE LTD, SINGAPORE, FILED 8-28-2001.

**NETSYMBOLS****CLASS 9—ELECTRICAL AND SCIENTIFIC APPARATUS**

FOR TRANSACTION PROCESSING COMPUTER SOFTWARE FOR THE FINANCE AND BANKING INDUSTRIES; COMPUTER SOFTWARE PLATFORM FOR FACILITATING AND ADMINISTERING THE USE OF WEB-BASED AND SERVER-BASED COMPUTER SOFTWARE APPLICATIONS FOR THE PROCESSING OF ELECTRONIC BANKING TRANSACTION AND INTERACTIVE CUSTOMER RELATIONSHIP MANAGEMENT; BLANK FLOPPY DISKS AND BLANK COMPUTER DISKS; COMPUTER SOFTWARE FOR USE IN ELECTRONIC BANKING; INSTRUCTIONAL MATERIAL, NAMELY, SYSTEM DOCUMENTATION, USER MANUALS AND TRAINING MANUALS RELATING TO COMPUTERS AND TO DATA, ALL RECORDED ON MAGNETIC COMPUTER TAPES, FLOPPY DISKS AND COMPUTER DISKS; ALL FOR USE BY RETAIL AND WHOLESALE FINANCIAL SERVICES INSTITUTIONS (U.S. CLS. 21, 23, 26, 36 AND 38).

FIRST USE 1-15-2001; IN COMMERCE 1-15-2001.

**CLASS 35—ADVERTISING AND BUSINESS**

FOR COMPUTERIZED DATABASE MANAGEMENT SERVICES, NAMELY, MIGRATION OF EXISTING LEGACY SYSTEMS OF BANKS OR FINANCE INSTITUTIONS TO READABLE DATABASES— DEVELOPMENT OF PROCESSES, NAMELY, BUSINESS PROCESS REENGINEERING (BPR) FOR ELECTRONIC INFORMATION AND COMMUNICATION SERVICES RELATING TO ALL ASPECTS OF FINANCIAL SERVICES (U.S. CLS. 100, 101 AND 102).

FIRST USE 1-15-2001; IN COMMERCE 1-15-2001.

SN 76-322,184. EVEREST INTERNATIONAL, LLC, OVERLAND PARK, KS. FILED 10-5-2001.

**I.Q. CHEW****CLASS 5—PHARMACEUTICALS**

FOR NUTRITIONAL, HERBAL AND VITAMIN SUPPLEMENTS IN BAR FORM SOLD AS PART OF A LINE OF NUTRITIONAL, HERBAL AND DIETARY SUPPLEMENTS BY WAY OF MULTI-LEVEL MARKING (U.S. CLS. 6, 18, 44, 46, 51 AND 52).

**CLASS 30—STAPLE FOODS**

FOR CEREAL-BASED SNACK FOODS; READY TO EAT CEREAL-BASED AND GRAIN-BASED FOOD BARS; CEREAL-BASED AND GRAIN-BASED BAKERY GOODS; AND NUTRITIONAL CANDY BARS, (U.S. CL. 46).  
RONALD MCMORROW, EXAMINING ATTORNEY

SN 76-347,277. PITA BREAK INC., TORONTO, ONTARIO, CANADA, FILED 12-10-2001.

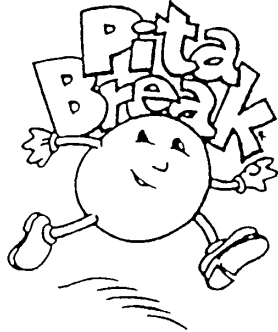

PRIORITY CLAIMED UNDER SEC. 44(D) ON CANADA APPLICATION NO. 1106401, FILED 6-13-2001, REG. NO. TMA612246, DATED 6-7-2004, EXPIRES 6-7-2019.

NO CLAIM IS MADE TO THE EXCLUSIVE RIGHT TO USE "PITA", APART FROM THE MARK AS SHOWN.

#### CLASS 30—STAPLE FOODS

FOR PITA BREAD PRODUCTS AND OTHER BREAD GOODS, INCLUDING, REGULAR, WHOLE WHEAT, ORGANIC WHOLE WHEAT, MULTI-GRAIN, CINNAMON-RAISIN, TOMATO BASIL, GARLIC, ZESTY OREGANO, JALAPENO, FLAX, PESTO, SUN-DRIED TOMATO, KAMUT AND SPELT PITA BREADS, MUESLI BREADS, AND LAVASH BREADS (U.S. CL. 46).

#### CLASS 42—SCIENTIFIC, COMPUTER AND LEGAL SERVICES

FOR RETAIL BAKERY STORE SERVICES AND WHOLESALE DISTRIBUTORSHIP OF PITA BREAD PRODUCTS AND OTHER BREAD GOODS (U.S. CLS. 100 AND 101).

SUSAN LESLIE DUBOIS, EXAMINING ATTORNEY

SN 76-347,291. PITA BREAK INC., TORONTO, ONTARIO, CANADA, FILED 12-10-2001.

## PITA BREAK

PRIORITY CLAIMED UNDER SEC. 44(D) ON CANADA APPLICATION NO. 1106399, FILED 6-13-2001, REG. NO. TMA612097, DATED 6-4-2004, EXPIRES 6-4-2019.

NO CLAIM IS MADE TO THE EXCLUSIVE RIGHT TO USE "PITA", APART FROM THE MARK AS SHOWN.

#### CLASS 30—STAPLE FOODS

FOR PITA BREAD PRODUCTS AND OTHER BREAD GOODS, INCLUDING, REGULAR, WHOLE WHEAT, ORGANIC WHOLE WHEAT, MULTI-GRAIN, CINNAMON-RAISIN, TOMATO BASIL, GARLIC, ZESTY OREGANO, JALAPENO, FLAX, PESTO, SUN-DRIED TOMATO, KAMUT AND SPELT PITA BREADS, MUESLI BREADS, AND LAVASH BREADS (U.S. CL. 46).

#### CLASS 42—SCIENTIFIC, COMPUTER AND LEGAL SERVICES

FOR RETAIL BAKERY STORE SERVICES AND WHOLESALE DISTRIBUTORSHIP OF PITA BREAD PRODUCTS AND OTHER BREAD GOODS (U.S. CLS. 100 AND 101).

SUSAN LESLIE DUBOIS, EXAMINING ATTORNEY

SN 76-355,506. RHF PRODUCTIONS LIMITED, ST. HELIER, JERSEY JE2 4LA, UNITED KINGDOM, FILED 1-3-2002.

## RED HOT AMATEUR

#### CLASS 9—ELECTRICAL AND SCIENTIFIC APPARATUS

FOR PRE-RECORDED VIDEO CASSETTES AND PRE-RECORDED VIDEO COMPACT DISCS FEATURING ADULT-THEMED ENTERTAINMENT (U.S. CLS. 21, 23, 26, 36 AND 38).

#### CLASS 38—COMMUNICATION

FOR SATELLITE SERVICES, NAMELY SATELLITE COMMUNICATIONS SERVICES, BROADCASTING SERVICES AND COMMUNICATIONS SERVICES FOR TELEVISION AND INTERNET, NAMELY, BROADCASTING PROGRAMS VIA A GLOBAL COMPUTER NETWORK, TELEVISION SERVICES, BROADCASTING AND TRANSMISSION OF TELEVISION PROGRAMS, BROADCAST AND TRANSMISSION OF CABLE TELEVISION PROGRAMS, BROADCASTING AND TRANSMISSION OF TELEVISION PROGRAMS BY SATELLITE, AND PAY-PER-VIEW TELEVISION TRANSMISSION SERVICES (U.S. CLS. 100, 101 AND 104).

#### CLASS 41—EDUCATION AND ENTERTAINMENT

FOR ENTERTAINMENT AND AMUSEMENT SERVICES, NAMELY, DISTRIBUTION OF TELEVISION PROGRAMMING TO CABLE TELEVISION SYSTEMS, PAY TELEVISION, SATELLITE TO TELEVISION, AND THE INTERNET, ALL CONTAINING ADULT-THEMED FILMS; PRODUCTION OF MOTION PICTURE FILMS AND VIDEO CASSETTES; PRODUCTION OF TELEVISION AND VIDEO CASSETTE TELEVISION PROGRAMS; PRODUCTION OF TELEVISION SHOWS FEATURING ADULT-THEMED FILMS AND ADULT THEMED DRAMA FOR CABLE, SATELLITE, THE INTERNET, PAY AND FREE TELEVISION (U.S. CLS. 100, 101 AND 107).

KARANENDRA S. CHHINA, EXAMINING ATTORNEY

SN 76-356,275. GARVEY, SCOTT, LA, CA. FILED 1-9-2002.

## PIECE



#### CLASS 6—METAL GOODS

FOR FIGURES OF COMMON METAL, FIGURINES OF COMMON METAL, METAL BOXES, METAL CHAINS, METAL DECORATIVE BOXES, METAL DOG TAGS, METAL KEY CHAINS, METAL LICENSE PLATES, METAL MONEY CLIPS, STATUES OF NON-PRECIOUS METAL, STATUETTES OF NON-PRECIOUS METAL, JEWELRY BOXES OF METAL (U.S. CLS. 2, 12, 13, 14, 23, 25 AND 50).

**CLASS 9—ELECTRICAL AND SCIENTIFIC APPARATUS**

FOR AUDIO AND VISUAL RECORDINGS IN ALL MEDIA, NAMELY, PRE-RECORDED AUDIO AND VIDEO CASSETTES, COMPACT DISCS, DIGITAL VIDEO DISCS, DIGITAL VERSATILE DISCS, AND CD-ROM DISCS FEATURING ENTERTAINMENT, MUSIC, COMEDIES, DOCUMENTARIES, ROMANCES, SCIENCE FICTION, HORROR, MYSTERIES, DRAMAS, ACTION ADVENTURES, ANIMATED AND LIVE ACTION FILMS, TELEVISION PROGRAMS, SPOKEN WORD, GAMES AND ACTIVITIES; VIDEO AND COMPUTER GAME PROGRAMS, COMPUTER GAME SOFTWARE, DECORATIVE MAGNETS, MOTION PICTURE AND TELEVISION FILMS FEATURING ACTION ADVENTURES, ANIMATION, SPOKEN WORD, DRAMAS, COMEDIES, DOCUMENTARIES, ROMANCES, SCIENCE FICTION, HORROR AND MYSTERIES; SUNGLASSES (U.S. CLS. 21, 23, 26, 36 AND 38).

**CLASS 12—VEHICLES**

FOR HUB CAP COVERS, LICENSE PLATE FRAMES, LICENSE PLATE HOLDERS (U.S. CLS. 19, 21, 23, 31, 35 AND 44).

**CLASS 14—JEWELRY**

FOR ASHTRAYS OF PRECIOUS METAL, BADGES OF PRECIOUS METAL, BELT BUCKLES OF PRECIOUS METAL FOR CLOTHING, BRACELETS, BRACELETS OF PRECIOUS METAL, CIGARETTE CASES MADE OF PRECIOUS METAL, DECORATIVE BOXES MADE OF PRECIOUS METAL, EARRINGS, FIGURES OF PRECIOUS METAL, FIGURINES OF PRECIOUS METAL, JEWELRY, JEWELRY CHAINS, JEWELRY PINS FOR USE ON HATS, LAPEL PINS, MEDALLIONS, NECKLACES, PINS BEING JEWELRY, PRECIOUS METAL MONEY CLIPS, RINGS BEING JEWELRY, SCULPTURES MADE OF PRECIOUS METAL, STATUES OF PRECIOUS METAL, STATUETTES OF PRECIOUS METAL (U.S. CLS. 2, 27, 28 AND 50).

**CLASS 16—PAPER GOODS AND PRINTED MATTER**

FOR PRINTED MATTER AND PAPER GOODS, NAMELY BOOKS FEATURING CHARACTERS FROM ANIMATED, ACTION ADVENTURE, COMEDY AND/OR DRAMA FEATURES; BUMPER STICKERS, CALENDARS, GREETING CARDS, HOLIDAY CARDS, TRADING CARDS, COMIC BOOKS, COMIC STRIPS IN GENERAL, DECALS, POSTERS, PHOTOGRAPHS, PRINTED PAPER LABELS, PRINTED TRANSFERS FOR EMBROIDERY FOR FABRIC APPLIQUES, PRINTED PATTERNS FOR COSTUMES AND T-SHIRTS, STATIONERY, MAGAZINES IN THE FIELD OF ENTERTAINMENT, SHEET MUSIC, MERCHANDISE BAGS (U.S. CLS. 2, 5, 22, 23, 29, 37, 38 AND 50).

**CLASS 18—LEATHER GOODS**

FOR ALL-PURPOSE ATHLETIC BAGS, ATTACHE CASES, BACKPACKS, BEACH BAGS, BEACH UMBRELLAS, BILLFOLDS, DAY PACKS, DOG COLLARS, DOG LEASHES, DUFFEL BAGS, FANNY PACKS, HANDBAGS, OVERNIGHT BAGS, PET CLOTHING, SHOULDER BAGS, UMBRELLAS, WAIST PACKS, WALLET (U.S. CLS. 1, 2, 3, 22 AND 41).

**CLASS 20—FURNITURE AND ARTICLES NOT OTHERWISE CLASSIFIED**

FOR JEWELRY BOXES NOT OF METAL, JEWELRY CASES NOT OF PRECIOUS METAL, NON-METAL CHAINS, NON-METAL KEY CHAINS, NON-METAL MONEY CLIPS, ORNAMENTS MADE OF PLASTIC, NOT INCLUDING CHRISTMAS TREE ORNAMENTS; SCULPTURES MADE OF PLASTIC, STATUES MADE OF PLASTIC, STATUETTES MADE OF PLASTIC (U.S. CLS. 2, 13, 22, 25, 32 AND 50).

**CLASS 21—HOUSEWARES AND GLASS**

FOR BEER MUGS, BEVERAGEWARE, BOTTLE OPENERS, COASTERS NOT OF PAPER AND NOT BEING TABLE LINEN, COMMEMORATIVE PLATES, DECORATIVE PLATES, FLASKS, HAIR BRUSHES, HAIR COMBS, LUNCH BOXES, LUNCH PAILS, MUGS, ORNAMENTS MADE OF CHINA, CRYSTAL, GLASS, PORCELAIN, NOT INCLUDING CHRISTMAS TREE ORNAMENTS (U.S. CLS. 2, 13, 23, 29, 30, 33, 40 AND 50).

**CLASS 22—CORDAGE AND FIBERS**

FOR GENERAL UTILITY BAGS FOR COMMERCIAL USE (U.S. CLS. 1, 2, 7, 19, 22, 42 AND 50).

**CLASS 25—CLOTHING**

FOR CLOTHING, NAMELY SHIRTS, T-SHIRTS, SHORTS, PANTS, OVERALLS, SWEATSHIRTS, DRESS SHIRTS, TANK TOPS, COATS, JOGGING SUITS, CAPS, HATS, BEANIES, SCARVES, SWEATPANTS, JACKETS, WIND RESISTANT JACKETS, BOOTS, BELTS, SHOES, SOCKS, SLACKS, SWEATERS, PULLOVERS, DRESSES, SKIRTS, BLOUSES, BEACHWEAR, LINGERIE, UNDERWEAR, COATS, BANDANAS (U.S. CLS. 22 AND 39).

**CLASS 26—FANCY GOODS**

FOR BELT BUCKLES NOT OF PRECIOUS METAL FOR CLOTHING, BELT CLASPS, HAIR CLIPS, HAT ORNAMENTS NOT OF PRECIOUS METAL, HAT PINS FOR SECURING HATS, ORNAMENTAL NOVELTY BUTTONS, ORNAMENTAL NOVELTY PINS (U.S. CLS. 37, 39, 40, 42 AND 50).

**CLASS 28—TOYS AND SPORTING GOODS**

FOR ACTION FIGURES AND ACCESSORIES THEREFOR, ADULT PARTY GAMES, BOARD GAMES, CHRISTMAS TREE DECORATIONS EXCEPT CONFECTIONERY OR ILLUMINATION ARTICLES, CHRISTMAS TREE ORNAMENTS EXCEPT CONFECTIONERY OR ILLUMINATION ARTICLES, COLLECTABLE TOY FIGURES, FACE MASKS, FANTASY CHARACTER TOYS, FOOTBALLS, PLAYING CARD CASES, PLAYING CARDS, PROMOTIONAL GAME CARDS, ROLE PLAYING GAME EQUIPMENT IN THE NATURE OF GAME BOOK MANUALS, ROLE PLAYING GAMES, RUBBER CHARACTER TOYS, SKATEBOARDS, SNOW BOARDS, SPORT BALLS, TOY ACTION FIGURES AND ACCESSORIES THEREFOR, TOY FIGURES AND YO-YOS (U.S. CLS. 22, 23, 38 AND 50).

**CLASS 34—SMOKERS' ARTICLES**

FOR ASHTRAYS NOT OF PRECIOUS METAL, CIGARETTE CASES NOT OF PRECIOUS METAL (U.S. CLS. 2, 8, 9 AND 17).

**CLASS 35—ADVERTISING AND BUSINESS**

FOR ON-LINE RETAIL STORE SERVICES IN THE FIELDS OF CLOTHING, JEWELRY, BOOKS, VIDEOS, RECORDINGS, COLLECTIBLES, HOUSEWARES, TOYS AND GIFTS; TALENT AGENCY SERVICES AND LITERARY AGENT SERVICES, NAMELY REPRESENTATION OF WRITERS, ACTORS, COMEDIANS, DIRECTORS, PRODUCERS, COMPUTER SOFTWARE DEVELOPERS AND INVENTORS OF NEW TECHNOLOGIES; REPRESENTATION OF INDIVIDUALS, GROUPS AND ENTITIES IN THE FIELD OF MUSICAL PERFORMANCE, COMEDY AND DIGITAL MEDIA; ARRANGING MUSICAL, ENTERTAINMENT AND MULTIMEDIA PRODUCTIONS FOR MARKETING AND TOURING; ARRANGING FOR MARKETING AND ARRANGING FOR DISTRIBUTION AND SYNDICATION OF TELEVISION PROGRAMS, MOTION PICTURES, TELEVISION AND MOTION PICTURE SCRIPTS, ADVERTISING AGENCIES, BUSINESS DEVELOPMENT SERVICES NAMELY, PROVIDING START-UP SUPPORT FOR BUSINESSES OF OTHERS, BUSINESS MANAGEMENT AND CONSULTATION SERVICES, BUSINESS MANAGEMENT PLANNING SERVICES, BUSINESS MARKETING



CONSULTING SERVICES, BUSINESS NETWORKING, BUSINESS RESEARCH, CONDUCTING MARKETING STUDIES, DIRECT MAIL ADVERTISING, DIRECT MARKETING ADVERTISING FOR OTHERS, DISSEMINATION OF ADVERTISING FOR OTHERS VIA THE INTERNET, MANAGEMENT OF PERFORMING ARTISTS, PERSONAL MANAGEMENT SERVICES FOR ENTERTAINERS, PERSONAL MANAGEMENT SERVICES FOR MUSICAL PERFORMERS, PROMOTING THE CONCERTS OF OTHERS, PROMOTING THE SALE OF GOODS AND SERVICES OF OTHERS THROUGH THE DISTRIBUTION OF PRINTED MATERIAL AND PROMOTIONAL CONTESTS, PROVIDING A WEB SITE WHICH FEATURES ADVERTISEMENTS FOR THE GOODS AND SERVICES OF OTHERS ON A GLOBAL COMPUTER NETWORK, PROVIDING INFORMATION ABOUT THE GOODS AND SERVICES OF OTHERS VIA THE GLOBAL COMPUTER NETWORK, PROVIDING ON-LINE DIRECTORY INFORMATION SERVICES ALSO FEATURING HYPERLINKS TO OTHER WEB SITES, PROVIDING SPACE AT A WEB SITE FOR THE ADVERTISEMENT OF THE GOODS AND SERVICES OF OTHERS, PUBLIC RELATIONS, PUBLICITY AGENTS, DISTRIBUTORSHIP SERVICES IN THE FIELD OF PHONOGRAPH RECORDS, AUDIO AND VIDEO TAPES, DIGITAL VERSATILE DISCS, AND CASSETTES AND COMPACT DISCS (U.S. CLS. 100, 101 AND 102).

#### **CLASS 36—INSURANCE AND FINANCIAL**

FOR ASSISTING SCREENWRITERS AND MOTION PICTURE, MUSICAL ENTERTAINMENT, AND MULTIMEDIA EVENT PRODUCERS IN OBTAINING FINANCING (U.S. CLS. 100, 101 AND 102).

#### **CLASS 38—COMMUNICATION**

FOR BROADCASTING PROGRAMS VIA GLOBAL COMPUTER NETWORK; STREAMING OF AUDIO MATERIAL ON THE INTERNET; STREAMING OF VIDEO MATERIAL ON THE INTERNET; SUBSCRIPTION BROADCASTING OF MUSIC VIA A GLOBAL COMPUTER NETWORK (U.S. CLS. 100, 101 AND 104).

#### **CLASS 41—EDUCATION AND ENTERTAINMENT**

FOR MUSIC PUBLISHING SERVICES; MUSIC PRODUCTION SERVICES; PRODUCTION OF VIDEO CASSETTES; PRODUCTION OF VIDEO DISCS FOR OTHERS; AUDIO RECORDING AND PRODUCTION; ENTERTAINMENT SERVICES IN THE NATURE OF ONGOING NEWS, COMEDY AND VARIETY TELEVISION PROGRAMS; MULTIMEDIA ENTERTAINMENT SOFTWARE PRODUCTION SERVICES; PRODUCTION AND DISTRIBUTION OF DIGITAL ONLINE PROGRAMS FEATURING AUDIO AND VISUAL CONTENT AND MUSIC AND MUSICAL BASED ENTERTAINMENT; AUDIO RECORDING AND PRODUCTION, COMPOSITION OF MUSIC FOR OTHERS, CONCERT BOOKING, DISC JOCKEYS FOR PARTIES AND SPECIAL EVENTS, DUBBING SERVICES, ENTERTAINMENT SERVICES NAMELY, PROVIDING A WEBSITE FEATURING MUSICAL PERFORMANCES, MUSICAL VIDEOS, RELATED FILM CLIPS, PHOTOGRAPHS, AND OTHER MULTIMEDIA MATERIALS, ENTERTAINMENT SERVICES NAMELY, PROVIDING ON-LINE REVIEWS OF MOVIES, BOOKS, MUSIC, ENTERTAINMENT SERVICES NAMELY, PROVIDING PRERECORDED MUSIC, INFORMATION IN THE FIELD OF MUSIC, AND COMMENTARY AND ARTICLES ABOUT MUSIC, ALL ONLINE VIA A GLOBAL COMPUTER NETWORK, ENTERTAINMENT SERVICES NAMELY, LIVE MUSIC CONCERTS, FAN CLUBS, MOTION PICTURE SONG PRODUCTION, MUSIC COMPOSITION FOR OTHERS, PHOTOGRAPHY SERVICES, PRODUCTION AND DISTRIBUTION OF MOTION PICTURES, PRODUCTION OF CABLE TELEVISION PROGRAMS, PRODUCTION OF RADIO AND TELEVISION PROGRAMS, PUBLICATION OF BOOKS, MAGAZINES AND COMICS, RECORD MASTER PRODUCTION, RECORDING STUDIOS, SONGWRITING SERVICES (U.S. CLS. 100, 101 AND 107).

#### **CLASS 42—SCIENTIFIC, COMPUTER AND LEGAL SERVICES**

FOR ANIMATION AND SPECIAL EFFECTS DESIGN FOR OTHERS; COMPUTER GRAPHICS SERVICES, COMPUTER SITE DESIGN, COMPUTER SOFTWARE CONSULTATION, COMPUTER SOFTWARE DESIGN FOR OTHERS, COMPUTER SOFTWARE DEVELOPMENT, GRAPHIC ART DESIGN, GRAPHIC ILLUSTRATION SERVICES FOR OTHERS, PRODUCT DEVELOPMENT, PRODUCT DEVELOPMENT CONSULTATION, PRODUCT DEVELOPMENT FOR OTHERS, AND PRODUCT RESEARCH; ACQUISITION, MANAGEMENT AND EXPLOITATION OF COPYRIGHTS IN MUSICAL AND/OR LYRICAL WORKS FOR AND ON BEHALF OF AUTHORS, COMPOSERS OR CONDUCTORS OF SUCH WORKS (U.S. CLS. 100 AND 101).

KARANENDRA S. CHHINA, EXAMINING ATTORNEY

SN 76-367,754. DATAWIRE COMMUNICATION NETWORKS INC., TORONTO, ONTARIO M9W 6L2, CANADA, FILED 2-5-2002.

### **DATAWIRE**

PRIORITY CLAIMED UNDER SEC. 44(D) ON CANADA APPLICATION NO. 1129009, FILED 1-24-2002, REG. NO. TMA611249, DATED 5-27-2004, EXPIRES 5-27-2019.

#### **CLASS 9—ELECTRICAL AND SCIENTIFIC APPARATUS**

FOR SOFTWARE PROVIDING FOR SECURE TRANSMISSION, RECEIPT AND DELIVERY OF DATA RELATED TO TRANSACTION PROCESSING FINANCIAL TRANSACTIONS INCLUDING CREDIT AND DEBIT CARDS TELECOMMUNICATIONS AUTHORIZATIONS (U.S. CLS. 21, 23, 26, 36 AND 38).

FIRST USE 7-0-1999; IN COMMERCE 7-0-1999.

#### **CLASS 38—COMMUNICATION**

FOR ELECTRONIC DELIVERY OF TRANSACTION DATA FOR OTHERS OVER A PROPRIETARY COMPUTER NETWORK (U.S. CLS. 100, 101 AND 104).

FIRST USE 7-0-1999; IN COMMERCE 7-0-1999.

MICHAEL BAIRD, EXAMINING ATTORNEY

SN 76-383,597. LUNDS UNIVERSITET, SE-221 00 LUND, SWEDEN, FILED 3-14-2002.

### **SWEGENE**

OWNER OF SWEDEN REG. NO. 356369, DATED 6-14-2002, EXPIRES 6-14-2012.

#### **CLASS 5—PHARMACEUTICALS**

FOR PHARMACEUTICAL, VETERINARY AND SANITARY PREPARATIONS FOR USE IN TREATMENT OF DISEASES CAUSED BY GENOMETIC DISORDERS (U.S. CLS. 6, 18, 44, 46, 51 AND 52).

#### **CLASS 9—ELECTRICAL AND SCIENTIFIC APPARATUS**

FOR COMPUTER PROGRAMS FOR USE IN BIOTECHNICAL ANALYSIS METHODS (U.S. CLS. 21, 23, 26, 36 AND 38).

**CLASS 10—MEDICAL APPARATUS**

FOR SURGICAL, MEDICAL, DENTAL, AND VETERINARY APPARATUS AND INSTRUMENTS TO BE USED IN CONNECTION WITH TREATMENT OF PERSONS SUFFERING FROM DISEASES CAUSED BY GENETIC DISORDERS; ARTIFICIAL LIMBS; EYES AND TEETH; ORTHOPEDIC SUPPORT BANDAGES, ELASTIC BANDAGES, COMPRESSION BANDAGES, BANDAGES FOR ANATOMICAL JOINTS (U.S. CLS. 26, 39 AND 44).

**CLASS 42—SCIENTIFIC, COMPUTER AND LEGAL SERVICES**

FOR SCIENTIFIC AND INDUSTRIAL RESEARCH; COMPUTER PROGRAMMING FOR OTHERS (U.S. CLS. 100 AND 101).  
KAREN K. BUSH, EXAMINING ATTORNEY

SN 76-388,016. HOME HOUSE LIMITED, LONDON W1H 6LN, ENGLAND, FILED 3-28-2002.

OWNER OF UNITED KINGDOM REG. NO. 2184574, DATED 12-16-1998, EXPIRES 12-16-2008.

SN 76-387,488. TECNOLOGIE SPAZIO S.R.L., 20123 MILAN, ITALY, FILED 3-27-2002.

PRIORITY CLAIMED UNDER SEC. 44(D) ON ERP N CMNTY TM OFC APPLICATION NO. 2,466,696, FILED 11-19-2001, REG. NO. 2466696, DATED 7-7-2003, EXPIRES 11-19-2011.

NO CLAIM IS MADE TO THE EXCLUSIVE RIGHT TO USE "TECNOLOGIE AND SRL", APART FROM THE MARK AS SHOWN.

THE APPLICANT CLAIMS THE COLORS AS FOLLOWS—THE LEFT HAND SIDE IS WHITE LETTERING ON BLACK BACKGROUND AND THE RIGHT SIDE IS BLACK LETTERING ON GREEN BACKGROUND.

THE WORD TECNOLOGIE CAN BE TRANSLATED AS "TECHNOLOGIES" AND THE WORD SPAZIO AS "SPACE".

**CLASS 35—ADVERTISING AND BUSINESS**

FOR SERVICES RELATED TO BUSINESS MANAGEMENT, BUSINESS OFFICE ADMINISTRATION AND OFFICE FUNCTIONS FOR OTHERS, MANAGEMENT OF COMPANY ADMINISTRATION SERVICES (U.S. CLS. 100, 101 AND 102).

**CLASS 36—INSURANCE AND FINANCIAL**

FOR FINANCIAL SERVICES IN THE MOVABLE PROPERTY AND REAL ESTATE FIELD, NAMELY, FINANCIAL VALUATION OF REAL ESTATE, PROJECT FINANCING; PLANNING, ESTIMATING, RESEARCH AND ASSESSMENT OF MORTGAGE FINANCING, INDEBTEDNESS; RE-FINANCING IN THE REAL ESTATE FIELD; REAL ESTATE PORTFOLIO ADMINISTRATION, RESIDENTIAL AND INDUSTRIAL BUILDING ADMINISTRATION (U.S. CLS. 100, 101 AND 102).

**CLASS 38—COMMUNICATION**

FOR TELECOMMUNICATION SERVICES PARTICULARLY FOR THE INTERNET, NAMELY, PERSONAL COMMUNICATION SERVICES (U.S. CLS. 100, 101 AND 104).

**CLASS 42—SCIENTIFIC, COMPUTER AND LEGAL SERVICES**

FOR COMPUTER PROGRAMMING, DESIGN AND DEVELOPMENT OF SOFTWARE AND INTERNET SITES FOR OTHERS (U.S. CLS. 100 AND 101).  
BRIAN NEVILLE, EXAMINING ATTORNEY

**CLASS 16—PAPER GOODS AND PRINTED MATTER**

FOR PRINTED MATTER, NAMELY, MAGAZINES, NEWSLETTERS AND BROCHURES IN THE FIELDS OF NEWS, CURRENT AFFAIRS, FASHION, FILM, CULTURES, FOOD, WINE, HISTORY, MUSIC AND PERFORMING ARTS, TRAVEL, HOTELS, RESTAURANTS, SPORTS AND FITNESS, HEALTH AND BEAUTY, AND PARTY PLANNING; PAPER, NAMELY, PAPER LABELS, PRE-PRINTED FORMS AND PAPER CARRIER BAGS; CARDS, NAMELY, ANNOUNCEMENT CARDS, BUSINESS CARDS, CHRISTMAS CARDS, GIFT CARDS, GREETING CARDS, MEMBERSHIP CARDS AND POSTCARDS; POSTERS; PAPER COASTERS; MENUS; MAPS; FOLDERS; AND NOTEPADS (U.S. CLS. 2, 5, 22, 23, 29, 37, 38 AND 50).

**CLASS 41—EDUCATION AND ENTERTAINMENT**

FOR HEALTH AND FITNESS CLUBS; PROVIDING FACILITIES FOR RECREATIONAL ACTIVITIES; DRINKING AND DINING CLUBS IN THE NATURE OF NIGHT CLUBS (U.S. CLS. 100, 101 AND 107).

**CLASS 43—HOTEL AND RESTAURANT SERVICES**

FOR HOTEL SERVICES, RESTAURANT SERVICES, CATERING SERVICES FOR THE PROVISION OF FOOD AND DRINK; PROVIDING PRIVATE PARTY FACILITIES; DRINKING AND DINING CLUBS IN THE NATURE OF RESTAURANTS AND BARS (U.S. CLS. 100 AND 101).

**CLASS 45—PERSONAL SERVICES**

FOR SOCIAL CLUBS; DRINKING AND DINING CLUBS IN THE NATURE OF SOCIAL CLUBS (U.S. CLS. 100 AND 101).

LINDA MICKLEBURGH, EXAMINING ATTORNEY

SN 76-391,803. PORTAS DEUTSCHLAND FOLIEN GMBH & CO. FABRIKATIONS KG, D-63128 DIETZENBACH, FED REP GERMANY, FILED 4-3-2002.

**PORTANOVA**

PRIORITY CLAIMED UNDER SEC. 44(D) ON ERP N CMNTY TM OFC APPLICATION NO. 002413532, FILED 10-16-2001, REG. NO. 002413532, DATED 3-31-2003, EXPIRES 10-16-2011.

OWNER OF U.S. REG. NO. 2,495,279.

**CLASS 6—METAL GOODS**

FOR BUILDING MATERIALS MADE PRIMARILY OF METAL, NAMELY DOORS, GATES, GARAGE DOORS, DOOR AND GATE FRAMES, FENCES, WINDOWS, WINDOW CASEMENTS AND SURFACE-MOUNTED WINDOW CASEMENTS, CANOPIES, WINDOW SILLS, PANELING FOR WALLS, CEILINGS AND RADIATORS; STAIRS, STEPS, BANISTERS; METAL HANDLES FOR DOORS, GATES, WINDOWS AND FURNITURE (U.S. CLS. 2, 12, 13, 14, 23, 25 AND 50).

**CLASS 19—NON-METALLIC BUILDING MATERIALS**

FOR NON-METALLIC BUILDING MATERIALS, NAMELY, DOORS, GATES, GARAGE DOORS, DOOR AND GATE FRAMES, FENCES, WINDOWS, WINDOW CASEMENTS AND SURFACE-MOUNTED CASEMENTS, WINDOW SILLS, WINDOW PANES, PANELING FOR WALLS, CEILINGS AND RADIATORS; NON-METAL STEPS AND BANISTERS; NON-METAL WINDOWS, NON-METAL FURNITURE, DOOR AND WINDOW FITTINGS, NAMELY, HANDLES, LATCHES, HINGES, TRIM PLATES; PRE-FABRICATED AND MODULAR NON-METAL CEILINGS AND FLOORS FOR BUILDINGS, AND PARQUET WOOD FLOORING; AND NON-METAL PRE-FABRICATED HOUSING (U.S. CLS. 1, 12, 33 AND 50).

**CLASS 20—FURNITURE AND ARTICLES NOT OTHERWISE CLASSIFIED**

FOR FURNITURE OF ALL TYPES, NAMELY, KITCHEN, LIVING ROOM AND BATHROOM FURNITURE; UPHOLSTERED FURNITURE AND PARTS THEREOF; FURNITURE MIRRORS AND FRAMES (U.S. CLS. 2, 13, 22, 25, 32 AND 50).

**CLASS 35—ADVERTISING AND BUSINESS**

FOR FRANCHISING SERVICES, NAMELY, OFFERING TECHNICAL ASSISTANCE IN THE ESTABLISHMENT AND/OR OPERATION OF BUILDING RENOVATION AND REFITTING BUSINESSES THROUGH PLANNING AND IMPLEMENTATION OF AND CONSULTANCY CONCERNING ECONOMIC, COMMERCIAL, ORGANIZATIONAL, MARKETING, MARKET RESEARCH, SALES PROMOTION AND ADVERTISING FOR BUILDING RENOVATION AND REFITTING BUSINESSES (U.S. CLS. 100, 101 AND 102).

**CLASS 37—CONSTRUCTION AND REPAIR**

FOR RENOVATION AND REFITTING OF BUILDINGS, PARTS OF BUILDINGS AND BUILDING AMENITIES, NAMELY, RENOVATION OF GATES, WINDOWS, STAIRS, DOORS, FURNITURE, RADIATOR PANELS, FLOORS, CEILINGS; AND CONSTRUCTION PLANNING AND CONSULTANCY SERVICES RELATING TO RENOVATION AND REFITTING OF BUILDINGS (U.S. CLS. 100, 103 AND 106).

THEODORE MCBRIDE, EXAMINING ATTORNEY

**CLASS 9—ELECTRICAL AND SCIENTIFIC APPARATUS**

FOR COMPUTERS; COMPUTER SOFTWARE AND PROGRAMS FOR NETWORK SECURITY; COMPUTER SOFTWARE AND PROGRAMS FOR PERFORMING FINANCIAL AND MONETARY TRANSACTIONS; COMPUTER SOFTWARE AND PROGRAMS USED FOR TRANSMISSION, REPRODUCING OR RECEIVING OF SOUND, IMAGES, VIDEO OR DATA; COMPUTER SOFTWARE AND PROGRAMS FOR ENHANCING AND FACILITATING USE AND ACCESS TO COMPUTER NETWORKS AND TELEPHONE NETWORKS; COMPUTER SOFTWARE FOR USE IN GENERAL PURPOSE DATABASE MANAGEMENT; COMPUTER E-COMMERCE AND MOBILE COMMERCE SOFTWARE TO ALLOW USERS TO SAFELY PLACE ORDERS AND MAKE PAYMENTS IN THE FIELD OF ELECTRONIC BUSINESS TRANSACTIONS VIA A GLOBAL COMPUTER NETWORK OR TELECOMMUNICATIONS NETWORK; TRAINING AND PRODUCT SUPPORT SOFTWARE IN THE FIELD OF COMMUNICATIONS; COMPUTER UTILITY SOFTWARE FOR PERFORMING COMPUTER MAINTENANCE WORK; MULTIMEDIA SYSTEMS, NAMELY, SOFTWARE FOR THE DISTRIBUTION OF INFORMATION AND INTERACTIVE CONTENT CONTAINING TEXT, IMAGES, VIDEO AND SOUND TO USERS IN THE FIELD OF COMMUNICATIONS AND MULTIMEDIA TERMINALS FOR COMPUTERS; COMPUTER SOFTWARE AND PROGRAMS FOR MANAGEMENT AND OPERATION OF WIRELESS TELECOMMUNICATIONS DEVICES, COMPUTER SOFTWARE AND PROGRAMS FOR ACCESSING, SEARCHING, INDEXING AND RETRIEVING INFORMATION AND DATA FROM GLOBAL COMPUTER NETWORKS AND GLOBAL COMMUNICATION NETWORKS; COMPUTER SOFTWARE AND PROGRAMS FOR SENDING AND RECEIVING SHORT MESSAGES AND ELECTRONIC MAIL AND FOR FILTERING NON-TEXT INFORMATION FROM THE DATA; SYSTEMS AND APPARATUS FOR ELECTRONIC MONEY TRANSACTIONS, NAMELY, BLANK SMART CARDS, ENCODED SMART CARDS CONTAINING PROGRAMMING TO ENABLE MONETARY TRANSACTIONS, AND SMART CARD READERS; CARDS FOR COMMUNICATIONS PURPOSES, NAMELY COMPUTER MEMORY CARDS, COMPUTER MODEM CARDS AND COMPUTER FAX MODEM CARDS FOR COMMUNICATION PURPOSES, ALL FOR USE WITH COMMUNICATIONS APPARATUS; ELECTRONIC PUBLICATIONS, NAMELY, COMPUTER USER MANUALS RECORDED ON COMPUTER MEDIA (U.S. CLS. 21, 23, 26, 36 AND 38).

**CLASS 35—ADVERTISING AND BUSINESS**

FOR LICENSING OF COMPUTER SOFTWARE, SOFTWARE APPLICATIONS AND DATABASES (U.S. CLS. 100, 101 AND 102).

**CLASS 36—INSURANCE AND FINANCIAL**

FOR INSURANCE, FINANCIAL AND MONETARY ANALYSIS, RESEARCH, FORECASTING AND CONSULTATION; REAL ESTATE CONSULTATION; INSURANCE, FINANCIAL AND MONETARY INFORMATION PROVIDED BY ELECTRONIC MEANS; INFORMATION RELATING TO REAL ESTATE PROVIDED BY ELECTRONIC MEANS; PROVIDING CONSULTATION AND ADVISORY SERVICES IN THE FIELD OF INSURANCE, FINANCIAL AND MONETARY ACTIVITIES VIA WIRELESS INFORMATION NETWORKS (U.S. CLS. 100, 101 AND 102).

SN 76-396,840. MERIDEA FINANCIAL SOFTWARE OY, 00381 HELSINKI, FINLAND, FILED 4-17-2002.



PRIORITY CLAIMED UNDER SEC. 44(D) ON FINLAND APPLICATION NO. T200200991, FILED 3-26-2002, REG. NO. 226289, DATED 1-15-2003, EXPIRES 1-15-2013.

**CLASS 38—COMMUNICATION**

FOR TELECOMMUNICATION AND WIRELESS COMMUNICATION SERVICES, NAMELY, SATELLITE TRANSMISSION, TELEPHONE COMMUNICATION, TELEGRAM TRANSMISSION, TELETXT, FACSIMILES, ELECTRONIC MAIL AND TELEVISION BROADCASTING; ELECTRONIC TRANSMISSION OF SOUND, IMAGES, VIDEO OR DATA; PROVIDING ACCESS TO TELECOMMUNICATIONS NETWORKS; PROVIDING TELECOMMUNICATIONS CONNECTIONS AND ACCESS TO A GLOBAL COMPUTER NETWORK; TELECOMMUNICATIONS CONSULTATION (U.S. CLS. 100, 101 AND 104).

**CLASS 42—SCIENTIFIC, COMPUTER AND LEGAL SERVICES**

FOR COMPUTER PROGRAMMING FOR OTHERS; TECHNICAL CONSULTATION AND RESEARCH IN THE FIELD OF INFORMATION TECHNOLOGY, COMPUTER DATABASES, COMPUTER PROGRAMS, COMPUTER PROGRAMMING, AND INFORMATION SYSTEMS; DESIGN AND DEVELOPMENT OF INFORMATION TECHNOLOGY SYSTEMS, COMPUTER DATABASES, COMPUTER PROGRAMS, AND TELECOMMUNICATIONS AND INFORMATION SYSTEMS FOR OTHERS; DESIGN AND TESTING OF NEW PRODUCTS FOR OTHERS IN THE FIELD OF INFORMATION TECHNOLOGY SYSTEMS, COMPUTER DATABASES, COMPUTER PROGRAMS, AND TELECOMMUNICATIONS AND INFORMATION SYSTEMS; PROVIDING CUSTOMIZED COMPUTER SERVICES THAT PERMIT A USER TO RECEIVE PERSONALIZED INFORMATION VIA THE GLOBAL COMPUTER NETWORK OR VIA HAND-HELD WIRELESS DEVICES INCLUDING RADIO PAGERS, CELLULAR TELEPHONES, PERSONAL COMMUNICATION SERVICES (PCS) AND PERSONAL DIGITAL ASSISTANTS (PDA'S); PROVIDING CUSTOMIZED AND PERSONALIZED INFORMATION AT THE SPECIFIC REQUEST OF END-USERS BY MEANS OF WIRELESS DEVICES OR GLOBAL COMPUTER NETWORKS; PROVIDING CUSTOMIZED ONLINE WEB PAGES FEATURING USER-DESIGNED INFORMATION, WHICH INCLUDES SEARCH ENGINES AND ONLINE WEB LINKS TO OTHER WEB SITES AND WHICH IS ACCESSIBLE VIA COMPUTER, LAND-LINE AND WIRELESS COMMUNICATION DEVICES; COMPUTER SERVICES FOR OTHERS, NAMELY, PROVIDING AUTHENTICATION AND VERIFICATION OF PARTIES TO COMPUTER TRANSACTIONS; DATA ENCRYPTION SERVICES; SERVICES CONNECTED TO ELECTRONIC SIGNATURES, NAMELY, VERIFYING THE IDENTITIES OF PARTIES TO ONLINE TRANSACTIONS FOR OTHERS; PROVIDING INFORMATION IN THE FIELD OF COMPUTER PROGRAMMING, COMPUTER PROGRAM DESIGN, DATABASE DESIGN AND USER INTERFACE DESIGN VIA A GLOBAL COMPUTER NETWORK; TECHNICAL SUPPORT, NAMELY, MONITORING OF TELECOMMUNICATION NETWORK SYSTEMS; COMPUTER SERVICES, NAMELY, DESIGNING GRAPHICAL USER INTERFACES FOR OTHERS; INSTALLATION, MAINTENANCE, REPAIR AND RENTAL OF COMPUTER PROGRAMS, SOFTWARE APPLICATIONS AND DATABASES; COMPUTER CONSULTATION SERVICES FOR OTHERS IN THE FIELD OF COMPUTER NETWORK MANAGEMENT AND COMPUTER NETWORK ADMINISTRATION; CUSTOM DESIGN AND ENGINEERING OF TELEPHONY SYSTEMS, NAMELY, TELECOMMUNICATIONS NETWORKS (U.S. CLS. 100 AND 101).

GINA FINK, EXAMINING ATTORNEY

SN 76-398,289. YLI CORPORATION, ROCK HILL, SC. FILED 4-22-2002.

**WASH-A-WAY****CLASS 16—PAPER GOODS AND PRINTED MATTER**

FOR WATER SOLUBLE PAPER FOR HOUSEHOLD SEWING USE (U.S. CLS. 2, 5, 22, 23, 29, 37, 38 AND 50). FIRST USE 8-0-1991; IN COMMERCE 8-0-1991.

**CLASS 23—YARNS AND THREADS**

FOR WATER SOLUBLE BASTING THREAD FOR HOUSEHOLD SEWING USE (U.S. CL. 43). FIRST USE 8-0-1991; IN COMMERCE 8-0-1991. MARGERY A. TIERNEY, EXAMINING ATTORNEY

SN 76-401,680. MR. GREEK RESTAURANTS INC., TORONTO, ONTARIO, CANADA, FILED 4-26-2002.

**MR. GREEK  
MEDITERRANEAN GRILL**

PRIORITY CLAIMED UNDER SEC. 44(D) ON CANADA APPLICATION NO. 1119619, FILED 10-26-2001, REG. NO. TMA615086, DATED 7-19-2004, EXPIRES 7-19-2019.

NO CLAIM IS MADE TO THE EXCLUSIVE RIGHT TO USE GREEK MEDITERRANEAN GRILL, APART FROM THE MARK AS SHOWN.

**CLASS 29—MEATS AND PROCESSED FOODS**

FOR PREPARED FOODS CONSISTING PRIMARILY OF MEAT, FISH, POULTRY OR VEGETABLES, FOR TAKE-OUT AND FOR CONSUMPTION ON THE PREMISES (U.S. CL. 46).

**CLASS 30—STAPLE FOODS**

FOR PREPARED FOODS, NAMELY, MEALS CONSISTING PRIMARILY OF PASTA, RICE, FOR TAKE-OUT AND FOR CONSUMPTION ON THE PREMISES (U.S. CL. 46).

**CLASS 43—HOTEL AND RESTAURANT SERVICES**

FOR RESTAURANT SERVICES AND TAKE-OUT FOOD SERVICES (U.S. CLS. 100 AND 101). INGRID C. EULIN, EXAMINING ATTORNEY

SN 76-404,255. CLEMENT ENTERPRISES, LLC, LEWISVILLE, ID. FILED 5-7-2002.

**IDAHOAN FAMOUS POTATO  
PRODUCTS**

OWNER OF U.S. REG. NOS. 578,703, 2,833,787 AND OTHERS.

NO CLAIM IS MADE TO THE EXCLUSIVE RIGHT TO USE "FAMOUS POTATO PRODUCTS", APART FROM THE MARK AS SHOWN.

SEC. 2(F) AS TO "IDAHOAN".

**CLASS 29—MEATS AND PROCESSED FOODS**

FOR PROCESSED POTATOES, NAMELY, FROZEN AND DEHYDRATED POTATOES AND MIXES FOR MAKING MASHED POTATOES (U.S. CL. 46).

**CLASS 31—NATURAL AGRICULTURAL PRODUCTS**

FOR FRESH POTATOES (U.S. CLS. 1 AND 46).  
TRACY WHITAKER-BOWN, EXAMINING ATTORNEY

SN 76-415,083. INTERNATIONAL STAR REGISTRY OF ILLINOIS, LTD., INGLESIDE, IL. FILED 6-6-2002.



OWNER OF U.S. REG. NOS. 1,356,046, 2,101,459 AND OTHERS.

NO CLAIM IS MADE TO THE EXCLUSIVE RIGHT TO USE "NAME A STAR", APART FROM THE MARK AS SHOWN.

**CLASS 16—PAPER GOODS AND PRINTED MATTER**

FOR PRINTS AND PUBLICATIONS, NAMELY, BOOKLETS, BROCHURES, CHARTS, AND SHEETS IDENTIFYING CELESTIAL BODIES, PERTAINING TO ASTRONOMY AND FOR PERSONS HAVING AN INTEREST IN ASTRONOMY AND TOPICS RELATED THERETO, AND PRINTED CERTIFICATES AND CHARTS USED TO NAME A STAR WITH THE CUSTOMER'S SELECTED NAME, BOOKS AND DIRECTORIES LISTING AND CATALOGING THE STARS THAT HAVE BEEN NAMED (U.S. CLS. 2, 5, 22, 23, 29, 37, 38 AND 50).  
FIRST USE 6-0-1999; IN COMMERCE 6-0-1999.

**CLASS 35—ADVERTISING AND BUSINESS**

FOR MAIL ORDER, TELEPHONE AND ON-LINE RETAIL STORE SERVICES FEATURING PRINTED PUBLICATIONS, BOOKLETS, BROCHURES, CHARTS AND SHEETS IDENTIFYING CELESTIAL BODIES AND THEIR LOCATIONS AND INFORMATION PERTAINING TO ASTRONOMY; MAIL ORDER, TELEPHONE AND ON-LINE RETAIL STORE SERVICES FEATURING PRINTED CERTIFICATES AND CHARTS USED TO NAME A STAR WITH THE CUSTOMER'S SELECTED NAME AND BOOKS AND DIRECTORIES LISTING AND CATALOGING THE STARS THAT HAVE BEEN NAMED (U.S. CLS. 100, 101 AND 102).

FIRST USE 6-0-1999; IN COMMERCE 6-0-1999.  
KEVON CHISOLM, EXAMINING ATTORNEY

SN 76-416,219. CHEN, RONG, VANCOUVER, BRITISH COLUMBIA, CANADA, FILED 5-31-2002.

**TILI**

PRIORITY CLAIMED UNDER SEC. 44(D) ON CANADA APPLICATION NO. 1139179, FILED 4-29-2002, REG. NO. TMA604737, DATED 3-10-2004, EXPIRES 3-10-2019.

**CLASS 7—MACHINERY**

FOR DISHWASHERS, CLOTHES WASHING MACHINES, ALTERNATING CURRENT GENERATORS, REFRIGERATION COMPRESSORS (U.S. CLS. 13, 19, 21, 23, 31, 34 AND 35).

**CLASS 11—ENVIRONMENTAL CONTROL APPARATUS**

FOR ELECTRIC AND GAS STOVES, FREEZERS, BUILT-IN AND PORTABLE ELECTRICAL SPACE HEATERS, WATER PURIFIERS, AIR CONDITIONERS AND PARTS THEREFOR, RANGE HOODS (U.S. CLS. 13, 21, 23, 31 AND 34).

WON TEAK OH, EXAMINING ATTORNEY

SN 76-421,052. TICONA GMBH, FRANKFURT AM MAIN, FED REP GERMANY, FILED 6-14-2002.

**CRYSTAL DEW**

OWNER OF FED REP GERMANY REG. NO. 30227285, DATED 6-3-2002, EXPIRES 6-30-2012.

**CLASS 1—CHEMICALS**

FOR UNPROCESSED PLASTICS (U.S. CLS. 1, 5, 6, 10, 26 AND 46).

**CLASS 20—FURNITURE AND ARTICLES NOT OTHERWISE CLASSIFIED**

FOR BEADS MADE FROM PLASTIC MATERIALS, USED FOR DECORATIVE PURPOSES OTHER THAN JEWELRY (U.S. CLS. 2, 13, 22, 25, 32 AND 50).

TRACY FLETCHER, EXAMINING ATTORNEY

SN 76-423,472. PUGET SOUND BLOOD CENTER AND PROGRAM, SEATTLE, WA. FILED 6-20-2002.

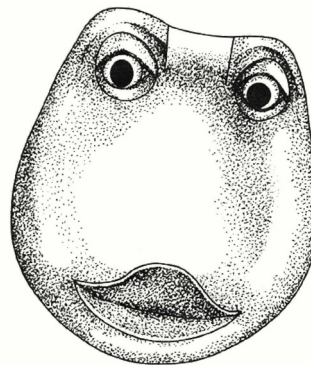

THE STIPPLING IS FOR SHADING PURPOSES ONLY.  
THE MARK CONSISTS OF A THREE-DIMENSIONAL CHARACTER IN THE FORM OF A RED BLOOD CELL WITH FACIAL FEATURES.

**CLASS 9—ELECTRICAL AND SCIENTIFIC APPARATUS**

FOR PRE-RECORDED EDUCATIONAL AUDIO, VIDEO TAPES, DVDS AND CD-ROMS; CHILDREN'S EDUCATIONAL SOFTWARE IN THE FIELD OF SCIENCE AND HEALTH; COMPUTER AND VIDEO GAME SOFTWARE; DISPOSABLE PLASTIC AND LATEX GLOVES FOR LABORATORY USE, DISPOSABLE, REUSABLE DISPENSER SYRINGES FOR LABORATORY USE, LABORATORY EQUIPMENT AND SUPPLIES, NAMELY TEST TUBES, GLASSWARE AND THERMOMETERS (U.S. CLS. 21, 23, 26, 36 AND 38).

FIRST USE 7-0-2000; IN COMMERCE 9-0-2000.

**CLASS 16—PAPER GOODS AND PRINTED MATTER**

FOR SERIES OF EDUCATIONAL BOOKS, WORKBOOKS, NEWSLETTERS, BROCHURES, MAGAZINES, PAMPHLETS, ALL IN THE FIELD OF HEALTH AND SCIENCE; BOOKMARKS, POST CARDS, STATIONERY, GREETING CARDS, POSTERS, CARTOON STRIPS AND PRINTS, CHILDREN'S ACTIVITY AND COLORING BOOKS, PENS, PENCILS, ERASERS, FLASH CARDS, INFORMATIONAL SHEETS ABOUT SCIENCE AND HEALTH, MEDICAL IDENTIFICATION CARDS, MEMO PADS, PAPER TOWELS, PICTURE BOOKS (U.S. CLS. 2, 5, 22, 23, 29, 37, 38 AND 50).

FIRST USE 7-0-2000; IN COMMERCE 9-0-2000.

**CLASS 41—EDUCATION AND ENTERTAINMENT**

FOR EDUCATIONAL DEMONSTRATIONS; EDUCATIONAL SERVICES, NAMELY, CONDUCTING CLASSES, SEMINARS, PROGRAMS, CONFERENCES AND WORKSHOPS IN THE FIELDS OF SCIENCE AND HEALTH AND DISTRIBUTING COURSE MATERIALS IN CONNECTION THEREWITH (U.S. CLS. 100, 101 AND 107).

FIRST USE 7-0-2000; IN COMMERCE 9-0-2000.

**CLASS 44—MEDICAL, BEAUTY AND AGRICULTURAL SERVICES**

FOR BLOOD BANK SERVICES, NAMELY, THE COLLECTION OF BLOOD, TESTING AND PROCESSING OF BLOOD; PRESERVATION AND STORAGE OF BLOOD AND BLOOD COMPONENTS; PROVIDING INFORMATION IN THE FIELD OF HEALTH (U.S. CLS. 100 AND 101).

FIRST USE 7-0-2000; IN COMMERCE 9-0-2000.

HEATHER THOMPSON, EXAMINING ATTORNEY

**CLASS 9—ELECTRICAL AND SCIENTIFIC APPARATUS**

FOR SURVEYING APPARATUS AND INSTRUMENTS, NAMELY GLOBAL POSITIONING SYSTEM INSTRUMENTS, DIGITIZING TABLES, DISTANCE METERS, LEVELS, THEODOLITES; BLANK MAGNETIC DATA-CARRIERS; CALCULATORS; DATA PROCESSORS AND COMPUTERS; BLANK OPTICAL DATA CARRIERS; COMPUTER MEMORIES; COMPUTER PERIPHERALS; RECORDED COMPUTER SOFTWARE AND RECORDED COMPUTER PROGRAMS CONTAINING OR USED FOR HANDLING GEOGRAPHICAL DATA AND GEOGRAPHICAL INFORMATION FOR USE IN THE FIELD OF CADASTRE, SURVEYING AND MAPPING (U.S. CLS. 21, 23, 26, 36 AND 38).

**CLASS 16—PAPER GOODS AND PRINTED MATTER**

FOR PRINTER MATTER, NAMELY ATLASES AND MAPS; BOOKBINDING MATERIAL, NAMELY CLOTH, TAPE AND WIRE; PHOTOGRAPHS; STATIONERY; ADHESIVES FOR STATIONERY AND HOUSEHOLD PURPOSES; PAINT BRUSHES; PRINTED INSTRUCTIONAL AND TEACHING MATERIAL IN THE FIELD OF CADASTRE, SURVEYING, MAPPING AND GEOGRAPHIC INFORMATION SYSTEMS; PRINTING TYPE; PRINTING BLOCKS; GEOGRAPHICAL MAPS (U.S. CLS. 2, 5, 22, 23, 29, 37, 38 AND 50).

**CLASS 35—ADVERTISING AND BUSINESS**

FOR DATA PROCESSING SERVICES; COMMERCIAL AND/OR INDUSTRIAL MANAGEMENT ASSISTANCE, COMMERCIAL AND BUSINESS INVESTIGATIONS AND BUSINESS APPRAISALS; COST PRICE ANALYSIS AND ECONOMIC FORECASTING; CONDUCTING MARKETING STUDIES AND MARKETING RESEARCH; SUBMITTING, COLLECTING AND EVALUATION OF STATISTICAL INFORMATION (U.S. CLS. 100, 101 AND 102).

**CLASS 42—SCIENTIFIC, COMPUTER AND LEGAL SERVICES**

FOR PROVIDING A COMPUTER DATABASE FOR GEOLOGICAL AND LAND SURVEYING; DESIGNING, UPDATING, MAINTENANCE AND RENTAL OF COMPUTER SOFTWARE; COMPUTER PROGRAMMING; PROVIDING COMPUTER DATA BASES COMPRISING GEOGRAPHICAL INFORMATION VIA GLOBAL NETWORKS; MAPPING, MAP-DRAWING AND CONSTRUCTION DRAFTING WITHIN THE FIELDS OF LAND SURVEYING AND INFRASTRUCTURE; DESIGNING COMPUTER SYSTEMS FOR GEOGRAPHICAL INFORMATION AND ANALYSIS BASED ON GEOGRAPHICAL INFORMATION; TECHNICAL CONSULTANCY FOR LAND SURVEYING SERVICES; INFORMATION SERVICES WITHIN THE FIELD OF LAND SURVEYING; RECOVERY OF COMPUTER DATA; SURVEY SERVICES, NAMELY, EVALUATION OF FOREST AREAS AND STANDING TIMBER; SURVEY SERVICES, NAMELY FILING AND COLLECTING LAND SURVEYING INFORMATION AND DOCUMENTATION; GEOLOGIC AND LAND SURVEY INFORMATION SERVICES, NAMELY, COMPILATION OF GEOGRAPHICAL INFORMATION FROM COMPUTER DATABASES; TERRAIN MODELING, NAMELY, CREATION AND ANALYSIS OF DIGITAL REPRESENTATIONS OF THE LAND SURFACE (U.S. CLS. 100 AND 101).

KATHLEEN M. VANSTON, EXAMINING ATTORNEY

SN 76-428,331. LANTMITERIVERKET, SE- 801 82 GAVLE, SWEDEN, FILED 6-24-2004.

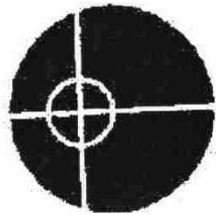

OWNER OF SWEDEN REG. NO. 353265, DATED 3-8-2002, EXPIRES 3-8-2012.

SN 76-435,911. CROSBY, INC., LOS ANGELES, CA. FILED 7-31-2002.

## SHELTER

### CLASS 20—FURNITURE AND ARTICLES NOT OTHERWISE CLASSIFIED

FOR FURNITURE (U.S. CLS. 2, 13, 22, 25, 32 AND 50). FIRST USE 6-1-1988; IN COMMERCE 6-1-1988.

### CLASS 35—ADVERTISING AND BUSINESS

FOR RETAIL STORE SERVICES IN THE FIELD OF FURNITURE AND HOME FURNISHINGS (U.S. CLS. 100, 101 AND 102).

FIRST USE 6-1-1988; IN COMMERCE 6-1-1988. BRIAN PINO, EXAMINING ATTORNEY

SN 76-454,816. GOLDEN BOY FOODS INC., BURNABY BRITISH COLUMBIA, CANADA, FILED 9-26-2002.

## FROM OUR FAMILY TO YOURS

PRIORITY CLAIMED UNDER SEC. 44(D) ON CANADA APPLICATION NO. 1,135,029, FILED 3-20-2002, REG. NO. TMA589075, DATED 9-8-2003, EXPIRES 9-8-2018.

### CLASS 29—MEATS AND PROCESSED FOODS

FOR PEANUT BUTTER, SNACKING NUTS, BAKING NUTS, DRIED FRUITS; TRAIL MIXES CONSISTING PRIMARILY OF PROCESSED FRUITS, RAW OR PROCESSED NUTS, RAW OR PROCESSED SEEDS, RAW OR PROCESSED RAISINS; PROCESSED BEANS AND PEAS; LENTILS AND PROCESSED MEDIUM SIZE FLAKED AND SHREDDED COCONUT (U.S. CL. 46).

FIRST USE 0-0-1996; IN COMMERCE 0-0-1996.

### CLASS 30—STAPLE FOODS

FOR SPICES AND RICE (U.S. CL. 46). FIRST USE 0-0-1996; IN COMMERCE 0-0-1996.

### CLASS 31—NATURAL AGRICULTURAL PRODUCTS

FOR UNPROCESSED BEANS AND UNPROCESSED PEAS (U.S. CLS. 1 AND 46).

FIRST USE 0-0-1996; IN COMMERCE 0-0-1996. KARANENDRA S. CHHINA, EXAMINING ATTORNEY

SN 76-458,495. PETRO STAR, INC., ANCHORAGE, AK. FILED 10-16-2002.

## FUELING ALASKA'S FUTURE

### CLASS 4—LUBRICANTS AND FUELS

FOR PETROLEUM PRODUCTS, NAMELY, FUEL, OIL, GASOLINE, DIESEL FUEL, AND CRUDE OIL (U.S. CLS. 1, 6 AND 15).

### CLASS 35—ADVERTISING AND BUSINESS

FOR RETAIL CONVENIENCE STORE SERVICES, RETAIL STORE AND WHOLESALE DISTRIBUTORSHIPS FEATURING PETROLEUM PRODUCTS, NAMELY, FUEL OIL, GASOLINE, DIESEL FUEL, AND CRUDE OIL (U.S. CLS. 100, 101 AND 102).

### CLASS 40—MATERIAL TREATMENT

FOR OIL AND FUEL REFINING SERVICES (U.S. CLS. 100, 103 AND 106).

KELLEY WELLS, EXAMINING ATTORNEY

SN 76-458,714. CONAGRA BRANDS, INC., OMAHA, NE. FILED 10-16-2002.

## COOKOUT HEROES

### CLASS 29—MEATS AND PROCESSED FOODS

FOR FRESH, FROZEN AND PROCESSED POULTRY; FROZEN PREPARED ENTREES CONSISTING PRIMARILY OF BEEF, PORK, OR POULTRY; FRANKFURTERS; SAUSAGES; PROCESSED MEATS; CANNED PORK AND BEANS; CANNED BEANS WITH SLICED WIENERS IN TOMATO SAUCE; FRENCH FRIED POTATOES; AND COOKING OIL (U.S. CL. 46).

### CLASS 30—STAPLE FOODS

FOR KETCHUP, MUSTARD, BARBECUE SAUCE, AND RELISH (U.S. CL. 46).

INGRID C. EULIN, EXAMINING ATTORNEY

SN 76-461,925. GOALSTRIKER GROUP LIMITED, FARNHAM, SURREY, GU10 3AB, UNITED KINGDOM, FILED 10-25-2002.

# GoalStriker



PRIORITY CLAIMED UNDER SEC. 44(D) ON ERP N CMNTY TM OFC APPLICATION NO. 2761385, FILED 7-3-2002, REG. NO. 2761385, DATED 2-25-2004, EXPIRES 7-3-2012.

### CLASS 9—ELECTRICAL AND SCIENTIFIC APPARATUS

FOR ELECTRONIC SOCCER GAMES CONSISTING OF A LIFE-SIZE AND SCALED-DOWN INTERACTIVE PENALTY GAME FOR USE WITH A SCREEN; COMPUTERIZED INTERACTIVE SOCCER SKILL GAMES ON CARTRIDGES, DISKETTES, CASSETTES, CD-ROMS, DVD-ROMS (U.S. CLS. 21, 23, 26, 36 AND 38).

### CLASS 28—TOYS AND SPORTING GOODS

FOR SPORTING GOODS AND GAMES AND PLAYTHINGS RELATING TO SPORTS, NAMELY SOCCER BALLS AND SOCCER TABLES FOR INDOOR USE; STAND-ALONE ELECTRONIC SOCCER GAMES CONSISTING OF A LIFE-SIZE AND SCALED-DOWN INTERACTIVE PENALTY GAME; COMPUTERIZED INTERACTIVE PENALTY GAME; COMPUTERIZED INTERACTIVE SOCCER SKILLS GAME (U.S. CLS. 22, 23, 38 AND 50).

**CLASS 41—EDUCATION AND ENTERTAINMENT**

FOR ENTERTAINMENT SERVICES, NAMELY PROVIDING INTERACTIVE ACTION SKILL GAMES RELATING TO SPORTS (U.S. CLS. 100, 101 AND 107).  
KEVON CHISOLM, EXAMINING ATTORNEY

SN 76-464,188. INTUIT INC., MOUNTAIN VIEW, CA. FILED 11-4-2002.

---

**INTUIT**

OWNER OF U.S. REG. NOS. 1,840,504, 1,944,876 AND OTHERS.

**CLASS 42—SCIENTIFIC, COMPUTER AND LEGAL SERVICES**

FOR TECHNICAL SUPPORT SERVICES, NAMELY TROUBLESHOOTING OF COMPUTER HARDWARE AND SOFTWARE PROBLEMS, DATA CONVERSION OF COMPUTER PROGRAM DATA OR INFORMATION; COMPUTER SOFTWARE INSTALLATION AND SETUP SERVICES; COMPUTER SOFTWARE AND SYSTEMS INTEGRATION SERVICES; COMPUTER SERVICES, NAMELY, DATA RECOVERY SERVICES; COMPUTER SOFTWARE INSTALLATION AND CONFIGURATION SUPPORT (U.S. CLS. 100 AND 101).  
FIRST USE 0-0-1984; IN COMMERCE 0-0-1984.

**CLASS 45—PERSONAL SERVICES**

FOR MONITORING OF COMPUTER SYSTEMS FOR SECURITY PURPOSES; COMPUTER SYSTEMS SECURITY SERVICES, NAMELY PASSWORD REMOVAL AND PROTECTION; SECURITY PRINTING, NAMELY ENCODING IDENTIFICATION INFORMATION ON VALUABLE DOCUMENTS (U.S. CLS. 100 AND 101).  
FIRST USE 2-0-1994; IN COMMERCE 2-0-1994.  
CHERYL CLAYTON, EXAMINING ATTORNEY

SN 76-464,701. MEDIA-TECH E.V., 60325 FRANKFURT, FED REP GERMANY, FILED 11-6-2002.

---

**MEDIA TECH**

PRIORITY CLAIMED UNDER SEC. 44(D) ON ERPNTY TM OFC APPLICATION NO. 002684744, FILED 5-6-2002, REG. NO. 2684744, DATED 6-18-2003, EXPIRES 5-6-2012.

**CLASS 16—PAPER GOODS AND PRINTED MATTER**

FOR INFORMATION BOOKLETS FEATURING INFORMATION ON REPRODUCTION AND MULTIPLICATION OF MEDIA; PRINTED MATTER— NAMELY BROCHURES, MAGAZINES, MANUALS, FEATURING INFORMATION ON REPRODUCTION AND MULTIPLICATION OF MEDIA; PRINTED INSTRUCTION AND TEACHING MATERIALS IN THE AREA OF INFORMATION ON REPRODUCTION AND MULTIPLICATION OF MEDIA (U.S. CLS. 2, 5, 22, 23, 29, 37, 38 AND 50).

**CLASS 35—ADVERTISING AND BUSINESS**

FOR COLLECTION AND DISSEMINATION OF INFORMATION AND DATA RELATING TO MARKETS; COLLECTION AND DISSEMINATION OF INFORMATION AND DATA RELATING TO TECHNOLOGIES AND STANDARDS FOR DIGITAL STORAGE OF INFORMATION ON OPTICAL DISCS; ORGANIZATION OF TRADE FAIRS IN THE FIELD OF REPRODUCTION AND MULTIPLICATION OF MEDIA (U.S. CLS. 100, 101 AND 102).

**CLASS 41—EDUCATION AND ENTERTAINMENT**

FOR ORGANIZATION OF CONFERENCES AND EXHIBITIONS IN THE FIELD OF REPRODUCTION OF MEDIA; PROVIDING OF EDUCATION AND TRAINING IN THE FIELD OF REPRODUCTION AND MULTIPLICATION OF MEDIA; ENTERTAINMENT, SPORTING AND CULTURAL ACTIVITIES PROVIDED IN CONNECTION WITH CONFERENCES, EXHIBITIONS AND TRADE FAIRS IN THE FIELD OF REPRODUCTION AND MULTIPLICATION OF MEDIA (U.S. CLS. 100, 101 AND 107).  
M. E. BODSON, EXAMINING ATTORNEY

SN 76-465,423. TRADING PLACES INTERNATIONAL, LAGUNA NIGUEL, CA. FILED 11-7-2002.

---

**PICK YOUR PRICE**

**CLASS 36—INSURANCE AND FINANCIAL**

FOR RESIDENTIAL REAL ESTATE RENTAL SERVICES, NAMELY, REAL ESTATE TIME-SHARING, TIME-SHARE TRADING FOR OTHERS AND TIME-SHARE MANAGEMENT, CONDOMINIUM RENTALS (U.S. CLS. 100, 101 AND 102).

**CLASS 39—TRANSPORTATION AND STORAGE**

FOR TRAVEL AGENCY SERVICES, NAMELY, MAKING RESERVATIONS AND BOOKINGS FOR TRANSPORTATION (U.S. CLS. 100 AND 105).

**CLASS 43—HOTEL AND RESTAURANT SERVICES**

FOR TRAVEL AGENCY SERVICES, NAMELY, MAKING RESERVATIONS AND BOOKINGS FOR TEMPORARY LODGING (U.S. CLS. 100 AND 101).  
WON TEAK OH, EXAMINING ATTORNEY

SN 76-467,095. SMITH, KIMBERLY ANN, PRINCETON, NJ. FILED 11-6-2002.

---

**PLAY DOG INTERNATIONAL**

NO CLAIM IS MADE TO THE EXCLUSIVE RIGHT TO USE "INTERNATIONAL", APART FROM THE MARK AS SHOWN.

**CLASS 18—LEATHER GOODS**

FOR CLOTHING FOR ANIMALS (U.S. CLS. 1, 2, 3, 22 AND 41).



**CLASS 28—TOYS AND SPORTING GOODS**

FOR DOLLS, DOLLHOUSES, PAPER DOLLS, PAPER DOLL CLOTHING, CLOTHING FOR DOLLS (U.S. CLS. 22, 23, 38 AND 50).

**CLASS 39—TRANSPORTATION AND STORAGE**

FOR TRANSPORTATION SERVICES, NAMELY TRANSPORTATION OF PERSONS AND PETS BY AIR (U.S. CLS. 100 AND 105).

DEZMONA MIZELLE, EXAMINING ATTORNEY

SN 76-467,156. DEUTSCHE TELEKOM AG, 53113 BONN, FED REP GERMANY, FILED 11-6-2002.

# MaxiAbo

PRIORITY CLAIMED UNDER SEC. 44(D) ON FED REP GERMANY APPLICATION NO. 30222357.6/3, FILED 5-6-2002, REG. NO. 30222357, DATED 4-7-2003, EXPIRES 5-31-2012.

**CLASS 9—ELECTRICAL AND SCIENTIFIC APPARATUS**

FOR ELECTRIC, ELECTRONIC, OPTICAL, MEASURING, SIGNALING, CONTROLLING AND TEACHING APPARATUS AND INSTRUMENTS, ALL FOR USE WITH TELECOMMUNICATIONS, NAMELY, APPARATUS FOR PRODUCING SOUND, IMAGES OR DATA, NAMELY, MAGNETIC AND OPTICAL DATA CARRIERS, DATA PROCESSORS AND COMPUTERS, NAMELY, MICROCOMPUTERS, MINICOMPUTERS, COMPUTER CENTRAL PROCESSORS, COMPUTER MONITORS, COMPUTER KEYBOARDS, COMPUTER TERMINALS, COMPUTER INTERFACE BOARDS, COMPUTER MEMORIES, COMPUTER LASER PRINTERS, COMPUTER IMPACT PRINTERS, COMPUTER DOT MATRIX PRINTERS, COMPUTER OPERATING SYSTEMS, COMPUTERS AND INSTRUCTIONAL MANUALS SOLD AS A UNIT, COMPUTER INTERFACE APPARATUS, NAMELY, COMPUTER MODEMS, COMPUTER MOUSE AND MOUSE PAD, COMPUTER PERIPHERALS AND PARTS THEREOF; COMPUTER PROGRAMS AND DATABASES FOR USE IN OPERATING TELECOMMUNICATIONS AND BUSINESS MANAGEMENT SYSTEMS AND RELATED INSTRUCTION MANUALS SOLD AS A UNIT; COMPUTER PROGRAMS, NAMELY, FINANCIAL ACCOUNTING SYSTEM SOFTWARE, SOFTWARE USED FOR THE PROVISION OF ONLINE INFORMATION SERVICES, NETWORK MANAGEMENT SOFTWARE, COMPUTER PROXY SOFTWARE FOR USE WITH OTHER SOFTWARE PROGRAMS, COMPUTER PROGRAMS AND SOFTWARE FOR CONTROLLING ACCESS AND ALARM MONITORING OF HOMES, APARTMENTS, BUILDINGS AND OTHER PROPERTIES, BILLING ANALYSIS SOFTWARE, AND SOFTWARE FOR NETWORK ACCESS CONTROL AND FOR CREATING AND MAINTAINING FIREWALLS; COMPUTER PROGRAMS FOR ACCESSING A GLOBAL COMPUTER NETWORK AND INTERACTIVE COMPUTER COMMUNICATIONS NETWORK; OPTICAL CABLES, OPTIC FILTERS, OPTICAL SCANNERS, OPTICAL CHARACTER READERS, OPTICAL DISCS, OPTICAL FIBERS, OPTICAL GLASS FOR SIGNAL TRANSMISSION, OPTIC TRANSMITTERS, OPTIC RECEIVERS, OPTICAL SIGNAL PROCESSING APPARATUS, OPTIC SWITCHES, OPTICAL ATTENUATORS, OPTICAL AMPLIFIERS, OPTICAL CHARACTER RECOGNITION APPARATUS, AND PARTS THEREOF; AUDIO, VIDEO AND DATA COMMUNICATIONS SYSTEMS, NAMELY, DIGITAL

AND ANALOGUE SIGNAL TRANSMITTERS, RECEIVERS AND CONVERTERS, RADIO AND TELEPHONE TRANSMITTERS, RECEIVERS AND SERVERS, ANSWERING MACHINES, TELECOMMUNICATION TRANSMISSION, RECEIVING AND STORAGE APPARATUS, NAMELY, TELECOMMUNICATIONS TRANSMITTING SETS, DATA TRANSMITTERS, FACSIMILE MACHINES, ELECTRONIC MAIL APPARATUS FOR ELECTRONIC EXCHANGE OF DATA IMAGES AND MESSAGES, REMOTE CONTROLS AND SET-TOP UNITS FOR TELEVISION, CINEMATOGRAPHIC TELEVISION AND AMUSEMENT EQUIPMENT, NAMELY, SIGNAL DECODERS, ELECTRICAL WIRE, ELECTRICAL WIRE CONNECTORS, INTEGRATED CIRCUITS, PRINTED CIRCUITS, ELECTRIC CIRCUITS, CIRCUIT BREAKERS, PRINTED CIRCUIT BOARDS, ELECTRIC CIRCUIT BOARDS, CIRCUIT CONNECTORS, ELECTRICAL CONTROLLERS, ELECTRICAL CONVERTERS, ELECTRICAL FUSES, ELECTRIC LUMINESCENT DISPLAY PANELS, ELECTRICAL SWITCH PLATES, ELECTRIC PLUGS, ANTENNAS, ELECTRICAL CABLES, COMPUTER CABLES, COMPUTER CHIPS, SILICON CHIPS, CHRONOGRAPHS FOR USE AS SPECIALIZED TIME RECORDING APPARATUS, ELECTRIC COILS, COMPUTER BUFFERS, BLANK COMPUTER DISCS, BLANK COMPUTER FLOPPY DISKS, COMPUTER HARD DISCS, ELECTRICAL CONDUCTORS, ACOUSTIC CONDUITS, ELECTRICAL CONDUITS, FIBER OPTIC CONDUITS AND PARTS THEREOF; COMPACT DISC PLAYERS, AUDIO AND VIDEO TAPE RECORDERS, AUDIO AND VIDEO TAPE PLAYERS, AUDIO AND VIDEO CASSETTE RECORDERS, AUDIO AND VIDEO CASSETTE PLAYERS, BLANK AUDIO AND VIDEO TAPES, CASSETTES, DISCS AND MICROFICHE; AUDIO AND VIDEO TAPES, CASSETTES, DISCS AND MICROFICHE FEATURING INFORMATION CONCERNING TELECOMMUNICATIONS, AND CONCERNING PERSONAL AND BUSINESS MANAGEMENT SYSTEMS; AUDIO AND VIDEO RECORDINGS IN THE FIELD OF TELECOMMUNICATIONS, INFORMATION TECHNOLOGY, SAFETY; TELEVISION AND TELEVISION PERIPHERAL EQUIPMENT, NAMELY CAMERAS, SET BOXES, REMOTE CONTROL UNITS FOR INTERACTIVE AND NON-INTERACTIVE USE; COMPUTER MEMORY, COMPUTER PERIPHERALS AND MODEMS; VIDEO MONITORS, AUTOMATIC VENDING MACHINES AND TIMING MECHANISMS THEREFOR, AND PARTS THEREOF; MACHINE READABLE, MAGNETICALLY ENCODED CARDS, NAMELY, PREPAID TELEPHONE CALLING CARDS AND CREDIT CARDS; SMART CARDS; DATA PROCESSORS AND READERS, WORD PROCESSORS, MAGNETIC CODED CARD READERS, MAGNETIC CODED KEY CARDS, NAMELY, FIDELITY CARDS, ELECTRONIC ENCRYPTION UNITS, LASERS NOT FOR MEDICAL USE, LIGHT EMITTING DIODES, LIGHT EMITTING DIODE DISPLAYS, MICROPROCESSORS, BLANK DATA CARRIERS, DEMAGNETIZERS FOR MAGNETIC TAPES, AND PARTS THEREOF; COMPUTER, DATA AND VIDEO NETWORKING AND REFERENCING EQUIPMENT, NAMELY, TELECONFERENCING EQUIPMENT AND AUDIOVISUAL TEACHING EQUIPMENT IN THE NATURE OF OVERHEAD FILM, PHOTOGRAPHIC AND SLIDE PROJECTORS, PROJECTION SCREENS, COMPUTER BASED INFORMATION DISPLAY EQUIPMENT, NAMELY, COMPUTERS WHICH DISPLAY INFORMATION ON AN OVERHEAD SCREEN, INTERCOMS; TELEPHONES, TELEPHONE ANSWERING MACHINES, TELEPHONE TRANSMITTERS, TELEPHONE NETWORKS, TELEPHONE WIRES, TELEPRINTERS, TELETYPEWRITERS, AND PARTS THEREOF, NAMELY, CALLER IDENTIFICATION BOXES, DIALING ASSEMBLIES, TELEPHONE UNITS, AUDIO OPERATED RELAYS, AUDIO OPERATED RELAYS, AUDIO/VIDEO SIGNAL AND OPTICAL FILTERS, PROTECTORS AND AUTOMATIC SIGNALING AND CONTROL EQUIPMENT, TELEMETERS, WIRELESS AND CELLULAR TELEPHONES, RADIO PAGERS, PORTABLE COMPUTER DEVICES, NAMELY LAPTOPS, HANDHELD AND POCKET COMPUTERS, FACSIMILE TRANSMITTERS AND RECEIVERS, WIRELESS FAX MACHINES, PERSONAL COMMUNICATIONS EQUIPMENT, NAMELY, PERSONAL DIGITAL ASSISTANTS, CALCULATORS AND RELATED PERIPHERALS; SATELLITE PROCESSORS, SATELLITES AND SATELLITE COMMUNICATION EARTH STATIONS BOTH STATIONARY AND MOVEABLE; AUDIO AND VIDEO RECORDINGS IN THE FIELD OF NEWS, SPORTS, ENTERTAINMENT, CULTURE, BUSINESS AND FINANCE, WEATHER AND TRAVEL; PRERE-

CORDED COMPACT DISCS, AUDIO CASSETTE TAPES, VIDEO CASSETTE TAPES, DIGITAL AUDIO TAPES AND DIGITAL VIDEO DISCS FEATURING MUSICAL, VARIETY, NEWS AND COMEDY SHOWS; COMPUTER GAME PROGRAMS FOR CHILDREN AND ADULTS; VIDEO AND COMPUTER GAME CARTRIDGES (U.S. CLS. 21, 23, 26, 36 AND 38).

#### **CLASS 16—PAPER GOODS AND PRINTED MATTER**

FOR PRINTED MATTER, NAMELY, TELEPHONE DIRECTORIES, BOOKS, NEWSLETTERS, PAMPHLETS, BROCHURES, MAGAZINES AND PAPERBACKS ALL IN THE FIELD OF TELECOMMUNICATIONS, PRINTED AND STAMPED PLASTIC AND CARDBOARD GREETING, BLANK, NOTE, AND INDEX CARDS; NOTE PAPER AND ENVELOPES, RUBBER STAMPS, NAME TAGS AND LABELS MADE FROM PAPER OR CARDBOARD, NOTEBOOKS, DIARIES, NOTE PAPERS, NOTE PADS, ADDRESS BOOKS, FOLDERS FOR LETTERS AND LOOSE PAPERS, CLEAR HOLE REINFORCEMENTS, STUDENT CALENDARS, STAMP ALBUMS AND PHOTO-ALBUMS; PAPER WEIGHTS, LETTER OPENERS, BLOTTER PADS; DESK TRAYS, DESK STANDS AND HOLDERS FOR HOLDING STATIONERY AND OFFICE IMPLEMENTS; PRINTED INSTRUCTIONAL AND TEACHING MATERIALS ALL IN THE FIELDS OF TELECOMMUNICATIONS, INFORMATION TECHNOLOGY, SAFETY, NEWS, SPORTS, ENTERTAINMENT, CULTURE, BUSINESS AND FINANCE, WEATHER AND TRAVEL; STATIONERY, RULERS, ERASERS, STAPLERS, STAPLES, PAPER CLIPS, BOOK MARKERS, CUTOUT SAMPLES AND STENCILS; SCRATCH PICTURES, PAPER, NAMELY, BOND PAPER AND ART PAPER, PVC STICKERS, GIFT WRAP PAPER; BLACKBOARDS, CHALK STICKS, ADHESIVES FOR STATIONERY OR HOUSEHOLD PURPOSES; DRAWING AND PAINTING MATERIALS, NAMELY, PENCILS, DRAWING PENCILS, PENS, DRAWING PENS, PAINT TRAYS, PAINTING SETS FOR ARTISTS, PAINTING SETS FOR CHILDREN, CRAFT PAINT KITS, AND PENCIL CASES; NON-MAGNETICALLY ENCODED, PREPAID TELEPHONE CALLING CARDS (U.S. CLS. 2, 5, 22, 23, 29, 37, 38 AND 50).

#### **CLASS 35—ADVERTISING AND BUSINESS**

FOR TELEPHONE DIRECTORY ASSISTANCE; ADVERTISING SERVICES, NAMELY, PREPARING AND PLACING ADVERTISEMENTS FOR OTHERS PROMOTING THE GOODS AND SERVICES OF OTHERS THROUGH PRINTED ADVERTISING, PRINTED DIRECTORIES, THROUGH ENCODED MEDIA, THROUGH THE DISSEMINATION OF PROMOTIONAL MATERIALS, THROUGH DIRECT MAIL ADVERTISING, THROUGH ELECTRONIC BILLBOARD ADVERTISING, PREPARING AUDIO-VISUAL PRESENTATIONS FOR USE IN ADVERTISING; BUSINESS SERVICES, NAMELY, BUSINESS APPRAISALS, BUSINESS AUDITING, PROVIDING BUSINESS INFORMATION, NAMELY, PREPARING BUSINESS REPORTS AND CONDUCTING BUSINESS RESEARCH, ANALYSIS AND SURVEYS, BUSINESS MANAGEMENT PLANNING, BUSINESS MANAGEMENT CONSULTATION, BUSINESS MANAGEMENT SUPERVISION, CONDUCTING BUSINESS NETWORKING FOR OTHERS; BUSINESS MANAGEMENT AND CONSULTING SERVICES EXCLUDING AGRICULTURAL BUSINESS MANAGEMENT AND CONSULTING SERVICES; BUSINESS INFORMATION SERVICES IN THE FIELD OF TELECOMMUNICATIONS, ADVERTISING, INFORMATION TECHNOLOGY, MARKETING AND RELATED FIELDS; RENTAL OF AUTOMATIC VENDING MACHINES; ORGANIZING JOB FAIRS; RENTAL OF DATA PROCESSING EQUIPMENT (U.S. CLS. 100, 101 AND 102).

#### **CLASS 36—INSURANCE AND FINANCIAL**

FOR INSURANCE SERVICES, NAMELY, INSURANCE BROKERAGE, INSURANCE CLAIMS PROCESSING; FINANCIAL SERVICES, NAMELY, CLEARING OF SECURE FINANCIAL TRANSACTIONS THROUGH ONLINE SERVICES; FINANCIAL ANALYSIS AND CONSULTATION, PROVIDING FINANCIAL INFORMATION, ISSUANCE OF SECURITIES, COMMERCIAL LENDING SERVICES, FINANCIAL PORTFOLIO MANAGEMENT, DISCOUNT BROKERAGE SERVICES, BROKERAGE OF SHARES AND BUSINESS VENTURES, BROKERAGE OF FUND SHARES, SECURITIES CONSULTING AND SAFE KEEPING, BROKERAGE OF PRODUCTIVE INVESTMENTS AND FUNDS; FINANCIAL SPONSORSHIP OF SPORTS, EDUCATIONAL AND ENTERTAINMENT PROGRAMS AND EVENTS; REAL ESTATE SERVICES, NAMELY BROKERAGE, MANAGEMENT, LEASING, APPRAISAL OF REAL PROPERTY; CUSTOMS BROKERAGE FOR THIRD PARTIES; MONETARY EXCHANGE; CREDIT CARD SERVICES; TELEPHONE CALLING CARD SERVICES; ELECTRONIC COMMERCE SERVICES, NAMELY, ELECTRONIC DEBIT AND CREDIT CARD PROCESSING SERVICES, FUNDS TRANSFER AND PAYMENT PROCESSING SERVICES; PROVIDING INFORMATION VIA THE TELEPHONE AND THE GLOBAL COMMUNICATION NETWORKS IN THE FIELD OF BUSINESS AND FINANCE (U.S. CLS. 100, 101 AND 102).

#### **CLASS 38—COMMUNICATION**

FOR TELECOMMUNICATIONS AND INFORMATION TECHNOLOGY SERVICES, NAMELY ELECTRIC, DIGITAL, CELLULAR AND WIRELESS TRANSMISSION OF VOICE, DATA, INFORMATION, IMAGES, SIGNALS AND MESSAGES AND TRANSMISSION OF VOICE, DATA, IMAGES, AUDIO, VIDEO AND INFORMATION VIA TELEPHONE, TELEVISION AND GLOBAL COMMUNICATION NETWORKS; PROVIDING TELECOMMUNICATIONS CONNECTIONS OVER A GLOBAL COMMUNICATIONS NETWORK, ELECTRONIC MAIL, VOICE MAIL AND MESSAGING SERVICES, NAMELY, THE RECORDING AND STORAGE AND SUBSEQUENT TRANSMISSION OF VOICE MESSAGES BY TELEPHONE; RENTAL OF TELECOMMUNICATIONS EQUIPMENT, NAMELY, EQUIPMENT FOR ELECTRONIC ACCESS TO GLOBAL TELECOMMUNICATIONS NETWORK, EQUIPMENT FOR TRANSMITTING, RECEIVING, RECORDING AND MONITORING VOICE, DATA, INFORMATION, IMAGES, SIGNALS, MESSAGES, COMPRISED OF DATA AND WORD PROCESSORS, AND TELECOMMUNICATIONS HARDWARE AND SOFTWARE AND COMPONENTS AND PERIPHERALS THEREOF FOR USE IN THE TELECOMMUNICATIONS INDUSTRY, AND RENTAL OF EQUIPMENT FOR TRANSMITTING, RECEIVING, RECORDING AND MONITORING COMPUTER PROGRAMS FOR USE IN OPERATING AND ACCESSING TELECOMMUNICATIONS SYSTEMS; AUDIO AND VIDEO BROADCASTING FEATURING ENTERTAINMENT IN THE NATURE OF LIVE VISUAL AND AUDIO PERFORMANCES, AND MUSICAL, VARIETY, NEWS AND COMEDY SHOWS; PROVIDING MULTIPLE-USER DIAL-UP AND DEDICATED ACCESS TO THE INTERNET; PERSONAL COMMUNICATIONS SERVICES; PAGER SERVICES; ELECTRONIC MAIL SERVICES; TRANSMISSION AND BROADCAST OF AUDIO AND VIDEO PROGRAMMING; PROVIDING MULTIPLE-USER ACCESS TO A GLOBAL COMMUNICATION INFORMATION NETWORK; LEASING TELECOMMUNICATIONS EQUIPMENT, COMPONENTS, SYSTEMS AND SUPPLIES (U.S. CLS. 100, 101 AND 104).

**CLASS 39—TRANSPORTATION AND STORAGE**

FOR WAREHOUSE STORAGE OF GOODS; STORAGE OF GOODS RELATING TO TELECOMMUNICATIONS, COMPUTERS AND OTHER INFORMATION TECHNOLOGY DEVICES; TRANSPORTATION OF GOODS BY TRUCK, SHIP, RAILWAY AND PLANE; ELECTRONIC STORAGE OF INFORMATION IN THE NATURE OF FILES AND DOCUMENTS; MANAGEMENT OF TRAFFIC FLOW THROUGH ADVANCED COMMUNICATIONS NETWORKS AND TECHNOLOGY; AIR TRAFFIC CONTROL SERVICES; TRAFFIC INFORMATION SERVICES PROVIDED BY TELEPHONE, CELLULAR TELEPHONE, RADIO, COMPUTER OVER A GLOBAL COMPUTER NETWORK; TRAVEL AGENCY SERVICES, NAMELY MAKING RESERVATIONS AND BOOKINGS FOR TRANSPORTATION; ARRANGING TRAVEL TOURS AND CRUISES (U.S. CLS. 100 AND 105).

**CLASS 41—EDUCATION AND ENTERTAINMENT**

FOR EDUCATION AND INSTRUCTION, NAMELY, EDUCATIONAL SERVICES IN THE NATURE OF CLASSES AND SEMINARS IN THE FIELDS OF BUSINESS, TELECOMMUNICATIONS AND COMPUTERS, AND THE DISTRIBUTION OF COURSE MATERIALS THEREWITH; ENTERTAINMENT IN THE NATURE OF VISUAL AND AUDIO PERFORMANCES, NAMELY, MUSICAL BAND, GYMNASIAC, DANCE, AND BALLET PERFORMANCES; ENTERTAINMENT SERVICES, NAMELY, PROVIDING MUSICAL, VARIETY, NEWS AND COMEDY SHOWS VIA A GLOBAL COMPUTER INFORMATION NETWORK; ENTERTAINMENT SERVICES, NAMELY, PROVIDING ON-LINE COMPUTER GAMES FOR CHILDREN AND ADULTS; PROVIDING ENTERTAINMENT INFORMATION AND GENERAL INFORMATION AT THE SPECIFIC REQUEST OF END-USERS BY MEANS OF TELEPHONE OR GLOBAL COMMUNICATIONS NETWORKS; ORGANIZING COMMUNITY SPORTING AND CULTURAL EVENTS; PUBLICATION OF BOOKS, MAGAZINES, JOURNALS, MANUALS, BROCHURES AND LEAFLETS ON THE SUBJECT OF TELECOMMUNICATIONS; ELECTRONIC PUBLISHING SERVICES, NAMELY, PUBLICATION OF TEXT AND GRAPHIC WORKS OF OTHERS ON TELECOMMUNICATIONS RECORDED ON ELECTRONIC MEDIA; ORGANIZING FAIRS AND EXHIBITIONS IN THE FIELD OF VISUAL AND AUDIO PERFORMANCES, NAMELY, ROCK GROUP, GYMNASIAC, DANCE, AND BALLET PERFORMANCES (U.S. CLS. 100, 101 AND 107).

**CLASS 42—SCIENTIFIC, COMPUTER AND LEGAL SERVICES**

FOR COMPUTER PROGRAMMING SERVICES FOR OTHERS; CONSULTING IN THE FIELD OF TELECOMMUNICATION, RENTAL OF SOFTWARE AND HARDWARE FOR ONLINE ACCESS; SERVICES OF AN INTERNET TRUST CENTER, NAMELY, ASSURANCE AND ADMINISTRATION OF DIGITAL KEYS AND/OR DIGITAL CERTIFICATES; PROFESSIONAL CONSULTANCY IN THE FIELD OF DATA PROCESSING; WEB PAGE HOSTING SERVICES; COMPUTER SERVICES, NAMELY, CREATING INDEXES OF INFORMATION AVAILABLE ON COMPUTER NETWORKS; CONSULTING AND DESIGN SERVICES IN THE FIELD OF INFORMATION TECHNOLOGY, COMPUTER PROGRAMMING, TELECOMMUNICATIONS AND GLOBAL COMMUNICATION NETWORKS; INSTALLATION, MAINTENANCE AND REPAIR OF COMPUTER SOFTWARE (U.S. CLS. 100 AND 101).

M. E. BODSON, EXAMINING ATTORNEY

SN 76-467,324. UNITED RECYCLING INDUSTRIES, INC., WEST CHICAGO, IL. FILED 11-15-2002.

**URI****CLASS 37—CONSTRUCTION AND REPAIR**

FOR REPAIR AND REFURBISHING OF ELECTRONIC EQUIPMENT, NAMELY COMPUTERS AND COMPUTER PERIPHERALS, HARD DRIVES, MONITORS, KEYBOARDS, EXTERNAL MODEMS, FACSIMILE MACHINES, DIAGNOSTIC EQUIPMENT AND MEDICAL EQUIPMENT (U.S. CLS. 100, 103 AND 106).

FIRST USE 11-19-1995; IN COMMERCE 11-19-1995.

**CLASS 40—MATERIAL TREATMENT**

FOR RECYCLING SERVICES (U.S. CLS. 100, 103 AND 106).

FIRST USE 1-19-1995; IN COMMERCE 1-19-1995.

TARAH HARDY, EXAMINING ATTORNEY

SN 76-469,005. DSD DERI SANAYICILERI DIS TICARET ANONIM SIRKETI, ZEYTINBURNU - ISTANBUL, TURKEY, FILED 11-21-2002.

**CLASS 18—LEATHER GOODS**

FOR LEATHER AND IMITATION LEATHER SOLD IN BULK, AND GOODS MADE OF THESE MATERIALS, NAMELY, LEATHER CLUTCH BAGS, LEATHER SHOPPING BAGS, LEATHER AND IMITATION LEATHER CARRY-ON BAGS, LEATHER AND IMITATION LEATHER GARMENT BAGS FOR TRAVEL, ATHLETIC BAGS, ALL PURPOSE SPORT BAGS, BEACH BAGS, BOOK BAGS, LUGGAGE, SHAVING BAGS SOLD EMPTY, SHOE BAGS FOR TRAVEL, SHOULDER BAGS, SUITCASES, WALLETS, HAT BOXES FOR TRAVEL, BUSINESS CASES, ATTACHE CASES, DOCUMENT CASES, COSMETIC CASES SOLD EMPTY, TOILET CASES SOLD EMPTY, DRIVING LICENSE CASES, PASSPORT CASES, CREDIT CARD CASES, CALLING CARD CASES, BUSINESS CARD CASES, KEY CASES, PURSES, CLUTCH PURSES, HANDBAGS, RUCKSACKS, BRIEF CASES, BACKPACKS, SATCHELS, SCHOOL SATCHELS; UMBRELLAS, PARASOLS, CANES, WHIPS, STIRRUP LEATHERS, SADDLE TREES, AND SADDLERY (U.S. CLS. 1, 2, 3, 22 AND 41).

**CLASS 25—CLOTHING**

FOR CLOTHING, NAMELY, FLANNEL SHIRTS, FLANNEL BLOUSES, JEANS, LEATHER CLOTHES, NAMELY, LEATHER PANTS, LEATHER WAISTCOATS, LEATHER DRESSES, LEATHER SKIRTS, LEATHER COATS AND LEATHER JACKETS, CASUAL WEAR, NAMELY, SWEAT SUITS, SWEAT SHIRTS, SWEAT PANTS, JUMPERS, BERMUDA SHORTS, WALKING SHORTS, DENIM JACKETS, OVERALLS, SHORTS AND TANK TOP SHIRTS, SPORTS WEAR, NAMELY, ATHLETIC UNIFORMS, GYM SHORTS, GYM SUITS, TENNIS WEAR, JOGGING SUITS, TRACKSUITS, SPORT SHIRTS, SPORT COATS, BATH AND BEACH WEAR, NAMELY, BATH SLIPPERS, BATHING CAPS, BATHING SUITS, BATHING TRUNKS, BEACH COVERUPS, SWIM TRUNKS, BIKINIS, SWIMMING SUITS, LOUNGEWEAR, UNDERWEAR, UNDERSHIRTS, PANTIES, BRAS, PETTICOATS, TIGHT BLOUSES, SHORT BLOUSES, CORSETS, DRESSING-GOWNS FOR THE MORNING, NIGHT-DRESSES, OVERCOATS, WOMAN'S OVERCOATS, HOODED OVERCOATS, LIGHT OVERCOATS, RAINCOATS, TRENCH COATS, DUFFEL COATS, JACKETS, COATS, TROUSERS, SKIRTS, SUITS, WAISTCOATS, SHIRTS, T-SHIRTS, SWEATSHIRTS, JUMPERS, SHORT CLOAKS, SWEATERS, BLOUSES, SHORTS, LONG SHORTS, OVERALLS, WORKING CLOTHES, NAMELY, SHIRTS, PANTS, COATS AND DUNGAREES, SCHOOL PINAFORES, SOCKS, FOOTWEAR, SHOES, WELLINGTON BOOTS, BOOTS, SLIPPERS, SANDALS, CHILD'S SHOES AND THEIR PARTS, SNEAKERS, SHOE PARTS, NAMELY, INNER SOLES AND HEELS, BABY'S CLOTHES, NAMELY, HEADWEAR, HATS, CAPS, BERETS, SPECIAL CLOTHES FOR BABIES NAMELY, BABY BIBS MADE OF CLOTH NOT PAPER, BABY SHIFTS, SWADDLING CLOTHES, PANTIES, BABY SLEEVELESS JACKETS, NYLON PANTIES; SUSPENDERS, SARONGS, INSERTED COLLARS, COLLARS, SCARVES, GARTERS, BELTS, NECK TIES, BOW-TIES, FOULARDS, GLOVES, SHAWLS, ARMBANDS, HEADBANDS, HEADWEAR, HEADGEAR, NAMELY, HATS, CAPS AND BERETS, AND CUFFS (U.S. CLS. 22 AND 39).

**CLASS 35—ADVERTISING AND BUSINESS**

FOR BUSINESS CONSULTATION SERVICES RELATING TO ESTABLISHMENT, ORGANIZATION AND MANAGEMENT OF SHOPPING CENTERS, SHOPS, MARKETS, STORES AND STORE CHAINS FOR THE TEXTILE, READY-MADE CLOTHES AND GARMENT INDUSTRY; BUSINESS CONSULTATION SERVICES RELATING TO ESTABLISHMENT OF OUTLET CHAINS FOR TEXTILE, READY-MADE CLOTHES AND GARMENT INDUSTRY THROUGH AGENCY AND FRANCHISE SYSTEMS; ADVERTISEMENT AND PROMOTION SERVICES, NAMELY, CREATING CORPORATE AND BRAND IDENTITY FOR OTHERS AND DISSEMINATION OF ADVERTISING FOR OTHERS VIA THE INTERNET FOR TEXTILE, READY-MADE CLOTHES AND GARMENT INDUSTRY; IMPORTATION AND EXPORTATION AGENCY SERVICES FOR TEXTILE, READY-MADE CLOTHES AND GARMENT INDUSTRY; ONLINE RETAIL STORE SERVICES, MAIL ORDER CATALOG SERVICES AND RETAIL OUTLETS FEATURING TEXTILES, READY-MADE CLOTHES, GARMENTS, SHOES AND LEATHER GOODS, AND RETAIL VARIETY STORES (U.S. CLS. 100, 101 AND 102).

ELIZABETH J. WINTER, EXAMINING ATTORNEY

SN 76-469,744. EAGLE PRECISION TECHNOLOGIES, INC., BRANFORD, ONTARIO, CANADA, FILED 11-25-2002.

**EATON LEONARD****CLASS 7—MACHINERY**

FOR METAL TUBE BENDING MACHINES (U.S. CLS. 13, 19, 21, 23, 31, 34 AND 35).  
FIRST USE 8-19-1974; IN COMMERCE 12-17-1974.

**CLASS 9—ELECTRICAL AND SCIENTIFIC APPARATUS**

FOR EQUIPMENT FOR THE MEASUREMENT OF TUBES FORMED BY TUBE BENDING MACHINES, NAMELY AN INTEGRATED UNIT WITH A SENSOR AND ASSOCIATED SOFTWARE TO PROVIDE DATA TO ENABLE ANALYSIS OF TUBE BENDING ANGLES (U.S. CLS. 21, 23, 26, 36 AND 38).  
FIRST USE 11-6-1973; IN COMMERCE 12-12-1973.

**CLASS 37—CONSTRUCTION AND REPAIR**

FOR REPAIR AND MAINTENANCE OF METAL TUBE BENDING MACHINES AND MEASURING EQUIPMENT FOR BENT TUBES AND SURFACES (U.S. CLS. 100, 103 AND 106).  
FIRST USE 12-17-1974; IN COMMERCE 12-17-1974.

BRIAN NEVILLE, EXAMINING ATTORNEY

SN 76-472,057. TISSUE SCIENCE LABORATORIES PLC, ALDERSHOT, HAMPSHIRE GU11 1EJ, UNITED KINGDOM, FILED 11-29-2002.

**TSL****CLASS 5—PHARMACEUTICALS**

FOR PREPARATIONS FOR THE TREATMENT, RECONSTRUCTION, RECONTOURING AND REPAIR OF HUMAN TISSUE FOR USE IN GENERAL, PLASTIC AND RECONSTRUCTIVE, UROLOGICAL, GYNECOLOGICAL, ORTHOPAEDIC, GASTRO-OESOPHAGEAL, ANAL, COLORECTAL AND ABDOMINAL SURGERY FORMED OF OR USING NATURAL COLLAGENOUS TISSUE MATERIALS; MEDICAL PREPARATIONS FOR THE TREATMENT, RECONSTRUCTION, RECONTOURING AND REPAIR OF HUMAN TISSUE; NONE OF THE AFOREMENTIONED BEING FOR VETERINARY USE (U.S. CLS. 6, 18, 44, 46, 51 AND 52).

FIRST USE 5-14-2002; IN COMMERCE 5-14-2002.

**CLASS 10—MEDICAL APPARATUS**

FOR SURGICAL AND MEDICAL IMPLANTS COMPRISING ARTIFICIAL MATERIALS FOR USE IN GENERAL, PLASTIC AND RECONSTRUCTIVE, UROLOGICAL, GYNECOLOGICAL, ORTHOPAEDIC, GASTRO-OESOPHAGEAL, ANAL, COLORECTAL AND ABDOMINAL SURGERY (U.S. CLS. 26, 39 AND 44).

FIRST USE 5-14-2002; IN COMMERCE 5-14-2002.

**CLASS 42—SCIENTIFIC, COMPUTER AND LEGAL SERVICES**

FOR SCIENTIFIC AND MEDICAL RESEARCH AND DEVELOPMENT IN THE FIELD OF DEVELOPMENT OF TISSUE RECONSTRUCTION AND REPAIR, INCLUDING WOUND MANAGEMENT; ADVISORY AND CONSULTANCY SERVICES RELATED THERETO (U.S. CLS. 100 AND 101).

FIRST USE 5-14-2002; IN COMMERCE 5-14-2002.  
ALICIA COLLINS, EXAMINING ATTORNEY

SN 76-472,059. TISSUE SCIENCE LABORATORIES PLC, ALDERSHOT, HAMPSHIRE GU11 1EJ, UNITED KINGDOM, FILED 11-29-2002.

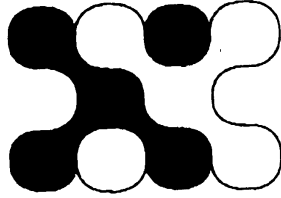

#### CLASS 5—PHARMACEUTICALS

FOR PREPARATIONS FOR THE TREATMENT, RECONSTRUCTION, RECONTOURING AND REPAIR OF HUMAN TISSUE FOR USE IN GENERAL, PLASTIC AND RECONSTRUCTIVE, UROLOGICAL, GYNECOLOGICAL, ORTHOPAEDIC, GASTRO-OESOPHAGEAL, ANAL, COLORECTAL AND ABDOMINAL SURGERY FORMED OF OR USING NATURAL COLLAGENOUS TISSUE MATERIALS; MEDICAL PREPARATIONS FOR THE TREATMENT, RECONSTRUCTION, RECONTOURING AND REPAIR OF HUMAN TISSUE; NONE OF THE AFOREMENTIONED BEING FOR VETERINARY USE (U.S. CLS. 6, 18, 44, 46, 51 AND 52).

FIRST USE 5-14-2002; IN COMMERCE 5-14-2002.

#### CLASS 10—MEDICAL APPARATUS

FOR SURGICAL AND MEDICAL IMPLANTS COMPRISING ARTIFICIAL MATERIALS FOR USE IN GENERAL, PLASTIC AND RECONSTRUCTIVE, UROLOGICAL, GYNECOLOGICAL, ORTHOPAEDIC, GASTRO-OESOPHAGEAL, ANAL, COLORECTAL AND ABDOMINAL SURGERY (U.S. CLS. 26, 39 AND 44).

FIRST USE 5-14-2002; IN COMMERCE 5-14-2002.

#### CLASS 42—SCIENTIFIC, COMPUTER AND LEGAL SERVICES

FOR SCIENTIFIC AND MEDICAL RESEARCH AND DEVELOPMENT IN THE FIELD OF DEVELOPMENT OF TISSUE RECONSTRUCTION AND REPAIR, INCLUDING WOUND MANAGEMENT; ADVISORY AND CONSULTANCY SERVICES RELATED THERETO (U.S. CLS. 100 AND 101).

FIRST USE 5-14-2002; IN COMMERCE 5-14-2002.  
ALICIA COLLINS, EXAMINING ATTORNEY

SN 76-472,904. CURB, MIKE, NASHVILLE, TN. FILED 12-9-2002.



NO CLAIM IS MADE TO THE EXCLUSIVE RIGHT TO USE "RECORDS", APART FROM THE MARK AS SHOWN.

#### CLASS 9—ELECTRICAL AND SCIENTIFIC APPARATUS

FOR PRERECORDED AUDIO DISCS, TAPES AND PHONOGRAPH RECORDS FEATURING MUSIC, PRERECORDED VIDEO DISCS AND TAPES FEATURING MUSIC, AND AUDIO AND VIDEO RECORDINGS FEATURING MUSIC DOWNLOADABLE VIA A GLOBAL COMPUTER NETWORK (U.S. CLS. 21, 23, 26, 36 AND 38).

#### CLASS 16—PAPER GOODS AND PRINTED MATTER

FOR POSTERS AND STICKERS (U.S. CLS. 2, 5, 22, 23, 29, 37, 38 AND 50).

#### CLASS 25—CLOTHING

FOR CLOTHING; NAMELY, T-SHIRTS, SWEAT-SHIRTS, POLO SHIRTS, SPORT SHIRTS, JACKETS, CAPS, AND JERSEYS (U.S. CLS. 22 AND 39).

#### CLASS 41—EDUCATION AND ENTERTAINMENT

FOR ENTERTAINMENT SERVICES, NAMELY, PRODUCTION OF VIDEO AND AUDIO RECORDINGS FEATURING MUSIC; AND PROVIDING PRERECORDED MUSIC AND VIDEO ONLINE VIA A GLOBAL COMPUTER NETWORK (U.S. CLS. 100, 101 AND 107).  
BRENDAN REGAN, EXAMINING ATTORNEY

SN 76-475,138. SANTOS, FABIAN SALAME, GALAPAGOS, ECUADOR, FILED 12-16-2002.

## THE FLOW OF LIFE

#### CLASS 14—JEWELRY

FOR JEWELRY (U.S. CLS. 2, 27, 28 AND 50).

#### CLASS 21—HOUSEWARES AND GLASS

FOR FIGURINES, SCULPTURES AND ORNAMENTS MADE OF CRYSTAL (U.S. CLS. 2, 13, 23, 29, 30, 33, 40 AND 50).  
GEORGIA CARTY, EXAMINING ATTORNEY

SN 76-476,476. KOLON INDUSTRIES, INC., KYUNGGI-DO, 427-040, REPUBLIC OF KOREA, FILED 12-18-2002.

## COOLON

OWNER OF REPUBLIC OF KOREA REG. NO. 527004, DATED 8-5-2002, EXPIRES 8-5-2012.

#### CLASS 23—YARNS AND THREADS

FOR ELASTIC THREAD AND YARN FOR TEXTILE USE, SYNTHETIC THREAD AND YARN FOR TEXTILE USE, EMBROIDERY THREAD AND YARN, WORSTED THREAD AND YARN, SPUN THREAD AND YARN, COTTON THREAD AND YARN, SILK THREAD AND YARN, HEMP THREAD AND YARN, RAYON THREAD AND YARN (U.S. CL. 43).

**CLASS 24—FABRICS**

FOR SYNTHETIC-FIBER FABRIC FOR MANUFACTURING CLOTHING, FURNITURE AND AUTOMOBILE UPHOLSTERY, AND LUGGAGE, WOOLEN FABRIC, SILK FABRIC FOR MANUFACTURING CLOTHING, FURNITURE AND AUTOMOBILE UPHOLSTERY, AND LUGGAGE, WATERPROOF FABRIC FOR MANUFACTURING CLOTHING, FURNITURE AND AUTOMOBILE UPHOLSTERY, AND LUGGAGE, NON-WOVEN TEXTILE FABRICS FOR MANUFACTURING CLOTHING, FURNITURE AND AUTOMOBILE UPHOLSTERY, AND LUGGAGE, COATED FABRIC WITH RESIN FOR MANUFACTURING CLOTHING, FURNITURE AND AUTOMOBILE UPHOLSTERY, AND LUGGAGE, FABRIC OF IMITATION ANIMAL SKINS, UNFITTED FURNITURE COVERINGS OF TEXTILE (U.S. CLS. 42 AND 50).

**CLASS 25—CLOTHING**

FOR STOCKINGS, SHIRTS, OVERCOATS, JACKETS, UNDERCLOTHING, WATERPROOF CLOTHING, NAMELY, JACKETS, COATS, HATS, CAPS, SLICKERS, PANTS, SHORTS, SHIRTS, T-SHIRTS, AND SWEATSHIRTS, BATHING SUITS, DRESSING GOWNS, READY-MADE CLOTHING, NAMELY, JACKETS, COATS, HATS, CAPS, SLICKERS, PANTS, SHORTS, SHIRTS, T-SHIRTS, AND SWEATSHIRTS, OUTER CLOTHING, NAMELY, JACKETS, COATS, HATS, CAPS, SLICKERS, PANTS, SHORTS, SHIRTS, T-SHIRTS, AND SWEATSHIRTS (U.S. CLS. 22 AND 39).

H. M. FISHER, EXAMINING ATTORNEY

SN 76-483,548. PETS INTERNATIONAL, LTD., ELK GROVE VILLAGE, IL. FILED 1-10-2003.

**SUPER PET**

OWNER OF U.S. REG. NO. 940,795.  
NO CLAIM IS MADE TO THE EXCLUSIVE RIGHT TO USE "PET", APART FROM THE MARK AS SHOWN.  
SEC. 2(F).

**CLASS 18—LEATHER GOODS**

FOR ANIMAL CARRIERS, ANIMAL HARNESSSES, AND ANIMAL LEASHES (U.S. CLS. 1, 2, 3, 22 AND 41).  
FIRST USE 6-0-1991; IN COMMERCE 6-0-1991.

**CLASS 19—NON-METALLIC BUILDING MATERIALS**

FOR AQUARIUM GRAVEL, MODULAR ANIMAL HOUSES FOR HAMSTERS, GERBILS, FERRETS AND RABBITS (U.S. CLS. 1, 12, 33 AND 50).  
FIRST USE 5-0-1989; IN COMMERCE 5-0-1989.

**CLASS 20—FURNITURE AND ARTICLES NOT OTHERWISE CLASSIFIED**

FOR PET CUSHIONS, PLAYHOUSES FOR PETS (U.S. CLS. 2, 13, 22, 25, 32 AND 50).  
FIRST USE 5-0-1988; IN COMMERCE 5-0-1988.

**CLASS 21—HOUSEWARES AND GLASS**

FOR ANIMAL ACTIVATED ANIMAL FEEDERS, BIRD FEEDERS, BIRD HOUSES, CAGES FOR PETS, CAT LITTER PANS, PET FEEDING DISHES, SMALL ANIMAL FEEDERS (U.S. CLS. 2, 13, 23, 29, 30, 33, 40 AND 50).  
FIRST USE 6-0-1987; IN COMMERCE 6-0-1987.

**CLASS 26—FANCY GOODS**

FOR ARTIFICIAL PLANTS (U.S. CLS. 37, 39, 40, 42 AND 50).  
FIRST USE 5-0-1988; IN COMMERCE 5-0-1988.

**CLASS 28—TOYS AND SPORTING GOODS**

FOR PET TOYS (U.S. CLS. 22, 23, 38 AND 50).  
FIRST USE 5-0-1985; IN COMMERCE 5-0-1985.  
ANGELA M. MICHELI, EXAMINING ATTORNEY

SN 76-484,143. TONG CONG TY BUU CHINH VIEN THONG VIET NAM (VIETNAM POST AND TELECOMMUNICATION), HANOI, VIETNAM, FILED 1-22-2003.



PRIORITY CLAIMED UNDER SEC. 44(D) ON VIETNAM APPLICATION NO. 4-2002-06030, FILED 9-24-2002, REG. NO. 44590, DATED 12-23-2002, EXPIRES 9-24-2012.

THE COLOR BLUE IS CLAIMED AS A DISTINCTIVE FEATURE OF THE MARK.

**CLASS 9—ELECTRICAL AND SCIENTIFIC APPARATUS**

FOR POST AND TELECOMMUNICATION EQUIPMENT, NAMELY, COPPER CABLES, FOAM-SKIN INSULATED TELEPHONE CABLES, DATA TRANSMISSION CABLES, TRUNK CABLE, COAXIAL CABLES, CONTROL CABLES, COPPER DROP WIRE FOR CONNECTING CUSTOMER EQUIPMENT TO THE CENTRAL OFFICE; TERMINALS NAMELY, TELEPHONES, MULTI-FUNCTIONAL TELEPHONES, DIGITAL CORDLESS TELEPHONES, CARDPHONE TELEPHONES; CONNECTION EQUIPMENT AND ACCESSORIES, NAMELY, CABLE CABINET FOR THE DISTRIBUTION OF MAIN TELEPHONE CABLE TO THE SUBSCRIBER BOX, SUBSCRIBER DISTRIBUTION BOXES, CABLE CLOSURES, MAIN DISTRIBUTION FRAME LINKING THE SWITCHING SYSTEM TO THE SUBSCRIBER CABLE NETWORK, AND PROTECTS THE EXCHANGE FROM OVER VOLTAGE OF OVER CURRENT BY OUTSIDE PLANT, OPTICAL DISTRIBUTION FRAME USED FOR FINAL TERMINATION OR DISTRIBUTION OF OPTICAL FIBERS; CONNECTION BLOCK NAMELY VERTICAL BLOCK AND HORIZONTAL BLOCK USED FOR CONNECTING CABLE PAIRS FROM EXCHANGES; ACCESSORIES FOR OPTICAL CABLE DISTRIBUTION NETWORK, NAMELY, OPTICAL DISTRIBUTION BOX, OPTICAL CABLE CLOSURES; POWER SUPPLY EQUIPMENT, NAMELY, POWER SUPPLY SYSTEM COMPRISED OF DIFFERENT INDEPENDENT ELECTRICAL POWER SUPPLIES, INDEPENDENT ELECTRICAL POWER SUPPLY SUPPLYING STABLE ELECTRICAL ENERGY FOR TELECOMMUNICATION EQUIPMENT, PHOTOVOLTAIC SOLAR CELLS; LIGHTNING PROTECTION EQUIPMENT, NAMELY, DIRECT STRIKE LIGHTNING PROTECTION ACTIVELY CAPTURING LIGHTNING STRIKES TO EARTH, LARGE PROTECTION AREA, EASY AND SIMPLE INSTALLATION, PROTECTION LIGHTNING TRANSFERRING ON POWER LINE PROTECTING EQUIPMENT FROM

LIGHTNING TRANSFERRING THROUGH POWER LINE, SHUNTING OUT ALL LIGHTNING SURGES, VERY SHORT REACTION TIME, DATA LINE LIGHTNING PROTECTION PREVENTING THE DAMAGES CAUSED BY LIGHTNING AGAINST THE EQUIPMENT, FEEDER LINE (USED TO CONNECT OUTDOOR ANTENNA TO INDOOR TELECOM EQUIPMENT) LIGHTNING PROTECTION, SUBSCRIBER LIGHTNING PROTECTOR USED FOR PROTECTING TERMINAL EQUIPMENT SUCH AS TELEPHONE, FAX MACHINES, AND MODEMS WHEN LIGHTNING OR ABNORMAL VOLTAGES INDUCE ON THE LINE, LIGHTNING PROTECTOR FOR COMPUTER NETWORKS USED FOR PROTECTING LOCAL AREA NETWORKS (LANS), LIGHTNING PROTECTOR FOR CONNECTION MODULE USED FOR PROTECTING CABLES AND CONNECTORS FROM ABNORMAL VOLTAGE AND LIGHTNING; SOFTWARE FOR BILLING CUSTOMER SUPPORT SYSTEM USED FOR BILLING FOR VARIOUS OTHER FIELDS IN TELECOMMUNICATIONS, SOFTWARE FOR CABLE NETWORK MANAGEMENT SYSTEM CABMAN/GIS (CABLE NETWORK MANAGEMENT SYSTEM - CABMAN/GIS) SPECIALIZED IN MANAGEMENT OF TELECOMMUNICATIONS MAP INFORMATION SYSTEM APPLYING IN VARIOUS OTHER SECTORS SUCH AS GEODESY AND TELECOMMUNICATIONS, CODE OPEN SYSTEM APPLICATION SOFTWARE USED FOR ENTERPRISE NETWORK OPERATORS AND INTERNET SERVICE PROVIDERS TO OFFER SERVICES SUCH AS MAIL, WEB HOSTING, DOMAIN NAME SERVER, AND FILE TRANSFERRING, SOFTWARE FOR EDUCATION INFORMATION SYSTEM PROVIDING CLIENTS WITH VARIOUS EDUCATION INFORMATION-RELATED SERVICES THROUGH PUBLIC SWITCHED TELEPHONE NETWORK AND INTERNET, NAMELY INFORMATION ABOUT STUDENT RECRUITMENT, INFORMATION EXCHANGE BETWEEN SCHOOL AND STUDENT'S FAMILY, SOFTWARE FOR INFORMATION AND APPLICATION GATEWAY (INFOGATE) USED FOR SERVICES USING COMBINATION OF TELECOMMUNICATION TECHNOLOGY (MOBILE AND FIXED NETWORKS), COMPUTER TECHNOLOGY AND DATA PROCESSING TECHNOLOGY, MULTIMEDIA COMMUNICATION SERVER, SECURITY SOFTWARE COMPRISED OF FINGERPRINT RECOGNITION TECHNOLOGY USED IN VARIOUS FIELDS SUCH AS TELECOMMUNICATIONS, BANKING, POLICE AND ARMY FOR CONTROLLING ACCESS TO NETWORK AND WORKSTATION USING BIOMETRIC METHODOLOGY, CONTROLLING ACCESS TO APPLICATIONS USING BIOMETRIC METHODOLOGY, CENTRALLY MANAGING USER NETWORK AND USER'S ACCESS PERMISSION SYSTEM, INFORMATION MANAGEMENT SYSTEM SOFTWARE USED FOR SYSTEM EXPANSION, SYSTEM ADMINISTRATION, SYSTEM INFORMATION UPDATE, INFORMATION CONTENT SENSOR, SECURITY, SOFTWARE FOR VULNERABILITY SCANNING AND DETECTING SYSTEM COMPRISED OF OPERATING SYSTEM, WEB SERVER, MAIL SERVER, FTP SERVER, TELNET SERVER, AND GOPHER SOFTWARE FOR ORGANIZING AND DISPLAYING FILES ON INTERNET SERVERS, SOFTWARE FOR INTERNET BASED TRAINING IN THE FIELD OF UNIVERSITY ENTRANCE EXAMINATION TRAINING TUTORIAL SERVICES, CUSTOMER RELATIONSHIP MANAGEMENT SOFTWARE USED FOR KEEPING CUSTOMERS INFORMATION AS WELL AS THEIR RELATIONS WITH THE ENTERPRISE, STORING CONTRACTS SIGNED BETWEEN THE ENTERPRISE AND THE CUSTOMERS, MANAGING USERS ACCORDING TO THEIR ROLE IN THE SYSTEM, REPORTING ON CONTACTS WITH CUSTOMER AND RELATION EXPANSION, COMMUNICATING BETWEEN THE MARKETING STAFF AND THE MANAGEMENT GROUP OF THE COMPANY, MAKING STATISTICAL ANALYSIS REPORTS ON MARKET AND CUSTOMER SITUATION, ON-LINE INFORMATION NETWORK SOFTWARE PROVIDING CURRENT NEWS, HIGHLY-INTERACTIVE FORUMS, SPECIALIZED REFERENCES FOR SPECIFIC ISSUES, EVENTS, DIGITAL IT, FOOTBALL, CULTURE, AND THE LIKE, ON-LINE IN INTERNET, VASC WEB-MAIL USED FOR PROVIDING A LARGE ARRAY OF FEATURES SUCH AS READING, COMPOSING AND SENDING EMAILS VIA DIFFERENT COMPUTERS WITH VARIOUS ATTACHED UTILITIES; POSTAL EQUIPMENT, NAMELY, POSTAGE METERS, ELECTRONIC SCALES (U.S. CLS. 21, 23, 26, 36 AND 38).

### **CLASS 35—ADVERTISING AND BUSINESS**

FOR ADVERTISING NAMELY, DISSEMINATION OF ADVERTISING FOR OTHERS VIA THE INTERNET, DIRECT MAIL ADVERTISING; EXPORT AND IMPORT AGENCIES; AND RETAIL STORE SERVICES FEATURING TELECOMMUNICATION MATERIALS AND EQUIPMENT, NAMELY, TELECOMMUNICATION SWITCHING, TRANSPORTING SYSTEMS, AND CUSTOMER PREMISE(S) EQUIPMENT (U.S. CLS. 100, 101 AND 102).

### **CLASS 36—INSURANCE AND FINANCIAL**

FOR MONEY ORDER SERVICES (U.S. CLS. 100, 101 AND 102).

### **CLASS 38—COMMUNICATION**

FOR TELECOMMUNICATION SERVICES, NAMELY, INTERNATIONAL LONG DISTANCE TELEPHONE SERVICES, OPERATOR-ASSISTED CALL TELEPHONE COMMUNICATION SERVICES, COLLECT CALL TELEPHONE COMMUNICATION SERVICES, HOME COUNTRY DIRECT LONG DISTANCE SERVICES, TELEPHONE ANSWERING SERVICES, TELEPHONE SERVICES USING VOICE OVER IP TECHNOLOGY, CELLULAR TELEPHONE SERVICE, PAGING SERVICE, TELEPHONE TELECOMMUNICATIONS SERVICES PROVIDED VIA PREPAID CALLING CARDS, FACSIMILE TRANSMISSION, TELEX TRANSMISSION, TELEGRAM TRANSMISSION SERVICE, ELECTRONIC DATA TRANSMISSION SERVICE, LEASED LINE SERVICE SUPPLYING THE ELECTRONIC DATA TRANSMISSION LINES FOR CUSTOMERS WHO WANT TO TRANSFER LARGE AMOUNT OF ELECTRONIC DATA, INTEGRATED SERVICE DIGITAL NETWORK (ISDN) SERVICES, VIDEO TELEPHONE SERVICES THAT ALLOWS THE USER TO SEE THE OTHER PARTY VIA A SCREEN WHILE TALKING, DOMESTIC AND INTERNATIONAL TRANSMISSION OF VIDEO AND ELECTRONIC IMAGES, VERY SMALL APPERATURE TERMINAL SATELLITE TRANSMISSION SERVICES, MARINE SATELLITE TRANSMISSION SERVICES, INTERNET ACCESS SERVICES PROVIDING MULTIPLE USER DIAL-UP AND DEDICATED ACCESS TO THE INTERNET; TELEGRAM TRANSMISSION IN THE FIELD OF FLOWER DELIVERY; CONSULTANCY IN THE FIELD OF TELECOMMUNICATIONS (U.S. CLS. 100, 101 AND 104).

### **CLASS 39—TRANSPORTATION AND STORAGE**

FOR TRANSPORTATION SERVICES, NAMELY, AIR TRANSPORTATION, FREIGHT TRANSPORTATION BY TRUCK, TRAIN, AIR; LOGISTICS, NAMELY FREIGHT FORWARDING AND WAREHOUSING SERVICES; POSTAL SERVICE, NAMELY, PARCEL DELIVERY AND PACKAGING ARTICLES FOR TRANSPORTATION, DELIVERY OF ADVERTISING DOCUMENTS TO THE ADDRESSES THAT ARE STORED ON A DATA BASE BY TRUCK AND AIR; PARCEL DELIVERY INCLUDING FULFILLMENT ON BEHALF OF CUSTOMERS ANY NECESSARY PROCEDURES SUCH AS CUSTOMS CLEARANCE AND PACKAGING PARCELS; DELIVERY OF NEWSPAPERS (U.S. CLS. 100 AND 105).  
WENDY GOODMAN, EXAMINING ATTORNEY

SN 76-484,150. 911 FITNESS, INC, MIAMI, FL. FILED 1-23-2003.



OWNER OF U.S. REG. NO. 2,379,171.  
NO CLAIM IS MADE TO THE EXCLUSIVE RIGHT TO USE "FITNESS AND HEART, MIND, MUSCLE", APART FROM THE MARK AS SHOWN.

#### CLASS 25—CLOTHING

FOR CLOTHING, NAMELY, SHIRTS, HATS, SHORTS, SWEAT PANTS, SWEAT SHIRTS AND JACKETS (U.S. CLS. 22 AND 39).

#### CLASS 41—EDUCATION AND ENTERTAINMENT

FOR CONDUCTING CLASSES, SEMINARS AND WORKSHOPS IN THE FIELD OF SPORTS, SCIENCE, HEALTH AND FITNESS (U.S. CLS. 100, 101 AND 107).  
ANDREA SAUNDERS, EXAMINING ATTORNEY

SN 76-490,837. NPF LIMITED, NECHELLS, BIRMINGHAM B7 SQT, UNITED KINGDOM, FILED 2-13-2003.

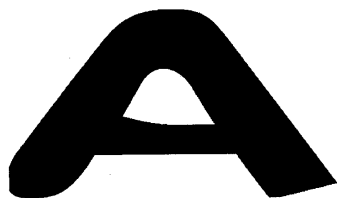

#### CLASS 9—ELECTRICAL AND SCIENTIFIC APPARATUS

FOR HEADGEAR, NAMELY PROTECTIVE HEADGEAR FOR USE IN PAINTBALLING; PAINTBALL GOGGLES (U.S. CLS. 21, 23, 26, 36 AND 38).

#### CLASS 25—CLOTHING

FOR CLOTHING, FOOTWEAR, HEADGEAR, NAMELY, T-SHIRTS, LONG-SLEEVE SHIRTS, POLO SHIRTS, HOODED TOPS, SHORTS, BASEBALL CAPS, BEANIES, HEAD BANDS AND WRIST BANDS; PROTECTIVE CLOTHING, NAMELY, PAINTBALL TROUSERS, PAINTBALL PANTS, PAINTBALL PLAYING TOPS, PAINTBALL PLAYING GLOVES; FOOTWEAR (U.S. CLS. 22 AND 39).

#### CLASS 28—TOYS AND SPORTING GOODS

FOR PAINT BALL GAME ACCESSORIES, NAMELY, PAINT BALL GUNS, PAINT BALLS, PAINT BALL MARKERS, AND PARTS AND FITTINGS THEREFOR; FACE MASKS FOR PAINTBALLING (U.S. CLS. 22, 23, 38 AND 50).  
CAROLYN CATALDO, EXAMINING ATTORNEY

SN 76-491,120. MILLIKEN, JAMES M., ST. FRANCIS, KS. FILED 2-19-2003.

## CAREFREE GARDENER

NO CLAIM IS MADE TO THE EXCLUSIVE RIGHT TO USE "GARDENER", APART FROM THE MARK AS SHOWN.

#### CLASS 11—ENVIRONMENTAL CONTROL APPARATUS

FOR AGRICULTURAL IRRIGATION UNITS (U.S. CLS. 13, 21, 23, 31 AND 34).

#### CLASS 17—RUBBER GOODS

FOR LANDSCAPE FABRIC FOR INHIBITING WEED GROWTH; LANDSCAPE FABRIC FOR INHIBITING WEED GROWTH AND RETAINING SOIL MOISTURE; LANDSCAPE FABRIC FOR CONTROLLING WEEDS AND SOIL EROSION; SYNTHETIC, POROUS LANDSCAPE FABRIC FOR INHIBITING WEED GROWTH; SYNTHETIC, POROUS LANDSCAPE FABRIC FOR EROSION CONTROL; POROUS LANDSCAPE FABRIC TO RETAIN GROUND MOISTURE AND PREVENT WEEDS; POROUS WATERING HOSE FOR AGRICULTURAL USE; POROUS WATERING HOSE FOR WATERING GARDEN PLANTS; IRRIGATION AND WEED CONTROL SYSTEMS COMPRISED OF POROUS WATERING HOSE AND LANDSCAPE FABRIC; LANDSCAPE FABRIC INCLUDING PLANTING SPACES FOR GROWING GARDEN PLANTS; LANDSCAPE FABRIC INCLUDING PLANTING SPACES FOR GROWING GARDEN PLANTS AND ATTACHED POROUS WATERING HOSE FOR IRRIGATION; SYNTHETIC LANDSCAPE FABRIC FOR WEED GROWTH PREVENTION, EROSION CONTROL, SOIL STABILITY AND RETENTION; PLANT WATERING SYSTEMS COMPRISED OF POROUS WATERING HOSE AND LANDSCAPE FABRIC; IRRIGATION SYSTEMS, COMPRISED OF POROUS WATERING HOSE ATTACHED TO THE UNDERSIDE OF POROUS LANDSCAPE FABRIC; IRRIGATION SYSTEMS, COMPRISED OF POROUS WATERING HOSE ATTACHED TO THE UNDERSIDE OF POROUS LANDSCAPE FABRIC INCLUDING PLANTING SPACES FOR GROWING GARDEN PLANTS; PLANT WATERING SYSTEMS COMPRISED OF IRRIGATION HOSES AND LANDSCAPE FABRIC; IRRIGATION AND WEED CONTROL SYSTEMS COMPRISED OF IRRIGATION HOSES AND LANDSCAPE FABRIC (U.S. CLS. 1, 5, 12, 13, 35 AND 50).  
WON TEAK OH, EXAMINING ATTORNEY

SN 76-492,164. WOLFCRAFT, INC., ITASCA, IL. FILED 2-21-2003.

## QUICK-JAW

OWNER OF U.S. REG. NO. 1,633,736.

#### CLASS 7—MACHINERY

FOR MITRE SAW STANDS (U.S. CLS. 13, 19, 21, 23, 31, 34 AND 35).  
FIRST USE 9-0-2002; IN COMMERCE 9-0-2002.

#### CLASS 8—HAND TOOLS

FOR HANDS TOOLS, NAMELY, BAR CLAMPS, RIGHT ANGLE CLAMPS RATCHET CLAMPS, SPRING CLAMPS AND METAL VISES (U.S. CLS. 23, 28 AND 44).  
FIRST USE 0-0-1993; IN COMMERCE 0-0-1993.



**CLASS 20—FURNITURE AND ARTICLES NOT OTHERWISE CLASSIFIED**

FOR INDUSTRIAL WORK TABLES, NAMELY CLAMPING TABLES (U.S. CLS. 2, 13, 22, 25, 32 AND 50). FIRST USE 0-0-1992; IN COMMERCE 0-0-1992.  
SONYA STEPHENS, EXAMINING ATTORNEY

**CLASS 31—NATURAL AGRICULTURAL PRODUCTS**

FOR LIVE PLANTS, PARTS OF LIVE PLANTS, CUTTINGS OF LIVE PLANTS, AND GENETICALLY MODIFIED EXAMPLES THEREOF; PLANT SEEDS AND PLANT SEEDS THAT ARE GENETICALLY MODIFIED; LIVE ANIMALS AND LIVE ANIMALS THAT ARE GENETICALLY MODIFIED (U.S. CLS. 1 AND 46).  
ALICIA COLLINS, EXAMINING ATTORNEY

SN 76-492,931. BENITEC AUSTRALIA LTD., ST. LUCIA, QLD, 4067, AUSTRALIA, FILED 2-25-2003.

SN 76-498,236. ALTIA CO., LTD., TOKYO, JAPAN, FILED 3-17-2003.

**BENITEC****ALTIA****CLASS 1—CHEMICALS**

FOR DIAGNOSTIC PREPARATIONS FOR SCIENTIFIC AND RESEARCH USE, NAMELY, PREPARATIONS CONTAINING SYNTHETIC NUCLEIC ACID, INCLUDING SYNTHETIC DNA, CLONED DNA AND RECOMBINANT DNA; SYNTHETIC RNA, CLONED RNA AND RECOMBINANT RNA; DNA AND RNA FOR SCIENTIFIC AND RESEARCH USE IN THE FIELDS OF AGRICULTURAL AND INDUSTRIAL BIOTECHNOLOGY; DNA AND RNA AND PREPARATIONS CONTAINING DNA AND/OR RNA FOR SCIENTIFIC AND RESEARCH USE IN THE REGULATION AND/OR EXPRESSION OF MAMMALIAN, HUMAN, PLANT, MICROBIAL AND SYNTHETIC GENES FOR USE IN THE FIELDS OF PHARMACEUTICAL RESEARCH AND AGRICULTURAL AND INDUSTRIAL BIOTECHNOLOGY; PHARMACEUTICAL AND OTHER DIAGNOSTIC PREPARATIONS FOR SCIENTIFIC AND RESEARCH USE IN THE FIELDS OF AGRICULTURAL AND INDUSTRIAL BIOTECHNOLOGY; PHARMACEUTICAL AND OTHER PREPARATIONS FOR USE IN THE FIELD OF PHARMACEUTICAL RESEARCH; YEAST, FUNGI, TISSUE CULTURE OF PLANTS, AND GENETICALLY MODIFIED EXAMPLES THEREOF FOR SCIENTIFIC OR RESEARCH USE (U.S. CLS. 1, 5, 6, 10, 26 AND 46).

**CLASS 12—VEHICLES**

FOR WIND SCREENS FOR VEHICLES; VEHICLE SEAT COVERS; VEHICLE MUDGUARDS; LUGGAGE CARRIERS FOR VEHICLES; LICENSE PLATE FRAMES; ANTI-SKID CHAINS, NAMELY, TIRE CHAINS; DOOR PANEL EDGE PROTECTORS FOR VEHICLES; CHILDREN'S CAR SEATS; BODY COVERS, NAMELY, FITTED AND SEMI-FITTED VEHICLE COVERS; LAND VEHICLE WHEELS; LAND VEHICLE BUMPERS; ANTI-THEFT ALARMS AND SIGNALS FOR VEHICLES; ADHESIVE RUBBER FOR REPAIRING LAND VEHICLE TIRE TUBES; ROOF AND REAR SPOILER FOR VEHICLES; SIDE-SILL PROTECTOR, NAMELY, VEHICLE DOOR SILL PROTECTORS; ELECTRONIC RETRACTABLE CORNER POLES FOR VEHICLES (U.S. CLS. 19, 21, 23, 31, 35 AND 44).

**CLASS 27—FLOOR COVERINGS**

FOR FLOOR COVERINGS FOR VEHICLES, NAMELY, CARPETS, CARPETING AND FLOOR MATS (U.S. CLS. 19, 20, 37, 42 AND 50).  
MARY CRAWFORD, EXAMINING ATTORNEY

**CLASS 5—PHARMACEUTICALS**

FOR DIAGNOSTIC PREPARATIONS FOR CLINICAL AND MEDICAL AND/OR VETERINARY LABORATORY USE, NAMELY, DNA AND/OR RNA AND PREPARATIONS CONTAINING DNA AND/OR RNA FOR THE REGULATION AND EXPRESSION OF MAMMALIAN, HUMAN, PLANT, MICROBIAL AND SYNTHETIC GENES FOR USE IN THE FIELDS OF HUMAN AND VETERINARY THERAPEUTICS; MEDICINAL AND BIOLOGICAL PREPARATIONS FOR CLINICAL OR MEDICAL LABORATORY USE INCLUDING PREPARATIONS FOR THE MODIFICATION OF GENE EXPRESSION; MEDICINAL AND BIOLOGICAL PREPARATIONS FOR PHARMACEUTICAL USE IN THE TREATMENT OF AIDS, HIV, HEPATITIS B AND C, VIRAL INFECTIONS AND DISEASES, CANCERS, BACTERIAL INFECTIONS, CENTRAL NERVOUS SYSTEM DISORDERS, DIABETES, OBESITY, GENETIC DISORDERS AND GENETIC ILLNESSES, AUTOIMMUNE, INFLAMMATORY; IMMUNODEFICIENCY, RESPIRATORY, CARDIOVASCULAR AND UROLOGIC DISEASES; PHARMACEUTICAL AND OTHER PREPARATIONS FOR USE IN THE FIELDS OF HUMAN AND VETERINARY THERAPEUTICS IN THE TREATMENT OF AIDS, HIV, HEPATITIS B AND C, VIRAL INFECTIONS AND DISEASES, CANCERS, BACTERIAL INFECTIONS, CENTRAL NERVOUS SYSTEM DISORDERS, DIABETES, OBESITY, GENETIC DISORDERS AND GENETIC ILLNESSES, AUTOIMMUNE, IMMUNODEFICIENCY; IMMUNODEFICIENCY, RESPIRATORY, CARDIOVASCULAR AND UROLOGIC DISEASES (U.S. CLS. 6, 18, 44, 46, 51 AND 52).

SN 76-499,538. SATECO AG, 8606 NANIKON, SWITZERLAND, FILED 3-21-2003.

**SATECO**

PRIORITY CLAIMED UNDER SEC. 44(D) ON SWITZERLAND APPLICATION NO. 00685/2003, FILED 2-5-2003, REG. NO. 510290, DATED 5-13-2003, EXPIRES 2-5-2013.

**CLASS 2—PAINTS**

FOR PAINTS, NAMELY, INKS FOR USE WITH KEYPADS IN SILICON ELASTOMERS, EXTERIOR AND INTERIOR PAINT; VARNISH; AND LACQUER IN THE NATURE OF A COATING (U.S. CLS. 6, 11 AND 16).

**CLASS 17—RUBBER GOODS**

FOR PLASTIC GOODS, NAMELY, EXTRUDED PLASTIC IN THE FORM OF BARS, BLOCKS, PELLETS, RODS, SHEETS, AND TUBES FOR USE IN MANUFACTURING (U.S. CLS. 1, 5, 12, 13, 35 AND 50).  
ELLEN B. AWRICH, EXAMINING ATTORNEY

SN 76-502,887. LELAS, TIHOMIR, ZAGREB, CROATIA,  
FILED 4-1-2003.

## NANOLAT

### CLASS 1—CHEMICALS

FOR CHEMICAL PRODUCTS FOR COMMERCIAL, SCIENTIFIC, PHOTOGRAPHIC, AGRICULTURAL, HORTICULTURAL AND FORESTRY PURPOSES NAMELY CHEMICAL ADDITIVES FOR USE IN THE MANUFACTURE OF FOOD SUPPLEMENTS (U.S. CLS. 1, 5, 6, 10, 26 AND 46).

### CLASS 5—PHARMACEUTICALS

FOR VETERINARY PREPARATIONS FOR HEALTH MAINTENANCE NAMELY MINERAL SUPPLEMENTS; DIETETIC NUTRITIONAL PREPARATIONS FOR MEDICAL PURPOSES; NUTRITIONAL SUPPLEMENTS FOR MEDICAL PURPOSES; DIETETIC NUTRITIONAL PREPARATIONS NAMELY FOOD SUPPLEMENTS BASED ON MINERALS; DIET SUPPLEMENTS FOR HEALTH MAINTENANCE, NAMELY VITAMINS, MINERALS, AND NUTRITIONAL SUPPLEMENTS; NUTRITIONAL SUPPLEMENTS FOR NON-MEDICAL PURPOSES NAMELY VITAMINS, AMINO ACIDS, MINERALS AND TRACE-ELEMENTS AS FOOD SUPPLEMENTS; PREPARATIONS BASED ON VITAMINS, TRACE-ELEMENTS AND/OR MINERALS FOR DIETETIC PURPOSES OR AS NUTRITION NAMELY FOOD SUPPLEMENTS; MINERAL WATERS FOR MEDICAL PURPOSES, MEDICATED BATH SALTS (U.S. CLS. 6, 18, 44, 46, 51 AND 52).

WANDA KAY PRICE, EXAMINING ATTORNEY

SN 76-507,622. BABOLAT VS, 69007 LYON, FRANCE, FILED  
4-17-2003.

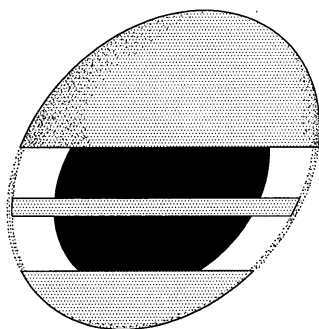

PRIORITY CLAIMED UNDER SEC. 44(D) ON FRANCE APPLICATION NO. 023190620, FILED 10-24-2002, REG. NO. 023190620, DATED 10-24-2002, EXPIRES 10-24-2012.

THE STIPPLING SHOWN IN THE MARK IS TO INDICATE SHADING.

### CLASS 7—MACHINERY

FOR STRINGING MACHINES (U.S. CLS. 13, 19, 21, 23, 31, 34 AND 35).

### CLASS 18—LEATHER GOODS

FOR LUGGAGE AND BAGS, NAMELY, RUCKSACKS, POUCHES, BAGS TO BE WORN ON A BELT, AND ALL-PURPOSE SPORTS BAGS (U.S. CLS. 1, 2, 3, 22 AND 41).

### CLASS 25—CLOTHING

FOR CLOTHING FOR TENNIS, SQUASH, BADMINTON, NAMELY, T-SHIRTS, SHORTS, POLO SHIRTS, SHIRTS, SWEATSHIRT, TROUSERS, JACKETS, TRACK-SUITS, AND SKIRTS, WRISTBANDS, SHOES, HEADGEAR, NAMELY, HEADBANDS, CAPS, HATS AND VISORS (U.S. CLS. 22 AND 39).

### CLASS 28—TOYS AND SPORTING GOODS

FOR SPORTS ARTICLES, NAMELY, TENNIS RACKETS, BADMINTON RACKETS, SQUASH RACKETS, RACKET BALLS, TENNIS BALLS, BADMINTON BALLS, SQUASH BALLS, BAGS FOR RACKETS, TENNIS BALL CLIPS FOR HOLDING TENNIS BALLS, STRINGS AND GUTS FOR RACKETS, BADMINTON SHUTTLECOCKS, ELBOW GUARDS FOR TENNIS, BADMINTON, AND SQUASH USE, WRIST GUARDS, FOR TENNIS, BADMINTON, AND SQUASH USE, HAND GRIPS FOR SPORTING EQUIPMENT, ANTIVIBRATORY DEVICES FOR RACKETS, NAMELY, VIBRATION ABSORBERS, PROTECTION PADS FOR RACKETS, PROTECTION TAPES FOR RACKETS, LEADS FOR BALANCING RACKETS, RACKETS, ESPECIALLY FOR TENNIS, SQUASH, BADMINTON, BAGS FOR TENNIS, SQUASH, BADMINTON (U.S. CLS. 22, 23, 38 AND 50).

JAMES A. RAUEN, EXAMINING ATTORNEY

SN 76-508,140. STORA ENSO OYJ, 00160 HELSINKI, FINLAND, FILED 4-15-2003.

## WOODHEART

PRIORITY CLAIMED UNDER SEC. 44(D) ON FINLAND APPLICATION NO. T200202950, FILED 10-18-2002, REG. NO. 228304, DATED 8-15-2003, EXPIRES 9-15-2013.

### CLASS 19—NON-METALLIC BUILDING MATERIALS

FOR BUILDING MATERIALS, NAMELY, SAWN TIMBER FOR USE IN JOINERY, MAKING FURNITURE AND CONSTRUCTION; AND SAWN TIMBER FOR USE AS BUILDING MATERIALS FOR MAKING FURNITURE, BEAMS, DOORS, DOOR FRAMES, WINDOWS, WINDOW FRAMES, INTERIOR PANELS, INTERIOR AND EXTERIOR WALLS AND WALL ELEMENTS, PARTITION ELEMENTS, FLOORING, ROOFING, CEILINGS, SCAFFOLDINGS, GARDEN FURNITURE, EXTERIOR CLADDINGS AND SAUNAS (U.S. CLS. 1, 12, 33 AND 50).

### CLASS 20—FURNITURE AND ARTICLES NOT OTHERWISE CLASSIFIED

FOR ROUGH AND SEMI-FINISHED UNSAWN, SAWN, AND PROCESSED WOOD PRODUCTS AND COMPONENTS, NAMELY, FURNITURE, GARDEN FURNITURE, SAUNA FURNITURE, AND PARTS THEREFORE (U.S. CLS. 2, 13, 22, 25, 32 AND 50).

### CLASS 39—TRANSPORTATION AND STORAGE

FOR TRANSPORTATION OF PASSENGER AND GOODS BY FERRY, BOAT, RAIL, AIR, TRUCK; PACKAGING ARTICLES FOR TRANSPORTATION AND WAREHOUSE STORAGE OF GOODS AND WARES; SHIPPING AND DELIVERIES OF GOODS BY TRUCK, AIR, BOAT, FERRY, RAIL; PROVIDING INFORMATION ON TRANSPORT AND STORAGE OF GOODS AND WARES (U.S. CLS. 100 AND 105).

DORITT L. CARROLL, EXAMINING ATTORNEY

SN 76-508,398. UNITED INDUSTRIES CORPORATION, ST. LOUIS, MO. FILED 4-21-2003.

SN 76-511,720. WEBER DISTRIBUTION WAREHOUSES, INC., SANTA FE SPRINGS, CA. FILED 5-6-2003.

## SCHULTZ

## THE STRONGEST LINK

SEC. 2(F).

OWNER OF U.S. REG. NO. 2,007,054.

### CLASS 1—CHEMICALS

FOR FERTILIZERS AND POTTING SOILS FOR DOMESTIC AND COMMERCIAL USE (U.S. CLS. 1, 5, 6, 10, 26 AND 46).  
FIRST USE 6-30-1971; IN COMMERCE 6-30-1971.

### CLASS 35—ADVERTISING AND BUSINESS

FOR TRANSPORTATION LOGISTICS SERVICES, NAMELY, PLANNING AND SCHEDULING SHIPMENTS FOR USERS OF TRANSPORTATION SERVICES; DISTRIBUTORSHIP SERVICES IN THE FIELD OF CHEMICALS, GROCERIES, TOYS, AUTOMOBILE ACCESSORIES, PAPER GOODS, HOUSEWARES, BEVERAGES, MEDICAL SUPPLIES, ELECTRONICS AND TELECOMMUNICATIONS EQUIPMENT, AND HEALTH AND BEAUTY CARE GOODS (U.S. CLS. 100, 101 AND 102).  
FIRST USE 1-0-1995; IN COMMERCE 1-0-1995.

### CLASS 5—PHARMACEUTICALS

FOR HERBICIDES, PESTICIDES, INSECTICIDES, RODENTICIDES AND FUNGICIDES FOR DOMESTIC AND COMMERCIAL USE (U.S. CLS. 6, 18, 44, 46, 51 AND 52).  
FIRST USE 5-1-1998; IN COMMERCE 5-1-1998.  
BRIAN PINO, EXAMINING ATTORNEY

### CLASS 39—TRANSPORTATION AND STORAGE

FOR FREIGHT TRANSPORTATION BY TRUCK AND FREIGHT STORAGE; DELIVERY OF GOODS BY TRUCK; WAREHOUSE STORAGE (U.S. CLS. 100 AND 105).  
FIRST USE 1-0-1995; IN COMMERCE 1-0-1995.  
ANGELA M. MICHELI, EXAMINING ATTORNEY

SN 76-510,649. MAURER, NEIL D., CINCINNATI, OH. FILED 4-30-2003.

## ON YOUR BEHALF

### CLASS 37—CONSTRUCTION AND REPAIR

FOR PREPARATION OF REAL ESTATE OF OTHERS FOR SALE, NAMELY CONSTRUCTION AND REPAIR OF BUILDINGS AND HOUSES, HOUSECLEANING AND HOUSE PAINTING (U.S. CLS. 100, 103 AND 106).

SN 76-512,986. AUTOMATED DOCUMENT EXCHANGE SERVICES INC., CHICAGO, IL. FILED 5-9-2003.

## ADEXS

### CLASS 44—MEDICAL, BEAUTY AND AGRICULTURAL SERVICES

FOR PREPARATION OF REAL ESTATE OF OTHERS FOR SALE, NAMELY YARD AND GROUNDS MAINTENANCE AND LANDSCAPE GARDENING (U.S. CLS. 100 AND 101).  
PATRICIA EVANKO, EXAMINING ATTORNEY

### CLASS 9—ELECTRICAL AND SCIENTIFIC APPARATUS

FOR ON-LINE, DOWNLOADABLE COMPUTER SOFTWARE TO CONVERT DATA INTO DIGITAL FORMAT, AND UPLOAD ELECTRONIC FILES, FOR ONLINE WAREHOUSING, INDEXING AND DISTRIBUTION IN THE FIELD OF CHEMICALS, PHARMACEUTICALS, TRANSPORTATION, HEALTHCARE AND MANUFACTURING (U.S. CLS. 21, 23, 26, 36 AND 38).  
FIRST USE 9-0-2002; IN COMMERCE 9-0-2002.

SN 76-511,329. WORLD KITCHEN (GHC), LLC, RESTON, VA. FILED 5-2-2003.

## INSIGNIA MATTE

OWNER OF U.S. REG. NO. 2,717,790.

### CLASS 35—ADVERTISING AND BUSINESS

FOR COMMERCIAL AND INDUSTRIAL RECORDS MANAGEMENT ASSISTANCE FOR UPDATING, WAREHOUSING AND DISTRIBUTING DIGITAL DATA VIA A GLOBAL COMPUTER NETWORK IN THE FIELD OF CHEMICALS, PHARMACEUTICALS, TRANSPORTATION, HEALTHCARE AND MANUFACTURING (U.S. CLS. 100, 101 AND 102).  
FIRST USE 9-0-2002; IN COMMERCE 9-0-2002.

### CLASS 8—HAND TOOLS

FOR KITCHEN KNIVES AND KITCHEN SHEARS (U.S. CLS. 23, 28 AND 44).

### CLASS 42—SCIENTIFIC, COMPUTER AND LEGAL SERVICES

FOR PROVIDING TEMPORARY USE OF ON-LINE, NON-DOWNLOADABLE SOFTWARE FOR WAREHOUSING, INDEXING, AND DISTRIBUTION OF DIGITAL DATA IN THE FIELD OF CHEMICALS, PHARMACEUTICALS, TRANSPORTATION, HEALTHCARE AND MANUFACTURING (U.S. CLS. 100 AND 101).  
FIRST USE 9-0-2002; IN COMMERCE 9-0-2002.  
MICHAEL WEBSTER, EXAMINING ATTORNEY

### CLASS 21—HOUSEWARES AND GLASS

FOR WOODEN CUTLERY BLOCKS (U.S. CLS. 2, 13, 23, 29, 30, 33, 40 AND 50).  
AMOS T. MATTHEWS, JR., EXAMINING ATTORNEY

SN 76-513,790. GHH SELECT LLC, ACTON, MA. FILED 5-13-2003.

SN 76-514,164. FONDAZIONE ARENA DI VERONA, 1-37121 VERONA, ITALY, FILED 5-12-2003.

## GHH SELECT

NO CLAIM IS MADE TO THE EXCLUSIVE RIGHT TO USE SELECT, APART FROM THE MARK AS SHOWN.

### CLASS 30—STAPLE FOODS

FOR COFFEE AND TEA (U.S. CL. 46).  
FIRST USE 2-18-2003; IN COMMERCE 2-18-2003.

### CLASS 35—ADVERTISING AND BUSINESS

FOR RETAIL STORE SERVICES FEATURING COFFEE BEANS AND TEA; MAIL ORDER SERVICES FEATURING COFFEE, TEA AND BULK COFFEE BEANS (U.S. CLS. 100, 101 AND 102).  
FIRST USE 2-18-2003; IN COMMERCE 2-18-2003.  
ANGELA M. MICHELI, EXAMINING ATTORNEY

SN 76-513,797. HORPHAG RESEARCH MANAGEMENT S.A., MEYRIN, SWITZERLAND, FILED 5-13-2003.

## PYCNO-Q10

OWNER OF U.S. REG. NOS. 1,769,633 AND 2,461,921.

### CLASS 3—COSMETICS AND CLEANING PREPARATIONS

FOR SKIN CARE CREAMS; NON-MEDICATED TOPICAL ANTIOXIDANT COSMETICS, NAMELY, FACIAL LOTIONS AND SKIN LOTIONS (U.S. CLS. 1, 4, 6, 50, 51 AND 52).

### CLASS 5—PHARMACEUTICALS

FOR DIETARY SUPPLEMENTS (U.S. CLS. 6, 18, 44, 46, 51 AND 52).  
LAURA KOVAISKY, EXAMINING ATTORNEY

SN 76-513,871. HILL COUNTRY BAKERY, LLC, SAN ANTONIO, TX. FILED 5-12-2003.

## HILL COUNTRY BAKERY

NO CLAIM IS MADE TO THE EXCLUSIVE RIGHT TO USE "BAKERY", APART FROM THE MARK AS SHOWN.

### CLASS 42—SCIENTIFIC, COMPUTER AND LEGAL SERVICES

FOR PRODUCT DEVELOPMENT, NAMELY, DEVELOPING BAKED FOOD PRODUCTS FOR OTHERS (U.S. CLS. 100 AND 101).  
FIRST USE 1-1-2002; IN COMMERCE 1-1-2002.

### CLASS 43—HOTEL AND RESTAURANT SERVICES

FOR CONTRACT FOOD SERVICES, NAMELY, BAKING FOOD PRODUCTS FOR OTHERS (U.S. CLS. 100 AND 101).  
FIRST USE 1-1-2002; IN COMMERCE 1-1-2002.  
GEORGIA CARTY, EXAMINING ATTORNEY

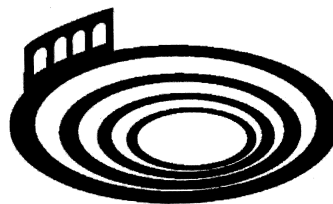

THE MARK CONSISTS OF A STYLIZED DESIGN OF AN AMPHITHEATER.

### CLASS 9—ELECTRICAL AND SCIENTIFIC APPARATUS

FOR PRE-RECORDED RECORDS, DVDS, AUDIO AND VIDEO TAPES, PRE-RECORDED COMPACT DISCS; ALL FEATURING CULTURE, MUSIC, LEISURE AND TOURISM INFORMATION (U.S. CLS. 21, 23, 26, 36 AND 38).

### CLASS 41—EDUCATION AND ENTERTAINMENT

FOR PUBLICATION OF BOOKS, ORGANIZING THEATRICAL AND MUSICAL PERFORMANCES, ORGANIZING EXHIBITIONS FOR EDUCATIONAL, CULTURAL, SPORTING AND ENTERTAINMENT PURPOSES, ORGANIZATION OF CONFERENCES, CONGRESSES, MEETINGS, SEMINARS, AND SYMPOSIA ON ART, CULTURE, LEISURE, MUSIC AND TOURISM, ARRANGING TICKET RESERVATIONS FOR SHOWS AND OTHER ENTERTAINMENT EVENTS (U.S. CLS. 100, 101 AND 107).

JOHN HWANG, EXAMINING ATTORNEY

SN 76-514,174. GKR KARATE AUSTRALIA PTY LTD, SOUTH AUSTRALIA, AUSTRALIA, FILED 5-12-2003.

## GO KAN RYU

OWNER OF AUSTRALIA REG. NO. 868308, DATED 3-8-2001, EXPIRES 3-8-2011.

NO CLAIM IS MADE TO THE EXCLUSIVE RIGHT TO USE "RYU", APART FROM THE MARK AS SHOWN.

### CLASS 16—PAPER GOODS AND PRINTED MATTER

FOR MAGAZINES, BOOKS AND NEWSLETTERS IN THE FIELD OF MARTIAL ARTS AND FITNESS (U.S. CLS. 2, 5, 22, 23, 29, 37, 38 AND 50).

### CLASS 25—CLOTHING

FOR CLOTHING, NAMELY GIs, BELTS, T-SHIRTS, TRACK SUITS, SHIRTS, POLOS, UNDERGARMENTS, JACKETS, PANTS, SHORTS AND SOCKS; HEADGEAR, NAMELY CAPS (U.S. CLS. 22 AND 39).

### CLASS 28—TOYS AND SPORTING GOODS

FOR MARTIAL ARTS EQUIPMENT, NAMELY, SHIN PROTECTORS AND FIST PROTECTORS (U.S. CLS. 22, 23, 38 AND 50).

**CLASS 35—ADVERTISING AND BUSINESS**

FOR DISSEMINATION OF ADVERTISING MATTER; BUSINESS MARKETING CONSULTING SERVICES; PROMOTING THE SALE OF GOODS AND SERVICES OF OTHERS THROUGH THE DISTRIBUTION OF PRINTED MATERIAL AND PROMOTIONAL CONTESTS; RETAIL OUTLETS FEATURING MARTIAL ARTS GOODS; WHOLESALE STORES FEATURING MARTIAL ARTS GOODS; MAIL ORDER SERVICES FEATURING MARTIAL ARTS GOODS; COMPUTERIZED ON-LINE RETAIL STORE SERVICES IN THE FIELD OF MARTIAL ARTS GOODS (U.S. CLS. 100, 101 AND 102).

**CLASS 41—EDUCATION AND ENTERTAINMENT**

FOR MARTIAL ARTS INSTRUCTION (U.S. CLS. 100, 101 AND 107).  
MIDGE BUTLER, EXAMINING ATTORNEY

SN 76-515,300. THE GOATMEAT PRODUCERS CO-OPERATIVE LIMITED, QUEENSLAND 4608, AUSTRALIA, FILED 5-19-2003.



OWNER OF AUSTRALIA REG. NO. 926267, DATED 7-25-2003, EXPIRES 9-6-2012.

NO CLAIM IS MADE TO THE EXCLUSIVE RIGHT TO USE "CO", APART FROM THE MARK AS SHOWN.

**CLASS 29—MEATS AND PROCESSED FOODS**

FOR MEAT FISH, POULTRY AND GAME; MEAT EXTRACTS; PRESERVED, DRIED AND COOKED FRUITS AND VEGETABLES; JELLIES, JAMS, EGGS, MILK AND MILK PRODUCTS, NAMELY, CHEESE AND YOGURT; EDIBLE OILS AND FATS (U.S. CL. 46).

**CLASS 31—NATURAL AGRICULTURAL PRODUCTS**

FOR LIVING ANIMALS; FRESH FRUITS AND VEGETABLES; FOODSTUFFS FOR ANIMALS (U.S. CLS. 1 AND 46).

KHANH LE, EXAMINING ATTORNEY

SN 76-518,168. 310 GLOBAL BRANDS, INC., MANHATTAN BEACH, CA. FILED 5-30-2003.

**310 MOTORING**

OWNER OF U.S. REG. NOS. 2,565,085, 2,581,111 AND OTHERS.

NO CLAIM IS MADE TO THE EXCLUSIVE RIGHT TO USE "MOTORING" EXCEPT IN CLASS 25, APART FROM THE MARK AS SHOWN.

**CLASS 1—CHEMICALS**

FOR CHEMICAL MOTOR OIL ADDITIVES; DETERGENT ADDITIVES FOR USE WITH MOTOR OIL (U.S. CLS. 1, 5, 6, 10, 26 AND 46).

**CLASS 2—PAINTS**

FOR COATINGS IN THE NATURE OF AUTOMOBILE FINISHING (U.S. CLS. 6, 11 AND 16).

**CLASS 3—COSMETICS AND CLEANING PREPARATIONS**

FOR AUTOMOBILE CLEANERS; AUTOMOBILE POLISH; AUTOMOBILE WAX AND CARNAUBA WAX FOR AUTOMOTIVE USE; POLYMER SEALANTS FOR CLEANING, SHINING AND PROTECTING AUTOMOBILE EXTERIOR SURFACES; AUTOMOTIVE CLEANING PREPARATIONS (U.S. CLS. 1, 4, 6, 50, 51 AND 52).

**CLASS 4—LUBRICANTS AND FUELS**

FOR AUTOMOTIVE LUBRICANTS; ALL PURPOSE PENETRATING OIL; AUTOMOTIVE GREASES; FUEL OIL (U.S. CLS. 1, 6 AND 15).

**CLASS 7—MACHINERY**

FOR AUTOMOTIVE EXHAUST PIPES; OIL, GAS AND AIR FILTERS FOR MOTORS AND ENGINES; CONVERSION KITS COMPOSED OF PARTS AND DEVICES THAT ENHANCE AND UPGRADE THE PERFORMANCE OF VEHICLE ENGINES, FUEL SYSTEMS, EXHAUST SYSTEMS AND SUSPENSION SYSTEMS (U.S. CLS. 13, 19, 21, 23, 31, 34 AND 35).

**CLASS 9—ELECTRICAL AND SCIENTIFIC APPARATUS**

FOR AUTOMOBILE NAVIGATIONAL SYSTEMS, NAMELY, GLOBAL POSITIONING SATELLITE RECEIVERS AND TRANSMITTERS FOR ACCESSING NAVIGATIONAL INFORMATION IN A MOTOR VEHICLE; AUTOMOBILE VIDEO SYSTEMS, NAMELY, TELEVISIONS, VIDEO SCREENS, CAMERAS, VIDEO GAME PLAYERS, CD PLAYERS, DVD PLAYERS, VCR PLAYERS, SPEAKERS, AND CONTROLS AND COMPONENTS THEREOF; AUTOMOBILE AUDIO SYSTEMS, NAMELY, RADIOS, STEREOs, TUNERS, SPEAKERS, CD PLAYERS, AUDIO CASSETTE PLAYERS, AMPLIFIERS, TELEPHONES, CELLULAR TELEPHONES, RADIO RECEIVERS, AND CONTROLS AND COMPONENTS THEREOF (U.S. CLS. 21, 23, 26, 36 AND 38).

**CLASS 12—VEHICLES**

FOR AUTOMOBILE COMPONENTS, NAMELY, WHEELS, TIRES; AUTOMOBILE BODIES; AUTOMOBILE BUMPERS; AUTOMOBILE SEAT CUSHIONS; AUTOMOBILE WINDSHIELD SUNSHADES; AUTOMOTIVE INTERIOR TRIM; PLASTIC PARTS FOR VEHICLES, NAMELY, AUTOMOTIVE EXTERIOR AND INTERIOR PLASTIC EXTRUDED DECORATIVE AND PROTECTIVE TRIM; LICENSE PLATE FRAMES AND HOLDERS (U.S. CLS. 19, 21, 23, 31, 35 AND 44).

**CLASS 16—PAPER GOODS AND PRINTED MATTER**

FOR PRINTED PUBLICATIONS, NAMELY, MAGAZINES FEATURING AUTOMOBILES, AUTOMOBILE ACCESSORIES AND CLOTHING (U.S. CLS. 2, 5, 22, 23, 29, 37, 38 AND 50).

**CLASS 25—CLOTHING**

FOR CLOTHING, NAMELY, SPORTS JERSEYS AND WRISTBANDS (U.S. CLS. 22 AND 39).

**CLASS 35—ADVERTISING AND BUSINESS**

FOR AUTOMOBILE REGISTRATION, NAMELY, ASSIGNMENT OF VEHICLE IDENTIFICATION NUMBERS TO DETER THEFT; RETAIL AUTOMOBILE PARTS AND ACCESSORIES STORES; DISTRIBUTORSHIPS IN THE FIELD OF AUTOMOTIVE PARTS (U.S. CLS. 100, 101 AND 102).

**CLASS 37—CONSTRUCTION AND REPAIR**

FOR AUTOMOBILE CLEANING; AUTOMOBILE CLEANING AND CAR WASHING; AUTOMOBILE DETAILING; AUTOMOBILE GREASING; AUTOMOBILE LUBRICATION; AUTOMOBILE PAINTING; AUTOMOBILE PINSTRIPING; AUTOMOBILE POLISHING; AUTOMOBILE REPAIR AND MAINTENANCE; AUTOMOBILE UNDERCOATING SERVICES; AUTOMOBILE WASHING; AUTOMOTIVE REFINISHING (U.S. CLS. 100, 103 AND 106).

**CLASS 41—EDUCATION AND ENTERTAINMENT**

FOR ENTERTAINMENT IN THE NATURE OF AUTOMOBILE RACES (U.S. CLS. 100, 101 AND 107).  
ANGELA M. MICHELI, EXAMINING ATTORNEY

SN 76-519,886. PHARD S.P.A., 80100 NAPOLI, ITALY, FILED 6-5-2003.



PRIORITY CLAIMED UNDER SEC. 44(D) ON ITALY APPLICATION NO. NA2002C00110, FILED 12-23-2002, REG. NO. 890149, DATED 5-6-2003, EXPIRES 5-6-2023.

**CLASS 16—PAPER GOODS AND PRINTED MATTER**

FOR PRINTING PAPER, POSTCARD PAPER, WRAPPING PAPER, WRITING AND DRAWING PAPER, ADDRESS AND SHIPPING ADHESIVE LABELS, NOTEBOOKS, MEMO PAPER, SKETCH BOOKS, COIN, PHOTOGRAPH AND STAMP ALBUMS, PENCILS, PENS, CRAYONS, PASTELS, RUBBER ERASERS, PHOTOGRAPH MOUNTS, PHOTOGRAPHS, MAGNETIC BLACKBOARDS, DRAWING PAPER, LETTER HOLDERS, WRITING TABLETS, CALENDARS, DIARIES, AND POSTCARDS (U.S. CLS. 2, 5, 22, 23, 29, 37, 38 AND 50).

**CLASS 18—LEATHER GOODS**

FOR LEATHER AND IMITATION LEATHER SOLD IN BULK; GOODS MADE OF THESE MATERIALS, NAMELY, BAGS, HANDBAGS, BRIEFCASES, SUITCASES, WALLETS, DOCUMENT CASES, PURSES, TRUNKS AND TRAVELING BAGS, ANIMAL SKINS AND HIDES; UMBRELLAS, PARASOLS AND WALKING STICKS, WHIPS, HARNESS AND SADDLERY (U.S. CLS. 1, 2, 3, 22 AND 41).

**CLASS 25—CLOTHING**

FOR CLOTHING, NAMELY, JACKETS, SHIRTS, COATS, TROUSERS, PULLOVERS, TIES, SOCKS, STOCKINGS, GLOVES, SCARVES, HATS, SWIMSUITS, TRACKSUITS, T-SHIRTS, UNDERWEAR, JEANS, NIGHTWEAR, SHOES, BOOTS, SLIPPERS AND BELTS (U.S. CLS. 22 AND 39).

MICHAEL SOUDERS, EXAMINING ATTORNEY

SN 76-521,197. STRATAGENE CALIFORNIA, LA JOLLA, CA. FILED 6-9-2003.

**STRATAGENE**

OWNER OF U.S. REG. NOS. 1,541,056, 2,737,172 AND OTHERS.

**CLASS 1—CHEMICALS**

FOR SCIENTIFIC AND RESEARCH LABORATORY REAGENTS FOR MOLECULAR BIOLOGICAL USE; NAMELY, CLONING VECTORS, INCLUDING CDNA CLONING VECTORS, GENOMIC CLONING VECTORS, EUKARYOTIC EXPRESSION VECTORS, PROKARYOTIC EXPRESSION VECTORS, AND YEAST SHUTTLE VECTORS, COMPETENT CELLS, HOST CELLS, PACKAGING EXTRACTS, POLYMERASE CHAIN REACTION OR PCR RELATED PRODUCTS, NUCLEIC ACID MARKERS, PROTEIN STANDARDS, ELECTROPHORESIS REAGENTS, PURIFICATION REAGENTS, BUFFERS, CUSTOM LIBRARIES, CDNA AND GENOMIC LIBRARIES, MODIFYING ENZYMES NAMELY, POLYMERASE, NUCLEASES, REVERSE TRANSCRIPTASES, LIGASES, KINASES, PHOSPHATASES, AND TRANSFERASES, RESTRICTION ENZYMES, MEDIA SUPPLEMENTS, LYMPHOKINES, AND CYTOKINES; KITS FOR MOLECULAR BIOLOGICAL USE; NAMELY, CDNA CLONING KITS, GENOMIC CLONING KITS, TRANSFECTION KITS, PURIFICATION KITS, POLYMERASE CHAIN REACTION OR PCR RELATED CLONING KITS, LIGASE CHAIN REACTION OR LCR KITS, LIBRARY CONSTRUCTION KITS, LABELING KITS, SEQUENCING KITS, MUTAGENESIS KITS, PROTEIN ANALYSIS KITS, TRANSCRIPTION KITS, TRANSLATION KITS, AND IN SITU HYBRIDIZATION KITS, SAID KITS PRIMARILY COMPRISING ENZYMES, REAGENTS, VECTORS AND ASSOCIATED EQUIPMENT, ALL FOR SCIENTIFIC AND RESEARCH USE; REAGENTS FOR LIFE SCIENCES (U.S. CLS. 1, 5, 6, 10, 26 AND 46).

FIRST USE 5-1-1986; IN COMMERCE 5-1-1986.

**CLASS 9—ELECTRICAL AND SCIENTIFIC APPARATUS**

FOR LABORATORY APPARATUS FOR MOLECULAR BIOLOGICAL USE; NAMELY, POWER SUPPLIES, ELECTROPHORESIS EQUIPMENT, NUCLEIC ACID TRANSFER AND HYBRIDIZATION EQUIPMENT, TEMPERATURE CYCLERS, MICROCENTRIFUGES, BENCHTOP COOLERS, RADIATION SHIELDS, AND PIPETTING EQUIPMENT; INSTRUMENTS FOR USE IN QUANTITATIVE POLYMERASE CHAIN REACTION ANALYSIS; INSTRUMENTATION AND EQUIPMENT FOR LIFE SCIENCES USE, NAMELY, COMPUTER HARDWARE, TUBES, PLATES, PIPETTE TIPS, SYRINGES, ASSAY TRAYS, GEL BOXES AND DRYERS, OVENS, LIGHT BOXES AND PARTS THEREFORE, LUMINESCENT PADS, CRYO PRESERVATION MODULES, SEQUENCING TRAYS, TRANSILLUMINATORS, CROSSLINKER, HEAT SEALERS, FILTERS, SPIN CUPS, GEL CASTING CASSETTES, GEL TRAYS, GEL COMBS, ELECTROELUTION CAPSULES, AND RADIATION SHIELDS (U.S. CLS. 21, 23, 26, 36 AND 38).

FIRST USE 5-1-1986; IN COMMERCE 5-1-1986.  
MICHAEL BAIRD, EXAMINING ATTORNEY

SN 76-521,198. STRATAGENE CALIFORNIA, LA JOLLA, CA.  
FILED 6-9-2003.

SN 76-521,501. NATRALITE FILTERS, INC., PALM BEACH  
GARDENS, FL. FILED 6-9-2003.



OWNER OF U.S. REG. NOS. 1,541,056, 2,737,172 AND  
OTHERS.

#### CLASS 1—CHEMICALS

FOR SCIENTIFIC AND RESEARCH LABORATORY REAGENTS FOR MOLECULAR BIOLOGICAL USE; NAMELY, CLONING VECTORS, INCLUDING CDNA CLONING VECTORS, GENOMIC CLONING VECTORS, EUKARYOTIC EXPRESSION VECTORS, PROKARYOTIC EXPRESSION VECTORS, AND YEAST SHUTTLE VECTORS, COMPETENT CELLS, HOST CELLS, PACKAGING EXTRACTS, POLYMERASE CHAIN REACTION OR PCR RELATED PRODUCTS, NUCLEIC ACID MARKERS, PROTEIN STANDARDS, ELECTROPHORESIS REAGENTS, PURIFICATION REAGENTS, BUFFERS, CUSTOM LIBRARIES, CDNA AND GENOMIC LIBRARIES, MODIFYING ENZYMES NAMELY, POLYMERASE, NUCLEASES, REVERSE TRANSCRIPTASES, LIGASES, KINASES, PHOSPHATASES, AND TRANSFERASES, RESTRICTION ENZYMES, MEDIA SUPPLEMENTS, LYMPHOKINES, AND CYTOKINES; KITS FOR MOLECULAR BIOLOGICAL USE; NAMELY, CDNA CLONING KITS, GENOMIC CLONING KITS, TRANSFECTION KITS, PURIFICATION KITS, POLYMERASE CHAIN REACTION OR PCR RELATED CLONING KITS, LIGASE CHAIN REACTION OR LCR KITS, LIBRARY CONSTRUCTION KITS, LABELING KITS, SEQUENCING KITS, MUTAGENESIS KITS, PROTEIN ANALYSIS KITS, TRANSCRIPTION KITS, TRANSLATION KITS, AND IN SITU HYBRIDIZATION KITS, SAID KITS PRIMARILY COMPRISING ENZYMES, REAGENTS, VECTORS AND ASSOCIATED EQUIPMENT, ALL FOR SCIENTIFIC AND RESEARCH USE; REAGENTS FOR LIFE SCIENCES (U.S. CLS. 1, 5, 6, 10, 26 AND 46).  
FIRST USE 5-1-1986; IN COMMERCE 5-1-1986.

#### CLASS 9—ELECTRICAL AND SCIENTIFIC APPARATUS

FOR LABORATORY APPARATUS FOR MOLECULAR BIOLOGICAL USE; NAMELY, POWER SUPPLIES, ELECTROPHORESIS EQUIPMENT, NUCLEIC ACID TRANSFER AND HYBRIDIZATION EQUIPMENT, TEMPERATURE CYCLERS, MICROCENTRIFUGES, BENCHTOP COOLERS, RADIATION SHIELDS, AND PIPETTING EQUIPMENT; INSTRUMENTS FOR USE IN QUANTITATIVE POLYMERASE CHAIN REACTION ANALYSIS; INSTRUMENTATION AND EQUIPMENT FOR LIFE SCIENCES USE, NAMELY, COMPUTER HARDWARE, TUBES, PLATES, PIPETTE TIPS, SYRINGES, ASSAY TRAYS, GEL BOXES AND DRYERS, OVENS, LIGHT BOXES AND PARTS THEREFORE, LUMINESCENT PADS, CRYO PRESERVATION MODULES, SEQUENCING TRAYS, TRANSILLUMINATORS, CROSSLINKER, HEAT SEALERS, FILTERS, SPIN CUPS, GEL CASTING CASSETTES, GEL TRAYS, GEL COMBS, ELECTROELUTION CAPSULES, AND RADIATION SHIELDS (U.S. CLS. 21, 23, 26, 36 AND 38).  
FIRST USE 5-1-1986; IN COMMERCE 5-1-1986.  
MICHAEL BAIRD, EXAMINING ATTORNEY

## NATRALITE

#### CLASS 9—ELECTRICAL AND SCIENTIFIC APPARATUS

FOR LIGHT FILTERS FOR FILTERING LIGHT EMITTED FROM COMPUTER MONITORS (U.S. CLS. 21, 23, 26, 36 AND 38).

#### CLASS 11—ENVIRONMENTAL CONTROL APPARATUS

FOR LIGHT FILTERS FOR FLUORESCENT LAMPS (U.S. CLS. 13, 21, 23, 31 AND 34).  
MARY BOAGNI, EXAMINING ATTORNEY

SN 76-522,356. ASTRA S.A.S. DI MARCOCCI GIUSEPPE & C.,  
SAN VENANZO (TERNI), ITALY, FILED 6-6-2003.



#### CLASS 10—MEDICAL APPARATUS

FOR ORTHOTIC INSERTS FOR FOOTWEAR AND ORTHOPEDIC SOLES FOR FOOTWEAR (U.S. CLS. 26, 39 AND 44).  
FIRST USE 3-3-2003; IN COMMERCE 3-3-2003.

#### CLASS 25—CLOTHING

FOR FOOTWEAR AND SOLES AND INNER SOLES FOR FOOTWEAR (U.S. CLS. 22 AND 39).  
FIRST USE 3-3-2003; IN COMMERCE 3-3-2003.  
ROBIN CHOSID, EXAMINING ATTORNEY

SN 76-522,493. LOWCARB GOURMET, INC., DESTIN, FL.  
FILED 6-13-2003.

## MIKE'S LOW CARB GOURMET

NO CLAIM IS MADE TO THE EXCLUSIVE RIGHT TO USE "LOW CARB GOURMET", APART FROM THE MARK AS SHOWN.

#### CLASS 29—MEATS AND PROCESSED FOODS

FOR FROZEN DINNERS AND MEAL ENTREES FOR BREAKFAST, LUNCH AND DINNER, AND FROZEN APPETIZERS CONSISTING OF PROTEINS, VEGETABLES AND SAUCE (U.S. CL. 46).

**CLASS 30—STAPLE FOODS**

FOR FROZEN DESSERTS, NAMELY, CAKES, ICE CREAM, PIES, PASTRIES, COOKIES AND FROZEN NOVELTIES, NAMELY, CONFECTIONS, ICE CREAM CONES AND ICE CREAM SANDWICHES (U.S. CL. 46).  
KAREN BRACEY, EXAMINING ATTORNEY

SN 76-524,981. C.S. LEWIS (PTE.) LTD., BEACH CENTRE, SINGAPORE, FILED 6-23-2003.



SN 76-522,954. ALABAMA WILDLIFE FEDERATION, INC., MILLBROOK, AL. AND ALABAMA INSTITUTE FOR DEAF AND BLIND FOUNDATION, INC., MILLBROOK, AL. FILED 6-17-2003.

OWNER OF U.S. REG. NOS. 2,274,838, 2,483,052 AND OTHERS.

**WILDPATHS****CLASS 35—ADVERTISING AND BUSINESS**

FOR RETAIL STORE SERVICES FEATURING BIRDHOUSES, BLUE BIRD BOXES, DUCK BOXES, AND BIRD FEEDERS; AND ON-LINE RETAIL STORE SERVICES FEATURING BIRDHOUSES, BLUE BIRD BOXES, DUCK BOXES AND BIRD FEEDERS (U.S. CLS. 100, 101 AND 102).  
FIRST USE 3-13-2003; IN COMMERCE 3-13-2003.

**CLASS 3—COSMETICS AND CLEANING PREPARATIONS**

FOR SOAPS; PERFUMERY; ESSENTIAL OILS FOR PERSONAL USE; COSMETICS; HAIR LOTIONS AND TOOTHPASTE. (U.S. CLS. 1, 4, 6, 50, 51 AND 52).

**CLASS 6—METAL GOODS**

FOR GOODS COMPRISED OF COMMON METAL, NAMELY, KEY CHAINS, NAME BADGES, KEY RINGS, NON-LUMINOUS AND NON-MECHANICAL METAL SIGNS, FIGURINES, IDENTIFICATION BRACELETS AND PIGGY BANKS; STATUES AND STATUETTES OF NON-PRECIOUS METAL. (U.S. CLS. 2, 12, 13, 14, 23, 25 AND 50).

**CLASS 41—EDUCATION AND ENTERTAINMENT**

FOR EDUCATIONAL SERVICES, NAMELY, PROVIDING TRAINING AND INSTRUCTION TO PERSONS WITH DISABILITIES IN THE FIELD OF OCCUPATIONAL SKILLS AND WORK HABITS (U.S. CLS. 100, 101 AND 107).  
FIRST USE 3-13-2003; IN COMMERCE 3-13-2003.

**CLASS 9—ELECTRICAL AND SCIENTIFIC APPARATUS**

FOR BLANK MAGNETIC DATA CARRIERS; COMPACT DISCS AND COMPUTER DISCS FEATURING FICTIONAL, EDUCATIONAL AND ENTERTAINMENT WORKS; COMPUTER SOFTWARE FOR EDUCATION AND ENTERTAINMENT, NAMELY, CHILDREN'S EDUCATIONAL COMPUTER SOFTWARE AND SOFTWARE PROGRAMS FEATURING GAMES, GRAPHICS AND INTERACTIVE PROGRAMS FOR THE ENTERTAINMENT AND EDUCATION OF CHILDREN; MOTION PICTURE FILMS AND CINEMATOGRAPHIC FILMS FEATURING FICTIONAL, EDUCATIONAL AND ENTERTAINMENT WORKS; BLANK VIDEO TAPES, VIDEO CASSETTES, AUDIO CASSETTES, VIDEO TAPES, AUDIO TAPES, COMPACT DISCS, CD ROMS, DVDS, MP3S, AND LASER DISCS; PRE-RECORDED VIDEO TAPES, VIDEO CASSETTES, AUDIO CASSETTES, VIDEO TAPES, AUDIO TAPES, COMPACT DISCS, CD ROMS, DVDS, MP3S AND LASER DISCS FEATURING FICTIONAL WORKS, EDUCATIONAL WORKS FOR CHILDREN AND ENTERTAINMENT WORKS; COMPUTER AND VIDEO GAME CARTRIDGES, CASSETTES, TAPES, DISCS AND SOFTWARE; ELECTRONIC PUBLICATIONS, NAMELY, CATALOGUES, BOOKS, ACTIVITY BOOKS, COLORING BOOKS, MAGAZINES, JOURNALS, NEWSLETTERS, ENCYCLOPEDIAS, MANUALS, CALENDARS, POSTERS AND BROCHURES FEATURING FICTIONAL WORKS, EDUCATIONAL WORKS FOR CHILDREN AND ENTERTAINMENT WORKS RECORDED ON COMPUTER MEDIA; DOWNLOADABLE ELECTRONIC PUBLICATIONS IN THE NATURE OF BOOKS, MAGAZINES, JOURNALS, NEWSLETTERS, ENCYCLOPEDIAS, MANUALS, CALENDARS, POSTERS AND BROCHURES FEATURING FICTIONAL WORKS, EDUCATIONAL WORKS FOR CHILDREN AND ENTERTAINMENT WORKS; DOWNLOADABLE COMPUTER GAMES; MOUSE PADS; EYEGLASSES, SUNGLASSES AND CASES THEREFORE; DECORATIVE MAGNETS; MAGNETICALLY ENCODED PREPAID TELEPHONE CARDS; LIGHT SWITCH PLATE COVERS; JOYSTICKS FOR PLAYING VIDEO GAMES; SPORT GOGGLES AND MASKS FOR USE IN SNORKELING, SKIN AND SCUBA DIVING; DIVING SUITS AND SNORKELS. (U.S. CLS. 21, 23, 26, 36 AND 38).

FIRST USE 3-13-2003; IN COMMERCE 3-13-2003.  
CIMMERIAN COLEMAN, EXAMINING ATTORNEY

SN 76-524,491. AMERICAN GUARDIAN WARRANTY SERVICES, INC., GLEN ELLYN, IL. FILED 6-23-2003.

**DENT ARMOR**

NO CLAIM IS MADE TO THE EXCLUSIVE RIGHT TO USE "DENT", APART FROM THE MARK AS SHOWN.

**CLASS 35—ADVERTISING AND BUSINESS**

FOR PROCESSING WARRANTY REGISTRATION DOCUMENTS FOR OTHERS AND ARRANGING FOR REPAIRS AND REPLACEMENTS PURSUANT TO THE WARRANTY (U.S. CLS. 100, 101 AND 102).  
FIRST USE 5-9-2003; IN COMMERCE 5-9-2003.

**CLASS 36—INSURANCE AND FINANCIAL**

FOR PROVIDING EXTENDED WARRANTIES ON AUTOMOBILES FOR THE REPAIR OF MINOR DENTS IN THEIR BODIES (U.S. CLS. 100, 101 AND 102).  
FIRST USE 5-9-2003; IN COMMERCE 5-9-2003.  
STANLEY I. OSBORNE, EXAMINING ATTORNEY



**CLASS 14—JEWELRY**

FOR JEWELRY; PRECIOUS GEMSTONES; CLOCKS; WATCHES; STATUES, STATUETTES AND FIGURINES OF PRECIOUS METAL AND MUSICAL FIGURINES OF PRECIOUS METAL. (U.S. CLS. 2, 27, 28 AND 50).

**CLASS 15—MUSICAL INSTRUMENTS**

FOR MUSICAL INSTRUMENTS; MUSICAL BOXES; MUSICAL FIGURINES. (U.S. CLS. 2, 21 AND 36).

**CLASS 16—PAPER GOODS AND PRINTED MATTER**

FOR PAPER, CARDBOARD AND GOODS MADE FROM THESE MATERIALS, NAMELY CONSTRUCTION PAPER, BOXES, BAGS, WRITING PAPER AND PADS, NOTE PADS, NOTE PAPER, MEMO PADS, GREETING CARDS, INVITATIONS, GIFT WRAP, BOWS, RIBBONS, BUSINESS CARD HOLDERS, NOTE CARDS, PAPER CONTAINERS, WRITING TABLETS; PHOTOGRAPHS; STATIONERY; CALENDARS; POSTERS; MAPS; BOOKMARKS; TRADING CARDS; ADHESIVES FOR STATIONERY OR HOUSEHOLD PURPOSES; PRINTED MATTER, NAMELY CATALOGUES, BOOKS, MAGAZINES, JOURNALS, NEWSLETTERS, ENCYCLOPEDIAS, MANUALS, AND BROCHURES FEATURING FICTIONAL, EDUCATIONAL AND ENTERTAINMENT WORKS; DIARIES; ACTIVITY BOOKS; PAINTING SETS; ARTS AND CRAFT PAINT KITS; CHALK; GLUE FOR HOUSEHOLD OR STATIONERY USE; PASTELS; CRAYONS; PENS; PENCILS; PENCIL SHARPENERS; HIGH LIGHTERS; PAINTING PALETTES; PAINT BRUSHES; PAINTING CANVASSES; PAPER HATS; PAPER NAPKINS; ENVELOPES; ADHESIVE BACKED PAPER LABELS; COIN AND PHOTOGRAPH ALBUMS; BINDERS; BOOKENDS; ADDRESS BOOKS; ANNIVERSARY BOOKS; APPOINTMENT BOOKS; BABY BOOKS; BOOK-KEEPING BOOKS; BUSINESS RECORD BOOKS; CHILDREN'S BOOKS; COLORING BOOKS; DATE BOOKS; EXPENSE BOOKS; ENGAGEMENT BOOKS; NOTEBOOKS; PICTURE BOOKS; TELEPHONE NUMBER BOOKS; TRAVEL BOOKS; FILE FOLDERS; PICTURES; POSTCARDS; SCRAPBOOKS; SCORE BOOKS; SCORE CARDS; SCORE PADS; SCORE SHEETS; STICKERS; BLOTTERS; PENCIL AND PEN HOLDERS; STAPLERS; HOLE PUNCHERS; PAPERWEIGHTS; DRAFTING, DRAWING AND UNGRADUATED RULERS; ADHESIVE TAPE DISPENSERS FOR HOUSEHOLD OR STATIONERY USE; PLASTIC BUBBLE PACKS FOR WRAPPING OR PACKAGING; PLASTIC BAGS, PAPER POUCHES FOR PACKAGING; PAPER ENVELOPES; BLISTER CARDS; PACKING PAPER FOR PACKAGING; PACKAGING MATERIALS MADE OF PLASTIC, PAPER, OR CARDBOARD, NAMELY, PAPER ENVELOPES FOR PACKAGING, PAPER FOR WRAPPING AND PACKAGING, PLASTIC BAGS FOR PACKAGING, PLASTIC OR PAPER BAGS FOR MERCHANDISE PACKAGING, CARDBOARD CARTONS, CARDBOARD CONTAINERS AND CARDBOARD MAILING TUBES; PAPER BABY BIBS; DISPOSABLE DIAPERS; PAPER PARTY HATS; AND PRE-PAID TELEPHONE CALLING CARDS, NOT MAGNETICALLY ENCODED (U.S. CLS. 2, 5, 22, 23, 29, 37, 38 AND 50).

**CLASS 18—LEATHER GOODS**

FOR GOODS MADE OF LEATHER AND LEATHER IMITATIONS, NAMELY, SUITCASES, LUGGAGE, TRAVEL BAGS, GARMENT BAGS FOR TRAVEL, SHOE BAGS FOR TRAVEL, TOILETRY BAGS SOLD EMPTY, COSMETIC BAGS SOLD EMPTY, CARRY-ON BAGS, PURSES, HANDBAGS, SHOULDER BAGS, CLUTCH BAGS, TOTE BAGS, DUFFEL BAGS, BEACH BAGS, BILLFOLDS, WALLETS, KEY CASES, KNAPSACKS, FANNY PACKS, WAIST PACKS, UMBRELLAS, PARASOLS, TRUNKS, BACKPACKS, ATTACHE CASES, TOTE BAGS, BOOK BAGS, BRIEF CASES, DOCUMENT CASES, BUSINESS CASES, ALL-PURPOSE SPORTS BAGS, GYM BAGS AND ATHLETIC BAGS. (U.S. CLS. 1, 2, 3, 22 AND 41).

**CLASS 20—FURNITURE AND ARTICLES NOT OTHERWISE CLASSIFIED**

FOR FURNITURE, MIRRORS, FURNITURE FRAMES, PICTURE FRAMES, EMBROIDERY FRAMES, BOOK RESTS, BOOK STANDS, DECORATIVE MOBILES, NON-TOY STUFFED ANIMALS, PLASTIC FIGURINES, FABRIC FIGURINES, GAZING WATER GLOBES, HANGERS FOR CLOTHES, DISPENSERS FOR PILLS AND CAPSULES SOLD EMPTY, PLASTIC PILLBOXES, PLASTIC SIGNS, PLASTIC BANNERS, PLASTIC CAKE DECORATIONS, PLASTIC CAPS, PLASTIC KEY CHAINS, KEY HOLDERS AND KEY RINGS, PLASTIC BADGE HOLDERS, PLASTIC NOVELTY LICENSE PLATES, PLASTIC GIFT PACKAGE DECORATIONS, PLASTIC HOLIDAY ORNAMENTS EXCLUDING CHRISTMAS TREE ORNAMENTS, DRINKING STRAWS, THROW PILLOWS, CUSHIONS, SLEEPING BAGS, TOY CHESTS, NON-ELECTRIC FANS FOR PERSONAL USE, FLAGPOLES, GLASS FOR USE IN FRAMING ART, JEWELRY BOXES AND CASES NOT OF METAL; GOODS OF WOOD, CORK, REED, CANE, WICKER, HORN, BONE, IVORY, WHALEBONE, SHELL, AMBER, MOTHER-OF-PEARL, MEERSCHAUM, PLASTER, PLASTIC, COLD CAST RESIN AND WAX NAMELY, BUSTS, FIGURINES, DESKTOP STATUARY, SCULPTURES, STATUES, STATUETTES, LETTER BOXES AND ORNAMENTS NOT FOR CHRISTMAS. (U.S. CLS. 2, 13, 22, 25, 32 AND 50).

**CLASS 21—HOUSEWARES AND GLASS**

FOR HOUSEHOLD AND KITCHEN UTENSILS, NAMELY, SPATULAS, STRAINERS, TURNERS, SIEVES, GRATERS, POT AND PAN SCRAPERS, ROLLING PINS, WHISKS, SKIMMERS, BASTING SPOONS, ICE CREAM SCOOPS, SERVING FORKS, FORKS FOR BARBEQUING, MIXING SPOONS, SERVING SPOONS, SLOTTED SPOONS, COOKING SKEWERS, ROLLING PINS; SCRUBBING COMBS, SPONGES AND BRUSHES, GLASS FABRICS FOR INDUSTRIAL USE; POLISHED PLATE GLASS, CERAMIC, GLASSWARE, PORCELAIN AND EARTHENWARE, NAMELY, BOWLS, PLATES, DISHES, CANISTER SETS, COFFEE CUPS, CANTEENS, CARAFES, CARVING BOARDS, GRAVY BOATS, ICE BUCKETS, MEAL TRAYS, SERVING TRAYS NOT OF PRECIOUS METAL; LUNCHBOXES, COLANDERS, PLATES, CUPS, ELECTRIC AND NON-ELECTRIC TOOTHBRUSHES, BOTTLES SOLD EMPTY, BOTTLE OPENERS, MUGS; GLASS STORAGE JUGS, DRINKING GLASSES, SHOT GLASSES, GLASS STORAGE JARS, SPICE RACKS, BEVERAGE GLASSWARE, BEVERAGE STIRRERS, DEMITASSE SETS CONSISTING OF CUPS AND SAUCERS, SUGAR AND CREAMER SETS FEATURING SUGAR BOWLS NOT OF PRECIOUS METAL AND CREAMER PITCHERS, COFFEE POTS NOT OF PRECIOUS METAL, PLANT AND FLOWER BASKETS; WICKER, STRAW, WOOD AND CLOTH BASKETS; PLASTIC BUCKETS, WOVEN FABRIC BUCKETS, TEA CADDIES, TEA SETS; COOKERY MOLDS, POTS AND PANS; COOKIE SHEETS; SERVING UTENSILS, NAMELY, LADLES, CAKE SERVERS, PIE SERVERS, TONGS; COASTERS NOT OF PAPER AND NOT TABLE LINEN, COCKTAIL SHAKERS, COOKIE CUTTERS, CORK SCREWS, CORN COB HOLDERS, DECANTERS, FLASKS, PLASTIC HOUSEHOLD GLOVES FOR GENERAL USE, DINNERWARE, CONTAINERS FOR HOUSEHOLD USE, ALL PURPOSE PORTABLE HOUSEHOLD CONTAINERS, CONTAINERS FOR HOUSEHOLD USE, NAMELY, GLOBES, BABY BATH TUBS, BACK SCRATCHERS, BAKEWARE, BAKING DISHES; BARWARE, NAMELY, CORKSCREWS, WINE BOTTLE FOIL CUTTERS, WINE GLASSES, CARAFES, DECANTERS, WINE RACKS, COOLERS FOR WINE AND CHAMPAGNE, PLASTIC BOTTLE STOPPERS AND POURERS, BOTTLE OPENERS, MEASURING JIGGERS, CRUMB SCRAPERS, FLASKS, CORK EXTRACTORS, CHAMPAGNE OPENERS, STAINLESS STEEL COCKTAIL SETS COMPRISED OF COCKTAIL PICKS AND SHAKERS SOLD TOGETHER AS A UNIT, SELTZER BOTTLES, HIGH BALL GLASSES AND WINE GOBLET; BIRD BATHS NOT BEING STRUCTURES, BIRD FEEDERS, BIRD HOUSES; CRYSTAL, CHINA, EARTHENWARE, GLASS, PORCELAIN AND TERRA COTTA BUSTS; CANDLESTICKS NOT OF PRECIOUS METAL, CERAMIC FIGURINES, CLEANING CLOTHS, CLOTHES PINS, TOWEL DISPENSERS, SOAP DISPENSERS, FOAM DRINK HOLDERS, HAIR BRUSHES, HAIR COMBS,

CERAMIC AND PORCELAIN HOLIDAY ORNAMENTS EXCLUDING CHRISTMAS TREE ORNAMENTS, INCENSE BURNERS, NAPKIN HOLDERS, NAPKIN RINGS NOT OF PRECIOUS METAL, ORNAMENTAL GLASS SPHERES, PAPER CUPS AND PLATES, PLASTIC CUPS AND PLATES, PEPPER GRINDERS AND MILLS, PORTABLE COOLERS, POTTIES FOR CHILDREN, RECIPE BOXES, SALT AND PEPPER SHAKERS, SHOE HORNS, SHOE TREES, TOILET PAPER HOLDERS, TOOTHPICKS, TOOTHPICK HOLDERS, TRASH CANS, TOWEL BARS AND HOLDERS, URNS, WATERING CANS, WIND CHIMES; ALL OF THE FOREGOING GOODS NOT MADE OF PRECIOUS METAL. (U.S. CLS. 2, 13, 23, 29, 30, 33, 40 AND 50).

#### **CLASS 24—FABRICS**

FOR TEXTILE AND TEXTILE GOODS, NAMELY, MATTRESS COVERS, MATTRESS PADS, BED COVERS, BED BLANKETS, BED CANOPIES, BED LINEN, BED PADS, BED SHEETS, BED SPREADS, BLANKET TROWS, COMFORTERS, COVERLETS, CRIB BUMPERS, CRIB CANOPIES, DUST RUFFLES, EIDERDOWN COVERS, EIDERDOWNS, PILLOW CASES, PILLOW COVERS, PILLOW SHAMS, RECEIVING BLANKETS, SHAMS, DUVETS, DUVET COVERS, QUILTS, TABLE COVERS, TABLE LINEN, TOWELS, AFGHANS, BARBECUE MITTS, BATH LINEN, BURP CLOTHS, CLOTH BANNERS, CLOTH DOILIES, CLOTH FLAGS, CLOTH LABELS, CLOTH PENNANTS, CURTAINS, DISH CLOTHS, DRAPERIES, FABRIC FLAGS, FABRIC TABLE RUNNERS, FABRIC TABLE TOPPERS, FABRIC VALANCES, FELT PENNANTS, FITTED TOILET LID COVERS MADE OF FABRIC OR FABRIC SUBSTITUTES, HANDKERCHIEFS, HOUSEHOLD LINEN, KIT COMPRISED OF FABRICS FOR MAKING QUILTS, LAP ROBES, LAP RUGS, OVEN MITTS, POT HOLDERS, SHOWER CURTAINS, SHROUDS, SWAGS, TABLE CLOTHS NOT OF PAPER, TABLE LINEN, NAMELY, COASTERS, NAPKINS, PLACE MATS, TEXTILE WALL HANGINGS, WASHCLOTHS AND WASHING MITTS. (U.S. CLS. 42 AND 50).

#### **CLASS 25—CLOTHING**

FOR CLOTHING, NAMELY, DRESSES, GOWNS, BEACHWEAR, SWIM WEAR, BLOUSES, BODY SUITS, BRAS, BUSTIERS, FOUNDATION GARMENTS, UNDERCLOTHES, UNDER GARMENTS, UNDERWEAR, BODY SUITS, SLIPS, SARONGS, NEGLIGEEES, LEOTARDS, UNITARDS, SHORTS, TOPS, BOTTOMS, COATS, HOSIERY, STOCKINGS, JACKETS, CAPES, PONCHOS, NIGHTWEAR, SLEEPWEAR, LINGERIE, ROBES, LOUNGEWEAR, NECKWEAR, TIES, PANTS, JEANS, RAINWEAR, SHIRTS, SCARVES, SHAWLS, KERCHIEFS, SKIRTS, JUMP SUITS, SKIWEAR, SOCKS, SUITS, SWEATERS, SWEATSHIRTS, SWEAT JACKETS, SWEAT SUITS, SWEATPANTS, EXERCISE SUITS, EXERCISE AND JOGGING SUITS, TIGHTS, LEGGINGS, T-SHIRTS, WRISTBANDS, HEADBANDS, TENNIS WEAR, TUXEDOS, VESTS, INFANTWEAR; FOOTWEAR; HEADWEAR, HATS, CAPS, VISORS, SHOWER CAPS, GLOVES, MITTENS, BELTS, APRONS, CLOTH DIAPERS, BANDANAS, HALLOWEEN COSTUMES, MASQUERADE COSTUMES AND BABY BIBS NOT OF PAPER. (U.S. CLS. 22 AND 39).

#### **CLASS 28—TOYS AND SPORTING GOODS**

FOR GAMES, NAMELY, PARLOR GAMES, BOARD GAMES, ACTION SKILL GAMES, ACTION TARGET GAMES, ARCADE GAMES, CARD GAMES, COIN-OPERATED VIDEO GAMES, DART GAMES, EQUIPMENT SOLD AS A UNIT FOR PLAYING BOARD, CARD AND ACTION TARGET GAMES, MANIPULATIVE GAMES, PARTY GAMES, PINBALL GAMES, HAND HELD UNIT FOR PLAYING ELECTRONIC GAMES, STAND ALONE VIDEO OUTPUT GAME MACHINES, DOMINOS; PLAYTHINGS AND TOYS, NAMELY, INFANT TOYS, CRIB TOYS, BATH AND WATER TOYS, TEDDY BEARS, PLUSH TOYS, STUFFED TOY ANIMALS, TOY ANIMALS, ACTION FIGURES, TOY TRAIN SETS, TOY FURNITURE, TOY TELEPHONES, TOY CLOCKS, TOY BUILDING AND CONSTRUCTION BLOCKS, TOY ROBOTS, TOY MUSICAL INSTRUMENTS, TOY CARS, WIND-UP TOYS, RIDE-ON TOYS, PULL TOYS, BALLOONS, DOLLS, DOLL HOUSES, DOLL HOUSE FURNITURE, PUPPETS, SHAPE SORTERS, FLYING DISCS,

JIGSAW AND MANIPULATIVE PUZZLES, PAPER FACE MASKS, YOYOS, KITES, TOY MODEL HOBBYCRAFT KITS, PINBALL MACHINES; GYMNASIAC AND SPORTING ARTICLES, NAMELY, BASEBALL GLOVES, BATTING GLOVES, BOXING GLOVES, GOALKEEPERS' GLOVES, GOLF GLOVES, HANDBALL GLOVES, HOCKEY GLOVES, KARATE GLOVES, RACQUETBALL GLOVES, SOFTBALL GLOVES, SWIMMING GLOVES, WATER SKI GLOVES, WEIGHT LIFTING GLOVES, BASEBALL MITTS, CATCHERS' MITTS, SOFTBALL MITTS, GOLF TEES, GOLF CLUBS, HEAD COVERS FOR GOLF CLUBS, TENNIS RACKETS, SCUBA FLIPPERS, SKATEBOARDS, ICE SKATES, ROLLER SKATES, SWIMMING FLOATS AND BOARDS FOR RECREATIONAL USE, SURF BOARDS, SWIMMING FLIPPERS, SNORKEL GEAR, NAMELY, SWIM FINNS, FLIPPERS FOR USE IN SNORKELING, SNORKEL STRAPS AND SNORKEL BAGS; BALLS, NAMELY, BASKETBALLS, BASEBALLS, FOOTBALLS, RUBBER BALLS, SOCCER BALLS, SUPER BALLS, GOLF BALLS, TENNIS BALLS; SPORT BALLS, KALEIDOSCOPIES, PLAYING CARDS, CHRISTMAS TREE DECORATIONS AND ORNAMENTS; TOY MUSICAL BOXES; PLASTIC BIKE TAGS; SNOW GLOBES. (U.S. CLS. 22, 23, 38 AND 50).

#### **CLASS 41—EDUCATION AND ENTERTAINMENT**

FOR ENTERTAINMENT SERVICES, NAMELY, PROVIDING PUPPET SHOWS, FILM SCREENINGS, LIVE MUSIC CONCERTS, PRODUCTION OF PLAYS, THEATER PRODUCTIONS, LIVE MUSICAL AND THEATRICAL STAGE SHOWS AND PERFORMANCES, AND PROVIDING MULTI-USER ON-LINE COMPUTER GAMES; THEME PARK SERVICES; PRODUCTION AND RENTAL OF SOUND, AUDIO AND VIDEO RECORDINGS; ENTERTAINMENT SERVICES, NAMELY, PROVIDING ON-LINE ENTERTAINMENT IN THE NATURE OF SOUND, AUDIO AND VIDEO RECORDINGS; PRODUCTION, PRESENTATION, DISTRIBUTION FOR OTHERS AND RENTAL OF TELEVISION AND RADIO PROGRAMS, FILMS, MOTION PICTURE FILMS AND THEATRICAL PRODUCTIONS; LITERARY AND MUSIC PUBLISHING SERVICES; SPORTING AND CULTURAL ACTIVITIES, NAMELY, ORGANIZING AND CONDUCTING SPORTING EVENTS, CULTURAL EVENTS AND ARTS EVENTS; ORGANIZING AND CONDUCTING FESTIVALS FEATURING A WIDE VARIETY OF ACTIVITIES, NAMELY, EXHIBITIONS IN THE FIELD OF FICTIONAL LITERARY WORKS; ON-LINE PUBLICATION OF BOOKS, ACTIVITY BOOKS, COLORING BOOKS, MAGAZINES, JOURNALS, NEWSLETTERS, ENCYCLOPEDIAS, MANUALS, CALENDARS, POSTERS AND BROCHURES FEATURING FICTIONAL, EDUCATIONAL AND ENTERTAINMENT WORKS; EDUCATIONAL SERVICES, NAMELY, CONDUCTING LECTURES, SEMINARS, READINGS, CONFERENCES, INTERACTIVE ROLE-PLAYING EXERCISES ALL IN THE FIELD OF EDUCATION AND ENTERTAINMENT; PROVIDING INFORMATION IN THE FIELD OF EDUCATION AND ENTERTAINMENT; PROVIDING INFORMATION IN THE FIELD OF ON-LINE COMPUTER GAMES AND COMPUTER ENHANCEMENTS FOR COMPUTER GAMES; PROVIDING INFORMATION IN THE FIELD OF FICTIONAL LITERARY WORKS; PROVIDING EDUCATIONAL AND ENTERTAINMENT INFORMATION, NAMELY, INFORMATION CONCERNING CHILDREN'S BOOKS AND MERCHANDISE AND ITEMS RELATED TO CHILDREN'S BOOKS; PROVIDING EDUCATIONAL AND ENTERTAINMENT INFORMATION CONCERNING FICTIONAL CHARACTERS, PLACES, LOCATIONS, CULTURAL EVENTS, PLAYS, LECTURES AND PARTIES RELATING TO BOOK PRESENTATIONS AND PROMOTION (U.S. CLS. 100, 101 AND 107).

ELIZABETH PIGNATELLO, EXAMINING ATTORNEY

SN 76-525,311. PHONAK HOLDING AG, CH-8712 STAFA, SWITZERLAND, FILED 6-17-2003.

# Xtra

## CLASS 9—ELECTRICAL AND SCIENTIFIC APPARATUS

FOR AUDIO GOODS TO IMPROVE ACOUSTIC PERCEPTION IN THE FIELD OF HEARING AIDS AND HEARING AID ACCESSORIES, NAMELY, AUDIO RECEIVERS, AMPLIFIERS, LOUD SPEAKERS, AND TRANSMITTERS (U.S. CLS. 21, 23, 26, 36 AND 38).

## CLASS 10—MEDICAL APPARATUS

FOR HEARING AIDS AND ACCESSORIES THEREFOR (U.S. CLS. 26, 39 AND 44).  
ROBERT COGGINS, EXAMINING ATTORNEY

SN 76-526,483. FLEETCOR TECHNOLOGIES, INC., NORCROSS, GA. FILED 6-20-2003.

**FUELMAN**  
FLEET CARD

OWNER OF U.S. REG. NOS. 1,363,666, 1,430,472 AND 1,430,474.

NO CLAIM IS MADE TO THE EXCLUSIVE RIGHT TO USE "FLEET CARD", APART FROM THE MARK AS SHOWN.

## CLASS 35—ADVERTISING AND BUSINESS

FOR RETAIL MOTOR FUEL SUPPLY SERVICES FOR VEHICLE FLEET OWNERS; PREPARING BUSINESS REPORTS FOR THE TRANSPORTATION AND VEHICLE FLEET INDUSTRIES; BILLING AND DATA PROCESSING SERVICES FOR THE TRANSPORTATION AND VEHICLE FLEET INDUSTRIES; BUSINESS MANAGEMENT, INVENTORY CONTROL, AND BOOKKEEPING FOR THE TRANSPORTATION AND VEHICLE FLEET INDUSTRIES; AND WHOLESALE DISTRIBUTORSHIPS FEATURING MOTOR VEHICLE FUELS, LUBRICANTS, AND PETROLEUM PRODUCTS (U.S. CLS. 100, 101 AND 102).

FIRST USE 2-0-2000; IN COMMERCE 2-0-2000.

## CLASS 36—INSURANCE AND FINANCIAL

FOR CREDIT CARD SERVICES FOR THE PURPOSE OF PURCHASING MOTOR FUELS, PETROLEUM PRODUCTS, AND VEHICLE MAINTENANCE, OPERATING THROUGH RETAIL FUEL STATIONS, TRUCK STOPS, AND AUTOMATED FUELING OUTLETS (U.S. CLS. 100, 101 AND 102).

FIRST USE 2-0-2000; IN COMMERCE 2-0-2000.

## CLASS 37—CONSTRUCTION AND REPAIR

FOR PROVIDING VEHICLE MAINTENANCE SERVICES TO VEHICLE FLEET OWNERS (U.S. CLS. 100, 103 AND 106).

FIRST USE 2-0-2000; IN COMMERCE 2-0-2000.

BRIAN PINO, EXAMINING ATTORNEY

SN 76-526,833. RITZ CAMERA CENTERS, INC., BELTSVILLE, MD. FILED 7-2-2003.

## CAPTURE YOUR WORLD

## CLASS 35—ADVERTISING AND BUSINESS

FOR RETAIL CAMERA STORE AND PHOTOGRAPHY SERVICES (U.S. CLS. 100, 101 AND 102).

FIRST USE 5-1-1999; IN COMMERCE 5-1-1999.

## CLASS 40—MATERIAL TREATMENT

FOR FILM PROCESSING AND PHOTO FINISHING SERVICES (U.S. CLS. 100, 103 AND 106).

FIRST USE 5-1-1999; IN COMMERCE 5-1-1999.

DEZMONA MIZELLE, EXAMINING ATTORNEY

SN 76-526,869. RABA JARMUIPARI HOLDING RT., BUDAI UT 1., HUNGARY, FILED 6-23-2003.



## CLASS 6—METAL GOODS

FOR MATERIALS OF METAL FOR RAILWAY TRACKS; MASS PRODUCTS OF METAL AND GOODS OF COMMON METAL NOT INCLUDED IN OTHER CLASSES, NAMELY, STEELS, PLATES, BARS, CASTINGS AND FORGINGS (U.S. CLS. 2, 12, 13, 14, 23, 25 AND 50).

## CLASS 7—MACHINERY

FOR MOTORS NOT FOR LAND VEHICLES, NAMELY MOTORS FOR BOATS AND AIRCRAFT; COUPLINGS FOR MACHINES; TRANSMISSION COMPONENTS NOT FOR LAND VEHICLES, NAMELY, TRANSMISSION GEARS FOR MACHINES (U.S. CLS. 13, 19, 21, 23, 31, 34 AND 35).

**CLASS 12—VEHICLES**

FOR VEHICLES, NAMELY, TRACTORS, LOCOMOTIVES AND TRAINS; APPARATUS FOR LOCOMOTION BY LAND, AIR OR WATER, NAMELY, ENGINES FOR LAND VEHICLES; LAND VEHICLE PARTS, NAMELY, CHASSIS, AXLES, LAND VEHICLE CAR SEATS AND SEAT FRAMES, SEAT ADJUSTERS, CHILD SEAT FRAMES, LUGGAGE RACK DOORS, DRIVER SEATS; CRASHBOXES, NAMELY, ENERGY ABSORBING DEVICES USED IN VEHICLES TO PREVENT DAMAGE TO SUPPORTING COMPONENTS; SPRING FORCE KEEPERS, NAMELY, LOCKING DEVICES USED TO HOLD VALVE RETAINERS IN PLACE ON VEHICLE VALVE STEMS; PEDAL SETS AND BRAKE DRUMS, MIRROR HOLDER FRAMES, BUMPER; RAILWAY ROLLING STOCK, PARTS AND ACCESSORIES THEREFORE, NAMELY, BUFFERS, NAMELY CUSHIONING DEVICES MOUNTED ON THE EXTREME ENDS OF VEHICLES TO ABSORB SHOCKS ARISING DURING COUPLING AND MOTION, BOGIES, VEHICLE SPRING SUSPENSION MECHANISMS, AUXILIARY GEAR BOXES, VEHICLE SERVO STEERINGS, NAMELY, STEERING UNITS FOR LAND VEHICLES AND PARTS THEREOF; DRIVING GEARS, LAND VEHICLE TRANSMISSIONS AND REPLACEMENT PARTS THEREOF (U.S. CLS. 19, 21, 23, 31, 35 AND 44).

DEZMONA MIZELLE, EXAMINING ATTORNEY

SN 76-527,522. LAUGHLIN/CONSTABLE, INC., MILWAUKEE, WI. FILED 7-3-2003.

**OUR BUSINESS CREATES  
IDEAS. OUR IDEAS CREATE  
BUSINESS.**

**CLASS 35—ADVERTISING AND BUSINESS**

FOR ADVERTISING AGENCY SERVICES; PUBLIC RELATIONS SERVICES; DEVELOPING AND EXECUTING PROMOTIONAL CAMPAIGNS FOR BUSINESSES; STRATEGIC BUSINESS PLANNING FOR BRAND DEVELOPMENT (U.S. CLS. 100, 101 AND 102).

FIRST USE 10-0-2002; IN COMMERCE 10-0-2002.

**CLASS 42—SCIENTIFIC, COMPUTER AND LEGAL SERVICES**

FOR COMPUTER SERVICES, NAMELY DEVELOPING AND IMPLEMENTING WEBSITES FOR OTHERS; COMPUTER SOFTWARE DESIGN FOR OTHERS FOR USE ON A GLOBAL COMPUTER NETWORK; COMMERCIAL AND GRAPHIC ART DESIGN, NAMELY PACKAGE DESIGN AND BROCHURE DESIGN (U.S. CLS. 100 AND 101).

FIRST USE 10-0-2002; IN COMMERCE 10-0-2002.  
MONIQUE MILLER, EXAMINING ATTORNEY

SN 76-528,255. RIBECA, ANDREA, WASHINGTON, DC. AND OTTAVIANI, GIUSEPPE, WASHINGTON, DC. FILED 7-7-2003.

**NU NRG**

**CLASS 9—ELECTRICAL AND SCIENTIFIC APPARATUS**

FOR SERIES OF MUSICAL SOUND RECORDINGS, PRERECORDED COMPACT DISCS, AUDIO CASSETTES, DIGITAL VIDEO DISCS, PHONOGRAPH RECORDS AND DIGITAL AUDIO FILES FEATURING MUSIC (U.S. CLS. 21, 23, 26, 36 AND 38).

FIRST USE 1-0-2001; IN COMMERCE 1-0-2001.

**CLASS 41—EDUCATION AND ENTERTAINMENT**

FOR ENTERTAINMENT SERVICES, NAMELY LIVE PERFORMANCES BY A MUSICAL PERFORMER AND NAMELY, DISC JOCKEY SERVICES (U.S. CLS. 100, 101 AND 107).

FIRST USE 12-0-2001; IN COMMERCE 12-0-2001.

ROBERT C. CLARK JR., EXAMINING ATTORNEY

SN 76-529,458. AMERICAN ASSOCIATION OF MOTORCYCLE INJURY LAWYERS, INC., PHOENIX, AZ. FILED 7-15-2003.



THE COLOR(S) ORANGE, YELLOW, TAN, RED, AND GREEN IS/ARE CLAIMED AS A FEATURE OF THE MARK.

THE COLOR ORANGE APPEARS ON THE HEAD OF THE TIGER IN THE MARK, THE COLOR TAN APPEARS ON THE SIDES OF THE HEAD OF THE TIGER IN THE MARK, THE COLOR RED APPEARS IN THE TONGUE AREA OF THE TIGER IN THE MARK, THE COLOR GREEN APPEARS IN THE EYES OF THE TIGER IN THE MARK, AND THE COLOR YELLOW APPEARS AS STRIPING ON THE PORTION OF A ROAD IN THE MARK.

**CLASS 35—ADVERTISING AND BUSINESS**

FOR ASSOCIATION SERVICES; NAMELY PROMOTING THE INTERESTS OF LAWYERS WHO HAVE AN INTEREST IN PERSONAL INJURY AND ACCIDENT LAW; ASSOCIATION SERVICES; NAMELY PROMOTING THE INTERESTS OF LAWYERS AND LAW PROFESSIONALS; ASSOCIATION SERVICES; NAMELY PROMOTING THE INTERESTS OF MOTORCYCLISTS AND MOTORCYCLE DRIVERS (U.S. CLS. 100, 101 AND 102).

FIRST USE 1-1-2001; IN COMMERCE 1-1-2001.

**CLASS 42—SCIENTIFIC, COMPUTER AND LEGAL SERVICES**

FOR LEGAL SERVICES; NAMELY LEGAL SERVICES, LEGAL ADVISORY SERVICES, PROVISION OF LEGAL CONSULTATIONS, LEGAL ADVICE AND REPRESENTATION OF OTHERS IN LEGAL MATTERS, LEGAL RESEARCH, NOTARY PUBLIC SERVICES AND PROVIDING INFORMATION IN THE FIELD OF PERSONAL INJURY AND ACCIDENT LAW (U.S. CLS. 100 AND 101).

FIRST USE 1-1-2001; IN COMMERCE 1-1-2001.

CIMMERIAN COLEMAN, EXAMINING ATTORNEY

SN 76-529,585. AMK HOLDINGS LTD, DELAFIELD, WI. FILED 7-14-2003.

SN 76-529,819. LONDON ENTERPRISES LIMITED, RICHMOND, BRITISH COLUMBIA, CANADA, FILED 7-17-2003.

**LANG**



SEC. 2(F).

PRIORITY CLAIMED UNDER SEC. 44(D) ON CANADA APPLICATION NO. 1,171,216, FILED 3-14-2003, REG. NO. TMA615440, DATED 7-22-2004, EXPIRES 7-22-2019.  
 NO CLAIM IS MADE TO THE EXCLUSIVE RIGHT TO USE "RESORT" AND "CANADA", APART FROM THE MARK AS SHOWN.  
 THE ENGLISH TRANSLATION OF "SONORA" IS "SOUND".

**CLASS 4—LUBRICANTS AND FUELS**

FOR CANDLES (U.S. CLS. 1, 6 AND 15). FIRST USE 6-0-1999; IN COMMERCE 6-0-1999.

**CLASS 35—ADVERTISING AND BUSINESS**

FOR RETAIL GIFT AND CONVENIENCE STORE SERVICES (U.S. CLS. 100, 101 AND 102).

**CLASS 16—PAPER GOODS AND PRINTED MATTER**

FOR STATIONERY AND OTHER PAPER PRODUCTS, NAMELY BOOKS OF FICTION, CALENDARS, DECORATIVE BOXES, LITHOGRAPHIC PRINTS, GREETING CARDS, NOTE CARDS, INVITATIONS, WRITING PAPER, AND ENVELOPES (U.S. CLS. 2, 5, 22, 23, 29, 37, 38 AND 50).  
 FIRST USE 9-0-1982; IN COMMERCE 9-0-1982.

**CLASS 39—TRANSPORTATION AND STORAGE**

FOR ARRANGING EXCURSIONS FOR TOURISTS (U.S. CLS. 100 AND 105).

**CLASS 43—HOTEL AND RESTAURANT SERVICES**

FOR PROVIDING TEMPORARY HOUSING ACCOMMODATIONS; RESORT LODGING SERVICES AND CONFERENCE CENTER (U.S. CLS. 100 AND 101).

**CLASS 20—FURNITURE AND ARTICLES NOT OTHERWISE CLASSIFIED**

FOR PICTURE FRAMES (U.S. CLS. 2, 13, 22, 25, 32 AND 50). FIRST USE 5-0-1996; IN COMMERCE 5-0-1996.

**CLASS 44—MEDICAL, BEAUTY AND AGRICULTURAL SERVICES**

FOR HEALTH SPA SERVICES, NAMELY, COSMETIC BODY CARE SERVICES; HEALTH SPA AND EXERCISE FACILITIES (U.S. CLS. 100 AND 101).  
 GEORGIA CARTY, EXAMINING ATTORNEY

**CLASS 21—HOUSEWARES AND GLASS**

FOR PORCELAIN AND EARTHENWARE PRODUCTS, NAMELY CUPS, SAUCERS, DISHES, PLATES, JUGS, BOWLS, MUGS, JARS, BOWLS, PITCHERS, VASES, SERVING TRAYS, CROCKS, CANDLE STICKS, CANDLE BASES, CANDLE HOLDERS, FIGURINES AND MINIATURE BUILDINGS (U.S. CLS. 2, 13, 23, 29, 30, 33, 40 AND 50).  
 FIRST USE 5-0-1998; IN COMMERCE 5-0-1998.

SN 76-529,932. SWAROVSKI-OPTIK K.G., A-6060 ABSAM, AUSTRIA, FILED 7-16-2003.



**CLASS 28—TOYS AND SPORTING GOODS**

FOR CHRISTMAS TREE ORNAMENTS (U.S. CLS. 22, 23, 38 AND 50). FIRST USE 5-0-1998; IN COMMERCE 5-0-1998.  
 HOWARD SMIGA, EXAMINING ATTORNEY

PRIORITY CLAIMED UNDER SEC. 44(D) ON AUSTRALIA APPLICATION NO. AM270/2003, FILED 1-17-2003, REG. NO. 209299, DATED 1-17-2003, EXPIRES 1-17-2013.

**CLASS 7—MACHINERY**

FOR MILLING MACHINES; POWER OPERATED METAL WORKING TOOLS, NAMELY, KNURLING WHEELS; ATTACHMENTS FOR MACHINE TOOLS, NAMELY, KNURLING TOOLS; AND MACHINE TOOL HOLDERS (U.S. CLS. 13, 19, 21, 23, 31, 34 AND 35).

SN 76-531,808. GARDINER-CALDWELL GROUP LIMITED, CHESHIRE, SK11 7HQ, ENGLAND, FILED 7-24-2003.

**GARDINER-CALDWELL****CLASS 8—HAND TOOLS**

FOR HAND-OPERATED KNURLING TOOLS (U.S. CLS. 23, 28 AND 44).  
CAROLINE WEIMER, EXAMINING ATTORNEY

**CLASS 41—EDUCATION AND ENTERTAINMENT**

FOR EDUCATIONAL SERVICES, NAMELY, CONDUCTING CONTINUING MEDICAL EDUCATION CLASSES (U.S. CLS. 100, 101 AND 107).

**CLASS 42—SCIENTIFIC, COMPUTER AND LEGAL SERVICES**

FOR PROVIDING SCIENTIFIC INFORMATION (U.S. CLS. 100 AND 101).

**CLASS 44—MEDICAL, BEAUTY AND AGRICULTURAL SERVICES**

FOR PROVIDING MEDICAL INFORMATION (U.S. CLS. 100 AND 101).  
MONIQUE MILLER, EXAMINING ATTORNEY

SN 76-531,794. EXHART ENVIRONMENTAL SYSTEMS, INC., CHATSWORTH, CA. FILED 7-23-2003.

**EXHART****CLASS 6—METAL GOODS**

FOR DECORATIVE METAL GARDEN STAKES (U.S. CLS. 2, 12, 13, 14, 23, 25 AND 50).  
FIRST USE 12-1-2000; IN COMMERCE 12-1-2000.

**CLASS 9—ELECTRICAL AND SCIENTIFIC APPARATUS**

FOR VERMIN DETERRENT DEVICES, NAMELY DEVICES THAT EMIT ELECTRICAL SIGNALS TO DETER ANIMALS (U.S. CLS. 21, 23, 26, 36 AND 38).  
FIRST USE 9-1-1987; IN COMMERCE 9-1-1987.

SN 76-532,156. LI, BERNARD A., RANCHO SANTA FE, CA. FILED 7-24-2003.

**CLASS 11—ENVIRONMENTAL CONTROL APPARATUS**

FOR ELECTRICAL DEVICES, NAMELY SOLAR POWERED AND ELECTRICALLY ENERGIZED LIGHT EMITTING RODS THAT ARE INSERTED IN LAWNS FOR AESTHETICS AND FOR LIGHTINGS EFFECTS (U.S. CLS. 13, 21, 23, 31 AND 34).  
FIRST USE 9-1-1999; IN COMMERCE 9-1-1999.

**AKULA**

THE TERM "AKULA" IS A RUSSIAN WORD MEANING SHARK.

**CLASS 20—FURNITURE AND ARTICLES NOT OTHERWISE CLASSIFIED**

FOR DECORATIVE NON-METAL GARDEN STAKES (U.S. CLS. 2, 13, 22, 25, 32 AND 50).  
FIRST USE 12-1-2000; IN COMMERCE 12-1-2000.

**CLASS 9—ELECTRICAL AND SCIENTIFIC APPARATUS**

FOR PROTECTIVE EYEWEAR FOR USE IN THE SPORT OF PAINTBALL (U.S. CLS. 21, 23, 26, 36 AND 38).

**CLASS 21—HOUSEWARES AND GLASS**

FOR WIND CHIMES (U.S. CLS. 2, 13, 23, 29, 30, 33, 40 AND 50).  
FIRST USE 12-1-2000; IN COMMERCE 12-1-2000.

**CLASS 25—CLOTHING**

FOR CLOTHING FOR USE IN THE SPORT OF PAINTBALL, NAMELY, PANTS, JACKETS, JERSEYS, SHIRTS, VESTS, WRIST BANDS, SHORTS AND GLOVES (U.S. CLS. 22 AND 39).

**CLASS 28—TOYS AND SPORTING GOODS**

FOR HOLIDAY DECORATIONS, NAMELY ARTIFICIAL CHRISTMAS TREES AND CHRISTMAS AND HALLOWEEN CHARACTERS IN THE NATURE OF TOY FIGURES AND DOLLS (U.S. CLS. 22, 23, 38 AND 50).  
FIRST USE 6-1-2002; IN COMMERCE 6-1-2002.  
JUDITH GRUNDY, EXAMINING ATTORNEY

**CLASS 28—TOYS AND SPORTING GOODS**

FOR PAINTBALLS, PAINTBALL GUNS, AND PAINTBALL ACCESSORIES, NAMELY, AMMUNITION, AMMUNITION HARNESSSES, AMMUNITION HOLDERS, GRIPS, LOADERS, AIR TANKS, CLEANING KITS, CARRYING CASES, ADJUSTABLE SIGHTS, AND TARGETS (U.S. CLS. 22, 23, 38 AND 50).  
RUSS HERMAN, EXAMINING ATTORNEY

SN 76-532,314. THE BIGGER GAME COMPANY, NORTH KINGSTOWN, RI. FILED 7-25-2003.

SN 76-533,335. BSH BOSCH UND SIEMENS HAUSGERATE GMBH, MUNICH, FED REP GERMANY, FILED 7-18-2003.

## THE BIGGER GAME

### CLASS 16—PAPER GOODS AND PRINTED MATTER

FOR PRINTED INSTRUCTIONAL AND TEACHING MATERIAL IN THE FIELD OF PROFESSIONAL GROWTH AND TRANSFORMATION (U.S. CLS. 2, 5, 22, 23, 29, 37, 38 AND 50).

FIRST USE 8-4-2002; IN COMMERCE 8-4-2002.

### CLASS 41—EDUCATION AND ENTERTAINMENT

FOR EDUCATIONAL SERVICES, NAMELY CONDUCTING CLASSES, WORKSHOPS, AND TRAINING SESSIONS IN THE FIELD OF PROFESSIONAL GROWTH AND TRANSFORMATION (U.S. CLS. 100, 101 AND 107).

FIRST USE 8-4-2002; IN COMMERCE 8-4-2002.

MELVIN AXILBUND, EXAMINING ATTORNEY

SN 76-532,385. FOPPA PEDRETTI S.P.A., GRUMELLO DEL MONTE (BERGAMO), ITALY, FILED 7-3-2003.

## FOPPAPEDRETTI

OWNER OF ERPN CMNTY TM OFC REG. NO. 337,022, DATED 12-4-1998, EXPIRES 9-2-2006.

OWNER OF U.S. REG. NO. 2,215,080.

### CLASS 20—FURNITURE AND ARTICLES NOT OTHERWISE CLASSIFIED

FOR INFANT WALKERS, HIGHCHAIRS, TRAYS NOT OF METAL FOR HIGHCHAIRS AND CHANGING TABLES, PADDED HIGHCHAIR INSERTS, BABY CHAIRS, MEDICINE CABINETS, SECURITY CABINETS, INFANT'S CRADLES, CLOTHES HANGERS, SMALL ARMCHAIRS, FOLDING BEDS FOR BABIES, COTS, CRIBS, SMALL TABLES, TABLES FOR CHANGING BABIES' DIAPERS, WARDROBES, CUPBOARDS, DRESSERS, CHESTS OF DRAWERS, DRESSING TABLES, MATTRESSES, CUSHIONS, PILLOWS, CHAIRS, ARMCHAIRS, DESKS, TYPING DESKS, WRITING DESKS, BEDS, CLOSETS, SHOE CLOSETS, BENCHES, TABLES, DESK CHAIRS, SEATS, FOOTSTOOLS, DRAWERS, SOFAS, FURNITURE MIRRORS, NON-METAL LADDERS, TEA CARTS, CLOTHES HOOKS NOT OF METAL, MANNEQUINS, NON-METAL DOOR HANDLES AND KNOBS MADE OF WOOD AND PLASTIC, NON-METAL WINDOW HANDLES; UMBRELLA STANDS, TOY CHESTS, CHESTS, STAIRCASE SCREENS (U.S. CLS. 2, 13, 22, 25, 32 AND 50).

FIRST USE 12-31-1980; IN COMMERCE 7-31-1997.

### CLASS 28—TOYS AND SPORTING GOODS

FOR CRIB MOBILES, PRAM MOBILES, DOLL FURNITURE, TOY BOXES, TOY BLACKBOARDS, BABY MULTIPLE ACTIVITY TOYS, TOY VEHICLES, RIDE-ON TOYS (U.S. CLS. 22, 23, 38 AND 50).

VIVIAN MICZNIK FIRST, EXAMINING ATTORNEY

## MODERN-ART

PRIORITY CLAIMED UNDER SEC. 44(D) ON FED REP GERMANY APPLICATION NO. 30303160307, FILED 1-22-2003, REG. NO. 30303160, DATED 2-20-2003, EXPIRES 1-31-2013.

### CLASS 7—MACHINERY

FOR ELECTRIC KITCHEN MACHINES AND EQUIPMENT FOR DOMESTIC FOOD AND BEVERAGE PREPARATION AND PROCESSING, NAMELY MINCING MACHINES, MIXING AND KNEADING MACHINES, PRESSING MACHINES, JUICE EXTRACTORS, JUICE CENTRIFUGES, GRINDERS, SLICING MACHINES, AND PARTS THEREFORE; ELECTRIC MOTOR-DRIVEN TOOLS, NAMELY, ELECTRIC CAN OPENERS, KNIFE SHARPENERS AND PARTS THEREFORE (U.S. CLS. 13, 19, 21, 23, 31, 34 AND 35).

### CLASS 11—ENVIRONMENTAL CONTROL APPARATUS

FOR ELECTRIC AND/OR FUEL OPERATED KITCHEN APPLIANCES FOR COOKING, BAKING, FRYING, GRILLING, TOASTING, THAWING, AND HOT-KEEPING OF FOODS, NAMELY, ELECTRIC HOT PLATES, IMMERSION HEATERS, ELECTRIC COOKING POTS, MICROWAVE OVENS FOR COOKING AND PARTS THEREFORE; ELECTRIC COFFEE MAKERS AND PARTS THEREFORE (U.S. CLS. 13, 21, 23, 31 AND 34).

TRACY CROSS, EXAMINING ATTORNEY

SN 76-534,340. BLUE DIESEL, LLC, WESTERVILLE, OH. FILED 7-22-2003.

## smartPLATFORM

### CLASS 35—ADVERTISING AND BUSINESS

FOR BUSINESS CONSULTING SERVICES, NAMELY, ASSISTING CLIENTS IN MAXIMIZING THE POTENTIAL OF THEIR BRAND BY PROVIDING INTERACTIVE ADVICE ON TARGETING ONE'S OWN CLIENT BASE (U.S. CLS. 100, 101 AND 102).

FIRST USE 6-1-2003; IN COMMERCE 6-1-2003.

### CLASS 41—EDUCATION AND ENTERTAINMENT

FOR PROVIDING A WEBSITE WHICH FEATURES INTERACTIVE TRAINING AND INTERACTIVE CONTINUING EDUCATION PROGRAMS IN THE FIELD OF MEDICINE, AND WHICH PROVIDES AN INTERACTIVE SPEAKER'S BUREAU NAMELY, AN ON-LINE RESOURCE TO PROVIDE COMPANIES WITH EDUCATIONAL SPEAKERS IN THE FIELD OF MEDICINE (U.S. CLS. 100, 101 AND 107).

FIRST USE 6-1-2003; IN COMMERCE 6-1-2003.

JAMES GRIFFIN, EXAMINING ATTORNEY

SN 76-537,084. WARSTEINER BRAUEREI HAUS CRAMER KG, WARSTEIN, FED REP GERMANY, FILED 8-11-2003.



OWNER OF FED REP GERMANY REG. NO. 30343771, DATED 8-27-2003, EXPIRES 8-31-2013.

OWNER OF U.S. REG. NOS. 1,259,589, 2,746,040 AND OTHERS.

NO CLAIM IS MADE TO THE EXCLUSIVE RIGHT TO USE "BIEREN", APART FROM THE MARK AS SHOWN.

THE ENGLISH TRANSLATION OF "EINE KÖNIGIN UNTER DEN BIEREN" IS "A QUEEN AMONG BEERS".

#### CLASS 32—LIGHT BEVERAGES

FOR BEER, BEER BASED COOLERS; AND NON-ALCOHOLIC DRINKS, NAMELY, NON-ALCOHOLIC BEER (U.S. CLS. 45, 46 AND 48).

#### CLASS 43—HOTEL AND RESTAURANT SERVICES

FOR PROVIDING OF FOOD AND DRINK, NAMELY, CAFES, CAFETERIAS, COCKTAIL LOUNGES, COCKTAIL LOUNGE BUFFETS, BAR SERVICES, DELICATESSEN RESTAURANTS, FOOD PREPARATION, PUBLIC HOUSE SERVICES, RESTAURANTS, SALAD BARS, SELF-SERVICE RESTAURANTS, SNACK BARS, TAKE-OUT RESTAURANT SERVICES, TEMPORARY ACCOMMODATION, NAMELY, HOTEL SERVICES FOR PREFERRED CUSTOMERS, HOTELS, MOTELS, RENTAL OF ROOMS; RESORT AND LODGING SERVICES, RESORT HOTELS, TOURIST HOMES, TOURIST HOTELS (U.S. CLS. 100 AND 101).

SAMUEL E. SHARPER JR., EXAMINING ATTORNEY

SN 76-540,742. MIRACLE HOUSE OF NEW YORK, INC., NEW YORK, NY. FILED 8-14-2003.

## MIRACLE HOUSE

OWNER OF U.S. REG. NO. 1,719,089.

#### CLASS 43—HOTEL AND RESTAURANT SERVICES

FOR PROVIDING TEMPORARY HOUSING ACCOMMODATION AND MEALS TO THE CAREGIVERS OF PEOPLE LIVING WITH AIDS, HIV AND CANCER (U.S. CLS. 100 AND 101).

FIRST USE 9-7-1990; IN COMMERCE 9-7-1990.

#### CLASS 44—MEDICAL, BEAUTY AND AGRICULTURAL SERVICES

FOR PROVIDING PEER COUNSELING TO THE CAREGIVERS OF PEOPLE LIVING WITH AIDS, HIV AND CANCER IN THE FIELD OF HEALTH (U.S. CLS. 100 AND 101).

FIRST USE 9-7-1990; IN COMMERCE 9-7-1990.

CHARLES JOYNER, EXAMINING ATTORNEY

SN 76-541,066. CONSUMER ELECTRONICS ASSOCIATION, ARLINGTON, VA. FILED 8-29-2003.

## CES

OWNER OF U.S. REG. NO. 2,724,672.

#### CLASS 35—ADVERTISING AND BUSINESS

FOR BUSINESS SERVICES, NAMELY, MAINTAINING A DATABASE OF CERTIFIED TELECOMMUNICATIONS PROFESSIONALS, SERVICE PROVIDERS, AND INSTALLERS IN INTERNATIONAL CLASS 35 (U.S. CLS. 100, 101 AND 102).

FIRST USE 3-1-2002; IN COMMERCE 3-1-2002.

#### CLASS 41—EDUCATION AND ENTERTAINMENT

FOR EDUCATIONAL SERVICES, NAMELY, PROVIDING INSTRUCTION IN THE FIELDS OF ELECTRONIC HOME SYSTEMS, HEATING SYSTEMS, AIR CONDITIONING SYSTEMS, CABLE TELEVISIONS, AUDIO EQUIPMENT, COMPUTERS, FOOD HEATING AND COOLING APPLIANCES, FOOD PROCESSING APPLIANCES, CONTROL SYSTEMS FOR COORDINATING AND CONTROLLING THE OPERATION OF ELECTRONIC SYSTEMS IN THE HOME, LIGHTING SYSTEMS, SECURITY SYSTEMS, COMMUNICATION SYSTEMS, TELEPHONES, PAGERS, INTERCOM SYSTEMS, GLOBAL NETWORK COMMUNICATION SYSTEMS, ENVIRONMENTAL SYSTEMS, SYSTEMS FOR CONTROLLING HEATING, VENTILATION, AND AIR CONDITIONING SYSTEMS, WATER MANAGEMENT, ELECTRICAL WIRING OF HOUSES FOR PROPER ELECTRICAL DISTRIBUTION, CONTROLLING SECURITY, AND COMPUTER AND TELEVISION SYSTEMS (U.S. CLS. 100, 101 AND 107).

FIRST USE 3-1-2002; IN COMMERCE 3-1-2002.

JOHN E. MICHOS, EXAMINING ATTORNEY

SN 76-541,259. INDEPENDENT BUSINESS TEAM, INC., NEW YORK, NY. FILED 8-19-2003.

## OYA YUBI SEDAI

THE FOREIGN WORDING IN THE MARK TRANSLATES INTO ENGLISH AS THUMB GENERATION.

#### CLASS 25—CLOTHING

FOR MEN'S, WOMEN'S, CHILDREN'S CLOTHING, NAMELY, T-SHIRTS, SWEATSHIRTS, JEANS, JACKETS, SWEATPANTS, SHIRTS, PANTS, SWEATERS, SHOES, HATS, UNDERWEAR, SLEEPWEAR, BELTS, GLOVES, SCARVES AND SOCKS (U.S. CLS. 22 AND 39).



**CLASS 41—EDUCATION AND ENTERTAINMENT**

FOR ENTERTAINMENT IN THE NATURE OF ONGOING ANIMATED TELEVISION PROGRAMS AND TELEVISION PROGRAMS FOR CHILDREN; AND PROVIDING A WEBSITE FEATURING INFORMATION ABOUT TELEVISION PROGRAMS AND PROGRAM CHARACTERS (U.S. CLS. 100, 101 AND 107).

MARK T. MULLEN, EXAMINING ATTORNEY

SN 76-543,561. SHADOWBROOK VINEYARDS, LLC, WALNUT CREEK, CA. FILED 9-10-2003.

## SHADOWBROOK VINEYARDS :

NO CLAIM IS MADE TO THE EXCLUSIVE RIGHT TO USE "VINEYARD", APART FROM THE MARK AS SHOWN.

**CLASS 29—MEATS AND PROCESSED FOODS**

FOR PROCESSED FRUIT, NAMELY, PROCESSED GRAPES FOR USE IN WINE PRODUCTION (U.S. CL. 46).

**CLASS 31—NATURAL AGRICULTURAL PRODUCTS**

FOR FRESH GRAPES FOR USE IN WINE PRODUCTION (U.S. CLS. 1 AND 46).

**CLASS 33—WINES AND SPIRITS**

FOR WINE (U.S. CLS. 47 AND 49).  
JACQUELINE A. LAVINE, EXAMINING ATTORNEY

SN 76-543,666. VOLKSWAGEN OF AMERICA, INC., AUBURN HILLS, MI. FILED 8-28-2003.

## FOR THE LOVE OF AUTOMOBILES

**CLASS 12—VEHICLES**

FOR AUTOMOBILES, TRUCKS, VANS, SPORT UTILITY VEHICLES, LORRIES, TRAILERS, NAMELY, TRAILERS FOR CARGO, REFRIGERATED TRAILERS, TRAILERS FOR MOBILE WORKPLACE EQUIPMENT FOR REPAIR AND MAINTENANCE SERVICES, BUSES, TRAINS, LOCOMOTIVES, BICYCLES, TRICYCLES, MOTORCYCLES, SNOWMOBILES, AIRPLANES, BOATS AND SHIPS, HOT AIR VEHICULAR BALLOONS AND DIRIGIBLES, CAMPING TRAILERS, FOLDING AND HARD SIDE TRUCK CAMPING TRAILERS, MOTOR HOMES, CONVERSION VANS, TRAVEL TRAILERS, CAMPER COACHES AND STRUCTURAL AND REPLACEMENT PARTS FOR ALL OF THE AFORESAID GOODS, COMPLETE ENGINES FOR LAND VEHICLES AND STRUCTURAL AND REPLACEMENT PARTS THEREFOR (U.S. CLS. 19, 21, 23, 31, 35 AND 44).

**CLASS 25—CLOTHING**

FOR CLOTHING OF ALL KINDS, NAMELY, PARKAS, ANORAKS, APRONS, ASCOTS, ATHLETIC UNIFORMS, BABUSHKAS, BABY BUNTING, BALLOON PANTS, NECK BANDS, SWEAT BANDS, WRIST BANDS, BATHING SUITS, BATHING TRUNKS, BATHROBES, BEACH COVERUPS, BEACHWEAR, BED JACKETS, GARTER BELTS, MONEY BELTS, BELTS, BERMUDA SHORTS, CLOTH BABY BIBS, SKI BIBS, BIKINIS, BLAZERS, BLOOMERS, BLOUSES, BLOUSONS, BOAS, BODY SHAPERS, BODY SUITS, BOLEROS, BOTTOMS, BOW TIES, BOXER SHORTS, BRAS, BRASSIERES, BREECHES, BRIEFS, BABY BUNTING, BUSTIERS, CAFTANS, CAMISOLES, CAPES, CARDIGANS, CASSOCKS, CHAPS, CHASUBLES, CHEMISES, CHEMISETTES, CLOTH DIAPERS, FUR COATS, LAB COATS, LEATHER COATS, OVER COATS, RAIN COATS, SPORT COATS, SUIT COATS, TOP COATS, COATS, COLLARS, COMBINATIONS, COMPETITORS' NUMBERS OF TEXTILE, CORSELETS, FOUNDATION GARMENTS, NAMELY, CORSETS AND GIRDLES, HALLOWEEN COSTUMES, MASQUERADE COSTUMES, MASQUERADE COSTUMES AND MASKS SOLD IN CONNECTION THEREWITH, COVERALLS, COVERUPS, CRAVATS, CREEPERS, CUFFS, CULOTTES, CUMMERBUNDS, DICKIES, DRESS SHIELDS, DRESSES, DRESSING GOWNS, DRY SUITS, DUNGAREES, DUSTERS, ESPADRILLES, EVENING GOWNS, FISHING VESTS, FISHING WADERS, FLIGHT SUITS, FOUL WEATHER GEAR, FOUNDATION GARMENTS, FROCKS, FUR CLOAKS, FUR JACKETS, FUR STOLEES, GABERDINES, GAITERS, GAUCHOS, SKI GLOVES, GLOVES, GOLF SHIRTS, NIGHT GOWNS, WEDDING GOWNS, GOWNS, GREATCOATS, GYM SHORTS, GYM SUITS, HALTER TOPS, HOODS, HOSIERY, HOUSECOATS, INFANT DIAPER COVERS, INFANTWEAR, LEATHER JACKETS, WIND RESISTANT JACKETS, JACKETS, JEANS, JERKINS, JERSEYS, JODHPURS, JOGGING SUITS, JUMPERS, JUMPSUITS, KERCHIEFS, KILTS, KIMONOS, KNEE HIGHS, KNICKERS, KNIT SHIRTS, LAYETTES, LEG WARMERS, LEGGINGS, LEOTARDS, LIGHT-REFLECTING COATS, LIGHT-REFLECTING JACKETS, LINGERIE, LOUNGWEAR, MAILLOTS, MANTILLAS, MANTLES, MINISKIRTS, MITTENS, MUFFLERS, MUFFS, MUU MUUS, NECKERCHIEFS, NECKWEAR, NEGLIGEES, NIGHT SHIRTS, NURSE'S APPAREL, NAMELY, DRESSES, HATS, SHIRTS, PANTS, LEGGINGS, COATS AND GLOVES, NURSING APPAREL, NAMELY, DRESSES, HATS, SHIRTS, PANTS, LEGGINGS, COATS AND GLOVES, OVERALLS, OVERCOATS, SHOULDER PADS FOR CLOTHING, PAJAMAS, PANTALOONS, PANTIES, SKI PANTS, SNOW PANTS, SWEAT PANTS, TAP PANTS, PANTS, PANTSUITS, PANTYHOSE, PARAMENTS, PAREU, PARKAS, PEDAL PUSHERS, PEIGNOIRS, PELERINES, PELISSES, PETTICOATS, PINAFORES, PLAY SUITS, PLUS FOURS, POCKET SQUARES, POLO SHIRTS, PONCHOS, PULLOVERS, QUILTED VESTS, RAIN SUITS, RAINWEAR, ROBES, ROMPERS, SARIS, SARONGS, SASHES, SHAWLS, SHIFTS, SPORT SHIRTS, SWEAT SHIRTS, UNDER SHIRTS, SHIRTS, SHORT SETS, SHORTALLS, SWEAT SHORTS, SHORTS, SINGLETTS, SKI MASKS, SKI SUITS, SKI WEAR, SKIRTS, SKORTS, SLACKS, SLEEP MASKS, SLEEPWEAR, SLIPS, SMOCKS, SNOW SUITS, SNOWBOARD GLOVES, STOCKINGS, STOLEES, SWEAT SUITS, VESTED SUITS, WARM-UP SUITS, WET SUITS, SUITS, SUNSUITS, SUSPENDERS, SWADDLING CLOTHES, TURTLENECK SWEATERS, V-NECK SWEATERS, SWEATERS, SWIM TRUNKS, SWIM WEAR, SWIMSUITS, T-SHIRTS, TAILLEURS, TANGAS, TANK TOPS, TEDDIES, TENNIS WEAR, THERMAL UNDERWEAR, TIES, TIGHTS, TOGAS, TOPS, TOQUES, TRACKSUITS, TROUSERS, TUNICS, TURBANS, TURTLENECKS, TUXEDOS, UNDERCLOTHES, UNDERGARMENTS, UNDERPANTS, UNDERSHIRTS, UNDERWEAR, UNIFORMS, UNITARDS, VELTS, VESTS, WAISTCOATS, WINDSHIRTS, WRAPS, ZOOT SUITS; FOOTWEAR OF ALL KINDS NAMELY, AFTER SKI BOOTS, SKI BOOT BAGS, SOCKS, ANKLETS, ATHLETIC FOOTWEAR, ATHLETIC SHOES, BOOTIES, SKI BOOTS, BOOTS, TOE BOXES, CLEATS FOR ATTACHMENT TO SPORTS SHOES, CLOGS, GALOSHES, GOLF SHOES, HEEL INSERTS, HEELS, INNER SOLES, HEEL INSERTS, INSOLES, MOCCASINS, MUKLUKS, OVERSHOES, RUBBERS, SANDALS, SHOES, SLIPPERS, SNEAKERS, THERMAL SOCKS, SOCKS, SNOWBOARD BOOTS, SWEATSOCKS, THERMAL SOCKS, THONGS, WATER SOCKS, ZORI; HEADGEAR FOR WEAR OF ALL KINDS

NAMELY, BANDANAS, BANDEAUX, HEAD BANDS, BASEBALL CAPS, BATHING CAPS, BERETS, BONNETS, SHOWER CAPS, CAPS, EAR MUFFS, HATS, SUN VISORS, VISORS; NECKTIES, SCARVES (U.S. CLS. 22 AND 39).

#### **CLASS 28—TOYS AND SPORTING GOODS**

FOR GAMES AND PLAYTHINGS, NAMELY, SCALE MODEL VEHICLES; GYMNASTIC APPARATUS; GYMNASTIC HORIZONTAL BARS; GYMNASTIC PARALLEL BARS; GYMNASTIC TRAINING STOOLS; GYMNASTIC VAULTING HORSES; SPORTING ARTICLES OF ALL KINDS, NAMELY, BALLOONS, BALLS FOR GAMES, NAMELY, CRICKET BALLS, FIELD HOCKEY BALLS, GOLF BALLS, LACROSSE BALLS, PADDLE BALLS, PLATFORM TENNIS BALLS, PLAYGROUND BALLS, RACQUET BALLS, RUBBER ACTION BALLS, RUGBY BALLS, SOCCER BALLS, SPORT BALLS, BASEBALLS, BASKET BALLS, BILLIARD BALLS, BOWLING BALLS, FOOT BALLS, HAND BALLS, NET BALLS, SQUASH BALLS, TABLE TENNIS BALLS, TENNIS BALLS, TETHER BALLS, VOLLEY BALLS; BASEBALL GLOVES; BATS FOR GAMES; CHRISTMAS TREE ORNAMENTS, NAMELY, BELLS; BILLIARD TABLES; BOB-SLEIGHS; BODY-BUILDING AND BODY-TRAINING APPARATUS NAMELY, WEIGHT LIFTING BENCHES AND BENCH ACCESSORIES, CHEST EXPANDERS, EXERCISE TREADMILLS, EXERCISE TABLES, EXERCISE BARS, EXERCISE BENCHES, STATIONARY EXERCISE BICYCLES, EXERCISE DOORWAY GYM BARS, MANUALLY OPERATED EXERCISE EQUIPMENT, EXERCISE EQUIPMENT FOR LATERAL MOVEMENT IN A SKATING MOTION, EXERCISE EQUIPMENT, NAMELY, STAIR-STEPPING MACHINES, EXERCISE MACHINES, POWERED TREADMILLS FOR RUNNING, ROWING MACHINES, WEIGHT LIFTING MACHINES, EXERCISING PULLEYS AND MANUALLY OPERATED JOGGING MACHINES, EXERCISE PLATFORMS, EXERCISE TRAMPOLINES, EXERCISE WEIGHT CUFFS, EXERCISE WEIGHTS, MANUAL LEG EXERCISERS, WEIGHT LIFTING BELTS, WEIGHT LIFTING GLOVES, EXERCISE WEIGHTS, LEG WEIGHTS, ANKLE AND WRIST WEIGHTS FOR EXERCISE; BOWS FOR ARCHERY; BOXING GLOVES; TOY BUILDING BLOCKS; BUILDING GAMES; BOARD GAMES, NAMELY, CHECKERS; GOLF CLUBS; DARTS; DOLLS; KNEE GUARDS AND ELBOW GUARDS FOR ATHLETIC USE; FENCING EQUIPMENT, NAMELY FOILS; FISH HOOKS; FLIPPERS FOR SWIMMING; TABLES FOR INDOOR FOOTBALL; GAMES, NAMELY, ACTION SKILL GAMES, ACTION-TYPE TARGET GAMES, EQUIPMENT SOLD AS A UNIT FOR PLAYING ACTION TYPE TARGET GAMES, ADULTS' AND CHILDREN'S PARTY GAMES, AERO-DYNAMIC DISK FOR USE IN PLAYING CATCHING GAMES, ARCADE GAMES, PADDLE BALL GAMES, BOARD GAMES, CARD GAMES, COIN-OPERATED VIDEO GAMES, ELECTRONIC DART GAMES, EQUIPMENT SOLD AS A UNIT FOR PLAYING BOARD GAMES, EQUIPMENT SOLD AS A UNIT FOR PLAYING CARD GAMES, HAND HELD UNIT FOR PLAYING ELECTRONIC GAMES, HAND HELD UNIT FOR PLAYING VIDEO GAMES, MANIPULATIVE GAMES, PARLOR GAMES, PINBALL GAMES, ROLE PLAYING GAMES, OUTDOOR ACTIVITY GAMES IN THE NATURE OF VOLLEYBALL, HORSESHOES AND DARTS; GOLF GLOVES; GLOVES FOR GAMES, NAMELY, BASEBALL BATTING GLOVES, BASEBALL GLOVES, BATTING GLOVES, BICYCLING GLOVES, BOXING GLOVES, GOAL KEEPERS' GLOVES, HANDBALL GLOVES, HOCKEY GLOVES, KARATE GLOVES, SOFTBALL GLOVES, SWIMMING GLOVES, WATERSKI GLOVES; GOLF BAGS; GOLF CLUBS; SCUBA EQUIPMENT, NAMELY, SPEARFISHING HARPOON GUNS; GUT FOR FISHING; GUT FOR RACKETS; HANG GLIDERS; ROCK CLIMBERS SAFETY HARNESS; HOCKEY STICKS; ICE SKATES; KITES; LINES FOR FISHING; COSTUME MASKS; TOY MOBILES; TOY SCALE MODEL VEHICLES AND RELATED ACCESSORIES SOLD AS UNITS; NETS FOR SPORTS; PROTECTIVE PADDING FOR PLAYING BASEBALL, FOOTBALL, ICE HOCKEY AND CRICKET; PROTECTIVE PADS, NAMELY, FIELD HOCKEY GOALIE PADS, FOOTBALL SHOULDER PADS, ICE HOCKEY GOALIE PADS, KARATE KICK PADS, KARATE SHIN PADS, KARATE TARGET PADS, ELBOW PADS FOR ATHLETIC USE, HAND PADS FOR ATHLETIC USE, SHIN PADS FOR ATHLETIC USE, INFLATABLE FLOAT

MATTRESSES OR PADS FOR RECREATIONAL USE; TOY PISTOLS; PLAY SWIMMING POOLS; PUPPETS; RACKETS FOR FOR BADMINTON, FOR TENNIS, FOR TABLE TENNIS, FOR SQUASH, FOR RACQUETBALL; RODS FOR FISHING; TOY SCOOTERS; SKATEBOARDS; SKIS; SNOW SLEDS FOR RECREATIONAL USE; PLAYGROUND EQUIPMENT, NAMELY, SLIDES; SPINNING TOPS; VAULTING SPRING BOARDS; SURF BOARDS; SURF SKIS; TABLES FOR TABLE TENNIS; TARGETS; TEDDY BEARS; TOYS FOR DOMESTIC PETS; WATER-SKIS (U.S. CLS. 22, 23, 38 AND 50).

#### **CLASS 37—CONSTRUCTION AND REPAIR**

FOR CONSTRUCTION, REPAIR, DISMANTLING AND MAINTENANCE OF VEHICLES IN THE NATURE OF VEHICLE REPAIR IN THE COURSE OF VEHICLE BREAKDOWN SERVICE, CLEANING, SERVICING AND VARNISHING OF VEHICLES (U.S. CLS. 100, 103 AND 106).

TANYA AMOS, EXAMINING ATTORNEY

SN 76-545,212. AMOAKO, NANA, WASHINGTON, DC. FILED 9-17-2003.

### **NAANA B.**

THE NAME NAANA B. IDENTIFIES A LIVING INDIVIDUAL WHOSE CONSENT IS OF RECORD.

#### **CLASS 18—LEATHER GOODS**

FOR HANDBAGS (U.S. CLS. 1, 2, 3, 22 AND 41).

#### **CLASS 25—CLOTHING**

FOR CLOTHING, NAMELY, SKIRTS, PANTS, DRESSES, BLOUSES AND SHIRTS (U.S. CLS. 22 AND 39).

MARY CRAWFORD, EXAMINING ATTORNEY

SN 76-547,097. INFOTRAC, INC., LEESBURG, FL. FILED 9-10-2003.

# **INFOTRAC**

#### **CLASS 9—ELECTRICAL AND SCIENTIFIC APPARATUS**

FOR COMPUTER SOFTWARE PROVIDING TRAINING, SAFE-HANDLING PROCEDURES AND RELATED INFORMATION IN THE FIELDS OF HAZARDOUS MATERIALS, DANGEROUS GOODS AND PRODUCT SAFETY (U.S. CLS. 21, 23, 26, 36 AND 38).

FIRST USE 6-1-1989; IN COMMERCE 6-1-1989.

#### **CLASS 35—ADVERTISING AND BUSINESS**

FOR COMPUTERIZED DATABASE MANAGEMENT (U.S. CLS. 100, 101 AND 102).

FIRST USE 6-1-1989; IN COMMERCE 6-1-1989.

**CLASS 39—TRANSPORTATION AND STORAGE**

FOR TRANSPORTATION CONSULTING, NAMELY, CONSULTING IN THE FIELD OF TRANSPORTATION OF HAZARDOUS MATERIALS AND DANGEROUS GOODS; ELECTRONIC INFORMATION SERVICES, NAMELY, RECEIVING AND STORING MATERIAL SAFETY DATA SHEETS AND RELATED DATA FOR SUBSCRIBERS AND RETRIEVING THE SHEETS AND THE DATA AT THE REQUEST OF THE SUBSCRIBERS, THEIR CUSTOMERS AND THE GENERAL PUBLIC (U.S. CLS. 100 AND 105).

FIRST USE 6-1-1989; IN COMMERCE 6-1-1989.

**CLASS 40—MATERIAL TREATMENT**

FOR HAZARDOUS WASTE MANAGEMENT SERVICES; EMERGENCY RESPONSE SERVICES IN THE NATURE OF DECONTAMINATION OF HAZARDOUS MATERIALS (U.S. CLS. 100, 103 AND 106).

FIRST USE 6-1-1989; IN COMMERCE 6-1-1989.

**CLASS 41—EDUCATION AND ENTERTAINMENT**

FOR EDUCATIONAL SERVICES, NAMELY, PROVIDING TRAINING SERVICES IN THE NATURE OF CLASSROOM INSTRUCTION, COMPUTER-BASED TRAINING, AND WEB-BASED TRAINING IN THE FIELDS OF HAZARDOUS MATERIALS, DANGEROUS GOODS AND PRODUCT SAFETY, AND DISTRIBUTING COURSE MATERIAL IN CONNECTION THEREWITH (U.S. CLS. 100, 101 AND 107).

FIRST USE 6-1-1989; IN COMMERCE 6-1-1989.

**CLASS 42—SCIENTIFIC, COMPUTER AND LEGAL SERVICES**

FOR DEVELOPMENT OF DATABASES WITH REGARD TO THE RULES AND REGULATIONS FOR CORRECT CLASSIFICATION, PACKAGING AND SHIPPING OF HAZARDOUS MATERIALS, DANGEROUS GOODS AND PRODUCT SAFETY; DEVELOPMENT OF COMPUTER SOFTWARE IN THE FIELDS OF HAZARDOUS MATERIALS, DANGEROUS GOODS AND PRODUCT SAFETY; PROVIDING TEMPORARY USE OF NON-DOWNLOADABLE COMPUTER SOFTWARE FOR MONITORING TRANSPORTATION OF HAZARDOUS MATERIALS; PROVIDING A WEBSITE ON THE GLOBAL COMPUTER NETWORK FEATURING INFORMATION ABOUT THE FIELDS OF HAZARDOUS MATERIALS, DANGEROUS GOODS AND PRODUCT SAFETY (U.S. CLS. 100 AND 101).

FIRST USE 6-1-1989; IN COMMERCE 6-1-1989.

ESTHER BELENKER, EXAMINING ATTORNEY

SN 76-548,195. DIMENSIONS 100 INC., WINNIPEG, R3E 0S2, MANITOBA, CANADA, FILED 9-11-2003.

**MONDETTA**

OWNER OF CANADA REG. NO. TMA402,252, DATED 9-4-1992, EXPIRES 9-4-2007.

**CLASS 6—METAL GOODS**

FOR METAL KEY CHAINS (U.S. CLS. 2, 12, 13, 14, 23, 25 AND 50).

**CLASS 18—LEATHER GOODS**

FOR LEATHER KEY CHAINS (U.S. CLS. 1, 2, 3, 22 AND 41).

**CLASS 20—FURNITURE AND ARTICLES NOT OTHERWISE CLASSIFIED**

FOR NON-METAL KEY CHAINS (U.S. CLS. 2, 13, 22, 25, 32 AND 50).

**CLASS 24—FABRICS**

FOR TOWELS (U.S. CLS. 42 AND 50).

**CLASS 25—CLOTHING**

FOR CASUAL PANTS, HATS, JACKETS, JEANS; PAJAMAS, PANTS, ROBES, SHORTS, SHIRTS, SOCKS, SWEATERS, SWEATPANTS, SWEATSHIRTS, T-SHIRTS, TANK TOPS, UNDERWEAR, UNI-SEX DRESS-SHIRTS, WOMEN'S SUITS, MEN'S SUITS, AND LEATHER JACKETS (U.S. CLS. 22 AND 39).

**CLASS 33—WINES AND SPIRITS**

FOR ALCOHOLIC BEVERAGES, NAMELY, WINE AND SPIRITS, NAMELY, DISTILLED SPIRITS MADE OF BRANDY, RICE, CORN AND BARLEY (U.S. CLS. 47 AND 49).

**CLASS 40—MATERIAL TREATMENT**

FOR CUSTOM MANUFACTURING OF CLOTHING WITH CUSTOMER SPECIFIED DESIGNS AND/OR WORDING ON THEM FOR SCHOOLS AND ORGANIZATIONS (U.S. CLS. 100, 103 AND 106).

**CLASS 43—HOTEL AND RESTAURANT SERVICES**

FOR RESTAURANT SERVICES (U.S. CLS. 100 AND 101).

LINDA MICKLEBURGH, EXAMINING ATTORNEY

SN 76-553,492. VICTORIA DONNELLY AND ALLAN WILLIAMS PARTNERSHIP, THE, KANATA, ONTARIO K2M 2C3, CANADA, FILED 10-2-2003.

**IP-MEX**

PRIORITY CLAIMED UNDER SEC. 44(D) ON CANADA APPLICATION NO. 1174139, FILED 4-11-2003, REG. NO. TMA613978, DATED 7-2-2004, EXPIRES 7-2-2019.

**CLASS 9—ELECTRICAL AND SCIENTIFIC APPARATUS**

FOR COMPUTER SOFTWARE, NAMELY SOFTWARE FOR USE IN THE FIELD OF INTELLECTUAL PROPERTY (IP) FOR CREATING, MODIFYING, STORING, SEARCHING, ORGANIZING, DISPLAYING AND ANALYZING IP INFORMATION, EVALUATING, MANAGING, MONITORING AND TRACKING IP ASSETS AND CORRESPONDING IP BUDGETS, FOR USE IN RETRIEVAL AND DELIVERY OF IP INFORMATION OVER A NETWORK, AND FOR USE IN LICENSING AND SELLING OF IP (U.S. CLS. 21, 23, 26, 36 AND 38).

**CLASS 16—PAPER GOODS AND PRINTED MATTER**

FOR PRINTED MATTERS, NAMELY IP NEWSLETTERS, BROCHURES, COURSE MATERIALS RELATED TO IP AND USER MANUALS FEATURING INSTRUCTIONS AND INFORMATION IN REFERENCE TO COMPUTER SOFTWARE FOR USE IN THE FIELD OF IP (U.S. CLS. 2, 5, 22, 23, 29, 37, 38 AND 50).

**CLASS 41—EDUCATION AND ENTERTAINMENT**

FOR EDUCATION SERVICES, NAMELY PROVIDING TRAINING, COURSES AND SEMINARS TO OTHERS IN THE FIELD OF INTELLECTUAL PROPERTY, AND COMPUTER TRAINING IN THE USE AND OPERATION OF SOFTWARE FOR USE IN THE FIELD OF INTELLECTUAL PROPERTY (U.S. CLS. 100, 101 AND 107).

**CLASS 42—SCIENTIFIC, COMPUTER AND LEGAL SERVICES**

FOR LEGAL SERVICES, LEGAL CONSULTATION SERVICES, PATENT LICENSING SERVICES, PATENT LICENSING CONSULTATION SERVICES IN THE NATURE OF PREPARING PATENT APPLICATIONS, OBTAINING PATENTS AND OTHER IP ASSETS FOR CLIENTS, SEARCHING IP INFORMATION; CONDUCTING IP COMPETITIVE INTELLIGENCE; DEVELOPING IP STRATEGY; PREPARING IP BUDGET; EVALUATING IP; IDENTIFYING IP INFRINGEMENT AND LICENSING AND FACILITATING THE SELLING OF IP; COMPUTER CONSULTING SERVICES, NAMELY CONSULTATION REGARDING THE DEVELOPMENT, INSTALLATION AND MAINTENANCE OF COMPUTER SOFTWARE FOR USE IN THE FIELD OF IP, FOR USE IN RETRIEVAL AND DELIVERY OF IP INFORMATION OVER A NETWORK, AND FOR USE IN ON-LINE LICENSING AND SELLING OF IP (U.S. CLS. 100 AND 101).

CHRISTOPHER ADKINS, EXAMINING ATTORNEY

---

SN 76-554,899. JULIUS SAMANN LTD., HAMILTON HM12, BERMUDA, FILED 10-24-2003.

**MI CASA**

OWNER OF U.S. REG. NOS. 2,474,467 AND 2,552,643.  
THE ENGLISH TRANSLATION OF "MI CASA" IS "MY HOUSE".

**CLASS 3—COSMETICS AND CLEANING PREPARATIONS**

FOR INCENSE (U.S. CLS. 1, 4, 6, 50, 51 AND 52).  
FIRST USE 10-25-2001; IN COMMERCE 10-25-2001.

**CLASS 4—LUBRICANTS AND FUELS**

FOR SCENTED CANDLES (U.S. CLS. 1, 6 AND 15).  
FIRST USE 1-31-2003; IN COMMERCE 1-31-2003.  
JENNIFER CHICOSKI, EXAMINING ATTORNEY

---

SN 76-555,563. HANLEY-WOOD, LLC, WASHINGTON, DC, FILED 10-31-2003.

**HANLEY WOOD**

THE NAME HANLEY WOOD IDENTIFIES A LIVING INDIVIDUAL WHOSE CONSENT IS OF RECORD.

**CLASS 16—PAPER GOODS AND PRINTED MATTER**

FOR PERIODIC PUBLICATIONS, NAMELY MAGAZINES, BOOKLETS AND NEWSLETTERS PERTAINING TO THE BUILDING, HOUSING, CONSTRUCTION AND HOME IMPROVEMENT INDUSTRIES (U.S. CLS. 2, 5, 22, 23, 29, 37, 38 AND 50).

FIRST USE 11-1-2003; IN COMMERCE 1-1-2004.

**CLASS 35—ADVERTISING AND BUSINESS**

FOR BUSINESS MARKETING CONSULTING SERVICES AND ADVERTISING SERVICES NAMELY CREATING CORPORATE AND BRAND IDENTITY FOR OTHERS; ARRANGING AND CONDUCTING TRADE SHOWS AND EXPOSITIONS IN THE FIELD OF BUILDING, HOUSING, CONSTRUCTION AND HOME IMPROVEMENT; DIRECT MARKETING SERVICES FOR OTHERS; ON-LINE RETAIL STORE SERVICES FEATURING HOME PLANS, PROJECT PLANS AND HOME BUILDING PRODUCTS (U.S. CLS. 100, 101 AND 102).

FIRST USE 11-1-2003; IN COMMERCE 11-11-2003.

**CLASS 37—CONSTRUCTION AND REPAIR**

FOR ONLINE SERVICES, NAMELY PROVIDING CUSTOMIZED ONLINE WEB PAGES IN THE FIELD OF BUILDING, HOUSING, CONSTRUCTION AND HOME IMPROVEMENT AND ONLINE WEB LINKS TO OTHER WEB SITES (U.S. CLS. 100, 103 AND 106).

FIRST USE 11-1-2003; IN COMMERCE 12-10-2003.

**CLASS 41—EDUCATION AND ENTERTAINMENT**

FOR OFFERING AND CONDUCTING EDUCATIONAL SEMINARS ON BUILDING, HOUSING, CONSTRUCTION AND HOME IMPROVEMENT (U.S. CLS. 100, 101 AND 107).

FIRST USE 11-1-2003; IN COMMERCE 11-11-2003.

KATHERINE STOIDES, EXAMINING ATTORNEY

---

SN 76-555,993. EXPLICIT MEDIA, INC., GARDNERVILLE, NV, FILED 11-3-2003.

**ACTIVE VIDEO SOLUTION**

THE MARK CONSISTS OF STANDARD CHARACTERS WITHOUT CLAIM TO ANY PARTICULAR FONT, STYLE, SIZE, OR COLOR.

NO CLAIM IS MADE TO THE EXCLUSIVE RIGHT TO USE VIDEO, APART FROM THE MARK AS SHOWN.

**CLASS 35—ADVERTISING AND BUSINESS**

FOR ADVERTISING SERVICES, NAMELY, PLACING ADVERTISEMENTS FOR OTHERS (U.S. CLS. 100, 101 AND 102).

FIRST USE 8-30-2002; IN COMMERCE 8-30-2002.

**CLASS 42—SCIENTIFIC, COMPUTER AND LEGAL SERVICES**

FOR GRAPHIC ART DESIGN SERVICES (U.S. CLS. 100 AND 101).

FIRST USE 8-30-2002; IN COMMERCE 8-30-2002.

G. T. GLYNN, EXAMINING ATTORNEY

SN 76-556,490. UNITED STATES OLYMPIC COMMITTEE,  
COLORADO SPRINGS, CO. FILED 11-4-2003.

## NYC 2012

OWNER OF U.S. REG. NOS. 2,377,659 AND 2,468,437.

### CLASS 4—LUBRICANTS AND FUELS

FOR CANDLES (U.S. CLS. 1, 6 AND 15).

### CLASS 9—ELECTRICAL AND SCIENTIFIC APPARATUS

FOR PRE-RECORDED VIDEOTAPES, AUDIO TAPES, CASSETTE TAPES, DVDS AND CD-ROMS FEATURING ELITE SPORTS COMPETITIONS AND DEMONSTRATIONS AND CULTURAL EVENTS; DECORATIVE MAGNETS; AND SUNGLASSES (U.S. CLS. 21, 23, 26, 36 AND 38).

### CLASS 12—VEHICLES

FOR LAND VEHICLES, NAMELY, AUTOMOBILES AND TRUCKS, AND STRUCTURAL PARTS THEREFOR (U.S. CLS. 19, 21, 23, 31, 35 AND 44).

### CLASS 16—PAPER GOODS AND PRINTED MATTER

FOR NEWSLETTERS AND BROCHURES CONCERNING A SPORTS ORGANIZATION AND ELITE-LEVEL SPORT COMPETITIONS; POSTERS; STATIONERY, NOTE PAPER, NOTECARDS AND ENVELOPES; NOTE PADS; CALENDARS; TRADING CARDS; PENS, PENCILS AND PEN AND PENCIL SETS; NOTEBOOKS AND BINDERS; DIARIES AND JOURNALS; BOOK MARKS; PAPER CLIP HOLDERS; PAPER WEIGHTS; PAPER BANNERS, DECALS AND WINDSHIELD DECAL STRIPS; AND PAPER NAPKINS (U.S. CLS. 2, 5, 22, 23, 29, 37, 38 AND 50).

### CLASS 29—MEATS AND PROCESSED FOODS

FOR MEATS AND PROCESSED FOODS, NAMELY, FRENCH FRIED POTATOES, POTATO-BASED SNACK FOODS, AND CHEESE (U.S. CL. 46).

### CLASS 30—STAPLE FOODS

FOR BREAKFAST CEREALS, BREADS, CEREAL-BASED SNACK-FOODS, AND MIXES FOR BAKERY GOODS (U.S. CL. 46).

### CLASS 32—LIGHT BEVERAGES

FOR SODA POP AND COLAS, FRUIT JUICES, BOTTLED DRINKING WATER, AND BEER (U.S. CLS. 45, 46 AND 48).

### CLASS 35—ADVERTISING AND BUSINESS

FOR PROMOTING PARTICIPATION WITH AND SELECTION FOR THE US TEAM FOR AN INTERNATIONAL ATHLETIC EVENT; PROMOTING THE GOODS AND SERVICES OF OTHERS BY ARRANGING FOR SPONSORS TO AFFILIATE THEIR GOODS AND SERVICES WITH ELITE ATHLETIC EVENTS (U.S. CLS. 100, 101 AND 102).

### CLASS 36—INSURANCE AND FINANCIAL

FOR FINANCIAL SERVICES, NAMELY BANKING, CREDIT CARD, DEBIT CARD, CHARGE CARD, STORED VALUE CARD AND BILL PAYMENT SERVICES (U.S. CLS. 100, 101 AND 102).

### CLASS 38—COMMUNICATION

FOR TELECOMMUNICATIONS SERVICES, NAMELY, PERSONAL COMMUNICATION SERVICES, TELEPHONE COMMUNICATION SERVICES, AND LONG DISTANCE TELEPHONE SERVICES (U.S. CLS. 100, 101 AND 104).

### CLASS 39—TRANSPORTATION AND STORAGE

FOR TRANSPORTATION OF PASSENGERS AND/OR GOODS BY AIR, RAIL, BUS, AND TRUCK (U.S. CLS. 100 AND 105).

### CLASS 43—HOTEL AND RESTAURANT SERVICES

FOR PROVIDING TEMPORARY HOUSING ACCOMMODATIONS; HOTEL SERVICES; RESTAURANT SERVICES (U.S. CLS. 100 AND 101).

JEFFERY COWARD, EXAMINING ATTORNEY

SN 76-558,275. HAY HOUSE, INC., CARLSBAD, CA. FILED 10-27-2003.



### CLASS 9—ELECTRICAL AND SCIENTIFIC APPARATUS

FOR PRE-RECORDED VIDEOCASSETTES, DVDS, AUDIOCASSETTES AND COMPACT DISCS FEATURING MUSIC, SPOKEN WORD, SEMINARS AND LECTURES IN THE FIELDS OF FINANCIAL ADVICE, PSYCHOLOGY, SPIRITUALITY, AND SELF IMPROVEMENT (U.S. CLS. 21, 23, 26, 36 AND 38).

FIRST USE 2-0-1987; IN COMMERCE 2-0-1987.

### CLASS 16—PAPER GOODS AND PRINTED MATTER

FOR BOOKS IN THE FIELD OF FINANCIAL ADVICE, PSYCHOLOGY, SPIRITUALITY, AND SELF IMPROVEMENT; CALENDARS; MOTIVATIONAL CARDS; AND PRINTED YOGA AND SELF IMPROVEMENT MATERIALS (U.S. CLS. 2, 5, 22, 23, 29, 37, 38 AND 50).

FIRST USE 2-0-1987; IN COMMERCE 2-0-1987.

**CLASS 41—EDUCATION AND ENTERTAINMENT**

FOR EDUCATIONAL SEMINARS IN THE FIELDS OF FINANCIAL ADVICE, PSYCHOLOGY, SPIRITUALITY, AND SELF IMPROVEMENT (U.S. CLS. 100, 101 AND 107).

FIRST USE 2-0-1987; IN COMMERCE 2-0-1987.  
DEZMONA MIZELLE, EXAMINING ATTORNEY

SN 76-558,318. PEWAG AUSTRIA GMBH, 8010 GRAZ, AUSTRIA, FILED 11-7-2003.

**KWB STAR ALLOY**

NO CLAIM IS MADE TO THE EXCLUSIVE RIGHT TO USE ALLOY, APART FROM THE MARK AS SHOWN.

**CLASS 6—METAL GOODS**

FOR METAL CHAINS AND THEIR COMPONENTS; METAL LIFTING/SLING CHAINS AND THEIR PARTS; METAL HOOKS, IN PARTICULAR EYE HOOKS, LOAD HOOKS, SAFETY LOAD HOOKS, SWIVEL SAFETY LOAD HOOKS, FOUNDRY HOOKS, GRAB HOOKS, SHORTENING HOOKS, FORK HOOKS, CLEVIS HOOKS, CLEVIS SAFETY HOOKS/CLEVIS SLING HOOKS, CLEVIS FOUNDRY HOOKS; SHEET METAL PLATE HOOKS; METAL CLEVIS SHACKLES; METAL CHAIN SLINGS, METAL LIFTING CHAIN SLINGS AND THEIR COMPONENTS, IN PARTICULAR MASTER LINKS, MASTER LINK ASSEMBLIES/FOUR LEG SETS, CLEVIS COUPLER SETS/CLEVIS MASTER SETS, TRANSITION LINKS, CONNECTING LINKS (U.S. CLS. 2, 12, 13, 14, 23, 25 AND 50).

**CLASS 12—VEHICLES**

FOR CHAINS FOR VEHICLES AND THEIR COMPONENTS, IN PARTICULAR ANTISKID CHAINS, SNOW CHAINS/TIRE CHAINS, TIRE PROTECTION CHAINS (U.S. CLS. 19, 21, 23, 31, 35 AND 44).

CAROLINE WEIMER, EXAMINING ATTORNEY

SN 76-558,377. RACE-WEST COMPANY, CLARKS SUMMIT, PA. FILED 11-7-2003.

**RACE-WEST****CLASS 31—NATURAL AGRICULTURAL PRODUCTS**

FOR FRUITS AND VEGETABLES, NAMELY, FRESH ONIONS, POTATOES, CHERRIES AND APPLES (U.S. CLS. 1 AND 46).

FIRST USE 5-0-2001; IN COMMERCE 5-0-2001.

**CLASS 32—LIGHT BEVERAGES**

FOR BOTTLED DRINKING WATER (U.S. CLS. 45, 46 AND 48).

PRISCILLA MILTON, EXAMINING ATTORNEY

SN 76-559,023. OPERADORA LAS ALITAS S.A. DE C.V., MONTERREY, N.L., MEXICO, FILED 11-13-2003.

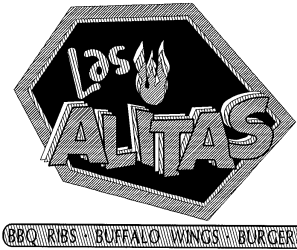

NO CLAIM IS MADE TO THE EXCLUSIVE RIGHT TO USE "ALITAS", "BBQ RIBS", "BUFFALO WINGS", AND "BURGERS", APART FROM THE MARK AS SHOWN.

THE LINING SHOWN IN THE DRAWING IS INTENDED TO INDICATE CONTRASTING COLORS AND DOES NOT INDICATE PARTICULAR COLORS. COLOR IS NOT A FEATURE OF THE MARK.

THE ENGLISH TRANSLATION OF THE SPANISH WORDING "LAS ALITAS" IS "THE WINGS".

**CLASS 30—STAPLE FOODS**

FOR HOT SAUCE (U.S. CL. 46).  
FIRST USE 10-1-2002; IN COMMERCE 10-1-2002.

**CLASS 43—HOTEL AND RESTAURANT SERVICES**

FOR RESTAURANT SERVICES (U.S. CLS. 100 AND 101).

FIRST USE 3-5-2001; IN COMMERCE 3-5-2001.  
INGA ERVIN, EXAMINING ATTORNEY

SN 76-559,212. CAL AGRI PRODUCTS, LLC, LOS ANGELES, CA. FILED 11-12-2003.

**AGRI-TERRA**

THE MARK CONSISTS OF STANDARD CHARACTERS WITHOUT CLAIM TO ANY PARTICULAR FONT, STYLE, SIZE, OR COLOR.

**CLASS 1—CHEMICALS**

FOR PLANT GROWTH REGULATORS FOR AGRICULTURAL USE (U.S. CLS. 1, 5, 6, 10, 26 AND 46).

FIRST USE 8-0-2001; IN COMMERCE 8-0-2001.

**CLASS 5—PHARMACEUTICALS**

FOR INSECT GROWTH REGULATORS FOR AGRICULTURAL USE (U.S. CLS. 6, 18, 44, 46, 51 AND 52).

FIRST USE 8-0-2001; IN COMMERCE 8-0-2001.  
MICHAEL HALL, EXAMINING ATTORNEY

SN 76-559,844. PDS ASSOCIATES, INC., DANBURY, CT.  
FILED 10-29-2003.

SN 76-561,066. 3D EXHIBITS, INC., ELK GROVE VILLAGE,  
IL. FILED 11-19-2003.

# AMÉLIE

## CLASS 11—ENVIRONMENTAL CONTROL APPARATUS

FOR PLUMBING FITTINGS, NAMELY, SPOUTS FOR TUBS AND BATHS; FAUCETS; SHOWER CONTROL VALVES; TUB FILLERS, NAMELY, SPOUTS; EXPOSED AND NON-EXPOSED SHOWER SYSTEMS COMPRISING OF VALVE TRIM, THERMOSTATIC VALVE TRIM, WALL VALVE TRIM WITH CROSS HANDLE OR LEVER HANDLE, THERMOSTATIC VALVE TRIM WITH CROSS HANDLE OR LEVER HANDLE, HAND SHOWER ON HOOK; HAND SHOWER SYSTEMS, NAMELY, HAND HELD SHOWER HEADS; SHOWER HANDLE WITH DECORATIVE VALVE TRIM; TUB AND BATH MIXERS, NAMELY, MIXER FAUCETS FOR WATER PIPES; BIDET FITTINGS, NAMELY, HANDLES, SPOUTS, TRAPS AND VALVES (U.S. CLS. 13, 21, 23, 31 AND 34).  
FIRST USE 4-0-2003; IN COMMERCE 4-0-2003.

## CLASS 21—HOUSEWARES AND GLASS

FOR BATH ACCESSORIES NAMELY, HOLDERS FOR TOILET PAPER; TOWEL BARS; AND SOAP BASKETS (U.S. CLS. 2, 13, 23, 29, 30, 33, 40 AND 50).  
FIRST USE 4-0-2003; IN COMMERCE 4-0-2003.  
JEFF DEFORD, EXAMINING ATTORNEY

SN 76-560,752. AUTOMATION ARTS, INC., MIDDLETON,  
WI. FILED 11-17-2003.

# AUTOMATION ARTS

THE MARK CONSISTS OF STANDARD CHARACTERS WITHOUT CLAIM TO ANY PARTICULAR FONT, STYLE, SIZE, OR COLOR.

OWNER OF U.S. REG. NO. 2,612,114.  
NO CLAIM IS MADE TO THE EXCLUSIVE RIGHT TO USE "AUTOMATION", APART FROM THE MARK AS SHOWN.

## CLASS 35—ADVERTISING AND BUSINESS

FOR RETAIL STORE SERVICES FEATURING HOME AND AUDIO/VIDEO SYSTEMS AND EQUIPMENT (U.S. CLS. 100, 101 AND 102).  
FIRST USE 12-1-2000; IN COMMERCE 12-1-2000.

## CLASS 37—CONSTRUCTION AND REPAIR

FOR INSTALLATION AND MAINTENANCE OF HOME AND AUDIO/VIDEO SYSTEMS AND EQUIPMENT (U.S. CLS. 100, 103 AND 106).  
FIRST USE 12-1-2000; IN COMMERCE 12-1-2000.  
GWEN STOKOLS, EXAMINING ATTORNEY

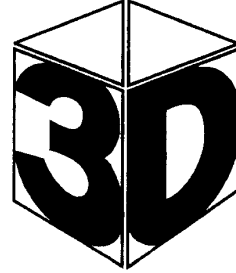

SEC. 2(F).

## CLASS 39—TRANSPORTATION AND STORAGE

FOR PROVIDING STORAGE OF TRADE SHOW EXHIBITS; TRANSPORTATION OF TRADE SHOW EXHIBITS BY TRUCK, AIR AND BOAT; AND DELIVERY OF TRADE SHOW EXHIBITS (U.S. CLS. 100 AND 105).  
FIRST USE 7-21-1995; IN COMMERCE 7-21-1995.

## CLASS 40—MATERIAL TREATMENT

FOR MANUFACTURE AND ASSEMBLY OF TRADE SHOW EXHIBITS FOR OTHERS (U.S. CLS. 100, 103 AND 106).  
FIRST USE 7-21-1995; IN COMMERCE 7-21-1995.

## CLASS 42—SCIENTIFIC, COMPUTER AND LEGAL SERVICES

FOR CUSTOM DESIGN OF TRADE SHOW EXHIBITS AND DISPLAYS (U.S. CLS. 100 AND 101).  
FIRST USE 7-21-1995; IN COMMERCE 7-21-1995.  
CHRIS WELLS, EXAMINING ATTORNEY

SN 76-562,093. HEIDELBERGER DRUCKMASCHINEN AG,  
69115 HEIDELBERG, FED REP GERMANY, FILED 11-26-2003.

# LinoScript

THE MARK CONSISTS OF STANDARD CHARACTERS WITHOUT CLAIM TO ANY PARTICULAR FONT, STYLE, SIZE, OR COLOR.

OWNER OF U.S. REG. NO. 1,276,927.

## CLASS 9—ELECTRICAL AND SCIENTIFIC APPARATUS

FOR TYPEFACE FONTS OF TYPOGRAPHICAL CHARACTERS RECORDED ON MAGNETIC MEDIA; DIGITALLY STORED FONTS OF TYPOGRAPHICAL CHARACTERS RECORDED ON COMPUTER MEDIA (U.S. CLS. 21, 23, 26, 36 AND 38).  
FIRST USE 0-0-1926; IN COMMERCE 0-0-1926.

**CLASS 16—PAPER GOODS AND PRINTED MATTER**

FOR PRINTING FONTS OF TYPOGRAPHICAL CHARACTERS (U.S. CLS. 2, 5, 22, 23, 29, 37, 38 AND 50).  
FIRST USE 0-0-1926; IN COMMERCE 0-0-1926.  
LINDA E. BLOHM, EXAMINING ATTORNEY

SN 76-566,700. MARK MCMANUS, INC., FORT MYERS, FL.  
FILED 12-23-2003.

SN 76-566,473. OWNER REVOLUTION INC., ADAIR, IA.  
FILED 12-22-2003.

**OWNER REVOLUTION INC.**

NO CLAIM IS MADE TO THE EXCLUSIVE RIGHT TO USE "INC.", APART FROM THE MARK AS SHOWN.

**CLASS 19—NON-METALLIC BUILDING MATERIALS**

FOR PLASTIC, NON-METAL MODULAR FLOATING DOCKS AND ASSOCIATED PARTS THEREFOR (U.S. CLS. 1, 12, 33 AND 50).

**CLASS 20—FURNITURE AND ARTICLES NOT OTHERWISE CLASSIFIED**

FOR POINT OF PURCHASE DISPLAYS FOR LOTTERY TICKET DISPENSERS AND DISPLAYS AND ASSOCIATED PARTS THEREFORE (U.S. CLS. 2, 13, 22, 25, 32 AND 50).

**CLASS 35—ADVERTISING AND BUSINESS**

FOR BUSINESS CONSULTING SERVICES, NAMELY PROVIDING GUIDANCE AND ADVICE TO OTHERS ON THE OPERATION OF EMPLOYEE STOCK OWNERSHIP PLANS AND COMPANY ORGANIZATIONAL DYNAMICS AND LEADERSHIP, INNOVATIONS AND CREATIVITY DEVELOPMENT (U.S. CLS. 100, 101 AND 102).

**CLASS 40—MATERIAL TREATMENT**

FOR CUSTOM MANUFACTURING OF PLASTIC FABRICATION, INJECTION MOLDING, ROTATIONAL MOLDING, VACUUM FORMING AND PRODUCT DECORATIONS FOR OTHERS (U.S. CLS. 100, 103 AND 106).  
RENEE MCCRAY, EXAMINING ATTORNEY



THE STIPPLING IS FOR SHADING PURPOSES ONLY.

**CLASS 12—VEHICLES**

FOR POWERBOATS; POWERBOATS AND STRUCTURAL PARTS THEREFOR (U.S. CLS. 19, 21, 23, 31, 35 AND 44).

**CLASS 16—PAPER GOODS AND PRINTED MATTER**

FOR DECALS; POSTERS; PAPER BABY BIBS (U.S. CLS. 2, 5, 22, 23, 29, 37, 38 AND 50).

**CLASS 18—LEATHER GOODS**

FOR ALL-PURPOSE SPORT BAGS; ALL PURPOSE ATHLETIC BAGS (U.S. CLS. 1, 2, 3, 22 AND 41).

**CLASS 25—CLOTHING**

FOR CLOTHING EXCLUDING FOOTWEAR, NAMELY, APRONS, BABY BIBS NOT OF PAPER, BANDANAS, BATHROBES, BEACHWEAR, BELTS, BLAZERS, BLOUSES, BOXER SHORTS, BRAS, BRIEFS, BUSTIERS, CAMISOLES, CAPS, CARDIGANS, CLOTH BIBS, CLOTH DIAPERS, WRAP-AROUNDS, COATS, COVER-UPS, DRESSES, FOUL WEATHER GEAR, GLOVES, GOLF SHIRTS, HEADWEAR, HATS, HEAD BANDS, HEAD SCARVES, INFANT DIAPER COVERS, INFANTWEAR, JACKETS, JEANS, JERSEYS, JOGGING PANTS, JOGGING SUITS, JUMPSUITS, LAYETTES, LINGERIE, LOUNGEWEAR, MEN'S AND WOMEN'S JACKETS, COATS, TROUSERS AND VESTS, MINISKIRTS, MITTENS, NECK BANDS, NECKERCHIEFS, NECKTIES, NECKWEAR, NIGHTWEAR, OVERCOATS, OVERALLS, PAJAMAS, PANTIES, PANTS, PULLOVERS, RAINWEAR, ROBES, ROMPERS, SARONGS, SCARVES, SHAWLS, SHIRTS, SHORTS, SHOULDER WRAPS, SKIRTS, SKORTS, SLACKS, SLEEPWEAR, SOCKS, SPORTS OVERUNIFORMS, SUITS, SUNSUITS, SWEAT PANTS, SWEAT SHIRTS, SWEATSHORTS, SWEAT SUITS, SWEATBANDS, SWEATERS, SWIM WEAR, SWIMSUITS, TANK TOPS, TOPS, T-SHIRTS, TURTLENECKS, UNDERWEAR, UNIFORMS, VISORS, WARM UP SUITS, WATERPROOF JACKETS AND PANTS, WIND RESISTANT JACKETS, WINDSHIRTS, WRISTBANDS (U.S. CLS. 22 AND 39).

**CLASS 37—CONSTRUCTION AND REPAIR**

FOR MAINTENANCE, REPAIR AND RESTORATION OF BOATS (U.S. CLS. 100, 103 AND 106).



**CLASS 40—MATERIAL TREATMENT**

FOR MANUFACTURE OF BOATS AND BOAT PARTS TO THE ORDER AND/OR SPECIFICATION OF OTHERS (U.S. CLS. 100, 103 AND 106).

KATHY DE JONGE, EXAMINING ATTORNEY

SN 76-569,890. NEW YORK STOCK EXCHANGE, INC., NEW YORK, NY. FILED 1-13-2004.

**NYSE TRADEWORKS**

THE MARK CONSISTS OF STANDARD CHARACTERS WITHOUT CLAIM TO ANY PARTICULAR FONT, STYLE, SIZE, OR COLOR.

OWNER OF U.S. REG. NOS. 909,350, 2,674,864 AND OTHERS.

SN 76-566,867. TEAM 02 INVESTMENTS, LLC, COLORADO SPRINGS, CO. FILED 12-8-2003.

**Outrageous Oasis**

THE MARK CONSISTS OF STANDARD CHARACTERS WITHOUT CLAIM TO ANY PARTICULAR FONT, STYLE, SIZE, OR COLOR.

**CLASS 25—CLOTHING**

FOR T-SHIRTS; HATS (U.S. CLS. 22 AND 39).

**CLASS 41—EDUCATION AND ENTERTAINMENT**

FOR RECREATIONAL SERVICES IN THE NATURE OF WATER PARKS (U.S. CLS. 100, 101 AND 107).

**CLASS 43—HOTEL AND RESTAURANT SERVICES**

FOR RESORT HOTELS; PROVIDING CONVENTION FACILITIES FOR GENERAL PURPOSES (U.S. CLS. 100 AND 101).

KELLY CHOE, EXAMINING ATTORNEY

**CLASS 9—ELECTRICAL AND SCIENTIFIC APPARATUS**

FOR COMPUTER SOFTWARE FOR USE IN CONNECTION WITH TRADING, NAMELY, ORDER MANAGEMENT OF SECURITIES TRANSACTIONS, DISSEMINATION OF SECURITIES TRANSACTION DATA, INCLUDING TRACKING AND MESSAGING CAPABILITIES VIA ELECTRONIC MEANS (U.S. CLS. 21, 23, 26, 36 AND 38).

**CLASS 36—INSURANCE AND FINANCIAL**

FOR CONDUCTING A SECURITIES EXCHANGE AND RELATED STOCK MARKET SERVICES, NAMELY, COMPILING, ORGANIZING AND DISSEMINATING FINANCIAL AND SECURITIES INFORMATION, ELECTRONIC SECURITIES TRADING FOR OTHERS; ELECTRONIC PROCESSING OF TRANSACTIONS INVOLVING ORDERS FOR THE PURCHASE AND SALE OF SECURITIES; PROVIDING SECURITIES ORDER DATA TO OTHERS VIA GLOBAL COMPUTER NETWORKS AND OTHER ELECTRONIC MEANS; PROVIDING SECURITIES ORDER MANAGEMENT SYSTEM WITH TRACKING AND MESSAGING CAPABILITIES VIA ELECTRONIC MEANS (U.S. CLS. 100, 101 AND 102).

REGINA DRUMMOND, EXAMINING ATTORNEY

SN 76-567,212. JOHN ZIDIAN CO., INC., COITSVILLE, OH. FILED 12-24-2003.

**Starletta**

THE MARK CONSISTS OF STANDARD CHARACTERS WITHOUT CLAIM TO ANY PARTICULAR FONT, STYLE, SIZE, OR COLOR.

**CLASS 29—MEATS AND PROCESSED FOODS**

FOR OLIVE OIL (U.S. CL. 46).

**CLASS 30—STAPLE FOODS**

FOR FOOD, NAMELY, PASTA, PASTA SAUCES, ALIMENTARY PASTES, TOMATO SAUCES, VINEGAR, NOODLES, AND BREAD CRUMBS (U.S. CL. 46).

CURTIS FRENCH, EXAMINING ATTORNEY

SN 76-570,220. RARE, ARLINGTON, VA. FILED 1-16-2004.

**RARE**

THE MARK CONSISTS OF STANDARD CHARACTERS WITHOUT CLAIM TO ANY PARTICULAR FONT, STYLE, SIZE, OR COLOR.

**CLASS 35—ADVERTISING AND BUSINESS**

FOR PROMOTING PUBLIC AWARENESS OF THE NEED FOR ENVIRONMENTAL CONSERVATION (U.S. CLS. 100, 101 AND 102).

FIRST USE 9-30-1973; IN COMMERCE 10-1-1973.

**CLASS 39—TRANSPORTATION AND STORAGE**

FOR TRAVEL AND TOUR GUIDE SERVICES; TRAVEL AGENCY SERVICES, NAMELY, MAKING RESERVATIONS AND BOOKINGS FOR TRANSPORTATION; ARRANGING TRAVEL TOURS (U.S. CLS. 100 AND 105).

FIRST USE 6-10-1997; IN COMMERCE 6-11-1997.

**CLASS 41—EDUCATION AND ENTERTAINMENT**

FOR EDUCATIONAL SERVICES, NAMELY, CONDUCTING CLASSES, SEMINARS, CONFERENCES AND WORKSHOPS IN THE FIELDS OF ENVIRONMENTAL CONSERVATION, ECO-TOURISM, SOCIAL MARKETING, LANGUAGE, AND PUBLIC USE PLANNING; TRAINING OF OTHERS IN THE FIELDS OF PROMOTION AND DEVELOPMENT OF ENVIRONMENTAL CONSERVATION, ECO-TOURISM, SOCIAL MARKETING, LANGUAGE, AND PUBLIC USE PLANNING (U.S. CLS. 100, 101 AND 107).

FIRST USE 8-16-1985; IN COMMERCE 8-16-1985.

**CLASS 43—HOTEL AND RESTAURANT SERVICES**

FOR TRAVEL AGENCY SERVICES, NAMELY, MAKING RESERVATIONS AND BOOKINGS FOR TEMPORARY LODGING (U.S. CLS. 100 AND 101).

FIRST USE 6-10-2002; IN COMMERCE 6-11-2002.

KATHY DE JONGE, EXAMINING ATTORNEY

SN 76-570,222. RUI ROYAL INTERNATIONAL CORPORATION, ST. LAURENT, QUÉBEC, CANADA, FILED 1-16-2004.

**CLASS 8—HAND TOOLS**

FOR HAND TOOLS—NAMELY, AXES, DRILL BITS, HACKSAWS, HACKSAW BLADES, HAMMERS, NUT DRIVERS, PLIERS, SCREWDRIVER BITS, SCREWDRIVERS, SOCKET SETS, TWIST DRILLS, WRECKING BARS, AND WRENCHES (U.S. CLS. 23, 28 AND 44).

**CLASS 9—ELECTRICAL AND SCIENTIFIC APPARATUS**

FOR TAPE MEASURES (U.S. CLS. 21, 23, 26, 36 AND 38).

HOWARD B. LEVINE, EXAMINING ATTORNEY

SN 76-570,223. RUI ROYAL INTERNATIONAL CORPORATION, ST. LAURENT, QUÉBEC, CANADA, FILED 1-16-2004.

**diane's**

**CLASS 8—HAND TOOLS**

FOR HAND TOOLS—NAMELY, AXES, DRILL BITS, HACKSAWS, HACKSAW BLADES, HAMMERS, NUT DRIVERS, PLIERS, SCREWDRIVER BITS, SCREWDRIVERS, SOCKET SETS, TWIST DRILLS, WRECKING BARS, AND WRENCHES (U.S. CLS. 23, 28 AND 44).

**CLASS 9—ELECTRICAL AND SCIENTIFIC APPARATUS**

FOR TAPE MEASURES (U.S. CLS. 21, 23, 26, 36 AND 38).

HOWARD B. LEVINE, EXAMINING ATTORNEY

SN 76-570,938. TRUTECH, IDAHO FALLS, ID. FILED 1-15-2004.

**ONSHORE ALLIANCE**

NO CLAIM IS MADE TO THE EXCLUSIVE RIGHT TO USE "ALLIANCE", APART FROM THE MARK AS SHOWN.

**CLASS 35—ADVERTISING AND BUSINESS**

FOR BUSINESS AND CONSULTING SERVICES, NAMELY, BUSINESS MANAGEMENT CONSULTING, BUSINESS PROCESS MANAGEMENT AND CONSULTING, BUSINESS CONSULTING SERVICES IN THE FIELDS OF COMPUTERS AND RELATED INFORMATION TECHNOLOGY; BUSINESS MANAGEMENT SERVICES AND BUSINESS OPERATIONS SERVICES, NAMELY, PROVIDING INFORMATION IN BUSINESS MATTERS, PERSONNEL AND BUSINESS MANAGEMENT IN THE FIELDS OF INFORMATION SYSTEMS DESIGN, SPECIFICATION AND PROCUREMENT OF COMPUTER HARDWARE AND SOFTWARE FOR OTHERS; BUSINESS INFORMATION SERVICES IN THE FIELDS OF BUSINESS CHANGE MANAGEMENT, BUSINESS PROCESS MANAGEMENT, BUSINESS STRATEGIC MANAGEMENT AND PLANNING SERVICES, BUSINESS TECHNOLOGY AND BUSINESS NETWORKING; STAFFING AND OUTSOURCING SERVICES USING LOCAL AND NATIONAL COMPUTER NETWORKS WITHIN THE UNITED STATES FOR OTHERS IN THE FIELDS OF COMPUTERS, COMPUTER SOFTWARE, AND COMPUTER SYSTEMS; PROVIDING INFORMATION ABOUT BUSINESS CONSULTING (U.S. CLS. 100, 101 AND 102).

**CLASS 42—SCIENTIFIC, COMPUTER AND LEGAL SERVICES**

FOR LOCAL AND REMOTE INFORMATION TECHNOLOGY AND COMPUTER CONSULTING SERVICES USING LOCAL AND NATIONAL COMPUTER NETWORKS WITHIN THE UNITED STATES FOR OTHERS IN THE AREAS OF COMPUTERS, COMPUTER SOFTWARE AND COMPUTER SYSTEMS, NAMELY, ANALYZING MODELING, DESIGNING, DEVELOPING, PROGRAMMING, INTEGRATING, IMPLEMENTING, MANAGING, MAINTAINING, AND MONITORING COMPUTER HARDWARE, COMPUTERIZED SOFTWARE INFORMATION SYSTEMS, SOFTWARE NETWORKS, COMPUTER SOFTWARE ADMINISTRATION, COMPUTER HARDWARE SYSTEMS ADMINISTRATION AND TELECOMMUNICATION SYSTEMS; TECHNICAL SUPPORT SERVICES, NAMELY, TROUBLESHOOTING OF COMPUTER HARDWARE AND SOFTWARE PROBLEMS VIA TELEPHONE, ELECTRONIC MAIL, IN PERSON REQUEST, AND REGULAR MAIL; PROVIDING INFORMATION ABOUT INFORMATION TECHNOLOGY, COMPUTERS, AND COMPUTER SYSTEMS; MANAGEMENT OF COMPUTER SYSTEMS THAT UTILIZE LOCAL, NATIONAL, AND GLOBAL COMPUTER NETWORKS TO OBTAIN INFORMATION, FOR THE PURCHASE OF PRODUCTS AND SERVICES, AND TO PERMIT FINANCIAL TRANSACTIONS BETWEEN CONSUMERS AND BUSINESSES (U.S. CLS. 100 AND 101).

CATHERINE CAIN, EXAMINING ATTORNEY

SN 76-571,509. MILLER'S INC., PITTSBURG, KS. FILED 1-21-2004.

**MPIX**

THE MARK CONSISTS OF STANDARD CHARACTERS WITHOUT CLAIM TO ANY PARTICULAR FONT, STYLE, SIZE, OR COLOR.

**CLASS 35—ADVERTISING AND BUSINESS**

FOR ONLINE RETAIL STORE SERVICES FEATURING DIGITAL ENHANCEMENT AND MANIPULATION OF PHOTOGRAPHS AND IMAGES, PRINTING PHOTOGRAPHS, REPRODUCING PHOTOGRAPHS, AND FINISHING PHOTOGRAPHS (U.S. CLS. 100, 101 AND 102).  
FIRST USE 8-22-2003; IN COMMERCE 8-22-2003.

**CLASS 38—COMMUNICATION**

FOR ELECTRONIC DELIVERY OF IMAGES AND PHOTOGRAPHS VIA THE INTERNET (U.S. CLS. 100, 101 AND 104).  
FIRST USE 8-22-2003; IN COMMERCE 8-22-2003.

**CLASS 42—SCIENTIFIC, COMPUTER AND LEGAL SERVICES**

FOR HOSTING OF DIGITAL CONTENT AND DIGITAL IMAGES ON THE INTERNET (U.S. CLS. 100 AND 101).  
FIRST USE 8-22-2003; IN COMMERCE 8-22-2003.  
PAUL F. GAST, EXAMINING ATTORNEY

SN 76-571,976. ASSOCIATED REGIONAL AND UNIVERSITY PATHOLOGISTS, INC., SALT LAKE CITY, UT. FILED 1-22-2004.

MOVING TO THE NEXT LEVEL

THE MARK CONSISTS OF STANDARD CHARACTERS WITHOUT CLAIM TO ANY PARTICULAR FONT, STYLE, SIZE, OR COLOR.

**CLASS 35—ADVERTISING AND BUSINESS**

FOR BUSINESS CONSULTATION SERVICES FOR LABORATORY, MEDICAL AND HEALTH CARE ORGANIZATIONS, HOSPITALS AND PROVIDERS IN THE FIELDS OF PROMOTION, MARKETING, MARKETING MATERIALS, MARKETING DEVELOPMENT, MARKET RESEARCH, MARKET SURVEYS, SALES DEVELOPMENT, SALES TRAINING, LABORATORY SERVICE DIRECTORIES, BRAND DEVELOPMENT, BUSINESS DEVELOPMENT, CONTRACT NEGOTIATIONS, COMPETITION, BUSINESS PLANS, LABORATORY SERVICES, PLACING ORDERS FOR LABORATORY SERVICES, SUPPLY AND STORAGE OF LABORATORY GOODS, DELIVERY OF LABORATORY GOODS, COURIER SERVICES, REFERRALS, THIRD PARTY SERVICE PROVIDERS, FACTORS TO CONSIDER IN SELECTING THIRD PARTY SERVICE PROVIDERS, LABORATORY SPECIMEN FLOW AUDITS, LABORATORY PROCESS EFFICIENCY, PATIENT CARE, PATIENT SERVICE CENTERS, CUSTOMER SERVICE, CUSTOMER LOYALTY, PHYSICIAN CONNECTIVITY, RESULT DELIVERY, EMPLOYEE HIRING, EMPLOYEE RETENTION, EMPLOYEE MOTIVATION, FEE SCHEDULES, BILLING, LABORATORY COST ANALYSIS, AND BUSINESS COST ANALYSIS (U.S. CLS. 100, 101 AND 102).  
FIRST USE 6-22-2003; IN COMMERCE 6-22-2003.

**CLASS 41—EDUCATION AND ENTERTAINMENT**

FOR EDUCATIONAL SERVICES, NAMELY ARRANGING AND CONDUCTING TRAINING AND CLASSES FOR LABORATORY, MEDICAL AND HEALTH CARE ORGANIZATIONS, HOSPITALS AND PROVIDERS IN THE FIELDS OF PROMOTION, MARKETING, MARKETING MATERIALS, MARKETING DEVELOPMENT, MARKET RESEARCH, MARKET SURVEYS, SALES DEVELOPMENT, SALES TRAINING, LABORATORY SERVICE DIRECTORIES, BRAND DEVELOPMENT, BUSINESS DEVELOPMENT, CONTRACT NEGOTIATIONS, COMPETITION, BUSINESS PLANS, LABORATORY SERVICES, PLACING ORDERS FOR LABORATORY SERVICES, SUPPLY AND STORAGE OF LABORATORY GOODS, DELIVERY OF LABORATORY GOODS, COURIER SERVICES, REFERRALS, THIRD PARTY SERVICE PROVIDERS, FACTORS TO CONSIDER IN SELECTING THIRD PARTY SERVICE PROVIDERS, LABORATORY SPECIMEN FLOW AUDITS, LABORATORY PROCESS EFFICIENCY, PATIENT CARE, PATIENT SERVICE CENTERS, CUSTOMER SERVICE, CUSTOMER LOYALTY, PHYSICIAN CONNECTIVITY, RESULT DELIVERY, EMPLOYEE HIRING, EMPLOYEE RETENTION, EMPLOYEE MOTIVATION, FEE SCHEDULES, BILLING, LABORATORY COST ANALYSIS, AND BUSINESS COST ANALYSIS (U.S. CLS. 100, 101 AND 107).  
FIRST USE 6-22-2003; IN COMMERCE 6-22-2003.  
SEAN DWYER, EXAMINING ATTORNEY

SN 76-572,143. RIVERDEEP INTERACTIVE LEARNING LIMITED, DUBLIN 2, IRELAND, FILED 1-22-2004.

DESTINATION SUCCESS

THE MARK CONSISTS OF STANDARD CHARACTERS WITHOUT CLAIM TO ANY PARTICULAR FONT, STYLE, SIZE, OR COLOR.  
OWNER OF U.S. REG. NOS. 2,065,894, 2,554,481 AND 2,578,138.

**CLASS 9—ELECTRICAL AND SCIENTIFIC APPARATUS**

FOR COMPUTER SOFTWARE AND AUDIO TAPES, ALL FEATURING EDUCATIONAL CONTENT IN THE FIELD OF ACADEMIC SUBJECTS TAUGHT IN ELEMENTARY AND SECONDARY SCHOOLS; COMPUTER SOFTWARE AND AUDIO TAPES, ALL FEATURING PROFESSIONAL DEVELOPMENT AND TRAINING CONTENT FOR TEACHERS IN ELEMENTARY AND SECONDARY SCHOOLS (U.S. CLS. 21, 23, 26, 36 AND 38).

SN 76-573,082. HAYDELL, R. E., II, OKLAHOMA CITY, OK. FILED 1-29-2004.

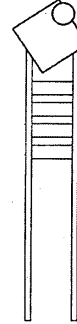

**CLASS 16—PAPER GOODS AND PRINTED MATTER**

FOR BOOKS, PRINTED INSTRUCTIONAL AND EDUCATIONAL MATERIALS, AND TEACHING MANUALS, ALL IN THE FIELD OF ACADEMIC SUBJECTS TAUGHT IN ELEMENTARY AND SECONDARY SCHOOLS OR RELATING TO THE PREPARATION OF GRANT SUBMISSIONS AND THE OBTAINING OF GRANTS FOR ELEMENTARY AND SECONDARY SCHOOLS (U.S. CLS. 2, 5, 22, 23, 29, 37, 38 AND 50).

**CLASS 35—ADVERTISING AND BUSINESS**

FOR PROMOTIONAL AND ADVERTISING SERVICES FOR LESSEES OF SHOPPING CENTERS (U.S. CLS. 100, 101 AND 102).

**CLASS 36—INSURANCE AND FINANCIAL**

FOR REAL ESTATE ACQUISITION AND MANAGEMENT SERVICES, NAMELY THE ACQUISITION AND MANAGEMENT OF SHOPPING CENTERS; SHOPPING CENTER SERVICES, NAMELY, ACQUISITION, LEASING AND MANAGEMENT OF SHOPPING CENTERS; REAL ESTATE SERVICES, NAMELY, BUYING, SELLING AND MANAGING REAL PROPERTY (U.S. CLS. 100, 101 AND 102).

**CLASS 41—EDUCATION AND ENTERTAINMENT**

FOR EDUCATIONAL SERVICES, NAMELY, CONDUCTING PROGRAMS IN THE FIELD OF PROFESSIONAL DEVELOPMENT AND TRAINING FOR TEACHERS IN ELEMENTARY AND SECONDARY SCHOOLS; CONSULTING, INSTRUCTIONAL, AND TRAINING SERVICES IN THE FIELD OF PREPARING GRANT SUBMISSIONS AND OBTAINING GRANTS FOR ELEMENTARY AND SECONDARY SCHOOLS; PROVIDING A WEB SITE THAT FEATURES EDUCATIONAL, INSTRUCTIONAL, AND TRAINING CONTENT IN THE FIELD OF ELEMENTARY AND SECONDARY SCHOOL EDUCATION (U.S. CLS. 100, 101 AND 107).

**CLASS 37—CONSTRUCTION AND REPAIR**

FOR REAL ESTATE DEVELOPMENT AND PLANNING SERVICES, NAMELY PLANNING, LAYING OUT AND BUILDING OF COMMERCIAL BUILDINGS AND SHOPPING CENTERS; CONSTRUCTION SERVICES, NAMELY SITE SELECTION, PLANNING, DEVELOPMENT AND CONSTRUCTION OF COMMERCIAL BUILDINGS AND SHOPPING CENTERS (U.S. CLS. 100, 103 AND 106).

WILLIAM BRECKENFELD, EXAMINING ATTORNEY

SN 76-573,668. TUCKER-ROCKY CORPORATION, INC., WILMINGTON, DE. FILED 1-28-2004.

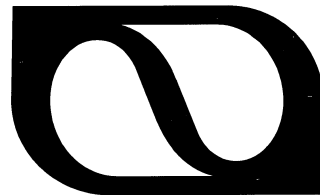

**CLASS 42—SCIENTIFIC, COMPUTER AND LEGAL SERVICES**

FOR PROVIDING TEMPORARY ACCESS VIA THE INTERNET TO NON-DOWNLOADABLE SOFTWARE FEATURING EDUCATIONAL CONTENT IN THE FIELD OF ACADEMIC SUBJECTS TAUGHT IN ELEMENTARY AND SECONDARY SCHOOLS AND FEATURING PROFESSIONAL DEVELOPMENT AND TRAINING CONTENT FOR TEACHERS IN ELEMENTARY AND SECONDARY SCHOOLS (U.S. CLS. 100 AND 101).  
MARGERY A. TIERNEY, EXAMINING ATTORNEY

OWNER OF U.S. REG. NOS. 2,002,789 AND 2,334,956.

**CLASS 9—ELECTRICAL AND SCIENTIFIC APPARATUS**

FOR BICYCLE HELMETS, MOTORCYCLE HELMETS (U.S. CLS. 21, 23, 26, 36 AND 38).

**CLASS 12—VEHICLES**

SN 76-573,834. JTMD LLC, NEW YORK, NY. FILED 2-4-2004.

FOR STRUCTURAL PARTS AND ACCESSORIES OF MOTORCYCLES, NAMELY, BIKE STANDS, CHAINS, CROSS BAR PADS, FORK BOOTS, FRAME GUARDS, LEVER GUARDS, PIPE GUARDS, RADIATOR GUARDS, ROOST DEFLECTORS, SEAT COVERS, SHIFT LEVERS, AND SKID PADS (U.S. CLS. 19, 21, 23, 31, 35 AND 44).

**CLASS 25—CLOTHING**

FOR MOTORCYCLE APPAREL, NAMELY, WOMEN'S AND MEN'S PANTS, JACKETS, JERSEYS, GLOVES, SOCKS, TOPS, T-SHIRTS, HATS, BELTS, VESTS, CHAPS, BOOTS (U.S. CLS. 22 AND 39).

LINDA E. BLOHM, EXAMINING ATTORNEY



SN 76-573,793. NICHOLS, MARK WILLIAM, SAN DIEGO, CA. FILED 1-30-2004.

**SIMPURE**

THE MARK CONSISTS OF STANDARD CHARACTERS WITHOUT CLAIM TO ANY PARTICULAR FONT, STYLE, SIZE, OR COLOR.

OWNER OF U.S. REG. NO. 2,570,269.

**CLASS 3—COSMETICS AND CLEANING PREPARATIONS**

FOR HAIR CARE PRODUCTS, NAMELY, SHAMPOOS, CONDITIONERS, SPRAY AND SCULPTING GELS, HAIR COLORING PREPARATIONS AND WAVING LOTIONS; SKIN CARE PRODUCTS, NAMELY, MOISTURIZERS, TONERS, SKIN CLEANSING PREPARATIONS, LOTIONS, MASQUES AND ASTRINGENTS FOR COSMETIC PURPOSES; COLOR COSMETICS, NAMELY, LIPSTICKS, EYE-SHADOWS, FOUNDATION CREMES, BLUSHES, FACE POWDERS, EYE PENCILS, LIP PENCILS AND MASCARA; PERSONAL HYGIENE PRODUCTS, NAMELY, BATH SOAPS, TOTAL BODY CLEANING PREPARATIONS, TOILET WATERS, PERFUMES AND COLOGNES, MASSAGE OILS AND LOTIONS; SKIN CREAMS, SKIN LOTIONS, SKIN EMOLLIENTS, MOISTURIZING BODY OILS AND LOTIONS, FOOT CARE PRODUCTS, NAMELY, FOOT DEODORANT SPRAYS, NON-MEDICATED FOOT POWDERS AND NON-MEDICATED FOOT CREAMS; ESSENTIAL OILS FOR PERSONAL USE; INCENSE; TOOTH-CARE PRODUCTS, NAMELY, TOOTH GEL, TOOTH PASTE, TOOTH POLISH AND TOOTH POWDERS (U.S. CLS. 1, 4, 6, 50, 51 AND 52).

**CLASS 35—ADVERTISING AND BUSINESS**

FOR ONLINE RETAIL STORE SERVICES AND RETAIL STORE SERVICES IN THE FIELD OF COSMETICS, TOILETRIES, FRAGRANCES, AND PERFUMES, FRAGRANCE ROOM SPRAYS, SKIN CARE PRODUCTS, HAIR CARE PRODUCTS, CANDLES, ESSENTIAL OILS, INCENSE, BOOKS, JEWELRY, NUTRITIONAL SUPPLEMENTS AND TEAS (U.S. CLS. 100, 101 AND 102).

DORITT L. CARROLL, EXAMINING ATTORNEY

**CLASS 20—FURNITURE AND ARTICLES NOT OTHERWISE CLASSIFIED**

FOR MATTRESSES, PILLOWS, AND BEDS (U.S. CLS. 2, 13, 22, 25, 32 AND 50).

**CLASS 24—FABRICS**

FOR TOWELS; LINENS, NAMELY BED SHEETS, PILLOW CASES, BED BLANKETS, COMFORTERS, DUVETS, DUVET COVERS (U.S. CLS. 42 AND 50).

LINDA MICKLEBURGH, EXAMINING ATTORNEY

SN 76-976,764. TENNIS PROPERTIES B.V., AMSTERDAM, NETHERLANDS, FILED 5-16-2000.

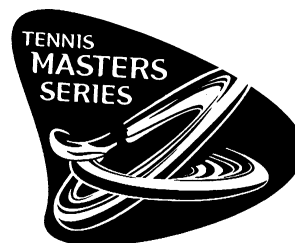

PRIORITY CLAIMED UNDER SEC. 44(D) ON BENELUX APPLICATION NO. 0951782, FILED 12-2-1999, REG. NO. 0658763, DATED 12-2-1999, EXPIRES 12-2-2009.

NO CLAIM IS MADE TO THE EXCLUSIVE RIGHT TO USE "TENNIS", "SERIES", APART FROM THE MARK AS SHOWN.

**CLASS 38—COMMUNICATION**

FOR TELECOMMUNICATION SERVICES NAMELY, PERSONAL COMMUNICATION SERVICES VIA MOBILE PHONES, TELEX, ELECTRONIC COMPUTER TERMINALS, TELEGRAPH, TELEPHONE OR FACSIMILE; PAGING BY RADIO; NETWORK CONFERENCING SERVICES, NAMELY, COMMUNICATIONS BY TELEVISION FOR MEETINGS, TELEVISION BROADCASTING; CABLE TELEVISION BROADCASTING; RADIO BROADCASTING (U.S. CLS. 100, 101 AND 104).

**CLASS 41—EDUCATION AND ENTERTAINMENT**

FOR VIDEOTAPE PRODUCTION; PROVIDING SPORTS RECORDS AND SPORTS STATISTICAL INFORMATION; EDUCATIONAL SERVICES, NAMELY CONDUCTING CLASSES, SEMINARS, CONFERENCES, WORKSHOPS IN THE FIELD OF SPORT AND DISTRIBUTING COURSE MATERIALS IN CONNECTION THEREWITH; ENTERTAINMENT SERVICES, NAMELY, CONDUCTING LOTTERIES FOR OTHERS, SPORTING AND CULTURAL ACTIVITIES, ORGANIZATION OF SPORTING AND CULTURAL EVENTS AND ACTIVITIES FOR OTHERS; PROVIDING FACILITIES FOR TENNIS SPORTS TOURNAMENTS; RENTAL SERVICES FOR AUDIO AND VIDEO EQUIPMENT, RADIO, TELEVISION PROGRAM; PRODUCTION OF ANIMATION MOVIES; PRODUCTION OF ANIMATION TV PROGRAMS, ARRANGING FOR TICKET RESERVATIONS FOR SHOWS AND OTHER ENTERTAINMENT EVENTS; TIMING OF SPORTS EVENTS; ENTERTAINER MANAGING SERVICES; BROADCASTING OF A COMMERCIAL SITE ON THE INTERNET FEATURING SPORT/ TENNIS INFORMATION; PROVIDING AN ON-LINE COMPUTER DATABASE IN THE FIELD OF TENNIS" (U.S. CLS. 100, 101 AND 107).

JOHN DALIER, EXAMINING ATTORNEY

SN 78-037,974. DADA CORPORATION, SEOUL, REPUBLIC OF KOREA, FILED 12-6-2000.



The logo for DADA, featuring the word "dada" in a lowercase, bold, sans-serif font. The letters are filled with a dense, stippled pattern. A horizontal line is positioned directly beneath the text.

OWNER OF U.S. REG. NO. 1,896,120.

**CLASS 14—JEWELRY**

FOR NECKLACE, EARRINGS (U.S. CLS. 2, 27, 28 AND 50).

**CLASS 26—FANCY GOODS**

FOR ARTIFICIAL FLOWERS AND BUTTONS FOR CLOTHING, HAIR ACCESSORIES NAMELY HAIR CLIPS AND HAIRBAND (U.S. CLS. 37, 39, 40, 42 AND 50).

JENNIFER KRISP, EXAMINING ATTORNEY

SN 76-976,994. TOURNAMENT RESORTS, LLC, VONORE, TN. FILED 7-1-2003.

**TOURNAMENT RESORTS****CLASS 18—LEATHER GOODS**

FOR GOLF UMBRELLAS (U.S. CLS. 1, 2, 3, 22 AND 41).

**CLASS 21—HOUSEWARES AND GLASS**

FOR CUPS, DRINKING GLASSES, AND MUGS (U.S. CLS. 2, 13, 23, 29, 30, 33, 40 AND 50).

**CLASS 25—CLOTHING**

FOR CLOTHING AND HEADWEAR, NAMELY, CAPS, COATS, HATS, JACKETS, COATS, SHIRTS, SHORTS, SKIRTS, SOCKS, SPORTCOATS, SWEAT PANTS, SWEATSHIRTS, SWEATERS, T-SHIRTS, VESTS, VISORS, RAINSUITS AND WINDSHIRTS (U.S. CLS. 22 AND 39).

**CLASS 28—TOYS AND SPORTING GOODS**

FOR GOLF EQUIPMENT, NAMELY, GOLF BALLS, GOLF TEES, GOLF BAGS, GOLF CLUBS, GOLF BALL MARKERS, AND GOLF FLAGS (U.S. CLS. 22, 23, 38 AND 50).

**CLASS 35—ADVERTISING AND BUSINESS**

FOR RETAIL STORE SERVICES FEATURING GOLF RELATED ITEMS (U.S. CLS. 100, 101 AND 102).

REBECCA GILBERT, EXAMINING ATTORNEY

SN 78-040,862. WACHOVIA SECURITIES, LLC, CHARLOTTE, NC. FILED 12-28-2000.

**HELPING CLIENTS  
ACHIEVE THEIR DREAMS****CLASS 35—ADVERTISING AND BUSINESS**

FOR TAX PLANNING SERVICES (U.S. CLS. 100, 101 AND 102).

**CLASS 36—INSURANCE AND FINANCIAL**

FOR FINANCIAL SERVICES RENDERED TO INDIVIDUALS, NAMELY, INVESTMENT ADVISORY SERVICES; INVESTMENT AND PORTFOLIO MANAGEMENT SERVICES; AGENCY AND BROKERAGE OF MUTUAL FUNDS, UNIT INVESTMENT TRUSTS, STOCKS, COMMODITIES AND BONDS; ESTATE PLANNING AND MANAGEMENT SERVICES; TRUST PLANNING AND MANAGEMENT SERVICES; INVESTMENT AND RETAIL BANKING SERVICES; AND PROVIDING INFORMATION IN THE FIELDS OF INSURANCE, BANKING, INVESTMENTS, AND FINANCIAL SERVICES VIA THE INTERNET (U.S. CLS. 100, 101 AND 102).

JENNIFER KRISP, EXAMINING ATTORNEY

SN 78-060,952. IQARA HOLDINGS LIMITED, READING, UNITED KINGDOM, FILED 4-28-2001.

## IQARA

OWNER OF UNITED KINGDOM REG. NO. 2268643, DATED 10-5-2001, EXPIRES 4-27-2011.

### CLASS 4—LUBRICANTS AND FUELS

FOR FUEL FOR MOTOR VEHICLES, NAMELY, NATURAL GAS, HYDROGEN GAS, CRUDE OILS, GAS, NAMELY LIQUEFIED NATURAL GAS, COMPRESSED NATURAL GAS, LIQUEFIED HYDROGEN GAS, COMPRESSED HYDROGEN GAS, ALL PURPOSE PENETRATING OIL; LIQUEFIED NATURAL GAS SOLD IN CYLINDERS FOR USE IN TORCHES (U.S. CLS. 1, 6 AND 15).

### CLASS 7—MACHINERY

FOR MACHINES AND MACHINE TOOLS, NAMELY NATURAL GAS COMPRESSOR, NATURAL GAS REFORMERS, FUEL STORAGE BANKS, FUEL STORAGE TANKS, DISPENSERS, NATURAL GAS ENGINES, HYDROGEN GAS ENGINES, DUEL FUEL ENGINES, HYBRID ENGINES, FUEL CELLS, GASOLINE ENGINES DIESEL ENGINES, ELECTRIC MOTOR; ENGINES, NAMELY AIRCRAFT ENGINES, BOAT ENGINES; MOTORS, NAMELY AIRCRAFT MOTORS, BOAT MOTORS, ELECTRIC MOTORS FOR MACHINES; COMPRESSORS, NAMELY NATURAL GAS COMPRESSORS, AIR COMPRESSORS, AIR COMPRESSORS FOR VEHICLES, COMPRESSORS FOR AIR CONDITIONERS, COMPRESSORS FOR MACHINES, COMPRESSORS FOR REFRIGERATORS; PIPE INSTALLATION MACHINES; PUMPS, NAMELY FUEL PUMPS FOR LAND VEHICLES, MACERATOR PUMPS, ELECTRIC PUMPS, CENTRIFUGAL PUMPS, COMPRESSED AIR PUMPS, OIL DRAIN PUMPS, OIL PUMPS FOR LAND VEHICLES, OIL PUMPS FOR USE IN MOTORS AND ENGINES (U.S. CLS. 13, 19, 21, 23, 31, 34 AND 35).

### CLASS 11—ENVIRONMENTAL CONTROL APPARATUS

FOR HEAT PUMPS; LIGHTING APPARATUS, NAMELY ELECTRIC LIGHTING FIXTURES, ELECTRIC TRACK LIGHTING, FIBER OPTIC LIGHTING FIXTURES USED IN CONJUNCTION WITH ELECTRICAL ILLUMINATORS, AUTOMOTIVE HEADLIGHTS; HEATING APPARATUS, NAMELY ELECTRIC HEATING FANS, ELECTRIC RADIATORS FOR HEATING BUILDINGS, ELECTRIC HEATERS FOR COMMERCIAL USE, ELECTRIC SPACE HEATERS, KEROSENE HEATERS, PORTABLE ELECTRIC HEATERS— WATER HEATERS DOMESTIC, COMMERCIAL, INDUSTRIAL WATER HEATERS; CENTRAL AIR AND CONDITIONERS (U.S. CLS. 13, 21, 23, 31 AND 34).

### CLASS 12—VEHICLES

FOR ENGINES AND MOTORS FOR LAND VEHICLES; VEHICLES, NAMELY AUTOMOBILES, BOATS, AIRPLANES, SHIPS, TRAINS, BUSES, MASS TRANSPORTATION VEHICLES, ALL FUELED OR PARTLY FUELED BY NATURAL GAS, HYDROGEN, COMPRESSED NATURAL GAS, LIQUID NATURAL GAS, COMPRESSED HYDROGEN, LIQUEFIED NATURAL GAS, NAMELY AUTOMOBILES, BOATS, AIRPLANES, SHIPS, TRAINS, BUSES (U.S. CLS. 19, 21, 23, 31, 35 AND 44).

### CLASS 36—INSURANCE AND FINANCIAL

FOR INSURANCE SERVICES, NAMELY INSURANCE ADMINISTRATION IN THE FIELD OF VEHICLES, HOME, ACCIDENT, FIRE, OFFICE EQUIPMENT AND COMMERCIAL, INSURANCE ADMINISTRATION, INSURANCE AGENCIES, INSURANCE AGENCIES IN THE FIELD OF VEHICLES, HOME, ACCIDENT, FIRE, OFFICE EQUIPMENT AND COMMERCIAL ELECTRONIC PROCESSING OF INSURANCE CLAIMS AND PAYMENT DATE, INSURANCE BROKERAGE, INSURANCE CLAIMS PROCESSING, INSURANCE CONSULTATION SERVICES; LOAN AND CREDIT FACILITIES, NAMELY, CREDIT CARDS, FUEL CARDS FOR FLEETS, SAVINGS AND LOAN ASSOCIATION, CREDIT AGENCIES, CREDIT UNIONS; UNDERWRITING PROGRAMS IN THE FIELD OF APPLIANCES; DEBIT CARD SERVICES; LEASING SERVICES, NAMELY APARTMENTS AND OFFICE SPACE; FINANCIAL SERVICES, NAMELY, FINANCIAL ANALYSIS AND CONSULTATION, FINANCIAL FORECASTING LEASE-PURCHASE FINANCING (U.S. CLS. 100, 101 AND 102).

### CLASS 37—CONSTRUCTION AND REPAIR

FOR LEASING SERVICES, NAMELY, COMPRESSOR, STORAGE VESSELS, STORAGE TANKS, DISPENSERS, REFORMERS, CENTRIFUGAL PUMPS; INSTALLATIONS OF GAS APPLIANCES, MAINTENANCE AND/OR REPAIR OF GAS APPLIANCE AND COMPRESSORS; LAYING REFURBISHING AND CONSTRUCTION OF PIPELINES; PIPE INSTALLATION AND REPAIR; REPAIR AND REFURBISHING OF ROADS; REFURBISHING AND CONSTRUCTION OF GAS; GAS INSTALLATION, MAINTENANCE AND REPAIR; INSTALLATION OF BUILDING INSULATION; LAND DEVELOPMENT SERVICES, NAMELY PLANNING AND LAYING OUR OF RESIDENTIAL AND/OR COMMERCIAL COMMUNITIES, ENVIRONMENTAL REMEDIATION SERVICES, NAMELY, WASTE DISPOSAL (U.S. CLS. 100, 103 AND 106).

### CLASS 40—MATERIAL TREATMENT

FOR OIL AND GAS PRODUCTION SERVICES— GENERATION OF ELECTRICITY AND ENERGY (U.S. CLS. 100, 103 AND 106).

### CLASS 42—SCIENTIFIC, COMPUTER AND LEGAL SERVICES

FOR LEASING SERVICES, NAMELY LEASING COMPUTER FACILITIES, LEASING COMPUTERS; CONSUMER PRODUCT SAFETY TESTING OF GAS APPLIANCES AND PIPE WORK CARRYING GAS; SCIENTIFIC, ENGINEERING AND ENVIRONMENTAL RESEARCH AND DEVELOPMENT SERVICES, GEOPHYSICAL AND GEOLOGICAL SURVEYING SERVICES; COMPUTER SERVICES, NAMELY COMPUTER GRAPHIC SERVICES, COMPUTER SERVICES, COMPUTER CONSULTATION SERVICES, PROVIDING SEARCH ENGINES FOR OBTAINING DATA ON A GLOBAL COMPUTER NETWORK, DATA RECOVERY SERVICES MAINTENANCE AND UPDATING OF COMPUTER SOFTWARE; COMPUTER SOFTWARE DESIGN AND PROGRAMMING FOR OTHERS; INSPECTION OF GAS PIPELINES (U.S. CLS. 100 AND 101).

PAULA MAYS, EXAMINING ATTORNEY

SN 78-074,684. SCIENTON TECHNOLOGIES INC., TORONTO, ONTARIO, CANADA, FILED 7-19-2001.

## TRUST MODEL ROUTER

PRIORITY CLAIMED UNDER SEC. 44(D) ON CANADA APPLICATION NO. 1105851, FILED 6-11-2001, REG. NO. TMA614581, DATED 7-9-2004, EXPIRES 7-9-2019.

NO CLAIM IS MADE TO THE EXCLUSIVE RIGHT TO USE "ROUTER", APART FROM THE MARK AS SHOWN.

**CLASS 9—ELECTRICAL AND SCIENTIFIC APPARATUS**

FOR COMPUTER SOFTWARE USED TO FACILITATE ELECTRONIC TRANSACTIONS ACCORDING TO SECURITY SPECIFICATIONS IN THE PUBLIC AND PRIVATE SECTORS (U.S. CLS. 21, 23, 26, 36 AND 38).

**CLASS 42—SCIENTIFIC, COMPUTER AND LEGAL SERVICES**

FOR COMPUTER SECURITY ROUTER SERVICES, NAMELY, FACILITATING ELECTRONIC TRANSACTIONS ACCORDING TO SPECIFIC SECURE REGULATIONS AND SPECIFICATIONS RELATING TO SPECIFIC ROUTERS (U.S. CLS. 100 AND 101).

THEODORE MCBRIDE, EXAMINING ATTORNEY

SN 78-117,819. KINEK TECHNOLOGIES INC., SAINT JOHN, NEW BRUNSWICK, CANADA, FILED 3-27-2002.

**INTELLIGENTLY  
MANAGING THE LAST MILE**

PRIORITY CLAIMED UNDER SEC. 44(D) ON CANADA APPLICATION NO. 1121099, FILED 11-5-2001, REG. NO. TMA590950, DATED 9-26-2003, EXPIRES 9-26-2018.

**CLASS 9—ELECTRICAL AND SCIENTIFIC APPARATUS**

FOR COMPUTER SOFTWARE USED TO LINK BUSINESSES TO BUSINESSES, AND BUSINESSES TO CONSUMERS, TO FACILITATE THE SALE, PURCHASE AND DELIVERY OF PRODUCTS OR SERVICES TO INDIVIDUALS AND BUSINESSES ON A GLOBAL COMPUTER NETWORK (U.S. CLS. 21, 23, 26, 36 AND 38).

**CLASS 42—SCIENTIFIC, COMPUTER AND LEGAL SERVICES**

FOR INSTALLATION AND MAINTENANCE OF COMPUTER SOFTWARE IN THE FIELD OF BUSINESS TRANSACTION PROCESS, NAMELY, INSTALLATION AND MAINTENANCE OF WEB-BASED COMPUTER SOFTWARE WHICH ALLOWS USERS TO FACILITATE THE SALE, PURCHASE, AND DELIVERY OF PRODUCTS TO INDIVIDUALS AND BUSINESSES VIA THE INTERNET (U.S. CLS. 100 AND 101).

FLORENTINA BLANDU, EXAMINING ATTORNEY

SN 78-091,457. SITA DVANCED TRAVEL SOLUTIONS LIMITED, GODAMLING SURREY, ENGLAND, FILED 11-2-2001.

iTravelDirect

PRIORITY CLAIMED UNDER SEC. 44(D) ON ERP CMNTY TM OFC APPLICATION NO. 1163831, FILED 6-14-1999, REG. NO. 1163831, DATED 7-6-2000, EXPIRES 6-14-2009.

**CLASS 9—ELECTRICAL AND SCIENTIFIC APPARATUS**

FOR COMPUTER SOFTWARE FOR APPLICATION AND DATABASE INTEGRATION, FOR CONNECTING GLOBAL COMPUTER NETWORKS, AND FOR FACILITATING, DEVELOPING AND IMPLEMENTING ELECTRONIC COMMERCE TRANSACTIONS, ALL IN THE FIELD OF GENERAL USE; AND INSTRUCTION MANUALS AND PUBLICATIONS IN ELECTRONIC FORMAT SOLD TOGETHER THEREWITH AS A UNIT (U.S. CLS. 21, 23, 26, 36 AND 38).

FIRST USE 1-1-2000; IN COMMERCE 1-1-2000.

SN 78-128,964. ROYALBLUE FINANCIAL PLC, WOKING, SURREY, UNITED KINGDOM, FILED 5-15-2002.

**FIDESSA**

PRIORITY CLAIMED UNDER SEC. 44(D) ON UNITED KINGDOM APPLICATION NO. 2297447, FILED 4-9-2002, REG. NO. 2297447, DATED 4-9-2002, EXPIRES 4-9-2012.  
OWNER OF U.S. REG. NO. 2,231,381.

**CLASS 42—SCIENTIFIC, COMPUTER AND LEGAL SERVICES**

FOR COMPUTER PROGRAMMING FOR OTHERS; COMPUTER SYSTEMS ANALYSIS; TECHNICAL RESEARCH IN THE FIELD OF COMPUTER PROGRAMMING; CONSULTACY SERVICES RELATING TO THE DESIGN AND INSTALLATION OF COMPUTER; CONSULTACY SERVICES IN THE FIELD OF COMPUTER HARDWARE AND SOFTWARE; APPLICATION SOFTWARE INSTALLATION SERVICES; MAINTENANCE OF COMPUTER SOFTWARE; AND TECHNICAL SUPPORT, NAMELY, MONITORING OF NETWORK SYSTEMS (U.S. CLS. 100 AND 101).

FIRST USE 1-1-2000; IN COMMERCE 1-1-2000.  
ANN E. SAPPENFIELD, EXAMINING ATTORNEY

**CLASS 35—ADVERTISING AND BUSINESS**

FOR LICENSING OF COMPUTERS, COMPUTER HARDWARE, COMPUTER FIRMWARE AND COMPUTER SOFTWARE; LICENSING OF TELECOMMUNICATIONS APPARATUS; CONSULTATION SERVICES RELATED TO THE AFORESAID SERVICES (U.S. CLS. 100, 101 AND 102).



**CLASS 42—SCIENTIFIC, COMPUTER AND LEGAL SERVICES**

FOR LEASING AND RENTAL OF COMPUTERS, COMPUTER HARDWARE, COMPUTER FIRMWARE, COMPUTER SOFTWARE; LEASING AND RENTAL OF TELECOMMUNICATIONS APPARATUS; COMPUTER ASSISTANCE, NAMELY, SUPPORT SERVICES FOR TROUBLESHOOTING COMPUTER HARDWARE, COMPUTER FIRMWARE, COMPUTER SOFTWARE; COMPUTER SERVICES FOR THE FINANCIAL SERVICES AND FINANCIAL TRADING INDUSTRY, NAMELY, COMPUTER SERVICES FOR FACILITATING AND MANAGING ELECTRONIC ORDER FLOW, CAPTURE AND MANAGEMENT OF ORDERS, ORDER ROUTING, MONITORING AND PROVIDING INFORMATION ON FINANCIAL MARKET DATA AND TRADING DETAILS, FINANCIAL MARKET NEWS, TRADE REPORTING, EXCHANGE CON ACTIVITY, NAMELY, ESTABLISHING CONNECTION BETWEEN CUSTOMER SYSTEMS AND STOCK EXCHANGES AND CHECKING THE FORMAT OF INFORMATION SENT AND RECEIVED FROM THE STOCK EXCHANGES, POSITION MANAGEMENT AND ON-LINE TRADING AND FINANCIAL PRODUCTS; COMPUTER PROGRAMMING FOR OTHERS; PLANNING, CONFIGURATION, DEVELOPMENT, IMPLEMENTATION, DESIGN AND COMMISSIONING OF COMPUTER HARDWARE, COMPUTER FIRMWARE, COMPUTER SOFTWARE AND COMPUTER SYSTEMS FOR OTHERS; COMMISSIONING, CONFIGURATION, IMPLEMENTATION AND INTEGRATION OF COMPUTER PERIPHERAL DEVICES, COMPUTER PROGRAMS, DATA PROCESSING APPARATUS AND INSTRUMENTS, ELECTRONIC AND ELECTRICAL APPARATUS AND INSTRUMENTS, TELECOMMUNICATIONS APPARATUS AND AUDIO-VISUAL TEACHING APPARATUS; MAINTENANCE OF COMPUTER SOFTWARE; UPDATING OF COMPUTER SOFTWARE; COMPUTER PROJECT MANAGEMENT SERVICES; CONSULTATION SERVICES RELATED TO THE AFORESAID SERVICES (U.S. CLS. 100 AND 101).

KIMBERLY PERRY, EXAMINING ATTORNEY

**CLASS 16—PAPER GOODS AND PRINTED MATTER**

FOR PRINTED MATTER, NAMELY, BOOKS, LEAFLETS, BROCHURES, NEWSLETTERS AND REPORTS ALL ABOUT THE BUSINESS OF CHAMBERS OF COMMERCE; PRINTED PUBLICATIONS, NAMELY, BOOKS, BOOKLETS, BROCHURES, LEAFLETS, NEWSLETTERS AND REPORTS REGARDING GUIDELINES, STANDARDS, CASE-STUDIES AND NOTICES, ALL ABOUT THE BUSINESS OF CHAMBERS OF COMMERCE; PHOTOGRAPHS, STATIONERY; PRINTED INSTRUCTIONAL, EDUCATIONAL AND TEACHING MATERIALS FOR USE IN CONFERENCE AND WORKSHOP SESSIONS RELATING TO THE BUSINESS OF CHAMBERS OF COMMERCE MANAGEMENT, STRUCTURE, SERVICES AND ACTIVITIES (U.S. CLS. 2, 5, 22, 23, 29, 37, 38 AND 50).

**CLASS 35—ADVERTISING AND BUSINESS**

FOR ADVERTISING AND BUSINESS INFORMATION SERVICES RELATING TO CHAMBERS OF COMMERCE; MEMBERS BUSINESS OPPORTUNITIES, PRODUCTS AND SERVICES AND DIRECTORIES OF CHAMBERS AND MEMBERS; IMPORT-EXPORT AGENCIES; COMPUTER DATABASE MANAGEMENT; BUSINESS SERVICES, NAMELY PROVIDING COMPUTER DATABASES REGARDING THE PURCHASE AND SALE OF A WIDE VARIETY OF PRODUCTS AND SERVICES OF OTHERS; ORGANIZATION OF EXHIBITIONS FOR COMMERCIAL OR ADVERTISING PURPOSES, NAMELY MARKETING PRODUCTS AND SERVICES OF CHAMBERS OF COMMERCE AND OF SUPPLIERS AND COMMERCIAL PARTNERS OF CHAMBERS OF COMMERCE; CUSTOMS CLEARANCE SERVICES (U.S. CLS. 100, 101 AND 102).

SN 78-138,524. INTERNATIONAL CHAMBER OF COMMERCE, PARIS, FRANCE, FILED 6-25-2002.

**WCF**

PRIORITY CLAIMED UNDER SEC. 44(D) ON ERPNCMNTY TM OFC APPLICATION NO. 002558211, FILED 1-25-2002, REG. NO. 002558211, DATED 3-22-2004, EXPIRES 1-25-2012.

**CLASS 9—ELECTRICAL AND SCIENTIFIC APPARATUS**

FOR COMPUTER PROGRAMS AND COMPUTER SOFTWARE USED TO EXCHANGE DATA AND INFORMATION BETWEEN CHAMBERS OF COMMERCE AND BETWEEN MEMBER COMPANIES, FOR USE IN MEMBERSHIP DATABASE MANAGEMENT, FOR USE IN THE FIELDS OF INTERNATIONAL BUSINESS AND COMMERCIAL TRANSACTIONS; ELECTRONIC PUBLICATIONS, NAMELY, BOOKS, NEWSLETTERS, REPORTS AND BROCHURES IN ELECTRONIC FORM RECORDED ON DATA CARRIERS AND DOWNLOADABLE ELECTRONIC PUBLICATIONS, NAMELY, GUIDELINES, REPORTS, STANDARDS, CASE STUDIES AND NOTICES ALL RELATING TO PRODUCTS AND SERVICES OF CHAMBERS OF COMMERCE, PROVIDED ON-LINE FROM A COMPUTER DATABASE AND THE INTERNET (U.S. CLS. 21, 23, 26, 36 AND 38).

**CLASS 36—INSURANCE AND FINANCIAL**

FOR CUSTOMS BROKERAGE SERVICES, NAMELY, FINANCIAL GUARANTEE SERVICES FOR CUSTOM DUTIES AND TAXES IN THE FORM OF THE ADMINISTRATION OF INTERNATIONAL CUSTOMS CARNET, KNOWN AS ATA CARNET, SERVICES FOR FACILITATING DUTY-FREE TEMPORARY IMPORTATION AND RE-EXPORTATION OF GOODS (U.S. CLS. 100, 101 AND 102).

**CLASS 41—EDUCATION AND ENTERTAINMENT**

FOR EDUCATIONAL SERVICES, NAMELY CONDUCTING CONFERENCES, CONGRESSES AND WORKSHOPS; ORGANIZING EXHIBITIONS FOR EDUCATIONAL PURPOSES RELATING TO MANAGEMENT, SERVICES, DEVELOPMENT AND SUPPORT FOR CHAMBERS OF COMMERCE, NON GOVERNMENTAL ORGANIZATIONS AND AGENCIES; PUBLICATION OF BOOKS AND TEXTS IN ANY MEDIUM, INCLUDING IN ELECTRONIC FORM; ALL IN THE FIELDS OF INTERNATIONAL BUSINESS AND COMMERCIAL TRANSACTIONS, IMPORT-EXPORT SERVICES AND ELECTRONIC COMMERCE SERVICES (U.S. CLS. 100, 101 AND 107).

LINDA E. BLOHM, EXAMINING ATTORNEY

SN 78-146,107. UNOPIU' EUROPA S.P.A., SORIANO NEL CIMINO, ITALY, FILED 7-22-2002.

# UNOPIU'

PRIORITY CLAIMED UNDER SEC. 44(D) ON ITALY APPLICATION NO. BS2002C00194, FILED 4-19-2002, REG. NO. 872613, DATED 7-9-2002, EXPIRES 4-19-2012.

THE ENGLISH TRANSLATION OF "UNOPIU" IS "ONE MORE".

## CLASS 6—METAL GOODS

FOR METAL GRATINGS, METAL CHAIN LINK FENCES; METAL TRELLISES, METAL STATION AWNINGS, IRON VERANDAS (U.S. CLS. 2, 12, 13, 14, 23, 25 AND 50).

## CLASS 16—PAPER GOODS AND PRINTED MATTER

FOR CATALOGS IN THE FIELD OF OUTDOOR FURNITURE; GENERAL FEATURE MAGAZINES; MAGAZINES ON THE SUBJECT OF OUTDOOR FURNISHINGS (U.S. CLS. 2, 5, 22, 23, 29, 37, 38 AND 50).

## CLASS 19—NON-METALLIC BUILDING MATERIALS

FOR NONMETAL GRATINGS; NONMETAL FENCES; NONMETAL TRELLISES; GAZEBOS, PAVILIONS, WOODEN VERANDAS; WOOD FLOORINGS (U.S. CLS. 1, 12, 33 AND 50).

## CLASS 20—FURNITURE AND ARTICLES NOT OTHERWISE CLASSIFIED

FOR FURNITURE MADE OF IRON, TEAK RATTAN, AND LOOM (U.S. CLS. 2, 13, 22, 25, 32 AND 50).

## CLASS 21—HOUSEWARES AND GLASS

FOR FLOWER POTS (U.S. CLS. 2, 13, 23, 29, 30, 33, 40 AND 50).

## CLASS 22—CORDAGE AND FIBERS

FOR NONMETAL AWNINGS (U.S. CLS. 1, 2, 7, 19, 22, 42 AND 50).

LAURIEL DALIER, EXAMINING ATTORNEY

SN 78-146,128. BIO999 INC., TAICHUNG, TAIWAN, FILED 7-22-2002.

## ATTACHIN

## CLASS 1—CHEMICALS

FOR CELL CULTURE REAGENTS FOR SCIENTIFIC RESEARCH (U.S. CLS. 1, 5, 6, 10, 26 AND 46).

## CLASS 5—PHARMACEUTICALS

FOR ANTIBIOTICS; PROTEIN AND INSECT CELL CULTURE FOR MEDICAL DIAGNOSTIC LABORATORY USE; SKIN WOUND DRESSING; ANTI-ULCER TABLET; LECITHIN FOR USE AS A DIETARY SUPPLEMENT; PHARMACEUTICAL PREPARATIONS FOR THE TREATMENT OF JOINT INFLAMMATION AS A RESULT OF TRAUMA; ANALGESICS; ANIMAL VACCINE FOR HORSES, COWS, PIGS, DOGS, AND CATS; AND VITAMINE FOR HORSES, COWS, PIGS, DOGS, AND CATS (U.S. CLS. 6, 18, 44, 46, 51 AND 52).

LAURIEL DALIER, EXAMINING ATTORNEY

SN 78-148,984. CAF NOMINEES LIMITED, KENT, UNITED KINGDOM, FILED 7-30-2002.

## GIVENOW

PRIORITY CLAIMED UNDER SEC. 44(D) ON ERPN CMNTY TM OFC APPLICATION NO. 002776672, FILED 7-11-2002, REG. NO. 002776672, DATED 8-29-2003, EXPIRES 7-11-2012.

## CLASS 9—ELECTRICAL AND SCIENTIFIC APPARATUS

FOR DOWNLOADABLE ELECTRONIC PUBLICATIONS IN THE NATURE OF BOOKS, MAGAZINES, NEWSPAPERS, JOURNALS, PERIODICALS, NEWSLETTERS, PAMPHLETS, BROCHURES, LEAFLETS, REPORTS, MANUALS, AND INFORMATIONAL DOCUMENTATION, IN THE FIELD OF CHARITABLE AND NOT-FOR-PROFIT ORGANIZATIONS AND THEIR DONORS, SUPPORTERS AND BENEFICIARIES (U.S. CLS. 21, 23, 26, 36 AND 38).

## CLASS 41—EDUCATION AND ENTERTAINMENT

FOR EDUCATIONAL SERVICES, NAMELY CONDUCTING CLASSES, CONFERENCES, SEMINARS, WORKSHOPS, TRAINING AND DISTANCE LEARNING COURSES IN THE FIELD OF CHARITABLE AND NOT-FOR-PROFIT ACTIVITIES; PUBLISHING OF BOOKS, TEXT, LEAFLETS, REPORTS AND MAGAZINES (U.S. CLS. 100, 101 AND 107).

TINA L. SNAPP, EXAMINING ATTORNEY

SN 78-152,326. SPA SENSATIONS, LTD., TORONTO, ONTARIO, CANADA, FILED 8-8-2002.



The logo for Spa Sensations features the word "Spa" in a large, elegant, cursive script font. Below it, the word "SENSATIONS" is written in a smaller, clean, sans-serif, all-caps font. A horizontal line is positioned above the word "SENSATIONS".

PRIORITY CLAIMED UNDER SEC. 44(D) ON CANADA APPLICATION NO. 1131566, FILED 2-19-2002, REG. NO. TMA602572, DATED 2-18-2004, EXPIRES 2-18-2019.

NO CLAIM IS MADE TO THE EXCLUSIVE RIGHT TO USE "SPA", APART FROM THE MARK AS SHOWN.

**CLASS 3—COSMETICS AND CLEANING PREPARATIONS**

FOR NON-MEDICATED SKIN CARE PREPARATIONS, NAMELY BATH AND MASSAGE OILS, LOTIONS, SOAPS, SKIN CARE ACCESSORIES, TEXTURIZERS, TONERS, CREAMS, OILS, CLEANSERS, AROMA THERAPY OILS, BODY OIL, BODY POWDER, BODY CREAM, BATH GEL, BATH OIL, HAND CREAM, FOOT CREAM, SKIN CLEANSING CREAM, FACE CREAMS, SHOWER AND BATH GEL, AND HAIR CARE PREPARATIONS (U.S. CLS. 1, 4, 6, 50, 51 AND 52).

**CLASS 4—LUBRICANTS AND FUELS**

FOR AROMATHERAPY CANDLES (U.S. CLS. 1, 6 AND 15).

**CLASS 25—CLOTHING**

FOR CLOTH BODY WRAPS, BOOTIES AND MITTENS (U.S. CLS. 22 AND 39).

MICHAEL BAIRD, EXAMINING ATTORNEY

SN 78-156,977. SHOGAKUKAN PRODUCTION CO., LTD., TOKYO, JAPAN, FILED 8-22-2002.

**CLASS 25—CLOTHING**

FOR MEN'S, WOMEN'S, CHILDREN'S AND INFANT'S CLOTHING, NAMELY SHIRTS, T-SHIRTS, TANK TOPS, VEST, SWEAT SHIRTS, PANTS, SHORTS, BABY BIB NOT OF PAPER, SKIRTS, BLOUSES, DRESSES, SUSPENDERS, SWEATERS, JACKETS, COATS, RAIN COATS, SNOW SUITS, TIES, HATS, CAPS, BELTS, SCARVES, GLOVES, MITTENS, HEADWEAR, FOOTWEAR, SLEEPWEAR, NAMELY, PAJAMAS, LOUNGEWEAR, ROBES, NIGHTGOWNS, UNDERWEAR, BOOTS, BOXER SHORTS, SHOES, SNEAKERS, ATHLETIC SHOES, SANDALS, OVERALLS, BEACH SANDALS, BATHING SUITS, BEACHWEAR, SLIPPER, BOOTIES, SWIMWEAR, HALLOWEEN AND CHRISTMAS COSTUMES, SOCKS, LEOTARDS, SHOWER CAPS, HEAD BANDS, SUN VISORS, HOSIERY, MASQUERADE COSTUMES (U.S. CLS. 22 AND 39).

**CLASS 28—TOYS AND SPORTING GOODS**

FOR TOYS, GAMES AND PLAYTHINGS, NAMELY, PLUSH TOYS, DOLLS, ACTION SKILL GAMES, BOARD GAMES, CARD GAMES, MANIPULATIVE PUZZLES, TOY ACTION FIGURES AND ACCESSORIES THEREFORE, MANIPULATIVE GAMES, HAND HELD UNITS FOR PLAYING ELECTRONIC GAMES, GAME CARDS, NON-ELECTRONIC HAND-HELD SKILLS GAMES, STAND ALONE VIDEO GAME MACHINES, HAND HELD UNITS FOR PLAYING VIDEO GAMES, SQUEEZE TOYS, TOY FIGURES AND ACCESSORIES THEREFORE, PLAY SETS FOR ACTION FIGURES, PLAY SETS FOR MASQUERADE GAMES, ROLE-PLAYING GAME SETS, BATH TOYS, BEACH TOYS, MULTIPLE ACTIVITY BABY TOYS, PUPPETS, TOY FILM CARTRIDGES AND VIEWERS, BEAN BAGS, PULL TOYS, BABY RATTLES, RIDE-ON TOYS, ELECTRONIC LEARNING TOYS, CHRISTMAS DECORATIONS, CHRISTMAS TREE ORNAMENTS, AIR MATTRESSES FOR RECREATIONAL USE, TOY VEHICLES, TOY SCOOTERS, ICE SKATES, ROLLER SKATES, SPORTS BALLS, BEACH BALLS, PLAYGROUND BALLS, FLYING DISCS, SKATEBOARDS, INFLATABLE SWIM FLOATS FOR RECREATIONAL USE, JUMP ROPES, KITES, INFLATABLE SWIMMING POOLS, PLAYGROUND SAND BOXES, SNOW SLEDS FOR RECREATIONAL USE, SNOW BOARDS, TENNIS RACKET TAPE GRIP COVERS, WIND UP TOYS, BALLOONS, TOY BUILDING BLOCKS, CONSTRUCTION TOYS, TOY BANKS, TOY SHOVELS, TOY STATUETTES AND TOY FIGURINES MADE OF MOLDED PLASTIC, CASES FOR PLAY ACCESSORIES, TOY STRUCTURES, AND ACTION FIGURES, DOLL CLOTHING AND COSTUMES, DOLL ACCESSORIES, YO-YOS, HOBBY CRAFT KITS FOR CHILDREN, TOY FOAM BALLS (U.S. CLS. 22, 23, 38 AND 50).

MITCHELL FRONT, EXAMINING ATTORNEY

SN 78-168,203. DIAGEO NORTH AMERICA, INC., STAMFORD, CT. FILED 9-26-2002.

**CLASS 32—LIGHT BEVERAGES**

FOR FLAVORED BREWED MALT BEER; FLAVORED BREWED NON-ALCOHOLIC MALT BEVERAGES (U.S. CLS. 45, 46 AND 48).

**CLASS 33—WINES AND SPIRITS**

FOR ALCOHOLIC BEVERAGES, NAMELY, DISTILLED SPIRITS (U.S. CLS. 47 AND 49).

Lauriel Dalier, Examining Attorney

SN 78-172,278. SUPERVALU INC., EDEN PRAIRIE, MN.  
FILED 10-8-2002.



### CLASS 29—MEATS AND PROCESSED FOODS

FOR PROCESSED ALMONDS; PROCESSED FRUIT; PROCESSED APRICOTS; PROCESSED CHERRIES; PROCESSED COCONUT; PROCESSED MANDARIN ORANGES; PROCESSED CRANBERRIES; CRANBERRY SAUCE; MARASCHINO CHERRIES; CANNED FRUIT; PROCESSED PRUNES; PROCESSED STRAWBERRIES; PROCESSED RASPBERRIES; RAISINS; RHUBARB CUTS; FRUIT-BASED SNACK FOOD; PROCESSED VEGETABLES; PROCESSED ARTICHOKE; PROCESSED ASPARAGUS; PROCESSED GREEN CHILES; PROCESSED GREEN PEAS; PROCESSED GREEN PEPPERS; PROCESSED SPINACH; SLICED BAMBOO SHOOTS; BAKED BEANS; PROCESSED BEANS; PROCESSED COLLARD GREENS; PROCESSED MUSHROOMS; PROCESSED OLIVES; FRENCH FRIED ONIONS; PICKLES; FRENCH FRY POTATOES; POTATOES AU GRATIN; POTATO CHIPS; HASHBROWN POTATOES; INSTANT POTATOES; SCALLOPED POTATOES; FROZEN POTATOES; PROCESSED POTATOES; PROCESSED YAMS; PROCESSED PUMPKIN; SAUERKRAUT; COOKED SQUASH; CANNED TOMATOES; TOMATO PASTE; CHOPPED TURNIP GREENS; PROCESSED WATER CHESTNUTS; CANNED VEGETABLES; FROZEN VEGETABLES; FROZEN MIXED VEGETABLES; STEWED VEGETABLES; COLE SLAW; FRUIT SALAD; TROPICAL FRUIT SALAD; ORANGE MARMALADE; FRUIT FILLING; FRUIT-BASED FILLING FOR CAKES AND PIES; PRUNE SPREAD; PIMENTO SPREAD; JAM; JELLY; BEEF PATTIES; POT ROAST; HAM; BACON; IMITATION BACON BITS; PORK; CANNED PORK AND BEANS; SAUSAGE; POLISH SAUSAGE; SALAMI; SLICED PEPPERONI; LUNCHEON MEAT; BOLOGNA; BEEF WIENERS; CORN DOGS; BRATWURST; BRAUNSCHWEIGER; CHICKEN; TURKEY; FROZEN FISH; FISH FILLETS; SEAFOOD; SHRIMP; CANNED SALMON; CANNED TUNA FISH; CHILI; CORNED BEEF HASH; BUTTER; MARGARINE; BUTTERMILK; HALF AND HALF CREAM; CHEESE; COTTAGE CHEESE; CREAM CHEESE; CREAM CHEESE FILLING; EGG SUBSTITUTE; EGGS; DIPS; MILK; NON-DAIRY CREAMER; NON-DAIRY WHIPPED TOPPING; WHIPPING CREAM; WHIPPED TOPPING; SOUR CREAM; YOGURT; BOUILLON CUBES; CHICKEN BROTH; BEEF BROTH; SOUP; COOKING SPRAY; CORN OIL; OLIVE OIL; PEANUT OIL; SALAD OIL; SHORTENING; SOY/CANOLA OIL BLEND; SOYBEAN OIL; SUNFLOWER OIL; VEGETABLE OIL; VEGETABLE OIL SPREAD; NUT TOPPING; NUTS, NAMELY, PROCESSED NUTS; PEANUTS; PEANUT BUTTER; SUNFLOWER SEEDS; FROZEN MEALS CONSISTING PRIMARILY OF MEAT, POULTRY OR VEGETABLES; PRE-PACKAGED DINNERS CONSISTING PRIMARILY OF MEAT, SEAFOOD OR POULTRY SERVED WITH PASTA, RICE AND/OR VEGETABLES; POTATO SALAD; SAUSAGE; APPLE SAUCE; PROCESSED MUSTARD GREENS, NAMELY, CANNED AND FROZEN MUSTARD GREENS; NUTS FOR BAKING; GELATIN; ALL FOR RETAIL USE (U.S. CL. 46).  
FIRST USE 8-1-1983; IN COMMERCE 8-1-1983.

### CLASS 30—STAPLE FOODS

FOR ALFREDO SAUCE SEASONING MIX; BEEF STEW SEASONING MIX; BEEF STROGANOFF SEASONING MIX; SEASONED COATING FOR POULTRY; CHILI SEASONING MIX; ENCHILADA SEASONING MIX; GRAVY MIXES; HOLLANDAISE SAUCE SEASONING MIX; MEATLOAF SEASONING MIX; SLOPPY JOE SEASONING MIX; SPAGHETTI SEASONING MIX; TACO SEASONING MIX; SALT; PEPPER; SPICES; ALMOND FLAVORING; FOOD ADDITIVES FOR NON-NUTRITIONAL PURPOSES FOR USE AS FLAVORINGS; CONFECTIONERY CHIPS FOR BAKING; BAKING SODA; CAKE MIXES; MIXES FOR BAKERY GOODS; BROWN SUGAR; POWDERED SUGAR; SUGAR; SUGAR SUBSTITUTES; FLOUR; CANDY; COOKIES; BROWNIES; CAKE BARS; CAKE MIXES; CINNAMON ROLLS; CUPCAKES; DANISH MIX; DONUTS; FOOD BARS, NAMELY, READY TO EAT CEREAL DERIVED FOOD BARS; MARSHMALLOWS; FRUIT PIES; PASTRIES; PIE CRUST; STREUDELS; LADYFINGERS; TOASTER PASTRIES; TURNOVERS; BAGELS; BISCUITS; BREAD; HAMBURGER BUNS; HOT DOG BUNS; BREAD CRUMBS; BREADSTICKS; CHOW MEIN NOODLES; CROUTONS; ENGLISH MUFFINS; BREAKFAST CEREAL; HOT CEREAL; OATMEAL; GRITS; HOMINY; READY-TO-EAT CEREAL DERIVED FOOD BARS; STUFFING MIXES CONTAINING BREAD; PIZZA CRUST DOUGH; BROWN RICE; RICE; FRIED RICE MIX; INSTANT RICE; PACKAGED MEALS CONSISTING PRIMARILY OF RICE WITH BEEF, BROCCOLI, CHICKEN AND/OR CHEESE; RICE PILAF MIX; PANCAKE MIXES; PASTA; MACARONI AND CHEESE; NOODLE AND SAUCE MIX; MEALS CONSISTING PRIMARILY OF PASTA; RAMEN NOODLES; PIEROGIES; POT PIES; TURKEY POT PIE; PIZZA; CORN TORTILLAS; FLOUR TORTILLAS; TACO SHELLS; WAFFLES; CORN CHIPS; CHEESE FLAVORED SNACKS, NAMELY, CHEESE BALLS; CRACKERS; CRUNCHY CURL SNACKS, NAMELY, CHEESE CURLS; FLAVORED TORTILLA CHIPS; PROCESSED POPCORN; PRETZELS; TORTILLA CHIPS; BALSAMIC VINEGAR; BARBEQUE SAUCE; CATSUP; CHILI SAUCE; COCKTAIL SAUCE; CORN SYRUP; DIJON MUSTARD; FROSTING; ICING; FLAVORED GELATIN; GRAVY; HONEY; HORSERADISH; HOT SAUCE; KETCHUP; CHOCOLATE-BASED FILLINGS FOR CAKES AND PIES; PUDDING; CHOCOLATE-FLAVORED SYRUP; MAPLE SYRUP; MAYONNAISE; MUSTARD; PASTA SAUCE; PIZZA SAUCE; RELISH; SLOPPY JOE SAUCE; SALAD DRESSINGS; SALSA; SOY SAUCE; STEAK SAUCE; TACO SAUCE; TOMATO SAUCE; VINEGAR; VINEGAR CIDER; RED WINE VINEGAR; IMITATION VANILLA; VANILLA EXTRACT; WORCESTERSHIRE SAUCE; ICE CREAM; ICE CREAM BARS; ICE CREAM CONES; ICE CREAM SANDWICHES; SHERBET; ICE; COFFEE; TEA; AND TEA BAGS; SALSA CON QUESO; CORNMEAL; ALL FOR RETAIL USE (U.S. CL. 46).  
FIRST USE 8-1-1983; IN COMMERCE 8-1-1983.

### CLASS 32—LIGHT BEVERAGES

FOR SWEET APPLE CIDER; FRUIT PUNCH; FRUIT JUICE; SELTZER; SODA WATER; SOFT DRINKS; DRINKING WATER; SPRING WATER; AND SPARKLING WATER; ALL FOR RETAIL USE (U.S. CLS. 45, 46 AND 48).  
FIRST USE 8-1-1983; IN COMMERCE 8-1-1983.  
ARETHA SOMERVILLE, EXAMINING ATTORNEY

SN 78-176,065. SPINE NEXT, 33080 BORDEAUX, FRANCE.  
FILED 10-18-2002.

**FIDJI**

PRIORITY CLAIMED UNDER SEC. 44(D) ON FRANCE APPLICATION NO. 023160868, FILED 4-22-2002, REG. NO. 023160868, DATED 4-22-2002, EXPIRES 4-22-2012.

**CLASS 10—MEDICAL APPARATUS**

FOR SURGICAL APPARATUS AND INSTRUMENTS, NAMELY, RETRACTORS, DISTRATORS, REAMERS, CURETTES, IMPACTOR SHAFTS, SLIDING MALLETS, GRAFT TAMPERS, EXTRACTION BLOCKERS, CAGE HOLDERS, SCALPELS, KNIVES, CANNULAE, CATHETERS, SURGICAL COMPRESSORS, POSTERIOR CURETTES, FOR SURGICAL PURPOSES; IMPLANTS, NAMELY SURGICAL IMPLANTS COMPOSED OF ARTIFICIAL MATERIAL; ORTHOPEDIC ARTICLES, NAMELY IMPLANTS FOR SURGERY OF THE SPINAL COLUMN, NAMELY, INTERVEBRAL CAGES, CERVICAL CAGES, DISC PROSTHESES (U.S. CLS. 26, 39 AND 44).

**CLASS 44—MEDICAL, BEAUTY AND AGRICULTURAL SERVICES**

FOR INFORMATION SERVICES IN HEALTH MATTERS (U.S. CLS. 100 AND 101).  
WILLIAM P. SHANAHAN, EXAMINING ATTORNEY

SN 78-176,068. SPINE NEXT, 33080 BORDEAUX, FRANCE,  
FILED 10-18-2002.

**SHIRAZ**

PRIORITY CLAIMED UNDER SEC. 44(D) ON FRANCE APPLICATION NO. 023160865, FILED 4-22-2002, REG. NO. 023160865, DATED 4-22-2002, EXPIRES 4-22-2012.

**CLASS 10—MEDICAL APPARATUS**

FOR SURGICAL APPARATUS AND INSTRUMENTS, NAMELY, RETRACTORS, DISTRATORS, REAMERS, CURETTES, IMPACTOR SHAFTS, SLIDING MALLETS, GRAFT TAMPERS, EXTRACTION BLOCKERS, CAGE HOLDERS, SCALPELS, KNIVES, CANNULAE, CATHETERS, SURGICAL COMPRESSORS, POSTERIOR CURETTES, FOR SURGICAL PURPOSES; IMPLANTS, NAMELY SURGICAL IMPLANTS COMPOSED OF ARTIFICIAL MATERIAL; ORTHOPEDIC ARTICLES, NAMELY IMPLANTS FOR SURGERY OF THE SPINAL COLUMN, NAMELY, INTERVEBRAL CAGES, CERVICAL CAGES, DISC PROSTHESES (U.S. CLS. 26, 39 AND 44).

**CLASS 44—MEDICAL, BEAUTY AND AGRICULTURAL SERVICES**

FOR INFORMATION SERVICES IN HEALTH MATTERS (U.S. CLS. 100 AND 101).  
WILLIAM P. SHANAHAN, EXAMINING ATTORNEY

SN 78-177,152. PARISI SPORTS, INC., FAIR LAWN, NJ,  
FILED 10-22-2002.

**SPEED KILLS****CLASS 25—CLOTHING**

FOR SHIRTS AND CAPS (U.S. CLS. 22 AND 39).

**CLASS 41—EDUCATION AND ENTERTAINMENT**

FOR EDUCATIONAL SERVICES IN THE NATURE PHYSICAL FITNESS AND PHYSICAL FITNESS SPEED TRAINING; TRAINING IN THE NATURE OF TESTING, EVALUATION AND COUNSELING ABOUT PHYSICAL FITNESS AND PHYSICAL FITNESS SPEED (U.S. CLS. 100, 101 AND 107).

KARANENDRA S. CHHINA, EXAMINING ATTORNEY

SN 78-184,209. UNIVERSAL GRANITE & MARBLE, INC.,  
NAPERVILLE, IL. FILED 11-12-2002.

**STONE HABITAT**

NO CLAIM IS MADE TO THE EXCLUSIVE RIGHT TO USE "STONE", APART FROM THE MARK AS SHOWN.

**CLASS 11—ENVIRONMENTAL CONTROL APPARATUS**

FOR STONE, MARBLE, AND GRANITE PRODUCTS, NAMELY, FIREPLACES AND SHOWER AND BATH SURROUNDS FOR RESIDENTIAL AND COMMERCIAL USES (U.S. CLS. 13, 21, 23, 31 AND 34).

**CLASS 19—NON-METALLIC BUILDING MATERIALS**

FOR STONE, MARBLE, AND GRANITE PRODUCTS, NAMELY, FLOOR TILES FOR RESIDENTIAL AND COMMERCIAL USES (U.S. CLS. 1, 12, 33 AND 50).

**CLASS 20—FURNITURE AND ARTICLES NOT OTHERWISE CLASSIFIED**

FOR STONE, MARBLE, AND GRANITE PRODUCTS, NAMELY, KITCHEN COUNTERTOPS AND BATHROOM VANITIES FOR RESIDENTIAL AND COMMERCIAL USES (U.S. CLS. 2, 13, 22, 25, 32 AND 50).

**CLASS 35—ADVERTISING AND BUSINESS**

FOR RETAIL STORE SERVICES FEATURING STONE, MARBLE, AND GRANITE PRODUCTS, NAMELY, KITCHEN COUNTERTOPS, FIREPLACES, BATHROOM VANITIES, SHOWER AND BATH SURROUNDS, AND TILE FLOORING, AND STONE CLEANING AND SEALING PRODUCTS FOR RESIDENTIAL AND COMMERCIAL USES (U.S. CLS. 100, 101 AND 102).

SCOTT BALDWIN, EXAMINING ATTORNEY

SN 78-185,462. JOHN M. FLOYD & ASSOCIATES, INC.,  
BAYTOWN, TX. FILED 11-15-2002.

**OVERDRAFT TRUST**

NO CLAIM IS MADE TO THE EXCLUSIVE RIGHT TO USE "OVERDRAFT", APART FROM THE MARK AS SHOWN.

**CLASS 35—ADVERTISING AND BUSINESS**

FOR BUSINESS MANAGEMENT SERVICES FOR FINANCIAL INSTITUTIONS, BUSINESS CONSULTING, NAMELY ECONOMIC AND STRATEGIC PLANNING CONSULTING FOR FINANCIAL INSTITUTIONS; BUSINESS MARKETING CONSULTING, NAMELY CONDUCTING MARKETING STUDIES FOR DESIGNING AND IMPLEMENTING OVERDRAFT PRIVILEGE PROGRAMS (U.S. CLS. 100, 101 AND 102).

**CLASS 36—INSURANCE AND FINANCIAL**

FOR CHECKING ACCOUNT OVERDRAFT PRIVILEGE SERVICES FOR FINANCIAL INSTITUTIONS, NAMELY PROVIDING SERVICES THAT ALLOW FINANCIAL INSTITUTIONS TO OFFER OVERDRAFT PRIVILEGES TO THEIR CUSTOMERS; FINANCIAL SERVICES, NAMELY, MANAGING CHECKING ACCOUNTS WITH OVERDRAFT PRIVILEGES; FINANCIAL CONSULTATION IN THE FIELD OF DEPOSIT ACCOUNTS AND EARNINGS IMPROVEMENT; FINANCIAL MANAGEMENT (U.S. CLS. 100, 101 AND 102).

**CLASS 41—EDUCATION AND ENTERTAINMENT**

FOR TRAINING SERVICES IN THE USE AND OPERATION OF DESIGNING, IMPLEMENTING AND REPORTING OF OVERDRAFT PRIVILEGE PROGRAMS (U.S. CLS. 100, 101 AND 107).

**CLASS 42—SCIENTIFIC, COMPUTER AND LEGAL SERVICES**

FOR COMPUTER CONSULTING SERVICES IN THE FIELD OF DESIGN AND IMPLEMENTATION OF SOFTWARE SYSTEMS THAT GENERATE OVERDRAFT PRIVILEGE PRODUCTS FOR FINANCIAL INSTITUTIONS (U.S. CLS. 100 AND 101).

BERYL GARDNER, EXAMINING ATTORNEY

**CLASS 5—PHARMACEUTICALS**

FOR PHARMACEUTICAL AND VETERINARY PREPARATIONS, NAMELY PHARMACEUTICAL PREPARATIONS FOR USE IN THE TREATMENT OF CLINICAL DISEASES AND DISORDERS OF LOCAL OR SYSTEMIC NATURE, IN HUMAN BEINGS AND ANIMALS; BONE FILLERS, NAMELY BONE CEMENT FOR MEDICAL USE; BONE FILLERS IN THE NATURE OF BONE IMPLANTS MADE FROM LIVING TISSUE; CELL CULTURE, NAMELY, BIODEGRADABLE POLYMERS FOR THE CULTIVATION OF CELLS FOR MEDICAL USE; MEDICAL PLASTERS; DRESSINGS FOR ANY KIND OF WOUND REQUIRING MEDICAL TREATMENT; DENTAL WAX; ALL PURPOSE DISINFECTANTS; PREPARATIONS FOR DESTROYING VERMIN; FUNGICIDES FOR DOMESTIC USE (U.S. CLS. 6, 18, 44, 46, 51 AND 52).

**CLASS 10—MEDICAL APPARATUS**

FOR SURGICAL, MEDICAL, DENTAL AND VETERINARY APPARATUS AND INSTRUMENTS, NAMELY, MEDICAL AND DIAGNOSTIC DEVICES, NAMELY ARTIFICIAL LIMBS, EYES, TEETH, TISSUE, BONE, CARTILAGE AND SKIN; SURGICAL, MEDICAL, DENTAL AND VETERINARY IMPLANTS CONSISTING OF ARTIFICIAL MATERIALS; SUTURES; BONE FILLERS IN THE NATURE OF BONE IMPLANTS MADE FROM ARTIFICIAL MATERIALS (U.S. CLS. 26, 39 AND 44).

**CLASS 42—SCIENTIFIC, COMPUTER AND LEGAL SERVICES**

FOR SCIENTIFIC AND TECHNOLOGICAL SERVICES, NAMELY, SCIENTIFIC RESEARCH, TECHNICAL CONSULTATION AND RESEARCH IN THE FIELD OF DRUG DELIVERY AND TISSUE ENGINEERING; MEDICAL RESEARCH (U.S. CLS. 100 AND 101).

**CLASS 44—MEDICAL, BEAUTY AND AGRICULTURAL SERVICES**

FOR MEDICAL SERVICES (U.S. CLS. 100 AND 101).  
BRETT J. GOLDEN, EXAMINING ATTORNEY

SN 78-190,984. DESCOURS S.A., 43120 MONISTROL SUR LOIRE, FRANCE, FILED 12-4-2002.

SN 78-186,295. CHIENNA B.V., BILTHOVEN, NETHERLANDS, FILED 11-18-2002.

**CHIENNA**



OWNER OF BENELUX REG. NO. 0715051, DATED 5-8-2002, EXPIRES 5-8-2012.

PRIORITY CLAIMED UNDER SEC. 44(D) ON FRANCE APPLICATION NO. 02/3183079, FILED 9-12-2002, REG. NO. 023183079, DATED 9-12-2002, EXPIRES 9-12-2012.  
THE MARK CONSISTS OF TWO BIRDS IN THE GRASS.

**CLASS 1—CHEMICALS**

FOR CHEMICALS USED IN INDUSTRY, SCIENCE AND PHOTOGRAPHY, AS WELL AS IN AGRICULTURE, HORTICULTURE AND FORESTRY, NAMELY BIODEGRADABLE POLYMERS USED IN THE MANUFACTURE OF PHARMACEUTICAL PRODUCTS AND MEDICAL DEVICES; UNPROCESSED ARTIFICIAL RESINS USED IN THE MANUFACTURE OF PHARMACEUTICAL PRODUCTS AND MEDICAL DEVICES; POLYMERS USED IN THE MANUFACTURE OF CONTROLLED RELEASE PHARMACEUTICAL PREPARATIONS; CERAMIC COATINGS FOR USE IN THE MANUFACTURE OF BONE FILLERS (U.S. CLS. 1, 5, 6, 10, 26 AND 46).

**CLASS 24—FABRICS**

FOR FABRIC FLAGS, FABRIC TABLE RUNNERS, FABRIC VALANCES, AND TEXTILE FABRICS FOR THE MANUFACTURE OF CLOTHING (U.S. CLS. 42 AND 50).

**CLASS 25—CLOTHING**

FOR CLOTHING, NAMELY, SCARVES AND DRESS SASHES (U.S. CLS. 22 AND 39).  
TINA L. SNAPP, EXAMINING ATTORNEY

SN 78-191,596. KINEK TECHNOLOGIES INC., SAINT JOHN,  
NEW BRUNSWICK, FILED 12-5-2002.



PRIORITY CLAIMED UNDER SEC. 44(D) ON CANADA  
APPLICATION NO. 1147366, FILED 7-22-2002, REG. NO.  
612133, DATED 6-4-2004, EXPIRES 6-4-2019.

THE STIPPLING IS FOR SHADING PURPOSES ONLY.  
THE MARK CONSISTS OF TWO LETTERS K THAT ARE  
MIRRORED HORIZONTALLY SO THAT THE ONE ON THE  
RIGHT IS LATERALLY REVERSED BETWEEN WHICH IS A  
SHADED SPHERE..

#### CLASS 9—ELECTRICAL AND SCIENTIFIC APPARATUS

FOR COMPUTER SOFTWARE USED TO LINK BUSI-  
NESSES TO BUSINESSES, AND BUSINESSES TO CON-  
SUMERS, TO FACILITATE THE SALE, PURCHASE AND  
DELIVERY OF PRODUCTS OR SERVICES TO INDIVI-  
DUALS AND BUSINESSES ON A GLOBAL COMPUTER  
NETWORK. (U.S. CLS. 21, 23, 26, 36 AND 38).

#### CLASS 42—SCIENTIFIC, COMPUTER AND LEGAL SERVICES

FOR INSTALLATION AND MAINTENANCE OF COM-  
PUTER SOFTWARE IN THE FIELD OF BUSINESS  
TRANSACTION PROCESSING, NAMELY, INSTALLA-  
TION AND MAINTENANCE OF WEB-BASED COMPU-  
TER SOFTWARE WHICH ALLOWS USERS TO  
FACILITATE THE SALE, PURCHASE, AND DELIVERY  
OF PRODUCTS TO INDIVIDUALS AND BUSINESSES  
VIA THE INTERNET. (U.S. CLS. 100 AND 101).  
JILL C. ALT, EXAMINING ATTORNEY

SN 78-192,630. JT INTERNATIONAL DISTRIBUTORS, INC.,  
INDIANAPOLIS, IN. FILED 12-9-2002.



NO CLAIM IS MADE TO THE EXCLUSIVE RIGHT TO  
USE "BITS & SPURS", APART FROM THE MARK AS  
SHOWN.

THE GRAY SHADING/STIPPLING WHICH APPEARS ON  
THE "STAR" PORTION OF THE DRAWING IS A FEATURE  
OF THE MARK AND IS NOT INTENDED TO INDICATE  
COLOR.

#### CLASS 6—METAL GOODS

FOR METAL HARDWARE FOR EQUESTRIAN EQUIP-  
MENT, NAMELY, STIRRUPS AND SPURS (U.S. CLS. 2,  
12, 13, 14, 23, 25 AND 50).  
FIRST USE 11-30-1995; IN COMMERCE 11-30-1995.

#### CLASS 18—LEATHER GOODS

FOR SADDLERY, NAMELY, EQUINE BITS AND  
SPUR STRAPS (U.S. CLS. 1, 2, 3, 22 AND 41).  
FIRST USE 11-30-1995; IN COMMERCE 11-30-1995.  
JOHN GARTNER, EXAMINING ATTORNEY

SN 78-193,365. N. V. ORGANON, OSS, NETHERLANDS,  
FILED 12-11-2002.

#### FOLLISTIM AQ PEN

NO CLAIM IS MADE TO THE EXCLUSIVE RIGHT TO  
USE AQ PEN, APART FROM THE MARK AS SHOWN.

#### CLASS 5—PHARMACEUTICALS

FOR PHARMACEUTICAL PREPARATIONS FOR STI-  
MULATION OF THE HUMAN FERTILITY (U.S. CLS. 6,  
18, 44, 46, 51 AND 52).

#### CLASS 10—MEDICAL APPARATUS

FOR MEDICAL DEVICES FOR HUMAN PURPOSES,  
NAMELY, HYPEDERMIC SYRINGES FOR MEDICAL  
PURPOSES; INJECTORS FOR MEDICAL PURPOSES  
(U.S. CLS. 26, 39 AND 44).

ALICE BENMAMAN, EXAMINING ATTORNEY

SN 78-194,288. COMPAGNIE FRANCAISE DU CRISTAL -  
DAUM, 92300 LEVALLOIS-PERRET, FRANCE, FILED 12-  
13-2002.

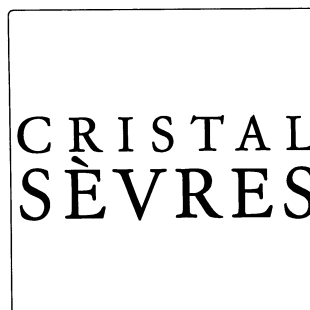

OWNER OF U.S. REG. NO. 1,486,937 AND OTHERS.  
NO CLAIM IS MADE TO THE EXCLUSIVE RIGHT TO  
USE CRISTAL, APART FROM THE MARK AS SHOWN.  
THE ENGLISH TRANSLATION OF CRISTAL SEVRES IS  
CRYSTAL SEPARATE.

**CLASS 21—HOUSEWARES AND GLASS**

FOR CRYSTAL KITCHEN AND TABLE WARES, NAMELY, DISHES AND PLATES, CUPS, SAUCERS, TEA POTS, BOWLS, CONTAINERS FOR FOODSTUFFS OR BEVERAGES, SALT AND PEPPER SHAKERS, SERVING TRAYS AND SERVING BOWLS; SMALL DISHES, TEA AND COFFEE CUPS, SOUP TUREENS, SAUCEBOATS, GRAVY BOATS, VEGETABLE DISHES, COFFEE POTS NOT OF PRECIOUS METAL, CHEESE COVERS; DINNER SERVICES COMPRISED OF TABLE GLASSES, WATER CARAFES, WINE DECANTERS, ICE-CREAM CUPS, AND BAR ARTICLES, NAMELY, WHISKY TUMBLERS, BEER AND CORDIAL GLASSES, PORT GLASSES, TASTING GLASSES, STEMWARE, GOBLET AND GLASSES; POTS AND CARAFES, CRYSTAL CANDY BOXES, CRYSTAL CONFIT BOXES, CRYSTAL BOTTLE STOPPERS; DOOR HANDLES OF CRYSTAL; URNS OF CRYSTAL; CRYSTAL DECORATING AND ORNAMENTAL PIECES, NAMELY, VASES, CUPS, BOWLS, CANDLE STICKS, CANDLE HOLDERS, CANDELABRUMS, WORKS OF ART, NAMELY, FIGURINES, STATUETTES; CRYSTAL POWDER BOXES, PERFUME VAPORIZERS OF CRYSTAL SOLD EMPTY, NAPKIN RINGS OF CRYSTAL, MENU HOLDERS OF CRYSTAL (U.S. CLS. 2, 13, 23, 29, 30, 33, 40 AND 50).

FIRST USE 2-26-2001, THE MARK WAS FIRST USED ANYWHERE IN A DIFFERENT FORM OTHER THAN THAT SOUGHT TO BE REGISTERED ON 00/00/1932.; IN COMMERCE 3-12-2001, THE MARK WAS FIRST USED IN COMMERCE IN A DIFFERENT FORM OTHER THAN THAT SOUGHT TO BE REGISTERED ON 00/00/1932..

**CLASS 34—SMOKERS' ARTICLES**

FOR CRYSTAL ASHTRAYS, CRYSTAL CASES FOR CIGARETTES OR CIGARS, CRYSTAL PIPE HOLDERS (U.S. CLS. 2, 8, 9 AND 17).

FIRST USE 2-26-2001; IN COMMERCE 3-12-2001. JAMES GRIFFIN, EXAMINING ATTORNEY

**CLASS 41—EDUCATION AND ENTERTAINMENT**

FOR ORGANIZATION AND CONDUCTING OF COLLOQUIA, CONFERENCES, CONGRESSES, SEMINARS, SYMPOSIA, TRAINING WORKSHOPS AND MOTIVATIONAL PROGRAMS, ALL IN THE FIELDS OF BUSINESS ADMINISTRATION, ORGANIZATIONAL DEVELOPMENT AND TRAINING OF PERSONNEL; ORGANIZATION OF EDUCATIONAL AND ENTERTAINMENT COMPETITIONS IN THE FIELD OF BUSINESS ADMINISTRATION; AND PUBLISHING HOUSE SERVICES, NAMELY PUBLISHING JOURNALS, BOOKS AND MAGAZINES IN PRINTED AND ELECTRONIC FORMAT WHICH FEATURE BUSINESS ADMINISTRATION AND ORGANIZATIONAL AND PERSONNEL DEVELOPMENT (U.S. CLS. 100, 101 AND 107).

IRENE D. WILLIAMS, EXAMINING ATTORNEY

SN 78-196,491. THE COCA-COLA COMPANY, ATLANTA, GA. FILED 12-19-2002.



SN 78-196,223. SKIRL, STEFAN, RUPPERTSWEILER, FED REP GERMANY, AND SCHWALB, ULRICH, KOLN, FED REP GERMANY, FILED 12-19-2002.

OWNER OF U.S. REG. NOS. 22,406, 1,752,201 AND OTHERS.

**TETA**

OWNER OF FED REP GERMANY REG. NO. 30076811, DATED 12-28-2000, EXPIRES 10-31-2010.

**CLASS 6—METAL GOODS**

FOR DECORATED TINS, KEY CHAINS, NON-MECHANICAL AND NON-LUMINOUS METAL SIGNS, AND FIGURINES, ALL MADE OF COMMON METALS; DIE CAST AND COMMON METAL CHRISTMAS HOLIDAY ORNAMENTS NOT BEING TREE ORNAMENTS (U.S. CLS. 2, 12, 13, 14, 23, 25 AND 50).

**CLASS 16—PAPER GOODS AND PRINTED MATTER**

FOR PRINTED PRODUCTS, NAMELY, NEWSPAPERS, JOURNALS, BROCHURES, MAGAZINES AND BOOKS FEATURING BUSINESS ADMINISTRATION; PRINTED PUBLICATIONS IN THE NATURE OF SCIENTIFIC PAPERS AND PRINTED ADVERTISING FOR OTHERS, ALL IN THE FIELD OF BUSINESS ADMINISTRATION; PAPER TISSUES, PAPER BOOKMARKS, GREETING CARDS, POSTCARDS AND CALENDARS; PROSPECTUSES FEATURING BUSINESS ADMINISTRATION, ORGANIZATIONAL DEVELOPMENT AND PERSONNEL DEVELOPMENT; AND PRINTED EDUCATIONAL MATERIALS FEATURING BUSINESS ADMINISTRATION, ORGANIZATIONAL DEVELOPMENT AND PERSONNEL DEVELOPMENT (U.S. CLS. 2, 5, 22, 23, 29, 37, 38 AND 50).

**CLASS 9—ELECTRICAL AND SCIENTIFIC APPARATUS**

FOR LUMINOUS METAL SIGNS (U.S. CLS. 21, 23, 26, 36 AND 38).

**CLASS 11—ENVIRONMENTAL CONTROL APPARATUS**

FOR ELECTRIC STRING LIGHTS FOR CHRISTMAS TREES (U.S. CLS. 13, 21, 23, 31 AND 34).

**CLASS 15—MUSICAL INSTRUMENTS**

FOR MUSIC BOXES AND MUSICAL DIORAMAS (U.S. CLS. 2, 21 AND 36).



**CLASS 16—PAPER GOODS AND PRINTED MATTER**

FOR GREETING CARDS; POST CARDS; PAPER NAME TAGS; PAPER LABELS; STICKERS; GIFTWRAP PAPER; GIFTWRAP TISSUE; PAPER OR FABRIC GIFT BAGS; PAPER GIFTWRAP RIBBONS; POSTERS; PAPER TABLECLOTHS, PLACEMATS, AND NAPKINS; PAPER PARTY DECORATIONS; BOOKMARKS; AND CALENDARS (U.S. CLS. 2, 5, 22, 23, 29, 37, 38 AND 50).

**CLASS 21—HOUSEWARES AND GLASS**

FOR FIGURINES MADE OF PORCELAIN, CERAMIC, GLASS; DECORATIVE COLLECTIBLE PLATES; COOKIE JARS; DINNERWARE OF CERAMIC; MUGS; GLASSWARE; CANDLE HOLDERS NOT OF PRECIOUS METAL AND DECORATIVE CHRISTMAS HOLIDAY GLASS ORNAMENTS NOT BEING TREE ORNAMENTS (U.S. CLS. 2, 13, 23, 29, 30, 33, 40 AND 50).

**CLASS 25—CLOTHING**

FOR CLOTHING, NAMELY, SHIRTS AND TOPS FOR MEN, WOMEN AND CHILDREN; HEADWEAR; SOCKS; SCARVES; NIGHTSHIRTS; PAJAMAS; TIES, AND BOXER SHORTS (U.S. CLS. 22 AND 39).

**CLASS 28—TOYS AND SPORTING GOODS**

FOR SNOW GLOBES, PLAYING CARDS, CHRISTMAS STOCKINGS, CHRISTMAS TREE SKIRTS, CHRISTMAS TREE DECORATIONS; CHRISTMAS TREE ORNAMENTS IN THE NATURE OF PLUSH ORNAMENTS, ANIMATED ORNAMENTS, FIBER OPTIC ORNAMENTS, PEARLESCENT ORNAMENTS, BLOW MOLDED ORNAMENTS, AND GLASS ORNAMENTS; CHRISTMAS TREE TOPERS; TOY VEHICLES, TOY ELECTRIC TRAINS, AND MANIPULATIVE PUZZLES (U.S. CLS. 22, 23, 38 AND 50).

ROBERT COGGINS, EXAMINING ATTORNEY

SN 78-196,759. SUN DENSHI K.K., DBA SUN CORPORATION, KONAN-SHI, AICHI-KEN, JAPAN, FILED 12-20-2002.

**CLOCK TOWER****CLASS 9—ELECTRICAL AND SCIENTIFIC APPARATUS**

FOR VIDEO GAME CARTRIDGES, INTERACTIVE VIDEO GAME PROGRAMS, VIDEO GAME DISCS, VIDEO GAME SOFTWARE, COMPUTER GAME SOFTWARE, COMPUTER GAME DISCS, DOWNLOADABLE COMPUTER GAME PROGRAMS, AND VIDEO GAME PROGRAMS ON CD-ROMS (U.S. CLS. 21, 23, 26, 36 AND 38).

**CLASS 16—PAPER GOODS AND PRINTED MATTER**

FOR SERIES OF BOOKS, PERIODICALS, INFORMATIONAL BROCHURES, AND PRINTED INSTRUCTIONAL AND TEACHING MATERIALS, ALL RELATING TO COMPUTER AND VIDEO GAME SOFTWARE, COMPUTER AND VIDEO GAMES, TOYS, GAMES, PLAYTHINGS AND SOFTWARE THEREFOR; STATIONERY, NAMELY, STATIONERY-TYPE PORTFOLIOS, SPIRAL BOUND NOTEBOOKS, NOTE PADS AND WRITING PADS; POSTERS, TRADING CARDS, GREETING CARDS, STICKERS AND PACKAGING PAPER (U.S. CLS. 2, 5, 22, 23, 29, 37, 38 AND 50).

**CLASS 28—TOYS AND SPORTING GOODS**

FOR HAND-HELD GAME APPARATUS ADAPTED FOR USE WITH LIQUID CRYSTAL DISPLAYS; OTHER TOYS, NAMELY, BOARD GAMES, CARD GAMES, COSTUME MASKS, DOLLS AND ACCESSORIES THEREFOR, DOLLS AND PLAYSETS THEREFOR; GAME MACHINES, NAMELY, STAND ALONE VIDEO MACHINES AND LCD GAME MACHINES (U.S. CLS. 22, 23, 38 AND 50).

GLENN CLARK, EXAMINING ATTORNEY

SN 78-197,878. BAKER HUGHES INCORPORATED, HOUSTON, TX. FILED 12-26-2002.

**HYPERION****CLASS 7—MACHINERY**

FOR VALVES AND VALVE ACTUATORS, NAMELY HYDRAULIC VALVE ACTUATORS, BEING PARTS OF SAFETY VALVES USED TO CONTROL FLOW IN OIL, GAS, WATER, AND INJECTION WELLS (U.S. CLS. 13, 19, 21, 23, 31, 34 AND 35).

**CLASS 9—ELECTRICAL AND SCIENTIFIC APPARATUS**

FOR AUTOMATIC VALVES USED TO CONTROL FLUID FLOW, NAMELY, SAFETY VALVES, ELECTRONICALLY CONTROLLED VALVES, HYDRAULICALLY-CONTROLLED VALVES, ELECTRO-HYDRAULICALLY CONTROLLED VALVES AND REMOTELY ACTUATED VALVES, NAMELY, FLOW CONTROL VALVES AND CONTROLLED FLUID AND GAS FLOW VALVES, AND PARTS THEREOF, ALL OF THE FOREGOING BEING PARTS FOR TOOLS AND EQUIPMENT FOR OIL, GAS, WATER, AND INJECTION WELLS (U.S. CLS. 21, 23, 26, 36 AND 38).

ROBIN CHOSID, EXAMINING ATTORNEY

SN 78-203,698. NILES STEEL TANK COMPANY, NILES, MI. FILED 1-15-2003.



NO CLAIM IS MADE TO THE EXCLUSIVE RIGHT TO USE "STEEL TANK", APART FROM THE MARK AS SHOWN.

**CLASS 6—METAL GOODS**

FOR METAL STORAGE TANKS (U.S. CLS. 2, 12, 13, 14, 23, 25 AND 50).

**CLASS 11—ENVIRONMENTAL CONTROL APPARATUS**

FOR HOT WATER STORAGE TANKS (U.S. CLS. 13, 21, 23, 31 AND 34).

**CLASS 40—MATERIAL TREATMENT**

FOR METAL TANK AND PRESSURE AND PROCESSING VESSEL FABRICATION AND FINISHING SERVICES (U.S. CLS. 100, 103 AND 106).

ZACHARY BELLO, EXAMINING ATTORNEY

SN 78-204,844. EUROVIA MANAGEMENT, 92500 RUEIL MALMAISON, FRANCE, FILED 1-18-2003.

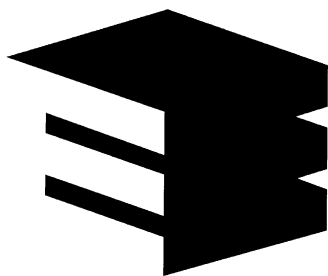

OWNER OF FRANCE REG. NO. 97680456, DATED 6-2-1997, EXPIRES 6-2-2007.

THE MARK CONSISTS OF THE LETTER E IN SPECIAL TYPE STYLE.

**CLASS 2—PAINTS**

FOR EXTERIOR PAINTS; VARNISHES; LACQUERS USED AS A COATING FOR ROAD SURFACES AND ROAD SIGNS (U.S. CLS. 6, 11 AND 16).

**CLASS 4—LUBRICANTS AND FUELS**

FOR BENZENE FUEL; BITUMINOUS-COAL OIL; COAL TAR OIL (U.S. CLS. 1, 6 AND 15).

**CLASS 19—NON-METALLIC BUILDING MATERIALS**

FOR PRODUCTS AND MATERIALS FOR MAKING AND SURFACING ROADS, NAMELY, ASPHALT, PITCH AND BITUMEN, BITUMEN ASPHALT AND BITUMEN BASED SEALANTS (U.S. CLS. 1, 12, 33 AND 50).

**CLASS 37—CONSTRUCTION AND REPAIR**

FOR CONSTRUCTION AND REPAIR OF BUILDINGS; PUBLIC WORKS, NAMELY, ROAD CONSTRUCTION; MASONRY SERVICES; INSTALLATION OF BUILDING INSULATION; MAINTENANCE AND CLEANING OF BUILDINGS; MINING EXTRACTION SERVICES (U.S. CLS. 100, 103 AND 106).

**CLASS 40—MATERIAL TREATMENT**

FOR TREATMENT AND CONVERSION OF RAW MATERIALS INTO FINISHED PRODUCTS, NOTABLY OF TAR, BITUMEN AND OTHERS COAL TAR OIL PRODUCTS, INTO PRODUCTS SUCH AS HYDROCARBON BINDERS OR INTO SPECIAL PRODUCTS FOR USE IN COATING AND TREATMENT OF BLAST FURNACE SLAGS AND FOR THE TREATMENT OF BENZENE FUELS (U.S. CLS. 100, 103 AND 106).

**CLASS 42—SCIENTIFIC, COMPUTER AND LEGAL SERVICES**

FOR ENGINEERING SERVICES IN THE FIELD OF ROAD WORKS; DESIGN FOR OTHERS IN THE FIELD OF ROAD WORKS; TECHNICAL CONSULTATION AND RESEARCH IN THE FIELD OF DESIGN, ENGINEERING AND CONSTRUCTION OF ROAD WORKS; LEGAL SERVICES IN THE FIELD OF DESIGN, ENGINEERING AND CONSTRUCTION OF ROAD WORKS; COMPUTER SOFTWARE DESIGN FOR OTHERS IN THE FIELD OF ROAD WORKS; CONSULTING SERVICES IN THE FIELD OF DESIGN, SELECTION, IMPLEMENTATION AND USE OF COMPUTER HARDWARE AND SOFTWARE SYSTEMS FOR OTHERS; ARCHITECTURAL DESIGN IN THE FIELD OF ROAD WORKS; EXPERT WITNESS SERVICES IN THE FIELD OF DESIGN, ENGINEERING AND CONSTRUCTION OF ROAD WORKS (U.S. CLS. 100 AND 101).

STEVEN R. FINE, EXAMINING ATTORNEY

SN 78-209,096. TOPPS COMPANY, INC., THE, NEW YORK, NY, FILED 1-30-2003.

**RING POP**

OWNER OF U.S. REG. NO. 1,040,693.

NO CLAIM IS MADE TO THE EXCLUSIVE RIGHT TO USE "RING", APART FROM THE MARK AS SHOWN.

**CLASS 3—COSMETICS AND CLEANING PREPARATIONS**

FOR COSMETICS AND BATH AND BEAUTY PRODUCTS, NAMELY, NAIL POLISH, LIP GLOSS, LIP BALM, LIPSTICK, EYE SHADOW, BODY GLITTER, SHIMMER POWDER, BODY SHIMMER, BATH GEL, SHOWER GEL, BODY LOTION, NON-MEDICATED ANTI-BACTERIAL SKIN GEL, SOAP, SHAMPOO, BUBBLE BATH, BATH BEADS, BATH FIZZLES, BATH SALTS AND BATH SOAP IN THE FORM OF CONFETTI (U.S. CLS. 1, 4, 6, 50, 51 AND 52).

**CLASS 28—TOYS AND SPORTING GOODS**

FOR TOYS, NAMELY, CRAFT KITS FOR MAKING COSMETICS AND BATH AND BEAUTY PRODUCTS AND CRAFT KITS FOR MAKING PLASTIC JEWELRY, CONSTRUCTION TOYS, TOY BUILDING BLOCKS, INTERLOCKING PIECES THAT FORM TOY FIGURES, MANIPULATIVE PUZZLES, THREE DIMENSIONAL JIGSAW PUZZLES, TOY FIGURES, ACTION FIGURES AND ACCESSORIES THEREFOR, COLLECTABLE TOY FIGURES, PLASTIC TOY FIGURINES, DOLLS, PLUSH TOYS, STUFFED TOYS, BATTERY OPERATED ACTION TOYS, PARTY FAVORS IN THE NATURE OF SMALL TOYS AND KEY CHAINS, BOARD GAMES, CARD GAMES, PLAYING CARDS, TOY CANDY DISPENSERS, AND TOY GUM DISPENSERS (U.S. CLS. 22, 23, 38 AND 50).

MICHAEL BAIRD, EXAMINING ATTORNEY

SN 78-211,906. CRICK SOFTWARE LIMITED, NORTHAMPTON, UNITED KINGDOM, FILED 2-6-2003.

SN 78-215,377. ODENSE MARCIPAN A/S, 5000 ODENSE C, DENMARK, FILED 2-15-2003.

## WORDBAR

### CLASS 9—ELECTRICAL AND SCIENTIFIC APPARATUS

FOR COMPUTER SOFTWARE FOR ASSISTING USERS IN WORD PROCESSING; COMPUTER SOFTWARE FOR ASSISTING USERS IN DATA ENTRY; PRE-RECORDED DISCS AND/OR COMPACT DISCS BEARING SOFTWARE FOR ASSISTING USERS IN WORD PROCESSING; PRE-RECORDED DISCS AND/OR COMPACT DISCS BEARING SOFTWARE FOR ASSISTING USERS IN DATA ENTRY; COMPUTER PROGRAMS FOR USE IN SPEECH, LANGUAGE AND WRITING EDUCATION; EDUCATIONAL SOFTWARE FEATURING INSTRUCTION IN LANGUAGE EDUCATION (U.S. CLS. 21, 23, 26, 36 AND 38).

FIRST USE 1-1-1999; IN COMMERCE 4-1-2001.

### CLASS 16—PAPER GOODS AND PRINTED MATTER

FOR PRINTED MATTER, NAMELY INSTRUCTION MANUALS AND USER GUIDES FOR COMPUTER SOFTWARE AND/OR EDUCATIONAL COMPUTER SOFTWARE IN THE FIELD OF SPEECH, LANGUAGE AND WRITING EDUCATION; PRINTED INSTRUCTIONAL, EDUCATIONAL, AND TEACHING MATERIALS IN THE FIELD OF SPEECH, LANGUAGE AND WRITING EDUCATION (U.S. CLS. 2, 5, 22, 23, 29, 37, 38 AND 50).

FIRST USE 1-1-1999; IN COMMERCE 4-1-2001.  
CURTIS FRENCH, EXAMINING ATTORNEY

SN 78-213,618. ME & MY BIG IDEAS, INC., LAKE FOREST, CA. FILED 2-11-2003.

## A KID LIKE ME!

### CLASS 16—PAPER GOODS AND PRINTED MATTER

FOR PAPER GOODS AND PRINTER MATTER, NAMELY STATIONERY, STICKERS, RUBBER STAMPS, INK PADS, COLORED PENCILS, DECORATIVE SCRAPBOOK PAPER, SCRAPBOOK PAGE BORDERS, BOOKS AND NEWSLETTERS ON THE SUBJECT OF SCRAPBOOKING, DIARIES, GREETING CARDS, WRAPPING PAPER, CALENDARS, PAPER TOWELS, NAPKINS, TISSUES, PHOTO ALBUMS, SCRAPBOOKS, AND ADDRESS BOOKS, BOOK ENDS, PAINTING SETS, ARTS AND CRAFT PAINT KITS, SEWING PATTERNS FOR MAKING DOLLS AND CLOTHES, PAPER PARTY HATS, PARTY FAVOR BAGS, BINDERS, FOLDERS, MEMO PADS, PENCILS, PENS, ERASERS, BLANK JOURNALS FOR PERSONAL USE, POSTERS, ADHESIVE NOTE PAPER, BULLETIN BOARDS, BANK CHECKS, WRAPPERS FOR CANDY BARS, ACTIVITY AND ART KITS, NAMELY, SCRAPBOOK KITS COMPRISING STICKERS, DECORATIVE PAPERS, ADHESIVE EMBELLISHMENTS, AND RIBBONS; RUBBER STAMP KITS COMPRISING RUBBER STAMPS AND INK PADS; CHECK KITS COMPRISING CHECKS, RUBBER STAMPS, INK PADS AND STICKERS; BELT-MAKING KITS COMPRISING BELTS, RIBBONS, BEADS, BELT BUCKLES AND/OR FASTENERS (U.S. CLS. 2, 5, 22, 23, 29, 37, 38 AND 50).

### CLASS 27—FLOOR COVERINGS

FOR FLOOR COVERINGS, NAMELY AREA RUGS AND WALL BORDERS (U.S. CLS. 19, 20, 37, 42 AND 50).  
SCOTT BALDWIN, EXAMINING ATTORNEY



OWNER OF U.S. REG. NO. 2,181,746.

NO CLAIM IS MADE TO THE EXCLUSIVE RIGHT TO USE ODENSE AND 1909, APART FROM THE MARK AS SHOWN.

THE MARK CONSISTS OF THE WORD ODENSE IN SPECIAL FORM, THE NUMBER 1909 WITH AN ARBITRARY DESIGN.

### CLASS 29—MEATS AND PROCESSED FOODS

FOR PRESERVED, DRIED AND COOKED FRUITS AND VEGETABLES; PROCESSED NUTS, ALMONDS AND APRICOT KERNELS AND MIXTURES CONSISTING PRIMARILY OF PROCESSED NUTS, ALMONDS AND APRICOT KERNELS; JAMS, MARMALADE, FRUIT SAUCES, EDIBLE OILS AND FATS THAT ARE NON-DAIRY BASED, VEGETABLE-BASED FATS FOR IMPROVING BAKING PREPARATIONS; DAIRY-BASED AND NON-DAIRY BASED CREAM POWDERS AND CREAM FOR CAKES, PASTRY AND BAKERY PRODUCTS (U.S. CL. 46).

### CLASS 30—STAPLE FOODS

FOR BREAD, BAKERY PRODUCTS, CAKES, PASTRY AND CONFECTIONERY, NAMELY, CANDY; RAW MATERIALS IN THE FORM OF ALMOND PASTE, MARZIPAN, CARAMEL-BASED NOUGAT, CHOCOLATE TRUFFLE AND CHOCOLATE-BASED NOUGAT TRUFFLE; CHOCOLATES; SUGAR-BASED, CANDY-BASED AND CHOCOLATE-BASED CONFECTIONERY PASTE AND BAKING PASTE FOR BAKING PURPOSES AND FOR MAKING PASTRY AND CONFECTIONERY ARTICLES; PREMIXED FLOUR-BASED AND SUGAR-BASED INGREDIENTS, FOR MAKING BREAD, BAKERY PRODUCTS AND PASTRY; EDIBLE DECORATIONS FOR CAKES AND BAKERY PRODUCTS (U.S. CL. 46).

ROBERT LORENZO, EXAMINING ATTORNEY

SN 78-216,350. THE CREATIVE ASSEMBLY LIMITED, SOUTHWATER NR. HORSHAM, WEST SUSSEX, UNITED KINGDOM, FILED 2-19-2003.

## ROME: TOTAL WAR

PRIORITY CLAIMED UNDER SEC. 44(D) ON ERPN CMNTY TM OFC APPLICATION NO. 002919512, FILED 12-14-2002, REG. NO. 002919512, DATED 3-19-2004, EXPIRES 12-14-2012.

OWNER OF U.S. REG. NOS. 2,434,637 AND 2,497,062.

**CLASS 9—ELECTRICAL AND SCIENTIFIC APPARATUS**

FOR COMPUTERS, COMPUTER HARDWARE, AND COMPUTER PRODUCTS, NAMELY, COMPUTER GAME DISKS, COMPUTER GAME PROGRAMS AND SOFTWARE, MULTIMEDIA SOFTWARE RECORDED ON A CD-ROM FEATURING COMPUTER GAMES, COMPUTER GAME SOFTWARE THAT IS DOWNLOADABLE FROM A GLOBAL COMPUTER NETWORK, COMPUTER FIRMWARE FOR USE IN CONNECTION WITH COMPUTER GAMES, COMPUTER MOUSE PADS; ELECTRONIC GAMES APPARATUS, NAMELY, COMPUTER AND VIDEO GAME CARTRIDGES, VIDEO GAME CARTRIDGES FOR HAND-HELD ELECTRONIC GAME UNITS, COMPUTER GAME CASSETTES AND TAPES, AND COMPUTER GAME CONTROLLERS AND DISKS; VIDEO GAME MACHINES FOR USE WITH TELEVISION SETS; VIDEO GAME CARTRIDGES; VIDEO GAME PROGRAMS; PRE-RECORDED VIDEO TAPES FEATURING COMPUTER GAMES AND CHILDREN'S PROGRAMS FEATURING ANIMATED CHARACTERS BASED ON COMPUTER GAMES; DOWNLOADABLE ELECTRONIC PUBLICATIONS IN THE NATURE OF MAGAZINES, JOURNALS AND NEWSLETTERS IN THE FIELD OF COMPUTER GAMES INFORMATION; INTERACTIVE ENTERTAINMENT SOFTWARE FOR PLAYING GAMES IN THE NATURE OF COMPUTER GAME SOFTWARE; SOUND AND VIDEO RECORDINGS FEATURING MUSIC AND ANIMATED CHARACTERS FOR USE WITH COMPUTER GAMES; PRE-RECORDED MAGNETIC DATA CARRIERS FEATURING TELEVISION PROGRAMS AND FILMS FEATURING INFORMATION ON COMPUTER GAMES AND ANIMATED CHARACTERS BASED ON COMPUTER GAMES, CINEMATOGRAPHIC FILMS FEATURING INFORMATION ON COMPUTER GAMES AND ANIMATED CHARACTERS BASED ON COMPUTER GAMES, MOTION PICTURE FILMS FOR BROADCAST ON TELEVISION FEATURING ACTION, ADVENTURE, HISTORICAL DOCUMENTARY DRAMA AND GAME SHOWS AND; PRE-RECORD DISCS FEATURING COMPUTER GAMES (U.S. CLS. 21, 23, 26, 36 AND 38).

**CLASS 28—TOYS AND SPORTING GOODS**

FOR GAMES, TOYS AND PLAYTHINGS, NAMELY, BOARD GAMES, ACTION SKILL GAMES, CARD GAMES, HAND-HELD UNITS FOR PLAYING ELECTRONIC GAMES; TOY ACTION FIGURES AND ACCESSORIES THEREFORE, DOLLS AND ACCESSORIES THEREFORE; TOY VEHICLES AND ELECTRONICALLY OPERATED TOY VEHICLES; PLAYSETS FOR DOLLS AND TOY ACTION FIGURES AND CASES FOR PLAY ACCESSORIES; TOY CRAFT KITS COMPRISING MOLDS AND MOLDING COMPOUNDS FOR MAKING TOY FIGURES; TOY MODEL VEHICLES AND RELATED ACCESSORIES SOLD AS UNITS (U.S. CLS. 23, 38 AND 50).

**CLASS 41—EDUCATION AND ENTERTAINMENT**

FOR ENTERTAINMENT SERVICES, NAMELY, PROVIDING ONLINE COMPUTER AND VIDEO GAMES; ENTERTAINMENT IN THE NATURE OF ON-GOING TELEVISION AND RADIO PROGRAMS FEATURING INFORMATION ON COMPUTER AND VIDEO GAMES, AND CHILDREN'S PROGRAMS FEATURING ANIMATED ACTION CHARACTERS BASED ON COMPUTER VIDEO GAMES; PRODUCTION AND EDITING OF DIGITAL AND MOTION PICTURE FILMS, RADIO PROGRAMS AND TELEVISION PROGRAMS; AMUSEMENT ARCADE SERVICES (U.S. CLS. 100, 101 AND 107).  
TANYA AMOS, EXAMINING ATTORNEY

SN 78-221,631. BOOTS HEALTHCARE USA, INC., WILMINGTON, DE. FILED 3-4-2003.

**CONTROL. IT'S A BEAUTIFUL THING****CLASS 3—COSMETICS AND CLEANING PREPARATIONS**

FOR SKIN CLEANSING PREPARATIONS; SKIN CARE PREPARATIONS FOR EXTERNAL APPLICATION FOR PIMPLES AND ACNE, NAMELY LOTIONS, GELS AND CREAMS; MEDICATED SOAP (U.S. CLS. 1, 4, 6, 50, 51 AND 52).

**CLASS 5—PHARMACEUTICALS**

FOR ANTI-ACNE PREPARATIONS (U.S. CLS. 6, 18, 44, 46, 51 AND 52).  
GENE MACIOL, EXAMINING ATTORNEY

SN 78-224,145. NEDERLANDSE DASSENFABRIEK MIC-RO VERKOOP B.V., CAPELLE A/D IJSSEL, NETHERLANDS, FILED 3-11-2003.

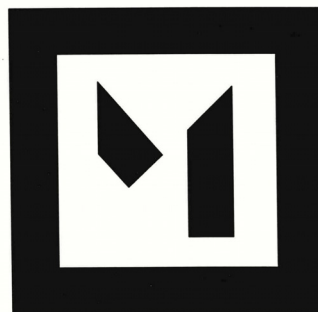
**CLASS 14—JEWELRY**

FOR PRECIOUS METALS AND THEIR ALLOYS AND GOODS IN PRECIOUS METALS OR COATED THEREWITH, NAMELY CUFFLINKS; JEWELRY; PRECIOUS GEMSTONES; HOROLOGICAL AND CHRONOMETRIC INSTRUMENTS, NAMELY WATCHES (U.S. CLS. 2, 27, 28 AND 50).

**CLASS 18—LEATHER GOODS**

FOR LEATHER AND IMITATION LEATHER SOLD IN BULK; ANIMAL SKINS, HIDES; TRUNKS AND TRAVELING BAGS; UMBRELLAS, PARASOLS AND WALKING STICKS, WHIPS, HARNESSSES AND SADDLERY (U.S. CLS. 1, 2, 3, 22 AND 41).

**CLASS 25—CLOTHING**

FOR CLOTHING, NAMELY BELTS, SHIRTS, T-SHIRTS, JACKETS AND SUSPENDERS; FOOTWEAR; HEADWEAR; TIES (U.S. CLS. 22 AND 39).  
TRICIA THOMPCKINS, EXAMINING ATTORNEY

SN 78-229,746. KCI LICENSING, INC., SAN ANTONIO, TX.  
FILED 3-25-2003.

## NANOGRAFTER

### CLASS 5—PHARMACEUTICALS

FOR WOUND COVERINGS, NAMELY PROCESSED SKIN TISSUE GRAFTS FOR SURGICAL PURPOSES (U.S. CLS. 6, 18, 44, 46, 51 AND 52).

### CLASS 10—MEDICAL APPARATUS

FOR MEDICAL INSTRUMENTS AND DEVICES FOR TISSUE REMOVAL, NAMELY, DERMATOMES, TISSUE CUTTERS, AND PARTS AND ACCESSORIES FOR THE FOREGOING (U.S. CLS. 26, 39 AND 44).

NELSON SNYDER, EXAMINING ATTORNEY

---

SN 78-230,206. PAWEL, JODI, JOHNSTON, SPRINGBORO, OH. FILED 3-26-2003.

## TOOLSHOP

### CLASS 16—PAPER GOODS AND PRINTED MATTER

FOR PRINTED MATERIALS, NAMELY EDUCATIONAL BOOKS, EDUCATIONAL WORKSBOOKS, WORKSHEETS AND POSTERS ALL IN THE FIELD OF RELATIONSHIP ENHANCEMENT AND PERSONAL AND LEADERSHIP DEVELOPMENT (U.S. CLS. 2, 5, 22, 23, 29, 37, 38 AND 50).

FIRST USE 1-0-1990; IN COMMERCE 1-0-1990.

### CLASS 41—EDUCATION AND ENTERTAINMENT

FOR EDUCATIONAL SERVICES, NAMELY PROVIDING SEMINARS, CLASSES, AND WORKSHOPS IN THE FIELD OF RELATIONSHIP ENHANCEMENT AND PERSONAL AND LEADERSHIP DEVELOPMENT (U.S. CLS. 100, 101 AND 107).

FIRST USE 1-0-1990; IN COMMERCE 1-0-1990.

JANICE L. MCMORROW, EXAMINING ATTORNEY

---

SN 78-231,535. ALFRED KLETT KG, REMSCHEID, FED REP GERMANY, FILED 3-28-2003.

**Precision**

PRIORITY CLAIMED UNDER SEC. 44(D) ON FED REP GERMANY APPLICATION NO. 30256046.7/0, FILED 11-15-2002, REG. NO. 30256046, DATED 3-5-2003, EXPIRES 11-30-2012.

THE STIPPLING IS A FEATURE OF THE MARK.  
THE MARK CONSISTS OF THE WORD "PRECISION" WITH A HORIZONTAL WHITE LINE EXTENDING THROUGHOUT THE MARK AND A HORIZONTAL BLACK LINE DISPOSED IN THE CENTER OF THE HORIZONTAL

WHITE LINE. THE LETTER "O" ALSO HAS A VERTICAL WHITE LINE EXTENDING THERETHROUGH AND INTERSECTING THE HORIZONTAL WHITE LINE. A VERTICAL BLACK LINE EXTENDS CENTRALLY OF THE VERTICAL WHITE LINE AND INTERSECTS THE HORIZONTAL BLACK LINE. THE "O" FURTHER FEATURES A CIRCULAR WHITE LINE WITH A CIRCULAR BLACK LINE CENTERED THEREIN. THE CIRCULAR BLACK LINE INTERSECTS THE HORIZONTAL AND VERTICAL BLACK LINES. A QUARTER OF THE "O" IS STIPLED.

### CLASS 7—MACHINERY

FOR MACHINES FOR THE TREATMENT AND PROCESSING OF BOXES OF PAPERBOARD AND CORRUGATED PAPER, NAMELY CUTTING AND FOLDING OF THE PAPERBOARD AND CORRUGATED PAPER, AND STRUCTURAL PARTS THEREFOR (U.S. CLS. 13, 19, 21, 23, 31, 34 AND 35).

### CLASS 9—ELECTRICAL AND SCIENTIFIC APPARATUS

FOR ELECTRICAL CONTROLS FOR USE IN OPERATING MACHINES THAT CUT AND FOLD PAPERBOARD AND CORRUGATED PAPER FOR MAKING PAPERBOARD AND CORRUGATED PAPER BOXES (U.S. CLS. 21, 23, 26, 36 AND 38).

CHERYL CLAYTON, EXAMINING ATTORNEY

---

SN 78-232,198. R & D SOCIEDAD ANONIMA (RICOS & DELICIOSOS S.A.), PALMIRA, VALLE, COLOMBIA, FILED 3-31-2003.

## DIMONTI

### CLASS 29—MEATS AND PROCESSED FOODS

FOR (BASED ON 44(E)) MEATS, FISH, AND POULTRY; MEAT PRODUCTS, NAMELY COLD CUTS, SALAMI, AND SAUSAGES; PRESERVED, DRIED AND COOKED FRUITS AND VEGETABLES (U.S. CL. 46).

### CLASS 30—STAPLE FOODS

FOR (BASED ON INTENT TO USE) ENTREES CONSISTING PRIMARILY OF RICE (U.S. CL. 46).

DANIEL CAPSHAW, EXAMINING ATTORNEY

---

SN 78-232,410. KAYSER-ROTH CORPORATION, GREENSBORO, NC. FILED 4-1-2003.

june  
&daisy

THE MARK CONSISTS OF STYLIZED WORDS FOR JUNE & DAISY WITH OUTLINE OF A FLOWER.

### CLASS 14—JEWELRY

FOR JEWELRY (U.S. CLS. 2, 27, 28 AND 50).

**CLASS 25—CLOTHING**

FOR PANTIES, UNDERWEAR, SLEEPWEAR, SOCKS, PANTYHOSE, HOSIERY, TIGHTS, LEG WARMERS, AND LEGGINGS (U.S. CLS. 22 AND 39).

**CLASS 26—FANCY GOODS**

FOR BROOCHES AND HAIR ACCESSORIES, NAMELY, TWISTERS, CLAW CLIPS, AND SNAP CLIPS (U.S. CLS. 37, 39, 40, 42 AND 50).

GINA FINK, EXAMINING ATTORNEY

---

SN 78-234,850. LONGS DRUG STORES CALIFORNIA, INC., WALNUT CREEK, CA. FILED 4-7-2003.

**HOLIDAY PLACE**

NO CLAIM IS MADE TO THE EXCLUSIVE RIGHT TO USE "HOLIDAY", APART FROM THE MARK AS SHOWN.

**CLASS 4—LUBRICANTS AND FUELS**

FOR CANDLES (U.S. CLS. 1, 6 AND 15).

**CLASS 6—METAL GOODS**

FOR HOLIDAY FIGURINES MADE OF COMMON METAL; METAL HOLIDAY ORNAMENTS NOT BEING TREE ORNAMENTS (U.S. CLS. 2, 12, 13, 14, 23, 25 AND 50).

**CLASS 8—HAND TOOLS**

FOR CUTLERY AND EATING UTENSILS MADE OF PLASTIC NAMELY FORKS, SPOONS AND KNIVES; WOODEN NUTCRACKERS (U.S. CLS. 23, 28 AND 44).

**CLASS 11—ENVIRONMENTAL CONTROL APPARATUS**

FOR ELECTRIC ORNAMENTAL/DECORATIVE LIGHTS AND HOLIDAY ORNAMENTS (U.S. CLS. 13, 21, 23, 31 AND 34).

**CLASS 16—PAPER GOODS AND PRINTED MATTER**

FOR PAPER GOODS AND PRINTED MATTER, NAMELY GIFT WRAP, GIFT BAGS, GIFT BOXES, GIFT WRAP BOWS; PAPER NAPKINS, PAPER TABLECLOTHS (U.S. CLS. 2, 5, 22, 23, 29, 37, 38 AND 50).

**CLASS 20—FURNITURE AND ARTICLES NOT OTHERWISE CLASSIFIED**

FOR SOFT SCULPTURE WALL DECORATIONS WITH LIGHTS, HOLIDAY FIGURINES MADE OF PLASTIC, AND HOLIDAY FIGURINES MADE OF WOOD (U.S. CLS. 2, 13, 22, 25, 32 AND 50).

**CLASS 21—HOUSEWARES AND GLASS**

FOR TABLEWARE, NAMELY PLATES, CUPS, SAUCERS, AND SERVING DISHES, HOLIDAY FIGURINES MADE OF GLASS AND CERAMIC (U.S. CLS. 2, 13, 23, 29, 30, 33, 40 AND 50).

**CLASS 24—FABRICS**

FOR TEXTILE TOWELS; TEXTILE TABLECLOTHS; RUGS; POTHOLDERS; TEXTILE PLACEMATS; HOLIDAY ORNAMENTS AND FIGURINES MADE OF FABRIC (U.S. CLS. 42 AND 50).

**CLASS 26—FANCY GOODS**

FOR PAPER AND PLASTIC GIFT RIBBON (U.S. CLS. 37, 39, 40, 42 AND 50).

**CLASS 28—TOYS AND SPORTING GOODS**

FOR ARTIFICIAL CHRISTMAS TREES; CHRISTMAS TREE STANDS; HOLIDAY DECORATIONS, NAMELY CHRISTMAS TREE ORNAMENTS NOT BEING LUMINARY OR CONFECTIONERY ORNAMENTS, GARLANDS (U.S. CLS. 22, 23, 38 AND 50).

TRACY WHITAKER-BOWN, EXAMINING ATTORNEY

---

SN 78-236,274. SOFLEX CONTACT LENS INDUSTRIES LTD., D.N. MISGAV, ISRAEL, FILED 4-10-2003.

**ENI-EYE****CLASS 5—PHARMACEUTICALS**

FOR PHARMACEUTICAL PREPARATIONS, NAMELY CONTACT LENS SOLUTIONS (U.S. CLS. 6, 18, 44, 46, 51 AND 52).

**CLASS 9—ELECTRICAL AND SCIENTIFIC APPARATUS**

FOR CONTACT LENSES (U.S. CLS. 21, 23, 26, 36 AND 38).

WILLIAM P. SHANAHAN, EXAMINING ATTORNEY

---

SN 78-236,640. INDUSTRIA NACIONAL COLOMBIANA DE ARTICULOS METALICOS, S.A., ANTIOQUIA, COLOMBIA, FILED 4-11-2003.



THE MARK CONSISTS OF A STYLIZED "S" IN WHITE SURROUNDED BY A BLACK CIRCLE WITH WHITE TRIM TO THE LEFT OF THE STYLIZED WORD "STEIN" WITH A LINE FROM THE CIRCLE UNDERLINING STEIN. BELOW IN A BLACK BOX WITH WHITE LETTERING THE WORD "ACEROINOXIDABLE".

**CLASS 8—HAND TOOLS**

FOR FLATWARE, TABLEWARE AND CUTLERY, NAMELY, FORKS, KNIVES AND SPOONS (U.S. CLS. 23, 28 AND 44).

FIRST USE 1-22-2002; IN COMMERCE 1-22-2002.

**CLASS 21—HOUSEWARES AND GLASS**

FOR KITCHENWARE, NAMELY, POTS, PANS, PLATES, CUPS, BOWLS AND MUGS (U.S. CLS. 2, 13, 23, 29, 30, 33, 40 AND 50).

FIRST USE 1-22-2002; IN COMMERCE 1-22-2002.  
DAWN FELDMAN, EXAMINING ATTORNEY

SN 78-239,049. PREMIERE VISION- TISSUS CREATION, LYON, FRANCE, FILED 4-17-2003.

**PREMIÈREVISION**

PRIORITY CLAIMED UNDER SEC. 44(D) ON FRANCE APPLICATION NO. 023191573, FILED 10-30-2002, REG. NO. 023191573, DATED 10-30-2002, EXPIRES 10-30-2012.  
OWNER OF U.S. REG. NOS. 1,541,813 AND 2,161,227.

**CLASS 35—ADVERTISING AND BUSINESS**

FOR ORGANIZATION OF EXHIBITIONS FOR COMMERCIAL OR ADVERTISING PURPOSES RELATED TO THE TEXTILE AND FASHION INDUSTRIES; ORGANIZATION AND ADMINISTRATIVE MANAGEMENT OF PROFESSIONAL TRADE FAIRS RELATED TO THE TEXTILE AND FASHION INDUSTRIES; ORGANIZATION OF PROFESSIONAL TRADE FAIRS AND MANAGEMENT OF PROFESSIONAL TRADE FAIRS AND EXHIBITIONS RELATED TO TEXTILE AND FASHION INDUSTRIES; ECONOMIC INFORMATION RELATED TO THE TEXTILE AND FASHION INDUSTRIES; MARKETING STUDIES; BUSINESS INFORMATION RELATED TO THE TEXTILE AND FASHION INDUSTRIES; ECONOMIC FORECASTING AND ANALYSIS RELATING TO FASHION TRENDS; STUDIES AND ANALYSIS OF CONSUMER HABITS RELATED TO FASHION AND FASHION TRENDS (U.S. CLS. 100, 101 AND 102).

**CLASS 41—EDUCATION AND ENTERTAINMENT**

FOR PUBLICATION OF PRINTED BOOKS, JOURNALS, MAGAZINES, EXCEPT THOSE IN RELATION WITH CINEMATOGRAPHIC TOPICS AND PERFORMING ARTS TOPICS; PRODUCTION AND DISTRIBUTION OF MOTION PICTURE FILMS AND TELEVISION PROGRAMS, EXCEPT THOSE IN RELATION TO CINEMATOGRAPHIC TOPICS AND PERFORMING ARTS TOPICS; ARRANGING AND CONDUCTING EDUCATIONAL SYMPOSIUMS AND CONFERENCES (U.S. CLS. 100, 101 AND 107).

**CLASS 45—PERSONAL SERVICES**

FOR PROVIDING INFORMATION IN THE FIELDS OF FASHION AND TEXTILES, NAMELY, PRESENTATION OF FASHION TRENDS AND FABRIC COLLECTIONS; STUDIES AND ANALYSIS RELATED TO FASHION AND TRENDS, NAMELY, SOCIOLOGICAL STUDIES, SOCIAL AND CULTURAL STUDIES, STUDIES AND ANALYSIS OF SOCIAL BEHAVIORS, STUDIES AND ANALYSIS OF SOCIAL AND CULTURAL EVOLUTIONS, AND SOCIAL AND CULTURAL ANALYSIS; PROVIDING INFORMATION RELATED TO OBSERVATIONS AND DEFINITIONS OF FASHION TRENDS AND FASHIONS; PROVIDING INFORMATION RELATED TO THE EVOLUTION OF HABITS OF CONSUMPTION OF FASHIONS AND TRENDS OF CLOTHING (U.S. CLS. 100 AND 101).

ALICIA COLLINS, EXAMINING ATTORNEY

SN 78-242,618. AVEX INC., TOKYO, JAPAN, FILED 4-28-2003.

**CYBORG009**

**CLASS 9—ELECTRICAL AND SCIENTIFIC APPARATUS**

FOR PRERECORDED VIDEO DISCS AND VIDEO TAPES FEATURING ANIMATION FILMS (U.S. CLS. 21, 23, 26, 36 AND 38).

**CLASS 28—TOYS AND SPORTING GOODS**

FOR BILLIARD GAME PLAYING EQUIPMENT, PINBALL-TYPE GAMES, DOLLS, ELECTRIC ACTION TOYS, TOY PISTOLS, FANTASY CHARACTER TOYS, PLASTIC CHARACTER TOYS, RUBBER CHARACTER TOYS, PUZZLES, NOT INCLUDING CROSSWORD PUZZLES, PROMOTIONAL GAME CARDS, BOARD GAMES, CARD GAMES, BALLOONS (U.S. CLS. 22, 23, 38 AND 50).

**CLASS 41—EDUCATION AND ENTERTAINMENT**

FOR ENTERTAINMENT SERVICES, NAMELY AN ONGOING TELEVISION SERIES OF ANIMATED CARTOONS (U.S. CLS. 100, 101 AND 107).

KARLA PERKINS, EXAMINING ATTORNEY

SN 78-243,970. DONTRON, INC., IRVING, TX, FILED 4-30-2003.

**#1 IN THE STREETS**

NO CLAIM IS MADE TO THE EXCLUSIVE RIGHT TO USE #1, APART FROM THE MARK AS SHOWN.

**CLASS 16—PAPER GOODS AND PRINTED MATTER**

FOR PRINTED MATTER, NAMELY POSTERS, POSTCARDS, PAPER ADVERTISING BANNERS AND INFORMATIONAL FLYERS RELATING TO RADIO BROADCASTING, RECORDING AND PUBLISHING OF MUSIC, PRESENTATION OF LIVE MUSICAL PERFORMANCES, PRODUCTION OF MUSICALS, CONCERTS AND FILMS, ORGANIZATION OF MUSICAL PERFORMANCES, MANAGEMENT OF LIVE SHOWS AND LIVE PERFORMANCES; PHOTOGRAPHS, NAMELY MOUNTED PHOTOGRAPHS AND UNMOUNTED PHOTOGRAPHS (U.S. CLS. 2, 5, 22, 23, 29, 37, 38 AND 50).

FIRST USE 6-0-2002; IN COMMERCE 6-0-2002.

**CLASS 38—COMMUNICATION**

FOR RADIO BROADCASTING SERVICES (U.S. CLS. 100, 101 AND 104).

FIRST USE 6-0-2002; IN COMMERCE 6-0-2002.

**CLASS 41—EDUCATION AND ENTERTAINMENT**

FOR ENTERTAINMENT SERVICES, NAMELY, MUSIC PUBLISHING SERVICES; RECORDING STUDIO SERVICES; CONCERT SERVICES, NAMELY, CONCERT BOOKING; PROVIDING ON-LINE INFORMATION IN THE FIELD OF ENTERTAINMENT INFORMATION FOR THE RADIO AND MUSIC INDUSTRIES (U.S. CLS. 100, 101 AND 107).

FIRST USE 6-0-2002; IN COMMERCE 6-0-2002.

SOPHIA S. KIM, EXAMINING ATTORNEY

SN 78-244,101. ASIA PACIFIC FUEL CELL TECHNOLOGIES, LTD., TAIPEI, TAIWAN, FILED 4-30-2003.



PRIORITY CLAIMED UNDER SEC. 44(D) ON TAIWAN APPLICATION NO. 092018546, FILED 4-17-2003, REG. NO. 01076088, DATED 12-1-2003, EXPIRES 11-30-2013.

OWNER OF TAIWAN REG. NO. 952720, DATED 8-1-2001, EXPIRES 7-31-2011.

OWNER OF TAIWAN REG. NO. 138999, DATED 2-16-2001, EXPIRES 2-15-2011.

OWNER OF TAIWAN REG. NO. 166490, DATED 7-16-2002, EXPIRES 7-15-2012.

OWNER OF TAIWAN REG. NO. 998785, DATED 5-16-2002, EXPIRES 5-15-2012.

OWNER OF TAIWAN REG. NO. 1006416, DATED 7-16-2002, EXPIRES 7-15-2012.

#### CLASS 6—METAL GOODS

FOR METAL GAS STORAGE TANKS, NAMELY, HYDROGEN STORAGE CANISTERS AND TANKS MADE OF METAL (U.S. CLS. 2, 12, 13, 14, 23, 25 AND 50).

#### CLASS 7—MACHINERY

FOR BASED ON ITU ELECTRIC GENERATORS, NAMELY FUEL CELL POWER GENERATORS, DC POWER GENERATORS, AC POWER GENERATORS, AND EMERGENCY POWER GENERATORS; POWER GENERATORS FOR MOTORIZED LAND VEHICLES (U.S. CLS. 13, 19, 21, 23, 31, 34 AND 35).

#### CLASS 9—ELECTRICAL AND SCIENTIFIC APPARATUS

FOR FUEL CELLS (U.S. CLS. 21, 23, 26, 36 AND 38).

#### CLASS 12—VEHICLES

FOR TWO-WHEELED VEHICLES, NAMELY, MOTORIZED SCOOTERS; THREE-WHEELED VEHICLES, NAMELY, FUEL CELL POWERED CARS; POWER ASSISTED VEHICLES, NAMELY, SCOOTERS; ELECTRIC CARS; ELECTRIC MOTORS FOR LAND VEHICLES (U.S. CLS. 19, 21, 23, 31, 35 AND 44).

#### CLASS 42—SCIENTIFIC, COMPUTER AND LEGAL SERVICES

FOR FUEL CELL RELATED PRODUCT RESEARCH, PRODUCT DEVELOPMENT AND PRODUCT DEVELOPMENT CONSULTATION; ENERGY USAGE FACILITY DESIGNING, NAMELY, ENGINEERING DESIGN SERVICES FOR EFFICIENT ENERGY USAGE; ENVIRONMENTAL PROTECTION TECHNICAL CONSULTING; TECHNICAL RESEARCH, NAMELY, MEASUREMENT OF ENVIRONMENTAL POLLUTION; MECHANICAL AND ELECTRICAL ENGINEERING TECHNICAL CONSULTING (U.S. CLS. 100 AND 101).

JOHN GARTNER, EXAMINING ATTORNEY

SN 78-246,724. SAFETY CENTER, INC., NEW YORK, NY. FILED 5-7-2003.



NO CLAIM IS MADE TO THE EXCLUSIVE RIGHT TO USE "BABY", APART FROM THE MARK AS SHOWN.

THE COLORS RED, BLUE, YELLOW AND GREEN ARE CLAIMED AS FEATURES OF THE MARK.

THE MARK CONSISTS OF THE WORDING BABY EVERYWHERE WRITTEN IN STYLIZED LETTERS AND TO THE RIGHT OF A LINED SILHOUETTE OF A GLOBE IN THE CENTER OF WHICH IS A CIRCLE HAVING A RED INNER CIRCLE WHICH IS SURROUNDED BY THE COLORS YELLOW, BLUE AND GREEN. THE LETTERING IN THE WORDING IS RED AND THE GLOBE IS BLUE.

#### CLASS 16—PAPER GOODS AND PRINTED MATTER

FOR BOOKS, BROCHURES AND PAMPHLETS RELATING TO THE FIELD OF CHILD SAFETY, BINDERS AND FOLDERS FOR HOLDING INFORMATION RELATING TO THE FIELD OF CHILD SAFETY, NAMELY, BABYSITTER INFORMATION, DOCTOR AND EMERGENCY TELEPHONE NUMBERS AND ADDRESSES, AND A CHECKLIST INDICATING WHAT TO DO IN THE CASE OF A MEDICAL EMERGENCY (U.S. CLS. 2, 5, 22, 23, 29, 37, 38 AND 50).

#### CLASS 18—LEATHER GOODS

FOR BACKPACKS AND DIAPER BAGS (U.S. CLS. 1, 2, 3, 22 AND 41).

#### CLASS 21—HOUSEWARES AND GLASS

FOR THERMAL INSULATED BAGS FOR FOOD OR BEVERAGES (U.S. CLS. 2, 13, 23, 29, 30, 33, 40 AND 50).  
CYNTHIA SLOAN, EXAMINING ATTORNEY

SN 78-247,236. JT INTERNATIONAL DISTRIBUTORS, INC., INDIANAPOLIS, IN. FILED 5-8-2003.



THE MARK CONSISTS OF DESIGN PLUS WORDS, LETTERS, AND/OR NUMBERS.

#### CLASS 6—METAL GOODS

FOR METAL SADDLERY HARDWARE; NAMELY, SNAP HOOKS, BULL SNAPS, REIN SNAPS, BOLT SNAPS, PANIC SNAPS, SPRING HOOKS, DEE RINGS, CURB CHAINS, LEAD CHAINS, BUCKLES, CONCHOS, ROSETTES, CHICAGO SCREWS, SWIVEL SNAPS, ROPE SNAPS AND ROPE CLAMPS (U.S. CLS. 2, 12, 13, 14, 23, 25 AND 50).

FIRST USE 10-31-1986; IN COMMERCE 10-31-1986.



**CLASS 8—HAND TOOLS**

FOR SADDLERY HARDWARE; NAMELY HOOF TRIM KITS COMPRISED PRIMARILY OF RASPS, HOOF KNIVES, NIPPERS AND SHOE PULLERS/SPREADERS (U.S. CLS. 23, 28 AND 44).

FIRST USE 10-31-1986; IN COMMERCE 10-31-1986.  
BRIDGETT SMITH, EXAMINING ATTORNEY

SN 78-250,502. JAFER LIMITED, HAMILTON, BERMUDA,  
FILED 5-15-2003.



OWNER OF U.S. REG. NO. 1,241,758.

THE MARK CONSISTS OF AN ORANGE RECTANGLE WITH A RED SLASH WITH THE WORD "RADIANTE" IN ORANGE LETTERING AND THE WORD "YANBAL" IN WHITE LETTERING.

THE FOREIGN WORDING IN THE MARK TRANSLATES INTO ENGLISH AS "BRILLIANT".

SN 78-247,787. EUBIONIC DENTAL GMBH, ROTKREUZ,  
SWITZERLAND, FILED 5-9-2003.

**DENTAPEEK**

PRIORITY CLAIMED UNDER SEC. 44(D) ON FED REP GERMANY APPLICATION NO. 30255146.8/0, FILED 11-12-2002, REG. NO. 30255146, DATED 5-28-2003, EXPIRES 11-30-2012.

**CLASS 1—CHEMICALS**

FOR PLASTICS IN THE FORM OF POWDERS, PASTES, GRANULATES, EMULSIONS AND DISPERSIONS FOR INDUSTRIAL USE (U.S. CLS. 1, 5, 6, 10, 22 AND 46).

**CLASS 5—PHARMACEUTICALS**

FOR DENTAL STOPPINGS; DENTAL IMPRESSION MATERIALS AND SUBSTANCES; DENTAL AMALGAMS; DENTAL CEMENT; DENTAL ALLOYS; DENTAL VARNISH; PORCELAIN FOR THE MANUFACTURE OF DENTAL SETTINGS; DENTAL ADHESIVES; ADHESIVES FOR DENTURES; DENTAL PACKAGING AND DENTAL FACING MATERIAL (U.S. CLS. 6, 18, 44, 46, 51 AND 52).

**CLASS 10—MEDICAL APPARATUS**

FOR DENTAL IMPLANTS AND ARTIFICIAL TEETH; DENTURES MADE OF PLASTIC; PLASTIC MATERIALS FOR MAKING DENTURES; ARTIFICIAL LIMBS; DENTURES; DENTAL CAPS; DENTAL BRIDGES; REMOVABLE DENTURES; FIXED DENTURES; DENTAL BRACES, ORTHODONTIC APPLIANCES, TOOTH PINS AND SUPPORTS, DENTAL CLAMPS, MIXING POTS AND DENTAL PLATES, PLASTER OF PARIS FOR DENTAL PURPOSES; RUBBER PLATES FOR DENTAL PURPOSES AND SURGICAL IMPLANTS (U.S. CLS. 26, 39 AND 44).

**CLASS 17—RUBBER GOODS**

FOR PLASTICS IN THE FORM OF BARS, BLOCKS, PELLETS, RODS, SHEETS AND TUBES FOR MAKING DENTURES (U.S. CLS. 1, 5, 12, 13, 35 AND 50).  
EDWARD NELSON, EXAMINING ATTORNEY

**CLASS 18—LEATHER GOODS**

FOR HOUSE MARK FOR USE IN CONNECTION WITH ALL OF THE FOLLOWING GOODS—ATHLETIC BAGS, ATTACHE CASES, CIGARETTE CASES OF LEATHER AND IMITATION LEATHER, BABY BACKPACKS, ALL PURPOSE SPORTS BAGS, BEACH BAGS, CARRY-ON BAGS, CLUTCH BAGS, DIAPER BAGS, GYM BAGS, LEATHER BAGS, SCHOOL BAGS, TRAVEL BAGS, SHOULDER BAGS, BRIEFCASES, COSMETIC CASES SOLD EMPTY, HANDBAGS, HUNTING BAGS, LEATHER SOLD IN BULK, IMITATION LEATHER SOLD IN BULK, LUGGAGE, STRAPS FOR LUGGAGE, LUGGAGE CARTS, LUGGAGE TAGS, OVERNIGHT BAGS, SHOPPING BAGS, SHOULDER BAGS, SUITCASES, WAIST BAGS, WALLETS, TOTE BAGS, EVENING BAGS, LEATHER KEY CHAINS, COIN PURSES, AND BUSINESS CARD CASES (U.S. CLS. 1, 2, 3, 22 AND 41).

**CLASS 25—CLOTHING**

FOR HOUSE MARK FOR USE IN CONNECTION WITH ALL OF THE FOLLOWING GOODS—PANTIES, PANTS, BALLOON PANTS, SKI PANTS, SNOW PANTS, SWEATPANTS, TAP PANTS, PANTSUITS, PANTYHOSE, POLO SHIRTS, PONCHOS, PULLOVERS, RAINWEAR, SHIRTS, SHOES, SHORTS, UNDERSHIRTS, NIGHT SHIRTS, GOLF SHIRTS, KNIT SHIRTS, SHOULDER PADS FOR CLOTHING, SHOWER CAPS, SKIRTS, SLEEPWEAR, SOCKS, STOCKINGS, STOLEES, SUITS, SWEATSHIRTS, SWEATERS, SWEATSOCKS, BATHING SUITS, SWIMSUITS, T-SHIRTS, TANGAS, BOW TIES, TIES, SWIM TRUNKS, BATHING TRUNKS, UNDERPANTS, UNDERWEAR, V-NECK SWEATERS, VESTED SUITS, VESTS, WET SUITS, WARM-UP SUITS, GYM SUITS, JOGGING SUITS, PLAY SUITS, BEACH COVERUPS, BEACHWEAR, BED JACKETS, BELTS, BUCKLES, BIKINIS, BLAZERS, BLOOMERS, BLOUSES, BODYSHAPERS, BODY SUITS, BOXER SHORTS, BRAS, BRASSIERES, CAMISOLES, CAPS, CHEMISES, COATS, FUR COATS, LAB COATS, LEATHER COATS, OVERCOATS, RAINCOATS, SPORTCOATS, SUIT COATS, TOPCOATS, GLOVES, GYM SHORTS, HATS, TENNISWEAR, TROUSERS, INFANTWEAR, JACKETS, FUR JACKETS, LEATHER JACKETS, WIND-RESISTANT JACKETS, JEANS, JERSEYS, JUMPERS, MONEY BELTS, NEGLIGES AND PAJAMAS (U.S. CLS. 22 AND 39).

**CLASS 26—FANCY GOODS**

FOR HOUSE MARK FOR USE IN CONNECTION WITH ALL OF THE FOLLOWING GOODS—LACE AND EMBROIDERY, RIBBONS AND BRAID; BUTTONS FOR CLOTHING, HOOKS AND EYES, SAFETY PINS, BOBBY PINS AND NEEDLES; ARTIFICIAL FLOWERS (U.S. CLS. 37, 39, 40, 42 AND 50).

**CLASS 28—TOYS AND SPORTING GOODS**

FOR HOUSE MARK FOR USE IN CONNECTION WITH THE FOLLOWING GOODS— TOYS, NAMELY, WOODEN TRUCKS, WOODEN BLOCKS, WOODEN DOLLS, WOODEN CARS, WOODEN BALLS, PLUSH TOYS, SPORT BALLS, PLASTIC PLAYGROUND BALLS, PLASTIC DOLLS, PLASTIC TOY TRUCKS PLASTIC BLOCKS, PLASTIC CARS, PLASTIC CHARACTER TOYS; BOARD GAMES; DECORATIONS FOR CHRISTMAS TREES (U.S. CLS. 22, 23, 38 AND 50).

WILLIAM BRECKENFELD, EXAMINING ATTORNEY

SN 78-251,422. GORDON-TYNES PRODUCTIONS, INC., ORLANDO, FL. FILED 5-19-2003.

**COMEDY NIGHT SCHOOL**

NO CLAIM IS MADE TO THE EXCLUSIVE RIGHT TO USE "COMEDY", APART FROM THE MARK AS SHOWN.

**CLASS 9—ELECTRICAL AND SCIENTIFIC APPARATUS**

FOR MOTION PICTURE FILMS FEATURING VARIETY SHOWS, SKITS, SKETCH COMEDY AND MUSICAL PERFORMANCES BY INDIVIDUALS, GROUPS AND BANDS. (U.S. CLS. 21, 23, 26, 36 AND 38).

**CLASS 25—CLOTHING**

FOR ARTICLES OF CLOTHING, FOR MEN, WOMEN AND CHILDREN, NAMELY, PAJAMAS, NIGHTSHIRTS, ROBES, JOGGING SUITS, SWEAT SUITS, T-SHIRTS, SWEATSHIRTS, JERSEYS, MUSCLE SHIRTS, TANK TOPS, COLLAR SHIRTS, BLOUSES, SHORTS, TROUSERS, PANTS, JUMPERS, OVERALLS, ROMPERS, DRESSES, SKIRTS, SHORT SETS COMPRISED OF SHORTS AND TOPS, SWEATERS, CARDIGANS, JACKETS, COATS, ANORAKS, PONCHOS, RAINCOATS, SCARVES, BANDANNAS, UNDERWEAR, VESTS, KNITTED HEADWEAR, HATS AND CAPS, VISORS, TIES, BELTS AND SUSPENDERS, SOCKS, TIGHTS, LEGGINGS, HOSIERY, GLOVES, MITTENS, APRONS, SWIMSUITS, CLOTH BABY BIBS, FOOTWEAR AND MASQUERADE COSTUMES. (U.S. CLS. 22 AND 39).

**CLASS 41—EDUCATION AND ENTERTAINMENT**

FOR ENTERTAINMENT SERVICES, NAMELY ONGOING TELEVISION PROGRAMS FEATURING VARIETY SHOWS, SKITS, SKETCH COMEDY, MUSICAL PERFORMANCES BY INDIVIDUALS, GROUPS AND BANDS, PARODIES AND HUMOR (U.S. CLS. 100, 101 AND 107).

SCOTT OSICK, EXAMINING ATTORNEY

SN 78-251,913. KING DAVID COFFEE ROASTERS, INC., NASHUA, NH. FILED 5-20-2003.

**KING DAVID COFFEE ROASTERS**

NO CLAIM IS MADE TO THE EXCLUSIVE RIGHT TO USE "COFFEE ROASTERS", APART FROM THE MARK AS SHOWN.

THE NAME IN THE MARK DOES NOT IDENTIFY A LIVING INDIVIDUAL.

**CLASS 30—STAPLE FOODS**

FOR COFFEE, COFFEE BEANS, ROASTED WHOLE BEAN COFFEE AND COFFEE BLEND, GROUND COFFEE (U.S. CL. 46).

FIRST USE 6-26-2003; IN COMMERCE 6-26-2003.

**CLASS 35—ADVERTISING AND BUSINESS**

FOR RETAIL, WHOLESALE, MAIL-ORDER SERVICES AND PACKAGING, AND SHIPPING IN THE FIELDS OF COFFEE, COFFEE BEANS, GROUND COFFEE, AND COFFEE-RELATED PRODUCTS (U.S. CLS. 100, 101 AND 102).

FIRST USE 6-26-2003; IN COMMERCE 6-26-2003.

CATHERINE FAINT, EXAMINING ATTORNEY

SN 78-251,975. HABERMAN, TOM, FORT LAUDERDALE, FL. FILED 5-20-2003.

**LEISURE FOR LESS****CLASS 35—ADVERTISING AND BUSINESS**

FOR REAL ESTATE ADVERTISING SERVICES; EXCHANGE SERVICES, NAMELY BARTERING OF GOODS FOR OTHERS; TRAVEL MANAGEMENT; OPERATING ON-LINE MARKETPLACES FOR SELLERS OF GOODS AND/OR SERVICES; REAL ESTATE MARKETING SERVICES, NAMELY ONLINE SERVICES FEATURING TOURS OF RESIDENTIAL REAL ESTATE, ONLINE ORDERING SERVICES FEATURING REAL ESTATE RENTALS, AND REAL ESTATE MARKETING SERVICES, NAMELY PROMOTING FOR SALE THE TIME-SHARE SERVICES OF OTHERS BY ONLINE ADVERTISING AND ADVERTISING IN OTHER PRINT AND ELECTRONIC MEDIA (U.S. CLS. 100, 101 AND 102).

**CLASS 36—INSURANCE AND FINANCIAL**

FOR FINANCIAL EXCHANGE; LEASING OF REAL PROPERTY; LEASING OF APARTMENTS; OPERATING MARKETPLACES FOR BUYERS AND SELLERS OF REAL ESTATE; REAL ESTATE EQUITY SHARING, NAMELY MANAGING AND ARRANGING FOR CO-OWNERSHIP OF REAL ESTATE; REAL ESTATE INVESTMENT; REAL ESTATE LISTING; REAL ESTATE MANAGEMENT; REAL ESTATE SYNDICATION; REAL ESTATE TIMESHARING; RENTAL OF APARTMENTS; RENTAL OF HOMES; RENTAL OF CABINS; VACATION REAL ESTATE TIME SHARING; YACHT BROKERAGE; APARTMENT AND HOUSING LOCATING SERVICES FOR OTHERS; REAL ESTATE PROCUREMENT FOR OTHERS; REAL ESTATE ACQUISITION SERVICES; AND REAL ESTATE SERVICES NAMELY RENTALS AND LEASING OF VACATION TIMESHARE PROPERTIES (U.S. CLS. 100, 101 AND 102).

**CLASS 43—HOTEL AND RESTAURANT SERVICES**

FOR TRAVEL AGENCY SERVICES, NAMELY BOOKING OF LODGING ACCOMMODATIONS, MAKING RESERVATIONS AND BOOKING TEMPORARY LODGING FOR OTHERS, MAKING RESERVATIONS AND BOOKINGS FOR RESTAURANTS AND MEALS, ARRANGING TEMPORARY HOUSING ACCOMMODATIONS, AND MAKING HOTEL RESERVATIONS FOR OTHERS; RENTAL OF ROOMS; RESORT LODGING SERVICES AND RESORT HOTELS (U.S. CLS. 100 AND 101).

ODESSA BIBBINS, EXAMINING ATTORNEY

SN 78-252,444. BODY OF CONFIDENCE, LEWISVILLE, TX.  
FILED 5-21-2003.

**Body of CONFIDENCE**

**CLASS 3—COSMETICS AND CLEANING PREPARATIONS**

FOR HEALTH PRODUCTS, NAMELY, ANTI-AGING FACE CREAMS AND POWDERS; SKIN CARE PRODUCTS, NAMELY, NON-MEDICATED SKIN SERUM (U.S. CLS. 1, 4, 6, 50, 51 AND 52).

FIRST USE 7-25-2000; IN COMMERCE 7-25-2000.

**CLASS 5—PHARMACEUTICALS**

FOR NUTRITIONAL PRODUCTS, NAMELY, DIETARY SUPPLEMENTS, NUTRITIONAL SUPPLEMENTS, NUTRITIONALLY FORTIFIED DRINKS, VITAMIN SUPPLEMENTS (U.S. CLS. 6, 18, 44, 46, 51 AND 52).

FIRST USE 7-25-2000; IN COMMERCE 7-25-2000.  
CAROLYN CATALDO, EXAMINING ATTORNEY

SN 78-258,209. VAIS, VALERIE, AKA (MONIQUE, CATHERINE, LAURENCE, SYLVIE), PARIS, FRANCE, FILED 6-4-2003.

**KWYE**

OWNER OF FRANCE REG. NO. 023189350, DATED 10-17-2002, EXPIRES 10-17-2012.

**CLASS 30—STAPLE FOODS**

FOR TAKE AWAY AND FAST FOOD, NAMELY, SANDWICHES, PIZZAS, HAMBURGER SANDWICHES, BREAD, CAKES, PASTRIES, ICE CREAM, PANCAKES, BISCUITS, CHOCOLATE, AND SWEETS, NAMELY, CANDIES OF COOKED SUGAR, GUM BALLS, CARAMELS, CHEWING GUMS, NOUGATS, PASTILLES, ALMOND PASTE, AND LIQUORICES (U.S. CL. 46).

**CLASS 43—HOTEL AND RESTAURANT SERVICES**

FOR RESTAURANTS, SELF SERVICE RESTAURANTS, AND CATERING (U.S. CLS. 100 AND 101).  
WILLIAM BRECKENFELD, EXAMINING ATTORNEY

SN 78-260,068. JOHNS MANVILLE, DENVER, CO. FILED 6-9-2003.

**THE PEAK ADVANTAGE**

**CLASS 35—ADVERTISING AND BUSINESS**

FOR INCENTIVE AWARD PROGRAMS FOR ROOFING CONTRACTORS TO PROMOTE THE SALE OF ROOFING PRODUCTS AND ON-THE-JOB SAFETY; AND SALES LEADS IN THE NATURE OF REFERRALS TO ROOFING CONTRACTORS IN THE FIELD OF ROOFING SERVICES (U.S. CLS. 100, 101 AND 102).

**CLASS 41—EDUCATION AND ENTERTAINMENT**

FOR EDUCATIONAL SERVICES, NAMELY, PROVIDING TRAINING PROGRAMS AND SEMINARS ON THE SUBJECT OF ROOF BUILDING, PRODUCT INSTALLATION, AND SAFETY; AND EDUCATIONAL SERVICES, NAMELY, PROVIDING INCENTIVES TO ROOFING CONTRACTORS TO DEMONSTRATE EXCELLENCE IN THE FIELD OF ROOFING (U.S. CLS. 100, 101 AND 107).

**CLASS 42—SCIENTIFIC, COMPUTER AND LEGAL SERVICES**

FOR TESTING, ANALYSIS, AND EVALUATION OF THE SERVICES OF ROOFING CONTRACTORS (U.S. CLS. 100 AND 101).

ROBERT COGGINS, EXAMINING ATTORNEY

SN 78-260,344. RONALD BLUE & CO., ATLANTA, GA.  
FILED 6-10-2003.

**STEWARDSHIP COACH**

NO CLAIM IS MADE TO THE EXCLUSIVE RIGHT TO USE "STEWARDSHIP", APART FROM THE MARK AS SHOWN.

**CLASS 35—ADVERTISING AND BUSINESS**

FOR TAX CONSULTATION SERVICES (U.S. CLS. 100, 101 AND 102).

**CLASS 36—INSURANCE AND FINANCIAL**

FOR FINANCIAL PLANNING AND CONSULTATION SERVICES; ESTATE PLANNING AND CONSULTATION SERVICES; INVESTMENT CONSULTATION SERVICES; AND CONSULTATION IN THE FIELD OF MONETARY CHARITABLE GIVING (U.S. CLS. 100, 101 AND 102).  
STEVEN R. FINE, EXAMINING ATTORNEY

SN 78-261,487. WESTINGHOUSE BRAKE AND SIGNAL HOLDINGS LIMITED, LONDON, UNITED KINGDOM,  
FILED 6-12-2003.

 **FUTUR**

PRIORITY CLAIMED UNDER SEC. 44(D) ON ERPN CMNTY TM OFC APPLICATION NO. 003006616, FILED 1-13-2003.

**CLASS 9—ELECTRICAL AND SCIENTIFIC APPARATUS**

FOR ELECTRIC AND ELECTRONIC MANAGEMENT, CONTROL, SUPERVISION OR DISPLAY APPARATUS IN THE NATURE OF INTERLOCKING APPARATUS, COMMUNICATION APPARATUS AND APPARATUS FOR TRAIN DETECTION AND MOVEMENT CONTROL, STATUS DATA COLLECTION, PROVIDING ROUTE INFORMATION, TRAFFIC MANAGEMENT, USER INTERFACING, ON-BOARD CONTROL AND COMMUNICATION, ALL FOR USE IN RAILWAY TRANSPORT SYSTEMS; COMPUTER SOFTWARE AND COMPUTER PROGRAMS USED FOR INTERLOCKING APPARATUS, COMMUNICATION APPARATUS AND APPARATUS FOR TRAIN DETECTION AND MOVEMENT CONTROL, STATUS DATA COLLECTION, PROVIDING ROUTE INFORMATION, TRAFFIC MANAGEMENT, USER INTERFACING, ON-BOARD CONTROL AND COMMUNICATION, ALL FOR USE IN RAILWAY TRANSPORT SYSTEMS (U.S. CLS. 21, 23, 26, 36 AND 38).

SN 78-262,931. AKTSIONERNE TOVARYSTVO ZAKRYTOGO TYPU "KHARKIVSKA BISKVITNA FABRYKA", KHARKIV, UKRAINE, FILED 6-16-2003.



NO CLAIM IS MADE TO THE EXCLUSIVE RIGHT TO USE "BISVIT SHOKOLD", APART FROM THE MARK AS SHOWN.

THE COLOR(S) ORANGE AND YELLOW IS/ARE CLAIMED AS A FEATURE OF THE MARK.

THE COLOR ORANGE APPEARS AS THE BACKGROUND COLOR BETWEEN THE INNER AND OUTER OVAL. THE COLOR YELLOW APPEARS AS THE COLOR OF THE RIM OF THE OUTER CIRCLE, THE INNER CIRCLE, THE LETTERING AND THE DESIGN ELEMENT IN THE CENTER OF THE DESIGN.

THE FOREIGN WORDING IN THE MARK TRANSLATES INTO ENGLISH AS "CHOCOLATE BISCUIT".

THE NON-LATIN CHARACTERS IN THE MARK TRANSLITERATE TO BISVIT SHOKOLD AND THIS MEANS CHOCOLATE BISCUIT IN ENGLISH.

**CLASS 37—CONSTRUCTION AND REPAIR**

FOR INSTALLATION, MAINTENANCE, AND REPAIR SERVICES, ALL RELATING TO ELECTRIC AND ELECTRONIC MANAGEMENT, CONTROL, SUPERVISION OR DISPLAY APPARATUS IN THE NATURE OF INTERLOCKING APPARATUS, COMMUNICATION APPARATUS AND APPARATUS FOR TRAIN DETECTION AND MOVEMENT CONTROL, STATUS DATA COLLECTION, PROVIDING ROUTE INFORMATION, TRAFFIC MANAGEMENT, USER INTERFACING, ON-BOARD CONTROL AND COMMUNICATION, ALL FOR USE IN RAILWAY TRANSPORT SYSTEMS (U.S. CLS. 100, 103 AND 106).

**CLASS 29—MEATS AND PROCESSED FOODS**

FOR MARMALADE (U.S. CL. 46).

**CLASS 30—STAPLE FOODS**

FOR BISCUITS, WAFFLES, CARAMELS, NON-MEDICATED LOZENGES, CONFECTIONARY, CONFECTIONARY FOR DECORATING CHRISTMAS TREES, CANDY, PEPPERMINT CANDY, MACAROONS, ALMOND CONFECTIONARY, COOKIES, PASTRIES, EDIBLE DECORATIONS FOR CAKES, GINGERBREAD, MALT BISCUITS, RUSKS, MARSHMALLOWS, PETIT-BEURRE BISCUITS, CAKES, PETIT FOURS, CRACKERS, TARTS, HALVAH, SWEETMEATS, SUGAR, CHOCOLATE AND PASTRIES (U.S. CL. 46).

MICHAEL WEBSTER, EXAMINING ATTORNEY

**CLASS 42—SCIENTIFIC, COMPUTER AND LEGAL SERVICES**

FOR DESIGN FOR OTHERS, CONSULTATION, PROJECT MANAGEMENT SERVICES, ALL RELATING TO ELECTRIC AND ELECTRONIC MANAGEMENT, CONTROL, SUPERVISION OR DISPLAY APPARATUS IN THE NATURE OF INTERLOCKING APPARATUS, COMMUNICATION APPARATUS AND APPARATUS FOR TRAIN DETECTION AND MOVEMENT CONTROL, STATUS DATA COLLECTION, PROVIDING ROUTE INFORMATION, TRAFFIC MANAGEMENT, USER INTERFACING, ON-BOARD CONTROL AND COMMUNICATION, ALL FOR USE IN RAILWAY TRANSPORT SYSTEMS (U.S. CLS. 100 AND 101).

JULIA HARDY COFIELD, EXAMINING ATTORNEY

SN 78-263,823. THE JIM HARRIS GROUP, INC, PENSACOLA, FL. FILED 6-18-2003.

**ACHIEVE GREAT RESULTS****CLASS 9—ELECTRICAL AND SCIENTIFIC APPARATUS**

FOR PRERECORDED AUDIO AND VIDEO CASSETTES AND CDS/DVDS FEATURING INFORMATION ON BUSINESS MANAGEMENT, LEADERSHIP, EMPLOYEE AND PERSONAL DEVELOPMENT (U.S. CLS. 21, 23, 26, 36 AND 38).

**CLASS 16—PAPER GOODS AND PRINTED MATTER**

FOR EDUCATIONAL BOOKS IN THE FIELD OF BUSINESS MANAGEMENT, LEADERSHIP, EMPLOYEE, AND PERSONAL DEVELOPMENT (U.S. CLS. 2, 5, 22, 23, 29, 37, 38 AND 50).

**CLASS 35—ADVERTISING AND BUSINESS**

FOR GENERAL BUSINESS CONSULTING (U.S. CLS. 100, 101 AND 102).

**CLASS 41—EDUCATION AND ENTERTAINMENT**

FOR CONDUCTING EDUCATIONAL SEMINARS AND WORKSHOPS ON BUSINESS MANAGEMENT, LEADERSHIP, EMPLOYEE AND PERSONAL DEVELOPMENT (U.S. CLS. 100, 101 AND 107).

JOHN LINCOSKI, EXAMINING ATTORNEY

**CLASS 37—CONSTRUCTION AND REPAIR**

FOR REAL ESTATE DEVELOPMENT AND CUSTOM CONSTRUCTION OF HOMES. (U.S. CLS. 100, 103 AND 106).

CHERYL STEPLIGHT, EXAMINING ATTORNEY

SN 78-270,020. VENUS GOLF LLC, LA QUINTA, CA. FILED 7-2-2003.

SN 78-268,766. NEWMAN, MATTHEW, NEW ROADS, LA. FILED 6-30-2003.

**EVOLVED HARVEST****CLASS 1—CHEMICALS**

FOR PLANT FOOD AND FERTILIZERS DESIGNED TO PRODUCE FORAGE FOR WILDLIFE AND DOMESTIC ANIMALS (U.S. CLS. 1, 5, 6, 10, 26 AND 46).

**CLASS 31—NATURAL AGRICULTURAL PRODUCTS**

FOR PLANT SEEDS DESIGNED TO PRODUCE FORAGE FOR WILDLIFE AND DOMESTIC ANIMALS (U.S. CLS. 1 AND 46).

VIVIAN MICZNIK FIRST, EXAMINING ATTORNEY

**CLASS 25—CLOTHING**

FOR CLOTHING, NAMELY, CAPS, SHIRTS, SWEATSHIRTS, AND VISORS (U.S. CLS. 22 AND 39).

FIRST USE 4-0-2003; IN COMMERCE 4-0-2003.

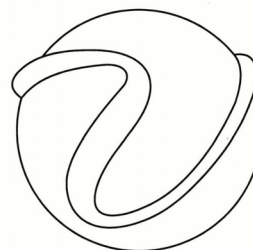

SN 78-269,714. BILTMORE FARMS, INC., ASHEVILLE, NC. FILED 7-2-2003.

**BILTMORE VALE****CLASS 36—INSURANCE AND FINANCIAL**

FOR REAL ESTATE BROKERAGE. (U.S. CLS. 100, 101 AND 102).

**CLASS 37—CONSTRUCTION AND REPAIR**

FOR REAL ESTATE DEVELOPMENT AND CUSTOM CONSTRUCTION OF HOMES. (U.S. CLS. 100, 103 AND 106).

CHERYL STEPLIGHT, EXAMINING ATTORNEY

**CLASS 41—EDUCATION AND ENTERTAINMENT**

FOR GOLF INSTRUCTIONAL SCHOOLS, CLINICS AND MOTIVATIONAL SPEAKING ENGAGEMENTS (U.S. CLS. 100, 101 AND 107).

FIRST USE 5-20-2002; IN COMMERCE 5-20-2002.

MELVIN AXILBUND, EXAMINING ATTORNEY

SN 78-273,199. JOLY, PIERRE, PARIS, FRANCE, FILED 7-11-2003.

**SOFT RENT**

PRIORITY CLAIMED UNDER SEC. 44(D) ON FRANCE APPLICATION NO. 033209679, FILED 2-14-2003, REG. NO. 033209679, DATED 2-14-2003, EXPIRES 2-14-2013.

NO CLAIM IS MADE TO THE EXCLUSIVE RIGHT TO USE RENT IN INTERNATIONAL CLASS 41 ONLY, APART FROM THE MARK AS SHOWN.

SN 78-269,718. BILTMORE FARMS, INC., ASHEVILLE, NC. FILED 7-2-2003.

**THE RAMBLE AT BILTMORE FOREST****CLASS 36—INSURANCE AND FINANCIAL**

FOR REAL ESTATE BROKERAGE. (U.S. CLS. 100, 101 AND 102).

**CLASS 28—TOYS AND SPORTING GOODS**

FOR ICESKATES (U.S. CLS. 22, 23, 38 AND 50).

**CLASS 41—EDUCATION AND ENTERTAINMENT**

FOR RENTAL OF ICESKATES (U.S. CLS. 100, 101 AND 107).

BARBARA GAYNOR, EXAMINING ATTORNEY

SN 78-275,487. LUXURY LIVING, EAST HAMPTON, NY.  
FILED 7-17-2003.



NO CLAIM IS MADE TO THE EXCLUSIVE RIGHT TO USE "LUXURY LIVING" AS TO INTERNATIONAL CLASS 36, APART FROM THE MARK AS SHOWN.

THE STIPPLING IN THE DRAWING IS FOR SHADING PURPOSES, AND IS NOT A FEATURE OF THE MARK.

THE MARK CONSISTS OF TWO INITIALS OF THE COMPANY NAME.

#### CLASS 35—ADVERTISING AND BUSINESS

FOR RETAIL STORE SERVICES, AVAILABLE THROUGH COMPUTER COMMUNICATIONS AND INTERACTIVE TELEVISION; FEATURING THE FOLLOWING PRODUCTS— HOME FURNISHINGS, NAMELY, ARMCHAIRS, ARMOIRES, ART PICTURES, ART PRINTS, KITCHEN; NAMELY, APPLIANCES, OUTDOOR GRILLS, WARMING DRAWERS, OVENS, BEVERAGE DISPENSERS, MICROWAVES, REFRIGERATORS, FREEZERS, COFFEE SYSTEMS, WASHERS, DRYERS, DISHWASHERS, RANGES, STOVETOPS, WINE COOLERS, HOODS, DOUGH MAKERS, ESPRESSO, ICE CREAM MAKERS, JUICERS, COFFEE GRINDERS, BLENDERS, WATER KETTLES, TOASTERS, FOOD PROCESSORS, CONVECTION OVENS, MIXERS, BABY CARRIAGES, BARBEQUE GRILLS, BARBEQUE MITTS, BATHRUBS, BEVERAGE WARE, BIDETS, BIRD FEEDERS, BIRD HOUSES, BOOKCASES, CABINETS, CANDLE HOLDERS NOT OF PRECIOUS METAL, CANDLE HOLDERS OF PRECIOUS METAL, CANDLE LANTERNS, CHANDELIERS, CLOCKS, COFFEE PORTS NOT OF PRECIOUS METAL, COFFEE POTS OF PRECIOUS METAL, COFFEE ROASTING OVENS, INSERTS, COOLERS FOR WINE DISHWARE NAMELY, CHINA, PLATES, SERVING TRAYS, COLUMNS, DOOR CASINGS; NOT OF METAL DOOR CASINGS, OF METAL DOOR FRAMES, NOT OF METAL DOOR FRAMES, OF METAL DOOR HARDWARE, NAMELY, HOOKS, HINGES, PULLS, RINGS, KNOBS, BOLTS, KNOCKERS, PLATES, DEADBOLTS, LEVERS, DOOR MATS OF METAL, DOOR MATS NOT OF METAL, RUGS, WALL PAPER, FANS ELECTRIC CEILING FLOORS, NAMELY, WOOD, STONE, FURNITURE CHESTS, FURNITURE DESKS, FURNITURE CONSOLE TABLES, FURNITURE DINING TABLES, FURNITURE SOFAS, FURNITURE CHAIRS, FURNITURE DRESSERS, FURNITURE BUFFETS, FURNITURE SERVERS, FURNITURE BOOKCASES, FURNITURE LINEN PRESS, FURNITURE HUTCHES, FURNITURE WALL RACKS, GARDEN STATUES, GARDEN FOUNTAINS; GARDEN ARBORS, GARDEN POTS, GARDEN PLANTERS, GARDEN PLANTS, GARDEN CUPOLAS, GARDEN THERMOMETERS, GARDEN URNS, GARDEN UMBRELLAS, GARDEN WEATHERVANES, GARDEN LIGHTING, GARDEN BENCHES, GARDEN TABLES, GARDEN BIRDBATHS, GARDEN BIRDHOUSES, GARDEN BIRDFEEDERS, GAS GRILLS, GAS LAMPS, GAS RANGES, GAS STOVES, HAMMOCKS, HAND HELD SHOWER HEADS, HAND HELD SHOWERS, HOT TUBS, HOUSEHOLD LINEN, HOUSEHOLD UTENSILS NAMELY SALAD SERVERS, WHISKERS, LADLES, BARBEQUE SETS, ICE CREAM MAKERS, JUTE, KITCHEN KNIFE BOARDS, KNIVES, NAMELY CHEFS, KITCHEN, BUTCHER, PARING, CARVING, KNOBS, LAMPS, FINIALS, LAMP SHADES, LAMPS, TABLE, FLOOR HANGING, FENCE, OUTDOOR, LEATHER BOOKS, LEATHER ACCESSORY BOXES, CASHMERE TROWS, CASHMERE, MAGAZINE RACKS, METAL COOKING PANS, METAL DOOR BOLTS, METALS DOOR FRAMES, METAL DOOR KICK PLATES, METAL DOOR LATCHES, METAL DOOR-

KNOCKERS, METAL FENCE PANELS, METAL FENCE POSTS, METAL GARAGE DOORS, MEAL GARDEN STAKES, METAL GARMENT HOOKS, METAL HOUSE NUMBERS, METAL KNOBS, METAL KNOCKERS, METAL LETTER SHUTTERS, METAL WINDOWS, MIRRORS, FURNITURE, MOLDINGS, NAPKIN HOLDERS NOT OF PRECIOUS METAL, NAPKIN RINGS OF PRECIOUS METAL, NIGHTSTANDS, NON-METAL FENCE PANELS NON-METAL GARDEN STAKES, NON-METAL FENCE POSTS, NON-METAL GATES AND FENCES, NON-METAL ROOFING NON-METAL SHINGLES, OFFICE FURNITURE PARING KNIVES, PILLOW CASES, PILLOW COVERS, PILLOW SHAMS, RUGS, NAMELY, SEAGRASS, SISAL, WOOL, CHENILLE, COTTON JUTES, SERVING LADLES SERVING PLATTERS OF PRECIOUS METAL SERVING PLATTERS NOT OF PRECIOUS METAL SERVING SPOONS SERVING TONGS, SHOWER CADDIES, SHOWER DOORS, SHOWER ENCLOSURES, SILVER STERLING NAMELY SERVING TRAYS, CANDLABRAS, SILVERWARE SOAP DISHES, SOAP DISPENSERS SOAP HOLDERS SPOONS, STORAGE CONTAINERS MADE OF WICKER, TABLECLOTHS, NAPKINS, PLACEMATS, COASTERS, TEAK KETTLES TOILETS, TREK LIGHTING, WINE BUCKETS, WINE RACKS MADE OF METAL, WINE RACKS NOT MADE OF METAL (U.S. CLS. 100, 101 AND 102).

FIRST USE 4-1-1996; IN COMMERCE 10-26-2002.

#### CLASS 36—INSURANCE AND FINANCIAL

FOR REAL ESTATE BROKERAGE (U.S. CLS. 100, 101 AND 102).

FIRST USE 4-1-1996; IN COMMERCE 2-11-1997.

SUSAN LESLIE DUBOIS, EXAMINING ATTORNEY

SN 78-276,914. FREMANTLEMEDIA NORTH AMERICA, INC., SANTA MONICA, CA. FILED 7-21-2003.



#### CLASS 9—ELECTRICAL AND SCIENTIFIC APPARATUS

FOR PRE-RECORDED AUDIO AND VIDEO CASSETTES, COMPACT DISCS, VIDEO DISCS, RECORDS AND CD-ROMS, ALL OF THE FOREGOING FEATURING REALITY SHOWS; VIDEO GAME MACHINE THAT IS ADAPTED OR INTENDED FOR USE WITH A TELEVISION, MONITOR OR SOME OTHER FORM OF DISPLAY APPARATUS WHICH IS SEPARATE FROM THE VIDEO GAME MACHINE; COMPUTER GAME EQUIPMENT CONTAINING MEMORY DEVICES, NAMELY, DISCS; INTERACTIVE VIDEO GAME PROGRAMS; ELECTRONICALLY OR MAGNETICALLY ACTIVATED PRE-PAID TELEPHONE DEBIT CARDS; MAGNETS; INTERACTIVE COMPUTER GAME SOFTWARE DOWNLOADED FROM A GLOBAL COMPUTER NETWORK; EYEGASSES AND SUNGLASSES; GAMING MACHINES; GAMING EQUIPMENT, NAMELY, SLOT MACHINES WITH OR WITHOUT VIDEO OUTPUT; AUTOMATIC TELEPHONE DIALERS; COVERS FOR TELEPHONE RECEIVERS NOT MADE OF PAPER; TELEPHONE RECEIVERS; TELEPHONE ANSWERING MACHINES; TELEPHONE APPARATUS, NAMELY INTERCOMS (U.S. CLS. 21, 23, 26, 36 AND 38).

**CLASS 16—PAPER GOODS AND PRINTED MATTER**

FOR POSTERS, CALENDARS, NOTEBOOKS, BINDERS, DAILY ORGANIZERS, MEMO PADS, STICKERS, COMIC BOOKS, WRITING PAPER, ENVELOPES, GREETING CARDS, PAPER COASTERS, PAPER MATS, NEWSPAPERS FOR GENERAL CIRCULATION, BOOKS AND MAGAZINES IN THE FIELD OF REALITY SHOWS, PHOTOGRAPHS, POSTCARDS, TRADING CARDS, CARDBOARD STAND-UP CUTOUTS FEATURING PHOTOGRAPHS OR ARTWORK, PREPAID PHONE DEBIT CARDS WITHOUT MAGNETIC CODING, TRADING CARD MILK BOTTLE CAPS AND PERSONAL CHECKS (U.S. CLS. 2, 5, 22, 23, 29, 37, 38 AND 50).

**CLASS 28—TOYS AND SPORTING GOODS**

FOR TARGET GAMES, KITES, TOY ACTION FIGURES, DISC TOSS TOYS, BOWS AND ARROWS, TOY BALLS, DOLLS, DOLL PLAYSETS, PLUSH TOYS, TOY VEHICLES, TOY TRUCKS, TOY BUCKET AND SHOVEL SETS, ROLLER SKATES, TOY MODEL HOBBYCRAFT KITS, TOY ROCKETTS, TOY GUNS, TOY HOLSTERS, MUSICAL TOYS, JIGSAW PUZZLES, BADMINTON SETS, BUBBLE MAKING WANDS AND SOLUTION SETS, TOY FIGURINES, TOY BANKS, PUPPETS, TOY BALLOONS, YO-YOS, SKATEBOARDS, TOY SCOOTERS, FACE MASKS, STAND-ALONE VIDEO GAME MACHINES, LCD GAME MACHINES, HAND-HELD UNIT FOR PLAYING ELECTRONIC GAMES, BUT SPECIFICALLY EXCLUDING DICE GAMES AND COMPUTER SOFTWARE GAMES (U.S. CLS. 22, 23, 38 AND 50).

**CLASS 35—ADVERTISING AND BUSINESS**

FOR PUBLIC OPINION POLLING SERVICES IN THE FIELD OF RELATIONSHIPS; PROVIDING PUBLIC OPINION POLLING IN THE FIELD OF RELATIONSHIPS (U.S. CLS. 100, 101 AND 102).

FIRST USE 7-9-2003; IN COMMERCE 7-9-2003.

**CLASS 41—EDUCATION AND ENTERTAINMENT**

FOR ENTERTAINMENT SERVICES IN THE NATURE OF A CONTINUING TELEVISION REALITY PROGRAM (U.S. CLS. 100, 101 AND 107).

FIRST USE 7-9-2003; IN COMMERCE 7-9-2003.  
DAVID H. STINE, EXAMINING ATTORNEY

**CLASS 41—EDUCATION AND ENTERTAINMENT**

FOR PROVIDING SEMINARS AND ONLINE TRAINING FOR FIRST RESPONDERS (U.S. CLS. 100, 101 AND 107).

FIRST USE 5-15-2003; IN COMMERCE 6-30-2003.  
JANICE L. MCMORROW, EXAMINING ATTORNEY

SN 78-277,476. EDUCATION DIRECT, LLC, LOS ANGELES, CA. FILED 7-22-2003.

**GET AHEAD MATH**

NO CLAIM IS MADE TO THE EXCLUSIVE RIGHT TO USE MATH, APART FROM THE MARK AS SHOWN.

**CLASS 9—ELECTRICAL AND SCIENTIFIC APPARATUS**

FOR COMPUTER SOFTWARE, NAMELY PROGRAMS DESIGNED TO ASSIST ELEMENTARY, MIDDLE AND HIGH SCHOOL STUDENTS STUDY ARITHMETIC, MATHEMATICS, GEOMETRY AND RELATED SUBJECTS, AND TO ASSIST PARENTS AND TEACHERS IN TEACHING THEIR RESPECTIVE CHILDREN AND STUDENTS (U.S. CLS. 21, 23, 26, 36 AND 38).

**CLASS 16—PAPER GOODS AND PRINTED MATTER**

FOR EDUCATIONAL BOOKS, NAMELY TEXTBOOKS, WORK BOOKS, INSTRUCTIONAL MANUALS FOR THE EDUCATIONAL SOFTWARE, STUDY AIDS, FLASH CARDS, PRACTICE TESTS AND TEXTBOOK SUPPLEMENTS (U.S. CLS. 2, 5, 22, 23, 29, 37, 38 AND 50).

**CLASS 41—EDUCATION AND ENTERTAINMENT**

FOR EDUCATIONAL SERVICES, NAMELY PROVIDING EDUCATIONAL SERVICES RELATED TO PRIMARY, MIDDLE AND HIGH SCHOOL MATHEMATICS THROUGH COMPUTERIZED ONLINE NETWORK AND BY PERSONAL TEACHER OR TUTOR INSTRUCTION ONLINE OR THROUGH AUTOMATED TELEPHONE CALL CENTERS; PROVIDING TEACHER TRAINING RELATED TO PRIMARY, MIDDLE AND HIGH SCHOOL MATHEMATICS THROUGH COMPUTERIZED ONLINE NETWORK, SEMINARS AND WORKSHOPS (U.S. CLS. 100, 101 AND 107).

G. T. GLYNN, EXAMINING ATTORNEY

SN 78-277,104. PRIMEDIA WORKPLACE LEARNING, INC., CARROLLTON, TX. FILED 7-22-2003.



**Homeland One**

First Responder Network

NO CLAIM IS MADE TO THE EXCLUSIVE RIGHT TO USE HOMELAND AND FIRST RESPONDER NETWORK, APART FROM THE MARK AS SHOWN.

THE MARK CONSISTS OF THE TERM "HOMELAND ONE FIRST RESPONDERS NETWORK" ABOVE WHICH IS AN IMAGE OF A STAR.

**CLASS 9—ELECTRICAL AND SCIENTIFIC APPARATUS**

FOR VIDEOS AND CD ROMS CONTAINING INFORMATION FOR FIRST RESPONDERS (U.S. CLS. 21, 23, 26, 36 AND 38).

FIRST USE 5-15-2003; IN COMMERCE 6-30-2003.

SN 78-278,378. SBC KNOWLEDGE VENTURES, L.P., AUSTIN, TX. FILED 7-24-2003.

**FREEDOMLINK**

OWNER OF U.S. REG. NOS. 1,122,266 AND 1,633,862.

**CLASS 9—ELECTRICAL AND SCIENTIFIC APPARATUS**

FOR TELECOMMUNICATIONS PRODUCTS, NAMELY, GATEWAYS FOR USE IN WIRELESS COMMUNICATIONS SYSTEMS (U.S. CLS. 21, 23, 26, 36 AND 38).

**CLASS 38—COMMUNICATION**

FOR TELECOMMUNICATIONS SERVICES, NAMELY, WIRELESS ELECTRONIC TRANSMISSION OF VOICE, MESSAGES, DATA AND INFORMATION; AND HIGH-SPEED INTERNET ACCESS SERVICES (U.S. CLS. 100, 101 AND 104).

KATHY DE JONGE, EXAMINING ATTORNEY

SN 78-280,897. ROBERTSON, JOHN, W, WEATHERFORD, OK. FILED 7-30-2003.

**TUNES & TINT****CLASS 35—ADVERTISING AND BUSINESS**

FOR RETAIL STORE FEATURING CAR STEREOs, CAR AMPLIFIERS, CAR VIDEO SYSTEM, VEHICLE NAVIGATION SYSTEMS, RADAR DETECTORS, CELLULAR PHONES, CELLULAR PHONE ACCESSORIES, HOME STEREOs, HOME AMPLIFIERS, HOME THEATRE SYSTEMS (U.S. CLS. 100, 101 AND 102).

FIRST USE 8-15-1991; IN COMMERCE 8-15-1991.

**CLASS 37—CONSTRUCTION AND REPAIR**

FOR INSTALLATION OF CAR STEREOs, CAR AMPLIFIERS, CAR VIDEO SYSTEM, VEHICLE NAVIGATION SYSTEMS, RADAR DETECTORS, CELLULAR PHONES, CELLULAR PHONE ACCESSORIES, HOME STEREOs, HOME AMPLIFIERS, HOME THEATRE SYSTEMS (U.S. CLS. 100, 103 AND 106).

FIRST USE 8-15-1991; IN COMMERCE 8-15-1991.

**CLASS 40—MATERIAL TREATMENT**

FOR AUTOMOTIVE, COMMERCIAL AND RESIDENTIAL GLASS TINTING (U.S. CLS. 100, 103 AND 106).

FIRST USE 8-15-1991; IN COMMERCE 8-15-1991.

LINDA E. BLOHM, EXAMINING ATTORNEY

SN 78-281,846. OB HOLDING, PARIS, FRANCE, FILED 8-1-2003.

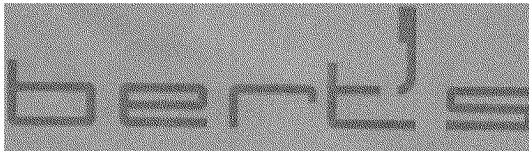

OWNER OF FRANCE REG. NO. 013123915, DATED 9-27-2001, EXPIRES 9-27-2011.

THE COLOR GRAY IS CLAIMED AS A DISTINCTIVE FEATURE OF THE MARK.

THE COLOR GRAY APPEARS IN THE BACKGROUND OF THE MARK, AND THE TRADEMARK IS WRITTEN IN GREEN LETTERS ON THE GRAY BACKGROUND.

**CLASS 41—EDUCATION AND ENTERTAINMENT**

FOR CONDUCTING ENTERTAINMENT EXHIBITIONS IN THE NATURE OF FASHION SHOWS, SHOOTING OF FILMS, OF VIDEO CLIPS, TELEVISION BROADCASTING, OF COMMERCIALS, ADVERTISEMENTS AND ADVERTISING SPOTS; ENTERTAINMENT, NAMELY, LIVE MUSIC CONCERTS; ELECTRONIC PUBLISHING SERVICES, NAMELY, PUBLICATION OF TEXT AND GRAPHIC WORKS OF OTHERS IN BOOKS, VIDEO CASSETTES, COMPACT DISCS, DIGITAL VERSATILE DISCS, ONLINE, FIELD OF COOKING (U.S. CLS. 100, 101 AND 107).

**CLASS 43—HOTEL AND RESTAURANT SERVICES**

FOR ARENA SERVICES, NAMELY PROVIDING FACILITIES FOR SPORTS, CONCERTS, CONVENTIONS AND EXHIBITIONS; PROVIDING BANQUET AND SOCIAL FUNCTION FACILITIES FOR SPECIAL OCCASIONS; RESTAURANTS, CAFE AND BAR SERVICES; ARRANGING TEMPORARY HOUSING ACCOMMODATIONS; MAKING HOTEL RESERVATIONS FOR OTHERS; CONSULTING SERVICES IN THE FIELD OF FILM LOCATIONS; MAKING HOTEL RESERVATIONS FOR OTHERS (U.S. CLS. 100 AND 101).

SUSAN LESLIE DUBOIS, EXAMINING ATTORNEY

SN 78-285,215. TOYOTA JIDOSHA KABUSHIKI KAISHA, TA TOYOTA MOTOR CORPORATION, TOYOTA-SHI, JAPAN, FILED 8-8-2003.



OWNER OF U.S. REG. NO. 2,762,080 AND OTHERS. THE ENGLISH TRANSLATION OF THE JAPANESE TERM TOYOTA IN THE MARK IS RICHFIELD.

**CLASS 35—ADVERTISING AND BUSINESS**

FOR PROVIDING INFORMATION ON THE ACQUISITION OF VEHICLES EQUIPPED TO ACCOMMODATE HANDICAPPED PERSONS AND EQUIPMENT FOR THOSE VEHICLES (U.S. CLS. 100, 101 AND 102).

FIRST USE 10-1-2001; IN COMMERCE 10-1-2001.

**CLASS 36—INSURANCE AND FINANCIAL**

FOR PROVIDING FINANCING FOR THE ACQUISITION BY PURCHASE OR LEASE OF VEHICLES EQUIPPED TO ACCOMMODATE HANDICAPPED PERSONS AND EQUIPMENT FOR THOSE VEHICLES (U.S. CLS. 100, 101 AND 102).

FIRST USE 10-1-2001; IN COMMERCE 10-1-2001.

**CLASS 37—CONSTRUCTION AND REPAIR**

FOR PROVIDING INFORMATION ON THE MODIFICATION OF VEHICLES EQUIPPED TO ACCOMMODATE HANDICAPPED PERSONS AND EQUIPMENT FOR THOSE VEHICLES (U.S. CLS. 100, 103 AND 106).

FIRST USE 10-1-2001; IN COMMERCE 10-1-2001.

**CLASS 39—TRANSPORTATION AND STORAGE**

FOR PROVIDING INFORMATION ON THE USE OF VEHICLES EQUIPPED TO ACCOMMODATE HANDICAPPED PERSONS AND EQUIPMENT FOR THOSE VEHICLES (U.S. CLS. 100 AND 105).

FIRST USE 10-1-2001; IN COMMERCE 10-1-2001.

**CLASS 41—EDUCATION AND ENTERTAINMENT**

FOR PROVIDING INFORMATION ON SOURCES OF TRAINING FOR USING VEHICLES EQUIPPED TO ACCOMMODATE HANDICAPPED PERSONS (U.S. CLS. 100, 101 AND 107).

FIRST USE 10-1-2001; IN COMMERCE 10-1-2001.



**CLASS 44—MEDICAL, BEAUTY AND AGRICULTURAL SERVICES**

FOR PROVIDING INFORMATION ON ASSESSMENT OF HANDICAPPED PERSONS FOR THE USE OF VEHICLES AND EQUIPMENT EQUIPPED FOR USE BY HANDICAPPED PERSONS (U.S. CLS. 100 AND 101).

FIRST USE 10-1-2001; IN COMMERCE 10-1-2001.  
CHRISTOPHER BUONGIORNO, EXAMINING ATTORNEY

SN 78-285,650. CREATIVA INTERIORS LLC, NORTH BERGEN, NJ. FILED 8-11-2003.



THE ENGLISH TRANSLATION OF THE WORD "PRIMOR" IN THE MARK IS "BEAUTY".

**CLASS 20—FURNITURE AND ARTICLES NOT OTHERWISE CLASSIFIED**

FOR DECORATIVE BED PILLOWS, PILLOWS AND CYLINDRICAL NECKROLL PILLOWS (U.S. CLS. 2, 13, 22, 25, 32 AND 50).

**CLASS 24—FABRICS**

FOR COMFORTERS, BED SHEETS, PILLOW CASES, PILLOW SHAMS, BED RUFFLES, BED SKIRTS, BED SPREADS, QUILTS, BED BLANKETS AND BLANKET THROWS, MATTRESS PADS, CRIB BUMPERS, WINDOW TREATMENTS, NAMELY, CURTAINS, CURTAIN TIE BACKS MADE OF FABRIC, FABRIC VALANCES AND PANELS, TOWELS, WASH CLOTHS, FABRIC TABLE CLOTHS, FABRIC NAPKINS, HOUSEHOLD LINENS AND SHOWER CURTAINS (U.S. CLS. 42 AND 50).

CHARLES JOYNER, EXAMINING ATTORNEY

SN 78-286,094. INNOVATIVE TECHNOLOGY SERVICES, INC., GROTON, MA. FILED 8-12-2003.

**GameFilm**  
**tools**

NO CLAIM IS MADE TO THE EXCLUSIVE RIGHT TO USE GAME FILM TOOLS, APART FROM THE MARK AS SHOWN.

THE MARK CONSISTS OF GAME FILM TOOLS IS BLACK LETTERS WITH A BOLD RED LINE UNDER THE WORDS GAMEFILM. THE LETTER T IN TOOLS IS A BOLD RED LINE INTERSECTION WITH THE UNDERLINED WORDS.

**CLASS 9—ELECTRICAL AND SCIENTIFIC APPARATUS**

FOR (BASED ON USE IN COMMERCE) COMPUTER SOFTWARE PROVIDING STORAGE, RETRIEVAL, AND COMPARISON OF FOOTBALL FORMATIONS, ROSTERS, AND VIDEO PLAYBACK IN SUPPORT OF FOOTBALL ANALYSIS (U.S. CLS. 21, 23, 26, 36 AND 38).

FIRST USE 5-15-2003; IN COMMERCE 6-29-2003.

**CLASS 21—HOUSEWARES AND GLASS**

FOR (BASED ON INTENT TO USE) GLASSWARE, NAMELY BEVERAGE GLASSWARE (U.S. CLS. 2, 13, 23, 29, 30, 33, 40 AND 50).

**CLASS 25—CLOTHING**

FOR (BASED ON INTENT TO USE) CLOTHING, NAMELY, SHIRTS, PANTS, AND HATS (U.S. CLS. 22 AND 39).

MARGERY A. TIERNEY, EXAMINING ATTORNEY

SN 78-291,876. HEALTHMEDIA, INC., ANN ARBOR, MI. FILED 8-25-2003.

HealthMedia  
care

OWNER OF U.S. REG. NOS. 2,276,506, 2,324,542 AND 2,577,770.

SEC. 2(F) AS TO "HEALTHMEDIA".

**CLASS 16—PAPER GOODS AND PRINTED MATTER**

FOR PUBLICATIONS, NAMELY, PRINTED MATERIALS IN THE NATURE OF QUESTIONNAIRES, GUIDEBOOKS, SUPPLEMENTAL GUIDES, PERSONALLY TAILORED GUIDES, AND NEWSLETTERS, ALL IN THE FIELDS OF WELLNESS, HEALTH PROMOTION, PREVENTATIVE HEALTH CARE, DISEASE MANAGEMENT, BEHAVIOR CHANGE, AND HEALTH RISK ASSESSMENT (U.S. CLS. 2, 5, 22, 23, 29, 37, 38 AND 50).

**CLASS 41—EDUCATION AND ENTERTAINMENT**

FOR PROVIDING ONLINE QUESTIONNAIRES, GUIDEBOOKS, SUPPLEMENTAL GUIDES, AND NEWSLETTERS, ALL IN THE FIELDS OF WELLNESS, HEALTH PROMOTION, PREVENTATIVE HEALTH CARE, DISEASE MANAGEMENT, AND HEALTH RISK ASSESSMENT; AND PROVIDING TAILORED FOLLOW-UP MATERIALS, NAMELY, PERSONALLY TAILORED GUIDES AND NEWSLETTERS IN THE FIELDS OF WELLNESS, HEALTH PROMOTION, PREVENTATIVE HEALTH CARE, DISEASE MANAGEMENT, AND HEALTH RISK ASSESSMENT (U.S. CLS. 100, 101 AND 107).

**CLASS 44—MEDICAL, BEAUTY AND AGRICULTURAL SERVICES**

FOR COLLECTION AND ANALYSIS OF HEALTH, LIFESTYLE, AND PERSONAL INFORMATION AND CREATION OF PERSONAL GUIDES FOR USE BY INDIVIDUALS IN CONNECTION WITH THEIR OWN WELLNESS, PREVENTATIVE HEALTH CARE, DISEASE MANAGEMENT AND BEHAVIOR CHANGE, VIA A GLOBAL COMPUTER NETWORK; AND PROVIDING INFORMATION IN THE FIELDS OF WELLNESS, HEALTH PROMOTION, PREVENTATIVE HEALTH CARE, DISEASE MANAGEMENT, AND HEALTH RISK ASSESSMENT VIA ELECTRONIC MAIL (U.S. CLS. 100 AND 101).

Laura Kovaisky, Examining Attorney

**CLASS 39—TRANSPORTATION AND STORAGE**

FOR TRANSPORTATION OF GOODS BY AIR, BOAT, RAIL, VEHICLE; PACKAGING ARTICLES FOR TRANSPORTATION; STORAGE OF GOODS FOR OTHERS; WAREHOUSING SERVICES; ISSUING OF TRANSPORTATION AND CUSTOMS PAPERS, CERTIFICATES, BILLS OF LADING AND DOCUMENTS FOR GOODS; CONSULTATION IN THE FIELD OF TRANSPORTATION OF GOODS; LOGISTICS SERVICES, NAMELY, TRANSPORT BROKERAGE, FREIGHT BROKERAGE, FREIGHT FORWARDING, ARRANGING SYNCHRONIZED SHIPMENT AND DELIVERY OF GOODS FOR OTHERS IN CONNECTION WITH INVENTORY AND MANUFACTURING CONTROLS; LOGISTICS INFORMATION SERVICES, NAMELY, INFORMATION REGARDING TRANSPORTATION AND STORAGE OF GOODS (U.S. CLS. 100 AND 105).

**CLASS 42—SCIENTIFIC, COMPUTER AND LEGAL SERVICES**

FOR DEVELOPMENT, MAINTENANCE, REPAIR, INSTALLATION AND IMPLEMENTATION OF COMPUTER SOFTWARE, ALL IN CONNECTION WITH LOGISTICS SERVICES (U.S. CLS. 100 AND 101).

Ron Fairbanks, Examining Attorney

SN 78-292,739. MAERSK LOGISTICS INTERNATIONAL A/S, 2100 COPENHAGEN O, DENMARK, FILED 8-27-2003.

**SPECTIVE**

PRIORITY CLAIMED UNDER SEC. 44(D) ON DENMARK APPLICATION NO. VA20030116, FILED 3-24-2003, REG. NO. VR200301963, DATED 6-10-2003, EXPIRES 6-10-2013.

**CLASS 9—ELECTRICAL AND SCIENTIFIC APPARATUS**

FOR COMPUTER SOFTWARE FOR USE IN PLANNING, MANAGING AND TRACKING DELIVERY AND SHIPMENT OF GOODS IN CONNECTION WITH LOGISTICS SERVICES (U.S. CLS. 21, 23, 26, 36 AND 38).

**CLASS 16—PAPER GOODS AND PRINTED MATTER**

FOR PRINTED MATTER, NAMELY, BROCHURES AND MAGAZINES IN THE FIELD OF BUSINESS MANAGEMENT, LOGISTICS AND TRAVEL; PRINTED LABELS NOT OF TEXTILES; BUSINESS AND BLANK FORMS, NAMELY, DELIVERY NOTES, CUSTOMS FORMS, AND TRANSPORTATION PAPERS FOR USE IN THE TRANSPORTATION OF GOODS, ALL RELATING TO OR FOR USE IN THE FIELD OF LOGISTICS SERVICES (U.S. CLS. 2, 5, 22, 23, 29, 37, 38 AND 50).

**CLASS 35—ADVERTISING AND BUSINESS**

FOR BUSINESS ADMINISTRATION AND LOCALIZATION OF FREIGHT AND GOODS, NAMELY, TRANSPORTATION LOGISTICS SERVICES IN THE NATURE OF COMPUTERIZED TRACKING AND TRACING OF PACKAGES IN TRANSIT; ONLINE TRANSPORTATION LOGISTICS SERVICES, NAMELY, ARRANGING, MANAGEMENT, PLANNING, SCHEDULING AND LOCALIZATION OF FREIGHT AND GOODS VIA COMPUTER; LOGISTICS INFORMATION SERVICES, NAMELY, INFORMATION REGARDING PLANNING AND SCHEDULING OF SHIPMENTS FOR USERS OF TRANSPORTATION SERVICES (U.S. CLS. 100, 101 AND 102).

**CLASS 38—COMMUNICATION**

FOR DATA AND TELECOMMUNICATIONS SERVICES, NAMELY, TRANSMISSION AND TRANSFER OF IMAGES, INFORMATION AND E-MAILS VIA DATA, CELLULAR AND TELECOMMUNICATION NETWORKS, ALL FOR USE IN THE FIELD OF LOGISTICS SERVICES (U.S. CLS. 100, 101 AND 104).

SN 78-295,529. SOCIETY OF MOTION PICTURE AND TELEVISION ENGINEERS, WHITE PLAINS, NY. FILED 9-3-2003.



OWNER OF U.S. REG. NOS. 1,245,151, 1,245,279 AND 1,250,221.

**CLASS 9—ELECTRICAL AND SCIENTIFIC APPARATUS**

FOR MOTION PICTURE FILMS IN THE FIELD OF STANDARDS OF MOTION IMAGING FOR THE MOTION PICTURE AND TELEVISION INDUSTRIES; PRE-RECORDED VIDEO TAPES, PRE-RECORDED AUDIO MAGNETIC TAPES AND PRE-RECORDED CD-ROMS FEATURING STANDARDS OF MOTION IMAGING FOR THE MOTION PICTURE AND TELEVISION INDUSTRIES; COMPUTER SOFTWARE FOR USE IN CREATING AND GENERATING MOTION IMAGING FOR THE MOTION PICTURE AND TELEVISION INDUSTRIES (U.S. CLS. 21, 23, 26, 36 AND 38).

FIRST USE 12-0-1997; IN COMMERCE 12-0-1997.

**CLASS 16—PAPER GOODS AND PRINTED MATTER**

FOR PRINTED MATTER NAMELY, TECHNICAL AND EDUCATIONAL BOOKS, JOURNALS, REPORTS, PAMPHLETS AND CHARTS IN THE FIELD OF MOTION IMAGING FOR THE MOTION PICTURE AND TELEVISION INDUSTRIES (U.S. CLS. 2, 5, 22, 23, 29, 37, 38 AND 50).

FIRST USE 12-0-1997; IN COMMERCE 12-0-1997.  
ELISSA GARBER KON, EXAMINING ATTORNEY

SN 78-296,128. MR. FORMAL, INC., PORTLAND, OR. FILED 9-4-2003.

**MR. FORMAL****CLASS 35—ADVERTISING AND BUSINESS**

FOR RETAIL FORMAL WEAR STORES (U.S. CLS. 100, 101 AND 102).

FIRST USE 11-30-1975; IN COMMERCE 11-30-1975.

**CLASS 45—PERSONAL SERVICES**

FOR RENTAL OF FORMAL WEAR (U.S. CLS. 100 AND 101).

FIRST USE 11-30-1975; IN COMMERCE 11-30-1975.  
ANN E. SAPPENFIELD, EXAMINING ATTORNEY

SN 78-296,479. SJP MEDIA, L.L.C., HOLBROOK, NY. FILED 9-5-2003.

**OPINIONATED ABOUT****CLASS 16—PAPER GOODS AND PRINTED MATTER**

FOR SERIES OF GUIDE BOOKS AND MAGAZINES ON DINING, FOOD, TRAVEL, ENTERTAINMENT, SHOPPING, LITERATURE, POLITICS, LOCAL AND WORLD AFFAIRS, SPORTS AND MATTERS OF GENERAL INTEREST (U.S. CLS. 2, 5, 22, 23, 29, 37, 38 AND 50).

**CLASS 35—ADVERTISING AND BUSINESS**

FOR PROVIDING AND SOLICITING ONLINE OPINION INFORMATION ABOUT DINING, FOOD, TRAVEL, ENTERTAINMENT, SHOPPING, LITERATURE, POLITICS, LOCAL AND WORLD AFFAIRS, SPORTS AND MATTERS OF GENERAL INTEREST (U.S. CLS. 100, 101 AND 102).

WILLIAM P. SHANAHAN, EXAMINING ATTORNEY

SN 78-296,507. SIMPLICITY MANUFACTURING, INC., PORT WASHINGTON, WI. FILED 9-5-2003.

**FAST BACK****CLASS 7—MACHINERY**

FOR LAWN MOWERS (U.S. CLS. 13, 19, 21, 23, 31, 34 AND 35).

**CLASS 12—VEHICLES**

FOR LAWN TRACTORS (U.S. CLS. 19, 21, 23, 31, 35 AND 44).

WILLIAM P. SHANAHAN, EXAMINING ATTORNEY

SN 78-300,646. STORYMANAGER, INC., OAKLAND, CA. FILED 9-15-2003.

**STICKYPITCH****CLASS 9—ELECTRICAL AND SCIENTIFIC APPARATUS**

FOR COMPUTER SOFTWARE TO FACILITATE THE IDENTIFICATION, EVALUATION, EXPLOITATION, AND MANAGEMENT OF HUMAN RESOURCES, INVENTIONS, BRANDS, CREATIVE EXPRESSION, AND NOVEL IDEAS, AS WELL AS IMPROVE PROFESSIONAL AND PERSONAL COMMUNICATIONS SKILLS, FOR NON-PROFITS, BUSINESSES AND INDIVIDUALS (U.S. CLS. 21, 23, 26, 36 AND 38).

FIRST USE 9-8-2003; IN COMMERCE 9-8-2003.

**CLASS 35—ADVERTISING AND BUSINESS**

FOR BUSINESS CONSULTING SERVICES, NAMELY, PROVIDING ON-LINE SUPPORT FOR BUSINESSES OF OTHERS IN THE AREAS OF HUMAN RESOURCES MANAGEMENT, PRODUCT DEVELOPMENT, AND BRAND IDENTITY (U.S. CLS. 100, 101 AND 102).

FIRST USE 9-8-2003; IN COMMERCE 9-8-2003.

LINDA M. KING, EXAMINING ATTORNEY

SN 78-300,925. EPSTEIN, JOEL M., ROCKVILLE, MD. FILED 9-16-2003.

**FRICION FACTOR****CLASS 9—ELECTRICAL AND SCIENTIFIC APPARATUS**

FOR PRERECORDED AUDIO AND VIDEO TAPES, COMPACT DISCS AND DVDS, ALL FEATURING BUSINESS MANAGEMENT AND MARKETING STRATEGIES (U.S. CLS. 21, 23, 26, 36 AND 38).

**CLASS 16—PAPER GOODS AND PRINTED MATTER**

FOR PRINTED MATERIALS, NAMELY NOTEBOOKS AND WORKBOOKS, AND TRAINING MANUALS FOR CORPORATIONS, SAID MATERIALS BEING IN THE FIELD OF BUSINESS MANAGEMENT AND MARKETING STRATEGIES (U.S. CLS. 2, 5, 22, 23, 29, 37, 38 AND 50).

**CLASS 35—ADVERTISING AND BUSINESS**

FOR BUSINESS MANAGEMENT CONSULTATION SERVICES (U.S. CLS. 100, 101 AND 102).

**CLASS 41—EDUCATION AND ENTERTAINMENT**

FOR EDUCATIONAL SERVICES FOR COMMERCIAL ENTERPRISES, NAMELY, PROVIDING WORKSHOPS AND SEMINARS IN THE FIELD OF BUSINESS MANAGEMENT AND MARKETING STRATEGIES; AND TRAINING IN THE FIELD OF BUSINESS MANAGEMENT AND MARKETING STRATEGIES FOR COMMERCIAL ENTERPRISES (U.S. CLS. 100, 101 AND 107).  
MARC LEIPZIG, EXAMINING ATTORNEY

**CLASS 22—CORDAGE AND FIBERS**

FOR TWINES MADE OF NATURAL AND SYNTHETIC FIBERS FOR TYING AND LACING (U.S. CLS. 1, 2, 7, 19, 22, 42 AND 50).  
FIRST USE 3-31-1960; IN COMMERCE 3-31-1960.

**CLASS 23—YARNS AND THREADS**

FOR SEWING THREADS MADE OF NATURAL AND SYNTHETIC FIBERS FOR INDUSTRIAL USE (U.S. CL. 43).  
FIRST USE 3-31-1960; IN COMMERCE 3-31-1960.  
RENEE MCCRAY, EXAMINING ATTORNEY

SN 78-302,163. LOGICAL GROUP SERVICES LIMITED, SLOUGH BERKSHIRE, UNITED KINGDOM, FILED 9-18-2003.

**LOGICALIS**

THE MARK CONSISTS OF "LOGICAL" IN GRAY AND "IS" IN RED. COLOR IS A DISTINGUISHING FEATURE OF THE MARK.

**CLASS 9—ELECTRICAL AND SCIENTIFIC APPARATUS**

FOR COMPUTER HARDWARE AND SOFTWARE, NAMELY, COMPUTERS, COMMUNICATIONS SERVERS, DATA PROCESSORS, AND PARTS THEREOF (U.S. CLS. 21, 23, 26, 36 AND 38).

SN 78-311,112. MANPOWER INC., MILWAUKEE, WI. FILED 10-8-2003.

**CLASS 35—ADVERTISING AND BUSINESS**

FOR DISTRIBUTORSHIP SERVICES IN THE FIELD OF COMPUTER HARDWARE, SOFTWARE AND PERIPHERALS (U.S. CLS. 100, 101 AND 102).

**CLASS 37—CONSTRUCTION AND REPAIR**

FOR INSTALLATION, MAINTENANCE, REPAIR AND UPGRADING OF COMPUTER HARDWARE, COMPUTER SERVERS, AND COMPUTER NETWORKS FOR BUSINESSES AND RELATED CONSULTING SERVICES (U.S. CLS. 100, 103 AND 106).

**CLASS 38—COMMUNICATION**

FOR TELECOMMUNICATIONS SERVICES, NAMELY, PROVIDING TELECOMMUNICATIONS CONNECTIONS TO WORLDWIDE GLOBAL COMPUTER NETWORKS (U.S. CLS. 100, 101 AND 104).  
DAVID C. REIHNER, EXAMINING ATTORNEY



SN 78-305,868. LUDLOW TEXTILES COMPANY, INC., LUDLOW, MA. FILED 9-26-2003.

**CLASS 9—ELECTRICAL AND SCIENTIFIC APPARATUS**

FOR COMPUTER SOFTWARE FOR ASSESSING JOB, BUSINESS, CONTACT CENTER, CUSTOMER SERVICE, CLERICAL ACCOUNTING, BASIC ACCOUNTING, WORD PROCESSING, AND/OR OFFICE AUTOMATION SOFTWARE SKILLS; COMPUTER SOFTWARE FOR USE IN JOB, BUSINESS, WORD PROCESSING, AND/OR OFFICE AUTOMATION SOFTWARE TRAINING (U.S. CLS. 21, 23, 26, 36 AND 38).

**CLASS 16—PAPER GOODS AND PRINTED MATTER**

FOR PRINTED TESTING MATERIALS USED TO EVALUATE EMPLOYEES SKILLS AT TASKS NEEDED FOR LIGHT INDUSTRIAL WORK AND PRINTED INSTRUCTIONAL MANUALS SOLD TOGETHER AS A UNIT; PRINTED INSTRUCTIONAL MATERIALS FOR USE IN JOB SKILL TRAINING; PRINTED INSTRUCTIONAL MATERIALS IN THE FIELD OF HUMAN RESOURCES; STRUCTURED INTERVIEW FORMS USED TO INTERVIEW JOB APPLICANTS OVER THE TELEPHONE TO DETERMINE VERBAL COMMUNICATION SKILLS, INCLUDING PACE, VOLUME, SOUND QUALITY, ENUNCIATION, AND COMMAND OF THE LANGUAGE; INTERVIEW FORMS, INSTRUCTION SHEETS, AND AUDIO CASSETTE TAPES SOLD AND USED AS A UNIT FOR TRAINING THE INTERVIEWERS; STRUCTURED JOB SKILLS FORM USED TO IDENTIFY AND RECORD EMPLOYMENT SKILLS AND SKILL LEVELS AND TO CREATE EMPLOYMENT CAREER DEVELOPMENT PLANS FOR JOB APPLICANTS, AND INSTRUCTIONAL MANUALS FOR USE THEREWITH, DISTRIBUTED AS A UNIT; PRINTED TESTING MATERIALS USED TO EVALUATE EMPLOYEE SKILLS AT TASKS NEEDED FOR LIGHT INDUSTRIAL WORK AND PRINTED INSTRUCTIONAL MANUALS SOLD TOGETHER AS A UNIT; WRITTEN TEST AND SCORING MATERIALS, AND SAMPLE AUDIOCASSETTE DICTATION TAPES FURNISHED THEREWITH AS A UNIT, FOR EVALUATING THE PROFICIENCY OF COMPUTERIZED OFFICE EQUIPMENT OPERATORS; PRINTED EMPLOYEE INTAKE FORMS; BUSINESS FORMS; PRINTED AND PARTIALLY PRINTED FORMS; PRINTED TRAINING MANUALS FOR JOB SKILL TRAINING; PRINTED MONOGRAPHS, NEWSLETTERS AND BULLETINS, ALL IN THE FIELD OF HUMAN RESOURCES (U.S. CLS. 2, 5, 22, 23, 29, 37, 38 AND 50).

**CLASS 20—FURNITURE AND ARTICLES NOT OTHERWISE CLASSIFIED**

FOR PLASTIC TESTING DEVICES USED TO EVALUATE EMPLOYEE SKILLS AT TASKS NEEDED FOR LIGHT INDUSTRIAL WORK AND PRINTED INSTRUCTIONAL MANUALS SOLD TOGETHER AS A UNIT (U.S. CLS. 2, 13, 22, 25, 32 AND 50).

**CLASS 35—ADVERTISING AND BUSINESS**

FOR EMPLOYMENT AGENCY SERVICES; TEMPORARY AND PERMANENT EMPLOYMENT AGENCY SERVICES; EMPLOYEE LEASING; EMPLOYMENT RELATED SERVICES, NAMELY PROVIDING JOB PLACEMENT, CAREER DEVELOPMENT, EMPLOYMENT RECRUITMENT, AND GENERAL EMPLOYMENT INFORMATION TO OTHERS; BUSINESS MANAGEMENT AND CONSULTING SERVICES, NAMELY, ASSISTING BUSINESSES IN MANAGING WORKFORCE CHANGES, NAMELY, MERGERS, ACQUISITIONS, AMALGAMATIONS, DOWNSIZING, AND EXPANSION; PERSONNEL MANAGEMENT, HUMAN RESOURCES MANAGEMENT; EMPLOYMENT OUTPLACEMENT CONSULTATION SERVICES FOR PERSONNEL AFFECTED BY WORKFORCE CHANGES; SUPPLYING TO OTHERS ON A TEMPORARY AND PERMANENT BASIS ENGINEERS, COMPUTER PROGRAMMERS, DRAFTSMEN, AND SKILLED TECHNICAL PERSONNEL; PROVIDING AND MANAGING CONTRACT PERSONNEL PROGRAMS; ANALYZING AND CONSULTING ON PERSONNEL NEEDS; PROVIDING CONTRACT, TEMPORARY, AND PERMANENT PERSONNEL STAFFING SERVICES; ARRANGING FOR AND MANAGING THE PROVISION OF TEMPORARY CONTRACT PERSONNEL; PERSONNEL MANAGEMENT AND CONSULTANCY SERVICES; PROVIDING INFORMATION AND CONSULTANCY SERVICES ON THE PROCUREMENT OF TEMPORARY, CONTRACT, AND PERMANENT PERSONNEL; COMPUTER ON-LINE ORDERING VIA A GLOBAL INFORMATION NETWORK, AND PROVIDING COMPUTER ON-LINE REPORTS VIA A GLOBAL INFORMATION NETWORK, ALL IN THE FIELD OF PERSONNEL PROCUREMENT; HUMAN RESOURCES CONSULTING ON RECRUITING, TRAINING AND TESTING OF EMPLOYEES; CONTRACT AND PERMANENT STAFFING AGENCY SERVICES FEATURING

STAFF PROFESSIONALS IN FINANCE, INFORMATION TECHNOLOGY, ENGINEERING, SCIENTIFIC AND TECHNICAL PERSONNEL, AS WELL AS OFFICE ADMINISTRATIVE STAFF, FACTORY STAFF, INDUSTRIAL STAFF AND CALL CENTER STAFF; SERVING AS A HUMAN RESOURCE DEPARTMENT FOR OTHERS; EMPLOYMENT OUTPLACEMENT SERVICES; TESTING TO DETERMINE EMPLOYMENT SKILLS; EMPLOYMENT COUNSELING; WORKFORCE DEVELOPMENT SERVICES; PROVIDING CAREER INFORMATION VIA A WEBSITE ON A GLOBAL INFORMATION NETWORK; PROVIDING INFORMATION ON JOBS VIA A WEBSITE ON A GLOBAL INFORMATION NETWORK; PROVIDING AN ON-LINE COMPUTER DATABASE IN THE FIELDS OF CONTRACT AND PERMANENT PERSONNEL STAFFING; PROVIDING EMPLOYEE SCREENING AND ASSESSMENT TOOLS VIA A WEBSITE ON A GLOBAL INFORMATION NETWORK (U.S. CLS. 100, 101 AND 102).

**CLASS 41—EDUCATION AND ENTERTAINMENT**

FOR PROVIDING TRAINING IN BUSINESS AND JOB SKILLS AND OFFICE TECHNOLOGY; PROVIDING ON-LINE COURSES OF STUDY IN THE FOLLOWING – INFORMATION TECHNOLOGY, SOFTWARE USE, JOB AND BUSINESS SKILLS – VIA A WEBSITE ON A GLOBAL INFORMATION NETWORK; CAREER COUNSELING SERVICES (U.S. CLS. 100, 101 AND 107).

ARETHA SOMERVILLE, EXAMINING ATTORNEY

SN 78-313,127. SYNGENTA PARTICIPATIONS AG, BASEL, SWITZERLAND, FILED 10-14-2003.

**GWANIPA****CLASS 29—MEATS AND PROCESSED FOODS**

FOR PRESERVED, DRIED, COOKED AND FROZEN FRUITS AND VEGETABLES (U.S. CL. 46).

**CLASS 31—NATURAL AGRICULTURAL PRODUCTS**

FOR AGRICULTURAL, HORTICULTURAL AND FORESTRY PRODUCTS AND GRAINS, NAMELY FRUIT AND VEGETABLE SEEDS; LIVING NATURAL PLANTS; SEEDLINGS; YOUNG LIVING PLANTS; LIVING PLANT CUTTINGS; OTHER PLANT MATERIAL, NAMELY FRUIT AND VEGETABLE SEED WHICH ARE SUITABLE FOR MULTIPLICATION (U.S. CLS. 1 AND 46).

CYNTHIA SLOAN, EXAMINING ATTORNEY

SN 78-313,130. SYNGENTA PARTICIPATIONS AG, BASEL, SWITZERLAND, FILED 10-14-2003.

**KUMATO****CLASS 29—MEATS AND PROCESSED FOODS**

FOR PRESERVED, DRIED, COOKED AND FROZEN FRUITS AND VEGETABLES (U.S. CL. 46).

**CLASS 31—NATURAL AGRICULTURAL PRODUCTS**

FOR AGRICULTURAL, HORTICULTURAL AND FORESTRY PRODUCTS AND GRAINS, NAMELY FRUIT AND VEGETABLE SEEDS; LIVING NATURAL PLANTS; SEEDLINGS; YOUNG LIVING PLANTS; LIVING PLANT CUTTINGS; OTHER PLANT MATERIAL, NAMELY FRUIT AND VEGETABLE SEED WHICH AM SUITABLE FOR MULTIPLICATION (U.S. CLS. 1 AND 46).

CYNTHIA SLOAN, EXAMINING ATTORNEY

**CLASS 41—EDUCATION AND ENTERTAINMENT**

FOR EDUCATIONAL SERVICES, NAMELY, PROVIDING EXAMINATION PREPARATION AND REVIEW COURSES FOR FINANCIAL EXAMS (U.S. CLS. 100, 101 AND 107).

FIRST USE 1-3-2003; IN COMMERCE 1-3-2003.

ALICE SUE CARRUTHERS, EXAMINING ATTORNEY

SN 78-319,168. BECHTEL GROUP, INC., SAN FRANCISCO, CA. FILED 10-27-2003.

**BeceA**

**CLASS 9—ELECTRICAL AND SCIENTIFIC APPARATUS**

FOR COMPUTER SOFTWARE FOR OPERATION, SPONSORSHIP AND CONDUCTING OF AUCTIONS THROUGH INTERNET WEB SITES (U.S. CLS. 21, 23, 26, 36 AND 38).

**CLASS 35—ADVERTISING AND BUSINESS**

FOR AUCTIONEERING SERVICES FOR OTHERS; SPONSORING AND CONDUCTING AUCTIONS FOR OTHERS THROUGH AN INTERNET WEB SITE; CONSULTING SERVICES IN THE FIELD OF SPONSORING AND CONDUCTING AUCTIONS FOR OTHERS THROUGH AN INTERNET WEB SITE (U.S. CLS. 100, 101 AND 102).

**CLASS 41—EDUCATION AND ENTERTAINMENT**

FOR EDUCATIONAL SERVICES, NAMELY, CONDUCTING CLASSES, SEMINARS AND WORKSHOPS IN THE FIELD OF INTERNET AUCTIONS (U.S. CLS. 100, 101 AND 107).

CAROLYN CATALDO, EXAMINING ATTORNEY

SN 78-320,399. THE UPPER ROOM, NASHVILLE, TN. FILED 10-29-2003.

**COMPANIONS IN MINISTRY**

OWNER OF U.S. REG. NO. 2,753,556.

**CLASS 16—PAPER GOODS AND PRINTED MATTER**

FOR PRINTED PUBLICATIONS, NAMELY, BOOKS, BOOKMARKS, BROCHURES, CALENDARS, GREETING CARDS, CATALOGUES, HANDBILLS, JOURNALS, MAGAZINES, MANUALS, NEWSLETTERS, PAMPHLETS, POSTCARDS, PRINTS, STUDY GUIDES AND WORKBOOKS, IN THE FIELDS OF PRAYER, SPIRITUALITY AND RELIGION (U.S. CLS. 2, 5, 22, 23, 29, 37, 38 AND 50).

**CLASS 41—EDUCATION AND ENTERTAINMENT**

FOR COMPUTER SERVICES, NAMELY, PROVIDING ON-LINE PUBLICATIONS, NAMELY, BOOKS, CATALOGUES, JOURNALS, MAGAZINES, NEWSLETTERS, STUDY GUIDES AND WORKBOOKS, IN THE FIELDS OF PRAYER, SPIRITUALITY AND RELIGION; AND, COMPUTER SERVICES, NAMELY, PROVIDING INFORMATION IN THE FIELDS OF PRAYER, SPIRITUALITY AND RELIGION VIA A GLOBAL COMPUTER NETWORK (U.S. CLS. 100, 101 AND 107).

CAROLINE WOOD, EXAMINING ATTORNEY

SN 78-323,957. PRIEGEL, JACK C., EL PASO, TX. FILED 11-6-2003.

**WIND GEAR DIRECT**

THE MARK CONSISTS OF STANDARD CHARACTERS WITHOUT CLAIM TO ANY PARTICULAR FONT, STYLE, SIZE, OR COLOR.

NO CLAIM IS MADE TO THE EXCLUSIVE RIGHT TO USE "WIND GEAR", APART FROM THE MARK AS SHOWN.

SN 78-319,915. WANG, JUN, JERSEY CITY, NJ. FILED 10-28-2003.

**JUNWEI**

**CLASS 16—PAPER GOODS AND PRINTED MATTER**

FOR PRINTED INSTRUCTIONAL MATERIALS FOR USE IN CONDUCTING REVIEW CLASSES FOR FINANCIAL EXAMS (U.S. CLS. 2, 5, 22, 23, 29, 37, 38 AND 50).

FIRST USE 1-3-2003; IN COMMERCE 1-3-2003.

**CLASS 6—METAL GOODS**

FOR WINDSURFING PERFORMANCE ITEMS, NAMELY, METAL RIGGING ADJUSTERS (U.S. CLS. 2, 12, 13, 14, 23, 25 AND 50).

**CLASS 9—ELECTRICAL AND SCIENTIFIC APPARATUS**

FOR WINDSURFING PERFORMANCE ITEMS, NAMELY, HIGH-VISIBILITY WIND SOCKS FOR INDICATING WIND DIRECTION AND SPEED (U.S. CLS. 21, 23, 26, 36 AND 38).

**CLASS 22—CORDAGE AND FIBERS**

FOR WINDSURFING PERFORMANCE ITEMS, NAMELY, NON-METAL RIGGING ADJUSTERS AND ROPES (U.S. CLS. 1, 2, 7, 19, 22, 42 AND 50).  
IRA J. GOODSAD, EXAMINING ATTORNEY

---

SN 78-324,313. HOUSESAVVY NATIONAL, LLC, NORWELL, MA. FILED 11-6-2003.

# HOUSESAVVY

THE MARK CONSISTS OF STANDARD CHARACTERS WITHOUT CLAIM TO ANY PARTICULAR FONT, STYLE, SIZE, OR COLOR.

**CLASS 35—ADVERTISING AND BUSINESS**

FOR FRANCHISING SERVICES AND FRANCHISE SUPPORT SERVICES, NAMELY, RENDERING TECHNICAL ASSISTANCE TO OTHERS IN THE ESTABLISHMENT AND OPERATION OF REAL ESTATE OFFICES AND REAL ESTATE BROKERAGE AND CONSULTING BUSINESSES; BUSINESS MARKETING AND CONSULTING SERVICES RELATED THERETO (U.S. CLS. 100, 101 AND 102).

**CLASS 36—INSURANCE AND FINANCIAL**

FOR OPERATING MARKETPLACES FOR SELLERS OF REAL ESTATE; REAL ESTATE LISTING SERVICES; REAL ESTATE BROKERAGE SERVICES; CONSULTING SERVICES FOR SELLERS OF REAL ESTATE (U.S. CLS. 100, 101 AND 102).

TRICIA SONNEBORN, EXAMINING ATTORNEY

---

SN 78-325,486. EVEN ST. PRODUCTIONS, LTD., NEW YORK, NY. FILED 11-10-2003.

# SLY AND THE FAMILY STONE

THE MARK CONSISTS OF STANDARD CHARACTERS WITHOUT CLAIM TO ANY PARTICULAR FONT, STYLE, SIZE, OR COLOR.

**CLASS 9—ELECTRICAL AND SCIENTIFIC APPARATUS**

FOR MUSICAL SOUND RECORDINGS (U.S. CLS. 21, 23, 26, 36 AND 38).  
FIRST USE 10-9-1967; IN COMMERCE 10-9-1967.

**CLASS 16—PAPER GOODS AND PRINTED MATTER**

FOR POSTERS (U.S. CLS. 2, 5, 22, 23, 29, 37, 38 AND 50).  
FIRST USE 10-9-1967; IN COMMERCE 10-9-1967.

**CLASS 41—EDUCATION AND ENTERTAINMENT**

FOR PROVIDING A WEBSITE ON A GLOBAL COMPUTER NETWORK FEATURING INFORMATION ON A MUSICAL GROUP AND ITS SOUND RECORDINGS, VIDEO RECORDINGS, AND PHOTOS (U.S. CLS. 100, 101 AND 107).  
FIRST USE 2-0-2003; IN COMMERCE 2-0-2003.  
LINDA MICKLEBURGH, EXAMINING ATTORNEY

---

SN 78-325,897. TRANSCAT, INC., ROCHESTER, NY. FILED 11-11-2003.

# CALTRAK

THE MARK CONSISTS OF STANDARD CHARACTERS WITHOUT CLAIM TO ANY PARTICULAR FONT, STYLE, SIZE, OR COLOR.

**CLASS 35—ADVERTISING AND BUSINESS**

FOR MANAGEMENT FOR OTHERS OF A COMPUTERIZED DATABASE AND TRACKING SYSTEM CONTAINING INFORMATION REGARDING THE HISTORY, CALIBRATION AND REPAIR RECORD OF THE CUSTOMER'S TEST, MEASUREMENT AND CALIBRATION INSTRUMENTS; PROVIDING CUSTOMERS ON REQUEST WITH RECORDS OF THE HISTORY, CALIBRATION AND REPAIR RECORD OF THE CUSTOMER'S TEST, MEASUREMENT AND CALIBRATION INSTRUMENTS (U.S. CLS. 100, 101 AND 102).

FIRST USE 5-0-1992; IN COMMERCE 5-0-1992.

**CLASS 45—PERSONAL SERVICES**

FOR PROVIDING CUSTOMERS WITH RECALIBRATION REMINDER NOTICES IN THE FIELD OF INSTRUMENT CALIBRATION REPAIR AND MEASUREMENT (U.S. CLS. 100 AND 101).  
FIRST USE 5-0-1992; IN COMMERCE 5-0-1992.  
JOHN LINCOSKI, EXAMINING ATTORNEY

SN 78-326,089. NEW YORK DOG SPA & HOTEL, INC., NEW YORK, NY. FILED 11-11-2003.

## DOG SPA

THE MARK CONSISTS OF STANDARD CHARACTERS WITHOUT CLAIM TO ANY PARTICULAR FONT, STYLE, SIZE, OR COLOR.

OWNER OF U.S. REG. NO. 2,700,846.

NO CLAIM IS MADE TO THE EXCLUSIVE RIGHT TO USE "DOG", APART FROM THE MARK AS SHOWN.

### CLASS 35—ADVERTISING AND BUSINESS

FOR RETAIL STORE SERVICES AND COMPUTERIZED ON-LINE RETAIL SERVICES FEATURING PET ACCESSORIES, NAMELY, CLOTHING, COLLARS, LEASHES, CARRIERS, FEEDING DISHES AND BOWLS, FOOD AND TREATS, GROOMING IMPLEMENTS, TOYS AND BEDS; PROVIDING A WEB SITE FEATURING CONSUMER PRODUCT INFORMATION ABOUT PET PRODUCTS (U.S. CLS. 100, 101 AND 102).

### CLASS 44—MEDICAL, BEAUTY AND AGRICULTURAL SERVICES

FOR PROVIDING A WEB SITE FEATURING INFORMATION ABOUT PETS AND PET CARE (U.S. CLS. 100 AND 101).

BRIAN PINO, EXAMINING ATTORNEY

SN 78-328,783. CUISINE SOLUTIONS, INC., ALEXANDRIA, VA. FILED 11-17-2003.

# ENROBÉ

OWNER OF U.S. REG. NO. 2,751,265.

THE MARK CONSISTS OF THE FRENCH WORD "ENROBE", WITH AN ACUTE ACCENT OVER THE LETTER "E".

THE ENGLISH TRANSLATION OF THE WORD ENROBE IN THE MARK IS ENROBED.

### CLASS 29—MEATS AND PROCESSED FOODS

FOR FROZEN AND REFRIGERATED MEAT, FISH, OR FRUIT ENCASED IN A SAUCE, CHOCOLATE, OR CONFECTIONARY COATING (U.S. CL. 46).

### CLASS 30—STAPLE FOODS

FOR FROZEN AND REFRIGERATED PASTA OR RICE ENCASED IN SAUCE (U.S. CL. 46).  
CAROL SPILS, EXAMINING ATTORNEY

SN 78-329,336. KFI, INC., ROOSEVELT, NY. FILED 11-18-2003.

## ELIZABETH AUSTEN

THE MARK CONSISTS OF STANDARD CHARACTERS WITHOUT CLAIM TO ANY PARTICULAR FONT, STYLE, SIZE, OR COLOR.

OWNER OF U.S. REG. NO. 2,829,658.

THE NAME ELIZABETH AUSTEN DOES NOT IDENTIFY A LIVING INDIVIDUAL.

### CLASS 24—FABRICS

FOR BED SHEETS, COMFORTERS, PILLOW SHAMS, DUST RUFFLES, CURTAINS, DRAPES, TABLE CLOTHS, NAPKINS, PLACEMATS, TABLE RUNNERS, SEAT COVERS, THROWS, DECORATIVE UPHOLSTERY, DRAPERY, WINDOW TREATMENT FABRICS, ACCESSORY FABRICS, AND ACCESSORY FABRIC FOR HOME DECORATING (U.S. CLS. 42 AND 50).

### CLASS 25—CLOTHING

FOR LADIES' CLOTHING; NAMELY, JACKETS, COATS, DRESSES, SUITS, PANTS, BLOUSES, SKIRTS, LINGERIE, PAJAMAS, NIGHTWEAR, ROBES, BELTS AND SCARVES, APRONS (U.S. CLS. 22 AND 39).

CHERYL STEPLIGHT, EXAMINING ATTORNEY

SN 78-329,695. MARK ANTHONY INTERNATIONAL SRL, ST. JAMES, BARBADOS, FILED 11-18-2003.



OWNER OF U.S. REG. NOS. 2,501,401, 2,657,704 AND OTHERS.

NO CLAIM IS MADE TO THE EXCLUSIVE RIGHT TO USE "LIGHT" FOR INTERNATIONAL CLASSES 32 AND 33 ONLY, APART FROM THE MARK AS SHOWN.

THE STIPPLING IS FOR SHADING PURPOSES.

THE MARK CONSISTS OF THE WORDS MIKE'S LIGHT SUPERIMPOSED OVER A STYLIZED LEMON DESIGN.

### CLASS 18—LEATHER GOODS

FOR BAGS, NAMELY, TOTE BAGS, DUFFEL BAGS, GYM BAGS, BRIEFCASES, BEACH BAGS, FANNY PACKS AND BACKPACKS (U.S. CLS. 1, 2, 3, 22 AND 41).



**CLASS 25—CLOTHING**

FOR CLOTHING, NAMELY, SHIRTS, T-SHIRTS, JACKETS, SWEATSHIRTS AND CAPS (U.S. CLS. 22 AND 39).

SN 78-331,376. ETHICAL MARKETPLACE, LLC, ST. AUGUSTINE, FL. FILED 11-21-2003.

**CLASS 32—LIGHT BEVERAGES**

FOR LEMON-FLAVORED BREWED MALT-BASED ALCOHOLIC BEVERAGES IN THE NATURE OF BEER (U.S. CLS. 45, 46 AND 48).

**ETHICAL MARKETS**

THE MARK CONSISTS OF STANDARD CHARACTERS WITHOUT CLAIM TO ANY PARTICULAR FONT, STYLE, SIZE, OR COLOR.

**CLASS 33—WINES AND SPIRITS**

FOR LEMON-FLAVORED ALCOHOLIC MALT COOLERS, ALCOHOLIC BEVERAGES PRODUCED FROM A BREWED MALT BASE WITH NATURAL LEMON FLAVOR (U.S. CLS. 47 AND 49).

PATRICIA EVANKO, EXAMINING ATTORNEY

**CLASS 36—INSURANCE AND FINANCIAL**

FOR PROVIDING A WEBSITE FEATURING INFORMATION IN THE FIELD OF SOCIALLY RESPONSIBLE INVESTING (U.S. CLS. 100, 101 AND 102).

SN 78-331,361. FX ALLIANCE, LLC, NEW YORK, NY. FILED 11-21-2003.

**CLASS 41—EDUCATION AND ENTERTAINMENT**

FOR EDUCATION AND ENTERTAINMENT IN THE NATURE OF A TELEVISION SERIES IN THE FIELD OF SOCIALLY RESPONSIBLE INVESTING (U.S. CLS. 100, 101 AND 107).

LESLIE RICHARDS, EXAMINING ATTORNEY

SN 78-331,936. SUTHERLAND, DUNCAN B., PEBBLE BEACH, CA. FILED 11-23-2003.

**QUICKFILL****ATHENIQUE AGELESS SKIN**

THE MARK CONSISTS OF STANDARD CHARACTERS WITHOUT CLAIM TO ANY PARTICULAR FONT, STYLE, SIZE, OR COLOR.

THE MARK CONSISTS OF STANDARD CHARACTERS WITHOUT CLAIM TO ANY PARTICULAR FONT, STYLE, SIZE, OR COLOR.

NO CLAIM IS MADE TO THE EXCLUSIVE RIGHT TO USE "AGELESS SKIN", APART FROM THE MARK AS SHOWN.

**CLASS 36—INSURANCE AND FINANCIAL**

FOR FINANCIAL SERVICES, NAMELY, PROVIDING REAL-TIME SECURITIES AND CURRENCY PRICE INFORMATION (U.S. CLS. 100, 101 AND 102).

**CLASS 41—EDUCATION AND ENTERTAINMENT**

FOR EDUCATIONAL SERVICES, NAMELY CONDUCTING CLASSES, CONFERENCES, SEMINARS, AND WORKSHOPS FEATURING THE CORRECTION OF AESTHETIC SKIN PROBLEMS AND THE LIFE-LONG MAINTENANCE OF HEALTHY SKIN. (U.S. CLS. 100, 101 AND 107).

**CLASS 42—SCIENTIFIC, COMPUTER AND LEGAL SERVICES**

FOR PROVIDING TEMPORARY USE OF ON-LINE NON-DOWNLOADABLE SOFTWARE FOR EXECUTING SECURITIES AND CURRENCY TRADING IN REAL TIME (U.S. CLS. 100 AND 101).

BRIAN NEVILLE, EXAMINING ATTORNEY

**CLASS 44—MEDICAL, BEAUTY AND AGRICULTURAL SERVICES**

FOR MEDICAL SERVICES AND SKIN CARE SERVICES FEATURING CHEMICAL PEELS, ACNE TREATMENTS, MICRODERMABRASION, FILLER INJECTIONS, PROCEDURES FOR THE REMOVAL OF WRINKLES, CAPILLARIES, AGE SPOTS, SKIN DISCOLORATION, SUN DAMAGE, TATTOOS, SPIDER AND VARICOSE VEINS, FACIAL AND BODY HAIR, AND PROCEDURES FOR STIMULATING COLLAGEN PRODUCTION, EVENING AND/OR LIGHTENING SKIN TONE, AND SKIN RESURFACING. (U.S. CLS. 100 AND 101).

TINA L. SNAPP, EXAMINING ATTORNEY

SN 78-334,199. BEDIAMOL, CLAIRE E., HUNTINGTON BEACH, CA. FILED 11-29-2003.

SN 78-334,969. DELTA T CORPORATION, LEXINGTON, KY. FILED 12-2-2003.

# Surf Dad



THE MARK CONSISTS OF STANDARD CHARACTERS WITHOUT CLAIM TO ANY PARTICULAR FONT, STYLE, SIZE, OR COLOR.

## CLASS 16—PAPER GOODS AND PRINTED MATTER

FOR STICKERS AND BUMPER STICKERS (U.S. CLS. 2, 5, 22, 23, 29, 37, 38 AND 50).

## CLASS 25—CLOTHING

FOR CLOTHING, NAMELY, T-SHIRTS, LONG SLEEVE SHIRTS, HATS, VISORS, CAPS, TANK-TOPS, SWEATSHIRTS, TIES, APRONS, JACKETS (U.S. CLS. 22 AND 39).

MICHAEL HALL, EXAMINING ATTORNEY

SN 78-334,921. CZT/ACN TRADEMARKS, L.L.C., SCHAUMBURG, IL. FILED 12-2-2003.

# NIELSEN OUTDOOR

THE MARK CONSISTS OF STANDARD CHARACTERS WITHOUT CLAIM TO ANY PARTICULAR FONT, STYLE, SIZE, OR COLOR.

OWNER OF U.S. REG. NOS. 540,915 AND 1,551,874.

NO CLAIM IS MADE TO THE EXCLUSIVE RIGHT TO USE "OUTDOOR", APART FROM THE MARK AS SHOWN.

## CLASS 9—ELECTRICAL AND SCIENTIFIC APPARATUS

FOR PERSONAL GLOBAL POSITIONING SATELLITE DEVICE FOR USE IN TRACKING TRAVELS BY SUBJECT (U.S. CLS. 21, 23, 26, 36 AND 38).

## CLASS 35—ADVERTISING AND BUSINESS

FOR MARKET RESEARCH SERVICES; OUTDOOR ADVERTISING RESEARCH SERVICES AND MEDIA AUDIENCE MEASUREMENT SERVICES; AND DEMOGRAPHIC RESEARCH SERVICES (U.S. CLS. 100, 101 AND 102).

RONALD MCMORROW, EXAMINING ATTORNEY

OWNER OF U.S. REG. NO. 2,678,232.

NO CLAIM IS MADE TO THE EXCLUSIVE RIGHT TO USE FAN, APART FROM THE MARK AS SHOWN.

## CLASS 11—ENVIRONMENTAL CONTROL APPARATUS

FOR CEILING FANS, ELECTRIC FANS (U.S. CLS. 13, 21, 23, 31 AND 34).

## CLASS 25—CLOTHING

FOR FULL LINE OF CLOTHING (U.S. CLS. 22 AND 39).

CHRIS WELLS, EXAMINING ATTORNEY

SN 78-335,061. NEXT INNOVATIONS, LTD, BEMIDJI, MN. FILED 12-2-2003.

# EyCatchers

THE MARK CONSISTS OF STANDARD CHARACTERS WITHOUT CLAIM TO ANY PARTICULAR FONT, STYLE, SIZE, OR COLOR.

## CLASS 6—METAL GOODS

FOR WIND ORNAMENT MADE OF STEEL AND POWDER-COATED FOR A HIGHLY REFLECTIVE FINISH (U.S. CLS. 2, 12, 13, 14, 23, 25 AND 50).

FIRST USE 9-15-2003; IN COMMERCE 9-30-2003.

## CLASS 20—FURNITURE AND ARTICLES NOT OTHERWISE CLASSIFIED

FOR WINDCHIMES (U.S. CLS. 2, 13, 22, 25, 32 AND 50).

FIRST USE 9-15-2003; IN COMMERCE 9-30-2003.  
WILLIAM VERHOSEK, EXAMINING ATTORNEY

SN 78-335,848. BLUE FALCON NETWORKS, INC., LOS ANGELES, CA. FILED 12-3-2003.

SN 78-337,100. KOBRA INTERNATIONAL LTD., NEW YORK, NY. FILED 12-5-2003.

# AKIMBO

# NICKI BY NICOLE MILLER

THE MARK CONSISTS OF STANDARD CHARACTERS WITHOUT CLAIM TO ANY PARTICULAR FONT, STYLE, SIZE, OR COLOR.

## CLASS 9—ELECTRICAL AND SCIENTIFIC APPARATUS

FOR COMPUTER HARDWARE, SET TOP BOXES AND COMPUTER SOFTWARE, NAMELY AUDIO AND VIDEO RECEIVERS AND TRANSMITTERS AND COMPUTER SOFTWARE PROGRAMS ENABLING RECEIPT, DOWNLOAD, PLAYING, VIEWING, RENTAL AND PURCHASE OF AUDIO, VIDEO, DATA, TELEVISION PROGRAMMING, MOVIES, SPORTS, GAMES, EDUCATIONAL PROGRAMMING AND MUSIC TRANSMISSIONS THROUGH THE USE OF INTERNET CONNECTIONS; DOWNLOADABLE MOVIES AND MUSICAL SOUND RECORDINGS THROUGH THE USE OF INTERNET CONNECTIONS TO COMPUTER HARDWARE AND RECEIVER AND TRANSMITTER APPARATUS THAT CONNECT TO A TELEVISION SET OR MONITOR (U.S. CLS. 21, 23, 26, 36 AND 38).

## CLASS 38—COMMUNICATION

FOR TELECOMMUNICATIONS SERVICES, NAMELY SUBSCRIPTION, PAY-PER-VIEW AND VIDEO-ON-DEMAND PERSONALIZED TELEVISION TRANSMISSION SERVICES PROVIDING AUDIO, VIDEO, DATA, TELEVISION PROGRAMMING, MOVIES, SPORTS, GAMES, EDUCATIONAL PROGRAMMING AND MUSIC TRANSMISSIONS THROUGH THE USE OF INTERNET CONNECTIONS TO COMPUTER HARDWARE AND RECEIVER AND TRANSMITTER APPARATUS THAT CONNECT TO A TELEVISION SET OR MONITOR (U.S. CLS. 100, 101 AND 104).

## CLASS 41—EDUCATION AND ENTERTAINMENT

FOR RENTAL OF TELEVISION PROGRAMMING, MOVIES, SPORTS, GAMES, EDUCATIONAL PROGRAMMING AND MUSIC TRANSMISSIONS THROUGH THE USE OF INTERNET CONNECTIONS TO COMPUTER HARDWARE AND RECEIVER AND TRANSMITTER APPARATUS THAT CONNECT TO A TELEVISION SET OR MONITOR (U.S. CLS. 100, 101 AND 107).  
WON TEAK OH, EXAMINING ATTORNEY

THE MARK CONSISTS OF STANDARD CHARACTERS WITHOUT CLAIM TO ANY PARTICULAR FONT, STYLE, SIZE, OR COLOR.

OWNER OF U.S. REG. NOS. 1,454,374, 2,237,645 AND OTHERS.

THE NAME(S), PORTRAIT(S), AND/OR SIGNATURE(S) SHOWN IN THE MARK IDENTIFIES NICOLE MILLER, WHOSE CONSENT(S) TO REGISTER IS SUBMITTED.

## CLASS 9—ELECTRICAL AND SCIENTIFIC APPARATUS

FOR CELL PHONE CASES; EYEWEAR, NAMELY, EYEGASSES AND SUNGLASSES. (U.S. CLS. 21, 23, 26, 36 AND 38).

## CLASS 16—PAPER GOODS AND PRINTED MATTER

FOR PRINTED MATTER, NAMELY, DATE BOOKS, ADDRESS BOOKS, CALENDARS, PERSONAL ORGANIZERS (U.S. CLS. 2, 5, 22, 23, 29, 37, 38 AND 50).

## CLASS 18—LEATHER GOODS

FOR PURSES, HANDBAGS, WRIST MOUNTED CARRYALLS, COSMETIC BAGS SOLD EMPTY, NAMELY, MAKE-UP BAGS, PET ACCESSORIES, NAMELY, PET CLOTHING, PET LEASHES AND PET COLLARS, DIAPER BAGS, UMBRELLAS, BEACH UMBRELLAS, AND BABY CARRIERS WORN ON THE BODY (U.S. CLS. 1, 2, 3, 22 AND 41).

## CLASS 25—CLOTHING

FOR MEN'S AND WOMEN'S CLOTHING, NAMELY, SHIRTS, PANTS, JACKETS, SOCKS; SLEEPWEAR, LOUNGEWEAR, UNDERWEAR, SHORTS AND BOY SHORTS; FOOTWEAR, SHOES; COATS, WOMEN'S COATS AND OVERCOATS (U.S. CLS. 22 AND 39).  
BRENDAN MCCAULEY, EXAMINING ATTORNEY

SN 78-337,398. THE GENERAL HOSPITAL CORPORATION, BOSTON, MA. FILED 12-6-2003.

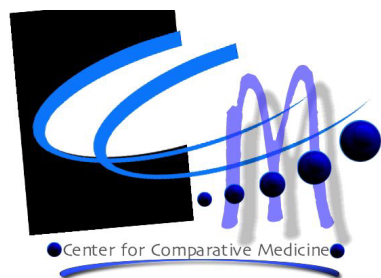

NO CLAIM IS MADE TO THE EXCLUSIVE RIGHT TO USE "CENTER FOR COMPARATIVE MEDICINE", APART FROM THE MARK AS SHOWN.

THE COLOR(S) BLACK, BLUE AND GREY IS/ARE CLAIMED AS A DISTINCTIVE FEATURE OF THE MARK.

THE MARK CONSISTS OF THE STYLIZED LETTERS CCM SHOWN IN BLUE, A RECTANGULAR BLACK SHAPE INTO WHICH THE INITIAL LETTER C INTRUDES, A SERIES OF BLUE CIRCULAR SHAPES AND THE WORDS CENTER FOR COMPARATIVE MEDICINE SHOWN IN GREY ABOVE A DOWNWARD-CURVING HORIZONTAL BLUE LINE.

#### CLASS 9—ELECTRICAL AND SCIENTIFIC APPARATUS

FOR COMPUTER SOFTWARE FOR MANAGING ANIMAL RESEARCH FACILITIES; DOWNLOADABLE NEWSLETTERS, JOURNALS, PAMPHLETS, ARTICLES, BOOKS AND BOOKLETS IN THE FIELD OF LABORATORY ANIMALS AND THEIR USE IN MEDICAL AND SCIENTIFIC RESEARCH; LABORATORY EQUIPMENT, NAMELY, ELECTRONIC MONITORS FOR USE IN ANIMAL RESEARCH FACILITIES (U.S. CLS. 21, 23, 26, 36 AND 38).

#### CLASS 16—PAPER GOODS AND PRINTED MATTER

FOR PRINTED NEWSLETTERS, JOURNALS, PAMPHLETS, ARTICLES, BOOKS AND BOOKLETS IN THE FIELD OF LABORATORY ANIMALS AND THEIR USE IN MEDICAL AND SCIENTIFIC RESEARCH (U.S. CLS. 2, 5, 22, 23, 29, 37, 38 AND 50).

#### CLASS 21—HOUSEWARES AND GLASS

FOR CAGES FOR LABORATORY ANIMALS (U.S. CLS. 2, 13, 23, 29, 30, 33, 40 AND 50).

#### CLASS 41—EDUCATION AND ENTERTAINMENT

FOR EDUCATIONAL SERVICES, NAMELY, SEMINARS, CONFERENCES, WORKSHOPS, CLASSES AND LECTURES IN THE FIELD OF LABORATORY ANIMALS AND THEIR USE IN MEDICAL AND SCIENTIFIC RESEARCH, AND DISTRIBUTING COURSE MATERIALS IN CONNECTION THEREWITH; PROVIDING ONLINE NEWSLETTERS, JOURNALS, PAMPHLETS, ARTICLES, BOOKS AND BOOKLETS IN THE FIELD OF LABORATORY ANIMALS AND THEIR USE IN MEDICAL AND SCIENTIFIC RESEARCH (U.S. CLS. 100, 101 AND 107).

#### CLASS 44—MEDICAL, BEAUTY AND AGRICULTURAL SERVICES

FOR ANIMAL HUSBANDRY AND VETERINARY SERVICES FOR LABORATORY ANIMALS (U.S. CLS. 100 AND 101).  
KIMBERLY FRYE, EXAMINING ATTORNEY

SN 78-338,231. RECKITT BENCKISER INC., PARSIPPANY, NJ. FILED 12-9-2003.

## LINEN SUNSHINE

THE MARK CONSISTS OF STANDARD CHARACTERS WITHOUT CLAIM TO ANY PARTICULAR FONT, STYLE, SIZE, OR COLOR.

#### CLASS 5—PHARMACEUTICALS

FOR AIR FRESHENING AND PERFUMING PREPARATIONS FOR THE ATMOSPHERE, NAMELY ROOM AIR FRESHENERS; HOUSEHOLD DEODORANTS NOT FOR PERSONAL USE; AIR FRESHENING PREPARATIONS; AROMATIC PREPARATIONS AND SUBSTANCES FOR FRESHENING THE AIR; PERFUMED AIR FRESHENING PREPARATIONS; PREPARATIONS FOR FRESHENING THE AMBIENT ATMOSPHERE, NAMELY ROOM AIR FRESHENERS (U.S. CLS. 6, 18, 44, 46, 51 AND 52).

#### CLASS 21—HOUSEWARES AND GLASS

FOR DISPENSERS OR CONTAINERS MADE OF GLASS FOR SCENTING THE ATMOSPHERE OR FOR DISPENSING PERFUMES, AIR FRESHENING OR AIR PURIFYING PREPARATIONS INTO THE AMBIENT ATMOSPHERE (U.S. CLS. 2, 13, 23, 29, 30, 33, 40 AND 50).  
CAROLINE WOOD, EXAMINING ATTORNEY

SN 78-338,286. C/HCA, INC., NASHVILLE, TN. FILED 12-9-2003.



NO CLAIM IS MADE TO THE EXCLUSIVE RIGHT TO USE "MEDICAL CENTER", APART FROM THE MARK AS SHOWN.

THE MARK CONSISTS IN PART OF THE TERM MAINLAND MEDICAL CENTER WHEREIN THE "A" CHARACTERS SUGGEST IN PART BIRDS IN FLIGHT. THE PORTION OF THE MARK COMPRISED OF A CROSS DESIGN IS NOT DISPLAYED IN THE COLOR RED OR A COLORABLE IMITATION THEREOF. APPLICANT DOES NOT USE AND WILL NOT USE THE CROSS DESIGN THAT APPEARS IN ITS MARK IN THE COLOR RED OR A COLORABLE IMITATION THEREOF.

#### CLASS 36—INSURANCE AND FINANCIAL

FOR FINANCIAL INVESTMENT IN THE FIELD OF HEALTH CARE BUSINESSES (U.S. CLS. 100, 101 AND 102).

**CLASS 42—SCIENTIFIC, COMPUTER AND LEGAL SERVICES**

FOR MEDICAL AND SCIENTIFIC RESEARCH, NAMELY CONDUCTING CLINICAL TRIALS, MEDICAL RESEARCH (U.S. CLS. 100 AND 101).

**CLASS 44—MEDICAL, BEAUTY AND AGRICULTURAL SERVICES**

FOR HEALTH CARE SERVICES, HOSPITAL SERVICES AND MEDICAL SERVICES, NAMELY INPATIENT, OUTPATIENT, AND ACUTE CARE; AND PROVIDING SURGICAL, OBSTETRICAL, CARDIOLOGY, EMERGENCY, REHABILITATION, PEDIATRIC, AND ONCOLOGY AND HEMATOLOGY SERVICES (U.S. CLS. 100 AND 101).

RONALD MCMORROW, EXAMINING ATTORNEY

**CLASS 42—SCIENTIFIC, COMPUTER AND LEGAL SERVICES**

FOR INFORMATION TECHNOLOGY CONSULTING SERVICES IN THE FIELDS OF TELECOMMUNICATIONS, COMPUTER NETWORKING, BUSINESS REENGINEERING, SYSTEMS INTEGRATION, CLIENT/SERVER SOLUTIONS, COMPUTER SOFTWARE DEVELOPMENT, AND INTELLIGENT INFORMATION SYSTEMS AND PRODUCTS; CONSULTING SERVICES IN THE FIELDS OF ENVIRONMENTAL POLICY AND REGULATORY DEVELOPMENT, NAMELY REVIEWING STANDARDS AND PRACTICES TO ASSURE COMPLIANCE WITH ENVIRONMENTAL LAWS AND REGULATIONS; ALTERNATIVE DISPUTE RESOLUTION; TECHNICAL ANALYSIS SERVICES, NAMELY REVIEWING STANDARDS AND PRACTICES TO ASSURE COMPLIANCE WITH NATIONAL DEFENSE AND INDUSTRIAL C4ISR (COMMAND, CONTROL, COMMUNICATIONS, COMPUTERS, INTELLIGENCE, SURVEILLANCE AND RECONNAISSANCE) PROGRAMS; COMPUTER SYSTEMS ENGINEERING AND INTEGRATION CONSULTING SERVICES FEATURING ANALYSIS, SIMULATION, AND MODELING OF VARIOUS GOVERNMENT OPERATIONS; COMPUTER SOFTWARE DESIGN AND DEVELOPMENT FOR OTHERS RELATING TO NETWORK MODELING, PROCESS PERFORMANCE MODELING, AND DECISION SUPPORT AND VISUALIZATION TOOLS; ENGINEERING SERVICES, NAMELY, SPECIALIZED ENGINEERING IN THE FIELD OF UNMANNED AERIAL VEHICLES. (U.S. CLS. 100 AND 101).

TINA L. SNAPP, EXAMINING ATTORNEY

SN 78-338,375. SRA INTERNATIONAL, INC., FAIRFAX, VA. FILED 12-9-2003.



OWNER OF U.S. REG. NOS. 2,094,996, 2,097,456 AND 2,290,369.

THE MARK CONSISTS OF THE LETTERS SRA ENCLOSED BY AN ORBIT AND A PLANET.

**CLASS 9—ELECTRICAL AND SCIENTIFIC APPARATUS**

FOR COMPUTER SOFTWARE, NAMELY SEARCH ENGINES, ARCHIVING SOFTWARE, SOFTWARE THAT RECOGNIZES AND ANALYZES PATTERNS IN DATABASES; SOFTWARE FOR SCHEDULING TRANSPORTATION, ACQUISITION, AND DEPLOYMENT OF EQUIPMENT AND PERSONNEL; SOFTWARE THAT CONSOLIDATES, SUMMARIZES AND ANALYZES BUSINESS INFORMATION; COMMUNICATIONS SOFTWARE FOR CONNECTING GLOBAL COMPUTER NETWORKS AND INTERNAL CORPORATE NETWORKS. (U.S. CLS. 21, 23, 26, 36 AND 38).

**CLASS 25—CLOTHING**

FOR SHIRTS, T-SHIRTS, SWEATSHIRTS, HATS, SWEATPANTS, JACKETS AND CAPS. (U.S. CLS. 22 AND 39).

**CLASS 35—ADVERTISING AND BUSINESS**

FOR BUSINESS CONSULTING SERVICES IN THE FIELDS OF STRATEGIC AND ORGANIZATIONAL FACILITATION, BUSINESS MANAGEMENT PLANNING FOR EMERGENCY SITUATIONS; AND BUSINESS ORGANIZATIONAL CONSULTATION IN THE FIELD OF WORKPLACE PLANNING AND PERFORMANCE MEASUREMENT SERVICES (U.S. CLS. 100, 101 AND 102).

**CLASS 37—CONSTRUCTION AND REPAIR**

FOR CONSULTING SERVICES IN THE FIELD OF LAND REVITALIZATION, NAMELY RENOVATING, RESTORING AND MAKING NEW USE OF POLLUTED LANDS. (U.S. CLS. 100, 103 AND 106).

SN 78-339,061. RASER TECHNOLOGIES, INC., PROVO, UT. FILED 12-10-2003.

**SYMETRON**

THE MARK CONSISTS OF STANDARD CHARACTERS WITHOUT CLAIM TO ANY PARTICULAR FONT, STYLE, SIZE, OR COLOR.

**CLASS 7—MACHINERY**

FOR ELECTRIC MOTORS FOR MACHINES. (U.S. CLS. 13, 19, 21, 23, 31, 34 AND 35).

**CLASS 9—ELECTRICAL AND SCIENTIFIC APPARATUS**

FOR ELECTRIC MOTOR CONTROLLERS FOR USE WITH MACHINES. (U.S. CLS. 21, 23, 26, 36 AND 38).

SUSAN HAYASH, EXAMINING ATTORNEY

SN 78-339,526. STARR PRODUCTIONS, LLC., HOLLYWOOD, CA. FILED 12-11-2003.



NO CLAIM IS MADE TO THE EXCLUSIVE RIGHT TO USE "PRODUCTIONS", APART FROM THE MARK AS SHOWN.

**CLASS 9—ELECTRICAL AND SCIENTIFIC APPARATUS**

FOR DIGITAL VIDEO DISCS (DVDS) AND VIDEOTAPES IN THE FIELD OF ADULT ENTERTAINMENT (U.S. CLS. 21, 23, 26, 36 AND 38).  
FIRST USE 11-1-2003; IN COMMERCE 11-1-2003.

**CLASS 35—ADVERTISING AND BUSINESS**

FOR ON LINE RETAIL STORE SERVICES IN THE FIELD OF ADULT ENTERTAINMENT PRODUCTS (U.S. CLS. 100, 101 AND 102).  
FIRST USE 11-1-2003; IN COMMERCE 11-1-2003.

**CLASS 41—EDUCATION AND ENTERTAINMENT**

FOR ENTERTAINMENT SERVICES, NAMELY, PROVIDING ADULT ORIENTED INFORMATION AND ADULT ENTERTAINMENT SERVICES OVER A GLOBAL COMPUTER NETWORK (U.S. CLS. 100, 101 AND 107).  
FIRST USE 11-1-2003; IN COMMERCE 11-1-2003.  
NORA BUCHANAN WILL, EXAMINING ATTORNEY

SN 78-343,600. SPANGLER, AMY, ATLANTA, GA. FILED 12-19-2003.

**AMY'S BABY**

THE MARK CONSISTS OF STANDARD CHARACTERS WITHOUT CLAIM TO ANY PARTICULAR FONT, STYLE, SIZE, OR COLOR.  
NO CLAIM IS MADE TO THE EXCLUSIVE RIGHT TO USE "BABY", APART FROM THE MARK AS SHOWN.

**CLASS 9—ELECTRICAL AND SCIENTIFIC APPARATUS**

FOR PRE-RECORDED CD'S, VIDEO TAPES, AND DVD'S FEATURING BREASTFEEDING INSTRUCTIONS AND INFORMATION; PHOTOGRAPHIC SLIDE TRANSPARENCY SETS FEATURING BREASTFEEDING INSTRUCTIONS AND INFORMATION. (U.S. CLS. 21, 23, 26, 36 AND 38).

**CLASS 16—PAPER GOODS AND PRINTED MATTER**

FOR BOOKS, BOOKMARKS, BROCHURES, AND POCKET GUIDES FEATURING BREASTFEEDING INSTRUCTIONS AND INFORMATION. (U.S. CLS. 2, 5, 22, 23, 29, 37, 38 AND 50).  
JENNIFER MARTIN, EXAMINING ATTORNEY

SN 78-343,617. ROHM AND HAAS COMPANY, PHILADELPHIA, PA. FILED 12-19-2003.

**ROHM AND HAAS**

THE MARK CONSISTS OF STANDARD CHARACTERS WITHOUT CLAIM TO ANY PARTICULAR FONT, STYLE, SIZE, OR COLOR.  
OWNER OF U.S. REG. NOS. 990,595 AND 2,657,258.

**CLASS 3—COSMETICS AND CLEANING PREPARATIONS**

FOR GENERAL PURPOSE CLEANING, POLISHING, ABRASIVE AND STRIPPING LIQUIDS AND POWDERS, SCOURING LIQUIDS AND POWDERS (U.S. CLS. 1, 4, 6, 50, 51 AND 52).

**CLASS 7—MACHINERY**

FOR PADS FOR POLISHING MACHINES FOR ELECTRONIC COMPONENTS AND COMPUTER DISKS; MACHINES FOR TREATING CHEMICALS AND SOLUTIONS (U.S. CLS. 13, 19, 21, 23, 31, 34 AND 35).  
KATHERINE STOIDES, EXAMINING ATTORNEY

SN 78-343,622. SPANGLER, AMY, ATLANTA, GA. FILED 12-19-2003.



**CLASS 9—ELECTRICAL AND SCIENTIFIC APPARATUS**

FOR PRE-RECORDED CD'S, VIDEO TAPES, AND DVD'S FEATURING INSTRUCTIONS AND INFORMATION ON BREASTFEEDING AND INFANT CARE; PHOTOGRAPHIC SLIDE TRANSPARENCY SETS FEATURING INSTRUCTIONS AND INFORMATION ON BREASTFEEDING AND INFANT CARE. (U.S. CLS. 21, 23, 26, 36 AND 38).

**CLASS 16—PAPER GOODS AND PRINTED MATTER**

FOR BOOKS, BOOKMARKS, BROCHURES, AND POCKET GUIDES FEATURING INSTRUCTIONS AND INFORMATION ON BREASTFEEDING AND INFANT CARE. (U.S. CLS. 2, 5, 22, 23, 29, 37, 38 AND 50).  
JENNIFER MARTIN, EXAMINING ATTORNEY

SN 78-344,756. IMG ACADEMIES LLP, CLEVELAND, OH. FILED 12-23-2003.

**BOLLETTIERI TENNIS ACADEMY**

THE MARK CONSISTS OF STANDARD CHARACTERS WITHOUT CLAIM TO ANY PARTICULAR FONT, STYLE, SIZE, OR COLOR.

OWNER OF U.S. REG. NO. 1,809,534.  
NO CLAIM IS MADE TO THE EXCLUSIVE RIGHT TO USE TENNIS ACADEMY, APART FROM THE MARK AS SHOWN.

THE NAME(S), PORTRAIT(S), AND/OR SIGNATURE(S) SHOWN IN THE MARK IDENTIFIES NICK BOLLETTIERI, WHOSE CONSENT(S) TO REGISTER IS SUBMITTED.

**CLASS 35—ADVERTISING AND BUSINESS**

FOR MANAGING, MAINTAINING AND OPERATING TENNIS FACILITIES OF OTHERS (U.S. CLS. 100, 101 AND 102).

FIRST USE 0-0-1987; IN COMMERCE 0-0-1987.

**CLASS 41—EDUCATION AND ENTERTAINMENT**

FOR INSTRUCTION IN THE FIELDS OF TENNIS TRAINING, PHYSICAL PERFORMANCE AND CONDITIONING, AND MENTAL EFFICIENCY (U.S. CLS. 100, 101 AND 107).

FIRST USE 0-0-1987; IN COMMERCE 0-0-1987.

KATHERINE STOIDES, EXAMINING ATTORNEY

SN 78-344,866. LI & FUNG (B.V.I.) LIMITED, TORTOLA, BR. VIRGIN ISLANDS, FILED 12-23-2003.

**BLACK CAT FULL LINE DEALER**

THE MARK CONSISTS OF STANDARD CHARACTERS WITHOUT CLAIM TO ANY PARTICULAR FONT, STYLE, SIZE, OR COLOR.

NO CLAIM IS MADE TO THE EXCLUSIVE RIGHT TO USE "FULL LINE DEALER IN CLASS 35", APART FROM THE MARK AS SHOWN.

**CLASS 13—FIREARMS**

FOR FIREWORKS (U.S. CLS. 2 AND 9).

**CLASS 35—ADVERTISING AND BUSINESS**

FOR RETAIL STORES FEATURING FIREWORKS (U.S. CLS. 100, 101 AND 102).

KARANENDRA S. CHHINA, EXAMINING ATTORNEY

SN 78-347,940. PROCTOR FINANCIAL, INC., WELLESLEY, MA. FILED 1-5-2004.

**PROCTOR FINANCIAL**

THE MARK CONSISTS OF STANDARD CHARACTERS WITHOUT CLAIM TO ANY PARTICULAR FONT, STYLE, SIZE, OR COLOR.

NO CLAIM IS MADE TO THE EXCLUSIVE RIGHT TO USE "FINANCIAL", APART FROM THE MARK AS SHOWN.

**CLASS 36—INSURANCE AND FINANCIAL**

FOR FINANCIAL INVESTMENT SERVICES IN THE NATURE OF FINANCIAL PLANNING FOR RETIREMENT AND PROVIDING RELATED INVESTMENT ADVICE (U.S. CLS. 100, 101 AND 102).

FIRST USE 8-20-1994; IN COMMERCE 8-20-1994.

**CLASS 41—EDUCATION AND ENTERTAINMENT**

FOR PROVIDING TRAINING AND EDUCATIONAL SEMINARS IN FINANCIAL PLANNING FOR RETIREMENT AND RETIREMENT INVESTMENTS (U.S. CLS. 100, 101 AND 107).

FIRST USE 8-20-1994; IN COMMERCE 8-20-1994.  
ODESSA BIBBINS, EXAMINING ATTORNEY

---

SN 78-348,521. CAST IRON FILTER LLC, DAVIDSON, NC. FILED 1-6-2004.

## Cast Iron Filter

THE MARK CONSISTS OF STANDARD CHARACTERS WITHOUT CLAIM TO ANY PARTICULAR FONT, STYLE, SIZE, OR COLOR.

**CLASS 9—ELECTRICAL AND SCIENTIFIC APPARATUS**

FOR COMPACT DISCS FEATURING MUSIC (U.S. CLS. 21, 23, 26, 36 AND 38).

FIRST USE 1-0-1999; IN COMMERCE 7-0-1999.

**CLASS 16—PAPER GOODS AND PRINTED MATTER**

FOR STICKERS, POSTERS (U.S. CLS. 2, 5, 22, 23, 29, 37, 38 AND 50).

FIRST USE 1-0-1999; IN COMMERCE 7-0-1999.

**CLASS 25—CLOTHING**

FOR T-SHIRTS (U.S. CLS. 22 AND 39).

FIRST USE 1-0-1999; IN COMMERCE 7-0-1999.

LEIGH CAROLINE CASE, EXAMINING ATTORNEY

---

SN 78-349,295. BUFFETT, JIMMY, KEY WEST, FL. FILED 1-8-2004.

## IN SEARCH OF MARGARITAVILLE

THE MARK CONSISTS OF STANDARD CHARACTERS WITHOUT CLAIM TO ANY PARTICULAR FONT, STYLE, SIZE, OR COLOR.

OWNER OF U.S. REG. NOS. 2,172,663 AND 2,729,442.

**CLASS 18—LEATHER GOODS**

FOR LUGGAGE, SUITCASES, LUGGAGE TAGS, UMBRELLAS, TRAVEL BAGS, OVERNIGHT BAGS, TOTE BAGS, BEACH BAGS, GARMENT BAGS FOR TRAVEL, LEATHER KEY CHAINS, COIN PURSES, WAIST PACKS AND BACKPACKS (U.S. CLS. 1, 2, 3, 22 AND 41).

**CLASS 28—TOYS AND SPORTING GOODS**

FOR GOLF BAGS AND PLAYING CARDS (U.S. CLS. 22, 23, 38 AND 50).

EVELYN BRADLEY, EXAMINING ATTORNEY

---

SN 78-349,471. STERLING PUBLISHING CO., INC., NEW YORK, NY. FILED 1-8-2004.



**STERLING  
PUBLISHING**

OWNER OF U.S. REG. NO. 1,970,955.  
NO CLAIM IS MADE TO THE EXCLUSIVE RIGHT TO USE "PUBLISHING" OR "PUBLISHING CO., INC.", APART FROM THE MARK AS SHOWN.  
THE MARK CONSISTS OF A FANCIFUL DEPICTION OF THE LETTER "S" AND THE WORDS STERLING PUBLISHING CO., INC.

**CLASS 16—PAPER GOODS AND PRINTED MATTER**

FOR BOOKS ON A VARIETY OF TOPICS (U.S. CLS. 2, 5, 22, 23, 29, 37, 38 AND 50).

**CLASS 41—EDUCATION AND ENTERTAINMENT**

FOR BOOK PUBLISHING SERVICES (U.S. CLS. 100, 101 AND 107).

DORITT L. CARROLL, EXAMINING ATTORNEY



SN 78-349,725. BEAUTY HOLDING COMPANY, INC., HAMILTON, BERMUDA, FILED 1-9-2004.

## SAVAGE BRONZE

THE MARK CONSISTS OF STANDARD CHARACTERS WITHOUT CLAIM TO ANY PARTICULAR FONT, STYLE, SIZE, OR COLOR.

OWNER OF U.S. REG. NO. 2,806,741.

NO CLAIM IS MADE TO THE EXCLUSIVE RIGHT TO USE BRONZE, APART FROM THE MARK AS SHOWN.

### CLASS 21—HOUSEWARES AND GLASS

FOR APPLICATOR MITTS FOR USE IN CONNECTION WITH SUNLESS TANNING PREPARATIONS (U.S. CLS. 2, 13, 23, 29, 30, 33, 40 AND 50).

### CLASS 24—FABRICS

FOR TOWELS FOR USE IN CONNECTION WITH SUNLESS TANNING PREPARATIONS (U.S. CLS. 42 AND 50).

TARAH HARDY, EXAMINING ATTORNEY

SN 78-350,550. DIGIMARC CORPORATION, TUALATIN, OR. FILED 1-12-2004.

## DIGIMARC ID SYSTEMS

THE MARK CONSISTS OF STANDARD CHARACTERS WITHOUT CLAIM TO ANY PARTICULAR FONT, STYLE, SIZE, OR COLOR.

OWNER OF U.S. REG. NOS. 2,085,032, 2,848,290 AND OTHERS.

NO CLAIM IS MADE TO THE EXCLUSIVE RIGHT TO USE "ID SYSTEMS", APART FROM THE MARK AS SHOWN.

### CLASS 9—ELECTRICAL AND SCIENTIFIC APPARATUS

FOR COMPUTER SOFTWARE FOR USE IN PRODUCING, TRACKING AND ISSUING IDENTIFICATION DOCUMENTS AND DRIVER'S LICENSES (U.S. CLS. 21, 23, 26, 36 AND 38).

### CLASS 37—CONSTRUCTION AND REPAIR

FOR INSTALLATION AND MAINTENANCE OF COMPUTER SYSTEMS FOR PRODUCING, TRACKING AND ISSUING IDENTIFICATION DOCUMENTS AND DRIVER'S LICENSES (U.S. CLS. 100, 103 AND 106).

### CLASS 41—EDUCATION AND ENTERTAINMENT

FOR TRAINING OTHERS IN THE FIELD OF PRODUCING, TRACKING AND ISSUING IDENTIFICATION DOCUMENTS AND DRIVER'S LICENSES AND IN THE USE OF SOFTWARE AND EQUIPMENT TO PRODUCE, TRACK AND ISSUE IDENTIFICATION DOCUMENTS AND DRIVER'S LICENSES (U.S. CLS. 100, 101 AND 107).

### CLASS 42—SCIENTIFIC, COMPUTER AND LEGAL SERVICES

FOR INSTALLATION AND MAINTENANCE OF COMPUTER SOFTWARE FOR PRODUCING, TRACKING AND ISSUING IDENTIFICATION DOCUMENTS AND DRIVER'S LICENSES; AND PROVIDING TECHNICAL SUPPORT SERVICES VIA THE TELEPHONE AND ONLINE, NAMELY TROUBLESHOOTING OF COMPUTER SOFTWARE PROBLEMS FOR COMPUTER SOFTWARE AND HARDWARE THAT IS USED FOR PRODUCING, TRACKING AND ISSUING IDENTIFICATION DOCUMENTS AND DRIVER'S LICENSES (U.S. CLS. 100 AND 101).

### CLASS 45—PERSONAL SERVICES

FOR PROVIDING DATABASES CONTAINING FINGERPRINT, FACIAL, SIGNATURE AND OTHER IDENTIFICATION INFORMATION FOR USE BY BUSINESS, GOVERNMENT, MILITARY AND LAW ENFORCEMENT (U.S. CLS. 100 AND 101).

MATTHEW PAPPAS, EXAMINING ATTORNEY

SN 78-350,668. ANNE T. SPURGEON, SAN ANTONIO, TX. FILED 1-12-2004.

## fringe element(s)

THE MARK CONSISTS OF STANDARD CHARACTERS WITHOUT CLAIM TO ANY PARTICULAR FONT, STYLE, SIZE, OR COLOR.

### CLASS 18—LEATHER GOODS

FOR BACK PACKS, BEACH BAGS, BOOK BAGS, PURSES, DAY PACKS, DIAPER BAGS, HAND BAGS, ATHLETIC BAGS, TOTE BAGS (U.S. CLS. 1, 2, 3, 22 AND 41).

### CLASS 25—CLOTHING

FOR FOOTWEAR, SHOES, NAMELY, SANDALS, THONGS, BEACH SHOES (U.S. CLS. 22 AND 39).

HELEN BRYAN, EXAMINING ATTORNEY

SN 78-350,893. ODYSSEY ADVENTURES, INC., PLANTATION, FL. FILED 1-12-2004.

## SUPERPOOL

THE MARK CONSISTS OF STANDARD CHARACTERS WITHOUT CLAIM TO ANY PARTICULAR FONT, STYLE, SIZE, OR COLOR.

### CLASS 28—TOYS AND SPORTING GOODS

FOR BOARD GAME OF CHANCE ON PRE-PRINTED SHEETS USED BY CONTESTANTS WHO MUST CORRECTLY ANSWER TRIVIA QUESTIONS IN ADDITION TO MATCHING THE SCORES OF PROFESSIONAL OR COLLEGIATE SPORTS TEAMS IN ORDER TO WIN PRE-PRINTED PLAY MONEY OR PRIZES (U.S. CLS. 22, 23, 38 AND 50).

FIRST USE 12-21-2003; IN COMMERCE 12-21-2003.

### CLASS 35—ADVERTISING AND BUSINESS

FOR DISSEMINATING ADVERTISING FOR OTHERS; PROMOTING THE GOODS AND SERVICES OF OTHERS BY ARRANGING FOR SPONSORS; BUSINESS MARKETING PLANNING IN THE FIELDS PUBLIC RELATIONS EVENTS, PRODUCT ADVERTISING AND CONDUCTING ADVERTISING CAMPAIGNS FOR THE GOODS AND SERVICES OF OTHERS; BUSINESS CONSULTING SERVICES FOR COMMERCIAL BUSINESSES, OTHER TYPES OF BUSINESSES, PERSONNEL MANAGEMENT AND RECRUITMENT SERVICES; DIRECT MARKETING (U.S. CLS. 100, 101 AND 102).

FIRST USE 12-21-2003; IN COMMERCE 12-21-2003.  
KIMBERLY FRYE, EXAMINING ATTORNEY

SN 78-351,219. LIKISMA PRESENTATIONS LTD, WELLINGBOROUGH, NORTHANTS, UNITED KINGDOM, FILED 1-13-2004.

## LIKISMA

THE MARK CONSISTS OF STANDARD CHARACTERS WITHOUT CLAIM TO ANY PARTICULAR FONT, STYLE, SIZE, OR COLOR.

### CLASS 3—COSMETICS AND CLEANING PREPARATIONS

FOR ESSENTIAL OILS FOR PERSONAL USE; AROMATHERAPY CREAMS, LOTIONS AND OILS FOR PERSONAL USE; HAIR CARE PRODUCTS, NAMELY SHAMPOOS, CONDITIONERS; SKIN CARE PRODUCTS, NAMELY SKIN CLEANSING PREPARATIONS, MOISTURIZERS, TONERS, GELS, LOTIONS, CREAMS, MASQUES AND ASTRINGENTS FOR COSMETIC PURPOSES; PERSONAL HYGIENE PRODUCTS, NAMELY BODY CLEANING PREPARATIONS, MASSAGE OILS AND LOTIONS; SKIN CREAMS, SKIN LOTIONS, SKIN EMOLLIENTS, MOISTURIZING BODY OILS AND LOTIONS (U.S. CLS. 1, 4, 6, 50, 51 AND 52).

FIRST USE 4-0-2001; IN COMMERCE 4-0-2001.

### CLASS 21—HOUSEWARES AND GLASS

FOR NON-ELECTRIC AND NON-BATTERY OPERATED AROMATHERAPY UNITS (U.S. CLS. 2, 13, 23, 29, 30, 33, 40 AND 50).

FIRST USE 4-0-2001; IN COMMERCE 4-0-2001.

REGINA DRUMMOND, EXAMINING ATTORNEY

SN 78-351,434. SMITHKLINE BEECHAM, PHILADELPHIA, PA. FILED 1-13-2004.

## RESTORING STABILITY

THE MARK CONSISTS OF STANDARD CHARACTERS WITHOUT CLAIM TO ANY PARTICULAR FONT, STYLE, SIZE, OR COLOR.

### CLASS 35—ADVERTISING AND BUSINESS

FOR PROMOTING PUBLIC AWARENESS OF THE TREATMENT AND MANAGEMENT OF BIPOLAR DISEASES AND DISORDERS BY CONDUCTING PATIENT SCREENING PROGRAMS AND THROUGH TELEVISION AND RADIO PUBLIC SERVICE ANNOUNCEMENTS (U.S. CLS. 100, 101 AND 102).

### CLASS 44—MEDICAL, BEAUTY AND AGRICULTURAL SERVICES

FOR HEALTH INFORMATION SERVICES, NAMELY PROVIDING INFORMATION ON BIPOLAR DISEASES AND DISORDERS AND SELF-MANAGEMENT SKILLS FOR PATIENTS WITH BIPOLAR DISEASES AND/OR DISORDERS THROUGH GLOBAL COMPUTER NETWORKS, AND AN INTERACTIVE TELEPHONE VOICE RESPONSE SYSTEM (U.S. CLS. 100 AND 101).

CAROLINE WOOD, EXAMINING ATTORNEY

SN 78-351,664. MYSENTIENT IRELAND (I.P.) LIMITED,  
BOULDER, CO. FILED 1-14-2004.

SN 78-352,292. AGSTAR FINANCIAL SERVICES, ACA,  
MANKATO, MN. FILED 1-15-2004.

## MYSENTIENT

THE MARK CONSISTS OF STANDARD CHARACTERS WITHOUT CLAIM TO ANY PARTICULAR FONT, STYLE, SIZE, OR COLOR.

### CLASS 9—ELECTRICAL AND SCIENTIFIC APPARATUS

FOR COMPUTER SOFTWARE PLATFORM FOR A VARIETY OF CUSTOMER INTERFACE AND CUSTOMER SERVICE APPLICATIONS INTEGRATING CORE TECHNOLOGIES OF ARTIFICIAL INTELLIGENCE, NATURAL LANGUAGE PROCESSING AND ANIMATION (U.S. CLS. 21, 23, 26, 36 AND 38).

### CLASS 42—SCIENTIFIC, COMPUTER AND LEGAL SERVICES

FOR COMPUTER CONSULTING SERVICES RELATED TO THE CUSTOMIZATION AND IMPLEMENTATION OF COMPONENTS OF A COMPUTER SOFTWARE PLATFORM FOR A VARIETY OF CUSTOMER INTERFACE AND CUSTOMER SERVICE APPLICATIONS INTEGRATING CORE TECHNOLOGIES OF ARTIFICIAL INTELLIGENCE, NATURAL LANGUAGE PROCESSING AND ANIMATION (U.S. CLS. 100 AND 101).  
JOHN HWANG, EXAMINING ATTORNEY

SN 78-351,990. SOCIETE DES PRODUITS NESTLE S.A., 1800  
VEVEY, SWITZERLAND, FILED 1-14-2004.

## LAUREL HILL BISTRO

THE MARK CONSISTS OF STANDARD CHARACTERS WITHOUT CLAIM TO ANY PARTICULAR FONT, STYLE, SIZE, OR COLOR.

### CLASS 29—MEATS AND PROCESSED FOODS

FOR FROZEN PREPARED ENTREES CONSISTING PRIMARILY OF MEAT, FISH OR POULTRY (U.S. CL. 46).

### CLASS 30—STAPLE FOODS

FOR FROZEN PREPARED ENTREES CONSISTING PRIMARILY OF PASTA OR RICE (U.S. CL. 46).  
STACY WAHLBERG, EXAMINING ATTORNEY

## PPF FINANCE

THE MARK CONSISTS OF STANDARD CHARACTERS WITHOUT CLAIM TO ANY PARTICULAR FONT, STYLE, SIZE, OR COLOR.

NO CLAIM IS MADE TO THE EXCLUSIVE RIGHT TO USE FINANCE, APART FROM THE MARK AS SHOWN.

### CLASS 35—ADVERTISING AND BUSINESS

FOR AGRICULTURAL BUSINESS CONSULTATION; TAX PLANNING FOR FARMERS AND RANCHERS (U.S. CLS. 100, 101 AND 102).

### CLASS 36—INSURANCE AND FINANCIAL

FOR FINANCIAL SERVICES, NAMELY, AGRICULTURAL LOANS AND LEASES; LEASING OF FARMS; AGRICULTURAL LOAN FINANCING; FARM RISK MANAGEMENT; AGRICULTURAL LEASING-PURCHASE FINANCING; FINANCIAL ANALYSIS AND CONSULTATION REGARDING FARM BUSINESS RECORDS (U.S. CLS. 100, 101 AND 102).  
SUE LAWRENCE, EXAMINING ATTORNEY

SN 78-352,613. NURTURING PATHWAYS, INC., LYNNWOOD, WA. FILED 1-15-2004.

## NURTURING PATHWAYS

THE MARK CONSISTS OF STANDARD CHARACTERS WITHOUT CLAIM TO ANY PARTICULAR FONT, STYLE, SIZE, OR COLOR.

### CLASS 16—PAPER GOODS AND PRINTED MATTER

FOR PRINTED INSTRUCTIONAL, EDUCATIONAL, AND TEACHING MATERIALS, NAMELY, BROCHURES, TRAINING MANUALS, INSTRUCTIONAL BOOKS, BOOKLETTES, PAMPHLETS, AND CHILDREN'S BOOKS IN THE FIELDS OF DANCE, CREATIVE MOVEMENT AND EARLY CHILDHOOD DEVELOPMENT (U.S. CLS. 2, 5, 22, 23, 29, 37, 38 AND 50).  
FIRST USE 4-25-2001; IN COMMERCE 4-25-2001.

**CLASS 41—EDUCATION AND ENTERTAINMENT**

FOR EDUCATIONAL SERVICES, NAMELY, PROVIDING COURSES OF INSTRUCTION FOR PARENTS, CHILDREN, AND TEACHERS IN THE FIELDS OF DANCE, CREATIVE MOVEMENT, AND EARLY CHILDHOOD DEVELOPMENT (U.S. CLS. 100, 101 AND 107).

FIRST USE 4-25-2001; IN COMMERCE 4-25-2001.  
 NAAKWAMA ANKRAH, EXAMINING ATTORNEY

SN 78-352,792. NOVEN PHARMACEUTICALS, INC., MIAMI, FL. FILED 1-16-2004.

**CLASS 5—PHARMACEUTICALS**

FOR PHARMACEUTICAL PREPARATIONS DISPENSED BY PRESCRIPTION ONLY, NAMELY TRANSDERMAL ADHESIVE MATRIX PATCHES INTO WHICH A WIDE VARIETY OF BIOLOGICALLY ACTIVE AGENTS ARE PLACED FOR THE SYSTEMIC TREATMENT OF ALLERGIC, CARDIO-VASCULAR, INFECTIOUS, NEUROLOGICAL, INFLAMMATORY, IMMUNOLOGICAL, METABOLIC, VIRAL, MICROBIAL, OSTEOPATHIC, DIETARY, RESPIRATORY, PSYCHIATRIC, HORMONAL, DENTAL, DERMAL, MUSCULAR, AND EXCRETORY DISEASES, CONDITIONS, DEFICIENCIES AND DISORDERS (U.S. CLS. 6, 18, 44, 46, 51 AND 52).

**CLASS 40—MATERIAL TREATMENT**

FOR MANUFACTURE OF TRANSDERMAL PATCHES FOR DELIVERY OF BIOLOGICALLY ACTIVE AGENTS TO ORDER AND/OR SPECIFICATION OF OTHERS (U.S. CLS. 100, 103 AND 106).

DOMINICK J. SALEMI, EXAMINING ATTORNEY

SN 78-352,709. PURE NETWORKS, INC., SEATTLE, WA. FILED 1-15-2004.

**IT JUST NETWORKS**

SN 78-353,956. BRIDGESTONE SPORTS CO., LTD, TOKYO, JAPAN, FILED 1-20-2004.

THE MARK CONSISTS OF STANDARD CHARACTERS WITHOUT CLAIM TO ANY PARTICULAR FONT, STYLE, SIZE, OR COLOR.

NO CLAIM IS MADE TO THE EXCLUSIVE RIGHT TO USE NETWORKS, APART FROM THE MARK AS SHOWN.

**INSIDE THE GOLFER  
 INSIDE THE GAME**

**CLASS 9—ELECTRICAL AND SCIENTIFIC APPARATUS**

FOR COMPUTER SOFTWARE FOR CONNECTING HOME COMPUTER NETWORK USERS (U.S. CLS. 21, 23, 26, 36 AND 38).

**CLASS 42—SCIENTIFIC, COMPUTER AND LEGAL SERVICES**

FOR COMPUTER CONSULTATION; TECHNICAL CONSULTATION IN THE FIELD OF DESIGN AND NETWORKING OF PERSONAL COMPUTERS; TECHNICAL SUPPORT SERVICES, NAMELY, TROUBLESHOOTING OF COMPUTER HARDWARE AND SOFTWARE PROBLEMS; COMPUTER NETWORK DESIGN FOR OTHERS; COMPUTER PROGRAMMING FOR OTHERS; COMPUTER SERVICES, NAMELY CREATING INDEXES OF INFORMATION, SITES AND OTHER RESOURCES AVAILABLE ON COMPUTER NETWORKS (U.S. CLS. 100 AND 101).

SUE LAWRENCE, EXAMINING ATTORNEY

THE MARK CONSISTS OF STANDARD CHARACTERS WITHOUT CLAIM TO ANY PARTICULAR FONT, STYLE, SIZE, OR COLOR.

**CLASS 18—LEATHER GOODS**

FOR BOSTON BAGS, SHOE CASES FOR TRAVEL AND GOLFING, UMBRELLAS AND PARASOLS (U.S. CLS. 1, 2, 3, 22 AND 41).

**CLASS 24—FABRICS**

FOR TOWELS AND HANDKERCHIEFS (U.S. CLS. 42 AND 50).

**CLASS 25—CLOTHING**

FOR GOLF SHOES, BELTS, SPORTSWEAR, NAMELY SHIRTS, SHORTS, PANTS, JACKETS, CAPS, HATS, SOCKS (U.S. CLS. 22 AND 39).

**CLASS 28—TOYS AND SPORTING GOODS**

FOR GOLF BALLS, GOLF CLUBS, GOLF BAGS, GOLF CLUB HEAD COVERS, GOLF GLOVES, AND GOLF CLUB TRAVEL CASES (U.S. CLS. 22, 23, 38 AND 50).  
CAROL SPILS, EXAMINING ATTORNEY

**CLASS 9—ELECTRICAL AND SCIENTIFIC APPARATUS**

FOR VENDING MACHINES (U.S. CLS. 21, 23, 26, 36 AND 38).

**CLASS 30—STAPLE FOODS**

FOR COFFEE (U.S. CL. 46).

**CLASS 35—ADVERTISING AND BUSINESS**

FOR COFFEE VENDING MACHINE SERVICES (U.S. CLS. 100, 101 AND 102).  
GRETTA YAO, EXAMINING ATTORNEY

SN 78-354,117. HEALTH ALLIANCE PLAN OF MICHIGAN, DETROIT, MI. FILED 1-20-2004.



SN 78-355,233. TONY POWER CO. LTD., MONTEREY PARK, CA. FILED 1-21-2004.

**CLASS 36—INSURANCE AND FINANCIAL**

FOR ADMINISTRATION OF THIRD PARTY PREFERRED PROVIDER ORGANIZATIONS AND HEALTH MAINTENANCE ORGANIZATIONS IN THE FIELD OF HEALTH CARE (U.S. CLS. 100, 101 AND 102).

**CLASS 44—MEDICAL, BEAUTY AND AGRICULTURAL SERVICES**

FOR HEALTH CARE SERVICES IN THE NATURE OF A HEALTH MAINTENANCE ORGANIZATION AND PROVIDER ORGANIZATION (U.S. CLS. 100 AND 101).  
JEFFERY COWARD, EXAMINING ATTORNEY



SN 78-354,189. AMERICA VENDORS, INC., MIAMI, FL. FILED 1-20-2004.



**CLASS 7—MACHINERY**

FOR AGRICULTURAL MACHINERY, NAMELY, TILLERS, SPRAYERS, TRIMMERS, AND CHAIN SAWS, AIR COMPRESSORS, DIESEL ENGINES FOR MACHINES, DIESEL ENGINES NOT FOR LAND VEHICLES, ELECTRIC GENERATORS, GASOLINE ENGINES NOT FOR LAND VEHICLES, LAND MOWERS, SNOW BLOWERS, AND WATER PUMPS FOR USE IN MOTORS AND ENGINES (U.S. CLS. 13, 19, 21, 23, 31, 34 AND 35).

**CLASS 11—ENVIRONMENTAL CONTROL APPARATUS**

FOR AIR CONDITIONERS (U.S. CLS. 13, 21, 23, 31 AND 34).  
DAVID ELTON, EXAMINING ATTORNEY

THE MARK CONSISTS OF STANDARD CHARACTERS WITHOUT CLAIM TO ANY PARTICULAR FONT, STYLE, SIZE, OR COLOR.

SN 78-355,789. BAKER HUGHES INCORPORATED, HOUSTON, TX. FILED 1-22-2004.

# FASTFRAC

THE MARK CONSISTS OF STANDARD CHARACTERS WITHOUT CLAIM TO ANY PARTICULAR FONT, STYLE, SIZE, OR COLOR.

## CLASS 7—MACHINERY

FOR DOWNHOLE OIL FIELD EQUIPMENT NAMELY PACKERS AND BRIDGE PLUGS, USED IN OIL AND GAS WELLS TO ISOLATE THE FLOW OF FLUIDS TO OR FROM GEOLOGIC FORMATIONS (U.S. CLS. 13, 19, 21, 23, 31, 34 AND 35).

## CLASS 9—ELECTRICAL AND SCIENTIFIC APPARATUS

FOR DOWNHOLE OIL FIELD EQUIPMENT NAMELY FLOW REGULATORS USED IN OIL AND GAS WELLS (U.S. CLS. 21, 23, 26, 36 AND 38).

ALLISON HOLTZ, EXAMINING ATTORNEY

---

SN 78-355,944. TOKYOPOP INC., LOS ANGELES, CA. FILED 1-22-2004.

# PRINCESS AI

THE MARK CONSISTS OF STANDARD CHARACTERS WITHOUT CLAIM TO ANY PARTICULAR FONT, STYLE, SIZE, OR COLOR.

THE FOREIGN WORDING IN THE MARK TRANSLATES INTO ENGLISH AS LOVE.

## CLASS 9—ELECTRICAL AND SCIENTIFIC APPARATUS

FOR VIDEO PRODUCTS, NAMELY, PRE-RECORDED VIDEO CASSETTES AND DVDS FEATURING ANIMATION, AND LIVE-ACTION TELEVISION PROGRAMS AND MOTION PICTURE FILMS; MUSICAL SOUND RECORDINGS, COMPACT DISKS FEATURING MUSIC; LUMINOUS SIGNS; PLAYER-OPERATED ELECTRONIC CONTROLLERS FOR ELECTRONIC VIDEO GAME MACHINES, COMPUTER GAME SOFTWARE, COMPUTER GAME TAPES AND CARTRIDGES; VIDEO GAME SOFTWARE, COMPUTER GAMES CONTAINING MEMORY DEVICES, NAMELY, DISKS; SUNGLASSES, EYEGLASSES, EYEGLASS FRAMES, AND PROTECTIVE CASES FOR EYEGLASSES; AND CALCULATORS (U.S. CLS. 21, 23, 26, 36 AND 38).

## CLASS 16—PAPER GOODS AND PRINTED MATTER

FOR PUBLICATIONS, NAMELY, COMIC BOOKS, MANGA, NAMELY, ASIAN STYLE COMIC BOOKS, MAGAZINES IN THE FIELD OF FICTION AND GRAPHIC ARTS; CALENDARS, POSTERS, DAILY PLANNERS, ORIGAMI PAPER, BOOK COVERS, GREETING CARDS, STATIONERY, WRITING PAPER AND ENVELOPES, MEMO PADS, THREE-RING BINDERS, STICKERS, STICKER ALBUMS, GIFT WRAPPING PAPER, PAPER NAPKINS, PAPER PARTY HATS, TRADING CARDS, COLORING BOOKS, FICTION AND NON-FICTION BOOKS FOR CHILDREN, FICTION AND NON-FICTION BOOKS FOR ADULTS IN THE FIELD OF FANTASY; CHILDREN'S ACTIVITY BOOKS, ILLUSTRATED BOOKS FOR CHILDREN AND ADULTS, RUBBER STAMPS, STAPLERS, PENS, PENCILS, CRAYONS, MARKERS, PENCIL ERASERS, AND PENCIL CASES AND BOXES (U.S. CLS. 2, 5, 22, 23, 29, 37, 38 AND 50).

## CLASS 25—CLOTHING

FOR CLOTHING, NAMELY, MEN'S, WOMEN'S AND CHILDREN'S PANTS, JEANS, SHORTS, SKIRTS, DRESSES, GOWNS, SHIRTS, T-SHIRTS, HALTER TOPS, TANK TOPS, BLOUSES, COATS, TRENCH COATS, JACKETS, VESTS, SWEATERS, PULLOVERS, COVERALLS, COVER-UPS, BODY SUITS, JUMPSUITS, WARM-UP SUITS, SWEATSHIRTS, SWEATPANTS, KILTS, KERICHS, LEGGINGS, TIGHTS, PANTYHOSE, LEOTARDS, SOCKS, TIES, BRAS, UNDERWEAR, UNDERSHIRTS, UNDERPANTS, PANTIES, INFANTWEAR, JUMPERS, ROMPERS, GLOVES, MITTENS, ROBES, PAJAMAS, NIGHTGOWNS, LINGERIE, PONCHOS, RAINCOATS, SUSPENDERS, BELTS, HATS, CAPS, VISORS, BANDANNAS, HEAD BANDS, WRIST BANDS, BEACH COVER-UPS, BEACHWEAR, SWIM SUITS; FOOTWEAR, NAMELY, ATHLETIC SHOES, SNEAKERS, SLIPPERS, SANDALS AND BOOTS; AND HALLOWEEN COSTUMES (U.S. CLS. 22 AND 39).

## CLASS 41—EDUCATION AND ENTERTAINMENT

FOR ENTERTAINMENT IN THE NATURE OF PRODUCTION AND DISTRIBUTION OF MOTION PICTURES, ANIMATED AND LIVE TELEVISION PRODUCTION, DISTRIBUTION OF TELEVISION PROGRAMS FOR OTHERS, RECORD PRODUCTION; PROVIDING A WEBSITE FEATURING ENTERTAINMENT INFORMATION IN THE FIELDS OF ELECTRONIC GAME PROGRAMS, AND OTHER ENTERTAINMENT TOPICS RELATED TO ELECTRONIC GAME PROGRAMS, PRODUCTION OF VIDEO CASSETTES AND DVDS; PROVIDING ON-LINE COMPUTER GAMES (U.S. CLS. 100, 101 AND 107).

TARAH HARDY, EXAMINING ATTORNEY

SN 78-356,043. SPARLING, JOSEPH J., CHAPEL HILL, NC. FILED 1-22-2004.

# Cradle to Classroom

## CLASS 25—CLOTHING

FOR MEN'S AND WOMEN'S CLOTHING, NAMELY, TEE SHIRTS, SHIRTS, PANTS, SHORTS, JEANS, AND SKIRTS; SPORTSWEAR, NAMELY, SWIMSUITS AND JACKETS (U.S. CLS. 22 AND 39).

## CLASS 41—EDUCATION AND ENTERTAINMENT

FOR ENTERTAINMENT SERVICES, NAMELY, PROVIDING A WEBSITE FEATURING ENTERTAINMENT INFORMATION CONCERNING CARIBBEAN CULTURE; ORGANIZING CULTURAL EVENTS AND ACTIVITIES, FESTIVALS AND CONCERTS (U.S. CLS. 100, 101 AND 107).

KEVON CHISOLM, EXAMINING ATTORNEY

SN 78-357,281. SOY BASICS, LLC, NEW HAMPTON, IA. FILED 1-26-2004.

THE MARK CONSISTS OF STANDARD CHARACTERS WITHOUT CLAIM TO ANY PARTICULAR FONT, STYLE, SIZE, OR COLOR.

## CLASS 16—PAPER GOODS AND PRINTED MATTER

FOR EDUCATIONAL PUBLICATIONS, NAMELY, TRAINING MANUALS IN THE FIELD OF PARENTING AND EARLY CHILDHOOD EDUCATION (U.S. CLS. 2, 5, 22, 23, 29, 37, 38 AND 50).

## CLASS 41—EDUCATION AND ENTERTAINMENT

FOR TRAINING SERVICES IN THE FIELD OF PARENTING AND EARLY CHILDHOOD EDUCATION (U.S. CLS. 100, 101 AND 107).

KIMBERLY PERRY, EXAMINING ATTORNEY

# NATURAL EXPRESSIONS

THE MARK CONSISTS OF STANDARD CHARACTERS WITHOUT CLAIM TO ANY PARTICULAR FONT, STYLE, SIZE, OR COLOR.

## CLASS 4—LUBRICANTS AND FUELS

FOR CANDLES (U.S. CLS. 1, 6 AND 15).

## CLASS 21—HOUSEWARES AND GLASS

FOR CANDLE ACCESSORIES, NOT OF PRECIOUS METAL, NAMELY, CANDLE HOLDERS, CANDLE JARS, CANDLE VOTIVES, AND CANDLE RINGS (U.S. CLS. 2, 13, 23, 29, 30, 33, 40 AND 50).

LINDA MICKLEBURGH, EXAMINING ATTORNEY

SN 78-356,784. NÙECON LLC, RIVERDALE, NY. FILED 1-23-2004.

# CARÜBBEAN

SN 78-357,319. THE BRAINY BABY COMPANY LLC, ALPHARETTA, GA. FILED 1-26-2004.

THE MARK CONSISTS OF STANDARD CHARACTERS WITHOUT CLAIM TO ANY PARTICULAR FONT, STYLE, SIZE, OR COLOR.

NO CLAIM IS MADE TO THE EXCLUSIVE RIGHT TO USE CARIBBEAN, APART FROM THE MARK AS SHOWN.

## CLASS 3—COSMETICS AND CLEANING PREPARATIONS

FOR BODY LOTIONS AND COSMETICS (U.S. CLS. 1, 4, 6, 50, 51 AND 52).

# HAPPY HAMMY

THE MARK CONSISTS OF STANDARD CHARACTERS WITHOUT CLAIM TO ANY PARTICULAR FONT, STYLE, SIZE, OR COLOR.

**CLASS 9—ELECTRICAL AND SCIENTIFIC APPARATUS**

FOR SERIES OF PRERECORDED VIDEOTAPES, AUDIO CASSETTES, DIGITAL VIDEO DISCS AND COMPACT DISCS FEATURING LIVE AND ANIMATED EDUCATIONAL MATERIALS INTENDED TO DEVELOP AND IMPROVE THE CREATIVE AND INTELLECTUAL FACULTIES OF INFANTS AND CHILDREN (U.S. CLS. 21, 23, 26, 36 AND 38).

**CLASS 16—PAPER GOODS AND PRINTED MATTER**

FOR CALENDARS, BABY AND CHILDREN'S BOOKS OF ALL TYPES, SHEET MUSIC, PHOTO AND SCRAPBOOK ALBUMS, GIFT WRAPPING PAPER, GREETING CARDS, ARTS AND CRAFT PAINT KITS, MARKERS, CRAYONS, PENS, PENCILS, STICKERS, RUBBER STAMPS, STAMP PADS, STATIONERY, CRAFT PAPER, PENCIL BOXES, AND PRINTED TEACHING MATERIALS FEATURING EDUCATIONAL MATERIALS FOR USE IN DEVELOPING AND IMPROVING THE CREATIVE AND INTELLECTUAL FACULTIES OF INFANTS AND CHILDREN (U.S. CLS. 2, 5, 22, 23, 29, 37, 38 AND 50).

REBECCA GILBERT, EXAMINING ATTORNEY

---

SN 78-358,398. INTELLISIST, LLC, BELLEVUE, WA. FILED 1-27-2004.

**SPEECHFORMS**

THE MARK CONSISTS OF STANDARD CHARACTERS WITHOUT CLAIM TO ANY PARTICULAR FONT, STYLE, SIZE, OR COLOR.

**CLASS 9—ELECTRICAL AND SCIENTIFIC APPARATUS**

FOR COMPUTER HARDWARE AND SOFTWARE FOR INFORMATION TECHNOLOGY ENGINEERING, FOR USE PARTICULARLY IN THE FIELD OF AUTOMATED VOICE COMMUNICATIONS AND TELEMATICS (U.S. CLS. 21, 23, 26, 36 AND 38).

FIRST USE 6-29-2001; IN COMMERCE 6-29-2001.

**CLASS 42—SCIENTIFIC, COMPUTER AND LEGAL SERVICES**

FOR INFORMATION TECHNOLOGY ENGINEERING, INFORMATION TECHNOLOGY DEVELOPMENT FOR OTHERS, AND CONSULTING RELATED THERETO, PARTICULARLY FOR AUTOMATED VOICE COMMUNICATIONS AND TELEMATICS (U.S. CLS. 100 AND 101).

FIRST USE 6-29-2001; IN COMMERCE 6-29-2001.  
KIMBERLY PERRY, EXAMINING ATTORNEY

SN 78-358,967. PINCH - PIZZA BY THE INCH, INC., NEW YORK, NY. FILED 1-28-2004.

# PINCH

THE MARK CONSISTS OF STANDARD CHARACTERS WITHOUT CLAIM TO ANY PARTICULAR FONT, STYLE, SIZE, OR COLOR.

**CLASS 30—STAPLE FOODS**

FOR PIZZA; PREPARED ENTREES CONSISTING PRIMARILY OF PASTA (U.S. CL. 46).

FIRST USE 11-22-2003; IN COMMERCE 11-22-2003.

**CLASS 43—HOTEL AND RESTAURANT SERVICES**

FOR RESTAURANT SERVICES (U.S. CLS. 100 AND 101).

FIRST USE 11-22-2003; IN COMMERCE 11-22-2003.

RICHARD WHITE, EXAMINING ATTORNEY

---

SN 78-358,998. SIRNA THERAPEUTICS, INC., BOULDER, CO. FILED 1-28-2004.

**CLASS 1—CHEMICALS**

FOR MEDICINAL AND BIOLOGICAL PREPARATIONS FOR RESEARCH AND LABORATORY USE, NAMELY, PREPARATIONS FOR THE MODULATION OF GENE EXPRESSION WORKING AT DNA, TRANSCRIPTION, RNA OR TRANSLATION PROCESSES (U.S. CLS. 1, 5, 6, 10, 26 AND 46).



**CLASS 5—PHARMACEUTICALS**

FOR PREPARATIONS FOR PHARMACEUTICAL, CLINICAL OR MEDICAL LABORATORY USE, NAMELY, PREPARATIONS FOR THE MODULATION OF GENE EXPRESSION WORKING AT DNA, TRANSCRIPTION, RNA OR TRANSLATION PROCESSES (U.S. CLS. 6, 18, 44, 46, 51 AND 52).

SUE LAWRENCE, EXAMINING ATTORNEY

**CLASS 9—ELECTRICAL AND SCIENTIFIC APPARATUS**

FOR DOWNLOADABLE ELECTRONIC NEWSLETTERS IN THE FIELDS OF CORPORATE TRANSACTIONS AND CORPORATE, LEGAL AND FINANCIAL DEVELOPMENTS (U.S. CLS. 21, 23, 26, 36 AND 38).

**CLASS 16—PAPER GOODS AND PRINTED MATTER**

FOR NEWSLETTERS IN THE FIELDS OF CORPORATE TRANSACTIONS AND CORPORATE, LEGAL AND FINANCIAL DEVELOPMENTS (U.S. CLS. 2, 5, 22, 23, 29, 37, 38 AND 50).

BARBARA BROWN, EXAMINING ATTORNEY

SN 78-359,297. DOLCE FOOD CORP., BROOKLYN, NY.  
FILED 1-29-2004.

---

**CREAMLEE**

SN 78-362,284. ROHO, INC., BELLEVILLE, IL. FILED 2-4-2004.

THE MARK CONSISTS OF STANDARD CHARACTERS WITHOUT CLAIM TO ANY PARTICULAR FONT, STYLE, SIZE, OR COLOR.

**CLASS 29—MEATS AND PROCESSED FOODS**

FOR YOGURT BASED DESSERTS; YOGURT BASED DESSERTS WITH FRUIT; YOGURT BASED DESSERTS WITH FRUIT, CHOCOLATE AND OTHER FLAVORINGS; WHIPPED CREAM (U.S. CL. 46).

**CLASS 30—STAPLE FOODS**

FOR PUDDING BASED DESSERTS; PUDDING BASED DESSERTS WITH FRUIT; PUDDING BASED DESSERTS WITH FRUIT, CHOCOLATE AND OTHER FLAVORINGS; CHOCOLATE MOUSSE; CHEESECAKE (U.S. CL. 46).

DAVID TAYLOR, EXAMINING ATTORNEY

---

**LTV**

SN 78-360,846. EYGN LIMITED, NASSAU, BAHAMAS,  
FILED 2-2-2004.

THE MARK CONSISTS OF STANDARD CHARACTERS WITHOUT CLAIM TO ANY PARTICULAR FONT, STYLE, SIZE, OR COLOR.

**InterChange**

**CLASS 12—VEHICLES**

FOR VEHICLE SEATS, NAMELY, AIR CELL SEAT CUSHIONS FOR AUTOMOBILES, TRUCKS, BUSES, AIRPLANES AND WHEELCHAIRS (U.S. CLS. 19, 21, 23, 31, 35 AND 44).

**CLASS 20—FURNITURE AND ARTICLES NOT OTHERWISE CLASSIFIED**

FOR SEAT CUSHIONS, NAMELY, AIR CELL SEAT CUSHIONS FOR OFFICE CHAIRS (U.S. CLS. 2, 13, 22, 25, 32 AND 50).

JENNIFER CHICOSKI, EXAMINING ATTORNEY

THE MARK CONSISTS OF STANDARD CHARACTERS WITHOUT CLAIM TO ANY PARTICULAR FONT, STYLE, SIZE, OR COLOR.

SN 78-362,606. LEE, JUSTIN, SANTA FE SPRINGS, CA.  
FILED 2-4-2004.

## NANOBEAUTY

THE MARK CONSISTS OF STANDARD CHARACTERS WITHOUT CLAIM TO ANY PARTICULAR FONT, STYLE, SIZE, OR COLOR.

### CLASS 3—COSMETICS AND CLEANING PREPARATIONS

FOR NON-MEDICATED COSMETICS NAMELY, ANTI-AGING CREAM, ANTI-WRINKLE CREAM, ASTRINGENTS, FACIAL CREAM, SKIN MOISTURIZER, SKIN CLEANSING LOTION, SKIN CONDITIONER, FACIAL EXFOLIANT, FACIAL MASQUE, FACIAL TONER, EYE MAKEUP REMOVER, COTTON BALLS FOR COSMETIC USE, COSMETIC APPLICATOR PAD, LIPSTICK, LIP GLOSS, FOUNDATION, CONCEALER, EYE SHADOW, EYE LINER PENCIL, EYEBROW PENCIL, BLUSH, FACE POWDER, AND HAIR PRODUCTS (U.S. CLS. 1, 4, 6, 50, 51 AND 52).

### CLASS 10—MEDICAL APPARATUS

FOR FACIAL TONING MACHINE FOR COSMETIC USE (U.S. CLS. 26, 39 AND 44).  
LAURA KOVAISKY, EXAMINING ATTORNEY

SN 78-364,171. FACTOR 5, LLC, SAN RAFAEL, CA. FILED 2-6-2004.

## ANIMAL WARS

THE MARK CONSISTS OF STANDARD CHARACTERS WITHOUT CLAIM TO ANY PARTICULAR FONT, STYLE, SIZE, OR COLOR.

NO CLAIM IS MADE TO THE EXCLUSIVE RIGHT TO USE ANIMAL, APART FROM THE MARK AS SHOWN.

### CLASS 9—ELECTRICAL AND SCIENTIFIC APPARATUS

FOR COMPUTER GAME SOFTWARE; INTERACTIVE MULTIMEDIA COMPUTER GAME PROGRAMS; INTERACTIVE VIDEO GAME PROGRAMS; VIDEO GAME SOFTWARE AND VIDEO GAME MACHINES FOR USE WITH PERSONAL COMPUTERS AND TELEVISIONS; COMPUTER AND VIDEO GAME TAPES, DISCS, CASSETTES, AND CARTRIDGES; COMPUTER AND VIDEO GAME ACCESSORIES, NAMELY, COMPUTER JOY STICKS AND JOYPADS, COMPUTER MOUSE AND MOUSE PADS, COMPUTER PERIPHERALS, PRERECORDED AUDIO AND VIDEO TAPES, LASER DISCS, DVD DISCS, VIDEO DISCS, COMPACT DISCS, AND CD-ROMS FEATURING VIDEO GAMES; AND MANUALS SUPPLIED THEREWITH (U.S. CLS. 21, 23, 26, 36 AND 38).

### CLASS 28—TOYS AND SPORTING GOODS

FOR COIN-OPERATED VIDEO OUTPUT GAMES; STAND ALONE VIDEO GAME MACHINES; ELECTRONIC EDUCATIONAL GAME MACHINES; HANDHELD UNITS FOR PLAYING VIDEO GAMES; HANDHELD UNITS FOR PLAYING ELECTRONIC GAMES, AND MANUALS SUPPLIED THEREWITH (U.S. CLS. 22, 23, 38 AND 50).

AMY HELLA, EXAMINING ATTORNEY

SN 78-364,176. FACTOR 5, LLC, SAN RAFAEL, CA. FILED 2-6-2004.

## BATTLE SQUADRON

THE MARK CONSISTS OF STANDARD CHARACTERS WITHOUT CLAIM TO ANY PARTICULAR FONT, STYLE, SIZE, OR COLOR.

### CLASS 9—ELECTRICAL AND SCIENTIFIC APPARATUS

FOR COMPUTER GAME SOFTWARE; INTERACTIVE MULTIMEDIA COMPUTER GAME PROGRAMS; INTERACTIVE VIDEO GAME PROGRAMS; VIDEO GAME SOFTWARE AND VIDEO GAME MACHINES FOR USE WITH PERSONAL COMPUTERS AND TELEVISIONS; COMPUTER AND VIDEO GAME TAPES, DISCS, CASSETTES, AND CARTRIDGES; COMPUTER AND VIDEO GAME ACCESSORIES, NAMELY, COMPUTER JOY STICKS AND JOYPADS, COMPUTER MOUSE AND MOUSE PADS, COMPUTER PERIPHERALS, PRERECORDED AUDIO AND VIDEO TAPES, LASER DISCS, DVD DISCS, VIDEO DISCS, COMPACT DISCS, AND CD-ROMS FEATURING VIDEO GAMES; AND MANUALS SUPPLIED THEREWITH (U.S. CLS. 21, 23, 26, 36 AND 38).

### CLASS 28—TOYS AND SPORTING GOODS

FOR COIN-OPERATED VIDEO OUTPUT GAMES; STAND ALONE VIDEO GAME MACHINES; ELECTRONIC EDUCATIONAL GAME MACHINES; HANDHELD UNITS FOR PLAYING VIDEO GAMES; HANDHELD UNITS FOR PLAYING ELECTRONIC GAMES, AND MANUALS SUPPLIED THEREWITH (U.S. CLS. 22, 23, 38 AND 50).

LAURA KOVAISKY, EXAMINING ATTORNEY

SN 78-364,815. THOSE CHARACTERS FROM CLEVELAND, INC., CLEVELAND, OH. FILED 2-9-2004.

SN 78-365,036. THE QUAKER OATS COMPANY, CHICAGO, IL. FILED 2-9-2004.



## HERSELF THE ELF

THE MARK CONSISTS OF STANDARD CHARACTERS WITHOUT CLAIM TO ANY PARTICULAR FONT, STYLE, SIZE, OR COLOR.

OWNER OF U.S. REG. NO. 1,264,976.

### CLASS 16—PAPER GOODS AND PRINTED MATTER

FOR GREETING CARDS, GIFT WRAP PAPER, PAPER GIFT BAGS, PAPER NAPKINS, PENS, PENCILS, ERASERS, STATIONERY, STATIONERY-TYPE PORTFOLIOS, BINDERS, STICKERS, TEMPORARY TATTOOS, STORY BOOKS, COLORING BOOKS, CHILDREN'S ACTIVITY BOOKS, FLASH CARDS, PAPER PARTY HATS, BOOKMARKS, CALENDARS, DIARIES, ADDRESS BOOKS, PENCIL CASES, PAPER BANNERS, BULLETIN BOARDS, POSTERS, RUBBER STAMPS, AND WORKBOOKS CONTAINING PRE-PRINTED EXERCISES DIRECTED TO READING, WRITING, ARITHMETIC AND OTHER ELEMENTARY SCHOOL SUBJECTS (U.S. CLS. 2, 5, 22, 23, 29, 37, 38 AND 50).

### CLASS 18—LEATHER GOODS

FOR BACKPACKS, TOTE BAGS, PURSES, WALLETS, LUGGAGE, UMBRELLAS, COSMETIC CASES SOLD EMPTY (U.S. CLS. 1, 2, 3, 22 AND 41).

### CLASS 21—HOUSEWARES AND GLASS

FOR PLATES, CUPS, MUGS, COASTERS NOT OF PAPER AND NOT BEING TABLE LINEN, HAIR BRUSHES, HAIR COMBS, CERAMIC FIGURINES, TOOTHBRUSHES (U.S. CLS. 2, 13, 23, 29, 30, 33, 40 AND 50).

### CLASS 24—FABRICS

FOR TABLE LINEN, PILLOW CASES, BED SHEETS, QUILTS, BEDSPREADS, CURTAINS, BED BLANKETS, TEXTILE FABRICS FOR USE IN THE MANUFACTURE OF CLOTHING (U.S. CLS. 42 AND 50).

### CLASS 25—CLOTHING

FOR SOCKS, SHOES, SLIPPERS, SANDALS, SHIRTS, SLEEPWEAR, DRESSES, PANTS, TIGHTS, BELTS, HATS, GLOVES, SCARVES, PANTIES, SHORTS, SWIMSUITS, HALLOWEEN COSTUMES (U.S. CLS. 22 AND 39).

### CLASS 28—TOYS AND SPORTING GOODS

FOR DOLLS, EQUIPMENT SOLD AS A UNIT FOR PLAYING BOARD GAMES, EQUIPMENT SOLD AS A UNIT FOR PLAYING CARD GAMES, PUZZLES, CHRISTMAS TREE ORNAMENTS, TOY PLAYSETS FOR DOLLS, PARTY FAVORS IN THE FORM OF SMALL TOYS, STUFFED TOY FIGURES, BALLOONS (U.S. CLS. 22, 23, 38 AND 50).

DORITT L. CARROLL, EXAMINING ATTORNEY

OWNER OF U.S. REG. NOS. 26,253, 1,346,584 AND OTHERS.

### CLASS 29—MEATS AND PROCESSED FOODS

FOR SOY-BASED FOOD BEVERAGES USED AS A MILK SUBSTITUTE, SNACK MIXES CONSISTING PRIMARILY OF PROCESSED NUTS, SNACKS CONSISTING PRIMARILY OF PROCESSED FRUITS AND SNACKS CONSISTING PRIMARILY OF PROCESSED VEGETABLES (U.S. CL. 46).

### CLASS 30—STAPLE FOODS

FOR GRAIN-BASED SNACKS AND GRAIN-BASED BEVERAGES (U.S. CL. 46).

### CLASS 32—LIGHT BEVERAGES

FOR FRUIT JUICES, VEGETABLE JUICES, WHEY BEVERAGES AND SOY-BASED BEVERAGES NOT BEING MILK SUBSTITUTES (U.S. CLS. 45, 46 AND 48).  
DAWN HAN, EXAMINING ATTORNEY

SN 78-365,062. THE QUAKER OATS COMPANY, CHICAGO, IL. FILED 2-9-2004.



OWNER OF U.S. REG. NOS. 26,253, 1,346,584 AND OTHERS.

NO CLAIM IS MADE TO THE EXCLUSIVE RIGHT TO USE "HEALTHY LIFESTYLE FOOD", APART FROM THE MARK AS SHOWN.

### CLASS 29—MEATS AND PROCESSED FOODS

FOR SOY-BASED FOOD BEVERAGES USED AS A MILK SUBSTITUTE, SNACK MIXES CONSISTING PRIMARILY OF PROCESSED NUTS, SNACKS CONSISTING PRIMARILY OF PROCESSED FRUITS AND SNACKS CONSISTING PRIMARILY OF PROCESSED VEGETABLES (U.S. CL. 46).

### CLASS 30—STAPLE FOODS

FOR GRAIN-BASED SNACKS AND GRAIN-BASED BEVERAGES (U.S. CL. 46).

### CLASS 32—LIGHT BEVERAGES

FOR FRUIT JUICES, VEGETABLE JUICES, WHEY BEVERAGES AND SOY-BASED BEVERAGES NOT BEING MILK SUBSTITUTES (U.S. CLS. 45, 46 AND 48).  
DAWN HAN, EXAMINING ATTORNEY

SN 78-365,145. RAPPINBRANDS, LLC, WHITE PLAINS, NY.  
FILED 2-9-2004.

## RAPPINBRANDS

THE MARK CONSISTS OF STANDARD CHARACTERS WITHOUT CLAIM TO ANY PARTICULAR FONT, STYLE, SIZE, OR COLOR.

### CLASS 25—CLOTHING

FOR SHIRTS, JACKETS, HATS, HOSIERY, FOOTWEAR, T-SHIRTS, SWEAT SHIRTS, SWEATPANTS, PANTS, TANK TOPS, JERSEYS, SHORTS, PAJAMAS, SPORT SHIRTS, RUGBY SHIRTS, BASKETBALL SHIRTS, BASKETBALL SHORTS, SWEATERS, BELTS, TIES, CLOTH BIBS, HEAD BANDS, WRIST BANDS, APRONS, BOXER SHORTS, SLACKS, CAPS, EAR MUFFS, GLOVES, TURTLENECK SWEATERS, V NECK SWEATERS, TUNICS, VESTS, QUILTED VESTS, BLOUSES, CHEMISES, JOGGING SUITS, MINI SKIRTS, VISORS, BANDANAS, RAIN COATS, SOCKS, SHOES, BOOTS, SLIPPERS, POLO SHIRTS, UNDERGARMENTS, UNDERSHIRTS, OVERALLS, FASHION SCARVES, PARKAS, WALKING SHORTS, KNIT SHORTS, WOVEN SHIRTS, WOVEN DRESSES, PULLOVERS, CARDIGANS, DRESSES, TRACK SUITS, GOLF SHIRTS, DRESS SHIRTS, ARMBANDS, SNEAKERS, JEANS, UNIFORMS, BRAS, ROBES, TIGHTS, BRIEFS, SLEEP WEAR, LOUNGEWEAR, HALTER TOPS, GYM SHORTS, BEACH WEAR, LEGGINGS, LEOTARDS, MITTENS, UNDERPANTS, GIRDLES, MASQUERADE COSTUMES, INFANT WEAR, SANDALS, BLAZERS, SWIMWEAR, JUMPSUITS, KNEE HIGHS, LEG WARMERS, PANTYHOSE, PANTIES, ROMPERS, SHAWLS, SKIRTS, STOCKINGS, TENNIS WEAR, GOWNS, BONNETS, LINGERIE, UNITARDS, BATHING CAPS, WARM UP PANTS, BIKE SHORTS, SNOW PANTS, SKI WEAR, SNOWSUITS, PEIGNOIRS, SLIPS, CAMISOLES, BUSTIERS, TEDDIES, TUXEDOS, BATHING SUITS, BATHING COVER UPS, TEAM UNIFORMS, DANCEWEAR NAMELY BODY-SUITS, PLAYSUITS, CLOTH DIAPERS, TROUSERS, NIGHTGOWNS, SWIM TRUNKS AND MEN'S SUITS (U.S. CLS. 22 AND 39).

### CLASS 33—WINES AND SPIRITS

FOR ALCOHOLIC BEVERAGES, NAMELY DISTILLED SPIRITS, LIQUEURS AND WINES (U.S. CLS. 47 AND 49).  
MARGERY A. TIERNEY, EXAMINING ATTORNEY

SN 78-365,224. ABBYY SOFTWARE LIMITED, NICOSIA, CYPRUS, FILED 2-10-2004.

## FLEXICAPTURE

THE MARK CONSISTS OF STANDARD CHARACTERS WITHOUT CLAIM TO ANY PARTICULAR FONT, STYLE, SIZE, OR COLOR.

### CLASS 9—ELECTRICAL AND SCIENTIFIC APPARATUS

FOR COMPUTER AND ELECTRONIC DEVICES, NAMELY, OPTICAL SCANNERS, OPTICAL CHARACTER RECOGNITION DEVICES, AND FORM PROCESSORS; COMPUTER SOFTWARE HAVING LEXICAL FEATURES FOR SEMANTIC, LEXICOGRAPHIC AND MORPHOLOGIC ANALYSIS; COMPUTER SOFTWARE FEATURING ELECTRONIC DICTIONARIES, TRANSLATION DICTIONARIES, AND SPELL CHECKERS; COMPUTER SOFTWARE FOR ARCHIVAL STORAGE OF LEXICAL DATA FOR USE IN ELECTRONIC DICTIONARIES, SPELL CHECKERS AND OTHER SEMANTIC AND/OR LEXICOGRAPHIC DEVICES; COMPUTER SOFTWARE FOR OPTICAL CHARACTER IMAGE RECOGNITION AND FORM PROCESSING; COMPUTER SOFTWARE FOR MANAGEMENT OF ELECTRONIC DOCUMENTS DEALING WITH SPEECH-TO-TEXT RECOGNITION AND TEXT-TO-SPEECH RECOGNITION, LANGUAGE TRANSLATION SPELL CHECKING, ARCHIVING LEXICAL DATA FOR ELECTRONIC DICTIONARIES, FORM PROCESSING, MANAGEMENT OF ELECTRONIC DOCUMENTS SPEECH-TO-TEXT RECOGNITION AND TEXT-TO-SPEECH RECOGNITION, SCANNER MANAGEMENT, WORD PROCESSING, FORM PREPARATION, TEXT EDITING, GRAPHICS MANAGEMENT AND OPERATING PRINTERS, FILM RECORDERS AND TYPESETTERS (U.S. CLS. 21, 23, 26, 36 AND 38).

### CLASS 42—SCIENTIFIC, COMPUTER AND LEGAL SERVICES

FOR COMPUTER CONSULTING SERVICES, COMPUTER NETWORK DESIGN SERVICES AND SOFTWARE DEVELOPMENT IN THE FIELDS OF OPTICAL SCANNING, OPTICAL CHARACTER RECOGNITION, FORM PROCESSING, SEMANTIC, LEXICOGRAPHIC AND MORPHOLOGIC ANALYSIS, ELECTRONIC DICTIONARIES, LANGUAGE TRANSLATION, SPELL CHECKING; ARCHIVAL STORAGE OF LEXICAL DATA FOR USE IN ELECTRONIC DICTIONARIES, FORM PROCESSING, MANAGEMENT OF ELECTRONIC DOCUMENTS SPEECH-TO-TEXT RECOGNITION AND TEXT-TO-SPEECH RECOGNITION, SCANNER MANAGEMENT, WORD PROCESSING, FORM PREPARATION, TEXT EDITING, GRAPHICS MANAGEMENT AND MANAGING AND OPERATING PRINTERS, FILM RECORDERS AND TYPESETTERS (U.S. CLS. 100 AND 101).

DORITT L. CARROLL, EXAMINING ATTORNEY

SN 78-369,346. SEMINIS VEGETABLE SEEDS, INC., OXNARD, CA. AND GRIFFIN PRODUCE COMPANY, INC., SALINAS, CA. FILED 2-17-2004.

## LETTUCE JAMMERS

THE MARK CONSISTS OF STANDARD CHARACTERS WITHOUT CLAIM TO ANY PARTICULAR FONT, STYLE, SIZE, OR COLOR.

NO CLAIM IS MADE TO THE EXCLUSIVE RIGHT TO USE "LETTUCE", APART FROM THE MARK AS SHOWN.

### CLASS 29—MEATS AND PROCESSED FOODS

FOR VEGETABLES, SPECIFICALLY, LETTUCE THAT IS CUT, FROZEN, COOKED, GRILLED, PROCESSED, PRESERVED, AND SLICED; FROZEN, PREPARED AND PACKAGED ENTREES CONSISTING PRIMARILY OF STUFFED LETTUCE SHELLS; FROZEN, PREPARED, AND PACKAGED MEALS CONSISTING PRIMARILY OF STUFFED LETTUCE SHELLS; GARDEN SALADS; VEGETABLE SALADS (U.S. CL. 46).

**CLASS 31—NATURAL AGRICULTURAL PRODUCTS**

SN 78-396,564. PHILOSOPHY, INC., PHOENIX, AZ. FILED 4-5-2004.

FOR VEGETABLES, SPECIFICALLY, LETTUCE THAT IS FRESH, RAW AND UNPROCESSED (U.S. CLS. 1 AND 46).  
JIM RINGLE, EXAMINING ATTORNEY

**PHILOSOPHY**

SN 78-395,374. THE MCGRAW-HILL COMPANIES, INC., NEW YORK, NY. FILED 4-2-2004.

THE MARK CONSISTS OF STANDARD CHARACTERS WITHOUT CLAIM TO ANY PARTICULAR FONT, STYLE, SIZE, OR COLOR.

**CLASS 16—PAPER GOODS AND PRINTED MATTER**

FOR GREETING CARDS (U.S. CLS. 2, 5, 22, 23, 29, 37, 38 AND 50).

**MCGRAW-HILL  
CONSTRUCTION  
NETWORK**

**CLASS 41—EDUCATION AND ENTERTAINMENT**

FOR PUBLISHING SERVICES, NAMELY, BOOKS, SHORT STORIES, PAMPHLETS, NEWSLETTERS, MAGAZINES, AND MUSICAL WORKS (U.S. CLS. 100, 101 AND 107).  
DAVID MURRAY, EXAMINING ATTORNEY

SN 78-402,717. ALTAIR ADVISERS, LLC, CHICAGO, IL. FILED 4-15-2004.

THE MARK CONSISTS OF STANDARD CHARACTERS WITHOUT CLAIM TO ANY PARTICULAR FONT, STYLE, SIZE, OR COLOR.

OWNER OF U.S. REG. NOS. 775,383, 2,424,004 AND OTHERS.

NO CLAIM IS MADE TO THE EXCLUSIVE RIGHT TO USE "CONSTRUCTION NETWORK", APART FROM THE MARK AS SHOWN.



**CLASS 37—CONSTRUCTION AND REPAIR**

FOR ONLINE SERVICES, NAMELY, PROVIDING AN INTEGRATED DATABASE WHICH ALLOWS USERS TO ACCESS NEWS AND INFORMATION, PROJECT LEADS CONTENT, PRODUCT CONTENT, BIDS, ANALYSIS, FUNCTIONAL DESIGN AND CONSTRUCTION RELATED APPLICATIONS ALL FOR THE DESIGN AND CONSTRUCTION INDUSTRY (U.S. CLS. 100, 103 AND 106).

FIRST USE 6-0-2003; IN COMMERCE 6-0-2003.

NO CLAIM IS MADE TO THE EXCLUSIVE RIGHT TO USE "ADVISERS", APART FROM THE MARK AS SHOWN.

**CLASS 36—INSURANCE AND FINANCIAL**

FOR INVESTMENT CONSULTING AND FINANCIAL PLANNING SERVICES (U.S. CLS. 100, 101 AND 102).  
FIRST USE 6-1-2002; IN COMMERCE 6-1-2002.

**CLASS 42—SCIENTIFIC, COMPUTER AND LEGAL SERVICES**

FOR PROVIDING TEMPORARY USE OF ONLINE NON-DOWNLOADABLE SOFTWARE FOR USE AS A SPREAD SHEET WHICH ENABLES USERS TO CUSTOMIZE DESIGN PLANS AND CONSTRUCTION PLANS (U.S. CLS. 100 AND 101).

FIRST USE 6-0-2003; IN COMMERCE 6-0-2003.  
DAWN HAN, EXAMINING ATTORNEY

**CLASS 41—EDUCATION AND ENTERTAINMENT**

FOR EDUCATIONAL SERVICES, NAMELY, SEMINARS IN THE FIELD OF FINANCIAL PLANNING AND INVESTMENT (U.S. CLS. 100, 101 AND 107).  
FIRST USE 6-1-2002; IN COMMERCE 6-1-2002.  
AMY ALFIERI, EXAMINING ATTORNEY

SN 78-409,537. IVOCLAR VIVADENT, INC., AMHERST, NY.  
FILED 4-28-2004.

SN 78-426,813. THE COCA-COLA COMPANY, ATLANTA,  
GA. FILED 5-28-2004.

# COROSEAL

# AMORINO

THE MARK CONSISTS OF STANDARD CHARACTERS WITHOUT CLAIM TO ANY PARTICULAR FONT, STYLE, SIZE, OR COLOR.

## CLASS 5—PHARMACEUTICALS

FOR MATERIALS FOR USE IN DENTISTRY, PARTICULARLY MATERIALS AND ACCESSORIES FOR MAKING DENTAL IMPRESSIONS, MATERIALS FOR MODELS, CROWNS AND BRIDGES, INLAYS, TOOTH FILLING MATERIALS, PULP PROTECTION AND ROOT TREATMENT, ADHESIVE AGENTS, PROTECTIVE VARNISHES FOR TEETH, DIAGNOSTICS, COMPOSITES, MATERIALS FOR THE TREATMENT OF CARIES AND PERIODONTOSIS, ADHESIVES, TOOTH FILLING MATERIALS (U.S. CLS. 6, 18, 44, 46, 51 AND 52).

## CLASS 10—MEDICAL APPARATUS

FOR APPARATUS AND INSTRUMENTS FOR DENTAL TECHNOLOGY, NAMELY APPLICATION INSTRUMENTS, SYRINGES AND CAPSULES (U.S. CLS. 26, 39 AND 44).  
ZACHARY BELLO, EXAMINING ATTORNEY

THE MARK CONSISTS OF STANDARD CHARACTERS WITHOUT CLAIM TO ANY PARTICULAR FONT, STYLE, SIZE, OR COLOR.

## CLASS 29—MEATS AND PROCESSED FOODS

FOR STEAMED MILK WITH FLAVORED SYRUPS (U.S. CL. 46).

## CLASS 30—STAPLE FOODS

FOR COFFEE, GOURMET BLACK COFFEE, TEA, LATTE, ESPRESSO, CAPPUCINO, MOCHA, HOT CHOCOLATE, COFFEE BLENDS; TEA BLENDS, NAMELY, CHAI TEA, BLACK TEA, EARL GREY TEA, GREEN TEA, AND CAMOMILE TEA; AND COFFEES WITH FLAVORED SYRUPS (U.S. CL. 46).  
DAVID MURRAY, EXAMINING ATTORNEE

\* \* \* \* \*

## SECTION 2.— INTERNATIONAL CLASSIFICATION

The short titles associated below with the international class numbers are terms designed merely for quick identification and are not an official part of the international classification. The full names of international classes are given in section 6.1 of the trademark rules of practice.

The designation "U.S. Cl." appearing in this section refers to the U.S. class in effect prior to Sep. 1, 1973 rather than the international class which applies to applications filed on or after that date. For adoption of international classification see notice in the OFFICIAL GAZETTE of Jun. 26, 1973 (911 O.G. TM 210).

### Application in one class

#### CLASS 1—CHEMICALS

SN 76-378,741. DAK AMERICAS, L.L.C., CHARLOTTE, NC.  
FILED 3-5-2002.

**LASER+**

FOR SYNTHETIC RESIN COMPOUNDS IN THE FORM OF POLYMER CHIPS USED FOR THE MANUFACTURE OF BOTTLES, CUPS, LIDS, TRAYS AND CONTAINERS (U.S. CLS. 1, 5, 6, 10, 26 AND 46).  
GLENN CLARK, EXAMINING ATTORNEY

SN 76-491,202. NEXIA BIOTECHNOLOGIES INC., VAU-DREUIL-DORION, QUEBEC, CANADA, FILED 2-19-2003.

**PROTEXIA**

FOR RECOMBINANT PROTEINS IN THE FORM OF BIOMATERIALS FOR USE IN THE MANUFACTURE OF PHARMACEUTICALS FOR THE PREVENTION, TREATMENT AND DETECTION OF TOXIC EFFECTS OF NERVE AGENTS AND OTHER CHEMICALS (U.S. CLS. 1, 5, 6, 10, 26 AND 46).  
YSA DEJESUS, EXAMINING ATTORNEY

SN 76-521,412. STRATAGENE CALIFORNIA, LA JOLLA, CA.  
FILED 6-9-2003.

**PBLUESCRIPT**

OWNER OF U.S. REG. NO. 1,507,647.  
NO CLAIM IS MADE TO THE EXCLUSIVE RIGHT TO USE "II", APART FROM THE MARK AS SHOWN.  
FOR LABORATORY REAGENTS FOR MOLECULAR BIOLOGICAL AND LIFE SCIENCES USE, NAMELY, NUCLEIC ACID VECTORS FOR GENE CLONING, GENE CHARACTERIZATION, AND GENE TRANSFER; KITS FOR CONSTRUCTING CDNA LIBRARIES PRIMARILY COMPOSED OF REAGENTS AND VECTORS (U.S. CLS. 1, 5, 6, 10, 26 AND 46).  
FIRST USE 4-1-1986; IN COMMERCE 4-1-1986.  
MICHAEL BAIRD, EXAMINING ATTORNEY

#### CLASS 1—(Continued).

SN 76-522,819. PARIS GOURMET OF NEW YORK INC., CARLSTADT, NJ. FILED 6-16-2003.

**RAPIDGEL**

FOR INSTANT POWDER GELIFIER IN THE NATURE OF A CHEMICAL COMPOSITION FOR MAKING GELATIN DESSERTS USED FOR PROFESSIONAL COOKING (U.S. CLS. 1, 5, 6, 10, 26 AND 46).  
BRIDGETT SMITH, EXAMINING ATTORNEY

SN 76-531,743. GLOBAL PROTEIN PRODUCTS, WINSLOW, ME. FILED 7-23-2003.

**TOP & TAIL**

FOR FOOD PRESERVATIVE COMPOSITIONS, NAMELY, FOOD SENESENCE INHIBITOR, NAMELY, A POLYSACCHARIDE PROTEIN COMPLEX USED FOR PRESERVING FOOD (U.S. CLS. 1, 5, 6, 10, 26 AND 46).  
BILL DAWE, EXAMINING ATTORNEY

SN 76-531,744. GLOBAL PROTEIN PRODUCTS, WINSLOW, ME. FILED 7-23-2003.

**CLEAN & CORE**

FOR FOOD PRESERVATIVE COMPOSITIONS, NAMELY, FOOD SENESENCE INHIBITOR, NAMELY, A POLYSACCHARIDE PROTEIN COMPLEX USED FOR PRESERVING FOOD (U.S. CLS. 1, 5, 6, 10, 26 AND 46).  
BILL DAWE, EXAMINING ATTORNEY

**CLASS 1—(Continued).**

SN 78-277,632. ALLIED FASTENER AND TOOL, INC., LAKE WORTH, FL. FILED 7-23-2003.



THE MARK CONSISTS OF "ALLIED +" - A STYLIZED "A" CONSISTING OF A SMALLER COLORED CAPITAL "A" INSIDE A LARGER WHITE CAPITAL "A" THAT IS NOT CLOSED AT THE TOP FOLLOWED BY WHITE BLOCK LETTERED CAPITAL "LLIED" AND A LARGE WHITE PLUS SYMBOL AGAINST A DARKER COLORED BACKGROUND.

FOR EPOXY ADHESIVES FOR CONSTRUCTION, GENERAL BONDING AND REPAIR PURPOSES (U.S. CLS. 1, 5, 6, 10, 26 AND 46).

FIRST USE 7-21-2003; IN COMMERCE 7-21-2003.  
STANLEY I. OSBORNE, EXAMINING ATTORNEY

---

SN 78-332,750. DUPONT CANADA, INC., MISSISSAUGA, CANADA, FILED 11-25-2003.

**ZEMID**

THE MARK CONSISTS OF STANDARD CHARACTERS WITHOUT CLAIM TO ANY PARTICULAR FONT, STYLE, SIZE, OR COLOR.

FOR POLYETHYLENE RESIN FOR USE IN THE PLASTICS INDUSTRY (U.S. CLS. 1, 5, 6, 10, 26 AND 46).  
FIRST USE 1-18-1988; IN COMMERCE 1-18-1988.  
PAUL F. GAST, EXAMINING ATTORNEY

**CLASS 1—(Continued).**

SN 78-352,305. H & H SPECIALTIES, INC., FRANKLIN, TN. FILED 1-15-2004.

**HARD BLOK**

THE MARK CONSISTS OF STANDARD CHARACTERS WITHOUT CLAIM TO ANY PARTICULAR FONT, STYLE, SIZE, OR COLOR.

FOR CHEMICAL ADDITIVE, NAMELY, A WATER JACKET FILLER COMPRISED OF ENGINE BLOCK CEMENT FOR USE IN HIGH-PERFORMANCE RACING ENGINES TO IMPROVE PERFORMANCE (U.S. CLS. 1, 5, 6, 10, 26 AND 46).

FIRST USE 5-1-1988; IN COMMERCE 6-7-1988.  
BRIAN BROWN, EXAMINING ATTORNEY

---

SN 78-354,090. BIOLAB SERVICES, INC., WILMINGTON, DE. FILED 1-20-2004.

**WONDER TAB**

THE MARK CONSISTS OF STANDARD CHARACTERS WITHOUT CLAIM TO ANY PARTICULAR FONT, STYLE, SIZE, OR COLOR.

FOR WATER TREATMENT CHEMICALS FOR SWIMMING POOLS AND SPAS (U.S. CLS. 1, 5, 6, 10, 26 AND 46).

NAAKWAMA ANKRAH, EXAMINING ATTORNEY



**CLASS 1—(Continued).**

SN 78-357,474. ALBEMARLE CORPORATION, BATON ROUGE, LA. FILED 1-26-2004.

**CLASS 1—(Continued).**

SN 78-360,462. M-I L.L.C., HOUSTON, TX. FILED 1-30-2004.

# WELLFORM

# TENAZAGEL

THE MARK CONSISTS OF STANDARD CHARACTERS WITHOUT CLAIM TO ANY PARTICULAR FONT, STYLE, SIZE, OR COLOR.

FOR CHEMICALS USED IN OIL DRILLING; EMULSIFICATION, CORROSION INHIBITION, FLUID LOSS CONTROL, WELL COMPLETION AND SUSPENSION CONTROL FLUIDS FOR OIL FIELD AND INDUSTRIAL USE (U.S. CLS. 1, 5, 6, 10, 26 AND 46).

HELEN BRYAN, EXAMINING ATTORNEY

THE MARK CONSISTS OF STANDARD CHARACTERS WITHOUT CLAIM TO ANY PARTICULAR FONT, STYLE, SIZE, OR COLOR.

FOR PETROLEUM INDUSTRY CHEMICALS, NAMELY, A DRILLING FLUID ADDITIVE FOR USE IN THE OIL AND GAS WELL DRILLING INDUSTRY (U.S. CLS. 1, 5, 6, 10, 26 AND 46).

RONALD AIKENS, EXAMINING ATTORNEY

---

SN 78-360,146. M-I L.L.C., HOUSTON, TX. FILED 1-30-2004.

---

SN 78-360,463. M-I L.L.C., HOUSTON, TX. FILED 1-30-2004.

# TENAZA

# TENAZATROL

THE MARK CONSISTS OF STANDARD CHARACTERS WITHOUT CLAIM TO ANY PARTICULAR FONT, STYLE, SIZE, OR COLOR.

FOR PETROLEUM INDUSTRY CHEMICALS, NAMELY, A DRILLING FLUIDS AND DRILLING FLUID ADDITIVES FOR USE IN THE SUBTERRANEAN WELL DRILLING INDUSTRY (U.S. CLS. 1, 5, 6, 10, 26 AND 46).

RONALD AIKENS, EXAMINING ATTORNEY

THE MARK CONSISTS OF STANDARD CHARACTERS WITHOUT CLAIM TO ANY PARTICULAR FONT, STYLE, SIZE, OR COLOR.

FOR PETROLEUM INDUSTRY CHEMICALS, NAMELY, A DRILLING FLUID ADDITIVE FOR USE IN THE OIL AND GAS WELL DRILLING INDUSTRY (U.S. CLS. 1, 5, 6, 10, 26 AND 46).

RONALD AIKENS, EXAMINING ATTORNEY

**CLASS 1—(Continued).**

SN 78-360,465. M-I L.L.C., HOUSTON, TX. FILED 1-30-2004.

**CLASS 1—(Continued).**

SN 78-360,469. M-I L.L.C., HOUSTON, TX. FILED 1-30-2004.

# TENAZALIG

# TENAZAMUL

THE MARK CONSISTS OF STANDARD CHARACTERS WITHOUT CLAIM TO ANY PARTICULAR FONT, STYLE, SIZE, OR COLOR.

FOR PETROLEUM INDUSTRY CHEMICALS, NAMELY, A DRILLING FLUID ADDITIVE FOR USE IN THE OIL AND GAS WELL DRILLING INDUSTRY (U.S. CLS. 1, 5, 6, 10, 26 AND 46).

RONALD AIKENS, EXAMINING ATTORNEY

THE MARK CONSISTS OF STANDARD CHARACTERS WITHOUT CLAIM TO ANY PARTICULAR FONT, STYLE, SIZE, OR COLOR.

FOR PETROLEUM INDUSTRY CHEMICALS, NAMELY, A DRILLING FLUID ADDITIVE FOR USE IN THE OIL AND GAS WELL DRILLING INDUSTRY (U.S. CLS. 1, 5, 6, 10, 26 AND 46).

RONALD AIKENS, EXAMINING ATTORNEY

---

SN 78-360,467. M-I L.L.C., HOUSTON, TX. FILED 1-30-2004.

---

SN 78-360,470. M-I L.L.C., HOUSTON, TX. FILED 1-30-2004.

# TENAZATHIN

# TENAZAWET

THE MARK CONSISTS OF STANDARD CHARACTERS WITHOUT CLAIM TO ANY PARTICULAR FONT, STYLE, SIZE, OR COLOR.

FOR PETROLEUM INDUSTRY CHEMICALS, NAMELY, A DRILLING FLUID ADDITIVE FOR USE IN THE OIL AND GAS WELL DRILLING INDUSTRY (U.S. CLS. 1, 5, 6, 10, 26 AND 46).

RONALD AIKENS, EXAMINING ATTORNEY

THE MARK CONSISTS OF STANDARD CHARACTERS WITHOUT CLAIM TO ANY PARTICULAR FONT, STYLE, SIZE, OR COLOR.

FOR PETROLEUM INDUSTRY CHEMICALS, NAMELY, A DRILLING FLUID ADDITIVE FOR USE IN THE OIL AND GAS WELL DRILLING INDUSTRY (U.S. CLS. 1, 5, 6, 10, 26 AND 46).

RONALD AIKENS, EXAMINING ATTORNEY

**CLASS 1—(Continued).**

SN 78-360,472. M-I L.L.C., HOUSTON, TX. FILED 1-30-2004.

**CLASS 1—(Continued).**

SN 78-366,004. FOLIAR NUTRIENTS, INC., CAIRO, GA. FILED 2-11-2004.

# TENAZACOAT

THE MARK CONSISTS OF STANDARD CHARACTERS WITHOUT CLAIM TO ANY PARTICULAR FONT, STYLE, SIZE, OR COLOR.  
FOR PETROLEUM INDUSTRY CHEMICALS, NAMELY, A DRILLING FLUID ADDITIVE FOR USE IN THE OIL AND GAS WELL DRILLING INDUSTRY (U.S. CLS. 1, 5, 6, 10, 26 AND 46).  
RONALD AIKENS, EXAMINING ATTORNEY

# MEGA-PHOS

THE MARK CONSISTS OF STANDARD CHARACTERS WITHOUT CLAIM TO ANY PARTICULAR FONT, STYLE, SIZE, OR COLOR.  
FOR FERTILIZERS FOR RESIDENTIAL AND AGRICULTURAL USE (U.S. CLS. 1, 5, 6, 10, 26 AND 46).  
GIANCARLO CASTRO, EXAMINING ATTORNEY

SN 78-360,477. M-I L.L.C., HOUSTON, TX. FILED 1-30-2004.

# TENAZADRIL

THE MARK CONSISTS OF STANDARD CHARACTERS WITHOUT CLAIM TO ANY PARTICULAR FONT, STYLE, SIZE, OR COLOR.  
FOR PETROLEUM INDUSTRY CHEMICALS, NAMELY, A DRILLING FLUID ADDITIVE FOR USE IN THE OIL AND GAS WELL DRILLING INDUSTRY (U.S. CLS. 1, 5, 6, 10, 26 AND 46).  
RONALD AIKENS, EXAMINING ATTORNEY

SN 78-366,012. FUNCTIONALIZED POLYMERS, INC., NANUET, NY. FILED 2-11-2004.

SN 78-363,860. AMERICAN PACIFIC CORPORATION, LAS VEGAS, NV. FILED 2-6-2004.

# HARMONY

# HALOTRON BRX

THE MARK CONSISTS OF STANDARD CHARACTERS WITHOUT CLAIM TO ANY PARTICULAR FONT, STYLE, SIZE, OR COLOR.  
OWNER OF U.S. REG. NO. 1,798,447.  
FOR FIRE SUPPRESSION AGENTS (U.S. CLS. 1, 5, 6, 10, 26 AND 46).  
CYNTHIA SLOAN, EXAMINING ATTORNEY

THE MARK CONSISTS OF STANDARD CHARACTERS WITHOUT CLAIM TO ANY PARTICULAR FONT, STYLE, SIZE, OR COLOR.  
FOR FUNCTIONALIZED POLYMERS FOR USE IN THE PLASTIC AND CHEMICAL INDUSTRIES (U.S. CLS. 1, 5, 6, 10, 26 AND 46).  
GIANCARLO CASTRO, EXAMINING ATTORNEY

**CLASS 1—(Continued).**

SN 78-389,049. M-I L.L.C., HOUSTON, TX. FILED 3-23-2004.

**Tenazamod**

THE MARK CONSISTS OF STANDARD CHARACTERS WITHOUT CLAIM TO ANY PARTICULAR FONT, STYLE, SIZE, OR COLOR.

FOR PETROLEUM INDUSTRY CHEMICALS, NAMELY, A DRILLING FLUID ADDITIVE FOR USE IN THE OIL AND GAS WELL DRILLING INDUSTRY (U.S. CLS. 1, 5, 6, 10, 26 AND 46).

RONALD AIKENS, EXAMINING ATTORNEY

**CLASS 2—(Continued).**

SN 76-574,849. FARROW & BALL HOLDINGS LIMITED, DORSET BH21 7NL, ENGLAND, FILED 2-6-2004.

**F & B**

FOR OIL AND EMULSION EXTERIOR AND INTERIOR PAINT (U.S. CLS. 6, 11 AND 16).  
FIRST USE 12-0-1998; IN COMMERCE 12-0-1998.  
M. E. BODSON, EXAMINING ATTORNEY

SN 78-260,276. THE SHERWIN-WILLIAMS COMPANY, CLEVELAND, OH. FILED 6-10-2003.

**DECKSCAPES**

**CLASS 2—PAINTS**

SN 76-417,363. AKTIEBOLAGET WILH. BECKER, SE-263 83 HOGANAS, SWEDEN, FILED 5-31-2002.

**Beckers**

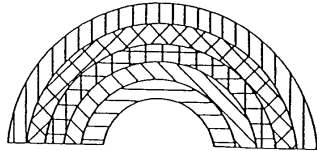

THE MARK CONSISTS OF STANDARD CHARACTERS WITHOUT CLAIM TO ANY PARTICULAR FONT, STYLE, SIZE, OR COLOR.

FOR PROTECTIVE AND DECORATIVE COATINGS USED IN THE NATURE OF PAINTS AND STAINS (U.S. CLS. 6, 11 AND 16).

MARY CRAWFORD, EXAMINING ATTORNEY

SN 78-260,695. GENEVA SCIENTIFIC, INC., DBA BARCO PRODUCTS COMPANY, BATAVIA, IL. FILED 6-10-2003.

**AS-303**

PRIORITY CLAIMED UNDER SEC. 44(D) ON SWEDEN APPLICATION NO. 0203147, FILED 4-30-2002, REG. NO. 365538, DATED 2-20-2004, EXPIRES 2-20-2014.

THE DRAWING IS LINED FOR THE COLORS BLUE, GREEN, YELLOW, ORANGE AND RED.

FOR PAINTS, NAMELY, INDUSTRIAL PAINTS; VARNISHES; LACQUERS IN THE NATURE OF A COATING; COATINGS AND POWDER COATINGS FOR THE INDUSTRIAL FINISHING OF METAL AND PLASTIC; PAINT PRIMERS; ENAMEL IN THE NATURE OF HOUSE PAINT; PRESERVATIVES AGAINST RUST AND AGAINST DETERIORATION OF WOOD; COLORANTS FOR USE IN THE MANUFACTURE OF PAINT; MORDANTS FOR USE IN THE PAINT INDUSTRY; METALS IN FOIL AND POWDER FORM FOR PAINTERS (U.S. CLS. 6, 11 AND 16).

JEFF DEFORD, EXAMINING ATTORNEY

FOR ANTI-SLIP FLOOR TREATMENT (U.S. CLS. 6, 11 AND 16).  
FIRST USE 9-0-2000; IN COMMERCE 9-0-2000.  
MICHAEL ENGEL, EXAMINING ATTORNEY

**CLASS 2—(Continued).**

SN 78-341,108. RENO, PHILIP, SAN FRANCISCO, CA. FILED 12-15-2003.

**PHILIP'S PERFECT  
COLORS**

THE MARK CONSISTS OF STANDARD CHARACTERS WITHOUT CLAIM TO ANY PARTICULAR FONT, STYLE, SIZE, OR COLOR.

NO CLAIM IS MADE TO THE EXCLUSIVE RIGHT TO USE "PERFECT COLORS", APART FROM THE MARK AS SHOWN.

THE NAME(S), PORTRAIT(S), AND/OR SIGNATURE(S) SHOWN IN THE MARK IDENTIFIES PHILIP RENO, WHOSE CONSENT(S) TO REGISTER IS SUBMITTED.

FOR INTERIOR AND EXTERIOR PAINT (U.S. CLS. 6, 11 AND 16).

DEZMONA MIZELLE, EXAMINING ATTORNEY

SN 78-352,941. PPG INDUSTRIES OHIO, INC., CLEVELAND, OH. FILED 1-16-2004.

**DITECH**

THE MARK CONSISTS OF STANDARD CHARACTERS WITHOUT CLAIM TO ANY PARTICULAR FONT, STYLE, SIZE, OR COLOR.

FOR COATING COMPOSITIONS IN THE NATURE OF PAINT FOR APPLICATION TO VEHICLES (U.S. CLS. 6, 11 AND 16).

MARC LEIPZIG, EXAMINING ATTORNEY

**CLASS 3—COSMETICS AND CLEANING PREPARATIONS**

SN 76-197,195. APEX PRODUCTS COMPANY, MEMPHIS, TN. FILED 1-19-2001.

**KARMA MEMPHIS**

NO CLAIM IS MADE TO THE EXCLUSIVE RIGHT TO USE MEMPHIS, APART FROM THE MARK AS SHOWN.

FOR PERFUMES; COSMETICS; SKIN CARE PREPARATIONS, NAMELY, WRINKLE REMOVING SKIN CARE PREPARATIONS, NON-MEDICATED SUN TAN LOTIONS, SKIN TEXTURIZERS, SKIN EMOLLIENTS, HAND CREAMS, COSMETIC FACIAL CREAMS, SKIN TONE CREAMS, SKIN LOTIONS, SKIN MOISTURIZERS, COCOA BUTTER SKIN CREAMS AND STICKS, BEAUTY BARS FOR CLEANSING AND CONDITIONING SKIN, AND FACIAL SCRUBS; PREPARATIONS FOR THE CARE OF THE HAIR; ESSENTIAL OILS FOR PERSONAL USE; BODY AND FACE SOAPS; CREAMS, GELS AND LOTIONS FOR THE SKIN; PERSONAL DEODORANTS, ANTI-PERSPIRANTS; HAIR SHAMPOOS; MASSAGE OILS; SHOWER AND BATH PREPARATIONS, NAMELY, BUBBLE BATHS, BATH OILS, BATH GELS, AND FOOT SCRUBS; AROMATHERAPY PREPARATIONS, NAMELY, FRAGRANCE THERAPY OILS, CREAMS AND LOTIONS; TOILET WATERS, EAU DE COLOGNE HAIR LOTIONS, SKIN LOTIONS, SKIN CREAMS AND SKIN GELS; MAKE UP PREPARATIONS; LIPSTICK; EYE PENCIL LINERS; PREPARATIONS FOR NAILS; FALSE NAILS AND FALSE EYELASHES AND ADHESIVES FOR FIXING SUCH; COTTON STICKS AND COTTON WOOL FOR COSMETIC USE; NAIL POLISH OR VARNISH; PREPARATIONS FOR REMOVING NAIL POLISH OR VARNISH; SHOWER GELS AND CREAMS; TALCUM POWDER; SHAVING AND AFTER-SHAVE PREPARATIONS; BRONZING POWDER; COTTON COSMETIC POWDER PUFFS; AND MAKE-UP COSMETICS AND BRUSHES FOR APPLYING MAKE UP SOLD AS A UNIT (U.S. CLS. 1, 4, 6, 50, 51 AND 52).

LOURDES AYALA, EXAMINING ATTORNEY

SN 76-443,596. TOWNLEY INC., NEW YORK, NY. FILED 8-19-2002.

**BEAUTY MARK**

FOR COSMETICS, NAMELY, FOUNDATION POWDERS, MASCARA, EYE SHADOW, LIPSTICK, LIP GLOSS, NAIL POLISH, GLITTER GEL USED ON SKIN, GLITTER FOR HAIR, AND GLITTER HAIR SPRAY (U.S. CLS. 1, 4, 6, 50, 51 AND 52).

H. M. FISHER, EXAMINING ATTORNEY

SN 76-508,817. AMOREPACIFIC CORPORATION, YONGSAN-KU, SEOUL, REPUBLIC OF KOREA, FILED 4-8-2003.

**WATER SLEEPING PACK**

NO CLAIM IS MADE TO THE EXCLUSIVE RIGHT TO USE WATER AND PACK, APART FROM THE MARK AS SHOWN.

FOR FACIAL MASKS, NON-MEDICATED MASSAGE GELS, SKIN MILK LOTIONS, PERFUMES, COTTON WOOL FOR COSMETIC PURPOSES, COSMETIC SOAPS, SHAMPOOS, TOOTHPASTE, AND NON-MEDICATED SKIN MOISTURIZING SERUMS (U.S. CLS. 1, 4, 6, 50, 51 AND 52).

KELLY BOULTON, EXAMINING ATTORNEY

**CLASS 3—(Continued).**

SN 76-532,616. LABORATOIRES DARPHIN, 75001 PARIS, FRANCE, FILED 7-25-2003.

**VITALDERM**

PRIORITY CLAIMED UNDER SEC. 44(D) ON FRANCE APPLICATION NO. 033209684, FILED 2-14-2003, REG. NO. 033209684, DATED 2-14-2003, EXPIRES 2-14-2013.

FOR PERFUMES AND COSMETICS (U.S. CLS. 1, 4, 6, 50, 51 AND 52).

BILL DAWE, EXAMINING ATTORNEY

SN 76-533,067. BDV.LLC, DBA PROGRESSIVE BEAUTY BRANDS, CHASKA, MN. FILED 7-28-2003.

**SAME AS**

FOR NON-MEDICATED HAIR AND SKIN CARE PREPARATIONS (U.S. CLS. 1, 4, 6, 50, 51 AND 52).

THEODORE MCBRIDE, EXAMINING ATTORNEY

SN 76-539,952. SIMMONS, KIMORA LEE, NEW YORK, NY. FILED 7-24-2003.

**KIMORA**

FOR FRAGRANCES, NAMELY, PERFUME, EAU DE TOILETTE, AND COLOGNE (U.S. CLS. 1, 4, 6, 50, 51 AND 52).

SUE LAWRENCE, EXAMINING ATTORNEY

SN 76-545,679. HOUSE OF MOHAN CORPORATION, WASHINGTON, DE. FILED 9-22-2003.

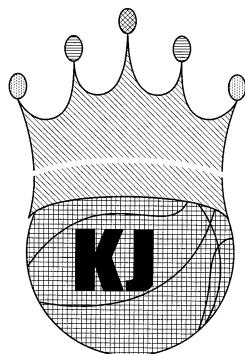

THE MARK CONSISTS OF A YELLOW BASKETBALL AND A GREEN CROWN WITH (FROM LEFT TO RIGHT) THE FIRST DOT AND FIFTH DOT BEING PURPLE, THE SECOND DOT AND FOURTH DOT BEING BLUE AND THE THIRD (MIDDLE) DOT BEING ORANGE.

FOR INCENSE AND ESSENTIAL OILS FOR PERSONAL USE (U.S. CLS. 1, 4, 6, 50, 51 AND 52).

DEZMONA MIZELLE, EXAMINING ATTORNEY

**CLASS 3—(Continued).**

SN 76-555,477. TRAN, HUNG, SAN CLEMENTE, CA. FILED 10-30-2003.

**AFFIATATI**

THE ENGLISH TRANSLATION OF THE WORD AFFIATATI IN THE MARK IS UNSPOKEN AFFECTION BETWEEN TWO PEOPLE IN LOVE.

FOR BEAUTY PRODUCTS AND COSMETIC PRODUCTS, NAMELY, NON-MEDICATED SKINCARE PREPARATIONS, SKIN LOTION, SKIN CREAM, SKIN MILK, BUBBLE BATH, BATH OIL, BATH BEADS, FACIAL MASQUES, MAKE-UP PRODUCTS, NAMELY, FOUNDATION MAKE UP, EYE SHADOW, EYE LINER, MASCARA, FACE POWDER, BLUSH, LIPSTICK, LIP GLOSS, FINGER NAIL POLISH, PERFUMERY, NAMELY PERFUME, EAU DE TOILETTE, COLOGNE, SCENTED LOTIONS, CREMES AND GELS, PERSONAL ESSENTIAL OILS, BODY SPLASH, AND AROMATHERAPY LOTIONS AND OILS, HAIRCARE PREPARATIONS, NAMELY, HAIR SHAMPOO AND HAIR CONDITIONERS, TOILET SOAPS, AND SUNCARE PREPARATIONS (U.S. CLS. 1, 4, 6, 50, 51 AND 52).

LINDA E. BLOHM, EXAMINING ATTORNEY

SN 76-562,552. REVIVA LABS, INC., HADDONFIELD, NJ. FILED 12-2-2003.



NO CLAIM IS MADE TO THE EXCLUSIVE RIGHT TO USE "LABS", APART FROM THE MARK AS SHOWN.

FOR FACIAL MASKS; SOAPS; AND COSMETICS AND SKIN CARE PRODUCTS, NAMELY SKIN CREAMS, SKIN LOTIONS, SKIN CLEANSERS, AND SKIN TONERS (U.S. CLS. 1, 4, 6, 50, 51 AND 52).

FIRST USE 9-30-1971; IN COMMERCE 9-30-1971.

ELLEN PERKINS, EXAMINING ATTORNEY

SN 76-572,493. ENVIROCON TECHNOLOGIES, INC., MIDLAND, TX. FILED 1-26-2004.

**ENVIROPET PLUS**

THE MARK CONSISTS OF STANDARD CHARACTERS WITHOUT CLAIM TO ANY PARTICULAR FONT, STYLE, SIZE, OR COLOR.

FOR PET ODOR AND STAIN REMOVER (U.S. CLS. 1, 4, 6, 50, 51 AND 52).

KIMBERLY FRYE, EXAMINING ATTORNEY

**CLASS 3—(Continued).**

SN 76-573,908. UNITE EUROTHERAPY, INC., SAN DIEGO, CA. FILED 2-4-2004.

**UNITE EUROTHERAPY**

FOR HAIR CARE PRODUCTS; NAMELY, SHAMPOOS, CONDITIONERS, SCULPTING LOTION, SCULPTING FOAM, GELS, SPRAYS AND WAVING AND SETTING LOTIONS (U.S. CLS. 1, 4, 6, 50, 51 AND 52).

FIRST USE 7-1-2002; IN COMMERCE 7-1-2002.  
JEFFREY S. MOLINOFF, EXAMINING ATTORNEY

SN 78-127,625. AVON PRODUCTS, INC., NEW YORK, NY. FILED 5-9-2002.

**REDEFINE**

FOR COSMETICS, NAMELY FACIAL FOUNDATION. (U.S. CLS. 1, 4, 6, 50, 51 AND 52).

JOHN DWYER, EXAMINING ATTORNEY

SN 78-211,343. UNIVERSITY NUTRACEUTICALS OF ARIZONA, DBA NUBIAN SILK, PHOENIX, AZ. FILED 2-5-2003.

*Nubian Silk*

FOR COSMETICS; NON-MEDICATED HEALTH AND BEAUTY PRODUCTS FOR THE SKIN AND HAIR, NAMELY, HAIR SHAMPOOS, HAIR CONDITIONERS, HAIR OILS, HAIR NOURISHERS, HAIR POMADES, HAIR CARE PREPARATIONS IN THE NATURE OF FINISHING SPRAYS, SKIN LOTIONS, SKIN OILS AND SKIN SOAPS (U.S. CLS. 1, 4, 6, 50, 51 AND 52).

FIRST USE 4-1-2002; IN COMMERCE 4-1-2002.  
KATHY DE JONGE, EXAMINING ATTORNEY

SN 78-226,868. AMOREPACIFIC CORPORATION, SEOUL, REPUBLIC OF KOREA, FILED 3-18-2003.

**STAR PURE**

OWNER OF REPUBLIC OF KOREA REG. NO. 0573588, DATED 2-5-2004, EXPIRES 2-5-2014.

FOR SKIN CLEANSING FOAM, COSMETIC SOAP, NAMELY SKIN SOAP, SKIN MILK LOTION, PERFUME, LAVENDER OIL FOR PERSONAL USE, DISPOSABLE WIPES IMPREGNATED WITH COSMETIC LOTION, SHAMPOO, TOOTH PASTE, LIPSTICK (U.S. CLS. 1, 4, 6, 50, 51 AND 52).

BRETT J. GOLDEN, EXAMINING ATTORNEY

**CLASS 3—(Continued).**

SN 78-246,087. INDUSTRIAS ALEN, S.A. DE C.V., SANTA CATARINA, N.L., MEXICO, FILED 5-6-2003.



NO CLAIM IS MADE TO THE EXCLUSIVE RIGHT TO USE LAVENDER AND SCENTS, APART FROM THE MARK AS SHOWN.

FOR ALL PURPOSE LIQUID CLEANING PREPARATIONS (U.S. CLS. 1, 4, 6, 50, 51 AND 52).  
INGA ERVIN, EXAMINING ATTORNEY

SN 78-277,444. UNITED STATES PUMICE COMPANY, CHATSWORTH, CA. FILED 7-22-2003.

**NATURAL 4 IN 1**

NO CLAIM IS MADE TO THE EXCLUSIVE RIGHT TO USE NATURAL, APART FROM THE MARK AS SHOWN.

FOR COSMETICS, NAMELY, SKIN LOTIONS AND PREPARATIONS FOR CLEANSING, EXFOLIATING, SCRUBBING AND MOISTURIZING THE BODY (U.S. CLS. 1, 4, 6, 50, 51 AND 52).

MATTHEW KLINE, EXAMINING ATTORNEY

SN 78-279,928. MAUI GIRL & CO., PAIJA, HI. FILED 7-28-2003.

**MAUI GIRL**

OWNER OF U.S. REG. NOS. 2,487,933 AND 2,632,037.  
FOR AFTER SUN LOTION, HAIR CONDITIONER AND SHAMPOO, COSMETICS, PERFUMES, ESSENTIAL OILS FOR PERSONAL USE, LIP BALM, SUNTAN OIL, AND ALL TYPES OF TANNING PRODUCTS APPLIED TO THE SKIN, NAMELY SUN TAN GELS, SKIN GELS FOR ACCELERATING, ENHANCING OR EXTENDING TANS (U.S. CLS. 1, 4, 6, 50, 51 AND 52).

DARRYL SPRUILL, EXAMINING ATTORNEY

**CLASS 3—(Continued).**

SN 78-282,304. HERBARIA, LLC, ST. LOUIS, MO. FILED 8-1-2003.

**HERBARIA**

FOR BODY SOAP AND NON-MEDICATED PET SOAP (U.S. CLS. 1, 4, 6, 50, 51 AND 52).  
FIRST USE 10-5-2002; IN COMMERCE 10-5-2003.  
LINDA E. BLOHM, EXAMINING ATTORNEY

SN 78-296,309. ENPRANI CO., LTD., SEOUL, REPUBLIC OF KOREA, FILED 9-4-2003.

**Dan Harbor**  
댄 하버

OWNER OF REPUBLIC OF KOREA REG. NO. 0528182, DATED 9-14-1998, EXPIRES 9-14-2008.  
OWNER OF REPUBLIC OF KOREA REG. NO. 40-0528182, DATED 8-21-2002, EXPIRES 8-21-2012.

THE NAME DAN HARBOR DOES NOT IDENTIFY A LIVING INDIVIDUAL.

THE TRANSLITERATION OF THE KOREAN CHARACTERS IN THE MARK IS DAN HARBOR.

FOR SKIN FRESHENERS, NAMELY, SKIN EMOLLIENTS, SKIN CLEANSERS, SKIN TONERS, SKIN CLARIFIERS AND SKIN CONDITIONERS; COLD CREAM; SKIN, HAIR, FACIAL AND BODY LOTIONS; SKIN CLEANSING CREAMS; DISPOSABLE WIPES IMPREGNATED WITH CHEMICALS OR COMPOUNDS FOR PERSONAL HYGIENE; HAIR SHAMPOOS; LIQUID DETERGENT SOAPS; AND TOOTH PASTE, SUN SCREEN LOTIONS AND BATH SOAPS (U.S. CLS. 1, 4, 6, 50, 51 AND 52).

J. TINGLEY, EXAMINING ATTORNEY

SN 78-299,720. BEAUTY HOLDING COMPANY, INC., HAMILTON HM12, BERMUDA, FILED 9-12-2003.

**CRYSTAL NAIL GLASS**

NO CLAIM IS MADE TO THE EXCLUSIVE RIGHT TO USE NAIL, APART FROM THE MARK AS SHOWN.  
FOR NAIL CARE PREPARATIONS, NAMELY NAIL POLISH (U.S. CLS. 1, 4, 6, 50, 51 AND 52).  
FIRST USE 9-30-1994; IN COMMERCE 9-30-1994.  
ANNE MADDEN, EXAMINING ATTORNEY

**CLASS 3—(Continued).**

SN 78-299,726. BEAUTY HOLDING COMPANY, INC., HAMILTON HM12, BERMUDA, FILED 9-12-2003.

**CRYSTAL NAIL QUICK**

NO CLAIM IS MADE TO THE EXCLUSIVE RIGHT TO USE "NAIL", APART FROM THE MARK AS SHOWN.  
FOR NAIL CARE PREPARATIONS AND TREATMENTS, NAMELY NAIL POLISH (U.S. CLS. 1, 4, 6, 50, 51 AND 52).  
FIRST USE 9-30-1994; IN COMMERCE 9-30-1994.  
ANNE MADDEN, EXAMINING ATTORNEY

SN 78-299,729. BEAUTY HOLDING COMPANY, INC., HAMILTON HM12, BERMUDA, FILED 9-12-2003.

**CRYSTAL NAIL THICK**

NO CLAIM IS MADE TO THE EXCLUSIVE RIGHT TO USE NAIL, APART FROM THE MARK AS SHOWN.  
FOR NAIL CARE PREPARATIONS, NAMELY NAIL STRENGTHENER (U.S. CLS. 1, 4, 6, 50, 51 AND 52).  
FIRST USE 9-30-1994; IN COMMERCE 9-30-1994.  
ANNE MADDEN, EXAMINING ATTORNEY

SN 78-318,524. LUFTMAN, DEBRA B., ENCINO, CA. FILED 10-24-2003.

**MYOX**

FOR FACIAL CLEANSER, SUN BLOCK, FACIAL LOTION, FACIAL CREAM, BEAUTY MASK, BODY MASK, SKIN MASK, FACIAL MASK, MAKE-UP, FACIAL MOISTURIZER, EYE CREAM, FACIAL GEL AND HAND CREAM (U.S. CLS. 1, 4, 6, 50, 51 AND 52).  
JUDITH GRUNDY, EXAMINING ATTORNEY

SN 78-329,083. HOUSECHEM, INC., WALDWICK, NJ. FILED 11-17-2003.



THE MARK CONSISTS OF THE MARK CONSISTS OF THE WORD HOUSECHEM WITH A BOX AROUND THE ENTIRE WORD AND THE WORD HOUSE AS LIGHT LETTERS ON A DARK BACKGROUND, AND THE WORD CHEM AS DARK LETTERS ON A LIGHT BACKGROUND.  
FOR TOILET BOWL CLEANERS AND ALL PURPOSE CLEANING PREPARATIONS (U.S. CLS. 1, 4, 6, 50, 51 AND 52).

FIRST USE 12-1-1987; IN COMMERCE 12-1-1987.  
GINNY ISAACSON, EXAMINING ATTORNEY



**CLASS 3—(Continued).**

SN 78-331,840. NEDBOY, ROBIN L, NEW YORK, NY. FILED 11-22-2003.

**CITRUS GROVE**

THE MARK CONSISTS OF STANDARD CHARACTERS WITHOUT CLAIM TO ANY PARTICULAR FONT, STYLE, SIZE, OR COLOR.

NO CLAIM IS MADE TO THE EXCLUSIVE RIGHT TO USE "CITRUS", APART FROM THE MARK AS SHOWN.

FOR NON-MEDICATED SKIN CARE PREPARATIONS, NAMELY, ANTI-AGING CREAM, ANTI-WRINKLE CREAM, ASTRINGENT FOR COSMETIC PURPOSES, BODY CREAM, BODY EMULSION, BODY LOTION, BODY MILK, BODY OIL, BODY SCRUB, BODY SPRAY, EXFOLIANTS FOR SKIN, EYE CREAM, EYE GEL, FACIAL CLEANSER, FACIAL CREAM, FACIAL EMULSIONS, FACIAL MASKS, FACIAL SCRUB, HAND CREAM, HAND LOTION, HAND SOAP, MOISTURIZING MILKS, NON-MEDICATED BODY SOAK, NON-MEDICATED FOOT CREAM, SHOWER GEL, SKIN CLARIFIERS, SKIN CLEANSERS, SKIN CLEANSING CREAM, SKIN CLEANSING LOTION, SKIN CONDITIONERS, SKIN CREAM, SKIN EMOLLIENTS, SKIN LOTION, SKIN MASKS, SKIN MOISTURIZER, SKIN SOAP, SKIN TONER, SOAP FOR COSMETIC PURPOSES; SHAVING PREPARATIONS, NAMELY, SHAVING BALM, SHAVING CREAM, SHAVING FOAM, SHAVING GEL, SHAVING LOTION, SHAVING SOAP, AFTER-SHAVE GEL, AFTER-SHAVE LOTION; BATH ADDITIVES, NAMELY, BATH BEADS, BATH CRYSTALS, BATH FOAMS, BATH GELS, BATH MILK, BATH OILS, BATH PEARLS, BUBBLE BATH, NON-MEDICATED BATH SALTS; FRAGRANCES, NAMELY, ESSENTIAL OILS FOR PERSONAL USE, PERFUME, EAU DE TOILETTE (U.S. CLS. 1, 4, 6, 50, 51 AND 52).

FIRST USE 11-1-2002; IN COMMERCE 11-1-2002.  
WON TEAK OH, EXAMINING ATTORNEY

SN 78-337,620. KIMBERLY-CLARK WORLDWIDE, INC., NEENAH, WI. FILED 12-8-2003.



NO CLAIM IS MADE TO THE EXCLUSIVE RIGHT TO USE TEAR-FREE, APART FROM THE MARK AS SHOWN.

THE MARK CONSISTS OF OVAL, DROP AND WORDS. FOR DISPOSABLE BABY WASHCLOTHS IMPREGNATED WITH SKIN CLEANSERS; BABY BATH CLEANSERS AND WASHES (U.S. CLS. 1, 4, 6, 50, 51 AND 52).

LESLEY LAMOTHE, EXAMINING ATTORNEY

**CLASS 3—(Continued).**

SN 78-341,288. PERRICONE, NICHOLAS V., MERIDEN, CT. FILED 12-16-2003.

**N.V. Perricone, M.D.  
Cosmeceuticals**

OWNER OF U.S. REG. NO. 2,237,822.

NO CLAIM IS MADE TO THE EXCLUSIVE RIGHT TO USE "M.D." AND "COSMECEUTICALS", APART FROM THE MARK AS SHOWN.

THE MARK CONSISTS OF A MORTAR AND PESTLE DESIGN AND, TO THE RIGHT OF THE DESIGN, THE WORDS N.V. PERRICONE, M.D. POSITIONED ABOVE A HORIZONTAL LINE AND THE WORD COSMECEUTICALS POSITIONED BELOW THE SAME HORIZONTAL LINE.

FOR COSMETICS, NAMELY, NON-MEDICATED LIP BALMS, NAIL AND CUTICLE CREAMS, AND SKIN CARE PREPARATIONS, NAMELY, SKIN AND FACIAL CREAMS AND LOTIONS, AND SKIN CLEANSERS (U.S. CLS. 1, 4, 6, 50, 51 AND 52).

FIRST USE 2-26-1998; IN COMMERCE 5-11-1998.  
ANN LINNEHAN, EXAMINING ATTORNEY

SN 78-342,611. SMITHKLINE BEECHAM CORPORATION, PHILADELPHIA, PA. FILED 12-18-2003.

**PERSONAL WHITE**

THE MARK CONSISTS OF STANDARD CHARACTERS WITHOUT CLAIM TO ANY PARTICULAR FONT, STYLE, SIZE, OR COLOR.

NO CLAIM IS MADE TO THE EXCLUSIVE RIGHT TO USE "WHITE", APART FROM THE MARK AS SHOWN.

FOR TOOTH WHITENING PREPARATIONS (U.S. CLS. 1, 4, 6, 50, 51 AND 52).

BARBARA BROWN, EXAMINING ATTORNEY

SN 78-342,615. SMITHKLINE BEECHAM CORPORATION, PHILADELPHIA, PA. FILED 12-18-2003.

**AQUAFRESH PERSONAL  
WHITE**

THE MARK CONSISTS OF STANDARD CHARACTERS WITHOUT CLAIM TO ANY PARTICULAR FONT, STYLE, SIZE, OR COLOR.

OWNER OF U.S. REG. NOS. 1,006,821, 2,615,649 AND OTHERS.

NO CLAIM IS MADE TO THE EXCLUSIVE RIGHT TO USE "WHITE", APART FROM THE MARK AS SHOWN.

FOR TOOTH WHITENING PREPARATIONS (U.S. CLS. 1, 4, 6, 50, 51 AND 52).

BARBARA BROWN, EXAMINING ATTORNEY

**CLASS 3—(Continued).**

SN 78-350,739. INTIMATE BEAUTY CORPORATION, DBA VICTORIA'S SECRET BEAUTY, NEW YORK, NY. FILED 1-12-2004.

**SHEERLY PRETTY**

THE MARK CONSISTS OF STANDARD CHARACTERS WITHOUT CLAIM TO ANY PARTICULAR FONT, STYLE, SIZE, OR COLOR.

FOR PERSONAL CARE PRODUCTS, NAMELY, AFTERSHAVE GELS, AFTERSHAVE LOTION, ANTI-PERSPIRANT, ARTIFICIAL NAILS, ASTRINGENT FOR THE FACE, ASTRINGENT FOR THE SKIN, BATH BEADS, BATH OIL, BATH SALTS, BLUSH, BODY GLITTER, BODY MIST, BODY OIL, BODY SCRUB, BODY WASH, BUBBLE BATH, COLOGNE, CREAM FOR THE BODY, CREAM FOR THE CUTICLES, CREAM FOR THE EYES, CREAM FOR THE FACE, CREAM FOR THE FEET, CREAM FOR THE HANDS, DEODORANTS FOR PERSONAL USE, ESSENTIAL OILS FOR PERSONAL USE, EXFOLIATING PREPARATIONS FOR THE SKIN, EYE GELS, EYE MAKEUP PENCILS, EYE MASKS, EYE SHADOW, FACE HIGHLIGHTER, FACE MASKS, FACE MIST, FACE SCRUB, NON-MEDICATED FOOT SOAKS, FACE TONERS, FOUNDATION, FRAGRANT BODY SPLASH, FRAGRANT BODY MIST, HAIR CONDITIONER, HAIR DYES, HAIR GLITTER, HAIR HIGHLIGHTER, HAIR MASCARA, HAIR POMADE, HAIR RINSES, HAIR REMOVING CREAMS, HAIR SHAMPOO, HAIR SPRAY, HAIR STRAIGHTENER, HAIR STYLING GEL, HAIR STYLING MOUSSE, LOTION FOR THE BODY, LOTION FOR THE FACE, LOTION FOR THE FEET, LOTION FOR THE HANDS, LIP BALM, LIP GLOSS, LIP LINER, LIP MAKEUP PENCILS, LIPSTICK, MAKEUP FOR THE BODY, MAKEUP FOR THE FACE, MAKEUP REMOVER, MASCARA, MASSAGE CREAM, MASSAGE LOTION, MASSAGE OIL, NAIL POLISH, NAIL POLISH REMOVER, NAIL STENCILS, NON-MEDICATED BLEMISH STICK, NON-MEDICATED CLEANSER FOR THE FACE, NON-MEDICATED FOOT SPRAY, NON-MEDICATED MASSAGE OINTMENT, OIL BLOT- TING SHEETS FOR THE SKIN, PERFUME, POWDER FOR THE BODY, POWDER FOR THE FACE, POWDER FOR THE FEET, PUMICE STONES FOR PERSONAL USE, SALT SCRUBS FOR THE SKIN, SHAVING CREAM, SHAVING GELS, SHOWER CREAM, SHOWER GEL, SKIN BRONZING CREAM, SOAP FOR THE BODY, SOAP FOR THE FACE, SOAP FOR THE HANDS, SUN BLOCK FOR THE BODY, SUN BLOCK FOR THE FACE, SUNTAN LOTION FOR THE BODY, SUNTAN LOTION FOR THE FACE, SUNLESS TANNING LOTION FOR THE BODY, SUNLESS TANNING LOTION FOR THE FACE, PRE-SUNTANNING LOTION FOR THE BODY, PRE-SUNTANNING LOTION FOR THE FACE, POST-SUNTANNING LOTION FOR THE BODY, POST-SUNTANNING LOTION FOR THE FACE AND TALCUM POWDER (U.S. CLS. 1, 4, 6, 50, 51 AND 52).  
DOUGLAS LEE, EXAMINING ATTORNEY

**CLASS 3—(Continued).**

SN 78-352,090. FIVE STAR TRADING LTD, NORTH VAN- COUVER, BRITISH COLUMBIA, CANADA, FILED 1-14- 2004.

**Wax-A-Way**

THE MARK CONSISTS OF STANDARD CHARACTERS WITHOUT CLAIM TO ANY PARTICULAR FONT, STYLE, SIZE, OR COLOR.

FOR COSMETICS, SPECIFICALLY DEPILATORIES FOR UNWANTED HAIR REMOVAL (U.S. CLS. 1, 4, 6, 50, 51 AND 52).  
FIRST USE 10-28-1994; IN COMMERCE 10-28-1994.  
ELIZABETH PIGNATELLO, EXAMINING ATTORNEY

---

SN 78-352,549. MAKE-UP ART COSMETICS INC., NEW YORK, NY. FILED 1-15-2004.

**LIPGLASS TASTI**

THE MARK CONSISTS OF STANDARD CHARACTERS WITHOUT CLAIM TO ANY PARTICULAR FONT, STYLE, SIZE, OR COLOR.

OWNER OF U.S. REG. NO. 2,131,290.  
FOR COSMETICS (U.S. CLS. 1, 4, 6, 50, 51 AND 52).  
FIRST USE 12-18-2003; IN COMMERCE 12-18-2003.  
HELEN BRYAN, EXAMINING ATTORNEY

**CLASS 3—(Continued).**

SN 78-352,871. FRIEDMAN, BRADLEY J, SHERMAN OAKS, CA. FILED 1-16-2004.

**CLASS 3—(Continued).**

SN 78-354,332. TURTLE WAX, INC., CHICAGO, IL. FILED 1-20-2004.

**BIDET IN A BOTTLE**

**THE NEW STANDARD  
IN SHINE**

THE MARK CONSISTS OF STANDARD CHARACTERS WITHOUT CLAIM TO ANY PARTICULAR FONT, STYLE, SIZE, OR COLOR.

FOR TROPICAL SKIN CLEANSER FOR PERSONAL HYGIENE PURPOSES (U.S. CLS. 1, 4, 6, 50, 51 AND 52).  
PRISCILLA MILTON, EXAMINING ATTORNEY

THE MARK CONSISTS OF STANDARD CHARACTERS WITHOUT CLAIM TO ANY PARTICULAR FONT, STYLE, SIZE, OR COLOR.

FOR PREPARATIONS FOR CLEANING, WASHING, POLISHING, WAXING AND PRESERVING THE SURFACES OF VEHICLES (U.S. CLS. 1, 4, 6, 50, 51 AND 52).  
JOHN E. MICHOS, EXAMINING ATTORNEY

SN 78-353,162. SIGNATURE CLUB A LTD., TAMPA, FL. FILED 1-16-2004.

SN 78-354,582. MARIA B. COSMETICS, WEST COVINA, CA. FILED 1-20-2004.

**FIRMFILL**

**face couture**

THE MARK CONSISTS OF STANDARD CHARACTERS WITHOUT CLAIM TO ANY PARTICULAR FONT, STYLE, SIZE, OR COLOR.

FOR COSMETICS (U.S. CLS. 1, 4, 6, 50, 51 AND 52).  
MARLENE BELL, EXAMINING ATTORNEY

THE MARK CONSISTS OF STANDARD CHARACTERS WITHOUT CLAIM TO ANY PARTICULAR FONT, STYLE, SIZE, OR COLOR.

NO CLAIM IS MADE TO THE EXCLUSIVE RIGHT TO USE "FACE", APART FROM THE MARK AS SHOWN.

FOR COSMETICS, NAMELY FACE POWDERS, FOUNDATIONS, BLUSHES, EYESHADOWS, LIPSTICKS, LIP GLOSSES, AND NON-MEDICATED SKIN CARE PREPARATIONS (U.S. CLS. 1, 4, 6, 50, 51 AND 52).  
FIRST USE 1-1-2004; IN COMMERCE 1-1-2004.

DAWN HAN, EXAMINING ATTORNEY

SN 78-353,172. SIGNATURE CLUB A LTD., TAMPA, FL. FILED 1-16-2004.

**JET TECH WET SET**

THE MARK CONSISTS OF STANDARD CHARACTERS WITHOUT CLAIM TO ANY PARTICULAR FONT, STYLE, SIZE, OR COLOR.

FOR COSMETICS, NAMELY, POWDERS FOR FACE AND EYE (U.S. CLS. 1, 4, 6, 50, 51 AND 52).  
MARLENE BELL, EXAMINING ATTORNEY

**CLASS 3—(Continued).**

SN 78-355,060. LAVENDER MEADOWS, PETALUMA, CA.  
FILED 1-21-2004.

**CLASS 3—(Continued).**

SN 78-356,914. ROY, LUC, MISSION, BRITISH COLUMBIA,  
CANADA, FILED 1-23-2004.

**BUBBLE OR NOTHING**

THE MARK CONSISTS OF STANDARD CHARACTERS  
WITHOUT CLAIM TO ANY PARTICULAR FONT, STYLE,  
SIZE, OR COLOR.

NO CLAIM IS MADE TO THE EXCLUSIVE RIGHT TO  
USE "BUBBLE", APART FROM THE MARK AS SHOWN.  
FOR BUBBLE BATH (U.S. CLS. 1, 4, 6, 50, 51 AND 52).  
FIRST USE 1-7-2004; IN COMMERCE 1-7-2004.  
EUGENIA MARTIN, EXAMINING ATTORNEY

**VALOR ULTRA**

THE MARK CONSISTS OF STANDARD CHARACTERS  
WITHOUT CLAIM TO ANY PARTICULAR FONT, STYLE,  
SIZE, OR COLOR.

FOR LAUNDRY DETERGENT; DETERGENTS FOR  
DISHES AND DISHWASHERS, MULTIPURPOSE  
HOUSEHOLD CLEANERS AND FABRIC SOFTENERS  
(U.S. CLS. 1, 4, 6, 50, 51 AND 52).

FIRST USE 1-23-2004; IN COMMERCE 1-23-2004.  
TRICIA THOMPCKINS, EXAMINING ATTORNEY

SN 78-357,125. BEAUTY ELITE GROUP INC., HOUSTON,  
TX. FILED 1-24-2004.

SN 78-355,274. PUREPET, INC., LIVERMORE, CA. FILED 1-  
21-2004.



The logo for PUREPET features the word "PUREPET" in a bold, serif font. The letters "P" and "T" are significantly larger and more stylized than the other letters. The word is underlined with a thick, dark line.

**SHEER SILK**

THE MARK CONSISTS OF STANDARD CHARACTERS  
WITHOUT CLAIM TO ANY PARTICULAR FONT, STYLE,  
SIZE, OR COLOR.

FOR SHAMPOO, CONDITIONER, HAIR GEL, HAIR  
MOUSSE, HAIR COLOR, AND HAIRSPRAY (U.S. CLS. 1,  
4, 6, 50, 51 AND 52).

LANA PHAM, EXAMINING ATTORNEY

SN 78-357,499. LACOSTE ALLIGATOR S.A., CH-1211 GENE-  
VA 3, SWITZERLAND, FILED 1-26-2004.

**STYLE ON SKIN**

FOR NON-MEDICATED SHAMPOO, CONDITIONERS,  
DEODORIZING MIST, FINISHING SPRAY AND RINSE-  
LESS SHAMPOO SPRAY FOR DOMESTIC ANIMALS  
(U.S. CLS. 1, 4, 6, 50, 51 AND 52).

FIRST USE 6-15-1988; IN COMMERCE 11-1-1988.  
DAVID ELTON, EXAMINING ATTORNEY

THE MARK CONSISTS OF STANDARD CHARACTERS  
WITHOUT CLAIM TO ANY PARTICULAR FONT, STYLE,  
SIZE, OR COLOR.

FOR PERFUMERY (U.S. CLS. 1, 4, 6, 50, 51 AND 52).  
FIRST USE 12-31-2002; IN COMMERCE 12-31-2002.  
BRIAN NEVILLE, EXAMINING ATTORNEY

**CLASS 3—(Continued).**

SN 78-358,109. PHILOSOPHY, INC., PHOENIX, AZ. FILED 1-27-2004.

**LET'S PARTY**

THE MARK CONSISTS OF STANDARD CHARACTERS WITHOUT CLAIM TO ANY PARTICULAR FONT, STYLE, SIZE, OR COLOR.

FOR COSMETICS, NAMELY, LIPSTICK, LIP GLOSS, LIP LINER, LIP BALM, BLUSH, FOUNDATION, EYE SHADOW, EYE LINER, MASCARA, CONCEALER, COSMETIC PENCILS, AND FACIAL POWDER; FRAGRANCES, NAMELY, PERFUME, COLOGNE, AND AFTER-SHAVE LOTION AND GEL; NON-MEDICATED SKIN CARE PRODUCTS, NAMELY, SOAP, SCRUBS, TONER, CONDITIONER, EXFOLIATORS, SKIN CLARIFIER, WRINKLE REMOVING SKIN CARE PREPARATIONS, AND MOISTURIZER; FACE AND BODY LOTION, CREAM, OIL, GEL AND SPRAY; SUN SCREEN PREPARATIONS, NAMELY, LOTION, CREAM, GEL AND SPRAY; NON-MEDICATED FACE AND BODY SKIN LIGHTENER; HAIR CARE PRODUCTS, NAMELY, SHAMPOO, CONDITIONER, RINSE, GEL, MOUSSE, SPRAY AND TONIC; BATH CARE PRODUCTS, NAMELY, SOAP, SALTS CRYSTALS, BEADS, GEL, OIL, POWDER, AND BUBBLE BATH; SCENTED HEAD-TO-TOE BODY WASH; NAIL CARE PREPARATIONS, NAMELY, CUTICLE CREAM, CUTICLE REMOVING PREPARATIONS, NAIL ENAMEL, NAIL POLISH, NAIL POLISH REMOVER, NAIL POLISH BASE COAT, NAIL POLISH TOP COAT, AND NAIL STRENGTHENERS; PERSONAL DEODORANT; TOOTH WHITENING GELS, CREAMS, AND PASTES; FOOT CARE PRODUCTS, NAMELY SCRUBS, LOTIONS, CREAMS, DEODORANT, AND EXFOLIATORS; MEN'S TOILETRIES, NAMELY COLOGNE, AFTER-SHAVE LOTION AND GEL; SKIN CLEANSER, SKIN SCRUBS, SKIN TONER, SKIN CREAM, SHAVING GEL, SHAVING CREAM, TOILET WATER, PERSONAL DEODORANT, SHAMPOO, BODY LOTION, BODY TALC, AND SKIN MOISTURIZER; BABY CARE PRODUCTS, NAMELY, BABY LOTIONS, CREAMS, OINTMENTS, SOAPS, POWDERS, AND SHAMPOO; FACIAL AND BODY HAIR DEPILATORY WAXES, CREAMS, LOTIONS, BLEACHING AND COLORING PREPARATIONS; MAKE-UP KITS AND GIFT SETS COMPRISED OF ONE OR MORE OF LIPSTICK, LIP GLOSS, LIP LINER, LIP BALM, BLUSH, FOUNDATION, EYE SHADOW, EYE LINER, MASCARA, CONCEALER, COSMETIC PENCILS, AND FACIAL POWDER, FRAGRANCES, NAMELY, PERFUME, COLOGNE, AND AFTER-SHAVE LOTION AND GEL, NON-MEDICATED SKIN CARE PRODUCTS, NAMELY, SOAP, SCRUBS, TONER, CONDITIONER, EXFOLIATORS, SKIN CLARIFIER, WRINKLE REMOVING SKIN CARE PREPARATIONS, AND MOISTURIZER, FACE AND BODY LOTION, CREAM, OIL, GEL AND SPRAY, SUN SCREEN PREPARATIONS, NAMELY, LOTION, CREAM, GEL, AND SPRAY, NON-MEDICATED FACE AND BODY SKIN LIGHTENER, HAIR CARE PRODUCTS, NAMELY, SHAMPOO, CONDITIONER, RINSE, GEL MOUSSE, SPRAY AND TONIC, BATH CARE PRODUCTS, NAMELY, SOAP, SALTS, CRYSTALS, BEADS, GEL OIL, POWDER, AND BUBBLE BATH, SCENTED HEAD-TO-TOE BODY WASH, NAIL CARE PREPARATIONS, NAMELY, CUTICLE CREAM, CUTICLE REMOVING PREPARATIONS, NAIL ENAMEL, NAIL POLISH, NAIL POLISH REMOVER, NAIL POLISH BASE COAT, NAIL POLISH TOP COAT, AND NAIL STRENGTHENERS, PERSONAL DEODORANT, TOOTH WHITENING GELS, CREAMS, AND PASTES, FOOT CARE PRODUCTS,

**CLASS 3—(Continued).**

NAMELY, SCRUBS, LOTIONS, CREAMS, DEODORANT, AND EXFOLIATORS, MEN'S TOILETRIES, NAMELY, COLOGNE, AFTER-SHAVE LOTION AND GEL, SKIN CLEANSER, SKIN SCRUBS, SKIN TONER, SKIN CREAM, SHAVING GEL, SHAVING CREAM, TOILET WATER, PERSONAL DEODORANT, SHAMPOO, BODY LOTION, BODY TALC AND SKIN MOISTURIZER, BABY CARE PRODUCTS, NAMELY, BABY LOTIONS, CREAMS, OINTMENTS, SOAPS, POWDERS AND SHAMPOO, FACIAL AND BODY HAIR DEPILATORY WAXES, CREAMS, LOTIONS, BLEACHING AND COLORING PREPARATIONS (U.S. CLS. 1, 4, 6, 50, 51 AND 52).  
BERYL GARDNER, EXAMINING ATTORNEY

SN 78-358,164. MILBON CO., LTD., OSAKA, JAPAN, FILED 1-27-2004.

**FAIRFORME**

THE MARK CONSISTS OF STANDARD CHARACTERS WITHOUT CLAIM TO ANY PARTICULAR FONT, STYLE, SIZE, OR COLOR.

OWNER OF U.S. REG. NO. 1,501,840.  
FOR PERMANENT WAVING PREPARATIONS; COLD PERMANENT WAVING PREPARATIONS (U.S. CLS. 1, 4, 6, 50, 51 AND 52).  
FIRST USE 4-30-2001; IN COMMERCE 11-30-2001.  
RICHARD WHITE, EXAMINING ATTORNEY

SN 78-359,209. ADVANCED TECHNOLOGY SYSTEMS, INC., INDIANAPOLIS, IN. FILED 1-29-2004.

**DARK DESIRE**

THE MARK CONSISTS OF STANDARD CHARACTERS WITHOUT CLAIM TO ANY PARTICULAR FONT, STYLE, SIZE, OR COLOR.

FOR SKIN CARE PREPARATIONS, NAMELY, NON-MEDICATED INDOOR AND OUTDOOR TANNING PREPARATIONS (U.S. CLS. 1, 4, 6, 50, 51 AND 52).  
TONJA GASKINS, EXAMINING ATTORNEY

**CLASS 3—(Continued).**

SN 78-359,518. CANAVATI, VICTOR A., MONTERREY, MEXICO, AND SARQUIS, CATALINA, MONTERREY, MEXICO, FILED 1-29-2004.

**CLASS 3—(Continued).**

SN 78-360,108. W.J. HAGERTY & SONS, LTD., INC., SOUTH BEND, IN. FILED 1-30-2004.

## STAY BRIGHT

THE MARK CONSISTS OF STANDARD CHARACTERS WITHOUT CLAIM TO ANY PARTICULAR FONT, STYLE, SIZE, OR COLOR.

FOR LAUNDRY DETERGENT (U.S. CLS. 1, 4, 6, 50, 51 AND 52).

RON FAIRBANKS, EXAMINING ATTORNEY

---

SN 78-360,081. RENATURE SKIN CARE INC., NEW YORK, NY. FILED 1-30-2004.

## DAILY AFFIRMATION

THE MARK CONSISTS OF STANDARD CHARACTERS WITHOUT CLAIM TO ANY PARTICULAR FONT, STYLE, SIZE, OR COLOR.

FOR SKIN CARE PRODUCTS, NAMELY, CLEANSING LOTIONS, MASKS AND PEELS; FACE SHAMPOO, SKIN SCRUBS, SKIN TONERS, MASKS AND PEELS; ANTI WRINKLE CREAMS, ANTI-AGING CREAMS, MOISTURE CREAMS, LOTIONS FOR DAY AND NIGHT, SKIN WHITENING CREAM, EYE CREAM, EYE GEL, TONING LOTIONS, MASKS AND PEELS; SKIN SERUM, SKIN EMULSIONS; COSMETICS; HAIR CARE PRODUCTS NAMELY; SHAMPOO, CONDITIONER; STYLING GEL, MOUSSE, AND CREAM; HAIR MOISTURIZER; HOT OIL TREATMENT; POMADE (U.S. CLS. 1, 4, 6, 50, 51 AND 52).

FIRST USE 6-1-2003; IN COMMERCE 6-1-2003.  
JAMES A. RAUEN, EXAMINING ATTORNEY

## R-22

THE MARK CONSISTS OF STANDARD CHARACTERS WITHOUT CLAIM TO ANY PARTICULAR FONT, STYLE, SIZE, OR COLOR.

FOR TARNISH PREVENTATIVE PREPARATIONS (U.S. CLS. 1, 4, 6, 50, 51 AND 52).

FIRST USE 0-0-1960; IN COMMERCE 0-0-1960.  
CAROLYN GRAY, EXAMINING ATTORNEY

---

SN 78-361,088. JOHNSON & JOHNSON, NEW BRUNSWICK, NJ. FILED 2-2-2004.

## COOLWIPES

THE MARK CONSISTS OF STANDARD CHARACTERS WITHOUT CLAIM TO ANY PARTICULAR FONT, STYLE, SIZE, OR COLOR.

FOR FEMININE NON-MEDICATED TOWELETTES (U.S. CLS. 1, 4, 6, 50, 51 AND 52).

JENNIFER MARTIN, EXAMINING ATTORNEY

**CLASS 3—(Continued).**

SN 78-361,208. PACIFIC WORLD CORPORATION, LAKE FOREST, CA. FILED 2-2-2004.

**NAILENE SALON TREATMENTS**

THE MARK CONSISTS OF STANDARD CHARACTERS WITHOUT CLAIM TO ANY PARTICULAR FONT, STYLE, SIZE, OR COLOR.

OWNER OF U.S. REG. NOS. 1,383,877 AND 2,808,714. NO CLAIM IS MADE TO THE EXCLUSIVE RIGHT TO USE "SALON TREATMENTS", APART FROM THE MARK AS SHOWN.

FOR NATURAL NAIL PREPARATIONS, NAMELY, STRENGTHENER, HARDENER, LENGTHENER, BASE COAT, TOP COAT (U.S. CLS. 1, 4, 6, 50, 51 AND 52).  
CYNTHIA SLOAN, EXAMINING ATTORNEY



SN 78-362,444. THE GILLETTE COMPANY, BOSTON, MA. FILED 2-4-2004.

**Reveal The Goddess In You**

THE MARK CONSISTS OF STANDARD CHARACTERS WITHOUT CLAIM TO ANY PARTICULAR FONT, STYLE, SIZE, OR COLOR.

FOR SHAVE PREPARATIONS, NAMELY SHAVING CREAM; SHAVING GEL; AND SHAVING LOTION (U.S. CLS. 1, 4, 6, 50, 51 AND 52).  
TRICIA SONNEBORN, EXAMINING ATTORNEY



SN 78-363,989. OLMSTEAD, MICHAEL J., DEL MAR, CA. FILED 2-6-2004.



FOR TOOTHPASTE AND MOUTH WASH (U.S. CLS. 1, 4, 6, 50, 51 AND 52).  
GINNY ISAACSON, EXAMINING ATTORNEY

**CLASS 3—(Continued).**

SN 78-364,105. LINE TATE, INC., BELLEVILLE, NJ. FILED 2-6-2004.

**SHADES**

THE MARK CONSISTS OF STANDARD CHARACTERS WITHOUT CLAIM TO ANY PARTICULAR FONT, STYLE, SIZE, OR COLOR.

FOR TALCUM POWDER (U.S. CLS. 1, 4, 6, 50, 51 AND 52).  
LINDA E. BLOHM, EXAMINING ATTORNEY



SN 78-364,488. TROPICAL ENTERPRISES INTERNATIONAL, INC., TAMPA, FL. FILED 2-8-2004.



THE MARK CONSISTS OF THE MARK IS AN OFFSET OVAL WITH THE SUN ON THE UPPER RIGHT CORNER. THE BRAND SUNSCREENZ IS WRITTEN IN STYLIZED LETTERS. AN ARTIST'S INTERPRETATION OF WATER IS SEEN ON THE LEFT UPPER AND RIGHT LOWER SECTIONS OF THE MARK.

FOR SUN BLOCK PACKAGED IN INDIVIDUAL "WIPE" PACKAGES (U.S. CLS. 1, 4, 6, 50, 51 AND 52).  
FIRST USE 1-1-2000; IN COMMERCE 10-1-2000.  
WILLIAM P. SHANAHAN, EXAMINING ATTORNEY



SN 78-372,247. BUFFETT, JIMMY, KEY WEST, FL. FILED 2-23-2004.

**LICENSE TO CHILL**

THE MARK CONSISTS OF STANDARD CHARACTERS WITHOUT CLAIM TO ANY PARTICULAR FONT, STYLE, SIZE, OR COLOR.

FOR SUN TAN OIL, SCENTED BODY SPRAY, SUN-TAN LOTIONS, SUNSCREENS, NON-MEDICATED LIP BALM, BATH SALTS, SKIN SOAPS, SKIN LOTIONS, AND SKIN GELS (U.S. CLS. 1, 4, 6, 50, 51 AND 52).  
RICHARD WHITE, EXAMINING ATTORNEY

**CLASS 3—(Continued).**

SN 78-385,334. TANNER, JANELLE HOLDEN, MANHATTAN BEACH, CA. FILED 3-16-2004.

**BANILLA BLING**

THE MARK CONSISTS OF STANDARD CHARACTERS WITHOUT CLAIM TO ANY PARTICULAR FONT, STYLE, SIZE, OR COLOR.

FOR TOOTH PASTES (U.S. CLS. 1, 4, 6, 50, 51 AND 52).  
AMY ALFIERI, EXAMINING ATTORNEY

SN 78-399,205. FIRST LINE, INC., INDIANAPOLIS, IN. FILED 4-9-2004.

**My Passion**

THE MARK CONSISTS OF STANDARD CHARACTERS WITHOUT CLAIM TO ANY PARTICULAR FONT, STYLE, SIZE, OR COLOR.

FOR SUN TANNING, SUNLESS TANNING AND MOISTURIZING CREAMS, LOTIONS AND OILS (U.S. CLS. 1, 4, 6, 50, 51 AND 52).

EUGENIA MARTIN, EXAMINING ATTORNEY

SN 78-399,211. FIRST LINE, INC., INDIANAPOLIS, IN. FILED 4-9-2004.

**SIMPLY DIVINE**

THE MARK CONSISTS OF STANDARD CHARACTERS WITHOUT CLAIM TO ANY PARTICULAR FONT, STYLE, SIZE, OR COLOR.

FOR SUN TANNING, SUNLESS TANNING AND MOISTURIZING CREAMS, LOTIONS AND OILS (U.S. CLS. 1, 4, 6, 50, 51 AND 52).

EUGENIA MARTIN, EXAMINING ATTORNEY

**CLASS 4—LUBRICANTS AND FUELS**

SN 76-571,081. EKOL, AB, 58941 LINKOPING, SWEDEN, FILED 1-20-2004.

**EKOL PROFESSIONAL**

THE MARK CONSISTS OF STANDARD CHARACTERS WITHOUT CLAIM TO ANY PARTICULAR FONT, STYLE, SIZE, OR COLOR.

NO CLAIM IS MADE TO THE EXCLUSIVE RIGHT TO USE "PROFESSIONAL", APART FROM THE MARK AS SHOWN.

THE MARK DOES NOT HAVE ANY SIGNIFICANCE IN THE RELEVANT TRADE BEYOND ITS FAME AS A TRADEMARK OR ANY MEANING IN A FOREIGN LANGUAGE. EKOL IS COMPRISED OF THE FIRST TWO LETTERS OF THE WORD "EKSJO" FOLLOWED BY THE FIRST TWO LETTERS OF THE WORD "OLJEFABRIK." THOSE TWO WORDS TOGETHER MEAN IN ENGLISH "EKSJO'S OIL FACTORY." EKSJO IS THE TOWN IN SWEDEN WHERE THE OILS WERE FIRST MANUFACTURED.

FOR OILS TO CONDITION, HYDRATE AND SEAL LEATHER, AND TO KEEP LEATHER SUPPLE (U.S. CLS. 1, 6 AND 15).

FIRST USE 1-1-1904; IN COMMERCE 6-16-2003.

YONG KIM, EXAMINING ATTORNEY

SN 78-314,528. MARATHON ASHLAND PETROLEUM LLC, FINDLAY, OH. FILED 10-16-2003.

**AMERICLEAN**

OWNER OF U.S. REG. NO. 2,053,709.

FOR GASOLINE (U.S. CLS. 1, 6 AND 15).

IRENE D. WILLIAMS, EXAMINING ATTORNEY

SN 78-328,519. CHANDELIGHT LLC, NEWBURYPORT, MA. FILED 11-15-2003.

**Chandelight**

THE MARK CONSISTS OF STANDARD CHARACTERS WITHOUT CLAIM TO ANY PARTICULAR FONT, STYLE, SIZE, OR COLOR.

FOR CANDLES FOR USE AS A LIGHTING FIXTURE ACCESSORY WITH CHANDELIERS AND SCONCES (U.S. CLS. 1, 6 AND 15).

FIRST USE 12-2-2003; IN COMMERCE 1-27-2004.

JEAN IM, EXAMINING ATTORNEY



**CLASS 4—(Continued).**

SN 78-356,438. TECUMSEH PRODUCTS COMPANY, TECUMSEH, MI. FILED 1-23-2004.

**EPALUBE**

THE MARK CONSISTS OF STANDARD CHARACTERS WITHOUT CLAIM TO ANY PARTICULAR FONT, STYLE, SIZE, OR COLOR.

FOR INDUSTRIAL AND GENERAL PURPOSE LUBRICANTS (U.S. CLS. 1, 6 AND 15).

RICHARD A. STRASER, EXAMINING ATTORNEY

**CLASS 5—(Continued).**

SN 76-007,133. CEREBOS PACIFIC LIMITED, GREAT WORLD CITY EAST OFFICE TOWER, SINGAPORE, FILED 3-22-2000.

白 蘭 氏

OWNER OF SINGAPORE REG. NO. 2032/95, DATED 3-8-1995. EXPIRES 3-8-2005.

OWNER OF U.S. REG. NOS. 1,582,185, 2,056,845 AND OTHERS.

THE FIRST CHINESE CHARACTER, TRANSLITERATED AS "BAI", IS A CHINESE FAMILY NAME, MEANING: "WHITE; CLEAR; BRIGHT; CLEAN; PURE". THE SECOND CHARACTER, TRANSLITERATED AS "LAN", MEANS "ORCHID". THE THIRD CHARACTER, TRANSLITERATED AS "SHI", MEANS "FAMILY" OR "CLAN" OR IS "A CHARACTER PLACED AFTER A MARRIED WOMAN'S MAIDEN NAME". THE CHINESE CHARACTERS IN THE MARK ARE A PHONETIC APPROXIMATION OF APPLICANT'S ENGLISH WORD TRADEMARK "BRAND'S".

FOR HEALTH FOOD SUPPLEMENTS CONTAINING ROYAL JELLY, COD LIVER OIL, MINERAL SUPPLEMENTS, MINERAL FOOD-SUPPLEMENTS, MINERAL DIETARY SUPPLEMENTS FOR HUMANS, VITAMINS, VITAMIN PREPARATIONS, VITAMIN SUPPLEMENTS, VITAMIN TABLETS, HEALTH FOOD SUPPLEMENTS, POLLEN FOR USE AS DIETARY FOOD SUPPLEMENTS, BEE POLLEN AS HEALTH FOOD SUPPLEMENTS, FOOD AND DIETARY SUPPLEMENTS, DIETARY SUPPLEMENTS CONTAINING AMINO ACIDS, NUTRITIONAL SUPPLEMENTS, HEALTH FOOD SUPPLEMENTS CONTAINING FIBER, HEALTH FOOD SUPPLEMENTS CONTAINING ENZYMES, HEALTH FOOD SUPPLEMENTS CONTAINING FORTIFYING FOODSTUFFS (U.S. CLS. 6, 18, 44, 46, 51 AND 52).

BRIDGETT SMITH, EXAMINING ATTORNEY

SN 76-369,670. ADVANCED NUTRIENT SCIENCE, LLC, LARGO, FL. FILED 2-11-2002.

**MEGA PROTEIN**

OWNER OF U.S. REG. NO. 2,503,693.

NO CLAIM IS MADE TO THE EXCLUSIVE RIGHT TO USE "PROTEIN", APART FROM THE MARK AS SHOWN.

FOR NUTRITIONAL SUPPLEMENTS AND NUTRITIONAL SUPPLEMENTS IN THE FORM OF SPORT BARS, ALL CONTAINING PROTEIN (U.S. CLS. 6, 18, 44, 46, 51 AND 52).

FIRST USE 12-22-1999; IN COMMERCE 12-22-1999.

MARC LEIPZIG, EXAMINING ATTORNEY

**CLASS 5—PHARMACEUTICALS**

SN 75-673,720. EUTHENICS INTERNATIONAL, INC., GOLDEN, CO. FILED 4-1-1999.

**Vitala-Trim**

FOR DIETARY SUPPLEMENTS (U.S. CLS. 6, 18, 44, 46, 51 AND 52).

FIRST USE 1-1-1999; IN COMMERCE 1-1-1999.

DORITT L. CARROLL, EXAMINING ATTORNEY

SN 76-442,427. SCHERING AKTIENGESELLSCHAFT, BERLIN, FED REP GERMANY, FILED 8-16-2002.

**INTRAVIST**

OWNER OF FED REP GERMANY REG. NO. 30240931, DATED 3-6-2003, EXPIRES 8-31-2012.

FOR PHARMACEUTICAL PREPARATIONS USED IN MEDICAL DIAGNOSTIC PROCEDURES, NAMELY, CONTRAST MEDIA FOR USE WITH X-RAY, MAGNETIC RESONANCE AND ULTRASOUND EQUIPMENT (U.S. CLS. 6, 18, 44, 46, 51 AND 52).

BARNEY CHARLON, EXAMINING ATTORNEY

**CLASS 5—(Continued).**

SN 76-476,644. KAZ, INCORPORATED, NEW YORK, NY.  
FILED 12-16-2002.

**NOSQUITO**

FOR INSECT REPELLENTS (U.S. CLS. 6, 18, 44, 46, 51  
AND 52).

FIRST USE 11-10-1999; IN COMMERCE 11-10-1999.  
CAROLYN CATALDO, EXAMINING ATTORNEY

**CLASS 5—(Continued).**

SN 76-532,038. NUMICO FINANCIAL SERVICES, S.A., CH-  
1003 LAUSANNE, SWITZERLAND, FILED 7-9-2003.

**METAB-O-FX**

FOR DIETARY AND NUTRITIONAL SUPPLEMENTS  
(U.S. CLS. 6, 18, 44, 46, 51 AND 52).

TRICIA THOMPSON, EXAMINING ATTORNEY

SN 76-492,267. MARKET AMERICA, INC., GREENSBORO,  
NC. FILED 2-24-2003.



FOR DIETARY SUPPLEMENTS FOR ASSISTING IN  
OBTAINING SLEEP (U.S. CLS. 6, 18, 44, 46, 51 AND 52).  
DARRYL SPRUILL, EXAMINING ATTORNEY

SN 76-540,100. HILL VIEW INTERNATIONAL GROUP, INC.,  
FOUNTAIN VALLEY, CA. FILED 8-11-2003.



SN 76-496,388. SNAPPLE BEVERAGE CORP., WHITE  
PLAINS, NY. FILED 3-10-2003.

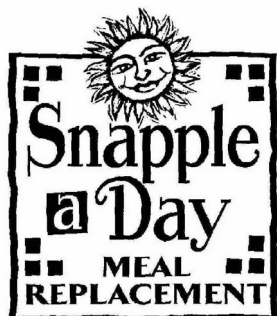

OWNER OF U.S. REG. NOS. 1,156,585, 2,304,347 AND  
OTHERS.

NO CLAIM IS MADE TO THE EXCLUSIVE RIGHT TO  
USE "MEAL REPLACEMENT", APART FROM THE MARK  
AS SHOWN.

FOR MEAL REPLACEMENT DRINKS (U.S. CLS. 6, 18,  
44, 46, 51 AND 52).

FIRST USE 2-17-2003; IN COMMERCE 2-17-2003.  
LINDA M. KING, EXAMINING ATTORNEY

FOR DIETARY SUPPLEMENTS NAMELY, GRAPE  
SEED EXTRACT, BILBERRY, BLACK COHOSH, CAY-  
ENNE, CITRIMAX, COENZYME Q10, GRANBERRY,  
ECHINACEA, ELDERBERRY EXTRACT, GARLIC,  
GINKGO BILOBA, GINSENG, GOLDEN SEAL, GREEN  
TEA, PINE EXTRACTS, GUARANA, GUGGULSTER-  
ONE, GYMNEMA, HAWTHORN, MILK THISTLE, PYC-  
NOGENOL, PYGEUM, SAW PALMETTO, STEVIA, ST;  
JONS WORT, YOHIMBE, MONOVESA, MELATONIN,  
NOTO GINGSENG, ALOE VERA, GARLIC OIL, FISH  
OIL, FISH OIL, DEEP FISH OIL, PUMPKIN SEED OIL,  
LECITHIN, LIQUID CALCIUM, SQALENE, COW CO-  
LOSTRUMS, MARINE OIL, EVENING PRIMROSE OIL,  
SEABUCKTHORN OIL, PINE OIL, SAFFLOWER OIL,  
BEE PROPOLIS, PLACENTA, RNA/DNA, SPIRULINA,  
SHARK CARTILAGE, NATURAL ROSE HIP OIL, SOY  
LECITHIN, CORAL CALCIUM, MULTIAMINO-ACID,  
NUCLEIACID DNA/RNA, FISH PROTEIN, MILK THIS-  
TLE, NATURAL HCA, NATURAL SOFTAVONE, NONI-  
EXTRACT, RED DEHYDROEPIANDROSTERONE, DHA-  
DOCOSAHEXAENOIC ACID, EPAICOSAPENTAENOIC  
ACID, GINGER EXTRACT, MELATONIN, MULTI VITA-  
MINS, PSP P1:YSACCHARIDEP PEPTIDE; MINERALS  
SUPPLEMENTS, NAMELY, BORON, CALCIUM, CHRO-  
MIUM, COPPER, IODINE, IRON, MAGNESIUM, MAN-  
GANESE, MOLYBDENUM, PHOSPHORUS, POTASSIUM,  
SELENIUM, SILICON, VANADIUM, ZINC; VITAMINS,  
NAMELY, THIAMIN, RIBOFLAVIN, NIACIN, PYRI-  
DOXINE, CYANOCOBALAMIN, FOLACIN, BIOTIN, VI-  
TAMIN A, VITAMIN B-COMPLEX, VITAMIN D,  
VITAMIN E, AND VITAMIN K (U.S. CLS. 6, 18, 44, 46,  
51 AND 52).

FIRST USE 1-0-1999; IN COMMERCE 1-0-1999.

SHAUNIA WALLACE, EXAMINING ATTORNEY

**CLASS 5—(Continued).**

SN 76-540,762. HEALTHY PETS, INC., HAYWARD, CA.  
FILED 8-15-2003.

**JOINT ASSIST**

NO CLAIM IS MADE TO THE EXCLUSIVE RIGHT TO  
USE JOINT, APART FROM THE MARK AS SHOWN.  
FOR NUTRITIONAL SUPPLEMENTS FOR ANIMALS  
AND HUMANS (U.S. CLS. 6, 18, 44, 46, 51 AND 52).  
PRISCILLA MILTON, EXAMINING ATTORNEY

SN 76-542,286. IVOCLAR VIVADENT, INC., AMHERST, NY.  
FILED 9-3-2003.

**IPS ERIS**

FOR CERAMIC MATERIALS FOR USE IN PRODU-  
CING DENTAL RESTORATIONS, NAMELY INLAYS,  
ONLAYS, VENEERS AND CROWNS (U.S. CLS. 6, 18, 44,  
46, 51 AND 52).  
FIRST USE 1-3-2002; IN COMMERCE 1-3-2002.  
INGA ERVIN, EXAMINING ATTORNEY

SN 76-551,829. PIERRE FABRE MEDICAMENT, 92100 BOU-  
LOGNE, FRANCE, FILED 10-16-2003.

**RIBOMUNYL**

OWNER OF FRANCE REG. NO. 1,302,037, DATED 3-12-  
1985, EXPIRES 3-12-2005.  
OWNER OF U.S. REG. NO. 2,167,186.  
FOR PHARMACEUTICAL PRODUCTS, NAMELY,  
MEDICINES FOR THE PREVENTION AND TREAT-  
MENT OF DISEASES OF MICROBIOTIC OR VIRAL  
ORIGIN, VACCINES, IMMUNOSTIMULATING PRE-  
PARATIONS; PHARMACEUTICAL PREPARATIONS  
USEFUL FOR THE PREVENTION AND TREATMENT  
OF DISEASES OF THE RESPIRATORY ORGANS (U.S.  
CLS. 6, 18, 44, 46, 51 AND 52).  
TONJA GASKINS, EXAMINING ATTORNEY

SN 76-552,623. TRIPLE CROWN NUTRITION, INC., WAY-  
ZATA, MN. FILED 10-20-2003.

**SLEEK**

OWNER OF U.S. REG. NO. 880,547.  
FOR FOOD SUPPLEMENT INCLUDING VITAMINS  
AND MINERALS FOR THE CONDITIONING OF  
HORSES (U.S. CLS. 6, 18, 44, 46, 51 AND 52).  
FIRST USE 5-9-1967; IN COMMERCE 5-9-1967.  
JOHN GARTNER, EXAMINING ATTORNEY

**CLASS 5—(Continued).**

SN 76-555,324. PR-OSTEO, L.L.C., WESTLAKE VILLAGE,  
CA. FILED 10-27-2003.

**AKESO**

FOR DIETARY SUPPLEMENTS CONSISTING OF VI-  
TAMINS, MINERALS, HERBAL EXTRACTS AND  
OTHER NUTRIENTS; NON-PRESCRIPTION MEDI-  
CINES AND DRUGS, NAMELY, MEDICATED CREAMS,  
SALVES, OINTMENTS, PILLS, TABLETS, CAPSULES  
AND LOTIONS FOR USE IN THE TREATMENT OF  
ARTHRITIS, RHEUMATISM, DIABETES, HEADACHE  
AND MIGRAINES, CONDITIONS AFFECTING MEMO-  
RY, CHOLESTEROL, ERECTILE DYSFUNCTION, IN-  
CONTINENCE, HEART HEALTH, VISION DISORDERS,  
OBESITY, PROSTATE HEALTH, PRE-MENSTRUAL  
SYNDROME, ASTHMA, OSTEOPOROSIS, INTESTINAL  
HEALTH, BLOOD PRESSURE, MENOPAUSE, COLD  
AND FLU SYMPTOMS, SLEEP DISORDERS, ANXIETY,  
ALLERGIES AND DYSPEPSIA; HOMEOPATHIC REME-  
DIES, NAMELY, PREPARATIONS FOR INTERNAL OR  
TOPICAL USE FOR THE TREATMENT OF ARTHRITIS,  
RHEUMATISM, DIABETES, HEADACHE AND MI-  
GRAINES, CONDITIONS AFFECTING MEMORY, CHOLE-  
STEROL, ERECTILE DYSFUNCTION, INCONTINENCE,  
HEART HEALTH, VISION DISOR-  
DERS, OBESITY, PROSTATE HEALTH, PRE-MENSTRU-  
AL SYNDROME, ASTHMA, OSTEOPOROSIS,  
INTESTINAL HEALTH, BLOOD PRESSURE, MENO-  
PAUSE, COLD AND FLU SYMPTOMS, SLEEP DISOR-  
DERS, ANXIETY, ALLERGIES AND DYSPEPSIA; AND  
PRESCRIPTION MEDICINES AND DRUGS FOR THE  
RELIEF OF ARTHRITIS, RHEUMATISM, DIABETES,  
HEADACHE AND MIGRAINES, CONDITIONS AFFECT-  
ING MEMORY, CHOLESTEROL, ERECTILE DYSFUNC-  
TION, INCONTINENCE, HEART PROBLEMS, VISION  
DISORDERS, OBESITY, PROSTATE PROBLEMS, PRE-  
MENSTRUAL SYNDROME, ASTHMA, OSTEOPOROSIS,  
INTESTINAL DISORDERS, BLOOD PRESSURE, MENO-  
PAUSE, COLD AND FLU SYMPTOMS, SLEEP DISOR-  
DERS, ANXIETY, ALLERGIES AND DYSPEPSIA (U.S.  
CLS. 6, 18, 44, 46, 51 AND 52).  
AMY GEARIN, EXAMINING ATTORNEY

SN 76-555,974. YUNBO LIU, ROSEMEAD, CA. FILED 11-3-  
2003.

秃雞丸  
TUJIWAN

THE FOREIGN WORDING IN THE MARK TRANSLATES  
INTO ENGLISH AS BALD CHICKEN PILL.  
THE NON-LATIN CHARACTER(S) IN THE MARK  
TRANSLITERATES INTO TUJIWAN, AND THIS MEANS  
BALD CHICKEN PILL IN ENGLISH.  
FOR NUTRICEUTICAL FOR USE AS DIETARY SUP-  
PLEMENT (U.S. CLS. 6, 18, 44, 46, 51 AND 52).  
PATRICIA EVANKO, EXAMINING ATTORNEY

**CLASS 5—(Continued).**

SN 76-563,648. LIFEKEY, INC., CINCINNATI, OH. FILED 11-24-2003.

**ENZYTE, THE ONCE-  
A-DAY TABLET FOR  
NATURAL MALE  
ENHANCEMENT**

THE MARK CONSISTS OF STANDARD CHARACTERS WITHOUT CLAIM TO ANY PARTICULAR FONT, STYLE, SIZE, OR COLOR.

OWNER OF U.S. REG. NO. 2,621,098.  
FOR HERBAL DIETARY SUPPLEMENTS (U.S. CLS. 6, 18, 44, 46, 51 AND 52).  
ROBERT LORENZO, EXAMINING ATTORNEY

SN 76-570,033. SARADA AYURVEDIC REMEDIES, NORTH HOLLYWOOD, CA. FILED 12-24-2003.

**FLU BUSTER**

THE MARK CONSISTS OF STANDARD CHARACTERS WITHOUT CLAIM TO ANY PARTICULAR FONT, STYLE, SIZE, OR COLOR.

NO CLAIM IS MADE TO THE EXCLUSIVE RIGHT TO USE "FLU", APART FROM THE MARK AS SHOWN.

FOR HERBAL PREPARATION USED AS A DIETARY SUPPLEMENT FOR PREVENTING, MITIGATING, TREATING OR RELIEVING THE SYMPTOMS OF THE FLU AND FOR PROMOTING THE IMMUNE SYSTEM AND CLEANSING THE HUMAN LYMPH SYSTEM (U.S. CLS. 6, 18, 44, 46, 51 AND 52).

FIRST USE 10-31-1993; IN COMMERCE 10-31-1993.  
BARBARA BROWN, EXAMINING ATTORNEY

SN 76-570,921. PRASCO, LLC, CINCINNATI, OH. FILED 1-15-2004.

**SOLIA**

FOR PHARMACEUTICAL PREPARATIONS FOR PREVENTING PREGNANCY (U.S. CLS. 6, 18, 44, 46, 51 AND 52).

PAULA MAYS, EXAMINING ATTORNEY

**CLASS 5—(Continued).**

SN 76-573,920. PHARMAVITE LLC, MISSION HILLS, CA. FILED 2-4-2004.

**CRANSOLUTIONS**

THE MARK CONSISTS OF STANDARD CHARACTERS WITHOUT CLAIM TO ANY PARTICULAR FONT, STYLE, SIZE, OR COLOR.

FOR NUTRITIONAL AND DIETARY SUPPLEMENTS (U.S. CLS. 6, 18, 44, 46, 51 AND 52).  
ZACHARY BELLO, EXAMINING ATTORNEY

SN 78-036,787. GLAXOSMITHKLINE BIOLOGICALS S.A., RIXENSART, BELGIUM, FILED 11-28-2000.

**TEPRIX**

PRIORITY CLAIMED UNDER SEC. 44(D) ON ERP N CMNTY TM OFC APPLICATION NO. 001992304, FILED 12-11-2000, REG. NO. 1992304, DATED 4-2-2002, EXPIRES 12-11-2010.

FOR VACCINES FOR HUMAN USE (U.S. CLS. 6, 18, 44, 46, 51 AND 52).  
IRENE D. WILLIAMS, EXAMINING ATTORNEY

SN 78-049,301. ANDRX CORPORATION, DAVIE, FL. FILED 2-20-2001.

**ZYPRO**

FOR PHARMACEUTICAL PREPARATIONS, NAMELY, SUBSTANCES FOR THE TREATMENT AND PREVENTION OF DISEASES OF THE CENTRAL NERVOUS SYSTEM AND TO ASSIST IN THE CESSATION OF USE OF TOBACCO PRODUCTS (U.S. CLS. 6, 18, 44, 46, 51 AND 52).

AMY HELLA, EXAMINING ATTORNEY

SN 78-133,517. AMGEN INC., THOUSAND OAKS, CA. FILED 6-5-2002.

**REVAGEN**

FOR PHARMACEUTICAL PREPARATIONS, NAMELY, ERYTHROPOIESIS STIMULATING PROTEIN (U.S. CLS. 6, 18, 44, 46, 51 AND 52).

MARLENE BELL, EXAMINING ATTORNEY

**CLASS 5—(Continued).**

SN 78-203,003. BRISTOL-MYERS SQUIBB COMPANY, NEW YORK, NY. FILED 1-14-2003.

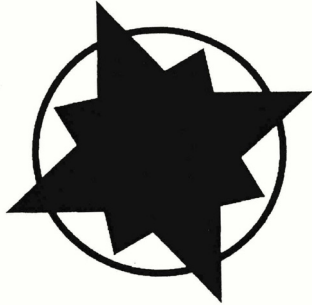

THE MARK CONSISTS OF A STYLIZED COMPASS. FOR PHARMACEUTICAL PREPARATIONS FOR USE IN HYPERCHOLESTEROLEMIA THERAPY (U.S. CLS. 6, 18, 44, 46, 51 AND 52).  
AMY ALFIERI, EXAMINING ATTORNEY

SN 78-250,568. NATURAL FACTORS NUTRITIONAL PRODUCTS LTD., COQUITLAM, BRITISH COLUMBIA, CANADA, FILED 5-15-2003.

**REVITALX & DETOXITECH**

PRIORITY CLAIMED UNDER SEC. 44(D) ON CANADA APPLICATION NO. 1177132, FILED 5-15-2003.  
FOR DIETARY SUPPLEMENTS, NUTRITIONAL FOOD SUPPLEMENTS, VITAMINS, MINERALS, HERBS AND ENZYMES FORMULATED TO PROVIDE EFFECTIVE SUPPORT FOR INTENSIVE DETOXIFICATION, LIVER HEALTH AND GASTROINTESTINAL HEALING (U.S. CLS. 6, 18, 44, 46, 51 AND 52).  
KARANENDRA S. CHHINA, EXAMINING ATTORNEY

SN 78-290,072. RAINFOREST NUTRITIONALS, INC., PHOENIX, AZ. FILED 8-20-2003.

**VINICOL**

THE MARK CONSISTS OF STANDARD CHARACTERS WITHOUT CLAIM TO ANY PARTICULAR FONT, STYLE, SIZE, OR COLOR.  
FOR DIETARY AND NUTRITIONAL SUPPLEMENTS IN CAPSULE FORM. (U.S. CLS. 6, 18, 44, 46, 51 AND 52).  
TARAH HARDY, EXAMINING ATTORNEY

**CLASS 5—(Continued).**

SN 78-300,182. BRISTOL-MYERS SQUIBB COMPANY, NEW YORK, NY. FILED 9-15-2003.

**ABILIFY ORAFLASH**

OWNER OF U.S. REG. NO. 2,772,697.  
FOR ANTI-PSYCHOTIC PHARMACEUTICAL PREPARATION (U.S. CLS. 6, 18, 44, 46, 51 AND 52).  
RONALD AIKENS, EXAMINING ATTORNEY

SN 78-316,068. SHIONOGI & CO., LTD., OSAKA, JAPAN, FILED 10-20-2003.

**OPRIBAX**

PRIORITY CLAIMED UNDER SEC. 44(D) ON JAPAN APPLICATION NO. 2003-32320, FILED 4-21-2003, REG. NO. 4730727, DATED 12-5-2003, EXPIRES 12-5-2013.  
FOR ANTIBIOTIC PREPARATIONS (U.S. CLS. 6, 18, 44, 46, 51 AND 52).  
DORITT L. CARROLL, EXAMINING ATTORNEY

SN 78-342,548. VARIED INDUSTRIES CORPORATION, MASON CITY, IA. FILED 12-18-2003.



FOR NUTRITIONAL ADDITIVES FOR LIVESTOCK FEED (U.S. CLS. 6, 18, 44, 46, 51 AND 52).  
FIRST USE 12-30-1998; IN COMMERCE 12-30-1998.  
KELLY CHOE, EXAMINING ATTORNEY

**CLASS 5—(Continued).**

SN 78-349,750. BAUSCH & LOMB INCORPORATED, ROCHESTER, NY. FILED 1-9-2004.

# MoistureLoc

FOR OPHTHALMIC PREPARATIONS, NAMELY CONTACT LENS SOLUTIONS, EYEDROPS AND EYE LUBRICANTS (U.S. CLS. 6, 18, 44, 46, 51 AND 52).  
TARAH HARDY, EXAMINING ATTORNEY

---

SN 78-350,181. NATURAL THOUGHTS, INC., SAN DIEGO, CA. FILED 1-9-2004.

## POLAR LOTION

THE MARK CONSISTS OF STANDARD CHARACTERS WITHOUT CLAIM TO ANY PARTICULAR FONT, STYLE, SIZE, OR COLOR.

OWNER OF U.S. REG. NO. 2,142,853.  
NO CLAIM IS MADE TO THE EXCLUSIVE RIGHT TO USE LOTION, APART FROM THE MARK AS SHOWN, FOR ANALGESIC LOTIONS, BALMS, CREMES AND GELS (U.S. CLS. 6, 18, 44, 46, 51 AND 52).  
FIRST USE 4-1-1997; IN COMMERCE 4-1-1997.  
WON TEAK OH, EXAMINING ATTORNEY

---

SN 78-352,214. TRIARCO INDUSTRIES, INC., WAYNE, NJ. FILED 1-15-2004.

## CarboChrome

THE MARK CONSISTS OF STANDARD CHARACTERS WITHOUT CLAIM TO ANY PARTICULAR FONT, STYLE, SIZE, OR COLOR.

FOR VITAMINS, MINERALS, NUTRITIONAL AND DIETARY SUPPLEMENTS (U.S. CLS. 6, 18, 44, 46, 51 AND 52).

JOHN DALIER, EXAMINING ATTORNEY

**CLASS 5—(Continued).**

SN 78-352,218. VITAL-O PERFORMANCE INC., EAST NORTHPORT, NY. FILED 1-15-2004.

## CORE HEALTH

THE MARK CONSISTS OF STANDARD CHARACTERS WITHOUT CLAIM TO ANY PARTICULAR FONT, STYLE, SIZE, OR COLOR.

FOR NUTRITIONAL SUPPLEMENTS (U.S. CLS. 6, 18, 44, 46, 51 AND 52).  
JEFFREY S. MOLINOFF, EXAMINING ATTORNEY

---

SN 78-353,964. SMITHKLINE BEECHAM CORPORATION, PHILADELPHIA, PA. FILED 1-20-2004.

## TUMS DAILYCAL +D

THE MARK CONSISTS OF STANDARD CHARACTERS WITHOUT CLAIM TO ANY PARTICULAR FONT, STYLE, SIZE, OR COLOR.

OWNER OF U.S. REG. NOS. 1,979,915, 2,335,450 AND OTHERS.  
FOR ANTACIDS AND CALCIUM SUPPLEMENTS (U.S. CLS. 6, 18, 44, 46, 51 AND 52).  
STEVEN JACKSON, EXAMINING ATTORNEY

---

SN 78-354,339. FMC CORPORATION, PHILADELPHIA, PA. FILED 1-20-2004.

## HERO

THE MARK CONSISTS OF STANDARD CHARACTERS WITHOUT CLAIM TO ANY PARTICULAR FONT, STYLE, SIZE, OR COLOR.

FOR INSECTICIDES FOR USE IN AGRICULTURE (U.S. CLS. 6, 18, 44, 46, 51 AND 52).

ANN E. SAPPENFIELD, EXAMINING ATTORNEY

**CLASS 5—(Continued).**

SN 78-354,466. NUTRACEA, EL DORADO HILLS, CA. FILED 1-20-2004.

**CLASS 5—(Continued).**

SN 78-356,061. SKINMEDICA, INC., CARLSBAD, CA. FILED 1-22-2004.

VitaCea

DESONATE

THE MARK CONSISTS OF STANDARD CHARACTERS WITHOUT CLAIM TO ANY PARTICULAR FONT, STYLE, SIZE, OR COLOR.

FOR NUTRITIONAL SUPPLEMENTS AND DIETARY SUPPLEMENTS (U.S. CLS. 6, 18, 44, 46, 51 AND 52).  
JOHN HWANG, EXAMINING ATTORNEY

THE MARK CONSISTS OF STANDARD CHARACTERS WITHOUT CLAIM TO ANY PARTICULAR FONT, STYLE, SIZE, OR COLOR.

FOR DERMATOLOGICAL PREPARATIONS; PHARMACEUTICAL PREPARATIONS, NAMELY A STEROID PREPARATION FOR TOPICAL APPLICATION (U.S. CLS. 6, 18, 44, 46, 51 AND 52).  
KAREN BRACEY, EXAMINING ATTORNEY

SN 78-354,586. SUPERGEN, INC., DUBLIN, CA. FILED 1-20-2004.

SN 78-357,178. PROPRIETARY NUTRITIONALS INC., BRANTFORD, ONTARIO, CANADA, FILED 1-25-2004.

MITOZYTREX

CellCharge

THE MARK CONSISTS OF STANDARD CHARACTERS WITHOUT CLAIM TO ANY PARTICULAR FONT, STYLE, SIZE, OR COLOR.

FOR PHARMACEUTICAL PRODUCTS, NAMELY DRUGS FOR USE IN TREATING CANCERS (U.S. CLS. 6, 18, 44, 46, 51 AND 52).  
DAWN HAN, EXAMINING ATTORNEY

THE MARK CONSISTS OF STANDARD CHARACTERS WITHOUT CLAIM TO ANY PARTICULAR FONT, STYLE, SIZE, OR COLOR.

FOR FOOD SUPPLEMENT (U.S. CLS. 6, 18, 44, 46, 51 AND 52).  
AISHA CLARKE, EXAMINING ATTORNEY

**CLASS 5—(Continued).**

SN 78-357,389. PFIZER INC., NEW YORK, NY. FILED 1-26-2004.

# LONCEFOR

THE MARK CONSISTS OF STANDARD CHARACTERS WITHOUT CLAIM TO ANY PARTICULAR FONT, STYLE, SIZE, OR COLOR.

FOR VETERINARY ANTIBIOTIC FOR COMPANION ANIMALS (U.S. CLS. 6, 18, 44, 46, 51 AND 52).  
ALLISON HOLTZ, EXAMINING ATTORNEY

SN 78-357,477. VISEN MEDICAL, INC., WOBURN, MA. FILED 1-26-2004.

# PROTEASENSE

THE MARK CONSISTS OF STANDARD CHARACTERS WITHOUT CLAIM TO ANY PARTICULAR FONT, STYLE, SIZE, OR COLOR.

FOR BIOMEDICAL REAGENTS IN THE NATURE OF CONTRAST MEDIA FOR IN VIVO IMAGING OF MOLECULAR AND MORPHOLOGIC TARGETS AND PROCESSES IN HUMANS AND ANIMALS (U.S. CLS. 6, 18, 44, 46, 51 AND 52).  
HELEN BRYAN, EXAMINING ATTORNEY

**CLASS 5—(Continued).**

SN 78-358,947. INAMED CORPORATION, SANTA BARBARA, CA. FILED 1-28-2004.

# HYDRAFILL

THE MARK CONSISTS OF STANDARD CHARACTERS WITHOUT CLAIM TO ANY PARTICULAR FONT, STYLE, SIZE, OR COLOR.

FOR PHARMACEUTICAL PREPARATIONS FOR THE TREATMENT OF GLABELLAR LINES AND FACIAL WRINKLES (U.S. CLS. 6, 18, 44, 46, 51 AND 52).  
MICHAEL KEATING, EXAMINING ATTORNEY

SN 78-360,854. FUJISAWA HEALTHCARE, INC., DEERFIELD, IL. FILED 2-2-2004.

# A-DAP

THE MARK CONSISTS OF STANDARD CHARACTERS WITHOUT CLAIM TO ANY PARTICULAR FONT, STYLE, SIZE, OR COLOR.

FOR PHARMACEUTICAL, NAMELY A TOPICAL PREPARATION FOR THE TREATMENT OF ACNE (U.S. CLS. 6, 18, 44, 46, 51 AND 52).  
BARBARA BROWN, EXAMINING ATTORNEY



**CLASS 5—(Continued).**

SN 78-360,912. NUTRACEA, EL DORADO HILLS, CA. FILED 2-2-2004.

**CLASS 5—(Continued).**

SN 78-361,499. APPLIED FOOD AND SPECIALTIES, GUELPH, ONTARIO, CANADA, FILED 2-3-2004.

**CESTEMINOL350**

**NutraThrive**

THE MARK CONSISTS OF STANDARD CHARACTERS WITHOUT CLAIM TO ANY PARTICULAR FONT, STYLE, SIZE, OR COLOR.

FOR SMOKING CESSATION PRODUCT, NAMELY, A NICOTINE FREE HOMEOPATHIC SUPPLEMENT TO HELP PEOPLE QUIT SMOKING (U.S. CLS. 6, 18, 44, 46, 51 AND 52).

JOHN DWYER, EXAMINING ATTORNEY

THE MARK CONSISTS OF STANDARD CHARACTERS WITHOUT CLAIM TO ANY PARTICULAR FONT, STYLE, SIZE, OR COLOR.

FOR NUTRITIONAL SUPPLEMENTS AND DIETARY SUPPLEMENTS (U.S. CLS. 6, 18, 44, 46, 51 AND 52).

TARAH HARDY, EXAMINING ATTORNEY

SN 78-363,568. MCLAUGHLIN GORMLEY KING COMPANY, MINNEAPOLIS, MN. FILED 2-6-2004.

SN 78-361,191. MAJESTIC DRUG CO., INC., SOUTH FALLS-BURG, NY. FILED 2-2-2004.

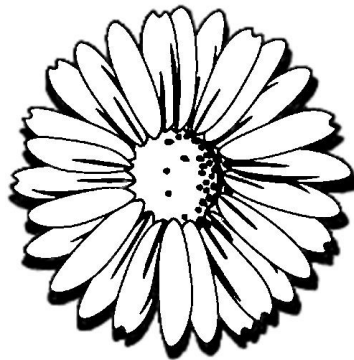

**REFILIT**

OWNER OF U.S. REG. NOS. 2,482,723, 2,604,860 AND OTHERS.

THE MARK CONSISTS OF THE DESIGN OF A FLOWER. FOR INSECTICIDES FOR AGRICULTURAL, INDUSTRIAL, INSTITUTIONAL, COMMERCIAL, RESIDENTIAL, HOUSEHOLD, AND VETERINARY USE (U.S. CLS. 6, 18, 44, 46, 51 AND 52).

FIRST USE 3-1-2001. THE MARK WAS FIRST USED ANYWHERE IN A DIFFERENT FORM OTHER THAN THAT SOUGHT TO BE REGISTERED ON 11/16/2000. ; IN COMMERCE 3-1-2001. THE MARK WAS FIRST USED IN COMMERCE IN A DIFFERENT FORM OTHER THAN THAT SOUGHT TO BE REGISTERED ON 11/16/0200..

ELISSA GARBER KON, EXAMINING ATTORNEY

THE MARK CONSISTS OF STANDARD CHARACTERS WITHOUT CLAIM TO ANY PARTICULAR FONT, STYLE, SIZE, OR COLOR.

FOR DENTAL CEMENT (U.S. CLS. 6, 18, 44, 46, 51 AND 52).

SEAN DWYER, EXAMINING ATTORNEY

**CLASS 5—(Continued).**

SN 78-365,282. PROMETHEAN LIFESCIENCES, INC., PITTSBURGH, PA. FILED 2-10-2004.

**CLASS 5—(Continued).**

SN 78-398,987. PFIZER INC., NEW YORK, NY. FILED 4-8-2004.

**GammaGraft**

**SOLOZITH**

THE MARK CONSISTS OF STANDARD CHARACTERS WITHOUT CLAIM TO ANY PARTICULAR FONT, STYLE, SIZE, OR COLOR.

FOR IRRADIATED HUMAN SKIN ALLOGRAFT FOR TREATING WOUNDS (U.S. CLS. 6, 18, 44, 46, 51 AND 52). FIRST USE 10-0-1997; IN COMMERCE 10-20-1998. GIANCARLO CASTRO, EXAMINING ATTORNEY

THE MARK CONSISTS OF STANDARD CHARACTERS WITHOUT CLAIM TO ANY PARTICULAR FONT, STYLE, SIZE, OR COLOR.

OWNER OF U.S. REG. NO. 1,702,392. FOR ANTIBIOTIC PREPARATION (U.S. CLS. 6, 18, 44, 46, 51 AND 52). MARC LEIPZIG, EXAMINING ATTORNEY

---

SN 78-398,982. PFIZER INC., NEW YORK, NY. FILED 4-8-2004.

---

SN 78-399,004. PFIZER INC., NEW YORK, NY. FILED 4-8-2004.

**SINGLEZITH**

**ZITHROMAX COMPLETE**

THE MARK CONSISTS OF STANDARD CHARACTERS WITHOUT CLAIM TO ANY PARTICULAR FONT, STYLE, SIZE, OR COLOR.

OWNER OF U.S. REG. NO. 1,702,392. FOR ANTIBIOTIC PREPARATION (U.S. CLS. 6, 18, 44, 46, 51 AND 52). MARC LEIPZIG, EXAMINING ATTORNEY

THE MARK CONSISTS OF STANDARD CHARACTERS WITHOUT CLAIM TO ANY PARTICULAR FONT, STYLE, SIZE, OR COLOR.

OWNER OF U.S. REG. NO. 1,702,392. FOR ANTIBIOTIC PREPARATION (U.S. CLS. 6, 18, 44, 46, 51 AND 52). MARC LEIPZIG, EXAMINING ATTORNEY

**CLASS 5—(Continued).**

SN 78-449,306. THE NATURAL FERTILITY AWARENESS COMPANY INC., HANNA, ALBERTA, CANADA, FILED 7-12-2004.

**OVU-TRAC**

THE MARK CONSISTS OF STANDARD CHARACTERS WITHOUT CLAIM TO ANY PARTICULAR FONT, STYLE, SIZE, OR COLOR.

FOR OVULATION PREDICTOR KIT BASED ON THE SALIVA FERN TEST (U.S. CLS. 6, 18, 44, 46, 51 AND 52). FIRST USE 12-18-1996; IN COMMERCE 12-30-1997. TANYA AMOS, EXAMINING ATTORNEY

**CLASS 6—METAL GOODS**

SN 76-470,084. BLOCK AND COMPANY, INC., WHEELING, IL. FILED 11-26-2002.

**FORT KNOX**

FOR METAL CASH BOXES AND SECURITY BOXES (U.S. CLS. 2, 12, 13, 14, 23, 25 AND 50). ANN LINNEHAN, EXAMINING ATTORNEY

SN 76-517,074. BERG, RICHARD, GREENVILLE, RI. FILED 5-2-2003.

**THE GREMLIN BELL**

NO CLAIM IS MADE TO THE EXCLUSIVE RIGHT TO USE BELL, APART FROM THE MARK AS SHOWN. FOR METAL BELLS (U.S. CLS. 2, 12, 13, 14, 23, 25 AND 50). FIRST USE 3-18-2001; IN COMMERCE 3-18-2001. CATHERINE FAINT, EXAMINING ATTORNEY

**CLASS 6—(Continued).**

SN 76-529,162. RIVET ILLIMITES MONTREAL INC., VILLE ST-LAURENT ONTARIO, CANADA, FILED 7-3-2003.

**RIV**

PRIORITY CLAIMED UNDER SEC. 44(D) ON CANADA APPLICATION NO. 1165597, FILED 1-27-2003, REG. NO. TMA605463, DATED 3-17-2004, EXPIRES 3-17-2019. FOR METAL FASTENERS, NAMELY, RIVETS (U.S. CLS. 2, 12, 13, 14, 23, 25 AND 50). FIRST USE 4-30-1999; IN COMMERCE 4-30-1999. PRISCILLA MILTON, EXAMINING ATTORNEY

SN 76-531,037. GUARDIAN POOL FENCE SYSTEMS, INC., VAN NUYS, CA. FILED 7-21-2003.

**CHILD GUARD**

FOR REMOVABLE METAL POOL FENCES DESIGNED FOR THE DO-IT-YOURSELF CUSTOMER (U.S. CLS. 2, 12, 13, 14, 23, 25 AND 50). FIRST USE 12-0-2002; IN COMMERCE 12-0-2002. JERI J. FICKES, EXAMINING ATTORNEY

SN 76-543,004. ATI PROPERTIES, INC., ALBANY, OR. FILED 8-25-2003.

**AL CLEAN**

FOR STAINLESS STEEL HAVING A SURFACE THAT IS FINGERPRINT RESISTANT (U.S. CLS. 2, 12, 13, 14, 23, 25 AND 50). ROBIN CHOSID, EXAMINING ATTORNEY

SN 76-562,452. PRO TECT ASSOCIATES, INC., NORTH-FIELD, IL. FILED 11-12-2003.

**E-Z PROP**

NO CLAIM IS MADE TO THE EXCLUSIVE RIGHT TO USE "PROP", APART FROM THE MARK AS SHOWN. FOR METAL SUPPORT POLES WITH EXTENSION RODS (U.S. CLS. 2, 12, 13, 14, 23, 25 AND 50). FIRST USE 10-14-2003; IN COMMERCE 10-14-2003. IRA J. GOODSID, EXAMINING ATTORNEY

**CLASS 6—(Continued).**

SN 76-562,939. ASMITH MANUFACTURING COMPANY, TAICHUNG, TAIWAN, FILED 11-17-2003.



FOR DOOR STOPS OF METAL, METAL CLAMPS FOR ATTACHMENT OF FURNITURE TO FLOORS, METAL CABINET DOOR CATCHES, METAL CASTERS, METAL DOOR LATCHES, METAL HANDLES FOR DOORS, METAL HANDLES FOR DRAWERS, METAL HINGES, METAL LATCHES, METAL LATCH BARS, METAL LOCKS, METAL LOCK BOXES, METAL LOCK CYLINDERS, METAL LOCKING MECHANISMS, METAL PULLS FOR DRAWERS, METAL TRESTLES FOR USE AS TABLE SUPPORTS (U.S. CLS. 2, 12, 13, 14, 23, 25 AND 50).

FIRST USE 7-1-2002; IN COMMERCE 7-1-2002.  
KIM SAITO, EXAMINING ATTORNEY

SN 76-574,048. TIGHTON FASTENER & SUPPLY, INC., OMAHA, NE. FILED 1-26-2004.

# Timber-Pro

THE MARK CONSISTS OF STANDARD CHARACTERS WITHOUT CLAIM TO ANY PARTICULAR FONT, STYLE, SIZE, OR COLOR.

FOR METAL FASTENERS, NAMELY, NAILS AND STAPLES FOR CONSTRUCTION USE (U.S. CLS. 2, 12, 13, 14, 23, 25 AND 50).

FIRST USE 12-15-2003; IN COMMERCE 12-15-2003.  
SHARON MEIER, EXAMINING ATTORNEY

SN 78-299,890. INSPIRE INDUSTRIES, LLC, MIDDLETON, WI. FILED 9-12-2003.

## FLIP CLIP

NO CLAIM IS MADE TO THE EXCLUSIVE RIGHT TO USE CLIP, APART FROM THE MARK AS SHOWN.

FOR METAL CLIPS THAT ATTACH TO WALL STUDS FOR USE AS A STORAGE DEVICE (U.S. CLS. 2, 12, 13, 14, 23, 25 AND 50).

MITCHELL FRONT, EXAMINING ATTORNEY

**CLASS 6—(Continued).**

SN 78-345,329. HUGG MANUFACTURING, INC., WEST-SIDE, IA. FILED 12-24-2003.

# PortaAnchor

THE MARK CONSISTS OF STANDARD CHARACTERS WITHOUT CLAIM TO ANY PARTICULAR FONT, STYLE, SIZE, OR COLOR.

FOR METAL ANCHORS FOR SECURING CARGO VIA STRAP OR CHAIN (U.S. CLS. 2, 12, 13, 14, 23, 25 AND 50).  
TRICIA SONNEBORN, EXAMINING ATTORNEY

SN 78-355,148. MARLER, REBECCA L., FORT WAYNE, IN. FILED 1-21-2004.

# HOOK-ITS

THE MARK CONSISTS OF STANDARD CHARACTERS WITHOUT CLAIM TO ANY PARTICULAR FONT, STYLE, SIZE, OR COLOR.

FOR METAL HOOKS (U.S. CLS. 2, 12, 13, 14, 23, 25 AND 50).

MICHAEL KAZAZIAN, EXAMINING ATTORNEY

**CLASS 6—(Continued).**

SN 78-355,326. COMMISSION FOR THE LAS VEGAS CENTENNIAL, LAS VEGAS, NV. FILED 1-21-2004.



NO CLAIM IS MADE TO THE EXCLUSIVE RIGHT TO USE LAS VEGAS AND 1905-2005, APART FROM THE MARK AS SHOWN.

THE COLOR(S) RED, WHITE AND BLUE IS/ARE CLAIMED AS A FEATURE OF THE MARK.

THE MARK CONSISTS OF A RED SIGN WITH THE WHITE STYLIZED WORDS AND NUMBERS LAS VEGAS CENTENNIAL 1905-2005, WITH BLUE AND WHITE CIRCLES AROUND THE SIGN, AND A BLUE STAR WHICH ARE SUPERIMPOSED OVER A BLUE STAND. THE COLOR(S) BLUE, RED AND WHITE IS/ARE CLAIMED AS A DISTINCTIVE FEATURE OF THE MARK.

FOR METAL KEY CHAINS, METAL BANKS, METAL BOXES, JEWELRY BOXES OF NON-PRECIOUS METAL, METAL MONEY CLIPS, AND SCULPTURES MADE OF NON-PRECIOUS METAL (U.S. CLS. 2, 12, 13, 14, 23, 25 AND 50).

KIMBERLY PERRY, EXAMINING ATTORNEY

SN 78-364,959. NEWFREY LLC, NEWARK, DE. FILED 2-9-2004.

## THE BEAUTY OF STRENGTH

THE MARK CONSISTS OF STANDARD CHARACTERS WITHOUT CLAIM TO ANY PARTICULAR FONT, STYLE, SIZE, OR COLOR.

FOR METAL DOOR HARDWARE, NAMELY, KNOBS, LEVERS, LEVER SETS, HANDLES, HANDLESETS, DEADBOLTS, KEYS AND KEY BLANKS (U.S. CLS. 2, 12, 13, 14, 23, 25 AND 50).

ZHALEH DELANEY, EXAMINING ATTORNEY

**CLASS 7—MACHINERY**

SN 76-515,059. READING TECHNOLOGIES OF DELAWARE, INC., WILMINGTON, DE. FILED 4-24-2003.

## INVERSE-FLOW

FOR PNEUMATIC FILTERS FOR USE WITH COMPRESSED AIR LINES (U.S. CLS. 13, 19, 21, 23, 31, 34 AND 35).

FIRST USE 4-18-1989; IN COMMERCE 4-18-1989.  
SUSAN HAYASH, EXAMINING ATTORNEY

SN 76-516,985. READING TECHNOLOGIES OF DELAWARE, INC., WILMINGTON, DE. FILED 5-19-2003.

## EXSICCATOR

FOR PNEUMATIC FILTERS FOR USE WITH COMPRESSED AIR LINES FOR MECHANICAL PURPOSES (U.S. CLS. 13, 19, 21, 23, 31, 34 AND 35).

FIRST USE 5-19-2003; IN COMMERCE 5-19-2003.  
LAURA KOVAISKY, EXAMINING ATTORNEY

SN 76-521,569. FENNER U.S., INC., MANHEIM, PA. FILED 6-9-2003.



FOR PULLEYS, TENSIONERS, AND DRIVE BELT GUIDES, ALL BEING PARTS OF MACHINES (U.S. CLS. 13, 19, 21, 23, 31, 34 AND 35).

FIRST USE 9-7-1999; IN COMMERCE 9-7-1999.  
ANDREW LAWRENCE, EXAMINING ATTORNEY

SN 76-528,498. VALENTITE, LLC, MADISON HEIGHTS, MI. FILED 7-2-2003.

## VALEDGE

FOR TOOLS FOR METAL CUTTING, NAMELY TURNING, MILLING, GROOVING, DRILLING, THREADING AND BORING TOOLS; AND CUTTING INSERTS AND TOOL HOLDERS FOR POWER OPERATED METAL CUTTING MACHINES AND TOOLS; AND COMPONENT PARTS THEREFOR (U.S. CLS. 13, 19, 21, 23, 31, 34 AND 35).

DOMINIC J. FERRAIUOLO, EXAMINING ATTORNEY

**CLASS 7—(Continued).**

SN 76-531,450. HAINBUCH GMBH SPANNENDE TECHNIK, D-71672 MARBACH, FED REP GERMANY, FILED 7-22-2003.

**SPANNTOP**

OWNER OF FED REP GERMANY REG. NO. 980024, DATED 5-12-1978, RENEWED AS REG. NO. 980024, DATED 6-1-1998, EXPIRES 5-30-2008.

FOR CLAMPING DEVICES FOR MACHINE TOOLS, NAMELY COLLET CHUCKS AND PARTS THEREFOR, NAMELY, BASIC BODIES AND CLAMPING HEADS; STATIONARY CHUCKS AND PARTS THEREFOR, NAMELY CHUCK BODIES AND CLAMPING HEADS (U.S. CLS. 13, 19, 21, 23, 31, 34 AND 35).

CAROLINE WOOD, EXAMINING ATTORNEY

SN 76-536,419. BSH BOSCH UND SIEMENS HAUSGERATE GMBH, MUNICH, FED REP GERMANY, FILED 7-31-2003.

**HYDROSAFE**

FOR DISHWASHERS AND PARTS THEREFORE (U.S. CLS. 13, 19, 21, 23, 31, 34 AND 35).

CAROLYN CATALDO, EXAMINING ATTORNEY

SN 76-546,953. BERLIN METALS LLC, HAMMOND, IN. FILED 9-25-2003.



The logo for VildaV92 features the word "Vilda" in a stylized, bold, serif font, followed by "V92" in a similar font. Below the text is a thick, horizontal black bar with a slight shadow effect.

FOR MACHINERY PRODUCING SUPPORT BARS FOR THERMAL WINDOW ELEMENTS (U.S. CLS. 13, 19, 21, 23, 31, 34 AND 35).

CAROLYN CATALDO, EXAMINING ATTORNEY

SN 76-560,866. SPX CORPORATION, CHARLOTTE, NC. FILED 11-19-2003.

**TRU-FIT**

THE MARK CONSISTS OF STANDARD CHARACTERS WITHOUT CLAIM TO ANY PARTICULAR FONT, STYLE, SIZE, OR COLOR.

FOR INDUSTRIAL PUMPS, NAMELY, POSITIVE DISPLACEMENT PUMPS (U.S. CLS. 13, 19, 21, 23, 31, 34 AND 35).

M. L. HERSHKOWITZ, EXAMINING ATTORNEY

**CLASS 7—(Continued).**

SN 76-562,504. PELLETRON CORPORATION, LANCASTER, PA. FILED 12-1-2003.

**FINE-ALYZER**

FOR MACHINE EQUIPMENT TO ANALYZE PARTICULATE MATERIAL, NAMELY, PLASTIC PELLETS, TO DETERMINE THE AMOUNT OF NON-PLASTIC CONTAMINANTS IN THE MATERIAL (U.S. CLS. 13, 19, 21, 23, 31, 34 AND 35).

AMY GEARIN, EXAMINING ATTORNEY

SN 76-572,338. RED ARROW PRODUCTS COMPANY, LLC, MANITOWOC, WI. FILED 1-26-2004.

**GRILL MARKER**

THE MARK CONSISTS OF STANDARD CHARACTERS WITHOUT CLAIM TO ANY PARTICULAR FONT, STYLE, SIZE, OR COLOR.

FOR MACHINES FOR SPRAYING FOOD COLORING AGENTS AND COMPOUNDS ONTO FOOD (U.S. CLS. 13, 19, 21, 23, 31, 34 AND 35).

HOWARD B. LEVINE, EXAMINING ATTORNEY

SN 76-573,012. TOTANI CORPORATION, KYOTO 601-8213, JAPAN, FILED 2-2-2004.



THE COLOR(S) WHITE, ORANGE AND BLACK IS/ARE CLAIMED AS A FEATURE OF THE MARK.

THE WORD PORTION OF THE MARK CONSISTS OF SIX LETTERS FORMING THE WORD "TOTANI," AND THE FIRST LETTER, "T," THE THIRD LETTER, "T," AND THE FIFTH LETTER, "N," ALL APPEAR IN THE COLOR WHITE; THE SECOND LETTER, "O," THE FOURTH LETTER, "A," AND THE SIXTH LETTER, "I," APPEAR IN THE COLOR ORANGE. THE COLOR BLACK PROVIDES A BACKGROUND FOR THE WORDING IN THE MARK.

FOR PLASTIC POUCH MAKING MACHINES, PLASTIC BAG MAKING MACHINES, DEVICE FOR INSERTING A SPOUT INTO A BAG, MACHINES FOR PACKAGING OR WRAPPING STANDARD POLYETHYLENE BAGS, AND PARTS AND FITTINGS THEREFOR, AND INVERTER-CONTROLLED EDGE TRIM WINDERS FOR DISPOSING OF EDGE TRIM CREATED IN THE BAG MAKING PROCESS (U.S. CLS. 13, 19, 21, 23, 31, 34 AND 35).

FIRST USE 11-0-1986; IN COMMERCE 11-0-1986.  
DORITT L. CARROLL, EXAMINING ATTORNEY

**CLASS 7—(Continued).**

SN 78-173,227. BAE SYSTEMS CONTROLS INC., JOHNSON CITY, NY. FILED 10-10-2002.

**HYBRIDRIVE**

SEC. 2(F).  
FOR PROPULSION SYSTEMS UTILIZING DUAL SOURCES OF POWER, NAMELY, ELECTRICITY SOURCES IN THE NATURE OF BATTERIES, ULTRACAPACITORS, FUEL CELLS, AND SIMILAR MEANS OF ELECTRICAL POWER STORAGE AND PRIME MOVER MEANS FOR PROVIDING MECHANICAL POWER INCLUDING GASOLINE ENGINES, DIESEL ENGINES AND FUEL CELLS, PRIMARILY COMPRISED OF A GENERATOR WHICH CONVERTS MECHANICAL ENERGY TO ELECTRICAL ENERGY, A MOTOR WHICH CONVERTS ELECTRIC ENERGY INTO MECHANICAL ENERGY AND PROPULSION COMPULSION SYSTEMS IN THE NATURE OF COMPUTER CONTROLLED ELECTRONICS FOR CONTROLLING THE FLOW OF ELECTRICITY BETWEEN EACH GENERATOR TO EACH ELECTRICAL STORAGE MEANS AND EACH MOTOR, FOR USE ONLY IN BUSES AND TRUCKS (U.S. CLS. 13, 19, 21, 23, 31, 34 AND 35).

FIRST USE 8-0-1997; IN COMMERCE 8-0-1997.  
PAM WILLIS, EXAMINING ATTORNEY

SN 78-215,609. SEARS BRANDS, LLC, HOFFMAN ESTATES, IL. FILED 2-17-2003.

**DIEHARD**

OWNER OF U.S. REG. NOS. 858,218, 2,677,217 AND OTHERS.

FOR ALTERNATORS FOR LAND VEHICLES; STARTERS FOR MOTORS AND ENGINES; AND FAN BELT TENSIONERS FOR MOTORS AND ENGINES (U.S. CLS. 13, 19, 21, 23, 31, 34 AND 35).

FIRST USE 10-1-2001; IN COMMERCE 10-1-2001.  
TINA L. SNAPP, EXAMINING ATTORNEY

SN 78-248,595. LINEAR TRANSFER SYSTEMS LTD., BARRIE, ONTARIO, CANADA, FILED 5-12-2003.

**FRONT AND REAR MOUNT -  
FR CLASS**

FOR HEAVY INDUSTRIAL MACHINES FOR MOVEMENT OF WORK PIECES THROUGH A MULTI-STATION PRESS HAVING DIES FOR PART FORMATION (U.S. CLS. 13, 19, 21, 23, 31, 34 AND 35).  
INGA ERVIN, EXAMINING ATTORNEY

SN 78-276,119. KOP-FLEX, INC., HANOVER, MD. FILED 7-18-2003.

**CENTURIAN**

FOR POWER TRANSMISSION SHAFT COUPLINGS FOR COMMERCIAL AND INDUSTRIAL MACHINES AND PARTS THEREFOR. (U.S. CLS. 13, 19, 21, 23, 31, 34 AND 35).

THEODORE MCBRIDE, EXAMINING ATTORNEY

**CLASS 7—(Continued).**

SN 78-316,241. FEDERAL-MOGUL WORLD WIDE INC., SOUTHFIELD, MI. FILED 10-21-2003.

**POWER BOOST**

NO CLAIM IS MADE TO THE EXCLUSIVE RIGHT TO USE "POWER", APART FROM THE MARK AS SHOWN.

FOR SPARK PLUG WIRE SETS. (U.S. CLS. 13, 19, 21, 23, 31, 34 AND 35).

ASMAT KHAN, EXAMINING ATTORNEY

SN 78-325,579. KOGANEI CORPORATION, TOKYO, JAPAN, FILED 11-10-2003.



PRIORITY CLAIMED UNDER SEC. 44(D) ON JAPAN APPLICATION NO. 2003-092538, FILED 10-21-2003, REG. NO. 4760584, DATED 4-2-2004, EXPIRES 4-2-2014.

NO CLAIM IS MADE TO THE EXCLUSIVE RIGHT TO USE "COAXIAL" AND "PUMP", APART FROM THE MARK AS SHOWN.

FOR PUMPS FOR USE IN DISPENSING PHOTO RESIST SOLUTIONS TO SEMICONDUCTOR MANUFACTURING MACHINES AND APPARATUS (U.S. CLS. 13, 19, 21, 23, 31, 34 AND 35).

CAROLYN CATALDO, EXAMINING ATTORNEY

SN 78-351,072. SPRAYING SYSTEMS COMPANY, WHEATON, IL. FILED 1-13-2004.

**ZMEG**

THE MARK CONSISTS OF STANDARD CHARACTERS WITHOUT CLAIM TO ANY PARTICULAR FONT, STYLE, SIZE, OR COLOR.

FOR SPRAY NOZZLES AS PART OF POWER OPERATED SPRAYERS FOR INDUSTRIAL AND AGRICULTURAL USES (U.S. CLS. 13, 19, 21, 23, 31, 34 AND 35).

WON TEAK OH, EXAMINING ATTORNEY

**CLASS 7—(Continued).**

SN 78-351,303. CONAIR CORPORATION, STAMFORD, CT. FILED 1-13-2004.

# PREPMATE

THE MARK CONSISTS OF STANDARD CHARACTERS WITHOUT CLAIM TO ANY PARTICULAR FONT, STYLE, SIZE, OR COLOR.

FOR ELECTRIC AND SMALL KITCHEN APPLIANCES FOR DOMESTIC AND COMMERCIAL USE, NAMELY, ELECTRIC FOOD CHOPPERS AND GRINDERS, ELECTRIC HAND-HELD MIXERS, ELECTRIC HAND-HELD FOOD BLENDERS, ELECTRIC COUNTERTOP FOOD BLENDERS (U.S. CLS. 13, 19, 21, 23, 31, 34 AND 35).  
DAWN HAN, EXAMINING ATTORNEY

**CLASS 7—(Continued).**

SN 78-352,422. GENESIS TILLAGE, INC., HOPE, IN. FILED 1-15-2004.

# GENESIS TILLAGE

THE MARK CONSISTS OF STANDARD CHARACTERS WITHOUT CLAIM TO ANY PARTICULAR FONT, STYLE, SIZE, OR COLOR.

NO CLAIM IS MADE TO THE EXCLUSIVE RIGHT TO USE "TILLAGE", APART FROM THE MARK AS SHOWN.  
FOR SOIL AERATOR (U.S. CLS. 13, 19, 21, 23, 31, 34 AND 35).  
FIRST USE 8-1-2003; IN COMMERCE 8-1-2003.  
WILLIAM P. SHANAHAN, EXAMINING ATTORNEY

SN 78-352,545. HANDI QUILTER COMPANY, INC., CENTERVILLE, UT. FILED 1-15-2004.

SN 78-351,667. FEDERAL-MOGUL WORLD WIDE INC., BLOOMFIELD HILLS, MI. FILED 1-14-2004.



NO CLAIM IS MADE TO THE EXCLUSIVE RIGHT TO USE O.E. FIT AND FORM ASSURANCE, APART FROM THE MARK AS SHOWN.

THE MARK CONSISTS OF THE LETTERS "O.E." AS WELL AS GRAPHIC DEPICTIONS OF SPARK PLUG WIRES ENCIRCLED BY THE WORDS "FIT AND FORM ASSURANCE."

FOR SPARK PLUG WIRES (U.S. CLS. 13, 19, 21, 23, 31, 34 AND 35).  
JOHN HWANG, EXAMINING ATTORNEY

# HQ SIXTEEN

THE MARK CONSISTS OF STANDARD CHARACTERS WITHOUT CLAIM TO ANY PARTICULAR FONT, STYLE, SIZE, OR COLOR.

NO CLAIM IS MADE TO THE EXCLUSIVE RIGHT TO USE "SIXTEEN", APART FROM THE MARK AS SHOWN.

FOR PORTABLE QUILTING FRAME AND CARRIAGE WHICH ATTACHES TO A SEWING MACHINE FOR THE MAKING OF QUILTS (U.S. CLS. 13, 19, 21, 23, 31, 34 AND 35).

FIRST USE 2-1-2003; IN COMMERCE 2-1-2003.  
GRETTA YAO, EXAMINING ATTORNEY



**CLASS 7—(Continued).**

SN 78-355,534. SNAPPER PRODUCTS, INC., MC DONOUGH, GA. FILED 1-22-2004.

**CLASS 7—(Continued).**

SN 78-356,928. DYNAPOWERNAMICS INC., ST. LOUIS, MO. FILED 1-23-2004.

Z-VAC



THE MARK CONSISTS OF STANDARD CHARACTERS WITHOUT CLAIM TO ANY PARTICULAR FONT, STYLE, SIZE, OR COLOR.

FOR COMMERCIAL GRASS CATCHERS (U.S. CLS. 13, 19, 21, 23, 31, 34 AND 35).

FIRST USE 5-0-2003; IN COMMERCE 5-0-2003.  
AMY ALFIERI, EXAMINING ATTORNEY

NO CLAIM IS MADE TO THE EXCLUSIVE RIGHT TO USE INC., APART FROM THE MARK AS SHOWN.

THE COLOR(S) BLACK, YELLOW, GREEN, RED, AND THERE IS AN ANIMATION EFFECT WHEN IT IS ON THE INTERNET. IS/ARE CLAIMED AS A DISTINCTIVE FEATURE OF THE MARK.

THE MARK CONSISTS OF A CIRCLE WITH A BLACK BORDER FILLED WITH COLOR YELLOW. HAVING THE CORPORATE NAME ARCED AT THE TOP IN BLACK TEXT AND A COMPANY SLOGAN ARCED AT THE BOTTOM IN BLACK TEXT. ALSO HAVING A SOLID BLACK SHAPE PLACED IN THE MIDDLE OF THE SAID CIRCLE WITH TWO GREEN BANDS PLACED IN THE MIDDLE OF THE SOLID BLACK SHAPE. SETTING ON THESE TWO GREEN BANDS IS A RED SCOPE SITE AND BOTH THE RED AND GREEN ITEMS HAVE GLOW SPARKS AT THE ENDS OF EACH THAT ANIMATE WHEN IT IS ON THE INTERNET, BY MEANS OF AN ANIMATION EFFECT.

THE MARK CONSISTS OF A CIRCLE WITH A BLACK BORDER FILLED WITH COLOR YELLOW.

FOR METALWORKING MACHINE TOOLS (U.S. CLS. 13, 19, 21, 23, 31, 34 AND 35).

JEFFREY S. MOLINOFF, EXAMINING ATTORNEY

SN 78-356,507. FREDERICK MANUFACTURING CORPORATION, KANSAS CITY, MO. FILED 1-23-2004.

SN 78-358,629. COE NEWNES/MCGEHEE ULC, SALMON ARM, BRITISH COLUMBIA, CANADA, FILED 1-28-2004.

FUSION

ROBOGANG

THE MARK CONSISTS OF STANDARD CHARACTERS WITHOUT CLAIM TO ANY PARTICULAR FONT, STYLE, SIZE, OR COLOR.

FOR PARTS FOR OUTDOOR POWER EQUIPMENT, NAMELY BLADES (U.S. CLS. 13, 19, 21, 23, 31, 34 AND 35).

HELEN BRYAN, EXAMINING ATTORNEY

THE MARK CONSISTS OF STANDARD CHARACTERS WITHOUT CLAIM TO ANY PARTICULAR FONT, STYLE, SIZE, OR COLOR.

FOR MACHINE PARTS FOR USE IN OPTIMIZING SAWMILL OPERATIONS, NAMELY, VERTICAL OR HORIZONTAL CURVE SAWING GANG EDGERS (U.S. CLS. 13, 19, 21, 23, 31, 34 AND 35).

GEORGIA CARTY, EXAMINING ATTORNEY

**CLASS 7—(Continued).**

SN 78-359,106. TAPCO INTERNATIONAL CORPORATION,  
WIXOM, MI. FILED 1-28-2004.

# MAXTRAX

THE MARK CONSISTS OF STANDARD CHARACTERS  
WITHOUT CLAIM TO ANY PARTICULAR FONT, STYLE,  
SIZE, OR COLOR.

FOR SAW TABLES AND PARTS RELATED THERETO  
(U.S. CLS. 13, 19, 21, 23, 31, 34 AND 35).  
ANN LINNEHAN, EXAMINING ATTORNEY

**CLASS 7—(Continued).**

SN 78-361,001. MOLD-MASTERS LIMITED, GEORGETOWN,  
CANADA, FILED 2-2-2004.

# PIVOT-LINK

THE MARK CONSISTS OF STANDARD CHARACTERS  
WITHOUT CLAIM TO ANY PARTICULAR FONT, STYLE,  
SIZE, OR COLOR.

FOR PLASTICS MOLDING EQUIPMENT, NAMELY,  
NOZZLE AND MANIFOLDS (U.S. CLS. 13, 19, 21, 23, 31,  
34 AND 35).

SUE LAWRENCE, EXAMINING ATTORNEY

---

SN 78-360,178. SPRAYING SYSTEMS COMPANY, WHEA-  
TON, IL. FILED 1-30-2004.

# QJA

THE MARK CONSISTS OF STANDARD CHARACTERS  
WITHOUT CLAIM TO ANY PARTICULAR FONT, STYLE,  
SIZE, OR COLOR.

OWNER OF U.S. REG. NOS. 1,267,719 AND 1,267,720.  
FOR SPRAY NOZZLES BEING PARTS OF A MA-  
CHINE FOR SPRAYING A VARIETY OF LIQUIDS FOR  
INDUSTRIAL AND AGRICULTURAL APPLICATIONS  
(U.S. CLS. 13, 19, 21, 23, 31, 34 AND 35).

FIRST USE 12-31-1987; IN COMMERCE 12-31-1987.  
BARBARA BROWN, EXAMINING ATTORNEY

---

SN 78-365,261. ROYAL APPLIANCE MFG. CO., GLENWIL-  
LOW, OH. FILED 2-10-2004.

# CRUISER

THE MARK CONSISTS OF STANDARD CHARACTERS  
WITHOUT CLAIM TO ANY PARTICULAR FONT, STYLE,  
SIZE, OR COLOR.

FOR ELECTRICAL VACUUM CLEANERS FOR DO-  
MESTIC AND COMMERCIAL USE (U.S. CLS. 13, 19, 21,  
23, 31, 34 AND 35).

ZHALEH DELANEY, EXAMINING ATTORNEY

**CLASS 7—(Continued).**

SN 78-372,294. BUFFETT, JIMMY, KEY WEST, FL. FILED 2-23-2004.

**LICENSE TO CHILL**

THE MARK CONSISTS OF STANDARD CHARACTERS WITHOUT CLAIM TO ANY PARTICULAR FONT, STYLE, SIZE, OR COLOR.

FOR ELECTRIC FOOD AND DRINK BLENDERS (U.S. CLS. 13, 19, 21, 23, 31, 34 AND 35).  
RICHARD WHITE, EXAMINING ATTORNEY

SN 78-396,100. ANGEL CO. LTD., OSAKA, JAPAN, FILED 4-5-2004.

**ANGEL EYE**

THE MARK CONSISTS OF STANDARD CHARACTERS WITHOUT CLAIM TO ANY PARTICULAR FONT, STYLE, SIZE, OR COLOR.

FOR PLAYING CARD DEALING MACHINE AND PARTS THEREFORE (U.S. CLS. 13, 19, 21, 23, 31, 34 AND 35).  
REGINA DRUMMOND, EXAMINING ATTORNEY

**CLASS 8—HAND TOOLS**

SN 76-562,314. CARON INTERNATIONAL, INC., WASHINGTON, NC. FILED 11-28-2003.

**EMBELLISH-KNIT!**

FOR HAND-HELD CIRCULAR MANUAL KNITTING MACHINE WHICH PRODUCES KNITTED CORDING FOR YARN (U.S. CLS. 23, 28 AND 44).  
MARLENE BELL, EXAMINING ATTORNEY

**CLASS 8—(Continued).**

SN 78-211,826. H.A. KIDD AND COMPANY LIMITED, TORONTO, CANADA, FILED 2-6-2003.

**SOFTKUT**

PRIORITY CLAIMED UNDER SEC. 44(D) ON CANADA APPLICATION NO. 1166030, FILED 1-27-2003, REG. NO. TMA609041, DATED 4-30-2004, EXPIRES 4-30-2019.

FOR SCISSORS FOR SEWING AND HOUSEHOLD USE (U.S. CLS. 23, 28 AND 44).  
RON FAIRBANKS, EXAMINING ATTORNEY

SN 78-342,800. GENERAL MILLS, INC., MINNEAPOLIS, MN. FILED 12-18-2003.

**ADELPHIA**

THE MARK CONSISTS OF STANDARD CHARACTERS WITHOUT CLAIM TO ANY PARTICULAR FONT, STYLE, SIZE, OR COLOR.

THE ENGLISH TRANSLATION OF ADELPHIA IS BROTHER.

FOR FLATWARE, NAMELY, FORKS, KNIVES AND SPOONS (U.S. CLS. 23, 28 AND 44).  
MICHELLE S. WISEMAN, EXAMINING ATTORNEY

SN 78-352,222. BROADCAST ARTS GROUP, INC., DEER-FIELD BEACH, FL. FILED 1-15-2004.

**SQUEEZE CHEF PRO**

THE MARK CONSISTS OF STANDARD CHARACTERS WITHOUT CLAIM TO ANY PARTICULAR FONT, STYLE, SIZE, OR COLOR.

FOR KITCHEN UTENSILS, NAMELY HAND-OPERATED MECHANICAL VEGETABLE SLICERS (U.S. CLS. 23, 28 AND 44).  
JEFFREY S. MOLINOFF, EXAMINING ATTORNEY

**CLASS 8—(Continued).**

SN 78-354,163. MACHINA CO., LTD., SAITAMA-KEN, JAPAN, FILED 1-20-2004.

DIATITAN

THE MARK CONSISTS OF STANDARD CHARACTERS WITHOUT CLAIM TO ANY PARTICULAR FONT, STYLE, SIZE, OR COLOR.

FOR KITCHEN KNIVES, HUNTING KNIVES, FOLDING KNIVES AND CHEF KNIVES (U.S. CLS. 23, 28 AND 44).

TANYA AMOS, EXAMINING ATTORNEY

**CLASS 8—(Continued).**

SN 78-357,944. PRECISION INSTRUMENTS, INC., DES PLAINES, IL. FILED 1-27-2004.



THE MARK CONSISTS OF A STYLIZED LETTER P, FOR HAND TOOLS, NAMELY TORQUE WRENCHES (U.S. CLS. 23, 28 AND 44).

FIRST USE 1-0-2003; IN COMMERCE 1-0-2003.

DANIELLE MATTESSICH, EXAMINING ATTORNEY

SN 78-360,019. SWANSON TOOL CO., INC., FRANKFORT, IL. FILED 1-30-2004.

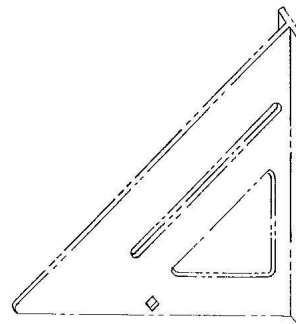

OWNER OF U.S. REG. NO. 2,696,847.

THE MARK CONSISTS OF A DIAMOND-SHAPED CUT-OUT THAT APPEARS ON THE HAND TOOLS. THE DOTTED LINES ON THE DRAWING SHOW THE PLACEMENT OF THE MARK ON THE GOODS AND ARE NOT INTENDED TO INDICATE COLOR.

SEC. 2(F).

FOR HAND TOOLS, NAMELY, SQUARES (U.S. CLS. 23, 28 AND 44).

FIRST USE 9-1-1997; IN COMMERCE 9-1-1997.

ALICE BENMAMAN, EXAMINING ATTORNEY

SN 78-354,724. IRWIN INDUSTRIAL TOOL COMPANY, FREEPORT, IL. FILED 1-21-2004.

BLUE BLADE

THE MARK CONSISTS OF STANDARD CHARACTERS WITHOUT CLAIM TO ANY PARTICULAR FONT, STYLE, SIZE, OR COLOR.

NO CLAIM IS MADE TO THE EXCLUSIVE RIGHT TO USE BLADE, APART FROM THE MARK AS SHOWN. FOR UTILITY KNIVES (U.S. CLS. 23, 28 AND 44).

LINDA E. BLOHM, EXAMINING ATTORNEY

**CLASS 8—(Continued).**

SN 78-363,320. THE GREAT AMERICAN TOOL COMPANY, INC., GETZVILLE, NY. FILED 2-5-2004.

# GATSTIX

THE MARK CONSISTS OF STANDARD CHARACTERS WITHOUT CLAIM TO ANY PARTICULAR FONT, STYLE, SIZE, OR COLOR.

OWNER OF U.S. REG. NO. 1,824,921.  
FOR HAND-OPERATED SHARPENING TOOL FOR KNIVES, FOOD UTENSILS AND SCISSORS (U.S. CLS. 23, 28 AND 44).

FIRST USE 1-0-1993; IN COMMERCE 1-0-1993.  
SUSAN HAYASH, EXAMINING ATTORNEY

**CLASS 9—ELECTRICAL AND SCIENTIFIC APPARATUS**

SN 75-613,633. COGNEX CORPORATION, NATICK, MA. FILED 12-30-1998.

## MVS-8000

FOR INTEGRATED COMPUTER SYSTEMS COMPRISING HARDWARE AND SOFTWARE FOR MACHINE VISION APPLICATIONS, NAMELY, LOCATING, GUIDING, IDENTIFYING, MEASURING AND/OR INSPECTING OBJECTS (U.S. CLS. 21, 23, 26, 36 AND 38).

FIRST USE 3-2-1998; IN COMMERCE 3-2-1998.  
KEVON CHISOLM, EXAMINING ATTORNEY

SN 75-894,623. BAE SYSTEMS INFORMATION AND ELECTRONIC SYSTEMS INTEGRATION INC., MANASSA, VA. FILED 1-11-2000.

## RAD6000

OWNER OF U.S. REG. NO. 2,279,942.  
FOR INTEGRATED CIRCUITS WITH A TOLERANCE FOR RADIATION SOLD TO THE DEFENSE, AVIONICS AND SPACE MARKETS (U.S. CLS. 21, 23, 26, 36 AND 38).  
GLENN CLARK, EXAMINING ATTORNEY

**CLASS 9—(Continued).**

SN 75-902,432. SAVANT DESIGN ILLUSTRATIONS, LAS VEGAS, NV. FILED 1-24-2000.



FOR ELECTRONIC LED DISPLAY BOARD FOR RUNNING VIDEO SIGNS, FOR USE OUTDOOR AND INDOOR (U.S. CLS. 21, 23, 26, 36 AND 38).

KELLY BOULTON, EXAMINING ATTORNEY

SN 76-015,726. VIRIDIS BIOTECH INC., SAINTE-FOY, QUEBEC, G1V 4G5, CANADA, FILED 4-3-2000.

## SOLIDHYB

PRIORITY CLAIMED UNDER SEC. 44(D) ON CANADA APPLICATION NO. 1031833, FILED 10-8-1999, REG. NO. TMA593559, DATED 10-30-2003, EXPIRES 10-30-2018.

FOR LIFE SCIENCE RESEARCH DEVICE, NAMELY, A SLIDE AND GEL INSTRUMENT FOR CONDUCTING IN SITU HYBRIDIZATION, DETECTION AND STUDIES OF BIOLOGICAL SYSTEMS AND BIOLOGICAL INTERACTIONS (U.S. CLS. 21, 23, 26, 36 AND 38).

MARC LEIPZIG, EXAMINING ATTORNEY

SN 76-056,043. WEBZ PTY LTD, PADDINGTON, QLD, AUSTRALIA, FILED 5-24-2000.

## EDITLIVE

PRIORITY CLAIMED UNDER SEC. 44(D) ON AUSTRALIA APPLICATION NO. 815518, FILED 11-26-1999, REG. NO. 815518, DATED 6-13-2002, EXPIRES 11-26-2009.

FOR COMPUTER AUTHORING SOFTWARE FOR USE ON COMPUTER COMMUNICATIONS NETWORKS, NAMELY SOFTWARE FOR CREATING, EDITING AND DELIVERING TEXTUAL AND GRAPHIC INFORMATION, LOCALLY AND REMOTELY; COMPUTER SOFTWARE FOR AUTHORING FOR THE WORLD WIDE WEB; COMPUTER SOFTWARE FOR ENHANCING THE CAPABILITIES OF WEB BROWSER SOFTWARE (U.S. CLS. 21, 23, 26, 36 AND 38).

MICHAEL KAZAZIAN, EXAMINING ATTORNEY

SN 76-058,241. GENERAL ELECTRIC COMPANY, WAUKESHA, WI. FILED 5-25-2000.

## ENTEGRA

FOR COMPUTER WORKSTATIONS, NAMELY, VIDEO DISPLAY UNITS AND COMPUTER SOFTWARE FOR USE IN CONNECTION WITH A MEDICAL DIAGNOSTIC IMAGING WORKSTATION (U.S. CLS. 21, 23, 26, 36 AND 38).

MICHAEL BAIRD, EXAMINING ATTORNEY

**CLASS 9—(Continued).**

SN 76-107,989. ANTEL INTERNATIONAL, INC., ROCK-FORD, IL. FILED 8-14-2000.



NO CLAIM IS MADE TO THE EXCLUSIVE RIGHT TO USE "INTERNATIONAL, INC.", APART FROM THE MARK AS SHOWN.

FOR HIGH PERFORMANCE ANTENNAS FOR THE WIRELESS INDUSTRY (U.S. CLS. 21, 23, 26, 36 AND 38). FIRST USE 8-1-1998; IN COMMERCE 8-1-1998. GEORGIA CARTY, EXAMINING ATTORNEY

SN 76-120,104. KNOWLEDGEFLOW, INC., VALLEY FORGE, PA. FILED 8-30-2000.

**WEBANGEL**

FOR COMPUTER SOFTWARE FOR USE IN THE TRANSFER OF INFORMATION AND THE CONDUCT OF COMMERCIAL TRANSACTIONS CROSS LOCAL, NATIONAL AND WORLD-WIDE INFORMATION NETWORKS; SEARCHING AND RETRIEVING INFORMATION, SITES, AND OTHER RESOURCES ON COMPUTER NETWORKS; COMPUTER SOFTWARE, NAMELY, A DIRECTORY OF INFORMATION, SITES AND RESOURCES AVAILABLE ON COMPUTER NETWORKS (U.S. CLS. 21, 23, 26, 36 AND 38).

MARGERY A. TIERNEY, EXAMINING ATTORNEY

SN 76-120,422. CAPITAL STREAM, INC., SEATTLE, WA. FILED 8-31-2000.

**BLUEWIRE**

FOR COMPUTER SOFTWARE DOWNLOADED FROM A GLOBAL COMPUTER NETWORK FOR USE IN COMMERCIAL REAL ESTATE MORTGAGE TRANSACTIONS (U.S. CLS. 21, 23, 26, 36 AND 38).

GLENN CLARK, EXAMINING ATTORNEY

SN 76-146,545. COMMUNICATIONS INFORMATION SOFTWARE, INC., DBA C. I. S., SUWANEE, GA. FILED 10-13-2000.

**FOCUS ONE**

FOR COMPUTER SOFTWARE FOR USE IN NETWORK DESIGN AND MANAGEMENT (U.S. CLS. 21, 23, 26, 36 AND 38).

FIRST USE 8-16-1997; IN COMMERCE 8-16-1997. CAROLYN CATALDO, EXAMINING ATTORNEY

**CLASS 9—(Continued).**

SN 76-160,563. HELBRECHT, ANDREAS, 51674 WIEHL, FED REP GERMANY, FILED 11-6-2000.

**BIKER EYES**

OWNER OF ERPN CMNTY TM OFC REG. NO. 001948041, DATED 1-20-2004, EXPIRES 1-20-2014.

NO CLAIM IS MADE TO THE EXCLUSIVE RIGHT TO USE "BIKER", APART FROM THE MARK AS SHOWN.

FOR ACCIDENT AND PROTECTIVE-HELMETS FOR BICYCLISTS, MOTORBIKERS AND SKIERS; PROTECTIVE GLOVES; SWIM MASKS, DIVING MASKS AND SCUBA DIVING MASKS; SPECTACLES; SPECTACLE GLASSES; SPECTACLE FRAMES; SUNGLASSES; SPORT GLASSES; SPECTACLES FOR MOTORBIKERS; SPECTACLES FOR CORRECTING SIGHT DEFECTS; ACCESSORIES FOR SPECTACLES, NAMELY, SPECTACLE CASES AND RETAINING SPORTS BANDS; CONTACT LENSES; GOGGLES, NAMELY PROTECTIVE GOGGLES, DIVING GOGGLES, SWIMMING, BIKING AND SKIING GOGGLES (U.S. CLS. 21, 23, 26, 36 AND 38).

MICHAEL ENGEL, EXAMINING ATTORNEY

SN 76-224,965. PLAZMIC INC., WATERLOO, ONTARIO, CANADA, FILED 3-15-2001.

**PLAZMIC MEDIA ENGINE**

PRIORITY CLAIMED UNDER SEC. 44(D) ON CANADA APPLICATION NO. 1096025, FILED 3-14-2001, REG. NO. TMA606349, DATED 3-26-2004, EXPIRES 3-26-2019.

NO CLAIM IS MADE TO THE EXCLUSIVE RIGHT TO USE "MEDIA ENGINE", APART FROM THE MARK AS SHOWN.

FOR COMPUTER SOFTWARE FOR USE IN COMPUTER GRAPHICS, COMPUTER ANIMATION, ANIMATION AND VISUAL SIMULATION; COMPUTER SOFTWARE USED FOR CREATING AND DISPLAYING MULTI-MEDIA CONTENT ON COMPUTERS, PERSONAL DIGITAL ASSISTANTS AND OTHER DIGITAL DEVICES (U.S. CLS. 21, 23, 26, 36 AND 38).

CAROLINE WEIMER, EXAMINING ATTORNEY

SN 76-269,685. SONY KABUSHIKI KAISHA, TA SONY CORPORATION, SHINAGAWA-KU, TOKYO, JAPAN, FILED 6-11-2001.

**QUALIA**

PRIORITY CLAIMED UNDER SEC. 44(D) ON UNITED KINGDOM APPLICATION NO. 2256516, FILED 12-21-2000.

OWNER OF JAPAN REG. NO. 4572895, DATED 3-31-2002, EXPIRES 3-31-2012.

FOR DIGITAL AUDIO PLAYERS/RECORDERS WHICH USE INTEGRATED CIRCUITS AS RECORDING MEDIA, AUDIO TAPE PLAYERS/RECORDERS; AUDIO DISC PLAYERS/RECORDERS; RADIO TUNERS, AUDIO RECEIVERS, AUDIO AMPLIFIERS, AUDIO SPEAKERS, HEADPHONES, EARPHONES, MICROPHONES, TELEVISIONS, LIQUID CRYSTAL DISPLAYS, LCD PROJECTORS, TELEVISION TUBES, CATHODE RAYTUBES, VIDEO TAPE PLAYERS/RECORDERS, VIDEO DISC PLAYERS/RECORDERS; SET TOP BOXES, NAMELY COMPUTER SOFTWARE AND HARDWARE WHICH CAN CONVERT, SUPPLY AND TRANSMIT AUDIO AND VIDEO DATA; VIDEO CAMERAS, VIDEO CAMERAS COMBINED WITH VIDEO RECORDERS/PLAYERS, ELECTRONIC STILL CAMERAS, CELLULAR TELEPHONES; FACSIMILE MACHINES, PERSONAL DIGITAL ASSISTANTS ("PDAS"), COMPUTER CENTRAL PROCESSING UNITS, COMPUTER PERIPH-

**CLASS 9—(Continued).**

ERALS, NAMELY, DISC DRIVES, MONITORS, KEYBOARDS, MICE AND LOUDSPEAKERS; COMPUTER APPLICATION SOFTWARE FOR USE IN PLAYING, RECORDING AND EDITING SOUND, IMAGE AND DATA SIGNALS; SCANNERS, COMPUTER PRINTERS; BLANK MAGNETIC TAPES, BLANK OPTICAL DISCS, BLANK MAGNETIC DISCS, BLANK MAGNETO-OPTICAL DISCS, PACKAGED SEMICONDUCTORS; INTEGRATED CIRCUITS CONTAINING PROGRAMMING USED FOR AUDIO, VIDEO OR COMPUTER DATA PROCESSING; PRE-RECORDED AUDIO, VIDEO AND/OR COMPUTER DATA NAMELY, COMPACT DISCS, FLOPPY DISCS, AUDIO CASSETTE TAPES, VIDEO CASSETTE TAPES, MINIDISCS, DIGITAL VERSATILE DISCS, MAGNETO-OPTICAL DISCS, PACKAGED SEMICONDUCTORS AND IC CHIPS, ALL FEATURING MUSIC, MOVIES, PICTURES, ANIMATIONS AND WRITINGS; DATA RECORDING MEDIA, NAMELY, MAGNETIC TAPES, OPTICAL DISCS, MAGNETIC DISCS, MAGNETO-OPTICAL DISCS, AND INTEGRATED CIRCUITS ALL FEATURING MUSIC, MOVIES, PICTURES, ANIMATIONS AND WRITINGS; STORAGE MEDIA FOR AUDIO/VISUAL/COMPUTER DATA, NAMELY, COMPACT DISCS, BLANK FLOPPY DISCS, AUDIO CASSETTE TAPES, VIDEO CASSETTE TAPES, MINI DISCS, DIGITAL VERSATILE DISCS, MAGNETO-OPTICAL DISCS, PACKAGED SEMICONDUCTORS, IC CHIPS; BATTERIES, VIDEO GAME MACHINES FOR USE WITH TELEVISIONS, AUDIO AND VIDEO DATA PROCESSORS, DATA TRANSMISSION CABLES, ROBOTS FOR ENTERTAINMENT USE (U.S. CLS. 21, 23, 26, 36 AND 38).

WENDY GOODMAN, EXAMINING ATTORNEY

SN 76-388,628. ARM LIMITED, CAMBRIDGE, UNITED KINGDOM, FILED 3-28-2002.

**SECURCORE**

FOR COMPUTER HARDWARE, NAMELY INTEGRATED CIRCUITS, SMART CARDS, MICRO-PROCESSORS, MICROPROCESSOR CORES, MACRO CELLS, MICROCONTROLLERS, BUS INTERFACES AND PRINTED CIRCUIT BOARDS, CONTAINING A SECURITY COMPONENT, AND USER MANUALS FOR USE THEREWITH SOLD AS A UNIT; COMPUTER SOFTWARE USED IN AND FOR USE IN THE DESIGN AND DEVELOPMENT INTEGRATED CIRCUITS, SMART CARDS, MICROPROCESSORS, MICROPROCESSOR CORES, MACRO CELLS, MICROCONTROLLERS, BUS INTERFACES AND PRINTED CIRCUIT BOARDS, CONTAINING A SECURITY COMPONENT; COMPUTER SOFTWARE USED IN, AND FOR USE IN THE DESIGN AND DEVELOPMENT OF APPLICATION SOFTWARE AND OPERATING SYSTEM SOFTWARE; AND USER MANUALS FOR USE THEREWITH SOLD AS A UNIT (U.S. CLS. 21, 23, 26, 36 AND 38).

FIRST USE 10-0-2000; IN COMMERCE 10-0-2000.  
MONIQUE MILLER, EXAMINING ATTORNEY

**CLASS 9—(Continued).**

SN 76-429,311. TELEDYNE TECHNOLOGIES INCORPORATED, WEST LOS ANGELES, CA. FILED 7-11-2002.

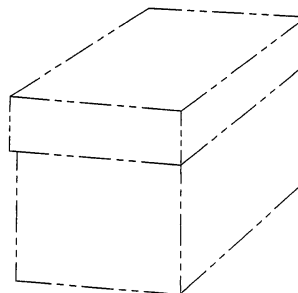

OWNER OF U.S. REG. NO. 1,419,798.

THE MARK CONSISTS OF THE COLOR PINK AS APPLIED TO SUBSTANTIALLY THE ENTIRE SURFACE OF THE GOODS. THE DOTTED OUTLINE OF THE GOODS IN THE DRAWING IS INTENDED TO SHOW THE APPLICATION OF THE MARK AND IS NOT A PART OF THE MARK.

SEC. 2(F).

FOR ELECTRIC STORAGE BATTERIES FOR COMMERCIAL AND CIVILIAN AIRCRAFT (U.S. CLS. 21, 23, 26, 36 AND 38).

FIRST USE 7-1-1977; IN COMMERCE 7-1-1977.

GLENN CLARK, EXAMINING ATTORNEY

SN 76-449,131. RALPH EDWARDS PRODUCTIONS, HOLLYWOOD, CA. FILED 9-13-2002.

**IT COULD BE YOU**

FOR AUDIO AND VISUAL RECORDINGS, NAMELY, CASSETTE TAPES, COMPACT DISCS, PHONOGRAPH RECORDS, AUDIO AND VIDEO TAPES, ALL FEATURING MATERIAL FROM A TELEVISION GAME SHOW; CD-ROM GAMES APPARATUS, NAMELY VIDEO GAME MACHINES FOR USE WITH TELEVISIONS; INTERACTIVE VIDEO GAME DEVICES COMPRISED OF COMPUTER HARDWARE AND SOFTWARE AND ACCESSORIES, NAMELY GAME CONSOLES, GAME CONTROLLERS, AND SOFTWARE FOR OPERATING GAME CONTROLLERS, SLOT MACHINES, COIN AND CARD OPERATED MACHINES FOR PLAYING GAMES OF CHANCE; EYEGLASSES AND SUNGLASSES; ELECTRONICALLY OR MAGNETICALLY ACTIVATED PREPAID TELEPHONE DEBIT CARDS; MAGNETS; DOWNLOADABLE INTERACTIVE COMPUTER GAME SOFTWARE (U.S. CLS. 21, 23, 26, 36 AND 38).

RONALD AIKENS, EXAMINING ATTORNEY

**CLASS 9—(Continued).**

SN 76-473,289. SHARP KABUSHIKI KAISHA, TA SHARP CORPORATION, OSAKA 545-8522, JAPAN, FILED 11-20-2002.

**FANTASTIC MOVIE  
CREATOR**

NO CLAIM IS MADE TO THE EXCLUSIVE RIGHT TO USE MOVIE CREATOR, APART FROM THE MARK AS SHOWN.

FOR SOFTWARE FOR EDITING AND/OR COMPOSING ORIGINAL SHORT VIDEO CLIPS AND/OR MOVIES ON A PERSONAL COMPUTER (U.S. CLS. 21, 23, 26, 36 AND 38).

CAROLYN CATALDO, EXAMINING ATTORNEY

---

SN 76-474,440. INTELLIVID CORPORATION, CAMBRIDGE, MA. FILED 12-10-2002.

**PROTECTING PEOPLE AND  
ASSETS WITH INTELLIGENT  
VIDEO ANALYSIS**

FOR COMPUTER-AIDED SURVEILLANCE SYSTEMS COMPRISED OF COMPUTER HARDWARE AND SOFTWARE THAT ANALYZE, COLLATE AND DISPLAY IMAGES AND DATA FROM A VARIETY OF SOURCES IN THE NATURE OF VIDEO CAMERAS, DIGITAL CAMERAS, RADAR, SONAR OR FORWARD LOOKING INFRA RED DEVICES, POINT OF SALE TERMINALS, EMPLOYEE TIME CLOCK SYSTEMS, EMPLOYEE ACCESS CONTROL SYSTEMS, PHOTO-ELECTRIC BEAMS, PROXIMITY SENSORS, ACCESS CONTROL SYSTEMS THAT GENERATE A DIGITAL DATA STREAM, ELECTRONIC ARTICLE SURVEILLANCE SYSTEMS, RADIO FREQUENCY IDENTIFICATION SYSTEMS, ULTRA-WIDEBAND SENSING SYSTEMS, AND POSITION SENSORS. (U.S. CLS. 21, 23, 26, 36 AND 38).

KATHLEEN M. VANSTON, EXAMINING ATTORNEY

---

SN 76-476,136. ORAXION, INC., PASADENA, CA. FILED 8-28-2002.



NO CLAIM IS MADE TO THE EXCLUSIVE RIGHT TO USE "DIAGNOSTICS", APART FROM THE MARK AS SHOWN.

FOR DEVICES FOR MEASURING THE TOPOGRAPHY, CURVATURE AND STRESS OF SEMICONDUCTOR WAFERS; OPTOELECTRONICS DEVICES, NAMELY, FLAT PANEL DISPLAYS; THIN FILM MEASUREMENT DEVICES FOR MEASURING TOPOGRAPHY, CURVATURE AND STRESS (U.S. CLS. 21, 23, 26, 36 AND 38).

NELSON SNYDER, EXAMINING ATTORNEY

**CLASS 9—(Continued).**

SN 76-479,299. KOKAM ENGINEERING CO., LTD., CHUNG-CHEONGNAM-DO, 320-844, REPUBLIC OF KOREA, FILED 12-31-2002.

**KOKAM**

PRIORITY CLAIMED UNDER SEC. 44(D) ON REPUBLIC OF KOREA APPLICATION NO. 40-2002-0030, FILED 7-4-2002, REG. NO. 0559933, DATED 9-19-2003, EXPIRES 9-19-2013.

FOR LITHIUM SECONDARY BATTERIES, MP3 PLAYER, DIGITAL CAMERA, CHARGER FOR BATTERIES, PROTECTIVE ELECTRICAL CIRCUIT FOR BATTERIES, PORTABLE TELECOMMUNICATION APPARATUS, NAMELY PERSONAL DIGITAL ASSISTANTS AND CELLULAR TELEPHONES; PHOTOGRAPHY FLASHLIGHTS, NAMELY FLASHBULBS AND PHOTOFLASHES (U.S. CLS. 21, 23, 26, 36 AND 38).

ALICIA COLLINS, EXAMINING ATTORNEY

---

SN 76-479,731. CELESTRON ACQUISITION, LLC, TORRANCE, CA. FILED 12-30-2002.

**SKYMASTER**

FOR BINOCULARS (U.S. CLS. 21, 23, 26, 36 AND 38).

MICHAEL ENGEL, EXAMINING ATTORNEY

---

SN 76-480,165. TURPIN, LARRY, ESCONDIDO, CA. FILED 12-26-2002.

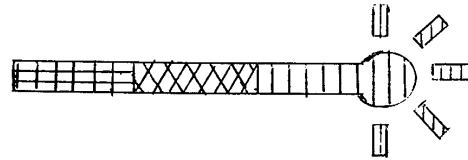

THE DESIGN CONSISTS OF A HORIZONTAL LINE WHICH, FROM LEFT TO RIGHT, CHANGES FROM YELLOW TO AMBER TO RED AND ENDS WITH A RED DOT ENCIRCLED BY OUTWARDLY RADIATING RED LINES.

FOR MEASURING INSTRUMENT FOR USE IN MEASURING THE EXACT DROP AND GAIT IN CONSTRUCTING A GATE, FENCE, OR THE LIKE, ON A SLOPING TERRAIN, SAID INSTRUMENT CONSISTS OF A NON-MEDICAL LASER, CARPENTER'S LEVEL, MEASURING TAPE AND A MAGNETIC ATTACHMENT (U.S. CLS. 21, 23, 26, 36 AND 38).

MARC LEIPZIG, EXAMINING ATTORNEY



**CLASS 9—(Continued).**

SN 76-484,235. ICP GLOBAL TECHNOLOGIES INC., MONTREAL, QUEBEC, H3N 1W5, CANADA, FILED 1-23-2003.

**BATTERYSAVER FLEX**

NO CLAIM IS MADE TO THE EXCLUSIVE RIGHT TO USE BATTERYSAVER, APART FROM THE MARK AS SHOWN.

FOR SOLAR PANEL BATTERY CHARGES AND SOLAR PANEL POWER SUPPLIES (U.S. CLS. 21, 23, 26, 36 AND 38).

DORITT L. CARROLL, EXAMINING ATTORNEY

---

SN 76-492,054. NCI TECHNOLOGY INC., PALATINE, IL. FILED 2-21-2003.

**NCITECHNOLOGY**

FOR COMPUTER SOFTWARE FOR DATA BASE MANAGEMENT, WORD PROCESSING AND SPREAD SHEET, REPORT AND PRESENTATION, WEB BASED APPLICATIONS, AND HARDWARE IMBEDDED PROGRAMS FOR USE IN THE FIELD OF ENTERPRISE RESOURCES MANAGEMENT PROGRAMS (U.S. CLS. 21, 23, 26, 36 AND 38).

VIVIAN MICZNIK FIRST, EXAMINING ATTORNEY

---

SN 76-495,420. SEIKO EPSON KABUSHIKI KAISHA, DBA SEIKO EPSON CORPORATION, SHINJUKU-KU, TOKYO, JAPAN, FILED 2-21-2003.

**PPPS**  
*Professional Portrait Printing System*

PRIORITY CLAIMED UNDER SEC. 44(D) ON JAPAN APPLICATION NO. 2003-004379, FILED 1-23-2003, REG. NO. 4749366, DATED 2-20-2004, EXPIRES 2-20-2014.

FOR COMPUTERS, INK-JET PRINTERS, AND LIQUID CRYSTAL DISPLAYS; PORTRAIT PRINTING SYSTEM, NAMELY FILLED INK CARTRIDGES FOR COMPUTER PRINTERS, COMPUTERS, PRINTERS, DISPLAYS, COMPUTER SOFTWARE FOR PROCESSING DIGITAL IMAGES, AND CONTROLLING PRINTER OPERATION, PRINTING PAPER, AND MANUALS, SOLD AS A SET (U.S. CLS. 21, 23, 26, 36 AND 38).

NORA BUCHANAN WILL, EXAMINING ATTORNEY

**CLASS 9—(Continued).**

SN 76-507,299. IT OPTICS, INC., LOS ANGELES, CA. FILED 4-4-2003.

NO CLAIM IS MADE TO THE EXCLUSIVE RIGHT TO USE "EYE WEAR", APART FROM THE MARK AS SHOWN. THE LINING OR SHADING SHOWN IN THE DRAWING IS A FEATURE OF THE MARK AND NOT INTENDED TO INDICATE COLOR.

THE WORD MARK "I-WEAR" WITH A SWAG UNDERNEATH.

FOR EYEGLASSES; SUNGLASSES; AND EYEGLASS ACCESSORIES, NAMELY, EYEGLASS CASES, EYEGLASS CHAINS, EYEGLASS FRAMES, AND EYEGLASS CLEANING CLOTH (U.S. CLS. 21, 23, 26, 36 AND 38).

FIRST USE 9-0-2002; IN COMMERCE 9-0-2002.

SUSAN LESLIE DUBOIS, EXAMINING ATTORNEY

---

SN 76-517,650. APPLIED CONCEPTS, INC., WILLOUGHBY HILLS, OH. FILED 5-5-2003.

**DA VINCI**

FOR ELECTRONIC ACCOUNTING AND MANAGEMENT SYSTEM COMPRISED OF A NETWORK OF USER DISPLAY TERMINALS CONNECTED TO A HOST CENTRAL PROCESSING UNIT USED BY BINGO HALLS AND CASINOS (U.S. CLS. 21, 23, 26, 36 AND 38).

FIRST USE 10-0-2000; IN COMMERCE 10-0-2000.

CIMMERIAN COLEMAN, EXAMINING ATTORNEY

---

SN 76-519,388. HEALTH MANAGEMENT GROUP, INC., THE, AKRON, OH. FILED 6-4-2003.

**SMART PORTIONS**

NO CLAIM IS MADE TO THE EXCLUSIVE RIGHT TO USE PORTIONS, APART FROM THE MARK AS SHOWN.

FOR COMPARTMENTALIZED MEASURING DISHES FOR FOOD; DIETARY INSTRUCTIONAL TOOL RELATED THERETO, NAMELY, PRINTED DISC FOR DETERMINING CALORIE LEVEL OF CERTAIN FOODS, SOLD AS A UNIT (U.S. CLS. 21, 23, 26, 36 AND 38).

ZACHARY BELLO, EXAMINING ATTORNEY

**CLASS 9—(Continued).**

SN 76-521,124. SMART TECHNOLOGIES INC., CALGARY, ALBERTA, CANADA, FILED 6-6-2003.



FOR DIGITAL TOUCH TECHNOLOGY, NAMELY, DIGITAL CAMERAS AND COMPUTER SOFTWARE TO DETERMINE THE LOCATION OF A TOUCH OR A NEAR-TOUCH OF A DISPLAY SURFACE IN ORDER TO NAVIGATE AND CONTROL COMPUTER APPLICATIONS AS IF PERFORMED THROUGH THE COMPUTER'S MOUSE (U.S. CLS. 21, 23, 26, 36 AND 38).

FIRST USE 3-12-2003; IN COMMERCE 3-12-2003.  
MICHAEL BAIRD, EXAMINING ATTORNEY

SN 76-522,335. L.F.P., INC., BEVERLY HILLS, CA. FILED 6-5-2003.

## HUSTLER'S ANAL SEDUCTION

OWNER OF U.S. REG. NOS. 1,011,001, 2,410,985 AND OTHERS.

NO CLAIM IS MADE TO THE EXCLUSIVE RIGHT TO USE ANAL SEDUCTION, APART FROM THE MARK AS SHOWN.

FOR PRE-RECORDED VIDEO TAPES AND DIGITAL VIDEO DISCS (DVDS) IN THE FIELD OF ADULT ENTERTAINMENT (U.S. CLS. 21, 23, 26, 36 AND 38).

FIRST USE 5-27-2003; IN COMMERCE 5-27-2003.  
NAAKWAMA ANKRAH, EXAMINING ATTORNEY

SN 76-527,448. NAVAERO AB, 852 34 SUNDSVALL, SWEDEN, FILED 6-23-2003.

## NAVAERO

FOR DISPLAY HARDWARE FOR USE IN AIRPLANES COMPRISED OF A MONITOR, WITH OR WITHOUT A COMPUTER, CABLES, OPERATING SOFTWARE, EMERGENCY BATTERY BACK-UP POWER PACK, INTERFACE CONNECTORS, ALL FOR USE WITH THE MONITOR BY AIRPLANE PILOTS, FOR USE IN NAVIGATION SYSTEMS (U.S. CLS. 21, 23, 26, 36 AND 38).

EUGENIA MARTIN, EXAMINING ATTORNEY

**CLASS 9—(Continued).**

SN 76-533,775. LOHSE, VICTORIA, DBA PURE HEART, SAUSALITO, CA. FILED 7-31-2003.

## PURE HEART ANGEL KIDS

NO CLAIM IS MADE TO THE EXCLUSIVE RIGHT TO USE "KIDS", APART FROM THE MARK AS SHOWN.

FOR COMPUTER GAME SOFTWARE, ELECTRONIC GAME PROGRAMS, VIDEO GAME CARTRIDGES, VIDEO GAME SOFTWARE AND VIDEOTAPES AND DVDS CONTAINING CHILDREN'S ENTERTAINMENT (U.S. CLS. 21, 23, 26, 36 AND 38).

NICHOLAS ALTREE, EXAMINING ATTORNEY

SN 76-535,972. GPT GLENDALE, INC., ATTLEBORO FALLS, MA. FILED 7-25-2003.

## I-BLOCK

FOR EYE-SHIELDS, NAMELY, SAFETY GOGGLES USED BY PATIENTS TO PROTECT EYES DURING MEDICAL TREATMENT (U.S. CLS. 21, 23, 26, 36 AND 38).

BILL DAWE, EXAMINING ATTORNEY

SN 76-537,594. I-D-X COMPANY LIMITED, KAWASAKI-SHI, KANAGAWA-KEN, JAPAN, FILED 8-14-2003.

## I-TRAX

FOR BATTERIES AND THEIR ACCESSORIES, NAMELY, POWER CABLES, ELECTRICAL BATTERY CONNECTORS, AND ELECTRICAL BATTERY CHARGERS AND DISCHARGERS, FOR VIDEO CAMERAS FOR THE BROADCAST AND VIDEO INDUSTRY (U.S. CLS. 21, 23, 26, 36 AND 38).

ELIZABETH HUGHITT, EXAMINING ATTORNEY

SN 76-538,675. ADVANCED TECHNOLOGIES GROUP, INC., LOMBARD, IL. FILED 8-8-2003.

## ACTIVE VISUAL SYSTEM

NO CLAIM IS MADE TO THE EXCLUSIVE RIGHT TO USE "VISUAL SYSTEMS", APART FROM THE MARK AS SHOWN.

FOR COMPUTER SOFTWARE NAMELY, FOR USE IN FACILITY MANAGEMENT FOR (A) SPACE UTILIZATION, (B) PROPERTY, MAINTENANCE AND ASBESTOS MANAGEMENT, (C) MONITORING BUILDING COMPLIANCE WITH LEGAL REQUIREMENTS PERTAINING TO THE DISABLED, (D) MEDICAL GAS, ELECTRICAL, HVAC, PLUMBING, COMMUNICATION AND LIFE SAFETY SYSTEMS, (E) ENVIRONMENTAL SERVICES, AND (F) FACILITY CONDITION ASSESSMENT (U.S. CLS. 21, 23, 26, 36 AND 38).

FIRST USE 9-1-1997; IN COMMERCE 9-1-1997.

PAULA MAYS, EXAMINING ATTORNEY

**CLASS 9—(Continued).**

SN 76-540,173. SKYDON CORP., CITY OF INDUSTRY, CA.  
FILED 8-11-2003.

**EXPURGEN**

OWNER OF U.S. REG. NO. 2,814,124.  
FOR ELECTROLYSIS CELL HAVING A POSITIVE ELECTRODE AND A NEGATIVE ELECTRODE THAT SEPARATES THE IONS IN A SOLUTION ACCORDING TO THEIR RESPECTIVE CHARGES UPON PASSAGE OF ELECTRIC CURRENT; ELECTRONIC EQUIPMENT, NAMELY ELECTROLYSIS CELL FOR USE IN THE MANUFACTURE OF VARIOUS IONIC SOLUTIONS (U.S. CLS. 21, 23, 26, 36 AND 38).  
FIRST USE 3-21-2002; IN COMMERCE 3-30-2002.  
DORITT L. CARROLL, EXAMINING ATTORNEY

---

SN 76-544,182. TOURMALINE NETWORKS, INC., SOLANA BEACH, CA. FILED 8-28-2003.

**EMAIL EXECUTIVE**

NO CLAIM IS MADE TO THE EXCLUSIVE RIGHT TO USE "EMAIL", APART FROM THE MARK AS SHOWN.  
FOR COMPUTER SOFTWARE AND DOWNLOADABLE COMPUTER SOFTWARE FOR WIRELESS TELECOMMUNICATIONS AND ELECTRONIC MAIL APPLICATIONS, NAMELY, A CELL PHONE BASED UTILITY FOR READING, COMPOSING, SENDING, RECEIVING, AND MANAGING ELECTRONIC MAIL (U.S. CLS. 21, 23, 26, 36 AND 38).  
FIRST USE 10-6-2002; IN COMMERCE 3-1-2003.  
JOHN LINCOSKI, EXAMINING ATTORNEY

---

SN 76-546,484. POZEN SERVICES INC., LA GRANGE, IL.  
FILED 9-24-2003.

**SO TELL ME...**

FOR COMPUTER SOFTWARE PROGRAM FOR ORGANIZING AND DISPLAYING PERSONAL MEDICAL AND HEALTH INFORMATION (U.S. CLS. 21, 23, 26, 36 AND 38).  
KATHRYN COWARD, EXAMINING ATTORNEY

**CLASS 9—(Continued).**

SN 76-547,938. PROTEL, INC., LAKELAND, FL. FILED 9-29-2003.



OWNER OF U.S. REG. NOS. 1,472,072 AND 1,962,120.  
FOR TELEPHONES, ELECTRONIC TELEPHONE OPERATION EQUIPMENT, NAMELY COIN, CARD-OPERATED AND TOLL TELEPHONE TEST SETS, TELEPHONE HOUSINGS AND COMPONENTS THEREFORE; COMPUTER SOFTWARE FOR OPERATION AND MANAGEMENT OF COIN, CARD-OPERATED AND TOLL TELEPHONE EQUIPMENT; COMPUTER SOFTWARE FOR OPERATION AND MANAGEMENT OF TOLL WIRELESS AND WIRELINE TELEPHONE EQUIPMENT; ELECTRICALLY OPERATED COIN MECHANISMS FOR USE IN VENDING DEVICES AND OTHER COIN-OPERATED DEVICES, INCLUDING PAY TELEPHONES, GENERAL PURPOSE VENDING MACHINES, NEWSPAPER VENDING MACHINES, AMUSEMENT GAMES AND RIDES, CAR WASHING AND VACUUMING VENDING MACHINES, AND CLOTHES WASHING AND CLEANING MACHINES; ELECTRICALLY OPERATED COIN MECHANISMS SOLD AS AN INTEGRAL COMPONENT OF PAY PHONES, GENERAL PURPOSE VENDING MACHINES, AND NEWSPAPER VENDING MACHINES; COMPUTER SOFTWARE AND HARDWARE FOR REMOTE OPERATION AND MANAGEMENT OF VENDING MACHINES; AND TELEPHONE LINE SECURITY EQUIPMENT, NAMELY, ELECTRICAL CIRCUITS FOR TELEPHONE LINE TAP DETECTION AND TELEPHONE LINE CUT DETECTION (U.S. CLS. 21, 23, 26, 36 AND 38).  
FIRST USE 10-0-1998; IN COMMERCE 10-0-1998.  
ALICIA COLLINS, EXAMINING ATTORNEY

---

SN 76-551,536. CINCOM SYSTEMS, INC., CINCINNATI, OH.  
FILED 10-16-2003.

**CINCOM TIGER**

OWNER OF U.S. REG. NOS. 1,051,726, 2,176,738 AND OTHERS.  
FOR COMPUTER SOFTWARE THAT ACCESSES, INTEGRATES, JOINS AND CACHES DATA FROM HETEROGENEOUS DATA SOURCES WITH SUPPORT FOR RELATIONAL, OBJECT - ORIENTED AND XML DATABASE MANAGEMENT CAPABILITIES INCLUDING XML TAGGING, QUERYING, STORAGE AND RETRIEVAL CAPABILITIES (U.S. CLS. 21, 23, 26, 36 AND 38).  
FIRST USE 5-13-2003; IN COMMERCE 5-13-2003.  
NICHOLAS ALTREE, EXAMINING ATTORNEY

**CLASS 9—(Continued).**

SN 76-554,161. TELEFONIX, INC., WAUKEGAN, IL. FILED 10-27-2003.

**TELEFONIX**

OWNER OF U.S. REG. NO. 2,677,612.  
FOR ELECTRONIC COMPONENTS, NAMELY CORD REELS AND CORD STORAGE DEVICES; AND CURRENT CARRYING WIRE AND WIRING DEVICES, NAMELY CABLE ASSEMBLIES (U.S. CLS. 21, 23, 26, 36 AND 38).

FIRST USE 1-31-1989; IN COMMERCE 5-31-1989.  
PRISCILLA MILTON, EXAMINING ATTORNEY

SN 76-556,738. POWER BATTERY CO., INC., PATERSON, NJ. FILED 11-4-2003.

**POWER** 

NO CLAIM IS MADE TO THE EXCLUSIVE RIGHT TO USE "POWER", APART FROM THE MARK AS SHOWN.

FOR AUTOMOTIVE, TRUCK AND INDUSTRIAL BATTERIES, VALVE REGULATED LEAD ACID BATTERIES, WET LEAD ACID BATTERIES, BATTERY CHARGERS, BATTERY CABINETS AND BATTERY RACK SYSTEMS, BATTERY POWERED STANDBY AND BACKUP POWER SYSTEMS AND RELATED POWER SYSTEM COMPONENTS, NAMELY, CIRCUIT BREAKERS, ELECTRIC JUNCTION BOXES, BATTERY TERMINAL BLOCKS, BATTERY CABLES AND ELECTRICAL FUSES (U.S. CLS. 21, 23, 26, 36 AND 38).

FIRST USE 0-0-1975; IN COMMERCE 0-0-1975.  
KATHRYN COWARD, EXAMINING ATTORNEY

SN 76-556,861. TELSTON, INC., SEOUL, 135-815, REPUBLIC OF KOREA, FILED 10-21-2003.

**X-SOUND** 

FOR PERSONAL HOME AND MOBILE AUDIO SURROUND SOUND SYSTEM CONSISTING OF AMBIANCE AND SURROUND SOUND PROCESSORS, SOUND AMPLIFIERS, SURROUND SOUND CIRCUITS, AUDIO CABLES, ELECTRICAL CONNECTORS, CASSETTE PLAYERS, CASSETTE RECORDERS, AUDIO COMPACT DISC PLAYERS, HEADPHONES, AUDIO RECEIVERS, LOUD SPEAKERS, POWERED SUBWOOFERS, RADIO RECEIVERS, RADIO TRANSMITTERS, SIGNAL PROCESSORS, SPEAKER SELECTORS, SURGE PROTECTORS, POWER STRIPS, STEREO TUNERS, TURNTABLES, VOLUME SWITCHES, WIRELESS HEADPHONES, WIRELESS AUDIO TRANSMITTERS, AND COMPUTER CABLES (U.S. CLS. 21, 23, 26, 36 AND 38).

BARBARA A. LOUGHRAN, EXAMINING ATTORNEY

**CLASS 9—(Continued).**

SN 76-562,390. SECURITY LABS INC., NOBLESVILLE, IN. FILED 12-1-2003.

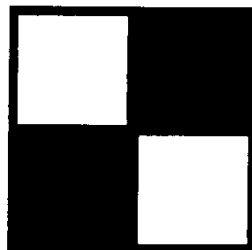

FOR SECURITY VIDEO TAPE RECORDER VHS, VIDEO MONITORS, VIDEO CAMERAS, VIDEO PROCESSOR (U.S. CLS. 21, 23, 26, 36 AND 38).

FIRST USE 11-7-2003; IN COMMERCE 11-7-2003.  
SHARON MEIER, EXAMINING ATTORNEY

SN 76-564,648. ENETLOAN.COM, INC., GARDEN CITY, NY. FILED 12-11-2003.

**LOAN PLACER**

NO CLAIM IS MADE TO THE EXCLUSIVE RIGHT TO USE "LOAN", APART FROM THE MARK AS SHOWN.

FOR COMPUTER PROGRAM FOR ANALYZING DATA REGARDING QUALIFICATIONS FOR A MORTGAGE AND CONSUMER CREDIT (U.S. CLS. 21, 23, 26, 36 AND 38).

CAROLYN GRAY, EXAMINING ATTORNEY

SN 76-565,410. ENOVATION SOLUTIONS, LTD., COLUMBUS, OH. FILED 12-3-2003.

**DIRECT HIT**

THE MARK CONSISTS OF STANDARD CHARACTERS WITHOUT CLAIM TO ANY PARTICULAR FONT, STYLE, SIZE, OR COLOR.

FOR COMPUTER SOFTWARE USED IN THE MANAGEMENT OF MARKETING AND SALES FUNCTIONS OF HOME REMODELING BUSINESSES (U.S. CLS. 21, 23, 26, 36 AND 38).

DOMINICK J. SALEMI, EXAMINING ATTORNEY

**CLASS 9—(Continued).**

SN 76-566,336. ARROW TRU-LINE, INC., ARCHBOLD, OH. FILED 12-22-2003.

**APCO**

THE MARK CONSISTS OF STANDARD CHARACTERS WITHOUT CLAIM TO ANY PARTICULAR FONT, STYLE, SIZE, OR COLOR.

OWNER OF U.S. REG. NO. 2,118,737.  
FOR COMPUTER SOFTWARE PROGRAMS FOR FIGURING OVERHEAD SECTIONAL DOOR CHARACTERISTICS AND INSTRUCTION MANUALS SOLD AS A UNIT (U.S. CLS. 21, 23, 26, 36 AND 38).  
FIRST USE 0-0-1994; IN COMMERCE 0-0-1994.  
STEVEN BERK, EXAMINING ATTORNEY

SN 76-566,562. COMMSCOPE PROPERTIES LLC, SPARKS, NV. FILED 12-23-2003.

**COMMSCOPE SOLUTIONS**

THE MARK CONSISTS OF STANDARD CHARACTERS WITHOUT CLAIM TO ANY PARTICULAR FONT, STYLE, SIZE, OR COLOR.

OWNER OF U.S. REG. NOS. 898,651, 2,678,856 AND OTHERS.  
FOR COMMUNICATIONS CABLE, NAMELY, COAXIAL CABLE, TWISTED PAIR CABLE, FIBER OPTIC CABLE, AND HYBRIDS THEREOF, AND CABLE CONNECTORS THEREFOR; FIBER OPTIC WIRE, CORDS AND CABLES; WIRE PATCH CORDS; FIBER OPTIC INTERCONNECTION CABLES; TELECOMMUNICATIONS ADAPTORS; TELECOMMUNICATIONS CONNECTORS, PLUGS, JACKS AND CONNECTING BLOCKS; TELECOMMUNICATIONS DEVICES THAT REPEAT, RESHAPE, OR REFORMAT SIGNALS FROM DATA TERMINALS AND CONTROLLERS; TELECOMMUNICATIONS BRACKETS, CLIPS AND CLAMPS TO HOUSE AND SUPPORT CABLE AND TELECOMMUNICATIONS EQUIPMENT ALL DISTRIBUTED AS A UNIT AND; ELECTRICAL WIRE FOR USE IN THE TELECOMMUNICATIONS INDUSTRY (U.S. CLS. 21, 23, 26, 36 AND 38).  
RONALD MCMORROW, EXAMINING ATTORNEY

**CLASS 9—(Continued).**

SN 76-570,114. COMMSCOPE PROPERTIES LLC, SPARKS, NV. FILED 1-14-2004.

**CommScope**  
CARRIER SOLUTIONS

OWNER OF U.S. REG. NOS. 898,651, 2,678,856 AND OTHERS.

NO CLAIM IS MADE TO THE EXCLUSIVE RIGHT TO USE "CARRIER", APART FROM THE MARK AS SHOWN.  
FOR TELECOMMUNICATIONS PRODUCTS; NAMELY, TELEPHONE CABLE SYSTEMS COMPRISING DISTRIBUTION FRAMES, CABLES, CONNECTORS, CABLE RACKS AND DUCTS FOR USE WITH CENTRAL OFFICE SWITCHING TRANSMISSION APPARATUS (U.S. CLS. 21, 23, 26, 36 AND 38).  
RONALD MCMORROW, EXAMINING ATTORNEY

SN 76-570,115. COMMSCOPE PROPERTIES LLC, SPARKS, NV. FILED 1-14-2004.

**COMMSCOPE CARRIER SOLUTIONS**

THE MARK CONSISTS OF STANDARD CHARACTERS WITHOUT CLAIM TO ANY PARTICULAR FONT, STYLE, SIZE, OR COLOR.

OWNER OF U.S. REG. NOS. 898,651, 2,678,856 AND OTHERS.  
NO CLAIM IS MADE TO THE EXCLUSIVE RIGHT TO USE "CARRIER", APART FROM THE MARK AS SHOWN.  
FOR TELECOMMUNICATIONS PRODUCTS; NAMELY, TELEPHONE CABLE SYSTEMS COMPRISING DISTRIBUTION FRAMES, CABLES, CONNECTORS, CABLE RACKS AND DUCTS FOR USE WITH CENTRAL OFFICE SWITCHING TRANSMISSION APPARATUS (U.S. CLS. 21, 23, 26, 36 AND 38).  
RONALD MCMORROW, EXAMINING ATTORNEY

SN 76-570,888. ROBERT BOSCH GMBH, 70839 GERLINGEN, FED REP GERMANY, FILED 1-16-2004.

**EAZEO**

THE MARK CONSISTS OF STANDARD CHARACTERS WITHOUT CLAIM TO ANY PARTICULAR FONT, STYLE, SIZE, OR COLOR.

FOR ELECTRIC AND ELECTRONICAL OBSERVATION CAMERAS (U.S. CLS. 21, 23, 26, 36 AND 38).  
IRENE D. WILLIAMS, EXAMINING ATTORNEY

**CLASS 9—(Continued).**

SN 78-002,385. CARDIFF SOFTWARE, INC., VISTA, CA. FILED 4-3-2000.

**LIQUIDOFFICE**

FOR COMPUTER SOFTWARE PROGRAMS FOR CREATING, PROCESSING, SHARING, AND VIEWING BUSINESS DOCUMENTS AND FORMS OVER AN INTRANET OR OVER THE INTERNET (U.S. CLS. 21, 23, 26, 36 AND 38).

JOHN GARTNER, EXAMINING ATTORNEY

SN 78-032,028. AT&T CORP., NEW YORK, NY. FILED 10-24-2000.

**ADVANTIS**

OWNER OF U.S. REG. NOS. 1,933,438, 2,056,011 AND OTHERS.

FOR MAGNETIC CALLING CARDS AND PREPAID MAGNETIC CALLING CARDS (U.S. CLS. 21, 23, 26, 36 AND 38).

ANN E. SAPPENFIELD, EXAMINING ATTORNEY

SN 78-060,201. TECH SYSTEM TECHNOLOGY LIMITED, HONG KONG, HONG KONG, FILED 4-25-2001.

**OPENCARE**

FOR COMPUTER SOFTWARE FOR USE IN COLLECTING BILLING DATA, MANAGING SUBSCRIBER INFORMATION, PROCESSING ACCOUNTS RECEIVABLE, MANAGING DELINQUENT ACCOUNTS AND ISSUING INVOICES IN THE FIELDS OF CONVERGENT BILLING, CUSTOMER CARE, IP MEDIATION, INTERNET SERVICE PROVISIONING, AND REVENUE MODELLING (U.S. CLS. 21, 23, 26, 36 AND 38).

FIRST USE 0-0-2000; IN COMMERCE 0-0-2000.

ANN E. SAPPENFIELD, EXAMINING ATTORNEY

SN 78-060,204. TECH SYSTEM TECHNOLOGY LIMITED, HONG KONG, HONG KONG, FILED 4-25-2001.

**IOPENCARE**

FOR COMPUTER SOFTWARE FOR USE OVER A GLOBAL COMPUTER NETWORK, WHICH PROVIDES THE INTERNET BUSINESS UNITS WITH SELF-CARE, SERVICE PROVISIONING, CUSTOMER CARE AND AGENT MANAGEMENT THAT INTERFACE WITH IP BASED CONVERGENT BILLING AND CUSTOMER CARE SYSTEM (U.S. CLS. 21, 23, 26, 36 AND 38).

FIRST USE 0-0-2000; IN COMMERCE 0-0-2000.

ANN E. SAPPENFIELD, EXAMINING ATTORNEY

**CLASS 9—(Continued).**

SN 78-116,136. SIMPLEXGRINNELL LP, WESTMINSTER, MA. FILED 3-20-2002.

**SAFELINC**

FOR SOFTWARE LOCATED IN A FIRE ALARM CONTROL PANEL MODULE FOR ENABLING REMOTE ACCESS TO THE FIRE ALARM CONTROL PANEL'S INFORMATION VIA A NETWORK (U.S. CLS. 21, 23, 26, 36 AND 38).

ANN E. SAPPENFIELD, EXAMINING ATTORNEY

SN 78-137,389. ENLEAGUE SYSTEMS, INCORPORATED, ATLANTA, GA. FILED 6-20-2002.

**ENLEAGUE**

FOR COMPUTER SOFTWARE, NAMELY, SEMANTIC INTEGRATION SOFTWARE FOR INTEGRATING DATA, APPLICATIONS, AND BUSINESS PROCESSES WITHIN AND BETWEEN ORGANIZATIONS THROUGH THE USE OF ONTOLOGICAL MODELS AND WITHIN THE CONTEXT OF A DESCRIPTION LOGIC FRAMEWORK (U.S. CLS. 21, 23, 26, 36 AND 38).

ANN E. SAPPENFIELD, EXAMINING ATTORNEY

SN 78-149,141. MEDION AG, ESSEN, FED REP GERMANY, FILED 7-31-2002.

**MEGAPIXX**

PRIORITY CLAIMED UNDER SEC. 44(D) ON FED REP GERMANY APPLICATION NO. 30220030409, FILED 4-20-2002, REG. NO. 30220030.4, DATED 4-20-2002, EXPIRES 4-30-2012.

FOR COMMUNICATION AND ENTERTAINMENT APPARATUS, NAMELY, RADIOS, DIGITAL VIDEO DISC RECORDER, PORTABLE LISTENING DEVICES, NAMELY, MP3 PLAYERS, CAR RADIOS, RECORD PLAYERS, CASSETTE RECORDERS, EAR PHONES, VIDEO CAMERAS AND VIDEO RECORDERS, DIGITAL COMPACT DISC PLAYERS, MAGNETIC AUDIO TAPE RECORDERS, LOUDSPEAKERS, TELEVISION SETS, AUDIO MIXERS, AUDIO SPEAKERS, DIGITAL AUDIO TAPE PLAYERS, MUSICAL JUKE BOXES, LOUDSPEAKER SYSTEMS CONSISTING OF LOUDSPEAKERS, AMPLIFIERS AND A COMBINATION OF ONE OR MORE OF A RADIO TUNER, COMPACT DISC PLAYER AND TAPE PLAYER; TELEPHONE, AUDIO, VIDEO AND STEREO RECEIVERS; TRANSPONDERS, LIQUID CRYSTAL DISPLAYS; GRAPHIC EQUALIZER, VIDEO MONITORS, TELEVISIONS; REPLACEMENT PARTS FOR COMMUNICATION AND ENTERTAINMENT APPARATUS, NAMELY, ACOUSTIC CONDUITS, ELECTRICITY CONDUITS, FIBRE OPTIC LIGHT AND IMAGE CONDUITS, ELECTRICAL CIRCUITS FOR USE IN AMUSEMENT GAME MACHINES FOR REPRODUCING MUSIC, SPEECH AND SPECIAL EFFECTS, ELECTRONIC EFFECTS PEDALS FOR USE WITH SOUND AMPLIFIERS; BLANK VIDEO CASSETTE TAPES; PRERECORDED VIDEO CASSETTE TAPES FEATURING MOVING PICTURES, MOTION PICTURE FILMS, AND MUSIC; BLANK COMPACT DISCS, DVDS AND AUDIO CASSETTE TAPES; PRERECORDED COMPACT DISCS, DVDS AND AUDIO CASSETTE TAPES FEATURING MOVING PICTURES, MOTION PICTURE FILMS, AND MUSIC; ANTENNAS, COMBINATION RADIO AUDIO CASSETTE RECORDERS, COMBINATION RADIO COMPACT DISC RECORDERS, COMBINATION RADIO MP-3 RECORDERS, COMBINATION RADIO MEMORY CHIP RECORDERS, PROJECTORS, NAMELY, MOVIE PRO-

**CLASS 9—(Continued).**

JECTORS, PHOTOGRAPHIC PROJECTORS, SLIDE PROJECTORS, OVERHEAD PROJECTORS; VIDEO AND AUDIO FADERS, MICROPHONES, APPARATUS FOR EDITING IMAGES, NAMELY, APPARATUS FOR CUFFING IMAGES AND COMPUTERS FOR DIGITALLY EDITING ELECTRONIC IMAGES; DICTATING MACHINES, WALKIE-TALKIES, MONITORING APPARATUS AND OPERATIONAL SYSTEMS MADE THEREOF, NAMELY, PHOTOGRAPHIC AND VIDEO CAMERAS, ELECTRONIC MOTION AND TOUCH SENSITIVE SWITCHES, VIDEO MONITORS, COMPUTER OPERATING SOFTWARE; ELECTRIC CALCULATORS, ELECTRONIC CALCULATORS, POCKET CALCULATORS; ELECTRONIC DATA PROCESSORS, COMPUTER AND COMPUTER PERIPHERAL EQUIPMENT AND PARTS THEREOF, NAMELY, PERSONAL COMPUTERS, COMPUTERS FOR GAMES, HOME COMPUTERS, NOTEBOOK COMPUTERS, COMPUTER MONITORS, AUDIO SPEAKERS, DATA INPUT-OUTPUT APPARATUS, NAMELY, COMPUTER KEYBOARDS, COMPUTER JOYSTICK, VIDEO GAME INTERACTIVE CONTROL FLOOR PADS AND COMPUTER MOUSE; SCANNERS, COMPUTER PRINTERS, PRINTER INTERFACE CONVERTERS, COMPUTER TERMINALS, COMPUTER INTERFACE CARDS, BLANK DISKETTES AND CD-ROM; PRERECORDED COMPUTER DISKETTES AND CD-ROM FEATURING MOVING PICTURES, MOTION PICTURE FILMS, AND MUSIC; DRIVES OF ALL KIND, NAMELY, HARD DRIVES FOR COMPUTERS, BACKUP DRIVES FOR COMPUTERS, CD DRIVES FOR COMPUTERS, CD-ROM DRIVES, COMPUTER DISK DRIVES, DIGITAL VIDEO DISK DRIVES, OPTICAL DISK DRIVES; STORAGE MODULES, NAMELY, BLANK TAPES FOR STORAGE OF COMPUTER DATA; COMPUTER DATA STORAGE SYSTEMS COMPRISED OF BLANK OPTICAL DISKS, BLANK DIGITAL COMPACT DISCS, BLANK MAGNETIC DATA CARRIERS, MEMORY CARDS, CD-ROM WRITERS AND MAGNETIC CODED CARD READERS, FLASH MEMORY CARD READERS, ENCODED CHIP CARD READERS; CD-ROM WRITERS, COMPUTER MAIN BOARDS; PLUG-IN-COMPONENTS, NAMELY, MODEMS, ISDN-CARDS, SOUND CARDS, GRAPHIC CARDS; DIGITAL CAMERAS; COMPUTER PROGRAMS, EXCLUDING SOFTWARE PROGRAMS FOR PRODUCING OPTICALLY VARIABLE DEVICES AND SECURITY DEVICES, STORED ON CD-ROM AND TAPES FOR STORAGE OF COMPUTER DATA, NAMELY, COMMUNICATIONS SOFTWARE FOR CONNECTING COMPUTER NETWORK USERS AND GLOBAL COMPUTER NETWORKS, COMPUTER COMMUNICATIONS SOFTWARE TO ALLOW CUSTOMERS TO ACCESS BANK ACCOUNT INFORMATION AND TRANSACT BUSINESS, COMPUTER E-COMMERCE SOFTWARE TO ALLOW USERS TO PERFORM ELECTRONIC BUSINESS TRANSACTIONS VIA A GLOBAL COMPUTER NETWORK, COMPUTER GAME PROGRAMS, COMPUTER OPERATING PROGRAMS, COMPUTER PROGRAMS FOR USE IN DATABASE MANAGEMENT, FOR USE AS A SPREAD SHEET AND FOR WORD PROCESSING, COMPUTER SEARCH ENGINE SOFTWARE, COMPUTER SOFTWARE TO AUTOMATE DATA WAREHOUSING, COMPUTER SOFTWARE TO CONTROL AND IMPROVE COMPUTER AUDIO EQUIPMENT SOUND QUALITY, COMPUTER SOFTWARE TO ENHANCE THE AUDIO-VISUAL CAPABILITIES OF MULTIMEDIA APPLICATIONS, NAMELY FOR THE INTEGRATION OF TEXT, AUDIO GRAPHICS, STILL IMAGES AND MOVING PICTURES, COMPUTER TELEPHONY SOFTWARE, COMPUTER UTILITY PROGRAMS, DATA COMPRESSION SOFTWARE, DATABASE MANAGEMENT SOFTWARE FOR GENERAL USE, DESKTOP PUBLISHING SOFTWARE, DOWNLOADABLE SOFTWARE FOR USE IN DATABASE MANAGEMENT; COMPUTER GAME SOFTWARE; PHOTOCOPYING MACHINES, CAMERA TRIPODS, CAMERA FLASHES, PHOTOGRAPHIC EXPOSURE METERS, FILM PORTRAIT CAMERAS, MOVIE PROJECTORS, PHOTOGRAPHIC SLIDE TRANSPARENCIES, PHOTOGRAPHIC SLIDE TRANSPARENCIES FRAMES; ELECTRIC AND ELECTRONIC APPARATUS AND INSTRUMENTS AS WELL AS PARTS THEREOF FOR USE IN TELECOMMUNICATION AND COMMUNICATION ENGINEERING, NAMELY, ISDN TELEPHONES, TELEPHONES, DIGITAL TELEPHONES, WIRELESS TELEPHONES, MOBILE TELEPHONES, RADIO-RECEIVERS WITH LIGHT EMITTING DIODE DISPLAYS, TELEPHONE EARPIECES, TELEPHONE ANSWERING MA-

**CLASS 9—(Continued).**

CHINES, FACSIMILE MACHINES, PRESS-TO-TALK INTERCOM BOXES, HANDS FREE SETS FOR CONNECTION ON TELECOMMUNICATION APPARATUS COMPRISED OF COMBINATIONS OF EAR PHONES, MICROPHONES AND EXTERNAL CONTROLLERS; FLASH MEMORY CARDS; MEMORY CARDS, ELECTRIC ACCUMULATORS; TRANSMITTING AND RECEIVING STATIONS FOR COMMUNICATION ENGINEERING AND DATA COMMUNICATION COMPRISED OF ANTENNAS, PARABOLIC ANTENNAS, AUDIO, IMAGE AND TELEPHONE RECEIVERS, DECODERS, MODEMS, CONVERTERS, MICROWAVE-CONVERTERS, SOUND AMPLIFIERS, WAVE GUIDES, ANTENNA CONNECTING SOCKETS, ALARM DEVICES, NAMELY, FIRE ALARMS, SMOKE ALARMS, ANTI-INTRUSION ALARMS, PERSONAL SECURITY ALARMS, ACCESS ALARMS AND BURGLAR ALARMS; EYEGASSES, EYEGASS CASES; ELECTRICAL HOUSEHOLD UTENSILS, NAMELY, SHEET WELDING APPARATUS, NAMELY WELDING ELECTRODES AND WELDING TORCHES, SCALES AND KITCHEN SCALES, ELECTRIC HAIR CURLING RODS, ELECTRIC IRONS, THERMOMETERS NOT FOR MEDICAL USE; WEATHER STATIONS, NAMELY WEATHER BALLOONS; BICYCLE COMPUTERS, NAMELY, ELECTRICAL MEASURING DEVICE THAT INCORPORATES THE FUNCTIONS OF SPEEDOMETERS AND ODOMETERS; CABLES, NAMELY, CABLES FOR CONNECTING COMMUNICATION AND ENTERTAINMENT APPARATUS, COAXIAL, COMPUTER, ELECTRICAL AND FIBRE OPTIC CABLES; ELECTRICAL CABLE CLAMPS, ELECTRIC CONNECTORS, ELECTRIC PLUGS, BATTERIES, ELECTRIC ACCUMULATORS AND ELECTRIC POWER SUPPLIES; CAMCORDER, PHOTOGRAPHIC CAMERAS, DVD PLAYERS (U.S. CLS. 21, 23, 26, 36 AND 38).  
JOHN DWYER, EXAMINING ATTORNEY

---

SN 78-152,937. MULTI-TECH SYSTEMS, INC., MOUNDS VIEW, MN. FILED 8-9-2002.

**SOCKETMODEM**

SEC. 2(F).  
FOR MODEMS; MODEM ADAPTORS; MODEM CIRCUIT BOARDS AND CARDS (U.S. CLS. 21, 23, 26, 36 AND 38).  
FIRST USE 1-31-1994; IN COMMERCE 1-31-1994.  
DEZMONA MIZELLE, EXAMINING ATTORNEY

---

SN 78-159,689. PURE ENERGY BATTERY INC., RICHMOND HILL, ONTARIO, CANADA, FILED 8-30-2002.

**DESK JOCKEY**

PRIORITY CLAIMED UNDER SEC. 44(D) ON CANADA APPLICATION NO. 1132938, FILED 3-1-2002, REG. NO. 613349, DATED 6-22-2004, EXPIRES 6-22-2019.  
FOR RADIOS (U.S. CLS. 21, 23, 26, 36 AND 38).  
FIRST USE 7-4-2002; IN COMMERCE 7-15-2002.  
DARRYL SPRUILL, EXAMINING ATTORNEY

**CLASS 9—(Continued).**

SN 78-175,196. VISIONS TECHNOLOGY IN EDUCATION, SPRINGFIELD, OR. FILED 10-16-2002.

**WRITER'S COMPANION**

NO CLAIM IS MADE TO THE EXCLUSIVE RIGHT TO USE WRITER'S, APART FROM THE MARK AS SHOWN.

FOR EDUCATIONAL SOFTWARE FEATURING INSTRUCTION IN CREATIVE WRITING (U.S. CLS. 21, 23, 26, 36 AND 38).

FIRST USE 10-1-2002; IN COMMERCE 11-1-2002.  
JAMES GRIFFIN, EXAMINING ATTORNEY

SN 78-190,016. LINKLATERS LIMITED, KINCARDINE, ONTARIO, CANADA, FILED 12-2-2002.

**RESCOM**

PRIORITY CLAIMED UNDER SEC. 44(D) ON CANADA APPLICATION NO. 1142685, FILED 6-3-2002, REG. NO. TMA605280, DATED 3-16-2004, EXPIRES 3-16-2019.

FOR PERSONAL INTERCOMS FOR PROVIDING ASSISTED COMMUNICATIONS FOR WORKERS IN HAZARDOUS OR INDUSTRIAL ENVIRONMENTS, NAMELY, PERSONAL INTERCOM HEADSETS, PERSONAL INTERCOMS FOR HEAD MOUNTING, ELECTRICAL DISTRIBUTION BOXES, LIFE SAFETY ROPE WITH INTEGRAL COMMUNICATION WIRING, ELECTRICAL POWER EXTENSION CORDS, ELECTRICAL COUPLERS TO JOIN COMMUNICATION WIRING, AMPLIFIER AND AUDIO SPEAKER/MICROPHONE ASSEMBLIES; CASES AND CARRYING BAGS FOR CARRYING PARTS OF PERSONAL INTERCOMS FOR PROVIDING ASSISTED COMMUNICATIONS FOR WORKERS IN HAZARDOUS OR INDUSTRIAL ENVIRONMENTS (U.S. CLS. 21, 23, 26, 36 AND 38).

FIRST USE 0-0-1992; IN COMMERCE 0-0-1992.  
LINDA M. KING, EXAMINING ATTORNEY

**CLASS 9—(Continued).**

SN 78-193,536. WINE & SPIRIT EDUCATION TRUST LIMITED, LONDON, UNITED KINGDOM, FILED 12-11-2002.



NO CLAIM IS MADE TO THE EXCLUSIVE RIGHT TO USE "EDUCATIONAL TRUST", APART FROM THE MARK AS SHOWN.

SEC. 2(F).

FOR PRE-RECORDED MAGNETIC DATA CARRIERS FEATURING INFORMATION ABOUT ALCOHOLIC BEVERAGES; COMPACT DISCS FEATURING INFORMATION ABOUT ALCOHOLIC BEVERAGES; DOWNLOADABLE ELECTRONIC PUBLICATIONS IN THE NATURE OF MANUALS, NEWSLETTERS, MAGAZINE ARTICLES, PRESENTATION PACKS AND BOOKS IN THE FIELD OF ALCOHOLIC BEVERAGES; ELECTRONIC PUBLICATIONS, NAMELY, BOOKS, MAGAZINES AND MANUALS FEATURING INFORMATION ABOUT ALCOHOLIC BEVERAGES RECORDED ON COMPUTER MEDIA; PHOTOGRAPHIC SLIDE TRANSPARENCIES FEATURING INFORMATION ABOUT ALCOHOLIC BEVERAGES; AND PRE-RECORDED VIDEO TAPES FEATURING ALCOHOLIC BEVERAGES (U.S. CLS. 21, 23, 26, 36 AND 38).

FIRST USE 1-1-1989; IN COMMERCE 1-1-1995.  
JULIE WATSON, EXAMINING ATTORNEY

SN 78-197,687. USA TECHNOLOGIES, INC., MALVERN, PA. FILED 12-24-2002.

**SNACKMISER**

OWNER OF U.S. REG. NO. 2,628,447.

FOR PLUG-LOAD CONTROL DEVICE FOR NON-REFRIGERATED DRY GOODS VENDING MACHINES THAT MONITORS OCCUPANCY TO PERIODICALLY POWER DOWN THE LIGHTS (U.S. CLS. 21, 23, 26, 36 AND 38).

FIRST USE 12-23-2002; IN COMMERCE 12-23-2002.  
SHARI SHEFFIELD, EXAMINING ATTORNEY

SN 78-201,270. ZEKI, ORAK, SAN FRANCISCO, CA. FILED 1-8-2003.



FOR COMPUTER GAME SOFTWARE FEATURING COLOR MATCHING PUZZLE GAME (U.S. CLS. 21, 23, 26, 36 AND 38).

ALLISON HOLTZ, EXAMINING ATTORNEY



**CLASS 9—(Continued).**

SN 78-217,671. DYNAMIC SOLUTIONS INTERNATIONAL, ENGLEWOOD, CO. FILED 2-21-2003.

*SuperC.W.T.*

FOR COMPUTER HARDWARE USED IN THE MANUFACTURE AND PRODUCTION OF PLASTIC CUSTOMER LOYALTY AND AFFINITY CARDS, IN CONJUNCTION WITH USE OF APPLICANT'S PROPRIETARY SOFTWARE (U.S. CLS. 21, 23, 26, 36 AND 38).

FIRST USE 12-19-2002; IN COMMERCE 12-19-2002.  
LINDA POWELL, EXAMINING ATTORNEY

SN 78-228,245. PYRO 99, S.L., MADRID, SPAIN, FILED 3-20-2003.

**COMMANDOS 3  
DESTINATION BERLIN**

PRIORITY CLAIMED UNDER SEC. 44(D) ON UNITED KINGDOM APPLICATION NO. 2326188, FILED 3-11-2003, REG. NO. 2326188, DATED 8-23-2003, EXPIRES 8-23-2010.

OWNER OF U.S. REG. NOS. 2,590,474, 2,593,619 AND 2,625,402.

NO CLAIM IS MADE TO THE EXCLUSIVE RIGHT TO USE "BERLIN", APART FROM THE MARK AS SHOWN.

FOR COMPUTER GAMES SOFTWARE; COMPUTER GAMES SOFTWARE DOWNLOADABLE FROM A REMOTE COMPUTER LOCATION OR RECORDED ON CD-ROMS, COMPACT DISCS, AND GAME CARTRIDGES; DOWNLOADABLE ELECTRONIC PUBLICATIONS IN THE NATURE OF NEWSLETTERS AND MAGAZINES FEATURING ACTION AND ADVENTURE GAMES (U.S. CLS. 21, 23, 26, 36 AND 38).

BARBARA GAYNOR, EXAMINING ATTORNEY

SN 78-235,365. MOTOROLA, INC., SCHAUMBURG, IL. FILED 4-8-2003.

**NO DRAWING-SENSORY  
MARK**

THE MARK CONSISTS OF AN ELECTRONIC CHIRP CONSISTING OF A TONE AT 1800 HZ PLAYED AT A CADENCE OF 24 MILLISECONDS ON, 24 MS OFF, 24 MS ON, 24 MS OFF, 48 MS ON.

FOR CELLULAR TELEPHONES AND TWO-WAY RADIOS (U.S. CLS. 21, 23, 26, 36 AND 38).

FIRST USE 4-30-1996; IN COMMERCE 4-30-1996.  
DAVID TAYLOR, EXAMINING ATTORNEY

**CLASS 9—(Continued).**

SN 78-236,557. KEY SYSTEMS, INC., FISHERS, NY. FILED 4-11-2003.

 **Key Systems**  
**The Door Man** INC.

NO CLAIM IS MADE TO THE EXCLUSIVE RIGHT TO USE KEY SYSTEMS INC. THE DOOR, APART FROM THE MARK AS SHOWN.

THE MARK CONSISTS OF KEY SYSTEMS, INC. OVERLAID BY THE WORDS THE DOOR MAN.

FOR COMPUTERIZED ELECTRONIC LOCKING CONTROLS FOR GARAGE DOORS, WAREHOUSE DOORS, ROLLING DOORS OR ANY DOOR REQUIRING SECURITY PERMITTING ACCESS ONLY BY DESIGNATED PERSONS, REQUIRING DESIGNATED PERSONS TO BE PRESENT WHILE DOOR IS IN OPEN POSITION, KEY IS RETAINED IN LOCKING MECHANISM TO BE RELEASED ONLY AFTER DOOR IS CLOSED (U.S. CLS. 21, 23, 26, 36 AND 38).

KEVON CHISOLM, EXAMINING ATTORNEY

SN 78-258,651. ALTOVA GMBH, WIEN (VIENNA), AUSTRIA, FILED 6-5-2003.

 **mapforce**

FOR COMPUTER SOFTWARE FOR USE AS A VISUAL DATA INTEGRATION TOOL TO TRANSFORM, ACCESS, AND MANIPULATE DATA EXPRESSED IN A PARTICULAR DATA STORAGE FORMAT INTO THAT OF ANOTHER DATA STORAGE FORMAT; COMPUTER SOFTWARE FOR FACILITATING AUTO-GENERATED SOFTWARE CODE REQUIRED TO IMPLEMENT SUCH DATA TRANSFERS FROM ONE ELECTRONIC FORMAT IN A RUN-TIME ENVIRONMENT, THROUGH THE GENERATION OF CUSTOMIZED OUTPUT CODE IN A VARIETY OF DIFFERENT OUTPUT LANGUAGES (U.S. CLS. 21, 23, 26, 36 AND 38).

STANLEY I. OSBORNE, EXAMINING ATTORNEY

**CLASS 9—(Continued).**

SN 78-262,882. INTELLIGENT PHOTONICS CONTROL CORP., KANATA, ONTARIO, CANADA, FILED 6-16-2003.

## BRINGING INTELLIGENCE TO LIGHT

PRIORITY CLAIMED UNDER SEC. 44(D) ON CANADA APPLICATION NO. 1162623, FILED 12-17-2002, REG. NO. TMA605423, DATED 3-16-2004, EXPIRES 3-16-2019.

FOR ELECTRONIC CONTROLS FOR OPTICAL COMPONENTS THAT GENERATE, MODULATE, EQUALIZE, AMPLIFY, ATTENUATE, FILTER OR MONITOR LIGHT NAMELY, OPTICAL AMPLIFIERS, OPTICAL POWER MONITORS, VARIABLE OPTICAL ATTENUATORS, DYNAMIC GAIN EQUALIZERS, RECONFIGURABLE OPTICAL ADD/DROP MULTIPLEXERS, TUNABLE LASERS, INTEGRATED PHOTODIODE ARRAYS, DISPERSION COMPENSATION DEVICES, FIBER LASERS, DETECTOR ARRAYS, OPTICAL MULTIPLEXER/DEMULTIPLEXER DEVICES, FIBER OPTIC GYROS, BIOMEDICAL PHOTONIC SENSORS AND DIAGNOSTIC DEVICES, OPTICAL SWITCHING FUNCTIONS, LIDAR RANGING DEVICES, FREE SPACE OPTICAL WIRELESS SOURCES AND DETECTORS, COMPACT SPECTROSCOPIC ANALYSIS FUNCTIONS, OPTICAL STRAIN AND TEMPERATURE SENSORS AND ARRAYS (U.S. CLS. 21, 23, 26, 36 AND 38).

SUSAN LESLIE DUBOIS, EXAMINING ATTORNEY

SN 78-263,138. LEGATO SYSTEMS, INC., MOUNTAIN VIEW, CA. FILED 6-17-2003.

## EMAILXAMINER

SEC. 2(F).  
FOR COMPUTER SOFTWARE FOR BUSINESS MONITORING AND MANAGEMENT OF ELECTRONIC COMMUNICATIONS (U.S. CLS. 21, 23, 26, 36 AND 38).  
FIRST USE 12-0-2001; IN COMMERCE 12-0-2001.  
INGRID C. EULIN, EXAMINING ATTORNEY

SN 78-266,530. UNIVERSITY CORPORATION FOR ATMOSPHERIC RESEARCH, BOULDER, CO. FILED 6-24-2003.

## HOTPLATE

FOR ELECTRONIC SENSOR THAT PROVIDES MEASUREMENTS OF VARIOUS ASPECTS OF WEATHER IN THE ENVIRONMENT, NAMELY, A SENSOR THAT PROVIDES REAL-TIME LIQUID EQUIVALENT PRECIPITATION RATES, WIND SPEED, AND THE ABILITY TO DISTINGUISH BLOWING FROM FALLING PRECIPITATION (U.S. CLS. 21, 23, 26, 36 AND 38).

ASMAT KHAN, EXAMINING ATTORNEY

**CLASS 9—(Continued).**

SN 78-269,969. ORAMETRIX, INC., RICHARDSON, TX. FILED 7-2-2003.

## ORASCANNER

FOR HAND-HELD SCANNING CAMERAS FOR IN-VIVO SCANNING OF TEETH OR SCANNING MODELS OF TEETH TO CAPTURE THREE-DIMENSIONAL DATA OF TEETH AND ADJACENT TISSUES (U.S. CLS. 21, 23, 26, 36 AND 38).

FIRST USE 5-31-2000; IN COMMERCE 10-29-2002.

INGRID C. EULIN, EXAMINING ATTORNEY

SN 78-270,065. GIEBELER, JAMES FREDERICK, SAN BERNARDINO, CA. FILED 7-2-2003.



NO CLAIM IS MADE TO THE EXCLUSIVE RIGHT TO USE "SIRENS", APART FROM THE MARK AS SHOWN.

FOR BASED ON USE— MECHANICAL SIRENS FOR MOBILE EMERGENCY VEHICLES; BASED ON INTENT TO USE— MECHANICAL SIRENS (U.S. CLS. 21, 23, 26, 36 AND 38).

FIRST USE 11-15-1997; IN COMMERCE 4-7-1998.

ROBERT COGGINS, EXAMINING ATTORNEY

SN 78-270,731. SIEMENS MEDICAL SOLUTIONS USA, INC., CONCORD, CA. FILED 7-5-2003.

## SUREBEAM DOSIMETRY

NO CLAIM IS MADE TO THE EXCLUSIVE RIGHT TO USE DOSIMETRY, APART FROM THE MARK AS SHOWN.

FOR COMPUTER SOFTWARE FOR CONTROLLING BEAM FORMATION AND DOSE LINEARITY TO REDUCE X-RAY CONTAMINATION IN ELECTRON MEDICAL TREATMENTS OF PATIENTS; FEATURE OF X-RAY APPARATUS WHICH IS DESIGNED TO CONTROL BEAM FORMATION AND DOSE LINEARITY TO REDUCE X-RAY CONTAMINATION IN THE ELECTRON MEDICAL TREATMENT OF PATIENTS (U.S. CLS. 21, 23, 26, 36 AND 38).

DORITT L. CARROLL, EXAMINING ATTORNEY

**CLASS 9—(Continued).**

SN 78-278,439. SOUTH DAKOTA STATE UNIVERSITY, BROOKINGS, SD. FILED 7-24-2003.

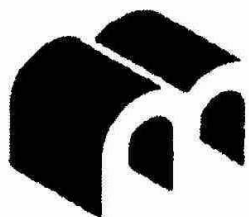

FOR COMPUTER SOFTWARE FOR USE IN CREATING ONLINE EDUCATIONAL AND LEARNING ENVIRONMENTS AND FOR CREATING WEB-BASED EDUCATIONAL COMPUTER APPLICATIONS (U.S. CLS. 21, 23, 26, 36 AND 38).

JENNIFER MARTIN, EXAMINING ATTORNEY

SN 78-279,510. S3 PUBLISHING TECHNOLOGIES, INC., PHOENIX, AZ. FILED 7-28-2003.

**CISPUB**

FOR COMPUTER SOFTWARE FOR PUBLISHERS, USED FOR DATA STORAGE AND FOR THE FACILITATION OF ORDER FULFILLMENT, INVENTORY CONTROL, WAREHOUSE MANAGEMENT, INVOICING AND PICKING LISTS, JOB COSTING, ROYALTY MANAGEMENT, SUBSCRIPTION MANAGEMENT, STANDING ORDER FULFILLMENT, ACCOUNTS RECEIVABLE MANAGEMENT, E-COMMERCE TRANSACTIONS, ELECTRONIC DATA INTERCHANGE, CREDIT CARD PROCESSING, ACCOUNTS PAYABLE MANAGEMENT AND GENERAL LEDGER MANAGEMENT (U.S. CLS. 21, 23, 26, 36 AND 38).

FIRST USE 1-1-1983; IN COMMERCE 1-1-1983.  
SUE LAWRENCE, EXAMINING ATTORNEY

SN 78-281,113. EMPA EIDGENÖSSISCHE MATERIALPRÜFUNGS- UND FORSCHUNGSANSTALT, DÜBENDORF, SWITZERLAND, FILED 7-30-2003.

**uncertainty**MANAGER

PRIORITY CLAIMED UNDER SEC. 44(D) ON SWITZERLAND APPLICATION NO. 524382003, FILED 7-11-2003, REG. NO. 514075, DATED 9-11-2003, EXPIRES 7-11-2013.

FOR COMPUTER SOFTWARE FOR USE IN MODELING EXPERIMENTAL CALCULATIONS FOR USE IN THE AREAS OF ANALYTICAL CHEMISTRY AND MEASURING (U.S. CLS. 21, 23, 26, 36 AND 38).

LINDA MICKLEBURGH, EXAMINING ATTORNEY

**CLASS 9—(Continued).**

SN 78-286,056. REALVUE SIMULATION TECHNOLOGIES, INC., AUSTIN, TX. FILED 8-12-2003.

**REALVUE**

FOR SIMULATION TRAINING SOFTWARE FOR THE PURPOSE OF TRAINING OPERATORS AND MAINTAINERS OF COMPLEX EQUIPMENT, MACHINERY, AND SOFTWARE-BASED SYSTEMS IN THEIR USE AND OPERATION (U.S. CLS. 21, 23, 26, 36 AND 38).

FIRST USE 6-8-2002; IN COMMERCE 6-8-2002.  
SUSAN HAYASH, EXAMINING ATTORNEY

SN 78-292,209. RENAISSANCE LEARNING, INC., WISCONSIN RAPIDS, WI. FILED 8-26-2003.



FOR COMPUTER SOFTWARE, NAMELY, A MULTILINGUAL COMPUTER PROGRAM THAT PROVIDES A TEXT AND MULTIMEDIA WORD PROCESSING ENVIRONMENT TO SUPPORT WRITING, REVISING, EDITING, ILLUSTRATING AND PUBLISHING, THE CREATION OF MULTIMEDIA PRESENTATIONS, REPORTS AND NEWSLETTERS, AND THE TRANSFORMATION OF WRITING INTO SPEECH OR LISTENING TO INSTRUCTOR COMMENTS, AND ALLOWS INSTRUCTORS TO CUSTOMIZE LESSONS AND MANAGE DAILY STUDENT WRITING (U.S. CLS. 21, 23, 26, 36 AND 38).

FIRST USE 9-0-1994; IN COMMERCE 9-0-1995.  
GEORGE LORENZO, EXAMINING ATTORNEY

SN 78-293,959. MARKETSOFT SOFTWARE CORPORATION, LEXINGTON, MA. FILED 8-29-2003.

**ACCELERATE REVENUE  
GROWTH**

FOR COMPUTER SOFTWARE FOR MANAGING MARKETING CAMPAIGNS AND SALES INFORMATION FOR USE BY BUSINESSES (U.S. CLS. 21, 23, 26, 36 AND 38).

BERYL GARDNER, EXAMINING ATTORNEY

**CLASS 9—(Continued).**

SN 78-297,416. S&C ELECTRIC CO., CHICAGO, IL. FILED 9-8-2003.

**AVC**

SEC. 2(F).  
FOR ELECTRIC POWER DEVICES, NAMELY REACTIVE POWER COMPENSATORS (U.S. CLS. 21, 23, 26, 36 AND 38).

FIRST USE 1-1-1993; IN COMMERCE 1-1-1993.  
SHARON MEIER, EXAMINING ATTORNEY

SN 78-308,497. S.P.C. FRANCE, 69140 RILLIEUX LA PAPE, FRANCE, FILED 10-2-2003.

**MALYPASS**

PRIORITY CLAIMED UNDER SEC. 44(D) ON FRANCE APPLICATION NO. 033219801, FILED 4-9-2003, REG. NO. 033219801, DATED 4-9-2003, EXPIRES 4-9-2013.

FOR SOFTWARE FOR ACTIVATING, CONTROLLING, RECORDING, MONITORING, CORRECTING, SETTING AND GAUGING DOSING MACHINES FOR DOSING LIQUIDS AND POWDERS FOR USE IN A VARIETY OF FIELDS (U.S. CLS. 21, 23, 26, 36 AND 38).  
TINA L. SNAPP, EXAMINING ATTORNEY

SN 78-311,978. SARA LEE GLOBAL FINANCE, L.L.C., WILMINGTON, DE. FILED 10-10-2003.

**C9**

FOR SUNGLASSES (U.S. CLS. 21, 23, 26, 36 AND 38).  
MICHAEL BAIRD, EXAMINING ATTORNEY

SN 78-311,980. SARA LEE GLOBAL FINANCE, L.L.C., WILMINGTON, DE. FILED 10-10-2003.

**C9 BY CHAMPION**

OWNER OF U.S. REG. NOS. 1,756,925, 2,004,276 AND OTHERS.  
FOR SUNGLASSES (U.S. CLS. 21, 23, 26, 36 AND 38).  
MICHAEL BAIRD, EXAMINING ATTORNEY

**CLASS 9—(Continued).**

SN 78-316,353. LASERSOFT IMAGING USA, LONGBOAT KEY, FL. FILED 10-21-2003.



FOR COMPUTER SOFTWARE, NAMELY, SOFTWARE DESIGNED TO BE USED WITH A SCANNER CONTROLLING CONVERSION FROM COLORS TO GREY (U.S. CLS. 21, 23, 26, 36 AND 38).

FIRST USE 6-8-2001; IN COMMERCE 6-8-2001.  
JIM RINGLE, EXAMINING ATTORNEY

SN 78-316,411. HAYES, THOMAS JEROME, WESTMONT, IL. FILED 10-21-2003.

**MUSIC MEGABASE**

NO CLAIM IS MADE TO THE EXCLUSIVE RIGHT TO USE MUSIC, APART FROM THE MARK AS SHOWN.

FOR COMPUTER SOFTWARE FEATURING A MUSIC REFERENCE DATABASE (U.S. CLS. 21, 23, 26, 36 AND 38).

FIRST USE 12-7-1995; IN COMMERCE 5-2-2002.  
PRISCILLA MILTON, EXAMINING ATTORNEY

SN 78-316,521. HAYES, THOMAS JEROME, WESTMONT, IL. FILED 10-21-2003.

**MUSICPRINT**

FOR COMPUTER SOFTWARE THAT PREDICTS HIT-MUSIC PREFERENCES FOR AN INDIVIDUAL OR GROUP AND DEVELOPS AND STORES A PERSONALIZED MUSIC PROFILE UNIQUE TO THAT USER (U.S. CLS. 21, 23, 26, 36 AND 38).

PRISCILLA MILTON, EXAMINING ATTORNEY

SN 78-317,683. BURNETT, ROBERT C., FORT WORTH, TX. FILED 10-23-2003.

**INTERACTIVE AFFINITIES**

NO CLAIM IS MADE TO THE EXCLUSIVE RIGHT TO USE "INTERACTIVE", APART FROM THE MARK AS SHOWN.

FOR INTERACTIVE CREDIT CARD HARDWARE, I.E.; MAGNETICALLY ENCODED CD-ROM TO BE USED AS INTERACTIVE TRANSACTION CARD (U.S. CLS. 21, 23, 26, 36 AND 38).

SUSAN STIGLITZ, EXAMINING ATTORNEY

**CLASS 9—(Continued).**

SN 78-328,969. KPMG LLP, NEW YORK, NY. FILED 11-17-2003.

**CLASS 9—(Continued).**

SN 78-336,673. NIMBLEFISH TECHNOLOGIES, INC., SAN FRANCISCO, CA. FILED 12-4-2003.

**TAX PRO-VISION  
WORKPAPERS**

**INDIVIDUA**

THE MARK CONSISTS OF STANDARD CHARACTERS WITHOUT CLAIM TO ANY PARTICULAR FONT, STYLE, SIZE, OR COLOR.

NO CLAIM IS MADE TO THE EXCLUSIVE RIGHT TO USE "TAX", APART FROM THE MARK AS SHOWN.

FOR COMPUTER SOFTWARE IN THE FIELD OF TAX PREPARATION AND TAX PLANNING (U.S. CLS. 21, 23, 26, 36 AND 38).

SEAN DWYER, EXAMINING ATTORNEY

THE MARK CONSISTS OF STANDARD CHARACTERS WITHOUT CLAIM TO ANY PARTICULAR FONT, STYLE, SIZE, OR COLOR.

FOR COMPUTER SOFTWARE USED IN CREATING CUSTOMIZED PRINT AND ELECTRONIC DIRECT MARKETING ADVERTISING MATERIALS FOR BUSINESSES (U.S. CLS. 21, 23, 26, 36 AND 38).

BRENDAN MCCAULEY, EXAMINING ATTORNEY

SN 78-331,352. PROJECT MANAGEMENT INSTITUTE, INC., NEWTOWN SQUARE, PA. FILED 11-21-2003.

SN 78-339,527. PAIVA \* FREDRICKSEN, LLC, SPARTA, NJ. FILED 12-11-2003.

**PMBOK**

**STRONG \* LEADER**

THE MARK CONSISTS OF STANDARD CHARACTERS WITHOUT CLAIM TO ANY PARTICULAR FONT, STYLE, SIZE, OR COLOR.

OWNER OF U.S. REG. NO. 2,255,230.

FOR ELECTRONIC PUBLICATIONS, NAMELY, REFERENCE BOOKS IN THE FIELD OF PROJECT MANAGEMENT RECORDED ON COMPUTER MEDIA (U.S. CLS. 21, 23, 26, 36 AND 38).

FIRST USE 12-31-1997; IN COMMERCE 12-31-1997.

YONG KIM, EXAMINING ATTORNEY

THE MARK CONSISTS OF STANDARD CHARACTERS WITHOUT CLAIM TO ANY PARTICULAR FONT, STYLE, SIZE, OR COLOR.

NO CLAIM IS MADE TO THE EXCLUSIVE RIGHT TO USE "LEADER", APART FROM THE MARK AS SHOWN.

FOR EDUCATIONAL SOFTWARE FEATURING INSTRUCTION IN EMPLOYEE TRAINING, BUSINESS MANAGEMENT AND BUSINESS CONSULTING (U.S. CLS. 21, 23, 26, 36 AND 38).

BRIDGETT SMITH, EXAMINING ATTORNEY

**CLASS 9—(Continued).**

SN 78-339,679. DIBLASI, LOUIS, EAST RUTHERFORD, NJ.  
FILED 12-11-2003.

**CLASS 9—(Continued).**

SN 78-339,712. ADOBE SYSTEMS INCORPORATED, SAN  
JOSE, CA. FILED 12-11-2003.

# Photoshop



THE COLORS RED AND BLACK ARE CLAIMED AS A FEATURE OF THE MARK.

THE WORDING "MY PERMISSION" IN THE MARK APPEARS IN THE COLOR BLACK AND THE LINE THAT PASSES THROUGH THE WORDING "MY PERMISSION" APPEARS IN THE COLOR BLACK. THE HEART DESIGN IN THE MARK APPEARS IN THE COLOR RED AND IS OUTLINED AT THE BORDERS IN THE COLOR BLACK.

THE MARK CONSISTS OF RED HEART.

FOR PRERECORDED VIDEOS FEATURING ADULT ENTERTAINMENT (U.S. CLS. 21, 23, 26, 36 AND 38).

GEORGIA CARTY, EXAMINING ATTORNEY

THE MARK CONSISTS OF STANDARD CHARACTERS WITHOUT CLAIM TO ANY PARTICULAR FONT, STYLE, SIZE, OR COLOR.

OWNER OF U.S. REG. NOS. 1,651,380 AND 1,850,242.

FOR COMPUTER SOFTWARE FOR CREATING, VIEWING, MANIPULATING, EDITING, MANAGING, INDEXING, CATALOGUING, SORTING, ORGANIZING, STORING, TRANSFERRING, SYNCHRONIZING, PRINTING, AND EXCHANGING DIGITAL PHOTOGRAPHS, DIGITAL AND GRAPHIC IMAGES, DATA, TEXT, AUDIO, VIDEO, MULTIMEDIA AND INTERACTIVE DOCUMENTS AND WORKS, TEXT DOCUMENTS, AND RECORDED INFORMATION; COMPUTER SOFTWARE FOR TRANSFERRING DIGITAL PHOTOGRAPHS, DIGITAL AND GRAPHIC IMAGES, DATA, TEXT, AUDIO, VIDEO, MULTIMEDIA AND INTERACTIVE DOCUMENTS AND WORKS, TEXT DOCUMENTS, AND RECORDED INFORMATION TO CD-ROM DISCS AND DIGITAL VIDEO DISCS; COMPUTER SOFTWARE FOR TRANSFERRING DIGITAL PHOTOGRAPHS, DIGITAL AND GRAPHIC IMAGES, DATA, TEXT, AUDIO, VIDEO, MULTIMEDIA AND INTERACTIVE DOCUMENTS AND WORKS, TEXT DOCUMENTS, AND RECORDED INFORMATION FOR USE OVER COMPUTER NETWORKS, WIRELESS NETWORKS AND GLOBAL COMMUNICATION NETWORKS; COMPUTER PROGRAMS AND COMPUTER TUTORIAL SOFTWARE FOR CREATING GREETING CARDS, CALENDARS, BOOKS, DOCUMENTS, AUTOMATED PDF SLIDE SHOWS, AND WEB PHOTO GALLERIES AND ALBUMS; FILE MANAGEMENT SOFTWARE FOR OPENING AND CONVERTING PHOTOGRAPHIC, DIGITAL, AND GRAPHIC IMAGES, DATA, TEXT, DOCUMENTS, AUDIO, VIDEO, MULTIMEDIA WORKS, AND RECORDED INFORMATION TO VARIOUS FILE FORMATS; AND USERS' MANUALS AND INSTRUCTIONAL BOOKS SOLD AS A UNIT THEREWITH (U.S. CLS. 21, 23, 26, 36 AND 38).

FIRST USE 2-2-1990; IN COMMERCE 2-2-1990.

PAULA MAYS, EXAMINING ATTORNEY

**CLASS 9—(Continued).**

SN 78-340,755. HARY, DAVID, SANTA MONICA, CA. FILED 12-15-2003.

**CLASS 9—(Continued).**

SN 78-340,860. CLIENTS & PROFITS, INC., OCEANSIDE, CA. FILED 12-15-2003.

gCells

Clients & Profits  
ASAP

THE MARK CONSISTS OF STANDARD CHARACTERS WITHOUT CLAIM TO ANY PARTICULAR FONT, STYLE, SIZE, OR COLOR.

FOR COMPUTER SOFTWARE FOR INTERNET-BASED CONTENT MANAGEMENT (U.S. CLS. 21, 23, 26, 36 AND 38).

SUSAN HAYASH, EXAMINING ATTORNEY

THE MARK CONSISTS OF STANDARD CHARACTERS WITHOUT CLAIM TO ANY PARTICULAR FONT, STYLE, SIZE, OR COLOR.

OWNER OF U.S. REG. NO. 1,729,095.  
FOR COMPUTER PROGRAM FOR USE BY ADVERTISING AGENCIES FOR JOB TRACKING, CLIENT MANAGEMENT, TIMEKEEPING, SCHEDULING AND BILLING (U.S. CLS. 21, 23, 26, 36 AND 38).

BARNEY CHARLON, EXAMINING ATTORNEY

SN 78-340,765. HARY, DAVID, SANTA MONICA, CA. FILED 12-15-2003.

SN 78-340,988. CELESTIAL SEASONINGS, INC., BOULDER, CO. FILED 12-15-2003.

gPortals



THE MARK CONSISTS OF STANDARD CHARACTERS WITHOUT CLAIM TO ANY PARTICULAR FONT, STYLE, SIZE, OR COLOR.

FOR COMPUTER SOFTWARE FOR INTERNET-BASED CONTENT MANAGEMENT (U.S. CLS. 21, 23, 26, 36 AND 38).

SUSAN HAYASH, EXAMINING ATTORNEY

THE MARK CONSISTS OF THE STYLIZED WORDS CELESTIAL SEASONINGS WITHIN AN OVAL WHICH SURROUNDS THE DESIGN OF A BEAR HEAD.

FOR MAGNETS (U.S. CLS. 21, 23, 26, 36 AND 38).  
FIRST USE 11-1-2002; IN COMMERCE 11-1-2002.

LEIGH CAROLINE CASE, EXAMINING ATTORNEY

**CLASS 9—(Continued).**

SN 78-341,127. ESPN, INC., BRISTOL, CT. FILED 12-15-2003.



OWNER OF U.S. REG. NOS. 2,211,559 AND 2,648,501.  
THE MARK CONSISTS OF THE STYLIZED REPRESENTATION OF THE TERM X GAMES WITH A CIRCLE DESIGN ABOVE THE LETTER X.

FOR OPTICAL WEAR, NAMELY, SUNGLASSES, EYEGLASSES, GOGGLES, AND PROTECTIVE EYEWEAR; PORTABLE LISTENING DEVICES, NAMELY, MP3 PLAYERS; PORTABLE CD PLAYERS; BOOM BOXES; WALKIE TALKIES; TELEVISIONS; DVD PLAYERS; PRE-RECORDED CDS, VIDEO TAPES, AND DVDS FEATURING SPORTS (U.S. CLS. 21, 23, 26, 36 AND 38).  
J. TINGLEY, EXAMINING ATTORNEY

SN 78-341,140. ESPN, INC., BRISTOL, CT. FILED 12-15-2003.

**XG X GAMES**

THE MARK CONSISTS OF STANDARD CHARACTERS WITHOUT CLAIM TO ANY PARTICULAR FONT, STYLE, SIZE, OR COLOR.

OWNER OF U.S. REG. NOS. 2,104,924, 2,211,559 AND OTHERS.

FOR OPTICAL WEAR, NAMELY, SUNGLASSES, EYEGLASSES, GOGGLES, AND PROTECTIVE EYEWEAR COMPRISING GLASSES AND GOGGLES FOR USE IN SPORTS; PORTABLE LISTENING DEVICES, NAMELY, MP3 PLAYERS; PORTABLE CD PLAYERS; BOOM BOXES; WALKIE TALKIES; TELEVISIONS; DVD PLAYERS; PRE-RECORDED CDS, VIDEO TAPES, AND DVDS FEATURING SPORTS (U.S. CLS. 21, 23, 26, 36 AND 38).

G. T. GLYNN, EXAMINING ATTORNEY

**CLASS 9—(Continued).**

SN 78-341,285. DIAMOND POWER INTERNATIONAL, INC., LANCASTER, OH. FILED 12-16-2003.

**SmeltCam**

THE MARK CONSISTS OF STANDARD CHARACTERS WITHOUT CLAIM TO ANY PARTICULAR FONT, STYLE, SIZE, OR COLOR.

FOR INFRARED CAMERAS (U.S. CLS. 21, 23, 26, 36 AND 38).

CHRIS WELLS, EXAMINING ATTORNEY

SN 78-342,317. HILTON TRADING CORPORATION, MIAMI, FL. FILED 12-17-2003.

**ACCUBANKER USA**

THE MARK CONSISTS OF STANDARD CHARACTERS WITHOUT CLAIM TO ANY PARTICULAR FONT, STYLE, SIZE, OR COLOR.

NO CLAIM IS MADE TO THE EXCLUSIVE RIGHT TO USE "USA", APART FROM THE MARK AS SHOWN.

FOR AUTOMATED PAPER CURRENCY COUNTERS; CURRENCY PROCESSING APPARATUS, NAMELY, CURRENCY COUNTERS AND CURRENCY BATCHERS; COUNTERFEIT CURRENCY DETECTION MACHINES; COIN COUNTING MACHINES; POINT-OF-SALE TERMINALS; ENCODED ELECTRONIC CHIP CARDS CONTAINING PROGRAMMING USED TO DETECT FOR COUNTERFEIT CURRENCY; CASH HANDLING PRODUCT, NAMELY, CURRENCY COUNTERS WITH COUNTERFEIT CURRENCY DETECTION FUNCTIONS (U.S. CLS. 21, 23, 26, 36 AND 38).

FIRST USE 4-1-2000; IN COMMERCE 7-1-2000.

STEVEN R. FINE, EXAMINING ATTORNEY



**CLASS 9—(Continued).**

SN 78-343,867. SIAMACK HAGHIGHI, LAGUNA NIGUEL, CA. FILED 12-20-2003.

**CLASS 9—(Continued).**

SN 78-345,546. TELEMEDIA MARKETING & DESIGN, INC., NEW YORK, NY. FILED 12-24-2003.



**TE EXTRAÑO MEXICO**

NO CLAIM IS MADE TO THE EXCLUSIVE RIGHT TO USE "ADAPTIVE LABS", APART FROM THE MARK AS SHOWN.

THE COLOR BLUE IS CLAIMED AS A FEATURE OF THE MARK.

THE COLOR BLUE APPEARS IN THE STYLIZED SEMI-CONDUCTOR DESIGN TO THE LEFT AND BELOW THE WORDING "ADAPTIVE LABS" IN THE MARK."

FOR SEMICONDUCTOR CHIPS AND SYSTEMS COMPRISED OF SEMICONDUCTORS FOR WIRELESS AND VIDEO COMMUNICATION (U.S. CLS. 21, 23, 26, 36 AND 38).

KATHY DE JONGE, EXAMINING ATTORNEY

THE MARK CONSISTS OF STANDARD CHARACTERS WITHOUT CLAIM TO ANY PARTICULAR FONT, STYLE, SIZE, OR COLOR.

NO CLAIM IS MADE TO THE EXCLUSIVE RIGHT TO USE "MEXICO", APART FROM THE MARK AS SHOWN.

THE FOREIGN WORDING IN THE MARK TRANSLATES INTO ENGLISH AS I MISS YOU.

FOR MAGNETICALLY ENCODED PRE-PAID TELEPHONE CALLING CARD (U.S. CLS. 21, 23, 26, 36 AND 38).

FIRST USE 1-1-2001; IN COMMERCE 1-1-2001.

ELIZABETH J. WINTER, EXAMINING ATTORNEY

SN 78-345,109. INTEGRATED MANAGEMENT SOLUTIONS, INC., HUNTSVILLE, AL. FILED 12-23-2003.

SN 78-346,569. LIFE SYSTEMS, INC, ROCKAWAY, NJ. FILED 12-30-2003.

**WINTOX**

**ChiroPad**

THE MARK CONSISTS OF STANDARD CHARACTERS WITHOUT CLAIM TO ANY PARTICULAR FONT, STYLE, SIZE, OR COLOR.

FOR COMPUTER SOFTWARE FOR USE IN DATABASE MANAGEMENT IN THE FIELD OF TOXICOLOGY LABORATORY WORKFLOW AND CONTROL (U.S. CLS. 21, 23, 26, 36 AND 38).

FIRST USE 4-7-1999; IN COMMERCE 4-7-1999.

JOHN DWYER, EXAMINING ATTORNEY

THE MARK CONSISTS OF STANDARD CHARACTERS WITHOUT CLAIM TO ANY PARTICULAR FONT, STYLE, SIZE, OR COLOR.

FOR COMPUTER SOFTWARE FOR DOCTOR'S DOCUMENTATION OF PATIENT CARE (U.S. CLS. 21, 23, 26, 36 AND 38).

FIRST USE 4-23-1993; IN COMMERCE 4-23-1993.

TRICIA THOMPSON, EXAMINING ATTORNEY

**CLASS 9—(Continued).**

SN 78-347,861. ORBIT IRRIGATION PRODUCTS, INC.,  
BOUNTIFUL, UT. FILED 1-5-2004.

# DIAL STAR

THE MARK CONSISTS OF STANDARD CHARACTERS  
WITHOUT CLAIM TO ANY PARTICULAR FONT, STYLE,  
SIZE, OR COLOR.

NO CLAIM IS MADE TO THE EXCLUSIVE RIGHT TO  
USE "DIAL", APART FROM THE MARK AS SHOWN.

FOR IRRIGATION TIMER (U.S. CLS. 21, 23, 26, 36  
AND 38).

FIRST USE 10-19-2000; IN COMMERCE 10-19-2000.  
DAVID H. STINE, EXAMINING ATTORNEY

**CLASS 9—(Continued).**

SN 78-349,448. NORCROSS MARINE PRODUCT, INC.,  
ORLANDO, FL. FILED 1-8-2004.

# Enjoy Your Freedom

THE MARK CONSISTS OF STANDARD CHARACTERS  
WITHOUT CLAIM TO ANY PARTICULAR FONT, STYLE,  
SIZE, OR COLOR.

FOR ELECTRONIC PRODUCTS FOR MARINE AND  
NAUTICAL USE, NAMELY, ECHO SOUNDERS, SPEED  
INDICATORS, SONAR DETECTORS, DEPTH FINDERS,  
AND GLOBAL POSITIONING NAVIGATIONAL SYS-  
TEMS COMPRISING RECEIVERS, TRANSMITTERS  
AND MONITORS (U.S. CLS. 21, 23, 26, 36 AND 38).

FIRST USE 3-1-2003; IN COMMERCE 3-1-2003.  
ANN LINNEHAN, EXAMINING ATTORNEY

---

SN 78-348,994. AUDIO VIDEO SPECIALISTS LTD., CEN-  
TRAL HONG KONG, CHINA, FILED 1-7-2004.

# RECOIL

THE MARK CONSISTS OF STANDARD CHARACTERS  
WITHOUT CLAIM TO ANY PARTICULAR FONT, STYLE,  
SIZE, OR COLOR.

FOR ELECTRONIC CABLES AND CABLES FOR THE  
TRANSMISSION OF SOUNDS AND IMAGES, ELECTRIC  
WIRES, AND CABLE CONNECTORS; AMPLIFIERS,  
AUDIO SPEAKERS, SPEAKER MOUNTS, AUDIO AND  
VIDEO RECEIVERS, STEREO AND AUDIO AND VIDEO  
TUNERS, CD PLAYERS, SUBWOOFERS, MP3 PLAYERS,  
HEAD PHONES, CASSETTE PLAYERS, RADIOS, CD  
STORAGE RACKS AND CD STORAGE WALLETS,  
AND CONVERTERS (U.S. CLS. 21, 23, 26, 36 AND 38).

JOHN DWYER, EXAMINING ATTORNEY

---

SN 78-349,848. SAFECOM TECHNOLOGY INC, ENCINO, CA.  
FILED 1-9-2004.

# CompuGuard

THE MARK CONSISTS OF STANDARD CHARACTERS  
WITHOUT CLAIM TO ANY PARTICULAR FONT, STYLE,  
SIZE, OR COLOR.

FOR COMPUTER SOFTWARE FOR REMOTE ACCESS  
SECURITY ACTIVATED VIA A WIRELESS RADIO  
FREQUENCY OR RF KEY TO PROTECT AGAINST  
UNAUTHORIZED PC AND LAPTOP ACCESS (U.S. CLS.  
21, 23, 26, 36 AND 38).

ZHALEH DELANEY, EXAMINING ATTORNEY

**CLASS 9—(Continued).**

SN 78-350,251. LENG, ROGER C., HOLMDEL, NJ. FILED 1-10-2004.

**CLASS 9—(Continued).**

SN 78-350,685. NIPPON DENKI KABUSHIKI KAISHA, DBA NEC CORPORATION, TOKYO, JAPAN, FILED 1-12-2004.

**eDataExpress**

**TRUEFORCE**

THE MARK CONSISTS OF STANDARD CHARACTERS WITHOUT CLAIM TO ANY PARTICULAR FONT, STYLE, SIZE, OR COLOR.

FOR COMPUTER SOFTWARE PLATFORM FOR DATA COMMUNICATION AND DELIVERY ACCELERATION (U.S. CLS. 21, 23, 26, 36 AND 38).

JILL C. ALT, EXAMINING ATTORNEY

THE MARK CONSISTS OF STANDARD CHARACTERS WITHOUT CLAIM TO ANY PARTICULAR FONT, STYLE, SIZE, OR COLOR.

FOR COMPUTERS; COMPUTER SERVERS; COMPUTER DISK STORAGE UNITS; COMPUTER DISK STORAGE ACCELERATORS; HARD DISK DRIVES; CD-ROM DRIVES (U.S. CLS. 21, 23, 26, 36 AND 38).

TRICIA SONNEBORN, EXAMINING ATTORNEY

SN 78-350,645. LASERMAX, INC., ROCHESTER, NY. FILED 1-12-2004.

SN 78-350,734. TYCO ELECTRONICS CORPORATION, MIDDLETOWN, PA. FILED 1-12-2004.

**HOLOMAX**

**PARA-OPTIX**

THE MARK CONSISTS OF STANDARD CHARACTERS WITHOUT CLAIM TO ANY PARTICULAR FONT, STYLE, SIZE, OR COLOR.

FOR OPTICAL SIGHT FOR FIREARMS (U.S. CLS. 21, 23, 26, 36 AND 38).

HENRY S. ZAK, EXAMINING ATTORNEY

THE MARK CONSISTS OF STANDARD CHARACTERS WITHOUT CLAIM TO ANY PARTICULAR FONT, STYLE, SIZE, OR COLOR.

FOR CABLE ASSEMBLIES AND PARTS RELATED THERETO; TRANSCEIVERS AND PARTS RELATED THERETO (U.S. CLS. 21, 23, 26, 36 AND 38).

FIRST USE 8-18-2003; IN COMMERCE 8-18-2003.  
CAROL SPILS, EXAMINING ATTORNEY

**CLASS 9—(Continued).**

SN 78-350,757. MICRON SYSTEMS INC., ROCHELLE PARK, NJ. FILED 1-12-2004.

**CLASS 9—(Continued).**

SN 78-351,839. TURNER DESIGNS, INC., SUNNYVALE, CA. FILED 1-14-2004.



OWNER OF U.S. REG. NO. 2,224,747.  
NO CLAIM IS MADE TO THE EXCLUSIVE RIGHT TO USE "WEB", APART FROM THE MARK AS SHOWN.  
THE MARK CONSISTS OF THE STYLIZED WORDS LAW CAREER AND WEB, AFTER WHICH APPEARS AN ARTISTIC RENDERING OF A COURTHOUSE SUPERIMPOSED WITHIN A CIRCLE.

FOR COMPUTER SOFTWARE FOR TRACKING AND PROCESSING STUDENT AND EMPLOYER DATA, MONITORING AND RECONCILING INTERVIEW SCHEDULES, CALCULATING EMPLOYMENT STATISTICS, MAINTAINING JOB LISTINGS, AND GENERATING REPORTS ON ALL OF THE FOREGOING; DATABASE SOFTWARE USED BY LAW SCHOOLS FOR TRACKING RECRUITING BY LAW FIRMS (U.S. CLS. 21, 23, 26, 36 AND 38).

FIRST USE 11-1-2003; IN COMMERCE 1-1-2004.  
EVELYN BRADLEY, EXAMINING ATTORNEY

## Cyclops-7

THE MARK CONSISTS OF STANDARD CHARACTERS WITHOUT CLAIM TO ANY PARTICULAR FONT, STYLE, SIZE, OR COLOR.

FOR SCIENTIFIC INSTRUMENTS FOR MEASURING FLUORESCENCE, NAMELY SUBMERSIBLE FLUOROMETERS (U.S. CLS. 21, 23, 26, 36 AND 38).  
ELIZABETH PIGNATELLO, EXAMINING ATTORNEY

SN 78-351,795. INTEGRITY SOFTWARE SOLUTIONS, INC., BRECKSVILLE, OH. FILED 1-14-2004.

SN 78-352,502. TAYLOR PRECISION GROUP, LLC, COMMERCE TOWNSHIP, MI. FILED 1-15-2004.

## ROADBOSS

THE MARK CONSISTS OF STANDARD CHARACTERS WITHOUT CLAIM TO ANY PARTICULAR FONT, STYLE, SIZE, OR COLOR.

FOR COMPUTER SOFTWARE FOR USE IN THE TRANSPORTATION INDUSTRY FOR THE PURPOSES OF ACCOUNTING AND ADMINISTRATION OF BUSINESS OPERATIONS (U.S. CLS. 21, 23, 26, 36 AND 38).

ALICE SUE CARRUTHERS, EXAMINING ATTORNEY

## PROHELIX

THE MARK CONSISTS OF STANDARD CHARACTERS WITHOUT CLAIM TO ANY PARTICULAR FONT, STYLE, SIZE, OR COLOR.

FOR SCALES (U.S. CLS. 21, 23, 26, 36 AND 38).  
FIRST USE 0-0-1992; IN COMMERCE 0-0-1992.

DOMINICK J. SALEMI, EXAMINING ATTORNEY

**CLASS 9—(Continued).**

SN 78-352,610. PDF COMPLETE, INC., AUSTIN, TX. FILED 1-15-2004.

**CLASS 9—(Continued).**

SN 78-354,045. MULTIMEDIA GAMES, INC., AUSTIN, TX. FILED 1-20-2004.

# PDF Complete

# Platinum Bars Jackpot

THE MARK CONSISTS OF STANDARD CHARACTERS WITHOUT CLAIM TO ANY PARTICULAR FONT, STYLE, SIZE, OR COLOR.

NO CLAIM IS MADE TO THE EXCLUSIVE RIGHT TO USE "PDF", APART FROM THE MARK AS SHOWN.

FOR COMPUTER SOFTWARE FOR CREATING, EDITING, SAVING AND/OR VIEWING PDF FORMATTED FILES (U.S. CLS. 21, 23, 26, 36 AND 38).

FIRST USE 12-1-2002; IN COMMERCE 3-4-2003.  
RENEE MCCRAY, EXAMINING ATTORNEY

THE MARK CONSISTS OF STANDARD CHARACTERS WITHOUT CLAIM TO ANY PARTICULAR FONT, STYLE, SIZE, OR COLOR.

NO CLAIM IS MADE TO THE EXCLUSIVE RIGHT TO USE JACKPOT, APART FROM THE MARK AS SHOWN.

FOR GAMING MACHINES FOR PLAYING ELECTRONIC GAMES OF CHANCE; ELECTRONIC SLOT MACHINES; VIDEO LOTTERY TERMINALS (U.S. CLS. 21, 23, 26, 36 AND 38).

ELIZABETH PIGNATELLO, EXAMINING ATTORNEY

SN 78-353,998. UNIVERSAL REMOTE CONTROL, INC., HARRISON, NY. FILED 1-20-2004.

SN 78-354,047. MULTIMEDIA GAMES, INC., AUSTIN, TX. FILED 1-20-2004.

# CUSTOMIZER

# Miner '49er

THE MARK CONSISTS OF STANDARD CHARACTERS WITHOUT CLAIM TO ANY PARTICULAR FONT, STYLE, SIZE, OR COLOR.

FOR UNIVERSAL REMOTE CONTROLS FOR HOUSEHOLD ELECTRONIC APPLIANCES (U.S. CLS. 21, 23, 26, 36 AND 38).

SUSAN STIGLITZ, EXAMINING ATTORNEY

THE MARK CONSISTS OF STANDARD CHARACTERS WITHOUT CLAIM TO ANY PARTICULAR FONT, STYLE, SIZE, OR COLOR.

FOR GAMING MACHINES FOR PLAYING ELECTRONIC GAMES OF CHANCE; ELECTRONIC SLOT MACHINES; VIDEO LOTTERY TERMINALS (U.S. CLS. 21, 23, 26, 36 AND 38).

ELIZABETH PIGNATELLO, EXAMINING ATTORNEY

**CLASS 9—(Continued).**

SN 78-354,050. MULTIMEDIA GAMES, INC., AUSTIN, TX.  
FILED 1-20-2004.

**CLASS 9—(Continued).**

SN 78-354,053. MULTIMEDIA GAMES, INC., AUSTIN, TX.  
FILED 1-20-2004.

## Meat & Potatoes

## Hotter 'N Hell

THE MARK CONSISTS OF STANDARD CHARACTERS WITHOUT CLAIM TO ANY PARTICULAR FONT, STYLE, SIZE, OR COLOR.

FOR GAMING MACHINES FOR PLAYING ELECTRONIC GAMES OF CHANCE; ELECTRONIC SLOT MACHINES; VIDEO LOTTERY TERMINALS (U.S. CLS. 21, 23, 26, 36 AND 38).

ELIZABETH PIGNATELLO, EXAMINING ATTORNEY

THE MARK CONSISTS OF STANDARD CHARACTERS WITHOUT CLAIM TO ANY PARTICULAR FONT, STYLE, SIZE, OR COLOR.

FOR GAMING MACHINES FOR PLAYING ELECTRONIC GAMES OF CHANCE; ELECTRONIC SLOT MACHINES; VIDEO LOTTERY TERMINALS (U.S. CLS. 21, 23, 26, 36 AND 38).

SCOTT OSCLICK, EXAMINING ATTORNEY

---

SN 78-354,051. MULTIMEDIA GAMES, INC., AUSTIN, TX.  
FILED 1-20-2004.

---

SN 78-354,074. MULTIMEDIA GAMES, INC., AUSTIN, TX.  
FILED 1-20-2004.

## Lucky Break

## Behind Bars

THE MARK CONSISTS OF STANDARD CHARACTERS WITHOUT CLAIM TO ANY PARTICULAR FONT, STYLE, SIZE, OR COLOR.

FOR GAMING MACHINES FOR PLAYING ELECTRONIC GAMES OF CHANCE; ELECTRONIC SLOT MACHINES; VIDEO LOTTERY TERMINALS (U.S. CLS. 21, 23, 26, 36 AND 38).

ELIZABETH PIGNATELLO, EXAMINING ATTORNEY

THE MARK CONSISTS OF STANDARD CHARACTERS WITHOUT CLAIM TO ANY PARTICULAR FONT, STYLE, SIZE, OR COLOR.

FOR GAMING MACHINES FOR PLAYING ELECTRONIC GAMES OF CHANCE; ELECTRONIC SLOT MACHINES; VIDEO LOTTERY TERMINALS (U.S. CLS. 21, 23, 26, 36 AND 38).

MATTHEW KLINE, EXAMINING ATTORNEY

**CLASS 9—(Continued).**

SN 78-354,260. URBAN, KEITH, NASHVILLE, TN. FILED 1-20-2004.

**CLASS 9—(Continued).**

SN 78-354,553. BALLY GAMING INTERNATIONAL, INC., LAS VEGAS, NV. FILED 1-20-2004.



**WILD CROWN**

FOR SERIES OF MUSICAL SOUND RECORDINGS AND AUDIOVISUAL RECORDINGS, NAMELY COMPACT DISCS; AND DECORATIVE MAGNETS (U.S. CLS. 21, 23, 26, 36 AND 38).  
MATTHEW KLINE, EXAMINING ATTORNEY

THE MARK CONSISTS OF STANDARD CHARACTERS WITHOUT CLAIM TO ANY PARTICULAR FONT, STYLE, SIZE, OR COLOR.  
FOR GAMING DEVICES, NAMELY SLOT MACHINES, WITH OR WITHOUT VIDEO OUTPUT (U.S. CLS. 21, 23, 26, 36 AND 38).  
LAURA KOVAISKY, EXAMINING ATTORNEY

SN 78-354,413. MICROSOFT CORPORATION, REDMOND, WA. FILED 1-20-2004.

SN 78-354,792. MATTHEWS, NORMAN G, PASADENA, MD. FILED 1-21-2004.

**CANDARA**

**Goodtone**

THE MARK CONSISTS OF STANDARD CHARACTERS WITHOUT CLAIM TO ANY PARTICULAR FONT, STYLE, SIZE, OR COLOR.  
FOR COMPUTER SOFTWARE FOR USE IN DISPLAYING AND PRINTING DIGITAL TYPEFACE DESIGNS, TYPOGRAPHICAL ORNAMENTS AND CHARACTER FONTS (U.S. CLS. 21, 23, 26, 36 AND 38).  
ODESSA BIBBINS, EXAMINING ATTORNEY

THE MARK CONSISTS OF STANDARD CHARACTERS WITHOUT CLAIM TO ANY PARTICULAR FONT, STYLE, SIZE, OR COLOR.  
FOR GUITAR AMPLIFIERS (U.S. CLS. 21, 23, 26, 36 AND 38).  
GINA HAYES, EXAMINING ATTORNEY

**CLASS 9—(Continued).**

SN 78-354,893. STRIKEIRON, INC., DURHAM, NC. FILED 1-21-2004.

**CLASS 9—(Continued).**

SN 78-355,100. BALLY GAMING INTERNATIONAL, INC., LAS VEGAS, NV. FILED 1-21-2004.

# STRIKEIRON

# THE BIG MONTE

THE MARK CONSISTS OF STANDARD CHARACTERS WITHOUT CLAIM TO ANY PARTICULAR FONT, STYLE, SIZE, OR COLOR.

FOR COMPUTER SOFTWARE FOR VIEWING, EXTRACTING AND FORMATING DATA FROM WEB SERVICE APPLICATIONS; FOR COMBINING MULTIPLE WEB SERVICE APPLICATIONS; FOR INTEGRATING WEB SERVICE APPLICATION INTO COMMON BUSINESS SOFTWARE APPLICATIONS; FOR ANALYZING THE DATA REQUIREMENTS, DATA STRUCTURES, BEHAVIOR AND RESULTS OF WEB SERVICE APPLICATIONS; FOR LOCATING AND INTERPRETING WEB SERVICE APPLICATIONS; AND FOR TESTING AND UTILIZING WEB SERVICE APPLICATIONS (U.S. CLS. 21, 23, 26, 36 AND 38).

FIRST USE 6-19-2003; IN COMMERCE 9-17-2003.  
MICHAEL KEATING, EXAMINING ATTORNEY

THE MARK CONSISTS OF STANDARD CHARACTERS WITHOUT CLAIM TO ANY PARTICULAR FONT, STYLE, SIZE, OR COLOR.

FOR GAMING DEVICES, NAMELY SLOT MACHINES, WITH OR WITHOUT VIDEO OUTPUT (U.S. CLS. 21, 23, 26, 36 AND 38).

GRETTA YAO, EXAMINING ATTORNEY

SN 78-355,190. BALLY GAMING INTERNATIONAL, INC., LAS VEGAS, NV. FILED 1-21-2004.

SN 78-355,065. BALLY GAMING INTERNATIONAL, INC., LAS VEGAS, NV. FILED 1-21-2004.

# GAMETICKER

## INDEPENDENCE PAY

THE MARK CONSISTS OF STANDARD CHARACTERS WITHOUT CLAIM TO ANY PARTICULAR FONT, STYLE, SIZE, OR COLOR.

FOR GAMING DEVICES, NAMELY SLOT MACHINES, WITH OR WITHOUT VIDEO OUTPUT (U.S. CLS. 21, 23, 26, 36 AND 38).

GRETTA YAO, EXAMINING ATTORNEY

THE MARK CONSISTS OF STANDARD CHARACTERS WITHOUT CLAIM TO ANY PARTICULAR FONT, STYLE, SIZE, OR COLOR.

FOR COMPUTER SOFTWARE USED TO SUMMARIZE AND DISPLAY STATISTICAL SLOT MACHINE INFORMATION TO CASINO EXECUTIVES IN THE FORM OF VIDEO DISPLAYS THAT MAY BE CUSTOMIZED BY EACH USER OF SUCH COMPUTER SOFTWARE (U.S. CLS. 21, 23, 26, 36 AND 38).

GRETTA YAO, EXAMINING ATTORNEY



**CLASS 9—(Continued).**

SN 78-355,221. PROPIX ELECTRONIC LTD., VICTORIA, CANADA, FILED 1-21-2004.

# PROPIX

THE MARK CONSISTS OF STANDARD CHARACTERS WITHOUT CLAIM TO ANY PARTICULAR FONT, STYLE, SIZE, OR COLOR.

FOR MULTIMEDIA PROJECTORS; MULTIMEDIA LCD (LIQUID CRYSTAL DISPLAY) PROJECTORS, NAMELY, ELECTRONIC APPARATUS FOR REPRODUCING ELECTRONICALLY DEFINED IMAGES SUPPLIED BY AN EXTERNAL ELECTRONIC MEDIA SOURCE, SUCH AS VIDEO AND COMPUTER GRAPHIC IMAGES, UPON A LIQUID CRYSTAL DISPLAY PANEL AND OPTICALLY PROJECTING THE IMAGES THUS FORMED; PROJECTION SCREENS (U.S. CLS. 21, 23, 26, 36 AND 38).

MATTHEW KLINE, EXAMINING ATTORNEY

SN 78-355,335. BALLY GAMING INTERNATIONAL, INC., LAS VEGAS, NV. FILED 1-21-2004.

# MONEY FRENZY

THE MARK CONSISTS OF STANDARD CHARACTERS WITHOUT CLAIM TO ANY PARTICULAR FONT, STYLE, SIZE, OR COLOR.

FOR GAMING DEVICES, NAMELY SLOT MACHINES, WITH OR WITHOUT VIDEO OUTPUT (U.S. CLS. 21, 23, 26, 36 AND 38).

TARAH HARDY, EXAMINING ATTORNEY

**CLASS 9—(Continued).**

SN 78-355,348. COMMISSION FOR THE LAS VEGAS CENTENNIAL, LAS VEGAS, NV. FILED 1-21-2004.



NO CLAIM IS MADE TO THE EXCLUSIVE RIGHT TO USE LAS VEGAS AND 1905-2005, APART FROM THE MARK AS SHOWN.

THE COLOR(S) RED, WHITE AND BLUE IS/ARE CLAIMED AS A DISTINCTIVE FEATURE OF THE MARK.

THE MARK CONSISTS OF A RED SIGN WITH THE WHITE STYLIZED WORDS AND NUMBERS LAS VEGAS CENTENNIAL 1905-2005, WITH BLUE AND WHITE CIRCLES AROUND THE SIGN, AND A BLUE STAR.

FOR WIRELESS TELEPHONES; COVERS FOR WIRELESS TELEPHONE RECEIVERS NOT MADE OF PAPER; PREPAID TELEPHONE CARDS MAGNETICALLY CODED; CREDIT CARDS MAGNETICALLY CODED; PRERECORDED CDS, DVDS, CASSETTE TAPES AND VHS TAPES FEATURING MUSICAL EVENTS; COMPUTERS; HAND HELD COMPUTERS (U.S. CLS. 21, 23, 26, 36 AND 38).

KIMBERLY PERRY, EXAMINING ATTORNEY

SN 78-355,622. TARGUS GROUP INTERNATIONAL, INC., ANAHEIM, CA. FILED 1-22-2004.

# BUBBLESLEEVES

THE MARK CONSISTS OF STANDARD CHARACTERS WITHOUT CLAIM TO ANY PARTICULAR FONT, STYLE, SIZE, OR COLOR.

FOR STORAGE AND CARRYING CASES FOR PORTABLE ELECTRONIC MEDIA AND ACCESSORIES, NAMELY, CASES FOR STORING AND TRANSPORTING COMPACT DISCS AND DIGITAL VIDEO DISCS, COMPACT DISC RECORDERS AND PLAYERS, DIGITAL VIDEO DISC RECORDERS AND PLAYERS, MP3 RECORDERS AND PLAYERS, AND COMPACT DISC AND DIGITAL VIDEO DISC STORAGE BINDERS (U.S. CLS. 21, 23, 26, 36 AND 38).

FIRST USE 12-31-1999; IN COMMERCE 12-31-1999.

DAVID MURRAY, EXAMINING ATTORNEY

**CLASS 9—(Continued).**

SN 78-355,670. ENHOUSE AMERICA, INC., BEAUMONT, TX. FILED 1-22-2004.

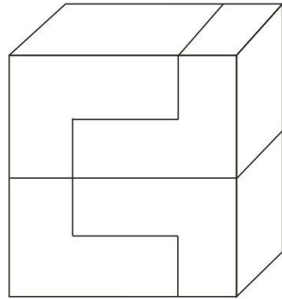

OWNER OF U.S. REG. NO. 2,779,619.  
 FOR COMPUTER SOFTWARE FOR USE IN MANAGEMENT AND TRACKING OF BUSINESS INVENTORY, MANAGEMENT AND TRACKING OF HOUSEHOLD AND PERSONAL ITEMS (U.S. CLS. 21, 23, 26, 36 AND 38).  
 FIRST USE 10-17-2002; IN COMMERCE 10-17-2002.  
 G. T. GLYNN, EXAMINING ATTORNEY

SN 78-356,028. PBE, LLC, BRACEY, VA. FILED 1-22-2004.

**THE POWER OF BREAK  
 EVEN**

THE MARK CONSISTS OF STANDARD CHARACTERS WITHOUT CLAIM TO ANY PARTICULAR FONT, STYLE, SIZE, OR COLOR.  
 FOR ACCOUNTING AND BUSINESS MANAGEMENT SOFTWARE (U.S. CLS. 21, 23, 26, 36 AND 38).  
 STACY WAHLBERG, EXAMINING ATTORNEY

**CLASS 9—(Continued).**

SN 78-356,099. PGM SYSTEMS, INC., WHATELY, MA. FILED 1-23-2004.

**iStart**

THE MARK CONSISTS OF STANDARD CHARACTERS WITHOUT CLAIM TO ANY PARTICULAR FONT, STYLE, SIZE, OR COLOR.  
 FOR COMPUTER SOFTWARE DEVELOPMENT TOOL, NAMELY USED TO DESIGN, DEVELOP AND DEPLOY SOFTWARE BUSINESS APPLICATIONS AND INSTRUCTIONAL MANUALS SOLD THEREWITH AS A UNIT (U.S. CLS. 21, 23, 26, 36 AND 38).  
 FIRST USE 3-11-2004; IN COMMERCE 3-11-2004.  
 PRISCILLA MILTON, EXAMINING ATTORNEY

SN 78-357,267. RED CHIP COMPANY LTD., ROAD TOWN, TORTOLA, BR. VIRGIN ISLANDS, FILED 1-26-2004.

**EUROPORT**

THE MARK CONSISTS OF STANDARD CHARACTERS WITHOUT CLAIM TO ANY PARTICULAR FONT, STYLE, SIZE, OR COLOR.  
 FOR AUDIO EQUIPMENT, NAMELY, MIXERS (U.S. CLS. 21, 23, 26, 36 AND 38).  
 BRENDAN MCCAULEY, EXAMINING ATTORNEY

**CLASS 9—(Continued).**

SN 78-357,271. LOGIC SOFTWARE INC., RICHARDSON, TX.  
FILED 1-26-2004.

**CLASS 9—(Continued).**

SN 78-357,671. FLOWLINE, INC., LOS ALAMITOS, CA.  
FILED 1-26-2004.

CodeIQ

MIGHTYMO

THE MARK CONSISTS OF STANDARD CHARACTERS  
WITHOUT CLAIM TO ANY PARTICULAR FONT, STYLE,  
SIZE, OR COLOR.

FOR COMPUTER SOFTWARE DEVELOPMENT TOOL  
(U.S. CLS. 21, 23, 26, 36 AND 38).  
LOURDES AYALA, EXAMINING ATTORNEY

THE MARK CONSISTS OF STANDARD CHARACTERS  
WITHOUT CLAIM TO ANY PARTICULAR FONT, STYLE,  
SIZE, OR COLOR.

FOR ULTRASONIC SENSORS FOR USE IN TANK  
LEVEL INVENTORY MONITORING AND CONTROL  
(U.S. CLS. 21, 23, 26, 36 AND 38).  
BRENDAN MCCAULEY, EXAMINING ATTORNEY

SN 78-357,515. IGT, RENO, NV. FILED 1-26-2004.

SN 78-357,808. AXIUM INTERNATIONAL, INC., LOS AN-  
GELES, CA. FILED 1-26-2004.

FROG PRINCESS

MOVIETRAX

THE MARK CONSISTS OF STANDARD CHARACTERS  
WITHOUT CLAIM TO ANY PARTICULAR FONT, STYLE,  
SIZE, OR COLOR.

OWNER OF U.S. REG. NO. 2,583,669.  
FOR GAMING MACHINES, NAMELY, SLOT MA-  
CHINES WITH OR WITHOUT VIDEO OUTPUT, VIDEO  
LOTTERY TERMINALS, OR GAMING MACHINES FOR  
PLAY OF AN INTERACTIVE, ELECTRONIC BINGO  
GAME (U.S. CLS. 21, 23, 26, 36 AND 38).  
SCOTT BALDWIN, EXAMINING ATTORNEY

THE MARK CONSISTS OF STANDARD CHARACTERS  
WITHOUT CLAIM TO ANY PARTICULAR FONT, STYLE,  
SIZE, OR COLOR.

FOR ACCOUNTING AND FINANCIAL MANAGE-  
MENT SOFTWARE (U.S. CLS. 21, 23, 26, 36 AND 38).  
THEODORE MCBRIDE, EXAMINING ATTORNEY

**CLASS 9—(Continued).**

SN 78-358,180. INTERCERVE, INC., HUNTERSVILLE, NC.  
FILED 1-27-2004.

**CLASS 9—(Continued).**

SN 78-359,317. ZIENA OPTIMIZATION INC., EVANSTON, IL.  
FILED 1-29-2004.

**SQL SENTRY**

THE MARK CONSISTS OF STANDARD CHARACTERS WITHOUT CLAIM TO ANY PARTICULAR FONT, STYLE, SIZE, OR COLOR.

NO CLAIM IS MADE TO THE EXCLUSIVE RIGHT TO USE "SQL", APART FROM THE MARK AS SHOWN.

FOR COMPUTER SOFTWARE FOR MANAGING COMPUTER SOFTWARE APPLICATIONS AND COMPUTER EQUIPMENT, NAMELY BY PROVIDING SCHEDULING, MONITORING, ALERTING AND REPORTING CAPABILITIES; AND ALL INSTRUCTION MANUALS SOLD AND DISTRIBUTED THEREWITH (U.S. CLS. 21, 23, 26, 36 AND 38).

FIRST USE 8-19-2003; IN COMMERCE 8-19-2003.  
JILL C. ALT, EXAMINING ATTORNEY

---

SN 78-358,847. KODAK POLYCHROME GRAPHICS LLC,  
NORWALK, CT. FILED 1-28-2004.

**DIRECTWORKS**

THE MARK CONSISTS OF STANDARD CHARACTERS WITHOUT CLAIM TO ANY PARTICULAR FONT, STYLE, SIZE, OR COLOR.

FOR SOFTWARE FOR USE IN PRINTING AND GRAPHIC ARTS WORKFLOW (U.S. CLS. 21, 23, 26, 36 AND 38).

DANIEL CAPSHAW, EXAMINING ATTORNEY

---

SN 78-358,968. COMPUCREDIT CORPORATION, ATLANTA,  
GA. FILED 1-28-2004.



FOR MAGNETICALLY ENCODED CREDIT CARDS  
(U.S. CLS. 21, 23, 26, 36 AND 38).  
LINDA E. BLOHM, EXAMINING ATTORNEY

**KNITRO**

THE MARK CONSISTS OF STANDARD CHARACTERS WITHOUT CLAIM TO ANY PARTICULAR FONT, STYLE, SIZE, OR COLOR.

FOR COMPUTER SOFTWARE FOR SOLVING MATH PROBLEMS (U.S. CLS. 21, 23, 26, 36 AND 38).

FIRST USE 1-16-2001; IN COMMERCE 3-2-2001.

NORA BUCHANAN WILL, EXAMINING ATTORNEY

---

SN 78-360,031. BOSCH SECURITY SYSTEMS, INC., FAIR-  
PORT, NY. FILED 1-30-2004.

**CHAMBERMAID**

THE MARK CONSISTS OF STANDARD CHARACTERS WITHOUT CLAIM TO ANY PARTICULAR FONT, STYLE, SIZE, OR COLOR.

FOR ELECTRIC AND ELECTRONIC SENSORS FOR DETECTING THE PRESENCE OF GAS, SMOKE, HEAT, MOTION, PRODUCTS OF COMBUSTION AND RADIATION, AND COMPONENTS THEREFOR, NAMELY, SELF SEALING ENTRY PORTS AND VALVES (U.S. CLS. 21, 23, 26, 36 AND 38).

WILLIAM P. SHANAHAN, EXAMINING ATTORNEY

**CLASS 9—(Continued).**

SN 78-360,097. CHEVEREZ, JULIA, LOS ANGELES, CA. FILED 1-30-2004.

**CLASS 9—(Continued).**

SN 78-360,265. M-TECH INDUSTRIAL (PTY) LTD, POTCHEFSTROOM, SOUTH AFRICA, FILED 1-30-2004.

**you will die and  
the party will go  
on**

**FLOWNEX**

THE MARK CONSISTS OF STANDARD CHARACTERS WITHOUT CLAIM TO ANY PARTICULAR FONT, STYLE, SIZE, OR COLOR.

FOR MUSICAL SOUND AND VIDEO RECORDINGS (U.S. CLS. 21, 23, 26, 36 AND 38).

EVELYN BRADLEY, EXAMINING ATTORNEY

THE MARK CONSISTS OF STANDARD CHARACTERS WITHOUT CLAIM TO ANY PARTICULAR FONT, STYLE, SIZE, OR COLOR.

FOR COMPUTER SOFTWARE FOR ANALYSIS AND DESIGN IN THE FIELD OF THERMAL-FLUID NETWORKS AND SYSTEMS (U.S. CLS. 21, 23, 26, 36 AND 38). FIRST USE 4-1-2003; IN COMMERCE 6-1-2003.

STEVEN JACKSON, EXAMINING ATTORNEY

SN 78-360,180. SKYSCAPE, INC., HUDSON, MA. FILED 1-30-2004.

SN 78-360,287. SOPHOS PLC, ABINGDON, UNITED KINGDOM, FILED 1-30-2004.

**DRDRUGS**

**PUREVIEW**

THE MARK CONSISTS OF STANDARD CHARACTERS WITHOUT CLAIM TO ANY PARTICULAR FONT, STYLE, SIZE, OR COLOR.

FOR DOWNLOADABLE SOFTWARE, NAMELY A COMPREHENSIVE AND CUSTOMIZABLE DATABASE OFFERING INFORMATION REGARDING THE CLINICAL USE OF MEDICATIONS AND NATURAL REMEDIES (U.S. CLS. 21, 23, 26, 36 AND 38).

FIRST USE 6-1-2001; IN COMMERCE 6-1-2001.

DORITT L. CARROLL, EXAMINING ATTORNEY

THE MARK CONSISTS OF STANDARD CHARACTERS WITHOUT CLAIM TO ANY PARTICULAR FONT, STYLE, SIZE, OR COLOR.

FOR COMPUTER SOFTWARE, NAMELY SOFTWARE THAT INTERPRETS EMAIL MESSAGES INTO MULTIPLE FORMATS FOR ANALYSIS (U.S. CLS. 21, 23, 26, 36 AND 38).

FIRST USE 1-2-2004; IN COMMERCE 1-26-2004.

H. M. FISHER, EXAMINING ATTORNEY

**CLASS 9—(Continued).**

SN 78-360,332. SOPHOS PLC, ABINGDON, UNITED KINGDOM, FILED 1-30-2004.

**CLASS 9—(Continued).**

SN 78-360,530. HOLLEY, DEREK J., DAYTON, OH. FILED 1-30-2004.

**PURETRACE****Dress Code**

THE MARK CONSISTS OF STANDARD CHARACTERS WITHOUT CLAIM TO ANY PARTICULAR FONT, STYLE, SIZE, OR COLOR.

FOR COMPUTER SOFTWARE, NAMELY SOFTWARE THAT EVALUATES EMAIL MESSAGE SOURCES AND DESTINATION LOCATIONS (U.S. CLS. 21, 23, 26, 36 AND 38).

FIRST USE 1-2-2004; IN COMMERCE 1-26-2004.  
H. M. FISHER, EXAMINING ATTORNEY

THE MARK CONSISTS OF STANDARD CHARACTERS WITHOUT CLAIM TO ANY PARTICULAR FONT, STYLE, SIZE, OR COLOR.

FOR MUSICAL SOUND RECORDINGS (U.S. CLS. 21, 23, 26, 36 AND 38).

FIRST USE 1-1-1995; IN COMMERCE 1-1-1996.  
JIM RINGLE, EXAMINING ATTORNEY

---

SN 78-360,370. SOPHOS PLC, ABINGDON, UNITED KINGDOM, FILED 1-30-2004.

---

SN 78-360,695. SOLATRON TECHNOLOGIES INCORPORATED, VICTORVILLE, CA. FILED 2-1-2004.

**PUREDETECT****SOLATRON**

THE MARK CONSISTS OF STANDARD CHARACTERS WITHOUT CLAIM TO ANY PARTICULAR FONT, STYLE, SIZE, OR COLOR.

FOR COMPUTER SOFTWARE, NAMELY SOFTWARE THAT ANALYZES EMAIL MESSAGES FOR CONTENT AND STRUCTURE INDICATORS (U.S. CLS. 21, 23, 26, 36 AND 38).

FIRST USE 1-2-2004; IN COMMERCE 1-26-2004.  
H. M. FISHER, EXAMINING ATTORNEY

THE MARK CONSISTS OF STANDARD CHARACTERS WITHOUT CLAIM TO ANY PARTICULAR FONT, STYLE, SIZE, OR COLOR.

FOR SOLAR COLLECTORS, PHOTOVOLTAIC CELLS, INVERTERS AND BATTERIES (U.S. CLS. 21, 23, 26, 36 AND 38).

FIRST USE 11-10-1999; IN COMMERCE 11-25-1999.  
TARAH HARDY, EXAMINING ATTORNEY

**CLASS 9—(Continued).**

SN 78-360,876. IGT, RENO, NV. FILED 2-2-2004.

**CLASS 9—(Continued).**

SN 78-361,158. NAVTRAK, INC., SALISBURY, MD. FILED 2-2-2004.

# BAUBLE BATH

# NEXJOB

THE MARK CONSISTS OF STANDARD CHARACTERS WITHOUT CLAIM TO ANY PARTICULAR FONT, STYLE, SIZE, OR COLOR.

FOR GAMING MACHINES, NAMELY, SLOT MACHINES WITH OR WITHOUT VIDEO OUTPUT, VIDEO LOTTERY TERMINALS, GAMING MACHINES FOR PLAY OF AN INTERACTIVE, ELECTRONIC BINGO GAME (U.S. CLS. 21, 23, 26, 36 AND 38).

STEVEN R. FINE, EXAMINING ATTORNEY

THE MARK CONSISTS OF STANDARD CHARACTERS WITHOUT CLAIM TO ANY PARTICULAR FONT, STYLE, SIZE, OR COLOR.

FOR SOFTWARE APPLICATION THAT RUNS ON A CELL PHONE THAT ENABLES A COMPANY'S DISPATCHERS TO SEND AND RECEIVE JOB-RELATED INFORMATION AND DIRECTIONS TO AND FROM FIELD WORKERS (U.S. CLS. 21, 23, 26, 36 AND 38).

CAROLYN CATALDO, EXAMINING ATTORNEY

---

SN 78-360,879. IGT, RENO, NV. FILED 2-2-2004.

---

SN 78-361,229. POINT BLANK BODY ARMOR, INC., OAKLAND PARK, FL. FILED 2-2-2004.

# AFTER TAXES

# GENESIS

THE MARK CONSISTS OF STANDARD CHARACTERS WITHOUT CLAIM TO ANY PARTICULAR FONT, STYLE, SIZE, OR COLOR.

FOR GAMING MACHINES, NAMELY, SLOT MACHINES WITH OR WITHOUT VIDEO OUTPUT, VIDEO LOTTERY TERMINALS, OR GAMING MACHINES FOR PLAY OF AN INTERACTIVE, ELECTRONIC BINGO GAME (U.S. CLS. 21, 23, 26, 36 AND 38).

STEVEN R. FINE, EXAMINING ATTORNEY

THE MARK CONSISTS OF STANDARD CHARACTERS WITHOUT CLAIM TO ANY PARTICULAR FONT, STYLE, SIZE, OR COLOR.

OWNER OF U.S. REG. NO. 2,709,207. FOR PROTECTIVE BODY ARMOR, NAMELY, BALLISTIC, BULLET, SLASH AND STAB RESISTANT BODY ARMOR AND PROTECTIVE CLOTHING (U.S. CLS. 21, 23, 26, 36 AND 38).

RONALD MCMORROW, EXAMINING ATTORNEY

**CLASS 9—(Continued).**

SN 78-361,275. JAMBA JUICE COMPANY, SAN FRANCISCO, CA. FILED 2-2-2004.



OWNER OF U.S. REG. NOS. 2,014,541, 2,526,399 AND OTHERS.

THE MARK CONSISTS OF THE WORDS "JAMBA JUICE" IN A SEMI-CIRCLE IN A STYLIZED FONT ABOVE A SWIRL DESIGN REPRESENTING A FRUIT SMOOTHIE.

FOR PRERECORDED COMPACT DISCS, DVDS, AUDIOTAPES, VIDEOTAPES, AND VIDEODISCS, FEATURING MUSIC (U.S. CLS. 21, 23, 26, 36 AND 38).

FIRST USE 12-31-2003; IN COMMERCE 12-31-2003.  
INGRID C. EULIN, EXAMINING ATTORNEY

**CLASS 9—(Continued).**

SN 78-362,064. ALLTRADE TOOLS LLC, LONG BEACH, CA. FILED 2-3-2004.

**XXL**

THE MARK CONSISTS OF STANDARD CHARACTERS WITHOUT CLAIM TO ANY PARTICULAR FONT, STYLE, SIZE, OR COLOR.

FOR TAPE MEASURES (U.S. CLS. 21, 23, 26, 36 AND 38).

REGINA DRUMMOND, EXAMINING ATTORNEY

SN 78-362,393. FONIX CORPORATION, SANDY, UT. FILED 2-4-2004.

SN 78-361,279. SEXY MAGAZINES LLC, THE, LOS ANGELES, CA. FILED 2-2-2004.

**DECtalk**

**THE SEXY MAGAZINES**

THE MARK CONSISTS OF STANDARD CHARACTERS WITHOUT CLAIM TO ANY PARTICULAR FONT, STYLE, SIZE, OR COLOR.

FOR SERIES OF MUSICAL SOUND RECORDINGS AND PRERECORDED COMPACT DISCS, VIDEOTAPES, VIDEODISCS, VIDEOCASSETTES, CD-ROMS, DVDS, DATS, AND LASERDISCS, ALL FEATURING MUSIC; DOWNLOADABLE AUDIO AND VIDEO RECORDINGS FEATURING MUSIC (U.S. CLS. 21, 23, 26, 36 AND 38).

LINDA MICKLEBURGH, EXAMINING ATTORNEY

THE MARK CONSISTS OF STANDARD CHARACTERS WITHOUT CLAIM TO ANY PARTICULAR FONT, STYLE, SIZE, OR COLOR.

FOR COMPUTER EQUIPMENT; NAMELY, COMPUTER HARDWARE AND SOFTWARE THAT TRANSLATES ALPHANUMERIC TEXT INTO HUMAN SPEECH, AND INSTRUCTION MANUALS SOLD OR DISTRIBUTED THEREWITH AS A UNIT (U.S. CLS. 21, 23, 26, 36 AND 38).

FIRST USE 7-26-1986; IN COMMERCE 7-26-1986.

LESLEY LAMOTHE, EXAMINING ATTORNEY



**CLASS 9—(Continued).**

SN 78-362,835. VITALWORKS INC., RIDGEFIELD, CT. FILED 2-5-2004.

**CLASS 9—(Continued).**

SN 78-363,367. HARDING MARKETING COMMUNICATIONS, INC., SAN JOSE, CA. FILED 2-5-2004.

# OPTISHOP

# NetMarcom

THE MARK CONSISTS OF STANDARD CHARACTERS WITHOUT CLAIM TO ANY PARTICULAR FONT, STYLE, SIZE, OR COLOR.

FOR COMPUTER SOFTWARE FOR USE IN MANAGING THE BUSINESS OF OPTICIANS, NAMELY, ORDERING OF CONTACTS, GLASSES, LENSES AND FRAMES, LAB ORDERS, INSURANCE BILLING, PATIENT BILLING, LETTER AND DOCUMENT GENERATION, USER TRACKING, ORDER MANAGEMENT AND TRACKING, PRESCRIPTION MANAGEMENT AND TRACKING, INVENTORY MANAGEMENT AND TRACKING, SALES AND INVENTORY REPORTING (U.S. CLS. 21, 23, 26, 36 AND 38).

FIRST USE 10-0-2001; IN COMMERCE 10-0-2001.  
LINDA E. BLOHM, EXAMINING ATTORNEY

THE MARK CONSISTS OF STANDARD CHARACTERS WITHOUT CLAIM TO ANY PARTICULAR FONT, STYLE, SIZE, OR COLOR.

FOR COMPUTER SOFTWARE FOR MARKETING CONTENT MANAGEMENT (U.S. CLS. 21, 23, 26, 36 AND 38).

ANDREW BENZMILLER, EXAMINING ATTORNEY

SN 78-363,366. MCGRAW-EDISON COMPANY, HOUSTON, TX. FILED 2-5-2004.

SN 78-363,509. RFQ, INC., SAN RAFAEL, CA. FILED 2-5-2004.

# FLEXINSPECTOR



FOR ELECTRICAL DISTRIBUTION TRANSFORMERS (U.S. CLS. 21, 23, 26, 36 AND 38).  
FIRST USE 4-30-1997; IN COMMERCE 4-30-1997.  
ANDREW BENZMILLER, EXAMINING ATTORNEY

THE MARK CONSISTS OF STANDARD CHARACTERS WITHOUT CLAIM TO ANY PARTICULAR FONT, STYLE, SIZE, OR COLOR.

FOR VIDEO SENSOR WITH LEARNING AND RECOGNITION CAPABILITIES FOR INDUSTRIAL MACHINE VISION AND QUALITY CONTROL (U.S. CLS. 21, 23, 26, 36 AND 38).

LINDA E. BLOHM, EXAMINING ATTORNEY

**CLASS 9—(Continued).**

SN 78-364,006. SHURE INCORPORATED, NILES, IL. FILED 2-6-2004.

**UHF-R**

THE MARK CONSISTS OF STANDARD CHARACTERS WITHOUT CLAIM TO ANY PARTICULAR FONT, STYLE, SIZE, OR COLOR.

FOR WIRELESS AUDIO SYSTEMS, COMPRISING WIRELESS TRANSMITTERS AND WIRELESS RECEIVERS (U.S. CLS. 21, 23, 26, 36 AND 38).  
CAROLINE WOOD, EXAMINING ATTORNEY

SN 78-364,402. LOUD GAMES, CLIFTON, NJ. FILED 2-7-2004.

**Aquus**

THE MARK CONSISTS OF STANDARD CHARACTERS WITHOUT CLAIM TO ANY PARTICULAR FONT, STYLE, SIZE, OR COLOR.

FOR ELECTRONIC GAME PROGRAMS; DOWNLOADABLE ELECTRONIC GAME PROGRAMS; DOWNLOADABLE COMPUTER GAME SOFTWARE FOR PLAYING GAMES OVER COMPUTER NETWORKS (U.S. CLS. 21, 23, 26, 36 AND 38).  
ELLEN PERKINS, EXAMINING ATTORNEY

**CLASS 9—(Continued).**

SN 78-364,440. VALHALLA GAMES, LLC, XENIA, OH. FILED 2-8-2004.

**Valhalla Games,  
LLC**

THE MARK CONSISTS OF STANDARD CHARACTERS WITHOUT CLAIM TO ANY PARTICULAR FONT, STYLE, SIZE, OR COLOR.

NO CLAIM IS MADE TO THE EXCLUSIVE RIGHT TO USE GAMES LLC, APART FROM THE MARK AS SHOWN, FOR COMPUTER GAME SOFTWARE (U.S. CLS. 21, 23, 26, 36 AND 38).  
DORITT L. CARROLL, EXAMINING ATTORNEY

SN 78-365,091. MICROVISION, INC., BOTHELL, WA. FILED 2-9-2004.

**NOMAD**

OWNER OF U.S. REG. NO. 2,725,199.  
FOR PORTABLE HEAD-MOUNTED VIDEO MONITOR FOR INDUSTRIAL, MEDICAL, SECURITY, SAFETY, COMMERCIAL AND SIMILAR APPLICATIONS (U.S. CLS. 21, 23, 26, 36 AND 38).  
SHAUNIA WALLACE, EXAMINING ATTORNEY

SN 78-365,097. MICROVISION, INC., BOTHELL, WA. FILED 2-9-2004.

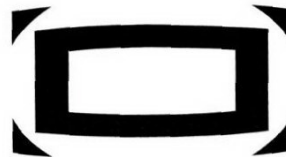

FOR PORTABLE HEAD-MOUNTED VIDEO MONITOR FOR INDUSTRIAL, MEDICAL, SECURITY, SAFETY, COMMERCIAL AND SIMILAR APPLICATIONS (U.S. CLS. 21, 23, 26, 36 AND 38).  
SHAUNIA WALLACE, EXAMINING ATTORNEY

**CLASS 9—(Continued).**

SN 78-365,666. LEXAR MEDIA, INC., FREMONT, CA. FILED 2-10-2004.

**SHOOT & SHARE**

THE MARK CONSISTS OF STANDARD CHARACTERS WITHOUT CLAIM TO ANY PARTICULAR FONT, STYLE, SIZE, OR COLOR.

FOR COMPUTER SOFTWARE FOR TRANSFERRING, STORING, TRANSPORTING, AND RECOVERING ELECTRONIC DATA BETWEEN ELECTRONIC STORAGE DEVICES; COMPUTER SOFTWARE FOR ENCODING DIGITAL FILM DATA; COMPUTER SOFTWARE FOR USE IN PHOTOGRAPH EDITING, NAMING AND ORGANIZING, AND DOWNLOADING, STORING, ORGANIZING, TRANSMITTING, EDITING, CODING, DECODING, AND PLAYING DIGITAL SOUND AND IMAGE DATA; DIGITAL FILM; DIGITAL FILM READERS; SOLID STATE STORAGE MEDIA; DIGITAL STORAGE MEDIA READERS; USB FLASH DRIVES; FLASH MEMORY CARDS; NON-VOLATILE MEMORY CARDS (U.S. CLS. 21, 23, 26, 36 AND 38).  
LINDA E. BLOHM, EXAMINING ATTORNEY

SN 78-365,790. WARNER BROS. ENTERTAINMENT INC., BURBANK, CA. FILED 2-10-2004.

**OOMPA LOOMPA**

THE MARK CONSISTS OF STANDARD CHARACTERS WITHOUT CLAIM TO ANY PARTICULAR FONT, STYLE, SIZE, OR COLOR.

FOR MOTION PICTURE FILMS FEATURING COMEDY, DRAMA, ACTION, ADVENTURE AND/OR ANIMATION, AND MOTION PICTURE FILMS FOR BROADCAST ON TELEVISION FEATURING COMEDY, DRAMA, ACTION, ADVENTURE AND/OR ANIMATION; PRERECORDED VINYL RECORDS, AUDIO TAPES, AUDIO-VIDEO TAPES, AUDIO VIDEO CASSETTES, AUDIO VIDEO DISCS, AND DIGITAL VERSATILE DISCS FEATURING MUSIC, COMEDY, DRAMA, ACTION, ADVENTURE, AND/OR ANIMATION; STEREO HEADPHONES; BATTERIES; CORDLESS TELEPHONES; HAND-HELD CALCULATORS; AUDIO CASSETTE AND CD PLAYERS; CD ROM COMPUTER GAME DISCS; HAND-HELD KARAOKE PLAYERS, TELEPHONE AND/OR RADIO PAGERS; SHORT MOTION PICTURE FILM CASSETTES FEATURING COMEDY, DRAMA, ACTION, ADVENTURE AND/OR ANIMATION TO BE USED WITH HAND-HELD VIEWERS OR PROJECTORS; VIDEO CASSETTE RECORDERS AND

**CLASS 9—(Continued).**

PLAYERS, COMPACT DISC PLAYERS, DIGITAL AUDIO TAPE RECORDERS AND PLAYERS, ELECTRONIC DIARIES; RADIOS; MOUSE PADS; EYEGLASSES, SUNGLASSES AND CASES THEREFORE; AUDIO TAPES AND BOOKLETS SOLD AS A UNIT FEATURING COMEDY, DRAMA, ACTION, ADVENTURE, ANIMATION AND MUSIC INFORMATION; COMPUTER PROGRAMS, NAMELY, SOFTWARE LINKING DIGITIZED VIDEO AND AUDIO MEDIA TO A GLOBAL COMPUTER INFORMATION NETWORK; GAME EQUIPMENT SOLD AS A UNIT FOR PLAYING A PARLOR-TYPE COMPUTER GAME; VIDEO AND COMPUTER GAME PROGRAMS; VIDEO GAME CARTRIDGES AND CASSETTES; CELLULAR TELEPHONE ACCESSORIES, NAMELY HANDS-FREE ACCESSORIES, CELLULAR TELEPHONE COVERS AND CELLULAR TELEPHONE FACE COVERS; ENCODED MAGNETIC CARDS, NAMELY, PHONE CARDS, CREDIT CARDS, CASH CARDS, DEBIT CARDS AND MAGNETIC KEY CARDS; AND DECORATIVE MAGNETS (U.S. CLS. 21, 23, 26, 36 AND 38).

GEOFFREY FOSDICK, EXAMINING ATTORNEY

SN 78-365,821. IGT, RENO, NV. FILED 2-10-2004.

**MOOLA MOTHER LODE**

THE MARK CONSISTS OF STANDARD CHARACTERS WITHOUT CLAIM TO ANY PARTICULAR FONT, STYLE, SIZE, OR COLOR.

OWNER OF U.S. REG. NO. 2,293,956.  
FOR GAMING MACHINES, NAMELY, SLOT MACHINES WITH OR WITHOUT VIDEO OUTPUT, VIDEO LOTTERY TERMINALS, GAMING MACHINES FOR PLAY OF AN INTERACTIVE, ELECTRONIC BINGO GAME (U.S. CLS. 21, 23, 26, 36 AND 38).  
LINDA M. KING, EXAMINING ATTORNEY

SN 78-365,893. OVERHOLSER, RAY C., OCALA, FL. FILED 2-10-2004.

**Dr O's MagnifEyes**

THE MARK CONSISTS OF STANDARD CHARACTERS WITHOUT CLAIM TO ANY PARTICULAR FONT, STYLE, SIZE, OR COLOR.

NO CLAIM IS MADE TO THE EXCLUSIVE RIGHT TO USE MAGNIFIES, APART FROM THE MARK AS SHOWN.

FOR MAGNIFYING GLASSES (U.S. CLS. 21, 23, 26, 36 AND 38).

TRICIA SONNEBORN, EXAMINING ATTORNEY

**CLASS 9—(Continued).**

SN 78-367,308. IGT, RENO, NV. FILED 2-12-2004.

**MOTHER LODE**

THE MARK CONSISTS OF STANDARD CHARACTERS WITHOUT CLAIM TO ANY PARTICULAR FONT, STYLE, SIZE, OR COLOR.

FOR GAMING MACHINES, NAMELY, SLOT MACHINES WITH OR WITHOUT VIDEO OUTPUT, VIDEO LOTTERY TERMINALS, GAMING MACHINES FOR PLAY OF AN INTERACTIVE, ELECTRONIC BINGO GAME (U.S. CLS. 21, 23, 26, 36 AND 38).

LINDA M. KING, EXAMINING ATTORNEY

**CLASS 9—(Continued).**

SN 78-378,149. MOTOROLA, INC., SCHAUMBURG, IL. FILED 3-3-2004.

**MOTOSYNC**

THE MARK CONSISTS OF STANDARD CHARACTERS WITHOUT CLAIM TO ANY PARTICULAR FONT, STYLE, SIZE, OR COLOR.

FOR SOFTWARE FOR SYNCHRONIZATION OF TELEPHONE EMAILS, CONTACTS AND CALENDAR ITEMS FOR COMPUTER EMAIL CONTACTS, AND CALENDAR ITEMS (U.S. CLS. 21, 23, 26, 36 AND 38).

DARRYL SPRUILL, EXAMINING ATTORNEY

SN 78-370,391. BENSON RECORDS, INC., FRANKLIN, TN. FILED 2-19-2004.



FOR PRE-RECORDED CDS AND AUDIO CASSETTE TAPES FEATURING A SERIES OF MUSICAL SOUND RECORDINGS (U.S. CLS. 21, 23, 26, 36 AND 38).

FIRST USE 2-0-1995; IN COMMERCE 2-0-1995.  
SUSAN HAYASH, EXAMINING ATTORNEY

SN 78-387,867. IGT, RENO, NV. FILED 3-19-2004.

SN 78-375,667. 2FAST, LLC, SNOHOMISH, WA. FILED 2-27-2004.



FOR PRERECORDED VIDEO CASSETTES AND DVDS FEATURING MOTORSPORTS; VIDEO GAME DISCS; DVDS FEATURING MOTORSPORTS (U.S. CLS. 21, 23, 26, 36 AND 38).

JAMES GRIFFIN, EXAMINING ATTORNEY

**TWICE YOUR HONEY**

THE MARK CONSISTS OF STANDARD CHARACTERS WITHOUT CLAIM TO ANY PARTICULAR FONT, STYLE, SIZE, OR COLOR.

FOR GAMING MACHINES, NAMELY, SLOT MACHINES WITH OR WITHOUT VIDEO OUTPUT, VIDEO LOTTERY TERMINALS, GAMING MACHINES FOR PLAY OF AN INTERACTIVE, ELECTRONIC BINGO GAME (U.S. CLS. 21, 23, 26, 36 AND 38).

BRENDAN REGAN, EXAMINING ATTORNEY

**CLASS 9—(Continued).**

SN 78-398,060. SARA LEE GLOBAL FINANCE, L.L.C., WILMINGTON, DE. FILED 4-7-2004.



OWNER OF U.S. REG. NOS. 1,127,251, 1,566,064 AND OTHERS.

FOR PRE-RECORDED AUDIO VIDEO TAPES, AUDIO CASSETTES AND DVD'S FEATURING INSTRUCTION AND INFORMATION ON THE FIELDS OF HEALTH, EXERCISE, NUTRITION, SPORTS, DIET, SPORT FASHION AND LIFESTYLE (U.S. CLS. 21, 23, 26, 36 AND 38). BRENDAN REGAN, EXAMINING ATTORNEY

**CLASS 10—MEDICAL APPARATUS**

SN 76-077,581. ST. JUDE MEDICAL, INC., ST. PAUL, MN. FILED 6-28-2000.

**SJM QUATTRO**

FOR HEART VALVES AND ACCESSORIES, NAMELY, VALVE SIZER SETS (U.S. CLS. 26, 39 AND 44). FIRST USE 5-28-1999; IN COMMERCE 5-28-1999. HOWARD B. LEVINE, EXAMINING ATTORNEY

SN 76-109,050. PACESETTER, INC., SYLMAR, CA. FILED 8-14-2000.

**NAVIGATOR**

FOR MEDICAL INSTRUMENTS, NAMELY CARDIAC STIMULATION LEADS (U.S. CLS. 26, 39 AND 44). CURTIS FRENCH, EXAMINING ATTORNEY

**CLASS 10—(Continued).**

SN 76-463,305. KIRWAN SURGICAL PRODUCTS, INC., MARSHFIELD, MA. FILED 10-31-2002.



FOR REUSABLE ELECTROSURGICAL FORCEPS AND ELECTROSURGICAL GENERATORS FOR USE IN OPHTHAMOLOGIC SURGERY, NEUROSURGERY, PLASTIC SURGERY AND EAR, NOSE AND THROAT SURGERY (U.S. CLS. 26, 39 AND 44). JEFF DEFORD, EXAMINING ATTORNEY

SN 76-471,274. SYNTHES (U.S.A.), PAOLI, PA. FILED 11-18-2002.

**ARCH**

FOR IMPLANTS, NAMELY SPACERS OF VARIOUS MATERIALS, NAMELY NON-LIVING NATURAL ALLOGRAFT BONE, POLYMERS AND METALS, BONE PLATES AND BONE SCREWS, ALL FOR MEDICAL AND SURGICAL PROCEDURES FOR USE IN THE SPINE AND OTHER ORTHOPEDIC APPLICATIONS; MEDICAL AND SURGICAL INSTRUMENTS, NAMELY TRIAL SPACERS, GRAFT HOLDERS, LAMINA ELEVATORS, CURETTES, PLATE HOLDERS, DRILL BITS AND SCREW DRIVE SHAFTS AND HANDLES; MODULES COMPRISED OF SCREWS, MINI PLATES, PLATE HOLDERS, DRILL BITS AND SCREWDRIVER SHAFTS AND HANDLES ALL FOR MEDICAL AND SURGICAL PROCEDURES FOR USE IN THE SPINE AND OTHER ORTHOPEDIC APPLICATIONS; AND GRAPHIC CASES COMPRISED PRIMARILY OF METAL FOR HOLDING THE MODULES AND INSTRUMENTS (U.S. CLS. 26, 39 AND 44). JEFF DEFORD, EXAMINING ATTORNEY

SN 76-488,475. MICROTEK MEDICAL HOLDINGS, INC., NORCROSS, GA. FILED 2-10-2003.



NO CLAIM IS MADE TO THE EXCLUSIVE RIGHT TO USE "DRAPE", APART FROM THE MARK AS SHOWN. FOR MEDICAL APPARATUS, NAMELY, SURGICAL DRAPES (U.S. CLS. 26, 39 AND 44). FIRST USE 4-0-1999; IN COMMERCE 4-0-1999. BARNEY CHARLON, EXAMINING ATTORNEY

**CLASS 10—(Continued).**

SN 76-573,905. ALFRED, JUDITH, BROOKLYN, NY. FILED 2-4-2004.

*Only You!*

WHERE HEALTHY RELATIONSHIPS BEGIN.

FOR CONDOMS; SURGICAL MASKS; SUPPORTS FOR ANKLES, WRISTS AND BACKS FOR MEDICAL USE; BREAST PADS AND ABDOMINAL PADS; EYE PATCHES FOR MEDICAL USE; CASES FITTED FOR MEDICAL INSTRUMENTS AND/OR FOR USE BY DOCTORS; HEATING CUSHIONS FOR MEDICAL PURPOSES; ORTHOPEDIC BELTS; ARCH SUPPORTS FOR SHOES AND BOOTS (U.S. CLS. 26, 39 AND 44).

JEFFREY S. MOLINOFF, EXAMINING ATTORNEY

SN 78-257,560. LRC PRODUCTS LIMITED, LONDON, UNITED KINGDOM, FILED 6-3-2003.

**OPTIFIT**

FOR GLOVES, FINGERSTALLS AND FINGERCOATS, ALL FOR MEDICAL, DENTAL, SURGICAL OR VETERINARY USE; GLOVES FOR MEDICAL USE FOR USE IN HOSPITALS (U.S. CLS. 26, 39 AND 44).

FIRST USE 12-20-2002; IN COMMERCE 12-20-2002.

INGA ERVIN, EXAMINING ATTORNEY

SN 78-272,377. KERBEROS PROXIMAL SOLUTIONS, INC., MOUNTAIN VIEW, CA. FILED 7-9-2003.

**RINSPIRATOR**

FOR MEDICAL DEVICES, NAMELY, IRRIGATION AND ASPIRATION DEVICES FOR EXCHANGE OF FLUIDS IN A BODY LUMEN. (U.S. CLS. 26, 39 AND 44).

CAROLYN CATALDO, EXAMINING ATTORNEY

SN 78-272,379. KERBEROS PROXIMAL SOLUTIONS, INC., MOUNTAIN VIEW, CA. FILED 7-9-2003.

**RINSPIRATION**

FOR MEDICAL DEVICES, NAMELY, IRRIGATION AND ASPIRATION DEVICES FOR EXCHANGE OF FLUIDS IN A BODY LUMEN. (U.S. CLS. 26, 39 AND 44).

CAROLYN CATALDO, EXAMINING ATTORNEY

**CLASS 10—(Continued).**

SN 78-273,347. LRC PRODUCTS LIMITED, LONDON, UNITED KINGDOM, FILED 7-11-2003.

**DUREX EXPRESS**

OWNER OF U.S. REG. NOS. 1,226,560, 2,584,678 AND OTHERS.

FOR CONDOMS; APPLICATORS FOR USE WITH THE AFORESAID; CONTRIVANCES, NAMELY, DIAPHRAGMS, CERVICAL CAPS, INTRAUTERINE DEVICES AND FEMALE CONDOMS MADE OF NATURAL OR SYNTHETIC RUBBER OR LIKE MATERIALS FOR HYGIENIC, PROPHYLACTIC OR MEDICAL PURPOSES (U.S. CLS. 26, 39 AND 44).

ESTHER BELENKER, EXAMINING ATTORNEY

SN 78-274,097. SECOND SIGHT, LLC, SYLMAR, CA. FILED 7-14-2003.

**SECOND SIGHT**

FOR ELECTROTHERAPY MEDICAL DEVICES NAMELY NEURO-STIMULATION DEVICES, STIMULATING AND RECORDING ELECTRODE IMPLANTS, OCULAR AND RETINAL PROSTHESES AND RETINAL IMPLANTS; RETINAL ELECTRODES INTEGRALLY ATTACHED TO IMPLANTABLE RETINAL STIMULATORS, AND SYSTEMS, NAMELY ELECTRODES, STIMULATORS, HEADPIECES AND WEARABLE VIDEO PROCESSORS, FOR THE TREATMENT OF BLINDNESS (U.S. CLS. 26, 39 AND 44).

FIRST USE 1-7-1999; IN COMMERCE 1-7-1999.

NORA BUCHANAN WILL, EXAMINING ATTORNEY

SN 78-282,661. MUCHISKY, THOMAS P., EARTH CITY, MO. FILED 8-4-2003.

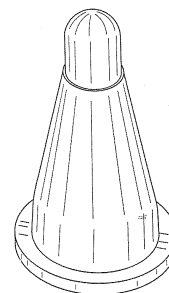

OWNER OF U.S. REG. NOS. 2,039,795, 2,066,217 AND OTHERS.

THE MARK CONSISTS OF THE CONFIGURATION OF AN APPLICATOR FOR A HAND-HELD MASSAGER. THE APPLICATOR CONSISTS OF A CONE-SHAPED ATTACHMENT HAVING A FIRM RUBBER TIP.

SEC. 2(F).

FOR APPLICATOR FOR HAND-HELD MASSAGER (U.S. CLS. 26, 39 AND 44).

FIRST USE 0-0-1965; IN COMMERCE 0-0-1970.

GINA HAYES, EXAMINING ATTORNEY

**CLASS 10—(Continued).**

SN 78-292,356. MEDLINE INDUSTRIES, INC., MUNDELEIN, IL. FILED 8-26-2003.

**FLATPAK**

FOR CATHETERIZATION KITS, NAMELY KITS COMPRISED OF CATHETERS, URINE COLLECTION BASINS, SWABSTICKS, UNDERPADS, DRAPES, GLOVES, LUBRICATING JELLY AND SPECIMEN CONTAINERS (U.S. CLS. 26, 39 AND 44).

CHARLES JOYNER, EXAMINING ATTORNEY

---

SN 78-296,637. KABUSHIKI KAISHA TOP, TOKYO, JAPAN, FILED 9-5-2003.

**REGIOBLOCK**

FOR NEEDLES FOR USE IN SURGERY; NEEDLES FOR THERAPEUTIC MEDICAL PROCEDURES; NEEDLES FOR ANAESTHETIC PROCEDURES; INJECTION NEEDLES FOR NERVE BLOCK; OTHER NEEDLES FOR MEDICAL PURPOSES (U.S. CLS. 26, 39 AND 44).

NELSON SNYDER, EXAMINING ATTORNEY

---

SN 78-296,641. KABUSHIKI KAISHA TOP, TOKYO, JAPAN, FILED 9-5-2003.

**NERVEJECT**

FOR NEEDLES FOR USE IN SURGERY; NEEDLES FOR THERAPEUTIC MEDICAL PROCEDURES; NEEDLES FOR ANAESTHETIC PROCEDURES; INJECTION NEEDLES FOR NERVE BLOCK; OTHER NEEDLES FOR MEDICAL PURPOSES (U.S. CLS. 26, 39 AND 44).

NELSON SNYDER, EXAMINING ATTORNEY

---

SN 78-325,026. JESSOP PRECISION PRODUCTS, INC., DBA THE SUREMARK COMPANY, DBA SUREMARK, SIMI VALLEY, CA. FILED 11-7-2003.

**SUREMARK**

THE MARK CONSISTS OF STANDARD CHARACTERS WITHOUT CLAIM TO ANY PARTICULAR FONT, STYLE, SIZE, OR COLOR.

FOR MEDICAL IMAGING MARKERS, NAMELY INDICATORS AND DELINEATORS USED FOR MARKING ANATOMY OF PATIENTS FOR MEDICAL IMAGING PROCEDURES (U.S. CLS. 26, 39 AND 44).

FIRST USE 6-0-1997; IN COMMERCE 6-0-1997.  
PAULA MAHONEY, EXAMINING ATTORNEY

**CLASS 10—(Continued).**

SN 78-335,053. NPS PHARMACEUTICALS, INC., SALT LAKE CITY, UT. FILED 12-2-2003.

**OSMATE**

THE MARK CONSISTS OF STANDARD CHARACTERS WITHOUT CLAIM TO ANY PARTICULAR FONT, STYLE, SIZE, OR COLOR.

FOR DRUG DELIVERY APPARATUS, NAMELY, PATIENT TRIGGERED INJECTOR FOR THE DELIVERY OF PHARMACEUTICALS (U.S. CLS. 26, 39 AND 44).  
ALEX KEAM, EXAMINING ATTORNEY

---

SN 78-336,911. CLEVEMED NEUROWAVE INC., CLEVELAND, OH. FILED 12-5-2003.

**NeuroSense**

THE MARK CONSISTS OF STANDARD CHARACTERS WITHOUT CLAIM TO ANY PARTICULAR FONT, STYLE, SIZE, OR COLOR.

FOR NEURAL PHYSIOLOGICAL MEDICAL MONITORS (U.S. CLS. 26, 39 AND 44).  
CAROL SPILS, EXAMINING ATTORNEY

**CLASS 10—(Continued).**

SN 78-336,965. BECTON, DICKINSON AND COMPANY, FRANKLIN LAKES, NJ. FILED 12-5-2003.



OWNER OF U.S. REG. NO. 2,821,715.  
FOR MEDICAL DEVICES, NAMELY, SYRINGES (U.S. CLS. 26, 39 AND 44).  
FIRST USE 6-15-2003; IN COMMERCE 6-15-2003.  
KATHLEEN M. VANSTON, EXAMINING ATTORNEY

SN 78-341,816. SANARUS MEDICAL, INC., PLEASANTON, CA. FILED 12-16-2003.

**STICK-FREEZE  
TECHNOLOGY**

THE MARK CONSISTS OF STANDARD CHARACTERS WITHOUT CLAIM TO ANY PARTICULAR FONT, STYLE, SIZE, OR COLOR.

NO CLAIM IS MADE TO THE EXCLUSIVE RIGHT TO USE "TECHNOLOGY", APART FROM THE MARK AS SHOWN.

FOR MEDICAL DEVICES AND INSTRUMENTS FOR USE IN SURGICAL APPLICATIONS, NAMELY BIOPSY DEVICES SPECIFICALLY FOR THE DIAGNOSIS, TREATMENT, ABLATION, REMOVAL, AND/OR FOLLOW UP OF TUMORS (U.S. CLS. 26, 39 AND 44).

BARBARA BROWN, EXAMINING ATTORNEY

SN 78-341,820. STORM TECHNOLOGIES, INC., CAMARILLO, CA. FILED 12-16-2003.

**Dermatool**

THE MARK CONSISTS OF STANDARD CHARACTERS WITHOUT CLAIM TO ANY PARTICULAR FONT, STYLE, SIZE, OR COLOR.

FOR MEDICAL DEVICE, NAMELY, WART REMOVAL TOOL (U.S. CLS. 26, 39 AND 44).

BARBARA BROWN, EXAMINING ATTORNEY

**CLASS 10—(Continued).**

SN 78-349,194. ACTIVE ANKLE SYSTEMS, INC., LOUISVILLE, KY. FILED 1-8-2004.

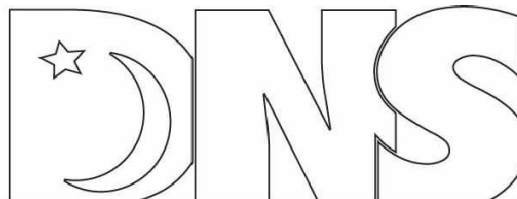

THE MARK CONSISTS OF THE STYLIZED LETTERS "DNS" WITH THE DESIGN ELEMENTS OF A CRESCENT MOON AND A STAR.

FOR ORTHOPEDIC SPLINTS FOR THE FOOT AND ANKLE (U.S. CLS. 26, 39 AND 44).

ALEXANDER L. POWERS, EXAMINING ATTORNEY

SN 78-349,783. BECTON DICKINSON CRITICAL CARE SYSTEMS PTE, LTD., FRANKLIN LAKES, NJ. FILED 1-9-2004.

**SAFEDRAW**

THE MARK CONSISTS OF STANDARD CHARACTERS WITHOUT CLAIM TO ANY PARTICULAR FONT, STYLE, SIZE, OR COLOR.

FOR CLOSED LOOP BLOOD SAMPLING SYSTEM COMPRISING A BLUNT PLASTIC SAFE NEEDLE, SELF-SEALING BLOOD SAMPLING SEPTUM, VOLUME-RESTRICTED SYRINGE, DISPOSABLE PRESSURE TRANSDUCER AND PRESSURE LINE (U.S. CLS. 26, 39 AND 44).

FIRST USE 12-31-1998; IN COMMERCE 12-31-1998.

DEZMONA MIZELLE, EXAMINING ATTORNEY



**CLASS 10—(Continued).**

SN 78-350,924. OXYSURE SYSTEMS, INC., FRISCO, TX. FILED 1-12-2004.

**OXYSURE**

THE MARK CONSISTS OF STANDARD CHARACTERS WITHOUT CLAIM TO ANY PARTICULAR FONT, STYLE, SIZE, OR COLOR.

FOR MEDICAL DEVICES, NAMELY, OXYGEN GENERATING APPARATUS, PARTS AND FITTINGS FOR SUCH APPARATUS, OXYGEN MASKS AND REFILL PACKS OR REFILL CARTRIDGES (U.S. CLS. 26, 39 AND 44).

ALEXANDER L. POWERS, EXAMINING ATTORNEY

**CLASS 10—(Continued).**

SN 78-353,636. NOVARTIS AG, BASEL, SWITZERLAND, FILED 1-19-2004.

**COMFORT HOLD**

THE MARK CONSISTS OF STANDARD CHARACTERS WITHOUT CLAIM TO ANY PARTICULAR FONT, STYLE, SIZE, OR COLOR.

FOR BREAST PUMPS (U.S. CLS. 26, 39 AND 44).  
ANN E. SAPPENFIELD, EXAMINING ATTORNEY

SN 78-355,395. CALFACIOR CORPORATION, COLUMBUS, OH. FILED 1-22-2004.

SN 78-353,333. UNIVERSITY OF WASHINGTON, SEATTLE, WA. FILED 1-16-2004.

**TELLER ACUITY  
CARDS**

THE MARK CONSISTS OF STANDARD CHARACTERS WITHOUT CLAIM TO ANY PARTICULAR FONT, STYLE, SIZE, OR COLOR.

NO CLAIM IS MADE TO THE EXCLUSIVE RIGHT TO USE "ACUITY CARDS", APART FROM THE MARK AS SHOWN.

FOR CARDS PRINTED WITH LINES OF VARYING WIDTHS, TOGETHER WITH INSTRUCTION, USED FOR TESTING AND ANALYZING VISION OF INFANTS AND SMALL CHILDREN (U.S. CLS. 26, 39 AND 44).

FIRST USE 5-1-1986; IN COMMERCE 5-1-1986.  
JEFFERY COWARD, EXAMINING ATTORNEY



FOR THERMAL THERAPY SYSTEM, NAMELY, UN-TETHERED TEMPERATURE IMPLANTS EXTERNALLY EXCITED TO BROADCAST RESONANT FREQUENCY SIGNALS IN COMBINATION WITH A TISSUE HEATING ASSEMBLY AND A TEMPERATURE MONITOR RESPONSIVE TO THE BROADCAST RESONANT FREQUENCY SIGNALS OF THE IMPLANTS; TEMPERATURE MEASURING SYSTEM, NAMELY, UN-TETHERED TEMPERATURE IMPLANTS EXTERNALLY EXCITED TO BROADCAST RESONANT FREQUENCY SIGNALS IN COMBINATION WITH A TEMPERATURE MONITOR RESPONSIVE TO THE BROADCAST RESONANT FREQUENCY SIGNALS OF THE IMPLANTS (U.S. CLS. 26, 39 AND 44).

SHAUNIA WALLACE, EXAMINING ATTORNEY

**CLASS 10—(Continued).**

SN 78-356,622. PIONEER LABORATORIES, INC., MARQUETTE, MI. FILED 1-23-2004.

# QUANTUM

THE MARK CONSISTS OF STANDARD CHARACTERS WITHOUT CLAIM TO ANY PARTICULAR FONT, STYLE, SIZE, OR COLOR.

FOR SPINAL IMPLANTS COMPOSED OF ARTIFICIAL MATERIAL; SPINAL FIXATION DEVICES (U.S. CLS. 26, 39 AND 44).

KIMBERLY PERRY, EXAMINING ATTORNEY

---

SN 78-360,015. BECTON, DICKINSON AND COMPANY, FRANKLIN LAKES, NJ. FILED 1-30-2004.

# BD AUTOSHIELD

THE MARK CONSISTS OF STANDARD CHARACTERS WITHOUT CLAIM TO ANY PARTICULAR FONT, STYLE, SIZE, OR COLOR.

FOR MEDICAL NEEDLES (U.S. CLS. 26, 39 AND 44).  
ALICE BENMAMAN, EXAMINING ATTORNEY

---

SN 78-360,839. MEDTRONIC, INC., MINNEAPOLIS, MN. FILED 2-2-2004.

# SYNERGY COMPACT+

THE MARK CONSISTS OF STANDARD CHARACTERS WITHOUT CLAIM TO ANY PARTICULAR FONT, STYLE, SIZE, OR COLOR.

OWNER OF U.S. REG. NOS. 2,515,706 AND 2,748,689.  
FOR MEDICAL DEVICE, NAMELY, IMPLANTABLE NEUROSTIMULATOR FOR THE TREATMENT OF CHRONIC PAIN (U.S. CLS. 26, 39 AND 44).  
ELLEN PERKINS, EXAMINING ATTORNEY

**CLASS 10—(Continued).**

SN 78-360,951. LIFEGEAR, INC., EL MONTE, CA. FILED 2-2-2004.

# TRAVELPRO

THE MARK CONSISTS OF STANDARD CHARACTERS WITHOUT CLAIM TO ANY PARTICULAR FONT, STYLE, SIZE, OR COLOR.

FOR PORTABLE MASSAGE CHAIR (U.S. CLS. 26, 39 AND 44).  
TARAH HARDY, EXAMINING ATTORNEY

---

SN 78-361,797. IMAGE-GUIDED NEUROLOGICS, INC., MELBOURNE, FL. FILED 2-3-2004.

# NEXFRAME

THE MARK CONSISTS OF STANDARD CHARACTERS WITHOUT CLAIM TO ANY PARTICULAR FONT, STYLE, SIZE, OR COLOR.

FOR SURGICAL DEVICES, NAMELY, SKULL-MOUNTED SURGICAL INSTRUMENT TRAJECTORY GUIDES FOR USE IN NEUROSURGERY (U.S. CLS. 26, 39 AND 44).  
JENNIFER MARTIN, EXAMINING ATTORNEY

**CLASS 10—(Continued).**

SN 78-363,232. ABBOTT LABORATORIES, ABBOTT PARK, IL. FILED 2-5-2004.

**TRIMAXX**

THE MARK CONSISTS OF STANDARD CHARACTERS WITHOUT CLAIM TO ANY PARTICULAR FONT, STYLE, SIZE, OR COLOR.  
FOR MEDICAL DEVICE, NAMELY A STENT (U.S. CLS. 26, 39 AND 44).  
ELISSA GARBER KON, EXAMINING ATTORNEY

SN 78-363,789. SCIENTIFIC INTAKE LIMITED CO., ATLANTA, GA. FILED 2-6-2004.

**Thanks to my  
Dentist**

THE MARK CONSISTS OF STANDARD CHARACTERS WITHOUT CLAIM TO ANY PARTICULAR FONT, STYLE, SIZE, OR COLOR.  
FOR RETAINER-LIKE ORAL APPARATUS DESIGNED AND USED TO MODIFY ORAL INTAKE BEHAVIOR OF ITEMS THAT CAN BE CONSUMED SUCH AS FOOD, BEVERAGES, SMOKE AND NARCOTICS (U.S. CLS. 26, 39 AND 44).  
TRICIA SONNEBORN, EXAMINING ATTORNEY

**CLASS 10—(Continued).**

SN 78-364,264. MENTOR CORPORATION, SANTA BARBARA, CA. FILED 2-6-2004.

**POP-SPEC**

THE MARK CONSISTS OF STANDARD CHARACTERS WITHOUT CLAIM TO ANY PARTICULAR FONT, STYLE, SIZE, OR COLOR.  
FOR VAGINAL SPECULUM (U.S. CLS. 26, 39 AND 44).  
STEVEN R. FINE, EXAMINING ATTORNEY

**CLASS 11—ENVIRONMENTAL CONTROL APPARATUS**

SN 75-787,828. AVENUE, INC., THE, WILMINGTON, DE. FILED 8-30-1999.

**AVENUE HOME**

OWNER OF U.S. REG. NOS. 2,218,272, 2,251,168 AND OTHERS.  
NO CLAIM IS MADE TO THE EXCLUSIVE RIGHT TO USE "HOME", APART FROM THE MARK AS SHOWN.  
FOR LAMPS, LAMP SHADES (U.S. CLS. 13, 21, 23, 31 AND 34).  
JAMES A. RAUEN, EXAMINING ATTORNEY

SN 76-464,579. FOCUS INDUSTRIES, INC., LAKE FOREST, CA. FILED 11-1-2002.

**FOCUS LANDSCAPE LIGHTING**

NO CLAIM IS MADE TO THE EXCLUSIVE RIGHT TO USE LANDSCAPE LIGHTING, APART FROM THE MARK AS SHOWN.  
FOR LANDSCAPE, ARCHITECTURAL AND OUTDOOR ELECTRICAL LIGHTING FIXTURES AND APPARATUS, NAMELY ELECTRICAL LANDSCAPE LIGHTING FIXTURES (U.S. CLS. 13, 21, 23, 31 AND 34).  
FIRST USE 12-1-1989; IN COMMERCE 12-1-1989.  
WON TEAK OH, EXAMINING ATTORNEY

**CLASS 11—(Continued).**

SN 76-527,325. FANIMATION DESIGN & MANUFACTURING, INC., LEBANON, IN. FILED 6-30-2003.

**AMAZON**

FOR MOTOR HOUSINGS FOR ELECTRIC CEILING FANS (U.S. CLS. 13, 21, 23, 31 AND 34).  
BRIAN NEVILLE, EXAMINING ATTORNEY

SN 76-544,696. ABCO METALS INC., CHATHAM, MA. FILED 9-15-2003.

**UNION-TEE**

FOR PLUMBING FIXTURE, NAMELY, A QUICK CONNECT AND QUICK DISCONNECT PLUMBING FIXTURE WITH MULTIPLE CONNECTABLE FITTINGS (U.S. CLS. 13, 21, 23, 31 AND 34).  
CHERYL CLAYTON, EXAMINING ATTORNEY

SN 76-545,724. GO! PRODUCTS, INC., ELMHURST, IL. FILED 9-22-2003.



NO CLAIM IS MADE TO THE EXCLUSIVE RIGHT TO USE "PRODUCTS", APART FROM THE MARK AS SHOWN. FOR MOVABLE TABLES TO HOLD GAS GRILLS (U.S. CLS. 13, 21, 23, 31 AND 34).  
FIRST USE 6-1-2003; IN COMMERCE 6-1-2003.  
SCOTT OSCLICK, EXAMINING ATTORNEY

SN 76-551,384. PDS ASSOCIATES, INC., DANBURY, CT. FILED 9-23-2003.

**MEDOC**

FOR PLUMBING FITTINGS AND FIXTURES, NAMELY FAUCETS; SINKS; AND KITCHEN FAUCETS (U.S. CLS. 13, 21, 23, 31 AND 34).  
FIRST USE 7-0-1999; IN COMMERCE 7-0-1999.  
JEFF DEFORD, EXAMINING ATTORNEY

**CLASS 11—(Continued).**

SN 76-560,867. SPX CORPORATION, CHARLOTTE, NC. FILED 11-19-2003.

**SMARTTECH**

THE MARK CONSISTS OF STANDARD CHARACTERS WITHOUT CLAIM TO ANY PARTICULAR FONT, STYLE, SIZE, OR COLOR.  
FOR AIR DRYERS, NAMELY, INDUSTRIAL DRYERS FOR HEATING AND DEHUMIDIFYING; ELECTRIC DEHYDRATORS (U.S. CLS. 13, 21, 23, 31 AND 34).  
M. L. HERSHKOWITZ, EXAMINING ATTORNEY

SN 76-566,935. MONITOR PRODUCTS, INC., MONMOUTH JUNCTION, NJ. FILED 12-10-2003.

**SOUP-A-MATIC**

THE MARK CONSISTS OF STANDARD CHARACTERS WITHOUT CLAIM TO ANY PARTICULAR FONT, STYLE, SIZE, OR COLOR.  
FOR ELECTRIC SOUP HOLDER AND AUTOMATIC SOUP DISPENSER (U.S. CLS. 13, 21, 23, 31 AND 34).  
JOSETTE BEVERLY, EXAMINING ATTORNEY

SN 76-570,468. P.L.I. ENTERPRISES, INC., SAN DIMAS, CA. FILED 1-16-2004.

**LEGATO**

FOR LIGHTING FIXTURES, NAMELY, INDIRECT AND DIRECT/INDIRECT LINEAR LIGHT FIXTURES INCORPORATING FLUORESCENT OR INCANDESCENT LAMPS, OR BOTH, IN VARIOUS CONFIGURATIONS (U.S. CLS. 13, 21, 23, 31 AND 34).  
FIRST USE 10-15-2002; IN COMMERCE 10-15-2002.  
CHERYL CLAYTON, EXAMINING ATTORNEY

**CLASS 11—(Continued).**

SN 78-197,773. GLACIER BAY, INC., OAKLAND, CA. FILED 12-24-2002.

**GLACIER BAY**

FOR REFRIGERATION EQUIPMENT, NAMELY, FOOD AND BEVERAGE CHILLING UNITS AND AIR CONDITIONING UNITS (U.S. CLS. 13, 21, 23, 31 AND 34).

FIRST USE 9-20-1990; IN COMMERCE 7-28-1991.  
TRICIA SONNEBORN, EXAMINING ATTORNEY

SN 78-283,169. PARKSON CORPORATION, FORT LAUDERDALE, FL. FILED 8-5-2003.

**AQUA GUARD PF PLUS**

OWNER OF U.S. REG. NO. 1,542,397.  
FOR MECHANICAL IN-TANK WATER FILTER SCREEN THAT REMOVES SUSPENDED AND SOLID MATERIALS FROM A WATER STREAM (U.S. CLS. 13, 21, 23, 31 AND 34).

BARBARA GAYNOR, EXAMINING ATTORNEY

SN 78-298,882. ANIL, BAKERI ACHAL, AHMEDABAD, INDIA, FILED 9-11-2003.

**SYMPHONY PORTABLE  
EVAPORATIVE AIR COOLER**

NO CLAIM IS MADE TO THE EXCLUSIVE RIGHT TO USE PORTABLE EVAPORATIVE AIR COOLER, APART FROM THE MARK AS SHOWN.

FOR (BASED ON USE IN COMMERCE) EVAPORATIVE AIR COOLER; (BASED ON INTENT TO USE) AIR COOLER (U.S. CLS. 13, 21, 23, 31 AND 34).

LESLEY LAMOTHE, EXAMINING ATTORNEY

SN 78-334,691. PARK-OHIO INDUSTRIES, INC., BOAZ, AL. FILED 12-1-2003.

**AUTOTRON**

THE MARK CONSISTS OF STANDARD CHARACTERS WITHOUT CLAIM TO ANY PARTICULAR FONT, STYLE, SIZE, OR COLOR.

FOR INDUCTION HEATERS FOR SOLDERING AND HEATING METALS (U.S. CLS. 13, 21, 23, 31 AND 34).

FIRST USE 4-17-2003; IN COMMERCE 4-17-2003.  
JENNIFER CHICOSKI, EXAMINING ATTORNEY

**CLASS 11—(Continued).**

SN 78-350,889. EML TECHNOLOGIES LLC, DANVILLE, CA. FILED 1-12-2004.

**BEACON**

THE MARK CONSISTS OF STANDARD CHARACTERS WITHOUT CLAIM TO ANY PARTICULAR FONT, STYLE, SIZE, OR COLOR.

FOR ELECTRIC WORKLIGHTS (U.S. CLS. 13, 21, 23, 31 AND 34).

KIMBERLY FRYE, EXAMINING ATTORNEY

SN 78-353,944. SPEEDLINE CORPORATION, WALTON HILLS, OH. FILED 1-20-2004.

**SMOKE-SAFE**

THE MARK CONSISTS OF STANDARD CHARACTERS WITHOUT CLAIM TO ANY PARTICULAR FONT, STYLE, SIZE, OR COLOR.

FOR PLUMBING ACCESSORIES, NAMELY, FITTING COVERS FOR USE IN PIPING SYSTEMS (U.S. CLS. 13, 21, 23, 31 AND 34).

FIRST USE 4-16-1985; IN COMMERCE 4-16-1985.  
JACQUELINE A. LAVINE, EXAMINING ATTORNEY

SN 78-354,165. SELECT BRANDS, INC., LENEXA, KS. FILED 1-20-2004.

**THE HEALTHY COOKIE  
JAR**

THE MARK CONSISTS OF STANDARD CHARACTERS WITHOUT CLAIM TO ANY PARTICULAR FONT, STYLE, SIZE, OR COLOR.

FOR ELECTRICAL APPLIANCE FOR PRESERVING AND CHILLING FRUIT (U.S. CLS. 13, 21, 23, 31 AND 34).

TANYA AMOS, EXAMINING ATTORNEY

**CLASS 11—(Continued).**

SN 78-355,603. ENERCO TECHNICAL PRODUCTS, INC., CLEVELAND, OH. FILED 1-22-2004.

**CLASS 11—(Continued).**

SN 78-372,307. BUFFETT, JIMMY, KEY WEST, FL. FILED 2-23-2004.

## PROFESSIONAL SERIES

THE MARK CONSISTS OF STANDARD CHARACTERS WITHOUT CLAIM TO ANY PARTICULAR FONT, STYLE, SIZE, OR COLOR.

FOR RADIANT HEATERS, NAMELY, PATIO HEATERS, FORCED AIR KEROSENE HEATERS, FORCED AIR PROPANE HEATERS, PORTABLE RADIANT HEATERS, RADIANT TUBE HEATERS, RADIANT OVER-HEAD HEATERS, AND CONVECTION HEATERS (U.S. CLS. 13, 21, 23, 31 AND 34).

KIMBERLY PERRY, EXAMINING ATTORNEY

## LICENSE TO CHILL

THE MARK CONSISTS OF STANDARD CHARACTERS WITHOUT CLAIM TO ANY PARTICULAR FONT, STYLE, SIZE, OR COLOR.

FOR FREEZERS AND BARBECUE GRILLS (U.S. CLS. 13, 21, 23, 31 AND 34).

RICHARD WHITE, EXAMINING ATTORNEY

**CLASS 12—VEHICLES**

SN 75-919,315. WING ENTERPRISES, INC., SPRINGVILLE, UT. FILED 2-15-2000.

## QUICK DRAW

FOR TRAILER HITCHES FOR LIGHT-AND MEDIUM-DUTY PASSENGER VEHICLES AND LIGHT-DUTY TRUCKS (U.S. CLS. 19, 21, 23, 31, 35 AND 44).

JULIE WATSON, EXAMINING ATTORNEY

SN 78-358,569. CONAIR CORPORATION, STAMFORD, CT. FILED 1-28-2004.

SN 76-245,612. FUJI JUKOGYO KABUSHIKI KAISHA, TA FUJI HEAVY INDUSTRIES LTD., SHINJUKU-KU, TOKYO, JAPAN, FILED 4-23-2001.

## BRAT

FOR AUTOMOBILES AND STRUCTURAL PARTS THEREFOR (U.S. CLS. 19, 21, 23, 31, 35 AND 44).

THEODORE MCBRIDE, EXAMINING ATTORNEY

## SUPREME

THE MARK CONSISTS OF STANDARD CHARACTERS WITHOUT CLAIM TO ANY PARTICULAR FONT, STYLE, SIZE, OR COLOR.

OWNER OF U.S. REG. NO. 2,559,837.

FOR ELECTRIC AND BATTERY OPERATED KITCHEN APPLIANCES, NAMELY, TOASTERS, COFFEE MAKERS, ICE CREAM MAKERS AND WAFFLE IRONS (U.S. CLS. 13, 21, 23, 31 AND 34).

SUSAN LESLIE DUBOIS, EXAMINING ATTORNEY

SN 76-452,527. TRAVES, ROMILLY WEBSTER, MEDINA, OH. FILED 9-25-2002.

## SKY CATCH

NO CLAIM IS MADE TO THE EXCLUSIVE RIGHT TO USE CATCH, APART FROM THE MARK AS SHOWN.

FOR STRUCTURAL PART FOR AIRPLANES, NAMELY A BRASS METAL, CHROME PLATED, TENSION ADJUSTABLE AIRPLANE DOOR LATCH USED TO HOLD AN AIRCRAFT DOOR OPEN (U.S. CLS. 19, 21, 23, 31, 35 AND 44).

FIRST USE 3-3-1975; IN COMMERCE 3-3-1975.

MARY BOAGNI, EXAMINING ATTORNEY

**CLASS 12—(Continued).**

SN 76-481,989. DORI MILNER, CLERMONT, FL. FILED 1-13-2003.



NO CLAIM IS MADE TO THE EXCLUSIVE RIGHT TO USE WHEELIE RIDE AND DEPICTION OF THE MOTORCYCLE, APART FROM THE MARK AS SHOWN.

THE MARK CONSISTS OF A DESIGN OF A MOTORCYCLE AND RIDER IN FRONT OF A BACKGROUND CONSISTING OF THE WORDS XTREME WHEELIE RIDE. A PORTION OF THE UNITED STATES FLAG IS SUPERIMPOSED OVER THE WORD XTREME.

FOR MECHANICAL AMUSEMENT RIDE, NAMELY A STATIONARY MOTORCYCLE (U.S. CLS. 19, 21, 23, 31, 35 AND 44).

CURTIS FRENCH, EXAMINING ATTORNEY

SN 76-549,688. HOLLYWOOD RACKS, COMPTON, CA. FILED 9-22-2003.

**HOLLYWOOD**  
R A C K S

NO CLAIM IS MADE TO THE EXCLUSIVE RIGHT TO USE "RACKS", APART FROM THE MARK AS SHOWN.

FOR RACKS FOR SECURING BICYCLES, SKIS, CARGO AND OTHER ATHLETIC EQUIPMENT TO AUTOMOTIVE VEHICLES (U.S. CLS. 19, 21, 23, 31, 35 AND 44).

FIRST USE 1-5-1987; IN COMMERCE 1-5-1987.  
LAURA KOVAISKY, EXAMINING ATTORNEY

SN 76-571,112. PRIMEX MARKETING INC., BENICIA, CA. FILED 1-21-2004.

**WHEELIEEZ**

THE MARK CONSISTS OF STANDARD CHARACTERS WITHOUT CLAIM TO ANY PARTICULAR FONT, STYLE, SIZE, OR COLOR.

FOR WHEELCHAIRS AND STRUCTURAL PARTS THEREFOR; DOLLY FOR USE IN MOVING WHEELCHAIRS (U.S. CLS. 19, 21, 23, 31, 35 AND 44).

ESTHER A. BORSUK, EXAMINING ATTORNEY

**CLASS 12—(Continued).**

SN 78-026,437. DAIMLERCHRYSLER CORPORATION, AUBURN HILLS, MI. FILED 9-18-2000.

**PT CRUISER**

OWNER OF U.S. REG. NO. 2,371,607 AND OTHERS.  
FOR BICYCLES AND MOTORIZED SCOOTERS (U.S. CLS. 19, 21, 23, 31, 35 AND 44).  
REBECCA SMITH, EXAMINING ATTORNEY

SN 78-189,212. DISSAN PTY LTD., SYDNEY, NSW, AUSTRALIA, FILED 11-26-2002.

**SUNRUNNER**  
SPORT CRUISERS

PRIORITY CLAIMED UNDER SEC. 44(D) ON AUSTRALIA APPLICATION NO. 914911, FILED 5-31-2002, REG. NO. 914911, DATED 5-31-2002, EXPIRES 5-31-2012.

NO CLAIM IS MADE TO THE EXCLUSIVE RIGHT TO USE "SPORT CRUISERS", APART FROM THE MARK AS SHOWN.

FOR MARINE VEHICLES, NAMELY, BOATS, MOTOR BOATS, SHIPS, RECREATIONAL WATERCRAFT AND THE STRUCTURAL PARTS FOR THE SAME (U.S. CLS. 19, 21, 23, 31, 35 AND 44).

JENNIFER MARTIN, EXAMINING ATTORNEY

SN 78-265,004. LOOK CYCLE INTERNATIONAL, NEVERS, FRANCE, FILED 6-20-2003.

**ERGOSTEM**

PRIORITY CLAIMED UNDER SEC. 44(D) ON FRANCE APPLICATION NO. 033203192, FILED 1-8-2003, REG. NO. 033203192, DATED 1-8-2003, EXPIRES 1-8-2013.

FOR VEHICLES, NAMELY, BICYCLES, MOTORCYCLES; TIRES; TUBELESS TIRES; INNER TUBES FOR VEHICLE TIRES; HORNS FOR VEHICLES; LUGGAGE NETS FOR BICYCLES; DIRECTIONAL SIGNALS FOR BICYCLES; BICYCLE STANDS; FRAMES FOR BICYCLES; BRAKES FOR BICYCLES; PARTS FOR BICYCLES AND MOTORCYCLES, NAMELY, HANDLE BARS; WHEEL RIMS FOR BICYCLES; TIRE PUMPS; BICYCLE SADDLES; BICYCLE BELLS; GEARING FOR BICYCLES; BICYCLE PEDALS; WHEEL HUBS FOR BICYCLES; PNEUMATIC TIRES (U.S. CLS. 19, 21, 23, 31, 35 AND 44).

TRACY WHITAKER-BOWN, EXAMINING ATTORNEY

**CLASS 12—(Continued).**

SN 78-333,678. CLARK MATERIAL HANDLING COMPANY, LEXINGTON, KY. FILED 11-26-2003.

**CLASS 12—(Continued).**

SN 78-354,922. GROS CUIEE, INC., STAFFORD, TX. FILED 1-21-2004.

**BUILT TO LAST.**

**BLOCK-HEADZ**

THE MARK CONSISTS OF STANDARD CHARACTERS WITHOUT CLAIM TO ANY PARTICULAR FONT, STYLE, SIZE, OR COLOR.  
FOR POWER AND NON-POWER OPERATED INDUSTRIAL MATERIAL HANDLING TRUCKS USED MERELY TO TRANSPORT GOODS; ENGINE AND MOTOR-DRIVEN INDUSTRIAL LIFT TRUCKS; FORK-LIFTS (U.S. CLS. 19, 21, 23, 31, 35 AND 44).  
FIRST USE 10-27-2003; IN COMMERCE 11-7-2003.  
LINDA ESTRADA, EXAMINING ATTORNEY

THE MARK CONSISTS OF STANDARD CHARACTERS WITHOUT CLAIM TO ANY PARTICULAR FONT, STYLE, SIZE, OR COLOR.  
FOR VEHICLE SEAT HEADREST COVERS (U.S. CLS. 19, 21, 23, 31, 35 AND 44).  
DAVID TAYLOR, EXAMINING ATTORNEY

SN 78-354,078. DEERE & COMPANY, MOLINE, IL. FILED 1-20-2004.

SN 78-359,294. AJ INDUSTRIES, INC., LAPORTE, IN. FILED 1-29-2004.

**BUCK**

**Upstop**

THE MARK CONSISTS OF STANDARD CHARACTERS WITHOUT CLAIM TO ANY PARTICULAR FONT, STYLE, SIZE, OR COLOR.  
FOR ALL-TERRAIN VEHICLES (U.S. CLS. 19, 21, 23, 31, 35 AND 44).  
FIRST USE 10-31-2003; IN COMMERCE 10-31-2003.  
JENNIFER MARTIN, EXAMINING ATTORNEY

THE MARK CONSISTS OF STANDARD CHARACTERS WITHOUT CLAIM TO ANY PARTICULAR FONT, STYLE, SIZE, OR COLOR.  
FOR WHEELCHAIR BRAKING DEVICE (U.S. CLS. 19, 21, 23, 31, 35 AND 44).  
FIRST USE 2-1-1999; IN COMMERCE 2-1-1999.  
DORITT L. CARROLL, EXAMINING ATTORNEY



**CLASS 12—(Continued).**

SN 78-364,537. MICHELIN NORTH AMERICA, INC., GREENVILLE, SC. FILED 2-9-2004.

**COUNTRY TRAIL**

THE MARK CONSISTS OF STANDARD CHARACTERS WITHOUT CLAIM TO ANY PARTICULAR FONT, STYLE, SIZE, OR COLOR.

FOR PNEUMATIC TIRES AND INNER TUBES FOR VEHICLE WHEELS; TREADS FOR RECAPPING TIRES, TRACKS FOR TRACKED-LAND VEHICLES (U.S. CLS. 19, 21, 23, 31, 35 AND 44).

ELLEN B. AWRICH, EXAMINING ATTORNEY



SN 78-370,212. BUFFETT, JIMMY, KEY WEST, FL. FILED 2-18-2004.

**MARGARITAVICH**

THE MARK CONSISTS OF STANDARD CHARACTERS WITHOUT CLAIM TO ANY PARTICULAR FONT, STYLE, SIZE, OR COLOR.

FOR BOATS AND STRUCTURAL PARTS THEREFOR (U.S. CLS. 19, 21, 23, 31, 35 AND 44).

RICHARD WHITE, EXAMINING ATTORNEY



SN 78-372,312. BUFFETT, JIMMY, KEY WEST, FL. FILED 2-23-2004.

**LICENSE TO CHILL**

THE MARK CONSISTS OF STANDARD CHARACTERS WITHOUT CLAIM TO ANY PARTICULAR FONT, STYLE, SIZE, OR COLOR.

FOR RAFTS, OARS, AND PADDLES; FITTED AND SEMI-FITTED CAR COVERS; TIRE COVERS; CAR SEAT COVERS; AUTOMOBILE WINDSHIELD SUNSHADES; LICENSE PLATE FRAMES; CAR DRINK HOLDERS; BOATS AND STRUCTURAL PARTS THEREFOR (U.S. CLS. 19, 21, 23, 31, 35 AND 44).

RICHARD WHITE, EXAMINING ATTORNEY

**CLASS 12—(Continued).**

SN 78-398,018. SARA LEE GLOBAL FINANCE, L.L.C., WILMINGTON, DE. FILED 4-7-2004.



OWNER OF U.S. REG. NOS. 1,127,251, 1,566,064 AND OTHERS.

FOR BABY STROLLERS, BABY JOGGING STROLLERS, CANOPIES AND COVERS FOR BABY STROLLERS, CHILD CARRYING TRAILERS FOR USE IN TRANSPORTING CHILDREN WHILE HIKING, JOGGING, WALKING, SKIING, SNOW SHOEING OR SKATING (U.S. CLS. 19, 21, 23, 31, 35 AND 44).

BRENDAN REGAN, EXAMINING ATTORNEY



**CLASS 13—FIREARMS**

SN 76-509,738. WORLD WIDE ORDNANCE, INC., PLANTATION, FL. FILED 4-28-2003.

**CAMBI**

THE MARK TRANSLATES FROM ITALIAN INTO ENGLISH AS "CHANGES".

FOR MAGAZINE LOADERS FOR GUNS (U.S. CLS. 2 AND 9).

JERI J. FICKES, EXAMINING ATTORNEY



SN 78-352,841. SPRINGFIELD FIREWORKS, INC., BLUFFTON, IN. FILED 1-16-2004.

**BIRDMAN**

THE MARK CONSISTS OF STANDARD CHARACTERS WITHOUT CLAIM TO ANY PARTICULAR FONT, STYLE, SIZE, OR COLOR.

FOR FIREWORKS (U.S. CLS. 2 AND 9).

CHARLES L. JENKINS, EXAMINING ATTORNEY

**CLASS 14—JEWELRY**

SN 76-275,016. KRISTALL JEWELER, INC., BEVERLY HILLS, CA. FILED 6-22-2001.



THE  
DIAMONDS  
OF RUSSIA.

NO CLAIM IS MADE TO THE EXCLUSIVE RIGHT TO USE "KRISTALL", AND "THE DIAMONDS OF RUSSIA", APART FROM THE MARK AS SHOWN.

THE ENGLISH TRANSLATION OF THE WORD "KRISTALL" IN THE MARK IS "CRYSTAL".

FOR GOODS MADE WHOLLY OR SIGNIFICANTLY IN PART OF DIAMONDS FROM RUSSIA AND PRECIOUS METALS AND THEIR ALLOYS AND GOODS IN PRECIOUS METALS OR COATED THEREWITH, SPECIFICALLY, JEWELRY, PRECIOUS GEMSTONES, RINGS, BRACELETS, EARRINGS, NECKLACES, PENDANTS, CUFF LINKS, HOROLOGICAL AND CHRONOLOGICAL INSTRUMENTS, NAMELY, CLOCKS, WATCHES, AND CHRONOMETERS, AND ASHTRAYS AND POWDER COMPACTS MADE OF PRECIOUS METALS (U.S. CLS. 2, 27, 28 AND 50).

FIRST USE 4-1-2001; IN COMMERCE 4-1-2001.  
JOHN DWYER, EXAMINING ATTORNEY

SN 76-498,184. LORENZ S.P.A., MILAN, ITALY, FILED 3-14-2003.

LAURENS

OWNER OF ITALY REG. NO. 651755, DATED 5-23-1995, EXPIRES 3-24-2014.

OWNER OF U.S. REG. NO. 2,050,524.

FOR CHRONOMETRIC AND HOROLOGICAL INSTRUMENTS, NAMELY, WATCHES, CLOCKS, WRIST-WATCHES; POCKET WATCHES; TABLE CLOCKS (U.S. CLS. 2, 27, 28 AND 50).

INGA ERVIN, EXAMINING ATTORNEY

**CLASS 14—(Continued).**

SN 76-502,050. LIBMAN & COMPANY LIMITED, DOWNSVIEW, ONTARIO M3J 2P4, CANADA, FILED 3-26-2003.

## THE FOREVER COLLECTION

PRIORITY CLAIMED UNDER SEC. 44(D) ON CANADA APPLICATION NO. 1,168,943, FILED 2-21-2003.

NO CLAIM IS MADE TO THE EXCLUSIVE RIGHT TO USE COLLECTION, APART FROM THE MARK AS SHOWN, FOR JEWELRY (U.S. CLS. 2, 27, 28 AND 50).  
ESTHER BELENKER, EXAMINING ATTORNEY

SN 76-554,645. SWANWICK HOLDINGS LIMITED, ROAD TOWN, TORTOLA, BR. VIRGIN ISLANDS, FILED 10-10-2003.

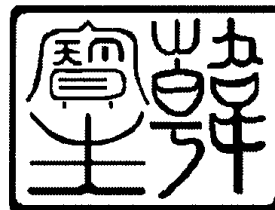

THE CHINESE CHARACTERS IN THE MARK TRANSLITERATE TO "PO SUN HON" AND THIS MEANS "JEWELS", "PRECIOUS", "LIFE" AND "PRODUCE" IN ENGLISH.

FOR JEWELRY (U.S. CLS. 2, 27, 28 AND 50).  
FIRST USE 7-19-2003; IN COMMERCE 7-19-2003.  
MICHELE SWAIN, EXAMINING ATTORNEY

SN 78-179,587. TEMPUS INTERNATIONAL CORPORATION, MIAMI, FL. FILED 10-29-2002.



DECO

OWNER OF U.S. REG. NOS. 2,129,527, 2,129,528 AND 2,673,449.

NO CLAIM IS MADE TO THE EXCLUSIVE RIGHT TO USE "DECO", APART FROM THE MARK AS SHOWN.

FOR WATCHES (U.S. CLS. 2, 27, 28 AND 50).  
FIRST USE 7-20-2001; IN COMMERCE 7-20-2001.

WON TEAK OH, EXAMINING ATTORNEY

**CLASS 14—(Continued).**

SN 78-180,729. MAEMI S.R.L., FIRENZE, ITALY, FILED 10-31-2002.

marco zaia  
p r e z i o s i

PRIORITY CLAIMED UNDER SEC. 44(D) ON ITALY APPLICATION NO. BG2002C00013, FILED 5-31-2002, REG. NO. 008787188, DATED 5-31-2002, EXPIRES 5-31-2012.

NO CLAIM IS MADE TO THE EXCLUSIVE RIGHT TO USE PREZIOSI, APART FROM THE MARK AS SHOWN.

MARCO ZAIA IS A LIVING INDIVIDUAL WHOSE CONSENT IS OF RECORD.

THE ENGLISH TRANSLATION OF THE MARK MARCO ZAIA PREZIOSI IS MARCO ZAIA PRECIOUS THINGS.

FOR OBJETS D'ART OF PRECIOUS METAL AND THEIR ALLOYS, NAMELY, KEY RINGS IN VALUABLE METALS AND ALLOYS OR COATED WITH VALUABLE METALS AND ALLOYS; JEWELRY; GEMSTONES; WATCHES, CLOCKS AND ALARM CLOCKS (U.S. CLS. 2, 27, 28 AND 50).

DOMINICK J. SALEMI, EXAMINING ATTORNEY

SN 78-280,254. KARAT PLATINUM, LLC, NEW YORK, NY. FILED 7-29-2003.

**10 KARAT PLATINUM**

NO CLAIM IS MADE TO THE EXCLUSIVE RIGHT TO USE "PLATINUM", APART FROM THE MARK AS SHOWN. FOR JEWELRY MADE IN SIGNIFICANT PART OF PLATINUM (U.S. CLS. 2, 27, 28 AND 50).

CAROLYN CATALDO, EXAMINING ATTORNEY

SN 78-294,074. ROGERS BLUE JAYS BASEBALL PARTNERSHIP, TORONTO, ONTARIO, CANADA, FILED 8-29-2003.



OWNER OF U.S. REG. NOS. 1,147,361, 2,619,938 AND OTHERS.

FOR JEWELRY, NAMELY, BRACELETS, CHARMS, EARRINGS, RINGS, NECKLACES, PENDANTS, WATCHES, COSTUME JEWELRY, MEDALLIONS, ORNAMENTAL METAL PINS, LAPEL PINS, TIE CLIPS, TIE FASTENERS, CUFF LINKS, METAL BELT BUCKLES OF PRECIOUS METAL, TIE TACKS, TIE PINS, MONEY CLIPS OF PRECIOUS METAL, CLOCKS, WALL CLOCKS, ALARM CLOCKS, PENNANT CLOCKS, CLOCK KEYCHAINS, NON-MONETARY COINS OF PRECIOUS METAL, TROPHIES OF PRECIOUS METAL, AND METAL ASHTRAYS OF PRECIOUS METAL (U.S. CLS. 2, 27, 28 AND 50).

KATHERINE STOIDES, EXAMINING ATTORNEY

**CLASS 14—(Continued).**

SN 78-294,100. ROGERS BLUE JAYS BASEBALL PARTNERSHIP, TORONTO, ONTARIO, CANADA, FILED 8-29-2003.



OWNER OF U.S. REG. NOS. 1,147,361, 2,619,938 AND OTHERS.

FOR JEWELRY, NAMELY, BRACELETS, CHARMS, EARRINGS, RINGS, NECKLACES, PENDANTS, WATCHES, COSTUME JEWELRY, MEDALLIONS, ORNAMENTAL METAL PINS, LAPEL PINS, TIE CLIPS, TIE FASTENERS, CUFF LINKS, METAL BELT BUCKLES OF PRECIOUS METAL, TIE TACKS, TIE PINS, MONEY CLIPS OF PRECIOUS METAL, CLOCKS, WALL CLOCKS, ALARM CLOCKS, PENNANT CLOCKS, CLOCK KEYCHAINS, NON-MONETARY COINS OF PRECIOUS METAL, TROPHIES OF PRECIOUS METAL, AND METAL ASHTRAYS OF PRECIOUS METAL (U.S. CLS. 2, 27, 28 AND 50).

KATHERINE STOIDES, EXAMINING ATTORNEY

SN 78-348,100. LAXMI JEWEL, INC., NEW YORK, NY. FILED 1-6-2004.

**NOOR QUEEN OF PRINCESS**

THE MARK CONSISTS OF STANDARD CHARACTERS WITHOUT CLAIM TO ANY PARTICULAR FONT, STYLE, SIZE, OR COLOR.

THE NAME(S), PORTRAIT(S), AND/OR SIGNATURE(S) SHOWN IN THE MARK DOES NOT IDENTIFY A PARTICULAR LIVING INDIVIDUAL.

THE FOREIGN WORDING IN THE MARK TRANSLATES INTO ENGLISH AS DIVINE LIGHT.

FOR JEWELRY (U.S. CLS. 2, 27, 28 AND 50).

ELISSA GARBER KON, EXAMINING ATTORNEY

**CLASS 14—(Continued).**

SN 78-350,602. METALTRONIC TECHNOLOGY, INC., MIAMI, FL. FILED 1-12-2004.

**WOMAN INSTINCT**

THE MARK CONSISTS OF STANDARD CHARACTERS WITHOUT CLAIM TO ANY PARTICULAR FONT, STYLE, SIZE, OR COLOR.

NO CLAIM IS MADE TO THE EXCLUSIVE RIGHT TO USE "WOMAN", APART FROM THE MARK AS SHOWN. FOR JEWELRY (U.S. CLS. 2, 27, 28 AND 50).  
EVELYN BRADLEY, EXAMINING ATTORNEY

SN 78-352,487. SUMIT DIAMOND CORPORATION, NEW YORK, NY. FILED 1-15-2004.

**TARA BRITE-WHITE**

THE MARK CONSISTS OF STANDARD CHARACTERS WITHOUT CLAIM TO ANY PARTICULAR FONT, STYLE, SIZE, OR COLOR.

FOR JEWELRY, NAMELY, BRACELETS, EARRINGS, RINGS, PENDANTS, NECKLACES, CHARMS, PINS AND BROOCHES: DIAMONDS, PRECIOUS AND SEMI-PRECIOUS GEMSTONES (U.S. CLS. 2, 27, 28 AND 50).  
DOMINICK J. SALEMI, EXAMINING ATTORNEY

SN 78-357,207. TIMOTHY JOHN CHASE, SCRANTON, PA. FILED 1-25-2004.

**NEVER ENDING LOVE**

THE MARK CONSISTS OF STANDARD CHARACTERS WITHOUT CLAIM TO ANY PARTICULAR FONT, STYLE, SIZE, OR COLOR.

FOR JEWELRY (U.S. CLS. 2, 27, 28 AND 50).  
RAUL CORDOVA, EXAMINING ATTORNEY

**CLASS 14—(Continued).**

SN 78-358,301. YURMAN STUDIOS INC., NEW YORK, NY. FILED 1-27-2004.

**Oceanna**

THE MARK CONSISTS OF STANDARD CHARACTERS WITHOUT CLAIM TO ANY PARTICULAR FONT, STYLE, SIZE, OR COLOR.

FOR FINE JEWELRY, PRECIOUS STONES AND WATCHES (U.S. CLS. 2, 27, 28 AND 50).  
SHARI SHEFFIELD, EXAMINING ATTORNEY

SN 78-358,908. CLARKE, MICHAEL E., DALLAS, TX. FILED 1-28-2004.

**Internet Prices In Person**

THE MARK CONSISTS OF STANDARD CHARACTERS WITHOUT CLAIM TO ANY PARTICULAR FONT, STYLE, SIZE, OR COLOR.

FOR DIAMONDS (U.S. CLS. 2, 27, 28 AND 50).  
LAURA KOVAISKY, EXAMINING ATTORNEY

SN 78-360,018. SAMUEL AARON, INC., LONG ISLAND CITY, NY. FILED 1-30-2004.

**ROYAL SYMPHONY**

THE MARK CONSISTS OF STANDARD CHARACTERS WITHOUT CLAIM TO ANY PARTICULAR FONT, STYLE, SIZE, OR COLOR.

OWNER OF U.S. REG. NO. 1,724,622.  
FOR JEWELRY (U.S. CLS. 2, 27, 28 AND 50).  
FIRST USE 10-31-2002; IN COMMERCE 10-31-2002.  
ALICE BENMAMAN, EXAMINING ATTORNEY

**CLASS 14—(Continued).**

SN 78-360,380. SILVER MINE INC., CONCORD, NC. FILED 1-30-2004.

**CLASS 14—(Continued).**

SN 78-362,160. JOSTENS, INC., MINNEAPOLIS, MN. FILED 2-4-2004.

**Doghouse Diamonds**

THE MARK CONSISTS OF STANDARD CHARACTERS WITHOUT CLAIM TO ANY PARTICULAR FONT, STYLE, SIZE, OR COLOR.

NO CLAIM IS MADE TO THE EXCLUSIVE RIGHT TO USE DIAMONDS, APART FROM THE MARK AS SHOWN. FOR DIAMONDS SET IN STERLING SILVER (U.S. CLS. 2, 27, 28 AND 50).

SHARON MEIER, EXAMINING ATTORNEY

**HERITAGE**

SN 78-361,086. LANA UNLIMITED CO., HIGHWOOD, IL. FILED 2-2-2004.

THE MARK CONSISTS OF STANDARD CHARACTERS WITHOUT CLAIM TO ANY PARTICULAR FONT, STYLE, SIZE, OR COLOR.

FOR JEWELRY, NAMELY CLASS RINGS (U.S. CLS. 2, 27, 28 AND 50).

FIRST USE 12-31-1968; IN COMMERCE 12-31-1968. AMY HELLA, EXAMINING ATTORNEY

**JUST ADD SKIN**

THE MARK CONSISTS OF STANDARD CHARACTERS WITHOUT CLAIM TO ANY PARTICULAR FONT, STYLE, SIZE, OR COLOR.

FOR JEWELRY (U.S. CLS. 2, 27, 28 AND 50). KATHY DE JONGE, EXAMINING ATTORNEY

SN 78-362,253. JOSTENS, INC., MINNEAPOLIS, MN. FILED 2-4-2004.

**NUANCE**

SN 78-361,677. FOSSIL, INC., RICHARDSON, TX. FILED 2-3-2004.

**CHRISTIAN BENET**

THE MARK CONSISTS OF STANDARD CHARACTERS WITHOUT CLAIM TO ANY PARTICULAR FONT, STYLE, SIZE, OR COLOR.

THE NAME(S), PORTRAIT(S), AND/OR SIGNATURE(S) SHOWN IN THE MARK DOES NOT IDENTIFY A PARTICULAR LIVING INDIVIDUAL.

FOR WATCHES AND CLOCKS (U.S. CLS. 2, 27, 28 AND 50).

ELLEN PERKINS, EXAMINING ATTORNEY

THE MARK CONSISTS OF STANDARD CHARACTERS WITHOUT CLAIM TO ANY PARTICULAR FONT, STYLE, SIZE, OR COLOR.

FOR JEWELRY, NAMELY CLASS RINGS (U.S. CLS. 2, 27, 28 AND 50).

FIRST USE 3-29-2003; IN COMMERCE 7-1-2003. LAURA KOVAISKY, EXAMINING ATTORNEY

**CLASS 14—(Continued).**

SN 78-364,689. HEARTS ON FIRE COMPANY, BOSTON, MA.  
FILED 2-9-2004.

**CLASS 14—(Continued).**

SN 78-379,378. TEMPUS INTERNATIONAL CORP., MIAMI,  
FL. FILED 3-5-2004.

# FELICITY

THE MARK CONSISTS OF STANDARD CHARACTERS  
WITHOUT CLAIM TO ANY PARTICULAR FONT, STYLE,  
SIZE, OR COLOR.  
FOR JEWELRY (U.S. CLS. 2, 27, 28 AND 50).  
STEVEN R. FINE, EXAMINING ATTORNEY



# STONE

SN 78-372,318. BUFFETT, JIMMY, KEY WEST, FL. FILED 2-  
23-2004.

## LICENSE TO CHILL

THE MARK CONSISTS OF STANDARD CHARACTERS  
WITHOUT CLAIM TO ANY PARTICULAR FONT, STYLE,  
SIZE, OR COLOR.  
FOR JEWELRY, LAPEL PINS, WATCHES AND  
CLOCKS (U.S. CLS. 2, 27, 28 AND 50).  
RICHARD WHITE, EXAMINING ATTORNEY

OWNER OF U.S. REG. NOS. 2,129,527, 2,129,528 AND  
2,715,932.

NO CLAIM IS MADE TO THE EXCLUSIVE RIGHT TO  
USE "STONE", APART FROM THE MARK AS SHOWN.

THE COLOR(S) RED AND WHITE IS/ARE CLAIMED AS  
A DISTINCTIVE FEATURE OF THE MARK.

THE MARK CONSISTS OF A RED CIRCLE AND IN THE  
INSIDE OF THE CIRCLE IS THE LETTER M AND BELOW  
THE LETTER M IS THE LETTER W, BOTH LETTERS  
BEING IN WHITE.

FOR JEWELRY MADE OF PRECIOUS METAL OR  
COATED THEREWITH, BELT BUCKLES AND MONEY  
CLIPS MADE OF PRECIOUS METAL OR COATED  
THEREWITH; CUFFLINKS; TIE CLIPS, PINS, AND  
TACKS; COSTUME JEWELRY; WATCHES, WATCH  
FOBS, BANDS, STRAPS, BRACELETS, AND CHAINS;  
CLOCKS; DECORATIVE ITEMS MADE OF PRECIOUS  
METAL OR COATED THEREWITH, NAMELY, BOWLS,  
PLATTERS, SERVING TRAYS, JUGS, PLATES, MUGS,  
VASES, CACHE POTS, ICE BUCKETS, CANISTERS,  
CRUETS, PENCIL CUPS, LETTER OPENERS, DESK  
TRAYS, SERVING TRAYS, DECORATIVE TRAYS, CAN-  
DLESTICKS, CANDELABRAS, CANDLE HOLDERS,  
CANDLE RINGS, CANDLE SNUFFERS, CANDLE  
TRAYS, DECORATIVE BOXES, JEWELRY BOXES, JEW-  
ELRY CASES, PICTURE FRAMES, DECORATIVE  
STANDS, DECORATIVE PEDESTALS, CIGARETTE  
CASES, CIGARETTE BOXES, CIGARETTE HOLDERS,  
CIGARETTE LIGHTERS, ASHTRAYS, COFFEE SER-  
VICES, TEA SERVICES, AND NAPKIN RINGS (U.S.  
CLS. 2, 27, 28 AND 50).

REBECCA GILBERT, EXAMINING ATTORNEY

**CLASS 15—MUSICAL INSTRUMENTS**

SN 76-321,839. PERIPOLE-BERGERAULT, INC., SALEM, OR.  
FILED 10-5-2001.

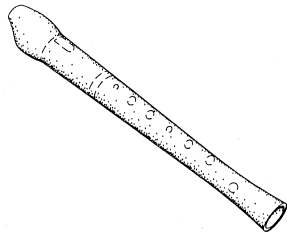

THE STIPPLING IS A FEATURE OF THE MARK AND IS NOT INTENDED TO INDICATE COLOR.

THE MARK CONSISTS OF A RECORDER TRADE DRESS IN WHICH THE RECORDER HAS A RENAISSANCE-SHAPED BODY THAT IS DARK BROWN IN COLOR.

SEC. 2(F).  
FOR MUSICAL INSTRUMENTS, NAMELY RECORDERS (U.S. CLS. 2, 21 AND 36).

FIRST USE 1-3-1994; IN COMMERCE 1-3-1994.  
ANN LINNEHAN, EXAMINING ATTORNEY

---

SN 78-372,335. BUFFETT, JIMMY, KEY WEST, FL. FILED 2-23-2004.

**LICENSE TO CHILL**

THE MARK CONSISTS OF STANDARD CHARACTERS WITHOUT CLAIM TO ANY PARTICULAR FONT, STYLE, SIZE, OR COLOR.

FOR MUSICAL INSTRUMENTS; GUITAR PICKS (U.S. CLS. 2, 21 AND 36).

RICHARD WHITE, EXAMINING ATTORNEY

**CLASS 16—PAPER GOODS AND PRINTED MATTER**

SN 74-565,023. HOOPS L.P., VANCOUVER, BRITISH COLUMBIA, CANADA, FILED 8-24-1994.



PRIORITY CLAIMED UNDER SEC. 44(D) ON CANADA APPLICATION NO. 759408, FILED 7-28-1994, REG. NO. TMA522,667, DATED 2-4-2000, EXPIRES 2-4-2015.

OWNER OF U.S. REG. NO. 2,100,590.

NO CLAIM IS MADE TO THE EXCLUSIVE RIGHT TO USE "VANCOUVER", APART FROM THE MARK AS SHOWN.

THE LINING SHOWN IN THE DRAWING IS A FEATURE OF THE MARK, AND IS NOT INTENDED TO INDICATE COLOR.

FOR PUBLICATIONS AND PRINTED MATTER, NAMELY, BASKETBALL TRADING CARDS, DANCE TEAM TRADING CARDS, MASCOT TRADING CARDS, ENTERTAINMENT TRADING CARDS, STICKERS, DECALS, COMMEMORATIVE BASKETBALL STAMPS, POST CARDS, PAPER PLACE MATS, NOTE CARDS, MEMO PADS, BALL POINT PENS, PENCILS, 3-RING BINDERS, STATIONERY FOLDERS, WIREBOUND NOTEBOOKS, PORTFOLIO NOTEBOOKS, UNMOUNTED AND MOUNTED PHOTOGRAPHS, POSTERS, CALENDARS, BUMPER STICKERS, BOOK COVERS, WRAPPING PAPER, CHILDREN'S ACTIVITY BOOKS, STATISTICAL BOOKS IN THE FIELD OF BASKETBALL, GUIDE BOOKS AND REFERENCE BOOKS FOR BASKETBALL, MAGAZINES IN THE FIELD OF BASKETBALL, SOUVENIR BASKETBALL GAME PROGRAMS, PAPER PENNANTS, STATIONERY, STATIONERY-TYPED PORTFOLIOS, AND STATISTICAL SHEETS FOR BASKETBALL TOPICS, NEWSLETTERS AND PAMPHLETS IN THE FIELD OF BASKETBALL FOR DISTRIBUTION TO THE TELEVISION AND RADIO MEDIA (U.S. CLS. 2, 5, 22, 23, 29, 37, 38 AND 50).

GINNY ISAACSON, EXAMINING ATTORNEY

---

SN 76-329,793. KIMBERLY-CLARK DE MEXICO, S.A. DE C.V., C.P. 11510, MEXICO, MEXICO, FILED 10-24-2001.

**EXCELLENCE**

FOR HANDBOOKS, COPYBOOKS, NOTEBOOKS AND EXERCISE BOOKS ALL CONTAINING ONLY BLANK PAGES, EXCLUDING MAGAZINES (U.S. CLS. 2, 5, 22, 23, 29, 37, 38 AND 50).

MARTHA FROMM, EXAMINING ATTORNEY

**CLASS 16—(Continued).**

SN 76-381,176. AMERICAN MANAGEMENT ASSOCIATION INTERNATIONAL, NEW YORK, NY. FILED 3-11-2002.

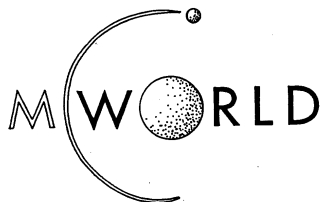

OWNER OF U.S. REG. NO. 2,424,070.  
THE STIPPLING IN THE DRAWING IS A FEATURE OF THE MARK AND DOES NOT INDICATE COLOR.

FOR EDUCATIONAL BOOKS RELATING TO BUSINESS MANAGEMENT; PRINTED INFORMATIONAL MATERIALS IN THE FORM OF BROCHURES RELATING TO BUSINESS MANAGEMENT; PAMPHLETS RELATING TO BUSINESS MANAGEMENT; CATALOGS FOR USE IN THE FIELD OF BUSINESS MANAGEMENT; SEMINAR PROGRAM MATERIALS, NAMELY COURSE OUTLINES AND NOTEBOOKS CONTAINING INSTRUCTIONAL PROGRAMS, QUESTION AND ANSWER SHEETS AND FACTUAL MATERIAL FOR USE AS TEACHING DEVICES ALL FOR USE IN THE FIELD OF BUSINESS MANAGEMENT (U.S. CLS. 2, 5, 22, 23, 29, 37, 38 AND 50).

JENNIFER MARTIN, EXAMINING ATTORNEY

SN 76-425,015. OAG WORLDWIDE LIMITED, DUNSTABLE, BEDFORDSHIRE, UNITED KINGDOM, FILED 6-24-2002.

## OAG EXECUTIVE FLIGHT GUIDE

OWNER OF U.S. REG. NOS. 812,569, 2,336,275 AND OTHERS.

NO CLAIM IS MADE TO THE EXCLUSIVE RIGHT TO USE "EXECUTIVE FLIGHT GUIDE", APART FROM THE MARK AS SHOWN.

FOR PRINTED GUIDES FEATURING TRAVEL INFORMATION (U.S. CLS. 2, 5, 22, 23, 29, 37, 38 AND 50).

GEOFFREY FOSDICK, EXAMINING ATTORNEY

SN 76-472,357. TRAVELCLICK, INC., SCHAUMBURG, IL. FILED 12-5-2002.

## RATEVIEW

FOR PRINTED MATTER, NAMELY, NEWSLETTERS, BROCHURES, REPORTS AND ALERTS RELATING TO TRAVEL-RELATED RATES AND TO THE PRICE AND INVENTORY AVAILABILITY OF TRAVEL-RELATED PROVIDERS, FINANCIAL AND STATISTICAL DATA, AND INFORMATION RELATING TO THE TRAVEL INDUSTRY (U.S. CLS. 2, 5, 22, 23, 29, 37, 38 AND 50).

TRICIA SONNEBORN, EXAMINING ATTORNEY

**CLASS 16—(Continued).**

SN 76-489,353. PILOT CORPORATION OF AMERICA, TRUMBULL, CT. FILED 2-11-2003.

## PERMA-GEL

FOR WRITING INSTRUMENTS (U.S. CLS. 2, 5, 22, 23, 29, 37, 38 AND 50).

GEORGE LORENZO, EXAMINING ATTORNEY

SN 76-514,923. WHOLE FOODS MARKET IP, L.P., AUSTIN, TX. FILED 5-16-2003.

## WHOLE BABY

OWNER OF U.S. REG. NOS. 1,961,586, 2,696,348 AND OTHERS.

NO CLAIM IS MADE TO THE EXCLUSIVE RIGHT TO USE "BABY", APART FROM THE MARK AS SHOWN.

FOR PRINTED MATTER AND PAPER PRODUCTS OFFERED THROUGH OWNER'S LICENSED RETAIL GROCERY STORES, NAMELY BROCHURES, PAMPHLETS AND PRINTED GUIDES ON PRENATAL, POSTNATAL AND EARLY CHILDHOOD NUTRITION, HEALTH, WELLNESS AND BODY CARE (U.S. CLS. 2, 5, 22, 23, 29, 37, 38 AND 50).

ANDREA SAUNDERS, EXAMINING ATTORNEY

SN 76-514,991. SEIKODO CORPORATION, NAGOYA, AI-CHI-KEN, JAPAN, FILED 5-16-2003.

## BARCODE CATS

FOR STICKER BOOKS; STATIONERY; AND PRINTED MATTER, NAMELY, PICTURE POSTCARDS, SHEET MUSIC, SONG BOOKS, CALENDARS, PRINTED TIMETABLES, CHILDREN'S BOOKS, COMIC BOOKS, PICTURE BOOKS, GEOGRAPHICAL MAPS, AND DIARIES (U.S. CLS. 2, 5, 22, 23, 29, 37, 38 AND 50).

CYNTHIA SLOAN, EXAMINING ATTORNEY

SN 76-533,776. LOHSE, VICTORIA, DBA PURE HEART, SAUSALITO, CA. FILED 7-31-2003.

## PURE HEART ANGEL KIDS

NO CLAIM IS MADE TO THE EXCLUSIVE RIGHT TO USE "KIDS", APART FROM THE MARK AS SHOWN.

FOR PRINTED MATTER AND PUBLICATIONS, NAMELY, BOOK MARKS, CHILDREN'S ACTIVITY BOOKS, DECORATIVE FIGURES ATTACHABLE TO PENCILS, FELT-TIP MARKERS, GREETING CARDS, PENCILS, STICKERS, BOOK COVERS, CALENDARS, CHILDREN'S BOOKS, COMIC BOOKS, ERASERS, GIFT WRAPPING PAPER, INVITATION CARDS, MAGAZINES REGARDING VIDEO GAMES, MEMO PADS, NOTE PADS, NOTEBOOKS, PAPER NAPKINS, PAPER PARTY HATS, PAPERBACK BOOKS FEATURING CHILDREN'S STORYLINES AND CHARACTERS, PENCIL SHARPENERS, PENS, PICTURE STORYBOOKS, POSTERS, RING BINDERS, RUBBER STAMPS, SCRATCH PADS, STAPLERS, STATIONARY, STATIONARY-TYPE PORTFOLIOS, STICKER ALBUMS AND TRADING CARDS (U.S. CLS. 2, 5, 22, 23, 29, 37, 38 AND 50).

NICHOLAS ALTREE, EXAMINING ATTORNEY



**CLASS 16—(Continued).**

SN 76-537,204. GEMS OF GOD, INC., RYE, NH. FILED 8-13-2003.

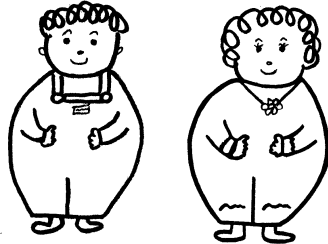

FOR SERIES OF PRINTED MATERIAL, NAMELY INSPIRATIONAL BOOKS AND MAGAZINES (U.S. CLS. 2, 5, 22, 23, 29, 37, 38 AND 50).  
JERI J. FICKES, EXAMINING ATTORNEY

SN 76-538,309. ESSENCE OF LIFE LTD., TEL AVIV 64367, ISRAEL, FILED 8-18-2003.

**LET'S JOIN TOGETHER**

PRIORITY CLAIMED UNDER SEC. 44(D) ON ISRAEL APPLICATION NO. 162808, FILED 2-16-2003, REG. NO. 162808, DATED 2-3-2004, EXPIRES 2-16-2010.

FOR BOOKS, DIARIES, NEWSPAPERS AND MAGAZINES RELATING TO THE DEVELOPMENT OF SELF-AWARENESS; BOOKS RELATING TO THE DEVELOPMENT OF SELF-AWARENESS, INTER-PERSONAL COMMUNICATIONS AND MUTUAL RESPECT IN THE SOCIETY; POSTERS; CALENDARS; GREETING CARDS; PENS AND PENCILS; PAPER BABY BIBS; CATALOGS IN THE FIELD OF DEVELOPMENT OF SELF-AWARENESS (U.S. CLS. 2, 5, 22, 23, 29, 37, 38 AND 50).  
CHRIS WELLS, EXAMINING ATTORNEY

SN 76-540,448. WARD KRAFT, INC., FORT SCOTT, KS. FILED 8-14-2003.

**MIGHTY TAC**

FOR PAPER LABELS; PAPER TAGS AND BUSINESS FORMS WITH PAPER LABELS (U.S. CLS. 2, 5, 22, 23, 29, 37, 38 AND 50).  
ANGELA M. MICHELI, EXAMINING ATTORNEY

**CLASS 16—(Continued).**

SN 76-541,058. PHOTO FINISHERS SUPPLIES INC., LONG ISLAND CITY, NY. FILED 8-29-2003.

*Arya*  
Collection

NO CLAIM IS MADE TO THE EXCLUSIVE RIGHT TO USE "COLLECTION", APART FROM THE MARK AS SHOWN.

THE WORD "ARYA" DOES HAVE A MEANING IN THE FARSI/IRANIAN LANGUAGE AND LITERALLY TRANSLATED MEANS, "CLEAN, PURE OR UNBLEMISHED." FOR PHOTO ALBUMS OF VARIOUS DIFFERENT SIZES; INK JET PRINTING PAPER USED FOR COMPUTERS AND FOR PHOTOGRAPHIC USES (U.S. CLS. 2, 5, 22, 23, 29, 37, 38 AND 50).

JENNIFER CHICOSKI, EXAMINING ATTORNEY

SN 76-545,622. ARROW INTERNATIONAL, INC., CLEVELAND, OH. FILED 9-22-2003.

**COMFORT FIT**

NO CLAIM IS MADE TO THE EXCLUSIVE RIGHT TO USE "FIT", APART FROM THE MARK AS SHOWN.

FOR INK DAUBERS (U.S. CLS. 2, 5, 22, 23, 29, 37, 38 AND 50).

ROBIN CHOSID, EXAMINING ATTORNEY

SN 76-546,074. WORLD WIDE IMPORTS ENTERPRISES, INC., FT. LAUDERDALE, FL. FILED 9-22-2003.

**CORAREPLICA**

FOR ARTIFICIAL CORAL FOR USE IN AQUARIUMS AND AQUATIC DISPLAYS (U.S. CLS. 2, 5, 22, 23, 29, 37, 38 AND 50).

BILL DAWE, EXAMINING ATTORNEY

SN 76-547,394. WATT PUBLISHING CO., MOUNT MORRIS, IL. FILED 9-12-2003.

**UPHOLSTERY DESIGN MANAGEMENT**

SEC. 2(F).  
FOR MAGAZINES IN THE FIELD OF FURNITURE MANUFACTURE, REPAIR, AND RESTORATION (U.S. CLS. 2, 5, 22, 23, 29, 37, 38 AND 50).

FIRST USE 4-0-1988; IN COMMERCE 4-0-1988.

ANGELA M. MICHELI, EXAMINING ATTORNEY

**CLASS 16—(Continued).**

SN 76-552,389. VANGUARDE MEDIA, INC., NEW YORK, NY. FILED 9-29-2003.

**HONEY BRIDE**

OWNER OF U.S. REG. NO. 2,258,144.  
NO CLAIM IS MADE TO THE EXCLUSIVE RIGHT TO USE "BRIDE", APART FROM THE MARK AS SHOWN.  
FOR MAGAZINES PUBLISHED PERIODICALLY FEATURING INFORMATION ON FASHION, WEDDINGS WEDDING PLANNING, LIFESTYLES AND MATTERS OF GENERAL INTEREST (U.S. CLS. 2, 5, 22, 23, 29, 37, 38 AND 50).  
THOMAS V. SHAW, EXAMINING ATTORNEY

SN 76-567,418. ANNUAL REVIEWS, INC., PALO ALTO, CA. FILED 12-29-2003.

**ANNUAL REVIEW OF ENVIRONMENT AND RESOURCES**

OWNER OF U.S. REG. NOS. 1,179,129, 1,186,729 AND OTHERS.  
NO CLAIM IS MADE TO THE EXCLUSIVE RIGHT TO USE "ENVIRONMENT AND RESOURCES", APART FROM THE MARK AS SHOWN.  
SEC. 2(F) AS TO "ANNUAL REVIEW OF".  
FOR SERIES OF VOLUMES PUBLISHED PERIODICALLY, EACH VOLUME COMPRISING A COMPILATION OF SCHOLARLY CRITICAL REVIEWS REGARDING DEVELOPMENTS IN THE FIELD OF ENVIRONMENT AND RESOURCES (U.S. CLS. 2, 5, 22, 23, 29, 37, 38 AND 50).  
FIRST USE 12-1-2003, THE MARK WAS USED IN ANOTHER FORM AS EARLY AS 1985.; IN COMMERCE 12-1-2003.  
CIMMERIAN COLEMAN, EXAMINING ATTORNEY

SN 76-571,969. GOLFSMITH INTERNATIONAL, INC., AUSTIN, TX. FILED 1-22-2004.

**CLUBMAKER**

THE MARK CONSISTS OF STANDARD CHARACTERS WITHOUT CLAIM TO ANY PARTICULAR FONT, STYLE, SIZE, OR COLOR.  
FOR PRINTED PUBLICATIONS, NAMELY, MAGAZINES AND BOOKS IN THE FIELD OF GOLF (U.S. CLS. 2, 5, 22, 23, 29, 37, 38 AND 50).  
FIRST USE 0-0-1991; IN COMMERCE 0-0-1991.  
SEAN DWYER, EXAMINING ATTORNEY

**CLASS 16—(Continued).**

SN 76-573,760. MCCLATCHY MANAGEMENT SERVICES, INC., SACRAMENTO, CA. FILED 2-3-2004.

**MERCED SUN-STAR**

THE MARK CONSISTS OF STANDARD CHARACTERS WITHOUT CLAIM TO ANY PARTICULAR FONT, STYLE, SIZE, OR COLOR.  
NO CLAIM IS MADE TO THE EXCLUSIVE RIGHT TO USE "MERCED", APART FROM THE MARK AS SHOWN.  
FOR NEWSPAPERS, FOR GENERAL CIRCULATION (U.S. CLS. 2, 5, 22, 23, 29, 37, 38 AND 50).  
FIRST USE 5-1-1925; IN COMMERCE 5-1-1925.  
ESTHER A. BORSUK, EXAMINING ATTORNEY

SN 76-574,165. PHOEBEWORKS, LTD., NEW YORK, NY. FILED 2-4-2004.

**Mike HOME**

NO CLAIM IS MADE TO THE EXCLUSIVE RIGHT TO USE "HOME", APART FROM THE MARK AS SHOWN.  
MIKE IS THE NAME OF A LIVING INDIVIDUAL WHOSE CONSENT IS OF RECORD.  
FOR MAGAZINES FEATURING HOME INTERIOR AND EXTERIOR DESIGN AND DECORATION, HOME FURNISHINGS, HOME REMODELING, COOKING AND ENTERTAINMENT (U.S. CLS. 2, 5, 22, 23, 29, 37, 38 AND 50).  
LINDA POWELL, EXAMINING ATTORNEY

SN 78-138,321. FELPS, PAULA S., LEWISVILLE, TX. FILED 6-24-2002.

**PETROPOLITAN MAGAZINE**

NO CLAIM IS MADE TO THE EXCLUSIVE RIGHT TO USE "MAGAZINE", APART FROM THE MARK AS SHOWN.  
FOR PUBLICATION OF MAGAZINES (U.S. CLS. 2, 5, 22, 23, 29, 37, 38 AND 50).  
KIMBERLY PERRY, EXAMINING ATTORNEY

SN 78-214,674. PLENUM PUBLISHING CORP., NEW YORK, NY. FILED 2-13-2003.

**CATALYSIS LETTERS**

NO CLAIM IS MADE TO THE EXCLUSIVE RIGHT TO USE "LETTERS", APART FROM THE MARK AS SHOWN.  
SEC. 2(F).  
FOR PERIODICALLY ISSUED JOURNAL IN THE FIELD OF CHEMISTRY (U.S. CLS. 2, 5, 22, 23, 29, 37, 38 AND 50).  
FIRST USE 12-1-1988; IN COMMERCE 12-1-1988.  
MARC LEIPZIG, EXAMINING ATTORNEY

**CLASS 16—(Continued).**

SN 78-272,847. THE POTTER'S INN, COLORADO SPRINGS, CO. FILED 7-10-2003.

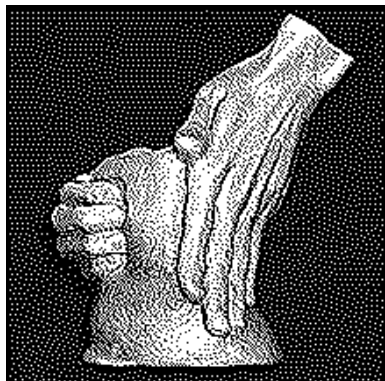

THE STIPLING IS A FEATURE OF THE MARK AND IS NOT INTENDED TO INDICATE COLOR.

THE COLOR(S) GRAY IS/ARE CLAIMED AS A FEATURE OF THE MARK.

THE COLOR GRAY APPEARS IN THE "HANDS OF CLAY."

FOR PRINTED MATERIALS, NAMELY, BOOKS, STUDY GUIDES AND BROCHURES IN THE FIELD OF RELIGIOUS MATTERS, AND GREETING CARDS (U.S. CLS. 2, 5, 22, 23, 29, 37, 38 AND 50).

WILLIAM BRECKENFELD, EXAMINING ATTORNEY

SN 78-273,908. ROBERTS, PHYLLIS A., MT. AIRY, MD. AND ABELL, JASON, COLUMBUS, OH. FILED 7-14-2003.

**CORNELIUS CAT**

FOR CHILDREN'S STORYBOOKS, COLORING BOOKS, COMIC BOOKS AND ACTIVITY BOOKS, STATIONERY, PENS, PENCILS, AND CRAYONS; PEN/PENCIL CASES AND HOLDERS, POSTCARDS, MEMO PADS, NOTE PAPER, NOTE PADS AND NOTEBOOKS, STICKERS, STICKER BOOKS AND STICKER ALBUMS, GREETING CARDS, POSTERS, RUBBER STAMPS AND STAMP PADS, BOOKMARKS; CALENDARS, NOTE CARDS, PAPER PARTY HATS, PAPER NAPKINS, PAPER TABLECLOTHS, PARTY INVITATIONS, GIFT WRAPPING PAPER; LUNCH BAGS MADE OF SYNTHETIC FABRIC; DRAWING INSTRUMENTS, NAMELY, TRACING SETS COMPRISING PLASTIC OUTLINES OF CHARACTERS (U.S. CLS. 2, 5, 22, 23, 29, 37, 38 AND 50).

JOHN SCHUYLER YARD, EXAMINING ATTORNEY

SN 78-280,504. AHOLD RETAIL SERVICES AG, KLOSTERS, SWITZERLAND, FILED 7-29-2003.

**UNDIE UPS**

NO CLAIM IS MADE TO THE EXCLUSIVE RIGHT TO USE UNDIE, APART FROM THE MARK AS SHOWN.

FOR DISPOSABLE DIAPERS AND DISPOSABLE TRAINING PANTS (U.S. CLS. 2, 5, 22, 23, 29, 37, 38 AND 50).

FIRST USE 12-15-2003; IN COMMERCE 12-15-2003.

KEVON CHISOLM, EXAMINING ATTORNEY

**CLASS 16—(Continued).**

SN 78-284,310. US PUBLISHING, INC, LA GRANGE, KY. FILED 8-7-2003.



NO CLAIM IS MADE TO THE EXCLUSIVE RIGHT TO USE U.S. FARMER, APART FROM THE MARK AS SHOWN.

FOR MONTHLY MAGAZINE FOR ADVERTISING TO THE FARMING COMMUNITY (U.S. CLS. 2, 5, 22, 23, 29, 37, 38 AND 50).

FIRST USE 2-0-1999; IN COMMERCE 2-0-1999.

ANN LINNEHAN, EXAMINING ATTORNEY

SN 78-301,884. ICON GROUP INTERNATIONAL, INC., SAN DIEGO, CA. FILED 9-17-2003.

**THE ROSETTA EDITION**

NO CLAIM IS MADE TO THE EXCLUSIVE RIGHT TO USE EDITION, APART FROM THE MARK AS SHOWN.

FOR BOOKS, NAMELY DICTIONARIES (U.S. CLS. 2, 5, 22, 23, 29, 37, 38 AND 50).

FIRST USE 4-0-2004; IN COMMERCE 4-0-2004.

SUSAN LESLIE DUBOIS, EXAMINING ATTORNEY

**CLASS 16—(Continued).**

SN 78-302,060. MARVEL CHARACTERS, INC., LOS ANGELES, CA. FILED 9-18-2003.



OWNER OF U.S. REG. NOS. 870,506, 1,741,813 AND 1,754,033.

FOR PRINTED MATTER AND PAPER GOODS, NAMELY COMIC BOOKS AND COMIC MAGAZINES AND STORIES IN ILLUSTRATED FORM; CHILDREN'S BOOKS, CHILDREN'S ACTIVITY BOOKS, COLORING BOOKS, STICKER BOOKS; STICKERS; BUMPER STICKERS; POSTERS; TRADING CARDS; COLLECTOR ALBUMS FOR TRADING CARDS; ART SUPPLIES, NAMELY CRAYONS, MARKERS, COLORED PENCILS, ARTS AND CRAFT PAINT KITS, PAINT BRUSHES, PRE-PRINTED SHEETS OR POSTERS FOR COLORING OR PAINTING; SLATES FOR WRITING AND DRAWING; CHALK AND CHALKBOARDS FOR HOME USE; DECALS AND HEAT TRANSFERS; SCHOOL SUPPLIES, NAMELY PENS, PENCILS, ERASERS, PENCIL CASES, PENCIL SHARPENERS, DRAWING RULERS, PAPER STAPLERS, PAPERWEIGHTS, NOTEBOOKS, FOLDERS, RING BINDERS, SPIRAL NOTEPADS, BOOK COVERS AND BOOKMARKS; PAPER DOOR KNOB HANGERS; STATIONERY, WRITING PAPER, ENVELOPES, NOTE CARDS, GREETING CARDS, POSTCARDS, NOTEPADS, MEMO PADS; APPOINTMENT BOOKS; CALENDARS; PRINTED PATTERNS FOR COSTUMES; PAPER PARTY GOODS NAMELY GIFT WRAPPING PAPER, PAPER DOILIES, CREPE PAPER, PRINTED PAPER INVITATIONS, PAPER CAKE DECORATIONS, PAPER NAPKINS, PAPER PLACE MATS, PAPER PARTY HATS, DECORATIVE PAPER CENTERPIECES AND PAPER TABLECLOTHS (U.S. CLS. 2, 5, 22, 23, 29, 37, 38 AND 50).  
DARRYL SPRULL, EXAMINING ATTORNEY

**CLASS 16—(Continued).**

SN 78-330,943. CINERGEN, LLC, BLUE BELL, PA. FILED 11-20-2003.

**THE PHYSICAL  
DEPENDENCE  
QUESTIONNAIRE  
(PDQ)**

THE MARK CONSISTS OF STANDARD CHARACTERS WITHOUT CLAIM TO ANY PARTICULAR FONT, STYLE, SIZE, OR COLOR.

NO CLAIM IS MADE TO THE EXCLUSIVE RIGHT TO USE "THE PHYSICAL DEPENDENCE QUESTIONNAIRE", APART FROM THE MARK AS SHOWN.

FOR QUESTIONNAIRE IN THE FIELD OF HEALTH, AND INSTRUCTIONS FOR SAME (U.S. CLS. 2, 5, 22, 23, 29, 37, 38 AND 50).

FIRST USE 4-14-1999; IN COMMERCE 4-14-1999.  
DAVID MURRAY, EXAMINING ATTORNEY

SN 78-329,440. POTLATCH CORPORATION, SPOKANE, WA. FILED 11-18-2003.

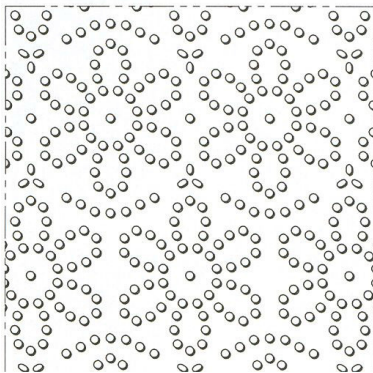

THE MARK CONSISTS OF A REPETITIVE PATTERN OF A MULTIPLE PETALLED FLOWER COMPRISED OF ROUND DOTS AND FURTHER SURROUNDED BY SEMI-CIRCULAR POLKA DOTTED BORDERS WHICH SEPARATE THE RESPECTIVE MULTIPLE PETALLED FLOWERS AND WHICH IS APPLIED TO THE ENTIRE SURFACE OF THE GOODS. THE DOTTED OUTLINE OF THE GOODS IS INTENDED TO SHOW THE POSITION OF THE MARK AND IS NOT A PART OF THE MARK.

FOR PAPER TOWELS AND NAPKINS (U.S. CLS. 2, 5, 22, 23, 29, 37, 38 AND 50).  
JENNIFER CHICOSKI, EXAMINING ATTORNEY

SN 78-340,771. ROSE ART INDUSTRIES, INC., LIVINGSTON, NJ. FILED 12-15-2003.

**IT'S DEFINITELY ME**

THE MARK CONSISTS OF STANDARD CHARACTERS WITHOUT CLAIM TO ANY PARTICULAR FONT, STYLE, SIZE, OR COLOR.

FOR SCRAPBOOK MAKING KIT CONTAINING DIARY, JOURNAL, PAPER, STICKERS, GLUE STICKS, SCISSORS, PENS, STENCIL, ADHESIVE TAPE, PHOTO MOUNTING CORNERS, AND ALBUM SOLD TOGETHER AS A UNIT (U.S. CLS. 2, 5, 22, 23, 29, 37, 38 AND 50).

M. E. BODSON, EXAMINING ATTORNEY

**CLASS 16—(Continued).**

SN 78-341,437. CCLS - CULTURAL CENTER FOR LANGUAGE STUDIES CORPORATION, MIAMI, FL. FILED 12-16-2003.

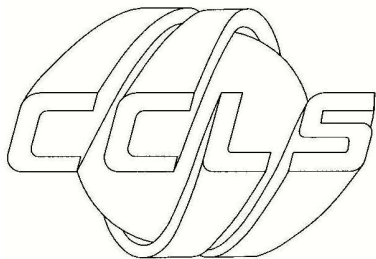

OWNER OF U.S. REG. NO. 1,732,981.  
THE MARK CONSISTS OF A SPHERE WITH THE LETTERS CCLS IN THE FOREFRONT WITH TWO RIBBONS WRAPPING AROUND THE SPHERE AND INTERCONNECTING THE FIRST LETTER C TO THE LETTER L AND THE SECOND LETTER C TO THE LETTER S.  
FOR PRINTED EDUCATIONAL MATERIALS PERTAINING TO A WIDE VARIETY OF SCHOOL SUBJECTS AND TOPICS (U.S. CLS. 2, 5, 22, 23, 29, 37, 38 AND 50).  
FIRST USE 9-12-2003; IN COMMERCE 9-12-2003.  
BRIAN BROWN, EXAMINING ATTORNEY

**CLASS 16—(Continued).**

SN 78-347,277. HOLLAND USA, INC., NORTH MANKATO, MN. FILED 1-2-2004.

# CONQUEST

THE MARK CONSISTS OF STANDARD CHARACTERS WITHOUT CLAIM TO ANY PARTICULAR FONT, STYLE, SIZE, OR COLOR.  
FOR PENS (U.S. CLS. 2, 5, 22, 23, 29, 37, 38 AND 50).  
M. E. BODSON, EXAMINING ATTORNEY

SN 78-348,139. GEORGIA-PACIFIC CORPORATION, ATLANTA, GA. FILED 1-6-2004.

SN 78-345,221. PACER TECHNOLOGY, RANCHO CUCA-MONGA, CA. FILED 12-23-2003.

# PLASTIC-FUSE

# GORAG

THE MARK CONSISTS OF STANDARD CHARACTERS WITHOUT CLAIM TO ANY PARTICULAR FONT, STYLE, SIZE, OR COLOR.  
OWNER OF U.S. REG. NOS. 1,933,568 AND 2,095,411.  
FOR ADHESIVES FOR STATIONARY AND HOUSEHOLD USE (U.S. CLS. 2, 5, 22, 23, 29, 37, 38 AND 50).  
ODESSA BIBBINS, EXAMINING ATTORNEY

THE MARK CONSISTS OF STANDARD CHARACTERS WITHOUT CLAIM TO ANY PARTICULAR FONT, STYLE, SIZE, OR COLOR.  
FOR DISPOSABLE, CELLULOSE WIPERS (U.S. CLS. 2, 5, 22, 23, 29, 37, 38 AND 50).  
FIRST USE 1-1-2004; IN COMMERCE 1-1-2004.  
ZHALEH DELANEY, EXAMINING ATTORNEY

**CLASS 16—(Continued).**

SN 78-349,723. BEAUTY HOLDING COMPANY, INC., HAMILTON, BERMUDA, FILED 1-9-2004.

**CLASS 16—(Continued).**

SN 78-350,353. SPS STUDIOS, INC., LA JOLLA, CA. FILED 1-11-2004.

**SALLY BEAUTY**

THE MARK CONSISTS OF STANDARD CHARACTERS WITHOUT CLAIM TO ANY PARTICULAR FONT, STYLE, SIZE, OR COLOR.

OWNER OF U.S. REG. NOS. 2,582,384, 2,612,903 AND OTHERS.

NO CLAIM IS MADE TO THE EXCLUSIVE RIGHT TO USE BEAUTY, APART FROM THE MARK AS SHOWN.

FOR MAGAZINE FEATURING ARTICLES ON BEAUTY AND LIFESTYLE SOLUTIONS AND PROMOTING BEAUTY TOOLS AND PRODUCTS (U.S. CLS. 2, 5, 22, 23, 29, 37, 38 AND 50).

FIRST USE 1-1-2004; IN COMMERCE 1-1-2004.  
TARAH HARDY, EXAMINING ATTORNEY

**Cheerful Cards**

THE MARK CONSISTS OF STANDARD CHARACTERS WITHOUT CLAIM TO ANY PARTICULAR FONT, STYLE, SIZE, OR COLOR.

NO CLAIM IS MADE TO THE EXCLUSIVE RIGHT TO USE "CARDS", APART FROM THE MARK AS SHOWN.

FOR GREETING CARDS (U.S. CLS. 2, 5, 22, 23, 29, 37, 38 AND 50).

DORITT L. CARROLL, EXAMINING ATTORNEY

SN 78-350,271. FISCHER, LINDA M, DBA TRAITOR DACHSHUND BOOKS, NEW YORK, NY. FILED 1-10-2004.

SN 78-350,516. SINGLE SOURCE STRATEGIES, INC., NEW YORK, NY. FILED 1-12-2004.

**AD-A-SNACK**

THE COLOR(S) MUSTARD YELLOW IS/ARE CLAIMED AS A DISTINCTIVE FEATURE OF THE MARK.

THE COLOR YELLOW APPEARS ON THE DOG AND THE TIP OF ITS NOSE.

THE MARK CONSISTS OF A DACHSHUND, FOR SERIES OF FICTION BOOKS (U.S. CLS. 2, 5, 22, 23, 29, 37, 38 AND 50).

FIRST USE 10-1-2003; IN COMMERCE 12-1-2003.  
DANIEL CAPSHAW, EXAMINING ATTORNEY

THE MARK CONSISTS OF STANDARD CHARACTERS WITHOUT CLAIM TO ANY PARTICULAR FONT, STYLE, SIZE, OR COLOR.

FOR CARDBOARD AND PAPER-BASED FOOD AND BEVERAGE CARRIERS (U.S. CLS. 2, 5, 22, 23, 29, 37, 38 AND 50).

ALEX KEAM, EXAMINING ATTORNEY

**CLASS 16—(Continued).**

SN 78-352,347. FULP, CHARLES T., DANVILLE, VA. FILED 1-15-2004.

**CLASS 16—(Continued).**

SN 78-353,177. SINGING NEWS, INC., BOONE, NC. FILED 1-16-2004.

**HARRY JOHNSON**

**SINGING NEWS**

THE MARK CONSISTS OF STANDARD CHARACTERS WITHOUT CLAIM TO ANY PARTICULAR FONT, STYLE, SIZE, OR COLOR.

HARRY JOHNSON DOES NOT IDENTIFY A PARTICULAR LIVING INDIVIDUAL.

FOR COMIC BOOKS (U.S. CLS. 2, 5, 22, 23, 29, 37, 38 AND 50).

WILLIAM P. SHANAHAN, EXAMINING ATTORNEY

THE MARK CONSISTS OF STANDARD CHARACTERS WITHOUT CLAIM TO ANY PARTICULAR FONT, STYLE, SIZE, OR COLOR.

OWNER OF U.S. REG. NO. 1,604,548.

NO CLAIM IS MADE TO THE EXCLUSIVE RIGHT TO USE "NEWS", APART FROM THE MARK AS SHOWN.

SEC. 2(F).

FOR MAGAZINE RELATING TO SOUTHERN GOSPEL MUSIC (U.S. CLS. 2, 5, 22, 23, 29, 37, 38 AND 50).

FIRST USE 5-0-1984; IN COMMERCE 5-0-1984.

MARLENE BELL, EXAMINING ATTORNEY

SN 78-353,170. SINGING NEWS, INC., BOONE, NC. FILED 1-16-2004.

SN 78-353,747. BAUER CREATIVE SERVICES, INC., ENGLEWOOD, NJ. FILED 1-19-2004.

**THE PRINTED VOICE  
OF SOUTHERN  
GOSPEL MUSIC**

**CLOSE UP**

THE MARK CONSISTS OF STANDARD CHARACTERS WITHOUT CLAIM TO ANY PARTICULAR FONT, STYLE, SIZE, OR COLOR.

OWNER OF U.S. REG. NO. 1,604,548.

NO CLAIM IS MADE TO THE EXCLUSIVE RIGHT TO USE "SOUTHERN GOSPEL MUSIC", APART FROM THE MARK AS SHOWN.

FOR MAGAZINE RELATING TO SOUTHERN GOSPEL MUSIC (U.S. CLS. 2, 5, 22, 23, 29, 37, 38 AND 50).

FIRST USE 5-0-1984; IN COMMERCE 5-0-1984.

MARLENE BELL, EXAMINING ATTORNEY

THE MARK CONSISTS OF STANDARD CHARACTERS WITHOUT CLAIM TO ANY PARTICULAR FONT, STYLE, SIZE, OR COLOR.

FOR GENERAL FEATURE MAGAZINES; ENTERTAINMENT MAGAZINES (U.S. CLS. 2, 5, 22, 23, 29, 37, 38 AND 50).

JAMES GRIFFIN, EXAMINING ATTORNEY

**CLASS 16—(Continued).**

SN 78-353,752. BAUER CREATIVE SERVICES, INC., ENGLEWOOD, NJ. FILED 1-19-2004.

# RED CARPET

THE MARK CONSISTS OF STANDARD CHARACTERS WITHOUT CLAIM TO ANY PARTICULAR FONT, STYLE, SIZE, OR COLOR.

FOR GENERAL FEATURE MAGAZINES; ENTERTAINMENT MAGAZINES (U.S. CLS. 2, 5, 22, 23, 29, 37, 38 AND 50).

JAMES GRIFFIN, EXAMINING ATTORNEY

**CLASS 16—(Continued).**

SN 78-354,245. URBAN, KEITH, NASHVILLE, TN. FILED 1-20-2004.

# GUITAR MONKEY

THE MARK CONSISTS OF STANDARD CHARACTERS WITHOUT CLAIM TO ANY PARTICULAR FONT, STYLE, SIZE, OR COLOR.

NO CLAIM IS MADE TO THE EXCLUSIVE RIGHT TO USE "GUITAR", APART FROM THE MARK AS SHOWN.

FOR PAPER GOODS AND PRINTED MATTER, NAMELY PHOTOGRAPHS, CALENDARS, POSTERS, NEWSLETTERS IN THE FIELD OF MUSIC, BUMPER STICKERS AND STICKERS (U.S. CLS. 2, 5, 22, 23, 29, 37, 38 AND 50).

WON TEAK OH, EXAMINING ATTORNEY

SN 78-354,114. GARTRELL, NANETTE K., SAN FRANCISCO, CA. FILED 1-20-2004.

# HOW TO SAY NO IN 10,000 WORDS OR LESS

THE MARK CONSISTS OF STANDARD CHARACTERS WITHOUT CLAIM TO ANY PARTICULAR FONT, STYLE, SIZE, OR COLOR.

FOR BOOKS, IN THE SUBJECT MATTER OF SELF-HELP, WOMEN'S ISSUES AND PSYCHIATRY (U.S. CLS. 2, 5, 22, 23, 29, 37, 38 AND 50).

NAAKWAMA ANKRAH, EXAMINING ATTORNEY

SN 78-354,285. URBAN, KEITH, NASHVILLE, TN. FILED 1-20-2004.



FOR PAPER GOODS AND PRINTED MATTER, NAMELY, PHOTOGRAPHS, CALENDARS, POSTERS, NEWSLETTERS IN THE FIELD OF MUSIC, BUMPER STICKERS AND STICKERS (U.S. CLS. 2, 5, 22, 23, 29, 37, 38 AND 50).

MATTHEW KLINE, EXAMINING ATTORNEY



**CLASS 16—(Continued).**

SN 78-354,330. ABROMOVITZ, JAIME, PHOENIX, AZ. FILED 1-20-2004.

## BRINGING OUT YOUR INNER MAGIC

THE MARK CONSISTS OF STANDARD CHARACTERS WITHOUT CLAIM TO ANY PARTICULAR FONT, STYLE, SIZE, OR COLOR.

FOR SERIES OF BOOKS FOR CHILDREN; ADDRESS BOOKS; PHOTOGRAPH ALBUMS; APPOINTMENT BOOKS; AUTOGRAPH BOOKS; BOOKMARKS; CARDS BEARING UNIVERSAL GREETINGS; CARTOON PRINTS; CARTOON STRIPS; CHILDREN'S ACTIVITY BOOKS; CHILDREN'S BOOKS; CHILDREN'S STORYBOOKS; CHRISTMAS CARDS; COLORING BOOKS; COMIC BOOKS; COMPOSITION BOOKS; CONSTRUCTION PAPER; CRAFT PAPER; CRAYONS; CROSSWORD PUZZLES; DATE BOOKS; DECORATIVE PENCIL-TOP ORNAMENTS; DRAWING PADS; DRAWING PAPER; DRAWING PENCILS; ENGAGEMENT BOOKS; FELT PENS; FELT TIP PENS; FLASH CARDS; GENERAL FEATURE MAGAZINE; GIFT CARDS; GIFT WRAPPING PAPER; GREETING CARDS; GUEST BOOKS; HIGHLIGHTING MARKERS; HIGHLIGHTING PENS; ILLUSTRATION PAPER; KRAFT PAPER; MARKERS; MARKING PENS; MEMO PADS; MODELING CLAY FOR CHILDREN; NOTE BOOKS; NOTE CARDS; NOTE PADS; OCCASION CARDS; PAINT APPLICATORS; PAINT BRUSHES; PAINT PADDLES; PAINT STICK MARKERS; PAINTING SETS; PAINTING SETS FOR CHILDREN; PALETTES FOR PAINTING; PAPER BADGES; PAPER LABELS; PAPER NAME BADGES; PAPER NOTE TABLETS; PAPER TAGS; PENCILS; PENS; PICTURE BOOKS; PICTURE POSTCARDS; PLACE CARDS; POSTCARDS; PRINTED PAPER LABELS; ROLLER BALL PENS; SCRAPBOOK ALBUMS; SCRAPBOOKS; SCRATCH PADS; SKETCH BOOKS; SKETCH PADS; SOCIAL NOTE CARDS; SONG BOOKS; STAMP ALBUMS; STICK MARKERS; STICKERS; STUDY GUIDES; TALKING CHILDREN'S BOOKS; TELEPHONE NUMBER BOOKS; TRACING PAPER; WRITING INSTRUMENTS; WRITING PADS; WRITING PAPER; AND WRITING TABLETS (U.S. CLS. 2, 5, 22, 23, 29, 37, 38 AND 50).

JOHN E. MICHOS, EXAMINING ATTORNEY

SN 78-354,518. CONDON, JULIE, ALBUQUERQUE, NM. FILED 1-20-2004.

## Until We Eat Again

THE MARK CONSISTS OF STANDARD CHARACTERS WITHOUT CLAIM TO ANY PARTICULAR FONT, STYLE, SIZE, OR COLOR.

FOR PUBLICATIONS, NAMELY, MAGAZINES FEATURING RESTAURANT GUIDES ACCORDING TO GEOGRAPHIC AREA (U.S. CLS. 2, 5, 22, 23, 29, 37, 38 AND 50).

TARAH HARDY, EXAMINING ATTORNEY

**CLASS 16—(Continued).**

SN 78-354,560. FREEDOM COMMUNICATIONS, INC., DBA THE ORANGE COUNTY REGISTER, SANTA ANA, CA. FILED 1-20-2004.

## FIND IT. SELL IT.

THE MARK CONSISTS OF STANDARD CHARACTERS WITHOUT CLAIM TO ANY PARTICULAR FONT, STYLE, SIZE, OR COLOR.

FOR NEWSPAPERS FOR GENERAL CIRCULATION (U.S. CLS. 2, 5, 22, 23, 29, 37, 38 AND 50).

MATTHEW KLINE, EXAMINING ATTORNEY

SN 78-354,648. ALLIED ELECTRONICS INC., FORT WORTH, TX. FILED 1-21-2004.

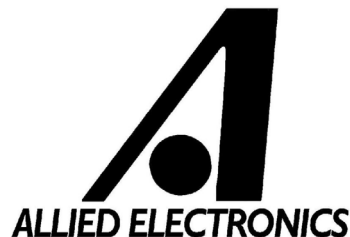

OWNER OF U.S. REG. NOS. 2,271,634, 2,707,231 AND 2,773,580.

NO CLAIM IS MADE TO THE EXCLUSIVE RIGHT TO USE "ELECTRONICS", APART FROM THE MARK AS SHOWN.

FOR CATALOGS, MANUALS AND PURCHASING GUIDES FOR INDUSTRIAL SALE AND DISTRIBUTION OF PASSIVE AND ELECTRONIC COMPONENTS, ELECTRICAL TEST EQUIPMENT AND EXPERIMENTAL EQUIPMENT, AND HAND TOOLS FOR USE IN THE ELECTRONICS INDUSTRY (U.S. CLS. 2, 5, 22, 23, 29, 37, 38 AND 50).

FIRST USE 5-23-2001; IN COMMERCE 5-23-2001.

DAVID MURRAY, EXAMINING ATTORNEY

**CLASS 16—(Continued).**

SN 78-355,902. NATIONAL CASA ASSOCIATION, SEATTLE, WA. FILED 1-22-2004.

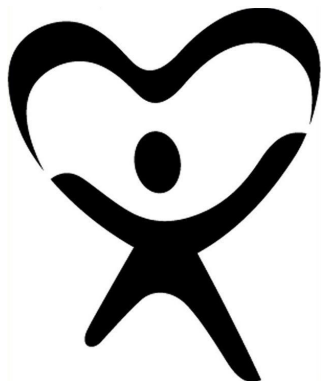

THE MARK CONSISTS OF A STICK FIGURE WITH UPSTRETCHED ARMS AND THE ARMS FORM THE BOTTOM HALF OF AN OUTLINE OF A HEART.

FOR PRINTED MATERIALS, NAMELY, BOOKS, BROCHURES, HANDBOOKS, MAGAZINES, MANUALS AND NEWSLETTERS RELATING TO THE REPRESENTATION OF THE BEST INTERESTS OF CHILDREN IN COURT; EDUCATIONAL PUBLICATIONS IN THE FIELD OF REPRESENTING THE BEST INTERESTS OF CHILDREN IN COURT; POSTERS; PENS; PENCILS; STATIONERY (U.S. CLS. 2, 5, 22, 23, 29, 37, 38 AND 50).  
KIMBERLY FRYE, EXAMINING ATTORNEY

SN 78-356,509. DAVID & GOLIATH, INC., CLEARWATER, FL. FILED 1-23-2004.

**MR. DOODIE**

THE MARK CONSISTS OF STANDARD CHARACTERS WITHOUT CLAIM TO ANY PARTICULAR FONT, STYLE, SIZE, OR COLOR.

FOR ADDRESS BOOKS, BUMPER STICKERS, CALENDARS, DIARY BOOKS, ENVELOPES, FOLDERS, GREETING CARDS, LETTER PAPER, NOTEBOOKS, POSTCARDS, POSTERS, STATIONERY (U.S. CLS. 2, 5, 22, 23, 29, 37, 38 AND 50).

HELEN BRYAN, EXAMINING ATTORNEY

**CLASS 16—(Continued).**

SN 78-357,494. AMERICAN EXPRESS COMPANY, NEW YORK, NY. FILED 1-26-2004.

**STRATEGIES &  
INSIGHTS FOR THE  
DISCERNING  
INVESTOR**

THE MARK CONSISTS OF STANDARD CHARACTERS WITHOUT CLAIM TO ANY PARTICULAR FONT, STYLE, SIZE, OR COLOR.

FOR FINANCIAL PLANNING NEWSLETTER (U.S. CLS. 2, 5, 22, 23, 29, 37, 38 AND 50).

BRIAN NEVILLE, EXAMINING ATTORNEY

SN 78-357,502. AMERICAN EXPRESS COMPANY, NEW YORK, NY. FILED 1-26-2004.

**FORWARD FOCUS**

THE MARK CONSISTS OF STANDARD CHARACTERS WITHOUT CLAIM TO ANY PARTICULAR FONT, STYLE, SIZE, OR COLOR.

FOR FINANCIAL PLANNING NEWSLETTER (U.S. CLS. 2, 5, 22, 23, 29, 37, 38 AND 50).

BRIAN NEVILLE, EXAMINING ATTORNEY

SN 78-358,506. NORTH AMERICAN MEMBERSHIP GROUP, INC., MINNETONKA, MN. FILED 1-28-2004.

**STREET THUNDER**

THE MARK CONSISTS OF STANDARD CHARACTERS WITHOUT CLAIM TO ANY PARTICULAR FONT, STYLE, SIZE, OR COLOR.

FOR MAGAZINES IN THE FIELD OF AUTOMOBILES AND AUTOMOTIVE EVENTS (U.S. CLS. 2, 5, 22, 23, 29, 37, 38 AND 50).

ALICE BENMAMAN, EXAMINING ATTORNEY

**CLASS 16—(Continued).**

SN 78-358,508. FORT JAMES OPERATING COMPANY, ATLANTA, GA. FILED 1-28-2004.

**CLASS 16—(Continued).**

SN 78-365,770. WARNER BROS. ENTERTAINMENT INC., BURBANK, CA. FILED 2-10-2004.

**QUILTED**

THE MARK CONSISTS OF STANDARD CHARACTERS WITHOUT CLAIM TO ANY PARTICULAR FONT, STYLE, SIZE, OR COLOR.  
OWNER OF U.S. REG. NOS. 1,877,561, 2,663,438 AND OTHERS.  
SEC. 2(F).  
FOR BATH TISSUE (U.S. CLS. 2, 5, 22, 23, 29, 37, 38 AND 50).  
FIRST USE 1-7-1993; IN COMMERCE 1-7-1993.  
ALICE BENMAMAN, EXAMINING ATTORNEY

**CHARLIE AND THE  
CHOCOLATE  
FACTORY**

SN 78-359,940. TIME INC., NEW YORK, NY. FILED 1-30-2004.

**ALL YOURS**

THE MARK CONSISTS OF STANDARD CHARACTERS WITHOUT CLAIM TO ANY PARTICULAR FONT, STYLE, SIZE, OR COLOR.  
FOR GENERAL INTEREST MAGAZINE (U.S. CLS. 2, 5, 22, 23, 29, 37, 38 AND 50).  
ELISSA GARBER KON, EXAMINING ATTORNEY

THE MARK CONSISTS OF STANDARD CHARACTERS WITHOUT CLAIM TO ANY PARTICULAR FONT, STYLE, SIZE, OR COLOR.  
FOR PRINTED MATTER AND PAPER GOODS—NAMESLY, BOOKS FEATURING CHARACTERS FROM ANIMATED, ACTION ADVENTURE, COMEDY AND/OR DRAMA FEATURES, COMIC BOOKS, CHILDREN'S BOOKS, MAGAZINES FEATURING CHARACTERS FROM ANIMATED, ACTION ADVENTURE, COMEDY AND/OR DRAMA FEATURES, COLORING BOOKS, CHILDREN'S ACTIVITY BOOKS; STATIONERY, WRITING PAPER, ENVELOPES, NOTEBOOKS, DIARIES, NOTE CARDS, GREETING CARDS, TRADING CARDS; LITHOGRAPHS; PENS, PENCILS, CASES THEREFOR, ERASERS, CRAYONS, MARKERS, COLORED PENCILS, PAINTING SETS, CHALK AND CHALKBOARDS; DECALS, HEAT TRANSFERS; POSTERS; MOUNTED AND/OR UNMOUNTED PHOTOGRAPHS; BOOK COVERS, BOOK MARKS, CALENDARS, GIFT WRAPPING PAPER; PAPER PARTY FAVORS AND PAPER PARTY DECORATIONS—NAMESLY, PAPER NAPKINS, PAPER DOILIES, PAPER PLACE MATS, CREPE PAPER, PAPER HATS, INVITATIONS, PAPER TABLE CLOTHS, PAPER CAKE DECORATIONS; PRINTED TRANSFERS FOR EMBROIDERY OR FABRIC APPLIQUES; PRINTED PATTERNS FOR COSTUMES, PAJAMAS, SWEATSHIRTS AND T-SHIRTS (U.S. CLS. 2, 5, 22, 23, 29, 37, 38 AND 50).  
GEOFFREY FOSDICK, EXAMINING ATTORNEY

**CLASS 16—(Continued).**

SN 78-365,792. WARNER BROS. ENTERTAINMENT INC.,  
BURBANK, CA. FILED 2-10-2004.

**CLASS 16—(Continued).**

SN 78-374,742. ABROMOVITZ, JAIME, PHOENIX, AZ. FILED  
2-26-2004.

## GOBSTOPPING WILLIES

## OOMPA LOOMPA

THE MARK CONSISTS OF STANDARD CHARACTERS WITHOUT CLAIM TO ANY PARTICULAR FONT, STYLE, SIZE, OR COLOR.

FOR PRINTED MATTER AND PAPER GOODS—NAMESLY, BOOKS FEATURING CHARACTERS FROM ANIMATED, ACTION ADVENTURE, COMEDY AND/OR DRAMA FEATURES, COMIC BOOKS, CHILDREN'S BOOKS, MAGAZINES FEATURING CHARACTERS FROM ANIMATED, ACTION ADVENTURE, COMEDY AND/OR DRAMA FEATURES, COLORING BOOKS, CHILDREN'S ACTIVITY BOOKS; STATIONERY, WRITING PAPER, ENVELOPES, NOTEBOOKS, DIARIES, NOTE CARDS, GREETING CARDS, TRADING CARDS; LITHOGRAPHS; PENS, PENCILS, CASES THEREFOR, ERASERS, CRAYONS, MARKERS, COLORED PENCILS, PAINTING SETS, CHALK AND CHALKBOARDS; DECALS, HEAT TRANSFERS; POSTERS; MOUNTED AND/OR UNMOUNTED PHOTOGRAPHS; BOOK COVERS, BOOK MARKS, CALENDARS, GIFT WRAPPING PAPER; PAPER PARTY FAVORS AND PAPER PARTY DECORATIONS—NAMESLY, PAPER NAPKINS, PAPER DOILIES, PAPER PLACE MATS, CREPE PAPER, PAPER HATS, INVITATIONS, PAPER TABLE CLOTHS, PAPER CAKE DECORATIONS; PRINTED TRANSFERS FOR EMBROIDERY OR FABRIC APPLIQUES; PRINTED PATTERNS FOR COSTUMES, PAJAMAS, SWEATSHIRTS AND T-SHIRTS (U.S. CLS. 2, 5, 22, 23, 29, 37, 38 AND 50).  
GEOFFREY FOSDICK, EXAMINING ATTORNEY

THE MARK CONSISTS OF STANDARD CHARACTERS WITHOUT CLAIM TO ANY PARTICULAR FONT, STYLE, SIZE, OR COLOR.

FOR SERIES OF BOOKS FOR CHILDREN; ADDRESS BOOKS; PHOTOGRAPH ALBUMS; APPOINTMENT BOOKS; AUTOGRAPH BOOKS; BOOKMARKS; CARDS BEARING UNIVERSAL GREETINGS; CARTOON PRINTS; CARTOON STRIPS; CHILDREN'S ACTIVITY BOOKS; CHILDREN'S BOOKS; CHILDREN'S STORYBOOKS; CHRISTMAS CARDS; COLORING BOOKS; COMIC BOOKS; COMPOSITION BOOKS; CONSTRUCTION PAPER; CRAFT PAPER; CRAYONS; CROSSWORD PUZZLES; DATE BOOKS; DECORATIVE PENCIL-TOP ORNAMENTS; DRAWING PADS; DRAWING PAPER; DRAWING PENCILS; ENGAGEMENT BOOKS; FELT PENS; FELT TIP PENS; FLASH CARDS; GENERAL FEATURE MAGAZINE; GIFT CARDS; GIFT WRAPPING PAPER; GREETING CARDS; GUEST BOOKS; HIGHLIGHTING MARKERS; HIGHLIGHTING PENS; ILLUSTRATION PAPER; KRAFT PAPER; MARKERS; MARKING PENS; MEMO PADS; MODELING CLAY FOR CHILDREN; NOTE BOOKS; NOTE CARDS; NOTE PADS; OCCASION CARDS; PAINT APPLICATORS; PAINT BRUSHES; PAINT PADDLES; PAINT STICK MARKERS; PAINTING SETS; PAINTING SETS FOR CHILDREN; PALETTES FOR PAINTING; PAPER BADGES; PAPER LABELS; PAPER NAME BADGES; PAPER NOTE TABLETS; PAPER TAGS; PENCILS; PENS; PICTURE BOOKS; PICTURE POSTCARDS; PLACE CARDS; POSTCARDS; PRINTED PAPER LABELS; ROLLER BALL PENS; SCRAPBOOK ALBUMS; SCRAPBOOKS; SCRATCH PADS; SKETCH BOOKS; SKETCH PADS; SOCIAL NOTE CARDS; SONG BOOKS; STAMP ALBUMS; STICK MARKERS; STICKERS; STUDY GUIDES; TALKING CHILDREN'S BOOKS; TELEPHONE NUMBER BOOKS; TRACING PAPER; WRITING INSTRUMENTS; WRITING PADS; WRITING PAPER; AND WRITING TABLETS (U.S. CLS. 2, 5, 22, 23, 29, 37, 38 AND 50).

JOHN E. MICHOS, EXAMINING ATTORNEY

**CLASS 16—(Continued).**SN 78-374,747. ABROMOVITZ, JAIME, PHOENIX, AZ. FILED  
2-26-2004.**CLASS 16—(Continued).**SN 78-374,750. ABROMOVITZ, JAIME, PHOENIX, AZ. FILED  
2-26-2004.**SQUIDDLES****DOODLEY-DOO**

THE MARK CONSISTS OF STANDARD CHARACTERS WITHOUT CLAIM TO ANY PARTICULAR FONT, STYLE, SIZE, OR COLOR.

FOR SERIES OF BOOKS FOR CHILDREN; ADDRESS BOOKS; PHOTOGRAPH ALBUMS; APPOINTMENT BOOKS; AUTOGRAPH BOOKS; BOOKMARKS; CARDS BEARING UNIVERSAL GREETINGS; CARTOON PRINTS; CARTOON STRIPS; CHILDREN'S ACTIVITY BOOKS; CHILDREN'S BOOKS; CHILDREN'S STORYBOOKS; CHRISTMAS CARDS; COLORING BOOKS; COMIC BOOKS; COMPOSITION BOOKS; CONSTRUCTION PAPER; CRAFT PAPER; CRAYONS; CROSSWORD PUZZLES; DATE BOOKS; DECORATIVE PENCIL-TOP ORNAMENTS; DRAWING PADS; DRAWING PAPER; DRAWING PENCILS; ENGAGEMENT BOOKS; FELT PENS; FELT TIP PENS; FLASH CARDS; GENERAL FEATURE MAGAZINE; GIFT CARDS; GIFT WRAPPING PAPER; GREETING CARDS; GUEST BOOKS; HIGHLIGHTING MARKERS; HIGHLIGHTING PENS; ILLUSTRATION PAPER; KRAFT PAPER; MARKERS; MARKING PENS; MEMO PADS; MODELING CLAY FOR CHILDREN; NOTE BOOKS; NOTE CARDS; NOTE PADS; OCCASION CARDS; PAINT APPLICATORS; PAINT BRUSHES; PAINT PADDLES; PAINT STICK MARKERS; PAINTING SETS; PAINTING SETS FOR CHILDREN; PALETTES FOR PAINTING; PAPER BADGES; PAPER LABELS; PAPER NAME BADGES; PAPER NOTE TABLETS; PAPER TAGS; PENCILS; PENS; PICTURE BOOKS; PICTURE POSTCARDS; PLACE CARDS; POSTCARDS; PRINTED PAPER LABELS; ROLLER BALL PENS; SCRAPBOOK ALBUMS; SCRAPBOOKS; SCRATCH PADS; SKETCH BOOKS; SKETCH PADS; SOCIAL NOTE CARDS; SONG BOOKS; STAMP ALBUMS; STICK MARKERS; STICKERS; STUDY GUIDES; TALKING CHILDREN'S BOOKS; TELEPHONE NUMBER BOOKS; TRACING PAPER; WRITING INSTRUMENTS; WRITING PADS; WRITING PAPER; AND WRITING TABLETS (U.S. CLS. 2, 5, 22, 23, 29, 37, 38 AND 50).

JOHN E. MICHOS, EXAMINING ATTORNEY

THE MARK CONSISTS OF STANDARD CHARACTERS WITHOUT CLAIM TO ANY PARTICULAR FONT, STYLE, SIZE, OR COLOR.

FOR SERIES OF BOOKS FOR CHILDREN; ADDRESS BOOKS; PHOTOGRAPH ALBUMS; APPOINTMENT BOOKS; AUTOGRAPH BOOKS; BOOKMARKS; CARDS BEARING UNIVERSAL GREETINGS; CARTOON PRINTS; CARTOON STRIPS; CHILDREN'S ACTIVITY BOOKS; CHILDREN'S BOOKS; CHILDREN'S STORYBOOKS; CHRISTMAS CARDS; COLORING BOOKS; COMIC BOOKS; COMPOSITION BOOKS; CONSTRUCTION PAPER; CRAFT PAPER; CRAYONS; CROSSWORD PUZZLES; DATE BOOKS; DECORATIVE PENCIL-TOP ORNAMENTS; DRAWING PADS; DRAWING PAPER; DRAWING PENCILS; ENGAGEMENT BOOKS; FELT PENS; FELT TIP PENS; FLASH CARDS; GENERAL FEATURE MAGAZINE; GIFT CARDS; GIFT WRAPPING PAPER; GREETING CARDS; GUEST BOOKS; HIGHLIGHTING MARKERS; HIGHLIGHTING PENS; ILLUSTRATION PAPER; KRAFT PAPER; MARKERS; MARKING PENS; MEMO PADS; MODELING CLAY FOR CHILDREN; NOTE BOOKS; NOTE CARDS; NOTE PADS; OCCASION CARDS; PAINT APPLICATORS; PAINT BRUSHES; PAINT PADDLES; PAINT STICK MARKERS; PAINTING SETS; PAINTING SETS FOR CHILDREN; PALETTES FOR PAINTING; PAPER BADGES; PAPER LABELS; PAPER NAME BADGES; PAPER NOTE TABLETS; PAPER TAGS; PENCILS; PENS; PICTURE BOOKS; PICTURE POSTCARDS; PLACE CARDS; POSTCARDS; PRINTED PAPER LABELS; ROLLER BALL PENS; SCRAPBOOK ALBUMS; SCRAPBOOKS; SCRATCH PADS; SKETCH BOOKS; SKETCH PADS; SOCIAL NOTE CARDS; SONG BOOKS; STAMP ALBUMS; STICK MARKERS; STICKERS; STUDY GUIDES; TALKING CHILDREN'S BOOKS; TELEPHONE NUMBER BOOKS; TRACING PAPER; WRITING INSTRUMENTS; WRITING PADS; WRITING PAPER; AND WRITING TABLETS (U.S. CLS. 2, 5, 22, 23, 29, 37, 38 AND 50).

JOHN E. MICHOS, EXAMINING ATTORNEY

**CLASS 16—(Continued).**

SN 78-377,432. TEMPUS INTERNATIONAL CORP., MIAMI, FL. FILED 3-2-2004.



OWNER OF U.S. REG. NOS. 2,129,527, 2,129,528 AND 2,715,932.

NO CLAIM IS MADE TO THE EXCLUSIVE RIGHT TO USE "MAGAZINE", APART FROM THE MARK AS SHOWN. THE COLOR(S) RED AND WHITE IS/ARE CLAIMED AS A DISTINCTIVE FEATURE OF THE MARK.

THE MARK CONSISTS OF A RED CIRCLE AND INSIDE THE CIRCLE IS THE LETTER M AND DIRECTLY BELOW THE LETTER M IS THE PHRASE A LIFE LESS ORDINARY MAGAZINE, AND DIRECTLY BELOW THE PHRASE IS THE LETTER W, ALL LETTERS AND WORDS BEING IN WHITE.

FOR COMBINATION MAGAZINE AND CATALOG RELATED TO WATCHES, JEWELRY, CLOTHING AND OTHER LUXURY GOODS (U.S. CLS. 2, 5, 22, 23, 29, 37, 38 AND 50).

REBECCA GILBERT, EXAMINING ATTORNEY

**CLASS 16—(Continued).**

SN 78-394,818. FMR CORP., BOSTON, MA. FILED 4-1-2004.

# FIDELITY+

THE MARK CONSISTS OF STANDARD CHARACTERS WITHOUT CLAIM TO ANY PARTICULAR FONT, STYLE, SIZE, OR COLOR.

OWNER OF U.S. REG. NOS. 1,277,373, 2,108,052 AND OTHERS.

FOR PERIODICAL PUBLICATIONS, NAMELY FINANCIAL MAGAZINES (U.S. CLS. 2, 5, 22, 23, 29, 37, 38 AND 50).

ANN E. SAPPENFIELD, EXAMINING ATTORNEY

SN 78-378,716. THREE BY THREE, INC., SEATTLE, WA. FILED 3-4-2004.

# POPMARK

THE MARK CONSISTS OF STANDARD CHARACTERS WITHOUT CLAIM TO ANY PARTICULAR FONT, STYLE, SIZE, OR COLOR.

FOR BOOKMARK (U.S. CLS. 2, 5, 22, 23, 29, 37, 38 AND 50).

FIRST USE 1-10-2004; IN COMMERCE 1-10-2004.

DAVID MURRAY, EXAMINING ATTORNEY

SN 78-398,066. SARA LEE GLOBAL FINANCE, L.L.C., WILMINGTON, DE. FILED 4-7-2004.



OWNER OF U.S. REG. NOS. 1,127,251, 1,566,064 AND OTHERS.

FOR PUBLICATIONS NAMELY BOOKS, TRAINING MANUALS, JOURNALS, NEWSLETTERS AND MAGAZINES IN THE FIELDS OF HEALTH, EXERCISE, NUTRITION, SPORTS DIET, SPORT FASHION AND LIFESTYLE (U.S. CLS. 2, 5, 22, 23, 29, 37, 38 AND 50).

BRENDAN REGAN, EXAMINING ATTORNEY

**CLASS 16—(Continued).**

SN 78-398,088. SARA LEE GLOBAL FINANCE, L.L.C., WILMINGTON, DE. FILED 4-7-2004.



OWNER OF U.S. REG. NOS. 1,127,251, 1,566,064 AND OTHERS.

FOR PUBLICATIONS NAMELY BOOKS, TRAINING MANUALS, JOURNALS, NEWSLETTERS, MAGAZINES, IN THE FIELDS OF HEALTH, EXERCISE, NUTRITION, SPORTS, DIET, SPORT FASHION AND LIFESTYLE (U.S. CLS. 2, 5, 22, 23, 29, 37, 38 AND 50).

BRENDAN REGAN, EXAMINING ATTORNEY

---

SN 78-412,167. SABIN, ELLEN, NEW YORK, NY. FILED 5-3-2004.

**WATERING CAN**

THE MARK CONSISTS OF STANDARD CHARACTERS WITHOUT CLAIM TO ANY PARTICULAR FONT, STYLE, SIZE, OR COLOR.

FOR CHILDREN'S BOOKS; CHILDREN'S ACTIVITY BOOKS AND TEACHER'S GUIDES RELATING THERETO; SERIES OF FICTION BOOKS; SERIES OF NON-FICTION BOOKS AND BOOKS AND ACTIVITY AND JOURNAL BOOKS ALL RELATING TO TOPICS OF PHILANTHROPY, TOLERANCE, ROLE MODELS AND OTHER CHARACTER-BUILDING ISSUES (U.S. CLS. 2, 5, 22, 23, 29, 37, 38 AND 50).

MICHAEL BAIRD, EXAMINING ATTORNEY

**CLASS 17—RUBBER GOODS**

SN 75-682,547. NOLATO SUNNEX EQUIPMENT AB, S-686 28 SUNNE, SWEDEN, FILED 4-14-1999.



FOR RUBBER AND GUTTA-PERCHA SHOES, HANDLES AND SHOCK ABSORBERS FOR INDUSTRIAL MACHINERY (U.S. CLS. 1, 5, 12, 13, 35 AND 50).

LINDA M. KING, EXAMINING ATTORNEY

**CLASS 17—(Continued).**

SN 76-126,867. STAMFORD GROUP LIMITED, THE, STALY-BRIDGE, CHESHIRE, ENGLAND, FILED 9-11-2000.

**PRONTO-PEX**

OWNER OF UNITED KINGDOM REG. NO. 2229903, DATED 4-18-2000, EXPIRES 4-18-2010.

FOR PLASTIC TUBING FOR USE IN PLUMBING, WATER DISTRIBUTION AND CENTRAL HEATING SYSTEMS; TUBES, FLEXIBLE TUBES, PIPES AND HOSES, ALL MADE OF EXTRUDED PLASTICS, FOR USE IN PLUMBING, WATER DISTRIBUTION AND CENTRAL HEATING SYSTEMS; PLASTIC PIPE CONNECTORS AND COUPLERS FOR USE IN PLUMBING, WATER DISTRIBUTION AND CENTRAL HEATING SYSTEMS; POLYETHENE PIPING INTENDED FOR FLOOR HEATING, CONVENTIONAL CENTRAL HEATING PURPOSES AND SANITARY WARM AND COLD WATER SYSTEMS (U.S. CLS. 1, 5, 12, 13, 35 AND 50).

ESTHER BELENKER, EXAMINING ATTORNEY

---

SN 76-526,783. NATIONAL GYPSUM PROPERTIES, LLC, CHARLOTTE, NC. FILED 7-1-2003.



THE MARK CONSISTS OF A PYRAMID DESIGN WITH THE COLORS BLACK, WHITE, GOLD, WHITE AND RED IN DESCENDING ORDER.

FOR DRYWALL JOINT TAPE, WALLBOARD JOINT COMPOUNDS AND BUILDING INSULATION (U.S. CLS. 1, 5, 12, 13, 35 AND 50).

TRICIA THOMPSON, EXAMINING ATTORNEY

**CLASS 17—(Continued).**

SN 78-351,041. NEW HEIGHTS RECOVERY AND POWER, LLC, FORD HEIGHTS, IL. FILED 1-13-2004.



NO CLAIM IS MADE TO THE EXCLUSIVE RIGHT TO USE "RUBBER" AND THE LIKENESS REPRESENTING THE OUTLINE OF THE CONTINENTAL UNITED STATES, APART FROM THE MARK AS SHOWN.

THE MARK CONSISTS OF ALL AROUND RUBBER AND DESIGN.

FOR RECYCLED RUBBER IN CRUMB RUBBER PARTICLE, NUGGET AND BUFFING FORM FOR USE AS A GROUND COVERING FOR PLAYGROUNDS AND SPORTS FIELDS, FOR LAWN CARE, FOR LANDSCAPING, ASPHALT BINDERS AND FOR FURTHER MANUFACTURING (U.S. CLS. 1, 5, 12, 13, 35 AND 50).

LINDA E. BLOHM, EXAMINING ATTORNEY

SN 78-358,042. FOAMEX L.P., LINWOOD, PA. FILED 1-27-2004.

**REFLEX MEMORY**

THE MARK CONSISTS OF STANDARD CHARACTERS WITHOUT CLAIM TO ANY PARTICULAR FONT, STYLE, SIZE, OR COLOR.

OWNER OF U.S. REG. NOS. 2,129,337, 2,849,196 AND OTHERS.

FOR POLYURETHANE FOAMS USED IN THE CONSTRUCTION OF FURNITURE CUSHIONS, FURNITURE SEATS, FURNITURE BACKS, MATTRESSES AND MATTRESS TOPPERS (U.S. CLS. 1, 5, 12, 13, 35 AND 50).

JOSETTE BEVERLY, EXAMINING ATTORNEY

**CLASS 17—(Continued).**

SN 78-363,386. PACE INDUSTRIES, INC., REEDSBURG, WI. FILED 2-5-2004.

**DIGI-HIPS**

THE MARK CONSISTS OF STANDARD CHARACTERS WITHOUT CLAIM TO ANY PARTICULAR FONT, STYLE, SIZE, OR COLOR.

FOR SPECIALLY ENGINEERED EXTRUDED STYRENIC SHEET FOR THE UV DIGITAL INDUSTRY, FOR USE IN THE MANUFACTURE OF POINT OF PURCHASE DISPLAYS, SIGNAGE, AND OTHER RETAIL PROMOTIONAL ITEMS (U.S. CLS. 1, 5, 12, 13, 35 AND 50).

FIRST USE 9-22-2003; IN COMMERCE 9-22-2003.

SHAUNIA WALLACE, EXAMINING ATTORNEY

**CLASS 18—LEATHER GOODS**

SN 76-514,922. WHOLE FOODS MARKET IP, L.P., AUSTIN, TX. FILED 5-16-2003.

**WHOLE BABY**

NO CLAIM IS MADE TO THE EXCLUSIVE RIGHT TO USE "BABY", APART FROM THE MARK AS SHOWN.

FOR TOTE BAGS (U.S. CLS. 1, 2, 3, 22 AND 41).

ANDREA SAUNDERS, EXAMINING ATTORNEY

SN 76-517,913. FIELD STATION, INC., HERMANTOWN, MN. FILED 5-29-2003.



NO CLAIM IS MADE TO THE EXCLUSIVE RIGHT TO USE "RELIABLE SOFTGOODS AND DULUTH, MINNESOTA", APART FROM THE MARK AS SHOWN.

FOR LUGGAGE, BACKPACKS, HANDBAGS, BRIEFCASES (U.S. CLS. 1, 2, 3, 22 AND 41).

ASMAT KHAN, EXAMINING ATTORNEY



**CLASS 18—(Continued).**

SN 76-550,021. SWANY AMERICA CORPORATION, JOHNSTOWN, NY. FILED 10-8-2003.

**WALKING STICK**

FOR LUGGAGE (U.S. CLS. 1, 2, 3, 22 AND 41).  
JENNIFER MARTIN, EXAMINING ATTORNEY

SN 76-576,924. SMITH, JAMES TODD, NEW YORK, NY. FILED 1-16-2004.

**PRESERVE THE SEXY**

THE MARK CONSISTS OF STANDARD CHARACTERS WITHOUT CLAIM TO ANY PARTICULAR FONT, STYLE, SIZE, OR COLOR.

FOR ALL-PURPOSE SPORTS AND ATHLETIC BAGS, FANNY PACKS, BACKPACKS, KNAPSACKS, SPORTS PACKS, WAIST PACKS, GYM BAGS, DUFFEL BAGS, DIAPER BAGS, TOTE BAGS, BOOK BAGS, HAND BAGS, PURSES, CLUTCH PURSES, CHANGE PURSES, SHOULDER BAGS, CARRY-ON BAGS, TRAVEL BAGS, GARMENT BAGS FOR TRAVEL, LEATHER SHOPPING BAGS, BEACH BAGS, SATCHELS, LUGGAGE, LUGGAGE TAGS, TRUNKS, SUITCASES, COSMETIC CASES SOLD EMPTY, TOILETRY CASES SOLD EMPTY, VANITY CASES SOLD EMPTY, COSMETIC BAGS SOLD EMPTY, TOOL BAGS SOLD EMPTY, ATTACHE CASES, BRIEFCASES, BRIEFCASE-TYPE PORTFOLIOS, MEN'S CLUTCHES, BUSINESS CASES, BUSINESS CARD CASES, CREDIT CARD CASES, CALLING CARD CASES, PASSPORT CASES, KEY CASES, LEATHER KEY CHAINS, COIN POUCHES, WALLETS, BILLFOLDS, UMBRELLAS AND PARASOLS (U.S. CLS. 1, 2, 3, 22 AND 41).

PAULA MAYS, EXAMINING ATTORNEY

SN 78-240,960. DITTRICH, ALEXANDRA RENATE, SCHWAEBISCH GMUEND, FED REP GERMANY, AND BURCHARD, BETTINA, SCHWAEBISCH GMUEND, FED REP GERMANY, FILED 4-23-2003.

**LEMONFISH**

OWNER OF FED REP GERMANY REG. NO. 30109059, DATED 4-17-2001, EXPIRES 2-28-2011.

FOR (BASED ON USE IN COMMERCE) ALL-PURPOSE SPORTS BAGS, ALL-PURPOSE ATHLETIC BAGS, ANIMAL GAME BAGS, ATHLETIC BAGS, BARREL BAGS, BEACH BAGS, BOOK BAGS, BOSTON BAGS; CARRY-ON BAGS, CLUTCH BAGS, COSMETIC BAGS SOLD EMPTY, DIAPER BAGS, DUFFEL BAGS, FEED BAGS FOR ANIMALS, GARMENT BAGS FOR TRAVEL, GYM BAGS, HUNTERS' GAME BAGS, LEATHER SHOPPING BAGS, MESH SHOPPING BAGS, OVERNIGHT BAGS, ROLL BAGS, SCHOOL BAGS, SCHOOL BOOK BAGS, SHAVING BAGS SOLD EMPTY, SHOE BAGS FOR TRAVEL, SHOPPING BAGS WITH WHEELS ATTACHED, SHOULDER BAGS, SOUVENIR BAGS, SPORTSMAN'S HUNTING BAGS, SUIT BAGS, TEXTILE SHOPPING BAGS, TOOL BAGS SOLD EMPTY, TOTE BAGS, TRAVEL BAGS, TRAVELING BAGS, WRIST MOUNTED CARRYALL BAGS, BABY BACKPACKS, BACKPACKS, WALLETS, SUITCASES, ATTACHE CASES, BUSINESS CARD CASES, BUSINESS CASES, CALLING CARD CASES, CATALOG CASES, COSMETIC CASES SOLD EMPTY, CREDIT CARD CASES, DOCU-

**CLASS 18—(Continued).**

MENT CASES, KEY CASES, LIPSTICK CASES, NAME CARD CASES, OVERNIGHT CASES, TOILETRY CASES SOLD EMPTY, TRAIN CASES, VANITY CASES SOLD EMPTY; (BASED ON 44(E)) GOODS MADE OF LEATHER AND LEATHER IMITATIONS, NAMELY ALL-PURPOSE SPORTS BAGS, ALL-PURPOSE ATHLETIC BAGS, ANIMAL GAME BAGS, ATHLETIC BAGS, BARREL BAGS, BEACH BAGS, BOOK BAGS, BOSTON BAGS; CARRY-ON BAGS, CLUTCH BAGS, COSMETIC BAGS SOLD EMPTY, DIAPER BAGS, DUFFEL BAGS, FEED BAGS FOR ANIMALS, GARMENT BAGS FOR TRAVEL, GYM BAGS, HUNTERS' GAME BAGS, LEATHER SHOPPING BAGS, OVERNIGHT BAGS, ROLL BAGS, SCHOOL BAGS, SCHOOL BOOK BAGS, SHAVING BAGS SOLD EMPTY, SHOE BAGS FOR TRAVEL, SHOPPING BAGS WITH WHEELS ATTACHED, SHOULDER BAGS, SOUVENIR BAGS, SPORTSMAN'S HUNTING BAGS, SUIT BAGS, TOOL BAGS SOLD EMPTY, TOTE BAGS, TRAVEL BAGS, TRAVELING BAGS, WRIST MOUNTED CARRYALL BAGS, BABY BACKPACKS, BACKPACKS, WALLETS, SUITCASES, ATTACHE CASES, BUSINESS CARD CASES, BUSINESS CASES, CALLING CARD CASES, CATALOG CASES, COSMETIC CASES SOLD EMPTY, CREDIT CARD CASES, DOCUMENT CASES, KEY CASES, LIPSTICK CASES, NAME CARD CASES, OVERNIGHT CASES, TOILETRY CASES SOLD EMPTY, TRAIN CASES, VANITY CASES SOLD EMPTY; AND ALL-PURPOSE SPORTS BAGS, ALL-PURPOSE ATHLETIC BAGS, ANIMAL GAME BAGS, ATHLETIC BAGS, BARREL BAGS, BEACH BAGS, BOOK BAGS, BOSTON BAGS; CARRY-ON BAGS, CLUTCH BAGS, COSMETIC BAGS SOLD EMPTY, DIAPER BAGS, DUFFEL BAGS, FEED BAGS FOR ANIMALS, GARMENT BAGS FOR TRAVEL, GYM BAGS, HUNTERS' GAME BAGS, LEATHER SHOPPING BAGS, MESH SHOPPING BAGS, OVERNIGHT BAGS, ROLL BAGS, SCHOOL BAGS, SCHOOL BOOK BAGS, SHAVING BAGS SOLD EMPTY, SHOE BAGS FOR TRAVEL, SHOPPING BAGS WITH WHEELS ATTACHED, SHOULDER BAGS, SOUVENIR BAGS, SPORTSMAN'S HUNTING BAGS, SUIT BAGS, TEXTILE SHOPPING BAGS, TOOL BAGS SOLD EMPTY, TOTE BAGS, TRAVEL BAGS, TRAVELING BAGS, WRIST MOUNTED CARRYALL BAGS, BABY BACKPACKS, BACKPACKS, WALLETS, SUITCASES, ATTACHE CASES, BUSINESS CARD CASES, BUSINESS CASES, CALLING CARD CASES, CATALOG CASES, COSMETIC CASES SOLD EMPTY, CREDIT CARD CASES, DOCUMENT CASES, KEY CASES, LIPSTICK CASES, NAME CARD CASES, OVERNIGHT CASES, TOILETRY CASES SOLD EMPTY, TRAIN CASES, VANITY CASES SOLD EMPTY ALL MADE OF SYNTHETIC MATERIALS (U.S. CLS. 1, 2, 3, 22 AND 41).

FIRST USE 3-5-2001; IN COMMERCE 3-5-2001.  
LINDA POWELL, EXAMINING ATTORNEY

SN 78-280,490. HARO DESIGN, INC., CARDIFF BY THE SEA, CA. FILED 7-29-2003.

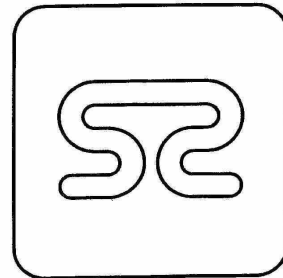

FOR LUGGAGE, BACKPACKS, FANNY PACKS, AND ALL PURPOSE SPORTS BAGS (U.S. CLS. 1, 2, 3, 22 AND 41).

CAROLINE WOOD, EXAMINING ATTORNEY

**CLASS 18—(Continued).**

SN 78-290,304. NBA PROPERTIES, INC., NEW YORK, NY.  
FILED 8-21-2003.



FOR ATHLETIC BAGS, SHOE BAGS FOR TRAVEL, OVERNIGHT BAGS, UMBRELLAS, BACKPACKS, BABY BACKPACKS, DUFFEL BAGS, TOTE BAGS, LUGGAGE, LUGGAGE TAGS, PATIO UMBRELLAS, VALISES, ATTACHE CASES, BILLFOLDS, WALLETS, BRIEFCASES, CANES, BUSINESS CARD CASES, BOOK BAGS, ALL PURPOSE SPORTS BAGS, GOLF UMBRELLAS, GYM BAGS, PURSES, COIN PURSES, FANNY PACKS, WAIST PACKS, COSMETIC CASES SOLD EMPTY, GARMENT BAGS FOR TRAVEL, HANDBAGS, KEY CASES, KNAPSACKS, SUITCASES, TOILETRY CASES SOLD EMPTY, TRUNKS FOR TRAVELING AND RUCKSACKS (U.S. CLS. 1, 2, 3, 22 AND 41).

RICHARD A. STRASER, EXAMINING ATTORNEY

SN 78-302,065. MARVEL CHARACTERS, INC., LOS ANGELES, CA. FILED 9-18-2003.



OWNER OF U.S. REG. NOS. 870,506, 1,741,813 AND 1,754,033.

FOR LEATHER BAGS; HANDBAGS, CLUTCHES AND PURSES, WALLETS, COIN PURSES, KEY CASES, GYM BAGS, SCHOOL BAGS, BOOK BAGS, TOTE BAGS, BACKPACKS, KNAPSACKS, SHOEBAGS FOR TRAVEL, LUGGAGE AND CARRY-ON BAGS, TOILETRY CASES SOLD EMPTY; SPORTS BAGS, DUFFEL BAGS, WRIST MOUNTED CARRY ALL BAGS, WAIST POUCHES, FANNY PACKS, UMBRELLAS (U.S. CLS. 1, 2, 3, 22 AND 41).

DARRYL SPRUILL, EXAMINING ATTORNEY

**CLASS 18—(Continued).**

SN 78-324,487. NEWS-JOURNAL CORPORATION, DAYTONA BEACH, FL. FILED 11-7-2003.

## NEWS-JOURNAL CENTER

THE MARK CONSISTS OF STANDARD CHARACTERS WITHOUT CLAIM TO ANY PARTICULAR FONT, STYLE, SIZE, OR COLOR.

OWNER OF U.S. REG. NOS. 1,910,449, 2,633,669 AND OTHERS.

FOR CANVAS TOTE BAGS (U.S. CLS. 1, 2, 3, 22 AND 41).

WILLIAM VERHOSEK, EXAMINING ATTORNEY

SN 78-340,342. HAMILTON, KARI T./KARI, SACRAMENTO, CA. FILED 12-12-2003.

## karibags

THE MARK CONSISTS OF STANDARD CHARACTERS WITHOUT CLAIM TO ANY PARTICULAR FONT, STYLE, SIZE, OR COLOR.

FOR PURSES AND ACCESSORIES, NAMELY, BELTS SOLD AS A UNIT (U.S. CLS. 1, 2, 3, 22 AND 41).

PRISCILLA MILTON, EXAMINING ATTORNEY

SN 78-350,600. INVISTA NORTH AMERICA S.A.R.L., WILMINGTON, DE. FILED 1-12-2004.



## INVISTA

FOR WALLETS, PURSES, LUGGAGE, BACKPACKS, TOTE BAGS, BRIEFCASES (U.S. CLS. 1, 2, 3, 22 AND 41).

EVELYN BRADLEY, EXAMINING ATTORNEY

**CLASS 18—(Continued).**

SN 78-354,021. SAMSONITE CORPORATION, DENVER, CO.  
FILED 1-20-2004.

**CLASS 18—(Continued).**

SN 78-362,656. FLYING SOUTH, INC., LITTLEROCK, CA.  
FILED 2-4-2004.

**The Adventure Pack  
Pet Carrier**

**PRELUDE**

THE MARK CONSISTS OF STANDARD CHARACTERS WITHOUT CLAIM TO ANY PARTICULAR FONT, STYLE, SIZE, OR COLOR.

NO CLAIM IS MADE TO THE EXCLUSIVE RIGHT TO USE "PACK PET CARRIER", APART FROM THE MARK AS SHOWN.

FOR TRAVELING PET CARRIER (U.S. CLS. 1, 2, 3, 22 AND 41).

LINDA M. KING, EXAMINING ATTORNEY

THE MARK CONSISTS OF STANDARD CHARACTERS WITHOUT CLAIM TO ANY PARTICULAR FONT, STYLE, SIZE, OR COLOR.

FOR LUGGAGE (U.S. CLS. 1, 2, 3, 22 AND 41).  
ANDREW BENZMILLER, EXAMINING ATTORNEY

SN 78-365,089. ATHALON SPORTGEAR, INC., NEW YORK, NY. FILED 2-9-2004.

SN 78-357,644. LATIBAER EHF., GARDABAER, ICELAND, FILED 1-26-2004.

**OTIS**

**SPORTACUS**

THE MARK CONSISTS OF STANDARD CHARACTERS WITHOUT CLAIM TO ANY PARTICULAR FONT, STYLE, SIZE, OR COLOR.

FOR TRAVEL BAGS, ALL-PURPOSE SPORT BAGS, ATHLETIC BAGS (U.S. CLS. 1, 2, 3, 22 AND 41).

FIRST USE 9-16-2003; IN COMMERCE 9-16-2003.  
SHAUNIA WALLACE, EXAMINING ATTORNEY

THE MARK CONSISTS OF STANDARD CHARACTERS WITHOUT CLAIM TO ANY PARTICULAR FONT, STYLE, SIZE, OR COLOR.

FOR ALL-PURPOSE ATHLETIC BAGS, BABY BACKPACKS, BABY CARRIERS WORN ON THE BODY, BACKPACKS, BEACH BAGS, BEACH UMBRELLAS, BRIEFCASES, CARRY-ON BAGS, CHANGE PURSES, CLUTCH BAGS, CLUTCH PURSES, DAYPACKS, DIAPER BAGS, DRAWSTRING POUCHES, DUFFEL BAGS, FANNY PACKS, FOOTLOCKERS, GARMENT BAGS FOR TRAVEL, GOLF UMBRELLAS, GYM BAGS, HANDBAGS, HAT BOXES FOR TRAVEL, HAVERSACKS, INFANT CARRIERS WORN ON THE BODY, KEY CASES, KNAPSACKS, POCKETBOOKS, SCHOOL BAGS, SCHOOL BOOK BAGS, SHOULDER BAGS, SOUVENIR BAGS, TRAVEL BAGS, TOTE BAGS, UMBRELLA COVERS, UMBRELLA HANDLES, UMBRELLA RINGS, UMBRELLAS, WAIST PACKS, WALLETS, WRIST MOUNTED CARRYALL BAGS, WRIST MOUNTED PURSES (U.S. CLS. 1, 2, 3, 22 AND 41).

ANDREA K. NADELMAN, EXAMINING ATTORNEY

**CLASS 19—NON-METALLIC BUILDING MATERIALS**

SN 76-261,691. HOOVIS, BRUCE A., FORT MYERS, FL. FILED 5-23-2001.

**WIND KING**

FOR NONMETAL DOORS AND NONMETAL WINDOWS FOR BUILDINGS (U.S. CLS. 1, 12, 33 AND 50).  
THEODORE MCBRIDE, EXAMINING ATTORNEY

**CLASS 19—(Continued).**

SN 76-518,955. INTERNATIONAL BEAMS, INC., POHENE-GAMOOK (QUEBEC), CANADA, FILED 6-2-2003.



PRIORITY CLAIMED UNDER SEC. 44(D) ON CANADA APPLICATION NO. 1163000, FILED 12-20-2002, REG. NO. TMA605514, DATED 3-17-2004, EXPIRES 3-17-2019.

NO CLAIM IS MADE TO THE EXCLUSIVE RIGHT TO USE "BEAMS", APART FROM THE MARK AS SHOWN. FOR WOODEN BEAMS (U.S. CLS. 1, 12, 33 AND 50). FIRST USE 10-16-2001; IN COMMERCE 4-9-2003. INGA ERVIN, EXAMINING ATTORNEY

**CLASS 19—(Continued).**

SN 76-575,144. MDL DOORS INC., BRUSSELS, ONTARIO, CANADA, FILED 2-11-2004.

# MDL

THE MARK CONSISTS OF STANDARD CHARACTERS WITHOUT CLAIM TO ANY PARTICULAR FONT, STYLE, SIZE, OR COLOR.

FOR NON-METAL DOORS, NAMELY, RESIDENTIAL AND COMMERCIAL DOORS (U.S. CLS. 1, 12, 33 AND 50).

FIRST USE 12-31-1985; IN COMMERCE 12-31-1985. LAURA KOVAISKY, EXAMINING ATTORNEY

SN 76-575,654. TEXAS CEMENT PRODUCTS, INC., HOUSTON, TX. FILED 2-2-2004.

# PORCELAINMAX

THE MARK CONSISTS OF STANDARD CHARACTERS WITHOUT CLAIM TO ANY PARTICULAR FONT, STYLE, SIZE, OR COLOR.

FOR DRY-SET MORTAR FOR BONDING PORCELAIN TILE, CERAMIC TILE AND NATURAL STONE (U.S. CLS. 1, 12, 33 AND 50).

FIRST USE 11-3-2003; IN COMMERCE 11-3-2003. ANDREW BENZMILLER, EXAMINING ATTORNEY

SN 76-526,785. NATIONAL GYPSUM PROPERTIES, LLC, CHARLOTTE, NC. FILED 7-1-2003.



THE MARK CONSISTS OF A PYRAMID DESIGN WITH THE COLORS BLACK, WHITE, GOLD, WHITE AND RED IN DESCENDING ORDER.

FOR WAILBOARDS, CEMENT BOARDS AND GYPSUM PANELS, NON-METAL CEILING PANELS, AND PLASTER (U.S. CLS. 1, 12, 33 AND 50).

TRICIA THOMPSON, EXAMINING ATTORNEY

SN 76-575,655. TEXAS CEMENT PRODUCTS, INC., HOUSTON, TX. FILED 2-2-2004.

# PORCELAINSET

THE MARK CONSISTS OF STANDARD CHARACTERS WITHOUT CLAIM TO ANY PARTICULAR FONT, STYLE, SIZE, OR COLOR.

FOR DRY-SET MORTAR FOR BONDING PORCELAIN TILE, CERAMIC TILE AND NATURAL STONE (U.S. CLS. 1, 12, 33 AND 50).

FIRST USE 10-6-2003; IN COMMERCE 10-6-2003. ANDREW BENZMILLER, EXAMINING ATTORNEY

**CLASS 19—(Continued).**

SN 78-316,118. INDUSTRIAS AUXILIARES FAUS S.L., VELEN-  
LENCIA, SPAIN, FILED 10-20-2003.



NO CLAIM IS MADE TO THE EXCLUSIVE RIGHT TO  
USE "MICRO BEVEL", APART FROM THE MARK AS  
SHOWN.

FOR LAMINATE FLOORING (U.S. CLS. 1, 12, 33 AND  
50).

MARK T. MULLEN, EXAMINING ATTORNEY



SN 78-354,878. PLURI-CAPITAL (PCI) INC., JONQUIERE,  
QUEBEC, CANADA, FILED 1-21-2004.

**HEVERWOOD**

THE MARK CONSISTS OF STANDARD CHARACTERS  
WITHOUT CLAIM TO ANY PARTICULAR FONT, STYLE,  
SIZE, OR COLOR.

FOR WOOD FLOORS, DECKING BOARDS FOR PAT-  
IOS, WOOD EXTERIOR CLADDING FOR CONSTRU-  
TION AND BUILDING, WOOD WINDOWS AND WOOD  
CONSTRUCTION ELEMENTS, NAMELY SHORES, SUP-  
PORT AND BRACES ALL TREATED BY A HIGH  
TEMPERATURE WOOD PROCESS (U.S. CLS. 1, 12, 33  
AND 50).

MELVIN AXILBUND, EXAMINING ATTORNEY



SN 78-358,794. ADAM, PAUL, JEFFERSON CITY, MO.  
FILED 1-28-2004.

**MAYTRX**

THE MARK CONSISTS OF STANDARD CHARACTERS  
WITHOUT CLAIM TO ANY PARTICULAR FONT, STYLE,  
SIZE, OR COLOR.

FOR RETAINING WALL BLOCKS (U.S. CLS. 1, 12, 33  
AND 50).

SHAUNIA WALLACE, EXAMINING ATTORNEY

**CLASS 19—(Continued).**

SN 78-360,941. CL INDUSTRIES, LEESBURG, FL. FILED 2-2-  
2004.

**KOOL TONE**

THE MARK CONSISTS OF STANDARD CHARACTERS  
WITHOUT CLAIM TO ANY PARTICULAR FONT, STYLE,  
SIZE, OR COLOR.

FOR EXPOSED AGGREGATE SWIMMING POOL FIN-  
ISH (U.S. CLS. 1, 12, 33 AND 50).

TARAH HARDY, EXAMINING ATTORNEY



SN 78-369,679. FAIRMOUNT MINERALS, INC., CHARDON,  
OH. FILED 2-18-2004.

**SPECTRAQUARTZ**

THE MARK CONSISTS OF STANDARD CHARACTERS  
WITHOUT CLAIM TO ANY PARTICULAR FONT, STYLE,  
SIZE, OR COLOR.

FOR COLORED SAND FOR USE AS BUILDING  
MATERIALS, IN CEMENT, IN FLOORING, IN POOL  
LININGS, AND AS AN ADDITIVE TO GROUT (U.S. CLS.  
1, 12, 33 AND 50).

YSA DEJESUS, EXAMINING ATTORNEY



**CLASS 20—FURNITURE AND ARTICLES NOT  
OTHERWISE CLASSIFIED**

SN 76-415,417. ASPEN FURNITURE DESIGNS, INC., PHOE-  
NIX, AZ. FILED 5-23-2002.

**ASPEN FURNITURE**

NO CLAIM IS MADE TO THE EXCLUSIVE RIGHT TO  
USE "FURNITURE", APART FROM THE MARK AS  
SHOWN.

FOR FURNITURE; NAMELY, TABLES, CHAIRS,  
BOOKCASES, TEA CARTS, CABINETS, WALL SYS-  
TEMS/UNITS, DRAWER CHESTS, DRAWER DRESSERS,  
ARMOIRES, NIGHTSTANDS, DESKS, BEDROOM FUR-  
NITURE, COMPUTER FURNITURE AND ENTERTAIN-  
MENT CENTER FURNITURE (U.S. CLS. 2, 13, 22, 25, 32  
AND 50).

FIRST USE 12-1-1979; IN COMMERCE 12-21-1979.

JAMES A. RAUEN, EXAMINING ATTORNEY

**CLASS 20—(Continued).**

SN 76-477,220. FERRARI PARTLOW JEWELRY, BATON ROUGE, LA. FILED 12-20-2002.



NO CLAIM IS MADE TO THE EXCLUSIVE RIGHT TO USE "JEWELRY" OR "ITALIAN ARTISTRY" OR "AMERICAN", APART FROM THE MARK AS SHOWN.

DESIGN OF DECORATIVE LETTERING OF THE WORDS FERRARI PARTLOW JEWELRY WITH AN ANVIL SEPARATING THE WORDS FERRARI AND PARTLOW. THE ANVIL HAS AN F AND P ON IT.

FOR JEWELRY BOXES OF NOT OF METAL (U.S. CLS. 2, 13, 22, 25, 32 AND 50).  
DORITT L. CARROLL, EXAMINING ATTORNEY

SN 76-478,359. MARSHALL VENTILATED MATTRESS COMPANY LIMITED, DOWNSVIEW, ONTARIO, CANADA, FILED 12-26-2002.

PRIORITY CLAIMED UNDER SEC. 44(D) ON CANADA APPLICATION NO. 1163531, FILED 12-24-2002, REG. NO. TMA605263, DATED 3-16-2004, EXPIRES 3-16-2019.

FOR MATTRESSES, NOT FOR MEDICAL PURPOSES, FOR HEALTH CARE FACILITIES (U.S. CLS. 2, 13, 22, 25, 32 AND 50).

JOHN SCHUYLER YARD, EXAMINING ATTORNEY

SN 76-501,311. SOLARFECTIVE PRODUCTS LIMITED, TORONTO, ONTARIO, CANADA, FILED 3-25-2003.

**TELEVENT**

PRIORITY CLAIMED UNDER SEC. 44(D) ON CANADA APPLICATION NO. 1172041, FILED 3-24-2003, REG. NO. TMA611936, DATED 6-3-2004, EXPIRES 6-3-2014.

FOR WINDOW BLINDS AND SHADES (U.S. CLS. 2, 13, 22, 25, 32 AND 50).

DORITT L. CARROLL, EXAMINING ATTORNEY

**CLASS 20—(Continued).**

SN 76-531,799. GROUPE LACASSE INC., ST-PIE, QUEBEC, CANADA, FILED 7-23-2003.

OWNER OF U.S. REG. NO. 2,264,251.  
SEC. 2(F).  
FOR OFFICE FURNITURE (U.S. CLS. 2, 13, 22, 25, 32 AND 50).  
FIRST USE 3-0-1991; IN COMMERCE 3-0-1991.  
BILL DAWE, EXAMINING ATTORNEY

SN 76-537,341. LARSEN, CHARLES, MURRIETA, CA. FILED 8-14-2003.

**CHIN CHILLER**

FOR PET BED FOR USE BY CHINCHILLAS (U.S. CLS. 2, 13, 22, 25, 32 AND 50).  
FIRST USE 2-1-2003; IN COMMERCE 4-1-2003.  
HOWARD SMIGA, EXAMINING ATTORNEY

SN 76-544,237. ROOSA, BRUCE T., GILLETTE, WY. FILED 9-10-2003.

**KOOLKNOBS**

FOR DIE-CAST PLASTIC KNOBS FOR AUTOMOBILES AND MOTOCYCLES (U.S. CLS. 2, 13, 22, 25, 32 AND 50).  
FIRST USE 3-30-2001; IN COMMERCE 3-30-2001.  
PRISCILLA MILTON, EXAMINING ATTORNEY

SN 76-557,823. VALLEE, ARTHUR A, WOODBURY, NJ. FILED 10-20-2003.

**IDENTA STRAW**

THE MARK CONSISTS OF STANDARD CHARACTERS WITHOUT CLAIM TO ANY PARTICULAR FONT, STYLE, SIZE, OR COLOR.

NO CLAIM IS MADE TO THE EXCLUSIVE RIGHT TO USE STRAW, APART FROM THE MARK AS SHOWN.

FOR DRINKING STRAWS USED TO IDENTIFY DIFFERENT TYPES OF DRINKS (U.S. CLS. 2, 13, 22, 25, 32 AND 50).

CATHERINE CAIN, EXAMINING ATTORNEY

**CLASS 20—(Continued).**

SN 76-566,194. A.P.C.- 2000, INC., CLOVIS, CA. FILED 12-19-2003.

**COMFY PET**

THE MARK CONSISTS OF STANDARD CHARACTERS WITHOUT CLAIM TO ANY PARTICULAR FONT, STYLE, SIZE, OR COLOR.

NO CLAIM IS MADE TO THE EXCLUSIVE RIGHT TO USE "PET", APART FROM THE MARK AS SHOWN.

FOR PET FURNITURE (U.S. CLS. 2, 13, 22, 25, 32 AND 50).

FIRST USE 2-1-2000; IN COMMERCE 2-1-2000.  
HOWARD SMIGA, EXAMINING ATTORNEY

---

SN 76-570,315. PIERETTI, CHERYL J., DOYLESTOWN, PA. FILED 1-12-2004.

**HUBBY WEDGE**

THE MARK CONSISTS OF STANDARD CHARACTERS WITHOUT CLAIM TO ANY PARTICULAR FONT, STYLE, SIZE, OR COLOR.

NO CLAIM IS MADE TO THE EXCLUSIVE RIGHT TO USE "WEDGE", APART FROM THE MARK AS SHOWN.

FOR WEDGE-SHAPED PILLOW USED TO PREVENT SNORING (U.S. CLS. 2, 13, 22, 25, 32 AND 50).

KATHRYN COWARD, EXAMINING ATTORNEY

---

SN 78-130,968. NORTHPOLE LIMITED, KOWLOON, HONG KONG, FILED 5-24-2002.

**WOOFS & WHISKERS**

NO CLAIM IS MADE TO THE EXCLUSIVE RIGHT TO USE WHISKERS OR WOOF, APART FROM THE MARK AS SHOWN.

FOR INFLATABLE MATTRESSES FOR CATS AND DOGS (U.S. CLS. 2, 13, 22, 25, 32 AND 50).

IRENE D. WILLIAMS, EXAMINING ATTORNEY

---

SN 78-211,617. DISNEY ENTERPRISES, INC., BURBANK, CA. FILED 2-6-2003.

**BROTHER BEAR**

FOR SLEEPING BAGS; PICTURE FRAMES; JEWELRY BOXES NOT MADE OF METAL OR PRECIOUS METAL; PILLOWS; MIRRORS; PLASTIC ORNAMENTAL BADGES (U.S. CLS. 2, 13, 22, 25, 32 AND 50).

MARTHA SANTOMARTINO, EXAMINING ATTORNEY

**CLASS 20—(Continued).**

SN 78-283,243. SPRING AIR-MOUNTAIN WEST, INC., SALT LAKE CITY, UT. FILED 8-5-2003.

**SPACE MEMORY FOAM TECHNOLOGY**

NO CLAIM IS MADE TO THE EXCLUSIVE RIGHT TO USE "MEMORY FOAM TECHNOLOGY", APART FROM THE MARK AS SHOWN.

FOR BEDDING, NAMELY MATTRESSES AND BOX SPRINGS (U.S. CLS. 2, 13, 22, 25, 32 AND 50).

JENNIFER MARTIN, EXAMINING ATTORNEY

---

SN 78-297,680. MONSTER MASH, KOWLOON, HONG KONG, CHINA, FILED 9-9-2003.

**MONSTER MASH**

FOR BATTERY-OPERATED DECORATIVE ACCESSORY FOR HALLOWEEN, NAMELY, A PLASTIC LIKENESS OF TEETH WITH MOVING PARTS, SOUNDS AND VOICES (U.S. CLS. 2, 13, 22, 25, 32 AND 50).

RON FAIRBANKS, EXAMINING ATTORNEY

---

SN 78-303,648. PROGRESSIVE FURNITURE, INC., SWANTON, OH. FILED 9-22-2003.

**JACOB MATTHEW FURNITURE**

NO CLAIM IS MADE TO THE EXCLUSIVE RIGHT TO USE "FURNITURE", APART FROM THE MARK AS SHOWN.

THE NAME JACOB MATTHEW DOES NOT IDENTIFY A LIVING INDIVIDUAL.

FOR FURNITURE (U.S. CLS. 2, 13, 22, 25, 32 AND 50).

JANICE L. MCMORROW, EXAMINING ATTORNEY

**CLASS 20—(Continued).**

SN 78-330,883. FRANK LLOYD WRIGHT FOUNDATION, SCOTTSDALE, AZ. FILED 11-20-2003.

# USONIAN

THE MARK CONSISTS OF STANDARD CHARACTERS WITHOUT CLAIM TO ANY PARTICULAR FONT, STYLE, SIZE, OR COLOR.

OWNER OF U.S. REG. NOS. 1,663,645 AND 1,663,673.  
FOR FURNITURE, NAMELY TABLES, CHAIRS, BEDROOM FURNITURE, COUCHES, DESKS, DRAWERS, CHESTS OF DRAWERS, BEDS, BED FRAMES, FIGURES MADE OF BONE, IVORY, PLASTER, PLASTIC, WAX AND WOOD, FIGURINES MADE OF BONE, IVORY, PLASTER, PLASTIC AND WOOD, FILING CABINETS, FOOTSTOOLS, BEDROOM FURNITURE, LAWN FURNITURE, LIVING ROOM FURNITURE, OFFICE FURNITURE, OUTDOOR FURNITURE, LOVE SEATS, PICTURE FRAMES, MAGAZINE RACKS, THROW PILLOWS, ORNAMENTS MADE OF BONE, IVORY, PLASTER, PLASTIC, WAX AND WOOD, SCULPTURES MADE OF BONE, IVORY, PLASTER, PLASTIC, WAX AND WOOD, SHELVES, SOFAS, SOFT SCULPTURE WALL DECORATIONS, STATUES MADE OF BONE, IVORY, PLASTER, PLASTIC, WAX AND WOOD, AND STATUETTES MADE OF BONE, IVORY, PLASTER, PLASTIC, WAX AND WOOD (U.S. CLS. 2, 13, 22, 25, 32 AND 50).  
REGINA DRUMMOND, EXAMINING ATTORNEY

SN 78-340,991. CELESTIAL SEASONINGS, INC., BOULDER, CO. FILED 12-15-2003.



THE MARK CONSISTS OF THE STYLIZED WORDS CELESTIAL SEASONINGS WITHIN AN OVAL WHICH SURROUNDS THE DESIGN OF A BEAR HEAD.  
FOR KEY CHAINS MADE OF PLASTIC; WOOD CRATES (U.S. CLS. 2, 13, 22, 25, 32 AND 50).  
FIRST USE 11-1-2002; IN COMMERCE 11-1-2002.  
LEIGH CAROLINE CASE, EXAMINING ATTORNEY

**CLASS 20—(Continued).**

SN 78-350,195. VIRCO MGMT. CORPORATION, TORRANCE, CA. FILED 1-9-2004.

# SIGMA

THE MARK CONSISTS OF STANDARD CHARACTERS WITHOUT CLAIM TO ANY PARTICULAR FONT, STYLE, SIZE, OR COLOR.

FOR SCHOOL CLASSROOM FURNITURE, NAMELY, DESKS (U.S. CLS. 2, 13, 22, 25, 32 AND 50).  
DORITT L. CARROLL, EXAMINING ATTORNEY

SN 78-352,368. SOUNDSEAT INCORPORATED, SALISBURY, NC. FILED 1-15-2004.

# SoundSeat

THE MARK CONSISTS OF STANDARD CHARACTERS WITHOUT CLAIM TO ANY PARTICULAR FONT, STYLE, SIZE, OR COLOR.

FOR SEATING FOR MUSICIANS, GUITARISTS, DRUMMERS, KEYBOARD PLAYERS, AND OTHER PLAYERS OF MUSICAL INSTRUMENTS (U.S. CLS. 2, 13, 22, 25, 32 AND 50).  
FIRST USE 8-1-1999; IN COMMERCE 8-1-1999.  
DAWN HAN, EXAMINING ATTORNEY



**CLASS 20—(Continued).**

SN 78-352,844. MZ TRADEMARK, LLC, SOLON, OH. FILED 1-16-2004.

**SLAYMAKER**

THE MARK CONSISTS OF STANDARD CHARACTERS WITHOUT CLAIM TO ANY PARTICULAR FONT, STYLE, SIZE, OR COLOR.

OWNER OF U.S. REG. NO. 2,261,343.  
FOR PLASTIC TOOL BOXES AND PLASTIC STORAGE CONTAINERS OF A GENERAL NATURE (U.S. CLS. 2, 13, 22, 25, 32 AND 50).  
CHARLES L. JENKINS, EXAMINING ATTORNEY

**CLASS 20—(Continued).**

SN 78-354,232. ALLIED ELECTRONICS INC., FORT WORTH, TX. FILED 1-20-2004.



OWNER OF U.S. REG. NOS. 2,707,231, 2,713,585 AND 2,773,580.

NO CLAIM IS MADE TO THE EXCLUSIVE RIGHT TO USE "ELECTRONICS", APART FROM THE MARK AS SHOWN.

FOR NON-METAL WALL MOUNTED ENCLOSURES; NON-METAL STORAGE BINS; NON-METAL STORAGE CASES; WOOD KNOBS; PLASTIC KNOBS; NON-METAL HANDLES FOR ELECTRONIC CONTROLS AND INSTRUMENTS; NON-METAL SCREWS; AND NON-METAL STORAGE CABINETS AND DRAWERS (U.S. CLS. 2, 13, 22, 25, 32 AND 50).

FIRST USE 5-23-2001; IN COMMERCE 5-23-2001.  
DAVID MURRAY, EXAMINING ATTORNEY

SN 78-354,087. WISE, ROBERT WILLIAM, SEATTLE, WA. FILED 1-20-2004.

**H2XUV**

THE MARK CONSISTS OF STANDARD CHARACTERS WITHOUT CLAIM TO ANY PARTICULAR FONT, STYLE, SIZE, OR COLOR.

FOR WORKBENCHES (U.S. CLS. 2, 13, 22, 25, 32 AND 50).  
JENNIFER MARTIN, EXAMINING ATTORNEY

SN 78-355,109. PLASTICADE PRODUCTS CORPORATION, SKOKIE, IL. FILED 1-21-2004.

**SIMPO**

THE MARK CONSISTS OF STANDARD CHARACTERS WITHOUT CLAIM TO ANY PARTICULAR FONT, STYLE, SIZE, OR COLOR.

FOR PLASTIC STANDS FOR SIGNS (U.S. CLS. 2, 13, 22, 25, 32 AND 50).  
ANDREA K. NADELMAN, EXAMINING ATTORNEY

**CLASS 20—(Continued).**

SN 78-357,667. LATIBAER EHF., GARDABAER, ICELAND,  
FILED 1-26-2004.

**CLASS 20—(Continued).**

SN 78-365,891. SITONIT OFFICE SEATING, INC., CYPRESS,  
CA. FILED 2-10-2004.

**SPORTACUS**

THE MARK CONSISTS OF STANDARD CHARACTERS  
WITHOUT CLAIM TO ANY PARTICULAR FONT, STYLE,  
SIZE, OR COLOR.

FOR BEDROOM FURNITURE, FITTED FABRIC FUR-  
NITURE COVERS, FURNITURE CHESTS, DRESSERS,  
TABLES, FURNITURE, NAMELY, TOY BOXES; JEW-  
ELRY BOXES NOT MADE OF PRECIOUS METALS,  
PICTURE FRAMES; SLEEPING BAGS; MIRRORS,  
NAMELY, HAND-HELD MIRRORS, LOCKER MIR-  
RORS, MIRRORS ENHANCED BY ELECTRIC LIGHTS,  
PERSONAL COMPACT MIRRORS; PILLOWS; PLASTIC  
NAME BADGES (U.S. CLS. 2, 13, 22, 25, 32 AND 50).  
ANDREA K. NADELMAN, EXAMINING ATTORNEY

**CENSUS**

THE MARK CONSISTS OF STANDARD CHARACTERS  
WITHOUT CLAIM TO ANY PARTICULAR FONT, STYLE,  
SIZE, OR COLOR.

FOR FURNITURE, NAMELY AN OFFICE CHAIR (U.S.  
CLS. 2, 13, 22, 25, 32 AND 50).  
TRICIA SONNEBORN, EXAMINING ATTORNEY

SN 78-358,161. BACKSAVER ACQUISITION CORP., HOLLIS-  
TON, MA. FILED 1-27-2004.

SN 78-394,754. LATIBAER EHF., GARDABAER, ICELAND,  
FILED 4-1-2004.

**WONDERCELL**

THE MARK CONSISTS OF STANDARD CHARACTERS  
WITHOUT CLAIM TO ANY PARTICULAR FONT, STYLE,  
SIZE, OR COLOR.

FOR SEAT AND BACK CUSHIONS (U.S. CLS. 2, 13, 22,  
25, 32 AND 50).  
CAROLINE WOOD, EXAMINING ATTORNEY



FOR FURNITURE, NAMELY, BEDROOM FURNI-  
TURE, FURNITURE CHESTS, DRESSERS, TABLES,  
AND TOY BOXES; FITTED FABRIC FURNITURE COV-  
ERS; JEWELRY BOXES NOT MADE OF PRECIOUS  
METALS; PICTURE FRAMES; SLEEPING BAGS; MIR-  
RORS, NAMELY, HAND-HELD MIRRORS, LOCKER  
MIRRORS, MIRRORS ENHANCED BY ELECTRIC  
LIGHTS, AND PERSONAL COMPACT MIRRORS; PIL-  
LOWS; PLASTIC NAME BADGES (U.S. CLS. 2, 13, 22, 25,  
32 AND 50).  
ZHALEH DELANEY, EXAMINING ATTORNEY

**CLASS 21—HOUSEWARES AND GLASS**

SN 76-407,451. GOOD FLAG ENTERPRISE CO., LTD.,  
TAOYUAN HSJEN, TAIWAN, FILED 5-3-2002.

**GOOD FLAG**

FOR CUPS, PAPER CUPS, PLASTIC CUPS, CONTAINERS FOR FOOD, PAPER CONTAINERS FOR FOOD, PLASTIC CONTAINERS FOR FOOD, LUNCH BOXES, PAPER LUNCH BOXES, PLASTIC LUNCH BOXES, DINNERWARES PAPER DINNERWARES PLASTIC DINNERWARES (U.S. CLS. 2, 13, 23, 29, 30, 33, 40 AND 50).  
FIRST USE 10-11-1995; IN COMMERCE 10-11-1995.  
INGRID C. EULIN, EXAMINING ATTORNEY

SN 76-528,211. LODGE MANUFACTURING COMPANY,  
SOUTH PITTSBURG, TN. FILED 7-7-2003.

**LODGE GEAR**

OWNER OF U.S. REG. NOS. 1,497,789, 2,701,181 AND OTHERS.  
NO CLAIM IS MADE TO THE EXCLUSIVE RIGHT TO USE GEAR, APART FROM THE MARK AS SHOWN.  
FOR COOKING ACCESSORIES FOR KITCHEN CAMP, NAMELY, DEEP FRY BASKETS, TRIPODS, SPLATTER SCREENS, LID LIFTER, LID STAND, TONGS, FORKS, LADLES, SPOONS, SPATULAS, HOUSEHOLD GLOVES FOR GENERAL USE AND CAST IRON SCRUBBER (U.S. CLS. 2, 13, 23, 29, 30, 33, 40 AND 50).  
FIRST USE 1-6-2003; IN COMMERCE 1-6-2003.  
ROBERT C. CLARK JR., EXAMINING ATTORNEY

SN 76-570,099. HOSLEY INTERNATIONAL TRADING CORPORATION, LYNWOOD, IL. FILED 1-15-2004.

**Lifestyle**  
décor

NO CLAIM IS MADE TO THE EXCLUSIVE RIGHT TO USE "DECOR", APART FROM THE MARK AS SHOWN.  
FOR CANDLE HOLDERS NOT OF PRECIOUS METAL (U.S. CLS. 2, 13, 23, 29, 30, 33, 40 AND 50).  
LANA PHAM, EXAMINING ATTORNEY

**CLASS 21—(Continued).**

SN 76-573,408. TIRE PROS FRANCCORP, SIMI VALLEY, CA.  
FILED 1-29-2004.

**TIRE PROS**

OWNER OF U.S. REG. NO. 1,592,463.  
FOR KITCHEN ITEMS, NAMELY, MUGS, CUPS, DRINKING GLASSES, PLASTIC COASTERS AND COASTERS NOT OF PAPER OR OF TABLE LINEN AND PORTABLE BEVERAGE COOLERS (U.S. CLS. 2, 13, 23, 29, 30, 33, 40 AND 50).  
FIRST USE 12-31-1981; IN COMMERCE 2-1-1987.  
ELISSA GARBER KON, EXAMINING ATTORNEY

SN 78-072,994. IMS, INC., TULSA, OK. FILED 7-9-2001.

**SURECARE**

FOR DISPOSABLE LATEX GLOVES FOR GENERAL USE (U.S. CLS. 2, 13, 23, 29, 30, 33, 40 AND 50).  
SUSAN HAYASH, EXAMINING ATTORNEY

SN 78-177,783. TYCO PLASTICS SERVICES AG, SCHAFFHAUSEN, SWITZERLAND, FILED 10-24-2002.

**PARTY ACCENTS**

NO CLAIM IS MADE TO THE EXCLUSIVE RIGHT TO USE "PARTY", APART FROM THE MARK AS SHOWN.  
FOR DISPOSABLE PLASTIC SERVING WARE, NAMELY, CUPS, DISHES AND BEVERAGE CONTAINERS MADE OF PLASTIC (U.S. CLS. 2, 13, 23, 29, 30, 33, 40 AND 50).  
FIRST USE 3-1-1999; IN COMMERCE 3-1-1999.  
THEODORE MCBRIDE, EXAMINING ATTORNEY

SN 78-209,809. JHAMB, RAJINDER, ANAHEIM, CA. FILED 2-1-2003.

**I-FLOSS**

FOR DENTAL FLOSS (U.S. CLS. 2, 13, 23, 29, 30, 33, 40 AND 50).  
FIRST USE 1-5-2003; IN COMMERCE 1-5-2003.  
SUSAN LESLIE DUBOIS, EXAMINING ATTORNEY

**CLASS 21—(Continued).**

SN 78-295,567. KAO KABUSHIKI KAISHA A/T/A, AKA KAO CORPORATION, TOKYO, JAPAN, FILED 9-3-2003.



OWNER OF U.S. REG. NOS. 1,429,692, 1,524,054 AND OTHERS.

"KAO" TRANSLATES INTO ENGLISH AS "THE QUEEN OF FLOWERS".

FOR MOPS AND WIPES FOR HOUSEHOLD CLEANING PURPOSES, NAMELY, CLEANING CLOTHS (U.S. CLS. 2, 13, 23, 29, 30, 33, 40 AND 50).

TRACY CROSS, EXAMINING ATTORNEY

**CLASS 21—(Continued).**

SN 78-329,125. LYON FOUR LLC, MADISON HEIGHTS, MI. FILED 11-17-2003.

**POWER BOTTLE USA**

THE MARK CONSISTS OF STANDARD CHARACTERS WITHOUT CLAIM TO ANY PARTICULAR FONT, STYLE, SIZE, OR COLOR.

NO CLAIM IS MADE TO THE EXCLUSIVE RIGHT TO USE BOTTLE, USA, APART FROM THE MARK AS SHOWN.

FOR DRINKING CONTAINERS FOR USE IN SPORTING ACTIVITIES (U.S. CLS. 2, 13, 23, 29, 30, 33, 40 AND 50).

FIRST USE 11-7-1994; IN COMMERCE 11-7-1994.

KENNETH D. BATTLE, EXAMINING ATTORNEY

SN 78-302,316. SCHOTT ZWIESEL AG, ZWIESEL, FED REP GERMANY, FILED 9-18-2003.

**TRITAN**

PRIORITY CLAIMED UNDER SEC. 44(D) ON FED REP GERMANY APPLICATION NO. 30314992.2, FILED 3-20-2003, REG. NO. 30314992, DATED 4-10-2003, EXPIRES 3-31-2013.

FOR (BASED ON INTENT TO USE)(BASED ON 44(E)) HOUSEHOLD, HOTEL, RESTAURANT, BAR AND TABLE BEVERAGE GLASSWARE; BEVERAGE GLASSWARE; STEMWARE AND TUMBLERS MADE FROM GLASS, CRYSTAL GLASS OR LEAD GLASS (U.S. CLS. 2, 13, 23, 29, 30, 33, 40 AND 50).

JOHN DWYER, EXAMINING ATTORNEY

SN 78-336,791. JAFE DECORATING CO., GREENVILLE, OH. FILED 12-5-2003.

**Colors by Jafe**

SN 78-315,393. SCHALLA, JODIE L., LITTLETON, CO. FILED 10-17-2003.

**BASKETZETERA**

FOR GIFT BASKETS MADE OF WICKER, STRAW, WOOD, CLOTH (U.S. CLS. 2, 13, 23, 29, 30, 33, 40 AND 50).

ALICE BENMAMAN, EXAMINING ATTORNEY

THE MARK CONSISTS OF STANDARD CHARACTERS WITHOUT CLAIM TO ANY PARTICULAR FONT, STYLE, SIZE, OR COLOR.

NO CLAIM IS MADE TO THE EXCLUSIVE RIGHT TO USE "COLORS", APART FROM THE MARK AS SHOWN.

FOR STAINED GLASS [DECORATION] (U.S. CLS. 2, 13, 23, 29, 30, 33, 40 AND 50).

TONI HICKEY, EXAMINING ATTORNEY

**CLASS 21—(Continued).**

SN 78-339,822. JAMES V. BECHTEL AND LORINDA J. BECHTEL, CAPITOLA, CA. FILED 12-12-2003.

**CLASS 21—(Continued).**

SN 78-352,182. FORT JAMES OPERATING COMPANY, ATLANTA, GA. FILED 1-15-2004.

# Wild Earth

# DIXIE

THE MARK CONSISTS OF STANDARD CHARACTERS WITHOUT CLAIM TO ANY PARTICULAR FONT, STYLE, SIZE, OR COLOR.

FOR UNIQUE CERAMIC FANTASY SCULPTURES (U.S. CLS. 2, 13, 23, 29, 30, 33, 40 AND 50).

FIRST USE 1-1-1975; IN COMMERCE 1-1-1975.

JEFFREY S. MOLINOFF, EXAMINING ATTORNEY

THE MARK CONSISTS OF STANDARD CHARACTERS WITHOUT CLAIM TO ANY PARTICULAR FONT, STYLE, SIZE, OR COLOR.

OWNER OF U.S. REG. NOS. 120,264, 2,745,307 AND OTHERS.

FOR PAPER PLATE HOLDER, PLATE AND KITCHEN CUP DISPENSERS, PLASTIC CUTLERY ORGANIZER (U.S. CLS. 2, 13, 23, 29, 30, 33, 40 AND 50).

BRENDAN REGAN, EXAMINING ATTORNEY

---

SN 78-340,997. CELESTIAL SEASONINGS, INC., BOULDER, CO. FILED 12-15-2003.

---

SN 78-352,187. FORT JAMES OPERATING COMPANY, ATLANTA, GA. FILED 1-15-2004.



# KRAZY KRITTERS

THE MARK CONSISTS OF THE STYLIZED WORDS CELESTIAL SEASONINGS WITHIN AN OVAL WHICH SURROUNDS THE DESIGN OF A BEAR HEAD.

FOR MUGS AND TEAPOTS NOT OF PRECIOUS METALS (U.S. CLS. 2, 13, 23, 29, 30, 33, 40 AND 50).

FIRST USE 11-1-2002; IN COMMERCE 11-1-2002.

LEIGH CAROLINE CASE, EXAMINING ATTORNEY

THE MARK CONSISTS OF STANDARD CHARACTERS WITHOUT CLAIM TO ANY PARTICULAR FONT, STYLE, SIZE, OR COLOR.

OWNER OF U.S. REG. NO. 2,745,307.

FOR PAPER PLATE HOLDER, PLASTIC PLATE AND KITCHEN CUP DISPENSER, PLASTIC CUTLERY ORGANIZER (U.S. CLS. 2, 13, 23, 29, 30, 33, 40 AND 50).

BRENDAN REGAN, EXAMINING ATTORNEY

**CLASS 21—(Continued).**

SN 78-357,304. SOY BASICS, LLC, NEW HAMPTON, IA.  
FILED 1-26-2004.

**CLASS 21—(Continued).**

SN 78-360,682. HATHCOAT STUDIOS LTD, COLORADO  
SPRINGS, CO. FILED 2-1-2004.

**WIND WARMERS**

THE MARK CONSISTS OF STANDARD CHARACTERS  
WITHOUT CLAIM TO ANY PARTICULAR FONT, STYLE,  
SIZE, OR COLOR.

FOR CANDLE ACCESSORIES, NOT OF PRECIOUS  
METAL, NAMELY, JAR TOPPERS (U.S. CLS. 2, 13, 23, 29,  
30, 33, 40 AND 50).

M. E. BODSON, EXAMINING ATTORNEY



SN 78-359,271. EVENFLO COMPANY, INC., VANDALIA, OH.  
FILED 1-29-2004.

**Brittany  
Collection**

THE MARK CONSISTS OF STANDARD CHARACTERS  
WITHOUT CLAIM TO ANY PARTICULAR FONT, STYLE,  
SIZE, OR COLOR.

NO CLAIM IS MADE TO THE EXCLUSIVE RIGHT TO  
USE COLLECTION, APART FROM THE MARK AS SHOWN.

FOR GLASS DINNERWARE (U.S. CLS. 2, 13, 23, 29, 30,  
33, 40 AND 50).

TARAH HARDY, EXAMINING ATTORNEY



SN 78-362,023. ECKSTEIN, MICHAEL G., NEWTOWN  
SQUARE, PA. FILED 2-3-2004.

**SURESIP**

because it's YOUR  
dootie!

THE MARK CONSISTS OF STANDARD CHARACTERS  
WITHOUT CLAIM TO ANY PARTICULAR FONT, STYLE,  
SIZE, OR COLOR.

FOR CHILDREN'S DRINKING CONTAINERS AND  
VALVES THEREFOR (U.S. CLS. 2, 13, 23, 29, 30, 33, 40  
AND 50).

PRISCILLA MILTON, EXAMINING ATTORNEY

THE MARK CONSISTS OF STANDARD CHARACTERS  
WITHOUT CLAIM TO ANY PARTICULAR FONT, STYLE,  
SIZE, OR COLOR.

FOR AEROSOL FREEZE SPRAY THAT HARDENS  
AND SOLIDIFIES ANIMAL WASTE (U.S. CLS. 2, 13, 23,  
29, 30, 33, 40 AND 50).

FIRST USE 2-1-2004; IN COMMERCE 2-1-2004.

SUSAN STIGLITZ, EXAMINING ATTORNEY

**CLASS 21—(Continued).**

SN 78-362,735. SYSCO CORPORATION, HOUSTON, TX.  
FILED 2-4-2004.

**EARTH PLUS**

THE MARK CONSISTS OF STANDARD CHARACTERS  
WITHOUT CLAIM TO ANY PARTICULAR FONT, STYLE,  
SIZE, OR COLOR.

OWNER OF U.S. REG. NO. 2,185,170.  
FOR PAPER CUPS (U.S. CLS. 2, 13, 23, 29, 30, 33, 40  
AND 50).

MICHELE SWAIN, EXAMINING ATTORNEY

SN 78-388,933. THE EVERCARE COMPANY, ALPHARETTA,  
GA. FILED 3-23-2004.

**POP-UP LINT ROLL  
AND GO**

THE MARK CONSISTS OF STANDARD CHARACTERS  
WITHOUT CLAIM TO ANY PARTICULAR FONT, STYLE,  
SIZE, OR COLOR.

NO CLAIM IS MADE TO THE EXCLUSIVE RIGHT TO  
USE "POP-UP", APART FROM THE MARK AS SHOWN.

FOR ROLLER-TYPE LINT REMOVERS FOR USE IN  
REMOVING FOREIGN PARTICLES FROM CLOTHING,  
FURNITURE, UPHOLSTERY AND THE LIKE (U.S. CLS.  
2, 13, 23, 29, 30, 33, 40 AND 50).

KELLY CHOE, EXAMINING ATTORNEY

SN 78-401,581. BOBBY JONES FILM, LLC, CHARLOTTE, NC.  
FILED 4-14-2004.

**BOBBY JONES STROKE  
OF GENIUS**

THE MARK CONSISTS OF STANDARD CHARACTERS  
WITHOUT CLAIM TO ANY PARTICULAR FONT, STYLE,  
SIZE, OR COLOR.

BOBBY JONES DOES NOT IDENTIFY A PARTICULAR  
LIVING INDIVIDUAL.

FOR HOUSEWARES, NAMELY BEVERAGE CUPS  
AND MUGS (U.S. CLS. 2, 13, 23, 29, 30, 33, 40 AND 50).

FIRST USE 3-15-2004; IN COMMERCE 3-15-2004.

THEODORE MCBRIDE, EXAMINING ATTORNEY

**CLASS 22—CORDAGE AND FIBERS**

SN 78-348,737. ARTEVA TECHNOLOGIES S.A.R.L., ZURICH,  
SWITZERLAND, FILED 1-7-2004.



OWNER OF U.S. REG. NOS. 2,433,932 AND 2,433,953.  
NO CLAIM IS MADE TO THE EXCLUSIVE RIGHT TO  
USE "FR" AND "BLEND", APART FROM THE MARK AS  
SHOWN.

FOR FLAME RESISTANT FIBERS USED IN THE  
MANUFACTURE OF FABRICS (U.S. CLS. 1, 2, 7, 19, 22,  
42 AND 50).

FIRST USE 3-10-2003; IN COMMERCE 3-10-2003.

MICHAEL HALL, EXAMINING ATTORNEY

**CLASS 23—YARNS AND THREADS**

SN 78-350,114. SUPREME ELASTIC CORPORATION, HICK-  
ORY, NC. FILED 1-9-2004.



OWNER OF U.S. REG. NOS. 2,030,401 AND 2,109,842.  
NO CLAIM IS MADE TO THE EXCLUSIVE RIGHT TO  
USE SUPREME, APART FROM THE MARK AS SHOWN.

THE MARK CONSISTS OF A WORD(S) PORTION PLUS  
THE DESIGN OF A MAN IN A FIGHTING STANCE.

FOR CHEMICALLY TREATED YARN HAVING ANTI-  
MICROBIAL PROPERTIES (U.S. CL. 43).

MICHELE SWAIN, EXAMINING ATTORNEY

**CLASS 23—(Continued).**

SN 78-350,623. INVISTA NORTH AMERICA S.A.R.L., WILMINGTON, DE. FILED 1-12-2004.



FOR YARNS AND THREADS FOR TEXTILE USE (U.S. CL. 43).

TRICIA SONNEBORN, EXAMINING ATTORNEY

**CLASS 24—FABRICS**

SN 76-562,512. TEXTIL OLIUS, S.A., 08202 SABADELL, SPAIN, FILED 12-1-2003.

**FELTINA**

OWNER OF SPAIN REG. NO. 291134, DATED 5-24-1955, EXPIRES 9-18-2005.

FOR FABRICS, NAMELY, FELT FABRICS, PLUSH FABRICS, PLUSH PADDED CLOTHS, FELTED CLOTHS (U.S. CLS. 42 AND 50).

FIRST USE 4-0-1968; IN COMMERCE 6-0-1985.  
DAVID MURRAY, EXAMINING ATTORNEY

SN 76-567,287. HATTERAS HAMMOCKS, INC., GREENVILLE, NC. FILED 12-29-2003.

**DURACORD**

THE MARK CONSISTS OF STANDARD CHARACTERS WITHOUT CLAIM TO ANY PARTICULAR FONT, STYLE, SIZE, OR COLOR.

FOR FABRIC FOR USE IN THE MANUFACTURE OF HAMMOCKS AND OUTDOOR FURNITURE (U.S. CLS. 42 AND 50).

GINNY ISAACSON, EXAMINING ATTORNEY

**CLASS 24—(Continued).**

SN 78-246,970. KN LTD., SAN RAFAEL, CA. FILED 5-7-2003.

**KN KAREN NEUBURGER  
LOOK GOOD . . . GET  
COMFORTABLE**

OWNER OF U.S. REG. NOS. 2,166,550, 2,722,732 AND OTHERS.

THE NAME "KAREN NEUBURGER" IDENTIFIES A LIVING INDIVIDUAL WHOSE CONSENT IS OF RECORD.

FOR TOWELS, BED SHEETS, BED LINENS, PILLOW CASES, BED CLOTHS, AND BEDSPREADS (U.S. CLS. 42 AND 50).

TRACY CROSS, EXAMINING ATTORNEY

SN 78-248,060. UNITED WORLDWIDE RESOURCES, LLC, SPRINGFIELD, MO. FILED 5-9-2003.

**TECHSTRAND**  
GLOBAL COMPOSITE REINFORCEMENTS

NO CLAIM IS MADE TO THE EXCLUSIVE RIGHT TO USE GLOBAL COMPOSITE REINFORCEMENTS, APART FROM THE MARK AS SHOWN.

FOR FIBERGLASS COMPOSITE REINFORCEMENT FABRIC FOR USE IN LAND, SEA AND AEROSPACE APPLICATIONS (U.S. CLS. 42 AND 50).

MARY BOAGNI, EXAMINING ATTORNEY

SN 78-350,627. INVISTA NORTH AMERICA S.A.R.L., WILMINGTON, DE. FILED 1-12-2004.



FOR TEXTILE GOODS, NAMELY FABRIC MATTRESS COVERS, TABLE CLOTHS, BED BLANKETS, COMFORTERS, QUILTS, PILLOW CASES, BED SHEETS, TOWELS, FABRIC FOR UPHOLSTERY, FABRIC FOR PANTS, SHIRTS, DRESSES, SHORTS, COATS, JACKETS, SHOES AND HATS (U.S. CLS. 42 AND 50).

EVELYN BRADLEY, EXAMINING ATTORNEY



**CLASS 24—(Continued).**

SN 78-354,161. PLAYA PERFECTION, INC., BEREA, OH.  
FILED 1-20-2004.

**CLASS 24—(Continued).**

SN 78-354,777. PLAYA PERFECTION, INC., BEREA, OH.  
FILED 1-21-2004.

**PLAYA PERFECTION**

**CREATIVE PRODUCTS  
FOR BEACH  
MODESTY AND SUN  
PROTECTION**

THE MARK CONSISTS OF STANDARD CHARACTERS  
WITHOUT CLAIM TO ANY PARTICULAR FONT, STYLE,  
SIZE, OR COLOR.

NO CLAIM IS MADE TO THE EXCLUSIVE RIGHT TO  
USE "PLAYA", APART FROM THE MARK AS SHOWN.  
THE ENGLISH TRANSLATION OF PLAYA IS BEACH.  
FOR TOWELS (U.S. CLS. 42 AND 50).  
TANYA AMOS, EXAMINING ATTORNEY

THE MARK CONSISTS OF STANDARD CHARACTERS  
WITHOUT CLAIM TO ANY PARTICULAR FONT, STYLE,  
SIZE, OR COLOR.

FOR TOWELS (U.S. CLS. 42 AND 50).  
BRIAN PINO, EXAMINING ATTORNEY

SN 78-354,237. BRUNTON INTERNATIONAL, INC., DAL-  
LAS, TX. FILED 1-20-2004.

SN 78-364,180. INDUSTRIAL COATINGS GROUP, INC.,  
KINGSPORT, TN. FILED 2-6-2004.

**THRILLOW**

**IMPERIUM**

THE MARK CONSISTS OF STANDARD CHARACTERS  
WITHOUT CLAIM TO ANY PARTICULAR FONT, STYLE,  
SIZE, OR COLOR.

FOR TEXTILE GOODS; NAMELY A THROW BLAN-  
KET THAT CAN BE FOLDED INTO A POCKET MAK-  
ING A PILLOW (U.S. CLS. 42 AND 50).  
FIRST USE 3-1-2003; IN COMMERCE 3-1-2003.  
JANICE L. MCMORROW, EXAMINING ATTORNEY

THE MARK CONSISTS OF STANDARD CHARACTERS  
WITHOUT CLAIM TO ANY PARTICULAR FONT, STYLE,  
SIZE, OR COLOR.

FOR COATED EMBOSSABLE CLOTH WITH  
LEATHER-LIKE APPEARANCE (U.S. CLS. 42 AND 50).  
LAURA KOVAISKY, EXAMINING ATTORNEY

**CLASS 25—CLOTHING**

SN 75-755,184. BOUSKA, GARY J. JR., VANCOUVER, WA.  
FILED 8-12-1999.



FOR CLOTHING, NAMELY, T-SHIRTS, SHIRTS,  
CAPS, HATS (U.S. CLS. 22 AND 39).  
RONALD MCMORROW, EXAMINING ATTORNEY

SN 76-382,581. TARGET BRANDS, INC., MINNEAPOLIS,  
MN. FILED 3-15-2002.

**CIRCO**

OWNER OF U.S. REG. NOS. 2,693,011, 2,695,470 AND  
2,717,303.

THE ENGLISH TRANSLATION OF "CIRCO" IS "CIR-  
CUS".

FOR CHILDREN'S APPAREL, NAMELY, TOPS,  
PANTS, JUMPERS, DRESSES, SHOES AND UNDER-  
WEAR (U.S. CLS. 22 AND 39).

FIRST USE 7-16-2000; IN COMMERCE 7-16-2000.  
SCOTT OSICK, EXAMINING ATTORNEY

SN 76-437,749. HOLIDAY IN S.R.L., BOLOGNA, ITALY,  
FILED 8-2-2002.



NO CLAIM IS MADE TO THE EXCLUSIVE RIGHT TO  
USE "CORTINA" AND "JEANS", APART FROM THE MARK  
AS SHOWN.

FOR CLOTHING AND KNITWEAR NAMELY JACK-  
ETS, COATS, OVERCOATS, RAINCOATS, PARKAS,  
BLOUSONS, WAISTCOATS, SUITS, SKIRTS, TROUSERS,  
PANTS, BREECHES, HATS, CAPS, GLOVES, SOCKS,  
STOCKINGS, SHAWLS, SCARVES, BELTS, PULLOVERS,  
VESTS, CAMISOLES, DRESSES FOR WOMEN, TEE-  
SHIRTS, SHIRTS, SWEATERS, CARDIGANS, BLOUSES  
AND UNDERWEAR (U.S. CLS. 22 AND 39).

SHARI SHEFFIELD, EXAMINING ATTORNEY

**CLASS 25—(Continued).**

SN 76-446,185. MICHELANGELO S.P.A., NAPOLI, ITALY,  
FILED 8-30-2002.

**BARBARA ISAIA**

OWNER OF ERPN CMNTY TM OFC REG. NO. 002743110,  
DATED 6-30-2003, EXPIRES 6-21-2012.

THE NAME BARBARA ISAIA IDENTIFIES A LIVING  
INDIVIDUAL WHOSE CONSENT IS OF RECORD.

FOR CLOTHING, NAMELY, SUITS MADE OF  
LEATHER; SHIRTS; BLOUSES; SKIRTS; TAILLEURS;  
JACKETS; TROUSERS; SHORTS; SPORT JERSEYS; T-  
SHIRTS; PAJAMAS; STOCKINGS; SINGLETS; CORSETS;  
SUSPENDERS; PANTS; UNDERWEAR; HATS; SCARVES;  
HEADSCARVES; NECKTIES; OVERCOATS; TOPCOATS;  
SWIMSUITS; TRACKSUITS; WIND RESISTANT JACK-  
ETS; SKI PANTS; BELTS; FUR OVERCOATS; SHOE  
WEAR; NAMELY SLIPPERS, SHOES, SPORTS SHOES,  
BOOTS AND SANDALS (U.S. CLS. 22 AND 39).

CHRISTOPHER BUONGIORNO, EXAMINING ATTOR-  
NEY

SN 76-475,327. PRIVACY ISSUE, INC., KENNESAW, GA.  
FILED 12-13-2002.

*Privacy Issue*

FOR PANTIES BRAS, SWIM WEAR, LOUNGE WEAR  
(U.S. CLS. 22 AND 39).

FIRST USE 8-22-2002; IN COMMERCE 8-22-2002.  
GEORGIA CARTY, EXAMINING ATTORNEY

SN 76-479,498. SH INTERNATIONAL, CHANTILLY, VA.  
FILED 12-30-2002.

**NA MODE**

FOR SHIRTS, PANTS, UNDERWEARS, SOCKS, JACK-  
ETS, HATS (U.S. CLS. 22 AND 39).

FIRST USE 10-15-2002; IN COMMERCE 10-15-2002.  
ANDREA SAUNDERS, EXAMINING ATTORNEY

**CLASS 25—(Continued).**

SN 76-485,070. WARD, JAMES H., DBA JIM WARD DESIGN & ILLUSTRATION, ST. LOUIS, MO. FILED 1-27-2003.



FOR CLOTHING; NAMELY, T-SHIRTS, SWEAT-SHIRTS, JACKETS, CAPS AND HEADBANDS (U.S. CLS. 22 AND 39).

RUSS HERMAN, EXAMINING ATTORNEY

SN 76-492,451. LERMAN, DINA, NEW YORK, NY. FILED 2-25-2003.



FOR CLOTHING, NAMELY CHILDREN'S JACKETS, SHIRTS, PANTS, HATS, MITTENS, BODYSUITS, T-SHIRTS, OVERALLS, SHIRTS, SOCKS, AND COTTON BIBS (U.S. CLS. 22 AND 39).

ZACHARY BELLO, EXAMINING ATTORNEY

SN 76-503,280. LA SENZA INC., MISSISSAUGA, ONTARIO, CANADA, FILED 3-31-2003.

**LA SENZA SHAPERS**

OWNER OF U.S. REG. NOS. 1,800,379, 2,614,315 AND OTHERS.

NO CLAIM IS MADE TO THE EXCLUSIVE RIGHT TO USE "SHAPERS", APART FROM THE MARK AS SHOWN.

THE ENGLISH TRANSLATION OF LA SENZA IS "THE WITHOUT".

FOR BRASSIERES, BRA STRAP EXTENDERS, BRA STRAP PADS, SELF ADHESIVE BRAS, LOW BACK BRA CONVERTERS, STRAPLESS BACKLESS UNDERWIRE BRAS AND REPLACEMENT TAPE FOR USE WITH THE AFORESAID GOODS, AND SUPPORT CUPS (U.S. CLS. 22 AND 39).

ROBERT LORENZO, EXAMINING ATTORNEY

**CLASS 25—(Continued).**

SN 76-510,826. KLEIN, MICHEL, 75001, PARIS, FRANCE, FILED 4-30-2003.

**MICHEL KLEIN**

THE NAME MICHEL KLEIN IN THE MARK IDENTIFIES A LIVING INDIVIDUAL WHOSE CONSENT IS OF RECORD.

FOR SHIRTS, DRESSES, JACKETS, SKIRTS, PANTS; KNITWEAR NAMELY SWEATERS, PULLOVERS, VESTS, CARDIGANS, BONNETS, CAPS, HATS, AND SCARVES; T-SHIRTS, SWEAT-SHIRTS, COATS, RAIN COATS, AND BEACH WEAR (U.S. CLS. 22 AND 39).

FIRST USE 0-0-1974; IN COMMERCE 0-0-1974.

DAVID TAYLOR, EXAMINING ATTORNEY

SN 76-517,756. ROCKER, DAVID, FAYETTEVILLE, GA. FILED 5-5-2003.



THE LETTER "C" ENCIRCLES THE LETTER "L" WITH THE WORDS "CHRISTLINE DARE TO CROSS OVER" POSITIONED AS SHOWN BELOW.

FOR CLOTHING, NAMELY, SHIRTS PANTS JACKETS, COATS, HATS, CAPS, SOCKS, HEADBANDS, WRIST BANDS (U.S. CLS. 22 AND 39).

FIRST USE 3-3-2003; IN COMMERCE 3-3-2003.

LAURA KOVAISKY, EXAMINING ATTORNEY

SN 76-520,878. GLOCK, MICHAEL W., DBA SLYX FASHIONS, FALLS CHURCH, VA. FILED 6-5-2003.

**SLYX FASHIONS**

NO CLAIM IS MADE TO THE EXCLUSIVE RIGHT TO USE FASHIONS, APART FROM THE MARK AS SHOWN.

FOR LATEX CLOTHING, NAMELY, LATEX CATSUIITS, LATEX JUMP SUITS, LATEX DRESSES, LATEX SKIRTS, LATEX SHIRTS, LATEX TOPS, LATEX LEGGINGS, LATEX PANTS, LATEX TANK TOPS, LATEX SHORTS, LATEX WRIST BANDS, LATEX GAUNTLETS, AND LATEX WAIST CINCHERS (U.S. CLS. 22 AND 39).

FIRST USE 5-22-1997; IN COMMERCE 5-22-1997.

SCOTT OSLICK, EXAMINING ATTORNEY

**CLASS 25—(Continued).**

SN 76-530,251. SHIMAMURA, SEIICHIRO, TOKYO, JAPAN,  
FILED 7-7-2003.

0044

FOR CLOTHING, NAMELY, BELTS, CAPS, COATS,  
FOOTWEAR, HATS, JACKETS, OVERCOATS, PANTS,  
PULLOVERS, SHIRTS, SHOES, SKIRTS, SWEATERS,  
TEE-SHIRTS, TROUSERS, AND KNITWEAR, NAMELY,  
SWEATERS, MITTENS, KNIT SHIRTS, WAISTCOATS,  
VESTS, CARDIGANS, SHAWLS, SCARVES, KNIT CAPS,  
JUMPERS, AND KNIT HATS (U.S. CLS. 22 AND 39).

BARBARA GAYNOR, EXAMINING ATTORNEY

SN 76-533,295. WIGWAM MILLS, INC., SHEBOYGAN, WI.  
FILED 7-16-2003.

**ARCTICSOCK**

FOR MEN'S, WOMEN'S AND CHILDREN'S SOCKS  
(U.S. CLS. 22 AND 39).

BILL DAWE, EXAMINING ATTORNEY

SN 76-534,039. AHARONI, SHAHPASSAND, HOLON, IS-  
RAEL, FILED 8-1-2003.

**KENNEDY**

FOR CLOTHING, NAMELY, BATHING CAPS, BATH-  
ROBES, BELTS, BERMUDA SHORTS, BLOUSES, BOOTS,  
BRASSIERES, CAMISOLES, CAPES, CAPS, CARDIGAN  
SWEATERS, CASUAL SHOES, COATS, CULOTTES,  
DRESSES, DRESS SHOES, EARMUFFS, FOOTWEAR,  
GALOSHES, GARTERS, GIRDLES, GLOVES, HATS,  
HEADBANDS, HOSIERY, JACKETS, MITTENS, NECK-  
ERCHIEFS, NECKTIES, OUTERWEAR JACKETS, OVER-  
ALLS, OVERCOATS, OVERSHOES, PANTS,  
PANTYHOSE, PULLOVER SWEATERS, RAINCOATS,  
SANDALS, SCARVES, SHIRTS, SHOES, SKI MASKS,  
SKIRTS, SLIPS, SNEAKERS, SNOWSUITS, SOCKS,  
SPORTS JACKETS, SPORTS SHOES, STOCKINGS,  
SUITS, SUSPENDERS, SWEATERS, SWEATSHIRTS,  
SWIMMING TRUNKS, SWIMSUITS, TROUSERS, T-  
SHIRTS, TUXEDOS, UNDERPANTS, UNDERSHIRTS,  
VESTS, AND KNITWEAR, NAMELY, BLOUSES, CAPES,  
CAPS, CARDIGAN SWEATERS, COATS, CULOTTES,  
DRESSES, GLOVES, HATS, HOSIERY, JACKETS, MIT-  
TENS, NECKTIES, PANTS, PULLOVER SWEATERS,  
SCARVES, SHIRTS, SKIRTS, SPORTS JACKETS, SUITS,  
SWEATERS, TROUSERS, AND VESTS (U.S. CLS. 22 AND  
39).

CHERYL CLAYTON, EXAMINING ATTORNEY

**CLASS 25—(Continued).**

SN 76-538,820. SCHALLER, JAMES C., PHOENIX, AZ. FILED  
8-20-2003.

**DOT PALM**

FOR CLOTHING, NAMELY, HATS, VISORS, SHIRTS,  
SHORTS AND PANTS (U.S. CLS. 22 AND 39).  
LINDA M. KING, EXAMINING ATTORNEY

SN 76-540,705. MCQUILLEN, NIN F, SAINT PETERSBURG,  
FL. FILED 8-15-2003.

**IX-XI REMEMBER**

NO CLAIM IS MADE TO THE EXCLUSIVE RIGHT TO  
USE IX-XI, APART FROM THE MARK AS SHOWN.  
FOR SHIRTS (U.S. CLS. 22 AND 39).  
FIRST USE 6-0-2002; IN COMMERCE 6-0-2002.  
WILLIAM BRECKENFELD, EXAMINING ATTORNEY

SN 76-542,949. CHICA, INC., SAN FERNANDO, CA. FILED 9-  
8-2003.

**ROCKERA**

FOR CLOTHING, NAMELY, SHIRTS, T-SHIRTS,  
DRESSES, SKIRTS, PYJAMAS, SWIMSUITS, SWEAT  
SHIRTS, SWEAT PANTS, TANK TOPS, SHORTS, PANTS,  
JACKETS, SNOW BIBS, GLOVES, SHOES, ATHLETIC  
SHOES, SANDALS, SLIPPERS, BOOTS, BEACH FOOT-  
WEAR, HATS, CAPS, VISORS AND UNDERWEAR;  
THERMAL WEAR, NAMELY, THERMAL UNDER-  
WEAR, THERMAL SOCKS (U.S. CLS. 22 AND 39).  
JOHN DALIER, EXAMINING ATTORNEY

SN 76-550,257. SLAUGHTER, KEITH, DUBLIN, OH. FILED  
10-9-2003.



FOR CAPS, VISORS, HATS, SWEATSHIRTS, SWEAT-  
PANTS, PULLOVER HOODED SWEATSHIRTS, JACK-  
ETS, VESTS, SHORTS, GYM SHORTS, SLEEVELESS T-  
SHIRTS, T-SHIRTS, TANK TOPS, SOCKS, HEADBANDS,  
SHIRTS, ANORAKS, PARKAS, WRISTBANDS, JERSEYS,  
TURTLENECKS, SWEATERS (U.S. CLS. 22 AND 39).

MICHELE SWAIN, EXAMINING ATTORNEY

**CLASS 25—(Continued).**

SN 76-551,491. LEVEL 27, LLC, GLENDALE, CA. FILED 9-26-2003.

**LEVEL 27 CLOTHING**

NO CLAIM IS MADE TO THE EXCLUSIVE RIGHT TO USE "CLOTHING", APART FROM THE MARK AS SHOWN. FOR CLOTHING, NAMELY, SHIRTS, TEE SHIRTS, SWEATSHIRTS, PANTS, JACKETS, SHORTS, HEADWEAR, HATS, CAPS (U.S. CLS. 22 AND 39). FIRST USE 9-1-2001; IN COMMERCE 9-1-2001. JIM RINGLE, EXAMINING ATTORNEY

**CLASS 25—(Continued).**

SN 76-573,345. MORNING GLOW, INC., GARDENA, CA. FILED 2-2-2004.

**FreshGirl**

SN 76-567,494. MCGRATH, CATHERINE E., NORTH AND-OVER, MA. FILED 12-18-2003.

**JACKI**

THE MARK CONSISTS OF STANDARD CHARACTERS WITHOUT CLAIM TO ANY PARTICULAR FONT, STYLE, SIZE, OR COLOR. NO CLAIM IS MADE TO THE EXCLUSIVE RIGHT TO USE "GIRL", APART FROM THE MARK AS SHOWN. FOR WOMEN'S CLOTHING, NAMELY DRESSES, TOPS, BLOUSES, SHIRTS, PANTS, JACKETS, SKIRTS, SWEATERS, AND SHORTS (U.S. CLS. 22 AND 39). FIRST USE 1-15-2004; IN COMMERCE 1-15-2004. LAURA KOVAISKY, EXAMINING ATTORNEY

THE MARK CONSISTS OF STANDARD CHARACTERS WITHOUT CLAIM TO ANY PARTICULAR FONT, STYLE, SIZE, OR COLOR. FOR HOSPITAL SHIRTS; HOSPITAL SHIRTS FOR BREAST CANCER PATIENTS; HOSPITAL SHIRTS FOR SURGICAL AND NON-SURGICAL BREAST CANCER PATIENTS; HOSPITAL SHIRTS WITH NON-METAL FASTENERS FOR EASE OF DRESSING AND ACCESSIBILITY IN MEDICAL EXAMINATIONS; HOSPITAL SHIRTS WITH AN INSIDE POCKET FOR HOLDING SURGICAL DRAINS (U.S. CLS. 22 AND 39). GINA HAYES, EXAMINING ATTORNEY

SN 76-575,138. ALEX 2000 S.R.L., 20052 MONZA (ML), ITALY, FILED 2-11-2004.

SN 76-572,789. ASHAWAY LINE & TWINE MFG. CO., ASHAWAY, RI. FILED 1-28-2004.

**ASHAWAY**

**Walk Street**

OWNER OF U.S. REG. NOS. 156,168, 1,179,366 AND OTHERS. FOR FOOTWEAR, NAMELY, ATHLETIC FOOTWEAR (U.S. CLS. 22 AND 39). C. DIONNE CLYBURN, EXAMINING ATTORNEY

FOR CLOTHES, NAMELY T-SHIRTS, TROUSERS, SWEATSHIRTS, JACKETS, HATS, SCARVES, NECKTIES, SOCKS, PANTYHOSE, GLOVES, CLOTHING BELT, SHOES, BOOTS, SANDALS, WOODEN SHOES, SLIPPERS (U.S. CLS. 22 AND 39). DAWN FELDMAN, EXAMINING ATTORNEY

**CLASS 25—(Continued).**

SN 78-114,006. LABTIS-JARDIM, ODESSA G, RAHWAY, NJ.  
FILED 3-11-2002.



NO CLAIM IS MADE TO THE EXCLUSIVE RIGHT TO USE BABY, APART FROM THE MARK AS SHOWN.

THE MARK CONSISTS OF A FANCIFUL STANDING PILLOW COMBINED WITH BABY BEL.

FOR CLOTHING FOR GIRLS NEWBORN TO 8 YEARS OF AGE NAMELY DRESSES, BLOUSES, SKIRTS, TROUSERS, SWEATERS, VESTS, PULLOVERS, ROMPERS, CAPS, OVERCOATS, T-SHIRT, BELTS, SHOES AND SANDALS (U.S. CLS. 22 AND 39).

FIRST USE 8-8-2001; IN COMMERCE 10-18-2001.  
ESTHER A. BORSUK, EXAMINING ATTORNEY

SN 78-155,019. GENMAR IP LLC, MINNEAPOLIS, MN.  
FILED 8-16-2002.

**ASX**

FOR CLOTHING, NAMELY, SHIRTS, SHORTS, SWEATSHIRTS, SWEATPANTS, JACKETS, SWEATERS AND HATS, ALL FOR THE PROMOTION OF A PARTICULAR LINE OF BOATS (U.S. CLS. 22 AND 39).

ELISSA GARBER KON, EXAMINING ATTORNEY

SN 78-157,013. BODICE'N KNIT, INC., LOS ANGELES, CA.  
FILED 8-22-2002.

**SHEENA L**

WE, SOPHIA & KANG HYON LEE, AS PARENT OF SHEENA LEE GIVE THE CONSENT AGREEMENT TO BODICE 'N KNIT, INC. TO USE THE NAME OF OUR DAUGHTER. SHEENA IS CURRENTLY A MINOR OF THE AGE OF 3.

FOR WOMEN KNIT SWEATER (U.S. CLS. 22 AND 39).  
CAROLYN GRAY, EXAMINING ATTORNEY

**CLASS 25—(Continued).**

SN 78-173,737. WHITECAP VENTURES LTD., ROADTOWN, BR. VIRGIN ISLANDS, FILED 10-11-2002.

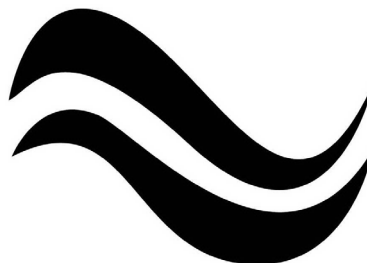

THE MARK CONSISTS OF TWO PARALLEL WAVY LINES.

FOR CLOTHING, NAMELY SWIMWEAR, BATHING SUITS, AND COVERUPS (U.S. CLS. 22 AND 39).

FIRST USE 3-7-2003; IN COMMERCE 3-7-2003.  
PRISCILLA MILTON, EXAMINING ATTORNEY

SN 78-213,112. SOUTHERN TRADING IMPORT & EXPORT CO. LTD., KOWLOON, HONG KONG, FILED 2-10-2003.

**COUBERG**

FOR FOOTWEAR, NAMELY, WORKING SHOES, CASUAL SHOES, SPORT SHOES AND HIKING SHOES FOR MEN, WOMEN AND CHILDREN (U.S. CLS. 22 AND 39).

FIRST USE 3-15-2003; IN COMMERCE 3-15-2003.  
ODESSA BIBBINS, EXAMINING ATTORNEY

SN 78-220,557. DEBORAH A IRVING AND RICK J IRVING PARTNERSHIP, THE, CHICAGO, IL. FILED 3-1-2003.



NO CLAIM IS MADE TO THE EXCLUSIVE RIGHT TO USE "CHICAGO", APART FROM THE MARK AS SHOWN.

FOR CLOTHING AND HEADWEAR, NAMELY, HATS, SHIRTS, T-SHIRTS, CAPS, JACKETS AND SWEATSHIRTS (U.S. CLS. 22 AND 39).

FIRST USE 10-16-2001; IN COMMERCE 10-16-2001.  
INGA ERVIN, EXAMINING ATTORNEY

**CLASS 25—(Continued).**

SN 78-226,325. PLATINUM HOTEL GROUP, LLC, HENDERSON, NV. FILED 3-17-2003.



THE MARK CONSISTS OF A STYLIZED DRAWING OF THE LETTER M.

FOR MEN'S AND WOMEN'S CLOTHING, NAMELY, SHIRTS, HATS, PANTS, BATHROBES, SHORTS, VISORS, BLOUSES, JACKETS, SWEATSHIRTS, SWEATPANTS, SOCKS, VESTS, BATHING SUITS (U.S. CLS. 22 AND 39). FIRST USE 10-1-2002; IN COMMERCE 10-1-2002. JANICE L. MCMORROW, EXAMINING ATTORNEY

SN 78-246,977. KN LTD., SAN RAFAEL, CA. FILED 5-7-2003.

**KN KAREN NEUBURGER  
LOOK GOOD . . . GET  
COMFORTABLE**

OWNER OF U.S. REG. NOS. 2,166,550, 2,722,732 AND OTHERS.

THE NAME "KAREN NEUBURGER" IDENTIFIES A LIVING INDIVIDUAL WHOSE CONSENT IS OF RECORD.

FOR WOMEN'S AND GIRLS' HOSIERY; DAY WEAR IN THE NATURE OF DRESSES, SKIRTS, PANTS, BLOUSES, SHIRTS; ACTIVE WEAR IN THE NATURE OF JEANS, DRESSES, BODY SUITS, BELTS AND GLOVES; AND ATHLETIC WEAR IN THE NATURE OF SWIMWEAR, SWEATSHIRTS; WOMEN'S AND GIRLS' SLEEPWEAR, UNDERGARMENTS; LOUNGEWEAR IN THE NATURE OF ROBES AND COVERUPS; SPORTSWEAR IN THE NATURE OF SHORTS, SWEATSUITS; ACTIVE WEAR IN THE NATURE OF SHOES, SLIPPERS; SPORTSWEAR IN THE NATURE OF SHOES, SLIPPERS (U.S. CLS. 22 AND 39).

TRACY CROSS, EXAMINING ATTORNEY

SN 78-260,729. SEAFORD, STACEY, D., CREEDMOOR, NC. FILED 6-10-2003.

**DIXIE DARLIN'**

FOR T-SHIRTS, SWEAT SHIRTS, HATS AND CAPS (U.S. CLS. 22 AND 39).

FIRST USE 8-11-2000; IN COMMERCE 11-19-2002.

JOHN DWYER, EXAMINING ATTORNEY

**CLASS 25—(Continued).**

SN 78-269,206. OTT, PATRICK, M., MENTOR, OH. FILED 7-1-2003.

**RESISTANCE WEAR**

SEC. 2(F).

FOR EXERCISE APPAREL, NAMELY HATS, SHIRTS, JACKETS, VESTS, SWEATPANTS, SWEATSHIRTS, SHORTS, SPORTS BRAS, SOCKS (U.S. CLS. 22 AND 39). FIRST USE 1-31-1995; IN COMMERCE 1-31-1995. ESTHER BELENKER, EXAMINING ATTORNEY

SN 78-274,164. LI CHING HU, INC., SOUTH EL MONTE, CA. FILED 7-15-2003.



NO CLAIM IS MADE TO THE EXCLUSIVE RIGHT TO USE "SPORTY", APART FROM THE MARK AS SHOWN.

FOR T-SHIRTS, TANK TOPS, SWEATSHIRTS, SWEATPANTS, SHORTS, PANTS, DRESSES, SKIRTS, BRA TOPS, LEGGINGS, BIKE SHORTS, AND CAPS (U.S. CLS. 22 AND 39).

FIRST USE 2-1-2002; IN COMMERCE 2-1-2002.

GEOFFREY FOSDICK, EXAMINING ATTORNEY

SN 78-278,270. FAISON, CEDRIK, WINSTON-SALEM, NC. FILED 7-24-2003.

**COLORFLOW COLLECTION**

NO CLAIM IS MADE TO THE EXCLUSIVE RIGHT TO USE "COLLECTION", APART FROM THE MARK AS SHOWN.

FOR ABSTRACT ART CLOTHING, NAMELY, PANTS, SHIRTS, SHORTS, SHOES, SKIRTS, BLOUSES, TOPS, AND BOTTOMS (U.S. CLS. 22 AND 39).

RICHARD A. STRASER, EXAMINING ATTORNEY

**CLASS 25—(Continued).**

SN 78-285.074. OLLIEVANA LICENSING GROUP, LLC,  
SANTA BARBARA, CA. FILED 8-8-2003.



**SCAM-CO.'s**

**DUD FIRECRACKER**

Watch them tremble before your very eyes. Women, children and brave men alike! **REAL LOOKING!**  
No. 0844 10kg \$1.00

FOR APPAREL, NAMELY HEADWEAR, FOOTWEAR, RAINWEAR, LOUNGEWEAR, TOPS AND BOTTOMS, TANK TOPS, CROP-TOPS, T-SHIRTS, SHIRTS, NECKTIES, ASCOTS, SWEATSHIRTS, SWEAT PANTS, SWEAT SUITS, CARDIGANS, SWEATERS, JACKETS, COATS, JERSEYS, VESTS, PULLOVERS, PANTS, WORKOUT SUITS, BRIEFS, UNDERSHIRTS, JEANS, BLOUSES, LEGGINGS, LONGJOHNS, SKORTS, SHORTS, SLEEP SHORTS, ROMPERS, TROUSERS, JUMPSUITS, OVERALLS, SKIRTS, DRESSES, JUMPERS, SWIMWEAR, NAMELY, BATHING SUITS AND COVER-UPS, LEOTARDS, TIGHTS, SLEEPWEAR, SLEEP SHIRTS, PAJAMAS, NIGHTSHIRTS, ROBES, NIGHTGOWNS, SLIPPERS, SLIPPER SOCKS, SOCKS, HOSIERY, BANDANNAS, SCARVES, SHAWLS, SUSPENDERS, BATH ROBES, DRESSING GOWNS, APRONS, MUFFLERS, HATS, CAPS, HEADBANDS, GLOVES, BELTS, LINGERIE, WOMEN'S UNDERWEAR, NAMELY BRAS, PANTIES AND THONGS AND MEN'S UNDERWEAR, NAMELY BOXER SHORTS AND BRIEFS (U.S. CLS. 22 AND 39).

FIRST USE 7-27-2003; IN COMMERCE 7-27-2003.  
M. L. HERSHKOWITZ, EXAMINING ATTORNEY

**CLASS 25—(Continued).**

SN 78-285.096. OLLIEVANA LICENSING GROUP, LLC,  
SANTA BARBARA, CA. FILED 8-8-2003.



**SCAM-CO.'s**

**FOAMING SUGAR**

Looks just like real sugar, but that's where the resemblance stops.  
AB57 35¢

SN 78-285.093. OLLIEVANA LICENSING GROUP, LLC,  
SANTA BARBARA, CA. FILED 8-8-2003.



**SCAM-CO.'s**

**FLESH EATING PLANTS**  
The most unusual plant in the world! Eats flies, bugs, insects, even meat. Instructions & special soil included.

#202 \$1.00

FOR APPAREL, NAMELY HEADWEAR, FOOTWEAR, RAINWEAR, LOUNGEWEAR, TOPS AND BOTTOMS, TANK TOPS, CROP-TOPS, T-SHIRTS, SHIRTS, NECKTIES, ASCOTS, SWEATSHIRTS, SWEAT PANTS, SWEAT SUITS, CARDIGANS, SWEATERS, JACKETS, COATS, JERSEYS, VESTS, PULLOVERS, PANTS, WORKOUT SUITS, BRIEFS, UNDERSHIRTS, JEANS, BLOUSES, LEGGINGS, LONGJOHNS, SKORTS, SHORTS, SLEEP SHORTS, ROMPERS, TROUSERS, JUMPSUITS, OVERALLS, SKIRTS, DRESSES, JUMPERS, SWIMWEAR, NAMELY, BATHING SUITS AND COVER-UPS, LEOTARDS, TIGHTS, SLEEPWEAR, SLEEP SHIRTS, PAJAMAS, NIGHTSHIRTS, ROBES, NIGHTGOWNS, SLIPPERS, SLIPPER SOCKS, SOCKS, HOSIERY, BANDANNAS, SCARVES, SHAWLS, SUSPENDERS, BATH ROBES, DRESSING GOWNS, APRONS, MUFFLERS, HATS, CAPS, HEADBANDS, GLOVES, BELTS, LINGERIE, WOMEN'S UNDERWEAR, NAMELY BRAS, PANTIES AND THONGS AND MEN'S UNDERWEAR, NAMELY BOXER SHORTS AND BRIEFS (U.S. CLS. 22 AND 39).

FIRST USE 7-27-2003; IN COMMERCE 7-27-2003.  
MICHELE SWAIN, EXAMINING ATTORNEY

FOR APPAREL, NAMELY HEADWEAR, FOOTWEAR, RAINWEAR, LOUNGEWEAR, TOPS AND BOTTOMS, TANK TOPS, CROP-TOPS, T-SHIRTS, SHIRTS, NECKTIES, ASCOTS, SWEATSHIRTS, SWEAT PANTS, SWEAT SUITS, CARDIGANS, SWEATERS, JACKETS, COATS, JERSEYS, VESTS, PULLOVERS, PANTS, WORKOUT SUITS, BRIEFS, UNDERSHIRTS, JEANS, BLOUSES, LEGGINGS, LONGJOHNS, SKORTS, SHORTS, SLEEP SHORTS, ROMPERS, TROUSERS, JUMPSUITS, OVERALLS, SKIRTS, DRESSES, JUMPERS, SWIMWEAR, NAMELY, BATHING SUITS AND COVER-UPS, LEOTARDS, TIGHTS, SLEEPWEAR, SLEEP SHIRTS, PAJAMAS, NIGHTSHIRTS, ROBES, NIGHTGOWNS, SLIPPERS, SLIPPER SOCKS, SOCKS, HOSIERY, BANDANNAS, SCARVES, SHAWLS, SUSPENDERS, BATH ROBES, DRESSING GOWNS, APRONS, MUFFLERS, HATS, CAPS, HEADBANDS, GLOVES, BELTS, LINGERIE, WOMEN'S UNDERWEAR, NAMELY BRAS, PANTIES AND THONGS AND MEN'S UNDERWEAR, NAMELY BOXER SHORTS AND BRIEFS (U.S. CLS. 22 AND 39).

FIRST USE 7-27-2003; IN COMMERCE 7-27-2003.  
MICHELE SWAIN, EXAMINING ATTORNEY



**CLASS 25—(Continued).**

SN 78-285,107. OLLIEVANA LICENSING GROUP, LLC, SANTA BARBARA, CA. FILED 8-8-2003.

**CLASS 25—(Continued).**

SN 78-285,263. OLLIEVANA LICENSING GROUP, LLC, SANTA BARBARA, CA. FILED 8-8-2003.

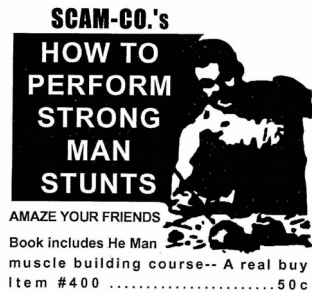

FOR APPAREL, NAMELY HEADWEAR, FOOTWEAR, RAINWEAR, LOUNGEWEAR, TOPS AND BOTTOMS, TANK TOPS, CROP-TOPS, T-SHIRTS, SHIRTS, NECKTIES, ASCOTS, SWEATSHIRTS, SWEAT PANTS, SWEAT SUITS, CARDIGANS, SWEATERS, JACKETS, COATS, JERSEYS, VESTS, PULLOVERS, PANTS, WORKOUT SUITS, BRIEFS, UNDERSHIRTS, JEANS, BLOUSES, LEGGINGS, LONGJOHNS, SKORTS, SHORTS, SLEEP SHORTS, ROMPERS, TROUSERS, JUMPSUITS, OVERALLS, SKIRTS, DRESSES, JUMPERS, SWIMWEAR, NAMELY, BATHING SUITS AND COVER-UPS, LEOTARDS, TIGHTS, SLEEPWEAR, SLEEP SHIRTS, PAJAMAS, NIGHTSHIRTS, ROBES, NIGHTGOWNS, SLIPPERS, SLIPPER SOCKS, SOCKS, HOSIERY, BANDANNAS, SCARVES, SHAWLS, SUSPENDERS, BATH ROBES, DRESSING GOWNS, APRONS, MUFFLERS, HATS, CAPS, HEADBANDS, GLOVES, BELTS, LINGERIE, WOMEN'S UNDERWEAR, NAMELY BRAS, PANTIES AND THONGS AND MEN'S UNDERWEAR, NAMELY BOXER SHORTS AND BRIEFS (U.S. CLS. 22 AND 39).

FIRST USE 7-27-2003; IN COMMERCE 7-27-2003.  
 MICHELE SWAIN, EXAMINING ATTORNEY

FOR APPAREL, NAMELY HEADWEAR, FOOTWEAR, RAINWEAR, LOUNGEWEAR, TOPS AND BOTTOMS, TANK TOPS, CROP-TOPS, T-SHIRTS, SHIRTS, NECKTIES, ASCOTS, SWEATSHIRTS, SWEAT PANTS, SWEAT SUITS, CARDIGANS, SWEATERS, JACKETS, COATS, JERSEYS, VESTS, PULLOVERS, PANTS, WORKOUT SUITS, BRIEFS, UNDERSHIRTS, JEANS, BLOUSES, LEGGINGS, LONGJOHNS, SKORTS, SHORTS, SLEEP SHORTS, ROMPERS, TROUSERS, JUMPSUITS, OVERALLS, SKIRTS, DRESSES, JUMPERS, SWIMWEAR, NAMELY, BATHING SUITS AND COVER-UPS, LEOTARDS, TIGHTS, SLEEPWEAR, SLEEP SHIRTS, PAJAMAS, NIGHTSHIRTS, ROBES, NIGHTGOWNS, SLIPPERS, SLIPPER SOCKS, SOCKS, HOSIERY, BANDANNAS, SCARVES, SHAWLS, SUSPENDERS, BATH ROBES, DRESSING GOWNS, APRONS, MUFFLERS, HATS, CAPS, HEADBANDS, GLOVES, BELTS, LINGERIE, WOMEN'S UNDERWEAR, NAMELY BRAS, PANTIES AND THONGS AND MEN'S UNDERWEAR, NAMELY BOXER SHORTS AND BRIEFS (U.S. CLS. 22 AND 39).

FIRST USE 7-27-2003; IN COMMERCE 7-27-2003.  
 WILLIAM P. SHANAHAN, EXAMINING ATTORNEY

**CLASS 25—(Continued).**

SN 78-287,056. OLLIEVANA LICENSING GROUP, LLC, SANTA BARBARA, CA. FILED 8-13-2003.

**CLASS 25—(Continued).**

SN 78-287,075. OLLIEVANA LICENSING GROUP, LLC, SANTA BARBARA, CA. FILED 8-13-2003.



**SCAM-CO.'S LEARN HYPNOTIC CONTROL**  
 Develop your sudden hypnotic power to control the minds and bodies of men and women. Learn to perform amazing feats and entertainment at parties. Easily learned from the new book 25 Lessons in Hypnotism.  
**No. 7212 .....45¢**

FOR APPAREL, NAMELY HEADWEAR, FOOTWEAR, RAINWEAR, LOUNGEWEAR, TOPS AND BOTTOMS, TANK TOPS, CROP-TOPS, T-SHIRTS, SHIRTS, NECKTIES, ASCOTS, SWEATSHIRTS, SWEAT PANTS, SWEAT SUITS, CARDIGANS, SWEATERS, JACKETS, COATS, JERSEYS, VESTS, PULLOVERS, PANTS, WORKOUT SUITS, BRIEFS, UNDERSHIRTS, JEANS, BLOUSES, LEGGINGS, LONGJOHNS, SKORTS, SHORTS, SLEEP SHORTS, ROMPERS, TROUSERS, JUMPSUITS, OVERALLS, SKIRTS, DRESSES, JUMPERS, SWIMWEAR, NAMELY, BATHING SUITS AND COVER-UPS, LEOTARDS, TIGHTS, SLEEPWEAR, SLEEP SHIRTS, PAJAMAS, NIGHTSHIRTS, ROBES, NIGHTGOWNS, SLIPPERS, SLIPPER SOCKS, SOCKS, HOSIERY, BANDANNAS, SCARVES, SHAWLS, SUSPENDERS, BATH ROBES, DRESSING GOWNS, APRONS, MUFFLERS, HATS, CAPS, HEADBANDS, GLOVES, BELTS, LINGERIE, WOMEN'S UNDERWEAR, NAMELY BRAS, PANTIES AND THONGS AND MEN'S UNDERWEAR, NAMELY BOXER SHORTS AND BRIEFS (U.S. CLS. 22 AND 39).

FIRST USE 7-27-2003; IN COMMERCE 7-27-2003.  
 WILLIAM P. SHANAHAN, EXAMINING ATTORNEY

SN 78-287,215. LINDA HARTMAN INTIMATES, LLC, RALEIGH, NC. FILED 8-14-2003.

**LINDA HARTMAN**

FOR APPAREL, NAMELY HEADWEAR, FOOTWEAR, RAINWEAR, LOUNGEWEAR, TOPS AND BOTTOMS, TANK TOPS, CROP-TOPS, T-SHIRTS, SHIRTS, NECKTIES, ASCOTS, SWEATSHIRTS, SWEAT PANTS, SWEAT SUITS, CARDIGANS, SWEATERS, JACKETS, COATS, JERSEYS, VESTS, PULLOVERS, PANTS, WORKOUT SUITS, BRIEFS, UNDERSHIRTS, JEANS, BLOUSES, LEGGINGS, LONGJOHNS, SKORTS, SHORTS, SLEEP SHORTS, ROMPERS, TROUSERS, JUMPSUITS, OVERALLS, SKIRTS, DRESSES, JUMPERS, SWIMWEAR, NAMELY, BATHING SUITS AND COVER-UPS, LEOTARDS, TIGHTS, SLEEPWEAR, SLEEP SHIRTS, PAJAMAS, NIGHTSHIRTS, ROBES, NIGHTGOWNS, SLIPPERS, SLIPPER SOCKS, SOCKS, HOSIERY, BANDANNAS, SCARVES, SHAWLS, SUSPENDERS, BATH ROBES, DRESSING GOWNS, APRONS, MUFFLERS, HATS, CAPS, HEADBANDS, GLOVES, BELTS, LINGERIE, WOMEN'S UNDERWEAR, NAMELY BRAS, PANTIES AND THONGS AND MEN'S UNDERWEAR, NAMELY BOXER SHORTS AND BRIEFS (U.S. CLS. 22 AND 39).

FIRST USE 7-27-2003; IN COMMERCE 7-27-2003.  
 WILLIAM P. SHANAHAN, EXAMINING ATTORNEY

THE NAME(S), PORTRAIT(S), AND/OR SIGNATURE(S) SHOWN IN THE MARK IDENTIFIES LINDA HARTMAN, WHOSE CONSENT(S) TO REGISTER IS SUBMITTED.

FOR CLOTHING, NAMELY, BODY SHAPERS, BODY SUITS, BRAS, BUSTIERS, CAMISOLES, FOUNDATION GARMENTS, GARTER BELTS, GIRDLES, HOSIERY, KNEE HIGHS, LEOTARDS, LINGERIE, LOUNGEWEAR, NEGLIGEES, NIGHT GOWNS, NIGHT SHIRTS, PAJAMAS, PANTIES, PANTYHOSE, SLEEPWEAR, SLIPS, SOCKS, STOCKINGS, TEDDIES, TIGHTS, UNDERPANTS, UNDERSHIRTS, UNDERWEAR AND VESTS (U.S. CLS. 22 AND 39).

FIRST USE 12-31-1999; IN COMMERCE 12-31-1999.  
 H. M. FISHER, EXAMINING ATTORNEY

**CLASS 25—(Continued).**

SN 78-290,912. RIDE TO WORK, PROCTOR, MN. FILED 8-22-2003.

**WORK TO RIDE RIDE TO WORK**

FOR SPECIALTY MOTORCYCLE CLOTHING AND ACCESSORIES, MORE SPECIFICALLY MOTORCYCLE JACKETS, SUITS, PANTS, SCARVES AND T-SHIRTS (U.S. CLS. 22 AND 39).

FIRST USE 0-0-1989; IN COMMERCE 0-0-1989.  
DEZMONA MIZELLE, EXAMINING ATTORNEY

SN 78-300,985. VALENTINO, LOUIS R., METHUEN, MA. FILED 9-16-2003.

**AMERICAN LATINO**

FOR CLOTHING NAMELY: T-SHIRTS, HATS, SHORTS, TANK TOPS, APRONS, SWEATERS, PANTS, SWEAT PANTS, SWEAT SHIRTS, SHIRTS, GOLF SHIRTS, ATHLETIC JERSEYS, SPORT SHIRTS, SWIM WEAR; NAMELY TRUNKS, BIKINIS AND SWIM SUITS, TUBE TOPS, UNDERWEAR, BOXERS, HAULTERS, CAPRI PANTS, POLOS, SLEEVELESS T-SHIRTS, COATS, CAPS, SHOES, SLIPPERS, SNEAKERS, SCARFS (U.S. CLS. 22 AND 39).

KENNETH D. BATTLE, EXAMINING ATTORNEY

SN 78-303,412. MEADOWS, ROBERT, DBA CAPITAL CLOTHING, LONG BEACH, CA. FILED 9-22-2003.



NO CLAIM IS MADE TO THE EXCLUSIVE RIGHT TO USE CLOTHING, APART FROM THE MARK AS SHOWN. THE MARK CONSISTS IN PART OF THE BACK-TO-BACK, STYLIZED LETTERS CC.

FOR CLOTHING, NAMELY, BEACH COVER-UPS, BOARD SHORTS, BELTS, BIKINIS, BLOUSES, BODY SUITS, COATS, DRESSES, GLOVES, JACKETS, JEANS, JERSEYS, JUMPSUITS, JACKETS, OVERALLS, OVERCOATS, PANTS, PULLOVERS, SCARVES, SHIRTS, SHORTS, SKIRTS, SLACKS, SNOW PANTS, SNOW SUITS, SOCKS, SUN VISORS, SWEATERS, SWIM SHORTS, TANK TOPS, TIES, T-SHIRTS, AND UNDERGARMENTS; HEADGEAR, NAMELY, BANDANAS, BASEBALL CAPS, BERETS, EAR MUFFS, AND HATS; FOOTWEAR, NAMELY, ATHLETIC SHOES, BOOTS, BOOTIES, BOOTS, SANDALS, SHOES, SLIPPERS, SNEAKERS, AND THONGS (U.S. CLS. 22 AND 39).

PRISCILLA MILTON, EXAMINING ATTORNEY

**CLASS 25—(Continued).**

SN 78-306,472. KING, ZAK, ANCHORAGE, AK. FILED 9-29-2003.

**KING CLOTHING**

NO CLAIM IS MADE TO THE EXCLUSIVE RIGHT TO USE "CLOTHING", APART FROM THE MARK AS SHOWN. FOR CLOTHING AND HEADWEAR, NAMELY T-SHIRTS, SHORTS, SWEAT PANTS, SWEAT SHIRTS, JACKETS, HATS, JEANS, SLACKS, WOVEN SHIRTS, KNIT SHIRTS, TANK TOPS AND SOCKS (U.S. CLS. 22 AND 39).

FIRST USE 7-22-2003; IN COMMERCE 7-22-2003.  
KIM SAITO, EXAMINING ATTORNEY

SN 78-308,208. JT INTERNATIONAL DISTRIBUTORS, INC., INDIANAPOLIS, IN. FILED 10-1-2003.



FOR RIDING APPAREL IN THE NATURE OF COATS (U.S. CLS. 22 AND 39).

FIRST USE 10-31-1987; IN COMMERCE 10-31-1987.  
BRIDGETT SMITH, EXAMINING ATTORNEY

SN 78-311,972. SARA LEE GLOBAL FINANCE, L.L.C., WILMINGTON, DE. FILED 10-10-2003.

**C9**

FOR MEN'S, WOMEN'S AND CHILDREN'S CLOTHING, NAMELY, PANTS, SHIRTS, T-SHIRTS, SHORTS, SWEATSHIRTS, SWEATPANTS, UNDERWEAR, SHOES, SOCKS; SPORTS BRAS AND TOPS (U.S. CLS. 22 AND 39).

KAREN BRACEY, EXAMINING ATTORNEY

**CLASS 25—(Continued).**

SN 78-313,303. LOVETEEES.COM, STUDIO CITY, CA. FILED 10-14-2003.

**I** ♥ **Cali**

NO CLAIM IS MADE TO THE EXCLUSIVE RIGHT TO USE "CALI", APART FROM THE MARK AS SHOWN. FOR T-SHIRTS (U.S. CLS. 22 AND 39). KIMBERLY PERRY, EXAMINING ATTORNEY

SN 78-314,973. KOBRA INTERNATIONAL, LTD., NEW YORK, NY. FILED 10-17-2003.

**MILLERGIRL @ NICOLE MILLER**

NICOLE MILLER IDENTIFIES A PARTICULAR LIVING INDIVIDUAL WHOSE CONSENT IS OF RECORD. FOR WOMEN'S PANTS, SHIRTS, TANK TOPS, SKIRTS, JACKETS, DRESSES, SWEATERS, SHORTS AND JEANS (U.S. CLS. 22 AND 39). CAROLYN CATALDO, EXAMINING ATTORNEY

SN 78-316,207. E.S. ORIGINALS, INC., NEW YORK, NY. FILED 10-21-2003.

**FABRI-LITE**

FOR FOOTWEAR (U.S. CLS. 22 AND 39). NAAKWAMA ANKRAH, EXAMINING ATTORNEY

SN 78-316,705. BROOKER, ALLISON, LOS ANGELES, CA. FILED 10-21-2003.

**SE\_KÜ** SKATEWEAR

NO CLAIM IS MADE TO THE EXCLUSIVE RIGHT TO USE "SKATEWEAR", APART FROM THE MARK AS SHOWN.

FOR GARMENTS FOR ICE SKATING, NAMELY, DRESSES, SKIRTS, PANTS, SWEAT SHIRTS, LEOTARDS, T SHIRTS, TIGHTS, LEG WARMERS, ARM WARMERS, BOOT COVERS, JACKETS, HATS, SCARVES (U.S. CLS. 22 AND 39). FIRST USE 5-1-2003; IN COMMERCE 5-15-2003. CHERYL STEPLIGHT, EXAMINING ATTORNEY

**CLASS 25—(Continued).**

SN 78-317,736. KRACHT, TOM ALBERT, GARDEN GROVE, CA. FILED 10-23-2003.

**SIN FOR SALE**

FOR T-SHIRTS (U.S. CLS. 22 AND 39). CAROLYN CATALDO, EXAMINING ATTORNEY

SN 78-328,763. KLASSIC WRAPS, INC., CHICAGO, IL. FILED 11-17-2003.

**KLASSIC SOLUTIONS**

THE MARK CONSISTS OF STANDARD CHARACTERS WITHOUT CLAIM TO ANY PARTICULAR FONT, STYLE, SIZE, OR COLOR.

NO CLAIM IS MADE TO THE EXCLUSIVE RIGHT TO USE "CLASSIC", APART FROM THE MARK AS SHOWN.

FOR CLOTHING, NAMELY, HEADWEAR, HEAD WRAPS, SCARVES, HAT BANDS, SASHES, SHOULDER DRAPES, SHAWLS, SARONGS AND SKULL CAPS (U.S. CLS. 22 AND 39).

SEAN DWYER, EXAMINING ATTORNEY

SN 78-332,435. PACIFIC SHOE CORPORATION, HUNTINGTON BEACH, CA. FILED 11-24-2003.

**MEZLAN**

THE MARK CONSISTS OF STANDARD CHARACTERS WITHOUT CLAIM TO ANY PARTICULAR FONT, STYLE, SIZE, OR COLOR.

OWNER OF U.S. REG. NOS. 1,891,185 AND 2,400,686.

FOR SHOES (U.S. CLS. 22 AND 39).

FIRST USE 12-31-1969; IN COMMERCE 12-31-1983.

KATHRYN COWARD, EXAMINING ATTORNEY

**CLASS 25—(Continued).**

SN 78-338,536. FERA INTERNATIONAL CORPORATION,  
TORRANCE, CA. FILED 12-9-2003.



OWNER OF U.S. REG. NO. 1,406,801.  
FOR CLOTHING, NAMELY, SKIWEAR (U.S. CLS. 22  
AND 39).  
FIRST USE 11-18-2003; IN COMMERCE 11-18-2003.  
VIVIAN MICZNIK FIRST, EXAMINING ATTORNEY

SN 78-342,002. SHERWOOD ARCHERY, INC., BELLEVUE,  
NE. FILED 12-17-2003.



OWNER OF U.S. REG. NO. 2,446,945.  
NO CLAIM IS MADE TO THE EXCLUSIVE RIGHT TO  
USE "ARCHERY INC.", APART FROM THE MARK AS  
SHOWN.  
THE MARK CONSISTS OF A DESIGN OF A HAT AND  
FEATHER WITH A BANNER APPEARING THEREUNDER.  
FOR CLOTHING, NAMELY, PANTS, SHIRTS, HATS,  
SOCKS, GLOVES, COVERALLS, COATS, JACKETS,  
THERMAL UNDERWEAR, BOOTS, ALL FOR USE IN  
CONNECTION WITH THE SPORT OF ARCHERY (U.S.  
CLS. 22 AND 39).  
DORITT L. CARROLL, EXAMINING ATTORNEY

SN 78-344,438. R.G. BARRY (TEXAS) L.P., PICKERINGTON,  
OH. FILED 12-22-2003.

**TRACK STRIDERS**

THE MARK CONSISTS OF STANDARD CHARACTERS  
WITHOUT CLAIM TO ANY PARTICULAR FONT, STYLE,  
SIZE, OR COLOR.  
FOR FOOTWEAR, NAMELY FLIP FLOPS, SANDALS,  
SLIPPERS, SLIPPER SOCKS (U.S. CLS. 22 AND 39).  
TARAH HARDY, EXAMINING ATTORNEY

**CLASS 25—(Continued).**

SN 78-347,381. HKK ENTERPRISES, INC., ALPINE, CA.  
FILED 1-2-2004.



NO CLAIM IS MADE TO THE EXCLUSIVE RIGHT TO  
USE SPORTS, APART FROM THE MARK AS SHOWN.  
FOR WOMENS AND GIRLS SPORTS APPAREL;  
NAMELY, SHORTS, SHIRTS, TEE-SHIRTS, BRAS,  
SOCKS, SHOES, PANTS, WINDRESISTANT SHIRTS,  
RAINWEAR, HALTERS, HATS, VISORS, SWIMSUITS,  
SWIM CAPS (U.S. CLS. 22 AND 39).  
PRISCILLA MILTON, EXAMINING ATTORNEY

SN 78-349,082. WARNER BROS. ENTERTAINMENT INC.,  
BURBANK, CA. FILED 1-7-2004.

**THE SORTING HAT**

THE MARK CONSISTS OF STANDARD CHARACTERS  
WITHOUT CLAIM TO ANY PARTICULAR FONT, STYLE,  
SIZE, OR COLOR.

OWNER OF U.S. REG. NOS. 2,595,096 AND 2,759,251.  
NO CLAIM IS MADE TO THE EXCLUSIVE RIGHT TO  
USE "HAT", APART FROM THE MARK AS SHOWN.  
FOR CLOTHING FOR MEN, WOMEN AND CHILDREN -  
NAMELY, SHIRTS, T-SHIRTS, SWEATSHIRTS,  
JOGGING SUITS, TROUSERS, PANTS, SHORTS, TANK  
TOPS, RAINWEAR, CLOTH BABY BIBS, SKIRTS,  
BLOUSES, DRESSES, SUSPENDERS, SWEATERS, JACKETS,  
COATS, RAINCOATS, SNOW SUITS, TIES, ROBES,  
HATS, CAPS, SUNVISORS, BELTS, SCARVES, SLEEPWEAR,  
PAJAMAS, LINGERIE, UNDERWEAR, BOOTS, SHOES,  
SNEAKERS, SANDALS, BOOTIES, SLIPPER SOCKS,  
SWIMWEAR AND MASQUERADE AND HALLOWEEN  
COSTUMES AND MASKS SOLD IN CONNECTION  
THEREWITH (U.S. CLS. 22 AND 39).  
LINDA M. KING, EXAMINING ATTORNEY

**CLASS 25—(Continued).**

SN 78-349,411. L.C. GROUP, INC., DBA LIQUID CULTURE, SARASOTA, FL. FILED 1-8-2004.

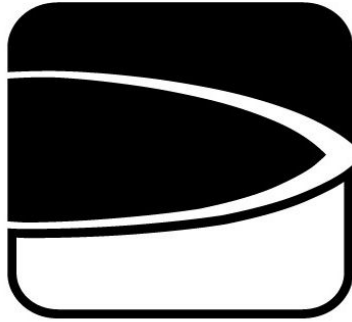

FOR SHIRTS, PANTS, SHORTS, HATS, CAPS, SWIM WEAR (U.S. CLS. 22 AND 39).  
WILLIAM VERHOSEK, EXAMINING ATTORNEY

**CLASS 25—(Continued).**

SN 78-350,926. REQUISITE SOLUTIONS INCORPORATED, CHICAGO, IL. FILED 1-12-2004.

**PATRIOT NATION**

THE MARK CONSISTS OF STANDARD CHARACTERS WITHOUT CLAIM TO ANY PARTICULAR FONT, STYLE, SIZE, OR COLOR.

FOR FOOTWEAR; HEADWEAR; APPAREL, NAMELY, T-SHIRTS, SHIRTS, SHOOTING SHIRTS, SHORTS, SWEAT PANTS, SWEAT SHIRTS, PANTS, CAPS, HATS, WRIST BANDS, HEAD BANDS, SOCKS, WARM-UP SUITS, JACKETS, BOXER SHORTS AND FLEECE TOPS (U.S. CLS. 22 AND 39).  
ALEXANDER L. POWERS, EXAMINING ATTORNEY

SN 78-350,509. HOT TOPIC, INC., CITY OF INDUSTRY, CA. FILED 1-12-2004.

SN 78-351,709. DIM S.A., PARIS, FRANCE, FILED 1-14-2004.



**DIMOBILE**

OWNER OF U.S. REG. NOS. 2,592,892, 2,592,894 AND 2,776,258.

THE MARK CONSISTS OF A HEART SURROUNDED BY A LARGE FLAME.

FOR CLOTHING, NAMELY, DRESSES, SKIRTS, BLOUSES, JACKETS, PANTS, SHORTS, T-SHIRTS, SWEATERS, SCARVES, JUMPERS, LINGERIE, PAJAMAS, NIGHTGOWNS, ROBES, LOUNGEWEAR, CASUAL DRESSY SHOES, SANDALS, BOOTS, RUBBER BOOTS, FOOTWEAR, SLIPS, UNDERGARMENTS, PANTIES, SWEATPANTS, SWEATSHIRTS, SWEATSUITS; PERFORMANCE WEAR, NAMELY, JERSEYS, BICYCLE PANTS, GYMNASIATIC SUITS; SPORTSWEAR, NAMELY PRINTED T-SHIRTS, SWIMWEAR, SWIMSUIT COVER-UPS, LEOTARDS, TIGHTS, SOCKS, SHORTS AND HATS; OUTERWEAR, NAMELY, OVERCOATS, VESTS, SHELLS, OVERALLS, KNIT HATS, SCARVES, GLOVES; AND HEADGEAR, NAMELY, HATS, CAPS AND VISORS (U.S. CLS. 22 AND 39).  
ALEX KEAM, EXAMINING ATTORNEY

THE MARK CONSISTS OF STANDARD CHARACTERS WITHOUT CLAIM TO ANY PARTICULAR FONT, STYLE, SIZE, OR COLOR.

FOR T-SHIRTS, TANK TOPS, CAMISOLES, PANTS, SHIRTS, JACKETS, SKIRTS, SWEATERS, UNDERWEAR, TIGHTS, SHORTS, PANTIES AND BRAS (U.S. CLS. 22 AND 39).  
STACY WAHLBERG, EXAMINING ATTORNEY

**CLASS 25—(Continued).**

SN 78-351,936. L.F.P., INC., BEVERLY HILLS, CA. FILED 1-14-2004.

**THE HUSTLER CLUB**

THE MARK CONSISTS OF STANDARD CHARACTERS WITHOUT CLAIM TO ANY PARTICULAR FONT, STYLE, SIZE, OR COLOR.

OWNER OF U.S. REG. NOS. 2,410,985, 2,689,852 AND 2,773,372.

FOR CLOTHING, NAMELY, SHIRTS, T-SHIRTS, SWEATSHIRTS, BEACH WEAR, BLOUSES, COATS, COVERALLS, DRESSES, HEAD WEAR, JACKETS, JEANS, JOGGING SUITS, SWEATERS, JUMPERS, LEG WARMERS, LEGGINGS, LINGERIE, LOUNGE WEAR, NECKWEAR, PANTS, SHORTS, SCARVES, SKI WEAR, SLACKS, SLEEP WEAR, TANK TOPS, SOCKS, VESTS, LINGERIE, UNDERWEAR; FOOTWEAR, NAMELY, SHOES, BOOTS, SOCKS, SANDALS AND THONGS; LEATHER WEAR, NAMELY, BODY SUITS, PANTS, TOPS, BELTS, STRAPS, HARNESSSES, HOODS, MASKS, BLINDFOLDS, GAGS, COLLARS, CHOKERS, HAND-CUFFS AND ANKLE CUFFS (U.S. CLS. 22 AND 39).

GRETTA YAO, EXAMINING ATTORNEY

SN 78-352,091. RSDG INTERNATIONAL, INC., MONROVIA, CA. FILED 1-14-2004.

**PINK POODLE**

THE MARK CONSISTS OF STANDARD CHARACTERS WITHOUT CLAIM TO ANY PARTICULAR FONT, STYLE, SIZE, OR COLOR.

FOR CHILDREN'S CLOTHING; NAMELY, SHIRTS, T-SHIRTS, TANK TOPS, BLOUSES, SKIRTS, PANTS, JUMPERS, OVERALLS, SWEATERS, SWEATSHIRTS, SWEAT-PANTS, JACKETS, LEGGINGS, SOCKS, MUFFLERS, CAPS AND HATS (U.S. CLS. 22 AND 39).

ELIZABETH PIGNATELLO, EXAMINING ATTORNEY

SN 78-352,371. HEINRICH, KYLE, HUNTINGTON BEACH, CA. FILED 1-15-2004.



FOR FOOTWEAR, T-SHIRTS, SWEATSHIRTS AND HATS (U.S. CLS. 22 AND 39).

JEFFREY S. MOLINOFF, EXAMINING ATTORNEY

**CLASS 25—(Continued).**

SN 78-352,442. SHOLK, JEFFREY CLAY, LEUCADIA, CA. FILED 1-15-2004.

**PUP DOG**

THE MARK CONSISTS OF STANDARD CHARACTERS WITHOUT CLAIM TO ANY PARTICULAR FONT, STYLE, SIZE, OR COLOR.

FOR CLOTHING, NAMELY, SHIRTS, T-SHIRTS, SHORTS, PANTS, JACKETS, SWIMSUITS AND HATS (U.S. CLS. 22 AND 39).

JOHN LINCOSKI, EXAMINING ATTORNEY

SN 78-352,609. DICARLO, LOUIS, NEW YORK, NY. FILED 1-15-2004.

**Lucchetto**

THE MARK CONSISTS OF STANDARD CHARACTERS WITHOUT CLAIM TO ANY PARTICULAR FONT, STYLE, SIZE, OR COLOR.

THE FOREIGN WORDING IN THE MARK TRANSLATES INTO ENGLISH AS LOCK.

FOR CLOTHING, NAMELY, PANTS, JACKETS, SHIRTS, COATS, SWEATERS, BELTS, SHOES, HATS, UNDERWEAR, BRAS, SWIMSUITS, SOCKS, PANTY HOSE, VESTS, DRESSES, SLACKS, SHORTS, AND SKIRTS (U.S. CLS. 22 AND 39).

NAKWAMA ANKRAH, EXAMINING ATTORNEY

**CLASS 25—(Continued).**

SN 78-353,531. BACKSTREETPROMOTIONS.COM INC, ST PETERSBURG, FL. FILED 1-19-2004.

# Got Dog

THE MARK CONSISTS OF STANDARD CHARACTERS WITHOUT CLAIM TO ANY PARTICULAR FONT, STYLE, SIZE, OR COLOR.

FOR HATS, VISORS, T-SHIRTS, SWEATSHIRTS, POLO SHIRTS, SHORTS AND JEANS (U.S. CLS. 22 AND 39).

FIRST USE 1-7-2004; IN COMMERCE 1-15-2004.  
RONALD AIKENS, EXAMINING ATTORNEY

---

SN 78-353,655. HATS WITH GLASSES, LLC, CHARLOTTE, NC. FILED 1-19-2004.

# SHADESAVER

THE MARK CONSISTS OF STANDARD CHARACTERS WITHOUT CLAIM TO ANY PARTICULAR FONT, STYLE, SIZE, OR COLOR.

FOR HATS (U.S. CLS. 22 AND 39).  
FIRST USE 11-15-2003; IN COMMERCE 1-16-2004.  
DARRYL SPRUILL, EXAMINING ATTORNEY

---

SN 78-354,954. DEBI ROSE MEDIA, NAPA, CA. FILED 1-21-2004.

# MAKING IT MEATLESS

THE MARK CONSISTS OF STANDARD CHARACTERS WITHOUT CLAIM TO ANY PARTICULAR FONT, STYLE, SIZE, OR COLOR.

FOR APRONS, T-SHIRTS, SWEATSHIRTS, SHIRTS, JACKETS, SWEATERS, CAPS, HATS, SCARVES AND NECKTIES (U.S. CLS. 22 AND 39).

FIRST USE 11-30-2003; IN COMMERCE 11-30-2003.  
ANN E. SAPPENFIELD, EXAMINING ATTORNEY

**CLASS 25—(Continued).**

SN 78-355,874. JONES INVESTMENT CO. INC., WILMINGTON, DE. FILED 1-22-2004.

# JEANSTAR

THE MARK CONSISTS OF STANDARD CHARACTERS WITHOUT CLAIM TO ANY PARTICULAR FONT, STYLE, SIZE, OR COLOR.

FOR CLOTHING, NAMELY, DRESSES, SKIRTS, PANTS, SHORTS, TOPS, SHIRTS, BLOUSES, JUMPSUITS AND JACKETS (U.S. CLS. 22 AND 39).

FIRST USE 7-15-2003; IN COMMERCE 7-15-2003.  
RON FAIRBANKS, EXAMINING ATTORNEY

---

SN 78-356,253. MALIBU SHIRTS, INC., MALIBU, CA. FILED 1-23-2004.

# SURF LEGENDS OF HAWAII

THE MARK CONSISTS OF STANDARD CHARACTERS WITHOUT CLAIM TO ANY PARTICULAR FONT, STYLE, SIZE, OR COLOR.

FOR SHIRTS, T-SHIRTS, TANK TOPS, TUBE TOPS, SKIRTS, DRESSES, SOCKS, SWEATSHIRTS, SWEATERS, JACKETS, BATHING SUITS, SHORTS, PANTS, HATS, CAPS, BEANIES (U.S. CLS. 22 AND 39).

BRIAN PINO, EXAMINING ATTORNEY



**CLASS 25—(Continued).**

SN 78-356,605. DAVID & GOLIATH, INC., CLEARWATER, FL. FILED 1-23-2004.

**JACK THE NERD**

THE MARK CONSISTS OF STANDARD CHARACTERS WITHOUT CLAIM TO ANY PARTICULAR FONT, STYLE, SIZE, OR COLOR.

FOR BASEBALL CAPS, BOXER BRIEFS, BOXER SHORTS, BRIEFS, PAJAMAS, PANTIES, SHIRTS, SLIPPERS, SOCKS, THONGS, T-SHIRTS, UNDERGARMENTS, UNDERPANTS, UNDERSHIRTS, UNDERWEAR (U.S. CLS. 22 AND 39).

DAVID TAYLOR, EXAMINING ATTORNEY

**CLASS 25—(Continued).**

SN 78-357,476. INDIGOGROUP U S A, GARDENA, CA. FILED 1-26-2004.

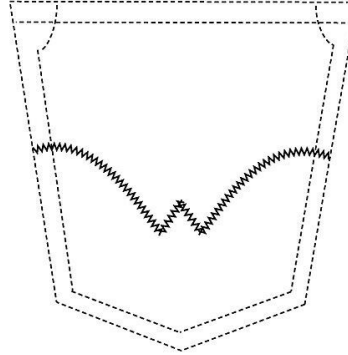

THE MARK CONSISTS OF FANCIFUL STITCHED WINGED-SHAPED PATTERN. DOTTED LINES REPRESENT POSITION OF MARK ONLY AND ARE NOT PART OF THE MARK.

FOR CLOTHING, NAMELY, JEANS, PANTS, SHORTS, SKIRTS, JACKETS (U.S. CLS. 22 AND 39).

HELEN BRYAN, EXAMINING ATTORNEY

SN 78-357,430. REGALITI, INC., NEW YORK, NY. FILED 1-26-2004.

**EXTREME FLEECE**

THE MARK CONSISTS OF STANDARD CHARACTERS WITHOUT CLAIM TO ANY PARTICULAR FONT, STYLE, SIZE, OR COLOR.

NO CLAIM IS MADE TO THE EXCLUSIVE RIGHT TO USE "FLEECE", APART FROM THE MARK AS SHOWN.

FOR LADIES' KNITTED TOPS, PULLOVERS, SWEATSHIRTS, JACKETS, VESTS, PANTS, AND SKIRTS (U.S. CLS. 22 AND 39).

CAROLYN CATALDO, EXAMINING ATTORNEY

SN 78-357,785. MALIBU SHIRTS, INC., MALIBU, CA. FILED 1-26-2004.

**MALIBU SURFBOARD COMPANY**

THE MARK CONSISTS OF STANDARD CHARACTERS WITHOUT CLAIM TO ANY PARTICULAR FONT, STYLE, SIZE, OR COLOR.

NO CLAIM IS MADE TO THE EXCLUSIVE RIGHT TO USE "MALIBU" AND "COMPANY", APART FROM THE MARK AS SHOWN.

FOR SHIRTS, T-SHIRTS, TANK TOPS, SKIRTS, DRESSES, SOCKS, SWEATSHIRTS, SWEATERS, JACKETS, BATHING SUITS, SHORTS, PANTS, HATS, CAPS, BEANIES (U.S. CLS. 22 AND 39).

MICHAEL KEATING, EXAMINING ATTORNEY

**CLASS 25—(Continued).**

SN 78-358,079. FORTUNE FASHIONS INDUSTRIES, LLC,  
VERNON, CA. FILED 1-27-2004.

## BEST PALS

THE MARK CONSISTS OF STANDARD CHARACTERS  
WITHOUT CLAIM TO ANY PARTICULAR FONT, STYLE,  
SIZE, OR COLOR.

FOR CLOTHING, NAMELY, T-SHIRTS, SWEAT-  
SHIRTS, TANK TOPS, SWEATERS, SHIRTS, FLEECE  
JACKETS, FLEECE CARDIGANS, SWEATPANTS, LEG-  
GINGS, SHORTS, PANTS, UNDERGARMENTS, LOUN-  
GEWEAR, SLEEPWEAR; HEADWEAR, NAMELY, CAPS  
AND VISORS (U.S. CLS. 22 AND 39).

FIRST USE 3-20-1994; IN COMMERCE 3-20-1994.  
RON FAIRBANKS, EXAMINING ATTORNEY

---

SN 78-358,101. LATIBAER EHF., GARDABAER, ICELAND,  
FILED 1-27-2004.

## SPORTACUS

THE MARK CONSISTS OF STANDARD CHARACTERS  
WITHOUT CLAIM TO ANY PARTICULAR FONT, STYLE,  
SIZE, OR COLOR.

FOR CLOTH BIBS, SWEATERS, HALLOWEEN COS-  
TUMES, DRESSES, GLOVES, MITTENS, ANKLETS,  
HOSIERY, SOCKS, INFANT WEAR, JACKETS, PANTS,  
SWEAT PANTS, SWEAT SHIRTS, SHIRTS, SHORTS,  
SLEEPERS, NIGHTGOWNS, TANK TOPS, VESTS,  
SKIRTS, LEGGINGS, SCARVES, TIES, ANORAKS,  
APRONS, ATHLETIC FOOTWEAR, ATHLETIC SHOES,  
ATHLETIC UNIFORMS, BASEBALL CAPS, BATH SLIP-  
PERS, BATHING SUITS, BATHROBES, BEACH SHOES,  
BEACHWEAR, CLOTHING BELTS, BIKINIS, FOOTBALL  
SHOES, FOOTWEAR, NAMELY PUMPS, RUBBERS,  
SNEAKERS AND SANDALS, HEADGEAR, NAMELY  
HATS, CAPS, PAJAMAS, SNOW PANTS, SNOW SUITS,  
SNOWBOARD BOOTS, SNOWBOARD GLOVES, T-  
SHIRTS, UNDERCLOTHES, AND BICYCLE GLOVES  
(U.S. CLS. 22 AND 39).

ANDREA K. NADELMAN, EXAMINING ATTORNEY

**CLASS 25—(Continued).**

SN 78-358,771. MCM GROUP INTERNATIONAL, INC., SAN  
PEDRO, CA. FILED 1-28-2004.

## Second Chance Creations

THE MARK CONSISTS OF STANDARD CHARACTERS  
WITHOUT CLAIM TO ANY PARTICULAR FONT, STYLE,  
SIZE, OR COLOR.

NO CLAIM IS MADE TO THE EXCLUSIVE RIGHT TO  
USE "CREATIONS", APART FROM THE MARK AS  
SHOWN.

FOR CLOTHING, NAMELY, SHIRTS, JACKETS AND  
BELTS (U.S. CLS. 22 AND 39),  
RICHARD WHITE, EXAMINING ATTORNEY

---

SN 78-358,877. MITCHWORLD, L.L.C., SCOTTSDALE, AZ.  
FILED 1-28-2004.

## THE MAN-WRAP

THE MARK CONSISTS OF STANDARD CHARACTERS  
WITHOUT CLAIM TO ANY PARTICULAR FONT, STYLE,  
SIZE, OR COLOR.

FOR ROBES (U.S. CLS. 22 AND 39),  
FIRST USE 10-16-2003; IN COMMERCE 11-17-2003.  
MICHAEL KEATING, EXAMINING ATTORNEY

**CLASS 25—(Continued).**

SN 78-358,924. ASKEW, REBECCA A., LITTLETON, CO. FILED 1-28-2004.

**HAUGHTY**

THE MARK CONSISTS OF STANDARD CHARACTERS WITHOUT CLAIM TO ANY PARTICULAR FONT, STYLE, SIZE, OR COLOR.

FOR CLOTHING FOR MEN, WOMEN, AND CHILDREN, NAMELY, HATS, HEADBANDS, NECK WARMERS AND SCARVES; HOODS, MITTENS AND GLOVES; SHIRTS, T-SHIRTS, PANTS, SHORTS, COATS, JACKETS, SWEATSHIRTS, DRESSES, SWEATERS, PAJAMAS, ROBES, INFANT WEAR, SOCKS AND FOOTWEAR (U.S. CLS. 22 AND 39).

WILLIAM VERHOSEK, EXAMINING ATTORNEY

**CLASS 25—(Continued).**

SN 78-359,502. WAX LLC, NEW YORK, NY. FILED 1-29-2004.



FOR ATHLETIC SHOES, BATHING SUITS, BATH-ROBES, BEACHWEAR, COATS, GLOVES, HATS, HOSIERY, JACKETS, JEANS, PAJAMAS, PANTS, SANDALS, SHIRTS, SOCKS, SWEATERS, SWEATSUITS, SWEATSHIRTS, T-SHIRTS, UNDERWEAR (U.S. CLS. 22 AND 39).

ZACHARY BELLO, EXAMINING ATTORNEY

SN 78-358,966. LERENA, HERNANDEZ JAVIER, ARNEDO, SPAIN, FILED 1-28-2004.

**CAPODARTE**

THE MARK CONSISTS OF STANDARD CHARACTERS WITHOUT CLAIM TO ANY PARTICULAR FONT, STYLE, SIZE, OR COLOR.

FOR FOOTWEAR, NAMELY, BOOTS, SHOES, SLIPPERS, CLOGS AND SANDALS (U.S. CLS. 22 AND 39). FIRST USE 11-1-2003; IN COMMERCE 11-17-2003.

MICHAEL KAZAZIAN, EXAMINING ATTORNEY

SN 78-359,520. MUNNE, ALAN, ORLANDO, FL. FILED 1-29-2004.

**ANKLE BREAKER**

THE MARK CONSISTS OF STANDARD CHARACTERS WITHOUT CLAIM TO ANY PARTICULAR FONT, STYLE, SIZE, OR COLOR.

FOR CLOTHING, NAMELY, SHIRTS, T-SHIRTS, JACKETS, PANTS, SHORTS, SWEAT PANTS, SWEAT SHIRTS, HATS, CAPS, SWEAT BANDS, ROBES, SOCKS AND SHOES (U.S. CLS. 22 AND 39).

RON FAIRBANKS, EXAMINING ATTORNEY

**CLASS 25—(Continued).**

SN 78-361,210. POLLAK IMPORT-EXPORT CORPORATION,  
NEW YORK, NY. FILED 2-2-2004.

# PAK-A-JAK

THE MARK CONSISTS OF STANDARD CHARACTERS  
WITHOUT CLAIM TO ANY PARTICULAR FONT, STYLE,  
SIZE, OR COLOR.

FOR JACKET IN A SELF COLORED BAG (U.S. CLS. 22  
AND 39).

FIRST USE 5-0-2003; IN COMMERCE 12-0-2003.  
CYNTHIA SLOAN, EXAMINING ATTORNEY

**CLASS 25—(Continued).**

SN 78-361,749. KHEMIRI, HAMAIED, LOS ANGELES, CA.  
FILED 2-3-2004.

# CUACO

THE MARK CONSISTS OF STANDARD CHARACTERS  
WITHOUT CLAIM TO ANY PARTICULAR FONT, STYLE,  
SIZE, OR COLOR.

FOR MEN'S, WOMEN'S AND JUNIOR'S JEANS AND  
SHIRTS (U.S. CLS. 22 AND 39).

FIRST USE 1-15-2004; IN COMMERCE 1-15-2004.  
JIM RINGLE, EXAMINING ATTORNEY

---

SN 78-362,736. MARKS, ROBERT D., INDIANAPOLIS, IN.  
FILED 2-4-2004.

---

SN 78-361,362. FARR, SEAN R., PETLAUMA, CA. AND  
ERSKINE, JOHN M., RIO NIDO, CA. FILED 2-2-2004.

EVERYDAY FREAK



THE COLOR(S) BLACK, WHITE, GREEN, RED IS/ARE  
CLAIMED AS A DISTINCTIVE FEATURE OF THE MARK.

THE MARK CONSISTS OF MAN WITH RED SPIRAL EYE,  
GREEN PANTS, IN A WHITE STRAIGHT JACKET CURLED  
IN A WHITE CIRCLE. THE TEXT IS IN A CAPITAL  
LETTERS WITH THE FIRST LETTER OF EACH WORD (E,  
D & F) LARGER THAN THE REST OF THE LETTERS. THE  
LARGER LETTERS HAVE RIVETS OUTLINED IN BLACK.

FOR HATS AND SHIRTS (U.S. CLS. 22 AND 39).  
FIRST USE 4-6-2002; IN COMMERCE 1-21-2003.  
ALICE BENMAMAN, EXAMINING ATTORNEY

# CHINTZY

THE MARK CONSISTS OF STANDARD CHARACTERS  
WITHOUT CLAIM TO ANY PARTICULAR FONT, STYLE,  
SIZE, OR COLOR.

FOR BELTS (U.S. CLS. 22 AND 39).  
MICHELE SWAIN, EXAMINING ATTORNEY

**CLASS 25—(Continued).**

SN 78-362,784. PROMOWORX, WOBURN, MA. FILED 2-4-2004.

**CLASS 25—(Continued).**

SN 78-362,859. CEJON ACCESSORIES, INC., NEW YORK, NY. FILED 2-5-2004.

**CEJON BEACHWEAR****Hoobie**

THE MARK CONSISTS OF STANDARD CHARACTERS WITHOUT CLAIM TO ANY PARTICULAR FONT, STYLE, SIZE, OR COLOR.

OWNER OF U.S. REG. NOS. 1,772,462 AND 2,282,071.

NO CLAIM IS MADE TO THE EXCLUSIVE RIGHT TO USE "BEACHWEAR", APART FROM THE MARK AS SHOWN.

FOR SWIMSUITS, PANTS AND PAREU (U.S. CLS. 22 AND 39).

FIRST USE 11-0-2003; IN COMMERCE 11-0-2003.

CATHERINE CAIN, EXAMINING ATTORNEY

THE MARK CONSISTS OF STANDARD CHARACTERS WITHOUT CLAIM TO ANY PARTICULAR FONT, STYLE, SIZE, OR COLOR.

FOR SHIRTS, SWEAT SHIRTS, PANTS, SHORTS, HATS, CAPS, BATHING SUITS, WRISTBANDS, VESTS, JACKETS, RAIN BOOTS, RAIN COATS, RAIN JACKETS, RAIN SUITS, TANK TOPS, HALTER TOPS, BRAS, BRIEFS, THERMAL UNDERWEAR, THONGS, UNDERWEAR, GLOVES, SOCKS (U.S. CLS. 22 AND 39).

MICHELE SWAIN, EXAMINING ATTORNEY

SN 78-363,311. DRAB, FRANCIS P., CHELTENHAM, PA. FILED 2-5-2004.

**The Comfortable  
Tool**

THE MARK CONSISTS OF STANDARD CHARACTERS WITHOUT CLAIM TO ANY PARTICULAR FONT, STYLE, SIZE, OR COLOR.

FOR MEN'S, LADIES'S AND CHILDREN'S SOCKS AND HOSIERY (U.S. CLS. 22 AND 39).

GIANCARLO CASTRO, EXAMINING ATTORNEY

SN 78-362,853. CEJON ACCESSORIES, INC., NEW YORK, NY. FILED 2-5-2004.

**CEJON**

SN 78-363,323. MAIDENFORM, INC., NEW YORK, NY. FILED 2-5-2004.

**ONE FABULOUS  
MOMENT**

THE MARK CONSISTS OF STANDARD CHARACTERS WITHOUT CLAIM TO ANY PARTICULAR FONT, STYLE, SIZE, OR COLOR.

OWNER OF U.S. REG. NOS. 1,772,462 AND 2,282,071.

FOR SCARVES, BEACHWEAR, BEACH WRAPS, PAREU AND SWIMSUITS (U.S. CLS. 22 AND 39).

FIRST USE 4-0-1993; IN COMMERCE 4-0-1993.

CATHERINE CAIN, EXAMINING ATTORNEY

THE MARK CONSISTS OF STANDARD CHARACTERS WITHOUT CLAIM TO ANY PARTICULAR FONT, STYLE, SIZE, OR COLOR.

FOR WOMEN'S UNDERGARMENTS, FOUNDATION GARMENTS, LINGERIE, BRASSIERES, BUSTIERS, PANTIES, UNDERWEAR, BRIEFS, BODY BRIEFERS, BODY SUITS, SHAPEWEAR, GIRDLES, CAMISOLES, SLEEPWEAR (U.S. CLS. 22 AND 39).

TRICIA SONNEBORN, EXAMINING ATTORNEY

**CLASS 25—(Continued).**

SN 78-363,334. MAIDENFORM, INC., NEW YORK, NY.  
FILED 2-5-2004.

**ONE FABULOUS FEEL**

THE MARK CONSISTS OF STANDARD CHARACTERS WITHOUT CLAIM TO ANY PARTICULAR FONT, STYLE, SIZE, OR COLOR.

FOR WOMEN'S UNDERGARMENTS, FOUNDATION GARMENTS, LINGERIE, BRASSIERES, BUSTIERS, PANTIES, UNDERWEAR, BRIEFS, BODY BRIEFERS, BODY SUITS, SHAPEWEAR, GIRDLES, CAMISOLES, SLEEPWEAR (U.S. CLS. 22 AND 39).

TRICIA SONNEBORN, EXAMINING ATTORNEY

SN 78-365,258. RAPPINBRANDS, LLC, WHITE PLAINS, NY.  
FILED 2-10-2004.

**LUCKY NITES**

THE MARK CONSISTS OF STANDARD CHARACTERS WITHOUT CLAIM TO ANY PARTICULAR FONT, STYLE, SIZE, OR COLOR.

FOR SHIRTS, JACKETS, HATS, HOSIERY, FOOTWEAR, T-SHIRTS, SWEAT SHIRTS, SWEATPANTS, PANTS, TANK TOPS, JERSEYS, SHORTS, PAJAMAS, SPORT SHIRTS, RUGBY SHIRTS, BASKETBALL SHIRTS, BASKETBALL SHORTS, SWEATERS, BELTS, TIES, CLOTH BIBS, HEAD BANDS, WRIST BANDS, APRONS, BOXER SHORTS, SLACKS, CAPS, EAR MUFFS, GLOVES, TURTLENECK SWEATERS, V NECK SWEATERS, TUNICS, VESTS, QUILTED VESTS, BLOUSES, CHEMISES, JOGGING SUITS, MINI SKIRTS, VISORS, BANDANAS, RAIN COATS, SOCKS, SHOES, BOOTS, SLIPPERS, POLO SHIRTS, UNDERGARMENTS, UNDERSHIRTS, OVERALLS, FASHION SCARVES, PARKAS, WALKING SHORTS, KNIT SHORTS, WOVEN SHIRTS, WOVEN DRESSES, PULLOVERS, CARDIGANS, DRESSES, TRACK SUITS, GOLF SHIRTS, DRESS SHIRTS, ARMBANDS, SNEAKERS, JEANS, UNIFORMS, BRAS, ROBES, TIGHTS, BRIEFS, SLEEP WEAR, LOUNGEWEAR, HALTER TOPS, GYM SHORTS, BEACH WEAR, LEGGINGS, LEOTARDS, MITTENS, UNDERPANTS, GIRDLES, MASQUERADE COSTUMES, INFANT WEAR, SANDALS, BLAZERS, SWIMWEAR, JUMPSUITS, KNEE HIGHS, LEG WARMERS, PANTY-HOSE, PANTIES, ROMPERS, SHAWLS, SKIRTS, STOCKINGS, TENNIS WEAR, GOWNS, BONNETS, LINGERIE, UNITARDS, BATHING CAPS, WARM UP PANTS, BIKE SHORTS, SNOW PANTS, SKI WEAR, SNOWSUITS, PEIGNOIRS, SLIPS, CAMISOLES, BUSTIERS, TEDDIES, TUXEDOS, BATHING SUITS, BATHING COVER UPS, TEAM UNIFORMS, DANCEWEAR NAMELY BODY-SUITS, PLAYSUITS, CLOTH DIAPERS, TROUSERS, NIGHTGOWNS, SWIM TRUNKS AND MEN'S SUITS (U.S. CLS. 22 AND 39).

MARGERÝ A. TIERNEY, EXAMINING ATTORNEY

**CLASS 26—FANCY GOODS**

SN 76-551,063. RENE OF PARIS, INC., VAN NUYS, CA.  
FILED 9-23-2003.

**SUPREME AMORE HUMAN HAIR SERIES**

THE MARK CONSISTS OF STANDARD CHARACTERS WITHOUT CLAIM TO ANY PARTICULAR FONT, STYLE, SIZE, OR COLOR.

OWNER OF U.S. REG. NO. 2,572,175.

NO CLAIM IS MADE TO THE EXCLUSIVE RIGHT TO USE SUPREME AND HUMAN HAIR SERIES, APART FROM THE MARK AS SHOWN.

THE ENGLISH TRANSLATION OF "AMORE" IS "LOVE" OR "AFFECTION".

FOR WIGS AND HAIRPIECES (U.S. CLS. 37, 39, 40, 42 AND 50).

FIRST USE 5-30-2003; IN COMMERCE 5-30-2003.

LAURA KOVAISKY, EXAMINING ATTORNEY

SN 76-553,081. HAIR ZEST INT'L, INC., PARAMOUNT, CA.  
FILED 9-29-2003.

**OSCAR K**

FOR WIGS AND HAIR PIECES (U.S. CLS. 37, 39, 40, 42 AND 50).

FIRST USE 1-1-2000; IN COMMERCE 1-1-2000.

GIANCARLO CASTRO, EXAMINING ATTORNEY

SN 76-567,538. INGENUITY, INC., WEST PALM BEACH, FL.  
FILED 12-17-2003.

**INGENUITY**

THE MARK CONSISTS OF STANDARD CHARACTERS WITHOUT CLAIM TO ANY PARTICULAR FONT, STYLE, SIZE, OR COLOR.

FOR HUMAN HAIR EXTENSIONS, SYNTHETIC HAIR EXTENSIONS, HUMAN HAIR WIGS, SYNTHETIC HAIR WIGS, HAIR ACCESSORIES, NAMELY HAIR CLIPS, HAIR PINS, AND HAIR ORNAMENTS (U.S. CLS. 37, 39, 40, 42 AND 50).

ALLISON HOLTZ, EXAMINING ATTORNEY

**CLASS 26—(Continued).**

SN 78-354,243. ALLIED ELECTRONICS INC., FORT WORTH, TX. FILED 1-20-2004.

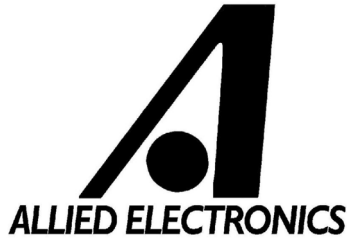

OWNER OF U.S. REG. NOS. 2,707,231, 2,713,586 AND 2,773,580.

NO CLAIM IS MADE TO THE EXCLUSIVE RIGHT TO USE "ELECTRONICS", APART FROM THE MARK AS SHOWN.

FOR SNAP FASTENERS, SLIDE FASTENERS, AND HOOK AND LOOP FASTENING TAPE (U.S. CLS. 37, 39, 40, 42 AND 50).

FIRST USE 5-23-2001; IN COMMERCE 5-23-2001.  
DAVID MURRAY, EXAMINING ATTORNEY

SN 78-359,346. SOMMERVILLE, ANNJANETTE M, YORBA LINDA, CA. FILED 1-29-2004.



THE COLOR(S) GREEN,PINK,YELLOW IS/ARE CLAIMED AS A DISTINCTIVE FEATURE OF THE MARK.  
THE MARK CONSISTS OF GREEN LETTERS AND PINK FLOWERS WITH YELLOW CENTERS REPRESENTING THE LETTER "O".

FOR HAIR ORNAMENTS (U.S. CLS. 37, 39, 40, 42 AND 50).  
HEATHER THOMPSON, EXAMINING ATTORNEY

**CLASS 27—FLOOR COVERINGS**

SN 76-574,848. FARROW & BALL HOLDINGS LIMITED, DORSET BH21 7NL, ENGLAND, FILED 2-6-2004.



FOR WALLPAPER (U.S. CLS. 19, 20, 37, 42 AND 50).  
FIRST USE 12-0-1998; IN COMMERCE 12-0-1998.  
M. E. BODSON, EXAMINING ATTORNEY

SN 78-351,661. INTERNATIONAL FLOORS OF AMERICA, INC., FLORENCE, AL. FILED 1-14-2004.



THE MARK CONSISTS OF STANDARD CHARACTERS WITHOUT CLAIM TO ANY PARTICULAR FONT, STYLE, SIZE, OR COLOR.

FOR VINYL FLOOR COVERINGS (U.S. CLS. 19, 20, 37, 42 AND 50).

FIRST USE 7-31-1997; IN COMMERCE 7-31-1997.  
JOHN HWANG, EXAMINING ATTORNEY

**CLASS 28—TOYS AND SPORTING GOODS**

SN 75-607,990. COSTCO WHOLESALE CORPORATION, ISSAQUAH, WA. FILED 12-18-1998.



FOR DECORATIONS FOR CHRISTMAS TREES; CHRISTMAS TREE STANDS; ORNAMENTS FOR CHRISTMAS TREES; CHRISTMAS DECORATIONS, NAMELY, SLEIGHS, NUTCRACKER FIGURINES, SANTAS, REINDEER, AND SNOWMEN; CHRISTMAS ORNAMENTS NOT INCLUDING CHRISTMAS TREE ORNAMENTS; CHRISTMAS TREE SKIRTS; CHRISTMAS TREE STAND COVERS; CHRISTMAS STOCKINGS; CHRISTMAS STOCKING HOLDERS; ARTIFICIAL CHRISTMAS GARLANDS; ARTIFICIAL CHRISTMAS WREATHS; ANIMATED AND NON-ANIMATED CHRISTMAS TOY DECORATIONS, MODELS AND FIGURINES USED FOR DECORATIVE DISPLAY (U.S. CLS. 22, 23, 38 AND 50).

FIRST USE 9-23-1991; IN COMMERCE 9-23-1991.  
DANIEL CAPSHAW, EXAMINING ATTORNEY

**CLASS 28—(Continued).**

SN 76-153,082. LEYNIAN LTD. CO., NEW SMYMA BEACH, FL. FILED 10-24-2000.

**FREESTYLE**

FOR TOYS, EXCEPT FOR CONSTRUCTION TOYS, NAMELY, TOY VEHICLES, DOLLS, ROBOTS, BOARD GAMES AND ACTION FIGURES; TOY VEHICLE PLAYSETS; ELECTRIC VEHICLE RACING SETS; MODEL CARS, MODEL PLANES, MODEL BOATS, MODEL TRAINS, AND VEHICLE MODEL KITS; PLUSH TOYS; AND RADIO CONTROLLED TOYS, NAMELY, R/C VEHICLES AND ROBOTS (U.S. CLS. 22, 23, 38 AND 50).  
PAULA MAHONEY, EXAMINING ATTORNEY

SN 76-284,834. TOMMY HILFIGER LICENSING, INC., WILMINGTON, DE. FILED 7-5-2001.

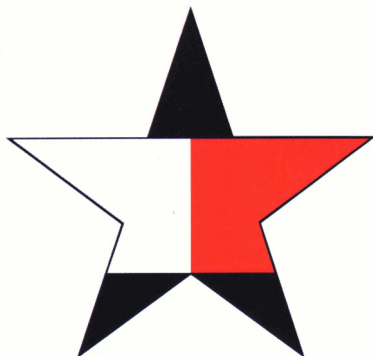

OWNER OF U.S. REG. NOS. 1,460,988, 2,025,974 AND OTHERS.

THE COLOR(S) RED, WHITE AND BLUE IS/ARE CLAIMED AS A FEATURE OF THE MARK.

THE MARK CONSISTS OF A FIVE-POINTED STAR INCLUDING THE COLORS RED, WHITE AND BLUE. THE TOP POINT AND BOTTOM TWO POINTS ARE BLUE. THE MIDDLE OF THE STAR IS DIVIDED INTO TWO EQUAL PARTS. THE RIGHT SIDE, INCLUDING THE RIGHT POINT, IS RED AND THE LEFT SIDE, INCLUDING THE LEFT POINT, IS WHITE.

FOR TOYS, GAMES, PLAYTHINGS, CHILDREN'S AND INFANTS TOYS, NAMELY, BABY RATTLES; PLAY BLOCKS; PLUSH BLOCKS; STUFFED AND PLUSH ANIMALS; INFANT CRIB TOYS; PUPPETS; MOBILES; PLAY QUILTS; MUSIC BOXES; SQUEEZABLE SQUEAKING TOYS; WASHABLE PLAY BOOKS; EDUCATIONAL AND PARLOR-TYPE BOARD AND CARD GAMES; GOLF ACCESSORIES; NAMELY, CLUB HEAD COVERS; GOLF BALL SLEEVES; TENNIS RACKET COVERS; PLAY PAILS AND SHOVELS; KITES, BOOMERANGS; CHRISTMAS TREE ORNAMENTS (U.S. CLS. 22, 23, 38 AND 50).

FIRST USE 10-31-2000; IN COMMERCE 10-31-2000.  
M. L. HERSHKOWITZ, EXAMINING ATTORNEY

**CLASS 28—(Continued).**

SN 76-296,907. TAKARA CO., LTD., AOTO KATSUSHIKAKU, JAPAN, FILED 8-8-2001.

**BEYBLADE**

FOR DIAMOND GAMES, TOY SPINNING TOPS, MASCOT DOLLS AND SKATEBOARDS (U.S. CLS. 22, 23, 38 AND 50).

AMY HELLA, EXAMINING ATTORNEY

SN 76-366,829. ARCHER, MICHAEL WILLIAM, LONDON, ONTARIO, CANADA, FILED 2-5-2002.

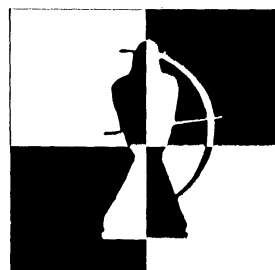

**Archers Chess**

PRIORITY CLAIMED UNDER SEC. 44(D) ON CANADA APPLICATION NO. 1113061, FILED 8-15-2001, REG. NO. TMA611084, DATED 5-26-2004, EXPIRES 5-26-2019.

NO CLAIM IS MADE TO THE EXCLUSIVE RIGHT TO USE "CHESS", APART FROM THE MARK AS SHOWN. FOR BOARD GAME (U.S. CLS. 22, 23, 38 AND 50).  
AMY GEARIN, EXAMINING ATTORNEY

SN 76-461,385. WGP, LLC C/O JOHN D. FLYNN C/O BRASS EAGLE, LLC, BENTONVILLE, AR. FILED 10-24-2002.

**OUTKAST**

FOR PAINTBALL MARKERS, COMPONENTS FOR PAINTBALL MARKERS, NAMELY, CONTAINERS, FILL ADAPTERS, REGULATORS, BARRELS, FILL ADAPTERS, OPEN SIGHTS, TELESCOPIC SIGHTS; PAINTBALL GUNS FOR FIRING TAG CARTRIDGES; PAINTBALL ACCESSORIES, NAMELY, TAGGING PELLETS AND CARTRIDGES; PAINTBALL AMMUNITION, NAMELY, PAINTBALLS AND PELLETS (U.S. CLS. 22, 23, 38 AND 50).

FIRST USE 8-1-2002; IN COMMERCE 8-1-2002.  
WON TEAK OH, EXAMINING ATTORNEY



**CLASS 28—(Continued).**

SN 76-524,303. BEE TEE INCORPORATED, TUCKERTON, NJ. FILED 6-13-2003.

The logo for ULTRA VIO'S features the word 'ULTRA' in a simple, outlined font, followed by 'VIO'S' in a larger, more stylized font. The 'V' is particularly large and has a sun-like symbol with rays above it.

FOR JIGSAW PUZZLES HAVING PHOTOSENSITIVE INKS TO CHANGE COLOR WHEN EXPOSED TO SUN-LIGHT (U.S. CLS. 22, 23, 38 AND 50).  
NELSON SNYDER, EXAMINING ATTORNEY

**CLASS 28—(Continued).**

SN 76-538,310. ESSENCE OF LIFE LTD., TEL AVIV 64367, ISRAEL, FILED 8-18-2003.

**LET'S JOIN TOGETHER**

PRIORITY CLAIMED UNDER SEC. 44(D) ON ISRAEL APPLICATION NO. 162809, FILED 2-16-2003, REG. NO. 162809, DATED 2-3-2004, EXPIRES 2-16-2010.

FOR STUFFED DOLLS, DOLLS, DOLL PLAYSETS, STUFFED TOY ANIMALS, EDUCATIONAL TOYS, NAMELY, CHILDRENS' ACTIVITY KITS UTILIZING INTERCHANGEABLE DESIGN STICKERS, PRE-CUT PLASTIC MATERIALS, CARDBOARD AND OTHER MATERIALS; GAMES (U.S. CLS. 22, 23, 38 AND 50).  
CHRIS WELLS, EXAMINING ATTORNEY

SN 76-527,030. PITSCO, INC., PITTSBURG, KS. FILED 6-30-2003.

**QUIZ WIZARD**

FOR ELECTRONIC GAME EQUIPMENT FOR INDICATING PRIORITY OF PARTICIPANT RESPONSES TO ORAL QUESTIONS POSED DURING A GAME, SOLD TO EDUCATORS AND EDUCATIONAL INSTITUTIONS (U.S. CLS. 22, 23, 38 AND 50).  
MICHAEL SOUDERS, EXAMINING ATTORNEY

SN 76-549,770. MERIT INDUSTRIES, INC., BENSALEM, PA. FILED 9-15-2003.

**MEGATOUCH MAXX  
SAPPHIRE EDITION**

NO CLAIM IS MADE TO THE EXCLUSIVE RIGHT TO USE "EDITION", APART FROM THE MARK AS SHOWN.  
FOR COIN OPERATED VIDEO OUTPUT GAME MACHINES (U.S. CLS. 22, 23, 38 AND 50).  
FIRST USE 7-25-2003; IN COMMERCE 7-25-2003.  
PATRICIA EVANKO, EXAMINING ATTORNEY

SN 76-528,031. REVELL-MONOGRAM, LLC, NORTH-BROOK, IL. FILED 7-7-2003.

**LOW-RODS**

FOR PLASTIC TOY MODEL HOBBYCRAFT KITS; PLASTIC TOY MODEL KIT CARS; DIE CAST TOYS, NAMELY, TOY VEHICLES (U.S. CLS. 22, 23, 38 AND 50).  
LINDA E. BLOHM, EXAMINING ATTORNEY

SN 76-565,229. KINGMAN INTERNATIONAL CORPORATION, BALDWIN PARK, CA. FILED 12-15-2003.

The logo for SPYDER e-MARKERS features the word 'SPYDER' in a large, bold, stylized font with a jagged, 'spider-like' appearance. Below it, 'e-MARKERS' is written in a smaller, simpler font.

SN 76-530,810. FUNRISE TOYS LTD., TSIMSHATSUI EAST, KOWLOON, HONG KONG, FILED 7-18-2003.

**LIBERATOR**

FOR TOYS, NAMELY, TOY MILITARY VEHICLES, PLANES, HELICOPTERS, AIRCRAFT CARRIERS, SUBMARINES AND TOY PLAYSETS THEREFOR (U.S. CLS. 22, 23, 38 AND 50).  
RICHARD A. STRASER, EXAMINING ATTORNEY

OWNER OF U.S. REG. NOS. 2,323,197, 2,544,704 AND OTHERS.

NO CLAIM IS MADE TO THE EXCLUSIVE RIGHT TO USE "E-MARKERS", APART FROM THE MARK AS SHOWN.

THE MARK CONSISTS OF THE WORDS SPYDER E-MARKERS IN A PARTICULAR FONT THAT ARE DISTINCTIVE FEATURES OF THE MARK. THE MARK IS DEPICTED IN BLACK AND WHITE COLORS WHICH IS NOT A DISTINCTIVE PORTION OF THE MARK.

FOR PAINTBALL GUNS, AND ACCESSORIES THEREFOR IN THE NATURE OF BARRELS, GRIP FRAMES, FRAME COVERS, GRIPS, EXPANSION CHAMBERS, SIGHT RAILS, TRIGGER ASSEMBLIES, BARREL PLUGS, AND TURBULENCE BOLTS (U.S. CLS. 22, 23, 38 AND 50).

WON TEAK OH, EXAMINING ATTORNEY

**CLASS 28—(Continued).**

SN 78-026,440. DAIMLERCHRYSLER CORPORATION, AUBURN HILLS, MI. FILED 9-18-2000.

**PT CRUISER**

OWNER OF U.S. REG. NO. 2,371,607 AND OTHERS. FOR TOYS, NAMELY, MODEL REPLICAS OF LAND VEHICLES. (U.S. CLS. 22, 23, 38 AND 50).  
REBECCA SMITH, EXAMINING ATTORNEY

SN 78-028,033. ESTERHUYSE, NICOLAAS KENNE, STRAND, WESTERN CAPE, SOUTH AFRICA, FILED 9-28-2000.

**30 SECONDS**

OWNER OF SOUTH AFRICA REG. NO. 1998/14173, DATED 8-11-1998, EXPIRES 8-11-2008.

FOR EQUIPMENT SOLD AS A UNIT FOR PLAYING A BOARD GAME, NAMELY, A PLAYING BOARD, RULES OF PLAY, NAME AND WORD CARDS, CARD AND BOX HOLDERS, TIMER, DIE AND PLAYER TOKENS (U.S. CLS. 22, 23, 38 AND 50).

LAURA KOVAISKY, EXAMINING ATTORNEY

SN 78-100,655. KELSON, MICHAEL, NEW YORK, NY. FILED 1-3-2002.

**HIP HOP PARTY BALLOONS**

NO CLAIM IS MADE TO THE EXCLUSIVE RIGHT TO USE "PARTY BALLOONS", APART FROM THE MARK AS SHOWN.

FOR BALLOONS WITH SPECIAL MESSAGES FOR ALL OCCASIONS (U.S. CLS. 22, 23, 38 AND 50).

FIRST USE 7-23-2001; IN COMMERCE 7-23-2001.

AMY HELLA, EXAMINING ATTORNEY

SN 78-288,539. MATTEL, INC., EL SEGUNDO, CA. FILED 8-18-2003.

**SPIT 'N STICK**

FOR TOYS, GAMES AND PLAYTHINGS, NAMELY, TOY ACTION FIGURES AND ACCESSORIES THEREFOR (U.S. CLS. 22, 23, 38 AND 50).

TONJA GASKINS, EXAMINING ATTORNEY

**CLASS 28—(Continued).**

SN 78-289,061. FERRARI S.P.A., 41100 MODENA, ITALY, FILED 8-19-2003.

**FERRARI**

OWNER OF ERPN CMNTY TM OFC REG. NO. 001616473, DATED 11-27-1998, EXPIRES 1-30-2007.

OWNER OF U.S. REG. NOS. 1,825,268, 2,801,663 AND OTHERS.

FOR TOY AND PLAYTHINGS, NAMELY TOY MODEL CARS IN AN ASSEMBLY KIT FORM, TOY MODEL VEHICLES, TOY COLLECTION MODELS REPRODUCING AUTOMOBILES AND OTHER VEHICLES; TOY BUILDING STRUCTURES, DOLLS, DOLL'S CLOTHING, ACCESSORIES FOR DOLLS, SOFT FELT TOYS, TOY VEHICLE TRACKS, TOY REAL SIZE NON-OPERATING REPLICAS OF AUTOMOBILES FOR ORNAMENT, ENTERTAINMENT AND EXHIBITION PURPOSES; GAME PUZZLES, VIDEO GAMES, NAMELY STAND ALONE VIDEO GAME MACHINES, AMUSEMENT APPARATUS, NAMELY PINBALL MACHINES, HAND HELD VIDEO GAMES; TENNIS BAGS, GOLF BAGS, GOLF POUCHES, GOLF CLUBS, PLAYING CARDS (U.S. CLS. 22, 23, 38 AND 50).

ANN LINNEHAN, EXAMINING ATTORNEY

SN 78-296,498. MATTEL, INC., EL SEGUNDO, CA. FILED 9-5-2003.

**DUCHESS EMMA**

THE LIKENESS (OR, "PORTRAIT") IN THE MARK DOES NOT IDENTIFY A LIVING INDIVIDUAL.

FOR TOYS, GAMES AND PLAYTHINGS, NAMELY, DOLLS, DOLL CLOTHING AND DOLL ACCESSORIES (U.S. CLS. 22, 23, 38 AND 50).

ANN E. SAPPENFIELD, EXAMINING ATTORNEY

SN 78-303,293. PROSOFT SOFTWARE, INC., WAYNE, PA. FILED 9-22-2003.

**CMETRICK**

FOR MANIPULATIVE PUZZLES (U.S. CLS. 22, 23, 38 AND 50).

FIRST USE 2-28-2004; IN COMMERCE 3-10-2004.

BARBARA GAYNOR, EXAMINING ATTORNEY

SN 78-316,958. LOVELL, JOHN G., SR., DBA BONUS GAMES, KNOXVILLE, TN. FILED 10-22-2003.

**JACKS OR BETTER**

OWNER OF U.S. REG. NO. 1,741,242.

SEC. 2(F).

FOR PRINTED GAME CARDS (U.S. CLS. 22, 23, 38 AND 50).

FIRST USE 4-5-1988; IN COMMERCE 4-5-1988.

DAWN FELDMAN, EXAMINING ATTORNEY

**CLASS 28—(Continued).**

SN 78-317,858. TAKARA U.S.A. CORPORATION, NEW YORK, NY. FILED 10-23-2003.

**ACE LEGEND**

FOR TOY MODEL AIRPLANES AND RELATED ACCESSORIES, SOLD AS A UNIT (U.S. CLS. 22, 23, 38 AND 50).

REBECCA GILBERT, EXAMINING ATTORNEY

---

SN 78-324,151. KID'S DIVISION OF MOTOR VEHICLES LLC, MARINA DEL REY, CA. FILED 11-6-2003.

**KID'S DIVISION OF  
MOTOR VEHICLES**

THE MARK CONSISTS OF STANDARD CHARACTERS WITHOUT CLAIM TO ANY PARTICULAR FONT, STYLE, SIZE, OR COLOR.

FOR TOYS, NAMELY, TOY TRUCKS AND CARS, TOY MODEL TRUCKS AND CARS AND TOY COLLECTIBLE TRUCKS AND CARS AND TOY CAR AND TRUCK DISPLAY CASES (U.S. CLS. 22, 23, 38 AND 50).

FIRST USE 10-8-2001; IN COMMERCE 6-26-2002.  
LESLEY LAMOTHE, EXAMINING ATTORNEY

---

SN 78-332,898. DRAGON TOYS LTD., HAMILTON, BERMU-  
DA, FILED 11-25-2003.

**WONDERFUL KIDS**

THE MARK CONSISTS OF STANDARD CHARACTERS WITHOUT CLAIM TO ANY PARTICULAR FONT, STYLE, SIZE, OR COLOR.

FOR DOLLS (U.S. CLS. 22, 23, 38 AND 50).  
G. T. GLYNN, EXAMINING ATTORNEY

**CLASS 28—(Continued).**

SN 78-335,086. FUN 4 EVERY 1, INC., LAWRENCEVILLE, GA. FILED 12-2-2003.



FOR INFLATABLE MOONBOUNCES AND PLAYGROUND EQUIPMENT, NAMELY, SLIDES (U.S. CLS. 22, 23, 38 AND 50).

ALEX KEAM, EXAMINING ATTORNEY

---

SN 78-339,141. POWERLUNG, INC., HOUSTON, TX. FILED  
12-10-2003.

**BreatheAir**

THE MARK CONSISTS OF STANDARD CHARACTERS WITHOUT CLAIM TO ANY PARTICULAR FONT, STYLE, SIZE, OR COLOR.

FOR MANUALLY OPERATED EXERCISE EQUIPMENT, NAMELY, AN INHALANT-FREE HAND-HELD LUNG MUSCLE RESISTANCE TRAINING DEVICE (U.S. CLS. 22, 23, 38 AND 50).

ALICIA COLLINS, EXAMINING ATTORNEY

**CLASS 28—(Continued).**

SN 78-340,070. J. RICHARD INDUSTRIES, INC., TOLEDO, OH. FILED 12-12-2003.

**CLASS 28—(Continued).**

SN 78-340,550. UNIVERSAL MANUFACTURING CO., INC., KANSAS CITY, MO. FILED 12-13-2003.

# THE REAL SINGLEWALL

# DAKOTA 300

THE MARK CONSISTS OF STANDARD CHARACTERS WITHOUT CLAIM TO ANY PARTICULAR FONT, STYLE, SIZE, OR COLOR.

NO CLAIM IS MADE TO THE EXCLUSIVE RIGHT TO USE "SINGLEWALL", APART FROM THE MARK AS SHOWN.

FOR BASEBALL AND SOFTBALL BATS (U.S. CLS. 22, 23, 38 AND 50).

ALICIA COLLINS, EXAMINING ATTORNEY

THE MARK CONSISTS OF STANDARD CHARACTERS WITHOUT CLAIM TO ANY PARTICULAR FONT, STYLE, SIZE, OR COLOR.

OWNER OF U.S. REG. NOS. 1,499,731 AND 1,743,356.

FOR GAME CARDS AND GAME TICKETS FOR PLAYING GAMES OF CHANCE (U.S. CLS. 22, 23, 38 AND 50).

FIRST USE 9-1-1994; IN COMMERCE 9-1-1994.

ALEX KEAM, EXAMINING ATTORNEY

SN 78-343,988. DEMARS, STEVEN C., GLENEDEN BEACH, OR. FILED 12-21-2003.

SN 78-340,549. UNIVERSAL MANUFACTURING CO., INC., KANSAS CITY, MO. FILED 12-13-2003.

# TRIPLE SEVEN SLOTS

# CRABHAWK

THE MARK CONSISTS OF STANDARD CHARACTERS WITHOUT CLAIM TO ANY PARTICULAR FONT, STYLE, SIZE, OR COLOR.

NO CLAIM IS MADE TO THE EXCLUSIVE RIGHT TO USE "TRIPLE SEVEN", APART FROM THE MARK AS SHOWN.

FOR GAME CARDS AND GAME TICKETS FOR PLAYING GAMES OF CHANCE (U.S. CLS. 22, 23, 38 AND 50).

FIRST USE 5-8-2003; IN COMMERCE 5-8-2003.

ALEX KEAM, EXAMINING ATTORNEY

THE MARK CONSISTS OF STANDARD CHARACTERS WITHOUT CLAIM TO ANY PARTICULAR FONT, STYLE, SIZE, OR COLOR.

FOR SPORT FISHING EQUIPMENT, NAMELY, CRAB TRAP IN THE NATURE OF A WIRE FRAME HAVING A FLEXIBLE MESH DISPOSED THEREOVER AND A BAIT HOLDER AFFIXED THEREIN (U.S. CLS. 22, 23, 38 AND 50).

FIRST USE 8-6-2002; IN COMMERCE 8-6-2002.

G. T. GLYNN, EXAMINING ATTORNEY

**CLASS 28—(Continued).**

SN 78-348,861. LAUER TOYS, INC., ST. LOUIS, MO. FILED 1-7-2004.

**CLASS 28—(Continued).**

SN 78-350,894. INRAY FITNESS PRODUCTS CORP., TAOYUAN HSIEN, TAIWAN, FILED 1-12-2004.

**WIGGLY WATERBABIES**

**Pro Energy**

THE MARK CONSISTS OF STANDARD CHARACTERS WITHOUT CLAIM TO ANY PARTICULAR FONT, STYLE, SIZE, OR COLOR.

OWNER OF U.S. REG. NO. 1,776,630.  
FOR DOLLS AND ACCESSORIES (U.S. CLS. 22, 23, 38 AND 50).  
LOURDES AYALA, EXAMINING ATTORNEY

THE MARK CONSISTS OF STANDARD CHARACTERS WITHOUT CLAIM TO ANY PARTICULAR FONT, STYLE, SIZE, OR COLOR.

FOR GYMNASTIC HORIZONTAL BARS; SPRING BARS FOR EXERCISING; MANUALLY-OPERATED EXERCISE EQUIPMENT; STATIONARY EXERCISE BICYCLES; AEROBIC STEP MACHINES; EXERCISE TRAMPOLINES; LEG WEIGHTS FOR EXERCISING; AND EXERCISING EQUIPMENTS, NAMELY, ROWING MACHINES, WEIGHT LIFTING MACHINES, PULLEYS, MANUALLY OPERATED JOGGING MACHINES, AND CHEST EXPANDERS (U.S. CLS. 22, 23, 38 AND 50).  
KIMBERLY FRYE, EXAMINING ATTORNEY

SN 78-350,457. SASSY PRODUCT DEVELOPMENT AND MARKETING, INC., LAFAYETTE, CA. FILED 1-12-2004.

SN 78-350,902. CASEY, CARL, EL SOBRANTE, CA. FILED 1-12-2004.

**GEYSER FLYER**

**LIBERTY BELL**

THE MARK CONSISTS OF STANDARD CHARACTERS WITHOUT CLAIM TO ANY PARTICULAR FONT, STYLE, SIZE, OR COLOR.

NO CLAIM IS MADE TO THE EXCLUSIVE RIGHT TO USE "FLYER", APART FROM THE MARK AS SHOWN.  
FOR FLYING DISC TOY (U.S. CLS. 22, 23, 38 AND 50).  
ELIZABETH PIGNATELLO, EXAMINING ATTORNEY

THE MARK CONSISTS OF STANDARD CHARACTERS WITHOUT CLAIM TO ANY PARTICULAR FONT, STYLE, SIZE, OR COLOR.

FOR FISHING LURES (U.S. CLS. 22, 23, 38 AND 50).  
SHARON MEIER, EXAMINING ATTORNEY

**CLASS 28—(Continued).**

SN 78-351,332. N'GEN NEW GENERATION INNOVATIONS L.L.C., LITTLETON, CO. FILED 1-13-2004.

**DynaFlex**

FOR PET TOYS MADE OF COMBINED ELASTOMERS;  
PET TOYS (U.S. CLS. 22, 23, 38 AND 50).  
BRIAN PINO, EXAMINING ATTORNEY

SN 78-351,629. FISHEL, ALAN GREGG, VIENNA, VA. FILED 1-14-2004.

**GEOCHALLENGE CARDS**

THE MARK CONSISTS OF STANDARD CHARACTERS WITHOUT CLAIM TO ANY PARTICULAR FONT, STYLE, SIZE, OR COLOR.

NO CLAIM IS MADE TO THE EXCLUSIVE RIGHT TO USE "CARDS", APART FROM THE MARK AS SHOWN.

FOR PLAYING CARDS, NAMELY CARDS USED IN GEOGRAPHY-RELATED GAMES TO HAVE FUN AND TEACH GEOGRAPHY (U.S. CLS. 22, 23, 38 AND 50).

ANN LINNEHAN, EXAMINING ATTORNEY

SN 78-352,211. NEW ARCHERY PRODUCTS CORP., FOREST PARK, IL. FILED 1-15-2004.

**NAPFLAGE**

THE MARK CONSISTS OF STANDARD CHARACTERS WITHOUT CLAIM TO ANY PARTICULAR FONT, STYLE, SIZE, OR COLOR.

FOR ARCHERY GOODS, NAMELY, ARCHERY COMPONENTS MOUNTED TO AN ARCHERY BOW, INCLUDING BOW STABILIZERS (U.S. CLS. 22, 23, 38 AND 50).

JOHN DALIER, EXAMINING ATTORNEY

**CLASS 28—(Continued).**

SN 78-352,216. NEW ARCHERY PRODUCTS CORP., FOREST PARK, IL. FILED 1-15-2004.

**SPINTAB**

THE MARK CONSISTS OF STANDARD CHARACTERS WITHOUT CLAIM TO ANY PARTICULAR FONT, STYLE, SIZE, OR COLOR.

FOR ARCHERY GOODS, NAMELY, ARROWHEADS, BROADHEADS, AND BLADES FOR ARROWHEADS OR BROADHEADS (U.S. CLS. 22, 23, 38 AND 50).

JOHN DALIER, EXAMINING ATTORNEY

SN 78-353,450. BANDAI ENTERTAINMENT INC., CYPRESS, CA. FILED 1-17-2004.

**DICE DNA  
INTEGRATED  
CYBERNETIC  
ENTERPRISES**

THE MARK CONSISTS OF STANDARD CHARACTERS WITHOUT CLAIM TO ANY PARTICULAR FONT, STYLE, SIZE, OR COLOR.

FOR VIDEO GAMES, NAMELY COIN OPERATED AND AUTOMATIC VIDEO GAME MACHINES IN THE NATURE OF AMUSEMENT PARK MACHINES AND COIN OPERATED VEHICLES FOR USE IN AMUSEMENT PARKS; ELECTRONIC GAME MACHINES, NAMELY VIDEO AND STAND ALONE OUTPUT GAMES MACHINES; LCD GAME MACHINES; PINBALL MACHINES, ARCADE GAMES; BALLS FOR GAMES, NAMELY BASEBALLS, BEACH BALLS, RUBBER BALLS AND SPORTS BALLS; MAGIC TRICKS, DOMINOES, MARBLES FOR GAMES; STUFFED TOYS, TOY VEHICLES, TOY FIGURES, TOY ROBOTS; TOYS FOR INTELLECTUAL TRAINING, NAMELY ACTIVITY TOYS AND BOARD GAMES, TOY SPINNING TOPS, KITES, YO-YO'S, PUZZLES; CARD GAMES, AND PROMOTIONAL CARD GAMES; PLASTIC MODEL KITS, NAMELY TOY MODEL HOBBY CRAFT KITS AND SCALE MODEL VEHICLES; TOYS IN THE NATURE OF CANDY DISPENSERS; CONSTRUCTION SETS AND BUILDING BLOCKS (U.S. CLS. 22, 23, 38 AND 50).

CAROLINE WEIMER, EXAMINING ATTORNEY

**CLASS 28—(Continued).**

SN 78-353,659. FONTAINE, MARIA, PICO RIVERA, CA. FILED 1-19-2004.

**CLASS 28—(Continued).**

SN 78-354,242. KARSTEN MANUFACTURING CORPORATION, PHOENIX, AZ. FILED 1-20-2004.

GloryRing

TRAILBLAZER

THE MARK CONSISTS OF STANDARD CHARACTERS WITHOUT CLAIM TO ANY PARTICULAR FONT, STYLE, SIZE, OR COLOR.

FOR DANCE HOOPS, DANCE HOOPS CONSISTING OF A RING ONTO WHICH COLORED RIBBONS ARE ATTACHED (U.S. CLS. 22, 23, 38 AND 50).

FIRST USE 1-31-2003; IN COMMERCE 1-16-2004.  
JOSETTE BEVERLY, EXAMINING ATTORNEY

THE MARK CONSISTS OF STANDARD CHARACTERS WITHOUT CLAIM TO ANY PARTICULAR FONT, STYLE, SIZE, OR COLOR.

FOR GOLF CLUBS (U.S. CLS. 22, 23, 38 AND 50).  
JANICE L. MCMORROW, EXAMINING ATTORNEY

SN 78-354,262. URBAN, KEITH, NASHVILLE, TN. FILED 1-20-2004.

SN 78-353,903. GEOFFREY, INC., WAYNE, NJ. FILED 1-20-2004.

PERI THE PUPPY  
RESCUE SET



THE MARK CONSISTS OF STANDARD CHARACTERS WITHOUT CLAIM TO ANY PARTICULAR FONT, STYLE, SIZE, OR COLOR.

NO CLAIM IS MADE TO THE EXCLUSIVE RIGHT TO USE PUPPY, APART FROM THE MARK AS SHOWN.

FOR PLUSH TOYS, TOY MEDICAL EQUIPMENT, TOY FOOD CAN, TOY COLLAR AND BRUSH (U.S. CLS. 22, 23, 38 AND 50).

ALICE BENMAMAN, EXAMINING ATTORNEY

FOR TOYS, NAMELY STUFFED ANIMALS (U.S. CLS. 22, 23, 38 AND 50).

JEAN IM, EXAMINING ATTORNEY

**CLASS 28—(Continued).**

SN 78-354,294. LIFETIME PRODUCTS, INC., CLEARFIELD, UT. FILED 1-20-2004.

**SHATTER GUARD**

THE MARK CONSISTS OF STANDARD CHARACTERS WITHOUT CLAIM TO ANY PARTICULAR FONT, STYLE, SIZE, OR COLOR.

FOR BASKETBALL EQUIPMENT, NAMELY, RIMS, BACKBOARDS, POLES, GOALS, NETS, FIXED BASKETBALL STANDARDS, IN-GROUND BASKETBALL STANDARDS, PORTABLE BASKETBALL STANDARDS, WEIGHT-BEARING BALLAST BASE FOR PORTABLE BASKETBALL STANDARDS, BASKETBALL GOAL HEIGHT ADJUSTMENT MECHANISMS, ARCADE-TYPE BASKETBALL GAMES AND RETURN MECHANISMS FOR RETURNING A BASKETBALL TO A USER (U.S. CLS. 22, 23, 38 AND 50).

PAUL F. GAST, EXAMINING ATTORNEY



SN 78-355,199. SPATAZZA, CARL, WINTER SPRINGS, FL. FILED 1-21-2004.

**MAFIAPOLY**

THE MARK CONSISTS OF STANDARD CHARACTERS WITHOUT CLAIM TO ANY PARTICULAR FONT, STYLE, SIZE, OR COLOR.

FOR BOARD GAMES (U.S. CLS. 22, 23, 38 AND 50). SEAN DWYER, EXAMINING ATTORNEY

**CLASS 28—(Continued).**

SN 78-355,294. BURROWS GOLF, INC., VALENCIA, CA. FILED 1-21-2004.

**HAMMERHEAD**

THE MARK CONSISTS OF STANDARD CHARACTERS WITHOUT CLAIM TO ANY PARTICULAR FONT, STYLE, SIZE, OR COLOR.

FOR GOLF CLUBS AND COMPONENT PARTS THEREOF, NAMELY, HEADS, SHAFTS AND GRIPS (U.S. CLS. 22, 23, 38 AND 50).

BRIDGETT SMITH, EXAMINING ATTORNEY



SN 78-356,518. RYAN, JOHN, NEW ROCHELLE, NY. AND DIGUGLIEMO, JOSEPH J., HARTSDALE, NY. FILED 1-23-2004.

**ABCLIMB**

THE MARK CONSISTS OF STANDARD CHARACTERS WITHOUT CLAIM TO ANY PARTICULAR FONT, STYLE, SIZE, OR COLOR.

FOR EXERCISE EQUIPMENT, NAMELY ABDOMINAL CONDITIONING MACHINE (U.S. CLS. 22, 23, 38 AND 50).

HELEN BRYAN, EXAMINING ATTORNEY



**CLASS 28—(Continued).**

SN 78-357,334. ROSSI INDUSTRIES, INC., CARPENTERSVILLE, IL. FILED 1-26-2004.

**CLASS 28—(Continued).**

SN 78-357,916. SOP SERVICES, INC., LAS VEGAS, NV. FILED 1-27-2004.

**TUSCANY**

THE MARK CONSISTS OF STANDARD CHARACTERS WITHOUT CLAIM TO ANY PARTICULAR FONT, STYLE, SIZE, OR COLOR.  
FOR GOLF PUTTERS (U.S. CLS. 22, 23, 38 AND 50).  
GRETTA YAO, EXAMINING ATTORNEY

**KICK ZONE**

THE MARK CONSISTS OF STANDARD CHARACTERS WITHOUT CLAIM TO ANY PARTICULAR FONT, STYLE, SIZE, OR COLOR.  
FOR SOCCER AND FOOSBALL GAME TABLES (U.S. CLS. 22, 23, 38 AND 50).  
NORA BUCHANAN WILL, EXAMINING ATTORNEY

SN 78-357,765. JAS. D. EASTON, INC., VAN NUYS, CA. FILED 1-26-2004.

SN 78-358,039. ICON IP, INC., LOGAN, UT. FILED 1-27-2004.

**OPTIFLEX**

THE MARK CONSISTS OF STANDARD CHARACTERS WITHOUT CLAIM TO ANY PARTICULAR FONT, STYLE, SIZE, OR COLOR.  
FOR BASEBALL AND SOFTBALL BATS (U.S. CLS. 22, 23, 38 AND 50).  
MARTHA FROMM, EXAMINING ATTORNEY

**FUN RING**

THE MARK CONSISTS OF STANDARD CHARACTERS WITHOUT CLAIM TO ANY PARTICULAR FONT, STYLE, SIZE, OR COLOR.  
NO CLAIM IS MADE TO THE EXCLUSIVE RIGHT TO USE "RING", APART FROM THE MARK AS SHOWN.  
FOR TRAMPOLINE ENCLOSURES (U.S. CLS. 22, 23, 38 AND 50).  
FIRST USE 11-0-1998; IN COMMERCE 11-0-1998.  
DARRYL SPRUILL, EXAMINING ATTORNEY

**CLASS 28—(Continued).**

SN 78-359,015. BIG BOING TOYS, LLC, SAUSALITO, CA.  
FILED 1-28-2004.

**TUB TUNES**

THE MARK CONSISTS OF STANDARD CHARACTERS  
WITHOUT CLAIM TO ANY PARTICULAR FONT, STYLE,  
SIZE, OR COLOR.

NO CLAIM IS MADE TO THE EXCLUSIVE RIGHT TO  
USE "TUB", APART FROM THE MARK AS SHOWN.  
FOR MUSICAL BATH TOYS (U.S. CLS. 22, 23, 38 AND  
50).

CHARLES JOYNER, EXAMINING ATTORNEY

**CLASS 28—(Continued).**

SN 78-360,154. LANE MASTERS, INC., STOCKTON, CA.  
FILED 1-30-2004.

**A Z O BY LANE  
MASTERS**

THE MARK CONSISTS OF STANDARD CHARACTERS  
WITHOUT CLAIM TO ANY PARTICULAR FONT, STYLE,  
SIZE, OR COLOR.

FOR BOWLING BALLS (U.S. CLS. 22, 23, 38 AND 50).  
FIRST USE 11-1-2003; IN COMMERCE 11-1-2003.

WILLIAM P. SHANAHAN, EXAMINING ATTORNEY

SN 78-361,907. EBSCO INDUSTRIES, INC., BIRMINGHAM,  
AL. FILED 2-3-2004.

**TRANSLATOR**

THE MARK CONSISTS OF STANDARD CHARACTERS  
WITHOUT CLAIM TO ANY PARTICULAR FONT, STYLE,  
SIZE, OR COLOR.

FOR DEER CALL (U.S. CLS. 22, 23, 38 AND 50).  
ALICE BENMAMAN, EXAMINING ATTORNEY

SN 78-359,308. J&M CUSTOM MOLD INC., COVENTRY, RI.  
FILED 1-29-2004.

**Crescent**

THE MARK CONSISTS OF STANDARD CHARACTERS  
WITHOUT CLAIM TO ANY PARTICULAR FONT, STYLE,  
SIZE, OR COLOR.

FOR GOLF CLUBS (U.S. CLS. 22, 23, 38 AND 50).  
NORA BUCHANAN WILL, EXAMINING ATTORNEY

SN 78-362,457. HUNTER'S SPECIALTIES, INC., CEDAR  
RAPIDS, IA. FILED 2-4-2004.

**MAC DADDY**

THE MARK CONSISTS OF STANDARD CHARACTERS  
WITHOUT CLAIM TO ANY PARTICULAR FONT, STYLE,  
SIZE, OR COLOR.

FOR HUNTING GAME CALLS (U.S. CLS. 22, 23, 38  
AND 50).

ELLEN PERKINS, EXAMINING ATTORNEY

**CLASS 28—(Continued).**

SN 78-364,393. ROSEKNOWS, INC., VIENNA, VA. FILED 2-7-2004.

**Everything a Board  
Game Should Be**

THE MARK CONSISTS OF STANDARD CHARACTERS WITHOUT CLAIM TO ANY PARTICULAR FONT, STYLE, SIZE, OR COLOR.

FOR BOARD GAMES; EQUIPMENT SOLD AS A UNIT FOR PLAYING A BOARD GAME (U.S. CLS. 22, 23, 38 AND 50).

FIRST USE 1-30-2004; IN COMMERCE 1-30-2004.

ELLEN PERKINS, EXAMINING ATTORNEY

---

SN 78-364,476. MANHATTAN GROUP, LLC, MINNEAPOLIS, MN. FILED 2-8-2004.

**VANESSA**

THE MARK CONSISTS OF STANDARD CHARACTERS WITHOUT CLAIM TO ANY PARTICULAR FONT, STYLE, SIZE, OR COLOR.

FOR DOLLS; PAPER DOLLS; GAMES, NAMELY, PARLOR GAMES, BOARD GAMES AND ACTIVITY GAMES; HOBBY CRAFT KITS COMPRISING KITS TO DECORATE AND CREATE DOLLS AND DOLL ACCESSORIES USING PAPER AND FABRIC; KITS TO CREATE HAIR ORNAMENTS, JEWELRY AND OTHER PERSONAL ACCESSORIES FOR CHILDREN AND DOLLS; PUZZLES; PARTY FAVORS IN THE NATURE OF NOISEMAKERS AND SMALL TOYS; DOLL FURNITURE; DOLL CLOTHING; DOLL ACCESSORIES; STUFFED ANIMALS FOR DOLLS; AND TOY PURSES (U.S. CLS. 22, 23, 38 AND 50).

DANIEL CAPSHAW, EXAMINING ATTORNEY

**CLASS 28—(Continued).**

SN 78-365,794. WARNER BROS. ENTERTAINMENT INC., BURBANK, CA. FILED 2-10-2004.

**OOMPA LOOMPA**

THE MARK CONSISTS OF STANDARD CHARACTERS WITHOUT CLAIM TO ANY PARTICULAR FONT, STYLE, SIZE, OR COLOR.

FOR TOYS AND SPORTING GOODS, INCLUDING GAMES AND PLAYTHINGS—NAMELY, ACTION FIGURES AND ACCESSORIES THEREFOR; PLUSH TOYS; BALLOONS; BATHTUB TOYS; RIDE-ON TOYS; EQUIPMENT SOLD AS A UNIT FOR PLAYING CARD GAMES; TOY VEHICLES; DOLLS; FLYING DISCS; ELECTRONIC HAND-HELD GAME UNIT; GAME EQUIPMENT SOLD AS A UNIT FOR PLAYING A BOARD GAME, A CARD GAME, A MANIPULATIVE GAME, A PARLOR GAME AND AN ACTION TYPE TARGET GAME; STAND ALONE VIDEO OUTPUT GAME MACHINES; JIGSAW AND MANIPULATIVE PUZZLES; PAPER FACE MASKS; SKATEBOARDS; ICE SKATES; WATER SQUIRTING TOYS; BALLS—NAMELY, PLAYGROUND BALLS, SOCCER BALLS, BASEBALLS, BASKETBALLS; BASEBALL GLOVES; SWIMMING FLOATS FOR RECREATIONAL USE; KICKBOARD FLOTATION DEVICES FOR RECREATIONAL USE; SURFBOARDS; SWIM BOARDS FOR RECREATIONAL USE; SWIM FINS; TOY BAKEWARE AND TOY COOKWARE; TOY BANKS; TOY SNOW GLOBES; AND CHRISTMAS TREE ORNAMENTS (U.S. CLS. 22, 23, 38 AND 50).

GEOFFREY FOSDICK, EXAMINING ATTORNEY

---

SN 78-366,288. AMERICAN GATEWAY MARKETING, INC., CAMARILLO, CA. FILED 2-11-2004.

**Aeromat**

THE MARK CONSISTS OF THE WORD "AEROMAT" IN A STYLIZED FORMAT APPEARING ABOVE A BLACK FIGURE WITH WHITE CIRCLES RANDOMLY THROUGHOUT.

FOR EXERCISE EQUIPMENT, NAMELY PERSONAL EXERCISE MATS, PERSONAL YOGA MATS, PERSONAL PILATES MATS, YOGA STRAPS (U.S. CLS. 22, 23, 38 AND 50).

FIRST USE 4-1-2000; IN COMMERCE 4-1-2000.

DORITT L. CARROLL, EXAMINING ATTORNEY

**CLASS 28—(Continued).**

SN 78-380,295. THE ORIGINAL SAN FRANCISCO TOY-MAKERS, SOUTH SAN FRAN, CA. FILED 3-8-2004.

**CLASS 28—(Continued).**

SN 78-388,284. THE ORIGINAL SAN FRANCISCO TOY-MAKERS, SOUTH SAN FRANCISCO, CA. FILED 3-22-2004.

**Blazin' Thunder**

**CYBON**

THE MARK CONSISTS OF STANDARD CHARACTERS WITHOUT CLAIM TO ANY PARTICULAR FONT, STYLE, SIZE, OR COLOR.

FOR RADIO CONTROL TOY AIRPLANE (U.S. CLS. 22, 23, 38 AND 50).  
DAVID MURRAY, EXAMINING ATTORNEY

THE MARK CONSISTS OF STANDARD CHARACTERS WITHOUT CLAIM TO ANY PARTICULAR FONT, STYLE, SIZE, OR COLOR.

FOR HUMAN LIKE TOY ROBOT THAT WALKS SINGS AND PLAYS GAMES (U.S. CLS. 22, 23, 38 AND 50).  
DAVID MURRAY, EXAMINING ATTORNEY

SN 78-385,777. PURSUIT MARKETING, INC., DES PLAINES, IL. FILED 3-17-2004.

SN 78-402,959. PURSUIT MARKETING, INC., DES PLAINES, IL. FILED 4-16-2004.

**STINGER**

**IGNITER**

THE MARK CONSISTS OF STANDARD CHARACTERS WITHOUT CLAIM TO ANY PARTICULAR FONT, STYLE, SIZE, OR COLOR.

FOR PAINTBALL MARKERS, PAINTBALLS, AND PAINTBALL EQUIPMENT, NAMELY, PAINTBALL MARKER BARRELS, PAINTBALL MARKER EXPANSION CHAMBERS, NON-TELESCOPIC PAINTBALL MARKER SIGHTS, PAINTBALL MARKER BARREL PLUGS AND PAINTBALL FILLER ADAPTERS (U.S. CLS. 22, 23, 38 AND 50).  
ZHALEH DELANEY, EXAMINING ATTORNEY

THE MARK CONSISTS OF STANDARD CHARACTERS WITHOUT CLAIM TO ANY PARTICULAR FONT, STYLE, SIZE, OR COLOR.

FOR PAINTBALL MARKERS, PAINTBALLS, AND PAINTBALL EQUIPMENT, NAMELY, PAINTBALL MARKER BARRELS, PAINTBALL MARKER EXPANSION CHAMBERS, NON-TELESCOPIC PAINTBALL MARKER SIGHTS, PAINTBALL MARKER BARREL PLUGS AND PAINTBALL FILLER ADAPTERS (U.S. CLS. 22, 23, 38 AND 50).  
ZHALEH DELANEY, EXAMINING ATTORNEY

**CLASS 28—(Continued).**

SN 78-408,251. CALLAWAY GOLF COMPANY, CARLSBAD, CA. FILED 4-26-2004.

**CLASS 28—(Continued).**

SN 78-408,285. CALLAWAY GOLF COMPANY, CARLSBAD, CA. FILED 4-26-2004.

**X440**

**X500**

THE MARK CONSISTS OF STANDARD CHARACTERS WITHOUT CLAIM TO ANY PARTICULAR FONT, STYLE, SIZE, OR COLOR.  
FOR GOLF CLUBS, GOLF CLUB HEADCOVERS, GOLF BAGS (U.S. CLS. 22, 23, 38 AND 50).  
MARLENE BELL, EXAMINING ATTORNEY

THE MARK CONSISTS OF STANDARD CHARACTERS WITHOUT CLAIM TO ANY PARTICULAR FONT, STYLE, SIZE, OR COLOR.  
FOR GOLF CLUBS, GOLF CLUB HEADCOVERS AND GOLF BAGS (U.S. CLS. 22, 23, 38 AND 50).  
MARLENE BELL, EXAMINING ATTORNEY

---

SN 78-408,278. CALLAWAY GOLF COMPANY, CARLSBAD, CA. FILED 4-26-2004.

---

SN 78-408,516. CALLAWAY GOLF COMPANY, CARLSBAD, CA. FILED 4-27-2004.

**X490**

**X505**

THE MARK CONSISTS OF STANDARD CHARACTERS WITHOUT CLAIM TO ANY PARTICULAR FONT, STYLE, SIZE, OR COLOR.  
FOR GOLF CLUBS, GOLF CLUB HEADCOVERS AND GOLF BAGS (U.S. CLS. 22, 23, 38 AND 50).  
MARLENE BELL, EXAMINING ATTORNEY

THE MARK CONSISTS OF STANDARD CHARACTERS WITHOUT CLAIM TO ANY PARTICULAR FONT, STYLE, SIZE, OR COLOR.  
FOR GOLF CLUBS, GOLF CLUB HEADCOVERS AND GOLF BAGS (U.S. CLS. 22, 23, 38 AND 50).  
MARLENE BELL, EXAMINING ATTORNEY

**CLASS 28—(Continued).**

SN 78-408,520. CALLAWAY GOLF COMPANY, CARLSBAD, CA. FILED 4-27-2004.

**X515**

THE MARK CONSISTS OF STANDARD CHARACTERS WITHOUT CLAIM TO ANY PARTICULAR FONT, STYLE, SIZE, OR COLOR.  
FOR GOLF CLUBS, GOLF CLUB HEADCOVERS AND GOLF BAGS (U.S. CLS. 22, 23, 38 AND 50).  
MARLENE BELL, EXAMINING ATTORNEY

**CLASS 29—(Continued).**

SN 76-567,909. CALIFORNIA NATURAL PRODUCTS, LA-THROP, CA. FILED 12-22-2003.

**BAKETRIM**

THE MARK CONSISTS OF STANDARD CHARACTERS WITHOUT CLAIM TO ANY PARTICULAR FONT, STYLE, SIZE, OR COLOR.  
FOR CARBOHYDRATE-BASED FAT SUBSTITUTE FOR USE AS AN INGREDIENT IN FOODS (U.S. CL. 46).  
MICHAEL HALL, EXAMINING ATTORNEY

SN 78-160,807. CUCINA ANTICA FOODS CORPORATION, BRIARCLIFF MANOR, NY. FILED 9-5-2002.

*Cucina Antica*

**CLASS 29—MEATS AND PROCESSED FOODS**

SN 76-130,415. FOOD SCIENCES CORPORATION, MT. LAUREL, NJ. FILED 9-18-2000.

**WELL AND HEALTHY  
WOMAN**

FOR SNACK BARS CONTAINING SOY PROTEIN (U.S. CL. 46).  
LEIGH CAROLINE CASE, EXAMINING ATTORNEY

THE ENGLISH TRANSLATION OF THE WORD "CUCINA ANTICA" IN THE MARK IS "ANCIENT KITCHEN".  
FOR OLIVE OIL (U.S. CL. 46).  
FIRST USE 11-1-1998; IN COMMERCE 11-1-1998.  
NORA BUCHANAN WILL, EXAMINING ATTORNEY

SN 78-195,663. HAIN PURE FOOD CO., INC., MELVILLE, NY. FILED 12-18-2002.



SN 76-484,449. ROSEDA BEEF, LLC, MONKTON, MD. FILED 12-20-2002.

**ROSEDA**

FOR BEEF (U.S. CL. 46).  
FIRST USE 10-0-2000; IN COMMERCE 4-0-2003.  
ZACHARY BELLO, EXAMINING ATTORNEY

OWNER OF U.S. REG. NOS. 771,195, 2,634,522 AND OTHERS.

NO CLAIM IS MADE TO THE EXCLUSIVE RIGHT TO USE "PURE SNACKS", APART FROM THE MARK AS SHOWN.

FOR VEGETABLE BASED SNACK FOODS; SOY BASED SNACK FOODS (U.S. CL. 46).  
FIRST USE 10-1-2002; IN COMMERCE 10-1-2002.  
IRENE D. WILLIAMS, EXAMINING ATTORNEY

**CLASS 29—(Continued).**

SN 78-250,911. OPEN JOINT STOCK COMPANY "WIMM-BILL-DANN FOODS", MOSCOW, RUSSIAN FED., FILED 5-16-2003.

**Милая мила**

OWNER OF RUSSIAN FED. REG. NO. 177301, DATED 10-23-1997, EXPIRES 10-23-2007.

THE FOREIGN WORDING IN THE MARK TRANSLATES INTO ENGLISH AS NICE MILLA.

THE NON-LATIN CHARACTER(S) IN THE MARK TRANSLITERATES INTO MILAYA MILLA, AND THIS MEANS NICE MILLA IN ENGLISH.

FOR MILK, MILK PRODUCTS, NAMELY, DAIRY PRODUCTS EXCLUDING ICE CREAM, ICE MILK AND FROZEN YOGURT; HALF AND HALF [MILK AND CREAM MIXTURE], RENNET, CREAM; YOGURT; KEFIR, KUMISS, MILK BEVERAGES, NAMELY, CHOCOLATE MILK; DAIRY-BASED BEVERAGES, DAIRY-BASED CHOCOLATE FOOD BEVERAGES, MILK-BASED BEVERAGE CONTAINING COFFEE, WHEY, WHIPPED CREAM, BUTTER AND CHEESE (U.S. CL. 46).

MARGERY A. TIERNEY, EXAMINING ATTORNEY

SN 78-280,562. AHOLD RETAIL SERVICES AG, KLOSTERS, SWITZERLAND, FILED 7-29-2003.

**TASTEE CHEEZ**

NO CLAIM IS MADE TO THE EXCLUSIVE RIGHT TO USE "CHEESE", APART FROM THE MARK AS SHOWN.

FOR PROCESSED CHEESE (U.S. CL. 46).

KEVON CHISOLM, EXAMINING ATTORNEY

SN 78-280,588. AHOLD RETAIL SERVICES AG, KLOSTERS, SWITZERLAND, FILED 7-29-2003.

**CHEEZYMELT**

FOR PROCESSED CHEESE (U.S. CL. 46).

KEVON CHISOLM, EXAMINING ATTORNEY

**CLASS 29—(Continued).**

SN 78-280,899. SYSCO CORPORATION, HOUSTON, TX. FILED 7-30-2003.



OWNER OF U.S. REG. NOS. 2,074,248 AND 2,081,966. FOR JUICE BARS, AND PROTEIN FRUIT BARS AND POUCHES (U.S. CL. 46).

NORA BUCHANAN WILL, EXAMINING ATTORNEY

SN 78-297,974. PURESOURCE INC., GUELPH, ONTARIO, CANADA, FILED 9-9-2003.



PRIORITY CLAIMED UNDER SEC. 44(D) ON CANADA APPLICATION NO. 1,181,181, FILED 6-10-2003.

NO CLAIM IS MADE TO THE EXCLUSIVE RIGHT TO USE "REAL TROPICAL", APART FROM THE MARK AS SHOWN.

FOR APPLE AND TROPICAL FRUIT BASED DRIED FRUIT SNACK (U.S. CL. 46).

JENNIFER CHICOSKI, EXAMINING ATTORNEY

SN 78-346,358. TIP TOP FOODS, INC., COLUMBUS, OH. FILED 12-30-2003.

**SOUR C**

THE MARK CONSISTS OF STANDARD CHARACTERS WITHOUT CLAIM TO ANY PARTICULAR FONT, STYLE, SIZE, OR COLOR.

NO CLAIM IS MADE TO THE EXCLUSIVE RIGHT TO USE "SOUR", APART FROM THE MARK AS SHOWN.

FOR MILK AND VEGETABLE OIL BASED DRESSING, USED IN BAKING AND COOKING FOR SUCH FOODS AS SALADS AND POTATOES, AND AS A BASE FOR COCKTAIL DIPS (U.S. CL. 46).

FIRST USE 4-25-1964; IN COMMERCE 4-27-1964.

BRENDAN REGAN, EXAMINING ATTORNEY

**CLASS 29—(Continued).**

SN 78-354,551. PIERRE FOODS, INC., CINCINNATI, OH.  
FILED 1-20-2004.

**BODY BY PIERRE**

THE MARK CONSISTS OF STANDARD CHARACTERS  
WITHOUT CLAIM TO ANY PARTICULAR FONT, STYLE,  
SIZE, OR COLOR.

OWNER OF U.S. REG. NOS. 1,876,055, 2,784,407 AND  
OTHERS.

FOR PROCESSED POULTRY AND PROCESSED MEAT  
(U.S. CL. 46).

ALICE SUE CARRUTHERS, EXAMINING ATTORNEY

**CLASS 29—(Continued).**

SN 78-357,655. LATIBAER EHF., GARDABAER, ICELAND,  
FILED 1-26-2004.

**SPORTACUS**

THE MARK CONSISTS OF STANDARD CHARACTERS  
WITHOUT CLAIM TO ANY PARTICULAR FONT, STYLE,  
SIZE, OR COLOR.

FOR MEAT, FISH, POULTRY AND GAME; MEAT  
EXTRACT; PRESERVED, DRIED AND COOKED  
FRUITS AND VEGETABLES; JELLIES; JAMS; CRAN-  
BERRY SAUCE; APPLESAUCE; COMPOTES; EGGS,  
MILK; DAIRY PRODUCTS EXCLUDING ICE CREAM,  
ICE MILK AND FROZEN YOGURT; POTATO-BASED  
SNACK FOODS; FRUIT PRESERVES; FRUIT-BASED  
SNACK FOODS; PROCESSED PEANUTS; POTATO  
CHIPS; FRENCH FRIES; PROCESSED NUTS; PEANUT  
BUTTER; EDIBLE OILS AND FATS (U.S. CL. 46).

ANDREA K. NADELMAN, EXAMINING ATTORNEY

SN 78-355,871. ROBIN HOOD MULTIFOODS CORPORA-  
TION, MARKHAM, ONTARIO, CANADA, FILED 1-22-  
2004.

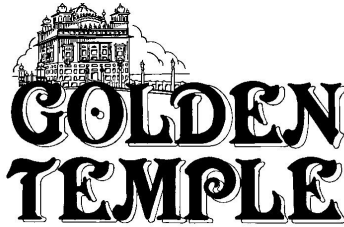

OWNER OF U.S. REG. NOS. 1,297,895 AND 2,026,781.  
FOR PREPARED AND PACKAGED FROZEN MEAT-  
BASED AND VEGETARIAN FOOD COMBINATIONS,  
CONSISTING PRIMARILY OF MEAT, POULTRY, FISH  
OR VEGETABLES WITH COOKING SAUCES, BREAD  
OR RICE; SNACK DIPS; LENTIL CHIPS (U.S. CL. 46).  
KIMBERLY FRYE, EXAMINING ATTORNEY

SN 78-358,971. ARCHER-DANIELS-MIDLAND COMPANY,  
DECATUR, IL. FILED 1-28-2004.

**NUTRISOY NEXT**

SN 78-356,834. PROMARK BRANDS INC., BOISE, ID. FILED  
1-23-2004.

**THE POWER OF RED**

THE MARK CONSISTS OF STANDARD CHARACTERS  
WITHOUT CLAIM TO ANY PARTICULAR FONT, STYLE,  
SIZE, OR COLOR.

FOR FROZEN ENTREES AND SIDE DISHES CON-  
SISTING OF CHICKEN, BEEF, FISH AND/OR VEGETA-  
BLES (U.S. CL. 46).

FIRST USE 10-1-2003; IN COMMERCE 10-1-2003.

TRICIA THOMPSON, EXAMINING ATTORNEY

THE MARK CONSISTS OF STANDARD CHARACTERS  
WITHOUT CLAIM TO ANY PARTICULAR FONT, STYLE,  
SIZE, OR COLOR.

OWNER OF U.S. REG. NO. 1,686,614.  
FOR ISOLATED SOY PROTEINS FOR USE AS FOOD  
ADDITIVES, FOOD FILLERS, AND MEAT EXTENDERS  
OR SUBSTITUTES (U.S. CL. 46).

RICHARD A. STRASER, EXAMINING ATTORNEY



**CLASS 29—(Continued).**

SN 78-360,149. FRITO-LAY NORTH AMERICA, INC., PLANO, TX. FILED 1-30-2004.

# KARATE

THE MARK CONSISTS OF STANDARD CHARACTERS WITHOUT CLAIM TO ANY PARTICULAR FONT, STYLE, SIZE, OR COLOR.

FOR PROCESSED NUTS, NAMELY PEANUTS (U.S. CL. 46).

ARETHA SOMERVILLE, EXAMINING ATTORNEY



SN 78-360,377. NISSIN FOODS (U.S.A.) COMPANY, INC., GARDENA, CA. FILED 1-30-2004.

# MUCH MORE THAN A SOUP

THE MARK CONSISTS OF STANDARD CHARACTERS WITHOUT CLAIM TO ANY PARTICULAR FONT, STYLE, SIZE, OR COLOR.

FOR SOUP MIXES CONSISTING PRIMARILY OF DEHYDRATED ORIENTAL NOODLES WITH DEHYDRATED CONDIMENTS (U.S. CL. 46).

FIRST USE 5-1-1985; IN COMMERCE 5-1-1985.  
SHARON MEIER, EXAMINING ATTORNEY

**CLASS 29—(Continued).**

SN 78-361,993. UNIFOODS S.A. DE C.V., COLONIA INDUSTRIAL VALLEJO, MEXICO, FILED 2-3-2004.

# BONACULT

THE MARK CONSISTS OF STANDARD CHARACTERS WITHOUT CLAIM TO ANY PARTICULAR FONT, STYLE, SIZE, OR COLOR.

FOR PROCESSED, CANNED, AND FRESH MEATS, POULTRY AND GAME, NAMELY, BEEF, BOLOGNA, FRANKFURTERS, PORK, CHICKEN, DUCK, TURKEY, LAMB, VENISON; SEAFOOD, NAMELY, FISH, SHRIMP, AND SHELLFISH; MEAT EXTRACTS; PROCESSED FRUITS AND VEGETABLES, NAMELY, PROCESSED BEANS, PROCESSED PEAS, PROCESSED CARROTS, PROCESSED TOMATOES, TOMATO PASTE, TOMATO PUREE, PROCESSED OLIVES, PROCESSED PICKLES, PROCESSED PEPPERS; PROCESSED JELLIES, JAMS; EGGS; PROCESSED AND FRESH DAIRY PRODUCTS, NAMELY, MILK, CHEESE, YOGURT, AND SOUR CREAM; PROCESSED NUTS AND PROCESSED EDIBLE SEEDS; EDIBLE OILS AND FATS, NAMELY, COOKING OIL, LARD, BUTTER AND MARGARINE; SOUPS; PREPARED ENTREES CONSISTING PRIMARILY OF MEAT, POULTRY, FISH OR VEGETABLES (U.S. CL. 46).

MARTHA SANTOMARTINO, EXAMINING ATTORNEY



**CLASS 30—STAPLE FOODS**

SN 75-893,363. PAN-O-GOLD BAKING CO., ST. CLOUD, MN. FILED 1-7-2000.

# NEW ENGLAND

SEC. 2(F).

FOR FRESHLY BAKED BREAD (U.S. CL. 46).  
FIRST USE 1-3-1989; IN COMMERCE 1-3-1989.

ELIZABETH HUGHITT, EXAMINING ATTORNEY

**CLASS 30—(Continued).**

SN 76-341,911. CLUB MEDITERRANEE, PARIS, FRANCE,  
FILED 11-26-2001.



FOR STAPLE FOODS, NAMELY, BAKERY GOODS,  
BREAD, CANDY, CHOCOLATE (U.S. CL. 46).  
KENNETH D. BATTLE, EXAMINING ATTORNEY

SN 76-387,514. KABUSHIKI KAISHA MITSUKAN GROUP  
HONSHA, DBA MITSUKAN GROUP CORPORATION,  
HANDA-SHI AICHI-KEN, JAPAN, FILED 3-27-2002.

# 味滋康

THE transliteration of the non-Latin characters is "MITSUKAN" in Chinese and "MIJIKOU" in Japanese, and the meaning of three non-Latin characters of the mark in English is "TASTE", "NOURISHMENT", and "PEACEFUL" respectively.  
FOR VINEGAR (U.S. CL. 46).  
FIRST USE 4-0-1991; IN COMMERCE 4-0-1999.  
YSA DEJESUS, EXAMINING ATTORNEY

SN 76-401,642. BOTANAS Y DERIVADOS, S.A. DE C.V.,  
GUADALUPE, N.L., MEXICO, FILED 4-29-2002.

## CHURRITOS

FOR CORN CHIPS (U.S. CL. 46).  
WANDA KAY PRICE, EXAMINING ATTORNEY

**CLASS 30—(Continued).**

SN 76-406,291. PEABODYS COFFEE, INC., ROCKLIN, CA,  
FILED 5-10-2002.



NO CLAIM IS MADE TO THE EXCLUSIVE RIGHT TO USE COFFEE, APART FROM THE MARK AS SHOWN.  
FOR GROUND AND WHOLE BEAN COFFEE, HERBAL AND NON-HERBAL TEAS; COFFEE, TEA, BEVERAGES MADE WITH A BASE OF COFFEE AND/OR ESPRESSO; READY-TO-DRINK COFFEE BEVERAGES (U.S. CL. 46).  
KENNETH D. BATTLE, EXAMINING ATTORNEY

SN 76-472,435. CAMARDO S.P.A., 86025 RIPALIMOSANI  
(CB), ITALY, FILED 12-3-2002.



PRIORITY CLAIMED UNDER SEC. 44(D) ON ITALY APPLICATION NO. IT-RM2002C00, FILED 11-13-2002, REG. NO. 00910019, DATED 9-26-2003, EXPIRES 11-13-2012.

NO CLAIM IS MADE TO THE EXCLUSIVE RIGHT TO USE ESPRESSO, APART FROM THE MARK AS SHOWN.  
FOR COFFEE, COFFEE BEANS, DECAFFEINATED COFFEE, INSTANT COFFEE IN TABLET FORM, COFFEE SUBSTITUTES, COFFEE BASED BEVERAGES, NAMELY, COFFEE BASED BEVERAGES CONTAINING MILK, AND NONALCOHOLIC FLAVORED COFFEES (U.S. CL. 46).  
WANDA KAY PRICE, EXAMINING ATTORNEY

**CLASS 30—(Continued).**

SN 76-484,105. BEACON SWEETS & CHOCOLATES (PTY) LIMITED, SANDTON, SOUTH AFRICA, FILED 1-23-2003.

**ST CHOCOLAT**

NO CLAIM IS MADE TO THE EXCLUSIVE RIGHT TO USE CHOCOLAT, APART FROM THE MARK AS SHOWN. "ST" IS THE ABBREVIATION OF THE WORD "SAINT", AND "CHOCOLAT" IS THE FRENCH WORD FOR "CHOCOLATE".

FOR CONFECTIONERY, NAMELY CHOCOLATE, CHOCOLATES, CANDY (U.S. CL. 46).  
MITCHELL FRONT, EXAMINING ATTORNEY

SN 76-505,784. GRUPO BIMBO, S.A. DE C.V., DELEGACION ALVARO OBREGON, MEXICO, FILED 4-11-2003.

**CHOCOROCKO**

FOR BAKERY PRODUCTS, NAMELY COOKIES, CANDY, SNACK CAKES AND CRACKERS (U.S. CL. 46).  
ANDREA SAUNDERS, EXAMINING ATTORNEY

SN 76-506,056. GLOBEHOLDING SA, 1009 PULLY, SWITZERLAND, FILED 4-8-2003.

**ARTHUR'S**

PRIORITY CLAIMED UNDER SEC. 44(D) ON SWITZERLAND APPLICATION NO. 505895, FILED 10-10-2002, REG. NO. 505895, DATED 12-17-2002, EXPIRES 10-10-2012.

FOR COFFEE; CHICORY BASED COFFEE SUBSTITUTES AND GRAIN BASED COFFEE SUBSTITUTES; COFFEE-BASED BEVERAGES; COCOA; COCOA-BASED BEVERAGES; CONFECTIONERY, NAMELY, CANDY, PASTRY; CHOCOLATE; SUGAR; SWEETMEATS (U.S. CL. 46).

RUSS HERMAN, EXAMINING ATTORNEY

SN 76-511,253. LARSON PROMOTIONS INC., PROV. OF PANAMA, PANAMA, FILED 5-1-2003.



NO CLAIM IS MADE TO THE EXCLUSIVE RIGHT TO USE "CAFE" AND "LAS TIENDAS DEL CAFE COLOMBIANO", APART FROM THE MARK AS SHOWN.

THE ENGLISH TRANSLATION OF "LA MISION CAFE & CULTURA" IS "THE MISSION COFFEE AND CULTURE"; AND THE ENGLISH TRANSLATION OF "LAS TIENDAS DEL CAFE COLOMBIANO" IS "THE COLOMBIAN COFFEE STORES".

FOR COFFEE AND COFFEE-BASED BEVERAGES CONTAINING MILK (U.S. CL. 46).

MARK T. MULLEN, EXAMINING ATTORNEY

**CLASS 30—(Continued).**

SN 76-521,082. SIN IN A BOX, LLC, DALLAS, TX, FILED 6-6-2003.

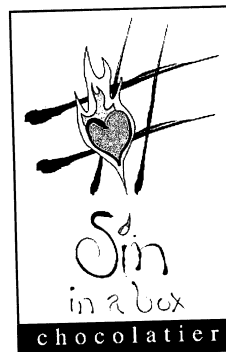

NO CLAIM IS MADE TO THE EXCLUSIVE RIGHT TO USE "IN A BOX" OR "CHOCOLATIER", APART FROM THE MARK AS SHOWN.

THE STIPLING IS A FEATURE OF THE MARK AND DOES NOT INDICATE COLOR. THE STIPLING IS FOR SHADING PURPOSES ONLY.

THE COLOR(S) MEDIUM BROWN AND LIGHT BROWN WITH BLACK LINES IS/ARE CLAIMED AS A FEATURE OF THE MARK.

THE COLOR MEDIUM BROWN APPEARS IN THE HEART AND THE TEARDROP BELOW THE HEART; THE COLOR LIGHT BROWN APPEARS IN THE FLAMES AND THE CENTER OF THE TEARDROP. THE COLOR BLACK APPEARS IN THE LINES WITHIN THE LOGO.

THE MARK CONSISTS OF THE WORDING "SIN IN A BOX, CHOCOLATIER" ACCOMPANIED BY A DRAWING OF A HEART IN FLAMES.

THE FOREIGN WORDING IN THE MARK TRANSLATES INTO ENGLISH AS CHOCOLATE MAKER.

FOR CHOCOLATE CANDY (U.S. CL. 46).

FIRST USE 3-1-2002; IN COMMERCE 3-1-2002.

DORITT L. CARROLL, EXAMINING ATTORNEY

SN 76-523,990. SEGEL, ALAN J., BRYN MAWR, PA, FILED 6-19-2003.

**FLAVOR MAGIC**

NO CLAIM IS MADE TO THE EXCLUSIVE RIGHT TO USE "FLAVOR", APART FROM THE MARK AS SHOWN.

FOR FOOD FLAVORINGS, NAMELY, PLASTIC SHEETS COVERED WITH FOOD FLAVORINGS AND SPICES, AND WHICH ARE USED TO IMPART SAID FOOD FLAVORINGS AND SPICES TO MEAT, CHICKEN AND FISH (U.S. CL. 46).

JOHN DWYER, EXAMINING ATTORNEY

**CLASS 30—(Continued).**

SN 76-526,478. KEVIN WILLIAM CAMBRIDGE, DOVER, NH. FILED 6-20-2003.



NO CLAIM IS MADE TO THE EXCLUSIVE RIGHT TO USE PASTA CO., APART FROM THE MARK AS SHOWN. FOR FRESH PASTA, SAUCES, RAVIOLI (U.S. CL. 46). FIRST USE 1-1-1990; IN COMMERCE 1-1-1990. HEATHER THOMPSON, EXAMINING ATTORNEY

**CLASS 30—(Continued).**

SN 76-538,266. MASCOPART LTDA., SAO PAULO, BRAZIL, FILED 8-19-2003.



THE MARK "TRADICIONAL" MAY BE TRANSLATED AS "TRADITIONAL." THE WORD "CISNE" IS MAY BE TRANSLATED INTO ENGLISH AS "SWAN." FOR SEASONINGS, SPICES AND SALT (U.S. CL. 46). ARETHA SOMERVILLE, EXAMINING ATTORNEY

SN 76-530,945. INTEGRATED BAKERY RESOURCES, INC., LAKE OSWEGO, OR. FILED 7-21-2003.



NO CLAIM IS MADE TO THE EXCLUSIVE RIGHT TO USE NUTRITION, APART FROM THE MARK AS SHOWN. THE LINING SHOWN IN THE MARK IS USED TO INDICATE SHADING. FOR BREAD, BREAKFAST CEREALS, COOKIES AND PIZZA DOUGH (U.S. CL. 46). SUSAN LESLIE DUBOIS, EXAMINING ATTORNEY

SN 76-538,272. MASCOPART LTDA., SAO PAULO, BRAZIL, FILED 8-19-2003.



NO CLAIM IS MADE TO THE EXCLUSIVE RIGHT TO USE "LIGHT", APART FROM THE MARK AS SHOWN. THE WORD "CISNE" MAY BE TRANSLATED INTO ENGLISH AS "SWAN". FOR SEASONINGS, SPICES AND SALT (U.S. CL. 46). KIMBERLY PERRY, EXAMINING ATTORNEY

SN 76-533,830. INCUBRANDS CORPORATION, LIGHTHOUSE POINT, FL. FILED 7-31-2003.

**BRILLIANT**

FOR READY-TO-DRINK PROTEIN SHAKES AND CEREAL-BASED FOOD BARS (U.S. CL. 46). JERI J. FICKES, EXAMINING ATTORNEY

SN 76-549,481. A.E. STALEY MANUFACTURING COMPANY, DECATUR, IL. FILED 9-22-2003.

**DEXSTAR**

FOR DEXTROSE AND DEXTROSE AGGLOMERATED WITH MALTO DEXTRIN FOR USE IN THE CONFECTION, FOOD TABLETING AND PREPARED FOODS AREA. (U.S. CL. 46). HOWARD SMIGA, EXAMINING ATTORNEY

**CLASS 30—(Continued).**

SN 76-559,571. T. W. GARNER FOOD COMPANY, WINSTON-SALEM, NC. FILED 11-5-2003.



OWNER OF U.S. REG. NOS. 694,334, 2,337,198 AND OTHERS.

NO CLAIM IS MADE TO THE EXCLUSIVE RIGHT TO USE "75TH ANNIVERSARY" AND "FOOD COMPANY", APART FROM THE MARK AS SHOWN.

THE COLORS RED, YELLOW AND GRAY ARE CLAIMED AS A FEATURE OF THE MARK.

THE COWBOY FIGURE AND WHIP ARE RED, THE WORDING 75TH ANNIVERSARY IS YELLOW, AND THE HORSESHOE IS GRAY.

FOR HOT SAUCE, HONEY MUSTARD, CHICKEN WING SAUCE, SEA FOOD SAUCE, AND CHILI SAUCE (U.S. CL. 46).

MELVIN AXILBUND, EXAMINING ATTORNEY

SN 76-566,582. AMERICA'S CATCH, INC., ITTA BENA, MS. FILED 12-23-2003.

**SKINNYDIP'N**

THE MARK CONSISTS OF STANDARD CHARACTERS WITHOUT CLAIM TO ANY PARTICULAR FONT, STYLE, SIZE, OR COLOR.

FOR SEASONED COATING MIX FOR CHICKEN, SHRIMP, FISH AND OTHER MEAT (U.S. CL. 46).

KELLY BOULTON, EXAMINING ATTORNEY

SN 76-571,025. RAINIER ORGANIC NATURAL FOOD BAKING COMPANY, INC., AUBURN, WA. FILED 1-20-2004.

**RAINIER ORGANIC BAKERY**

THE MARK CONSISTS OF STANDARD CHARACTERS WITHOUT CLAIM TO ANY PARTICULAR FONT, STYLE, SIZE, OR COLOR.

OWNER OF U.S. REG. NOS. 1,815,059 AND 2,871,796.

NO CLAIM IS MADE TO THE EXCLUSIVE RIGHT TO USE "ORGANIC BAKERY", APART FROM THE MARK AS SHOWN.

FOR WIDE VARIETY OF BAKERY GOODS; BREAD (U.S. CL. 46).

REBECCA GILBERT, EXAMINING ATTORNEY

**CLASS 30—(Continued).**

SN 76-572,336. RED ARROW PRODUCTS COMPANY, LLC, MANITOWOC, WI. FILED 1-26-2004.

**OFF THE GRILL**

THE MARK CONSISTS OF STANDARD CHARACTERS WITHOUT CLAIM TO ANY PARTICULAR FONT, STYLE, SIZE, OR COLOR.

FOR FLAVOR ADDITIVES FOR NON-NUTRITIONAL PURPOSES (U.S. CL. 46).

HOWARD B. LEVINE, EXAMINING ATTORNEY

SN 76-574,843. TASTYKAKE INVESTMENT COMPANY, WILMINGTON, DE. FILED 2-6-2004.

**KUPIDKAKES**

THE MARK CONSISTS OF STANDARD CHARACTERS WITHOUT CLAIM TO ANY PARTICULAR FONT, STYLE, SIZE, OR COLOR.

OWNER OF U.S. REG. NOS. 696,852, 2,582,559 AND OTHERS.

FOR BAKERY PRODUCTS (U.S. CL. 46).

FIRST USE 1-5-2004; IN COMMERCE 1-5-2004.

M. E. BODSON, EXAMINING ATTORNEY

SN 78-270,972. CARGILL, INCORPORATED, WAYZATA, MN. FILED 7-7-2003.

**EMCAP-INSTANT**

OWNER OF U.S. REG. NO. 2,688,912.

FOR FOOD STARCHES (U.S. CL. 46).

MARLENE BELL, EXAMINING ATTORNEY

**CLASS 30—(Continued).**

SN 78-275,294. HANSENS, NAAMLOZE VENNOOTSCHAP, B-8630 VEURNE, BELGIUM, FILED 7-17-2003.



PRIORITY CLAIMED UNDER SEC. 44(D) ON BENELUX APPLICATION NO. 1025620, FILED 1-22-2003, REG. NO. 733015, DATED 1-22-2003, EXPIRES 1-22-2013.

NO CLAIM IS MADE TO THE EXCLUSIVE RIGHT TO USE "CHOCOLATES", APART FROM THE MARK AS SHOWN.

FOR CHOCOLATE AND CHOCOLATE PRODUCTS, NAMELY, PRALINES, BONBONS, CHOCOLATE SEASHELLS AND TRUFFLES; SMALL CAKES, NAMELY, CHEESE BISCUITS, BISCUITS, CONFECTIONERY, NAMELY, BAKERY DESERTS; CANDY; SNACKS AND MIXTURES OF SNACKS, NAMELY, CEREAL BASED SNACK FOOD, SNACK MIX CONSISTING OF CRACKERS, PRETZELS, CANDIED NUTS AND/OR POPPED POPCORN; COCKTAIL SNACKS, NAMELY, CHOCOLATE COVERED NUTS AND PRETZELS; PROCESSED POPCORN; CRACKERS; FLOUR, PREPARATIONS MADE FROM CEREALS, NAMELY, READY TO EAT CEREAL DERIVED FOOD BARS; BREAD; PASTRIES; AND ICE-CREAM (U.S. CL. 46).

FIRST USE 1-22-2003; IN COMMERCE 6-1-2003.  
ANDREA K. NADELMAN, EXAMINING ATTORNEY

SN 78-280,553. AHOLD RETAIL SERVICES AG, KLOSTERS, SWITZERLAND, FILED 7-29-2003.

**TWISTO'S**

FOR COOKIES (U.S. CL. 46).  
FIRST USE 11-15-2003; IN COMMERCE 11-15-2003.  
KEVON CHISOLM, EXAMINING ATTORNEY

SN 78-280,564. AHOLD RETAIL SERVICES AG, KLOSTERS, SWITZERLAND, FILED 7-29-2003.

**SPARKLING CHIP'UMS**

FOR COOKIES (U.S. CL. 46).  
KEVON CHISOLM, EXAMINING ATTORNEY

SN 78-280,571. AHOLD RETAIL SERVICES AG, KLOSTERS, SWITZERLAND, FILED 7-29-2003.

**RANGLERS**

FOR CORN CHIPS (U.S. CL. 46).  
FIRST USE 7-25-2003; IN COMMERCE 7-25-2003.  
KEVON CHISOLM, EXAMINING ATTORNEY

**CLASS 30—(Continued).**

SN 78-280,585. AHOLD RETAIL SERVICES AG, KLOSTERS, SWITZERLAND, FILED 7-29-2003.

**CHIP'UMS**

FOR COOKIES AND FROZEN CONFECTIONS (U.S. CL. 46).

FIRST USE 1-15-2004; IN COMMERCE 1-15-2004.  
KEVON CHISOLM, EXAMINING ATTORNEY

SN 78-280,593. AHOLD RETAIL SERVICES AG, KLOSTERS, SWITZERLAND, FILED 7-29-2003.

**WHEAT'UMS**

FOR CRACKERS (U.S. CL. 46).  
FIRST USE 11-15-2003; IN COMMERCE 11-15-2003.  
KEVON CHISOLM, EXAMINING ATTORNEY

SN 78-292,804. MARS, INCORPORATED, MC LEAN, VA, FILED 8-27-2003.

**YEOMAN**

FOR RICE (U.S. CL. 46).  
FIRST USE 5-17-1995; IN COMMERCE 5-17-1995.  
DAVID TAYLOR, EXAMINING ATTORNEY

SN 78-315,658. BISTRO NEW YORK INTERNATIONAL INC., ASTORIA, NY, FILED 10-20-2003.

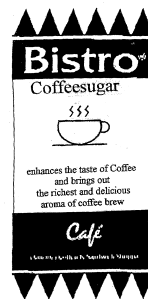

NO CLAIM IS MADE TO THE EXCLUSIVE RIGHT TO USE "BISTRO", "COFFEE SUGAR", "ENHANCES THE TASTE OF COFFEE AND BRINGS OUT THE RICHEST AND DELICIOUS AROMA OF COFFEE BREW" OR "CAFE", APART FROM THE MARK AS SHOWN.

THE MARK CONSISTS OF THE WORDS BISTRO; COFFEESUGAR, ENHANCES THE TASTE OF COFFEE AND BRINGS OUT THE RICHEST AND DELICIOUS AROMA OF COFFEE BREW; CAFE AND REPRESENTATION OF A CUP OF COFFEE ALL APPEARING ON A LABEL.

FOR SUGAR AND FOOD FLAVORINGS (U.S. CL. 46).  
JAMES A. RAUEN, EXAMINING ATTORNEY

**CLASS 30—(Continued).**

SN 78-324,729. CHEEZY BUSINESS, INC., NEW YORK, NY.  
FILED 11-7-2003.

**JACKIE MASON'S  
FAMOUS BROADWAY  
CHEESECAKE**

THE MARK CONSISTS OF STANDARD CHARACTERS WITHOUT CLAIM TO ANY PARTICULAR FONT, STYLE, SIZE, OR COLOR.

NO CLAIM IS MADE TO THE EXCLUSIVE RIGHT TO USE "FAMOUS" AND "CHEESECAKE", APART FROM THE MARK AS SHOWN.

THE NAME JACKIE MASON IDENTIFIES A LIVING INDIVIDUAL WHOSE CONSENT IS OF RECORD.

FOR CHEESECAKE (U.S. CL. 46).

FIRST USE 10-0-2003; IN COMMERCE 10-0-2003.

KAREN K. BUSH, EXAMINING ATTORNEY

---

SN 78-327,934. BRAR NATURAL FLOUR MILLS INC.,  
WINNIPEG, MANITOBA, CANADA, FILED 11-14-2003.



THE LINING IS A FEATURE OF THE MARK AND DOES NOT INDICATE COLOR.

THE MARK CONSISTS OF LION DESIGN.

FOR FLOUR (U.S. CL. 46).

FIRST USE 8-1-2002; IN COMMERCE 8-1-2002.

CAROLYN CATALDO, EXAMINING ATTORNEY

---

SN 78-333,142. CARGILL, INCORPORATED, WAYZATA,  
MN. FILED 11-25-2003.

**MAPLE MADNESS**

THE MARK CONSISTS OF STANDARD CHARACTERS WITHOUT CLAIM TO ANY PARTICULAR FONT, STYLE, SIZE, OR COLOR.

NO CLAIM IS MADE TO THE EXCLUSIVE RIGHT TO USE "MAPLE", APART FROM THE MARK AS SHOWN.

FOR FRENCH TOAST (U.S. CL. 46).

KAREN K. BUSH, EXAMINING ATTORNEY

**CLASS 30—(Continued).**

SN 78-341,002. CELESTIAL SEASONINGS, INC., BOULDER,  
CO. FILED 12-15-2003.



THE MARK CONSISTS OF THE STYLIZED WORDS CELESTIAL SEASONINGS WITHIN AN OVAL WHICH SURROUNDS THE DESIGN OF A BEAR HEAD.

FOR HONEY (U.S. CL. 46).

FIRST USE 11-1-2002; IN COMMERCE 11-1-2002.

LEIGH CAROLINE CASE, EXAMINING ATTORNEY

---

SN 78-349,450. FUDGE KITCHENS, INC., CAPE MAY, NJ.  
FILED 1-8-2004.



NO CLAIM IS MADE TO THE EXCLUSIVE RIGHT TO USE ORIGINAL FUDGE, APART FROM THE MARK AS SHOWN.

THE MARK CONSISTS OF THE LITERAL MARK AND A LOGO OF A CHEF STIRRING A KETTLE; APPLICANT DOES NOT ASSERT A CLAIM TO PARTICULAR COLOR OR SIZE.

FOR CANDY (U.S. CL. 46).

FIRST USE 5-1-1974; IN COMMERCE 5-1-1974.

ANN LINNEHAN, EXAMINING ATTORNEY

**CLASS 30—(Continued).**

SN 78-350,462. HASTY, PAMELA K, COLORADO SPRINGS, CO. FILED 1-12-2004.

Outside The  
Breadbox

THE MARK CONSISTS OF STANDARD CHARACTERS WITHOUT CLAIM TO ANY PARTICULAR FONT, STYLE, SIZE, OR COLOR.

FOR BAKERY DESSERTS, BAKERY GOODS, BAKERY PRODUCTS, MIXES FOR BAKERY GOODS (U.S. CL. 46).

FIRST USE 3-12-2003; IN COMMERCE 6-1-2003.

ELIZABETH PIGNATELLO, EXAMINING ATTORNEY

SN 78-350,890. DISHAKA GOURMET IMPORTS, L.L.C., HOUSTON, TX. FILED 1-12-2004.

AGED TO PERFECTION

THE MARK CONSISTS OF STANDARD CHARACTERS WITHOUT CLAIM TO ANY PARTICULAR FONT, STYLE, SIZE, OR COLOR.

FOR RICE (U.S. CL. 46).

KIMBERLY FRYE, EXAMINING ATTORNEY

**CLASS 30—(Continued).**

SN 78-352,352. UNCLE WAFFLES, LTD., CLEVELAND HEIGHTS, OH. FILED 1-15-2004.

dreamwaffles

THE MARK CONSISTS OF STANDARD CHARACTERS WITHOUT CLAIM TO ANY PARTICULAR FONT, STYLE, SIZE, OR COLOR.

FOR WAFFLES (U.S. CL. 46).

MATTHEW KLINE, EXAMINING ATTORNEY

SN 78-352,360. UNCLE WAFFLES, LTD., CLEVELAND HEIGHTS, OH. FILED 1-15-2004.

PJ Snackenwaffles

THE MARK CONSISTS OF STANDARD CHARACTERS WITHOUT CLAIM TO ANY PARTICULAR FONT, STYLE, SIZE, OR COLOR.

FOR WAFFLES (U.S. CL. 46).

DAWN HAN, EXAMINING ATTORNEY

SN 78-354,261. SARA LEE BAKERY GROUP, INC., ST. LOUIS, MO. FILED 1-20-2004.

WHOLE GRAINS FOR  
THE WHOLE FAMILY

THE MARK CONSISTS OF STANDARD CHARACTERS WITHOUT CLAIM TO ANY PARTICULAR FONT, STYLE, SIZE, OR COLOR.

FOR BREAD, BUNS AND ROLLS (U.S. CL. 46).

DAVID MURRAY, EXAMINING ATTORNEY



**CLASS 30—(Continued).**

SN 78-354,264. SARA LEE BAKERY GROUP, INC., ST. LOUIS, MO. FILED 1-20-2004.

**CLASS 30—(Continued).**

SN 78-354,589. PIERRE FOODS, INC., CINCINNATI, OH. FILED 1-20-2004.

**AS NATURE INTENDED**

THE MARK CONSISTS OF STANDARD CHARACTERS WITHOUT CLAIM TO ANY PARTICULAR FONT, STYLE, SIZE, OR COLOR.  
FOR BREAD, BUNS AND ROLLS (U.S. CL. 46).  
DAVID MURRAY, EXAMINING ATTORNEY

**BALANCE CHECK**

THE MARK CONSISTS OF STANDARD CHARACTERS WITHOUT CLAIM TO ANY PARTICULAR FONT, STYLE, SIZE, OR COLOR.  
FOR SANDWICHES AND BAKERY GOODS (U.S. CL. 46).  
DAWN HAN, EXAMINING ATTORNEY

SN 78-354,278. SARA LEE BAKERY GROUP, INC., ST. LOUIS, MO. FILED 1-20-2004.

SN 78-355,427. THE KRYSTAL COMPANY, CHATTANOOGA, TN. FILED 1-22-2004.

**THE GOODNESS AS NATURE INTENDED**

THE MARK CONSISTS OF STANDARD CHARACTERS WITHOUT CLAIM TO ANY PARTICULAR FONT, STYLE, SIZE, OR COLOR.  
FOR BREAD, BUNS AND ROLLS (U.S. CL. 46).  
DAVID MURRAY, EXAMINING ATTORNEY

**B.A. BURGER**

THE MARK CONSISTS OF STANDARD CHARACTERS WITHOUT CLAIM TO ANY PARTICULAR FONT, STYLE, SIZE, OR COLOR.  
NO CLAIM IS MADE TO THE EXCLUSIVE RIGHT TO USE BURGER, APART FROM THE MARK AS SHOWN.  
FOR SPECIALLY PREPARED SANDWICHES FOR CONSUMPTION ON OR OFF THE PREMISES (U.S. CL. 46).  
SUE LAWRENCE, EXAMINING ATTORNEY

SN 78-354,585. PIERRE FOODS, INC., CINCINNATI, OH. FILED 1-20-2004.

SN 78-357,203. SPECIALTY COFFEE ASSOCIATION OF AMERICA, INC., LONG BEACH, CA. FILED 1-25-2004.

**CALORIE CHECK**

THE MARK CONSISTS OF STANDARD CHARACTERS WITHOUT CLAIM TO ANY PARTICULAR FONT, STYLE, SIZE, OR COLOR.  
FOR SANDWICHES AND BAKERY GOODS (U.S. CL. 46).  
DAWN HAN, EXAMINING ATTORNEY

**BREW ACROSS AMERICA**

THE MARK CONSISTS OF STANDARD CHARACTERS WITHOUT CLAIM TO ANY PARTICULAR FONT, STYLE, SIZE, OR COLOR.  
FOR COFFEE BEVERAGES MADE FROM ROASTED COFFEE BEANS (U.S. CL. 46).  
RAUL CORDOVA, EXAMINING ATTORNEY

**CLASS 30—(Continued).**

SN 78-357,293. LIPTON INVESTMENTS, INC., WILMINGTON, DE. FILED 1-26-2004.

**POPSICLE X-TREME  
SPORT**

THE MARK CONSISTS OF STANDARD CHARACTERS WITHOUT CLAIM TO ANY PARTICULAR FONT, STYLE, SIZE, OR COLOR.

OWNER OF U.S. REG. NOS. 177,230, 2,668,524 AND OTHERS.

FOR FROZEN CONFECTIONS (U.S. CL. 46).

LINDA MICKLEBURGH, EXAMINING ATTORNEY

---

SN 78-357,314. BARILLA AMERICA, INC., BANNOCKBURN, IL. FILED 1-26-2004.

**EXPERIENCE THE  
SAUCE ITALIANS  
EMBRACE AS THEIR  
OWN**

THE MARK CONSISTS OF STANDARD CHARACTERS WITHOUT CLAIM TO ANY PARTICULAR FONT, STYLE, SIZE, OR COLOR.

FOR SAUCES (U.S. CL. 46).

GLENN CLARK, EXAMINING ATTORNEY

**CLASS 30—(Continued).**

SN 78-357,656. LATIBAER EHF., GARDABAER, ICELAND, FILED 1-26-2004.

**SPORTACUS**

THE MARK CONSISTS OF STANDARD CHARACTERS WITHOUT CLAIM TO ANY PARTICULAR FONT, STYLE, SIZE, OR COLOR.

FOR COFFEE, TEA, COCOA, ARTIFICIAL COFFEE, SUGAR, RICE, TAPIOCA, SAGO, ARTIFICIAL COFFEE; FLOUR AND PROCESSED CEREALS; BISCUITS, BREAKFAST CEREALS, MUESLI, CAKES, CANDY, CHEWING GUM, CHOCOLATE, WHITE CHOCOLATE, COCOA MIX, COOKIES, EDIBLE DECORATIONS FOR CAKES, BAKERY AND FROZEN DAIRY DESSERTS; GINGERBREAD; TABLE SYRUP; ICE CREAM; EDIBLE ICES; LOLLIPOPS; MACARONI; NOODLES; PASTA; PASTRIES; PEANUT BRITTLE; PEPPERMINT CANDY SWEETS; FRUIT GUMMY CANDIES; PIES; PIZZAS; POPPED POPCORN; PUDDINGS; SHERBETS; SORBETS; TARTS AND WAFFLES; READY-TO-SERVE MEALS AND SEMI-COOKED MEALS, MAINLY CONSISTING OF RICE AND/OR NOODLES AND/OR PASTAS; PRETZELS; CORN CHIPS; ICE MILK; FROZEN YOGURT; BREAD; FROZEN CONFECTIONS; FLAVORED ICES; HONEY, TREACLE; YEAST, BAKING-POWDER; SALT, MUSTARD; VINEGAR, SAUCES; SPICES; ICE; UN-POPPED POPCORN (U.S. CL. 46).

ANDREA K. NADELMAN, EXAMINING ATTORNEY

---

SN 78-359,265. FAREBROTHER, GARY A., LINCOLN, CA. FILED 1-29-2004.

**DOS VATOS**

THE MARK CONSISTS OF STANDARD CHARACTERS WITHOUT CLAIM TO ANY PARTICULAR FONT, STYLE, SIZE, OR COLOR.

THE FOREIGN WORDING IN THE MARK TRANSLATES INTO ENGLISH AS TWO DUDES.

FOR SALSA (U.S. CL. 46).

PRISCILLA MILTON, EXAMINING ATTORNEY

**CLASS 30—(Continued).**

SN 78-360,840. SARA LEE FOODS, INC., CINCINNATI, OH.  
FILED 2-2-2004.

**DOUBLE PLAY**

THE MARK CONSISTS OF STANDARD CHARACTERS WITHOUT CLAIM TO ANY PARTICULAR FONT, STYLE, SIZE, OR COLOR.

FOR HOT DOG IN A BUN (U.S. CL. 46).  
FIRST USE 8-15-2003; IN COMMERCE 8-15-2003.  
ELLEN PERKINS, EXAMINING ATTORNEY

SN 78-369,752. THE QUAKER OATS COMPANY, CHICAGO, IL. FILED 2-18-2004.

**QUAKER Q-SMART**

THE MARK CONSISTS OF STANDARD CHARACTERS WITHOUT CLAIM TO ANY PARTICULAR FONT, STYLE, SIZE, OR COLOR.

OWNER OF U.S. REG. NOS. 26,253, 2,417,400 AND OTHERS.  
FOR GRAIN-BASED SNACK FOODS (U.S. CL. 46).  
DAWN HAN, EXAMINING ATTORNEY

**CLASS 31—NATURAL AGRICULTURAL PRODUCTS**

SN 76-294,263. SUNNILAND CORPORATION, SANFORD, FL. FILED 8-3-2001.



NO CLAIM IS MADE TO THE EXCLUSIVE RIGHT TO USE "CORPORATION", APART FROM THE MARK AS SHOWN.

FOR MULCH (U.S. CLS. 1 AND 46).  
WANDA KAY PRICE, EXAMINING ATTORNEY

SN 76-375,346. INGENKO PTY., LTD., CLAYTON, VICTORIA, 3168, AUSTRALIA, FILED 2-25-2002.

**INGENKO**

FOR LIVE ANIMALS (U.S. CLS. 1 AND 46).  
FIRST USE 6-0-2001; IN COMMERCE 6-0-2001.  
GEORGIA CARTY, EXAMINING ATTORNEY

SN 76-389,064. HAAS OUTDOORS, INC., WEST POINT, MS. FILED 3-28-2002.

**GREEN PATCH PLUS**

NO CLAIM IS MADE TO THE EXCLUSIVE RIGHT TO USE "PLUS", APART FROM THE MARK AS SHOWN.

FOR PLANT SEED, NAMELY, SEED FOR GROWING PLANTS INTENDED AND DESIGNED FOR CONSUMPTION BY WILDLIFE (U.S. CLS. 1 AND 46).  
FIRST USE 2-2-2002; IN COMMERCE 2-2-2002.  
GEORGIA CARTY, EXAMINING ATTORNEY

SN 76-454,696. CLEMENT ENTERPRISES, LLC, LEWISVILLE, ID. FILED 10-2-2002.

**THE NATION'S FINEST**

OWNER OF U.S. REG. NOS. 774,745 AND 814,137. SEC. 2(F).  
FOR FRESH POTATOES; FRESH ONIONS (U.S. CLS. 1 AND 46).  
FIRST USE 9-0-1997; IN COMMERCE 9-0-1997.  
KARANENDRA S. CHHINA, EXAMINING ATTORNEY

**CLASS 31—(Continued).**

SN 76-473,029. LONG, WALTER G., ALLENTOWN, PA.  
FILED 11-25-2002.

**VENISON VYTTLES**

NO CLAIM IS MADE TO THE EXCLUSIVE RIGHT TO  
USE "VENISON", APART FROM THE MARK AS SHOWN.  
FOR AGRICULTURAL SEEDS, NAMELY, SEEDS FOR  
GROWING ANIMAL FOODSTUFFS (U.S. CLS. 1 AND  
46).

FIRST USE 11-27-2002; IN COMMERCE 11-27-2002.  
INGA ERVIN, EXAMINING ATTORNEY

---

SN 76-539,400. ORSCHELN FARM AND HOME LLC, MO-  
BERLY, MO. FILED 8-20-2003.

**COUNTRY LANE SUPREME**

OWNER OF U.S. REG. NOS. 2,213,482 AND 2,672,121.  
NO CLAIM IS MADE TO THE EXCLUSIVE RIGHT TO  
USE "SUPREME", APART FROM THE MARK AS SHOWN.  
FOR ANIMAL FEEDS AND ANIMAL FOODSTUFF  
(U.S. CLS. 1 AND 46).

WANDA KAY PRICE, EXAMINING ATTORNEY

---

SN 76-555,118. THE HARTZ MOUNTAIN CORPORATION,  
SECAUCUS, NJ. FILED 10-29-2003.

**WARDLEY TEN POND STIX**

OWNER OF U.S. REG. NOS. 579,502, 720,091 AND  
2,236,068.

NO CLAIM IS MADE TO THE EXCLUSIVE RIGHT TO  
USE POND STICKS, APART FROM THE MARK AS  
SHOWN.

FOR FISH FOOD (U.S. CLS. 1 AND 46).  
AMY HELLA, EXAMINING ATTORNEY

---

SN 76-555,119. THE HARTZ MOUNTAIN CORPORATION,  
SECAUCUS, NJ. FILED 10-29-2003.

**WARDLEY TEN POND  
FLAKES**

OWNER OF U.S. REG. NOS. 579,502, 720,091 AND  
2,236,068.

NO CLAIM IS MADE TO THE EXCLUSIVE RIGHT TO  
USE POND FLAKES, APART FROM THE MARK AS  
SHOWN.

FOR FISH FOOD (U.S. CLS. 1 AND 46).  
AMY HELLA, EXAMINING ATTORNEY

**CLASS 31—(Continued).**

SN 76-558,823. SEMINIS VEGETABLE SEEDS, INC., OX-  
NARD, CA. FILED 11-10-2003.

**SENZA**

THE FOREIGN WORDING IN THE MARK TRANSLATES  
INTO ENGLISH AS WITHOUT.

FOR FRESH, RAW AND UNPROCESSED VEGETA-  
BLES; FRESH, RAW AND UNPROCESSED FRUITS;  
AGRICULTURAL SEEDS. (U.S. CLS. 1 AND 46).

MICHELE SWAIN, EXAMINING ATTORNEY

---

SN 76-562,214. BOMAN, ROGER K., DBA BOMAN PACK-  
ING, ORANGE COVE, CA. FILED 11-14-2003.

**TRUSTY SWEET**

NO CLAIM IS MADE TO THE EXCLUSIVE RIGHT TO  
USE "SWEET", APART FROM THE MARK AS SHOWN.  
FOR FRESH FRUIT (U.S. CLS. 1 AND 46).

CAROLYN CATALDO, EXAMINING ATTORNEY

---

SN 76-569,360. THE MEOW MIX COMPANY, SECAUCUS,  
NJ. FILED 1-12-2004.

**FELINE MIGNON**

FOR CAT FOOD AND CAT TREATS (U.S. CLS. 1 AND  
46).

BRIDGETT SMITH, EXAMINING ATTORNEY

**CLASS 31—(Continued).**

SN 78-205,317. BETHKE, CHARLES, WILLIAMSTON, MI.  
FILED 1-21-2003.



NO CLAIM IS MADE TO THE EXCLUSIVE RIGHT TO USE "ORCHIDS", APART FROM THE MARK AS SHOWN. THE COLOR PINK IS CLAIMED AS A FEATURE OF THE PETALS OF THE ORCHID.

THE MARK CONSISTS OF PINK PHALENOPSIS BLOOM AND THE WORDS "EZ-CARE ORCHIDS" CURVED ALONG BLOOM.

FOR LIVE ORCHIDS (U.S. CLS. 1 AND 46).  
FIRST USE 9-24-2002; IN COMMERCE 9-24-2002.  
AMY ALFIERI, EXAMINING ATTORNEY

SN 78-265,330. LIDL STIFTUNG & CO. KG, NECKARSULM,  
FED REP GERMANY, FILED 6-20-2003.



OWNER OF FED REP GERMANY REG. NO. 2084422,  
DATED 11-9-1994, RENEWED AS REG. NO. 2084422, DATED  
6-30-2004, EXPIRES 6-30-2014.

OWNER OF U.S. REG. NO. 2,507,106.  
THE LINING IN THE DRAWING IS FOR SHADING  
PURPOSES ONLY.

FOR FOODSTUFF FOR ANIMALS (U.S. CLS. 1 AND  
46).  
GEORGIA CARTY, EXAMINING ATTORNEY

**CLASS 31—(Continued).**

SN 78-291,812. REEVES, JOANNA M., CAROLINA, WV.  
FILED 8-25-2003.

**JO JO BONES**

THE MARK CONSISTS OF STANDARD CHARACTERS WITHOUT CLAIM TO ANY PARTICULAR FONT, STYLE, SIZE, OR COLOR.

NO CLAIM IS MADE TO THE EXCLUSIVE RIGHT TO USE "BONES", APART FROM THE MARK AS SHOWN.

FOR DOG TREATS, NAMELY, EDIBLE DOG BISCUITS AND BONES, AND MIXES FOR EDIBLE DOG BISCUITS AND BONES (U.S. CLS. 1 AND 46).

FIRST USE 7-1-1998; IN COMMERCE 7-1-1998.  
DANIEL CAPSHAW, EXAMINING ATTORNEY

SN 78-310,562. SPACIFIC GROWERS LIMITED, WAIUKU,  
NEW ZEALAND, FILED 10-7-2003.

**LEUCHID**

PRIORITY CLAIMED UNDER SEC. 44(D) ON NEW ZEALAND APPLICATION NO. 678268, FILED 5-1-2003, REG. NO. 678268, DATED 5-30-2003, EXPIRES 5-1-2010.

FOR HORTICULTURAL PRODUCTS, NAMELY LIVING PLANTS, DRIED PLANTS, LIVE FLOWERS, CUT FLOWERS, SEEDLINGS AND DRIED FLOWERS, DRIED AND LIVE FLOWER ARRANGEMENTS, SEEDS AND BULBS. (U.S. CLS. 1 AND 46).

JOHN DWYER, EXAMINING ATTORNEY

SN 78-336,788. SERGEANT'S PET CARE PRODUCTS, INC.,  
OMAHA, NE. FILED 12-5-2003.

**GEISLER GOURMET**

THE MARK CONSISTS OF STANDARD CHARACTERS WITHOUT CLAIM TO ANY PARTICULAR FONT, STYLE, SIZE, OR COLOR.

OWNER OF U.S. REG. NO. 973,692.  
NO CLAIM IS MADE TO THE EXCLUSIVE RIGHT TO USE "GOURMET", APART FROM THE MARK AS SHOWN. FOR EDIBLE PET TREATS AND PET FOOD (U.S. CLS. 1 AND 46).

FIRST USE 9-20-2001; IN COMMERCE 9-20-2001.  
JENNIFER MARTIN, EXAMINING ATTORNEY

**CLASS 31—(Continued).**

SN 78-343,301. RALCO-MIX PRODUCTS, INC., MARSHALL, MN. FILED 12-19-2003.



THE COLOR(S) LIGHT GREEN AND DARK GREEN IS/ ARE CLAIMED AS A FEATURE OF THE MARK.

THE COLOR LIGHT GREEN APPEARS IN THE "R" PORTION OF THE MARK, AND THE COLOR DARK GREEN APPEARS IN THE "EGANO" PORTION OF THE MARK.

THE MARK CONSISTS OF THE WORD REGANO WITH A STYLIZED LETTER "R".

FOR ANIMAL FOODSTUFFS CONTAINING OREGANO OIL (U.S. CLS. 1 AND 46).

GIANCARLO CASTRO, EXAMINING ATTORNEY

---

SN 78-349,400. THE KONG COMPANY, GOLDEN, CO. FILED 1-8-2004.

**BREATH TAMERS**

THE MARK CONSISTS OF STANDARD CHARACTERS WITHOUT CLAIM TO ANY PARTICULAR FONT, STYLE, SIZE, OR COLOR.

NO CLAIM IS MADE TO THE EXCLUSIVE RIGHT TO USE BREATH, APART FROM THE MARK AS SHOWN.

FOR EDIBLE PET TREATS CONTAINING BREATH FRESHENING COMPONENTS (U.S. CLS. 1 AND 46).

ALEXANDER L. POWERS, EXAMINING ATTORNEY

---

SN 78-351,066. MILK SPECIALTIES COMPANY, DUNDEE, IL. FILED 1-13-2004.

**WE FEED THE CHAMPIONS**

THE MARK CONSISTS OF STANDARD CHARACTERS WITHOUT CLAIM TO ANY PARTICULAR FONT, STYLE, SIZE, OR COLOR.

FOR ANIMAL FEED, NAMELY, HORSE FEED (U.S. CLS. 1 AND 46).

ALEX KEAM, EXAMINING ATTORNEY

**CLASS 31—(Continued).**

SN 78-351,068. D & D COMMODITIES LIMITED, STEPHEN, MN. FILED 1-13-2004.

**MIXIN'S 'N FIXIN'S**

THE MARK CONSISTS OF STANDARD CHARACTERS WITHOUT CLAIM TO ANY PARTICULAR FONT, STYLE, SIZE, OR COLOR.

FOR FOOD FOR ANIMALS (U.S. CLS. 1 AND 46).

WON TEAK OH, EXAMINING ATTORNEY

---

SN 78-352,367. FRANCESCONI, MICHAEL J., STAFFORD, VA. FILED 1-15-2004.

**KidGrown**

THE MARK CONSISTS OF STANDARD CHARACTERS WITHOUT CLAIM TO ANY PARTICULAR FONT, STYLE, SIZE, OR COLOR.

FOR AGRICULTURE, HORTICULTURE AND FORESTRY PRODUCTS, NAMELY, PLANT SEEDS, LIVING PLANTS, LIVE TREES, LIVE FLOWERS, FRESH FRUITS, FRESH VEGETABLES AND FRESH HERBS (U.S. CLS. 1 AND 46).

FIRST USE 1-10-2004; IN COMMERCE 1-12-2004.

DAWN HAN, EXAMINING ATTORNEY

**CLASS 31—(Continued).**

SN 78-356,911. SOUTHERN SELECTIONS, LLC, LOGANVILLE, GA. FILED 1-23-2004.

**AERYN**

THE MARK CONSISTS OF STANDARD CHARACTERS WITHOUT CLAIM TO ANY PARTICULAR FONT, STYLE, SIZE, OR COLOR.  
FOR TRIDENT MAPLE TREES (U.S. CLS. 1 AND 46).  
TRICIA THOMPSON, EXAMINING ATTORNEY

SN 78-356,917. SOUTHERN SELECTIONS, LLC, LOGANVILLE, GA. FILED 1-23-2004.

**VALYNOR**

THE MARK CONSISTS OF STANDARD CHARACTERS WITHOUT CLAIM TO ANY PARTICULAR FONT, STYLE, SIZE, OR COLOR.  
FOR TRIDENT MAPLE TREES (U.S. CLS. 1 AND 46).  
DAVID TAYLOR, EXAMINING ATTORNEY

**CLASS 32—LIGHT BEVERAGES**

SN 76-399,222. HERBN TONICS, LLC, BEVERLY HILLS, CA. FILED 4-23-2002.

**HERBN TONICS**

NO CLAIM IS MADE TO THE EXCLUSIVE RIGHT TO USE "TONICS", APART FROM THE MARK AS SHOWN.  
FOR NON-ALCOHOLIC BEVERAGES, NAMELY, CARBONATED AND NON-CARBONATED BEVERAGES AND OTHER NON-ALCOHOLIC DRINKS, NAMELY, FLAVORED AND UNFLAVORED WATERS, FRUIT DRINKS, FRUIT JUICES, SOFT DRINKS, SPORTS DRINKS, CARBONATED AND NON-CARBONATED WATERS; CONCENTRATES, SYRUPS, AND PREPARATIONS FOR THE MAKING OF BEVERAGES, NAMELY, SOFT DRINKS, FLAVORED WATERS, FRUIT DRINKS, FRUIT JUICES, AND SPORTS DRINKS (U.S. CLS. 45, 46 AND 48).  
GEORGIA CARTY, EXAMINING ATTORNEY

SN 76-546,860. THE GAMBRINUS COMPANY, SAN ANTONIO, TX. FILED 9-11-2003.

**ROESELARE**

FOR BEER (U.S. CLS. 45, 46 AND 48).  
BARBARA A. LOUGHRAN, EXAMINING ATTORNEY

SN 76-547,845. GRANNAN, JAMES EDWARD, LOS ANGELES, CA. FILED 9-29-2003.

**BUTTMONKEY**

FOR BEER (U.S. CLS. 45, 46 AND 48).  
FIRST USE 2-0-1999; IN COMMERCE 2-0-1999.  
ANGELA M. MICHELI, EXAMINING ATTORNEY

SN 78-117,249. MENDOCINO BREWING COMPANY, INC., UKIAH, CA. FILED 3-25-2002.

**BLUE HERON**

SUBJECT TO CONCURRENT USE PROCEEDING WITH BRIDGEPORT BREWING COMPANY. APPLICANT CLAIMS EXCLUSIVE RIGHT TO USE THE MARK IN THE ENTIRE UNITED STATES WITH THE EXCEPTION OF OREGON, IDAHO, WASHINGTON AND MONTANA.  
FOR BEER, ALE AND LAGER (U.S. CLS. 45, 46 AND 48).  
FIRST USE 7-0-1985; IN COMMERCE 7-0-1985.  
LINDA M. KING, EXAMINING ATTORNEY

**CLASS 32—(Continued).**

SN 78-141,547. TY NANT SPRING WATER LIMITED, CEREDIGION, UNITED KINGDOM, FILED 7-5-2002.

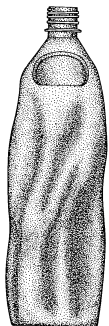

PRIORITY CLAIMED UNDER SEC. 44(D) ON UNITED KINGDOM APPLICATION NO. 2297924, FILED 4-2-2002, REG. NO. 2297924, DATED 4-2-2002, EXPIRES 4-2-2012.

THE STIPPLING IS TO INDICATE SHADING ILLUSTRATING THE BOTTLE CONTOURS AND DOES NOT INDICATE COLOR.

THE MARK CONSISTS OF A CONFIGURATION OF A WATER BOTTLE WITH CURVACEOUS CONTOUR PATTERNING.

FOR BOTTLED DRINKING WATER; BOTTLED MINERAL WATER; SPRING WATER AND AERATED WATER (U.S. CLS. 45, 46 AND 48).

FIRST USE 12-10-2001; IN COMMERCE 2-0-2002.  
CAROLINE WOOD, EXAMINING ATTORNEY

SN 78-218,870. INFRA METAL ESTABLISHMENT, FL-9492 ESCHEN, LIECHTENSTEIN, FILED 2-25-2003.



**wellfit**

THE CHINESE CHARACTER APPEARING IN THE MARK TRANSLITERATES TO SHENG, WHICH TRANSLATES TO MEAN LIFE.

FOR SOFT DRINKS, SPORTS DRINKS, ISOTONIC DRINKS THAT BOOST ENERGY; SOFT DRINKS, SPORTS DRINKS, AND ISOTONIC DRINK ALL CONTAINING PLANT EXTRACTS END/OR AMINO ACIDS (U.S. CLS. 45, 46 AND 48).

FIRST USE 12-4-2002; IN COMMERCE 12-4-2002.  
ESTHER BELENKER, EXAMINING ATTORNEY

**CLASS 32—(Continued).**

SN 78-270,160. VIA MAX, INC., NEW YORK, NY. FILED 7-3-2003.

**AQUAMAX**

FOR BOTTLED WATER (U.S. CLS. 45, 46 AND 48).  
MELVIN AXILBUND, EXAMINING ATTORNEY

SN 78-284,591. HESSINGER, CRAIG PATRICK, BISMARCK, ND. FILED 8-7-2003.

**CANADAKOTA**

FOR BOTTLED DRINKING WATER; BEER (U.S. CLS. 45, 46 AND 48).  
AMY HELLA, EXAMINING ATTORNEY

SN 78-291,747. MCG MARKETING CONSULTANTS, INC., NEW YORK, NY. FILED 8-25-2003.

**MEXI LIME**

OWNER OF U.S. REG. NOS. 2,239,045 AND 2,392,255.  
NO CLAIM IS MADE TO THE EXCLUSIVE RIGHT TO USE "LIME", APART FROM THE MARK AS SHOWN.  
FOR SOFT DRINKS (U.S. CLS. 45, 46 AND 48).  
PATRICIA EVANKO, EXAMINING ATTORNEY

SN 78-291,754. MCG MARKETING CONSULTANTS, INC., NEW YORK, NY. FILED 8-25-2003.

**MEXI ORANGE**

OWNER OF U.S. REG. NOS. 2,239,045 AND 2,392,255.  
NO CLAIM IS MADE TO THE EXCLUSIVE RIGHT TO USE "ORANGE", APART FROM THE MARK AS SHOWN.  
FOR SOFT DRINKS (U.S. CLS. 45, 46 AND 48).  
PATRICIA EVANKO, EXAMINING ATTORNEY

SN 78-304,970. BROUWERIJ NACIONAL BALASHI NV, ARUBA, ARUBA, FILED 9-24-2003.

**TROPICAL AWA**

NO CLAIM IS MADE TO THE EXCLUSIVE RIGHT TO USE "AWA", APART FROM THE MARK AS SHOWN.  
THE ENGLISH TRANSLATION OF THE FOREIGN WORDING "AWA" IN THE MARK TROPICAL AWA IS "WATER".

FOR SPRING WATER (U.S. CLS. 45, 46 AND 48).  
CAROLYN CATALDO, EXAMINING ATTORNEY



**CLASS 32—(Continued).**

SN 78-351,679. AMERICAN WATER STAR, INC., LAS VEGAS, NV. FILED 1-14-2004.

**Geyser Kid-Lite**

THE MARK CONSISTS OF STANDARD CHARACTERS WITHOUT CLAIM TO ANY PARTICULAR FONT, STYLE, SIZE, OR COLOR.

OWNER OF U.S. REG. NO. 2,569,068.

FOR BEVERAGES, NAMELY BOTTLED WATER, FLAVORED WATER AND FRUIT JUICES (U.S. CLS. 45, 46 AND 48).

JOHN HWANG, EXAMINING ATTORNEY

---

SN 78-351,933. SONORA BREWING COMPANY, LLC, PHOENIX, AZ. FILED 1-14-2004.

**INEBRIATOR**

THE MARK CONSISTS OF STANDARD CHARACTERS WITHOUT CLAIM TO ANY PARTICULAR FONT, STYLE, SIZE, OR COLOR.

FOR BEER, ALE, OR LAGER (U.S. CLS. 45, 46 AND 48).

FIRST USE 12-19-2001; IN COMMERCE 8-15-2003.

GRETTA YAO, EXAMINING ATTORNEY

---

SN 78-353,174. THE KROGER CO. OF MICHIGAN, LIVONIA, MI. FILED 1-16-2004.

**EXTREME FUSION**

THE MARK CONSISTS OF STANDARD CHARACTERS WITHOUT CLAIM TO ANY PARTICULAR FONT, STYLE, SIZE, OR COLOR.

FOR FRUIT JUICE DRINKS (U.S. CLS. 45, 46 AND 48).

FIRST USE 4-0-2004; IN COMMERCE 4-0-2004.

MARLENE BELL, EXAMINING ATTORNEY

**CLASS 32—(Continued).**

SN 78-357,657. LATIBAER EHF., GARDABAER, ICELAND, FILED 1-26-2004.

**SPORTACUS**

THE MARK CONSISTS OF STANDARD CHARACTERS WITHOUT CLAIM TO ANY PARTICULAR FONT, STYLE, SIZE, OR COLOR.

FOR NON-ALCOHOLIC BEVERAGES, NAMELY, CARBONATED SOFT DRINKS, NON-CARBONATED SOFT DRINKS, FRUIT DRINKS, FRUIT JUICES, FRUIT PUNCHES, FRUIT-FLAVORED DRINKS; FRUIT FLAVORED ADES; VEGETABLE JUICE; VEGETABLE DRINKS; VEGETABLE JUICE CONCENTRATES; SPORT DRINKS; SMOOTHIES AND BOTTLED WATER; AND SYRUPS, CONCENTRATES AND POWDERS FOR MAKING BEVERAGES, NAMELY, FLAVORED WATERS, SOFT DRINKS, SPORTS DRINKS, FRUIT DRINKS, PUNCHES AND ADES; MINERAL AND AERATED WATERS (U.S. CLS. 45, 46 AND 48).

ANDREA K. NADELMAN, EXAMINING ATTORNEY

---

SN 78-358,069. ANHEUSER-BUSCH INCORPORATED, SAINT LOUIS, MO. FILED 1-27-2004.

**FRESH.SMOOTH.REAL.  
IT'S ALL HERE**

THE MARK CONSISTS OF STANDARD CHARACTERS WITHOUT CLAIM TO ANY PARTICULAR FONT, STYLE, SIZE, OR COLOR.

FOR BEER (U.S. CLS. 45, 46 AND 48).

FIRST USE 2-29-2004; IN COMMERCE 2-29-2004.

REGINA DRUMMOND, EXAMINING ATTORNEY

**CLASS 32—(Continued).**

SN 78-358,075. ANHEUSER-BUSCH INCORPORATED,  
SAINT LOUIS, MO. FILED 1-27-2004.

IT'S ALL HERE

THE MARK CONSISTS OF STANDARD CHARACTERS  
WITHOUT CLAIM TO ANY PARTICULAR FONT, STYLE,  
SIZE, OR COLOR.

FOR BEER (U.S. CLS. 45, 46 AND 48).  
FIRST USE 2-29-2004; IN COMMERCE 2-29-2004.  
RON FAIRBANKS, EXAMINING ATTORNEY

SN 78-358,899. BEAR REPUBLIC BREWING CO., INC.,  
HEALDSBURG, CA. FILED 1-28-2004.



NO CLAIM IS MADE TO THE EXCLUSIVE RIGHT TO  
USE "INDIA PALE ALE", APART FROM THE MARK AS  
SHOWN.

THE MARK CONSISTS OF THE WORD "RACER" IN  
STYLIZED LETTERING ARCED THE NUMBER "5" WHICH  
APPEARS WITHIN A CIRCLE AND THE WORDS "INDIA  
PALE ALE" INTERLINEATING THE BOTTOM PORTION  
OF THE CIRCLE. THE AFOREMENTIONED WORDS AND  
DESIGN BEING SUPERIMPOSED ON A REPRESENTATIVE  
CHECKER FLAG.

FOR BREWED MALT-BASED ALCOHOLIC BEV-  
ERAGES IN THE NATURE OF BEER AND ALE (U.S.  
CLS. 45, 46 AND 48).

FIRST USE 11-30-1998; IN COMMERCE 11-30-1998.  
DAVID TAYLOR, EXAMINING ATTORNEY

**CLASS 32—(Continued).**

SN 78-359,094. COBB, JAMES W., TRINITY, TX. FILED 1-28-  
2004.

one cool move

THE MARK CONSISTS OF STANDARD CHARACTERS  
WITHOUT CLAIM TO ANY PARTICULAR FONT, STYLE,  
SIZE, OR COLOR.

FOR SOFT DRINK (U.S. CLS. 45, 46 AND 48).  
MARY BOAGNI, EXAMINING ATTORNEY

SN 78-359,285. THE B. MANISCHEWITZ COMPANY, LLC,  
JERSEY CITY, NJ. FILED 1-29-2004.

MANISCHEWITZ

THE MARK CONSISTS OF STANDARD CHARACTERS  
WITHOUT CLAIM TO ANY PARTICULAR FONT, STYLE,  
SIZE, OR COLOR.

OWNER OF U.S. REG. NOS. 630,579, 2,342,048 AND  
OTHERS.

SEC. 2(F).  
FOR GRAPE JUICE (U.S. CLS. 45, 46 AND 48).  
DORITT L. CARROLL, EXAMINING ATTORNEY

SN 78-359,789. COMEBACK BREWING, INC., SAN ANTO-  
NIO, TX. FILED 1-29-2004.



FOR BEER AND ALE (U.S. CLS. 45, 46 AND 48).  
FIRST USE 1-16-2004; IN COMMERCE 2-23-2004.  
JOSETTE BEVERLY, EXAMINING ATTORNEY

**CLASS 32—(Continued).**

SN 78-360,115. HALSER IV, JOSEPH G., MILWAUKEE, WI.  
FILED 1-30-2004.

**WEINER DOG WITBIER**

THE MARK CONSISTS OF STANDARD CHARACTERS  
WITHOUT CLAIM TO ANY PARTICULAR FONT, STYLE,  
SIZE, OR COLOR.

NO CLAIM IS MADE TO THE EXCLUSIVE RIGHT TO  
USE WITBIER, APART FROM THE MARK AS SHOWN.  
FOR BEER (U.S. CLS. 45, 46 AND 48).  
SHARON MEIER, EXAMINING ATTORNEY

SN 78-365,254. RAPPINBRANDS, LLC, WHITE PLAINS, NY.  
FILED 2-10-2004.

**LUCKY NITES**

THE MARK CONSISTS OF STANDARD CHARACTERS  
WITHOUT CLAIM TO ANY PARTICULAR FONT, STYLE,  
SIZE, OR COLOR.

FOR BEER; MINERAL WATERS, AERATED WATERS,  
CARBONATED WATERS, FLAVORED WATERS AND  
OTHER NON-ALCOHOLIC BEVERAGES, NAMELY,  
PUNCHES, SOFT DRINKS, SMOOTHIES AND LEMON-  
ADES; SPORTS DRINKS; ENERGY DRINKS; ISOTONIC  
DRINKS, HYPERTONIC DRINKS AND HYPOTONIC  
DRINKS, FOR USE AND/OR AS REQUIRED BY ATH-  
LETES AND THOSE ENGAGED IN ACTIVE OR STRESS-  
FUL SPORTS AND ACTIVITIES; FRUIT JUICES AND  
FRUIT DRINKS, VEGETABLE JUICES AND VEGETA-  
BLE DRINKS; SYRUPS, POWDERS, CONCENTRATES  
AND EFFERVESCENT TABLETS FOR MAKING NON-  
ALCOHOLIC DRINKS AND BEVERAGES; NON-ALCO-  
HOLIC COCKTAILS AND DRINKS IN THE NATURE OF  
SOFT DRINKS, NON-ALCOHOLIC BEER, NON-ALCO-  
HOLIC PUNCHES, NON-ALCOHOLIC COCKTAIL  
MIXES, NON-ALCOHOLIC MALT COOLERS, NON-AL-  
COHOLIC FRUIT DRINKS, NON-ALCOHOLIC WINE,  
NON-ALCOHOLIC WINE COCKTAILS, NON-ALCO-  
HOLIC LIQUEURS AND NON-ALCOHOLIC MIXED  
COCKTAILS (U.S. CLS. 45, 46 AND 48).  
MARGERY A. TIERNEY, EXAMINING ATTORNEY

**CLASS 32—(Continued).**

SN 78-403,603. FLOREZ, STAN R., SCOTTSDALE, AZ. FILED  
4-17-2004.



The logo for "Witness Water Project" features the word "Witness" in a large, stylized, black script font. Below it, the word "Water" is written in a similar script font, with a stylized eye shape integrated into the letter 'o'. Underneath "Water", the word "PROJECT" is written in a smaller, bold, black, sans-serif font.

NO CLAIM IS MADE TO THE EXCLUSIVE RIGHT TO  
USE "WATER", APART FROM THE MARK AS SHOWN.  
FOR BOTTLED DRINKING WATER (U.S. CLS. 45, 46  
AND 48).  
REGINA DRUMMOND, EXAMINING ATTORNEY

SN 78-403,605. FLOREZ, STAN R., SCOTTSDALE, AZ. FILED  
4-17-2004.



The logo for "Windows of Heaven" features the words "Windows" and "Heaven" written in a large, elegant, cursive script font. The word "of" is written in a smaller, simpler font between "Windows" and "Heaven".

FOR BOTTLED DRINKING WATER (U.S. CLS. 45, 46  
AND 48).  
REGINA DRUMMOND, EXAMINING ATTORNEY

**CLASS 33—WINES AND SPIRITS**

SN 75-651,038. BOEGER WINERY, INC., PLACERVILLE, CA.  
FILED 3-1-1999.

**MILAGRO**

MILAGRO MAY BE TRANSLATED AS "MIRACLE."  
FOR WINES (U.S. CLS. 47 AND 49).  
FIRST USE 12-15-1997; IN COMMERCE 2-9-1998.  
ESTHER BELENKER, EXAMINING ATTORNEY

**CLASS 33—(Continued).**

SN 76-193,190. PAVONA WINES, INC., MONTEREY, CA.  
FILED 1-16-2001.

**ZAVONA**

THE WORD "ZAVONA" DOES NOT HAVE ANY PARTI-  
CULAR MEANING.

FOR WINE (U.S. CLS. 47 AND 49).  
DAWN FELDMAN, EXAMINING ATTORNEY

SN 76-275,936. YATES, MICHAEL C., DBA NAPA RED-  
WOODS ESTATE, NAPA, CA. FILED 6-21-2001.

**NAPA REDWOODS ESTATE**

NO CLAIM IS MADE TO THE EXCLUSIVE RIGHT TO  
USE "NAPA", APART FROM THE MARK AS SHOWN.  
FOR WINE (U.S. CLS. 47 AND 49).  
FIRST USE 11-29-2000; IN COMMERCE 11-29-2000.  
MARK T. MULLEN, EXAMINING ATTORNEY

SN 76-316,223. TARRAWARRA ESTATE PTY. LTD., VIC-  
TORIA 3003, AUSTRALIA, FILED 9-21-2001.

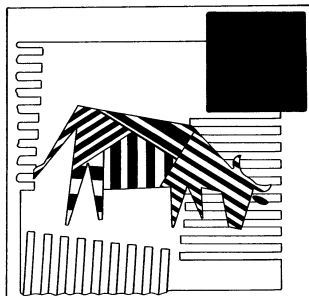

PRIORITY CLAIMED UNDER SEC. 44(D) ON AUSTRALIA  
APPLICATION NO. 870350, FILED 3-23-2001, REG. NO.  
870350, DATED 3-23-2001, EXPIRES 3-23-2011.  
FOR ALCOHOLIC BEVERAGES, NAMELY, WINE  
(U.S. CLS. 47 AND 49).  
ROBERT LORENZO, EXAMINING ATTORNEY

SN 76-526,874. UVAS DEL VALLE S.A., SALTA CITY,  
ARGENTINA, FILED 6-23-2003.

**INCA TRAIL**

FOR ALCOHOLIC DRINKS, NAMELY, WINES, PORT  
WINES, LIQUEURS, HARD CIDER, AND SPARKLING  
WINE (U.S. CLS. 47 AND 49).  
BRENDAN MCCAULEY, EXAMINING ATTORNEY

**CLASS 33—(Continued).**

SN 76-530,332. SOUTHERN COMFORT PROPERTIES, INC.,  
SAN RAFAEL, CA. FILED 7-18-2003.

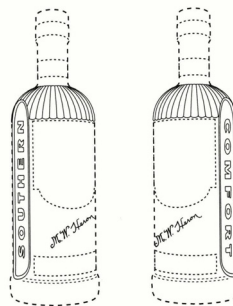

OWNER OF U.S. REG. NOS. 317,529, 2,797,121 AND  
OTHERS.

NO CLAIM IS MADE TO THE EXCLUSIVE RIGHT TO  
USE THE THREE-DIMENSIONAL ELEMENTS OF A  
ROUND CAP, A CYLINDRICAL NECK AND A ROUND  
BASE OF A BOTTLE, APART FROM THE MARK AS  
SHOWN.

THE MARK CONSISTS OF A THREE-DIMENSIONAL  
CONFIGURATION OF A BOTTLE WITH FLUTING  
AROUND THE SHOULDER BELOW THE NECK, COM-  
BINED WITH LITERAL ELEMENTS AS FOLLOWS: AN  
EMBOSSSED SIGNATURE DESIGN COMPRISED OF THE  
WORDS "M.W. HERON" APPEARS DIAGONALLY ON THE  
FRONT LOWER SIDE OF THE BOTTLE. THE MARK ALSO  
CONTAINS A CONCAVE, ELONGATED, OVAL DEPRES-  
SION ON THE LEFT AND RIGHT SIDES OF THE BOTTLE  
WITH THE WORD "SOUTHERN" EMBOSSSED VERTI-  
CALLY FROM BOTTOM TO TOP ON THE LEFT SIDE  
AND THE WORD "COMFORT" EMBOSSSED VERTI-  
CALLY FROM TOP TO BOTTOM ON THE RIGHT SIDE OF  
THE BOTTLE. THE DOTTED OR BROKEN LINES IN THE  
DRAWING ARE INTENDED TO SHOW THE POSITION  
OF THE LABELS THAT ARE PLACED ON THE BOTTLE AS  
WELL AS THE PORTIONS OF THE CONFIGURATION OF  
THE BOTTLE THAT ARE NOT CLAIMED AS FEATURES  
OF THE MARK.

SEC. 2(F) AS TO THE SHOULDER FLUTING DESIGN.  
FOR ALCOHOLIC BEVERAGES; NAMELY, DIS-  
TILLED SPIRITS (U.S. CLS. 47 AND 49).  
FIRST USE 6-30-2001; IN COMMERCE 6-30-2001.  
JENNIFER CHICOSKI, EXAMINING ATTORNEY

SN 76-532,543. QUINTA DE VENTOZELO - SOCIEDADE  
AGRICOLA E COMERCIAL, S.A., AKA QUINTA DE  
VENTOZELO, P-5130-135 SAO JOAO DA PESQUEIRA,  
PORTUGAL, FILED 7-25-2003.

**VENTOZELO**

OWNER OF PORTUGAL REG. NO. 228922, DATED 6-29-  
1990, EXPIRES 6-29-2010.  
FOR WINES, PORT WINES AND BRANDIES (U.S. CLS.  
47 AND 49).  
MIDGE BUTLER, EXAMINING ATTORNEY

**CLASS 33—(Continued).**

SN 76-558,333. DRINK TANK LTD., NEW YORK, NY. FILED 11-12-2003.

**PIE-TINIS**

FOR PREPARED ALCOHOLIC COCKTAIL (U.S. CLS. 47 AND 49).  
FIRST USE 10-15-2002; IN COMMERCE 10-15-2002.  
JUDITH GRUNDY, EXAMINING ATTORNEY

SN 76-569,481. GEERLINGS & WADE, INC., CANTON, MA. FILED 1-12-2004.

**CIRCLE SPRINGS**

THE MARK CONSISTS OF STANDARD CHARACTERS WITHOUT CLAIM TO ANY PARTICULAR FONT, STYLE, SIZE, OR COLOR.

FOR WINES (U.S. CLS. 47 AND 49).  
LOURDES AYALA, EXAMINING ATTORNEY

SN 78-156,863. PAUNOVICH, PALMER, DALLAS, TX. FILED 8-22-2002.

**Palmera**

THE FOREIGN WORDING IN THE MARK TRANSLATES INTO ENGLISH AS PALM TREE.  
FOR WINE (U.S. CLS. 47 AND 49).  
SUSAN LESLIE DUBOIS, EXAMINING ATTORNEY

SN 78-189,460. GROUPEMENT FONCIER AGRICOLE DU CHATEAU DE PRESSAC, 33330 SAINT-EMILION, FRANCE, FILED 11-27-2002.

**CHATEAU DE PRESSAC**

NO CLAIM IS MADE TO THE EXCLUSIVE RIGHT TO USE "CHATEAU", APART FROM THE MARK AS SHOWN. THE FOREIGN WORDING IN THE MARK TRANSLATES INTO ENGLISH AS CASTLE OF PRESSAC.  
FOR WINES (U.S. CLS. 47 AND 49).  
FIRST USE 0-0-1499; IN COMMERCE 11-0-1987.  
HOWARD SMIGA, EXAMINING ATTORNEY

**CLASS 33—(Continued).**

SN 78-209,931. DOWNUNDER BEVERAGES & SPIRITS PTY LTD, QUEENSLAND, AUSTRALIA, FILED 2-2-2003.

**DOWNUNDER RUM**

NO CLAIM IS MADE TO THE EXCLUSIVE RIGHT TO USE RUM, APART FROM THE MARK AS SHOWN.  
FOR BOTTLED SPIRITS, NAMELY A RUM PRODUCED AND BOTTLED IN QUEENSLAND, AUSTRALIA (U.S. CLS. 47 AND 49).  
MARY I. SPARROW, EXAMINING ATTORNEY

SN 78-261,414. VINA LEYDA LIMITADA, SANTIAGO, CHILE, FILED 6-12-2003.

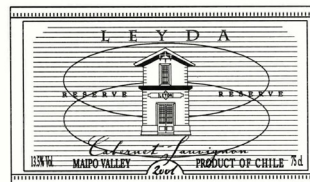

NO CLAIM IS MADE TO THE EXCLUSIVE RIGHT TO USE "RESERVE...CABERNET SAUVIGNON...13.5%VOL...-MAIPO VALLEY... PRODUCT OF CHILE...75CL.", APART FROM THE MARK AS SHOWN.

THE LINING SHOWN IN THE DRAWING IS A FEATURE OF THE MARK AND NOT INTENDED TO SHOW COLOR.  
FOR WINE (U.S. CLS. 47 AND 49).  
STEPHANIE DAVIS, EXAMINING ATTORNEY

SN 78-265,607. SIZ, LLC, WHITE PLAINS, NY. FILED 6-22-2003.

**SIZZURP PURPLE PUNCH**

NO CLAIM IS MADE TO THE EXCLUSIVE RIGHT TO USE "PURPLE PUNCH", APART FROM THE MARK AS SHOWN.

FOR ALCOHOLIC BEVERAGES, NAMELY DISTILLED SPIRITS, LIQUEURS AND WINES; PREPARED ALCOHOLIC COCKTAILS (U.S. CLS. 47 AND 49).  
DORITT L. CARROLL, EXAMINING ATTORNEY

SN 78-304,087. LIQUID INTERNATIONAL PREMIUM SPIRITS CO., NEW YORK, NY. FILED 9-23-2003.

**NAKASAKI**

FOR DISTILLED ALCOHOLIC BEVERAGES, NAMELY, SAKI (RICE WINE) (U.S. CLS. 47 AND 49).  
INGA ERVIN, EXAMINING ATTORNEY

**CLASS 33—(Continued).**

SN 78-307,058. CARNEVALE, STEVE, SAN FRANCISCO, CA.  
FILED 9-30-2003.

**BLUE OAK**

NO CLAIM IS MADE TO THE EXCLUSIVE RIGHT TO  
USE "OAK", APART FROM THE MARK AS SHOWN.  
FOR WINE (U.S. CLS. 47 AND 49).  
MICHELE SWAIN, EXAMINING ATTORNEY

---

SN 78-348,475. UNFILTERED NAPA LLC, NAPA, CA. FILED  
1-6-2004.

**SEVEN SINNERS**

THE MARK CONSISTS OF STANDARD CHARACTERS  
WITHOUT CLAIM TO ANY PARTICULAR FONT, STYLE,  
SIZE, OR COLOR.  
FOR WINE (U.S. CLS. 47 AND 49).  
BRIAN NEVILLE, EXAMINING ATTORNEY

---

SN 78-350,517. DIME GROUP INTERNATIONAL, INC.,  
BUFFALO GROVE, IL. FILED 1-12-2004.

**STOLAT**

THE MARK CONSISTS OF STANDARD CHARACTERS  
WITHOUT CLAIM TO ANY PARTICULAR FONT, STYLE,  
SIZE, OR COLOR.  
FOR VODKA (U.S. CLS. 47 AND 49).  
ALEX KEAM, EXAMINING ATTORNEY

**CLASS 33—(Continued).**

SN 78-352,365. BOEDECKER CELLARS, PORTLAND, OR.  
FILED 1-15-2004.

**Boedecker Cellars**

THE MARK CONSISTS OF STANDARD CHARACTERS  
WITHOUT CLAIM TO ANY PARTICULAR FONT, STYLE,  
SIZE, OR COLOR.

NO CLAIM IS MADE TO THE EXCLUSIVE RIGHT TO  
USE "CELLARS", APART FROM THE MARK AS SHOWN.  
FOR WINE (U.S. CLS. 47 AND 49).  
DAWN HAN, EXAMINING ATTORNEY

---

SN 78-353,771. SAN ANTONIO WINERY, INC., LOS AN-  
GELES, CA. FILED 1-19-2004.

**CAMDEN COURT**

THE MARK CONSISTS OF STANDARD CHARACTERS  
WITHOUT CLAIM TO ANY PARTICULAR FONT, STYLE,  
SIZE, OR COLOR.

FOR WINE (U.S. CLS. 47 AND 49).  
FIRST USE 11-1-2002; IN COMMERCE 11-1-2002.  
JAMES GRIFFIN, EXAMINING ATTORNEY

---

SN 78-355,165. ZCAPITAL, INC., LOS ANGELES, CA. FILED  
1-21-2004.

**BAMsa BOOke**

THE MARK CONSISTS OF STANDARD CHARACTERS  
WITHOUT CLAIM TO ANY PARTICULAR FONT, STYLE,  
SIZE, OR COLOR.

FOR ALCOHOLIC BEVERAGES, NAMELY, SAKE,  
GIN, VODKA, SCOTCH AND TEQUILA (U.S. CLS. 47  
AND 49).

ODESSA BIBBINS, EXAMINING ATTORNEY

**CLASS 33—(Continued).**

SN 78-355,210. ROBERT MONDAVI WINERY, NAPA, CA.  
FILED 1-21-2004.

**CLASS 33—(Continued).**

SN 78-359,957. FETZER VINEYARDS, HOPLAND, CA.  
FILED 1-30-2004.

# FETISH

THE MARK CONSISTS OF STANDARD CHARACTERS  
WITHOUT CLAIM TO ANY PARTICULAR FONT, STYLE,  
SIZE, OR COLOR.  
FOR ALCOHOLIC BEVERAGES, NAMELY WINE (U.S.  
CLS. 47 AND 49).  
SUE LAWRENCE, EXAMINING ATTORNEY

---

SN 78-360,489. ROBERT MONDAVI WINERY, NAPA, CA.  
FILED 1-30-2004.

THE MARK CONSISTS OF STANDARD CHARACTERS  
WITHOUT CLAIM TO ANY PARTICULAR FONT, STYLE,  
SIZE, OR COLOR.  
FOR WINE (U.S. CLS. 47 AND 49).  
KELLY CHOE, EXAMINING ATTORNEY

# QUILTS

THE MARK CONSISTS OF STANDARD CHARACTERS  
WITHOUT CLAIM TO ANY PARTICULAR FONT, STYLE,  
SIZE, OR COLOR.  
FOR WINE (U.S. CLS. 47 AND 49).  
RONALD AIKENS, EXAMINING ATTORNEY

---

SN 78-359,060. ROBERT MONDAVI WINERY, NAPA, CA.  
FILED 1-28-2004.

---

SN 78-365,264. RAPPINBRANDS, LLC, WHITE PLAINS, NY.  
FILED 2-10-2004.

# TASTE OUR SMALL WINERY TRADITION

# RAPPINBRANDS' STORM

THE MARK CONSISTS OF STANDARD CHARACTERS  
WITHOUT CLAIM TO ANY PARTICULAR FONT, STYLE,  
SIZE, OR COLOR.  
FOR WINE (U.S. CLS. 47 AND 49).  
ANN LINNEHAN, EXAMINING ATTORNEY

THE MARK CONSISTS OF STANDARD CHARACTERS  
WITHOUT CLAIM TO ANY PARTICULAR FONT, STYLE,  
SIZE, OR COLOR.  
FOR ALCOHOLIC BEVERAGES, NAMELY DISTILLED  
SPIRITS, LIQUEURS AND WINES (U.S. CLS. 47 AND 49).  
MARGERY A. TIERNEY, EXAMINING ATTORNEY

**CLASS 33—(Continued).**

SN 78-366,965. KANGRA GROUP PTY LTD, JOHANNESBURG, SOUTH AFRICA, FILED 2-12-2004.

**CLASS 34—(Continued).**

SN 78-354,364. LIBERTY BRANDS LLC, MELVILLE, NY, FILED 1-20-2004.

**RAILROAD RED**

THE MARK CONSISTS OF STANDARD CHARACTERS WITHOUT CLAIM TO ANY PARTICULAR FONT, STYLE, SIZE, OR COLOR.

OWNER OF SOUTH AFRICA REG. NO. 933971, DATED 5-17-1993, EXPIRES 5-17-2013.

NO CLAIM IS MADE TO THE EXCLUSIVE RIGHT TO USE "RED", APART FROM THE MARK AS SHOWN.

FOR WINES (U.S. CLS. 47 AND 49).

DAWN HAN, EXAMINING ATTORNEY

**LIBERTY SELECT**

THE MARK CONSISTS OF STANDARD CHARACTERS WITHOUT CLAIM TO ANY PARTICULAR FONT, STYLE, SIZE, OR COLOR.

NO CLAIM IS MADE TO THE EXCLUSIVE RIGHT TO USE SELECT, APART FROM THE MARK AS SHOWN.

FOR CIGARETTES (U.S. CLS. 2, 8, 9 AND 17).

MICHAEL KAZAZIAN, EXAMINING ATTORNEY

**CLASS 34—SMOKERS' ARTICLES**

SN 76-519,711. J.C. NEWMAN CIGAR COMPANY, TAMPA, FL. FILED 6-3-2003.

**RIGOLETTO BLACK TIGER**

OWNER OF U.S. REG. NOS. 1,244,748, 2,146,131 AND OTHERS.

FOR CIGARS (U.S. CLS. 2, 8, 9 AND 17).

FIRST USE 4-19-2004; IN COMMERCE 4-19-2004.

BRIDGETT SMITH, EXAMINING ATTORNEY

SN 78-361,821. SINO PACIFIC GROUP, INC, EL MONTE, CA, FILED 2-3-2004.

SN 78-354,324. LIBERTY BRANDS LLC, MELVILLE, NY, FILED 1-20-2004.

**SINO****CIRCLE Z**

THE MARK CONSISTS OF STANDARD CHARACTERS WITHOUT CLAIM TO ANY PARTICULAR FONT, STYLE, SIZE, OR COLOR.

FOR CIGARETTES (U.S. CLS. 2, 8, 9 AND 17).

ESTHER A. BORSUK, EXAMINING ATTORNEY

THE MARK CONSISTS OF STANDARD CHARACTERS WITHOUT CLAIM TO ANY PARTICULAR FONT, STYLE, SIZE, OR COLOR.

FOR CIGARETTE TAR FILTER (U.S. CLS. 2, 8, 9 AND 17).

STEVEN R. FINE, EXAMINING ATTORNEY



**CLASS 35—(Continued).****SERVICE MARKS****CLASS 35—ADVERTISING AND BUSINESS**

SN 75-812,051. TOVAH LADIER, DBA TLD ADVISORS, ALEXANDRIA, VA. FILED 9-29-1999.

**RESULTS WORLDWIDE**

NO CLAIM IS MADE TO THE EXCLUSIVE RIGHT TO USE "WORLDWIDE", APART FROM THE MARK AS SHOWN.

FOR INTERNATIONAL BUSINESS MANAGEMENT CONSULTING (U.S. CLS. 100, 101 AND 102).  
EUGENIA MARTIN, EXAMINING ATTORNEY

SN 75-891,766. HOUND IS LOOSE.COM, INC., THE, CARMEL, CA. FILED 1-7-2000.

**FRANCHISE HOUND**

NO CLAIM IS MADE TO THE EXCLUSIVE RIGHT TO USE "FRANCHISE", APART FROM THE MARK AS SHOWN.

FOR ONLINE BUSINESS ADVICE AND COUNSELING IN THE FIELD OF FRANCHISING (U.S. CLS. 100, 101 AND 102).

THEODORE MCBRIDE, EXAMINING ATTORNEY

SN 76-058,782. J.C.H. ENTERPRISES, INC., NORTH LAS VEGAS, NV. FILED 5-27-2000.

**THE DISTRIBUTION SOLUTION**

FOR INDUSTRIAL ELECTRICAL WHOLESALERS, NAMELY, DISTRIBUTORSHIPS OF ELECTRICAL AND ELECTRONIC WIRING CABLES; CUSTOM CABLES AND ASSEMBLIES; POWER CABLES; SCSI CABLE ASSEMBLIES; FIBER-OPTIC ASSEMBLIES; PATCH-CORDS; COAXIAL CABLES AND ERICSSON-TYPE CABLES; CABLE ASSEMBLIES; DISCRETE WIRING HARNESSES AND HYDRA CABLE ASSEMBLIES (U.S. CLS. 100, 101 AND 102).

MIDGE BUTLER, EXAMINING ATTORNEY

**CLASS 35—(Continued).**

SN 76-085,833. FIRSTGATE INTERNET AG, 50670 KOLN, FED REP GERMANY, FILED 7-11-2000.



PRIORITY CLAIMED UNDER SEC. 44(D) ON ERPNCMNTY TM OFC APPLICATION NO. 001679901, FILED 6-30-2000, REG. NO. 001679901, DATED 6-4-2002, EXPIRES 6-30-2010.

THE COLOR(S) RED, ORANGE, YELLOW, BLACK, AND WHITE IS/ARE CLAIMED AS A FEATURE OF THE MARK. THE COLOR(S) RED, ORANGE, YELLOW, BLACK, AND WHITE IS/ARE APART OF THE MARK.

THE MARK CONSISTS OF CONCENTRIC CIRCLES IN THE FOLLOWING ORDER: THIN YELLOW, WIDE BLACK (WITH FIRSTGATE SUPERIMPOSED IN WHITE ON THE UPPER ARC), THIN YELLOW, WITH A CENTER CONSISTING OF RED AND YELLOW STRIPES BLENDING INTO SOLID RED, WITH THE WORDS CLICK & BUY SUPERIMPOSED THEREON IN WHITE. THE DESIGN OF A HAND APPEARS IN WHITE TO THE RIGHT OF "& BUY."

FOR DEVELOPING PROMOTIONAL CAMPAIGNS FOR BUSINESS; BUSINESS MANAGEMENT; COOPERATIVE ADVERTISING AND MARKETING; BUSINESS MARKETING CONSULTATION; AND COPYRIGHT MANAGEMENT VIA THE INTERNET (U.S. CLS. 100, 101 AND 102).

ELLEN B. AWRICH, EXAMINING ATTORNEY

SN 76-120,105. KNOWLEDGEFLOW, INC., VALLEY FORGE, PA. FILED 8-30-2000.

**WEBANGEL**

FOR PROMOTING THE GOODS AND SERVICES OF OTHERS BY PLACING ADVERTISEMENTS AND PROMOTIONAL DISPLAYS IN AN ELECTRONIC SITE ACCESSED THROUGH COMPUTER NETWORKS; THROUGH A CONSUMER LOYALTY PROGRAM OFFERING REWARDS (U.S. CLS. 100, 101 AND 102).

MARGERY A. TIERNEY, EXAMINING ATTORNEY

SN 76-160,610. MERKLEY NEWMAN HARTY, INC., NEW YORK, NY. FILED 11-7-2000.

**BIRTH**

FOR ADVERTISING AGENCY SERVICES (U.S. CLS. 100, 101 AND 102).

JOHN DWYER, EXAMINING ATTORNEY

**CLASS 35—(Continued).**

SN 76-272,521. RMC OF ILLINOIS, INC., CHICAGO, IL. FILED 6-18-2001.



FOR HUMAN RESOURCE CONSULTATION SERVICES, CAREER MANAGEMENT SERVICES, CAREER TRANSITION SERVICES AND PERSONNEL MANAGEMENT CONSULTATION SERVICES (U.S. CLS. 100, 101 AND 102).

FIRST USE 8-1-2000; IN COMMERCE 1-1-2001.  
RONALD MCMORROW, EXAMINING ATTORNEY

---

SN 76-315,836. BBK, LTD., SOUTHFIELD, MI. FILED 9-21-2001.

**BUSINESS BUILDING KNOWLEDGE**

NO CLAIM IS MADE TO THE EXCLUSIVE RIGHT TO USE "BUSINESS", APART FROM THE MARK AS SHOWN.  
FOR TURNAROUND MANAGEMENT CONSULTING SERVICES, NAMELY CORPORATE RENEWAL, OPERATIONS IMPROVEMENT, INTERIM MANAGEMENT, ORGANIZATIONAL AND FINANCIAL RESTRUCTURING, LITIGATION SUPPORT SERVICES, AND PRODUCT AND SUPPLIER ANALYSIS, ALL FOR TROUBLED COMPANIES (U.S. CLS. 100, 101 AND 102).

FIRST USE 11-3-2000; IN COMMERCE 12-22-2000.  
KARANENDRA S. CHHINA, EXAMINING ATTORNEY

---

SN 76-405,657. BROWN & WILLIAMSON TOBACCO CORPORATION, LOUISVILLE, KY. FILED 5-10-2002.

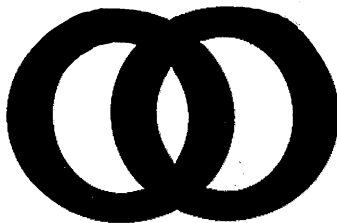

FOR MERCHANDISING SERVICES FOR INDUCING THE PURCHASING PUBLIC TO BUY THE GOODS OF OTHERS THROUGH A PROMOTIONAL GIFT REDEMPTION PROGRAM (U.S. CLS. 100, 101 AND 102).

FIRST USE 10-0-2000; IN COMMERCE 10-0-2000.  
ROBERT LORENZO, EXAMINING ATTORNEY

**CLASS 35—(Continued).**

SN 76-451,907. SANDHU, HARVINDER, SURREY, BRITISH COLUMBIA V3W 9P6, CANADA, FILED 9-23-2002.



PRIORITY CLAIMED UNDER SEC. 44(D) ON CANADA APPLICATION NO. 1139355, FILED 4-30-2002, REG. NO. TMA607393, DATED 4-13-2004, EXPIRES 4-13-2019.

FOR PROMOTING THE SALE OF GOODS AND SERVICES OF OTHERS BY ADVERTISING; PROMOTING EVENTS OF OTHERS (U.S. CLS. 100, 101 AND 102).  
KEVON CHISOLM, EXAMINING ATTORNEY

---

SN 76-454,052. UNIVERSAL BEAUTY RESOURCES, INC., READING, PA. FILED 9-30-2002.



NO CLAIM IS MADE TO THE EXCLUSIVE RIGHT TO USE BEAUTY RESOURCES, APART FROM THE MARK AS SHOWN.

FOR MERCHANDISE PACKAGING IN THE MEDICAL, HYGIENIC, AND BEAUTY CARE FIELDS (U.S. CLS. 100, 101 AND 102).

FIRST USE 12-21-2001; IN COMMERCE 12-21-2001.  
JEFFREY S. MOLINOFF, EXAMINING ATTORNEY

**CLASS 35—(Continued).**

SN 76-455,541. GRAZIANO, MARGARET, ARLINGTON HEIGHTS, IL. FILED 9-30-2002.

**ALLIANCE HR NETWORK**

NO CLAIM IS MADE TO THE EXCLUSIVE RIGHT TO USE "HR NETWORK", APART FROM THE MARK AS SHOWN.

FOR EMPLOYMENT SERVICES, NAMELY, PROVIDING TEMPORARY AND CONTRACT EMPLOYEES (U.S. CLS. 100, 101 AND 102).

DAVID H. STINE, EXAMINING ATTORNEY

SN 76-473,385. COMQUEST RESEARCH INC., TORONTO, ONTARIO, CANADA, FILED 11-26-2002.

**COMQUEST**

OWNER OF CANADA REG. NO. TMA478,491, DATED 6-14-1997, EXPIRES 6-14-2012.

FOR MARKET RESEARCH AND PUBLIC OPINION SURVEYS (U.S. CLS. 100, 101 AND 102).

FIRST USE 1-0-1991; IN COMMERCE 1-0-1991.

MARC LEIPZIG, EXAMINING ATTORNEY

SN 76-496,125. TALENT TREE EMPLOYMENT SERVICES, INC., HOUSTON, TX. FILED 3-10-2003.

**EMPLOYHR**

FOR COMPREHENSIVE EMPLOYEE ADMINISTRATIVE SERVICES, NAMELY HUMAN RESOURCES ADMINISTRATION AND HUMAN RESOURCES CONSULTATION (U.S. CLS. 100, 101 AND 102).

FIRST USE 1-1-2003; IN COMMERCE 1-1-2003.

MICHAEL KEATING, EXAMINING ATTORNEY

SN 76-496,626. IMEDIA COMMUNICATIONS, INC., DANA POINT, CA. FILED 3-11-2003.



NO CLAIM IS MADE TO THE EXCLUSIVE RIGHT TO USE "BRAND", APART FROM THE MARK AS SHOWN.

FOR ARRANGING AND CONDUCTING TRADE SHOW EXHIBITIONS IN THE FIELD OF INTERACTING MEDIA AND MARKETING; PROVIDING TRADE INFORMATION IN THE FIELD OF INTERACTIVE MEDIA AND MARKETING; DISSEMINATION OF ADVERTISING MATTER FOR OTHERS (U.S. CLS. 100, 101 AND 102).

FIRST USE 10-1-2001; IN COMMERCE 10-1-2001.

GEORGIA CARTY, EXAMINING ATTORNEY

**CLASS 35—(Continued).**

SN 76-503,089. LEON'S FURNITURE LIMITED, WESTON, ONTARIO, CANADA, FILED 4-1-2003.

**IT'S ALL ABOUT TRUST**

PRIORITY CLAIMED UNDER SEC. 44(D) ON CANADA APPLICATION NO. 1,170,451, FILED 3-7-2003, REG. NO. TMA614064, DATED 7-5-2004, EXPIRES 7-5-2019.

FOR RETAIL STORE SERVICES SUPPLYING TO THE PUBLIC FURNISHINGS AND ARTICLES FOR THE HOME (U.S. CLS. 100, 101 AND 102).

KENNETH D. BATTLE, EXAMINING ATTORNEY

SN 76-505,038. CONFERENCE AMERICA, INC., MONTGOMERY, AL. FILED 4-7-2003.

**CONFERENCEVANTAGE**

FOR PROMOTING THE USE OF TELECOMMUNICATIONS, AUDIO TELECONFERENCING, VIDEO TELECONFERENCING, DATA THE CONFERENCE AND INTERNET CONFERENCE SERVICES THROUGH THE ADMINISTRATION OF AN INCENTIVE PROGRAM (U.S. CLS. 100, 101 AND 102).

FIRST USE 4-3-2003; IN COMMERCE 4-3-2003.

JOHN E. MICHOS, EXAMINING ATTORNEY

SN 76-514,916. WHOLE FOODS MARKET IP, L.P., AUSTIN, TX. FILED 5-16-2003.

**WHOLE BABY**

NO CLAIM IS MADE TO THE EXCLUSIVE RIGHT TO USE "BABY", APART FROM THE MARK AS SHOWN.

FOR PROMOTING PUBLIC AWARENESS OF THE NEED FOR PROPER PRENATAL, POSTNATAL AND EARLY CHILDHOOD NUTRITION, HEALTH AND WELLNESS (U.S. CLS. 100, 101 AND 102).

ANDREA SAUNDERS, EXAMINING ATTORNEY

SN 76-518,558. COMPUTER AND COMMUNICATIONS INDUSTRY ASSOCIATION, WASHINGTON, DC. FILED 6-2-2003.

**OSAIA**

FOR ASSOCIATION SERVICES, NAMELY PROMOTING THE INTERESTS OF USERS AND DEVELOPERS OF OPEN SOURCE SOFTWARE (U.S. CLS. 100, 101 AND 102).

FIRST USE 4-22-2003; IN COMMERCE 4-22-2003.

DANIELLE MATTESSICH, EXAMINING ATTORNEY

**CLASS 35—(Continued).**

SN 76-524,126. HAWKINSON FORD COMPANY, OAK LAWN, IL. FILED 6-20-2003.

**BONAFIDE E-SPECIAL**

NO CLAIM IS MADE TO THE EXCLUSIVE RIGHT TO USE E-SPECIAL, APART FROM THE MARK AS SHOWN. FOR AUTOMOBILE DEALERSHIP SERVICES (U.S. CLS. 100, 101 AND 102).  
FIRST USE 9-0-2002; IN COMMERCE 9-0-2002.  
HOWARD SMIGA, EXAMINING ATTORNEY

**CLASS 35—(Continued).**

SN 76-533,156. LUSHTOYS, INC, WILMINGTON, DE. FILED 7-28-2003.

**LUSHTOYS**

SN 76-528,201. OPTION ONE MORTGAGE CORPORATION, IRVINE, CA. FILED 7-7-2003.

**CLUB ONE**

FOR CONDUCTING EMPLOYEE INCENTIVE AWARD PROGRAMS TO PROMOTE JOB PRODUCTIVITY (U.S. CLS. 100, 101 AND 102).  
ROBERT C. CLARK JR., EXAMINING ATTORNEY

THE MARK CONSISTS OF STANDARD CHARACTERS WITHOUT CLAIM TO ANY PARTICULAR FONT, STYLE, SIZE, OR COLOR.

FOR ONLINE RETAIL STORE SERVICES FEATURING ADULT PRODUCTS, NAMELY TOYS, GAMES, LOTIONS, AND CONDOMS (U.S. CLS. 100, 101 AND 102).  
FIRST USE 10-4-2002; IN COMMERCE 10-4-2002.  
JERI J. FICKES, EXAMINING ATTORNEY

SN 76-531,449. DISABLED AMERICAN VETERANS, COLD SPRING, KY. FILED 7-22-2003.

**DISABLED AMERICAN VETERANS**

OWNER OF U.S. REG. NO. 2,658,083.  
SEC. 2(F).  
FOR ASSOCIATION SERVICES, NAMELY PROMOTING THE INTERESTS OF DISABLED VETERANS (U.S. CLS. 100, 101 AND 102).  
FIRST USE 0-0-1921; IN COMMERCE 0-0-1921.  
G. T. GLYNN, EXAMINING ATTORNEY

SN 76-533,553. JOHN E. HERBERT, NUTLEY, NJ. FILED 7-30-2003.



NO CLAIM IS MADE TO THE EXCLUSIVE RIGHT TO USE PARTNERS AND INC, APART FROM THE MARK AS SHOWN.

THE COLORS GREEN AND BLACK ARE CLAIMED AS FEATURES OF THE MARK.

THE COLOR DARK GREEN APPEARING AS THE COLOR OF THE BORDER OF THE SQUARE AND RECTANGLE AND THE INTERLOCKING OVALS, THE COLOR LIGHT GREEN APPEARING AS THE INSIDE COLOR OF THE SQUARE AND RECTANGLE AND THE COLOR BLACK APPEARING AS THE COLOR OF ALL THE LETTERS.

THE MARK CONSISTS OF A SQUARE CONTAINING THREE INTERLOCKING OVALS WITH THE LETTER S INSIDE THE TOP OVAL, THE LETTER G IN THE LEFT OVAL AND THE LETTER P IN THE RIGHT OVAL. THE SQUARE IS INTERSECTED ON THE RIGHT SIDE BY A RECTANGLE CONTAINING THE WORDS STRATEGIC GROWTH PARTNERS, INC.

FOR EXECUTIVE RECRUITING OF INSURANCE AND FINANCIAL SERVICES PROFESSIONALS FOR INSURANCE AND FINANCIAL SERVICES COMPANIES (U.S. CLS. 100, 101 AND 102).

FIRST USE 11-21-2002; IN COMMERCE 11-21-2002.  
JEFF DEFORD, EXAMINING ATTORNEY

SN 76-532,055. AMS, INC., MINNEAPOLIS, MN. FILED 7-9-2003.

**AMS GIFT REGISTRY SERVICES**

NO CLAIM IS MADE TO THE EXCLUSIVE RIGHT TO USE "GIFT REGISTRY SERVICES", APART FROM THE MARK AS SHOWN.  
FOR GIFT REGISTRY SERVICES (U.S. CLS. 100, 101 AND 102).  
KELLY BOULTON, EXAMINING ATTORNEY

**CLASS 35—(Continued).**

SN 76-534,372. LONG & FOSTER COMPANIES, INC., FAIRFAX, VA. FILED 8-4-2003.

## ON THE MOVE WITH LONG & FOSTER

OWNER OF U.S. REG. NOS. 1,488,781, 2,254,958 AND OTHERS.

FOR PROVIDING RELOCATION COORDINATION SERVICES, AN ONLINE DIRECTORY OF VENDORS AND REFERRALS REGARDING THE GOODS AND SERVICES OF OTHERS IN THE FIELDS OF FURNITURE MOVING AND STORAGE SERVICES, PACKAGING ARTICLES FOR TRANSPORTATION, RENTAL OR LEASING OF TRUCKS AND MOVING VANS AND ARRANGEMENT OF TEMPORARY HOUSING ACCOMMODATIONS VIA A GLOBAL COMPUTER NETWORK; PROMOTING THE GOODS AND SERVICES OF OTHERS BY ARRANGING DISCOUNTS AND INCENTIVES ON THE GOODS OR SERVICES OF OTHERS RELATING TO RELOCATION AND MOVING (U.S. CLS. 100, 101 AND 102).

FIRST USE 4-1-2003; IN COMMERCE 4-1-2003.  
ANDREA SAUNDERS, EXAMINING ATTORNEY

**CLASS 35—(Continued).**

SN 76-536,408. LARKIN ENTERPRISES, INC., BANGOR, ME. FILED 8-1-2003.



NO CLAIM IS MADE TO THE EXCLUSIVE RIGHT TO USE "ENTERPRISES, INC.", APART FROM THE MARK AS SHOWN.

FOR STAFFING SERVICES TO THE CONSTRUCTION INDUSTRY (U.S. CLS. 100, 101 AND 102).

FIRST USE 1-1-1998; IN COMMERCE 1-1-1998.  
ELIZABETH HUGHITT, EXAMINING ATTORNEY

SN 76-535,817. GENCO TRANSPORTATION MANAGEMENT LLC, PITTSBURGH, PA. FILED 7-29-2003.

## CARRIERIO

FOR TRANSPORTATION LOGISTICS SERVICES, NAMELY, ARRANGING FOR PICK-UP, DELIVERY, RETURN AND ROUTING OF FREIGHT VIA GROUND CARRIERS BY PREPARING REQUESTS FOR QUOTE PACKAGES TO BE SENT TO POTENTIAL CARRIERS, INCLUDING ANALYZING HISTORICAL DATA, CREATING BENCHMARK COSTS AND STRUCTURING NEW NETWORKS AND BY DISTRIBUTING THE REQUEST FOR QUOTE PACKAGES TO POTENTIAL CARRIERS AND MANAGING ELECTRONICALLY THE REQUEST FOR QUOTE PROCESS USING WEB ENABLED TECHNOLOGY AND BY ANALYZING RESPONSES RECEIVED TO THE REQUEST FOR QUOTE PACKAGES AND NEGOTIATING CONTRACTS WITH CARRIERS; AND BY NEGOTIATING CONTRACTS WITH CARRIERS INCLUDING PREPARING AND ARRANGING ROUTING GUIDE REQUIREMENTS, SERVICE STANDARDS, BILLING, CARRIER PAYMENT, SERVICE AUDITS AND CARRIER COMPLIANCE (U.S. CLS. 100, 101 AND 102).

FIRST USE 2-0-2002; IN COMMERCE 2-0-2002.  
ROBERT C. CLARK JR., EXAMINING ATTORNEY

SN 76-536,468. FLEMING, MONTA CAPRICE SPOONER, FLOWER MOUND, TX. FILED 7-28-2003.

## GO NANNIES

NO CLAIM IS MADE TO THE EXCLUSIVE RIGHT TO USE "NANNIES", APART FROM THE MARK AS SHOWN.

FOR PROVIDING ONLINE DOMESTIC AND CHILD CARE EMPLOYMENT, REFERRAL AND PLACEMENT INFORMATION WHICH ALLOWS THE USERS TO REGISTER AND POST THEIR INFORMATION TO BE REVIEWED AND EXCHANGED BY SAID USERS AND OTHERS; FEATURING, FILTERING, SORTING, CLEARING AND SEARCHING INFORMATION ENTRIES AT SAID SITE; EMPLOYMENT BACKGROUND VERIFICATION; AUTOMATIC MATCHING OF PERSONS AND/OR ENTITIES REQUESTING PLACEMENT OR EMPLOYMENT AS NANNIES AND/OR DOMESTICS WITH PERSONS OR ENTITIES REQUESTING NANNIES AND/OR DOMESTICS; PROVIDING LINKS TO THE WEBSITES OF OTHERS FEATURING DOMESTIC CHILD CARE EMPLOYMENT INFORMATION AND SERVICES; INTERVIEW DATA; AND A LIST OF PREFERENCES FOR PERSONS, NANNIES AND DOMESTICS (U.S. CLS. 100, 101 AND 102).

CHARLES JOYNER, EXAMINING ATTORNEY

**CLASS 35—(Continued).**

SN 76-538,931. OLAYAN INVESTMENTS COMPANY ESTABLISHMENT, ATHENS, GREECE, FILED 8-7-2003.



FOR PROVIDING BUSINESS REPRESENTATION AND/OR BUSINESS PARTNERING IN THE NATURE OF MANAGEMENT, CONSULTATION, PLANNING, OPERATIONS AND/OR ORGANIZATION IN THE MIDDLE EAST IN REGARD TO CONSUMER, MEDICAL, INDUSTRIAL, CONSTRUCTION, ENGINEERING, AND OIL AND GAS PRODUCTS AND SERVICES; DISTRIBUTORSHIPS IN THE FIELD OF CONSUMER, MEDICAL, INDUSTRIAL, CONSTRUCTION, ENGINEERING AND OIL AND GAS PRODUCTS AND SERVICES (U.S. CLS. 100, 101 AND 102).

FIRST USE 4-1-1975; IN COMMERCE 4-1-1975.  
ZACHARY BELLO, EXAMINING ATTORNEY

SN 76-543,268. GEMSTAR DEVELOPMENT CORPORATION, LOS ANGELES, CA. FILED 9-8-2003.

**GUIDEOS**

FOR ADVERTISING SERVICES, NAMELY, PROMOTING THE GOODS AND SERVICES OF OTHERS BY PREPARING AND PLACING INFORMATIONAL AND PROMOTIONAL ADVERTISEMENTS VIA TELEVISION AND CABLE PROGRAMMING AND VIA INTERACTIVE TELEVISION AND CABLE PROGRAMMING (U.S. CLS. 100, 101 AND 102).

RUSS HERMAN, EXAMINING ATTORNEY

SN 76-544,082. ROUTINE INVESTMENTS, LLC, SHREWSBURY, NJ. FILED 8-29-2003.



FOR DISTRIBUTORSHIP SERVICES IN THE FIELD OF NETWORKING AND TELECOMMUNICATIONS EQUIPMENT AND COMPUTER HARDWARE AND SOFTWARE (U.S. CLS. 100, 101 AND 102).

TARAH HARDY, EXAMINING ATTORNEY

**CLASS 35—(Continued).**

SN 76-544,858. ROCKWELL, JOHN W., OAKLAND, CA. FILED 9-4-2003.



The business circulator's place on the web

NO CLAIM IS MADE TO THE EXCLUSIVE RIGHT TO USE "B2BCIRC.COM", APART FROM THE MARK AS SHOWN.

FOR INFORMATIONAL WEBSITE IN THE FIELD OF MAGAZINE CIRCULATION (U.S. CLS. 100, 101 AND 102).

DANIEL CAPSHAW, EXAMINING ATTORNEY

SN 76-547,957. SPOILED CHICS, LLC, UPPER ST. CLAIR, PA. FILED 9-29-2003.

**HAUTE STUFF FOR COOL CHICS**

FOR RETAIL SHOP-AT-HOME PARTIES FEATURING PERSONAL ACCESSORIES IN THE FIELD OF FASHION, NAMELY JEWELRY, HANDBAGS, AND CLOTHING (U.S. CLS. 100, 101 AND 102).

FIRST USE 1-15-2003; IN COMMERCE 1-15-2003.  
JOHN KELLY, EXAMINING ATTORNEY

SN 76-553,762. ARBAIN MANAGEMENT CORP., FAIRFIELD, NJ. FILED 10-23-2003.



OWNER OF U.S. REG. NO. 2,393,691.

NO CLAIM IS MADE TO THE EXCLUSIVE RIGHT TO USE WALFURNITURE, APART FROM THE MARK AS SHOWN.

FOR COMPUTERIZED ONLINE ORDERING SERVICES IN THE FIELD OF FURNITURE, ENTERTAINMENT CENTERS AND ACCESSORIES (U.S. CLS. 100, 101 AND 102).

HOWARD SMIGA, EXAMINING ATTORNEY

**CLASS 35—(Continued).**

SN 76-553,952. DOCTORS ON LIENS, INC., SHERMAN OAKS, CA. FILED 10-8-2003.

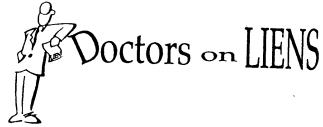

NO CLAIM IS MADE TO THE EXCLUSIVE RIGHT TO USE DOCTORS, APART FROM THE MARK AS SHOWN.

THE MARK CONSISTS OF LINE DRAWN CHARACTER OF A DOCTOR LEANING AGAINST AND TILTING THE LETTER "D" IN THE PHRASE "DOCTORS ON LIENS".

FOR MARKETING AND ADVERTISING SERVICES IN THE NATURE OF DOCTOR REFERRALS (U.S. CLS. 100, 101 AND 102).

FIRST USE 8-9-1995; IN COMMERCE 8-9-1995.  
CHRIS WELLS, EXAMINING ATTORNEY

SN 76-554,632. BALL DYNAMICS INTERNATIONAL, INC., LONGMONT, CO. FILED 10-9-2003.



OWNER OF U.S. REG. NO. 2,296,010.  
NO CLAIM IS MADE TO THE EXCLUSIVE RIGHT TO USE BALL AND INTERNATIONAL INC., APART FROM THE MARK AS SHOWN.

FOR WHOLESALE AND RETAIL DISTRIBUTORSHIPS AND RETAIL STORE OUTLETS FEATURING EXERCISE, FITNESS, REHABILITATION AND THERAPY PRODUCTS; ON-LINE WHOLESALE AND RETAIL STORES FEATURING EXERCISE, FITNESS, REHABILITATION AND THERAPY PRODUCTS (U.S. CLS. 100, 101 AND 102).

FIRST USE 1-7-2003; IN COMMERCE 1-20-2003.  
LESLEY LAMOTHE, EXAMINING ATTORNEY

SN 76-555,926. REDMON DESIGN COMPANY, P.A., MAITLAND, FL. FILED 11-3-2003.

**ALFRESCO LIVING**

FOR RETAIL STORE SERVICES FEATURING GARDEN FURNISHINGS NAMELY, OUTDOOR FURNITURE, FABRICS, PLANTERS, STATUARY URNS, VASES, BIRDBATHS, SUNDIALS, FOUNTAINS, TRELISES, GAZEBOS, HAMMOCKS, LIGHTING, OUTDOOR FIREPLACES, OUTDOOR GAMES AND GAME EQUIPMENT (U.S. CLS. 100, 101 AND 102).

FIRST USE 9-26-2002; IN COMMERCE 9-26-2002.  
KATHERINE STOIDES, EXAMINING ATTORNEY

**CLASS 35—(Continued).**

SN 76-556,385. SMITHSONIAN FOLKWAYS RECORDINGS, WASHINGTON, DC. FILED 10-30-2003.



Smithsonian Folkways Recordings

OWNER OF U.S. REG. NOS. 1,003,626, 2,824,627 AND OTHERS.

NO CLAIM IS MADE TO THE EXCLUSIVE RIGHT TO USE "RECORDINGS", APART FROM THE MARK AS SHOWN.

FOR COMPUTERIZED ONLINE ORDERING SERVICES IN THE FIELD OF COMPACT DISCS AND OTHER AUDIO MEDIA FEATURING TRADITIONAL MUSIC, SPOKEN WORD, NATURAL AND HUMAN-MADE SOUNDS (U.S. CLS. 100, 101 AND 102).

FIRST USE 7-13-1992; IN COMMERCE 7-13-1992.  
DORITT L. CARROLL, EXAMINING ATTORNEY

SN 76-562,157. AMERICAN HOSPITAL ASSOCIATION, CHICAGO, IL. FILED 11-14-2003.



FOR CONSULTING SERVICES, NAMELY ADVISING, GUIDING AND ASSISTING IN THE DEVELOPMENT, IMPLEMENTATION AND COORDINATION OF EMPLOYEE RECOGNITION PROGRAMS TO PROMOTE ON THE JOB PERFORMANCE IN THE HEALTH CARE INDUSTRY (U.S. CLS. 100, 101 AND 102).

FIRST USE 7-10-2003; IN COMMERCE 7-10-2003.  
KELLY BOULTON, EXAMINING ATTORNEY

SN 76-565,783. TREMONTI, RALPH M., DBA LISTING CONNECTION, RANCHO VISTA, CA. FILED 12-5-2003.

**LISTING CONNECTION**

NO CLAIM IS MADE TO THE EXCLUSIVE RIGHT TO USE "LISTING", APART FROM THE MARK AS SHOWN.  
FOR COOPERATIVE ADVERTISING AND MARKETING (U.S. CLS. 100, 101 AND 102).

FIRST USE 10-10-1989; IN COMMERCE 10-10-1989.  
KATHERINE STOIDES, EXAMINING ATTORNEY

**CLASS 35—(Continued).**

SN 76-566,650. RON JON SURF SHOP OF FLA., INC., COCOA BEACH, FL. FILED 12-22-2003.

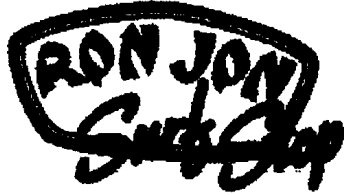

OWNER OF U.S. REG. NOS. 1,619,480, 2,771,175 AND OTHERS.

THE NAME "RON JON" DOES NOT IDENTIFY A LIVING INDIVIDUAL.

FOR CONVENIENCE STORE SERVICES (U.S. CLS. 100, 101 AND 102).

LINDA E. BLOHM, EXAMINING ATTORNEY

SN 76-569,028. ABRIVO COMMUNICATIONS, LLC, FAIRFIELD, NJ. FILED 1-9-2004.



NO CLAIM IS MADE TO THE EXCLUSIVE RIGHT TO USE "COMMUNICATIONS", APART FROM THE MARK AS SHOWN.

FOR DISTRIBUTORSHIP SERVICES IN THE FIELD OF TELEPHONE COMMUNICATIONS SYSTEMS (U.S. CLS. 100, 101 AND 102).

FIRST USE 1-20-2003; IN COMMERCE 1-20-2003.  
ROBERT COGGINS, EXAMINING ATTORNEY

SN 76-569,234. NET PROFIT, INC., GREENVILLE, SC. FILED 1-12-2004.



FOR TAX CONSULTATION AND PREPARATION SERVICES, NAMELY IDENTIFYING, CALCULATING AND ADMINISTERING TAX CREDITS AND INCENTIVE PROGRAMS (U.S. CLS. 100, 101 AND 102).

FIRST USE 10-0-2003; IN COMMERCE 10-0-2003.  
KARLA PERKINS, EXAMINING ATTORNEY

**CLASS 35—(Continued).**

SN 76-570,245. TRADER PUBLISHING COMPANY, NORFOLK, VA. FILED 1-15-2004.

**TIMESHARESAVER.COM**

FOR ADVERTISING SERVICES, NAMELY, PREPARING AND DISSEMINATING ADVERTISING FOR OTHERS VIA AN ONLINE ELECTRONIC COMMUNICATIONS NETWORK (U.S. CLS. 100, 101 AND 102).

FIRST USE 6-21-2003; IN COMMERCE 6-21-2003.  
TRACY FLETCHER, EXAMINING ATTORNEY

SN 76-571,761. HOUSE OF FAITH SAN ANGELO, INC., SAN ANGELO, TX. FILED 1-26-2004.



FOR ONLINE RETAIL STORE SERVICES FEATURING BOOKS, VIDEOTAPES, AUDIOTAPES AND WORKBOOKS IN THE FIELD OF RELIGION AND BIBLE STUDY (U.S. CLS. 100, 101 AND 102).

G. MAYERSCHOFF, EXAMINING ATTORNEY

SN 76-571,938. RACKSPACE, LTD., SAN ANTONIO, TX. FILED 1-16-2004.

**ALTEREGO**

THE MARK CONSISTS OF STANDARD CHARACTERS WITHOUT CLAIM TO ANY PARTICULAR FONT, STYLE, SIZE, OR COLOR.

FOR OUTSOURCING SERVICES FOR OTHERS IN THE FIELD OF INFORMATION TECHNOLOGY; BUSINESS MANAGEMENT SERVICES; PROVIDING CUSTOMER RELATIONS MANAGEMENT, BILLING SERVICES AND CUSTOMER SUPPORT SERVICES TO PROVIDERS AND RESELLERS OF APPLICATION HOSTING AND WEB HOSTING SERVICES (U.S. CLS. 100, 101 AND 102).

MARC LEIPZIG, EXAMINING ATTORNEY



**CLASS 35—(Continued).**

SN 76-572,495. ORTHODONTIC CENTERS OF AMERICA, INC., METAIRIE, LA. FILED 1-26-2004.



NO CLAIM IS MADE TO THE EXCLUSIVE RIGHT TO USE OUTSOURCE, APART FROM THE MARK AS SHOWN.

FOR BUSINESS MANAGEMENT OF ORTHODONTIC, DENTIST AND PHYSICIAN OFFICES, BUSINESS MANAGEMENT CONSULTATION IN THE FIELD OF ORTHODONTIC, DENTIST AND PHYSICIAN OFFICES AND PROVIDING TECHNICAL ASSISTANCE IN CONNECTION WITH THE ESTABLISHMENT AND/OR OPERATION OF ORTHODONTIC, DENTIST AND PHYSICIAN OFFICES (U.S. CLS. 100, 101 AND 102).

FIRST USE 12-15-2003; IN COMMERCE 12-15-2003.  
GEORGE LORENZO, EXAMINING ATTORNEY

SN 76-572,622. RICHARDSON, CYNTHIA, HOUSTON, TX. FILED 1-23-2004.

## LORDS OF BEAUTY

THE MARK CONSISTS OF STANDARD CHARACTERS WITHOUT CLAIM TO ANY PARTICULAR FONT, STYLE, SIZE, OR COLOR.

FOR RETAIL STORES SERVICES IN THE FIELD OF CLOTHING AND CLOTHING ACCESSORIES (U.S. CLS. 100, 101 AND 102).

FIRST USE 1-0-1989; IN COMMERCE 1-0-1989.  
CHARLES JOYNER, EXAMINING ATTORNEY

SN 76-573,914. C.S.F. CORP., WILMINGTON, DE. FILED 2-4-2004.

## KELSEY

THE MARK CONSISTS OF STANDARD CHARACTERS WITHOUT CLAIM TO ANY PARTICULAR FONT, STYLE, SIZE, OR COLOR.

THE NAME(S), PORTRAIT(S), AND/OR SIGNATURE(S) SHOWN IN THE MARK DOES NOT IDENTIFY A PARTICULAR LIVING INDIVIDUAL.

FOR ON-LINE RETAIL STORE SERVICES FEATURING A VIRTUAL MODEL UPON WHICH CLOTHING CAN BE SUPERIMPOSED TO GUIDE THE USER IN CHOOSING CLOTHING (U.S. CLS. 100, 101 AND 102).

ZACHARY BELLO, EXAMINING ATTORNEY

**CLASS 35—(Continued).**

SN 76-573,915. C.S.F. CORP., WILMINGTON, DE. FILED 2-4-2004.

## KELSEY'S KLOSET

THE MARK CONSISTS OF STANDARD CHARACTERS WITHOUT CLAIM TO ANY PARTICULAR FONT, STYLE, SIZE, OR COLOR.

THE NAME(S), PORTRAIT(S), AND/OR SIGNATURE(S) SHOWN IN THE MARK DOES NOT IDENTIFY A PARTICULAR LIVING INDIVIDUAL.

FOR ON-LINE RETAIL SERVICES IN THE FIELD OF APPAREL THROUGH WHICH USERS CAN VIRTUALLY TRY-ON CLOTHING ON A DIGITAL BODY (U.S. CLS. 100, 101 AND 102).

ZACHARY BELLO, EXAMINING ATTORNEY

SN 78-156,632. ADP, INC., ROSELAND, NJ. FILED 8-22-2002.

## PROCUREMENT EXPERT

NO CLAIM IS MADE TO THE EXCLUSIVE RIGHT TO USE "EXPERT", APART FROM THE MARK AS SHOWN.

FOR PROVIDING INFORMATION ABOUT THE GOODS AND SERVICES OF OTHERS VIA THE INTERNET BY PROVIDING A WEBSITE IN WHICH USERS CAN LINK TO ON-LINE RETAILERS AND MANUFACTURERS IN THE FIELDS OF OFFICE SUPPLIES, OFFICE EQUIPMENT, COMPUTER HARDWARE AND COMPUTER SOFTWARE, PRINTING SERVICES, PAPER, AND JANITORIAL AND MAINTENANCE SUPPLIES; ADMINISTRATION OF A DISCOUNT PROGRAM THAT ENABLES PARTICIPANTS TO OBTAIN DISCOUNTS ON GOODS AND SERVICES THROUGH A DESIGNATED WEBSITE; ONLINE ORDERING SERVICES FEATURING OFFICE SUPPLIES, OFFICE EQUIPMENT, COMPUTER HARDWARE AND COMPUTER SOFTWARE, PRINTING SERVICES, PAPER, AND JANITORIAL AND MAINTENANCE SUPPLIES (U.S. CLS. 100, 101 AND 102).

INGA ERVIN, EXAMINING ATTORNEY

SN 78-176,051. CHS THERAPY TECHNOLOGIES CORP., SALT LAKE CITY, UT. FILED 10-18-2002.



NO CLAIM IS MADE TO THE EXCLUSIVE RIGHT TO USE LOCUMS, INC., APART FROM THE MARK AS SHOWN.

FOR HEALTHCARE RECRUITING AND STAFFING SERVICES (U.S. CLS. 100, 101 AND 102).

FIRST USE 7-1-2001; IN COMMERCE 7-1-2001.

WILLIAM P. SHANAHAN, EXAMINING ATTORNEY

**CLASS 35—(Continued).**

SN 78-179,750. DRAGON MANUFACTURING, INC., MINNEAPOLIS, MN. FILED 10-29-2002.



FOR RETAIL SERVICES BY DIRECT SOLICITATION BY SALES AGENTS AND COMPUTERIZED ON-LINE RETAIL SERVICES IN THE FIELD OF MADE-TO-ORDER METAL, PLASTIC AND OTHER TYPES OF MACHINE AND INDUSTRIAL COMPONENTS; WHOLESALE ORDERING SERVICES FEATURING MADE-TO-ORDER METAL, PLASTIC AND OTHER TYPES OF MACHINE AND INDUSTRIAL COMPONENTS (U.S. CLS. 100, 101 AND 102).

FIRST USE 3-12-2002; IN COMMERCE 3-12-2002.  
DAVID H. STINE, EXAMINING ATTORNEY

SN 78-212,190. GARRITY COMMUNICATIONS, INC., ITHACA, NY. FILED 2-7-2003.

**TWEENIORS**

FOR MARKET RESEARCH, MARKET RESEARCH SERVICES, DEMOGRAPHIC CONSULTATION, MARKETING SERVICES, AND ADVERTISING SERVICES PERTAINING TO A SPECIFIC DEMOGRAPHIC SEGMENT OF THE POPULATION, AGE 55-70 (U.S. CLS. 100, 101 AND 102).

FIRST USE 12-6-2002; IN COMMERCE 5-28-2004.  
JANICE L. MCMORROW, EXAMINING ATTORNEY

SN 78-228,344. BRANN, LLC, WILTON, CT. FILED 3-21-2003.

**INSIGHT FASTRACK**

FOR MARKET RESEARCH SERVICES, NAMELY, QUANTITATIVE AND QUALITATIVE MARKET RESEARCH IN THE FIELD OF CONSUMER PREFERENCE SURVEYS AND BRAND CONNECTION SURVEYS. (U.S. CLS. 100, 101 AND 102).

THEODORE MCBRIDE, EXAMINING ATTORNEY

SN 78-245,960. LINKEDIN, LTD, MOUNTAIN VIEW, CA. FILED 5-5-2003.

**LINKEDIN.COM**

FOR ONLINE BUSINESS NETWORKING SERVICES (U.S. CLS. 100, 101 AND 102).  
SUSAN LESLIE DUBOIS, EXAMINING ATTORNEY

**CLASS 35—(Continued).**

SN 78-256,818. A.M. CASTLE & CO., FRANKLIN PARK, IL. FILED 6-2-2003.

**THE BAR PROFESSIONALS**

NO CLAIM IS MADE TO THE EXCLUSIVE RIGHT TO USE "PROFESSIONALS", APART FROM THE MARK AS SHOWN.

FOR MARKETING SERVICES, NAMELY DIRECT MARKETING AND ADVERTISING, AND DISTRIBUTORSHIP SERVICES IN THE FIELD OF FERROUS AND NON-FERROUS MATERIALS (U.S. CLS. 100, 101 AND 102).

FIRST USE 7-21-2003; IN COMMERCE 7-21-2003.  
ROBIN CHOSID, EXAMINING ATTORNEY

SN 78-269,561. THE SCRAPPIN' STOP INC., OWINGS MILLS, MD. FILED 7-2-2003.

**THE SCRAPPIN' STOP**

NO CLAIM IS MADE TO THE EXCLUSIVE RIGHT TO USE "SCRAPPING", APART FROM THE MARK AS SHOWN.

FOR RETAIL STORE SERVICES FEATURING SCRAPBOOK SUPPLIES (U.S. CLS. 100, 101 AND 102).  
ODESSA BIBBINS, EXAMINING ATTORNEY

SN 78-271,815. VLE PROPERTIES, INC., CORINTH, MS. FILED 7-8-2003.

**THE GREAT AMERICAN HOME STORE**

NO CLAIM IS MADE TO THE EXCLUSIVE RIGHT TO USE HOME STORE, APART FROM THE MARK AS SHOWN.

FOR RETAIL STORE SERVICES FEATURING FURNITURE AND FURNITURE ACCESSORIES (U.S. CLS. 100, 101 AND 102).

REBECCA GILBERT, EXAMINING ATTORNEY

**CLASS 35—(Continued).**

SN 78-273,135. RUSH ENTERPRISES, INC., NEW BRAUNFELS, TX. FILED 7-11-2003.

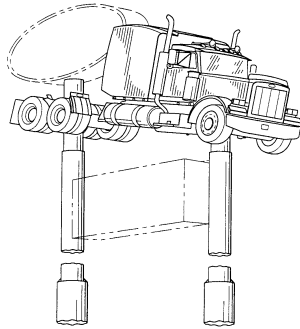

OWNER OF U.S. REG. NO. 2,258,288.  
 THE LINING IS A FEATURE OF THE MARK AND DOES NOT INDICATE COLOR.  
 THE MARK CONSISTS OF AN ACTUAL SEMI TRACTOR MOUNTED ATOP TWO POLES, WITH THE FRONT OF THE SEMI TRACTOR ANGLED SLIGHTLY DOWNWARD TOWARD THE GROUND.  
 SEC. 2(F).  
 FOR DEALERSHIPS IN THE FIELD OF TRUCKS AND RELATED PARTS AND ACCESSORIES (U.S. CLS. 100, 101 AND 102).  
 FIRST USE 9-0-1995; IN COMMERCE 9-0-1995.  
 KATHERINE STOIDES, EXAMINING ATTORNEY

---

SN 78-274,978. SACHDEV, RAVI, TOWACO, NJ. FILED 7-16-2003.

**MEDICALWIRE**

FOR ADVERTISING AND MARKETING, NAMELY, DIRECT MARKETING ADVERTISING FOR OTHERS THROUGH ELECTRONIC, INTERNET, BROADCAST, PRINT, FAX, AND PERSONAL MEDIA (U.S. CLS. 100, 101 AND 102).  
 FIRST USE 10-30-1996; IN COMMERCE 10-30-1996.  
 BARBARA BROWN, EXAMINING ATTORNEY

**CLASS 35—(Continued).**

SN 78-276,549. BAUGH SUPPLY CHAIN COOPERATIVE, INC., HOUSTON, TX. FILED 7-21-2003.

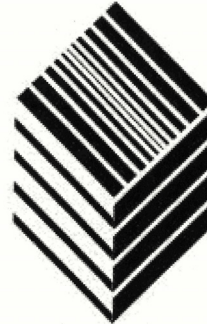

FOR SUPPLY CHAIN MANAGEMENT, NAMELY, BUSINESS MANAGEMENT, ORGANIZATIONAL PLANNING AND IMPLEMENTATION OF MEASURES TO COORDINATE PROCESSES INVOLVED IN PRODUCING, SHIPPING AND DISTRIBUTING PRODUCTS; DISTRIBUTORSHIP SERVICES FEATURING FOOD AND RELATED NON-FOOD ITEMS TO RESTAURANTS, INSTITUTIONS, AND OTHER EATING ESTABLISHMENTS (U.S. CLS. 100, 101 AND 102).  
 KEVON CHISOLM, EXAMINING ATTORNEY

---

SN 78-278,410. CAVALIERE, JAMES, MISSION VIEJO, CA. FILED 7-24-2003.

**UNDERMIND**

FOR ADVERTISING AGENCIES, NAMELY, PROMOTING THE SERVICES OF THE APPAREL INDUSTRY THROUGH THE DISTRIBUTION OF PRINTED AND AUDIO PROMOTIONAL MATERIALS AND BY RENDERING SALES PROMOTION ADVICE; BUSINESS MANAGEMENT CONSULTATION FOR THE APPAREL INDUSTRY (U.S. CLS. 100, 101 AND 102).  
 AMY GEARIN, EXAMINING ATTORNEY

---

SN 78-283,590. LOW CARB ENTERPRISES, INC., SANTA MONICA, CA. FILED 8-5-2003.

**HEAVENLY LOW CARB**

NO CLAIM IS MADE TO THE EXCLUSIVE RIGHT TO USE LOW CARB, APART FROM THE MARK AS SHOWN.  
 FOR RETAIL GROCERY STORE SERVICES, ONLINE RETAIL STORE SERVICES AND DISTRIBUTION SERVICES FEATURING FOOD PRODUCTS AND FOOD SUPPLEMENTS (U.S. CLS. 100, 101 AND 102).  
 DAWN FELDMAN, EXAMINING ATTORNEY

**CLASS 35—(Continued).**

SN 78-289,072. FERRARI S.P.A., 41100 MODENA, ITALY, FILED 8-19-2003.

**FERRARI**

OWNER OF ERPN CMNTY TM OFC REG. NO. 001616473, DATED 11-27-1998, EXPIRES 1-30-2007.

OWNER OF U.S. REG. NOS. 2,307,112, 2,801,663 AND OTHERS.

FOR RETAIL, WHOLESALE STORES AND DISTRIBUTORSHIP SERVICES IN THE FIELD OF CLOTHING, FOOTWEAR, HEADGEAR, CARS AND AUTOMOTIVE PARTS, COSMETICS, TOILETRIES, JEWELRY, COSTUME JEWELRY, WATCH-MAKING, STATIONERY, LIBRARY, OPTICAL GOODS, PHOTOGRAPHY, HI-FI GOODS, SCIENTIFIC GOODS, LEATHER GOODS, TEXTILE GOODS, FANCY GOODS, TOYS AND PLAYTHINGS, SMOKER'S ARTICLES, MUGS; RETAIL STORE SERVICES ALL RELATING TO TOILETRIES, COSMETICS, PERSONAL CARE PRODUCTS, PERFUMERY, HAIR CARE PRODUCTS, SOAPS, DENTIFRICES, KEY RINGS, KEY HOLDERS, KEY CASES, PILL BOXES, PINS, BADGES, TAGS, TROPHIES, ARTISTIC OBJECTS OF COMMON METAL, ORNAMENTS OF COMMON METAL MADE UP WITH CAR COMPONENTS, EYEWEAR, SAFETY HELMETS, VIDEOS, TELEPHONES, CELLULAR PHONES, CELLULAR PHONE MASKS, CELLULAR PHONE FREEHAND KITS, CD-ROMS, COMPUTER GAMES AND VIDEO GAMES, COMPUTER SOFTWARE, SCREEN SAVERS, COMPUTER MICE, MOUSE PADS, PORTABLE COMPUTERS, LAPTOP COMPUTERS, NOTEBOOK COMPUTERS, PRINTERS, COMPUTER MONITORS, BAROMETERS WITH DIGITAL DISPLAYS, WIRELESS WEATHER STATIONS, PERSONAL DIGITAL ASSISTANTS, WIDE SCREEN ALARMS, ORGANIZERS, TRANSLATORS, PROJECTION DEVICES; APPARATUS FOR RECORDING, TRANSMISSION OR REPRODUCTION OF SOUND OR IMAGES, TV SETS, HI-FI, CAMERAS, DIGITAL CAMERAS, DIGITAL PROJECTORS, CHOROLOGICAL AND CHRONOMETRIC INSTRUMENTS AND APPARATUS, WATCHES, STOPWATCHES, CLOCKS, CHRONOMETERS; TIE-PINS, TIE-CLIPS, CUFF-LINKS, JEWELRY, GOODS IN PRECIOUS METAL OR COATED THEREWITH, PAPER, CARDBOARD AND GOODS MADE FROM THOSE MATERIALS, PRINTED MATTER, PHOTOGRAPHS, STATIONERY, PLAYING CARDS, WRITING IMPLEMENTS, BOOKS, PERIODICALS, OFFICE REQUISITES EXCEPT FURNITURE, CALENDARS, FLAGS, STICKERS AND ADHESIVE LABELS, PEN HOLDERS, ALBUMS, DRAWING KITS, PHOTOGRAPHS IN WIDE DIMENSION FOR DECORATIVE PURPOSES, LITHOGRAPHS, POSTERS, POSTCARDS, GREETING CARDS, WRAPPING PAPERS, SMALL BLACKBOARDS, DOCUMENT FOLDERS, CARDHOLDERS, DOCUMENT HOLDERS, STAMPS, WRITING AND DRAWING INSTRUMENTS, GOODS MADE FROM LEATHER OR PRINCIPALLY OF LEATHER, TRUNKS, SUIT CASES, TRAVELLING BAGS, UMBRELLAS, ATTACHE CASES, BRIEFCASES, WALLETS, PURSES, RUCKSACKS, BAGS, BELT BAGS, SADDLERY, TRAVEL SET NECESSARIES, BEACH TOWELS, TABLE CLOTHS, NAPKINS, TEXTILE GOODS, SHEETS, BLANKETS, BEDCLOTHES, BATH TOWELS, CLOTHING, FOOTWEAR, OUTERWEAR, UNDERWEAR, SLEEPWEAR, HEADGEAR, SCARVES, GLOVES, BUTTONS, FANCY PINS, MUGS, TOYS, GAMES, DOLLS AND DOLL'S CLOTHING, ACCESSORIES FOR DOLLS, SOFT FELT TOYS, PLAYTHINGS, PUZZLES, TENNIS BAGS, GOLF BAGS, GOLF POUCHES, GOLF CLUBS, SPORTING ARTICLES, GLASSWARE, MODEL CARS, MODEL CARS (TOYS OR PLAYTHINGS) FOR SALE IN AN ASSEMBLY KIT FORM, MODEL VEHICLES, SCALE MODEL CARS (ORNAMENTS), SCALE MODEL VEHICLES (TOYS AND PLAYTHINGS), RADIO CONTROLLED SCALE MODEL VEHICLES, TOY VEHICLE TRACKS, ASHTRAYS (U.S. CLS. 100, 101 AND 102).

ANN LINNEHAN, EXAMINING ATTORNEY

**CLASS 35—(Continued).**

SN 78-300,815. SANDERS, ANTHONY, CLEVELAND, OH. FILED 9-16-2003.



NO CLAIM IS MADE TO THE EXCLUSIVE RIGHT TO USE RECORDS, APART FROM THE MARK AS SHOWN.

FOR WHOLESALE DISTRIBUTORSHIPS, RETAIL STORES AND ELECTRONIC RETAILING SERVICES VIA COMPUTER, ALL FEATURING COMPACT DISCS AND AUDIO CASSETTES FEATURING MUSICAL SOUND RECORDINGS (U.S. CLS. 100, 101 AND 102).

JOHN DWYER, EXAMINING ATTORNEY

SN 78-301,545. MAYTAG CORPORATION, NEWTON, IA. FILED 9-17-2003.

**MAYTAG HOME**

OWNER OF U.S. REG. NOS. 326,065, 868,637 AND OTHERS.

NO CLAIM IS MADE TO THE EXCLUSIVE RIGHT TO USE HOME, APART FROM THE MARK AS SHOWN.

FOR RETAIL STORE SERVICES FEATURING APPLIANCES AND HOUSEWARES (U.S. CLS. 100, 101 AND 102).

JOSETTE BEVERLY, EXAMINING ATTORNEY

SN 78-314,964. FUSION CREATIVE GROUP INC., NEW BERLIN, WI. FILED 10-17-2003.

**FUSION CREATIVE GROUP**

NO CLAIM IS MADE TO THE EXCLUSIVE RIGHT TO USE CREATIVE GROUP, APART FROM THE MARK AS SHOWN.

FOR ADVERTISING AGENCIES AND BUSINESS MARKETING SERVICES (U.S. CLS. 100, 101 AND 102).

YSA DEJESUS, EXAMINING ATTORNEY

SN 78-315,087. SCHERBA INDUSTRIES, INC., BRUNSWICK, OH. FILED 10-17-2003.

**PROMOTION OUT OF BOX**

NO CLAIM IS MADE TO THE EXCLUSIVE RIGHT TO USE PROMOTION, APART FROM THE MARK AS SHOWN.

FOR RETAIL STORE SERVICES AND RENTAL SERVICES FEATURING INFLATABLES FOR USE IN PROMOTIONAL EVENTS (U.S. CLS. 100, 101 AND 102).

WILLIAM P. SHANAHAN, EXAMINING ATTORNEY

**CLASS 35—(Continued).**

SN 78-318,054. VIVIANO FLOWER SHOP, INC., ST. CLAIR SHORES, MI. FILED 10-24-2003.

**VIVIANO FLOWER SHOP**

NO CLAIM IS MADE TO THE EXCLUSIVE RIGHT TO USE FLOWER SHOP, APART FROM THE MARK AS SHOWN.

SEC. 2(F).  
FOR RETAIL STORE SERVICES FEATURING FLOWERS (U.S. CLS. 100, 101 AND 102).  
FIRST USE 12-31-1937; IN COMMERCE 12-31-1997.  
TARAH HARDY, EXAMINING ATTORNEY

**CLASS 35—(Continued).**

SN 78-324,491. NEWS-JOURNAL CORPORATION, DAYTONA BEACH, FL. FILED 11-7-2003.

**NEWS-JOURNAL  
CENTER**

SN 78-319,183. PHAN, TRI T., MOUNTAIN VIEW, CA. FILED 10-27-2003.

**1 CALL AUCTIONS**

NO CLAIM IS MADE TO THE EXCLUSIVE RIGHT TO USE "AUCTIONS", APART FROM THE MARK AS SHOWN. FOR AUCTIONS OF GOODS VIA THE TELEPHONE AND COMPUTER NETWORKS, INCLUDING THE INTERNET (U.S. CLS. 100, 101 AND 102).  
JOSETTE BEVERLY, EXAMINING ATTORNEY

THE MARK CONSISTS OF STANDARD CHARACTERS WITHOUT CLAIM TO ANY PARTICULAR FONT, STYLE, SIZE, OR COLOR.

OWNER OF U.S. REG. NOS. 1,910,449, 2,633,669 AND OTHERS.

NO CLAIM IS MADE TO THE EXCLUSIVE RIGHT TO USE "CENTER", APART FROM THE MARK AS SHOWN. FOR PROVIDING FACILITIES FOR BUSINESS MEETINGS (U.S. CLS. 100, 101 AND 102).

WILLIAM VERHOSEK, EXAMINING ATTORNEY

SN 78-319,451. RACK ROOM SHOES OF VIRGINIA LLC, CHARLOTTE, NC. FILED 10-28-2003.

**FOR THE LOVE OF  
SHOES.**

THE MARK CONSISTS OF STANDARD CHARACTERS WITHOUT CLAIM TO ANY PARTICULAR FONT, STYLE, SIZE, OR COLOR.

NO CLAIM IS MADE TO THE EXCLUSIVE RIGHT TO USE "SHOES", APART FROM THE MARK AS SHOWN.

FOR RETAIL STORE SERVICES FEATURING FOOTWEAR AND RELATED ACCESSORIES (U.S. CLS. 100, 101 AND 102).

FIRST USE 9-1-2003; IN COMMERCE 9-1-2003.  
LAURA KOVAISKY, EXAMINING ATTORNEY

SN 78-334,293. CHAMBERS, KEITH SHERWOOD, ANAHEIM, CA. FILED 12-1-2003.

**dadadogma**

SN 78-321,173. PATIENT MARKETING GROUP, INC., PENNINGTON, NJ. FILED 10-30-2003.

**Consumer<sup>R</sup>xperience  
SCORECARD**

FOR DIRECT MARKETING AND ADVERTISING FOR OTHERS IN THE FIELD OF PRESCRIPTION PRODUCTS OF OTHERS (U.S. CLS. 100, 101 AND 102).

FIRST USE 9-1-2003; IN COMMERCE 9-1-2003.  
JANICE L. MCMORROW, EXAMINING ATTORNEY

THE MARK CONSISTS OF STANDARD CHARACTERS WITHOUT CLAIM TO ANY PARTICULAR FONT, STYLE, SIZE, OR COLOR.

FOR ADVERTISING AGENCIES (U.S. CLS. 100, 101 AND 102).

ELIZABETH PIGNATELLO, EXAMINING ATTORNEY

**CLASS 35—(Continued).**

SN 78-334,505. BROWN JORDAN INTERNATIONAL, INC.,  
POMPANO BEACH, FL. FILED 12-1-2003.

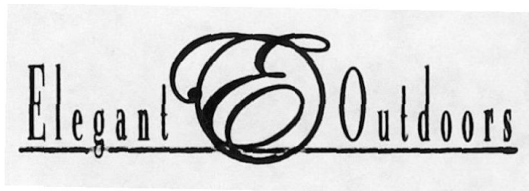

NO CLAIM IS MADE TO THE EXCLUSIVE RIGHT TO  
USE "OUTDOORS", APART FROM THE MARK AS SHOWN.

THE MARK CONSISTS OF THE WORDS ELEGANT  
OUTDOORS IN STYLIZED LETTERING, UNDERLINED,  
WITH A FANCIFUL DESIGN OF AN AMPERSAND AP-  
PEARING BETWEEN THE WORDS.

FOR DEALERSHIPS IN THE FIELD OF FURNITURE  
(U.S. CLS. 100, 101 AND 102).

FIRST USE 10-21-2003; IN COMMERCE 10-31-2003.

DAVID H. STINE, EXAMINING ATTORNEY

SN 78-334,830. BLECHMAN, BRUCE J., SCOTTSDALE, AZ.  
FILED 12-1-2003.

**Travel Free  
America**

THE MARK CONSISTS OF STANDARD CHARACTERS  
WITHOUT CLAIM TO ANY PARTICULAR FONT, STYLE,  
SIZE, OR COLOR.

FOR CONTESTS AND INCENTIVE TRAVEL AWARD  
PROGRAMS TO PROMOTE THE SALE OF PRODUCTS  
AND SERVICES OF OTHERS (U.S. CLS. 100, 101 AND  
102).

HELEN BRYAN, EXAMINING ATTORNEY

**CLASS 35—(Continued).**

SN 78-341,407. HERSHEY CHOCOLATE & CONFECTION-  
ERY CORPORATION, WHEAT RIDGE, CO. FILED 12-16-  
2003.

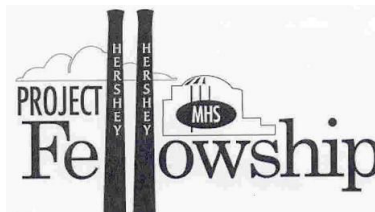

OWNER OF U.S. REG. NOS. 54,041 AND 1,455,684.  
NO CLAIM IS MADE TO THE EXCLUSIVE RIGHT TO  
USE "PROJECT FELLOWSHIP", APART FROM THE MARK  
AS SHOWN.

THE MARK CONSISTS OF THE WORDS PROJECT  
FELLOWSHIP WITH TWO SMOKESTACKS FORMING  
THE TWO "L'S" OF "FELLOWSHIP". THE STYLIZED DE-  
SIGN OF A CLOUD APPEARS OVER THE WORD "PRO-  
JECT" AND BEHIND THE SMOKE STACKS. THE  
STYLIZED DESIGN OF A BUILDING APPEARS ABOVE  
THE "OWS" OF "FELLOWSHIP" AND THE LETTERS "MHS"  
APPEAR ON AN OVAL THAT IS SUPERIMPOSED ON THE  
BUILDING. COLOR IS NOT CLAIMED AS PART OF THE  
MARK.

SEC. 2(F) AS TO HERSHEY.

FOR ASSOCIATION SERVICES, NAMELY, PROMOT-  
ING THE INTERESTS OF COMMUNITY ORGANIZA-  
TIONS IN DERRY TOWNSHIP, PENNSYLVANIA (U.S.  
CLS. 100, 101 AND 102).

PRISCILLA MILTON, EXAMINING ATTORNEY

SN 78-345,535. TEEZE INTERNATIONAL, INC., OLDSMAR,  
FL. FILED 12-24-2003.

**TEEZE**

THE MARK CONSISTS OF STANDARD CHARACTERS  
WITHOUT CLAIM TO ANY PARTICULAR FONT, STYLE,  
SIZE, OR COLOR.

FOR ORGANIZING AND CONDUCTING TRADE  
SHOWS, TRADE SHOW EXHIBITIONS, EXPOSITIONS,  
CONVENTIONS AND VENDOR SHOWCASES FEATUR-  
ING MODELS, MODELING AGENCIES, MANAGEMENT  
COMPANIES, PHOTOGRAPHERS, APPAREL MANU-  
FACTURERS AND DISTRIBUTORS AND WHOLESALE  
AND RETAIL STORE OPERATORS AND INTERNET  
OUTLETS ALL IN THE FASHION INDUSTRY (U.S.  
CLS. 100, 101 AND 102).

ELIZABETH J. WINTER, EXAMINING ATTORNEY

**CLASS 35—(Continued).**

SN 78-346,805. ANSWERS SYSTEMS INC., OLDSMAR, FL. FILED 12-31-2003.

**CLASS 35—(Continued).**

SN 78-347,685. INTERNATIONAL ORDER OF THE GOLDEN RULE, BRIDGETON, MO. FILED 1-5-2004.

OptiShare

GOLDEN SERVICES  
GROUP

THE MARK CONSISTS OF STANDARD CHARACTERS WITHOUT CLAIM TO ANY PARTICULAR FONT, STYLE, SIZE, OR COLOR.

FOR SERVICE OF TARGETED MARKETING, VIA DATABASE MANAGEMENT, TO BUSINESS OPERATORS (U.S. CLS. 100, 101 AND 102).  
MICHAEL ENGEL, EXAMINING ATTORNEY

THE MARK CONSISTS OF STANDARD CHARACTERS WITHOUT CLAIM TO ANY PARTICULAR FONT, STYLE, SIZE, OR COLOR.

OWNER OF U.S. REG. NOS. 1,429,662 AND 1,819,308.  
NO CLAIM IS MADE TO THE EXCLUSIVE RIGHT TO USE "SERVICES GROUP", APART FROM THE MARK AS SHOWN.

FOR ASSOCIATION SERVICES, NAMELY, PROMOTING THE INTERESTS OF FUNERAL DIRECTORS AND DEATH CARE PROFESSIONALS (U.S. CLS. 100, 101 AND 102).  
EVELYN BRADLEY, EXAMINING ATTORNEY

SN 78-347,019. BRANDERS, INC., TULSA, OK. FILED 12-31-2003.

SN 78-348,776. ZIFF DAVIS PUBLISHING HOLDINGS INC., NEW YORK, NY. FILED 1-7-2004.

LOOPS

CIO INSIGHT  
BRANDTRAK

THE MARK CONSISTS OF STANDARD CHARACTERS WITHOUT CLAIM TO ANY PARTICULAR FONT, STYLE, SIZE, OR COLOR.

FOR RETAIL STORES IN THE FIELD OF KNITTING AND CROCHET (U.S. CLS. 100, 101 AND 102).  
JENNIFER MARTIN, EXAMINING ATTORNEY

THE MARK CONSISTS OF STANDARD CHARACTERS WITHOUT CLAIM TO ANY PARTICULAR FONT, STYLE, SIZE, OR COLOR.

OWNER OF U.S. REG. NOS. 2,665,544 AND 2,686,531.  
FOR MARKET RESEARCH SERVICES, NAMELY, CONDUCTING MARKET RESEARCH SURVEYS AND STUDIES AND ANALYZING RESULTS WITH RESPECT TO TECHNOLOGY RELATED GOODS AND SERVICES (U.S. CLS. 100, 101 AND 102).  
JACQUELINE A. LAVINE, EXAMINING ATTORNEY

**CLASS 35—(Continued).**

SN 78-350,164. UNIVERSAL ATM NETWORK, INC., SACRAMENTO, CA. FILED 1-9-2004.

# The Usual

THE MARK CONSISTS OF STANDARD CHARACTERS WITHOUT CLAIM TO ANY PARTICULAR FONT, STYLE, SIZE, OR COLOR.

FOR ORDER-TAKING SERVICES FOR OTHERS IN THE FIELD OF RESTAURANT TAKE-OUT AND DELIVERY (U.S. CLS. 100, 101 AND 102).

WON TEAK OH, EXAMINING ATTORNEY

**CLASS 35—(Continued).**

SN 78-351,220. AMERICAN BUSINESS RESOURCES, INC., DBA IMANGAL.COM, TARRYTOWN, NY. FILED 1-13-2004.

# IMANGAL.COM

THE MARK CONSISTS OF STANDARD CHARACTERS WITHOUT CLAIM TO ANY PARTICULAR FONT, STYLE, SIZE, OR COLOR.

FOR ONLINE RETAIL STORES FEATURING GENERAL MERCHANDISE AND GIFTS, NAMELY, AUDIO CDS, BEAUTY SUPPLIES AND COSMETICS, BOOKS, DVDS AND VIDEO CDS, CLOTHING, GIFT CERTIFICATES, HANDICRAFTS, MUSICAL INSTRUMENTS, JEWELRY, MAGAZINES, PAINTINGS, PHONE CARDS, RELIGIOUS ITEMS, AND SWEETS AND SNACKS (U.S. CLS. 100, 101 AND 102).

REGINA DRUMMOND, EXAMINING ATTORNEY

SN 78-350,515. ADVANCED PERSONNEL, INC., NORTH-BROOK, IL. FILED 1-12-2004.

# Mad About Quality

THE MARK CONSISTS OF STANDARD CHARACTERS WITHOUT CLAIM TO ANY PARTICULAR FONT, STYLE, SIZE, OR COLOR.

FOR EMPLOYMENT AGENCY; EMPLOYMENT COUNSELING, HIRING, RECRUITING, PLACEMENT, STAFFING AND CAREER NETWORKING SERVICES (U.S. CLS. 100, 101 AND 102).

ALEX KEAM, EXAMINING ATTORNEY

SN 78-351,503. SLEEP COUNTRY USA, INC., KENT, WA. FILED 1-13-2004.

# REST ASSURED GUARANTEE

THE MARK CONSISTS OF STANDARD CHARACTERS WITHOUT CLAIM TO ANY PARTICULAR FONT, STYLE, SIZE, OR COLOR.

NO CLAIM IS MADE TO THE EXCLUSIVE RIGHT TO USE "GUARANTEE", APART FROM THE MARK AS SHOWN.

FOR RETAIL FURNITURE STORES (U.S. CLS. 100, 101 AND 102).

BRIAN PINO, EXAMINING ATTORNEY



**CLASS 35—(Continued).**

SN 78-351,836. THE INFOSEC GROUP, LLC, WASHINGTON, DC. FILED 1-14-2004.

**THE INFOSEC GROUP**

THE MARK CONSISTS OF STANDARD CHARACTERS WITHOUT CLAIM TO ANY PARTICULAR FONT, STYLE, SIZE, OR COLOR.

NO CLAIM IS MADE TO THE EXCLUSIVE RIGHT TO USE "GROUP", APART FROM THE MARK AS SHOWN.

FOR EXECUTIVE SEARCH AND PLACEMENT SERVICES (U.S. CLS. 100, 101 AND 102).

FIRST USE 9-27-2002; IN COMMERCE 9-5-2003.

ELIZABETH PIGNATELLO, EXAMINING ATTORNEY

SN 78-352,509. RSL INTERACTIVE, INC., SEATTLE, WA. FILED 1-15-2004.

**PLANNED  
COMMUNITIES**

THE MARK CONSISTS OF STANDARD CHARACTERS WITHOUT CLAIM TO ANY PARTICULAR FONT, STYLE, SIZE, OR COLOR.

FOR ADVERTISING SERVICES, NAMELY CREATING AND MANAGING MARKETING AND ADVERTISING CAMPAIGNS FOR FESTIVAL AND EVENT SPONSORS; CREATING AND MANAGING MARKETING AND ADVERTISING CAMPAIGNS IN THE FIELD OF NATIONAL AND INTERNATIONAL FESTIVALS AND EVENTS; CREATING MARKETING AND ADVERTISING CAMPAIGNS BY COMBINING INDIVIDUAL FESTIVALS, FAIRS AND SPECIAL EVENTS INTO CUSTOM AGGREGATIONS THROUGH PROPRIETARY DATABASES IN THE FIELD OF NATIONAL AND INTERNATIONAL FESTIVALS AND EVENTS; CREATING AND MANAGING MARKETING AND ADVERTISING CAMPAIGNS FOR FESTIVAL AND EVENT PROMOTERS; PROMOTING THE GOODS AND SERVICES OF OTHERS BY CREATING MARKETING AND ADVERTISING OPPORTUNITIES FOR SPONSORS TO AFFILIATE THEIR GOODS AND SERVICES WITH FESTIVALS AND EVENTS; PROMOTING THE GOODS AND SERVICES OF OTHERS THROUGH THE CUSTOM AGGREGATIONS OF INDIVIDUAL FESTIVALS, FAIRS AND SPECIAL EVENTS; PROVIDING BUSINESS MARKETING INFORMATION; BUSINESS MARKETING CONSULTING SERVICES; DISSEMINATION OF ADVERTISING FOR OTHERS VIA THE INTERNET, RADIO AND TELEVISION (U.S. CLS. 100, 101 AND 102).

FIRST USE 9-19-2003; IN COMMERCE 9-19-2003.

DOMINICK J. SALEMI, EXAMINING ATTORNEY

**CLASS 35—(Continued).**

SN 78-352,543. DAIMLERCHRYSLER CORPORATION, AUBURN HILLS, MI. FILED 1-15-2004.



OWNER OF U.S. REG. NOS. 526,175, 1,081,322 AND 1,129,553.

THE MARK CONSISTS OF THE WORDS JEEP EVERYDAY HEROES ADORNED WITH RIBBONS AND STARS.

FOR PROMOTING THE SALE OF MOTOR VEHICLES THROUGH THE ADMINISTRATION OF AN INCENTIVE AWARD PROGRAM, NAMELY, PROVIDING VEHICLE PURCHASE OR LEASE INCENTIVES TO FIRE, POLICE, PARAMEDIC OR MILITARY PERSONNEL (U.S. CLS. 100, 101 AND 102).

GRETTA YAO, EXAMINING ATTORNEY

SN 78-354,203. CITICORP, NEW YORK, NY. FILED 1-20-2004.

**PIZAZZ**

THE MARK CONSISTS OF STANDARD CHARACTERS WITHOUT CLAIM TO ANY PARTICULAR FONT, STYLE, SIZE, OR COLOR.

FOR PROMOTING THE GOODS AND SERVICES OF OTHERS THROUGH CREDIT CARD CUSTOMER LOYALTY, REWARD AND REDEMPTION PROGRAMS (U.S. CLS. 100, 101 AND 102).

WILLIAM P. SHANAHAN, EXAMINING ATTORNEY

**CLASS 35—(Continued).**

SN 78-354,659. ALLIED ELECTRONICS INC., FORT WORTH, TX. FILED 1-21-2004.



OWNER OF U.S. REG. NOS. 2,271,634, 2,707,231 AND 2,773,580.

NO CLAIM IS MADE TO THE EXCLUSIVE RIGHT TO USE "ELECTRONICS", APART FROM THE MARK AS SHOWN.

FOR ONLINE ORDERING SERVICES AND MAIL ORDER SERVICES FEATURING PASSIVE AND ELECTRONIC COMPONENTS, ELECTRICAL TEST EQUIPMENT AND EXPERIMENTAL EQUIPMENT AND HAND TOOLS FOR USE IN THE ELECTRONICS INDUSTRY VIA CATALOGS (U.S. CLS. 100, 101 AND 102).  
FIRST USE 5-23-2001; IN COMMERCE 5-23-2001.

DAVID MURRAY, EXAMINING ATTORNEY

---

SN 78-354,971. FAIRX PHARMACEUTICALS, INC., MINNEAPOLIS, MN. FILED 1-21-2004.

# FAIRCARE

THE MARK CONSISTS OF STANDARD CHARACTERS WITHOUT CLAIM TO ANY PARTICULAR FONT, STYLE, SIZE, OR COLOR.

FOR RETAIL DRUGSTORE AND PHARMACY SERVICES IN THE FIELD OF PRESCRIPTION AND NON-PRESCRIPTION PHARMACEUTICALS; RETAIL DRUGSTORE AND PHARMACY SERVICES PROVIDED ONLINE VIA A GLOBAL COMPUTER NETWORK; RETAIL DRUGSTORE AND PHARMACY SERVICES PROVIDED BY MEANS OF MAIL ORDER (U.S. CLS. 100, 101 AND 102).

RONALD AIKENS, EXAMINING ATTORNEY

**CLASS 35—(Continued).**

SN 78-355,046. ARMY NATIONAL GUARD, ARLINGTON, VA. FILED 1-21-2004.

# YOU CAN

THE MARK CONSISTS OF STANDARD CHARACTERS WITHOUT CLAIM TO ANY PARTICULAR FONT, STYLE, SIZE, OR COLOR.

FOR PROMOTING THE INTERESTS OF MILITARY PERSONNEL WITH RESPECT PRIMARILY TO RECRUITMENT AND RETENTION, AND THE PUBLIC AWARENESS OF THE NEED FOR COMMUNITY SERVICE (U.S. CLS. 100, 101 AND 102).

FIRST USE 7-1-1996; IN COMMERCE 7-1-1996.

YSA DEJESUS, EXAMINING ATTORNEY

---

SN 78-355,519. HOWARD JARVIS TAXPAYERS ASSOCIATION, LOS ANGELES, CA. FILED 1-22-2004.

# HJTA

THE MARK CONSISTS OF STANDARD CHARACTERS WITHOUT CLAIM TO ANY PARTICULAR FONT, STYLE, SIZE, OR COLOR.

FOR TAX ADVISORY SERVICES (U.S. CLS. 100, 101 AND 102).

FIRST USE 1-1-1988; IN COMMERCE 1-1-1988.

RICHARD WHITE, EXAMINING ATTORNEY

**CLASS 35—(Continued).**

SN 78-355,555. IDEA OUTPOST, LLC, APPLETON, WI. FILED 1-22-2004.

**CLASS 35—(Continued).**

SN 78-355,565. IDEA OUTPOST, LLC, APPLETON, WI. FILED 1-22-2004.

# DISHGUSTED

THE MARK CONSISTS OF STANDARD CHARACTERS WITHOUT CLAIM TO ANY PARTICULAR FONT, STYLE, SIZE, OR COLOR.

FOR BUSINESS MARKETING; DIRECT MAIL CONSULTING SERVICES; DIRECT MARKETING ADVERTISING FOR OTHERS; PROVIDING BUSINESS MARKETING INFORMATION AND BUSINESS MARKETING CONSULTING SERVICES (U.S. CLS. 100, 101 AND 102).

DAVID MURRAY, EXAMINING ATTORNEY

# DISHAPPOINTED

THE MARK CONSISTS OF STANDARD CHARACTERS WITHOUT CLAIM TO ANY PARTICULAR FONT, STYLE, SIZE, OR COLOR.

FOR BUSINESS MARKETING; DIRECT MAIL CONSULTING SERVICES; DIRECT MARKETING ADVERTISING FOR OTHERS; PROVIDING BUSINESS MARKETING INFORMATION AND BUSINESS MARKETING CONSULTING SERVICES (U.S. CLS. 100, 101 AND 102).

DAVID MURRAY, EXAMINING ATTORNEY

SN 78-355,559. IDEA OUTPOST, LLC, APPLETON, WI. FILED 1-22-2004.

# DISHGRUNTLED

THE MARK CONSISTS OF STANDARD CHARACTERS WITHOUT CLAIM TO ANY PARTICULAR FONT, STYLE, SIZE, OR COLOR.

FOR BUSINESS MARKETING; DIRECT MAIL CONSULTING SERVICES; DIRECT MARKETING ADVERTISING FOR OTHERS; PROVIDING BUSINESS MARKETING INFORMATION AND BUSINESS MARKETING CONSULTING SERVICES (U.S. CLS. 100, 101 AND 102).

DAVID MURRAY, EXAMINING ATTORNEY

SN 78-355,885. UTILITRACK, INC., BOSTON, MA. FILED 1-22-2004.

# Utilitrack

THE MARK CONSISTS OF STANDARD CHARACTERS WITHOUT CLAIM TO ANY PARTICULAR FONT, STYLE, SIZE, OR COLOR.

FOR ONLINE UTILITY BILL TRACKING, ANALYZING AND REPORTING SERVICE (U.S. CLS. 100, 101 AND 102).

YSA DEJESUS, EXAMINING ATTORNEY

**CLASS 35—(Continued).**

SN 78-355,911. NATIONAL CASA ASSOCIATION, SEATTLE, WA. FILED 1-22-2004.



THE MARK CONSISTS OF A STICK FIGURE WITH UPSTRETCHED ARMS AND THE ARMS FORM THE BOTTOM HALF OF AN OUTLINE OF A HEART.

FOR PROMOTION OF PUBLIC AWARENESS OF THE NEED FOR ADVOCATES TO REPRESENT THE BEST INTERESTS OF DEPENDENT, NEGLECTED AND ABUSED CHILDREN IN COURT; DEVELOPING, ORGANIZING AND CONDUCTING VOLUNTEER RECRUITING ACTIVITIES AND CORPORATE SPONSORSHIP AND PARTNERSHIP ACTIVITIES IN THE FIELD OF REPRESENTING THE BEST INTERESTS OF CHILDREN IN COURT (U.S. CLS. 100, 101 AND 102).

GIANCARLO CASTRO, EXAMINING ATTORNEY

**CLASS 35—(Continued).**

SN 78-357,305. MCRAE'S, INC., BIRMINGHAM, AL. FILED 1-26-2004.

**CLUB LIBBY LU**

THE MARK CONSISTS OF STANDARD CHARACTERS WITHOUT CLAIM TO ANY PARTICULAR FONT, STYLE, SIZE, OR COLOR.

OWNER OF U.S. REG. NOS. 2,571,942 AND 2,646,577.

FOR RETAIL STORE SERVICES FEATURING GIRLS' CLOTHING, COSMETICS, BATH PRODUCTS FOR HAIR AND SKIN, FASHION AND HAIR ACCESSORIES, COSTUME JEWELRY, BED LINENS AND PILLOWS (U.S. CLS. 100, 101 AND 102).

FIRST USE 8-16-2000; IN COMMERCE 8-16-2000.

M. E. BODSON, EXAMINING ATTORNEY

SN 78-356,967. TODAY'S WINDOW FASHIONS, FRAZIER PARK, CA. FILED 1-23-2004.

**TODAY'S BLINDS**

THE MARK CONSISTS OF STANDARD CHARACTERS WITHOUT CLAIM TO ANY PARTICULAR FONT, STYLE, SIZE, OR COLOR.

OWNER OF U.S. REG. NO. 2,074,284.

NO CLAIM IS MADE TO THE EXCLUSIVE RIGHT TO USE "BLINDS", APART FROM THE MARK AS SHOWN.

FOR RETAIL STORE SERVICES FEATURING WINDOW COVERINGS (U.S. CLS. 100, 101 AND 102).

MATTHEW KLINE, EXAMINING ATTORNEY

SN 78-357,741. PETON FINE WINE & SPIRITS, INC., MIAMI LAKES, FL. FILED 1-26-2004.

**BOTT****ies**

THE MARK CONSISTS OF THE WORD BOTTLES EXCEPT THAT THE "L" HAS BEEN REPLACED WITH THE OUTLINE OF A HIGH-SHOULDERED WINE BOTTLE.

FOR RETAIL STORE FOR ALCOHOLIC BEVERAGES (U.S. CLS. 100, 101 AND 102).

FIRST USE 9-15-2003; IN COMMERCE 9-15-2003.

CURTIS FRENCH, EXAMINING ATTORNEY

**CLASS 35—(Continued).**

SN 78-358,141. RANCH AND HOME SUPPLY, LLC, BOZEMAN, MT. FILED 1-27-2004.



NO CLAIM IS MADE TO THE EXCLUSIVE RIGHT TO USE "RANCH & HOME SUPPLY", APART FROM THE MARK AS SHOWN.

THE COLOR(S) BROWN AND WHITE IS/ARE CLAIMED AS A FEATURE OF THE MARK.

THE MARK CONSISTS OF A BROWN OVAL CONTAINING THE WORDS MURDOCH'S RANCH & HOME SUPPLY AND THE WHITE SILHOUETTE OF A GALLOPING HORSE.

FOR RETAIL STORE SERVICES FEATURING HAND AND POWER TOOLS; LAWN AND GARDEN EQUIPMENT AND SUPPLIES; HARDWARE; RANCH AND FARM SUPPLIES; TACK; PET FOOD AND ANIMAL FEED; SEEDS; APPAREL; WORK CLOTHING, GLOVES AND FOOTWEAR; GIFT SHOP SERVICES; ONLINE AND MAIL ORDER RETAIL STORE SERVICES FEATURING HAND AND POWER TOOLS; LAWN AND GARDEN EQUIPMENT AND SUPPLIES; HARDWARE; RANCH AND FARM SUPPLIES; TACK; PET FOOD AND ANIMAL FEED; SEEDS; APPAREL; WORK CLOTHING, GLOVES AND FOOTWEAR (U.S. CLS. 100, 101 AND 102).  
JEFFREY S. MOLINOFF, EXAMINING ATTORNEY

SN 78-358,431. MECHANICAL SERVANTS, INC., MELROSE PARK, IL. FILED 1-27-2004.

**PEOPLE ON THE GO**

THE MARK CONSISTS OF STANDARD CHARACTERS WITHOUT CLAIM TO ANY PARTICULAR FONT, STYLE, SIZE, OR COLOR.

FOR WHOLESALE DISTRIBUTORSHIP SERVICES IN THE FIELDS OF DRUG AND HEALTH PRODUCTS, COSMETICS, AND BEAUTY AIDS, TOILETRIES, SUNDRIES, AND NOTIONS, WHICH ARE PACKAGED IN INDIVIDUAL PORTIONS (U.S. CLS. 100, 101 AND 102).  
KAREN K. BUSH, EXAMINING ATTORNEY

**CLASS 35—(Continued).**

SN 78-359,098. NATIONAL PORK BOARD, CLIVE, IA. FILED 1-28-2004.

**BACON MAKES IT BETTER**

THE MARK CONSISTS OF STANDARD CHARACTERS WITHOUT CLAIM TO ANY PARTICULAR FONT, STYLE, SIZE, OR COLOR.

FOR ASSOCIATION SERVICES, NAMELY PROMOTING THE INTERESTS OF THE MEMBERS OF THE PORK INDUSTRY (U.S. CLS. 100, 101 AND 102).

FIRST USE 4-0-2001; IN COMMERCE 4-0-2001.  
ANN LINNEHAN, EXAMINING ATTORNEY

SN 78-359,108. LOOKCLICKPRINT, INC., LOS LUNAS, NM. FILED 1-28-2004.

**Image is Everything**

THE MARK CONSISTS OF STANDARD CHARACTERS WITHOUT CLAIM TO ANY PARTICULAR FONT, STYLE, SIZE, OR COLOR.

FOR COMPUTERIZED ON-LINE RETAIL SERVICES IN THE FIELD OF REPRODUCTION OF VISUAL IMAGES, INCLUDING ON-DEMAND PRINTING OF REPRODUCTIONS OF WORKS OF ART, PAINTINGS, AND PHOTOGRAPHS (U.S. CLS. 100, 101 AND 102).  
ANN LINNEHAN, EXAMINING ATTORNEY

**CLASS 35—(Continued).**

SN 78-359,490. ETHYL CORPORATION, RICHMOND, VA.  
FILED 1-29-2004.

**NEWMARKET**

THE MARK CONSISTS OF STANDARD CHARACTERS  
WITHOUT CLAIM TO ANY PARTICULAR FONT, STYLE,  
SIZE, OR COLOR.

FOR PLACING ADVERTISEMENTS FOR OTHERS,  
NAMELY, THE PLACEMENT OF COUPON AND AD-  
VERTISING DISPENSER BOXES IN STORES (U.S. CLS.  
100, 101 AND 102).

CHARLES JOYNER, EXAMINING ATTORNEY

SN 78-360,022. MENASHA CORPORATION, NEENAH, WI.  
FILED 1-30-2004.

**DELIDOLLARS**

THE MARK CONSISTS OF STANDARD CHARACTERS  
WITHOUT CLAIM TO ANY PARTICULAR FONT, STYLE,  
SIZE, OR COLOR.

FOR PLACING ADVERTISEMENTS FOR OTHERS,  
NAMELY, THE PLACEMENT OF COUPON AND AD-  
VERTISING DISPENSER BOXES IN STORES (U.S. CLS.  
100, 101 AND 102).

ARETHA SOMERVILLE, EXAMINING ATTORNEY

SN 78-360,026. MENASHA CORPORATION, NEENAH, WI.  
FILED 1-30-2004.

**BAKERYDOLLARS**

THE MARK CONSISTS OF STANDARD CHARACTERS  
WITHOUT CLAIM TO ANY PARTICULAR FONT, STYLE,  
SIZE, OR COLOR.

FOR PLACING ADVERTISEMENTS FOR OTHERS,  
NAMELY, THE PLACEMENT OF COUPON AND AD-  
VERTISING DISPENSER BOXES IN STORES (U.S. CLS.  
100, 101 AND 102).

KAREN BRACEY, EXAMINING ATTORNEY

**CLASS 35—(Continued).**

SN 78-360,032. MENASHA CORPORATION, NEENAH, WI.  
FILED 1-30-2004.

**SEAFOODDOLLARS**

THE MARK CONSISTS OF STANDARD CHARACTERS  
WITHOUT CLAIM TO ANY PARTICULAR FONT, STYLE,  
SIZE, OR COLOR.

FOR PLACING ADVERTISEMENTS FOR OTHERS,  
NAMELY, THE PLACEMENT OF COUPON AND AD-  
VERTISING DISPENSER BOXES IN STORES (U.S. CLS.  
100, 101 AND 102).

WILLIAM P. SHANAHAN, EXAMINING ATTORNEY

SN 78-360,344. NATIONAL SYSTEMS CONTRACTORS AS-  
SOCIATION, CEDAR RAPIDS, IA. FILED 1-30-2004.

**CONNECT TV**

THE MARK CONSISTS OF STANDARD CHARACTERS  
WITHOUT CLAIM TO ANY PARTICULAR FONT, STYLE,  
SIZE, OR COLOR.

FOR ARRANGING AND CONDUCTING TRADE  
SHOW EXHIBITIONS FOR CONTRACTORS IN THE  
FIELD OF ELECTRONIC SYSTEMS (U.S. CLS. 100, 101  
AND 102).

CHERYL STEPLIGHT, EXAMINING ATTORNEY

SN 78-360,849. METABOLIC NUTRITION, INC., NORTH  
MIAMI BEACH, FL. FILED 2-2-2004.

**A GREAT BODY NEVER  
GOES OUT OF STYLE**

THE MARK CONSISTS OF STANDARD CHARACTERS  
WITHOUT CLAIM TO ANY PARTICULAR FONT, STYLE,  
SIZE, OR COLOR.

FOR ONLINE INFORMATION SERVICES, NAMELY  
PROVIDING INFORMATION ON DIETARY, SPORTS  
PERFORMANCE AND HEALTH PRODUCTS (U.S. CLS.  
100, 101 AND 102).

FIRST USE 7-21-2000; IN COMMERCE 7-21-2000.

BARBARA BROWN, EXAMINING ATTORNEY

**CLASS 35—(Continued).**

SN 78-361,183. MARITZ INC., FENTON, MO. FILED 2-2-2004.

**CLASS 35—(Continued).**

SN 78-363,268. MAGNA-LASTIC DEVICES, INC., CARHAGE, IL. FILED 2-5-2004.

# TRIBUTES



THE MARK CONSISTS OF STANDARD CHARACTERS WITHOUT CLAIM TO ANY PARTICULAR FONT, STYLE, SIZE, OR COLOR.

FOR ADMINISTERING BUSINESS INCENTIVE PROGRAMS FOR MOTIVATING EMPLOYEES, DISTRIBUTORS, AND DEALERS (U.S. CLS. 100, 101 AND 102).  
SEAN DWYER, EXAMINING ATTORNEY

THE COLOR(S) BLUE, WHITE AND BLACK IS/ARE CLAIMED AS A DISTINCTIVE FEATURE OF THE MARK.

THE HEXAGON PART OF THE MARK IS BLUE AND WHITE WITH THE SWIRLING ARROWS IN BLACK

FOR LICENSING OF TORQUE, FORCE AND ANGLE SENSORS, TORQUE, FORCE AND ANGLE CONTROLLERS AND TORQUE, FORCE AND ANGLE MEASURING DEVICES (U.S. CLS. 100, 101 AND 102).  
SUSAN HAYASH, EXAMINING ATTORNEY

SN 78-363,027. ROYAL MAX ENTERPRISES, INC., LAWRENCE, NY. FILED 2-5-2004.

SN 78-363,321. DIGITAL HOME WORKING GROUP, PORTLAND, OR. FILED 2-5-2004.

# MAX SEARCH

# DLNA

THE MARK CONSISTS OF STANDARD CHARACTERS WITHOUT CLAIM TO ANY PARTICULAR FONT, STYLE, SIZE, OR COLOR.

FOR MANAGEMENT OF PERFORMING ARTISTS (U.S. CLS. 100, 101 AND 102).  
LINDA E. BLOHM, EXAMINING ATTORNEY

THE MARK CONSISTS OF STANDARD CHARACTERS WITHOUT CLAIM TO ANY PARTICULAR FONT, STYLE, SIZE, OR COLOR.

FOR ASSOCIATION SERVICES, NAMELY, PROMOTING THE INTERESTS OF THE CONSUMER ELECTRONICS INDUSTRY AND STANDARDS FOR NETWORKED DIGITAL CONSUMER ELECTRONICS PRODUCTS AND SERVICES (U.S. CLS. 100, 101 AND 102).  
SUSAN HAYASH, EXAMINING ATTORNEY

**CLASS 35—(Continued).**

SN 78-363,359. PROFESSIONALPAGE, INC., WESTLAKE VILLAGE, CA. FILED 2-5-2004.

## REVOLUTION OF THE WORK FORCE

THE MARK CONSISTS OF STANDARD CHARACTERS WITHOUT CLAIM TO ANY PARTICULAR FONT, STYLE, SIZE, OR COLOR.

FOR PROVIDING A WEBSITE FEATURING A SUBSCRIPTION BASED REFERRAL SERVICE WHEREIN AVAILABLE SUBSCRIBING COURT REPORTERS, INTERPRETERS AND VIDEOGRAPHERS ARE MATCHED WITH AVAILABLE JOBS (U.S. CLS. 100, 101 AND 102).

ANGELA M. MICHELI, EXAMINING ATTORNEY

---

SN 78-364,182. FAIRWEATHER SALMON, LLC, SEATTLE, WA. FILED 2-6-2004.

## FAIRWEATHER

THE MARK CONSISTS OF STANDARD CHARACTERS WITHOUT CLAIM TO ANY PARTICULAR FONT, STYLE, SIZE, OR COLOR.

FOR WHOLESALE DISTRIBUTORSHIP OF SEAFOOD (U.S. CLS. 100, 101 AND 102).

FIRST USE 9-15-1998; IN COMMERCE 9-15-1998.

JOHN HWANG, EXAMINING ATTORNEY

---

SN 78-379,542. VIACOM INTERNATIONAL INC., NEW YORK, NY. FILED 3-5-2004.

## VIACOM OUTDOOR

THE MARK CONSISTS OF STANDARD CHARACTERS WITHOUT CLAIM TO ANY PARTICULAR FONT, STYLE, SIZE, OR COLOR.

OWNER OF U.S. REG. NOS. 1,008,233, 2,451,488 AND OTHERS.

NO CLAIM IS MADE TO THE EXCLUSIVE RIGHT TO USE "OUTDOOR", APART FROM THE MARK AS SHOWN.

FOR DISSEMINATION OF OUT OF HOME ADVERTISING FOR OTHERS ON BILLBOARDS, BUSES, RAILWAYS AND STREET FURNITURE (U.S. CLS. 100, 101 AND 102).

FIRST USE 8-1-2001; IN COMMERCE 8-1-2001.

AMY ALFIERI, EXAMINING ATTORNEY

**CLASS 35—(Continued).**

SN 78-384,710. AVIATION WORLD INC., TORONTO, ONTARIO, CANADA, FILED 3-15-2004.

## Aviation World

THE MARK CONSISTS OF STANDARD CHARACTERS WITHOUT CLAIM TO ANY PARTICULAR FONT, STYLE, SIZE, OR COLOR.

NO CLAIM IS MADE TO THE EXCLUSIVE RIGHT TO USE "AVIATION", APART FROM THE MARK AS SHOWN.

FOR RETAIL STORE SERVICES, FEATURING, PILOT SUPPLIES, AVIATION BOOKS, HOBBY SUPPLIES; COMPUTERIZED ON-LINE RETAIL STORE SERVICES FEATURING PILOT SUPPLIES, AVIATION BOOKS, HOBBY SUPPLIES (U.S. CLS. 100, 101 AND 102).

DAVID MURRAY, EXAMINING ATTORNEY

---

SN 78-393,964. UNIQUE PHOTO, INC., FLORHAM PARK, NJ. FILED 3-31-2004.

## UNIQUE TOTS

THE MARK CONSISTS OF STANDARD CHARACTERS WITHOUT CLAIM TO ANY PARTICULAR FONT, STYLE, SIZE, OR COLOR.

OWNER OF U.S. REG. NO. 2,335,605.

NO CLAIM IS MADE TO THE EXCLUSIVE RIGHT TO USE "TOTS", APART FROM THE MARK AS SHOWN.

FOR WHOLESALE DISTRIBUTORSHIP FEATURING BABY BOTTLES, BABY NIPPLES AND TOPS THEREFOR, PLATES, CUPS, BOWLS, EATING UTENSILS, CLEANING SUPPLIES, PACIFIERS, BIBS, RATTLES, TEETHERS, TOYS, MOBILES, LAMPS, NIGHT LIGHTS, SWITCH PLATES FOR LIGHTS, BLANKETS, GIFT BOXES, RULERS, TOTES, DIAPER BAGS, DOLLS, WASH CLOTHS, MEDICINE DROPPERS, ASPIRATORS, HAIR BANDS, HAIR BRUSHES, COMBS, WINDOW SHADES, HANGERS, MITTENS AND TOWELS (U.S. CLS. 100, 101 AND 102).

FIRST USE 3-15-2004; IN COMMERCE 3-15-2004.

ELLEN PERKINS, EXAMINING ATTORNEY



**CLASS 35—(Continued).**

SN 78-396,138. TICKETS.COM, INC., COSTA MESA, NY. FILED 4-5-2004.

**PROVENUEONLINE**

THE MARK CONSISTS OF STANDARD CHARACTERS WITHOUT CLAIM TO ANY PARTICULAR FONT, STYLE, SIZE, OR COLOR.

FOR BUSINESS MANAGEMENT SERVICES FOR FRONT-OFFICE FUNCTIONS THAT SUPPORT ENTERTAINMENT, SPORTS, CULTURAL AND EDUCATIONAL FACILITIES IN RELATION TO THE SALE, RESALE AND TRANSFER OF INDIVIDUAL AND SEASON TICKETS TO CONSUMERS; BUSINESS MANAGEMENT SERVICES FOR FRONT-OFFICE FUNCTIONS THAT SUPPORT ENTERTAINMENT, SPORTS, CULTURAL AND EDUCATIONAL FACILITIES IN RELATION TO EVENT PROMOTIONS, GIFT CERTIFICATES AND TARGETED MARKETING REPORTING (U.S. CLS. 100, 101 AND 102).

FIRST USE 1-20-2003; IN COMMERCE 1-20-2003.  
DAVID MURRAY, EXAMINING ATTORNEY

**CLASS 36—(Continued).**

SN 76-256,446. CDC IXIS ASSET MANAGEMENT DISTRIBUTORS, L.P., BOSTON, MA. FILED 5-14-2001.



NO CLAIM IS MADE TO THE EXCLUSIVE RIGHT TO USE "INVEST FUNDS", APART FROM THE MARK AS SHOWN.

THE STIPPLING IS FOR SHADING PURPOSES ONLY. FOR MUTUAL FUNDS BROKERAGE, DISTRIBUTION AND INVESTMENT SERVICES (U.S. CLS. 100, 101 AND 102).

FIRST USE 5-1-2001; IN COMMERCE 5-1-2001.  
RONALD MCMORROW, EXAMINING ATTORNEY

SN 76-280,001. LEGG MASON WOOD WALKER, INCORPORATED, BALTIMORE, MD. FILED 7-6-2001.

**CLASS 36—INSURANCE AND FINANCIAL**

SN 75-758,414. UNITY RISK PARTNERS INSURANCE SERVICES, INC., WALNUT CREEK, CA. FILED 7-23-1999.

**UNITY RISK PARTNERS  
INSURANCE SERVICES, INC.**

NO CLAIM IS MADE TO THE EXCLUSIVE RIGHT TO USE "RISK" AND "INSURANCE SERVICES, INC.", APART FROM THE MARK AS SHOWN.

FOR INSURANCE BROKERAGE, ADMINISTRATION AND UNDERWRITING IN THE FIELDS OF PROPERTY INSURANCE, CASUALTY INSURANCE, FIRE INSURANCE, MARINE INSURANCE, LIABILITY INSURANCE, ACCIDENT INSURANCE AND HEALTH INSURANCE, BUT NOT INCLUDING LIFE INSURANCE (U.S. CLS. 100, 101 AND 102).

FIRST USE 5-1-1999; IN COMMERCE 5-1-1999.  
KELLY BOULTON, EXAMINING ATTORNEY

SN 76-088,265. INLEAGUE, INC., SAN BRUNO, CA. FILED 7-12-2000.

**INLEAGUE**

FOR INSURANCE BROKERAGE SERVICES IN THE FIELD OF HEALTH, MEDICAL, DENTAL, LIFE AND WORKMAN'S COMPENSATION INSURANCE; BANKING SERVICES (U.S. CLS. 100, 101 AND 102).

MARC LEIPZIG, EXAMINING ATTORNEY

**TOTAL PICTURE**

FOR FINANCIAL SERVICES, NAMELY A SERVICE PROVIDED THROUGH AN INTERNET WEBSITE WHICH ALLOWS CUSTOMERS TO VIEW PERSONAL ACCOUNT INFORMATION (E.G., BANK ACCOUNTS, CREDIT CARD STATEMENTS, INVESTMENT ACCOUNTS, INSURANCE ACCOUNTS AND 401(K) PLAN ACCOUNTS) AT ONE TIME (U.S. CLS. 100, 101 AND 102).

FIRST USE 4-17-2001; IN COMMERCE 4-17-2001.  
TONI HICKEY, EXAMINING ATTORNEY

SN 76-470,133. NORTH AMERICAN COMPANY FOR LIFE AND HEALTH INSURANCE, CHICAGO, IL. FILED 11-14-2002.

**FORMS FACTORY**

NO CLAIM IS MADE TO THE EXCLUSIVE RIGHT TO USE FORMS, APART FROM THE MARK AS SHOWN.

FOR PROVIDING AN ON-LINE COMPUTER DATABASE IN THE FIELD OF LIFE INSURANCE POLICY INFORMATION (U.S. CLS. 100, 101 AND 102).

FIRST USE 11-8-2001; IN COMMERCE 11-8-2001.  
CHRISTOPHER ADKINS, EXAMINING ATTORNEY

**CLASS 36—(Continued).**

SN 76-485,152. BEAZLEY GROUP PLC, LONDON EC3N 1AA, UNITED KINGDOM, FILED 1-27-2003.

**BEAZLEY**

PRIORITY CLAIMED UNDER SEC. 44(D) ON UNITED KINGDOM APPLICATION NO. 2317982, FILED 12-6-2002. SEC. 2(F).

FOR INSURANCE SERVICES, NAMELY, UNDERWRITING INSURANCE AND REINSURANCE IN THE FIELDS OF SPECIALITY RISK, COMMERCIAL PROPERTY, RETAIL, PERSONAL PROPERTY, TREATIES AND THE MARINE SECTORS (U.S. CLS. 100, 101 AND 102).

FIRST USE 12-31-1986; IN COMMERCE 12-31-1986. ZACHARY BELLO, EXAMINING ATTORNEY

SN 76-489,877. WESTERN MEMBERS FINANCIAL SERVICES, LLC, AKA/ WESTERN MEMBERS INSURANCE SERVICES, LLC, HAWTHORNE, CA. FILED 2-10-2003.

**WESTERN MEMBERS  
FINANCIAL SERVICES**

NO CLAIM IS MADE TO THE EXCLUSIVE RIGHT TO USE MEMBERS FINANCIAL SERVICES, APART FROM THE MARK AS SHOWN.

FOR FINANCIAL SERVICES IN THE NATURE OF FINANCIAL ANALYSIS AND CONSULTATION; FINANCIAL INVESTMENT IN THE FIELD OF SECURITIES, STOCKS, BONDS, MUTUAL FUNDS, ANNUITIES, UNIT INVESTMENT TRUST; FINANCIAL PLANNING; FINANCIAL SERVICES, NAMELY INVESTMENT FUND TRANSFER AND TRANSACTION SERVICES; FINANCIAL INFORMATION PROVIDED BY ELECTRONIC MEANS; FINANCIAL PORTFOLIO MANAGEMENT; FINANCIAL RESEARCH; FUND INVESTMENT CONSULTATION; MUTUAL FUNDS INVESTMENT; INVESTMENT ADVICE INVESTMENT BROKERAGE; INVESTMENT OF FUNDS FOR OTHERS; INSURANCE SERVICES, NAMELY INSURANCE BROKERAGE IN THE FIELD OF LIABILITY INSURANCE, AUTOMOBILE LIABILITY INSURANCE, GENERAL LIABILITY INSURANCE, CASUALTY INSURANCE, PROPERTY INSURANCE, FIRE INSURANCE, LIFE INSURANCE, ACCIDENTAL DEATH AND DISMEMBERMENT INSURANCE, HEALTH INSURANCE, ACCIDENT INSURANCE, MARINE INSURANCE, MEDICAL AND PREPAID HEALTH CARE, LEGAL SERVICES CONTRACTS, EXTENDED WARRANTY CONTRACTS; INSURANCE AGENCIES IN THE FIELD OF LIFE, HEALTH, ACCIDENT, FIRE, MARINE, MEDICAL AND PREPAID HEALTH CARE, AND LEGAL SERVICES; INSURANCE CONSULTATION (U.S. CLS. 100, 101 AND 102).

FIRST USE 5-0-1989; IN COMMERCE 5-0-1989. SCOTT OSCLICK, EXAMINING ATTORNEY

**CLASS 36—(Continued).**

SN 76-519,618. TYNES REALTY, WOODBRIDGE, VA. FILED 5-20-2003.

**TR TYNES REALTY**

NO CLAIM IS MADE TO THE EXCLUSIVE RIGHT TO USE "REALTY", APART FROM THE MARK AS SHOWN.

FOR REAL ESTATE BROKERAGE; LEASING OF COMMERCIAL, RESIDENTIAL, LOT-LAND REAL ESTATE; LEASING OF COMMERCIAL, RESIDENTIAL AND LOT-LAND REAL ESTATE; REAL ESTATE BROKERAGE FOR COMMERCIAL, RESIDENTIAL AND LOT-LAND REAL ESTATE; REAL ESTATE PROCUREMENT FOR OTHERS OF COMMERCIAL, RESIDENTIAL AND LOT-LAND REAL ESTATE; COMMERCIAL, RESIDENTIAL AND LOT-LAND REAL ESTATE LISTING; RENTAL OF RESIDENTIAL APARTMENTS; RENTAL OF COMMERCIAL OFFICE SPACE (U.S. CLS. 100, 101 AND 102).

CHRISTOPHER ADKINS, EXAMINING ATTORNEY

SN 76-527,616. ADVANCIAL FEDERAL CREDIT UNION, DALLAS, TX. FILED 6-24-2003.

**ADVANCIAL CHECK CLEAR**

OWNER OF U.S. REG. NOS. 2,605,888 AND 2,689,300. NO CLAIM IS MADE TO THE EXCLUSIVE RIGHT TO USE "CHECK CLEAR", APART FROM THE MARK AS SHOWN.

FOR CREDIT UNION SERVICES (U.S. CLS. 100, 101 AND 102).

FIRST USE 4-1-2003; IN COMMERCE 4-1-2003.

DOMINIC J. FERRAIUOLO, EXAMINING ATTORNEY

SN 76-532,864. MCCAUSLAND, ANDREW, WINNETKA, IL. FILED 7-28-2003.



THE  
M c CAUSLAND  
GROUP

ADVANCED WEALTH ARCHITECTURE

NO CLAIM IS MADE TO THE EXCLUSIVE RIGHT TO USE "GROUP", APART FROM THE MARK AS SHOWN.

FOR FINANCIAL SERVICES, NAMELY FINANCIAL ANALYSIS, PLANNING AND CONSULTATION; FINANCIAL INVESTMENT IN THE FIELD OF SECURITIES; INVESTMENT ADVICE AND CONSULTATION; INVESTMENT MANAGEMENT OF AND DISTRIBUTION OF VARIABLE ANNUITIES; BROKERAGE IN THE FIELD OF INSURANCE AND STOCKS; INSURANCE CONSULTATION (U.S. CLS. 100, 101 AND 102).

FLORENTINA BLANDU, EXAMINING ATTORNEY

**CLASS 36—(Continued).**

SN 76-535,214. BERG, BOB, MILWAUKEE, WI. FILED 8-7-2003.

**DAZZLING DELICACIES**

FOR CHARITABLE FUNDRAISING SERVICES (U.S. CLS. 100, 101 AND 102).  
FIRST USE 6-0-2003; IN COMMERCE 6-0-2003.  
THEODORE MCBRIDE, EXAMINING ATTORNEY

SN 76-537,162. AEGON DIRECT MARKETING SERVICES, INC., FRAZER, PA. FILED 8-4-2003.

**INDEPENDENCE 100**

FOR INSURANCE SERVICES, NAMELY INSURANCE BROKERAGE, CONSULTATION, ADMINISTRATION, UNDERWRITING, PROVIDER, AGENT AND CLAIMS PROCESSING SERVICES FOR ALL TYPES OF INSURANCE (U.S. CLS. 100, 101 AND 102).  
GWEN STOKOLS, EXAMINING ATTORNEY

SN 76-540,755. RYAN, BECK & CO., LIVINGSTON, NJ. FILED 8-18-2003.

**WASHINGTON CROSSING ADVISORS**

NO CLAIM IS MADE TO THE EXCLUSIVE RIGHT TO USE "ADVISORS", APART FROM THE MARK AS SHOWN. FOR FINANCIAL SERVICES, NAMELY, INVESTMENT BROKERAGE, FINANCIAL PLANNING AND FINANCIAL CONSULTATION (U.S. CLS. 100, 101 AND 102).  
LAURA KOVAISKY, EXAMINING ATTORNEY

SN 76-545,422. THE PENSION BOARDS - UNITED CHURCH OF CHRIST, INC., NEW YORK, NY. FILED 9-17-2003.

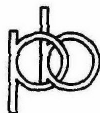

**The Pension Boards**

NO CLAIM IS MADE TO THE EXCLUSIVE RIGHT TO USE PB AND PENSION BOARDS, APART FROM THE MARK AS SHOWN.

FOR ADMINISTRATION OF LIFE, HEALTH, DISABILITY, DENTAL, AND SUPPLEMENTAL INSURANCE PLANS FOR RETIRED CLERGY, LAY EMPLOYEES, AND THEIR FAMILIES; ADMINISTRATION OF PENSION FUNDS FOR RETIRED CLERGY, LAY EMPLOYEES, AND THEIR FAMILIES (U.S. CLS. 100, 101 AND 102).  
FIRST USE 10-1-2002; IN COMMERCE 10-1-2002.  
STEVEN BERK, EXAMINING ATTORNEY

**CLASS 36—(Continued).**

SN 76-546,339. ANNUITY FINANCIAL & INSURANCE SERVICES, INC., NORTH HOLLYWOOD, CA. FILED 9-22-2003.

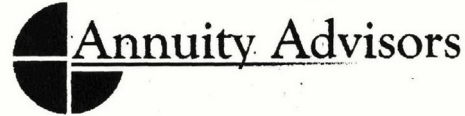

NO CLAIM IS MADE TO THE EXCLUSIVE RIGHT TO USE "ANNUITY ADVISORS", APART FROM THE MARK AS SHOWN.

FOR INSURANCE BROKERAGE AND ADMINISTRATION SERVICES (U.S. CLS. 100, 101 AND 102).  
FIRST USE 12-31-1999; IN COMMERCE 12-31-1999.  
HOWARD SMIGA, EXAMINING ATTORNEY

SN 76-547,307. WOODMEN MORTGAGE SERVICES, INC., OMAHA, NE. FILED 8-26-2003.

**WOODMEN MORTGAGE SERVICES**

OWNER OF U.S. REG. NOS. 868,519, 890,680 AND 2,767,582.

NO CLAIM IS MADE TO THE EXCLUSIVE RIGHT TO USE "MORTGAGE SERVICES", APART FROM THE MARK AS SHOWN.

FOR MORTGAGE BANKING SERVICES (U.S. CLS. 100, 101 AND 102).  
AMOS T. MATTHEWS, JR., EXAMINING ATTORNEY

SN 76-547,308. WOODMEN INSURANCE AGENCY, INC., OMAHA, NE. FILED 8-26-2003.

**WOODMEN INSURANCE AGENCY**

OWNER OF U.S. REG. NOS. 868,519, 890,680 AND 2,767,582.

NO CLAIM IS MADE TO THE EXCLUSIVE RIGHT TO USE "INSURANCE AGENCY", APART FROM THE MARK AS SHOWN.

FOR GENERAL INSURANCE AGENCY (U.S. CLS. 100, 101 AND 102).  
AMOS T. MATTHEWS, JR., EXAMINING ATTORNEY

**CLASS 36—(Continued).**

SN 76-548,922. CITY NATIONAL BANCSHARES CORPORATION, NEWARK, NJ. FILED 9-4-2003.

## UNITED CITIES NATIONAL BANK

FOR CONSUMER BANKING SERVICES, NAMELY, SAVINGS AND CHECKING SERVICE, IRAS AND CDS, DIRECT DEPOSIT AND ACH, PROVIDING VISA CARDS, SAFE DEPOSIT BOXES, ON-LINE BANKING, WIRE TRANSFERS, MONEY ORDERS, TELBANC SERVICES AND INVESTMENTS SERVICES; LOAN AND BUSINESS SERVICES, NAMELY, BUSINESS LOANS, COMMERCIAL MORTGAGES, CHURCH LOANS, RESIDENTIAL MORTGAGES, AUTO AND PERSONAL LOANS, HOME EQUITY LOANS, BUSINESS CHECKING AND SAVINGS, ESCROW MANAGEMENT, MERCHANT CARD SERVICES, KEOGH AND SEP ACCOUNTS, AND NIGHT DEPOSITORY (U.S. CLS. 100, 101 AND 102).

JOHN DALIER, EXAMINING ATTORNEY

SN 76-553,242. GENERAL RE CORPORATION, STAMFORD, CT. FILED 10-21-2003.



OWNER OF U.S. REG. NOS. 2,400,106, 2,777,799 AND OTHERS.

NO CLAIM IS MADE TO THE EXCLUSIVE RIGHT TO USE "LIFEHEALTH", APART FROM THE MARK AS SHOWN.

FOR INSURANCE AND REINSURANCE SERVICES, NAMELY, UNDERWRITING OF ALL TYPES OF HEALTH INSURANCE, LIFE INSURANCE AND REINSURANCE; RISK MANAGEMENT SERVICES; INSURANCE CLAIMS PROCESSING; INSURANCE CLAIMS MANAGEMENT; INSURANCE CLAIMS ADJUSTMENT; ACTUARIAL SERVICES; CONSULTATION SERVICES IN THE FIELDS OF UNDERWRITING HEALTH INSURANCE, LIFE INSURANCE AND REINSURANCE, RISK MANAGEMENT SERVICES, INSURANCE CLAIMS PROCESSING, INSURANCE CLAIMS MANAGEMENT, INSURANCE CLAIMS ADJUSTMENT, AND ACTUARIAL SERVICES (U.S. CLS. 100, 101 AND 102).

FIRST USE 11-3-2003; IN COMMERCE 11-3-2003.

ANGELA M. MICHELI, EXAMINING ATTORNEY

**CLASS 36—(Continued).**

SN 76-553,488. MIDDLESEX MUTUAL ASSURANCE COMPANY, MIDDLETOWN, CT. AND CHAMBER INSURANCE TRUST, ORANGE, CT. FILED 9-30-2003.



NO CLAIM IS MADE TO THE EXCLUSIVE RIGHT TO USE COVERAGE, APART FROM THE MARK AS SHOWN. THE MARK CONSISTS OF STYLIZED LETTERING.

FOR UNDERWRITING PROPERTY, CASUALTY, GROUP DENTAL, PRESCRIPTION DRUG, AND LONG TERM CARE INSURANCE (U.S. CLS. 100, 101 AND 102).

KAREN K. BUSH, EXAMINING ATTORNEY

SN 76-553,569. ALLIANCE PAYMENT SOLUTIONS INC., LANSING, MI. FILED 10-3-2003.



NO CLAIM IS MADE TO THE EXCLUSIVE RIGHT TO USE "PAYMENT SOLUTIONS, INC.", APART FROM THE MARK AS SHOWN.

FOR FINANCIAL LOCKBOX SERVICES, NAMELY, AUTOMATIC LOCKBOX SERVICES FOR THE COLLECTION AND PROCESSING OF PAYMENT OF CUSTOMERS' ACCOUNTS (U.S. CLS. 100, 101 AND 102).

FIRST USE 3-1-2003; IN COMMERCE 3-1-2003.

CHERYL CLAYTON, EXAMINING ATTORNEY

SN 76-560,937. SPECTRUM VISION SYSTEMS, INC., OVERLAND PARK, KS. FILED 10-29-2003.

## PREFERRED VISION CARE

OWNER OF U.S. REG. NO. 2,194,388.

NO CLAIM IS MADE TO THE EXCLUSIVE RIGHT TO USE "VISION CARE", APART FROM THE MARK AS SHOWN.

SEC. 2(F).

FOR ORGANIZING AND ADMINISTERING A PREFERRED PROVIDER ORGANIZATION IN THE FIELD OF EYEGLASSES AND RELATED VISION CARE PRODUCTS AND OPHTHALMIC SERVICES (U.S. CLS. 100, 101 AND 102).

FIRST USE 3-1-1987; IN COMMERCE 3-1-1987.

MICHAEL BAIRD, EXAMINING ATTORNEY

**CLASS 36—(Continued).**

SN 76-562,364. AMERIHALL, INC., PROSPECT HEIGHTS, IL. FILED 12-1-2003.

# INTERMLS

THE MARK CONSISTS OF STANDARD CHARACTERS WITHOUT CLAIM TO ANY PARTICULAR FONT, STYLE, SIZE, OR COLOR.

FOR PROVIDING A WEBSITE ON A GLOBAL COMPUTER NETWORK WITH INFORMATION RELATING TO THE BUYING AND SELLING OF REAL ESTATE, REAL ESTATE TRANSACTIONS AND REAL ESTATE AGENTS (U.S. CLS. 100, 101 AND 102).

BRETT J. GOLDEN, EXAMINING ATTORNEY

**CLASS 36—(Continued).**

SN 78-211,764. CHICAGO CLIMATE EXCHANGE, INC., CHICAGO, IL. FILED 2-6-2003.



THE STIPPLING IN THE DRAWING IS A FEATURE OF THE MARK AND DOES NOT INDICATE COLOR.

FOR COMMODITY EXCHANGE SERVICES, NAMELY, DIOXIDE AND OTHER GREENHOUSE GAS EMISSIONS EXCHANGE SERVICES THAT FACILITATE THE TRADING OR SALE OF CARBON DIOXIDE AND OTHER GREENHOUSE GAS EMISSIONS ALLOWANCES AND OFFSETS BETWEEN BUSINESS AND OTHER MARKET PARTICIPANTS (U.S. CLS. 100, 101 AND 102).

FIRST USE 8-28-2000; IN COMMERCE 8-28-2000.  
PATRICIA EVANKO, EXAMINING ATTORNEY

SN 76-562,490. THE PHILADELPHIA FOUNDATION, PHILADELPHIA, PA. FILED 11-17-2003.

## ALEX'S LEMONADE STAND FUND

THE MARK CONSISTS OF STANDARD CHARACTERS WITHOUT CLAIM TO ANY PARTICULAR FONT, STYLE, SIZE, OR COLOR.

NO CLAIM IS MADE TO THE EXCLUSIVE RIGHT TO USE LEMONADE STAND FUND, APART FROM THE MARK AS SHOWN.

THE NAME ALEX IN THE MARK DOES NOT IDENTIFY A LIVING INDIVIDUAL.

FOR CHARITABLE SERVICES, NAMELY FUND RAISING FOR MEDICAL TREATMENT AND RESEARCH (U.S. CLS. 100, 101 AND 102).

FIRST USE 8-0-2002; IN COMMERCE 8-0-2002.  
MELVIN AXILBUND, EXAMINING ATTORNEY

SN 78-212,160. MONEYTREE, INC., SEATTLE, WA. FILED 2-7-2003.



THE MARK CONSISTS OF A STYLIZED CATERPILLAR WITH HUMAN CHARACTERISTICS. DOTTED LINES INDICATE PLACEMENT OF U.S. DOLLAR BILLS. THE DOLLAR BILLS REPRESENTED BY THE DOTTED LINES ARE NOT CLAIMED AS PART OF THE MARK.

FOR FINANCIAL SERVICES, NAMELY, CHECK CASHING SERVICES AND SHORT TERM LOAN SERVICES, NAMELY, PAYDAY LOAN ADVANCES (U.S. CLS. 100, 101 AND 102).

FIRST USE 2-1-2001, MAY 1998. ; IN COMMERCE 2-1-2001, MAY 1998..  
CURTIS FRENCH, EXAMINING ATTORNEY

SN 76-566,179. MORTGAGE INFORMATION SOURCE, INC., ST. LOUIS, MO. FILED 12-19-2003.

# MiSource

THE MARK CONSISTS OF STANDARD CHARACTERS WITHOUT CLAIM TO ANY PARTICULAR FONT, STYLE, SIZE, OR COLOR.

FOR PROVIDING FINANCIAL INFORMATION BY ELECTRONIC MEANS, INCLUDING CREDIT REPORTS AND REAL PROPERTY REPORTS, INCLUDING RESIDENTIAL AND MORTGAGE LOAN REPORTS, TO INFORMATION-USING CLIENTS IN THE MORTGAGE INDUSTRY (U.S. CLS. 100, 101 AND 102).

FIRST USE 2-1-2002; IN COMMERCE 2-1-2002.  
JOSETTE BEVERLY, EXAMINING ATTORNEY

**CLASS 36—(Continued).**

SN 78-274,964. IDT NETHERLANDS, B.V. (PUERTO RICO BRANCH), SAN JUAN, PUERTO RICO, FILED 7-16-2003.

**PURPLE**

FOR PREPAID TELEPHONE CALLING CARD AND TELEPHONE DEBIT CARD SERVICES (U.S. CLS. 100, 101 AND 102).  
FIRST USE 7-7-2003; IN COMMERCE 7-7-2003.  
ESTHER BELENKER, EXAMINING ATTORNEY

SN 78-274,970. IDT NETHERLANDS, B.V. (PUERTO RICO BRANCH), SAN JUAN, PUERTO RICO, FILED 7-16-2003.

**PINK**

FOR PRE-PAID TELEPHONE CALLING CARD AND TELEPHONE DEBIT CARD SERVICES (U.S. CLS. 100, 101 AND 102).  
FIRST USE 7-7-2003; IN COMMERCE 7-7-2003.  
ESTHER BELENKER, EXAMINING ATTORNEY

SN 78-284,984. HISTORIC ROYAL PALACES, SURREY, UNITED KINGDOM, FILED 8-8-2003.

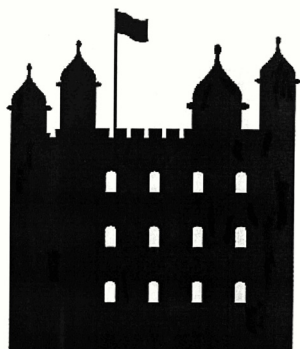

PRIORITY CLAIMED UNDER SEC. 44(D) ON ERPN CMNTY TM OFC APPLICATION NO. 003059086, FILED 2-18-2003, REG. NO. 003059086, DATED 2-24-2004, EXPIRES 2-18-2013.

FOR CHARITABLE FUND RAISING (U.S. CLS. 100, 101 AND 102).  
LINDA E. BLOHM, EXAMINING ATTORNEY

SN 78-303,955. INCAPITAL HOLDINGS, LLC, CHICAGO, IL, FILED 9-23-2003.

**INFLATION-PROTECTED INTERNOTES**

OWNER OF U.S. REG. NO. 2,509,374.  
FOR INVESTMENT BROKERAGE SERVICES, NAMELY, AGENCY SERVICES IN THE FIELD OF CORPORATE BOND NOTES (U.S. CLS. 100, 101 AND 102).  
CAROLYN GRAY, EXAMINING ATTORNEY

**CLASS 36—(Continued).**

SN 78-308,829. SAFEGUARD HEALTH ENTERPRISES, INC., ALISO VIEJO, CA. FILED 10-2-2003.



OWNER OF U.S. REG. NOS. 1,345,267, 2,304,864 AND 2,304,865.

NO CLAIM IS MADE TO THE EXCLUSIVE RIGHT TO USE "VISION", APART FROM THE MARK AS SHOWN.

THE MARK CONSISTS OF A RED "SMILE" WITH BLACK WORDS. COLOR IS NOT A FEATURE OF THE MARK.

FOR ADMINISTRATION OF PRE-PAID AND FEE FOR SERVICE VISION HEALTH CARE PLANS (U.S. CLS. 100, 101 AND 102).

ELISSA GARBER KON, EXAMINING ATTORNEY

SN 78-324,119. NATIONAL BANK OF ARIZONA, PHOENIX, AZ. FILED 11-6-2003.



NO CLAIM IS MADE TO THE EXCLUSIVE RIGHT TO USE "NATIONAL BANK OF ARIZONA", APART FROM THE MARK AS SHOWN.

THE COLOR(S) BLACK AND GOLD IS/ARE CLAIMED AS A DISTINCTIVE FEATURE OF THE MARK.

THE MARK CONSISTS OF A SPIRALING CIRCLE/SWIRL IN GOLD, NATIONAL BANK IN BLACK, AND OF ARIZONA IN GOLD.

FOR BANKING SERVICES, NAMELY BANKING, INVESTMENT BANKING SERVICES, MORTGAGE BANKING AND ON-LINE BANKING SERVICES AND FINANCIAL SERVICES, NAMELY FINANCIAL MANAGEMENT, MONEY LENDING, FINANCIAL INFORMATION PROCESSING, FINANCIAL RESEARCH, FINANCIAL ANALYSIS AND CONSULTATION, AND FINANCIAL PLANNING (U.S. CLS. 100, 101 AND 102).

MATTHEW KLINE, EXAMINING ATTORNEY

**CLASS 36—(Continued).**

SN 78-326,159. DUN & BRADSTREET, INC., SHORT HILLS, NJ. FILED 11-11-2003.

**FINANCIAL STRESS  
SCORE**

THE MARK CONSISTS OF STANDARD CHARACTERS WITHOUT CLAIM TO ANY PARTICULAR FONT, STYLE, SIZE, OR COLOR.

NO CLAIM IS MADE TO THE EXCLUSIVE RIGHT TO USE "FINANCIAL SCORE", APART FROM THE MARK AS SHOWN.

FOR FINANCIAL AND CREDIT INFORMATION SERVICES; NAMELY, PROVIDING EVALUATION INFORMATION ON BUSINESSES PROVIDED VIA SOFTWARE (U.S. CLS. 100, 101 AND 102).

FIRST USE 0-0-1997; IN COMMERCE 0-0-1997.  
G. T. GLYNN, EXAMINING ATTORNEY

SN 78-327,573. LYNN, CHRISTINE E., BOCA RATON, FL. FILED 11-13-2003.

**Lynn Insurance  
Group**

THE MARK CONSISTS OF STANDARD CHARACTERS WITHOUT CLAIM TO ANY PARTICULAR FONT, STYLE, SIZE, OR COLOR.

NO CLAIM IS MADE TO THE EXCLUSIVE RIGHT TO USE "INSURANCE GROUP", APART FROM THE MARK AS SHOWN.

FOR INSURANCE AGENCY SERVICES (U.S. CLS. 100, 101 AND 102).  
FIRST USE 1-1-1925; IN COMMERCE 1-1-1925.  
KAREN K. BUSH, EXAMINING ATTORNEY

**CLASS 36—(Continued).**

SN 78-330,520. FAMILY CHRISTIAN STORES, INC., GRAND RAPIDS, MI. FILED 11-20-2003.

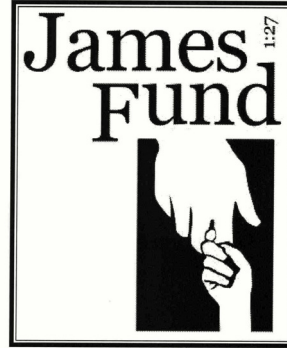

NO CLAIM IS MADE TO THE EXCLUSIVE RIGHT TO USE "JAMES 1:27" AND "FUND", APART FROM THE MARK AS SHOWN.

FOR CHARITABLE FOUNDATION SERVICES; NAMELY, CHARITABLE FUND RAISING, PROVIDING CHARITABLE FINANCIAL ASSISTANCE AND GRANTS TO ORPHANS AND WIDOWS AND ORGANIZATIONS THAT SUPPORT ORPHANS OR WIDOWS; ELEEMOSYNARY SERVICES IN THE FIELD OF MONETARY DONATIONS TO INDIVIDUALS AND ORGANIZATIONS (U.S. CLS. 100, 101 AND 102).

FIRST USE 10-15-2003; IN COMMERCE 10-15-2003.  
WON TEAK OH, EXAMINING ATTORNEY

SN 78-332,349. J. GIORDANO SECURITIES, LLC, STAMFORD, CT. FILED 11-24-2003.

**FOCUS ITB**

THE MARK CONSISTS OF STANDARD CHARACTERS WITHOUT CLAIM TO ANY PARTICULAR FONT, STYLE, SIZE, OR COLOR.

FOR FINANCIAL SERVICES, NAMELY, PROVIDING A SECURITIES TRADING PLATFORM AND INFORMATION REGARDING THE PURCHASE OF SECURITIES (U.S. CLS. 100, 101 AND 102).

GLENN CLARK, EXAMINING ATTORNEY

**CLASS 36—(Continued).**

SN 78-334,527. SOUNDEXCHANGE, INC., WASHINGTON, DC. FILED 12-1-2003.

**PLAYS**

THE MARK CONSISTS OF STANDARD CHARACTERS WITHOUT CLAIM TO ANY PARTICULAR FONT, STYLE, SIZE, OR COLOR.

FOR PROVIDING FINANCIAL INFORMATION VIA A GLOBAL COMPUTER NETWORK TO REGISTERED SUBSCRIBERS WITH REGARD TO ROYALTIES DERIVED FROM THE USE OF COPYRIGHTED MATERIALS (U.S. CLS. 100, 101 AND 102).

ELLEN B. AWRICH, EXAMINING ATTORNEY

SN 78-335,756. FRANKLIN RESOURCES, INC., SAN MATEO, CA. FILED 12-3-2003.

**INVEST WITH A  
RETIREMENT  
LEADER**

THE MARK CONSISTS OF STANDARD CHARACTERS WITHOUT CLAIM TO ANY PARTICULAR FONT, STYLE, SIZE, OR COLOR.

FOR FINANCIAL AND INVESTMENT MANAGEMENT, ADMINISTRATION, ADVISORY, ANALYSIS, CONSULTATION, AND INFORMATION SERVICES; MUTUAL FUND ADMINISTRATION, ADVISORY, DISTRIBUTION, INFORMATION AND CONSULTATION SERVICES; PROVIDING CUSTODIAL ADMINISTRATION OF FUNDS OF OTHERS (U.S. CLS. 100, 101 AND 102).

HELEN BRYAN, EXAMINING ATTORNEY

**CLASS 36—(Continued).**

SN 78-336,886. VECTOR INSURANCE SERVICES, LLC, INDIANAPOLIS, IN. FILED 12-5-2003.

**VECTOR INSURANCE  
SERVICES**

THE MARK CONSISTS OF STANDARD CHARACTERS WITHOUT CLAIM TO ANY PARTICULAR FONT, STYLE, SIZE, OR COLOR.

NO CLAIM IS MADE TO THE EXCLUSIVE RIGHT TO USE INSURANCE SERVICES, APART FROM THE MARK AS SHOWN.

FOR INSURANCE SERVICES, NAMELY, OUT-SOURCED ADMINISTRATIVE SERVICES IN THE NATURE OF INSURANCE CLAIMS ADMINISTRATION, INSURANCE CLAIMS PROCESSING, INSURANCE POLICY ADMINISTRATION AND COLLECTION AGENCIES SERVICES IN THE FIELD OF LIFE INSURANCE (U.S. CLS. 100, 101 AND 102).

FIRST USE 3-0-2004; IN COMMERCE 3-0-2004.

ELIZABETH J. WINTER, EXAMINING ATTORNEY

SN 78-337,583. PRANETA FINANCIAL, INC., JACKSONVILLE, FL. FILED 12-8-2003.



NO CLAIM IS MADE TO THE EXCLUSIVE RIGHT TO USE "FINANCIAL", APART FROM THE MARK AS SHOWN.

THE COLOR(S) BLUE GRAY AND WHITE ARE CLAIMED AS A FEATURE OF THE MARK.

THE COLOR BLUE IS USED FOR THE WORD PRANETA APPEARING ON THE TOP OF THE MARK. THE COLOR BLUE IS USED IN THE FORM OF A HOUSE APPEARING AT THE BOTTOM OF THE MARK. THE COLOR WHITE IS USED FOR THE WORD FINANCIAL JUST BELOW PRANETA. THE COLOR WHITE IS ALSO USED FOR THE WINDOW OF THE HOUSE, OUTLINING THE DOOR ON THE HOUSE AND OUTLINING THE ROOF OF THE HOUSE. THE COLOR GRAY IS USED IN THE MIDDLE OF THE MARK.

FOR FINANCIAL SERVICES, NAMELY MORTGAGE LENDING, FINANCIAL ANALYSIS, AND CONSULTATION (U.S. CLS. 100, 101 AND 102).

FIRST USE 8-15-2003; IN COMMERCE 8-15-2003.

JENNIFER CHICOSKI, EXAMINING ATTORNEY



**CLASS 36—(Continued).**

SN 78-338,860. POLARIS HOME FUNDING CORP., GRANDVILLE, MI. FILED 12-10-2003.

**CLASS 36—(Continued).**

SN 78-344,459. EMPLOYERS MUTUAL CASUALTY COMPANY, DES MOINES, IA. FILED 12-22-2003.

**EMC NATIONAL LIFE COMPANY**

**SoLoFee**

THE MARK CONSISTS OF STANDARD CHARACTERS WITHOUT CLAIM TO ANY PARTICULAR FONT, STYLE, SIZE, OR COLOR.

OWNER OF U.S. REG. NOS. 2,654,581, 2,756,083 AND OTHERS.

NO CLAIM IS MADE TO THE EXCLUSIVE RIGHT TO USE "NATIONAL LIFE COMPANY", APART FROM THE MARK AS SHOWN.

FOR LIFE, HEALTH, ACCIDENT, ANNUITY AND SUPPLEMENTAL BENEFITS INSURANCE UNDERWRITING SERVICES (U.S. CLS. 100, 101 AND 102).

FIRST USE 7-1-2003; IN COMMERCE 7-1-2003.  
DANIELLE MATTESSICH, EXAMINING ATTORNEY

THE MARK CONSISTS OF STANDARD CHARACTERS WITHOUT CLAIM TO ANY PARTICULAR FONT, STYLE, SIZE, OR COLOR.

FOR MORTGAGE BANKING, MORTGAGE BROKERAGE AND MORTGAGE LENDING (U.S. CLS. 100, 101 AND 102).

HOWARD B. LEVINE, EXAMINING ATTORNEY

SN 78-345,727. 15.NET INTERNATIONAL, INC., FAIRHOPE, AL. FILED 12-26-2003.

SN 78-338,985. SOUTHEAST CORPORATE FEDERAL CREDIT UNION, TALLAHASSEE, FL. FILED 12-10-2003.

**convertible card**



THE MARK CONSISTS OF STANDARD CHARACTERS WITHOUT CLAIM TO ANY PARTICULAR FONT, STYLE, SIZE, OR COLOR.

NO CLAIM IS MADE TO THE EXCLUSIVE RIGHT TO USE "CARD", APART FROM THE MARK AS SHOWN.

FOR PRE-PAID PURCHASE CARD SERVICES NAMELY, PROCESSING ELECTRONIC PAYMENTS MADE THROUGH PREPAID CARDS (U.S. CLS. 100, 101 AND 102).

FIRST USE 12-26-2003; IN COMMERCE 12-26-2003.  
RICHARD A. STRASER, EXAMINING ATTORNEY

FOR BUSINESS FINANCIAL SERVICES PROVIDED TO THE CREDIT UNION INDUSTRY, NAMELY, LOAN UNDERWRITING SERVICES (U.S. CLS. 100, 101 AND 102).

NORA BUCHANAN WILL, EXAMINING ATTORNEY

**CLASS 36—(Continued).**

SN 78-346,740. RETAIL WEST, INC., SAN FRANCISCO, CA.  
FILED 12-30-2003.

**CLASS 36—(Continued).**

SN 78-349,756. LEVOVITZ, YERUCHEM, NEW YORK, NY.  
FILED 1-9-2004.

*retailwest*

eMedKey

NO CLAIM IS MADE TO THE EXCLUSIVE RIGHT TO  
USE "RETAIL", APART FROM THE MARK AS SHOWN.  
FOR REAL ESTATE BROKERAGE AND REAL ES-  
TATE CONSULTATION FOR RETAILERS AND RETAIL  
REAL ESTATE OWNERS, DEVELOPERS AND PROP-  
ERTY MANAGERS (U.S. CLS. 100, 101 AND 102).  
FIRST USE 5-1-2003; IN COMMERCE 6-1-2003.  
ELLEN PERKINS, EXAMINING ATTORNEY

THE MARK CONSISTS OF STANDARD CHARACTERS  
WITHOUT CLAIM TO ANY PARTICULAR FONT, STYLE,  
SIZE, OR COLOR.  
FOR ONLINE THIRD PARTY ELECTRONIC MONEY  
MOVEMENT PROCESSING (U.S. CLS. 100, 101 AND 102).  
LEIGH CAROLINE CASE, EXAMINING ATTORNEY

---

SN 78-348,217. CALIFORNIA BANK & TRUST, SAN DIEGO,  
CA. FILED 1-6-2004.

---

SN 78-350,568. TILLMAN HARTLEY LLC, GAINESVILLE,  
FL. FILED 1-12-2004.

BANKING FOR  
CALIFORNIANS, BY  
CALIFORNIANS.

Family Board of  
Directors

THE MARK CONSISTS OF STANDARD CHARACTERS  
WITHOUT CLAIM TO ANY PARTICULAR FONT, STYLE,  
SIZE, OR COLOR.  
FOR BANKING SERVICES (U.S. CLS. 100, 101 AND  
102).  
FIRST USE 8-0-2003; IN COMMERCE 8-0-2003.  
BARBARA RUTLAND, EXAMINING ATTORNEY

THE MARK CONSISTS OF STANDARD CHARACTERS  
WITHOUT CLAIM TO ANY PARTICULAR FONT, STYLE,  
SIZE, OR COLOR.  
FOR ESTATE PLANNING (U.S. CLS. 100, 101 AND  
102).  
SEAN DWYER, EXAMINING ATTORNEY

**CLASS 36—(Continued).**

SN 78-351,064. AUTO AUCTION SERVICES CORP., ATLANTA, GA. FILED 1-13-2004.

**CLASS 36—(Continued).**

SN 78-352,157. UNIVERSAL FINANCIAL SERVICES, INC., JACKSONVILLE, FL. FILED 1-14-2004.

LIVEREPOS.COM

Universalcos

THE MARK CONSISTS OF STANDARD CHARACTERS WITHOUT CLAIM TO ANY PARTICULAR FONT, STYLE, SIZE, OR COLOR.  
FOR DEBT RECOVERY, NAMELY, AUTOMOTIVE REPOSSESSION SERVICES (U.S. CLS. 100, 101 AND 102).  
FIRST USE 7-0-2003; IN COMMERCE 7-0-2003.  
WON TEAK OH, EXAMINING ATTORNEY

THE MARK CONSISTS OF STANDARD CHARACTERS WITHOUT CLAIM TO ANY PARTICULAR FONT, STYLE, SIZE, OR COLOR.  
FOR REAL ESTATE BOKERAGE AND MORTGAGE LENDING (U.S. CLS. 100, 101 AND 102).  
CAROL SPILS, EXAMINING ATTORNEY

SN 78-352,156. UNIVERSAL FINANCIAL SERVICES, INC., JACKSONVILLE, FL. FILED 1-14-2004.

SN 78-352,493. AMERICAN EXPRESS COMPANY, NEW YORK, NY. FILED 1-15-2004.

Unertia

BLUE JAM SESSIONS

THE MARK CONSISTS OF STANDARD CHARACTERS WITHOUT CLAIM TO ANY PARTICULAR FONT, STYLE, SIZE, OR COLOR.  
FOR REAL ESTATE BROKERAGE AND MORTGAGE LENDING (U.S. CLS. 100, 101 AND 102).  
CAROL SPILS, EXAMINING ATTORNEY

THE MARK CONSISTS OF STANDARD CHARACTERS WITHOUT CLAIM TO ANY PARTICULAR FONT, STYLE, SIZE, OR COLOR.  
FOR CHARITABLE FUND RAISING (U.S. CLS. 100, 101 AND 102).  
DOMINICK J. SALEMI, EXAMINING ATTORNEY

**CLASS 36—(Continued).**

SN 78-352,501. INSTINET, LLC, NEW YORK, NY. FILED 1-15-2004.

# CBX

THE MARK CONSISTS OF STANDARD CHARACTERS WITHOUT CLAIM TO ANY PARTICULAR FONT, STYLE, SIZE, OR COLOR.

FOR FINANCIAL SERVICES, NAMELY, SECURITIES BROKERAGE SERVICES; ELECTRONIC TRADING OF SECURITIES; EQUITIES PORTFOLIO TRADING SERVICES; PROVIDING INFORMATION ABOUT FINANCIAL INVESTMENTS; PROVIDING INFORMATION VIA AN ON-LINE ELECTRONIC NETWORK IN THE FIELD OF SECURITIES BROKERAGE, ELECTRONIC TRADING OF SECURITIES, AND FINANCIAL INVESTMENTS (U.S. CLS. 100, 101 AND 102).

DOMINICK J. SALEMI, EXAMINING ATTORNEY

SN 78-352,547. TRILOGY PAYMENT SERVICES, INC, LAS VEGAS, NV. FILED 1-15-2004.

# SuperPay

THE MARK CONSISTS OF STANDARD CHARACTERS WITHOUT CLAIM TO ANY PARTICULAR FONT, STYLE, SIZE, OR COLOR.

FOR PAYMENT SERVICES FOR CONSUMER BILL PAYMENT (U.S. CLS. 100, 101 AND 102).

MATTHEW KLINE, EXAMINING ATTORNEY

**CLASS 36—(Continued).**

SN 78-352,548. PROFESSIONAL CAPITAL SERVICES, LLC, PHILADELPHIA, PA. FILED 1-15-2004.

# YOU PICK THE FUNDS...AND WE'LL DO THE REST

THE MARK CONSISTS OF STANDARD CHARACTERS WITHOUT CLAIM TO ANY PARTICULAR FONT, STYLE, SIZE, OR COLOR.

FOR FINANCIAL AND ADMINISTRATIVE SERVICES, NAMELY, RETIREMENT PLAN SERVICES (U.S. CLS. 100, 101 AND 102).

FIRST USE 9-18-2002; IN COMMERCE 9-18-2002.

NAAKWAMA ANKRAH, EXAMINING ATTORNEY

SN 78-352,726. ALLIANZ LIFE INSURANCE COMPANY OF NORTH AMERICA, MINNEAPOLIS, MN. FILED 1-15-2004.

# THE BEST AT NEXT

THE MARK CONSISTS OF STANDARD CHARACTERS WITHOUT CLAIM TO ANY PARTICULAR FONT, STYLE, SIZE, OR COLOR.

FOR INSURANCE SERVICES, NAMELY INSURANCE UNDERWRITING, REINSURANCE UNDERWRITING, VARIABLE LIFE INSURANCE UNDERWRITING, ANNUITIES AND VARIABLE ANNUITIES UNDERWRITING, HEALTH INSURANCE UNDERWRITING, INSURANCE ADMINISTRATION, INSURANCE CONSULTATION, LIFE INSURANCE UNDERWRITING, ACCIDENT INSURANCE UNDERWRITING, HEALTH AND MEDICAL INSURANCE UNDERWRITING, OPERATING A NETWORK OF TRANSPLANT PROVIDERS, STOP LOSS INSURANCE, PROVIDER EXCESS INSURANCE, HEALTH MAINTENANCE ORGANIZATION INSURANCE, INSURANCE AGENCIES IN THE FIELDS OF LIFE INSURANCE, ACCIDENT INSURANCE, HEALTH AND MEDICAL INSURANCE, LONG TERM CARE INSURANCE, INSURANCE ACTUARIAL SERVICES, UNDERWRITING ANNUITIES AND VARIABLE ANNUITIES, INSURANCE BROKERAGE, INSURANCE CLAIMS PROCESSING AND ADJUSTMENT; AND FINANCIAL SERVICES, NAMELY, FINANCIAL AND INVESTMENT CONSULTATION, MUTUAL FUND BROKERAGE, FINANCIAL PLANNING AND RESEARCH, INVESTMENT SERVICES, NAMELY, FUNDS INVESTMENT, INVESTMENT MANAGEMENT AND ESTATE PLANNING SERVICES, MUTUAL FUND DISTRIBUTION, SECURITIES BROKERAGE; PROVIDING INSURANCE AND FINANCIAL INFORMATION VIA GLOBAL COMPUTER INFORMATION NETWORKS; ADMINISTRATION OF EMPLOYEE BENEFIT PLANS AND PENSION PLANS (U.S. CLS. 100, 101 AND 102).

JOHN DALIER, EXAMINING ATTORNEY

**CLASS 36—(Continued).**

SN 78-352,965. PROGRESSIVE CASUALTY INSURANCE COMPANY, MAYFIELD VILLAGE, OH. FILED 1-16-2004.

**SERIOUS VEHICLE  
INSURANCE FOR  
SERIOUS  
OUTDOORSMEN**

THE MARK CONSISTS OF STANDARD CHARACTERS WITHOUT CLAIM TO ANY PARTICULAR FONT, STYLE, SIZE, OR COLOR.

FOR INSURANCE UNDERWRITING AND ADMINISTRATION SERVICES FOR RECREATION VEHICLES, INCLUDING MOTOR HOMES, MOTORCYCLES, SNOWMOBILES, BOATS AND PERSONAL WATERCRAFT; NAMELY, INSURANCE PREMIUM QUOTING, TAKING AND PROCESSING INSURANCE APPLICATIONS, POLICY ISSUANCE AND SERVICING, AND CLAIMS ADJUSTMENT AND PROCESSING; PROVIDING CONSUMER INFORMATION VIA A GLOBAL COMPUTER INFORMATION NETWORK REGARDING INSURANCE UNDERWRITING AND SERVICING IN THE FIELDS OF PROPERTY AND CASUALTY INSURANCE (U.S. CLS. 100, 101 AND 102).

PRISCILLA MILTON, EXAMINING ATTORNEY

SN 78-353,332. REAL ESTATE GROUP LLC, THE, EVERETT, WA. FILED 1-16-2004.

**Integrated Agent**

THE MARK CONSISTS OF STANDARD CHARACTERS WITHOUT CLAIM TO ANY PARTICULAR FONT, STYLE, SIZE, OR COLOR.

NO CLAIM IS MADE TO THE EXCLUSIVE RIGHT TO USE "AGENT", APART FROM THE MARK AS SHOWN.

FOR REAL ESTATE BROKERAGE AND MORTGAGE BROKERAGE (U.S. CLS. 100, 101 AND 102).

FIRST USE 9-25-2000; IN COMMERCE 5-31-2001.  
JEFFERY COWARD, EXAMINING ATTORNEY

**CLASS 36—(Continued).**

SN 78-353,745. AMERICAN INTERNATIONAL GROUP, INC., NEW YORK, NY. FILED 1-19-2004.

**WE KNOW THE DEAL**

THE MARK CONSISTS OF STANDARD CHARACTERS WITHOUT CLAIM TO ANY PARTICULAR FONT, STYLE, SIZE, OR COLOR.

FOR FINANCIAL INFORMATION SERVICES, NAMELY, PROVIDING INFORMATION ON TRANSACTION-RELATED RISKS (U.S. CLS. 100, 101 AND 102).

FIRST USE 12-1-2003; IN COMMERCE 12-1-2003.  
JAMES GRIFFIN, EXAMINING ATTORNEY

SN 78-354,469. N E A DEVELOPMENT CORP., BALTIMORE, MD. FILED 1-20-2004.

**NEW ENTERPRISE  
ASSOCIATES**

THE MARK CONSISTS OF STANDARD CHARACTERS WITHOUT CLAIM TO ANY PARTICULAR FONT, STYLE, SIZE, OR COLOR.

SEC. 2(F).

FOR INVESTMENT OF FUNDS FOR OTHERS (U.S. CLS. 100, 101 AND 102).

FIRST USE 0-0-1978; IN COMMERCE 0-0-1978.

JOHN HWANG, EXAMINING ATTORNEY

SN 78-355,209. PROPAY USA, INC., OREM, UT. FILED 1-21-2004.

**PUSH TO PAY**

THE MARK CONSISTS OF STANDARD CHARACTERS WITHOUT CLAIM TO ANY PARTICULAR FONT, STYLE, SIZE, OR COLOR.

FOR FINANCIAL SERVICES NAMELY ELECTRONIC FUNDS TRANSFER, INCLUDING WIRELESS (U.S. CLS. 100, 101 AND 102).

KELLY CHOE, EXAMINING ATTORNEY

**CLASS 36—(Continued).**

SN 78-357,713. BIMINI MORTGAGE MANAGEMENT, INC., VERO BEACH, FL. FILED 1-26-2004.

## BIMINI INVESTMENT MANAGEMENT

THE MARK CONSISTS OF STANDARD CHARACTERS WITHOUT CLAIM TO ANY PARTICULAR FONT, STYLE, SIZE, OR COLOR.

NO CLAIM IS MADE TO THE EXCLUSIVE RIGHT TO USE "INVESTMENT MANAGEMENT", APART FROM THE MARK AS SHOWN.

FOR REAL ESTATE INVESTMENT TRUST SERVICES (U.S. CLS. 100, 101 AND 102).

GIANCARLO CASTRO, EXAMINING ATTORNEY

**CLASS 36—(Continued).**

SN 78-359,046. BINGHAM, OSBORN & SCARBOROUGH, LLC, SAN FRANCISCO, CA. FILED 1-28-2004.

## We Manage the Money You Want to Keep

THE MARK CONSISTS OF STANDARD CHARACTERS WITHOUT CLAIM TO ANY PARTICULAR FONT, STYLE, SIZE, OR COLOR.

FOR INVESTMENT MANAGEMENT SERVICES, INCLUDING WEALTH MANAGEMENT, FINANCIAL PLANNING, RETIREMENT PLANNING, ESTATE PLANNING, CHARITABLE PLANNING, PORTFOLIO DIVERSIFICATION, INSURANCE PROGRAMS AND TAX MANAGEMENT (U.S. CLS. 100, 101 AND 102).

RONALD MCMORROW, EXAMINING ATTORNEY

SN 78-358,434. INTERNETPERILS, INC., WILMINGTON, DE. FILED 1-27-2004.

## IPerils

THE MARK CONSISTS OF STANDARD CHARACTERS WITHOUT CLAIM TO ANY PARTICULAR FONT, STYLE, SIZE, OR COLOR.

FOR INTERNET BUSINESS RISK MANAGEMENT (U.S. CLS. 100, 101 AND 102).

DAVID MURRAY, EXAMINING ATTORNEY

SN 78-359,303. PHOENIX LIFE INSURANCE COMPANY, HARTFORD, CT. FILED 1-29-2004.

## ADD VALUE TO WEALTH

SN 78-358,970. COMPUCREDIT CORPORATION, ATLANTA, GA. FILED 1-28-2004.



FOR CREDIT CARD SERVICES (U.S. CLS. 100, 101 AND 102).

LINDA E. BLOHM, EXAMINING ATTORNEY

THE MARK CONSISTS OF STANDARD CHARACTERS WITHOUT CLAIM TO ANY PARTICULAR FONT, STYLE, SIZE, OR COLOR.

FOR INSURANCE BROKERAGE SERVICES; INSURANCE ADMINISTRATION; INSURANCE CLAIMS PROCESSING; INSURANCE UNDERWRITING; INVESTMENT BROKERAGE SERVICES; INVESTMENT MANAGEMENT; PROVIDING INVESTMENT ADVICE; PROVIDING FUNDS INVESTMENT FOR OTHERS; MUTUAL FUNDS INVESTMENT SERVICES; UNDERWRITING PRIVATE PLACEMENT LIFE INSURANCE AND ANNUITIES SERVICES; ANNUITY SERVICES, NAMELY ANNUITY UNDERWRITING, BROKERAGE, ADMINISTRATION AND DISTRIBUTION SERVICES (U.S. CLS. 100, 101 AND 102).

NORA BUCHANAN WILL, EXAMINING ATTORNEY

**CLASS 36—(Continued).**

SN 78-359,785. INFONE LLC, BEAVERTON, OR. FILED 1-29-2004.

**CLASS 36—(Continued).**

SN 78-362,052. THE BOHAN GROUP, INC., SAN FRANCISCO, CA. FILED 2-3-2004.

IMAGINE YOUR LIFE  
WITH A PERSONAL  
ASSISTANT

BRAINSCAN

THE MARK CONSISTS OF STANDARD CHARACTERS WITHOUT CLAIM TO ANY PARTICULAR FONT, STYLE, SIZE, OR COLOR.

FOR PROVIDING STOCK QUOTE INFORMATION BY TELEPHONE OR AUTOMATED METHODS (U.S. CLS. 100, 101 AND 102).

FIRST USE 1-30-2004; IN COMMERCE 1-30-2004.  
JOSETTE BEVERLY, EXAMINING ATTORNEY

THE MARK CONSISTS OF STANDARD CHARACTERS WITHOUT CLAIM TO ANY PARTICULAR FONT, STYLE, SIZE, OR COLOR.

OWNER OF U.S. REG. NOS. 2,385,540 AND 2,622,732.  
FOR FINANCIAL ANALYSIS AND CONSULTATION SERVICES, NAMELY, REVIEWING, ANALYZING, PROVIDING DUE DILIGENCE, UNDERWRITING, QUALITY CONTROL, AUDITING AND REPORTING ON LOANS, LOAN PORTFOLIOS AND LINES OF CREDIT (U.S. CLS. 100, 101 AND 102).

SHAUNIA WALLACE, EXAMINING ATTORNEY

---

SN 78-361,173. METROPOLITAN LIFE INSURANCE COMPANY, NEW YORK, NY. FILED 2-2-2004.

---

SN 78-362,737. AMERICAN ADMINISTRATIVE GROUP, INC., BARRINGTON, IL. FILED 2-4-2004.

GRANDPROTECT

TOTAL ACCESS

THE MARK CONSISTS OF STANDARD CHARACTERS WITHOUT CLAIM TO ANY PARTICULAR FONT, STYLE, SIZE, OR COLOR.

FOR INSURANCE SERVICE; NAMELY, INSURANCE BROKERAGE, AGENCY, ADMINISTRATION, AND UNDERWRITING SERVICES IN THE FIELDS OF HOME, VEHICLE, MOTORCYCLE, BOAT, AND INDIVIDUAL LIABILITY AND PROPERTY INSURANCE (U.S. CLS. 100, 101 AND 102).

NELSON SNYDER, EXAMINING ATTORNEY

THE MARK CONSISTS OF STANDARD CHARACTERS WITHOUT CLAIM TO ANY PARTICULAR FONT, STYLE, SIZE, OR COLOR.

OWNER OF U.S. REG. NO. 2,086,450.  
FOR THIRD PARTY ADMINISTRATION OF HEALTH INSURANCE CLAIMS (U.S. CLS. 100, 101 AND 102).

MICHELE SWAIN, EXAMINING ATTORNEY

**CLASS 36—(Continued).**

SN 78-372,543. MORTGAGE AMERICA, L.L.C., KANSAS CITY, MO. FILED 2-23-2004.

# ADVAHOME

THE MARK CONSISTS OF STANDARD CHARACTERS WITHOUT CLAIM TO ANY PARTICULAR FONT, STYLE, SIZE, OR COLOR.

FOR MORTGAGE BROKERAGE AND MORTGAGE LENDING (U.S. CLS. 100, 101 AND 102).  
DARRYL SPRUILL, EXAMINING ATTORNEY

SN 78-379,452. FMR CORP., BOSTON, MA. FILED 3-5-2004.

# FIDELITY NETREWARDS

THE MARK CONSISTS OF STANDARD CHARACTERS WITHOUT CLAIM TO ANY PARTICULAR FONT, STYLE, SIZE, OR COLOR.

OWNER OF U.S. REG. NOS. 1,277,373, 1,481,037 AND OTHERS.

FOR PROVIDING FINANCIAL INFORMATION IN THE NATURE OF PERIODIC SUMMARIES FOR EMPLOYEES OF THEIR TOTAL COMPENSATION AND BENEFITS; FINANCIAL INFORMATION PROVIDED BY ELECTRONIC MEANS (U.S. CLS. 100, 101 AND 102).  
ANN E. SAPPENFIELD, EXAMINING ATTORNEY

**CLASS 36—(Continued).**

SN 78-380,787. HYATT CORPORATION, CHICAGO, IL. FILED 3-9-2004.

# HYATT WILD OAK RESORT

THE MARK CONSISTS OF STANDARD CHARACTERS WITHOUT CLAIM TO ANY PARTICULAR FONT, STYLE, SIZE, OR COLOR.

OWNER OF U.S. REG. NOS. 945,384, 2,731,433 AND OTHERS.

NO CLAIM IS MADE TO THE EXCLUSIVE RIGHT TO USE "RESORT", APART FROM THE MARK AS SHOWN.

FOR VACATION REAL ESTATE TIME SHARING SERVICES (U.S. CLS. 100, 101 AND 102).  
ROBERT COGGINS, EXAMINING ATTORNEY

SN 78-386,052. HARRIS TEETER, INC., MATTHEWS, NC. FILED 3-17-2004.



THE COLOR(S) RED, YELLOW, LIGHT BLUE AND DARK BLUE IS/ARE CLAIMED AS A DISTINCTIVE FEATURE OF THE MARK.

THE MARK CONSISTS OF THE WORDS TOGETHER IN EDUCATION WHICH ARE IN RED AND OUTLINED IN BLACK. THESE WORDS ARE UNDERLINED WITH A HORIZONTAL WEDGE SHAPE IN LIGHT BLUE, TO THE LEFT OF THE WORDING IS THE HAND PRINT OF AN ADULT LEFT HAND IN YELLOW WHICH IS OUTLINED IN BLACK, AND IN THE MIDDLE OF THIS ADULT HAND PRINT IS THE HAND PRINT OF A CHILD'S RIGHT HAND IN DARK BLUE.

FOR CHARITABLE FUND RAISING SERVICES, NAMELY, SHARING PROFITS FROM SALES OF THE APPLICANT'S PRIVATE LABEL GROCERY PRODUCTS WITH NOT-FOR-PROFIT PUBLIC AND PRIVATE COMMUNITY SCHOOLS (U.S. CLS. 100, 101 AND 102).

FIRST USE 8-31-1998; IN COMMERCE 8-31-1998.  
GEORGIA CARTY, EXAMINING ATTORNEY



**CLASS 36—(Continued).**

SN 78-389,166. SUNRISE COFFEE COMPANY, INC., LAGUNA NIGUEL, CA. FILED 3-23-2004.

**SUNRISE HARVEST**

THE MARK CONSISTS OF STANDARD CHARACTERS WITHOUT CLAIM TO ANY PARTICULAR FONT, STYLE, SIZE, OR COLOR.

FOR CHARITABLE FUND RAISING SERVICES (U.S. CLS. 100, 101 AND 102).  
CATHERINE CAIN, EXAMINING ATTORNEY

**CLASS 37—(Continued).**

SN 76-563,631. XTERMITE, INC., SAN DIEGO, CA. FILED 11-24-2003.

**THE WE DON'T TENT COMPANY**

THE MARK CONSISTS OF STANDARD CHARACTERS WITHOUT CLAIM TO ANY PARTICULAR FONT, STYLE, SIZE, OR COLOR.

FOR TERMITE AND PEST CONTROL SERVICE (U.S. CLS. 100, 103 AND 106).  
FIRST USE 8-1-1998; IN COMMERCE 8-1-1998.  
KAREN K. BUSH, EXAMINING ATTORNEY

**CLASS 37—CONSTRUCTION AND REPAIR**

SN 76-495,152. HOMELAND SAFETY SYSTEMS, INC., BENTON, LA. FILED 2-28-2003.

**HOMELAND SAFETY  
SYSTEMS**

NO CLAIM IS MADE TO THE EXCLUSIVE RIGHT TO USE "SAFETY SYSTEMS", APART FROM THE MARK AS SHOWN.

FOR COMMERCIAL AND RESIDENTIAL ALARM AND SAFETY SYSTEM SERVICES IN THE NATURE OF INSTALLING ALARM SYSTEMS (U.S. CLS. 100, 103 AND 106).

GINNY ISAACSON, EXAMINING ATTORNEY

SN 76-568,502. ALFREDSON, BRIAN K, LINCOLNWOOD, IL. FILED 1-5-2004.

**ACCURATE EDGE**

FOR RESIDENTIAL AND COMMERCIAL PAINTING CONTRACTOR (U.S. CLS. 100, 103 AND 106).

JANICE L. MCMORROW, EXAMINING ATTORNEY

SN 76-551,667. INTERFACE SECURITY SYSTEMS, L.L.C., EARTH CITY, MO. FILED 10-16-2003.

**INTERFACE SECURITY  
SYSTEMS**

NO CLAIM IS MADE TO THE EXCLUSIVE RIGHT TO USE "SECURITY SYSTEMS", APART FROM THE MARK AS SHOWN.

SEC. 2(F).

FOR INSTALLATION AND MAINTENANCE OF A VARIETY OF ADVANCED ELECTRONIC AND COMPUTERIZED SECURITY COMPONENTS AND/OR SYSTEMS SUCH AS INTRUSION AND FIRE ALARMS, ACCESS CONTROL, VIDEO SURVEILLANCE, PARKING CONTROL AND MANAGEMENT SYSTEMS, INFORMATION MANAGEMENT SYSTEMS, ASSET TRACKING AND MANAGEMENT SYSTEMS (U.S. CLS. 100, 103 AND 106).

FIRST USE 9-15-1995; IN COMMERCE 9-15-1995.  
ZACHARY BELLO, EXAMINING ATTORNEY

SN 76-569,284. TIRE PROS FRANCCORP, SIMI VALLEY, CA. FILED 1-12-2004.

**TIRE PROS**

OWNER OF U.S. REG. NO. 1,592,463.  
NO CLAIM IS MADE TO THE EXCLUSIVE RIGHT TO USE "TIRE", APART FROM THE MARK AS SHOWN.

FOR MAINTENANCE AND REPAIR OF VEHICLE TIRES AND WHEELS (U.S. CLS. 100, 103 AND 106).

FIRST USE 12-31-1981; IN COMMERCE 2-1-1987.  
IRA J. GOODSAD, EXAMINING ATTORNEY

**CLASS 37—(Continued).**

SN 78-243,849. OSBORN, DAVID L., POINT REYES, CA. FILED 4-30-2003.

**Moisture Consultants**

NO CLAIM IS MADE TO THE EXCLUSIVE RIGHT TO USE "MOISTURE CONSULTANTS", APART FROM THE MARK AS SHOWN.

FOR PROVIDING WATER LOSS AND MOISTURE INTRUSION SERVICES TO THE INSURANCE INDUSTRY, THE BUILDING INDUSTRY, COMMERCIAL AND RESIDENTIAL PROPERTY OWNERS, AND TO COMMERCIAL AND RESIDENTIAL TENANTS WITH REGARD TO WATER, MOISTURE, AND MOLD PROBLEMS; NAMELY, PROVIDING CONSULTING SERVICES IN THE FIELD OF MOISTURE AND MOLD REMEDIATION, PROVIDING INVESTIGATIONS AND MONITORING OF MOISTURE AND MOLD PROBLEMS, AND PROVIDING PROJECT MANAGEMENT AND DRYING PROTOCOL SERVICES IN THE NATURE OF WATER, MOISTURE, AND MOLD REMEDIATION SERVICES (U.S. CLS. 100, 103 AND 106).

FIRST USE 8-15-2001; IN COMMERCE 3-20-2003. ELIZABETH HUGHITT, EXAMINING ATTORNEY

---

SN 78-312,222. JAKOPIN, PHILIP, MINNEAPOLIS, MN. FILED 10-10-2003.

**CREATING SPACES**

FOR BUILDING CONSTRUCTION; RESTORATION IN THE FIELD OF FURNITURE AND BUILDINGS (U.S. CLS. 100, 103 AND 106).

LANA PHAM, EXAMINING ATTORNEY

---

SN 78-312,225. PHILIP JAKOPIN, MINNEAPOLIS, MN. FILED 10-10-2003.

**DOING IT YOURSELF  
DOESN'T HAVE TO MEAN  
DOING IT ALONE**

FOR BUILDING CONSTRUCTION; RESTORATION IN THE FIELD OF FURNITURE AND BUILDINGS (U.S. CLS. 100, 103 AND 106).

LANA PHAM, EXAMINING ATTORNEY

---

SN 78-314,864. SKOK, JOSEPH MATHEW, SURPRISE, AZ. FILED 10-17-2003.

**BEFORE YOU TAKE THE  
PLUNGE, CALL US!**

FOR PLUMBING SERVICE (U.S. CLS. 100, 103 AND 106).

NORA BUCHANAN WILL, EXAMINING ATTORNEY

**CLASS 37—(Continued).**

SN 78-316,722. SHIEL-SEXTON COMPANY INC., INDIANAPOLIS, IN. FILED 10-21-2003.

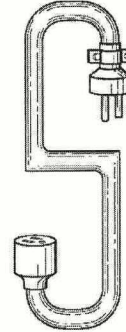

THE LINING SHOWN IN THE DRAWING IS A FEATURE OF THE MARK.

FOR BUILDING CONSTRUCTION AND REAL ESTATE DEVELOPMENT SERVICES (U.S. CLS. 100, 103 AND 106).

FIRST USE 3-0-2000; IN COMMERCE 3-0-2000. KATHY DE JONGE, EXAMINING ATTORNEY

---

SN 78-316,723. SHIEL-SEXTON COMPANY INC., INDIANAPOLIS, IN. FILED 10-21-2003.

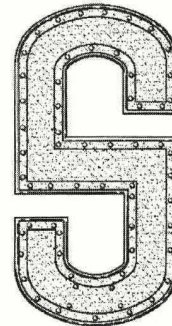

THE LINING SHOWN IN THE DRAWING IS A FEATURE OF THE MARK. THE STIPPLING SHOWN THE DRAWING IS FOR SHADING PURPOSES ONLY AND IS NOT A FEATURE OF THE MARK.

FOR BUILDING CONSTRUCTION AND REAL ESTATE DEVELOPMENT SERVICES (U.S. CLS. 100, 103 AND 106).

FIRST USE 3-0-2000; IN COMMERCE 3-0-2000. KATHY DE JONGE, EXAMINING ATTORNEY

**CLASS 37—(Continued).**

SN 78-351,812. EAST COAST DORMER, INC., BETHPAGE, NY. FILED 1-14-2004.

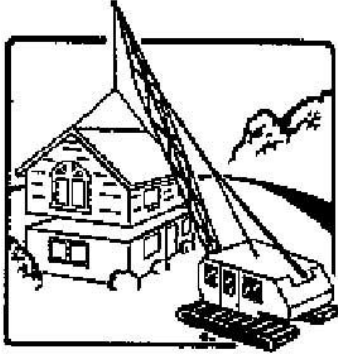

FOR CONSTRUCTION OF CUSTOM MODULAR EXTENSIONS AND ADDITIONS TO ALREADY EXISTING HOMES (U.S. CLS. 100, 103 AND 106).  
FIRST USE 12-1-1991; IN COMMERCE 12-1-1991.  
SHAUNIA WALLACE, EXAMINING ATTORNEY

**CLASS 37—(Continued).**

SN 78-355,910. BRICKELL FINANCIAL SERVICES MOTOR CLUB, INC., DBA ROAD AMERICA MOTOR CLUB, CORAL GABLES, FL. FILED 1-22-2004.

## Security Platinum

THE MARK CONSISTS OF STANDARD CHARACTERS WITHOUT CLAIM TO ANY PARTICULAR FONT, STYLE, SIZE, OR COLOR.

FOR AUTOMOBILE ASSOCIATION SERVICES, NAMELY PROVIDING EMERGENCY ROADSIDE ASSISTANCE SERVICES TO MOTOR VEHICLE OWNERS AND MOTORISTS (U.S. CLS. 100, 103 AND 106).  
FIRST USE 12-1-2003; IN COMMERCE 12-1-2003.  
RENEE MCCRAY, EXAMINING ATTORNEY

SN 78-351,879. OWENS, THEODOR B., CORRALES, NM. FILED 1-14-2004.

## Building With Awareness

THE MARK CONSISTS OF STANDARD CHARACTERS WITHOUT CLAIM TO ANY PARTICULAR FONT, STYLE, SIZE, OR COLOR.

NO CLAIM IS MADE TO THE EXCLUSIVE RIGHT TO USE "BUILDING", APART FROM THE MARK AS SHOWN.  
FOR PROVIDING INFORMATION IN THE FIELD OF CONSTRUCTION OF SUSTAINABLE BUILDINGS VIA THE INTERNET (U.S. CLS. 100, 103 AND 106).  
FIRST USE 10-1-1999; IN COMMERCE 10-10-2000.  
SEAN DWYER, EXAMINING ATTORNEY

SN 78-357,862. TIDWELL, JEFFREY, CUMMING, GA. FILED 1-27-2004.

## JUNKEXPRESS

THE MARK CONSISTS OF STANDARD CHARACTERS WITHOUT CLAIM TO ANY PARTICULAR FONT, STYLE, SIZE, OR COLOR.

FOR DISPOSAL FOR OTHERS OF UNWANTED ITEMS FROM HOMES AND BUSINESSES (U.S. CLS. 100, 103 AND 106).  
CATHERINE CAIN, EXAMINING ATTORNEY

**CLASS 37—(Continued).**

SN 78-358,148. SOUTHERN ELECTRICOM COMPANY, LIZELLA, GA. FILED 1-27-2004.



**CLASS 37—(Continued).**

SN 78-361,903. TOP BRASS MARKETING & SERVICES, INC., NORTH KANSAS CITY, MO. FILED 2-3-2004.

**TOP BRASS**

NO CLAIM IS MADE TO THE EXCLUSIVE RIGHT TO USE COMPANY, APART FROM THE MARK AS SHOWN.  
 FOR CONSULTATION, INSTALLATION, MAINTENANCE AND REPAIR SERVICES IN THE FIELD OF LIGHTING, DATA CABLING, GENERATOR SYSTEMS, SECURITY SYSTEMS, FIBER OPTICS, UNINTERRUPTIBLE POWER SUPPLY SYSTEMS AND FIRE ALARM SYSTEMS (U.S. CLS. 100, 103 AND 106).  
 FIRST USE 7-1-1997; IN COMMERCE 7-1-1997.  
 JEFFREY S. MOLINOFF, EXAMINING ATTORNEY

THE MARK CONSISTS OF STANDARD CHARACTERS WITHOUT CLAIM TO ANY PARTICULAR FONT, STYLE, SIZE, OR COLOR.  
 FOR JANITORIAL SERVICES (U.S. CLS. 100, 103 AND 106).  
 FIRST USE 4-1-1981; IN COMMERCE 4-1-1981.  
 ALICE BENMAMAN, EXAMINING ATTORNEY

SN 78-361,297. INTERNATIONAL COMMUNICATIONS TECHNOLOGIES CORP., MONTCLAIR, NJ. FILED 2-2-2004.

**SHINE-O-GRAM**

THE MARK CONSISTS OF STANDARD CHARACTERS WITHOUT CLAIM TO ANY PARTICULAR FONT, STYLE, SIZE, OR COLOR.  
 FOR SHOE SHINING SERVICES (U.S. CLS. 100, 103 AND 106).  
 GINA FINK, EXAMINING ATTORNEY

SN 78-363,675. JAMES PADDEN, HAYMARKET, VA. FILED 2-6-2004.



THE MARK CONSISTS OF A TRIANGLE OVER THE WORD "UP" TO CREATE AN "UP SYMBOL" AS WELL AS A DEPICTION OF A SHED WITH A ROOF. THE FOUR SHEDS BELOW REINFORCE THIS IMAGE.  
 FOR CUSTOM CONSTRUCTION OF SHEDS AND KIT SHEDS (U.S. CLS. 100, 103 AND 106).  
 FIRST USE 3-0-1999; IN COMMERCE 2-0-2001.  
 SCOTT BALDWIN, EXAMINING ATTORNEY

**CLASS 37—(Continued).**

SN 78-364,992. DELTIC TIMBER CORPORATION, EL DORADO, AR. FILED 2-9-2004.



OWNER OF U.S. REG. NO. 978,386.  
THE MARK CONSISTS OF THE WORD DELTIC IN A TRIANGLE DESIGN.  
FOR REAL ESTATE DEVELOPMENT SERVICES (U.S. CLS. 100, 103 AND 106).  
FIRST USE 1-0-1987; IN COMMERCE 1-0-1987.  
ANDREA K. NADELMAN, EXAMINING ATTORNEY

**CLASS 38—(Continued).**

SN 76-387,048. KENEFICK, JAMES, RESTON, VA. FILED 3-27-2002.

## CHANGE THE WORLD. ONE CALL AT A TIME

FOR LONG DISTANCE TELEPHONE COMMUNICATION SERVICES (U.S. CLS. 100, 101 AND 104).  
MICHAEL ENGEL, EXAMINING ATTORNEY

SN 76-539,846. ITOWN COMMUNICATIONS, INC., VIENNA, VA. FILED 8-8-2003.

## ITOWN COMMUNICATIONS

**CLASS 38—COMMUNICATION**

SN 75-271,385. CHILDREN'S BROADCASTING CORPORATION, MINNEAPOLIS, MN. FILED 4-8-1997.

## MILLENNIUM MINUTE

FOR RADIO BROADCASTING (U.S. CLS. 100, 101 AND 104).  
ELLEN B. AWRICH, EXAMINING ATTORNEY

SN 76-346,203. COVISTA, INC., LITTLE FALLS, NJ. FILED 12-6-2001.



NO CLAIM IS MADE TO THE EXCLUSIVE RIGHT TO USE "LONG DISTANCE", APART FROM THE MARK AS SHOWN.

THE STIPPLING IN THE DRAWING APPEARS FOR SHADING PURPOSES ONLY.

FOR TELECOMMUNICATIONS SERVICES, NAMELY DOMESTIC AND INTERNATIONAL LONG DISTANCE TELEPHONE COMMUNICATIONS SERVICES AND ELECTRONIC TRANSMISSION OF VOICE MESSAGES AND DATA (U.S. CLS. 100, 101 AND 104).

FIRST USE 11-30-2001; IN COMMERCE 11-30-2001.  
WON TEAK OH, EXAMINING ATTORNEY

NO CLAIM IS MADE TO THE EXCLUSIVE RIGHT TO USE "COMMUNICATIONS", APART FROM THE MARK AS SHOWN.

FOR TELECOMMUNICATIONS SERVICES, NAMELY, LOCAL, LONG DISTANCE, AND INTERNATIONAL VOICE, TEXT, FACSIMILE, VIDEO AND DATA BY MEANS OF TELEPHONE; TELEGRAPHIC; RADIO; CABLE AND SATELLITE TRANSMISSIONS; FRAME RELAY TELECOMMUNICATIONS SERVICES, NAMELY, PROVIDING FRAME RELAY CONNECTIVITY SERVICES FOR DATA TRANSFER; VIRTUAL NETWORK TELECOMMUNICATIONS SERVICES, NAMELY, PROVIDING FIBER OPTIC NETWORK SERVICES; ELECTRONIC MAIL AND VOICE MAIL AND MESSAGING SERVICES; ELECTRONIC TRANSMISSION OF DATA; ELECTRONIC DATA TRANSMISSION PACKET SERVICES; COMPUTER AIDED TRANSMISSION OF MESSAGES AND IMAGES; AUDIO AND VIDEO TELECONFERENCING SERVICES; PRIVATE LINE VOICE, TEXT, FACSIMILE, VIDEO AND DATA TELECOMMUNICATIONS BY MEANS OF TELEPHONE, TELEGRAPHIC, RADIO, CABLE AND SATELLITE TRANSMISSIONS; INTEGRATED SERVICES DIGITAL NETWORK OR ISDN TELECOMMUNICATIONS SERVICES; TRANSMISSION OF VOICE, TEXT, FACSIMILE, VIDEO AND DATA VIA SATELLITE, RADIO, TERRESTRIAL AND UNDERSEA TELECOMMUNICATIONS LINKS; TELEVISION TRANSMISSION SERVICES; 800 TELEPHONE COMMUNICATIONS SERVICES; 900 TELEPHONE COMMUNICATIONS SERVICES; WORLDWIDE SWITCHED VOICE, DATA, VIDEO AND MULTIMEDIA TRANSMISSION SERVICES; LOCATION INDEPENDENT PERSONAL COMMUNICATIONS SERVICES COMPRISING MOBILE, VOICE, DATA AND FACSIMILE TRANSMISSION SERVICES; PROVIDING TELECOMMUNICATIONS CONNECTIONS TO WORLDWIDE GLOBAL COMPUTER NETWORKS, OTHER COMPUTER NETWORKS, ON-LINE SERVICES AND BULLETIN BOARDS FEATURING A WIDE VARIETY OF FIELDS AND TOPICS; PROVIDING BACK BONE TELECOMMUNICATIONS NETWORK SERVICES TO OTHERS TO ENABLE THEM TO DISPLAY CONTENT ON WORLDWIDE GLOBAL COMPUTER NETWORKS, OTHER COMPUTER NETWORKS, ON-LINE SERVICES AND BULLETIN BOARDS BY PROVIDING TELECOMMUNICATIONS CONNECTIONS TO A GLOBAL COMPUTER NETWORK; PROVIDING

**CLASS 38—(Continued).**

TELECOMMUNICATIONS CONNECTIONS TO ON-LINE INFORMATION SERVICES BY PROVIDING A HIGH SPEED ACCESS TO AREA NETWORKS AND A GLOBAL COMPUTER INFORMATION NETWORK; CABLE RADIO AND TELEVISION TRANSMISSION OF ENTERTAINMENT SERVICES AND VOICE, VIDEO, DATA AND FACSIMILE TELEPHONY SERVICES; INTERNET ACCESS SERVICES TELECOMMUNICATIONS SERVICES, NAMELY, PROVIDING FIBER OPTIC NETWORK SERVICES; PROVIDING HIGH SPEED ACCESS TO AREA NETWORKS AND GLOBAL COMPUTER INFORMATION NETWORKS; PROVIDING HIGH-CAPACITY BANDWIDTH ACCESS TO COMMUNICATIONS NETWORKS CABLE TELEVISION TRANSMISSION SERVICES, NAMELY TRANSMITTING TELEVISION PROGRAMMING AND TWO-WAY COMMUNICATION CAPABILITY TO CABLE COMPANIES AND OTHER MULTI-CHANNEL DISTRIBUTORS ENABLING CUSTOMERS OF THE DISTRIBUTORS TO SELECT PROGRAMMING AND CONDUCT OTHER TWO-WAY COMMUNICATION WITH THE DISTRIBUTOR (U.S. CLS. 100, 101 AND 104).

ROBERT LORENZO, EXAMINING ATTORNEY

---

SN 76-558,515. CONFERENCE PLUS, INC., SCHAUMBURG, IL. FILED 11-13-2003.

**WEBPLUS**

THE MARK CONSISTS OF STANDARD CHARACTERS WITHOUT CLAIM TO ANY PARTICULAR FONT, STYLE, SIZE, OR COLOR.

OWNER OF U.S. REG. NOS. 1,703,753 AND 2,616,418.

FOR TELECOMMUNICATION SERVICES, NAMELY, AUDIO TELECONFERENCING, VIDEO TELECONFERENCING, AUDIO CONFERENCING, VIDEO CONFERENCING, WEB-BASED CONFERENCING AND TELECONFERENCING OVER THE INTERNET (U.S. CLS. 100, 101 AND 104).

FIRST USE 6-0-2003; IN COMMERCE 6-0-2003.

EVELYN BRADLEY, EXAMINING ATTORNEY

---

SN 76-558,517. CONFERENCE PLUS, INC., SCHAUMBURG, IL. FILED 11-13-2003.

**VIEWPLUS**

THE MARK CONSISTS OF STANDARD CHARACTERS WITHOUT CLAIM TO ANY PARTICULAR FONT, STYLE, SIZE, OR COLOR.

OWNER OF U.S. REG. NOS. 1,703,753 AND 2,616,418.

FOR TELECOMMUNICATION SERVICES, NAMELY, AUDIO TELECONFERENCING, VIDEO TELECONFERENCING, AUDIO CONFERENCING, VIDEO CONFERENCING, WEB-BASED CONFERENCING AND TELECONFERENCING OVER THE INTERNET (U.S. CLS. 100, 101 AND 104).

EVELYN BRADLEY, EXAMINING ATTORNEY

**CLASS 38—(Continued).**

SN 78-031,990. WEBEX COMMUNICATIONS, INC., SAN JOSE, CA. FILED 10-23-2000.

**WEBEX MEETING CENTER**

OWNER OF U.S. REG. NO. 2,102,292.

FOR MULTIMEDIA COMMUNICATIONS SERVICES IN REAL TIME, NAMELY, VIDEO AND AUDIO TELECONFERENCING, WHICH ALSO ALLOWS USERS TO TRANSMIT AND ACCESS ELECTRONIC DATA, DOCUMENTS AND SOFTWARE APPLICATIONS VIA THE INTERNET (U.S. CLS. 100, 101 AND 104).

FIRST USE 2-7-1999; IN COMMERCE 2-7-1999.

JOHN KELLY, EXAMINING ATTORNEY

---

SN 78-082,117. NEXCOM TELECOMMUNICATIONS, LLC, EAGAN, MN. FILED 8-31-2001.

**NEXCOM**

FOR TELECOMMUNICATIONS SERVICES, NAMELY, LOCAL, LONG DISTANCE AND INTERNATIONAL TRANSMISSION OF VOICE, DATA, GRAPHICS AND FACSIMILE COMMUNICATIONS; TELECOMMUNICATIONS SERVICES, NAMELY INTEGRATION OF E-MAIL, VOICE MAIL, FACSIMILE AND REAL TIME COMMUNICATIONS, AND FACILITATING VOICE-ENABLED TRANSACTIONS BY MEANS OF TELECOMMUNICATIONS NETWORKS; TELEPHONE CALLING CARD SERVICES (U.S. CLS. 100, 101 AND 104).

FIRST USE 8-17-1998; IN COMMERCE 8-17-1998.

THEODORE MCBRIDE, EXAMINING ATTORNEY

---

SN 78-115,738. VIS ITV LIMITED, DUNDEE, UNITED KINGDOM, FILED 3-19-2002.

**IRACE**

OWNER OF GREAT BRITAIN REG. NO. 2309575, DATED 9-3-2002, EXPIRES 9-3-2012.

FOR BROADCASTING SERVICES, NAMELY REAL-TIME ANIMATION BROADCASTING; TELEVISION BROADCASTING; CABLE TELEVISION BROADCASTING; VIDEO BROADCASTING; AUDIO BROADCASTING; RADIO BROADCASTING; BROADCASTING PROGRAMS VIA A WIRELESS COMMUNICATIONS NETWORK; ELECTRONIC DELIVERY OF IMAGES AND PHOTOGRAPHS VIA A WIRELESS COMMUNICATIONS NETWORK; BROADCASTING PROGRAMS VIA A GLOBAL COMPUTER NETWORK; ELECTRONIC DELIVERY OF IMAGES AND PHOTOGRAPHS VIA A GLOBAL COMPUTER NETWORK. (U.S. CLS. 100, 101 AND 104).

MARK T. MULLEN, EXAMINING ATTORNEY

**CLASS 38—(Continued).**

SN 78-348,694. BELLSOUTH INTELLECTUAL PROPERTY CORPORATION, WILMINGTON, DE. FILED 1-7-2004.

**CLASS 38—(Continued).**

SN 78-352,663. SKYPE TECHNOLOGIES, S.A., ENCINO, CA. FILED 1-15-2004.

**WAVEGATE**

**SKYPE**

THE MARK CONSISTS OF STANDARD CHARACTERS WITHOUT CLAIM TO ANY PARTICULAR FONT, STYLE, SIZE, OR COLOR.

FOR TELECOMMUNICATION SERVICES, NAMELY PRIVATE LINE VOICE, TEXT, FACSIMILE, VIDEO AND DATA TELECOMMUNICATIONS TRANSMISSIONS SERVICES (U.S. CLS. 100, 101 AND 104).

ELLEN PERKINS, EXAMINING ATTORNEY

THE MARK CONSISTS OF STANDARD CHARACTERS WITHOUT CLAIM TO ANY PARTICULAR FONT, STYLE, SIZE, OR COLOR.

FOR PROVIDING VOICE OVER INTERNET PROTOCOL (VOIP) PEER-TO-PEER COMMUNICATIONS, ELECTRONIC TRANSMISSION OF DATA AND DOCUMENTS OVER COMPUTER TERMINALS, AND INSTANT MESSAGING SERVICES (U.S. CLS. 100, 101 AND 104).

KHANH LE, EXAMINING ATTORNEY

SN 78-353,451. BANDAI ENTERTAINMENT INC., CYPRESS, CA. FILED 1-17-2004.

SN 78-348,696. BELLSOUTH INTELLECTUAL PROPERTY CORPORATION, WILMINGTON, DE. FILED 1-7-2004.

**EXTRA MILE PLUS**

**DICE DNA  
INTEGRATED  
CYBERNETIC  
ENTERPRISES**

THE MARK CONSISTS OF STANDARD CHARACTERS WITHOUT CLAIM TO ANY PARTICULAR FONT, STYLE, SIZE, OR COLOR.

FOR TELECOMMUNICATIONS SERVICES, NAMELY ELECTRONIC TRANSMISSION OF DATA, SOUND, TEXT AND IMAGE MESSAGES, AND VIDEO (U.S. CLS. 100, 101 AND 104).

ELLEN PERKINS, EXAMINING ATTORNEY

THE MARK CONSISTS OF STANDARD CHARACTERS WITHOUT CLAIM TO ANY PARTICULAR FONT, STYLE, SIZE, OR COLOR.

FOR STREAMING OF AUDIO AND/OR VIDEO MATERIAL ON THE INTERNET RELATING TO JAPANESE ANIMATION FROM A CONNECTION TO THE GLOBAL COMPUTER NETWORK (U.S. CLS. 100, 101 AND 104).

CAROLINE WEIMER, EXAMINING ATTORNEY

**CLASS 38—(Continued).**

SN 78-364,004. INTRADO INC., LONGMONT, CO. FILED 2-6-2004.

# V9-1-1

THE MARK CONSISTS OF STANDARD CHARACTERS WITHOUT CLAIM TO ANY PARTICULAR FONT, STYLE, SIZE, OR COLOR.

OWNER OF U.S. REG. NOS. 2,173,471, 2,204,802 AND OTHERS.

FOR INTERNET TELEPHONY SERVICES; TELECOMMUNICATION SERVICES, NAMELY, LOCAL AND LONG DISTANCE TRANSMISSION OF VOICE, DATA, GRAPHICS, IMAGES, MESSAGES BY MEANS OF TELEPHONE, CABLE, INTERNET, SATELLITE AND GLOBAL COMMUNICATIONS NETWORKS; ELECTRONIC TRANSMISSION OF MESSAGES AND DATA; ELECTRONIC VOICE MESSAGING, NAMELY, THE RECORDING AND SUBSEQUENT TRANSMISSION OF VOICE MESSAGES BY TELEPHONE AND GLOBAL COMPUTER NETWORKS; ELECTRONIC, ELECTRIC, AND DIGITAL TRANSMISSION OF VOICE, DATA, IMAGES, SIGNALS, AND MESSAGES (U.S. CLS. 100, 101 AND 104).

CAROLINE WOOD, EXAMINING ATTORNEY

SN 78-399,061. SKYPE TECHNOLOGIES, S.A., ENCINO, CA. FILED 4-8-2004.

# POCKETSKYPE

THE MARK CONSISTS OF STANDARD CHARACTERS WITHOUT CLAIM TO ANY PARTICULAR FONT, STYLE, SIZE, OR COLOR.

FOR PROVIDING VOICE OVER INTERNET PROTOCOL (VOIP) PEER-TO-PEER COMMUNICATIONS, ELECTRONIC TRANSMISSION OF DATA AND DOCUMENTS OVER COMPUTER TERMINALS, AND INSTANT MESSAGING SERVICES (U.S. CLS. 100, 101 AND 104).

KHANH LE, EXAMINING ATTORNEY

**CLASS 39—TRANSPORTATION AND STORAGE**

SN 76-268,360. MERCHANDISE MOVERS INC., BAYONNE, NJ. FILED 6-7-2001.

**MERCHANDISE MOVERS**

OWNER OF U.S. REG. NO. 2,287,174.  
SEC. 2(F).

FOR FREIGHT SERVICES IN THE NATURE OF CARGO LOADING AND UNLOADING, RECEIVING, INSPECTION AND VERIFICATION OF CARGO, ALL PROVIDED AT THE DISTRIBUTION CENTER FACILITIES OF OTHERS, AND OVERFLOW WAREHOUSING SERVICES PROVIDED TO OTHERS (U.S. CLS. 100 AND 105).

FIRST USE 10-14-1997; IN COMMERCE 10-14-1997.  
WANDA KAY PRICE, EXAMINING ATTORNEY

SN 76-448,765. TRANSITAMERICA, LLC, ST. JOSEPH, MO. FILED 9-12-2002.

 The logo for TransitAmerica features the word "TransitAmerica" in a bold, italicized sans-serif font. To the left of the text is a stylized graphic consisting of several horizontal lines of varying lengths, suggesting motion or a train. A small star is positioned above the letter 'i' in "America".

NO CLAIM IS MADE TO THE EXCLUSIVE RIGHT TO USE "TRANSIT AMERICA", APART FROM THE MARK AS SHOWN.

FOR COMMUTER TRAIN AND LIGHT RAIL PASSENGER TRANSPORTATION SERVICES (U.S. CLS. 100 AND 105).

KARANENDRA S. CHHINA, EXAMINING ATTORNEY

SN 76-509,425. PERSONAL GOURMET, INC., TEMPE, AZ. FILED 4-25-2003.

 The logo for Personal Gourmet features a stylized chef's hat (toque) on the left, with the words "Personal Gourmet" in a bold, serif font to its right. The hat has a small decorative element on top.

NO CLAIM IS MADE TO THE EXCLUSIVE RIGHT TO USE "GOURMET", APART FROM THE MARK AS SHOWN. FOR HOME DELIVERY OF UNCOOKED FOOD PRODUCTS AND WINE (U.S. CLS. 100 AND 105).

FIRST USE 8-16-2001; IN COMMERCE 8-16-2001.  
ALICIA COLLINS, EXAMINING ATTORNEY



**CLASS 39—(Continued).**

SN 76-517,098. LAKEVILLE MOTOR EXPRESS, INC., ST. PAUL, MN. FILED 5-27-2003.

**LME**

FOR TRANSPORTATION OF GOODS BY TRUCK, TRANSPORTATION BROKERAGE SERVICES, AND FREIGHT INTERCHANGE SERVICES (U.S. CLS. 100 AND 105).

FIRST USE 0-0-1978; IN COMMERCE 0-0-1978.  
ESTHER BELENKER, EXAMINING ATTORNEY

**CLASS 39—(Continued).**

SN 78-262,611. BELCORP OF CALIFORNIA, CORP., LOS ANGELES, CA. FILED 6-15-2003.

**PLAYERS CAR RENTAL**

NO CLAIM IS MADE TO THE EXCLUSIVE RIGHT TO USE "CAR RENTAL", APART FROM THE MARK AS SHOWN.

FOR RENTAL AND LEASING OF MOTOR VEHICLES, NAMELY, LUXURY CARS, EXOTIC CARS, SEDANS, SPORT UTILITIES VEHICLES, CONVERTIBLES, CABRIOLETS, AND SPORT CARS (U.S. CLS. 100 AND 105).  
FIRST USE 6-15-2003; IN COMMERCE 6-15-2003.  
HEATHER THOMPSON, EXAMINING ATTORNEY

SN 76-525,492. LADD 1998 REAL PROPERTIES, LTD., DALLAS, TX. FILED 6-25-2003.

**STORAGE CHOICE**

NO CLAIM IS MADE TO THE EXCLUSIVE RIGHT TO USE STORAGE, APART FROM THE MARK AS SHOWN.

FOR RENTING OF PRIVATE STORAGE SPACES (U.S. CLS. 100 AND 105).  
INGRID C. EULIN, EXAMINING ATTORNEY

SN 78-284,490. MAGELLAN GP, LLC, TULSA, OK. FILED 8-7-2003.

**MAGELLAN MIDSTREAM PARTNERS**

NO CLAIM IS MADE TO THE EXCLUSIVE RIGHT TO USE "MIDSTREAM PARTNERS", APART FROM THE MARK AS SHOWN.

FOR STORAGE, TRANSPORTATION AND DISTRIBUTION OF PETROLEUM PRODUCTS AND AMMONIA (U.S. CLS. 100 AND 105).  
MICHAEL ENGEL, EXAMINING ATTORNEY

SN 76-576,081. RELIABLE RUNNERS COURIER SERVICE, INC., EASTLAKE, OH. FILED 2-9-2004.

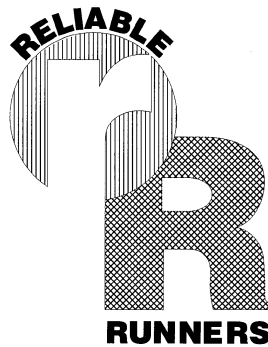

OWNER OF U.S. REG. NO. 2,353,483.  
THE "R" PORTION OF THE MARK ON THE ENCLOSED DRAWING IS SHADED FOR THE COLOR RED AND THE "R" PORTION OF THE MARK IS SHADED FOR THE COLOR ORANGE, BUT THE COLORS ARE NOT CLAIMED AS A DISTINCTIVE FEATURE OF THE MARK.

FOR BUSINESS AND RESIDENTIAL COURIER SERVICE (U.S. CLS. 100 AND 105).  
FIRST USE 3-1-2002; IN COMMERCE 3-1-2002.  
INGRID C. EULIN, EXAMINING ATTORNEY

SN 78-287,005. MOBILE ENTERTAINMENT, LLC, BLOOMINGTON, MN. FILED 8-13-2003.



**HUMAN ON A STICK**

FOR LEASING AND RENTAL OF MOTORIZED, SELF-PROPELLED, WHEELED PERSONAL MOBILITY DEVICES FOR HUMAN TRANSPORT, NAMELY, WHEELCHAIRS, SCOOTERS, UTILITY CARTS, AND CHARIOTS (U.S. CLS. 100 AND 105).

RON FAIRBANKS, EXAMINING ATTORNEY

**CLASS 39—(Continued).**

SN 78-325,695. E.I. PARTNERS, INC., HOUSTON, TX. FILED  
11-10-2003.

**EVERYONES  
LIMOUSINES**

THE MARK CONSISTS OF STANDARD CHARACTERS  
WITHOUT CLAIM TO ANY PARTICULAR FONT, STYLE,  
SIZE, OR COLOR.

NO CLAIM IS MADE TO THE EXCLUSIVE RIGHT TO  
USE LIMOUSINES, APART FROM THE MARK AS SHOWN.  
FOR LIMOUSINE SERVICES (U.S. CLS. 100 AND 105).  
SOPHIA S. KIM, EXAMINING ATTORNEY

---

SN 78-350,344. YOUNG, ROBERT J., ALEXANDRIA, VA.  
FILED 1-11-2004.

**FreedomGuide**

THE MARK CONSISTS OF STANDARD CHARACTERS  
WITHOUT CLAIM TO ANY PARTICULAR FONT, STYLE,  
SIZE, OR COLOR.

FOR MOBILE AUDIO TOUR GUIDE SERVICE (U.S.  
CLS. 100 AND 105).  
EVELYN BRADLEY, EXAMINING ATTORNEY

**CLASS 39—(Continued).**

SN 78-351,502. AK LOGISTICS, INC., SHARON, MA. FILED  
1-13-2004.

**AK Logistics**

THE MARK CONSISTS OF STANDARD CHARACTERS  
WITHOUT CLAIM TO ANY PARTICULAR FONT, STYLE,  
SIZE, OR COLOR.

NO CLAIM IS MADE TO THE EXCLUSIVE RIGHT TO  
USE "LOGISTICS", APART FROM THE MARK AS SHOWN.

FOR FREIGHT BROKERAGE; SUPPLY CHAIN SER-  
VICES, NAMELY, STORAGE, TRANSPORTATION AND  
DELIVERY OF DOCUMENTS, PACKAGES, RAW MA-  
TERIALS, AND OTHER FREIGHT FOR OTHERS BY  
AIR, RAIL, SHIP OR TRUCK (U.S. CLS. 100 AND 105).  
BRIAN PINO, EXAMINING ATTORNEY

---

SN 78-357,436. ANDREW SCHMIDT, DOWNERS GROVE, IL.  
FILED 1-26-2004.

**HexiSTOR**

THE MARK CONSISTS OF STANDARD CHARACTERS  
WITHOUT CLAIM TO ANY PARTICULAR FONT, STYLE,  
SIZE, OR COLOR.

FOR STORAGE SERVICES FOR ARCHIVING DATA-  
BASES, IMAGES AND OTHER ELECTRONIC DATA  
(U.S. CLS. 100 AND 105).

FIRST USE 4-0-2003; IN COMMERCE 4-0-2003.  
CAROLYN CATALDO, EXAMINING ATTORNEY

**CLASS 39—(Continued).**

SN 78-359,790. INFONE LLC, BEAVERTON, OR. FILED 1-29-2004.

**IMAGINE YOUR LIFE  
WITH A PERSONAL  
ASSISTANT**

THE MARK CONSISTS OF STANDARD CHARACTERS WITHOUT CLAIM TO ANY PARTICULAR FONT, STYLE, SIZE, OR COLOR.

FOR PROVIDING TURN-BY-TURN DRIVING INSTRUCTIONS BETWEEN TWO GEOGRAPHIC LOCATIONS; PROVIDING FLIGHT ARRIVAL AND DEPARTURE INFORMATION; PROVIDING TRAVEL INFORMATION; PROVIDING TRAFFIC INFORMATION; ELECTRONIC STORAGE OF MESSAGES REGARDING PRODUCTS, SERVICES, EVENTS, ACTIVITIES, ATTRACTIONS AND FACILITIES IN PARTICULAR GEOGRAPHIC LOCATIONS (U.S. CLS. 100 AND 105).

FIRST USE 1-30-2004; IN COMMERCE 1-30-2004.  
JOSETTE BEVERLY, EXAMINING ATTORNEY

**CLASS 40—MATERIAL TREATMENT**

SN 76-478,340. RITZ CAMERA CENTERS, INC., BELTSVILLE, MD. FILED 12-26-2002.

**BIG PRINT CENTRAL**

NO CLAIM IS MADE TO THE EXCLUSIVE RIGHT TO USE "BIG PRINT", APART FROM THE MARK AS SHOWN. FOR FILM PROCESSING AND PHOTO FINISHING SERVICES (U.S. CLS. 100, 103 AND 106).

FIRST USE 11-1-1998; IN COMMERCE 11-1-1998.  
JOHN SCHUYLER YARD, EXAMINING ATTORNEY

SN 76-514,717. MCCLURE, STEWART D., VISTA, CA. FILED 5-16-2003.

**CLEARWATER SOLUTIONS**

NO CLAIM IS MADE TO THE EXCLUSIVE RIGHT TO USE "SOLUTIONS", APART FROM THE MARK AS SHOWN.

FOR DECONTAMINATION TREATMENT OF STREET-DRAINAGE WATER BEARING ENVIRONMENTALLY HAZARDOUS POLLUTANTS AND BACTERIA; -AND CONSULTATION PURSUANT THERETO (U.S. CLS. 100, 103 AND 106).

FIRST USE 4-26-2003; IN COMMERCE 4-26-2003.  
ARETHA SOMERVILLE, EXAMINING ATTORNEY

**CLASS 40—(Continued).**

SN 76-534,131. QUASAR GROUP, TUSTIN, CA. FILED 8-4-2003.

**DIGITAL ORTHOTICS**

NO CLAIM IS MADE TO THE EXCLUSIVE RIGHT TO USE ORTHOTICS, APART FROM THE MARK AS SHOWN. FOR CUSTOM MANUFACTURE OF ORTHOTICS FOR USE WITH FOOTWARE (U.S. CLS. 100, 103 AND 106).

FIRST USE 10-1-1999; IN COMMERCE 10-1-1999.  
BILL DAWE, EXAMINING ATTORNEY

SN 76-558,895. CANVAS ON DEMAND, LLC, DURHAM, NC. FILED 11-10-2003.

**CANVAS ON DEMAND**

THE MARK CONSISTS OF STANDARD CHARACTERS WITHOUT CLAIM TO ANY PARTICULAR FONT, STYLE, SIZE, OR COLOR.

NO CLAIM IS MADE TO THE EXCLUSIVE RIGHT TO USE "CANVAS", APART FROM THE MARK AS SHOWN.

FOR TRANSFORMATION OF PHOTOGRAPHS FOR OTHERS INTO A STRETCHED CANVAS PIECE OF ART THAT SIMULATES AN ACTUAL OIL PAINTING (U.S. CLS. 100, 103 AND 106).

FIRST USE 9-30-2003; IN COMMERCE 9-30-2003.  
MICHAEL HALL, EXAMINING ATTORNEY

SN 76-572,050. ULTRAPEDICS LTD., BROOKLYN, NY. FILED 1-26-2004.

**ULTRAPEDICS LTD.**

THE MARK CONSISTS OF STANDARD CHARACTERS WITHOUT CLAIM TO ANY PARTICULAR FONT, STYLE, SIZE, OR COLOR.

NO CLAIM IS MADE TO THE EXCLUSIVE RIGHT TO USE "LTD.", APART FROM THE MARK AS SHOWN.

FOR CUSTOM MANUFACTURER AND FITTING OF ORTHOTIC AND PROSTHETIC DEVICES FOR OTHERS (U.S. CLS. 100, 103 AND 106).

FIRST USE 3-15-1985; IN COMMERCE 3-15-1985.  
J. TINGLEY, EXAMINING ATTORNEY

**CLASS 40—(Continued).**

SN 76-572,989. NALCO COMPANY, NAPERVILLE, IL. FILED 1-29-2004.

**ULTRARO**

OWNER OF U.S. REG. NO. 2,719,870.  
 FOR CONSULTING SERVICE REGARDING REVERSE OSMOSIS TREATMENT FOR THE WATER INDUSTRY (U.S. CLS. 100, 103 AND 106).  
 FIRST USE 1-0-2004; IN COMMERCE 1-0-2004.  
 C. DIONNE CLYBURN, EXAMINING ATTORNEY

SN 78-306,487. H2A ENVIRONMENTAL, LTD., SOUTHLAKE, TX. FILED 9-29-2003.



NO CLAIM IS MADE TO THE EXCLUSIVE RIGHT TO USE ENVIRONMENTAL LTD, APART FROM THE MARK AS SHOWN.  
 FOR ENVIRONMENTAL REMEDIATION SERVICES, NAMELY SOIL, WASTE AND/OR WATER TREATMENT SERVICES (U.S. CLS. 100, 103 AND 106).  
 DEZMONA MIZELLE, EXAMINING ATTORNEY

**CLASS 40—(Continued).**

SN 78-345,605. TAIWAN SEMICONDUCTOR MANUFACTURING COMPANY, LIMITED, HSIN-CHU, TAIWAN, FILED 12-25-2003.

**TSMC COMPATIBLE**

THE MARK CONSISTS OF STANDARD CHARACTERS WITHOUT CLAIM TO ANY PARTICULAR FONT, STYLE, SIZE, OR COLOR.  
 OWNER OF U.S. REG. NOS. 2,042,335, 2,227,071 AND OTHERS.  
 NO CLAIM IS MADE TO THE EXCLUSIVE RIGHT TO USE "COMPATIBLE", APART FROM THE MARK AS SHOWN.  
 FOR CUSTOM MANUFACTURE OF SEMICONDUCTORS, MEMORY CHIPS, WAFERS AND INTEGRATED CIRCUITS (U.S. CLS. 100, 103 AND 106).  
 BRENDAN REGAN, EXAMINING ATTORNEY

SN 78-357,385. AMERICAN INTERNATIONAL REMEDIATION CORPORATION, GARDNERVILLE, NV. FILED 1-26-2004.



THE COLOR(S) YELLOW AND BLACK IS/ARE CLAIMED AS A DISTINCTIVE FEATURE OF THE MARK.  
 THE LETTERS CHLORO ARE BLACK WITH YELLOW OUTLINE, THE LETTERS FIX ARE YELLOW WITH BLACK OUTLINE, AND THE OVAL IS YELLOW AND FADES TO BLACK FROM RIGHT TO LEFT.  
 THE MARK CONSISTS OF STYLIZED LETTERING INSIDE AND THROUGH A STYLIZED OVAL.  
 FOR ENVIRONMENTAL REMEDIATION SERVICES, NAMELY, SOIL, WASTE AND/OR WATER TREATMENT SERVICES (U.S. CLS. 100, 103 AND 106).  
 KIMBERLY PERRY, EXAMINING ATTORNEY

**CLASS 40—(Continued).**

SN 78-359,296. ANOLAZE CORPORATION, RIVIERA BEACH, FL. FILED 1-29-2004.

# VITRALASE

THE MARK CONSISTS OF STANDARD CHARACTERS WITHOUT CLAIM TO ANY PARTICULAR FONT, STYLE, SIZE, OR COLOR.

OWNER OF U.S. REG. NO. 2,266,191.  
FOR LASER SCRIBING AND VITRIFICATION OF NON-METAL BUILDING MATERIALS, NAMELY BRICKS, PAVERS, AND TERRA-COTTA AND CERAMIC TILES (U.S. CLS. 100, 103 AND 106).

FIRST USE 7-10-1997; IN COMMERCE 7-10-1997.  
NORA BUCHANAN WILL, EXAMINING ATTORNEY

SN 78-363,314. MAGNA-LASTIC DEVICES, INC., CARHAGE, IL. FILED 2-5-2004.



THE COLOR(S) BLUE, WHITE AND BLACK IS/ARE CLAIMED AS A DISTINCTIVE FEATURE OF THE MARK. THE HEXAGON PART OF THE MARK IS BLUE AND WHITE WITH THE SWIRLING ARROWS IN BLACK.

THE MARK CONSISTS OF A DESIGN COMPRISING A BLUE AND WHITE HEXAGON CONTAINING THREE SWIRLING BLACK ARROWS.

FOR MANUFACTURE OF TORQUE, FORCE AND ANGLE SENSORS, TORQUE, FORCE AND ANGLE CONTROLLERS AND TORQUE, FORCE AND ANGLE MEASURING DEVICES TO THE ORDER AND SPECIFICATION OF OTHERS (U.S. CLS. 100, 103 AND 106).  
SUSAN HAYASH, EXAMINING ATTORNEY

**CLASS 41—EDUCATION AND ENTERTAINMENT**

SN 75-387,603. TOS, L.L.C., SEATTLE, WA. FILED 11-10-1997.

# ADVENTURE-BEYOND REALITY

FOR ENTERTAINMENT AND RECREATIONAL SERVICES, NAMELY, PROVIDING FACILITIES FOR RECREATIONAL ACTIVITIES FEATURING VIRTUAL REALITY FLIGHT SIMULATION AND OTHER ROLE-PLAYING COMBAT MISSIONS AND FANTASY SCENARIOS (U.S. CLS. 100, 101 AND 107).

FIRST USE 3-0-1995; IN COMMERCE 3-0-1995.  
LINDA M. KING, EXAMINING ATTORNEY

SN 75-403,515. UNITED STATES OLYMPIC COMMITTEE, COLORADO SPRINGS, CO. FILED 12-3-1997.

# ATHENS 2004

OWNER OF U.S. REG. NOS. 1,952,198 AND 2,718,293.  
FOR PUBLICATION OF BOOKS, NEWSPAPERS AND MAGAZINES; CONDUCTING ENTERTAINMENT EXHIBITIONS IN THE NATURE OF PARADES; CONDUCTING ENTERTAINMENT EXHIBITIONS IN THE NATURE OF THEME PARKS; ORGANIZING SPORT COMPETITIONS AND GAMES, NAMELY, ORGANIZING INTERNATIONAL COMPETITIVE ATHLETIC MULTIPLE SPORTS COMPETITIONS; ORGANIZING CULTURAL EVENTS; NAMELY, MUSICAL, THEATRICAL AND DANCE EXHIBITIONS, ART EXHIBITS AND CRAFT EXHIBITIONS; ENTERTAINMENT SERVICES, NAMELY, RADIO AND TELEVISION PROGRAMMING FEATURING INTERNATIONAL ATHLETIC EVENTS AND SUBJECT MATTER RELATED THERETO; AND MOTION PICTURE FILM PRODUCTION (U.S. CLS. 100, 101 AND 107).

ANDREA K. NADELMAN, EXAMINING ATTORNEY

SN 75-663,618. MILLENNIUM PAGEANT, INC., HADDON HEIGHTS, NJ. FILED 3-19-1999.

# ATLANTIS

FOR BEAUTY, TALENT AND MODELING PAGEANTS (U.S. CLS. 100, 101 AND 107).  
ROBIN CHOSID, EXAMINING ATTORNEY

SN 76-239,734. BURKE, TOMMY, HUNTLEY, IL. FILED 4-12-2001.

# slitheryn

FOR ENTERTAINMENT SERVICES, NAMELY, LIVE PERFORMANCES BY A MUSICAL BAND (U.S. CLS. 100, 101 AND 107).

FIRST USE 10-6-2000; IN COMMERCE 10-6-2000.  
KAREN M. STRYZ, EXAMINING ATTORNEY

**CLASS 41—(Continued).**

SN 76-333,001. VULCAN SPORTS MEDIA, INC., ST. LOUIS, MO. FILED 11-2-2001.

**SPORTING NEWS FLASH!**

OWNER OF U.S. REG. NOS. 1,175,109, 2,143,659 AND OTHERS.

NO CLAIM IS MADE TO THE EXCLUSIVE RIGHT TO USE "NEWS FLASH", APART FROM THE MARK AS SHOWN.

SEC. 2(F) AS TO "SPORTING NEWS".

FOR PRODUCTION OF RADIO PROGRAMS IN THE FIELD OF SPORTS; ENTERTAINMENT AND BROADCAST SERVICES IN THE NATURE OF RADIO PROGRAMS IN THE FIELD OF SPORTS; PROVISION OF INFORMATION IN THE FIELD OF SPORTS, VIA THE INTERNET AND WIRELESS COMMUNICATIONS (U.S. CLS. 100, 101 AND 107).

FIRST USE 3-26-2001; IN COMMERCE 3-26-2001.

ELIZABETH HUGHITT, EXAMINING ATTORNEY

**CLASS 41—(Continued).**

SN 76-476,970. CELESTIAL PICTURES LIMITED, KOW-LOON, HONG KONG, FILED 12-18-2002.



THE MARK CONSISTS OF A LADY SITTING ON A ROCK IN THE MIDDLE OF WATER.

FOR PRODUCTION AND DISTRIBUTION OF MOTION PICTURES AND DOCUMENTARIES; SCRIPT WRITING SERVICES; AUDIO RECORDING AND PRODUCTION OF MUSIC; CONDUCTING ENTERTAINMENT EXHIBITIONS IN THE NATURE OF FILM FESTIVALS AND IN RELATION TO FILM TECHNOLOGY; CONDUCTING AWARD CEREMONIES TO PROMOTE EXCELLENCE IN THE ENTERTAINMENT INDUSTRY; ENTERTAINMENT IN THE NATURE OF TELEVISION SHOWS AND DOCUMENTARIES IN THE FIELDS OF ACTION/ADVENTURE, COMEDY, CRIME, DRAMA, HORROR, MUSICALS, SCIENCE FICTION, WAR, WESTERNS, SOAP OPERAS, MARTIAL ARTS, SPORTS, NEWS, AND GAME SHOWS; ENTERTAINMENT IN THE NATURE OF LIVE AND ON-LINE MUSICAL PERFORMANCES, FILM FESTIVALS, AND FASHION SHOWS; PROVIDING ON-LINE COMPUTER GAMES; ENTERTAINMENT IN THE NATURE OF VISUAL AND AUDIO PERFORMANCES, DANCE PERFORMANCES, AMUSEMENT PARK SHOWS, AND THEATRE PRODUCTIONS; ENTERTAINMENT SERVICES, NAMELY PROVIDING A WEB SITE FEATURING MUSICAL PERFORMANCES, MUSICAL VIDEOS, PHOTOGRAPHS, MOVIES, LIVE-ACTIONS, COMEDIES, DRAMAS, RELATED FILM CLIPS, AND OTHER MULTIMEDIA MATERIALS, AND RELATED REVIEWS; ENTERTAINMENT SERVICES, NAMELY LIVE, TELEVISED AND MOVIE APPEARANCES BY PROFESSIONAL ENTERTAINERS, MOVIE STARS, SINGERS, AND SPORTS CELEBRITIES; ENTERTAINMENT SERVICES, NAMELY PROVIDING TELEVISION PROGRAMS IN THE FIELDS OF MOVIES, LIVE-ACTIONS, COMEDIES, AND DRAMAS VIA A GLOBAL COMPUTER NETWORK; ENTERTAINMENT SERVICES, NAMELY PROVIDING ON-LINE REVIEWS OF MOVIES, LIVE-ACTIONS, COMEDIES, DRAMAS, BOOKS, MUSIC AND COMPUTER GAMES; ARRANGING TICKET RESERVATIONS FOR SHOWS AND OTHER ENTERTAINMENT EVENTS; EDUCATIONAL AND ENTERTAINMENT SERVICES, NAMELY PROVIDING MOTIVATIONAL AND EDUCATIONAL SPEAKERS; ENTERTAINMENT IN THE NATURE OF COMPETITIONS IN THE FIELDS OF FILMS, TELEVISION SHOWS, TELEVISION SERIES, MUSIC, FASHION, SPORTS, ANIMATION SHOWS, DANCE, THEATRE PRODUCTIONS, AND ON-LINE COMPUTER GAMES; ENTERTAINMENT SERVICES, NAMELY PROVIDING PRERECORDED MUSIC, INFORMATION IN THE FIELD OF MUSIC, AND COMMENTARY AND ARTICLES ABOUT MUSIC, ALL ON-LINE VIA A GLOBAL COMPUTER NETWORK AND ELECTRONIC GLOBAL COMMUNICATIONS NETWORK; ENTERTAINMENT, NAMELY LIVE PERFORMANCES BY MUSICAL BANDS; ENTERTAINMENT, NAMELY LIVE MUSIC CONCERTS; RADIO ENTERTAINMENT PRODUCTION; ENTERTAINMENT SERVICES, NAMELY PROVIDING RADIO PROGRAMS, TELEVISION PROGRAMS, AND CONDUCTING CONTESTS AND FESTIVALS IN THE FIELDS OF MUSIC, FILM, SPORTS, ANIMATION, AND AUDIO AND VISUAL SHOWS VIA A GLOBAL COMPUTER NETWORK;

SN 76-462,932. LEEGE, SHAWN, VENICE, CA. FILED 10-24-2002.



NO CLAIM IS MADE TO THE EXCLUSIVE RIGHT TO USE "PRIVATE TRAINING", APART FROM THE MARK AS SHOWN.

FOR PROVIDING ONE ON ONE PRIVATE PHYSICAL FITNESS INSTRUCTION (U.S. CLS. 100, 101 AND 107).

KELLY BOULTON, EXAMINING ATTORNEY

**CLASS 41—(Continued).**

ENTERTAINMENT SERVICES, NAMELY CONDUCTING CONTESTS ON BOARD CRUISE SHIPS FOR PASSENGERS OF ALL AGES, IN FUNCTION ROOMS, STADIUMS, EXHIBITION CENTERS, CONCERT HALLS, PARKS, OR SHIPPING MALLS; RADIO ENTERTAINMENT SERVICES, NAMELY RADIO PROGRAMS FEATURING PERFORMANCES BY FICTIONAL CHARACTERS, RADIO OR SPORTS OR MOVIE OR GAMES PERSONALITIES, PROFESSIONAL ENTERTAINERS, MOVIE STARS, SINGERS OR SPORTS CELEBRITIES; MOVIE STUDIOS; MOVIE THEATRES; AND PRODUCTION OF RADIO AND TELEVISION PROGRAMS; ANIMATION PRODUCTION SERVICES (U.S. CLS. 100, 101 AND 107).

TONI HICKEY, EXAMINING ATTORNEY

SN 76-478,731. LATINA MEDIA VENTURES LLC, NEW YORK, NY. FILED 12-23-2002.

**LATINA MEDIA VENTURES**

OWNER OF U.S. REG. NOS. 2,804,076 AND 2,839,474. NO CLAIM IS MADE TO THE EXCLUSIVE RIGHT TO USE MEDIA, APART FROM THE MARK AS SHOWN.

SEC. 2(F) LATINA.  
FOR PUBLICATION OF A MAGAZINE (U.S. CLS. 100, 101 AND 107).

FIRST USE 6-0-2000; IN COMMERCE 6-0-2000.  
JOHN HWANG, EXAMINING ATTORNEY

SN 76-485,059. OTSUKA PHARMACEUTICAL CO., LTD., TOKYO, JAPAN, FILED 1-27-2003.

**INSTRIDE!**

FOR PROVIDING ADVICE AND INFORMATION ON WALKING AND EXERCISE (U.S. CLS. 100, 101 AND 107).

FIRST USE 5-10-1995; IN COMMERCE 5-10-1995.  
ZACHARY BELLO, EXAMINING ATTORNEY

SN 76-489,098. VOLICH, GREG, CURRUMBIN VALLEY QUEENSLAND, AUSTRALIA, FILED 2-10-2003.

**THE GOD EXPERIENCE**

NO CLAIM IS MADE TO THE EXCLUSIVE RIGHT TO USE "GOD", APART FROM THE MARK AS SHOWN.

FOR ENTERTAINMENT SERVICES, NAMELY, PRODUCTION OF CHRISTIAN EXHIBITIONS FEATURING AUDIO VISUAL PRESENTATIONS, HISTORICAL ARTIFACTS AND REPLICATES, INTERACTIVE TECHNOLOGY, SPECIAL EFFECTS, AND LIGHTING; ENTERTAINMENT IN THE NATURE OF THEATER PRODUCTIONS AND SHOWS FEATURING DRAMATIC ACTING AND MUSICAL PERFORMANCES (U.S. CLS. 100, 101 AND 107).

GEOFFREY FOSDICK, EXAMINING ATTORNEY

**CLASS 41—(Continued).**

SN 76-490,079. BACKYARD JAMS, INC., SHARON, MA. FILED 2-20-2003.

**BACKYARD JAMS**

NO CLAIM IS MADE TO THE EXCLUSIVE RIGHT TO USE "JAMS", APART FROM THE MARK AS SHOWN.

FOR EDUCATIONAL, RECREATIONAL AND ENTERTAINMENT SERVICES, NAMELY, PROVIDING WORKSHOPS, LIVE MUSICAL PERFORMANCE EVENTS, AND COURSES OF INSTRUCTION IN THE FIELDS OF MUSIC COMPOSITION, MUSICAL PERFORMANCE, AND MUSICAL RECORDING FOR INDIVIDUALS AND GROUP ENSEMBLES; MUSICAL PRODUCTION AND RECORDING STUDIOS (U.S. CLS. 100, 101 AND 107).

DAWN FELDMAN, EXAMINING ATTORNEY

SN 76-490,727. THE CARTOON NETWORK LP, LLLP, ATLANTA, GA. FILED 2-11-2003.

**WIN WHEEL**

NO CLAIM IS MADE TO THE EXCLUSIVE RIGHT TO USE "WHEEL", APART FROM THE MARK AS SHOWN.

FOR ENTERTAINMENT SERVICES IN THE NATURE OF AN ONLINE GAME (U.S. CLS. 100, 101 AND 107).

BRIAN PINO, EXAMINING ATTORNEY

SN 76-503,008. JOHN PATTISON, TORONTO, ONTARIO, CANADA, FILED 4-1-2003.

**PUPPETS WHO KILL**

PRIORITY CLAIMED UNDER SEC. 44(D) ON CANADA APPLICATION NO. 1156305, FILED 10-18-2002, REG. NO. TMA609364, DATED 5-5-2004, EXPIRES 5-5-2019.

NO CLAIM IS MADE TO THE EXCLUSIVE RIGHT TO USE PUPPETS, APART FROM THE MARK AS SHOWN.

FOR ENTERTAINMENT IN THE NATURE OF A SERIES OF TELEVISION PROGRAMS IN THE FIELD OF COMEDY (U.S. CLS. 100, 101 AND 107).

JENNIFER CHICOSKI, EXAMINING ATTORNEY

SN 76-507,584. WORLDDATWORK, SCOTTSDALE, AZ. FILED 4-18-2003.

**CERTIFIED  
COMPENSATION  
PROFESSIONAL**

SEC. 2(F).

FOR EDUCATIONAL SERVICES, NAMELY, PROVIDING COURSES AND TESTING IN THE FIELD OF EMPLOYEE REMUNERATION AND EMPLOYEE REWARD SYSTEMS (U.S. CLS. 100, 101 AND 107).

FIRST USE 12-0-1976; IN COMMERCE 12-0-1976.

MIDGE BUTLER, EXAMINING ATTORNEY

**CLASS 41—(Continued).**

SN 76-521,279. SOFT TISSUE THERAPY, INC., LAFAYETTE, LA. FILED 6-9-2003.

## SOFT TISSUE NORMALIZATION

NO CLAIM IS MADE TO THE EXCLUSIVE RIGHT TO USE "SOFT TISSUE", APART FROM THE MARK AS SHOWN.

FOR TEACHING IN THE FIELD OF MASSAGE INVOLVING A TECHNIQUE FOR MANIPULATION OF SOFT TISSUE OF THE BODY (U.S. CLS. 100, 101 AND 107).

FIRST USE 4-4-2003; IN COMMERCE 4-4-2003.  
MICHAEL BAIRD, EXAMINING ATTORNEY

SN 76-529,276. HINGEL, CHRISTOPHER MICHAEL, PITTSFORD, NY. FILED 7-7-2003.

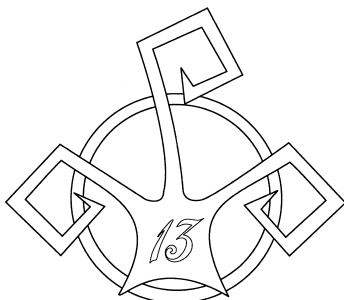

FOR ENTERTAINMENT SERVICES, NAMELY, LIVE PERFORMANCES BY A MUSICIAN (U.S. CLS. 100, 101 AND 107).

FIRST USE 7-3-1993; IN COMMERCE 7-3-1993.  
TARAH HARDY, EXAMINING ATTORNEY

SN 76-533,096. INDIANA BEHAVIORAL HEALTH CHOICES, INC., INDIANAPOLIS, IN. FILED 7-28-2003.



*Supporting Parents. Strengthening Families.*

NO CLAIM IS MADE TO THE EXCLUSIVE RIGHT TO USE "SUPPORTING PARENTS, STRENGTHENING FAMILIES", APART FROM THE MARK AS SHOWN.

FOR EDUCATIONAL SERVICES, NAMELY, PROVIDING SUPPORT AND ADVOCACY TRAINING SERVICES TO PARENTS AND FAMILIES (U.S. CLS. 100, 101 AND 107).

FIRST USE 1-0-2003; IN COMMERCE 1-0-2003.  
ROBERT C. CLARK JR., EXAMINING ATTORNEY

**CLASS 41—(Continued).**

SN 76-534,634. KENFIELD & ASSOCIATES, P.C., MINNEAPOLIS, MN. FILED 8-4-2003.

## MYSKY

FOR EDUCATION SERVICES, NAMELY, CONDUCTING PROGRAMS TO ASSIST INDIVIDUALS DEALING WITH THE FEAR OF FLYING. (U.S. CLS. 100, 101 AND 107).

STEPHANIE DAVIS, EXAMINING ATTORNEY

SN 76-535,537. NATIONAL TAX INSTITUTE, INC., BURLINGTON, MA. FILED 7-24-2003.

## CPETV.COM

FOR PROVIDING INFORMATION IN THE FIELD OF CONTINUING EDUCATION AND CONTINUING EDUCATION COURSES BY MEANS OF A GLOBAL COMPUTER INFORMATION NETWORK (U.S. CLS. 100, 101 AND 107).

JOHN HWANG, EXAMINING ATTORNEY

SN 76-536,876. GUIDEPOSTS, A CHURCH CORPORATION, CARMEL, NY. FILED 8-11-2003.

## RU LAUGHING @ ME?

FOR ENTERTAINMENT SERVICES, NAMELY A WEBSITE FEATURING HUMOR, TRIVIA AND VARIOUS AMUSING TOPICS NAMELY, THE EXPLORATION OF EMBARRASSING MOMENTS AND FUNNY WEB SITES VIA A GLOBAL COMPUTER NETWORK (U.S. CLS. 100, 101 AND 107).

FIRST USE 12-0-2000; IN COMMERCE 12-0-2000.  
BILL DAWE, EXAMINING ATTORNEY

SN 76-537,547. WIZARD WORKFORCE DEVELOPMENT INC., RICHMOND, VA. FILED 8-1-2003.

## THERE'S MAGIC IN EVERYONE

THE MARK CONSISTS OF STANDARD CHARACTERS WITHOUT CLAIM TO ANY PARTICULAR FONT, STYLE, SIZE, OR COLOR.

FOR TRAINING SERVICES IN THE FIELD OF CUSTOMER SERVICE COMMUNICATION SKILLS AND LEADERSHIP (U.S. CLS. 100, 101 AND 107).

FIRST USE 10-0-1998; IN COMMERCE 10-0-1998.  
BILL DAWE, EXAMINING ATTORNEY



**CLASS 41—(Continued).**

SN 76-538,308. ESSENCE OF LIFE LTD., TEL AVIV 64367, ISRAEL, FILED 8-18-2003.

**LET'S JOIN TOGETHER**

PRIORITY CLAIMED UNDER SEC. 44(D) ON ISRAEL APPLICATION NO. 162810, FILED 2-16-2003, REG. NO. 162810, DATED 2-3-2004, EXPIRES 2-16-2010.

FOR ORGANIZING AND CONDUCTING SEMINARS, LECTURES, DEBATES AND TRAINING WORKSHOPS, AND EDUCATIONAL COLLOQUIA, CONFERENCES AND CONVENTIONS, BOTH OFF-LINE AND ON-LINE, ALL IN THE FIELD OF THE DEVELOPMENT OF SELF-AWARENESS, INTER-PERSONAL COMMUNICATION, AND MUTUAL RESPECT IN THE SOCIETY; PUBLICATION OF BOOKS AND MAGAZINES; ENTERTAINMENT SERVICES, NAMELY, PRODUCTION OF TELEVISION PROGRAMS, VIDEO TAPES, VIDEO CASSETTES AND VIDEO DISCS (U.S. CLS. 100, 101 AND 107).

CHRIS WELLS, EXAMINING ATTORNEY

---

SN 76-538,800. HOOKER, LEONARD G., GALLOWAY, NJ, FILED 8-20-2003.

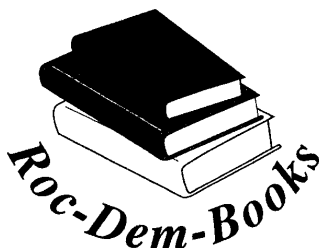

NO CLAIM IS MADE TO THE EXCLUSIVE RIGHT TO USE "PICTORIAL REPRESENTATION OF THE BOOKS", APART FROM THE MARK AS SHOWN.

FOR EDUCATIONAL SERVICES NAMELY CONDUCTING PROGRAMS IN THE FIELD OF ENCOURAGING STUDENTS TO STAY IN SCHOOL AND READ (U.S. CLS. 100, 101 AND 107).

FIRST USE 8-25-2003; IN COMMERCE 8-25-2003.  
DEZMONA MIZELLE, EXAMINING ATTORNEY

---

SN 76-547,584. LEFT COAST WRITERS, LLC, OAKLAND, CA, FILED 9-30-2003.

**LEFT COAST WRITERS**

NO CLAIM IS MADE TO THE EXCLUSIVE RIGHT TO USE "WRITERS", APART FROM THE MARK AS SHOWN.

FOR PUBLICATION OF BOOKS, PROVIDING AND CONDUCTING WORKSHOPS, SALONS, SEMINARS AND CONFERENCES IN THE FIELD OF WRITING, PROVIDING NEWSLETTERS IN THE FIELD OF WRITING VIA EMAIL, AND EDITORIAL CONSULTATION (U.S. CLS. 100, 101 AND 107).

FIRST USE 9-30-2002; IN COMMERCE 2-26-2003.  
ELIZABETH HUGHITT, EXAMINING ATTORNEY

**CLASS 41—(Continued).**

SN 76-548,152. ARIAS, JAVIER C., NEW YORK, NY, FILED 9-30-2003.



NO CLAIM IS MADE TO THE EXCLUSIVE RIGHT TO USE "GRUPO", APART FROM THE MARK AS SHOWN.

THE ENGLISH TRANSLATION OF GRUPO IN THE MARK IS GROUP.

FOR ENTERTAINMENT SERVICES IN THE NATURE OF A LIVE MUSICAL GROUP (U.S. CLS. 100, 101 AND 107).

FIRST USE 12-30-2002; IN COMMERCE 1-4-2003.  
KELLY BOULTON, EXAMINING ATTORNEY

---

SN 76-549,700. WEAVER OFFICIAL PUBLICATIONS, INC., DENVER, CO, FILED 10-7-2003.

**WEAVER OFFICIAL PUBLICATIONS**

NO CLAIM IS MADE TO THE EXCLUSIVE RIGHT TO USE "OFFICIAL PUBLICATIONS", APART FROM THE MARK AS SHOWN.

FOR TRAVEL MAGAZINE PUBLISHING SERVICES CONSISTING OF THE PUBLICATION OF OFFICIAL VISITORS' GUIDES, TRAVEL PLANNERS' GUIDES, MEETING PLANNERS' GUIDES, VISITORS' POCKET GUIDES, AND RELATED PUBLICATIONS FOR METROPOLITAN VISITORS', CONVENTION, AND TOURISM BUREAUS (U.S. CLS. 100, 101 AND 107).

FIRST USE 7-1-2003; IN COMMERCE 7-1-2003.  
JERI J. FICKES, EXAMINING ATTORNEY

---

SN 76-549,775. WEAVER OFFICIAL PUBLICATIONS, INC., DENVER, CO, FILED 10-7-2003.

**BE SEEN**

FOR TRAVEL MAGAZINE PUBLISHING SERVICES CONSISTING OF THE PUBLICATION OF OFFICIAL VISITORS' GUIDES, TRAVEL PLANNERS' GUIDES, MEETING PLANNERS' GUIDES, VISITORS' POCKET GUIDES, AND RELATED PUBLICATIONS FOR METROPOLITAN VISITORS', CONVENTION, AND TOURISM BUREAUS (U.S. CLS. 100, 101 AND 107).

FIRST USE 7-1-2003; IN COMMERCE 7-1-2003.  
ANGELA M. MICHELI, EXAMINING ATTORNEY

**CLASS 41—(Continued).**

SN 76-550,126. GOODMAN, LISHA KAY, MESA, AZ. FILED 10-8-2003.

**TOTS UNIVERSITY**

NO CLAIM IS MADE TO THE EXCLUSIVE RIGHT TO USE TOTS, APART FROM THE MARK AS SHOWN.

FOR EDUCATIONAL SERVICES, NAMELY, CONDUCTING COURSES OF INSTRUCTION TO TEACHERS AND THE OWNERS OF CHILDCARE AND DAY CARE CENTERS IN THE FIELD OF CHILD CARE AND DAY CARE CENTERS FOR THE EDUCATION OF PRE-SCHOOL AGED CHILDREN; PROVIDING EDUCATIONAL FACILITIES (U.S. CLS. 100, 101 AND 107).

FIRST USE 12-11-2000; IN COMMERCE 12-11-2000.

BILL DAWE, EXAMINING ATTORNEY

SN 76-550,800. GOLDING FITNESS PROGRAMS, INC., LOS ANGELES, CA. FILED 10-10-2003.

**YOUR BODY IS MADE TO MOVE**

FOR TRAINING SERVICES IN THE FIELD OF PHYSICAL FITNESS AND EXERCISE (U.S. CLS. 100, 101 AND 107).

FIRST USE 3-1-1997; IN COMMERCE 3-1-1997.

BILL DAWE, EXAMINING ATTORNEY

SN 76-552,057. ADVANCED RESEARCH AND TECHNOLOGY INSTITUTE, INC., BLOOMINGTON, IN. FILED 10-15-2003.

**INDIANA CAREER AND POSTSECONDARY ADVANCEMENT CENTER**

NO CLAIM IS MADE TO THE EXCLUSIVE RIGHT TO USE "CAREER AND POST SECONDARY", APART FROM THE MARK AS SHOWN.

SEC. 2(F).

FOR CONSULTING SERVICES, NAMELY CONSULTING OTHERS IN THE FIELD OF EDUCATION, CONSULTING STUDENTS WITH RESPECT TO UNIVERSITY AND CAREER CHOICES (U.S. CLS. 100, 101 AND 107).

FIRST USE 9-1-1997; IN COMMERCE 9-1-1997.

RUDY R. SINGLETON, EXAMINING ATTORNEY

SN 76-552,100. GREATER PARK CITY COMPANY, PARK CITY, UT. FILED 9-29-2003.

**FAST TRACKS**

FOR SKI RESORT SERVICES, NAMELY PROVIDING EXPRESS, AUTOMATED ACCESS TO SKI LIFTS BY MEANS OF A SKI LIFT PASS (U.S. CLS. 100, 101 AND 107).

FIRST USE 11-30-2002; IN COMMERCE 11-30-2002.

AMOS T. MATTHEWS, JR., EXAMINING ATTORNEY

**CLASS 41—(Continued).**

SN 76-553,490. BIBLE SCHOLARS, INC., AUSTIN, TX. FILED 10-2-2003.

**BIBLE SCHOLARS**

NO CLAIM IS MADE TO THE EXCLUSIVE RIGHT TO USE BIBLE, APART FROM THE MARK AS SHOWN.

FOR PROVIDING A WEBSITE FEATURING EDUCATIONAL INFORMATION AND EDUCATIONAL RESEARCH INFORMATION FOR BIBLICAL INSTRUCTION (U.S. CLS. 100, 101 AND 107).

FIRST USE 3-1-2002; IN COMMERCE 3-1-2002.

KEVON CHISOLM, EXAMINING ATTORNEY

SN 76-553,633. MARSHALL, FRANK, WASHINGTON, DC. AND JACKSON, LATIF, WASHINGTON, DC. AND HOLLAND, JASEN, WASHINGTON, DC. FILED 10-22-2003.

**LISSEN**

FOR ENTERTAINMENT SERVICES, NAMELY LIVE PERFORMANCES BY A MUSICAL GROUP (U.S. CLS. 100, 101 AND 107).

JENNIFER CHICOSKI, EXAMINING ATTORNEY

SN 76-556,636. HARRISON, JOHN ANDREW, ALONA, OR. FILED 10-17-2003.

**AGA**  
American Guitar Academy

NO CLAIM IS MADE TO THE EXCLUSIVE RIGHT TO USE "AMERICAN GUITAR ACADEMY", APART FROM THE MARK AS SHOWN.

FOR EDUCATIONAL SERVICES NAMELY CONDUCTING CLASSES IN THE FIELD OF MUSIC (U.S. CLS. 100, 101 AND 107).

FIRST USE 5-1-2003; IN COMMERCE 5-1-2003.

GEORGE LORENZO, EXAMINING ATTORNEY

**CLASS 41—(Continued).**

SN 76-557,098. PALATINE PARK DISTRICT, PALATINE, IL.  
FILED 10-10-2003.



NO CLAIM IS MADE TO THE EXCLUSIVE RIGHT TO USE "PALATINE HILLS G.C.", APART FROM THE MARK AS SHOWN.

FOR GOLF COURSE PROVIDING LEISURE AND COMPETITIVE PLAY; GOLF DRIVING RANGE; INSTRUCTIONS IN THE FIELD OF GOLF (U.S. CLS. 100, 101 AND 107).

FIRST USE 4-1-1999; IN COMMERCE 4-1-1999.  
KATHRYN COWARD, EXAMINING ATTORNEY

SN 76-562,780. CURTIS, W. ROBERT, NEW YORK, NY.  
FILED 11-14-2003.

## PROTEIN WARS

THE MARK CONSISTS OF STANDARD CHARACTERS WITHOUT CLAIM TO ANY PARTICULAR FONT, STYLE, SIZE, OR COLOR.

FOR TELEVISION SHOW ABOUT COOKING (U.S. CLS. 100, 101 AND 107).

AISHA CLARKE, EXAMINING ATTORNEY

SN 76-564,515. ARENA FOOTBALL LEAGUE LLC, CHICAGO, IL. FILED 12-10-2003.

## NEW ORLEANS VODOO DOLLS

THE MARK CONSISTS OF STANDARD CHARACTERS WITHOUT CLAIM TO ANY PARTICULAR FONT, STYLE, SIZE, OR COLOR.

NO CLAIM IS MADE TO THE EXCLUSIVE RIGHT TO USE "NEW ORLEANS", APART FROM THE MARK AS SHOWN.

FOR ENTERTAINMENT IN THE NATURE OF ORGANIZING AND PRESENTING LIVE PERFORMANCES BY A CHEERLEADING AND DANCING GROUP; ORGANIZING AND PRESENTING LIVE MUSICAL AND DANCE PERFORMANCES PROVIDED BEFORE LIVE AUDIENCES AND LIVE ON TELEVISION, RADIO, GLOBAL COMPUTER NETWORK AND OTHER MEDIA (U.S. CLS. 100, 101 AND 107).

FIRST USE 12-2-2003; IN COMMERCE 12-2-2003.  
JOHN GARTNER, EXAMINING ATTORNEY

**CLASS 41—(Continued).**

SN 76-564,546. DYNAMIC GAMING SOLUTIONS, INC., GARDEN CITY, GA. FILED 12-10-2003.



NO CLAIM IS MADE TO THE EXCLUSIVE RIGHT TO USE CASINO, APART FROM THE MARK AS SHOWN. FOR ENTERTAINMENT SERVICES IN THE NATURE OF PROVIDING CASINO GAMING (U.S. CLS. 100, 101 AND 107).

DAWN FELDMAN, EXAMINING ATTORNEY

SN 76-566,292. ZANG, SHERYL M., MERRICK, NY. FILED 12-19-2003.

## FIT-ABILITY

THE MARK CONSISTS OF STANDARD CHARACTERS WITHOUT CLAIM TO ANY PARTICULAR FONT, STYLE, SIZE, OR COLOR.

FOR EDUCATIONAL SERVICES, NAMELY, PHYSICAL FITNESS INSTRUCTION AND PHYSICAL FITNESS CLASSES FOR CHILDREN AND TEENAGERS; BEHAVIOR MODIFICATION INSTRUCTION FOR CHILDREN AND TEENAGERS AND STRESS REDUCTION INSTRUCTION FOR CHILDREN AND TEENAGERS (U.S. CLS. 100, 101 AND 107).

FIRST USE 8-15-2003; IN COMMERCE 8-15-2003.  
BRETT J. GOLDEN, EXAMINING ATTORNEY

SN 76-569,035. PROFESSOR OF BOXING PHOTOGRAPHY, INC., BROOKLYN, NY. FILED 1-9-2004.



PROFESSOR OF BOXING PHOTOGRAPHY, INC.

NO CLAIM IS MADE TO THE EXCLUSIVE RIGHT TO USE "BOXING PHOTOGRAPHY INC.", APART FROM THE MARK AS SHOWN.

FOR PHOTOGRAPHY SERVICES (U.S. CLS. 100, 101 AND 107).

RENEE MCCRAY, EXAMINING ATTORNEY

**CLASS 41—(Continued).**

SN 76-569,362. THE FOREST HIGHLANDS ASSOCIATION, FLAGSTAFF, AZ. FILED 1-12-2004.



THE MARK CONSISTS OF PINE CONES DESIGN. FOR RECREATIONAL SERVICES, NAMELY, GOLF COURSE FACILITIES (U.S. CLS. 100, 101 AND 107). FIRST USE 1-1-1985; IN COMMERCE 1-1-1988. BRIDGETT SMITH, EXAMINING ATTORNEY

**CLASS 41—(Continued).**

SN 76-571,779. TEA WITH SHERI, LLC, DEVON, PA. FILED 1-26-2004.

**TEA WITH SHERI**

THE MARK CONSISTS OF STANDARD CHARACTERS WITHOUT CLAIM TO ANY PARTICULAR FONT, STYLE, SIZE, OR COLOR.

FOR ENTERTAINMENT SERVICES, NAMELY, AN ON-GOING AUDIO AND VISUAL PROGRAM DISTRIBUTED OVER AUDIO AND VIDEO MEDIA, NAMELY VIA TELEVISION, SATELLITE, WIRELESS, FIBER OPTICS, CABLE AND A GLOBAL COMPUTER NETWORK IN THE FIELDS OF ALTERNATIVE MEDICINE, ART, COLLECTIBLES, CRAFTS, DIET, EXERCISE, FOOD, HEALTH, HOBBIES, HOME DECOR, LIFESTYLE, MUSIC, NUTRITION, RESTAURANTS, RELAXATION TECHNIQUES AND ACTIVITIES, SHOPPING, SPORTS, TRAVEL AND VOLUNTEERISM (U.S. CLS. 100, 101 AND 107).

EDWARD NELSON, EXAMINING ATTORNEY

SN 76-570,435. METROPOLITAN TRANSPORTATION AUTHORITY, NEW YORK, NY. FILED 1-12-2004.

THE NEW YORK SUBWAY A CENTURY OF PROGRESS IN MOTION

THE MARK CONSISTS OF STANDARD CHARACTERS WITHOUT CLAIM TO ANY PARTICULAR FONT, STYLE, SIZE, OR COLOR.

OWNER OF U.S. REG. NO. 2,777,548.

FOR ORGANIZING AND CONDUCTING A CENTENIAL CELEBRATION FOR THE NEW YORK CITY SUBWAY NAMELY, ORGANIZING AND CONDUCTING CULTURAL EVENTS, ART AND PHOTOGRAPHY EXHIBITS, ENTERTAINMENT, NAMELY FIREWORKS DISPLAYS, MUSICAL PERFORMANCES, COMMUNITY EVENTS, LECTURES, FILM SERIES, HISTORICAL EXHIBITIONS, SUBWAY SYSTEM EXCURSIONS AND NEW YORK CITY NEIGHBORHOOD TOURS, AND EDUCATIONAL WORKSHOPS IN THE FIELD OF THE HISTORY OF PUBLIC TRANSPORTATION IN THE NEW YORK CITY REGION, IN PARTICULAR, THE NEW YORK CITY SUBWAY (U.S. CLS. 100, 101 AND 107).

FIRST USE 10-0-2003; IN COMMERCE 10-0-2003. MATTHEW PAPPAS, EXAMINING ATTORNEY

SN 76-573,115. ROBINSON, MORLENA, DBA WALK FOR ME, NEW YORK, NY. FILED 1-30-2004.



COLORS RED, YELLOW AND BLACK ARE CLAIMED AS DISTINCTIVE FEATURES OF THE MARK.

THE MARK CONSISTS OF THE WORDS WALK FOR ME, PRINTED IN BLACK, SUPERIMPOSED ON AN ANGLED YELLOW SQUARE WITH A RED SHADOW AND THE SILHOUETTE OF A WOMAN, ALSO IN RED.

FOR CONDUCTING MODELING AND PERSONAL DEVELOPMENT WORKSHOPS (U.S. CLS. 100, 101 AND 107).

FIRST USE 12-8-2003; IN COMMERCE 12-12-2003. CHERYL STEPLIGHT, EXAMINING ATTORNEY

**CLASS 41—(Continued).**

SN 76-574,123. RUSSIKOFF, RONALD K., PHILADELPHIA, PA. FILED 2-4-2004.

# One2Kno

THE MARK CONSISTS OF STANDARD CHARACTERS WITHOUT CLAIM TO ANY PARTICULAR FONT, STYLE, SIZE, OR COLOR.

FOR ENTERTAINMENT IN THE NATURE OF VISUAL AND AUDIO PERFORMANCES, NAMELY, MUSICAL BAND, ROCK GROUP, GYMNASTIC, DANCE, AND BALLET PERFORMANCES (U.S. CLS. 100, 101 AND 107).  
LINDA E. BLOHM, EXAMINING ATTORNEY

SN 76-575,896. MCDOWELL, THOMAS J., CARMEL, CA. FILED 2-9-2004.

# MONSTER SHOW

OWNER OF U.S. REG. NOS. 2,460,601 AND 2,464,825.  
NO CLAIM IS MADE TO THE EXCLUSIVE RIGHT TO USE SHOW, APART FROM THE MARK AS SHOWN.  
SEC. 2(F).  
FOR ENTERTAINMENT IN THE NATURE OF THEATER PRODUCTIONS (U.S. CLS. 100, 101 AND 107).  
FIRST USE 9-28-1997; IN COMMERCE 10-19-1997.  
JEFFREY S. MOLINOFF, EXAMINING ATTORNEY

SN 78-083,711. HARTLEY, MORRIS JAMES, ENCINITAS, CA. FILED 9-13-2001.

# BOTTOM LINE GOLF

NO CLAIM IS MADE TO THE EXCLUSIVE RIGHT TO USE "GOLF", APART FROM THE MARK AS SHOWN.  
FOR EDUCATIONAL SERVICES, NAMELY, PROVIDING COURSES OF INSTRUCTION AND CLINICS IN THE FIELD OF GOLF (U.S. CLS. 100, 101 AND 107).  
JENNIFER KRIS, EXAMINING ATTORNEY

SN 78-131,058. ICBC BROADCAST HOLDINGS, INC, NEW YORK, NY. FILED 5-24-2002.

# FERTILE GROUND

FOR ON GOING RADIO PROGRAM FOCUSING ON ISSUES RELATED TO AFRICA (U.S. CLS. 100, 101 AND 107).  
FIRST USE 1-26-2002; IN COMMERCE 1-26-2002.  
YSA DEJESUS, EXAMINING ATTORNEY

**CLASS 41—(Continued).**

SN 78-132,435. CENTER FOR PROFESSIONAL ADVANCEMENT, INC., THE, E.BRUNSWICK, NJ. FILED 5-31-2002.



NO CLAIM IS MADE TO THE EXCLUSIVE RIGHT TO USE "CENTER," "SCIENCE," "ENGINEERING," "MANAGEMENT," AND "FOUNDED 1967", APART FROM THE MARK AS SHOWN.

THE MARK CONSISTS OF THE WORDS CENTER FOR PROFESSIONAL ADVANCEMENT 1967 IN A CIRCLE SURROUNDING A DEPICTION OF A BUILDING WITH COLUMNS, WITH THE WORDS "SCIENCE," "ENGINEERING" AND "MANAGEMENT" ACROSS THE TOP OF THE BUILDING IN THE BACKGROUND; SILHOUETTES OF 3 PEOPLE IN THE MIDDLE; AND AN OIL LAMP WITH A BURNING FLAME IN THE FOREGROUND.

SEC. 2(F) AS TO "CENTER FOR PROFESSIONAL ADVANCEMENT".

FOR EDUCATIONAL SERVICES, NAMELY, CONDUCTING TECHNICAL SEMINARS AND WORKSHOPS FOR PROFESSIONAL, TECHNICAL AND MANAGERIAL EDUCATION IN A VARIETY OF TECHNICAL FIELDS INCLUDING, BUT NOT LIMITED TO, SCIENCE, PHARMACEUTICAL TECHNOLOGY AND MANUFACTURING (U.S. CLS. 100, 101 AND 107).  
FIRST USE 1-1-1968; IN COMMERCE 1-1-1968.

LINDA M. KING, EXAMINING ATTORNEY

SN 78-154,557. TARGET BRANDS, INC., MINNEAPOLIS, MN. FILED 8-15-2002.

# ART ON THE TOWN

FOR SPONSORING AND ORGANIZING AN ARTS AND CRAFTS FESTIVAL (U.S. CLS. 100, 101 AND 107).  
CURTIS FRENCH, EXAMINING ATTORNEY

SN 78-155,415. MARYLHURST UNIVERSITY, MARYLHURST, OR. FILED 8-19-2002.

# THE ART GYM

NO CLAIM IS MADE TO THE EXCLUSIVE RIGHT TO USE "ART", APART FROM THE MARK AS SHOWN.  
FOR ARRANGING AND CONDUCTING ART GALLERY EXHIBITIONS (U.S. CLS. 100, 101 AND 107).  
FIRST USE 9-1-1980; IN COMMERCE 9-1-1980.  
DORITT L. CARROLL, EXAMINING ATTORNEY

**CLASS 41—(Continued).**

SN 78-187,123. GENIUS CENTER, THE, MONTEBELLO, VA.  
FILED 11-20-2002.



THE MARK CONSISTS OF A GENIE BOTTLE.  
FOR EDUCATIONAL SERVICES, NAMELY, PROVIDING RESOURCES, CLASSES, SEMINARS, WORKSHOPS, AND PROGRAMS IN THE AREAS OF CHILD DEVELOPMENT, ACADEMIC ACHIEVEMENT, FAMILY/CHILD ADVOCACY AND CURRICULUM DEVELOPMENT AND CONSULTATION THEREOF (U.S. CLS. 100, 101 AND 107).

ALICE BENMAMAN, EXAMINING ATTORNEY

SN 78-189,794. PRENTISS, DAVID L., PROVIDENCE, RI.  
FILED 11-28-2002.

**GOOD THINKING WORKS**

FOR TRAINING SERVICES IN THE FIELD OF ETHICS, PROBLEM-SOLVING, DIVERSITY, AND EMPLOYEE ASSISTANCE (U.S. CLS. 100, 101 AND 107).

FIRST USE 8-5-2002; IN COMMERCE 8-5-2002.  
IRENE D. WILLIAMS, EXAMINING ATTORNEY

SN 78-197,995. ASSOCIATION OF AMERICAN MEDICAL COLLEGES, WASHINGTON, DC. FILED 12-26-2002.



OWNER OF U.S. REG. NO. 1,942,759.  
NO CLAIM IS MADE TO THE EXCLUSIVE RIGHT TO USE "ASSOCIATION", APART FROM THE MARK AS SHOWN.

SEC. 2(F) AS TO "GME TRACK" AND "ASSOCIATION OF AMERICAN MEDICAL COLLEGES".

FOR PROVIDING ONLINE INFORMATION IN THE FIELD OF MEDICAL PROFESSIONAL RESIDENCY TRAINING PROGRAMS (U.S. CLS. 100, 101 AND 107).

FIRST USE 8-0-1999; IN COMMERCE 8-0-1999.  
ROBERT COGGINS, EXAMINING ATTORNEY

**CLASS 41—(Continued).**

SN 78-219,377. IPROBE MULTILINGUAL SOLUTIONS, INC., NEW YORK, NY. FILED 2-26-2003.

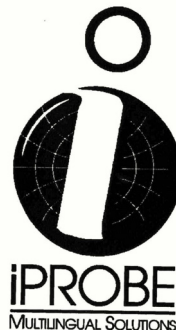

NO CLAIM IS MADE TO THE EXCLUSIVE RIGHT TO USE "MULTILINGUAL SOLUTIONS", APART FROM THE MARK AS SHOWN.

THE MARK CONSISTS OF THE WORDING "IPROBE MULTILINGUAL SOLUTIONS" WITH A BAR AND THE DESIGN OF A GLOBE WITH MERIDIANS AND THE LETTER "I". THE GLOBE AND THE WORDING IN THE MARK APPEAR IN THE COLOR BLUE AND THE LETTER "I" APPEARS IN THE COLOR YELLOW.

FOR TRANSLATION SERVICES; AUDIO, VIDEO AND DIGITAL TRANSCRIPTION SERVICES; VOICE DUBBING SERVICES; AND AUDIOTAPE AND VIDEOTAPE PRODUCTION SERVICES (U.S. CLS. 100, 101 AND 107).

FIRST USE 2-1-2001; IN COMMERCE 2-1-2001.  
DAVID C. REIHNER, EXAMINING ATTORNEY

SN 78-219,741. BECKER, SHELBY J., HUNTLEY, IL. FILED 2-27-2003.

**T.I.E.S.**

**TAKING INTERNET EDUCATION SERIOUSLY**

FOR EDUCATION SERVICES, NAMELY CONDUCTING CLASSES, SEMINARS, WORKSHOPS AND LECTURES FOR SCHOOLS, LAW ENFORCEMENT AGENCIES, PARENTS AND CHILDREN IN THE FIELD OF SAFE USE OF THE INTERNET BY CHILDREN (U.S. CLS. 100, 101 AND 107).

FIRST USE 4-1-2002; IN COMMERCE 4-1-2002.  
TRACY CROSS, EXAMINING ATTORNEY

SN 78-220,311. RAPIER, WILLIAM K, BARDSTOWN, KY.  
FILED 2-28-2003.

**STEEL DREAMS  
PRODUCTION**

NO CLAIM IS MADE TO THE EXCLUSIVE RIGHT TO USE PRODUCTION, APART FROM THE MARK AS SHOWN.

FOR TV SHOW PRODUCTION (U.S. CLS. 100, 101 AND 107).

AMY HELLA, EXAMINING ATTORNEY

**CLASS 41—(Continued).**

SN 78-249,317. OAKES, R. CURTIS, SAN FRANCISCO, CA. FILED 5-13-2003.

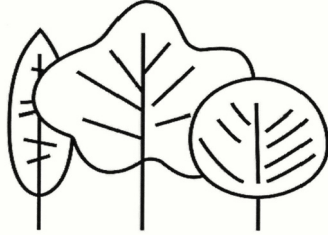

FOR EDUCATIONAL SERVICES, NAMELY PROVIDING CLASSES, SEMINARS AND WORKSHOPS IN THE FIELDS OF REAL ESTATE AND FINANCIAL EDUCATION (U.S. CLS. 100, 101 AND 107).  
SHARI SHEFFIELD, EXAMINING ATTORNEY

SN 78-253,037. STINSON-ADAMS, ANGELA, DECATUR, GA. FILED 5-22-2003.



THE STIPPLING IS FOR SHADING PURPOSES.  
THE COLOR(S) GRAY IS/ARE CLAIMED AS A FEATURE OF THE MARK.  
THE COLOR GRAY APPEARS IN THE WORD "QUALITY".

FOR EDUCATIONAL SERVICES NAMELY PROVIDING INCENTIVES AND CONDUCTING TUTORIAL AND SELF ESTEEM PROGRAMS FOR GIRLS AND BOYS IN THE MIDDLE SCHOOL ARENA (U.S. CLS. 100, 101 AND 107).

ALICE BENMAMAN, EXAMINING ATTORNEY

SN 78-256,615. THE SAME FOUNDATION, COLORADO SPRINGS, CO. FILED 5-31-2003.



THE MARK CONSISTS OF THE WORDS "POWER FOR LIVING VICTORIOUSLY", WITH THE WORDS "RENEWED MIND" ON A KEY BETWEEN THE WORDS "FOR", AND "LIVING", ON A BACKGROUND OF RED WITH A BLUE AND GREEN RECTANGULAR BORDER.

FOR EDUCATIONAL SERVICES, NAMELY, CONDUCTING CLASSES AND PRACTICAL LIVING SEMINARS IN THE FIELD OF THE BIBLE (U.S. CLS. 100, 101 AND 107).

FIRST USE 4-9-2003; IN COMMERCE 5-30-2003.  
MICHAEL KAZAZIAN, EXAMINING ATTORNEY

**CLASS 41—(Continued).**

SN 78-257,306. TV ONE, LLC, LANHAM, MD. FILED 6-2-2003.

**TV ONE**

NO CLAIM IS MADE TO THE EXCLUSIVE RIGHT TO USE "TV", APART FROM THE MARK AS SHOWN.

FOR PROVIDING ON-LINE NEWSLETTERS AND MAGAZINES IN THE FIELDS OF MUSIC, FASHION, COMEDY, SPORTS, NEWS, DRAMA, DANCE, TALK SHOWS, GAME SHOWS, REALITY SHOWS, VARIETY SHOWS, LIVE PERFORMANCES, HEALTH AND FITNESS, LIFESTYLE, TRAVEL, AND TOPICS OF GENERAL INTEREST; DISSEMINATION OF INFORMATION ON NEWS, ENTERTAINMENT, SPORTS, FASHION AND MUSIC VIA A GLOBAL COMPUTER NETWORK; CHARITABLE SERVICES, NAMELY, PROVIDING MUSICAL INSTRUMENTS TO OTHERS (U.S. CLS. 100, 101 AND 107).

LAURA KOVAISKY, EXAMINING ATTORNEY

SN 78-259,807. HOWORLD PRODUCTIONS, LLC, PORTLAND, ME. FILED 6-9-2003.

**HOWORLD**

FOR ENTERTAINMENT SERVICES IN THE NATURE OF AN ON-GOING TELEVISION AND RADIO PROGRAM AND CONDUCTING ON-LINE EXHIBITIONS AND DISPLAYS AND INTERACTIVE EXHIBITS VIA A WEB SITE IN THE FIELD OF HOMEMAKING, HOME CARE, COOKING, HOUSEKEEPING, DECORATING, GARDENING, ENTERTAINING, CRAFTS, ANTIQUE COLLECTING, AND PARTY PLANNING (U.S. CLS. 100, 101 AND 107).

SUSAN HAYASH, EXAMINING ATTORNEY

SN 78-262,551. BRAUNSTON, DENNIS, ISSAQUAH, WA. FILED 6-14-2003.



D E N T A L  
L E A R N I N G  
C E N T E R S

NO CLAIM IS MADE TO THE EXCLUSIVE RIGHT TO USE DENTAL LEARNING CENTERS, APART FROM THE MARK AS SHOWN.

FOR EDUCATIONAL SERVICES, NAMELY CONDUCTING WORKSHOPS, SEMINARS AND CLASSES IN THE FIELD OF DENTAL IMAGING (U.S. CLS. 100, 101 AND 107).

FIRST USE 6-10-2002; IN COMMERCE 7-1-2002.  
G. T. GLYNN, EXAMINING ATTORNEY

**CLASS 41—(Continued).**

SN 78-269,598. PEMAQUID PRODUCTIONS, LLC, PORTLAND, ME. FILED 7-2-2003.

**LETSGO.TV**

FOR ENTERTAINMENT, NAMELY VIDEO PRODUCTION OF TELEVISION SHOWS FEATURING ADVENTURE TRAVEL AND OUTDOOR ACTIVITIES (U.S. CLS. 100, 101 AND 107).

TRACY FLETCHER, EXAMINING ATTORNEY

---

SN 78-275,807. RINEHART, DAVID, GLENN, SAN FRANCISCO, CA. FILED 7-18-2003.

**STARE**

FOR ON-LINE LIBRARY AND ENTERTAINMENT SERVICES, NAMELY, PROVIDING ELECTRONIC LIBRARY AND ENTERTAINMENT SERVICES WHICH FEATURE NOTEBOOKS, NEWSPAPERS, MAGAZINES, PHOTOGRAPHS AND IMAGES VIA AN ON-LINE COMPUTER NETWORK (U.S. CLS. 100, 101 AND 107).

FIRST USE 7-1-1995; IN COMMERCE 9-1-1995.

SUSAN HAYASH, EXAMINING ATTORNEY

---

SN 78-277,047. LEVINE, MARK H., ALEXANDRIA, VA. FILED 7-22-2003.

**INSIDE SCOOP**

FOR ENTERTAINMENT IN THE NATURE OF ONGOING TALK SHOWS IN THE FIELD OF POLITICS AND CURRENT EVENTS (U.S. CLS. 100, 101 AND 107).

FIRST USE 6-22-2003; IN COMMERCE 6-22-2003.

GEOFFREY FOSDICK, EXAMINING ATTORNEY

---

SN 78-282,456. STROHL, GEORGE, F III, PALMERTON, PA. FILED 8-8-2003.

**TROUBLED WINE**

FOR ENTERTAINMENT SERVICES IN THE NATURE OF LIVE MUSICAL PERFORMANCES BY A BAND (U.S. CLS. 100, 101 AND 107).

M. L. HERSHKOWITZ, EXAMINING ATTORNEY

**CLASS 41—(Continued).**

SN 78-287,083. HERD, SCOTT G., SALT LAKE CITY, UT. FILED 8-13-2003.

**GENEOGRAPHIES**

FOR CUSTOM WRITING SERVICES; AND ELECTRONIC PUBLISHING SERVICES, NAMELY, PUBLICATION OF TEXT AND GRAPHIC WORKS ON CD, DVD, AND ON-LINE AND FEATURING GENEALOGICAL, FAMILY-HISTORY, AND HISTORIC-BIOGRAPHICAL INFORMATION (U.S. CLS. 100, 101 AND 107).

FIRST USE 7-30-2003; IN COMMERCE 8-11-2003.

KATHERINE STOIDES, EXAMINING ATTORNEY

---

SN 78-291,794. BLUE CANARY, INC., WHITE PLAINS, NY. FILED 8-25-2003.

**BLOGSTAKES**

FOR ENTERTAINMENT SERVICES, NAMELY, PROVIDING ONLINE SWEEPSTAKES AND CONTESTS VIA A GLOBAL COMPUTER NETWORK (U.S. CLS. 100, 101 AND 107).

FIRST USE 8-18-2003; IN COMMERCE 8-18-2003.

KEVON CHISOLM, EXAMINING ATTORNEY

---

SN 78-293,887. MARVEL CHARACTERS, INC., LOS ANGELES, CA. FILED 8-29-2003.

**HULK**

OWNER OF U.S. REG. NOS. 970,791, 2,325,512 AND OTHERS.

FOR ONGOING TELEVISION PROGRAMS FEATURING ANIMATED CARTOON CHARACTERS OR LIVE ACTION ADVENTURE (U.S. CLS. 100, 101 AND 107).

FIRST USE 12-31-1966; IN COMMERCE 12-31-1966.

BERYL GARDNER, EXAMINING ATTORNEY

---

SN 78-295,215. ZAYDEL, RICHARD, SANTA ANA, CA. FILED 9-3-2003.

**MOHAWK RADIO**

NO CLAIM IS MADE TO THE EXCLUSIVE RIGHT TO USE "RADIO", APART FROM THE MARK AS SHOWN.

FOR ENTERTAINMENT SERVICES, NAMELY, PROVIDING PRERECORDED MUSIC, INFORMATION IN THE FIELD OF MUSIC, AND COMMENTARY AND ARTICLES ABOUT MUSIC, ALL ON-LINE VIA A GLOBAL COMPUTER NETWORK (U.S. CLS. 100, 101 AND 107).

FIRST USE 6-1-2002; IN COMMERCE 6-1-2003.

ROBIN CHOSID, EXAMINING ATTORNEY



**CLASS 41—(Continued).**

SN 78-297,761. SWANN, DAVID EARL, OXNARD, CA.  
FILED 9-9-2003.



NO CLAIM IS MADE TO THE EXCLUSIVE RIGHT TO USE "FITNESS STUDIOS", APART FROM THE MARK AS SHOWN.

FOR HEALTH CLUB SERVICES, NAMELY PROVIDING INSTRUCTION AND EQUIPMENT IN THE FIELD OF PHYSICAL EXERCISE (U.S. CLS. 100, 101 AND 107).  
MICHAEL BAIRD, EXAMINING ATTORNEY

SN 78-305,590. HEART OF AMERICA FAMILY SERVICES, INC., KANSAS CITY, KS. FILED 9-25-2003.

**WHAT'S DRIVING YOU?**

FOR EDUCATIONAL AND TRAINING SERVICES; NAMELY, TRAINING COURSES AND SEMINARS FOR DRIVING VEHICLES SAFELY (U.S. CLS. 100, 101 AND 107).

FIRST USE 3-24-2002; IN COMMERCE 3-24-2002.  
PRISCILLA MILTON, EXAMINING ATTORNEY

SN 78-306,040. SANGA YOGA, LLC, COMMERCE TOWNSHIP, MI. FILED 9-26-2003.

**SANGA YOGA**

NO CLAIM IS MADE TO THE EXCLUSIVE RIGHT TO USE "YOGA", APART FROM THE MARK AS SHOWN.

FOR YOGA INSTRUCTION, NAMELY, CLASSES, WORKSHOPS, RETREATS, PRIVATE SESSIONS AND TEACHER TRAINING IN THE FIELD OF YOGA (U.S. CLS. 100, 101 AND 107).

WILLIAM P. SHANAHAN, EXAMINING ATTORNEY

SN 78-309,552. PARRINGTON, STEVEN P., DBA 24 FRAME, LAS VEGAS, NV. FILED 10-6-2003.

**VEGAS HEAT**

NO CLAIM IS MADE TO THE EXCLUSIVE RIGHT TO USE VEGAS, APART FROM THE MARK AS SHOWN.

FOR PRODUCTION OF TELEVISION SHOWS (U.S. CLS. 100, 101 AND 107).

BRIDGETT SMITH, EXAMINING ATTORNEY

**CLASS 41—(Continued).**

SN 78-318,286. ROOTSEY, JAMES V., MELBOURNE, FL.  
FILED 10-24-2003.



NO CLAIM IS MADE TO THE EXCLUSIVE RIGHT TO USE "PRESS", APART FROM THE MARK AS SHOWN.

FOR PUBLISHER OF TRADE BOOKS AND BOOK-PROMOTIONAL PAMPHLETS (U.S. CLS. 100, 101 AND 107).

AMY HELLA, EXAMINING ATTORNEY

SN 78-318,575. VOORSANGER, NEIL, BROOKLYN, NY.  
FILED 10-24-2003.

**FASTLEARN**

FOR TRAINING SERVICES, NAMELY CONDUCTING WORKSHOPS IN THE FIELD OF SELF-IMPROVEMENT (U.S. CLS. 100, 101 AND 107).

PRISCILLA MILTON, EXAMINING ATTORNEY

SN 78-318,765. LORFING, INC., HOUSTON, TX. FILED 10-27-2003.

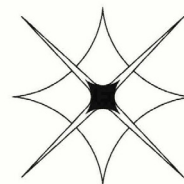
**GITTINGS**

OWNER OF U.S. REG. NO. 1,670,647.  
FOR PORTRAIT PHOTOGRAPHY SERVICES (U.S. CLS. 100, 101 AND 107).

FIRST USE 6-0-2001, THE MARK WAS FIRST USED ANYWHERE IN A DIFFERENT FORM OTHER THAN THAT SOUGHT TO BE REGISTERED ON 00/00/1933.; IN COMMERCE 7-0-2001, THE MARK WAS FIRST USED IN COMMERCE IN A DIFFERENT FORM OTHER THAN THAT SOUGHT TO BE REGISTERED ON 00/00/1955..

RENEE MCCRAY, EXAMINING ATTORNEY

**CLASS 41—(Continued).**

SN 78-322,144. BROWN, MARC K, AUSTIN, TX. FILED 11-3-2003.

**Digitalegacy**

THE MARK CONSISTS OF STANDARD CHARACTERS WITHOUT CLAIM TO ANY PARTICULAR FONT, STYLE, SIZE, OR COLOR.

FOR VIDEOTAPING AND PHOTOGRAPHY SERVICES; DVD PRODUCTION SERVICES (U.S. CLS. 100, 101 AND 107).

FIRST USE 1-0-2003; IN COMMERCE 6-0-2003.  
CAROLYN CATALDO, EXAMINING ATTORNEY

**CLASS 41—(Continued).**

SN 78-324,492. NEWS-JOURNAL CORPORATION, DAYTONA BEACH, FL. FILED 11-7-2003.

**NEWS-JOURNAL  
CENTER**

THE MARK CONSISTS OF STANDARD CHARACTERS WITHOUT CLAIM TO ANY PARTICULAR FONT, STYLE, SIZE, OR COLOR.

OWNER OF U.S. REG. NOS. 1,910,449, 2,633,669 AND OTHERS.

NO CLAIM IS MADE TO THE EXCLUSIVE RIGHT TO USE "CENTER", APART FROM THE MARK AS SHOWN.

FOR EDUCATION SERVICES IN THE FIELD OF FINE ARTS; ENTERTAINMENT SERVICES, NAMELY THE PRESENTATION OF THEATRICAL, MUSICAL, AND CINEMATIC SHOWS AND PERFORMANCES, AND CULTURAL EXHIBITIONS (U.S. CLS. 100, 101 AND 107).

WILLIAM VERHOSEK, EXAMINING ATTORNEY

SN 78-322,272. CABELA'S INC, SIDNEY, NE. FILED 11-3-2003.

**T.A.G.S**

THE MARK CONSISTS OF STANDARD CHARACTERS WITHOUT CLAIM TO ANY PARTICULAR FONT, STYLE, SIZE, OR COLOR.

FOR MISCELLANEOUS SERVICES, NAMELY, ASSISTING OTHERS IN APPLYING FOR AND OBTAINING HUNTING LICENSES (U.S. CLS. 100, 101 AND 107).

FIRST USE 1-5-2004; IN COMMERCE 1-5-2004.  
ALEXANDER L. POWERS, EXAMINING ATTORNEY

SN 78-326,928. NCSN, INC., NEW YORK, NY. FILED 11-12-2003.

**ISTV**

THE MARK CONSISTS OF STANDARD CHARACTERS WITHOUT CLAIM TO ANY PARTICULAR FONT, STYLE, SIZE, OR COLOR.

FOR TELEVISION AND CABLE TELEVISION PROGRAMMING AND PRODUCTION SERVICES (U.S. CLS. 100, 101 AND 107).

ALEX KEAM, EXAMINING ATTORNEY

**CLASS 41—(Continued).**

SN 78-328,289. CRANIUM INC., SEATTLE, WA. FILED 11-14-2003.

**CLASS 41—(Continued).**

SN 78-334,377. REAL ESTATE MEDIA, INC., NEW YORK, NY. FILED 12-1-2003.

**CRANIUM**

**GlobeSt.com**

THE MARK CONSISTS OF STANDARD CHARACTERS WITHOUT CLAIM TO ANY PARTICULAR FONT, STYLE, SIZE, OR COLOR.

OWNER OF U.S. REG. NOS. 2,267,778, 2,652,364 AND OTHERS.

NO CLAIM IS MADE TO THE EXCLUSIVE RIGHT TO USE COALITION AND ASSOCIATIONS, APART FROM THE MARK AS SHOWN.

FOR ENTERTAINMENT SERVICES, NAMELY, INTERACTIVE ONLINE GAMES SHOWS, ON-GOING TELEVISION PROGRAMS IN THE FIELD OF GAME SHOWS AND CHILDREN'S SHOWS, TELEVISION SERIES FEATURING GAMES AND GAMES ENTERTAINMENT SHOWS, AND SPECIAL TELEVISION GAMES PROGRAMS; EDUCATIONAL SERVICES, NAMELY, PROVIDING PUZZLES, TRIVIA QUESTIONS, BRAIN-TEASERS AND OTHER GAMES AND ACTIVITIES THAT TEACH PHYSICAL SKILLS, SOCIAL SKILLS, LEARNING SKILLS, MATH SKILLS, READING SKILLS, WRITING SKILLS AND LANGUAGE SKILLS AT THE PRESCHOOL, PRIMARY AND SECONDARY SCHOOL LEVELS AND FOR ADULTS (U.S. CLS. 100, 101 AND 107).

EVELYN BRADLEY, EXAMINING ATTORNEY

THE MARK CONSISTS OF STANDARD CHARACTERS WITHOUT CLAIM TO ANY PARTICULAR FONT, STYLE, SIZE, OR COLOR.

FOR PROVIDING ON-LINE MAGAZINES IN THE FIELD OF REAL ESTATE (U.S. CLS. 100, 101 AND 107).

FIRST USE 7-30-2000; IN COMMERCE 7-30-2000.  
CAROLINE WOOD, EXAMINING ATTORNEY

SN 78-334,598. CDT TRAINING, INC., ELMWOOD PARK, NJ. FILED 12-1-2003.

SN 78-334,259. CHILDS, JONATHAN W., WILLINGBORO, NJ. FILED 11-30-2003.

**Most Hated  
Entertainment**

**BARSAFE**

THE MARK CONSISTS OF STANDARD CHARACTERS WITHOUT CLAIM TO ANY PARTICULAR FONT, STYLE, SIZE, OR COLOR.

NO CLAIM IS MADE TO THE EXCLUSIVE RIGHT TO USE "ENTERTAINMENT", APART FROM THE MARK AS SHOWN.

FOR ENTERTAINMENT IN THE NATURE OF VISUAL AND AUDIO PERFORMANCES, NAMELY, MUSICAL BAND, ROCK GROUP, GYMNASTIC, DANCE, AND BALLET PERFORMANCES (U.S. CLS. 100, 101 AND 107).

EVELYN BRADLEY, EXAMINING ATTORNEY

THE MARK CONSISTS OF STANDARD CHARACTERS WITHOUT CLAIM TO ANY PARTICULAR FONT, STYLE, SIZE, OR COLOR.

FOR CONDUCTING INSTRUCTIONAL PROGRAMS, NAMELY, A SAFETY AND SELF DEFENSE COURSE FOR DOORMEN, BOUNCERS, AND BAR AND RESTAURANT EMPLOYEES (U.S. CLS. 100, 101 AND 107).

EVELYN BRADLEY, EXAMINING ATTORNEY

**CLASS 41—(Continued).**

SN 78-338,489. NICKEL SLOT PRODUCTIONS, LLC,  
BROOKLYN, NY. FILED 12-9-2003.

## Nickel Slot Productions

THE MARK CONSISTS OF STANDARD CHARACTERS  
WITHOUT CLAIM TO ANY PARTICULAR FONT, STYLE,  
SIZE, OR COLOR.

NO CLAIM IS MADE TO THE EXCLUSIVE RIGHT TO  
USE PRODUCTIONS, APART FROM THE MARK AS  
SHOWN.

FOR MOTION PICTURE FILM PRODUCTION (U.S.  
CLS. 100, 101 AND 107).

WON TEAK OH, EXAMINING ATTORNEY

**CLASS 41—(Continued).**

SN 78-341,213. FERTEL, MORTON, BALTIMORE, MD.  
FILED 12-16-2003.

## Marriage Fitness

THE MARK CONSISTS OF STANDARD CHARACTERS  
WITHOUT CLAIM TO ANY PARTICULAR FONT, STYLE,  
SIZE, OR COLOR.

NO CLAIM IS MADE TO THE EXCLUSIVE RIGHT TO  
USE "MARRIAGE", APART FROM THE MARK AS SHOWN.

FOR CONDUCTING SEMINARS AND LECTURES ON  
THE TOPIC OF IMPROVING MARRIAGE RELATION-  
SHIPS (U.S. CLS. 100, 101 AND 107).

HELEN BRYAN, EXAMINING ATTORNEY

SN 78-346,039. GEOFFREY, INC., WAYNE, NJ. FILED 12-29-  
2003.

SN 78-340,185. CARDINAL FITNESS OF DARIEN, L.L.C.,  
DARIEN, IL. FILED 12-12-2003.

## CARDINAL FITNESS

THE MARK CONSISTS OF STANDARD CHARACTERS  
WITHOUT CLAIM TO ANY PARTICULAR FONT, STYLE,  
SIZE, OR COLOR.

NO CLAIM IS MADE TO THE EXCLUSIVE RIGHT TO  
USE "FITNESS", APART FROM THE MARK AS SHOWN.

FOR PROVIDING PHYSICAL FITNESS AND EXER-  
CISE CONSULTATION, INSTRUCTION AND FACIL-  
ITIES (U.S. CLS. 100, 101 AND 107).

FIRST USE 10-6-2003; IN COMMERCE 10-6-2003.

JEAN IM, EXAMINING ATTORNEY

## GEOFFREY'S FUNDAY

THE MARK CONSISTS OF STANDARD CHARACTERS  
WITHOUT CLAIM TO ANY PARTICULAR FONT, STYLE,  
SIZE, OR COLOR.

OWNER OF U.S. REG. NOS. 2,652,783, 2,824,074 AND  
OTHERS.

FOR EDUCATIONAL AND ENTERTAINMENT SER-  
VICES, NAMELY CONDUCTING ACTIVITY PRO-  
GRAMS FOR CHILDREN AND ADULTS (U.S. CLS. 100,  
101 AND 107).

FIRST USE 2-1-2004; IN COMMERCE 2-1-2004.

JULIE WATSON, EXAMINING ATTORNEY

**CLASS 41—(Continued).**

SN 78-346,184. STRAMLER, JAMES H., HOUSTON, TX. FILED 12-29-2003.

**Universal  
Solutions**

THE MARK CONSISTS OF STANDARD CHARACTERS WITHOUT CLAIM TO ANY PARTICULAR FONT, STYLE, SIZE, OR COLOR.

NO CLAIM IS MADE TO THE EXCLUSIVE RIGHT TO USE "SOLUTIONS", APART FROM THE MARK AS SHOWN.

FOR EDUCATIONAL SERVICES, NAMELY, RESEARCHING AND CONDUCTING SEMINARS TO RAISE HUMAN AWARENESS AND CONSCIOUSNESS AND TO PROVIDE SOLUTIONS WHICH WOULD ENABLE HUMANITY TO LIVE A BETTER EXISTENCE ON EARTH, AND DISTRIBUTING COURSE MATERIALS IN CONNECTION THEREWITH (U.S. CLS. 100, 101 AND 107).

CYNTHIA SLOAN, EXAMINING ATTORNEY

SN 78-347,227. FINEPOINT MARKETING, INC., KENWOOD, CA. FILED 1-1-2004.

**Finepoint Circuit  
Breaker  
Conference**

THE MARK CONSISTS OF STANDARD CHARACTERS WITHOUT CLAIM TO ANY PARTICULAR FONT, STYLE, SIZE, OR COLOR.

NO CLAIM IS MADE TO THE EXCLUSIVE RIGHT TO USE "CIRCUIT BREAKER CONFERENCE", APART FROM THE MARK AS SHOWN.

FOR EDUCATIONAL SERVICES, NAMELY, ARRANGING AND CONDUCTING CONFERENCES, SEMINARS, AND WORKSHOPS FOR INDIVIDUALS INVOLVED WITH CIRCUIT BREAKERS IN THE ELECTRIC POWER INDUSTRY (U.S. CLS. 100, 101 AND 107).

FIRST USE 5-28-1999; IN COMMERCE 5-28-1999.  
JILL C. ALT, EXAMINING ATTORNEY

**CLASS 41—(Continued).**

SN 78-348,142. WE: WOMEN'S ENTERTAINMENT LLC, JERICHO, NY. FILED 1-6-2004.

**TAKE MY KIDS  
PLEASE!**

THE MARK CONSISTS OF STANDARD CHARACTERS WITHOUT CLAIM TO ANY PARTICULAR FONT, STYLE, SIZE, OR COLOR.

FOR ENTERTAINMENT SERVICES, NAMELY, AN ON-GOING REALITY-BASED CABLE TELEVISION PROGRAM FEATURING DRAMA AND COMEDY (U.S. CLS. 100, 101 AND 107).

ZHALEH DELANEY, EXAMINING ATTORNEY

SN 78-348,255. CLIF BAR INC., BERKELEY, CA. FILED 1-6-2004.



OWNER OF U.S. REG. NOS. 2,143,787 AND 2,573,420.  
NO CLAIM IS MADE TO THE EXCLUSIVE RIGHT TO USE "PACE TEAM", APART FROM THE MARK AS SHOWN.

FOR PROVIDING MARATHON PACING SERVICES FOR RUNNERS (U.S. CLS. 100, 101 AND 107).

FIRST USE 12-15-2003; IN COMMERCE 12-15-2003.  
BARBARA RUTLAND, EXAMINING ATTORNEY

SN 78-348,317. DOG BREEDERS ONLINE DIRECTORY, INC., MARINA DEL REY, CA. FILED 1-6-2004.

**THE STRAIGHT POOP**

THE MARK CONSISTS OF STANDARD CHARACTERS WITHOUT CLAIM TO ANY PARTICULAR FONT, STYLE, SIZE, OR COLOR.

FOR PROVIDING A NEWSLETTER PERTAINING TO DOGS VIA E-MAIL (U.S. CLS. 100, 101 AND 107).

FIRST USE 12-31-1999; IN COMMERCE 12-31-1999.  
RAUL CORDOVA, EXAMINING ATTORNEY

**CLASS 41—(Continued).**

SN 78-348,346. LOYOT, AMELIE, SCITUATE, MA. FILED 1-6-2004.

**CLASS 41—(Continued).**

SN 78-349,101. BUSINESSPEAK INC., CAMBRIDGE, MA. FILED 1-7-2004.

## LITTLE SEEKERS

THE MARK CONSISTS OF STANDARD CHARACTERS WITHOUT CLAIM TO ANY PARTICULAR FONT, STYLE, SIZE, OR COLOR.

FOR ENTERTAINMENT SERVICES, NAMELY WRITING SCRIPTS AND TREATMENTS FOR OTHERS; WRITING CHILDREN'S STORIES; PRODUCTION OF AUDIO VISUAL PROGRAMS FOR CHILDREN, CHILDREN'S TALK SHOWS, AND CHILDREN'S MOVIES FOR DISSEMINATION IN ALL MEDIA; PROVIDING A WEB SITE FEATURING CHILD-ORIENTED CONTENT; EDUCATION SERVICES, NAMELY PROVIDING AUDIO VISUAL PROGRAMMING FOR CHILDREN (U.S. CLS. 100, 101 AND 107).

HENRY S. ZAK, EXAMINING ATTORNEY

## eBriefcase

THE MARK CONSISTS OF STANDARD CHARACTERS WITHOUT CLAIM TO ANY PARTICULAR FONT, STYLE, SIZE, OR COLOR.

FOR EDUCATIONAL SERVICES, NAMELY, PROVIDING SEMINARS AND COURSES OF INSTRUCTION FOR PROFESSIONALS IN ENGLISH (U.S. CLS. 100, 101 AND 107).

THEODORE MCBRIDE, EXAMINING ATTORNEY

SN 78-348,452. ANAMIKA, RANCHO SANTA FE, CA. FILED 1-6-2004.

SN 78-349,900. LETTERS & SCIENCES, LLC, WHIPPANY, NJ. FILED 1-9-2004.

## SAKKARA TEMPLE OF AWAKENING



THE MARK CONSISTS OF STANDARD CHARACTERS WITHOUT CLAIM TO ANY PARTICULAR FONT, STYLE, SIZE, OR COLOR.

OWNER OF U.S. REG. NOS. 1,969,642 AND 2,706,934.

NO CLAIM IS MADE TO THE EXCLUSIVE RIGHT TO USE "SAKKARA", APART FROM THE MARK AS SHOWN.

FOR EDUCATIONAL SERVICES, NAMELY CONDUCTING WORKSHOPS AND CLASSES IN THE FIELD OF PHYSICAL, EMOTIONAL, MENTAL AND SPIRITUAL WELLNESS, AND THE DISSEMINATION OF PRINTED MATERIALS AND MULTI MEDIA MATERIALS IN CONNECTION THEREWITH (U.S. CLS. 100, 101 AND 107).

EVELYN BRADLEY, EXAMINING ATTORNEY

NO CLAIM IS MADE TO THE EXCLUSIVE RIGHT TO USE "ADVANCES IN CANCER RESEARCH AND PRACTICE", APART FROM THE MARK AS SHOWN.

FOR EDUCATIONAL SERVICES, NAMELY, DEVELOPING AND CONVENING AN ANNUAL CANCER NURSING SCIENTIFIC SYMPOSIUM; EDUCATIONAL SERVICES, NAMELY, DEVELOPING AND CONVENING AN ONCOLOGY PHARMACY SCIENTIFIC SYMPOSIUM (U.S. CLS. 100, 101 AND 107).

KARANENDRA S. CHHINA, EXAMINING ATTORNEY

**CLASS 41—(Continued).**

SN 78-350,642. UNITED AIR LINES, INC., ELK GROVE TOWNSHIP, IL. FILED 1-12-2004.

**CLASS 41—(Continued).**

SN 78-352,909. NICKERSON, JOHN, FOLSOM, CA. FILED 1-16-2004.

# YOGATROPOLIS

# TEDVIDEO

THE MARK CONSISTS OF STANDARD CHARACTERS WITHOUT CLAIM TO ANY PARTICULAR FONT, STYLE, SIZE, OR COLOR.

FOR YOGA INSTRUCTION SERVICES (U.S. CLS. 100, 101 AND 107).

MARC LEIPZIG, EXAMINING ATTORNEY

---

SN 78-353,066. HARRAH'S OPERATING COMPANY, INC., LAS VEGAS, NV. FILED 1-16-2004.

THE MARK CONSISTS OF STANDARD CHARACTERS WITHOUT CLAIM TO ANY PARTICULAR FONT, STYLE, SIZE, OR COLOR.

FOR PROVIDING IN-FLIGHT ENTERTAINMENT SERVICES, NAMELY AUDIO-VISUAL BROADCASTS, VIDEOS AND FILMS FOR PERSONAL LISTENING AND VIEWING (U.S. CLS. 100, 101 AND 107).

REGINA DRUMMOND, EXAMINING ATTORNEY

# WORLD SERIES OF CRAPS

THE MARK CONSISTS OF STANDARD CHARACTERS WITHOUT CLAIM TO ANY PARTICULAR FONT, STYLE, SIZE, OR COLOR.

NO CLAIM IS MADE TO THE EXCLUSIVE RIGHT TO USE "CRAPS", APART FROM THE MARK AS SHOWN.

FOR CASINO ENTERTAINMENT SERVICES; SPONSORING AND CONDUCTING CRAP GAMES AND CONTESTS; PLANNING AND MANAGING EXHIBITION SHOWS FOR GAMING TOURNAMENTS; PRODUCING TELEVISION PROGRAM FEATURING GAMING TOURNAMENTS (U.S. CLS. 100, 101 AND 107).

ANNE MADDEN, EXAMINING ATTORNEY

---

SN 78-352,225. BAYER HEALTHCARE LLC, PITTSBURGH, PA. FILED 1-15-2004.

---

SN 78-353,185. VIACOM INTERNATIONAL INC., NEW YORK, NY. FILED 1-16-2004.

# PARTNERING WITH THE PROFESSION

# 20 MILLION LOUD

THE MARK CONSISTS OF STANDARD CHARACTERS WITHOUT CLAIM TO ANY PARTICULAR FONT, STYLE, SIZE, OR COLOR.

FOR PROVIDING EDUCATIONAL SERVICES, NAMELY SEMINARS AND WORKSHOPS FOR VETERINARIANS TO DEVELOP BUSINESS SKILLS, AND COURSE MATERIALS DISTRIBUTED THEREWITH (U.S. CLS. 100, 101 AND 107).

GLENN CLARK, EXAMINING ATTORNEY

THE MARK CONSISTS OF STANDARD CHARACTERS WITHOUT CLAIM TO ANY PARTICULAR FONT, STYLE, SIZE, OR COLOR.

FOR SERIES OF TELEVISION ON AIR SPOTS, PROGRAMS AND INTERSTITIALS, OFFERED PERIODICALLY, ON POLITICAL AND ELECTION ISSUES (U.S. CLS. 100, 101 AND 107).

ANNE MADDEN, EXAMINING ATTORNEY

**CLASS 41—(Continued).**

SN 78-353,455. BANDAI ENTERTAINMENT INC., CYPRESS, CA. FILED 1-17-2004.

DICE DNA  
INTEGRATED  
CYBERNETIC  
ENTERPRISES

THE MARK CONSISTS OF STANDARD CHARACTERS WITHOUT CLAIM TO ANY PARTICULAR FONT, STYLE, SIZE, OR COLOR.

FOR ENTERTAINMENT SERVICES, NAMELY, PROVIDING ON-LINE MUSIC, MOVIES AND INFORMATION REGARDING GAMES, MUSIC AND A TELEVISION SERIES; ENTERTAINMENT IN THE NATURE OF A TELEVISION ANIMATED CARTOON SERIES TO BE BROADCASTED VIA NETWORK, CABLE AND SATELLITE TRANSMISSION (U.S. CLS. 100, 101 AND 107).

CAROLINE WEIMER, EXAMINING ATTORNEY

SN 78-353,663. NATIONAL SCIENCE AND TECHNOLOGY EDUCATION PARTNERSHIP, ARLINGTON, VA. FILED 1-19-2004.

TechXplore

THE MARK CONSISTS OF STANDARD CHARACTERS WITHOUT CLAIM TO ANY PARTICULAR FONT, STYLE, SIZE, OR COLOR.

FOR EDUCATIONAL SERVICES, NAMELY, PROVIDING INTERNET-BASED SCIENCE COURSES THROUGH COLLABORATIVE RESEARCH PROJECTS FOR K-12 STUDENTS (U.S. CLS. 100, 101 AND 107).

FIRST USE 7-1-2002; IN COMMERCE 7-1-2002.  
JOSETTE BEVERLY, EXAMINING ATTORNEY

**CLASS 41—(Continued).**

SN 78-353,817. MONEY, KATHY, SAN FRANCISCO, CA. FILED 1-19-2004.

RED HOT HOUSE OF  
LOVE

THE MARK CONSISTS OF STANDARD CHARACTERS WITHOUT CLAIM TO ANY PARTICULAR FONT, STYLE, SIZE, OR COLOR.

FOR ENTERTAINMENT SERVICES, NAMELY PROVIDING A WEB SITE FEATURING IMAGES, SOUND, VIDEO, RELATED FILM CLIPS AND OTHER MULTIMEDIA MATERIALS (U.S. CLS. 100, 101 AND 107).

SHARI SHEFFIELD, EXAMINING ATTORNEY

SN 78-354,044. ARTSONIA LLC, CHICAGO, IL. FILED 1-20-2004.



THE MARK CONSISTS OF ARTSONIA TEXT WITH A PAINT BLOB AS THE DOT ON THE LETTER I.

FOR EDUCATIONAL SERVICES, NAMELY, CONDUCTING ON-LINE EXHIBITIONS AND DISPLAYS AND INTERACTIVE EXHIBITS IN THE FIELD OF THE ARTS (U.S. CLS. 100, 101 AND 107).

FIRST USE 8-1-2000; IN COMMERCE 8-1-2000.

ELIZABETH PIGNATELLO, EXAMINING ATTORNEY

SN 78-354,199. BOWERMASTER, JAMES H., DES MOINES, IA. FILED 1-20-2004.

THE JAZZ MAN SHOW

THE MARK CONSISTS OF STANDARD CHARACTERS WITHOUT CLAIM TO ANY PARTICULAR FONT, STYLE, SIZE, OR COLOR.

NO CLAIM IS MADE TO THE EXCLUSIVE RIGHT TO USE "SHOW", APART FROM THE MARK AS SHOWN. SEC. 2(F).

FOR ENTERTAINMENT, NAMELY, A RADIO SHOW FEATURING JAZZ MUSIC (U.S. CLS. 100, 101 AND 107).

FIRST USE 2-1-1992; IN COMMERCE 2-1-1992.  
DORITT L. CARROLL, EXAMINING ATTORNEY



**CLASS 41—(Continued).**

SN 78-354,206. SHAFFSTALL, JAY, COLUMBUS, OH. FILED 1-20-2004.

## Discover Who You Can Be

THE MARK CONSISTS OF STANDARD CHARACTERS WITHOUT CLAIM TO ANY PARTICULAR FONT, STYLE, SIZE, OR COLOR.

FOR CONDUCTING WORKSHOPS AND SEMINARS IN PERSONAL GROWTH (U.S. CLS. 100, 101 AND 107).  
ODESSA BIBBINS, EXAMINING ATTORNEY

---

SN 78-354,299. URBAN, KEITH, NASHVILLE, TN. FILED 1-20-2004.



FOR ENTERTAINMENT SERVICES, NAMELY, LIVE MUSICAL PERFORMANCES BY A SOLO RECORDING ARTIST; PROVIDING A WEB SITE FEATURING PRE-RECORDED MUSICAL AUDIO CLIPS, PHOTOGRAPHS, NEWS, REVIEWS AND OTHER MULTIMEDIA ARTICLES IN CONNECTION WITH A SOLO RECORDING ARTIST; AND FAN CLUB SERVICES (U.S. CLS. 100, 101 AND 107).

MATTHEW KLINE, EXAMINING ATTORNEY

**CLASS 41—(Continued).**

SN 78-354,302. URBAN, KEITH, NASHVILLE, TN. FILED 1-20-2004.

## GUITAR MONKEY

THE MARK CONSISTS OF STANDARD CHARACTERS WITHOUT CLAIM TO ANY PARTICULAR FONT, STYLE, SIZE, OR COLOR.

NO CLAIM IS MADE TO THE EXCLUSIVE RIGHT TO USE "GUITAR", APART FROM THE MARK AS SHOWN.

FOR ENTERTAINMENT SERVICES, NAMELY, LIVE MUSICAL PERFORMANCES BY A SOLO RECORDING ARTIST; PROVIDING A WEB SITE FEATURING PRE-RECORDED MUSICAL AUDIO CLIPS, PHOTOGRAPHS, NEWS, REVIEWS AND OTHER MULTIMEDIA ARTICLES IN CONNECTION WITH A SOLO RECORDING ARTIST; AND FAN CLUB SERVICES (U.S. CLS. 100, 101 AND 107).

MATTHEW KLINE, EXAMINING ATTORNEY

---

SN 78-354,717. KIWANIS INTERNATIONAL, INC., INDIANAPOLIS, IN. FILED 1-21-2004.

## KEY LEADER

THE MARK CONSISTS OF STANDARD CHARACTERS WITHOUT CLAIM TO ANY PARTICULAR FONT, STYLE, SIZE, OR COLOR.

FOR EDUCATIONAL SERVICES, NAMELY CONDUCTING A LEADERSHIP TRAINING PROGRAM FOR YOUNG MEN AND WOMEN IN THEIR FRESHMEN THROUGH SENIOR YEARS IN HIGH SCHOOL WITH THE GOAL OF DEVELOPING MORAL CHARACTER, LEADERSHIP SKILLS, AND LOYALTY TO SCHOOL, COMMUNITY AND NATION (U.S. CLS. 100, 101 AND 107).

JOHN DALIER, EXAMINING ATTORNEY

**CLASS 41—(Continued).**

SN 78-357,352. SCHLUMBERGER TECHNOLOGY CORPORATION, SUGAR LAND, TX. FILED 1-26-2004.

### MAINTAIN SPACE AND VISIBILITY

THE MARK CONSISTS OF STANDARD CHARACTERS WITHOUT CLAIM TO ANY PARTICULAR FONT, STYLE, SIZE, OR COLOR.

FOR TRAINING SERVICES IN THE FIELD OF MOTOR VEHICLE OPERATION AND SAFETY (U.S. CLS. 100, 101 AND 107).

ANDREW BENZMILLER, EXAMINING ATTORNEY

---

SN 78-357,551. PAUL, CHARLES, SAN DIEGO, CA. FILED 1-26-2004.

### AMERICA'S 'FUNNEST' FAMILY

THE MARK CONSISTS OF STANDARD CHARACTERS WITHOUT CLAIM TO ANY PARTICULAR FONT, STYLE, SIZE, OR COLOR.

NO CLAIM IS MADE TO THE EXCLUSIVE RIGHT TO USE "AMERICA'S" OR "FAMILY", APART FROM THE MARK AS SHOWN.

FOR ORGANIZING AND CONDUCTING A CONTEST WHEREBY THE CONTESTANTS COMPETE BY SUBMITTING INFORMATION ON THEIR ACTIVITIES WHICH CREATE FUN, LAUGHTER, AND LIGHT-HEARTEDNESS WITH MEANINGFUL, POSITIVE RESULTS IN THEIR HOME, FAMILY AND COMMUNITY (U.S. CLS. 100, 101 AND 107).

DAWN FELDMAN, EXAMINING ATTORNEY

---

SN 78-357,561. PAUL, CHARLES, SAN DIEGO, CA. FILED 1-26-2004.

### AMERICA'S 'FUNNEST' DAD

THE MARK CONSISTS OF STANDARD CHARACTERS WITHOUT CLAIM TO ANY PARTICULAR FONT, STYLE, SIZE, OR COLOR.

NO CLAIM IS MADE TO THE EXCLUSIVE RIGHT TO USE "AMERICA'S" OR "DAD", APART FROM THE MARK AS SHOWN.

FOR ORGANIZING AND CONDUCTING A CONTEST WHEREBY THE CONTESTANTS COMPETE BY SUBMITTING INFORMATION ON THEIR ACTIVITIES WHICH CREATE FUN, LAUGHTER, AND LIGHT-HEARTEDNESS WITH MEANINGFUL, POSITIVE RESULTS IN THEIR HOME, FAMILY AND COMMUNITY (U.S. CLS. 100, 101 AND 107).

DAWN FELDMAN, EXAMINING ATTORNEY

**CLASS 41—(Continued).**

SN 78-357,575. PAUL, CHARLES, SAN DIEGO, CA. FILED 1-26-2004.

### AMERICA'S 'FUNNEST' MOM

THE MARK CONSISTS OF STANDARD CHARACTERS WITHOUT CLAIM TO ANY PARTICULAR FONT, STYLE, SIZE, OR COLOR.

NO CLAIM IS MADE TO THE EXCLUSIVE RIGHT TO USE AMERICA'S AND MOM, APART FROM THE MARK AS SHOWN.

FOR ORGANIZING AND CONDUCTING A CONTEST WHEREBY THE CONTESTANTS COMPETE BY SUBMITTING INFORMATION ON THEIR ACTIVITIES WHICH CREATE FUN, LAUGHTER, AND LIGHT-HEARTEDNESS WITH MEANINGFUL, POSITIVE RESULTS IN THEIR HOME, FAMILY AND COMMUNITY (U.S. CLS. 100, 101 AND 107).

KAREN K. BUSH, EXAMINING ATTORNEY

---

SN 78-357,599. AMERICAN CANCER SOCIETY, PENNSYLVANIA DIVISION, INC., ATLANTA, GA. FILED 1-26-2004.

### MOVERS & SHAPERS

THE MARK CONSISTS OF STANDARD CHARACTERS WITHOUT CLAIM TO ANY PARTICULAR FONT, STYLE, SIZE, OR COLOR.

FOR EDUCATIONAL SERVICES, NAMELY, CONDUCTING NUTRITION AND FITNESS EDUCATION PROGRAMS TO PROMOTE HEALTHY LIFESTYLES IN SCHOOLS, WORKSITES AND COMMUNITIES (U.S. CLS. 100, 101 AND 107).

FIRST USE 8-1-2002; IN COMMERCE 11-1-2002.

JOHN DWYER, EXAMINING ATTORNEY

**CLASS 41—(Continued).**

SN 78-357,661. LATIBAER EHF., GARDABAER, ICELAND,  
FILED 1-26-2004.

# SPORTACUS

THE MARK CONSISTS OF STANDARD CHARACTERS WITHOUT CLAIM TO ANY PARTICULAR FONT, STYLE, SIZE, OR COLOR.

FOR AMUSEMENT ARCADES, AMUSEMENT CENTERS, AMUSEMENT PARKS, ANIMAL EXHIBITIONS, ANIMATION PRODUCTION SERVICES, ARRANGING AND CONDUCTING ATHLETIC COMPETITIONS, ARRANGING AND CONDUCTING EDUCATIONAL CONFERENCES, ARRANGING FOR TICKET RESERVATIONS FOR SHOWS AND OTHER ENTERTAINMENT EVENTS, AUDIO RECORDING AND PRODUCTION, BALLET SCHOOLS, BASEBALL CAMPS, BASKETBALL CAMPS, CABLE TELEVISION PROGRAMMING, CHILDREN'S ENTERTAINMENT AND AMUSEMENT CENTERS, NAMELY, INTERACTIVE PLAY AREAS, CINEMA STUDIOS, CINEMA THEATERS, COMPUTER CAMPS, COMPUTER EDUCATION TRAINING SERVICES, COMPUTER EDUCATION TRAINING, DANCE SCHOOLS, DANCE STUDIOS, DEVELOPING EDUCATIONAL MANUALS FOR OTHERS IN THE FIELD OF HEALTH AND FITNESS, DISC JOCKEYS FOR PARTIES AND SPECIAL EVENTS, EDUCATIONAL SERVICES, NAMELY, PROVIDING COURSES OF INSTRUCTION AT THE PRIMARY, SECONDARY, LEVEL, ENTERTAINMENT IN THE NATURE OF BASKETBALL GAMES, ENTERTAINMENT IN NATURE OF CIRCUSES, ENTERTAINMENT IN THE NATURE OF COMPETITIONS IN THE FIELD OF ATHLETICS, ENTERTAINMENT IN THE NATURE OF DANCE PERFORMANCES, ENTERTAINMENT IN THE NATURE OF AN AMUSEMENT PARK RIDES, ENTERTAINMENT IN THE NATURE OF FASHION SHOWS, ENTERTAINMENT IN NATURE OF FOOTBALL GAMES, ENTERTAINMENT IN THE NATURE OF GYMNASTIC PERFORMANCES, ENTERTAINMENT IN THE NATURE OF HOCKEY GAMES, ENTERTAINMENT IN THE NATURE OF SOCCER GAMES, ENTERTAINMENT IN THE NATURE OF SPORTS TOURNAMENTS, ENTERTAINMENT IN THE NATURE OF THEATER PRODUCTIONS, ENTERTAINMENT IN THE NATURE OF VISUAL AND AUDIO PERFORMANCES, NAMELY MUSICAL BAND, ROCK GROUP, GYMNASTIC, DANCE, AND BALLET PERFORMANCES, JUDO INSTRUCTIONS, KARATE INSTRUCTION, LIBRARIES, MOTION PICTURE FILM PRODUCTION, MOTION PICTURE SONG PRODUCTION, MOTION PICTURE THEATERS, MOVIE STUDIOS, MOVIE THEATERS, MULTIMEDIA ENTERTAINMENT SOFTWARE PRODUCTION SERVICES, MUSEUMS, MUSIC COMPOSITION FOR OTHERS, MUSIC PRODUCTION SERVICES, MUSIC PUBLISHING SERVICES, MUSIC TRANSCRIPTION FOR OTHERS, NURSERY SCHOOLS, OFFICIATING AT SPORTS CONTESTS, ORGANIZING COMMUNITY SPORTING AND CULTURAL EVENTS, PERSONAL TRAINER SERVICES, PERSONAL TRAINING SERVICES, NAMELY, STRENGTH AND CONDITIONING TRAINING, PHYSICAL EDUCATION SERVICES, PHYSICAL FITNESS INSTRUCTION, PRODUCTION AND DISTRIBUTION OF MOTION PICTURES, PRODUCTION OF CABLE TELEVISION PROGRAMS, PRODUCTION OF CLOSED CAPTION TELEVISION PROGRAMS, PRODUCTION OF RADIO AND TELEVISION PROGRAMS, PRODUCTION OF VIDEO DISCS FOR OTHERS, PROVIDING A COMPUTER GAME THAT MAY BE ACCESSED NETWORK-WIDE BY NETWORK USERS,

**CLASS 41—(Continued).**

PROVIDING INFORMATION ON-LINE RELATING TO COMPUTER GAMES AND COMPUTER ENHANCEMENT FOR GAMES, PROVIDING SPORTS FACILITIES, PROVIDING THEME PARK SERVICES, PUBLICATION OF BOOKS, BROCHURES, JOURNALS, LEAFLETS, MAGAZINES, MANUALS, TEXT BOOKS, RADIO ENTERTAINMENT PRODUCTION, RECORD PRODUCTION, RECREATIONAL CAMPS, RECREATIONAL PARK SERVICES, ROLLER SKATING INSTRUCTION, SKI RESORTS, SOCCER CAMPS, SOCCER INSTRUCTION, SPORT CAMPS, SUMMER CAMPS, TELEVISION PRODUCTION (U.S. CLS. 100, 101 AND 107).  
ANDREA K. NADELMAN, EXAMINING ATTORNEY

SN 78-357,992. STORCH, MAJA, 78234 ENGEN, FED REP GERMANY, FILED 1-27-2004.

## REWIRE YOUR BRAIN

THE MARK CONSISTS OF STANDARD CHARACTERS WITHOUT CLAIM TO ANY PARTICULAR FONT, STYLE, SIZE, OR COLOR.

FOR PROFESSIONAL AND PERSONAL DEVELOPMENT SEMINARS AND WORKSHOPS (U.S. CLS. 100, 101 AND 107).

FIRST USE 1-12-2004; IN COMMERCE 1-12-2004.  
RON FAIRBANKS, EXAMINING ATTORNEY

SN 78-358,505. AUSTIN COMMUNITY COLLEGE, AUSTIN, TX. FILED 1-28-2004.

## Start Here. Get There.

THE MARK CONSISTS OF STANDARD CHARACTERS WITHOUT CLAIM TO ANY PARTICULAR FONT, STYLE, SIZE, OR COLOR.

FOR EDUCATIONAL SERVICES, NAMELY, PROVIDING COURSES OF INSTRUCTION AT THE COMMUNITY COLLEGE LEVEL (U.S. CLS. 100, 101 AND 107).

FIRST USE 3-1-1999; IN COMMERCE 3-1-1999.  
ALICE BENMAMAN, EXAMINING ATTORNEY

**CLASS 41—(Continued).**

SN 78-358,671. GEIER, JAY A., MASON, OH. FILED 1-28-2004.

# Moodism

THE MARK CONSISTS OF STANDARD CHARACTERS WITHOUT CLAIM TO ANY PARTICULAR FONT, STYLE, SIZE, OR COLOR.

FOR EDUCATIONAL SERVICES, NAMELY PROVIDING PROGRAMS IN THE AREA OF PERSONAL DEVELOPMENT (U.S. CLS. 100, 101 AND 107).

FIRST USE 7-1-2003; IN COMMERCE 7-23-2003.  
DARRYL SPRUILL, EXAMINING ATTORNEY

SN 78-358,696. GEIER, JAY A., MASON, OH. FILED 1-28-2004.

THE MARK CONSISTS OF A FACE WHEREIN THE EYES OF THE FACE ARE MADE FROM THE "OO" IN THE WORD "MOODISM".

FOR EDUCATIONAL SERVICES, NAMES PROVIDING PROGRAMS IN THE AREA OF PERSONAL DEVELOPMENT (U.S. CLS. 100, 101 AND 107).

FIRST USE 7-1-2003; IN COMMERCE 7-23-2003.  
DARRYL SPRUILL, EXAMINING ATTORNEY

SN 78-358,909. LMNO PRODUCTIONS, INC., ENCINO, CA. FILED 1-28-2004.

## THE LITTLEST BRIDE

THE MARK CONSISTS OF STANDARD CHARACTERS WITHOUT CLAIM TO ANY PARTICULAR FONT, STYLE, SIZE, OR COLOR.

FOR ENTERTAINMENT IN THE NATURE OF AN ONGOING RELATIONSHIP/DATING REALITY TELEVISION PROGRAM FEATURING SINGLE MEN WHO ARE LITTLE PEOPLE CHOOSING WHO TO DATE AMONGST SEVERAL SINGLE WOMEN WHO ARE ALSO LITTLE PEOPLE (U.S. CLS. 100, 101 AND 107).

LAURA KOVAISKY, EXAMINING ATTORNEY

**CLASS 41—(Continued).**

SN 78-359,019. BENJAMIN, CHARLES BROOKS, HARRISMAN, TN. FILED 1-28-2004.



## LYCAN ENTERTAINMENT

NO CLAIM IS MADE TO THE EXCLUSIVE RIGHT TO USE "ENTERTAINMENT", APART FROM THE MARK AS SHOWN.

THE MARK CONSISTS OF THE LETTERS THAT ARE IN A STYLIZED FORMAT WITH THE BOTTOMS OF THE LETTERS COMING TO A POINT.

FOR MOTION PICTURE FILM PRODUCTION (U.S. CLS. 100, 101 AND 107).

GINA FINK, EXAMINING ATTORNEY

SN 78-359,181. DBLS HOLDINGS, LTD., NEWTON, MA. FILED 1-29-2004.

## LINKING KNOWLEDGE TO ACTION

THE MARK CONSISTS OF STANDARD CHARACTERS WITHOUT CLAIM TO ANY PARTICULAR FONT, STYLE, SIZE, OR COLOR.

FOR TRAINING AND EDUCATIONAL PROGRAMS IN THE FIELD OF SALES (U.S. CLS. 100, 101 AND 107).

JOHN DWYER, EXAMINING ATTORNEY

SN 78-359,766. EXTENDED DISC CARIBBEAN LTD., KINGSTON 8, JAMAICA, FILED 1-29-2004.

## Success with People

THE MARK CONSISTS OF STANDARD CHARACTERS WITHOUT CLAIM TO ANY PARTICULAR FONT, STYLE, SIZE, OR COLOR.

FOR TRAINING SERVICES IN THE FIELD OF THE DEVELOPMENT OF INDIVIDUALS, TEAMS AND ORGANIZATIONS (U.S. CLS. 100, 101 AND 107).

INGRID C. EULIN, EXAMINING ATTORNEY

**CLASS 41—(Continued).**

SN 78-359,791. INFONE LLC, BEAVERTON, OR. FILED 1-29-2004.

IMAGINE YOUR LIFE  
WITH A PERSONAL  
ASSISTANT

THE MARK CONSISTS OF STANDARD CHARACTERS WITHOUT CLAIM TO ANY PARTICULAR FONT, STYLE, SIZE, OR COLOR.

FOR PROVIDING INFORMATION ABOUT THE VENUE, TIME, TICKET INFORMATION, CONTENT, RESERVATION INFORMATION AND REVIEWS FOR PUBLIC EVENTS, ATTRACTIONS, PUBLIC ACTIVITIES, SPORTS EVENTS, CONFERENCES, LECTURES, CLASSES, FESTIVALS, AND EXHIBITS (U.S. CLS. 100, 101 AND 107).

FIRST USE 1-30-2004; IN COMMERCE 1-30-2004.  
JOSETTE BEVERLY, EXAMINING ATTORNEY

**CLASS 41—(Continued).**

SN 78-360,185. GOODSTEIN, RONALD, ROCK HILL, NY. FILED 1-30-2004.



FOR EDUCATIONAL PROGRAM FOR CHILDREN IN FOURTH THROUGH TWELFTH GRADES DESIGNED TO DISCOURAGE AND PREVENT BULLYING AND TEASING AMONG THE STUDENTS AND THEIR PEERS, AIMED AT PREVENTING SCHOOL VIOLENCE, AND DISTRIBUTING WRITTEN MATERIALS, TEACHING TOOLS AND PROMOTIONAL ITEMS TO SCHOOL SETTINGS IN CONNECTION THEREWITH (U.S. CLS. 100, 101 AND 107).

CAROLYN GRAY, EXAMINING ATTORNEY

SN 78-360,156. GOODSTEIN, RONALD, ROCK HILL, NY. FILED 1-30-2004.

SN 78-360,466. SALEM COMMUNICATIONS HOLDING CORPORATION, CAMARILLO, CA. FILED 1-30-2004.

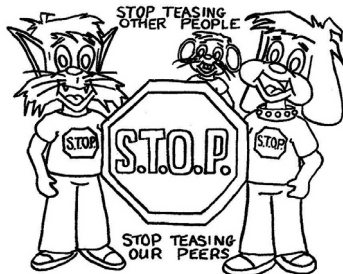

**BIG SPLASH**

FOR EDUCATIONAL PROGRAM FOR CHILDREN IN PRE-K THROUGH THIRD GRADE DESIGNED TO DISCOURAGE AND PREVENT BULLYING AND TEASING AMONG CHILDREN, AND DISTRIBUTING WRITTEN MATERIALS, TEACHING TOOLS AND PROMOTIONAL ITEMS TO SCHOOL SETTINGS IN CONNECTION THEREWITH (U.S. CLS. 100, 101 AND 107).

CAROLYN GRAY, EXAMINING ATTORNEY

THE MARK CONSISTS OF STANDARD CHARACTERS WITHOUT CLAIM TO ANY PARTICULAR FONT, STYLE, SIZE, OR COLOR.

FOR ENTERTAINMENT SERVICES IN THE NATURE OF FESTIVALS FEATURING MUSICAL AND OTHER ENTERTAINMENT (U.S. CLS. 100, 101 AND 107).

FIRST USE 6-30-1989; IN COMMERCE 6-30-1989.  
WILLIAM BRECKENFELD, EXAMINING ATTORNEY

**CLASS 41—(Continued).**

SN 78-360,644. FLUID THE BAND, AUCKLAND, NEW ZEALAND, FILED 1-31-2004.

**CLASS 41—(Continued).**

SN 78-361,528. FABBRICA D'ARMI P. BERETTA, S.P.A., 25063 GARDONE VAL TROMPIA, ITALY, FILED 2-3-2004.

## Like a Storm

THE MARK CONSISTS OF STANDARD CHARACTERS WITHOUT CLAIM TO ANY PARTICULAR FONT, STYLE, SIZE, OR COLOR.

FOR ENTERTAINMENT IN THE NATURE OF VISUAL AND AUDIO PERFORMANCES, NAMELY, MUSICAL BAND, ROCK GROUP, GYMNASTIC, DANCE, AND BALLET PERFORMANCES (U.S. CLS. 100, 101 AND 107).  
SHARON MEIER, EXAMINING ATTORNEY

## WORLD OF BERETTA

THE MARK CONSISTS OF STANDARD CHARACTERS WITHOUT CLAIM TO ANY PARTICULAR FONT, STYLE, SIZE, OR COLOR.

OWNER OF U.S. REG. NOS. 587,716, 2,786,096 AND OTHERS.

FOR ENTERTAINMENT SERVICES, NAMELY, A TELEVISION SERIES IN THE NATURE OF AN OUTDOOR ADVENTURE SHOW (U.S. CLS. 100, 101 AND 107).

KEVON CHISOLM, EXAMINING ATTORNEY

SN 78-361,272. THE SEXY MAGAZINES LLC, LOS ANGELES, CA. FILED 2-2-2004.

SN 78-361,782. ANIPLEX, INC., TOKYO, JAPAN, FILED 2-3-2004.

## THE SEXY MAGAZINES

THE MARK CONSISTS OF STANDARD CHARACTERS WITHOUT CLAIM TO ANY PARTICULAR FONT, STYLE, SIZE, OR COLOR.

FOR ENTERTAINMENT SERVICES IN THE NATURE OF LIVE MUSICAL PERFORMANCES BY A PERFORMER OR GROUP; FAN CLUB SERVICES; AND ENTERTAINMENT SERVICES, NAMELY, PROVIDING A WEB SITE FEATURING MUSICAL PERFORMANCES, MUSICAL VIDEOS, RELATED FILM CLIPS, PHOTOGRAPHS AND OTHER MULTIMEDIA MATERIALS, COMMENTARY AND ARTICLES ABOUT MUSIC AND ENTERTAINMENT, AND PERSONAL AND MUSICAL INFORMATION REGARDING A MUSICAL GROUP OR PERFORMER AND ITS LIVE AND RECORDED PERFORMANCES (U.S. CLS. 100, 101 AND 107).  
LINDA MICKLEBURGH, EXAMINING ATTORNEY

## Fullmetal Alchemist

THE MARK CONSISTS OF STANDARD CHARACTERS WITHOUT CLAIM TO ANY PARTICULAR FONT, STYLE, SIZE, OR COLOR.

FOR VIDEOTAPE PRODUCTION; TELEVISION SHOW PRODUCTION (U.S. CLS. 100, 101 AND 107).

PAUL F. GAST, EXAMINING ATTORNEY

**CLASS 41—(Continued).**

SN 78-362,734. BARROW, JACOB E., MISSOULA, MT. FILED 2-4-2004.

**CLASS 41—(Continued).**

SN 78-365,798. WARNER BROS. ENTERTAINMENT INC., BURBANK, CA. FILED 2-10-2004.

**OOMPA LOOMPA**

**The Krooks**

THE MARK CONSISTS OF STANDARD CHARACTERS WITHOUT CLAIM TO ANY PARTICULAR FONT, STYLE, SIZE, OR COLOR.

FOR ENTERTAINMENT IN THE NATURE OF LIVE MUSIC GROUP (U.S. CLS. 100, 101 AND 107).  
FIRST USE 1-1-2003; IN COMMERCE 3-1-2003.  
LINDA E. BLOHM, EXAMINING ATTORNEY

THE MARK CONSISTS OF STANDARD CHARACTERS WITHOUT CLAIM TO ANY PARTICULAR FONT, STYLE, SIZE, OR COLOR.

FOR ENTERTAINMENT SERVICES IN THE NATURE OF LIVE-ACTION, COMEDY, DRAMA AND ANIMATED TELEVISION SERIES; PRODUCTION OF LIVE-ACTION, COMEDY, DRAMA AND ANIMATED MOTION PICTURE THEATRICAL FILMS; PRODUCTION OF LIVE-ACTION, COMEDY, DRAMA AND ANIMATED MOTION PICTURE THEATRICAL FILMS; THEATRICAL PERFORMANCES BOTH ANIMATED AND LIVE ACTION; INTERNET SERVICES PROVIDING INFORMATION VIA AN ELECTRONIC GLOBAL COMPUTER NETWORK IN THE FIELD OF ENTERTAINMENT RELATING SPECIFICALLY TO MUSIC, MOVIES, AND TELEVISION; PROVIDING GENERAL INTEREST NEWS, ENTERTAINMENT, AND EDUCATIONAL INFORMATION VIA A GLOBAL COMPUTER NETWORK; AND PROVIDING INFORMATION FOR AND ACTUAL ENTERTAINMENT VIA ELECTRONIC GLOBAL COMMUNICATIONS NETWORK IN THE NATURE OF LIVE-ACTION, COMEDY, DRAMA AND ANIMATED PROGRAMS AND PRODUCTION OF LIVE-ACTION COMEDY, ACTION AND ANIMATED MOTION FILMS FOR DISTRIBUTION VIA A GLOBAL COMPUTER NETWORK (U.S. CLS. 100, 101 AND 107).  
GEOFFREY FOSDICK, EXAMINING ATTORNEY

SN 78-363,327. ARES TRADING S.A., VAUMARCUS, SWITZERLAND, FILED 2-5-2004.

SN 78-388,989. CHANNING BETE COMPANY, INC., SOUTH DEERFIELD, MA. FILED 3-23-2004.

**SAINT**

**BUILDING RESPECT**

THE MARK CONSISTS OF STANDARD CHARACTERS WITHOUT CLAIM TO ANY PARTICULAR FONT, STYLE, SIZE, OR COLOR.

FOR TRAINING IN THE USE OF MEDICAL INJECTION DEVICES (U.S. CLS. 100, 101 AND 107).  
FIRST USE 2-21-2004; IN COMMERCE 2-21-2004.  
SUSAN HAYASH, EXAMINING ATTORNEY

THE MARK CONSISTS OF STANDARD CHARACTERS WITHOUT CLAIM TO ANY PARTICULAR FONT, STYLE, SIZE, OR COLOR.

FOR EDUCATIONAL SERVICES, NAMELY, CONDUCTING PROGRAMS IN THE FIELD OF BEHAVIOR MANAGEMENT THAT ENCOURAGE HEALTHY, POSITIVE BEHAVIORS AND PREVENT DESTRUCTIVE BEHAVIOR AMONG YOUNG PEOPLE IN THE AREAS OF MENTAL HEALTH, PHYSICAL HEALTH, VIOLENCE, SAFETY, SOCIAL SKILLS, AND ACADEMIC SKILLS VIA THE INTERNET (U.S. CLS. 100, 101 AND 107).  
MICHAEL KAZAZIAN, EXAMINING ATTORNEY

**CLASS 41—(Continued).**

SN 78-389,125. BLACK ENTERTAINMENT TELEVISION, INC., WASHINGTON, DC. FILED 3-23-2004.

**BET SPEAK NOW**

THE MARK CONSISTS OF STANDARD CHARACTERS WITHOUT CLAIM TO ANY PARTICULAR FONT, STYLE, SIZE, OR COLOR.

OWNER OF U.S. REG. NOS. 1,511,259, 2,602,285 AND OTHERS.

FOR ENTERTAINMENT SERVICES IN THE NATURE OF A POLITICAL TELEVISION SERIES (U.S. CLS. 100, 101 AND 107).

ZACHARY BELLO, EXAMINING ATTORNEY

SN 78-393,379. HEALTHPOINT, LTD., SAN ANTONIO, TX. FILED 3-30-2004.

**OPENING MINDS.  
CLOSING WOUNDS.**

THE MARK CONSISTS OF STANDARD CHARACTERS WITHOUT CLAIM TO ANY PARTICULAR FONT, STYLE, SIZE, OR COLOR.

FOR EDUCATIONAL SERVICES, NAMELY, PROVIDING SEMINARS TO PROFESSIONALS IN THE MEDICAL, PHARMACEUTICAL, AND HEALTHCARE FIELDS, AND TO HEALTHCARE RECIPIENTS (U.S. CLS. 100, 101 AND 107).

GRETTA YAO, EXAMINING ATTORNEY

SN 78-398,081. SARA LEE GLOBAL FINANCE, L.L.C., WILMINGTON, DE. FILED 4-7-2004.



OWNER OF U.S. REG. NOS. 1,127,251, 1,566,064 AND OTHERS.

FOR COMPUTER SERVICES NAMELY PROVIDING ON-LINE PUBLICATIONS, NAMELY MANUALS, JOURNALS, NEWSLETTERS AND MAGAZINES IN THE FIELDS OF HEALTH, EXERCISE, NUTRITION, SPORTS, DIET, SPORT FASHION AND LIFESTYLE (U.S. CLS. 100, 101 AND 107).

BRENDAN REGAN, EXAMINING ATTORNEY

**CLASS 41—(Continued).**

SN 78-403,217. IGT, RENO, NV. FILED 4-16-2004.

**WHEELIONAIRE**

THE MARK CONSISTS OF STANDARD CHARACTERS WITHOUT CLAIM TO ANY PARTICULAR FONT, STYLE, SIZE, OR COLOR.

FOR ENTERTAINMENT SERVICES, NAMELY, CONDUCTING A GAME OF CHANCE SIMULTANEOUSLY AT MULTIPLE, INDEPENDENT GAMING ESTABLISHMENTS (U.S. CLS. 100, 101 AND 107).

BRENDAN REGAN, EXAMINING ATTORNEY

**CLASS 42—SCIENTIFIC, COMPUTER AND LEGAL SERVICES**

SN 75-029,556. EDGE SYSTEMS, LLC, NAPERVILLE, IL. FILED 12-8-1995.

**EDGE**

FOR COMPUTER SYSTEMS AND SOFTWARE DESIGN FOR OTHERS WORKING IN AN OFFICE ENVIRONMENT; COMPUTER CONSULTATION, NAMELY, PROVIDE ASSISTANCE TO CUSTOMERS IN THE SELECTION OF COMPUTER SYSTEMS AND COMPUTER SOFTWARE FOR USE IN OFFICE AUTOMATION; MAINTENANCE OF OFFICE COMPUTER SOFTWARE (U.S. CLS. 100 AND 101).

FIRST USE 1-30-1985; IN COMMERCE 1-30-1985.

JANICE L. MCMORROW, EXAMINING ATTORNEY

SN 75-411,305. FRONT RANGE INTERNET, INC., FORT COLLINS, CO. FILED 12-29-1997.

**VERINET**

FOR PROVIDING MULTIPLE USER ACCESS TO A GLOBAL COMPUTER INFORMATION NETWORK FOR THE TRANSFER AND DISSEMINATION OF A WIDE RANGE OF INFORMATION; COMPUTER SERVICES, NAMELY, HOSTING WEB SITES OF OTHERS ON A COMPUTER SERVER FOR A GLOBAL COMPUTER NETWORK; COMPUTER SERVICES, NAMELY, CREATING AND MAINTAINING WEB SITES FOR OTHERS; COMPUTER SERVICES, NAMELY, DESIGNING AND IMPLEMENTING NETWORK WEB PAGES AND WEB SITES FOR OTHERS (U.S. CLS. 100 AND 101).

FIRST USE 12-20-1995; IN COMMERCE 12-20-1995.

LINDA M. KING, EXAMINING ATTORNEY



**CLASS 42—(Continued).**

SN 75-429,662. OPENDWG ALLIANCE, SEATTLE, WA.  
FILED 2-5-1998.

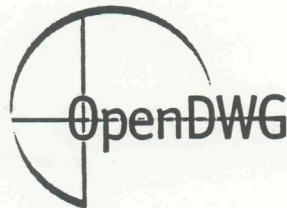

FOR CONSULTING SERVICES IN THE FIELD OF COMPUTER SOFTWARE AND COMPUTER SOFTWARE TOOLS AND STANDARDS; PROVIDING MULTIPLE-USER ACCESS TO A GLOBAL COMPUTER INFORMATION NETWORK FOR THE TRANSFER AND DISSEMINATION OF A WIDE RANGE OF INFORMATION (U.S. CLS. 100 AND 101).

FIRST USE 2-0-1998; IN COMMERCE 2-0-1998.  
ESTHER BELENKER, EXAMINING ATTORNEY

SN 75-551,558. MISSING CHILDREN MINNESOTA, MINNEAPOLIS, MN. FILED 9-10-1998.

## MISSING CHILDREN MINNESOTA

SEC. 2(F).

FOR PROVIDING DIRECT ASSISTANCE TO FAMILIES SEARCHING FOR MISSING CHILDREN OR VULNERABLE ADULTS, NAMELY SOCIAL SERVICES FOR FAMILIES IN SUCH SEARCHES, NAMELY, SUPPORT SERVICES IN THE NATURE OF COUNSELING SERVICES, ADVOCACY SERVICES, PROVIDING A TWENTY-FOUR HOUR CRISIS HOTLINE, PROVIDING CASE MANAGEMENT SERVICES, COMMUNICATING WITH LAW ENFORCEMENT OFFICIALS ON BEHALF OF MISSING CHILDREN AND THEIR FAMILIES (U.S. CLS. 100 AND 101).

FIRST USE 9-0-1986; IN COMMERCE 9-0-1989.  
NANCY CLARKE, EXAMINING ATTORNEY

**CLASS 42—(Continued).**

SN 75-554,766. NOVAVISION, INC., BOCA RATON, FL.  
FILED 9-17-1998.

## NOVAVISION

OWNER OF FED REP GERMANY REG. NO. 39709433,  
DATED 4-3-1998, EXPIRES 3-31-2007.

OWNER OF U.S. REG. NO. 2,240,087.

FOR MEDICAL CARE NAMELY, HOUSING PATIENTS AND SUPPLYING THEM WITH FOOD, TESTING, TRAINING AND TREATING PEOPLE WITH NERVOUS SYSTEM, NEUROLOGICAL, OPHTHALMOLOGICAL AND PSYCHOLOGICAL IMPEDIMENTS; DEVELOPMENT AND DESIGN OF COMPUTER PROCESSING PROGRAMS FOR OTHERS; HEALTH CARE SERVICES, NAMELY PROVIDING INFORMATION RELATING TO AND CONNECTED TO PERSONS WITH NERVOUS SYSTEM, NEUROLOGICAL, OPHTHALMOLOGICAL AND PSYCHOLOGICAL IMPEDIMENTS FEATURING MEDICAL AND PSYCHOLOGICAL DIAGNOSIS AND THERAPY PROCESSES VIA IN-HOUSE, LOCAL, REGIONAL AND GLOBAL COMPUTER INFORMATION NETWORKS (U.S. CLS. 100 AND 101).

VERNA BETH RIRIE, EXAMINING ATTORNEY

SN 76-105,400. PHARMATEK LABORATORIES, INC., SAN DIEGO, CA. FILED 8-8-2000.

## PHARMATEK LABORATORIES

NO CLAIM IS MADE TO THE EXCLUSIVE RIGHT TO USE "LABORATORIES", APART FROM THE MARK AS SHOWN.

FOR PHARMACEUTICAL PRODUCT DEVELOPMENT THAT IDENTIFIES COMPATIBLE ORAL FORMULATIONS FOR NEW DRUG CANDIDATES, APPLYING PHYSIOCHEMICAL EVALUATION TECHNIQUES TO TRADITIONAL AND STATE OF THE ART PHARMACEUTICAL EXCIPIENTS USING A COMPATIBILITY MATRIX (U.S. CLS. 100 AND 101).

FIRST USE 4-19-1999; IN COMMERCE 4-19-1999.  
MICHAEL ENGEL, EXAMINING ATTORNEY

SN 76-120,107. KNOWLEDGEFLOW, INC., VALLEY FORGE, PA. FILED 8-30-2000.

## WEBANGEL

FOR COMPUTER SERVICES, NAMELY, COMPUTERIZED ON-LINE SERVICE TO FACILITATE THE IDENTIFICATION AND COLLECTION OF WEBSITES TO CREATE COMMUNITIES OF INTEREST (U.S. CLS. 100 AND 101).

MARGERY A. TIERNEY, EXAMINING ATTORNEY

**CLASS 42—(Continued).**

SN 76-239,317. MADAN, CAROLE M., ALPHARETTA, GA. FILED 4-11-2001.

**MOMMA NATURE**

FOR COUNSELING IN THE FIELD OF HEALTH, SPIRITUALITY, LIFESTYLE ISSUES, DISABILITY RECOVERY AND TRAUMA SURVIVAL; LANDSCAPE GARDENING DESIGN FOR OTHERS (U.S. CLS. 100 AND 101).

LINDA M. KING, EXAMINING ATTORNEY

SN 76-510,801. FNF INTELLECTUAL PROPERTY HOLDINGS, INC., SANTA BARBARA, CA. FILED 4-30-2003.

**ROPT ONLINE**

NO CLAIM IS MADE TO THE EXCLUSIVE RIGHT TO USE "ONLINE", APART FROM THE MARK AS SHOWN.

FOR PROVIDING TEMPORARY USE OF ONLINE NON-DOWNLOADABLE COMPUTER SOFTWARE FOR COORDINATING ORDER PLACEMENT, TRACKING, STATUSING, DOCUMENT PREPARATION, EQUITY CALCULATION, MANAGING AND PROVIDING INFORMATION RELATING TO RELOCATION, REFINANCE, PURCHASE MONEY, REAL ESTATE OWNED AND COMMERCIAL AND RESIDENTIAL REAL ESTATE TRANSACTIONS (U.S. CLS. 100 AND 101).

FIRST USE 2-0-1998; IN COMMERCE 2-0-1998.  
BRIAN PINO, EXAMINING ATTORNEY

SN 76-522,092. HARRIS PUBLICATIONS, INC., NEW YORK, NY. FILED 6-2-2003.

**RIDES**

FOR PROVIDING A WEBSITE FEATURING INFORMATION AND NEWS IN THE FIELD OF AUTOMOBILES (U.S. CLS. 100 AND 101).

LAURA KOVAISKY, EXAMINING ATTORNEY

SN 76-523,499. LYDIAN TRUST COMPANY, PALM BEACH GARDENS, FL. FILED 6-18-2003.

**TALENTMINE**

FOR PROVIDING TEMPORARY USE OF NON-DOWNLOADABLE COMPUTER SOFTWARE FOR ASSISTING COMPANIES TO SCREEN AND SELECT EMPLOYMENT CANDIDATES AND TO MATCH EMPLOYMENT CANDIDATES AND EMPLOYEES BY PERSONALITY TRAITS, SKILL, STRENGTHS AND EMPLOYER WORK CULTURE PRIORITIES TO APPROPRIATE JOB POSITIONS (U.S. CLS. 100 AND 101).

FIRST USE 2-0-2002; IN COMMERCE 2-0-2002.  
NAAKWAMA ANKRAH, EXAMINING ATTORNEY

**CLASS 42—(Continued).**

SN 76-539,847. ITOWN COMMUNICATIONS, INC., VIENNA, VA. FILED 8-8-2003.

**ITOWN COMMUNICATIONS**

NO CLAIM IS MADE TO THE EXCLUSIVE RIGHT TO USE "COMMUNICATIONS", APART FROM THE MARK AS SHOWN.

FOR COMPUTER SERVICE, NAMELY, ACTING AS AN APPLICATION SERVICE PROVIDER IN THE FIELD OF KNOWLEDGE MANAGEMENT TO HOST COMPUTER APPLICATION SOFTWARE FOR SEARCHING AND RETRIEVING INFORMATION FROM DATABASES AND COMPUTER NETWORKS; COMPUTER SERVICES, NAMELY CREATING INDEXES OF INFORMATION, SITES AND OTHER RESOURCES AVAILABLE ON COMPUTER NETWORKS; PROVIDING CUSTOMIZED ON-LINE WEB PAGES FEATURING USER-DEFINED INFORMATION, WHICH INCLUDES SEARCH ENGINES AND ONLINE WEB LINKS TO OTHER WEB SITES; PROVIDING SPECIFIC INFORMATION AS REQUESTED BY CUSTOMERS VIA THE INTERNET FOR CUSTOMIZED SEARCHING (U.S. CLS. 100 AND 101).

ROBERT LORENZO, EXAMINING ATTORNEY

SN 76-545,879. LSM CONSULTING, DESPLAINES, IL. FILED 9-22-2003.

**WAY COOL STUFF**

FOR PROVIDING AN ONLINE MAGAZINE VIA A GLOBAL COMPUTER NETWORK IN THE FIELDS OF TOPICS OF INTEREST TO CHILDREN, ISSUES AND NEWS RELATED TO VARIOUS LOCALITIES, CELEBRATIONS, CULTURE, IDEAS AND BOOK REVIEWS, AND MULTIMEDIA (U.S. CLS. 100 AND 101).

FIRST USE 7-31-2001; IN COMMERCE 7-31-2001.  
ALLISON HOLTZ, EXAMINING ATTORNEY

SN 76-561,327. FEDERMAN AND PHELAN, L.L.P., PHILADELPHIA, PA. FILED 11-21-2003.



FOR LEGAL SERVICES, NAMELY, CREDITORS RIGHTS, FORECLOSURE, REAL ESTATE, BANKRUPTCY AND COMMERCIAL LITIGATION (U.S. CLS. 100 AND 101).

FIRST USE 11-13-2000; IN COMMERCE 11-13-2000.  
JOHN HWANG, EXAMINING ATTORNEY

**CLASS 42—(Continued).**

SN 76-568,486. ARMSTRONG MANAGEMENT SERVICES, INC., FAIRFAX, VA. FILED 1-5-2004.

# ARMSTRONGCONNECT

THE MARK CONSISTS OF STANDARD CHARACTERS WITHOUT CLAIM TO ANY PARTICULAR FONT, STYLE, SIZE, OR COLOR.

FOR APPLICATION SERVICE PROVIDER (ASP) FEATURING SOFTWARE IN THE FIELD OF PROPERTY MANAGEMENT FOR USE IN COMMUNICATION, DATABASE MANAGEMENT AND DATA ACCESS BETWEEN PROPERTY MANAGERS, ASSOCIATION BOARDS AND RESIDENTS (U.S. CLS. 100 AND 101).

FIRST USE 12-29-2003; IN COMMERCE 12-29-2003.  
JANICE L. MCMORROW, EXAMINING ATTORNEY

**CLASS 42—(Continued).**

SN 78-187,733. UNOVO, INCORPORATED, SAN FRANCISCO, CA. FILED 11-21-2002.

# UNOVO

FOR DESIGN AND TESTING FOR NEW PRODUCT DEVELOPMENT, DESIGN AND TESTING OF NEW PRODUCTS FOR OTHERS, PRODUCT DEVELOPMENT CONSULTATION, PRODUCT RESEARCH AND DEVELOPMENT (U.S. CLS. 100 AND 101).

FIRST USE 8-15-2004; IN COMMERCE 8-15-2004.  
LAURIEL DALIER, EXAMINING ATTORNEY

SN 76-572,803. ROGERS & THEOBALD, P.A., PHOENIX, AZ. FILED 1-20-2004.

# ROGERS & THEOBALD

THE MARK CONSISTS OF STANDARD CHARACTERS WITHOUT CLAIM TO ANY PARTICULAR FONT, STYLE, SIZE, OR COLOR.

FOR LEGAL SERVICES (U.S. CLS. 100 AND 101).  
FIRST USE 11-18-1999; IN COMMERCE 11-18-1999.  
CAROL SPILS, EXAMINING ATTORNEY

# "GOT META-DATA?"

NO CLAIM IS MADE TO THE EXCLUSIVE RIGHT TO USE "META-DATA", APART FROM THE MARK AS SHOWN.

FOR CONSULTING SERVICES IN THE FIELD OF DESIGN, SELECTION, IMPLEMENTATION AND USE OF COMPUTER SOFTWARE SYSTEMS FOR OTHERS (U.S. CLS. 100 AND 101).

FIRST USE 3-15-2001; IN COMMERCE 4-1-2003.  
RON FAIRBANKS, EXAMINING ATTORNEY

SN 78-272,289. ARTICULATE SOFTWARE INC., MOUNTAIN VIEW, CA. FILED 7-9-2003.

# ARTICULATE SOFTWARE

NO CLAIM IS MADE TO THE EXCLUSIVE RIGHT TO USE "SOFTWARE", APART FROM THE MARK AS SHOWN.

FOR COMPUTER PROGRAMMING FOR OTHERS, COMPUTER SOFTWARE DEVELOPMENT (U.S. CLS. 100 AND 101).  
FIRST USE 6-13-2003; IN COMMERCE 6-13-2003.  
JOHN GARTNER, EXAMINING ATTORNEY

SN 76-573,206. ULTRABRIDGE, INC., HUNT VALLEY, MD. FILED 1-27-2004.



OWNER OF U.S. REG. NOS. 2,634,044 AND 2,634,045.  
FOR APPLICATION SERVICE PROVIDER FEATURING SOFTWARE IN THE FIELD OF HEALTHCARE (U.S. CLS. 100 AND 101).

FIRST USE 4-0-2002; IN COMMERCE 4-0-2002.  
LOURDES AYALA, EXAMINING ATTORNEY

SN 78-274,337. DEBT RESOLVE, INC., WHITE PLAINS, NY. FILED 7-15-2003.



FOR ALTERNATIVE DISPUTE RESOLUTION SERVICES PROVIDED ONLINE (U.S. CLS. 100 AND 101).  
FIRST USE 2-20-2003; IN COMMERCE 2-20-2003.  
DOMINICK J. SALEMI, EXAMINING ATTORNEY

**CLASS 42—(Continued).**

SN 78-275,237. OPSWARE INC., SUNNYVALE, CA. FILED 7-16-2003.

**DCML**

FOR TECHNICAL RESEARCH IN THE FIELD OF ARCHITECTURAL DESIGN AND COMPONENTS OF A DESIGN CENTER AND ARCHITECTURAL DESIGN RELATED TO THE COMPONENTS OF A DESIGN CENTER (U.S. CLS. 100 AND 101).  
INGRID C. EULIN, EXAMINING ATTORNEY

SN 78-282,732. MINDSPAN CORP., MAHWAH, NJ. FILED 8-4-2003.

**DIRECTLINKRX**

FOR PROVISION OF INFORMATION REGARDING PRODUCTS AND SERVICES OF PHARMACEUTICAL, BIOTECHNOLOGY AND DENTAL COMPANIES; PROVIDING A WEBSITE WHEREBY HEALTHCARE PROFESSIONALS, PATIENTS AND PHARMACEUTICAL, BIOTECHNOLOGY AND DENTAL COMPANIES CAN EXCHANGE INFORMATION REGARDING THE PRODUCTS AND SERVICES OF PHARMACEUTICAL, BIOTECHNOLOGY AND DENTAL COMPANIES (U.S. CLS. 100 AND 101).  
DAVID TAYLOR, EXAMINING ATTORNEY

SN 78-288,198. MULTISALES, INC., DULUTH, GA. FILED 8-15-2003.

**SITEPASS**

FOR COMPUTER SERVICES, NAMELY, PROVIDING CUSTOMIZED ONLINE WEB PAGES FEATURING USER-DEFINED INFORMATION WHICH INCLUDES LINKS TO OTHER WEBSITES ALL THROUGH ENTRY OF A SINGLE USER NAME AND PASSWORD (U.S. CLS. 100 AND 101).  
FIRST USE 7-31-2003; IN COMMERCE 7-31-2003.  
BERYL GARDNER, EXAMINING ATTORNEY

SN 78-290,150. LOGICAL GROUP SERVICES LIMITED, SLOUGH BERKSHIRE, UNITED KINGDOM, FILED 8-21-2003.



NO CLAIM IS MADE TO THE EXCLUSIVE RIGHT TO USE "INTEGRATION SOLUTIONS", APART FROM THE MARK AS SHOWN.

FOR COMPUTER SERVICES, NAMELY, CONSULTING IN THE FIELD OF COMPUTER HARDWARE AND SOFTWARE, INTEGRATION OF COMPUTER SYSTEMS, NETWORK MANAGEMENT, INFORMATION TECHNOLOGY, AND MAINTENANCE OF COMPUTER SOFTWARE FOR OTHERS (U.S. CLS. 100 AND 101).  
ESTHER BELENKER, EXAMINING ATTORNEY

**CLASS 42—(Continued).**

SN 78-307,089. BAYBICK, JEFFREY H., CROWNSVILLE, MD. FILED 9-30-2003.

**BAY LABS**

NO CLAIM IS MADE TO THE EXCLUSIVE RIGHT TO USE "LABS", APART FROM THE MARK AS SHOWN.  
FOR MEDICAL LABORATORIES (U.S. CLS. 100 AND 101).  
LANA PHAM, EXAMINING ATTORNEY

SN 78-330,805. CRISIS PREVENTION INSTITUTE, INC., BROOKFIELD, WI. FILED 11-20-2003.

**PREPARE TRACK**

THE MARK CONSISTS OF STANDARD CHARACTERS WITHOUT CLAIM TO ANY PARTICULAR FONT, STYLE, SIZE, OR COLOR.

FOR PROVIDING TEMPORARY USE OF ON-LINE NON-DOWNLOADABLE COMPUTER PROGRAMS ACCESSIBLE TO REGISTERED USERS VIA THE INTERNET FOR PLANNING, MANAGING AND MEASURING THE RESULTS OF EDUCATIONAL AND TRAINING SERVICES (U.S. CLS. 100 AND 101).  
BARBARA RUTLAND, EXAMINING ATTORNEY

SN 78-332,996. RASER TECHNOLOGIES, INC., PROVO, UT. FILED 11-25-2003.

**SYMETRON**

THE MARK CONSISTS OF STANDARD CHARACTERS WITHOUT CLAIM TO ANY PARTICULAR FONT, STYLE, SIZE, OR COLOR.

FOR LICENSING OF TECHNOLOGY FOR ELECTRIC MOTORS AND ELECTRIC MOTOR CONTROLLERS (U.S. CLS. 100 AND 101).  
SUSAN HAYASH, EXAMINING ATTORNEY

**CLASS 42—(Continued).**

SN 78-333,011. RASER TECHNOLOGIES, INC., PROVO, UT.  
FILED 11-25-2003.

**CLASS 42—(Continued).**

SN 78-337,911. MILLER, IONA LEE, SAN FRANCISCO, CA.  
AND MILLER, STEVEN JAY, SAN FRANCISCO, CA.  
FILED 12-8-2003.

**RASER**

**URBAN VOCAB**

THE MARK CONSISTS OF STANDARD CHARACTERS  
WITHOUT CLAIM TO ANY PARTICULAR FONT, STYLE,  
SIZE, OR COLOR.

FOR LICENSING OF TECHNOLOGY FOR ELECTRO-  
MAGNETIC SCIENCES (U.S. CLS. 100 AND 101).  
SUSAN HAYASH, EXAMINING ATTORNEY

THE MARK CONSISTS OF STANDARD CHARACTERS  
WITHOUT CLAIM TO ANY PARTICULAR FONT, STYLE,  
SIZE, OR COLOR.

FOR THE LICENSING OF INTELLECTUAL PROP-  
ERTY, NAMELY COPYRIGHTED WORKS OF ART  
(U.S. CLS. 100 AND 101).

FIRST USE 1-0-2003; IN COMMERCE 1-0-2003.  
JENNIFER KRISP, EXAMINING ATTORNEY

SN 78-334,974. CLEARDESK SOLUTIONS, INC., AUSTIN,  
TX. FILED 12-2-2003.

SN 78-345,609. TAIWAN SEMICONDUCTOR MANUFAC-  
TURING COMPANY, LIMITED, HSIN-CHU, TAIWAN,  
FILED 12-25-2003.

**CLEARDESK**

**TSMC COMPATIBLE**

THE MARK CONSISTS OF STANDARD CHARACTERS  
WITHOUT CLAIM TO ANY PARTICULAR FONT, STYLE,  
SIZE, OR COLOR.

FOR COMPUTER SERVICES, NAMELY, ACTING AS  
AN APPLICATION SERVICE PROVIDER IN THE FIELD  
OF KNOWLEDGE MANAGEMENT TO HOST DATA-  
BASE SOFTWARE FOR THE IMPLEMENTATION OF  
BUSINESS PROCESSES TO ENABLE COLLABORATION  
BETWEEN USERS (U.S. CLS. 100 AND 101).

FIRST USE 11-1-2003; IN COMMERCE 11-1-2003.  
CHARLES L. JENKINS, EXAMINING ATTORNEY

THE MARK CONSISTS OF STANDARD CHARACTERS  
WITHOUT CLAIM TO ANY PARTICULAR FONT, STYLE,  
SIZE, OR COLOR.

OWNER OF U.S. REG. NOS. 2,042,335, 2,227,071 AND  
OTHERS.

NO CLAIM IS MADE TO THE EXCLUSIVE RIGHT TO  
USE "COMPATIBLE", APART FROM THE MARK AS  
SHOWN.

FOR PRODUCT RESEARCH, CUSTOM DESIGN AND  
TESTING FOR NEW PRODUCT DEVELOPMENT, AND  
TECHNOLOGY CONSULTATION SERVICES REGARD-  
ING ELECTRICAL AND ELECTRONIC PRODUCTS,  
SEMICONDUCTORS, SEMICONDUCTOR SYSTEMS,  
SEMICONDUCTOR CELL LIBRARIES, WAFER AND  
INTEGRATED CIRCUITS (U.S. CLS. 100 AND 101).

BRENDAN REGAN, EXAMINING ATTORNEY

**CLASS 42—(Continued).**

SN 78-346,519. REESE, RALPH, PITTSBURGH, PA. FILED 12-30-2003.

# RIPEN

THE MARK CONSISTS OF STANDARD CHARACTERS WITHOUT CLAIM TO ANY PARTICULAR FONT, STYLE, SIZE, OR COLOR.

FOR LICENSING OF INTELLECTUAL PROPERTY (U.S. CLS. 100 AND 101).

SHAUNIA WALLACE, EXAMINING ATTORNEY

---

SN 78-346,524. REESE, RALPH, PITTSBURGH, PA. FILED 12-30-2003.

# YIPPEE!

THE MARK CONSISTS OF STANDARD CHARACTERS WITHOUT CLAIM TO ANY PARTICULAR FONT, STYLE, SIZE, OR COLOR.

FOR LICENSING OF INTELLECTUAL PROPERTY (U.S. CLS. 100 AND 101).

SHAUNIA WALLACE, EXAMINING ATTORNEY

---

SN 78-346,528. REESE, RALPH, PITTSBURGH, PA. FILED 12-30-2003.

# THINKING OUT LOUD

THE MARK CONSISTS OF STANDARD CHARACTERS WITHOUT CLAIM TO ANY PARTICULAR FONT, STYLE, SIZE, OR COLOR.

FOR LICENSING OF INTELLECTUAL PROPERTY (U.S. CLS. 100 AND 101).

SHAUNIA WALLACE, EXAMINING ATTORNEY

**CLASS 42—(Continued).**

SN 78-346,769. GLENDA F. NIMMO, THE WOODLANDS, TX. FILED 12-30-2003.

# CAD RELIEF

THE MARK CONSISTS OF STANDARD CHARACTERS WITHOUT CLAIM TO ANY PARTICULAR FONT, STYLE, SIZE, OR COLOR.

NO CLAIM IS MADE TO THE EXCLUSIVE RIGHT TO USE "CAD", APART FROM THE MARK AS SHOWN.

FOR COMPUTER AIDED DRAFTING AND MANUAL DRAFTING SERVICE (U.S. CLS. 100 AND 101).

FIRST USE 8-22-2003; IN COMMERCE 12-1-2003.

ANN LINNEHAN, EXAMINING ATTORNEY

---

SN 78-347,465. HAYDEN, PHILLIP ALLEN, NORCROSS, GA. FILED 1-3-2004.

# SOLARA

THE MARK CONSISTS OF STANDARD CHARACTERS WITHOUT CLAIM TO ANY PARTICULAR FONT, STYLE, SIZE, OR COLOR.

FOR COMPUTER SERVICES, NAMELY, PROVIDING SEARCH ENGINES FOR SEARCHING, COMPILING, INDEXING AND ORGANIZING INFORMATION ON A GLOBAL COMPUTER NETWORK (U.S. CLS. 100 AND 101).

FIRST USE 4-23-2003; IN COMMERCE 11-1-2003.

SUSAN HAYASH, EXAMINING ATTORNEY

**CLASS 42—(Continued).**

SN 78-348,264. GRINES, CINDY L., ROYAL OAK, MI. FILED 1-6-2004.

**CLASS 42—(Continued).**

SN 78-351,425. ABBOTT LABORATORIES, ABBOTT PARK, IL. FILED 1-13-2004.

**CROSSBREAK**

**HERO**

THE MARK CONSISTS OF STANDARD CHARACTERS WITHOUT CLAIM TO ANY PARTICULAR FONT, STYLE, SIZE, OR COLOR.  
FOR MEDICAL RESEARCH (U.S. CLS. 100 AND 101).  
FIRST USE 7-25-2003; IN COMMERCE 7-25-2003.  
RAUL CORDOVA, EXAMINING ATTORNEY

THE MARK CONSISTS OF STANDARD CHARACTERS WITHOUT CLAIM TO ANY PARTICULAR FONT, STYLE, SIZE, OR COLOR.  
FOR CONDUCTING CLINICAL TRIALS FOR MEDICAL PURPOSES (U.S. CLS. 100 AND 101).  
JAMES A. RAUEN, EXAMINING ATTORNEY

SN 78-348,706. CLOCK TOWER LAW GROUP, MAYNARD, MA. FILED 1-7-2004.

SN 78-353,452. KRONICK, STEVEN, BETHESDA, MD. FILED 1-17-2004.

**CLOCK TOWER LAW  
GROUP**

**ESKEEZ DESIGN**

THE MARK CONSISTS OF STANDARD CHARACTERS WITHOUT CLAIM TO ANY PARTICULAR FONT, STYLE, SIZE, OR COLOR.  
NO CLAIM IS MADE TO THE EXCLUSIVE RIGHT TO USE "LAW GROUP", APART FROM THE MARK AS SHOWN.  
FOR LEGAL SERVICES IN THE FIELD OF INTELLECTUAL PROPERTY, NAMELY PATENT, TRADEMARK, COPYRIGHT, AND TRADE SECRET MATTERS (U.S. CLS. 100 AND 101).  
FIRST USE 1-1-2004; IN COMMERCE 1-1-2004.  
JOHN E. MICHOS, EXAMINING ATTORNEY

THE MARK CONSISTS OF STANDARD CHARACTERS WITHOUT CLAIM TO ANY PARTICULAR FONT, STYLE, SIZE, OR COLOR.  
NO CLAIM IS MADE TO THE EXCLUSIVE RIGHT TO USE "DESIGN", APART FROM THE MARK AS SHOWN.  
FOR PROFESSIONAL GRAPHIC AND WEB DESIGN SERVICES (U.S. CLS. 100 AND 101).  
FIRST USE 6-1-2002; IN COMMERCE 9-1-2003.  
CAROLINE WEIMER, EXAMINING ATTORNEY

**CLASS 42—(Continued).**

SN 78-354,470. MICROSOFT CORPORATION, REDMOND, WA. FILED 1-20-2004.



NO CLAIM IS MADE TO THE EXCLUSIVE RIGHT TO USE HD, APART FROM THE MARK AS SHOWN.

FOR PROVIDING INFORMATION AND HOSTING OF DIGITAL CONTENT VIA THE INTERNET IN THE FIELDS OF MUSIC, SOUND, AUDIO AND VIDEO RECORDING AND PLAYBACK, AND COMPUTER AND HOME ENTERTAINMENT DEVICES (U.S. CLS. 100 AND 101).

FIRST USE 1-8-2004; IN COMMERCE 1-8-2004.  
JOHN HWANG, EXAMINING ATTORNEY

**CLASS 42—(Continued).**

SN 78-355,711. NORINSBERG, JON L., NEW YORK, NY. FILED 1-22-2004.

THE JUSTICE  
HOTLINE

THE MARK CONSISTS OF STANDARD CHARACTERS WITHOUT CLAIM TO ANY PARTICULAR FONT, STYLE, SIZE, OR COLOR.

FOR LEGAL SERVICES (U.S. CLS. 100 AND 101).  
DEZMONA MIZELLE, EXAMINING ATTORNEY

SN 78-354,678. NYCON, INC., WESTERLY, RI. FILED 1-21-2004.

P2P

THE MARK CONSISTS OF STANDARD CHARACTERS WITHOUT CLAIM TO ANY PARTICULAR FONT, STYLE, SIZE, OR COLOR.

FOR CONSULTING SERVICES, NAMELY, PROVIDING TECHNICAL INFORMATION CONCERNING THE USE OF REINFORCING FIBERS IN READY MIX CONCRETE MATERIALS (U.S. CLS. 100 AND 101).  
MELVIN AXILBUND, EXAMINING ATTORNEY

SN 78-357,185. MERRILL, THEODORE H., BEN LOMOND, CA. FILED 1-25-2004.

emBuild

THE MARK CONSISTS OF STANDARD CHARACTERS WITHOUT CLAIM TO ANY PARTICULAR FONT, STYLE, SIZE, OR COLOR.

FOR COMPUTER SOFTWARE DESIGN FOR OTHERS (U.S. CLS. 100 AND 101).  
FIRST USE 1-1-2004; IN COMMERCE 1-1-2004.  
AISHA CLARKE, EXAMINING ATTORNEY



**CLASS 42—(Continued).**

SN 78-360,999. CYRLIN, ALAN, TARZANA, CA. FILED 2-2-2004.

# The Alacrity Advantage

THE MARK CONSISTS OF STANDARD CHARACTERS WITHOUT CLAIM TO ANY PARTICULAR FONT, STYLE, SIZE, OR COLOR.

FOR LEGAL SERVICES (U.S. CLS. 100 AND 101).  
SUE LAWRENCE, EXAMINING ATTORNEY

SN 78-364,348. MAGNA-LASTIC DEVICES, INC., CARHAGE, IL. FILED 2-7-2004.



THE COLOR(S) BLUE, WHITE AND BLACK IS/ARE CLAIMED AS A DISTINCTIVE FEATURE OF THE MARK. THE COLOR BLUE & WHITE APPEAR IN THE HEXAGON AND THE COLOR BLACK APPEARS IN THE SWIRLING ARROWS.

THE MARK CONSISTS OF A DESIGN COMPRISING A BLUE AND WHITE HEXAGON CONTAINING THREE SWIRLING BLACK ARROWS.

FOR RESEARCH AND DEVELOPMENT OF TORQUE, FORCE AND ANGLE SENSORS, TORQUE, FORCE AND ANGLE CONTROLLERS AND TORQUE, FORCE AND ANGLE MEASURING APPARATUS FOR OTHERS (U.S. CLS. 100 AND 101).

SUSAN HAYASH, EXAMINING ATTORNEY

**CLASS 43—HOTEL AND RESTAURANT SERVICES**

SN 76-401,065. TRAVELLER'S INN HOTEL GROUP LTD., VICTORIA, BRITISH COLUMBIA, FILED 4-26-2002.

## TRAVELLER'S INN HOTELS & RESORTS

OWNER OF U.S. REG. NO. 1,454,694.

NO CLAIM IS MADE TO THE EXCLUSIVE RIGHT TO USE "INN HOTELS & RESORTS", APART FROM THE MARK AS SHOWN.

SEC. 2(F).

FOR HOTEL, MOTEL AND RESORT LODGING SERVICES; BOOKING TEMPORARY LODGING FOR TRAVELERS; BARS AND RESTAURANT SERVICES (U.S. CLS. 100 AND 101).

BARBARA GAYNOR, EXAMINING ATTORNEY

SN 76-515,628. HWANG, MARK, DIAMOND BAR, CA. FILED 4-25-2003.



NO CLAIM IS MADE TO THE EXCLUSIVE RIGHT TO USE "CALIFORNIA CHICKEN ROASTERS", APART FROM THE MARK AS SHOWN.

THE MARK IS USED ONLY WITH THE DISTINCTIVE SPELLING OF "CALIFORNIA CHICKEN ROASTERS". "CALIFORNIA IS IN SCRIPT STYLE, AND "CHICKEN ROASTERS" IN BLOCK LETTER. THERE ARE THREE YELLOW CARTOON EGG FIGURES WITH THE MIDDLE FIGURE WEARING A RED APRON.

FOR RESTAURANT SERVICES FEATURING CHICKEN AND TURKEY (U.S. CLS. 100 AND 101).

FIRST USE 2-8-1996; IN COMMERCE 2-8-1996.

REBECCA SMITH, EXAMINING ATTORNEY

SN 76-529,341. STACY, JOHN, CAPE NEDDICK, ME. AND STACY, GAIL, CAPE NEDDICK, ME. FILED 7-14-2003.

## FLO'S TAKE OUT SOME KINDA GOOD

NO CLAIM IS MADE TO THE EXCLUSIVE RIGHT TO USE "TAKE OUT", APART FROM THE MARK AS SHOWN.

FOR TAKE-OUT RESTAURANT SERVICES FEATURING PREPARED AND READY TO EAT HOT DOG SANDWICHES (U.S. CLS. 100 AND 101).

FIRST USE 8-1-2003; IN COMMERCE 8-1-2003.

AMY GEARIN, EXAMINING ATTORNEY

**CLASS 43—(Continued).**

SN 76-529,464. CECC INVESTMENTS, LLC, SEATTLE, WA. FILED 7-15-2003.

**SMUDGIE BAR**

NO CLAIM IS MADE TO THE EXCLUSIVE RIGHT TO USE "BAR", APART FROM THE MARK AS SHOWN. FOR RETAIL ICE CREAM PARLOR SERVICES (U.S. CLS. 100 AND 101).  
KAREN K. BUSH, EXAMINING ATTORNEY

SN 76-551,132. TRUONG, MAI, SACRAMENTO, CA. AND TRUONG, TRUNG, SACRAMENTO, CA. FILED 9-25-2003.

**BOBO CAFE VIETNAMESE CUISINE**

NO CLAIM IS MADE TO THE EXCLUSIVE RIGHT TO USE CAFE VIETNAMESE CUISINE, APART FROM THE MARK AS SHOWN. FOR RESTAURANT SERVICES (U.S. CLS. 100 AND 101).  
FIRST USE 1-1-1997; IN COMMERCE 1-1-1997.  
MICHAEL WEBSTER, EXAMINING ATTORNEY

SN 76-574,285. ROY ROGERS TRADEMARK COMPANY, LLC, FREDERICK, MD. FILED 2-6-2004.

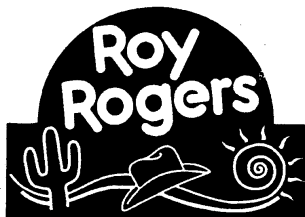

OWNER OF U.S. REG. NOS. 882,909, 1,844,584 AND OTHERS. FOR RESTAURANT SERVICES (U.S. CLS. 100 AND 101).  
FIRST USE 10-0-1998; IN COMMERCE 11-0-2000.  
DAWN FELDMAN, EXAMINING ATTORNEY

SN 76-587,085. CANAL GROUP, INC., CHICAGO, IL. FILED 4-5-2004.

**DESERT RAIN**

THE MARK CONSISTS OF STANDARD CHARACTERS WITHOUT CLAIM TO ANY PARTICULAR FONT, STYLE, SIZE, OR COLOR. OWNER OF U.S. REG. NO. 2,689,158. FOR RESTAURANT AND COCKTAIL LOUNGE SERVICES (U.S. CLS. 100 AND 101).  
GRETTA YAO, EXAMINING ATTORNEY

**CLASS 43—(Continued).**

SN 78-145,400. FREE OCEAN BEVERAGE, INC., ROWLAND HEIGHTS, CA. FILED 7-18-2002.



THE NON-LATIN CHARACTERS IN THE MARK TRANSLITERATE TO KU CHA FON AND THIS TRANSLATES TO COOL STATION. FOR NON-ALCOHOLIC BEVERAGE SERVICES, NAMELY, BAR SERVICES FEATURING NON-ALCOHOLIC BEVERAGES (U.S. CLS. 100 AND 101).  
JOHN DWYER, EXAMINING ATTORNEY

SN 78-146,180. LEE, RONALD, K, PEARL CITY, HI. FILED 7-22-2002.

**DIRTY LICKINS**

FOR CHICKEN RESTAURANT (U.S. CLS. 100 AND 101).  
DORITT L. CARROLL, EXAMINING ATTORNEY

SN 78-146,345. P AND E INVESTMENT, INC., GREENSPORO, NC. FILED 7-22-2002.

**SAKURA EXPRESS**

NO CLAIM IS MADE TO THE EXCLUSIVE RIGHT TO USE "EXPRESS", APART FROM THE MARK AS SHOWN. THE ENGLISH TRANSLATION OF "SAKURA" IS "CHERRY BLOSSOM". FOR FAST FOOD RESTAURANT SERVICES (U.S. CLS. 100 AND 101).  
FIRST USE 7-31-2001; IN COMMERCE 7-31-2001.  
ESTHER A. BORSUK, EXAMINING ATTORNEY

**CLASS 43—(Continued).**

SN 78-203,701. LA CREPERIE, INC., CHICAGO, IL. FILED 1-15-2003.



OWNER OF U.S. REG. NOS. 1,744,718 AND 1,820,279.  
NO CLAIM IS MADE TO THE EXCLUSIVE RIGHT TO USE "BRETAGNE" AND "FRANCE", APART FROM THE MARK AS SHOWN.

THE LINING IS A FEATURE OF THE MARK AND DOES NOT INDICATE COLOR.

THE ENGLISH TRANSLATION OF "BRETAGNE" IS "BRITTANY".

FOR RESTAURANT SERVICES (U.S. CLS. 100 AND 101).

FIRST USE 8-2-2002; IN COMMERCE 8-2-2002.  
ZACHARY BELLO, EXAMINING ATTORNEY

SN 78-295,060. 350 MARKET STREET INC., SAINT PAUL, MN. FILED 9-2-2003.

**PAZZALUNA**

THE FOREIGN WORDING IN THE MARK TRANSLATES INTO ENGLISH AS CRAZY MOON.

FOR RESTAURANT SERVICES (U.S. CLS. 100 AND 101).

FIRST USE 7-27-1998; IN COMMERCE 7-27-1998.  
BERYL GARDNER, EXAMINING ATTORNEY

SN 78-324,493. NEWS-JOURNAL CORPORATION, DAYTONA BEACH, FL. FILED 11-7-2003.

**NEWS-JOURNAL  
CENTER**

THE MARK CONSISTS OF STANDARD CHARACTERS WITHOUT CLAIM TO ANY PARTICULAR FONT, STYLE, SIZE, OR COLOR.

OWNER OF U.S. REG. NOS. 1,910,449, 2,633,669 AND OTHERS.

NO CLAIM IS MADE TO THE EXCLUSIVE RIGHT TO USE "CENTER", APART FROM THE MARK AS SHOWN.

FOR PROVIDING FACILITIES FOR CONCERTS, CONVENTIONS, EXHIBITIONS, BANQUETS, AND SOCIAL FUNCTIONS (U.S. CLS. 100 AND 101).

WILLIAM VERHOSEK, EXAMINING ATTORNEY

**CLASS 43—(Continued).**

SN 78-325,800. JUICE IT UP FRANCHISE CORP., IRVINE, CA. FILED 11-10-2003.



THE COLOR(S) PINK, PURPLE, YELLOW, AND GREEN IS/ARE CLAIMED AS A DISTINCTIVE FEATURE OF THE MARK.

THE BLENDER CONTAINS PINK STRAWBERRIES WITH GREEN CAPS, YELLOW BANANA SLICES, A PINK CHERRY WITH A GREEN STEM, A YELLOW MELON SLICE, PURPLE BLUEBERRIES, AND A GREEN KIWI SLICE.

THE MARK CONSISTS OF A HIGHLY STYLIZED REPRESENTATION OF A GREEN BLENDER WITH A PURPLE SWIRL UNDERNEATH IT. COLOR IS A FEATURE OF THIS MARK.

FOR RESTAURANT SERVICES PROVIDING FRUITS AND VEGETABLE JUICES AND JUICE SMOOTHIES (U.S. CLS. 100 AND 101).

FIRST USE 1-31-2003; IN COMMERCE 1-31-2003.  
ALICIA COLLINS, EXAMINING ATTORNEY

SN 78-329,124. BOUDREAUX'S CAJUN KITCHEN, INC., BELLAIRE, TX. FILED 11-17-2003.

**HOME OF THE  
MONSTER SHRIMP**

THE MARK CONSISTS OF STANDARD CHARACTERS WITHOUT CLAIM TO ANY PARTICULAR FONT, STYLE, SIZE, OR COLOR.

NO CLAIM IS MADE TO THE EXCLUSIVE RIGHT TO USE SHRIMP, APART FROM THE MARK AS SHOWN.

FOR RESTAURANT SERVICES (U.S. CLS. 100 AND 101).

LESLEY LAMOTHE, EXAMINING ATTORNEY

**CLASS 43—(Continued).**

SN 78-332,925. RICCIARDI, PETER P, BRANSON, MO. FILED 11-25-2003.



FOR MOTEL(S) AND RESORT(S) (U.S. CLS. 100 AND 101).  
SUSAN HAYASH, EXAMINING ATTORNEY

**CLASS 43—(Continued).**

SN 78-351,581. Z PIZZA INTERNATIONAL, NEWPORT BEACH, CA. FILED 1-13-2004.



OWNER OF U.S. REG. NO. 2,283,061.  
NO CLAIM IS MADE TO THE EXCLUSIVE RIGHT TO USE "PIZZA", APART FROM THE MARK AS SHOWN.  
THE COLORS PANTONE #165 TOMATO-ORANGE PANTONE #617 PEA-SOUP GREEN ARE CLAIMED AS A DISTINCTIVE FEATURE OF THE MARK.

EACH LETTER IS PANTONE #165 TOMATO-ORANGE WITH A WHITE OUTLINE AND A BLACK LINE OUTLINE ON THE OUTSIDE. THE CIRCLE AND BANNER BACKGROUND COLORS ARE PANTONE #617 PEA SOUP GREEN.

THE MARK CONSISTS OF A STYLIZED LETTER "Z" FOLLOWED BY THE WORD "PIZZA" IMMEDIATELY TO THE RIGHT OF THE "Z". THE "Z" IS PARTIALLY SUPERIMPOSED OVER A SIMILAR SIZED CIRCLE THAT IS ATTACHED TO A UPWARD ARCHING CURVED BANNER LOCATED TO THE RIGHT OF THE CIRCLE THAT IS THE BACKDROP FOR THE WORD "PIZZA".

FOR RESTAURANTS, CARRY-OUT RESTAURANTS AND RESTAURANTS FEATURING HOME DELIVERY, ALL FEATURING GOURMET PIZZAS, PASTAS AND SANDWICHES (U.S. CLS. 100 AND 101).  
ANNE MADDEN, EXAMINING ATTORNEY

SN 78-339,139. HARRIS, SHERMAN, PALM DESERT, CA. FILED 12-10-2003.

**SHERMAN'S DELI & BAKERY**

THE MARK CONSISTS OF STANDARD CHARACTERS WITHOUT CLAIM TO ANY PARTICULAR FONT, STYLE, SIZE, OR COLOR.

NO CLAIM IS MADE TO THE EXCLUSIVE RIGHT TO USE "DELI & BAKERY", APART FROM THE MARK AS SHOWN.

FOR RESTAURANT SERVICES AND DELICATESSEN (U.S. CLS. 100 AND 101).

FIRST USE 1-1-1996; IN COMMERCE 1-1-1996.  
GEORGE LORENZO, EXAMINING ATTORNEY

SN 78-351,583. Z PIZZA INTERNATIONAL, NEWPORT BEACH, CA. FILED 1-13-2004.



OWNER OF U.S. REG. NO. 2,283,061.  
NO CLAIM IS MADE TO THE EXCLUSIVE RIGHT TO USE "PIZZA", APART FROM THE MARK AS SHOWN.  
THE COLORS PANTONE #165 TOMATO-ORANGE PANTONE #617 PEA-SOUP GREEN ARE CLAIMED AS A DISTINCTIVE FEATURE OF THE MARK.

EACH LETTER IS PANTONE #165 TOMATO-ORANGE WITH A WHITE OUTLINE AND A BLACK LINE OUTLINE ON THE OUTSIDE. THE CIRCLE BACKGROUND FOR THE "Z" IS PANTONE #617 PEA SOUP GREEN.

THE MARK CONSISTS OF A STYLIZED LETTER "Z" FOLLOWED BY THE WORD "PIZZA" IMMEDIATELY TO THE RIGHT OF THE "Z". THE "Z" IS PARTIALLY SUPERIMPOSED OVER A SIMILAR SIZED CIRCLE.

FOR RESTAURANTS, CARRY-OUT RESTAURANTS AND RESTAURANTS FEATURING HOME DELIVERY, ALL FEATURING GOURMET PIZZAS, PASTAS AND SANDWICHES (U.S. CLS. 100 AND 101).

ANNE MADDEN, EXAMINING ATTORNEY

**CLASS 43—(Continued).**

SN 78-353,661. PHEASANT MALL RESTAURANT GROUP, INC., NASHUA, NH. FILED 1-19-2004.

OWNER OF U.S. REG. NO. 2,243,763.  
FOR RESTAURANT AND BAR SERVICES (U.S. CLS. 100 AND 101).  
FIRST USE 10-0-1998; IN COMMERCE 10-0-1998.  
JOSETTE BEVERLY, EXAMINING ATTORNEY

SN 78-353,780. FAST FRESH ITALIAN, LLC, NORTH BARRINGTON, IL. FILED 1-19-2004.

## CIAO FOR NOW

THE MARK CONSISTS OF STANDARD CHARACTERS WITHOUT CLAIM TO ANY PARTICULAR FONT, STYLE, SIZE, OR COLOR.  
FOR RESTAURANT AND CATERING SERVICES (U.S. CLS. 100 AND 101).  
FIRST USE 3-6-2004; IN COMMERCE 3-6-2004.  
ANDREA SAUNDERS, EXAMINING ATTORNEY

SN 78-355,700. COMMISSION FOR THE LAS VEGAS CENTENNIAL, LAS VEGAS, NV. FILED 1-22-2004.



NO CLAIM IS MADE TO THE EXCLUSIVE RIGHT TO USE LAS VEGAS AND 1905-2005, APART FROM THE MARK AS SHOWN.

THE COLOR(S) RED, WHITE AND BLUE IS/ARE CLAIMED AS A DISTINCTIVE FEATURE OF THE MARK.  
THE MARK CONSISTS OF A RED SIGN WITH THE WHITE STYLIZED WORDS AND NUMBERS LAS VEGAS CENTENNIAL 1905-2005, WITH BLUE AND WHITE CIRCLES AROUND THE SIGN, AND A BLUE STAR.

FOR TRAVEL AGENCY SERVICES, NAMELY, MAKING RESERVATIONS AND BOOKINGS FOR TEMPORARY LODGING, RESTAURANTS AND MEALS (U.S. CLS. 100 AND 101).

KIMBERLY PERRY, EXAMINING ATTORNEY

**CLASS 43—(Continued).**

SN 78-357,114. CREATIVE CORPORATE CATERING, INC., GOLDEN VALLEY, MN. FILED 1-24-2004.

## MEETING MEALS MADE EASY

THE MARK CONSISTS OF STANDARD CHARACTERS WITHOUT CLAIM TO ANY PARTICULAR FONT, STYLE, SIZE, OR COLOR.  
FOR CATERING (U.S. CLS. 100 AND 101).  
FIRST USE 9-0-2001; IN COMMERCE 9-0-2001.  
CAROLINE WOOD, EXAMINING ATTORNEY

SN 78-358,293. MADRAS SARAVANA BHAVAN, INC., DECATUR, GA. FILED 1-27-2004.

## MSB

THE MARK CONSISTS OF STANDARD CHARACTERS WITHOUT CLAIM TO ANY PARTICULAR FONT, STYLE, SIZE, OR COLOR.  
FOR RESTAURANT SERVICES (U.S. CLS. 100 AND 101).  
FIRST USE 11-30-2001; IN COMMERCE 11-30-2001.  
SHARI SHEFFIELD, EXAMINING ATTORNEY

SN 78-359,224. CONSUMERS CHOICE COFFEE, INC., LOUISVILLE, KY. FILED 1-29-2004.

## WILLOW CREEK COFFEE

THE MARK CONSISTS OF STANDARD CHARACTERS WITHOUT CLAIM TO ANY PARTICULAR FONT, STYLE, SIZE, OR COLOR.

NO CLAIM IS MADE TO THE EXCLUSIVE RIGHT TO USE "COFFEE", APART FROM THE MARK AS SHOWN.

FOR COFFEE SUPPLY SERVICES FOR BUSINESSES (U.S. CLS. 100 AND 101).

TONJA GASKINS, EXAMINING ATTORNEY

**CLASS 43—(Continued).**

SN 78-359,548. PIZZA HUT, INC., DALLAS, TX. FILED 1-29-2004.

**CLASS 43—(Continued).**

SN 78-360,857. Y ASSOCIATES, INC., NEW YORK, NY. FILED 2-2-2004.

**FAIR & SQUARE**

**SEA**

THE MARK CONSISTS OF STANDARD CHARACTERS WITHOUT CLAIM TO ANY PARTICULAR FONT, STYLE, SIZE, OR COLOR.

FOR RESTAURANT SERVICES (U.S. CLS. 100 AND 101).

JOHN DWYER, EXAMINING ATTORNEY

THE MARK CONSISTS OF STANDARD CHARACTERS WITHOUT CLAIM TO ANY PARTICULAR FONT, STYLE, SIZE, OR COLOR.

FOR RESTAURANT SERVICES (U.S. CLS. 100 AND 101).

FIRST USE 12-0-2000; IN COMMERCE 12-0-2000.  
BARBARA BROWN, EXAMINING ATTORNEY

SN 78-360,017. MARRIOTT INTERNATIONAL, INC., BETHESDA, MD. FILED 1-30-2004.

SN 78-361,062. SONNY'S FRANCHISE COMPANY, MAITLAND, FL. FILED 2-2-2004.

**FOR TRAVELERS WHO  
KNOW**

**SONNY'S BIG DEAL**

THE MARK CONSISTS OF STANDARD CHARACTERS WITHOUT CLAIM TO ANY PARTICULAR FONT, STYLE, SIZE, OR COLOR.

FOR HOTEL SERVICES; RESTAURANT SERVICES; PROVISION OF GENERAL PURPOSE FACILITIES FOR MEETINGS, CONFERENCES AND EXHIBITIONS; PROVISION OF BANQUET AND SOCIAL FUNCTION FACILITIES FOR SPECIAL OCCASIONS; AND RESERVATION SERVICES FOR HOTEL ACCOMODATIONS FOR OTHERS (U.S. CLS. 100 AND 101).

ALICE BENMAMAN, EXAMINING ATTORNEY

THE MARK CONSISTS OF STANDARD CHARACTERS WITHOUT CLAIM TO ANY PARTICULAR FONT, STYLE, SIZE, OR COLOR.

OWNER OF U.S. REG. NOS. 1,149,089, 1,152,738 AND 2,651,370.

FOR RESTAURANT SERVICES (U.S. CLS. 100 AND 101).

KAREN BRACEY, EXAMINING ATTORNEY

**CLASS 43—(Continued).**

SN 78-363,102. ASSAF, VITTORIO, NEW YORK, NY. AND GRANATO, FABIO, NEW YORK, NY. FILED 2-5-2004.

# LOLLIPOP

THE MARK CONSISTS OF STANDARD CHARACTERS WITHOUT CLAIM TO ANY PARTICULAR FONT, STYLE, SIZE, OR COLOR.

FOR RESTAURANT AND BAR SERVICES (U.S. CLS. 100 AND 101).

STEVEN R. FINE, EXAMINING ATTORNEY

**CLASS 44—MEDICAL, BEAUTY AND AGRICULTURAL SERVICES**

SN 76-387,359. BEIDER, SHAY, LOS ANGELES, CA. FILED 3-26-2002.

# INTEGRATIVE TOUCH

NO CLAIM IS MADE TO THE EXCLUSIVE RIGHT TO USE "TOUCH", APART FROM THE MARK AS SHOWN.

FOR MEDICAL SERVICES, NAMELY, PROVIDING THERAPEUTIC TOUCH SERVICES TO PATIENTS IN A MEDICAL ENVIRONMENT (U.S. CLS. 100 AND 101).

FIRST USE 6-0-2000; IN COMMERCE 6-0-2000.  
INGA ERVIN, EXAMINING ATTORNEY

SN 76-468,666. TRALE, INC., DALEVILLE, IN. FILED 11-8-2002.



FOR HEALTHCARE MANAGEMENT SERVICES, NAMELY, PERSONNEL RISK ASSESSMENTS, HEALTH RISK ASSESSMENTS AND COMPREHENSIVE HEALTH STATUS REPORTS FOR USE IN THE FIELDS OF INSURANCE, BUSINESS HEALTHCARE, AND EMPLOYMENT EDUCATION (U.S. CLS. 100 AND 101).

FIRST USE 11-20-2001; IN COMMERCE 11-20-2001.  
EUGENIA MARTIN, EXAMINING ATTORNEY

**CLASS 44—(Continued).**

SN 76-473,521. FANCY PUBLICATIONS, INC., LOS ANGELES, CA. FILED 12-2-2002.

# ANIMAL NETWORK

OWNER OF U.S. REG. NO. 2,346,249.  
NO CLAIM IS MADE TO THE EXCLUSIVE RIGHT TO USE "NETWORK", APART FROM THE MARK AS SHOWN. SEC. 2(F).

FOR COMPUTER SERVICES, NAMELY, PROVIDING A WEBSITE FOR THE TRANSFER AND DISSEMINATION OF INFORMATION REGARDING PET CARE AND ANIMAL HEALTH (U.S. CLS. 100 AND 101).

FIRST USE 2-0-1996; IN COMMERCE 2-0-1996.  
SUSAN LESLIE DUBOIS, EXAMINING ATTORNEY

SN 76-524,302. FAMILY PRACTICE INQUIRIES NETWORK CONSORTIUM INC., COLUMBIA, MO. FILED 6-13-2003.



NO CLAIM IS MADE TO THE EXCLUSIVE RIGHT TO USE FAMILY PRACTICE INQUIRIES NETWORK, APART FROM THE MARK AS SHOWN.

FOR PROVIDING A DATABASE OF MEDICAL INFORMATION VIA THE INTERNET FOR USE IN ANSWERING PHYSICIAN'S QUESTION AT THE POINT OF CARE (U.S. CLS. 100 AND 101).

FIRST USE 4-22-2003; IN COMMERCE 4-22-2003.  
BRIAN PINO, EXAMINING ATTORNEY

SN 76-537,943. DELNOR-COMMUNITY HEALTH SYSTEM, GENEVA, IL. FILED 8-4-2003.



THE MARK CONSISTS OF THE DESIGN ELEMENT IN THE MARK CONSISTS OF TWO CONVERGING, CURVED TRIANGLES IN THE STYLE OF A CHECK MARK PRECEDING THE WORD PART OF THE MARK.

FOR MANAGED HEALTH CARE SERVICES (U.S. CLS. 100 AND 101).

FIRST USE 3-0-2001; IN COMMERCE 3-0-2001.  
PAUL F. GAST, EXAMINING ATTORNEY

**CLASS 44—(Continued).**

SN 76-540,973. STARPOINT HEALTHCARE GROUP, MISSOULA, MT. FILED 8-29-2003.

**STARPOINT**<sub>LLC</sub>  
*Healthcare Group*

NO CLAIM IS MADE TO THE EXCLUSIVE RIGHT TO USE "LLC HEALTHCARE GROUP", APART FROM THE MARK AS SHOWN.

THE MARK CONSISTS OF THE WORDING "STARPOINT LLC HEALTHCARE GROUP" WITH THE SILHOUETTE OF A MAN FORMING THE LETTER "I" IN "STARPOINT". FOR MANAGED HEALTH CARE SERVICES (U.S. CLS. 100 AND 101).

FIRST USE 5-1-2003; IN COMMERCE 7-1-2003.  
DORITT L. CARROLL, EXAMINING ATTORNEY

SN 76-546,112. FURST, CHARLES J, LOS ANGELES, CA. AND GREEN-ALVAREZ, ARLENE, LOS ANGELES, CA. FILED 9-2-2003.

**MEMSCREEN**

FOR NEUROPSYCHOLOGICAL MEMORY TESTING (U.S. CLS. 100 AND 101).

FIRST USE 8-25-2003; IN COMMERCE 8-27-2003.  
BILL DAWE, EXAMINING ATTORNEY

SN 76-550,856. ALLERGY INSTITUTE, A MEDICAL CORPORATION, FRESNO, CA. FILED 10-14-2003.

**ALLERGY INSTITUTE**

NO CLAIM IS MADE TO THE EXCLUSIVE RIGHT TO USE INSTITUTE, APART FROM THE MARK AS SHOWN. SEC. 2(F).

FOR MEDICAL SERVICES (U.S. CLS. 100 AND 101).  
FIRST USE 12-0-1992; IN COMMERCE 12-0-1992.  
CIMMERIAN COLEMAN, EXAMINING ATTORNEY

SN 76-551,741. THE HOSPICES OF THE NATIONAL CAPITAL REGION, FAIRFAX, VA. FILED 10-10-2003.



FOR MEDICAL SERVICES, NAMELY, HOSPICE AND PALLIATIVE SERVICES (U.S. CLS. 100 AND 101).  
KELLY BOULTON, EXAMINING ATTORNEY

**CLASS 44—(Continued).**

SN 76-552,698. THE WOODBRIDGE ALTERNATIVE, FAYETTEVILLE, NC. FILED 10-20-2003.

**BRIDGING THE GAP WITH  
BRIGHT BEGINNINGS**

FOR MENTAL HEALTH SERVICES, NAMELY, GROUP HOME SERVICES FOR CHILDREN WITH EMOTIONAL AND BEHAVIORAL DISTURBANCES AND OTHER SPECIAL NEEDS (U.S. CLS. 100 AND 101).

FIRST USE 0-0-1998; IN COMMERCE 0-0-1998.  
STEVEN BERK, EXAMINING ATTORNEY

SN 76-555,157. PSYCHOLOGY SOCIAL-SKILLS PEER GROUPS, P.L.L.C., NEW YORK, NY. FILED 10-29-2003.



**SOCIAL-SKILLS  
PEER PLAY GROUPS**

NO CLAIM IS MADE TO THE EXCLUSIVE RIGHT TO USE "SOCIAL-SKILLS PEER PLAY GROUP", APART FROM THE MARK AS SHOWN.

FOR PSYCHOLOGICAL COUNSELING, NAMELY, PROVIDING CHILDREN WITH ASSISTANCE IN DEVELOPING SOCIAL SKILLS (U.S. CLS. 100 AND 101).

FIRST USE 10-0-1993; IN COMMERCE 10-0-1993.  
TONI HICKEY, EXAMINING ATTORNEY

SN 76-563,326. NEW LEAF SALON, INC., BOYLSTON, MA. FILED 12-4-2003.

**NEW LEAF**

THE MARK CONSISTS OF STANDARD CHARACTERS WITHOUT CLAIM TO ANY PARTICULAR FONT, STYLE, SIZE, OR COLOR.

FOR BEAUTY SALON SERVICES, NAMELY, HAIR DRESSING AND GROOMING SERVICES, FEATURING HAIR CUTTING, HAIR STYLING, HAIR COLORING, MAKE-UP APPLICATION, COSMETOLOGY WAXING, MANICURES AND PEDICURES (U.S. CLS. 100 AND 101).

FIRST USE 10-6-2003; IN COMMERCE 10-6-2003.  
ASMAT KHAN, EXAMINING ATTORNEY



**CLASS 44—(Continued).**

SN 78-264,788. QUIT SMOKING INTERNATIONAL LTD., WATERFORD, IRELAND, FILED 6-19-2003.



FOR MEDICAL SERVICES; VETERINARY SERVICES; TREATMENT SERVICES AIMING AT GETTING RID OF THE VICE OF SMOKING BY ELECTRONIC STIMULATION (U.S. CLS. 100 AND 101).  
MICHAEL ENGEL, EXAMINING ATTORNEY

SN 78-267,598. FOOT AND ANKLE CLINICS OF AMERICA LLC, CHICAGO, IL. FILED 6-26-2003.

## FOOT & ANKLE CLINICS OF AMERICA

SEC. 2(F).  
FOR PODIATRIC SERVICES, NAMELY, MEDICAL AND SURGICAL SERVICES, PHYSICAL THERAPY SERVICES, PHYSICAL REHABILITATION SERVICES, MEDICAL TESTING SERVICES, ORTHOTICS SERVICES AND CLINICS (U.S. CLS. 100 AND 101).  
FIRST USE 4-30-1991; IN COMMERCE 4-30-1991.  
VIVIAN MICZNIK FIRST, EXAMINING ATTORNEY

SN 78-267,605. FOOT & ANKLE CLINICS OF AMERICA LLC, CHICAGO, IL. FILED 6-26-2003.



NO CLAIM IS MADE TO THE EXCLUSIVE RIGHT TO USE "FOOT & ANKLE CLINICS OF AMERICA", APART FROM THE MARK AS SHOWN.

FOR PODIATRIC SERVICES, NAMELY, MEDICAL AND SURGICAL SERVICES, PHYSICAL THERAPY SERVICES, PHYSICAL REHABILITATION SERVICES, MEDICAL TESTING SERVICES, ORTHOTICS SERVICES, AND CLINICS (U.S. CLS. 100 AND 101).  
FIRST USE 4-30-1991; IN COMMERCE 4-30-1991.  
VIVIAN MICZNIK FIRST, EXAMINING ATTORNEY

**CLASS 44—(Continued).**

SN 78-278,561. L'OREAL USA CREATIVE, INC., NEW YORK, NY. FILED 7-24-2003.

## KIEHL'S

OWNER OF U.S. REG. NO. 1,618,321.  
SEC. 2(F).  
FOR PROVIDING INFORMATION CONCERNING THE USE AND SELECTION OF COSMETICS, PERSONAL CARE PRODUCTS AND BEAUTY TREATMENTS VIA THE INTERNET (U.S. CLS. 100 AND 101).  
FIRST USE 10-25-2001; IN COMMERCE 10-25-2001.  
ELIZABETH HUGHITT, EXAMINING ATTORNEY

SN 78-315,662. LEE, GEUN BAE, MEXICO DF, MEXICO, FILED 10-20-2003.

## HOTPUNCTURE

FOR ACUPUNCTURE SERVICES (U.S. CLS. 100 AND 101).  
INGA ERVIN, EXAMINING ATTORNEY

SN 78-336,738. HAWAII PACIFIC HEALTH, HONOLULU, HI. FILED 12-4-2003.



## Hawaii Pacific Health

NO CLAIM IS MADE TO THE EXCLUSIVE RIGHT TO USE "HAWAII" AND "HEALTH", APART FROM THE MARK AS SHOWN.

THE MARK CONSISTS OF WORDS HAWAII PACIFIC HEALTH TOGETHER WITH A DESIGN OF THREE INDIVIDUALS PADDLING A CANOE WITH LANDSCAPE AND MOON IN THE BACKGROUND.

FOR MEDICAL AND HEALTH CARE SERVICES (U.S. CLS. 100 AND 101).  
FIRST USE 12-1-2003; IN COMMERCE 12-1-2003.  
KATHERINE STOIDES, EXAMINING ATTORNEY

**CLASS 44—(Continued).**

SN 78-337,667. BRAIN TRAINING ASSOCIATES, INC., PLANO, TX. FILED 12-8-2003.

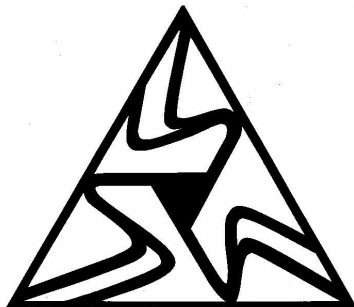

FOR REHABILITATION OF DEVELOPMENTAL AND SENSORY PROCESSING DISORDERS (U.S. CLS. 100 AND 101).

JAMES A. RAUEN, EXAMINING ATTORNEY

SN 78-344,042. FRANCISCO SUAREZ-MEDEROS, M.D., NORTH MIAMI, FL. FILED 12-22-2003.

**NUEVO CAMINAR**

THE MARK CONSISTS OF STANDARD CHARACTERS WITHOUT CLAIM TO ANY PARTICULAR FONT, STYLE, SIZE, OR COLOR.

THE FOREIGN WORDING IN THE MARK TRANSLATES INTO ENGLISH AS NEW TO WALK.

FOR REHABILITATION OF DRUG AND ALCOHOL ADDICTED PATIENTS (U.S. CLS. 100 AND 101).

MATTHEW KLINE, EXAMINING ATTORNEY

SN 78-345,264. STAR HAIRCARE SERVICES, INC., SOUTH SAN FRANCISCO, CA. FILED 12-23-2003.

**HAIRWORKS FAMILY SALON**

THE MARK CONSISTS OF STANDARD CHARACTERS WITHOUT CLAIM TO ANY PARTICULAR FONT, STYLE, SIZE, OR COLOR.

NO CLAIM IS MADE TO THE EXCLUSIVE RIGHT TO USE "FAMILY SALON", APART FROM THE MARK AS SHOWN.

FOR HAIR SALON AND BARBER SHOP SERVICES (U.S. CLS. 100 AND 101).

WILLIAM P. SHANAHAN, EXAMINING ATTORNEY

**CLASS 44—(Continued).**

SN 78-350,921. RHODES, PAUL ORIEN, FLOWERY BRANCH, GA. FILED 1-12-2004.

**UNCLE FREDDIE'S**

THE MARK CONSISTS OF STANDARD CHARACTERS WITHOUT CLAIM TO ANY PARTICULAR FONT, STYLE, SIZE, OR COLOR.

FOR TATTOOING AND BODY PIERCING SERVICES (U.S. CLS. 100 AND 101).

CAROLINE WOOD, EXAMINING ATTORNEY

SN 78-352,435. BACHAYEV, MIKHAIL, DENVER, CO. FILED 1-15-2004.

**MISHKA SURGICAL SERVICES**

THE MARK CONSISTS OF STANDARD CHARACTERS WITHOUT CLAIM TO ANY PARTICULAR FONT, STYLE, SIZE, OR COLOR.

NO CLAIM IS MADE TO THE EXCLUSIVE RIGHT TO USE "SURGICAL SERVICES", APART FROM THE MARK AS SHOWN.

FOR MEDICAL SERVICES (U.S. CLS. 100 AND 101).

FIRST USE 8-7-2000; IN COMMERCE 8-7-2000.

VERNA BETH RIRIE, EXAMINING ATTORNEY

SN 78-355,786. THE MENTA GROUP, INC., NFP, AURORA, IL. FILED 1-22-2004.

**WE GROW POTENTIAL**

THE MARK CONSISTS OF STANDARD CHARACTERS WITHOUT CLAIM TO ANY PARTICULAR FONT, STYLE, SIZE, OR COLOR.

FOR MENTAL HEALTH SERVICES (U.S. CLS. 100 AND 101).

FIRST USE 1-1-2000; IN COMMERCE 1-1-2000.

ANDREW BENZMILLER, EXAMINING ATTORNEY

**CLASS 44—(Continued).**

SN 78-359,891. MATTSON JACK GROUP, INC., THE, ST. LOUIS, MO. FILED 1-30-2004.

**HEALTHGALLERY**

THE MARK CONSISTS OF STANDARD CHARACTERS WITHOUT CLAIM TO ANY PARTICULAR FONT, STYLE, SIZE, OR COLOR.

FOR COMPUTER SERVICES, NAMELY, PROVIDING A SUBSCRIPTION BASED DATABASE FOR INTERACTION AND ANALYSIS VIA A COMPUTER INFORMATION NETWORK DESIGNED TO ALLOW USERS TO SEARCH AND RETRIEVE U.S. GOVERNMENT HEALTH STATISTICS, PROFILES, GENERAL HEALTH STATUS INFORMATION, AND PATIENT TREATMENT INFORMATION, INCLUDING HOSPITAL INPATIENT DATA, PHYSICIAN OFFICE DATA, AND EMERGENCY ROOM AND OUTPATIENT DATA (U.S. CLS. 100 AND 101).

CAROLYN CATALDO, EXAMINING ATTORNEY

SN 78-360,425. INFLEXION, INC., NEWTON, MA. FILED 1-30-2004.

**MSB**

THE MARK CONSISTS OF STANDARD CHARACTERS WITHOUT CLAIM TO ANY PARTICULAR FONT, STYLE, SIZE, OR COLOR.

FOR PROVIDING A WEB SITE FEATURING INFORMATION IN THE FIELD OF HEALTH, NAMELY, AN INTERACTIVE WEBSITE ON THE GLOBAL INFORMATION NETWORK CONTAINING CLINICAL INFORMATION ON HEALTH AND DRUG ISSUES FOR COLLEGE STUDENTS (U.S. CLS. 100 AND 101).

FIRST USE 4-0-2002; IN COMMERCE 10-7-2002.

DAVID TAYLOR, EXAMINING ATTORNEY

**CLASS 44—(Continued).**

SN 78-366,226. THE MENTA GROUP, INC., NFP, AURORA, IL. FILED 2-11-2004.

**THE MENTA WAY**

THE MARK CONSISTS OF STANDARD CHARACTERS WITHOUT CLAIM TO ANY PARTICULAR FONT, STYLE, SIZE, OR COLOR.

NO CLAIM IS MADE TO THE EXCLUSIVE RIGHT TO USE WAY, APART FROM THE MARK AS SHOWN.

FOR MENTAL HEALTH SERVICES (U.S. CLS. 100 AND 101).

FIRST USE 1-1-2001; IN COMMERCE 1-1-2001.

CAROLYN GRAY, EXAMINING ATTORNEY

**CLASS 45—PERSONAL SERVICES**

SN 76-399,378. VERISECURE SYSTEMS, INC., PLANTATION, FL. FILED 4-23-2002.

**VERISECURE SYSTEMS**

NO CLAIM IS MADE TO THE EXCLUSIVE RIGHT TO USE "SYSTEMS", APART FROM THE MARK AS SHOWN.

FOR SECURITY PRINTING, NAMELY, ENCODING IDENTIFICATION INFORMATION ON VALUABLE DOCUMENTS AND PRODUCTS (U.S. CLS. 100 AND 101).

FIRST USE 2-5-2002; IN COMMERCE 2-5-2002.

GEOFFREY FOSDICK, EXAMINING ATTORNEY

SN 76-536,881. GUIDEPOSTS, A CHURCH CORPORATION, CARMEL, NY. FILED 8-11-2003.

**WHAT PRAYER CAN DO**

FOR PROVIDING PERSONAL, SPIRITUAL AND POSITIVE AND FAITHFILLED INFORMATION, NAMELY TRUE STORIES OF HOPE AND INSPIRATION, PRACTICAL SOLUTIONS TO EVERYDAY PROBLEMS, AND PRAYERS, VIA THE GLOBAL COMPUTER NETWORK (U.S. CLS. 100 AND 101).

FIRST USE 11-0-2000; IN COMMERCE 11-0-2000.

SAMUEL E. SHARPER JR., EXAMINING ATTORNEY

**CLASS 45—(Continued).**

SN 76-536,886. GUIDEPOSTS, A CHURCH CORPORATION, CARMEL, NY. FILED 8-11-2003.

**DAILY THOUGHTS**

FOR PROVIDING PERSONAL, SPIRITUAL AND POSITIVE AND FAITHFILLED INFORMATION, NAMELY TRUE STORIES OF HOPE AND INSPIRATION, PRACTICAL SOLUTIONS TO EVERYDAY PROBLEMS, AND PRAYERS, VIA THE GLOBAL COMPUTER NETWORK (U.S. CLS. 100 AND 101).

FIRST USE 11-0-2000; IN COMMERCE 11-0-2000.  
SAMUEL E. SHARPER JR., EXAMINING ATTORNEY

**CLASS 45—(Continued).**

SN 78-336,060. DISNEY ENTERPRISES, INC., BURBANK, CA. FILED 12-3-2003.

**D-CARDS**

THE MARK CONSISTS OF STANDARD CHARACTERS WITHOUT CLAIM TO ANY PARTICULAR FONT, STYLE, SIZE, OR COLOR.

FOR ON-LINE SERVICES, NAMELY, PROVIDING ELECTRONIC GREETING CARDS VIA THE INTERNET (U.S. CLS. 100 AND 101).

FIRST USE 1-1-1998; IN COMMERCE 1-1-1998.  
EDWARD NELSON, EXAMINING ATTORNEY

SN 76-536,887. GUIDEPOSTS, A CHURCH CORPORATION, CARMEL, NY. FILED 8-11-2003.

**AFTERGLOW**

FOR PROVIDING PERSONAL, SPIRITUAL, POSITIVE AND FAITHFILLED INFORMATION, NAMELY TRUE STORIES OF HOPE AND INSPIRATION, PRACTICAL SOLUTIONS TO EVERYDAY PROBLEMS, AND PRAYERS, VIA THE GLOBAL COMPUTER NETWORK (U.S. CLS. 100 AND 101).

FIRST USE 3-4-2002; IN COMMERCE 3-4-2002.  
SAMUEL E. SHARPER JR., EXAMINING ATTORNEY

SN 78-400,837. MATCHNET PLC, BEVERLY HILLS, CA. FILED 4-13-2004.

**HELPING PEOPLE  
CLICK**

SN 76-560,045. SPECIALTY MATCH NETWORK, INC., LAGUNA BEACH, CA. FILED 11-14-2003.

**MYCOUNTRYMATCH.COM**

THE MARK CONSISTS OF STANDARD CHARACTERS WITHOUT CLAIM TO ANY PARTICULAR FONT, STYLE, SIZE, OR COLOR.

FOR ON-LINE COMPUTER DATING SERVICES; ON-LINE MATCH MAKING SERVICES; ON-LINE SOCIAL INTRODUCTION AGENCY SERVICES (U.S. CLS. 100 AND 101).

MICHELE SWAIN, EXAMINING ATTORNEY

THE MARK CONSISTS OF STANDARD CHARACTERS WITHOUT CLAIM TO ANY PARTICULAR FONT, STYLE, SIZE, OR COLOR.

FOR PROVIDING ON-LINE PERSONAL INTRODUCTIONS THROUGH A WEBSITE, ACCESSED VIA INTERCONNECTED GLOBAL COMPUTER NETWORKS, FOR THE PURPOSE OF MAKING ACQUAINTANCES, FRIENDSHIP, AND LONG TERM RELATIONSHIPS (U.S. CLS. 100 AND 101).

FIRST USE 4-4-2004; IN COMMERCE 4-4-2004.  
JOHN KELLY, EXAMINING ATTORNEY

SECTION 4.—PRIOR UNITED STATES CLASSIFICATION

APPLICATION IN ONE CLASS

CERTIFICATION MARKS

CLASS A—GOODS  
SN 76-558,632. SCHOOLS INTEROPERABILITY FRAME-  
WORK, WASHINGTON, DC. FILED 11-10-2003.



NO CLAIM IS MADE TO THE EXCLUSIVE RIGHT TO USE COMPLIANT, APART FROM THE MARK AS SHOWN.  
THE CERTIFICATION MARK, AS USED BY PERSONS AUTHORIZED BY THE CERTIFIER, CERTIFIES THAT THE GOODS BEARING THE MARK CONSIST OF EDUCATIONAL AND SCHOOL ADMINISTRATION SOFTWARE PROGRAMS THAT MEET PUBLISHED STANDARDS FOR AUTOMATIC SHARING OF DATA  
SEC. 2(F) AS TO "SCHOOLS INTEROPERABILITY FRAMEWORK"  
FOR COMPUTER SOFTWARE.  
FIRST USE 4-25-2003; IN COMMERCE 4-25-2003.  
MICHELE SWAIN, EXAMINING ATTORNEY

SN 78-320,274. UNITED FOOD & COMMERCIAL WORKERS INTERNATIONAL UNION, AFL-CIO, CLC, WASHINGTON, DC. FILED 10-29-2003.



OWNER OF U.S. REG. NOS. 1,212,828, 2,703,637 AND OTHERS.  
NO CLAIM IS MADE TO THE EXCLUSIVE RIGHT TO USE "UNION MADE", APART FROM THE MARK AS SHOWN.

THE CERTIFICATION MARK, AS USED UNDER AUTHORITY OF THE CERTIFIER OR BY PERSONS AUTHORIZED BY THE CERTIFIER, CERTIFIES THAT THE GOODS WERE PRODUCED BY MEMBERS OF UNITED FOOD & COMMERCIAL WORKERS INTERNATIONAL UNION, AFL-CIO, CLC AND IN ACCORDANCE WITH ADOPTED STANDARDS THERETO.  
FOR PRINTED MATERIALS.  
FIRST USE 10-16-2001; IN COMMERCE 10-16-2001.  
WILLIAM VERHOSEK, EXAMINING ATTORNEY

CLASS B—SERVICES

SN 76-532,924. INTERNATIONAL SOCIETY OF ARBORICULTURE, INC., CHAMPAIGN, IL. FILED 7-28-2003.

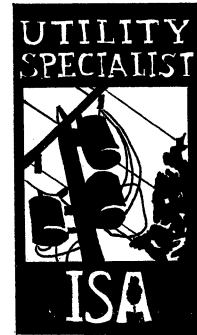

OWNER OF U.S. REG. NOS. 1,786,035 AND 2,253,017.  
NO CLAIM IS MADE TO THE EXCLUSIVE RIGHT TO USE UTILITY SPECIALISTS, APART FROM THE MARK AS SHOWN.  
THE CERTIFICATION MARK, AS INTENDED TO BE USED BY PERSONS AUTHORIZED BY THE CERTIFIER, CERTIFIES THAT THESE PERSONS, WHO ARE PERFORMING THE SERVICES IDENTIFIED ABOVE, HAVE DEMONSTRATED SATISFACTORY, ADVANCED PROFESSIONAL KNOWLEDGE IN THE FIELD OF ARBORICULTURE, INCLUDING: PROPER PLANT AND TREE IDENTIFICATION AND CARE; PLANTING, MAINTAINING, AND TREATING PLANTS AND TREES; ELECTRIC UTILITY PRUNING; VEGETATION MANAGEMENT; ELECTRICAL KNOWLEDGE; CUSTOMER RELATIONS; AND EMERGENCY MANAGEMENT, IN ACCORDANCE WITH REQUIREMENTS ESTABLISHED BY THE CERTIFIER, INCLUDING THE COMPLETION OF THE NECESSARY PROFESSIONAL OCCUPATIONAL REQUIREMENTS; SUCCESSFUL COMPLETION OF A KNOWLEDGE-BASED WRITTEN EXAMINATION; AND, COMPLETION OF THE REQUIRED CONTINUING EDUCATION UNITS FOR RECERTIFICATION.  
FOR ARBORICULTURE.  
RUSS HERMAN, EXAMINING ATTORNEY

SN 76-532,926. INTERNATIONAL SOCIETY OF ARBORICULTURE, INC., CHAMPAIGN, IL. FILED 7-28-2003.

**ISA CERTIFIED TREE  
WORKER CLIMBER  
SPECIALIST**

OWNER OF U.S. REG. NOS. 1,786,035 AND 2,253,017.  
NO CLAIM IS MADE TO THE EXCLUSIVE RIGHT TO USE CERTIFIED TREE WORKER CLIMBER, APART FROM THE MARK AS SHOWN.

THE CERTIFICATION MARK, AS USED BY PERSONS AUTHORIZED BY THE CERTIFIER, CERTIFIES THAT THESE PERSONS, WHO ARE PERFORMING THE SERVICES IDENTIFIED ABOVE, HAVE DEMONSTRATED SATISFACTORY, ADVANCED PROFESSIONAL KNOWLEDGE IN THE FIELD OF ARBORICULTURE, INCLUDING: PROPER PLANT AND TREE CARE; IDENTIFYING, PLANTING, MAINTAINING, AND TREATING PLANTS AND TREES; TREE REMOVAL; TREE CLIMBING AND CORRESPONDING RIGGING; KNOT TYING AND SAFETY PROCEDURES, IN ACCORDANCE WITH THE REQUIREMENTS ESTABLISHED BY THE CERTIFIER, INCLUDING THE: SATISFACTION OF PROFESSIONAL OCCUPATIONAL ELIGIBILITY REQUIREMENTS; SUCCESSFUL COMPLETION OF A COMPREHENSIVE KNOWLEDGE AND SKILLS EXAMINATION; AND CONTINUING EDUCATION REQUIREMENTS.

FOR SERVICES IN THE FIELD OF ARBORICULTURE.  
FIRST USE 3-0-2000; IN COMMERCE 3-0-2000.  
RUSS HERMAN, EXAMINING ATTORNEY

SN 78-352,430. MAKLAF HOLDINGS, INC., CARSON CITY, NV. FILED 1-15-2004.

**SPE**

THE MARK CONSISTS OF STANDARD CHARACTERS WITHOUT CLAIM TO ANY PARTICULAR FONT, STYLE, SIZE, OR COLOR.

THE CERTIFICATION MARK, AS INTENDED TO BE USED BY AUTHORIZED PERSONS, IS INTENDED TO CERTIFY THAT THESE PERSONS, WHO PERFORM PROJECT MANAGEMENT, DEMONSTRATE CONTINUED EXCELLENCE IN SUCH FIELD IN ACCORDANCE WITH REQUIREMENTS ESTABLISHED BY CERTIFIER.  
FOR PROJECT MANAGEMENT.  
VERNA BETH RIRIE, EXAMINING ATTORNEY

SN 78-356,810. PROJECT MANAGEMENT INSTITUTE, INC., NEWTOWN SQUARE, PA. FILED 1-23-2004.

**OPM3 Approved  
Assessor**

THE MARK CONSISTS OF STANDARD CHARACTERS WITHOUT CLAIM TO ANY PARTICULAR FONT, STYLE, SIZE, OR COLOR.

NO CLAIM IS MADE TO THE EXCLUSIVE RIGHT TO USE "APPROVED ASSESSOR", APART FROM THE MARK AS SHOWN.

THE CERTIFICATION MARK, INTENDED TO BE USED BY AUTHORIZED PERSONS, IS INTENDED TO CERTIFY THAT THE INDIVIDUAL OR BUSINESS DISPLAYING THE MARK HAS SUFFICIENT KNOWLEDGE AND EXPERIENCE TO ASSESS AN ORGANIZATION TO DETERMINE ITS LEVEL OF MATURITY IN PERFORMING PROJECT AND PROGRAM MANAGEMENT IN ACCORDANCE WITH THE REQUIREMENTS ESTABLISHED BY THE CERTIFIER.

FOR MANAGEMENT ASSESSMENT SERVICES RELATED TO PROJECT AND PROGRAM MANAGEMENT.  
BARBARA BROWN, EXAMINING ATTORNEY

\* \* \* \* \*

# TRADEMARK REGISTRATIONS ISSUED

## PRINCIPAL REGISTER

### SECTION 1.— INTERNATIONAL CLASSIFICATION

The short titles associated below with the international class numbers are terms designed merely for quick identification and are not an official part of the international classification. The full names of international classes are given in section 6.1 of the trademark rules of practice.

The designation "U.S. Cl." appearing in this section refers to the U.S. class in effect prior to Sep. 1, 1973 rather than the international class which applies to applications filed on or after that date. For adoption of international classification see notice in the OFFICIAL GAZETTE of Jun. 26, 1973 (911 O.G. TM 210).

#### CLASS 1—CHEMICALS

- 2,898,433. **ALSTOM AND DESIGN.** ALSTOM, MULTIPLE CLASS, (INT. CLS. 1, 6, 7, 9, 11, 12, 13, 16, 17, 19, 21, 24, 35, 36, 37, 38, 39, 40, 41 AND 42), (U.S. CLS. 1, 2, 5, 6, 9, 10, 12, 13, 14, 19, 21, 22, 23, 25, 26, 29, 30, 31, 33, 34, 35, 36, 37, 38, 40, 42, 44, 46, 50, 100, 101, 102, 103, 104, 105, 106 AND 107). SN 75-565,686. PUB. 8-10-2004. FILED 10-9-1998.
- 2,898,483. **WSC. EIWEISS CHEMICAL CORPORATION,** (U.S. CLS. 1, 5, 6, 10, 26 AND 46). SN 76-084,828. PUB. 9-3-2002. FILED 7-7-2000.
- 2,898,539. **MICROFLEX.** POROUS MEDIA CORPORATION, (U.S. CLS. 1, 5, 6, 10, 26 AND 46). SN 76-285,938. PUB. 7-30-2002. FILED 7-9-2001.
- 2,898,585. **LIFE LINK.** ROD MCLELLAN CO., (U.S. CLS. 1, 5, 6, 10, 26 AND 46). SN 76-399,065. PUB. 8-10-2004. FILED 4-17-2002.
- 2,898,613. **EDDA.** FRIZ BIOCHEM GMBH, MULTIPLE CLASS, (INT. CLS. 1, 5, 7, 9, 10 AND 42), (U.S. CLS. 1, 5, 6, 10, 13, 18, 19, 21, 23, 26, 31, 34, 35, 36, 38, 39, 44, 46, 51, 52, 100 AND 101). SN 76-429,950. PUB. 8-10-2004. FILED 7-12-2002.
- 2,898,628. **NATIVE EARTH.** J-RICH CLINIC, INC., DBA REAL PURITY, MULTIPLE CLASS, (INT. CLS. 1, 3 AND 5), (U.S. CLS. 1, 4, 5, 6, 10, 18, 26, 44, 46, 50, 51 AND 52). SN 76-445,263. PUB. 8-10-2004. FILED 6-17-2002.
- 2,898,656. **PECKER PATCH AND DESIGN.** CROSSLINK TECHNOLOGY INC., (U.S. CLS. 1, 5, 6, 10, 26 AND 46). SN 76-459,953. PUB. 8-10-2004. FILED 10-10-2002.
- 2,898,680. **PANEL-TAC.** HPI PRODUCTS CORP, (U.S. CLS. 1, 5, 6, 10, 26 AND 46). SN 76-471,910. PUB. 9-16-2003. FILED 12-3-2002.
- 2,898,732. **PLASTICENE.** ATOFINA PETROCHEMICALS, INC., (U.S. CLS. 1, 5, 6, 10, 26 AND 46). SN 76-496,819. PUB. 8-10-2004. FILED 3-13-2003.
- 2,898,756. **REDI-GRO.** REDI-GRO PRODUCTS, MULTIPLE CLASS, (INT. CLS. 1 AND 31), (U.S. CLS. 1, 5, 6, 10, 26 AND 46). SN 76-502,787. PUB. 12-2-2003. FILED 3-27-2003.
- 2,898,965. **GRAY GOOSE.** HI-GEAR PRODUCTS, INC., (U.S. CLS. 1, 5, 6, 10, 26 AND 46). SN 76-531,362. PUB. 3-30-2004. FILED 7-14-2003.
- 2,898,979. **ECOLEASE (STYLIZED).** KEMI S.R.L., (U.S. CLS. 1, 5, 6, 10, 26 AND 46). SN 76-533,824. PUB. 8-10-2004. FILED 7-17-2003.
- 2,899,022. **FLUIDS MANAGEMENT AND DESIGN.** FLUIDS MANAGEMENT II, LTD., (U.S. CLS. 1, 5, 6, 10, 26 AND 46). SN 76-541,870. PUB. 8-10-2004. FILED 9-2-2003.
- 2,899,023. **FLUIDS MANAGEMENT.** FLUIDS MANAGEMENT II, LTD., (U.S. CLS. 1, 5, 6, 10, 26 AND 46). SN 76-541,874. PUB. 8-10-2004. FILED 9-2-2003.
- 2,899,310. **ENFORCE.** IMPERIAL WESTERN PRODUCTS, INC., MULTIPLE CLASS, (INT. CLS. 1, 3 AND 4), (U.S. CLS. 1, 4, 5, 6, 10, 15, 26, 46, 50, 51 AND 52). SN 78-131,222. PUB. 7-15-2003. FILED 5-25-2002.
- 2,899,422. **GAX.** COGNIS CORPORATION, (U.S. CLS. 1, 5, 6, 10, 26 AND 46). SN 78-204,396. PUB. 9-30-2003. FILED 1-17-2003.
- 2,899,465. **G&T SSPTYPER.** G&T BIOTECH, INC., (U.S. CLS. 1, 5, 6, 10, 26 AND 46). SN 78-229,127. PUB. 8-10-2004. FILED 3-24-2003.
- 2,899,478. **PERIDOR.** BAYER AKTIENGESELLSCHAFT, MULTIPLE CLASS, (INT. CLS. 1 AND 5), (U.S. CLS. 1, 5, 6, 10, 18, 26, 44, 46, 51 AND 52). SN 78-234,094. PUB. 1-20-2004. FILED 4-4-2003.
- 2,899,480. **BIO MIRACLE.** ORGANIC PRODUCTS INC., (U.S. CLS. 1, 5, 6, 10, 26 AND 46). SN 78-234,909. PUB. 12-23-2003. FILED 4-7-2003.
- 2,899,531. **HOWARD'S SPRING.** HOWARD FERTILIZER COMPANY, (U.S. CLS. 1, 5, 6, 10, 26 AND 46). SN 78-243,597. PUB. 8-10-2004. FILED 4-30-2003.
- 2,899,580. **MISCELLANEOUS DESIGN.** HANGZHOU SANHE FOOD ADDITIVE CO., LTD., (U.S. CLS. 1, 5, 6, 10, 26 AND 46). SN 78-251,279. PUB. 8-10-2004. FILED 5-18-2003.
- 2,899,605. **ALAND AND DESIGN.** JIANGSU JIANGSHAN PHARMACEUTICAL CO., LTD., (U.S. CLS. 1, 5, 6, 10, 26 AND 46). SN 78-254,275. PUB. 8-10-2004. FILED 5-26-2003.
- 2,899,606. **BLUEDRUM (STYLIZED).** JIANGSU JIANGSHAN PHARMACEUTICAL CO., LTD., (U.S. CLS. 1, 5, 6, 10, 26 AND 46). SN 78-254,276. PUB. 8-10-2004. FILED 5-26-2003.
- 2,899,612. **COBRABOND (STYLIZED).** BRAZETEC GMBH, MULTIPLE CLASS, (INT. CLS. 1 AND 6), (U.S. CLS. 1, 2, 5, 6, 10, 12, 13, 14, 23, 25, 26, 46 AND 50). SN 78-255,092. PUB. 8-10-2004. FILED 5-28-2003.
- 2,899,651. **MISCELLANEOUS DESIGN.** KEMIRA GRO-WHOW OY, (U.S. CLS. 1, 5, 6, 10, 26 AND 46). SN 78-262,006. PUB. 8-10-2004. FILED 6-13-2003.
- 2,899,670. **GROROX.** GENERAL HYDROPONICS, INC., (U.S. CLS. 1, 5, 6, 10, 26 AND 46). SN 78-266,366. PUB. 3-2-2004. FILED 6-24-2003.
- 2,899,671. **N-VIS.** HALLIBURTON ENERGY SERVICES, INC., (U.S. CLS. 1, 5, 6, 10, 26 AND 46). SN 78-266,432. PUB. 3-16-2004. FILED 6-24-2003.
- 2,899,733. **ZAP-A-GAP.** PACER TECHNOLOGY, MULTIPLE CLASS, (INT. CLS. 1 AND 16), (U.S. CLS. 1, 2, 5, 6, 10, 22, 23, 26, 29, 37, 38, 46 AND 50). SN 78-287,470. PUB. 8-10-2004. FILED 8-14-2003.
- 2,899,845. **PROBODY.** DIREVO BIOTECH AG, MULTIPLE CLASS, (INT. CLS. 1, 5, 9 AND 42), (U.S. CLS. 1, 5, 6, 10, 18, 21, 23, 26, 36, 38, 44, 46, 51, 52, 100 AND 101). SN 78-314,689. PUB. 8-10-2004. FILED 10-16-2003.
- 2,899,923. **STRESS-X (BLOCK FORM).** HIKARI SALES USA, INC., (U.S. CLS. 1, 5, 6, 10, 26 AND 46). SN 78-322,534. PUB. 8-10-2004. FILED 11-3-2003.

#### CLASS 2—PAINTS

- 2,898,961. **U.S. PAINT AND DESIGN.** U.S. PAINT CORPORATION, (U.S. CLS. 6, 11 AND 16). SN 76-530,768. PUB. 8-10-2004. FILED 7-21-2003.
- 2,899,363. **WOODIUM.** KEMIRA CHEMICALS OY, MULTIPLE CLASS, (INT. CLS. 2 AND 5), (U.S. CLS. 6, 11, 16, 18, 44, 46, 51 AND 52). SN 78-172,210. PUB. 8-10-2004. FILED 10-8-2002.
- 2,899,394. **BRITE.** WELD-AID PRODUCTS, INC., (U.S. CLS. 6, 11 AND 16). SN 78-192,131. PUB. 8-10-2004. FILED 12-6-2002.
- 2,899,751. **TITAN HARDCOAT.** SHAMIR INSIGHT, INC., (U.S. CLS. 6, 11 AND 16). SN 78-294,224. PUB. 8-10-2004.

FILED 8-29-2003.  
2,899,781. **MISCELLANEOUS DESIGN**. LF, LLC, MULTIPLE CLASS, (INT. CLS. 2 AND 16), (U.S. CLS. 2, 5, 6, 11, 16, 22, 23, 29, 37, 38 AND 50). SN 78-300,200. PUB. 8-10-2004. FILED 9-15-2003.

### CLASS 3—COSMETICS AND CLEANING PREPARATIONS

2,898,439. **AYURA (STYLIZED)**. SHISEIDO COMPANY LTD., MULTIPLE CLASS, (INT. CLS. 3 AND 21), (U.S. CLS. 1, 2, 4, 6, 13, 23, 29, 30, 33, 40, 51 AND 52). SN 75-636,027. PUB. 8-10-2004. FILED 2-8-1999.

2,898,448. **FOR FUN IN THE SUN.....GET ON THE BOAT! AND DESIGN**. SUN PHARMACEUTICALS CORP., (U.S. CLS. 1, 4, 6, 50, 51 AND 52). SN 75-812,803. PUB. 9-4-2001. FILED 10-1-1999.

2,898,496. **MAXI WHITE**. GAPARDIS HEALTH & BEAUTY, INC., (U.S. CLS. 1, 4, 6, 50, 51 AND 52). SN 76-126,718. PUB. 2-12-2002. FILED 9-11-2000.

2,898,501. **B (STYLIZED)**. BACCARAT, MULTIPLE CLASS, (INT. CLS. 3, 11, 14, 18 AND 21), (U.S. CLS. 1, 2, 3, 4, 6, 13, 21, 22, 23, 27, 28, 29, 30, 31, 33, 34, 40, 41, 50, 51 AND 52). SN 76-138,318. PUB. 6-4-2002. FILED 9-29-2000.

2,898,513. **FRESH RAIN**. CONOPCO, INC., DBA LEVER BROTHERS COMPANY, (U.S. CLS. 1, 4, 6, 50, 51 AND 52). SN 76-212,626. PUB. 10-14-2003. FILED 2-20-2001.

2,898,524. **FRESH RAIN**. CONOPCO, INC., DBA LEVER BROTHERS COMPANY, (U.S. CLS. 1, 4, 6, 50, 51 AND 52). SN 76-292,879. PUB. 10-7-2003. FILED 4-9-2001.

2,898,543. **IKELIA**. PIERRE FABRE S.A., MULTIPLE CLASS, (INT. CLS. 3 AND 5), (U.S. CLS. 1, 4, 6, 18, 44, 46, 50, 51 AND 52). SN 76-292,879. PUB. 8-10-2004. FILED 7-31-2001.

2,898,544. **GAGA PURE PLATINUM**. SUKLJIAN, CHRISTINA, (U.S. CLS. 1, 4, 6, 50, 51 AND 52). SN 76-305,015. PUB. 10-22-2002. FILED 8-27-2001.

2,898,586. **HIERBAS DE IBIZA TOT MON COR FEIS ALEGRAR PERFUMES AND DESIGN**. TORRES SAGRERA, ANTONIO, (U.S. CLS. 1, 4, 6, 50, 51 AND 52). SN 76-399,155. PUB. 8-10-2004. FILED 4-23-2002.

2,898,599. **RAIN-SILK**. FRIEDAUER, PETER, (U.S. CLS. 1, 4, 6, 50, 51 AND 52). SN 76-415,954. PUB. 8-10-2004. FILED 6-6-2002.

2,898,628 ( *See Class 1 for this trademark*).

2,898,632. **SILHOE**. PIERRE FABRE DERMO-COSMETIQUE, MULTIPLE CLASS, (INT. CLS. 3 AND 5), (U.S. CLS. 1, 4, 6, 18, 44, 46, 50, 51 AND 52). SN 76-449,262. PUB. 8-10-2004. FILED 9-13-2002.

2,898,657. **ALPEN SECRETS**. LABORATOIRES COLBA INC., MULTIPLE CLASS, (INT. CLS. 3 AND 21), (U.S. CLS. 1, 2, 4, 6, 13, 23, 29, 30, 33, 40, 50, 51 AND 52). SN 76-460,278. PUB. 9-30-2003. FILED 10-15-2002.

2,898,686. **MISCELLANEOUS DESIGN**. THE NEW ZEALAND WAY LIMITED, MULTIPLE CLASS, (INT. CLS. 3, 7, 9, 11, 12, 16, 20, 27, 28, 32 AND 33), (U.S. CLS. 1, 2, 4, 5, 6, 13, 19, 20, 21, 22, 23, 25, 26, 29, 31, 32, 34, 35, 36, 37, 38, 42, 44, 45, 46, 47, 48, 49, 50, 51 AND 52). SN 76-474,361. PUB. 8-10-2004. FILED 12-3-2002.

2,898,695. **D-CONTRAXOL**. LANCOME PARFUMS ET BEAUTE & CIE, (U.S. CLS. 1, 4, 6, 50, 51 AND 52). SN 76-480,901. PUB. 11-11-2003. FILED 1-8-2003.

2,898,731. **A NATURAL DIFFERENCE**. A NATURAL DIFFERENCE INC., MULTIPLE CLASS, (INT. CLS. 3 AND 44), (U.S. CLS. 1, 4, 6, 50, 51, 52, 100 AND 101). SN 76-496,377. PUB. 8-10-2004. FILED 3-10-2003.

2,898,733. **DAMN SEXY HEAVENLY**. LEAPFROG (UK) LIMITED, (U.S. CLS. 1, 4, 6, 50, 51 AND 52). SN 76-497,494. PUB. 12-23-2003. FILED 3-14-2003.

2,898,827. **MENOT (STYLIZED)**. ELON INCORPORATED, (U.S. CLS. 1, 4, 6, 50, 51 AND 52). SN 76-512,509. PUB. 8-10-2004. FILED 5-8-2003.

2,898,842. **MISCELLANEOUS DESIGN**. HILLYARD ENTERPRISES, INC., (U.S. CLS. 1, 4, 6, 50, 51 AND 52). SN 76-514,180. PUB. 8-10-2004. FILED 5-14-2003.

2,898,851. **GRAND SCENTRAL STATION**. SPADAFORA, CAROLANN, (U.S. CLS. 1, 4, 6, 50, 51 AND 52). SN 76-

514,665. PUB. 8-10-2004. FILED 5-16-2003.

2,898,856. **ALOE VET**. WEST AGRO, INC., (U.S. CLS. 1, 4, 6, 50, 51 AND 52). SN 76-515,338. PUB. 8-10-2004. FILED 5-19-2003.

2,898,861. **DINO-FIZZ**. SMITH & VANDIVER, INC., (U.S. CLS. 1, 4, 6, 50, 51 AND 52). SN 76-515,998. PUB. 8-10-2004. FILED 5-21-2003.

2,898,866. **CELMOIST AND DESIGN**. WATT HEALTH SCIENCES, INC., (U.S. CLS. 1, 4, 6, 50, 51 AND 52). SN 76-516,369. PUB. 8-10-2004. FILED 5-22-2003.

2,898,887. **MARLIES MÖLLER PASHMISILK**. JUVENA (INTERNATIONAL) AG, MULTIPLE CLASS, (INT. CLS. 3 AND 21), (U.S. CLS. 1, 2, 4, 6, 13, 23, 29, 30, 33, 40, 50, 51 AND 52). SN 76-518,909. PUB. 8-10-2004. FILED 6-2-2003.

2,898,920. **THE POWER OF OCEAN KELP**. ECO HOLDINGS, LLC, (U.S. CLS. 1, 4, 6, 50, 51 AND 52). SN 76-521,839. PUB. 12-30-2003. FILED 6-2-2003.

2,898,935. **BLAST**. CLEANING SYSTEMS, INC., (U.S. CLS. 1, 4, 6, 50, 51 AND 52). SN 76-524,174. PUB. 3-23-2004. FILED 6-20-2003.

2,899,049. **CHILLIN' WITH THE BOYS**. CALIFORNIA TAN, INC., (U.S. CLS. 1, 4, 6, 50, 51 AND 52). SN 76-545,748. PUB. 8-10-2004. FILED 9-22-2003.

2,899,106. **ALL (STYLIZED)**. CHESEBROUGH-POND'S INC., (U.S. CLS. 1, 4, 6, 50, 51 AND 52). SN 76-552,266. PUB. 8-10-2004. FILED 10-17-2003.

2,899,123. **HGH TRAUMA-FIX**. DREAMOUS CORPORATION USA, INC., MULTIPLE CLASS, (INT. CLS. 3 AND 5), (U.S. CLS. 1, 4, 6, 18, 44, 46, 50, 51 AND 52). SN 76-553,444. PUB. 8-10-2004. FILED 10-22-2003.

2,899,142. **BEAUTY/TECH**. ALCONE COMPANY, INC., (U.S. CLS. 1, 4, 6, 50, 51 AND 52). SN 76-555,190. PUB. 8-10-2004. FILED 10-29-2003.

2,899,151. **BLAST**. CHEMICAL SPECIALTIES, LLC, (U.S. CLS. 1, 4, 6, 50, 51 AND 52). SN 76-555,720. PUB. 8-10-2004. FILED 10-31-2003.

2,899,188. **DYNAMI' CURL**. LABORATOIRE GARNIER & CIE, (U.S. CLS. 1, 4, 6, 50, 51 AND 52). SN 76-557,473. PUB. 8-10-2004. FILED 10-23-2003.

2,899,208. **25TH EDITION AND DESIGN**. ALOE VERA OF AMERICA, INC., (U.S. CLS. 1, 4, 6, 50, 51 AND 52). SN 76-558,398. PUB. 8-10-2004. FILED 11-7-2003.

2,899,212. **NAIL ARMOR**. ORLY INTERNATIONAL, INC., (U.S. CLS. 1, 4, 6, 50, 51 AND 52). SN 76-558,568. PUB. 8-10-2004. FILED 10-27-2003.

2,899,217. **HIMALAYA NEPHESH (BLOCK FORM)**. CM LINX CORPORATION, MULTIPLE CLASS, (INT. CLS. 3 AND 30), (U.S. CLS. 1, 4, 6, 46, 50, 51 AND 52). SN 76-558,809. PUB. 8-10-2004. FILED 11-10-2003.

2,899,218. **LOTHANTIQUE (BLOCK FORM)**. L'OTHANTIQUE, INC., MULTIPLE CLASS, (INT. CLS. 3 AND 4), (U.S. CLS. 1, 4, 6, 15, 50, 51 AND 52). SN 76-558,839. PUB. 8-10-2004. FILED 11-10-2003.

2,899,264. **HAPPY CHEEKS (BLOCK FORM)**. YOUNGSKIN, LLC, (U.S. CLS. 1, 4, 6, 50, 51 AND 52). SN 76-581,140. PUB. 8-10-2004. FILED 10-1-2003.

2,899,265. **LOVE ME DEW (BLOCK FORM)**. YOUNGSKIN, LLC, (U.S. CLS. 1, 4, 6, 50, 51 AND 52). SN 76-581,141. PUB. 8-10-2004. FILED 10-1-2003.

2,899,275. **SMACKERSVILLE**. BONNE BELL, INC., (U.S. CLS. 1, 4, 6, 50, 51 AND 52). SN 76-977,019. PUB. 10-29-2002. FILED 9-5-2001.

2,899,310 ( *See Class 1 for this trademark*).

2,899,389. **ALL WASHED MIO AND DESIGN**. MASSIMO GUARDUCCI S.R.L., (U.S. CLS. 1, 4, 6, 50, 51 AND 52). SN 78-188,016. PUB. 8-10-2004. FILED 11-22-2002.

2,899,428. **HEART OF GOLD AND DESIGN**. SC LICENSING CORP, MULTIPLE CLASS, (INT. CLS. 3, 21 AND 26), (U.S. CLS. 1, 2, 4, 6, 13, 23, 29, 30, 33, 37, 39, 40, 42, 50, 51 AND 52). SN 78-209,983. PUB. 8-10-2004. FILED 2-3-2003.

2,899,464. **H.C. ESSENTIALS**. TEAM IN FOCUS, LLC, (U.S. CLS. 1, 4, 6, 50, 51 AND 52). SN 78-229,064. PUB. 8-10-2004. FILED 3-24-2003.

2,899,482. **SPEED STICK 24/7 AND DESIGN**. COLGATE-PALMOLIVE COMPANY, (U.S. CLS. 1, 4, 6, 50, 51 AND 52). SN 78-235,181. PUB. 8-10-2004. FILED 4-8-2003.

2,899,563. **EXTRA FRESH**. SMITHKLINE BEECHAM CORPORATION, (U.S. CLS. 1, 4, 6, 50, 51 AND 52). SN 78-249,302. PUB. 1-6-2004. FILED 5-13-2003.



- 2,899,583. **MYPLAIRE**. MILBON CO., LTD., (U.S. CLS. 1, 4, 6, 50, 51 AND 52). SN 78-251,518. PUB. 8-10-2004. FILED 5-19-2003.
- 2,899,598. **PRIME SOURCE**. BUNZL DISTRIBUTION USA, INC., MULTIPLE CLASS, (INT. CLS. 3 AND 5), (U.S. CLS. 1, 4, 6, 18, 44, 46, 50, 51 AND 52). SN 78-253,712. PUB. 8-10-2004. FILED 5-23-2003.
- 2,899,676. **YOUTHFUL ESSENTIALS (STYLIZED)**. FRICK-HYATT, CHARLENE A., AND HYATT, DUANE G., (U.S. CLS. 1, 4, 6, 50, 51 AND 52). SN 78-267,720. PUB. 3-16-2004. FILED 6-26-2003.
- 2,899,802. **STRIPOXY (STYLIZED)**. GENERAL CHEMICAL, (U.S. CLS. 1, 4, 6, 50, 51 AND 52). SN 78-307,125. PUB. 8-10-2004. FILED 9-30-2003.
- 2,899,843. **PARVATI**. HOOK, JOHANNA K, (U.S. CLS. 1, 4, 6, 50, 51 AND 52). SN 78-314,437. PUB. 8-10-2004. FILED 10-16-2003.
- 2,899,844. **LAKSHMI**. HOOK, JOHANNA, K, (U.S. CLS. 1, 4, 6, 50, 51 AND 52). SN 78-314,443. PUB. 8-10-2004. FILED 10-16-2003.
- 2,899,846. **MOTHERS INCREDIBLE BILLET METAL POLISH**. MOTHERS POLISHES WAXES CLEANERS, (U.S. CLS. 1, 4, 6, 50, 51 AND 52). SN 78-314,783. PUB. 8-10-2004. FILED 10-16-2003.
- 2,899,874. **COLLECTIVE WELLBEING**. DAVIES GATE LLC, (U.S. CLS. 1, 4, 6, 50, 51 AND 52). SN 78-317,943. PUB. 8-10-2004. FILED 10-23-2003.
- 2,899,876. **POLIDENT SMOKERS**. BLOCK DRUG COMPANY, INC., (U.S. CLS. 1, 4, 6, 50, 51 AND 52). SN 78-318,096. PUB. 8-10-2004. FILED 10-24-2003.
- 2,899,900. **GALV-OFF**. CHASE PRODUCTS COMPANY, (U.S. CLS. 1, 4, 6, 50, 51 AND 52). SN 78-320,513. PUB. 8-10-2004. FILED 10-29-2003.
- 2,899,944. **ANTIQUÉ FRUIT AND DESIGN**. NEDBOY, ROBIN L., (U.S. CLS. 1, 4, 6, 50, 51 AND 52). SN 78-324,584. PUB. 8-10-2004. FILED 11-7-2003.
- 2,899,947. **HI-FIBER MASCARA (BLOCK FORM)**. SASSABY, INC., (U.S. CLS. 1, 4, 6, 50, 51 AND 52). SN 78-324,799. PUB. 8-10-2004. FILED 11-7-2003.
- 2,899,977. **RICURA (BLOCK FORM)**. RICURA TECHNOLOGIES, LLC, MULTIPLE CLASS, (INT. CLS. 3, 5, 11 AND 35), (U.S. CLS. 1, 4, 6, 13, 18, 21, 23, 31, 34, 44, 46, 50, 51, 52, 100, 101 AND 102). SN 78-326,786. PUB. 8-10-2004. FILED 11-12-2003.
- 2,899,990. **HOUSECHEM (BLOCK FORM)**. HOUSECHEM, INC., (U.S. CLS. 1, 4, 6, 50, 51 AND 52). SN 78-329,099. PUB. 8-10-2004. FILED 11-17-2003.
- 2,899,996. **DIVINE CULT (BLOCK FORM)**. TSCHUBAROV, SYLVIA, (U.S. CLS. 1, 4, 6, 50, 51 AND 52). SN 78-330,940. PUB. 8-10-2004. FILED 11-20-2003.

#### CLASS 4—LUBRICANTS AND FUELS

- 2,898,527. **BP AND DESIGN**. BP P.L.C., MULTIPLE CLASS, (INT. CLS. 4, 35, 37, 38 AND 42), (U.S. CLS. 1, 6, 15, 100, 101, 102, 103, 104 AND 106). SN 76-243,740. PUB. 8-10-2004. FILED 4-23-2001.
- 2,898,877. **MISCELLANEOUS DESIGN**. GMI HOLDINGS, INC., DBA THE GENIE COMPANY, MULTIPLE CLASS, (INT. CLS. 4, 9, 20, 36 AND 37), (U.S. CLS. 1, 2, 6, 13, 15, 21, 22, 23, 25, 26, 32, 36, 38, 50, 100, 101, 102, 103 AND 106). SN 76-518,316. PUB. 8-10-2004. FILED 5-30-2003.
- 2,899,124. **EMPIRE**. EMPIRE CANDLE MANUFACTURING LLC, (U.S. CLS. 1, 6 AND 15). SN 76-553,673. PUB. 8-10-2004. FILED 10-23-2003.
- 2,899,191. **FARM GROWN (BLOCK FORM)**. SMITH MOUNTAIN INDUSTRIES, INC., MULTIPLE CLASS, (INT. CLS. 4 AND 21), (U.S. CLS. 1, 2, 6, 13, 15, 23, 29, 30, 33, 40 AND 50). SN 76-557,547. PUB. 8-10-2004. FILED 11-6-2003.
- 2,899,218 ( *See Class 3 for this trademark*).
- 2,899,310 ( *See Class 1 for this trademark*).
- 2,899,432. **PACIFIC SHORES**. BATH & BODY WORKS, INC., (U.S. CLS. 1, 6 AND 15). SN 78-212,294. PUB. 9-30-2003. FILED 2-7-2003.
- 2,899,496. **ULTRATANE**. MASTER APPLIANCE CORP., (U.S. CLS. 1, 6 AND 15). SN 78-237,852. PUB. 11-25-2003. FILED 4-15-2003.
- 2,899,596. **HLX**. CASTROL LIMITED, (U.S. CLS. 1, 6 AND 15). SN 78-253,504. PUB. 8-10-2004. FILED 5-23-2003.
- 2,899,942. **COUNTRY HARVEST CANDLES (BLOCK FORM)**. THOMSON, SCOTT MARK, (U.S. CLS. 1, 6 AND 15). SN 78-324,449. PUB. 8-10-2004. FILED 11-6-2003.
- 2,899,979. **MACHO QUEBRACHO (BLOCK FORM)**. TRI-WORLD, INC., (U.S. CLS. 1, 6 AND 15). SN 78-327,176. PUB. 8-10-2004. FILED 11-13-2003.
- 2,899,991. **HOUSECHEM (BLOCK FORM)**. HOUSECHEM, INC., (U.S. CLS. 1, 6 AND 15). SN 78-329,107. PUB. 8-10-2004. FILED 11-17-2003.

#### CLASS 5—PHARMACEUTICALS

- 2,898,431. **PRO PERFORMANCE LABORATORIES**. GENERAL NUTRITION INVESTMENT COMPANY, (U.S. CLS. 6, 18, 44, 46, 51 AND 52). SN 75-520,245. PUB. 10-5-1999. FILED 7-16-1998.
- 2,898,460. **NATUREGLIDE**. LES PRODUITS ASSOCIES LPBROXO S.A., (U.S. CLS. 6, 18, 44, 46, 51 AND 52). SN 75-917,835. PUB. 8-7-2001. FILED 2-14-2000.
- 2,898,477. **SOLUTEIN**. AMPC, INC., DBA AMERICAN PROTEIN CORPORATION, (U.S. CLS. 6, 18, 44, 46, 51 AND 52). SN 76-054,323. PUB. 4-10-2001. FILED 5-22-2000.
- 2,898,495. **ORTHO ORTHENE FIRE ANT KILLER AND DESIGN**. OMS INVESTMENTS, INC., (U.S. CLS. 6, 18, 44, 46, 51 AND 52). SN 76-126,545. PUB. 10-22-2002. FILED 9-12-2000.
- 2,898,506. **T36 (STYLIZED)**. ALDA PHARMACEUTICALS CORP., (U.S. CLS. 6, 18, 44, 46, 51 AND 52). SN 76-185,746. PUB. 8-10-2004. FILED 12-26-2000.
- 2,898,535. **PHASE IT**. PHASE IT INTELLIGENT SOLUTIONS AG, MULTIPLE CLASS, (INT. CLS. 5, 9 AND 42), (U.S. CLS. 6, 18, 21, 23, 26, 36, 38, 44, 46, 51, 52, 100 AND 101). SN 76-273,634. PUB. 2-17-2004. FILED 6-19-2001.
- 2,898,543 ( *See Class 3 for this trademark*).
- 2,898,557. **QUICK-SORB AND DESIGN**. NATURE'S ANSWER, INC., (U.S. CLS. 6, 18, 44, 46, 51 AND 52). SN 76-350,361. PUB. 8-10-2004. FILED 12-20-2001.
- 2,898,566. **SUPER BLEND**. WRIGHT ENRICHMENT, INC., (U.S. CLS. 6, 18, 44, 46, 51 AND 52). SN 76-365,127. PUB. 8-10-2004. FILED 1-30-2002.
- 2,898,576. **DR. RATH'S PROTECT FORMULA**. RATH, MATTHIAS, MULTIPLE CLASS, (INT. CLS. 5, 30 AND 32), (U.S. CLS. 6, 18, 44, 45, 46, 48, 51 AND 52). SN 76-384,757. PUB. 12-23-2003. FILED 3-20-2002.
- 2,898,608. **ADVANCED MEDICAL LABS (STYLIZED)**. PRO HEALTH, INC., (U.S. CLS. 6, 18, 44, 46, 51 AND 52). SN 76-426,315. PUB. 8-10-2004. FILED 6-24-2002.
- 2,898,613 ( *See Class 1 for this trademark*).
- 2,898,615. **FLUORIDEX DAILY DEFENSE**. DISCUS DENTAL IMPRESSIONS, INC, (U.S. CLS. 6, 18, 44, 46, 51 AND 52). SN 76-430,872. PUB. 8-10-2004. FILED 7-15-2002.
- 2,898,621. **DEXALONE**. XANODYNE PHARMACAL, INC., (U.S. CLS. 6, 18, 44, 46, 51 AND 52). SN 76-436,666. PUB. 9-23-2003. FILED 8-1-2002.
- 2,898,628 ( *See Class 1 for this trademark*).
- 2,898,632 ( *See Class 3 for this trademark*).
- 2,898,665. **ULTRA CARB 3000**. PINNACLE MARKETING, LLC, (U.S. CLS. 6, 18, 44, 46, 51 AND 52). SN 76-464,509. PUB. 8-10-2004. FILED 11-4-2002.
- 2,898,673. **ENTEROGRAB**. NEUTEC PHARMA PLC, (U.S. CLS. 6, 18, 44, 46, 51 AND 52). SN 76-467,639. PUB. 8-10-2004. FILED 11-18-2002.
- 2,898,727. **DOPPLERVIST**. SCHERING AKTIENGESELLSCHAFT, (U.S. CLS. 6, 18, 44, 46, 51 AND 52). SN 76-494,660. PUB. 11-25-2003. FILED 2-24-2003.
- 2,898,740. **TENTRILLO**. MEDIGENE AG, (U.S. CLS. 6, 18, 44, 46, 51 AND 52). SN 76-498,488. PUB. 8-10-2004. FILED 3-19-2003.
- 2,898,749. **3 IN 1 (STYLIZED)**. THE HARTZ MOUNTAIN CORPORATION, (U.S. CLS. 6, 18, 44, 46, 51 AND 52). SN 76-500,294. PUB. 12-9-2003. FILED 3-25-2003.
- 2,898,763. **ECOSTAIN**. MERIDIAN BIOSCIENCE INC., (U.S. CLS. 6, 18, 44, 46, 51 AND 52). SN 76-504,417. PUB. 8-10-2004.

- FILED 6-19-2002.
- 2,898,771. **MISCELLANEOUS DESIGN**. HERITAGE HEALTH PRODUCTS COMPANY, MULTIPLE CLASS, (INT. CLS. 5 AND 41), (U.S. CLS. 6, 18, 44, 46, 51, 52, 100, 101 AND 107). SN 76-506,281. PUB. 8-10-2004. FILED 4-14-2003.
- 2,898,874. **FOREVER YOUNG, INC.**, RAHIMI, DAVID, (U.S. CLS. 6, 18, 44, 46, 51 AND 52). SN 76-518,050. PUB. 8-10-2004. FILED 5-6-2003.
- 2,898,876. **URICON**. AGRI LABORATORIES, LTD., (U.S. CLS. 6, 18, 44, 46, 51 AND 52). SN 76-518,306. PUB. 8-10-2004. FILED 5-30-2003.
- 2,898,909. **PERPETUEM**. FRANK, BRIAN DAVID, (U.S. CLS. 6, 18, 44, 46, 51 AND 52). SN 76-520,156. PUB. 3-16-2004. FILED 5-23-2003.
- 2,898,911. **PURRRFORMANCE**. DYNAMITE MARKETING, INC., (U.S. CLS. 6, 18, 44, 46, 51 AND 52). SN 76-520,672. PUB. 1-13-2004. FILED 5-22-2003.
- 2,898,981. **YAYABEARS**. MARKS, WOLFGANG, (U.S. CLS. 6, 18, 44, 46, 51 AND 52). SN 76-534,088. PUB. 2-3-2004. FILED 7-21-2003.
- 2,899,002. **VENARIN**. NUTRICA, INC., (U.S. CLS. 6, 18, 44, 46, 51 AND 52). SN 76-537,555. PUB. 4-13-2004. FILED 8-4-2003.
- 2,899,079. **CERALYTE**. CERA PRODUCTS, INC., (U.S. CLS. 6, 18, 44, 46, 51 AND 52). SN 76-549,604. PUB. 8-10-2004. FILED 10-6-2003.
- 2,899,097. **MISCELLANEOUS DESIGN**. SANTARUS, INC., (U.S. CLS. 6, 18, 44, 46, 51 AND 52). SN 76-551,381. PUB. 8-10-2004. FILED 9-23-2003.
- 2,899,113. **PROMILIN**. TECHNICAL SOURCING INTERNATIONAL, INC., (U.S. CLS. 6, 18, 44, 46, 51 AND 52). SN 76-552,688. PUB. 8-10-2004. FILED 10-20-2003.
- 2,899,123 ( *See Class 3 for this trademark*).
- 2,899,167. **IMPERVA (STYLIZED)**. SHOFU, INC., (U.S. CLS. 6, 18, 44, 46, 51 AND 52). SN 76-556,498. PUB. 8-10-2004. FILED 11-4-2003.
- 2,899,192. **TOROMAN (BLOCK FORM)**. HIGH POINT HERBALS, DBA BIO TEST LABS, (U.S. CLS. 6, 18, 44, 46, 51 AND 52). SN 76-557,571. PUB. 8-10-2004. FILED 11-6-2003.
- 2,899,193. **ARDORON (BLOCK FORM)**. HIGH POINT HERBALS, DBA BIO TEST LABS, (U.S. CLS. 6, 18, 44, 46, 51 AND 52). SN 76-557,573. PUB. 8-10-2004. FILED 11-6-2003.
- 2,899,214. **DRAGON FORMULA (STYLIZED)**. LU, ZHENG, (U.S. CLS. 6, 18, 44, 46, 51 AND 52). SN 76-558,603. PUB. 8-10-2004. FILED 11-10-2003.
- 2,899,269. **INTELECTOR (BLOCK FORM)**. COVEX FARMA, S.L., (U.S. CLS. 6, 18, 44, 46, 51 AND 52). SN 76-588,717. PUB. 8-10-2004. FILED 4-26-2004.
- 2,899,300. **TRIPLE-BOOST**. IRWIN NATURALS, (U.S. CLS. 6, 18, 44, 46, 51 AND 52). SN 78-118,161. PUB. 1-6-2004. FILED 3-28-2002.
- 2,899,341. **ACELL**. ACELL, INC., (U.S. CLS. 6, 18, 44, 46, 51 AND 52). SN 78-155,781. PUB. 8-10-2004. FILED 8-20-2002.
- 2,899,362. **SWEETEASE**. ADVOCATE INTERNATIONAL, L.L.C., (U.S. CLS. 6, 18, 44, 46, 51 AND 52). SN 78-171,397. PUB. 8-10-2004. FILED 10-5-2002.
- 2,899,363 ( *See Class 2 for this trademark*).
- 2,899,390. **GENTRA**. GENTRA SYSTEMS, INC., (U.S. CLS. 6, 18, 44, 46, 51 AND 52). SN 78-189,051. PUB. 8-10-2004. FILED 11-26-2002.
- 2,899,405. **MAXSIZE**. M D SCIENCE LAB, LLC, (U.S. CLS. 6, 18, 44, 46, 51 AND 52). SN 78-197,452. PUB. 8-10-2004. FILED 12-23-2002.
- 2,899,413. **INTESTAID**. DIETARY SUPPLEMENT SYSTEMS, GLOBAL, INC., AND WYRESIDE PRODUCTS LIMITED, (U.S. CLS. 6, 18, 44, 46, 51 AND 52). SN 78-200,795. PUB. 8-10-2004. FILED 1-7-2003.
- 2,899,414. **PEOPLE-HELP-PEOPLE**. RATH, MATTHIAS, MULTIPLE CLASS, (INT. CLS. 5, 16, 41, 42 AND 44), (U.S. CLS. 2, 5, 6, 18, 22, 23, 29, 37, 38, 44, 46, 50, 51, 52, 100, 101 AND 107). SN 78-201,103. PUB. 9-16-2003. FILED 1-8-2003.
- 2,899,423. **LET'S GET NATURAL!**. RAYBURN, DEBRA J., (U.S. CLS. 6, 18, 44, 46, 51 AND 52). SN 78-204,864. PUB. 12-30-2003. FILED 1-18-2003.
- 2,899,444. **REGENICARE**. MAXCELL BIOSCIENCE, INC., DBA OASIS WELLNESS NETWORK, (U.S. CLS. 6, 18, 44, 46, 51 AND 52). SN 78-219,865. PUB. 9-30-2003. FILED 2-27-2003.
- 2,899,450. **LO-CHOL**. ADVANCED PLANT PHARMACEUTICALS, INC., (U.S. CLS. 6, 18, 44, 46, 51 AND 52). SN 78-223,633. PUB. 4-27-2004. FILED 3-10-2003.
- 2,899,455. **FLOWERS FX**. RESERVE HOLDINGS, LLC, (U.S. CLS. 6, 18, 44, 46, 51 AND 52). SN 78-225,207. PUB. 8-10-2004. FILED 3-13-2003.
- 2,899,467. **NUCLEOMAXX (STYLIZED)**. PHARMA NORD APS, (U.S. CLS. 6, 18, 44, 46, 51 AND 52). SN 78-231,022. PUB. 8-10-2004. FILED 3-27-2003.
- 2,899,478 ( *See Class 1 for this trademark*).
- 2,899,491. **TYSABRI**. ELAN PHARMA INTERNATIONAL LIMITED, (U.S. CLS. 6, 18, 44, 46, 51 AND 52). SN 78-236,985. PUB. 8-10-2004. FILED 4-11-2003.
- 2,899,502. **POLLILIPID**. GOODE, INC., (U.S. CLS. 6, 18, 44, 46, 51 AND 52). SN 78-239,246. PUB. 8-10-2004. FILED 4-17-2003.
- 2,899,521. **BIONNEY**. CERAMCO INC., (U.S. CLS. 6, 18, 44, 46, 51 AND 52). SN 78-241,616. PUB. 8-10-2004. FILED 4-24-2003.
- 2,899,527. **PEROXYGEL**. METAMIND ENTERPRISES INCORPORATED, (U.S. CLS. 6, 18, 44, 46, 51 AND 52). SN 78-242,564. PUB. 11-25-2003. FILED 4-27-2003.
- 2,899,568. **DAILY SOLUTIONS PACK**. ROEX, INC., (U.S. CLS. 6, 18, 44, 46, 51 AND 52). SN 78-249,968. PUB. 8-10-2004. FILED 5-14-2003.
- 2,899,589. **MB-10 TABLETS**. QUIP LABORATORIES, INC., (U.S. CLS. 6, 18, 44, 46, 51 AND 52). SN 78-252,156. PUB. 8-10-2004. FILED 5-20-2003.
- 2,899,598 ( *See Class 3 for this trademark*).
- 2,899,600. **CARB CHEATER**. HD NUTRITION, INC., (U.S. CLS. 6, 18, 44, 46, 51 AND 52). SN 78-253,859. PUB. 8-10-2004. FILED 5-23-2003.
- 2,899,607. **ALAND AND DESIGN**. JIANGSU JIANGSHAN PHARMACEUTICAL CO., LTD., (U.S. CLS. 6, 18, 44, 46, 51 AND 52). SN 78-254,279. PUB. 8-10-2004. FILED 5-26-2003.
- 2,899,616. **TIPSTOP**. GAMBRO HOSPITAL AG, (U.S. CLS. 6, 18, 44, 46, 51 AND 52). SN 78-255,725. PUB. 8-10-2004. FILED 5-29-2003.
- 2,899,627. **ITC**. INTERNATIONAL TECHNIDYNE CORP., MULTIPLE CLASS, (INT. CLS. 5, 8, 10, 18, 21 AND 28), (U.S. CLS. 1, 2, 3, 6, 13, 18, 22, 23, 26, 28, 29, 30, 33, 38, 39, 40, 41, 44, 46, 50, 51 AND 52). SN 78-258,603. PUB. 4-13-2004. FILED 6-5-2003.
- 2,899,634. **ADVANCE7**. ALMARK PRODUCTS, INC, (U.S. CLS. 6, 18, 44, 46, 51 AND 52). SN 78-259,934. PUB. 12-23-2003. FILED 6-9-2003.
- 2,899,645. **ORTHOGEL**. NATURAL NUTRITION SOLUTIONS USA CORP., (U.S. CLS. 6, 18, 44, 46, 51 AND 52). SN 78-260,966. PUB. 8-10-2004. FILED 6-11-2003.
- 2,899,659. **STARBAR**. WELLMARK INTERNATIONAL, (U.S. CLS. 6, 18, 44, 46, 51 AND 52). SN 78-263,059. PUB. 8-10-2004. FILED 6-16-2003.
- 2,899,660. **SOOTHERBS**. AMERIFIT NUTRITION, (U.S. CLS. 6, 18, 44, 46, 51 AND 52). SN 78-263,146. PUB. 1-6-2004. FILED 6-17-2003.
- 2,899,689. **PEXEVA**. SYNTHON PHARMACEUTICALS, LTD., (U.S. CLS. 6, 18, 44, 46, 51 AND 52). SN 78-271,367. PUB. 8-10-2004. FILED 7-8-2003.
- 2,899,700. **PNEUMOSTAR**. NOVARTIS AG, (U.S. CLS. 6, 18, 44, 46, 51 AND 52). SN 78-274,263. PUB. 5-18-2004. FILED 7-15-2003.
- 2,899,711. **AZILECT**. TEVA PHARMACEUTICAL INDUSTRIES LTD., (U.S. CLS. 6, 18, 44, 46, 51 AND 52). SN 78-279,632. PUB. 8-10-2004. FILED 7-28-2003.
- 2,899,720. **NIVERBA**. GLAXO GROUP LIMITED, (U.S. CLS. 6, 18, 44, 46, 51 AND 52). SN 78-283,106. PUB. 8-10-2004. FILED 8-5-2003.
- 2,899,814. **HEMOSURE**. HEMOSURE INC., (U.S. CLS. 6, 18, 44, 46, 51 AND 52). SN 78-310,205. PUB. 8-10-2004. FILED 10-7-2003.
- 2,899,821. **CARNOSEE**. VITAMIN RESEARCH PRODUCTS, INC., (U.S. CLS. 6, 18, 44, 46, 51 AND 52). SN 78-311,021. PUB. 8-10-2004. FILED 10-8-2003.
- 2,899,845 ( *See Class 1 for this trademark*).
- 2,899,916. **UMAXX-15 (BLOCK FORM)**. BIOGENETICS, INC., (U.S. CLS. 6, 18, 44, 46, 51 AND 52). SN 78-322,282. PUB. 8-10-2004. FILED 11-3-2003.
- 2,899,925. **TINTRACT (BLOCK FORM)**. ROBINSON, LOREN, CARL, (U.S. CLS. 6, 18, 44, 46, 51 AND 52). SN 78-322,834. PUB. 8-10-2004. FILED 11-4-2003.
- 2,899,943. **MUSEUM OF BEAUTY AND DESIGN**. NEDBOY,

ROBIN L., (U.S. CLS. 6, 18, 44, 46, 51 AND 52). SN 78-324,525. PUB. 8-10-2004. FILED 11-7-2003.  
2,899,977 ( *See Class 3 for this trademark* ).  
2,899,992. **HOUSECHEM (BLOCK FORM)**. HOUSECHEM, INC., (U.S. CLS. 6, 18, 44, 46, 51 AND 52). SN 78-329,120. PUB. 8-10-2004. FILED 11-17-2003.  
2,899,999. **CIRCUS (BLOCK FORM)**. F.A. PRODUCTS, L.P., (U.S. CLS. 6, 18, 44, 46, 51 AND 52). SN 78-332,102. PUB. 8-10-2004. FILED 11-24-2003.  
2,900,001. **CIRCUS AND DESIGN**. F.A. PRODUCTS, L.P., (U.S. CLS. 6, 18, 44, 46, 51 AND 52). SN 78-332,129. PUB. 8-10-2004. FILED 11-24-2003.  
2,900,010. **QUICK SHIELD (BLOCK FORM)**. NOVARTIS AG, (U.S. CLS. 6, 18, 44, 46, 51 AND 52). SN 78-332,785. PUB. 8-10-2004. FILED 11-25-2003.

---

### CLASS 6—METAL GOODS

2,898,417. **INTIMIDATOR**. SNAP-ON TECHNOLOGIES, INC., (U.S. CLS. 2, 12, 13, 14, 23, 25 AND 50). SN 75-269,553. PUB. 2-10-1998. FILED 4-4-1997.  
2,898,433 ( *See Class 1 for this trademark* ).  
2,898,487. **SOLISOLAR**. ERTL, THOMAS, MULTIPLE CLASS, (INT. CLS. 6, 7, 9, 11, 19, 35, 36, 37, 38, 39, 40, 41 AND 42), (U.S. CLS. 1, 2, 12, 13, 14, 19, 21, 23, 25, 26, 31, 33, 34, 35, 36, 38, 50, 100, 101, 102, 103, 104, 105, 106 AND 107). SN 76-097,781. PUB. 2-17-2004. FILED 7-26-2000.  
2,898,573. **HDW AND DESIGN**. HOWALDTSWERKE-DEUTSCHE WERFT AG, MULTIPLE CLASS, (INT. CLS. 6, 7, 9, 11, 12, 13, 19, 20, 35, 37, 41 AND 42), (U.S. CLS. 1, 2, 9, 12, 13, 14, 19, 21, 22, 23, 25, 26, 31, 32, 33, 34, 35, 36, 38, 44, 50, 100, 101, 102, 103, 106 AND 107). SN 76-381,707. PUB. 8-10-2004. FILED 3-13-2002.  
2,898,600. **STAYWELL**. REILOR HOLDINGS LIMITED, MULTIPLE CLASS, (INT. CLS. 6, 9 AND 19), (U.S. CLS. 1, 2, 12, 13, 14, 21, 23, 25, 26, 33, 36, 38 AND 50). SN 76-417,985. PUB. 8-10-2004. FILED 6-5-2002.  
2,898,683. **TOP FLOW**. IOG CANADA INC., MULTIPLE CLASS, (INT. CLS. 6 AND 9), (U.S. CLS. 2, 12, 13, 14, 21, 23, 25, 26, 36, 38 AND 50). SN 76-473,534. PUB. 8-10-2004. FILED 12-5-2002.  
2,898,730. **TUCHENHAGEN**. TUCHENHAGEN GMBH, MULTIPLE CLASS, (INT. CLS. 6, 7 AND 9), (U.S. CLS. 2, 12, 13, 14, 19, 21, 23, 25, 26, 31, 34, 35, 36, 38 AND 50). SN 76-494,866. PUB. 8-10-2004. FILED 3-5-2003.  
2,898,797. **WORLD CLASS CONSERVATORY SYSTEMS AND DESIGN**. ULTRAFRAME (UK) LIMITED, MULTIPLE CLASS, (INT. CLS. 6, 19, 37 AND 42), (U.S. CLS. 1, 2, 12, 13, 14, 23, 25, 33, 50, 100, 101, 103 AND 106). SN 76-509,593. PUB. 8-10-2004. FILED 4-25-2003.  
2,898,872. **PALLETRAK**. ENGINEERED PRODUCTS, INC., (U.S. CLS. 2, 12, 13, 14, 23, 25 AND 50). SN 76-517,438. PUB. 8-10-2004. FILED 5-27-2003.  
2,898,946. **HAYER & BOECKER**. HAYER & BOECKER, MULTIPLE CLASS, (INT. CLS. 6 AND 7), (U.S. CLS. 2, 12, 13, 14, 19, 21, 23, 25, 31, 34, 35 AND 50). SN 76-527,766. PUB. 8-10-2004. FILED 7-8-2003.  
2,899,238. **GAMMA-X**. KERN SPECIAL TOOLS COMPANY, INCORPORATED, (U.S. CLS. 2, 12, 13, 14, 23, 25 AND 50). SN 76-559,913. PUB. 8-10-2004. FILED 10-31-2003.  
2,899,281. **SKT**. ROAD SYSTEMS, INC., (U.S. CLS. 2, 12, 13, 14, 23, 25 AND 50). SN 78-039,258. PUB. 1-29-2002. FILED 12-14-2000.  
2,899,292. **REDLINE AND DESIGN**. QUEST INDUSTRIES, INC., MULTIPLE CLASS, (INT. CLS. 6, 7, 9, 11, 12 AND 20), (U.S. CLS. 2, 12, 13, 14, 19, 21, 22, 23, 25, 26, 31, 32, 34, 35, 36, 38, 44 AND 50). SN 78-098,682. PUB. 9-30-2003. FILED 12-17-2001.  
2,899,319. **CO-BOLT**. CARROSSERIE HESS AG, MULTIPLE CLASS, (INT. CLS. 6, 7, 12 AND 37), (U.S. CLS. 2, 12, 13, 14, 19, 21, 23, 25, 31, 34, 35, 44, 50, 100, 103 AND 106). SN 78-136,634. PUB. 5-4-2004. FILED 6-18-2002.  
2,899,403. **MINIGLIDE**. UPONOR INNOVATION AB, MULTIPLE CLASS, (INT. CLS. 6, 9 AND 17), (U.S. CLS. 1, 2, 5, 12, 13, 14, 21, 23, 25, 26, 35, 36, 38 AND 50). SN 78-197,097. PUB. 8-10-2004. FILED 12-21-2002.

2,899,404. **MICROGLIDE**. UPONOR INNOVATION AB, MULTIPLE CLASS, (INT. CLS. 6, 9 AND 17), (U.S. CLS. 1, 2, 5, 12, 13, 14, 21, 23, 25, 26, 35, 36, 38 AND 50). SN 78-197,104. PUB. 8-10-2004. FILED 12-21-2002.  
2,899,504. **AMIANITIT**. AMIANITIT TECHNOLOGY SERVICES GMBH, MULTIPLE CLASS, (INT. CLS. 6 AND 19), (U.S. CLS. 1, 2, 12, 13, 14, 23, 25, 33 AND 50). SN 78-239,397. PUB. 8-10-2004. FILED 4-18-2003.  
2,899,554. **GATES AND DESIGN**. GATES & SONS, INC., MULTIPLE CLASS, (INT. CLS. 6 AND 19), (U.S. CLS. 1, 2, 12, 13, 14, 23, 25, 33 AND 50). SN 78-247,790. PUB. 8-10-2004. FILED 5-9-2003.  
2,899,591. **THE FOREVER CAP**. CHIM CAP CORP. (U.S. CLS. 2, 12, 13, 14, 23, 25 AND 50). SN 78-252,573. PUB. 8-10-2004. FILED 5-21-2003.  
2,899,612 ( *See Class 1 for this trademark* ).  
2,899,644. **ENTRASEC**. GUNNEBO PERIMETER PROTECTION AB, MULTIPLE CLASS, (INT. CLS. 6, 9 AND 37), (U.S. CLS. 2, 12, 13, 14, 21, 23, 25, 26, 36, 38, 50, 100, 103 AND 106). SN 78-260,809. PUB. 8-10-2004. FILED 6-11-2003.  
2,899,764. **AWT AND DESIGN**. ACTION WINDOOR TECHNOLOGY, INC., (U.S. CLS. 2, 12, 13, 14, 23, 25 AND 50). SN 78-297,660. PUB. 8-10-2004. FILED 9-9-2003.  
2,899,863. **CLIMATERITE AND DESIGN**. LARSON MANUFACTURING COMPANY OF SOUTH DAKOTA, INC., (U.S. CLS. 2, 12, 13, 14, 23, 25 AND 50). SN 78-316,292. PUB. 8-10-2004. FILED 10-21-2003.  
2,899,889. **SQT**. THYSSENKRUPP MATERIALS, INC., (U.S. CLS. 2, 12, 13, 14, 23, 25 AND 50). SN 78-319,476. PUB. 8-10-2004. FILED 10-28-2003.  
2,899,910. **PUNCTUATE AND DESIGN**. BARNES & NOBLE, INC., MULTIPLE CLASS, (INT. CLS. 6, 9, 11, 16, 18 AND 20), (U.S. CLS. 1, 2, 3, 5, 12, 13, 14, 21, 22, 23, 25, 26, 29, 31, 32, 34, 36, 37, 38, 41 AND 50). SN 78-321,755. PUB. 8-10-2004. FILED 10-31-2003.  
2,899,918. **JUMBO 2000 (BLOCK FORM)**. PEERLESS INDUSTRIES, INC., (U.S. CLS. 2, 12, 13, 14, 23, 25 AND 50). SN 78-322,366. PUB. 8-10-2004. FILED 11-3-2003.  
2,899,968. **BENNINGTON (BLOCK FORM)**. REVERE COPPER PRODUCTS, INC., (U.S. CLS. 2, 12, 13, 14, 23, 25 AND 50). SN 78-326,023. PUB. 8-10-2004. FILED 11-11-2003.

---

### CLASS 7—MACHINERY

2,898,433 ( *See Class 1 for this trademark* ).  
2,898,478. **YARD MACHINES**. MTD PRODUCTS INC, MULTIPLE CLASS, (INT. CLS. 7 AND 12), (U.S. CLS. 13, 19, 21, 23, 31, 34, 35 AND 44). SN 76-064,767. PUB. 8-10-2004. FILED 6-7-2000.  
2,898,487 ( *See Class 6 for this trademark* ).  
2,898,491. **BLADEMASTER AND DESIGN**. GUSPRO INCORPORATED, (U.S. CLS. 13, 19, 21, 23, 31, 34 AND 35). SN 76-116,358. PUB. 8-10-2004. FILED 8-24-2000.  
2,898,519. **MULTIBORE**. 600 UK LIMITED, DBA CRAWFORD COLLETS, (U.S. CLS. 13, 19, 21, 23, 31, 34 AND 35). SN 76-222,022. PUB. 8-10-2004. FILED 3-9-2001.  
2,898,540. **ALIMAK**. ALIMAK AB, (U.S. CLS. 13, 19, 21, 23, 31, 34 AND 35). SN 76-286,143. PUB. 8-10-2004. FILED 7-12-2001.  
2,898,555. **PROCESS CONER (BLOCK FORM)**. MURATA KIKAI KABUSHIKI KAISHA, (U.S. CLS. 13, 19, 21, 23, 31, 34 AND 35). SN 76-344,158. PUB. 8-10-2004. FILED 12-3-2001.  
2,898,573 ( *See Class 6 for this trademark* ).  
2,898,613 ( *See Class 1 for this trademark* ).  
2,898,640. **MIT (STYLIZED)**. MANUFACTURING INTEGRATION TECHNOLOGY LTD, (U.S. CLS. 13, 19, 21, 23, 31, 34 AND 35). SN 76-453,279. PUB. 8-10-2004. FILED 9-20-2002.  
2,898,652. **AUTOCAM AND DESIGN**. AUTOCAM CORPORATION, MULTIPLE CLASS, (INT. CLS. 7, 9 AND 12), (U.S. CLS. 13, 19, 21, 23, 26, 31, 34, 35, 36, 38 AND 44). SN 76-459,343. PUB. 8-10-2004. FILED 10-18-2002.  
2,898,674. **INTERCEPT MICRO FILTERS**. PROTEAM, INC., (U.S. CLS. 13, 19, 21, 23, 31, 34 AND 35). SN 76-468,003. PUB. 8-10-2004. FILED 11-12-2002.  
2,898,686 ( *See Class 3 for this trademark* ).  
2,898,699. **TRT AND DESIGN**. TRT OIL-OFF GMBH, MULTIPLE CLASS, (INT. CLS. 7, 11 AND 37), (U.S. CLS. 13, 19, 21,

- 23, 31, 34, 35, 100, 103 AND 106). SN 76-482,397. PUB. 8-10-2004. FILED 1-10-2003.
- 2,898,708. **CONVERTECH AND DESIGN**. CONVERTECH, INC., (U.S. CLS. 13, 19, 21, 23, 31, 34 AND 35). SN 76-486,852. PUB. 8-10-2004. FILED 1-31-2003.
- 2,898,730 ( *See Class 6 for this trademark*).
- 2,898,744. **J D N 1745 AND DESIGN**. J.D. NEUHAUS GMBH & CO. KG, MULTIPLE CLASS, (INT. CLS. 7, 8 AND 9), (U.S. CLS. 13, 19, 21, 23, 26, 28, 31, 34, 35, 36, 38 AND 44). SN 76-499,591. PUB. 8-10-2004. FILED 3-21-2003.
- 2,898,775. **LAWN LOADER AND DESIGN**. WELCH WELDING, INC., (U.S. CLS. 13, 19, 21, 23, 31, 34 AND 35). SN 76-507,224. PUB. 8-10-2004. FILED 4-17-2003.
- 2,898,787. **R RAM AND DESIGN**. RAM INDUSTRIES INC., (U.S. CLS. 13, 19, 21, 23, 31, 34 AND 35). SN 76-508,667. PUB. 8-10-2004. FILED 4-22-2003.
- 2,898,788. **CASAGRANDE**. CASAGRANDE SPA, MULTIPLE CLASS, (INT. CLS. 7 AND 12), (U.S. CLS. 13, 19, 21, 23, 31, 34, 35 AND 44). SN 76-508,736. PUB. 8-10-2004. FILED 4-22-2003.
- 2,898,870. **DIMAS**. DIMAS AKTIEBOLAGET, (U.S. CLS. 13, 19, 21, 23, 31, 34 AND 35). SN 76-517,144. PUB. 8-10-2004. FILED 5-27-2003.
- 2,898,871. **INNOV-IS (STYLIZED)**. BROTHER INDUSTRIES, LTD., (U.S. CLS. 13, 19, 21, 23, 31, 34 AND 35). SN 76-517,305. PUB. 8-10-2004. FILED 5-23-2003.
- 2,898,938. **STINGER**. B & G CHEMICALS & EQUIPMENT COMPANY, INC., (U.S. CLS. 13, 19, 21, 23, 31, 34 AND 35). SN 76-524,929. PUB. 2-10-2004. FILED 6-24-2003.
- 2,898,946 ( *See Class 6 for this trademark*).
- 2,898,959. **U UNIVERSAL HANDLING EQUIPMENT AND DESIGN**. UNIVERSAL HANDLING EQUIPMENT COMPANY LIMITED, MULTIPLE CLASS, (INT. CLS. 7 AND 12), (U.S. CLS. 13, 19, 21, 23, 31, 34, 35 AND 44). SN 76-530,339. PUB. 8-10-2004. FILED 7-9-2003.
- 2,898,964. **TALON**. SCHILLER-PFEIFFER, INC., (U.S. CLS. 13, 19, 21, 23, 31, 34 AND 35). SN 76-531,266. PUB. 4-13-2004. FILED 7-11-2003.
- 2,898,973. **GLIDEPATH**. GLIDEPATH LIMITED, MULTIPLE CLASS, (INT. CLS. 7, 35 AND 37), (U.S. CLS. 13, 19, 21, 23, 31, 34, 35, 100, 101, 102, 103 AND 106). SN 76-532,847. PUB. 8-10-2004. FILED 7-16-2003.
- 2,898,982. **PRECISION TARGETING**. EQUIPMENT MANUFACTURING CORPORATION, (U.S. CLS. 13, 19, 21, 23, 31, 34 AND 35). SN 76-534,339. PUB. 8-10-2004. FILED 7-22-2003.
- 2,899,013. **SILAGE MASTER**. SLABY, KENNETH A., (U.S. CLS. 13, 19, 21, 23, 31, 34 AND 35). SN 76-540,649. PUB. 8-10-2004. FILED 8-28-2003.
- 2,899,032. **BCA**. NTN-BCA CORPORATION, (U.S. CLS. 13, 19, 21, 23, 31, 34 AND 35). SN 76-542,873. PUB. 8-10-2004. FILED 9-8-2003.
- 2,899,048. **S AND DESIGN**. CTB IP, INC., MULTIPLE CLASS, (INT. CLS. 7 AND 11), (U.S. CLS. 13, 19, 21, 23, 31, 34 AND 35). SN 76-545,494. PUB. 8-10-2004. FILED 9-5-2003.
- 2,899,058. **HOT STREET PIPES**. S.B. D. MUFFLERS LLC, (U.S. CLS. 13, 19, 21, 23, 31, 34 AND 35). SN 76-546,932. PUB. 8-10-2004. FILED 9-25-2003.
- 2,899,253. **TACSEW (BLOCK FORM)**. TACONY CORPORATION, (U.S. CLS. 13, 19, 21, 23, 31, 34 AND 35). SN 76-561,812. PUB. 8-10-2004. FILED 11-24-2003.
- 2,899,292 ( *See Class 6 for this trademark*).
- 2,899,315. **SANACTY**. SANYO DENKI CO., LTD., MULTIPLE CLASS, (INT. CLS. 7, 9, 12, 41 AND 42), (U.S. CLS. 13, 19, 21, 23, 26, 31, 34, 35, 36, 38, 44, 100, 101 AND 107). SN 78-135,844. PUB. 8-10-2004. FILED 6-14-2002.
- 2,899,316. **SANMOTION**. SANYO DENKI CO., LTD., MULTIPLE CLASS, (INT. CLS. 7, 9, 12, 41 AND 42), (U.S. CLS. 13, 19, 21, 23, 26, 31, 34, 35, 36, 38, 44, 100, 101 AND 107). SN 78-135,847. PUB. 8-10-2004. FILED 6-14-2002.
- 2,899,319 ( *See Class 6 for this trademark*).
- 2,899,416. **M B AND DESIGN**. MAX BAERMANN GMBH, MULTIPLE CLASS, (INT. CLS. 7, 9 AND 12), (U.S. CLS. 13, 19, 21, 23, 26, 31, 34, 35, 36, 38 AND 44). SN 78-201,596. PUB. 8-10-2004. FILED 1-9-2003.
- 2,899,417. **OTTO YORK AND DESIGN**. KOCH-GLITSCH, LP, (U.S. CLS. 13, 19, 21, 23, 31, 34 AND 35). SN 78-201,693. PUB. 12-2-2003. FILED 1-9-2003.
- 2,899,448. **WETLACE**. RIETER PERFOJET, MULTIPLE

- CLASS, (INT. CLS. 7 AND 24), (U.S. CLS. 13, 19, 21, 23, 31, 34, 35, 42 AND 50). SN 78-222,424. PUB. 8-10-2004. FILED 3-6-2003.
- 2,899,458. **MISCELLANEOUS DESIGN**. INTERNATIONAL TRUCK INTELLECTUAL PROPERTY COMPANY, LLC, MULTIPLE CLASS, (INT. CLS. 7, 12, 35, 36, 37 AND 39), (U.S. CLS. 13, 19, 21, 23, 31, 34, 35, 44, 100, 101, 102, 103, 105 AND 106). SN 78-225,802. PUB. 11-25-2003. FILED 3-14-2003.
- 2,899,476. **SBL**. SBL MACHINERY CO., LTD., (U.S. CLS. 13, 19, 21, 23, 31, 34 AND 35). SN 78-234,032. PUB. 12-2-2003. FILED 4-4-2003.
- 2,899,548. **EZ FIRE**. SEARS BRANDS, LLC, (U.S. CLS. 13, 19, 21, 23, 31, 34 AND 35). SN 78-246,800. PUB. 8-10-2004. FILED 5-7-2003.
- 2,899,581. **HOGZILLA**. C. W. MANUFACTURING, INC., (U.S. CLS. 13, 19, 21, 23, 31, 34 AND 35). SN 78-251,398. PUB. 2-10-2004. FILED 5-19-2003.
- 2,899,587. **CAPRESSO**. CAPRESSO, INC., MULTIPLE CLASS, (INT. CLS. 7, 11, 21 AND 30), (U.S. CLS. 2, 13, 19, 21, 23, 29, 30, 31, 33, 34, 35, 40, 46 AND 50). SN 78-251,960. PUB. 8-10-2004. FILED 5-20-2003.
- 2,899,696. **NEO**. SEB, MULTIPLE CLASS, (INT. CLS. 7, 11 AND 21), (U.S. CLS. 2, 13, 19, 21, 23, 29, 30, 31, 33, 34, 35, 40 AND 50). SN 78-273,424. PUB. 8-10-2004. FILED 7-11-2003.
- 2,899,712. **MPV**. MARK'S MACHINE COMPANY, INC., (U.S. CLS. 13, 19, 21, 23, 31, 34 AND 35). SN 78-279,836. PUB. 8-10-2004. FILED 7-28-2003.
- 2,899,777. **MEGAVANTIS**. DRAISWERKE, INC., (U.S. CLS. 13, 19, 21, 23, 31, 34 AND 35). SN 78-299,153. PUB. 8-10-2004. FILED 9-11-2003.
- 2,899,824. **SPICE UP YOUR SAW**. FREUD TMM, INC., (U.S. CLS. 13, 19, 21, 23, 31, 34 AND 35). SN 78-311,303. PUB. 8-10-2004. FILED 10-9-2003.
- 2,899,965. **READY FILTER (BLOCK FORM)**. SAKAKEENY, MICHAEL A., (U.S. CLS. 13, 19, 21, 23, 31, 34 AND 35). SN 78-325,804. PUB. 8-10-2004. FILED 11-10-2003.
- 2,899,989. **ROTO-ROOTER (BLOCK FORM)**. ROTO-ROOTER CORPORATION, (U.S. CLS. 13, 19, 21, 23, 31, 34 AND 35). SN 78-328,720. PUB. 8-10-2004. FILED 11-17-2003.

---

## CLASS 8—HAND TOOLS

- 2,898,726. **4MYFRIEND**. 4MYFRIEND, (U.S. CLS. 23, 28 AND 44). SN 76-492,918. PUB. 8-10-2004. FILED 2-27-2003.
- 2,898,744 ( *See Class 7 for this trademark*).
- 2,898,828. **K AND DESIGN**. BUD K WORLDWIDE, INC., (U.S. CLS. 23, 28 AND 44). SN 76-512,609. PUB. 12-2-2003. FILED 4-21-2003.
- 2,899,627 ( *See Class 5 for this trademark*).
- 2,899,963. **SLIMLINE (BLOCK FORM)**. ANDIS COMPANY, (U.S. CLS. 23, 28 AND 44). SN 78-325,638. PUB. 8-10-2004. FILED 11-10-2003.

---

## CLASS 9—ELECTRICAL AND SCIENTIFIC APPARATUS

- 2,898,420. **PRIMETIME AND DESIGN**. T.D. SALES AND MARKETING, INC., (U.S. CLS. 21, 23, 26, 36 AND 38). SN 75-415,622. PUB. 2-9-1999. FILED 1-9-1998.
- 2,898,421. **UNITYMAIL**. MESSAGEMEDIA, INC., (U.S. CLS. 21, 23, 26, 36 AND 38). SN 75-493,639. PUB. 8-10-2004. FILED 5-28-1998.
- 2,898,422. **CEGETEL AND DESIGN**. CEGETEL, MULTIPLE CLASS, (INT. CLS. 9, 16, 38 AND 42), (U.S. CLS. 2, 5, 21, 22, 23, 26, 29, 36, 37, 38, 50, 100, 101 AND 104). SN 75-494,738. PUB. 8-10-2004. FILED 6-2-1998.
- 2,898,433 ( *See Class 1 for this trademark*).
- 2,898,435. **ICCONCEPT**. INTEGRATED CHIPWARE, INC., MULTIPLE CLASS, (INT. CLS. 9 AND 42), (U.S. CLS. 21, 23, 26, 36, 38, 100 AND 101). SN 75-598,222. PUB. 8-10-2004. FILED 12-2-1998.
- 2,898,438. **CONNECTRIX**. EMC CORPORATION, (U.S. CLS. 21, 23, 26, 36 AND 38). SN 75-635,945. PUB. 3-27-2001. FILED

- 2-8-1999.
- 2,898,445. **MICROMUSE**. MICROMUSE PLC, MULTIPLE CLASS, (INT. CLS. 9, 37, 41 AND 42), (U.S. CLS. 21, 23, 26, 36, 38, 100, 101, 103, 106 AND 107). SN 75-778,273. PUB. 3-20-2001. FILED 8-17-1999.
- 2,898,449. **VDO DAYTON**. MANNESMANN VDO AG, MULTIPLE CLASS, (INT. CLS. 9, 35, 37, 38, 39, 41 AND 42), (U.S. CLS. 21, 23, 26, 36, 38, 100, 101, 102, 103, 104, 105, 106 AND 107). SN 75-822,099. PUB. 9-2-2003. FILED 10-13-1999.
- 2,898,452. **BESTPRACTICES**. SHARED DATA SYSTEMS, INC., (U.S. CLS. 21, 23, 26, 36 AND 38). SN 75-856,972. PUB. 10-2-2001. FILED 11-23-1999.
- 2,898,454. **S4**. DATA SYSTEMS, INC, MULTIPLE CLASS, (INT. CLS. 9, 16 AND 42), (U.S. CLS. 2, 5, 21, 22, 23, 26, 29, 36, 37, 38, 50, 100 AND 101). SN 75-868,719. PUB. 8-10-2004. FILED 12-10-1999.
- 2,898,476. **PLEXUS**. TELICA, INC., (U.S. CLS. 21, 23, 26, 36 AND 38). SN 76-035,086. PUB. 8-21-2001. FILED 4-20-2000.
- 2,898,479. **MISCELLANEOUS DESIGN**. KONAMI CORPORATION, (U.S. CLS. 21, 23, 26, 36 AND 38). SN 76-074,595. PUB. 10-8-2002. FILED 6-21-2000.
- 2,898,480. **BRIDGES.COM**. BRIDGES.COM INC., MULTIPLE CLASS, (INT. CLS. 9, 16, 41 AND 42), (U.S. CLS. 2, 5, 21, 22, 23, 26, 29, 36, 37, 38, 50, 100, 101 AND 107). SN 76-076,324. PUB. 9-10-2002. FILED 6-21-2000.
- 2,898,481. **AUTONOMY KENJIN (STYLIZED)**. AUTONOMY CORPORATION PLC, MULTIPLE CLASS, (INT. CLS. 9 AND 42), (U.S. CLS. 21, 23, 26, 36, 38, 100 AND 101). SN 76-080,971. PUB. 8-10-2004. FILED 6-30-2000.
- 2,898,486. **TRACKERCAM**. VERGHESE, GILBERT, (U.S. CLS. 21, 23, 26, 36 AND 38). SN 76-093,452. PUB. 8-10-2004. FILED 7-12-2000.
- 2,898,487 ( *See Class 6 for this trademark*).
- 2,898,498. **UBS WARBURG DIRECT AND DESIGN**. UBS AG, MULTIPLE CLASS, (INT. CLS. 9, 16, 35, 36, 38 AND 42), (U.S. CLS. 2, 5, 21, 22, 23, 26, 29, 36, 37, 38, 50, 100, 101, 102 AND 104). SN 76-136,032. PUB. 8-5-2003. FILED 9-27-2000.
- 2,898,500. **SOLINO**. RIEDI, MARKUS, MULTIPLE CLASS, (INT. CLS. 9, 11, 35 AND 42), (U.S. CLS. 13, 21, 23, 26, 31, 34, 36, 38, 100, 101 AND 102). SN 76-138,072. PUB. 8-10-2004. FILED 9-28-2000.
- 2,898,505. **BIGBANGWIDTH**. BIGBANGWIDTH, INC., MULTIPLE CLASS, (INT. CLS. 9 AND 42), (U.S. CLS. 21, 23, 26, 36, 38, 100 AND 101). SN 76-168,343. PUB. 8-10-2004. FILED 11-20-2000.
- 2,898,512. **ELIXENT**. ELIXENT LIMITED, (U.S. CLS. 21, 23, 26, 36 AND 38). SN 76-212,120. PUB. 7-16-2002. FILED 2-20-2001.
- 2,898,515. **ACSC ADVANCED CASINO SYSTEMS CORPORATION AND DESIGN**. ADVANCED CASINO SYSTEMS CORPORATION, (U.S. CLS. 21, 23, 26, 36 AND 38). SN 76-216,639. PUB. 7-29-2003. FILED 2-26-2001.
- 2,898,517. **IDECAD (STYLIZED)**. IDE YAPI BILGISAYAR DESTEKLI TASARIM MUHENDISLIK DANISMANLIK TAAHHUT LTD. STI, MULTIPLE CLASS, (INT. CLS. 9 AND 42), (U.S. CLS. 21, 23, 26, 36, 38, 100 AND 101). SN 76-217,429. PUB. 8-10-2004. FILED 2-22-2001.
- 2,898,522. **MCMAZE**. PIERCE, JOSEPH ALEXANDER, (U.S. CLS. 21, 23, 26, 36 AND 38). SN 76-231,234. PUB. 1-7-2003. FILED 3-28-2001.
- 2,898,528. **EON**. NEOWARE SYSTEMS, INC., (U.S. CLS. 21, 23, 26, 36 AND 38). SN 76-250,078. PUB. 12-24-2002. FILED 5-2-2001.
- 2,898,530. **SPYRAL SYSTEM CARRASCO SOFTWARE AND DESIGN**. CARRASCO & ASOCIADOS CONSULTORES CIA. LTDA., (U.S. CLS. 21, 23, 26, 36 AND 38). SN 76-254,290. PUB. 6-3-2003. FILED 5-9-2001.
- 2,898,532. **EC AND DESIGN**. SOFTCARE ELECTRONIC COMMERCE INC., MULTIPLE CLASS, (INT. CLS. 9 AND 42), (U.S. CLS. 21, 23, 26, 36, 38, 100 AND 101). SN 76-267,245. PUB. 8-10-2004. FILED 6-6-2001.
- 2,898,533. **FIRESTORE**. FOCUS ENHANCEMENTS, INC., (U.S. CLS. 21, 23, 26, 36 AND 38). SN 76-268,438. PUB. 5-28-2002. FILED 6-6-2001.
- 2,898,535 ( *See Class 5 for this trademark*).
- 2,898,537. **GIGAVISION**. KINOTON GMBH, (U.S. CLS. 21, 23, 26, 36 AND 38). SN 76-282,911. PUB. 8-10-2004. FILED 7-3-2001.
- 2,898,546. **BESTALK AND DESIGN**. INVENTEC BESTA CO., LTD., (U.S. CLS. 21, 23, 26, 36 AND 38). SN 76-309,474. PUB. 9-24-2002. FILED 9-7-2001.
- 2,898,548. **I MODULE AND DESIGN**. BOE HYDIS TECHNOLOGY CO., LTD., (U.S. CLS. 21, 23, 26, 36 AND 38). SN 76-314,608. PUB. 8-10-2004. FILED 9-18-2001.
- 2,898,552. **MISCELLANEOUS DESIGN**. CHARHOUSE INTERNATIONAL LEARNING CORPORATION, MULTIPLE CLASS, (INT. CLS. 9 AND 16), (U.S. CLS. 2, 5, 21, 22, 23, 26, 29, 36, 37, 38 AND 50). SN 76-327,608. PUB. 10-22-2002. FILED 10-18-2001.
- 2,898,560. **SERDUCT**. MANAGEMENT SCIENCE LIMITED, (U.S. CLS. 21, 23, 26, 36 AND 38). SN 76-359,833. PUB. 5-11-2004. FILED 1-17-2002.
- 2,898,565. **M AND DESIGN**. MACONOMY A/S, MULTIPLE CLASS, (INT. CLS. 9, 16, 35, 38, 41 AND 42), (U.S. CLS. 2, 5, 21, 22, 23, 26, 29, 36, 37, 38, 50, 100, 101, 102, 104 AND 107). SN 76-361,812. PUB. 8-10-2004. FILED 1-22-2002.
- 2,898,571. **PHIL AND DESIGN**. PRAXCIM INC., MULTIPLE CLASS, (INT. CLS. 9, 14, 16, 21, 28, 30 AND 41), (U.S. CLS. 2, 5, 13, 21, 22, 23, 26, 27, 28, 29, 30, 33, 36, 37, 38, 40, 46, 50, 100, 101 AND 107). SN 76-379,522. PUB. 8-10-2004. FILED 3-7-2002.
- 2,898,573 ( *See Class 6 for this trademark*).
- 2,898,575. **THE SUMMIT GROUP**. SUMMIT GROUP, LLC, THE, MULTIPLE CLASS, (INT. CLS. 9, 16 AND 35), (U.S. CLS. 2, 5, 21, 22, 23, 26, 29, 36, 37, 38, 50, 100, 101 AND 102). SN 76-384,464. PUB. 8-10-2004. FILED 3-19-2002.
- 2,898,577. **SUNSYSTEMS AND DESIGN**. SYSTEMS UNION HOLDINGS LIMITED, (U.S. CLS. 21, 23, 26 AND 38). SN 76-385,616. PUB. 1-28-2003. FILED 3-21-2002.
- 2,898,579. **SNOW BUDDIES**. ENCORE GROUP, INC., THE, MULTIPLE CLASS, (INT. CLS. 9, 16, 18, 25 AND 28), (U.S. CLS. 1, 2, 3, 5, 21, 22, 23, 26, 29, 36, 37, 38, 39, 41 AND 50). SN 76-392,195. PUB. 6-10-2003. FILED 4-5-2002.
- 2,898,583. **J.L. INDUSTRIES**. ACTIVAR, INC., MULTIPLE CLASS, (INT. CLS. 9 AND 20), (U.S. CLS. 2, 13, 21, 22, 23, 25, 26, 32, 36, 38 AND 50). SN 76-396,737. PUB. 8-10-2004. FILED 4-16-2002.
- 2,898,584. **MISCELLANEOUS DESIGN**. CEYBA INC., MULTIPLE CLASS, (INT. CLS. 9 AND 42), (U.S. CLS. 21, 23, 26, 36, 38, 100 AND 101). SN 76-399,052. PUB. 8-10-2004. FILED 4-22-2002.
- 2,898,587. **PTB WORLD**. HTB LIMITED, MULTIPLE CLASS, (INT. CLS. 9, 16, 35, 38 AND 41), (U.S. CLS. 2, 5, 21, 22, 23, 26, 29, 36, 37, 38, 50, 100, 101, 102, 104 AND 107). SN 76-401,614. PUB. 8-10-2004. FILED 4-29-2002.
- 2,898,589. **WARCOMMANDER**. CDV SOFTWARE ENTERTAINMENT AG, MULTIPLE CLASS, (INT. CLS. 9 AND 42), (U.S. CLS. 21, 23, 26, 36, 38, 100 AND 101). SN 76-402,854. PUB. 12-3-2002. FILED 4-30-2002.
- 2,898,592. **E-ROW (STYLIZED)**. CONCEPT 2, INC., (U.S. CLS. 21, 23, 26, 36 AND 38). SN 76-407,988. PUB. 8-10-2004. FILED 5-15-2002.
- 2,898,595. **ANGEL MINISTRIES AND DESIGN**. ANGEL MINISTRIES, (U.S. CLS. 21, 23, 26, 36 AND 38). SN 76-412,243. PUB. 12-17-2002. FILED 5-21-2002.
- 2,898,600 ( *See Class 6 for this trademark*).
- 2,898,613 ( *See Class 1 for this trademark*).
- 2,898,618. **MERIDIAN PAYMATCH**. MERIDIAN SYSTEMS CONSULTING, INC., (U.S. CLS. 21, 23, 26, 36 AND 38). SN 76-433,304. PUB. 7-8-2003. FILED 7-23-2002.
- 2,898,619. **ASPHERICON**. ASPHERICON GMBH, MULTIPLE CLASS, (INT. CLS. 9 AND 40), (U.S. CLS. 21, 23, 26, 36, 38, 100, 103 AND 106). SN 76-436,246. PUB. 8-10-2004. FILED 7-29-2002.
- 2,898,625. **EXAMPLE SERVER**. DUCK CREEK TECHNOLOGIES, INC., (U.S. CLS. 21, 23, 26, 36 AND 38). SN 76-442,766. PUB. 8-10-2004. FILED 8-22-2002.
- 2,898,630. **COOLFLO**. RAWLINGS SPORTING GOODS COMPANY, INC., (U.S. CLS. 21, 23, 26, 36 AND 38). SN 76-447,350. PUB. 8-10-2004. FILED 9-6-2002.
- 2,898,635. **EQUAL2NEW**. CABLEXPRESS CORPORATION, (U.S. CLS. 21, 23, 26, 36 AND 38). SN 76-450,623. PUB. 5-6-2003. FILED 7-8-2002.
- 2,898,637. **UCA**. SAMSUNG TECHWIN CO., LTD., (U.S. CLS. 21, 23, 26, 36 AND 38). SN 76-451,077. PUB. 8-10-2004. FILED 9-13-2002.

- 2,898,652 ( *See Class 7 for this trademark*).
- 2,898,653. **MISCELLANEOUS DESIGN**. SUNRISE INDUSTRIES, INC., DBA DAWN OF SILENCE MUSIC, (U.S. CLS. 21, 23, 26, 36 AND 38). SN 76-459,652. PUB. 8-10-2004. FILED 10-21-2002.
- 2,898,654. **2-VU (STYLIZED)**. ESTARI, INC., (U.S. CLS. 21, 23, 26, 36 AND 38). SN 76-459,664. PUB. 8-10-2004. FILED 10-21-2002.
- 2,898,655. **MJ-12**. ALIENWARE CORPORATION, (U.S. CLS. 21, 23, 26, 36 AND 38). SN 76-459,730. PUB. 8-10-2004. FILED 10-11-2002.
- 2,898,660. **POCKET PM (STYLIZED)**. DUDLEY, GARRY W., (U.S. CLS. 21, 23, 26, 36 AND 38). SN 76-462,154. PUB. 8-10-2004. FILED 10-28-2002.
- 2,898,679. **THE CRITICAL VISION SYSTEM AND DESIGN**. THE CRITICAL ILLNESS INSURANCE CENTRE LTD., MULTIPLE CLASS, (INT. CLS. 9 AND 16), (U.S. CLS. 2, 5, 21, 22, 23, 26, 29, 36, 37, 38 AND 50). SN 76-471,488. PUB. 3-2-2004. FILED 11-29-2002.
- 2,898,681. **FLAIR MONDADORI**. ARNOLDO MONDADORI EDITORE S.P.A., MULTIPLE CLASS, (INT. CLS. 9, 16 AND 38), (U.S. CLS. 2, 5, 21, 22, 23, 26, 29, 36, 37, 38, 50, 100, 101 AND 104). SN 76-472,431. PUB. 8-10-2004. FILED 12-3-2002.
- 2,898,682. **FLAIR & FASHION**. ARNOLDO MONDADORI EDITORE S.P.A., MULTIPLE CLASS, (INT. CLS. 9, 16 AND 38), (U.S. CLS. 2, 5, 21, 22, 23, 26, 29, 36, 37, 38, 50, 100, 101 AND 104). SN 76-472,437. PUB. 8-10-2004. FILED 12-3-2002.
- 2,898,683 ( *See Class 6 for this trademark*).
- 2,898,685. **RSI ID TECHNOLOGIES AND DESIGN**. RSI ID TECHNOLOGIES, MULTIPLE CLASS, (INT. CLS. 9 AND 16), (U.S. CLS. 2, 5, 21, 22, 23, 26, 29, 36, 37, 38 AND 50). SN 76-474,290. PUB. 8-10-2004. FILED 12-6-2002.
- 2,898,686 ( *See Class 3 for this trademark*).
- 2,898,690. **AFRISOUL**. AFRISOUL MUSIC INTERNATIONAL, LC, (U.S. CLS. 21, 23, 26, 36 AND 38). SN 76-477,434. PUB. 8-10-2004. FILED 12-20-2002.
- 2,898,694. **S AA&G AND DESIGN**. A.A.G. STUCCHI S.P.A., MULTIPLE CLASS, (INT. CLS. 9 AND 11), (U.S. CLS. 13, 21, 23, 26, 31, 34, 36 AND 38). SN 76-479,874. PUB. 8-10-2004. FILED 1-2-2003.
- 2,898,696. **THE DATSUNS**. HELLSQUAD RECORDS LIMITED, MULTIPLE CLASS, (INT. CLS. 9, 25 AND 41), (U.S. CLS. 21, 22, 23, 26, 36, 38, 39, 100, 101 AND 107). SN 76-481,642. PUB. 8-10-2004. FILED 1-10-2003.
- 2,898,707. **DB AND DESIGN**. CANDLE CORPORATION, (U.S. CLS. 21, 23, 26, 36 AND 38). SN 76-486,840. PUB. 10-21-2003. FILED 2-3-2003.
- 2,898,710. **DIGITAL PERFORMER**. MARK OF THE UNICORN, INC., (U.S. CLS. 21, 23, 26, 36 AND 38). SN 76-487,365. PUB. 8-10-2004. FILED 1-30-2003.
- 2,898,711. **ME AND DESIGN**. MOBILE EDGE LLC, (U.S. CLS. 21, 23, 26, 36 AND 38). SN 76-487,484. PUB. 9-23-2003. FILED 2-4-2003.
- 2,898,721. **JUST AVA AND DESIGN**. JUSTER CO., LTD., (U.S. CLS. 21, 23, 26, 36 AND 38). SN 76-491,580. PUB. 8-10-2004. FILED 2-20-2003.
- 2,898,730 ( *See Class 6 for this trademark*).
- 2,898,735. **MANIKEN**. ZAHOUREK SYSTEMS, INCORPORATED, MULTIPLE CLASS, (INT. CLS. 9, 16, 41 AND 42), (U.S. CLS. 2, 5, 21, 22, 23, 26, 29, 36, 37, 38, 50, 100, 101 AND 107). SN 76-497,649. PUB. 8-10-2004. FILED 3-17-2003.
- 2,898,744 ( *See Class 7 for this trademark*).
- 2,898,784. **I-DO**. EDINBURGH PETROLEUM SERVICES LIMITED, MULTIPLE CLASS, (INT. CLS. 9, 37 AND 42), (U.S. CLS. 21, 23, 26, 36, 38, 100, 101, 103 AND 106). SN 76-508,357. PUB. 8-10-2004. FILED 4-21-2003.
- 2,898,785. **KFORM PROJECT MANAGER**. K-FORM, INC., (U.S. CLS. 21, 23, 26, 36 AND 38). SN 76-508,412. PUB. 8-10-2004. FILED 4-9-2003.
- 2,898,792. **THERE RECORDS**. EVERS, AL, (U.S. CLS. 21, 23, 26, 36 AND 38). SN 76-509,175. PUB. 8-10-2004. FILED 4-21-2003.
- 2,898,800. **P L S**. CUBIC DEFENSE APPLICATIONS, INC., (U.S. CLS. 21, 23, 26, 36 AND 38). SN 76-509,917. PUB. 8-10-2004. FILED 4-28-2003.
- 2,898,815. **MAN-IT**. VIA INFORMATION TOOLS, INC., (U.S. CLS. 21, 23, 26, 36 AND 38). SN 76-511,946. PUB. 8-10-2004. FILED 4-18-2003.
- 2,898,822. **SILENX**. SILENX CORPORATION, (U.S. CLS. 21, 23, 26, 36 AND 38). SN 76-512,221. PUB. 8-10-2004. FILED 5-7-2003.
- 2,898,824. **MISCELLANEOUS DESIGN**. AMONG FRIENDS RECORDS INC., MULTIPLE CLASS, (INT. CLS. 9 AND 41), (U.S. CLS. 21, 23, 26, 36, 38, 100, 101 AND 107). SN 76-512,354. PUB. 8-10-2004. FILED 4-16-2003.
- 2,898,825. **APOSTAR**. RWE PILLER-GMBH, (U.S. CLS. 21, 23, 26, 36 AND 38). SN 76-512,397. PUB. 8-10-2004. FILED 5-5-2003.
- 2,898,829. **SIMPLE REMOTE**. SIMPLE REMOTE, LLC, (U.S. CLS. 21, 23, 26, 36 AND 38). SN 76-512,820. PUB. 8-10-2004. FILED 5-8-2003.
- 2,898,836. **MISCELLANEOUS DESIGN**. DESPER PRODUCTS, INC., A WHOLLY OWNED SUBSIDIARY OF SPATIALIZER AUDIO LABORATORIES, INC., (U.S. CLS. 21, 23, 26, 36 AND 38). SN 76-513,613. PUB. 8-10-2004. FILED 5-12-2003.
- 2,898,839. **SHORT-STOP**. COOPER TECHNOLOGIES COMPANY, (U.S. CLS. 21, 23, 26, 36 AND 38). SN 76-513,943. PUB. 8-10-2004. FILED 4-14-2003.
- 2,898,846. **EMC TECHNOLOGY, INC.**. EMC TECHNOLOGY, INC., (U.S. CLS. 21, 23, 26, 36 AND 38). SN 76-514,457. PUB. 8-10-2004. FILED 5-14-2003.
- 2,898,847. **EMC TECHNOLOGY INC. AND DESIGN**. EMC TECHNOLOGY, INC., (U.S. CLS. 21, 23, 26, 36 AND 38). SN 76-514,458. PUB. 8-10-2004. FILED 5-14-2003.
- 2,898,852. **FICTITIOUS RECORDS (STYLIZED)**. DAVIS, MICHAEL THOMAS, DBA FICTITIOUS RECORDS, (U.S. CLS. 21, 23, 26, 36 AND 38). SN 76-514,849. PUB. 8-10-2004. FILED 5-16-2003.
- 2,898,877 ( *See Class 4 for this trademark*).
- 2,898,882. **MPOWER 4000 AND DESIGN**. SARGENT MANUFACTURING COMPANY, (U.S. CLS. 21, 23, 26, 36 AND 38). SN 76-518,708. PUB. 1-13-2004. FILED 5-15-2003.
- 2,898,898. **MOBY POWER**. MOBYPower CO., LTD., (U.S. CLS. 21, 23, 26, 36 AND 38). SN 76-519,308. PUB. 8-10-2004. FILED 6-2-2003.
- 2,898,904. **FMG**. DEVORE AVIATION CORPORATION OF AMERICA, (U.S. CLS. 21, 23, 26, 36 AND 38). SN 76-519,552. PUB. 8-10-2004. FILED 6-4-2003.
- 2,898,907. **MISCELLANEOUS DESIGN**. KARASIK, RANDAL B., (U.S. CLS. 21, 23, 26, 36 AND 38). SN 76-520,000. PUB. 1-20-2004. FILED 6-5-2003.
- 2,898,918. **20-20 KITCHEN BUILDER**. 20-20 TECHNOLOGIES INC., (U.S. CLS. 21, 23, 26, 36 AND 38). SN 76-521,418. PUB. 8-10-2004. FILED 6-9-2003.
- 2,898,963. **NEUZEIT**. HEIDELBERGER DRUCKMASCHINEN AG, MULTIPLE CLASS, (INT. CLS. 9 AND 16), (U.S. CLS. 2, 5, 21, 22, 23, 26, 29, 36, 37, 38 AND 50). SN 76-531,024. PUB. 8-10-2004. FILED 7-21-2003.
- 2,898,997. **COHERENT VIEW**. XSB, INC., (U.S. CLS. 21, 23, 26, 36 AND 38). SN 76-536,479. PUB. 8-10-2004. FILED 7-31-2003.
- 2,899,017. **SMART-PLATE**. HURST CHEMICAL COMPANY, (U.S. CLS. 21, 23, 26, 36 AND 38). SN 76-540,788. PUB. 8-10-2004. FILED 8-15-2003.
- 2,899,025. **MYLINE (BLOCK FORM)**. RALEY'S TM, INC., (U.S. CLS. 21, 23, 26, 36 AND 38). SN 76-542,214. PUB. 8-10-2004. FILED 9-2-2003.
- 2,899,031. **FACES AND DESIGN**. SIGN FACES LLC, (U.S. CLS. 21, 23, 26, 36 AND 38). SN 76-542,864. PUB. 8-10-2004. FILED 9-8-2003.
- 2,899,059. **READING DYNAMICS**. FPS TRAINING CORP., MULTIPLE CLASS, (INT. CLS. 9 AND 16), (U.S. CLS. 2, 5, 21, 22, 23, 26, 29, 36, 37, 38 AND 50). SN 76-546,939. PUB. 8-10-2004. FILED 9-25-2003.
- 2,899,063. **BASE TRAINER (STYLIZED)**. ADVANCED MULTIMEDIA DEVICES INC., (U.S. CLS. 21, 23, 26, 36 AND 38). SN 76-547,985. PUB. 8-10-2004. FILED 9-29-2003.
- 2,899,064. **PARTNER FOUR (STYLIZED)**. ADVANCED MULTIMEDIA DEVICES INC., (U.S. CLS. 21, 23, 26, 36 AND 38). SN 76-547,987. PUB. 8-10-2004. FILED 9-29-2003.
- 2,899,065. **PARTNER ONE (STYLIZED)**. ADVANCED MULTIMEDIA DEVICES INC., (U.S. CLS. 21, 23, 26, 36 AND 38). SN 76-547,989. PUB. 8-10-2004. FILED 9-29-2003.
- 2,899,066. **SKYBITZ**. SKYBITZ, INC., (U.S. CLS. 21, 23, 26, 36 AND 38). SN 76-548,096. PUB. 8-10-2004. FILED 9-29-2003.
- 2,899,070. **SWAMP CABBAGE**. PARKS, WALTER JOHN IV, MULTIPLE CLASS, (INT. CLS. 9 AND 41), (U.S. CLS. 21, 23,

- 26, 36, 38, 100, 101 AND 107). SN 76-548,482. PUB. 8-10-2004. FILED 10-1-2003.
- 2,899,071. **BELLADONNA ENTERTAINMENT AND DESIGN.** BELLADONNA ENTERTAINMENT, LLC, (U.S. CLS. 21, 23, 26, 36 AND 38). SN 76-548,489. PUB. 8-10-2004. FILED 10-1-2003.
- 2,899,074. **TYN DAL DISPLAYS AND DESIGN.** WYTEC HOLDING B.V., MULTIPLE CLASS, (INT. CLS. 9, 11 AND 37), (U.S. CLS. 13, 21, 23, 26, 31, 34, 36, 38, 100, 103 AND 106). SN 76-549,027. PUB. 8-10-2004. FILED 10-6-2003.
- 2,899,075. **INFO-AIRPORT.** CASTLE ROCK TECHNOLOGIES, LLC, (U.S. CLS. 21, 23, 26, 36 AND 38). SN 76-549,288. PUB. 8-10-2004. FILED 10-6-2003.
- 2,899,080. **VIDEO VOYEUR.** CALIFORNIA EXOTIC NOVELTIES LLC, (U.S. CLS. 21, 23, 26, 36 AND 38). SN 76-549,676. PUB. 8-10-2004. FILED 9-22-2003.
- 2,899,089. **MISCELLANEOUS DESIGN.** IQ BIOMETRIX, INC., (U.S. CLS. 21, 23, 26, 36 AND 38). SN 76-550,430. PUB. 8-10-2004. FILED 10-9-2003.
- 2,899,090. **FANCRAFTIC! AND DESIGN.** RANDALL, VALERIE, MULTIPLE CLASS, (INT. CLS. 9 AND 16), (U.S. CLS. 2, 5, 21, 22, 23, 26, 29, 36, 37, 38 AND 50). SN 76-550,796. PUB. 8-10-2004. FILED 10-10-2003.
- 2,899,120. **NO MANS LAND.** CDV SOFTWARE ENTERTAINMENT AG, MULTIPLE CLASS, (INT. CLS. 9, 16 AND 42), (U.S. CLS. 2, 5, 21, 22, 23, 26, 29, 36, 37, 38, 50, 100 AND 101). SN 76-553,319. PUB. 8-10-2004. FILED 10-22-2003.
- 2,899,125. **RENAISSANCE.** MILSO INDUSTRIES, INC., MULTIPLE CLASS, (INT. CLS. 9, 16, 35, 36, 37, 41, 42 AND 45), (U.S. CLS. 2, 5, 21, 22, 23, 26, 29, 36, 37, 38, 50, 100, 101, 102, 103, 106 AND 107). SN 76-553,759. PUB. 8-10-2004. FILED 10-23-2003.
- 2,899,130. **FESTIVAL OF ANIMATION.** MELLOW MANOR PRODUCTIONS, INC., MULTIPLE CLASS, (INT. CLS. 9 AND 41), (U.S. CLS. 21, 23, 26, 36, 38, 100, 101 AND 107). SN 76-554,265. PUB. 8-10-2004. FILED 10-27-2003.
- 2,899,134. **MEETINGPLAZA.** NTT-IT CORPORATION, MULTIPLE CLASS, (INT. CLS. 9 AND 38), (U.S. CLS. 21, 23, 26, 36, 38, 100, 101 AND 104). SN 76-554,677. PUB. 8-10-2004. FILED 10-9-2003.
- 2,899,137. **TEMPASURE.** USA SCIENTIFIC, INC., (U.S. CLS. 21, 23, 26, 36 AND 38). SN 76-554,847. PUB. 8-10-2004. FILED 10-14-2003.
- 2,899,163. **CARS (STYLIZED).** COMPUWARE CORPORATION, (U.S. CLS. 21, 23, 26, 36 AND 38). SN 76-556,466. PUB. 8-10-2004. FILED 11-4-2003.
- 2,899,173. **POINTWISE AND DESIGN.** POINTWISE, INC., MULTIPLE CLASS, (INT. CLS. 9 AND 42), (U.S. CLS. 21, 23, 26, 36, 38, 100 AND 101). SN 76-556,924. PUB. 8-10-2004. FILED 11-5-2003.
- 2,899,175. **SELECT SPEC AND DESIGN.** HUBBELL INCORPORATED, (U.S. CLS. 21, 23, 26, 36 AND 38). SN 76-556,963. PUB. 8-10-2004. FILED 11-5-2003.
- 2,899,183. **SSIFT (STYLIZED).** PROSANOS CORPORATION, (U.S. CLS. 21, 23, 26, 36 AND 38). SN 76-557,325. PUB. 8-10-2004. FILED 11-6-2003.
- 2,899,185. **IGEN THE COGNITIVE AGENT SOFTWARE TOOLKIT AND DESIGN.** CHI SYSTEMS, INC., (U.S. CLS. 21, 23, 26, 36 AND 38). SN 76-557,334. PUB. 8-10-2004. FILED 11-6-2003.
- 2,899,197. **THE ALLMAN BROTHERS BAND.** THE ABB MERCHANDISING CO., INC., (U.S. CLS. 21, 23, 26, 36 AND 38). SN 76-557,900. PUB. 8-10-2004. FILED 10-21-2003.
- 2,899,200. **LEXIA COMPREHENSIVE READING TEST.** LEXIA LEARNING SYSTEMS, INC., (U.S. CLS. 21, 23, 26, 36 AND 38). SN 76-557,968. PUB. 8-10-2004. FILED 10-20-2003.
- 2,899,201. **LEXIA INICIO A LA LECTURA.** LEXIA LEARNING SYSTEMS, INC., (U.S. CLS. 21, 23, 26, 36 AND 38). SN 76-557,969. PUB. 8-10-2004. FILED 10-20-2003.
- 2,899,202. **LEXIA CROSS-TRAINER.** LEXIA LEARNING SYSTEMS, INC., (U.S. CLS. 21, 23, 26, 36 AND 38). SN 76-557,970. PUB. 8-10-2004. FILED 10-20-2003.
- 2,899,210. **AMERICA'S BRAVEST (BLOCK FORM).** THE GLOVE CORPORATION, (U.S. CLS. 21, 23, 26, 36 AND 38). SN 76-558,479. PUB. 8-10-2004. FILED 11-10-2003.
- 2,899,226. **CHEETAH (BLOCK FORM).** TOUCHSCREEN KONNECTION OASIS, INC., (U.S. CLS. 21, 23, 26, 36 AND 38). SN 76-559,223. PUB. 8-10-2004. FILED 11-12-2003.
- 2,899,234. **ATOMIC CLOCK.** RIVERDEEP INTERACTIVE LEARNING LIMITED, (U.S. CLS. 21, 23, 26, 36 AND 38). SN 76-559,648. PUB. 8-10-2004. FILED 10-31-2003.
- 2,899,254. **EXALTED WORD (BLOCK FORM).** SPEAK THE WORD CHURCH INTERNATIONAL, (U.S. CLS. 21, 23, 26, 36 AND 38). SN 76-562,523. PUB. 8-10-2004. FILED 11-10-2003.
- 2,899,256. **JONATHON BRANDMEIER (BLOCK FORM).** BRANDMEIER, JONATHON, (U.S. CLS. 21, 23, 26, 36 AND 38). SN 76-563,526. PUB. 8-10-2004. FILED 11-20-2003.
- 2,899,257. **ULTRAFORCE (BLOCK FORM).** FLIR SYSTEMS, INC., (U.S. CLS. 21, 23, 26, 36 AND 38). SN 76-563,592. PUB. 8-10-2004. FILED 11-24-2003.
- 2,899,266. **IF YOU WERE MINE (STYLIZED).** CAMPUS CRUSADE FOR CHRIST, INC., MULTIPLE CLASS, (INT. CLS. 9, 16, 41 AND 45), (U.S. CLS. 2, 5, 21, 22, 23, 26, 29, 36, 37, 38, 50, 100, 101 AND 107). SN 76-581,987. PUB. 8-10-2004. FILED 3-17-2004.
- 2,899,267. **HOPE FOR ORPHANS (STYLIZED).** CAMPUS CRUSADE FOR CHRIST, INC., MULTIPLE CLASS, (INT. CLS. 9, 16, 41 AND 45), (U.S. CLS. 2, 5, 21, 22, 23, 26, 29, 36, 37, 38, 50, 100, 101 AND 107). SN 76-581,988. PUB. 8-10-2004. FILED 3-17-2004.
- 2,899,278. **FORREST CONSULTING.** FORREST CONSULTING, INC., (U.S. CLS. 21, 23, 26, 36 AND 38). SN 78-030,850. PUB. 12-23-2003. FILED 10-16-2000.
- 2,899,284. **CREAM RECORDS.** THE ADALAH BENNETT SHAW TRUST, MULTIPLE CLASS, (INT. CLS. 9 AND 25), (U.S. CLS. 21, 22, 23, 26, 36, 38 AND 39). SN 78-062,358. PUB. 8-10-2004. FILED 5-7-2001.
- 2,899,285. **NETOUTLOOK.** OMNITRON SYSTEMS TECHNOLOGY, INC., (U.S. CLS. 21, 23, 26, 36 AND 38). SN 78-065,626. PUB. 8-10-2004. FILED 5-24-2001.
- 2,899,288. **ORGANIC VISION.** ZN VISION TECHNOLOGIES AG, MULTIPLE CLASS, (INT. CLS. 9, 10, 35, 37, 38 AND 42), (U.S. CLS. 21, 23, 26, 36, 38, 39, 44, 100, 101, 102, 103, 104 AND 106). SN 78-088,161. PUB. 10-28-2003. FILED 10-12-2001.
- 2,899,292 ( *See Class 6 for this trademark*).
- 2,899,296. **MISCELLANEOUS DESIGN.** TREND COMMUNICATIONS LIMITED, (U.S. CLS. 21, 23, 26, 36 AND 38). SN 78-105,756. PUB. 8-10-2004. FILED 1-30-2002.
- 2,899,297. **UTILITY DATA RESOURCES A METERSMART COMPANY AND DESIGN.** UTILITY DATA RESOURCES, INC., MULTIPLE CLASS, (INT. CLS. 9, 35, 38 AND 42), (U.S. CLS. 21, 23, 26, 36, 38, 100, 101, 102 AND 104). SN 78-107,974. PUB. 8-10-2004. FILED 2-11-2002.
- 2,899,301. **XBOOK.** WESTERN SKYLAND CORPORATION, (U.S. CLS. 21, 23, 26, 36 AND 38). SN 78-118,520. PUB. 11-5-2002. FILED 3-30-2002.
- 2,899,304. **CORTX CENTRAL INTELLIGENCE AND DESIGN.** INFOSCAPE PTY LTD, (U.S. CLS. 21, 23, 26, 36 AND 38). SN 78-121,903. PUB. 2-10-2004. FILED 4-16-2002.
- 2,899,315 ( *See Class 7 for this trademark*).
- 2,899,316 ( *See Class 7 for this trademark*).
- 2,899,322. **M MULTIMEDIACARD (STYLIZED).** MULTIMEDIACARD ASSOCIATION, (U.S. CLS. 21, 23, 26, 36 AND 38). SN 78-139,947. PUB. 8-10-2004. FILED 6-28-2002.
- 2,899,325. **GIANT STEP.** GIANT STEP RECORDS, INC., (U.S. CLS. 21, 23, 26, 36 AND 38). SN 78-144,212. PUB. 8-10-2004. FILED 7-16-2002.
- 2,899,329. **ALPHA INNOTECH AND DESIGN.** BFI BUSINESS FINANCE, (U.S. CLS. 21, 23, 26, 36 AND 38). SN 78-149,446. PUB. 8-10-2004. FILED 7-31-2002.
- 2,899,330. **NEXCORPORATE.** NEXTANCE, INC., (U.S. CLS. 21, 23, 26, 36 AND 38). SN 78-152,721. PUB. 5-13-2003. FILED 8-9-2002.
- 2,899,331. **NEXGOVERNMENT.** NEXTANCE, INC., (U.S. CLS. 21, 23, 26, 36 AND 38). SN 78-152,751. PUB. 5-6-2003. FILED 8-9-2002.
- 2,899,332. **NEXIP.** NEXTANCE, INC., (U.S. CLS. 21, 23, 26, 36 AND 38). SN 78-152,787. PUB. 5-13-2003. FILED 8-9-2002.
- 2,899,333. **NEXPROCUREMENT.** NEXTANCE, INC., (U.S. CLS. 21, 23, 26, 36 AND 38). SN 78-152,809. PUB. 5-13-2003. FILED 8-9-2002.
- 2,899,334. **NEXSALES.** NEXTANCE, INC., (U.S. CLS. 21, 23, 26, 36 AND 38). SN 78-152,817. PUB. 5-6-2003. FILED 8-9-2002.

- 2,899,335. **NEXSUPPORT**. NEXTANCE, INC., (U.S. CLS. 21, 23, 26, 36 AND 38). SN 78-152,829. PUB. 5-6-2003. FILED 8-9-2002.
- 2,899,343. **BUSINESS WIRE**. BUSINESS WIRE, MULTIPLE CLASS, (INT. CLS. 9, 38 AND 41), (U.S. CLS. 21, 23, 26, 36, 38, 100, 101, 104 AND 107). SN 78-158,895. PUB. 8-10-2004. FILED 8-28-2002.
- 2,899,347. **PROTIS**. DADE BEHRING MARBURG GMBH, (U.S. CLS. 21, 23, 26, 36 AND 38). SN 78-162,784. PUB. 3-23-2004. FILED 9-11-2002.
- 2,899,348. **SECOND SON AND DESIGN**. SOESBEE, TED, (U.S. CLS. 21, 23, 26, 36 AND 38). SN 78-162,799. PUB. 8-10-2004. FILED 9-11-2002.
- 2,899,352. **EXSTREAMER**. BARIX AG, MULTIPLE CLASS, (INT. CLS. 9 AND 42), (U.S. CLS. 21, 23, 26, 36, 38, 100 AND 101). SN 78-168,089. PUB. 8-10-2004. FILED 9-26-2002.
- 2,899,355. **HANDHELD CONTACT BY WIRES-END**. WIRES-END LLC, MULTIPLE CLASS, (INT. CLS. 9, 35 AND 42), (U.S. CLS. 21, 23, 26, 36, 38, 100, 101 AND 102). SN 78-168,580. PUB. 8-10-2004. FILED 9-27-2002.
- 2,899,359. **HOMECHOICE AND DESIGN**. BELDEN TECHNOLOGIES, INC., (U.S. CLS. 21, 23, 26, 36 AND 38). SN 78-170,205. PUB. 8-10-2004. FILED 10-2-2002.
- 2,899,364. **MLINE**. BIOHIT OYJ, (U.S. CLS. 21, 23, 26, 36 AND 38). SN 78-172,341. PUB. 8-10-2004. FILED 10-8-2002.
- 2,899,371. **STABLCOR**. THERMALWORKS, INC., (U.S. CLS. 21, 23, 26, 36 AND 38). SN 78-177,189. PUB. 8-10-2004. FILED 10-22-2002.
- 2,899,374. **TELELINGUA INTERNATIONAL AND DESIGN**. TELELINGUA, S.A., MULTIPLE CLASS, (INT. CLS. 9, 35, 41 AND 42), (U.S. CLS. 21, 23, 26, 36, 38, 100, 101, 102 AND 107). SN 78-179,129. PUB. 8-10-2004. FILED 10-28-2002.
- 2,899,377. **ACOUSTIC ZEN TECHNOLOGIES**. ACOUSTIC ZEN TECHNOLOGIES, (U.S. CLS. 21, 23, 26, 36 AND 38). SN 78-180,071. PUB. 9-30-2003. FILED 10-30-2002.
- 2,899,388. **PERMETRICS**. BLUE CUBE STRATEGIC, MULTIPLE CLASS, (INT. CLS. 9 AND 42), (U.S. CLS. 21, 23, 26, 36, 38, 100 AND 101). SN 78-187,916. PUB. 8-10-2004. FILED 11-22-2002.
- 2,899,393. **PCA POWERSUITE**. NEXANT, INC., MULTIPLE CLASS, (INT. CLS. 9, 35 AND 42), (U.S. CLS. 21, 23, 26, 36, 38, 100, 101 AND 102). SN 78-189,726. PUB. 8-10-2004. FILED 11-27-2002.
- 2,899,395. **GOLDPFEIL**. ELCON SYSTEMTECHNIK GMBH, MULTIPLE CLASS, (INT. CLS. 9, 37 AND 38), (U.S. CLS. 21, 23, 26, 36, 38, 100, 101, 103, 104 AND 106). SN 78-192,765. PUB. 8-10-2004. FILED 12-10-2002.
- 2,899,402. **LUCRATIVE RECORDS**. CERDA, RODOLFO, JR, (U.S. CLS. 21, 23, 26, 36 AND 38). SN 78-196,168. PUB. 8-10-2004. FILED 12-19-2002.
- 2,899,403 ( *See Class 6 for this trademark*).
- 2,899,404 ( *See Class 6 for this trademark*).
- 2,899,408. **IR INTREPID RECORDS AND DESIGN**. SR PRODUCTIONS INC., (U.S. CLS. 21, 23, 26, 36 AND 38). SN 78-198,799. PUB. 8-10-2004. FILED 12-31-2002.
- 2,899,409. **NXTERA**. E-CUBE SYSTEMS, LLC, (U.S. CLS. 21, 23, 26, 36 AND 38). SN 78-200,053. PUB. 10-21-2003. FILED 1-4-2003.
- 2,899,416 ( *See Class 7 for this trademark*).
- 2,899,420. **GRANDIA**. GAME ARTS CO., LTD., (U.S. CLS. 21, 23, 26, 36 AND 38). SN 78-202,404. PUB. 8-10-2004. FILED 1-12-2003.
- 2,899,435. **INFOSTRUXURE**. INGREDIENT TECHNOLOGIES CORPORATION, INC., (U.S. CLS. 21, 23, 26, 36 AND 38). SN 78-215,514. PUB. 10-14-2003. FILED 2-16-2003.
- 2,899,452. **MVI**. KBA-GIORI S.A., MULTIPLE CLASS, (INT. CLS. 9 AND 16), (U.S. CLS. 2, 5, 21, 22, 23, 26, 29, 36, 37, 38 AND 50). SN 78-224,099. PUB. 8-10-2004. FILED 3-11-2003.
- 2,899,454. **AGT AND DESIGN**. APPLIED GLOBAL TECHNOLOGIES, INC., MULTIPLE CLASS, (INT. CLS. 9, 38 AND 42), (U.S. CLS. 21, 23, 26, 36, 38, 100, 101 AND 104). SN 78-224,239. PUB. 8-10-2004. FILED 3-11-2003.
- 2,899,460. **MYVP (STYLIZED)**. INFINEON TECHNOLOGIES AG, MULTIPLE CLASS, (INT. CLS. 9, 38 AND 42), (U.S. CLS. 21, 23, 26, 36, 38, 100, 101 AND 104). SN 78-227,112. PUB. 8-10-2004. FILED 3-18-2003.
- 2,899,475. **MISCELLANEOUS DESIGN**. DREAM HOME SOURCE, INC., MULTIPLE CLASS, (INT. CLS. 9, 16 AND 35), (U.S. CLS. 2, 5, 21, 22, 23, 26, 29, 36, 37, 38, 50, 100, 101 AND 102). SN 78-233,982. PUB. 8-10-2004. FILED 4-4-2003.
- 2,899,483. **ICE INET CREDIT EXCHANGE (BLOCK FORM)**. BESSENBACHER CO. THE, (U.S. CLS. 21, 23, 26, 36 AND 38). SN 78-235,629. PUB. 8-10-2004. FILED 4-9-2003.
- 2,899,485. **QVISION AND DESIGN**. Q1 LABS INC., (U.S. CLS. 21, 23, 26, 36 AND 38). SN 78-235,968. PUB. 8-10-2004. FILED 4-9-2003.
- 2,899,507. **LIGHTWAVE**. COSTA DEL MAR SUNGLASSES, INC., (U.S. CLS. 21, 23, 26, 36 AND 38). SN 78-239,559. PUB. 12-23-2003. FILED 4-18-2003.
- 2,899,519. **CEG WORLDWIDE**. CEG WORLDWIDE LLC, MULTIPLE CLASS, (INT. CLS. 9, 16 AND 41), (U.S. CLS. 2, 5, 21, 22, 23, 26, 29, 36, 37, 38, 50, 100, 101 AND 107). SN 78-241,287. PUB. 8-10-2004. FILED 4-23-2003.
- 2,899,525. **SMARTEMP SIGNALS READY TEMPERATURE AND AUTO OFF AND DESIGN**. HP INTELLECTUAL CORP., (U.S. CLS. 21, 23, 26, 36 AND 38). SN 78-241,990. PUB. 8-10-2004. FILED 4-25-2003.
- 2,899,526. **LIVE-CALL**. VIDEO GAMING TECHNOLOGIES, INC., (U.S. CLS. 21, 23, 26, 36 AND 38). SN 78-242,438. PUB. 8-10-2004. FILED 4-26-2003.
- 2,899,541. **NAVICAT**. PREMIUMSOFT CYBERTECH, LTD., (U.S. CLS. 21, 23, 26, 36 AND 38). SN 78-245,997. PUB. 4-20-2004. FILED 5-6-2003.
- 2,899,556. **STATERA**. CORTEX BIOPHYSIK GMBH, MULTIPLE CLASS, (INT. CLS. 9, 10 AND 44), (U.S. CLS. 21, 23, 26, 36, 38, 39, 44, 100 AND 101). SN 78-248,307. PUB. 8-10-2004. FILED 5-12-2003.
- 2,899,564. **CHIEFTEC**. STM, INC., (U.S. CLS. 21, 23, 26, 36 AND 38). SN 78-249,553. PUB. 8-10-2004. FILED 5-14-2003.
- 2,899,570. **TOUCHSITE**. SURGICAL NAVIGATION TECHNOLOGIES, INC., (U.S. CLS. 21, 23, 26, 36 AND 38). SN 78-250,032. PUB. 8-10-2004. FILED 5-15-2003.
- 2,899,578. **XTREME STREET COMMUNICATOR**. COBRA ELECTRONICS CORPORATION, (U.S. CLS. 21, 23, 26, 36 AND 38). SN 78-250,780. PUB. 8-10-2004. FILED 5-16-2003.
- 2,899,584. **MISCELLANEOUS DESIGN**. BLUE AGAVE SOFTWARE, INC., (U.S. CLS. 21, 23, 26, 36 AND 38). SN 78-251,663. PUB. 8-10-2004. FILED 5-19-2003.
- 2,899,585. **BLUE AGAVE**. BLUE AGAVE SOFTWARE, INC., (U.S. CLS. 21, 23, 26, 36 AND 38). SN 78-251,667. PUB. 8-10-2004. FILED 5-19-2003.
- 2,899,604. **INTERVIEWSMART**. CAREER SERVICES GROUP, INC., MULTIPLE CLASS, (INT. CLS. 9 AND 16), (U.S. CLS. 2, 5, 21, 22, 23, 26, 29, 36, 37, 38 AND 50). SN 78-254,253. PUB. 8-10-2004. FILED 5-26-2003.
- 2,899,614. **PST ATTENDER**. SHERPA SOFTWARE GROUP, INC., (U.S. CLS. 21, 23, 26, 36 AND 38). SN 78-255,234. PUB. 8-10-2004. FILED 5-28-2003.
- 2,899,620. **VISITVIEW**. BOARD OF REGENTS OF THE UNIVERSITY OF WISCONSIN, (U.S. CLS. 21, 23, 26, 36 AND 38). SN 78-257,527. PUB. 8-10-2004. FILED 6-3-2003.
- 2,899,644 ( *See Class 6 for this trademark*).
- 2,899,655. **MAPTRIX**. MALE, ALISTAIR W, MULTIPLE CLASS, (INT. CLS. 9, 16 AND 42), (U.S. CLS. 2, 5, 21, 22, 23, 26, 29, 36, 37, 38, 50, 100 AND 101). SN 78-262,645. PUB. 8-10-2004. FILED 6-16-2003.
- 2,899,663. **FUSION TEXT**. DOLBEY AND COMPANY, (U.S. CLS. 21, 23, 26, 36 AND 38). SN 78-263,899. PUB. 8-10-2004. FILED 6-18-2003.
- 2,899,664. **FUSION SPEECH**. DOLBEY AND COMPANY, (U.S. CLS. 21, 23, 26, 36 AND 38). SN 78-263,911. PUB. 8-10-2004. FILED 6-18-2003.
- 2,899,667. **REP TIME (STYLIZED)**. DATASENSE, INC., (U.S. CLS. 21, 23, 26, 36 AND 38). SN 78-265,215. PUB. 5-25-2004. FILED 6-20-2003.
- 2,899,669. **KNITTING PRETTY**. SACKMAN, STEVEN, M., AND MORAY, JILL, (U.S. CLS. 21, 23, 26, 36 AND 38). SN 78-265,863. PUB. 8-10-2004. FILED 6-23-2003.
- 2,899,677. **ONSTAGE**. VISIBLE LIGHT, (U.S. CLS. 21, 23, 26, 36 AND 38). SN 78-268,623. PUB. 8-10-2004. FILED 6-30-2003.
- 2,899,683. **RAE SYSTEMS AND DESIGN**. RAE SYSTEMS INC., (U.S. CLS. 21, 23, 26, 36 AND 38). SN 78-269,463. PUB. 8-10-2004. FILED 7-1-2003.
- 2,899,685. **GIFTRAP HEALTH CARE SOLUTIONS AND DESIGN**. GIFTRAP CORPORATION, (U.S. CLS. 21, 23, 26, 36 AND 38). SN 78-270,369. PUB. 8-10-2004. FILED 7-3-2003.



- 2,899,690. **LARA CROFT TOMB RAIDER: THE OSIRIS CODEX**. CORE DESIGN LIMITED, (U.S. CLS. 21, 23, 26, 36 AND 38). SN 78-272,084. PUB. 8-10-2004. FILED 7-9-2003.
- 2,899,693. **D.M. DINWIDDIE, PHYSICIAN-IN-TRAINING**. HEALTH MEDIA LAB, INC., (U.S. CLS. 21, 23, 26, 36 AND 38). SN 78-273,102. PUB. 8-10-2004. FILED 7-11-2003.
- 2,899,695. **ALLMOTION AND DESIGN**. GOODIN, DAVID, (U.S. CLS. 21, 23, 26, 36 AND 38). SN 78-273,299. PUB. 8-10-2004. FILED 7-11-2003.
- 2,899,699. **BOYOHO**. U.S.A. C-MARK LIGHT & AUDIO INC., (U.S. CLS. 21, 23, 26, 36 AND 38). SN 78-273,892. PUB. 8-10-2004. FILED 7-14-2003.
- 2,899,704. **DIASOLAR**. MITSUBISHI ELECTRIC CORPORATION, (U.S. CLS. 21, 23, 26, 36 AND 38). SN 78-275,582. PUB. 8-10-2004. FILED 7-17-2003.
- 2,899,707. **SERVICEDIRECTOR INDEPENDENT AUTOMOTIVE REPAIR SHOP SOFTWARE AND DESIGN**. DU BOISE, SABRE, SIMONE, (U.S. CLS. 21, 23, 26, 36 AND 38). SN 78-277,393. PUB. 8-10-2004. FILED 7-22-2003.
- 2,899,715. **OPRISKCENTER**. CENTERPRISE SERVICES, INC., (U.S. CLS. 21, 23, 26, 36 AND 38). SN 78-280,473. PUB. 8-10-2004. FILED 7-29-2003.
- 2,899,726. **PNY TECHNOLOGIES VERTO AND DESIGN**. PNY TECHNOLOGIES, INC., (U.S. CLS. 21, 23, 26, 36 AND 38). SN 78-284,847. PUB. 8-10-2004. FILED 8-8-2003.
- 2,899,752. **D.M. DINWIDDIE**. HEALTH MEDIA LAB, INC., (U.S. CLS. 21, 23, 26, 36 AND 38). SN 78-294,483. PUB. 8-10-2004. FILED 8-31-2003.
- 2,899,761. **BEA WEBLOGIC SERVER**. BEA SYSTEMS, INC., (U.S. CLS. 21, 23, 26, 36 AND 38). SN 78-296,419. PUB. 8-10-2004. FILED 9-5-2003.
- 2,899,773. **DURAV**. THOMAS & BETTS INTERNATIONAL, INC., (U.S. CLS. 21, 23, 26, 36 AND 38). SN 78-298,549. PUB. 8-10-2004. FILED 9-10-2003.
- 2,899,785. **DIABETES PILOT: INFORMATION MANAGEMENT FOR PEOPLE WITH DIABETES**. DIGITAL ALTI-TUDES, LLC, (U.S. CLS. 21, 23, 26, 36 AND 38). SN 78-302,399. PUB. 8-10-2004. FILED 9-18-2003.
- 2,899,810. **LEPRO**. PROLEGION INC., (U.S. CLS. 21, 23, 26, 36 AND 38). SN 78-308,344. PUB. 8-10-2004. FILED 10-2-2003.
- 2,899,831. **KIDMATCH**. TALON MEDICAL LTD., (U.S. CLS. 21, 23, 26, 36 AND 38). SN 78-312,850. PUB. 8-10-2004. FILED 10-13-2003.
- 2,899,835. **TSI AND DESIGN**. TELEMATIC SYSTEMS, INC., MULTIPLE CLASS, (INT. CLS. 9 AND 42), (U.S. CLS. 21, 23, 26, 36, 38, 100 AND 101). SN 78-313,687. PUB. 8-10-2004. FILED 10-15-2003.
- 2,899,845 ( *See Class 1 for this trademark*).
- 2,899,848. **HOMERUNNER**. TELECOMMUNICATION DEVICES INDUSTRIES, DBA TDI LLC, (U.S. CLS. 21, 23, 26, 36 AND 38). SN 78-315,046. PUB. 8-10-2004. FILED 10-17-2003.
- 2,899,850. **4LOCALTV**. VANDERHORST, CHRISTOPHER R., (U.S. CLS. 21, 23, 26, 36 AND 38). SN 78-315,145. PUB. 8-10-2004. FILED 10-17-2003.
- 2,899,853. **AUTOGRAPH EVERYDAY**. SHAMIR INSIGHT, INC., (U.S. CLS. 21, 23, 26, 36 AND 38). SN 78-315,369. PUB. 8-10-2004. FILED 10-17-2003.
- 2,899,855. **AMPLIFYING YOUR LIFE**. PLANTRONICS, INC., (U.S. CLS. 21, 23, 26, 36 AND 38). SN 78-315,438. PUB. 8-10-2004. FILED 10-17-2003.
- 2,899,878. **IT'S ALL CONNECTED**. DANCIK INTERNATIONAL, LTD., MULTIPLE CLASS, (INT. CLS. 9, 38 AND 42), (U.S. CLS. 21, 23, 26, 36, 38, 100, 101 AND 104). SN 78-318,384. PUB. 8-10-2004. FILED 10-24-2003.
- 2,899,880. **EDGENUITI**. EDGENUITI WORLDWIDE, LTD., (U.S. CLS. 21, 23, 26, 36 AND 38). SN 78-318,508. PUB. 8-10-2004. FILED 10-24-2003.
- 2,899,883. **SIMRAN**. A & J DISTRIBUTORS INC., (U.S. CLS. 21, 23, 26, 36 AND 38). SN 78-318,931. PUB. 8-10-2004. FILED 10-27-2003.
- 2,899,907. **STEP-N-CHECK**. RAPID ACCU-FORM, INC., (U.S. CLS. 21, 23, 26, 36 AND 38). SN 78-321,186. PUB. 8-10-2004. FILED 10-30-2003.
- 2,899,910 ( *See Class 6 for this trademark*).
- 2,899,959. **ACCUTOWER (BLOCK FORM)**. US DIGITAL MEDIA, INC., (U.S. CLS. 21, 23, 26, 36 AND 38). SN 78-325,559. PUB. 8-10-2004. FILED 11-10-2003.
- 2,899,960. **R RAININGDATA AND DESIGN**. RAINING DATA CORPORATION, (U.S. CLS. 21, 23, 26, 36 AND 38). SN 78-325,599. PUB. 8-10-2004. FILED 11-10-2003.
- 2,899,969. **AXESSION AND DESIGN**. SAMSUNG AMERICA, INC., (U.S. CLS. 21, 23, 26, 36 AND 38). SN 78-326,216. PUB. 8-10-2004. FILED 11-11-2003.
- 2,899,971. **ENA (BLOCK FORM)**. AGILENT TECHNOLOGIES, INC., (U.S. CLS. 21, 23, 26, 36 AND 38). SN 78-326,342. PUB. 8-10-2004. FILED 11-11-2003.
- 2,899,978. **X80 (BLOCK FORM)**. CROSSBEAM SYSTEMS, INC., (U.S. CLS. 21, 23, 26, 36 AND 38). SN 78-326,872. PUB. 8-10-2004. FILED 11-12-2003.
- 2,899,993. **MEDCOR AND DESIGN**. MEDCOR, INC., MULTIPLE CLASS, (INT. CLS. 9, 35 AND 44), (U.S. CLS. 21, 23, 26, 36, 38, 100, 101 AND 102). SN 78-329,620. PUB. 8-10-2004. FILED 11-18-2003.
- 2,900,011. **NOMADIX (BLOCK FORM)**. NOMADIX, INC., (U.S. CLS. 21, 23, 26, 36 AND 38). SN 78-332,867. PUB. 8-10-2004. FILED 11-25-2003.
- 2,900,012. **MISCELLANEOUS DESIGN**. MIJA INDUSTRIES, INC., (U.S. CLS. 21, 23, 26, 36 AND 38). SN 78-332,890. PUB. 8-10-2004. FILED 11-25-2003.
- 2,900,014. **VON DUTCH (BLOCK FORM)**. VON DUTCH ORIGINALS, LLC., MULTIPLE CLASS, (INT. CLS. 9 AND 16), (U.S. CLS. 2, 5, 21, 22, 23, 26, 29, 36, 37, 38 AND 50). SN 78-341,172. PUB. 8-10-2004. FILED 12-15-2003.
- 2,900,016. **KNOWLEDGEMASTER (BLOCK FORM)**. DBLS HOLDINGS, LTD., (U.S. CLS. 21, 23, 26, 36 AND 38). SN 78-364,765. PUB. 8-10-2004. FILED 2-9-2004.
- 2,900,017. **VCA (BLOCK FORM)**. VCA LABS, INC., (U.S. CLS. 21, 23, 26, 36 AND 38). SN 78-372,995. PUB. 8-10-2004. FILED 2-24-2004.
- 2,900,020. **SNK (STYLIZED)**. SNK PLAYMORE CORPORATION, MULTIPLE CLASS, (INT. CLS. 9 AND 28), (U.S. CLS. 21, 22, 23, 26, 36, 38 AND 50). SN 78-975,318. PUB. 8-10-2004. FILED 8-2-2002.
- 2,900,021. **NEO GEO ADVANCED ENTERTAINMENT SYSTEM (STYLIZED)**. SNK PLAYMORE CORPORATION, MULTIPLE CLASS, (INT. CLS. 9 AND 28), (U.S. CLS. 21, 22, 23, 26, 36, 38 AND 50). SN 78-975,319. PUB. 8-10-2004. FILED 8-2-2002.

---

## CLASS 10—MEDICAL APPARATUS

- 2,898,437. **HORIZON**. BIOPRO, INC., (U.S. CLS. 26, 39 AND 44). SN 75-606,092. PUB. 8-10-2004. FILED 12-15-1998.
- 2,898,510. **ACCUPUMP**. SAINT-GOBAIN CALMAR INC., (U.S. CLS. 26, 39 AND 44). SN 76-209,656. PUB. 8-10-2004. FILED 2-12-2001.
- 2,898,521. **THE CHI MACHINE**. HSIN TEN ENTERPRISE USA, INC., (U.S. CLS. 26, 39 AND 44). SN 76-230,612. PUB. 3-12-2002. FILED 3-26-2001.
- 2,898,549. **SERIES 5 PARAGON (STYLIZED)**. Q-TECH LABORATORIES PTY LTD, (U.S. CLS. 26, 39 AND 44). SN 76-320,233. PUB. 8-10-2004. FILED 9-24-2001.
- 2,898,606. **TRUZONE**. MONAGHAN MEDICAL CORPORATION, (U.S. CLS. 26, 39 AND 44). SN 76-420,626. PUB. 8-10-2004. FILED 6-13-2002.
- 2,898,613 ( *See Class 1 for this trademark*).
- 2,898,623. **DERMOCELL**. DERMOCCELL COLOMBIA LTDA., (U.S. CLS. 26, 39 AND 44). SN 76-437,216. PUB. 8-10-2004. FILED 8-1-2002.
- 2,898,765. **LUMINEXX**. C.R. BARD, INC., (U.S. CLS. 26, 39 AND 44). SN 76-504,912. PUB. 2-3-2004. FILED 4-4-2003.
- 2,898,782. **RID-A-TICK**. JACOBSON, MELVIN L., (U.S. CLS. 26, 39 AND 44). SN 76-508,102. PUB. 8-10-2004. FILED 4-21-2003.
- 2,898,888. **MASSAGEPRO AND DESIGN**. MASSAGERS DIRECT, INC., (U.S. CLS. 26, 39 AND 44). SN 76-518,940. PUB. 8-10-2004. FILED 6-2-2003.
- 2,898,891. **KEYLOCK**. CAVEX HOLLAND B.V., (U.S. CLS. 26, 39 AND 44). SN 76-519,064. PUB. 8-10-2004. FILED 5-13-2003.
- 2,898,957. **LETS YOU BE YOU**. TP ORTHODONTICS, INC., MULTIPLE CLASS, (INT. CLS. 10 AND 35), (U.S. CLS. 26, 39, 44, 100, 101 AND 102). SN 76-530,150. PUB. 8-10-2004. FILED 6-30-2003.

- 2,899,007. **SAF-T CLIK**. SMITHS MEDICAL ASD, INC., (U.S. CLS. 26, 39 AND 44). SN 76-538,421. PUB. 8-10-2004. FILED 8-19-2003.
- 2,899,081. **PEARL PANTHER**. CALIFORNIA EXOTIC NOVELTIES LLC, (U.S. CLS. 26, 39 AND 44). SN 76-549,678. PUB. 8-10-2004. FILED 9-22-2003.
- 2,899,082. **OPTIMUM POWER**. CALIFORNIA EXOTIC NOVELTIES LLC, (U.S. CLS. 26, 39 AND 44). SN 76-549,680. PUB. 8-10-2004. FILED 9-22-2003.
- 2,899,110. **SHARPS DEPOT**. SHARPS MANUFACTURING, INC., (U.S. CLS. 26, 39 AND 44). SN 76-552,397. PUB. 8-10-2004. FILED 9-29-2003.
- 2,899,288 ( *See Class 9 for this trademark*).
- 2,899,342. **ACELL**. ACELL, INC., (U.S. CLS. 26, 39 AND 44). SN 78-155,813. PUB. 8-10-2004. FILED 8-20-2002.
- 2,899,361. **USI FLUSHSWITCH**. ULTRASONIC SERVICES, INC., (U.S. CLS. 26, 39 AND 44). SN 78-170,823. PUB. 8-10-2004. FILED 10-3-2002.
- 2,899,473. **THERASPORT**. SWEDE-O, INC., (U.S. CLS. 26, 39 AND 44). SN 78-233,591. PUB. 12-2-2003. FILED 4-3-2003.
- 2,899,556 ( *See Class 9 for this trademark*).
- 2,899,595. **BIO-A-SAFE (STYLIZED)**. GOLDEN PHOENIX FIBERWEBS, INC., (U.S. CLS. 26, 39 AND 44). SN 78-253,206. PUB. 8-10-2004. FILED 5-22-2003.
- 2,899,627 ( *See Class 5 for this trademark*).
- 2,899,650. **HIGHLIGHT (STYLIZED)**. HUNTLEIGH TECHNOLOGY PLC, (U.S. CLS. 26, 39 AND 44). SN 78-261,996. PUB. 5-11-2004. FILED 6-13-2003.
- 2,899,741. **BRACE PAK**. WALTER MORROW JR., (U.S. CLS. 26, 39 AND 44). SN 78-291,240. PUB. 8-10-2004. FILED 8-22-2003.
- 2,899,762. **WOMBAT**. R82 A/S, MULTIPLE CLASS, (INT. CLS. 10 AND 12), (U.S. CLS. 19, 21, 23, 26, 31, 35, 39 AND 44). SN 78-297,359. PUB. 8-10-2004. FILED 9-8-2003.
- 2,899,763. **CROCODILE**. R82 A/S, MULTIPLE CLASS, (INT. CLS. 10 AND 12), (U.S. CLS. 19, 21, 23, 26, 31, 35, 39 AND 44). SN 78-297,375. PUB. 8-10-2004. FILED 9-8-2003.
- 2,899,800. **AUTO-VENT**. REPROCESSING PRODUCTS CORP (RPC), (U.S. CLS. 26, 39 AND 44). SN 78-306,515. PUB. 8-10-2004. FILED 9-29-2003.
- 2,899,806. **E-Z-DRAW**. REPROCESSING PRODUCTS CORP (RPC), (U.S. CLS. 26, 39 AND 44). SN 78-307,906. PUB. 8-10-2004. FILED 10-1-2003.
- 2,899,873. **HEARTCRICKET**. DEL MAR REYNOLDS MEDICAL, (U.S. CLS. 26, 39 AND 44). SN 78-317,885. PUB. 8-10-2004. FILED 10-23-2003.
- 2,899,887. **INVISIBLE FACE LIFT COMBS**. HALF MOON STUDIO, INC., (U.S. CLS. 26, 39 AND 44). SN 78-319,191. PUB. 8-10-2004. FILED 10-27-2003.
- 2,899,892. **THE POSTUREWORKS**. THE POSTUREWORKS LLC, (U.S. CLS. 26, 39 AND 44). SN 78-320,043. PUB. 8-10-2004. FILED 10-29-2003.
- 2,899,893. **ELLYS**. SCIENT'X, (U.S. CLS. 26, 39 AND 44). SN 78-320,151. PUB. 8-10-2004. FILED 10-29-2003.
- 2,899,913. **MIRAGE ACTIVA (STYLIZED)**. RESMED LIMITED, (U.S. CLS. 26, 39 AND 44). SN 78-322,221. PUB. 8-10-2004. FILED 11-3-2003.
- 2,899,914. **MIRAGE ACTIVA (BLOCK FORM)**. RESMED LIMITED, (U.S. CLS. 26, 39 AND 44). SN 78-322,253. PUB. 8-10-2004. FILED 11-3-2003.
- 2,898,500 ( *See Class 9 for this trademark*).
- 2,898,501 ( *See Class 3 for this trademark*).
- 2,898,504. **ZIP**. ZIP HEATERS (AUSTRALIA) PTY LIMITED, (U.S. CLS. 13, 21, 23, 31 AND 34). SN 76-168,203. PUB. 4-20-2004. FILED 11-21-2000.
- 2,898,545. **ROBATHERM**. ROBATHERM GMBH, (U.S. CLS. 13, 21, 23, 31 AND 34). SN 76-306,300. PUB. 8-10-2004. FILED 8-28-2001.
- 2,898,573 ( *See Class 6 for this trademark*).
- 2,898,647. **GRANDMAC**. GRANDMAC OUTDOOR INC., MULTIPLE CLASS, (INT. CLS. 11 AND 35), (U.S. CLS. 13, 21, 23, 31, 34, 100, 101 AND 102). SN 76-455,509. PUB. 12-30-2003. FILED 9-25-2002.
- 2,898,686 ( *See Class 3 for this trademark*).
- 2,898,694 ( *See Class 9 for this trademark*).
- 2,898,699 ( *See Class 7 for this trademark*).
- 2,898,810. **CAN QUALITY IN A CUP!**. MCCANN'S ENGINEERING & MFG. CO., (U.S. CLS. 13, 21, 23, 31 AND 34). SN 76-511,640. PUB. 8-10-2004. FILED 5-5-2003.
- 2,898,831. **SUN SHINE AND DESIGN**. CALIFORNIA SUNSHINE, INC., (U.S. CLS. 13, 21, 23, 31 AND 34). SN 76-513,114. PUB. 8-10-2004. FILED 5-9-2003.
- 2,898,840. **BRINGING THE OUTDOORS INDOORS**. MARSHALL OUTDOOR PRODUCTS, LLC, (U.S. CLS. 13, 21, 23, 31 AND 34). SN 76-514,116. PUB. 8-10-2004. FILED 5-14-2003.
- 2,898,906. **ULTRADEK**. MUNTERS CORPORATION, (U.S. CLS. 13, 21, 23, 31 AND 34). SN 76-519,746. PUB. 8-10-2004. FILED 6-3-2003.
- 2,898,928. **OLYMPIAN**. HON TECHNOLOGY INC., (U.S. CLS. 13, 21, 23, 31 AND 34). SN 76-522,826. PUB. 2-24-2004. FILED 6-16-2003.
- 2,898,980. **PETRUCCELLI**. TURBO POWER, INC., (U.S. CLS. 13, 21, 23, 31 AND 34). SN 76-534,067. PUB. 8-10-2004. FILED 8-1-2003.
- 2,898,996. **SMELLKILLER**. FRIELING USA, INC., (U.S. CLS. 13, 21, 23, 31 AND 34). SN 76-536,200. PUB. 8-10-2004. FILED 8-11-2003.
- 2,899,044. **SCC**. RATIONAL AG, (U.S. CLS. 13, 21, 23, 31 AND 34). SN 76-545,146. PUB. 8-10-2004. FILED 9-16-2003.
- 2,899,048 ( *See Class 7 for this trademark*).
- 2,899,062. **JUNYAN (STYLIZED)**. JUN YAN AUTO INDUSTRIAL CO., LTD., (U.S. CLS. 13, 21, 23, 31 AND 34). SN 76-547,857. PUB. 8-10-2004. FILED 9-29-2003.
- 2,899,074 ( *See Class 9 for this trademark*).
- 2,899,132. **PEDI-TAN**. GOLDEN FEET LTD., (U.S. CLS. 13, 21, 23, 31 AND 34). SN 76-554,499. PUB. 8-10-2004. FILED 10-8-2003.
- 2,899,159. **THE AMERICAN SALAMANDER HEATER (BLOCK FORM)**. VOGELZANG INTERNATIONAL CORPORATION, (U.S. CLS. 13, 21, 23, 31 AND 34). SN 76-556,351. PUB. 8-10-2004. FILED 11-4-2003.
- 2,899,187. **AIRLETTE AND DESIGN**. AIRLETTE MANUFACTURING CORPORATION, (U.S. CLS. 13, 21, 23, 31 AND 34). SN 76-557,446. PUB. 8-10-2004. FILED 11-6-2003.
- 2,899,224. **BRV AND DESIGN**. ADVANCED MODERN TECHNOLOGIES CORPORATION, (U.S. CLS. 13, 21, 23, 31 AND 34). SN 76-559,110. PUB. 8-10-2004. FILED 11-10-2003.
- 2,899,292 ( *See Class 6 for this trademark*).
- 2,899,353. **KWC TETRA**. KWC AG, MULTIPLE CLASS, (INT. CLS. 11 AND 21), (U.S. CLS. 2, 13, 21, 23, 29, 30, 31, 33, 34, 40 AND 50). SN 78-168,354. PUB. 8-10-2004. FILED 9-26-2002.
- 2,899,382. **KWC LEONARDO**. KWC AG, MULTIPLE CLASS, (INT. CLS. 11 AND 21), (U.S. CLS. 2, 13, 21, 23, 29, 30, 31, 33, 34, 40 AND 50). SN 78-182,002. PUB. 8-10-2004. FILED 11-5-2002.
- 2,899,587 ( *See Class 7 for this trademark*).
- 2,899,625. **TAS TURBINE AIR SYSTEMS AND DESIGN**. PIERSON, TOM LINWOOD, (U.S. CLS. 13, 21, 23, 31 AND 34). SN 78-258,455. PUB. 8-10-2004. FILED 6-4-2003.
- 2,899,639. **SYSTEM SAVER**. MORTON INTERNATIONAL, INC., (U.S. CLS. 13, 21, 23, 31 AND 34). SN 78-260,535. PUB. 8-10-2004. FILED 6-10-2003.
- 2,899,642. **WWW.TUBGUY.COM**. PARKER, JOHN W., (U.S. CLS. 13, 21, 23, 31 AND 34). SN 78-260,679. PUB. 8-10-2004. FILED 6-10-2003.
- 2,899,672. **THE UTTERMOST CO. AND DESIGN**. THE UTTERMOST COMPANY, (U.S. CLS. 13, 21, 23, 31 AND 34). SN 78-266,535. PUB. 8-10-2004. FILED 6-24-2003.

## CLASS 11—ENVIRONMENTAL CONTROL APPARATUS

- 2,898,433 ( *See Class 1 for this trademark*).
- 2,898,443. **ESPRESSO ITALIANO AND DESIGN**. ISITUTO NAZIONALE ESPRESSO, MULTIPLE CLASS, (INT. CLS. 11 AND 30), (U.S. CLS. 13, 21, 23, 31, 34 AND 46). SN 75-744,598. PUB. 6-3-2003. FILED 7-7-1999.
- 2,898,450. **ONEIDA ROYAL AND DESIGN**. ECR INTERNATIONAL, INC., (U.S. CLS. 13, 21, 23, 31 AND 34). SN 75-825,720. PUB. 5-30-2000. FILED 10-18-1999.
- 2,898,457. **ADVANTA BY MAAX**. MAAX INC., (U.S. CLS. 13, 21, 23, 31 AND 34). SN 75-891,088. PUB. 12-31-2002. FILED 1-7-2000.
- 2,898,487 ( *See Class 6 for this trademark*).

- 2,899,681. **DE DION**. HERBEAU, LIONEL, (U.S. CLS. 13, 21, 23, 31 AND 34). SN 78-269,377. PUB. 8-10-2004. FILED 7-1-2003.
- 2,899,696 ( *See Class 7 for this trademark*).
- 2,899,703. **KWC 1922**. KWC AG, MULTIPLE CLASS, (INT. CLS. 11 AND 21), (U.S. CLS. 2, 13, 21, 23, 29, 30, 31, 33, 34, 40 AND 50). SN 78-275,062. PUB. 8-10-2004. FILED 7-16-2003.
- 2,899,742. **LOOP & FRIENDS**. VILLEROY & BOCK A.G., (U.S. CLS. 13, 21, 23, 31 AND 34). SN 78-291,843. PUB. 8-10-2004. FILED 8-25-2003.
- 2,899,754. **AIR-ZONE**. MARTIN, ROBERT, (U.S. CLS. 13, 21, 23, 31 AND 34). SN 78-294,675. PUB. 8-10-2004. FILED 9-2-2003.
- 2,899,786. **MISCELLANEOUS DESIGN**. RECLAIM FILTERS AND SYSTEMS, INC., (U.S. CLS. 13, 21, 23, 31 AND 34). SN 78-302,444. PUB. 8-10-2004. FILED 9-18-2003.
- 2,899,816. **TAHOE**. KOHLER CO., (U.S. CLS. 13, 21, 23, 31 AND 34). SN 78-310,285. PUB. 8-10-2004. FILED 10-7-2003.
- 2,899,849. **QUADRA-HULL**. CULLIGAN INTERNATIONAL COMPANY, (U.S. CLS. 13, 21, 23, 31 AND 34). SN 78-315,095. PUB. 8-10-2004. FILED 10-17-2003.
- 2,899,872. **BLU OX CO2 GENERATOR AND DESIGN**. REINHOLD MANUFACTURING LTD., (U.S. CLS. 13, 21, 23, 31 AND 34). SN 78-317,716. PUB. 8-10-2004. FILED 10-23-2003.
- 2,899,881. **VIRTUAL HP**. SMI HOME PRODUCTS, INC., (U.S. CLS. 13, 21, 23, 31 AND 34). SN 78-318,705. PUB. 8-10-2004. FILED 10-27-2003.
- 2,899,905. **PREVENT AND DESIGN**. PERMATRON CORPORATION, (U.S. CLS. 13, 21, 23, 31 AND 34). SN 78-320,926. PUB. 8-10-2004. FILED 10-30-2003.
- 2,899,910 ( *See Class 6 for this trademark*).
- 2,899,966. **JOE BOXER (BLOCK FORM)**. JOE BOXER COMPANY, LLC, (U.S. CLS. 13, 21, 23, 31 AND 34). SN 78-326,002. PUB. 8-10-2004. FILED 11-11-2003.
- 2,899,977 ( *See Class 3 for this trademark*).
- 2,900,005. **TIMEX (BLOCK FORM)**. TIMEX CORPORATION, (U.S. CLS. 13, 21, 23, 31 AND 34). SN 78-332,303. PUB. 8-10-2004. FILED 11-24-2003.
- 2,900,023. **POWER PLUS**. 99¢ ONLY STORES, (U.S. CLS. 13, 21, 23, 31 AND 34). SN 78-975,437. PUB. 8-10-2004. FILED 2-10-2003.
- TRADING, INC., (U.S. CLS. 19, 21, 23, 31, 35 AND 44). SN 76-500,242. PUB. 11-11-2003. FILED 3-25-2003.
- 2,898,780. **APOLLO**. AUTOMATIC EQUIPMENT MANUFACTURING COMPANY, (U.S. CLS. 19, 21, 23, 31, 35 AND 44). SN 76-507,982. PUB. 8-10-2004. FILED 4-21-2003.
- 2,898,781. **SPORT GUARD**. AUTOMATIC EQUIPMENT MANUFACTURING COMPANY, (U.S. CLS. 19, 21, 23, 31, 35 AND 44). SN 76-508,014. PUB. 8-10-2004. FILED 4-21-2003.
- 2,898,788 ( *See Class 7 for this trademark*).
- 2,898,796. **RANCHER**. HONDA GIKEN KOGYO KABUSHIKI KAISHA (HONDA MOTOR CO., LTD.), (U.S. CLS. 19, 21, 23, 31, 35 AND 44). SN 76-509,558. PUB. 12-23-2003. FILED 4-25-2003.
- 2,898,798. **B\*TWIN AND DESIGN**. DECATHLON, MULTIPLE CLASS, (INT. CLS. 12, 21 AND 25), (U.S. CLS. 2, 13, 19, 21, 22, 23, 29, 30, 31, 33, 35, 39, 40, 44 AND 50). SN 76-509,730. PUB. 8-10-2004. FILED 4-28-2003.
- 2,898,834. **SP SPORT 270**. SRI USA, INC., (U.S. CLS. 19, 21, 23, 31, 35 AND 44). SN 76-513,510. PUB. 1-27-2004. FILED 5-12-2003.
- 2,898,873. **MMIC AND DESIGN**. MOBILE MEDICAL INTERNATIONAL CORPORATION, (U.S. CLS. 19, 21, 23, 31, 35 AND 44). SN 76-517,715. PUB. 12-16-2003. FILED 5-28-2003.
- 2,898,880. **BENETTI**. AZIMUT-BENETTI S.P.A., (U.S. CLS. 19, 21, 23, 31, 35 AND 44). SN 76-518,537. PUB. 8-10-2004. FILED 5-12-2003.
- 2,898,919. **RC SOLUTIONS**. SCARLA, ROBERT, (U.S. CLS. 19, 21, 23, 31, 35 AND 44). SN 76-521,773. PUB. 8-10-2004. FILED 6-10-2003.
- 2,898,959 ( *See Class 7 for this trademark*).
- 2,898,974. **122**. BAYERISCHE MOTOREN WERKE AKTIENGESELLSCHAFT, (U.S. CLS. 19, 21, 23, 31, 35 AND 44). SN 76-533,611. PUB. 4-27-2004. FILED 7-30-2003.
- 2,898,975. **222**. BAYERISCHE MOTOREN WERKE AKTIENGESELLSCHAFT, (U.S. CLS. 19, 21, 23, 31, 35 AND 44). SN 76-533,612. PUB. 4-27-2004. FILED 7-30-2003.
- 2,898,984. **SHALLOW SPORT AND DESIGN**. SHALLOW SPORT OF TEXAS, INC., (U.S. CLS. 19, 21, 23, 31, 35 AND 44). SN 76-534,839. PUB. 8-10-2004. FILED 8-5-2003.
- 2,898,995. **QUICKPORT**. WINNEBAGO INDUSTRIES, INC., (U.S. CLS. 19, 21, 23, 31, 35 AND 44). SN 76-536,155. PUB. 4-20-2004. FILED 7-28-2003.
- 2,899,006. **VORTEX**. THOR TECH, INC., (U.S. CLS. 19, 21, 23, 31, 35 AND 44). SN 76-538,167. PUB. 5-11-2004. FILED 8-18-2003.
- 2,899,027. **130**. BAYERISCHE MOTOREN WERKE AKTIENGESELLSCHAFT, (U.S. CLS. 19, 21, 23, 31, 35 AND 44). SN 76-542,385. PUB. 6-1-2004. FILED 9-3-2003.
- 2,899,028. **125**. BAYERISCHE MOTOREN WERKE AKTIENGESELLSCHAFT, (U.S. CLS. 19, 21, 23, 31, 35 AND 44). SN 76-542,386. PUB. 6-1-2004. FILED 9-3-2003.
- 2,899,209. **WE'VE GOT YOUR BACK (STYLIZED)**. P & R ACCESSORIES, LLC, (U.S. CLS. 19, 21, 23, 31, 35 AND 44). SN 76-558,474. PUB. 8-10-2004. FILED 11-10-2003.
- 2,899,292 ( *See Class 6 for this trademark*).
- 2,899,315 ( *See Class 7 for this trademark*).
- 2,899,316 ( *See Class 7 for this trademark*).
- 2,899,319 ( *See Class 6 for this trademark*).
- 2,899,351. **DOMINA**. P4 GROUP LLC, (U.S. CLS. 19, 21, 23, 31, 35 AND 44). SN 78-167,229. PUB. 10-14-2003. FILED 9-24-2002.
- 2,899,412. **STILL SITTING ON TOWELS? (BLOCK FORM)**. ROGUE RIVER SPORTS, INC., (U.S. CLS. 19, 21, 23, 31, 35 AND 44). SN 78-200,510. PUB. 8-10-2004. FILED 1-6-2003.
- 2,899,416 ( *See Class 7 for this trademark*).
- 2,899,458 ( *See Class 7 for this trademark*).
- 2,899,459. **RAZR 2**. CHENG SHIN RUBBER USA, INC., (U.S. CLS. 19, 21, 23, 31, 35 AND 44). SN 78-226,414. PUB. 11-18-2003. FILED 3-17-2003.
- 2,899,469. **HALVORSEN AND DESIGN**. HALVORSEN BOATS PTY LTD, (U.S. CLS. 19, 21, 23, 31, 35 AND 44). SN 78-231,718. PUB. 8-10-2004. FILED 3-30-2003.
- 2,899,725. **NS**. TIRECO, INC., (U.S. CLS. 19, 21, 23, 31, 35 AND 44). SN 78-284,760. PUB. 5-11-2004. FILED 8-8-2003.
- 2,899,762 ( *See Class 10 for this trademark*).
- 2,899,763 ( *See Class 10 for this trademark*).
- 2,899,771. **CYFAC**. CYFAC, MULTIPLE CLASS, (INT. CLS. 12 AND 25), (U.S. CLS. 19, 21, 22, 23, 31, 35, 39 AND 44). SN 78-

## CLASS 12—VEHICLES

2,898,433 ( *See Class 1 for this trademark*).

2,898,441. **MOBILE TRADITION**. CONOVER, MAX K., (U.S. CLS. 19, 21, 23, 31, 35 AND 44). SN 75-699,744. PUB. 7-10-2001. FILED 5-6-1999.

2,898,474. **PRIVATEER**. TREK BICYCLE CORPORATION, (U.S. CLS. 19, 21, 23, 31, 35 AND 44). SN 76-026,307. PUB. 8-10-2004. FILED 4-14-2000.

2,898,478 ( *See Class 7 for this trademark*).

2,898,573 ( *See Class 6 for this trademark*).

2,898,614. **MISCELLANEOUS DESIGN**. NISH, TERRY, DBA NISH MOTORSPORTS, MULTIPLE CLASS, (INT. CLS. 12 AND 35), (U.S. CLS. 19, 21, 23, 31, 35, 44, 100, 101 AND 102). SN 76-430,242. PUB. 2-4-2003. FILED 7-1-2002.

2,898,652 ( *See Class 7 for this trademark*).

2,898,686 ( *See Class 3 for this trademark*).

2,898,691. **FUSION**. CURRIE TECHNOLOGIES, INC., (U.S. CLS. 19, 21, 23, 31, 35 AND 44). SN 76-477,779. PUB. 8-26-2003. FILED 12-24-2002.

2,898,722. **MICART**. MIND WURX, L.L.C., (U.S. CLS. 19, 21, 23, 31, 35 AND 44). SN 76-491,835. PUB. 8-10-2004. FILED 2-21-2003.

2,898,724. **MIXTO**. DAIMLERCHRYSLER AG, (U.S. CLS. 19, 21, 23, 31, 35 AND 44). SN 76-492,148. PUB. 8-10-2004. FILED 2-24-2003.

2,898,739. **YRCADION**. COMPAGNIE GENERALE DES ETABLISSEMENTS MICHELIN - MICHELIN & CIE, (U.S. CLS. 19, 21, 23, 31, 35 AND 44). SN 76-498,347. PUB. 8-10-2004. FILED 3-18-2003.

2,898,747. **TANKMAN**. BOREEM INT'L TRADING, INC., (U.S. CLS. 19, 21, 23, 31, 35 AND 44). SN 76-500,241. PUB. 11-11-2003. FILED 3-25-2003.

2,898,748. **MISCELLANEOUS DESIGN**. BOREEM INT'L

298,202. PUB. 8-10-2004. FILED 9-9-2003.  
 2,899,803. **H AND DESIGN**. C. RAYMOND HUNT ASSOCIATES, INC., (U.S. CLS. 19, 21, 23, 31, 35 AND 44). SN 78-307,477. PUB. 8-10-2004. FILED 9-30-2003.

---

### CLASS 13—FIREARMS

2,898,433 ( *See Class 1 for this trademark*).  
 2,898,573 ( *See Class 6 for this trademark*).

---

### CLASS 14—JEWELRY

2,898,415. **GUARDIAN ANGEL**. TREASURES AND TRINKETS INC., (U.S. CLS. 2, 27, 28 AND 50). SN 74-434,985. PUB. 11-13-2001. FILED 9-13-1993.  
 2,898,446. **PS2 (STYLIZED)**. KABUSHIKI KAISHA SONY COMPUTER ENTERTAINMENT, TA SONY COMPUTER ENTERTAINMENT INC., MULTIPLE CLASS, (INT. CLS. 14, 16, 18, 25, 28, 38 AND 41), (U.S. CLS. 1, 2, 3, 5, 22, 23, 27, 28, 29, 37, 38, 39, 41, 50, 100, 101, 104 AND 107). SN 75-798,172. PUB. 8-10-2004. FILED 9-13-1999.  
 2,898,497. **USS NEW JERSEY**. HOME PORT ALLIANCE FOR THE USS NEW JERSEY, INC., MULTIPLE CLASS, (INT. CLS. 14, 21 AND 25), (U.S. CLS. 2, 13, 22, 23, 27, 28, 29, 30, 33, 39, 40 AND 50). SN 76-134,252. PUB. 8-10-2004. FILED 9-25-2000.  
 2,898,501 ( *See Class 3 for this trademark*).  
 2,898,516. **BLACK HILLS GOLD AND DESIGN**. COLEMAN COMPANY, (U.S. CLS. 2, 27, 28 AND 50). SN 76-217,114. PUB. 3-26-2002. FILED 2-27-2001.  
 2,898,571 ( *See Class 9 for this trademark*).  
 2,898,603. **BALENCIAGA**. BALENCIAGA, (U.S. CLS. 2, 27, 28 AND 50). SN 76-418,521. PUB. 8-10-2004. FILED 6-10-2002.  
 2,898,611. **STARTER DE LALIQUE (STYLIZED)**. LALIQUE, (U.S. CLS. 2, 27, 28 AND 50). SN 76-427,910. PUB. 8-26-2003. FILED 6-28-2002.  
 2,898,651. **KC (STYLIZED)**. FICKEN, KERRY CATHERINE, (U.S. CLS. 2, 27, 28 AND 50). SN 76-458,739. PUB. 12-30-2003. FILED 10-17-2002.  
 2,898,704. **HEART 2 HEART AND DESIGN**. M. FABRIKANT & SONS, INC., (U.S. CLS. 2, 27, 28 AND 50). SN 76-486,447. PUB. 10-21-2003. FILED 1-31-2003.  
 2,898,716. **HAMPTON BAY**. OMNI QUARTZ, LTD., (U.S. CLS. 2, 27, 28 AND 50). SN 76-488,666. PUB. 9-23-2003. FILED 2-7-2003.  
 2,898,773. **TOMJ**. 1509313 ONTARIO LIMITED, DBA TOM JEWELLERY, MULTIPLE CLASS, (INT. CLS. 14 AND 35), (U.S. CLS. 2, 27, 28, 50, 100, 101 AND 102). SN 76-506,988. PUB. 8-10-2004. FILED 4-11-2003.  
 2,898,779. **JJ AND DESIGN**. JOLEE MICKESH, (U.S. CLS. 2, 27, 28 AND 50). SN 76-507,942. PUB. 8-10-2004. FILED 4-21-2003.  
 2,898,833. **WATERFORD IRELAND (STYLIZED)**. WATERFORD WEDGWOOD PLC, (U.S. CLS. 2, 27, 28 AND 50). SN 76-513,375. PUB. 8-10-2004. FILED 5-9-2003.  
 2,899,021. **MISCELLANEOUS DESIGN**. BEDAT & CO. LLC, (U.S. CLS. 2, 27, 28 AND 50). SN 76-541,339. PUB. 8-10-2004. FILED 8-28-2003.  
 2,899,033. **TROMBONE**. CARTIER INTERNATIONAL B.V., (U.S. CLS. 2, 27, 28 AND 50). SN 76-543,044. PUB. 8-10-2004. FILED 8-25-2003.  
 2,899,034. **ALCOVE**. CARTIER INTERNATIONAL B.V., (U.S. CLS. 2, 27, 28 AND 50). SN 76-543,045. PUB. 8-10-2004. FILED 8-25-2003.  
 2,899,101. **HELZBERG DIAMOND SYMPHONIES**. COLUMBIA INSURANCE COMPANY, (U.S. CLS. 2, 27, 28 AND 50). SN 76-551,820. PUB. 8-10-2004. FILED 10-16-2003.  
 2,899,107. **MENOTTE**. CARTIER INTERNATIONAL B.V., (U.S. CLS. 2, 27, 28 AND 50). SN 76-552,355. PUB. 8-10-2004. FILED 9-26-2003.  
 2,899,271. **BB-62**. HOME PORT ALLIANCE FOR THE USS NEW JERSEY, INC., MULTIPLE CLASS, (INT. CLS. 14, 18, 21 AND 25), (U.S. CLS. 1, 2, 3, 13, 22, 23, 27, 28, 29, 30, 33, 39,

40, 41 AND 50). SN 76-975,636. PUB. 8-10-2004. FILED 9-25-2000.  
 2,899,385. **SONNY BOY AND DESIGN**. DELTA BROADCASTING, INC., (U.S. CLS. 2, 27, 28 AND 50). SN 78-184,905. PUB. 8-10-2004. FILED 11-14-2002.  
 2,899,386. **STYLEMANIA**. DESIGNS BY SKAFFLES, INC., MULTIPLE CLASS, (INT. CLS. 14, 25 AND 26), (U.S. CLS. 2, 22, 27, 28, 37, 39, 40, 42 AND 50). SN 78-185,129. PUB. 8-12-2003. FILED 11-14-2002.  
 2,899,399. **ALI KHAN**. ALI KHAN DESIGNS, INC., (U.S. CLS. 2, 27, 28 AND 50). SN 78-193,989. PUB. 8-10-2004. FILED 12-12-2002.  
 2,899,724. **CHIC DOGGIE BY COREY AND DESIGN**. GELMAN, COREY, MULTIPLE CLASS, (INT. CLS. 14, 18 AND 26), (U.S. CLS. 1, 2, 3, 22, 27, 28, 37, 39, 40, 41, 42 AND 50). SN 78-284,672. PUB. 8-10-2004. FILED 8-7-2003.  
 2,899,815. **MELIBEE**. RICHEMONT INTERNATIONAL SA, (U.S. CLS. 2, 27, 28 AND 50). SN 78-310,215. PUB. 8-10-2004. FILED 10-7-2003.  
 2,899,836. **LIFE XPRESSIONS**. JOSTENS, INC., (U.S. CLS. 2, 27, 28 AND 50). SN 78-313,797. PUB. 8-10-2004. FILED 10-15-2003.  
 2,899,955. **PHOEBE'S PHASHIONS HAUTE COUTURE FOR THE STYLISH CANINE (BLOCK FORM)**. PHOEBE'S PHASHIONS, L.L.C., (U.S. CLS. 2, 27, 28 AND 50). SN 78-325,358. PUB. 8-10-2004. FILED 11-10-2003.  
 2,900,008. **BEAUTY & BRAINS (BLOCK FORM)**. MOVADO LLC, (U.S. CLS. 2, 27, 28 AND 50). SN 78-332,438. PUB. 8-10-2004. FILED 11-24-2003.

---

### CLASS 15—MUSICAL INSTRUMENTS

2,898,529. **AEOLIAN**. GIBSON GUITAR CORP., (U.S. CLS. 2, 21 AND 36). SN 76-250,753. PUB. 8-10-2004. FILED 5-2-2001.  
 2,898,559. **GERHARD SCHNEIDER**. VOGTLANDISCHE MUSIKINSTRUMENTENFABRIK GMBH, (U.S. CLS. 2, 21 AND 36). SN 76-351,756. PUB. 8-10-2004. FILED 12-20-2001.  
 2,898,720. **BUMBLE BEE**. GIBSON GUITAR CORP., (U.S. CLS. 2, 21 AND 36). SN 76-491,210. PUB. 8-10-2004. FILED 2-19-2003.  
 2,898,917. **PIANO BAR**. MOOG MUSIC, INC., (U.S. CLS. 2, 21 AND 36). SN 76-521,022. PUB. 8-10-2004. FILED 6-9-2003.  
 2,899,974. **VICTOR (BLOCK FORM)**. VICTOR, (U.S. CLS. 2, 21 AND 36). SN 78-326,416. PUB. 8-10-2004. FILED 11-11-2003.

---

### CLASS 16—PAPER GOODS AND PRINTED MATTER

2,898,414. **SELF-REALIZATION FELLOWSHIP FOUNDED 1920 PARAMAHANSA YOGANANDA AND DESIGN**. SELF-REALIZATION FELLOWSHIP CHURCH, (U.S. CLS. 2, 5, 22, 23, 29, 37, 38 AND 50). SN 74-380,806. PUB. 8-10-2004. FILED 4-16-1993.  
 2,898,422 ( *See Class 9 for this trademark*).  
 2,898,433 ( *See Class 1 for this trademark*).  
 2,898,446 ( *See Class 14 for this trademark*).  
 2,898,454 ( *See Class 9 for this trademark*).  
 2,898,480 ( *See Class 9 for this trademark*).  
 2,898,498 ( *See Class 9 for this trademark*).  
 2,898,552 ( *See Class 9 for this trademark*).  
 2,898,565 ( *See Class 9 for this trademark*).  
 2,898,567. **SOUTHERN LIVING DECORATING STEP-BY-STEP**. SOUTHERN LIVING, INC., (U.S. CLS. 2, 5, 22, 23, 29, 37, 38 AND 50). SN 76-366,823. PUB. 8-10-2004. FILED 2-5-2002.  
 2,898,571 ( *See Class 9 for this trademark*).  
 2,898,574. **THE NEW LIGHTSPEED READING PROGRAM**. HOYT, ROBERT ANTHONY, (U.S. CLS. 2, 5, 22, 23, 29, 37, 38 AND 50). SN 76-382,076. PUB. 8-10-2004. FILED 3-12-2002.  
 2,898,575 ( *See Class 9 for this trademark*).  
 2,898,579 ( *See Class 9 for this trademark*).  
 2,898,587 ( *See Class 9 for this trademark*).  
 2,898,645. **NOTE CARDS BY ME! AND DESIGN**. WRITE

- EXPRESSIONS, LLC, (U.S. CLS. 2, 5, 22, 23, 29, 37, 38 AND 50). SN 76-454,576. PUB. 8-10-2004. FILED 9-26-2002.
- 2,898,663. **P&L PUBLISHING**. P&L PUBLISHING GROUP, MULTIPLE CLASS, (INT. CLS. 16, 40 AND 41), (U.S. CLS. 2, 5, 22, 23, 29, 37, 38, 50, 100, 101, 103, 106 AND 107). SN 76-463,140. PUB. 8-10-2004. FILED 10-15-2002.
- 2,898,667. **LJP**. ALM PROPERTIES, INC., MULTIPLE CLASS, (INT. CLS. 16 AND 41), (U.S. CLS. 2, 5, 22, 23, 29, 37, 38, 50, 100, 101 AND 107). SN 76-465,507. PUB. 8-10-2004. FILED 11-1-2002.
- 2,898,679 ( *See Class 9 for this trademark*).
- 2,898,681 ( *See Class 9 for this trademark*).
- 2,898,682 ( *See Class 9 for this trademark*).
- 2,898,685 ( *See Class 9 for this trademark*).
- 2,898,686 ( *See Class 3 for this trademark*).
- 2,898,700. **GRIDIRON HERITAGE**. DONRUSS PLAYOFF, L.P., (U.S. CLS. 2, 5, 22, 23, 29, 37, 38 AND 50). SN 76-483,035. PUB. 11-18-2003. FILED 1-14-2003.
- 2,898,735 ( *See Class 9 for this trademark*).
- 2,898,746. **PLAN & POST AND DESIGN**. THE CHARLES ROBERTSON COMPANIES, INC., (U.S. CLS. 2, 5, 22, 23, 29, 37, 38 AND 50). SN 76-499,892. PUB. 8-10-2004. FILED 3-24-2003.
- 2,898,753. **GROWTH**. RESOURCE MANAGEMENT SERVICE, INC., (U.S. CLS. 2, 5, 22, 23, 29, 37, 38 AND 50). SN 76-502,117. PUB. 12-9-2003. FILED 3-25-2003.
- 2,898,767. **BS BICISPORT AND DESIGN**. COMPAGNIA EDITORIALE SRL, (U.S. CLS. 2, 5, 22, 23, 29, 37, 38 AND 50). SN 76-505,302. PUB. 8-10-2004. FILED 4-9-2003.
- 2,898,772. **FATALI (STYLIZED)**. GALLERY, FATALI, DBA MICHAEL FATALI, (U.S. CLS. 2, 5, 22, 23, 29, 37, 38 AND 50). SN 76-506,473. PUB. 8-10-2004. FILED 4-14-2003.
- 2,898,790. **THE REGAL SWAN AND DESIGN**. REGAL SWAN, THE, (U.S. CLS. 2, 5, 22, 23, 29, 37, 38 AND 50). SN 76-509,078. PUB. 8-10-2004. FILED 4-23-2003.
- 2,898,802. **THE BIG GREEN BOX**. TOXCO, INC., MULTIPLE CLASS, (INT. CLS. 16 AND 40), (U.S. CLS. 2, 5, 22, 23, 29, 37, 38, 50, 100, 103 AND 106). SN 76-510,244. PUB. 8-10-2004. FILED 4-28-2003.
- 2,898,803. **HEART ART AND DESIGN**. HARGROVE, DAPHNE, (U.S. CLS. 2, 5, 22, 23, 29, 37, 38 AND 50). SN 76-510,289. PUB. 8-10-2004. FILED 4-29-2003.
- 2,898,826. **ACTION FOR HEALTHY KIDS**. HEALTHY SCHOOLS, INCORPORATED, MULTIPLE CLASS, (INT. CLS. 16, 35 AND 41), (U.S. CLS. 2, 5, 22, 23, 29, 37, 38, 50, 100, 101, 102 AND 107). SN 76-512,498. PUB. 8-10-2004. FILED 5-1-2003.
- 2,898,849. **FINBAR**. DICKSON, DENNIS G., (U.S. CLS. 2, 5, 22, 23, 29, 37, 38 AND 50). SN 76-514,520. PUB. 8-10-2004. FILED 5-14-2003.
- 2,898,890. **SPRINT**. SPRINT COMMUNICATIONS COMPANY L.P., (U.S. CLS. 2, 5, 22, 23, 29, 37, 38 AND 50). SN 76-519,039. PUB. 8-10-2004. FILED 5-14-2003.
- 2,898,930. **PERFORMA CREAM**. STORA ENSO OYJ, (U.S. CLS. 2, 5, 22, 23, 29, 37, 38 AND 50). SN 76-522,903. PUB. 8-10-2004. FILED 6-17-2003.
- 2,898,963 ( *See Class 9 for this trademark*).
- 2,899,010. **SPECTRUM PLASTICS**. SPECTRUM PLASTICS, INC., MULTIPLE CLASS, (INT. CLS. 16 AND 17), (U.S. CLS. 1, 2, 5, 12, 13, 22, 23, 29, 35, 37, 38 AND 50). SN 76-539,606. PUB. 8-10-2004. FILED 8-21-2003.
- 2,899,011. **THE MILITANT**. THE ANCHOR FOUNDATION, INC., (U.S. CLS. 2, 5, 22, 23, 29, 37, 38 AND 50). SN 76-539,784. PUB. 8-10-2004. FILED 8-25-2003.
- 2,899,047. **PARTY PAK**. SWEETHEART CUP COMPANY INC., MULTIPLE CLASS, (INT. CLS. 16 AND 21), (U.S. CLS. 2, 5, 13, 22, 23, 29, 30, 33, 37, 38, 40 AND 50). SN 76-545,416. PUB. 8-10-2004. FILED 9-17-2003.
- 2,899,059 ( *See Class 9 for this trademark*).
- 2,899,083. **SKILLSUSA CHAMPIONS**. SKILLSUSA-VICA, (U.S. CLS. 2, 5, 22, 23, 29, 37, 38 AND 50). SN 76-550,084. PUB. 8-10-2004. FILED 10-8-2003.
- 2,899,088. **ASFL AND DESIGN**. PAULSON, THEODORE A., (U.S. CLS. 2, 5, 22, 23, 29, 37, 38 AND 50). SN 76-550,423. PUB. 8-10-2004. FILED 10-10-2003.
- 2,899,090 ( *See Class 9 for this trademark*).
- 2,899,098. **MATCH**. MAJESTIC PROPERTIES, INC., MULTIPLE CLASS, (INT. CLS. 16 AND 35), (U.S. CLS. 2, 5, 22, 23, 29, 37, 38, 50, 100, 101 AND 102). SN 76-551,407. PUB. 8-10-2004. FILED 9-25-2003.
- 2,899,108. **HONEY HAIR & BEAUTY**. VANGUARDE MEDIA, INC., (U.S. CLS. 2, 5, 22, 23, 29, 37, 38 AND 50). SN 76-552,381. PUB. 8-10-2004. FILED 9-29-2003.
- 2,899,109. **SAVOY PROFESSIONAL**. VANGUARDE MEDIA, INC., (U.S. CLS. 2, 5, 22, 23, 29, 37, 38 AND 50). SN 76-552,385. PUB. 8-10-2004. FILED 9-29-2003.
- 2,899,119. **VICTORY LANE**. CLARKE AMERICAN CHECKS INC., (U.S. CLS. 2, 5, 22, 23, 29, 37, 38 AND 50). SN 76-553,240. PUB. 8-10-2004. FILED 10-21-2003.
- 2,899,120 ( *See Class 9 for this trademark*).
- 2,899,125 ( *See Class 9 for this trademark*).
- 2,899,149. **CHICKS ON CHECKS**. HILDEBRAND, TAMMY S., AND HILDEBRAND, RICHARD R., (U.S. CLS. 2, 5, 22, 23, 29, 37, 38 AND 50). SN 76-555,637. PUB. 8-10-2004. FILED 10-30-2003.
- 2,899,154. **AVA (BLOCK FORM)**. ASSOCIATION FOR VASCULAR ACCESS, MULTIPLE CLASS, (INT. CLS. 16 AND 35), (U.S. CLS. 2, 5, 22, 23, 29, 37, 38, 50, 100, 101 AND 102). SN 76-556,069. PUB. 8-10-2004. FILED 11-3-2003.
- 2,899,155. **JAVA (BLOCK FORM)**. ASSOCIATION FOR VASCULAR ACCESS, (U.S. CLS. 2, 5, 22, 23, 29, 37, 38 AND 50). SN 76-556,072. PUB. 8-10-2004. FILED 11-3-2003.
- 2,899,194. **ALPHAACCENTS**. STAMPIN' UP! INC., (U.S. CLS. 2, 5, 22, 23, 29, 37, 38 AND 50). SN 76-557,638. PUB. 8-10-2004. FILED 10-27-2003.
- 2,899,211. **DIGESTIVE HEALTH & NUTRITION LIVING BETTER WITH IBS IBD HEARTBURN LACTOSE INTOLERANCE OTHER GI CONDITIONS AND DESIGN**. FOUNDATION FOR DIGESTIVE HEALTH AND NUTRITION, INC., (U.S. CLS. 2, 5, 22, 23, 29, 37, 38 AND 50). SN 76-558,481. PUB. 8-10-2004. FILED 11-10-2003.
- 2,899,229. **WRITING YOU CAN FEEL (BLOCK FORM)**. SAKURA COLOR PRODUCTS OF AMERICA, INC., (U.S. CLS. 2, 5, 22, 23, 29, 37, 38 AND 50). SN 76-559,302. PUB. 8-10-2004. FILED 11-14-2003.
- 2,899,236. **COLLEGE PROWLER**. COLLEGEPROWLER, INC., MULTIPLE CLASS, (INT. CLS. 16 AND 41), (U.S. CLS. 2, 5, 22, 23, 29, 37, 38, 50, 100, 101 AND 107). SN 76-559,699. PUB. 8-10-2004. FILED 10-31-2003.
- 2,899,266 ( *See Class 9 for this trademark*).
- 2,899,267 ( *See Class 9 for this trademark*).
- 2,899,307. **CIRCLE OF CARE SCREENING DIAGNOSIS TREATMENT FOLLOW-UP AND DESIGN**. SANARUS MEDICAL, INC., (U.S. CLS. 2, 5, 22, 23, 29, 37, 38 AND 50). SN 78-126,992. PUB. 5-27-2003. FILED 5-7-2002.
- 2,899,346. **ARTIVISE (STYLIZED)**. DISKIN, DAVID, (U.S. CLS. 2, 5, 22, 23, 29, 37, 38 AND 50). SN 78-162,210. PUB. 8-10-2004. FILED 9-9-2002.
- 2,899,350. **PRAIRIEBUSINESS**. GRAND FORKS HERALD, INC., (U.S. CLS. 2, 5, 22, 23, 29, 37, 38 AND 50). SN 78-166,838. PUB. 8-10-2004. FILED 9-23-2002.
- 2,899,354. **THE TRAVEL MOM**. KAUFMAN, EMILY, MULTIPLE CLASS, (INT. CLS. 16 AND 41), (U.S. CLS. 2, 5, 22, 23, 29, 37, 38, 50, 100, 101 AND 107). SN 78-168,411. PUB. 8-10-2004. FILED 9-26-2002.
- 2,899,366. **RADER FISHMAN**. RADER, FISHMAN & GRAUER PLLC, MULTIPLE CLASS, (INT. CLS. 16 AND 42), (U.S. CLS. 2, 5, 22, 23, 29, 37, 38, 50, 100 AND 101). SN 78-173,698. PUB. 8-10-2004. FILED 10-11-2002.
- 2,899,414 ( *See Class 5 for this trademark*).
- 2,899,424. **HEBREW ROOTS**. WHEELOCK, SUSAN ALEENE, (U.S. CLS. 2, 5, 22, 23, 29, 37, 38 AND 50). SN 78-207,418. PUB. 8-10-2004. FILED 1-27-2003.
- 2,899,426. **SHADOWRUN AND DESIGN**. WIZKIDS LLC, (U.S. CLS. 2, 5, 22, 23, 29, 37, 38 AND 50). SN 78-208,497. PUB. 8-10-2004. FILED 1-29-2003.
- 2,899,442. **SAIWON AND DESIGN**. SAIWON TTS LTD, (U.S. CLS. 2, 5, 22, 23, 29, 37, 38 AND 50). SN 78-218,943. PUB. 8-10-2004. FILED 2-25-2003.
- 2,899,451. **SHOWCASE**. REGIONAL PERFORMING ARTS CENTER, INC., (U.S. CLS. 2, 5, 22, 23, 29, 37, 38 AND 50). SN 78-223,975. PUB. 11-4-2003. FILED 3-11-2003.
- 2,899,452 ( *See Class 9 for this trademark*).
- 2,899,468. **THE DARK CHRONICLES (BLOCK FORM)**. SOROKA, CYNTHIA, (U.S. CLS. 2, 5, 22, 23, 29, 37, 38 AND 50). SN 78-231,529. PUB. 8-10-2004. FILED 3-28-2003.

- 2,899,475 ( *See Class 9 for this trademark.* )  
 2,899,500. **TIER-55**. MEDIA RECOVERY INC., DBA THE DAMAGE PREVENTION COMPANY, (U.S. CLS. 2, 5, 22, 23, 29, 37, 38 AND 50). SN 78-238,836. PUB. 8-10-2004. FILED 4-17-2003.  
 2,899,509. **MISCELLANEOUS DESIGN**. COTTENOIR, ROSEMARY, MULTIPLE CLASS, (INT. CLS. 16 AND 28), (U.S. CLS. 2, 5, 22, 23, 29, 37, 38 AND 50). SN 78-239,601. PUB. 2-10-2004. FILED 4-18-2003.  
 2,899,512. **FANCY T'S**. FANCY T'S, (U.S. CLS. 2, 5, 22, 23, 29, 37, 38 AND 50). SN 78-239,785. PUB. 8-10-2004. FILED 4-19-2003.  
 2,899,517. **SLOT TRAX**. LASER LOCK TECHNOLOGIES, INC., (U.S. CLS. 2, 5, 22, 23, 29, 37, 38 AND 50). SN 78-241,037. PUB. 8-10-2004. FILED 4-23-2003.  
 2,899,519 ( *See Class 9 for this trademark.* )  
 2,899,524. **LARSEN AND DESIGN**. COWTAN AND TOUT, INC., (U.S. CLS. 2, 5, 22, 23, 29, 37, 38 AND 50). SN 78-241,976. PUB. 8-10-2004. FILED 4-25-2003.  
 2,899,528. **MCGRAW HILL AND DESIGN**. THE MCGRAW-HILL COMPANIES, INC., MULTIPLE CLASS, (INT. CLS. 16 AND 41), (U.S. CLS. 2, 5, 22, 23, 29, 37, 38, 50, 100, 101 AND 107). SN 78-242,725. PUB. 8-10-2004. FILED 4-28-2003.  
 2,899,537. **GALLERY OF LOVE (STYLIZED)**. GREEN, JOEL, (U.S. CLS. 2, 5, 22, 23, 29, 37, 38 AND 50). SN 78-245,380. PUB. 12-16-2003. FILED 5-3-2003.  
 2,899,549. **BRAIN WAVES**. BRAIN LLC, MULTIPLE CLASS, (INT. CLS. 16 AND 36), (U.S. CLS. 2, 5, 22, 23, 29, 37, 38, 50, 100, 101 AND 102). SN 78-246,982. PUB. 8-10-2004. FILED 5-7-2003.  
 2,899,604 ( *See Class 9 for this trademark.* )  
 2,899,615. **TANA'S HABITAT**. TANA'S HABITAT MULTIMEDIA, LLC, DBA TANA'S HABITAT MULTIMEDIA, LLC, (U.S. CLS. 2, 5, 22, 23, 29, 37, 38 AND 50). SN 78-255,447. PUB. 8-10-2004. FILED 5-28-2003.  
 2,899,617. **NOTW**. C28, INC., MULTIPLE CLASS, (INT. CLS. 16, 25 AND 26), (U.S. CLS. 2, 5, 22, 23, 29, 37, 38, 39, 40, 42 AND 50). SN 78-256,181. PUB. 8-10-2004. FILED 5-30-2003.  
 2,899,618. **TD CHANNELS**. MEDIA GENERAL COMMUNICATIONS, INC., (U.S. CLS. 2, 5, 22, 23, 29, 37, 38 AND 50). SN 78-256,258. PUB. 8-10-2004. FILED 5-30-2003.  
 2,899,619. **RAGS AND DESIGN**. KIMBERLY-CLARK WORLDWIDE, INC., (U.S. CLS. 2, 5, 22, 23, 29, 37, 38 AND 50). SN 78-256,325. PUB. 8-10-2004. FILED 5-30-2003.  
 2,899,621. **AMERICAN SCHOOL & UNIVERSITY**. PRIMEDIA BUSINESS MAGAZINES & MEDIA INC., (U.S. CLS. 2, 5, 22, 23, 29, 37, 38 AND 50). SN 78-258,159. PUB. 1-20-2004. FILED 6-4-2003.  
 2,899,622. **CMAA CONSTRUCTION MANAGEMENT ASSOCIATION OF AMERICA (STYLIZED)**. CONSTRUCTION MANAGEMENT ASSOCIATION OF AMERICA, (U.S. CLS. 2, 5, 22, 23, 29, 37, 38 AND 50). SN 78-258,245. PUB. 8-10-2004. FILED 6-4-2003.  
 2,899,638. **KIEWAYS**. PETER KIEWIT SONS', INC., (U.S. CLS. 2, 5, 22, 23, 29, 37, 38 AND 50). SN 78-260,312. PUB. 8-10-2004. FILED 6-10-2003.  
 2,899,647. **LET'S GO RVING**. STAG-PARKWAY, INC., (U.S. CLS. 2, 5, 22, 23, 29, 37, 38 AND 50). SN 78-261,648. PUB. 8-10-2004. FILED 6-12-2003.  
 2,899,652. **MACKTRACKS**. MACK TRUCKS, INC., (U.S. CLS. 2, 5, 22, 23, 29, 37, 38 AND 50). SN 78-262,296. PUB. 8-10-2004. FILED 6-13-2003.  
 2,899,655 ( *See Class 9 for this trademark.* )  
 2,899,733 ( *See Class 1 for this trademark.* )  
 2,899,743. **SEAL PRESS**. AVALON PUBLISHING GROUP INCORPORATED, (U.S. CLS. 2, 5, 22, 23, 29, 37, 38 AND 50). SN 78-291,892. PUB. 8-10-2004. FILED 8-25-2003.  
 2,899,744. **MISCELLANEOUS DESIGN**. AVALON PUBLISHING GROUP INCORPORATED, (U.S. CLS. 2, 5, 22, 23, 29, 37, 38 AND 50). SN 78-291,898. PUB. 8-10-2004. FILED 8-25-2003.  
 2,899,755. **MR. THINKER**. HAIN PUBLISHING INC., (U.S. CLS. 2, 5, 22, 23, 29, 37, 38 AND 50). SN 78-294,726. PUB. 8-10-2004. FILED 9-2-2003.  
 2,899,768. **LIVING ON THE LINKS**. TIME4 MEDIA, INC., (U.S. CLS. 2, 5, 22, 23, 29, 37, 38 AND 50). SN 78-297,919. PUB. 8-10-2004. FILED 9-9-2003.  
 2,899,781 ( *See Class 2 for this trademark.* )  
 2,899,858. **EVERYTHING FOR YOUR PHONE. YOUR PHONE FOR EVERYTHING.** CELLCO PARTNERSHIP, DBA VERIZON WIRELESS, (U.S. CLS. 2, 5, 22, 23, 29, 37, 38 AND 50). SN 78-315,671. PUB. 8-10-2004. FILED 10-20-2003.  
 2,899,859. **KIDS' FAQS AND DESIGN**. CREATIVE PUBLISHING INTERNATIONAL INC., (U.S. CLS. 2, 5, 22, 23, 29, 37, 38 AND 50). SN 78-315,742. PUB. 8-10-2004. FILED 10-20-2003.  
 2,899,884. **S-CAT SECORD CONTEXTUAL ARTICULATION TESTS**. SUPER DUPER INC., DBA SUPER DUPER PUBLICATIONS, (U.S. CLS. 2, 5, 22, 23, 29, 37, 38 AND 50). SN 78-318,952. PUB. 8-10-2004. FILED 10-27-2003.  
 2,899,906. **LEAN PRESS**. HOPEFULS, INC., DBA LEAN PRESS, (U.S. CLS. 2, 5, 22, 23, 29, 37, 38 AND 50). SN 78-321,003. PUB. 8-10-2004. FILED 10-30-2003.  
 2,899,910 ( *See Class 6 for this trademark.* )  
 2,899,920. **WHIMSICAL WISDOM (BLOCK FORM)**. SANTELL, LINDA A., MULTIPLE CLASS, (INT. CLS. 16 AND 25), (U.S. CLS. 2, 5, 22, 23, 29, 37, 38, 39 AND 50). SN 78-322,421. PUB. 8-10-2004. FILED 11-3-2003.  
 2,899,983. **MISCELLANEOUS DESIGN**. THE CAROLINA TRADER INCORPORATED, (U.S. CLS. 2, 5, 22, 23, 29, 37, 38 AND 50). SN 78-328,016. PUB. 8-10-2004. FILED 11-14-2003.  
 2,899,994. **MEETINGS SOUTH (BLOCK FORM)**. STAMATS MEETINGS MEDIA, INC., (U.S. CLS. 2, 5, 22, 23, 29, 37, 38 AND 50). SN 78-330,200. PUB. 8-10-2004. FILED 11-19-2003.  
 2,900,007. **MODEL-NETICS (BLOCK FORM)**. MAIN EVENT MANAGEMENT CORPORATION, (U.S. CLS. 2, 5, 22, 23, 29, 37, 38 AND 50). SN 78-332,353. PUB. 8-10-2004. FILED 11-24-2003.  
 2,900,014 ( *See Class 9 for this trademark.* )  
 2,900,018. **ART (BLOCK FORM)**. TRADERSCOACH.COM, INC., MULTIPLE CLASS, (INT. CLS. 16 AND 41), (U.S. CLS. 2, 5, 22, 23, 29, 37, 38, 50, 100, 101 AND 107). SN 78-394,198. PUB. 8-10-2004. FILED 3-31-2004.  
 2,900,019. **FIREHOUSE SUBS**. FIREHOUSE RESTAURANT GROUP, INC., (U.S. CLS. 2, 5, 22, 23, 29, 37, 38 AND 50). SN 78-975,138. PUB. 8-10-2004. FILED 1-8-2003.
- 
- CLASS 17—RUBBER GOODS**
- 2,898,433 ( *See Class 1 for this trademark.* )  
 2,898,523. **NOVUS**. KONINKLIJKE ECONOSTO N.V., (U.S. CLS. 1, 5, 12, 13, 35 AND 50). SN 76-235,417. PUB. 11-12-2002. FILED 4-4-2001.  
 2,898,598. **FIRE BREAK**. CLAYTON CORPORATION, DBA CONVENIENCE PRODUCTS, (U.S. CLS. 1, 5, 12, 13, 35 AND 50). SN 76-415,715. PUB. 2-11-2003. FILED 5-29-2002.  
 2,898,937. **ZELUX**. WESTLAKE PLASTICS COMPANY, INC., (U.S. CLS. 1, 5, 12, 13, 35 AND 50). SN 76-524,641. PUB. 2-10-2004. FILED 6-23-2003.  
 2,899,010 ( *See Class 16 for this trademark.* )  
 2,899,403 ( *See Class 6 for this trademark.* )  
 2,899,404 ( *See Class 6 for this trademark.* )  
 2,899,410. **EGRIPS**. FLEXIBLE INNOVATION, LTD, (U.S. CLS. 1, 5, 12, 13, 35 AND 50). SN 78-200,215. PUB. 8-10-2004. FILED 1-6-2003.  
 2,899,433. **OPALUS**. KEIWA KABUSHIKI KAISHA, DBA KEIWA, INC., (U.S. CLS. 1, 5, 12, 13, 35 AND 50). SN 78-214,355. PUB. 8-10-2004. FILED 2-13-2003.  
 2,899,499. **RAIL APE**. SHERMAN, KEITH E., (U.S. CLS. 1, 5, 12, 13, 35 AND 50). SN 78-238,824. PUB. 8-10-2004. FILED 4-17-2003.  
 2,899,633. **FUSEAL 25/50**. GEORGE FISCHER SLOANE, INC., MULTIPLE CLASS, (INT. CLS. 17 AND 19), (U.S. CLS. 1, 5, 12, 13, 33, 35 AND 50). SN 78-259,676. PUB. 8-10-2004. FILED 6-8-2003.  
 2,899,886. **FLEXVAC**. THE FLEXAUST COMPANY, INC., (U.S. CLS. 1, 5, 12, 13, 35 AND 50). SN 78-319,042. PUB. 8-10-2004. FILED 10-27-2003.  
 2,899,937. **TECHMAT PLUS (BLOCK FORM)**. TECHMAT PLUS, (U.S. CLS. 1, 5, 12, 13, 35 AND 50). SN 78-323,922. PUB. 8-10-2004. FILED 11-6-2003.

**CLASS 18—LEATHER GOODS**

- 2,898,423. **PEGASE (STYLIZED)**. LOUIS VUITTON MALLE-TIER, (U.S. CLS. 1, 2, 3, 22 AND 41). SN 75-501,931. PUB. 8-10-2004. FILED 6-10-1998.
- 2,898,446 ( *See Class 14 for this trademark*).
- 2,898,501 ( *See Class 3 for this trademark*).
- 2,898,578. **GENTLE FAWN**. GENTLE FAWN DESIGNS (CANADA) LIMITED, MULTIPLE CLASS, (INT. CLS. 18 AND 25), (U.S. CLS. 1, 2, 3, 22, 39 AND 41). SN 76-388,896. PUB. 8-10-2004. FILED 3-28-2002.
- 2,898,579 ( *See Class 9 for this trademark*).
- 2,898,581. **U AND DESIGN**. UNI-PACK INTERNATIONAL, INC., (U.S. CLS. 1, 2, 3, 22 AND 41). SN 76-395,880. PUB. 8-10-2004. FILED 4-15-2002.
- 2,898,644. **J.M. WESTON (STYLIZED)**. J.M. WESTON, MULTIPLE CLASS, (INT. CLS. 18 AND 25), (U.S. CLS. 1, 2, 3, 22, 39 AND 41). SN 76-454,460. PUB. 8-10-2004. FILED 3-25-2002.
- 2,898,661. **CLUB SANTOS LAGUNA AND DESIGN**. SANTOS LAGUNA, S.A. DE C.V., (U.S. CLS. 1, 2, 3, 22 AND 41). SN 76-462,194. PUB. 6-1-2004. FILED 10-28-2002.
- 2,898,675. **KODIAK ISLAND SERIES AND DESIGN**. STRIKE ON, LLC, (U.S. CLS. 1, 2, 3, 22 AND 41). SN 76-468,753. PUB. 8-10-2004. FILED 11-21-2002.
- 2,898,693. **DO! FAMILY**. KABUSHIKI KAISHA DO FAMILY, MULTIPLE CLASS, (INT. CLS. 18 AND 25), (U.S. CLS. 1, 2, 3, 22, 39 AND 41). SN 76-479,665. PUB. 8-10-2004. FILED 1-2-2003.
- 2,898,705. **RENO (BLOCK FORM)**. TASHDJIAN TRADING CO. INC., (U.S. CLS. 1, 2, 3, 22 AND 41). SN 76-486,576. PUB. 8-10-2004. FILED 1-24-2003.
- 2,898,894. **ROCKY AND DESIGN**. ROCKY SHOES & BOOTS, INC., MULTIPLE CLASS, (INT. CLS. 18, 25 AND 28), (U.S. CLS. 1, 2, 3, 22, 38, 39, 41 AND 50). SN 76-519,218. PUB. 8-10-2004. FILED 5-19-2003.
- 2,898,902. **BRIDGES (BLOCK FORM)**. BRIDGES, WILLIAM E., MULTIPLE CLASS, (INT. CLS. 18 AND 28), (U.S. CLS. 1, 2, 3, 22, 23, 38, 41 AND 50). SN 76-519,407. PUB. 8-10-2004. FILED 4-28-2003.
- 2,898,991. **TIE TOWELS AND DESIGN**. MONTOYA, ENRIQUE LUIS, (U.S. CLS. 1, 2, 3, 22 AND 41). SN 76-536,029. PUB. 8-10-2004. FILED 7-28-2003.
- 2,899,057. **GIGI OLIVIA**. NG, CHEE KIN, (U.S. CLS. 1, 2, 3, 22 AND 41). SN 76-546,831. PUB. 8-10-2004. FILED 9-9-2003.
- 2,899,127. **EQUITECH AND DESIGN**. CHAMPION TRADING, INC., MULTIPLE CLASS, (INT. CLS. 18 AND 25), (U.S. CLS. 1, 2, 3, 22, 39 AND 41). SN 76-553,924. PUB. 8-10-2004. FILED 10-24-2003.
- 2,899,271 ( *See Class 14 for this trademark*).
- 2,899,314. **MISCELLANEOUS DESIGN**. GROUNDED, INC., MULTIPLE CLASS, (INT. CLS. 18, 25, 38 AND 41), (U.S. CLS. 1, 2, 3, 22, 39, 41, 100, 101, 104 AND 107). SN 78-135,839. PUB. 8-10-2004. FILED 6-14-2002.
- 2,899,338. **TRIPPEN (STYLIZED)**. SPIETH, ANGELA, AND OEHLER, MICHAEL, MULTIPLE CLASS, (INT. CLS. 18 AND 25), (U.S. CLS. 1, 2, 3, 22, 39 AND 41). SN 78-154,607. PUB. 8-10-2004. FILED 8-15-2002.
- 2,899,356. **AVENT URBAN BAG**. CANNON RUBBER LIMITED, (U.S. CLS. 1, 2, 3, 22 AND 41). SN 78-168,859. PUB. 11-4-2003. FILED 9-27-2002.
- 2,899,368. **MERCANTI FIORENTINI AND DESIGN**. CALZATURIFICIO LADY KENT S.N.C. DI CAMPINOTI ROBERTO E C., MULTIPLE CLASS, (INT. CLS. 18 AND 25), (U.S. CLS. 1, 2, 3, 22, 39 AND 41). SN 78-175,119. PUB. 6-1-2004. FILED 10-16-2002.
- 2,899,545. **GRANITE SPRINGS**. GLIMPSON, LLC, (U.S. CLS. 1, 2, 3, 22 AND 41). SN 78-246,693. PUB. 12-23-2003. FILED 5-7-2003.
- 2,899,546. **GRANITE SPRINGS AND DESIGN**. GLIMPSON, LLC, (U.S. CLS. 1, 2, 3, 22 AND 41). SN 78-246,696. PUB. 3-23-2004. FILED 5-7-2003.
- 2,899,627 ( *See Class 5 for this trademark*).
- 2,899,724 ( *See Class 14 for this trademark*).
- 2,899,792. **OMNIBUS**. HERMES INTERNATIONAL, (U.S. CLS. 1, 2, 3, 22 AND 41). SN 78-304,936. PUB. 8-10-2004. FILED 9-24-2003.
- 2,899,817. **MISCELLANEOUS DESIGN**. DELVALLE, OPHELIA, (U.S. CLS. 1, 2, 3, 22 AND 41). SN 78-310,364. PUB. 8-10-2004. FILED 10-7-2003.

2,899,895. **MISCELLANEOUS DESIGN**. HEARTS ON FIRE COMPANY, (U.S. CLS. 1, 2, 3, 22 AND 41). SN 78-320,352. PUB. 8-10-2004. FILED 10-29-2003.

2,899,910 ( *See Class 6 for this trademark*).

2,899,980. **FLEXIBILITY IS OUR GREATEST STRENGTH (BLOCK FORM)**. FIBERBUILT UMBRELLAS, (U.S. CLS. 1, 2, 3, 22 AND 41). SN 78-327,193. PUB. 8-10-2004. FILED 11-13-2003.

**CLASS 19—NON-METALLIC BUILDING MATERIALS**

- 2,898,433 ( *See Class 1 for this trademark*).
- 2,898,487 ( *See Class 6 for this trademark*).
- 2,898,554. **MATLAY DANCE SURFACE AND DESIGN**. LIN-CIR, MATT G., (U.S. CLS. 1, 12, 33 AND 50). SN 76-339,563. PUB. 8-10-2004. FILED 11-19-2001.
- 2,898,573 ( *See Class 6 for this trademark*).
- 2,898,600 ( *See Class 6 for this trademark*).
- 2,898,672. **SCS FLOORING SYSTEMS**. SCS FLOORING SYSTEMS, MULTIPLE CLASS, (INT. CLS. 19 AND 27), (U.S. CLS. 1, 12, 19, 20, 33, 37, 42 AND 50). SN 76-467,579. PUB. 7-29-2003. FILED 11-15-2002.
- 2,898,688. **EP HENRY (STYLIZED)**. E.P. HENRY CORPORATION, MULTIPLE CLASS, (INT. CLS. 19 AND 35), (U.S. CLS. 1, 12, 33, 50, 100, 101 AND 102). SN 76-475,729. PUB. 8-10-2004. FILED 12-16-2002.
- 2,898,797 ( *See Class 6 for this trademark*).
- 2,898,863. **CASABLANCA**. RLF, INC., MULTIPLE CLASS, (INT. CLS. 19 AND 35), (U.S. CLS. 1, 12, 33, 50, 100, 101 AND 102). SN 76-516,240. PUB. 2-10-2004. FILED 5-23-2003.
- 2,898,931. **MERRIMACK VALLEY WOOD PRODUCTS AND DESIGN**. MERRIMACK VALLEY WOOD PRODUCTS, INC., (U.S. CLS. 1, 12, 33 AND 50). SN 76-523,110. PUB. 8-10-2004. FILED 6-16-2003.
- 2,899,036. **PREMIUM EXPOSED**. C&D LUMBER CO., (U.S. CLS. 1, 12, 33 AND 50). SN 76-543,534. PUB. 8-10-2004. FILED 8-27-2003.
- 2,899,061. **DBX1000**. CONSTRUCTION SOLUTIONS, L.L.C., (U.S. CLS. 1, 12, 33 AND 50). SN 76-546,964. PUB. 8-10-2004. FILED 9-25-2003.
- 2,899,268. **ROYAL CREST (BLOCK FORM)**. ROYAL GROUP TECHNOLOGIES LIMITED, (U.S. CLS. 1, 12, 33 AND 50). SN 76-585,046. PUB. 8-10-2004. FILED 4-5-2004.
- 2,899,481. **ECOSELECT AND DESIGN**. THE TIMBER PROMOTION COUNCIL, MULTIPLE CLASS, (INT. CLS. 19, 20 AND 31), (U.S. CLS. 1, 2, 12, 13, 22, 25, 32, 33, 46 AND 50). SN 78-234,981. PUB. 8-10-2004. FILED 4-8-2003.
- 2,899,504 ( *See Class 6 for this trademark*).
- 2,899,508. **DURA-GUARD**. HOOVER TREATED WOOD PRODUCTS, INC., (U.S. CLS. 1, 12, 33 AND 50). SN 78-239,580. PUB. 1-13-2004. FILED 4-18-2003.
- 2,899,516. **MEGABLOCK**. COMPOSITE TECHNOLOGIES CORPORATION, (U.S. CLS. 1, 12, 33 AND 50). SN 78-241,026. PUB. 8-10-2004. FILED 4-23-2003.
- 2,899,554 ( *See Class 6 for this trademark*).
- 2,899,579. **TECHNISTONE**. TECHNISTONE USA, INC., (U.S. CLS. 1, 12, 33 AND 50). SN 78-251,033. PUB. 8-10-2004. FILED 5-16-2003.
- 2,899,633 ( *See Class 17 for this trademark*).
- 2,899,746. **MICROFINE**. DE NEEF CONSTRUCTION CHEMICALS, INC., (U.S. CLS. 1, 12, 33 AND 50). SN 78-292,250. PUB. 8-10-2004. FILED 8-26-2003.
- 2,899,765. **AWT AND DESIGN**. ACTION WINDOOR TECHNOLOGY, INC., (U.S. CLS. 1, 12, 33 AND 50). SN 78-297,662. PUB. 8-10-2004. FILED 9-9-2003.
- 2,899,997. **NANO CRETE (BLOCK FORM)**. VERSATILE BUILDING PRODUCTS, INC., (U.S. CLS. 1, 12, 33 AND 50). SN 78-331,024. PUB. 8-10-2004. FILED 11-20-2003.

**CLASS 20—FURNITURE AND ARTICLES NOT OTHERWISE CLASSIFIED**

- 2,898,458. **E-Z FILL**. IMPACT PRODUCTS, INC., (U.S. CLS. 2, 13, 22, 25, 32 AND 50). SN 75-906,285. PUB. 8-10-2004. FILED 1-28-2000.
- 2,898,464. **M MERCURY AND DESIGN**. MERCURY ARREDAMENTI S.P.A., (U.S. CLS. 2, 13, 22, 25, 32 AND 50). SN 75-929,809. PUB. 8-10-2004. FILED 2-28-2000.
- 2,898,525. **BABY ON BOARD**. DOREL JUVENILE GROUP, INC., (U.S. CLS. 2, 13, 22, 25, 32 AND 50). SN 76-237,643. PUB. 8-10-2004. FILED 4-9-2001.
- 2,898,573 ( *See Class 6 for this trademark*).
- 2,898,580. **TIMBERTANKS**. TIMBERTANKS AMERICA, LTD., (U.S. CLS. 2, 13, 22, 25, 32 AND 50). SN 76-393,558. PUB. 8-10-2004. FILED 4-10-2002.
- 2,898,583 ( *See Class 9 for this trademark*).
- 2,898,612. **DIEFFEBI METAL FURNITURE & OFFICE DESIGN AND DESIGN**. DIEFFEBI S.P.A., (U.S. CLS. 2, 13, 22, 25, 32 AND 50). SN 76-429,792. PUB. 9-30-2003. FILED 7-10-2002.
- 2,898,646. **MISCELLANEOUS DESIGN**. SHANDON INDUSTRIES TRUST, COMPRISING STEVE ANGLE, A U.S. CITIZEN, (U.S. CLS. 2, 13, 22, 25, 32 AND 50). SN 76-454,688. PUB. 8-10-2004. FILED 10-2-2002.
- 2,898,686 ( *See Class 3 for this trademark*).
- 2,898,725. **HTLINTERNATIONAL**. HTL INTERNATIONAL HOLDINGS LIMITED, (U.S. CLS. 2, 13, 22, 25, 32 AND 50). SN 76-492,188. PUB. 9-30-2003. FILED 2-24-2003.
- 2,898,841. **MISCELLANEOUS DESIGN**. HILLYARD ENTERPRISES, INC., MULTIPLE CLASS, (INT. CLS. 20, 21, 24, 25 AND 28), (U.S. CLS. 2, 13, 22, 23, 25, 29, 30, 32, 33, 38, 39, 40, 42 AND 50). SN 76-514,177. PUB. 8-10-2004. FILED 5-14-2003.
- 2,898,877 ( *See Class 4 for this trademark*).
- 2,898,944. **KRONEN CASEWORK AND DESIGN**. SALISBURY LUMBER COMPANY, INC., (U.S. CLS. 2, 13, 22, 25, 32 AND 50). SN 76-527,240. PUB. 8-10-2004. FILED 6-30-2003.
- 2,898,953. **IC CABANFOR AND DESIGN**. ISABEL CABANILLAS, S.A., (U.S. CLS. 2, 13, 22, 25, 32 AND 50). SN 76-528,731. PUB. 8-10-2004. FILED 7-8-2003.
- 2,898,969. **BUNKAPS**. HARLEY CORPORATION, (U.S. CLS. 2, 13, 22, 25, 32 AND 50). SN 76-532,110. PUB. 8-10-2004. FILED 7-3-2003.
- 2,898,987. **RA AND DESIGN**. SHABBY CHIC, INC., MULTIPLE CLASS, (INT. CLS. 20 AND 24), (U.S. CLS. 2, 13, 22, 25, 32, 42 AND 50). SN 76-535,689. PUB. 8-10-2004. FILED 8-8-2003.
- 2,899,001. **ESTATE BY RSI AND DESIGN**. RSI HOLDING CORPORATION, (U.S. CLS. 2, 13, 22, 25, 32 AND 50). SN 76-537,246. PUB. 8-10-2004. FILED 8-14-2003.
- 2,899,039. **THE NETBRELLA AND DESIGN**. THE NETBRELLA COMPANY, LLC, (U.S. CLS. 2, 13, 22, 25, 32 AND 50). SN 76-543,901. PUB. 8-10-2004. FILED 8-29-2003.
- 2,899,114. **EASYBOLT**. STANDARD FEDERAL BANK N.A., (U.S. CLS. 2, 13, 22, 25, 32 AND 50). SN 76-552,729. PUB. 8-10-2004. FILED 10-20-2003.
- 2,899,277. **SNOW BUDDIES SNOWVILLE**. ENCORE GROUP, INC., THE, (U.S. CLS. 2, 13, 22, 25, 32 AND 50). SN 78-013,941. PUB. 8-26-2003. FILED 6-22-2000.
- 2,899,292 ( *See Class 6 for this trademark*).
- 2,899,387. **UNIVERSAL SLATE**. UNIVERSAL SLATE INTERNATIONAL INC., (U.S. CLS. 2, 13, 22, 25, 32 AND 50). SN 78-185,862. PUB. 8-10-2004. FILED 11-16-2002.
- 2,899,481 ( *See Class 19 for this trademark*).
- 2,899,498. **CLUSTER PUFF**. HOLLANDER HOME FASHIONS CORP., MULTIPLE CLASS, (INT. CLS. 20, 22 AND 24), (U.S. CLS. 1, 2, 7, 13, 19, 22, 25, 32, 42 AND 50). SN 78-238,380. PUB. 8-10-2004. FILED 4-16-2003.
- 2,899,566. **HANGOUTS**. GOLDBERG, ROBERT D, MULTIPLE CLASS, (INT. CLS. 20, 22 AND 25), (U.S. CLS. 1, 2, 7, 13, 19, 22, 25, 32, 39, 42 AND 50). SN 78-249,686. PUB. 8-10-2004. FILED 5-14-2003.
- 2,899,574. **CANDELARIA**. HOME INTERIORS & GIFTS, INC., MULTIPLE CLASS, (INT. CLS. 20 AND 21), (U.S. CLS. 2, 13, 22, 23, 25, 29, 30, 32, 33, 40 AND 50). SN 78-250,436. PUB. 8-10-2004. FILED 5-15-2003.
- 2,899,636. **NEW HARBOUR AND DESIGN**. NEW HARBOUR, INC., (U.S. CLS. 2, 13, 22, 25, 32 AND 50). SN 78-260,023. PUB. 8-10-2004. FILED 6-9-2003.

- 2,899,658. **LINVILLE**. BROYHILL FURNITURE INDUSTRIES, INC., (U.S. CLS. 2, 13, 22, 25, 32 AND 50). SN 78-262,900. PUB. 8-10-2004. FILED 6-16-2003.
- 2,899,679. **ENDURO**. GSC TECHNOLOGY CORPORATION, (U.S. CLS. 2, 13, 22, 25, 32 AND 50). SN 78-268,880. PUB. 3-2-2004. FILED 6-30-2003.
- 2,899,706. **MARK MONTANO**. MONTANO, MARK, MULTIPLE CLASS, (INT. CLS. 20 AND 25), (U.S. CLS. 2, 13, 22, 25, 32, 39 AND 50). SN 78-277,144. PUB. 8-10-2004. FILED 7-22-2003.
- 2,899,721. **I D MAN**. SECURE IMAGE CORPORATION, (U.S. CLS. 2, 13, 22, 25, 32 AND 50). SN 78-283,705. PUB. 8-10-2004. FILED 8-6-2003.
- 2,899,829. **SALON FACTORY**. DELGUIDICE, ANITA THERESA, (U.S. CLS. 2, 13, 22, 25, 32 AND 50). SN 78-312,096. PUB. 8-10-2004. FILED 10-10-2003.
- 2,899,877. **THAT'S MY TICKET**. THAT'S MY TICKET LLC, (U.S. CLS. 2, 13, 22, 25, 32 AND 50). SN 78-318,159. PUB. 8-10-2004. FILED 10-24-2003.
- 2,899,904. **MISCELLANEOUS DESIGN**. R.J. THOMAS MANUFACTURING COMPANY, INC., (U.S. CLS. 2, 13, 22, 25, 32 AND 50). SN 78-320,891. PUB. 8-10-2004. FILED 10-30-2003.
- 2,899,910 ( *See Class 6 for this trademark*).
- 2,899,976. **SPEC-FLEK (BLOCK FORM)**. COLUMBIA MANUFACTURING, INC., (U.S. CLS. 2, 13, 22, 25, 32 AND 50). SN 78-326,766. PUB. 8-10-2004. FILED 11-12-2003.

**CLASS 21—HOUSEWARES AND GLASS**

- 2,898,433 ( *See Class 1 for this trademark*).
- 2,898,439 ( *See Class 3 for this trademark*).
- 2,898,497 ( *See Class 14 for this trademark*).
- 2,898,501 ( *See Class 3 for this trademark*).
- 2,898,570. **BEER SANFORD'S AND DESIGN**. SANFORD'S GRUB & PUB, INC., MULTIPLE CLASS, (INT. CLS. 21, 25 AND 43), (U.S. CLS. 2, 13, 22, 23, 29, 30, 33, 39, 40, 50, 100 AND 101). SN 76-369,293. PUB. 8-10-2004. FILED 2-11-2002.
- 2,898,571 ( *See Class 9 for this trademark*).
- 2,898,657 ( *See Class 3 for this trademark*).
- 2,898,798 ( *See Class 12 for this trademark*).
- 2,898,841 ( *See Class 20 for this trademark*).
- 2,898,887 ( *See Class 3 for this trademark*).
- 2,898,943. **UTOPIA**. METRO/THEBE, INC., (U.S. CLS. 2, 13, 23, 29, 30, 33, 40 AND 50). SN 76-527,041. PUB. 8-10-2004. FILED 6-30-2003.
- 2,899,047 ( *See Class 16 for this trademark*).
- 2,899,136. **EVERYTHING BUT THE CAMPFIRE**. THIS, LLC, MULTIPLE CLASS, (INT. CLS. 21 AND 30), (U.S. CLS. 2, 13, 23, 29, 30, 33, 40, 46 AND 50). SN 76-554,841. PUB. 8-10-2004. FILED 10-14-2003.
- 2,899,182. **POOPY DOO (BLOCK FORM)**. CROWN PRODUCTS, LLC, (U.S. CLS. 2, 13, 23, 29, 30, 33, 40 AND 50). SN 76-557,276. PUB. 8-10-2004. FILED 11-5-2003.
- 2,899,191 ( *See Class 4 for this trademark*).
- 2,899,239. **STURDIWARE (BLOCK FORM)**. SABERT CORPORATION, (U.S. CLS. 2, 13, 23, 29, 30, 33, 40 AND 50). SN 76-559,928. PUB. 8-10-2004. FILED 11-3-2003.
- 2,899,271 ( *See Class 14 for this trademark*).
- 2,899,276. **HAKUHODO**. HAKUHODO CO., LTD., (U.S. CLS. 2, 13, 23, 29, 30, 33, 40 AND 50). SN 76-977,082. PUB. 3-30-2004. FILED 6-30-2003.
- 2,899,353 ( *See Class 11 for this trademark*).
- 2,899,357. **SILARGAN**. SILIT-WERKE GMBH & CO. KG, (U.S. CLS. 2, 13, 23, 29, 30, 33, 40 AND 50). SN 78-169,352. PUB. 8-10-2004. FILED 9-30-2002.
- 2,899,382 ( *See Class 11 for this trademark*).
- 2,899,428 ( *See Class 3 for this trademark*).
- 2,899,434. **SIGNAL TECHNOLOGY**. DR. FRESH, INC., (U.S. CLS. 2, 13, 23, 29, 30, 33, 40 AND 50). SN 78-215,405. PUB. 10-14-2003. FILED 2-15-2003.
- 2,899,510. **ART FOR THE TABLE**. MSRF, INC., MULTIPLE CLASS, (INT. CLS. 21 AND 30), (U.S. CLS. 2, 13, 23, 29, 30, 33, 40, 46 AND 50). SN 78-239,685. PUB. 8-10-2004. FILED 4-18-2003.
- 2,899,530. **THE HOME VALET COMPANY**. RDI INTERNATIONAL LIMITED, (U.S. CLS. 2, 13, 23, 29, 30, 33, 40 AND



50). SN 78-243,312. PUB. 8-10-2004. FILED 4-29-2003.  
 2,899,574 ( *See Class 20 for this trademark*).  
 2,899,587 ( *See Class 7 for this trademark*).  
 2,899,627 ( *See Class 5 for this trademark*).  
 2,899,696 ( *See Class 7 for this trademark*).  
 2,899,703 ( *See Class 11 for this trademark*).  
 2,899,896. **MISCELLANEOUS DESIGN**. HEARTS ON FIRE COMPANY, (U.S. CLS. 2, 13, 23, 29, 30, 33, 40 AND 50). SN 78-320,364. PUB. 8-10-2004. FILED 10-29-2003.

---

## CLASS 22—CORDAGE AND FIBERS

2,898,728. **E AND DESIGN**. GEARY, ROBERT B., DBA ENSIGN CLASS ASSOCIATION, (U.S. CLS. 1, 2, 7, 19, 22, 42 AND 50). SN 76-494,678. PUB. 8-10-2004. FILED 2-25-2003.  
 2,899,135. **UNDERWOOD COTTON**. UNDERWOOD COTTON CO., (U.S. CLS. 1, 2, 7, 19, 22, 42 AND 50). SN 76-554,689. PUB. 8-10-2004. FILED 10-9-2003.  
 2,899,498 ( *See Class 20 for this trademark*).  
 2,899,566 ( *See Class 20 for this trademark*).  
 2,899,912. **SOK IT (BLOCK FORM)**. SOK-IT CORPORATION, (U.S. CLS. 1, 2, 7, 19, 22, 42 AND 50). SN 78-321,986. PUB. 8-10-2004. FILED 11-2-2003.

---

## CLASS 23—YARNS AND THREADS

2,899,443. **BURMILANA**. MADEIRA USA LTD., (U.S. CL. 43). SN 78-218,972. PUB. 8-10-2004. FILED 2-26-2003.  
 2,899,688. **SUPREME PROTECTOR SHIELD**. SUPREME ELASTIC CORPORATION, (U.S. CL. 43). SN 78-271,164. PUB. 8-10-2004. FILED 7-7-2003.

---

## CLASS 24—FABRICS

2,898,433 ( *See Class 1 for this trademark*).  
 2,898,604. **AMERICAN SPIRIT A SPECIAL COMMEMORATIVE EDITION QUILT KIT AND DESIGN**. FABRIC EDITIONS LTD., (U.S. CLS. 42 AND 50). SN 76-418,604. PUB. 7-22-2003. FILED 6-7-2002.  
 2,898,670. **NIVES ZANOTTO**. ZANOTTO SA, MULTIPLE CLASS, (INT. CLS. 24 AND 25), (U.S. CLS. 22, 39, 42 AND 50). SN 76-466,357. PUB. 6-1-2004. FILED 11-1-2002.  
 2,898,766. **CELEBRATION QUILTS AND DESIGN**. CELEBRATION QUILTS, INC., MULTIPLE CLASS, (INT. CLS. 24 AND 40), (U.S. CLS. 42, 50, 100, 103 AND 106). SN 76-505,001. PUB. 8-10-2004. FILED S.R. 4-7-2003; AM. P.R. 5-11-2004.  
 2,898,841 ( *See Class 20 for this trademark*).  
 2,898,868. **FOSS**. FOSS MANUFACTURING COMPANY, INC., (U.S. CLS. 42 AND 50). SN 76-516,756. PUB. 8-10-2004. FILED 5-8-2003.  
 2,898,987 ( *See Class 20 for this trademark*).  
 2,898,990. **TIE TOWELS AND DESIGN**. MONTOYA, ENRIQUE LUIS, (U.S. CLS. 42 AND 50). SN 76-536,028. PUB. 8-10-2004. FILED 7-28-2003.  
 2,899,261. **STOPP-RIPP (STYLIZED)**. MINX PRODUCTS, INC., (U.S. CLS. 42 AND 50). SN 76-563,736. PUB. 8-10-2004. FILED 11-24-2003.  
 2,899,448 ( *See Class 7 for this trademark*).  
 2,899,498 ( *See Class 20 for this trademark*).  
 2,899,757. **APRES ULTRA ABSORBENT TOWELS (STYLIZED)**. TEIJIN SHOJI, (U.S. CLS. 42 AND 50). SN 78-295,509. PUB. 8-10-2004. FILED 9-3-2003.  
 2,899,897. **MISCELLANEOUS DESIGN**. HEARTS ON FIRE COMPANY, (U.S. CLS. 42 AND 50). SN 78-320,371. PUB. 8-10-2004. FILED 10-29-2003.  
 2,900,024. **CLAIRE'S**. CLAIRE'S BOUTIQUES, INC., (U.S. CLS. 42 AND 50). SN 78-975,453. PUB. 8-10-2004. FILED 7-31-2002.

## CLASS 25—CLOTHING

2,898,430. **GIRL FRIENDS BY ANITA G AND DESIGN**. ANITA, G. INC., (U.S. CLS. 22 AND 39). SN 75-518,297. PUB. 8-10-2004. FILED 7-13-1998.  
 2,898,442. **GM CUSTOM FIBERGLASSING WATERPROOF AND DESIGN**. MARTZ, GREGORY, (U.S. CLS. 22 AND 39). SN 75-707,767. PUB. 6-13-2000. FILED 5-17-1999.  
 2,898,446 ( *See Class 14 for this trademark*).  
 2,898,497 ( *See Class 14 for this trademark*).  
 2,898,520. **BVONO (STYLIZED)**. BUONO S.N.C. DI BUONO EUSTACHIO E ISONZO MARIA PIA, (U.S. CLS. 22 AND 39). SN 76-226,477. PUB. 8-10-2004. FILED 3-19-2001.  
 2,898,547. **WONDERBABY!**. METHODIST MEDICAL CENTER OF ILLINOIS, (U.S. CLS. 22 AND 39). SN 76-313,940. PUB. 4-22-2003. FILED 9-18-2001.  
 2,898,570 ( *See Class 21 for this trademark*).  
 2,898,578 ( *See Class 18 for this trademark*).  
 2,898,579 ( *See Class 9 for this trademark*).  
 2,898,590. **STC FOOTWEAR INC. THE SHOE TECHNOLOGY COMPANY**. CHAUSSURES STC INC., (U.S. CLS. 22 AND 39). SN 76-405,468. PUB. 6-8-2004. FILED 5-9-2002.  
 2,898,610. **PATRICIA FIELD (STYLIZED)**. FIELD, PATRICIA, (U.S. CLS. 22 AND 39). SN 76-427,774. PUB. 4-6-2004. FILED 7-5-2002.  
 2,898,629. **BRIGG**. GRUNDENS USA, LTD., (U.S. CLS. 22 AND 39). SN 76-446,761. PUB. 8-10-2004. FILED 8-29-2002.  
 2,898,644 ( *See Class 18 for this trademark*).  
 2,898,649. **FGCU AND DESIGN**. FLORIDA GULF COAST UNIVERSITY BOARD OF TRUSTEES, (U.S. CLS. 22 AND 39). SN 76-456,308. PUB. 6-24-2003. FILED 10-1-2002.  
 2,898,670 ( *See Class 24 for this trademark*).  
 2,898,692. **PVORY**. STRETCH MANUFACTURING, INC., (U.S. CLS. 22 AND 39). SN 76-478,327. PUB. 8-10-2004. FILED 12-26-2002.  
 2,898,693 ( *See Class 18 for this trademark*).  
 2,898,696 ( *See Class 9 for this trademark*).  
 2,898,697. **US GIRLS AND DESIGN**. DAVEY, LANE MARIE, (U.S. CLS. 22 AND 39). SN 76-481,999. PUB. 8-10-2004. FILED 1-13-2003.  
 2,898,701. **MISCELLANEOUS DESIGN**. GUEVARA, MICHAEL, AND LADINES, ENRIQUE, AND GERGES, SABRI, (U.S. CLS. 22 AND 39). SN 76-484,317. PUB. 8-10-2004. FILED 1-23-2003.  
 2,898,793. **LA PETITE ROTHSCHILD**. S. ROTHSCHILD & CO., INC., (U.S. CLS. 22 AND 39). SN 76-509,334. PUB. 1-6-2004. FILED 4-25-2003.  
 2,898,794. **ROTHSCHILD SPORT**. S. ROTHSCHILD & CO., INC., (U.S. CLS. 22 AND 39). SN 76-509,336. PUB. 1-6-2004. FILED 4-25-2003.  
 2,898,795. **CLASSICS BY S. ROTHSCHILD**. S. ROTHSCHILD & CO., INC., (U.S. CLS. 22 AND 39). SN 76-509,477. PUB. 12-23-2003. FILED 4-25-2003.  
 2,898,798 ( *See Class 12 for this trademark*).  
 2,898,807. **MISCELLANEOUS DESIGN**. SOMETHING FOR NOTHING, INC., (U.S. CLS. 22 AND 39). SN 76-511,114. PUB. 8-10-2004. FILED 5-2-2003.  
 2,898,841 ( *See Class 20 for this trademark*).  
 2,898,857. **SQUARE ONE**. LITTLE DEVIL, INC., (U.S. CLS. 22 AND 39). SN 76-515,568. PUB. 2-17-2004. FILED 5-19-2003.  
 2,898,862. **LE PETIT ROTHSCHILD**. S. ROTHSCHILD & CO., INC., (U.S. CLS. 22 AND 39). SN 76-516,133. PUB. 1-6-2004. FILED 4-25-2003.  
 2,898,892. **SOMO**. CASCADIA FASHIONS RESOURCES INC., (U.S. CLS. 22 AND 39). SN 76-519,079. PUB. 8-10-2004. FILED 5-16-2003.  
 2,898,894 ( *See Class 18 for this trademark*).  
 2,898,896. **P IL PERUGINO AND DESIGN**. CIDIESTE S.R.L., (U.S. CLS. 22 AND 39). SN 76-519,258. PUB. 8-10-2004. FILED 5-21-2003.  
 2,898,925. **PERSONALITY**. THE GEMLO GROUP, INC., DBA STAR SUPPLY, (U.S. CLS. 22 AND 39). SN 76-522,420. PUB. 8-10-2004. FILED 6-16-2003.  
 2,898,932. **GUMBO KIDS AND DESIGN**. GUMBO KIDS COMPANY, LLC, (U.S. CLS. 22 AND 39). SN 76-523,144. PUB. 2-10-2004. FILED 6-16-2003.  
 2,898,989. **TIE TOWELS AND DESIGN**. MONTOYA, ENRIQUE LUIS, (U.S. CLS. 22 AND 39). SN 76-536,027. PUB. 8-10-2004. FILED 7-28-2003.

- 2,898,994. **ORR 4 HOCKEY AND DESIGN**. THE ORR HOCKEY GROUP, INC., (U.S. CLS. 22 AND 39). SN 76-536,112. PUB. 8-10-2004. FILED 7-30-2003.
- 2,899,030. **STACY CLAIRE BOYD**. BLOOMSTON, STACY BOYD, (U.S. CLS. 22 AND 39). SN 76-542,593. PUB. 8-10-2004. FILED 9-5-2003.
- 2,899,046. **HILFIGER DENIM**. TOMMY HILFIGER LICENSING, INC., (U.S. CLS. 22 AND 39). SN 76-545,300. PUB. 8-10-2004. FILED 9-8-2003.
- 2,899,060. **KAALU RELIQ, INC.**, (U.S. CLS. 22 AND 39). SN 76-546,959. PUB. 8-10-2004. FILED 9-25-2003.
- 2,899,069. **ABARTH**. FIAT AUTO S.P.A., (U.S. CLS. 22 AND 39). SN 76-548,359. PUB. 6-1-2004. FILED 10-1-2003.
- 2,899,078. **MISCELLANEOUS DESIGN**. SWEATER.COM, INC., (U.S. CLS. 22 AND 39). SN 76-549,324. PUB. 8-10-2004. FILED 10-3-2003.
- 2,899,086. **COLOSO (STYLIZED)**. SISTEMAS DE CONSULTA E INVESTIGACION S.A. DE C.V., (U.S. CLS. 22 AND 39). SN 76-550,299. PUB. 8-10-2004. FILED 10-9-2003.
- 2,899,093. **DETECTION IN TIME**. WIDMYER-NATALE, SHAWN, (U.S. CLS. 22 AND 39). SN 76-551,219. PUB. 8-10-2004. FILED 9-22-2003.
- 2,899,127 ( *See Class 18 for this trademark*).
- 2,899,145. **SOFT WALK AND DESIGN**. PHOENIX FOOTWEAR GROUP, INC., (U.S. CLS. 22 AND 39). SN 76-555,287. PUB. 8-10-2004. FILED 10-28-2003.
- 2,899,213. **PC'S PATRICK COX (STYLIZED)**. BARTLEHIEM N.V., (U.S. CLS. 22 AND 39). SN 76-558,599. PUB. 8-10-2004. FILED 10-28-2003.
- 2,899,228. **VC (STYLIZED)**. VASSAR COLLEGE, MULTIPLE CLASS, (INT. CLS. 25 AND 41), (U.S. CLS. 22, 39, 100, 101 AND 107). SN 76-559,287. PUB. 8-10-2004. FILED 11-12-2003.
- 2,899,231. **RUBII AND DESIGN**. FAR TAR, INC., (U.S. CLS. 22 AND 39). SN 76-559,388. PUB. 8-10-2004. FILED 11-13-2003.
- 2,899,248. **ANABIL USA AND DESIGN**. ANABIL USA INC., (U.S. CLS. 22 AND 39). SN 76-561,101. PUB. 8-10-2004. FILED 11-3-2003.
- 2,899,249. **MISCELLANEOUS DESIGN**. THE TJX COMPANIES, INC., (U.S. CLS. 22 AND 39). SN 76-561,253. PUB. 8-10-2004. FILED 11-24-2003.
- 2,899,250. **GEL-MESA TRAIL (STYLIZED)**. ASICS CORPORATION, (U.S. CLS. 22 AND 39). SN 76-561,306. PUB. 8-10-2004. FILED 11-12-2003.
- 2,899,271 ( *See Class 14 for this trademark*).
- 2,899,284 ( *See Class 9 for this trademark*).
- 2,899,293. **AMERICAN FEVER**. CHANTRE DANIEL, (U.S. CLS. 22 AND 39). SN 78-102,439. PUB. 1-27-2004. FILED 1-14-2002.
- 2,899,308. **COSMIC CUTIES AND DESIGN**. HENRY, DAVIS, (U.S. CLS. 22 AND 39). SN 78-127,033. PUB. 8-10-2004. FILED 5-8-2002.
- 2,899,314 ( *See Class 18 for this trademark*).
- 2,899,327. **STRETCH STRIPE SKAMP**. SARA LEE CORPORATION, (U.S. CLS. 22 AND 39). SN 78-147,494. PUB. 8-10-2004. FILED 7-25-2002.
- 2,899,338 ( *See Class 18 for this trademark*).
- 2,899,340. **LITTLEPAW AND DESIGN**. CHOU, SHUN YUNG GENO, MULTIPLE CLASS, (INT. CLS. 25 AND 28), (U.S. CLS. 22, 23, 38, 39 AND 50). SN 78-154,835. PUB. 8-12-2003. FILED 8-16-2002.
- 2,899,365. **BOD AND DESIGN**. BOD, (U.S. CLS. 22 AND 39). SN 78-173,326. PUB. 9-2-2003. FILED 10-10-2002.
- 2,899,368 ( *See Class 18 for this trademark*).
- 2,899,370. **THE BIG ORANGE ARMY (STYLIZED)**. BIG ORANGE ARMY, THE, (U.S. CLS. 22 AND 39). SN 78-175,738. PUB. 1-13-2004. FILED 10-17-2002.
- 2,899,376. **GIRLS LINGERIE AND DESIGN**. DUTEXDOR-BPA, (U.S. CLS. 22 AND 39). SN 78-179,767. PUB. 1-27-2004. FILED 10-29-2002.
- 2,899,378. **K AND DESIGN**. BUNZL DISTRIBUTION USA, INC., (U.S. CLS. 22 AND 39). SN 78-180,230. PUB. 9-9-2003. FILED 10-30-2002.
- 2,899,386 ( *See Class 14 for this trademark*).
- 2,899,400. **CHALKTALK**. KIDVEST, INC., MULTIPLE CLASS, (INT. CLS. 25 AND 28), (U.S. CLS. 22, 23, 38, 39 AND 50). SN 78-195,140. PUB. 8-10-2004. FILED 12-17-2002.
- 2,899,418. **DIVONNA (STYLIZED)**. YOO, HO SEONG, (U.S. CLS. 22 AND 39). SN 78-201,743. PUB. 8-10-2004. FILED 1-9-2003.
- 2,899,427. **LOCAL 83 LISTENERS' UNION ESTABLISHED 2002 ALL AROUND THE WORLD WWW.LOCAL-83.COM AND DESIGN**. PORTABLE JOHN, INC., (U.S. CLS. 22 AND 39). SN 78-209,254. PUB. 8-10-2004. FILED 1-30-2003.
- 2,899,441. **J&ELISABETH FOR ANALPA (STYLIZED)**. ANALPA INC., (U.S. CLS. 22 AND 39). SN 78-217,547. PUB. 8-10-2004. FILED 2-21-2003.
- 2,899,446. **SWEET SUE**. GAGWEAR, INC., (U.S. CLS. 22 AND 39). SN 78-220,988. PUB. 10-28-2003. FILED 3-3-2003.
- 2,899,453. **TITAN GAMES**. UNITED STATES OLYMPIC COMMITTEE, (U.S. CLS. 22 AND 39). SN 78-224,226. PUB. 11-4-2003. FILED 3-11-2003.
- 2,899,489. **RED TAPE**. JAWORSKI, JEFFREY E., AND WUSSOW, JASON, (U.S. CLS. 22 AND 39). SN 78-236,585. PUB. 12-9-2003. FILED 4-11-2003.
- 2,899,536. **P PUGILIST FIGHTING IN THE STRUGGLE OF LIFE AND DESIGN**. TYYO, INC., (U.S. CLS. 22 AND 39). SN 78-244,849. PUB. 8-10-2004. FILED 5-2-2003.
- 2,899,555. **HOULIHAN'S**. HOULIHAN'S RESTAURANTS, INC., (U.S. CLS. 22 AND 39). SN 78-247,996. PUB. 8-10-2004. FILED 5-9-2003.
- 2,899,566 ( *See Class 20 for this trademark*).
- 2,899,582. **WORLDTRIBE**. WORLDTRIBE PRODUCTIONS PTY LTD, (U.S. CLS. 22 AND 39). SN 78-251,493. PUB. 8-10-2004. FILED 5-19-2003.
- 2,899,597. **SACKATOGA STABLE**. FUNNY CIDE VENTURES LLC, (U.S. CLS. 22 AND 39). SN 78-253,556. PUB. 8-10-2004. FILED 5-23-2003.
- 2,899,617 ( *See Class 16 for this trademark*).
- 2,899,648. **I.N.C. INTERNATIONAL CONCEPTS WOMAN**. FEDERATED BRANDS, INC., (U.S. CLS. 22 AND 39). SN 78-261,651. PUB. 8-10-2004. FILED 6-12-2003.
- 2,899,656. **WARNER'S WITHOUT A STITCH**. WARNACO U.S., INC., (U.S. CLS. 22 AND 39). SN 78-262,689. PUB. 8-10-2004. FILED 6-16-2003.
- 2,899,657. **MISCELLANEOUS DESIGN**. MARCO POLO EXPLORERS, INC., (U.S. CLS. 22 AND 39). SN 78-262,870. PUB. 8-10-2004. FILED 6-16-2003.
- 2,899,662. **MONEY AND DESIGN**. MONEY CLOTHING LIMITED, (U.S. CLS. 22 AND 39). SN 78-263,782. PUB. 8-10-2004. FILED 6-18-2003.
- 2,899,674. **BVD AND DESIGN**. THE B.V.D. LICENSING CORPORATION, (U.S. CLS. 22 AND 39). SN 78-267,085. PUB. 8-10-2004. FILED 6-25-2003.
- 2,899,706 ( *See Class 20 for this trademark*).
- 2,899,708. **HELE AND DESIGN**. MURRAY, MICHAEL, (U.S. CLS. 22 AND 39). SN 78-277,706. PUB. 8-10-2004. FILED 7-23-2003.
- 2,899,753. **TUTTI CUTI AND DESIGN**. SANTORO, LUCIO AND SANTORO, MEERA PARTNERSHIP, THE, (U.S. CLS. 22 AND 39). SN 78-294,653. PUB. 8-10-2004. FILED 9-2-2003.
- 2,899,770. **M AND DESIGN**. MONTGOMERY PROFESSIONAL BASEBALL CLUB, LLC, (U.S. CLS. 22 AND 39). SN 78-298,088. PUB. 8-10-2004. FILED 9-9-2003.
- 2,899,771 ( *See Class 12 for this trademark*).
- 2,899,774. **CREATIVE KNITWEAR N E S W AND DESIGN**. MARKS, NEAL, (U.S. CLS. 22 AND 39). SN 78-298,735. PUB. 8-10-2004. FILED 9-10-2003.
- 2,899,798. **JINSIYI AND DESIGN**. SUN, YIGUO, (U.S. CLS. 22 AND 39). SN 78-306,429. PUB. 8-10-2004. FILED 9-28-2003.
- 2,899,807. **EG (STYLIZED)**. NIAD INDUSTRIES, LLC, DBA ERVINGEOFFREY, (U.S. CLS. 22 AND 39). SN 78-307,945. PUB. 8-10-2004. FILED 10-1-2003.
- 2,899,811. **GLAMOUR CLOSET AND DESIGN**. GLAMOUR CLOSET, LLC, (U.S. CLS. 22 AND 39). SN 78-308,470. PUB. 8-10-2004. FILED 10-2-2003.
- 2,899,832. **BODY STEP AND DESIGN**. THE STEP COMPANY, (U.S. CLS. 22 AND 39). SN 78-312,960. PUB. 8-10-2004. FILED 10-13-2003.
- 2,899,834. **BODY FLOW AND DESIGN**. THE STEP COMPANY, (U.S. CLS. 22 AND 39). SN 78-312,983. PUB. 8-10-2004. FILED 10-13-2003.
- 2,899,839. **E Z 2 B M E**. CURRIE, ROGER A., (U.S. CLS. 22 AND 39). SN 78-313,857. PUB. 8-10-2004. FILED 10-15-2003.
- 2,899,920 ( *See Class 16 for this trademark*).
- 2,899,929. **MISCELLANEOUS DESIGN**. PONY INTERNATIONAL, LLC, (U.S. CLS. 22 AND 39). SN 78-323,142.

PUB. 8-10-2004. FILED 11-4-2003.  
 2,899,930. **MISCELLANEOUS DESIGN. PONY INTERNATIONAL, LLC**, (U.S. CLS. 22 AND 39). SN 78-323,146. PUB. 8-10-2004. FILED 11-4-2003.  
 2,899,932. **PHILOSOPHY DANE LEWIS (BLOCK FORM). REPUBLIC CLOTHING CORPORATION**, (U.S. CLS. 22 AND 39). SN 78-323,225. PUB. 8-10-2004. FILED 11-5-2003.  
 2,899,981. **TORTOLA (BLOCK FORM). VIEWPOINT INTERNATIONAL, INC.**, (U.S. CLS. 22 AND 39). SN 78-327,590. PUB. 8-10-2004. FILED 11-13-2003.

---

### CLASS 26—FANCY GOODS

2,898,769. **FLASHING FLIRT. EXCEPTIONAL PRODUCTS, INC.**, (U.S. CLS. 37, 39, 40, 42 AND 50). SN 76-505,432. PUB. 8-10-2004. FILED 4-10-2003.  
 2,898,889. **LINZICLIP. LINSHELL HOLDINGS LIMITED**, (U.S. CLS. 37, 39, 40, 42 AND 50). SN 76-519,038. PUB. 8-10-2004. FILED 5-14-2003.  
 2,899,235. **SINGLE WEFT. BEAUTY ELEMENTS CORP.**, (U.S. CLS. 37, 39, 40, 42 AND 50). SN 76-559,695. PUB. 8-10-2004. FILED 10-31-2003.  
 2,899,358. **KANDI RIBA, S D**, (U.S. CLS. 37, 39, 40, 42 AND 50). SN 78-169,536. PUB. 8-10-2004. FILED 9-30-2002.  
 2,899,386 ( *See Class 14 for this trademark*).  
 2,899,428 ( *See Class 3 for this trademark*).  
 2,899,617 ( *See Class 16 for this trademark*).  
 2,899,724 ( *See Class 14 for this trademark*).  
 2,899,779. **ZURY LIKE HAIR. ROYAL IMEX INC.**, (U.S. CLS. 37, 39, 40, 42 AND 50). SN 78-299,917. PUB. 8-10-2004. FILED 9-12-2003.

---

### CLASS 27—FLOOR COVERINGS

2,898,672 ( *See Class 19 for this trademark*).  
 2,898,686 ( *See Class 3 for this trademark*).  
 2,898,770. **LIFELINES (STYLIZED). MANNINGTON MILLS, INC.**, (U.S. CLS. 19, 20, 37, 42 AND 50). SN 76-505,925. PUB. 8-10-2004. FILED 4-14-2003.  
 2,898,850. **FLOOR SAVERS. CONTINENTAL QUILTING COMPANY, INC.**, (U.S. CLS. 19, 20, 37, 42 AND 50). SN 76-514,521. PUB. 8-10-2004. FILED 5-14-2003.  
 2,899,575. **TOUGH GUY. TOUGH GUY PRODUCTS INC.**, (U.S. CLS. 19, 20, 37, 42 AND 50). SN 78-250,441. PUB. 8-10-2004. FILED 5-15-2003.  
 2,899,576. **MISCELLANEOUS DESIGN. TOUGH GUY PRODUCTS INC.**, (U.S. CLS. 19, 20, 37, 42 AND 50). SN 78-250,443. PUB. 8-10-2004. FILED 5-15-2003.  
 2,899,577. **TOUGH GUY AND DESIGN. TOUGH GUY PRODUCTS INC.**, (U.S. CLS. 19, 20, 37, 42 AND 50). SN 78-250,446. PUB. 8-10-2004. FILED 5-15-2003.

---

### CLASS 28—TOYS AND SPORTING GOODS

2,898,436. **BENGAL BITE. DEMARTINO, JEFFREY R.**, (U.S. CLS. 22, 23, 38 AND 50). SN 75-598,798. PUB. 1-4-2000. FILED 12-3-1998.  
 2,898,446 ( *See Class 14 for this trademark*).  
 2,898,459. **MEGATOYS. P.C. WOO, INC., DBA MEGATOYS**, (U.S. CLS. 22, 23, 38 AND 50). SN 75-911,751. PUB. 6-5-2001. FILED 2-8-2000.  
 2,898,462. **M (STYLIZED). MARS, INCORPORATED**, (U.S. CLS. 22, 23, 38 AND 50). SN 75-921,165. PUB. 10-24-2000. FILED 2-16-2000.  
 2,898,488. **THE PLAYERS' CHOICE. INTERNATIONAL GAMCO, INC.**, (U.S. CLS. 22, 23, 38 AND 50). SN 76-099,286. PUB. 8-10-2004. FILED 7-31-2000.  
 2,898,571 ( *See Class 9 for this trademark*).  
 2,898,579 ( *See Class 9 for this trademark*).  
 2,898,686 ( *See Class 3 for this trademark*).  
 2,898,741. **COBRA AND DESIGN. HASBRO, INC.**, (U.S. CLS.

22, 23, 38 AND 50). SN 76-499,085. PUB. 11-18-2003. FILED 3-20-2003.  
 2,898,742. **THERM-O-CARESS. B.B. TRESOR INC.**, (U.S. CLS. 22, 23, 38 AND 50). SN 76-499,171. PUB. 8-10-2004. FILED 3-20-2003.  
 2,898,745. **KEVFLEX. FISHER, DALE P.**, (U.S. CLS. 22, 23, 38 AND 50). SN 76-499,837. PUB. 11-4-2003. FILED 3-24-2003.  
 2,898,751. **PIT VIPER. DIAMOND TOUR GOLF WHOLESALE SALERS, INC.**, (U.S. CLS. 22, 23, 38 AND 50). SN 76-500,817. PUB. 1-27-2004. FILED 3-3-2003.  
 2,898,837. **ARCEE. HASBRO, INC.**, (U.S. CLS. 22, 23, 38 AND 50). SN 76-513,744. PUB. 8-10-2004. FILED 5-13-2003.  
 2,898,841 ( *See Class 20 for this trademark*).  
 2,898,894 ( *See Class 18 for this trademark*).  
 2,898,897. **FUNNEL BALL AND DESIGN. BCI BURKE COMPANY, LLC**, (U.S. CLS. 22, 23, 38 AND 50). SN 76-519,281. PUB. 1-13-2004. FILED 5-30-2003.  
 2,898,902 ( *See Class 18 for this trademark*).  
 2,899,091. **SURE GLOW (STYLIZED). DANIEL M. SEGEL**, (U.S. CLS. 22, 23, 38 AND 50). SN 76-550,979. PUB. 8-10-2004. FILED 9-22-2003.  
 2,899,161. **FLASH-BOT (BLOCK FORM). HASBRO, INC.**, (U.S. CLS. 22, 23, 38 AND 50). SN 76-556,434. PUB. 8-10-2004. FILED 11-4-2003.  
 2,899,220. **COBRA B.A.T. (STYLIZED). HASBRO, INC.**, (U.S. CLS. 22, 23, 38 AND 50). SN 76-558,996. PUB. 8-10-2004. FILED 11-12-2003.  
 2,899,221. **CROSS HAIR (STYLIZED). HASBRO, INC.**, (U.S. CLS. 22, 23, 38 AND 50). SN 76-558,997. PUB. 8-10-2004. FILED 11-12-2003.  
 2,899,222. **WILD BILL (STYLIZED). HASBRO, INC.**, (U.S. CLS. 22, 23, 38 AND 50). SN 76-558,998. PUB. 8-10-2004. FILED 11-12-2003.  
 2,899,223. **DR. MINDBENDER (STYLIZED). HASBRO, INC.**, (U.S. CLS. 22, 23, 38 AND 50). SN 76-558,999. PUB. 8-10-2004. FILED 11-12-2003.  
 2,899,244. **SUNSHINE BUDDIES (BLOCK FORM). TOMY CORPORATION**, (U.S. CLS. 22, 23, 38 AND 50). SN 76-560,612. PUB. 8-10-2004. FILED 11-17-2003.  
 2,899,291. **RACK 'N' ROLL BOWL. POOF-SLINKY, INC.**, (U.S. CLS. 22, 23, 38 AND 50). SN 78-096,035. PUB. 8-10-2004. FILED 11-30-2001.  
 2,899,340 ( *See Class 25 for this trademark*).  
 2,899,384. **DIRTBAG. FITZGERALD, GRAY & ROSS, INC., DBA FLYING CLIPPER ALTERNATIVE SPORTS**, (U.S. CLS. 22, 23, 38 AND 50). SN 78-183,337. PUB. 8-10-2004. FILED 11-8-2002.  
 2,899,397. **KWIKBALL. SPORTWALL INTERNATIONAL, INC.**, (U.S. CLS. 22, 23, 38 AND 50). SN 78-193,555. PUB. 8-10-2004. FILED 12-11-2002.  
 2,899,400 ( *See Class 25 for this trademark*).  
 2,899,429. **FLUX (STYLIZED). LOONEY, ANDREW**, (U.S. CLS. 22, 23, 38 AND 50). SN 78-210,456. PUB. 8-10-2004. FILED 2-4-2003.  
 2,899,431. **ALIVAN'S MASTER WANDMAKERS AND DESIGN. WEDZIK, DAVID**, (U.S. CLS. 22, 23, 38 AND 50). SN 78-212,208. PUB. 8-10-2004. FILED 2-7-2003.  
 2,899,494. **.625 MAGNUM. COLD STEEL, INC.**, (U.S. CLS. 22, 23, 38 AND 50). SN 78-237,780. PUB. 2-10-2004. FILED 4-15-2003.  
 2,899,509 ( *See Class 16 for this trademark*).  
 2,899,557. **PUSH. CARLSON, ERIC, ROBERT**, (U.S. CLS. 22, 23, 38 AND 50). SN 78-248,464. PUB. 8-10-2004. FILED 5-12-2003.  
 2,899,573. **MOMENTIZED. SWING SYNC USA, INC., MULTIPLE CLASS, (INT. CLS. 28, 37 AND 40), (U.S. CLS. 22, 23, 38, 50, 100, 103 AND 106)**. SN 78-250,292. PUB. 5-25-2004. FILED 5-15-2003.  
 2,899,626. **MECOA. MODEL ENGINE CORPORATION OF AMERICA**, (U.S. CLS. 22, 23, 38 AND 50). SN 78-258,520. PUB. 8-10-2004. FILED 6-5-2003.  
 2,899,627 ( *See Class 5 for this trademark*).  
 2,899,714. **EDUCARDS. YEARWOOD, RICHARD**, (U.S. CLS. 22, 23, 38 AND 50). SN 78-279,993. PUB. 2-17-2004. FILED 7-29-2003.  
 2,899,730. **CYCRAFT (BLOCK FORM). SIMULINE, INC.**, (U.S. CLS. 22, 23, 38 AND 50). SN 78-286,574. PUB. 8-10-2004. FILED 8-13-2003.

- 2,899,868. **LUCKY SEVEN**. SAMUEL, MARTIN HOWARD, (U.S. CLS. 22, 23, 38 AND 50). SN 78-316,757. PUB. 8-10-2004. FILED 10-21-2003.
- 2,899,870. **REBELLION R (STYLIZED)**. REBELLION SPORT AB. (U.S. CLS. 22, 23, 38 AND 50). SN 78-317,185. PUB. 8-10-2004. FILED 10-22-2003.
- 2,899,921. **MEGA HERO (BLOCK FORM)**. P. C. WOO, INC., DBA MEGATOYS, (U.S. CLS. 22, 23, 38 AND 50). SN 78-322,425. PUB. 8-10-2004. FILED 11-3-2003.
- 2,899,933. **SPOOKS (BLOCK FORM)**. HOOTIE ENTERPRISES, LLC, (U.S. CLS. 22, 23, 38 AND 50). SN 78-323,684. PUB. 8-10-2004. FILED 11-5-2003.
- 2,899,934. **ARSENAL (BLOCK FORM)**. AUSTAD'S GOLF, INC., (U.S. CLS. 22, 23, 38 AND 50). SN 78-323,798. PUB. 8-10-2004. FILED 11-6-2003.
- 2,899,935. **READING RAILROAD (BLOCK FORM)**. RUOCCHIO, ALBERT C., (U.S. CLS. 22, 23, 38 AND 50). SN 78-323,837. PUB. 8-10-2004. FILED 11-6-2003.
- 2,899,951. **BOSTON & MAINE RAILROAD (BLOCK FORM)**. RUOCCHIO, ALBERT C., (U.S. CLS. 22, 23, 38 AND 50). SN 78-325,096. PUB. 8-10-2004. FILED 11-7-2003.
- 2,900,020 ( *See Class 9 for this trademark*).
- 2,900,021 ( *See Class 9 for this trademark*).

---

#### CLASS 29—MEATS AND PROCESSED FOODS

- 2,898,484. **BOCA**. BOCA FOODS COMPANY, (U.S. CL. 46). SN 76-085,874. PUB. 6-12-2001. FILED 7-10-2000.
- 2,898,507. **THE ORIGINAL OKAMI AND DESIGN**. OKAMI INC., MULTIPLE CLASS, (INT. CLS. 29 AND 30), (U.S. CL. 46). SN 76-190,830. PUB. 8-10-2004. FILED 1-3-2001.
- 2,898,550. **W WOKIE DOKIE AND DESIGN**. DAN ISACSSON AB, MULTIPLE CLASS, (INT. CLS. 29, 30 AND 42), (U.S. CLS. 46, 100 AND 101). SN 76-320,835. PUB. 8-10-2004. FILED 9-26-2001.
- 2,898,591. **J\*ONE\*1 S RANCH AND DESIGN**. J-ONE-S RANCH, INC., (U.S. CL. 46). SN 76-405,648. PUB. 2-17-2004. FILED 5-10-2002.
- 2,898,605. **MAD SNAX**. MAD MEALS, LLC, (U.S. CL. 46). SN 76-419,365. PUB. 12-23-2003. FILED 6-10-2002.
- 2,898,607. **VOIELLO TORRE ANNUNZIATA-NAPOLI AND DESIGN**. BARILLA G. E R. FRATELLI - SOCIETA PER AZIONI, MULTIPLE CLASS, (INT. CLS. 29 AND 30), (U.S. CL. 46). SN 76-422,424. PUB. 7-15-2003. FILED 6-19-2002.
- 2,898,622. **LOGAN FARMS**. LOGAN FARMS, INC., MULTIPLE CLASS, (INT. CLS. 29, 35 AND 43), (U.S. CLS. 46, 100, 101 AND 102). SN 76-436,935. PUB. 8-10-2004. FILED 8-1-2002.
- 2,898,642. **NATURAL BRIDGE SEAFOOD CO LTD AND DESIGN**. NATURAL BRIDGE SEAFOOD COMPANY LTD., (U.S. CL. 46). SN 76-453,357. PUB. 8-10-2004. FILED 9-27-2002.
- 2,898,830. **SOUTHEAST SHELLFISH (STYLIZED)**. SOUTHEAST SHELLFISH, INC., (U.S. CL. 46). SN 76-512,949. PUB. 8-10-2004. FILED 5-9-2003.
- 2,898,853. **MIDLAND ORCHARD**. MIDLAND FARMS, INC., (U.S. CL. 46). SN 76-514,863. PUB. 8-10-2004. FILED 5-16-2003.
- 2,898,864. **MISCELLANEOUS DESIGN**. OBERWEIS DAIRY, INC., (U.S. CL. 46). SN 76-516,331. PUB. 2-17-2004. FILED 5-22-2003.
- 2,898,865. **MISCELLANEOUS DESIGN**. OBERWEIS DAIRY, INC., (U.S. CL. 46). SN 76-516,334. PUB. 2-17-2004. FILED 5-22-2003.
- 2,898,867. **MISCELLANEOUS DESIGN**. OBERWEIS DAIRY, INC., (U.S. CL. 46). SN 76-516,472. PUB. 2-17-2004. FILED 5-22-2003.
- 2,898,878. **DELICIOUS WM AND DESIGN**. EASTREND ENTERPRISES INC., (U.S. CL. 46). SN 76-518,367. PUB. 8-10-2004. FILED 5-12-2003.
- 2,898,956. **VENECRAB (BLOCK FORM)**. CARIBBEAN IMPORTS, INC., (U.S. CL. 46). SN 76-529,989. PUB. 8-10-2004. FILED 7-14-2003.
- 2,899,024. **CHILI CHEDDAR**. SONOMA FOODS, INC., (U.S. CL. 46). SN 76-542,206. PUB. 8-10-2004. FILED 9-2-2003.
- 2,899,052. **VENTISQUEROS**. PRODUCTOS DEL MAR VEN-
- TISQUEROS S.A., (U.S. CL. 46). SN 76-546,276. PUB. 8-10-2004. FILED 9-23-2003.
- 2,899,311. **SK GOURMET (STYLIZED)**. SOPHISTICATED KITCHENS, INC., DBA SK GOURMET, INC., MULTIPLE CLASS, (INT. CLS. 29 AND 30), (U.S. CL. 46). SN 78-133,565. PUB. 6-3-2003. FILED 6-6-2002.
- 2,899,328. **KETTLE FRIED AND DESIGN**. WILLOW BROOK FOODS, INC., (U.S. CL. 46). SN 78-149,411. PUB. 9-23-2003. FILED 7-31-2002.
- 2,899,449. **GREAT FOOD, GREAT FUN!**. PLAYFUL PALATE, L.L.C., (U.S. CL. 46). SN 78-222,966. PUB. 11-18-2003. FILED 3-7-2003.
- 2,899,535. **FRUITS 'N MORE**. WAYMOUTH FARMS, INC., (U.S. CL. 46). SN 78-244,541. PUB. 8-10-2004. FILED 5-1-2003.
- 2,899,544. **VERKA DAHI**. QUALITY PRODUCTS, INC., (U.S. CL. 46). SN 78-246,533. PUB. 8-10-2004. FILED 5-7-2003.
- 2,899,565. **BUBBA BURGER BACON**. THE BUBBA BACON COMPANY, LLC, (U.S. CL. 46). SN 78-249,683. PUB. 8-10-2004. FILED 5-14-2003.
- 2,899,624. **ENCHANTED FOODS AND DESIGN**. ENCHANTED FOODS, INC., (U.S. CL. 46). SN 78-258,380. PUB. 2-17-2004. FILED 6-4-2003.
- 2,899,684. **MCP AND DESIGN**. MEXICAN CHEESE PRODUCERS, INC., MULTIPLE CLASS, (INT. CLS. 29 AND 30), (U.S. CL. 46). SN 78-269,681. PUB. 2-17-2004. FILED 7-2-2003.
- 2,899,702. **ODYSSEY SLIM ADVANTAGE**. PREMIER NUTRITION, INC., (U.S. CL. 46). SN 78-274,651. PUB. 8-10-2004. FILED 7-15-2003.
- 2,899,796. **A TASTE OF INDONESIA**. ATOI-USA, LLC, MULTIPLE CLASS, (INT. CLS. 29 AND 30), (U.S. CL. 46). SN 78-306,325. PUB. 8-10-2004. FILED 9-26-2003.
- 2,899,797. **A TASTE OF INDONESIA AND DESIGN**. ATOI-USA, LLC, MULTIPLE CLASS, (INT. CLS. 29 AND 30), (U.S. CL. 46). SN 78-306,330. PUB. 8-10-2004. FILED 9-26-2003.
- 2,899,830. **LO CARB-U**. MAY, JASON, AND MAY, ROSEMARY, (U.S. CL. 46). SN 78-312,482. PUB. 8-10-2004. FILED 10-11-2003.
- 2,899,967. **CONFIDANT AND DESIGN**. ROCHESTER MEAT COMPANY, (U.S. CL. 46). SN 78-326,015. PUB. 8-10-2004. FILED 11-11-2003.

---

#### CLASS 30—STAPLE FOODS

- 2,898,443 ( *See Class 11 for this trademark*).
- 2,898,475. **ACE BANDITO AND DESIGN**. HAVANA'S LIMITED, INC., (U.S. CL. 46). SN 76-032,227. PUB. 8-10-2004. FILED 4-24-2000.
- 2,898,507 ( *See Class 29 for this trademark*).
- 2,898,514. **LIFE IS TOO SHORT TO BE BITTER**. RYAN BROS. COFFEE, INC., (U.S. CL. 46). SN 76-216,469. PUB. 8-21-2001. FILED 2-23-2001.
- 2,898,550 ( *See Class 29 for this trademark*).
- 2,898,571 ( *See Class 9 for this trademark*).
- 2,898,576 ( *See Class 5 for this trademark*).
- 2,898,607 ( *See Class 29 for this trademark*).
- 2,898,609. **KICK'RS (STYLIZED)**. PROMARK INTERNATIONAL, INC., (U.S. CL. 46). SN 76-426,756. PUB. 1-7-2003. FILED 7-1-2002.
- 2,898,676. **DOS MARIAS, FINCA DOS MARIAS**. DOS MARIAS, (U.S. CL. 46). SN 76-468,794. PUB. 8-10-2004. FILED 11-7-2002.
- 2,898,923. **CHEEZ-TEEZ**. THE TEE-ZEL COMPANY, INC., (U.S. CL. 46). SN 76-522,348. PUB. 3-2-2004. FILED 6-5-2003.
- 2,898,929. **THIN-N-THIK**. A.E. STALEY MANUFACTURING COMPANY, (U.S. CL. 46). SN 76-522,835. PUB. 8-10-2004. FILED 6-16-2003.
- 2,898,933. **RUMMO IL MUGNAIO DI VIA DEI MULINI AND DESIGN**. RUMMO S.P.A., (U.S. CL. 46). SN 76-523,227. PUB. 8-10-2004. FILED 6-11-2003.
- 2,898,954. **GUMMI BREAKFAST**. MEDERER GMBH, (U.S. CL. 46). SN 76-529,958. PUB. 8-10-2004. FILED 7-15-2003.
- 2,898,955. **GUMMI DINNER**. MEDERER GMBH, (U.S. CL. 46). SN 76-529,959. PUB. 8-10-2004. FILED 7-15-2003.
- 2,899,042. **HERBA-THIN (BLOCK FORM)**. KHAZAN ENTERPRISE INC., (U.S. CL. 46). SN 76-544,572. PUB. 8-10-2004.

FILED 9-12-2003.  
 2,899,121. **CAROLINA COOKIE COMPANY**. CONFECTION CONCEPTS, INC., DBA CAROLINA COOKIE COMPANY, (U.S. CL. 46). SN 76-553,412. PUB. 8-10-2004. FILED 10-22-2003.  
 2,899,136 ( *See Class 21 for this trademark*).  
 2,899,174. **OIGATSUO (BLOCK FORM)**. KABUSHIKI KAISHA MITSUKAN GROUP HONSHA, TA MITSUKAN GROUP CORPORATION, (U.S. CL. 46). SN 76-556,951. PUB. 8-10-2004. FILED 11-5-2003.  
 2,899,195. **PRESCO FOOD SEASONINGS**. PRESCO FOOD SEASONINGS, INC., MULTIPLE CLASS, (INT. CLS. 30 AND 40), (U.S. CLS. 46, 100, 103 AND 106). SN 76-557,842. PUB. 8-10-2004. FILED 10-22-2003.  
 2,899,215. **SNOWMONSTER (STYLIZED)**. ANDY'S FROZEN CUSTARD, INC., (U.S. CL. 46). SN 76-558,626. PUB. 8-10-2004. FILED 11-10-2003.  
 2,899,216. **PASQUINI (STYLIZED)**. PASQUINI IMPORTS, INC., DBA PASQUINI ESPRESSO CO., (U.S. CL. 46). SN 76-558,637. PUB. 8-10-2004. FILED 11-10-2003.  
 2,899,217 ( *See Class 3 for this trademark*).  
 2,899,270. **BIG M AND DESIGN**. MERCHANTS COMPANY, THE, MULTIPLE CLASS, (INT. CLS. 30 AND 39), (U.S. CLS. 46, 100 AND 105). SN 76-975,566. PUB. 1-13-2004. FILED 1-12-2001.  
 2,899,311 ( *See Class 29 for this trademark*).  
 2,899,320. **MISCELLANEOUS DESIGN**. KENCRAFT, INC., (U.S. CL. 46). SN 78-138,692. PUB. 8-10-2004. FILED 6-25-2002.  
 2,899,321. **MISCELLANEOUS DESIGN**. KENCRAFT, INC., (U.S. CL. 46). SN 78-138,706. PUB. 8-10-2004. FILED 6-25-2002.  
 2,899,462. **ORBIT JUST BRUSHED CLEAN FEELING AND DESIGN**. WM. WRIGLEY JR. COMPANY, (U.S. CL. 46). SN 78-228,067. PUB. 11-11-2003. FILED 3-20-2003.  
 2,899,490. **KELLOGG'S RAISIN BRAN**. KELLOGG COMPANY, (U.S. CL. 46). SN 78-236,590. PUB. 1-13-2004. FILED 4-11-2003.  
 2,899,503. **MADE FOR CHILDREN LOVED BY CHILDREN**. AUGUST STORCK KG, (U.S. CL. 46). SN 78-239,395. PUB. 8-10-2004. FILED 4-18-2003.  
 2,899,510 ( *See Class 21 for this trademark*).  
 2,899,523. **ADAMS**. CADBURY ADAMS USA LLC, (U.S. CL. 46). SN 78-241,818. PUB. 8-10-2004. FILED 4-24-2003.  
 2,899,540. **SOUTHERN SEASONINGS LOUISIANE AND DESIGN**. SOUTHERN SEASONINGS, INC., (U.S. CL. 46). SN 78-245,818. PUB. 8-10-2004. FILED 5-5-2003.  
 2,899,559. **NUTTY MUNKEY**. NUTTY MUNKEY, INC., (U.S. CL. 46). SN 78-249,033. PUB. 3-30-2004. FILED 5-13-2003.  
 2,899,572. **CAFFINO**. CAFFINO, INC., (U.S. CL. 46). SN 78-250,210. PUB. 8-10-2004. FILED 5-15-2003.  
 2,899,587 ( *See Class 7 for this trademark*).  
 2,899,640. **MARITIME MORNING BLEND**. SEATTLE'S BEST COFFEE, LLC, (U.S. CL. 46). SN 78-260,553. PUB. 8-10-2004. FILED 6-10-2003.  
 2,899,684 ( *See Class 29 for this trademark*).  
 2,899,709. **JAVA COOKIES COFFARO'S BAKING CO AND DESIGN**. COFFARO'S ITALIA, INC., (U.S. CL. 46). SN 78-278,656. PUB. 8-10-2004. FILED 7-24-2003.  
 2,899,739. **DIXIE CRYSTALS AND DESIGN**. RAGUS HOLDINGS, INC., (U.S. CL. 46). SN 78-290,503. PUB. 8-10-2004. FILED 8-21-2003.  
 2,899,745. **CLIP GUMMI STARS**. AMERICAN MULTI-CINEMA, INC., (U.S. CL. 46). SN 78-292,211. PUB. 8-10-2004. FILED 8-26-2003.  
 2,899,767. **IMPERIAL SUGAR AND DESIGN**. RAGUS HOLDINGS, INC., (U.S. CL. 46). SN 78-297,890. PUB. 8-10-2004. FILED 9-9-2003.  
 2,899,796 ( *See Class 29 for this trademark*).  
 2,899,797 ( *See Class 29 for this trademark*).  
 2,899,805. **OFFICE CAFE AND DESIGN**. SNOW VALLEY, INC., MULTIPLE CLASS, (INT. CLS. 30, 39 AND 43), (U.S. CLS. 46, 100, 101 AND 105). SN 78-307,589. PUB. 8-10-2004. FILED 9-30-2003.  
 2,899,862. **THE SPICY VIKING**. THE SPICY VIKING, LLC, (U.S. CL. 46). SN 78-316,120. PUB. 8-10-2004. FILED 10-20-2003.  
 2,899,941. **HUNTER MIX (BLOCK FORM)**. SQUIRREL

BRAND HOLDINGS, L.P., (U.S. CL. 46). SN 78-324,281. PUB. 8-10-2004. FILED 11-6-2003.

---

## CLASS 31—NATURAL AGRICULTURAL PRODUCTS

2,898,756 ( *See Class 1 for this trademark*).  
 2,899,045. **HEALTHY BAKER ALL NATURAL DOG BISCUITS AND DESIGN**. PETEDGE, INC., (U.S. CLS. 1 AND 46). SN 76-545,215. PUB. 8-10-2004. FILED 9-5-2003.  
 2,899,068. **MISCELLANEOUS DESIGN**. RICHARD BAGDASARIAN, INC., (U.S. CLS. 1 AND 46). SN 76-548,176. PUB. 8-10-2004. FILED 9-11-2003.  
 2,899,085. **SECOND NATURE AND DESIGN**. CENTRAL FIBER CORPORATION, (U.S. CLS. 1 AND 46). SN 76-550,165. PUB. 8-10-2004. FILED 10-8-2003.  
 2,899,128. **BARNBURGER**. REDBARN PET PRODUCTS, INC., (U.S. CLS. 1 AND 46). SN 76-554,150. PUB. 8-10-2004. FILED 10-23-2003.  
 2,899,157. **GOLDEN NECK**. AMERICAN MUSSEL HARVESTERS, INC., (U.S. CLS. 1 AND 46). SN 76-556,195. PUB. 8-10-2004. FILED 10-16-2003.  
 2,899,225. **WEED WHOMPIN' (BLOCK FORM)**. ROD MCLELLAN CO., (U.S. CLS. 1 AND 46). SN 76-559,134. PUB. 8-10-2004. FILED 11-10-2003.  
 2,899,438. **SNEAK-A-PILL**. STEP UP CONCEPTS, LLC, (U.S. CLS. 1 AND 46). SN 78-216,302. PUB. 8-10-2004. FILED 2-19-2003.  
 2,899,481 ( *See Class 19 for this trademark*).  
 2,899,608. **ALAND AND DESIGN**. JIANGSU JIANGSHAN PHARMACEUTICAL CO., LTD., (U.S. CLS. 1 AND 46). SN 78-254,284. PUB. 8-10-2004. FILED 5-26-2003.  
 2,899,609. **BLUEDRUM (STYLIZED)**. JIANGSU JIANGSHAN PHARMACEUTICAL CO., LTD., (U.S. CLS. 1 AND 46). SN 78-254,285. PUB. 8-10-2004. FILED 5-26-2003.  
 2,899,819. **CRANBERRY PUNCH**. LACEBARK, INC., (U.S. CLS. 1 AND 46). SN 78-310,845. PUB. 8-10-2004. FILED 10-8-2003.  
 2,899,825. **CHEZ PUPPY**. CHEZ PUPPY, (U.S. CLS. 1 AND 46). SN 78-311,484. PUB. 8-10-2004. FILED 10-9-2003.  
 2,900,004. **CULTIVATING QUALITY (BLOCK FORM)**. MILLS DISTRIBUTING COMPANY, (U.S. CLS. 1 AND 46). SN 78-332,258. PUB. 8-10-2004. FILED 11-24-2003.

---

## CLASS 32—LIGHT BEVERAGES

2,898,416. **OREGON ORIGINAL**. OREGON BEER AND BREWING COMPANY, INC. I, (U.S. CLS. 45, 46 AND 48). SN 74-730,463. PUB. 6-16-1998. FILED 9-18-1995.  
 2,898,434. **KOSTRITZER SCHWARZBIER AND DESIGN**. KOSTRITZER SCHWARZBIERBRAUEREI GMBH & CO, (U.S. CLS. 45, 46 AND 48). SN 75-568,814. PUB. 8-10-2004. FILED 10-13-1998.  
 2,898,576 ( *See Class 5 for this trademark*).  
 2,898,686 ( *See Class 3 for this trademark*).  
 2,898,715. **MISCELLANEOUS DESIGN**. STOURDZA, ALEXANDRE, MULTIPLE CLASS, (INT. CLS. 32 AND 33), (U.S. CLS. 45, 46, 47, 48 AND 49). SN 76-488,364. PUB. 1-27-2004. FILED 2-7-2003.  
 2,899,115. **THE HOLLYWOOD**. DR. TORO'S MIXING COMPANY, INC., (U.S. CLS. 45, 46 AND 48). SN 76-552,917. PUB. 8-10-2004. FILED 10-20-2003.  
 2,899,345. **THE GREETING BOTTLE CO.**. PARTY JUICE, INC., (U.S. CLS. 45, 46 AND 48). SN 78-161,070. PUB. 8-10-2004. FILED 9-5-2002.  
 2,899,542. **DIALLA**. HOLY LAND BRAND INC., (U.S. CLS. 45, 46 AND 48). SN 78-246,232. PUB. 8-10-2004. FILED 5-6-2003.  
 2,899,682. **THE MEXICAN PARTY BEER**. COORS GLOBAL PROPERTIES, INC., (U.S. CLS. 45, 46 AND 48). SN 78-269,438. PUB. 4-6-2004. FILED 7-1-2003.  
 2,899,756. **AQUA MARIA**. MARIENBAD WATERS, A.S., (U.S. CLS. 45, 46 AND 48). SN 78-294,819. PUB. 8-10-2004. FILED 9-2-2003.

- 2,899,854. **CHASER PALE**. TAYLOR, KENT C., (U.S. CLS. 45, 46 AND 48). SN 78-315,412. PUB. 8-10-2004. FILED 10-17-2003.
- 2,899,939. **HENRY WEINHARD'S PRIVATE RESERVE FOUNDED 1856 AND DESIGN**. MILLER PRODUCTS COMPANY, (U.S. CLS. 45, 46 AND 48). SN 78-324,048. PUB. 8-10-2004. FILED 11-6-2003.
- 2,900,009. **MISCELLANEOUS DESIGN**. NEW BELGIUM BREWING COMPANY, INC., (U.S. CLS. 45, 46 AND 48). SN 78-332,498. PUB. 8-10-2004. FILED 11-24-2003.

**CLASS 34—SMOKERS' ARTICLES**

- 2,899,053. **UNITED AMERICAN BLEND AND DESIGN**. N.V. SUMATRA TOBACCO TRADING COMPANY, (U.S. CLS. 2, 8, 9 AND 17). SN 76-546,282. PUB. 8-10-2004. FILED 9-23-2003.
- 2,899,105. **PUSH-LITE**. CENTERFIRE INC., (U.S. CLS. 2, 8, 9 AND 17). SN 76-552,213. PUB. 8-10-2004. FILED 9-29-2003.
- 2,899,318. **SINGLE SWEETS**. FUEGO CUBANO CORPORATION, (U.S. CLS. 2, 8, 9 AND 17). SN 78-136,430. PUB. 12-9-2003. FILED 6-17-2002.
- 2,899,588. **101**. HBI INTERNATIONAL, (U.S. CLS. 2, 8, 9 AND 17). SN 78-252,075. PUB. 8-10-2004. FILED 5-20-2003.

**SERVICE MARKS****CLASS 33—WINES AND SPIRITS**

- 2,898,451. **STOLICHNAYA STOLI VANIL AND DESIGN**. ALLIED DOMEQ INTERNATIONAL HOLDINGS BV, (U.S. CLS. 47 AND 49). SN 75-852,935. PUB. 8-10-2004. FILED 11-19-1999.
- 2,898,463. **MOZART**. H. C. KÖNIG GMBH, (U.S. CLS. 47 AND 49). SN 75-928,401. PUB. 8-10-2004. FILED 2-25-2000.
- 2,898,668. **3 RRR**. COOPERATIVA AGRICOLA CONTROL PISQUERO DE ELQUI Y LIMARI LIMITADA, (U.S. CLS. 47 AND 49). SN 76-465,899. PUB. 8-10-2004. FILED 10-31-2002.
- 2,898,686 ( *See Class 3 for this trademark*).
- 2,898,715 ( *See Class 32 for this trademark*).
- 2,898,783. **MICHU AND DESIGN**. CHANG, JEFF F., (U.S. CLS. 47 AND 49). SN 76-508,238. PUB. 8-10-2004. FILED 4-21-2003.
- 2,898,806. **CHATEAU CANON LA GAFFELIERE**. SOCIETE CIVILE D'EXPLOITATION DES VIGNOBLES COMTES DE NEIPPERG, (U.S. CLS. 47 AND 49). SN 76-510,571. PUB. 8-10-2004. FILED 5-1-2003.
- 2,898,908. **RINGBOLT**. RINGBOLT PTY LTD, (U.S. CLS. 47 AND 49). SN 76-520,045. PUB. 8-10-2004. FILED 6-6-2003.
- 2,898,924. **BASTIANICH**. AZIENDA AGRICOLA BASTIANICH, (U.S. CLS. 47 AND 49). SN 76-522,388. PUB. 8-10-2004. FILED 6-2-2003.
- 2,898,940. **ALIWEN**. VIÑA UNDURRAGA S.A., (U.S. CLS. 47 AND 49). SN 76-525,509. PUB. 8-10-2004. FILED 6-24-2003.
- 2,899,306. **CAPUTO**. WISCON CORP., (U.S. CLS. 47 AND 49). SN 78-126,624. PUB. 1-28-2003. FILED 5-6-2002.
- 2,899,419. **KATHRYN HALL**. KATHRYN HALL VINEYARDS, (U.S. CLS. 47 AND 49). SN 78-201,804. PUB. 8-10-2004. FILED 1-9-2003.
- 2,899,486. **SVS (STYLIZED)**. ROBERT MONDAVI WINERY, (U.S. CLS. 47 AND 49). SN 78-236,411. PUB. 12-16-2003. FILED 4-10-2003.
- 2,899,628. **GHOST OAK**. ROBERT MONDAVI WINERY, (U.S. CLS. 47 AND 49). SN 78-258,707. PUB. 2-24-2004. FILED 6-5-2003.
- 2,899,686. **FINCA RESALSO EMILIO MORO AND DESIGN**. BODEGAS EMILIO MORO, S.L., (U.S. CLS. 47 AND 49). SN 78-270,459. PUB. 8-10-2004. FILED 7-3-2003.
- 2,899,738. **VELIO**. MONTECASTELLI SELECTIONS, LTD., (U.S. CLS. 47 AND 49). SN 78-290,127. PUB. 8-10-2004. FILED 8-21-2003.
- 2,899,747. **GRASOVKA**. UNDERBERG AG, (U.S. CLS. 47 AND 49). SN 78-292,719. PUB. 8-10-2004. FILED 8-27-2003.
- 2,899,852. **SERIENCE**. CORUS ESTATES & VINEYARDS, LLC, (U.S. CLS. 47 AND 49). SN 78-315,327. PUB. 8-10-2004. FILED 10-17-2003.
- 2,899,856. **SIX PRONG**. CORUS ESTATES & VINEYARDS, LLC, (U.S. CLS. 47 AND 49). SN 78-315,460. PUB. 8-10-2004. FILED 10-17-2003.
- 2,899,865. **PRIME MALT**. CLASSIC WINE IMPORTS, INC., (U.S. CLS. 47 AND 49). SN 78-316,471. PUB. 8-10-2004. FILED 10-21-2003.
- 2,899,866. **PRIME MALT SELECTION**. CLASSIC WINE IMPORTS, INC., (U.S. CLS. 47 AND 49). SN 78-316,507. PUB. 8-10-2004. FILED 10-21-2003.

**CLASS 35—ADVERTISING AND BUSINESS**

- 2,898,418. **CARECOMPASS**. HEALTHMAGIC, (U.S. CLS. 100, 101 AND 102). SN 75-323,220. PUB. 1-11-2000. FILED 7-3-1997.
- 2,898,425. **HOTEL CRESCENT COURT**. RRCC LIMITED PARTNERSHIP, (U.S. CLS. 100, 101 AND 102). SN 75-507,186. PUB. 6-15-1999. FILED 6-23-1998.
- 2,898,426. **THE CRESCENT CLUB**. ROSEWOOD HOTELS AND RESORTS HOLDINGS, INC., (U.S. CLS. 100, 101 AND 102). SN 75-507,249. PUB. 6-8-1999. FILED 6-23-1998.
- 2,898,433 ( *See Class 1 for this trademark*).
- 2,898,440. **AUTO REWARDS**. FONTANA, DARRYL, DBA AUTO REWARDS, (U.S. CLS. 100, 101 AND 102). SN 75-645,850. PUB. 9-11-2001. FILED 2-22-1999.
- 2,898,444. **TOOL DEPOT**. NEW SIOUX CITY IRON COMPANY, THE, (U.S. CLS. 100, 101 AND 102). SN 75-760,992. PUB. 12-31-2002. FILED 7-26-1999.
- 2,898,449 ( *See Class 9 for this trademark*).
- 2,898,467. **MISCELLANEOUS DESIGN**. OCWEN FEDERAL BANK, FSB, (U.S. CLS. 100, 101 AND 102). SN 76-006,851. PUB. 7-15-2003. FILED 3-22-2000.
- 2,898,468. **MIXUP**. PROMOTORA MUSICAL S.A. DE C.V., (U.S. CLS. 100, 101 AND 102). SN 76-014,292. PUB. 10-9-2001. FILED 3-31-2000.
- 2,898,472. **CARMEL PLAZA AND DESIGN**. MACERICH CARMEL LIMITED PARTNERSHIP, MULTIPLE CLASS, (INT. CLS. 35 AND 36), (U.S. CLS. 100, 101 AND 102). SN 76-024,446. PUB. 7-15-2003. FILED 4-12-2000.
- 2,898,473. **LAKEWOOD CENTER**. MACERICH LAKEWOOD, LLC, MULTIPLE CLASS, (INT. CLS. 35 AND 36), (U.S. CLS. 100, 101 AND 102). SN 76-024,448. PUB. 7-15-2003. FILED 4-12-2000.
- 2,898,487 ( *See Class 6 for this trademark*).
- 2,898,489. **IQ411**. QSENT, INC., MULTIPLE CLASS, (INT. CLS. 35 AND 42), (U.S. CLS. 100, 101 AND 102). SN 76-101,090. PUB. 8-10-2004. FILED 8-1-2000.
- 2,898,492. **WENOTIFY (STYLIZED)**. UA, INC., (U.S. CLS. 100, 101 AND 102). SN 76-118,100. PUB. 8-10-2004. FILED 8-29-2000.
- 2,898,493. **ZEMI ENTERTAINMENT**. ZEMI ENTERTAINMENT L.L.C., MULTIPLE CLASS, (INT. CLS. 35 AND 41), (U.S. CLS. 100, 101, 102 AND 107). SN 76-118,447. PUB. 10-29-2002. FILED 8-29-2000.
- 2,898,498 ( *See Class 9 for this trademark*).
- 2,898,500 ( *See Class 9 for this trademark*).
- 2,898,502. **SPLASHWORKS**. SPLASHWORKS INC., (U.S. CLS. 100, 101 AND 102). SN 76-158,445. PUB. 6-1-2004. FILED 11-2-2000.
- 2,898,503. **PINPOINT MEDIA**. PINPOINT INTERACTIVE MEDIA, INC., (U.S. CLS. 100, 101 AND 102). SN 76-159,050. PUB. 8-10-2004. FILED 11-3-2000.
- 2,898,508. **VCFO YOUR VIRTUAL TEAM**. VIRTUALCFO, INC., MULTIPLE CLASS, (INT. CLS. 35, 36 AND 42), (U.S. CLS. 100, 101 AND 102). SN 76-192,298. PUB. 11-19-2002. FILED 1-10-2001.
- 2,898,511. **MORE TH>N FROM ROYAL & SUNALLIANCE AND DESIGN**. ROYAL & SUN ALLIANCE INSURANCE GROUP PLC, MULTIPLE CLASS, (INT. CLS. 35, 36 AND

- 42), (U.S. CLS. 100, 101 AND 102). SN 76-210,152. PUB. 8-10-2004. FILED 2-12-2001.
- 2,898,526. **ESSIBUY.COM AN ENGINEERED SUPPORT SYSTEMS, INC. COMPANY AND DESIGN.** ENGINEERED SUPPORT SYSTEMS, INC., (U.S. CLS. 100, 101 AND 102). SN 76-242,027. PUB. 8-20-2002. FILED 4-17-2001.
- 2,898,527 ( *See Class 4 for this trademark*).
- 2,898,536. **GO AMERICA AND DESIGN.** GO AMERICA, L.L.C. (U.S. CLS. 100, 101 AND 102). SN 76-278,162. PUB. 7-2-2002. FILED 6-29-2001.
- 2,898,541. **IS2.** IS2 STAFFING SERVICES INC., (U.S. CLS. 100, 101 AND 102). SN 76-292,581. PUB. 8-10-2004. FILED 7-31-2001.
- 2,898,542. **BRIGHT.NET AND DESIGN.** COM NET, INC., MULTIPLE CLASS, (INT. CLS. 35, 38 AND 42), (U.S. CLS. 100, 101, 102 AND 104). SN 76-292,841. PUB. 8-10-2004. FILED 7-31-2001.
- 2,898,553. **TAKEMEON VACATION AND DESIGN.** BLUE-GREEN CORPORATION, MULTIPLE CLASS, (INT. CLS. 35, 39 AND 43), (U.S. CLS. 100, 101, 102 AND 105). SN 76-336,638. PUB. 8-10-2004. FILED 11-14-2001.
- 2,898,556. **KNOWLLENCE.** KNOWLLENCE, MULTIPLE CLASS, (INT. CLS. 35 AND 42), (U.S. CLS. 100, 101 AND 102). SN 76-349,547. PUB. 12-30-2003. FILED 12-18-2001.
- 2,898,564. **TEXAS TECH ALUMNI ASSOCIATION.** TEXAS TECH UNIVERSITY, (U.S. CLS. 100, 101 AND 102). SN 76-361,121. PUB. 8-10-2004. FILED 1-22-2002.
- 2,898,565 ( *See Class 9 for this trademark*).
- 2,898,568. **MERCHANT OF VINO.** WHOLE FOODS MARKET IP, L.P., (U.S. CLS. 100, 101 AND 102). SN 76-367,219. PUB. 8-10-2004. FILED 2-5-2002.
- 2,898,573 ( *See Class 6 for this trademark*).
- 2,898,575 ( *See Class 9 for this trademark*).
- 2,898,582. **ADELANTE.** DGWB, INC., (U.S. CLS. 100, 101 AND 102). SN 76-395,904. PUB. 8-10-2004. FILED 4-15-2002.
- 2,898,587 ( *See Class 9 for this trademark*).
- 2,898,588. **MITSUBISHI.** MITSUBISHI SHOJI KAISHA, LTD., MULTIPLE CLASS, (INT. CLS. 35, 36, 37, 38, 39, 40, 41, 42, 43, 44 AND 45), (U.S. CLS. 100, 101, 102, 103, 104, 105, 106 AND 107). SN 76-402,148. PUB. 8-10-2004. FILED 5-1-2002.
- 2,898,596. **SELECTSTAFF AND DESIGN.** SELECT STAFFING SOLUTIONS, (U.S. CLS. 100, 101 AND 102). SN 76-412,395. PUB. 4-8-2003. FILED 5-22-2002.
- 2,898,614 ( *See Class 12 for this trademark*).
- 2,898,616. **CENTURION OF AKRON.** MID-WEST PRESORT MAILING SERVICES, INC., (U.S. CLS. 100, 101 AND 102). SN 76-431,281. PUB. 8-10-2004. FILED 7-15-2002.
- 2,898,617. **NDRI.** NATIONAL DISEASE RESEARCH INTERCHANGE, MULTIPLE CLASS, (INT. CLS. 35, 39 AND 42), (U.S. CLS. 100, 101, 102 AND 105). SN 76-432,742. PUB. 8-10-2004. FILED 7-18-2002.
- 2,898,620. **CARRIER 1 ONE AND DESIGN.** CARRIER ONE INC., MULTIPLE CLASS, (INT. CLS. 35 AND 39), (U.S. CLS. 100, 101, 102 AND 105). SN 76-436,373. PUB. 8-10-2004. FILED 7-31-2002.
- 2,898,622 ( *See Class 29 for this trademark*).
- 2,898,624. **ESSESSNET.** COMMUNICATION DEVELOPMENT ASSOCIATES, INC., MULTIPLE CLASS, (INT. CLS. 35 AND 41), (U.S. CLS. 100, 101, 102 AND 107). SN 76-441,273. PUB. 8-10-2004. FILED 8-19-2002.
- 2,898,633. **VIP USA AND DESIGN.** VIP MARKETING, INC., MULTIPLE CLASS, (INT. CLS. 35 AND 36), (U.S. CLS. 100, 101 AND 102). SN 76-450,053. PUB. 12-2-2003. FILED 9-16-2002.
- 2,898,638. **PMA.** PROPERTY MARKET ANALYSIS LLP, MULTIPLE CLASS, (INT. CLS. 35 AND 36), (U.S. CLS. 100, 101 AND 102). SN 76-452,056. PUB. 8-10-2004. FILED 9-19-2002.
- 2,898,647 ( *See Class 11 for this trademark*).
- 2,898,650. **LUCKY SCENT AND DESIGN.** FRANK H. WRIGHT AND ADAM EASTWOOD, GENERAL PARTNERSHIP, THE, (U.S. CLS. 100, 101 AND 102). SN 76-457,409. PUB. 5-13-2003. FILED 10-10-2002.
- 2,898,671. **BLISTECH.** BPSI HOLDINGS, INC., MULTIPLE CLASS, (INT. CLS. 35 AND 39), (U.S. CLS. 100, 101, 102 AND 105). SN 76-466,902. PUB. 1-6-2004. FILED 11-14-2002.
- 2,898,677. **LIFESTYLE SOLUTIONS AND DESIGN.** SHAVER, DEBRAH, (U.S. CLS. 100, 101 AND 102). SN 76-469,467. PUB. 12-23-2003. FILED 11-15-2002.
- 2,898,678. **CHESAPEAKE SECURITY SERVICE CO. AND DESIGN.** CHESAPEAKE LOCK & SAFE SERVICE CO., TA CHESAPEAKE SECURITY SERVICE CO., MULTIPLE CLASS, (INT. CLS. 35, 37, 42 AND 45), (U.S. CLS. 100, 101, 102, 103 AND 106). SN 76-471,365. PUB. 8-10-2004. FILED 11-27-2002.
- 2,898,688 ( *See Class 19 for this trademark*).
- 2,898,689. **LEE HECHT HARRISON CAREER MOBILITY INDEX.** LEE HECHT HARRISON LLC, (U.S. CLS. 100, 101 AND 102). SN 76-477,289. PUB. 8-10-2004. FILED 12-19-2002.
- 2,898,706. **MISCELLANEOUS DESIGN.** PRACTICE LOGIX, INC., MULTIPLE CLASS, (INT. CLS. 35 AND 44), (U.S. CLS. 100, 101 AND 102). SN 76-486,804. PUB. 12-30-2003. FILED 2-3-2003.
- 2,898,717. **PILLS ON WHEELS.** SUTPHIN DRUGS, INC., MULTIPLE CLASS, (INT. CLS. 35 AND 39), (U.S. CLS. 100, 101, 102 AND 105). SN 76-489,598. PUB. 8-10-2004. FILED 2-14-2003.
- 2,898,718. **STATESMAN.COM.** COX TEXAS NEWSPAPERS, L.P., MULTIPLE CLASS, (INT. CLS. 35, 39, 41, 42 AND 43), (U.S. CLS. 100, 101, 102, 105 AND 107). SN 76-489,780. PUB. 8-10-2004. FILED 2-14-2003.
- 2,898,723. **IPS.** LANE INDIVIDUAL PRACTICE ASSOCIATION, INC., (U.S. CLS. 100, 101 AND 102). SN 76-492,075. PUB. 4-6-2004. FILED 2-24-2003.
- 2,898,729. **CONDUIT MEDIA.** COUPONS, INC. (U.S. CLS. 100, 101 AND 102). SN 76-494,778. PUB. 8-10-2004. FILED 3-5-2003.
- 2,898,736. **ADVICAR.** ROONIES, LLC, (U.S. CLS. 100, 101 AND 102). SN 76-497,721. PUB. 11-18-2003. FILED 3-17-2003.
- 2,898,737. **NATIONAL INDUSTRIAL AUTOMATION SHOW AND CONFERENCE.** REED ELSEVIER INC., (U.S. CLS. 100, 101 AND 102). SN 76-497,912. PUB. 8-10-2004. FILED 3-17-2003.
- 2,898,738. **PRATO.** KARNAK MEN'S WEAR, INC., (U.S. CLS. 100, 101 AND 102). SN 76-498,228. PUB. 11-11-2003. FILED 3-17-2003.
- 2,898,743. **CENTRAL VACUUM STORES.** CENTRAL VACUUM STORES, INC., (U.S. CLS. 100, 101 AND 102). SN 76-499,403. PUB. 8-10-2004. FILED 3-21-2003.
- 2,898,752. **SESAC LATINA AND DESIGN.** SESAC, INC., MULTIPLE CLASS, (INT. CLS. 35 AND 36), (U.S. CLS. 100, 101 AND 102). SN 76-500,830. PUB. 8-10-2004. FILED 2-24-2003.
- 2,898,754. **TWENTYEAST AGENCY.** TWENTYEAST AGENCY, LLC, AND MARTIN MANAGEMENT, INC., (U.S. CLS. 100, 101 AND 102). SN 76-502,277. PUB. 11-4-2003. FILED 3-31-2003.
- 2,898,755. **TWENTYEAST.** TWENTYEAST AGENCY, LLC, AND MARTIN MANAGEMENT, INC., (U.S. CLS. 100, 101 AND 102). SN 76-502,281. PUB. 11-4-2003. FILED 3-31-2003.
- 2,898,760. **TNT PARTNERS.** TNT PARTNERS, LLC, MULTIPLE CLASS, (INT. CLS. 35, 38 AND 42), (U.S. CLS. 100, 101, 102 AND 104). SN 76-504,067. PUB. 8-10-2004. FILED 4-3-2003.
- 2,898,761. **H ROSEN HOTELS & RESORTS AND DESIGN.** ROSEN HOTELS AND RESORTS, INC., MULTIPLE CLASS, (INT. CLS. 35 AND 43), (U.S. CLS. 100, 101 AND 102). SN 76-504,088. PUB. 8-10-2004. FILED 4-4-2003.
- 2,898,773 ( *See Class 14 for this trademark*).
- 2,898,778. **T AND DESIGN.** TRIBECA FILM CENTER, INC., (U.S. CLS. 100, 101 AND 102). SN 76-507,670. PUB. 8-10-2004. FILED 4-18-2003.
- 2,898,791. **BOARD OF REGISTRY ASCP CERTIFICATION - THE STANDARD OF EXCELLENCE AND DESIGN.** AMERICAN SOCIETY FOR CLINICAL PATHOLOGY, INC., (U.S. CLS. 100, 101 AND 102). SN 76-509,091. PUB. 8-10-2004. FILED 4-23-2003.
- 2,898,804. **THE WATCH WAREHOUSE.** HANOHOV, BOAZ, (U.S. CLS. 100, 101 AND 102). SN 76-510,530. PUB. 8-10-2004. FILED 5-1-2003.
- 2,898,808. **CUBIC DEFENSE APPLICATIONS.** CUBIC DEFENSE APPLICATIONS, INC., MULTIPLE CLASS, (INT. CLS. 35, 37, 40 AND 41), (U.S. CLS. 100, 101, 102, 103, 106 AND 107). SN 76-511,497. PUB. 8-10-2004. FILED 5-5-2003.
- 2,898,809. **CASCADE NATURAL GAS CORPORATION.** CASCADE NATURAL GAS CORPORATION, (U.S. CLS. 100,

- 101 AND 102), SN 76-511,538. PUB. 8-10-2004. FILED 4-28-2003.
- 2,898,812. **TARGETTV 1234567890 AND DESIGN.** QCOM TV, INC., (U.S. CLS. 100, 101 AND 102). SN 76-511,759. PUB. 12-23-2003. FILED 5-6-2003.
- 2,898,817. **SBP SMALL BUSINESS PRODUCTS AND DESIGN.** SOFTWARE BUSINESS PRODUCTS CORPORATION, (U.S. CLS. 100, 101 AND 102). SN 76-511,993. PUB. 8-10-2004. FILED 5-5-2003.
- 2,898,826 ( *See Class 16 for this trademark*).
- 2,898,832. **SEDLAK INTERIORS.** SEDLAK INTERIORS, (U.S. CLS. 100, 101 AND 102). SN 76-513,155. PUB. 8-10-2004. FILED 5-9-2003.
- 2,898,854. **CROSSVUE.** @POS.COM, INC., MULTIPLE CLASS, (INT. CLS. 35 AND 39), (U.S. CLS. 100, 101, 102 AND 105). SN 76-515,063. PUB. 8-10-2004. FILED 4-23-2003.
- 2,898,855. **STRATEGIC EVENT DESIGN THE INTELLIGENT CHOICE AND DESIGN.** EVENTEMPS CORPORATION, DBA STRATEGIC EVENT DESIGN, (U.S. CLS. 100, 101 AND 102). SN 76-515,259. PUB. 8-10-2004. FILED 5-19-2003.
- 2,898,859. **WORLDWIDE FOOD EXPO AND DESIGN.** WORLDWIDE FOOD EXPO, LLC, (U.S. CLS. 100, 101 AND 102). SN 76-515,778. PUB. 1-27-2004. FILED 5-21-2003.
- 2,898,863 ( *See Class 19 for this trademark*).
- 2,898,881. **MISCELLANEOUS DESIGN.** BOBAK SAUSAGE COMPANY, MULTIPLE CLASS, (INT. CLS. 35 AND 43), (U.S. CLS. 100, 101 AND 102). SN 76-518,670. PUB. 8-10-2004. FILED 6-2-2003.
- 2,898,883. **LOG-BOX PLUS.** FIDUCIAIRE DE DISTRIBUTION INTERNATIONALE, MULTIPLE CLASS, (INT. CLS. 35, 36, 38 AND 39), (U.S. CLS. 100, 101, 102, 104 AND 105). SN 76-518,755. PUB. 8-10-2004. FILED 5-12-2003.
- 2,898,885. **MEDCAST AND DESIGN.** MEDCAST INC., MULTIPLE CLASS, (INT. CLS. 35 AND 44), (U.S. CLS. 100, 101 AND 102). SN 76-518,904. PUB. 8-10-2004. FILED 6-2-2003.
- 2,898,886. **RX MEDCAST HOME INFUSION SERVICES AND DESIGN.** MEDCAST INC., MULTIPLE CLASS, (INT. CLS. 35 AND 44), (U.S. CLS. 100, 101 AND 102). SN 76-518,905. PUB. 8-10-2004. FILED 6-2-2003.
- 2,898,893. **COBCONNECT.** HEALTH MANAGEMENT SYSTEMS, INC., (U.S. CLS. 100, 101 AND 102). SN 76-519,205. PUB. 8-10-2004. FILED 5-21-2003.
- 2,898,899. **CONVERSATIONS WITH THE WORKING WORLD..** JWT SPECIALIZED COMMUNICATIONS, INC., (U.S. CLS. 100, 101 AND 102). SN 76-519,370. PUB. 1-13-2004. FILED 6-4-2003.
- 2,898,900. **THE PEOPLE YOU CAN COUNT ON.** ATLANTIC CITY COIN & SLOT SERVICE COMPANY, INC., (U.S. CLS. 100, 101 AND 102). SN 76-519,376. PUB. 8-10-2004. FILED 6-4-2003.
- 2,898,901. **MISCELLANEOUS DESIGN.** BAREFOOT FLOORING, INC., (U.S. CLS. 100, 101 AND 102). SN 76-519,387. PUB. 1-20-2004. FILED 6-4-2003.
- 2,898,903. **SORGHOMICS.** SORGHUM PARTNERS, INC., MULTIPLE CLASS, (INT. CLS. 35 AND 44), (U.S. CLS. 100, 101 AND 102). SN 76-519,418. PUB. 8-10-2004. FILED 5-13-2003.
- 2,898,905. **SAM.** SILVA ARTIST MANAGEMENT LLC, DBA SAM, (U.S. CLS. 100, 101 AND 102). SN 76-519,583. PUB. 8-10-2004. FILED 6-4-2003.
- 2,898,912. **LUMPSUM PLUS (STYLIZED).** CORNERSTONE RELOCATION GROUP, LLC., (U.S. CLS. 100, 101 AND 102). SN 76-520,807. PUB. 8-10-2004. FILED 6-2-2003.
- 2,898,913. **HOMEPLUS (STYLIZED).** CORNERSTONE RELOCATION GROUP, LLC, (U.S. CLS. 100, 101 AND 102). SN 76-520,809. PUB. 8-10-2004. FILED 6-2-2003.
- 2,898,914. **PROLINK.** PROLINK SERVICES, L.L.C. - HOLDING, (U.S. CLS. 100, 101 AND 102). SN 76-520,870. PUB. 8-10-2004. FILED 6-5-2003.
- 2,898,922. **DON'T PAY THE DIFFERENCE IF YOU CAN'T TELL THE DIFFERENCE.** FARMSAVER.COM LLC, (U.S. CLS. 100, 101 AND 102). SN 76-522,345. PUB. 8-10-2004. FILED 6-5-2003.
- 2,898,926. **MISCELLANEOUS DESIGN.** HILLYARD ENTERPRISES, INC., MULTIPLE CLASS, (INT. CLS. 35, 37 AND 41), (U.S. CLS. 100, 101, 102, 103, 106 AND 107). SN 76-522,477. PUB. 8-10-2004. FILED 6-13-2003.
- 2,898,939. **CICERON.** CICERON, INC., MULTIPLE CLASS, (INT. CLS. 35 AND 42), (U.S. CLS. 100, 101 AND 102). SN 76-525,000. PUB. 8-10-2004. FILED 6-23-2003.
- 2,898,947. **WHAT A DISH.** RAJEWSKI, CHERYL, AND DOCARMO, RUI, MULTIPLE CLASS, (INT. CLS. 35 AND 43), (U.S. CLS. 100, 101 AND 102). SN 76-527,826. PUB. 4-13-2004. FILED 6-26-2003.
- 2,898,948. **WHAT A DISH AND DESIGN.** RAJEWSKI, CHERYL, AND DOCARMO, RUI, MULTIPLE CLASS, (INT. CLS. 35 AND 43), (U.S. CLS. 100, 101 AND 102). SN 76-527,828. PUB. 4-6-2004. FILED 6-26-2003.
- 2,898,949. **CATALOG COMPANION.** CHARLES SADEK IMPORT CO. INC., (U.S. CLS. 100, 101 AND 102). SN 76-528,046. PUB. 8-10-2004. FILED 7-7-2003.
- 2,898,957 ( *See Class 10 for this trademark*).
- 2,898,960. **HEATON RESOURCES MED-PASS, INC. AND DESIGN.** MED-PASS, INCORPORATED, (U.S. CLS. 100, 101 AND 102). SN 76-530,669. PUB. 8-10-2004. FILED 7-18-2003.
- 2,898,962. **DIXIE GUTTERGUARD AND DESIGN.** GUTTERGUARD, INC., MULTIPLE CLASS, (INT. CLS. 35 AND 37), (U.S. CLS. 100, 101, 102, 103 AND 106). SN 76-530,937. PUB. 8-10-2004. FILED 7-21-2003.
- 2,898,973 ( *See Class 7 for this trademark*).
- 2,898,977. **QSI QUALITY SERVICE INTEGRITY AND DESIGN.** THE VINCIT COMPANY, LLC, MULTIPLE CLASS, (INT. CLS. 35 AND 42), (U.S. CLS. 100, 101 AND 102). SN 76-533,753. PUB. 8-10-2004. FILED 7-21-2003.
- 2,898,978. **ASCENTIVES AND DESIGN.** HENDERSON/YATES/KARLS & ASSOCIATES, INC., (U.S. CLS. 100, 101 AND 102). SN 76-533,758. PUB. 5-4-2004. FILED 7-21-2003.
- 2,898,988. **ASK DOCTOR PC.** PC HOUSE CALL, INC., MULTIPLE CLASS, (INT. CLS. 35 AND 42), (U.S. CLS. 100, 101 AND 102). SN 76-535,847. PUB. 4-27-2004. FILED 7-30-2003.
- 2,898,992. **HEALTH @ YOUR FINGERTIPS.** MURPHY, STEPHEN M., DBA ZON SITE, (U.S. CLS. 100, 101 AND 102). SN 76-536,075. PUB. 8-10-2004. FILED 7-25-2003.
- 2,898,993. **ZON SITE AND DESIGN.** MURPHY, STEPHEN M., DBA ZON SITE, (U.S. CLS. 100, 101 AND 102). SN 76-536,076. PUB. 8-10-2004. FILED 7-25-2003.
- 2,898,998. **THE GARR GROUP.** THE GARR GROUP, L.L.C., (U.S. CLS. 100, 101 AND 102). SN 76-536,481. PUB. 8-10-2004. FILED 7-31-2003.
- 2,899,003. **SENTIGY PATHWAYS.** SENTIGY, INC., MULTIPLE CLASS, (INT. CLS. 35 AND 42), (U.S. CLS. 100, 101 AND 102). SN 76-537,632. PUB. 8-10-2004. FILED 8-7-2003.
- 2,899,009. **PRENDA MEX TU CASA DE EMPEÑO AND DESIGN.** PRESTAMOS PRENDARIOS DEPOFIN, S.A. DE C.V., (U.S. CLS. 100, 101 AND 102). SN 76-539,061. PUB. 8-10-2004. FILED 8-19-2003.
- 2,899,018. **SUMMIT AND DESIGN.** SUMMIT DOCUMENT SERVICES, INC., MULTIPLE CLASS, (INT. CLS. 35, 39, 40 AND 42), (U.S. CLS. 100, 101, 102, 103, 105 AND 106). SN 76-541,021. PUB. 8-10-2004. FILED 8-29-2003.
- 2,899,019. **SUMMIT.** SUMMIT DOCUMENT SERVICES, INC., MULTIPLE CLASS, (INT. CLS. 35, 39, 40 AND 42), (U.S. CLS. 100, 101, 102, 103, 105 AND 106). SN 76-541,022. PUB. 8-10-2004. FILED 8-29-2003.
- 2,899,026. **CARWRAPS.** CARWRAPS LLC, (U.S. CLS. 100, 101 AND 102). SN 76-542,322. PUB. 8-10-2004. FILED 8-25-2003.
- 2,899,029. **CIRCUITRONIX AND DESIGN.** CIRCUITRONIX, LLC, (U.S. CLS. 100, 101 AND 102). SN 76-542,578. PUB. 8-10-2004. FILED 9-5-2003.
- 2,899,041. **ON TIME AS PROMISED.** HOMER T. HAYWARD LUMBER COMPANY, INC., (U.S. CLS. 100, 101 AND 102). SN 76-544,392. PUB. 8-10-2004. FILED 9-12-2003.
- 2,899,067. **ATLANTA SYMPHONY ORCHESTRA.** ROBERT W. WOODRUFF ARTS CENTER, INC., MULTIPLE CLASS, (INT. CLS. 35 AND 41), (U.S. CLS. 100, 101, 102 AND 107). SN 76-548,102. PUB. 8-10-2004. FILED 9-12-2003.
- 2,899,073. **HOMEOWNERS UNITED.** HOMEOWNERS UNITED, LLC, (U.S. CLS. 100, 101 AND 102). SN 76-548,658. PUB. 8-10-2004. FILED 9-16-2003.
- 2,899,076. **ARIYA LOGISTIC SOLUTIONS AND DESIGN.** ARIYA LOGISTIC SOLUTIONS, LLC, (U.S. CLS. 100, 101 AND 102). SN 76-549,306. PUB. 8-10-2004. FILED 9-26-2003.
- 2,899,098 ( *See Class 16 for this trademark*).
- 2,899,099. **COMO ADVERTISING.** COMO ADVERTISING



- LLC, (U.S. CLS. 100, 101 AND 102). SN 76-551,652. PUB. 8-10-2004. FILED 10-16-2003.
- 2,899,100. **MISCELLANEOUS DESIGN**. SFA LLC, (U.S. CLS. 100, 101 AND 102). SN 76-551,731. PUB. 8-10-2004. FILED 10-10-2003.
- 2,899,103. **EVERYTHING EQUESTRIAN AND DESIGN**. EVERYTHING EQUESTRIAN, LTD., (U.S. CLS. 100, 101 AND 102). SN 76-551,961. PUB. 8-10-2004. FILED 10-14-2003.
- 2,899,111. **JAVA FIX (STYLIZED)**. JACK IN THE BOX INC., (U.S. CLS. 100, 101 AND 102). SN 76-552,580. PUB. 8-10-2004. FILED 10-20-2003.
- 2,899,118. **HEARTBEAT FOR LIFE AND DESIGN**. COUNCIL FOR AFFORDABLE QUALITY HEALTHCARE, INC., (U.S. CLS. 100, 101 AND 102). SN 76-553,143. PUB. 8-10-2004. FILED 10-21-2003.
- 2,899,122. **CAROLINA COOKIE COMPANY**. CONFECTION CONCEPTS, INC., DBA CAROLINA COOKIE COMPANY, (U.S. CLS. 100, 101 AND 102). SN 76-553,413. PUB. 8-10-2004. FILED 10-22-2003.
- 2,899,125 ( *See Class 9 for this trademark*).
- 2,899,143. **AFA ALZHEIMER'S FOUNDATION OF AMERICA AND DESIGN**. LONG ISLAND ALZHEIMER'S FOUNDATION, INC., (U.S. CLS. 100, 101 AND 102). SN 76-555,191. PUB. 8-10-2004. FILED 10-29-2003.
- 2,899,148. **CORPORATE VOICES FOR WORKING FAMILIES**. CORPORATE VOICES FOR WORKING FAMILIES, INC., (U.S. CLS. 100, 101 AND 102). SN 76-555,457. PUB. 8-10-2004. FILED 10-30-2003.
- 2,899,152. **SENTRY PROGRAM**. UHS OF DELAWARE, INC., MULTIPLE CLASS, (INT. CLS. 35, 36 AND 42), (U.S. CLS. 100, 101 AND 102). SN 76-555,873. PUB. 8-10-2004. FILED 10-14-2003.
- 2,899,154 ( *See Class 16 for this trademark*).
- 2,899,160. **CTS MANAGEMENT GROUP MANAGING FOR SUCCESS AND DESIGN**. CTS MANAGEMENT, LLC, (U.S. CLS. 100, 101 AND 102). SN 76-556,366. PUB. 8-10-2004. FILED 11-4-2003.
- 2,899,165. **FREERIDING ALL SURFACES (BLOCK FORM)**. SULLIVAN, ROBERT, AND SULLIVAN, GINAMARIE, (U.S. CLS. 100, 101 AND 102). SN 76-556,484. PUB. 8-10-2004. FILED 11-4-2003.
- 2,899,166. **SOLAID (BLOCK FORM)**. SULLIVAN, ROBERT, AND SULLIVAN, GINAMARIE, (U.S. CLS. 100, 101 AND 102). SN 76-556,485. PUB. 8-10-2004. FILED 11-4-2003.
- 2,899,168. **SCHOOL UNIFORMS AVAILABLE HERE! BEST SELECTION & SUPER LOW PRICES IN THE CITY! (STYLIZED)**. VALUE CITY OF MICHIGAN, INC., (U.S. CLS. 100, 101 AND 102). SN 76-556,520. PUB. 8-10-2004. FILED 10-17-2003.
- 2,899,169. **BUSINESS FOR GOOD (BLOCK FORM)**. IRAIN-MAKERS, LTD., (U.S. CLS. 100, 101 AND 102). SN 76-556,585. PUB. 8-10-2004. FILED 11-4-2003.
- 2,899,189. **AERO RECORDS & TITLE CO.**. AERO RECORDS & TITLE CO., MULTIPLE CLASS, (INT. CLS. 35, 36 AND 42), (U.S. CLS. 100, 101 AND 102). SN 76-557,509. PUB. 8-10-2004. FILED 10-20-2003.
- 2,899,190. **HALLOWEENSTREET.COM (STYLIZED)**. HAMBURGER, HOWARD, AND HAMBURGER, MORISSA, (U.S. CLS. 100, 101 AND 102). SN 76-557,535. PUB. 8-10-2004. FILED 11-6-2003.
- 2,899,204. **CONVERGENT**. CONVERGENT MEDIA SYSTEMS, INC., MULTIPLE CLASS, (INT. CLS. 35, 37, 38, 41 AND 42), (U.S. CLS. 100, 101, 102, 103, 104, 106 AND 107). SN 76-558,290. PUB. 8-10-2004. FILED 10-27-2003.
- 2,899,240. **DEVICEPHARM**. WILEMON, CLAY, AND STOVALL, THOMAS G., (U.S. CLS. 100, 101 AND 102). SN 76-560,133. PUB. 8-10-2004. FILED 10-31-2003.
- 2,899,241. **WORKFLOW, CONSULT, CREATE, CONNECT AND DESIGN**. WORKFLOW MANAGEMENT, INC., (U.S. CLS. 100, 101 AND 102). SN 76-560,210. PUB. 8-10-2004. FILED 11-3-2003.
- 2,899,262. **IT'S MORE THAN JUST WATER AND DESIGN**. NATIONAL GROUND WATER ASSOCIATION, (U.S. CLS. 100, 101 AND 102). SN 76-564,278. PUB. 8-10-2004. FILED 11-26-2003.
- 2,899,272. **AL DIA A PUBLICATION OF THE DALLAS MORNING NEWS**. THE BELO COMPANY, (U.S. CLS. 100, 101 AND 102). SN 76-976,144. PUB. 1-27-2004. FILED 5-6-2003.
- 2,899,274. **GET OUT MORE**. RODALE INC., MULTIPLE CLASS, (INT. CLS. 35 AND 41), (U.S. CLS. 100, 101, 102 AND 107). SN 76-976,757. PUB. 8-10-2004. FILED 3-12-2003.
- 2,899,280. **PCCW**. PCCW-HKT DATACOM SERVICES LIMITED, (U.S. CLS. 100, 101 AND 102). SN 78-037,049. PUB. 2-17-2004. FILED 11-29-2000.
- 2,899,286. **SYCOR**. SYCOR GMBH, MULTIPLE CLASS, (INT. CLS. 35, 37, 38, 39 AND 42), (U.S. CLS. 100, 101, 102, 103, 104, 105 AND 106). SN 78-071,767. PUB. 8-10-2004. FILED 6-29-2001.
- 2,899,288 ( *See Class 9 for this trademark*).
- 2,899,297 ( *See Class 9 for this trademark*).
- 2,899,298. **NETPR**. NETPR, INC., (U.S. CLS. 100, 101 AND 102). SN 78-115,898. PUB. 8-10-2004. FILED 3-19-2002.
- 2,899,299. **THE TOOL DEPOT AND DESIGN**. THE NEW SIOUX CITY IRON COMPANY, (U.S. CLS. 100, 101 AND 102). SN 78-116,332. PUB. 2-11-2003. FILED 3-20-2002.
- 2,899,312. **SHELLY BELLY MATERNITY AND DESIGN**. SHELLY BELLY, LLC, (U.S. CLS. 100, 101 AND 102). SN 78-134,678. PUB. 8-10-2004. FILED 6-11-2002.
- 2,899,324. **ALASKA LISTING EXCHANGE AND DESIGN**. ALASKA MULTIPLE LISTING SERVICE, INC., (U.S. CLS. 100, 101 AND 102). SN 78-142,855. PUB. 8-10-2004. FILED 7-10-2002.
- 2,899,326. **DIABETIC DEPOT**. 980009 ALBERTA LTD., (U.S. CLS. 100, 101 AND 102). SN 78-146,038. PUB. 8-10-2004. FILED 7-22-2002.
- 2,899,344. **LAND CAPITAL**. LAND CAPITAL GROUP, INC., MULTIPLE CLASS, (INT. CLS. 35, 36 AND 37), (U.S. CLS. 100, 101, 102, 103 AND 106). SN 78-160,350. PUB. 8-10-2004. FILED 9-3-2002.
- 2,899,349. **THE PARC AT TURNBERRY ISLE AND DESIGN**. CABI DEVELOPERS, LLC, MULTIPLE CLASS, (INT. CLS. 35, 36 AND 37), (U.S. CLS. 100, 101, 102, 103 AND 106). SN 78-166,491. PUB. 6-10-2003. FILED 9-20-2002.
- 2,899,355 ( *See Class 9 for this trademark*).
- 2,899,369. **THINK AHEAD BE AHEAD STAY AHEAD**. MURDICO, VINCENT A., (U.S. CLS. 100, 101 AND 102). SN 78-175,174. PUB. 7-15-2003. FILED 10-16-2002.
- 2,899,374 ( *See Class 9 for this trademark*).
- 2,899,381. **SUNAMI**. SMI HOME PRODUCTS, INC., (U.S. CLS. 100, 101 AND 102). SN 78-181,594. PUB. 8-10-2004. FILED 11-5-2002.
- 2,899,393 ( *See Class 9 for this trademark*).
- 2,899,396. **RECOGNIZING OUR UNITY; CELEBRATING OUR DIVERSITY**. THE WOMEN'S MOSAIC, (U.S. CLS. 100, 101 AND 102). SN 78-192,974. PUB. 8-10-2004. FILED 12-10-2002.
- 2,899,430. **PREMIERE BEAUTY AND DESIGN**. SCS ENTERPRISES, INC., MULTIPLE CLASS, (INT. CLS. 35 AND 44), (U.S. CLS. 100, 101 AND 102). SN 78-211,043. PUB. 8-10-2004. FILED 2-5-2003.
- 2,899,437. **PMM PM MATURITY LLC (STYLIZED)**. PM MATURITY, LLC, (U.S. CLS. 100, 101 AND 102). SN 78-216,277. PUB. 8-10-2004. FILED 2-19-2003.
- 2,899,456. **THE GREATEST HOMES ON EARTH!**. RASH, JAMES W., (U.S. CLS. 100, 101 AND 102). SN 78-225,572. PUB. 12-30-2003. FILED 3-14-2003.
- 2,899,458 ( *See Class 7 for this trademark*).
- 2,899,461. **AKER AND DESIGN**. RESOURCE GROUP INTERNATIONAL, INC., MULTIPLE CLASS, (INT. CLS. 35 AND 36), (U.S. CLS. 100, 101 AND 102). SN 78-227,148. PUB. 8-10-2004. FILED 3-18-2003.
- 2,899,463. **MISCELLANEOUS DESIGN**. NITAS VENTURES, INC., (U.S. CLS. 100, 101 AND 102). SN 78-228,754. PUB. 8-10-2004. FILED 3-21-2003.
- 2,899,475 ( *See Class 9 for this trademark*).
- 2,899,484. **CVS EASY TRANSFER**. CVS VANGUARD, INC., (U.S. CLS. 100, 101 AND 102). SN 78-235,861. PUB. 8-10-2004. FILED 4-9-2003.
- 2,899,487. **BRAND NAMES FOR LESS**. MARSHALLS OF NEVADA, INC., (U.S. CLS. 100, 101 AND 102). SN 78-236,568. PUB. 8-10-2004. FILED 4-11-2003.
- 2,899,488. **BRAND NAMES FOR LESS. EVERY DAY.**. MARSHALLS OF NEVADA, INC., (U.S. CLS. 100, 101 AND 102). SN 78-236,576. PUB. 8-10-2004. FILED 4-11-2003.
- 2,899,493. **THE LEADERSHIP ARCHITECTS**. LOMINGER LIMITED, INC., MULTIPLE CLASS, (INT. CLS. 35 AND

- 42), (U.S. CLS. 100, 101 AND 102). SN 78-237,431. PUB. 8-10-2004. FILED 4-14-2003.
- 2,899,495. **PUSHINDAISIES.COM A MORTUARY NOVELTY SHOP YOU'LL LOVE WHAT WE DIG UP FOR YOU! AND DESIGN.** FARRAR, CATHERINE, (U.S. CLS. 100, 101 AND 102). SN 78-237,822. PUB. 8-10-2004. FILED 4-15-2003.
- 2,899,511. **LATINOEYES.** CREATIVE & RESPONSE RESEARCH SERVICES, INC., (U.S. CLS. 100, 101 AND 102). SN 78-239,701. PUB. 8-10-2004. FILED 4-18-2003.
- 2,899,514. **BRETAIL.** HITCHCOCK, FLEMING & ASSOCIATES, INC., (U.S. CLS. 100, 101 AND 102). SN 78-240,121. PUB. 8-10-2004. FILED 4-21-2003.
- 2,899,515. **TOM STURGIS.** TOM STURGIS PRETZELS, INC., (U.S. CLS. 100, 101 AND 102). SN 78-240,169. PUB. 8-10-2004. FILED 4-21-2003.
- 2,899,518. **CTC (BLOCK FORM).** COMPACT TRACTOR CONNECTION, INC., (U.S. CLS. 100, 101 AND 102). SN 78-241,115. PUB. 8-10-2004. FILED 4-23-2003.
- 2,899,522. **HUDSON GLOBAL RESOURCES.** HUDSON HIGHLAND GROUP, INC., (U.S. CLS. 100, 101 AND 102). SN 78-241,631. PUB. 8-10-2004. FILED 4-24-2003.
- 2,899,534. **EVANGELISM TICKETS.** SMITH, JUSTIN A., (U.S. CLS. 100, 101 AND 102). SN 78-244,346. PUB. 8-10-2004. FILED 5-1-2003.
- 2,899,539. **RESOURCES IN BALANCE.** CARMEN SYSTEMS AB, MULTIPLE CLASS, (INT. CLS. 35 AND 42), (U.S. CLS. 100, 101 AND 102). SN 78-245,808. PUB. 8-10-2004. FILED 5-5-2003.
- 2,899,547. **CHURCH&MAIN, INC. UNCOMMON CREATIVITY AND COMMON SENSE (STYLIZED).** CHURCH & MAIN, INC., (U.S. CLS. 100, 101 AND 102). SN 78-246,707. PUB. 8-10-2004. FILED 5-7-2003.
- 2,899,552. **THE CEMENTWORKS (BLOCK FORM).** THE CEMENTWORKS, LLC, (U.S. CLS. 100, 101 AND 102). SN 78-247,675. PUB. 8-10-2004. FILED 5-9-2003.
- 2,899,567. **CRUISE CONTROL.** FINDWHAT.COM, (U.S. CLS. 100, 101 AND 102). SN 78-249,700. PUB. 8-10-2004. FILED 5-14-2003.
- 2,899,592. **BOWERY LIGHTING.** FUSS, ALAN, AND LIEBERMAN, DAVID, (U.S. CLS. 100, 101 AND 102). SN 78-252,738. PUB. 8-10-2004. FILED 5-21-2003.
- 2,899,599. **MISCELLANEOUS DESIGN.** STUDIO TORTA S.R.L., MULTIPLE CLASS, (INT. CLS. 35, 38, 41 AND 42), (U.S. CLS. 100, 101, 102, 104 AND 107). SN 78-253,808. PUB. 8-10-2004. FILED 5-23-2003.
- 2,899,603. **DELMAE GROCERY.** GEORGE LERIS, (U.S. CLS. 100, 101 AND 102). SN 78-254,229. PUB. 8-10-2004. FILED 5-26-2003.
- 2,899,613. **CREATIVE LIVING NETWORK.** DUNCAN ENTERPRISES, MULTIPLE CLASS, (INT. CLS. 35 AND 41), (U.S. CLS. 100, 101, 102 AND 107). SN 78-255,161. PUB. 8-10-2004. FILED 5-28-2003.
- 2,899,629. **ADVANCE AUTO PARTS AND DESIGN.** ADVANCE MERCHANDISING COMPANY, INC., (U.S. CLS. 100, 101 AND 102). SN 78-258,905. PUB. 12-30-2003. FILED 6-5-2003.
- 2,899,630. **ADVANCE AUTO PARTS. WE'RE READY IN ADVANCE. AND DESIGN.** ADVANCE MERCHANDISING COMPANY, INC., (U.S. CLS. 100, 101 AND 102). SN 78-258,981. PUB. 2-24-2004. FILED 6-5-2003.
- 2,899,637. **ZESCO.** ZESCO PRODUCTS INC., (U.S. CLS. 100, 101 AND 102). SN 78-260,106. PUB. 8-10-2004. FILED 6-9-2003.
- 2,899,646. **WHERE BEST GIFTS ARE MADE.** BUILD-A-BEAR WORKSHOP, INC., (U.S. CLS. 100, 101 AND 102). SN 78-261,456. PUB. 8-10-2004. FILED 6-12-2003.
- 2,899,649. **"IN A WORLD THAT DEMANDS CAPITAL, WE PROVIDE THE CURRENCY FOR GROWTH" (STYLIZED).** HIGHLAND CAPITAL CORP., MULTIPLE CLASS, (INT. CLS. 35, 36, 37, 38 AND 44), (U.S. CLS. 100, 101, 102, 103, 104 AND 106). SN 78-261,985. PUB. 8-10-2004. FILED 6-13-2003.
- 2,899,654. **RED PECKERS AND DESIGN.** 7-MILE INVESTMENT, INC., MULTIPLE CLASS, (INT. CLS. 35 AND 43), (U.S. CLS. 100, 101 AND 102). SN 78-262,371. PUB. 8-10-2004. FILED 6-13-2003.
- 2,899,675. **FARM MART AND DESIGN.** PRO GROUP, INC., (U.S. CLS. 100, 101 AND 102). SN 78-267,159. PUB. 8-10-2004. FILED 6-25-2003.
- 2,899,692. **TELIGENCE COMMUNICATIONS INC. AND DESIGN.** CHROMATIC SOFTWARE, INC., (U.S. CLS. 100, 101 AND 102). SN 78-272,967. PUB. 8-10-2004. FILED 7-10-2003.
- 2,899,694. **EEO LOGIC.** KUEHNL, BRUCE D., (U.S. CLS. 100, 101 AND 102). SN 78-273,295. PUB. 8-10-2004. FILED 7-11-2003.
- 2,899,697. **MANQUEST.** JW PUBLISHING, INC., (U.S. CLS. 100, 101 AND 102). SN 78-273,555. PUB. 3-23-2004. FILED 7-12-2003.
- 2,899,710. **MARKETING INTELLIGENCE.** CORPORATE PROJECT RESOURCES, INC., (U.S. CLS. 100, 101 AND 102). SN 78-279,068. PUB. 8-10-2004. FILED 7-25-2003.
- 2,899,718. **E SIZZLE AND DESIGN.** R.E. MICHEL COMPANY, INC., (U.S. CLS. 100, 101 AND 102). SN 78-281,254. PUB. 8-10-2004. FILED 7-31-2003.
- 2,899,735. **CITIZENS AGAINST LAWSUIT ABUSE.** AMERICAN TORT REFORM ASSOCIATION INCORPORATED, (U.S. CLS. 100, 101 AND 102). SN 78-288,476. PUB. 8-10-2004. FILED 8-18-2003.
- 2,899,737. **LOCATION3 + INNOVATIONN (STYLIZED).** CHAMPAIGN COUNTY ECONOMIC DEVELOPMENT CORPORATION, (U.S. CLS. 100, 101 AND 102). SN 78-290,011. PUB. 8-10-2004. FILED 8-21-2003.
- 2,899,760. **COYOTE FURNITURE COMPANY.** COYOTE FURNITURE COMPANY, LLC, (U.S. CLS. 100, 101 AND 102). SN 78-296,353. PUB. 8-10-2004. FILED 9-4-2003.
- 2,899,772. **GRAND RED TASTING.** MINNESOTA MONTHLY PUBLICATIONS INC, (U.S. CLS. 100, 101 AND 102). SN 78-298,401. PUB. 8-10-2004. FILED 9-10-2003.
- 2,899,782. **GENQUEST.** GENQUEST, INC., (U.S. CLS. 100, 101 AND 102). SN 78-300,905. PUB. 8-10-2004. FILED 9-16-2003.
- 2,899,784. **AQUATIC ADDICTION.** HEDBERG AGGREGATES, INC., (U.S. CLS. 100, 101 AND 102). SN 78-302,156. PUB. 8-10-2004. FILED 9-18-2003.
- 2,899,812. **1-888-KIDS-NOW.** GIFTS SHOP INTERNATIONAL, INC., (U.S. CLS. 100, 101 AND 102). SN 78-309,623. PUB. 8-10-2004. FILED 10-6-2003.
- 2,899,818. **CHANGE YOUR WORLD.** WORLD ENDEAVORS, LLC, (U.S. CLS. 100, 101 AND 102). SN 78-310,421. PUB. 8-10-2004. FILED 10-7-2003.
- 2,899,820. **TEXAS 288 AND DESIGN.** PEARLAND ECONOMIC DEVELOPMENT CORPORATION, (U.S. CLS. 100, 101 AND 102). SN 78-311,005. PUB. 8-10-2004. FILED 10-8-2003.
- 2,899,826. **CHAZ TAYLOR.** CHAZ TAYLOR, INC, (U.S. CLS. 100, 101 AND 102). SN 78-311,687. PUB. 8-10-2004. FILED 10-9-2003.
- 2,899,851. **JAUNT FOOTWEAR AND ACCESSORIES FOR THE HAPPY TRAVELER AND DESIGN.** NORTH BAY MANAGEMENT ADVISORS, INC., (U.S. CLS. 100, 101 AND 102). SN 78-315,214. PUB. 8-10-2004. FILED 10-17-2003.
- 2,899,857. **PATTI MORAN'S THE PROFESSIONAL PET SITTERS' BEST FRIEND AND DESIGN.** PATTI MORAN'S NEW BEGINNINGS, INC., (U.S. CLS. 100, 101 AND 102). SN 78-315,620. PUB. 8-10-2004. FILED 10-20-2003.
- 2,899,869. **RS ELECTRONICS.** TALCUP, INC., DBA RS ELECTRONICS, (U.S. CLS. 100, 101 AND 102). SN 78-317,012. PUB. 8-10-2004. FILED 10-22-2003.
- 2,899,871. **H.A.N.D. WIRELESS HAVE A NICE DAY WIRELESS AND DESIGN.** COUSINS, INC., (U.S. CLS. 100, 101 AND 102). SN 78-317,486. PUB. 8-10-2004. FILED 10-23-2003.
- 2,899,885. **YOUR INDEPENDENTLY OWNED ADVANTAGE PAYROLL SERVICES AND DESIGN.** PAYCHEX OF NEW YORK, LLC, (U.S. CLS. 100, 101 AND 102). SN 78-319,029. PUB. 8-10-2004. FILED 10-27-2003.
- 2,899,894. **CITY LIGHTS JEWELRY.** CITY LIGHTS JEWELRY, LLC, (U.S. CLS. 100, 101 AND 102). SN 78-320,333. PUB. 8-10-2004. FILED 10-29-2003.
- 2,899,902. **PREMIER POSITION.** THE INTERPUBLIC GROUP OF COMPANIES, INC., (U.S. CLS. 100, 101 AND 102). SN 78-320,681. PUB. 8-10-2004. FILED 10-30-2003.
- 2,899,926. **EYEGLASSESTOGO.COM (BLOCK FORM).** READY READING GLASSES, INC., (U.S. CLS. 100, 101 AND 102). SN 78-322,862. PUB. 8-10-2004. FILED 11-4-2003.
- 2,899,928. **MISCELLANEOUS DESIGN.** HAWES, CHRISTINE M., (U.S. CLS. 100, 101 AND 102). SN 78-323,132. PUB. 8-10-2004. FILED 11-4-2003.
- 2,899,956. **SORTIS AND DESIGN.** SORTIS, LLC, (U.S. CLS. 100, 101 AND 102). SN 78-325,425. PUB. 8-10-2004. FILED 11-

- 10-2003.  
2,899,958. **NEW JERSEY SINGLES CIRCUIT (BLOCK FORM)**. NEW JERSEY SINGLES CIRCUIT, L.L.C., (U.S. CLS. 100, 101 AND 102). SN 78-325,551. PUB. 8-10-2004. FILED 11-10-2003.
- 2,899,961. **HS HAT SHACK (STYLIZED)**. HAT SHACK, INC., (U.S. CLS. 100, 101 AND 102). SN 78-325,602. PUB. 8-10-2004. FILED 11-10-2003.
- 2,899,972. **MISCELLANEOUS DESIGN**. SCOTTSDALE RUNNING COMPANY, (U.S. CLS. 100, 101 AND 102). SN 78-326,399. PUB. 8-10-2004. FILED 11-11-2003.
- 2,899,973. **FEELS GOOD, RUNS RIGHT (BLOCK FORM)**. SCOTTSDALE RUNNING COMPANY, (U.S. CLS. 100, 101 AND 102). SN 78-326,408. PUB. 8-10-2004. FILED 11-11-2003.
- 2,899,977 ( *See Class 3 for this trademark*).
- 2,899,982. **SARA LEE (BLOCK FORM)**. SARA LEE CORPORATION, (U.S. CLS. 100, 101 AND 102). SN 78-327,887. PUB. 8-10-2004. FILED 11-14-2003.
- 2,899,993 ( *See Class 9 for this trademark*).
- 2,900,006. **EXPRESSIONS OF CARE (BLOCK FORM)**. TAYMARK, INC., (U.S. CLS. 100, 101 AND 102). SN 78-332,329. PUB. 8-10-2004. FILED 11-24-2003.
- 2,900,013. **THEFUTUREFASTER.COM (BLOCK FORM)**. UNITED STATES TELECOM ASSOCIATION, (U.S. CLS. 100, 101 AND 102). SN 78-335,725. PUB. 8-10-2004. FILED 12-3-2003.
- 
- CLASS 36—INSURANCE AND FINANCIAL**
- 2,898,413. **FIRST REPUBLIC**. FIRST REPUBLIC BANK, (U.S. CL. 102). SN 73-833,635. PUB. 8-10-2004. FILED 10-24-1989.
- 2,898,433 ( *See Class 1 for this trademark*).
- 2,898,469. **DR. PORTFOLIO**. LIFESTYLE PORTFOLIOS LIMITED, (U.S. CLS. 100, 101 AND 102). SN 76-017,670. PUB. 8-10-2004. FILED 4-3-2000.
- 2,898,470. **ONE SOURCE RETIREMENT PLAN SERVICES**. MILLIMAN & ROBERTSON, INC., (U.S. CLS. 100, 101 AND 102). SN 76-018,574. PUB. 7-15-2003. FILED 4-6-2000.
- 2,898,471. **CAPITAL FOR THE NEXT GENERATION**. GENERATION PARTNERS MANAGEMENT LLC, (U.S. CLS. 100, 101 AND 102). SN 76-021,804. PUB. 8-10-2004. FILED 4-7-2000.
- 2,898,472 ( *See Class 35 for this trademark*).
- 2,898,473 ( *See Class 35 for this trademark*).
- 2,898,487 ( *See Class 6 for this trademark*).
- 2,898,490. **APARTMENTSOURCE**. APARTMENTSOURCE.COM, INC., (U.S. CLS. 100, 101 AND 102). SN 76-110,497. PUB. 2-26-2002. FILED 8-16-2000.
- 2,898,498 ( *See Class 9 for this trademark*).
- 2,898,508 ( *See Class 35 for this trademark*).
- 2,898,511 ( *See Class 35 for this trademark*).
- 2,898,558. **A GRASS ROOTS APPROACH TO INVESTING**. FECHTOR, DETWILER & CO., INC., (U.S. CLS. 100, 101 AND 102). SN 76-351,512. PUB. 10-29-2002. FILED 12-20-2001.
- 2,898,588 ( *See Class 35 for this trademark*).
- 2,898,593. **800 PRIORITY**. AMERICAN TELEGRAM CORPORATION, MULTIPLE CLASS, (INT. CLS. 36 AND 38), (U.S. CLS. 100, 101, 102 AND 104). SN 76-409,626. PUB. 8-10-2004. FILED 5-17-2002.
- 2,898,631. **OUTPATIENT PAYMENT SYSTEM OPS**. GLOBAL CLAIM SERVICES, LLC, (U.S. CLS. 100, 101 AND 102). SN 76-449,082. PUB. 8-10-2004. FILED 9-10-2002.
- 2,898,633 ( *See Class 35 for this trademark*).
- 2,898,638 ( *See Class 35 for this trademark*).
- 2,898,639. **CSFBCONNECT (BLOCK FORM)**. CREDIT SUISSE GROUP, (U.S. CLS. 100, 101 AND 102). SN 76-452,966. PUB. 8-10-2004. FILED 9-20-2002.
- 2,898,643. **HIGH SPEED CASH AND DESIGN**. OSAKO, KENJI, (U.S. CLS. 100, 101 AND 102). SN 76-454,156. PUB. 8-10-2004. FILED 10-1-2002.
- 2,898,662. **QQQ**. NASDAQ STOCK MARKET, INC., THE, (U.S. CLS. 100, 101 AND 102). SN 76-462,475. PUB. 8-10-2004. FILED 10-21-2002.
- 2,898,666. **CORRESPONDENT OF CHOICE**. UNITED BANKERS' BANK, (U.S. CLS. 100, 101 AND 102). SN 76-465,096. PUB. 6-3-2003. FILED 11-7-2002.
- 2,898,684. **THE PURPOSE-DRIVEN FAMILY WEALTH BLUEPRINT**. BROWN & STREZA, LLP, (U.S. CLS. 100, 101 AND 102). SN 76-473,583. PUB. 7-29-2003. FILED 12-6-2002.
- 2,898,687. **BROKERAGE GROUP INTERNATIONAL, LLC AND DESIGN**. BROKERAGE GROUP INTERNATIONAL, LLC, (U.S. CLS. 100, 101 AND 102). SN 76-474,403. PUB. 8-19-2003. FILED 12-12-2002.
- 2,898,698. **KRAUS-ANDERSON (STYLIZED)**. KRAUS-ANDERSON, INCORPORATED, (U.S. CLS. 100, 101 AND 102). SN 76-482,052. PUB. 8-10-2004. FILED 1-13-2003.
- 2,898,709. **HEAD2HEAD AND DESIGN**. BREEDERS' CUP LIMITED, (U.S. CLS. 100, 101 AND 102). SN 76-487,177. PUB. 10-14-2003. FILED 2-4-2003.
- 2,898,712. **SIMPLE SOLUTIONS WORKSHEET**. TRANSAMERICA LIFE INSURANCE AND ANNUITY COMPANY, (U.S. CLS. 100, 101 AND 102). SN 76-487,646. PUB. 8-10-2004. FILED 2-4-2003.
- 2,898,713. **SIMPLE SOLUTIONS CALCULATOR**. TRANSAMERICA LIFE INSURANCE AND ANNUITY COMPANY, (U.S. CLS. 100, 101 AND 102). SN 76-487,647. PUB. 8-10-2004. FILED 2-4-2003.
- 2,898,714. **JULIUS BAR BROKERAGE ONEACCESS (STYLIZED)**. JULIUS BAR HOLDING AG, MULTIPLE CLASS, (INT. CLS. 36 AND 38), (U.S. CLS. 100, 101, 102 AND 104). SN 76-487,981. PUB. 5-25-2004. FILED 2-5-2003.
- 2,898,750. **HOMEFREE REALTY**. HOMEFREE MORTGAGE CORPORATION, (U.S. CLS. 100, 101 AND 102). SN 76-500,757. PUB. 8-10-2004. FILED 3-26-2003.
- 2,898,752 ( *See Class 35 for this trademark*).
- 2,898,758. **HOME QUARTERS**. HQ HOLDINGS, LLC, (U.S. CLS. 100, 101 AND 102). SN 76-503,016. PUB. 8-10-2004. FILED 4-1-2003.
- 2,898,843. **CAPITAL PRESERVATION PLAN**. NATIONWIDE LIFE INSURANCE COMPANY, (U.S. CLS. 100, 101 AND 102). SN 76-514,277. PUB. 8-10-2004. FILED 5-15-2003.
- 2,898,844. **MISCELLANEOUS DESIGN**. NATIONAL CHERRY BLOSSOM FESTIVAL, INC., (U.S. CLS. 100, 101 AND 102). SN 76-514,310. PUB. 8-10-2004. FILED 5-15-2003.
- 2,898,848. **THE FLORIDA MALL**. SIMON PROPERTY GROUP, L.P., (U.S. CLS. 100, 101 AND 102). SN 76-514,511. PUB. 8-10-2004. FILED 5-14-2003.
- 2,898,869. **GOLDENCARE WORKPLACE SOLUTIONS**. GOLDENCARE CORPORATION, (U.S. CLS. 100, 101 AND 102). SN 76-516,948. PUB. 8-10-2004. FILED 5-16-2003.
- 2,898,877 ( *See Class 4 for this trademark*).
- 2,898,883 ( *See Class 35 for this trademark*).
- 2,898,884. **EASYSTREET REALTY AND DESIGN**. EASY STREET REALTY, INC., (U.S. CLS. 100, 101 AND 102). SN 76-518,886. PUB. 8-10-2004. FILED 5-8-2003.
- 2,898,895. **ENSIS**. QSR MANAGEMENT LIMITED, (U.S. CLS. 100, 101 AND 102). SN 76-519,252. PUB. 8-10-2004. FILED 6-3-2003.
- 2,898,916. **NATIONAL CHECK NETWORK**. ELECTRONIC CLEARING HOUSE, INC., (U.S. CLS. 100, 101 AND 102). SN 76-520,913. PUB. 8-10-2004. FILED 6-9-2003.
- 2,898,950. **CREDIT BASED PROGRAM WITH NO BK SEASONING**. OPTION ONE MORTGAGE CORPORATION, (U.S. CLS. 100, 101 AND 102). SN 76-528,298. PUB. 8-10-2004. FILED 7-7-2003.
- 2,898,951. **THE BULL DOG CLUB OF AMERICA FOUNDED 1890 AND DESIGN**. THE BULL-DOG CLUB OF AMERICA, INC., MULTIPLE CLASS, (INT. CLS. 36 AND 41), (U.S. CLS. 100, 101, 102 AND 107). SN 76-528,462. PUB. 8-10-2004. FILED 7-9-2003.
- 2,898,966. **SECURITY BUILDER**. CONSECO SERVICES, LLC, (U.S. CLS. 100, 101 AND 102). SN 76-531,429. PUB. 8-10-2004. FILED 7-22-2003.
- 2,898,967. **NATIONAL ACHIEVEMENT**. NATIONAL MERIT SCHOLARSHIP CORPORATION, MULTIPLE CLASS, (INT. CLS. 36 AND 41), (U.S. CLS. 100, 101, 102 AND 107). SN 76-531,459. PUB. 8-10-2004. FILED 7-22-2003.
- 2,898,968. **TEAM ARGENT RACING**. ARGENT MORTGAGE COMPANY, LLC, (U.S. CLS. 100, 101 AND 102). SN 76-531,545. PUB. 2-24-2004. FILED 7-23-2003.
- 2,898,970. **ONE SOURCE**. OMNIUM WORLDWIDE, INC., (U.S. CLS. 100, 101 AND 102). SN 76-532,128. PUB. 4-6-2004. FILED 7-14-2003.

- 2,898,983. **MBNA INSTALLMENT**. MBNA AMERICA BANK, NATIONAL ASSOCIATION, (U.S. CLS. 100, 101 AND 102). SN 76-534,387. PUB. 8-10-2004. FILED 8-1-2003.
- 2,899,035. **SELECTIONS PLUS (STYLIZED)**. REGENCE BLUE SHIELD, MULTIPLE CLASS, (INT. CLS. 36 AND 44), (U.S. CLS. 100, 101 AND 102). SN 76-543,312. PUB. 8-10-2004. FILED 9-8-2003.
- 2,899,084. **ASSET-CARE LTC**. GOLDEN RULE INSURANCE COMPANY, (U.S. CLS. 100, 101 AND 102). SN 76-550,154. PUB. 8-10-2004. FILED 10-8-2003.
- 2,899,125 ( *See Class 9 for this trademark*).
- 2,899,133. **EMBARCADERO CENTER**. EMBARCADERO CENTER, INC., (U.S. CLS. 100, 101 AND 102). SN 76-554,637. PUB. 8-10-2004. FILED 10-9-2003.
- 2,899,152 ( *See Class 35 for this trademark*).
- 2,899,158. **MONTE HEWETT HOMES (STYLIZED)**. MONTE HEWETT HOMES, LLC, MULTIPLE CLASS, (INT. CLS. 36 AND 37), (U.S. CLS. 100, 101, 102, 103 AND 106). SN 76-556,342. PUB. 8-10-2004. FILED 11-3-2003.
- 2,899,171. **FORGET ME NOT (BLOCK FORM)**. CDOC, INC., (U.S. CLS. 100, 101 AND 102). SN 76-556,906. PUB. 8-10-2004. FILED 11-5-2003.
- 2,899,172. **PLANT A SEED OF HOPE (BLOCK FORM)**. CDOC, INC., (U.S. CLS. 100, 101 AND 102). SN 76-556,922. PUB. 8-10-2004. FILED 11-5-2003.
- 2,899,186. **CLIMB FOR LIFE (BLOCK FORM)**. HERA WOMEN'S CANCER FOUNDATION, (U.S. CLS. 100, 101 AND 102). SN 76-557,359. PUB. 8-10-2004. FILED 11-6-2003.
- 2,899,189 ( *See Class 35 for this trademark*).
- 2,899,219. **TBG FINANCIAL AND DESIGN**. TBG INSURANCE SERVICES CORPORATION, DBA TBG FINANCIAL, (U.S. CLS. 100, 101 AND 102). SN 76-558,964. PUB. 8-10-2004. FILED 11-10-2003.
- 2,899,233. **REPUBLIC OF SAVING (STYLIZED)**. ING USA HOLDING CORPORATION, MULTIPLE CLASS, (INT. CLS. 36 AND 41), (U.S. CLS. 100, 101, 102 AND 107). SN 76-559,487. PUB. 8-10-2004. FILED 11-12-2003.
- 2,899,245. **SETTING THE STANDARD OF EXCELLENCE FOR REAL ESTATE DEVELOPMENT (BLOCK FORM)**. THE SABALLUS COMPANIES, LTD., MULTIPLE CLASS, (INT. CLS. 36 AND 37), (U.S. CLS. 100, 101, 102, 103 AND 106). SN 76-560,739. PUB. 8-10-2004. FILED 11-17-2003.
- 2,899,246. **M AND DESIGN**. MERCANTILE BANCORP, INC., (U.S. CLS. 100, 101 AND 102). SN 76-560,756. PUB. 8-10-2004. FILED 11-17-2003.
- 2,899,252. **MISCELLANEOUS DESIGN**. SHOOSTER, DANIEL H., (U.S. CLS. 100, 101 AND 102). SN 76-561,649. PUB. 8-10-2004. FILED 11-12-2003.
- 2,899,258. **TBG FINANCIAL AND DESIGN**. TBG INSURANCE SERVICES CORPORATION, DBA TBG FINANCIAL, (U.S. CLS. 100, 101 AND 102). SN 76-563,623. PUB. 8-10-2004. FILED 11-21-2003.
- 2,899,259. **OPS (STYLIZED)**. NEHEMIAH CORPORATION OF CALIFORNIA, (U.S. CLS. 100, 101 AND 102). SN 76-563,636. PUB. 8-10-2004. FILED 11-24-2003.
- 2,899,260. **TBG FINANCIAL (BLOCK FORM)**. TBG INSURANCE SERVICES CORPORATION, DBA TBG FINANCIAL, (U.S. CLS. 100, 101 AND 102). SN 76-563,675. PUB. 8-10-2004. FILED 11-21-2003.
- 2,899,302. **SOLARBANK**. ECKHART, MICHAEL T., (U.S. CLS. 100, 101 AND 102). SN 78-119,016. PUB. 8-10-2004. FILED 4-2-2002.
- 2,899,344 ( *See Class 35 for this trademark*).
- 2,899,349 ( *See Class 35 for this trademark*).
- 2,899,372. **#1 HOME BUYER'S GUARDIAN AND DESIGN**. DELGALLO, MAGGIE L., (U.S. CLS. 100, 101 AND 102). SN 78-177,559. PUB. 12-9-2003. FILED 10-23-2002.
- 2,899,375. **CL TEL**. CLEAR LAKE INDEPENDENT TELEPHONE CO., MULTIPLE CLASS, (INT. CLS. 36, 37, 38 AND 42), (U.S. CLS. 100, 101, 102, 103, 104 AND 106). SN 78-179,563. PUB. 8-10-2004. FILED 10-29-2002.
- 2,899,379. **AH ASSOCIATED HARDWOODS INC. AND DESIGN**. ASSOCIATED HARDWOODS, INC., (U.S. CLS. 100, 101 AND 102). SN 78-180,496. PUB. 8-10-2004. FILED 10-31-2002.
- 2,899,383. **BLUE**. IDT NETHERLANDS, B.V. (PUERTO RICO BRANCH), (U.S. CLS. 100, 101 AND 102). SN 78-182,275. PUB. 2-3-2004. FILED 11-6-2002.
- 2,899,391. **THE CHECK CASHING STORE AND DESIGN**. CCS FINANCIAL SERVICES, INC., (U.S. CLS. 100, 101 AND 102). SN 78-189,197. PUB. 8-10-2004. FILED 11-26-2002.
- 2,899,406. **HomeCITY MORTGAGE**. RE-INVESTORS, INC., (U.S. CLS. 100, 101 AND 102). SN 78-198,442. PUB. 9-30-2003. FILED 12-30-2002.
- 2,899,407. **BUILDING ONE-ON-ONE RELATIONSHIPS**. EF&A FUNDING, L.L.C., (U.S. CLS. 100, 101 AND 102). SN 78-198,456. PUB. 7-29-2003. FILED 12-30-2002.
- 2,899,415. **HAWKEYE-SECURITY INSURANCE MEMBER OF LIBERTY MUTUAL GROUP AND DESIGN**. LIBERTY MUTUAL INSURANCE COMPANY, (U.S. CLS. 100, 101 AND 102). SN 78-201,143. PUB. 8-10-2004. FILED 1-8-2003.
- 2,899,421. **HERITAGE MAX**. NORTH AMERICAN COMPANY FOR LIFE AND HEALTH INSURANCE, (U.S. CLS. 100, 101 AND 102). SN 78-203,661. PUB. 11-4-2003. FILED 1-15-2003.
- 2,899,440. **PP PROVIDERPAY AND DESIGN**. P5, INC., (U.S. CLS. 100, 101 AND 102). SN 78-217,381. PUB. 8-10-2004. FILED 2-21-2003.
- 2,899,445. **LIONSTONE AND DESIGN**. LIONSTONE PARTNERS, LTD., (U.S. CLS. 100, 101 AND 102). SN 78-219,868. PUB. 11-4-2003. FILED 2-27-2003.
- 2,899,458 ( *See Class 7 for this trademark*).
- 2,899,461 ( *See Class 35 for this trademark*).
- 2,899,466. **CASTLE INSPECTION SERVICE**. CASTLE INSPECTION SERVICE, INC., (U.S. CLS. 100, 101 AND 102). SN 78-230,402. PUB. 8-10-2004. FILED 3-26-2003.
- 2,899,479. **DOLLAR REALTY AND DESIGN**. DOLLAR REALTY, INC., (U.S. CLS. 100, 101 AND 102). SN 78-234,246. PUB. 1-6-2004. FILED 4-4-2003.
- 2,899,520. **TMP THE MIRAMAR PLAN PROVIDED BY THE MIRAMAR GROUP AND DESIGN**. THE MIRAMAR GROUP, INC., (U.S. CLS. 100, 101 AND 102). SN 78-241,376. PUB. 8-10-2004. FILED 4-23-2003.
- 2,899,538. **NORTH CAROLINA COMMUNITY FEDERAL CREDIT UNION AND DESIGN**. NORTH CAROLINA COMMUNITY FEDERAL CREDIT UNION, (U.S. CLS. 100, 101 AND 102). SN 78-245,744. PUB. 8-10-2004. FILED 5-5-2003.
- 2,899,549 ( *See Class 16 for this trademark*).
- 2,899,558. **CLEARING THE PATH TO GLOBAL SUCCESS**. FAUNUS GROUP INTERNATIONAL, INC., (U.S. CLS. 100, 101 AND 102). SN 78-249,017. PUB. 8-10-2004. FILED 5-13-2003.
- 2,899,593. **CELES KING III**. CELES KING III AND ASSOCIATES, (U.S. CLS. 100, 101 AND 102). SN 78-252,870. PUB. 8-10-2004. FILED 5-21-2003.
- 2,899,623. **FUNDAMENTAL CHOICE**. PRUDENTIAL SECURITIES, INC., (U.S. CLS. 100, 101 AND 102). SN 78-258,311. PUB. 1-20-2004. FILED 6-4-2003.
- 2,899,631. **KALAHARI KONDOMINIUMS**. KALAHARI DEVELOPMENT LLC, MULTIPLE CLASS, (INT. CLS. 36 AND 43), (U.S. CLS. 100, 101 AND 102). SN 78-259,044. PUB. 8-10-2004. FILED 6-5-2003.
- 2,899,632. **NEWMARKET**. NEWMARKET CAPITAL PARTNERS, LLC, (U.S. CLS. 100, 101 AND 102). SN 78-259,329. PUB. 8-10-2004. FILED 6-6-2003.
- 2,899,649 ( *See Class 35 for this trademark*).
- 2,899,673. **NEWMARKET CAPITAL**. NEWMARKET CAPITAL PARTNERS, LLC, (U.S. CLS. 100, 101 AND 102). SN 78-266,823. PUB. 8-10-2004. FILED 6-25-2003.
- 2,899,678. **DB PENSIONEDGE**. HOOKER & HOLCOMBE, INC., (U.S. CLS. 100, 101 AND 102). SN 78-268,765. PUB. 3-23-2004. FILED 6-30-2003.
- 2,899,680. **MADISON ABSTRACT**. MADISON ABSTRACT, INC., (U.S. CLS. 100, 101 AND 102). SN 78-269,322. PUB. 8-10-2004. FILED 7-1-2003.
- 2,899,687. **PREMIER REALTY & MANAGEMENT**. GAUVIN REALTY & MANAGEMENT, INC., (U.S. CLS. 100, 101 AND 102). SN 78-270,656. PUB. 8-10-2004. FILED 7-4-2003.
- 2,899,698. **MISCELLANEOUS DESIGN**. CAPITAL ASSOCIATES, LLC, (U.S. CLS. 100, 101 AND 102). SN 78-273,859. PUB. 8-10-2004. FILED 7-14-2003.
- 2,899,728. **LEXUS MOBILITY AND DESIGN**. TOYOTA JIDOSHA KABUSHIKI KAISHA, TA TOYOTA MOTOR CORPORATION, (U.S. CLS. 100, 101 AND 102). SN 78-285,205. PUB. 8-10-2004. FILED 8-8-2003.

- 2,899,793. **HUNTER FINANCIAL GROUP, LLC.** HUNTER FINANCIAL GROUP, LLC, (U.S. CLS. 100, 101 AND 102). SN 78-304,995. PUB. 8-10-2004. FILED 9-24-2003.
- 2,899,795. **ACCESSALLSUP.COM.** ALLSUP, INC., (U.S. CLS. 100, 101 AND 102). SN 78-306,206. PUB. 8-10-2004. FILED 9-26-2003.
- 2,899,799. **THE PERSONAL FINANCIAL ADVANTAGE.** BERTRANG FINANCIAL CORP., (U.S. CLS. 100, 101 AND 102). SN 78-306,448. PUB. 8-10-2004. FILED 9-28-2003.
- 2,899,801. **WORLD ADVOCATES.** WORLD ADVOCATES, INC., (U.S. CLS. 100, 101 AND 102). SN 78-307,026. PUB. 8-10-2004. FILED 9-30-2003.
- 2,899,822. **KEY MOMENTS.** CATHOLIC KNIGHTS, (U.S. CLS. 100, 101 AND 102). SN 78-311,073. PUB. 8-10-2004. FILED 10-8-2003.
- 2,899,823. **FLEXCLEAR.** COMMODITIES DERIVATIVE EXCHANGE, INC., (U.S. CLS. 100, 101 AND 102). SN 78-311,168. PUB. 8-10-2004. FILED 10-8-2003.
- 2,899,828. **HANDHELD POWER AND DESIGN.** HANDHELD POWER, LLC, MULTIPLE CLASS, (INT. CLS. 36 AND 38), (U.S. CLS. 100, 101, 102 AND 104). SN 78-311,961. PUB. 8-10-2004. FILED 10-10-2003.
- 2,899,837. **NO BUYER LEFT BEHIND.** RE-DESIGNING WOMEN, INC., (U.S. CLS. 100, 101 AND 102). SN 78-313,827. PUB. 8-10-2004. FILED 10-15-2003.
- 2,899,847. **CHECKNOW.** CROSSCHECK, INC., (U.S. CLS. 100, 101 AND 102). SN 78-314,792. PUB. 8-10-2004. FILED 10-16-2003.
- 2,899,888. **INVESTING IN FUTURES.** CONNECTICUT STUDENT LOAN FOUNDATION, (U.S. CLS. 100, 101 AND 102). SN 78-319,362. PUB. 8-10-2004. FILED 10-28-2003.
- 2,899,908. **MY MORTGAGE PRO.** MY MORTGAGE PRO, (U.S. CLS. 100, 101 AND 102). SN 78-321,527. PUB. 8-10-2004. FILED 10-31-2003.
- 2,899,909. **FIRST HOUSTON.** FIRST HOUSTON MORTGAGE LIMITED, (U.S. CLS. 100, 101 AND 102). SN 78-321,731. PUB. 8-10-2004. FILED 10-31-2003.
- 2,899,922. **MISCELLANEOUS DESIGN.** SPUR CAPITAL PARTNERS, LLC, (U.S. CLS. 100, 101 AND 102). SN 78-322,518. PUB. 8-10-2004. FILED 11-3-2003.
- 2,899,924. **FLEXIBILITY. FOCUS. FULL SERVICE. (BLOCK FORM).** THE 401(K) COMPANY, (U.S. CLS. 100, 101 AND 102). SN 78-322,622. PUB. 8-10-2004. FILED 11-4-2003.
- 2,899,945. **DRIVE FOR HOPE (BLOCK FORM).** HOPE FOUNDATION, THE, (U.S. CLS. 100, 101 AND 102). SN 78-324,589. PUB. 8-10-2004. FILED 11-7-2003.
- 2,899,948. **BECAUSE SOME THINGS CAN'T WAIT UNTIL PAYDAY (BLOCK FORM).** CASH AMERICA INTERNATIONAL, INC., (U.S. CLS. 100, 101 AND 102). SN 78-324,808. PUB. 8-10-2004. FILED 11-7-2003.
- 2,899,949. **ACHIEVING SUCCESS BY INVESTING IN GREAT PEOPLE (BLOCK FORM).** ACKERLEY PARTNERS LLC, (U.S. CLS. 100, 101 AND 102). SN 78-324,895. PUB. 8-10-2004. FILED 11-7-2003.
- 2,899,953. **REALTY DIRECT AND DESIGN.** REALTY DIRECT FRANCHISE CORPORATION, (U.S. CLS. 100, 101 AND 102). SN 78-325,324. PUB. 8-10-2004. FILED 11-10-2003.
- 2,900,003. **METRO@WORK (BLOCK FORM).** METROPOLITAN CREDIT UNION, (U.S. CLS. 100, 101 AND 102). SN 78-332,234. PUB. 8-10-2004. FILED 11-24-2003.
- 2,900,015. **REALTY DIRECT (BLOCK FORM).** REALTY DIRECT FRANCHISE CORPORATION, (U.S. CLS. 100, 101 AND 102). SN 78-355,513. PUB. 8-10-2004. FILED 1-22-2004.
- 2,898,573 ( *See Class 6 for this trademark.*).
- 2,898,588 ( *See Class 35 for this trademark.*).
- 2,898,678 ( *See Class 35 for this trademark.*).
- 2,898,699 ( *See Class 7 for this trademark.*).
- 2,898,784 ( *See Class 9 for this trademark.*).
- 2,898,797 ( *See Class 6 for this trademark.*).
- 2,898,801. **BEDWETTERS IRRIGATION.** BEDWETTERS IRRIGATION SERVICES, LLC., (U.S. CLS. 100, 103 AND 106). SN 76-509,957. PUB. 8-10-2004. FILED 4-23-2003.
- 2,898,808 ( *See Class 35 for this trademark.*).
- 2,898,819. **SKW AND DESIGN.** SHAFER, KLINE & WARREN, INC., (U.S. CLS. 100, 103 AND 106). SN 76-512,023. PUB. 8-10-2004. FILED 5-5-2003.
- 2,898,823. **CC&E.** CONTROLLED CONSTRUCTION & ENGINEERING, INC., (U.S. CLS. 100, 103 AND 106). SN 76-512,259. PUB. 8-10-2004. FILED 5-7-2003.
- 2,898,877 ( *See Class 4 for this trademark.*).
- 2,898,926 ( *See Class 35 for this trademark.*).
- 2,898,962 ( *See Class 35 for this trademark.*).
- 2,898,973 ( *See Class 7 for this trademark.*).
- 2,899,037. **CAFFES-STEELE WINDOWS AND DOORS AND DESIGN.** CAFFES-STEELE CONTRACTING OF VIRGINIA, INC., (U.S. CLS. 100, 103 AND 106). SN 76-543,583. PUB. 8-10-2004. FILED 9-10-2003.
- 2,899,074 ( *See Class 9 for this trademark.*).
- 2,899,096. **RAW URBAN VISION.** RAW INTERNATIONAL INC., (U.S. CLS. 100, 103 AND 106). SN 76-551,313. PUB. 8-10-2004. FILED 10-10-2003.
- 2,899,112. **REPAIR REMODEL RESTORE AND MORE.** HANDYMAN MATTERS, INC., (U.S. CLS. 100, 103 AND 106). SN 76-552,616. PUB. 8-10-2004. FILED 10-20-2003.
- 2,899,125 ( *See Class 9 for this trademark.*).
- 2,899,146. **REED HISTORICAL DATA.** REED ELSEVIER INC., (U.S. CLS. 100, 103 AND 106). SN 76-555,353. PUB. 8-10-2004. FILED 10-14-2003.
- 2,899,147. **X-TEND-A-PERF.** BLACK WARRIOR WIRELINE CORP., MULTIPLE CLASS, (INT. CLS. 37 AND 42), (U.S. CLS. 100, 101, 103 AND 106). SN 76-555,400. PUB. 8-10-2004. FILED 10-30-2003.
- 2,899,158 ( *See Class 36 for this trademark.*).
- 2,899,177. **P N R D1 D2 AND DESIGN.** PRECISION FRANCHISING LLC, (U.S. CLS. 100, 103 AND 106). SN 76-557,180. PUB. 8-10-2004. FILED 10-30-2003.
- 2,899,178. **MISCELLANEOUS DESIGN.** PRECISION FRANCHISING LLC, (U.S. CLS. 100, 103 AND 106). SN 76-557,182. PUB. 8-10-2004. FILED 10-30-2003.
- 2,899,179. **MISCELLANEOUS DESIGN.** PRECISION FRANCHISING LLC, (U.S. CLS. 100, 103 AND 106). SN 76-557,183. PUB. 8-10-2004. FILED 10-30-2003.
- 2,899,180. **MISCELLANEOUS DESIGN.** PRECISION FRANCHISING LLC, (U.S. CLS. 100, 103 AND 106). SN 76-557,190. PUB. 8-10-2004. FILED 10-30-2003.
- 2,899,181. **MISCELLANEOUS DESIGN.** PRECISION FRANCHISING LLC, (U.S. CLS. 100, 103 AND 106). SN 76-557,191. PUB. 8-10-2004. FILED 10-30-2003.
- 2,899,204 ( *See Class 35 for this trademark.*).
- 2,899,242. **UNION PARK (BLOCK FORM).** UNION PARK AUTOMOTIVE GROUP, INC., (U.S. CLS. 100, 103 AND 106). SN 76-560,364. PUB. 8-10-2004. FILED 11-14-2003.
- 2,899,245 ( *See Class 36 for this trademark.*).
- 2,899,286 ( *See Class 35 for this trademark.*).
- 2,899,288 ( *See Class 9 for this trademark.*).
- 2,899,294. **GEEK RESCUE AND DESIGN.** ELECTRONIC BILLBOARDS, INC., (U.S. CLS. 100, 103 AND 106). SN 78-105,067. PUB. 12-24-2002. FILED 1-26-2002.
- 2,899,319 ( *See Class 6 for this trademark.*).
- 2,899,344 ( *See Class 35 for this trademark.*).
- 2,899,349 ( *See Class 35 for this trademark.*).
- 2,899,373. **WEITZ AND DESIGN.** WEITZ COMPANY, LLC, THE, (U.S. CLS. 100, 103 AND 106). SN 78-177,611. PUB. 8-10-2004. FILED 10-23-2002.
- 2,899,375 ( *See Class 36 for this trademark.*).
- 2,899,395 ( *See Class 9 for this trademark.*).
- 2,899,436. **RMC.** MITSUBISHI ELECTRIC CORPORATION, (U.S. CLS. 100, 103 AND 106). SN 78-215,943. PUB. 8-10-2004. FILED 2-18-2003.
- 2,899,447. **OCE EASYPAC (STYLIZED).** OCE-TECHNOLOGIES B.V., MULTIPLE CLASS, (INT. CLS. 37 AND 42), (U.S.

---

## CLASS 37—CONSTRUCTION AND REPAIR

- 2,898,433 ( *See Class 1 for this trademark.*).
- 2,898,445 ( *See Class 9 for this trademark.*).
- 2,898,449 ( *See Class 9 for this trademark.*).
- 2,898,456. **PIONEER RESTORATION.** REID, JOHN W., AND REID, CATHERINE L., DBA PIONEER RESTORATION, (U.S. CLS. 100, 103 AND 106). SN 75-882,803. PUB. 8-10-2004. FILED 12-29-1999.
- 2,898,487 ( *See Class 6 for this trademark.*).
- 2,898,527 ( *See Class 4 for this trademark.*).

- CLS. 100, 101, 103 AND 106). SN 78-221,173. PUB. 8-10-2004. FILED 3-4-2003.
- 2,899,458 ( *See Class 7 for this trademark*).
- 2,899,532. **CITY CHAIN AND DESIGN**. CITY CHAIN COMPANY LIMITED, (U.S. CLS. 100, 103 AND 106). SN 78-243,660. PUB. 8-10-2004. FILED 4-30-2003.
- 2,899,553. **TOWER PAINTING CO., INC. AND DESIGN**. TOWER PAINTING CO., INC., (U.S. CLS. 100, 103 AND 106). SN 78-247,772. PUB. 8-10-2004. FILED 5-9-2003.
- 2,899,573 ( *See Class 28 for this trademark*).
- 2,899,594. **CLEAN CREW**. CLEAN CREW, INC., (U.S. CLS. 100, 103 AND 106). SN 78-253,136. PUB. 8-10-2004. FILED 5-22-2003.
- 2,899,641. **BUILDING ON YOUR DREAMS**. CENTEX CORPORATION, (U.S. CLS. 100, 103 AND 106). SN 78-260,616. PUB. 8-10-2004. FILED 6-10-2003.
- 2,899,644 ( *See Class 6 for this trademark*).
- 2,899,649 ( *See Class 35 for this trademark*).
- 2,899,717. **AVIAWEST RESORTS AND DESIGN**. AVIAWEST RESORTS INC., (U.S. CLS. 100, 103 AND 106). SN 78-280,874. PUB. 8-10-2004. FILED 7-30-2003.
- 2,899,723. **CUMBERLAND LIGHT AND DESIGN**. CUMBERLAND LIGHT, LLC., (U.S. CLS. 100, 103 AND 106). SN 78-284,515. PUB. 8-10-2004. FILED 8-7-2003.
- 2,899,783. **SINCE 1939 AMOROSO CONSTRUCTION AND DESIGN**. S.J. AMOROSO CONSTRUCTION CO., INC., (U.S. CLS. 100, 103 AND 106). SN 78-301,202. PUB. 8-10-2004. FILED 9-16-2003.
- 2,899,789. **WILD GOOSE CHASE FO CANADA GOOSE CONTROL AND DESIGN**. MACINTYRE, GRETTA, (U.S. CLS. 100, 103 AND 106). SN 78-303,157. PUB. 8-10-2004. FILED 9-20-2003.
- 2,899,833. **MISCELLANEOUS DESIGN**. HIGH DESERT INVESTMENT CORPORATION, (U.S. CLS. 100, 103 AND 106). SN 78-312,971. PUB. 8-10-2004. FILED 10-13-2003.
- 2,899,867. **S AND DESIGN**. SHIEL-SEXTON COMPANY INC., (U.S. CLS. 100, 103 AND 106). SN 78-316,721. PUB. 8-10-2004. FILED 10-21-2003.
- 2,899,875. **RESTORING YOUR FUTURE**. DISASTER ONE, INC., (U.S. CLS. 100, 103 AND 106). SN 78-318,092. PUB. 8-10-2004. FILED 10-24-2003.
- 2,899,975. **THOMAS MOORE STUDIOS PAINTING AND DESIGN AND DESIGN**. THOMAS MOORE STUDIOS, INC., (U.S. CLS. 100, 103 AND 106). SN 78-326,693. PUB. 8-10-2004. FILED 11-12-2003.
- 2,899,987. **PLACEWORKS (BLOCK FORM)**. RICKARD, STUART, (U.S. CLS. 100, 103 AND 106). SN 78-328,443. PUB. 8-10-2004. FILED 11-14-2003.
- 2,898,682 ( *See Class 9 for this trademark*).
- 2,898,714 ( *See Class 36 for this trademark*).
- 2,898,760 ( *See Class 35 for this trademark*).
- 2,898,835. **IT'S ALL ABOUT YOU**. VALOR TELECOMMUNICATIONS, LLC., (U.S. CLS. 100, 101 AND 104). SN 76-513,562. PUB. 8-10-2004. FILED 5-12-2003.
- 2,898,883 ( *See Class 35 for this trademark*).
- 2,898,971. **EVANSINET AND DESIGN**. EVANS COMMUNICATIONS, (U.S. CLS. 100, 101 AND 104). SN 76-532,317. PUB. 8-10-2004. FILED 7-25-2003.
- 2,899,056. **CHANNEL G AND DESIGN**. CHANNEL G, NFP, (U.S. CLS. 100, 101 AND 104). SN 76-546,775. PUB. 8-10-2004. FILED 9-10-2003.
- 2,899,134 ( *See Class 9 for this trademark*).
- 2,899,204 ( *See Class 35 for this trademark*).
- 2,899,205. **(C) (BLOCK FORM)**. RPOST INTERNATIONAL LIMITED, INC., (U.S. CLS. 100, 101 AND 104). SN 76-558,316. PUB. 8-10-2004. FILED 11-7-2003.
- 2,899,232. **HAMILTON INTERNET RELAY AND DESIGN**. NEDELCO, INC., (U.S. CLS. 100, 101 AND 104). SN 76-559,399. PUB. 8-10-2004. FILED 11-13-2003.
- 2,899,273. **WENOTIFY (STYLIZED)**. UA, INC., (U.S. CLS. 100, 101 AND 104). SN 76-976,711. PUB. 8-10-2004. FILED 8-29-2000.
- 2,899,286 ( *See Class 35 for this trademark*).
- 2,899,288 ( *See Class 9 for this trademark*).
- 2,899,297 ( *See Class 9 for this trademark*).
- 2,899,314 ( *See Class 18 for this trademark*).
- 2,899,323. **SHADZI**. ATHARI, AMIR SHAHAB, (U.S. CLS. 100, 101 AND 104). SN 78-140,091. PUB. 8-10-2004. FILED 6-29-2002.
- 2,899,343 ( *See Class 9 for this trademark*).
- 2,899,375 ( *See Class 36 for this trademark*).
- 2,899,395 ( *See Class 9 for this trademark*).
- 2,899,454 ( *See Class 9 for this trademark*).
- 2,899,460 ( *See Class 9 for this trademark*).
- 2,899,543. **NETZERO HISPEED**. NETZERO, INC., (U.S. CLS. 100, 101 AND 104). SN 78-246,269. PUB. 12-23-2003. FILED 5-6-2003.
- 2,899,590. **INSTACALL**. PHOENIX CONFERENCING LLC, (U.S. CLS. 100, 101 AND 104). SN 78-252,284. PUB. 1-13-2004. FILED 5-20-2003.
- 2,899,599 ( *See Class 35 for this trademark*).
- 2,899,649 ( *See Class 35 for this trademark*).
- 2,899,766. **FUSEMAIL AND DESIGN**. FUSEMAIL, LLC, (U.S. CLS. 100, 101 AND 104). SN 78-297,877. PUB. 8-10-2004. FILED 9-9-2003.
- 2,899,794. **2 C ME WWW.2CME.TV AND DESIGN**. EYE JEWELS, INC., (U.S. CLS. 100, 101 AND 104). SN 78-305,536. PUB. 8-10-2004. FILED 9-25-2003.
- 2,899,828 ( *See Class 36 for this trademark*).
- 2,899,878 ( *See Class 9 for this trademark*).
- 2,899,952. **AIRPEAK (BLOCK FORM)**. AIRPEAK COMMUNICATIONS, LLC, (U.S. CLS. 100, 101 AND 104). SN 78-325,262. PUB. 8-10-2004. FILED 11-10-2003.
- 2,899,995. **THE LEADER IN LIFESTYLE MEDIA (BLOCK FORM)**. SCRIPPS NETWORKS, INC., (U.S. CLS. 100, 101 AND 104). SN 78-330,268. PUB. 8-10-2004. FILED 11-19-2003.

### CLASS 38—COMMUNICATION

- 2,898,422 ( *See Class 9 for this trademark*).
- 2,898,432. **YES TELEVISION**. YES TELEVISION (EUROPE) LIMITED, (U.S. CLS. 100, 101 AND 104). SN 75-560,148. PUB. 6-1-2004. FILED 9-28-1998.
- 2,898,433 ( *See Class 1 for this trademark*).
- 2,898,446 ( *See Class 14 for this trademark*).
- 2,898,449 ( *See Class 9 for this trademark*).
- 2,898,453. **ROGERS AND DESIGN**. ROGERS COMMUNICATIONS INC., (U.S. CLS. 100, 101 AND 104). SN 75-860,855. PUB. 1-27-2004. FILED 12-1-1999.
- 2,898,465. **PATRIOTNET**. PATRIOTNET, INC., MULTIPLE CLASS, (INT. CLS. 38 AND 42), (U.S. CLS. 100, 101 AND 104). SN 75-950,180. PUB. 8-10-2004. FILED 2-28-2000.
- 2,898,487 ( *See Class 6 for this trademark*).
- 2,898,494. **XO**. XO COMMUNICATIONS, INC., (U.S. CLS. 100, 101 AND 104). SN 76-124,997. PUB. 8-10-2004. FILED 9-8-2000.
- 2,898,498 ( *See Class 9 for this trademark*).
- 2,898,527 ( *See Class 4 for this trademark*).
- 2,898,542 ( *See Class 35 for this trademark*).
- 2,898,565 ( *See Class 9 for this trademark*).
- 2,898,587 ( *See Class 9 for this trademark*).
- 2,898,588 ( *See Class 35 for this trademark*).
- 2,898,593 ( *See Class 36 for this trademark*).
- 2,898,681 ( *See Class 9 for this trademark*).

### CLASS 39—TRANSPORTATION AND STORAGE

- 2,898,412. **VENICE SIMPLON ORIENT-EXPRESS AND DESIGN**. SOCIETE NATIONALE DES CHEMINS DE FER FRANCAIS - S.N.C.F., (U.S. CL. 105). SN 73-525,313. PUB. 3-1-1988. FILED 3-5-1985.
- 2,898,433 ( *See Class 1 for this trademark*).
- 2,898,449 ( *See Class 9 for this trademark*).
- 2,898,487 ( *See Class 6 for this trademark*).
- 2,898,538. **SITA AND DESIGN**. SITA, MULTIPLE CLASS, (INT. CLS. 39, 40 AND 42), (U.S. CLS. 100, 101, 103, 105 AND 106). SN 76-283,138. PUB. 8-10-2004. FILED 7-11-2001.
- 2,898,553 ( *See Class 35 for this trademark*).
- 2,898,588 ( *See Class 35 for this trademark*).
- 2,898,617 ( *See Class 35 for this trademark*).
- 2,898,620 ( *See Class 35 for this trademark*).

2,898,627. **EXPRESS BOOK FREIGHT. TRANSACTION, INC.**, (U.S. CLS. 100 AND 105). SN 76-444,880. PUB. 8-10-2004. FILED 8-26-2002.  
 2,898,671 ( *See Class 35 for this trademark*).  
 2,898,717 ( *See Class 35 for this trademark*).  
 2,898,718 ( *See Class 35 for this trademark*).  
 2,898,854 ( *See Class 35 for this trademark*).  
 2,898,883 ( *See Class 35 for this trademark*).  
 2,899,015. **SULLIVAN RIGGING. FREEMAN CAPITAL COMPANY**, (U.S. CLS. 100 AND 105). SN 76-540,671. PUB. 8-10-2004. FILED 8-28-2003.  
 2,899,018 ( *See Class 35 for this trademark*).  
 2,899,019 ( *See Class 35 for this trademark*).  
 2,899,251. **INTELLIGENT SOLUTIONS. POWERFUL RESULTS. (STYLIZED). YELLOW ROADWAY CORPORATION**, (U.S. CLS. 100 AND 105). SN 76-561,488. PUB. 8-10-2004. FILED 11-24-2003.  
 2,899,270 ( *See Class 30 for this trademark*).  
 2,899,286 ( *See Class 35 for this trademark*).  
 2,899,313. **FIRST FLIGHT OUT. SPEEDY PACKAGE DELIVERY, INC.**, (U.S. CLS. 100 AND 105). SN 78-135,561. PUB. 1-13-2004. FILED 6-13-2002.  
 2,899,380. **TOURGUIDE MIKE AUTOMATED VACATION PLANNER. TOURGUIDEMIKE, L.L.C.**, (U.S. CLS. 100 AND 105). SN 78-181,468. PUB. 8-10-2004. FILED 11-4-2002.  
 2,899,458 ( *See Class 7 for this trademark*).  
 2,899,805 ( *See Class 30 for this trademark*).  
 2,899,808. **SOUTHERN BELLE. SOUTHERN BELLE REFRIGERATED, LLC**, (U.S. CLS. 100 AND 105). SN 78-308,076. PUB. 8-10-2004. FILED 10-1-2003.  
 2,899,841. **EMC AND DESIGN. COWETA-FAYETTE ELECTRIC MEMBERSHIP CORPORATION**, (U.S. CLS. 100 AND 105). SN 78-314,098. PUB. 8-10-2004. FILED 10-15-2003.  
 2,899,898. **COVENANT TRANSPORT. CIP, INC.**, (U.S. CLS. 100 AND 105). SN 78-320,419. PUB. 8-10-2004. FILED 10-29-2003.

#### CLASS 40—MATERIAL TREATMENT

2,898,433 ( *See Class 1 for this trademark*).  
 2,898,487 ( *See Class 6 for this trademark*).  
 2,898,534. **HUDSON SCENIC STUDIO. HUDSON SCENIC STUDIO, INC.**, MULTIPLE CLASS, (INT. CLS. 40, 41 AND 42), (U.S. CLS. 100, 101, 103, 106 AND 107). SN 76-273,333. PUB. 8-10-2004. FILED 6-19-2001.  
 2,898,538 ( *See Class 39 for this trademark*).  
 2,898,588 ( *See Class 35 for this trademark*).  
 2,898,619 ( *See Class 9 for this trademark*).  
 2,898,663 ( *See Class 16 for this trademark*).  
 2,898,766 ( *See Class 24 for this trademark*).  
 2,898,768. **IMAGEMARK (STYLIZED). TUTTLE LAW PRINT, INC.**, (U.S. CLS. 100, 103 AND 106). SN 76-505,328. PUB. 8-10-2004. FILED 4-9-2003.  
 2,898,802 ( *See Class 16 for this trademark*).  
 2,898,808 ( *See Class 35 for this trademark*).  
 2,898,952. **TUSCAN SPICE. INNOVATIVE MARBLE AND TILE, INC.**, (U.S. CLS. 100, 103 AND 106). SN 76-528,670. PUB. 8-10-2004. FILED 7-2-2003.  
 2,899,018 ( *See Class 35 for this trademark*).  
 2,899,019 ( *See Class 35 for this trademark*).  
 2,899,129. **CIRRUS. CIRRUS TECHNOLOGY, INC.**, (U.S. CLS. 100, 103 AND 106). SN 76-554,206. PUB. 8-10-2004. FILED 10-27-2003.  
 2,899,195 ( *See Class 30 for this trademark*).  
 2,899,282. **PANELCRAFTERS AND DESIGN. LIBERTY WIRE & CABLE**, (U.S. CLS. 100, 103 AND 106). SN 78-041,637. PUB. 8-10-2004. FILED 1-3-2001.  
 2,899,425. **COLLECT INC. LEGACY MANUFACTURING, LLC**, (U.S. CLS. 100, 103 AND 106). SN 78-208,062. PUB. 8-10-2004. FILED 1-28-2003.  
 2,899,470. **CDI (STYLIZED). CONCRETE DESIGNS INC.**, (U.S. CLS. 100, 103 AND 106). SN 78-232,181. PUB. 10-21-2003. FILED 3-31-2003.  
 2,899,474. **EVERPURE AUTHORITY. CULLIGAN INTERNATIONAL COMPANY**, (U.S. CLS. 100, 103 AND 106). SN 78-233,744. PUB. 8-10-2004. FILED 4-3-2003.

2,899,505. **EMCON. EMCON EMANATION CONTROL LIMITED, MULTIPLE CLASS**, (INT. CLS. 40 AND 42), (U.S. CLS. 100, 101, 103 AND 106). SN 78-239,433. PUB. 8-10-2004. FILED 4-18-2003.  
 2,899,506. **EMCON AND DESIGN. EMCON EMANATION CONTROL LIMITED, MULTIPLE CLASS**, (INT. CLS. 40 AND 42), (U.S. CLS. 100, 101, 103 AND 106). SN 78-239,443. PUB. 8-10-2004. FILED 4-18-2003.  
 2,899,573 ( *See Class 28 for this trademark*).  
 2,899,653. **VERSAMED. VERSAMED MEDICAL SYSTEMS, LTD.**, (U.S. CLS. 100, 103 AND 106). SN 78-262,352. PUB. 8-10-2004. FILED 6-13-2003.  
 2,899,840. **CS AND DESIGN. C & S TURF CARE EQUIPMENT, INC.**, (U.S. CLS. 100, 103 AND 106). SN 78-313,864. PUB. 8-10-2004. FILED 10-15-2003.  
 2,899,864. **TOHO WATER AUTHORITY AND DESIGN. TOHOPEKALIGA WATER AUTHORITY**, (U.S. CLS. 100, 103 AND 106). SN 78-316,462. PUB. 8-10-2004. FILED 10-21-2003.  
 2,899,891. **ONE CALL GETS IT ALL! (800) 926-2600. THYSSENKRUPP MATERIALS, INC.**, (U.S. CLS. 100, 103 AND 106). SN 78-319,507. PUB. 8-10-2004. FILED 10-28-2003.

#### CLASS 41—EDUCATION AND ENTERTAINMENT

2,898,424. **THE SPA AT THE CRESCENT. RRCC LIMITED PARTNERSHIP**, (U.S. CLS. 100, 101 AND 107). SN 75-507,183. PUB. 6-15-1999. FILED 6-23-1998.  
 2,898,433 ( *See Class 1 for this trademark*).  
 2,898,445 ( *See Class 9 for this trademark*).  
 2,898,446 ( *See Class 14 for this trademark*).  
 2,898,449 ( *See Class 9 for this trademark*).  
 2,898,480 ( *See Class 9 for this trademark*).  
 2,898,485. **BIOSTRUCTURAL. THE NUTRACEUTICAL MEDICINE COMPANY INC.**, (U.S. CLS. 100, 101 AND 107). SN 76-092,268. PUB. 8-10-2004. FILED 7-20-2000.  
 2,898,487 ( *See Class 6 for this trademark*).  
 2,898,493 ( *See Class 35 for this trademark*).  
 2,898,509. **ADAM SMITH UNIVERSITY. GRUNEWALD, DONALD**, (U.S. CLS. 100, 101 AND 107). SN 76-206,074. PUB. 8-10-2004. FILED 2-7-2001.  
 2,898,534 ( *See Class 40 for this trademark*).  
 2,898,551. **"THE HEALTHY CHEF". RODALE INC.**, (U.S. CLS. 100, 101 AND 107). SN 76-325,301. PUB. 8-10-2004. FILED 10-15-2001.  
 2,898,561. **LAKE WINNIE. LAKE WINNEPESAUKAH, INC.**, (U.S. CLS. 100, 101 AND 107). SN 76-360,412. PUB. 8-10-2004. FILED 1-22-2002.  
 2,898,562. **LAKE WINNEPESAUKAH. LAKE WINNEPESAUKAH, INC.**, (U.S. CLS. 100, 101 AND 107). SN 76-360,414. PUB. 8-10-2004. FILED 1-22-2002.  
 2,898,563. **LAKE WINNIE AND DESIGN. LAKE WINNEPESAUKAH, INC.**, (U.S. CLS. 100, 101 AND 107). SN 76-360,415. PUB. 8-10-2004. FILED 1-22-2002.  
 2,898,565 ( *See Class 9 for this trademark*).  
 2,898,571 ( *See Class 9 for this trademark*).  
 2,898,572. **D.O.O.R.S.. GARY ACCORD/COMMUNITIES IN SCHOOLS, THE**, (U.S. CLS. 100, 101 AND 107). SN 76-379,732. PUB. 8-10-2004. FILED 3-11-2002.  
 2,898,573 ( *See Class 6 for this trademark*).  
 2,898,587 ( *See Class 9 for this trademark*).  
 2,898,588 ( *See Class 35 for this trademark*).  
 2,898,594. **B BROADWAY BEACON AWARDS AND DESIGN. THE MIDTOWN MANAGEMENT GROUP, INC., DBA INSIDE BROADWAY**, (U.S. CLS. 100, 101 AND 107). SN 76-412,173. PUB. 8-10-2004. FILED 5-22-2002.  
 2,898,597. **GAYJAYS. PRIDEVISION INC.**, (U.S. CLS. 100, 101 AND 107). SN 76-413,302. PUB. 8-10-2004. FILED 5-29-2002.  
 2,898,624 ( *See Class 35 for this trademark*).  
 2,898,634. **THE VANDALS. ESCALANTE, JOSEPH P.**, (U.S. CLS. 100, 101 AND 107). SN 76-450,425. PUB. 4-22-2003. FILED 9-17-2002.  
 2,898,641. **INTERNET ACADEMY AND DESIGN. INTERNET BUSINESS JAPAN CO., LTD.**, MULTIPLE CLASS, (INT. CLS. 41 AND 42), (U.S. CLS. 100, 101 AND 107). SN 76-453,347. PUB. 8-10-2004. FILED 9-27-2002.

- 2,898,659. **PERFORMANCE PEDAGOGY**. MARIAMA, MARGUERITE, (U.S. CLS. 100, 101 AND 107). SN 76-460,903. PUB. 8-10-2004. FILED 10-22-2002.
- 2,898,663 ( *See Class 16 for this trademark*).
- 2,898,664. **THE MASTERY OF ASTROLOGY**. THE ASTROLOGY COMPANY, INC., (U.S. CLS. 100, 101 AND 107). SN 76-463,960. PUB. 8-10-2004. FILED 8-5-2002.
- 2,898,667 ( *See Class 16 for this trademark*).
- 2,898,669. **EXTRAORDINARY LEARNING OPPORTUNITIES**. NATIONAL 4-H COUNCIL, (U.S. CLS. 100, 101 AND 107). SN 76-466,203. PUB. 8-10-2004. FILED 11-12-2002.
- 2,898,696 ( *See Class 9 for this trademark*).
- 2,898,702. **CORE**. C.O.R.E. DIGITAL PICTURES INC., (U.S. CLS. 100, 101 AND 107). SN 76-484,847. PUB. 8-10-2004. FILED 1-27-2003.
- 2,898,718 ( *See Class 35 for this trademark*).
- 2,898,735 ( *See Class 9 for this trademark*).
- 2,898,757. **THE WHOLE WIDE WORLD WITH RITA HOUSTON**. FORDHAM UNIVERSITY, (U.S. CLS. 100, 101 AND 107). SN 76-502,930. PUB. 8-10-2004. FILED 3-17-2003.
- 2,898,759. **V VERVE HEALTH & FITNESS AND DESIGN**. VERVE HEALTH AND FITNESS, (U.S. CLS. 100, 101 AND 107). SN 76-503,727. PUB. 12-9-2003. FILED 4-3-2003.
- 2,898,764. **A DIFFERENT BALL GAME**. NGC NETWORK INTERNATIONAL, LLC, (U.S. CLS. 100, 101 AND 107). SN 76-504,788. PUB. 8-10-2004. FILED 4-7-2003.
- 2,898,771 ( *See Class 5 for this trademark*).
- 2,898,774. **BOHEMIAN BIRTH CHART**. STENDEL, JOHN GLENN, (U.S. CLS. 100, 101 AND 107). SN 76-507,125. PUB. 8-10-2004. FILED 4-17-2003.
- 2,898,776. **HOME CASINO**. STANWORTH DEVELOPMENT LIMITED, (U.S. CLS. 100, 101 AND 107). SN 76-507,375. PUB. 8-10-2004. FILED 4-17-2003.
- 2,898,777. **HOME CASINO AND DESIGN**. STANWORTH DEVELOPMENT LIMITED, (U.S. CLS. 100, 101 AND 107). SN 76-507,376. PUB. 8-10-2004. FILED 4-17-2003.
- 2,898,805. **SCIENCE MAN AND DESIGN**. MINORITY AVIATION EDUCATION ASSOCIATION, INC., (U.S. CLS. 100, 101 AND 107). SN 76-510,536. PUB. 8-10-2004. FILED 5-1-2003.
- 2,898,808 ( *See Class 35 for this trademark*).
- 2,898,813. **VERTICAL LEAP**. HOLLINGSWORTH, ALFRED, (U.S. CLS. 100, 101 AND 107). SN 76-511,878. PUB. 8-10-2004. FILED 4-30-2003.
- 2,898,814. **HONEYCOMB CANYON**. SOLITUDE SKI CORPORATION, (U.S. CLS. 100, 101 AND 107). SN 76-511,937. PUB. 8-10-2004. FILED 4-18-2003.
- 2,898,816. **BEDROCK BILLIARDS**. BEDROCK BILLIARDS, INC., (U.S. CLS. 100, 101 AND 107). SN 76-511,951. PUB. 1-13-2004. FILED 5-5-2003.
- 2,898,820. **FLORIDA METROPOLITAN UNIVERSITY**. CORINTHIAN COLLEGES, INC., (U.S. CLS. 100, 101 AND 107). SN 76-512,144. PUB. 8-10-2004. FILED 5-6-2003.
- 2,898,821. **LTU HEALTHCARE**. CORINTHIAN COLLEGES, INC., (U.S. CLS. 100, 101 AND 107). SN 76-512,145. PUB. 8-10-2004. FILED 5-6-2003.
- 2,898,824 ( *See Class 9 for this trademark*).
- 2,898,826 ( *See Class 16 for this trademark*).
- 2,898,845. **STARZ FRUM MARZ**. SEIBERT, CARLTON, (U.S. CLS. 100, 101 AND 107). SN 76-514,418. PUB. 8-10-2004. FILED 5-15-2003.
- 2,898,910. **YOUTH ADVOCACY CENTER AND DESIGN**. YOUTH ADVOCACY CENTER, (U.S. CLS. 100, 101 AND 107). SN 76-520,389. PUB. 8-10-2004. FILED 6-5-2003.
- 2,898,926 ( *See Class 35 for this trademark*).
- 2,898,927. **ROGER WILLIAMS UNIVERSITY SCHOOL OF LAW AND DESIGN**. ROGER WILLIAMS UNIVERSITY, (U.S. CLS. 100, 101 AND 107). SN 76-522,714. PUB. 8-10-2004. FILED 6-16-2003.
- 2,898,951 ( *See Class 36 for this trademark*).
- 2,898,967 ( *See Class 36 for this trademark*).
- 2,898,976. **MISCELLANEOUS DESIGN**. THE BOARD OF TRUSTEES OF THE UNIVERSITY OF ALABAMA FOR THE UNIVERSITY OF ALABAMA AT BIRMINGHAM, MULTIPLE CLASS, (INT. CLS. 41, 42 AND 44), (U.S. CLS. 100, 101 AND 107). SN 76-533,692. PUB. 8-10-2004. FILED 7-31-2003.
- 2,898,985. **CATHARSIS PRODUCTIONS AND DESIGN**. CATHARSIS PRODUCTIONS, L.L.C., (U.S. CLS. 100, 101 AND 107). SN 76-535,514. PUB. 8-10-2004. FILED 7-28-2003.
- 2,898,986. **C.O.R.E. FEATURE ANIMATION**. C.O.R.E. DIGITAL PICTURES INC., (U.S. CLS. 100, 101 AND 107). SN 76-535,558. PUB. 8-10-2004. FILED 8-7-2003.
- 2,899,005. **SOUTHERN CALIFORNIA MINORITY BUSINESS DEVELOPMENT COUNCIL, INC. ORANGE COUNTY CHAPTER AND DESIGN**. SOUTHERN CALIFORNIA MINORITY BUSINESS DEVELOPMENT COUNCIL, INC., (U.S. CLS. 100, 101 AND 107). SN 76-537,851. PUB. 8-10-2004. FILED 8-15-2003.
- 2,899,014. **MERCY COLLEGE OF NORTHWEST OHIO AND DESIGN**. MERCY COLLEGE OF NORTHWEST OHIO, (U.S. CLS. 100, 101 AND 107). SN 76-540,663. PUB. 8-10-2004. FILED 8-28-2003.
- 2,899,016. **COME AWAY PLANTATION**. PLANTATION ACQUISITION, LLC, MULTIPLE CLASS, (INT. CLS. 41 AND 43), (U.S. CLS. 100, 101 AND 107). SN 76-540,690. PUB. 8-10-2004. FILED 8-28-2003.
- 2,899,020. **ON YOUR FEET**. HIRSCH, GARY, (U.S. CLS. 100, 101 AND 107). SN 76-541,226. PUB. 8-10-2004. FILED 8-19-2003.
- 2,899,038. **PINE COVE AT CRIER CREEK**. PINE COVE, INC., (U.S. CLS. 100, 101 AND 107). SN 76-543,774. PUB. 8-10-2004. FILED 9-9-2003.
- 2,899,051. **PERFORMANCE BOOSTER**. COLUMBINE HOLDING CORPORATION, DBA SYSTEMATION, (U.S. CLS. 100, 101 AND 107). SN 76-546,080. PUB. 8-10-2004. FILED 9-22-2003.
- 2,899,054. **SCHOLARSHIP LEADERSHIP SERVICE BRYANT ACADEMY AND DESIGN**. CARRIER CORPORATION, (U.S. CLS. 100, 101 AND 107). SN 76-546,426. PUB. 8-10-2004. FILED 9-23-2003.
- 2,899,055. **QUALITY EXPERIENCE LEADERSHIP CARRIER UNIVERSITY AND DESIGN**. CARRIER CORPORATION, (U.S. CLS. 100, 101 AND 107). SN 76-546,509. PUB. 8-10-2004. FILED 9-23-2003.
- 2,899,067 ( *See Class 35 for this trademark*).
- 2,899,070 ( *See Class 9 for this trademark*).
- 2,899,072. **H2 AND DESIGN**. UNIVERSITY OF CENTRAL FLORIDA, MULTIPLE CLASS, (INT. CLS. 41 AND 42), (U.S. CLS. 100, 101 AND 107). SN 76-548,613. PUB. 8-10-2004. FILED 10-3-2003.
- 2,899,087. **RED ROCKS PARK AND AMPHITHEATRE EST. 1941 AND DESIGN**. CITY AND COUNTY OF DENVER, ACTING BY AND THROUGH THE THEATRES AND ARENAS DIVISION OF THE DEPARTMENT OF GENERAL SERVICES, (U.S. CLS. 100, 101 AND 107). SN 76-550,324. PUB. 8-10-2004. FILED 9-22-2003.
- 2,899,094. **D2AXONOMY**. D SQUARED ASSESSMENTS, INC., (U.S. CLS. 100, 101 AND 107). SN 76-551,262. PUB. 8-10-2004. FILED 9-24-2003.
- 2,899,095. **D2MARC**. D SQUARED ASSESSMENTS, INC., (U.S. CLS. 100, 101 AND 107). SN 76-551,263. PUB. 8-10-2004. FILED 9-24-2003.
- 2,899,116. **NU IMAGE (STYLIZED)**. M3 MEDIA, INC., (U.S. CLS. 100, 101 AND 107). SN 76-552,942. PUB. 8-10-2004. FILED 10-2-2003.
- 2,899,125 ( *See Class 9 for this trademark*).
- 2,899,126. **101 JUICIEST HOLLYWOOD HOOKUPS**. E! ENTERTAINMENT TELEVISION, INC., (U.S. CLS. 100, 101 AND 107). SN 76-553,884. PUB. 8-10-2004. FILED 10-21-2003.
- 2,899,130 ( *See Class 9 for this trademark*).
- 2,899,139. **BLUE CHIP CASINO & HOTEL AND DESIGN**. BOYD GAMING CORPORATION, (U.S. CLS. 100, 101 AND 107). SN 76-554,853. PUB. 8-10-2004. FILED 10-9-2003.
- 2,899,144. **GREAT MUSIC FOR A GREAT CITY**. THE CITY UNIVERSITY OF NEW YORK THROUGH THE CONTINUING EDUCATION AND PUBLIC PROGRAMS DIVISION OF THE GRADUATE SCHOOL AND UNIVERSITY CENTER, (U.S. CLS. 100, 101 AND 107). SN 76-555,271. PUB. 8-10-2004. FILED 10-14-2003.
- 2,899,150. **PARTY PICS (STYLIZED)**. CANDID COLOR SYSTEMS, INC., (U.S. CLS. 100, 101 AND 107). SN 76-555,684. PUB. 8-10-2004. FILED 10-10-2003.
- 2,899,153. **DRIVE BY COMEDY (BLOCK FORM)**. ALL COMEDY NETWORKS, INC., (U.S. CLS. 100, 101 AND 107). SN 76-556,008. PUB. 8-10-2004. FILED 11-3-2003.



- 2,899,156. **THE WB AND DESIGN**. WARNER BROS. ENTERTAINMENT INC. (U.S. CLS. 100, 101 AND 107). SN 76-556,148. PUB. 8-10-2004. FILED 11-3-2003.
- 2,899,196. **CREATIVE HEARTWORK**. CREATIVE HEARTWORK, INC., (U.S. CLS. 100, 101 AND 107). SN 76-557,843. PUB. 8-10-2004. FILED 10-23-2003.
- 2,899,198. **JBW ENTERTAINMENT (STYLIZED)**. JBW ENTERTAINMENT, INC., (U.S. CLS. 100, 101 AND 107). SN 76-557,906. PUB. 8-10-2004. FILED 11-4-2003.
- 2,899,203. **MCR.H (STYLIZED)**. CORENET GLOBAL, INC., (U.S. CLS. 100, 101 AND 107). SN 76-558,038. PUB. 8-10-2004. FILED 11-7-2003.
- 2,899,204 ( See Class 35 for this trademark).
- 2,899,206. **BACK TO BACK (BLOCK FORM)**. THE QUEEN'S BROADCASTING CORPORATION, DBA QWBH, (U.S. CLS. 100, 101 AND 107). SN 76-558,320. PUB. 8-10-2004. FILED 11-7-2003.
- 2,899,227. **NEW-GLOBAL TRANSLATIONS (BLOCK FORM)**. TAPPER, GREG, (U.S. CLS. 100, 101 AND 107). SN 76-559,275. PUB. 8-10-2004. FILED 11-12-2003.
- 2,899,228 ( See Class 25 for this trademark).
- 2,899,233 ( See Class 36 for this trademark).
- 2,899,236 ( See Class 16 for this trademark).
- 2,899,266 ( See Class 9 for this trademark).
- 2,899,267 ( See Class 9 for this trademark).
- 2,899,274 ( See Class 35 for this trademark).
- 2,899,279. **MISCELLANEOUS DESIGN**. PCCW-HKT DATA-COM SERVICES LIMITED, (U.S. CLS. 100, 101 AND 107). SN 78-037,031. PUB. 8-10-2004. FILED 11-29-2000.
- 2,899,283. **MONSTER GAME**. HELL SURVIVORS, INC., (U.S. CLS. 100, 101 AND 107). SN 78-056,919. PUB. 3-26-2002. FILED 4-5-2001.
- 2,899,287. **GUY RADIO**. CORUS RADIO COMPANY, (U.S. CLS. 100, 101 AND 107). SN 78-083,345. PUB. 8-10-2004. FILED 9-10-2001.
- 2,899,303. **THE SPIKE (STYLIZED)**. NORTH RIVER TAVERN CORP., (U.S. CLS. 100, 101 AND 107). SN 78-120,202. PUB. 11-19-2002. FILED 4-8-2002.
- 2,899,314 ( See Class 18 for this trademark).
- 2,899,315 ( See Class 7 for this trademark).
- 2,899,316 ( See Class 7 for this trademark).
- 2,899,317. **MARKETWATCH**. MARKETWATCH.COM, INC., (U.S. CLS. 100, 101 AND 107). SN 78-136,094. PUB. 11-11-2003. FILED 6-15-2002.
- 2,899,337. **ABSOLUTE R.S.V.P. INC.**. ABSOLUTE R. S.V.P. INC, (U.S. CLS. 100, 101 AND 107). SN 78-154,026. PUB. 3-23-2004. FILED 8-14-2002.
- 2,899,343 ( See Class 9 for this trademark).
- 2,899,354 ( See Class 16 for this trademark).
- 2,899,367. **MAGIC TUMBLE BUS**. TUMBLE TIME GYMNASTICS, INC., (U.S. CLS. 100, 101 AND 107). SN 78-174,548. PUB. 5-27-2003. FILED 10-15-2002.
- 2,899,374 ( See Class 9 for this trademark).
- 2,899,392. **LEAPS LIFE EXCELERATOR ASSESSMENT OF PERSONAL SKILLS AND DESIGN**. PROVENIO GROUP, INC, (U.S. CLS. 100, 101 AND 107). SN 78-189,384. PUB. 8-10-2004. FILED 11-27-2002.
- 2,899,398. **CAPS**. CENTENARY COLLEGE, (U.S. CLS. 100, 101 AND 107). SN 78-193,907. PUB. 5-11-2004. FILED 12-12-2002.
- 2,899,411. **BUCKEYE NATIONALS**. UNITED STATES AUTO CLUB, INC., (U.S. CLS. 100, 101 AND 107). SN 78-200,440. PUB. 12-23-2003. FILED 1-6-2003.
- 2,899,414 ( See Class 5 for this trademark).
- 2,899,472. **MORE OPTIONS. MORE CHOICES. MORE CONTROL.** HARRAH'S LAS VEGAS, INC., (U.S. CLS. 100, 101 AND 107). SN 78-233,159. PUB. 8-10-2004. FILED 4-2-2003.
- 2,899,492. **EIN NEWS**. EUROPEAN INTERNET NETWORK, INC., (U.S. CLS. 100, 101 AND 107). SN 78-237,215. PUB. 2-10-2004. FILED 4-14-2003.
- 2,899,513. **THE PROFIT DOCTOR AND DESIGN**. ANDERSON, THOMAS STEPHEN, (U.S. CLS. 100, 101 AND 107). SN 78-240,072. PUB. 8-10-2004. FILED 4-21-2003.
- 2,899,519 ( See Class 9 for this trademark).
- 2,899,528 ( See Class 16 for this trademark).
- 2,899,529. **CLASSMATCH**. THE BOX PROJECT, (U.S. CLS. 100, 101 AND 107). SN 78-243,007. PUB. 1-13-2004. FILED 4-28-2003.
- 2,899,550. **SPIRITUAL BANQUET**. FAMMEREE, RICHARD A., JR., (U.S. CLS. 100, 101 AND 107). SN 78-247,202. PUB. 8-10-2004. FILED 5-8-2003.
- 2,899,551. **OVERCOMERS TELEVISION AND DESIGN**. RHEMA CHRISTIAN CENTER, (U.S. CLS. 100, 101 AND 107). SN 78-247,203. PUB. 8-10-2004. FILED 5-8-2003.
- 2,899,561. **OPENING DOORS OPENING MINDS AND DESIGN**. AMERICAN YOUTH HOSTELS, INC., (U.S. CLS. 100, 101 AND 107). SN 78-249,181. PUB. 8-10-2004. FILED 5-13-2003.
- 2,899,562. **BANK ON IT RECORDS AND DESIGN**. BANK ON IT RECORDS, INC., (U.S. CLS. 100, 101 AND 107). SN 78-249,275. PUB. 8-10-2004. FILED 5-13-2003.
- 2,899,569. **HOLLYWOOD STUDIOS AND DESIGN**. HOLLYWOOD STUDIOS, NFP, (U.S. CLS. 100, 101 AND 107). SN 78-250,014. PUB. 8-10-2004. FILED 5-15-2003.
- 2,899,571. **NORTHSHORE COOKERY AND DESIGN**. HOME CAFE, LLC, (U.S. CLS. 100, 101 AND 107). SN 78-250,045. PUB. 8-10-2004. FILED 5-15-2003.
- 2,899,586. **HAY DAYS GRASS DRAGS! (BLOCK FORM)**. SNOBARON'S SNOWMOBILE CLUB, INC., (U.S. CLS. 100, 101 AND 107). SN 78-251,750. PUB. 8-10-2004. FILED 5-19-2003.
- 2,899,599 ( See Class 35 for this trademark).
- 2,899,601. **SAFUNDI**. OFFENBURGER, ANDREW CHARLES, (U.S. CLS. 100, 101 AND 107). SN 78-254,146. PUB. 8-10-2004. FILED 5-25-2003.
- 2,899,611. **BAM BAM**. BAM BAM LEAGUE, INC., (U.S. CLS. 100, 101 AND 107). SN 78-254,704. PUB. 12-30-2003. FILED 5-27-2003.
- 2,899,613 ( See Class 35 for this trademark).
- 2,899,643. **ONE REEL AND DESIGN**. ONE REEL, (U.S. CLS. 100, 101 AND 107). SN 78-260,711. PUB. 8-10-2004. FILED 6-10-2003.
- 2,899,665. **LUCAS THEATRE FOR THE ARTS**. THE LUCAS THEATRE FOR THE ARTS, INC., (U.S. CLS. 100, 101 AND 107). SN 78-263,968. PUB. 3-23-2004. FILED 6-18-2003.
- 2,899,666. **CEJ&CO.COM AND DESIGN**. CARL ERIC JOHNSON & COMPANY, INC., (U.S. CLS. 100, 101 AND 107). SN 78-264,302. PUB. 8-10-2004. FILED 6-19-2003.
- 2,899,716. **LEAFLESS**. SPALDING, JEFFREY, SCOTT, (U.S. CLS. 100, 101 AND 107). SN 78-280,804. PUB. 8-10-2004. FILED 7-30-2003.
- 2,899,722. **DISHMAG**. SMASH MEDIA GROUP, INC., (U.S. CLS. 100, 101 AND 107). SN 78-284,284. PUB. 8-10-2004. FILED 8-7-2003.
- 2,899,731. **BNSS**. M. L. BURRIS CORPORATION, (U.S. CLS. 100, 101 AND 107). SN 78-287,090. PUB. 8-10-2004. FILED 8-13-2003.
- 2,899,732. **MIGHTY MEN**. MIGHTY MEN OF GOD, INC, (U.S. CLS. 100, 101 AND 107). SN 78-287,311. PUB. 8-10-2004. FILED 8-14-2003.
- 2,899,736. **MINDKOR (STYLIZED)**. MOLNE, RAINBOW, R.L, (U.S. CLS. 100, 101 AND 107). SN 78-289,300. PUB. 8-10-2004. FILED 8-19-2003.
- 2,899,740. **MISCELLANEOUS DESIGN**. TEXAS ASSOCIATION OF COMMUNITY HEALTH CENTERS, INC., MULTIPLE CLASS, (INT. CLS. 41 AND 42), (U.S. CLS. 100, 101 AND 107). SN 78-290,898. PUB. 8-10-2004. FILED 8-22-2003.
- 2,899,749. **GLOBE + HANDS AND DESIGN**. SANOFI-SYNTHELABO, MULTIPLE CLASS, (INT. CLS. 41 AND 42), (U.S. CLS. 100, 101 AND 107). SN 78-293,895. PUB. 8-10-2004. FILED 8-29-2003.
- 2,899,775. **FOOTBALL FIESTA**. HOUSTON NFL HOLDINGS, L.P., (U.S. CLS. 100, 101 AND 107). SN 78-298,748. PUB. 8-10-2004. FILED 9-10-2003.
- 2,899,776. **BOOT CAMP FOR GSA CONTRACTING**. CENTRE CONSULTING, INC., (U.S. CLS. 100, 101 AND 107). SN 78-299,083. PUB. 8-10-2004. FILED 9-11-2003.
- 2,899,778. **DEER PATH FILMS**. DEER PATH FILMS, INC., (U.S. CLS. 100, 101 AND 107). SN 78-299,851. PUB. 8-10-2004. FILED 9-12-2003.
- 2,899,780. **T3**. MEDCOM, INC., MULTIPLE CLASS, (INT. CLS. 41 AND 42), (U.S. CLS. 100, 101 AND 107). SN 78-299,932. PUB. 8-10-2004. FILED 9-12-2003.
- 2,899,804. **MI**. MAJORITY OF ONE FOUNDATION, (U.S. CLS. 100, 101 AND 107). SN 78-307,486. PUB. 8-10-2004. FILED 9-30-2003.
- 2,899,861. **FOLLOW THE LEADER**. EDUTAINMENT MEDIA, INC., (U.S. CLS. 100, 101 AND 107). SN 78-316,116. PUB. 8-

- 10-2004. FILED 10-20-2003.
- 2,899,879. **SHATTERING STEREOTYPES & UNLOCKING OPPORTUNITIES**. WESTFIELD, ELISA M., (U.S. CLS. 100, 101 AND 107). SN 78-318,415. PUB. 8-10-2004. FILED 10-24-2003.
- 2,899,882. **THE "I DO" DIARIES**. LIFETIME ENTERTAINMENT SERVICES, (U.S. CLS. 100, 101 AND 107). SN 78-318,841. PUB. 8-10-2004. FILED 10-27-2003.
- 2,899,890. **THE ACADEMIC APPROACH**. THE ACADEMIC APPROACH, LLC, (U.S. CLS. 100, 101 AND 107). SN 78-319,481. PUB. 8-10-2004. FILED 10-28-2003.
- 2,899,899. **MISCELLANEOUS DESIGN**. ALLIANCE OF NORTHEASTERN SECTIONS OF THE AMERICAN ASSOCIATION FOR CLINICAL CHEMISTRY, INC., (U.S. CLS. 100, 101 AND 107). SN 78-320,425. PUB. 8-10-2004. FILED 10-29-2003.
- 2,899,915. **MONEY STYLE (BLOCK FORM)**. CONSUMER CREDIT COUNSELING SERVICE OF THE MIDWEST, INC., (U.S. CLS. 100, 101 AND 107). SN 78-322,265. PUB. 8-10-2004. FILED 11-3-2003.
- 2,899,919. **MILLION DOLLAR IDEA (BLOCK FORM)**. WALKER, TODD, AND GOLDEN, JEAN, (U.S. CLS. 100, 101 AND 107). SN 78-322,411. PUB. 8-10-2004. FILED 11-3-2003.
- 2,899,927. **CHANGING THE COURSE (BLOCK FORM)**. PORTLAND ADVENTIST MEDICAL CENTER, (U.S. CLS. 100, 101 AND 107). SN 78-323,101. PUB. 8-10-2004. FILED 11-4-2003.
- 2,899,931. **VOLTI (BLOCK FORM)**. THE SAN FRANCISCO CHAMBER SINGERS, (U.S. CLS. 100, 101 AND 107). SN 78-323,165. PUB. 8-10-2004. FILED 11-5-2003.
- 2,899,950. **GOOD DAY ATLANTA (BLOCK FORM)**. NEW WORLD COMMUNICATIONS OF ATLANTA, INC., (U.S. CLS. 100, 101 AND 107). SN 78-325,087. PUB. 8-10-2004. FILED 11-7-2003.
- 2,899,954. **STAY, PLAY AND PARTY (BLOCK FORM)**. HARRAH'S OPERATING COMPANY, INC., MULTIPLE CLASS, (INT. CLS. 41 AND 43), (U.S. CLS. 100, 101 AND 107). SN 78-325,330. PUB. 8-10-2004. FILED 11-10-2003.
- 2,899,957. **FOR MY LIFE (BLOCK FORM)**. PLEASANT VALLEY CHURCH, INC., (U.S. CLS. 100, 101 AND 107). SN 78-325,449. PUB. 8-10-2004. FILED 11-10-2003.
- 2,899,962. **YOU CAN GET HERE FROM ANYWHERE (BLOCK FORM)**. THE DISTRICT BOARD OF TRUSTEES OF PENSACOLA JUNIOR COLLEGE, FLORIDA, (U.S. CLS. 100, 101 AND 107). SN 78-325,633. PUB. 8-10-2004. FILED 11-10-2003.
- 2,899,964. **E COAST CAMPUS (BLOCK FORM)**. THE DISTRICT BOARD OF TRUSTEES OF PENSACOLA JUNIOR COLLEGE, FLORIDA, (U.S. CLS. 100, 101 AND 107). SN 78-325,660. PUB. 8-10-2004. FILED 11-10-2003.
- 2,899,970. **GEORGE B. THOMPSON, THE MILLIONAIRE TRAINER (BLOCK FORM)**. THOMPSON, GEORGE B., (U.S. CLS. 100, 101 AND 107). SN 78-326,238. PUB. 8-10-2004. FILED 11-11-2003.
- 2,899,988. **YOGASPACE (BLOCK FORM)**. RAYMOND, NATASHA, (U.S. CLS. 100, 101 AND 107). SN 78-328,506. PUB. 8-10-2004. FILED 11-15-2003.
- 2,899,998. **ZAP THE GAP (BLOCK FORM)**. THE EDUCATION TRUST, INC., (U.S. CLS. 100, 101 AND 107). SN 78-332,003. PUB. 8-10-2004. FILED 11-24-2003.
- 2,900,000. **@RISK (BLOCK FORM)**. THE ESCAL INSTITUTE OF ADVANCED TECHNOLOGIES, INC., (U.S. CLS. 100, 101 AND 107). SN 78-332,128. PUB. 8-10-2004. FILED 11-24-2003.
- 2,900,002. **SEEDCOM (BLOCK FORM)**. TOYOTA MOTOR MANUFACTURING NORTH AMERICA, INC., (U.S. CLS. 100, 101 AND 107). SN 78-332,179. PUB. 8-10-2004. FILED 11-24-2003.
- 2,900,018 ( *See Class 16 for this trademark*).
- 2,900,022. **ROOSEVELT FRANKLIN**. RACHELL, LAWRENCE, (U.S. CLS. 100, 101 AND 107). SN 78-975,402. PUB. 8-10-2004. FILED 3-18-2003.

## CLASS 42—SCIENTIFIC, COMPUTER AND LEGAL SERVICES

- 2,898,419. **HOME COOKING WORTH GOING OUT FOR**. COLORADO RESTAURANT MANAGEMENT, INC., (U.S. CLS. 100 AND 101). SN 75-398,862. PUB. 2-1-2000. FILED 12-2-1997.
- 2,898,422 ( *See Class 9 for this trademark*).
- 2,898,427. **THE SPA AT THE CRESCENT**. RRCC LIMITED PARTNERSHIP, (U.S. CLS. 100 AND 101). SN 75-507,327. PUB. 6-8-1999. FILED 6-23-1998.
- 2,898,428. **THE CRESCENT CLUB**. ROSEWOOD HOTELS AND RESORTS HOLDINGS, INC., (U.S. CLS. 100 AND 101). SN 75-507,433. PUB. 6-1-1999. FILED 6-23-1998.
- 2,898,429. **HOTEL CRESCENT COURT**. RRCC LIMITED PARTNERSHIP, (U.S. CLS. 100 AND 101). SN 75-507,441. PUB. 6-29-1999. FILED 6-23-1998.
- 2,898,433 ( *See Class 1 for this trademark*).
- 2,898,435 ( *See Class 9 for this trademark*).
- 2,898,445 ( *See Class 9 for this trademark*).
- 2,898,449 ( *See Class 9 for this trademark*).
- 2,898,454 ( *See Class 9 for this trademark*).
- 2,898,455. **BIOKEY ASSAY (STYLIZED)**. KARO BIO USA, INC., (U.S. CLS. 100 AND 101). SN 75-877,611. PUB. 8-10-2004. FILED 12-20-1999.
- 2,898,461. **E EMANAGE.COM (STYLIZED)**. EMANAGE.COM, (U.S. CLS. 100 AND 101). SN 75-919,360. PUB. 8-20-2002. FILED 2-15-2000.
- 2,898,465 ( *See Class 38 for this trademark*).
- 2,898,466. **POWER MEASUREMENT**. POWER MEASUREMENT LTD., (U.S. CLS. 100 AND 101). SN 75-981,812. PUB. 8-10-2004. FILED 12-5-2000.
- 2,898,480 ( *See Class 9 for this trademark*).
- 2,898,481 ( *See Class 9 for this trademark*).
- 2,898,482. **MDI (STYLIZED)**. LOUISVILLE PUBLIC WAREHOUSE COMPANY, (U.S. CLS. 100 AND 101). SN 76-081,858. PUB. 4-9-2002. FILED 6-30-2000.
- 2,898,487 ( *See Class 6 for this trademark*).
- 2,898,489 ( *See Class 35 for this trademark*).
- 2,898,498 ( *See Class 9 for this trademark*).
- 2,898,499. **MEDIGUIDE**. MEDIGUIDE.COM, INC., (U.S. CLS. 100 AND 101). SN 76-138,057. PUB. 8-10-2004. FILED 9-28-2000.
- 2,898,500 ( *See Class 9 for this trademark*).
- 2,898,505 ( *See Class 9 for this trademark*).
- 2,898,508 ( *See Class 35 for this trademark*).
- 2,898,511 ( *See Class 35 for this trademark*).
- 2,898,517 ( *See Class 9 for this trademark*).
- 2,898,518. **FRESH MEXICAN GRILL**. LA SALSA, INC., (U.S. CLS. 100 AND 101). SN 76-218,078. PUB. 4-8-2003. FILED 3-1-2001.
- 2,898,527 ( *See Class 4 for this trademark*).
- 2,898,531. **WILLIAMSBURG LANDING**. WILLIAMSBURG LANDING, INC., (U.S. CLS. 100 AND 101). SN 76-254,463. PUB. 8-10-2004. FILED 5-9-2001.
- 2,898,532 ( *See Class 9 for this trademark*).
- 2,898,534 ( *See Class 40 for this trademark*).
- 2,898,535 ( *See Class 5 for this trademark*).
- 2,898,538 ( *See Class 39 for this trademark*).
- 2,898,542 ( *See Class 35 for this trademark*).
- 2,898,550 ( *See Class 29 for this trademark*).
- 2,898,556 ( *See Class 35 for this trademark*).
- 2,898,565 ( *See Class 9 for this trademark*).
- 2,898,569. **KNOWLEDGE FOR LIFE**. AFFINIUM PHARMACEUTICALS, INC., (U.S. CLS. 100 AND 101). SN 76-368,159. PUB. 8-10-2004. FILED 2-6-2002.
- 2,898,573 ( *See Class 6 for this trademark*).
- 2,898,584 ( *See Class 9 for this trademark*).
- 2,898,588 ( *See Class 35 for this trademark*).
- 2,898,589 ( *See Class 9 for this trademark*).
- 2,898,613 ( *See Class 1 for this trademark*).
- 2,898,617 ( *See Class 35 for this trademark*).
- 2,898,626. **DSC**. DATA SECURITY CORPORATION OF AMERICA, (U.S. CLS. 100 AND 101). SN 76-444,325. PUB. 8-10-2004. FILED 8-28-2002.
- 2,898,641 ( *See Class 41 for this trademark*).
- 2,898,648. **WHIPSTITCH 'N WHIMSY WEB DESIGN**. WHIPSTITCH 'N WHIMSY WEB DESIGN, (U.S. CLS. 100 AND 101). SN 76-456,117. PUB. 8-10-2004. FILED 9-30-2002.

- 2,898,678 ( *See Class 35 for this trademark* ).  
 2,898,703. **MEDAXXIS**. PER-SE TECHNOLOGIES, INC., (U.S. CLS. 100 AND 101). SN 76-486,177. PUB. 9-30-2003. FILED 1-30-2003.  
 2,898,718 ( *See Class 35 for this trademark* ).  
 2,898,735 ( *See Class 9 for this trademark* ).  
 2,898,760 ( *See Class 35 for this trademark* ).  
 2,898,784 ( *See Class 9 for this trademark* ).  
 2,898,786. **COMPASS AND DESIGN**. USED-CAR-PARTS.-COM, INC., (U.S. CLS. 100 AND 101). SN 76-508,602. PUB. 8-10-2004. FILED 4-22-2003.  
 2,898,797 ( *See Class 6 for this trademark* ).  
 2,898,799. **NORGLOBE**. NORGLOBE TECHNOLOGIES, INC., (U.S. CLS. 100 AND 101). SN 76-509,749. PUB. 8-10-2004. FILED 4-28-2003.  
 2,898,811. **HIX**. HIX, INC., (U.S. CLS. 100 AND 101). SN 76-511,715. PUB. 8-10-2004. FILED 5-6-2003.  
 2,898,818. **SKW AND DESIGN**. SHAFER, KLINE & WARREN, INC., (U.S. CLS. 100 AND 101). SN 76-512,021. PUB. 8-10-2004. FILED 5-5-2003.  
 2,898,858. **SABER PELEAR ES GANAR**. SERNA & ASSOCIATES, (U.S. CLS. 100 AND 101). SN 76-515,610. PUB. 8-10-2004. FILED 5-20-2003.  
 2,898,921. **QUADSIL**. QUADSIL, INC., (U.S. CLS. 100 AND 101). SN 76-522,123. PUB. 8-10-2004. FILED 6-11-2003.  
 2,898,934. **SEMEQUIP**. SEMEQUIP, INC., (U.S. CLS. 100 AND 101). SN 76-523,252. PUB. 8-10-2004. FILED 6-18-2003.  
 2,898,936. **MEMBERSMART**. CARDTRONIC TECHNOLOGY INC., (U.S. CLS. 100 AND 101). SN 76-524,299. PUB. 8-10-2004. FILED 6-13-2003.  
 2,898,939 ( *See Class 35 for this trademark* ).  
 2,898,945. **S! AND DESIGN**. SOLVING IT INTERNATIONAL, INC., (U.S. CLS. 100 AND 101). SN 76-527,251. PUB. 8-10-2004. FILED 6-30-2003.  
 2,898,976 ( *See Class 41 for this trademark* ).  
 2,898,977 ( *See Class 35 for this trademark* ).  
 2,898,988 ( *See Class 35 for this trademark* ).  
 2,898,999. **TRANSMOTION**. MOTIONPOINT CORPORATION, (U.S. CLS. 100 AND 101). SN 76-536,811. PUB. 8-10-2004. FILED 8-11-2003.  
 2,899,003 ( *See Class 35 for this trademark* ).  
 2,899,004. **APPTec**. APPTec LABORATORY SERVICES, INC., (U.S. CLS. 100 AND 101). SN 76-537,735. PUB. 4-20-2004. FILED 8-15-2003.  
 2,899,008. **EMAILIDEAS.COM**. SEARS, RICHARD R., (U.S. CLS. 100 AND 101). SN 76-538,714. PUB. 8-10-2004. FILED 8-20-2003.  
 2,899,018 ( *See Class 35 for this trademark* ).  
 2,899,019 ( *See Class 35 for this trademark* ).  
 2,899,040. **YIELD TO NONE AND DESIGN**. WALZER, JAMES G., (U.S. CLS. 100 AND 101). SN 76-544,341. PUB. 8-10-2004. FILED 9-12-2003.  
 2,899,050. **FLINTFOX**. QUALITY SYSTEMS LTD., (U.S. CLS. 100 AND 101). SN 76-545,789. PUB. 8-10-2004. FILED 9-8-2003.  
 2,899,072 ( *See Class 41 for this trademark* ).  
 2,899,104. **BH (STYLIZED)**. BRANDON HORNSBY, P.C., (U.S. CLS. 100 AND 101). SN 76-552,130. PUB. 8-10-2004. FILED 9-26-2003.  
 2,899,120 ( *See Class 9 for this trademark* ).  
 2,899,125 ( *See Class 9 for this trademark* ).  
 2,899,140. **CENTER FOR TRANSPORTATION RESEARCH AND DESIGN**. THE UNIVERSITY OF CHICAGO, WHICH OPERATES ARGONNE NATIONAL LABORATORY UNDER CONTRACT WITH THE U.S. DEPARTMENT OF ENERGY, (U.S. CLS. 100 AND 101). SN 76-555,125. PUB. 8-10-2004. FILED 10-29-2003.  
 2,899,147 ( *See Class 37 for this trademark* ).  
 2,899,152 ( *See Class 35 for this trademark* ).  
 2,899,162. **KEEPING PEOPLE AND INFORMATION CONNECTED (BLOCK FORM)**. SUNGARD RECOVERY SERVICES LP, (U.S. CLS. 100 AND 101). SN 76-556,459. PUB. 8-10-2004. FILED 11-4-2003.  
 2,899,173 ( *See Class 9 for this trademark* ).  
 2,899,184. **SSIFT (STYLIZED)**. PROSANOS CORPORATION, (U.S. CLS. 100 AND 101). SN 76-557,333. PUB. 8-10-2004. FILED 11-6-2003.  
 2,899,189 ( *See Class 35 for this trademark* ).  
 2,899,204 ( *See Class 35 for this trademark* ).  
 2,899,207. **WHEN IT'S GOT TO BE RIGHT, NOW. (BLOCK FORM)**. THE GCRH CORPORATION, (U.S. CLS. 100 AND 101). SN 76-558,372. PUB. 8-10-2004. FILED 11-12-2003.  
 2,899,243. **TR AND DESIGN**. TUESDAY REIGN, INC., (U.S. CLS. 100 AND 101). SN 76-560,578. PUB. 8-10-2004. FILED 11-17-2003.  
 2,899,255. **THE LAW FIRM FOR ASSOCIATIONS**. HOWE & HUTTON, LTD., (U.S. CLS. 100 AND 101). SN 76-562,623. PUB. 2-24-2004. FILED 10-21-2002.  
 2,899,286 ( *See Class 35 for this trademark* ).  
 2,899,288 ( *See Class 9 for this trademark* ).  
 2,899,289. **PACIFIC CLEARVISION INSTITUTE**. SCOTT A. CHERNE, M.D., P.C., (U.S. CLS. 100 AND 101). SN 78-093,585. PUB. 8-10-2004. FILED 11-15-2001.  
 2,899,297 ( *See Class 9 for this trademark* ).  
 2,899,315 ( *See Class 7 for this trademark* ).  
 2,899,316 ( *See Class 7 for this trademark* ).  
 2,899,336. **ERMANNNO SCERVINO AND DESIGN**. CARLOTTA S.R.L., (U.S. CLS. 100 AND 101). SN 78-152,915. PUB. 8-10-2004. FILED 8-9-2002.  
 2,899,352 ( *See Class 9 for this trademark* ).  
 2,899,355 ( *See Class 9 for this trademark* ).  
 2,899,366 ( *See Class 16 for this trademark* ).  
 2,899,374 ( *See Class 9 for this trademark* ).  
 2,899,375 ( *See Class 36 for this trademark* ).  
 2,899,388 ( *See Class 9 for this trademark* ).  
 2,899,393 ( *See Class 9 for this trademark* ).  
 2,899,414 ( *See Class 5 for this trademark* ).  
 2,899,447 ( *See Class 37 for this trademark* ).  
 2,899,454 ( *See Class 9 for this trademark* ).  
 2,899,460 ( *See Class 9 for this trademark* ).  
 2,899,493 ( *See Class 35 for this trademark* ).  
 2,899,505 ( *See Class 40 for this trademark* ).  
 2,899,506 ( *See Class 40 for this trademark* ).  
 2,899,533. **HAWKINS HAWKINS, DELAFIELD & WOOD AND DESIGN**. HAWKINS, DELAFIELD & WOOD LLP, (U.S. CLS. 100 AND 101). SN 78-243,884. PUB. 8-10-2004. FILED 4-30-2003.  
 2,899,539 ( *See Class 35 for this trademark* ).  
 2,899,560. **MOBILEDINE**. MEDIA IMAGE, INC., (U.S. CLS. 100 AND 101). SN 78-249,165. PUB. 8-10-2004. FILED 5-13-2003.  
 2,899,599 ( *See Class 35 for this trademark* ).  
 2,899,610. **SERVER CENTRAL AND DESIGN**. DEMAND INDUSTRIES, INC., DBA SERVER CENTRAL, (U.S. CLS. 100 AND 101). SN 78-254,431. PUB. 8-10-2004. FILED 5-27-2003.  
 2,899,655 ( *See Class 9 for this trademark* ).  
 2,899,661. **DESIGNS TO GO YOUR ONE STOP SIGN STORE INC. AND DESIGN**. DESIGNSTOGO, (U.S. CLS. 100 AND 101). SN 78-263,295. PUB. 8-10-2004. FILED 6-17-2003.  
 2,899,691. **ENTACT**. ENTACT SERVICES, LLC, (U.S. CLS. 100 AND 101). SN 78-272,129. PUB. 8-10-2004. FILED 7-9-2003.  
 2,899,719. **THRUPLUS**. CONOCOPHILLIPS COMPANY, (U.S. CLS. 100 AND 101). SN 78-281,702. PUB. 8-10-2004. FILED 7-31-2003.  
 2,899,727. **C-SITE**. STARFIELD TECHNOLOGIES, (U.S. CLS. 100 AND 101). SN 78-285,029. PUB. 8-10-2004. FILED 8-8-2003.  
 2,899,729. **C-SITE AND DESIGN**. STARFIELD TECHNOLOGIES, (U.S. CLS. 100 AND 101). SN 78-285,214. PUB. 8-10-2004. FILED 8-8-2003.  
 2,899,740 ( *See Class 41 for this trademark* ).  
 2,899,749 ( *See Class 41 for this trademark* ).  
 2,899,750. **VISUALPOINT**. VISUALPOINT INC., (U.S. CLS. 100 AND 101). SN 78-293,909. PUB. 8-10-2004. FILED 8-29-2003.  
 2,899,758. **TECHNI-CORR**. ARVCO CONTAINER CORPORATION, (U.S. CLS. 100 AND 101). SN 78-296,082. PUB. 8-10-2004. FILED 9-4-2003.  
 2,899,780 ( *See Class 41 for this trademark* ).  
 2,899,790. **ISTOPLEGALFORMS**. ISTOPLEGALFORMS, INC., (U.S. CLS. 100 AND 101). SN 78-303,913. PUB. 8-10-2004. FILED 9-22-2003.  
 2,899,791. **SWIFTMQ**. MUELLER, ANDREAS, (U.S. CLS. 100 AND 101). SN 78-304,708. PUB. 8-10-2004. FILED 9-24-2003.  
 2,899,809. **BADDA BING**. BROWN, MATHEW S., (U.S. CLS.

- 100 AND 101), SN 78-308,161. PUB. 8-10-2004. FILED 10-1-2003.
- 2,899,813. **CARBASE**. LUMINOUS SOFTWARE, LLC, (U.S. CLS. 100 AND 101), SN 78-309,901. PUB. 8-10-2004. FILED 10-6-2003.
- 2,899,835 ( *See Class 9 for this trademark*).
- 2,899,842. **THE BEST TEST IS THE ONE THAT GETS USED**. EXACT SCIENCES CORPORATION, (U.S. CLS. 100 AND 101), SN 78-314,358. PUB. 8-10-2004. FILED 10-16-2003.
- 2,899,845 ( *See Class 1 for this trademark*).
- 2,899,878 ( *See Class 9 for this trademark*).
- 2,899,901. **WHERE TO FIND IT**. THE INTERPUBLIC GROUP OF COMPANIES, INC., (U.S. CLS. 100 AND 101), SN 78-320,674. PUB. 8-10-2004. FILED 10-30-2003.
- 2,899,911. **FROM IDEA TO EXECUTION**. BLAKE & WANG P.A., (U.S. CLS. 100 AND 101), SN 78-321,850. PUB. 8-10-2004. FILED 10-31-2003.
- 2,899,938. **NSA LABS (BLOCK FORM)**. NEUROSCIENCE ASSOCIATES, INC., (U.S. CLS. 100 AND 101), SN 78-323,935. PUB. 8-10-2004. FILED 11-6-2003.
- 2,899,940. **COMPUSSETTLE.COM AND DESIGN**. SETTLEMENT SERVICES, LLC, (U.S. CLS. 100 AND 101), SN 78-324,164. PUB. 8-10-2004. FILED 11-6-2003.

#### CLASS 43—HOTEL AND RESTAURANT SERVICES

- 2,898,447. **DANNY'S RESTAURANT AND DESIGN**. LAREDO REAL FOODS, INC., (U.S. CLS. 100 AND 101), SN 75-812,801. PUB. 8-10-2004. FILED 10-1-1999.
- 2,898,553 ( *See Class 35 for this trademark*).
- 2,898,570 ( *See Class 21 for this trademark*).
- 2,898,588 ( *See Class 35 for this trademark*).
- 2,898,601. **MISCELLANEOUS DESIGN**. THE MARCUS CORPORATION, (U.S. CLS. 100 AND 101), SN 76-418,128. PUB. 8-10-2004. FILED S.R. 6-10-2002; AM. P.R. 6-10-2002.
- 2,898,602. **MISCELLANEOUS DESIGN**. THE MARCUS CORPORATION, (U.S. CLS. 100 AND 101), SN 76-418,129. PUB. 8-10-2004. FILED 6-10-2002.
- 2,898,622 ( *See Class 29 for this trademark*).
- 2,898,636. **SEASONS 52**. GMRI, INC., (U.S. CLS. 100 AND 101), SN 76-450,955. PUB. 8-10-2004. FILED 9-16-2002.
- 2,898,718 ( *See Class 35 for this trademark*).
- 2,898,761 ( *See Class 35 for this trademark*).
- 2,898,789. **BUFFALO PHILLY'S AND DESIGN**. BUFFALO PHILLY'S INC., (U.S. CLS. 100 AND 101), SN 76-508,772. PUB. 8-10-2004. FILED 4-22-2003.
- 2,898,860. **LIDIA'S KANSAS CITY**. LIDIA'S RESTAURANT GROUP LLC, (U.S. CLS. 100 AND 101), SN 76-515,916. PUB. 8-10-2004. FILED 4-28-2003.
- 2,898,879. **NAKATO JAPANESE RESTAURANT**. NAKATO, INC., (U.S. CLS. 100 AND 101), SN 76-518,469. PUB. 1-6-2004. FILED 5-7-2003.
- 2,898,881 ( *See Class 35 for this trademark*).
- 2,898,915. **BE WICKED FOR A WEEK**. VILLAGE RESORTS LIMITED, (U.S. CLS. 100 AND 101), SN 76-520,897. PUB. 2-17-2004. FILED 6-5-2003.
- 2,898,942. **BOB EVANS FARM FRESH TASTE**. BOB EVANS RESTAURANTS OF MICHIGAN, INC., (U.S. CLS. 100 AND 101), SN 76-526,173. PUB. 3-2-2004. FILED 6-26-2003.
- 2,898,947 ( *See Class 35 for this trademark*).
- 2,898,948 ( *See Class 35 for this trademark*).
- 2,898,958. **JUMBURRITO**. JUMBURRITO, INC., (U.S. CLS. 100 AND 101), SN 76-530,204. PUB. 4-20-2004. FILED 7-7-2003.
- 2,898,972. **SMOKIN' A BARBEQUE PLACE AND DESIGN**. SMOKIN'-NUMERO UNO, LLC, (U.S. CLS. 100 AND 101), SN 76-532,352. PUB. 8-10-2004. FILED 7-25-2003.
- 2,899,016 ( *See Class 41 for this trademark*).
- 2,899,077. **DOGWATER CAFE**. DROZDOG ENTERPRISES INC., (U.S. CLS. 100 AND 101), SN 76-549,313. PUB. 8-10-2004. FILED 9-30-2003.
- 2,899,092. **CAFE ARTISTE**. CAFE ARTISTE RESTAURANT, INC., (U.S. CLS. 100 AND 101), SN 76-551,062. PUB. 8-10-2004. FILED 9-23-2003.
- 2,899,138. **BLUE CHIP CASINO & HOTEL AND DESIGN**. BOYD GAMING CORPORATION, (U.S. CLS. 100 AND 101), SN 76-554,852. PUB. 8-10-2004. FILED 10-9-2003.
- 2,899,164. **PHAROS (BLOCK FORM)**. PHAROS OF WILMINGTON, LLC, (U.S. CLS. 100 AND 101), SN 76-556,467. PUB. 8-10-2004. FILED 11-4-2003.
- 2,899,170. **MUSTANG HARRY'S FINE FOODS & SPIRITS AND DESIGN**. 352 RESTAURANT CORP., (U.S. CLS. 100 AND 101), SN 76-556,756. PUB. 8-10-2004. FILED 10-22-2003.
- 2,899,176. **COSMOPOLITAN BREAD CAFÉ AND DESIGN**. PORTULAKA, LLC, (U.S. CLS. 100 AND 101), SN 76-557,039. PUB. 8-10-2004. FILED 9-29-2003.
- 2,899,199. **BENNIGAN'S GRILL & TAVERN AND DESIGN**. S&A RESTAURANT CORP., (U.S. CLS. 100 AND 101), SN 76-557,946. PUB. 8-10-2004. FILED 11-6-2003.
- 2,899,305. **CHICKEN BOX AND DESIGN**. WOLFE, SCOTT, AND WOLFE, JANE, (U.S. CLS. 100 AND 101), SN 78-126,217. PUB. 7-15-2003. FILED 5-3-2002.
- 2,899,339. **TRADITIONS**. NATIONAL CHURCH RESIDENCES, MULTIPLE CLASS, (INT. CLS. 43 AND 44), (U.S. CLS. 100 AND 101), SN 78-154,699. PUB. 11-4-2003. FILED 8-15-2002.
- 2,899,401. **FRENCH QUARTER CONNECTION**. CS&M ASSOCIATES, AND MARRIOTT CORPORATION, DBA SHERATON NEW ORLEANS HOTEL, (U.S. CLS. 100 AND 101), SN 78-195,696. PUB. 11-25-2003. FILED 12-18-2002.
- 2,899,439. **RHEINLANDER**. GUTENFOODS, INC., (U.S. CLS. 100 AND 101), SN 78-216,663. PUB. 8-10-2004. FILED 2-19-2003.
- 2,899,497. **SEE YOU ALONG THE WAY**. TM ACQUISITION CORP., (U.S. CLS. 100 AND 101), SN 78-238,301. PUB. 1-13-2004. FILED 4-16-2003.
- 2,899,501. **PRIME SIRLOIN STEAKS BUFFET BAKERY FAMILY STEAKHOUSE AND DESIGN**. CLAREMONT RESTAURANT GROUP, LLC, (U.S. CLS. 100 AND 101), SN 78-238,874. PUB. 8-10-2004. FILED 4-17-2003.
- 2,899,602. **BREAKTIME CLUB (BLOCK FORM)**. SHEPHERD'S CENTERS OF AMERICA, (U.S. CLS. 100 AND 101), SN 78-254,176. PUB. 8-10-2004. FILED 5-25-2003.
- 2,899,631 ( *See Class 36 for this trademark*).
- 2,899,635. **THE SAN LUIS RESORT**. FERTITTA HOSPITALITY, LLC, (U.S. CLS. 100 AND 101), SN 78-259,970. PUB. 8-10-2004. FILED 6-9-2003.
- 2,899,654 ( *See Class 35 for this trademark*).
- 2,899,668. **PIN SEEKERS**. PIN SEEKERS LTD LLC, (U.S. CLS. 100 AND 101), SN 78-265,445. PUB. 2-17-2004. FILED 6-21-2003.
- 2,899,701. **SUSHI METSUYAN AND DESIGN**. SUSHI METSUYAN, INC., (U.S. CLS. 100 AND 101), SN 78-274,423. PUB. 8-10-2004. FILED 7-15-2003.
- 2,899,734. **BRIXAGE WINE RATING MADE SIMPLE AND DESIGN**. ROUNDRIX CORPORATION, (U.S. CLS. 100 AND 101), SN 78-287,779. PUB. 8-10-2004. FILED 8-15-2003.
- 2,899,787. **MICHAEL BRYAN'S IRISH PUB**. WAKE ROBIN, LLC, (U.S. CLS. 100 AND 101), SN 78-302,552. PUB. 8-10-2004. FILED 9-17-2003.
- 2,899,788. **MICHAEL BRYAN'S IRISH PUB AND DESIGN**. WAKE ROBIN, LLC, (U.S. CLS. 100 AND 101), SN 78-302,565. PUB. 8-10-2004. FILED 9-17-2003.
- 2,899,805 ( *See Class 30 for this trademark*).
- 2,899,860. **800.4CHOICE**. CHOICE HOTELS INTERNATIONAL, INC., (U.S. CLS. 100 AND 101), SN 78-315,789. PUB. 8-10-2004. FILED 10-20-2003.
- 2,899,917. **PMS DELI (BLOCK FORM)**. PMS DELI, L.L.C., (U.S. CLS. 100 AND 101), SN 78-322,293. PUB. 8-10-2004. FILED 11-3-2003.
- 2,899,946. **LIBRARY BISTRO & BOOKSTORE BAR AND DESIGN**. FIRST ALEXIS HOTEL, L.P., (U.S. CLS. 100 AND 101), SN 78-324,763. PUB. 8-10-2004. FILED 11-7-2003.
- 2,899,954 ( *See Class 41 for this trademark*).
- 2,899,984. **THE PURPLE ONION (BLOCK FORM)**. THE PURPLE ONION, (U.S. CLS. 100 AND 101), SN 78-328,031. PUB. 8-10-2004. FILED 11-14-2003.

**CLASS 44—MEDICAL, BEAUTY AND AGRICULTURAL SERVICES**

- 2,898,588 ( *See Class 35 for this trademark* ).  
 2,898,658. **HEART'S DESIRE**. HEALTH CARE AND RETIREMENT CORPORATION OF AMERICA, (U.S. CLS. 100 AND 101). SN 76-460,627. PUB. 8-10-2004. FILED 10-22-2002.  
 2,898,706 ( *See Class 35 for this trademark* ).  
 2,898,719. **BEACHWOOD ORTHOPEDIC & PHYSICAL MEDICINE AND DESIGN**. DRS. GABELMAN & LEIZMAN, INC., (U.S. CLS. 100 AND 101). SN 76-491,083. PUB. 8-10-2004. FILED 2-12-2003.  
 2,898,731 ( *See Class 3 for this trademark* ).  
 2,898,734. **DERMASCREEN**. DERMASCREEN CORPORATION, (U.S. CLS. 100 AND 101). SN 76-497,591. PUB. 8-10-2004. FILED 3-17-2003.  
 2,898,762. **HOUSTON RADIOLOGY AND DESIGN**. HOUSTON RADIOLOGY ASSOCIATED P.A., AND RMI PHYSICIAN SERVICES CORPORATION, (U.S. CLS. 100 AND 101). SN 76-504,208. PUB. 8-10-2004. FILED 4-4-2003.  
 2,898,838. **PINY BEVERLY HILLS**. PINY, INC., (U.S. CLS. 100 AND 101). SN 76-513,842. PUB. 8-10-2004. FILED 5-9-2003.  
 2,898,875. **FOREVER YOUNG, INC.**. RAHIMI, DAVID, (U.S. CLS. 100 AND 101). SN 76-518,213. PUB. 8-10-2004. FILED 5-6-2003.  
 2,898,885 ( *See Class 35 for this trademark* ).  
 2,898,886 ( *See Class 35 for this trademark* ).  
 2,898,903 ( *See Class 35 for this trademark* ).  
 2,898,941. **THE 5 MINUTE TUNE-UP**. CREATIVE HAIRDRESSERS, INC., (U.S. CLS. 100 AND 101). SN 76-526,014. PUB. 8-10-2004. FILED 6-17-2003.  
 2,898,976 ( *See Class 41 for this trademark* ).  
 2,899,035 ( *See Class 36 for this trademark* ).  
 2,899,043. **CAREASSIST (STYLIZED)**. REGENCE BLUE SHIELD, (U.S. CLS. 100 AND 101). SN 76-544,681. PUB. 8-10-2004. FILED 9-15-2003.  
 2,899,117. **MIDWEST PROTON RADIOTHERAPY INSTITUTE**. ADVANCED RESEARCH AND TECHNOLOGY INSTITUTE, INC., (U.S. CLS. 100 AND 101). SN 76-552,972. PUB. 8-10-2004. FILED 10-21-2003.  
 2,899,131. **SCIENTIFIC TURF IF YOUR LAWN'S NOT TERRIFIC...CALL SCIENTIFIC! AND DESIGN**. SCIENTIFIC TURF, INC., (U.S. CLS. 100 AND 101). SN 76-554,457. PUB. 8-10-2004. FILED 10-27-2003.  
 2,899,141. **PAIN SOLVERS AND DESIGN**. PAIN SOLVERS, INC., (U.S. CLS. 100 AND 101). SN 76-555,126. PUB. 8-10-2004. FILED 10-29-2003.  
 2,899,263. **SHARE CARD (STYLIZED)**. PFIZER INC, (U.S. CLS. 100 AND 101). SN 76-567,586. PUB. 8-10-2004. FILED 12-18-2003.  
 2,899,339 ( *See Class 43 for this trademark* ).  
 2,899,360. **NATIONAL RADIO**. NATIONAL RADIO LABS, LLC, (U.S. CLS. 100 AND 101). SN 78-170,663. PUB. 8-10-2004. FILED 10-3-2002.  
 2,899,414 ( *See Class 5 for this trademark* ).  
 2,899,430 ( *See Class 35 for this trademark* ).  
 2,899,457. **C CARONDELET HEART INSTITUTE AND DESIGN**. CARONDELET HEALTH, (U.S. CLS. 100 AND 101). SN 78-225,709. PUB. 8-10-2004. FILED 3-14-2003.  
 2,899,471. **CLASSICSTAR LLC AND DESIGN**. CLASSICSTAR, LLC, (U.S. CLS. 100 AND 101). SN 78-232,612. PUB. 8-10-2004. FILED 4-1-2003.  
 2,899,477. **R AND DESIGN**. RAINBOW REHABILITATION CENTERS, INC., (U.S. CLS. 100 AND 101). SN 78-234,065. PUB. 8-10-2004. FILED 4-4-2003.  
 2,899,556 ( *See Class 9 for this trademark* ).  
 2,899,649 ( *See Class 35 for this trademark* ).  
 2,899,705. **HANDS ON HEALING (BLOCK FORM)**. ADVANCED PAIN MANAGEMENT & REHABILITATION, P.C., (U.S. CLS. 100 AND 101). SN 78-276,528. PUB. 8-10-2004. FILED 7-21-2003.  
 2,899,713. **HEALTH-PATTERNS**. HEALTH-PATTERNS CORPORATION, (U.S. CLS. 100 AND 101). SN 78-279,911. PUB. 8-10-2004. FILED 7-28-2003.  
 2,899,748. **THE BEACH TANNING STUDIOS (STYLIZED)**. THE BEACH STUDIOS INC, (U.S. CLS. 100 AND 101). SN 78-293,544. PUB. 8-10-2004. FILED 8-28-2003.  
 2,899,769. **ANODYNE NEUROPATHY CARE CENTER**. MEDASSIST-OP, INC., (U.S. CLS. 100 AND 101). SN 78-297,932.

- PUB. 8-10-2004. FILED 9-9-2003.  
 2,899,827. **KEEP KIDNEY EARLY EVALUATION PROGRAM AND DESIGN**. NATIONAL KIDNEY FOUNDATION, (U.S. CLS. 100 AND 101). SN 78-311,742. PUB. 8-10-2004. FILED 10-9-2003.  
 2,899,838. **WE WANT YOU LISTENING FOR A LIFETIME**. CONSUMER ELECTRONICS ASSOCIATION, (U.S. CLS. 100 AND 101). SN 78-313,854. PUB. 8-10-2004. FILED 10-15-2003.  
 2,899,903. **PAIN SOLVERS**. PAIN SOLVERS, INC., (U.S. CLS. 100 AND 101). SN 78-320,748. PUB. 8-10-2004. FILED 10-30-2003.  
 2,899,936. **NEW TALENTS (BLOCK FORM)**. VAN MICHAEL SALON, INC., (U.S. CLS. 100 AND 101). SN 78-323,842. PUB. 8-10-2004. FILED 11-6-2003.  
 2,899,986. **MISCELLANEOUS DESIGN**. FLORIDA HEART RESEARCH FOUNDATION, INC., (U.S. CLS. 100 AND 101). SN 78-328,142. PUB. 8-10-2004. FILED 11-14-2003.  
 2,899,993 ( *See Class 9 for this trademark* ).

**CLASS 45—PERSONAL SERVICES**

- 2,898,588 ( *See Class 35 for this trademark* ).  
 2,898,678 ( *See Class 35 for this trademark* ).  
 2,899,000. **DOWN TO EARTH**. GUIDEPOSTS, A CHURCH CORPORATION, (U.S. CLS. 100 AND 101). SN 76-536,880. PUB. 8-10-2004. FILED 8-11-2003.  
 2,899,012. **THE ASSOCIATION OF FREE LUTHERAN CONGREGATIONS**. THE CO-ORDINATING COMMITTEE OF THE ASSOCIATION OF FREE LUTHERAN CONGREGATIONS, (U.S. CLS. 100 AND 101). SN 76-540,258. PUB. 8-10-2004. FILED 8-26-2003.  
 2,899,102. **THE FAMILY KEEP YOUNG AND DESIGN**. THE FAMILY, INC., (U.S. CLS. 100 AND 101). SN 76-551,831. PUB. 8-10-2004. FILED 10-16-2003.  
 2,899,125 ( *See Class 9 for this trademark* ).  
 2,899,230. **RENAISSANCE FUNERAL HOMES (BLOCK FORM)**. NEW HYDE PARK FUNERAL HOME, INC., (U.S. CLS. 100 AND 101). SN 76-559,326. PUB. 8-10-2004. FILED 11-14-2003.  
 2,899,237. **CHRIST THE ONLY HOPE MINISTRIES (BLOCK FORM)**. SCOTT'S REVIVAL CENTER, INC., (U.S. CLS. 100 AND 101). SN 76-559,768. PUB. 8-10-2004. FILED 11-17-2003.  
 2,899,247. **WORLD REACH**. WORLD REACH, (U.S. CLS. 100 AND 101). SN 76-560,938. PUB. 8-10-2004. FILED 10-29-2003.  
 2,899,266 ( *See Class 9 for this trademark* ).  
 2,899,267 ( *See Class 9 for this trademark* ).  
 2,899,290. **WHERE LOVE CLICKS**. LIFEACCESS.COM, INC., (U.S. CLS. 100 AND 101). SN 78-094,084. PUB. 8-10-2004. FILED 11-19-2001.  
 2,899,295. **PRINCIPAL SECURITY GROUP AND DESIGN**. PRINCIPAL SECURITY GROUP, LLC, (U.S. CLS. 100 AND 101). SN 78-105,729. PUB. 9-30-2003. FILED 1-30-2002.  
 2,899,309. **EXPEDATE**. SCHIFF, KAREN L., DBA MARBLE HILL COMMUNICATIONS, (U.S. CLS. 100 AND 101). SN 78-130,619. PUB. 11-19-2002. FILED 5-22-2002.  
 2,899,759. **COWBOYS FOR CHRIST**. COWBOYS FOR CHRIST, (U.S. CLS. 100 AND 101). SN 78-296,333. PUB. 8-10-2004. FILED 9-4-2003.  
 2,899,985. **COUPLE TO COUPLE (BLOCK FORM)**. HOLLANDER COUNSELING ASSOCIATES, LLC, (U.S. CLS. 100 AND 101). SN 78-328,105. PUB. 8-10-2004. FILED 11-14-2003.

\* \* \* \* \*

# TRADEMARK REGISTRATIONS ISSUED UNDER SECTION 1(d)

The following marks have registered on the Principal Register pursuant to the intent-to-use provisions of Section 1(d) of the Trademark Act of 1946, as amended.

## SECTION 1.— INTERNATIONAL CLASSIFICATION

The short titles associated below with the international class numbers are terms designed merely for quick identification and are not an official part of the international classification. The full names of international classes are given in section 6.1 of the trademark rules of practice.

The designation "U.S. Cl." appearing in this section refers to the U.S. class in effect prior to Sep. 1, 1973 rather than the international class which applies to applications filed on or after that date. For adoption of international classification see notice in the OFFICIAL GAZETTE of Jun. 26, 1973 (911 O.G. TM 210).

### Application in more than one class

2,900,025. TAPEX PTY LIMITED, WATERLOO, NEW SOUTH WALES 2017, AUSTRALIA. SN 75-114,212. PUB. 10-5-1999, FILED 5-24-1996.

**TAPEX**

PRIORITY CLAIMED UNDER SEC. 44(D) ON AUSTRALIA APPLICATION NO. 701283, FILED 1-25-1996, REG. NO. 701283, DATED 1-25-1996, EXPIRES 1-25-2006.

OWNER OF AUSTRALIA REG. NO. 701283, DATED 1-25-1996, EXPIRES 1-25-2006.

#### CLASS 22—CORDAGE AND FIBERS

FOR COMMERCIAL NETS FOR THE TRANSPORTATION OR STORAGE OF MATERIALS IN BULK; RAW FIBROSE TEXTILE MATERIALS (U.S. CLS. 1, 2, 7, 19, 22, 42 AND 50).

FIRST USE 11-14-1968; IN COMMERCE 11-17-2002.

#### CLASS 40—MATERIAL TREATMENT

FOR MATERIAL TREATMENT SERVICES, NAMELY, CUTTING, PROCESSING AND TRANSFORMING NATURAL AND SYNTHETIC FIBRES, PLASTICS AND METAL ALLOYS; MANUFACTURING OF POLYETHYLENE, POLYPROPYLENE OR RAW FIBROSE TEXTILE MATERIALS TO THE ORDER AND SPECIFICATION OF OTHERS (U.S. CLS. 100, 103 AND 106).

FIRST USE 7-28-1995; IN COMMERCE 8-14-2002.

#### CLASS 42—SCIENTIFIC, COMPUTER AND LEGAL SERVICES

FOR WHOLESALE DISTRIBUTORSHIP SERVICES IN THE FIELD OF POLYETHYLENE, POLYPROPYLENE OR RAW FIBROSE TEXTILE MATERIALS (U.S. CLS. 100 AND 101).

FIRST USE 7-28-1995; IN COMMERCE 11-4-2002.

2,900,028. DALE OF NORWAY AS, VAKSDAL, NORWAY. SN 75-380,659. PUB. 6-11-2002, FILED 10-29-1997.

**DALE OF NORWAY**

THE MARK CONSISTS OF STANDARD CHARACTERS WITHOUT CLAIM TO ANY PARTICULAR FONT, STYLE, SIZE, OR COLOR.

NO CLAIM IS MADE TO THE EXCLUSIVE RIGHT TO USE NORWAY, APART FROM THE MARK AS SHOWN.

#### CLASS 23—YARNS AND THREADS

FOR - YARNS AND THREADS, FOR TEXTILE USE (U.S. CL. 43).

FIRST USE 0-0-1978; IN COMMERCE 0-0-1978.

#### CLASS 25—CLOTHING

FOR CLOTHING FOR MEN, WOMEN AND CHILDREN, NAMELY, KNITTED COATS, PANTS, JACKETS, SWEATERS, VESTS, DRESSES, CULOTTES, HATS, CAPS, SCARVES, MUFFLERS, SOCKS, GLOVES AND MITTENS (U.S. CLS. 22 AND 39).

FIRST USE 0-0-1978; IN COMMERCE 0-0-1978.

2,900,035. INTERNATIONAL DATA GROUP, INC., FRAMINGHAM, MA. SN 75-503,029. PUB. 10-15-2002, FILED 6-16-1998.

**BANDWIDTH WORLD**

#### CLASS 16—PAPER GOODS AND PRINTED MATTER

FOR PRINT PUBLICATIONS, NAMELY, NEWSLETTERS, MAGAZINES, AND SUPPLEMENTS SOLD THEREWITH, JOURNALS AND NEWSPAPERS ALL IN THE FIELDS OF COMPUTERS, COMPUTER SOFTWARE, ONLINE SERVICES, HIGH TECHNOLOGY, COMMUNICATIONS, INFORMATION TECHNOLOGY AND INFORMATION SERVICES (U.S. CLS. 2, 5, 22, 23, 29, 37, 38 AND 50).

FIRST USE 12-1-2003; IN COMMERCE 12-1-2003.

**CLASS 42—SCIENTIFIC, COMPUTER AND LEGAL SERVICES**

FOR PROVIDING A WEBSITE OF INFORMATION IN THE FIELDS OF COMPUTERS, COMPUTER SOFTWARE, ONLINE SERVICES, COMMUNICATIONS, INFORMATION TECHNOLOGY AND INFORMATION SERVICES; PROVIDING ONLINE PUBLICATIONS, NAMELY, NEWSLETTERS, MAGAZINES, AND SUPPLEMENTS SOLD THEREWITH, JOURNALS AND NEWSPAPERS ALL IN THE FIELDS OF COMPUTERS, COMPUTER SOFTWARE, ONLINE SERVICES, HIGH TECHNOLOGY, COMMUNICATIONS, INFORMATION TECHNOLOGY AND INFORMATION SERVICES (U.S. CLS. 100 AND 101).

FIRST USE 1-1-2004; IN COMMERCE 1-1-2004.

2,900,042. CO-TRUSTEES OF THE MICKEY CHARLES MANTLE MARITAL TRUST II, A TEXAS TRUST, THE CO-TRUSTEES COMPRISING MERLYN L. MANTLE AND JOHNNY LA FALIER, BOTH U.S. CITIZENS, THE, DALLAS, TX. SN 75-589,270. PUB. 11-5-2002, FILED 11-16-1998.

*Mickey C. Mantle*

THE NAME "MICKEY C. MANTLE" REFERS TO THE DECEASED HALL OF FAME BASEBALL PLAYER.

**CLASS 6—METAL GOODS**

FOR FIGURINES, SCULPTURES, STATUES AND TROPHIES ALL OF COMMON METAL (U.S. CLS. 2, 12, 13, 14, 23, 25 AND 50).

FIRST USE 0-0-1960; IN COMMERCE 0-0-1960.

**CLASS 14—JEWELRY**

FOR RINGS BEING JEWELRY, CLOCKS, WATCHES, CUFFLINKS, PENDANTS, FIGURINES OF PRECIOUS METAL, SCULPTURES OF PRECIOUS METAL, STATUES OF PRECIOUS METAL AND TROPHIES OF PRECIOUS METAL (U.S. CLS. 2, 27, 28 AND 50).

FIRST USE 0-0-1960; IN COMMERCE 0-0-1960.

**CLASS 16—PAPER GOODS AND PRINTED MATTER**

FOR BOOKS AND MAGAZINES IN THE FIELD OF BASEBALL TRADING CARDS, CALENDARS, TRADING CARD ALBUMS, BOTH MOUNTED AND UNMOUNTED PHOTOGRAPHS, GREETING CARDS AND PHOTOGRAPHIC LITHOGRAPHIC AND COLOR ART PRINTS (U.S. CLS. 2, 5, 22, 23, 29, 37, 38 AND 50).

FIRST USE 0-0-1952; IN COMMERCE 0-0-1952.

**CLASS 20—FURNITURE AND ARTICLES NOT OTHERWISE CLASSIFIED**

FOR FIGURINES, SCULPTURES AND STATUES OF PLASTIC AND WOOD; NON METAL TROPHIES (U.S. CLS. 2, 13, 22, 25, 32 AND 50).

FIRST USE 0-0-1960; IN COMMERCE 0-0-1960.

**CLASS 21—HOUSEWARES AND GLASS**

FOR FIGURINES, SCULPTURES AND STATUES OF CHINA, CRYSTAL AND GLASS, GLASS MUGS AND GLASS BUSTS (U.S. CLS. 2, 13, 23, 29, 30, 33, 40 AND 50).

FIRST USE 0-0-1988; IN COMMERCE 0-0-1988.

**CLASS 25—CLOTHING**

FOR BASEBALL UNIFORMS, ATHLETIC UNIFORMS, BASEBALL STYLE CAPS, GOLF SHIRTS, HATS, JACKETS, JOGGING SUITS, GYM AND WORKOUT SHIRTS AND SHORTS, NECKTIES, SHORTS, SWEATPANTS, SWEATSHIRTS, AND T-SHIRTS (U.S. CLS. 22 AND 39).

FIRST USE 0-0-1988; IN COMMERCE 0-0-1988.

**CLASS 28—TOYS AND SPORTING GOODS**

FOR ATHLETIC EQUIPMENT AND SPORTING GOODS, NAMELY BASEBALL EQUIPMENT, CONSISTING OF BASEBALL BAGS, BASEBALLS, BASEBALL BATS, AND BASEBALL GLOVES; ATHLETIC SUPPORTERS, GOLF CLUBS, GOLF BAGS; TOYS, NAMELY ACTION FIGURES AND DOLLS; SPORTS TOYS, NAMELY PLUSH TOYS AND LEARNING SETS COMPRISING CHILDREN'S MULTIPLE ACTIVITY TOY, ELECTRONIC EDUCATIONAL GAME MACHINES FOR CHILDREN (U.S. CLS. 22, 23, 38 AND 50).

FIRST USE 0-0-1954; IN COMMERCE 0-0-1954.

2,900,045. M + W ZANDER FACILITY MANAGEMENT GMBH, 90408 NURNBERG, FED REP GERMANY. SN 75-606,883. PUB. 10-29-2002, FILED 12-18-1998.

**m+w zander**

**CLASS 6—METAL GOODS**

FOR PORTABLE METAL STRUCTURES, NAMELY METAL CASINGS AND FRAMES AS PART OF FILTER FAN UNITS, CLIMATIC CHAMBERS, AIR-CONDITIONING UNITS, PAINT SPRAYING STANDS; BOOTHS AND SOUND-PROOF BOOTHS; CLEAN ROOM CEILINGS COMPRISING CEILING PANELS, FRAMES, CEILING GRIDS AND COVER PLATES OF METAL COMPOSITES; CLEAN ROOM WALLS COMPRISING WALL PANELS AND FRAMES OF METAL OR METAL COMPOSITES; METAL VENTILATING DUCTS; METAL VENTILATION PIPES; CLEAN ROOM SUPPLIES CONSISTING OF METAL CONNECTORS, CLIPS, BOLTS, JOINTS, ANCHORS; METAL CURTAIN WALLS; METAL FLOOR COVERINGS (U.S. CLS. 2, 12, 13, 14, 23, 25 AND 50).

FIRST USE 1-1-2000; IN COMMERCE 1-1-2000.

**CLASS 7—MACHINERY**

FOR PAINT SPRAYING STANDS; DUST, SOLVENT STEAM AND OIL MIST SUCTION AND SEPARATING UNITS AND DEVICES, CONSISTING OF METAL CASINGS, METAL HOODS, ELECTRIC FANS, VENTILATION FANS, SUCTION PUMPS, METAL DUCTS, AIR FILTERS, MIST ELIMINATORS; FANS (U.S. CLS. 13, 19, 21, 23, 31, 34 AND 35).

FIRST USE 1-1-2000; IN COMMERCE 1-1-2000.

2,900,057. L&P PROPERTY MANAGEMENT COMPANY, SOUTH GATE, CA. SN 75-736,580. PUB. 3-2-2004, FILED 6-24-1999.

**MEDALLION**

**CLASS 7—MACHINERY**

FOR MECHANICAL ACTUATORS FOR USE IN FURNITURE ROCKING MECHANISMS (U.S. CLS. 13, 19, 21, 23, 31, 34 AND 35).

FIRST USE 8-1-1999; IN COMMERCE 8-1-1999.

**CLASS 20—FURNITURE AND ARTICLES NOT OTHERWISE CLASSIFIED**

FOR FURNITURE PARTS, NAMELY, MOTION MECHANISMS COMPRISED OF METAL ROCKER UNITS, METAL ROCKER BASES, AND METAL ACTUATORS FOR USE IN MOTION FURNITURE (U.S. CLS. 2, 13, 22, 25, 32 AND 50).

FIRST USE 8-1-1999; IN COMMERCE 8-1-1999.

**CLASS 42—SCIENTIFIC, COMPUTER AND LEGAL SERVICES**

FOR ENGINEERING SERVICES AND ENGINEERING CONSULTING SERVICES RELATING TO INSTRUMENTS, EQUIPMENT, COMPONENTS, AND PROCESSES FOR OZONE-BASED AQUEOUS CLEANING, PROCESSING, AND SURFACE TREATMENT OF MATERIALS AND DEVICES (U.S. CLS. 100 AND 101).

FIRST USE 6-5-2000; IN COMMERCE 6-5-2000.

2,900,060. SILVER FOX LIMITED, HERTS AL7 1SA, UNITED KINGDOM. SN 75-771,344. PUB. 11-13-2001, FILED 8-9-1999.

**SILVER FOX****CLASS 9—ELECTRICAL AND SCIENTIFIC APPARATUS**

FOR COMPUTER SOFTWARE FOR THE DESIGN AND GENERATION OF LABELS, SIGNS, LABELING TAPES, AND IDENTIFICATION TAGS (U.S. CLS. 21, 23, 26, 36 AND 38).

FIRST USE 6-1-1999; IN COMMERCE 1-1-2000.

**CLASS 16—PAPER GOODS AND PRINTED MATTER**

FOR BLANK AND PRINTED PAPER LABELS AND LABEL TAPES; PLASTIC SHEETS AND LABELS FOR WRITING, PRINTING AND MARKING; BLANK AND PRINTED LABELS, NOT OF TEXTILES; BLANK AND PRINTED PAPER SIGNS; BLANK AND PRINTED PAPER IDENTIFICATION TAGS; BLANK AND PRINTED LABELS AND CHARACTERS SOLELY ADAPTED FOR MOUNTING ON MODULAR RAILS AND MODULAR RAILS SOLELY ADAPTED THEREFOR (U.S. CLS. 2, 5, 22, 23, 29, 37, 38 AND 50).

FIRST USE 1-1-1993; IN COMMERCE 1-1-1993.

**CLASS 42—SCIENTIFIC, COMPUTER AND LEGAL SERVICES**

FOR DESIGN AND DEVELOPMENT OF COMPUTER SOFTWARE; DESIGN AND DEVELOPMENT OF LABELING SYSTEMS AND SIGNAGE; INFORMATION AND ADVISORY SERVICES RELATING TO THE AFORESAID SERVICES (U.S. CLS. 100 AND 101).

FIRST USE 6-1-2000; IN COMMERCE 6-1-2000.

2,900,065. PHIFER SMITH CORPORATION, PALO ALTO, CA. SN 75-815,196. PUB. 8-28-2001, FILED 10-25-1999.

**HOTOZONE****CLASS 9—ELECTRICAL AND SCIENTIFIC APPARATUS**

FOR SEMICONDUCTOR WAFER PROCESSING APPARATUS, AND PARTS THEREOF, USED IN SEMICONDUCTOR DEVICE MANUFACTURING FOR PHOTORESIST STRIPPING, ETCHING, SURFACE CLEANING, OR SURFACE TREATMENT OF SEMICONDUCTOR WAFERS AND FLAT PANEL DISPLAY SUBSTRATES, FOR OZONE-BASED CLEANING, PROCESSING, AND SURFACE TREATMENT OF MATERIALS AND DEVICES (U.S. CLS. 21, 23, 26, 36 AND 38).

FIRST USE 5-24-2001; IN COMMERCE 6-3-2002.

2,900,069. FANTASY INC., BERKELEY, CA. SN 75-844,172. PUB. 1-28-2003, FILED 11-9-1999.

**SOULSVILLE U.S.A.**

NO CLAIM IS MADE TO THE EXCLUSIVE RIGHT TO USE "U.S.A.", APART FROM THE MARK AS SHOWN.

**CLASS 41—EDUCATION AND ENTERTAINMENT**

FOR ARRANGING AND CONDUCTING EDUCATIONAL CONFERENCES; EDUCATION SERVICES, NAMELY CONDUCTING SEMINARS, WORKSHOPS AND CLASSES IN THE FIELD OF MUSIC INSTRUCTION AND MUSIC HISTORY; MUSEUMS; COMMUNITY FESTIVALS FEATURING A VARIETY OF ACTIVITIES, NAMELY MUSICAL PERFORMANCES, FILM PRESENTATIONS, AND MUSIC HISTORY LECTURES; DEVELOPMENT AND DISSEMINATION OF EDUCATION MATERIALS OF OTHERS IN THE FIELD OF MUSIC, BIOGRAPHIES, AND HISTORY; LIBRARIES; ORGANIZING AND CONDUCTING COMMUNITY DEVELOPMENT AND EDUCATIONAL EVENTS IN THE NATURE OF CONFERENCES, SEMINARS, WORKSHOPS, AND FAIRS RELATING TO URBAN RENEWAL, SELF-IMPROVEMENT, AND PERSONAL MOTIVATION; PROVIDING FACILITIES FOR MUSICAL CONCERTS AND MUSIC EDUCATION LECTURES (U.S. CLS. 100, 101 AND 107).

FIRST USE 7-24-2002; IN COMMERCE 7-24-2002.

**CLASS 42—SCIENTIFIC, COMPUTER AND LEGAL SERVICES**

FOR PROMOTING PUBLIC AWARENESS OF THE NEED FOR MUSIC AND MUSIC EDUCATION IN COMMUNITY DEVELOPMENT; CAREER COUNSELING; CHILD CARE SERVICES (U.S. CLS. 100 AND 101).

FIRST USE 2-8-2000; IN COMMERCE 2-8-2000.

2,900,071. GRAND RESORT, LLC, NEWPORT BEACH, CA. SN 75-851,290. PUB. 3-27-2001, FILED 11-16-1999.

**UNIVERSITY OF SURF CITY**

NO CLAIM IS MADE TO THE EXCLUSIVE RIGHT TO USE "UNIVERSITY", APART FROM THE MARK AS SHOWN.



**CLASS 9—ELECTRICAL AND SCIENTIFIC APPARATUS**

FOR CLOTHING, NAMELY MEN'S AND WOMEN'S SHIRTS AND PANTS, DRESSES, SWEATERS, TEE SHIRTS, SHORTS, SKIRTS, SWEATPANTS, SWEATSHIRTS, SWEATSUITS, WARMUP SUITS, SOCKS, TENNIS SKIRTS, LEOTARDS, SWIMMING SUITS AND TENNIS WEAR; HATS, SHOES, OUTERWEAR, AND SWEATBANDS, HEADBANDS, NECK BANDS, WRIST BANDS, SWIMMING CAPS, BELTS FOR CLOTHING, FOOTWEAR, ATHLETIC SHOES, GOLFING SHOES, SWIMMING SHOES, AND VISORS (U.S. CLS. 21, 23, 26, 36 AND 38).

FIRST USE 6-1-2004; IN COMMERCE 6-1-2004.

**CLASS 41—EDUCATION AND ENTERTAINMENT**

FOR EDUCATIONAL SERVICES, NAMELY CONDUCTING CLASSES AND SEMINARS FOR THE GENERAL PUBLIC IN THE FIELD OF RECREATIONAL SPORTS (U.S. CLS. 100, 101 AND 107).

FIRST USE 6-1-2004; IN COMMERCE 6-1-2004.

**CLASS 8—HAND TOOLS**

FOR KITCHEN KNIVES, NAMELY, STEAK KNIVES, UTILITY KNIVES, SANDWICH KNIVES, CARVING KNIVES, AND PARING KNIVES, SOLD SEPARATELY OR TOGETHER WITH A HARDWOOD BLOCK KNIFE HOLDER, NON-ELECTRIC FRUIT AND VEGETABLE PEELERS, NON-ELECTRIC CAN OPENERS, HAND OPERATED EGG SLICERS, HAND OPERATED CHEESE SLICERS, HAND OPERATED PIZZA SLICERS, KITCHEN SHEARS, HAND OPERATED CHEESE SLICERS, HAND OPERATED SLICERS, HAND OPERATED CHOPPERS, MEAT TENDERIZERS, NAMELY, MALLETS (U.S. CLS. 23, 28 AND 44).

FIRST USE 0-0-2000; IN COMMERCE 0-0-2000.

---

2,900,072. KRAUSZ, F. RON, ST. HELENA., CA. SN 75-852,821. PUB. 5-15-2001, FILED 11-18-1999.

**ARKENSTONE****CLASS 29—MEATS AND PROCESSED FOODS**

FOR OLIVE OIL (U.S. CL. 46).  
FIRST USE 7-31-2004; IN COMMERCE 7-31-2004.

**CLASS 33—WINES AND SPIRITS**

FOR WINE (U.S. CLS. 47 AND 49).  
FIRST USE 7-31-2004; IN COMMERCE 7-31-2004.

---

2,900,076. WORLD KITCHEN, INC., ELMIRA, NY. SN 75-896,053. PUB. 10-21-2003, FILED 1-13-2000.



NO CLAIM IS MADE TO THE EXCLUSIVE RIGHT TO USE "KITCHEN", APART FROM THE MARK AS SHOWN.

**CLASS 9—ELECTRICAL AND SCIENTIFIC APPARATUS**

FOR COOKING THERMOMETERS, FOOD TIMERS, MEASURING CUPS AND SPOONS, AND MAGNETS (U.S. CLS. 21, 23, 26, 36 AND 38).

FIRST USE 5-0-2000; IN COMMERCE 5-0-2000.

**CLASS 21—HOUSEWARES AND GLASS**

FOR DINNERWARE, KITCHENWARE, NAMELY, GLASS, METAL, GLASS-CERAMIC AND/OR CERAMIC OVENWARE AND BAKEWARE; TABLEWARE, NAMELY, FOOD STORAGE CONTAINERS FORMED OF GLASS, GLASS-CERAMIC, CERAMIC, PLASTIC AND/OR CRYSTALLINE MATERIAL PRODUCED FROM GLASS BY HEAT TREATMENT THEREOF, AND COVERS, REPLACEMENT PARTS THEREOF, AND FOOD RECIPE BOOKLETS SOLD THEREWITH; METAL COOKING UTENSILS, NAMELY, SAUCE PANS, SAUCE POTS, FRYING PANS, DOUBLE BOILERS, SKILLETS, OMELETTE PANS, DUTCH OVENS, STOCK POTS, CASSEROLES, MIXING BOWLS, FONDUE PANS, POACHERS, COOKWARE STEAMERS, BUFFET POTS, NON-ELECTRIC KETTLES, TEA KETTLES, NON-ELECTRIC COFFEE PERCOLATORS, NON-ELECTRIC PASTRY BLENDERS, NON-ELECTRIC COFFEE MAKERS, AND SALAD SPINNERS; THERMALLY INSULATED CONTAINERS/CARRIERS FOR FOOD AND/OR BEVERAGES AND A PIECE OF GLASS OR GLASS CERAMIC COOKWARE, NAMELY, CASSEROLES, DISHES, BOWLS, OR POTS, OR BAKEWARE, SOLD AS A UNIT; KITCHEN TOOLS AND UTENSILS, NAMELY, SPATULAS, TURNERS, POT AND PAN SCRAPERS, GARLIC PRESSES, TONGS, BASTERS, CORN HOLDERS, CORN STRIPPERS, EGG SEPARATORS, BASTING/PASTRY BRUSHES, COOKWARE STEAMERS, WHISKS, FLOUR SIFTERS, BISCUIT/COOKIE CUTTERS, GRATERS, ICE CREAM/COOKIE SCOOPS, SPLATTER SCREENS, EGG POACHERS, JAR OPENERS, DISH AND POT BRUSHES, BURNER BIBS, BURNER COVERS, COOKING FORKS, COOKING SPOONS, LADLES, SLOTTED SPOONS, SPAGHETTI FORKS, STRAINERS, DISH DRAINERS, PIE KEEPERS AND PIE SERVERS, BARBECUE TOOLS, NAMELY, SKEWERS, SPATULAS, KNIVES, TONGS, FORKS, AND BRUSHES (U.S. CLS. 2, 13, 23, 29, 30, 33, 40 AND 50).

FIRST USE 5-0-2000; IN COMMERCE 5-0-2000.

2,900,079. LGC (HOLDINGS) LTD., TEDDINGTON, MIDDLESEX, TW11 0LY, UNITED KINGDOM. SN 75-914,172. PUB. 6-25-2002, FILED 2-9-2000.



*Setting standards  
in analytical science*

#### CLASS 1—CHEMICALS

FOR DIAGNOSTIC PREPARATIONS AND REAGENTS FOR SCIENTIFIC OR RESEARCH USE (U.S. CLS. 1, 5, 6, 10, 26 AND 46).

FIRST USE 9-0-1997; IN COMMERCE 9-0-1997.

#### CLASS 41—EDUCATION AND ENTERTAINMENT

FOR EDUCATION SERVICES, NAMELY, CONDUCTING SEMINARS, CONFERENCES, WORKSHOPS, TRAINING COURSES IN PERSON AND VIA GLOBAL COMPUTER NETWORKS IN THE FIELD OF ANALYTICAL AND BIOCHEMICAL SCIENCE, GENETIC MEASUREMENTS, CHEMICAL DIAGNOSTICS, VETERINARY DIAGNOSTICS, FORENSIC ANALYSIS, FOOD ANALYSIS, ENVIRONMENTAL ANALYSIS, ENVIRONMENTAL MANAGEMENT RESEARCH, DNA TESTING AND ANALYTICAL MOLECULAR BIOLOGY (U.S. CLS. 100, 101 AND 107).

FIRST USE 9-0-1997; IN COMMERCE 9-0-1997.

#### CLASS 42—SCIENTIFIC, COMPUTER AND LEGAL SERVICES

FOR TECHNICAL CONSULTING RESEARCH, VALIDATION AND DEVELOPMENT OF STANDARDS IN THE AREAS OF ANALYTICAL AND BIOCHEMICAL SCIENCE, GENETIC MEASUREMENTS, CHEMICAL DIAGNOSTICS, VETERINARY DIAGNOSTICS, FORENSIC ANALYSIS, FOOD ANALYSIS, ENVIRONMENTAL MANAGEMENT RESEARCH, DNA TESTING AND ANALYTICAL MOLECULAR BIOLOGY (U.S. CLS. 100 AND 101).

FIRST USE 9-0-1997; IN COMMERCE 9-0-1997.

2,900,081. CONTEXT MEDIA, INC., PROVIDENCE, RI. SN 75-922,446. PUB. 7-24-2001, FILED 2-18-2000.

**CONTEXTMEDIA.COM**

#### CLASS 40—MATERIAL TREATMENT

FOR DOCUMENT DATA TRANSFER AND PHYSICAL CONVERSION FROM ONE MEDIA TO ANOTHER (U.S. CLS. 100, 103 AND 106).

FIRST USE 4-28-2004; IN COMMERCE 4-28-2004.

#### CLASS 41—EDUCATION AND ENTERTAINMENT

FOR PROVIDING RADIO, TELEVISION, VIDEOTAPE AND OTHER DIGITAL MEDIA PRODUCTION SERVICES; ONLINE AND OFFLINE VIDEO AND VIDEOTAPE EDITING SERVICES (U.S. CLS. 100, 101 AND 107).

FIRST USE 4-28-2004; IN COMMERCE 4-28-2004.

#### CLASS 42—SCIENTIFIC, COMPUTER AND LEGAL SERVICES

FOR GRAPHIC ART DESIGN SERVICES; TECHNICAL INTEGRATION SERVICES IN THE FIELD OF COMPUTER HARDWARE AND SOFTWARE; CONSULTING SERVICES IN THE PRODUCTION, INTEGRATION AND DISTRIBUTION OF DIGITAL MEDIA (U.S. CLS. 100 AND 101).

FIRST USE 4-28-2004; IN COMMERCE 4-28-2004.

2,900,082. SEIKO INSTRUMENTS KABUSHIKI KAISHA, TA SEIKO INSTRUMENTS INC., CHIBA-SHI, CHIBA, JAPAN. SN 75-927,847. PUB. 6-12-2001, FILED 2-25-2000.

**SPRON**

#### CLASS 6—METAL GOODS

FOR COMMON METALS AND THEIR ALLOYS IN THE FORM OF SPRINGS, BARS, WIRES, BLOCKS, INGOTS, AND METAL RODS, FOR USE IN FURTHER MANUFACTURE; METAL BUILDING MATERIALS, NAMELY, METAL AND ALLOY LINES, PIPES AND TUBES; TRANSPORTABLE BUILDINGS OF METAL; MATERIALS OF METAL FOR RAILWAY TRACKS, NAMELY, SLIDING DOORS, SEPARATING WALLS; NON-ELECTRIC CABLES AND WIRES OF COMMON METAL; IRONMONGERY IN THE NATURE OF SMALL ITEMS OF METAL HARDWARE, NAMELY, HINGES, KNOBS, BRACKETS; PIPES AND TUBES OF METAL; METAL SAFES; COMMON METAL ORES FOR INDUSTRIAL AND MANUFACTURING USE (U.S. CLS. 2, 12, 13, 14, 23, 25 AND 50).

FIRST USE 3-10-2000; IN COMMERCE 3-10-2000.

#### CLASS 9—ELECTRICAL AND SCIENTIFIC APPARATUS

FOR SCIENTIFIC, NAUTICAL, SURVEYING, ELECTRIC, PHOTOGRAPHIC, CINEMATOGRAPHIC, OPTICAL, WEIGHING, MEASURING, SIGNALLING, CHECKING AND SUPERVISION, LIFE-SAVING AND TEACHING APPARATUS AND INSTRUMENTS, NAMELY, SENSORS AND DIAPHRAGMS; APPARATUS FOR RECORDING, TRANSMISSION OR REPRODUCTION OF SOUND OR IMAGES, NAMELY, COMPUTER MONITORS, SATELLITE-AIDED DATA RECORDERS; BLANK MAGNETIC DATA CARRIERS; BLANK RECORDING DISCS; AUTOMATIC VENDING MACHINES AND MECHANISMS FOR COIN-OPERATED APPARATUS; CASH REGISTERS; CALCULATING MACHINES; DATA PROCESSING EQUIPMENT, NAMELY, COMPUTERS; FIRE-EXTINGUISHING APPARATUS, NAMELY, FIRE EXTINGUISHERS (U.S. CLS. 21, 23, 26, 36 AND 38).

FIRST USE 3-10-2000; IN COMMERCE 3-10-2000.

2,900,085. WOMEN FIRST HEALTHCARE, INC., SAN DIEGO, CA. SN 75-983,123. PUB. 3-28-2000, FILED 5-20-1998.

## WOMEN FIRST HEALTHCARE

NO CLAIM IS MADE TO THE EXCLUSIVE RIGHT TO USE "HEALTHCARE", APART FROM THE MARK AS SHOWN.

### CLASS 5—PHARMACEUTICALS

FOR PHARMACEUTICAL PREPARATIONS USED FOR TREATMENT OF SYMPTOMS AND DISEASES IN WOMEN FROM PERIL-MENOPAUSE THROUGH POST-MENOPAUSE (U.S. CLS. 6, 18, 44, 46, 51 AND 52).  
FIRST USE 8-31-1998; IN COMMERCE 8-31-1998.

### CLASS 9—ELECTRICAL AND SCIENTIFIC APPARATUS

FOR PRERECORDED AUDIO AND VIDEO TAPES AND MULTI-MEDIA SOFTWARE RECORDED ON CD ROMS ON TOPICS ADDRESSING THE TREATMENT OF SYMPTOMS AND DISEASES IN WOMEN FROM PERIL-MENOPAUSE THROUGH POST-MENOPAUSE (U.S. CLS. 21, 23, 26, 36 AND 38).  
FIRST USE 4-14-1998; IN COMMERCE 4-14-1998.

### CLASS 16—PAPER GOODS AND PRINTED MATTER

FOR PUBLICATIONS, NAMELY, PAMPHLETS, NEWSLETTERS AND MAGAZINES ADDRESSING THE TREATMENT OF SYMPTOMS AND DISEASES IN WOMEN FROM PERIL-MENOPAUSE THROUGH POST-MENOPAUSE (U.S. CLS. 2, 5, 22, 23, 29, 37, 38 AND 50).  
FIRST USE 3-21-1999; IN COMMERCE 3-21-1999.

### CLASS 41—EDUCATION AND ENTERTAINMENT

FOR EDUCATIONAL SERVICES, NAMELY, CONDUCTING SEMINARS ADDRESSING THE TREATMENT OF SYMPTOMS AND DISEASES IN WOMEN FROM PERIL-MENOPAUSE THROUGH POST-MENOPAUSE (U.S. CLS. 100, 101 AND 107).  
FIRST USE 10-0-1998; IN COMMERCE 10-0-1998.

### CLASS 7—MACHINERY

FOR POWER OPERATED AUTO DEVICES, NAMELY, DC AIR COMPRESSORS, WINCHES; POWER TOOLS, NAMELY, JOINTERS, DRILLS, AND SCREWDRIVERS; AND POWER TOOL ACCESSORIES, NAMELY, ROUTER BITS, WIRE BRUSHES; PNEUMATIC TOOLS, NAMELY, IMPACT WRENCHES, DUAL ACTION SANDERS, COLLECT AIR DIE GRINDERS, SHORT AIR HAMMERS, REVERSIBLE AIR DRILL AND DRIVE RATCHET WRENCH; AND SEWING MACHINES; TABLE SAW ACCESSORIES, NAMELY, SUPPORT STANDS USED TO SUPPORT LARGE OR AWKWARD PIECES OF MATERIAL WHEN WORKING ON SAME, HOT MELT GLUE GUNS (U.S. CLS. 13, 19, 21, 23, 31, 34 AND 35).  
FIRST USE 6-30-1965; IN COMMERCE 6-30-1965.

### CLASS 8—HAND TOOLS

FOR HAND TOOLS, NAMELY, VISES, HAMMERS, CHISELS, PUNCHES, SAWS, HACK SAWS, HEX KEYS, WRENCHES, POCKET KNIVES, CLAMPS, DRILL BITS, SOCKET SETS, SOCKET RUNNERS, AND IMPACT SOCKETS; BARBECUE UTENSILS, NAMELY, TONGS, AND FORKS; AND GARDEN TOOLS, NAMELY, PRUNERS (U.S. CLS. 23, 28 AND 44).  
FIRST USE 0-0-1969; IN COMMERCE 4-0-1969.

### CLASS 9—ELECTRICAL AND SCIENTIFIC APPARATUS

FOR FUSES, BOOSTER CABLES, ELECTRIC PEST REPELLERS, ANTIFREEZE TESTERS, GOGGLES, SAFETY GLASSES, PROTECTIVE WORK GLOVES AND LEVELS; MEASURING TAPES, PLASTIC GASOLINE SIPHON HOSES SOLD AS A COMPONENT OF A HIGHWAY EMERGENCY KIT (U.S. CLS. 21, 23, 26, 36 AND 38).  
FIRST USE 10-0-1995; IN COMMERCE 10-0-1995.

2,900,093. MODERN HUMORIST, INC., NEW YORK, NY. SN 76-013,601. PUB. 9-11-2001, FILED 3-28-2000.

## MODERN HUMORIST

### CLASS 16—PAPER GOODS AND PRINTED MATTER

FOR MAGAZINE FOCUSING ON HUMOR IN SOCIAL AND POLITICAL COMMENTARY INCLUDING SATIRE AND IRONY (U.S. CLS. 2, 5, 22, 23, 29, 37, 38 AND 50).  
FIRST USE 2-15-2001; IN COMMERCE 2-15-2001.

### CLASS 42—SCIENTIFIC, COMPUTER AND LEGAL SERVICES

FOR COMPUTER SERVICES, NAMELY, PROVIDING AN ON-LINE MAGAZINE FOCUSING ON HUMOR SOCIAL AND POLITICAL COMMENTARY INCLUDING SATIRE AND IRONY (U.S. CLS. 100 AND 101).  
FIRST USE 4-30-2000; IN COMMERCE 4-30-2000.

2,900,086. PETERS GROUP WORLDWIDE, LLC, MINNETONKA, MN. SN 75-983,415. PUB. 12-5-2000, FILED 5-22-1998.

## MASTER CRAFT

### CLASS 6—METAL GOODS

FOR METAL TOOL BOXES, METAL TOOL CASES, METAL TOOL CHESTS, METAL FASTENERS, NAMELY, NUTS, BOLTS, SCREWS, WASHERS, ANCHORS, RIVETS, STUDS, AND PINS AND METAL TAP AND DIE SETS (U.S. CLS. 2, 12, 13, 14, 23, 25 AND 50).  
FIRST USE 4-0-1989; IN COMMERCE 4-0-1989.

2,900,099. NORTHERN TECHNOLOGIES INTERNATIONAL CORPORATION, BEACHWOOD, OH. SN 76-052,145. PUB. 11-5-2002, FILED 5-19-2000.

## MATCH TECH

### CLASS 17—RUBBER GOODS

FOR POLYMERIC FLEXIBLE AND RIGID PACKAGING STRUCTURES, NAMELY, FORMS, FILMS, FOAMS, SHEETING, AND WRAPPING MADE OF PLASTICS AND POLYMERS FROM RENEWABLE SOURCES TO PROTECT INDUSTRIAL AND COMMERCIAL PRODUCTS AGAINST CHEMICAL, ELECTROSTATIC, PHYSICAL AND ENVIRONMENTAL DAMAGE DURING TRANSPORTATION AND STORAGE (U.S. CLS. 1, 5, 12, 13, 35 AND 50).

FIRST USE 5-0-2001; IN COMMERCE 6-0-2001.

### CLASS 42—SCIENTIFIC, COMPUTER AND LEGAL SERVICES

FOR CONSULTATION IN THE FIELD OF DESIGN, ENGINEERING AND DEVELOPMENT OF PLASTIC, CERAMIC AND OTHER NON-METALLIC INDUSTRIAL AND COMMERCIAL PACKAGING MATERIALS, FORMULATIONS, STRUCTURES AND SYSTEMS TO PROTECT INDUSTRIAL AND COMMERCIAL PRODUCTS FROM CHEMICAL, ELECTROSTATIC, PHYSICAL AND ENVIRONMENTAL DAMAGE DURING SHIPMENT AND STORAGE (U.S. CLS. 100 AND 101).

FIRST USE 5-0-2001; IN COMMERCE 6-0-2001.

2,900,116. SPECIFIED TECHNOLOGIES INC., SOMERVILLE, NJ. SN 76-116,447. PUB. 6-12-2001, FILED 8-25-2000.

## HTO

### CLASS 2—PAINTS

FOR SEALER COATINGS FOR USE IN FIRE PREVENTION SUCH AS GLAZIERS' PUTTY (U.S. CLS. 6, 11 AND 16).

FIRST USE 6-25-2004; IN COMMERCE 6-25-2004.

### CLASS 7—MACHINERY

FOR MECHANICAL SEALS, NAMELY, FIXTURES FOR SURROUNDING CABLES AND CABLE SUPPORTS WHICH PENETRATE THROUGH WALLS, FLOORS AND CEILINGS FOR FIRE PREVENTION (U.S. CLS. 13, 19, 21, 23, 31, 34 AND 35).

FIRST USE 6-25-2004; IN COMMERCE 6-25-2004.

2,900,128. HALE PRODUCTS, INC., CONSHOHOCKEN, PA. SN 76-145,604. PUB. 12-10-2002, FILED 10-13-2000.



OWNER OF U.S. REG. NOS. 1,264,316, 1,585,822, AND OTHERS.

### CLASS 7—MACHINERY

FOR POWER OPERATED RESCUE TOOLS, NAMELY, POWER OPERATED PRY BARS, POWER UNITS THEREFORE, POWER OPERATED CUTTERS AND COMPONENTS THEREFORE, NAMELY, HOSES AND VALVES, CENTRIFUGAL PUMPS FOR MOUNTING ON FIRE TRUCKS AND CENTRIFUGAL PUMPS FOR STAND ALONE OPERATION FOR USE IN FIRE FIGHTING (U.S. CLS. 13, 19, 21, 23, 31, 34 AND 35).

FIRST USE 4-1-1998; IN COMMERCE 4-1-1998.

### CLASS 25—CLOTHING

FOR CLOTHING, NAMELY, JACKETS, SHIRTS AND HATS (U.S. CLS. 22 AND 39).

FIRST USE 4-1-1998; IN COMMERCE 4-1-1998.

2,900,130. IFCO SYSTEMS NORTH AMERICA, INC., HOUSTON, TX. SN 76-147,363. PUB. 8-20-2002, FILED 10-16-2000.



NO CLAIM IS MADE TO THE EXCLUSIVE RIGHT TO USE "SYSTEMS", APART FROM THE MARK AS SHOWN.

THE COLOR GREEN, BLACK AND WHITE ARE FEATURES OF THE MARK AND ARE USED AS FOLLOWS. THE COLOR GREEN IS USED IN THE CIRCLE OUTLINING THE LETTER "I" AND THE LETTER "I" IS WHITE. THE WORD "IFCO" IS GREEN AND THE WORD "SYSTEMS" IS BLACK.

### CLASS 20—FURNITURE AND ARTICLES NOT OTHERWISE CLASSIFIED

FOR NON-METAL SHIPPING PALLETS AND CONTAINERS MADE FROM PLASTIC MATERIAL, NAMELY MULTIPLE-WAY TRANSPORT CONTAINERS (U.S. CLS. 2, 13, 22, 25, 32 AND 50).

FIRST USE 9-3-2000; IN COMMERCE 9-30-2000.

### CLASS 39—TRANSPORTATION AND STORAGE

FOR RENTAL OF SHIPPING PALLETS AND RETURNABLE PACKAGING CONTAINERS (U.S. CLS. 100 AND 105).

FIRST USE 9-30-2000; IN COMMERCE 9-30-2000.

2,900,137. SECTOR, INC., NEW YORK, NY. SN 76-186,040. PUB. 7-23-2002, FILED 12-22-2000.



OWNER OF U.S. REG. NOS. 2,355,439 AND 2,501,162. THE STIPPLING IS FOR SHADING PURPOSES.

**CLASS 9—ELECTRICAL AND SCIENTIFIC APPARATUS**

FOR COMPUTER SOFTWARE FOR PROVIDING NETWORK COMMUNICATIONS, FINANCIAL SERVICES, SECURITIES SETTLEMENT, AND OPERATION OF A MARKET FOR THE TRADING OF SECURITIES VIA A COMPUTER NETWORK (U.S. CLS. 21, 23, 26, 36 AND 38).

FIRST USE 12-0-2001; IN COMMERCE 12-0-2001.

**CLASS 35—ADVERTISING AND BUSINESS**

FOR DATA PROCESSING SERVICES (U.S. CLS. 100, 101 AND 102).

FIRST USE 12-0-2001; IN COMMERCE 12-0-2001.

**CLASS 38—COMMUNICATION**

FOR COMMUNICATIONS SERVICES, NAMELY, DATA COMMUNICATIONS TRANSMITTED VIA SATELLITE TRANSMISSION, MICROWAVE TRANSMISSION, CABLE TRANSMISSION, FIBER OPTIC TRANSMISSION, ISDW TRANSMISSION, TELEPHONE TRUNK LINE TRANSMISSION, OPTICAL RELAY, RADIO AND CELLULAR TRANSMISSION (U.S. CLS. 100, 101 AND 104).

FIRST USE 12-0-2001; IN COMMERCE 12-0-2001.

**CLASS 9—ELECTRICAL AND SCIENTIFIC APPARATUS**

FOR INSTRUCTIONAL TAPES, CD AND VIDEOS, NAMELY, YOGA CLASSES ON AUDIO TAPE AND CD, YOGA CLASSES ON CD-ROM AND VIDEO AND SCREEN SAVER PROGRAMS FEATURING YOGA POSE-OF-THE-MONTH AND OTHER YOGA POSES (U.S. CLS. 21, 23, 26, 36 AND 38).

FIRST USE 4-1-2000; IN COMMERCE 4-1-2000.

**CLASS 16—PAPER GOODS AND PRINTED MATTER**

FOR PRINTED MATERIAL, NAMELY, A SERIES OF NON-FICTION BOOKS CONCERNING YOGA; GREETING CARDS; YOGA JOURNALS; CALENDARS; AND INSTRUCTIONAL POSTERS (U.S. CLS. 2, 5, 22, 23, 29, 37, 38 AND 50).

FIRST USE 6-1-2002; IN COMMERCE 6-1-2002.

**CLASS 25—CLOTHING**

FOR CLOTHING, NAMELY, T-SHIRTS, CAMIS, TANK-TOPS, YOGA PANTS, SWEATSHIRTS, LEGGINGS, CAPRI PANTS, SHORTS, SOCKS, CAPS, HATS, WORKOUT SUITS, SNEAKERS, AND JACKETS (U.S. CLS. 22 AND 39).

FIRST USE 6-2-2003; IN COMMERCE 6-2-2003.

2,900,145. TERA CLOUD CORPORATION, BELLEVUE, WA. SN 76-212,057. PUB. 7-2-2002, FILED 2-16-2001.

**TERACLOUD****CLASS 9—ELECTRICAL AND SCIENTIFIC APPARATUS**

FOR COMPUTER SOFTWARE AND HARDWARE FOR MONITORING, REPORTING, STORING, RETRIEVING AND MANAGING INFORMATION (U.S. CLS. 21, 23, 26, 36 AND 38).

FIRST USE 6-1-2001; IN COMMERCE 6-1-2001.

**CLASS 42—SCIENTIFIC, COMPUTER AND LEGAL SERVICES**

FOR COMPUTER SOFTWARE AND HARDWARE CONSULTING SERVICES; COMPUTER PROGRAMMING AND SOFTWARE DEVELOPMENT FOR OTHERS; COMPUTER PROGRAMMING AND SOFTWARE DEVELOPMENT FOR OTHERS TO ESTABLISH DATA MANAGEMENT AND STORAGE SOLUTIONS; COMPUTER CONSULTING SERVICES TO SOLVE INFORMATION MONITORING, REPORTING, STORAGE AND MANAGEMENT PROBLEMS (U.S. CLS. 100 AND 101).

FIRST USE 6-1-2001; IN COMMERCE 6-1-2001.

2,900,149. OM YOGA CENTER, INC., NEW YORK, NY. SN 76-224,646. PUB. 3-5-2002, FILED 3-12-2001.

**OM YOGA**

OWNER OF U.S. REG. NO. 2,302,226.  
NO CLAIM IS MADE TO THE EXCLUSIVE RIGHT TO USE "YOGA", APART FROM THE MARK AS SHOWN.

2,900,151. TERRABROOK APOLLO BEACH, L.P., DALLAS, TX. SN 76-232,834. PUB. 3-19-2002, FILED 3-23-2001.

**MIRABAY****CLASS 41—EDUCATION AND ENTERTAINMENT**

FOR GOLF CLUB SERVICES; PROVIDING SWIMMING FACILITIES; AND PROVIDING TENNIS COURT FACILITIES (U.S. CLS. 100, 101 AND 107).

FIRST USE 8-2-2003; IN COMMERCE 8-2-2003.

**CLASS 42—SCIENTIFIC, COMPUTER AND LEGAL SERVICES**

FOR RESTAURANT SERVICES (U.S. CLS. 100 AND 101).

FIRST USE 3-1-2004; IN COMMERCE 3-1-2004.

2,900,159. MALLO, THOMAS P., MESA, AZ. SN 76-268,255. PUB. 6-10-2003, FILED 6-6-2001.

**BUYDIRECT**

THE MARK CONSISTS OF STANDARD CHARACTERS WITHOUT CLAIM TO ANY PARTICULAR FONT, STYLE, SIZE, OR COLOR.

**CLASS 35—ADVERTISING AND BUSINESS**

FOR AUTOMOBILE DEALERSHIPS AND WHOLESALE DISTRIBUTORSHIPS FEATURING PRE-OWNED AUTOMOBILES (U.S. CLS. 100, 101 AND 102).  
FIRST USE 3-2-2004; IN COMMERCE 3-2-2004.

2,900,186. BETA DERMACEUTICALS, INC., SAN ANTONIO, TX. SN 76-314,557. PUB. 7-2-2002, FILED 9-19-2001.

**CLASS 39—TRANSPORTATION AND STORAGE**

FOR LEASING OF PRE-OWNED AUTOMOBILES (U.S. CLS. 100 AND 105).  
FIRST USE 3-2-2004; IN COMMERCE 3-2-2004.



OWNER OF U.S. REG. NO. 1,429,738.

2,900,174. MEAN TECH XCELLENT PRODUCTS PRIVATE LTD., SINGAPORE, SINGAPORE. SN 76-296,171. PUB. 7-9-2002, FILED 8-8-2001.

**CLASS 3—COSMETICS AND CLEANING PREPARATIONS**

FOR HAIR CARE AND SKIN CARE PRODUCTS, NAMELY, SKIN CLEANSERS AND SKIN MOISTURIZERS (U.S. CLS. 1, 4, 6, 50, 51 AND 52).  
FIRST USE 1-1-2003; IN COMMERCE 1-1-2003.

**PARTY Q****CLASS 11—ENVIRONMENTAL CONTROL APPARATUS**

FOR PATIO HEATERS AND BARBEQUE GRILLS (U.S. CLS. 13, 21, 23, 31 AND 34).  
FIRST USE 7-20-2002; IN COMMERCE 7-20-2002.

**CLASS 5—PHARMACEUTICALS**

FOR MEDICATED HAIR SHAMPOOS, MEDICATED SKIN CREAMS, DIAPER OINTMENTS AND HYDROCORTISONE LOTIONS, NOT INCLUDING PRODUCTS FOR USE AS ANTISEPTICS, MICROBICIDALS, ANTIBIOTICS OR ANTIFUNGALS (U.S. CLS. 6, 18, 44, 46, 51 AND 52).  
FIRST USE 1-1-2003; IN COMMERCE 1-1-2003.

**CLASS 20—FURNITURE AND ARTICLES NOT OTHERWISE CLASSIFIED**

FOR OUTDOOR FURNITURE (U.S. CLS. 2, 13, 22, 25, 32 AND 50).  
FIRST USE 7-20-2002; IN COMMERCE 7-20-2002.

2,900,192. GAESUNG GINSENG COOPERATIVE ASSOCIATION, KYONGGI-DO, REPUBLIC OF KOREA. SN 76-329,891. PUB. 11-5-2002, FILED 10-24-2001.

**CLASS 21—HOUSEWARES AND GLASS**

FOR BARBECUE UTENSILS, NAMELY, BRUSHES, FORKS, TONGS, TURNERS (U.S. CLS. 2, 13, 23, 29, 30, 33, 40 AND 50).  
FIRST USE 7-20-2002; IN COMMERCE 7-20-2002.

HAN SONG JUNG



2,900,180. JOHNSTONE, JOSEPH J., PORTLAND, OR. SN 76-304,288. PUB. 2-4-2003, FILED 8-24-2001.

**ANDROMEDA SNOWBOARDS**

NO CLAIM IS MADE TO THE EXCLUSIVE RIGHT TO USE "SNOWBOARDS", APART FROM THE MARK AS SHOWN.

NO CLAIM IS MADE TO THE EXCLUSIVE RIGHT TO USE THE REPRESENTATION OF THE DESIGN OF THE GINSENG ROOT, APART FROM THE MARK AS SHOWN.

THE STIPPLING IN THE DRAWING IS A FEATURE OF THE MARK AND IS NOT INTENDED TO INDICATE COLOR.

**CLASS 25—CLOTHING**

FOR TEE SHIRTS, SWEAT SHIRTS, HATS AND JACKETS (U.S. CLS. 22 AND 39).  
FIRST USE 12-0-2001; IN COMMERCE 12-0-2001.

**CLASS 29—MEATS AND PROCESSED FOODS**

FOR PROCESSED GINSENG FOR USE AS A VEGETABLE, NAMELY, FROZEN GINSENG, DRIED GINSENG, CANNED GINSENG, BOTTLED GINSENG, RED STEAMED GINSENG AND PROCESSED GINSENG (U.S. CL. 46).  
FIRST USE 5-12-2000; IN COMMERCE 11-10-2002.

**CLASS 28—TOYS AND SPORTING GOODS**

FOR SNOWBOARDS (U.S. CLS. 22, 23, 38 AND 50).  
FIRST USE 12-0-2001; IN COMMERCE 12-0-2001.

**CLASS 31—NATURAL AGRICULTURAL PRODUCTS**

FOR FRESH GINSENG, NAMELY, GREEN GINSENG AND RAW GINSENG (U.S. CLS. 1 AND 46).  
FIRST USE 5-12-2000; IN COMMERCE 11-10-2002.

**CLASS 32—LIGHT BEVERAGES**

FOR GINSENG JUICES FOR USE AS A BEVERAGE; SODA WATERS CONTAINING GINSENG; FRUIT JUICES CONTAINING GINSENG; NON-ALCOHOLIC SOFT DRINKS CONTAINING GINSENG; GINSENG FLAVORED SODA WATERS; GINSENG FLAVORED FRUIT JUICES; GINSENG FLAVORED NON-ALCOHOLIC SOFT DRINKS; GINSENG POWDERS FOR USE IN THE PREPARATION OF GINSENG JUICES; GINSENG EXTRACTS FOR USE IN THE PREPARATION OF GINSENG JUICES (U.S. CLS. 45, 46 AND 48).  
FIRST USE 5-12-2000; IN COMMERCE 11-10-2002.

2,900,203. TV-ONE, INC., LOMBARD, IL. SN 76-342,788. PUB. 12-17-2002, FILED 11-29-2001.

**TEAM DEMOLITION DERBY**

NO CLAIM IS MADE TO THE EXCLUSIVE RIGHT TO USE "DEMOLITION DERBY", APART FROM THE MARK AS SHOWN.

**CLASS 25—CLOTHING**

FOR CLOTHING, NAMELY, ATHLETIC FOOTWEAR, BANDANAS, HEADBANDS, SWEATBANDS, WRISTBANDS, CAPS, HATS, GLOVES, SHIRTS, PANTS, BATHING SUITS, BATHING TRUNKS, BATHROBES, BEACHWEAR, BELTS, BLAZERS, SUITS, BLOUSES, BOOTS, BOXER SHORTS, BRAS, MEN'S UNDERGARMENTS, WOMEN'S UNDERGARMENTS, COATS, FOOTWEAR, HOSIERY, JACKETS, LINGERIE, NECKWEAR, RAINWEAR, SWIMWEAR (U.S. CLS. 22 AND 39).  
FIRST USE 5-31-1999; IN COMMERCE 5-31-2000.

**CLASS 42—SCIENTIFIC, COMPUTER AND LEGAL SERVICES**

FOR ASSOCIATION SERVES, NAMELY, PROMOTING THE INTERESTS OF MEMBERS WHO CONDUCT ENTERTAINMENT EXHIBITIONS IN THE NATURE OF DEMOLITION DERBIES (U.S. CLS. 100 AND 101).  
FIRST USE 5-31-1999; IN COMMERCE 5-31-2000.

2,900,207. SQUARE ONE DEVELOPMENT, INC., DELTAVILLE, VA. SN 76-344,333. PUB. 10-1-2002, FILED 12-3-2001.

**COLLECTIVE WISDOM****CLASS 16—PAPER GOODS AND PRINTED MATTER**

FOR WRITING SETS CONSISTING OF STATIONERY, ENVELOPES, STENCILS (U.S. CLS. 2, 5, 22, 23, 29, 37, 38 AND 50).  
FIRST USE 6-0-2003; IN COMMERCE 6-0-2003.

**CLASS 28—TOYS AND SPORTING GOODS**

FOR EDUCATIONAL GAMES CONSISTING OF REPRODUCTIONS OF 18TH AND 19TH CENTURY GAMES, PUZZLES (U.S. CLS. 22, 23, 38 AND 50).  
FIRST USE 5-0-2002; IN COMMERCE 5-0-2002.

2,900,209. LOAD KING MANUFACTURING CO., JACKSONVILLE, FL. SN 76-344,948. PUB. 11-11-2003, FILED 12-4-2001.

**LK INDUSTRIES**

NO CLAIM IS MADE TO THE EXCLUSIVE RIGHT TO USE "INDUSTRIES", APART FROM THE MARK AS SHOWN.

**CLASS 37—CONSTRUCTION AND REPAIR**

FOR INSTALLATION OF POINT-OF-SALE SYSTEMS IN THE NATURE OF ELECTRONIC HARDWARE FIXTURES, BLENDERS, REFRIGERATION EQUIPMENT, BEVERAGE DISPENSERS, COFFEE AND ESPRESSO MACHINES, STOVES AND OVENS, PHARMACY WORKSTATIONS, INTERNAL ELECTRICAL AND PLUMBING SUB-SYSTEMS, AND CONVEYORS (U.S. CLS. 100, 103 AND 106).  
FIRST USE 6-0-2004; IN COMMERCE 6-0-2004.

**CLASS 40—MATERIAL TREATMENT**

FOR CUSTOM MANUFACTURE OF POINT-OF-SALE SYSTEMS IN THE NATURE OF ELECTRONIC HARDWARE FIXTURES, BLENDERS, REFRIGERATION EQUIPMENT, BEVERAGE DISPENSERS, COFFEE AND ESPRESSO MACHINES, STOVES AND OVENS, PHARMACY WORKSTATIONS, INTERNAL ELECTRICAL AND PLUMBING SUB-SYSTEMS, AND CONVEYORS (U.S. CLS. 100, 103 AND 106).  
FIRST USE 6-0-2004; IN COMMERCE 6-0-2004.

**CLASS 42—SCIENTIFIC, COMPUTER AND LEGAL SERVICES**

FOR PRODUCT DESIGN AND DEVELOPMENT FOR OTHERS IN THE FIELD OF POINT-OF-SALE SYSTEMS IN THE NATURE OF ELECTRONIC HARDWARE FIXTURES, BLENDERS, REFRIGERATION EQUIPMENT, BEVERAGE DISPENSERS, COFFEE AND ESPRESSO MACHINES, STOVES AND OVENS, PHARMACY WORKSTATIONS, INTERNAL ELECTRICAL AND PLUMBING SUB-SYSTEMS, AND CONVEYORS (U.S. CLS. 100 AND 101).  
FIRST USE 6-0-2004; IN COMMERCE 6-0-2004.

2,900,214. INSIGHT ENERGY, INC., WILMETTE, IL. SN 76-358,368. PUB. 4-29-2003, FILED 1-14-2002.

**INSIGHT ENERGY**

NO CLAIM IS MADE TO THE EXCLUSIVE RIGHT TO USE "ENERGY", APART FROM THE MARK AS SHOWN.

**CLASS 36—INSURANCE AND FINANCIAL**

FOR ARRANGING FOR FINANCING OF ENERGY GENERATION FACILITIES WORLDWIDE (U.S. CLS. 100, 101 AND 102).  
FIRST USE 9-15-2002; IN COMMERCE 9-15-2002.

**CLASS 40—MATERIAL TREATMENT**

FOR CONSULTING SERVICES IN THE FIELD OF ENERGY GENERATION (U.S. CLS. 100, 103 AND 106).  
FIRST USE 9-15-2002; IN COMMERCE 9-15-2002.

---

2,900,216. MAMA SITA'S HOLDING CO., INC., METRO MANILA, PHILIPPINES. SN 76-360,639. PUB. 1-20-2004, FILED 1-21-2002.

**CLASS 29—MEATS AND PROCESSED FOODS**

FOR MEAT, FISH, POULTRY, MEAT EXTRACT, PRESERVED, DRIED AND COOKED FRUITS AND VEGETABLES, JELLIES, JAMS, MILK, BUTTER, CHEESES, EDIBLE OILS, FRUIT PRESERVES, AND PICKLES (U.S. CL. 46).

FIRST USE 1-2-1999; IN COMMERCE 2-2-2001.

**CLASS 30—STAPLE FOODS**

FOR COFFEE, TEA, COCOA, SUGAR, COFFEE SUBSTITUTES, BREADS, BISCUITS, CAKES, PASTRIES, HONEY, MUSTARD, PEPPER, VINEGAR, SAUCES, AND SPICES (U.S. CL. 46).

FIRST USE 1-2-1999; IN COMMERCE 2-2-2001.

**CLASS 32—LIGHT BEVERAGES**

FOR AERATED AND MINERAL WATERS, NON-ALCOHOLIC DRINKS, NAMELY, SOFT DRINKS AND FRUIT FLAVORED DRINKS, FRUIT JUICES, SYRUPS FOR MAKING SOFT DRINKS AND FRUIT DRINKS (U.S. CLS. 45, 46 AND 48).

FIRST USE 1-2-1999; IN COMMERCE 2-2-2001.

---

2,900,219. MIDLAND COMMUNICATIONS PACKAGING, INC., LOUISVILLE, KY. SN 76-367,050. PUB. 11-25-2003, FILED 2-4-2002.

**MANUAL-MANAGEMENT****CLASS 35—ADVERTISING AND BUSINESS**

FOR ORDER FULFILLMENT SERVICES (U.S. CLS. 100, 101 AND 102).

FIRST USE 1-0-2003; IN COMMERCE 1-0-2003.

**CLASS 39—TRANSPORTATION AND STORAGE**

FOR STORAGE SERVICES FOR ARCHIVING DATABASES, IMAGES, AND OTHER ELECTRONIC DATA (U.S. CLS. 100 AND 105).

FIRST USE 1-0-2003; IN COMMERCE 1-0-2003.

**CLASS 40—MATERIAL TREATMENT**

FOR PRINTING, DIGITAL PRINTING, CD DUPLICATION AND DESKTOP PUBLISHING OF BINDERS, NOTEBOOKS, HANDBOOKS AND BOOKLETS FOR OTHERS; CONTRACT MANUFACTURING OF LOOSE-LEAF BINDERS AND CUSTOM INDEX TABS (U.S. CLS. 100, 103 AND 106).

FIRST USE 1-0-2003; IN COMMERCE 1-0-2003.

**CLASS 42—SCIENTIFIC, COMPUTER AND LEGAL SERVICES**

FOR GRAPHIC ART DESIGN; PROVIDING TEMPORARY USE OF ON-LINE NON-DOWNLOADABLE SOFTWARE FOR INFORMATION AND DATABASE MANAGEMENT (U.S. CLS. 100 AND 101).

FIRST USE 1-0-2003; IN COMMERCE 1-0-2003.

---

2,900,230. CAMPUS K12, INC., SAUGATUCK, MI. SN 76-375,402. PUB. 2-25-2003, FILED 2-26-2002.

**CAMPUS K12**

NO CLAIM IS MADE TO THE EXCLUSIVE RIGHT TO USE "K12", APART FROM THE MARK AS SHOWN.

**CLASS 9—ELECTRICAL AND SCIENTIFIC APPARATUS**

FOR COMPUTER SOFTWARE FOR USE IN PROFESSIONAL RE-CERTIFICATION, STUDENT CURRICULUM, AND EDUCATIONAL TESTING (U.S. CLS. 21, 23, 26, 36 AND 38).

FIRST USE 7-2-2002; IN COMMERCE 8-29-2002.

**CLASS 41—EDUCATION AND ENTERTAINMENT**

FOR EDUCATION SERVICES, NAMELY, CONDUCTING CLASSES, SEMINARS AND PRESENTATIONS OVER THE INTERNET IN THE FIELDS OF EDUCATION AND EDUCATION CURRICULUM FOR PROFESSIONAL RE-CERTIFICATION, AND DISTRIBUTING COURSE MATERIALS IN CONNECTION THEREWITH; EDUCATION TESTING (U.S. CLS. 100, 101 AND 107).

FIRST USE 7-2-2002; IN COMMERCE 8-29-2002.

---

2,900,241. BRIDGESTONE SPORTS CO., LTD, TOKYO 140-0013, JAPAN. SN 76-391,156. PUB. 10-29-2002, FILED 4-3-2002.

**CLASS 18—LEATHER GOODS**

FOR SHOES CASES FOR TRAVEL AND GOLFING, BOSTON BAGS, PARASOLS (U.S. CLS. 1, 2, 3, 22 AND 41).

FIRST USE 5-0-2004; IN COMMERCE 5-0-2004.

**CLASS 25—CLOTHING**

FOR GOLF SHOES, BELTS, SPORTSWEAR, NAMELY, SHIRTS, SHORTS, PANTS, JACKETS, HATS, SWEATERS, VESTS, SOCKS, CULOTTES, AND SKIRTS (U.S. CLS. 22 AND 39).

FIRST USE 6-0-2004; IN COMMERCE 6-0-2004.



2,900,242. BRIDGESTONE SPORTS CO., LTD., TOKYO 140-0013, JAPAN. SN 76-391,157. PUB. 10-29-2002, FILED 4-3-2002.

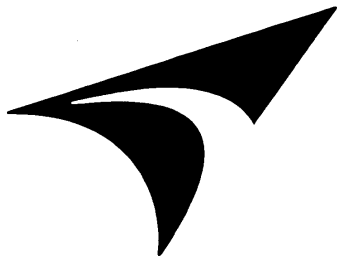

#### CLASS 18—LEATHER GOODS

FOR SHOE CASES FOR TRAVEL AND GOLFING, BOSTON BAGS AND PARASOLS (U.S. CLS. 1, 2, 3, 22 AND 41).

FIRST USE 5-0-2004; IN COMMERCE 5-0-2004.

#### CLASS 25—CLOTHING

FOR GOLF SHOES, BELTS, SPORTSWEAR, NAMELY, SHIRTS, SHORTS, PANTS, JACKETS, HATS, SWEATERS, VESTS, SOCKS, CULOTTES, AND SKIRTS (U.S. CLS. 22 AND 39).

FIRST USE 6-0-2004; IN COMMERCE 6-0-2004.

2,900,246. STETON TECHNOLOGY GROUP, INC., SANTA CLARA, UT. SN 76-394,409. PUB. 11-5-2002, FILED 4-11-2002.

## STETON

#### CLASS 9—ELECTRICAL AND SCIENTIFIC APPARATUS

FOR COMPUTER SOFTWARE, NAMELY DOWNLOADABLE SOFTWARE FOR CAPTURING AUDIT AND INSPECTION DATA ELECTRONICALLY; COMPUTER SOFTWARE FOR RECEIVING AUDIT AND INSPECTION DATA FROM A REMOTE SITE AND FOR ORGANIZING AND OPTIMIZING THAT DATA FOR REPORTING PURPOSES AND DISTRIBUTING THAT INFORMATION VIA COMMUNICATION NETWORKS; COMPUTER SOFTWARE FOR SAFETY MANAGEMENT AND QUALITY ASSURANCE MANAGEMENT (U.S. CLS. 21, 23, 26, 36 AND 38).

FIRST USE 2-1-2002; IN COMMERCE 2-1-2002.

#### CLASS 42—SCIENTIFIC, COMPUTER AND LEGAL SERVICES

FOR PROVIDING TEMPORARY USE OF NON-DOWNLOADABLE, BROWSER-BASED SOFTWARE FOR CAPTURING AUDIT AND INSPECTION DATA ELECTRONICALLY; PROVIDING TEMPORARY USE OF ON-LINE NON-DOWNLOADABLE REPORTING SYSTEM COMPUTER SOFTWARE WHICH PROVIDES ACCESS TO AUDIT RESULTS AND FEEDBACK REPORTS THROUGH A GLOBAL COMPUTER NETWORK (U.S. CLS. 100 AND 101).

FIRST USE 2-1-2002; IN COMMERCE 2-1-2002.

2,900,253. DISPLAY TEAM OY, HELSINKI, FINLAND. SN 76-396,727. PUB. 12-16-2003, FILED 4-16-2002.

## MAXIME CATMAN

THE NAME "MAXIME CATMAN" DOES NOT IDENTIFY A LIVING INDIVIDUAL.

#### CLASS 6—METAL GOODS

FOR METAL PARTS AND FITTINGS FOR EQUIPMENT AND INSTRUMENTS FOR MERCHANDISE DISPLAYS, NAMELY, RAILS AND SPRINGS (U.S. CLS. 2, 12, 13, 14, 23, 25 AND 50).

FIRST USE 9-12-2000; IN COMMERCE 8-0-2003.

#### CLASS 20—FURNITURE AND ARTICLES NOT OTHERWISE CLASSIFIED

FOR EQUIPMENT AND INSTRUMENTS FOR MERCHANDISE DISPLAYS, NAMELY, FOR SHELVING, NAMELY, SHELF DIVIDERS; EQUIPMENT AND INSTRUMENTS FOR MAKING PRODUCTS AVAILABLE IN THE NATURE OF COMPONENTS OF SHELVING, NAMELY SHELF DIVIDERS, DISPLAY RACKS, LABEL DISPLAY STRIPS, FRONT RISER STRIPS, ADJUSTABLE BACK PLATES, BACK REST, PUSHER LOCK AND RELEASE MECHANISMS, GRAVITY FEED STRIPS, FRONT STOPS, RAILS; PRODUCT INFORMATION EQUIPMENT AS A COMPONENT OF SHELVING, NAMELY, LABEL DISPLAY STRIPS; REPLACEMENT PARTS AND FITTINGS FOR ALL THE AFORESAID GOODS, NAMELY, SHELF DIVIDERS, DISPLAY RACKS, LABEL DISPLAY STRIPS, FRONT RISER STRIPS, ADJUSTABLE BACK PLATES, BACK REST, PUSHER LOCK AND RELEASE MECHANISMS, GRAVITY FEED STRIPS, FRONT STOPS, RAILS (U.S. CLS. 2, 13, 22, 25, 32 AND 50).

FIRST USE 9-12-2000; IN COMMERCE 8-0-2003.

2,900,256. MUSICHALL WORLDWIDE LIMITED, HAMILTON HM CX, BERMUDA. SN 76-400,931. PUB. 3-16-2004, FILED 4-29-2002.

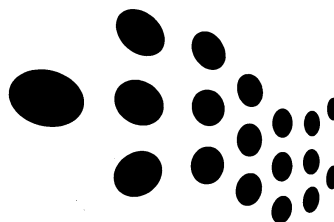

#### CLASS 9—ELECTRICAL AND SCIENTIFIC APPARATUS

FOR COMPUTER SOFTWARE USED TO CREATE, COMPOSE, COLLABORATE, RECORD, MIX, MANIPULATE AND EDIT SOUND AND MUSIC SAMPLES, AND PLAY BACK THE NEW MUSICAL AUDIO FILES; COMPUTER SOFTWARE FOR USE IN TRANSMITTING AND RECEIVING MUSICAL AUDIO FILES IN MULTIPLE SOUND FILE FORMATS ATTACHED TO ELECTRONIC AND WIRELESS INTERACTIVE APPLICATIONS; VIDEO GAME PLAYER MACHINES FOR USE WITH TELEVISIONS AND COMPUTERS; VIDEO GAME SOFTWARE; DOWNLOADABLE MUSICAL SOUND RECORDINGS DELIVERED VIA INTERACTIVE AND WIRELESS MEDIA, COMPUTER NETWORKS, CABLE, AND SATELLITE (U.S. CLS. 21, 23, 26, 36 AND 38).

FIRST USE 1-15-2002; IN COMMERCE 1-15-2002.

**CLASS 35—ADVERTISING AND BUSINESS**

FOR ONLINE RETAIL STORE SERVICES FEATURING MUSIC AND SOUND SAMPLES WHICH THE USER CAN USE TO RECORD, CREATE, COMPOSE, MIX, MANIPULATE AND EDIT SOUND ELEMENTS; PROMOTING THE GOODS AND SERVICES OF OTHERS IN VARIOUS INDUSTRIES BY AFFILIATING THEIR GOODS AND SERVICES TO INTERACTIVE MUSIC CREATION; PROMOTING THE SALE OF GOODS AND SERVICES OF OTHERS IN VARIOUS INDUSTRIES THROUGH THE DISTRIBUTION OF PRINTED, ELECTRONIC, DIGITAL AND AUDIO PROMOTIONAL MATERIALS; DEVELOPING PROMOTIONAL CAMPAIGNS FOR BUSINESSES (U.S. CLS. 100, 101 AND 102).

FIRST USE 7-6-2004; IN COMMERCE 7-6-2004.

**CLASS 38—COMMUNICATION**

FOR TRANSMISSION OF MUSIC, VOICE AND AUDIO VIA INTERACTIVE AND WIRELESS MEDIA; STREAMING OF AUDIO MATERIAL, NAMELY, PRERECORDED MUSIC ON THE INTERNET; PROVIDING ONLINE ELECTRONIC BULLETIN BOARDS FOR TRANSMISSION OF MESSAGES AMONG COMPUTER USERS CONCERNING MUSIC AND MUSIC CREATION; PROVIDING MULTIPLE-USER ACCESS TO A GLOBAL COMPUTER INFORMATION NETWORK; PROVIDING ONLINE FACILITIES, MAINLY PROVIDING ONLINE CHAT ROOMS FOR TRANSMISSION OF MESSAGES AND FOR REAL-TIME INTERACTION WITH OTHER COMPUTER USERS CONCERNING MUSIC AND MUSIC CREATION; ELECTRONIC MAIL SERVICES FEATURING MUSICAL ELECTRONIC MAIL; ELECTRONIC AND DIGITAL TRANSMISSION OF VOICE, DATA, IMAGES, SIGNALS AND MESSAGES (U.S. CLS. 100, 101 AND 104).

FIRST USE 1-15-2002; IN COMMERCE 1-15-2002.

**CLASS 41—EDUCATION AND ENTERTAINMENT**

FOR CREATION, COMPOSITION, AND COLLABORATION OF MUSIC FOR OTHERS; AUDIO RECORDING AND PRODUCTION; PROVIDING AN ONLINE COMPUTER DATABASE IN THE FIELD OF MUSIC AND MUSIC CREATION; ENTERTAINMENT SERVICES, NAMELY PROVIDING A WEB SITE FEATURING MUSICAL PERFORMANCES, MUSICAL VIDEOS; ENTERTAINMENT IN THE NATURE OF PRERECORDED MUSIC DELIVERED VIA INTERACTIVE AND WIRELESS MEDIA, COMPUTER NETWORKS, CABLE, AND SATELLITE; CREATION, COMPOSITION AND COLLABORATION OF MUSIC AND AUDIO FOR OTHERS; PROVIDING A WEB SITE FEATURING MUSICAL PERFORMANCES, MUSICAL VIDEOS, AND OTHER MULTIMEDIA MATERIALS; PROVIDING ONLINE FACILITIES, NAMELY, PROVIDING A WEBSITE FOR THE CREATION OF MUSIC (U.S. CLS. 100, 101 AND 107).

FIRST USE 2-24-2004; IN COMMERCE 2-24-2004.

2,900,258. SINCLAIR OIL COPORATION, SALT LAKE CITY, UT. SN 76-401,385. PUB. 2-18-2003, FILED 4-29-2002.

**SUN VALLEY****CLASS 6—METAL GOODS**

FOR GOODS MADE OF METAL, NAMELY, FIGURINES OF COMMON METAL, JEWELRY BOXES OF METAL, METAL BELLS, METAL CHARMS FOR IDENTIFYING DRINKS, METAL DECORATIVE BOXES, BASKETS OF COMMON METAL, METAL HOLIDAY ORNAMENTS - NOT TREE ORNAMENTS, METAL IDENTIFICATION BRACELETS OF NON-PRECIOUS METAL, METAL KEY CHAINS, METAL KEY FOBS, METAL KEY RINGS, STATUES AND STATUETTES OF NON-PRECIOUS METAL, NON-LUMINOUS AND NON-MECHANICAL METAL SIGNS (U.S. CLS. 2, 12, 13, 14, 23, 25 AND 50).

FIRST USE 0-0-1975; IN COMMERCE 0-0-1975.

**CLASS 8—HAND TOOLS**

FOR POCKET KNIVES AND SPOONS (U.S. CLS. 23, 28 AND 44).

FIRST USE 0-0-1985; IN COMMERCE 0-0-1985.

**CLASS 34—SMOKERS' ARTICLES**

FOR MATCHES (U.S. CLS. 2, 8, 9 AND 17).

FIRST USE 0-0-1956; IN COMMERCE 0-0-1956.

2,900,260. UNIVERSITY OF RICHMOND, UNIVERSITY OF RICHMOND, VA. SN 76-402,522. PUB. 4-22-2003, FILED 4-26-2002.

**CLASS 25—CLOTHING**

FOR SHIRTS, SOCKS, HATS, ALL SOLD OR DISTRIBUTED IN CONNECTION WITH A UNIVERSITY AND NOT IN CONNECTION WITH SKIING (U.S. CLS. 22 AND 39).

FIRST USE 9-1-2002; IN COMMERCE 9-1-2002.

**CLASS 41—EDUCATION AND ENTERTAINMENT**

FOR ENTERTAINMENT SERVICES, NAMELY CONDUCTING UNIVERSITY LEVEL ATHLETIC EVENTS, BUT NOT INCLUDING ICE HOCKEY (U.S. CLS. 100, 101 AND 107).

FIRST USE 9-1-2002; IN COMMERCE 9-1-2002.

2,900,265. REAL LIVING, INC., COLUMBUS, OH. SN 76-406,233. PUB. 12-23-2003, FILED 5-9-2002.

**REAL LIVING TITLE AGENCY**

NO CLAIM IS MADE TO THE EXCLUSIVE RIGHT TO USE "TITLE AGENCY", APART FROM THE MARK AS SHOWN.

**CLASS 36—INSURANCE AND FINANCIAL**

FOR INSURANCE AGENCIES IN THE FIELD OF REAL ESTATE TITLE INSURANCE (U.S. CLS. 100, 101 AND 102).

FIRST USE 9-12-2002; IN COMMERCE 9-12-2002.

**CLASS 42—SCIENTIFIC, COMPUTER AND LEGAL SERVICES**

FOR TITLE SEARCHING (U.S. CLS. 100 AND 101).

FIRST USE 9-12-2002; IN COMMERCE 9-12-2002.

2,900,270. VICI, LLC, ST. LOUIS, MO. SN 76-411,915. PUB. 4-15-2003, FILED 5-24-2002.



THE ENGLISH TRANSLATION OF "VICI" IS "I CONQUERED".

#### CLASS 18—LEATHER GOODS

FOR SPORTS DUFFEL BAGS (U.S. CLS. 1, 2, 3, 22 AND 41).

FIRST USE 6-7-2004; IN COMMERCE 6-7-2004.

#### CLASS 25—CLOTHING

FOR CLOTHING FOR MEN, WOMEN AND CHILDREN, NAMELY, SHORTS, PANTS, TEE-SHIRTS, SHIRTS, SWEATSHIRTS, SWEATPANTS, JACKETS, COATS, HATS, BANDANAS, SOCKS, CAPS, AND SHOES (U.S. CLS. 22 AND 39).

FIRST USE 6-7-2004; IN COMMERCE 6-7-2004.

#### CLASS 35—ADVERTISING AND BUSINESS

FOR PROVIDING ONLINE BUSINESS INFORMATION FOR USE BY BUSINESS MANAGERS AND THEIR EMPLOYEES TO HELP THEM DEFINE THEIR ROLES AND TO HELP THEM MAXIMIZE PRODUCTIVITY BY FOCUSING ON EMPLOYEE-SPECIFIC NEEDS AND GOALS; CONDUCTING BUSINESS RESEARCH AND SURVEYS; BUSINESS MANAGEMENT CONSULTATION (U.S. CLS. 100, 101 AND 102).

FIRST USE 0-0-2002; IN COMMERCE 0-0-2002.

#### CLASS 42—SCIENTIFIC, COMPUTER AND LEGAL SERVICES

FOR PROVIDING TEMPORARY USE OF ONLINE NON-DOWNLOADABLE SOFTWARE FOR USE IN RECORDING EMPLOYEES ANSWERS TO SURVEYS REGARDING EMPLOYEES' EXPECTATIONS ABOUT JOB/ COMPANY CHARACTERISTICS; PROVIDING TEMPORARY USE OF ONLINE NON-DOWNLOADABLE SOFTWARE FOR USE IN CREATING A SCORECARD WHICH ILLUSTRATES EMPLOYEES' VIEWS ABOUT WHERE THEY WORK (U.S. CLS. 100 AND 101).

FIRST USE 0-0-2002; IN COMMERCE 0-0-2002.

2,900,291. UNLEASH INC., SUMMIT, NJ. SN 76-431,417. PUB. 1-27-2004, FILED 7-16-2002.

2,900,274. NAME RITE, L.L.C., TEMECULA, CA. SN 76-416,638. PUB. 1-28-2003, FILED 5-31-2002.

### SPECIAL SENTIMENT

#### CLASS 16—PAPER GOODS AND PRINTED MATTER

FOR PHOTO ALBUMS (U.S. CLS. 2, 5, 22, 23, 29, 37, 38 AND 50).

FIRST USE 9-0-2002; IN COMMERCE 9-0-2002.

#### CLASS 20—FURNITURE AND ARTICLES NOT OTHERWISE CLASSIFIED

FOR PICTURE FRAMES (U.S. CLS. 2, 13, 22, 25, 32 AND 50).

FIRST USE 9-0-2002; IN COMMERCE 9-0-2002.



NO CLAIM IS MADE TO THE EXCLUSIVE RIGHT TO USE "INC.", APART FROM THE MARK AS SHOWN.

#### CLASS 35—ADVERTISING AND BUSINESS

FOR PROVIDING ONLINE BUSINESS INFORMATION FOR USE BY BUSINESS MANAGERS AND THEIR EMPLOYEES TO HELP THEM DEFINE THEIR ROLES AND TO HELP THEM MAXIMIZE PRODUCTIVITY BY FOCUSING ON EMPLOYEE-SPECIFIC NEEDS AND GOALS; CONDUCTING BUSINESS RESEARCH AND SURVEYS; BUSINESS MANAGEMENT CONSULTATION (U.S. CLS. 100, 101 AND 102).

FIRST USE 0-0-2002; IN COMMERCE 0-0-2002.

#### CLASS 42—SCIENTIFIC, COMPUTER AND LEGAL SERVICES

FOR PROVIDING TEMPORARY USE OF ONLINE NON-DOWNLOADABLE SOFTWARE FOR USE IN RECORDING EMPLOYEES ANSWERS TO SURVEYS REGARDING EMPLOYEES' EXPECTATIONS ABOUT JOB/ COMPANY CHARACTERISTICS; PROVIDING TEMPORARY USE OF ONLINE NON-DOWNLOADABLE SOFTWARE FOR USE IN CREATING A SCORECARD WHICH ILLUSTRATES EMPLOYEES' VIEWS ABOUT WHERE THEY WORK (U.S. CLS. 100 AND 101).

FIRST USE 0-0-2002; IN COMMERCE 0-0-2002.

2,900,290. UNLEASH INC., SUMMIT, NJ. SN 76-430,339. PUB. 1-27-2004, FILED 7-12-2002.

### UNLEASH INC.

NO CLAIM IS MADE TO THE EXCLUSIVE RIGHT TO USE "INC.", APART FROM THE MARK AS SHOWN.

2,900,292. GENOMATICA, INC., SAN DIEGO, CA. SN 76-431,435. PUB. 1-28-2003, FILED 7-17-2002.



#### **CLASS 9—ELECTRICAL AND SCIENTIFIC APPARATUS**

FOR COMPUTER MODELING SOFTWARE PROGRAMS FOR BIOLOGICAL SYSTEMS, SPECIFICALLY INTEGRATED COMPUTER SOFTWARE MODELS THAT SIMULATE THE FUNCTION, BEHAVIOR AND REGULATION OF COMPONENTS, SUCH AS GENES, PROTEINS AND METABOLITES, IN LIVING CELLS AND ORGANISMS UNDER VARYING CONDITIONS (U.S. CLS. 21, 23, 26, 36 AND 38).

FIRST USE 10-21-2003; IN COMMERCE 10-21-2003.

#### **CLASS 42—SCIENTIFIC, COMPUTER AND LEGAL SERVICES**

FOR COMPUTER MODELING SERVICES FOR BIOLOGICAL SYSTEMS, SPECIFICALLY DEVELOPING AND MAINTAINING INTEGRATED COMPUTER MODELS THAT SIMULATE THE FUNCTION, BEHAVIOR AND REGULATION OF COMPONENTS, SUCH AS GENES, PROTEINS AND METABOLITES, IN LIVING CELLS AND ORGANISMS UNDER VARYING CONDITIONS (U.S. CLS. 100 AND 101).

FIRST USE 8-24-2002; IN COMMERCE 8-24-2002.

2,900,301. UCI UNITED CONSULTANTS INTERNATIONAL S.A., LUXEMBOURG, GR. D., LUXEMBOURG. SN 76-438,706. PUB. 5-6-2003, FILED 8-8-2002.

### **UCI UNITED CONSULTANTS INTERNATIONAL**

NO CLAIM IS MADE TO THE EXCLUSIVE RIGHT TO USE "CONSULTANTS INTERNATIONAL", APART FROM THE MARK AS SHOWN.

#### **CLASS 35—ADVERTISING AND BUSINESS**

FOR BUSINESS MANAGEMENT AND CONSULTATION; MANAGEMENT ASSISTANCE (U.S. CLS. 100, 101 AND 102).

FIRST USE 7-1-2001; IN COMMERCE 6-24-2004.

#### **CLASS 36—INSURANCE AND FINANCIAL**

FOR INSURANCE ADMINISTRATION; FINANCING SERVICES; FINANCIAL PORTFOLIO MANAGEMENT; REAL ESTATE MANAGEMENT; AND FINANCIAL MANAGEMENT (U.S. CLS. 100, 101 AND 102).

FIRST USE 7-1-2001; IN COMMERCE 6-24-2004.

2,900,311. BUSH, E.B. HUTT, JR., BEVERLY HILLS, CA. SN 76-445,672. PUB. 4-22-2003, FILED 8-30-2002.

### **RIGHT BETWEEN THE EYES**

#### **CLASS 9—ELECTRICAL AND SCIENTIFIC APPARATUS**

FOR PRE-RECORDED VIDEO CASSETTES AND AUDIO CASSETTES FEATURING INFORMATION IN THE AREAS OF BUSINESS, FINANCE, SELF-IMPROVEMENT AND PERSONAL LEADERSHIP AND DEVELOPMENT (U.S. CLS. 21, 23, 26, 36 AND 38).

FIRST USE 7-13-2004; IN COMMERCE 7-13-2004.

#### **CLASS 35—ADVERTISING AND BUSINESS**

FOR CONSULTING SERVICES, IN THE FIELD OF BUSINESS; BUSINESS CONSULTING SERVICES IN THE FIELD OF LEADERSHIP DEVELOPMENT (U.S. CLS. 100, 101 AND 102).

FIRST USE 7-13-2004; IN COMMERCE 7-13-2004.

#### **CLASS 41—EDUCATION AND ENTERTAINMENT**

FOR EDUCATIONAL SERVICES, NAMELY, CONDUCTING SEMINARS, CLASSES AND WORKSHOPS IN THE FIELDS OF BUSINESS, FINANCE, SELF-IMPROVEMENT AND PERSONAL AND LEADERSHIP DEVELOPMENT (U.S. CLS. 100, 101 AND 107).

FIRST USE 11-12-2003; IN COMMERCE 11-12-2003.

2,900,328. YJ (USA) CORP., PORTLAND, OR. SN 76-449,850. PUB. 4-1-2003, FILED 9-16-2002.

### **BAZOONGI**

#### **CLASS 20—FURNITURE AND ARTICLES NOT OTHERWISE CLASSIFIED**

FOR CHILDREN'S SLEEPING BAGS (U.S. CLS. 2, 13, 22, 25, 32 AND 50).

FIRST USE 5-27-2003; IN COMMERCE 5-27-2003.

#### **CLASS 28—TOYS AND SPORTING GOODS**

FOR CHILDREN'S PLAY STRUCTURES; NAMELY, PLAYHOUSES, TUNNELS, AND PLAY TENTS (U.S. CLS. 22, 23, 38 AND 50).

FIRST USE 6-23-2004; IN COMMERCE 6-23-2004.

2,900,331. CRAY, SUE TURNER, LOS ANGELES, CA. SN 76-452,108. PUB. 10-21-2003, FILED 9-24-2002.

### **MANCHESTER GIRL**

#### **CLASS 16—PAPER GOODS AND PRINTED MATTER**

FOR POSTERS AND POSTCARDS (U.S. CLS. 2, 5, 22, 23, 29, 37, 38 AND 50).

FIRST USE 6-1-2003; IN COMMERCE 6-1-2003.

#### **CLASS 25—CLOTHING**

FOR T-SHIRTS (U.S. CLS. 22 AND 39).

FIRST USE 6-1-2003; IN COMMERCE 6-1-2003.

2,900,336. AXIS HEALTHCARE COMMUNICATIONS LLC, YARDLEY, PA. SN 76-454,704. PUB. 11-25-2003, FILED 10-2-2002.

## AXIS HEALTHCARE COMMUNICATIONS

NO CLAIM IS MADE TO THE EXCLUSIVE RIGHT TO USE "HEALTHCARE COMMUNICATIONS", APART FROM THE MARK AS SHOWN.

### CLASS 35—ADVERTISING AND BUSINESS

FOR ADVERTISING AGENCY SERVICES IN THE FIELD OF HEALTHCARE; DIRECT MARKETING ADVERTISING SERVICES IN THE FIELD OF HEALTHCARE; AND MARKET RESEARCH SERVICES IN THE FIELD OF HEALTHCARE (U.S. CLS. 100, 101 AND 102). FIRST USE 12-0-2002; IN COMMERCE 12-0-2002.

### CLASS 41—EDUCATION AND ENTERTAINMENT

FOR ORGANIZING AND CONDUCTING EDUCATIONAL CONFERENCES, SYMPOSIA, SEMINARS, SCIENTIFIC PRESENTATIONS, SALES TRAINING PROGRAMS AND PRESENTATIONS, AND SPEAKER TRAINING MEETINGS, ALL IN THE FIELD OF HEALTHCARE (U.S. CLS. 100, 101 AND 107). FIRST USE 12-0-2002; IN COMMERCE 12-0-2002.

2,900,374. BRIDOR INC., BOUCHERVILLE, QUEBEC, CANADA. SN 76-472,134. PUB. 6-17-2003, FILED 12-4-2002.

## LA BRIOCHE DORÉE

NO CLAIM IS MADE TO THE EXCLUSIVE RIGHT TO USE "BRIOCHE", APART FROM THE MARK AS SHOWN. THE ENGLISH TRANSLATION OF THE MARK IS "THE GOLDEN BRIOCHE".

### CLASS 30—STAPLE FOODS

FOR BAKERY GOODS, QUICHES AND FROZEN PIZZA (U.S. CL. 46). FIRST USE 9-19-1976; IN COMMERCE 9-1-2003.

### CLASS 35—ADVERTISING AND BUSINESS

FOR RETAIL BAKERY SHOPS (U.S. CLS. 100, 101 AND 102). FIRST USE 9-19-1976; IN COMMERCE 9-1-2003.

### CLASS 43—HOTEL AND RESTAURANT SERVICES

FOR RESTAURANT SERVICES (U.S. CLS. 100 AND 101). FIRST USE 9-19-1976; IN COMMERCE 9-1-2003.

2,900,393. BRUTOCO, RINALDO S., OJAI, CA. SN 76-482,727. PUB. 11-4-2003, FILED 1-15-2003.

2,900,361. GOLD MEDAL KARATE, INC., PHILADELPHIA, PA. SN 76-469,354. PUB. 2-10-2004, FILED 11-22-2002.

## ZHANG-SAH

THE TRANSLATION OF THE MARK IS "BRAVE SCHOLAR".

### CLASS 41—EDUCATION AND ENTERTAINMENT

FOR EDUCATIONAL SERVICES, NAMELY, PROVIDING COURSES OF INSTRUCTION AT THE PRE-KINDERGARTEN THROUGH GRADE 12 LEVEL, AFTER SCHOOL PROGRAMS AND PLAY GROUPS, TUTORING, ON AND OFF-SITE LEARNING PROGRAMS, ON AND OFF-SITE COMMUNITY SERVICE PROGRAMS, AND SUMMER CAMP SERVICES AND PROGRAMS; AND INSTRUCTIONAL SERVICES IN THE FIELDS OF ATHLETICS, MARTIAL ARTS, PHYSICAL FITNESS, AND CULTURAL AWARENESS (U.S. CLS. 100, 101 AND 107).

FIRST USE 10-4-1998; IN COMMERCE 10-4-1998.

### CLASS 43—HOTEL AND RESTAURANT SERVICES

FOR CHILD CARE SERVICES (U.S. CLS. 100 AND 101). FIRST USE 10-4-1998; IN COMMERCE 10-4-1998.



NO CLAIM IS MADE TO THE EXCLUSIVE RIGHT TO USE "RANCH", APART FROM THE MARK AS SHOWN.

### CLASS 29—MEATS AND PROCESSED FOODS

FOR ORGANIC AND NON-ORGANIC PROCESSED FOODS, NAMELY, GARLIC, ALOE VERA, AVOCADO, LAVENDER AND PROCESSED FRUITS AND VEGETABLES (U.S. CL. 46).

FIRST USE 2-1-2000; IN COMMERCE 2-1-2000.

### CLASS 31—NATURAL AGRICULTURAL PRODUCTS

FOR ORGANIC, FRESH, FARM PRODUCE, NAMELY, GARLIC, ALOE VERA, AVOCADO, LEMONS, BANANAS, MÊLONS, LAVENDER AND FRESH FRUITS AND VEGETABLES (U.S. CLS. 1 AND 46).

FIRST USE 2-1-2000; IN COMMERCE 2-1-2000.

2,900,406. YJ(USA) CORP., PORTLAND, OR. SN 76-489,182.  
PUB. 9-23-2003, FILED 2-10-2003.

The logo for 'Bazoongi Kids' features the word 'Bazoongi' in a large, stylized, black font with a star above the 'i'. To the right, the word 'Kids' is written in a smaller, cursive font. The entire logo is set against a white background.

**CLASS 20—FURNITURE AND ARTICLES NOT OTHERWISE CLASSIFIED**

FOR CHILDREN'S SLEEPING BAGS (U.S. CLS. 2, 13, 22, 25, 32 AND 50).  
FIRST USE 3-27-2003; IN COMMERCE 3-27-2003.

**CLASS 28—TOYS AND SPORTING GOODS**

FOR CHILDREN'S PLAY STRUCTURES; NAMELY, PLAYHOUSES, TUNNELS, AND PLAY TENTS (U.S. CLS. 22, 23, 38 AND 50).  
FIRST USE 6-23-2004; IN COMMERCE 6-23-2004.

2,900,417. KASH N' GOLD, LTD., RONKONKOMA, NY. SN 76-493,126. PUB. 1-6-2004, FILED 2-20-2003.

**KNG**

**CLASS 9—ELECTRICAL AND SCIENTIFIC APPARATUS**

FOR CONSUMER ELECTRONICS, NAMELY TELEPHONES; RADIOS; COMPACT DISC PLAYERS; TELEVISION AND ELECTRONIC REMOTE CONTROLS; COMBINATION CLOCK/RADIOS; CLOCKS; BOOM BOXES; COMBINATION TELEVISION/RADIO/COMPACT DISC PLAYERS WITH BUILT IN FLASHLIGHT; COMBINATION RADIO WITH BUILT IN FLASHLIGHT (U.S. CLS. 21, 23, 26, 36 AND 38).  
FIRST USE 1-23-2003; IN COMMERCE 1-23-2003.

**CLASS 11—ENVIRONMENTAL CONTROL APPARATUS**

FOR ELECTRIC NIGHT LIGHTS; LAMPS FEATURING ELECTRO-MECHANICAL MOVING CHARACTERS WHICH ROTATE AROUND THE BASE OF THE LAMP (U.S. CLS. 13, 21, 23, 31 AND 34).  
FIRST USE 1-23-2003; IN COMMERCE 1-23-2003.

**CLASS 20—FURNITURE AND ARTICLES NOT OTHERWISE CLASSIFIED**

FOR ANIMATED PICTURES FRAMES, NAMELY PICTURE FRAMES FEATURING ELECTRO-MECHANICAL CHARACTERS WHICH MOVE AROUND OR ABOUT THE FRAME (U.S. CLS. 2, 13, 22, 25, 32 AND 50).  
FIRST USE 1-23-2003; IN COMMERCE 1-23-2003.

2,900,418. KASH N' GOLD, LTD., RONKONKOMA, NY. SN 76-493,127. PUB. 1-6-2004, FILED 2-20-2003.

**KNG AMERICA**

NO CLAIM IS MADE TO THE EXCLUSIVE RIGHT TO USE "AMERICA", APART FROM THE MARK AS SHOWN.

**CLASS 9—ELECTRICAL AND SCIENTIFIC APPARATUS**

FOR CONSUMER ELECTRONICS, NAMELY TELEPHONES; RADIOS; COMPACT DISC PLAYERS; TELEVISION AND ELECTRONIC REMOTE CONTROLS; COMBINATION CLOCK/RADIOS; CLOCKS; BOOM BOXES; COMBINATION TELEVISION/RADIO/COMPACT DISC PLAYERS WITH BUILT IN FLASHLIGHT; COMBINATION RADIO WITH BUILT IN FLASHLIGHT (U.S. CLS. 21, 23, 26, 36 AND 38).  
FIRST USE 1-23-2003; IN COMMERCE 1-23-2003.

**CLASS 11—ENVIRONMENTAL CONTROL APPARATUS**

FOR ELECTRIC NIGHT LIGHTS; LAMPS FEATURING ELECTRO-MECHANICAL MOVING CHARACTERS WHICH ROTATE AROUND THE BASE OF THE LAMP (U.S. CLS. 13, 21, 23, 31 AND 34).  
FIRST USE 1-23-2003; IN COMMERCE 1-23-2003.

**CLASS 20—FURNITURE AND ARTICLES NOT OTHERWISE CLASSIFIED**

FOR ANIMATED PICTURES FRAMES, NAMELY PICTURE FRAMES FEATURING ELECTRO-MECHANICAL CHARACTERS WHICH MOVE AROUND OR ABOUT THE FRAME (U.S. CLS. 2, 13, 22, 25, 32 AND 50).  
FIRST USE 1-23-2003; IN COMMERCE 1-23-2003.

2,900,425. THE LITTLE PINK BOOK, INC., CHICAGO, IL. SN 76-495,303. PUB. 1-6-2004, FILED 3-6-2003.

**THE LITTLE PINK BOOK  
SHOPPING WITH A HEART**

NO CLAIM IS MADE TO THE EXCLUSIVE RIGHT TO USE "LITTLE PINK BOOK SHOPPING", APART FROM THE MARK AS SHOWN.

**CLASS 16—PAPER GOODS AND PRINTED MATTER**

FOR GUIDE AND COUPON BOOKS FOR UPSCALE SHOPPING (U.S. CLS. 2, 5, 22, 23, 29, 37, 38 AND 50).  
FIRST USE 3-6-2003; IN COMMERCE 3-6-2003.

**CLASS 35—ADVERTISING AND BUSINESS**

FOR PROMOTING THE GOODS AND SERVICES OF OTHERS THROUGH THE DISTRIBUTION OF GUIDE AND COUPON BOOKS (U.S. CLS. 100, 101 AND 102).  
FIRST USE 3-6-2003; IN COMMERCE 3-6-2003.

2,900,442. LAC COMMUNICATIONS, INC., CLOSTER, NJ. SN 76-501,687. PUB. 3-16-2004, FILED 3-24-2003.

## MAMA SAYS

### CLASS 9—ELECTRICAL AND SCIENTIFIC APPARATUS

FOR PRE-RECORDED AUDIO AND VIDEO TAPES FEATURING TOPICS AND STORIES OF INSPIRATION, SPIRITUALITY, PERSONAL DEVELOPMENT, SELF-ESTEEM AND SELF-FULFILLMENT, SELF-ANALYSIS, IDENTITY, HERITAGE, ETHNICITY, CULTURAL TRADITIONS AND CUSTOMS, AND MOTIVATION (U.S. CLS. 21, 23, 26, 36 AND 38).

FIRST USE 10-4-2002; IN COMMERCE 10-4-2002.

### CLASS 16—PAPER GOODS AND PRINTED MATTER

FOR SERIES OF PRINTED NON-FICTION BOOKS IN THE FIELD OF INSPIRATION, IDENTITY AND SELF-ESTEEM; PAPER GOODS AND PRINTED MATTER, NAMELY, BOOK MARKERS, CALENDARS, DATE BOOKS, GREETING CARDS, MOUNTED AND UNMOUNTED PHOTOGRAPHS, NEWSLETTERS IN THE FIELD OF INSPIRATION, IDENTITY AND SELF-ESTEEM, NOTE BOOKS AND NOTE PADS, PORTRAITS, POSTCARDS, POSTERS AND STATIONERY (U.S. CLS. 2, 5, 22, 23, 29, 37, 38 AND 50).

FIRST USE 10-4-2002; IN COMMERCE 10-4-2002.

2,900,466. METRA ELECTRONICS CORPORATION, HOLLY HILL, FL. SN 76-512,904. PUB. 11-25-2003, FILED 5-9-2003.

## THE INSTALL BAY

OWNER OF U.S. REG. NO. 1,583,473.

### CLASS 6—METAL GOODS

FOR FASTENERS FOR AUTOSOUND INSTALLATION, NAMELY, SCREWS, NUTS, BOLTS, AND RIVETS ALL MADE PRIMARILY OF METAL (U.S. CLS. 2, 12, 13, 14, 23, 25 AND 50).

FIRST USE 9-30-2003; IN COMMERCE 9-30-2003.

### CLASS 9—ELECTRICAL AND SCIENTIFIC APPARATUS

FOR AUTOMOTIVE INSTALLATION PARTS AND ACCESSORIES, NAMELY, ELECTRICAL CONNECTORS, TERMINALS TO INTERCONNECT ELECTRICAL WIRES, NYLON WIRE WRAP FOR ELECTRICAL WIRE, AND ELECTRICAL WIRE (U.S. CLS. 21, 23, 26, 36 AND 38).

FIRST USE 9-30-2003; IN COMMERCE 9-30-2003.

2,900,479. WALKER DIET INC., BOCA RATON, FL. SN 76-517,480. PUB. 3-23-2004, FILED 5-23-2003.

## WALKER DIET

NO CLAIM IS MADE TO THE EXCLUSIVE RIGHT TO USE "DIET", APART FROM THE MARK AS SHOWN.

### CLASS 5—PHARMACEUTICALS

FOR FOOD SUPPLEMENTS; VITAMINS; MINERAL SUPPLEMENTS; NUTRITIONAL SUPPLEMENTS; DIETARY SUPPLEMENTS; DIETARY DRINK MIX FOR USE AS A MEAL REPLACEMENT (U.S. CLS. 6, 18, 44, 46, 51 AND 52).

FIRST USE 1-16-2004; IN COMMERCE 1-16-2004.

### CLASS 29—MEATS AND PROCESSED FOODS

FOR LOW CARBOHYDRATE DAIRY BASED SHAKE MIX CONSISTING OF MILK PROTEIN CONCENTRATE, EGG WHITES AND PROTEIN; VEGETABLE BASED READY TO EAT FOOD BARS CONSISTING OF SOY, WHEY AND NATURAL PROTEINS (U.S. CL. 46).

FIRST USE 1-16-2004; IN COMMERCE 1-16-2004.

### CLASS 30—STAPLE FOODS

FOR CHOCOLATE BASED READY TO EAT FOOD BARS CONSISTING OF CHOCOLATE POWDERS, COCOA, CARAMEL, NUTS AND FLAVORINGS (U.S. CL. 46).

FIRST USE 1-16-2004; IN COMMERCE 1-16-2004.

2,900,490. NEXT HOLDINGS INC., NEW LONDON, MN. SN 76-520,528. PUB. 1-27-2004, FILED 5-30-2003.

## SNAPCASH

### CLASS 9—ELECTRICAL AND SCIENTIFIC APPARATUS

FOR MAGNETICALLY CODED DEBIT CARD (U.S. CLS. 21, 23, 26, 36 AND 38).

FIRST USE 9-6-2002; IN COMMERCE 2-1-2004.

### CLASS 36—INSURANCE AND FINANCIAL

FOR ELECTRONIC DEBIT TRANSACTIONS (U.S. CLS. 100, 101 AND 102).

FIRST USE 9-6-2002; IN COMMERCE 2-1-2004.

2,900,512. METRA ELECTRONICS CORPORATION, HOLLY HILL, FL. SN 76-535,385. PUB. 11-25-2003, FILED 7-28-2003.

**The Install Bay**  
Installation Hardware

OWNER OF U.S. REG. NO. 1,583,473.

NO CLAIM IS MADE TO THE EXCLUSIVE RIGHT TO USE "INSTALLATION HARDWARE", APART FROM THE MARK AS SHOWN.

### CLASS 6—METAL GOODS

FOR FASTENERS FOR AUTOSOUND INSTALLATION, NAMELY, SCREWS, NUTS, BOLTS, AND RIVETS ALL MADE PRIMARILY OF METAL (U.S. CLS. 2, 12, 13, 14, 23, 25 AND 50).

FIRST USE 9-30-2003; IN COMMERCE 9-30-2003.

**CLASS 9—ELECTRICAL AND SCIENTIFIC APPARATUS**

FOR AUTOMOTIVE INSTALLATION PARTS AND ACCESSORIES, NAMELY, ELECTRICAL CONNECTORS, TERMINALS TO INTERCONNECT ELECTRICAL WIRES, NYLON WIRE WRAP FOR ELECTRICAL WIRE, AND ELECTRICAL WIRE (U.S. CLS. 21, 23, 26, 36 AND 38).

FIRST USE 9-30-2003; IN COMMERCE 9-30-2003.

2,900,516. COOPERATIVE BEAUTY VENTURES, L.L.C., NEW YORK, NY. SN 76-976,386. PUB. 4-29-2003, FILED 3-21-2000.

**SUBSTANCE****CLASS 35—ADVERTISING AND BUSINESS**

FOR ONLINE RETAIL SERVICES FOR FRAGRANCES AND COSMETICS, NAMELY, HAIR, SKIN, LIP AND NAIL CARE PRODUCTS, DEODORANTS AND ANTI-PERSPIRANTS (U.S. CLS. 100, 101 AND 102).

FIRST USE 3-0-2000; IN COMMERCE 3-0-2000.

**CLASS 42—SCIENTIFIC, COMPUTER AND LEGAL SERVICES**

FOR COSMETIC AND COLOR ANALYSIS; CONSULTATION AND RESEARCH IN THE FIELD OF BEAUTY; PROVIDING INFORMATION IN THE FIELD OF COSMETICS, FRAGRANCES, PERSONAL CARE PRODUCTS AND LIFESTYLE BY MEANS OF A GLOBAL COMPUTER NETWORK; ZODIAC CONSULTATION AND ASTROLOGICAL FORECASTING (U.S. CLS. 100 AND 101).

FIRST USE 3-0-2000; IN COMMERCE 3-0-2000.

2,900,517. BAB SPORTS SA, SIERRE, SWITZERLAND. SN 76-976,574. PUB. 7-2-2002, FILED 3-6-2001.



PRIORITY CLAIMED UNDER SEC. 44(D) ON SWITZERLAND APPLICATION NO. 00624/2001, FILED 1-15-2001, REG. NO. 486920, DATED 7-15-2001, EXPIRES 1-15-2011.

THE MARK CONSISTS OF THE HEAD OF A BIRD IN A CIRCLE.

**CLASS 9—ELECTRICAL AND SCIENTIFIC APPARATUS**

FOR OPTICAL GOODS, NAMELY, EYEGLASSES, SPECTACLE FRAMES; SPECTACLES; SUNGLASSES; AVIATION GOGGLES; MOTORCYCLE GOGGLES; PROTECTIVE MASKS, NAMELY, MASKS TO PREVENT DUST AND PARTICLES FROM CONTACTING THE USER'S EYES (U.S. CLS. 21, 23, 26, 36 AND 38).

FIRST USE 4-18-2002; IN COMMERCE 4-18-2002.

**CLASS 25—CLOTHING**

FOR CLOTHING, NAMELY, SHIRTS AND HEAD WEAR (U.S. CLS. 22 AND 39).

FIRST USE 4-18-2002; IN COMMERCE 4-18-2002.

2,900,518. THOMAS, MARVIN W., SEATTLE, WA. SN 76-976,793. PUB. 8-20-2002, FILED 1-4-2002.

**PERSONAL VILLAGE****CLASS 41—EDUCATION AND ENTERTAINMENT**

FOR CONDUCTING WORKSHOPS, SEMINARS, AND LECTURES IN THE FIELD OF SELF-HELP (U.S. CLS. 100, 101 AND 107).

FIRST USE 10-25-2003; IN COMMERCE 10-25-2003.

**CLASS 44—MEDICAL, BEAUTY AND AGRICULTURAL SERVICES**

FOR PROVIDING SELF-HELP COUNSELING INFORMATION IN THE FIELD OF SOCIAL PSYCHOLOGY VIA THE INTERNET (U.S. CLS. 100 AND 101).

FIRST USE 6-1-2002; IN COMMERCE 6-1-2002.

2,900,519. TSA CORPORATE SERVICES, INC., ENGLEWOOD, CO. SN 76-976,854. PUB. 11-19-2002, FILED 9-27-2001.

**TOUR COLLECTION**

NO CLAIM IS MADE TO THE EXCLUSIVE RIGHT TO USE "COLLECTION", APART FROM THE MARK AS SHOWN.

**CLASS 25—CLOTHING**

FOR GOLF APPAREL, NAMELY, PANTS, SHORTS, JACKETS AND SHOES (U.S. CLS. 22 AND 39).

FIRST USE 7-0-2002; IN COMMERCE 7-0-2002.

**CLASS 28—TOYS AND SPORTING GOODS**

FOR GOLF EQUIPMENT, NAMELY, GOLF BALLS, GOLF CLUB COVERS, GOLF GLOVES, AND GOLF CLUB BAGS (U.S. CLS. 22, 23, 38 AND 50).

FIRST USE 7-0-2002; IN COMMERCE 7-0-2002.

2,900,520. SAUL ZAENTZ COMPANY, THE, DBA TOLKIEN ENTERPRISES, BERKELEY, CA. SN 76-976,902. PUB. 5-7-2002, FILED 9-28-2001.

**SAURON****CLASS 16—PAPER GOODS AND PRINTED MATTER**

FOR PRINTED MATTER NAMELY, POSTERS, ART PRINTS, BOOKMARKS, POSTCARDS (U.S. CLS. 2, 5, 22, 23, 29, 37, 38 AND 50).

FIRST USE 1-16-2003; IN COMMERCE 1-16-2003.

**CLASS 28—TOYS AND SPORTING GOODS**

FOR TOY ACTION FIGURES AND ACCESSORIES THEREFOR; TOY FIGURES, BOARD GAMES, COLLECTIBLE TOY FIGURES, ELECTRONIC ACTION TOYS, MECHANICAL ACTION TOYS, FANTASY CHARACTERS TOYS, POSITIONABLE TOY FIGURES, TALKING TOYS (U.S. CLS. 22, 23, 38 AND 50).

FIRST USE 4-21-2004; IN COMMERCE 4-21-2004.



2,900,521. SAUL ZAENTZ COMPANY, THE, DBA TOLKIEN ENTERPRISES, BERKELEY, CA. SN 76-976,903. PUB. 9-24-2002, FILED 9-28-2001.

## STRIDER

### CLASS 16—PAPER GOODS AND PRINTED MATTER

FOR PRINTED MATTER, NAMELY BOOKMARKS, POSTCARDS (U.S. CLS. 2, 5, 22, 23, 29, 37, 38 AND 50). FIRST USE 5-12-2004; IN COMMERCE 5-12-2004.

### CLASS 25—CLOTHING

FOR CLOTHING, NAMELY T-SHIRTS (U.S. CLS. 22 AND 39). FIRST USE 5-12-2004; IN COMMERCE 5-12-2004.

### CLASS 28—TOYS AND SPORTING GOODS

FOR TOY ACTION FIGURES AND ACCESSORIES THEREFOR, TOY FIGURES, COLLECTIBLE TOY FIGURES, TOY BOXES, FANTASY CHARACTER TOYS, POSITIONABLE TOY FIGURES, AND CHRISTMAS TREE ORNAMENTS (U.S. CLS. 22, 23, 38 AND 50). FIRST USE 5-12-2004; IN COMMERCE 5-12-2004.

2,900,523. WIBBLY WOBBLY WEIGH LIMITED, MANCHESTER, UNITED KINGDOM. SN 76-976,915. PUB. 2-4-2003, FILED 1-16-2002.

## TRAFFIC LIGHT DIET

PRIORITY CLAIMED UNDER SEC. 44(D) ON ERP N CMNTY TM OFC APPLICATION NO. 002316693, FILED 7-16-2001.

NO CLAIM IS MADE TO THE EXCLUSIVE RIGHT TO USE "DIET", APART FROM THE MARK AS SHOWN.

### CLASS 9—ELECTRICAL AND SCIENTIFIC APPARATUS

FOR FRIDGE MAGNETS (U.S. CLS. 21, 23, 26, 36 AND 38). FIRST USE 11-30-2001; IN COMMERCE 1-26-2004.

### CLASS 16—PAPER GOODS AND PRINTED MATTER

FOR PRINTED PUBLICATIONS, NAMELY, MAGAZINES AND BOOKS IN THE FIELD OF HEALTH, NUTRITION AND DIET; STATIONARY; STICKERS; INSTRUCTION MANUALS IN THE FIELD OF HEALTH, NUTRITION AND DIET; PAMPHLETS AND BROCHURES IN THE FIELD OF HEALTH, NUTRITION AND DIET; FACT SHEETS; AND POSTERS (U.S. CLS. 2, 5, 22, 23, 29, 37, 38 AND 50). FIRST USE 11-30-2001; IN COMMERCE 1-26-2004.

### CLASS 42—SCIENTIFIC, COMPUTER AND LEGAL SERVICES

FOR ADVISORY SERVICES RELATING TO DIET, HEALTH AND NUTRITION (U.S. CLS. 100 AND 101). FIRST USE 11-30-2001; IN COMMERCE 1-26-2004.

2,900,525. AMPCO II, LLC, RIVERHEAD, NY. SN 76-976,938. PUB. 9-24-2002, FILED 7-12-2001.



OWNER OF U.S. REG. NO. 2,239,740.

### CLASS 29—MEATS AND PROCESSED FOODS

FOR PROCESSED VEGETABLES; PRE-CUT VEGETABLE SALADS; PACKAGED MEALS CONSISTING PRIMARILY OF MEAT, FISH, POULTRY OR VEGETABLES (U.S. CL. 46).

FIRST USE 4-12-2002; IN COMMERCE 4-12-2002.

### CLASS 31—NATURAL AGRICULTURAL PRODUCTS

FOR FRESH FRUITS AND VEGETABLES (U.S. CLS. 1 AND 46).

FIRST USE 4-12-2002; IN COMMERCE 4-12-2002.

2,900,526. HIGH POINT MEDIA, LLC, GOLDEN, CO. SN 76-976,951. PUB. 11-4-2003, FILED 3-1-2002.

## HIGH POINT MEDIA

NO CLAIM IS MADE TO THE EXCLUSIVE RIGHT TO USE "MEDIA", APART FROM THE MARK AS SHOWN.

### CLASS 16—PAPER GOODS AND PRINTED MATTER

FOR NON-FICTION BOOKS IN THE FIELD OF NUTRITION, WELLNESS, EXERCISE, PERSONAL GROWTH AND HEALING; AND POSTERS (U.S. CLS. 2, 5, 22, 23, 29, 37, 38 AND 50). FIRST USE 3-11-2002; IN COMMERCE 3-11-2002.

### CLASS 41—EDUCATION AND ENTERTAINMENT

FOR PUBLICATION OF BOOKS IN THE FIELD OF NUTRITION, WELLNESS, EXERCISE, PERSONAL GROWTH AND HEALING (U.S. CLS. 100, 101 AND 107). FIRST USE 3-11-2002; IN COMMERCE 3-11-2002.

2,900,527. CREWS, CHRISTOPHER A., KINGSTON, NY. SN 76-976,960. PUB. 12-3-2002, FILED 9-19-2001.

## TREADHEAD

### CLASS 16—PAPER GOODS AND PRINTED MATTER

FOR DECALS AND AUTOMOBILE BUMPER STICKERS (U.S. CLS. 2, 5, 22, 23, 29, 37, 38 AND 50).  
FIRST USE 2-6-2003; IN COMMERCE 2-11-2003.

### CLASS 25—CLOTHING

FOR WEARING APPAREL, NAMELY, T-SHIRTS AND HATS (U.S. CLS. 22 AND 39).  
FIRST USE 2-6-2003; IN COMMERCE 2-11-2003.

2,900,531. UNITED STATES POSTAL SERVICE, WASHINGTON, DC. SN 76-976,981. PUB. 12-23-2003, FILED 3-18-2003.

## THE U.S. POSTAL SERVICE IS EVERYWHERE SO YOU CAN BE ANYWHERE

OWNER OF U.S. REG. NOS. 2,137,563, 2,485,456, AND OTHERS.

### CLASS 35—ADVERTISING AND BUSINESS

FOR SORTING, HANDLING, AND RECEIVING PACKAGES, ENVELOPES AND LETTERS (U.S. CLS. 100, 101 AND 102).  
FIRST USE 7-0-2004; IN COMMERCE 7-0-2004.

### CLASS 39—TRANSPORTATION AND STORAGE

FOR PICKUP, TRANSPORTATION, AND DELIVERY OF PACKAGES, ENVELOPES AND DOCUMENTS BY VARIOUS MODES OF TRANSPORTATION; ELECTRONIC STORAGE OF MESSAGES AND DATA (U.S. CLS. 100 AND 105).  
FIRST USE 7-0-2004; IN COMMERCE 7-0-2004.

2,900,535. BIRCHETT & ASSOCIATES, INC., MEMPHIS, TN. SN 78-005,103. PUB. 6-17-2003, FILED 4-21-2000.

## GRACE

OWNER OF U.S. REG. NO. 2,186,510.

### CLASS 16—PAPER GOODS AND PRINTED MATTER

FOR PRINTED PUBLICATIONS, NAMELY, MAGAZINE CONCERNING MATTERS OF INTEREST TO, AND PERTAINING TO THE LIFESTYLES OF, WOMEN OF COLOR (U.S. CLS. 2, 5, 22, 23, 29, 37, 38 AND 50).  
FIRST USE 3-1-1997; IN COMMERCE 3-1-1997.

### CLASS 42—SCIENTIFIC, COMPUTER AND LEGAL SERVICES

FOR COMPUTER SERVICES, NAMELY, PROVIDING ON-LINE MAGAZINE CONTENT CONCERNING MATTERS OF INTEREST TO, AND PERTAINING TO THE LIFESTYLES OF, WOMEN OF COLOR (U.S. CLS. 100 AND 101).

FIRST USE 3-1-1997; IN COMMERCE 3-1-1997.

2,900,536. ATTINGER, BILLY, J., SAN DIEGO, CA. AND Z STRATEGIES, INC., SAN DIEGO, CA. SN 78-008,270. PUB. 9-11-2001, FILED 5-15-2000.

## SENIOR MOMENTS

NO CLAIM IS MADE TO THE EXCLUSIVE RIGHT TO USE "SENIOR", APART FROM THE MARK AS SHOWN.

### CLASS 16—PAPER GOODS AND PRINTED MATTER

FOR PAPER AND PAPER ARTICLES, NAMELY, WRITING PAPER, WRAPPING PAPER, STATIONERY; GIFT WRAPPING PAPER; PAPER PARTY GOODS, NAMELY, PAPER PARTY BAGS, PAPER GIFT BAGS, PAPER PARTY DECORATIONS, PAPER PARTY HATS; PAPER CAKE DECORATIONS; POSTERS AND ART REPRODUCTIONS; ALBUMS FOR PHOTOGRAPHS AND SCRAPBOOKS; ADDRESS BOOKS; BOOKS, NAMELY, APPOINTMENT BOOKS, PICTURE BOOKS, PRAYER BOOKS, RECIPE BOOKS, ACTIVITY BOOKS, NAMELY BOOKS FEATURING WORD GAMES, PUZZLES AND COMICS NOTEBOOKS, DIARIES; PAPER BANNERS; CARTOONS, NAMELY, CARTOON PRINTS, NEWSPAPER CARTOONS; NEWSPAPER COMIC STRIPS; SERIES OF COMIC BOOKS; CALENDARS; PENS AND PENCILS; APPLIQUES IN THE FORM OF DECALS; GREETING AND BLANK CARDS; WRITING AND NOTE PAPER AND PADS; PAPER NAPKINS; PAPER PLACE MATS; PAPER BAGS; DECALS, STICKERS, BUMPER STICKERS (U.S. CLS. 2, 5, 22, 23, 29, 37, 38 AND 50).  
FIRST USE 8-1-2001; IN COMMERCE 8-1-2001.

### CLASS 21—HOUSEWARES AND GLASS

FOR PORCELAIN FIGURINES; PORCELAIN STATUETTES; VASES; MUGS INCLUDING GLASS MUGS, PORCELAIN MUGS; PLATES INCLUDING PAPER PLATES (U.S. CLS. 2, 13, 23, 29, 30, 33, 40 AND 50).  
FIRST USE 11-18-2003; IN COMMERCE 11-18-2003.

### CLASS 25—CLOTHING

FOR WEARING APPAREL NAMELY, SHIRTS, T-SHIRTS, SWEATSHIRTS, NIGHTSHIRTS, HATS, BASEBALL CAPS, BOXER SHORTS, ROBES, AND TIES (U.S. CLS. 22 AND 39).  
FIRST USE 11-18-2003; IN COMMERCE 11-18-2003.

2,900,540. PELLA CORPORATION, PELLA, IA. SN 78-042,162. PUB. 7-9-2002, FILED 1-8-2001.

## HASSLE-FREE

### CLASS 6—METAL GOODS

FOR METAL WINDOWS AND DOORS (U.S. CLS. 2, 12, 13, 14, 23, 25 AND 50).  
FIRST USE 2-28-2001; IN COMMERCE 2-28-2001.

**CLASS 19—NON-METALLIC BUILDING MATERIALS**

FOR NON-METAL WINDOWS AND DOORS (U.S. CLS. 1, 12, 33 AND 50).  
FIRST USE 2-28-2001; IN COMMERCE 2-28-2001.

2,900,553. CRYTEK STUDIOS GMBH & CO. KG, COBURG, FED REP GERMANY. SN 78-078,827. PUB. 4-16-2002, FILED 8-13-2001.

**CRYTEK**

2,900,545. ARTIFACT ENTERTAINMENT, INC., MESA, AZ. SN 78-053,919. PUB. 4-16-2002, FILED 3-19-2001.

**ARTIFACT ENTERTAINMENT**

NO CLAIM IS MADE TO THE EXCLUSIVE RIGHT TO USE "ENTERTAINMENT", APART FROM THE MARK AS SHOWN.

**CLASS 9—ELECTRICAL AND SCIENTIFIC APPARATUS**

FOR DOWNLOADABLE COMPUTER GAMES SOFTWARE FEATURING A MULTI-PLAYER, INTERACTIVE GAME PORTRAYING A VIRTUAL WORLD PLAYED VIA A GLOBAL COMPUTER NETWORK (U.S. CLS. 21, 23, 26, 36 AND 38).  
FIRST USE 12-0-2003; IN COMMERCE 6-0-2004.

**CLASS 42—SCIENTIFIC, COMPUTER AND LEGAL SERVICES**

FOR PROVIDING TEMPORARY USE OF ON-LINE NON-DOWNLOADABLE COMPUTER GAMES SOFTWARE FEATURING A MULTI-PLAYER, INTERACTIVE GAME PORTRAYING A VIRTUAL WORLD PLAYED VIA A GLOBAL COMPUTER NETWORK (U.S. CLS. 100 AND 101).  
FIRST USE 12-0-2003; IN COMMERCE 6-0-2004.

2,900,546. ARTIFACT ENTERTAINMENT, INC., MESA, AZ. SN 78-053,921. PUB. 4-16-2002, FILED 3-19-2001.

**ISTARIA****CLASS 9—ELECTRICAL AND SCIENTIFIC APPARATUS**

FOR DOWNLOADABLE COMPUTER GAMES SOFTWARE FEATURING A MULTI-PLAYER, INTERACTIVE GAME PORTRAYING A VIRTUAL WORLD PLAYED VIA A GLOBAL COMPUTER NETWORK (U.S. CLS. 21, 23, 26, 36 AND 38).  
FIRST USE 12-0-2003; IN COMMERCE 6-0-2004.

**CLASS 42—SCIENTIFIC, COMPUTER AND LEGAL SERVICES**

FOR PROVIDING TEMPORARY USE OF ON-LINE NON-DOWNLOADABLE COMPUTER GAMES SOFTWARE FEATURING A MULTI-PLAYER, INTERACTIVE GAME PORTRAYING A VIRTUAL WORLD PLAYED VIA A GLOBAL COMPUTER NETWORK (U.S. CLS. 100 AND 101).  
FIRST USE 12-0-2003; IN COMMERCE 6-0-2004.

**CLASS 9—ELECTRICAL AND SCIENTIFIC APPARATUS**

FOR SOFTWARE, NAMELY COMPUTER GAME SOFTWARE, VIDEO GAME SOFTWARE, GAME SOFTWARE FOR GAME OR VIDEO CONSOLES, SOFTWARE FOR DEVELOPING COMPUTER GAMES, VIDEO GAMES AND GAMES FOR GAME OR VIDEO CONSOLES, FOR PROVIDING COMPUTER GAMES, VIDEO GAMES AND GAMES FOR GAME OR VIDEO CONSOLES ONLINE OR BY MEANS OF A GLOBAL COMPUTER NETWORK, AND SOFTWARE TOOLS FOR IMAGE PROCESSING, FOR CONTROLLING OF AND INTERFACING WITH VIDEO CARDS AND FOR THE SIMULATION AND DISPLAYING OF PHYSICAL EFFECTS; COMPUTER GAME DISCS, TAPES AND CASSETTES; VIDEO GAME DISCS, ALSO AS AUXILIARY DEVICES FOR TV RECEIVERS; GAME DISCS, TAPES AND CASSETTES FOR GAME OR VIDEO CONSOLES; SOFTWARE FOR GAME OR VIDEO CONSOLES; COMPUTER GAMES SOFTWARE AND SOFTWARE FOR GAMES ON GAME OR VIDEO CONSOLES SUPPLIED ONLINE BY MEANS OF MULTIMEDIA ELECTRONIC BROADCAST OR ONLINE NETWORK TRANSMISSION; DOWNLOADABLE PUBLICATIONS IN THE NATURE OF BOOKS, MAGAZINES OR MANUALS IN ELECTRONIC FORM OR OTHER DATA PROVIDED BY MEANS OF MULTIMEDIA ELECTRONIC BROADCAST OR ONLINE NETWORK TRANSMISSION DEVOTED TO COMPUTER GAMES, VIDEO GAMES, GAMES FOR VIDEO OR GAME CONSOLES, ONLINE GAMING, IMAGE PROCESSING AND SOFTWARE TOOLS FOR IMAGE PROCESSING AND DESIGNING COMPUTER GAMES OR GAMES FOR VIDEO OR GAME CONSOLES; MAGNETIC OR OPTICAL DATA CARRIERS PRE-RECORDED WITH SOFTWARE FOR COMPUTER GAMES, SOFTWARE FOR GAME OR VIDEO CONSOLES, GAMES SOFTWARE, VIDEO GAMES SOFTWARE, SOFTWARE FOR ONLINE GAMING, SOFTWARE TOOLS FOR IMAGE PROCESSING AND FOR DESIGNING COMPUTER GAMES OR GAMES FOR VIDEO OR GAME CONSOLES; AND PRINTED MATTER IN THE NATURE OF BOOKS, BROCHURES, FLY SHEETS, LEAFLETS, INSTRUCTIONAL AND TEACHING MATERIAL, EXCEPT APPARATUS, ALL SOLD TOGETHER WITH THE AFORESAID GOODS (U.S. CLS. 21, 23, 26, 36 AND 38).  
FIRST USE 12-31-1999; IN COMMERCE 3-23-2004.

**CLASS 28—TOYS AND SPORTING GOODS**

FOR GAMES AND PLAYTHINGS, NAMELY ACTION GAMES, ACTION SKILL GAMES, STRATEGIC GAMES, SIMULATION GAMES, CARD GAMES AND TOY FIGURES (U.S. CLS. 22, 23, 38 AND 50).  
FIRST USE 12-31-1999; IN COMMERCE 3-23-2004.

**CLASS 41—EDUCATION AND ENTERTAINMENT**

FOR EDUCATIONAL SERVICES, NAMELY PROVIDING OF TRAINING IN THE FIELD OF VIDEO GAMES, GAMES FOR GAME OR VIDEO CONSOLES, SOFTWARE PROGRAMMING OF SUCH GAMES, SOFTWARE TOOLS FOR IMAGE PROCESSING; PUBLISHING OF COMPUTER GAME SOFTWARE AND VIDEO GAMES SOFTWARE; ELECTRONIC PUBLISHING SERVICES, NAMELY PUBLISHING OF TEXT AND GRAPHIC WORKS OF OTHERS ON CD-ROMS FEATURING INFORMATION CONCERNING COMPUTER GAMES, VIDEO GAMES, GAMES FOR VIDEO OR GAME CONSOLES, ONLINE GAMING, IMAGE PROCESSING

AND SOFTWARE TOOLS FOR IMAGE PROCESSING AND DESIGNING COMPUTER GAMES OR GAMES FOR VIDEO OR GAME CONSOLES; PROVIDING INFORMATION RELATING TO COMPUTER GAMES, VIDEO GAMES AND GAMES FOR GAME OR VIDEO CONSOLES, ALL BY MEANS OF MULTIMEDIA ELECTRONIC BROADCAST OR ONLINE NETWORK TRANSMISSION; ELECTRONIC GAME SERVICES, NAMELY PROVISION OF COMPUTER GAMES, VIDEO GAMES AND GAMES FOR GAME OR VIDEO CONSOLES ONLINE OR BY MEANS OF A GLOBAL COMPUTER NETWORK (U.S. CLS. 100, 101 AND 107).  
FIRST USE 12-31-1999; IN COMMERCE 3-23-2004.

2,900,559. SECET LLC, WILMINGTON, DE. SN 78-097,817.  
PUB. 12-30-2003, FILED 12-12-2001.

## INNOVATION TO COMMERCIALIZATION

2,900,555. ABBOTT LABORATORIES, ABBOTT PARK, IL.  
SN 78-080,391. PUB. 11-12-2002, FILED 8-21-2001.

### CI8200

#### CLASS 9—ELECTRICAL AND SCIENTIFIC APPARATUS

FOR DATA MANAGEMENT AND LABORATORY AUTOMATION SYSTEMS COMPRISED OF COMPUTER HARDWARE AND SOFTWARE FOR USE IN THE FIELD OF MEDICAL DIAGNOSTICS (U.S. CLS. 21, 23, 26, 36 AND 38).

FIRST USE 7-31-2001; IN COMMERCE 7-31-2001.

#### CLASS 10—MEDICAL APPARATUS

FOR DIAGNOSTIC APPARATUS FOR THE MEDICAL ANALYSIS OF BODILY FLUIDS AND TISSUE (U.S. CLS. 26, 39 AND 44).

FIRST USE 7-31-2001; IN COMMERCE 7-31-2001.

2,900,558. CONTINENTAL PET TECHNOLOGIES, INC.,  
TOLEDO, OH. SN 78-095,955. PUB. 2-4-2003, FILED 11-30-2001.

### SURSHOT

#### CLASS 40—MATERIAL TREATMENT

FOR MANUFACTURE TO THE ORDER AND/OR SPECIFICATION OF OTHERS OF PLASTIC BOTTLES USING INJECTION MOLDING TECHNOLOGY (U.S. CLS. 100, 103 AND 106).

FIRST USE 5-1-2002; IN COMMERCE 5-1-2002.

#### CLASS 42—SCIENTIFIC, COMPUTER AND LEGAL SERVICES

FOR DESIGN FOR OTHERS OF PLASTIC BOTTLES TO BE MADE USING INJECTION MOLDING TECHNOLOGY (U.S. CLS. 100 AND 101).

FIRST USE 5-1-2002; IN COMMERCE 5-1-2002.

#### CLASS 9—ELECTRICAL AND SCIENTIFIC APPARATUS

FOR COMPUTER SOFTWARE FOR COLLECTING AND MANAGING DATA, PERFORMING ANALYSES, CONDUCTING STUDIES, AND CREATING AND GENERATING REPORTS IN THE FIELDS OF INTELLECTUAL PROPERTY, FINANCE, INVESTMENT, HUMAN CAPITAL MANAGEMENT, MANAGEMENT, BUSINESS AND TECHNOLOGY; COMPUTER SOFTWARE FOR USE IN CREATING, PUBLISHING, UPDATING AND VERSIONING A COMPANY'S ELECTRONIC ASSETS; COMPUTER SOFTWARE FOR USE IN INTELLECTUAL ASSET MANAGEMENT, NAMELY SOFTWARE FOR SEARCHING, ORGANIZING, ANALYZING AND MANAGING INTELLECTUAL PROPERTY ASSETS; COMPUTER SOFTWARE THAT ENABLES USERS TO SEARCH, REVIEW, BUY, SELL, AND LICENSE PATENTS AND OTHER INTELLECTUAL PROPERTY, AND TO SOURCE DATA RELATED TO PATENTS AND OTHER INTELLECTUAL PROPERTY (U.S. CLS. 21, 23, 26, 36 AND 38).

FIRST USE 12-12-2001; IN COMMERCE 1-1-2004.

#### CLASS 35—ADVERTISING AND BUSINESS

FOR BUSINESS MANAGEMENT AND BUSINESS CONSULTING AND ADVISORY SERVICES; MARKET RESEARCH SERVICES; ACCOUNTING SERVICES; BUSINESS AUDITING SERVICES; TAX CONSULTING AND ADVISORY SERVICES; HUMAN RESOURCE CONSULTING, INTERIM MANAGEMENT AND RECRUITMENT SERVICES; ADVERTISING AND PROMOTIONAL SERVICES NAMELY CREATING CORPORATE AND BRAND IDENTIFY FOR OTHERS, PREPARING AUDIO-VISUAL PRESENTATIONS FOR USE IN ADVERTISING, ADVERTISING SLOGAN AND CARTOON CHARACTER LICENSING, THE RENTAL OF ADVERTISING SPACE, ELECTRONIC BILLBOARD ADVERTISING, DISSEMINATION OF ADVERTISING FOR OTHERS VIA THE INTERNET, PROVIDING TELEVISION ADVERTISING FOR OTHERS, AND THE ORGANIZING, ARRANGING, CONDUCTING AND PROMOTING TRADE SHOW EXHIBITIONS AND BUSINESS CONFERENCES IN THE FIELDS OF INNOVATION, INTELLECTUAL PROPERTY, FINANCE, INVESTMENT, HUMAN CAPITAL MANAGEMENT, BUSINESS, MANAGEMENT, SALES AND MARKETING; BUSINESS MANAGEMENT AND BUSINESS CONSULTING AND ADVISORY SERVICES IN THE FIELD OF INTELLECTUAL PROPERTY, CORPORATE DEVELOPMENT, FINANCING, ALLIANCES, JOINT VENTURES, MERGERS, ACQUISITIONS, TRADE SALES, INITIAL PUBLIC OFFERINGS, HUMAN CAPITAL MANAGEMENT, SALES MARKETING, PUBLIC RELATIONS, BUSINESS AND INFORMATION TECHNOLOGY; ORGANIZING BUSINESS EXHIBITIONS AND CONFERENCES IN THE FIELDS OF INNOVATION, INTELLECTUAL PROPERTY, FINANCE, INVESTMENT, HUMAN CAPITAL MANAGEMENT, BUSINESS MANAGEMENT, SALES AND MARKETING (U.S. CLS. 100, 101 AND 102).

FIRST USE 12-12-2001; IN COMMERCE 1-1-2004.

**CLASS 36—INSURANCE AND FINANCIAL**

FOR INVESTMENT ADVISORY SERVICES AND INVESTMENT MANAGEMENT SERVICES; FINANCIAL CONSULTING AND ADVISORY SERVICES, NAMELY, CORPORATE FINANCING SERVICES INCLUDING VENTURE CAPITAL FINANCING, MERGER AND ACQUISITION FINANCING AND ADVISORY SERVICES, ARRANGING LOANS FROM SEVERAL SOURCES FOR OTHERS, PRIVATE PLACEMENT SERVICES FOR DEBT AND EQUITY, AND INITIAL PUBLIC OFFERINGS; FINANCIAL VALUATION SERVICES IN THE AREAS OF BUSINESS ENTERPRISES, INTELLECTUAL PROPERTY, LICENSING, ASSETS, INVENTORIES, EQUIPMENT AND REAL ESTATE (U.S. CLS. 100, 101 AND 102).

FIRST USE 12-12-2001; IN COMMERCE 1-1-2004.

**CLASS 41—EDUCATION AND ENTERTAINMENT**

FOR CONSULTANCY SERVICES RELATING TO THE EDUCATION, TRAINING AND DEVELOPMENT OF PERSONNEL; ORGANIZING EDUCATIONAL EXHIBITIONS AND CONFERENCES IN THE FIELDS OF INNOVATION, INTELLECTUAL PROPERTY, FINANCE, INVESTMENT, HUMAN CAPITAL MANAGEMENT, BUSINESS MANAGEMENT, SALES AND MARKETING; PROVIDING EDUCATIONAL COURSES, LECTURES, WORKSHOPS AND SEMINARS, IN THE FIELDS OF INNOVATION, INTELLECTUAL PROPERTY, FINANCE, INVESTMENT, HUMAN CAPITAL MANAGEMENT, BUSINESS MANAGEMENT, SALES AND MARKETING; PUBLICATION OF BOOKS, MAGAZINES, NEWSLETTERS AND TEXT, RADIO AND AUDIO-VISUAL PROGRAM PRODUCTION SERVICES (U.S. CLS. 100, 101 AND 107).

FIRST USE 12-12-2001; IN COMMERCE 1-1-2004.

**CLASS 42—SCIENTIFIC, COMPUTER AND LEGAL SERVICES**

FOR LEGAL SERVICES; INFORMATION TECHNOLOGY MANAGEMENT, CONSULTING AND ADVISORY SERVICES; INTELLECTUAL PROPERTY MANAGEMENT AND CONSULTING SERVICES; TECHNOLOGY TRANSFER SERVICES, NAMELY, LICENSING AND TRANSFER OF INTELLECTUAL PROPERTY; REGISTRATION AND LICENSING OF PATENTS AND OTHER INTELLECTUAL PROPERTY; COMPUTER SERVICES, NAMELY, CONSULTING AND MAINTENANCE OF COMPUTER SOFTWARE FOR BUILDING, MANAGING AND MAINTAINING INTELLECTUAL PROPERTY DATABASES TO MAP AND DETERMINE VALUE, STRATEGIC AND TACTICAL ADVANTAGES FROM INTELLECTUAL PROPERTY ASSETS; COMPUTER SERVICES, NAMELY, PROVIDING SEARCH ENGINES FOR OBTAINING DATA RELATED TO PATENTS AND OTHER INTELLECTUAL PROPERTY; APPLICATION SERVICE PROVISION, NAMELY, HOSTING COMPUTER SOFTWARE APPLICATIONS FOR OTHERS; COMPUTER NETWORK AND INFORMATION SYSTEMS MANAGEMENT AND CONFIGURATION; PROVIDING ONLINE COMPUTER SERVICES, NAMELY, COMPUTER SOFTWARE CONFIGURATION, IMPLEMENTATION AND DESIGN FOR OTHERS; WEB DESIGN FOR OTHERS (U.S. CLS. 100 AND 101).

FIRST USE 12-12-2001; IN COMMERCE 1-1-2004.

2,900,564. BRIGHT PROSPECT SCHOLAR SUPPORT PROGRAM, POMONA, CA. SN 78-103,545. PUB. 9-23-2003, FILED 1-18-2002.



NO CLAIM IS MADE TO THE EXCLUSIVE RIGHT TO

USE "SCHOLAR SUPPORT PROGRAM" AS TO CLASSES 9, 16, 36 AND 41, APART FROM THE MARK AS SHOWN.

THE LINING IS A FEATURE OF THE MARK AND DOES NOT INDICATE COLOR.

**CLASS 9—ELECTRICAL AND SCIENTIFIC APPARATUS**

FOR EDUCATIONAL SOFTWARE FEATURING INSTRUCTION IN EDUCATIONAL TECHNIQUES, STUDY SKILLS, COLLEGE COUNSELING, SCHOLARSHIP GUIDANCE, COLLEGE ENTRANCE EXAMINATION PREPARATION, CAREER COUNSELING AND COLLEGE FINANCING; SOUVENIRS IN THE NATURE OF DECORATIVE REFRIGERATOR MAGNETS; MOUSE PADS; GRADUATED RULERS; CALCULATORS; CDS NAMELY, MULTIMEDIA SOFTWARE RECORDED ON CD-ROM FEATURING INSTRUCTION IN EDUCATIONAL TECHNIQUES, STUDY SKILLS, COLLEGE COUNSELING, SCHOLARSHIP GUIDANCE, COLLEGE ENTRANCE EXAMINATION PREPARATION, CAREER COUNSELING AND COLLEGE FINANCING (U.S. CLS. 21, 23, 26, 36 AND 38).

FIRST USE 6-14-2004; IN COMMERCE 6-14-2004.

**CLASS 16—PAPER GOODS AND PRINTED MATTER**

FOR PUBLICATIONS, NAMELY, MAGAZINES, NEWSLETTERS, BOOKS, PAMPHLETS, BROCHURES, CATALOGS, FLYERS AND LEAFLETS IN THE FIELD OF EDUCATION, STUDY SKILLS, COLLEGE COUNSELING, SCHOLARSHIP GUIDANCE, COLLEGE ENTRANCE EXAMINATION PREPARATION, CAREER COUNSELING AND COLLEGE FINANCING; NOTEBOOKS; CALENDARS; DATE BOOKS; PHOTO ALBUMS; PAPER WEIGHTS; DRAFTING, DRAWING AND UNGRADUATED RULERS; SOUVENIRS IN THE NATURE OF PAPER COASTERS, PAPER BANNERS, PAPER FLAGS POSTERS, PAPER PENNANTS, PENS AND PENCILS (U.S. CLS. 2, 5, 22, 23, 29, 37, 38 AND 50).

FIRST USE 6-11-2002; IN COMMERCE 6-11-2002.

**CLASS 25—CLOTHING**

FOR CLOTHING, NAMELY, T-SHIRTS, HATS, CAPS, SWEATSHIRTS, JACKETS, VESTS, HEADBANDS, WRISTBANDS, PANTS, SHORTS, SOCKS, UNDERWEAR, COATS, SCARVES, MITTENS, GLOVES (U.S. CLS. 22 AND 39).

FIRST USE 6-12-2004; IN COMMERCE 6-12-2004.

**CLASS 36—INSURANCE AND FINANCIAL**

FOR CHARITABLE FUND RAISING SERVICES; PROVIDING EDUCATIONAL SCHOLARSHIPS (U.S. CLS. 100, 101 AND 102).

FIRST USE 6-11-2002; IN COMMERCE 6-11-2002.

**CLASS 41—EDUCATION AND ENTERTAINMENT**

FOR EDUCATIONAL SERVICES, NAMELY, PROVIDING COURSES, WORKSHOPS, SEMINARS, DISTANCE LEARNING PROGRAMS IN THE FIELD OF EDUCATION, STUDY SKILLS, COLLEGE COUNSELING, SCHOLARSHIP GUIDANCE, COLLEGE ENTRANCE EXAMINATION PREPARATION, CAREER COUNSELING AND COLLEGE FINANCING (U.S. CLS. 100, 101 AND 107).

FIRST USE 6-11-2002; IN COMMERCE 6-11-2002.

2,900,573. CELERITY GROUP, INC., SANTA CLARA, CA. SN 78-113,613. PUB. 6-10-2003, FILED 3-8-2002.

## CELERITY

### CLASS 40—MATERIAL TREATMENT

FOR MANUFACTURE OF FLOW CONTROL SYSTEMS, GAS SYSTEMS, VALVE MANIFOLD BOXES, GAS ISOLATION BOXES, GAS STICKS, MASS FLOW CONTROLLERS, MODULAR GAS SYSTEMS, AND VAPOR DELIVERY SYSTEMS TO ORDER AND/OR SPECIFICATION OF OTHERS (U.S. CLS. 100, 103 AND 106).  
FIRST USE 5-1-2003; IN COMMERCE 5-1-2003.

### CLASS 42—SCIENTIFIC, COMPUTER AND LEGAL SERVICES

FOR ENGINEERING—DESIGN FOR OTHERS IN THE FIELD OF SEMICONDUCTOR, BIOTECHNOLOGY, AEROSPACE AND FUEL CELL INDUSTRIES NAMELY, DESIGN OF FLUID DELIVERY SYSTEMS (U.S. CLS. 100 AND 101).  
FIRST USE 5-1-2003; IN COMMERCE 5-1-2003.

2,900,579. PIZZA HUT, INC., DALLAS, TX. SN 78-116,900. PUB. 1-14-2003, FILED 3-22-2002.



OWNER OF U.S. REG. NOS. 729,847, 1,089,680, AND OTHERS.

NO CLAIM IS MADE TO THE EXCLUSIVE RIGHT TO USE "PIZZA" AND "EXPRESS", APART FROM THE MARK AS SHOWN.

### CLASS 29—MEATS AND PROCESSED FOODS

FOR MEAT, POULTRY, FRESHLY CUT VEGETABLES, AND CHEESES FOR TOPPINGS ON PIZZA PIES (U.S. CL. 46).  
FIRST USE 2-11-2003; IN COMMERCE 2-11-2003.

### CLASS 30—STAPLE FOODS

FOR PIZZA FOR CONSUMPTION ON OR OFF THE PREMISES (U.S. CL. 46).  
FIRST USE 2-11-2003; IN COMMERCE 2-11-2003.

### CLASS 43—HOTEL AND RESTAURANT SERVICES

FOR RESTAURANT SERVICES (U.S. CLS. 100 AND 101).  
FIRST USE 2-11-2003; IN COMMERCE 2-11-2003.

2,900,592. WESTBRIDGE TECHNOLOGY, INC., MOUNTAIN VIEW, CA. SN 78-124,237. PUB. 5-27-2003, FILED 4-25-2002.

## WESTBRIDGE

### CLASS 9—ELECTRICAL AND SCIENTIFIC APPARATUS

FOR COMPUTER SOFTWARE FOR DATABASE AND DATABASE NETWORK MANAGEMENT; ELECTRONIC ENCRYPTION UNITS COMPRISED OF COMPUTER SOFTWARE FOR DATA SECURITY, PRIVACY AND PROTECTION; COMPUTER SOFTWARE FOR THE DEVELOPMENT OF COMPUTER APPLICATIONS IN THE FIELD OF XML AND WEB SERVICES; COMPUTER SOFTWARE FOR LOGGING, REPORTING, AUDITING AND CHECKING THE COMPLIANCE OF COMPUTER NETWORK USAGE; COMPUTER SOFTWARE FOR THE TRANSMISSION AND ROUTING OF DATA AND MESSAGES; COMPUTER SOFTWARE FOR THE TESTING AND DEBUGGING OF WORKFLOW DATA BEING INTRODUCED TO THE NETWORK; COMPUTER SOFTWARE FOR THE ORGANIZATION AND STORAGE OF DIRECTORY INFORMATION; DATA PROCESSING COMPUTER SOFTWARE FOR CREATION OF INTERNAL NETWORK POLICIES; COMPUTER NETWORK INTEGRATION SOFTWARE FOR CONNECTING SOFTWARE AND HARDWARE APPLICATIONS PERTAINING TO THE MANAGEMENT OF CUSTOMER RELATIONS, TRADING EXCHANGES AND MARKETPLACE SOFTWARE, SUPPLY CHAIN INTEGRATION, ELECTRONIC COMMERCE APPLICATIONS, MIDDLEWARE PLATFORMS, NETWORK SECURITY APPLICATIONS AND PACKAGED APPLICATIONS (U.S. CLS. 21, 23, 26, 36 AND 38).  
FIRST USE 5-23-2002; IN COMMERCE 5-23-2002.

### CLASS 41—EDUCATION AND ENTERTAINMENT

FOR EDUCATIONAL SERVICES, NAMELY, CONDUCTING CLASSES, SEMINARS, CONFERENCES, AND WORKSHOPS IN THE USE OF COMPUTER SOFTWARE FOR CONNECTING TOGETHER ENTERPRISE SOFTWARE APPLICATIONS AND PLATFORMS, CUSTOMER RELATIONSHIP MANAGEMENT APPLICATIONS AND PLATFORMS, TRADING EXCHANGE AND MARKETPLACE SOFTWARE APPLICATIONS AND PLATFORMS, ELECTRONIC COMMERCE APPLICATIONS AND PLATFORMS, AND MIDDLEWARE PLATFORMS (U.S. CLS. 100, 101 AND 107).  
FIRST USE 5-23-2002; IN COMMERCE 5-23-2002.

### CLASS 42—SCIENTIFIC, COMPUTER AND LEGAL SERVICES

FOR WEB DEVELOPMENT AND DESIGN FOR OTHERS—CUSTOM DESIGN OF COMPUTER SOFTWARE FOR OTHERS; COMPUTER CONSULTING, INFORMATION TECHNOLOGY CONSULTING, AND COMPUTER NETWORK CONSULTING; COMPUTER SOFTWARE DESIGN AND DEVELOPMENT SERVICES FOR OTHERS, TECHNICAL SUPPORT SERVICES, NAMELY, TROUBLESHOOTING OF COMPUTER HARDWARE AND SOFTWARE PROBLEMS VIA TELEPHONE, ON-LINE, AND IN-PERSON (U.S. CLS. 100 AND 101).  
FIRST USE 5-23-2002; IN COMMERCE 5-23-2002.

2,900,595. GSI COMMERCE SOLUTIONS, INC., PENNSYLVANIA, PA. SN 78-128,442. PUB. 2-10-2004, FILED 5-14-2002.



NO CLAIM IS MADE TO THE EXCLUSIVE RIGHT TO USE "COMMERCE", APART FROM THE MARK AS SHOWN.

#### CLASS 35—ADVERTISING AND BUSINESS

FOR PRODUCT MERCHANDISING, NAMELY, PURCHASING AND MAINTAINING INVENTORY OF PRODUCTS FOR OTHERS; ORDER FULFILLMENT SERVICES; BUSINESS MARKETING CONSULTING SERVICES, NAMELY, PROVIDING BUSINESS ADVICE TO OTHERS IN DEVELOPING ONLINE RETAIL SITES AND DIRECT MARKETING RESPONSE BUSINESSES; CUSTOMER SERVICES IN THE FIELD OF RETAIL STORE SERVICES (U.S. CLS. 100, 101 AND 102).  
FIRST USE 6-0-2002; IN COMMERCE 6-0-2002.

#### CLASS 42—SCIENTIFIC, COMPUTER AND LEGAL SERVICES

FOR DEVELOPMENT OF NEW TECHNOLOGY FOR OTHERS IN THE FIELD OF RETAIL STORE SERVICES (U.S. CLS. 100 AND 101).  
FIRST USE 6-0-2002; IN COMMERCE 6-0-2002.

2,900,596. AMERICAN AUTOMOBILE ASSOCIATION, INC., HEATHROW, FL. SN 78-128,780. PUB. 12-9-2003, FILED 5-15-2002.

## AAA PREMIER

OWNER OF U.S. REG. NOS. 829,265, 849,165, AND OTHERS.

#### CLASS 35—ADVERTISING AND BUSINESS

FOR PROVIDING REFERRALS IN CONNECTION WITH AUTO BODY REPAIR SERVICES AND HOME REPAIR SERVICES AND HOME BUILDING AND HOME REPAIR SERVICES; ADMINISTRATION OF A DISCOUNT PROGRAM FOR ENABLING PARTICIPANTS TO OBTAIN DISCOUNTS ON GOODS AND SERVICES THROUGH USE OF A DISCOUNT MEMBERSHIP CARD; PROVIDING INFORMATION ABOUT VEHICLES FOR SALE (U.S. CLS. 100, 101 AND 102).  
FIRST USE 11-1-2001; IN COMMERCE 11-1-2001.

#### CLASS 36—INSURANCE AND FINANCIAL

FOR REIMBURSEMENT OF RENTAL CAR EXPENSES; INSURANCE UNDERWRITING IN THE FIELD OF AUTO, HOME, TRIP INTERRUPTION, VEHICLE MECHANICAL BREAKDOWN, AND VEHICLE RETURN INSURANCE; VEHICLE BROKERAGE SERVICES; PROVIDING EXTENDED VEHICLE WARRANTIES; LIFE AND TRAVEL ACCIDENT INSURANCE UNDERWRITING SERVICES; PROVIDING EXTENDED HOME WARRANTIES; PROVIDING INFORMATION ON VEHICLE PRICING (U.S. CLS. 100, 101 AND 102).  
FIRST USE 11-1-2001; IN COMMERCE 11-1-2001.

#### CLASS 37—CONSTRUCTION AND REPAIR

FOR EMERGENCY ROAD SIDE ASSISTANCE SERVICES (U.S. CLS. 100, 103 AND 106).  
FIRST USE 11-1-2001; IN COMMERCE 11-1-2001.

#### CLASS 38—COMMUNICATION

FOR TELECOMMUNICATIONS AND TELEMATICS SERVICES, NAMELY, PROVIDING WIRELESS VOICE AND DATA COMMUNICATION SERVICES FOR VEHICLE OPERATORS TO OBTAIN INFORMATION CONCERNING TRAFFIC, TRAVEL, EMERGENCY INFORMATION, POLICE ASSISTANCE, AND EMERGENCY RESCUE SERVICE (U.S. CLS. 100, 101 AND 104).  
FIRST USE 11-1-2001; IN COMMERCE 11-1-2001.

#### CLASS 39—TRANSPORTATION AND STORAGE

FOR TRAVEL AGENCY SERVICES, NAMELY, MAKING BOOKINGS AND RESERVATIONS FOR TRANSPORTATION; TRAVEL INFORMATION SERVICES IN THE NATURE OF ROUTE PLANNING FOR OTHERS (U.S. CLS. 100 AND 105).  
FIRST USE 11-1-2001; IN COMMERCE 11-1-2001.

#### CLASS 42—SCIENTIFIC, COMPUTER AND LEGAL SERVICES

FOR NOTARY PUBLIC SERVICES; VEHICLE INSPECTION SERVICES (U.S. CLS. 100 AND 101).  
FIRST USE 11-1-2001; IN COMMERCE 11-1-2001.

#### CLASS 43—HOTEL AND RESTAURANT SERVICES

FOR TRAVEL AGENCY SERVICES, NAMELY MAKING BOOKINGS AND RESERVATIONS FOR LODGINGS, RESTAURANTS, AND MEALS (U.S. CLS. 100 AND 101).  
FIRST USE 11-1-2001; IN COMMERCE 11-1-2001.

#### CLASS 45—PERSONAL SERVICES

FOR CONCIERGE SERVICES FOR OTHERS COMPRISING MAKING REQUESTED PERSONAL ARRANGEMENTS AND RESERVATIONS AND PROVIDING CUSTOMER-SPECIFIC INFORMATION TO MEET INDIVIDUAL NEEDS RENDERED TOGETHER IN A TRAVEL ADVICE ENVIRONMENT; HOME LOCK-OUT SERVICES, NAMELY, LOCKSMITHING IN THE NATURE OF OPENING LOCKS FOR OTHERS; FRAUD DETECTION SERVICES IN THE FIELD OF CREDIT CARD TRANSACTIONS (U.S. CLS. 100 AND 101).  
FIRST USE 11-1-2001; IN COMMERCE 11-1-2001.

2,900,603. HYDROSOURCE, INC., CANADENSIS, PA. SN 78-139,907. PUB. 5-6-2003, FILED 6-28-2002.

## DRAKESFLAKES

#### CLASS 6—METAL GOODS

FOR HOLIDAY AND SEASONAL ORNAMENTS MADE OF METAL (U.S. CLS. 2, 12, 13, 14, 23, 25 AND 50).  
FIRST USE 7-2-2002; IN COMMERCE 7-7-2002.

#### CLASS 20—FURNITURE AND ARTICLES NOT OTHERWISE CLASSIFIED

FOR PICTURE FRAMES (U.S. CLS. 2, 13, 22, 25, 32 AND 50).  
FIRST USE 7-2-2002; IN COMMERCE 7-7-2002.

2,900,606. DRAGONFIRE STUDIOS, INC., SHREVEPORT, LA. SN 78-140,325. PUB. 1-13-2004, FILED 7-1-2002.

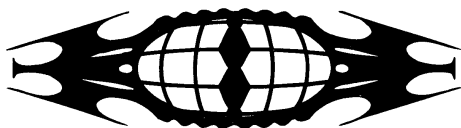

THE LINING IS A FEATURE OF THE MARK AND DOES NOT INDICATE COLOR.  
THE MARK CONSISTS OF A STYLIZED DRAGON EYE.

#### CLASS 6—METAL GOODS

FOR COLD CAST BRONZE FIGURES, FIGURINES, STATUES AND STATUETTES (U.S. CLS. 2, 12, 13, 14, 23, 25 AND 50).  
FIRST USE 7-15-2004; IN COMMERCE 7-15-2004.

#### CLASS 20—FURNITURE AND ARTICLES NOT OTHERWISE CLASSIFIED

FOR COLD CAST RESIN FIGURES, FIGURINES, STATUES AND STATUETTES (U.S. CLS. 2, 13, 22, 25, 32 AND 50).  
FIRST USE 9-1-2003; IN COMMERCE 9-1-2003.

2,900,608. LIDO CAPITAL PARTNERS, LLC, NEWPORT BEACH, CA. SN 78-144,488. PUB. 11-4-2003, FILED 7-16-2002.

## LIDO CAPITAL

NO CLAIM IS MADE TO THE EXCLUSIVE RIGHT TO USE "CAPITAL", APART FROM THE MARK AS SHOWN.

#### CLASS 35—ADVERTISING AND BUSINESS

FOR BUSINESS CONSULTING SERVICES (U.S. CLS. 100, 101 AND 102).  
FIRST USE 9-0-2003; IN COMMERCE 9-0-2003.

#### CLASS 36—INSURANCE AND FINANCIAL

FOR FINANCIAL CONSULTING SERVICES; INVESTMENT CONSULTING SERVICES; INVESTMENT ADVISORY SERVICES; INVESTMENT MANAGEMENT AND FUND MANAGEMENT; PRIVATE AND PUBLIC EQUITY INVESTMENTS (U.S. CLS. 100, 101 AND 102).  
FIRST USE 9-0-2003; IN COMMERCE 9-0-2003.

2,900,610. MINOVA INTERNATIONAL LIMITED, WITNEY OXFORDSHIRE, UNITED KINGDOM. SN 78-144,906. PUB. 5-13-2003, FILED 7-17-2002.

## ECLIPSE

#### CLASS 1—CHEMICALS

FOR RESIN GROUT (U.S. CLS. 1, 5, 6, 10, 26 AND 46).  
FIRST USE 1-0-2004; IN COMMERCE 1-0-2004.

#### CLASS 6—METAL GOODS

FOR METAL ANCHORING BOLT FOR USE IN MINING CONSTRUCTION (U.S. CLS. 2, 12, 13, 14, 23, 25 AND 50).  
FIRST USE 1-0-2004; IN COMMERCE 1-0-2004.

2,900,618. DAVOR JEDLICKA, TYLER, TX. SN 78-151,692. PUB. 5-20-2003, FILED 8-7-2002.

## AFFINOGRAPH

#### CLASS 9—ELECTRICAL AND SCIENTIFIC APPARATUS

FOR COMPUTER SOFTWARE FOR USE IN GENERATING AND PRINTING GRAPHICAL REPRESENTATIONS OF HUMAN FAMILY STRUCTURES; COMPUTER SOFTWARE FOR USE IN STORING, SORTING AND ORGANIZING DATA RELATING TO HUMAN FAMILY STRUCTURES; COMPUTER SOFTWARE FOR USE IN PROVIDING AUTOMATED INSTRUCTION IN THE FIELD OF HUMAN FAMILY STRUCTURES; PRE-RECORDED AUDIO TAPES, VIDEO TAPES, COMPACT DISKS, DVD DISKS AND CD-ROM DISKS CONTAINING EDUCATIONAL OR INSTRUCTIONAL MATERIAL IN THE FIELD OF HUMAN FAMILY STRUCTURES (U.S. CLS. 21, 23, 26, 36 AND 38).  
FIRST USE 7-16-2004; IN COMMERCE 7-16-2004.

#### CLASS 16—PAPER GOODS AND PRINTED MATTER

FOR PRINTED MATTER, NAMELY, BOOKS, WORKBOOKS, BROCHURES AND TRANSPARENCIES IN THE FIELD OF HUMAN FAMILY STRUCTURES; PERIODICAL PUBLICATIONS, NAMELY, MAGAZINES, NEWSPAPERS AND NEWSLETTERS IN THE FIELD OF HUMAN FAMILY STRUCTURES; PRINTED INSTRUCTIONAL AND TEACHING MATERIALS IN THE FIELD OF HUMAN FAMILY STRUCTURES; PRINTED MATTER, NAMELY, PRINTED FORMS, CHARTS AND GRAPHING PAPER; PRINTED AIDS AND TOOLS, NAMELY, TEST FORMS, ANSWER GUIDES, EVALUATION GUIDES AND CHECK LISTS FOR USE IN TESTING, ASSESSMENT, EVALUATION, COUNSELING AND INTERVENTION SERVICES; PRINTED AIDS AND TOOLS, NAMELY, TEST FORMS, DIAGNOSTIC FORMS, ANSWER GUIDES, EVALUATION GUIDES AND CHECK LISTS FOR USE IN PSYCHIATRIC SERVICES (U.S. CLS. 2, 5, 22, 23, 29, 37, 38 AND 50).  
FIRST USE 7-16-2004; IN COMMERCE 7-16-2004.

2,900,623. ROCKY MOUNTAIN BIOSYSTEMS, INC., GOLDEN, CO. SN 78-154,079. PUB. 4-15-2003, FILED 8-14-2002.

## RMBI

#### CLASS 5—PHARMACEUTICALS

FOR SURGICAL IMPLANTS COMPOSED OF LIVING TISSUE AND MEDICAL ADHESIVES FOR BINDING WOUNDS (U.S. CLS. 6, 18, 44, 46, 51 AND 52).  
FIRST USE 9-27-2002; IN COMMERCE 6-25-2004.

#### CLASS 10—MEDICAL APPARATUS

FOR ELECTROMAGNETIC DRUG DELIVERY APPARATUS FOR MEDICAL USE, ELECTROMAGNETIC MEDICAL DIAGNOSTIC IMAGING APPARATUS, ARTIFICIAL SURGICAL IMPLANTS AND MEDICAL SKIN ABRADERS (U.S. CLS. 26, 39 AND 44).  
FIRST USE 9-27-2002; IN COMMERCE 6-25-2004.



2,900,644. THE NATIONAL COUNCIL OF YOUNG MEN'S CHRISTIAN ASSOCIATIONS OF THE UNITED STATES OF AMERICA, CHICAGO, IL. SN 78-167,656. PUB. 4-22-2003, FILED 9-25-2002.

## ABUNDANT ASSETS ALLIANCE

### CLASS 9—ELECTRICAL AND SCIENTIFIC APPARATUS

FOR DOWNLOADABLE ELECTRONIC PUBLICATIONS IN THE NATURE OF TRAINING MANUALS IN THE FIELD OF THE MANAGEMENT AND OPERATION OF NONPROFIT ORGANIZATIONS (U.S. CLS. 21, 23, 26, 36 AND 38).

FIRST USE 11-0-2002; IN COMMERCE 11-0-2002.

### CLASS 16—PAPER GOODS AND PRINTED MATTER

FOR EDUCATIONAL PUBLICATIONS, NAMELY, TRAINING MANUALS IN THE FIELD OF THE MANAGEMENT AND OPERATION OF NONPROFIT ORGANIZATIONS (U.S. CLS. 2, 5, 22, 23, 29, 37, 38 AND 50).

FIRST USE 11-0-2002; IN COMMERCE 11-0-2002.

### CLASS 35—ADVERTISING AND BUSINESS

FOR PROVIDING INFORMATION IN THE FIELD OF THE MANAGEMENT AND OPERATION OF NONPROFIT ORGANIZATIONS VIA THE INTERNET (U.S. CLS. 100, 101 AND 102).

FIRST USE 11-0-2002; IN COMMERCE 11-0-2002.

2,900,648. CHANNING BETE COMPANY, INC., SOUTH DEERFIELD, MA. SN 78-170,353. PUB. 11-4-2003, FILED 10-2-2002.

## SUPPORTING SCHOOL SUCCESS

### CLASS 9—ELECTRICAL AND SCIENTIFIC APPARATUS

FOR PRE-RECORDED VIDEO CASSETTES, OPTICAL DISCS, COMPACT DISCS, AND EDUCATIONAL SOFTWARE RELATING TO PARENTING, CHILDREN'S EDUCATION, AND SOCIAL ISSUES THAT FACE CHILDREN AND TEENAGERS (U.S. CLS. 21, 23, 26, 36 AND 38).

FIRST USE 1-7-2004; IN COMMERCE 1-7-2004.

### CLASS 16—PAPER GOODS AND PRINTED MATTER

FOR PRINTED WORKBOOKS, MANUALS, GUIDES, ACTIVITY BOOKS AND RELATED PRINTED TEACHING MATERIALS RELATING TO PARENTING, CHILDREN'S EDUCATION, AND SOCIAL ISSUES THAT FACE CHILDREN AND TEENAGERS (U.S. CLS. 2, 5, 22, 23, 29, 37, 38 AND 50).

FIRST USE 1-7-2004; IN COMMERCE 1-7-2004.

2,900,649. LOGOTEC USA, LLC, SIERRA MADRE, CA. SN 78-170,464. PUB. 12-30-2003, FILED 10-3-2002.

## COOLFLEX

### CLASS 16—PAPER GOODS AND PRINTED MATTER

FOR LUNCH BAGS (U.S. CLS. 2, 5, 22, 23, 29, 37, 38 AND 50).

FIRST USE 1-1-2003; IN COMMERCE 1-1-2003.

### CLASS 21—HOUSEWARES AND GLASS

FOR PORTABLE COOLERS, THERMAL INSULATED TOTE BAGS AND CONTAINERS FOR FOOD OR BEVERAGES, LUNCH BOXES (U.S. CLS. 2, 13, 23, 29, 30, 33, 40 AND 50).

FIRST USE 1-1-2003; IN COMMERCE 1-1-2003.

2,900,659. LOG MAX, INC., VANCOUVER, WA. SN 78-180,143. PUB. 8-5-2003, FILED 10-30-2002.

## SIMPLY SMARTER

### CLASS 7—MACHINERY

FOR TIMBER HARVESTING MACHINES; ROTATION MOTORS, ROTORS, FOR TIMBER HARVESTING MACHINES (U.S. CLS. 13, 19, 21, 23, 31, 34 AND 35).

FIRST USE 4-0-2003; IN COMMERCE 4-0-2003.

### CLASS 9—ELECTRICAL AND SCIENTIFIC APPARATUS

FOR PROGRAMMABLE ELECTRONIC CONTROLLERS FOR TIMBER HARVESTING MACHINES (U.S. CLS. 21, 23, 26, 36 AND 38).

FIRST USE 4-0-2003; IN COMMERCE 4-0-2003.

2,900,663. BIOMET, INC., WARSAW, IN. SN 78-187,953. PUB. 11-25-2003, FILED 11-22-2002.

## PPS

### CLASS 5—PHARMACEUTICALS

FOR POROUS PLASMA SPRAY COATING USED IN CONNECTION WITH CEMENTLESS PROSTHETIC IMPLANTS (U.S. CLS. 6, 18, 44, 46, 51 AND 52).

FIRST USE 3-1-2004; IN COMMERCE 3-1-2004.

### CLASS 10—MEDICAL APPARATUS

FOR ORTHOPEDIC PROSTHETIC IMPLANTS (U.S. CLS. 26, 39 AND 44).

FIRST USE 3-1-2004; IN COMMERCE 3-1-2004.

2,900,671. BECKMAN COULTER, INC., FULLERTON, CA. SN 78-196,004. PUB. 2-24-2004, FILED 12-18-2002.

2,900,686. MASCO CORPORATION OF INDIANA, INDIANAPOLIS, IN. SN 78-201,230. PUB. 9-30-2003, FILED 1-8-2003.

## DXI

### CLASS 1—CHEMICALS

FOR DIAGNOSTIC REAGENTS FOR SCIENTIFIC OR RESEARCH USE (U.S. CLS. 1, 5, 6, 10, 26 AND 46). FIRST USE 7-21-2001; IN COMMERCE 6-27-2003.

### CLASS 9—ELECTRICAL AND SCIENTIFIC APPARATUS

FOR LABORATORY EQUIPMENT, NAMELY, AUTOMATED SAMPLE HANDLING EQUIPMENT, CLINICAL LABORATORY ANALYZERS, CHEMISTRY ANALYZERS AND SOFTWARE FOR USE THEREWITH, ALL IN THE FIELD OF SCIENTIFIC AND LABORATORY USE (U.S. CLS. 21, 23, 26, 36 AND 38). FIRST USE 7-21-2001; IN COMMERCE 6-27-2003.

### CLASS 10—MEDICAL APPARATUS

FOR MEDICAL AND LABORATORY DIAGNOSTIC EQUIPMENT, NAMELY, CLINICAL LABORATORY ANALYZERS, CHEMISTRY ANALYZERS, AND AUTOMATED SAMPLE HANDLING EQUIPMENT, ALL FOR MEDICAL USE (U.S. CLS. 26, 39 AND 44). FIRST USE 7-21-2001; IN COMMERCE 6-27-2003.

2,900,685. MASCO CORPORATION OF INDIANA, INDIANAPOLIS, IN. SN 78-201,227. PUB. 9-30-2003, FILED 1-8-2003.

## DMD TECHNOLOGY

NO CLAIM IS MADE TO THE EXCLUSIVE RIGHT TO USE "TECHNOLOGY", APART FROM THE MARK AS SHOWN.

### CLASS 9—ELECTRICAL AND SCIENTIFIC APPARATUS

FOR INFRARED SENSORS AND ELECTRONIC CONTROLLERS FOR FAUCETS, URINALS AND TOILETS (U.S. CLS. 21, 23, 26, 36 AND 38). FIRST USE 2-2-2004; IN COMMERCE 2-2-2004.

### CLASS 11—ENVIRONMENTAL CONTROL APPARATUS

FOR INFRARED SENSORS AND ELECTRONIC CONTROLLERS SOLD AS A COMPONENT AND FEATURE OF PLUMBING PRODUCTS, NAMELY, FAUCETS, URINALS AND TOILETS (U.S. CLS. 13, 21, 23, 31 AND 34). FIRST USE 2-2-2004; IN COMMERCE 2-2-2004.

## DMD

### CLASS 9—ELECTRICAL AND SCIENTIFIC APPARATUS

FOR INFRARED SENSORS AND ELECTRONIC CONTROLLERS FOR FAUCETS, URINALS AND TOILETS (U.S. CLS. 21, 23, 26, 36 AND 38). FIRST USE 2-2-2004; IN COMMERCE 2-2-2004.

### CLASS 11—ENVIRONMENTAL CONTROL APPARATUS

FOR INFRARED SENSORS AND ELECTRONIC CONTROLLERS SOLD AS A COMPONENT AND FEATURE OF PLUMBING PRODUCTS, NAMELY, FAUCETS, URINALS AND TOILETS (U.S. CLS. 13, 21, 23, 31 AND 34). FIRST USE 2-2-2004; IN COMMERCE 2-2-2004.

2,900,694. SUNGLASS HUT INTERNATIONAL, INC., MASON, OH. SN 78-203,502. PUB. 11-18-2003, FILED 1-15-2003.

## SOLE MIO

THE FOREIGN WORDING IN THE MARK TRANSLATES INTO ENGLISH AS "MY SUN".

### CLASS 35—ADVERTISING AND BUSINESS

FOR RETAIL OPTICAL STORE SERVICES (U.S. CLS. 100, 101 AND 102). FIRST USE 6-19-2003; IN COMMERCE 6-19-2003.

### CLASS 44—MEDICAL, BEAUTY AND AGRICULTURAL SERVICES

FOR OPTICIAN AND OPTOMETRIC SERVICES (U.S. CLS. 100 AND 101). FIRST USE 6-19-2003; IN COMMERCE 6-19-2003.

2,900,700. PPG INDUSTRIES OHIO, INC., CLEVELAND, OH. SN 78-205,530. PUB. 1-27-2004, FILED 1-21-2003.



NO CLAIM IS MADE TO THE EXCLUSIVE RIGHT TO USE "CERTIFIED FABRICATOR PROGRAM", APART FROM THE MARK AS SHOWN.

### CLASS 19—NON-METALLIC BUILDING MATERIALS

FOR BUILDING CONSTRUCTION GLASS (U.S. CLS. 1, 12, 33 AND 50). FIRST USE 3-31-2002; IN COMMERCE 3-31-2002.

**CLASS 41—EDUCATION AND ENTERTAINMENT**

FOR TRAINING SERVICES IN THE FIELD OF GLASS FABRICATION (U.S. CLS. 100, 101 AND 107).  
FIRST USE 3-31-2002; IN COMMERCE 3-31-2002.

**CLASS 42—SCIENTIFIC, COMPUTER AND LEGAL SERVICES**

FOR TESTING, ANALYSIS AND EVALUATION OF THE GOODS AND SERVICES OF OTHERS FOR THE PURPOSE OF CERTIFICATION IN THE FIELD OF GLASS FABRICATION (U.S. CLS. 100 AND 101).  
FIRST USE 3-31-2002; IN COMMERCE 3-31-2002.

2,900,704. KENNEDY, TERESA KAY-ABA, NEW YORK, NY.  
SN 78-212,676. PUB. 10-7-2003, FILED 2-9-2003.

**POWER LIVING****CLASS 9—ELECTRICAL AND SCIENTIFIC APPARATUS**

FOR PRERECORDED VIDEO TAPES, COMPACT DISCS, AND AUDIO TAPES FEATURING GUIDELINES FOR ATTAINING PERSONAL GOALS, IDENTIFYING AND REALIZING PERSONAL POTENTIAL, SELF-HELP EXERCISES, AS WELL AS INFORMATION IN THE SUBJECT AREAS OF HEALTH, INTEGRATIVE MEDICINE, NUTRITION, COOKING, MOTIVATION, EXERCISE, FITNESS, YOGA, MEDITATION, PERSONAL PRODUCTIVITY, BUSINESS AND SUCCESS (U.S. CLS. 21, 23, 26, 36 AND 38).

FIRST USE 4-30-2004; IN COMMERCE 6-19-2004.

**CLASS 16—PAPER GOODS AND PRINTED MATTER**

FOR BOOKS, BOOKLETS, NEWSLETTERS, MAGAZINES AND COMIC STRIPS IN THE FIELD OF ATTAINING PERSONAL GOALS, IDENTIFYING AND REALIZING PERSONAL POTENTIAL, SELF-HELP EXERCISES, HEALTH, INTEGRATIVE MEDICINE, NUTRITION, COOKING, MOTIVATION, EXERCISE, FITNESS, YOGA, MEDITATION, PERSONAL PRODUCTIVITY, BUSINESS AND SUCCESS; WRITING JOURNALS, APPOINTMENT BOOKS, NOTE PADS, PENS, ADDRESS BOOKS, SCRAPBOOK ALBUMS, DIARIES, CALENDARS, GREETING CARDS AND (U.S. CLS. 2, 5, 22, 23, 29, 37, 38 AND 50).

FIRST USE 12-13-2000; IN COMMERCE 5-10-2002.

**CLASS 41—EDUCATION AND ENTERTAINMENT**

FOR EDUCATIONAL SERVICES, NAMELY, CONDUCTING CLASSES, SEMINARS, CONFERENCES, WORKSHOPS IN THE FIELDS OF ATTAINING PERSONAL GOALS, IDENTIFYING AND REALIZING PERSONAL POTENTIAL, SELF-HELP EXERCISES, HEALTH, INTEGRATIVE MEDICINE, NUTRITION, COOKING, MOTIVATION, EXERCISE, FITNESS, YOGA, MEDITATION, PERSONAL PRODUCTIVITY, BUSINESS AND SUCCESS, AND DISTRIBUTING COURSE MATERIALS IN CONNECTION THEREWITH; ENTERTAINMENT, NAMELY A CONTINUING VARIETY SHOW BROADCAST OVER TELEVISION, AUDIO, VIDEO MEDIA, AND VIA A GLOBAL COMPUTER NETWORK (U.S. CLS. 100, 101 AND 107).

FIRST USE 1-10-2002; IN COMMERCE 1-10-2002.

2,900,743. INITIATE SYSTEMS, INC., CHICAGO, IL. SN 78-225,422. PUB. 4-13-2004, FILED 3-13-2003.

**INITIATE****CLASS 9—ELECTRICAL AND SCIENTIFIC APPARATUS**

FOR COMPUTER SOFTWARE FOR DATA QUALITY ANALYTICS, DATA QUALITY REMEDIATION AND DATA INTEGRATION; COMPUTER SOFTWARE FOR RECORDS MANAGEMENT AND DATABASE CREATION AND MANAGEMENT; COMPUTER SOFTWARE FOR IDENTITY MANAGEMENT; COMPUTER SOFTWARE FOR THE STORAGE AND TRACKING OF INFORMATION PERTAINING TO INDIVIDUALS, ENTITIES OR EVENTS (U.S. CLS. 21, 23, 26, 36 AND 38).  
FIRST USE 3-7-2003; IN COMMERCE 9-23-2003.

**CLASS 35—ADVERTISING AND BUSINESS**

FOR BUSINESS CONSULTING SERVICES IN THE FIELD OF DATA INTEGRATION; ELECTRONIC DATA PROCESSING SERVICES; OUTSOURCING SERVICES IN THE FIELD OF DATA INTEGRATION, ELECTRONIC DATA PROCESSING, DATA ANALYSIS, DATA EQUALITY REMEDIATION, AND IDENTITY MANAGEMENT (U.S. CLS. 100, 101 AND 102).

FIRST USE 3-7-2003; IN COMMERCE 9-23-2003.

**CLASS 42—SCIENTIFIC, COMPUTER AND LEGAL SERVICES**

FOR TECHNICAL CONSULTING SERVICES, NAMELY, DATA INTEGRATION CONSULTING SERVICES (U.S. CLS. 100 AND 101).

FIRST USE 3-7-2003; IN COMMERCE 9-23-2003.

2,900,771. BYRDCLIFFE COOKERY, LLC, FAIRFIELD, CT.  
SN 78-234,430. PUB. 11-11-2003, FILED 4-6-2003.

**WHAT YOU DO WITH TOFU****CLASS 29—MEATS AND PROCESSED FOODS**

FOR FRUIT-BASED AND VEGETABLE-BASED SPREADS (U.S. CL. 46).

FIRST USE 9-5-2003; IN COMMERCE 10-1-2003.

**CLASS 30—STAPLE FOODS**

FOR CHUTNEYS, MARINADES AND SAUCES (U.S. CL. 46).

FIRST USE 9-5-2003; IN COMMERCE 10-1-2003.

2,900,772. TERRA HARVEST FOODS, INCORPORATED, LOVES PARK, IL. SN 78-234,547. PUB. 9-30-2003, FILED 4-7-2003.

**TH FOODS**

NO CLAIM IS MADE TO THE EXCLUSIVE RIGHT TO USE "FOODS", APART FROM THE MARK AS SHOWN.

**CLASS 30—STAPLE FOODS**

FOR WHEAT, RICE AND CORN BASED SNACK FOODS, NAMELY, SESAME AND RICE STICKS, CRACKERS AND CHIPS (U.S. CL. 46).  
FIRST USE 6-1-2003; IN COMMERCE 1-1-2004.

2,900,840. NOVALOGIC, INC., CALABASAS, CA. SN 78-269,414. PUB. 2-24-2004, FILED 7-1-2003.

**CLASS 40—MATERIAL TREATMENT**

FOR PRIVATE LABEL BAKING SERVICES IN THE FIELD OF SNACK FOODS AND OTHER FOOD PRODUCTS (U.S. CLS. 100, 103 AND 106).  
FIRST USE 6-1-2003; IN COMMERCE 1-1-2004.

**JOINT OPERATIONS****CLASS 9—ELECTRICAL AND SCIENTIFIC APPARATUS**

FOR COMPUTER AND VIDEO GAME SOFTWARE, COMPUTER PROGRAMS RECORDED ON CD-ROM'S AND COMPACT DISCS FEATURING COMPUTER GAMES; ACCESSORIES FOR PLAYING ELECTRONIC COMPUTER GAMES, NAMELY TEMPLATES, COMPUTER GAME JOYSTICKS AND MANUALS THEREFORE, SOLD AS A UNIT (U.S. CLS. 21, 23, 26, 36 AND 38).  
FIRST USE 6-15-2004; IN COMMERCE 6-15-2004.

2,900,774. BELTIE, INC., LYMAN, ME. SN 78-236,771. PUB. 3-2-2004, FILED 4-11-2003.

**WINTERWOOD FARM**

NO CLAIM IS MADE TO THE EXCLUSIVE RIGHT TO USE "FARM", APART FROM THE MARK AS SHOWN.

**CLASS 41—EDUCATION AND ENTERTAINMENT**

FOR ENTERTAINMENT SERVICES, NAMELY, PROVIDING ON-LINE COMPUTER GAMES (U.S. CLS. 100, 101 AND 107).  
FIRST USE 6-15-2004; IN COMMERCE 6-15-2004.

**CLASS 1—CHEMICALS**

FOR SOIL AMENDMENTS, NAMELY, COMPOSTS, POTTING SOILS, NATURAL FERTILIZERS FOR DOMESTIC USE, NATURAL FERTILIZERS FOR AGRICULTURAL USE; PLANTING MIXES, NAMELY, NATURAL ORGANIC MATERIALS CONSISTING OF LOAM, FIBROUS ORGANICS, COMPOST AND SAND (U.S. CLS. 1, 5, 6, 10, 26 AND 46).  
FIRST USE 12-0-2003; IN COMMERCE 3-2-2004.

2,900,847. LOCKHART POWER COMPANY, LOCKHART, SC. SN 78-273,301. PUB. 5-4-2004, FILED 7-11-2003.

**CLASS 31—NATURAL AGRICULTURAL PRODUCTS**

FOR TOP SOILS AND MULCHES (U.S. CLS. 1 AND 46).  
FIRST USE 12-0-2003; IN COMMERCE 5-25-2004.



2,900,793. DATAMARK SERVICES, INC., HUNTERSVILLE, NC. SN 78-242,108. PUB. 12-23-2003, FILED 4-25-2003.

**CARDEROCK**

NO CLAIM IS MADE TO THE EXCLUSIVE RIGHT TO USE POWER, APART FROM THE MARK AS SHOWN.

**CLASS 35—ADVERTISING AND BUSINESS**

FOR DATA PROCESSING (U.S. CLS. 100, 101 AND 102).  
FIRST USE 7-28-2003; IN COMMERCE 7-28-2003.

**CLASS 39—TRANSPORTATION AND STORAGE**

FOR UTILITY SERVICES, NAMELY THE TRANSMISSION OF ELECTRICITY, PUBLIC UTILITY SERVICES IN THE NATURE OF DISTRIBUTION OF ELECTRICITY (U.S. CLS. 100 AND 105).  
FIRST USE 3-31-2004; IN COMMERCE 3-31-2004.

**CLASS 42—SCIENTIFIC, COMPUTER AND LEGAL SERVICES**

FOR APPLICATION SERVICE PROVIDER FEATURING SOFTWARE IN THE FIELD OF MARKETING FOR USE IN DATA PROCESSING; DATA WAREHOUSING; COMPUTER PROGRAMMING FOR OTHERS (U.S. CLS. 100 AND 101).  
FIRST USE 7-28-2003; IN COMMERCE 7-28-2003.

**CLASS 40—MATERIAL TREATMENT**

FOR GENERATION OF ELECTRICITY (U.S. CLS. 100, 103 AND 106).  
FIRST USE 3-31-2004; IN COMMERCE 3-31-2004.

2,900,854. METROPOLITAN LIFE INSURANCE COMPANY, NEW YORK, NY. SN 78-275,932. PUB. 4-6-2004, FILED 7-18-2003.

OWNER OF U.S. REG. NOS. 779,187, 1,274,680, AND OTHERS.

### CONDITIONCARE CONNECTION

#### CLASS 35—ADVERTISING AND BUSINESS

FOR ACCOUNTS RECEIVABLE MANAGEMENT SERVICES (U.S. CLS. 100, 101 AND 102). FIRST USE 10-1-2003; IN COMMERCE 10-1-2003.

#### CLASS 41—EDUCATION AND ENTERTAINMENT

FOR PROVIDING SEMINARS AND WORKSHOPS IN THE FIELD OF HEALTH, AND PROVIDING HEALTH EDUCATION MATERIALS IN CONNECTION THEREWITH (U.S. CLS. 100, 101 AND 107). FIRST USE 7-18-2003; IN COMMERCE 7-18-2003.

#### CLASS 36—INSURANCE AND FINANCIAL

FOR FINANCIAL SERVICES, NAMELY, FACTORING AGENCIES, LOAN FINANCING, TRADE FINANCE SERVICES, ELECTRONIC REMITTANCE SERVICES, LETTER OF CREDIT SERVICES, INTERNATIONAL COMMERCIAL BANKING SERVICES, CREDIT APPROVAL, CREDIT PROTECTION, CREDIT CONSULTATION, CREDIT RISK ASSESSMENT AND CREDIT RECOVERY AND COLLECTION (U.S. CLS. 100, 101 AND 102). FIRST USE 10-1-2003; IN COMMERCE 10-1-2003.

#### CLASS 44—MEDICAL, BEAUTY AND AGRICULTURAL SERVICES

FOR PROVIDING MEDICAL INFORMATION, NURSING ADVICE INFORMATION DIRECTLY TO CLIENTS WITH CERTAIN MEDICAL CONDITIONS; PROVIDING HEALTH CARE INFORMATION BY TELEPHONE AND INTERNET (U.S. CLS. 100 AND 101). FIRST USE 7-18-2003; IN COMMERCE 7-18-2003.

2,900,861. MYTHIC ENTERTAINMENT, INC., FAIRFAX, VA. SN 78-283,280. PUB. 4-13-2004, FILED 8-5-2003.

2,900,881. GENERAL ELECTRIC COMPANY, SCHENECTADY, NY. SN 78-975,511. PUB. 9-30-2003, FILED 2-13-2003.

### TRIALS OF ATLANTIS

### GE VERIWISE

#### CLASS 9—ELECTRICAL AND SCIENTIFIC APPARATUS

FOR COMPUTER GAME SOFTWARE AND VIDEO GAME SOFTWARE (U.S. CLS. 21, 23, 26, 36 AND 38). FIRST USE 10-28-2003; IN COMMERCE 10-28-2003.

#### CLASS 35—ADVERTISING AND BUSINESS

FOR REMOTE TRACKING AND MONITORING OF LAND VEHICLES, TRAILERS, CARGO CONTAINERS AND WATER VESSELS, AND PROVIDING BUSINESS, INVENTORY, MAINTENANCE AND POOLING REPORTS IN CONNECTION THEREWITH; REMOTE MONITORING OF SAFETY AND MAINTENANCE RECORDS OF LAND VEHICLES AND MARITIME VESSELS; REMOTE MONITORING OF AIR QUALITY OF MOVING AND STATIONARY VEHICLES (U.S. CLS. 100, 101 AND 102). FIRST USE 4-28-2003; IN COMMERCE 4-28-2003.

#### CLASS 41—EDUCATION AND ENTERTAINMENT

FOR OPERATING A REAL TIME GAME FOR OTHERS OVER GLOBAL AND LOCAL AREA COMPUTER NETWORKS (U.S. CLS. 100, 101 AND 107). FIRST USE 10-28-2003; IN COMMERCE 10-28-2003.

#### CLASS 42—SCIENTIFIC, COMPUTER AND LEGAL SERVICES

FOR PROVIDING REMOTE DIAGNOSTICS OF SAFETY AND/OR MAINTENANCE MALFUNCTIONS IN CONNECTION WITH LAND VEHICLES AND MARITIME VESSELS USED IN CONNECTION WITH THE COMMERCIAL SHIPMENT OF FREIGHT AND CARGO (U.S. CLS. 100 AND 101). FIRST USE 4-28-2003; IN COMMERCE 4-28-2003.

2,900,863. WELLS FARGO & COMPANY, MINNEAPOLIS, MN. SN 78-285,288. PUB. 12-16-2003, FILED 8-8-2003.

### WELLS FARGO CENTURY

\* \* \* \* \*

## SECTION 2.— INTERNATIONAL CLASSIFICATION

The short titles associated below with the international class numbers are terms designed merely for quick identification and are not an official part of the international classification. The full names of international classes are given in section 6.1 of the trademark rules of practice.

The designation "U.S. Cl." appearing in this section refers to the U.S. class in effect prior to Sep. 1, 1973 rather than the international class which applies to applications filed on or after that date. For adoption of international classification see notice in the OFFICIAL GAZETTE of Jun. 26, 1973 (911 O.G. TM 210).

### Application in one class

#### CLASS 1—CHEMICALS

2,900,029. EASTMAN CHEMICAL COMPANY, KINGSPORT, TN. SN 75-390,819. PUB. 9-22-1998, FILED 11-17-1997.

#### NUTRIENE

FOR NEUTRICEUTICAL CHEMICALS FOR USE IN THE MANUFACTURE OF NUTRITIONAL SUPPLEMENTS (U.S. CLS. 1, 5, 6, 10, 26 AND 46).  
FIRST USE 1-22-2001; IN COMMERCE 1-22-2001.

2,900,125. JOHNSON & JOHNSON, NEW BRUNSWICK, NJ. SN 76-132,437. PUB. 6-5-2001, FILED 9-21-2000.

#### GEMCOAT

FOR CHEMICAL COATING FOR PROTECTING EYE-GLASS LENSES (U.S. CLS. 1, 5, 6, 10, 26 AND 46).  
FIRST USE 10-22-2002; IN COMMERCE 10-22-2002.

2,900,190. MAGIC GREEN CORPORATION, SILEX, MO. SN 76-325,289. PUB. 5-7-2002, FILED 10-15-2001.

#### SALT EXIT

NO CLAIM IS MADE TO THE EXCLUSIVE RIGHT TO USE "SALT", APART FROM THE MARK AS SHOWN.  
FOR SOIL ADDITIVES, NAMELY, SOIL ADDITIVES CONTAINING CALCIUM HYDROXIDE (U.S. CLS. 1, 5, 6, 10, 26 AND 46).  
FIRST USE 5-31-2004; IN COMMERCE 5-31-2004.

2,900,430. NUTRA-PARK, INC., MIDDLETON, WI. SN 76-496,680. PUB. 11-4-2003, FILED 3-10-2003.

#### MASTERFRESH

FOR PLANT, FRUIT AND VEGETABLE PRESERVATIVES (U.S. CLS. 1, 5, 6, 10, 26 AND 46).  
FIRST USE 12-0-2003; IN COMMERCE 12-0-2003.

#### CLASS 1—(Continued).

2,900,492. UTELITE CORPORATION, COALVILLE, UT. SN 76-521,497. PUB. 3-23-2004, FILED 6-9-2003.

#### Your Root Solution

FOR SOIL TREATMENT COMPOSITIONS NAMELY A BLEND OF SOIL CONDITIONERS, PEAT MOSS AND KILN FIRED EXPANDED SHALE AGGREGATE (U.S. CLS. 1, 5, 6, 10, 26 AND 46).  
FIRST USE 5-13-2003; IN COMMERCE 5-13-2003.

2,900,560. FERRO CORPORATION, CLEVELAND, OH. SN 78-097,852. PUB. 9-3-2002, FILED 12-12-2001.

#### DURAGRIP

FOR SYNTHETIC RUBBER RESINS FOR USE IN THE MANUFACTURE OF MOLDED, EXTRUDED AND FILM-FORMED PARTS (U.S. CLS. 1, 5, 6, 10, 26 AND 46).  
FIRST USE 7-1-2004; IN COMMERCE 7-1-2004.

2,900,620. BAYER CROPSCIENCE LP, RESEARCH TRIANGLE PARK, NC. SN 78-153,553. PUB. 3-25-2003, FILED 8-13-2002.

#### FEEDS AT EVERY LEVEL FOR A DEEP DOWN GREEN THAT LASTS.

FOR FERTILIZERS FOR HOME, GARDEN AND LAWN USE AND FOR PROFESSIONAL USE (U.S. CLS. 1, 5, 6, 10, 26 AND 46).  
FIRST USE 1-1-2003; IN COMMERCE 1-1-2003.

**CLASS 1—(Continued).**

2,900,653. Q2 TECHNOLOGIES, LLC, MONTGOMERY, TX.  
SN 78-171,560. PUB. 11-11-2003, FILED 10-7-2002.



NO CLAIM IS MADE TO THE EXCLUSIVE RIGHT TO USE "TECHNOLOGIES", APART FROM THE MARK AS SHOWN.

FOR CHEMICALS FOR USE IN REMOVAL OF WASTE GASES AND MERCAPTANS OUT OF LANDFILL GAS, DIGESTER GAS, NATURAL GAS, REFINERY FLUE GAS AND AIR COLLECTION SYSTEMS; WASTE WATER TREATMENT CHEMICALS FOR INDUSTRIAL USE; HYDROGEN SULFIDE SCAVENGING CHEMICALS; SULFUR REMOVAL CHEMICALS; CHEMICALS FOR USE IN POTABLE WATER TREATMENT, ENVIRONMENTAL REMEDIATION ODOR CONTROL, OR IN HYDROCARBON TREATMENT; CHEMICALS FOR USE IN REMOVAL OF MERCAPTANS FROM HYDROCARBONS; CHEMICALS FOR USE IN REMOVING ACID GASES FROM STACK GASES (U.S. CLS. 1, 5, 6, 10, 26 AND 46).

FIRST USE 0-0-2001; IN COMMERCE 0-0-2001.

2,900,698. HI-TACH OIL CO., INC., KANNAPOLIS, NC. SN 78-203,822. PUB. 10-28-2003, FILED 1-16-2003.

**TUNER JUICE**

FOR CHEMICAL ADDITIVES FOR ENGINE OILS AND GASOLINE FUELS (U.S. CLS. 1, 5, 6, 10, 26 AND 46).

FIRST USE 7-8-2003; IN COMMERCE 7-8-2003.

**CLASS 2—PAINTS**

2,900,268. OASIS IMAGING PRODUCTS, INC., NASHUA, NH. SN 76-409,539. PUB. 2-25-2003, FILED 5-8-2002.

**IMAGE PRECISE TONER**

NO CLAIM IS MADE TO THE EXCLUSIVE RIGHT TO USE "IMAGE" AND "TONER", APART FROM THE MARK AS SHOWN.

FOR TONER CARTRIDGES AND COMPONENT PARTS THEREOF; TONER FOR USE IN PRINTERS, TONER FOR USE IN FACSIMILE MACHINES, TONER FOR USE IN PHOTOCOPIING MACHINES AND TONER FOR USE IN OTHER MACHINES USED TO TRANSFER AN IMAGE TO PAPER, CLOTH, PLASTIC, OR OTHER MATERIAL (U.S. CLS. 6, 11 AND 16).

FIRST USE 1-1-2002; IN COMMERCE 1-1-2002.

**CLASS 2—(Continued).**

2,900,487. TNEMEC COMPANY, INC., KANSAS CITY, MO.  
SN 76-518,980. PUB. 3-2-2004, FILED 6-2-2003.

**VERSATONE**

FOR PAINT-TYPE PROTECTIVE COATINGS USED TO INHIBIT CORROSION, RESIST DETERIORATION AND IMPROVE APPEARANCE, FOR APPLICATION AS A FINISH COATING TO CONCRETE AND METAL, USED INDUSTRY-WIDE (U.S. CLS. 6, 11 AND 16).

FIRST USE 1-0-2003; IN COMMERCE 1-0-2003.

2,900,722. KIDDE FIRE FIGHTING, INC., EXTON, PA. SN 78-219,640. PUB. 11-18-2003, FILED 2-27-2003.

**PERM-I-DENT II**

NO CLAIM IS MADE TO THE EXCLUSIVE RIGHT TO USE "II", APART FROM THE MARK AS SHOWN.

FOR COATINGS FOR FIRE HOSES (U.S. CLS. 6, 11 AND 16).

FIRST USE 1-1-2002; IN COMMERCE 1-1-2002.

2,900,779. BAYER AKTIENGESELLSCHAFT, LEVERKUSEN-BAYERWERK, FED REP GERMANY. SN 78-237,272. PUB. 2-24-2004, FILED 4-14-2003.

**BAYFAST**

OWNER OF U.S. REG. NOS. 1,484,862, 2,402,109, AND OTHERS.

FOR PIGMENTS (U.S. CLS. 6, 11 AND 16).

FIRST USE 3-3-1988; IN COMMERCE 3-3-1988.

**CLASS 3—COSMETICS AND CLEANING PREPARATIONS**

2,900,031. FLAGEOLI, LIMITED, LOS ANGELES, CA. SN 75-440,755. PUB. 5-15-2001, FILED 2-14-1998.

**SERIOUS ANSWERS**

FOR COSMETICS AND SKIN CARE PRODUCTS; NAMELY, LOTIONS AND CREAMS FOR THE FACE AND BODY, FACIAL GELS, MOISTURIZING SPRAYS, TONERS, FACIAL MASKS, SKIN LIGHTENERS, HAND WASHES, FACIAL CLEANSERS, SUNSCREENS AND SUNBLOCKS, SKIN CLARIFIERS, CLEANSING PATCHES AND MAKE-UP (U.S. CLS. 1, 4, 6, 50, 51 AND 52).

FIRST USE 7-20-2004; IN COMMERCE 7-20-2004.

**CLASS 3—(Continued).**

2,900,032. FLAGEOLI, LIMITED, LOS ANGELES, CA. SN 75-440,756. PUB. 5-15-2001, FILED 2-14-1998.

**SERIOUS SOLUTIONS**

FOR COSMETICS AND SKIN CARE PRODUCTS; NAMELY, LOTIONS AND CREAMS FOR THE FACE AND BODY (U.S. CLS. 1, 4, 6, 50, 51 AND 52).  
FIRST USE 7-20-2004; IN COMMERCE 7-20-2004.

2,900,047. SMITH, EARL L. JR., SAN DIEGO, CA. AND SMITH, PATRICIA M., SAN DIEGO, CA. SN 75-618,171. PUB. 11-23-1999, FILED 1-6-1999.

**MIRACLE BLUE**

NO CLAIM IS MADE TO THE EXCLUSIVE RIGHT TO USE "BLUE", APART FROM THE MARK AS SHOWN.

FOR ALL PURPOSE CLEANERS SOLD OTHER THAN THROUGH RETAIL CHANNELS OF TRADE, AND SOLD EXCLUSIVELY TO INDUSTRIAL AND INSTITUTIONAL PURCHASERS (U.S. CLS. 1, 4, 6, 50, 51 AND 52).  
FIRST USE 9-1-1997; IN COMMERCE 9-1-1997.

**CLASS 3—(Continued).**

2,900,160. 19TH HOLE PRODUCTS, LLC, SPRING LAKE HEIGHTS, NJ. SN 76-269,895. PUB. 3-18-2003, FILED 6-11-2001.

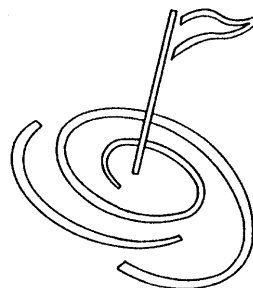

FOR COSMETICS AND SKIN CARE PRODUCTS, NAMELY, AFTER SHAVE LOTIONS, ANTI-PERSPIRANTS, ASTRINGENTS FOR COSMETIC PURPOSES, BABY OIL, BABY POWDER, BATH GEL, BATH OIL, BATH POWDER, BEAUTY MASKS, BODY CREAM, BODY OIL, BODY POWDER, COLOGNE, COLD CREAM, ESSENTIAL OILS FOR PERSONAL USE, FACIAL SCRUBS, HAND CREAM, MASSAGE LOTION FOR SKIN, MASSAGE OIL, NIGHT CREAM, PERFUME, PETROLEUM JELLY FOR COSMETIC PURPOSES, LIP BALM, FACE STICK, SHAVING CREAM, SHAVING GEL, SHAVING LOTION, SHOWER GEL, SKIN CLARIFIERS, SKIN CLEANSING CREAM, SKIN CLEANSING LOTION, SKIN CREAM, SKIN EMOLLIENTS, SKIN LOTION, SKIN MOISTURIZER, HAND LOTIONS, FACE CONDITIONERS AND MOISTURIZERS, TALCUM POWDER, TOILET SOAP, WINDSCREEN SKIN LOTION, SUN CARE PRODUCTS, NAMELY, HAIR SUN SCREENS, SUN SCREENS, SUN BLOCK, SUNTAN LOTIONS, AFTER-SUN LOTIONS, AND NON-MEDICATED OINTMENTS FOR THE PREVENTION AND TREATMENT OF SUNBURN; DISPOSABLE WIPES IMPREGNATED WITH CHEMICALS OR COMPOUNDS FOR PERSONAL HYGIENE (U.S. CLS. 1, 4, 6, 50, 51 AND 52).  
FIRST USE 1-1-2001; IN COMMERCE 1-1-2001.

2,900,162. BLISS WORLD LLC, BROOKLYN, NY. SN 76-278,881. PUB. 11-6-2001, FILED 6-27-2001.

**UnderArmy**

THE MARK CONSISTS OF STANDARD CHARACTERS WITHOUT CLAIM TO ANY PARTICULAR FONT, STYLE, SIZE, OR COLOR.

FOR PERSONAL DEODORANT AND ANTIPERSPIRANT (U.S. CLS. 1, 4, 6, 50, 51 AND 52).  
FIRST USE 8-0-2003; IN COMMERCE 5-0-2004.



**CLASS 3—(Continued).**

2,900,165. LG HOUSEHOLD & HEALTH CARE LTD., SEOUL 150-721, REPUBLIC OF KOREA. SN 76-285,223. PUB. 6-18-2002, FILED 7-13-2001.

**OHUI**

FOR COSMETICS; SKIN LOTIONS; SKIN TONERS; NON-MEDICATED SKIN ASTRINGENTS FOR COSMETIC PURPOSES; FACIAL CONCENTRATED EMULSION; AFTER SHAVE LOTIONS; SKIN CONDITIONERS; BLUSHER; PERFUMES; COLOGNES; SKIN CLEANSING CREAMS; SKIN MASSAGE CREAMS; MAKE-UP FOUNDATION IN THE FORM OF POWDER; LOTION AND CREAM; LIPSTICKS; TOILET WATER; TOILET CREAMS; SKIN MOISTURIZING CREAMS; NAIL POLISH REMOVER; MASCARA; EYE SHADOWS; EYEBROW PENCILS; EYE LINERS; BEAUTY MASKS; SUNBLOCK SKIN CREAMS; HAIR SHAMPOO; TOILET SOAPS; BODY CLEANSERS (U.S. CLS. 1, 4, 6, 50, 51 AND 52).  
FIRST USE 10-0-1997; IN COMMERCE 9-0-2003.

2,900,225. DAVID VILLARREAL, D.D.S., INC., WOODLAND HILLS, CA. SN 76-369,905. PUB. 10-1-2002, FILED 2-13-2002.

**ESTRELLA**

THE TERM "ESTRELLA" MAY BE TRANSLATED INTO ENGLISH AS "STAR".  
FOR DENTAL WHITENING KITS CONSISTING OF DENTAL WHITENING GEL AND FOAM TRAYS FOR HOLDING THE WHITENING GEL SOLD AS A UNIT (U.S. CLS. 1, 4, 6, 50, 51 AND 52).  
FIRST USE 6-15-2004; IN COMMERCE 6-15-2004.

2,900,382. IMUS, DEIRDRE, DARIEN, CT. SN 76-476,668. PUB. 12-2-2003, FILED 12-17-2002.

**GREENING THE CLEANING**

NO CLAIM IS MADE TO THE EXCLUSIVE RIGHT TO USE "CLEANING", APART FROM THE MARK AS SHOWN.  
FOR COMPLETE LINE OF NON-TOXIC ALL PURPOSE CLEANING PREPARATIONS (U.S. CLS. 1, 4, 6, 50, 51 AND 52).  
FIRST USE 0-0-2001; IN COMMERCE 0-0-2001.

2,900,388. HERBACEUTICALS, INC., NAPA, CA. SN 76-480,679. PUB. 11-4-2003, FILED 1-7-2003.

**NATUROOTS**

FOR NON-MEDICATED HAIR PREPARATIONS SOLD WITH HAIR DYES, HAIR GELS, HAIR RINSES AND HAIR CONDITIONS SOLD WITH APPLICATOR (U.S. CLS. 1, 4, 6, 50, 51 AND 52).  
FIRST USE 3-1-1997; IN COMMERCE 3-1-1997.

**CLASS 3—(Continued).**

2,900,469. L.C. LICENSING, INC., NEW YORK, NY. SN 76-513,512. PUB. 5-4-2004, FILED 5-12-2003.

**SPARK**  
liz claiborne

OWNER OF U.S. REG. NOS. 1,167,434, 1,426,489, AND OTHERS.

THE NAME "LIZ CLAIBORNE" IDENTIFIES A LIVING INDIVIDUAL WHOSE CONSENT IS OF RECORD.  
FOR PERFUMES, COLOGNES, TOILET SOAP, MOISTURIZING SKIN CREAM, SKIN CLEANSING CREAM, BODY LOTIONS, FACE POWDER, LIPSTICK, NAIL ENAMEL, HAIR SHAMPOOS, HAIR CONDITIONERS AND HAIR RINSES; PERFUMED TALCUM POWDER, AFTER SHAVE LOTION, SHAVING GEL, DEODORANT AND BATH SOAP, TOILET SOAP, BATH GEL, SHOWER GEL AND BODY SCRUB (U.S. CLS. 1, 4, 6, 50, 51 AND 52).  
FIRST USE 7-25-2003; IN COMMERCE 7-25-2003.

2,900,501. ORLY INTERNATIONAL, INC., CHATSWORTH, CA. SN 76-526,442. PUB. 3-23-2004, FILED 6-23-2003.

**TOUGH COOKIE**

FOR NAIL CARE PREPARATIONS (U.S. CLS. 1, 4, 6, 50, 51 AND 52).  
FIRST USE 5-1-2004; IN COMMERCE 5-1-2004.

2,900,542. DANOVIH, SHARON, OAKDALE, PA. SN 78-045,776. PUB. 4-9-2002, FILED 1-31-2001.

**VIOLET SKIN CARE  
ALGINATE SC**

NO CLAIM IS MADE TO THE EXCLUSIVE RIGHT TO USE "SKIN CARE ALGINATE SC", APART FROM THE MARK AS SHOWN.

FOR NON-MEDICATED SKIN CARE PRODUCTS, NAMELY SKIN CREAM AND SKIN LOTIONS FOR POST-OPERATIVE/PRE-OPERATIVE LASER, DERMABRASION, SURGICAL PEEL, FACE LIFT, AND POST-OPERATIVE BREAST AUGMENTATION/REDUCTION PROCEDURES (U.S. CLS. 1, 4, 6, 50, 51 AND 52).  
FIRST USE 9-15-2002; IN COMMERCE 9-20-2002.

**CLASS 3—(Continued).**

2,900,547. CROY TRUST LIMITED, ST. HELIER, JERSEY, UNITED KINGDOM. SN 78-060,573. PUB. 5-20-2003, FILED 4-26-2001.

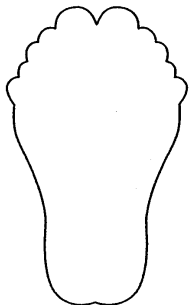

OWNER OF UNITED KINGDOM REG. NO. 2202960, DATED 7-14-1999, EXPIRES 7-14-2009.

OWNER OF UNITED KINGDOM REG. NO. 2202960, DATED 12-24-1999, EXPIRES 7-14-2009.

THE MARK CONSISTS OF THE SHAPE OF THE PACKAGING IN WHICH THE GOODS ARE PACKAGED AND SOLD, SUCH DESIGN CONSISTING OF THE OUTLINE OF TWO HUMAN FEET.

FOR TOILET PREPARATIONS AND COSMETICS, NAMELY, BATH OIL, FOAM BATH, SHOWER GEL, BATH CRYSTALS, BATH MILK, BATH POWDER, LIP GLOSS, LIP BALM, NIGHT CREAM, MOISTURIZING CREAM, MOISTURIZING GEL, HAND CREAM, HAND LOTION, BODY LOTION, EYE GEL, ASTRINGENTS, SKIN TONERS, FACE MASKS, FACE LOTION, FACE SCRUB, EYE MAKE-UP REMOVER, CLEANSING MILK, BODY OIL, MASSAGE OIL, SKIN SOAP, SKIN CLEANSING BARS, HAIR CONDITIONER, HAIR GEL, HAIR SHAMPOO, FOOT LOTIONS AND MUD PACKS FOR THE FACE AND THE BODY, PERFUMERY, ESSENTIAL OILS, HAIR LOTIONS AND DENTIFRICES; COSMETICS (U.S. CLS. 1, 4, 6, 50, 51 AND 52).

FIRST USE 5-31-1999; IN COMMERCE 5-31-1999.

2,900,571. PROSTRONG, INC., OAKVILLE, CT. SN 78-112,688. PUB. 3-25-2003, FILED 3-5-2002.

**PROARMOR**

OWNER OF U.S. REG. NOS. 2,169,729, 2,496,701, AND OTHERS.

FOR NAIL CARE PREPARATIONS, NAMELY NAIL POLISH, NAIL ENAMEL, NAIL HARDENER, NAIL STRENGTHENER, NAIL BUILDER, PARAFFIN NAIL TREATMENTS, NAIL SEALER, NAIL POLISH BASE COAT AND TOP COAT, NAIL CLEANSER, NAIL BUFFING CREAM, NAIL POLISH REMOVER, LIQUID NAIL POLISH DRYER, NAIL POLISH SMUDGE CORRECTOR, NAIL CONDITIONER, NAIL CREAM, NAIL MOISTURIZER, CUTICLE REMOVER CREAM, CUTICLE CONDITIONER, CUTICLE CREAM, AND CUTICLE MOISTURIZER; HAND CARE PREPARATIONS, NAMELY HAND CREAM AND MOISTURIZER (U.S. CLS. 1, 4, 6, 50, 51 AND 52).

FIRST USE 6-10-2004; IN COMMERCE 6-10-2004.

**CLASS 3—(Continued).**

2,900,601. E.T. BROWNE DRUG CO., INC., ENGLEWOOD CLIFFS, NJ. SN 78-137,398. PUB. 1-28-2003, FILED 6-20-2002.

**COCOA BUTTER BRONZE**

OWNER OF U.S. REG. NO. 1,497,346.  
NO CLAIM IS MADE TO THE EXCLUSIVE RIGHT TO USE "COCOA BUTTER", APART FROM THE MARK AS SHOWN.

FOR SUNTANNING PREPARATIONS AND SKIN MOISTURIZERS (U.S. CLS. 1, 4, 6, 50, 51 AND 52).

FIRST USE 6-30-2004; IN COMMERCE 6-30-2004.

2,900,613. HELEN OF TROY LIMITED, BRIDGETOWN, BARBADOS. SN 78-145,755. PUB. 7-29-2003, FILED 7-19-2002.

**CONDITION 3-IN-1**

OWNER OF U.S. REG. NO. 1,012,632.  
NO CLAIM IS MADE TO THE EXCLUSIVE RIGHT TO USE "3-IN-1", APART FROM THE MARK AS SHOWN.

FOR HAIR CARE PREPARATIONS (U.S. CLS. 1, 4, 6, 50, 51 AND 52).

FIRST USE 0-0-1991; IN COMMERCE 0-0-1991.

2,900,674. DAVE'S SODA & PET CITY, AGAWAM, MA. SN 78-196,679. PUB. 9-23-2003, FILED 12-20-2002.

**DOODISOLVE**

FOR NONTOXIC, BIODEGRADABLE CLEANER THAT INSTANTLY DISSOLVES BIRD DROPPINGS ON ALL SURFACES (U.S. CLS. 1, 4, 6, 50, 51 AND 52).

FIRST USE 2-20-2003; IN COMMERCE 2-20-2003.

2,900,710. JAFER LIMITED, HAMILTON, BERMUDA. SN 78-215,111. PUB. 1-20-2004, FILED 2-14-2003.

**IRRADIANT EYE**

NO CLAIM IS MADE TO THE EXCLUSIVE RIGHT TO USE "EYE", APART FROM THE MARK AS SHOWN.

FOR FACIAL MOISTURIZERS, COLD CREAMS, EYE CREAM, NIGHT CREAM, SKIN CREAM, VANISHING CREAM, SKIN MOISTURIZER, SKIN CLARIFIERS, SKIN EMOLLIENTS, SKIN LOTIONS, SKIN MOISTURIZERS, SKIN TONER, WRINKLE REMOVING SKIN CARE PREPARATIONS (U.S. CLS. 1, 4, 6, 50, 51 AND 52).

FIRST USE 5-12-2001; IN COMMERCE 4-30-2004.

**CLASS 3—(Continued).**

2,900,725. BORELL, MARJORIE, NEW YORK, NY. SN 78-220,599. PUB. 9-30-2003, FILED 3-2-2003.

**UVEIL**

FOR SKIN CREAMS WITH SUNSCREEN AND SUN BLOCK (U.S. CLS. 1, 4, 6, 50, 51 AND 52).  
FIRST USE 4-12-2004; IN COMMERCE 5-15-2004.

---

2,900,732. IN GEAR FASHIONS INC, MIAMI, FL. SN 78-223,315. PUB. 11-25-2003, FILED 3-8-2003.

**INGEAR**

FOR SUN BLOCK, NON-MEDICATED LIP PROTECTOR, PERSONAL DEODORANT, COSMETICS, BODY SPRAY, HAIR GEL, HAIR SHAMPOO (U.S. CLS. 1, 4, 6, 50, 51 AND 52).  
FIRST USE 10-1-1989; IN COMMERCE 4-6-2004.

---

2,900,783. GRABARSKY, JACKIE, H, EL SEGUNDO, CA. SN 78-238,011. PUB. 1-27-2004, FILED 4-15-2003.

**JACKIE'S NATURAL GARDEN**

FOR AROMATHERAPY PRODUCTS, NAMELY, OILS, LOTIONS, CREAMS AND PILLOWS COMPRISING POTPOURRI IN FABRIC CONTAINERS; WEARABLE NATURAL STONES FOR PERSONAL USE (U.S. CLS. 1, 4, 6, 50, 51 AND 52).  
FIRST USE 5-1-2003; IN COMMERCE 5-1-2003.

---

2,900,818. PRL USA HOLDINGS, INC., WILMINGTON, DE. SN 78-255,540. PUB. 3-23-2004, FILED 5-29-2003.

**SAVED BY THE GEL**

FOR HAIR STYLING PREPARATION (U.S. CLS. 1, 4, 6, 50, 51 AND 52).  
FIRST USE 1-0-2004; IN COMMERCE 1-0-2004.

---

2,900,845. BONNE BELL, INC., LAKEWOOD, OH. SN 78-270,429. PUB. 3-16-2004, FILED 7-3-2003.

**VITA GLOSS20**

FOR LIP GLOSS (U.S. CLS. 1, 4, 6, 50, 51 AND 52).  
FIRST USE 12-15-2003; IN COMMERCE 12-15-2003.

**CLASS 3—(Continued).**

2,900,851. BEZDETNY, EDWARD, FERNDALE, MI. SN 78-274,741. PUB. 3-16-2004, FILED 7-16-2003.

**CLEAR TOUCH**

FOR CLEANING PREPARATIONS, PARTICULARLY SUITED FOR CLEANING GLASS SURFACES (U.S. CLS. 1, 4, 6, 50, 51 AND 52).  
FIRST USE 8-0-2003; IN COMMERCE 8-0-2003.

---

2,900,859. BLEAMAN, DAVID, M., SCOTTSDALE, AZ. SN 78-281,783. PUB. 4-27-2004, FILED 7-31-2003.

**PIN HIGH COLADA**

FOR SUNSCREEN PREPARATIONS, NAMELY NON-MEDICATED LIP BALM AND SUNSCREEN LOTION (U.S. CLS. 1, 4, 6, 50, 51 AND 52).  
FIRST USE 1-28-2004; IN COMMERCE 1-28-2004.

---

2,900,860. BLEAMAN, DAVID M., SCOTTSDALE, AZ. SN 78-281,787. PUB. 4-27-2004, FILED 7-31-2003.

**FOREIGNAL**

FOR SUNSCREEN PREPARATIONS, NAMELY NON-MEDICATED LIP BALM AND SUNSCREEN LOTION (U.S. CLS. 1, 4, 6, 50, 51 AND 52).  
FIRST USE 1-28-2004; IN COMMERCE 1-28-2004.

---

2,900,869. L'OREAL USA CREATIVE, INC., NEW YORK, NY. SN 78-296,707. PUB. 4-27-2004, FILED 9-5-2003.

**WATER RUSH**

FOR HAIR CARE PREPARATIONS (U.S. CLS. 1, 4, 6, 50, 51 AND 52).  
FIRST USE 4-0-2004; IN COMMERCE 4-0-2004.

**CLASS 3—(Continued).**

2,900,872. L'OREAL USA CREATIVE, INC., NEW YORK, NY.  
SN 78-331,327. PUB. 4-27-2004, FILED 11-21-2003.

**CLASS 3—(Continued).**

2,900,874. L'OREAL USA CREATIVE, INC., NEW YORK, NY.  
SN 78-339,197. PUB. 5-4-2004, FILED 12-11-2003.

**GO CLEAN**

**POLISH UP**

THE MARK CONSISTS OF STANDARD CHARACTERS  
WITHOUT CLAIM TO ANY PARTICULAR FONT, STYLE,  
SIZE, OR COLOR.  
FOR HAIR SHAMPOO (U.S. CLS. 1, 4, 6, 50, 51 AND  
52).  
FIRST USE 4-0-2004; IN COMMERCE 4-0-2004.

THE MARK CONSISTS OF STANDARD CHARACTERS  
WITHOUT CLAIM TO ANY PARTICULAR FONT, STYLE,  
SIZE, OR COLOR.  
FOR HAIR STYLING PREPARATION (U.S. CLS. 1, 4, 6,  
50, 51 AND 52).  
FIRST USE 4-0-2004; IN COMMERCE 4-0-2004.

---

2,900,873. L'OREAL USA CREATIVE, INC., NEW YORK, NY.  
SN 78-332,764. PUB. 5-4-2004, FILED 11-25-2003.

---

2,900,875. L'OREAL USA CREATIVE, INC., NEW YORK, NY.  
SN 78-339,199. PUB. 5-4-2004, FILED 12-11-2003.

**FINISH UP**

**GET GROOMED**

THE MARK CONSISTS OF STANDARD CHARACTERS  
WITHOUT CLAIM TO ANY PARTICULAR FONT, STYLE,  
SIZE, OR COLOR.  
FOR HAIR CARE PREPARATION (U.S. CLS. 1, 4, 6, 50,  
51 AND 52).  
FIRST USE 4-0-2004; IN COMMERCE 4-0-2004.

THE MARK CONSISTS OF STANDARD CHARACTERS  
WITHOUT CLAIM TO ANY PARTICULAR FONT, STYLE,  
SIZE, OR COLOR.  
FOR HAIR STYLING PREPARATION (U.S. CLS. 1, 4, 6,  
50, 51 AND 52).  
FIRST USE 4-0-2004; IN COMMERCE 4-0-2004.

**CLASS 3—(Continued).**

2,900,876. L'OREAL USA CREATIVE, INC., NEW YORK, NY.  
SN 78-339,201. PUB. 5-4-2004, FILED 12-11-2003.

**CLASS 3—(Continued).**

2,900,878. L'OREAL USA CREATIVE, INC., NEW YORK, NY.  
SN 78-339,852. PUB. 4-27-2004, FILED 12-12-2003.

# GRIP TIGHT

# DENSIFY

THE MARK CONSISTS OF STANDARD CHARACTERS WITHOUT CLAIM TO ANY PARTICULAR FONT, STYLE, SIZE, OR COLOR.  
FOR HAIR STYLING PREPARATION (U.S. CLS. 1, 4, 6, 50, 51 AND 52).  
FIRST USE 4-0-2004; IN COMMERCE 4-0-2004.

THE MARK CONSISTS OF STANDARD CHARACTERS WITHOUT CLAIM TO ANY PARTICULAR FONT, STYLE, SIZE, OR COLOR.  
FOR HAIR SHAMPOOS (U.S. CLS. 1, 4, 6, 50, 51 AND 52).  
FIRST USE 4-0-2004; IN COMMERCE 4-0-2004.

2,900,877. L'OREAL USA CREATIVE, INC., NEW YORK, NY.  
SN 78-339,392. PUB. 4-27-2004, FILED 12-11-2003.

2,900,884. BONNE BELL, INC., LAKEWOOD, OH. SN 78-975,570. PUB. 3-16-2004, FILED 7-3-2003.

# CLIP 'N GO

FOR COSMETICS, NAMELY, NON-MEDICATED LIP BALMS, LIP GLOSSES, NON-MEDICATED BALMS CONTAINING SUN SCREEN AND LIP GLOSS CONTAINING SUN SCREEN (U.S. CLS. 1, 4, 6, 50, 51 AND 52).  
FIRST USE 12-15-2003; IN COMMERCE 12-15-2003.

# MANEUVER

## CLASS 4—LUBRICANTS AND FUELS

2,900,721. BLUE STAR CANDLES, L.P., LUBBOCK, TX. SN 78-219,074. PUB. 10-21-2003, FILED 2-26-2003.

# BOTIKA CANDLES

THE MARK CONSISTS OF STANDARD CHARACTERS WITHOUT CLAIM TO ANY PARTICULAR FONT, STYLE, SIZE, OR COLOR.  
FOR HAIR STYLING PREPARATION (U.S. CLS. 1, 4, 6, 50, 51 AND 52).  
FIRST USE 4-0-2004; IN COMMERCE 4-0-2004.

NO CLAIM IS MADE TO THE EXCLUSIVE RIGHT TO USE "CANDLES", APART FROM THE MARK AS SHOWN.  
FOR CANDLES (U.S. CLS. 1, 6 AND 15).  
FIRST USE 7-1-2004; IN COMMERCE 7-1-2004.

**CLASS 4—(Continued).**

2,900,830. CASTROL LIMITED, SWINDON, WILTSHIRE, UNITED KINGDOM. SN 78-263,688. PUB. 3-2-2004, FILED 6-18-2003.

## EVERYTHING ELSE IS JUST MOTOR OIL

FOR LUBRICANTS FOR MOTOR VEHICLES (U.S. CLS. 1, 6 AND 15).  
FIRST USE 8-31-2003; IN COMMERCE 8-31-2003.

**CLASS 5—PHARMACEUTICALS**

2,900,073. MOLECULAR TECHNOLOGY CORPORATION, NEW YORK, NY. SN 75-853,579. PUB. 10-16-2001, FILED 11-19-1999.

## MOLECUTEC

FOR PHARMACEUTICALS, NAMELY, THERAPEUTIC AND PROPHYLACTIC ANTIOXIDANT PREPARATIONS USED IN THE TREATMENT OF COMMON SKIN DISEASES AND TO PROMOTE WOUND HEALING, THERAPEUTIC AND PROPHYLACTIC ANTIOXIDANT PREPARATIONS USED IN THE TREATMENT OF DIABETES, THERAPEUTIC AND PROPHYLACTIC ANTIOXIDANT PREPARATIONS USED IN THE TREATMENT OF OBESITY, THERAPEUTIC AND PROPHYLACTIC ANTIOXIDANT PREPARATIONS USED IN THE TREATMENT OF INFLAMMATION, THERAPEUTIC AND PROPHYLACTIC ANTIOXIDANT PREPARATIONS USED IN THE TREATMENT OF GASTRO-INTESTINAL DISORDERS, THERAPEUTIC AND PROPHYLACTIC ANTIOXIDANT PREPARATIONS USED IN THE TREATMENT OF KIDNEY DISEASE, AND THERAPEUTIC AND PROPHYLACTIC ANTIOXIDANT PREPARATIONS USED IN THE TREATMENT OF LIVER DISEASE; SOLID CATALYST COMPOSITIONS USED IN THE TREATMENT OF SKIN DISEASES, AUTOIMMUNE DISEASES AND DIGESTIVE DISORDERS; AND VAGINAL PREPARATIONS IN THE FORM OF CREAMS, LOTIONS, GELS AND SUPPOSITORIES FOR USE IN THE TREATMENT OF BACTERIAL AND YEAST INFECTIONS (U.S. CLS. 6, 18, 44, 46, 51 AND 52).

FIRST USE 6-30-2002; IN COMMERCE 6-30-2002.

2,900,106. TRIARCO INDUSTRIES, INC., WAYNE, NJ. SN 76-084,532. PUB. 4-10-2001, FILED 7-7-2000.

## FENG SHUI

FOR VITAMINS, MINERALS, NUTRITIONAL AND DIETARY SUPPLEMENTS (U.S. CLS. 6, 18, 44, 46, 51 AND 52).

FIRST USE 7-6-2000; IN COMMERCE 7-6-2000.

**CLASS 5—(Continued).**

2,900,107. CELLEGY PHARMACEUTICALS, INC., SOUTH SAN FRANCISCO, CA. SN 76-089,287. PUB. 4-17-2001, FILED 7-14-2000.

## RECTOGESIC

FOR PHARMACEUTICAL PREPARATIONS AND OINTMENTS FOR THE TREATMENT OF RECTAL CONDITIONS, DISEASES AND DISORDERS (U.S. CLS. 6, 18, 44, 46, 51 AND 52).

FIRST USE 6-3-2004; IN COMMERCE 6-3-2004.

2,900,127. PURAPHARM INTERNATIONAL (H.K.), CENTRAL, HONG KONG. SN 76-136,922. PUB. 10-22-2002, FILED 9-27-2000.

## MENOAID

FOR PHARMACEUTICAL PREPARATIONS AND CHINESE HERBAL MEDICINES USED TO TREAT MENOPAUSAL SYNDROME/SYMPTOMS; HERBAL EXTRACTS FOR USE AS DIETARY; DIETARY SUPPLEMENTS (U.S. CLS. 6, 18, 44, 46, 51 AND 52).

FIRST USE 10-21-2000; IN COMMERCE 12-27-2001.

2,900,236. PHARMAVITE LLC, MISSION HILLS, CA. SN 76-381,810. PUB. 2-10-2004, FILED 3-13-2002.

## SOY BALANCE

NO CLAIM IS MADE TO THE EXCLUSIVE RIGHT TO USE "SOY", APART FROM THE MARK AS SHOWN.

FOR VITAMINS AND FOOD SUPPLEMENTS (U.S. CLS. 6, 18, 44, 46, 51 AND 52).

FIRST USE 4-17-2002; IN COMMERCE 4-17-2002.

2,900,263. BIOMUNE COMPANY, AKA BIOMUNE CO., LENEXA, KS. SN 76-403,662. PUB. 11-19-2002, FILED 5-3-2002.

## PNEUMOMUNE

FOR VETERINARY VACCINES FOR MAMMALIAN AND AVIAN USE (U.S. CLS. 6, 18, 44, 46, 51 AND 52).

FIRST USE 2-25-2003; IN COMMERCE 2-25-2003.

**CLASS 5—(Continued).**

2,900,363. PRAECIS PHARMACEUTICALS INCORPORATED, WALTHAM, MA. SN 76-469,825. PUB. 12-9-2003, FILED 11-25-2002.



**PLENAXIS**

THE STIPPLING IS FOR SHADING PURPOSES. FOR PHARMACEUTICAL PREPARATIONS FOR TREATMENT OF HORMONALLY RESPONSIVE CONDITIONS, NAMELY LHRJI ASSOCIATED CONDITIONS (U.S. CLS. 6, 18, 44, 46, 51 AND 52). FIRST USE 1-21-2004; IN COMMERCE 1-21-2004.

**CLASS 5—(Continued).**

2,900,378. NBTY, INC., BOHEMIA, NY. SN 76-474,824. PUB. 10-21-2003, FILED 12-10-2002.

**GINGER RELIEF**

NO CLAIM IS MADE TO THE EXCLUSIVE RIGHT TO USE "GINGER", APART FROM THE MARK AS SHOWN. FOR DIETARY AND HERBAL SUPPLEMENTS (U.S. CLS. 6, 18, 44, 46, 51 AND 52). FIRST USE 2-24-2003; IN COMMERCE 2-24-2003.

2,900,368. NATREN INC., WESTLAKE VILLAGE, CA. SN 76-471,011. PUB. 5-27-2003, FILED 11-20-2002.

**HEALTHY FLORA**

OWNER OF U.S. REG. NO. 2,036,482. NO CLAIM IS MADE TO THE EXCLUSIVE RIGHT TO USE "FLORA", APART FROM THE MARK AS SHOWN. FOR LACTOBACILLUS SOLD AS A DIETARY SUPPLEMENT (U.S. CLS. 6, 18, 44, 46, 51 AND 52). FIRST USE 6-8-2004; IN COMMERCE 6-8-2004.

2,900,411. METAGENICS, INC., SAN CLEMENTE, CA. SN 76-490,077. PUB. 10-21-2003, FILED 2-20-2003.

**KAPREX**

2,900,369. NATREN INC., WESTLAKE VILLAGE, CA. SN 76-471,013. PUB. 5-27-2003, FILED 11-20-2002.

**HEALTHY COLON**

OWNER OF U.S. REG. NO. 2,036,482. NO CLAIM IS MADE TO THE EXCLUSIVE RIGHT TO USE "COLON", APART FROM THE MARK AS SHOWN. FOR BIFIDOBACTERIA CULTURE SOLD AS A DIETARY SUPPLEMENT (U.S. CLS. 6, 18, 44, 46, 51 AND 52). FIRST USE 6-8-2004; IN COMMERCE 6-8-2004.

FOR DIETARY SUPPLEMENTS (U.S. CLS. 6, 18, 44, 46, 51 AND 52). FIRST USE 3-7-2003; IN COMMERCE 3-10-2003.

2,900,493. WESTLAKE LABORATORIES, INC., CLEVELAND, OH. SN 76-522,358. PUB. 1-20-2004, FILED 6-6-2003.

2,900,370. PH DOI, LLC, POTOMAC, MD. SN 76-471,080. PUB. 5-13-2003, FILED 11-19-2002.

**ADVANCED Q PLUS**

FOR NUTRITIONAL FOOD SUPPLEMENTS AND VITAMINS (U.S. CLS. 6, 18, 44, 46, 51 AND 52). FIRST USE 4-16-2004; IN COMMERCE 4-16-2004.

**AUTHIA**

FOR VITAMINS FOR PATIENTS WITH AUTISM (U.S. CLS. 6, 18, 44, 46, 51 AND 52). FIRST USE 8-29-2003; IN COMMERCE 9-10-2003.

**CLASS 5—(Continued).**

2,900,515. YAMANOUCHI PHARMACEUTICAL CO., LTD., CHUO-KU, TOKYO, JAPAN. AND YAMANOUCHI PHARMA TECHNOLOGIES, INC., PALO ALTO, CA. SN 76-976,104. PUB. 12-18-2001, FILED 3-27-2000.



FOR SWALLOW-FACILITATING FORMULATION SOLD AS AN INTEGRAL COMPONENT OF PHARMACEUTICAL PREPARATIONS FOR THE TREATMENT OF DISEASE OR HEALTH-RELATED CONDITIONS INVOLVING BLOOD AND BLOOD-FORMING ORGANS, THE CARDIAC CIRCULATORY SYSTEMS, THE PERIPHERAL VASCULAR CIRCULATORY SYSTEM, THE ENDOCRINE SYSTEM, THE GENITOURINARY SYSTEM, THE IMMUNE SYSTEM, INFECTIOUS AND PARASITIC CONDITIONS, THE UPPER AND LOWER DIGESTIVE SYSTEM, MENTAL DISORDERS, METABOLIC DISORDERS, MULTI-SYSTEM AND ILL-DEFINED CONDITIONS, MUSCULOSKELETAL SYSTEMS AND CONNECTIVE TISSUE, NEOPLASMS, THE NERVOUS SYSTEM, NUTRITIONAL DISORDERS, PREGNANCY, THE RESPIRATORY SYSTEM, SENSORY ORGAN CONDITIONS, SKIN AND SUBCUTANEOUS CONDITIONS (U.S. CLS. 6, 18, 44, 46, 51 AND 52).  
FIRST USE 2-16-2000; IN COMMERCE 1-16-2000.

**CLASS 5—(Continued).**

2,900,522. CONNETICS CORPORATION, PALO ALTO, CA. SN 76-976,908. PUB. 4-1-2003, FILED 4-17-2002.

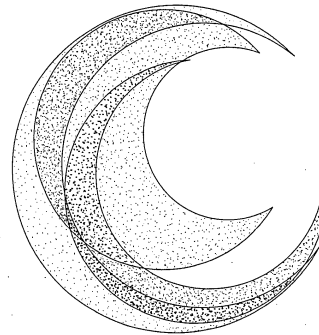

THE STIPPLING IS FOR SHADING PURPOSES ONLY NOT A FEATURE OF THE MARK.

THE MARK CONSISTS OF A STYLIZED DEPICTION OF SEVEN "C'S".

FOR PHARMACEUTICAL PREPARATIONS FOR THE PREVENTION AND TREATMENT OF DISEASES OF THE SKIN AND SKIN STRUCTURE, ABNORMAL GROWTH AND REMODELING DISORDERS, AND AUTOIMMUNE DISORDERS; DIAGNOSTIC REAGENTS FOR CLINICAL OR MEDICAL LABORATORY USE; DIAGNOSTIC TEST KITS PRIMARILY CONTAINING REAGENTS FOR CLINICAL OR MEDICAL LABORATORY USE FOR DISEASES INVOLVING SKIN AND STRUCTURE, ABNORMAL GROWTH AND REMODELING DISORDERS AND AUTO IMMUNE DISORDERS (U.S. CLS. 6, 18, 44, 46, 51 AND 52).  
FIRST USE 4-27-2002; IN COMMERCE 4-27-2002.



**CLASS 5—(Continued).**

2,900,524. SWISS HERBAL REMEDIES LTD., RICHMOND HILL ONTARIO, CANADA. SN 76-976,931. PUB. 10-7-2003, FILED 3-25-2002.



THE MARK CONSISTS OF A BLACK RECTANGLE WITH THE WORD "SWISS" AT THE TOP OF THE RECTANGLE AND THE WORD PHRASE "NATURAL SOURCES" DIRECTLY UNDER IT. ALL THREE WORDS IN WHITE LETTERS WITHIN THE UPPER HALF OF THE RECTANGLE. THE WORD "SWISS" APPEARS IN LETTERS MORE THAN TWICE THE SIZE OF THE LETTERS USED FOR THE WORDS "NATURAL SOURCES". THE LOWER HALF OF THE RECTANGLE SHOWS DESIGN ELEMENTS CONSISTING OF WHITE DRAWINGS OF SEVERAL FLOWERING PLANTS IN THE FOREGROUND AND SNOW-CAPPED MOUNTAINS IN THE BACKGROUND.

FOR VITAMINS, MINERAL SUPPLEMENTS, AND HERBAL SUPPLEMENTS IN TABLET AND CAPSULE FORM, VITAMINS IN LIQUID FORM (U.S. CLS. 6, 18, 44, 46, 51 AND 52).

FIRST USE 0-0-1985; IN COMMERCE 0-0-2002.

2,900,529. PEGASUS INTERNATIONAL, INC., FORT WASHINGTON, PA. SN 76-976,975. PUB. 9-3-2002, FILED 11-6-2001.

**SENSATIONAL SCENTS**

NO CLAIM IS MADE TO THE EXCLUSIVE RIGHT TO USE "SCENTS", APART FROM THE MARK AS SHOWN.

FOR AIR FRESHENERS, CARPET REFRESHERS, NAMELY FRAGRANCED SPRAYS AND POWDERS TO BE APPLIED TO CARPETS (U.S. CLS. 6, 18, 44, 46, 51 AND 52).

FIRST USE 12-15-2003; IN COMMERCE 12-15-2003.

2,900,534. STEMCO BIOMEDICAL, INC., DURHAM, NC. SN 76-977,001. PUB. 10-22-2002, FILED 1-29-2002.

**STEMCO BIOMEDICAL**

NO CLAIM IS MADE TO THE EXCLUSIVE RIGHT TO USE "BIOMEDICAL", APART FROM THE MARK AS SHOWN.

FOR DIAGNOSTIC REAGENTS FOR CLINICAL OR MEDICAL LABORATORY USE; PHARMACEUTICALS FOR USE IN THE TREATMENT OF CANCER, AUTO-IMMUNE AND DEGENERATIVE DISEASES, NAMELY, SYSTEMIC LUPUS ERYTHRYMATOSIS, DIABETES, ALZHEIMER'S DISEASE, PARKINSON'S DISEASE, AND ANEMIAS (U.S. CLS. 6, 18, 44, 46, 51 AND 52).

FIRST USE 6-1-2002; IN COMMERCE 6-1-2002.

**CLASS 5—(Continued).**

2,900,568. PFIZER INC., MORRIS PLAINS, NJ. SN 78-108,836. PUB. 7-23-2002, FILED 2-15-2002.

**TILANX**

FOR PHARMACEUTICAL PREPARATIONS FOR THE TREATMENT OF INFECTIOUS DISEASES AND IMMUNOLOGICAL AND VIRAL DISORDERS (U.S. CLS. 6, 18, 44, 46, 51 AND 52).

FIRST USE 6-16-2004; IN COMMERCE 6-16-2004.

2,900,627. DECAS CRANBERRY PRODUCTS, INC., WAREHAM, MA. SN 78-158,301. PUB. 4-1-2003, FILED 8-27-2002.

**NUTRICRAN**

FOR FRUIT-DERIVED DIETARY SUPPLEMENTS (U.S. CLS. 6, 18, 44, 46, 51 AND 52).

FIRST USE 2-24-2003; IN COMMERCE 2-24-2003.

2,900,665. CHEMCO INDUSTRIES, INC., LOS ANGELES, CA. SN 78-190,892. PUB. 12-16-2003, FILED 12-3-2002.

**JAPAN GREENWAVE**

NO CLAIM IS MADE TO THE EXCLUSIVE RIGHT TO USE "JAPAN", APART FROM THE MARK AS SHOWN.

FOR DIETARY AND NUTRITIONAL SUPPLEMENTS (U.S. CLS. 6, 18, 44, 46, 51 AND 52).

FIRST USE 12-4-2002; IN COMMERCE 12-4-2002.

2,900,682. RANBAXY LABORATORIES LIMITED, NEW DELHI, INDIA. SN 78-199,854. PUB. 8-26-2003, FILED 1-3-2003.

**RANICLOR**

FOR PHARMACEUTICAL AND MEDICINAL PREPARATIONS FOR HUMAN USE, NAMELY, ANTIBIOTICS (U.S. CLS. 6, 18, 44, 46, 51 AND 52).

FIRST USE 5-5-2004; IN COMMERCE 5-5-2004.

2,900,688. BAYER AKTIENGESELLSCHAFT, LEVERKUSEN-BAYERWERK, FED REP GERMANY. SN 78-201,937. PUB. 8-19-2003, FILED 1-10-2003.

**CO-RAL PLUS**

OWNER OF U.S. REG. NO. 679,075.  
FOR ANTIPARASITIC PREPARATIONS FOR USE ON ANIMALS (U.S. CLS. 6, 18, 44, 46, 51 AND 52).

FIRST USE 11-0-2001; IN COMMERCE 11-0-2001.

**CLASS 5—(Continued).**

2,900,696. KENT FEEDS, INC., MUSCATINE, IA. SN 78-203,599. PUB. 12-16-2003, FILED 1-15-2003.

**OVERDRIVE**

FOR ANIMAL FEED SUPPLEMENTS (U.S. CLS. 6, 18, 44, 46, 51 AND 52).  
FIRST USE 5-7-2003; IN COMMERCE 5-9-2003.

2,900,715. RAVO, AARON, LOS ANGELES, CA. AND RAVO, DAVID, LOS ANGELES, CA. SN 78-217,206. PUB. 9-23-2003, FILED 2-20-2003.

**ACHIEVE A TRIM BODY**

FOR MEAL REPLACEMENT BARS; VITAMIN, MINERAL AND DIETARY FOOD SUPPLEMENTS; NUTRITIONAL MEAL REPLACEMENT DRINKS (U.S. CLS. 6, 18, 44, 46, 51 AND 52).  
FIRST USE 6-16-2004; IN COMMERCE 6-16-2004.

2,900,727. BLISTEX INC., OAK BROOK, IL. SN 78-221,443. PUB. 10-21-2003, FILED 3-4-2003.

**STRI-DEX XPECT MORE**

OWNER OF U.S. REG. NOS. 693,083, 2,629,198, AND OTHERS.  
FOR MEDICATED TOPICAL PREPARATIONS FOR HUMAN USE FOR CLEANSING THE SKIN, TO PREVENT OR ALLEVIATE THE SYMPTOMS OF ACNE AND OTHER SKIN AFFLICTIONS, FOR SKIN AND LIP CARE PROTECTION, MEDICATED SKIN AND LIP SUN SCREEN PREPARATIONS, AND APPLICATORS OR PADS SOLD AS A COMPONENT WITH THE FOREGOING ITEMS (U.S. CLS. 6, 18, 44, 46, 51 AND 52).  
FIRST USE 10-31-2003; IN COMMERCE 10-31-2003.

2,900,786. ANABOLIC LABORATORIES, INC., LAKE FOREST, CA. SN 78-239,101. PUB. 11-4-2003, FILED 4-17-2003.

**NEURO-EASE**

FOR NUTRITIONAL AND DIETARY SUPPLEMENTS (U.S. CLS. 6, 18, 44, 46, 51 AND 52).  
FIRST USE 6-2-2003; IN COMMERCE 6-2-2003.

2,900,791. V.E.T. PHARMACEUTICALS, INC., FENTON, MO. SN 78-241,788. PUB. 12-2-2003, FILED 4-24-2003.

**LEVOSYN**

FOR MEDICATION FOR THE TREATMENT OF THYROID-RELATED DISORDERS IN ANIMALS (U.S. CLS. 6, 18, 44, 46, 51 AND 52).  
FIRST USE 8-2-2004; IN COMMERCE 8-2-2004.

**CLASS 5—(Continued).**

2,900,795. LONGJIANG RIVER HEALTH PRODUCTS, LLC, IRVINGTON ON HUDSON, NY. SN 78-242,256. PUB. 12-30-2003, FILED 4-25-2003.



THE FOREIGN WORDING IN THE MARK TRANSLATES INTO ENGLISH AS "DRAGON RIVER".  
FOR HERBAL FOOD SUPPLEMENTS (U.S. CLS. 6, 18, 44, 46, 51 AND 52).  
FIRST USE 1-21-2004; IN COMMERCE 1-21-2004.

2,900,809. PHARMANEX LLC, PROVO, UT. SN 78-252,969. PUB. 3-9-2004, FILED 5-22-2003.

**TRA THE RIGHT APPROACH**

FOR NUTRITIONAL, DIETARY AND HERBAL SUPPLEMENTS (U.S. CLS. 6, 18, 44, 46, 51 AND 52).  
FIRST USE 5-10-2003; IN COMMERCE 5-10-2003.

2,900,810. PHARMANEX LLC, PROVO, UT. SN 78-252,980. PUB. 1-6-2004, FILED 5-22-2003.

**TRA**

FOR NUTRITIONAL, DIETARY AND HERBAL SUPPLEMENTS (U.S. CLS. 6, 18, 44, 46, 51 AND 52).  
FIRST USE 5-10-2003; IN COMMERCE 5-10-2003.

2,900,868. MANNATECH, INC., COPPELL, TX. SN 78-292,904. PUB. 4-27-2004, FILED 8-27-2003.

**MTECH AO BLEND**

NO CLAIM IS MADE TO THE EXCLUSIVE RIGHT TO USE "AO BLEND", APART FROM THE MARK AS SHOWN.  
FOR DIETARY AND NUTRITIONAL SUPPLEMENTS; INGREDIENTS USED AS AN INTEGRAL COMPONENT OF DIETARY AND NUTRITIONAL SUPPLEMENTS (U.S. CLS. 6, 18, 44, 46, 51 AND 52).  
FIRST USE 8-30-2003; IN COMMERCE 8-30-2003.

**CLASS 6—METAL GOODS**

**CLASS 6—(Continued).**

2,900,084. COX, BOBBIE, J., DALLAS, TX. SN 75-960,141. PUB. 10-8-2002, FILED 3-14-2000.

**POSTAL VAULT**

NO CLAIM IS MADE TO THE EXCLUSIVE RIGHT TO USE "POSTAL", APART FROM THE MARK AS SHOWN, FOR SHEET METAL BOXES (U.S. CLS. 2, 12, 13, 14, 23, 25 AND 50).

FIRST USE 11-26-1999; IN COMMERCE 11-26-1999.

2,900,181. KLOCKNER & CO AG, 47057 DUISBURG, FED REP GERMANY. SN 76-304,913. PUB. 2-11-2003, FILED 8-27-2001.



THE MARK CONSISTS OF A STYLIZED DEPICTION OF A DOG RUNNING WITH A BALL IN ITS MOUTH.

FOR STEEL, ALUMINUM AND OTHER METALS, NAMELY, CARBON STEEL, ALLOY STEEL AND STAINLESS IN THE FORM OF STRUCTURALS, NAMELY, BEAMS, CHANNELS, ANGLES, TEES, ZEES, STRUCTURAL TUBES, PIPES, BARS, SHEETS, GRATING AND FLOORING PRODUCTS, NAMELY EXPANDED METAL, FLOOR PLATES (U.S. CLS. 2, 12, 13, 14, 23, 25 AND 50).

FIRST USE 10-0-1997; IN COMMERCE 10-0-1997.

2,900,334. BLAIN SUPPLY, INC., JANESVILLE, WI. SN 76-453,190. PUB. 3-9-2004, FILED 9-26-2002.

OWNER OF U.S. REG. NOS. 2,208,925 AND 2,260,503.

THE LINING AND THE STIPPLING SHOWN IN THE DRAWING ARE FEATURES OF THE MARK AND ARE NOT INTENDED TO INDICATE COLOR.

THE MARK CONSISTS OF THE WORDING "AGRIMASTER" WHERE THE LETTER "I" IN THE WORD IS THE STYLIZED REPRESENTATION OF A SILO AND CONSTITUTES THE LEFT LEG OF THE LETTER "M" AND WHERE THE SECOND LETTER "A" IN THE WORD CONTAINS A STAR.

FOR METAL WIRE FENCING AND FENCING COMPONENTS, NAMELY, BARB WIRE, BARBED WIRE, BARBLESS WIRE, FIELD FENCE, HARD WIRE CLOTH, UTILITY MESH, WELDED WIRE, YARD/KENNEL FENCE, GARDEN FENCE, HORSE FENCE, FOLDING FENCE, ELECTRIC FENCE WIRE, CONCRETE MESH, RE-MESH, REINFORCING MESH, POULTRY NETTING, CHICKEN WIRE, CHAIN LINK, BRACE WIRE AND UTILITY WIRE (U.S. CLS. 2, 12, 13, 14, 23, 25 AND 50).

FIRST USE 4-1-2002; IN COMMERCE 4-1-2002.

**CLASS 6—(Continued).**

2,900,433. ULTRA HARDWARE PRODUCTS LLC, PENNSAUKEN, NJ. SN 76-497,107. PUB. 3-23-2004, FILED 3-13-2003.



NO CLAIM IS MADE TO THE EXCLUSIVE RIGHT TO USE "CLASSIC HARDWARE FOR FINE HOMES", APART FROM THE MARK AS SHOWN.

FOR METAL HARDWARE FOR DOORS, NAMELY, HINGES, LOCKS, KICKPLATES, KNOCKERS, LOCK SETS CONSISTING OF METAL LOCKS AND KEYS THEREFOR, VIEWERS, MAIL SLOTS, HANDLES, DOOR STOPS, PUSH AND PULL PLATES (U.S. CLS. 2, 12, 13, 14, 23, 25 AND 50).

FIRST USE 4-1-2003; IN COMMERCE 4-1-2003.

2,900,549. NEWFREY LLC, NEWARK, DE. SN 78-062,519. PUB. 10-30-2001, FILED 5-8-2001.

**TWINSERT**

FOR METAL SCREW THREAD INSERTS (U.S. CLS. 2, 12, 13, 14, 23, 25 AND 50).

FIRST USE 12-31-1966; IN COMMERCE 12-31-1966.

2,900,551. KABUSHIKI KAISHA KOBE SEIKO SHO, TA KOBE STEEL, LTD., KOBE, JAPAN. SN 78-072,567. PUB. 6-25-2002, FILED 7-6-2001.

**SEGLESS**

FOR STEEL POWDER MIXTURE (U.S. CLS. 2, 12, 13, 14, 23, 25 AND 50).

FIRST USE 1-31-2003; IN COMMERCE 1-31-2003.

2,900,647. DAB DOOR COMPANY, INC., HIALEAH GARDENS, FL. SN 78-170,142. PUB. 5-6-2003, FILED 10-2-2002.

**WIND MASTER**

FOR METAL GARAGE DOORS (U.S. CLS. 2, 12, 13, 14, 23, 25 AND 50).

FIRST USE 10-9-2002; IN COMMERCE 10-9-2002.

**CLASS 6—(Continued).**

2,900,701. REICH, DAVID, DBA DAVID REICH CONSTRUCTION, TURLOCK, CA. SN 78-207,000. PUB. 10-14-2003, FILED 1-24-2003.

**FAST BRACKET**

FOR METAL SCAFFOLDING (U.S. CLS. 2, 12, 13, 14, 23, 25 AND 50).  
FIRST USE 10-3-2003; IN COMMERCE 10-3-2003.

2,900,849. QUALITY PIPE PRODUCTS, INC., TAYLOR, MI. SN 78-274,001. PUB. 3-23-2004, FILED 7-14-2003.

**THREAD-RITE**

FOR METAL PIPE FITTINGS (U.S. CLS. 2, 12, 13, 14, 23, 25 AND 50).  
FIRST USE 1-24-2004; IN COMMERCE 2-15-2004.

**CLASS 7—MACHINERY**

2,900,094. MILLENNIUM CELL, INC., NEW JERSEY, NJ. SN 76-013,605. PUB. 11-13-2001, FILED 3-28-2000.

**HYDROGEN ON DEMAND**

NO CLAIM IS MADE TO THE EXCLUSIVE RIGHT TO USE "HYDROGEN", APART FROM THE MARK AS SHOWN.

FOR MACHINES FOR GENERATING HYDROGEN GAS FOR CHEMICAL USE AND FOR USE IN FUEL CELLS, ENGINES OF ALL TYPES, HOT AIR BALLOONS AND ENERGY GENERATING DEVICES (U.S. CLS. 13, 19, 21, 23, 31, 34 AND 35).

FIRST USE 4-1-2003; IN COMMERCE 4-1-2003.

2,900,148. VENTURA HYDRAULIC & MACHINE WORKS, INC., VENTURA, CA. SN 76-222,489. PUB. 10-29-2002, FILED 3-9-2001.

**WALKING BEAM CHAIN JACK**

NO CLAIM IS MADE TO THE EXCLUSIVE RIGHT TO USE "CHAIN JACK", APART FROM THE MARK AS SHOWN.

FOR ANCHOR CHAIN WINCH AND A DECK STOPPER FOR TIGHTENING AND SECURING AN ANCHOR CHAIN TO THE DECK OF A FLOATING OFFSHORE VESSEL (U.S. CLS. 13, 19, 21, 23, 31, 34 AND 35).

FIRST USE 6-22-2004; IN COMMERCE 6-22-2004.

**CLASS 7—(Continued).**

2,900,205. RICH PALM ENTERPRISE CORP. LTD., SHENKENG, TAIWAN. SN 76-343,462. PUB. 10-15-2002, FILED 12-3-2001.

**GPTS**

FOR BEARINGS FOR TRANSMISSION SHAFTS, BEING PARTS OF MACHINES; ENGINE BEARINGS; MACHINE PARTS NAMELY, BEARINGS AND BUSHINGS; MACHINE PARTS, NAMELY, ROLLER BEARINGS; SHAFTS BEARINGS FOR VACUUM PUMPS; BELT WHEELS FOR CONVEYORS; TRANSMISSION GEARS FOR MACHINES; GEAR REDUCERS; PULLEYS BEING PARTS OF MACHINES; MACHINE PARTS, NAMELY, ROLLER CHAINS; ELEVATORS; HYDRAULIC DOOR CLOSERS; HYDRAULIC DOOR OPENERS; WOOD WORKING MACHINES, NAMELY, BAND SAWING MACHINES, CROSS-CUT CIRCULAR SAWS, SAW BLAZING CLAMPS, STRAIGHT SAW SHARPENERS, VENEER REELING AND UNREELING MACHINES, VENEER CLIPPERS, DOUBLE SIZERS, SANDERS FOR PLYWOOD, LUMBER CORE COMPOSERS, COLD PRESSES, BAND SCROLL SAWS, CIRCULAR SAW BENCHES, TRIMMING SAWS, PANEL SIZING CIRCULAR SAWS, HAND OPERATED TRIMMING MACHINES, DOUBLE SAWS, GANG RIP SAWS, RADIAL ARM SAWS, MULTI-BLADE CIRCULAR SAWS FOR PANEL SIZING, JIG SAWS, DOUBLE END SAWS FOR ROUND BAR, PLANERS, MILLING MACHINES, SINGLE-HEAD WOOD BORERS, WOOD LATHE MACHINES, AUTOMATIC WOOD LATHES, WOOD COPYING LATHES, ROUND BAR MAKING MACHINES, DOWEL MAKING MACHINES, DOWEL CUTTING MACHINES, POLISHING MACHINES FOR USE IN GRINDING AND POLISHING WOOD, GLUE SPREADERS, HOT PRESS LUMBER COMPOSERS, EDGE BANDING MACHINES, DRILLING AND TAPPING MACHINES (U.S. CLS. 13, 19, 21, 23, 31, 34 AND 35).

FIRST USE 3-16-2002; IN COMMERCE 3-16-2002.

2,900,303. PORTER-CABLE CORPORATION, JACKSON, TN. SN 76-440,459. PUB. 9-16-2003, FILED 8-14-2002.

**REDEFINING PERFORMANCE**

FOR AIR COMPRESSORS; POWER TOOLS AND PARTS THEREOF; NAMELY, TABLE SAWS, ABRASIVE CUT-OFF MACHINES, CIRCULAR SAWS, TRIM SAWS, BAND SAWS, BAYONET SAWS, MITER SAWS, RECIPROCATING SAWS, DRILLS, DRILL PRESSES, IMPACT DRIVERS, MAGNETIC DRILL PRESSES HAMMER DRILLS, CORDLESS DRILLS, ANGLE DRILLS, DRY-WALL TOOLS, IN THE NATURE OF DRYWALL DRIVERS, CUTOFF TOOL AND DRYWALL POWER SANDERS, FASTENER/SCREWDRIVERS, POWER TAPERS, IMPACT WRENCHES, RATCHET WRENCHES, SHEARS, PAINT REMOVERS, POCKET CUTTERS, CHIPPER/CLEANERS, ROUTERS AND ROUTER/SHARPERS, POWER PLANES, POWER PLANERS, RANDOM ORBIT SANDERS, DISC SANDERS, FINISHING SANDERS, BELT SANDERS, BELT SANDERS WITH DUST PICKUP, BENCH GRINDERS, SANDER/GRINDERS, SANDER/POLISHERS, POLISHERS, NIBBLERS, PLATE JOINERS, EDGE JOINERS, LAMINATE TRIMMERS, LAMINATE SLITTERS, LOCK MORTISERS AND REPLACEMENT PARTS FOR THE FOREGOING POWER TOOLS; POWER SAW BLADES, DRILL BITS AND ROUTER BITS; ROTARY HAMMERS; CIRCULAR POWER SAW ACCESSORIES; NAMELY, DUST COLLECTION BAG ASSEMBLY, VACUUM HOSE ASSEMBLY AND DUST NOZZLE ASSEMBLY, BLADE WRENCHES, CUTTING GUIDES AND DRIP GUIDES; DOVETAIL JIGS; DUST COLLECTION ATTACHMENTS FOR POWER TOOLS; ELECTRIC BAND SAW ACCESSORIES; NAMELY, SAW STAND AND PORTABLE VISE; ELEC-

**CLASS 7—(Continued).**

TRIC SANDER ACCESSORIES; NAMELY, REPLACEMENT PADS, ABRASIVE PAPER ROLLS, BELTS AND DISCS, AND PAPER ROLL DISPENSER; ELECTRIC SANDER/GRINDER/POLISHER ACCESSORIES; NAMELY, PADS, DISCS AND RELATED MOUNTING HARDWARE, AND WIRE BRUSHES; ELECTRIC PLATE JOINER ACCESSORIES; NAMELY, TILT FENCE, PLATE JOINING BISCUITS AND REPLACEMENT BLADES; ELECTRIC PLANE ACCESSORIES; NAMELY, PLANE CUTTERS, BEVEL PLANNING FENCES, GRINDING WHEELS, AND WRENCHES FOR PLANES; DOOR HANGING KIT CONSISTING OF POWER OPERATED PLANE, HINGE BUTT TEMPLATE, MORTISING BIT, LOCKNUT, TEMPLATE GUIDE AND STEEL CARRYING CASE; HEAT GUNS; NAILERS; PRE-WIRED TABLES WITH ADJUSTABLE FENCES FOR SUPPORTING ROUTERS AND SHAPERS; POWER STAPLERS; TEMPLATES FOR USE WITH ROUTING TOOLS, MORTISE AND TENON JIGS; STAIR TEMPLATES; PNEUMATIC POWER TOOLS, NAMELY NAILERS, STAPLERS, ANGLE ROTARY TOOL, CUT-OFF TOOL FOR CUTTING SHEET METAL, BOLTS AND FIBERGLASS, GRINDERS, RECIPROCATING SAWS, SHEARS, IMPACT WRENCHES, HAMMERS, SANDERS, DRILLS, WRENCHES, RATCHETS (U.S. CLS. 13, 19, 21, 23, 31, 34 AND 35).

FIRST USE 5-29-2003; IN COMMERCE 5-29-2003.

2,900,317. MARK VII EQUIPMENT LLC, ARVADA, CO. SN 76-447,904. PUB. 12-30-2003, FILED 9-9-2002.

**AQUADRI**

OWNER OF U.S. REG. NOS. 2,414,391, 2,459,993, AND 2,529,362.

FOR CAR WASHING EQUIPMENT FOR COMMERCIAL USE AND SOLD TO COMMERCIAL CAR WASH OWNERS, NAMELY, AUTOMATIC AND MANUALLY OPERATED MACHINES FOR DRYING THE EXTERIOR SURFACE OF AN AUTOMOTIVE VEHICLE (U.S. CLS. 13, 19, 21, 23, 31, 34 AND 35).

FIRST USE 11-19-2002; IN COMMERCE 11-22-2002.

2,900,399. PHOENIX ELECTRIC MFG. CO., CHICAGO, IL. SN 76-487,368. PUB. 11-11-2003, FILED 1-30-2003.

**Phoenix Constant Force Cartridge Brush Holder**

OWNER OF U.S. REG. NOS. 1,358,583, 2,328,990, AND OTHERS.

NO CLAIM IS MADE TO THE EXCLUSIVE RIGHT TO USE "CARTRIDGE BRUSH HOLDER", APART FROM THE MARK AS SHOWN.

FOR BRUSH HOLDERS, BRUSH HOLDER CAPS AND BRUSH HOLDER TERMINAL CLIPS FOR ELECTRIC MOTORS AND GENERATORS (U.S. CLS. 13, 19, 21, 23, 31, 34 AND 35).

FIRST USE 7-26-2004; IN COMMERCE 7-26-2004.

**CLASS 7—(Continued).**

2,900,449. DNA FILTERS LTD., 18450 NIKEA, ATHENS, GREECE. SN 76-503,992. PUB. 1-6-2004, FILED 4-4-2003.



NO CLAIM IS MADE TO THE EXCLUSIVE RIGHT TO USE "HIGH PERFORMANCE FILTERS", APART FROM THE MARK AS SHOWN.

THE STIPPLING IS A FEATURE OF THE MARK AND DOES NOT INDICATE COLOR.

THE MARK CONSISTS OF THE ORANGE WORDING, DNA, AND WHITE WORDING HIGH PERFORMANCE FILTERS, ON A ROYAL BLUE BACKGROUND.

FOR AIR FILTERS FOR MECHANICAL PURPOSES (U.S. CLS. 13, 19, 21, 23, 31, 34 AND 35).

FIRST USE 4-27-2004; IN COMMERCE 4-28-2004.

2,900,463. BARRY GRANT, INC., DAHLONEGA, GA. SN 76-511,986. PUB. 11-25-2003, FILED 5-5-2003.

**MIGHTY SUMO**

FOR FUEL PUMPS FOR HIGH PERFORMANCE COMBUSTION ENGINES FOR LAND VEHICLES (U.S. CLS. 13, 19, 21, 23, 31, 34 AND 35).

FIRST USE 3-0-2004; IN COMMERCE 3-0-2004.

2,900,488. WELEX INCORPORATED, BLUE BELL, PA. SN 76-519,757. PUB. 1-13-2004, FILED 6-5-2003.

**EVOLUTION**

FOR MACHINES FOR EXTRUDING PLASTIC (U.S. CLS. 13, 19, 21, 23, 31, 34 AND 35).

FIRST USE 6-23-2003; IN COMMERCE 6-23-2003.

**CLASS 7—(Continued).**

2,900,634. PORTER-CABLE CORPORATION, JACKSON, TN.  
SN 78-162,464. PUB. 3-23-2004, FILED 9-10-2002.

**FLEX  
PORTER+CABLE**

OWNER OF U.S. REG. NOS. 649,651, 1,926,188, AND OTHERS.

FOR ELECTRIC POWER TOOLS AND PARTS AND ACCESSORIES THEREFOR; NAMELY, ANGLE GRINDERS, STRAIGHT GRINDERS, GRINDING PADS AND DISC, CUTTING STONES, ROUGH-EDGE TRIMMERS, METAL SHEARS AND METAL NIBBLERS, SURFACE SANDING MACHINES, POLISHING MACHINES, AND GRINDING WHEELS, BRUSHES, BELTS AND PADS; CORE DRILLS AND BITS AND CUTTERS THEREFOR; SABER SAWS, JIG SAWS, BAND SAWS AND BLADES THEREFOR; MIXERS, MIXING STATIONS AND MIXING HEADS; CHASING, CUTTING AND MILLING MACHINES AND CUTTING DISCS FOR FLOORS AND WALLS; CORE DRILLING MACHINES, DRILL STANDS AND CORE DRILLING UNITS AND DRILL BITS THEREFOR, DRIVER DRILLS AND SCREWDRIVERS, DRILLING HAMMERS; GUTTER SUPPORT GROOVE CUTTERS, BATHTUB CUTTERS, AND CONCRETE CUTTERS, INDUSTRIAL VACUUM CLEANERS, RUCK SACK VACUUM CLEANERS AND HOSES THEREFOR (U.S. CLS. 13, 19, 21, 23, 31, 34 AND 35).

FIRST USE 10-1-2002; IN COMMERCE 10-1-2002.

2,900,661. S.G.S. TOOL COMPANY, MUNROE FALLS, OH.  
SN 78-184,210. PUB. 4-6-2004, FILED 11-12-2002.

**V-CARB**

OWNER OF U.S. REG. NOS. 1,620,844, 2,490,125, AND OTHERS.

FOR HIGH PERFORMANCE DRILL BITS AND END MILLS FOR POWER TOOLS (U.S. CLS. 13, 19, 21, 23, 31, 34 AND 35).

FIRST USE 3-1-2003; IN COMMERCE 3-1-2003.

2,900,747. OSG TAP & DIE, INC., GLENDALE HEIGHTS, IL.  
SN 78-225,853. PUB. 11-18-2003, FILED 3-14-2003.

**BLIZZARD**

FOR CUTTING TOOLS, NAMELY END MILLS (U.S. CLS. 13, 19, 21, 23, 31, 34 AND 35).

FIRST USE 11-0-2003; IN COMMERCE 11-0-2003.

**CLASS 8—HAND TOOLS****CLASS 8—(Continued).**

2,900,087. PETERS GROUP WORLDWIDE, LLC, MINNETONKA, MN. SN 75-983,504. PUB. 9-23-2003, FILED 3-4-1994.

**MASTER CRAFT PRO**

FOR HAND TOOLS, NAMELY, SCREWDRIVERS AND SCREWDRIVER BIT SETS, WRENCHES, SOCKETS AND SOCKET ACCESSORIES, NAMELY, EXTENSIONS AND ADAPTERS, AND PLIERS (U.S. CLS. 23, 28 AND 44).

FIRST USE 2-0-1998; IN COMMERCE 2-0-1998.

2,900,277. EK SUCCESS, LTD., CLIFTON, NJ. SN 76-419,657.  
PUB. 4-29-2003, FILED 6-12-2002.

**CUTTERPEDE**

FOR STRAIGHT EDGE CUTTING DEVICE FOR CUTTING PAPER (U.S. CLS. 23, 28 AND 44).

FIRST USE 3-20-2003; IN COMMERCE 3-20-2003.

2,900,308. BELL, JACK ATKINS JR., DBA J.A.BELL & ASSOCIATES, FLOWERY BRANCH, GA. SN 76-442,528.  
PUB. 4-29-2003, FILED 8-22-2002.

**LOOSENOOSE**

FOR MANUALLY-OPERATED HAND TOOLS, CONSISTING OF TWO SPRING-LOADED CLOSURES AND A SHORT LENGTH OF NON-ELASTIC LINE, FOR USE IN HOLDING OTHER TOOLS OR HARDWARE (U.S. CLS. 23, 28 AND 44).

FIRST USE 6-15-2004; IN COMMERCE 6-15-2004.

**CLASS 8—(Continued).**

2,900,396. FREELAND, BRIAN ELLISON, HAMPSHIRE RG24 8GF, ENGLAND. AND FREELAND, NEIL, HAMPSHIRE RG24 8GF, ENGLAND. AND FREELAND, STUART, HAMPSHIRE RG24 8GF, ENGLAND. SN 76-485,372. PUB. 1-20-2004, FILED 1-27-2003.

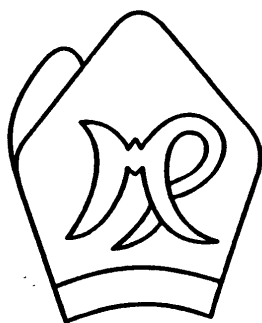

OWNER OF UNITED KINGDOM REG. NO. 1,580,491, DATED 8-3-1994, EXPIRES 8-3-2011.

DESIGN OF BISHOP'S HAT FOR HAND TOOLS, NAMELY, TOOL GUIDES FOR THE CUTTING OF MITRES, MITRE BOXES AND REPLACEMENT PARTS THEREFOR (U.S. CLS. 23, 28 AND 44).

FIRST USE 5-0-1999; IN COMMERCE 11-0-2001.

2,900,475. W.M.S. TRADE GROUP INTERNATIONAL, INC., SARASOTA, FL. SN 76-516,089. PUB. 1-13-2004, FILED 5-23-2003.

**ChefUSA** 

FOR CUTLERY, NAMELY, KITCHEN KNIVES (U.S. CLS. 23, 28 AND 44).

FIRST USE 7-1-2004; IN COMMERCE 7-1-2004.

2,900,720. TAYLOR, STEWART A., KINGSPORT, TN. SN 78-219,059. PUB. 10-28-2003, FILED 2-26-2003.

**FREEDOM FACTOR**

FOR CUTLERY, NAMELY POCKET, HUNTING, AND COLLECTORS KNIVES (U.S. CLS. 23, 28 AND 44).

FIRST USE 7-12-2004; IN COMMERCE 7-12-2004.

**CLASS 9—ELECTRICAL AND SCIENTIFIC APPARATUS****CLASS 9—(Continued).**

2,900,033. SOUTHPORT ADVISORS, FAIRFIELD, CT. SN 75-499,864. PUB. 4-20-1999, FILED 6-10-1998.

**SHARPSCREEN**

FOR SOFTWARE FOR USE BY FINANCIAL PROFESSIONALS IN EVALUATING MUTUAL FUNDS AS PART OF THEIR INVESTMENT SERVICES (U.S. CLS. 21, 23, 26, 36 AND 38).

FIRST USE 11-0-2002; IN COMMERCE 11-0-2002.

2,900,040. VISUAL LEGACY GROUP, LLC, CONWAY, NH. SN 75-583,238. PUB. 10-26-1999, FILED 11-5-1998.

**WINFAST**

FOR COMPUTER SOFTWARE WHICH TRANSLATES NONVISUAL APPLICATIONS PROGRAMS INTO VISUAL APPLICATIONS (U.S. CLS. 21, 23, 26, 36 AND 38).

FIRST USE 7-8-1999; IN COMMERCE 7-8-1999.

2,900,041. SCANZ COMMUNICATIONS, LLC, LOS ANGELES, CA. SN 75-583,512. PUB. 4-25-2000, FILED 11-5-1998.

**ScanZ Scannor**

NO CLAIM IS MADE TO THE EXCLUSIVE RIGHT TO USE "SCANNER". APART FROM THE MARK AS SHOWN. FOR HAND-HELD INSTANT REPLAY VIEWING DEVICE THAT STORES AND PLAYS BACK AUDIO AND VIDEO DATA (U.S. CLS. 21, 23, 26, 36 AND 38).

FIRST USE 7-8-2003; IN COMMERCE 7-8-2003.

2,900,044. TRACEDTECT, INC., SEATTLE, WA. SN 75-604,479. PUB. 5-2-2000, FILED 12-20-1998.

**NANO-BAND**

FOR ELECTROCHEMICAL SENSORS USED FOR STRIPPING VOLTAMMETRY, CYCLIC VOLTAMMETRY AND AMPEROMETRY (U.S. CLS. 21, 23, 26, 36 AND 38).

FIRST USE 2-7-2000; IN COMMERCE 2-7-2000.

**CLASS 9—(Continued).**

2,900,049. EQUITRAC CORPORATION, CORAL GABLES, FL. SN 75-636,009. PUB. 8-27-2002, FILED 2-8-1999.

**SYSTEM 4 WEB X**

OWNER OF U.S. REG. NO. 1,998,675.  
NO CLAIM IS MADE TO THE EXCLUSIVE RIGHT TO USE "SYSTEM" AND "WEB", APART FROM THE MARK AS SHOWN.

FOR COMPUTER SOFTWARE FOR USE BY ATTORNEYS AND OTHER PROFESSIONALS, NAMELY, SOFTWARE FOR TRACKING, REPORTING AND BILLING TIME AND EXPENSES, BASED IN PART ON INFORMATION TRANSMITTED TO AND FROM THE USER BY MEANS OF A GLOBAL COMPUTER INFORMATION NETWORK (U.S. CLS. 21, 23, 26, 36 AND 38).

FIRST USE 6-0-1999; IN COMMERCE 6-0-1999.

2,900,056. INVESTEC SECURITIES CORPORATION, DALLAS, TX. SN 75-735,568. PUB. 3-28-2000, FILED 7-21-1999.

**INSTAQUOTE**

FOR COMPUTER SOFTWARE PROGRAM FOR SEARCH, RETRIEVAL AND GRAPHICAL DISPLAY OF CURRENT FINANCIAL STOCK, FUTURES AND COMMODITY MARKET PRICES, CONDITIONS AND RELATED MARKET INFORMATION (U.S. CLS. 21, 23, 26, 36 AND 38).

FIRST USE 1-15-1998; IN COMMERCE 12-10-1999.

2,900,062. GENERAL BANDWIDTH, INC., AUSTIN, TX. SN 75-780,876. PUB. 1-14-2003, FILED 8-20-1999.

**GENERAL BANDWIDTH**

NO CLAIM IS MADE TO THE EXCLUSIVE RIGHT TO USE "BANDWIDTH", APART FROM THE MARK AS SHOWN.

FOR TELECOMMUNICATIONS EQUIPMENT, NAMELY VOICE OVER BROADBAND GATEWAYS (U.S. CLS. 21, 23, 26, 36 AND 38).

FIRST USE 7-1-1999; IN COMMERCE 2-14-2000.

2,900,068. SERVERWORKS CORPORATION, SANTA CLARA, CA. SN 75-841,146. PUB. 2-17-2004, FILED 11-4-1999.

**SERVERWORKS**

FOR INTEGRATED CIRCUITS (U.S. CLS. 21, 23, 26, 36 AND 38).

FIRST USE 6-0-2000; IN COMMERCE 6-0-2000.

**CLASS 9—(Continued).**

2,900,088. TAIYO YUDEN CO., LTD., TAITO-KU, TOKYO, JAPAN. SN 75-983,505. PUB. 8-10-1999, FILED 4-21-1997.

**TAIYO YUDEN**

NO CLAIM IS MADE TO THE EXCLUSIVE RIGHT TO USE "YUDEN", APART FROM THE MARK AS SHOWN.

THE NAME "TAIYO YUDEN" DOES NOT INDICATE THE NAME OF A SPECIFIC LIVING INDIVIDUAL.

THE ENGLISH TRANSLATION OF THE WORD "TAIYO" IN THE MARK IS "THE SUN". THE ENGLISH TRANSLATION OF THE WORD "YUDEN" IN THE MARK IS "DIELECTRIC".

FOR CERAMIC CAPACITORS, FIXED RESISTORS; ELECTRIC COILS; FERRITE CORES, MAGNETS; NTC THERMISTORS; EMI SUPPRESSION FILTERS INCLUDING FERRITE BEADS, CHOKE COILS, SPARK GAPS AND VARISTORS; ACOUSTIC TRANSDUCERS INCLUDING PIEZOELECTRIC RECEIVERS AND PIEZOELECTRIC SOUNDERS; HYBRID ICS; DC TO DC CONVERTERS; INVERTERS; SWITCHING POWER SUPPLIES; RADIO FREQUENCY COMPONENTS COMPRISING POWER AMPLIFIERS, RF MODULES AND ANTENNA UNITS; FILTERS INCLUDING DIELECTRIC FILTERS; DIELECTRIC RESONATORS AND LC FILTERS; BLANK RECORDABLE COMPACT DISKS (U.S. CLS. 21, 23, 26, 36 AND 38).

FIRST USE 10-1-1999; IN COMMERCE 4-1-2001.

2,900,092. TMAX SOFT CO., LTD., SEOUL, REPUBLIC OF KOREA. SN 76-011,001. PUB. 4-2-2002, FILED 3-24-2000.



FOR COMPUTER SYSTEM SOFTWARE FOR TRANSACTION PROCESSING MONITOR (TP MONITOR) (U.S. CLS. 21, 23, 26, 36 AND 38).

FIRST USE 1-27-2004; IN COMMERCE 1-27-2004.

2,900,101. JHANE BARNES (DEL.) INC., WILMINGTON, DE. SN 76-065,553. PUB. 4-3-2001, FILED 6-8-2000.

**JHANE BARNES**

OWNER OF U.S. REG. NOS. 1,235,742, 2,141,248, AND 2,336,112.

THE NAME "JHANE BARNES" IDENTIFIES A LIVING INDIVIDUAL WHOSE CONSENT IS OF RECORD.

FOR EYEGLASSES, EYEGLASS CASES, SUNGLASSES, EYEGLASS FRAMES AND EYE SHADES (U.S. CLS. 21, 23, 26, 36 AND 38).

FIRST USE 9-4-2003; IN COMMERCE 9-4-2003.



**CLASS 9—(Continued).**

2,900,112. CASPIAN NETWORKS, INC., SAN JOSE, CA. SN 76-102,441. PUB. 9-3-2002, FILED 8-2-2000.

**APEIRO**

THE ENGLISH TRANSLATION OF THE WORD "APEIRO" IN THE MARK IS "INFINITY".

FOR COMPUTER HARDWARE FOR USE IN DATA COMMUNICATIONS AND TELECOMMUNICATIONS; COMPUTER SOFTWARE FOR VOICE, DATA AND VIDEO SWITCHING AND TRANSPORT, AND INSTRUCTION MANUALS SOLD AS A UNIT THEREWITH; TELECOMMUNICATIONS AND DATA COMMUNICATIONS EQUIPMENT, NAMELY, SWITCHES, AND MULTIPLEXORS (U.S. CLS. 21, 23, 26, 36 AND 38).

FIRST USE 3-30-2004; IN COMMERCE 3-30-2004.

2,900,114. YAMATAKE CORPORATION, TOKYO 150-8316, JAPAN. SN 76-113,412. PUB. 5-22-2001, FILED 8-18-2000.

**COVAC**

OWNER OF U.S. REG. NOS. 2,341,089, 2,348,480, AND OTHERS.

FOR VACUUM SENSORS (U.S. CLS. 21, 23, 26, 36 AND 38).

FIRST USE 7-12-2004; IN COMMERCE 7-12-2004.

2,900,115. FRESH BAIT, INC., VAN NUYS, CA. SN 76-114,640. PUB. 10-22-2002, FILED 8-22-2000.



FOR PRERECORDED VIDEO TAPES, AND DISCS FEATURING ENTERTAINMENT CONSISTING OF COMEDY, HUMOR AND COMEDIC PERFORMANCES (U.S. CLS. 21, 23, 26, 36 AND 38).

FIRST USE 0-0-1997; IN COMMERCE 0-0-1997.

2,900,119. CARTOON NETWORK LP, LLLP, THE, ATLANTA, GA. SN 76-121,614. PUB. 7-3-2001, FILED 8-31-2000.

**SEALAB 2021**

FOR PRE-RECORDED AUDIO AND VIDEO CASSETTES AND CDS FEATURING CARTOON THEME SONGS AND CARTOONS; VIDEO GAME SOFTWARE; SUNGLASSES, EYEGLASS CASES; MOUSE PADS; AND DECORATIVE REFRIGERATOR MAGNETS FEATURING CARTOONS (U.S. CLS. 21, 23, 26, 36 AND 38).

FIRST USE 6-30-2004; IN COMMERCE 6-30-2004.

**CLASS 9—(Continued).**

2,900,133. BELEGGINGSMAATSCHAPPIJ ELDAP B.V., 4817 KA BREDA, NETHERLANDS. SN 76-161,846. PUB. 5-22-2001, FILED 11-8-2000.

**MR HANDSFREE CAR-KIT  
PRO**

NO CLAIM IS MADE TO THE EXCLUSIVE RIGHT TO USE "CAR-KIT", APART FROM THE MARK AS SHOWN.

FOR TELEPHONE APPARATUS, NAMELY, TELEPHONE ANSWERING MACHINES, INTERCOMS, AUTOMATIC TELEPHONE DIALERS, COVERS FOR TELEPHONE RECEIVERS NOT MADE OF PAPER, TELEPHONE ADAPTERS, TELEPHONES, CELLULAR TELEPHONES, RADIO TELEPHONES, VEHICLE TELEPHONES, MICROPHONES, EAR PHONES, TELECOMMUNICATION APPARATUS, NAMELY, FACSIMILE MACHINES, SATELLITE RECEIVERS, ANTENNAS (U.S. CLS. 21, 23, 26, 36 AND 38).

FIRST USE 7-5-2001; IN COMMERCE 7-5-2004.

2,900,134. DAYANG TECHNOLOGY DEVELOPMENT INC., BEIJING 100080, CHINA. SN 76-166,809. PUB. 2-11-2003, FILED 11-16-2000.



FOR COMPUTER PERIPHERAL EQUIPMENT, NAMELY, VIDEO DIGITIZERS, AUDIO DIGITIZERS, ANALOG TO DIGITAL AUDIO CONVERTERS, NATIONAL TELEVISION STANDARDS COMMITTEE TO RED-GREEN-BLUE SYNCHRONIZATION VIDEO AND SIGNAL CONVERTERS, SYNC GENERATORS, VIDEO LOCAL AREA NETWORK CONTROLLERS, VIDEO MONITOR CONTROLLERS, MONITORS, AUDIO AMPLIFIERS AND LOUD SPEAKERS, KEYBOARDS, MOUSE; DATA RECORDING APPARATUS CONNECTOR FOR STORING AND MANAGING MULTIMEDIA DATA BASED ON COMPUTER HARD DISK; VIDEO DISK RECORDER; DATA PROCESSING EQUIPMENT, NAMELY, DATA PROCESSORS; COMPUTER SOFTWARE FOR EDITING, MODIFYING, COMPOSING, STORING GRAPHS AND IMAGES IN THE AUDIO AND VIDEO FIELD AND FOR MANAGING MULTIMEDIA DATABASE; VIRTUAL STUDIO SYSTEM SOFTWARE FOR GENERATING A VIRTUAL SCENE BY USING COMPUTER GRAPH TECHNOLOGY AND REALIZING THE COMBINATION OF A VIRTUAL SCENE AND REAL PERSONS WITH TRACKING AND LOCATING TECHNOLOGY TO PRODUCE TELEVISION PROGRAMS; NON-LINEAR PRODUCING AND BROADCASTING NETWORK SOFTWARE FOR EDITING IMAGES TO COMPOSE PROGRAMS IN LATER STAGE, PRODUCING ADVERTISEMENT AND FILM LEADER OF TELEPLAYS, AND BROADCASTING DIGITAL SIGNALS IN THE VIDEO FIELD BASED ON HARD DISK STORAGE; SUBTITLE GENERATOR SYSTEM SOFTWARE FOR OVERLAPPING SUBTITLE, ANIMATION AND MOTION VIDEO IMAGES TO PRODUCE TELEVISION PROGRAMS; MULTIMEDIA AUDIO AND VIDEO NON-LINEAR EDITING SYSTEM SOFTWARE FOR EDITING IMAGES AND SOUND AND COMPOS-

**CLASS 9—(Continued).**

ING THE SAME TO PRODUCE TELEVISION PROGRAMS BASED ON DATA STORAGE MEDIUM; PROGRAM STORAGE AND MANAGEMENT SOFTWARE FOR STORING AND MANAGING MULTIMEDIA DATA BASED ON DATA STORAGE APPARATUS; PLAYING CONTROL SOFTWARE FOR CONTROLLING THE PLAY OF DIGITAL VIDEO AND AUDIO SIGNALS; CENTRAL PROCESSING UNIT, MICRO-PROCESSORS, SATELLITE PROCESSORS, SIGNAL PROCESSORS; COMPUTER HARDWARE AND SOFTWARE FOR NON-LINEAR DIGITAL AND ANALOG VIDEO AND AUDIO EDITING; INTEGRATED CIRCUIT BOARD; AUDIO WORKSTATION COMPRISED OF COMPUTER HARDWARE AND SOFTWARE USED TO MANIPULATE, EDIT, RECORD, PLAY, AND CREATE DIGITAL AUDIO DATA; VIDEO TAPE RECORDER; TELEVISION CAMERA; INSTRUMENTS FOR PRODUCING AND MANAGEMENT OF INSTRUCTIONAL PROGRAMS, NAMELY, THE SOFTWARE FOR PRODUCING AND MANAGEMENT OF INSTRUCTIONAL PROGRAMS (U.S. CLS. 21, 23, 26, 36 AND 38).

FIRST USE 12-13-1996; IN COMMERCE 4-19-1999.

---

2,900,135. EASTMAN KODAK COMPANY, ROCHESTER, NY. SN 76-167,166. PUB. 8-12-2003, FILED 11-17-2000.

## IMAGESMART DOCUMENT MASTERING

NO CLAIM IS MADE TO THE EXCLUSIVE RIGHT TO USE "DOCUMENT MASTERING", APART FROM THE MARK AS SHOWN.

FOR PROCESSING SOFTWARE FOR SCANNING, STORING, CORRECTING, RETOUCHING, DATA CONVERTING, DATA COMPRESSING, LAYING OUT, DISPLAYING, PROOFING, TRANSMITTING AND RECORDING OF IMAGES, GRAPHICS AND TEXT (U.S. CLS. 21, 23, 26, 36 AND 38).

FIRST USE 9-18-2000; IN COMMERCE 9-18-2000.

---

2,900,141. ATMEL CORPORATION, SAN JOSE, CA. SN 76-199,581. PUB. 10-30-2001, FILED 1-26-2001.

## LOGIC DOUBLING

NO CLAIM IS MADE TO THE EXCLUSIVE RIGHT TO USE "LOGIC", APART FROM THE MARK AS SHOWN.

FOR COMPLEX PROGRAMMABLE LOGIC SEMICONDUCTOR INTEGRATED CIRCUITS (U.S. CLS. 21, 23, 26, 36 AND 38).

FIRST USE 3-31-2001; IN COMMERCE 7-31-2001.

---

2,900,142. ELANCE, INC., SUNNYVALE, CA. SN 76-200,300. PUB. 8-6-2002, FILED 1-26-2001.

## ELANCE

FOR COMPUTER SOFTWARE, NAMELY, SOFTWARE TO IDENTIFY AND DEFINE THE SCOPE AND COMPONENTS OF PROJECTS; PROJECT MANAGEMENT SOFTWARE (U.S. CLS. 21, 23, 26, 36 AND 38).

FIRST USE 9-16-2002; IN COMMERCE 9-16-2002.

**CLASS 9—(Continued).**

2,900,143. ABB AB, VASTERAS, SWEDEN. SN 76-206,447. PUB. 5-7-2002, FILED 2-7-2001.

# AceTripleC

FOR COMPUTER SOFTWARE FOR USE IN THE FIELD OF ENGINEERING TO DEVELOP GENERAL SIMULATION TOOLS FOR SOLVING ELECTRIC, ELECTROMAGNETIC, THERMAL AND THERMOPLASTIC PROBLEMS AND FOR DYNAMIC SOLUTIONS OF SUCH PROBLEMS (U.S. CLS. 21, 23, 26, 36 AND 38).

FIRST USE 3-15-1986; IN COMMERCE 4-6-1993.

---

2,900,146. MENTOR ENGINEERING INC., CALGARY, AB, CANADA. SN 76-212,192. PUB. 7-30-2002, FILED 2-13-2001.

## STRYDER

FOR COMPUTER HARDWARE, NAMELY, HAND HELD AND PORTABLE COMPUTERS (U.S. CLS. 21, 23, 26, 36 AND 38).

FIRST USE 6-10-2003; IN COMMERCE 6-10-2003.

---

2,900,147. ALLSO INTERNATIONAL MARKETING PTY LIMITED, CAMPSIE, NEW SOUTH WALES, AUSTRALIA. SN 76-212,271. PUB. 1-7-2003, FILED 2-20-2001.



OWNER OF U.S. REG. NO. 2,249,837.  
FOR OPTICAL GOODS, NAMELY, SPECTACLES, SPECTACLE CASES AND SUNGLASSES (U.S. CLS. 21, 23, 26, 36 AND 38).

FIRST USE 7-0-1987; IN COMMERCE 6-3-1998.

**CLASS 9—(Continued).**

2,900,150. WALTER AG, TUBINGEN, FED REP GERMANY.  
SN 76-226,675. PUB. 3-2-2004, FILED 3-19-2001.

**HELI TOOLCHECK**

PRIORITY CLAIMED UNDER SEC. 44(D) ON FED REP GERMANY APPLICATION NO. 30094575.2/0, FILED 12-30-2000, REG. NO. 30094575, DATED 5-19-2003, EXPIRES 12-31-2010.

OWNER OF U.S. REG. NO. 2,063,185.  
FOR MEASURING MACHINES FOR USE BY TOOL MANUFACTURERS AND IN REGRINDERS TO MEASURE DIMENSIONAL PARAMETERS OF TOOLS (U.S. CLS. 21, 23, 26, 36 AND 38).

FIRST USE 6-30-2001; IN COMMERCE 9-30-2001.

---

2,900,163. X CONCEPTS, LLC, ESCONDIDO, CA. SN 76-279,274. PUB. 3-12-2002, FILED 7-2-2001.

**TECH DECK DUDE**

FOR SOFTWARE, NAMELY, VIDEO GAME SOFTWARE; PRE-RECORDED CD-ROMS, ALL FEATURING VIDEOTAPES AND CD-ROMS FEATURING CARTOONS (U.S. CLS. 21, 23, 26, 36 AND 38).

FIRST USE 7-5-2002; IN COMMERCE 6-3-2004.

---

2,900,167. ULTRATECH STEPPER, INC., SAN JOSE, CA. SN 76-287,663. PUB. 5-28-2002, FILED 7-19-2001.

**STAR**

FOR LITHOGRAPHIC AND IMPLANTING MACHINES FOR PRODUCING IMAGES, AND PRINTING OR IMPLANTING IMAGES ON WAFERS AND OTHER SUBSTRATES; ELECTRON-BEAM COLUMNS AND SYSTEMS; RETICLES AND MASKS FOR USE WITH SAID LITHOGRAPHIC AND IMPLANTING MACHINES; INTERACTIVE MAINTENANCE GUIDE SOFTWARE TO DECREASE CUSTOMER SUPPORT COSTS BY REDUCING MTTR, IMPROVING STEPPER UPTIME, AND ENHANCING THE OVERALL QUALITY OF MANUFACTURER SERVICE ACTIVITIES OF STEPPER MACHINES; SOFTWARE TO OPTIMIZE STEPPER PERFORMANCE FOR THE PRODUCTION OF SEMICONDUCTOR CHIPS; SOFTWARE FOR USE WITH HEAT TREATING, CLEANING, ETCHING, IMPLANTING AND LEVELING MACHINES FOR USE IN THE MANUFACTURE OF SEMICONDUCTORS; SPECIAL TOOLING FOR THE AFORESAID GOODS; AND MANUALS SOLD AS A UNIT WITH THE AFORESAID GOODS (U.S. CLS. 21, 23, 26, 36 AND 38).

FIRST USE 8-25-2003; IN COMMERCE 8-25-2003.

**CLASS 9—(Continued).**

2,900,168. ULTRATECH STEPPER, INC., SAN JOSE, CA. SN 76-287,664. PUB. 4-23-2002, FILED 7-19-2001.

**STAR 100**

NO CLAIM IS MADE TO THE EXCLUSIVE RIGHT TO USE "100", APART FROM THE MARK AS SHOWN.

FOR LITHOGRAPHIC AND IMPLANTING MACHINES FOR PRODUCING IMAGES, AND PRINTING OR IMPLANTING IMAGES ON WAFERS AND OTHER SUBSTRATES; ELECTRON-BEAM COLUMNS AND SYSTEMS; RETICLES AND MASKS FOR USE WITH SAID LITHOGRAPHIC AND IMPLANTING MACHINES; INTERACTIVE MAINTENANCE GUIDE SOFTWARE TO DECREASE CUSTOMER SUPPORT COSTS BY REDUCING MTTR, IMPROVING STEPPER UPTIME, AND ENHANCING THE OVERALL QUALITY OF MANUFACTURER SERVICE ACTIVITIES OF STEPPER MACHINES; SOFTWARE TO OPTIMIZE STEPPER PERFORMANCE FOR THE PRODUCTION OF SEMICONDUCTOR CHIPS; SOFTWARE FOR USE WITH THE HEAT TREATING, CLEANING, ETCHING, IMPLANTING AND LEVELING MACHINES FOR USE IN THE MANUFACTURE OF SEMICONDUCTORS; SPECIAL TOOLING FOR THE AFORESAID GOODS; AND MANUALS SOLD AS A UNIT WITH THE AFORESAID GOODS (U.S. CLS. 21, 23, 26, 36 AND 38).

FIRST USE 8-25-2003; IN COMMERCE 8-25-2003.

---

2,900,177. IGT, RENO, NV. SN 76-301,046. PUB. 11-20-2001, FILED 8-17-2001.

**USED CARS**

FOR GAMING MACHINES, NAMELY, SLOT MACHINES WITH OR WITHOUT A VIDEO OUTPUT (U.S. CLS. 21, 23, 26, 36 AND 38).

FIRST USE 2-11-2004; IN COMMERCE 2-26-2004.

**CLASS 9—(Continued).**

2,900,187. STRATIFY, INC., MOUNTAIN VIEW, CA. SN 76-317,534. PUB. 10-21-2003, FILED 9-25-2001.

**STRATIFY**

FOR COMPUTER SOFTWARE FOR USE IN INFORMATION, CONTENT AND DATABASE MANAGEMENT ENABLING THE HIERARCHICAL CATEGORIZATION OF DOCUMENTS AND OTHER CONTENT; DATA MANAGEMENT SOFTWARE TO CREATE, ENHANCE, OPTIMIZE, IDENTIFY AND ORGANIZE TAXONOMIES, NAMELY, A HIERARCHICAL STRUCTURE OF INFORMATION WHERE DOCUMENTS ARE GROUPED INTO SUBTOPICS AND THESE SUBTOPICS ARE CLUSTERED INTO LARGER TOPICS; COMPUTER SOFTWARE IN THE FIELD OF INFORMATION MANAGEMENT, FOR COLLECTING, LINKING, ORGANIZING AND PRIORITIZING DATA FROM MULTIPLE SOURCES INTO A HIERARCHICAL DISPLAY; COMPUTER SOFTWARE FOR ENHANCING CUSTOMER RELATIONSHIP MANAGEMENT SOFTWARE, SALES FORCE AUTOMATION SOFTWARE, CORPORATE PORTALS, SEARCH ENGINES AND NEWS AGGREGATION SERVICES BY ORGANIZING INFORMATION CONTAINED IN UNSTRUCTURED FORM AND IN STRUCTURED DATABASE FORM INTO TOPICAL SUBJECT MATTER HIERARCHIES FOR EASE OF ACCESS AND SEARCHING; DATABASE MANAGEMENT SOFTWARE; DATA COMPRESSION SOFTWARE; COMPUTER SOFTWARE FOR APPLICATION AND DATABASE INTEGRATION; USER MANUALS AND INSTRUCTIONAL BOOKS SOLD AS UNIT THEREWITH; DOWNLOADABLE ELECTRONIC PUBLICATIONS IN THE NATURE OF USER MANUALS AND INSTRUCTIONAL BOOKS IN THE FIELD OF COMPUTER SOFTWARE (U.S. CLS. 21, 23, 26, 36 AND 38).

FIRST USE 10-17-2001; IN COMMERCE 10-17-2001.

2,900,189. INTEGRATION ASSOCIATES INCORPORATED, MOUNTAIN VIEW, CA. SN 76-322,451. PUB. 6-4-2002, FILED 10-10-2001.

**EZRADIO**

THE MARK CONSISTS OF STANDARD CHARACTERS WITHOUT CLAIM TO ANY PARTICULAR FONT, STYLE, SIZE, OR COLOR.

NO CLAIM IS MADE TO THE EXCLUSIVE RIGHT TO USE "RADIO", APART FROM THE MARK AS SHOWN.

FOR INTEGRATED CIRCUITS FOR RADIO FREQUENCY COMMUNICATION DEVICES (U.S. CLS. 21, 23, 26, 36 AND 38).

FIRST USE 1-20-2004; IN COMMERCE 1-20-2004.

**CLASS 9—(Continued).**

2,900,191. NUVO TECHNOLOGIES, LLC, CINCINNATI, OH. SN 76-326,996. PUB. 4-27-2004, FILED 10-17-2001.

**NUVO**

FOR SOUND REPRODUCTION AND SOUND TRANSMITTING APPARATUS, NAMELY, CONTROLLER DEVICES, NAMELY AUDIO CONTROLLER DEVICES FOR FILTERING AND EQUALIZING SPEAKER SYSTEMS, TUNERS, MIXERS, AUDIO MIXERS, AND MODULATORS, AMPLIFIERS, SPEAKER SYSTEMS COMPRISING SPEAKERS, SPEAKER STANDS, AND SPEAKER CABLES, SOLD TOGETHER AS A UNIT, AS AN ENTIRE STUDIO, OFFICE OR HOME AUDIO SYSTEM, AND INVOLVING INSTALLATION OF THE ENTIRE AUDIO SYSTEM AS A UNIT, SOLD THROUGH DISTRIBUTORSHIPS, AND AS A UNIT, AND NOT AS STAND-ALONE PRODUCTS, AND NOT FOR USE WITH THIRD-PARTY STAND ALONE RADIO, TELEVISION OR TELEPHONE PRODUCTS (U.S. CLS. 21, 23, 26, 36 AND 38).

FIRST USE 6-4-2001; IN COMMERCE 1-7-2002.

2,900,194. MIDTRONICS, INC., WILLOWBROOK, IL. SN 76-331,334. PUB. 4-8-2003, FILED 10-29-2001.

**ONGUARD**

FOR AUTOMOTIVE ELECTRONIC BATTERY TESTERS FOR TESTING STORAGE BATTERIES; AUTOMOTIVE BATTERY TESTERS INTEGRAL WITH STORAGE BATTERIES; AUTOMOTIVE STORAGE BATTERIES WITH INTEGRAL BATTERY TESTERS (U.S. CLS. 21, 23, 26, 36 AND 38).

FIRST USE 11-4-2003; IN COMMERCE 11-4-2003.

2,900,195. ITT INDUSTRIES, INC., WHITE PLAINS, NY. SN 76-331,555. PUB. 11-18-2003, FILED 10-29-2001.

**K-DRIV**

FOR SOFTWARE FOR REMOTELY CONTROLLING UNMANNED LAND VEHICLES TO ENABLE PERFORMANCE OF REMOTE MILITARY OR NON-MILITARY MISSIONS (U.S. CLS. 21, 23, 26, 36 AND 38).

FIRST USE 6-0-2004; IN COMMERCE 6-0-2004.

**CLASS 9—(Continued).**

2,900,204. SORRENT, INC., SAN MATEO, CA. SN 76-342,855. PUB. 7-23-2002, FILED 11-28-2001.

**SORRENT**

FOR COMPUTER GAME SOFTWARE AND ENTERTAINMENT SOFTWARE, NAMELY, RING TONES, WALLPAPER GRAPHICS AND GRAPHICAL ICONS, FOR USE ON MOBILE AND CELLULAR TELEPHONES, HAND-HELD COMPUTERS, COMPUTERS, VIDEO GAME CONSOLES BOTH HAND-HELD AND FREE-STANDING, VIDEO GAME MACHINES FOR USE WITH TELEVISIONS, AND TELEVISION SET-TOP BOXES FOR USE IN ACCESSING A GLOBAL COMPUTER NETWORK (U.S. CLS. 21, 23, 26, 36 AND 38).  
FIRST USE 10-0-2001; IN COMMERCE 10-0-2001.

2,900,215. TEKER, LLC, RED BANK, NJ. SN 76-360,436. PUB. 10-22-2002, FILED 1-18-2002.

**HIERCODE**

FOR COMPUTER SOFTWARE FOR SEARCHING AN ONLINE DATABASE OF INTERNATIONAL CLASSIFICATIONS OF DISEASES FOR MEDICAL DIAGNOSTIC CODING (U.S. CLS. 21, 23, 26, 36 AND 38).  
FIRST USE 2-0-2002; IN COMMERCE 2-0-2002.

2,900,217. FUTURESTAR CORPORATION, THE, BLOOMINGTON, MN. SN 76-362,658. PUB. 11-4-2003, FILED 1-24-2002.

**FLOWFINDER**

FOR COMPUTER SOFTWARE FOR USE IN PREDICTING PERFORMANCE OF FLOWMETERS BASED ON THE VALUES OF VARIOUS CHARACTERISTICS OF FLUID PASSING THROUGH THE METERS, SUCH AS VISCOSITY AND DENSITY, AND FOR PROVIDING PERFORMANCE CURVES FOR THE VARIOUS FLOWMETERS (U.S. CLS. 21, 23, 26, 36 AND 38).  
FIRST USE 6-30-2003; IN COMMERCE 6-30-2003.

2,900,223. PHASIENT LEARNING TECHNOLOGIES, LLC, AMES, IA. SN 76-369,857. PUB. 8-27-2002, FILED 2-12-2002.

**PHASIENT**

FOR COMPUTER SOFTWARE FOR EDUCATION AND TRAINING ON WORKPLACE ISSUES AND SKILLS (U.S. CLS. 21, 23, 26, 36 AND 38).  
FIRST USE 4-0-2002; IN COMMERCE 4-0-2002.

**CLASS 9—(Continued).**

2,900,239. TENSOLITE COMPANY, ST. AUGUSTINE, FL. SN 76-389,237. PUB. 10-15-2002, FILED 4-1-2002.

**HDSI-DP**

OWNER OF U.S. REG. NO. 2,407,191.  
FOR ELECTRICAL WIRE AND CABLE ASSEMBLY (U.S. CLS. 21, 23, 26, 36 AND 38).  
FIRST USE 8-8-2003; IN COMMERCE 8-8-2003.

2,900,240. POST GLOVER RESISTORS, INC., ERLANGER, KY. SN 76-389,887. PUB. 10-29-2002, FILED 4-2-2002.

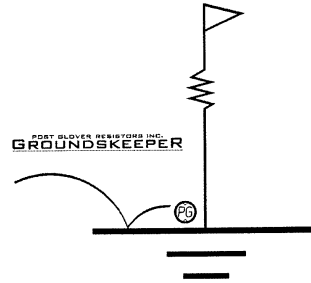

NO CLAIM IS MADE TO THE EXCLUSIVE RIGHT TO USE "RESISTORS INC.", APART FROM THE MARK AS SHOWN.

FOR ELECTRICAL INDUSTRIAL INSTRUMENT, NAMELY, A HIGH RESISTANCE GROUNDING UNIT FOR USE IN DETECTING AND LIMITING GROUND FAULTS (U.S. CLS. 21, 23, 26, 36 AND 38).  
FIRST USE 5-8-2003; IN COMMERCE 5-8-2003.

2,900,243. PEGASUS SYSTEMS, INC., NORTH WALES, PA. SN 76-391,343. PUB. 4-29-2003, FILED 4-4-2002.

**CRESYS**

FOR COMPUTER SOFTWARE THAT ANALYZES REAL ESTATE, CONSTRUCTION AND BUSINESS INFORMATION IN THE FIELDS OF REAL ESTATE SITE SELECTION, SITE ACQUISITION, CONSTRUCTION OPERATIONS, DISPOSITION AND STRATEGIC PLANNING (U.S. CLS. 21, 23, 26, 36 AND 38).  
FIRST USE 6-0-2002; IN COMMERCE 6-0-2002.

2,900,247. HART SPECIALTIES, INC., AMITYVILLE, NY. SN 76-394,952. PUB. 10-22-2002, FILED 4-12-2002.

**WORLDWIDE EYEWEAR**

NO CLAIM IS MADE TO THE EXCLUSIVE RIGHT TO USE "EYEWEAR", APART FROM THE MARK AS SHOWN. FOR EYEGLASSES, SUNGLASSES, READING GLASSES, EYEGLASS CASES AND EYEGLASS CHAINS (U.S. CLS. 21, 23, 26, 36 AND 38).  
FIRST USE 1-0-2002; IN COMMERCE 1-0-2002.

**CLASS 9—(Continued).**

2,900,252. OMNI FLOW COMPUTERS, INC., HOUSTON, TX. SN 76-396,058. PUB. 11-18-2003, FILED 4-16-2002.



FOR COMPUTERS, METER CONTROLLERS, COMMUNICATION HARDWARE AND SOFTWARE FOR THE FLOW MEASUREMENTS OF LIQUIDS AND GASES; AND MANUALS SOLD TOGETHER THEREWITH; FLOWMETERS AND RECORDING INSTRUMENTS HAVING EMBEDDED OPERATING SOFTWARE PROGRAMS FOR MEASUREMENT AND CONTROL OF GASES, LIQUIDS AND ELECTRICITY FLOWS IN CLOSED CONDUITS AND MANUALS SOLD TOGETHER THEREWITH; AND PC-BASED SOFTWARE FOR USE WITH MICROPROCESSOR-BASED ELECTRONIC HARDWARE FOR MEASUREMENT AND CONTROL OF GAS AND LIQUID FLOWS; AND MANUALS SOLD TOGETHER THEREWITH (U.S. CLS. 21, 23, 26, 36 AND 38).

FIRST USE 0-0-2002; IN COMMERCE 0-0-2002.

2,900,262. RF CODE, INC., MESA, AZ. SN 76-403,414. PUB. 6-17-2003, FILED 5-3-2002.

**MOBILETRAK**

FOR TRANSMITTERS, RECEIVERS, READERS, INTERROGATORS, TRANSPONDERS, TRANSCEIVERS, AND TAGS ALL USING RADIO FREQUENCY IDENTIFICATION FOR INVENTORY MANAGEMENT; AND SOFTWARE FOR CONTROLLING TRANSMITTERS, RECEIVERS, READERS, INTERROGATORS, TRANSPONDERS, TRANSCEIVERS, AND TAGS (U.S. CLS. 21, 23, 26, 36 AND 38).

FIRST USE 12-26-2001; IN COMMERCE 1-8-2002.

2,900,273. FULLER BROTHERS, INC., CLACKAMAS, OR. SN 76-416,511. PUB. 12-10-2002, FILED 6-3-2002.

**TAS**

OWNER OF U.S. REG. NO. 2,025,444.  
FOR INSTRUMENTS THAT MEASURE TEMPERATURE AND AIR PRESSURE OF TIRES (U.S. CLS. 21, 23, 26, 36 AND 38).

FIRST USE 6-18-2004; IN COMMERCE 6-18-2004.

**CLASS 9—(Continued).**

2,900,275. CALCULEX, INC., LAS CRUCES, NM. SN 76-418,530. PUB. 12-30-2003, FILED 6-7-2002.

**FLASHCACHE**

FOR BLANK DATA CARTRIDGES, NAMELY DATA RECORDING AND STORAGE DEVICES COMPRISING INTEGRATED MEMORY CIRCUITS CONTAINING NON-VOLATILE MEMORY; DATA CARTRIDGE DRIVES, NAMELY, DEVICES FOR RECORDING DATA ON DATA CARTRIDGES AND RETRIEVING DATA STORED ON DATA CARTRIDGES (U.S. CLS. 21, 23, 26, 36 AND 38).

FIRST USE 1-30-2004; IN COMMERCE 1-30-2004.

2,900,279. POWERIT PS AB, 611 29 NYKOPING, SWEDEN. SN 76-422,412. PUB. 11-11-2003, FILED 6-19-2002.

**POWERIT SOLUTIONS**

FOR ELECTRONIC DEVICES, NAMELY COMPUTER HARDWARE, ELECTRONIC CONTROLLERS AND SOFTWARE, FOR USE BY LARGE COMMERCIAL AND INDUSTRIAL ENERGY USERS IN MONITORING AND CONTROLLING THEIR ENERGY DEMAND AND CONSUMPTION (U.S. CLS. 21, 23, 26, 36 AND 38).

FIRST USE 1-31-2002; IN COMMERCE 2-28-2002.

2,900,281. NINTENDO OF AMERICA INC., REDMOND, WA. SN 76-425,583. PUB. 1-28-2003, FILED 6-27-2002.

**GAME & WATCH**

OWNER OF U.S. REG. NO. 1,340,597.  
FOR COMPUTER GAME CARTRIDGES; COMPUTER GAME PROGRAMS; COMPUTER GAME SOFTWARE; ELECTRONIC GAME CARTRIDGES; ELECTRONIC GAME PROGRAMS; ELECTRONIC GAME SOFTWARE; INTERACTIVE GAME CARTRIDGES; INTERACTIVE GAME PROGRAMS; INTERACTIVE GAME SOFTWARE; VIDEO GAME CARTRIDGES; VIDEO GAME PROGRAMS; VIDEO GAME SOFTWARE; ELECTRONIC MEMORY AND MAGNETIC TRADING CARDS FEATURING GAME PROGRAM AND DATA CONTENT (U.S. CLS. 21, 23, 26, 36 AND 38).

FIRST USE 5-15-2003; IN COMMERCE 5-15-2003.

**CLASS 9—(Continued).**

2,900,294. UBI SOFT, INC., SAN FRANCISCO, CA. SN 76-432,603. PUB. 11-5-2002, FILED 7-17-2002.

**FAR CRY**

FOR SOFTWARE AND ELECTRONIC GAMES, NAMELY SOFTWARE GAMES RECORDED ON CD-ROM AND DIGITAL VIDEO DISCS FOR COMPUTERS; SOFTWARE GAMES RECORDED ON CD-ROMS, DIGITAL VIDEO DISCS, AND CARTRIDGES FOR CONSOLE AND INDIVIDUAL, PORTABLE GAMING SYSTEMS; SOFTWARE GAMES THAT ARE DOWNLOADABLE FROM A REMOTE COMPUTER SITE; AND ON WEBSITES ON A GLOBAL COMPUTER NETWORK IN CONNECTION WITH THE SOFTWARE GAMES; AND SOFTWARE GAMES FOR MOBILE PHONES, PERSONAL DIGITAL ASSISTANTS, AND HANDHELD COMPUTERS (U.S. CLS. 21, 23, 26, 36 AND 38).  
FIRST USE 3-23-2004; IN COMMERCE 3-23-2004.

2,900,298. ROXIO, INC., SANTA CLARA, CA. SN 76-437,106. PUB. 3-18-2003, FILED 8-2-2002.

**EASY CD & DVD CREATOR**

OWNER OF U.S. REG. NO. 2,369,815.  
NO CLAIM IS MADE TO THE EXCLUSIVE RIGHT TO USE "CD & DVD CREATOR", APART FROM THE MARK AS SHOWN.  
FOR COMPUTER SOFTWARE FOR PRODUCING AND STORING DIGITAL INFORMATION, NAMELY, AUDIO, PHOTO, VIDEO AND TEXT DATA; COMPUTER SOFTWARE FOR CONVERTING AND STORING ANALOG DATA INTO DIGITAL DATA ON OPTICAL MEDIA; COMPUTER SOFTWARE FOR USE IN THE CONVERSION TO AND STORAGE OF AUDIO, PHOTO, VIDEO AND TEXT DATA ON OPTICAL MEDIA AND USER MANUALS PROVIDED TOGETHER THEREWITH AS A UNIT (U.S. CLS. 21, 23, 26, 36 AND 38).  
FIRST USE 2-0-2003; IN COMMERCE 2-0-2003.

2,900,304. INVENTEC CORPORATION, SHIH LIN DISTRICT TAIPEI, TAIWAN. SN 76-440,694. PUB. 9-9-2003, FILED 8-15-2002.

**ECHO**

FOR SERIES OF PRE-RECORDED VIDEO TAPES, DIGITAL VIDEO DISCS, AUDIO CASSETTES AND COMPACT DISCS INTENDED TO TEACH FOREIGN LANGUAGE TO ADULTS AND CHILDREN; EDUCATIONAL SOFTWARE FEATURING INSTRUCTION IN SPEECH AND LANGUAGE SKILLS; COMPUTER SOFTWARE FOR BUILDING AND EXECUTING INTERACTIVE MULTIMEDIA TRAINING AND EDUCATIONAL PROGRAM AND TESTS THEREFOR; WITH RELATED MANUALS, AND TEXTS, SOLD AS A UNIT; COMPUTER SOFTWARE FOR USE IN TRANSLATING FOREIGN LANGUAGES; SOFTWARE INSTALLED IN COMPUTER, PDA, ELECTRONIC TRANSLATOR FOR THE INTERNET FOR LEARNING FOREIGN LANGUAGES (U.S. CLS. 21, 23, 26, 36 AND 38).  
FIRST USE 5-25-2004; IN COMMERCE 5-25-2004.

**CLASS 9—(Continued).**

2,900,312. MULTIMEDIA GAMES, INC., AUSTIN, TX. SN 76-446,045. PUB. 4-8-2003, FILED 8-29-2002.

**ADRENALINE RUSH**

FOR GAMING MACHINES FOR PLAYING ELECTRONIC BINGO GAMES AND GAMES OF CHANCE (U.S. CLS. 21, 23, 26, 36 AND 38).  
FIRST USE 9-24-2003; IN COMMERCE 9-24-2003.

2,900,321. SONY COMPUTER ENTERTAINMENT AMERICA INC., FOSTER CITY, CA. SN 76-448,495. PUB. 11-11-2003, FILED 9-11-2002.



NO CLAIM IS MADE TO THE EXCLUSIVE RIGHT TO USE "ONLINE", APART FROM THE MARK AS SHOWN.  
THE STIPPLING IN THE MARK IS A FEATURE OF THE MARK, AND IS NOT INTENDED TO INDICATE COLOR.  
THE MARK CONSISTS IN PART OF A DESIGN OF A RECTANGLE WITH ROUNDED EDGES CONTAINING THREE BUTTONS OF VARYING SIZE.  
FOR COMPUTER VIDEO GAME SOFTWARE AND HARDWARE TO PLAY VIDEO GAMES ONLINE (U.S. CLS. 21, 23, 26, 36 AND 38).  
FIRST USE 9-11-2002; IN COMMERCE 9-11-2002.

2,900,324. JBL SOFT INC., NEW BRUNSWICK, CANADA. SN 76-448,780. PUB. 4-22-2003, FILED 9-12-2002.



PRIORITY CLAIMED UNDER SEC. 44(D) ON CANADA APPLICATION NO. 1,135,708, FILED 3-25-2002.  
NO CLAIM IS MADE TO THE EXCLUSIVE RIGHT TO USE "SALON", APART FROM THE MARK AS SHOWN.  
FOR BEAUTY SALON BUSINESS MANAGEMENT SOFTWARE AND POINT OF SALE SOFTWARE FOR USE IN MANAGING SALES ACTIVITIES, PRODUCT INVENTORY CONTROL, APPOINTMENT MANAGEMENT, FILE MANAGEMENT, FINANCIAL ANALYSIS AND CONTROL, SALE AND PURCHASE CONTROL (U.S. CLS. 21, 23, 26, 36 AND 38).  
FIRST USE 5-15-2001; IN COMMERCE 12-2-2002.

**CLASS 9—(Continued).**

2,900,325. TECHSMITH CORPORATION, OKEMOS, MI. SN 76-448,801. PUB. 4-15-2003, FILED 9-12-2002.

**CAMTASIA STUDIO**

OWNER OF U.S. REG. NO. 2,488,689.  
NO CLAIM IS MADE TO THE EXCLUSIVE RIGHT TO USE "STUDIO", APART FROM THE MARK AS SHOWN.  
FOR COMPUTER SOFTWARE, NAMELY, A VIDEO CAPTURE, ANIMATION, AND STREAMING UTILITY SOFTWARE (U.S. CLS. 21, 23, 26, 36 AND 38).  
FIRST USE 10-28-2002; IN COMMERCE 11-1-2002.

2,900,326. MIKOHN GAMING CORPORATION, LAS VEGAS, NV. SN 76-449,005. PUB. 12-16-2003, FILED 9-13-2002.

**TREASURES OF THE WORLD**

FOR GAMING EQUIPMENT, NAMELY, GAMING MACHINES USED FOR GAMBLING AND GAME SOFTWARE FOR OPERATING THE GAMING MACHINES SOLD AS A UNIT THEREWITH (U.S. CLS. 21, 23, 26, 36 AND 38).  
FIRST USE 2-13-2004; IN COMMERCE 2-13-2004.

2,900,332. GUYS WHO LOVE GOD, LLC, GLEN BURNIE, MD. SN 76-453,071. PUB. 4-29-2003, FILED 9-26-2002.

**GUYS WHO LOVE GOD**

FOR PRE-RECORDED AUDIO TAPES, AUDIO CASSETTES, AUDIO DISCS, COMPACT DISCS, DIGITAL AUDIO TAPES; MUSICAL SOUND RECORDINGS (U.S. CLS. 21, 23, 26, 36 AND 38).  
FIRST USE 9-30-2002; IN COMMERCE 9-30-2002.

2,900,338. MINISTERIO INTERNACIONAL EL REY JESUS, INC., MIAMI, FL. SN 76-455,207. PUB. 4-15-2003, FILED 9-30-2002.

**CLASS 9—(Continued).**

NO CLAIM IS MADE TO THE EXCLUSIVE RIGHT TO USE "INTERNACIONAL", "MINISTERIO" OR "JESUS", APART FROM THE MARK AS SHOWN.

"MINISTERIO INTERNACIONAL EL REY JESUS" MEANS "KING JESUS INTERNATIONAL MINISTRY" IN SPANISH.

FOR PRE-RECORDED AUDIO TAPES, COMPACT DISCS (CDS), DIGITAL VIDEO DISCS (DVDS), VIDEO TAPES AND PHONOGRAPH ALBUMS FEATURING WORSHIP SERVICES, SERMONS, RELIGIOUS INSTRUCTION AND CHRISTIAN MUSIC (U.S. CLS. 21, 23, 26, 36 AND 38).

FIRST USE 6-10-2003; IN COMMERCE 6-10-2003.

2,900,346. PRICEWATERHOUSECOOPERS LLP, NEW YORK, NY. SN 76-460,765. PUB. 12-9-2003, FILED 10-16-2002.

**ENTERPRISE SECURITY BUSINESS MODEL**

NO CLAIM IS MADE TO THE EXCLUSIVE RIGHT TO USE "SECURITY BUSINESS MODEL", APART FROM THE MARK AS SHOWN.

FOR COMPUTER SOFTWARE USED FOR DATABASE MANAGEMENT AND REPORT GENERATION IN THE FIELDS OF INFORMATION SECURITY AND PRIVACY (U.S. CLS. 21, 23, 26, 36 AND 38).

FIRST USE 12-23-2002; IN COMMERCE 7-1-2004.

2,900,349. NATIONAL WESTERN LIFE INSURANCE COMPANY, AUSTIN, TX. SN 76-463,573. PUB. 1-20-2004, FILED 11-1-2002.

**LIFE CYCLE IAS**

FOR COMPUTER SOFTWARE USED FOR ADMINISTERING DAILY BUSINESS ACTIVITIES OF AN INSURANCE COMPANY, NAMELY, INSURANCE POLICY MAINTENANCE, INSURANCE PREMIUM ACCOUNTING, AND INSURANCE AGENT COMMISSION PAYMENTS, IN THE FIELD OF LIFE INSURANCE AND ANNUITY UNDERWRITING (U.S. CLS. 21, 23, 26, 36 AND 38).

FIRST USE 10-29-2002; IN COMMERCE 9-2-2003.



**CLASS 9—(Continued).**

2,900,350. ELANVITAL CORPORATION, PING CHEN CITY, TAO YUAN HSIEN, TAIWAN. SN 76-464,270. PUB. 9-30-2003, FILED 11-4-2002.

**GREENERGER**

FOR CHILDREN'S EDUCATIONAL SOFTWARE; COMPUTER SOFTWARE FOR BUSINESS AND OFFICE APPLICATIONS NAMELY, WORD PROCESSING, BOOK-KEEPING, ACCOUNTING AND DATABASE MANAGEMENT; ENTERTAINMENT SOFTWARE, NAMELY, COMPUTER GAME SOFTWARE AND VIDEO GAME SOFTWARE; COMPUTER SOFTWARE FOR OPERATING COMPUTERS, COMPUTER SOFTWARE FOR COMPUTER-AIDED DESIGN, COMPUTER-AIDED MANUFACTURING AND COMPUTER-AIDED ENGINEERING FOR MECHANICAL DESIGN, ELECTRICAL DESIGN, INDUSTRIAL DESIGN AND THERMAL DESIGN; ELECTRIC REMOTE CONTROLS OR CORDLESS DEVICES, NAMELY, CORDLESS TELEPHONES, AND CORDLESS REMOTE CONTROLS FOR ELECTRONIC INSTRUMENTS, NAMELY, COMPUTERS AND HOME APPLIANCES (U.S. CLS. 21, 23, 26, 36 AND 38).

FIRST USE 3-5-2004; IN COMMERCE 4-20-2004.

2,900,351. SONY KABUSHIKI KAISHA, TA SONY CORPORATION, TOKYO, JAPAN. SN 76-464,539. PUB. 11-11-2003, FILED 10-28-2002.

**GIGA VAULT**

NO CLAIM IS MADE TO THE EXCLUSIVE RIGHT TO USE "GIGA", APART FROM THE MARK AS SHOWN. FOR COMPUTER HARD DISC DRIVES (U.S. CLS. 21, 23, 26, 36 AND 38).

FIRST USE 6-30-2002; IN COMMERCE 6-30-2002.

2,900,355. CLARITI EYEWEAR, INC., SANTA FE SPRINGS, CA. SN 76-466,373. PUB. 7-22-2003, FILED 11-4-2002.

**AIRMAG**

FOR EYEWEAR, NAMELY, EYEGLASSES, SUNGLASSES, FRAMES, SUNLENS CLIP-ONS, AND EYE-SHADES, AND PARTS THEREFOR (U.S. CLS. 21, 23, 26, 36 AND 38).

FIRST USE 2-3-2003; IN COMMERCE 2-20-2003.

2,900,356. IP HOLDINGS LLC, WILMINGTON, DE. SN 76-466,459. PUB. 7-15-2003, FILED 11-13-2002.

**BONGO**

FOR SUNGLASSES (U.S. CLS. 21, 23, 26, 36 AND 38). FIRST USE 6-0-2000; IN COMMERCE 6-0-2000.

**CLASS 9—(Continued).**

2,900,359. SONY KABUSHIKI KAISHA, TA SONY CORPORATION, TOKYO 141, JAPAN. SN 76-468,961. PUB. 11-11-2003, FILED 11-13-2002.



NO CLAIM IS MADE TO THE EXCLUSIVE RIGHT TO USE "DVD RECORDER, DUAL RW" AND "COMPATIBLE", APART FROM THE MARK AS SHOWN.

FOR DIGITAL VERSATILE DISC PLAYERS/RECORDERS (U.S. CLS. 21, 23, 26, 36 AND 38).

FIRST USE 6-30-2003; IN COMMERCE 6-30-2003.

2,900,367. INTUIT INC., MOUNTAIN VIEW, CA. SN 76-470,963. PUB. 2-3-2004, FILED 11-29-2002.

**INTUIT TRACK-IT!**

FOR COMPUTER SOFTWARE FOR USE IN THE FIELD OF HELP DESK MANAGEMENT, NAMELY COMPUTER SOFTWARE FOR TRACKING AND MANAGING INFORMATION TECHNOLOGY SUPPORT REQUESTS AND INCIDENT REPORTS FROM USERS AND FOR TRACKING AND MANAGING TECHNOLOGY EQUIPMENT SUPPORT HISTORIES AND SUPPORT COST REPORTING; COMPUTER SOFTWARE FOR USE IN THE FIELD OF INFORMATION TECHNOLOGY ASSET MANAGEMENT, NAMELY COMPUTER SOFTWARE FOR TRACKING, MANAGING AND AUDITING COMPUTER SOFTWARE LICENSES AND COMPLIANCE AND FOR TRACKING AND MANAGING INFORMATION ON COMPUTER HARDWARE ASSETS, LEASE, USER, VENDOR, INSTALLATION AND SYSTEM CONFIGURATION, ASSET PURCHASING AND INSTALLATION AND DEPLOYMENT OF COMPUTER SOFTWARE AND SOFTWARE UPDATES BY LOCAL OR REMOTE MEANS (U.S. CLS. 21, 23, 26, 36 AND 38).

FIRST USE 4-18-2003; IN COMMERCE 4-18-2003.

2,900,373. HAURI INC., SEOUL, REPUBLIC OF KOREA. SN 76-472,052. PUB. 2-24-2004, FILED 11-25-2002.

**LIVECALL**

FOR COMPUTER SOFTWARE FOR PROTECTING COMPUTERS AGAINST VIRUSES, DOWNLOADABLE SOFTWARE FOR USE IN PROTECTING COMPUTERS AGAINST VIRUSES, AND PRERECORDED FLOPPY DISKS CONTAINING COMPUTER SOFTWARE FOR PROTECTING COMPUTERS AGAINST VIRUSES (U.S. CLS. 21, 23, 26, 36 AND 38).

FIRST USE 3-2-1999; IN COMMERCE 3-20-2002.

**CLASS 9—(Continued).**

2,900,379. SYBASE, INC., DUBLIN, CA. SN 76-475,612. PUB. 8-19-2003, FILED 12-16-2002.

**ULTRALITE.NET**

FOR COMPUTER SOFTWARE FOR SMALL DATABASE MANAGEMENT AND APPLICATIONS DEVELOPMENT FOR OPTIMIZATION OF DATABASES TO MEMORY REQUIREMENTS OF APPLICATIONS ON MOBILE, HANDHELD, AND EMBEDDED SYSTEMS, AND FOR COMMUNICATION AND SYNCHRONIZATION OF DATA WITH AN ENTERPRISE DATABASE, AND INSTRUCTIONAL MANUALS SOLD AS A UNIT THEREWITH (U.S. CLS. 21, 23, 26, 36 AND 38).  
FIRST USE 8-31-2003; IN COMMERCE 8-31-2003.

2,900,387. REVERE SUPPLY CO., INC., WEST CALDWELL, NJ. SN 76-479,530. PUB. 9-9-2003, FILED 12-27-2002.

**COASTAL CRUISER**

FOR INFLATABLE LIFE RAFTS (U.S. CLS. 21, 23, 26, 36 AND 38).  
FIRST USE 6-10-2004; IN COMMERCE 6-10-2004.

2,900,389. INNOVENTIONS ENTERPRISES LTD., FARMINGDALE, NY. SN 76-481,323. PUB. 9-2-2003, FILED 1-8-2003.

**S-GARD**

FOR SCRATCH RESISTANT COATING SOLD AS AN INTEGRAL PART OF SUNGLASSES (U.S. CLS. 21, 23, 26, 36 AND 38).  
FIRST USE 1-0-2003; IN COMMERCE 1-0-2003.

2,900,397. PITCH COUNT, LLC, ANNANDALE, VA. SN 76-486,475. PUB. 1-27-2004, FILED 1-31-2003.

**COACH DAVE'S PITCH COUNT**

NO CLAIM IS MADE TO THE EXCLUSIVE RIGHT TO USE "PITCH COUNT", APART FROM THE MARK AS SHOWN.

THE NAME "COACH DAVE" IDENTIFIES A LIVING INDIVIDUAL WHOSE CONSENT IS OF RECORD.

FOR HANDHELD ELECTRONIC CALCULATOR USED TO RECORD NUMBER OF PITCHES AND CALCULATE PERCENTAGE OF STRIKES THROWN IN ORDER TO TRACK THE PERFORMANCE OF ONE OR MORE BASEBALL OR SOFTBALL PITCHERS (U.S. CLS. 21, 23, 26, 36 AND 38).

FIRST USE 1-28-2004; IN COMMERCE 1-28-2004.

**CLASS 9—(Continued).**

2,900,407. CHIPDATA, INC., RICHARDSON, TX. SN 76-489,326. PUB. 10-28-2003, FILED 2-12-2003.

**PKGXPRT**

FOR COMPUTER SOFTWARE FOR CREATION, CONVERSION, CAPTURE, TRANSFORMATION, STORAGE, MANAGEMENT, ACCESS, REVISION, CORRELATION AND VERIFICATION OF DATA RELATING TO ELECTRONIC DEVICES AND RELATED USED GUIDES DISTRIBUTED THEREWITH (U.S. CLS. 21, 23, 26, 36 AND 38).

FIRST USE 3-4-2003; IN COMMERCE 3-4-2003.

2,900,408. CHIPDATA, INC., RICHARDSON, TX. SN 76-489,327. PUB. 10-28-2003, FILED 2-12-2003.

**SYMXPRT**

FOR COMPUTER SOFTWARE FOR CREATION, CONVERSION, CAPTURE, TRANSFORMATION, STORAGE, MANAGEMENT, ACCESS, REVISION, CORRELATION AND VERIFICATION OF DATA RELATING TO ELECTRONIC DEVICES AND RELATED USER GUIDES DISTRIBUTED THEREWITH (U.S. CLS. 21, 23, 26, 36 AND 38).

FIRST USE 3-4-2003; IN COMMERCE 3-4-2003.

2,900,409. CHIPDATA, INC., RICHARDSON, TX. SN 76-489,329. PUB. 10-28-2003, FILED 2-12-2003.

**THE DESIGN CHAIN ACCELERATION COMPANY**

NO CLAIM IS MADE TO THE EXCLUSIVE RIGHT TO USE "COMPANY", APART FROM THE MARK AS SHOWN.

FOR COMPUTER SOFTWARE FOR CREATION, CAPTURE, CONVERSION, VERIFICATION, REVISION, STORAGE, MANAGEMENT, ACCESS, CORRELATION, TRANSFORMATION AND DISTRIBUTION OF DATA RELATING TO ELECTRONIC DEVICES AND RELATED USER GUIDES DISTRIBUTED THEREWITH (U.S. CLS. 21, 23, 26, 36 AND 38).

FIRST USE 3-4-2003; IN COMMERCE 3-4-2003.

2,900,416. LANDIS+GYR INC., LAFAYETTE, IN. SN 76-492,497. PUB. 11-4-2003, FILED 2-26-2003.

**FOCUS**

FOR ELECTRICITY METERS (U.S. CLS. 21, 23, 26, 36 AND 38).

FIRST USE 8-31-2003; IN COMMERCE 8-31-2003.

**CLASS 9—(Continued).**

2,900,428. FULL MEASURE INC., OCCOQUAN, VA. SN 76-496,238. PUB. 10-14-2003, FILED 3-10-2003.

**STAGE RIGHT**

FOR COMPUTER SOFTWARE, NAMELY, EDUCATIONAL SOFTWARE FOR PREPARING A HOUSE FOR SALE (U.S. CLS. 21, 23, 26, 36 AND 38).  
FIRST USE 3-0-2004; IN COMMERCE 3-0-2004.

2,900,429. KONAMI CORPORATION, CHIYODA-KU, TOKYO, JAPAN. SN 76-496,308. PUB. 11-11-2003, FILED 3-11-2003.

**THE SACRED CARDS**

NO CLAIM IS MADE TO THE EXCLUSIVE RIGHT TO USE "CARDS", APART FROM THE MARK AS SHOWN.  
FOR VIDEO GAME SOFTWARE; VIDEO GAME PROGRAMS; VIDEO GAME CD-ROMS; VIDEO GAME DIGITAL VERSATILE DISC-ROMS; COMPUTER GAME PROGRAMS; COMPUTER GAME CD-ROMS; COMPUTER GAME DIGITAL VERSATILE DISC-ROMS; ELECTRONIC GAME PROGRAMS; ELECTRONIC GAME CD-ROMS; ELECTRONIC GAME DIGITAL VERSATILE DISC-ROMS; CARTRIDGES AND CASSETTES FOR USE WITH HAND-HELD VIDEO GAME MACHINE; CIRCUIT BOARDS CONTAINING GAME PROGRAMS FOR USE WITH HAND-HELD VIDEO GAME MACHINE; VIDEO OUTPUT GAME MACHINES FOR USE WITH TELEVISIONS; DOWNLOADABLE ELECTRONIC GAME SOFTWARE AND DOWNLOADABLE VIDEO GAME SOFTWARE (U.S. CLS. 21, 23, 26, 36 AND 38).  
FIRST USE 11-4-2003; IN COMMERCE 11-4-2003.

2,900,432. OAKLEY, INC., FOOTHILL RANCH, CA. SN 76-497,105. PUB. 11-25-2003, FILED 3-13-2003.

**VALVE**

FOR PROTECTIVE EYEWEAR, NAMELY SPECTACLES, PRESCRIPTION EYEWEAR, NAMELY, SPECTACLES AND SUNGLASSES, ANTI-GLARE GLASSES AND SUNGLASSES AND PARTS THEREOF, NAMELY REPLACEMENT LENSES, FRAMES, EARSTEMS, AND NOSE PIECES; CASES SPECIALLY ADAPTED FOR SPECTACLES AND SUNGLASSES (U.S. CLS. 21, 23, 26, 36 AND 38).  
FIRST USE 2-21-2003; IN COMMERCE 2-21-2003.

2,900,443. USA AIRMOBILE, INC., FT. LAUDERDALE, FL. SN 76-502,356. PUB. 11-4-2003, FILED 3-31-2003.

**WISHBONE**

FOR FALL PROTECTION EQUIPMENT FOR FALL RESTRAINT, FALL ARREST, AND EMERGENCY RELEASE, NAMELY, HARNESES, LANYARDS, LINES, LADDER HOOKS, AND CARABINERS (U.S. CLS. 21, 23, 26, 36 AND 38).  
FIRST USE 4-1-2003; IN COMMERCE 4-1-2003.

**CLASS 9—(Continued).**

2,900,450. MICRODYNE COMPANY, L.L.C., SAVANNAH, MO. SN 76-504,815. PUB. 10-28-2003, FILED 4-7-2003.

**TATTLETALE**

FOR ELECTRONIC ESTRUS DETECTION DEVICE FOR USE WITH ANIMALS (U.S. CLS. 21, 23, 26, 36 AND 38).  
FIRST USE 9-18-2003; IN COMMERCE 9-18-2003.

2,900,458. KENMARK OPTICAL COMPANY, LOUISVILLE, KY. SN 76-509,046. PUB. 12-2-2003, FILED 4-23-2003.

**SALSA**

FOR EYEWEAR, NAMELY EYEGLASS FRAMES (U.S. CLS. 21, 23, 26, 36 AND 38).  
FIRST USE 8-1-2003; IN COMMERCE 8-1-2003.

2,900,486. FIKE CORPORATION, BLUE SPRINGS, MO. SN 76-518,944. PUB. 1-27-2004, FILED 6-2-2003.

**CEREX**

FOR EXPLOSION DETECTORS (U.S. CLS. 21, 23, 26, 36 AND 38).  
FIRST USE 2-28-2003; IN COMMERCE 6-30-2004.

2,900,489. EVETS CORPORATION, SAN CLEMENTE, CA. SN 76-520,038. PUB. 2-10-2004, FILED 6-6-2003.

**ROCK-A-BYE**

FOR SOUND EFFECT PEDALS FOR MUSICAL INSTRUMENTS (U.S. CLS. 21, 23, 26, 36 AND 38).  
FIRST USE 6-11-2004; IN COMMERCE 6-11-2004.

2,900,496. KABUSHIKI KAISHA SEGA, DBA SEGA CORPORATION, TOKYO 144-8531, JAPAN. SN 76-523,284. PUB. 1-20-2004, FILED 6-10-2003.

**SHINING FORCE**

FOR VIDEO GAME SOFTWARE; COMPUTER GAME PROGRAMS; COMPUTER GAME DISCS; VIDEO COMPUTER GAME PROGRAMS; HOME VIDEO COMPUTER GAME DISCS; GAME DISCS, CARTRIDGES AND CIRCUIT BOARDS CONTAINING GAME PROGRAMS FOR USE WITH HAND-HELD VIDEO GAME MACHINES WITH BUILT-IN SCREENS (U.S. CLS. 21, 23, 26, 36 AND 38).  
FIRST USE 3-0-1992; IN COMMERCE 3-0-1992.

**CLASS 9—(Continued).**

2,900,500. AVERMEDIA TECHNOLOGIES, INC., CHUNG-HO CITY, TAIPEI HSIEN, TAIWAN. SN 76-526,215. PUB. 2-3-2004, FILED 6-27-2003.

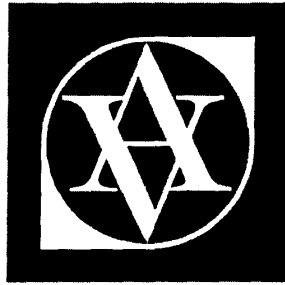

FOR COMPUTER PERIPHERALS; INTEGRATED CIRCUITS; COMPUTER INTERFACE BOARDS; COMPUTER MONITORS; VIDEO MONITORS; MOTION PICTURE CAMERAS; PHOTOGRAPHIC CAMERAS; PHOTOGRAPHIC PROJECTORS; SILICON CHIPS; TELEPHONES; TELEVISION SETS; COMPUTER TERMINALS (U.S. CLS. 21, 23, 26, 36 AND 38).

FIRST USE 10-1-2003; IN COMMERCE 10-1-2003.

2,900,502. SOLUTIONS BY DESIGN, INC., FRESNO, CA. SN 76-527,321. PUB. 2-24-2004, FILED 6-20-2003.

**SCREENPLAY**

FOR CDS CONTAINING INSTRUCTIONS TO ASSIST DOCTORS WITH NEW PATIENT ORIENTATION (U.S. CLS. 21, 23, 26, 36 AND 38).

FIRST USE 1-5-2004; IN COMMERCE 1-5-2004.

2,900,509. ALI CORPORATION, CHU TUNG JEN, HSINCHU HSIENG, TAIWAN. SN 76-531,603. PUB. 2-3-2004, FILED 7-17-2003.

FOR COMPUTER CHIPS; SILICON CHIPS; CIRCUIT BOARDS; COMPUTER FIRMWARE FOR USE AS INTERFACE SOFTWARE FOR CONTROLLING, COMMANDING AND INTEGRATING COMPUTER CHIPS; COMPUTER GAME EQUIPMENT CONTAINING MEMORY DEVICES, NAMELY, DISCS; INTEGRATED CIRCUITS; COMPUTER OPERATING SYSTEMS; SEMICONDUCTOR DEVICES; SEMICONDUCTORS (U.S. CLS. 21, 23, 26, 36 AND 38).

FIRST USE 10-1-2003; IN COMMERCE 10-1-2003.

**CLASS 9—(Continued).**

2,900,530. KONAMI CORPORATION, CHIYODA-KU, TOKYO, JAPAN. SN 76-976,980. PUB. 11-4-2003, FILED 3-7-2003.

**ENTHUSIA**

FOR VIDEO GAME SOFTWARE; VIDEO GAME PROGRAMS; VIDEO GAME CD-ROMS; VIDEO GAME DIGITAL VERSATILE DISC-ROMS; COMPUTER GAME PROGRAMS; COMPUTER GAME CD-ROMS; COMPUTER GAME DIGITAL VERSATILE DISC-ROMS; ELECTRONIC GAME PROGRAMS; ELECTRONIC GAME CD-ROMS; ELECTRONIC GAME DIGITAL VERSATILE DISC-ROMS; CARTRIDGES AND CASSETTES FOR USE WITH HAND-HELD VIDEO GAME MACHINE; CIRCUIT BOARDS CONTAINING GAME PROGRAMS FOR USE WITH HAND-HELD VIDEO GAME MACHINE; VIDEO OUTPUT GAME MACHINES FOR USE WITH TELEVISIONS; DOWNLOADABLE ELECTRONIC GAME SOFTWARE; DOWNLOADABLE COMPUTER GAME SOFTWARE AND DOWNLOADABLE VIDEO GAME SOFTWARE (U.S. CLS. 21, 23, 26, 36 AND 38).

FIRST USE 5-12-2004; IN COMMERCE 5-12-2004.

2,900,538. AGERE SYSTEMS INC., ALLENTOWN, PA. SN 78-037,397. PUB. 9-24-2002, FILED 12-1-2000.

**AGERE**

FOR INTEGRATED CIRCUITS; COMMUNICATION AND COMPUTER HARDWARE, NAMELY, NETWORK AND SIGNAL PROCESSORS, ELECTRONIC SWITCHES, DECODERS, DATA BUSES, PROCESSOR BUSES, FABRIC DATA SWITCHES, TRANSMITTERS; COMPUTER HARDWARE FOR INFORMATION STORAGE, NAMELY, DISK DRIVE CONTROLLERS; COMPUTER HARDWARE AND SOFTWARE DEVELOPMENT TOOLS; DIGITAL SIGNAL PROCESSORS; READ CHANNELS; PREAMPLIFIERS; MOTOR CONTROLLERS; PC CARD RADIOS; COMPUTER NETWORK ADAPTERS; ELECTRONIC COMMUNICATIONS NETWORKING COMPONENTS, NAMELY, FRAMERS; COMPUTER SWITCHES; NETWORK COMMUNICATION DRIVERS; NETWORK PROCESSORS; SEMICONDUCTORS; ROUTERS; COMPUTER SOFTWARE FOR USE IN THE MANAGEMENT OF WIRELESS COMMUNICATION SYSTEMS; MULTIPLEXERS; COMMUNICATIONS EQUIPMENT, NAMELY, MODEMS, ANTENNAS, SIGNAL CONVERTERS, MAPPERS FOR BROADBAND TRANSMISSION OF DATA, ACCESS POINTS, PCI ADAPTERS, BASE STATIONS AND CODERS; DECODERS; WIRELESS ACCESS TRANSMITTERS; MODULATORS FOR MULTIPLEXING AND DATA COMMUNICATIONS; AMPLIFIERS; RECEIVERS; TRANSCEIVERS; LOCAL AREA NETWORKS; COMPUTER SOFTWARE DRIVERS NAMELY, NETWORK COMMUNICATION DRIVERS; COMPUTER HARDWARE DRIVERS; REGENERATORS; BASE TRANSCEIVER STATIONS; MAPPERS FOR BROADBAND TRANSMISSION OF DATA; SATELLITE DIGITAL RADIO TRANSCEIVER AND SATELLITE DIGITAL RADIO RECEIVER (U.S. CLS. 21, 23, 26, 36 AND 38).

FIRST USE 7-26-1999; IN COMMERCE 7-26-1999.

**CLASS 9—(Continued).**

2,900,539. AGERE SYSTEMS INC., ALLENTOWN, PA. SN 78-037,411. PUB. 9-24-2002, FILED 12-1-2000.

agere systems

NO CLAIM IS MADE TO THE EXCLUSIVE RIGHT TO USE "SYSTEMS", APART FROM THE MARK AS SHOWN.

FOR LASERS NOT FOR MEDICAL USE; INTEGRATED CIRCUITS; COMMUNICATION AND COMPUTER HARDWARE, NAMELY, NETWORK AND SIGNAL PROCESSORS, OPTICAL SWITCHES, ELECTRONIC SWITCHES, TRANSPONDERS, OPTICAL RECEIVERS, DECODERS, DATA BUSES, PROCESSOR BUSES, FABRIC DATA SWITCHES, TRANSMITTERS; COMPUTER HARDWARE FOR INFORMATION STORAGE, NAMELY, DISK DRIVE CONTROLLERS; COMPUTER HARDWARE AND SOFTWARE DEVELOPMENT TOOLS; DIGITAL SIGNAL PROCESSORS; READ CHANNELS; PREAMPLIFIERS; MOTOR CONTROLLERS; PC CARD RADIOS; COMPUTER NETWORK ADAPTERS; ELECTRONIC COMMUNICATIONS NETWORKING COMPONENTS, NAMELY, FRAMERS; COMPUTER SWITCHES; NETWORK COMMUNICATION DRIVERS; NETWORK PROCESSORS; SEMICONDUCTORS; ROUTERS; COMPUTER SOFTWARE FOR USE IN THE MANAGEMENT OF WIRELESS COMMUNICATION SYSTEMS; MULTIPLEXERS; COMMUNICATIONS EQUIPMENT, NAMELY, MODEMS, ANTENNAS, SIGNAL CONVERTERS, MAPPERS FOR BROADBAND TRANSMISSION OF DATA, ACCESS POINTS, PCI ADAPTERS, BASE STATIONS AND CODERS; DECODERS; WIRELESS ACCESS TRANSMITTERS; MODULATORS FOR MULTIPLEXING AND DATA COMMUNICATIONS; AMPLIFIERS; RECEIVERS; TRANSCIEVERS; LOCAL AREA NETWORKS; COMPUTER SOFTWARE DRIVERS NAMELY, NETWORK COMMUNICATION DRIVERS; COMPUTER HARDWARE DRIVERS; REGENERATORS; BASE TRANSCIEVER STATIONS; MAPPERS FOR BROADBAND TRANSMISSION OF DATA; SATELLITE DIGITAL RADIO TRANSCIEVER AND SATELLITE DIGITAL RADIO RECEIVER (U.S. CLS. 21, 23, 26, 36 AND 38).

FIRST USE 12-5-2000; IN COMMERCE 2-19-2001.

2,900,548. ECHAVE, ALBERTO MARCELO, BERNAL, BUENOS AIRES, ARGENTINA. SN 78-061,858. PUB. 9-2-2003, FILED 5-3-2001.

**MAGNETIC CASH**

FOR COMPUTER SYSTEM COMPRISED OF COMPUTER HARDWARE AND COMPUTER SOFTWARE THAT ANALYSES DATA STORED ON MAGNETIC CARDS WHICH IS TRANSMITTED FROM AN ELECTRONIC PRINTED CIRCUIT BOARD TO ALLOW OPERATION OF VIDEO ARCADE GAMES OR ANY OTHER COIN OR TOKEN OPERATED DEVICE SUCH AS LAUNDRY MACHINES AND COMPUTERS WITH ACCESS TO THE INTERNET (U.S. CLS. 21, 23, 26, 36 AND 38).

FIRST USE 9-27-1999; IN COMMERCE 9-18-2000.

**CLASS 9—(Continued).**

2,900,556. VERT TECH LLC, WILMINGTON, DE. SN 78-088,822. PUB. 4-8-2003, FILED 10-17-2001.

Verticalnet

OWNER OF U.S. REG. NOS. 2,246,967, 2,594,367, AND OTHERS.

FOR COMPUTER SOFTWARE FOR USE IN THE ACQUISITION, TRACKING AND PAYMENT FOR GOODS AND SERVICES (U.S. CLS. 21, 23, 26, 36 AND 38).

FIRST USE 10-2-2001; IN COMMERCE 10-2-2001.

2,900,570. GRAITEC SA, BIEVRES, FRANCE. SN 78-111,949. PUB. 3-11-2003, FILED 3-1-2002.

advance  
DESIGN FOR AEC

NO CLAIM IS MADE TO THE EXCLUSIVE RIGHT TO USE "DESIGN FOR AEC", APART FROM THE MARK AS SHOWN.

FOR COMPUTER AIDED DESIGN (CAD) SOFTWARE FOR USE IN MODELING, CALCULATING, AND PRODUCING CONSTRUCTION DRAWINGS IN THE FIELD OF CIVIL ENGINEERING (U.S. CLS. 21, 23, 26, 36 AND 38).

FIRST USE 6-0-2000; IN COMMERCE 6-0-2003.

2,900,574. LITELINK, INC, HICKSVILLE, NY. SN 78-113,730. PUB. 10-28-2003, FILED 3-9-2002.

**LITELINK**

FOR COMMUNICATION TRANSMISSION SYSTEMS COMPRISING FIBER OPTICS, TRANSMITTERS AND RECEIVERS, UTILIZED IN TRANSMITTING VIDEO, AUDIO AND/OR DATA OVER FIBER OPTIC CABLES (U.S. CLS. 21, 23, 26, 36 AND 38).

FIRST USE 1-0-2003; IN COMMERCE 1-0-2003.

**CLASS 9—(Continued).**

2,900,582. COMPUTER ASSOCIATES THINK, INC., ISLANDIA, NY. SN 78-118,453. PUB. 11-5-2002, FILED 3-29-2002.

**CLASS 9—(Continued).**

2,900,643. DIGITAL INTERACTIVE STREAMS, INC., JACKSONVILLE, FL. SN 78-167,549. PUB. 5-27-2003, FILED 9-24-2002.

**ETRUST 20/20**

FOR COMPUTER SOFTWARE TO PROVIDE SECURITY IN DISTRIBUTING COMPUTING ENVIRONMENT AND TO ENABLE AN INTEGRATED VISUALIZATION OF PHYSICAL SECURE ACCESS AND INFORMATION SYSTEMS ACCESS IN REAL TIME AS WELL AS OVER A SPECIFIC TIME INTERVAL (U.S. CLS. 21, 23, 26, 36 AND 38).

FIRST USE 6-3-2003; IN COMMERCE 6-3-2003.



THE MARK CONSISTS OF THE STYLIZED LETTERS "DI".

FOR COMPUTER SOFTWARE FOR PROCESSING, ENCODING, TRANSCODING, DECODING, CROPPING, DEINTERLACING, FILTERING, ENHANCING, ENCRYPTING, DECRYPTING, MANAGING, REQUESTING, TRANSMITTING, DISTRIBUTING, BROADCASTING, RECEIVING AND PLAYING DIGITAL VIDEO DATA (U.S. CLS. 21, 23, 26, 36 AND 38).

FIRST USE 8-19-2003; IN COMMERCE 8-19-2003.

2,900,594. DENSEN, LAWRENCE, E, MELVILLE, NY. SN 78-126,064. PUB. 2-11-2003, FILED 5-3-2002.

**TUNER WEAR**

NO CLAIM IS MADE TO THE EXCLUSIVE RIGHT TO USE "WEAR", APART FROM THE MARK AS SHOWN. FOR PROTECTIVE GLOVES FOR USE IN THE AUTO INDUSTRY (U.S. CLS. 21, 23, 26, 36 AND 38).

FIRST USE 12-1-2002; IN COMMERCE 1-1-2003.

2,900,650. MEDTRONIC, INC., MINNEAPOLIS, MN. SN 78-170,530. PUB. 4-20-2004, FILED 10-3-2002.

**MAGELLAN**

FOR LABORATORY APPARATUS, NAMELY, CENTRIFUGE USED TO SEPARATE AND CONCENTRATE PLATELETS IN BLOOD SAMPLES (U.S. CLS. 21, 23, 26, 36 AND 38).

FIRST USE 12-31-2002; IN COMMERCE 12-31-2002.

2,900,632. LIBURD, STEVEN W., MOUNT VERNON, NY. SN 78-161,727. PUB. 12-9-2003, FILED 9-7-2002.

**SHOESTRING**

FOR COMPUTER SOFTWARE FOR BUDGETING FOR HOME AND BUSINESSES (U.S. CLS. 21, 23, 26, 36 AND 38).

FIRST USE 10-11-2002; IN COMMERCE 10-11-2002.

2,900,652. ZAXEL SYSTEMS, INC., LOS ALTOS HILLS, CA. SN 78-170,864. PUB. 4-29-2003, FILED 10-3-2002.

**ZAXTAR**

FOR COMPUTER SOFTWARE AND HARDWARE FOR USE IN ANIMATION, GRAPHICS AND IMAGE-BASED RENDERING APPLICATIONS; COMPUTER SOFTWARE AND HARDWARE FOR RECORDING, TRANSMISSION AND VIEWING OF SOUND/IMAGE DATA FOR MOVIES, COMPUTER GAMES, VISUALIZATION, AND BROADCAST (U.S. CLS. 21, 23, 26, 36 AND 38).

FIRST USE 10-0-2002; IN COMMERCE 6-0-2004.

**CLASS 9—(Continued).**

2,900,662. NEW SENSOR CORP., LONG ISLAND CITY, NY.  
SN 78-185,019. PUB. 6-17-2003, FILED 11-14-2002.

**MULLARD**

FOR VACUUM TUBES (U.S. CLS. 21, 23, 26, 36 AND 38).  
FIRST USE 7-29-2004; IN COMMERCE 7-29-2004.

2,900,664. CTS CORPORATION, ELKHART, IN. SN 78-189,672. PUB. 7-29-2003, FILED 11-27-2002.

**EMSWORLDWIDE**

FOR PRINTED CIRCUIT BOARDS, BACKPLANE ASSEMBLIES, PRINTED CIRCUIT ASSEMBLIES, CABLES ASSOCIATES WITH THE PRINTED CIRCUIT BOARDS AND ASSEMBLIES AND ENCLOSURES SYSTEMS (U.S. CLS. 21, 23, 26, 36 AND 38).  
FIRST USE 11-12-2002; IN COMMERCE 11-12-2002.

2,900,673. MICHAEL HENRY GAYTAN, D.D.S., ENCINO, CA. SN 78-196,520. PUB. 1-20-2004, FILED 12-19-2002.



NO CLAIM IS MADE TO THE EXCLUSIVE RIGHT TO USE "IMPLANT DENTISTRY EDUCATIONAL ACCESS & SYSTEMS", APART FROM THE MARK AS SHOWN.

THE MARK CONSISTS OF THE WORDING "IDEAS" INSIDE A BLUE RECTANGLE WHICH APPEARS ABOVE THE WORDING "IMPLANT DENTISTRY EDUCATIONAL ACCESS & SYSTEMS".

FOR CD'S AND DVD'S FEATURING EDUCATIONAL INFORMATION IN THE FIELD OF IMPLANT DENTISTRY AND TREATMENT PLANNING (U.S. CLS. 21, 23, 26, 36 AND 38).

FIRST USE 12-1-2002; IN COMMERCE 12-1-2002.

2,900,681. USER-CENTRIC ENTERPRISES, INC., WICHITA, KS. SN 78-199,495. PUB. 10-21-2003, FILED 1-2-2003.

**PUT THE WEATHER WHERE YOUR MAP IS**

NO CLAIM IS MADE TO THE EXCLUSIVE RIGHT TO USE "WEATHER" AND "MAP", APART FROM THE MARK AS SHOWN.

FOR GLOBAL POSITIONING SYSTEM, COMPUTER SOFTWARE FOR PROCESSING AND DISPLAYING AND MAPPING INFORMATION (U.S. CLS. 21, 23, 26, 36 AND 38).

FIRST USE 1-0-2003; IN COMMERCE 1-0-2003.

**CLASS 9—(Continued).**

2,900,683. MANNING, KENNETH, D., JESUP, GA. SN 78-200,883. PUB. 11-18-2003, FILED 1-7-2003.

**ROBO-CABLES**

FOR AUTOMOTIVE BOOSTER CABLES (U.S. CLS. 21, 23, 26, 36 AND 38).  
FIRST USE 12-5-2003; IN COMMERCE 6-1-2004.

2,900,684. ZEKI, ORAK, SAN FRANCISCO, CA. SN 78-201,162. PUB. 3-23-2004, FILED 1-8-2003.



FOR COMPUTER GAME SOFTWARE FEATURING A MEMORY AND STRATEGY GAME (U.S. CLS. 21, 23, 26, 36 AND 38).

FIRST USE 9-1-2000; IN COMMERCE 1-1-2001.

2,900,691. VENDMAX INTERNATIONAL INC., WINNIPEG, MANITOBA, CANADA. SN 78-203,448. PUB. 10-14-2003, FILED 1-15-2003.

**EZ MONEY VENDING SOFTWARE**

NO CLAIM IS MADE TO THE EXCLUSIVE RIGHT TO USE "MONEY VENDING SOFTWARE", APART FROM THE MARK AS SHOWN.

FOR COMPUTER SOFTWARE FOR USE IN TRACKING AND ANALYZING BUSINESS IN VENDING MACHINES (U.S. CLS. 21, 23, 26, 36 AND 38).

FIRST USE 8-1-2003; IN COMMERCE 9-1-2003.

**CLASS 9—(Continued).**

2,900,702. KASHYA, INC., SAN JOSE, CA. SN 78-207,255. PUB. 11-18-2003, FILED 1-27-2003.



THE LINING SHOWN IN THE DRAWING (BETWEEN THE LETTER "K" AND THE WORD "KASHYA") IS A FEATURE OF THE MARK.

FOR COMPUTER HARDWARE AND SOFTWARE FOR DATA STORAGE PROTECTION AND REPLICATION (U.S. CLS. 21, 23, 26, 36 AND 38).

FIRST USE 7-22-2002; IN COMMERCE 5-1-2003.

2,900,705. PARADYNE CORPORATION, LARGO, FL. SN 78-212,759. PUB. 10-28-2003, FILED 2-10-2003.

**IMARC**

FOR NETWORKING ACCESS DEVICES, NAMELY, CHANNEL SERVICE UNITS, DIGITAL SERVICE UNITS AND ROUTERS (U.S. CLS. 21, 23, 26, 36 AND 38).

FIRST USE 4-1-2003; IN COMMERCE 6-1-2003.

2,900,708. BORLAND SOFTWARE CORPORATION, SCOTTS VALLEY, CA. SN 78-214,209. PUB. 10-21-2003, FILED 2-12-2003.

**LIVESOURCE**

FOR COMPUTER PROGRAMS, NAMELY, COMPILERS AND ASSEMBLERS; VISUAL DEVELOPMENT SOFTWARE FOR USE IN CREATING APPLICATIONS AND PROGRAMS AND FOR DEVELOPING GRAPHICAL USER INTERFACES; GLOBAL COMPUTER NETWORK AND WEB-BASED COMPUTER PROGRAMS, APPLICATIONS COMPUTER PROGRAMS AND APPLICATION DEVELOPMENT SOFTWARE FOR USE IN DESIGNING, DEVELOPING, WRITING AND IMPLEMENTING USER-SPECIFIC APPLICATIONS AND GENERAL PURPOSE APPLICATION PROGRAMS; TOOLS AND UTILITIES FOR USE IN WRITING AND IMPLEMENTING COMPUTER PROGRAMS; PROGRAMMING SOFTWARE TOOLS FOR USE IN DEVELOPING, MAINTAINING, ENHANCING AND OPERATING COMPUTER PROGRAMS AND COMPUTER SYSTEMS; COMPUTER UTILITY PROGRAMS, AND USER MANUALS SOLD THEREWITH AS A UNIT (U.S. CLS. 21, 23, 26, 36 AND 38).

FIRST USE 6-1-2000; IN COMMERCE 6-1-2000.

**CLASS 9—(Continued).**

2,900,714. DENALI SOFTWARE, INC., PALO ALTO, CA. SN 78-216,896. PUB. 11-11-2003, FILED 2-20-2003.

**PURESPEC**

FOR COMPUTER SOFTWARE FOR DESIGNING, MODELING AND SIMULATING COMPUTER CHIP DESIGN AND CHIP INTERFACES, VERIFYING COMPLIANCE WITH CHIP INTERFACE SPECIFICATIONS, VERIFYING COMPATIBILITY OF COMPUTER CHIPS AND CHIP INTERFACES WITH OTHER DEVICES, DATA CHECKING, DATA GENERATION AND ANALYSIS, AND DEBUGGING, AND MANUALS SUPPLIED THEREWITH (U.S. CLS. 21, 23, 26, 36 AND 38).

FIRST USE 2-0-2003; IN COMMERCE 2-0-2003.

2,900,716. PEAVEY ELECTRONICS CORPORATION, MERIDIAN, MS. SN 78-218,658. PUB. 10-7-2003, FILED 2-25-2003.

**PR**

FOR LOUDSPEAKERS (U.S. CLS. 21, 23, 26, 36 AND 38).

FIRST USE 7-0-2003; IN COMMERCE 7-0-2003.

2,900,724. MODERN MARKETING CONCEPTS, INC., LOUISVILLE, KY. SN 78-220,207. PUB. 5-4-2004, FILED 2-28-2003.

**DETROLA**

FOR RADIOS, TELEPHONES AND TURNTABLES (U.S. CLS. 21, 23, 26, 36 AND 38).

FIRST USE 3-0-2003; IN COMMERCE 3-0-2003.

2,900,726. OLD NATIONAL BANCORP, EVANSVILLE, IN. SN 78-221,192. PUB. 11-11-2003, FILED 3-4-2003.

**FUNDRIVER**

FOR COMPUTER SOFTWARE FOR USE BY NON-PROFIT ORGANIZATIONS TO PERFORM ACCOUNTING TASKS (U.S. CLS. 21, 23, 26, 36 AND 38).

FIRST USE 1-0-2003; IN COMMERCE 2-26-2003.



**CLASS 9—(Continued).**

2,900,742. 1-REX, INC., FORT WORTH, TX. SN 78-225,301.  
PUB. 2-10-2004, FILED 3-13-2003.

**EZ-FLOW**

FOR WORK FLOW SYSTEM, COMPRISED OF COMPUTER SOFTWARE, COMPUTERS AND BAR CODE READERS USED TO TRACK THE FLOW OF PRESCRIPTION DATA THROUGH THE PHARMACY, INCLUDING ENTRY OF PRESCRIPTION INTO THE SYSTEM, FILLING OF THE PRESCRIPTION, VERIFICATION OF THE MEDICATION DISPENSED AND PRESCRIBED (U.S. CLS. 21, 23, 26, 36 AND 38).

FIRST USE 2-1-2003; IN COMMERCE 2-1-2003.

2,900,757. DATACOM SYSTEMS, INC., EAST SYRACUSE, NY. SN 78-230,883. PUB. 11-11-2003, FILED 3-27-2003.

**VERSALINK**

FOR COMPUTER NETWORK ACCESS EQUIPMENT, NAMELY, A MULTI-CHANNEL DEVICE FOR INTERCONNECTING NETWORK TEST AND MONITORING EQUIPMENT TO A COMPUTER NETWORK, AND USER MANUALS SOLD THEREWITH (U.S. CLS. 21, 23, 26, 36 AND 38).

FIRST USE 3-25-2003; IN COMMERCE 3-25-2003.

2,900,759. ULTIMATE TECHNOLOGY CORPORATION, VICTOR, NY. SN 78-230,996. PUB. 10-21-2003, FILED 3-27-2003.



OWNER OF U.S. REG. NOS. 2,022,127 AND 2,023,727.  
NO CLAIM IS MADE TO THE EXCLUSIVE RIGHT TO USE "TECHNOLOGY", APART FROM THE MARK AS SHOWN.

THE STIPPLING IS FOR SHADING PURPOSES ONLY AND DOES NOT INDICATE COLOR.

FOR POINT OF SALE ELECTRONIC TERMINALS, SOLD WITH OR WITHOUT CASH DRAWERS, POINT OF SALE ELECTRONIC DISPLAYS, ELECTRONIC POINT OF SALE CUSTOMER DISPLAYS, ELECTRONIC POINT OF SALE POLE DISPLAYS, POINT OF SALE AND COMPUTER KEYBOARDS, BAR CODE SCANNERS, MAGNETIC CARD READERS, RECEIPT PRINTERS, COMPUTERS, COMPUTER MONITORS, TOUCH SCREEN DISPLAYS, ELECTRICAL CABLES, POWER SUPPLIES, AND COMPUTER SOFTWARE FOR OPERATING, DIAGNOSING AND PROGRAMMING THE AFORESAID GOODS (U.S. CLS. 21, 23, 26, 36 AND 38).

FIRST USE 6-0-2003; IN COMMERCE 6-0-2003.

**CLASS 9—(Continued).**

2,900,768. FRED CLEMENTI, WARRENTON, VA. SN 78-233,341. PUB. 11-11-2003, FILED 4-3-2003.

**FASTXREF**

FOR COMPUTER SOFTWARE FOR CROSS-REFERENCING TOOLS, FASTENERS AND APPLICATIONS (U.S. CLS. 21, 23, 26, 36 AND 38).

FIRST USE 9-1-2003; IN COMMERCE 9-1-2003.

2,900,769. WESTON SOLUTIONS, INC., SEATTLE, WA. SN 78-234,077. PUB. 12-2-2003, FILED 4-4-2003.

**MAINBREAK**

FOR COMPUTER SOFTWARE FOR ENGINEERING PURPOSES (U.S. CLS. 21, 23, 26, 36 AND 38).

FIRST USE 1-26-2004; IN COMMERCE 1-26-2004.

2,900,780. INITIATE SYSTEMS, INC., CHICAGO, IL. SN 78-237,293. PUB. 4-13-2004, FILED 4-14-2003.

FOR COMPUTER SOFTWARE FOR DATA QUALITY ANALYTICS, DATA QUALITY REMEDIATION AND DATA INTEGRATION; COMPUTER SOFTWARE FOR RECORDS MANAGEMENT AND DATABASE CREATION AND MANAGEMENT; COMPUTER SOFTWARE FOR IDENTITY MANAGEMENT; COMPUTER SOFTWARE FOR THE STORAGE AND TRACKING OF INFORMATION PERTAINING TO INDIVIDUALS, ENTITIES OR EVENTS (U.S. CLS. 21, 23, 26, 36 AND 38).

FIRST USE 3-7-2003; IN COMMERCE 9-23-2003.

2,900,782. INTERNET SECURITY SYSTEMS, INC., ATLANTA, GA. SN 78-237,438. PUB. 1-6-2004, FILED 4-14-2003.

**PROVENTIA**

FOR COMPUTER HARDWARE; COMPUTER SOFTWARE FOR ASSESSING AND PROTECTING COMPUTER NETWORKS, SERVERS, APPLICATIONS AND DESKTOPS AGAINST ATTACK, INTRUSION AND MISUSE; COMPUTER SOFTWARE FOR PROTECTING DATA/INFORMATION STORED ON AND/OR TRANSMITTED ACROSS NETWORKS, SERVERS, APPLICATIONS AND DESKTOPS AGAINST ATTACK, INTRUSION AND MISUSE (U.S. CLS. 21, 23, 26, 36 AND 38).

FIRST USE 4-14-2003; IN COMMERCE 4-14-2003.

**CLASS 9—(Continued).**

2,900,792. RICHARDSON ELECTRONICS, LTD., LAFOX, IL. SN 78-242,047. PUB. 12-23-2003, FILED 4-25-2003.



The logo for ViewMEDX features the word "ViewMEDX" in a bold, sans-serif font. The "X" is significantly larger and more stylized than the other letters, with a horizontal line passing through its middle. The "View" is in a smaller font size than "MEDX".

FOR LIQUID CRYSTAL DISPLAYS FOR MEDICAL APPLICATIONS (U.S. CLS. 21, 23, 26, 36 AND 38). FIRST USE 6-7-2004; IN COMMERCE 6-7-2004.

2,900,797. MAX-VIZ, INC., PORTLAND, OR. SN 78-244,573. PUB. 11-25-2003, FILED 5-1-2003.



The logo for MAX-VIZ consists of the words "MAX" and "VIZ" in a bold, sans-serif font, separated by a small black circle. Above the "VIZ" part, there is a stylized graphic element resembling a curved line or a partial arc.

FOR ENHANCED VISION SYSTEMS COMPRISED OF CAMERAS, SENSORS, SIGNAL PROCESSORS AND DISPLAY MONITORS AND THEIR COMPONENTS (U.S. CLS. 21, 23, 26, 36 AND 38). FIRST USE 6-3-2003; IN COMMERCE 10-31-2003.

2,900,819. LANDMARK GRAPHICS CORPORATION, HOUSTON, TX. SN 78-256,867. PUB. 3-2-2004, FILED 6-2-2003.

**TOW/CS**

FOR COMPUTER PROGRAMS AND USER DOCUMENTATION SOLD AS A UNIT THEREWITH FOR USE IN THE MANAGEMENT AND REPORTING OF OIL AND GAS FIELD PROPERTIES (U.S. CLS. 21, 23, 26, 36 AND 38). FIRST USE 9-30-1996; IN COMMERCE 9-30-1996.

2,900,832. IGT, RENO, NV. SN 78-264,217. PUB. 11-25-2003, FILED 6-18-2003.

**SPIN 'N' HOLD**

FOR GAMING MACHINES, NAMELY, SLOT MACHINES WITH OR WITHOUT VIDEO OUTPUT OR VIDEO LOTTERY TERMINALS (U.S. CLS. 21, 23, 26, 36 AND 38). FIRST USE 8-5-2003; IN COMMERCE 9-5-2003.

**CLASS 9—(Continued).**

2,900,835. KUNG LONG BATTERIES INDUSTRIAL CO., LTD., NAN TOU CITY, NAN TOU HSIEN, TAIWAN. SN 78-264,811. PUB. 2-10-2004, FILED 6-19-2003.



The logo for LONG BATTERY features the word "LONG" in a large, bold, sans-serif font. The letter "O" is stylized with a white outline and a black center. Below "LONG" is the word "BATTERY" in a smaller, bold, sans-serif font.

NO CLAIM IS MADE TO THE EXCLUSIVE RIGHT TO USE "BATTERY", APART FROM THE MARK AS SHOWN. FOR ELECTRIC ACCUMULATORS FOR VEHICLES (U.S. CLS. 21, 23, 26, 36 AND 38). FIRST USE 4-11-2003; IN COMMERCE 5-1-2004.

2,900,855. IGT, RENO, NV. SN 78-277,950. PUB. 11-25-2003, FILED 7-23-2003.

**WILD DOUBLE STRIKE**

OWNER OF U.S. REG. NOS. 1,854,535, 2,341,598, AND OTHERS. FOR GAMING MACHINES, NAMELY, SLOT MACHINES WITH OR WITHOUT VIDEO OUTPUT OR VIDEO LOTTERY TERMINALS (U.S. CLS. 21, 23, 26, 36 AND 38). FIRST USE 10-9-2003; IN COMMERCE 11-11-2003.

2,900,870. MOBILE THINKING, LLC, SAN DIEGO, CA. SN 78-296,968. PUB. 4-27-2004, FILED 9-6-2003.

**MTRIAL**

FOR COMPUTER SOFTWARE FOR THE COLLECTION, EDITING, ORGANIZING, MODIFYING, BOOK MARKING, TRANSMISSION STORAGE AND SHARING OF DATA AND INFORMATION USED BY TEACHERS, EDUCATORS, AND ADMINISTRATORS (U.S. CLS. 21, 23, 26, 36 AND 38). FIRST USE 2-18-2004; IN COMMERCE 2-18-2004.

**CLASS 10—MEDICAL APPARATUS**

2,900,039. MEDSAFE TECHNOLOGIES L.L.C., ATLANTA, GA. SN 75-553,295. PUB. 4-3-2001, FILED 9-15-1998.

**CLICKSAFE**

FOR MEDICAL SYRINGES AND HYPODERMIC SYRINGES (U.S. CLS. 26, 39 AND 44). FIRST USE 5-15-2004; IN COMMERCE 5-15-2004.

**CLASS 10—(Continued).**

2,900,043. SCIMED LIFE SYSTEMS, INC., MAPLE GROVE, MN. SN 75-601,908. PUB. 7-2-2002, FILED 12-9-1998.

**CLS**

FOR MEDICAL GUIDE CATHETERS FOR USE DURING ANGIOPLASTY (U.S. CLS. 26, 39 AND 44).  
FIRST USE 11-0-1998; IN COMMERCE 11-0-1998.

**CLASS 10—(Continued).**

2,900,124. REGENERATION TECHNOLOGIES, INC., ALACHUA, FL. SN 76-128,518. PUB. 6-5-2001, FILED 9-14-2000.

**STERLING**

FOR TISSUE IMPLANTS, NAMELY BONE, CARTILAGE, SOFT OR HARD TISSUE, DERIVED FROM NON-HUMAN SPECIES, THAT IS TO SAY XENOGRAFT IMPLANTS (U.S. CLS. 26, 39 AND 44).  
FIRST USE 7-7-2004; IN COMMERCE 7-7-2004.

2,900,054. OLYMPUS OPTICAL COMPANY LIMITED, SHIBUYA-KU, TOKYO, JAPAN. SN 75-688,605. PUB. 5-15-2001, FILED 4-21-1999.

**OAW**

FOR MEDICAL APPARATUS, NAMELY, WORKSTATIONS COMPRISING A COMPUTER TERMINAL, A DISPLAY SCREEN AND A CENTRAL DATA PROCESSOR FOR CONTROLLING VIDEO PROCESSORS, LIGHT SOURCES, AND ELECTROSURGICAL OPERATING INSTRUMENTS FOR USE ENDOSCOPES (U.S. CLS. 26, 39 AND 44).  
FIRST USE 10-0-1994; IN COMMERCE 10-0-1994.

2,900,078. INOVISE MEDICAL, INC., NEWBERG, OR. SN 75-911,131. PUB. 12-4-2001, FILED 2-4-2000.



THE MARK CONSISTS OF A STYLIZED RENDERING, IN CURVILINEAR FORM, OF THE LOWER CAST LETTER "I".  
FOR MEDICAL EQUIPMENT, NAMELY, COMPUTER HARDWARE AND SOFTWARE FOR USE IN INTERPRETING, STORING, PRESENTING, AND COMMUNICATING ECG DATA AND RELATED INFORMATION (U.S. CLS. 26, 39 AND 44).  
FIRST USE 8-0-2003; IN COMMERCE 8-0-2003.

2,900,131. ZLB BIOPLASMA AG, CH-3000 BERN 22, SWITZERLAND. SN 76-155,254. PUB. 9-24-2002, FILED 10-30-2000.

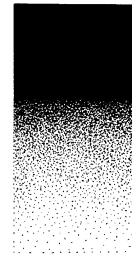
**ZLB**

THE STIPLING APPEARING THEREIN IS FOR SHADING PURPOSES ONLY.  
FOR DEVICES AND INSTRUMENTS FOR THE ADMINISTRATION AND DELIVERY OF PHARMACEUTICAL PREPARATIONS FOR USE IN THE HUMAN IMMUNE DISORDERS AND THE HUMAN IMMUNE SYSTEM (U.S. CLS. 26, 39 AND 44).  
FIRST USE 1-2-2001; IN COMMERCE 1-2-2001.

2,900,171. HARALD NORDIN SA, CH-1817 BRENT/MONTREUX, SWITZERLAND. SN 76-293,020. PUB. 11-6-2001, FILED 7-30-2001.

**ZIRIX**

FOR DENTAL POSTS AND ANCHORS, MADE OF ZIRCONIUM DIOXIDE, PARTICULARLY FOR THE CONSTRUCTION OF DENTAL CROWN (U.S. CLS. 26, 39 AND 44).  
FIRST USE 5-4-2001; IN COMMERCE 3-31-2004.

**CLASS 10—(Continued).**

2,900,198. BRITISH MILLERAIN COMPANY LIMITED, THE, LANCASHIRE, OL16 2XA, UNITED KINGDOM. SN 76-334,818. PUB. 11-26-2002, FILED 11-5-2001.

**ESPRIT HR**

THE ENGLISH TRANSLATION OF "ESPRIT" IS "SPIRIT". FOR TEXTILE GOODS FOR SURGICAL, MEDICAL AND VETERINARY PRODUCTS, NAMELY, INCONTINENCE SHEETS AND HOSPITAL MATTRESS COVERS (U.S. CLS. 26, 39 AND 44).

FIRST USE 11-11-2002; IN COMMERCE 11-11-2002.

2,900,264. SPINAL CONCEPTS, INC., AUSTIN, TX. SN 76-405,675. PUB. 4-8-2003, FILED 5-10-2002.

**FORTITUDE**

FOR MEDICAL DEVICES THAT ARE IMPLANTED IN HUMANS AND COUPLED TO HUMAN BONES FOR THE PURPOSE OF SUPPORTING OR STABILIZING BONE, AND EQUIPMENT TO FACILITATE IMPLANTATION OF SUCH DEVICES; MEDICAL DEVICES THAT ARE IMPLANTED IN HUMANS AND COUPLED TO HUMAN BONES FOR THE PURPOSE OF CONTAINING BONE ADHESION MATERIALS, AND EQUIPMENT TO FACILITATE IMPLANTATION OF SUCH DEVICES (U.S. CLS. 26, 39 AND 44).

FIRST USE 10-7-2002; IN COMMERCE 10-7-2002.

2,900,266. PARALLAX MEDICAL, INC., SUNNYVALE, CA. SN 76-408,207. PUB. 4-8-2003, FILED 5-15-2002.

**CDS**

FOR MEDICAL PRODUCTS USED IN THE FIELDS OF RADIOLOGY AND ORTHOPEDICS, PARTICULARLY, SYSTEMS FOR ACCESSING A HARD TISSUE IMPLANTATION SITE AND DELIVERING BONE CEMENT THERETO (U.S. CLS. 26, 39 AND 44).

FIRST USE 2-18-1998; IN COMMERCE 2-18-1998.

2,900,400. SYNTHES (U.S.A.), PAOLI, PA. SN 76-487,410. PUB. 10-14-2003, FILED 2-3-2003.

**CHRONOS**

FOR SYNTHETIC RESORBABLE BONE VOID FILLER (U.S. CLS. 26, 39 AND 44).

FIRST USE 11-26-2003; IN COMMERCE 11-26-2003.

**CLASS 10—(Continued).**

2,900,404. ANGIODYNAMICS, INC., QUEENSBURY, NY. SN 76-488,919. PUB. 10-14-2003, FILED 2-10-2003.

**MORPHEUS**

FOR PERIPHERALLY INSERTED CENTRAL CATHETER (U.S. CLS. 26, 39 AND 44).

FIRST USE 4-16-2004; IN COMMERCE 4-16-2004.

2,900,456. SURGICAL SPECIALTIES CORPORATION, READING, PA. SN 76-507,320. PUB. 11-25-2003, FILED 3-31-2003.

**ULTRAFIT**

FOR SURGICAL BLADES AND SCALPELS (U.S. CLS. 26, 39 AND 44).

FIRST USE 12-19-2003; IN COMMERCE 12-19-2003.

2,900,472. DUOPROSS MEDITECH CORPORATION, FARMINGDALE, NY. SN 76-515,030. PUB. 1-13-2004, FILED 5-16-2003.

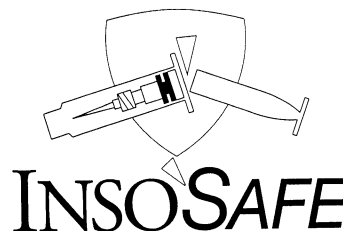

THE STIPPLING IS FOR SHADING PURPOSES ONLY. FOR MEDICAL APPARATUS, NAMELY RETRACTABLE SYRINGE FOR DIABETES TREATMENT (U.S. CLS. 26, 39 AND 44).

FIRST USE 6-0-2003; IN COMMERCE 5-0-2004.

2,900,499. MABIS HEALTHCARE, INC., LAKE FOREST, IL. SN 76-526,176. PUB. 2-3-2004, FILED 6-26-2003.

**READYREAD**

FOR DURABLE MEDICAL GOODS, NAMELY THERMOMETERS (U.S. CLS. 26, 39 AND 44).

FIRST USE 3-12-2004; IN COMMERCE 3-12-2004.

**CLASS 10—(Continued).**

2,900,619. NONIN MEDICAL, INC., PLYMOUTH, MN. SN 78-151,825. PUB. 4-1-2003, FILED 8-7-2002.

**THE SIXTH VITAL SIGN**

FOR PULSE OXIMETERS (U.S. CLS. 26, 39 AND 44).  
FIRST USE 4-27-2004; IN COMMERCE 4-27-2004.

2,900,711. WEISS, SOL, RESEDA, CA. SN 78-216,372. PUB. 11-4-2003, FILED 2-19-2003.

**SAFE-SPEC**

FOR SURGICAL INSTRUMENT, NAMELY, VAGINAL SPECULUM (U.S. CLS. 26, 39 AND 44).  
FIRST USE 5-0-2004; IN COMMERCE 6-2-2004.

2,900,879. ARIZANT HEALTHCARE INC., EDEN PRAIRIE, MN. SN 78-975,509. PUB. 9-16-2003, FILED 1-29-2003.

**ARIZANT**

FOR MEDICAL APPARATUS FOR HUMAN AND VETERINARY USE, NAMELY, BODY TEMPERATURE MANAGEMENT PRODUCTS COMPRISING FORCED AIR WARMING AND COOLING SYSTEMS FOR PATIENTS, BLOOD AND IV FLUIDS THAT PRIMARILY CONSIST OF A THERMAL UNIT, HOSE, TUBING, BODY COVER, BLANKET OR PATIENT GARMENT AND CONTROLS THEREFOR; FLUID AND BLOOD WARMING DEVICES AND DISPOSABLE ADMINISTRATION SETS; MEDICAL APPARATUS FOR WOUND MANAGEMENT, NAMELY WARMING SYSTEMS FOR WOUNDS THAT PRIMARILY CONSIST OF A WOUND COVER, A THERMAL UNIT, A TEMPERATURE CONTROL UNIT, A POWER SOURCE AND CONTROLS THEREFOR, AND WOUND COVERS SOLD FOR USE AS A COMPONENT OF A WOUND THERAPY SYSTEM CONSISTING PRIMARILY OF A WOUND COVER, A THERMAL UNIT, A TEMPERATURE CONTROL UNIT, A POWER SOURCE, AND CONTROLS THEREFOR (U.S. CLS. 26, 39 AND 44).  
FIRST USE 3-6-2003; IN COMMERCE 3-6-2003.

**CLASS 10—(Continued).**

2,900,880. ARIZANT HEALTHCARE INC., EDEN PRAIRIE, MN. SN 78-975,510. PUB. 9-16-2003, FILED 2-6-2003.



FOR MEDICAL APPARATUS FOR HUMAN AND VETERINARY USE, NAMELY, BODY TEMPERATURE MANAGEMENT PRODUCTS COMPRISING FORCED AIR WARMING AND COOLING SYSTEMS FOR PATIENTS, BLOOD AND IV FLUIDS THAT PRIMARILY CONSIST OF A THERMAL UNIT, HOSE, TUBING, BODY COVER, BLANKET OR PATIENT GARMENT AND CONTROLS THEREFOR; FLUID AND BLOOD WARMING DEVICES AND DISPOSABLE ADMINISTRATION SETS; MEDICAL APPARATUS FOR WOUND MANAGEMENT, NAMELY WARMING SYSTEMS FOR WOUNDS THAT PRIMARILY CONSIST OF A WOUND COVER, A THERMAL UNIT, A TEMPERATURE CONTROL UNIT, A POWER SOURCE AND CONTROLS THEREFOR, AND WOUND COVERS SOLD FOR USE AS A COMPONENT OF A WOUND THERAPY SYSTEM CONSISTING PRIMARILY OF A WOUND COVER, A THERMAL UNIT, A TEMPERATURE CONTROL UNIT, A POWER SOURCE, AND CONTROLS THEREFOR (U.S. CLS. 26, 39 AND 44).  
FIRST USE 3-6-2003; IN COMMERCE 3-6-2003.

**CLASS 11—ENVIRONMENTAL CONTROL APPARATUS**

2,900,053. ADVANCED PHOTONICS TECHNOLOGIES AG, 83052 BRUCKMUHL-HEUFELD, FED REP GERMANY. SN 75-684,019. PUB. 10-8-2002, FILED 4-16-1999.

**NIR**

FOR HEATERS, NAMELY INDUCTION HEATERS, RADIATING HEATERS, METAL COMPONENT HEATERS, CERAMIC HEATERS, THERMOFORMING HEATERS, CURING HEATERS; DRYERS; STERILIZERS; HEATED POLYMERIZERS; HEATED SCOURERS; DRYING MACHINES FOR PAINT AND VARNISHING INDUSTRY; DRYING MACHINES FOR THE COIL COATING INDUSTRY; DRYING MACHINES FOR THE FOIL INDUSTRY; DRYING MACHINES FOR THE PAPER INDUSTRY; DRYING MACHINES FOR THE GRAPHIC AND COMMERCIAL ARTS INDUSTRY; DRYING MACHINES FOR THE PRINTING INDUSTRY; DRYING MACHINES FOR THE FOOD INDUSTRY; DRYING MACHINES FOR THE GLASS-AND CERAMICS INDUSTRY; DRYING MACHINES FOR THE CHEMICAL INDUSTRY; DRYING MACHINES FOR THE AUTOMOBILE INDUSTRY; DRYING MACHINES

**CLASS 11—(Continued).**

FOR THE PACKING INDUSTRY; HAND DRYER FOR DRYING HANDS AFTER WASHING; CURING OVENS FOR PAINT AND VARNISHING INDUSTRY; CURING OVENS FOR THE COIL COATING INDUSTRY; CURING OVENS FOR THE FOIL INDUSTRY; CURING OVENS FOR THE FOOD INDUSTRY; CURING OVENS FOR THE GLASS-AND CERAMICS INDUSTRY; DRYING MACHINES FOR THE CHEMICAL INDUSTRY; CURING OVENS FOR THE PACKING INDUSTRY MACHINES FOR WASHING AND STERILIZATION PROCESSES FOR PAINT AND VARNISHING INDUSTRY; MACHINES FOR WASHING AND STERILIZATION PROCESSES FOR THE COIL COATING INDUSTRY; MACHINES FOR WASHING AND STERILIZATION PROCESSES FOR THE FOIL INDUSTRY; MACHINES FOR WASHING AND STERILIZATION PROCESSES FOR THE FOOD INDUSTRY; MACHINES FOR WASHING AND STERILIZATION PROCESSES FOR THE GLASS-AND CERAMICS INDUSTRY; MACHINES FOR WASHING AND STERILIZATION PROCESSES FOR THE CHEMICAL INDUSTRY (U.S. CLS. 13, 21, 23, 31 AND 34).

FIRST USE 12-31-1996; IN COMMERCE 12-31-1999.

2,900,213. BRASS CRAFT MANUFACTURING COMPANY, NOVI, MI. SN 76-357,421. PUB. 12-31-2002, FILED 1-11-2002.



FOR PLUMBING PRODUCTS, NAMELY, VALVES, PIPES, FLUID CONNECTORS, COUPLERS, HANDLES, SEALS, AND DRAINAGE WASTE CONNECTORS (U.S. CLS. 13, 21, 23, 31 AND 34).

FIRST USE 2-2-2002; IN COMMERCE 2-2-2002.

2,900,250. CONWAVE, INC., JACKSON, WY. SN 76-395,817. PUB. 4-29-2003, FILED 4-15-2002.

**MEDILITE**

FOR PENLIGHTS (U.S. CLS. 13, 21, 23, 31 AND 34).  
FIRST USE 7-3-2004; IN COMMERCE 7-3-2004.

2,900,285. CONVAIR COOLER CORPORATION, PHOENIX, AZ. SN 76-429,394. PUB. 2-11-2003, FILED 7-9-2002.

**POLAR PRIDE**

FOR EVAPORATIVE AIR COOLERS FOR LIVING AND WORKING SPACES; PORTABLE EVAPORATIVE AIR COOLERS FOR LIVING AND WORKING SPACES (U.S. CLS. 13, 21, 23, 31 AND 34).  
FIRST USE 2-15-2004; IN COMMERCE 2-15-2004.

**CLASS 11—(Continued).**

2,900,287. PURE 03 TECH, INC., ESCONDIDO, CA. SN 76-429,784. PUB. 11-11-2003, FILED 7-10-2002.



FOR WATER RECLAMATION SYSTEM CONSISTING OF WATER COLLECTION UNITS, PIPING, WATER TREATMENT EQUIPMENT IN THE NATURE OF AN OZONE GENERATOR, PUMPS AND WATER DISPENSING UNITS (U.S. CLS. 13, 21, 23, 31 AND 34).

FIRST USE 6-7-2004; IN COMMERCE 6-7-2004.

2,900,310. I.P. HOLDINGS, INC., GRAND PRAIRIE, TX. SN 76-443,505. PUB. 4-15-2003, FILED 8-26-2002.

**BOOK OWL**

NO CLAIM IS MADE TO THE EXCLUSIVE RIGHT TO USE "BOOK", APART FROM THE MARK AS SHOWN.

FOR READING LIGHT THAT ATTACHES TO BOOKS AND OTHER READING MATERIALS (U.S. CLS. 13, 21, 23, 31 AND 34).

FIRST USE 8-9-2003; IN COMMERCE 8-9-2003.

2,900,357. MINKA LIGHTING, INC., CORONA, CA. SN 76-466,910. PUB. 2-10-2004, FILED 11-14-2002.

**ENCINITAS**

FOR CEILING FANS AND ELECTRIC LIGHTING FIXTURES (U.S. CLS. 13, 21, 23, 31 AND 34).  
FIRST USE 2-11-2003; IN COMMERCE 2-11-2003.

2,900,358. MINKA LIGHTING, INC., CORONA, CA. SN 76-466,911. PUB. 2-17-2004, FILED 11-14-2002.

**CALIBRE**

THE ENGLISH TRANSLATION OF "CALIBRE" IS "CALIBER" OR "CALIBRATE".  
FOR CEILING FANS AND ELECTRIC LIGHTING FIXTURES (U.S. CLS. 13, 21, 23, 31 AND 34).  
FIRST USE 2-15-2003; IN COMMERCE 2-15-2003.

**CLASS 11—(Continued).**

2,900,377. TOEWS, BEN, DBA KABEN COMPANY, WINKLER, MANITOBA R6W 4C1, CANADA. SN 76-474,408. PUB. 10-21-2003, FILED 12-12-2002.

**REGENCY**

FOR WATER IONIZERS, AIR IONIZERS AND AIR OZONE GENERATORS FOR DOMESTIC USE (U.S. CLS. 13, 21, 23, 31 AND 34).  
FIRST USE 11-20-2002; IN COMMERCE 3-10-2004.

2,900,483. ENAGIC CO., LTD., TOKYO, JAPAN. SN 76-517,645. PUB. 2-10-2004, FILED 5-27-2003.

# Leveluk

FOR ELECTROLYTIC WATER GENERATORS FOR ELECTRICALLY DECOMPOSING TAP WATER TO GENERATE ELECTROLYTIC WATER AND FOR REMOVING CHLORINE ODOR FROM TAP WATER (U.S. CLS. 13, 21, 23, 31 AND 34).  
FIRST USE 6-30-2003; IN COMMERCE 6-30-2003.

2,900,588. INDOOR PURIFICATION SYSTEMS, INC., LAYTON, UT. SN 78-121,168. PUB. 6-24-2003, FILED 4-11-2002.



The logo for Surround Air Ionizers features a stylized cloud icon above the text "Surround Air Ionizers" in a bold, italicized sans-serif font.

NO CLAIM IS MADE TO THE EXCLUSIVE RIGHT TO USE "AIR IONIZERS", APART FROM THE MARK AS SHOWN.

FOR AIR PURIFIER/IONIZER FOR REMOVING AIR IMPURITIES IN AN INHABITED ROOM AT HABITABLE ROOM TEMPERATURES (U.S. CLS. 13, 21, 23, 31 AND 34).

FIRST USE 5-10-2004; IN COMMERCE 5-10-2004.

2,900,669. HUNTER FAN COMPANY, MEMPHIS, TN. SN 78-195,652. PUB. 4-6-2004, FILED 12-18-2002.

**TRIBECA**

FOR CEILING FANS (U.S. CLS. 13, 21, 23, 31 AND 34).  
FIRST USE 5-20-2003; IN COMMERCE 5-20-2003.

**CLASS 11—(Continued).**

2,900,713. GENLYTE THOMAS GROUP LLC, LOUISVILLE, KY. SN 78-216,799. PUB. 10-14-2003, FILED 2-20-2003.

**ORIGINS**

FOR ELECTRICAL LIGHTING FIXTURES (U.S. CLS. 13, 21, 23, 31 AND 34).  
FIRST USE 10-15-2003; IN COMMERCE 10-15-2003.

2,900,758. HERBEAU CREATIONS OF AMERICA, INC., NAPLES, FL. SN 78-230,936. PUB. 12-9-2003, FILED 3-27-2003.

**KITCHEN COUTURE**

NO CLAIM IS MADE TO THE EXCLUSIVE RIGHT TO USE "KITCHEN", APART FROM THE MARK AS SHOWN.

FOR SINKS; BATHTUBS; TOILETS; BIDETS; ELECTRIC LIGHTING FIXTURES; SCONCE LIGHTING FIXTURES; FAUCETS; HOT AND COLD WATER TAPS; HOT AND COLD MIXER WATER FAUCETS; WATER TAPS; PLUMBING FIXTURES, NAMELY SINK SPRAYERS, SINK TRAPS AND SHOWER SPRAYERS; FAUCETS AND COMPONENT PARTS THEREFOR, NAMELY CARTRIDGES, HANDLES, STEMS, SEATS, BALLS AND CAMS; PLUMBING FIXTURES FOR SHOWERS, TUBS, SINKS AND DRAINS, NAMELY TUB SPOUTS, FLOW VALVES AND DIVERTER VALVES AND COMPONENT PARTS AND ACCESSORIES THEREFOR, NAMELY SHOWER GLIDE RAILS, SHOWER RODS AND SINK, TUB AND DRAIN STRAINERS; FAUCET AERATORS; FAUCET SPRAYERS; MIXER FAUCETS FOR WATER PIPES; SHOWER CONTROL VALVES AND FAUCET FILTERS; WATER FAUCET SPOUT; SHOWERS; SHOWER SPRAYERS; SHOWER HEADS; SHOWER DOORS; WASHSTANDS; SHOWER ENCLOSURES; AND HOUSEHOLD PLUMBING FIXTURES AND ACCESSORIES, NAMELY COMPONENT PARTS FOR TOILETS AND TOILET TANKS, NAMELY PLUNGER CUPS, HANDLES, FLUSH LEVER ARMS AND FLAPPERS (U.S. CLS. 13, 21, 23, 31 AND 34).

FIRST USE 7-0-2003; IN COMMERCE 7-0-2003.

**CLASS 12—VEHICLES**

2,900,064. KENT INTERNATIONAL INC., PARSIPANNY, NJ. SN 75-806,138. PUB. 6-5-2001, FILED 9-22-1999.

**X FACTOR**

FOR BICYCLES, BICYCLE ACCESSORIES AND PARTS THEREFOR; NAMELY, SADDLES AND SADDLE COVERS, HANDLEBARS; WATER BOTTLE RACKS WHICH ATTACH TO BICYCLES, AIR PUMPS, BICYCLE LOCKS, BICYCLE RACKS FOR VEHICLES AND CYCLING BAGS (U.S. CLS. 19, 21, 23, 31, 35 AND 44).

FIRST USE 8-12-1999; IN COMMERCE 10-15-1999.

**CLASS 12—(Continued).**

2,900,152. CAR ACCESSORIES FOR WOMEN, INC., HOUSTON, TX. SN 76-235,042. PUB. 12-4-2001, FILED 4-3-2001.

**GO MIRROR**

NO CLAIM IS MADE TO THE EXCLUSIVE RIGHT TO USE "MIRROR", APART FROM THE MARK AS SHOWN.  
FOR MOTOR VEHICLE ACCESSORIES, NAMELY, AUTOMOBILE MIRRORS (U.S. CLS. 19, 21, 23, 31, 35 AND 44).

FIRST USE 7-1-2004; IN COMMERCE 7-1-2004.

2,900,161. GOODRICH CORPORATION, CHARLOTTE, NC. SN 76-270,371. PUB. 3-25-2003, FILED 6-12-2001.

**GOODRICH**

OWNER OF U.S. REG. NOS. 64,996, 1,423,775, AND OTHERS.

FOR SOUND ABSORBENT STRUCTURAL PANELS AND COMPOSITES FOR USE IN AEROSPACE AND MARINE VEHICLES; INTERIOR AND AIRFRAME STRUCTURAL PANELS FOR AEROSPACE VEHICLES (U.S. CLS. 19, 21, 23, 31, 35 AND 44).

FIRST USE 6-1-2001; IN COMMERCE 6-1-2001.

2,900,457. GREENBALL CORPORATION, LONG BEACH, CA. SN 76-508,355. PUB. 12-2-2003, FILED 4-21-2003.

**HIWAY TROOPER**

OWNER OF U.S. REG. NO. 2,170,227.  
FOR TIRES (U.S. CLS. 19, 21, 23, 31, 35 AND 44).  
FIRST USE 3-23-2004; IN COMMERCE 3-23-2004.

2,900,510. ACCURIDE CORPORATION, EVANSVILLE, IN. SN 76-532,081. PUB. 2-17-2004, FILED 7-14-2003.

**ACCU-SHIELD**

FOR COATED ALUMINUM WHEELS FOR LAND VEHICLES (U.S. CLS. 19, 21, 23, 31, 35 AND 44).  
FIRST USE 5-0-2003; IN COMMERCE 5-0-2003.

2,900,628. XU, XIN, INDIANAPOLIS, IN. SN 78-159,300. PUB. 4-29-2003, FILED 8-29-2002.

**SEIBON**

FOR AUTOMOBILE PARTS IN THE NATURE OF GROUND EFFECTS, NAMELY, BUMPERS, SPOILERS, HOOD, FENDERS, SKIRTS, AND EXTERIOR BODY PANELS (U.S. CLS. 19, 21, 23, 31, 35 AND 44).  
FIRST USE 12-1-2002; IN COMMERCE 5-1-2003.

**CLASS 12—(Continued).**

2,900,706. BLUE BIRD INVESTMENT CORPORATION, WILMINGTON, DE. SN 78-213,963. PUB. 10-21-2003, FILED 2-12-2003.



FOR BUSES (U.S. CLS. 19, 21, 23, 31, 35 AND 44).  
FIRST USE 6-20-2004; IN COMMERCE 6-20-2004.

2,900,707. BLUE BIRD INVESTMENT CORPORATION, WILMINGTON, DE. SN 78-213,968. PUB. 10-21-2003, FILED 2-12-2003.



FOR BUSES (U.S. CLS. 19, 21, 23, 31, 35 AND 44).  
FIRST USE 5-12-2004; IN COMMERCE 5-12-2004.

2,900,775. MARIN MOUNTAIN BIKES, INC., NOVATO, CA. SN 78-236,804. PUB. 11-4-2003, FILED 4-11-2003.

**FAIRFAX**

FOR BICYCLES (U.S. CLS. 19, 21, 23, 31, 35 AND 44).  
FIRST USE 8-1-2003; IN COMMERCE 8-1-2003.

2,900,776. MARIN MOUNTAIN BIKES, INC., NOVATO, CA. SN 78-236,810. PUB. 11-4-2003, FILED 4-11-2003.

**DRAKE'S BEACH**

FOR BICYCLES (U.S. CLS. 19, 21, 23, 31, 35 AND 44).  
FIRST USE 8-1-2003; IN COMMERCE 8-1-2003.

2,900,778. MARIN MOUNTAIN BIKES, INC., NOVATO, CA. SN 78-236,814. PUB. 11-4-2003, FILED 4-11-2003.

**HEART'S DESIRE BEACH**

FOR BICYCLES (U.S. CLS. 19, 21, 23, 31, 35 AND 44).  
FIRST USE 8-1-2003; IN COMMERCE 8-1-2003.



**CLASS 12—(Continued).**

2,900,813. ROYAL WINDYNE, LTD., RICHMOND, VA. SN 78-253,333. PUB. 3-16-2004, FILED 5-22-2003.

**RACEACE**

FOR PARTS AND ACCESSORIES FOR MOTORIZED VEHICLES AND MOTORCYCLES, NAMELY, FENDER LOUVERS, HOOD LOUVERS, HOOD STRAPS AND WINDSHIELDS (U.S. CLS. 19, 21, 23, 31, 35 AND 44).  
FIRST USE 9-15-2003; IN COMMERCE 9-15-2003.

**CLASS 14—JEWELRY**

2,900,286. NANDEI MCANALLY ENTERPRISES, BEAVER-TON, OR. SN 76-429,500. PUB. 2-11-2003, FILED 7-1-2002.

**WORLD PEACE THROUGH  
INDIVIDUAL ACTION**

OWNER OF U.S. REG. NOS. 2,470,931, 2,857,954, AND OTHERS.  
FOR JEWELRY (U.S. CLS. 2, 27, 28 AND 50).  
FIRST USE 1-1-2002; IN COMMERCE 7-1-2003.

2,900,451. INVICTA WATCH COMPANY OF AMERICA, INC., HOLLYWOOD, FL. SN 76-505,476. PUB. 1-20-2004, FILED 4-10-2003.

**COALITION FORCES**

FOR JEWELRY AND WATCHES (U.S. CLS. 2, 27, 28 AND 50).  
FIRST USE 11-21-2003; IN COMMERCE 11-21-2003.

2,900,494. MIZERIK ENTERPRISE, INC., HOUSTON, TX. SN 76-522,958. PUB. 1-13-2004, FILED 6-17-2003.

**TIJC**

FOR JEWELRY (U.S. CLS. 2, 27, 28 AND 50).  
FIRST USE 7-1-2004; IN COMMERCE 7-1-2004.

2,900,593. REPUBLIC ENTERTAINMENT INC., LOS ANGELES, CA. SN 78-124,469. PUB. 10-29-2002, FILED 4-26-2002.

**IT'S A WONDERFUL LIFE**

OWNER OF U.S. REG. NOS. 2,060,452, 2,229,322, AND OTHERS.  
FOR LAPEL PINS (U.S. CLS. 2, 27, 28 AND 50).  
FIRST USE 7-1-2003; IN COMMERCE 7-1-2003.

**CLASS 14—(Continued).**

2,900,689. MICHAEL ANTHONY JEWELERS, INC., MOUNT VERNON, NY. SN 78-202,727. PUB. 9-30-2003, FILED 1-13-2003.

**GLITTER 24 FACET**

NO CLAIM IS MADE TO THE EXCLUSIVE RIGHT TO USE "24 FACET", APART FROM THE MARK AS SHOWN.  
FOR JEWELRY (U.S. CLS. 2, 27, 28 AND 50).  
FIRST USE 9-19-2003; IN COMMERCE 9-19-2003.

2,900,748. GENENDER INTERNATIONAL, INC., WHEELING, IL. SN 78-226,330. PUB. 11-4-2003, FILED 3-17-2003.

**HI FI**

FOR WATCHES (U.S. CLS. 2, 27, 28 AND 50).  
FIRST USE 6-0-2003; IN COMMERCE 6-0-2003.

2,900,825. TIMEX CORPORATION, MIDDLEBURY, CT. SN 78-261,968. PUB. 4-27-2004, FILED 6-13-2003.

**LIFE IS TICKING**

FOR WATCHES (U.S. CLS. 2, 27, 28 AND 50).  
FIRST USE 9-0-2003; IN COMMERCE 9-0-2003.

**CLASS 15—MUSICAL INSTRUMENTS**

2,900,807. FENDER MUSICAL INSTRUMENTS CORPORATION, SCOTTSDALE, AZ. SN 78-249,514. PUB. 1-6-2004, FILED 5-14-2003.

**DIMENSION**

FOR GUITARS (U.S. CLS. 2, 21 AND 36).  
FIRST USE 5-1-2004; IN COMMERCE 5-1-2004.

**CLASS 16—PAPER GOODS AND PRINTED MATTER**

2,900,051. MAVETY MEDIA GROUP LTD., NEW YORK, NY. SN 75-659,535. PUB. 5-21-2002, FILED 3-12-1999.

**LEG SHOW LETTERS**

OWNER OF U.S. REG. NO. 1,227,478.  
NO CLAIM IS MADE TO THE EXCLUSIVE RIGHT TO USE "LETTERS", APART FROM THE MARK AS SHOWN.  
FOR ADULT ENTERTAINMENT MAGAZINES (U.S. CLS. 2, 5, 22, 23, 29, 37, 38 AND 50).  
FIRST USE 10-1-2003; IN COMMERCE 10-1-2003.

**CLASS 16—(Continued).**

2,900,070. PARRISH FINE ART, INC., GERMANTOWN, WI. SN 75-848,931. PUB. 8-7-2001, FILED 11-15-1999.

**MOUSE KING**

FOR FINE ART PRINTS AND GRAPHIC FINE ART REPRODUCTIONS; GREETING CARDS AND STATIONERY, PAPER HOLIDAY DECORATIONS AND ORNAMENTS (U.S. CLS. 2, 5, 22, 23, 29, 37, 38 AND 50).  
FIRST USE 10-30-2003; IN COMMERCE 10-30-2003.

2,900,153. NXLEVEL EDUCATION FOUNDATION, SANDY, UT. SN 76-249,076. PUB. 5-14-2002, FILED 4-16-2001.



FOR BOOKS IN THE FIELD OF BUSINESS AND PRINTED EDUCATIONAL MATERIALS IN THE FIELD OF BUSINESS (U.S. CLS. 2, 5, 22, 23, 29, 37, 38 AND 50).  
FIRST USE 6-11-2003; IN COMMERCE 6-11-2003.

2,900,182. PITSCO, INC., PITTSBURG, KS. SN 76-306,524. PUB. 6-10-2003, FILED 8-30-2001.

**ICE PAK**

FOR EDUCATIONAL KITS FOR STUDYING PHILOSOPHY, ORGANIZATIONAL SKILLS, SCIENCE, MATH, TECHNOLOGY, COMMUNICATIONS, AND SOCIAL STUDIES, CONSISTING PRIMARILY OF PRINTED INSTRUCTIONAL AND TEACHING MATERIALS, TEST MEDIA, AND INSTRUMENTS FOR SCIENTIFIC OBSERVATION AND MEASUREMENT, NAMELY, MODEL ROCKET LAUNCHERS TO MEASURE TRAJECTORY ANGLE AND LAUNCH ENERGY, STRUCTURE TESTERS TO MEASURE FORCE ON MODEL BRIDGES, TIMBER TESTERS TO MEASURE LOAD-BEARING CAPACITY OF STICKS, WIND METERS TO MEASURE WIND VELOCITY, AND PRESSURE GAGES TO MEASURE AIR PRESSURE, SOLD AS A UNIT TO ELEMENTARY, SECONDARY AND MIDDLE SCHOOLS (U.S. CLS. 2, 5, 22, 23, 29, 37, 38 AND 50).  
FIRST USE 1-2-2002; IN COMMERCE 1-2-2002.

**CLASS 16—(Continued).**

2,900,184. STONE CONTAINER CORPORATION, CHICAGO, IL. SN 76-307,795. PUB. 8-27-2002, FILED 8-31-2001.



**Your Paperboard  
Solutions Company**

NO CLAIM IS MADE TO THE EXCLUSIVE RIGHT TO USE "PAPERBOARD" AND "COMPANY", APART FROM THE MARK AS SHOWN.

FOR CORRUGATED PAPERBOARD BLANKS; PAPERBOARD PACKAGING, NAMELY, CONTAINERS AND BOXES (U.S. CLS. 2, 5, 22, 23, 29, 37, 38 AND 50).

FIRST USE 10-0-2001; IN COMMERCE 10-0-2001.

2,900,185. HEB GROCERY COMPANY, LP., SAN ANTONIO, TX. SN 76-312,082. PUB. 3-23-2004, FILED 9-10-2001.

**BALANCED LIVING**

FOR NEWSLETTERS FEATURING ARTICLES ON LIFESTYLES AND NUTRITION EXCLUDING RELIGIOUS SUBJECTS (U.S. CLS. 2, 5, 22, 23, 29, 37, 38 AND 50).

FIRST USE 1-0-2002; IN COMMERCE 1-0-2002.

2,900,229. REVIEW PUBLISHING LIMITED PARTNERSHIP, PHILADELPHIA, PA. SN 76-374,095. PUB. 4-22-2003, FILED 2-21-2002.

**SOUTH PHILLY REVIEW  
CHRONICLE**

OWNER OF U.S. REG. NOS. 2,428,365, 2,429,771, AND 2,431,368.

NO CLAIM IS MADE TO THE EXCLUSIVE RIGHT TO USE "CHRONICLE", APART FROM THE MARK AS SHOWN.

SEC. 2(F) AS TO "SOUTH PHILLY REVIEW" FOR WEEKLY NEWSPAPERS FOR GENERAL CIRCULATION (U.S. CLS. 2, 5, 22, 23, 29, 37, 38 AND 50).

FIRST USE 7-8-2004; IN COMMERCE 7-8-2004.

2,900,233. UNIVERSAL TV DISTRIBUTION HOLDINGS LLC, UNIVERSAL CITY, CA. SN 76-378,410. PUB. 10-15-2002, FILED 3-5-2002.

**LAW & ORDER**

OWNER OF U.S. REG. NOS. 2,588,624 AND 2,588,627. FOR PRINTED MATERIALS, NAMELY SERIES OF BOOKS ON THE SUBJECT OF AN ON-GOING DRAMATIC TELEVISION SERIES (U.S. CLS. 2, 5, 22, 23, 29, 37, 38 AND 50).

FIRST USE 2-0-1993; IN COMMERCE 2-0-1993.

**CLASS 16—(Continued).**

2,900,307. MEDIA WEST - GSI, INC., RENO, NV. SN 76-442,334. PUB. 10-28-2003, FILED 8-19-2002.

## USA TODAY SPORTS WEEKLY

OWNER OF U.S. REG. NOS. 1,738,275, 2,649,067, AND OTHERS.

NO CLAIM IS MADE TO THE EXCLUSIVE RIGHT TO USE "SPORTS WEEKLY", APART FROM THE MARK AS SHOWN.

SEC. 2(F) AS TO "USA".  
FOR NEWSPAPER FOR GENERAL CIRCULATION (U.S. CLS. 2, 5, 22, 23, 29, 37, 38 AND 50).  
FIRST USE 9-4-2002; IN COMMERCE 9-4-2002.

2,900,330. FOTO WEAR, INC., OLYPHANT, PA. SN 76-450,834. PUB. 5-6-2003, FILED 9-13-2002.

## DIGIJET

FOR HEAT TRANSFER PAPER (U.S. CLS. 2, 5, 22, 23, 29, 37, 38 AND 50).  
FIRST USE 9-30-2003; IN COMMERCE 9-30-2003.

2,900,421. LINC PEN & PLASTICS LIMITED, STATE OF WEST BENGAL, INDIA. SN 76-494,089. PUB. 11-4-2003, FILED 3-3-2003.

# Linc

FOR BALL POINT PENS AND REFILLS FOR BALL POINT PENS (U.S. CLS. 2, 5, 22, 23, 29, 37, 38 AND 50).  
FIRST USE 7-13-2004; IN COMMERCE 7-13-2004.

2,900,437. SPRINGS LICENSING GROUP, INC., FORT MILL, SC. SN 76-498,422. PUB. 10-28-2003, FILED 3-10-2003.

## SWEET MEMORIES

FOR PAPER PATTERNS FOR MAKING CLOTHES (U.S. CLS. 2, 5, 22, 23, 29, 37, 38 AND 50).  
FIRST USE 1-29-2003; IN COMMERCE 1-29-2003.

**CLASS 16—(Continued).**

2,900,514. MULRY, JILL, SEMINOLE, FL. SN 76-544,081. PUB. 4-27-2004, FILED 8-29-2003.

## ORCHID BABIES

THE MARK CONSISTS OF STANDARD CHARACTERS WITHOUT CLAIM TO ANY PARTICULAR FONT, STYLE, SIZE, OR COLOR.

NO CLAIM IS MADE TO THE EXCLUSIVE RIGHT TO USE "ORCHID", APART FROM THE MARK AS SHOWN.

FOR PHOTOGRAPHS OF ORCHIDS FOR PICTURES, CARDS, ACCESSORIES, CLOTHING (U.S. CLS. 2, 5, 22, 23, 29, 37, 38 AND 50).

FIRST USE 10-13-2003; IN COMMERCE 10-16-2003.

2,900,622. WEYERHAEUSER COMPANY, FEDERAL WAY, WA. SN 78-153,675. PUB. 5-27-2003, FILED 8-13-2002.

## PUMA

FOR PAPER FOR PRINTING AND BOOK PUBLISHING (U.S. CLS. 2, 5, 22, 23, 29, 37, 38 AND 50).  
FIRST USE 6-1-2002; IN COMMERCE 6-1-2002.

2,900,630. WHO'S THERE, INC., DBA KNOCK KNOCK, VENICE, CA. SN 78-161,008. PUB. 11-11-2003, FILED 9-5-2002.

## KNOCK KNOCK

FOR PUBLICATIONS AND PRINTED MATTER; NAMELY, STATIONERY; GREETING CARDS; NOTE CARDS; BLANK CARDS; WRAPPING PAPER; CATALOGS FEATURING STATIONERY, CARDS, GIFTS AND COLLECTIBLES; RUBBER STAMPS, RUBBER STAMP KITS COMPRISED OF STAMP PADS, STAMP PAD INKS AND RUBBER STAMPS; POSTERS; BOOKS, PAMPHLETS AND MAGAZINES IN THE FIELD OF GIFTS AND COLLECTIBLES (U.S. CLS. 2, 5, 22, 23, 29, 37, 38 AND 50).  
FIRST USE 6-1-2002; IN COMMERCE 6-1-2002.

2,900,723. LEFKOWITZ, LANIE, HOBOKEN, NJ. SN 78-220,103. PUB. 11-4-2003, FILED 2-28-2003.

## BRINGING BALANCE TO ALL SIDES

FOR PHYSICAL FITNESS JOURNAL (U.S. CLS. 2, 5, 22, 23, 29, 37, 38 AND 50).  
FIRST USE 8-23-2003; IN COMMERCE 8-23-2003.

**CLASS 16—(Continued).**

2,900,744. DRAPER, MELISSA, J., MINNEAPOLIS, MN. SN 78-225,460. PUB. 2-10-2004, FILED 3-13-2003.

**HOLLY THE COLLIE**

NO CLAIM IS MADE TO THE EXCLUSIVE RIGHT TO USE "COLLIE", APART FROM THE MARK AS SHOWN. FOR CHILDREN'S BOOKS (U.S. CLS. 2, 5, 22, 23, 29, 37, 38 AND 50).  
FIRST USE 9-5-2003; IN COMMERCE 9-16-2003.

2,900,761. NASH, JONATHAN, JR., OMAHA, NE. SN 78-231,753. PUB. 11-18-2003, FILED 3-31-2003.

**AJ'S TACO-TAINERS**

FOR TREATED PAPER TACO HOLDERS FOR HOLDING UPRIGHT AND TRANSPORTING TACOS, HARD AND SOFT TORTILLAS, WRAPS, FAJITAS, ENCHILADAS, BURRITOS, GORDITAS, CHALUPAS AND RELATED TORTILLA-BASED MEXICAN FOOD (U.S. CLS. 2, 5, 22, 23, 29, 37, 38 AND 50).  
FIRST USE 1-1-2002; IN COMMERCE 1-1-2002.

2,900,765. WIZKIDS, LLC, BELLEVUE, WA. SN 78-232,662. PUB. 11-18-2003, FILED 4-1-2003.

**SPORTSCLIX**

FOR BROCHURES AND BOOKLETS RELATING TO GAMES; PRINTED GAME INSTRUCTION SHEETS; PRINTED SCORING SHEETS; POSTERS (U.S. CLS. 2, 5, 22, 23, 29, 37, 38 AND 50).  
FIRST USE 10-17-2003; IN COMMERCE 10-17-2003.

2,900,802. LEARNING RESOURCES, INC., VERNON HILLS, IL. SN 78-248,405. PUB. 3-23-2004, FILED 5-12-2003.

**DECIMAL TOWER**

OWNER OF U.S. REG. NO. 2,110,995.  
NO CLAIM IS MADE TO THE EXCLUSIVE RIGHT TO USE "DECIMAL", APART FROM THE MARK AS SHOWN. FOR EDUCATIONAL BOOKS; FLASH CARD SETS; SETS OF PRINTED ACTIVITY CARDS; AND KITS COMPRISED PRIMARILY OF PRINTED ACTIVITY CARDS, STICKERS, AND INTERLOCKING MANIPULATIVE COMPONENTS AND A BASE UNIT; ALL FOR TEACHING MATHEMATICS (U.S. CLS. 2, 5, 22, 23, 29, 37, 38 AND 50).  
FIRST USE 12-16-2003; IN COMMERCE 12-16-2003.

2,900,803. LEARNING RESOURCES, INC., VERNON HILLS, IL. SN 78-248,407. PUB. 3-23-2004, FILED 5-12-2003.

**PERCENT TOWER****CLASS 16—(Continued).**

OWNER OF U.S. REG. NO. 2,110,995.  
NO CLAIM IS MADE TO THE EXCLUSIVE RIGHT TO USE "PERCENT", APART FROM THE MARK AS SHOWN. FOR EDUCATIONAL BOOKS; FLASH CARD SETS; SETS OF PRINTED ACTIVITY CARDS; AND KITS COMPRISED PRIMARILY OF PRINTED ACTIVITY CARDS, STICKERS, AND INTERLOCKING MANIPULATIVE COMPONENTS AND A BASE UNIT; ALL FOR TEACHING MATHEMATICS (U.S. CLS. 2, 5, 22, 23, 29, 37, 38 AND 50).  
FIRST USE 12-16-2003; IN COMMERCE 12-16-2003.

2,900,823. DEGNAN, DONALD A., BOULDER, CO. SN 78-259,856. PUB. 3-9-2004, FILED 6-9-2003.

**LIFE IN THE NEW SOUTH**

FOR MAGAZINE IN THE FIELD OF LIFESTYLES, FASHION, BEAUTY, HEALTH, HOME DECOR, HOME IMPROVEMENT, TRAVEL, ENTERTAINMENT, FOOD, GARDENING, BUSINESS, PERSONAL FINANCE, RELATIONSHIPS, CURRENT EVENTS, LITERATURE, HISTORY, AND FEATURES OF INTEREST FOR PEOPLE LIVING IN THE SOUTH (U.S. CLS. 2, 5, 22, 23, 29, 37, 38 AND 50).  
FIRST USE 4-30-2003; IN COMMERCE 10-24-2003.

2,900,850. KIMBERLY-CLARK WORLDWIDE, INC., NEE-NAH, WI. SN 78-274,298. PUB. 4-27-2004, FILED 7-15-2003.



NO CLAIM IS MADE TO THE EXCLUSIVE RIGHT TO USE "TRIPLE PROTECTION LEAK BARRIERS", APART FROM THE MARK AS SHOWN.  
THE MARK CONSISTS OF ARROW WITH WORDS. FOR DISPOSABLE DIAPERS AND COMPONENTS THEREOF (U.S. CLS. 2, 5, 22, 23, 29, 37, 38 AND 50).  
FIRST USE 9-1-2003; IN COMMERCE 9-1-2003.

2,900,856. MCKAY, GORDON, HUNTINGTON BEACH, CA. SN 78-278,274. PUB. 3-23-2004, FILED 7-24-2003.

**INBLOOM**

FOR STICKERS FOR DECORATION ON AUTOMOBILES, WINDOWS, SURFBOARDS, AND SIMILAR SURFACES (U.S. CLS. 2, 5, 22, 23, 29, 37, 38 AND 50).  
FIRST USE 10-1-2003; IN COMMERCE 10-1-2003.

**CLASS 16—(Continued).**

2,900,862. MULCAHY, RITA, MINNEAPOLIS, MN. SN 78-284,967. PUB. 2-24-2004, FILED 8-8-2003.

**TRICKS OF THE TRADE**

OWNER OF U.S. REG. NO. 2,600,431.  
FOR EDUCATIONAL PUBLICATIONS, NAMELY, A SERIES OF NON-FICTION BOOKS IN THE FIELD OF PROJECT MANAGEMENT (U.S. CLS. 2, 5, 22, 23, 29, 37, 38 AND 50).  
FIRST USE 12-31-1997; IN COMMERCE 11-1-2000.

2,900,883. ROSE ART INDUSTRIES, INC., LIVINGSTON, NJ. SN 78-975,558. PUB. 9-9-2003, FILED 7-30-2002.

**THINK SMART ROSE ART**

OWNER OF U.S. REG. NOS. 1,287,540, 2,519,834, AND OTHERS.

FOR CRAYONS; MARKERS; PENCILS; PENS; POSTER PEN SETS CONSISTING OF MARKERS, POSTER PENS, ERASERS, STAMPERS, BLACK AND WHITE POSTERS, AND MESSAGE BOARD CLEANER SOLD AS A UNIT; COLOR BY NUMBER KITS CONSISTING OF PRE-PRINTED PANELS, CRAYONS, PENCILS, PAINTS, AND PAINT BRUSHES, SOLD AS A UNIT; STICKERS; CHILDREN'S ART EASEL WITH A DESK FEATURE; CASES FOR PENS AND PENCILS; CRAFT PAPER; PENCIL SHARPENERS; STAMPERS USED TO MAKE GEOMETRIC SHAPES, LETTERS, NUMBERS, AND ANIMAL FIGURES; AND STAMPER MARKER (U.S. CLS. 2, 5, 22, 23, 29, 37, 38 AND 50).  
FIRST USE 2-13-2004; IN COMMERCE 2-13-2004.

**CLASS 17—RUBBER GOODS**

2,900,269. ROCKY MOUNTAIN COMPOSITES, INC., SPANISH FORK, UT. SN 76-411,058. PUB. 5-13-2003, FILED 5-23-2002.

**FIBEX**

FOR PLASTIC FILAMENT WOUND COMPOSITE MATERIALS IN THE FORM OF PROFILES, BOARDS, SHEETS, BLOCKS, RODS, POWDER, AND PELLETS FOR USE IN MANUFACTURING (U.S. CLS. 1, 5, 12, 13, 35 AND 50).  
FIRST USE 7-17-2003; IN COMMERCE 7-17-2003.

2,900,293. UNITED SPORTS SURFACING OF AMERICA, INC., IRVINE, CA. SN 76-432,299. PUB. 1-28-2003, FILED 7-19-2002.

**POLYSTAR**

FOR RUBBER COMPOUND MATERIAL FOR POURING SIDEWALKS AND TREE WELLS (U.S. CLS. 1, 5, 12, 13, 35 AND 50).  
FIRST USE 9-21-2002; IN COMMERCE 9-21-2002.

**CLASS 17—(Continued).**

2,900,313. UPONOR ALDYL COMPANY, SHAWNEE, OK. SN 76-446,326. PUB. 4-15-2003, FILED 9-3-2002.

**ULTRA-STRIPE**

FOR PLASTIC PIPE FOR GAS DISTRIBUTION (U.S. CLS. 1, 5, 12, 13, 35 AND 50).  
FIRST USE 7-19-2002; IN COMMERCE 7-19-2002.

2,900,335. BOULDIN CORPORATION, MCMINNVILLE, TN. SN 76-453,677. PUB. 12-2-2003, FILED 9-30-2002.

**FLUFF**

FOR CELLULOSE MATERIAL DERIVED FROM MUNICIPAL SOLID WASTE FOR THE PURPOSE OF MAKING USEFUL END PRODUCTS SUCH AS BUILDING MATERIALS AND A GROWING SUBSTRATE FOR PLANTS (U.S. CLS. 1, 5, 12, 13, 35 AND 50).  
FIRST USE 6-0-2001; IN COMMERCE 6-0-2003.

2,900,344. SAFESUPPLIES, INC., ROCHESTER, NY. SN 76-457,208. PUB. 11-4-2003, FILED 10-9-2002.

**PYROFEND**

FOR FIRE RETARDANT COMPOSITIONS FOR COMMERCIAL AND DOMESTIC USE (U.S. CLS. 1, 5, 12, 13, 35 AND 50).  
FIRST USE 11-18-2003; IN COMMERCE 4-30-2004.

2,900,364. SHURTAPE TECHNOLOGIES, LLC, HICKORY, NC. SN 76-469,905. PUB. 6-3-2003, FILED 11-25-2002.

**CF700**

OWNER OF U.S. REG. NOS. 2,634,962 AND 2,634,963.  
FOR PRESSURE SENSITIVE MASKING TAPE FOR USE IN THE FIELD OF PAINTING TRANSPORTATION VEHICLES (U.S. CLS. 1, 5, 12, 13, 35 AND 50).  
FIRST USE 12-1-2002; IN COMMERCE 12-1-2002.

2,900,365. SHURTAPE TECHNOLOGIES, LLC, HICKORY, NC. SN 76-469,906. PUB. 6-3-2003, FILED 11-25-2002.

**CF720**

OWNER OF U.S. REG. NOS. 2,634,962 AND 2,634,963.  
FOR PRESSURE SENSITIVE MASKING TAPE FOR USE IN THE FIELD OF PAINTING TRANSPORTATION VEHICLES (U.S. CLS. 1, 5, 12, 13, 35 AND 50).  
FIRST USE 12-1-2002; IN COMMERCE 12-1-2002.

**CLASS 17—(Continued).**

2,900,366. SHURTAPE TECHNOLOGIES, LLC, HICKORY, NC. SN 76-469,907. PUB. 6-3-2003, FILED 11-25-2002.

**CF740**

FOR PRESSURE SENSITIVE MASKING TAPE FOR USE IN THE FIELD OF PAINTING TRANSPORTATION VEHICLES (U.S. CLS. 1, 5, 12, 13, 35 AND 50).  
FIRST USE 12-1-2002; IN COMMERCE 12-1-2002.

---

2,900,624. ULTRAFAB, INC., FARMINGTON, NY. SN 78-155,151. PUB. 4-29-2003, FILED 8-16-2002.

**ULTRA PRO**

OWNER OF U.S. REG. NOS. 1,751,296, 2,583,359, AND OTHERS.

FOR WEATHERSTRIPPING FOR USE ON DOORS AND WINDOWS IN VEHICLES, HOMES, AND BUILDINGS (U.S. CLS. 1, 5, 12, 13, 35 AND 50).  
FIRST USE 7-12-2004; IN COMMERCE 7-13-2004.

---

2,900,787. QUIET SOLUTION, INC., SANTA CLARA, CA. SN 78-239,496. PUB. 12-2-2003, FILED 4-18-2003.

**QUIETROCK**

FOR SOUNDPROOFING MATERIALS FOR BUILDINGS (U.S. CLS. 1, 5, 12, 13, 35 AND 50).  
FIRST USE 3-15-2002; IN COMMERCE 1-1-2003.

---

**CLASS 18—LEATHER GOODS**

2,900,352. RICKARD, GAIL, IMLAY CITY, MI. SN 76-464,663. PUB. 8-19-2003, FILED 10-30-2002.

**SLOT SLINGER**

FOR FABRIC POUCH USED TO HOLD COIN BUCKETS (U.S. CLS. 1, 2, 3, 22 AND 41).  
FIRST USE 5-6-2004; IN COMMERCE 5-6-2004.

---

2,900,434. SHERWOOD, JULIE, ENCINITAS, CA. SN 76-497,781. PUB. 11-18-2003, FILED 3-17-2003.

*Lucia Bella*

"LUCIA" MEANS "LIGHT" AND "BELLA" MEANS "BEAUTIFUL" IN ITALIAN.  
FOR HANDBAGS AND PURSES AS FASHION ACCESSORIES (U.S. CLS. 1, 2, 3, 22 AND 41).  
FIRST USE 5-14-2003; IN COMMERCE 3-25-2004.

**CLASS 18—(Continued).**

2,900,804. SMITH-GARRITY, LTD., UPPERVILLE, VA. SN 78-248,696. PUB. 1-6-2004, FILED 5-12-2003.

**L'APOGEE**

THE FOREIGN WORDING IN THE MARK TRANSLATES INTO ENGLISH AS "THE APOGEE".  
FOR LEATHER SADDLES (U.S. CLS. 1, 2, 3, 22 AND 41).  
FIRST USE 7-11-2003; IN COMMERCE 7-11-2003.

---

**CLASS 19—NON-METALLIC BUILDING MATERIALS**

2,900,080. TYCO PLASTICS SERVICES AG, SCHAFFHAUSEN, SWITZERLAND. SN 75-916,474. PUB. 12-9-2003, FILED 2-11-2000.

**STORM BOARD**

FOR WEATHER-RESISTANT EXTERIOR WALL BOARD CONSTRUCTED FROM DIRECTIONALIZED WOOD FIBER PRESSURE LAMINATED IN TREATED PLYS SOLD FOR USE IN THE CONSTRUCTION OF PRE-FABRICATED OR MANUFACTURED HOUSING (U.S. CLS. 1, 12, 33 AND 50).  
FIRST USE 8-1-2004; IN COMMERCE 8-1-2004.

---

2,900,102. CASCADE POLE AND LUMBER COMPANY, TACOMA, WA. SN 76-066,883. PUB. 3-6-2001, FILED 6-9-2000.

**ERAIL**

FOR PLASTIC EXTRUSIONS, NAMELY HORIZONTAL MEMBERS FOR USE IN CONSTRUCTION OF DECKS AND FENCES (U.S. CLS. 1, 12, 33 AND 50).  
FIRST USE 4-2-2004; IN COMMERCE 4-2-2004.

---

2,900,103. CASCADE POLE AND LUMBER COMPANY, TACOMA, WA. SN 76-066,884. PUB. 3-6-2001, FILED 6-9-2000.

**ECLIP**

FOR PLASTIC EXTRUSION FASTENERS USED TO CONSTRUCT DECKS, FENCES, RAILINGS AND OTHER CONSTRUCTION APPLICATIONS (U.S. CLS. 1, 12, 33 AND 50).  
FIRST USE 5-25-2004; IN COMMERCE 5-25-2004.

**CLASS 19—(Continued).**

2,900,140. AMERICAN RECREATION PRODUCTS, INC., ST. LOUIS, MO. SN 76-198,317. PUB. 4-30-2002, FILED 1-23-2001.



NO CLAIM IS MADE TO THE EXCLUSIVE RIGHT TO USE "GRONHAUS", APART FROM THE MARK AS SHOWN.

THE ENGLISH TRANSLATION OF THE WORD "GRONHAUS" IN THE MARK IS "GREENHOUSE".

FOR GREENHOUSES SOLD UNASSEMBLED IN A KIT COMPRISED OF FABRIC PANELS AND METAL FRAMES (U.S. CLS. 1, 12, 33 AND 50).

FIRST USE 2-26-2001; IN COMMERCE 2-26-2001.

2,900,166. TYLER, RODNEY W., MEDINA, OH. SN 76-287,019. PUB. 3-19-2002, FILED 7-16-2001.

**FILTREXX**

FOR FULL LINE OF PRODUCTS USED FOR EROSION AND SEDIMENT CONTROL, NAMELY, STORMWATER MANAGEMENT, POND BANK STABILIZATION, AND OTHER ENVIRONMENTAL APPLICATIONS (U.S. CLS. 1, 12, 33 AND 50).

FIRST USE 9-15-2000; IN COMMERCE 9-15-2000.

2,900,208. STRATFORD HOMES LIMITED PARTNERSHIP, STRATFORD, WI. SN 76-344,923. PUB. 7-30-2002, FILED 12-4-2001.

**STRATFORD HOMES**

OWNER OF U.S. REG. NO. 1,511,781.

NO CLAIM IS MADE TO THE EXCLUSIVE RIGHT TO USE "HOMES", APART FROM THE MARK AS SHOWN.

FOR FACTORY BUILT HOMES (U.S. CLS. 1, 12, 33 AND 50).

FIRST USE 4-0-1973; IN COMMERCE 4-0-1973.

2,900,259. ALL AMERICAN HOMES, LLC, ELKHART, IN. SN 76-401,463. PUB. 10-29-2002, FILED 4-29-2002.

**AMERI-LOG**

FOR MODULAR HOMES (U.S. CLS. 1, 12, 33 AND 50).  
FIRST USE 3-0-2003; IN COMMERCE 3-0-2003.

**CLASS 19—(Continued).**

2,900,306. CREST, S.A. DE C.V., SAN PEDRO GARZA GARCIA, NUEVO LEON, MEXICO. SN 76-441,952. PUB. 11-11-2003, FILED 8-14-2002.

**CREST**

FOR MULTIPURPOSE DRY SET MORTAR FOR CERAMIC TILES OF HIGH, MEDIUM AND LOW WATER ABSORPTION (U.S. CLS. 1, 12, 33 AND 50).  
FIRST USE 7-9-2004; IN COMMERCE 7-9-2004.

2,900,385. DURO-LAST, INC., SAGINAW, MI. SN 76-479,460. PUB. 11-4-2003, FILED 12-31-2002.



FOR MEMBRANE SHEETING FOR ROOFS (U.S. CLS. 1, 12, 33 AND 50).  
FIRST USE 12-18-2002; IN COMMERCE 12-18-2002.

2,900,598. U.S. ARCHITECTURAL PRODUCTS, INC., LINCOLN, RI. SN 78-132,022. PUB. 3-25-2003, FILED 5-30-2002.

**CEM-STONE**

FOR DECORATIVE FIBER-REINFORCED CEMENT PANELS FOR APPLICATION TO EXPOSED BUILDING WALL SURFACES (U.S. CLS. 1, 12, 33 AND 50).  
FIRST USE 3-0-2003; IN COMMERCE 3-0-2003.

2,900,690. CAVALIER HOMES, INC., ADDISON, AL. SN 78-203,360. PUB. 9-23-2003, FILED 1-15-2003.

**UNI-WALL**

FOR NON-METAL WALLS WITHOUT BATTEN MOLDING, USED IN MANUFACTURED HOMES (U.S. CLS. 1, 12, 33 AND 50).  
FIRST USE 12-31-2003; IN COMMERCE 12-31-2003.

**CLASS 19—(Continued).**

2,900,839. SOUTHERN STAR CONCRETE, INC., AUSTIN, TX. SN 78-269,102. PUB. 4-13-2004, FILED 7-1-2003.

## SOUTHERN STAR CONCRETE

NO CLAIM IS MADE TO THE EXCLUSIVE RIGHT TO USE "CONCRETE", APART FROM THE MARK AS SHOWN. FOR READY-MIX CONCRETE (U.S. CLS. 1, 12, 33 AND 50).

FIRST USE 7-18-2003; IN COMMERCE 7-18-2003.

**CLASS 20—FURNITURE AND ARTICLES NOT OTHERWISE CLASSIFIED**

2,900,136. HOLLANDER HOME FASHIONS CORP., BOCA RATON, FL. SN 76-182,652. PUB. 3-9-2004, FILED 12-19-2000.

## WILD THING

FOR BED PILLOWS (U.S. CLS. 2, 13, 22, 25, 32 AND 50). FIRST USE 1-18-2001; IN COMMERCE 1-18-2001.

2,900,200. MARTHA STEWART LIVING OMNIMEDIA, INC., NEW YORK, NY. SN 76-337,180. PUB. 6-4-2002, FILED 11-13-2001.

## TURKEY HILL

FOR FURNITURE (U.S. CLS. 2, 13, 22, 25, 32 AND 50). FIRST USE 3-1-2004; IN COMMERCE 3-1-2004.

2,900,211. BLINDS TO GO INC., MONTREAL, CANADA. SN 76-354,186. PUB. 5-13-2003, FILED 12-31-2001.

## EXACTMATCH

PRIORITY CLAIMED UNDER SEC. 44(D) ON CANADA APPLICATION NO. 1,120,137, FILED 11-1-2001.

FOR WINDOW COVERINGS, NAMELY BLINDS, SHADES; AND PARTS AND COMPONENTS THEREFOR (U.S. CLS. 2, 13, 22, 25, 32 AND 50).

FIRST USE 1-0-2002; IN COMMERCE 1-0-2002.

2,900,255. MERILLAT INDUSTRIES, LLC, ADRIAN, MI. SN 76-397,709. PUB. 10-29-2002, FILED 4-17-2002.

## ESSENTIALS

FOR CABINETRY (U.S. CLS. 2, 13, 22, 25, 32 AND 50). FIRST USE 4-2-2002; IN COMMERCE 4-2-2002.

**CLASS 20—(Continued).**

2,900,257. SINCLAIR OIL CORPORATION, SALT LAKE CITY, UT. SN 76-401,200. PUB. 7-15-2003, FILED 4-29-2002.

## SUN VALLEY

OWNER OF U.S. REG. NO. 929,750. FOR NON-METAL KEY CHAINS, KEY RINGS, KEY TAGS AND PLASTIC BANNERS (U.S. CLS. 2, 13, 22, 25, 32 AND 50).

FIRST USE 1-1-1995; IN COMMERCE 1-1-1995.

2,900,267. THE TJX COMPANIES, INC., FRAMINGHAM, MA. SN 76-408,420. PUB. 7-15-2003, FILED 5-15-2002.

## WILLIAMSTOWN FRAME CO.

NO CLAIM IS MADE TO THE EXCLUSIVE RIGHT TO USE "FRAME CO.", APART FROM THE MARK AS SHOWN. FOR PICTURE FRAMES, PICTURE FRAMES FOR PHOTOGRAPHS; NON-METAL BOXES FOR DOMESTIC AND HOUSEHOLD STORAGE (U.S. CLS. 2, 13, 22, 25, 32 AND 50).

FIRST USE 4-4-2003; IN COMMERCE 4-4-2003.

2,900,276. THE TJX COMPANIES, INC., FRAMINGHAM, MA. SN 76-419,415. PUB. 11-11-2003, FILED 6-11-2002.

## MOLLY'S GARDEN

FOR PICTURE FRAMES, PICTURE FRAMES FOR PHOTOGRAPHS; NON-METAL BOXES FOR DOMESTIC AND HOUSEHOLD STORAGE (U.S. CLS. 2, 13, 22, 25, 32 AND 50).

FIRST USE 3-12-2003; IN COMMERCE 3-12-2003.

2,900,295. INGENIOUS DESIGNS LLC, ST. PETERSBURG, FL. SN 76-433,198. PUB. 5-13-2003, FILED 7-19-2002.

## HUGGABLE HOOKS

OWNER OF U.S. REG. NO. 2,291,442. NO CLAIM IS MADE TO THE EXCLUSIVE RIGHT TO USE "HOOKS", APART FROM THE MARK AS SHOWN.

FOR NON-METAL HOOKS FOR APPAREL, BED AND KITCHEN LINEN, AND MISCELLANEOUS HOUSEHOLD ITEMS (U.S. CLS. 2, 13, 22, 25, 32 AND 50).

FIRST USE 1-9-2003; IN COMMERCE 1-9-2003.



**CLASS 20—(Continued).**

2,900,296. HARRIS CORPORATION, MELBOURNE, FL. SN 76-436,456. PUB. 9-23-2003, FILED 7-30-2002.

**PRIMELINE**

FOR BROADCAST STUDIO FURNITURE (U.S. CLS. 2, 13, 22, 25, 32 AND 50).  
FIRST USE 1-30-2001; IN COMMERCE 1-30-2001.

2,900,309. STUDIO RTA, INC., PICO RIVERA, CA. SN 76-443,257. PUB. 11-4-2003, FILED 8-16-2002.

**OFFICE TECH**

NO CLAIM IS MADE TO THE EXCLUSIVE RIGHT TO USE "OFFICE", APART FROM THE MARK AS SHOWN.  
FOR READY-TO-ASSEMBLE FURNITURE (U.S. CLS. 2, 13, 22, 25, 32 AND 50).  
FIRST USE 12-0-2002; IN COMMERCE 12-0-2002.

2,900,420. COZAR ERGONOMICS INC., OAKVILLE, ONTARIO, CANADA. SN 76-493,732. PUB. 10-21-2003, FILED 2-28-2003.

**ALLEVIATE**

FOR MOBILE PADDED ELBOW SUPPORT FOR CHAIRS (U.S. CLS. 2, 13, 22, 25, 32 AND 50).  
FIRST USE 9-0-2003; IN COMMERCE 9-0-2003.

2,900,448. BARLOW, DAVID, SEMINOLE, FL. SN 76-503,731. PUB. 12-16-2003, FILED 4-3-2003.

**MAGNETIC MEMORIES**

NO CLAIM IS MADE TO THE EXCLUSIVE RIGHT TO USE "MAGNETIC", APART FROM THE MARK AS SHOWN.  
FOR MAGNETIC PICTURE FRAMES FOR FRAMING CHILDREN'S ARTWORK (U.S. CLS. 2, 13, 22, 25, 32 AND 50).  
FIRST USE 8-0-2003; IN COMMERCE 10-0-2003.

**CLASS 20—(Continued).**

2,900,604. DISCOVERY COMMUNICATIONS, INC., SILVER SPING, MD. SN 78-139,926. PUB. 5-6-2003, FILED 6-28-2002.

**TRADING SPACES**

OWNER OF U.S. REG. NO. 2,610,455.  
FOR PICTURE FRAMES; DECORATIVE SHELVES; MIRRORS; THROW PILLOWS WITH INTERCHANGEABLE COVERS AND SIZES; WINDOW SHADES; WINDOW ACCENTS, NAMELY, CURTAIN RODS, BRACKETS FOR HANGING RODS, DECORATIVE ACCESSORIES FOR THE ENDS OF RODS, FINIALS, WINDOW SHUTTERS AND FABRIC TIE BACKS; FURNITURE; VALENCES (U.S. CLS. 2, 13, 22, 25, 32 AND 50).  
FIRST USE 8-31-2003; IN COMMERCE 8-31-2003.

2,900,607. HOLLANDER HOME FASHIONS CORP., BOCA RATON, FL. SN 78-142,335. PUB. 8-26-2003, FILED 7-9-2002.

**PERFECT REST**

FOR PILLOWS, MATTRESS TOPPERS AND FEATHERBEDS (U.S. CLS. 2, 13, 22, 25, 32 AND 50).  
FIRST USE 1-3-2003; IN COMMERCE 1-3-2003.

2,900,629. NIGHTINGALE CORP., MISSISSAUGA, ONTARIO, CANADA. SN 78-160,816. PUB. 11-18-2003, FILED 9-5-2002.

**CXO**

FOR CHAIRS (U.S. CLS. 2, 13, 22, 25, 32 AND 50).  
FIRST USE 1-0-2004; IN COMMERCE 1-0-2004.

**CLASS 20—(Continued).**

2,900,651. GILLETTE COMPANY, THE, BOSTON, MA. SN 78-170,607. PUB. 7-29-2003, FILED 10-3-2002.

**M.A.B.S.**

THE MARK CONSISTS OF STANDARD CHARACTERS WITHOUT CLAIM TO ANY PARTICULAR FONT, STYLE, SIZE, OR COLOR.

FOR PERMANENT MERCHANDISING AND SALES UNITS AND DISPLAYS, NAMELY, DISPLAY RACKS AND METAL DISPLAY STANDS (U.S. CLS. 2, 13, 22, 25, 32 AND 50).

FIRST USE 7-6-2002; IN COMMERCE 7-6-2002.

2,900,695. DAVID NETTO DESIGN, LLC, NEW YORK, NY. SN 78-203,515. PUB. 9-23-2003, FILED 1-15-2003.

**Netto**collection

COLOR IS CLAIMED AS A FEATURE OF THE MARK. THE MARK CONSISTS OF THE WORDING "NETTOCOLLECTION" IN WHITE LETTERING SUPERIMPOSED ON A RED RECTANGLE DISSECTED BY A VERTICAL WHITE LINE.

FOR FURNITURE, BEDROOM FURNITURE, CHILDREN'S FURNITURE, AND PARTS FOR ALL OF THE AFOREMENTIONED GOODS (U.S. CLS. 2, 13, 22, 25, 32 AND 50).

FIRST USE 12-12-2003; IN COMMERCE 12-12-2003.

2,900,741. NEWELL WINDOW FURNISHINGS, INC., FREEPORT, IL. SN 78-225,055. PUB. 11-11-2003, FILED 3-13-2003.

**QuickShade**

FOR WINDOW SHADES AND BLINDS (U.S. CLS. 2, 13, 22, 25, 32 AND 50).

FIRST USE 6-1-2003; IN COMMERCE 6-1-2003.

**CLASS 20—(Continued).**

2,900,745. BEST FRIENDS, LLC, ROYAL OAK, MI. SN 78-225,540. PUB. 11-4-2003, FILED 3-14-2003.

**NEATSLEEP**

FOR DOG BEDS (U.S. CLS. 2, 13, 22, 25, 32 AND 50). FIRST USE 11-0-2003; IN COMMERCE 11-0-2003.

2,900,796. GEIGER INTERNATIONAL, INC., ATLANTA, GA. SN 78-243,061. PUB. 12-16-2003, FILED 4-29-2003.

**TABLET**

FOR OFFICE FURNITURE (U.S. CLS. 2, 13, 22, 25, 32 AND 50). FIRST USE 6-1-2003; IN COMMERCE 6-1-2003.

2,900,852. KOLCRAFT ENTERPRISES, INC., CHICAGO, IL. SN 78-274,845. PUB. 3-23-2004, FILED 7-16-2003.

**RECLINE N' DINE**

FOR HIGH CHAIRS (U.S. CLS. 2, 13, 22, 25, 32 AND 50). FIRST USE 4-1-2003; IN COMMERCE 1-1-2004.

**CLASS 21—HOUSEWARES AND GLASS**

**CLASS 21—(Continued).**

2,900,126. GANZ. WOODBRIDGE, ONTARIO, CANADA. SN 76-132,635. PUB. 4-23-2002, FILED 9-21-2000.

**TIME & AGAIN**

FOR GLASS ORNAMENTS, PORCELAIN ORNAMENTS, AND RESIN ORNAMENTS [NOT CHRISTMAS TREE ORNAMENTS]; SERVING TRAYS, JAR CANDLE HOLDERS, CRUETS FOR OIL AND VINEGAR, AND TEA POTS [NOT OF PRECIOUS METAL]; PORCELAIN, GLASS AND EARTHENWARE CANDY JARS, COOKIE JARS AND COOKIE TINS, NAMELY, COOKIE JARS; TERRA COTTA PLANT HOLDERS; STRAW BASKETS AND CANDLE COASTERS [NOT OF PAPER OR LINEN]; PORCELAIN AND GLASS SWITCH PLATES FOR LIGHTS AND ELECTRIC OUTLETS; PORCELAIN, GLASS AND EARTHENWARE DECORATIVE ITEMS, NAMELY, BELLS, CROSSES, DECORATIVE EGGS, BUTTERFLIES, HEARTS, CORNUCOPIA, HUMMINGBIRDS, CLOWNS, MINI TEA SETS AND DECORATIVE FIGURINES; PORCELAIN, GLASS AND EARTHENWARE HOUSEWARE ITEMS, NAMELY, CREAMERS, SOUP TUREENS, AND SOAP DISH; GLASS PLATES, DRINKING GLASSES, GOBLETS, HAND-BLOWN GLASS, PEWTER BOTTLE TOPPERS, PITCHERS, VASES, NON-METAL PIGGY BANKS, EMPTY GLASS BOTTLES, BOWLS, CERAMIC BOXES, NON-ELECTRIC NON-METAL COFFEE POTS, COOKIE CUTTERS, GRAVY BOATS, HALLOWEEN BOWLS, HANUKKAH PLATES, LOTION DISPENSERS, CAPPUCINO MUGS, MUGS, PIE PLATES, SALSA BOWLS, SALT AND PEPPER SHAKERS, HOLIDAY MUGS, HOLIDAY BOWLS, PORCELAIN TRINKET BOXES, SPOON RESTS, TISSUE CADDIES, CORK STOPPERS, RESIN VICTORIAN TEA SETS, BIRD HOUSES, BUTTERFLY HOUSES, CERAMIC TOOTH BRUSH HOLDERS, TRAVEL MUGS, TUMBLERS, WATERING CANS, TERRA COTTA WIND CHIMES (U.S. CLS. 2, 13, 23, 29, 30, 33, 40 AND 50).  
FIRST USE 1-20-2003; IN COMMERCE 1-20-2003.

2,900,261. DISNEY ENTERPRISES, INC., BURBANK, CA. SN 76-402,810. PUB. 5-20-2003, FILED 5-1-2002.

**WHERE MAGIC LIVES**

FOR CUPS AND MUGS (U.S. CLS. 2, 13, 23, 29, 30, 33, 40 AND 50).  
FIRST USE 10-31-2003; IN COMMERCE 10-31-2003.

2,900,283. WILLITTS DESIGNS INTERNATIONAL, INC., PETALUMA, CA. SN 76-427,725. PUB. 10-28-2003, FILED 7-1-2002.

**LITTLE PRIDE & JOYS**

FOR COLLECTIBLE, DECORATIVE PORCELAIN FIGURINES OF ETHNIC CHILDREN (U.S. CLS. 2, 13, 23, 29, 30, 33, 40 AND 50).  
FIRST USE 2-28-2003; IN COMMERCE 2-28-2003.

**CLASS 21—(Continued).**

2,900,297. HANDGARDS, INC., EL PASO, TX. SN 76-436,828. PUB. 1-20-2004, FILED 8-1-2002.

**PAN HANDLERS**

FOR PAN LINERS, NAMELY, HIGH TEMPERATURE NYLON AND HIGH DENSITY POLYETHYLENE PAN LINERS THAT HELP PREVENT FOOD FROM STICKING TO THE PAN WHILE STORING, WARMING AND COOKING FOOD (U.S. CLS. 2, 13, 23, 29, 30, 33, 40 AND 50).

FIRST USE 1-7-2003; IN COMMERCE 1-7-2003.

2,900,329. TIENSHAN, INC., S. NORWALK, CT. SN 76-450,595. PUB. 4-22-2003, FILED 7-18-2002.



FOR PORCELAIN DINNERWARE, CHINA DINNERWARE, AND EARTHENWARE DINNERWARE FOR TABLE USE (U.S. CLS. 2, 13, 23, 29, 30, 33, 40 AND 50).  
FIRST USE 2-10-2003; IN COMMERCE 2-10-2003.

2,900,375. HANA COBI CO., LTD., NAMDONG-KU, INCHEON, REPUBLIC OF KOREA. SN 76-472,655. PUB. 9-16-2003, FILED 12-6-2002.



NO CLAIM IS MADE TO THE EXCLUSIVE RIGHT TO USE "LOCK", APART FROM THE MARK AS SHOWN.

FOR HOUSEHOLD UTENSILS NOT OF PRECIOUS METAL, NAMELY, SOAP BOXES, TRASH CANS, COOKING POTS AND FRYING PANS, BOWLS, DISHES, PLATES, PLASTIC CUPS, CRUETS, KITCHEN LADLES, NON-ELECTRIC KITCHEN CONTAINERS, SERVING TRAYS, BUCKETS, ICE BUCKETS, BASINS, DRINKING VESSELS, THERMAL INSULATED BOTTLES FOR BEVERAGES AND FOOD, PICNIC CONTAINERS FOR FOODS AND HOUSEHOLD USE (U.S. CLS. 2, 13, 23, 29, 30, 33, 40 AND 50).

FIRST USE 3-15-2003; IN COMMERCE 3-15-2003.

**CLASS 21—(Continued).**

2,900,391. STONEAGE CERAMICS INTERNATIONAL HONG KONG LTD., WANCHAI, HONG KONG. SN 76-481,577. PUB. 4-27-2004, FILED 1-10-2003.

**LIVING ART**

FOR TABLEWARE AND TABLE ACCESSORIES MADE OF PORCELAIN, STONEWARE, EARTHENWARE AND GLASS, NAMELY, PLATES, CUPS, MUGS, SAUCERS, BOWLS, CANDLESTICK HOLDERS, AND VASES; SERVING PIECES MADE OF PORCELAIN, STONEWARE, EARTHENWARE AND GLASS, NAMELY, BOWLS, POT LIDS, SERVING PLATTERS, MEAL TRAYS AND SERVING DISHES (U.S. CLS. 2, 13, 23, 29, 30, 33, 40 AND 50).  
FIRST USE 9-1-2001; IN COMMERCE 9-1-2001.

2,900,410. TELEBRANDS CORP., FAIRFIELD, NJ. SN 76-489,723. PUB. 11-11-2003, FILED 2-11-2003.

**HANDY CHEF**

FOR HAND-HELD, MULTI-PURPOSE KITCHEN UTENSIL, NAMELY, A COMBINATION STIRRING WHISK AND SERVING TONGS (U.S. CLS. 2, 13, 23, 29, 30, 33, 40 AND 50).  
FIRST USE 3-5-2003; IN COMMERCE 3-5-2003.

2,900,414. SPADA, ROBERT, HUNTINGTON BEACH, CA. SN 76-490,771. PUB. 11-18-2003, FILED 2-10-2003.

**BUCKET BUDDY**

NO CLAIM IS MADE TO THE EXCLUSIVE RIGHT TO USE "BUCKET", APART FROM THE MARK AS SHOWN.  
FOR BUCKET ATTACHMENTS, NAMELY A BOARD THAT IS PLACED OVER THE TOP OPENING OF A BUCKET, THE BOARD HAVING AN OFF-CENTER OPENING FOR ALLOWING ACCESS INTO THE BUCKET, IN WHICH BAIT CAN BE STORED, AND WORK SPACE AROUND THE OPENING (U.S. CLS. 2, 13, 23, 29, 30, 33, 40 AND 50).  
FIRST USE 7-0-2004; IN COMMERCE 7-0-2004.

2,900,616. RECKITT BENCKISER INC., PARSIPPANY, NJ. SN 78-148,645. PUB. 3-25-2003, FILED 7-30-2002.

**CHORE BOY**

OWNER OF U.S. REG. NOS. 2,047,922, 2,052,743, AND OTHERS.  
FOR SOAP PAD CONTAINING DETERGENT FOR HOUSEHOLD USE (U.S. CLS. 2, 13, 23, 29, 30, 33, 40 AND 50).  
FIRST USE 3-23-2004; IN COMMERCE 3-23-2004.

**CLASS 21—(Continued).**

2,900,672. BLACK & DECKER CORPORATION, THE, TOWSON, MD. SN 78-196,074. PUB. 7-15-2003, FILED 12-19-2002.

**STRATFORD**

FOR BATH ACCESSORIES, NAMELY, TOWEL BARS, TOWEL RINGS, ROBE HOOKS, TISSUE HOLDERS AND TUMBLER HOLDERS (U.S. CLS. 2, 13, 23, 29, 30, 33, 40 AND 50).

FIRST USE 8-31-2003; IN COMMERCE 8-31-2003.

2,900,754. IMPERIAL BAG AND PAPER COMPANY, INC., BAYONNE, NJ. SN 78-227,645. PUB. 11-25-2003, FILED 3-19-2003.

**SERENITY**

FOR PAPER CUPS; PAPER PLATES (U.S. CLS. 2, 13, 23, 29, 30, 33, 40 AND 50).

FIRST USE 3-0-2003; IN COMMERCE 3-0-2003.

**CLASS 24—FABRICS**

2,900,234. PERFECT FIT INDUSTRIES, INC., MONROE, NC. SN 76-380,046. PUB. 10-15-2002, FILED 3-8-2002.

**ULTRA SOFT**

OWNER OF U.S. REG. NO. 2,055,764.  
NO CLAIM IS MADE TO THE EXCLUSIVE RIGHT TO USE "SOFT", APART FROM THE MARK AS SHOWN.  
FOR BLANKETS AND MATTRESS PADS (U.S. CLS. 42 AND 50).  
FIRST USE 3-8-2002; IN COMMERCE 6-1-2002.

2,900,572. GLOBAL TEXTILES, INC., HOUSTON, TX. SN 78-113,094. PUB. 2-11-2003, FILED 3-7-2002.

**BELISSIMA**

THE ENGLISH TRANSLATION OF THE WORD "BELISSIMA" MEANS "VERY BEAUTIFUL".  
FOR HOME TEXTILE PRODUCTS, NAMELY COMFORTERS, PILLOW SHAMS, BED SKIRTS, DUST RUFFLES, PILLOW CASES, PILLOW COVERS, DUVET COVERS, BED SPREADS, BED SHEETS, BLANKETS, DUVETS, FABRIC TABLE TOPPERS, TABLE CLOTHS, FABRIC TABLE RUNNERS, TEXTILE NAPKINS, TOWELS; WINDOW TREATMENTS; NAMELY, DRAPES, CURTAINS, SWAGS AND VALANCES (U.S. CLS. 42 AND 50).  
FIRST USE 6-19-2000; IN COMMERCE 1-0-2003.

**CLASS 25—CLOTHING**

**CLASS 25—(Continued).**

2,900,046. LYON ADVERTISING, INC., AUSTIN, TX. SN 75-614,350. PUB. 5-1-2001, FILED 12-31-1998.

## UNIVERSITY OF THE WORLD WIDE WEB

FOR CLOTHING, NAMELY, SHIRTS, AND CAPS (U.S. CLS. 22 AND 39).  
FIRST USE 7-0-2004; IN COMMERCE 7-0-2004.

2,900,067. BROTHERS BEER COMPANY, INC., DBA BROTHERS BREWING COMPANY, OAKLAND, CA. SN 75-828,553. PUB. 1-23-2001, FILED 10-21-1999.

## BROTHERS AN AMERICAN ORIGINAL JUST LIKE JAZZ

FOR CLOTHING AND SPORTS ACCESSORIES, NAMELY TOPS, FT-SHIRTS, POLO-SHIRTS, SWEATERS, SWEATSHIRTS, SHORTS, JACKETS, PARKAS, VESTS, HATS, CAPS (U.S. CLS. 22 AND 39).  
FIRST USE 12-0-1999; IN COMMERCE 12-0-1999.

2,900,095. ANDREU, JOSÉ CARLOS ANTÓN, 03330-CREVILLENTE, ALICANTE, SPAIN. SN 76-022,880. PUB. 5-1-2001, FILED 4-10-2000.



NO CLAIM IS MADE TO THE EXCLUSIVE RIGHT TO USE "TINY", APART FROM THE MARK AS SHOWN.

THE MARK CONSISTS OF THE WORDING "TINY ALL FOR THEM" AND DESIGN OF A TEDDY BEAR AND A BIRD.

FOR SHOES; FOOTWEAR; AND CLOTHING, NAMELY, TROUSERS, PANTS, SHORTS, T-SHIRTS, SHIRTS, SPORTS SHIRTS, POLO SHIRTS, KNIT SHIRTS, GYM SHORTS, AND SOCKS (U.S. CLS. 22 AND 39).  
FIRST USE 9-16-1997; IN COMMERCE 2-6-2002.

**CLASS 25—(Continued).**

2,900,098. LEAPHART, LANORRIS, NORRISTOWN, PA. SN 76-047,949. PUB. 5-14-2002, FILED 5-11-2000.



THE MARK CONSISTS OF A DESIGN OF A THREE-DIMENSIONAL LETTER "S" FROM THE ENGLISH COURTHAND SCRIPT AND THE WORDS "STRATEGIC - DON'T BLINK".

FOR CLOTHING, NAMELY, SHIRTS, BLOUSES, TOPS, PANTS, JEANS, SHIRTS, UNDERWEAR, BRAS, BOXERS, SOCKS, STOCKINGS, FOOTWEAR, HEADWEAR, COATS, SWEATERS, JACKETS, VESTS, SWEATSHIRTS, SWEATPANTS, DRESSES (U.S. CLS. 22 AND 39).  
FIRST USE 10-29-2000; IN COMMERCE 10-31-2000.

2,900,108. SCHOLASTIC INC., NEW YORK, NY. SN 76-091,133. PUB. 4-10-2001, FILED 7-17-2000.



OWNER OF U.S. REG. NOS. 273,405, 1,741,883, AND OTHERS.

FOR CHILDREN'S MASQUERADE COSTUMES (U.S. CLS. 22 AND 39).

FIRST USE 10-1-2001; IN COMMERCE 10-1-2001.

2,900,123. XO COMMUNICATIONS, INC., RESTON, VA. SN 76-125,993. PUB. 6-11-2002, FILED 9-8-2000.



THE MARK CONSISTS OF THE LETTERS "XO" IN STYLIZED FORM.

FOR CLOTHING, NAMELY, SHIRTS, SHORTS, T-SHIRTS, AND SWEATSHIRTS; HEADGEAR, NAMELY, HATS, ALL AS PROMOTIONAL AND PREMIUM ITEMS, NOT INTENDED FOR RESALE OTHER THAN IN COMPANY STORES, FOR USE BY ITS EMPLOYEES, AND FOR USE IN CONNECTION WITH ADVERTISING AND PROMOTION OF ITS TELECOMMUNICATIONS AND INTERNET SERVICES AND PRODUCTS (U.S. CLS. 22 AND 39).

FIRST USE 9-25-2000; IN COMMERCE 9-25-2000.

**CLASS 25—(Continued).**

2,900,138. PERRY ELLIS INTERNATIONAL, INC., MIAMI, FL. SN 76-190,455. PUB. 3-12-2002, FILED 1-3-2001.

**EXECUTIVE KHAKIS**

NO CLAIM IS MADE TO THE EXCLUSIVE RIGHT TO USE "KHAKIS", APART FROM THE MARK AS SHOWN. FOR CLOTHING, NAMELY, SHIRTS, SHORTS, PANTS, AND JACKETS (U.S. CLS. 22 AND 39). FIRST USE 4-9-2001; IN COMMERCE 4-9-2001.

2,900,139. PACIFIC KNITTING MILLS, INC., LOS ANGELES, CA. SN 76-191,621. PUB. 11-19-2002, FILED 1-8-2001.

**CHEMIN DE FER**

FOR CLOTHING, NAMELY, PANTS, JEANS, SHORTS, SOCKS, SHIRTS, BLOUSES, VESTS AND JACKETS (U.S. CLS. 22 AND 39). FIRST USE 3-0-2000; IN COMMERCE 3-0-2000.

2,900,156. NBDL ENTERPRISES, LLC, SECAUCUS, NJ. SN 76-264,382. PUB. 9-16-2003, FILED 5-30-2001.



OWNER OF U.S. REG. NOS. 2,599,556, 2,705,421, AND OTHERS.

NO CLAIM IS MADE TO THE EXCLUSIVE RIGHT TO USE "FAYETTEVILLE", APART FROM THE MARK AS SHOWN.

FOR CLOTHING, NAMELY HOSIERY, FOOTWEAR, T-SHIRTS, SHIRTS, SWEATSHIRTS, SWEATPANTS, PANTS, TANK TOPS, JERSEYS, SHORTS, PAJAMAS, SPORT SHIRTS, RUGBY SHIRTS, SWEATERS, BELTS, TIES, NIGHTSHIRTS, HATS, WARM-UP SUITS, WARM-UP PANTS, WARM-UP TOPS, JACKETS, PARKAS, COATS, CLOTH BIBS, HEAD BANDS, WRIST BANDS, APRONS, BOXER SHORTS, SLACKS, CAPS, EAR MUFFS, GLOVES, MITTENS, WOVEN AND KNIT SHIRTS (U.S. CLS. 22 AND 39).

FIRST USE 11-18-2001; IN COMMERCE 11-18-2001.

2,900,179. ROCKY MOUNTAIN HARLEY-DAVIDSON MOTOR COMPANY, LITTLETON, CO. SN 76-304,158. PUB. 1-21-2003, FILED 8-23-2001.

**SPEED SOCK**

NO CLAIM IS MADE TO THE EXCLUSIVE RIGHT TO USE "SOCK", APART FROM THE MARK AS SHOWN.

FOR HEAD GEAR, NAMELY HATS (U.S. CLS. 22 AND 39).

FIRST USE 8-0-2001; IN COMMERCE 8-0-2001.

**CLASS 25—(Continued).**

2,900,212. RHYTHM EAST LTD., TAIPEI, TAIWAN. SN 76-354,298. PUB. 12-30-2003, FILED 1-3-2002.



FOR CLOTHING, NAMELY, TOPS, BRAS, BOW TIES, TROUSERS, SKIRTS, SHIRTS, JACKETS, DRESSES, SUITS; DANCING WEAR, NAMELY, DRESSES, LEOTARDS, TIGHTS, PANTS, SHIRTS, SHORTS, SKIRTS, MIDRIFTS, TUTUS; COSTUMES FOR USE IN DANCING; LEOTARDS; SPORTSWEAR, NAMELY, PANTS, SHORTS, WOVEN SHIRTS, KNIT SHIRTS, SWEATERS, JACKETS, VESTS, JERSEYS, T-SHIRTS, SWEATSHIRTS, SWEAT PANTS, CAPS AND HATS; SHOES AND BOOTS, AND HOSIERY (U.S. CLS. 22 AND 39).

FIRST USE 8-1-2001; IN COMMERCE 1-5-2004.

2,900,237. ANTHONY CAPUTO, LLC, BRIDGEHAMPTON, NY. SN 76-382,288. PUB. 10-1-2002, FILED 3-14-2002.

**ANTHONY CAPUTO**

THE MARK IDENTIFIES THE NAME OF A LIVING INDIVIDUAL WHOSE CONSENT IS OF RECORD.

FOR CLOTHING IN ALL FABRICATIONS, NAMELY, PANTS, CYCLE PANTS, TROUSERS, SLACKS, JEANS, DENIM JEANS, JUMPERS, SHORTS, BOXER SHORTS, SHIRTS, T-SHIRTS, UNDER SHIRTS, RUGBY SHIRTS, POLO SHIRTS, TOPS, CROP TOPS, TANK TOPS, HALTER TOPS, SWEAT SHIRTS, SWEAT PANTS, WARM-UP SUITS, JOGGING SUITS, BLOUSES, SWEATERS, VESTS, FLEECE VESTS, PULLOVERS, FLEECE PULLOVERS, JACKETS, DINNER JACKETS, SPORTS JACKETS, GOLF AND COATS, BLAZERS, SUITS, TURTLENECKS, BELTS (U.S. CLS. 22 AND 39).

FIRST USE 1-25-2002; IN COMMERCE 1-25-2002.

**CLASS 25—(Continued).**

2,900,362. OMAR S.R.L., 20122 MILANO MI, ITALY. SN 76-469,432. PUB. 12-30-2003, FILED 11-14-2002.

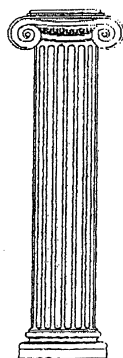

OWNER OF ERPN CMNTY TM OFC REG. NO. 549,287, DATED 3-30-1999, EXPIRES 6-3-2009.

THE LINING SHOWN IN THE DRAWING IS A FEATURE OF THE MARK AND NOT INTENDED TO INDICATE COLOR.

FOR HATS, CAPS, SCARVES, NECKERCHIEFS, BANDANNAS, NECKTIES, SHIRTS, POLO SHIRTS, T-SHIRTS, JACKETS, WAISTCOATS, SWEATERS, CARDIGANS, ANORAKS, OVERCOATS, RAINCOATS, SUITS AND DRESSES, SKIRTS, TROUSERS, SHORTS, PANTS, SWIMSUITS, PAJAMAS, NIGHTGOWNS, DRESSING GOWNS, LINGERIE, TRACKSUITS, SOCKS, STOCKINGS, BOOTS, SHOES, SLIPPERS, GLOVES AND BELTS (U.S. CLS. 22 AND 39).

FIRST USE 0-0-1995; IN COMMERCE 11-0-1997.

2,900,384. SHORTAL, JOE, LOS ANGELES, CA. SN 76-479,408. PUB. 9-16-2003, FILED 12-31-2002.

**BLACK JESUS**

FOR CLOTHING, NAMELY, SHIRTS, PANTS, T-SHIRTS, FOOTWEAR, HEADWEAR, BASEBALL CAPS, SHORTS, SWIMWEAR, LINGERIE, SWEAT SHIRTS, UNDERWEAR, JACKETS, DRESSES, AND SKIRTS (U.S. CLS. 22 AND 39).

FIRST USE 5-0-2004; IN COMMERCE 5-0-2004.

2,900,412. DORIS HOSIERY MILLS LTD., MONTREAL, QUEBEC, H2T 1S6, CANADA. SN 76-490,147. PUB. 10-28-2003, FILED 2-13-2003.

**DREAM SOLES**

FOR LEGWEAR, NAMELY SOCKS, PANTYHOSE, STOCKINGS, LEGGINGS, TIGHTS AND KNEE-HIGHS (U.S. CLS. 22 AND 39).

FIRST USE 2-0-2004; IN COMMERCE 2-0-2004.

**CLASS 25—(Continued).**

2,900,415. ZOTA USA INC., CITY OF INDUSTRY, CA. SN 76-491,956. PUB. 4-6-2004, FILED 2-26-2003.

**TOP RANK**

FOR FOOTWEAR (U.S. CLS. 22 AND 39).  
FIRST USE 7-0-2004; IN COMMERCE 7-0-2004.

2,900,435. FORTUNE FASHIONS INDUSTRIES LLC, VERNON, CA. SN 76-497,842. PUB. 10-28-2003, FILED 3-17-2003.

**FAME & FORTUNE**

FOR CLOTHING, NAMELY, FT-SHIRTS, SHIRTS, BLOUSES, SWEATSHIRTS, SWEATERS, VESTS, JACKETS, TANK TOPS, LEGGINGS, SHORTS, PANTS, SLACKS, SWEAT PANTS, OVERALLS, DRESSES, PAJAMAS, SKIRTS, SOCKS; HEAD WEAR, NAMELY, CAPS, HATS AND VISORS (U.S. CLS. 22 AND 39).

FIRST USE 4-30-2004; IN COMMERCE 5-17-2004.

2,900,440. RUSSELL ASSET MANAGEMENT, INC., WILMINGTON, DE. SN 76-499,251. PUB. 11-4-2003, FILED 3-12-2003.

**CLIMA-POWER**

FOR CLOTHING, FOR MEN, WOMEN, AND CHILDREN, NAMELY, WIND RESISTANT SUITS, TUNICS, PANTS, TOPS, T-SHIRTS, TANK TOPS, SHIRTS, SHORTS, ATHLETIC UNIFORMS, POLO SHIRTS, SPORTS BRAS, ATHLETIC JERSEYS, SWEATPANTS, SWEATSHIRTS, WRIST BANDS, JACKETS, PARKAS AND SOCKS (U.S. CLS. 22 AND 39).

FIRST USE 12-1-2003; IN COMMERCE 12-1-2003.

2,900,444. BELLEVILLE SHOE MANUFACTURING COMPANY, BELLEVILLE, IL. SN 76-502,389. PUB. 11-11-2003, FILED 3-31-2003.

**WT-2**

FOR FABRIC SOLD AS A COMPONENT OF A SHOE UPPER (U.S. CLS. 22 AND 39).  
FIRST USE 7-1-2003; IN COMMERCE 7-1-2003.

2,900,461. SMITH, RAYMOND EUGENE, CARSON CITY, NV. SN 76-510,442. PUB. 12-16-2003, FILED 4-29-2003.

**FUGGET-MAN SEZ**

FOR CLOTHING, NAMELY, T-SHIRTS, HATS, CAPS, JACKETS, AND SWEATSHIRTS (U.S. CLS. 22 AND 39).  
FIRST USE 6-21-2004; IN COMMERCE 6-21-2004.

**CLASS 25—(Continued).**

2,900,561. PEARSALL, TODD P., DBA KEG GYM, SAN DIEGO, CA. SN 78-100,151. PUB. 12-10-2002, FILED 12-28-2001.

**KEG MAN**

FOR CLOTHING, NAMELY, T-SHIRTS, SWEAT-SHIRTS, JERSEYS, SHIRTS, CAPS, HATS, PANTS, SHORTS, SHOES, SOCKS, COATS, BLAZERS, SPORTS BRAS, BEACH SHOES, SWIMWEAR, GOLF SHIRTS, GOLF PANTS, GOLF COATS, AND TANK TOPS (U.S. CLS. 22 AND 39).

FIRST USE 9-19-2003; IN COMMERCE 9-19-2003.

**CLASS 25—(Continued).**

2,900,635. COOGI PARTNERS, LLC, BROOKLYN, NY. SN 78-162,490. PUB. 10-28-2003, FILED 9-10-2002.

**COOGI**

OWNER OF U.S. REG. NOS. 1,499,662 AND 1,946,161.  
FOR CLOTHING, NAMELY SHIRTS, VESTS, SWEATERS, SHOES, CAPS, BANDANNAS, SHORTS, SWEAT SHIRTS, PANTS, BELTS FOR CLOTHING, SOCKS, SWIMWEAR, JACKETS, RAINWEAR, BLOUSES, DRESSES, FOOTWEAR, HOSIERY, SCARVES, HATS, HEAD BANDS, PAJAMAS AND SLEEPWEAR (U.S. CLS. 22 AND 39).

FIRST USE 11-17-2003; IN COMMERCE 11-17-2003.

2,900,563. PASH INDUSTRIES, LLC, GLEN COVE, NY. SN 78-101,187. PUB. 10-29-2002, FILED 1-7-2002.

**PASHA & JO**

FOR ARTICLES OF WEARING APPAREL FOR MEN, LADIES AND CHILDREN, NAMELY; JACKETS, WIND RESISTANT JACKETS, COATS, BLAZERS, SKIRTS, DRESSES, PANTS, SLACKS, JEANS, BERMUDA SHORTS, SHORTS, SHIRTS, BLOUSES, PULL-OVERS, VESTS, TEE-SHIRTS, TANK TOPS, UNDERWEAR, SWIM WEAR, TIES, SCARVES, BELTS, SOCKS, TIGHTS, STOCKINGS AND PANTY HOSE (U.S. CLS. 22 AND 39).

FIRST USE 1-1-2002; IN COMMERCE 1-1-2002.

2,900,639. FORTUNE FOOTWEAR, INC., NEW YORK, NY. SN 78-164,938. PUB. 5-6-2003, FILED 9-17-2002.

**MY SWEET FOOTWEAR**

NO CLAIM IS MADE TO THE EXCLUSIVE RIGHT TO USE "FOOTWEAR", APART FROM THE MARK AS SHOWN.

FOR FOOTWEAR, NAMELY, SHOES, SNEAKERS, SANDALS, SLIPPERS, BOOTS, PUMPS, CASUAL SHOES AND FLIP-FLOPS (U.S. CLS. 22 AND 39).

FIRST USE 3-31-2004; IN COMMERCE 3-31-2004.

2,900,569. ROMO, JACK, PORT ORCHARD, WA. SN 78-110,710. PUB. 3-25-2003, FILED 2-24-2002.



FOR APPAREL, NAMELY, SHIRTS, PANTS, DRESSES (U.S. CLS. 22 AND 39).

FIRST USE 7-14-2004; IN COMMERCE 7-14-2004.

2,900,676. DEBBY B. MALIVUK, DBA KEEP TRI-ING, SUNRISE, FL. SN 78-198,372. PUB. 10-28-2003, FILED 12-28-2002.



FOR SHIRTS, HATS, PANTS, JACKETS, GLOVES, VISORS, SHORTS AND IMPRINTABLE SPORTS ACCESSORIES (U.S. CLS. 22 AND 39).

FIRST USE 2-8-2003; IN COMMERCE 3-29-2004.



**CLASS 25—(Continued).**

2,900,677. HOLLANDER, SCOTT E, VENTURA, CA. SN 78-198,385. PUB. 9-16-2003, FILED 12-28-2002.



THE LINING AND STIPLING ARE A FEATURE OF THE MARK AND NOT INTENDED TO SHOW COLOR.  
FOR CLOTHING - VESTS / JACKETS FOR MAKING TRAVELING MORE COMFORTABLE (U.S. CLS. 22 AND 39).

FIRST USE 3-4-2003; IN COMMERCE 5-22-2003.

2,900,678. RICCARDO, RANDALL, SAN FRANCISCO, CA. SN 78-198,469. PUB. 11-11-2003, FILED 12-30-2002.



THE STIPLING IS A FEATURE OF THE MARK.  
THE NAME "GINO PAOLI" DOES NOT IDENTIFY THE NAME OF A LIVING INDIVIDUAL

FOR MEN'S, WOMEN'S AND CHILDREN'S CLOTHING, NAMELY, SHIRTS, PANTS, SHORTS, SKIRTS, VESTS, DRESSES, JACKETS, WINDSHIRTS, T-SHIRTS, SHOES, SOCKS, HATS AND COATS (U.S. CLS. 22 AND 39).

FIRST USE 10-1-2002; IN COMMERCE 3-3-2003.

2,900,728. JOHNSON, CLAUDE, GREENWICH, CT. SN 78-221,482. PUB. 10-21-2003, FILED 3-4-2003.

## PHYSICAL CULTURE SUPPLY COMPANY

FOR CLOTHING, NAMELY, SHIRTS, SHORTS, JERSEYS, UNIFORMS, HATS, CAPS, SCARVES, HEADBANDS, JACKETS, COATS, TOPS, PANTS, SOCKS, SHOES, FOOTWEAR, BOOTS, SLIPPERS, SNEAKERS, ATHLETIC FOOTWEAR, UNDERWEAR, SLEEPWEAR, TIES, BOTTOMS, WRISTBANDS, SWEATBANDS, HOSIERY, SWEAT SHIRTS, SWEAT PANTS, T-SHIRTS, SWIMWEAR, BEACHWEAR, DRESSES, JUMPERS, PLAY SUITS, THERMAL UNDERWEAR, BOXER SHORTS, JEANS, JUMPSUITS, SKIRTS, OVERALLS, LEGGINGS, WARM-UP SUITS, AND COMPRESSION SHORTS (U.S. CLS. 22 AND 39).

FIRST USE 5-15-2003; IN COMMERCE 9-15-2003.

**CLASS 25—(Continued).**

2,900,733. LOCKHEED MARTIN CORPORATION, BETHESDA, MD. SN 78-223,426. PUB. 11-18-2003, FILED 3-10-2003.

**F-22**

FOR CLOTHING, NAMELY TOPS, CAPS, JACKETS (U.S. CLS. 22 AND 39).  
FIRST USE 7-21-2003; IN COMMERCE 7-21-2003.

2,900,805. NOBLE GRACE LLC, NEW YORK, NY. SN 78-248,899. PUB. 2-17-2004, FILED 5-13-2003.

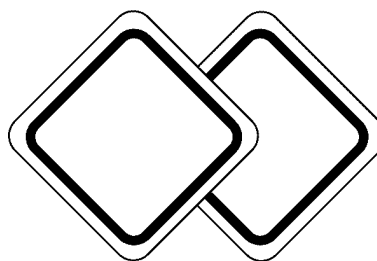

OWNER OF U.S. REG. NO. 2,606,054.  
THE MARK CONSISTS OF THE IMAGE RESEMBLING TWO OVERLAPPING ROAD SIGNS (DOUBLESIGN).

FOR APRONS, ATHLETIC UNIFORMS, BASEBALL CAPS, BOXER SHORTS, BRIEFS, CAPS, DRESSES, HATS, JERSEYS, KNIT SHIRTS, POLO SHIRTS, SHIRTS, SHORTS, SPORT SHIRTS, SWEAT PANTS, SWEAT SHIRTS, SWEATERS, SWIM TRUNKS, SWIM WEAR, SWIMSUITS, TENNIS WEAR, T-SHIRTS, UNDERCLOTHES, UNDERGARMENTS, UNDERPANTS, UNDERSHIRTS, UNDERWEAR (U.S. CLS. 22 AND 39).  
FIRST USE 7-15-2004; IN COMMERCE 7-15-2004.

2,900,826. VALLEY APPAREL COMPANY, CEDAR RAPIDS, IA. SN 78-262,070. PUB. 3-2-2004, FILED 6-13-2003.

## TRUE SCHOOL

FOR WEARING APPAREL, NAMELY, JERSEYS AND HEADWEAR (U.S. CLS. 22 AND 39).  
FIRST USE 8-2-2004; IN COMMERCE 8-2-2004.

2,900,827. VALLEY APPAREL COMPANY, CEDAR RAPIDS, IA. SN 78-262,072. PUB. 3-2-2004, FILED 6-13-2003.

## TRUE SCHOOL AUTHENTICS

NO CLAIM IS MADE TO THE EXCLUSIVE RIGHT TO USE "AUTHENTICS", APART FROM THE MARK AS SHOWN.

FOR WEARING APPAREL, NAMELY, JERSEYS AND HEADWEAR (U.S. CLS. 22 AND 39).  
FIRST USE 9-6-2003; IN COMMERCE 9-6-2003.

**CLASS 25—(Continued).**

2,900,828. TSI BRANDS, INC., WILMINGTON, DE. SN 78-263,489. PUB. 2-24-2004, FILED 6-17-2003.

**UNPLUGGED**

FOR CLOTHING, NAMELY PANTS AND SHORTS (U.S. CLS. 22 AND 39).  
FIRST USE 10-31-2003; IN COMMERCE 10-31-2003.

2,900,836. ICE JORDAN LLC, COLWYN, PA. SN 78-266,722. PUB. 3-23-2004, FILED 6-25-2003.

**CITY LEGENDZ**

FOR SHIRTS, PANTS, HATS, SHOES, SNEAKERS, HEADBANDS, WRIST BANDS, SOCKS, JERSEYS, SHORTS, SKIRTS, DRESSES (U.S. CLS. 22 AND 39).  
FIRST USE 7-1-2004; IN COMMERCE 7-1-2004.

2,900,837. KAYSER-ROTH CORPORATION, GREENSBORO, NC. SN 78-267,630. PUB. 3-30-2004, FILED 6-26-2003.

**HUE  
FLIPZ**

FOR FOOTWEAR (U.S. CLS. 22 AND 39).  
FIRST USE 2-29-2004; IN COMMERCE 2-29-2004.

2,900,843. BLAKELY, SARA, ATLANTA, GA. SN 78-270,130. PUB. 3-16-2004, FILED 7-3-2003.

**SLIM-X**

FOR WOMEN'S PANTS, SHIRTS AND BLOUSES (U.S. CLS. 22 AND 39).  
FIRST USE 9-30-2003; IN COMMERCE 3-5-2004.

**CLASS 26—FANCY GOODS****CLASS 26—(Continued).**

2,900,734. LOCKHEED MARTIN CORPORATION, BETHESDA, MD. SN 78-223,470. PUB. 11-18-2003, FILED 3-10-2003.

**F/A-22**

FOR DECORATIVE CLOTH SHOULDER PATCHES, EMBROIDERED PATCHES FOR CLOTHING (U.S. CLS. 37, 39, 40, 42 AND 50).  
FIRST USE 7-21-2003; IN COMMERCE 7-21-2003.

2,900,735. LOCKHEED MARTIN CORPORATION, BETHESDA, MD. SN 78-223,536. PUB. 11-25-2003, FILED 3-10-2003.

**F/A-22 RAPTOR**

FOR DECORATIVE CLOTH SHOULDER PATCHES, EMBROIDERED PATCHES FOR CLOTHING (U.S. CLS. 37, 39, 40, 42 AND 50).  
FIRST USE 7-21-2003; IN COMMERCE 7-21-2003.

2,900,820. ME & MY BIG IDEAS, INC., LAKE FOREST, CA. SN 78-258,093. PUB. 12-23-2003, FILED 6-4-2003.

**THREADS**

FOR DECORATIVE WOVEN RIBBONS WITH WOVEN IMPRINTED PHRASES FOR USE AS EMBELLISHMENTS FOR SCRAPBOOKS AND CRAFT PROJECTS (U.S. CLS. 37, 39, 40, 42 AND 50).  
FIRST USE 6-0-2003; IN COMMERCE 7-0-2003.

**CLASS 27—FLOOR COVERINGS**

2,900,197. PEACHTREE INTERNATIONAL LIMITED, HAMILTON HM MX, BERMUDA. SN 76-333,496. PUB. 4-16-2002, FILED 11-1-2001.

**TRACK TOUGH**

FOR HARD SURFACE COVERINGS FOR FLOORS; VINYL FLOOR COVERINGS (U.S. CLS. 19, 20, 37, 42 AND 50).  
FIRST USE 5-19-2002; IN COMMERCE 5-19-2002.

**CLASS 28—TOYS AND SPORTING GOODS**

2,900,117. JUSTKIDING, INC., ST. LOUIS PARK, MN. SN 76-116,844. PUB. 5-8-2001, FILED 8-25-2000.

**NAPKIDS**

FOR DOLLS IN THE NATURE OF FANCIFUL EFFIGIES MADE OF FOLDED BLANKETS (U.S. CLS. 22, 23, 38 AND 50).  
FIRST USE 7-29-2004; IN COMMERCE 7-29-2004.

**CLASS 28—(Continued).**

2,900,155. KONAMI CORPORATION, CHIYODA-KU, TOKYO, JAPAN. SN 76-252,965. PUB. 9-11-2001, FILED 5-7-2001.

**MAGICAL HATS**

FOR STAND-ALONE VIDEO GAME MACHINES; HAND-HELD UNITS FOR PLAYING ELECTRONIC GAMES; BOARD GAMES AND INSTRUCTIONAL MANUALS SOLD AS A UNIT THEREWITH; CARD GAMES; DICE; PROMOTIONAL GAME MATERIALS; GAME EQUIPMENT, NAMELY, CHIPS; TOYS, NAMELY, ACTION FIGURES, DOLLS AND PLAYSETS THEREFOR (U.S. CLS. 22, 23, 38 AND 50).

FIRST USE 9-0-2003; IN COMMERCE 9-0-2003.

2,900,157. NBDL ENTERPRISES, LLC, SECAUCUS, NJ. SN 76-264,393. PUB. 9-16-2003, FILED 5-30-2001.



OWNER OF U.S. REG. NOS. 2,599,556, 2,705,421, AND OTHERS.

NO CLAIM IS MADE TO THE EXCLUSIVE RIGHT TO USE "FAYETTEVILLE", APART FROM THE MARK AS SHOWN.

FOR TOYS, GAMES AND SPORTING GOODS, NAMELY BASKETBALLS; GOLF BALLS; PLAYGROUND BALLS; SPORTS BALLS; RUBBER ACTION BALLS AND FOAM ACTION BALLS; PLUSH BALLS; BASKETBALL NETS; BASKETBALL BACKBOARDS; PUMPS FOR INFLATING BASKETBALLS, AND NEEDLES THEREFOR; GOLF CLUBS, GOLF BAGS, GOLF PUTTERS, GOLF BALL GIFT SETS WITH DIVOT REPAIR TOOLS, OR TEES OR BALL MARKERS AND GOLF ACCESSORIES, NAMELY GOLF BAG COVERS, CLUB HEAD COVERS, GOLF GLOVES, GOLF BALL SLEEVES; BICYCLE TAGS; ELECTRONIC BASKETBALL TABLE TOP GAMES; BASKETBALL TABLE TOP GAMES; BASKETBALL BOARD GAMES; ELECTRONIC VIDEO ARCADE GAME MACHINES; BASKETBALL KIT COMPRISED OF A BASKETBALL NET AND WHISTLE; DOLLS; TOY ACTION FIGURES; STUFFED TOYS; JIGSAW PUZZLES; CHRISTMAS TREE ORNAMENTS; ACTION SKILL GAMES ARCADE GAMES; ADULT AND CHILDREN'S PARTY GAMES; TRIVIA INFORMATION GAMES (U.S. CLS. 22, 23, 38 AND 50).

FIRST USE 11-18-2001; IN COMMERCE 11-18-2001.

2,900,164. KONAMI CORPORATION, TOKYO, JAPAN. SN 76-281,831. PUB. 10-16-2001, FILED 7-9-2001.

**SKULL DICE**

FOR STAND-ALONE VIDEO GAME MACHINES; HAND-HELD UNITS FOR PLAYING ELECTRONIC GAMES; BOARD GAMES AND INSTRUCTIONAL MANUALS SOLD AS A UNIT THEREWITH; CARD GAMES; DICE; PROMOTIONAL GAME MATERIALS; GAME EQUIPMENT, NAMELY, CHIPS; TOYS, NAMELY ACTION FIGURES; DOLLS AND PLAYSETS THEREFOR (U.S. CLS. 22, 23, 38 AND 50).

FIRST USE 11-0-2003; IN COMMERCE 11-0-2003.

**CLASS 28—(Continued).**

2,900,173. BUTTERFLY CREATIONS, INC., GREENSBORO, NC. SN 76-295,513. PUB. 3-26-2002, FILED 8-6-2001.

**FRECKLES**

OWNER OF U.S. REG. NO. 2,427,479.  
FOR PLUSH TOYS ABOUT A DOG NAMED FRECKLES (U.S. CLS. 22, 23, 38 AND 50).  
FIRST USE 6-30-2004; IN COMMERCE 6-30-2004.

2,900,183. JOHN C. DETRICH AND JOSEPH J. AHEARN PARTNERSHIP, THE, ASHBURN, VA. SN 76-307,641. PUB. 5-28-2002, FILED 9-4-2001.

**CREEPSTERS**

FOR TOY DIE-CAST METAL CARS, TRACK AND ACCESSORIES THEREFOR (U.S. CLS. 22, 23, 38 AND 50).  
FIRST USE 8-1-2004; IN COMMERCE 8-1-2004.

2,900,201. YONEX KABUSHIKI KAISHA, TOKYO, JAPAN. SN 76-341,168. PUB. 5-27-2003, FILED 11-26-2001.

**V-CON**

FOR TENNIS RACKETS (U.S. CLS. 22, 23, 38 AND 50).  
FIRST USE 11-15-2001; IN COMMERCE 1-31-2002.

2,900,232. SUMITOMO RUBBER INDUSTRIES, LTD., KOBESHU, HYOGO, JAPAN. SN 76-376,931. PUB. 5-6-2003, FILED 2-28-2002.

**SRIXON PRO UR**

OWNER OF U.S. REG. NO. 2,120,674.  
NO CLAIM IS MADE TO THE EXCLUSIVE RIGHT TO USE "PRO", APART FROM THE MARK AS SHOWN.  
FOR GOLF BALLS (U.S. CLS. 22, 23, 38 AND 50).  
FIRST USE 5-22-2002; IN COMMERCE 8-0-2002.

**CLASS 28—(Continued).**

2,900,280. KETTLER INTERNATIONAL INC., VIRGINIA BEACH, VA. SN 76-424,980. PUB. 3-25-2003, FILED 6-25-2002.

**KETTMAXX**

THE MARK CONSISTS OF STANDARD CHARACTERS WITHOUT CLAIM TO ANY PARTICULAR FONT, STYLE, SIZE, OR COLOR.

FOR TOYS NAMELY, PLASTIC TRUCKS, CRANES AND TRACTORS (U.S. CLS. 22, 23, 38 AND 50).  
FIRST USE 3-1-2002; IN COMMERCE 3-1-2002.

2,900,299. GT MERCHANDISING & LICENSING LLC, NEW YORK, NY. SN 76-437,457. PUB. 3-23-2004, FILED 8-5-2002.

**SCULPTING STICK**

FOR MANUALLY OPERATED EXERCISE EQUIPMENT (U.S. CLS. 22, 23, 38 AND 50).  
FIRST USE 4-0-2003; IN COMMERCE 4-0-2003.

2,900,315. MOORE, SHERROD F., HONOLULU, HI. SN 76-447,246. PUB. 12-16-2003, FILED 9-6-2002.

**MILLENN GOLF & NIUM FLYERS**

NO CLAIM IS MADE TO THE EXCLUSIVE RIGHT TO USE "GOLF", APART FROM THE MARK AS SHOWN.

FOR EQUIPMENT SOLD AS A UNIT FOR PLAYING AN OUTDOOR ACTIVITY GAME IN THE NATURE OF A GOLF TARGET GAME (U.S. CLS. 22, 23, 38 AND 50).  
FIRST USE 4-30-2004; IN COMMERCE 4-30-2004.

2,900,319. HASBRO, INC., PAWTUCKET, RI. SN 76-448,437. PUB. 4-29-2003, FILED 9-11-2002.

**RAINBOW DASH****CLASS 28—(Continued).**

THE MARK CONSISTS OF STANDARD CHARACTERS WITHOUT CLAIM TO ANY PARTICULAR FONT, STYLE, SIZE, OR COLOR.

FOR TOY PONIES AND ACCESSORIES FOR USE THEREWITH (U.S. CLS. 22, 23, 38 AND 50).  
FIRST USE 4-11-2003; IN COMMERCE 4-11-2003.

2,900,320. HASBRO, INC., PAWTUCKET, RI. SN 76-448,441. PUB. 4-29-2003, FILED 9-11-2002.

**AMBERLOCKS**

FOR TOY PONIES AND ACCESSORIES FOR USE THEREWITH (U.S. CLS. 22, 23, 38 AND 50).  
FIRST USE 9-19-2003; IN COMMERCE 9-19-2003.

2,900,322. SONY COMPUTER ENTERTAINMENT AMERICA INC., FOSTER CITY, CA. SN 76-448,497. PUB. 4-22-2003, FILED 9-11-2002.

**IT'S YOUR WORLD NOW**

FOR BOARD GAMES AND ROLE PLAYING GAME EQUIPMENT IN THE NATURE OF GAME BOOK MANUALS (U.S. CLS. 22, 23, 38 AND 50).  
FIRST USE 8-12-2002; IN COMMERCE 8-12-2002.

2,900,354. THE CARTOON NETWORK LP, LLLP, ATLANTA, GA. SN 76-464,838. PUB. 6-3-2003, FILED 10-30-2002.

**CODENAME: KIDS NEXT DOOR**

FOR TOYS, SPORTING GOODS, GAMES AND PLAYTHINGS, NAMELY ACTION FIGURES AND ACCESSORIES THEREFOR, PLUSH TOYS, BALLOONS, BATHTUB TOYS, RIDE-ON TOYS, EQUIPMENT SOLD AS A UNIT FOR PLAYING CARD GAMES, TOY VEHICLES, DOLLS, FLYING DISCS, ELECTRONIC HAND-HELD GAME UNIT, GAME EQUIPMENT SOLD AS A UNIT FOR PLAYING A BOARD GAME A CARD GAME A MANIPULATIVE GAME A PARLOR GAME AND AN ACTION TYPE TARGET GAME, STAND ALONE VIDEO OUTPUT GAME MACHINES, JIGSAW AND MANIPULATIVE PUZZLES, PAPER FACE MASKS, SKATEBOARDS, ICE SKATES, WATER SQUIRTING TOYS, BALLS, NAMELY, PLAYGROUND BALLS, SOCCER BALLS BASEBALLS BASKETBALLS, BASEBALL GLOVES, SWIMMING FLOATS FOR RECREATIONAL USE, KICK BOARD FLOTATION DEVICES FOR RECREATIONAL USE, SURFBOARDS, SWIM BOARDS FOR RECREATIONAL USE, SWIM FINS, TOY BAKE WARE AND TOY COOKWARE, TOY BANKS, AND CHRISTMAS TREE ORNAMENTS (U.S. CLS. 22, 23, 38 AND 50).

FIRST USE 11-24-2002; IN COMMERCE 11-24-2002.

**CLASS 28—(Continued).**

2,900,405. DAIGLE, MARIE A., SOMERS, CT. SN 76-489,016.  
PUB. 12-2-2003, FILED 2-6-2003.

**PAT**

FOR EDUCATIONAL TOY NAMELY, A PLUSH CHARACTER USED AS A MANIPULATIVE TO ASSIST IN EDUCATION (U.S. CLS. 22, 23, 38 AND 50).  
FIRST USE 8-2-2004; IN COMMERCE 8-2-2004.

2,900,439. HASBRO, INC., PAWTUCKET, RI. SN 76-499,089.  
PUB. 11-18-2003, FILED 3-20-2003.

**EXPRESS YOURSELF**

FOR PARLOR GAMES (U.S. CLS. 22, 23, 38 AND 50).  
FIRST USE 10-24-2002; IN COMMERCE 10-24-2002.

2,900,455. WIZARDS OF THE COAST, INC., PAWTUCKET, RI. SN 76-506,810. PUB. 11-25-2003, FILED 4-14-2003.

**DRAGONEYE**

FOR FANTASY ROLE-PLAYING GAMES, BOARD GAMES AND GAME ACCESSORIES, NAMELY, MINIATURE FIGURINES USED IN ROLE PLAYING GAME SCENARIOS (U.S. CLS. 22, 23, 38 AND 50).  
FIRST USE 12-19-2003; IN COMMERCE 12-19-2003.

2,900,470. HASBRO, INC., PAWTUCKET, RI. SN 76-513,743.  
PUB. 1-20-2004, FILED 5-13-2003.

**SHARKTICON**

FOR TOY ACTION FIGURES, TOY VEHICLES AND TOY ROBOTS CONVERTIBLE INTO OTHER VISUAL TOY FORMS AND ACCESSORIES FOR USE THEREWITH (U.S. CLS. 22, 23, 38 AND 50).  
FIRST USE 10-10-2003; IN COMMERCE 10-10-2003.

2,900,471. HASBRO, INC., PAWTUCKET, RI. SN 76-513,745.  
PUB. 2-3-2004, FILED 5-13-2003.

**TRANSFORMERS  
ALTERNATORS**

OWNER OF U.S. REG. NOS. 1,348,237, 2,674,678, AND OTHERS.

FOR TOY ACTION FIGURES, TOY VEHICLES AND TOY ROBOTS CONVERTIBLE INTO OTHER VISUAL TOY FORMS AND ACCESSORIES FOR USE THEREWITH (U.S. CLS. 22, 23, 38 AND 50).  
FIRST USE 5-9-2003; IN COMMERCE 5-9-2003.

**CLASS 28—(Continued).**

2,900,480. HARTZ MOUNTAIN CORPORATION, THE, SECAUCUS, NJ. SN 76-517,510. PUB. 2-17-2004, FILED 5-28-2003.

**BLINK BLINK**

FOR PET TOYS (U.S. CLS. 22, 23, 38 AND 50).  
FIRST USE 1-1-2004; IN COMMERCE 1-1-2004.

2,900,481. HARTZ MOUNTAIN CORPORATION, THE, SECAUCUS, NJ. SN 76-517,517. PUB. 2-17-2004, FILED 5-28-2003.

**TUMBLE ALONG**

FOR PET TOYS (U.S. CLS. 22, 23, 38 AND 50).  
FIRST USE 1-1-2004; IN COMMERCE 1-1-2004.

2,900,482. THE HARTZ MOUNTAIN CORPORATION, SECAUCUS, NJ. SN 76-517,526. PUB. 2-24-2004, FILED 5-28-2003.

**ROPED IN**

FOR PET TOYS (U.S. CLS. 22, 23, 38 AND 50).  
FIRST USE 1-1-2004; IN COMMERCE 1-1-2004.

2,900,485. DAIWA SEIKO, INC., HIGASHIKURUME-CITY, TOKYO, JAPAN. SN 76-517,711. PUB. 2-3-2004, FILED 5-28-2003.

**INFINITE SPINN**

FOR FISHING REELS, FISHING RODS, FISHING LURES, FISHING SINKERS, FISHING FLOATS, FISHING TACKLE BOXES AND FISHING LINES (U.S. CLS. 22, 23, 38 AND 50).  
FIRST USE 1-0-2003; IN COMMERCE 1-0-2003.

2,900,503. HASBRO, INC., PAWTUCKET, RI. SN 76-527,372.  
PUB. 3-16-2004, FILED 6-30-2003.

**BERRY-PICKIN' FUN**

FOR TOY PONY PLAYSET AND ACCESSORIES FOR USE THEREWITH (U.S. CLS. 22, 23, 38 AND 50).  
FIRST USE 9-29-2003; IN COMMERCE 9-29-2003.

**CLASS 28—(Continued).**

2,900,504. HASBRO, INC., PAWTUCKET, RI. SN 76-528,334.  
PUB. 3-23-2004, FILED 7-10-2003.

**FUN TUNES TRACTOR**

NO CLAIM IS MADE TO THE EXCLUSIVE RIGHT TO USE "TRACTOR", APART FROM THE MARK AS SHOWN. FOR TOY VEHICLES AND ACCESSORIES FOR USE THEREWITH (U.S. CLS. 22, 23, 38 AND 50).  
FIRST USE 12-10-2002; IN COMMERCE 12-10-2002.

2,900,505. BROWN, GORDON LAVELLE, JR., ANDERSON, SC. SN 76-529,072. PUB. 3-9-2004, FILED 7-3-2003.

**FLEXI-STIX**

FOR FLEXIBLE EXERCISE ROD (U.S. CLS. 22, 23, 38 AND 50).  
FIRST USE 9-1-2003; IN COMMERCE 12-13-2003.

2,900,544. MATTEL, INC., EL SEGUNDO, CA. SN 78-049,353.  
PUB. 5-7-2002, FILED 2-20-2001.

**BATTLE LUGE**

OWNER OF U.S. REG. NOS. 1,221,918 AND 2,413,073. NO CLAIM IS MADE TO THE EXCLUSIVE RIGHT TO USE "LUGE", APART FROM THE MARK AS SHOWN. FOR TOY ACTION FIGURES AND ACCESSORIES THEREFOR (U.S. CLS. 22, 23, 38 AND 50).  
FIRST USE 9-21-2001; IN COMMERCE 9-21-2001.

2,900,562. KENN VISELMAN PRESENTS, NEW YORK, NY. SN 78-100,937. PUB. 10-21-2003, FILED 1-4-2002.

**I LOVE YOU BUNCHES**

FOR TOYS AND GAMES, NAMELY ACTION FIGURES AND ACTION FIGURES AND ACCESSORIES THEREFOR; SPORTS GAMES IN THE NATURE OF BALLS, NAMELY BASKETBALLS, PLAYGROUND BALLS, SPORT BALLS, FOAM BALLS; TOY BASKETBALL HOOP SETS; HOBBY CRAFT SETS FOR MOLDED FIGURES; TOY BANKS; TOY WATCHES; BATH TUB TOYS; CHILDREN'S MULTIPLE ACTIVITY TOYS; WATER SQUIRTING TOYS; TOY VEHICLES; WIND UP TOYS; JUMP ROPES; SLING SHOTS; AUDIO TOYS, NAMELY TOYS SOLD IN SETS WITH A CASSETTE AND A CARD GAME; VISUAL TOYS, NAMELY 3-D VIEWERS; ACTION TARGET GAMES; BOARD GAMES; CARD GAMES; ELECTRONIC GAME EQUIPMENT CONTAINING MEMORY DEVICES, NAMELY HAND-HELD UNITS WITH A WATCH FUNCTION; HAND HELD LIQUID CRYSTAL DISPLAY GAMES; COIN AND NON-COIN OPERATED GAME TABLES; PINBALL GAMES; JIGSAW PUZZLES; MANIPULATIVE PUZZLES; MECHANICAL TOY ROBOTS; BATTERY OPERATED TOY FIGURES; DOLLS; PUPPETS AND ACCESSORIES

**CLASS 28—(Continued).**

THEREFOR; PLAYSETS FOR DOLLS; DOLL CLOTHING AND COSTUMES; CHILDREN'S PLAY COSMETICS; ROLE PLAYING GAMES AND EQUIPMENT THEREFOR; SQUIRT GUNS; KITES; PAPER AND PLASTIC PARTY FAVORS IN THE NATURE OF SMALL TOYS AND NOISEMAKERS; BALLOONS; STUFFED AND PLUSH TOYS; LATEX SQUEEZE TOYS IN THE NATURE OF ANIMALS AND CHARACTERS; MUSICAL TOYS; INFLATABLE BATH TOYS; BEAN BAGS; BEAN BAG DOLLS; SNOW GLOBES; INFANT CRIB TOYS; SWIMMING TOYS, NAMELY SWIMMING FLOATS FOR RECREATIONAL USE; RIDE-ON TOYS; RIDE IN TOYS; INFLATABLE SWIMMING POOLS; TOY HOUSES AND TENTS; SURF BOARDS; KICK BOARDS; BODY BOARDS AND LEASHES THEREFOR; TOY SAND BOXES AND SAND TOYS, NAMELY PAILS AND SHOVELS; SLEDS; TOBOGGANS; SNOW SAUCERS; SNOW BOARDS; TOY BUILDING BLOCKS; MOBILES FOR CHILDREN; FLYING DISCS; PET TOYS; YO-YOS; PLAYING CARDS; PLAYING CARD CASES (U.S. CLS. 22, 23, 38 AND 50).  
FIRST USE 2-1-2003; IN COMMERCE 2-1-2003.

2,900,605. VIACOM INTERNATIONAL INC., NEW YORK, NY. SN 78-140,318. PUB. 7-29-2003, FILED 7-1-2002.

**GAK SPLAT SKRAAAP**

FOR REUSABLE TOY COMPOUND, NAMELY MODELING COMPOUND (U.S. CLS. 22, 23, 38 AND 50).  
FIRST USE 7-31-2002; IN COMMERCE 7-31-2002.

2,900,612. ZOO YORK, LLC, SOUTH RIVER, NJ. SN 78-145,252. PUB. 4-29-2003, FILED 7-18-2002.

**UNBREAKABLE**

FOR SPORTING GOODS, NAMELY, SKATEBOARDS AND THEIR COMPONENT PARTS (U.S. CLS. 22, 23, 38 AND 50).  
FIRST USE 2-0-2002; IN COMMERCE 2-0-2002.

2,900,626. 9015-6803 QUEBEC INCORPORATED, DBA AMCI, LASALLE, QUEBEC, CANADA. SN 78-158,115. PUB. 11-4-2003, FILED 8-27-2002.

**CADIE**

FOR GOLF EQUIPMENT AND ACCESSORIES, NAMELY, NON-MOTORIZED GOLF PULL CARTS AND GOLF BAGS (U.S. CLS. 22, 23, 38 AND 50).  
FIRST USE 3-0-1986; IN COMMERCE 1-0-1990.

**CLASS 28—(Continued).**

2,900,656. INFANTINO, LLC, SAN DIEGO, CA. SN 78-178,227.  
PUB. 7-8-2003, FILED 10-24-2002.

**SHOP & PLAY**

FOR CHILDREN'S ACTIVITY SHOPPING CART INSERT (U.S. CLS. 22, 23, 38 AND 50).  
FIRST USE 7-24-2002; IN COMMERCE 11-26-2002.

---

2,900,680. AHLBERG ROAD PRODUCTIONS, LLC, MINNEAPOLIS, MN. SN 78-198,775. PUB. 9-2-2003, FILED 12-30-2002.

**PRINCES AND FROGS**

FOR CARD GAME (U.S. CLS. 22, 23, 38 AND 50).  
FIRST USE 6-26-2003; IN COMMERCE 6-26-2003.

---

2,900,718. LISA FRANK, INC., TUCSON, AZ. SN 78-218,853.  
PUB. 11-11-2003, FILED 2-25-2003.

**DO DOTS**

FOR CHILDREN'S ACTIVITY KIT CONSISTING OF BEADS AND MOLDS FOR THE PURPOSE OF MAKING AND DECORATING ROOM ACCESSORIES (U.S. CLS. 22, 23, 38 AND 50).  
FIRST USE 2-1-2003; IN COMMERCE 7-31-2003.

---

2,900,729. BRINE, INC., MILFORD, MA. SN 78-221,784. PUB. 12-16-2003, FILED 3-5-2003.

**WEB-X**

FOR LACROSSE STICKS, LACROSSE STICK HEADS AND PARTS THEREOF (U.S. CLS. 22, 23, 38 AND 50).  
FIRST USE 9-4-2003; IN COMMERCE 9-4-2003.

**CLASS 28—(Continued).**

2,900,731. SWEDE INDUSTRIES, INC., CLAREMORE, OK. SN 78-223,139. PUB. 10-28-2003, FILED 3-7-2003.

*Quorum*

FOR FISHING TACKLE, FISHING RODS, FISHING REELS, FISHING ROD RACKS, FISHING ROD HOLDERS, FISHING ROD AND REEL COMBINATION PACKS, AND TACKLE BOXES (U.S. CLS. 22, 23, 38 AND 50).

FIRST USE 6-10-2003; IN COMMERCE 7-10-2004.

---

2,900,766. BALANCED BODY, INC., SACRAMENTO, CA. SN 78-232,765. PUB. 11-11-2003, FILED 4-1-2003.

**PRIMA**

FOR MANUALLY OPERATED EXERCISE EQUIPMENT (U.S. CLS. 22, 23, 38 AND 50).  
FIRST USE 9-1-2003; IN COMMERCE 9-1-2003.

---

2,900,767. BALANCED BODY, INC., SACRAMENTO, CA. SN 78-232,766. PUB. 11-11-2003, FILED 4-1-2003.

**STRATA**

FOR MANUALLY OPERATED EXERCISE EQUIPMENT (U.S. CLS. 22, 23, 38 AND 50).  
FIRST USE 9-1-2003; IN COMMERCE 9-1-2003.

---

2,900,777. MOOSE MOUNTAIN TOYMAKERS LTD., KOWLOON, HONG KONG. SN 78-236,813. PUB. 11-4-2003, FILED 4-11-2003.

**TALK-A-LOTS**

FOR TALKING TOYS AND ACCESSORIES THEREFOR (U.S. CLS. 22, 23, 38 AND 50).  
FIRST USE 5-14-2003; IN COMMERCE 5-19-2003.

---

2,900,781. MATTEL, INC., EL SEGUNDO, CA. SN 78-237,390. PUB. 11-4-2003, FILED 4-14-2003.

**FLAVAS**

FOR DOLLS, DOLL CLOTHING AND DOLL ACCESSORIES (U.S. CLS. 22, 23, 38 AND 50).  
FIRST USE 7-0-2003; IN COMMERCE 7-0-2003.

**CLASS 28—(Continued).**

2,900,789. INNOVATIVE BIOMECHANICAL SOLUTIONS, LLC, FISHERS, IN. SN 78-240,023. PUB. 1-13-2004, FILED 4-21-2003.

**STRETCHHORSE**

FOR EXERCISE EQUIPMENT; NAMELY, DEVICES FOR MUSCLE STRETCHING AND FLEXIBILITY (U.S. CLS. 22, 23, 38 AND 50).

FIRST USE 10-13-2003; IN COMMERCE 10-13-2003.

2,900,817. WINNING MOVES INC., DANVERS, MA. SN 78-255,506. PUB. 11-11-2003, FILED 5-29-2003.

**DOMINO SQUARES**

NO CLAIM IS MADE TO THE EXCLUSIVE RIGHT TO USE "DOMINO", APART FROM THE MARK AS SHOWN. FOR GAMES, NAMELY, DOMINO-TYPE GAMES (U.S. CLS. 22, 23, 38 AND 50).

FIRST USE 12-1-2003; IN COMMERCE 1-1-2004.

2,900,844. LITTLE KIDS, INC., PROVIDENCE, RI. SN 78-270,187. PUB. 5-4-2004, FILED 7-3-2003.

**BUBBLE TUMBLER MICRO MINIS**

NO CLAIM IS MADE TO THE EXCLUSIVE RIGHT TO USE "BUBBLE", APART FROM THE MARK AS SHOWN.

FOR TOY IN THE NATURE OF A CONTAINER USED TO HOLD LIQUID SOAP SOLUTION FOR MAKING BUBBLES (U.S. CLS. 22, 23, 38 AND 50).

FIRST USE 12-12-2003; IN COMMERCE 12-12-2003.

2,900,871. MAIERS, MARK, COLORADO SPRINGS, CO. SN 78-300,222. PUB. 5-11-2004, FILED 9-15-2003.

**DICKTIONARY**

FOR BOARD GAME AND ASSOCIATED EQUIPMENT COMPRISING A BOARD, GAME CARDS, MOVABLE PIECES, A TIMER AND CARD BOXES (U.S. CLS. 22, 23, 38 AND 50).

FIRST USE 4-1-2004; IN COMMERCE 4-1-2004.

2,900,882. CRANIUM INC., SEATTLE, WA. SN 78-975,534. PUB. 8-19-2003, FILED 12-23-2002.

**HULLABALOO**

FOR BOARD GAMES; EQUIPMENT SOLD AS A UNIT FOR PLAYING A BOARD GAME; EQUIPMENT SOLD AS A UNIT FOR PLAYING AN ELECTRONIC TYPE PARLOR GAME (U.S. CLS. 22, 23, 38 AND 50).

FIRST USE 7-11-2003; IN COMMERCE 7-11-2003.

**CLASS 29—MEATS AND PROCESSED FOODS**

2,900,034. FOSHEE, JOHN, HOUSTON, TX. SN 75-501,831. PUB. 5-27-2003, FILED 6-15-1998.

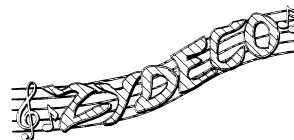

THE MARK IS LINED FOR THE COLORS GREEN, RED, AND YELLOW. FOR PROCESSED FOOD, NAMELY, SAUSAGE (U.S. CL. 46).

FIRST USE 7-8-2004; IN COMMERCE 7-8-2004.

2,900,050. OLIVE FARM, LLC, THE, PORTLAND, OR. SN 75-639,217. PUB. 6-13-2000, FILED 2-8-1999.

**FRESH DIRECT FROM TREE TO TABLE**

NO CLAIM IS MADE TO THE EXCLUSIVE RIGHT TO USE "FRESH DIRECT", APART FROM THE MARK AS SHOWN.

FOR FOOD PRODUCTS, NAMELY, OLIVE OIL, PROCESSED OLIVES, PROCESSED HERBS, HERB KITS CONSISTING PRIMARILY OF A VARIETY OF PROCESSED HERBS; DRIED APRICOTS AND DRIED FIGS (U.S. CL. 46).

FIRST USE 7-1-1999; IN COMMERCE 10-1-1999.

2,900,333. TYSON FOODS, INC., SPRINGDALE, AR. SN 76-453,184. PUB. 11-18-2003, FILED 9-26-2002.



NO CLAIM IS MADE TO THE EXCLUSIVE RIGHT TO USE "DOUBLE GLAZED", APART FROM THE MARK AS SHOWN.

FOR CHICKEN WINGS (U.S. CL. 46).

FIRST USE 6-1-2002; IN COMMERCE 6-1-2002.



**CLASS 29—(Continued).**

2,900,667. COLIMAN GRUPO SA DE CV, TECOMAN, JALISCO, MEXICO. SN 78-194,211. PUB. 1-20-2004, FILED 12-13-2002.



FOR DRIED AND COOKED FRUITS AND VEGETABLES (U.S. CL. 46).  
FIRST USE 10-18-1992; IN COMMERCE 7-20-2001.

2,900,751. AHOLD RETAIL SERVICES AG, KLOSTERS, SWITZERLAND. SN 78-226,750. PUB. 10-14-2003, FILED 3-18-2003.

**HOGS BREATH**

THE MARK CONSISTS OF STANDARD CHARACTERS WITHOUT CLAIM TO ANY PARTICULAR FONT, STYLE, SIZE, OR COLOR.  
FOR PORK RINDS (U.S. CL. 46).  
FIRST USE 3-3-2004; IN COMMERCE 3-3-2004.

2,900,853. LUIGINO'S, INC., DULUTH, MN. SN 78-275,532. PUB. 4-13-2004, FILED 7-17-2003.

**GARDEN BISTRO**

FOR PREPARED FROZEN OR PACKAGED ENTREES OR MEALS CONSISTING PRIMARILY OF MEAT, FISH, POULTRY, SEAFOOD, CHEESE, FRUIT AND/OR VEGETABLES (U.S. CL. 46).  
FIRST USE 7-3-2003; IN COMMERCE 7-3-2003.

**CLASS 30—STAPLE FOODS****CLASS 30—(Continued).**

2,900,075. IVERSON, RONALD C., EUSTIS, FL. SN 75-879,160. PUB. 5-8-2001, FILED 12-23-1999.



NO CLAIM IS MADE TO THE EXCLUSIVE RIGHT TO USE "OMEGA 3", APART FROM THE MARK AS SHOWN.  
FOR FOOD ADDITIVE INGREDIENTS CONTAINING THE UNSATURATED FATTY ACID DERIVED FROM VEGETABLE SOURCES, NAMELY, OMEGA-3 (U.S. CL. 46).  
FIRST USE 7-21-2004; IN COMMERCE 7-21-2004.

2,900,077. CABURY ADAMS USA LLC, PARSIPPANY, NJ. SN 75-902,989. PUB. 11-20-2001, FILED 1-24-2000.

**BUBBLICIOUS**

OWNER OF U.S. REG. NO. 1,064,061.  
FOR CONFECTIONERY PRODUCTS, NAMELY CANDY (U.S. CL. 46).  
FIRST USE 6-1-2004; IN COMMERCE 6-1-2004.

2,900,113. GREATER PACIFIC FOOD HOLDINGS, INC., MONTEREY, CA. SN 76-106,231. PUB. 10-8-2002, FILED 8-8-2000.



OWNER OF U.S. REG. NO. 2,120,404.  
NO CLAIM IS MADE TO THE EXCLUSIVE RIGHT TO USE "FOODS", APART FROM THE MARK AS SHOWN.  
FOR BEVERAGES, NAMELY, TEAS (U.S. CL. 46).  
FIRST USE 1-0-2001; IN COMMERCE 1-0-2001.

**CLASS 30—(Continued).**

2,900,144. A & W RESTAURANTS, INC., LOUISVILLE, KY. SN 76-209,152. PUB. 10-28-2003, FILED 2-12-2001.

**CRUISIN' COMBO**

NO CLAIM IS MADE TO THE EXCLUSIVE RIGHT TO USE "COMBO", APART FROM THE MARK AS SHOWN.  
FOR COMBINATION MEALS CONSISTING OF SANDWICHES, FRENCH FRIED POTATOES OR ONION RINGS AND A SOFT DRINK (U.S. CL. 46).  
FIRST USE 6-29-2003; IN COMMERCE 6-29-2003.

2,900,154. ALIMENTOS NATURALES SABROZA, S.A. DE C.V., 67114 CIUDAD GUADALUPE, NUEVO LEON, MEXICO. SN 76-250,496. PUB. 10-2-2001, FILED 5-2-2001.

**LA SALSERITA**

OWNER OF U.S. REG. NO. 1,844,571.  
THE ENGLISH TRANSLATION OF "LA SALSERITA" IS "THE LITTLE SAUCE BOWL".  
FOR PICANTE SAUCES (U.S. CL. 46).  
FIRST USE 6-13-2001; IN COMMERCE 9-17-2001.

2,900,251. TIPPCON, L.L.C., EL PASO, TX. SN 76-395,835. PUB. 10-15-2002, FILED 4-15-2002.

**THE FLAVORFUL FIRE**

FOR HOT SAUCES AND SALSA (U.S. CL. 46).  
FIRST USE 10-9-2002; IN COMMERCE 10-9-2002.

2,900,323. MIA, SAMUDE, DUSTON, NORTHAMPTON, UNITED KINGDOM. SN 76-448,755. PUB. 4-22-2003, FILED 9-12-2002.

**USED GUMS**

NO CLAIM IS MADE TO THE EXCLUSIVE RIGHT TO USE "GUMS", APART FROM THE MARK AS SHOWN.  
FOR NON-MEDICATED CONFECTIONARY, NAMELY, BUBBLE GUM AND CHEWING GUM (U.S. CL. 46).  
FIRST USE 4-25-2003; IN COMMERCE 2-19-2004.

2,900,343. SAFEWAY INC., PLEASANTON, CA. SN 76-456,952. PUB. 1-13-2004, FILED 9-30-2002.

**ATHENS BAKLAVA BAZAAR**

NO CLAIM IS MADE TO THE EXCLUSIVE RIGHT TO USE "ATHENS BAKLAVA", APART FROM THE MARK AS SHOWN.  
FOR ICE CREAM (U.S. CL. 46).  
FIRST USE 3-6-2003; IN COMMERCE 3-6-2003.

**CLASS 30—(Continued).**

2,900,372. HODGES, ROBERT, ARTESIA, NM. SN 76-471,841. PUB. 11-4-2003, FILED 11-26-2002.



THE MARK CONSISTS OF THE WORDS "ALIEN AMBUSH", "PREFERRED BY ALIENS IN ALL GALAXIES", AND "WE BROUGHT FIRE" SET AGAINST A SCENIC BACKGROUND WHICH INCLUDES HILLS, DESERT PLANTS, THE SUN, AND TWO ALIENS HOLDING CONTAINERS OF FOOD PRODUCT IN THEIR HANDS.  
FOR SALSA, SAUCES (U.S. CL. 46).  
FIRST USE 3-15-2004; IN COMMERCE 3-15-2004.

2,900,376. FOODMAN, LLC, AUSTIN, TX. SN 76-473,516. PUB. 10-14-2003, FILED 12-2-2002.

**FOODMAN'S ORIGINAL MATZA GRANOLA**

NO CLAIM IS MADE TO THE EXCLUSIVE RIGHT TO USE "ORIGINAL MATZA GRANOLA", APART FROM THE MARK AS SHOWN.  
FOR KOSHER GRAIN PRODUCTS, NAMELY, MATZA GRANOLA (U.S. CL. 46).  
FIRST USE 2-1-2002; IN COMMERCE 2-1-2002.

2,900,424. FRANKFORD CANDY & CHOCOLATE COMPANY, PHILADELPHIA, PA. SN 76-495,206. PUB. 1-13-2004, FILED 3-5-2003.

**DIG 'N DIPS**

THE MARK CONSISTS OF STANDARD CHARACTERS WITHOUT CLAIM TO ANY PARTICULAR FONT, STYLE, SIZE, OR COLOR.  
FOR CANDY (U.S. CL. 46).  
FIRST USE 12-18-2003; IN COMMERCE 12-18-2003.

**CLASS 30—(Continued).**

2,900,436. REAL TORINO, INC., MENDHAM, NJ. SN 76-497,991. PUB. 12-9-2003, FILED 3-6-2003.



OWNER OF U.S. REG. NOS. 1,397,017 AND 1,687,279.  
FOR PACKAGED TORTELLINI, RAVIOLI, PASTA,  
PASTRY, BREADSTICKS, AND SAUCES (U.S. CL. 46).  
FIRST USE 1-0-2002; IN COMMERCE 2-0-2002.

2,900,476. CHAMPION FOODS, L.L.C., DETROIT, MI. SN 76-516,737. PUB. 2-17-2004, FILED 5-2-2003.

**FAMILY FINEST**

NO CLAIM IS MADE TO THE EXCLUSIVE RIGHT TO  
USE "FINEST", APART FROM THE MARK AS SHOWN.  
FOR PIZZA CRUSTS, COOKIE DOUGH, AND MUF-  
FIN DOUGH (U.S. CL. 46).  
FIRST USE 11-11-2003; IN COMMERCE 11-11-2003.

2,900,498. VIGO IMPORTING COMPANY, TAMPA, FL. SN  
76-526,043. PUB. 3-16-2004, FILED 6-27-2003.

**STARS AND STRIPES**

FOR SEASONED MIX OF RICE AND TOASTED  
PASTA (U.S. CL. 46).  
FIRST USE 11-6-2003; IN COMMERCE 11-6-2003.

2,900,508. ATEECO, INC., SHENANDOAH, PA. SN 76-531,410.  
PUB. 2-17-2004, FILED 7-21-2003.

**THE PERFECT PAIRING OF  
PASTA AND POTATOES!**

FOR PIEROGIES (U.S. CL. 46).  
FIRST USE 10-0-2003; IN COMMERCE 12-0-2003.

**CLASS 30—(Continued).**

2,900,511. SHAYMEES CORPORATION, PLEASANTON, CA.  
SN 76-533,006. PUB. 4-13-2004, FILED 7-17-2003.

**TOO GOOD TO SHARE**

FOR CANDY (U.S. CL. 46).  
FIRST USE 12-17-2003; IN COMMERCE 12-17-2003.

2,900,591. SNACKS BY ME INC., MARIETTA, GA. SN 78-123,938. PUB. 10-29-2002, FILED 4-24-2002.

**CANOOKIES**

FOR COOKIES, CANDIES, BROWNIES, CHEESE-  
CAKES (U.S. CL. 46).  
FIRST USE 1-0-2004; IN COMMERCE 1-0-2004.

2,900,609. KABUSHIKI KAISHA GANSO TAKOMASA, OSA-  
KA-SHI, JAPAN. SN 78-144,867. PUB. 8-19-2003, FILED 7-  
17-2002.



THE MARK CONSISTS OF NON-LATIN (JAPANESE)  
AND LATIN CHARACTERS OF "TAKOMASA".

THE JAPANESE AND KANJI CHARACTERS IN THE  
MARK TRANSLITERATE TO "TAKO" AND "MASA" AND  
THIS MEANS "OCTOPUS" AND "PROSPERITY" IN EN-  
GLISH.

FOR TAKOYAKI, NAMELY, FRESH OR FROZEN  
GRILLED BALLS OF MIXED BATTER OF WATER,  
FLOUR AND EGG WITH A SMALL AMOUNT OF  
OCTOPUS IN EACH BALL; AKASHIYAKI, NAMELY,  
FRESH OR FROZEN EGG CUSTARD DUMPLINGS  
WITH A SMALL PIECE OF OCTOPUS IN EACH DUM-  
PLING, AND (U.S. CL. 46).

FIRST USE 5-31-1989; IN COMMERCE 3-19-2004.

**CLASS 30—(Continued).**

2,900,693. VIACOM INTERNATIONAL INC., NEW YORK, NY. SN 78-203,497. PUB. 9-16-2003, FILED 1-15-2003.

**KRABBY PATTIES**

FOR BREAD STICKS, BUBBLE GUM, CANDY CAKE DECORATIONS, EDIBLE CAKE DECORATIONS, CAKE MIXES, CAKES, CAKES AND CHOCOLATE BASED FILLINGS FOR PIES AND CAKES, CANDY, CANDY COATED POPCORN, CARAMEL POPCORN, CARAMELS, CEREAL BASED SNACK FOOD, CHEESE FLAVORED CORN PUFFED SNACKS, CHEWING GUM, CHOCOLATE CHIPS, CORN CHIPS, FLOUR BASED CHIPS, CHOCOLATE, CHOCOLATE COVERED NUTS, CHOCOLATE POWDER, CHOCOLATE SYRUP, CHOCOLATE TOPPING, COCOA MIXES, CONES FOR ICE CREAM, COOKIES, CORN CURLS, CRACKER AND CHEESE COMBINATIONS, CRACKERS, FOOD READY TO EAT CEREAL DERIVED FOOD BARS, FROSTING, FRUIT PIES, FLAVORED AND SWEETENED GELATINS, GRANOLA BASED SNACK BARS, HOT CHOCOLATE, POPPED POPCORN, PRETZELS, PUDDINGS, WAFFLES, ICE CREAM, ICE MILK, FLAVORED ICES, FROZEN CONFECTIONS, FROZEN YOGURT, FROZEN CUSTARD, ALL RELATING TO TELEVISION PROGRAMS (U.S. CL. 46).

FIRST USE 8-1-2003; IN COMMERCE 8-1-2003.

2,900,699. SULLIVAN, GARRY J, SAN BRUNO, CA. SN 78-204,828. PUB. 9-30-2003, FILED 1-18-2003.

**FOOD IMAGINEERING**

NO CLAIM IS MADE TO THE EXCLUSIVE RIGHT TO USE "FOOD", APART FROM THE MARK AS SHOWN.

FOR SAUCES AND MARINADES, NAMELY COOKING SAUCES (U.S. CL. 46).

FIRST USE 12-26-2003; IN COMMERCE 12-26-2004.

2,900,712. FUHGEDDABOUDIT FAMILY BRANDS, LLC, LIVERPOOL, NY. SN 78-216,584. PUB. 4-27-2004, FILED 2-19-2003.

**CAFE BELLA GIORNO**

NO CLAIM IS MADE TO THE EXCLUSIVE RIGHT TO USE "CAFE", APART FROM THE MARK AS SHOWN.

THE FOREIGN WORDING IN THE MARK TRANSLATES INTO ENGLISH AS CAFE BEAUTIFUL DAY.

FOR COFFEE (U.S. CL. 46).

FIRST USE 6-0-2003; IN COMMERCE 6-0-2003.

**CLASS 30—(Continued).**

2,900,752. MURRY, JAMES LLOYD JR., PLANO, TX. SN 78-227,356. PUB. 10-28-2003, FILED 3-19-2003.

**ELITE PERFORMANCE PANCAKE AND WAFFLE MIX**

NO CLAIM IS MADE TO THE EXCLUSIVE RIGHT TO USE "PANCAKE AND WAFFLE MIX", APART FROM THE MARK AS SHOWN.

FOR PANCAKE AND WAFFLE MIX (U.S. CL. 46).  
FIRST USE 6-17-2004; IN COMMERCE 6-25-2004.

2,900,773. MENDOCINO BEVERAGE CORPORATION, MENDOCINO, CA. SN 78-235,096. PUB. 11-4-2003, FILED 4-8-2003.

**POWER IT**

FOR TEA-BASED BEVERAGES WITH FRUIT FLAVORING (U.S. CL. 46).

FIRST USE 8-31-2003; IN COMMERCE 11-19-2003.

2,900,784. KENCRAFT, INC., ALPINE, UT. SN 78-238,147. PUB. 11-18-2003, FILED 4-15-2003.

**TWISTPOP**

FOR CANDY (U.S. CL. 46).

FIRST USE 5-13-2003; IN COMMERCE 5-13-2003.

2,900,857. ORAL FIXATION, LLC, HOPEWELL, NJ. SN 78-280,859. PUB. 4-27-2004, FILED 7-30-2003.

**7 DEADLY CINNAMON**

NO CLAIM IS MADE TO THE EXCLUSIVE RIGHT TO USE "CINNAMON", APART FROM THE MARK AS SHOWN.

FOR CONFECTIONERY, NAMELY, CANDY MINTS (U.S. CL. 46).

FIRST USE 8-1-2003; IN COMMERCE 10-1-2003.

2,900,858. ORAL FIXATION, LLC, HOPEWELL, NJ. SN 78-280,876. PUB. 4-27-2004, FILED 7-30-2003.

**GET YOUR FIX**

FOR CONFECTIONERY, NAMELY, CANDY MINTS (U.S. CL. 46).

FIRST USE 5-1-2003; IN COMMERCE 10-1-2003.

**CLASS 30—(Continued).**

2,900,867. S&S BRANDS, INC., WILMINGTON, DE. SN 78-290,930. PUB. 5-11-2004, FILED 8-22-2003.

## LOVE THAT THIN WHEAT CRUNCH

FOR CRACKERS (U.S. CL. 46).  
FIRST USE 12-0-2003; IN COMMERCE 12-0-2003.

**CLASS 31—NATURAL AGRICULTURAL PRODUCTS**

2,900,178. GORMAN, JEFFREY B., LOS ANGELES, CA. SN 76-301,481. PUB. 11-19-2002, FILED 8-3-2001.

## MOUSIES

FOR CAT FOOD AND PET FOOD (U.S. CLS. 1 AND 46).  
FIRST USE 6-21-2004; IN COMMERCE 6-21-2004.

2,900,218. FRESH PRODUCTS NORTHWEST, LLC, WENATCHEE, WA. SN 76-363,035. PUB. 7-30-2002, FILED 1-24-2002.

## CRUNCH PAK

OWNER OF U.S. REG. NO. 2,507,858.  
FOR FRESH FRUIT (U.S. CLS. 1 AND 46).  
FIRST USE 6-16-2004; IN COMMERCE 6-16-2004.

2,900,495. THE HARTZ MOUNTAIN CORPORATION, SECAUCUS, NJ. SN 76-523,109. PUB. 3-16-2004, FILED 6-16-2003.

## LM YOGURT SOYNU SURPRISE

OWNER OF U.S. REG. NOS. 1,899,093 AND 1,899,094.  
NO CLAIM IS MADE TO THE EXCLUSIVE RIGHT TO USE "YOGURT SOYNU", APART FROM THE MARK AS SHOWN.  
FOR BIRD FOOD; SMALL ANIMAL FOOD (U.S. CLS. 1 AND 46).  
FIRST USE 1-1-2004; IN COMMERCE 1-1-2004.

**CLASS 31—(Continued).**

2,900,528. AMPCO II, LLC, RIVERHEAD, NY. SN 76-976,968. PUB. 9-24-2002, FILED 3-8-2002.

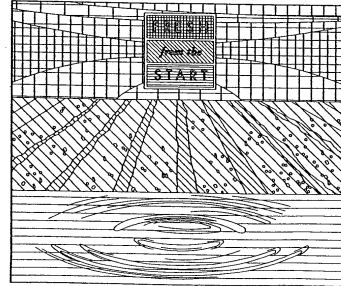

OWNER OF U.S. REG. NO. 2,239,740.  
THE MARK IS LINED FOR THE COLORS GOLD, GREEN, BLUE AND WHITE.  
FOR FRESH FRUITS AND VEGETABLES (U.S. CLS. 1 AND 46).  
FIRST USE 4-12-2002; IN COMMERCE 4-12-2002.

2,900,658. OMS INVESTMENTS, INC., LOS ANGELES, CA. SN 78-179,743. PUB. 11-11-2003, FILED 10-29-2002.



OWNER OF U.S. REG. NOS. 2,525,828, 2,618,699, AND OTHERS.  
NO CLAIM IS MADE TO THE EXCLUSIVE RIGHT TO USE "SELECT PLANTS", APART FROM THE MARK AS SHOWN.  
THE MARK CONSISTS OF THE WORDS "MIRACLE-GRO" WITH AN ARBITRARY DESIGN IN GREEN APPEARING OVER THE LETTER "I" SUPERIMPOSED ON A CIRCLE WITH A YELLOW BORDER, "SELECT PLANTS" APPEARING ON A PURPLE RIBBON WITH REPRESENTATION OF A FLOWERS IN RED, PINK, PURPLE AND A RED TOMATO. ALL APPEARING ON A GREEN AND YELLOW BACKGROUND.  
FOR LIVING HOUSE PLANTS (U.S. CLS. 1 AND 46).  
FIRST USE 3-0-2003; IN COMMERCE 3-0-2003.

**CLASS 31—(Continued).**

2,900,666. HEB GROCERY COMPANY, LP, SAN ANTONIO, TX. SN 78-192,550. PUB. 10-14-2003, FILED 12-9-2002.

**PREMIER PICKS**

FOR FRESH FRUITS; FRESH VEGETABLES (U.S. CLS. 1 AND 46).  
FIRST USE 5-22-2004; IN COMMERCE 5-22-2004.

2,900,756. LANDMARK SEED, LLC, SPOKANE, WA. SN 78-229,936. PUB. 12-2-2003, FILED 3-25-2003.

**SURVIVE-ALL**

FOR GRASS SEED TO BE PLANTED FOR USE AS TURF GRASS (U.S. CLS. 1 AND 46).  
FIRST USE 5-4-2004; IN COMMERCE 5-4-2004.

2,900,815. LAND O'LAKES, INC., ARDEN HILLS, MN. SN 78-255,023. PUB. 2-24-2004, FILED 5-28-2003.

**RALLY**

FOR AGRICULTURAL ANIMAL FEED (U.S. CLS. 1 AND 46).  
FIRST USE 10-21-2003; IN COMMERCE 10-21-2003.

2,900,831. SMITH, AMY, TERESA, POTOMAC FALLS, VA. SN 78-263,720. PUB. 4-27-2004, FILED 6-18-2003.



NO CLAIM IS MADE TO THE EXCLUSIVE RIGHT TO USE "COOKIES", APART FROM THE MARK AS SHOWN. FOR DOG BISCUITS, DOG TREATS, AND DOG BAKERY GOODS (U.S. CLS. 1 AND 46).  
FIRST USE 1-30-2002; IN COMMERCE 1-30-2002.

**CLASS 31—(Continued).**

2,900,841. BALL HORTICULTURAL COMPANY, WEST CHICAGO, IL. SN 78-269,576. PUB. 3-30-2004, FILED 7-2-2003.

**BABYWING**

FOR BEGONIA PLANTS AND SEEDS (U.S. CLS. 1 AND 46).  
FIRST USE 4-0-2003; IN COMMERCE 7-0-2003.

2,900,846. KRAFT FOODS HOLDINGS, INC., NORTHFIELD, IL. SN 78-272,754. PUB. 3-16-2004, FILED 7-10-2003.

**BAKERY BITES**

FOR PET FOOD (U.S. CLS. 1 AND 46).  
FIRST USE 3-15-2004; IN COMMERCE 3-15-2004.

**CLASS 32—LIGHT BEVERAGES**

2,900,625. THE PIGOTT GROUP, LLC, CANTON, GA. SN 78-157,522. PUB. 11-4-2003, FILED 8-24-2002.



NO CLAIM IS MADE TO THE EXCLUSIVE RIGHT TO USE "NATURAL SPRING WATER", APART FROM THE MARK AS SHOWN. FOR BOTTLED NATURAL SPRING WATER (U.S. CLS. 45, 46 AND 48).  
FIRST USE 12-1-2002; IN COMMERCE 12-1-2002.

**CLASS 32—(Continued).**

2,900,750. GORDON BIERSCHE BREWING COMPANY, LAS VEGAS, NV. SN 78-226,708. PUB. 11-4-2003, FILED 3-18-2003.



FOR BEER MANUFACTURED, DISTRIBUTED, AND SOLD IN TRADE CHANNELS OTHER THAN RESTAURANTS (U.S. CLS. 45, 46 AND 48).  
FIRST USE 12-31-1995; IN COMMERCE 12-31-1995.

2,900,760. SHASTA BEVERAGES, INC., HAYWARD, CA. SN 78-231,582. PUB. 11-25-2003, FILED 3-28-2003.

**SHORTZ**

FOR NON-ALCOHOLIC BEVERAGES, NAMELY JUICE DRINKS, CARBONATED SOFT DRINKS AND JUICE FLAVORED CARBONATED SOFT DRINKS (U.S. CLS. 45, 46 AND 48).  
FIRST USE 1-0-2003; IN COMMERCE 7-0-2003.

2,900,848. PEPSICO, INC., PURCHASE, NY. SN 78-273,722. PUB. 3-30-2004, FILED 7-14-2003.

**DEW U**

OWNER OF U.S. REG. NO. 1,200,615.  
FOR SOFT DRINKS (U.S. CLS. 45, 46 AND 48).  
FIRST USE 3-1-2004; IN COMMERCE 3-1-2004.

**CLASS 33—WINES AND SPIRITS**

2,900,026. CHATAM INTERNATIONAL INCORPORATED, WILMINGTON, DE. SN 75-342,541. PUB. 5-12-1998, FILED 8-18-1997.

**XANADU**

FOR DISTILLED SPIRITS (U.S. CLS. 47 AND 49).  
FIRST USE 7-15-2004; IN COMMERCE 7-15-2004.

**CLASS 33—(Continued).**

2,900,169. DE BORTOLI WINES PTY LIMITED, NEW SOUTH WALES 2680, AUSTRALIA. SN 76-289,737. PUB. 5-13-2003, FILED 7-24-2001.

**GULF STATION**

OWNER OF AUSTRALIA REG. NO. A674201, DATED 10-5-1995, EXPIRES 10-5-2005.  
FOR WINES, SPARKLING WINES, BRANDY AND DISTILLED SPIRITS, LIQUEURS, AND PREPARED ALCOHOLIC COCKTAILS (U.S. CLS. 47 AND 49).  
FIRST USE 10-0-1995; IN COMMERCE 4-0-2002.

2,900,254. PALM BAY IMPORTS, INC., BOCA RATON, FL. SN 76-396,896. PUB. 10-22-2002, FILED 4-18-2002.

**SUTTON & MAXWELL**

FOR ALCOHOLIC BEVERAGES, NAMELY, SCOTCH, BOURBON, COGNAC, BRANDY AND WHISKEY (U.S. CLS. 47 AND 49).  
FIRST USE 6-14-2004; IN COMMERCE 6-14-2004.

2,900,381. BODEGAS MUGA, S.A., 26200 HARO (LA RIOJA), SPAIN. SN 76-476,186. PUB. 1-20-2004, FILED 12-16-2002.

**ARO**

THE ENGLISH TRANSLATION OF "ARO" IS "A CIRCULAR PIECE".  
FOR WINES (U.S. CLS. 47 AND 49).  
FIRST USE 5-7-2004; IN COMMERCE 5-7-2004.

2,900,383. SAZERAC COMPANY, INC., NEW ORLEANS, LA. SN 76-476,803. PUB. 7-15-2003, FILED 12-4-2002.

**WAREHOUSE C**

FOR ALCOHOLIC BEVERAGES, NAMELY, WHISKIES (U.S. CLS. 47 AND 49).  
FIRST USE 10-17-2003; IN COMMERCE 10-17-2003.

2,900,394. DEBAN INVESTMENTS NO. 9 (PTY) LTD., CAPE-TOWN, SOUTH AFRICA. SN 76-483,439. PUB. 2-17-2004, FILED 1-21-2003.

**LONG NECK**

FOR WINE (U.S. CLS. 47 AND 49).  
FIRST USE 3-0-2004; IN COMMERCE 3-0-2004.

**CLASS 33—(Continued).**

2,900,427. UNITED STATES DISTILLED PRODUCTS COMPANY, PRINCETON, MN. SN 76-496,167. PUB. 11-11-2003, FILED 3-10-2003.

**PIERRE DELATOUR**

THE MARK DOES NOT IDENTIFY A PARTICULAR LIVING INDIVIDUAL.

FOR WINES (U.S. CLS. 47 AND 49).  
FIRST USE 10-0-2003; IN COMMERCE 11-0-2003.

2,900,441. WESTERFIELD, DINAH BIRD, XENIA, OH. SN 76-501,379. PUB. 11-11-2003, FILED 3-20-2003.

**ANTIQUARIAN  
EXTRAORDINAIRE**

FOR WINES AND DISTILLED ALCOHOLIC BEVERAGES, NAMELY, BOURBON, WHISKEY, VODKA AND SCOTCH (U.S. CLS. 47 AND 49).  
FIRST USE 6-28-2004; IN COMMERCE 6-28-2004.

2,900,447. GERAGHTY, BRIAN J., GROSSE POINTE SHORES, MI. SN 76-503,475. PUB. 12-2-2003, FILED 3-28-2003.

**WILLOW TREE**

FOR WINE (U.S. CLS. 47 AND 49).  
FIRST USE 12-5-2002; IN COMMERCE 12-25-2003.

2,900,507. HARVEST MOON VINEYARDS AND INVESTMENTS, LLC, SANTA ROSA, CA. SN 76-531,237. PUB. 3-30-2004, FILED 7-11-2003.

**RANDYZIN**

FOR WINE (U.S. CLS. 47 AND 49).  
FIRST USE 12-7-2003; IN COMMERCE 12-7-2003.

2,900,602. KRUPP BROTHERS WINERY LLC, NAPA, CA. SN 78-139,625. PUB. 1-13-2004, FILED 6-27-2002.

**BLACK BART**

FOR WINE (U.S. CLS. 47 AND 49).  
FIRST USE 11-24-2003; IN COMMERCE 7-2-2004.

**CLASS 33—(Continued).**

2,900,660. DOOSAN CORPORATION, SEOUL, REPUBLIC OF KOREA. SN 78-180,824. PUB. 12-2-2003, FILED 11-1-2002.

**SAAN**

FOR SOJU, NAMELY DISTILLED SPIRIT; REFINED RICE WINE; SYNTHETIC REFINED RICE WINE; PLUM WINE; CHAMPAGNE; WINE; WHISKY; CHINESE KAOLYANGJU; WINE COOLER; MEDICINE WINE (U.S. CLS. 47 AND 49).

FIRST USE 7-31-2002; IN COMMERCE 7-31-2002.

2,900,692. HATHAWAY TRADING CO., INC., WHITTIER, CA. SN 78-203,475. PUB. 2-17-2004, FILED 1-15-2003.

**FROGMORE CREEK**

FOR WINE (U.S. CLS. 47 AND 49).  
FIRST USE 3-15-2004; IN COMMERCE 3-15-2004.

2,900,709. INDUSTRIAS MONTERREY USA, INC., RICHMOND, VA. SN 78-214,507. PUB. 12-2-2003, FILED 2-13-2003.

**SAN THOME**

FOR DISTILLED SPIRITS (U.S. CLS. 47 AND 49).  
FIRST USE 4-0-2004; IN COMMERCE 4-0-2004.

2,900,717. CELEBRATION, INC., MIAMI SPRINGS, FL. SN 78-218,776. PUB. 10-21-2003, FILED 2-25-2003.

**SANDEVID**

FOR SANGRIA (U.S. CLS. 47 AND 49).  
FIRST USE 10-30-2003; IN COMMERCE 10-30-2003.

2,900,740. EGAN, JONATHAN F, NEW ORLEANS, LA. SN 78-224,917. PUB. 10-28-2003, FILED 3-12-2003.

**KIWI CROSSING**

FOR WINES (U.S. CLS. 47 AND 49).  
FIRST USE 2-3-2003; IN COMMERCE 4-3-2004.



**CLASS 33—(Continued).**

2,900,770. FRANCOISE, TRIAUD, 33250 PAULLAC, FRANCE. SN 78-234,135. PUB. 11-11-2003, FILED 4-4-2003.

**CHÂTEAU GLORIA**

THE MARK CONSISTS OF THE WORDS "CHATEAU" WITH A CIRCUMFLEX APPEARING OVER THE LETTER "A" AND THE WORD "GLORIA".  
FOR WINES (U.S. CLS. 47 AND 49).  
FIRST USE 0-0-1965; IN COMMERCE 0-0-1965.

**CLASS 34—SMOKERS' ARTICLES**

2,900,059. INTER AMERICA CIGAR COMPANY, MIAMI, FL. SN 75-753,734. PUB. 4-9-2002, FILED 7-17-1999.

**HAVANA SUNRISE**

NO CLAIM IS MADE TO THE EXCLUSIVE RIGHT TO USE "HAVANA", APART FROM THE MARK AS SHOWN.  
FOR CIGARS COMPOSED OF CUBAN SEED TOBACCO, CIGAR CUTTERS, CASES, LIGHTERS NOT OF PRECIOUS METAL, AND ASHTRAYS (U.S. CLS. 2, 8, 9 AND 17).  
FIRST USE 3-3-1999; IN COMMERCE 3-3-1999.

2,900,633. SANTA CLARA, INC., WHIPPANY, NJ. SN 78-162,459. PUB. 4-29-2003, FILED 9-10-2002.

**WILD THING**

FOR CIGARS (U.S. CLS. 2, 8, 9 AND 17).  
FIRST USE 7-1-2004; IN COMMERCE 7-1-2004.

**SERVICE MARKS****CLASS 35—ADVERTISING AND BUSINESS**

2,900,038. BEARDEN, DENNIS, HOUSTON, TX. SN 75-552,484. PUB. 3-28-2000, FILED 9-14-1998.



The logo for Air Management features the word "Air" in a stylized, italicized font with a horizontal line above it, followed by the word "Management" in a bold, sans-serif font.

FOR WHOLESALE DISTRIBUTORSHIPS FEATURING AIR CONDITIONING SUPPLIES FOR CONTRACTORS AND FOR MULTI-FAMILY HOUSING (U.S. CLS. 100, 101 AND 102).  
FIRST USE 10-0-2002; IN COMMERCE 10-0-2002.

**CLASS 35—(Continued).**

2,900,055. EPLUS INC., HERDON, VA. SN 75-709,736. PUB. 12-18-2001, FILED 5-19-1999.

**ONESOURCE**

FOR PROMOTING THE GOODS AND SERVICES OF OTHERS THROUGH ELECTRONIC CATALOGS OF SUCH GOODS AND SERVICES, SUCH CATALOGS AND TECHNICAL AND MARKETING INFORMATION RELATING TO SUCH GOODS AND SERVICES BEING ACCESSED THROUGH A SITE ON A GLOBAL COMPUTER NETWORK; PROVIDING INTERACTIVE SEARCHING AND SELECTION OF SUCH PRODUCTS AND SERVICES OF OTHERS THROUGH A SITE OF A GLOBAL COMPUTER NETWORK; LOCATING AND IDENTIFYING GOODS AND SERVICES SEARCHED BUT NOT FOUND; TAKING ORDERS FOR SUCH GOODS AND SERVICES OF OTHERS THROUGH A GLOBAL COMPUTER NETWORK AND TRANSMITTING SUCH ORDERS ELECTRONICALLY TO SUCH OTHERS PURSUANT TO FULFILLMENT OF SUCH ORDERS (U.S. CLS. 100, 101 AND 102).  
FIRST USE 6-0-1999; IN COMMERCE 6-0-1999.

2,900,096. CREATIVE MARKETING ASSOCIATES, INC., KANSAS CITY, MO. SN 76-037,463. PUB. 4-10-2001, FILED 4-28-2000.

**BAR CODE BINGO**

NO CLAIM IS MADE TO THE EXCLUSIVE RIGHT TO USE "BAR CODE", APART FROM THE MARK AS SHOWN.  
FOR DISSEMINATION OF ADVERTISING MATTER (U.S. CLS. 100, 101 AND 102).  
FIRST USE 6-25-2004; IN COMMERCE 6-25-2004.

2,900,110. MONITOR COMPANY GROUP LIMITED PARTNERSHIP, CAMBRIDGE, MA. SN 76-099,958. PUB. 3-26-2002, FILED 7-31-2000.

**M2C**

FOR PROVISION OF STRATEGIC MARKETING CONSULTING SERVICES FOR OTHERS (U.S. CLS. 100, 101 AND 102).  
FIRST USE 8-0-2000; IN COMMERCE 8-0-2000.

2,900,118. CYPHER GROUP LLC, THE, DBA CATCHWORD, OAKLAND, CA. SN 76-121,058. PUB. 10-23-2001, FILED 9-1-2000.

**CONNOTION**

FOR ELECTRONIC RETAILING SERVICES VIA COMPUTER FEATURING DOMAIN NAMES (U.S. CLS. 100, 101 AND 102).  
FIRST USE 3-19-2004; IN COMMERCE 3-19-2004.

**CLASS 35—(Continued).**

2,900,158. FIHEALTH, LLC, NASHVILLE, TN. SN 76-264,533. PUB. 12-18-2001, FILED 5-30-2001.

**FIHEALTH**

FOR BUSINESS CONSULTING SERVICES IN THE NATURE OF ACCOUNTING SERVICES IN THE FIELD OF PATIENT REIMBURSEMENT PROGRAMS FOR HEALTHCARE PROVIDERS (U.S. CLS. 100, 101 AND 102).

FIRST USE 5-29-2001; IN COMMERCE 10-22-2002.

2,900,193. FIRST COAST ENERGY, L.L.P., JACKSONVILLE, FL. SN 76-331,302. PUB. 5-13-2003, FILED 10-30-2001.

**DAILY'S**

FOR RETAIL STORE SERVICES FEATURING CONVENIENCE STORE ITEMS AND GASOLINE (U.S. CLS. 100, 101 AND 102).

FIRST USE 11-1-2003; IN COMMERCE 11-1-2003.

2,900,196. ELECTRONIC DATA SYSTEMS CORPORATION, PLANO, TX. SN 76-332,565. PUB. 4-30-2002, FILED 10-31-2001.

**FINFRAME**

FOR BUSINESS MANAGEMENT CONSULTING SERVICES FOR THE ASSESSMENT AND DEVELOPMENT OF INFORMATION TECHNOLOGY SERVICES FOR OTHERS (U.S. CLS. 100, 101 AND 102).

FIRST USE 12-1-2002; IN COMMERCE 12-1-2002.

2,900,199. RICHARD RAINS AND CARL WAGGONER PARTNERSHIP, THE, WOODRIDGE, IL. SN 76-335,433. PUB. 12-2-2003, FILED 11-8-2001.

**PET PUR'FECTION**

NO CLAIM IS MADE TO THE EXCLUSIVE RIGHT TO USE "PET", APART FROM THE MARK AS SHOWN.

FOR RETAIL STORE OF PET SUPPLIES AND PET FOODS (U.S. CLS. 100, 101 AND 102).

FIRST USE 1-1-2001; IN COMMERCE 7-1-2004.

**CLASS 35—(Continued).**

2,900,210. PROCTOR HOMER WARREN, INC., DBA PROCTOR FINANCIAL INSURANCE CORP., TROY, MI. SN 76-348,506. PUB. 11-25-2003, FILED 12-17-2001.

**DDI**

FOR OUTSOURCING SERVICES FOR OTHERS IN THE FIELD OF INSURANCE, NAMELY; MAIL PROCESSING, CATALOGUING AND DISTRIBUTION; DATA COLLECTION; COMPUTERIZED DATA ENTRY; ESCROW DISBURSEMENTS; INVOICING; PROCESSING OF NEW POLICIES, RENEWALS, ENDORSEMENTS, CANCELLATIONS AND REINSTATEMENTS; AGENT AND CARRIER NOTIFICATIONS; REAL-TIME COMPUTERIZED POLICY UPDATING; PREMIUM DISBURSEMENT PROCESSING; POLICY STATUS, HISTORY AND ACTIVITY REPORTING; STATISTICAL AND MANAGEMENT REPORTING; TELEPHONE CUSTOMER SUPPORT; AND AUTOMATIC CALL DISTRIBUTION REPORTING (U.S. CLS. 100, 101 AND 102).

FIRST USE 12-31-2001; IN COMMERCE 12-31-2001.

2,900,271. MILLER, JOHN L., CUSTER, WI. SN 76-413,105. PUB. 4-1-2003, FILED 5-29-2002.



NO CLAIM IS MADE TO THE EXCLUSIVE RIGHT TO USE "INNOVATIVE WELDING ACCESSORIES", APART FROM THE MARK AS SHOWN.

FOR WHOLESALE DISTRIBUTORSHIPS FEATURING WELDING EQUIPMENT AND WELDING ACCESSORIES (U.S. CLS. 100, 101 AND 102).

FIRST USE 4-9-2003; IN COMMERCE 4-9-2003.

2,900,278. RESOURCE HOLDINGS, LLC, COLUMBUS, OH. SN 76-422,243. PUB. 3-25-2003, FILED 6-19-2002.

**BRAND LENS**

NO CLAIM IS MADE TO THE EXCLUSIVE RIGHT TO USE "BRAND", APART FROM THE MARK AS SHOWN.

FOR BUSINESS MARKETING CONSULTING SERVICES (U.S. CLS. 100, 101 AND 102).

FIRST USE 10-3-2000; IN COMMERCE 10-3-2000.

**CLASS 35—(Continued).**

2,900,288. LITTLE DIVERSIFIED ARCHITECTURAL CONSULTING, INC., CHARLOTTE, NC. SN 76-430,193. PUB. 12-16-2003, FILED 7-12-2002.

**LITTLE**  
DIVERSIFIED ARCHITECTURAL CONSULTING

NO CLAIM IS MADE TO THE EXCLUSIVE RIGHT TO USE "DIVERSIFIED ARCHITECTURAL CONSULTING", APART FROM THE MARK AS SHOWN.

FOR MOVE MANAGEMENT NAMELY, MOVE ORCHESTRATION PLANNING, MOVE SCHEDULING, AND ON-SITE MOVE COORDINATION; CHURN PLANNING AND MANAGEMENT, NAMELY, MANAGING ONGOING MOVES (U.S. CLS. 100, 101 AND 102).

FIRST USE 7-1-2002; IN COMMERCE 7-1-2002.

2,900,327. ADRIENNE VITTADINI LLC, ENFIELD, CT. SN 76-449,845. PUB. 4-8-2003, FILED 9-16-2002.

**WORLD OF VITTADINI**

OWNER OF U.S. REG. NOS. 1,241,274, 1,912,150, AND OTHERS.

FOR RETAIL STORE SERVICES, MAIL ORDER CATALOG SERVICES, TELEPHONE SHOP AT HOME SERVICES, AND ELECTRONIC RETAILING SERVICES VIA A COMPUTER, ALL FEATURING APPAREL, WATCHES, JEWELRY, COSMETICS, PERFUME, PERSONAL HYGIENE PRODUCTS, HANDBAGS, LUGGAGE AND TRAVEL ACCESSORIES, BATH AND BED LINENS (U.S. CLS. 100, 101 AND 102).

FIRST USE 8-22-2002; IN COMMERCE 8-22-2002.

2,900,380. ADVANCETEL DIRECT, LLC, AUBURN, ME. SN 76-476,174. PUB. 5-4-2004, FILED 12-12-2002.

**ADVANCETEL DIRECT**

NO CLAIM IS MADE TO THE EXCLUSIVE RIGHT TO USE "DIRECT", APART FROM THE MARK AS SHOWN.

FOR TELEMARKETING SERVICES, NAMELY, PROMOTING AND TAKING ORDERS FOR THE GOODS AND SERVICES OF OTHERS, AND PROVIDING MARKET DATA RESULTING THEREFROM (U.S. CLS. 100, 101 AND 102).

FIRST USE 4-10-2003; IN COMMERCE 4-10-2003.

**CLASS 35—(Continued).**

2,900,390. FLAVORS OF NORTH AMERICA, INC., CAROL STREAM, IL. SN 76-481,381. PUB. 3-16-2004, FILED 1-10-2003.

**K.I.D. COUNCIL**

NO CLAIM IS MADE TO THE EXCLUSIVE RIGHT TO USE "KID", APART FROM THE MARK AS SHOWN.

FOR MARKET RESEARCH SERVICES, NAMELY CONDUCTING FOCUS GROUPS RELATING TO FOOD FLAVORING (U.S. CLS. 100, 101 AND 102).

FIRST USE 1-0-2003; IN COMMERCE 1-0-2003.

2,900,398. LEMA, MARK A., BURLINGTON, NJ. SN 76-486,761. PUB. 10-28-2003, FILED 2-3-2003.

**MUCHOSJOBS**

THE ENGLISH TRANSLATION OF "MUCHOSJOBS" IS "MANY JOBS".

FOR PROVIDING ON-LINE INFORMATION IN THE FIELDS OF EMPLOYMENT, RECRUITMENT, CAREERS, JOB RESOURCES, JOB LISTINGS AND RESUMES; PROVIDING ON-LINE EMPLOYMENT PLACEMENT SERVICES, NAMELY, RESUME MATCHING SERVICES VIA A GLOBAL COMPUTER NETWORK (U.S. CLS. 100, 101 AND 102).

FIRST USE 12-31-2001; IN COMMERCE 12-31-2001.

2,900,401. MEHTA, JIMIT H., CARLSBAD, CA. SN 76-487,507. PUB. 11-18-2003, FILED 2-3-2003.



NO CLAIM IS MADE TO THE EXCLUSIVE RIGHT TO USE "LAPTOPPARTS", APART FROM THE MARK AS SHOWN.

THE STIPLING IN THE DRAWING IS FOR SHADING PURPOSES ONLY, IS A FEATURE OF THE MARK AND IS NOT INTENDED TO INDICATE COLOR.

FOR RETAIL STORE SERVICES, MAIL ORDER CATALOG SERVICES AND COMPUTERIZED ON-LINE RETAIL STORE SERVICES FEATURING PORTABLE COMPUTERS AND PARTS THEREFOR VIA GLOBAL COMPUTER INFORMATION NETWORK (U.S. CLS. 100, 101 AND 102).

FIRST USE 3-1-2004; IN COMMERCE 3-1-2004.

**CLASS 35—(Continued).**

2,900,402. MEHTA, JIMIT H., CARLSBAD, CA. SN 76-487,508.  
PUB. 11-18-2003, FILED 2-3-2003.



**LaptopParts.com**

NO CLAIM IS MADE TO THE EXCLUSIVE RIGHT TO USE "LAPTOPPARTS.COM", APART FROM THE MARK AS SHOWN.

THE STIPPLING IN THE DRAWING IS FOR SHADING PURPOSES ONLY, IS A FEATURE OF THE MARK AND IS NOT INTENDED TO INDICATE COLOR.

FOR MAIL ORDER CATALOG SERVICES AND COMPUTERIZED ON-LINE RETAIL STORE SERVICES FEATURING PORTABLE COMPUTERS AND PARTS THEREFORE VIA A GLOBAL COMPUTER INFORMATION NETWORK (U.S. CLS. 100, 101 AND 102).

FIRST USE 3-1-2004; IN COMMERCE 3-1-2004.

2,900,423. LOVER'S LANE, WESTLAND, MI. SN 76-494,308.  
PUB. 11-18-2003, FILED 3-3-2003.

## LOVER'S TOY CHEST

FOR MAIL ORDER CATALOG SERVICES FEATURING INTIMATE APPAREL FOR WOMEN AND MEN, EROTICA JEWELRY, INTIMATE ADULT PRODUCTS SUCH AS MARITAL AIDS, DILDOS, RESTRAINTS, LOTIONS, OILS, LUBRICANTS, CONDOMS, ADULT GAG GIFTS, VIDEOS, BOOKS AND GAMES (U.S. CLS. 100, 101 AND 102).

FIRST USE 6-1-2003; IN COMMERCE 6-1-2003.

2,900,438. PRIVACY SOLUTIONS, INC., LA MESA, CA. SN 76-498,710. PUB. 10-21-2003, FILED 3-6-2003.

## PRIVACYGURUS

FOR BUSINESS CONSULTING SERVICES RELATED TO PRIVACY AND DATA SECURITY MATTERS (U.S. CLS. 100, 101 AND 102).

FIRST USE 3-19-2004; IN COMMERCE 3-19-2004.

2,900,452. GOSSWEILER, JAMES C., BALTIMORE, MD. SN 76-505,496. PUB. 11-25-2003, FILED 4-10-2003.

## PANGAEA HORIZON

FOR RETAIL BOOKSTORE SERVICES FEATURING BOOKS, MAGAZINES AND GENERAL GIFTWARE ITEMS (U.S. CLS. 100, 101 AND 102).

FIRST USE 4-1-2004; IN COMMERCE 4-1-2004.

**CLASS 35—(Continued).**

2,900,454. GOSSWEILER, JAMES C., BALTIMORE, MD. SN 76-505,632. PUB. 11-25-2003, FILED 4-10-2003.

## ONE EARTH, ONE PEOPLE, ONE FUTURE

FOR RETAIL BOOKSTORE SERVICES FEATURING BOOKS, MAGAZINES AND GENERAL GIFTWARE ITEMS (U.S. CLS. 100, 101 AND 102).

FIRST USE 4-1-2004; IN COMMERCE 4-1-2004.

2,900,459. GARDEN FEVER, LLC, PORTLAND, OR. SN 76-510,006. PUB. 12-9-2003, FILED 4-25-2003.

## GARDEN FEVER!

FOR RETAIL LAWN, GARDEN AND NURSERY STORES (U.S. CLS. 100, 101 AND 102).

FIRST USE 2-27-2003; IN COMMERCE 4-22-2003.

2,900,506. U.S.A. FOOD AGENTS, LLC, WASHINGTON, DC. SN 76-529,821. PUB. 4-27-2004, FILED 7-17-2003.



NO CLAIM IS MADE TO THE EXCLUSIVE RIGHT TO USE "U.S.A. FOOD AGENTS", APART FROM THE MARK AS SHOWN.

FOR COMMERCIAL REGISTERED DOMESTIC AGENT SERVICES FOR FOREIGN FOOD FACILITIES (U.S. CLS. 100, 101 AND 102).

FIRST USE 12-12-2003; IN COMMERCE 12-12-2003.

2,900,533. TRL GROUP, INC., NORWALK, CT. SN 76-976,990. PUB. 12-30-2003, FILED 4-24-2003.

## CLICK AWAY GETAWAY

FOR ADMINISTERING A CONSUMER-BENEFIT PROGRAM THAT ENTITLES MEMBERS TO RECEIVE DISCOUNTS ON TRAVEL AND LODGING (U.S. CLS. 100, 101 AND 102).

FIRST USE 7-0-2003; IN COMMERCE 7-0-2003.

**CLASS 35—(Continued).**

2,900,537. R.T. TEMPS, INC., P.C., WAYNE, PA. SN 78-027,911.  
PUB. 3-5-2002, FILED 9-27-2000.

## HEALTHCARE STAFFING INNOVATIONS

NO CLAIM IS MADE TO THE EXCLUSIVE RIGHT TO USE "HEALTHCARE STAFFING", APART FROM THE MARK AS SHOWN.

FOR TEMPORARY AND FULL TIME EMPLOYMENT AGENCY SERVICES FOR MEDICAL PERSONNEL (U.S. CLS. 100, 101 AND 102).

FIRST USE 12-11-2000; IN COMMERCE 12-11-2000.

2,900,586. POWER TIME, INC., DBA KAY INTERNATIONAL, WOODLAND HILLS, CA. SN 78-119,663. PUB. 12-9-2003, FILED 4-4-2002.



FOR ONLINE RETAIL STORE SERVICES FEATURING WATCHES, WRITING INSTRUMENTS AND JEWELRY (U.S. CLS. 100, 101 AND 102).

FIRST USE 11-30-2002; IN COMMERCE 11-30-2002.

2,900,587. HDMI LICENSING L.L.C., SUNNYVALE, CA. SN 78-120,480. PUB. 11-19-2002, FILED 4-9-2002.

## HDMI

FOR ASSOCIATION SERVICES, NAMELY, PROMOTING THE DEVELOPMENT AND ADOPTION OF A VOLUNTARY DIGITAL INTERFACE SPECIFICATION THAT PROVIDES AN INTEROPERABLE METHOD OF CONNECTING COMPUTER AND COMMUNICATIONS HARDWARE, CONSUMER ELECTRONICS DEVICES, COMPONENTS, AND PERIPHERALS (U.S. CLS. 100, 101 AND 102).

FIRST USE 7-8-2004; IN COMMERCE 7-8-2004.

**CLASS 35—(Continued).**

2,900,597. MIDWEST SEALANT SUPPLY, LEWIS CENTER, OH. SN 78-128,820. PUB. 4-13-2004, FILED 5-15-2002.



NO CLAIM IS MADE TO THE EXCLUSIVE RIGHT TO USE "MOISTURE PROTECTION", "MIDWEST SEALANT SUPPLY", "614.847.4075" AND "FIRESTOP SPECIALISTS", APART FROM THE MARK AS SHOWN.

FOR RETAIL SHOPS FEATURING BUILDING CONSTRUCTION MATERIALS IN THE FIELD OF SEALANT SUPPLIES (U.S. CLS. 100, 101 AND 102).

FIRST USE 6-15-1996; IN COMMERCE 6-15-1996.

2,900,631. WHO'S THERE, INC., DBA KNOCK KNOCK, VENICE, CA. SN 78-161,013. PUB. 11-11-2003, FILED 9-5-2002.

## KNOCK KNOCK

FOR ON-LINE STORE SERVICES, BOTH RETAIL AND WHOLESALE, FEATURING STATIONERY, CARDS, GIFTS, AND COLLECTIBLES (U.S. CLS. 100, 101 AND 102).

FIRST USE 10-1-2002; IN COMMERCE 10-1-2002.

2,900,637. AMERICAN DREAMCARD, LLC, LAS VEGAS, NV. SN 78-163,890. PUB. 5-6-2003, FILED 9-13-2002.

## AMERICAN DREAMCARD

FOR CONTESTS AND INCENTIVE AWARD PROGRAMS TO PROMOTE THE SALE OF PRODUCTS AND SERVICES OF OTHERS (U.S. CLS. 100, 101 AND 102).

FIRST USE 8-12-2002; IN COMMERCE 8-12-2002.

**CLASS 35—(Continued).**

2,900,641. CATALINA MARKETING INTERNATIONAL, INC., ST. PETERSBURG, FL. SN 78-165,920. PUB. 4-22-2003, FILED 9-19-2002.

**CLASS 35—(Continued).**

2,900,738. LEVINE, BLASZAK, BLOCK & BOOTHBY LLP, WASHINGTON, DC. SN 78-224,456. PUB. 11-18-2003, FILED 3-12-2003.

**CAREBRIEF**

FOR PROMOTING THE SALE OF HEALTH RELATED GOODS AND SERVICES OF OTHERS THROUGH THE DISTRIBUTION OF COUPONS, PREMIUMS, REBATES, DISCOUNTS, SAMPLES, INCENTIVES, PROMOTIONS, ADVERTISEMENTS AND MESSAGES, INCLUDING THOSE DISSEMINATED OVER A GLOBAL COMPUTER NETWORK (U.S. CLS. 100, 101 AND 102).

FIRST USE 9-10-2002; IN COMMERCE 9-10-2002.



2,900,642. TRANQUILLI, ADAM S., NEW PROVIDENCE, NJ. AND OSTERBERG, SCOTT E., MAPLEWOOD, NJ. SN 78-167,207. PUB. 11-11-2003, FILED 9-24-2002.

FOR BUSINESS CONSULTATION SERVICES FOR CUSTOMERS OF TELECOMMUNICATIONS PROVIDERS, HIGH TECHNOLOGY VENDORS AND RELATED ENTITIES (U.S. CLS. 100, 101 AND 102).

FIRST USE 9-15-2003; IN COMMERCE 9-15-2003.

**PSEUDOPLASMA RECORDS**

NO CLAIM IS MADE TO THE EXCLUSIVE RIGHT TO USE "RECORDS", APART FROM THE MARK AS SHOWN.

FOR PROMOTING THE SALE OF MUSIC CD'S OF MUSICAL BANDS BY PROVIDING INFORMATIONAL WEB SITES ABOUT THE BANDS ON THE INTERNET; PERSONAL MANAGEMENT SERVICES FOR MUSICAL PERFORMERS (U.S. CLS. 100, 101 AND 102).

FIRST USE 9-22-2001; IN COMMERCE 4-25-2004.

2,900,739. NEW ENGLAND DEVELOPMENT, INC., CAMBRIDGE, MA. SN 78-224,616. PUB. 10-28-2003, FILED 3-12-2003.

**SHOP AND FLY**

FOR ADVERTISING AND PROMOTING THE GOODS AND SERVICES OF OTHERS THROUGH THE USE OF COUPONS FOR DISCOUNTED TRAVEL FARES (U.S. CLS. 100, 101 AND 102).

FIRST USE 6-15-2004; IN COMMERCE 6-15-2004.

2,900,679. GROUP 1066, LLC, NEW YORK CITY, NY. SN 78-198,551. PUB. 9-2-2003, FILED 12-30-2002.

**WE HELP MAKE IT EASIER  
FOR YOUR CUSTOMERS TO  
BUY STUFF FROM YOU**

FOR BUSINESS CONSULTATION SERVICES IN THE FIELD OF PRODUCT PORTFOLIO ANALYSIS, BUSINESS PLANNING, BRANDING, SALES CHANNEL SELECTION, AND COMPETITIVE STRATEGY; BUSINESS MARKETING SERVICES; CONDUCTING BUSINESS AND MARKETING RESEARCH SURVEYS; DEVELOPMENT AND IMPLEMENTATION OF MARKETING STRATEGIES FOR OTHERS; ADVERTISING SERVICES FOR OTHERS, NAMELY, CREATING BRAND NAMES, LOGOS AND CORPORATE IDENTITIES; BUSINESS MANAGEMENT SERVICES IN THE FIELD OF BRAND NAMES, NAMELY, BRAND EVALUATION, BRAND POSITIONING, BRAND STRATEGY, PRODUCT PROMOTION SERVICES FOR OTHERS AND CONSULTATION SERVICES RELATED THERETO; CREATING TRADEMARKS FOR OTHERS; PROMOTIONAL SERVICES (U.S. CLS. 100, 101 AND 102).

FIRST USE 1-10-2002; IN COMMERCE 1-10-2002.

2,900,753. B & B VENTURES, INC., CHANHASSEN, MN. SN 78-227,514. PUB. 11-18-2003, FILED 3-19-2003.

**THE HURRIED CHEF**

FOR RETAIL STORE FOR THE PURCHASE OF PREPARED, COOKED MEAL ITEMS AND PREPARED, UNCOOKED MEAL ITEMS (U.S. CLS. 100, 101 AND 102).

FIRST USE 4-30-2003; IN COMMERCE 4-30-2003.

**CLASS 35—(Continued).**

2,900,762. BASSETT FURNITURE INDUSTRIES, INC., BASSETT, VA. SN 78-232,340. PUB. 11-11-2003, FILED 4-1-2003.

## YOU'VE NEVER BOUGHT FURNITURE LIKE THIS BEFORE

NO CLAIM IS MADE TO THE EXCLUSIVE RIGHT TO USE "FURNITURE", APART FROM THE MARK AS SHOWN.

FOR RETAIL STORE SERVICES FEATURING FURNITURE (U.S. CLS. 100, 101 AND 102).  
FIRST USE 4-1-2003; IN COMMERCE 5-1-2003.

2,900,763. PERMISSION STREAM (LLC), LOS ANGELES, CA. SN 78-232,367. PUB. 2-24-2004, FILED 4-1-2003.

## RELEVANT MEDIA

NO CLAIM IS MADE TO THE EXCLUSIVE RIGHT TO USE "MEDIA", APART FROM THE MARK AS SHOWN.

FOR PERFORMANCE-BASED COOPERATIVE MARKETING AND ADVERTISING SERVICES VIA THE INTERNET, NAMELY, OPERATING ONLINE MARKETPLACES THAT CONNECT THE BUSINESSES AND CONSUMERS THAT ARE MOST LIKELY TO PURCHASE SPECIFIC GOODS AND SERVICES TO THE ENTITIES THAT PROVIDE THOSE GOODS AND SERVICES (U.S. CLS. 100, 101 AND 102).  
FIRST USE 4-1-2003; IN COMMERCE 3-1-2004.

2,900,806. FOOD MARKETS NORTHWEST, INC., SEATTLE, WA. SN 78-249,311. PUB. 1-6-2004, FILED 5-13-2003.

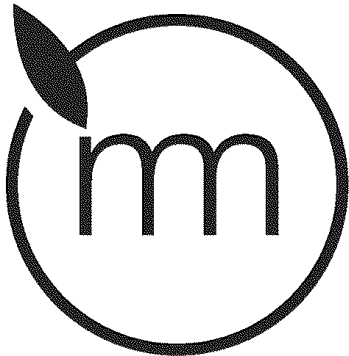

FOR RETAIL GROCERY STORE SERVICES (U.S. CLS. 100, 101 AND 102).  
FIRST USE 7-3-2003; IN COMMERCE 7-3-2003.

**CLASS 35—(Continued).**

2,900,816. MASSACHUSETTS DENTAL SOCIETY, SOUTH-BOROUGH, MA. SN 78-255,207. PUB. 2-24-2004, FILED 5-28-2003.

## GRIN AND WEAR IT

FOR DEVELOPING PROMOTIONAL CAMPAIGNS FOR USE OF MOUTH GUARDS (U.S. CLS. 100, 101 AND 102).

FIRST USE 9-1-2002; IN COMMERCE 9-1-2002.

2,900,822. BEN'S COOKIES (U.S.), INC., SALT LAKE CITY, UT. SN 78-259,585. PUB. 1-20-2004, FILED 6-6-2003.



FOR RETAIL BAKERY STORE SERVICES (U.S. CLS. 100, 101 AND 102).

FIRST USE 12-5-2003; IN COMMERCE 12-5-2003.

2,900,865. TANGIBLE IMPACT, INC., DUBLIN, OH. SN 78-287,755. PUB. 5-4-2004, FILED 8-14-2003.

## TANGIBLE IMPACT

FOR ADVERTISING AGENCY, FEATURING, ADVERTISING AND MARKETING FOR OTHERS IN VARIOUS MEDIA, NAMELY, INTERNET, PRINT, AND BROADCAST (U.S. CLS. 100, 101 AND 102).

FIRST USE 5-11-2004; IN COMMERCE 5-11-2004.

**CLASS 36—INSURANCE AND FINANCIAL**

**CLASS 36—(Continued).**

2,900,030. W.P. CAREY & CO. LLC, NEW YORK, NY. SN 75-406,419. PUB. 11-9-1999, FILED 12-17-1997.

**CAREY DIVERSIFIED**

NO CLAIM IS MADE TO THE EXCLUSIVE RIGHT TO USE "DIVERSIFIED", APART FROM THE MARK AS SHOWN.

FOR COMMERCIAL REAL ESTATE INVESTMENT SERVICES AND RELATED SERVICES, NAMELY, FINANCING, REAL ESTATE ACQUISITIONS AND DISPOSITIONS, REAL ESTATE RESTRUCTURING AND REAL ESTATE LEASING (U.S. CLS. 100, 101 AND 102).

FIRST USE 10-0-1997; IN COMMERCE 10-0-1997.

2,900,066. FIRST ELECTRONIC CORPORATION, DRAPER, UT. SN 75-822,866. PUB. 10-14-2003, FILED 10-14-1999.

**FIRST ELECTRONIC**

NO CLAIM IS MADE TO THE EXCLUSIVE RIGHT TO USE "ELECTRONIC", APART FROM THE MARK AS SHOWN.

FOR FINANCING SERVICES; BANKING SERVICES; CREDIT CARD SERVICES; PROVIDING A WEB SITE ON GLOBAL COMPUTER NETWORKS FEATURING INFORMATION IN THE FIELD OF BANKING (U.S. CLS. 100, 101 AND 102).

FIRST USE 6-22-2001; IN COMMERCE 6-22-2001.

2,900,083. HUB INTERNATIONAL LIMITED, TORONTO, ONTARIO, CANADA. SN 75-937,181. PUB. 8-19-2003, FILED 3-6-2000.

**HUB INTERNATIONAL**

NO CLAIM IS MADE TO THE EXCLUSIVE RIGHT TO USE "INTERNATIONAL", APART FROM THE MARK AS SHOWN.

FOR INSURANCE SERVICES, NAMELY INSURANCE BROKERAGE SERVICES, INSURANCE CONSULTING SERVICES, RISK MANAGEMENT SERVICES, INSURANCE RISK MANAGEMENT SERVICES; LIFE AND HEALTH INSURANCE BROKERAGE SERVICES; MORTGAGE BROKERAGE SERVICES; BROKERAGE OF GUARANTEED INVESTMENT CERTIFICATES, MUTUAL FUNDS, SEGREGATED FUNDS, AND BONDS AND STOCKS (U.S. CLS. 100, 101 AND 102).

FIRST USE 9-14-2000; IN COMMERCE 9-14-2000.

2,900,089. METRIS DIRECT, INC., ST. LOUIS PARK, MN. SN 75-983,508. PUB. 5-16-2000, FILED 10-13-1999.

**IADVANTAGES**

FOR BANKING SERVICES (U.S. CLS. 100, 101 AND 102).

FIRST USE 2-24-2000; IN COMMERCE 2-24-2000.

**CLASS 36—(Continued).**

2,900,097. TRADINGLAB BANCA S.P.A., MILAN, ITALY. SN 76-046,257. PUB. 7-31-2001, FILED 5-10-2000.



FOR RISK EVALUATION OF FINANCIAL INSTRUMENTS; FINANCIAL AND MONETARY AFFAIRS, NAMELY, BANKING, FINANCIAL MANAGEMENT SERVICES, AND INVESTMENT CONSULTANCY (U.S. CLS. 100, 101 AND 102).

FIRST USE 1-1-2000; IN COMMERCE 10-1-2003.

2,900,104. CNA FINANCIAL CORPORATION, CHICAGO, IL. SN 76-071,516. PUB. 11-6-2001, FILED 6-16-2000.

**CNANETPROTECT**

OWNER OF U.S. REG. NOS. 1,911,764, 2,344,403, AND OTHERS.

FOR INSURANCE WRITING SERVICES TO PROTECT BUSINESSES OR USERS INVOLVED IN ELECTRONIC COMMERCE IN THE EVENT OF DAMAGES, EXPENSES OR LOSSES RESULTING FROM DAMAGE TO WEB SITES, DATA, BUSINESS INFORMATION, OR INTERRUPTED ELECTRONIC BUSINESS OR ELECTRONIC COMMERCE ACTIVITIES (U.S. CLS. 100, 101 AND 102).

FIRST USE 3-3-2004; IN COMMERCE 3-3-2004.

2,900,105. MARKETGRADER.COM CORP., MIAMI, FL. SN 76-079,021. PUB. 10-16-2001, FILED 6-23-2000.

**MARKETGRADER.COM**

FOR PROVIDING FINANCIAL AND INVESTING INFORMATION VIA A GLOBAL COMPUTER INFORMATION NETWORK (U.S. CLS. 100, 101 AND 102).

FIRST USE 6-13-2003; IN COMMERCE 6-13-2003.

2,900,175. TRANSAMERICA RETAIL FINANCIAL SERVICES CORPORATION, HOFFMAN ESTATES, IL. SN 76-297,890. PUB. 2-25-2003, FILED 8-10-2001.

**CATALYST**

FOR RETAIL FINANCING, NAMELY CONSUMER CREDIT PROGRAMS FOR RETAILERS (U.S. CLS. 100, 101 AND 102).

FIRST USE 10-2-2001; IN COMMERCE 10-2-2001.



**CLASS 36—(Continued).**

2,900,206. GLOBAL CONSULTANTS DIRECT, INC., HAUPAUGE, NY. SN 76-344,321. PUB. 11-4-2003, FILED 12-4-2001.

## MAJOR DECISIONS MADE EASIER

FOR COMMERCIAL AND RESIDENTIAL REAL ESTATE AGENCIES AND FINANCING, AND MORTGAGE LENDING SERVICES (U.S. CLS. 100, 101 AND 102).  
FIRST USE 0-0-2001; IN COMMERCE 0-0-2001.

2,900,221. TOWER SQUARE SECURITIES, INC., HARTFORD, CT. SN 76-368,963. PUB. 5-20-2003, FILED 2-8-2002.

## TOWERCONNECT

FOR SECURITY BROKERAGE SERVICES, NAMELY PROVIDING FINANCIAL ACCOUNT INFORMATION FEATURING FINANCIAL AGGREGATION, TRACKING, PERFORMANCE AND REPORTING INFORMATION FINANCIAL PORTFOLIO MANAGEMENT (U.S. CLS. 100, 101 AND 102).  
FIRST USE 4-15-2002; IN COMMERCE 4-15-2002.

2,900,227. TOWER SQUARE SECURITIES, INC., HARTFORD, CT. SN 76-373,092. PUB. 5-20-2003, FILED 2-20-2002.

**TOWER**Connect

FOR SECURITY BROKERAGE SERVICES, NAMELY PROVIDING FINANCIAL ACCOUNT INFORMATION FEATURING FINANCIAL AGGREGATION, TRACKING, PERFORMANCE AND REPORTING INFORMATION FINANCIAL PORTFOLIO MANAGEMENT; PROVIDING SECURITY BROKERAGE SERVICES USERS WITH A WEB SITE FEATURING FINANCIAL ACCOUNT INFORMATION, FINANCIAL ACCOUNT AGGREGATION, FINANCIAL ACCOUNT TRACKING, FINANCIAL ACCOUNT REPORTING, FINANCIAL PORTFOLIO MANAGEMENT AND FINANCIAL PERFORMANCE REPORTING (U.S. CLS. 100, 101 AND 102).  
FIRST USE 4-15-2002; IN COMMERCE 4-15-2002.

**CLASS 36—(Continued).**

2,900,231. JEFFRIES AVLON, INC., NEW YORK, NY. SN 76-376,358. PUB. 4-8-2003, FILED 2-27-2002.



JEFFRIES MORRIS, INC.

NO CLAIM IS MADE TO THE EXCLUSIVE RIGHT TO USE "INC.", APART FROM THE MARK AS SHOWN.  
THE MARK DOES NOT IDENTIFY THE NAME OF A PARTICULAR LIVING OR DECEASED INDIVIDUAL.  
FOR LEASING OF COMMERCIAL AND RETAIL REAL ESTATE, REAL ESTATE INVESTMENT SERVICES, AND MANAGEMENT OF REAL ESTATE INVESTMENTS (U.S. CLS. 100, 101 AND 102).  
FIRST USE 4-0-2001; IN COMMERCE 4-0-2001.

2,900,282. VISION MEXICO, WASHINGTON, DC. SN 76-426,104. PUB. 7-22-2003, FILED 6-28-2002.

## VISION MEXICO

NO CLAIM IS MADE TO THE EXCLUSIVE RIGHT TO USE "MEXICO", APART FROM THE MARK AS SHOWN.  
FOR CHARITABLE SERVICES, NAMELY, FUNDRAISING AND THE PROVISION OF FINANCIAL AND IN-KIND CONTRIBUTIONS TO PUBLIC AND PRIVATE ENTITIES AND INDIVIDUALS (U.S. CLS. 100, 101 AND 102).  
FIRST USE 10-23-2002; IN COMMERCE 10-23-2002.

2,900,300. GATEWAY APPRAISAL, INC., ST. LOUIS, MO. SN 76-437,629. PUB. 11-18-2003, FILED 8-5-2002.

## GATEWAY APPRAISAL, INC.

NO CLAIM IS MADE TO THE EXCLUSIVE RIGHT TO USE "APPRAISAL INC.", APART FROM THE MARK AS SHOWN.  
FOR REAL ESTATE APPRAISAL SERVICES (U.S. CLS. 100, 101 AND 102).  
FIRST USE 9-1-1996; IN COMMERCE 9-1-1996.

**CLASS 36—(Continued).**

2,900,353. FIRSEL FEDERAL CREDIT UNION, MAPLE GROVE, MN. SN 76-464,666. PUB. 4-22-2003, FILED 10-30-2002.

**TopLine**  
Federal Credit Union

NO CLAIM IS MADE TO THE EXCLUSIVE RIGHT TO USE "FEDERAL CREDIT UNION", APART FROM THE MARK AS SHOWN.

FOR FINANCIAL SERVICES; NAMELY, CREDIT UNION AND BANKING SERVICES (U.S. CLS. 100, 101 AND 102).

FIRST USE 10-1-2002; IN COMMERCE 11-1-2002.

2,900,360. SELL4FREE REAL ESTATE SYSTEMS, INC., FISHERS, IN. SN 76-468,986. PUB. 11-4-2003, FILED 11-21-2002.

## IT'S YOUR MONEY . . . KEEP IT!

FOR REAL ESTATE BROKERAGE SERVICES (U.S. CLS. 100, 101 AND 102).

FIRST USE 2-24-2003; IN COMMERCE 2-24-2003.

2,900,371. LEVENSOHN CAPITAL MANAGEMENT LLC, SAN FRANCISCO, CA. SN 76-471,096. PUB. 10-28-2003, FILED 11-19-2002.

## LEVENSOHN VENTURE PARTNERS

OWNER OF U.S. REG. NO. 2,565,828.

NO CLAIM IS MADE TO THE EXCLUSIVE RIGHT TO USE "VENTURE PARTNERS", APART FROM THE MARK AS SHOWN.

SEC. 2(F).

FOR INVESTMENT ADVISORY SERVICES; DIRECT INVESTMENT SERVICES FOR FUNDS; VENTURE CAPITAL FUNDING SERVICES FOR EMERGING, DEVELOPING, AND LATE-STAGE COMPANIES; FUND INVESTMENT ADVICE AND VENTURE CAPITAL CONSULTATION; INVESTMENT AND FINANCIAL PORTFOLIO MANAGEMENT SERVICES; FINANCIAL ASSET MANAGEMENT SERVICES; FINANCIAL ASSET ALLOCATION SERVICES; INVESTMENT AND FINANCIAL PORTFOLIO MANAGER EVALUATION; FINANCIAL RESEARCH AND ANALYSIS, NAMELY, DUE DILIGENCE AND SELECTION SERVICES (U.S. CLS. 100, 101 AND 102).

FIRST USE 4-16-2003; IN COMMERCE 4-16-2003.

**CLASS 36—(Continued).**

2,900,464. PLAINSCAPITAL CORPORATION, DALLAS, TX. SN 76-512,875. PUB. 3-23-2004, FILED 5-9-2003.

**MomentumFunding**  
A PlainsCapital Company

NO CLAIM IS MADE TO THE EXCLUSIVE RIGHT TO USE "COMPANY", APART FROM THE MARK AS SHOWN. FOR FINANCIAL SERVICES, NAMELY LENDING SERVICES (U.S. CLS. 100, 101 AND 102).

FIRST USE 10-6-2003; IN COMMERCE 10-6-2003.

2,900,465. PLAINSCAPITAL CORPORATION, DALLAS, TX. SN 76-512,897. PUB. 12-30-2003, FILED 5-9-2003.

## PLAINSCAPITAL BANK

NO CLAIM IS MADE TO THE EXCLUSIVE RIGHT TO USE "BANK", APART FROM THE MARK AS SHOWN.

FOR BANKING SERVICES; MONEY LENDING SERVICES; COMMERCIAL LENDING SERVICES; MORTGAGE LENDING SERVICES; PERSONAL LENDING SERVICES; COMMERCIAL REAL ESTATE LENDING SERVICES; FINANCIAL MANAGEMENT AND CONSULTATION SERVICES; AND CASH MANAGEMENT SERVICES (U.S. CLS. 100, 101 AND 102).

FIRST USE 10-6-2003; IN COMMERCE 10-6-2003.

2,900,467. PAYSYSTEMS CORPORATION, MONTREAL, QUEBEC, CANADA. SN 76-513,205. PUB. 10-14-2003, FILED 5-9-2003.

## PSMANAGER

FOR CREDIT CARD TRANSACTION PROCESSING SERVICES; THIRD PARTY PAYMENT PROCESSING SERVICES; CHECK PROCESSING SERVICES (U.S. CLS. 100, 101 AND 102).

FIRST USE 6-1-2003; IN COMMERCE 6-30-2003.

**CLASS 36—(Continued).**

2,900,468. BANNER BANK, WALLA WALLA, WA. SN 76-513,264. PUB. 12-9-2003, FILED 5-12-2003.

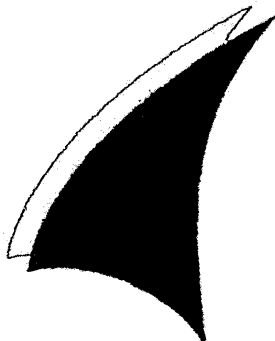

THE BANNER BANK DESIGN MARK CONSISTS OF THE REPRESENTATION OF TWO PARTIALLY OVERLAPPING SAILS.

FOR GENERAL BANKING SERVICES (U.S. CLS. 100, 101 AND 102).

FIRST USE 3-23-2000; IN COMMERCE 9-15-2000.

2,900,478. TRANSAMERICA CORPORATION, SAN FRANCISCO, CA. SN 76-517,470. PUB. 11-25-2003, FILED 5-27-2003.

**TRANSACCIDENT**

OWNER OF U.S. REG. NOS. 1,635,682, 2,525,199, AND OTHERS.

FOR ACCIDENT INSURANCE UNDERWRITING SERVICES (U.S. CLS. 100, 101 AND 102).

FIRST USE 5-3-2003; IN COMMERCE 5-3-2003.

2,900,491. UNIFIED TRUST COMPANY, NA, LEXINGTON, KY. SN 76-520,538. PUB. 4-13-2004, FILED 5-30-2003.

**UNIFIED RETIREMENT COUNSELOR**

NO CLAIM IS MADE TO THE EXCLUSIVE RIGHT TO USE RETIREMENT COUNSELOR, APART FROM THE MARK AS SHOWN.

FOR ON LINE FINANCIAL ANALYSIS AND CONSULTATION ON LINE FINANCIAL FORECASTING ON LINE FINANCIAL PORTFOLIO MANAGEMENT (U.S. CLS. 100, 101 AND 102).

FIRST USE 10-1-2003; IN COMMERCE 10-1-2003.

**CLASS 36—(Continued).**

2,900,583. IDT NETHERLANDS, B.V. (PUERTO RICO BRANCH), SAN JUAN, PUERTO RICO. SN 78-118,890. PUB. 11-5-2002, FILED 4-2-2002.

**SANCOCHO**

THE ENGLISH TRANSLATION OF THE WORD "SANCOCHO" IN THE MARK IS "A THICK PUERTO RICAN OR SPANISH SOUP".

FOR PREPAID CALLING CARD AND DEBIT CARD SERVICES (U.S. CLS. 100, 101 AND 102).

FIRST USE 3-1-2002; IN COMMERCE 3-1-2002.

2,900,615. SAFECO CORPORATION, SEATTLE, WA. SN 78-148,391. PUB. 2-17-2004, FILED 7-29-2002.

**UNCOMPLICATE**

OWNER OF U.S. REG. NOS. 1,057,198 AND 2,258,125.

FOR INSURANCE AND FINANCIAL SERVICES, NAMELY, UNDERWRITING OF PROPERTY, CASUALTY, LIFE, HEALTH AND ACCIDENT INSURANCE; BUSINESS LOAN FINANCING SERVICES; ANNUITY INVESTMENTS; MUTUAL FUND INVESTMENTS AND FINANCIAL ASSET MANAGEMENT (U.S. CLS. 100, 101 AND 102).

FIRST USE 2-12-2003; IN COMMERCE 9-6-2003.

2,900,668. CELINA INSURANCE GROUP, CELINA, OH. SN 78-194,742. PUB. 4-20-2004, FILED 12-16-2002.

**celina**  
INSURANCE GROUP

NO CLAIM IS MADE TO THE EXCLUSIVE RIGHT TO USE "CELINA INSURANCE GROUP", APART FROM THE MARK AS SHOWN.

THE MARK CONSISTS OF "CELINA INSURANCE GROUP" AND A HIGHLY STYLIZED LEAF DESIGN.

FOR PROPERTY CASUALTY INSURANCE SERVICES (U.S. CLS. 100, 101 AND 102).

FIRST USE 9-1-2003; IN COMMERCE 9-1-2003.

2,900,697. THE INDEPENDENT SAVINGS PLAN COMPANY, TAMPA, FL. SN 78-203,697. PUB. 11-25-2003, FILED 1-15-2003.

**991**

FOR LOAN FINANCING (U.S. CLS. 100, 101 AND 102).  
FIRST USE 10-0-1996; IN COMMERCE 7-0-2003.

**CLASS 36—(Continued).**

2,900,719. FMR CORP., BOSTON, MA. SN 78-218,982. PUB. 10-7-2003, FILED 2-26-2003.

**FMR**

FOR INVESTMENT MANAGEMENT SERVICES; INVESTMENT OF FUNDS FOR OTHERS (U.S. CLS. 100, 101 AND 102).

FIRST USE 5-0-2003; IN COMMERCE 5-0-2003.

2,900,764. WAYNE HUMMER INVESTMENTS, L.L.C., CHICAGO, IL. SN 78-232,641. PUB. 12-2-2003, FILED 4-1-2003.

**COMPLETE MONEY ACCESS ACCOUNT**

NO CLAIM IS MADE TO THE EXCLUSIVE RIGHT TO USE "MONEY ACCESS ACCOUNT", APART FROM THE MARK AS SHOWN.

FOR MONEY MANAGEMENT SERVICES (U.S. CLS. 100, 101 AND 102).

FIRST USE 7-0-2003; IN COMMERCE 7-0-2003.

2,900,785. BANK OF AMERICA CORPORATION, CHARLOTTE, NC. SN 78-238,308. PUB. 11-18-2003, FILED 4-16-2003.

**STUFF HAPPENS**

FOR BANKING AND RELATED FINANCIAL SERVICES (U.S. CLS. 100, 101 AND 102).

FIRST USE 6-2-2003; IN COMMERCE 6-2-2003.

2,900,800. AMERICAN LEBANESE SYRIAN ASSOCIATED CHARITIES, INC., MEMPHIS, TN. SN 78-246,858. PUB. 2-17-2004, FILED 5-7-2003.

**RUNWAY FOR LIFE**

FOR CHARITABLE FUND-RAISING SERVICES (U.S. CLS. 100, 101 AND 102).

FIRST USE 5-11-2002; IN COMMERCE 5-11-2002.

2,900,808. MCAVOY, ROBERT, W., SALEM, NH. SN 78-251,201. PUB. 4-6-2004, FILED 5-17-2003.

**MORTGAGEALL EXPRESS**

FOR MORTGAGE LENDING SERVICES FOR RESIDENTIAL AND COMMERCIAL BORROWERS (U.S. CLS. 100, 101 AND 102).

FIRST USE 7-25-2003; IN COMMERCE 12-14-2003.

**CLASS 36—(Continued).**

2,900,811. WELLS FARGO & COMPANY, MINNEAPOLIS, MN. SN 78-252,997. PUB. 2-10-2004, FILED 5-22-2003.

**WELLS FARGO SMARTPAY HOME FINANCING PLUS**

NO CLAIM IS MADE TO THE EXCLUSIVE RIGHT TO USE "HOME FINANCING", APART FROM THE MARK AS SHOWN.

FOR FINANCIAL SERVICES, NAMELY, MORTGAGE LOAN SERVICES, HOME EQUITY FINANCING AND REVOLVING LINES OF CREDIT (U.S. CLS. 100, 101 AND 102).

FIRST USE 7-7-2003; IN COMMERCE 7-7-2003.

2,900,812. WELLS FARGO & COMPANY, MINNEAPOLIS, MN. SN 78-253,007. PUB. 10-14-2003, FILED 5-22-2003.

**WELLS FARGO SMARTPAY HOME FINANCING**

OWNER OF U.S. REG. NOS. 779,187, 2,433,473, AND OTHERS.

NO CLAIM IS MADE TO THE EXCLUSIVE RIGHT TO USE "HOME FINANCING", APART FROM THE MARK AS SHOWN.

FOR FINANCIAL SERVICES, NAMELY, MORTGAGE LOAN SERVICES, HOME EQUITY FINANCING AND REVOLVING LINES OF CREDIT (U.S. CLS. 100, 101 AND 102).

FIRST USE 7-7-2003; IN COMMERCE 7-7-2003.

2,900,814. BANK OF AMERICA CORPORATION, CHARLOTTE, NC. SN 78-254,426. PUB. 12-30-2003, FILED 5-27-2003.

**CAMPUSEDGE**

FOR BANKING AND RELATED FINANCIAL SERVICES (U.S. CLS. 100, 101 AND 102).

FIRST USE 6-2-2003; IN COMMERCE 6-2-2003.

**CLASS 37—CONSTRUCTION AND REPAIR**

2,900,170. B-DRY SYSTEMS, INC., AKRON, OH. SN 76-292,851. PUB. 8-27-2002, FILED 7-31-2001.

**AQUAJETS**

FOR BASEMENT WATERPROOFING AND GUTTER-CLEANING SERVICES (U.S. CLS. 100, 103 AND 106).

FIRST USE 4-1-2000; IN COMMERCE 4-1-2000.

**CLASS 37—(Continued).**

2,900,248. CASUALTY CONTRATORS, INC., ANDERSON, SC. SN 76-395,040. PUB. 3-16-2004, FILED 4-11-2002.

  
**casualtycontractors**.inc.

NO CLAIM IS MADE TO THE EXCLUSIVE RIGHT TO USE "INC.", APART FROM THE MARK AS SHOWN. FOR RESTORATION CONSTRUCTION OF BUILDINGS AND HOMES (U.S. CLS. 100, 103 AND 106). FIRST USE 6-15-2000; IN COMMERCE 6-15-2000.

**CLASS 37—(Continued).**

2,900,473. HYPHEN SOLUTIONS, LTD., ADDISON, TX. SN 76-515,591. PUB. 1-27-2004, FILED 5-20-2003.

**HYPHEN SUPPLY**

NO CLAIM IS MADE TO THE EXCLUSIVE RIGHT TO USE "SUPPLY", APART FROM THE MARK AS SHOWN. FOR COMPUTER SERVICES, NAMELY, PROVIDING DATABASES FEATURING INFORMATION OF INTEREST TO RESIDENTIAL HOME BUILDERS AND IMPROVEMENT CONTRACTORS ENABLING THEM TO MANAGE CONSTRUCTION WORKFLOW AND SUPPLY SCHEDULES FOR CONSTRUCTION MATERIALS (U.S. CLS. 100, 103 AND 106). FIRST USE 6-18-2003; IN COMMERCE 6-18-2003.

2,900,341. TRANSEASTERN PROPERTIES, INC., CORAL SPRINGS, FL. SN 76-456,333. PUB. 6-17-2003, FILED 9-27-2002.

**THE SPIRIT OF AMERICA  
LIVES HERE**

FOR REAL ESTATE DEVELOPMENT SERVICES, NAMELY DEVELOPING A PLANNED COMMUNITY; HOMEBUILDING SERVICES; PLANNING AND LAYING OUT OF RESIDENTIAL COMMUNITIES; PLANNED COMMUNITY DEVELOPMENT SERVICES, NAMELY, PLANNING AND LAYING OUT OF RESIDENTIAL COMMUNITIES; LAND DEVELOPMENT SERVICES, NAMELY, CONSTRUCTION OF A PLANNED COMMUNITY DEVELOPMENT (U.S. CLS. 100, 103 AND 106). FIRST USE 6-25-2004; IN COMMERCE 6-25-2004.

2,900,543. HUGHES ENTERPRISES INC., BLOOMINGTON, MN. SN 78-046,284. PUB. 5-7-2002, FILED 2-2-2001.

**MODERN GARAGE**

NO CLAIM IS MADE TO THE EXCLUSIVE RIGHT TO USE "GARAGE", APART FROM THE MARK AS SHOWN. FOR CONSTRUCTION, REPAIR AND REMODELING OF GARAGES; INSTALLATION OF GARAGE STORAGE UNITS, NAMELY, SHELVING (U.S. CLS. 100, 103 AND 106). FIRST USE 6-15-2004; IN COMMERCE 6-15-2004.

2,900,386. CALIDAD AUTO TECH, INC., SAYLORSBURG, PA. SN 76-479,483. PUB. 5-27-2003, FILED 12-30-2002.

**COUNTER-INTELLIGENCE**

FOR AUTOMOBILE REPAIR AND MAINTENANCE (U.S. CLS. 100, 103 AND 106). FIRST USE 1-1-2004; IN COMMERCE 1-1-2004.

2,900,576. BARUH, BARRY F, DANVILLE, CA. SN 78-115,718. PUB. 11-26-2002, FILED 3-18-2002.

**GROUT WIZARD**

NO CLAIM IS MADE TO THE EXCLUSIVE RIGHT TO USE "GROUT", APART FROM THE MARK AS SHOWN. FOR GROUT CLEANING AND RESTORATION SERVICES (U.S. CLS. 100, 103 AND 106). FIRST USE 4-1-2002; IN COMMERCE 4-1-2002.

2,900,403. THE WILLS GROUP, INC., LAPLATA, MD. SN 76-488,646. PUB. 9-30-2003, FILED 2-10-2003.

**DASH IN CLEAN**

NO CLAIM IS MADE TO THE EXCLUSIVE RIGHT TO USE "CLEAN", APART FROM THE MARK AS SHOWN. FOR CAR WASH SERVICES (U.S. CLS. 100, 103 AND 106). FIRST USE 5-27-2004; IN COMMERCE 5-27-2004.

2,900,655. OUTRAGEOUSLY VINTAGE, INC., SEARSMONT, ME. SN 78-174,663. PUB. 12-9-2003, FILED 10-15-2002.

**OUTRAGEOUSLY VINTAGE**

NO CLAIM IS MADE TO THE EXCLUSIVE RIGHT TO USE "VINTAGE", APART FROM THE MARK AS SHOWN. FOR REPAIR, REBUILD, AND INSTALLATION OF MOTOR VEHICLE ENGINES (U.S. CLS. 100, 103 AND 106). FIRST USE 3-1-2003; IN COMMERCE 3-1-2003.

**CLASS 37—(Continued).**

2,900,790. NISOURCE CORPORATE SERVICES COMPANY, MERRILLVILLE, IN. SN 78-240,060. PUB. 12-2-2003, FILED 4-21-2003.

**KNOW HOW NO WORRIES**

FOR REPAIR SERVICES FOR FURNACES, WATER HEATERS AND AIR CONDITIONERS; REPAIR SERVICES FOR ELECTRICAL WIRING; AND REPAIR SERVICES FOR NATURAL GAS LINES (U.S. CLS. 100, 103 AND 106).

FIRST USE 1-1-2004; IN COMMERCE 1-1-2004.

---

2,900,794. MILLER, PAUL, HARTVILLE, OH. SN 78-242,247. PUB. 2-10-2004, FILED 4-25-2003.

**SWAP A TOP**

FOR INSTALLMENT OF REPLACEMENT COUNTER-TOPS FOR KITCHENS AND BATHROOMS (U.S. CLS. 100, 103 AND 106).

FIRST USE 10-1-2003; IN COMMERCE 10-1-2003.

---

2,900,798. MAX-VIZ, INC., PORTLAND, OR. SN 78-244,579. PUB. 11-25-2003, FILED 5-1-2003.



The logo for MAX VIZ features the word "MAX" in a bold, sans-serif font, followed by a stylized graphic of a curved line above a dot, and then the word "VIZ" in the same bold, sans-serif font.

FOR INSTALLATION, REFURBISHING AND REPAIR OF ENHANCED VISION SYSTEMS (U.S. CLS. 100, 103 AND 106).

FIRST USE 2-26-2004; IN COMMERCE 2-26-2004.

---

2,900,799. HALLIBURTON ENERGY SERVICES, INC., CARROLLTON, TX. SN 78-246,016. PUB. 1-13-2004, FILED 5-6-2003.

**FULLCIRCLE**

FOR ENVIRONMENTAL REMEDIATION SERVICES FOR OIL AND GAS WELLS, NAMELY, WASTE DISPOSAL OF CUTTING INJECTIONS FOR HOLE-CLEANING (U.S. CLS. 100, 103 AND 106).

FIRST USE 7-31-2003; IN COMMERCE 7-31-2003.

---

**CLASS 38—COMMUNICATION****CLASS 38—(Continued).**

2,900,121. AMERICA ONLINE, INC., DULLES, VA. SN 76-122,124. PUB. 11-19-2002, FILED 9-6-2000.

**CITIZEN2CITIZEN**

FOR TELECOMMUNICATIONS SERVICES, NAMELY, PROVIDING MULTIPLE-USER ACCESS TO COMPUTER NETWORKS; ELECTRONIC TRANSMISSION OF DATA, SOUNDS, IMAGES AND DOCUMENTS VIA COMPUTER NETWORKS; ELECTRONIC MAIL SERVICES; PROVIDING ONLINE ELECTRONIC BULLETIN BOARDS AND CHAT-ROOMS FOR TRANSMISSION OF MESSAGES AMONG COMPUTER USERS CONCERNING PUBLIC AFFAIRS AND GOVERNMENT ISSUES, SERVICES, AND RESOURCES (U.S. CLS. 100, 101 AND 104).

FIRST USE 12-18-2001; IN COMMERCE 12-18-2001.

---

2,900,220. SALEM COMMUNICATIONS HOLDING CORPORATION, CAMARILLO, CA. SN 76-368,775. PUB. 10-28-2003, FILED 2-8-2002.

**FAMILYTALK**

FOR RADIO BROADCASTING SERVICES (U.S. CLS. 100, 101 AND 104).

FIRST USE 9-12-2001; IN COMMERCE 9-12-2001.

---

2,900,318. THE SPOKEN HUB L.L.C., NEW YORK, NY. SN 76-448,070. PUB. 4-29-2003, FILED 9-9-2002.

**SPOKENOTE**

FOR TELECOMMUNICATION SERVICES, NAMELY, CONVERSION AND TRANSMISSION OF EMAILS TO VOICEMAILS AND VOICE MESSAGES (U.S. CLS. 100, 101 AND 104).

FIRST USE 7-1-2004; IN COMMERCE 7-1-2004.

---

2,900,340. ACX, LLC, ALEXANDRIA, VA. SN 76-455,221. PUB. 4-15-2003, FILED 9-30-2002.

**CALLREACH**

FOR TELECOMMUNICATION SERVICES, NAMELY, PROVIDING LOCAL AND LONG DISTANCE TELEPHONE SERVICES; PROVIDING ELECTRONIC VOICE, VOICE MAIL, FACSIMILE AND DATA TRANSMISSION, AND ELECTRONIC MAIL; PROVIDING TELEPHONIC ROUTING SERVICES, NAMELY ACTIVATING CALL FORWARDING FROM TELEPHONE TO TELEPHONE; PROVIDING COMMUNICATION CONNECTIONS FOR THE TRANSMISSION OF VOICE, ELECTRONIC MAIL AND DATA BY LINKING USERS VIA FACSIMILES AND TELEPHONES AND A GLOBAL COMPUTER NETWORK; PROVIDING ELECTRONIC DATA INTERCHANGE SERVICES (U.S. CLS. 100, 101 AND 104).

FIRST USE 2-24-2002; IN COMMERCE 7-6-2004.

**CLASS 38—(Continued).**

2,900,348. ITC DELTACOM COMMUNICATIONS, INC., HUNTSVILLE, AL. SN 76-463,527. PUB. 4-22-2003, FILED 11-1-2002.

**EVERYBODY'S TALKING**

FOR LOCAL AND LONG DISTANCE TELEPHONE SERVICES; PROVIDING MULTIPLE USER DIAL-UP AND DEDICATED ACCESS TO THE INTERNET (U.S. CLS. 100, 101 AND 104).

FIRST USE 1-1-2003; IN COMMERCE 1-1-2003.

2,900,392. SPANISH BROADCASTING SYSTEM, INC., CONUT GROVE, FL. SN 76-482,372. PUB. 12-2-2003, FILED S.R. 1-14-2003; AM. P.R. 7-22-2004.

**LA NUEVA ONDA DE CHICAGO**

NO CLAIM IS MADE TO THE EXCLUSIVE RIGHT TO USE "CHICAGO", APART FROM THE MARK AS SHOWN.

THE ENGLISH TRANSLATION OF THE SPANISH WORDS "LA NUEVA ONDA DE CHICAGO" IS "THE NEW GROOVE OF CHICAGO".

FOR RADIO BROADCASTING SERVICES (U.S. CLS. 100, 101 AND 104).

FIRST USE 1-6-2003; IN COMMERCE 1-6-2003.

2,900,413. PANAMSAT CORPORATION, WILTON, CT. SN 76-490,362. PUB. 10-21-2003, FILED 2-12-2003.

**G2 SATELLITE SOLUTIONS**

NO CLAIM IS MADE TO THE EXCLUSIVE RIGHT TO USE "SATELLITE", APART FROM THE MARK AS SHOWN.

FOR SATELLITE COMMUNICATION SERVICES (U.S. CLS. 100, 101 AND 104).

FIRST USE 3-0-2003; IN COMMERCE 3-0-2003.

2,900,566. NEW ORLEANS HORNETS NBA LIMITED PARTNERSHIP, A N.C. LIMITED PARTNERSHIP, NEW ORLEANS, LA. SN 78-104,925. PUB. 10-15-2002, FILED 1-25-2002.

**NEW ORLEANS HORNETS**

OWNER OF U.S. REG. NOS. 1,649,730, 2,195,363, AND OTHERS.

NO CLAIM IS MADE TO THE EXCLUSIVE RIGHT TO USE "NEW ORLEANS", APART FROM THE MARK AS SHOWN.

FOR WEBCASTING SERVICES IN THE NATURE OF PROVIDING ON-LINE CHAT ROOMS AND ON-LINE INTERACTIVE CHAT ROOMS WITH GUESTS FOR TRANSMISSION OF MESSAGES AMONG COMPUTER USERS CONCERNING THE FIELD OF BASKETBALL; BROADCASTING PROGRAMS OVER THE INTERNET; PROVIDING ON-LINE ELECTRONIC BULLETIN BOARDS FOR TRANSMISSION OF MESSAGES AMONG COMPUTER USERS CONCERNING THE FIELD OF BASKETBALL (U.S. CLS. 100, 101 AND 104).

FIRST USE 10-10-2002; IN COMMERCE 10-10-2002.

**CLASS 38—(Continued).**

2,900,703. CAPITALSOURCE FINANCE LLC, CHEVY CHASE, MD. SN 78-212,337. PUB. 11-4-2003, FILED 2-7-2003.



FOR TELECOMMUNICATION SERVICES, NAMELY LOCAL AND CELLULAR TELEPHONE SERVICES AND PAGING SERVICES (U.S. CLS. 100, 101 AND 104).

FIRST USE 11-1-2001; IN COMMERCE 11-1-2001.

2,900,834. WORLD PICKS LLC, BETHPAGE, NY. SN 78-264,753. PUB. 3-2-2004, FILED 6-19-2003.

**WORLD PICKS**

FOR VIDEO ON DEMAND TRANSMISSION SERVICES (U.S. CLS. 100, 101 AND 104).

FIRST USE 7-15-2003; IN COMMERCE 7-15-2003.

2,900,838. EVERYCALL COMMUNICATIONS, INC., BATON ROUGE, LA. SN 78-268,860. PUB. 3-9-2004, FILED 6-30-2003.

**LOCALUSA**

FOR TELEPHONE VOICE AND DATA COMMUNICATIONS SERVICES (U.S. CLS. 100, 101 AND 104).

FIRST USE 5-15-2004; IN COMMERCE 5-15-2004.

**CLASS 39—TRANSPORTATION AND STORAGE**

**CLASS 39—(Continued).**

2,900,552. FEED MEALS CORP., COCONUT GROVE, FL. SN 78-076,729. PUB. 7-2-2002, FILED 7-31-2001.



NO CLAIM IS MADE TO THE EXCLUSIVE RIGHT TO USE "MEALS", APART FROM THE MARK AS SHOWN. FOR FOOD DELIVERY (U.S. CLS. 100 AND 105). FIRST USE 2-15-2003; IN COMMERCE 8-15-2003.

2,900,584. NURIDE, INC., HERNDON, VA. SN 78-119,389. PUB. 11-5-2002, FILED 4-3-2002.

**NURIDE**

FOR PROVIDING TRANSPORTATION SYSTEM INFORMATION VIA THE INTERNET, NAMELY, PROVIDING INDIVIDUALS WITH REAL-TIME TRANSPORTATION INFORMATION CONCERNING RIDESHARE ARRANGEMENTS (U.S. CLS. 100 AND 105). FIRST USE 11-1-2002; IN COMMERCE 9-3-2003.

2,900,585. NURIDE, INC., HERNDON, VA. SN 78-119,414. PUB. 11-12-2002, FILED 4-3-2002.

**NURIDE MILES**

NO CLAIM IS MADE TO THE EXCLUSIVE RIGHT TO USE "MILES", APART FROM THE MARK AS SHOWN.

FOR TRANSPORTATION SERVICES, NAMELY, PROVIDING AN AWARD PROGRAM FOR USERS OF A RIDESHARING PROGRAM, NAMELY, PROVIDING CREDITS BASED ON ACCUMULATED MILES TRAVELED OR TRIPS TAKEN BY PROGRAM PARTICIPANTS (U.S. CLS. 100 AND 105). FIRST USE 11-1-2002; IN COMMERCE 9-3-2003.

**CLASS 39—(Continued).**

2,900,821. UNITED AIR LINES, INC., CHICAGO, IL. SN 78-259,358. PUB. 4-13-2004, FILED 6-6-2003.

**EASYSCHEDULE**

OWNER OF U.S. REG. NOS. 2,582,169, 2,582,170, AND 2,659,338.

FOR TRANSPORTATION INFORMATION SERVICES, NAMELY, PROVIDING AIRLINE FLIGHT INFORMATION OVER A GLOBAL COMMUNICATION NETWORK (U.S. CLS. 100 AND 105).

FIRST USE 8-15-2003; IN COMMERCE 8-15-2003.

**CLASS 40—MATERIAL TREATMENT**

2,900,550. PHARMACIA & UPJOHN COMPANY, PEAPACK, NJ. SN 78-070,062. PUB. 10-23-2001, FILED 6-20-2001.

**CENTRESOURCE**

FOR CONTRACT MANUFACTURING SERVICES (U.S. CLS. 100, 103 AND 106).

FIRST USE 8-15-2001; IN COMMERCE 8-15-2001.

2,900,567. L.W. MILBY, INC., NEW CARLISLE, OH. SN 78-105,761. PUB. 12-17-2002, FILED 1-30-2002.

**ARROWHEAD SOLUTIONS**

*A Wholly-Owned Company of L.W. Milby, Inc.*

NO CLAIM IS MADE TO THE EXCLUSIVE RIGHT TO USE "A WHOLLY-OWNED COMPANY OF L.W. MILBY, INC.", APART FROM THE MARK AS SHOWN.

FOR CUSTOM MANUFACTURE OF EXHIBITS FOR TRADESHOWS, MUSEUMS, CORPORATE LOBBIES, AND VISITOR CENTERS (U.S. CLS. 100, 103 AND 106).

FIRST USE 1-1-2002; IN COMMERCE 1-30-2002.



**CLASS 40—(Continued).**

2,900,617. AVURE TECHNOLOGIES INCORPORATED, KENT, WA. SN 78-149,013. PUB. 3-18-2003, FILED 7-30-2002.



FOR FOOD PROCESSING SERVICES; STERILIZATION SERVICES IN THE FIELD OF FOOD; LEASING OF FOOD PROCESSING AND STERILIZATION EQUIPMENT (U.S. CLS. 100, 103 AND 106).  
FIRST USE 11-0-2002; IN COMMERCE 11-0-2002.

**CLASS 41—EDUCATION AND ENTERTAINMENT**

2,900,048. INCONTACT SYSTEMS, INC., SAN DIEGO, CA. SN 75-625,159. PUB. 12-23-2003, FILED 1-22-1999.

**MENTORU**

FOR MOTIVATIONAL TRAINING SESSIONS, SEMINARS, COURSES, AND WORKSHOPS, DELIVERED IN PERSON, OR BY ELECTRONIC MEDIA, NAMELY, BY RADIO, TELEVISION AND VIA GLOBAL COMPUTER INFORMATION NETWORKS, IN THE FIELDS OF SALES AND MARKETING, LEADERSHIP, CUSTOMER SERVICE, COMMUNICATION, BUSINESS SKILLS, PERSONAL GROWTH, TECHNOLOGY, AND PRESENTATIONS (U.S. CLS. 100, 101 AND 107).  
FIRST USE 9-0-1999; IN COMMERCE 9-0-1999.

2,900,058. HOLLYWOOD MEDIA CORP., BOCA RATON, FL. SN 75-739,067. PUB. 5-15-2001, FILED 6-29-1999.

**WHERE MOVIEGOERS GO**

FOR ENTERTAINMENT SERVICES, NAMELY, PROVIDING ENTERTAINMENT INFORMATION AND AUDIOVISUAL WORKS BY MEANS OF AN INTERACTIVE GLOBAL COMPUTER NETWORK (U.S. CLS. 100, 101 AND 107).  
FIRST USE 7-28-2004; IN COMMERCE 7-28-2004.

**CLASS 41—(Continued).**

2,900,061. REALNETWORKS, INC., SEATTLE, WA. SN 75-780,524. PUB. 4-29-2003, FILED 9-16-1999.

**REAL**

FOR COMPUTER ENTERTAINMENT SERVICES, NAMELY, PROVIDING INFORMATION, PICTURES, VIDEO, TEXT AND/OR AUDIO MATERIAL RELATED TO MUSIC, COMEDY, MOTION PICTURE FILMS, POLITICAL DISCUSSION, CULTURAL EVENTS, BOOKS, TELEVISION, GAMES AND SPORTS OVER LOCAL AND GLOBAL INFORMATION NETWORKS (U.S. CLS. 100, 101 AND 107).  
FIRST USE 12-24-1996; IN COMMERCE 12-24-1996.

2,900,074. HANSARD, JERRY DWIGHT, MARION, AR. SN 75-869,185. PUB. 3-6-2001, FILED 12-10-1999.

**THE CIRCLE G RANCH**

FOR ENTERTAINMENT AND EDUCATION SERVICES, NAMELY, MUSEUM SERVICES AND PROVIDING WORKSHOPS AND SEMINARS IN THE FIELD OF ARTS AND MUSIC (U.S. CLS. 100, 101 AND 107).  
FIRST USE 5-15-2004; IN COMMERCE 5-15-2004.

2,900,100. EX LIBRIS (USA) INC., CHICAGO, IL. SN 76-064,691. PUB. 12-4-2001, FILED 6-7-2000.

**METAINDEX**

FOR RESEARCH SERVICES, NAMELY PROVIDING SERVICES IN THE NATURE OF EDUCATIONAL RESEARCH TO OTHERS TO RESEARCH AND LOCATE LIBRARY SERVICES AND MATERIALS NAMELY, BOOKS, PERIODICALS AND NEWSPAPERS VIA A WEB SITE (U.S. CLS. 100, 101 AND 107).  
FIRST USE 7-0-2004; IN COMMERCE 7-0-2004.

2,900,120. HOTEL AND LEISURE LIVING SERVICES, LTD., PORT PERRY, L9L 1B3 ONTARIO, CANADA. SN 76-122,012. PUB. 12-9-2003, FILED 9-5-2000.

**HOTEL FUN 4 KIDS**

PRIORITY CLAIMED UNDER SEC. 44(D) ON CANADA APPLICATION NO. 1049522, FILED 3-6-2000, REG. NO. TMA572321, DATED 12-16-2002, EXPIRES 12-16-2017.  
NO CLAIM IS MADE TO THE EXCLUSIVE RIGHT TO USE "HOTEL", APART FROM THE MARK AS SHOWN.  
FOR CONSULTING SERVICES FOR THE HOTEL, TRAVEL AND RESORT INDUSTRY, NAMELY, PROVIDING ASSISTANCE IN DEVELOPING PROGRAMS FOR PLAY ACTIVITIES FOR CHILDREN TRAVELING WITH THEIR PARENTS (U.S. CLS. 100, 101 AND 107).  
FIRST USE 2-16-2000; IN COMMERCE 2-16-2000.

**CLASS 41—(Continued).**

2,900,129. MEAGAN MEDICAL, INC., RENO, NV. SN 76-146,481. PUB. 11-13-2001, FILED 10-13-2000.



NO CLAIM IS MADE TO THE EXCLUSIVE RIGHT TO USE "NEUROSCIENCE", APART FROM THE MARK AS SHOWN.

FOR TRAINING IN THE USE OF MEDICAL DEVICES AND ACCESSORIES IN THE NATURE OF A SYSTEM COMPRISED OF ELECTRICAL STIMULATION GENERATORS, MEDICAL ELECTRODES, MEDICAL ELECTRODE APPLICATORS AND ELECTRODE CABLES (U.S. CLS. 100, 101 AND 107).

FIRST USE 3-31-2002; IN COMMERCE 3-31-2002.

2,900,132. AEROBICS AND FITNESS ASSOCIATION OF AMERICA, SHERMAN OAKS, CA. SN 76-158,316. PUB. 5-22-2001, FILED 11-1-2000.

## WELLNESS GETS PERSONAL

OWNER OF U.S. REG. NOS. 2,165,261, 2,165,262, AND 2,165,355.

NO CLAIM IS MADE TO THE EXCLUSIVE RIGHT TO USE "WELLNESS", APART FROM THE MARK AS SHOWN.

FOR EDUCATIONAL SERVICES AND TRAINING PROGRAMS, NAMELY, PROVIDING SEMINARS AND WORKSHOPS IN THE FIELD OF HEALTH, NUTRITION, FITNESS, EXERCISE, AND PERSONAL WELL-BEING, AND DISTRIBUTING COURSE MATERIALS IN CONNECTION THEREWITH (U.S. CLS. 100, 101 AND 107).

FIRST USE 8-13-2004; IN COMMERCE 8-13-2004.

2,900,176. EVANS & SUTHERLAND COMPUTER CORPORATION, SALT LAKE CITY, UT. SN 76-299,944. PUB. 4-22-2003, FILED 8-14-2001.

## SIM TECH

NO CLAIM IS MADE TO THE EXCLUSIVE RIGHT TO USE "TECH", APART FROM THE MARK AS SHOWN.

FOR EDUCATIONAL SERVICES, NAMELY COURSES ON THE SUBJECT OF COMPUTER SIMULATION FOR ENGINEERS AND TECHNICIANS WHO OPERATE AND MAINTAIN SIMULATION HARDWARE AND SOFTWARE COMPONENTS (U.S. CLS. 100, 101 AND 107).

FIRST USE 3-0-2001; IN COMMERCE 3-0-2001.

**CLASS 41—(Continued).**

2,900,188. MARBLE SLAB CREAMERY, INC., HOUSTON, TX. SN 76-318,693. PUB. 10-22-2002, FILED 9-27-2001.

## SLABBY

FOR ENTERTAINMENT SERVICES IN THE FORM OF PERSONAL APPEARANCES BY A MASCOT TO PROMOTE THE RESTAURANT SERVICES OF OTHERS (U.S. CLS. 100, 101 AND 107).

FIRST USE 11-1-1999; IN COMMERCE 11-1-1999.

2,900,202. NATIONAL HOCKEY LEAGUE, NEW YORK, NY. SN 76-341,868. PUB. 5-28-2002, FILED 11-26-2001.

## WORLD CUP OF HOCKEY

OWNER OF U.S. REG. NO. 2,269,322.

NO CLAIM IS MADE TO THE EXCLUSIVE RIGHT TO USE "HOCKEY", APART FROM THE MARK AS SHOWN.

FOR ENTERTAINMENT SERVICES, NAMELY HOCKEY CONTESTS IN A TOURNAMENT FORMAT (U.S. CLS. 100, 101 AND 107).

FIRST USE 6-30-1996; IN COMMERCE 6-30-1996.

2,900,224. SIDDLE, BRUCE, BELLEVILLE, IL. SN 76-369,864. PUB. 4-22-2003, FILED 2-12-2002.

## WARRIOR SCIENCE

NO CLAIM IS MADE TO THE EXCLUSIVE RIGHT TO USE "SCIENCE", APART FROM THE MARK AS SHOWN.

FOR EDUCATIONAL SERVICES, NAMELY, CONDUCTING SEMINARS AND CONFERENCES IN THE FIELD OF MILITARY AND CRIMINAL JUSTICE TRAINING TO TEACH, TRAIN, INSTRUCT AND PROVIDE USEFUL INFORMATION TO MILITARY AND CRIMINAL JUSTICE PERSONNEL AND TO TRAIN INSTRUCTORS TO PROVIDE SUCH EDUCATIONAL SERVICES AND DISTRIBUTING COURSE MATERIALS IN CONNECTION THEREWITH (U.S. CLS. 100, 101 AND 107).

FIRST USE 8-0-2000; IN COMMERCE 8-0-2000.

2,900,226. TARYN MANNING AND KELLIN MANNING, PARTNERSHIP, THE, DBA BOOMKAT, LOS ANGELES, CA. SN 76-370,825. PUB. 12-17-2002, FILED 2-13-2002.

## BOOMKAT

FOR ENTERTAINMENT SERVICES, NAMELY, LIVE AND RECORDED PERFORMANCES BY A MUSICAL GROUP (U.S. CLS. 100, 101 AND 107).

FIRST USE 6-1-2001; IN COMMERCE 6-1-2001.

**CLASS 41—(Continued).**

2,900,244. MAPS AIR MUSEUM, NORTH CANTON, OH. SN 76-392,176. PUB. 11-11-2003, FILED 4-5-2002.



NO CLAIM IS MADE TO THE EXCLUSIVE RIGHT TO USE "AIR MUSEUM", APART FROM THE MARK AS SHOWN.

FOR EDUCATIONAL SERVICES IN THE NATURE OF THE MUSEUM DEDICATED TO AND FEATURING THE HISTORY AND STUDY OF MILITARY AVIATION (U.S. CLS. 100, 101 AND 107).

FIRST USE 8-1-2002; IN COMMERCE 8-1-2002.

2,900,245. VOTE FOR AMERICA, INC., WASHINGTON, DC. SN 76-393,517. PUB. 12-2-2003, FILED 4-9-2002.



NO CLAIM IS MADE TO THE EXCLUSIVE RIGHT TO USE "AMERICA", APART FROM THE MARK AS SHOWN.

FOR EDUCATIONAL SERVICES DEDICATED TO ENCOURAGING PEOPLE TO VOTE, NAMELY, PROVIDING SEMINARS AND WORKSHOPS DESIGNED TO PREPARE CITIZENS TO SPEAK IN A NON-PARTISAN MANNER ABOUT POLITICAL ISSUES, ELECTION ISSUES AND OFFICES ON THE BALLOT AND TO ENCOURAGE CITIZENS TO VOTE (U.S. CLS. 100, 101 AND 107).

FIRST USE 1-1-2004; IN COMMERCE 1-1-2004.

**CLASS 41—(Continued).**

2,900,337. MINISTERIO INTERNACIONAL EL REY JESUS, INC., MIAMI, FL. SN 76-455,205. PUB. 5-13-2003, FILED 9-30-2002.



NO CLAIM IS MADE TO THE EXCLUSIVE RIGHT TO USE "MINISTERIO INTERNACIONAL" OR "JESUS", APART FROM THE MARK AS SHOWN.

"MINISTERIO INTERNACIONAL EL REY JESUS" MEANS "KING JESUS INTERNATIONAL MINISTRY" IN SPANISH.

FOR EDUCATIONAL SERVICES, NAMELY SPONSORING, HOSTING AND CONDUCTING SEMINARS, CLASSES, SUNDAY SCHOOL CLASSES AND COURSES ON INSTRUCTION ON RELIGION, BIBLE STUDY, CHRISTIAN WORSHIP, EVANGELISM AND MUSIC, AND FOR PRODUCTION AND DISTRIBUTION OF LIVE AND PRE-RECORDED RADIO AND TELEVISION BROADCASTS FEATURING WORSHIP SERVICES, SERMONS, RELIGIOUS MUSIC AND CHRISTIAN EDUCATIONAL INSTRUCTION (U.S. CLS. 100, 101 AND 107).

FIRST USE 10-23-2003; IN COMMERCE 10-23-2003.

2,900,339. MINISTERIO INTERNACIONAL EL REY JESUS, INC., MIAMI, FL. SN 76-455,208. PUB. 5-13-2003, FILED 9-30-2002.

## MINISTERIO INTERNACIONAL EL REY JESUS

NO CLAIM IS MADE TO THE EXCLUSIVE RIGHT TO USE "MINISTERIO INTERNACIONAL" OR "JESUS", APART FROM THE MARK AS SHOWN.

"MINISTERIO INTERNACIONAL EL REY JESUS" MEANS "KING JESUS INTERNATIONAL MINISTRY" IN SPANISH.

FOR EDUCATIONAL SERVICES, NAMELY SPONSORING, HOSTING AND CONDUCTING SEMINARS, CLASSES, SUNDAY SCHOOL CLASSES AND COURSES OF INSTRUCTION ON RELIGION, BIBLE STUDY, CHRISTIAN WORSHIP, EVANGELISM AND MUSIC; AND FOR PRODUCTION AND DISTRIBUTION OF LIVE AND PRE-RECORDED RADIO AND TELEVISION BROADCASTS FEATURING WORSHIP SERVICES, SERMONS, RELIGIOUS MUSIC AND CHRISTIAN EDUCATIONAL INSTRUCTION (U.S. CLS. 100, 101 AND 107).

FIRST USE 10-23-2003; IN COMMERCE 10-23-2003.

**CLASS 41—(Continued).**

2,900,342. OAKLAND COMMUNITY COLLEGE, BLOOMFIELD HILLS, MI. SN 76-456,881. PUB. 5-6-2003, FILED 10-7-2002.

**CREST**

FOR EDUCATIONAL SERVICES, NAMELY REAL-LIFE SCENARIO TRAINING FOR POLICE, FIRE AND EMS PERSONNEL (U.S. CLS. 100, 101 AND 107).  
FIRST USE 5-0-2004; IN COMMERCE 5-0-2004.

2,900,345. SEABOURN CRUISE LINE LIMITED, MIAMI, FL. SN 76-459,124. PUB. 10-21-2003, FILED 10-9-2002.

SEABOURN FAST FORWARD



OWNER OF U.S. REG. NOS. 2,147,466, 2,562,847, AND OTHERS.

FOR EDUCATIONAL SERVICES, NAMELY CONDUCTING LECTURES, INSTRUCTION, CLASSES, SEMINARS, CONFERENCES AND WORKSHOPS IN THE FIELD OF PROMOTING AND MARKETING CRUISES AND THE DISTRIBUTION OF COURSE MATERIALS IN CONNECTION THEREWITH (U.S. CLS. 100, 101 AND 107).

FIRST USE 9-30-2002; IN COMMERCE 9-30-2002.

2,900,347. SNELL MEDICAL COMMUNICATION INC., MONTREAL, QUEBEC, CANADA. SN 76-463,486. PUB. 6-3-2003, FILED 10-24-2002.

**INTERVENTIONAL  
CARDIOLOGY ROUNDS**

OWNER OF U.S. REG. NOS. 2,282,192, 2,557,887, AND 2,559,082.

NO CLAIM IS MADE TO THE EXCLUSIVE RIGHT TO USE "INTERVENTIONAL CARDIOLOGY", APART FROM THE MARK AS SHOWN.

FOR COMPUTER SERVICES, NAMELY PROVIDING AN ON-LINE MEDICAL NEWSLETTER (U.S. CLS. 100, 101 AND 107).

FIRST USE 3-15-2004; IN COMMERCE 3-15-2004.

2,900,426. NCL CORPORATION LTD., MIAMI, FL. SN 76-496,017. PUB. 10-21-2003, FILED 3-10-2003.

**STAR SEEKER**

FOR ENTERTAINMENT SERVICES IN THE NATURE OF A TALENT SHOW CONDUCTED ON A CRUISE SHIP (U.S. CLS. 100, 101 AND 107).

FIRST USE 1-1-2004; IN COMMERCE 1-1-2004.

**CLASS 41—(Continued).**

2,900,431. OUTDOOR LIFE NETWORK, L.L.C., STAMFORD, CT. SN 76-496,821. PUB. 11-18-2003, FILED 3-13-2003.

**BEACH AMBUSH**

NO CLAIM IS MADE TO THE EXCLUSIVE RIGHT TO USE "BEACH", APART FROM THE MARK AS SHOWN.  
FOR ONGOING TELEVISION SERIES IN THE FIELD OF SPORTING EVENTS (U.S. CLS. 100, 101 AND 107).  
FIRST USE 6-8-2003; IN COMMERCE 6-8-2003.

2,900,513. MEDIA CHOICE, LLC, SPRINGDALE, OH. SN 76-539,994. PUB. 2-10-2004, FILED 8-7-2003.



FOR PRODUCTION OF VIDEO DISCS FOR OTHERS (U.S. CLS. 100, 101 AND 107).  
FIRST USE 5-1-2003; IN COMMERCE 5-1-2003.

2,900,557. J-B LAB: THE INSTITUTE FOR INTERACTIVE JOURNALISM, WASHINGTON, DC. SN 78-095,605. PUB. 7-23-2002, FILED 11-29-2001.

**J-LAB**

FOR EDUCATIONAL SERVICES NAMELY, CONDUCTING SEMINAR, CONFERENCES AND WORKSHOPS WITHIN THE FIELD OF JOURNALISM, CONDUCTING EDUCATIONAL EXPERIMENTS IN THE PRACTICE OF INTERACTIVE JOURNALISM IN AN INCUBATED ENVIRONMENT AND DISTRIBUTION OF INSTRUCTIONAL AND TEACHING MATERIALS IN ASSOCIATION THEREFOR (U.S. CLS. 100, 101 AND 107).  
FIRST USE 8-14-2003; IN COMMERCE 8-14-2003.

**CLASS 41—(Continued).**

2,900,565. NEW ORLEANS HORNETS NBA LIMITED PARTNERSHIP, A N.C. LIMITED PARTNERSHIP, NEW ORLEANS, LA. SN 78-104,890. PUB. 10-15-2002, FILED 1-25-2002.

**NEW ORLEANS HORNETS**

OWNER OF U.S. REG. NOS. 1,649,730, 2,195,363, AND OTHERS.

NO CLAIM IS MADE TO THE EXCLUSIVE RIGHT TO USE "NEW ORLEANS", APART FROM THE MARK AS SHOWN.

FOR ENTERTAINMENT AND EDUCATIONAL SERVICES IN THE NATURE OF ONGOING TELEVISION AND RADIO PROGRAMS IN THE FIELD OF BASKETBALL AND RENDERING LIVE BASKETBALL GAMES AND BASKETBALL EXHIBITIONS; THE PRODUCTION AND DISTRIBUTION OF RADIO AND TELEVISION BROADCASTS OF BASKETBALL GAMES, BASKETBALL EVENTS AND PROGRAMS IN THE FIELD OF BASKETBALL; CONDUCTING AND ARRANGING BASKETBALL CLINICS AND COACHES CLINICS AND BASKETBALL EVENTS; ENTERTAINMENT SERVICES, NAMELY PROVIDING A WEBSITE FEATURING THE FOLLOWING CONTENT— TELEVISION HIGHLIGHTS, INTERACTIVE TELEVISION HIGHLIGHTS, VIDEO RECORDINGS, VIDEO STREAM RECORDINGS, INTERACTIVE VIDEO HIGHLIGHT SELECTIONS; RADIO PROGRAMS, RADIO HIGHLIGHTS, AND AUDIO RECORDINGS IN THE FIELD OF BASKETBALL, BASKETBALL NEWS IN THE NATURE OF INFORMATION, STATISTICS, TRIVIA AND PUBLIC OPINION ABOUT BASKETBALL, ON-LINE COMPUTER GAMES, VIDEO GAMES, INTERACTIVE VIDEO GAMES, ACTION SKILL GAMES, ARCADE GAMES, ADULTS' AND CHILDREN'S PARTY GAMES, BOARD GAMES, AND TRIVIA GAMES (U.S. CLS. 100, 101 AND 107).

FIRST USE 8-19-2002; IN COMMERCE 8-19-2002.

2,900,575. ENERGY & ENVIRONMENT TWENTY-ONE, INC., WASHINGTON, DC. SN 78-114,657. PUB. 10-22-2002, FILED 3-13-2002.

**POLIWEBS**

FOR EDUCATIONAL SERVICES, NAMELY, CONDUCTING DISCUSSION GROUPS AND SEMINARS IN THE FIELD OF POLITICS AND GOVERNMENT RELATIONS TO ELEVATE THE LEVEL OF POLITICAL AWARENESS AND INVOLVEMENT OF THE BUSINESS WORKFORCE (U.S. CLS. 100, 101 AND 107).

FIRST USE 10-31-2002; IN COMMERCE 10-31-2002.

2,900,577. SCRIPPS NETWORKS, INC., KNOXVILLE, NY. SN 78-116,180. PUB. 10-22-2002, FILED 3-20-2002.

**FINE LIVING ON DEMAND**

FOR ENTERTAINMENT SERVICES, NAMELY, THE PRODUCTION OF LIVE AND ON-DEMAND TELEVISION PROGRAMMING, DISTRIBUTED OVER TELEVISION, SATELLITE, WIRELESS, AUDIO AND VIDEO MEDIA, FIBER OPTICS, CABLE AND A GLOBAL COMPUTER NETWORK (U.S. CLS. 100, 101 AND 107).

FIRST USE 10-31-2002; IN COMMERCE 10-31-2002.

**CLASS 41—(Continued).**

2,900,580. BRANDON, LEE, LOS ANGELES, CA. SN 78-117,141. PUB. 10-15-2002, FILED 3-24-2002.

**BLONDE BOMBER**

FOR ENTERTAINMENT IN THE NATURE OF COMPETITIONS IN THE FIELD OF GOLF (U.S. CLS. 100, 101 AND 107).

FIRST USE 11-0-2001; IN COMMERCE 11-0-2001.

2,900,581. WNBA ENTERPRISES, LLC, SECAUCUS, NJ. SN 78-118,165. PUB. 11-26-2002, FILED 3-28-2002.

**THIS IS WHO I AM**

FOR ENTERTAINMENT AND EDUCATIONAL SERVICES IN THE NATURE OF ONGOING TELEVISION AND RADIO PROGRAMS IN THE FIELD OF BASKETBALL AND RENDERING LIVE BASKETBALL GAMES AND BASKETBALL EXHIBITIONS; THE PRODUCTION AND DISTRIBUTION OF RADIO AND TELEVISION BROADCASTS OF BASKETBALL GAMES, BASKETBALL EVENTS AND PROGRAMS IN THE FIELD OF BASKETBALL; CONDUCTING AND ARRANGING BASKETBALL CLINICS AND COACHES CLINICS AND BASKETBALL EVENTS; ENTERTAINMENT SERVICES, NAMELY PROVIDING A WEBSITE FEATURING THE FOLLOWING CONTENT; TELEVISION HIGHLIGHTS, INTERACTIVE TELEVISION HIGHLIGHTS, VIDEO RECORDINGS, VIDEO STREAM RECORDINGS, INTERACTIVE VIDEO HIGHLIGHT SELECTIONS, RADIO PROGRAMS, RADIO HIGHLIGHTS, AND AUDIO RECORDINGS IN THE FIELD OF BASKETBALL, BASKETBALL NEWS IN THE NATURE OF INFORMATION, STATISTICS, TRIVIA AND PUBLIC OPINION ABOUT BASKETBALL, ON-LINE COMPUTER GAMES, VIDEO GAMES, INTERACTIVE VIDEO GAMES, ACTION SKILL GAMES, ARCADE GAMES, ADULTS' AND CHILDREN'S PARTY GAMES, BOARD GAMES, AND TRIVIA GAMES; VIDEO RECORDINGS, VIDEO STREAM RECORDINGS, AND AUDIO RECORDINGS IN THE FIELD OF BASKETBALL PROVIDED OVER THE INTERNET; VIDEO GAME PROGRAMS, INTERACTIVE VIDEO GAMES AND TRIVIA GAME SOFTWARE PROVIDED OVER THE INTERNET; ACTION SKILL GAMES, ARCADE GAMES, ADULTS' AND CHILDREN'S PARTY GAMES, TRIVIA INFORMATION GAMES, AND BOARD GAMES PROVIDED OVER THE INTERNET; ELECTRONIC PUBLICATIONS IN THE NATURE OF MAGAZINES AND NEWSLETTERS IN THE FIELD OF BASKETBALL PROVIDED OVER THE INTERNET; COLORING BOOKS IN THE NATURE OF DRAWINGS AND PICTURES PROVIDED OVER THE INTERNET; CATALOGS PROVIDED OVER THE INTERNET FEATURING AN ARRAY OF BASKETBALL-THEMED PRODUCTS (U.S. CLS. 100, 101 AND 107).

FIRST USE 7-28-2002; IN COMMERCE 7-28-2002.

**CLASS 41—(Continued).**

2,900,599. FLORIDA HOSPITAL COLLEGE OF HEALTH SCIENCES, ORLANDO, FL. SN 78-135,810. PUB. 4-6-2004, FILED 6-14-2002.



THE STIPPLING IS FOR SHADING PURPOSES ONLY. FOR PROVIDING TECHNICAL SUPPORT TO USERS OF AN EDUCATIONAL WEBSITE THAT PROVIDES CONTINUING MEDICAL EDUCATION AND TRAINING OF HEALTHCARE PROFESSIONALS IN THE USE OF MEDICAL AND HEALTH RELATED EQUIPMENT, PROCEDURES AND TECHNOLOGY (U.S. CLS. 100, 101 AND 107).

FIRST USE 7-1-2002; IN COMMERCE 7-1-2002.

2,900,600. DOYLE, VICTORIA, JB, NEW YORK, NY. SN 78-136,470. PUB. 12-17-2002, FILED 6-18-2002.

**VINDALOO**

FOR MOTION PICTURE FILM PRODUCTION (U.S. CLS. 100, 101 AND 107).

FIRST USE 10-10-2003; IN COMMERCE 10-10-2003.

**CLASS 41—(Continued).**

2,900,611. WARNER BROS. ENTERTAINMENT INC., BURBANK, CA. SN 78-144,944. PUB. 9-9-2003, FILED 7-17-2002.

**TOON LAB**

NO CLAIM IS MADE TO THE EXCLUSIVE RIGHT TO USE "TOON", APART FROM THE MARK AS SHOWN.

FOR ENTERTAINMENT SERVICES IN THE NATURE OF LIVE-ACTION, COMEDY, DRAMA AND ANIMATED TELEVISION SERIES; PRODUCTION OF LIVE-ACTION, COMEDY, DRAMA AND ANIMATED TELEVISION SERIES; LIVE-ACTION, COMEDY, DRAMA AND ANIMATED MOTION PICTURE THEATRICAL FILMS; PRODUCTION OF LIVE-ACTION, COMEDY, DRAMA AND ANIMATED MOTION PICTURE THEATRICAL FILMS; THEATRICAL PERFORMANCES BOTH ANIMATED AND LIVE ACTION; INTERNET SERVICES PROVIDING INFORMATION VIA AN ELECTRONIC GLOBAL COMPUTER NETWORK IN THE FIELD OF ENTERTAINMENT RELATING SPECIFICALLY TO MUSIC, MOVIES, AND TELEVISION; PROVIDING GENERAL INTEREST NEWS, ENTERTAINMENT, AND EDUCATIONAL INFORMATION VIA A GLOBAL COMPUTER NETWORK; AND PROVIDING INFORMATION FOR AND ACTUAL ENTERTAINMENT VIA ELECTRONIC GLOBAL COMMUNICATIONS NETWORK IN THE NATURE OF LIVE-ACTION, COMEDY, DRAMA AND ANIMATED PROGRAMS AND PRODUCTION OF LIVE-ACTION COMEDY, ACTION AND ANIMATED MOTION FILMS FOR DISTRIBUTION VIA A GLOBAL COMPUTER NETWORK (U.S. CLS. 100, 101 AND 107).

FIRST USE 9-30-2001; IN COMMERCE 9-30-2001.

2,900,614. CLIFFORD, ALLAN J., LOUISVILLE, KY. SN 78-148,304. PUB. 2-11-2003, FILED 7-29-2002.

**FIELD OF SCREAMS**

FOR ENTERTAINMENT SERVICES IN THE NATURE OF A HUMAN WALK THROUGH TYPE MAZE (U.S. CLS. 100, 101 AND 107).

FIRST USE 7-10-2002; IN COMMERCE 7-10-2002.

2,900,621. FIRST NIGHT, INC., PROVIDENCE, RI. SN 78-153,630. PUB. 5-20-2003, FILED 8-13-2002.

**FIRSTWORKS**

FOR ORGANIZING VISUAL AND PERFORMING ARTS EXHIBITIONS AND PERFORMANCES FOR EDUCATIONAL AND ENTERTAINMENT PURPOSES (U.S. CLS. 100, 101 AND 107).

FIRST USE 2-1-2003; IN COMMERCE 1-1-2004.

**CLASS 41—(Continued).**

2,900,636. TRC INTERACTIVE, INC., HARRISBURG, PA. SN 78-162,562. PUB. 12-23-2003, FILED 9-10-2002.



FOR TRAINING SERVICES IN THE FIELD OF TELLER TRAINING FOR BANKS AND CREDIT UNIONS (U.S. CLS. 100, 101 AND 107).  
FIRST USE 1-1-1999; IN COMMERCE 1-1-1999.

2,900,640. SODEXHO OPERATIONS, LLC, GAITHERSBURG, MD. SN 78-165,103. PUB. 5-6-2003, FILED 9-17-2002.



NO CLAIM IS MADE TO THE EXCLUSIVE RIGHT TO USE "SCHOOL", APART FROM THE MARK AS SHOWN.  
FOR EDUCATIONAL SERVICES, NAMELY, CONDUCTING PROGRAMS IN THE FIELDS OF NUTRITION, DRUG AND SMOKING AVOIDANCE, SAFETY AND HEALTHY BEHAVIOR, AND DISTRIBUTING COURSE MATERIALS IN CONNECTION THEREWITH (U.S. CLS. 100, 101 AND 107).  
FIRST USE 3-1-2003; IN COMMERCE 3-1-2003.

2,900,646. INTERNATIONAL DATA GROUP, INC., FRAMINGHAM, MA. SN 78-170,117. PUB. 11-4-2003, FILED 10-2-2002.

**CSO PERSPECTIVES**

NO CLAIM IS MADE TO THE EXCLUSIVE RIGHT TO USE "CSO", APART FROM THE MARK AS SHOWN.  
FOR CONDUCTING EDUCATIONAL AND TRAINING CONFERENCES IN THE FIELD OF INFORMATION TECHNOLOGY (U.S. CLS. 100, 101 AND 107).  
FIRST USE 4-18-2004; IN COMMERCE 4-18-2004.

**CLASS 41—(Continued).**

2,900,654. BURTON, WILLIAM, DBA FLIP "BEAN" KNIGHT, STUDIO CITY, CA. SN 78-171,780. PUB. 11-4-2003, FILED 10-7-2002.

**FLIP BEAVIS KNIGHT & BEDTIME FOR BEAVIS THE BAND**

NO CLAIM IS MADE TO THE EXCLUSIVE RIGHT TO USE "BAND", APART FROM THE MARK AS SHOWN.  
FOR ENTERTAINMENT NAMELY, LIVE PERFORMANCES BY A MUSICAL BAND (U.S. CLS. 100, 101 AND 107).  
FIRST USE 2-1-2004; IN COMMERCE 2-1-2004.

2,900,657. THE WILDLIFE EXPERIENCE, INC., PARKER, CO. SN 78-178,304. PUB. 8-19-2003, FILED 10-25-2002.

**Max Brown**

THE NAME "MAX BROWN" DOES NOT IDENTIFY A LIVING INDIVIDUAL.  
FOR MUSEUM SERVICES (U.S. CLS. 100, 101 AND 107).  
FIRST USE 7-20-2004; IN COMMERCE 7-20-2004.

2,900,670. INVICTA CLUB, INC., SAN CLEMENTE, CA. SN 78-195,992. PUB. 9-30-2003, FILED 12-18-2002.

**THE INVICTA CLUB**

NO CLAIM IS MADE TO THE EXCLUSIVE RIGHT TO USE "CLUB", APART FROM THE MARK AS SHOWN.  
THE ENGLISH TRANSLATION OF THE SPANISH TERM "INVICTA" IS "CONQUEROR".  
FOR GOLF AND ENTERTAINMENT MEMBERSHIP CLUB SERVICES PROVIDING ACCESS AND PREFERRED MEMBERSHIP BENEFITS AT GOLF, CITY AND YACHT CLUBS, PLUS A NUMBER OF OTHER SPA AND ENTERTAINMENT SERVICES AND PRIVILEGES (U.S. CLS. 100, 101 AND 107).  
FIRST USE 1-1-2001; IN COMMERCE 1-1-2001.

**CLASS 41—(Continued).**

2,900,675. PFIZER HEALTH SOLUTIONS INC., NEW YORK, NY. SN 78-197,291. PUB. 8-26-2003, FILED 12-23-2002.

**PHS UNIVERSITY**

FOR TRAINING IN THE USE OF COMPUTER SOFTWARE APPLICATIONS IN THE MEDICAL FIELD (U.S. CLS. 100, 101 AND 107).

FIRST USE 3-31-2003; IN COMMERCE 3-31-2003.

2,900,730. PHILIP PELUSI PHYTOLINK 4.0, INC., PITTSBURGH, PA. SN 78-222,487. PUB. 11-4-2003, FILED 3-6-2003.

**S.P.A.C.E.**

FOR EDUCATIONAL SERVICES, NAMELY, CONDUCTING WORKSHOPS AND CONFERENCES IN THE FIELD OF DEVELOPING CREATIVE SKILLS FOR SERVICE-PROVIDING PROFESSIONALS OF BEAUTY SALONS, HAIRDRESSING SALONS, SKIN CARE SALONS, TANNING SALONS, AND HEALTH SPAS, AND IN THE FIELDS OF HAIR STYLING, COLOR AND COSMETIC ANALYSIS, PHOTOGRAPHY, SELECTING PHOTOGRAPHERS, AND SELECTING, OUTFITTING, POSING AND APPLYING MAKE-UP TO MODELS (U.S. CLS. 100, 101 AND 107).

FIRST USE 11-0-2003; IN COMMERCE 11-0-2003.

2,900,737. MICROSOFT CORPORATION, REDMOND, WA. SN 78-224,351. PUB. 11-25-2003, FILED 3-11-2003.

**PROJECT GOTHAM RACING**

OWNER OF U.S. REG. NO. 2,670,385.

NO CLAIM IS MADE TO THE EXCLUSIVE RIGHT TO USE "RACING", APART FROM THE MARK AS SHOWN.

FOR PROVIDING INFORMATION ON-LINE RELATING TO COMPUTER GAMES AND COMPUTER ENHANCEMENTS FOR GAMES; AND ENTERTAINMENT SERVICES, NAMELY, PROVIDING AN ON-LINE COMPUTER GAME (U.S. CLS. 100, 101 AND 107).

FIRST USE 11-18-2003; IN COMMERCE 11-18-2003.

2,900,746. CUNARD LINE LIMITED, MIAMI, FL. SN 78-225,778. PUB. 12-9-2003, FILED 3-14-2003.

**CUNARD CONNEXIONS**

OWNER OF U.S. REG. NOS. 927,552, 2,131,974, AND OTHERS.

THE NAME "CUNARD" DOES NOT IDENTIFY A LIVING INDIVIDUAL.

FOR EDUCATIONAL SERVICES, NAMELY, OFFERING WORKSHOPS, SEMINARS, CLASSES AND LECTURES ON COOKING, WINE APPRECIATION, FOREIGN LANGUAGES, PHOTOGRAPHY, FASHION, MUSIC, ART, POLITICS, HISTORY AND SCIENCE, WITH LECTURES BY LEADING CHEFS, COLLEGE PROFESSORS, TOP DIPLOMATS AND THE LIKE (U.S. CLS. 100, 101 AND 107).

FIRST USE 5-0-2003; IN COMMERCE 5-0-2003.

**CLASS 41—(Continued).**

2,900,749. FREEDOMZONE, INC., SANDY, UT. SN 78-226,604. PUB. 10-28-2003, FILED 3-17-2003.

**BURNING VAN**

FOR MUSIC PUBLISHING SERVICES, SOUND RECORDING STUDIOS, AND RECORDING STUDIOS (U.S. CLS. 100, 101 AND 107).

FIRST USE 4-14-2003; IN COMMERCE 4-14-2003.

2,900,833. GAVRILOV, KAREN, FORT LAUDERDALE, FL. SN 78-264,508. PUB. 2-24-2004, FILED 6-19-2003.



NO CLAIM IS MADE TO THE EXCLUSIVE RIGHT TO USE "YOGA", APART FROM THE MARK AS SHOWN.

THE MARK CONSISTS OF THE WORDS RED PEARL YOGA AND A SOLID RED-ORANGE CIRCLE WITH THE WORDS BREATHE... STRETCH... BECOME... INSIDE OF THE CIRCLE.

FOR EDUCATIONAL AND INSTRUCTIONAL SERVICES, NAMELY PROVIDING CLASSES, SEMINARS, WORKSHOPS, AND TRAINING SESSIONS IN THE FIELD OF YOGA (U.S. CLS. 100, 101 AND 107).

FIRST USE 7-1-2003; IN COMMERCE 10-1-2003.

2,900,864. NETWORK ENTERPRISES, INC., NEW YORK, NY. SN 78-285,749. PUB. 12-9-2003, FILED 8-11-2003.

**SPIKE TV VGA VIDEO GAME AWARDS**

NO CLAIM IS MADE TO THE EXCLUSIVE RIGHT TO USE "TV" AND "VIDEO GAME AWARDS", APART FROM THE MARK AS SHOWN.

FOR ENTERTAINMENT SERVICES IN THE NATURE OF AN ONGOING TELEVISION PROGRAM FEATURING LIVE ACTION, NAMELY, AN AWARDS SHOW FOR VIDEO GAMES; PROVIDING INFORMATION IN THE FIELD OF ENTERTAINMENT AND EDUCATION FEATURING LIVE ACTION, NAMELY, AN AWARDS SHOW FOR VIDEO GAMES RENDERED VIA COMPUTER BY MEANS OF A GLOBAL COMPUTER NETWORK (U.S. CLS. 100, 101 AND 107).

FIRST USE 12-3-2003; IN COMMERCE 12-3-2003.

**CLASS 42—SCIENTIFIC, COMPUTER AND LEGAL SERVICES**



**CLASS 42—(Continued).**

2,900,027. CITY OF AUSTIN, TEXAS, DBA AUSTIN ENERGY, AUSTIN, TX. SN 75-355,578. PUB. 5-19-1998, FILED 9-12-1997.

**ENERACT**

FOR REMOTE MONITORING OF ELECTRICAL POWER USAGE ACROSS MULTIPLE BUILDING SITES AND REGULATION OF ELECTRICAL USAGE ACROSS MULTIPLE BUILDING SITES (U.S. CLS. 100 AND 101).  
FIRST USE 2-14-1997; IN COMMERCE 2-14-1997.

---

2,900,036. APPLERA CORPORATION, ROCKVILLE, MD. SN 75-531,485. PUB. 5-1-2001, FILED 8-5-1998.

**CELERA**

FOR CONSULTATION AND RESEARCH IN THE FIELDS OF SCIENCE, TECHNOLOGY; COMPUTER SERVICES, NAMELY, PROVIDING DATABASES AND INFORMATION IN THE FIELDS OF SCIENCE, TECHNOLOGY; PROVIDING TEMPORARY USE OF ON-LINE NON-DOWNLOADABLE SOFTWARE FOR ACCESSING AND ANALYZING INFORMATION IN THE FIELDS OF SCIENCE, TECHNOLOGY; DEVELOPMENT OF NEW PRODUCTS FOR OTHERS IN THE FIELDS OF SCIENCE, TECHNOLOGY (U.S. CLS. 100 AND 101).  
FIRST USE 3-24-2000; IN COMMERCE 3-24-2000.

---

2,900,037. MS MANAGEMENT, L.L.C., METAIRIE, LA. SN 75-550,313. PUB. 10-15-2002, FILED 9-9-1998.

**FOODIES KITCHEN**

OWNER OF U.S. REG. NO. 2,417,841.  
NO CLAIM IS MADE TO THE EXCLUSIVE RIGHT TO USE "KITCHEN", APART FROM THE MARK AS SHOWN.  
FOR RESTAURANT SERVICES, RESTAURANT CARRY OUT SERVICES, DELICATESSEN SERVICES AND COCKTAIL LOUNGE SERVICES (U.S. CLS. 100 AND 101).  
FIRST USE 6-1-1999; IN COMMERCE 6-1-1999.

---

2,900,052. ARIBA, INC., SUNNYVALE, CA. SN 75-683,159. PUB. 6-24-2003, FILED 4-15-1999.

**ARIBALIVE**

OWNER OF U.S. REG. NOS. 2,202,102, 2,405,389, AND OTHERS.  
FOR COMPUTER PROGRAMMING FOR OTHERS AND COMPUTER CONSULTING SERVICES REGARDING THE USE AND MODIFICATION OF COMPUTER SOFTWARE (U.S. CLS. 100 AND 101).  
FIRST USE 0-0-1998; IN COMMERCE 0-0-1998.

**CLASS 42—(Continued).**

2,900,063. CLARK, D. JOSEPH, SEATTLE, WA. SN 75-791,879. PUB. 10-29-2002, FILED 9-3-1999.



Optimal Learning Environments

NO CLAIM IS MADE TO THE EXCLUSIVE RIGHT TO USE "OPTIMAL LEARNING ENVIRONMENTS", APART FROM THE MARK AS SHOWN.

FOR PROVIDING CONSULTING SERVICES IN THE FIELD OF EDUCATION (U.S. CLS. 100 AND 101).  
FIRST USE 7-13-2004; IN COMMERCE 7-13-2004.

---

2,900,090. APPLIED MINDS, INC., GLENDALE, CA. SN 76-000,707. PUB. 4-16-2002, FILED 3-15-2000.

**THE LITTLE BIG IDEA COMPANY**

NO CLAIM IS MADE TO THE EXCLUSIVE RIGHT TO USE "COMPANY", APART FROM THE MARK AS SHOWN.  
FOR INVENTION AND DESIGN SERVICES, NAMELY, THE INVENTION, DESIGN AND DEVELOPMENT OF NEW PRODUCTS AND PROCESSES; TECHNICAL CONSULTING IN CONNECTION WITH THE FOREGOING; LICENSING OF INVENTIONS AND LICENSING OF INTELLECTUAL PROPERTY (U.S. CLS. 100 AND 101).  
FIRST USE 7-7-2004; IN COMMERCE 7-7-2004.

---

2,900,091. MAINSTAY ENTERPRISES, INC., ANNAPOLIS, MD. SN 76-009,747. PUB. 12-25-2001, FILED 3-27-2000.

**MAINSTAY ENTERPRISES**

NO CLAIM IS MADE TO THE EXCLUSIVE RIGHT TO USE "ENTERPRISES", APART FROM THE MARK AS SHOWN.

FOR PHYSICAL SECURITY SERVICES IN THE NATURE OF RISK ANALYSIS AND EVALUATION; SALE OF SECURITY EQUIPMENT; COMPUTER NETWORK SECURITY SERVICES; DESIGNING SECURITY PROGRAMS FOR COMPUTER NETWORKS, AND PROVIDING RELATED CONSULTING SERVICES; COMPUTER SYSTEM ACCESS AND SECURITY SERVICES, NAMELY, REMOTE AND ON-SITE MONITORING OF SECURITY, ACCESS CONTROL; COMPUTER NETWORK SECURITY SERVICES IN THE NATURE OF PROVIDING COMPUTER PROGRAMMING AND UPDATING, NAMELY, PROVIDING MAINTENANCE OF COMPUTER CONNECTIONS OF LOCAL AREA, WIDE AREA; COMPUTER NETWORK SECURITY SERVICES IN THE NATURE OF PROVIDING COMPUTER PROGRAMMING AND UPDATING, NAMELY, PROVIDING MAINTENANCE OF COMPUTER SOFTWARE FOR NETWORKS (U.S. CLS. 100 AND 101).  
FIRST USE 6-0-1998; IN COMMERCE 6-0-1998.

**CLASS 42—(Continued).**

2,900,109. I NET CORP., ALEXANDRIA, VA. SN 76-092,730. PUB. 1-15-2002, FILED 7-19-2000.



FOR ON-LINE COMPUTER SERVICES, NAMELY REGISTRATION OF DOMAIN NAMES; HOSTING THE WEB SITES OF OTHERS ON A COMPUTER SERVER FOR A GLOBAL COMPUTER NETWORK; CREATING AND MAINTAINING WEB SITES FOR OTHERS (U.S. CLS. 100 AND 101).

FIRST USE 6-24-1998; IN COMMERCE 6-24-1998.

2,900,111. ACTIVX BIOSCIENCES, INC., LA JOLLA, CA. SN 76-101,887. PUB. 4-17-2001, FILED 8-2-2000.

**ACTIVX BIOSCIENCES**

NO CLAIM IS MADE TO THE EXCLUSIVE RIGHT TO USE "BIOSCIENCES", APART FROM THE MARK AS SHOWN.

FOR LABORATORY RESEARCH AND MONITORING OF CLINICAL TRIALS, NAMELY IN THE FIELD OF ACTIVITY-BASED PROTEOMICS (U.S. CLS. 100 AND 101).

FIRST USE 7-23-2001; IN COMMERCE 7-23-2001.

2,900,122. AMERICA ONLINE, INC., DULLES, VA. SN 76-122,751. PUB. 11-12-2002, FILED 9-6-2000.

**CITIZEN2CITIZEN**

FOR PROVIDING INFORMATION IN THE FIELD OF PUBLIC AFFAIRS AND GOVERNMENT ISSUES, SERVICES AND RESOURCES VIA ONLINE COMPUTER NETWORKS (U.S. CLS. 100 AND 101).

FIRST USE 12-18-2001; IN COMMERCE 12-18-2001.

**CLASS 42—(Continued).**

2,900,172. RICHARD A. ERDEY, MD, INC., COLUMBUS, OH. SN 76-295,164. PUB. 2-19-2002, FILED 8-6-2001.

**I CAN SEE CLEARLY**

FOR PROFESSIONAL OPHTHALMIC SERVICES, NAMELY, DIAGNOSIS AND TREATMENT OF EYE DISEASES AND CONDITIONS, REFRACTIVE SURGERY, NAMELY, LASIK, PHOTOREFRACTIVE KERATECTOMY (PRK), PHOTOTHERAPEUTIC KERATECTOMY (PTK), RADIAL KERATECTOMY (RK), AND ASTIGMATIC KERATOTOMY (AK), AND ANTERIOR SEGMENT, CORNEAL AND LENS SURGERY, NAMELY SMALL INCISION RAPID REHABILITATION CATARACT SURGERY, INTRAOCULAR LENS IMPLANTATION (IOL), CORNEAL TRANSPLANTATION SURGERY (PK), LASER TREATMENT FOR DIABETES AND GLAUCOMA, LASER COSMETIC SURGERY, NAMELY, BLEPHAROPLASTY AND SKIN RESURFACING, AND LASER SURGERY (U.S. CLS. 100 AND 101).

FIRST USE 12-15-2003; IN COMMERCE 5-14-2004.

2,900,222. TOWER SQUARE SECURITIES, INC., HARTFORD, CT. SN 76-368,965. PUB. 5-20-2003, FILED 2-8-2002.

**TOWERCONNECT**

FOR PROVIDING SECURITY BROKERAGE SERVICES USERS WITH TEMPORARY USE OF NON-DOWNLOADABLE SOFTWARE BY MEANS OF GLOBAL INFORMATION NETWORKS FOR FINANCIAL ACCOUNT INFORMATION, FINANCIAL ACCOUNT AGGREGATION, FINANCIAL ACCOUNT TRACKING, FINANCIAL ACCOUNT REPORTING, FINANCIAL PORTFOLIO MANAGEMENT AND FINANCIAL PERFORMANCE REPORTING (U.S. CLS. 100 AND 101).

FIRST USE 4-15-2002; IN COMMERCE 4-15-2002.

2,900,228. TOWER SQUARE SECURITIES, INC., HARTFORD, CT. SN 76-373,119. PUB. 5-20-2003, FILED 2-20-2002.

FOR PROVIDING SECURITY BROKERAGE SERVICES USERS WITH TEMPORARY USE OF NON-DOWNLOADABLE SOFTWARE BY MEANS OF GLOBAL INFORMATION NETWORKS FOR FINANCIAL ACCOUNT INFORMATION, FINANCIAL ACCOUNT AGGREGATION, FINANCIAL ACCOUNT TRACKING, FINANCIAL ACCOUNT REPORTING, FINANCIAL PORTFOLIO MANAGEMENT AND FINANCIAL PERFORMANCE REPORTING (U.S. CLS. 100 AND 101).

FIRST USE 4-15-2002; IN COMMERCE 4-15-2002.

**CLASS 42—(Continued).**

2,900,238. PLAYMEDIA SYSTEMS, INC., LAS VEGAS, NV. SN 76-386,322. PUB. 11-5-2002, FILED 3-20-2002.

**PCAMP**

OWNER OF U.S. REG. NO. 2,403,180.  
FOR PROVIDING TEMPORARY USE OF ON-LINE NON-DOWNLOADABLE COMPUTER HARDWARE AND SOFTWARE FOR ALLOWING CONDITIONAL ACCESS TO ANALOG OR DIGITAL AUDIOVISUAL CONTENT PLAYBACK, AND RECORDING, ENCODING, DECODING, ENCRYPTION, DECRYPTION, AND DISTRIBUTION FUNCTIONS (U.S. CLS. 100 AND 101).  
FIRST USE 7-21-2003; IN COMMERCE 7-21-2003.

2,900,249. ENGINION AG, 13355 BERLIN, FED REP GERMANY. SN 76-395,087. PUB. 3-25-2003, FILED 4-12-2002.

**ENGINION**

FOR SCIENTIFIC AND INDUSTRIAL RESEARCH; PRODUCT RESEARCH AND DEVELOPMENT FOR THE AUTOMOBILE INDUSTRY, FOR THE CURRENT GENERATING INDUSTRY AND THE WARMTH AND COOLING GENERATING INDUSTRY AS WELL AS IN THE FIELD OF THE PRODUCTION OF HEATERS AND COOLERS; CARRYING OUT OF RESEARCH CONTRACTS AND TECHNOLOGICAL DEVELOPMENT CONTRACTS AND CARRYING OUT OF ENGINEERING SERVICES REGARDING THE PRODUCTION OF MACHINES, MOTORS, COMPONENTS OF MOTORS AND ENGINES OF ALL TYPES, APPARATUS FOR STEAM GENERATING, VEHICLES AND APPARATUS ENGINES AND UNITS FOR THE SIMULTANEOUS GENERATION OF CURRENT AND WARMTH IN THE NATURE OF AUXILIARY POWER UNITS; LICENSING OF INTELLECTUAL PROPERTY RIGHTS (U.S. CLS. 100 AND 101).  
FIRST USE 8-12-2000; IN COMMERCE 8-12-2000.

2,900,272. SIDNEY B. BOWNE & SON, MINEOLA, NY. SN 76-415,638. PUB. 3-23-2004, FILED 6-10-2002.



NO CLAIM IS MADE TO THE EXCLUSIVE RIGHT TO USE "GROUP", APART FROM THE MARK AS SHOWN.

FOR ENGINEERING SERVICES, NAMELY CONSTRUCTION INSPECTION, HIGHWAY AND ROADWAY ENGINEERING, UTILITY AND SITE ENGINEERING, SURVEYING, WATER TREATMENT, STORAGE, DISTRIBUTION AND WATER QUALITY MONITORING, ENVIRONMENTAL INVESTIGATIONS, SOLID WASTE MANAGEMENT, AND RECREATIONAL FACILITY PLANNING; ARCHITECTURAL AND STRUCTURAL DESIGN SERVICES (U.S. CLS. 100 AND 101).  
FIRST USE 8-1-2002; IN COMMERCE 8-1-2002.

**CLASS 42—(Continued).**

2,900,302. GENE LOGIC, INC., GAITHERSBURG, MD. SN 76-440,016. PUB. 3-25-2003, FILED 8-12-2002.

**E-NORTHERN**

FOR TECHNICAL RESEARCH AND CONSULTING SERVICES IN THE FIELD OF GENOMICS (U.S. CLS. 100 AND 101).  
FIRST USE 8-0-2000; IN COMMERCE 8-0-2000.

2,900,314. TASK PERFORMANCE GROUP INC., DES PLAINES, IL. SN 76-446,974. PUB. 11-25-2003, FILED 9-5-2002.

**megaXML**

FOR INTEGRATION OF COMPUTER SYSTEMS AND NETWORKS FOR END-TO-END EDI/XML DOCUMENT INTERCHANGE AND ENTERPRISE APPLICATION INTEGRATION (U.S. CLS. 100 AND 101).  
FIRST USE 5-1-2003; IN COMMERCE 5-1-2003.

2,900,422. DAVITA INC., EL SEGUNDO, CA. SN 76-494,288. PUB. 10-21-2003, FILED 3-3-2003.

**Davita**  
CLINICAL RESEARCH

NO CLAIM IS MADE TO THE EXCLUSIVE RIGHT TO USE "CLINICAL RESEARCH", APART FROM THE MARK AS SHOWN.

FOR CLINICAL AND SCIENTIFIC RESEARCH, TRIALS, AND PRODUCT DEVELOPMENT IN THE FOLLOWING MEDICAL FIELDS— RENAL, HEPATIC, CARDIOVASCULAR, DERMATOLOGY, INFECTIOUS DISEASE, OBSTETRICS, GYNECOLOGY, AND NEUROLOGY (U.S. CLS. 100 AND 101).  
FIRST USE 10-0-2002; IN COMMERCE 10-2-2002.

**CLASS 42—(Continued).**

2,900,446. MARY MCSHEA BLAR AND RONNI KORN MILLER PARTNERSHIP, THE, LONG BEACH, NY. SN 76-503,248. PUB. 3-23-2004, FILED 4-2-2003.



FOR COMMERCIAL ART DESIGN AND GRAPHIC ART DESIGN OF GREETING CARDS FOR GREETING CARD COMPANIES (U.S. CLS. 100 AND 101). FIRST USE 1-1-2002; IN COMMERCE 6-30-2004.

2,900,477. AMERICAN INSTITUTE OF PHYSICS, AKA AIP, COLLEGE PARK, MD. SN 76-517,443. PUB. 2-10-2004, FILED 5-27-2003.

**SCITATION**

FOR PROVIDING VIA A GLOBAL COMPUTER INFORMATION NETWORK IN THE FIELD OF PHYSICS (U.S. CLS. 100 AND 101). FIRST USE 11-6-2003; IN COMMERCE 1-29-2004.

2,900,484. ESOL CO., LTD., TOKYO 168-0073, JAPAN. SN 76-517,667. PUB. 4-6-2004, FILED 5-5-2003.

**ESOL**

FOR PROVIDING COMPUTER SYSTEM INTEGRATION AND CUSTOMIZATION SERVICES IN THE NATURE OF PORTING REAL TIME OPERATING SYSTEMS SUITES INTO MICROPROCESSOR-EQUIPPED EMBEDDED SYSTEMS (U.S. CLS. 100 AND 101). FIRST USE 1-1-2000; IN COMMERCE 3-1-2004.

**CLASS 42—(Continued).**

2,900,532. VINCITI NETWORKS, INC., SANTA CLARA, CA. SN 76-976,987. PUB. 10-21-2003, FILED 1-30-2001.

**VINCITI**

FOR COMPUTER SERVICES, NAMELY, PROVIDING TEMPORARY USE OF ON-LINE NON-DOWNLOADABLE SOFTWARE FOR A WIRELESS COMMUNICATIONS INTERFACE THAT PERMITS OTHERWISE INCOMPATIBLE PROTOCOLS TO COMMUNICATE WITH EACH OTHER; COMPUTER SERVICES, NAMELY TECHNICAL SUPPORT SERVICES, NAMELY TROUBLE SHOOTING OF COMPUTER HARDWARE AND SOFTWARE PROBLEMS; APPLICATION SERVICE PROVIDER (ASP), FEATURING SOFTWARE FOR USE IN DATA BASE MANAGEMENT, E-MAIL ADMINISTRATION AND REMOTE APPLICATIONS MANAGEMENT AND MONITORING; COMPUTER SERVICES, NAMELY, PROVIDING TEMPORARY USE OF ON-LINE NON-DOWNLOADABLE SOFTWARE FOR REMOTE MANAGEMENT OF COMMUNICATIONS AND COMPUTER NETWORKS; MANAGEMENT OF INTERNAL AND GLOBAL COMPUTER NETWORKS; MANAGEMENT, MAINTENANCE AND MONITORING OF COMMUNICATIONS AND COMPUTER NETWORKS; MAINTENANCE OF COMPUTER SOFTWARE; COMPUTER CONSULTATION; COMPUTER DIAGNOSTIC SERVICES; UPDATING OF COMPUTER SOFTWARE; CONSULTING AND ENGINEERING SERVICES, NAMELY, PROVIDING CONSULTATION IN THE FIELD OF INFORMATION TECHNOLOGY, TELECOMMUNICATIONS, WIRELESS COMMUNICATIONS, ELECTRONIC COMMERCE AND COMMUNICATIONS AND COMPUTER NETWORKS AND ADVISING ON BENEFITS OF USING COMMUNICATIONS NETWORKS, COMPUTER NETWORKS AND THE GLOBAL COMPUTER INFORMATION NETWORK; INTEGRATION OF COMPUTER SYSTEMS AND NETWORKS; SOFTWARE IMPLEMENTATION AND DEVELOPMENT SERVICES; COMMUNICATIONS AND COMPUTER NETWORK SECURITY CONSULTING, ENGINEERING, ASSESSMENT, IMPLEMENTATION, FIREWALL DEPLOYMENT, MONITORING, MANAGEMENT AND INTRUSION DETECTION; COMMUNICATIONS AND COMPUTER NETWORK AUDITING; AND COMMUNICATIONS AND COMPUTER NETWORK DESIGN (U.S. CLS. 100 AND 101).

FIRST USE 4-1-2001; IN COMMERCE 1-1-2002.

2,900,541. MOSELEY . MARTENS, LLP, DALLAS, TX. SN 78-045,242. PUB. 8-20-2002, FILED 1-26-2001.

**...TAKING CARE OF BUSINESS**

FOR LEGAL SERVICES (U.S. CLS. 100 AND 101). FIRST USE 11-15-2000; IN COMMERCE 11-15-2000.

2,900,554. LEADIS TECHNOLOGY, SAN JOSE, CA. SN 78-079,557. PUB. 10-29-2002, FILED 8-16-2001.

**LEADIS**

FOR DESIGN AND TESTING OF NEW PRODUCTS FOR OTHERS; PRODUCT DEVELOPMENT FOR OTHERS; DEVELOPMENT OF NEW TECHNOLOGY FOR OTHERS IN THE FIELD OF SEMICONDUCTORS; AND ENGINEERING SERVICES (U.S. CLS. 100 AND 101).

FIRST USE 10-0-2000; IN COMMERCE 10-0-2000.

**CLASS 42—(Continued).**

2,900,590. GOLDFINGER COIN AND BULLION INC., CAMARILLO, CA. SN 78-121,389. PUB. 5-6-2003, FILED 4-12-2002.

**ATIP**

FOR PROVIDING TEMPORARY USE OF ON-LINE NON-DOWNLOADABLE SOFTWARE FOR USE IN AUTOMATIC PAYMENTS BETWEEN TWO OR MORE USERS OF ANY ONLINE PAYMENT SYSTEM (U.S. CLS. 100 AND 101).

FIRST USE 4-20-2002; IN COMMERCE 4-20-2002.

2,900,687. ISOTOPE LOGGING, INC., RICHARDSON, TX. SN 78-201,287. PUB. 9-2-2003, FILED 1-8-2003.

**ISOLOG**

FOR ANALYSIS AND TESTING FOR OIL WORKINGS; ANALYSIS OF OIL FIELDS; ANALYSIS OF OIL SOAKINGS; CHEMICAL ANALYSIS; TECHNICAL CONSULTATION AND RESEARCH IN THE FIELD OF GEOLOGY; AND MINERAL AND OIL ASSAYING (U.S. CLS. 100 AND 101).

FIRST USE 12-31-2003; IN COMMERCE 12-31-2003.

2,900,829. BARTHET FIRM, THE, MIAMI, FL. SN 78-263,641. PUB. 4-20-2004, FILED 6-17-2003.

**BARTHET LAWYERS TO BUSINESS**

NO CLAIM IS MADE TO THE EXCLUSIVE RIGHT TO USE LAWYERS TO BUSINESS, APART FROM THE MARK AS SHOWN.

THE NAME(S), PORTRAIT(S) AND/OR SIGNATURE(S) SHOWN IN THE MARK IDENTIFIES PATRICK C. BARTHET, WHOSE CONSENT TO REGISTER IS SUBMITTED.

FOR LEGAL SERVICES, NAMELY PROFESSIONAL SERVICES CONSISTING OF ADVICE (U.S. CLS. 100 AND 101).

FIRST USE 1-20-2003; IN COMMERCE 1-20-2003.

**CLASS 42—(Continued).**

2,900,866. UTOPIAN SOFTWARE CONCEPTS, INC., GLEN ALLEN, VA. SN 78-288,277. PUB. 4-27-2004, FILED 8-16-2003.

**ALTERTHOUGHT**

FOR COMPUTER PROJECT MANAGEMENT SERVICES; COMPUTER SOFTWARE DEVELOPMENT; COMPUTER CODE CONVERSION FOR OTHERS; COMPUTER CONSULTATION; COMPUTER DIAGNOSTIC SERVICES; COMPUTER NETWORK DESIGN FOR OTHERS; COMPUTER PROGRAMMING FOR OTHERS; COMPUTER SOFTWARE CONSULTATION; COMPUTER SOFTWARE DESIGN FOR OTHERS; COMPUTER SYSTEMS ANALYSIS; CONSULTING SERVICES IN THE FIELD OF DESIGN, SELECTION, IMPLEMENTATION AND USE OF COMPUTER HARDWARE AND SOFTWARE SYSTEMS FOR OTHERS (U.S. CLS. 100 AND 101).

FIRST USE 2-8-2004; IN COMMERCE 2-8-2004.

2,900,885. WELLSTAT THERAPEUTICS CORPORATION, GAITHERSBURG, MD. SN 78-975,572. PUB. 8-26-2003, FILED 6-26-2002.



FOR PHARMACEUTICAL AND BIOLOGICAL RESEARCH AND DEVELOPMENT SERVICES (U.S. CLS. 100 AND 101).

FIRST USE 5-17-2002; IN COMMERCE 5-18-2002.

**CLASS 43—HOTEL AND RESTAURANT SERVICES**

2,900,284. BLENNERHASSETT CORPORATION, PARKERSBURG, WV. SN 76-429,265. PUB. 3-25-2003, FILED 7-10-2002.

**SHARE THE LEGACY**

FOR HOTEL AND RESTAURANT SERVICES (U.S. CLS. 100 AND 101).

FIRST USE 9-0-2002; IN COMMERCE 9-0-2002.

**CLASS 43—(Continued).**

2,900,316. TIMES PUBLISHING COMPANY, ST. PETERSBURG, FL. SN 76-447,306. PUB. 3-23-2004, FILED 9-5-2002.

**ST. PETE TIMES FORUM**

OWNER OF U.S. REG. NOS. 1,587,715 AND 1,617,625.  
NO CLAIM IS MADE TO THE EXCLUSIVE RIGHT TO USE THE GEOGRAPHICAL LOCATION "ST. PETE" AND "FORUM", APART FROM THE MARK AS SHOWN.  
FOR ARENA SERVICES, NAMELY PROVIDING FACILITIES FOR SPORTS, CONCERTS, CONVENTIONS AND EXHIBITIONS (U.S. CLS. 100 AND 101).  
FIRST USE 9-4-2002; IN COMMERCE 9-4-2002.

2,900,453. SFS 39 INC., SAN FRANCISCO, CA. SN 76-505,547. PUB. 11-25-2003, FILED 4-10-2003.

**STINK N PIZZA**

NO CLAIM IS MADE TO THE EXCLUSIVE RIGHT TO USE "PIZZA", APART FROM THE MARK AS SHOWN.  
FOR RESTAURANT SERVICES (U.S. CLS. 100 AND 101).  
FIRST USE 2-14-2004; IN COMMERCE 2-14-2004.

2,900,497. TODHUNTER INTERNATIONAL, INC., WEST PALM BEACH, FL. SN 76-526,040. PUB. 3-16-2004, FILED 6-30-2003.

**CRUZAN QUARTER**

OWNER OF U.S. REG. NOS. 666,719, 1,199,014, AND OTHERS.  
FOR RESTAURANT AND BAR SERVICES (U.S. CLS. 100 AND 101).  
FIRST USE 1-5-2004; IN COMMERCE 1-5-2004.

2,900,578. PIZZA HUT, INC., DALLAS, TX. SN 78-116,899. PUB. 11-19-2002, FILED 3-22-2002.



OWNER OF U.S. REG. NOS. 729,847, 2,440,574, AND OTHERS.  
NO CLAIM IS MADE TO THE EXCLUSIVE RIGHT TO USE "PIZZA" AND "EXPRESS", APART FROM THE MARK AS SHOWN.  
FOR RESTAURANT SERVICES (U.S. CLS. 100 AND 101).  
FIRST USE 10-30-2001; IN COMMERCE 10-30-2001.

**CLASS 43—(Continued).**

2,900,638. LOLITA'S RESTAURANTS, INC., CHULA VISTA, CA. SN 78-164,412. PUB. 5-6-2003, FILED 9-16-2002.

**LOLITA'S MEXICAN FOOD**

NO CLAIM IS MADE TO THE EXCLUSIVE RIGHT TO USE "MEXICAN FOOD", APART FROM THE MARK AS SHOWN.  
FOR RESTAURANT SERVICES; TAKE-OUT RESTAURANT SERVICES (U.S. CLS. 100 AND 101).  
FIRST USE 7-23-2004; IN COMMERCE 7-23-2004.

2,900,645. BURRITO BEACH, LLC, CHICAGO, IL. SN 78-168,762. PUB. 9-2-2003, FILED 9-27-2002.



NO CLAIM IS MADE TO THE EXCLUSIVE RIGHT TO USE "MEXICAN GRILL", APART FROM THE MARK AS SHOWN.  
FOR RESTAURANT SERVICES (U.S. CLS. 100 AND 101).  
FIRST USE 4-1-2000; IN COMMERCE 4-1-2000.

2,900,736. CANTEBURY SHAKER VILLAGE, INC., CANTERBURY, NH. SN 78-223,958. PUB. 11-4-2003, FILED 3-11-2003.

**THE SHAKER TABLE**

FOR RESTAURANT SERVICES (U.S. CLS. 100 AND 101).  
FIRST USE 8-1-2004; IN COMMERCE 8-1-2004.

2,900,755. BURKEY, TORY D., YORK, PA. AND BURKEY, CHRISTINA L., YORK, PA. SN 78-228,514. PUB. 12-16-2003, FILED 3-21-2003.

**PALASTA!**

FOR RESTAURANT SERVICES FEATURING FOOD FOR CONSUMPTION ON AND OFF THE PREMISES (U.S. CLS. 100 AND 101).  
FIRST USE 6-1-2003; IN COMMERCE 6-1-2003.

**CLASS 43—(Continued).**

2,900,824. PIZZERIA UNO CORPORATION, WILMINGTON, DE. SN 78-261,237. PUB. 4-6-2004, FILED 6-11-2003.

**UNO CHICAGO GRILL**

OWNER OF U.S. REG. NOS. 1,089,458 AND 2,204,530.  
NO CLAIM IS MADE TO THE EXCLUSIVE RIGHT TO USE CHICAGO GRILL, APART FROM THE MARK AS SHOWN.

THE ENGLISH TRANSLATION OF THE WORD "UNO" IN THE MARK IS "ONE".

FOR RESTAURANT SERVICES (U.S. CLS. 100 AND 101).

FIRST USE 11-1-2002; IN COMMERCE 11-1-2002.

2,900,842. GOLDEN CORRAL CORPORATION, RALEIGH, NC. SN 78-269,647. PUB. 2-24-2004, FILED 7-2-2003.

**EVERYONE DESERVES A GOOD MEAL**

FOR RESTAURANT SERVICES (U.S. CLS. 100 AND 101).

FIRST USE 12-29-2003; IN COMMERCE 12-29-2003.

**CLASS 44—MEDICAL, BEAUTY AND AGRICULTURAL SERVICES**

2,900,235. UNIFIED LIMITED, LONDON, WC1H 9JP, UNITED KINGDOM. SN 76-381,709. PUB. 5-13-2003, FILED 3-13-2002.

BestTreatments 

NO CLAIM IS MADE TO THE EXCLUSIVE RIGHT TO USE "BEST TREATMENTS", APART FROM THE MARK AS SHOWN.

FOR PROVIDING HEALTH AND WELL-BEING INFORMATION OVER THE INTERNET (U.S. CLS. 100 AND 101).

FIRST USE 6-0-2002; IN COMMERCE 6-0-2002.

**CLASS 44—(Continued).**

2,900,289. LITTLE DIVERSIFIED ARCHITECTURAL CONSULTING, INC., CHARLOTTE, NC. SN 76-430,196. PUB. 11-11-2003, FILED 7-12-2002.

**LITTLE**  
DIVERSIFIED ARCHITECTURAL CONSULTING

NO CLAIM IS MADE TO THE EXCLUSIVE RIGHT TO USE "DIVERSIFIED ARCHITECTURAL CONSULTING", APART FROM THE MARK AS SHOWN.

FOR LANDSCAPE ARCHITECTURE, NAMELY PLANTING AND IRRIGATION DESIGN, HARDSCAPE DESIGN, SITE FURNISHINGS DESIGN, SITE AMENITIES DESIGN (U.S. CLS. 100 AND 101).

FIRST USE 7-1-2002; IN COMMERCE 7-1-2002.

2,900,305. WAYS OF WELLNESS, INC., REDWOOD CITY, CA. SN 76-441,756. PUB. 12-2-2003, FILED 8-20-2002.

**WOW**  
*ways of wellness*  
DYNAMICS

NO CLAIM IS MADE TO THE EXCLUSIVE RIGHT TO USE "WELLNESS DYNAMICS", APART FROM THE MARK AS SHOWN.

FOR PROVIDING PHYSICAL FITNESS INSTRUCTION (U.S. CLS. 100 AND 101).

FIRST USE 7-1-2004; IN COMMERCE 7-1-2004.

2,900,395. HAWAII MEDICAL SERVICE ASSOCIATION, HONOLULU, HI. SN 76-483,610. PUB. 10-28-2003, FILED 1-21-2003.

**HMSA**

FOR MEDICAL SERVICES, NAMELY, PROVIDING HEALTH INFORMATION AND CARE MANAGEMENT PROGRAMS AIMED AT REDUCING THE COSTS AND EFFECTS OF HEALTH CARE (U.S. CLS. 100 AND 101).

FIRST USE 5-1-1938; IN COMMERCE 5-1-1938.

2,900,419. CREATIVE HAIRDRESSERS, INC., FALLS CHURCH, VA. SN 76-493,329. PUB. 10-14-2003, FILED 2-21-2003.

**MORE IS LESS**

FOR HAIR SALON SERVICES (U.S. CLS. 100 AND 101).  
FIRST USE 4-1-2003; IN COMMERCE 4-1-2003.

**CLASS 45—(Continued).**

2,900,445. PROCUNIER, RONALD R., PEORIA, AZ. SN 76-503,071. PUB. 11-25-2003, FILED 3-28-2003.

**AMERICA'S CHOICE  
CHIROPRACTIC**

NO CLAIM IS MADE TO THE EXCLUSIVE RIGHT TO USE "CHIROPRACTIC", APART FROM THE MARK AS SHOWN.

FOR CHIROPRACTIC SERVICES, ACUPUNCTURE, NUTRITIONAL COUNSELING SERVICES, PHYSICAL THERAPY AND MASSAGE (U.S. CLS. 100 AND 101).  
FIRST USE 6-1-2003; IN COMMERCE 7-1-2004.

2,900,460. BLOW, INC., PEMBROKE PINES, FL. SN 76-510,122. PUB. 1-20-2004, FILED 4-28-2003.

**BLOW**

FOR BEAUTY SALON SERVICES (U.S. CLS. 100 AND 101).  
FIRST USE 9-16-2002; IN COMMERCE 9-16-2002.

2,900,474. GALVAN, RAMON ISAAC, FAIR LAWN, NJ. SN 76-516,026. PUB. 1-27-2004, FILED 5-23-2003.

**THE CENTER FOR BETTER  
SMILES**

NO CLAIM IS MADE TO THE EXCLUSIVE RIGHT TO USE "CENTER", APART FROM THE MARK AS SHOWN.  
FOR DENTAL SERVICES (U.S. CLS. 100 AND 101).  
FIRST USE 4-1-2004; IN COMMERCE 4-1-2004.

2,900,589. ROFFI, MARCO, 8032 ZURICH, SWITZERLAND. SN 78-121,316. PUB. 11-5-2002, FILED 4-12-2002.

**CVMSTAT**

FOR PROVIDING HEALTH CARE INFORMATION, NAMELY INFORMATION RELATING TO CARDIOVASCULAR DISEASES (U.S. CLS. 100 AND 101).  
FIRST USE 5-28-2004; IN COMMERCE 5-28-2004.

2,900,788. KIM K FORREST DDS MS, KATY, TX. SN 78-239,863. PUB. 12-2-2003, FILED 4-20-2003.

**CINCO RANCH  
ORTHODONTICS**

**CLASS 45—(Continued).**

NO CLAIM IS MADE TO THE EXCLUSIVE RIGHT TO USE "ORTHODONTICS", APART FROM THE MARK AS SHOWN.

THE FOREIGN WORDING IN THE MARK TRANSLATES INTO ENGLISH "CINCO" IS "FIVE".  
FOR ORTHODONTIC SERVICES (U.S. CLS. 100 AND 101).  
FIRST USE 3-24-2004; IN COMMERCE 3-24-2004.

2,900,801. DYAX CORP., CAMBRIDGE, MA. SN 78-247,466. PUB. 3-2-2004, FILED 5-8-2003.

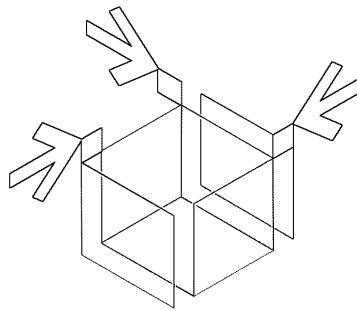

THE MARK CONSISTS OF THE DESIGN OF ARROWS AND RECTANGULAR SHAPES, SOME OF WHICH FORM A BOX.

FOR PROVIDING MEDICAL INFORMATION AND HEALTH CARE INFORMATION TO IMPROVE UNDERSTANDING BY HEALTH CARE PROVIDERS, PATIENTS, PATIENTS' FAMILIES AND THE GENERAL PUBLIC ABOUT THE GENETIC DISORDER HEREDITARY ANGIOEDEMA, ABOUT TREATMENTS FOR HEREDITARY ANGIOEDEMA AND ABOUT HEALTH CARE PROFESSIONALS WHOSE WORK RELATES TO HEREDITARY ANGIOEDEMA (U.S. CLS. 100 AND 101).  
FIRST USE 6-0-2004; IN COMMERCE 6-0-2004.

**CLASS 45—PERSONAL SERVICES**

2,900,462. INFOLINK SCREENING SERVICES, INC., CHATSWORTH, CA. SN 76-510,988. PUB. 1-20-2004, FILED 5-1-2003.

**INTEGRATED  
BACKGROUND SCREENING**

NO CLAIM IS MADE TO THE EXCLUSIVE RIGHT TO USE "BACKGROUND SCREENING", APART FROM THE MARK AS SHOWN.

FOR PRE-EMPLOYMENT BACKGROUND SCREENING (U.S. CLS. 100 AND 101).  
FIRST USE 8-1-2003; IN COMMERCE 8-1-2003.



# SUPPLEMENTAL REGISTER

These registrations are not subject to opposition.

## SECTION 1.— INTERNATIONAL CLASSIFICATION

The short titles associated below with the international class numbers are terms designed merely for quick identification and are not an official part of the international classification. The full names of international classes are given in section 6.1 of the trademark rules of practice.

The designation "U.S. Cl." appearing in this section refers to the U.S. class in effect prior to Sep. 1, 1973 rather than the international class which applies to applications filed on or after that date. For adoption of international classification see notice in the OFFICIAL GAZETTE of Jun. 26, 1973 (911 O.G. TM 210).

### Application in more than one class

2,900,886. UBS AG, ZURICH, SWITZERLAND. SN 75-508,698.  
FILED P.R. 6-25-1998; AM. S.R. 7-12-2004.

#### SWISS BANK CORPORATION

PRIORITY CLAIMED UNDER SEC. 44(D) ON SWITZERLAND APPLICATION NO. 04818/1998, FILED 6-17-1998, REG. NO. 457376, DATED 12-17-1998, EXPIRES 6-17-2008.

NO CLAIM IS MADE TO THE EXCLUSIVE RIGHT TO USE "BANK CORPORATION", APART FROM THE MARK AS SHOWN.

#### CLASS 14—JEWELRY

FOR INGOTS OF PRECIOUS METAL; MONETARY AND NON-MONETARY COINS OF PRECIOUS METAL (U.S. CLS. 2, 27, 28 AND 50).

#### CLASS 36—INSURANCE AND FINANCIAL

FOR CONSUMER CREDIT INSURANCE, SURETY INSURANCE, LIABILITY INSURANCE, LIFE INSURANCE, LOSS INSURANCE, RE-INSURANCE, INSURANCE ASSESSMENT, INSURANCE APPRAISAL, INSURANCE CONSULTANCY, INSURANCE BROKERAGE; FINANCIAL TRANSACTIONS, NAMELY, INVESTMENT FUND TRANSFER AND TRANSACTION SERVICES; FINANCIAL FORECASTING; FINANCIAL PLANNING; BANKING SERVICES AND STOCK MARKET SERVICES; FINANCIAL PORTFOLIO MANAGEMENT, SECURITY BROKERAGE, INSTITUTIONAL ASSET MANAGEMENT; FISCAL ASSESSMENTS AND EVALUATION; FINANCIAL SPONSORSHIP OF CULTURAL EVENTS, SPORTING EVENTS AND RESEARCH (U.S. CLS. 100, 101 AND 102).

2,900,887. HOLLYWOOD.COM, INC., BOCA RATON, FL. SN 75-739,693. FILED P.R. 6-29-1999; AM. S.R. 5-1-2000.

#### HOLLYWOOD.COM

OWNER OF U.S. REG. NO. 2,384,272.

#### CLASS 41—EDUCATION AND ENTERTAINMENT

FOR PROVIDING INFORMATION IN THE FIELD OF ENTERTAINMENT VIA A GLOBAL COMPUTER NETWORK (U.S. CLS. 100, 101 AND 107).  
FIRST USE 6-8-1999; IN COMMERCE 6-8-1999.

#### CLASS 42—SCIENTIFIC, COMPUTER AND LEGAL SERVICES

FOR COMPUTERIZED ONLINE SEARCH SERVICES IN THE FIELD OF ENTERTAINMENT (U.S. CLS. 100 AND 101).  
FIRST USE 6-8-1999; IN COMMERCE 6-8-1999.

2,900,899. NANOSCALE MATERIALS, INC., MANHATTAN, KS. SN 76-397,516. FILED P.R. 4-19-2002; AM. S.R. 2-17-2004.

#### NANOSCALE

#### CLASS 1—CHEMICALS

FOR CHEMICALS, NAMELY, METAL OXIDES FOR USE IN DESTRUCTIVE ABSORPTION OF TOXIC CHEMICALS AND BIOLOGICAL AGENTS, NEUTRALIZATION OF TOXIC INDUSTRIAL CHEMICALS, AIR FILTRATION, ACID GAS TREATMENT, POLISHING APPLICATIONS, ENHANCING THE PHYSICAL PROPERTIES OF PAINTS AND INDUSTRIAL COATINGS, AND TRANSPARENT ULTRAVIOLET ATTENUATION (U.S. CLS. 1, 5, 6, 10, 26 AND 46).  
FIRST USE 6-2-2003; IN COMMERCE 6-2-2003.

#### CLASS 6—METAL GOODS

FOR NANOCRYSTALLINE METAL FOR USE IN DESTRUCTIVE ABSORPTION OF TOXIC CHEMICALS AND BIOLOGICAL AGENTS, NEUTRALIZATION OF TOXIC INDUSTRIAL CHEMICALS, AIR FILTRATION, ACID GAS TREATMENT, POLISHING APPLICATIONS, ENHANCING THE PHYSICAL PROPERTIES OF PAINTS AND INDUSTRIAL COATINGS, AND TRANSPARENT ULTRAVIOLET ATTENUATION (U.S. CLS. 2, 12, 13, 14, 23, 25 AND 50).  
FIRST USE 6-2-2003; IN COMMERCE 6-2-2003.

**CLASS 42—SCIENTIFIC, COMPUTER AND LEGAL SERVICES**

FOR CHEMICAL RESEARCH, NAMELY, RESEARCH IN THE FIELD OF NANOPARTICLES (U.S. CLS. 100 AND 101).

FIRST USE 7-8-2002; IN COMMERCE 6-2-2003.

2,900,901. MARITIME INTELLIGENCE GROUP, INC., WASHINGTON, DC. SN 76-429,390. FILED P.R. 7-9-2002; AM. S.R. 5-19-2003.

**MARITIME INTELLIGENCE GROUP**

NO CLAIM IS MADE TO THE EXCLUSIVE RIGHT TO USE GROUP, APART FROM THE MARK AS SHOWN.

**CLASS 41—EDUCATION AND ENTERTAINMENT**

FOR EDUCATIONAL SERVICES, NAMELY, CONDUCTING CLASSES, SEMINARS, CONFERENCES, WORKSHOPS IN THE FIELD OF MARITIME SECURITY (U.S. CLS. 100, 101 AND 107).

FIRST USE 7-0-2002; IN COMMERCE 7-0-2002.

**CLASS 45—PERSONAL SERVICES**

FOR PROFESSIONAL SERVICES GIVING DIRECT AID IN THE OPERATIONS OR FUNCTIONS OF A COMMERCIAL OR GOVERNMENTAL UNDERTAKING, NAMELY CONSULTATION AND EVALUATIONS RELATED TO SECURITY SCREENING AND TERRORISM RISK PROFILING OF VESSELS (U.S. CLS. 100 AND 101).

FIRST USE 7-0-2002; IN COMMERCE 7-0-2002.

2,900,902. MARS INSTITUTE, PLEASANTON, CA. SN 76-460,726. FILED P.R. 10-23-2002; AM. S.R. 7-6-2004.

**MARS INSTITUTE**

NO CLAIM IS MADE TO THE EXCLUSIVE RIGHT TO USE "INSTITUTE", APART FROM THE MARK AS SHOWN.

**CLASS 41—EDUCATION AND ENTERTAINMENT**

FOR EDUCATIONAL CONSULTATION SERVICES RELATING TO THE EXPLORATION OF THE PLANET MARS (U.S. CLS. 100, 101 AND 107).

FIRST USE 6-23-2003; IN COMMERCE 6-23-2003.

**CLASS 42—SCIENTIFIC, COMPUTER AND LEGAL SERVICES**

FOR SCIENTIFIC AND INDUSTRIAL CONSULTATION AND RESEARCH SERVICES RELATING TO THE EXPLORATION OF THE PLANET MARS (U.S. CLS. 100 AND 101).

FIRST USE 6-23-2003; IN COMMERCE 6-23-2003.

2,900,905. AMERICAN COLLEGE OF CARDIOLOGY, BETHESDA, MD. SN 76-482,936. FILED P.R. 1-16-2003; AM. S.R. 8-12-2004.

**AMERICAN COLLEGE OF CARDIOLOGY FOUNDATION**

OWNER OF U.S. REG. NO. 1,602,945.

NO CLAIM IS MADE TO THE EXCLUSIVE RIGHT TO USE "COLLEGE" AND "FOUNDATION", APART FROM THE MARK AS SHOWN.

**CLASS 41—EDUCATION AND ENTERTAINMENT**

FOR EDUCATIONAL SERVICES, NAMELY, PROVIDING CONTINUING MEDICAL EDUCATION COURSES, CONFERENCES, SEMINARS, AND COURSES OF INSTRUCTION AT THE POST GRADUATE AND PROFESSIONAL LEVEL IN THE FIELD OF CARDIOLOGY AND CARDIOVASCULAR MEDICINE AND HEALTH (U.S. CLS. 100, 101 AND 107).

FIRST USE 12-0-2001; IN COMMERCE 12-0-2001.

**CLASS 44—MEDICAL, BEAUTY AND AGRICULTURAL SERVICES**

FOR PROVIDING INFORMATION AND INFORMATIONAL HEALTH GUIDELINES IN THE FIELD OF CARDIOLOGY AND CARDIOVASCULAR MEDICINE AND HEALTH (U.S. CLS. 100 AND 101).

FIRST USE 12-0-2001; IN COMMERCE 12-0-2001.

2,900,909. JELLY BELLY CANDY COMPANY, FAIRFIELD, CA. SN 76-497,826. FILED P.R. 3-17-2003; AM. S.R. 12-1-2003.

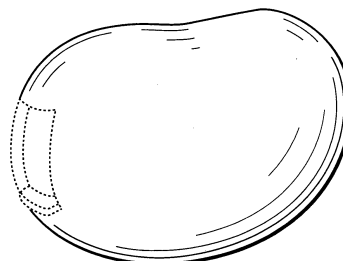

THE MARK CONSISTS OF THE PRODUCT PACKAGING FOR CANDY, NAMELY A THREE DIMENSIONAL CONFIGURATION OF A UNIQUE CONTAINER IN THE SHAPE OF A JELLY BEAN. THE LINING SHOWN IN THE DRAWING IS USED TO INDICATE THE 3-DIMENSIONAL ROUNDNESS OF THE MARK AND IS NOT A FEATURE OF THE MARK, AND DOES NOT INDICATE COLOR. THE MARK MAY BE ANY COLOR OR NO COLOR. THE DOTTED LINES ARE NOT PART OF THE MARK AND ARE INTENDED TO SHOW THE SLIDE OPENING OF THE CONTAINER ONLY.

**CLASS 20—FURNITURE AND ARTICLES NOT OTHERWISE CLASSIFIED**

FOR PLASTIC CONTAINER IN THE SHAPE OF A JELLY BEAN THAT WILL BE USED FOR PACKAGING CANDY (U.S. CLS. 2, 13, 22, 25, 32 AND 50).  
FIRST USE 6-4-2003; IN COMMERCE 6-4-2003.

**CLASS 30—STAPLE FOODS**

FOR CANDY AND A PLASTIC DISPENSING CONTAINER IN THE SHAPE OF A JELLY BEAN THEREFOR SOLD AS A UNIT (U.S. CL. 46).  
FIRST USE 6-4-2003; IN COMMERCE 6-4-2003.

2,900,916. STANDARD PARKING CORPORATION, CHICAGO, IL. SN 76-525,969. FILED P.R. 6-26-2003; AM. S.R. 6-21-2004.

**STANDARD ROAD ASSIST****CLASS 37—CONSTRUCTION AND REPAIR**

FOR EMERGENCY ROADSIDE SERVICES FOR AUTOMOBILES (U.S. CLS. 100, 103 AND 106).  
FIRST USE 1-1-2003; IN COMMERCE 1-1-2003.

**CLASS 39—TRANSPORTATION AND STORAGE**

FOR EMERGENCY AUTOMOBILE TOWING SERVICES (U.S. CLS. 100 AND 105).  
FIRST USE 1-1-2003; IN COMMERCE 1-1-2003.

2,900,926. ASSOCIATION FOR VASCULAR ACCESS, DRAPER, UT. SN 76-556,071. FILED P.R. 11-3-2003; AM. S.R. 6-1-2004.

**ASSOCIATION FOR VASCULAR ACCESS**

THE MARK CONSISTS OF STANDARD CHARACTERS WITHOUT CLAIM TO ANY PARTICULAR FONT, STYLE, SIZE, OR COLOR.  
NO CLAIM IS MADE TO THE EXCLUSIVE RIGHT TO USE "ASSOCIATION", APART FROM THE MARK AS SHOWN.

**CLASS 16—PAPER GOODS AND PRINTED MATTER**

FOR MAGAZINES AND JOURNALS IN THE FIELD OF HEALTH CARE FOR VASCULAR ACCESS PROFESSIONALS (U.S. CLS. 2, 5, 22, 23, 29, 37, 38 AND 50).  
FIRST USE 9-26-2003; IN COMMERCE 9-26-2003.

**CLASS 35—ADVERTISING AND BUSINESS**

FOR ASSOCIATION SERVICES, NAMELY, PROMOTING THE INTERESTS OF VASCULAR ACCESS PROFESSIONALS (U.S. CLS. 100, 101 AND 102).  
FIRST USE 9-15-2003; IN COMMERCE 9-15-2003.

2,900,939. TECHNO TREND AG, ERFURT, FED REP GERMANY. SN 78-265,721. FILED P.R. 6-23-2003; AM. S.R. 7-12-2004.

micro-html

PRIORITY CLAIMED UNDER SEC. 44(D) ON FED REP GERMANY APPLICATION NO. 30262002.8/0. FILED 12-23-2002, REG. NO. 30262002, DATED 2-24-2003, EXPIRES 12-31-2012.

**CLASS 9—ELECTRICAL AND SCIENTIFIC APPARATUS**

FOR AUDIO AND AUDIO-VISUAL RECEPTION AND PROCESSING DEVICES, NAMELY, RECEIVERS, SET-TOP BOXES, RECEPTION MODULES, MODEMS, PDA AND MOBILE TELEPHONES, COMPUTERS AND COMPONENTS AND COMPUTER PERIPHERALS FOR THE FOREGOING (U.S. CLS. 21, 23, 26, 36 AND 38).

**CLASS 37—CONSTRUCTION AND REPAIR**

FOR MAINTENANCE AND REPAIR SERVICES FOR AUDIO AND AUDIO-VISUAL RECEPTION AND PROCESSING DEVICES, COMPUTERS, AND COMPONENTS AND PERIPHERAL DEVICES FOR THE FOREGOING (U.S. CLS. 100, 103 AND 106).

**CLASS 42—SCIENTIFIC, COMPUTER AND LEGAL SERVICES**

FOR DEVELOPMENT OF PROGRAMS FOR OTHERS USED TO RUN AUDIO AND AUDIO-VISUAL RECEPTION AND PROCESSING DEVICES, COMPUTERS, AND COMPONENTS AND PERIPHERAL DEVICES FOR THE FOREGOING (U.S. CLS. 100 AND 101).

2,900,940. TECHNO TREND AG, ERFURT, FED REP GERMANY. SN 78-265,807. FILED P.R. 6-23-2003; AM. S.R. 7-12-2004.

μ-html

PRIORITY CLAIMED UNDER SEC. 44(D) ON FED REP GERMANY APPLICATION NO. 30262003.6/0. FILED 12-23-2002, REG. NO. 30262003, DATED 3-6-2003, EXPIRES 12-31-2012.

**CLASS 9—ELECTRICAL AND SCIENTIFIC APPARATUS**

FOR AUDIO AND AUDIO-VISUAL RECEPTION AND PROCESSING DEVICES, NAMELY, RECEIVERS, SET-TOP BOXES, RECEPTION MODULES, MODEMS, PDA AND MOBILE TELEPHONES, COMPUTERS AND COMPONENTS AND COMPUTER PERIPHERALS FOR THE FOREGOING (U.S. CLS. 21, 23, 26, 36 AND 38).

**CLASS 37—CONSTRUCTION AND REPAIR**

FOR MAINTENANCE AND REPAIR SERVICES FOR AUDIO AND AUDIO-VISUAL RECEPTION AND PROCESSING DEVICES, COMPUTERS, AND COMPONENTS AND PERIPHERAL DEVICES FOR THE FOREGOING (U.S. CLS. 100, 103 AND 106).

**CLASS 42—SCIENTIFIC, COMPUTER AND LEGAL SERVICES**

FOR DEVELOPMENT OF PROGRAMS FOR OTHERS USED TO RUN AUDIO AND AUDIO-VISUAL RECEPTION AND PROCESSING DEVICES, COMPUTERS, AND COMPONENTS AND PERIPHERAL DEVICES FOR THE FOREGOING (U.S. CLS. 100 AND 101).

\* \* \* \* \*

## SECTION 2.— INTERNATIONAL CLASSIFICATION

The short titles associated below with the international class numbers are terms designed merely for quick identification and are not an official part of the international classification. The full names of international classes are given in section 6.1 of the trademark rules of practice.

The designation "U.S. Cl." appearing in this section refers to the U.S. class in effect prior to Sep. 1, 1973 rather than the international class which applies to applications filed on or after that date. For adoption of international classification see notice in the OFFICIAL GAZETTE of Jun. 26, 1973 (911 O.G. TM 210).

### Application in one class

#### CLASS 4—LUBRICANTS AND FUELS

2,900,946. FRABILL, INC., JACKSON, WI. SN 78-319,692. FILED 10-28-2003.

**SUBZERO**

FOR GENERAL PURPOSE LOW TEMP GREASE (U.S. CLS. 1, 6 AND 15).  
FIRST USE 9-1-2000; IN COMMERCE 9-1-2000.

#### CLASS 9—ELECTRICAL AND SCIENTIFIC APPARATUS

2,900,915. FINNEGAN, HENDERSON, FARABOW, GARRETT & DUNNER, L.L.P., WASHINGTON, DC. SN 76-523,462. FILED P.R. 6-17-2003; AM. S.R. 7-13-2004.

### IP E-SOURCE

FOR DOWNLOADABLE COMPUTER FILES FEATURING LEGISLATIVE, REGULATORY, AND JUDICIAL INFORMATION IN THE FIELD OF INTELLECTUAL PROPERTY LAW; COMPACT DISCS, DVDS, AND COMPUTER-FILE STORAGE MECHANISMS, NAMELY, USB MEMORY DRIVE, FEATURING LEGISLATIVE, REGULATORY, AND JUDICIAL INFORMATION IN THE FIELD OF INTELLECTUAL PROPERTY LAW (U.S. CLS. 21, 23, 26, 36 AND 38).

FIRST USE 6-17-2003; IN COMMERCE 6-17-2003.

2,900,925. EYE RESPONSE TECHNOLOGIES, CHARLOTTEVILLE, VA. SN 76-552,973. FILED P.R. 10-21-2003; AM. S.R. 8-3-2004.

### GAZETRACKER

FOR COMPUTER SOFTWARE FOR USE IN RECORDING AND ANALYZING THE EYE MOVEMENTS, COMPUTER MOUSE MOVEMENTS, AND KEYBOARD KEYSTROKES OF TEST SUBJECTS WHO ARE USING VARIOUS SOFTWARE PROGRAMS OR RESPONDING TO STILL IMAGES, ANIMATIONS, OR VIDEOS (U.S. CLS. 21, 23, 26, 36 AND 38).

FIRST USE 6-18-1996; IN COMMERCE 8-3-1996.

#### CLASS 9—(Continued).

2,900,934. DYNAMIC SOLUTIONS INTERNATIONAL, ENGLEWOOD, CO. SN 78-217,679. FILED P.R. 2-21-2003; AM. S.R. 10-24-2003.

**CARDWRITER**

FOR COMPUTER SOFTWARE USED IN OPERATION OF MANUFACTURING EQUIPMENT FOR THE PRODUCTION OF PLASTIC CUSTOMER LOYALTY AND AFFINITY CARDS (U.S. CLS. 21, 23, 26, 36 AND 38).  
FIRST USE 8-14-2003; IN COMMERCE 8-14-2003.

2,900,949. COMBINENET, INC., PITTSBURGH, PA. SN 78-340,195. FILED P.R. 12-12-2003; AM. S.R. 8-9-2004.

### EXPRESSIVE BIDDING

THE MARK CONSISTS OF STANDARD CHARACTERS WITHOUT CLAIM TO ANY PARTICULAR FONT, STYLE, SIZE, OR COLOR.

FOR COMPUTER SOFTWARE FOR SUBMITTING, TRACKING AND ACCEPTING BIDDING PROPOSALS OVER A GLOBAL COMPUTER NETWORK; DOWNLOADABLE COMPUTER SOFTWARE FOR SUBMITTING, TRACKING AND ACCEPTING BIDDING PROPOSALS (U.S. CLS. 21, 23, 26, 36 AND 38).

FIRST USE 3-26-2002; IN COMMERCE 10-17-2002.

#### CLASS 10—MEDICAL APPARATUS

**CLASS 10—(Continued).**

2,900,921. THIRD PARTY INTERNATIONAL, INC., OCALA, FL. SN 76-536,310. FILED P.R. 8-11-2003; AM. S.R. 7-26-2004.

**STAGERIG**

FOR MUSICAL EQUIPMENT TRANSPORTATION, STORAGE AND PERFORMANCE DEVICE, NAMELY, A CABINET ON WHEELS TO HOUSE A MUSICIANS AMPLIFIER, FOOT SWITCHES, GUITAR AND MIKE CABLES, SPEAKERS AND AMPLIFIER HEAD (U.S. CLS. 26, 39 AND 44).  
FIRST USE 6-28-2004; IN COMMERCE 6-28-2004.

2,900,941. TAVTECH LTD., YEHUD, ISRAEL. SN 78-272,457. FILED P.R. 7-10-2003; AM. S.R. 8-3-2004.

**JETPEEL**

PRIORITY CLAIMED UNDER SEC. 44(D) ON ISRAEL APPLICATION NO. 162228, FILED 1-14-2003, REG. NO. 162228, DATED 1-14-2003, EXPIRES 1-14-2010.  
FOR APPARATUS AND INSTRUMENTS FOR DERMAL, EPIDERMAL, GUM AND TISSUE ABRASION, FOR SURGICAL, MEDICAL AND DENTAL USE (U.S. CLS. 26, 39 AND 44).

2,900,945. BREG, INC., VISTA, CA. SN 78-306,343. FILED P.R. 9-27-2003; AM. S.R. 8-4-2004.

**NEUTRAL WEDGE**

FOR THERAPEUTIC SUPPORT FOR MAINTAINING A STABLE POSITION OF THE ARM AND SHOULDER DURING REHABILITATION OF THE SAME (U.S. CLS. 26, 39 AND 44).  
FIRST USE 10-10-2003; IN COMMERCE 10-10-2003.

2,900,953. MAYER LABORATORIES, INC., OAKLAND, CA. SN 78-354,115. FILED 1-20-2004.

**Bi-directional**

THE MARK CONSISTS OF STANDARD CHARACTERS WITHOUT CLAIM TO ANY PARTICULAR FONT, STYLE, SIZE, OR COLOR.  
FOR MALE, NON-LATEX CONDOMS (U.S. CLS. 26, 39 AND 44).  
FIRST USE 1-1-2001; IN COMMERCE 1-1-2001.

**CLASS 11—ENVIRONMENTAL CONTROL APPARATUS**

2,900,943. HOBBY HILL LIGHTING, INC., STURTEVANT, WI. SN 78-280,742. FILED P.R. 7-30-2003; AM. S.R. 7-23-2004.

**NO-KORD**

FOR BATTERY OPERATED LIGHT FIXTURES (U.S. CLS. 13, 21, 23, 31 AND 34).  
FIRST USE 9-0-2003; IN COMMERCE 9-0-2003.

**CLASS 14—JEWELRY**

2,900,952. NICOLAI, MICHELLE M., BEVERLY HILLS, CA. SN 78-351,463. FILED P.R. 1-13-2004; AM. S.R. 8-10-2004.

**SALAMANDER**

THE MARK CONSISTS OF STANDARD CHARACTERS WITHOUT CLAIM TO ANY PARTICULAR FONT, STYLE, SIZE, OR COLOR.  
FOR JEWELRY MADE WITH OR WITHOUT PRECIOUS OR SEMI-PRECIOUS STONES, NAMELY, NECKLACES, BRACELETS, RINGS, EARRINGS, CUFFLINKS, PINS, BROOCHES, TIMEPIECES, NAMELY, WATCHES AND CLOCKS, AND BELT BUCKLES OF PRECIOUS METAL (U.S. CLS. 2, 27, 28 AND 50).  
FIRST USE 8-1-2003; IN COMMERCE 10-1-2003.

**CLASS 16—PAPER GOODS AND PRINTED MATTER**

2,900,900. PNS & WSS, INC., THOROFARE, NJ. SN 76-417,874. FILED P.R. 6-7-2002; AM. S.R. 10-21-2003.

**GLAUCOMA MANAGEMENT NEWS**

NO CLAIM IS MADE TO THE EXCLUSIVE RIGHT TO USE "NEWS", APART FROM THE MARK AS SHOWN.  
FOR MEDICAL NEWSLETTERS (U.S. CLS. 2, 5, 22, 23, 29, 37, 38 AND 50).  
FIRST USE 10-2-2002; IN COMMERCE 10-2-2002.

**CLASS 16—(Continued).**

2,900,914. HEARST COMMUNICATIONS, INC., NEW YORK, NY. SN 76-521,846. FILED P.R. 6-2-2003; AM. S.R. 8-3-2004.

**THE WINE CHRONICLE**

OWNER OF U.S. REG. NO. 1,133,668.  
FOR SYNDICATED NEWSPAPER FEATURES DEALING WITH FOOD, ENTERTAINMENT AND WINE (U.S. CLS. 2, 5, 22, 23, 29, 37, 38 AND 50).  
FIRST USE 6-29-2003; IN COMMERCE 6-29-2003.

---

2,900,918. ZEBRA PEN CORPORATION, EDISON, NJ. SN 76-529,957. FILED P.R. 7-15-2003; AM. S.R. 3-29-2004.

**CANDYPEN**

FOR WRITING INSTRUMENTS, NAMELY MARKERS, BALL-POINT PENS, MECHANICAL PENCILS, RETRACTABLE PENS, MULTIFUNCTIONAL PENS AND PENCILS, AND HIGHLIGHTING PENS (U.S. CLS. 2, 5, 22, 23, 29, 37, 38 AND 50).  
FIRST USE 11-18-2003; IN COMMERCE 3-2-2004.

---

2,900,923. VIBE VENTURES LLC, LOS ANGELES, CA. SN 76-541,284. FILED P.R. 8-19-2003; AM. S.R. 7-8-2004.

**SAY WORD**

FOR MAGAZINE SECTION FEATURING POETRY OR LYRICS CONTRIBUTED BY READERS (U.S. CLS. 2, 5, 22, 23, 29, 37, 38 AND 50).  
FIRST USE 4-0-2002; IN COMMERCE 4-0-2002.

---

2,900,932. AMERICAN ASSOCIATION OF INDIVIDUAL INVESTORS, INC., CHICAGO, IL. SN 78-199,858. FILED P.R. 1-3-2003; AM. S.R. 5-19-2004.

**STOCK SUPERSTARS REPORT**

NO CLAIM IS MADE TO THE EXCLUSIVE RIGHT TO USE "REPORT", APART FROM THE MARK AS SHOWN.  
FOR PUBLICATIONS AND PERIODICALS, NAMELY MAGAZINES, BOOKLETS, PAMPHLETS, BROCHURES, REPORTS, MANUALS AND NEWSLETTERS ALL DEALING WITH INVESTMENTS, INVESTMENT THEORY, STRATEGIES AND PRACTICE (U.S. CLS. 2, 5, 22, 23, 29, 37, 38 AND 50).  
FIRST USE 1-3-2003; IN COMMERCE 1-3-2003.

**CLASS 16—(Continued).**

2,900,947. ENTERTAINMENT WEEKLY INC., NEW YORK, NY. SN 78-329,835. FILED P.R. 11-19-2003; AM. S.R. 7-27-2004.

**THE MUST LIST**

THE MARK CONSISTS OF STANDARD CHARACTERS WITHOUT CLAIM TO ANY PARTICULAR FONT, STYLE, SIZE, OR COLOR.

NO CLAIM IS MADE TO THE EXCLUSIVE RIGHT TO USE "LIST", APART FROM THE MARK AS SHOWN.

FOR MAGAZINE SECTION FEATURING EDITORIAL RECOMMENDATIONS FOR MUSIC CD'S, VIDEOS, BOOKS AND OTHER MULTIMEDIA MATERIALS (U.S. CLS. 2, 5, 22, 23, 29, 37, 38 AND 50).

FIRST USE 6-13-2003; IN COMMERCE 6-13-2003.

---

**CLASS 17—RUBBER GOODS**

2,900,906. CONTINENTAL SUPPLY COMPANY, WOODLAND, CA. SN 76-484,434. FILED P.R. 1-21-2003; AM. S.R. 7-27-2004.

**STANDARD PIPE**

FOR PIPE, NAMELY POLYETHYLENE PIPE AND FITTINGS FOR USE IN GEOTHERMAL DRILLING, HEATING, AND COOLING (U.S. CLS. 1, 5, 12, 13, 35 AND 50).

FIRST USE 3-11-2003; IN COMMERCE 3-11-2003.

---

**CLASS 20—FURNITURE AND ARTICLES NOT OTHERWISE CLASSIFIED**

**CLASS 20—(Continued).**

2,900,895. VICTORINOX AG, CH-6438 IBACH-SCHWYZ, SWITZERLAND. SN 76-241,477. FILED P.R. 4-16-2001; AM. S.R. 4-23-2004.

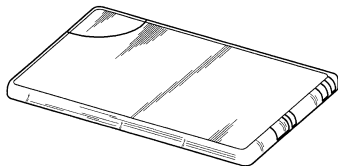

PRIORITY CLAIMED UNDER SEC. 44(D) ON SWITZERLAND APPLICATION NO. 12331/2000, FILED 10-16-2000, REG. NO. 482927, DATED 4-19-2001, EXPIRES 10-16-2010.

FOR CONTAINERS OF PLASTICS; PLASTICS CASES FOR IMPLEMENTS; IMPLEMENT HOLDERS OF PLASTICS; IMPLEMENT CONTAINERS FOR HAND TOOLS SUCH AS KNIVES, FILES, SCISSORS, WRITING INSTRUMENTS, TWEEZERS; HOLDERS OR CARRYING CASES OF PLASTICS FOR KEYS AND/OR FOODSTUFFS SUCH AS CHEWING GUM, CONFECTIONERY (U.S. CLS. 2, 13, 22, 25, 32 AND 50).  
FIRST USE 12-0-1996; IN COMMERCE 12-0-1996.

2,900,929. ATLANTA SNAPSEAL LTD., MARIETTA, GA. SN 76-562,890. FILED P.R. 11-18-2003; AM. S.R. 7-13-2004.

# SNAPSEAL

FOR CONTAINER CLOSURES OF PLASTIC (U.S. CLS. 2, 13, 22, 25, 32 AND 50).  
FIRST USE 10-9-2003; IN COMMERCE 10-9-2003.

**CLASS 25—CLOTHING**

2,900,931. TSI BRANDS, INC., WILMINGTON, DE. SN 78-187,566. FILED P.R. 11-21-2002; AM. S.R. 7-22-2004.

## STAIN PROTECTOR

FOR CLOTHING, NAMELY, PANTS, SLACKS AND SHORTS (U.S. CLS. 22 AND 39).  
FIRST USE 1-31-2004; IN COMMERCE 1-31-2004.

**CLASS 29—MEATS AND PROCESSED FOODS****CLASS 29—(Continued).**

2,900,935. KANSAS CITY STEAK COMPANY, LLC, KANSAS CITY, KS. SN 78-227,879. FILED P.R. 3-20-2003; AM. S.R. 2-26-2004.

## KANSAS LAND & CATTLE COMPANY

NO CLAIM IS MADE TO THE EXCLUSIVE RIGHT TO USE LAND & CATTLE COMPANY, APART FROM THE MARK AS SHOWN.  
FOR BEEF (U.S. CL. 46).  
FIRST USE 5-31-2003; IN COMMERCE 5-31-2003.

**CLASS 30—STAPLE FOODS**

2,900,904. HYDE & HYDE, INC., CORONA, CA. SN 76-479,189. FILED P.R. 12-30-2002; AM. S.R. 7-29-2004.

## CANDY TREATS

NO CLAIM IS MADE TO THE EXCLUSIVE RIGHT TO USE CANDY, APART FROM THE MARK AS SHOWN.  
FOR CANDY (U.S. CL. 46).  
FIRST USE 12-31-2002; IN COMMERCE 12-31-2002.

2,900,907. SCHMIDT BAKING COMPANY, INC., BALTIMORE, MD. SN 76-487,928. FILED P.R. 2-6-2003; AM. S.R. 8-17-2004.

## CHESAPEAKE GRAINS

FOR BAKERY PRODUCTS, INCLUDING BREAD (U.S. CL. 46).  
FIRST USE 10-1-2001; IN COMMERCE 10-1-2001.

2,900,913. ALANRIC FOOD DISTRIBUTORS, INC., THOROFARE, NJ. SN 76-521,401. FILED P.R. 6-9-2003; AM. S.R. 3-18-2004.

**BALSAMIC**  
*Table & Grill*  
**SAUCE**

NO CLAIM IS MADE TO THE EXCLUSIVE RIGHT TO USE "SAUCE", APART FROM THE MARK AS SHOWN.  
FOR SAUCES (U.S. CL. 46).  
FIRST USE 1-0-2003; IN COMMERCE 1-0-2003.



**CLASS 30—(Continued).**

2,900,919. HAWAIIAN HOST, INC., HONOLULU, HI. SN 76-534,710. FILED P.R. 7-23-2003; AM. S.R. 7-28-2004.

**MACNUT CRUNCH**

FOR CONFECTIONERY, NAMELY MACADAMIA NUT CANDIES (U.S. CL. 46).  
FIRST USE 3-7-2000; IN COMMERCE 3-7-2000.

2,900,936. BARILLA G. E. R. FRATELLI - SOCIETA PER AZIONI, PARMA, ITALY. SN 78-231,466. FILED P.R. 3-28-2003; AM. S.R. 3-9-2004.

**SPAGHETTI RIGATI**

NO CLAIM IS MADE TO THE EXCLUSIVE RIGHT TO USE "SPAGHETTI", APART FROM THE MARK AS SHOWN. THE ENGLISH TRANSLATION OF THE WORD RIGATI IS STRIPED.  
FOR PASTA, NAMELY, SPAGHETTI (U.S. CL. 46).  
FIRST USE 1-1-2003; IN COMMERCE 1-1-2003.

**CLASS 32—LIGHT BEVERAGES**

2,900,903. BROUWERIJ LINDEMANS, 1602 VLEZENBEEK, BELGIUM. SN 76-463,087. FILED P.R. 10-31-2002; AM. S.R. 7-22-2004.

**LINDEMANS**

PRIORITY CLAIMED UNDER SEC. 44(D) ON BENELUX APPLICATION NO. 1,012,865, FILED 6-14-2002, REG. NO. 0720640, DATED 6-14-2002, EXPIRES 6-14-2012.  
FOR BEER, PARTICULARLY LAMBIC BEER (U.S. CLS. 45, 46 AND 48).

**CLASS 33—WINES AND SPIRITS**

2,900,917. WILLIAM PITTERS LA GUILDE DU VIN, 33310 LORMONT, FRANCE. SN 76-528,652. FILED P.R. 7-11-2003; AM. S.R. 6-16-2004.

**PITTERS**

OWNER OF FRANCE REG. NO. 1640564, DATED 9-19-1990, EXPIRES 9-19-2010.  
THE MARK IS NOT THE NAME OF A LIVING INDIVIDUAL.  
FOR WINES (U.S. CLS. 47 AND 49).

**CLASS 34—SMOKERS' ARTICLES****CLASS 34—(Continued).**

2,900,933. TUCCI, LOUIS, DBA STOGIE POKER, PLANO, TX. SN 78-213,855. FILED P.R. 2-12-2003; AM. S.R. 4-26-2004.

**STOGIE POKER**

FOR CIGAR ACCESSORIES, NAMELY, CIGAR HOLDING TOOLS, NOT OF PRECIOUS METAL (U.S. CLS. 2, 8, 9 AND 17).  
FIRST USE 4-0-2002; IN COMMERCE 4-0-2002.

**SERVICE MARKS****CLASS 35—ADVERTISING AND BUSINESS**

2,900,888. NURSERYROOM, INC, LOS ANGELES, CA. SN 76-099,992. FILED P.R. 8-1-2000; AM. S.R. 12-3-2001.

**NURSERYROOM**

FOR ON-LINE RETAIL STORE SERVICES FEATURING HATS, BOOTIES, BABY CLOTHING, SHOES, BOOKS, STATIONERY, CARDS, AND PLUSH TOYS (U.S. CLS. 100, 101 AND 102).  
FIRST USE 11-21-2001; IN COMMERCE 11-21-2001.

2,900,889. CE NETWORK INC., THE, TORONTO, ONTARIO, CANADA. SN 76-113,667. FILED P.R. 8-21-2000; AM. S.R. 8-2-2004.

**CE NETWORK**

PRIORITY CLAIMED UNDER SEC. 44(D) ON CANADA APPLICATION NO. 1051778, FILED 3-22-2000, REG. NO. TMA579197, DATED 4-8-2003, EXPIRES 4-8-2018.

NO CLAIM IS MADE TO THE EXCLUSIVE RIGHT TO USE "CE", APART FROM THE MARK AS SHOWN.

FOR EDUCATIONAL SERVICES, NAMELY PROVIDING CONTINUING EDUCATION IN A VARIETY OF SUBJECTS RENDERED BY MEANS OF ON-LINE COURSES, CORRESPONDENCE COURSES, AND LIVE SEMINARS OR PRESENTATIONS, ENABLING INDIVIDUALS TO REMOTELY CONTACT EACH OTHER AND THE EDUCATION PROVIDER (U.S. CLS. 100, 101 AND 102).

**CLASS 35—(Continued).**

2,900,950. HERNANDEZ, IGNACIO JR., LA JOLLA, CA. SN 78-349,876. FILED P.R. 1-9-2004; AM. S.R. 8-12-2004.

**SEM EN ESPAÑOL**

THE MARK CONSISTS OF STANDARD CHARACTERS WITHOUT CLAIM TO ANY PARTICULAR FONT, STYLE, SIZE, OR COLOR.

NO CLAIM IS MADE TO THE EXCLUSIVE RIGHT TO USE "SEM", APART FROM THE MARK AS SHOWN.

THE FOREIGN WORDING "EN ESPAÑOL" IN THE MARK TRANSLATES INTO ENGLISH AS "IN SPANISH".

FOR BUSINESS MARKETING CONSULTING SERVICES IN THE NATURE OF ENHANCING SEARCH ENGINE VISIBILITY, NAMELY, FOR ENTERPRISES CONDUCTING BUSINESS ON THE INTERNET PRIMARILY FOCUSED IN THE HISPANIC AND LATIN AMERICAN MARKET THROUGH KEYWORD PHRASES IN SPANISH THROUGH SEARCH ENGINE POSITIONING, SEARCH ENGINE OPTIMIZATION OR SEARCH ENGINE MARKETING (U.S. CLS. 100, 101 AND 102).

FIRST USE 12-10-2003; IN COMMERCE 12-10-2003.

**CLASS 36—INSURANCE AND FINANCIAL**

2,900,897. A.G. EDWARDS & SONS, INC., ST. LOUIS, MO. SN 76-283,928. FILED P.R. 7-12-2001; AM. S.R. 2-24-2004.

**SELECT ADVISOR**

FOR CONSULTING SERVICES RELATING TO ASSET AND INVESTMENT MANAGEMENT (U.S. CLS. 100, 101 AND 102).

FIRST USE 7-0-2001; IN COMMERCE 1-0-2002.

2,900,908. INTERNATIONAL ASSOCIATION OF MERGER AND ACQUISITION PROFESSIONALS, DES MOINES, IA. SN 76-495,335. FILED P.R. 3-7-2003; AM. S.R. 7-28-2004.

**INTERNATIONAL NETWORK OF M&A PARTNERS**

NO CLAIM IS MADE TO THE EXCLUSIVE RIGHT TO USE "INTERNATIONAL", "NETWORK", AND "PARTNERS", APART FROM THE MARK AS SHOWN.

FOR PROVIDING INFORMATION TO CONSULTANTS IN THE FIELD OF MERGERS AND ACQUISITIONS; AND THE DISSEMINATION OF INFORMATION IN THE AREA OF FINANCE AND CORPORATE TRANSACTIONS OVER THE GLOBAL COMPUTER NETWORK (U.S. CLS. 100, 101 AND 102).

FIRST USE 2-1-2003; IN COMMERCE 2-1-2003.

**CLASS 36—(Continued).**

2,900,911. SUMMIT FINANCIAL GROUP, INC., MOORE-FIELD, WV. SN 76-507,847. FILED P.R. 4-18-2003; AM. S.R. 6-9-2004.

**LOUDOUN NATIONAL BANK**

NO CLAIM IS MADE TO THE EXCLUSIVE RIGHT TO USE NATIONAL BANK, APART FROM THE MARK AS SHOWN.

FOR BANKING SERVICES (U.S. CLS. 100, 101 AND 102).

FIRST USE 5-10-2002; IN COMMERCE 5-10-2002.

2,900,912. SUMMIT FINANCIAL GROUP, INC., MOORE-FIELD, WV. SN 76-507,849. FILED P.R. 4-18-2003; AM. S.R. 6-9-2004.

**SHENANDOAH VALLEY NATIONAL BANK**

NO CLAIM IS MADE TO THE EXCLUSIVE RIGHT TO USE NATIONAL BANK, APART FROM THE MARK AS SHOWN.

FOR BANKING SERVICES (U.S. CLS. 100, 101 AND 102).

FIRST USE 5-17-1999; IN COMMERCE 5-17-1999.

2,900,924. AMERICAN FIDELITY ASSURANCE COMPANY, OKLAHOMA CITY, OK. SN 76-546,000. FILED P.R. 9-22-2003; AM. S.R. 6-14-2004.

**PAYCHECK PROTECTOR**

OWNER OF U.S. REG. NO. 2,376,656.

FOR INSURANCE SERVICES, IN THE FIELD OF LIFE, HEALTH AND DISABILITY INSURANCE; INSURANCE ADMINISTRATION AND INSURANCE BROKERAGE SERVICES (U.S. CLS. 100, 101 AND 102).

FIRST USE 8-1-2003; IN COMMERCE 8-1-2003.

2,900,927. STATE EMPLOYEES CREDIT UNION OF MARYLAND, INC., LINTHICUM, MD. SN 76-559,670. FILED P.R. 10-31-2003; AM. S.R. 8-12-2004.

**BETTER BANKING, BETTER SERVICE**

FOR BANKING AND FINANCIAL SERVICES, NAMELY CREDIT UNION (U.S. CLS. 100, 101 AND 102).

FIRST USE 6-1-2004; IN COMMERCE 6-1-2004.

**CLASS 36—(Continued).**

2,900,951. VENTURESMART, INC., LAFAYETTE, CA. SN 78-349,895. FILED P.R. 1-9-2004; AM. S.R. 8-18-2004.

## Replacement Property Specialists

THE MARK CONSISTS OF STANDARD CHARACTERS WITHOUT CLAIM TO ANY PARTICULAR FONT, STYLE, SIZE, OR COLOR.

NO CLAIM IS MADE TO THE EXCLUSIVE RIGHT TO USE "PROPERTY", APART FROM THE MARK AS SHOWN. FOR REAL ESTATE INVESTMENT SERVICES; AND PROCESS MANAGEMENT SERVICES FOR CO-OWNERSHIP OF REAL ESTATE INVESTMENT PROPERTY EXCHANGES (U.S. CLS. 100, 101 AND 102).

FIRST USE 11-6-2002; IN COMMERCE 11-6-2002.

**CLASS 39—TRANSPORTATION AND STORAGE**

2,900,896. UNIVERSAL EXPRESS, INC., NEW YORK, NY. SN 76-260,371. FILED P.R. 5-21-2001; AM. S.R. 8-12-2004.

## LUGGAGE EXPRESS

NO CLAIM IS MADE TO THE EXCLUSIVE RIGHT TO USE "EXPRESS", APART FROM THE MARK AS SHOWN.

FOR TRANSPORTATION AND DELIVERY OF LUGGAGE FROM HOME, BUSINESSES AND HOTELS TO DESTINATIONS VIA AIR, TRUCK, BUS, RAIL AND BOAT (U.S. CLS. 100 AND 105).

FIRST USE 7-0-2001; IN COMMERCE 7-0-2001.

**CLASS 41—EDUCATION AND ENTERTAINMENT**

2,900,898. ALVAREZ, GASTON A., TEMECUECLA, CA. SN 76-290,316. FILED P.R. 7-25-2001; AM. S.R. 1-6-2003.

## GUARANTEED FITNESS

FOR HEALTH CLUB SERVICES (U.S. CLS. 100, 101 AND 107).

FIRST USE 7-17-2000; IN COMMERCE 7-17-2000.

**CLASS 41—(Continued).**

2,900,920. AEROBICS AND FITNESS ASSOCIATION OF AMERICA, SHERMAN OAKS, CA. SN 76-535,858. FILED P.R. 7-24-2003; AM. S.R. 6-29-2004.

## TEEN SHAPE-UP

FOR PROVIDING INFORMATION, ADVICE AND INSTRUCTION OVER A GLOBAL COMPUTER NETWORK ON THE SUBJECTS OF EXERCISE AND FITNESS (U.S. CLS. 100, 101 AND 107).

FIRST USE 6-28-2004; IN COMMERCE 6-28-2004.

2,900,922. INTERNATIONAL FOUNDATION OF HUMAN RIGHTS AND TOLERANCE, LOS ANGELES, CA. SN 76-536,916. FILED P.R. 7-28-2003; AM. S.R. 6-18-2004.

## YOUTH FOR HUMAN RIGHTS INTERNATIONAL

FOR PROVIDING MATERIALS FOR STUDENTS AND TEACHING GUIDES FOR SCHOOLS IN THE FIELD OF PREVENTING DISCRIMINATION AND PROMOTING RELIGIOUS TOLERANCE (U.S. CLS. 100, 101 AND 107).

FIRST USE 4-1-2001; IN COMMERCE 4-1-2001.

2,900,937. GREENSBORO SYMPHONY SOCIETY, INCORPORATED, GREENSBORO, NC. SN 78-250,257. FILED P.R. 5-15-2003; AM. S.R. 4-14-2004.

## CAROLINA POPS

NO CLAIM IS MADE TO THE EXCLUSIVE RIGHT TO USE "POPS", APART FROM THE MARK AS SHOWN.

FOR ENTERTAINMENT IN THE NATURE OF SYMPHONY ORCHESTRA PERFORMANCES; EDUCATIONAL SERVICES, NAMELY CONDUCTING PROGRAMS IN THE FIELD OF MUSICAL PERFORMANCE (U.S. CLS. 100, 101 AND 107).

FIRST USE 4-30-2002; IN COMMERCE 4-30-2002.

2,900,938. STAMP CAMP USA, KNOXVILLE, PA. SN 78-252,093. FILED P.R. 5-20-2003; AM. S.R. 8-6-2004.

## STAMP CAMP USA

NO CLAIM IS MADE TO THE EXCLUSIVE RIGHT TO USE "CAMP", APART FROM THE MARK AS SHOWN.

FOR ARRANGING AND CONDUCTING EDUCATIONAL CONFERENCES (U.S. CLS. 100, 101 AND 107).

FIRST USE 3-26-2001; IN COMMERCE 3-26-2001.

**CLASS 41—(Continued).**

2,900,944. SIMONSON, PETER, MIAMI BEACH, FL. SN 78-299,586. FILED P.R. 9-12-2003; AM. S.R. 8-4-2004.

**THE HOOVERS**

FOR ENTERTAINMENT SERVICES, NAMELY, LIVE PERFORMANCES BY A MUSICAL ARTIST (U.S. CLS. 100, 101 AND 107).

FIRST USE 12-31-2002; IN COMMERCE 12-31-2002.

2,900,948. FRITTS, JEREMY R., ROGERSVILLE, TN. AND FRITTS, LARRY W., ROGERSVILLE, TN. SN 78-339,262. FILED P.R. 12-11-2003; AM. S.R. 8-9-2004.



Bluegrass  
in the  
Smokies

FOR ENTERTAINMENT SERVICES, NAMELY, A LIVE BLUEGRASS CONCERT THAT, OFTENTIMES, INCLUDES MORE THAN ONE BAND, AND OFTENTIMES, LASTS MORE THAN ONE DAY (U.S. CLS. 100, 101 AND 107).

FIRST USE 12-19-1999; IN COMMERCE 6-4-2000.

**CLASS 42—SCIENTIFIC, COMPUTER AND LEGAL SERVICES**

2,900,890. HARDWICK, DEBORAH, NEW YORK, NY. SN 76-121,173. FILED P.R. 9-1-2000; AM. S.R. 6-24-2004.

**BUFFPEDICURE**

FOR DAY SPA SERVICES, NAMELY PEDICURES (U.S. CLS. 100 AND 101).

FIRST USE 11-30-2000; IN COMMERCE 11-30-2000.

2,900,891. GALLUP, INC., OMAHA, NE. SN 76-188,433. FILED P.R. 1-2-2001; AM. S.R. 8-4-2004.

**COMMUNICATION**

FOR PROVIDING A PERSONAL ANALYSIS OF AN INDIVIDUAL'S INHERENT STRENGTHS OVER AN INTERACTIVE WEBSITE ON A GLOBAL COMPUTER NETWORK (U.S. CLS. 100 AND 101).

FIRST USE 3-17-2000; IN COMMERCE 3-17-2000.

**CLASS 42—(Continued).**

2,900,892. GALLUP, INC., OMAHA, NE. SN 76-188,437. FILED P.R. 1-2-2001; AM. S.R. 8-4-2004.

**ANALYTICAL**

FOR PROVIDING A PERSONAL ANALYSIS OF AN INDIVIDUAL'S INHERENT STRENGTHS OVER AN INTERACTIVE WEBSITE ON A GLOBAL COMPUTER NETWORK (U.S. CLS. 100 AND 101).

FIRST USE 3-17-2000; IN COMMERCE 3-17-2000.

2,900,893. GALLUP, INC., OMAHA, NE. SN 76-188,438. FILED P.R. 1-2-2001; AM. S.R. 8-12-2004.

**ADAPTABILITY**

FOR PROVIDING A PERSONAL ANALYSIS OF AN INDIVIDUAL'S INHERENT STRENGTHS OVER AN INTERACTIVE WEBSITE ON A GLOBAL COMPUTER NETWORK (U.S. CLS. 100 AND 101).

FIRST USE 3-17-2000; IN COMMERCE 3-17-2000.

2,900,894. GALLUP, INC., OMAHA, NE. SN 76-188,462. FILED P.R. 1-2-2001; AM. S.R. 8-4-2004.

**RELATOR**

FOR PROVIDING A PERSONAL ANALYSIS OF AN INDIVIDUAL'S INHERENT STRENGTHS OVER AN INTERACTIVE WEBSITE ON A GLOBAL COMPUTER NETWORK (U.S. CLS. 100 AND 101).

FIRST USE 3-17-2000; IN COMMERCE 3-17-2000.

2,900,910. INTERNATIONAL GEMMOLOGICAL INSTITUTE, INC., NEW YORK, NY. SN 76-505,293. FILED P.R. 4-9-2003; AM. S.R. 8-31-2004.

**DIAMOND LABORATORY OF AMERICA**

FOR GEMOLOGICAL SERVICES, NAMELY, PROVIDING IDENTIFICATION, AUTHENTICATION, AND GRADATION OF DIAMONDS AND GEMSTONES AND ISSUING CERTIFICATES RELATED THERETO (U.S. CLS. 100 AND 101).

FIRST USE 5-1-2003; IN COMMERCE 5-15-2003.

**CLASS 44—(Continued).**

2,900,930. SUPPORT CT, ALPHARETTA, GA. SN 78-176,520.  
FILED P.R. 10-21-2002; AM. S.R. 6-2-2004.

**SUPPORTCT**

FOR ONLINE, EMAIL, TELEPHONE AND ONSITE  
TECHNICAL SUPPORT SERVICES FOR COMPUTER  
HARDWARE AND SOFTWARE PROBLEMS IN THE  
FIELD OF COMPUTER TELEPHONY (U.S. CLS. 100  
AND 101).

FIRST USE 12-6-2002; IN COMMERCE 12-6-2002.

**CLASS 43—(Continued).**

THE MARK CONSISTS OF THE THREE-DIMENSIONAL  
CONFIGURATION OF THE EXTERIOR OF THE BUILDING  
WHERE THE SERVICES ARE PROVIDED.

FOR RESTAURANT SERVICES FEATURING FROZEN  
CONFECTIONS (U.S. CLS. 100 AND 101).  
FIRST USE 9-1-2001; IN COMMERCE 9-1-2001.

**CLASS 44—MEDICAL, BEAUTY AND AGRICULTURAL SERVICES**

2,900,928. THE GOLDEN GOSLINGS, INC., LAKE SUCCESS,  
NY. SN 76-561,973. FILED P.R. 11-24-2003; AM. S.R. 8-10-  
2004.

**CLASS 43—HOTEL AND RESTAURANT SERVICES**

2,900,942. SHAKE'S FROZEN CUSTARD, INC., FAYETTE-  
VILLE, AR. SN 78-280,273. FILED P.R. 7-29-2003; AM. S.R.  
8-2-2004.

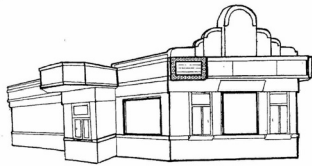

**THE COMPLETE NURSING HOME GUIDE**

THE MARK CONSISTS OF STANDARD CHARACTERS  
WITHOUT CLAIM TO ANY PARTICULAR FONT, STYLE,  
SIZE, OR COLOR.

FOR PROVIDING INFORMATION ON NURSING  
HOMES, NURSING HOME CARE AND NURSING  
HOME LIVING (U.S. CLS. 100 AND 101).  
FIRST USE 11-19-2003; IN COMMERCE 11-19-2003.

\* \* \* \* \*

# TRADEMARK REGISTRATIONS RENEWED

The designation "U.S. Cl." appearing in this section refers to the U.S. class in effect prior to Sep. 1, 1973 rather than the international class which applies to applications filed on or after that date. For adoption of international classification see notice in the OFFICIAL GAZETTE of Jun. 26, 1973 (911 O.G. TM 210).

25,036.	OMEGA AND DESIGN. U.S. CL. 27. (INT. CL. 14). REG. 7-24-1894.	594,375.	SHEERLUND (STYLIZED). U.S. CL. 1. (INT. CL. 31). REG. 8-31-1954.
84,431.	ALCAID (STYLIZED). U.S. CL. 15. (INT. CL. 4). REG. 12-12-1911.	594,917.	RED HEART AND DESIGN. U.S. CL. 43. (INT. CL. 23). REG. 9-7-1954.
99,306.	"UNIQUE". U.S. CL. 9. (INT. CL. 13). REG. 8-25-1914.	595,077.	SANISAC (STYLIZED). U.S. CL. 13. (INT. CL. 21). REG. 9-14-1954.
99,887.	AEROXON (STYLIZED). U.S. CL. 50. (INT. CL. 5). REG. 9-22-1914.	595,245.	SWISSEDENT. U.S. CL. 44. (INT. CL. 10). REG. 9-14-1954.
102,229.	WHEAT A LAXA. U.S. CL. 46. (INT. CL. 30). REG. 1-26-1915.	595,619.	SNORKEL. U.S. CL. 39. (INT. CL. 25). REG. 9-21-1954.
180,318.	GULISTAN (STYLIZED). U.S. CL. 42. (INT. CL. 27). REG. 2-26-1924.	595,769.	MISCELLANEOUS DESIGN. U.S. CL. 3. (INT. CL. 18). REG. 9-28-1954.
188,274.	NOBLE (STYLIZED). U.S. CL. 46. (INT. CL. 31). REG. 8-19-1924.	596,032.	CURAD (STYLIZED). U.S. CL. 44. (INT. CL. 5). REG. 9-28-1954.
188,577.	AQUASTAT (STYLIZED). U.S. CL. 26. (INT. CL. 9). REG. 9-2-1924.	596,258.	FOSTER (STYLIZED). U.S. CL. 16. (INT. CL. 2). REG. 10-5-1954.
190,361.	THE AMERICAN FIELD AND DESIGN. U.S. CL. 38. (INT. CL. 16). REG. 10-14-1924.	598,851.	GW (STYLIZED). U.S. CL. 46. (INT. CL. 30). REG. 11-30-1954.
191,298.	AMERICAN ACE (STYLIZED). U.S. CL. 36. (INT. CL. 15). REG. 11-4-1924.	598,896.	INSURANCE WORLDWIDE AIU AND DESIGN. U.S. CL. 102. (INT. CL. 36). REG. 11-30-1954.
200,061.	TRENTON. U.S. CL. 46. (INT. CL. 30). REG. 6-23-1925.	601,542.	STA-FRESH (STYLIZED). U.S. CL. 16. (INT. CL. 2). REG. 2-1-1955.
312,595.	MISCELLANEOUS DESIGN. U.S. CL. 49. (INT. CL. 33). REG. 5-1-1934.	606,488.	JAKSON (STYLIZED). U.S. CL. 42. (INT. CL. 24). REG. 5-24-1955.
316,118.	TITLEIST (STYLIZED). U.S. CL. 22. (INT. CL. 28). REG. 8-14-1934.	607,905.	MISCELLANEOUS DESIGN. U.S. CL. 23. (INT. CL. 8). REG. 6-28-1955.
317,330.	ROTAX (STYLIZED). U.S. CL. 6. (INT. CL. 1). REG. 9-18-1934.	608,065.	CAROLINA TREET (STYLIZED). U.S. CL. 46. (INT. CL. 30). REG. 6-28-1955.
318,113.	SKATING (STYLIZED). U.S. CL. 38. (INT. CL. 16). REG. 10-16-1934.	766,015.	MRS. FILBERT'S. U.S. CL. 46. (INT. CL. 30). REG. 3-3-1964.
407,340.	NAZARETH (STYLIZED). U.S. CL. 39. (INT. CL. 25). REG. 5-30-1944.	768,944.	PERMA-STOR. U.S. CL. 2. (INT. CL. 16). REG. 5-5-1964.
408,618.	KLEENEX (STYLIZED). U.S. CL. 37. (INT. CLS. 16, 26 AND 27). REG. 8-22-1944.	769,452.	AMP-TAB. U.S. CL. 21. (INT. CL. 9). REG. 5-12-1964.
408,653.	EUTECTRODE (STYLIZED). U.S. CL. 14. (INT. CL. 9). REG. 8-22-1944.	769,664.	COUNTRY OVEN. U.S. CL. 46. (INT. CLS. 1, 5, 29, 30, 31 AND 32). REG. 5-12-1964.
408,755.	LA FLOR DE LUIS MARTINEZ (STYLIZED). U.S. CL. 17. (INT. CL. 34). REG. 8-29-1944.	769,677.	STICKEE. U.S. CL. 50. (INT. CL. 20). REG. 5-12-1964.
408,780.	SANFORIZED. U.S. CL. 39. (INT. CL. 25). REG. 8-29-1944.	771,234.	CAFFE LOLITA (STYLIZED). U.S. CL. 49. (INT. CL. 33). REG. 6-9-1964.
409,130.	CREAM OF RYE (STYLIZED). U.S. CL. 46. (INT. CL. 30). REG. 9-19-1944.	772,606.	ALFONIC. U.S. CL. 6. (INT. CL. 1). REG. 7-7-1964.
410,186.	ORCHARD "SATISFACTION IN EVERY STITCH" ORCHARD YARNS AND DESIGN. U.S. CL. 43. (INT. CL. 23). REG. 11-14-1944.	772,712.	STING-RAY AND DESIGN. U.S. CL. 19. (INT. CL. 12). REG. 7-7-1964.
412,800.	TI-NAMEL. U.S. CL. 14. (INT. CL. 6). REG. 3-27-1945.	773,388.	SOUTHERN SERVES THE SOUTH. U.S. CL. 105. (INT. CL. 39). REG. 7-14-1964.
585,564.	THE TENPIN TATTLER. U.S. CL. 107. (INT. CL. 41). REG. 2-9-1954.	773,683.	CURPOLENE. U.S. CL. 37. (INT. CLS. 16, 26 AND 27). REG. 7-21-1964.
589,006.	TOPPER (STYLIZED). U.S. CL. 44. (INT. CL. 5). REG. 4-27-1954.	773,746.	HYDRADJUST (STYLIZED). U.S. CL. 44. (INT. CL. 10). REG. 7-21-1964.
589,466.	ZEST (STYLIZED). U.S. CL. 46. (INT. CL. 29). REG. 5-4-1954.	773,809.	ALUMA-PLANK. U.S. CL. 50. (INT. CL. 6). REG. 7-21-1964.
591,734.	SURGIPAD (STYLIZED). U.S. CL. 44. (INT. CL. 5). REG. 6-22-1954.	774,108.	ROSE TIARA. U.S. CL. 28. (INT. CL. 8). REG. 7-28-1964.
592,853.	MEET THE PRESS (STYLIZED). U.S. CL. 107. (INT. CL. 41). REG. 7-20-1954.	774,390.	BULLS EYE. U.S. CL. 16. (INT. CL. 2). REG. 8-4-1964.
593,490.	EMEROX (STYLIZED). U.S. CL. 6. (INT. CL. 1). REG. 8-10-1954.	774,436.	A AND DESIGN. U.S. CL. 19. (INT. CLS. 7, 12, 22 AND 27). REG. 8-4-1964.
593,688.	KLEEN KING. U.S. CL. 52. (INT. CL. 3). REG. 8-10-1954.	774,493.	BUT-N-SAVR. U.S. CL. 24. (INT. CL. 7). REG. 8-4-1964.
593,886.	HARRIS (STYLIZED). U.S. CL. 35. (INT. CL. 17). REG. 8-17-1954.	774,539.	SUMMIT. U.S. CL. 35. (INT. CL. 12). REG. 8-4-1964.
594,097.	MICROLITE. U.S. CL. 12. (INT. CL. 17). REG. 8-24-1954.	774,590.	MARTHA'S MINIATURES. U.S. CL. 39. (INT. CL. 25). REG. 8-4-1964.
594,203.	TAPER-LOCK (STYLIZED). U.S. CL. 23. (INT. CL. 7). REG. 8-24-1954.	774,610.	SONNET. U.S. CL. 39. (INT. CL. 25). REG. 8-4-1964.
594,355.	DEEP GLOSS (STYLIZED). U.S. CL. 4. (INT. CL. 3). REG. 8-24-1954.	774,679.	MEL-FRY. U.S. CL. 46. (INT. CL. 29). REG. 8-4-1964.
		774,710.	BEACON. U.S. CL. 51. (INT. CL. 3). REG. 8-4-1964.
		774,781.	AROSURF. U.S. CL. 6. (INT. CL. 1). REG. 8-11-1964.

- 774,856. E-SE. U.S. CL. 18. (INT. CL. 5). REG. 8-11-1964.  
 774,878. LORAIN. U.S. CL. 21. (INT. CL. 9). REG. 8-11-1964.  
 774,952. CARTHAGE. U.S. CL. 23. (INT. CL. 7). REG. 8-11-1964.  
 774,986. LAREDO. U.S. CL. 35. (INT. CL. 19). REG. 8-11-1964.  
 774,991. HI-LITER. U.S. CL. 37. (INT. CL. 16). REG. 8-11-1964.  
 775,003. DATAB. U.S. CL. 37. (INT. CL. 16). REG. 8-11-1964.  
 775,073. KEMIN. U.S. CL. 46. (INT. CL. 30). REG. 8-11-1964.  
 775,094. CHIQUITA AND DESIGN. U.S. CL. 46. (INT. CL. 7). REG. 8-11-1964.  
 775,279. R-E-A. U.S. CL. 21. (INT. CL. 9). REG. 8-18-1964.  
 775,472. TEMPO. U.S. CL. 46. (INT. CL. 32). REG. 8-18-1964.  
 775,515. TICO. U.S. CL. 50. (INT. CL. 7). REG. 8-18-1964.  
 775,632. MISCELLANEOUS DESIGN. U.S. CL. 14. (INT. CL. 6). REG. 8-25-1964.  
 775,741. U.S. BAIRD. U.S. CL. 23. (INT. CLS. 6, 7, 8, 9, 11, 12, 16, 21 AND 28). REG. 8-25-1964.  
 775,799. EXPRESSWEIGH. U.S. CL. 26. (INT. CL. 9). REG. 8-25-1964.  
 775,859. MISCELLANEOUS DESIGN. U.S. CL. 38. (INT. CL. 16). REG. 8-25-1964.  
 775,917. BUTCH AND DESIGN. U.S. CL. 46. (INT. CL. 31). REG. 8-25-1964.  
 776,003. AIRCAP. U.S. CL. 1. (INT. CL. 17). REG. 9-1-1964.  
 776,056. DRI-SLIDE. U.S. CL. 15. (INT. CL. 4). REG. 9-1-1964.  
 776,138. LOBSTER AND DESIGN. U.S. CL. 23. (INT. CL. 8). REG. 9-1-1964.  
 776,287. PEERLESS MAID. U.S. CL. 46. (INT. CL. 30). REG. 9-1-1964.  
 776,428. CUVAN. U.S. CL. 6. (INT. CL. 1). REG. 9-8-1964.  
 776,604. SEPRAPHORE. U.S. CL. 31. (INT. CL. 11). REG. 9-8-1964.  
 776,605. MASTER MERCHANT. U.S. CL. 32. (INT. CL. 20). REG. 9-8-1964.  
 777,071. HYCRON. U.S. CL. 39. (INT. CL. 25). REG. 9-15-1964.  
 777,114. VITARROZ AND DESIGN. U.S. CL. 46. (INT. CL. 29). REG. 9-15-1964.  
 777,226. GUNCLASE. U.S. CL. 12. (INT. CL. 19). REG. 9-22-1964.  
 777,377. COVENTRY. U.S. CL. 28. (INT. CL. 14). REG. 9-22-1964.  
 777,463. RESTORA (STYLIZED). U.S. CL. 42. (INT. CL. 24). REG. 9-22-1964.  
 777,786. ABRA-CAPS. U.S. CL. 23. (INT. CL. 7). REG. 9-29-1964.  
 777,997. KITCHENAID (STYLIZED). U.S. CL. 103. (INT. CL. 37). REG. 9-29-1964.  
 778,123. PROVEN. U.S. CL. 23. (INT. CLS. 6, 7, 8, 9, 11, 12, 16, 21 AND 28). REG. 10-6-1964.  
 778,186. ZIP JOINT. U.S. CL. 35. (INT. CL. 7). REG. 10-6-1964.  
 778,681. YARD GARD (STYLIZED). U.S. CL. 13. (INT. CL. 6). REG. 10-20-1964.  
 778,766. MISCELLANEOUS DESIGN. U.S. CL. 35. (INT. CL. 12). REG. 10-20-1964.  
 778,802. BERNINI. U.S. CL. 39. (INT. CL. 25). REG. 10-20-1964.  
 779,689. AEPD. U.S. CL. 6. (INT. CL. 1). REG. 11-10-1964.  
 779,879. V AND DESIGN. U.S. CL. 35. (INT. CL. 12). REG. 11-10-1964.  
 780,235. NORDSON. U.S. CL. 23. (INT. CL. 7). REG. 11-17-1964.  
 780,503. MARK. U.S. CL. 6. (INT. CL. 1). REG. 11-24-1964.  
 781,531. COPPER-COAT (STYLIZED). U.S. CL. 5. (INT. CL. 1). REG. 12-8-1964.  
 781,662. EQUILET (STYLIZED). U.S. CL. 18. (INT. CL. 5). REG. 12-15-1964.  
 781,920. CANE CAL. U.S. CL. 6. (INT. CL. 1). REG. 12-22-1964.  
 783,126. MISCELLANEOUS DESIGN. U.S. CL. 19. (INT. CL. 12). REG. 1-12-1965.  
 783,856. IRGAPADOL. U.S. CL. 6. (INT. CL. 1). REG. 1-26-1965.  
 784,642. PILOT. U.S. CL. 6. (INT. CL. 1). REG. 2-9-1965.  
 785,546. CANTATA. U.S. CL. 23. (INT. CL. 8). REG. 2-23-1965.  
 786,920. MACMOUNT. U.S. CL. 50. (INT. CL. 22). REG. 3-16-1965.  
 790,156. DUREZ.  
 790,567. EX-IT. U.S. CL. 6. (INT. CL. 1). REG. 6-8-1965.  
 791,327. SERVICEPAK PANEL AND DESIGN. U.S. CL. 21. (INT. CL. 9). REG. 6-22-1965.  
 793,111. REDI-MOUNT. U.S. CL. 37. (INT. CL. 16). REG. 7-20-1965.  
 977,625. MANSILEX. U.S. CL. 14. (INT. CL. 6). REG. 1-29-1974.  
 978,000. LSP. U.S. CL. 13. (INT. CL. 6). REG. 2-5-1974.  
 978,765. LITTLE AMERICA AND DESIGN. U.S. CLS. 100 AND 103. (INT. CLS. 37 AND 42). REG. 2-12-1974.  
 979,020. HUMI-FRESH. U.S. CL. 31. (INT. CL. 11). REG. 2-19-1974.  
 979,021. SPACE-GARD. U.S. CL. 31. (INT. CL. 11). REG. 2-19-1974.  
 979,427. TUNDRA-GRIP. U.S. CL. 35. (INT. CL. 12). REG. 2-26-1974.  
 979,700. JABEZ BURNS. U.S. CLS. 23, 26 AND 34 ONLY. (INT. CLS. 6, 7, 8, 9, 11, 12, 16, 21 AND 28). REG. 3-5-1974.  
 980,887. ROSS. U.S. CL. 19. (INT. CL. 12). REG. 3-26-1974.  
 981,535. HARTZELL. U.S. CL. 19. (INT. CL. 12). REG. 4-2-1974.  
 983,359. STEELMARK. U.S. CL. 35. (INT. CL. 12). REG. 5-7-1974.  
 983,593. FAST & FINE. U.S. CL. 1. (INT. CL. 31). REG. 5-14-1974.  
 984,654. SAVAGE AND DESIGN. U.S. CL. 51. (INT. CLS. 3 AND 5). REG. 5-21-1974.  
 985,647. SBARRO. U.S. CL. 100. (INT. CL. 42). REG. 6-4-1974.  
 986,860. SURFACE-SAVER (STYLIZED). U.S. CL. 23. (INT. CL. 21). REG. 6-25-1974.  
 987,821. SPECTRA. U.S. CL. 26. (INT. CL. 9). REG. 7-9-1974.  
 987,955. WENDELL FABRICS CORPORATION (STYLIZED). U.S. CL. 42. (INT. CL. 24). REG. 7-9-1974.  
 988,374. BLOKIT (STYLIZED). U.S. CL. 26. (INT. CL. 9). REG. 7-16-1974.  
 988,378. AUTOCON. U.S. CL. 26. (INT. CL. 9). REG. 7-16-1974.  
 988,696. LUBASIN. U.S. CL. 5. (INT. CL. 1). REG. 7-23-1974.  
 988,697. MISCELLANEOUS DESIGN. U.S. CL. 37 ONLY. (INT. CL. 16). REG. 7-23-1974.  
 988,779. MOOG (STYLIZED). U.S. CL. 19. (INT. CL. 12). REG. 7-23-1974.  
 988,819. ZOOM (STYLIZED). U.S. CLS. 38 AND 107 ONLY. (INT. CLS. 16 AND 41). REG. 7-23-1974.  
 988,980. EAGLE SHIRTMAKERS SINCE 1867 AND DESIGN. U.S. CL. 39. (INT. CL. 25). REG. 7-23-1974.  
 989,089. LI'L GUY AND DESIGN. U.S. CL. 46. (INT. CL. 30). REG. 7-23-1974.  
 989,180. AARON RENTS. U.S. CL. 101. (INT. CL. 42). REG. 7-23-1974.  
 989,250. VALU TIME AND DESIGN. INT. CL. 3. (U.S. CL. 51). REG. 7-30-1974.  
 989,592. CAWLEY AND DESIGN. U.S. CLS. 28 AND 50. (INT. CLS. 14 AND 19). REG. 7-30-1974.  
 989,617. GIBSON (STYLIZED). U.S. CL. 36. (INT. CL. 15). REG. 7-30-1974.  
 989,634. LOS ANGELES TIMES (STYLIZED). U.S. CL. 38. (INT. CL. 16). REG. 7-30-1974.  
 989,650. FLEXSTEP. U.S. CL. 39. (INT. CL. 25). REG. 7-30-1974.  
 989,701. LOU ANA AND DESIGN. U.S. CL. 46. (INT. CL. 29). REG. 7-30-1974.  
 989,938. CHEMCO AND DESIGN. U.S. CLS. 4, 6, 12 AND 52. (INT. CLS. 3 AND 5). REG. 8-6-1974.  
 989,977. PROXEL. U.S. CL. 6. (INT. CL. 1). REG. 8-6-1974.  
 989,991. ZIRCALEX. U.S. CL. 14. (INT. CL. 6). REG. 8-6-1974.  
 990,038. N NAKAMICHI AND DESIGN. U.S. CLS. 21 AND 36. (INT. CL. 9). REG. 8-6-1974.  
 990,046. RINGCONE. U.S. CL. 21. (INT. CLS. 7, 9, 11, 12 AND 15). REG. 8-6-1974.  
 990,085. ARTOS AND DESIGN. U.S. CL. 23. (INT. CL. 7). REG. 8-6-1974.  
 990,428. CUSTOMER CARE. U.S. CL. 103. (INT. CL. 37). REG. 8-6-1974.  
 990,548. MISCELLANEOUS DESIGN. INT. CL. 20. (U.S. CL. 32). REG. 8-13-1974.  
 990,586. RESPOND. INT. CL. 31. (U.S. CL. 46). REG. 8-13-1974.  
 990,632. SELECTRIDE. U.S. CL. 6. (INT. CL. 1). REG. 8-13-1974.

- 990,642. HAMBRO. U.S. CLS. 12 AND 100. (INT. CLS. 6 AND 42). REG. 8-13-1974.
- 990,673. VITRON-C-PLUS. U.S. CL. 18. (INT. CL. 5). REG. 8-13-1974.
- 990,727. RG. U.S. CL. 21. (INT. CL. 9). REG. 8-13-1974.
- 990,739. INSUL-CONNECT. U.S. CL. 21. (INT. CL. 9). REG. 8-13-1974.
- 990,746. H ORIGINAL HAUSSER ELASTOLIN AND DESIGN. U.S. CL. 22. (INT. CL. 28). REG. 8-13-1974.
- 990,792. VIBRANETICS. U.S. CL. 23. (INT. CL. 7). REG. 8-13-1974.
- 990,815. PROFESSIONAL. U.S. CL. 23. (INT. CL. 7). REG. 8-13-1974.
- 990,825. MISCELLANEOUS DESIGN. U.S. CL. 23. (INT. CLS. 7, 9 AND 16). REG. 8-13-1974.
- 990,829. BYFIELD. U.S. CL. 23. (INT. CL. 8). REG. 8-13-1974.
- 991,099. PLEXAMINO. INT. CL. 5. (U.S. CL. 18). REG. 8-20-1974.
- 991,107. SPH-4. INT. CL. 25. (U.S. CL. 39). REG. 8-20-1974.
- 991,128. SUCAROME. INT. CL. 30. (U.S. CL. 46). REG. 8-20-1974.
- 991,171. AQUAMAG. U.S. CL. 6. (INT. CL. 1). REG. 8-20-1974.
- 991,220. NAVTEC. U.S. CL. 13. (INT. CL. 6). REG. 8-20-1974.
- 991,308. INSTA-PRO (STYLIZED). U.S. CL. 23. (INT. CL. 7). REG. 8-20-1974.
- 991,366. OXISORB. U.S. CL. 34. (INT. CLS. 1 AND 11). REG. 8-20-1974.
- 991,446. TONEDOWN. U.S. CL. 39. (INT. CL. 9). REG. 8-20-1974.
- 991,463. JJ JUMPING-JACKS AND DESIGN. U.S. CL. 39. (INT. CL. 25). REG. 8-20-1974.
- 991,685. HALSTON. INT. CL. 3. (U.S. CLS. 51 AND 52). REG. 8-27-1974.
- 991,716. BIG EYES. INT. CL. 20. (U.S. CL. 32). REG. 8-27-1974.
- 991,813. MOD-U-KRAF. U.S. CL. 12. (INT. CL. 19). REG. 8-27-1974.
- 991,830. STANDOFF. U.S. CL. 16. (INT. CL. 2). REG. 8-27-1974.
- 991,897. NAUTILUS. U.S. CL. 22. (INT. CL. 28). REG. 8-27-1974.
- 991,969. STARFLAKE. U.S. CL. 28. (INT. CL. 14). REG. 8-27-1974.
- 992,111. ACCU-DOT. U.S. CL. 50. (INT. CL. 16). REG. 8-27-1974.
- 992,225. SUPER-HYDRIDE. U.S. CL. 6. (INT. CL. 1). REG. 8-27-1974.
- 992,239. HI-BRITE. INT. CL. 3. (U.S. CL. 52). REG. 9-3-1974.
- 992,350. LINEL. U.S. CL. 16. (INT. CL. 2). REG. 9-3-1974.
- 992,384. BEAD AND DESIGN. U.S. CL. 21. (INT. CL. 9). REG. 9-3-1974.
- 992,458. HYDRO SWING. U.S. CL. 23. (INT. CL. 7). REG. 9-3-1974.
- 992,938. BOBRICK. U.S. CLS. 2, 12, 13, 23 AND 32. (INT. CLS. 6, 7, 19 AND 20). REG. 9-10-1974.
- 993,282. FERTI-THAW. INT. CL. 1. (U.S. CL. 6). REG. 9-24-1974.
- 993,314. ALPHA KERI. INT. CL. 3. (U.S. CL. 52). REG. 9-24-1974.
- 993,360. KABA. INT. CL. 6. (U.S. CLS. 13 AND 25). REG. 9-24-1974.
- 993,589. STRUCTURWOOD. U.S. CL. 12. (INT. CL. 19). REG. 9-24-1974.
- 993,728. RAINBOW. U.S. CL. 21. (INT. CL. 9). REG. 9-24-1974.
- 994,026. TENDER VITTLES. U.S. CL. 46. (INT. CL. 31). REG. 9-24-1974.
- 994,043. FREEZE-N-EAT. U.S. CL. 46. (INT. CL. 30). REG. 9-24-1974.
- 994,491. ANCHOR. U.S. CLS. 6, 15, 16 AND 52. (INT. CLS. 1, 2, 3 AND 4). REG. 10-1-1974.
- 994,916. HAAG. U.S. CL. 23. (INT. CL. 7). REG. 10-1-1974.
- 995,179. DIAMOND VOGEL AND DESIGN. U.S. CL. 16. (INT. CL. 2). REG. 10-8-1974.
- 995,412. EARTHENWEAR. U.S. CL. 52. (INT. CL. 3). REG. 10-8-1974.
- 995,562. FERRALET. INT. CL. 5. (U.S. CL. 18). REG. 10-15-1974.
- 995,785. MISCELLANEOUS DESIGN. U.S. CL. 21. (INT. CL. 9). REG. 10-15-1974.
- 995,821. FALCON. U.S. CL. 26. (INT. CL. 9). REG. 10-15-1974.
- 995,968. SOFITEL. U.S. CL. 100. (INT. CL. 42). REG. 10-15-1974.
- 996,260. NO. 5. U.S. CL. 12. (INT. CL. 19). REG. 10-22-1974.
- 996,328. NORTH STAR. U.S. CL. 21. (INT. CL. 11). REG. 10-22-1974.
- 996,362. STANLEY STEEMER (STYLIZED). U.S. CL. 23. (INT. CL. 7). REG. 10-22-1974.
- 996,379. TURBULA. U.S. CL. 23. (INT. CL. 7). REG. 10-22-1974.
- 996,847. R (STYLIZED). INT. CL. 25. (U.S. CL. 39). REG. 10-29-1974.
- 996,895. AYC (STYLIZED). INT. CL. 34. (U.S. CL. 17). REG. 10-29-1974.
- 996,942. TITE SEAL SOLDER SEAL AND DESIGN. U.S. CL. 12. (INT. CL. 19). REG. 10-29-1974.
- 997,207. VERSATINT SUPRA. INT. CL. 2. (U.S. CL. 16). REG. 11-5-1974.
- 997,505. R (STYLIZED). U.S. CL. 22. (INT. CL. 25). REG. 11-5-1974.
- 997,656. SONOMA VINEYARDS. U.S. CL. 47. (INT. CL. 33). REG. 11-5-1974.
- 997,744. MR FRIENDLY AND DESIGN. U.S. CL. 101. (INT. CL. 42). REG. 11-5-1974.
- 998,042. METRO-MIX. INT. CL. 1. (U.S. CL. 1). REG. 11-12-1974.
- 998,842. C CHUBB AND DESIGN. U.S. CL. 100. (INT. CL. 36). REG. 11-19-1974.
- 999,101. GOURMET HOUSE. INT. CL. 30. (U.S. CL. 46). REG. 11-26-1974.
- 999,547. COWLES. INT. CL. 6. (U.S. CL. 13). REG. 12-17-1974.
- 999,670. HIGHBALL. INT. CL. 20. (U.S. CL. 50). REG. 12-17-1974.
- 1,000,672. CARTIER (STYLIZED). U.S. CL. 17. (INT. CL. 34). REG. 12-31-1974.
- 1,000,843. ECKANKAR. U.S. CL. 107. (INT. CL. 41). REG. 12-31-1974.
- 1,000,951. EXTRACT-O-MATIC. INT. CL. 7. (U.S. CL. 24). REG. 1-7-1975.
- 1,000,959. SOLOMATIC. INT. CL. 7. (U.S. CL. 23). REG. 1-7-1975.
- 1,001,129. SCORE INTERNATIONAL AND DESIGN. INT. CL. 35. (U.S. CL. 101). REG. 1-7-1975.
- 1,001,596. TP. INT. CL. 28. (U.S. CL. 22). REG. 1-14-1975.
- 1,001,883. NCL (STYLIZED). U.S. CL. 101. (INT. CL. 42). REG. 1-14-1975.
- 1,001,931. LIQUITINT. INT. CL. 2. (U.S. CL. 16). REG. 1-21-1975.
- 1,001,974. ROBUSTA. INT. CL. 7. (U.S. CL. 23). REG. 1-21-1975.
- 1,002,188. HONDA. U.S. CL. 21. (INT. CL. 7). REG. 1-21-1975.
- 1,002,950. LAND O'FROST. INT. CL. 29. (U.S. CL. 46). REG. 1-28-1975.
- 1,002,986. BALL AND DESIGN. INT. CL. 31. (U.S. CLS. 1 AND 46). REG. 1-28-1975.
- 1,003,331. STEELASTIC. U.S. CL. 23. (INT. CL. 7). REG. 1-28-1975.
- 1,004,954. PEOPLE CARING FOR PEOPLE. INT. CL. 42. (U.S. CL. 100). REG. 2-18-1975.
- 1,005,134. AMICAL. INT. CL. 1. (U.S. CL. 6). REG. 2-25-1975.
- 1,005,496. SHINO. U.S. CL. 4. (INT. CL. 21). REG. 2-25-1975.
- 1,006,206. SINCLAIR. INT. CL. 4. (U.S. CL. 15). REG. 3-11-1975.
- 1,006,485. SINCLAIR. INT. CL. 37. (U.S. CL. 103). REG. 3-11-1975.
- 1,006,675. STANLEY STEEMER. U.S. CL. 103 ONLY. (INT. CL. 37). REG. 3-11-1975.
- 1,007,096. RIP VAN LEE. U.S. CL. 32. (INT. CL. 20). REG. 3-18-1975.
- 1,007,236. STA-SOF-FRO. INT. CL. 3. (U.S. CL. 51). REG. 3-25-1975.
- 1,008,123. MISCELLANEOUS DESIGN. U.S. CL. 19. (INT. CL. 12). REG. 4-1-1975.
- 1,011,166. ALPHA MARITEX. U.S. CL. 42. (INT. CL. 24). REG. 5-20-1975.
- 1,011,451. PARABATH. INT. CL. 10. (U.S. CL. 44). REG. 5-27-1975.
- 1,012,244. BRUNSCHWIG & FILS. INT. CL. 24. (U.S. CL. 42). REG. 6-3-1975.
- 1,012,308. BRUNSCHWIG & FILS. INT. CL. 27. (U.S. CL. 37). REG. 6-3-1975.
- 1,013,251. SIAC. U.S. CL. 102. (INT. CL. 36). REG. 6-10-1975.
- 1,013,705. FREIGHTPAY. INT. CL. 36. (U.S. CL. 102). REG. 6-17-1975.



- 1,014,673. ENVIRONMENT ABSTRACTS. INT. CL. 16. (U.S. CL. 38). REG. 7-1-1975.
- 1,015,527. EASY WIPE. U.S. CL. 29. (INT. CL. 21). REG. 7-8-1975.
- 1,015,943. UP RITE. INT. CL. 32. (U.S. CL. 45). REG. 7-15-1975.
- 1,016,306. TEMPCO AND DESIGN. INT. CL. 11. (U.S. CL. 34). REG. 7-22-1975.
- 1,016,467. ECONOTECH. INT. CL. 42. (U.S. CL. 100). REG. 7-22-1975.
- 1,017,235. CYREZ. INT. CL. 1. (U.S. CLS. 1 AND 6). REG. 8-5-1975.
- 1,017,548. SLEEPYTIME. INT. CL. 30. (U.S. CL. 46). REG. 8-5-1975.
- 1,190,202. NATIONAL DATA CORPORATION. INT. CL. 35. (U.S. CL. 101). REG. 2-16-1982.
- 1,228,901. STING-EZE. INT. CL. 5. (U.S. CL. 18). REG. 3-1-1983.
- 1,229,018. MULTI-MODE. INT. CL. 9. (U.S. CL. 21). REG. 3-1-1983.
- 1,241,463. A ABLE REDDI ROOT'R (STYLIZED). INT. CL. 37. (U.S. CL. 103). REG. 6-7-1983.
- 1,242,507. OMBRE ROSE. INT. CL. 3. (U.S. CL. 51). REG. 6-21-1983.
- 1,244,083. WAGNER. INT. CLS. 3, 7 AND 20. (U.S. CLS. 2, 21, 23 AND 52). REG. 7-5-1983.
- 1,260,303. MISCELLANEOUS DESIGN. INT. CL. 42. (U.S. CLS. 100 AND 103). REG. 12-6-1983.
- 1,261,863. RICA BANANA AND DESIGN. INT. CL. 31. (U.S. CL. 46). REG. 12-20-1983.
- 1,264,589. DIAION. INT. CL. 1. (U.S. CL. 6). REG. 1-24-1984.
- 1,264,674. HERBALENZA. INT. CL. 5. (U.S. CL. 18). REG. 1-24-1984.
- 1,264,675. RESP. INT. CL. 5. (U.S. CL. 18). REG. 1-24-1984.
- 1,264,677. REJUVENAID. INT. CL. 5. (U.S. CL. 18). REG. 1-24-1984.
- 1,265,200. GOLD RUSH NUGGET AND DESIGN. INT. CL. 30. (U.S. CL. 46). REG. 1-24-1984.
- 1,265,535. RHEUM-AID. INT. CL. 5. (U.S. CL. 18). REG. 1-31-1984.
- 1,266,003. RUN-IN. INT. CL. 42. (U.S. CL. 101). REG. 1-31-1984.
- 1,266,036. CEDA. INT. CL. 37 ONLY. (U.S. CLS. 100, 103 AND 106 ONLY). REG. 2-7-1984.
- 1,266,742. TERRA-SEAL (STYLIZED). INT. CL. 1. (U.S. CL. 1). REG. 2-14-1984.
- 1,267,079. YANMAR AND DESIGN. INT. CL. 12. (U.S. CL. 19). REG. 2-14-1984.
- 1,267,466. MILL PAC (STYLIZED). INT. CL. 1. (U.S. CL. 6). REG. 2-21-1984.
- 1,267,492. CONDENSOL. INT. CL. 1. (U.S. CL. 6). REG. 2-21-1984.
- 1,267,565. RED & WHITE. INT. CLS. 29 AND 30 ONLY. (U.S. CL. 46). REG. 2-21-1984.
- 1,267,801. MICROMET (STYLIZED). INT. CL. 9. (U.S. CL. 26). REG. 2-21-1984.
- 1,267,896. SENORITA. INT. CL. 15. (U.S. CL. 36). REG. 2-21-1984.
- 1,268,113. ORACLE. INT. CL. 30. (U.S. CL. 46). REG. 2-21-1984.
- 1,268,358. SNAP-ON. INT. CL. 9. (U.S. CLS. 21 AND 26). REG. 2-21-1984.
- 1,269,072. AMERICAN PRODUCTS AND DESIGN. INT. CL. 11. (U.S. CLS. 13, 21, 23, 31 AND 34). REG. 3-6-1984.
- 1,270,117. ORECCIETTE BARESI. INT. CL. 30. (U.S. CL. 46). REG. 3-13-1984.
- 1,271,555. LOGICA. INT. CLS. 9, 38, 41 AND 42. (U.S. CLS. 26, 38, 100, 104 AND 107). REG. 3-27-1984.
- 1,271,613. TRIM PAC. INT. CL. 9. (U.S. CL. 21). REG. 3-27-1984.
- 1,272,418. WEL-PRESS. INT. CL. 7. (U.S. CL. 23). REG. 4-3-1984.
- 1,272,609. INTEGRITY. INT. CL. 12. (U.S. CL. 35). REG. 4-3-1984.
- 1,272,612. GARRETT. INT. CL. 12. (U.S. CLS. 19 AND 21). REG. 4-3-1984.
- 1,272,677. MARVEL UNIVERSE. INT. CL. 16. (U.S. CL. 38). REG. 4-3-1984.
- 1,274,443. ATHENIAN GYROS AND DESIGN. INT. CL. 29. (U.S. CL. 46). REG. 4-17-1984.
- 1,274,848. PP AND DESIGN. INT. CL. 7. (U.S. CL. 23). REG. 4-24-1984.
- 1,275,239. ROYAL HERITAGE COLLECTION (STYLIZED). INT. CL. 24. (U.S. CL. 42). REG. 4-24-1984.
- 1,275,665. PALATEX. INT. CL. 1. (U.S. CL. 6). REG. 5-1-1984.
- 1,276,603. RAMASIT. INT. CL. 1. (U.S. CL. 6). REG. 5-8-1984.
- 1,278,000. MPLS ST PAUL. INT. CL. 16. (U.S. CL. 38). REG. 5-15-1984.
- 1,278,100. KARRIE (STYLIZED). INT. CL. 25. (U.S. CL. 39). REG. 5-15-1984.
- 1,279,389. BUTOFAN. INT. CL. 1. (U.S. CL. 6). REG. 5-29-1984.
- 1,279,440. BASAZOL. INT. CL. 2. (U.S. CL. 6). REG. 5-29-1984.
- 1,279,991. R AND DESIGN. INT. CL. 28. (U.S. CL. 22). REG. 5-29-1984.
- 1,280,450. ALPHA KERI. INT. CL. 5. (U.S. CL. 18). REG. 6-5-1984.
- 1,281,282. HYCOE. INT. CL. 7. (U.S. CL. 23). REG. 6-12-1984.
- 1,281,470. R ROSS AND DESIGN. INT. CL. 12. (U.S. CL. 19). REG. 6-12-1984.
- 1,281,855. GENBANK. INT. CL. 35. (U.S. CL. 101). REG. 6-12-1984.
- 1,282,216. GGGG AND DESIGN. INT. CLS. 9, 14, 18, 24 AND 25. (U.S. CLS. 3, 26, 28, 39 AND 42). REG. 6-19-1984.
- 1,282,221. CHEMI-PRO. INT. CL. 9. (U.S. CLS. 26 AND 39). REG. 6-19-1984.
- 1,282,230. ADAMS. INT. CL. 9. (U.S. CL. 26). REG. 6-19-1984.
- 1,282,975. BOERICKE & TAFEL. INT. CL. 5. (U.S. CL. 18). REG. 6-26-1984.
- 1,283,061. BELTEX. INT. CL. 7. (U.S. CL. 23). REG. 6-26-1984.
- 1,283,608. NYSBA AND DESIGN. INT. CLS. 36 AND 41. (U.S. CLS. 102 AND 107). REG. 6-26-1984.
- 1,283,957. TK. INT. CL. 2. (U.S. CL. 16). REG. 7-3-1984.
- 1,284,233. INVADER. INT. CL. 15. (U.S. CL. 36). REG. 7-3-1984.
- 1,284,451. POLY M (STYLIZED). INT. CL. 28. (U.S. CL. 22). REG. 7-3-1984.
- 1,284,693. OH, THOSE SWEET BABY BONES (STYLIZED). INT. CL. 42. (U.S. CL. 100). REG. 7-3-1984.
- 1,285,482. LANIKAI. INT. CL. 32. (U.S. CL. 45). REG. 7-10-1984.
- 1,285,490. ARDMORE FARMS. INT. CL. 32. (U.S. CL. 46). REG. 7-10-1984.
- 1,285,506. CAPTAIN MORGAN AND DESIGN. INT. CL. 33. (U.S. CL. 49). REG. 7-10-1984.
- 1,285,549. MASTERCARD TRAVELERS CHEQUE AND DESIGN. INT. CL. 36. (U.S. CL. 102). REG. 7-10-1984.
- 1,285,690. SILIGEN. INT. CL. 1. (U.S. CL. 6). REG. 7-17-1984.
- 1,285,718. STICK IT AND DESIGN. INT. CL. 3. (U.S. CLS. 5 AND 51). REG. 7-17-1984.
- 1,285,765. DYCEDOL. INT. CL. 5. (U.S. CL. 18). REG. 7-17-1984.
- 1,285,981. EASY-TO-DO CROSSWORDS. INT. CL. 16. (U.S. CL. 38). REG. 7-17-1984.
- 1,286,039. SLEEP SOFA BY CLAUDE GABLE AND DESIGN. INT. CL. 20. (U.S. CL. 32). REG. 7-17-1984.
- 1,286,056. EMERSON. INT. CL. 21. (U.S. CLS. 2 AND 29). REG. 7-17-1984.
- 1,286,298. RHIZO-KOTE. INT. CL. 31. (U.S. CL. 1). REG. 7-17-1984.
- 1,286,302. GINSENG UP. INT. CL. 32. (U.S. CL. 45). REG. 7-17-1984.
- 1,286,316. MONIS. INT. CL. 33. (U.S. CL. 47). REG. 7-17-1984.
- 1,286,331. V. BIANCHI AND DESIGN. INT. CL. 33. (U.S. CL. 47). REG. 7-17-1984.
- 1,286,535. THE THISTLE & SHARMROCK. INT. CL. 41. (U.S. CL. 107). REG. 7-17-1984.
- 1,286,639. SRCC SOLAR CERTIFICATION ISCC & SEIA AND DESIGN. U.S. CL. A. REG. 7-17-1984.
- 1,286,687. INSLUME. INT. CL. 2. (U.S. CL. 16). REG. 7-24-1984.
- 1,286,702. JOHN AMICO. INT. CL. 3. (U.S. CL. 51). REG. 7-24-1984.
- 1,286,870. GOLDEN EAGLE. INT. CLS. 8 AND 21. (U.S. CLS. 2 AND 23). REG. 7-24-1984.
- 1,286,911. RAYCHEM. INT. CL. 9. (U.S. CLS. 21 AND 38). REG. 7-24-1984.
- 1,286,951. LICHROCARD. INT. CL. 9. (U.S. CL. 26). REG. 7-24-1984.
- 1,287,049. W WELTMEISTER AND DESIGN. INT. CL. 12. (U.S. CLS. 19 AND 23). REG. 7-24-1984.
- 1,287,262. MISCELLANEOUS DESIGN. INT. CL. 37. (U.S. CL. 103). REG. 7-24-1984.
- 1,287,326. CHRISTINE VALMY. INT. CLS. 41 AND 42. (U.S. CLS. 100 AND 107). REG. 7-24-1984.

- 1,287,333. CHRISTINE VALMY (STYLIZED). INT. CL. 42 ONLY. (U.S. CL. 100). REG. 7-24-1984.
- 1,287,357. NORTHWESTERN WILDCATS. INT. CL. 41. (U.S. CL. 107). REG. 7-24-1984.
- 1,287,407. CHRISTMAS PARADISE. INT. CL. 42. (U.S. CL. 101). REG. 7-24-1984.
- 1,287,531. TECHNI-SOLDER. INT. CL. 1. (U.S. CL. 6). REG. 7-31-1984.
- 1,287,536. SPAR. INT. CL. 1. (U.S. CL. 6). REG. 7-31-1984.
- 1,287,574. PINE POWER. INT. CL. 3. (U.S. CL. 52). REG. 7-31-1984.
- 1,287,770. FALCON AND DESIGN. INT. CL. 9. (U.S. CL. 26). REG. 7-31-1984.
- 1,287,817. POSIDYNE. INT. CL. 11. (U.S. CL. 31). REG. 7-31-1984.
- 1,287,819. TORO AND DESIGN. INT. CL. 11. (U.S. CL. 13). REG. 7-31-1984.
- 1,287,833. SACKNER AND DESIGN. INT. CLS. 12, 20 AND 22. (U.S. CLS. 1, 7, 19, 32 AND 50). REG. 7-31-1984.
- 1,287,845. LIBERATOR. INT. CL. 12. (U.S. CL. 35). REG. 7-31-1984.
- 1,287,944. SERRA-SIPE. INT. CL. 17. (U.S. CLS. 1 AND 35). REG. 7-31-1984.
- 1,287,986. WATERMAID. INT. CL. 21. (U.S. CLS. 2 AND 50). REG. 7-31-1984.
- 1,288,052. RED RIVER AND DESIGN. INT. CLS. 29 AND 30. (U.S. CL. 46). REG. 7-31-1984.
- 1,288,203. COMMON CENTS FOOD STORES AND DESIGN. INT. CLS. 37 AND 42. (U.S. CLS. 101 AND 103). REG. 7-31-1984.
- 1,288,284. MAX. INT. CL. 41. (U.S. CL. 107). REG. 7-31-1984.
- 1,288,389. KWIK FARMS AND DESIGN. INT. CL. 42. (U.S. CL. 101). REG. 7-31-1984.
- 1,288,493. LEAN 'N' TENDER. INT. CL. 29. (U.S. CL. 46). REG. 7-31-1984.
- 1,288,516. ORANGE COUNTY PERFORMING ARTS CENTER AND DESIGN. INT. CL. 41. (U.S. CL. 107). REG. 7-31-1984.
- 1,288,542. D-BLAZE (STYLIZED). INT. CL. 1. (U.S. CL. 6). REG. 8-7-1984.
- 1,288,626. ESCHER WYSS. INT. CLS. 11 AND 12 ONLY. (U.S. CLS. 13, 19, 21, 23, 31, 34, 35 AND 44). REG. 8-7-1984.
- 1,288,672. AGRI-VAC. INT. CL. 7. (U.S. CL. 23). REG. 8-7-1984.
- 1,288,676. UNI-TENSION AND DESIGN. INT. CL. 7. (U.S. CL. 23). REG. 8-7-1984.
- 1,288,679. BUMP FREE. INT. CL. 7. (U.S. CL. 23). REG. 8-7-1984.
- 1,288,837. AUTOBOX. INT. CL. 10. (U.S. CL. 44). REG. 8-7-1984.
- 1,288,873. MUSCO AND DESIGN. INT. CL. 11. (U.S. CL. 21). REG. 8-7-1984.
- 1,288,905. SAMICK. INT. CL. 15. (U.S. CL. 36). REG. 8-7-1984.
- 1,288,979. MISCELLANEOUS DESIGN. INT. CL. 28 ONLY. (U.S. CLS. 22 AND 50). REG. 8-7-1984.
- 1,288,986. THE DIMENSIONAL TRAINING SYSTEM: RESULTS THROUGH PEOPLE-SKILLS. INT. CL. 16. (U.S. CL. 38). REG. 8-7-1984.
- 1,289,029. BON-PEL. INT. CL. 18. (U.S. CL. 1). REG. 8-7-1984.
- 1,289,053. MICALETTERS. INT. CL. 20. (U.S. CL. 50). REG. 8-7-1984.
- 1,289,067. EVEREST ELITE. INT. CL. 20. (U.S. CL. 32). REG. 8-7-1984.
- 1,289,082. BEATRIX POTTER. INT. CL. 21. (U.S. CLS. 2, 22 AND 30). REG. 8-7-1984.
- 1,289,083. PETER RABBIT. INT. CL. 21. (U.S. CLS. 2 AND 30). REG. 8-7-1984.
- 1,289,084. MISCELLANEOUS DESIGN. INT. CL. 21. (U.S. CLS. 2 AND 30). REG. 8-7-1984.
- 1,289,150. PITFALL!. INT. CL. 28. (U.S. CLS. 22, 26 AND 38). REG. 8-7-1984.
- 1,289,236. MDI AND DESIGN. INT. CLS. 29, 30 AND 42. (U.S. CLS. 46 AND 101). REG. 8-7-1984.
- 1,289,242. LITTLE ORPHAN ORANGE AND DESIGN. INT. CL. 30. (U.S. CL. 46). REG. 8-7-1984.
- 1,289,251. WHITFIELD. INT. CL. 30. (U.S. CL. 46). REG. 8-7-1984.
- 1,289,322. VAL-PAK. INT. CL. 35. (U.S. CL. 101). REG. 8-7-1984.
- 1,289,346. SCHOOLPOWER. INT. CL. 36. (U.S. CL. 102). REG. 8-7-1984.
- 1,289,378. CAN AND DESIGN. INT. CL. 39. (U.S. CL. 105). REG. 8-7-1984.
- 1,289,394. SUMMERNATIONALS. INT. CL. 41. (U.S. CL. 107). REG. 8-7-1984.
- 1,289,409. THE DIMENSIONAL TRAINING SYSTEM: RESULTS THROUGH PEOPLE-SKILLS. INT. CL. 41. (U.S. CL. 107). REG. 8-7-1984.
- 1,289,413. CHANNEL HOME CENTERS. INT. CL. 42. (U.S. CL. 101). REG. 8-7-1984.
- 1,289,452. JO-ANN FABRICS. INT. CL. 42. (U.S. CL. 101). REG. 8-7-1984.
- 1,289,504. AUDIT. INT. CL. 9. (U.S. CL. 26). REG. 8-7-1984.
- 1,289,506. AUTOMIX. INT. CL. 9. (U.S. CL. 26). REG. 8-7-1984.
- 1,289,633. THERMASTIC (STYLIZED). INT. CL. 1. (U.S. CL. 12). REG. 8-14-1984.
- 1,289,634. PINNACLE. INT. CL. 1. (U.S. CL. 6). REG. 8-14-1984.
- 1,289,649. CLARION. INT. CL. 2. (U.S. CLS. 6 AND 11). REG. 8-14-1984.
- 1,289,651. INTERGARD. INT. CL. 2. (U.S. CL. 16). REG. 8-14-1984.
- 1,289,676. YSL (STYLIZED). INT. CL. 3. (U.S. CLS. 51 AND 52). REG. 8-14-1984.
- 1,289,678. YVES SAINT LAURENT (STYLIZED). INT. CL. 3. (U.S. CLS. 51 AND 52). REG. 8-14-1984.
- 1,289,695. DON POST STUDIOS. INT. CLS. 3 AND 28. (U.S. CLS. 22, 50 AND 51). REG. 8-14-1984.
- 1,289,786. ACCO. INT. CLS. 5 AND 31. (U.S. CL. 46). REG. 8-14-1984.
- 1,289,791. CONE LOC SEAL. INT. CL. 6. (U.S. CLS. 13 AND 25). REG. 8-14-1984.
- 1,289,792. LUMEX AND DESIGN. INT. CLS. 6, 10, 11 AND 20. (U.S. CLS. 13, 32 AND 44). REG. 8-14-1984.
- 1,289,804. ENCORE. INT. CL. 6. (U.S. CL. 12). REG. 8-14-1984.
- 1,289,824. ALADIN. INT. CL. 9 ONLY. (U.S. CLS. 26 AND 38). REG. 8-14-1984.
- 1,289,834. INGERSOLL AND DESIGN. INT. CL. 7. (U.S. CL. 23). REG. 8-14-1984.
- 1,289,837. GLASS MASTER. INT. CL. 7. (U.S. CL. 23). REG. 8-14-1984.
- 1,289,850. PRO FILE. INT. CL. 8. (U.S. CL. 44). REG. 8-14-1984.
- 1,289,904. COMSHARE. INT. CLS. 9 AND 16. (U.S. CL. 38). REG. 8-14-1984.
- 1,289,914. JETCOUNT (STYLIZED). INT. CL. 9. (U.S. CLS. 23 AND 26). REG. 8-14-1984.
- 1,289,915. JETSORT (STYLIZED). INT. CL. 9. (U.S. CLS. 23 AND 26). REG. 8-14-1984.
- 1,289,930. BPR. INT. CL. 9. (U.S. CLS. 13 AND 26). REG. 8-14-1984.
- 1,289,947. DYNA SPLINT SYSTEMS, INC. AND DESIGN. INT. CL. 10. (U.S. CL. 44). REG. 8-14-1984.
- 1,289,959. PORT A RAIN (STYLIZED). INT. CL. 11. (U.S. CL. 13). REG. 8-14-1984.
- 1,289,970. MISTER DEW DROP. INT. CL. 11. (U.S. CL. 13). REG. 8-14-1984.
- 1,289,985. MR. GOODBAR. INT. CL. 21 ONLY. (U.S. CLS. 2 AND 30). REG. 8-14-1984.
- 1,289,996. MISCELLANEOUS DESIGN. INT. CL. 16. (U.S. CLS. 22 AND 38). REG. 8-14-1984.
- 1,290,051. MISCELLANEOUS DESIGN. INT. CL. 16. (U.S. CL. 37). REG. 8-14-1984.
- 1,290,091. CSI. INT. CLS. 20, 37 AND 42. (U.S. CLS. 2, 50, 100 AND 103). REG. 8-14-1984.
- 1,290,101. MISCELLANEOUS DESIGN. INT. CL. 21. (U.S. CLS. 2, 13, 23, 29, 30, 33, 40 AND 50). REG. 8-14-1984.
- 1,290,103. MISCELLANEOUS DESIGN. INT. CL. 21. (U.S. CLS. 2, 13, 23, 29, 30, 33, 40 AND 50). REG. 8-14-1984.
- 1,290,135. SURE STEPS. INT. CL. 25. (U.S. CL. 39). REG. 8-14-1984.
- 1,290,249. PRESWICK & MOORE. INT. CL. 25. (U.S. CL. 39). REG. 8-14-1984.
- 1,290,265. ANYTHING GOES!. INT. CL. 27. (U.S. CL. 42). REG. 8-14-1984.
- 1,290,298. EXCELER AND DESIGN. INT. CL. 28. (U.S. CL. 22). REG. 8-14-1984.
- 1,290,445. GEORGE BRAZIL (STYLIZED). INT. CL. 37. (U.S. CL. 103). REG. 8-14-1984.
- 1,290,456. PRACTICAL RENT-A-CAR. INT. CL. 39. (U.S. CL. 105). REG. 8-14-1984.
- 1,290,461. MISCELLANEOUS DESIGN. INT. CL. 41 ONLY. (U.S. CLS. 100, 101 AND 107). REG. 8-14-1984.

- 1,290,487. FORCE. INT. CL. 42. (U.S. CLS. 100 AND 103). REG. 8-14-1984.
- 1,290,488. FORCE AND DESIGN. INT. CL. 42. (U.S. CLS. 100 AND 103). REG. 8-14-1984.
- 1,290,508. ALBARRE AND DESIGN. INT. CL. 42. (U.S. CLS. 100 AND 101). REG. 8-14-1984.
- 1,290,510. ROCKAWAY RECORDS. INT. CL. 42. (U.S. CL. 101). REG. 8-14-1984.
- 1,290,528. RUST CHECK. INT. CL. 2. (U.S. CL. 16). REG. 8-14-1984.
- 1,290,540. CADWELL. INT. CL. 10. (U.S. CL. 44). REG. 8-14-1984.
- 1,290,566. US CASKET AND DESIGN. INT. CL. 20. (U.S. CLS. 2 AND 50). REG. 8-14-1984.
- 1,290,601. DEXCEL. INT. CLS. 1 AND 2. (U.S. CL. 6). REG. 8-21-1984.
- 1,290,656. COLGATE AND DESIGN. INT. CL. 3. (U.S. CL. 51). REG. 8-21-1984.
- 1,290,667. YOUTH-DERM-RELIEF. INT. CL. 5. (U.S. CL. 18). REG. 8-21-1984.
- 1,290,759. ENDOCAM. INT. CL. 9. (U.S. CLS. 21, 23, 26, 36 AND 38). REG. 8-21-1984.
- 1,290,767. CIAO. INT. CLS. 18 AND 25 ONLY. (U.S. CLS. 3, 22, 39 AND 41). REG. 8-21-1984.
- 1,290,884. THERMOPOWER. INT. CL. 11. (U.S. CL. 34). REG. 8-21-1984.
- 1,290,909. NEWPORT. INT. CL. 12. (U.S. CL. 19). REG. 8-21-1984.
- 1,290,994. LUBRI-FAX. INT. CL. 16. (U.S. CL. 38). REG. 8-21-1984.
- 1,291,069. SLUMBERJACK. INT. CLS. 20, 22 AND 25. (U.S. CLS. 22, 32 AND 39). REG. 8-21-1984.
- 1,291,109. SAM MOORE. INT. CL. 20. (U.S. CL. 32). REG. 8-21-1984.
- 1,291,110. SAM MOORE FURNITURE INDUSTRIES. INT. CL. 20. (U.S. CL. 32). REG. 8-21-1984.
- 1,291,128. CHINET (STYLIZED). INT. CL. 21. (U.S. CL. 2). REG. 8-21-1984.
- 1,291,238. JOUJOU. INT. CL. 25. (U.S. CL. 39). REG. 8-21-1984.
- 1,291,308. MINILOON. INT. CL. 28. (U.S. CLS. 22 AND 50). REG. 8-21-1984.
- 1,291,437. VENADO ESPECIAL. INT. CL. 33. (U.S. CL. 49). REG. 8-21-1984.
- 1,291,453. STILLBROOK. INT. CL. 33. (U.S. CL. 49). REG. 8-21-1984.
- 1,291,454. STOLICHNAYA. INT. CL. 33. (U.S. CL. 49). REG. 8-21-1984.
- 1,291,542. ALFREDO AND DESIGN. INT. CL. 42. (U.S. CL. 100). REG. 8-21-1984.
- 1,291,543. BENTHAM'S RIVERFRONT RESTAURANT. INT. CL. 42. (U.S. CL. 100). REG. 8-21-1984.
- 1,291,562. SLUDGE CUTTER. INT. CL. 1. (U.S. CL. 6). REG. 8-28-1984.
- 1,291,588. KING SOOPERS. INT. CLS. 1, 5, 29, 30 AND 32. (U.S. CLS. 10, 18, 45 AND 46). REG. 8-28-1984.
- 1,291,719. CITRONOVA. INT. CL. 3. (U.S. CLS. 6, 18 AND 51). REG. 8-28-1984.
- 1,291,729. LILJEHOLMENS. INT. CL. 4. (U.S. CL. 15). REG. 8-28-1984.
- 1,291,760. SEVIN XLR. INT. CL. 5. (U.S. CL. 6). REG. 8-28-1984.
- 1,291,774. MEDIFAST. INT. CL. 5. (U.S. CL. 18). REG. 8-28-1984.
- 1,291,825. YARDSAVER. INT. CL. 6. (U.S. CL. 19). REG. 8-28-1984.
- 1,291,830. KITZ K-METAL (STYLIZED). INT. CL. 6. (U.S. CLS. 13 AND 14). REG. 8-28-1984.
- 1,291,842. MET-L-BRASIVE. INT. CL. 7. (U.S. CL. 4). REG. 8-28-1984.
- 1,291,846. GARRETT. INT. CL. 7. (U.S. CLS. 21, 23 AND 34). REG. 8-28-1984.
- 1,291,853. HEIM. INT. CL. 7. (U.S. CL. 23). REG. 8-28-1984.
- 1,291,862. CLEMLITE. INT. CL. 7. (U.S. CL. 23). REG. 8-28-1984.
- 1,291,867. UGO (STYLIZED). INT. CLS. 7 AND 12. (U.S. CLS. 19 AND 23). REG. 8-28-1984.
- 1,291,876. FLO CUT AND DESIGN. INT. CL. 7. (U.S. CL. 23). REG. 8-28-1984.
- 1,291,929. V P A S. INT. CL. 9. (U.S. CL. 26). REG. 8-28-1984.
- 1,291,944. ALOS. INT. CL. 9. (U.S. CL. 26). REG. 8-28-1984.
- 1,291,978. MISCELLANEOUS DESIGN. INT. CL. 9. (U.S. CLS. 26 AND 39). REG. 8-28-1984.
- 1,292,017. CHROMOPHARE. INT. CL. 10. (U.S. CL. 44). REG. 8-28-1984.
- 1,292,027. EPIX. INT. CL. 10. (U.S. CL. 44). REG. 8-28-1984.
- 1,292,068. ADD-A-TRAY. INT. CL. 11. (U.S. CLS. 23 AND 34). REG. 8-28-1984.
- 1,292,069. MANITOWOC AND DESIGN. INT. CL. 11. (U.S. CLS. 13 AND 31). REG. 8-28-1984.
- 1,292,100. POLYWOUND (STYLIZED). INT. CL. 11. (U.S. CL. 31). REG. 8-28-1984.
- 1,292,131. VENTURE (STYLIZED). INT. CL. 12. (U.S. CL. 19). REG. 8-28-1984.
- 1,292,146. DEFENDER. INT. CL. 13. (U.S. CL. 9). REG. 8-28-1984.
- 1,292,170. MISCELLANEOUS DESIGN. INT. CLS. 16 AND 21. (U.S. CLS. 2, 37, 38 AND 50). REG. 8-28-1984.
- 1,292,271. FLAKELINE. INT. CL. 17. (U.S. CL. 1). REG. 8-28-1984.
- 1,292,454. PROCASER TOURNAMENT. INT. CL. 28. (U.S. CL. 22). REG. 8-28-1984.
- 1,292,494. CHRISTOPHER'S FRUIT GEMS AND DESIGN. INT. CL. 30. (U.S. CL. 46). REG. 8-28-1984.
- 1,292,604. A TOUCH OF SUN. INT. CL. 3. (U.S. CL. 51). REG. 9-4-1984.
- 1,292,784. FOUNDATION. INT. CL. 15. (U.S. CL. 36). REG. 9-4-1984.
- 1,293,083. POSADA (STYLIZED). INT. CL. 30. (U.S. CL. 46). REG. 9-4-1984.
- 1,293,150. REED SMITH. INT. CL. 35. (U.S. CLS. 100 AND 101). REG. 9-4-1984.
- 1,293,171. FLIK (STYLIZED). INT. CL. 35. (U.S. CL. 101). REG. 9-4-1984.
- 1,293,208. AIRSCHOTT. INT. CLS. 36 AND 39. (U.S. CLS. 102 AND 105). REG. 9-4-1984.
- 1,293,240. LINCOLN NATIONAL AND DESIGN. INT. CL. 36. (U.S. CL. 102). REG. 9-4-1984.
- 1,293,288. NELSON AND DESIGN. INT. CL. 37. (U.S. CL. 103). REG. 9-4-1984.
- 1,293,293. ENMARK. INT. CLS. 37 AND 42. (U.S. CLS. 101 AND 103). REG. 9-4-1984.
- 1,293,533. IMPERIAL COURT DAUGHTERS OF ISIS. U.S. CL. 200. REG. 9-4-1984.
- 1,293,538. K AND DESIGN. U.S. CL. A. REG. 9-4-1984.
- 1,293,620. OXABAN-A. INT. CL. 1. (U.S. CL. 6). REG. 9-11-1984.
- 1,293,728. GIGI. INT. CL. 3. (U.S. CL. 51). REG. 9-11-1984.
- 1,293,820. WIDE HORIZONS. INT. CL. 5. (U.S. CL. 6). REG. 9-11-1984.
- 1,293,844. NASALCROM (STYLIZED). INT. CL. 5. (U.S. CL. 18). REG. 9-11-1984.
- 1,293,871. ALLY. INT. CL. 5. (U.S. CL. 6). REG. 9-11-1984.
- 1,294,096. HARBOR LINEN. INT. CLS. 24 AND 42 ONLY. (U.S. CLS. 42 AND 101). REG. 9-11-1984.
- 1,294,182. PJ AND DESIGN. INT. CL. 14. (U.S. CL. 28). REG. 9-11-1984.
- 1,294,212. LEONARD. INT. CL. 16. (U.S. CL. 29). REG. 9-11-1984.
- 1,294,220. KOLA LOKA (STYLIZED). INT. CL. 16. (U.S. CL. 5). REG. 9-11-1984.
- 1,294,308. WILKHAN FS. INT. CL. 20. (U.S. CL. 32). REG. 9-11-1984.
- 1,294,327. AQUA ANCHORS. INT. CL. 21. (U.S. CL. 2). REG. 9-11-1984.
- 1,294,343. CARE BEARS. INT. CL. 28 ONLY. (U.S. CL. 22). REG. 9-11-1984.
- 1,294,437. VIBRAM (STYLIZED). INT. CL. 25. (U.S. CL. 39). REG. 9-11-1984.
- 1,294,805. EVEREST. INT. CL. 32. (U.S. CL. 45). REG. 9-11-1984.
- 1,294,975. PORSTORATION. INT. CL. 37. (U.S. CL. 103). REG. 9-11-1984.
- 1,295,078. GODIVA. INT. CL. 42. (U.S. CL. 101). REG. 9-11-1984.
- 1,295,202. TENROC. INT. CL. 42. (U.S. CLS. 100 AND 101). REG. 9-11-1984.
- 1,295,299. SHOE GOO. INT. CL. 1. (U.S. CL. 6). REG. 9-18-1984.
- 1,295,301. COLLAFIX. INT. CL. 1. (U.S. CL. 5). REG. 9-18-1984.
- 1,295,354. FLAMEMASTER AND DESIGN. INT. CL. 1. (U.S. CL. 6). REG. 9-18-1984.
- 1,295,484. SLEEPY HOLLOW. INT. CL. 3. (U.S. CLS. 51 AND 52). REG. 9-18-1984.
- 1,295,586. ORUDIS. INT. CL. 5. (U.S. CL. 18). REG. 9-18-1984.
- 1,295,591. CLS. INT. CL. 5. (U.S. CL. 46). REG. 9-18-1984.

- 1,295,958. SCUBA. INT. CL. 11. (U.S. CL. 34). REG. 9-18-1984.  
 1,296,010. ROMA (STYLIZED). INT. CL. 14. (U.S. CL. 28). REG. 9-18-1984.  
 1,296,176. GROCERGRAM. INT. CL. 16. (U.S. CL. 38). REG. 9-18-1984.  
 1,296,225. LITE WATE. INT. CL. 19. (U.S. CL. 12). REG. 9-18-1984.  
 1,296,227. AR-153. INT. CL. 19. (U.S. CL. 12). REG. 9-18-1984.  
 1,296,228. CER LITE. INT. CL. 19. (U.S. CL. 12). REG. 9-18-1984.  
 1,296,233. MARCAST. INT. CL. 19. (U.S. CL. 12). REG. 9-18-1984.  
 1,296,663. FIESTA. INT. CL. 30. (U.S. CL. 46). REG. 9-18-1984.  
 1,296,845. MPSI. INT. CL. 36. (U.S. CLS. 101 AND 102). REG. 9-18-1984.  
 1,296,890. S TRIPLE AND DESIGN. INT. CL. 37. (U.S. CL. 103). REG. 9-18-1984.  
 1,297,022. RIDE THROUGH HISTORY. INT. CL. 41. (U.S. CL. 107). REG. 9-18-1984.  
 1,297,191. PRAIRIE SCHOONER. INT. CL. 42. (U.S. CL. 100). REG. 9-18-1984.  
 1,297,211. CROWNE PLAZA. INT. CL. 42. (U.S. CL. 100). REG. 9-18-1984.  
 1,297,384. ROSTA AND DESIGN. INT. CL. 7. (U.S. CLS. 23 AND 35). REG. 9-25-1984.  
 1,297,394. KNAPP AND DESIGN. INT. CL. 7. (U.S. CL. 23). REG. 9-25-1984.  
 1,297,445. MIKRON (STYLIZED). INT. CL. 10. (U.S. CL. 44). REG. 9-25-1984.  
 1,297,665. ST TROPEZ SWIMWEAR (STYLIZED). INT. CL. 25. (U.S. CL. 39). REG. 9-25-1984.  
 1,297,685. OLIVIER STRELLI. INT. CL. 25. (U.S. CL. 39). REG. 9-25-1984.  
 1,297,693. THERMOLDS AND DESIGN. INT. CL. 25. (U.S. CL. 39). REG. 9-25-1984.  
 1,298,195. WINNERS CORPORATION W AND DESIGN. INT. CL. 42. (U.S. CL. 100). REG. 9-25-1984.  
 1,298,295. FLAKETAR. INT. CL. 2. (U.S. CL. 16). REG. 10-2-1984.  
 1,298,339. PLAX. INT. CL. 5. (U.S. CL. 18). REG. 10-2-1984.  
 1,298,440. SANKYO. INT. CL. 9. (U.S. CLS. 21 AND 26). REG. 10-2-1984.  
 1,298,508. ETC (STYLIZED). INT. CLS. 9, 10 AND 11. (U.S. CLS. 13, 23, 24, 26, 31, 34 AND 44). REG. 10-2-1984.  
 1,298,682. CIRCLITE. INT. CL. 11. (U.S. CL. 21). REG. 10-2-1984.  
 1,298,838. MISCELLANEOUS DESIGN. INT. CL. 21. (U.S. CLS. 2, 30 AND 50). REG. 10-2-1984.  
 1,299,030. MANDARIN. INT. CL. 30. (U.S. CL. 46). REG. 10-2-1984.  
 1,299,262. E AND DESIGN. INT. CL. 6. (U.S. CLS. 2, 12, 13, 14, 23 AND 50). REG. 10-9-1984.  
 1,299,292. RAPID-AIR. INT. CL. 7. (U.S. CL. 23). REG. 10-9-1984.  
 1,299,554. FLEXIGRIP. INT. CL. 20. (U.S. CL. 50). REG. 10-9-1984.  
 1,300,117. GT PERFORMANCE. INT. CL. 4. (U.S. CL. 15). REG. 10-16-1984.  
 1,300,132. SLOW FLUORIDE. INT. CL. 5. (U.S. CL. 18). REG. 10-16-1984.  
 1,300,176. MISCELLANEOUS DESIGN. INT. CL. 7. (U.S. CL. 23). REG. 10-16-1984.  
 1,300,256. DASH II AND DESIGN. INT. CL. 9. (U.S. CL. 26). REG. 10-16-1984.  
 1,300,604. HUSKY. INT. CL. 22. (U.S. CL. 2). REG. 10-16-1984.  
 1,300,707. SI AND DESIGN. INT. CL. 27. (U.S. CL. 42). REG. 10-16-1984.  
 1,301,125. MISTOLIN. INT. CL. 3. (U.S. CLS. 4, 6 AND 52). REG. 10-23-1984.  
 1,301,243. TLC. INT. CL. 7. (U.S. CL. 23). REG. 10-23-1984.  
 1,301,249. MEINAN (STYLIZED). INT. CL. 7. (U.S. CL. 23). REG. 10-23-1984.  
 1,301,419. THERMAGOWN. INT. CL. 10. (U.S. CL. 44). REG. 10-23-1984.  
 1,301,697. DECAPLY. INT. CL. 19. (U.S. CL. 12). REG. 10-23-1984.  
 1,301,774. LOLA AND DESIGN. INT. CL. 25. (U.S. CL. 39). REG. 10-23-1984.  
 1,302,141. HV AND DESIGN. U.S. CL. A. REG. 10-23-1984.  
 1,302,145. Y'SHUA. INT. CLS. 14 AND 16. (U.S. CLS. 28 AND 38). REG. 10-23-1984.  
 1,302,410. CEFINASE. INT. CL. 9. (U.S. CL. 26). REG. 10-30-1984.  
 1,302,663. CELLUFOAM. INT. CL. 21. (U.S. CL. 29). REG. 10-30-1984.  
 1,302,742. COMFOR-TREDS. INT. CL. 25. (U.S. CL. 39). REG. 10-30-1984.  
 1,303,060. PROFIT REACH. INT. CL. 35. (U.S. CL. 101). REG. 10-30-1984.  
 1,303,161. Y.O. RANCH. INT. CL. 41 ONLY. (U.S. CL. 107). REG. 10-30-1984.  
 1,303,401. D & E. INT. CLS. 5 AND 42. (U.S. CLS. 18 AND 101). REG. 11-6-1984.  
 1,303,572. CECILWARE. INT. CLS. 11, 16 AND 21. (U.S. CLS. 2, 31 AND 34). REG. 11-6-1984.  
 1,303,632. CHAPELLE. INT. CL. 14. (U.S. CL. 27). REG. 11-6-1984.  
 1,303,644. ETTA (STYLIZED). INT. CL. 14. (U.S. CL. 28). REG. 11-6-1984.  
 1,303,645. MISCELLANEOUS DESIGN. INT. CL. 14. (U.S. CL. 28). REG. 11-6-1984.  
 1,303,877. SUN TOP AND DESIGN. INT. CL. 25. (U.S. CL. 39). REG. 11-6-1984.  
 1,304,334. XTRA DUTY. INT. CL. 3. (U.S. CL. 52). REG. 11-6-1984.  
 1,304,979. THE CAR AND LOCOMOTIVE CYCLOPEDIA. INT. CL. 16. (U.S. CL. 38). REG. 11-13-1984.  
 1,305,217. SHRIMPWRECK MARY. INT. CL. 33. (U.S. CL. 49). REG. 11-13-1984.  
 1,305,218. COMPETIDORA AND DESIGN. INT. CL. 34. (U.S. CL. 17). REG. 11-13-1984.  
 1,305,252. COSEK. INT. CL. 35. (U.S. CL. 101). REG. 11-13-1984.  
 1,305,316. ARTECH. INT. CL. 37. (U.S. CL. 103). REG. 11-13-1984.  
 1,305,321. RAINBOW MUFFLER AND DESIGN. INT. CL. 37. (U.S. CL. 103). REG. 11-13-1984.  
 1,305,331. F AND DESIGN. INT. CLS. 37 AND 42. (U.S. CLS. 100 AND 103). REG. 11-13-1984.  
 1,305,544. PAMS. INT. CL. 42. (U.S. CLS. 100 AND 101). REG. 11-13-1984.  
 1,305,606. REGANE. INT. CL. 1. (U.S. CLS. 6, 15 AND 52). REG. 11-20-1984.  
 1,306,244. WESTERN BAGEL AND DESIGN. INT. CL. 30. (U.S. CL. 46). REG. 11-20-1984.  
 1,306,261. COOKIE PUSS. INT. CL. 30. (U.S. CL. 46). REG. 11-20-1984.  
 1,306,698. CLEARLY NATURAL. INT. CL. 3. (U.S. CL. 52). REG. 11-27-1984.  
 1,307,013. FEATHER SOFT (STYLIZED). INT. CL. 16. (U.S. CL. 37). REG. 11-27-1984.  
 1,307,359. LATHAM SEEDS AND DESIGN. INT. CL. 31. (U.S. CL. 1). REG. 11-27-1984.  
 1,307,360. LATHAM. INT. CL. 31. (U.S. CL. 1). REG. 11-27-1984.  
 1,307,788. CRAY. INT. CL. 9. (U.S. CL. 26). REG. 12-4-1984.  
 1,307,911. POLAR KING. INT. CL. 11. (U.S. CL. 31). REG. 12-4-1984.  
 1,308,011. EMERSON. INT. CL. 17. (U.S. CLS. 12, 21 AND 35). REG. 12-4-1984.  
 1,308,207. CENTO AND DESIGN. INT. CLS. 29 AND 30. (U.S. CL. 46). REG. 12-4-1984.  
 1,308,373. EFFIE (STYLIZED). INT. CL. 41. (U.S. CL. 107). REG. 12-4-1984.  
 1,308,540. EXPERT EYES. INT. CL. 3. (U.S. CL. 51). REG. 12-11-1984.  
 1,308,664. NEWPORT SCROLL. INT. CL. 8. (U.S. CL. 23). REG. 12-11-1984.  
 1,309,133. DAVID AUSTIN. INT. CL. 25. (U.S. CL. 39). REG. 12-11-1984.  
 1,309,241. MINUTE MENU STEAKS. INT. CL. 29. (U.S. CL. 46). REG. 12-11-1984.  
 1,309,350. EMERSON. INT. CL. 37. (U.S. CL. 103). REG. 12-11-1984.  
 1,309,474. AF AFFILIATED FOODS INC (STYLIZED). INT. CL. 42. (U.S. CL. 101). REG. 12-11-1984.  
 1,309,642. MAGSTOP. INT. CL. 6. (U.S. CL. 13). REG. 12-18-1984.  
 1,309,945. ALDUS. INT. CL. 16. (U.S. CL. 14). REG. 12-18-1984.  
 1,310,316. KAMBLY (STYLIZED). INT. CL. 30. (U.S. CL. 46). REG. 12-18-1984.  
 1,310,711. DEKSWOOD. INT. CL. 3. (U.S. CL. 52). REG. 12-25-1984.  
 1,310,765. DYMO. INT. CLS. 6 AND 17. (U.S. CLS. 1 AND 14). REG. 12-25-1984.  
 1,310,782. SPEED SWING. INT. CL. 7. (U.S. CL. 23). REG. 12-25-1984.

- 1,310,794. LILLISTON. INT. CL. 7. (U.S. CL. 23). REG. 12-25-1984.
- 1,311,077. THERMOJACKET. INT. CL. 17. (U.S. CLS. 13, 21 AND 35). REG. 12-25-1984.
- 1,311,108. DURASTEP. INT. CL. 19. (U.S. CLS. 12 AND 20). REG. 12-25-1984.
- 1,311,211. POWER VEST. INT. CL. 28. (U.S. CL. 22). REG. 12-25-1984.
- 1,311,377. OMAE. INT. CL. 35. (U.S. CL. 101). REG. 12-25-1984.
- 1,311,800. CONSERVARE AND DESIGN. INT. CL. 1. (U.S. CL. 6). REG. 1-1-1985.
- 1,311,933. LIGHT APPETITE. INT. CL. 5. (U.S. CL. 18). REG. 1-1-1985.
- 1,312,013. CARDENE. INT. CL. 5. (U.S. CL. 18). REG. 1-1-1985.
- 1,312,144. MULTI-PREP. INT. CL. 9. (U.S. CL. 26). REG. 1-1-1985.
- 1,312,340. TENTE AND DESIGN. INT. CL. 20. (U.S. CLS. 13 AND 50). REG. 1-1-1985.
- 1,312,386. CHERSPUN. INT. CL. 23. (U.S. CL. 43). REG. 1-1-1985.
- 1,312,654. HOLDER'S. INT. CL. 37. (U.S. CL. 103). REG. 1-1-1985.
- 1,313,271. OFITE. INT. CL. 9. (U.S. CL. 26). REG. 1-8-1985.
- 1,313,746. TECATE. INT. CL. 32. (U.S. CL. 48). REG. 1-8-1985.
- 1,313,998. A-1. INT. CL. 42. (U.S. CL. 101). REG. 1-8-1985.
- 1,314,165. NYEBAR. INT. CL. 1. (U.S. CLS. 1 AND 6). REG. 1-15-1985.
- 1,314,271. V AND DESIGN. INT. CL. 5. (U.S. CL. 18). REG. 1-15-1985.
- 1,314,410. AUCOLOR. INT. CL. 9. (U.S. CL. 26). REG. 1-15-1985.
- 1,314,421. HYDRO-FOAM. INT. CL. 9. (U.S. CL. 13). REG. 1-15-1985.
- 1,314,450. POW'R GRIP AND DESIGN. INT. CL. 10. (U.S. CL. 44). REG. 1-15-1985.
- 1,316,186. LAZY DAZE ARTS & CRAFTS FESTIVAL JAM AND DESIGN. INT. CL. 41. (U.S. CL. 107). REG. 1-22-1985.
- 1,316,465. H-7. INT. CL. 3. (U.S. CL. 52). REG. 1-29-1985.
- 1,316,800. DUALWRAP. INT. CL. 10. (U.S. CL. 44). REG. 1-29-1985.
- 1,316,897. RIMSHOT. INT. CL. 15. (U.S. CL. 36). REG. 1-29-1985.
- 1,317,157. READY PAC PRODUCE. INT. CL. 29. (U.S. CL. 46). REG. 1-29-1985.
- 1,317,582. PAI AND DESIGN. INT. CLS. 6, 7, 9, 11 AND 12. (U.S. CLS. 19, 21, 23, 25, 26 AND 31). REG. 2-5-1985.
- 1,318,051. SUMMER SUPPERS. INT. CL. 16. (U.S. CL. 38). REG. 2-5-1985.
- 1,318,131. PLAS-T-COTE. INT. CL. 19. (U.S. CL. 12). REG. 2-5-1985.
- 1,319,510. FALLS CREEK. INT. CL. 25. (U.S. CL. 39). REG. 2-12-1985.
- 1,322,887. PERM FRESH. INT. CL. 3. (U.S. CL. 51). REG. 3-5-1985.
- 1,324,553. WOODFIELD. INT. CL. 19. (U.S. CL. 12). REG. 3-12-1985.
- 1,326,105. + POS AND DESIGN. INT. CL. 28. (U.S. CL. 22). REG. 3-19-1985.
- 1,326,389. THE ITALIAN PLACE TO BE. INT. CL. 42. (U.S. CL. 100). REG. 3-19-1985.
- 1,326,857. BREEDERS' CUP AND DESIGN. INT. CL. 14. (U.S. CL. 28). REG. 3-26-1985.
- 1,326,883. BASILIA. INT. CL. 16. (U.S. CL. 14). REG. 3-26-1985.
- 1,326,999. APS. INT. CLS. 20 AND 35. (U.S. CLS. 2 AND 101). REG. 3-26-1985.
- 1,327,127. ELVIS. INT. CL. 25. (U.S. CL. 39). REG. 3-26-1985.
- 1,327,165. FINGER'S FRIEND. INT. CL. 26. (U.S. CL. 40). REG. 3-26-1985.
- 1,327,280. CAFE LA LLAVE AND DESIGN. INT. CL. 30. (U.S. CL. 46). REG. 3-26-1985.
- 1,327,608. SLINGSCALE. INT. CL. 9. (U.S. CL. 26). REG. 3-26-1985.
- 1,327,818. MISCELLANEOUS DESIGN. INT. CL. 3. (U.S. CL. 51). REG. 4-2-1985.
- 1,328,335. SPORLASTIC. INT. CL. 10. (U.S. CL. 44). REG. 4-2-1985.
- 1,329,566. BREEDERS' CUP AND DESIGN. INT. CL. 16. (U.S. CLS. 23, 37 AND 38). REG. 4-9-1985.
- 1,329,595. BREEDERS' CUP AND DESIGN. INT. CL. 18. (U.S. CLS. 3 AND 41). REG. 4-9-1985.
- 1,329,764. BREEDERS' CUP AND DESIGN. INT. CL. 25. (U.S. CL. 39). REG. 4-9-1985.
- 1,332,622. CHARLEY'S EATING & DRINKING SALOON (STYLIZED). INT. CL. 42. (U.S. CL. 100). REG. 4-23-1985.
- 1,333,053. ABSOLYTE. INT. CL. 9. (U.S. CL. 21). REG. 4-30-1985.
- 1,333,076. MAXI-MASK. INT. CL. 9. (U.S. CLS. 26 AND 44). REG. 4-30-1985.
- 1,333,410. BREEDERS' CUP AND DESIGN. INT. CL. 28. (U.S. CLS. 22, 23, 38 AND 50). REG. 4-30-1985.
- 1,334,177. TOMLINSON. INT. CLS. 11 AND 21. (U.S. CLS. 2, 13 AND 34). REG. 5-7-1985.
- 1,335,068. MEGA-CHEL. INT. CL. 5. (U.S. CL. 18). REG. 5-14-1985.
- 1,335,443. DUDEN. INT. CLS. 16 AND 41. (U.S. CLS. 38, 101 AND 107). REG. 5-14-1985.
- 1,336,914. RECON. INT. CL. 28. (U.S. CL. 22). REG. 5-21-1985.
- 1,337,183. MISCELLANEOUS DESIGN. INT. CL. 37. (U.S. CL. 103). REG. 5-21-1985.
- 1,337,207. ACCORD SERVICES, INC.. INT. CL. 39. (U.S. CL. 105). REG. 5-21-1985.
- 1,337,208. METRO PARK WAREHOUSES INC. INT. CL. 39. (U.S. CL. 105). REG. 5-21-1985.
- 1,337,554. CTX AND DESIGN. INT. CLS. 7 AND 11. (U.S. CLS. 23 AND 34). REG. 5-28-1985.
- 1,338,571. ACOUSTIC WAVE. INT. CL. 9. (U.S. CL. 21). REG. 5-28-1985.
- 1,338,976. DARGAL. INT. CL. 9. (U.S. CL. 38). REG. 6-4-1985.
- 1,339,065. BLOCKER. INT. CL. 9. (U.S. CL. 21). REG. 6-4-1985.
- 1,339,965. NIK STOP. INT. CL. 5. (U.S. CL. 18). REG. 6-11-1985.
- 1,340,104. COMPU-COAT. INT. CL. 7. (U.S. CLS. 21 AND 23). REG. 6-11-1985.
- 1,340,615. OLD STANDBY. INT. CL. 15. (U.S. CL. 36). REG. 6-11-1985.
- 1,341,829. BAMBERKO. INT. CL. 1. (U.S. CLS. 6 AND 52). REG. 6-18-1985.
- 1,341,935. ULTRA. INT. CL. 3. (U.S. CL. 52). REG. 6-18-1985.
- 1,342,265. REPARTEE. INT. CL. 9. (U.S. CL. 38). REG. 6-18-1985.
- 1,342,417. RICOS. INT. CL. 11. (U.S. CLS. 21, 31 AND 34). REG. 6-18-1985.
- 1,342,444. CLINE (STYLIZED). INT. CL. 12. (U.S. CL. 19). REG. 6-18-1985.
- 1,342,458. ROUGHING IT SMOOTHLY. INT. CL. 12. (U.S. CL. 19). REG. 6-18-1985.
- 1,342,640. SMI AND DESIGN. INT. CLS. 18, 25, 32, 41 AND 42. (U.S. CLS. 3, 39, 45, 100 AND 107). REG. 6-18-1985.
- 1,342,736. BLUEBIRD OF HAPPINESS. INT. CL. 21. (U.S. CLS. 33 AND 50). REG. 6-18-1985.
- 1,343,148. CISCO. INT. CL. 33. (U.S. CL. 47). REG. 6-18-1985.
- 1,343,421. SAM'S TOWN. INT. CLS. 41 AND 42. (U.S. CLS. 100 AND 107). REG. 6-18-1985.
- 1,344,234. MISCELLANEOUS DESIGN. INT. CL. 12. (U.S. CL. 19). REG. 6-25-1985.
- 1,344,328. REESE'S. INT. CL. 16. (U.S. CL. 37). REG. 6-25-1985.
- 1,344,509. MISCELLANEOUS DESIGN. INT. CLS. 23 AND 24. (U.S. CLS. 42 AND 43). REG. 6-25-1985.
- 1,345,667. CHAMPION AND DESIGN. INT. CL. 7. (U.S. CL. 23). REG. 7-2-1985.
- 1,345,978. PERENY. INT. CL. 11. (U.S. CL. 34). REG. 7-2-1985.
- 1,346,096. 3 WISE MEN AND DESIGN. INT. CL. 16. (U.S. CL. 38). REG. 7-2-1985.
- 1,346,134. RIGHT ON! (STYLIZED). INT. CL. 16. (U.S. CL. 38). REG. 7-2-1985.
- 1,346,377. EVERLAST AND DESIGN. INT. CL. 25. (U.S. CL. 39). REG. 7-2-1985.
- 1,347,169. NUTRICARE. INT. CL. 5. (U.S. CLS. 18 AND 46). REG. 7-9-1985.
- 1,347,582. POLY-STAR. INT. CL. 11. (U.S. CL. 21). REG. 7-9-1985.
- 1,347,714. PUBLIC BROADCASTING REPORT. INT. CL. 16. (U.S. CL. 38). REG. 7-9-1985.
- 1,348,040. SOPHIE DESS. INT. CL. 25. (U.S. CL. 39). REG. 7-9-1985.
- 1,348,672. NORM THOMPSON. INT. CL. 42. (U.S. CL. 101). REG. 7-9-1985.

- 1,348,837. ERNO HYDRAPHEL LASZLO (STYLIZED). INT. CL. 3. (U.S. CL. 51). REG. 7-16-1985.
- 1,349,997. TILT. INT. CL. 41. (U.S. CL. 107). REG. 7-16-1985.
- 1,350,070. MISCELLANEOUS DESIGN. INT. CL. 42. (U.S. CL. 100). REG. 7-16-1985.
- 1,350,088. CASA DE BANDINI. INT. CL. 42. (U.S. CL. 100). REG. 7-16-1985.
- 1,350,382. FIRE-DEX. INT. CL. 9. (U.S. CL. 39). REG. 7-23-1985.
- 1,350,618. VARIETY AND DESIGN. INT. CL. 16. (U.S. CL. 38). REG. 7-23-1985.
- 1,351,174. POLY-ENA. INT. CL. 1. (U.S. CLS. 6 AND 18). REG. 7-30-1985.
- 1,352,215. MISCELLANEOUS DESIGN. INT. CL. 42. (U.S. CL. 100). REG. 7-30-1985.
- 1,577,275. NICODERM. INT. CL. 5. (U.S. CLS. 6, 18, 44, 46, 51 AND 52). REG. 1-16-1990.
- 1,737,127. CONTSHIP. INT. CL. 39. (U.S. CL. 105). REG. 12-1-1992.
- 1,762,290. RACQUETS. INT. CL. 3. (U.S. CLS. 51 AND 52). REG. 4-6-1993.
- 1,775,535. BIG HEAD TODD AND THE MONSTERS. INT. CL. 41. (U.S. CL. 107). REG. 6-8-1993.
- 1,781,246. FLEXI-CHARGE. INT. CL. 9. (U.S. CLS. 21 AND 23). REG. 7-13-1993.
- 1,782,636. THE SKIN PROTECTION SPECIALISTS. INT. CL. 16. (U.S. CL. 38). REG. 7-20-1993.
- 1,806,179. NATIONAL PHYSIQUE COMMITTEE USA BODY BUILDING AND DESIGN. INT. CLS. 25 AND 41. (U.S. CLS. 39 AND 107). REG. 11-23-1993.
- 1,807,435. DRUG STORE NEWS AND DESIGN. INT. CL. 16. (U.S. CL. 38). REG. 11-30-1993.
- 1,807,437. THE FLAG FACTORY AND DESIGN. INT. CL. 24 ONLY. (U.S. CL. 32). REG. 11-30-1993.
- 1,807,455. ANAHEIM HILLS NEWS. INT. CL. 16. (U.S. CL. 38). REG. 11-30-1993.
- 1,807,456. ANAHEIM BULLETIN. INT. CL. 16. (U.S. CL. 38). REG. 11-30-1993.
- 1,818,485. QUICKSTAND. INT. CL. 20. (U.S. CL. 32). REG. 1-25-1994.
- 1,818,541. JAVA COAST AND DESIGN. INT. CL. 30. (U.S. CL. 46). REG. 1-25-1994.
- 1,818,970. AMISH COUNTRY GAZEBOS AND DESIGN. INT. CL. 19. (U.S. CL. 12). REG. 2-1-1994.
- 1,819,284. MISCELLANEOUS DESIGN. INT. CL. 42. (U.S. CL. 100). REG. 2-1-1994.
- 1,819,336. AMERICA LIVE! AND DESIGN. INT. CL. 42. (U.S. CL. 100). REG. 2-1-1994.
- 1,819,452. RETRO-LINE. INT. CL. 11. (U.S. CLS. 31 AND 34). REG. 2-1-1994.
- 1,819,453. HEAT-LINE. INT. CL. 11. (U.S. CLS. 31 AND 34). REG. 2-1-1994.
- 1,819,527. MISTY MOUNTAIN SPRING WATER. INT. CL. 32. (U.S. CL. 45). REG. 2-1-1994.
- 1,819,557. HOMESTEAD VILLAGE. INT. CL. 42. (U.S. CL. 100). REG. 2-1-1994.
- 1,819,876. TRUCKERS MOVE PETRO AMERICA AND DESIGN. INT. CLS. 16, 21, 25, 26 AND 42. (U.S. CLS. 2, 38, 39, 40, 100, 101 AND 103). REG. 2-8-1994.
- 1,820,159. ROADSIDE DISPATCH. INT. CLS. 37 AND 39. (U.S. CLS. 103 AND 105). REG. 2-8-1994.
- 1,820,174. \* TIP. INT. CL. 39. (U.S. CLS. 100 AND 105). REG. 2-8-1994.
- 1,820,335. DO SPORTS. INT. CLS. 18, 25 AND 28. (U.S. CLS. 3, 22 AND 39). REG. 2-8-1994.
- 1,820,898. TETRAD. INT. CL. 1. (U.S. CLS. 1 AND 6). REG. 2-15-1994.
- 1,821,511. BANDIT COON. INT. CL. 28. (U.S. CL. 22). REG. 2-15-1994.
- 1,821,573. GOLDEN FLAVOR. INT. CL. 30. (U.S. CL. 46). REG. 2-15-1994.
- 1,821,731. MERCADO GAS SERVICES AND DESIGN. INT. CLS. 39 AND 42. (U.S. CLS. 101 AND 105). REG. 2-15-1994.
- 1,822,116. MODELTOOLS. INT. CL. 9. (U.S. CL. 38). REG. 2-15-1994.
- 1,822,135. SAIL EXPO. INT. CL. 35. (U.S. CL. 101). REG. 2-15-1994.
- 1,822,155. HYDRAULAN. INT. CLS. 1 AND 4. (U.S. CLS. 1, 6 AND 15). REG. 2-22-1994.
- 1,822,475. EFL. INT. CL. 9. (U.S. CLS. 21, 23, 26, 36 AND 38). REG. 2-22-1994.
- 1,822,576. FREEZE CONTROL. INT. CL. 11. (U.S. CLS. 26 AND 31). REG. 2-22-1994.
- 1,823,002. MISCELLANEOUS DESIGN. INT. CLS. 29, 30 AND 42. (U.S. CLS. 46 AND 101). REG. 2-22-1994.
- 1,823,003. CAMO PAK. INT. CL. 29. (U.S. CL. 46). REG. 2-22-1994.
- 1,823,021. COOKIE LOVER'S (STYLIZED). INT. CL. 30. (U.S. CL. 46). REG. 2-22-1994.
- 1,823,092. CHECK-WRITE AND DESIGN. INT. CL. 35. (U.S. CLS. 101 AND 102). REG. 2-22-1994.
- 1,823,416. SEAFOOD CELEBRATION. INT. CL. 42. (U.S. CL. 100). REG. 2-22-1994.
- 1,823,585. CANOGA. INT. CL. 7. (U.S. CL. 23). REG. 2-22-1994.
- 1,823,613. THEMEL. INT. CL. 9. (U.S. CL. 38). REG. 2-22-1994.
- 1,823,707. CODA. INT. CL. 16. (U.S. CL. 38). REG. 2-22-1994.
- 1,823,708. ZEALOT. INT. CL. 16. (U.S. CL. 38). REG. 2-22-1994.
- 1,824,100. MIKRO-ACM. INT. CL. 7. (U.S. CL. 23). REG. 3-1-1994.
- 1,824,227. ERA RECORDS AND DESIGN. INT. CL. 9. (U.S. CL. 36). REG. 3-1-1994.
- 1,824,579. TEMPFORCE AND DESIGN. INT. CL. 35. (U.S. CL. 101). REG. 3-1-1994.
- 1,824,651. EXTEND-A-MESSAGE. INT. CL. 40. (U.S. CLS. 103 AND 106). REG. 3-1-1994.
- 1,824,673. DMZ TO DELTA. INT. CL. 41. (U.S. CL. 107). REG. 3-1-1994.
- 1,824,709. MISCELLANEOUS DESIGN. INT. CL. 42. (U.S. CL. 100). REG. 3-1-1994.
- 1,824,764. CHEST PAIN EMERGENCY CENTER AND DESIGN. INT. CL. 42. (U.S. CL. 100). REG. 3-1-1994.
- 1,824,907. SPECTRA. INT. CL. 7. (U.S. CL. 23). REG. 3-8-1994.
- 1,824,966. MULTIFEED. INT. CL. 9. (U.S. CL. 26). REG. 3-8-1994.
- 1,825,473. BRIDGE VIEW BANK AND DESIGN. INT. CL. 36. (U.S. CL. 102). REG. 3-8-1994.
- 1,825,668. MISCELLANEOUS DESIGN. INT. CLS. 37 AND 42. (U.S. CLS. 100 AND 103). REG. 3-8-1994.
- 1,825,755. TIME:FRAME. INT. CL. 9. (U.S. CL. 38). REG. 3-8-1994.
- 1,825,789. A.I.R.S. INT. CL. 10. (U.S. CL. 44). REG. 3-8-1994.
- 1,827,217. LASER SCREED. INT. CL. 7. (U.S. CL. 23). REG. 3-22-1994.
- 1,827,344. BELT-WAY. INT. CL. 9. (U.S. CL. 26). REG. 3-22-1994.
- 1,827,581. FESTIVAL AND DESIGN. INT. CL. 29. (U.S. CL. 46). REG. 3-22-1994.
- 1,828,429. IMPERIAL CHOICE. INT. CL. 29. (U.S. CL. 46). REG. 3-29-1994.
- 1,829,864. JAMES B. FAIRCHILD. INT. CL. 25. (U.S. CL. 39). REG. 4-5-1994.
- 1,831,122. SUPERSCAN. INT. CL. 9. (U.S. CL. 26). REG. 4-19-1994.
- 1,831,154. ALL. INT. CL. 9. (U.S. CL. 21). REG. 4-19-1994.
- 1,831,202. PROPLEX. INT. CL. 9. (U.S. CL. 21). REG. 4-19-1994.
- 1,831,719. IN SERVICE TO AMERICA AND DESIGN. INT. CL. 42. (U.S. CL. 100). REG. 4-19-1994.
- 1,831,866. ADVANCED MOISTURE SYSTEM. INT. CL. 5. (U.S. CLS. 18 AND 51). REG. 4-19-1994.
- 1,833,076. MISCELLANEOUS DESIGN. INT. CL. 3. (U.S. CL. 51). REG. 4-26-1994.
- 1,833,082. WATERPETALS. INT. CL. 3. (U.S. CLS. 51 AND 52). REG. 4-26-1994.
- 1,833,148. UNIPATCH. INT. CL. 9. (U.S. CL. 21). REG. 4-26-1994.
- 1,833,772. QWIK RELEASE. INT. CL. 12. (U.S. CL. 19). REG. 5-3-1994.
- 1,834,330. LASERWORLD. INT. CL. 7. (U.S. CL. 26). REG. 5-3-1994.
- 1,834,586. FUN-PRINTS. INT. CL. 16. (U.S. CL. 37). REG. 5-3-1994.
- 1,835,625. MARKET-BY-PRICE. INT. CL. 35. (U.S. CLS. 100, 101 AND 102). REG. 5-10-1994.
- 1,835,893. ARM & HAMMER THE STANDARD OF PURITY AND DESIGN. INT. CLS. 1, 3, 5 AND 31. (U.S. CLS. 4, 6, 46, 51 AND 52). REG. 5-10-1994.
- 1,836,148. BIG ONES. INT. CL. 16. (U.S. CLS. 22, 37 AND 38). REG. 5-10-1994.
- 1,838,056. EDNA VALLEY VINEYARD. INT. CL. 33. (U.S. CL. 47). REG. 5-31-1994.
- 1,838,353. HOTPAINT. INT. CL. 6. (U.S. CL. 12). REG. 5-31-1994.

- 1,840,405. GUITAR RECORDINGS CLASSIC CUTS AND DESIGN. INT. CL. 9. (U.S. CL. 36). REG. 6-21-1994.
- 1,840,410. GUITAR RECORDINGS AND DESIGN. INT. CL. 9. (U.S. CL. 36). REG. 6-21-1994.
- 1,840,807. JOLIESSE. INT. CL. 33. (U.S. CL. 45). REG. 6-21-1994.
- 1,841,106. PARTNERSHIP. INT. CLS. 36 AND 42. (U.S. CLS. 101 AND 102). REG. 6-21-1994.
- 1,841,173. BEAVER STOP. INT. CL. 6. (U.S. CL. 13). REG. 6-21-1994.
- 1,841,312. BIG ONES (STYLIZED). INT. CL. 16. (U.S. CL. 38). REG. 6-21-1994.
- 1,841,332. ANTIQUARIAN. INT. CL. 16. (U.S. CL. 37). REG. 6-21-1994.
- 1,842,130. PAWNEE BILL'S WILD WEST SHOW. INT. CL. 41. (U.S. CL. 107). REG. 6-28-1994.
- 1,843,265. DUQUESNE. INT. CL. 41. (U.S. CL. 107). REG. 7-5-1994.
- 1,843,284. INTERNATIONAL FASHIONS BY SETA CORPORATION. INT. CL. 42. (U.S. CL. 101). REG. 7-5-1994.
- 1,843,420. DOMINATE. INT. CL. 3. (U.S. CL. 52). REG. 7-5-1994.
- 1,843,494. EMBASSY. INT. CL. 9. (U.S. CLS. 21 AND 26). REG. 7-5-1994.
- 1,843,504. ZEROS. INT. CL. 9. (U.S. CLS. 21, 23, 26, 36 AND 38). REG. 7-5-1994.
- 1,843,636. Z GRAFIX AND DESIGN. INT. CL. 16. (U.S. CL. 37). REG. 7-5-1994.
- 1,843,652. REMINGTON. INT. CL. 18. (U.S. CL. 3). REG. 7-5-1994.
- 1,844,113. QUALIFLO. INT. CL. 7. (U.S. CLS. 19, 23 AND 31). REG. 7-12-1994.
- 1,844,157. CALVIN COLLEGE. INT. CLS. 9, 14, 16, 20, 21, 24, 25, 28 AND 41. (U.S. CLS. 3, 13, 21, 22, 23, 25, 26, 27, 28, 30, 32, 33, 36, 37, 38, 39, 42, 50 AND 107). REG. 7-12-1994.
- 1,844,484. AGROFABRIC. INT. CL. 24. (U.S. CL. 42). REG. 7-12-1994.
- 1,844,772. AUTOMATED MAILMEN INC AND DESIGN. INT. CL. 39. (U.S. CLS. 100, 101 AND 105). REG. 7-12-1994.
- 1,844,917. FLOWER HOSPITAL AND DESIGN. INT. CL. 42. (U.S. CL. 100). REG. 7-12-1994.
- 1,844,949. PYROPEL. INT. CLS. 12, 17 AND 19. (U.S. CLS. 1, 2, 12, 19, 35 AND 42). REG. 7-12-1994.
- 1,845,322. SMOKER'S BLEND. INT. CL. 4. (U.S. CL. 15). REG. 7-19-1994.
- 1,845,540. MR MEAT SMOKER. INT. CL. 11. (U.S. CL. 34). REG. 7-19-1994.
- 1,845,574. BLUE MOUNTAIN ARTS VISIONS AND DESIGN. INT. CL. 16. (U.S. CL. 38). REG. 7-19-1994.
- 1,845,599. PERFORM GUARD. INT. CL. 17. (U.S. CL. 12). REG. 7-19-1994.
- 1,845,680. THUMBS UP!. INT. CL. 25 ONLY. (U.S. CL. 39). REG. 7-19-1994.
- 1,846,093. THE POSITIVE EFFECTS OF THE SUN. INT. CL. 3. (U.S. CL. 51). REG. 7-19-1994.
- 1,846,132. PULSAR. INT. CL. 9. (U.S. CLS. 23 AND 26). REG. 7-19-1994.
- 1,846,139. INPOSITION. INT. CL. 9. (U.S. CL. 38). REG. 7-19-1994.
- 1,846,424. X-52. INT. CL. 1. (U.S. CLS. 6 AND 15). REG. 7-26-1994.
- 1,846,446. VAPOR ACTION. INT. CL. 5. (U.S. CL. 18). REG. 7-26-1994.
- 1,846,462. AROMASIN. INT. CL. 5. (U.S. CL. 18). REG. 7-26-1994.
- 1,846,474. TGN AND DESIGN. INT. CLS. 6 AND 20. (U.S. CLS. 13 AND 32). REG. 7-26-1994.
- 1,846,700. HEALTH LAW ADVISER. INT. CL. 16. (U.S. CL. 38). REG. 7-26-1994.
- 1,846,718. PERFORMORE. INT. CL. 16. (U.S. CL. 37). REG. 7-26-1994.
- 1,846,762. CENTURY CC. INT. CL. 20. (U.S. CLS. 32 AND 44). REG. 7-26-1994.
- 1,846,768. POLAR-XL (STYLIZED). INT. CL. 21. (U.S. CL. 2). REG. 7-26-1994.
- 1,846,816. TOP CARE. INT. CL. 25. (U.S. CL. 39). REG. 7-26-1994.
- 1,846,835. LIGHTNING BINGO. INT. CL. 28. (U.S. CL. 22). REG. 7-26-1994.
- 1,846,912. BALLANTINE'S. INT. CL. 33. (U.S. CL. 49). REG. 7-26-1994.
- 1,846,935. RANDSTAD AND DESIGN. INT. CL. 35. (U.S. CL. 101). REG. 7-26-1994.
- 1,846,978. SPORTSMAN'S EDITION. INT. CL. 36. (U.S. CL. 102). REG. 7-26-1994.
- 1,847,003. LAMERS. INT. CL. 39. (U.S. CL. 105). REG. 7-26-1994.
- 1,847,225. MAXIVAC. INT. CL. 5. (U.S. CL. 18). REG. 7-26-1994.
- 1,847,231. WELDPAK. INT. CL. 6. (U.S. CL. 14). REG. 7-26-1994.
- 1,847,286. HUNTER'S BUDDY. INT. CL. 9. (U.S. CLS. 21 AND 36). REG. 7-26-1994.
- 1,847,300. PASSAGE. INT. CL. 10. (U.S. CL. 44). REG. 7-26-1994.
- 1,847,329. FOREVER-GOLD. INT. CL. 14. (U.S. CL. 28). REG. 7-26-1994.
- 1,847,432. CHICLETS (STYLIZED). INT. CL. 30. (U.S. CL. 46). REG. 7-26-1994.
- 1,847,522. RO-PLUS. INT. CL. 1. (U.S. CL. 6). REG. 8-2-1994.
- 1,847,532. MISCELLANEOUS DESIGN. INT. CL. 3. (U.S. CLS. 51 AND 52). REG. 8-2-1994.
- 1,847,540. MISCELLANEOUS DESIGN. INT. CL. 3. (U.S. CLS. 51 AND 52). REG. 8-2-1994.
- 1,847,596. ARTECH HOUSE. INT. CL. 9. (U.S. CLS. 21 AND 38). REG. 8-2-1994.
- 1,847,606. GENESYS. INT. CL. 9. (U.S. CLS. 21 AND 26). REG. 8-2-1994.
- 1,847,630. MTE CORPORATION (STYLIZED). INT. CL. 9. (U.S. CLS. 21 AND 26). REG. 8-2-1994.
- 1,847,634. ELITE. INT. CL. 9. (U.S. CL. 26). REG. 8-2-1994.
- 1,847,657. INFRA-STAT. INT. CL. 11. (U.S. CL. 34). REG. 8-2-1994.
- 1,847,770. A-S-D. INT. CL. 28. (U.S. CL. 22). REG. 8-2-1994.
- 1,847,771. AMERICANA CHRISTMAS ORNAMENT COLLECTION. INT. CL. 28. (U.S. CL. 50). REG. 8-2-1994.
- 1,847,774. NEBULA. INT. CL. 28. (U.S. CL. 22). REG. 8-2-1994.
- 1,847,791. KOZLOWSKI FARMS AND DESIGN. INT. CL. 29. (U.S. CL. 46). REG. 8-2-1994.
- 1,847,821. MISCELLANEOUS DESIGN. INT. CL. 31. (U.S. CL. 1). REG. 8-2-1994.
- 1,847,824. MISCELLANEOUS DESIGN. INT. CL. 31. (U.S. CLS. 1 AND 46). REG. 8-2-1994.
- 1,847,855. GRADUATE MANAGEMENT ADMISSION COUNCIL. INT. CL. 36. (U.S. CL. 102). REG. 8-2-1994.
- 1,847,913. FRANK ZAPPA. INT. CL. 41. (U.S. CL. 107). REG. 8-2-1994.
- 1,847,941. ROCKET-SHIP AND DESIGN. INT. CL. 42. (U.S. CL. 101). REG. 8-2-1994.
- 1,847,988. CHEMCARE. INT. CLS. 1, 6, 16, 17, 20 AND 42. (U.S. CLS. 2, 6, 35, 38, 50 AND 101). REG. 8-2-1994.
- 1,848,002. ACTION SNACKS. INT. CLS. 29 AND 30. (U.S. CL. 46). REG. 8-2-1994.
- 1,848,019. TEEN SPIRIT. INT. CL. 3. (U.S. CL. 51). REG. 8-2-1994.
- 1,848,047. COMPLETE. INT. CL. 5. (U.S. CLS. 18 AND 52). REG. 8-2-1994.
- 1,848,064. ECONOVALVE. INT. CL. 6. (U.S. CL. 13). REG. 8-2-1994.
- 1,848,077. H AND DESIGN. INT. CL. 7. (U.S. CL. 23). REG. 8-2-1994.
- 1,848,178. SHADOWMOUNT. INT. CL. 12. (U.S. CL. 19). REG. 8-2-1994.
- 1,848,211. TEACATTLE. INT. CL. 21. (U.S. CLS. 2 AND 13). REG. 8-2-1994.
- 1,848,324. SILVER WOLF. INT. CL. 33. (U.S. CL. 49). REG. 8-2-1994.
- 1,848,363. CHICAGO ONLINE. INT. CL. 42. (U.S. CLS. 100 AND 101). REG. 8-2-1994.
- 1,848,385. STATICPAINT. INT. CL. 2. (U.S. CL. 16). REG. 8-2-1994.
- 1,848,426. BAY AREA YELLOW CAB AND DESIGN. INT. CL. 39. (U.S. CL. 105). REG. 8-2-1994.
- 1,848,477. FORMULASHELL. INT. CL. 4. (U.S. CL. 15). REG. 8-9-1994.
- 1,848,522. T A&M BAND AND DESIGN. INT. CLS. 9, 16, 25 AND 41. (U.S. CLS. 36, 37, 38, 39 AND 107). REG. 8-9-1994.
- 1,848,699. TSO VISION QUEST. INT. CL. 35. (U.S. CL. 101). REG. 8-9-1994.
- 1,848,700. ARTICLEFIRST. INT. CLS. 35, 38 AND 42. (U.S. CLS. 100, 101 AND 104). REG. 8-9-1994.

- 1,848,736. OPTIMA. INT. CL. 39. (U.S. CL. 105). REG. 8-9-1994.
- 1,848,748. P.A.N.D.A. 2 CUB AND DESIGN. INT. CL. 41. (U.S. CL. 107). REG. 8-9-1994.
- 1,848,749. HOLLYWOOD VIDEO (STYLIZED). INT. CL. 41. (U.S. CLS. 100, 101 AND 107). REG. 8-9-1994.
- 1,848,759. THE EMPOWERING LEADER. INT. CL. 41. (U.S. CL. 107). REG. 8-9-1994.
- 1,848,777. JACK ASTOR'S BAR AND GRILL THE BEST JOINT IN TOWN! AND DESIGN. INT. CL. 42. (U.S. CL. 100). REG. 8-9-1994.
- 1,848,801. LIFEWAY CHRISTIAN STORE. INT. CL. 42. (U.S. CL. 101). REG. 8-9-1994.
- 1,848,815. ROAD PRIDE AND DESIGN. INT. CLS. 12 AND 42. (U.S. CLS. 19 AND 101). REG. 8-9-1994.
- 1,848,848. MISCELLANEOUS DESIGN. INT. CLS. 18 AND 25. (U.S. CLS. 3 AND 39). REG. 8-9-1994.
- 1,848,849. SLEEP ON AIR ANYTIME ANYWHERE. INT. CLS. 20 AND 28. (U.S. CLS. 2, 13, 22, 25, 32 AND 50). REG. 8-9-1994.
- 1,848,858. GROUP USA. INT. CLS. 18 AND 25 ONLY. (U.S. CLS. 3 AND 39). REG. 8-9-1994.
- 1,848,923. MISCELLANEOUS DESIGN. INT. CL. 3. (U.S. CL. 52). REG. 8-9-1994.
- 1,849,063. ECONOTIG. INT. CL. 9. (U.S. CLS. 21, 23, 26 AND 34). REG. 8-9-1994.
- 1,849,070. EXCHANGEMAX. INT. CL. 9. (U.S. CLS. 21 AND 26). REG. 8-9-1994.
- 1,849,086. D-SERV. INT. CL. 9. (U.S. CLS. 21 AND 26). REG. 8-9-1994.
- 1,849,132. WIRESCOPE. INT. CL. 9. (U.S. CLS. 21 AND 26). REG. 8-9-1994.
- 1,849,255. FOOD FOR THOUGHT. INT. CL. 16. (U.S. CL. 38). REG. 8-9-1994.
- 1,849,274. IT'S MORE. FOR LESS.. INT. CL. 16. (U.S. CL. 2). REG. 8-9-1994.
- 1,849,279. NAPOLEON HILL. INT. CL. 16. (U.S. CL. 38). REG. 8-9-1994.
- 1,849,293. PERFORMANCE PLUS. INT. CL. 19. (U.S. CLS. 12 AND 33). REG. 8-9-1994.
- 1,849,343. SENSUEDE. INT. CL. 24. (U.S. CL. 42). REG. 8-9-1994.
- 1,849,383. THE MIRACLE BRA. INT. CL. 25. (U.S. CL. 39). REG. 8-9-1994.
- 1,849,441. BABY SOFT EXPRESSION. INT. CL. 28. (U.S. CL. 22). REG. 8-9-1994.
- 1,849,447. STRIKE PRO. INT. CL. 28. (U.S. CL. 22). REG. 8-9-1994.
- 1,849,462. MILITARY FORCE. INT. CL. 28. (U.S. CL. 22). REG. 8-9-1994.
- 1,849,496. MISCELLANEOUS DESIGN. INT. CL. 29. (U.S. CL. 46). REG. 8-9-1994.
- 1,849,506. SOUP SECRETS. INT. CL. 29. (U.S. CL. 46). REG. 8-9-1994.
- 1,849,561. EUROSHOP (STYLIZED). INT. CL. 35. (U.S. CL. 101). REG. 8-9-1994.
- 1,849,595. EAP ADVANTAGE. INT. CL. 36. (U.S. CLS. 101 AND 102). REG. 8-9-1994.
- 1,849,631. BLADE PRODUCTIONS, INC.. INT. CL. 41. (U.S. CL. 107). REG. 8-9-1994.
- 1,849,666. GEOSCAD. INT. CL. 42. (U.S. CLS. 100 AND 101). REG. 8-9-1994.
- 1,849,685. TIBA. INT. CL. 42. (U.S. CLS. 100, 101 AND 107). REG. 8-9-1994.
- 1,849,690. AMERICAN STUDENT ASSISTANCE. INT. CLS. 16, 36 AND 42. (U.S. CLS. 38, 100 AND 102). REG. 8-9-1994.
- 1,849,724. FRUIT 'N BERRIES. INT. CL. 30. (U.S. CL. 46). REG. 8-9-1994.
- 1,849,745. PHARMO. INT. CL. 1 ONLY. (U.S. CL. 6). REG. 8-16-1994.
- 1,849,750. DIAMOND WATER CONDITIONING AND DESIGN. INT. CL. 1. (U.S. CL. 6). REG. 8-16-1994.
- 1,849,752. ALWAYS "A PERFECT MARK" AND DESIGN. INT. CLS. 2 AND 16. (U.S. CLS. 6, 11 AND 16). REG. 8-16-1994.
- 1,849,784. ATS AND DESIGN. INT. CL. 7. (U.S. CLS. 21 AND 23). REG. 8-16-1994.
- 1,849,788. NAIL GENIE (STYLIZED). INT. CL. 8. (U.S. CLS. 23 AND 44). REG. 8-16-1994.
- 1,849,823. GUARD-AC AND DESIGN. INT. CL. 9. (U.S. CLS. 21 AND 26). REG. 8-16-1994.
- 1,849,840. ENDOSHEATH. INT. CL. 10. (U.S. CL. 44). REG. 8-16-1994.
- 1,849,853. BOHNMIZER. INT. CL. 11. (U.S. CL. 31). REG. 8-16-1994.
- 1,849,855. POWERFLO. INT. CL. 12. (U.S. CLS. 19, 21, 23, 31, 35 AND 44). REG. 8-16-1994.
- 1,849,867. MARKETLINK STRATEGIC MARKETING SERVICES AND DESIGN. INT. CLS. 16 AND 35. (U.S. CLS. 38 AND 101). REG. 8-16-1994.
- 1,849,909. VYTEC. INT. CLS. 17, 19 AND 40. (U.S. CLS. 12, 103 AND 106). REG. 8-16-1994.
- 1,849,913. LAY-FLAT. INT. CL. 17. (U.S. CL. 1). REG. 8-16-1994.
- 1,849,917. PATIO PRODUCTS, INC. AND DESIGN. INT. CLS. 18 AND 20. (U.S. CLS. 1, 2, 3, 22, 32 AND 41). REG. 8-16-1994.
- 1,849,922. MISCELLANEOUS DESIGN. INT. CL. 18. (U.S. CLS. 3 AND 41). REG. 8-16-1994.
- 1,849,962. DREAMS + ACTION = REALITY. INT. CL. 25. (U.S. CL. 39). REG. 8-16-1994.
- 1,849,988. COLORADO PRIME FOODS. INT. CL. 29. (U.S. CL. 46). REG. 8-16-1994.
- 1,849,990. MISCELLANEOUS DESIGN. INT. CL. 29. (U.S. CL. 46). REG. 8-16-1994.
- 1,849,994. THE PRETZEL TWISTER. INT. CL. 30. (U.S. CL. 46). REG. 8-16-1994.
- 1,849,999. CAROLINA SWAMP STUFF (STYLIZED). INT. CL. 30. (U.S. CL. 46). REG. 8-16-1994.
- 1,850,002. 1ST AND DESIGN. INT. CL. 31. (U.S. CL. 46). REG. 8-16-1994.
- 1,850,011. DIAMOND CROWN. INT. CL. 34. (U.S. CL. 17). REG. 8-16-1994.
- 1,850,029. SCHOOL SAVINGS. INT. CL. 36. (U.S. CL. 102). REG. 8-16-1994.
- 1,850,030. TSI SPORTS. INT. CL. 36. (U.S. CL. 102). REG. 8-16-1994.
- 1,850,057. "K" LINE AND DESIGN. INT. CL. 39. (U.S. CL. 105). REG. 8-16-1994.
- 1,850,070. THE GREAT GAME OF BUSINESS. INT. CL. 41. (U.S. CL. 107). REG. 8-16-1994.
- 1,850,102. RUDY'S COUNTRY STORE AND BAR-B-Q. INT. CL. 42. (U.S. CL. 100). REG. 8-16-1994.
- 1,850,113. PUDGY PUMPKIN. INT. CL. 42. (U.S. CL. 101). REG. 8-16-1994.
- 1,850,114. NICCO NICHOLAS & COMPANY FOOD SERVICE DISTRIBUTOR AND DESIGN. INT. CL. 42. (U.S. CL. 101). REG. 8-16-1994.
- 1,850,119. DIVORCE FOR MEN ONLY. INT. CL. 42. (U.S. CL. 100). REG. 8-16-1994.
- 1,850,125. PARODY PRODUCTIONS. INT. CL. 42. (U.S. CLS. 100 AND 101). REG. 8-16-1994.
- 1,850,131. CHURCH AND CHAPEL FUNERAL SERVICE. INT. CL. 42. (U.S. CL. 100). REG. 8-16-1994.
- 1,850,148. SILVER PRO. INT. CL. 11 ONLY. (U.S. CLS. 21 AND 34). REG. 8-16-1994.
- 1,850,150. SEBASTIAN COLLECTIVE SALON MEMBER. INT. CL. 42 ONLY. (U.S. CLS. 100 AND 101). REG. 8-16-1994.
- 1,850,152. LIFEWAY. INT. CLS. 16 AND 42. (U.S. CLS. 37 AND 101). REG. 8-16-1994.
- 1,850,160. TAKING DONORS SERIOUSLY. INT. CLS. 9, 16 AND 41. (U.S. CLS. 21, 36, 38 AND 107). REG. 8-16-1994.
- 1,850,187. RABDOMUN. INT. CL. 5. (U.S. CL. 18). REG. 8-16-1994.
- 1,850,208. CLEVITE 77. INT. CL. 7. (U.S. CLS. 19 AND 23). REG. 8-16-1994.
- 1,850,234. THE IDEA CHANNEL. INT. CL. 9. (U.S. CL. 38). REG. 8-16-1994.
- 1,850,274. OSTEOPREP. INT. CL. 10. (U.S. CL. 44). REG. 8-16-1994.
- 1,850,284. CURLMASTER. INT. CL. 11. (U.S. CLS. 21 AND 34). REG. 8-16-1994.
- 1,850,295. SAFELOK. INT. CL. 12. (U.S. CLS. 19 AND 21). REG. 8-16-1994.
- 1,850,313. ARCHITECTS' FIRST SOURCE FOR PRODUCTS AND DESIGN. INT. CL. 16. (U.S. CL. 38). REG. 8-16-1994.
- 1,850,319. THE FRONT RUNNER. INT. CL. 16. (U.S. CL. 38). REG. 8-16-1994.
- 1,850,323. BUSINESS BAGS. INT. CL. 16. (U.S. CL. 2). REG. 8-16-1994.
- 1,850,329. INSULFRAX. INT. CL. 17. (U.S. CLS. 1, 5, 12, 13, 35 AND 50). REG. 8-16-1994.
- 1,850,331. AV ARMORVISION PLASTICS & GLASS AND DESIGN. INT. CL. 19. (U.S. CL. 12). REG. 8-16-1994.



- 1,850,349. BELSON. INT. CL. 21. (U.S. CL. 2). REG. 8-16-1994.
- 1,850,384. THE AMAZON TRAIL. INT. CL. 28. (U.S. CLS. 22 AND 38). REG. 8-16-1994.
- 1,850,390. CARIBBEAN DELIGHT. INT. CL. 29. (U.S. CL. 46). REG. 8-16-1994.
- 1,850,398. MOUNTAIN VIEW. INT. CL. 31. (U.S. CL. 46). REG. 8-16-1994.
- 1,850,417. FRIENDS FOR LIFE. INT. CL. 36. (U.S. CL. 102). REG. 8-16-1994.
- 1,850,428. AT&T NETPROTECT. INT. CL. 38. (U.S. CL. 104). REG. 8-16-1994.
- 1,850,457. ADVANCED-LOGIC. INT. CL. 9. (U.S. CLS. 21 AND 26). REG. 8-16-1994.
- 1,850,458. LOGIC. INT. CL. 9. (U.S. CLS. 21 AND 26). REG. 8-16-1994.
- 1,850,469. DESIGNER SERIES. INT. CL. 21. (U.S. CLS. 2, 13 AND 33). REG. 8-16-1994.
- 1,850,482. ON COURSE (STYLIZED). INT. CL. 1. (U.S. CL. 10). REG. 8-23-1994.
- 1,850,496. RECOVERY COMPLEX. INT. CL. 3. (U.S. CLS. 51 AND 52). REG. 8-23-1994.
- 1,850,512. TURMERIN (STYLIZED). INT. CL. 5. (U.S. CLS. 6 AND 18). REG. 8-23-1994.
- 1,850,513. PICROSIL (STYLIZED). INT. CL. 5. (U.S. CLS. 6 AND 18). REG. 8-23-1994.
- 1,850,515. NOW. INT. CL. 5. (U.S. CL. 18). REG. 8-23-1994.
- 1,850,516. EMCELLE. INT. CL. 5. (U.S. CL. 18). REG. 8-23-1994.
- 1,850,517. MISCELLANEOUS DESIGN. INT. CL. 5. (U.S. CL. 18). REG. 8-23-1994.
- 1,850,523. MARAUDER. INT. CL. 5. (U.S. CL. 6). REG. 8-23-1994.
- 1,850,539. CHAMPION. INT. CL. 7. (U.S. CL. 23). REG. 8-23-1994.
- 1,850,546. AMI AND DESIGN. INT. CL. 9. (U.S. CLS. 26 AND 38). REG. 8-23-1994.
- 1,850,571. MICROSCAN. INT. CL. 9. (U.S. CLS. 21 AND 26). REG. 8-23-1994.
- 1,850,580. CHILLCHECKER. INT. CL. 9. (U.S. CL. 26). REG. 8-23-1994.
- 1,850,606. TAPISTRON. INT. CL. 9. (U.S. CLS. 26 AND 32). REG. 8-23-1994.
- 1,850,609. T-PULL. INT. CL. 9. (U.S. CL. 26). REG. 8-23-1994.
- 1,850,636. POLY THERM. INT. CL. 11. (U.S. CL. 34). REG. 8-23-1994.
- 1,850,662. MISCELLANEOUS DESIGN. INT. CLS. 16 AND 25. (U.S. CLS. 2, 5, 22, 23, 29, 37, 38, 39 AND 50). REG. 8-23-1994.
- 1,850,663. G AND DESIGN. INT. CLS. 16 AND 25. (U.S. CLS. 2, 5, 22, 23, 29, 37, 38, 39 AND 50). REG. 8-23-1994.
- 1,850,696. STYROFOAM PLAZAMATE BRAND AND DESIGN. INT. CL. 17. (U.S. CL. 12). REG. 8-23-1994.
- 1,850,699. MARKER. INT. CLS. 18, 25 AND 28. (U.S. CLS. 3, 22 AND 39). REG. 8-23-1994.
- 1,850,740. RADIANCE BY WASHINGTON MILLINERY. INT. CL. 25. (U.S. CL. 39). REG. 8-23-1994.
- 1,850,757. WHITELAND. INT. CL. 25. (U.S. CL. 39). REG. 8-23-1994.
- 1,850,791. COCKSHUTT. INT. CL. 28. (U.S. CL. 22). REG. 8-23-1994.
- 1,850,794. STEVE JACKSON. INT. CL. 28. (U.S. CL. 22). REG. 8-23-1994.
- 1,850,795. STEVE JACKSON GAMES. INT. CL. 28. (U.S. CL. 22). REG. 8-23-1994.
- 1,850,824. STALINGRAD. INT. CL. 33. (U.S. CLS. 47 AND 49). REG. 8-23-1994.
- 1,850,869. PACIFIC MEZZANINE INVESTORS. INT. CL. 36. (U.S. CL. 102). REG. 8-23-1994.
- 1,850,889. SKYTOP BREWSTER. INT. CL. 37. (U.S. CL. 103). REG. 8-23-1994.
- 1,850,933. WASHINGTON NON-PROFIT LEGAL & TAX CONFERENCE. INT. CL. 41. (U.S. CLS. 101 AND 107). REG. 8-23-1994.
- 1,850,967. ENTERING BURRITOVILLE POP. 208 ELEV. 100FT. WE'RE MEXCELLENT! AND DESIGN. INT. CL. 42. (U.S. CL. 100). REG. 8-23-1994.
- 1,851,016. PRECISE COLOR SYSTEMS. INT. CL. 2. (U.S. CLS. 6, 16, 38 AND 52). REG. 8-23-1994.
- 1,851,065. ALLMED. INT. CL. 10. (U.S. CL. 44). REG. 8-23-1994.
- 1,851,076. VERSACOOLER. INT. CL. 11. (U.S. CL. 31). REG. 8-23-1994.
- 1,851,091. KIDCARE. INT. CL. 16. (U.S. CL. 38). REG. 8-23-1994.
- 1,851,097. THE PROVIDER. INT. CL. 20. (U.S. CL. 32). REG. 8-23-1994.
- 1,851,105. ROICA AND DESIGN. INT. CL. 23. (U.S. CL. 43). REG. 8-23-1994.
- 1,851,138. SALTWATER SAFARI. INT. CL. 28. (U.S. CL. 22). REG. 8-23-1994.
- 1,851,160. VIEW FRESH. INT. CL. 31. (U.S. CL. 46). REG. 8-23-1994.
- 1,851,178. YOU'VE HIT ROCK BOTTOM. INT. CL. 42. (U.S. CL. 100). REG. 8-23-1994.
- 1,851,191. OVERHEAD DOOR. INT. CL. 9. (U.S. CLS. 21 AND 26). REG. 8-23-1994.
- 1,851,192. IV SCANNER. INT. CL. 9. (U.S. CL. 26). REG. 8-23-1994.
- 1,851,199. CTS RELIEF KIT. INT. CL. 10. (U.S. CL. 44). REG. 8-23-1994.
- 1,851,222. THE CHURCH REAL ESTATE PROFESSIONALS. INT. CL. 36. (U.S. CLS. 101 AND 102). REG. 8-23-1994.
- 1,851,264. MISCELLANEOUS DESIGN. INT. CL. 4. (U.S. CL. 15). REG. 8-30-1994.
- 1,851,296. DURA-MAX. INT. CL. 7. (U.S. CL. 23). REG. 8-30-1994.
- 1,851,398. NEOSTAR MEDICAL. INT. CL. 10. (U.S. CL. 44). REG. 8-30-1994.
- 1,851,399. MISCELLANEOUS DESIGN. INT. CL. 10. (U.S. CL. 44). REG. 8-30-1994.
- 1,851,409. SENTRY WASH. INT. CL. 11. (U.S. CL. 13). REG. 8-30-1994.
- 1,851,415. TIGERSHARK AND DESIGN. INT. CL. 12. (U.S. CL. 19). REG. 8-30-1994.
- 1,851,489. NORTHWEST TRAILS. INT. CL. 18. (U.S. CL. 3). REG. 8-30-1994.
- 1,851,494. MERCER. INT. CL. 19. (U.S. CL. 12). REG. 8-30-1994.
- 1,851,496. LADLGUN. INT. CL. 19. (U.S. CL. 12). REG. 8-30-1994.
- 1,851,510. CHEF'S EDGE AND DESIGN. INT. CL. 21. (U.S. CL. 23). REG. 8-30-1994.
- 1,851,542. PERFECTION BY JUMPING-JACKS. INT. CL. 25. (U.S. CL. 39). REG. 8-30-1994.
- 1,851,544. FOXY AND DESIGN. INT. CL. 25. (U.S. CL. 39). REG. 8-30-1994.
- 1,851,735. FASHION INSTITUTE OF DESIGN & MERCHANDISING. INT. CL. 41. (U.S. CL. 107). REG. 8-30-1994.
- 1,851,806. VANITY (STYLIZED). INT. CL. 42. (U.S. CL. 39). REG. 8-30-1994.
- 1,851,834. FABRITECH. INT. CLS. 17, 20 AND 24. (U.S. CLS. 1, 32 AND 42). REG. 8-30-1994.
- 1,851,849. MISCELLANEOUS DESIGN. INT. CL. 3. (U.S. CL. 52). REG. 8-30-1994.
- 1,851,860. ALBUMARC. INT. CL. 5. (U.S. CL. 18). REG. 8-30-1994.
- 1,851,910. LAP PATPOS AND DESIGN. INT. CL. 10. (U.S. CL. 44). REG. 8-30-1994.
- 1,851,924. MERLIN. INT. CL. 10. (U.S. CL. 44). REG. 8-30-1994.
- 1,851,938. FIREPLUS. INT. CL. 11. (U.S. CL. 34). REG. 8-30-1994.
- 1,852,073. ME TOO KIDS. INT. CL. 42. (U.S. CL. 100). REG. 8-30-1994.
- 1,852,087. CATS USA. INT. CL. 16. (U.S. CL. 38). REG. 8-30-1994.
- 1,852,088. AQUARIUM USA. INT. CL. 16. (U.S. CL. 38). REG. 8-30-1994.
- 1,852,127. HYDRUS AND DESIGN. INT. CL. 2. (U.S. CL. 16). REG. 9-6-1994.
- 1,852,170. CB. INT. CL. 5. (U.S. CL. 6). REG. 9-6-1994.
- 1,852,236. POWERTRANS. INT. CL. 9. (U.S. CLS. 21 AND 26). REG. 9-6-1994.
- 1,852,317. MICROPORT. INT. CL. 10. (U.S. CL. 44). REG. 9-6-1994.
- 1,852,333. SAROX. INT. CL. 42 ONLY. (U.S. CL. 100). REG. 9-6-1994.
- 1,852,344. WORKSKIFF AND DESIGN. INT. CL. 12. (U.S. CL. 19). REG. 9-6-1994.
- 1,852,550. AM PM. INT. CL. 32. (U.S. CL. 45). REG. 9-6-1994.
- 1,852,552. STOLICHNAYA RUSSIAN VODKA AND DESIGN. INT. CL. 33. (U.S. CL. 49). REG. 9-6-1994.
- 1,852,645. EXPEDITION 8000. INT. CL. 39. (U.S. CL. 105). REG. 9-6-1994.
- 1,852,654. N.A.S.M. NATIONAL ACADEMY OF SPORTS MEDICINE AND DESIGN. INT. CL. 41. (U.S. CL. 107). REG. 9-6-1994.

- 1,852,695. SEAFARI. INT. CL. 41. (U.S. CL. 107). REG. 9-6-1994.
- 1,852,707. HELIOGRAMME. INT. CL. 42. (U.S. CL. 100). REG. 9-6-1994.
- 1,852,788. COPPERSTATE CHRONICLES. INT. CLS. 9 AND 41. (U.S. CLS. 21 AND 107). REG. 9-6-1994.
- 1,852,834. DECODERM. INT. CL. 3. (U.S. CLS. 1, 4, 6, 50, 51 AND 52). REG. 9-6-1994.
- 1,852,850. MEDLOGIC. INT. CL. 5. (U.S. CL. 18). REG. 9-6-1994.
- 1,852,875. ROGATOR. INT. CL. 7. (U.S. CL. 23). REG. 9-6-1994.
- 1,852,957. R & D DECISION ADVISOR. INT. CL. 9. (U.S. CL. 38). REG. 9-6-1994.
- 1,853,050. THE WORLD AT YOUR FEET. INT. CL. 16. (U.S. CL. 38). REG. 9-6-1994.
- 1,853,078. ARTRAC. INT. CL. 17. (U.S. CL. 35). REG. 9-6-1994.
- 1,853,197. CONFORM. INT. CL. 28. (U.S. CL. 22). REG. 9-6-1994.
- 1,853,343. THE HATTERAS COLLECTION. INT. CL. 42. (U.S. CL. 101). REG. 9-6-1994.
- 1,853,481. PHOENIX. INT. CL. 6. (U.S. CL. 13). REG. 9-13-1994.
- 1,853,482. PERMA-SCREEN. INT. CL. 6. (U.S. CL. 12). REG. 9-13-1994.
- 1,853,494. CONDE' AND DESIGN. INT. CL. 7. (U.S. CLS. 23 AND 24). REG. 9-13-1994.
- 1,853,615. LIFE OUTREACH INTERNATIONAL AND DESIGN. INT. CLS. 16 AND 42. (U.S. CLS. 38 AND 100). REG. 9-13-1994.
- 1,853,723. 1200. INT. CL. 28. (U.S. CL. 22). REG. 9-13-1994.
- 1,853,772. LONDON PRIDE. INT. CL. 32. (U.S. CL. 48). REG. 9-13-1994.
- 1,853,796. QUICKLINK. INT. CLS. 35 AND 36. (U.S. CLS. 101 AND 102). REG. 9-13-1994.
- 1,853,829. CONCORD HOMES. INT. CL. 37. (U.S. CL. 103). REG. 9-13-1994.
- 1,853,843. THE TOWING SYSTEMS EXPERTS UHAUL SINCE 1945 AND DESIGN. INT. CL. 39. (U.S. CL. 105). REG. 9-13-1994.
- 1,853,891. ACCOUNTABILITY TRAINING. INT. CL. 42. (U.S. CL. 100). REG. 9-13-1994.
- 1,853,981. WHITE DIAMONDS. INT. CL. 3. (U.S. CL. 51). REG. 9-13-1994.
- 1,854,143. TINY TIPS. INT. CL. 14. (U.S. CL. 28). REG. 9-13-1994.
- 1,854,384. TOUCH OF SILK. INT. CL. 3. (U.S. CL. 51). REG. 9-20-1994.
- 1,854,523. SST. INT. CL. 9. (U.S. CLS. 21 AND 26). REG. 9-20-1994.
- 1,854,579. ZERO ZONE. INT. CL. 11. (U.S. CL. 31). REG. 9-20-1994.
- 1,854,673. SCHIEBERSAND. INT. CL. 19. (U.S. CL. 12). REG. 9-20-1994.
- 1,854,783. TAFFY TWINS. INT. CL. 30. (U.S. CL. 46). REG. 9-20-1994.
- 1,855,022. RETAIN. INT. CLS. 9 AND 37 ONLY. (U.S. CLS. 38 AND 103). REG. 9-20-1994.
- 1,855,031. NO FEAR. INT. CLS. 14 AND 25. (U.S. CLS. 27, 28 AND 39). REG. 9-20-1994.
- 1,855,216. SAC STATE. INT. CL. 21. (U.S. CLS. 2 AND 23). REG. 9-20-1994.
- 1,855,272. HORSESHOES AND DESIGN. INT. CL. 25. (U.S. CL. 39). REG. 9-20-1994.
- 1,855,327. DIXIE. INT. CL. 31. (U.S. CL. 46). REG. 9-20-1994.
- 1,855,343. RESEARCH PROS DATABASES. INT. CL. 35. (U.S. CL. 101). REG. 9-20-1994.
- 1,855,464. CALECHE SOIE DE PARFUM HERMES AND DESIGN. INT. CL. 3. (U.S. CL. 51). REG. 9-27-1994.
- 1,855,534. SURE-FLOW. INT. CL. 9. (U.S. CLS. 21 AND 26). REG. 9-27-1994.
- 1,855,556. LIF. INT. CL. 9. (U.S. CL. 26). REG. 9-27-1994.
- 1,855,585. SUITPEOPLE. INT. CL. 9. (U.S. CL. 38). REG. 9-27-1994.
- 1,855,626. SITEMASTER 200. INT. CL. 9. (U.S. CL. 38). REG. 9-27-1994.
- 1,855,674. MISCELLANEOUS DESIGN. INT. CL. 12. (U.S. CL. 19). REG. 9-27-1994.
- 1,855,676. GIVI AND DESIGN. INT. CLS. 12 AND 18. (U.S. CLS. 3 AND 19). REG. 9-27-1994.
- 1,855,881. MISCELLANEOUS DESIGN. INT. CL. 30. (U.S. CL. 46). REG. 9-27-1994.
- 1,855,974. EQUUS. INT. CL. 36. (U.S. CLS. 101 AND 102). REG. 9-27-1994.
- 1,856,027. ATLANTIC COAST CONFERENCE. INT. CL. 41. (U.S. CL. 107). REG. 9-27-1994.
- 1,856,028. METRO NETWORKS AND DESIGN. INT. CL. 41. (U.S. CL. 107). REG. 9-27-1994.
- 1,856,064. MAX PAK. INT. CL. 42. (U.S. CL. 101). REG. 9-27-1994.
- 1,856,076. THE HEN HOUSE AND DESIGN. INT. CL. 42. (U.S. CL. 100). REG. 9-27-1994.
- 1,856,122. BANO'K (STYLIZED). INT. CLS. 16 AND 20. (U.S. CLS. 13 AND 23). REG. 9-27-1994.
- 1,856,133. C CAMPBELL'S KITCHEN AND DESIGN. INT. CLS. 29 AND 30. (U.S. CL. 46). REG. 9-27-1994.
- 1,856,160. DISCRETION. INT. CL. 3. (U.S. CL. 51). REG. 9-27-1994.
- 1,856,174. FEDERALLOY. INT. CL. 6. (U.S. CL. 14). REG. 9-27-1994.
- 1,856,218. LION. INT. CL. 9. (U.S. CL. 21). REG. 9-27-1994.
- 1,856,313. DEPECHE MODE. INT. CL. 25. (U.S. CL. 39). REG. 9-27-1994.
- 1,856,416. CIRCLE OF SERVICE AND DESIGN. INT. CL. 36. (U.S. CL. 102). REG. 9-27-1994.
- 1,856,479. SPECTRA. INT. CL. 1. (U.S. CL. 6). REG. 10-4-1994.
- 1,856,603. ROSE PARADE. INT. CLS. 14 AND 25 ONLY. (U.S. CLS. 2, 27, 28, 39 AND 50). REG. 10-4-1994.
- 1,856,694. MOTO JACKET AND DESIGN. INT. CL. 12. (U.S. CL. 50). REG. 10-4-1994.
- 1,856,727. LAMBS FARM. INT. CLS. 29, 30, 41 AND 42 ONLY. (U.S. CLS. 46, 100, 101 AND 107). REG. 10-4-1994.
- 1,856,785. PREP-PLANE. INT. CL. 21. (U.S. CL. 29). REG. 10-4-1994.
- 1,856,883. GLADE'S. INT. CL. 30. (U.S. CL. 46). REG. 10-4-1994.
- 1,856,911. RAGIN' RED. INT. CL. 33. (U.S. CL. 49). REG. 10-4-1994.
- 1,856,961. EVA. INT. CL. 36. (U.S. CLS. 101 AND 102). REG. 10-4-1994.
- 1,856,967. MERIDIAN - FUND INCORPORATED AND DESIGN. INT. CL. 36. (U.S. CL. 102). REG. 10-4-1994.
- 1,857,127. MASTER GRIPS. INT. CLS. 8 AND 21. (U.S. CL. 23). REG. 10-4-1994.
- 1,857,160. TVAC. INT. CL. 6. (U.S. CLS. 2 AND 14). REG. 10-4-1994.
- 1,857,320. JOYAS DE GOYA. INT. CL. 29. (U.S. CL. 46). REG. 10-4-1994.
- 1,857,478. E Z LOC. INT. CL. 6. (U.S. CLS. 13 AND 25). REG. 10-11-1994.
- 1,857,542. MISCELLANEOUS DESIGN. INT. CLS. 9 AND 41. (U.S. CLS. 36 AND 107). REG. 10-11-1994.
- 1,857,605. HYDRO-CHIL. INT. CL. 11. (U.S. CL. 13). REG. 10-11-1994.
- 1,857,678. ULTRA PRO. INT. CL. 16. (U.S. CL. 37). REG. 10-11-1994.
- 1,857,783. RED FOX P. INT. CL. 28. (U.S. CLS. 6 AND 22). REG. 10-11-1994.
- 1,857,808. MISCELLANEOUS DESIGN. INT. CL. 29. (U.S. CL. 46). REG. 10-11-1994.
- 1,858,037. EARLY ON. INT. CL. 42. (U.S. CL. 100). REG. 10-11-1994.
- 1,858,101. RENEGADE. INT. CL. 3. (U.S. CL. 52). REG. 10-11-1994.
- 1,858,139. ROYAL SHIELD. INT. CL. 10. (U.S. CL. 44). REG. 10-11-1994.
- 1,858,471. SAFE-T-FOLD. INT. CL. 9. (U.S. CL. 26). REG. 10-18-1994.
- 1,858,672. THE X-GIRL CLOTHING COMPANY. INT. CL. 25. (U.S. CL. 39). REG. 10-18-1994.
- 1,859,041. MISCELLANEOUS DESIGN. INT. CL. 42. (U.S. CL. 100). REG. 10-18-1994.
- 1,859,127. INPOWER. INT. CL. 9. (U.S. CL. 38). REG. 10-18-1994.
- 1,859,228. JOYAS DE GOYA. INT. CL. 30. (U.S. CL. 46). REG. 10-18-1994.
- 1,859,251. STEER STICKS. INT. CL. 31. (U.S. CL. 46). REG. 10-18-1994.
- 1,859,353. CHILD HEALTH INSTITUTE. INT. CL. 42. (U.S. CL. 100). REG. 10-18-1994.
- 1,859,412. EVELYN. INT. CL. 3. (U.S. CLS. 51 AND 52). REG. 10-25-1994.
- 1,859,427. INVADER. INT. CL. 5. (U.S. CL. 6). REG. 10-25-1994.

- 1,859,600. VSO. INT. CL. 9. (U.S. CLS. 21 AND 26). REG. 10-25-1994.
- 1,859,625. RODEO. INT. CL. 12. (U.S. CLS. 19 AND 23). REG. 10-25-1994.
- 1,859,721. CENTERSCORE. INT. CL. 19. (U.S. CL. 12). REG. 10-25-1994.
- 1,859,821. RIO VALLEY AND DESIGN. INT. CL. 29. (U.S. CL. 46). REG. 10-25-1994.
- 1,859,875. TEXMATI. INT. CL. 30. (U.S. CL. 46). REG. 10-25-1994.
- 1,859,919. LYNCHBURG LEMONADE. INT. CL. 33. (U.S. CL. 49). REG. 10-25-1994.
- 1,859,944. CLASSIC CAMPUS INNS. INT. CL. 35. (U.S. CL. 101). REG. 10-25-1994.
- 1,860,047. PROFORUM (STYLIZED). INT. CL. 41. (U.S. CL. 107). REG. 10-25-1994.
- 1,860,286. ON/X. INT. CL. 9. (U.S. CL. 38). REG. 10-25-1994.
- 1,860,348. LAGUNA. INT. CL. 11. (U.S. CL. 31). REG. 10-25-1994.
- 1,860,349. METEOR. INT. CL. 11. (U.S. CL. 31). REG. 10-25-1994.
- 1,860,476. LA SIERRA. INT. CL. 29. (U.S. CL. 46). REG. 10-25-1994.
- 1,860,499. JOYAS DE GOYA. INT. CL. 32. (U.S. CL. 45). REG. 10-25-1994.
- 1,860,520. PRIVATE ACCESS. INT. CL. 36. (U.S. CLS. 101 AND 102). REG. 10-25-1994.
- 1,860,625. DERMASIL. INT. CL. 3. (U.S. CL. 51). REG. 11-1-1994.
- 1,860,626. TEC. INT. CL. 3. (U.S. CLS. 4 AND 52). REG. 11-1-1994.
- 1,860,652. BIFIDOPHILUS FLORA FORCE. INT. CL. 5. (U.S. CLS. 18 AND 46). REG. 11-1-1994.
- 1,860,678. ANSPACH. INT. CLS. 7 AND 10. (U.S. CLS. 23 AND 44). REG. 11-1-1994.
- 1,860,829. THE ANSPACH EFFORT. INT. CL. 10. (U.S. CL. 44). REG. 11-1-1994.
- 1,860,861. ROBIC (STYLIZED). INT. CL. 14. (U.S. CL. 27). REG. 11-1-1994.
- 1,861,273. FRY'S FOOD & DRUG. INT. CL. 42. (U.S. CL. 101). REG. 11-1-1994.
- 1,861,387. AFFINITY BY COUNTRY COACH. INT. CL. 12. (U.S. CL. 19). REG. 11-1-1994.
- 1,861,560. HEWLETT PACKARD. INT. CLS. 2, 9 AND 10. (U.S. CLS. 11, 21, 23, 26, 36, 38 AND 44). REG. 11-8-1994.
- 1,861,713. EYE-EYE-EYE! AND DESIGN. INT. CL. 9. (U.S. CL. 26). REG. 11-8-1994.
- 1,861,923. TIPIAK AND DESIGN. INT. CL. 30 ONLY. (U.S. CL. 46). REG. 11-8-1994.
- 1,861,951. RED HILL VINEYARD. INT. CL. 33. (U.S. CL. 47). REG. 11-8-1994.
- 1,862,046. ALLIANCE. INT. CL. 41. (U.S. CLS. 101 AND 107). REG. 11-8-1994.
- 1,862,056. TUMBLE BUNNIES. INT. CL. 41. (U.S. CL. 107). REG. 11-8-1994.
- 1,862,321. FASTVSAM. INT. CL. 9. (U.S. CL. 38). REG. 11-15-1994.
- 1,862,328. SMART. INT. CL. 9. (U.S. CLS. 21 AND 26). REG. 11-15-1994.
- 1,862,333. NIGHTVISION (STYLIZED). INT. CL. 9. (U.S. CL. 21). REG. 11-15-1994.
- 1,862,440. MTA AND DESIGN. INT. CL. 12. (U.S. CLS. 19 AND 33). REG. 11-15-1994.
- 1,862,510. DECOLAM, INC. AND DESIGN. INT. CL. 19. (U.S. CL. 12). REG. 11-15-1994.
- 1,862,639. CHEES-TREME. INT. CL. 29. (U.S. CL. 46). REG. 11-15-1994.
- 1,862,653. ASHBY'S. INT. CL. 30. (U.S. CL. 46). REG. 11-15-1994.
- 1,862,884. WHERE AMERICA'S FARMERS SHOP AND DESIGN. INT. CL. 42. (U.S. CL. 101). REG. 11-15-1994.
- 1,862,945. FAMILY CAMPERS & RVERS FUN & FRIENDSHIPNCHA AND DESIGN. U.S. CL. 200. REG. 11-15-1994.
- 1,863,238. COZ. INT. CL. 21. (U.S. CL. 29). REG. 11-15-1994.
- 1,863,418. B FREE SIDE RELEASE AGENT AND DESIGN. INT. CL. 1. (U.S. CLS. 1 AND 6). REG. 11-22-1994.
- 1,863,499. LECTRON. INT. CL. 7. (U.S. CL. 23). REG. 11-22-1994.
- 1,863,612. OPINIONMETER. INT. CL. 9. (U.S. CL. 26). REG. 11-22-1994.
- 1,863,672. UB (STYLIZED). INT. CL. 20 ONLY. (U.S. CLS. 2 AND 32). REG. 11-22-1994.
- 1,863,750. HYDE PARK. INT. CL. 25. (U.S. CL. 39). REG. 11-22-1994.
- 1,863,823. REGGIE'S. INT. CLS. 29 AND 30. (U.S. CL. 46). REG. 11-22-1994.
- 1,863,835. CHERRYMAN. INT. CL. 29. (U.S. CL. 46). REG. 11-22-1994.
- 1,864,036. THE SCANTICON AND DESIGN. INT. CL. 42. (U.S. CLS. 100, 101 AND 107). REG. 11-22-1994.
- 1,864,065. RON JON SURF SHOP "ONE OF A KIND" AND DESIGN. INT. CL. 42. (U.S. CL. 101). REG. 11-22-1994.
- 1,864,134. PINTUCO. INT. CL. 2. (U.S. CL. 16). REG. 11-22-1994.
- 1,864,272. ASTOUNDING. INT. CL. 16. (U.S. CL. 38). REG. 11-22-1994.
- 1,864,324. CRYSTAL DYNAMICS. INT. CL. 28. (U.S. CLS. 22 AND 38). REG. 11-22-1994.
- 1,864,498. NO MISTAKE. INT. CL. 3. (U.S. CL. 51). REG. 11-29-1994.
- 1,864,537. LAUDIER (STYLIZED). INT. CLS. 9, 14, 16 AND 34. (U.S. CLS. 8, 26, 27, 28 AND 37). REG. 11-29-1994.
- 1,864,550. MISCELLANEOUS DESIGN. INT. CLS. 9, 14 AND 25 ONLY. (U.S. CLS. 2, 21, 22, 23, 26, 27, 28, 36, 38, 39 AND 50). REG. 11-29-1994.
- 1,864,584. TRACKER. INT. CL. 9. (U.S. CLS. 21 AND 26). REG. 11-29-1994.
- 1,864,598. III AND DESIGN. INT. CL. 9. (U.S. CL. 38). REG. 11-29-1994.
- 1,864,602. SKIMMER. INT. CL. 9. (U.S. CL. 26). REG. 11-29-1994.
- 1,864,991. COUNTRY CLUB KENNEL. INT. CLS. 41 AND 42. (U.S. CLS. 100, 101 AND 107). REG. 11-29-1994.
- 1,865,159. LOCLO. INT. CL. 5. (U.S. CL. 18). REG. 11-29-1994.
- 1,865,221. SOL-KNIT. INT. CL. 9. (U.S. CLS. 26 AND 39). REG. 11-29-1994.
- 1,865,489. PROFESSIONAL PHARMACIES. INT. CL. 42. (U.S. CLS. 100 AND 101). REG. 11-29-1994.
- 1,865,687. ENDO-EZE. INT. CL. 10. (U.S. CL. 44). REG. 12-6-1994.
- 1,865,761. H D AND DESIGN. INT. CL. 16. (U.S. CL. 38). REG. 12-6-1994.
- 1,865,854. ANA'S ACCOUTREMONTS. INT. CL. 25. (U.S. CL. 39). REG. 12-6-1994.
- 1,865,877. ATLANTIC COAST CONFERENCE. INT. CL. 28. (U.S. CL. 22). REG. 12-6-1994.
- 1,865,936. MIDLANDS CHOICE. INT. CL. 35. (U.S. CLS. 100 AND 101). REG. 12-6-1994.
- 1,865,972. AICF. INT. CL. 36. (U.S. CL. 102). REG. 12-6-1994.
- 1,865,978. UMA. INT. CLS. 37 AND 42. (U.S. CLS. 100 AND 103). REG. 12-6-1994.
- 1,866,178. RIFATER. INT. CL. 5. (U.S. CL. 18). REG. 12-6-1994.
- 1,866,180. AMYLIN AND DESIGN. INT. CL. 5. (U.S. CL. 18). REG. 12-6-1994.
- 1,866,183. PROGARD. INT. CL. 5. (U.S. CL. 18). REG. 12-6-1994.
- 1,866,222. OSCOR OMNI SPECTRAL CORRELATOR. INT. CL. 9. (U.S. CLS. 21 AND 26). REG. 12-6-1994.
- 1,866,303. HEALTHFLOW. INT. CL. 10. (U.S. CL. 44). REG. 12-6-1994.
- 1,866,466. CAMPO ZANIERI (STYLIZED). INT. CL. 25. (U.S. CL. 39). REG. 12-6-1994.
- 1,866,517. HAVE A PRETZEL MORNING. INT. CL. 30. (U.S. CL. 46). REG. 12-6-1994.
- 1,866,711. PROACTAZyme. INT. CL. 5. (U.S. CL. 18). REG. 12-13-1994.
- 1,866,712. INTRACEL. INT. CL. 5. (U.S. CL. 18). REG. 12-13-1994.
- 1,866,750. SKYJACK. INT. CL. 7. (U.S. CL. 23). REG. 12-13-1994.
- 1,866,863. AVIJET. INT. CL. 10. (U.S. CL. 44). REG. 12-13-1994.
- 1,866,922. WAD-LOCK. INT. CL. 13. (U.S. CL. 9). REG. 12-13-1994.
- 1,867,111. SEMINOLE. INT. CL. 29. (U.S. CL. 46). REG. 12-13-1994.
- 1,867,505. PALLET WORLD. INT. CL. 9. (U.S. CL. 26). REG. 12-13-1994.
- 1,867,698. ROPER RANGE GEAR. INT. CL. 25. (U.S. CL. 39). REG. 12-13-1994.

- 1,867,840. GREENLIGHT. INT. CL. 42. (U.S. CL. 101). REG. 12-13-1994.
- 1,867,899. BETCO. INT. CLS. 2, 3 AND 5. (U.S. CLS. 6, 16, 18 AND 52). REG. 12-20-1994.
- 1,867,920. PULL UP. INT. CL. 3. (U.S. CL. 52). REG. 12-20-1994.
- 1,867,976. FISHER. INT. CLS. 6, 7, 9, 11, 17 AND 37. (U.S. CLS. 13, 21, 23, 26, 31, 35 AND 103). REG. 12-20-1994.
- 1,868,014. MALL OF AMERICA. INT. CLS. 8, 14, 16, 18, 21, 25, 28 AND 36 ONLY. (U.S. CLS. 2, 3, 22, 23, 28, 30, 33, 37, 38, 39, 100, 101 AND 102). REG. 12-20-1994.
- 1,868,097. BANDA LOS LAGOS AND DESIGN. INT. CL. 9. (U.S. CLS. 21 AND 36). REG. 12-20-1994.
- 1,868,156. CU-SIL. INT. CL. 10. (U.S. CLS. 18 AND 44). REG. 12-20-1994.
- 1,868,176. LUXUS. INT. CL. 11. (U.S. CL. 13). REG. 12-20-1994.
- 1,868,369. STRENGTH THE ULTIMATE LEG TRAINING SYSTEM AND DESIGN. INT. CL. 25. (U.S. CL. 39). REG. 12-20-1994.
- 1,868,590. THE MILLS. INT. CL. 36. (U.S. CLS. 100, 101 AND 102). REG. 12-20-1994.
- 1,868,789. CORPORATE LINK. INT. CLS. 35, 39 AND 42. (U.S. CLS. 100, 101 AND 105). REG. 12-20-1994.
- 1,868,816. DEX4. INT. CL. 5. (U.S. CL. 18). REG. 12-20-1994.
- 1,868,984. COMPASS ATTACHE. INT. CL. 36. (U.S. CL. 102). REG. 12-20-1994.
- 1,869,139. PHASE 2. INT. CL. 1. (U.S. CL. 6). REG. 12-27-1994.
- 1,869,393. FILESWEEP. INT. CL. 9. (U.S. CL. 38). REG. 12-27-1994.
- 1,869,394. ROBOTPRO. INT. CL. 9. (U.S. CLS. 26 AND 38). REG. 12-27-1994.
- 1,869,407. UMF. INT. CL. 9. (U.S. CL. 38). REG. 12-27-1994.
- 1,869,446. VERSA-PURE. INT. CL. 11. (U.S. CLS. 13 AND 31). REG. 12-27-1994.
- 1,869,462. INLINE. INT. CL. 12. (U.S. CL. 19). REG. 12-27-1994.
- 1,869,743. HYDRO FLEECE. INT. CL. 25. (U.S. CL. 39). REG. 12-27-1994.
- 1,869,849. EUKANUBA VETERINARY DIETS. INT. CL. 31. (U.S. CL. 46). REG. 12-27-1994.
- 1,869,929. PLANNING TODAY TO MEET THE NEEDS OF TOMORROW. INT. CL. 36. (U.S. CLS. 101 AND 102). REG. 12-27-1994.
- 1,870,007. HERITAGE. INT. CL. 40. (U.S. CL. 106). REG. 12-27-1994.
- 1,870,084. FOOD EXPRESS. INT. CL. 42. (U.S. CLS. 100 AND 101). REG. 12-27-1994.
- 1,870,279. FIRST STRIKE. INT. CL. 3. (U.S. CL. 52). REG. 12-27-1994.
- 1,870,329. LOG BUSTER. INT. CL. 7. (U.S. CL. 23). REG. 12-27-1994.
- 1,870,338. EDGE Crafter. INT. CL. 8. (U.S. CL. 23). REG. 12-27-1994.
- 1,870,638. ULTRA-MAX. INT. CL. 26. (U.S. CLS. 39 AND 40). REG. 12-27-1994.
- 1,870,827. KEYS TO DYNAMIC LIVING. INT. CL. 41. (U.S. CL. 107). REG. 12-27-1994.
- 1,870,910. JANITOR UNIVERSITY. INT. CL. 41. (U.S. CL. 107). REG. 12-27-1994.
- 1,870,974. RAIL LUBRICANT. INT. CL. 4. (U.S. CL. 15). REG. 1-3-1995.
- 1,871,035. FRESH'N SQUEEZE (STYLIZED). INT. CL. 7. (U.S. CL. 23). REG. 1-3-1995.
- 1,871,168. MULT-A-RANGE. INT. CL. 9. (U.S. CLS. 9 AND 26). REG. 1-3-1995.
- 1,871,250. D'MARIO AND DESIGN. INT. CL. 14. (U.S. CL. 27). REG. 1-3-1995.
- 1,871,513. USMOTIVATION. INT. CLS. 35 AND 42. (U.S. CLS. 100 AND 101). REG. 1-3-1995.
- 1,871,532. GOOD NEIGHBOR PARKS. INT. CLS. 35 AND 42. (U.S. CLS. 100 AND 101). REG. 1-3-1995.
- 1,871,590. MISCELLANEOUS DESIGN. INT. CL. 37. (U.S. CL. 103). REG. 1-3-1995.
- 1,871,643. MANAGEMEN. INT. CLS. 41 AND 42. (U.S. CLS. 100 AND 107). REG. 1-3-1995.
- 1,871,671. MISCELLANEOUS DESIGN. INT. CL. 42. (U.S. CL. 100). REG. 1-3-1995.
- 1,871,752. GET A LOT FOR WHAT YOU'VE GOT. INT. CL. 42. (U.S. CL. 100). REG. 1-3-1995.
- 1,871,809. TRANSEAL. INT. CL. 5. (U.S. CL. 44). REG. 1-3-1995.
- 1,871,847. JS (STYLIZED). INT. CL. 9. (U.S. CL. 21). REG. 1-3-1995.
- 1,872,175. BIOSINE COMPLEX. INT. CL. 3. (U.S. CL. 51). REG. 1-10-1995.
- 1,872,214. UNISCAFF (STYLIZED). INT. CL. 6. (U.S. CLS. 12 AND 50). REG. 1-10-1995.
- 1,872,408. RODLITE. INT. CL. 12. (U.S. CL. 19). REG. 1-10-1995.
- 1,872,578. HAWAIIAN LEGENDS. INT. CL. 25. (U.S. CL. 39). REG. 1-10-1995.
- 1,872,612. VANGUARDS. INT. CL. 28. (U.S. CL. 22). REG. 1-10-1995.
- 1,872,687. MISCELLANEOUS DESIGN. INT. CL. 30. (U.S. CL. 46). REG. 1-10-1995.
- 1,872,878. PHILADELPHIA HEART INSTITUTE. INT. CL. 42 ONLY. (U.S. CL. 100). REG. 1-10-1995.
- 1,872,975. JARED THE GALLERIA OF JEWELRY. INT. CL. 42. (U.S. CLS. 100 AND 101). REG. 1-10-1995.
- 1,873,202. AUTOWORKS. INT. CL. 9. (U.S. CL. 21). REG. 1-10-1995.
- 1,873,227. PHOTODERM. INT. CL. 10. (U.S. CL. 44). REG. 1-10-1995.
- 1,873,464. C-11. INT. CL. 1. (U.S. CL. 6). REG. 1-17-1995.
- 1,873,487. CLAR + ION (STYLIZED). INT. CL. 1. (U.S. CL. 6). REG. 1-17-1995.
- 1,873,630. QVS. INT. CL. 9. (U.S. CL. 26). REG. 1-17-1995.
- 1,873,690. CELLAR SAVER. INT. CL. 9. (U.S. CLS. 21 AND 26). REG. 1-17-1995.
- 1,873,941. WE CLOTHE THE WORLD WITH QUALITY. INT. CL. 25. (U.S. CL. 39). REG. 1-17-1995.
- 1,873,977. F AND DESIGN. INT. CL. 28. (U.S. CLS. 22 AND 23). REG. 1-17-1995.
- 1,874,115. H. UPMANN APERITIFS. INT. CL. 34. (U.S. CL. 17). REG. 1-17-1995.
- 1,874,217. HOC AND DESIGN. INT. CL. 37. (U.S. CLS. 100 AND 103). REG. 1-17-1995.
- 1,874,646. CHESHIRE LINEN. INT. CL. 16. (U.S. CL. 38). REG. 1-17-1995.
- 1,874,906. MISCELLANEOUS DESIGN. INT. CL. 25. (U.S. CL. 39). REG. 1-17-1995.
- 1,874,967. ENZO-SNAKE. INT. CLS. 3 AND 5. (U.S. CL. 6). REG. 1-24-1995.
- 1,875,381. AMT. INT. CL. 28. (U.S. CL. 22). REG. 1-24-1995.
- 1,875,385. MISCELLANEOUS DESIGN. INT. CL. 28. (U.S. CL. 22). REG. 1-24-1995.
- 1,875,594. IDI AND DESIGN. INT. CL. 39. (U.S. CL. 105). REG. 1-24-1995.
- 1,875,605. SPIRIT OF THE WILD. INT. CL. 41. (U.S. CL. 107). REG. 1-24-1995.
- 1,875,785. SUBTLE DRAMATICS. INT. CL. 3. (U.S. CLS. 1, 4, 6, 50, 51 AND 52). REG. 1-24-1995.
- 1,875,859. OPTISEP. INT. CL. 9. (U.S. CLS. 26 AND 31). REG. 1-24-1995.
- 1,875,894. POLYCLEAR II. INT. CL. 11. (U.S. CL. 31). REG. 1-24-1995.
- 1,876,071. DON'T LET THIS ONE GET AWAY. INT. CL. 35. (U.S. CL. 101). REG. 1-24-1995.
- 1,876,427. PROLIANT. INT. CL. 9. (U.S. CL. 26). REG. 1-31-1995.
- 1,876,506. XENON STAR. INT. CL. 11. (U.S. CL. 21). REG. 1-31-1995.
- 1,876,508. TITAN. INT. CL. 11. (U.S. CL. 34). REG. 1-31-1995.
- 1,876,510. MICROLITE. INT. CL. 11. (U.S. CL. 31). REG. 1-31-1995.
- 1,876,538. THE JEWELER'S JEWELER.. INT. CL. 14. (U.S. CL. 28). REG. 1-31-1995.
- 1,876,648. MY LITTLE SALESMAN. INT. CL. 16. (U.S. CL. 38). REG. 1-31-1995.
- 1,876,981. HEALTH FOR HUMANITY. INT. CL. 41. (U.S. CL. 107). REG. 1-31-1995.
- 1,877,456. POWERNET. INT. CL. 9. (U.S. CL. 38). REG. 2-7-1995.
- 1,877,599. BOLDER BORDERS. INT. CL. 16. (U.S. CL. 37). REG. 2-7-1995.
- 1,877,807. PEPE'S. INT. CL. 30. (U.S. CL. 46). REG. 2-7-1995.
- 1,878,044. MISCELLANEOUS DESIGN. INT. CL. 41. (U.S. CL. 107). REG. 2-7-1995.
- 1,878,549. HEALTHMARK. INT. CLS. 10 AND 20. (U.S. CLS. 2 AND 44). REG. 2-14-1995.
- 1,879,029. P AND DESIGN. INT. CL. 42. (U.S. CL. 100). REG. 2-14-1995.
- 1,879,092. MULTI-SEP. INT. CL. 5. (U.S. CL. 18). REG. 2-14-1995.

- 1,879,112. POSI-FLOW. INT. CL. 7. (U.S. CL. 23). REG. 2-14-1995.
- 1,879,174. DENTAVIT. INT. CL. 10. (U.S. CL. 44). REG. 2-14-1995.
- 1,879,218. TRENCHCOAT. INT. CL. 17. (U.S. CL. 1). REG. 2-14-1995.
- 1,879,559. RAMTRON. INT. CL. 9. (U.S. CLS. 21 AND 26). REG. 2-21-1995.
- 1,879,717. FOOTNOTES. INT. CL. 16. (U.S. CLS. 22 AND 42). REG. 2-21-1995.
- 1,879,742. MEXIDEK. INT. CL. 16. (U.S. CL. 38). REG. 2-21-1995.
- 1,879,823. MISCELLANEOUS DESIGN. INT. CL. 25. (U.S. CL. 39). REG. 2-21-1995.
- 1,880,050. MID-CENTURY INSURANCE COMPANY. INT. CL. 36. (U.S. CLS. 101 AND 102). REG. 2-21-1995.
- 1,880,519. CHEMCAST. INT. CLS. 12, 40 AND 42. (U.S. CLS. 19, 35, 100, 103 AND 106). REG. 2-28-1995.
- 1,880,520. C (STYLIZED). INT. CLS. 12, 40 AND 42. (U.S. CLS. 19, 35, 100, 103 AND 106). REG. 2-28-1995.
- 1,880,667. ALASKAN FUR COMPANY (STYLIZED). INT. CL. 25. (U.S. CL. 39). REG. 2-28-1995.
- 1,881,013. HANNADOWNS. INT. CL. 42. (U.S. CL. 100). REG. 2-28-1995.
- 1,881,224. QUIETKEY. INT. CL. 9. (U.S. CL. 26). REG. 2-28-1995.
- 1,882,074. CSUS. INT. CL. 12. (U.S. CL. 19). REG. 3-7-1995.
- 1,882,123. FIRSTSTEPS. INT. CL. 16. (U.S. CL. 38). REG. 3-7-1995.
- 1,882,158. THREE CORNER. INT. CL. 16. (U.S. CL. 38). REG. 3-7-1995.
- 1,882,806. HIGHBRIGHT. INT. CL. 9. (U.S. CL. 26). REG. 3-7-1995.
- 1,883,890. HINES & ASSOCIATES, INC.. INT. CL. 35. (U.S. CLS. 100 AND 101). REG. 3-14-1995.
- 1,884,110. FLUID-LOK. INT. CL. 42. (U.S. CL. 101). REG. 3-14-1995.
- 1,884,223. PINE. INT. CL. 9. (U.S. CL. 38). REG. 3-14-1995.
- 1,884,644. PROWORXPLUS. INT. CL. 9. (U.S. CL. 38). REG. 3-21-1995.
- 1,884,668. MACRO-CORE. INT. CL. 9. (U.S. CL. 26). REG. 3-21-1995.
- 1,884,860. GUARDIAN. INT. CL. 16. (U.S. CLS. 2, 5, 22, 23, 29, 37, 38 AND 50). REG. 3-21-1995.
- 1,885,120. AMY'S KITCHEN. INT. CLS. 29 AND 30. (U.S. CL. 46). REG. 3-21-1995.
- 1,885,121. AMY'S. INT. CLS. 29 AND 30. (U.S. CL. 46). REG. 3-21-1995.
- 1,885,141. SEDUCTION. INT. CL. 30. (U.S. CL. 46). REG. 3-21-1995.
- 1,886,132. SNOWBEE (STYLIZED). INT. CLS. 25 AND 28. (U.S. CLS. 22 AND 39). REG. 3-28-1995.
- 1,886,483. QC WINDOWS. INT. CLS. 1 AND 5. (U.S. CLS. 6, 26 AND 44). REG. 3-28-1995.
- 1,886,873. ROBERTA'S. INT. CL. 3. (U.S. CLS. 1 AND 50). REG. 4-4-1995.
- 1,887,516. ADDICTIVE VOICE RECOGNITION TECHNIQUE. INT. CLS. 41 AND 42. (U.S. CLS. 100 AND 107). REG. 4-4-1995.
- 1,888,779. APPLETON ESTATE SINCE 1749 JAMAICA RUM AND DESIGN. INT. CL. 33. (U.S. CL. 49). REG. 4-11-1995.
- 1,889,203. FUTURE AUDIT. INT. CL. 9. (U.S. CL. 38). REG. 4-11-1995.
- 1,889,228. ESTILUZ. INT. CL. 11. (U.S. CL. 21). REG. 4-11-1995.
- 1,889,820. MISCELLANEOUS DESIGN. INT. CLS. 16 AND 25. (U.S. CLS. 2, 5, 22, 23, 29, 37, 38, 39 AND 50). REG. 4-18-1995.
- 1,889,875. CADACO. INT. CL. 16. (U.S. CL. 37). REG. 4-18-1995.
- 1,890,652. SUPERIOR VALUE AND DESIGN. INT. CL. 34. (U.S. CL. 17). REG. 4-18-1995.
- 1,890,846. JANUS. INT. CL. 9. (U.S. CL. 26). REG. 4-25-1995.
- 1,891,307. FIDM. INT. CLS. 35 AND 41. (U.S. CLS. 101 AND 107). REG. 4-25-1995.
- 1,891,617. DURA LIFE. INT. CL. 6. (U.S. CLS. 2 AND 13). REG. 4-25-1995.
- 1,892,064. E-Z LIFT. INT. CL. 12. (U.S. CL. 19). REG. 5-2-1995.
- 1,892,257. REDDY FRIES. INT. CL. 29. (U.S. CL. 46). REG. 5-2-1995.
- 1,892,258. REDDY VEGGIES. INT. CL. 29. (U.S. CL. 46). REG. 5-2-1995.
- 1,892,302. CRYSTAL GLEN. INT. CL. 32. (U.S. CL. 45). REG. 5-2-1995.
- 1,892,438. CARLSON CRAFT. INT. CL. 42. (U.S. CLS. 100 AND 101). REG. 5-2-1995.
- 1,892,594. FAXPOST. INT. CL. 9. (U.S. CLS. 26 AND 38). REG. 5-2-1995.
- 1,892,671. CAMPBELL CONTRACT. INT. CL. 20. (U.S. CL. 32). REG. 5-2-1995.
- 1,893,229. AMY'S (STYLIZED). INT. CLS. 29 AND 30. (U.S. CL. 46). REG. 5-9-1995.
- 1,894,582. TRUSTERMINATOR. INT. CL. 9. (U.S. CL. 38). REG. 5-16-1995.
- 1,894,592. BRO-TISSERIE. INT. CL. 11. (U.S. CL. 34). REG. 5-16-1995.
- 1,895,004. THERA-BAND. INT. CL. 10. (U.S. CL. 44). REG. 5-23-1995.
- 1,895,233. CHEF CENTO. INT. CL. 30. (U.S. CL. 46). REG. 5-23-1995.
- 1,895,875. ANCORDENSE. INT. CL. 6. (U.S. CL. 14). REG. 5-30-1995.
- 1,896,081. TRANS-PAL. INT. CL. 10. (U.S. CL. 44). REG. 5-30-1995.
- 1,896,191. TRAINS. INT. CL. 16. (U.S. CLS. 37 AND 38). REG. 5-30-1995.
- 1,896,471. EQUIFIRST. INT. CL. 36. (U.S. CLS. 101 AND 102). REG. 5-30-1995.
- 1,896,647. MISCELLANEOUS DESIGN. INT. CL. 42. (U.S. CLS. 100 AND 101). REG. 5-30-1995.
- 1,897,134. Z Z GALLERIE (STYLIZED). INT. CL. 42. (U.S. CLS. 100 AND 101). REG. 5-30-1995.
- 1,897,192. ADIRONDACK MT.. INT. CL. 19. (U.S. CL. 12). REG. 5-30-1995.
- 1,897,494. MISSISSIPPI QUEEN. INT. CL. 16. (U.S. CL. 38). REG. 6-6-1995.
- 1,898,130. SLUMBERJACK. INT. CL. 20. (U.S. CLS. 2, 13, 22, 25, 32 AND 50). REG. 6-6-1995.
- 1,898,322. KIDS CAFE AND DESIGN. INT. CL. 42. (U.S. CL. 100). REG. 6-6-1995.
- 1,898,462. TRANS FLUSH AND DESIGN. INT. CL. 1. (U.S. CLS. 6 AND 52). REG. 6-13-1995.
- 1,898,592. SIDEWINDER. INT. CL. 7. (U.S. CLS. 19 AND 23). REG. 6-13-1995.
- 1,899,292. LIONS. INT. CL. 41. (U.S. CL. 107). REG. 6-13-1995.
- 1,899,302. SAFETY SMART. INT. CL. 42. (U.S. CL. 100). REG. 6-13-1995.
- 1,900,370. FALCON. INT. CL. 8. (U.S. CL. 23). REG. 6-20-1995.
- 1,900,466. NEW SONGS FOR WORSHIPING CHURCHES. INT. CLS. 9 AND 16. (U.S. CLS. 36 AND 38). REG. 6-20-1995.
- 1,901,383. TECHNICAL NETWORK. INT. CL. 42. (U.S. CL. 100). REG. 6-20-1995.
- 1,901,464. THE NAME YOU CAN TRUST. INT. CLS. 7 AND 12. (U.S. CLS. 19, 23 AND 35). REG. 6-27-1995.
- 1,901,731. EXACT. INT. CL. 16. (U.S. CL. 37). REG. 6-27-1995.
- 1,901,787. QUAKER LACE AND DESIGN. INT. CL. 24. (U.S. CL. 42). REG. 6-27-1995.
- 1,901,806. LAUREN LEE. INT. CL. 25. (U.S. CLS. 22 AND 39). REG. 6-27-1995.
- 1,901,917. EAGLE TRANSMISSION. INT. CL. 37. (U.S. CL. 103). REG. 6-27-1995.
- 1,901,936. PENNSTAR FLIGHT AND DESIGN. INT. CLS. 39 AND 42. (U.S. CLS. 100 AND 105). REG. 6-27-1995.
- 1,902,122. KINKY KUFFS. INT. CL. 6. (U.S. CL. 25). REG. 6-27-1995.
- 1,902,394. GREAT PLAINS. INT. CL. 7. (U.S. CL. 23). REG. 7-4-1995.
- 1,902,566. ACCESS. INT. CL. 10. (U.S. CL. 44). REG. 7-4-1995.
- 1,902,899. FAMILY CLASSIC. INT. CL. 29. (U.S. CL. 46). REG. 7-4-1995.
- 1,902,978. 401 (K) CENTURY PLAN. INT. CL. 36. (U.S. CLS. 101 AND 102). REG. 7-4-1995.
- 1,903,658. SPORTSTALK. INT. CL. 28. (U.S. CLS. 22, 23, 38 AND 50). REG. 7-4-1995.
- 1,903,727. MISCELLANEOUS DESIGN. INT. CL. 30. (U.S. CL. 46). REG. 7-4-1995.
- 1,903,734. CHAIRMAN OF THE BOARD. INT. CL. 30. (U.S. CL. 46). REG. 7-4-1995.
- 1,904,399. LITTLE KRIS: SANTA CLAUS' SON. INT. CL. 16. (U.S. CL. 38). REG. 7-11-1995.
- 1,904,545. LITTLE KRIS: SANTA CLAUS' SON. INT. CL. 28. (U.S. CLS. 22, 38 AND 50). REG. 7-11-1995.
- 1,904,563. SHEBA AND DESIGN. INT. CL. 31. (U.S. CL. 46). REG. 7-11-1995.
- 1,904,644. MISCELLANEOUS DESIGN. INT. CLS. 37 AND 42. (U.S. CLS. 100 AND 103). REG. 7-11-1995.

- 1,904,865. POLYFLO. INT. CL. 1. (U.S. CLS. 1, 5, 6, 10, 26 AND 46). REG. 7-11-1995.
- 1,905,271. PLUVIMIN. INT. CL. 5. (U.S. CL. 18). REG. 7-18-1995.
- 1,905,460. FIBERCORE. INT. CL. 9. (U.S. CLS. 21 AND 26). REG. 7-18-1995.
- 1,906,000. RECOVER RECYCLE RECLAIM RECONDITION REUSE AND DESIGN. INT. CL. 40. (U.S. CL. 106). REG. 7-18-1995.
- 1,906,272. DURATUSS. INT. CL. 5. (U.S. CL. 18). REG. 7-18-1995.
- 1,906,762. LES RATE AND DESIGN. INT. CL. 36. (U.S. CLS. 100, 101 AND 102). REG. 7-18-1995.
- 1,906,903. NATIONAL CURRICULUM & TRAINING INSTITUTE. INT. CL. 16. (U.S. CLS. 2, 5, 22, 23, 29, 37, 38 AND 50). REG. 7-18-1995.
- 1,906,988. IRONMASTER AND DESIGN. INT. CL. 1. (U.S. CL. 6). REG. 7-25-1995.
- 1,907,208. DATABRITE. INT. CL. 9. (U.S. CLS. 21 AND 26). REG. 7-25-1995.
- 1,907,258. GOODMARK. INT. CL. 12. (U.S. CL. 19). REG. 7-25-1995.
- 1,907,270. HYDRA-BED. INT. CL. 12. (U.S. CLS. 19 AND 23). REG. 7-25-1995.
- 1,907,583. BANKMATE AND DESIGN. INT. CL. 36. (U.S. CLS. 101 AND 102). REG. 7-25-1995.
- 1,908,209. MICHAEL JACKSON. INT. CL. 9. (U.S. CLS. 21, 26, 36 AND 38). REG. 8-1-1995.
- 1,908,459. ROSSTHERM. INT. CL. 17. (U.S. CL. 23). REG. 8-1-1995.
- 1,908,556. CAT AND DESIGN. INT. CL. 25. (U.S. CLS. 22 AND 39). REG. 8-1-1995.
- 1,909,287. PARTNERS AGAINST PAIN. INT. CL. 16. (U.S. CLS. 2, 5, 22, 23, 29, 37, 38 AND 50). REG. 8-1-1995.
- 1,909,601. INTERNATIONAL SAFETY COUNCIL. INT. CL. 42. (U.S. CLS. 100 AND 101). REG. 8-1-1995.
- 1,909,653. OSMOTICS AND DESIGN. INT. CL. 3. (U.S. CLS. 1, 4, 6, 50, 51 AND 52). REG. 8-8-1995.
- 1,910,188. MISCELLANEOUS DESIGN. INT. CL. 25. (U.S. CL. 39). REG. 8-8-1995.
- 1,910,208. KLINGON. INT. CL. 28. (U.S. CL. 22). REG. 8-8-1995.
- 1,910,586. DOUBLE DIPPING. INT. CL. 42. (U.S. CL. 100). REG. 8-8-1995.
- 1,910,845. PLAN SPONSOR. INT. CL. 16. (U.S. CL. 38). REG. 8-8-1995.
- 1,911,028. IODO-FIVE. INT. CL. 5. (U.S. CLS. 6, 18, 44, 46, 51 AND 52). REG. 8-15-1995.
- 1,911,250. AAON. INT. CL. 11. (U.S. CL. 34). REG. 8-15-1995.
- 1,911,286. INTERIOR DESIGN. INT. CL. 16. (U.S. CL. 38). REG. 8-15-1995.
- 1,911,389. COSMOPOLITAN. INT. CL. 16. (U.S. CL. 38). REG. 8-15-1995.
- 1,911,747. HARTZ. INT. CLS. 36 AND 37. (U.S. CLS. 102 AND 103). REG. 8-15-1995.
- 1,911,753. HARTZ (STYLIZED). INT. CLS. 36 AND 37. (U.S. CLS. 102 AND 103). REG. 8-15-1995.
- 1,911,842. EARTH FORCE. INT. CL. 41. (U.S. CL. 107). REG. 8-15-1995.
- 1,911,958. DOUBLE DIP. INT. CL. 42. (U.S. CL. 100). REG. 8-15-1995.

\* \* \* \* \*

# TRADEMARK REGISTRATIONS CANCELED

The designation "U.S. Cl." appearing in this section refers to the U.S. class in effect prior to Sep. 1, 1973 rather than the international class which applies to applications filed on or after that date. For adoption of international classification see notice in the OFFICIAL GAZETTE of Jun. 26, 1973 (911 O.G. TM 210).

## SECTION 8

- |          |   |            |  |
|----------|---|------------|--|
| 177,054. | PRESTO (STYLIZED). U.S. CL. 6. REG. 12-11-1923.         | 761,642.   | PEAK LINE. U.S. CL. 37. REG. 12-17-1963.                                   |
| 177,065. | VIM. U.S. CL. 46. REG. 12-11-1923.                      | 761,648.   | REDI-LETTER. U.S. CL. 37. REG. 12-17-1963.                                 |
| 177,084. | MISCELLANEOUS DESIGN. U.S. CL. 46. REG. 12-11-1923.     | 761,649.   | NEEDLE SORT AND DESIGN. U.S. CL. 37. REG. 12-17-1963.                      |
| 177,085. | LOCHINVAR (STYLIZED). U.S. CL. 46. REG. 12-11-1923.     | 761,652.   | TAB JAC. U.S. CL. 37. REG. 12-17-1963.                                     |
| 177,086. | SILVER BUCKLE (STYLIZED). U.S. CL. 46. REG. 12-11-1923. | 761,663.   | SUN TRAIL. U.S. CL. 39. REG. 12-17-1963.                                   |
| 177,130. | BISLERI AND DESIGN. U.S. CL. 6. REG. 12-11-1923.        | 761,666.   | MALIA. U.S. CL. 39. REG. 12-17-1963.                                       |
| 177,132. | ORANGE QUENCH (STYLIZED). U.S. CL. 45. REG. 12-11-1923. | 761,669.   | YOUNGSET (STYLIZED). U.S. CL. 39. REG. 12-17-1963.                         |
| 177,163. | OUR DARLING. U.S. CL. 46. REG. 12-11-1923.              | 761,696.   | MONACO. U.S. CL. 46. REG. 12-17-1963.                                      |
| 177,214. | FAIR PLAY (STYLIZED). U.S. CL. 46. REG. 12-11-1923.     | 761,705.   | SHEFFIELD FARMS. U.S. CL. 46. REG. 12-17-1963.                             |
| 177,227. | PEACOCK AND DESIGN. U.S. CL. 46. REG. 12-11-1923.       | 761,706.   | BRESLER'S (STYLIZED). U.S. CL. 46. REG. 12-17-1963.                        |
| 177,230. | POPSICLE. U.S. CL. 46. REG. 12-11-1923.                 | 761,717.   | KERZO. U.S. CL. 51. REG. 12-17-1963.                                       |
| 177,234. | BAK-A-SPECIAL. U.S. CL. 46. REG. 12-11-1923.            | 761,732.   | D-TAR. U.S. CL. 52. REG. 12-17-1963.                                       |
| 404,650. | SHIPALLOY. U.S. CL. 13. REG. 12-14-1943.                | 761,736.   | FOAM-DET. U.S. CL. 52. REG. 12-17-1963.                                    |
| 404,657. | ACACIA. U.S. CL. 46. REG. 12-14-1943.                   | 761,738.   | AIR-TEC. U.S. CL. 52. REG. 12-17-1963.                                     |
| 404,659. | SCO-CO AND DESIGN. U.S. CL. 12. REG. 12-14-1943.        | 761,740.   | FRANCHISED RÖFFLER SCULPTUR KUT AND DESIGN. U.S. CL. 100. REG. 12-17-1963. |
| 404,660. | WINSULITE AND DESIGN. U.S. CL. 12. REG. 12-14-1943.     | 988,819.   | ZOOM (STYLIZED). U.S. CL. 22. ONLY. REG. 7-23-1974.                        |
| 761,501. | MICRO-SORB. INT. CL. 1. REG. 12-17-1963.                | 1,260,689. | OMNI PREP. INT. CL. 1. REG. 12-13-1983.                                    |
| 761,504. | STEREO (STYLIZED). INT. CL. 1. REG. 12-17-1963.         | 1,260,690. | UTAX. INT. CLS. 1, 9 AND 16. REG. 12-13-1983.                              |
| 761,527. | OOMPH. U.S. CL. 4. REG. 12-17-1963.                     | 1,260,691. | ENI AND DESIGN. INT. CLS. 1, 9 AND 16. REG. 12-13-1983.                    |
| 761,529. | PADLOCK ULTRAFLEX. U.S. CL. 5. REG. 12-17-1963.         | 1,260,692. | ULTRANOVA. INT. CL. 1. REG. 12-13-1983.                                    |
| 761,532. | KNOLL. U.S. CL. 6. REG. 12-17-1963.                     | 1,260,693. | COLUMBIA CALIBRE. INT. CLS. 1 AND 9. REG. 12-13-1983.                      |
| 761,533. | THIRAMAD. U.S. CL. 6. REG. 12-17-1963.                  | 1,260,697. | CLAW GLAS FIBERGLASS REPAIR KIT AND DESIGN. INT. CL. 1. REG. 12-13-1983.   |
| 761,536. | VISCOMAT. U.S. CL. 6. REG. 12-17-1963.                  | 1,260,703. | CARSONOL. INT. CL. 1. REG. 12-13-1983.                                     |
| 761,538. | LIQUID AND DESIGN. U.S. CLS. 6 AND 18. REG. 12-17-1963. | 1,260,706. | PLEXON. INT. CL. 1. REG. 12-13-1983.                                       |
| 761,542. | H - R (STYLIZED). U.S. CL. 6. REG. 12-17-1963.          | 1,260,710. | REVEAL. INT. CL. 1. REG. 12-13-1983.                                       |
| 761,543. | CYANASIZE. U.S. CL. 6. REG. 12-17-1963.                 | 1,260,713. | STP AND DESIGN. INT. CL. 1. REG. 12-13-1983.                               |
| 761,559. | RAIN-CLOX. U.S. CL. 13. REG. 12-17-1963.                | 1,260,718. | STANDFAST. INT. CL. 2. REG. 12-13-1983.                                    |
| 761,567. | KNOLL. U.S. CL. 18. REG. 12-17-1963.                    | 1,260,719. | FILLCOAT. INT. CLS. 2 AND 17. REG. 12-13-1983.                             |
| 761,574. | KEFLIN. U.S. CL. 18. REG. 12-17-1963.                   | 1,260,720. | VINY-LUX. INT. CL. 2. REG. 12-13-1983.                                     |
| 761,581. | TELEDIX AND DESIGN. U.S. CL. 21. REG. 12-17-1963.       | 1,260,728. | E EASTERDAY SUPPLY COMPANY AND DESIGN. INT. CLS. 3 AND 7. REG. 12-13-1983. |
| 761,582. | PAMO. U.S. CL. 21. REG. 12-17-1963.                     | 1,260,742. | HI C-PLEX. INT. CL. 5. REG. 12-13-1983.                                    |
| 761,583. | PAMOTOR. U.S. CL. 21. REG. 12-17-1963.                  | 1,260,743. | SOLUTION P-5. INT. CL. 5. REG. 12-13-1983.                                 |
| 761,586. | PLUS C + AND DESIGN. U.S. CL. 21. REG. 12-17-1963.      | 1,260,752. | MAMA-F. INT. CL. 5. REG. 12-13-1983.                                       |
| 761,594. | SUPERSHEATH. U.S. CL. 21. REG. 12-17-1963.              | 1,260,759. | SENIOR B-PLEX (STYLIZED). INT. CL. 5. REG. 12-13-1983.                     |
| 761,599. | TULLABEE. U.S. CL. 22. REG. 12-17-1963.                 | 1,260,762. | CONTIN. INT. CL. 5. REG. 12-13-1983.                                       |
| 761,615. | FULBAR. U.S. CL. 23. REG. 12-17-1963.                   | 1,260,766. | ICE MINT. INT. CL. 5. REG. 12-13-1983.                                     |
| 761,617. | DERITEND. U.S. CL. 23. REG. 12-17-1963.                 | 1,260,769. | CATH-SECURE. INT. CL. 5. REG. 12-13-1983.                                  |
| 761,622. | MILADY (STYLIZED). U.S. CL. 32. REG. 12-17-1963.        | 1,260,773. | PRECEF. INT. CL. 5. REG. 12-13-1983.                                       |
| 761,627. | KWIKEE AND DESIGN. U.S. CL. 34. REG. 12-17-1963.        | 1,260,774. | SWEETTES. INT. CL. 5. REG. 12-13-1983.                                     |
| 761,628. | MISCELLANEOUS DESIGN. U.S. CL. 34. REG. 12-17-1963.     | 1,260,776. | SWIVEL HEAD. INT. CL. 6. REG. 12-13-1983.                                  |
| 761,630. | D DURCO (STYLIZED). U.S. CL. 34. REG. 12-17-1963.       | 1,260,782. | BALDWIN AND DESIGN. INT. CL. 6. REG. 12-13-1983.                           |
| 761,633. | SOFT-FLEX. U.S. CL. 35. REG. 12-17-1963.                | 1,260,783. | D AND DESIGN. INT. CLS. 7 AND 9. REG. 12-13-1983.                          |
|          |   | 1,260,786. | K-VANE. INT. CL. 7. REG. 12-13-1983.                                       |
|          |   | 1,260,792. | TORK PAK AND DESIGN. INT. CL. 7. REG. 12-13-1983.                          |
|          |   | 1,260,801. | PENNS PPC LVANIA AND DESIGN. INT. CL. 7. REG. 12-13-1983.                  |
|          |   | 1,260,802. | DURA-CAP. INT. CL. 7. REG. 12-13-1983.                                     |
|          |   | 1,260,806. | AUTORODER. INT. CL. 7. REG. 12-13-1983.                                    |
|          |   | 1,260,819. | MICRO PORTABLE. INT. CL. 9. REG. 12-13-1983.                               |
|          |   | 1,260,822. | REDUCTOR. INT. CL. 9. REG. 12-13-1983.                                     |

- 1,260,823. KS AND DESIGN. INT. CL. 9. REG. 12-13-1983.  
 1,260,829. S (STYLIZED). INT. CL. 9. REG. 12-13-1983.  
 1,260,833. C CIRCUIT HOUND AND DESIGN. INT. CL. 9. REG. 12-13-1983.  
 1,260,839. TOUCH MAT. INT. CL. 9. REG. 12-13-1983.  
 1,260,842. IMS (STYLIZED). INT. CLS. 9 AND 39. REG. 12-13-1983.  
 1,260,845. INTERNATIONAL TECHNOLOGY GROUP. INT. CL. 9. REG. 12-13-1983.  
 1,260,847. TEROMAN. INT. CL. 9. REG. 12-13-1983.  
 1,260,849. SELECTOR 500. INT. CL. 9. REG. 12-13-1983.  
 1,260,853. DESIGNMASTER. INT. CL. 9. REG. 12-13-1983.  
 1,260,854. PYLE DRIVER. INT. CL. 9. REG. 12-13-1983.  
 1,260,856. AVI GUARDIAN. INT. CL. 10. REG. 12-13-1983.  
 1,260,859. ELITE (STYLIZED). INT. CL. 10. REG. 12-13-1983.  
 1,260,867. UNILOCK. INT. CL. 10. REG. 12-13-1983.  
 1,260,868. MADDAREST. INT. CL. 10. REG. 12-13-1983.  
 1,260,870. BON DEL (STYLIZED). INT. CL. 11. REG. 12-13-1983.  
 1,260,878. COLOR BRITE. INT. CL. 11. REG. 12-13-1983.  
 1,260,883. DF. INT. CL. 11. REG. 12-13-1983.  
 1,260,887. ENDLESS ROAD. INT. CLS. 12 AND 25. REG. 12-13-1983.  
 1,260,888. G165 UNISTEEL. INT. CL. 12. REG. 12-13-1983.  
 1,260,889. LEGEND. INT. CL. 12. REG. 12-13-1983.  
 1,260,893. MOTO-STAND. INT. CL. 12. REG. 12-13-1983.  
 1,260,906. WEISS. INT. CL. 16. REG. 12-13-1983.  
 1,260,912. PHOENIX FORCE. INT. CL. 16. REG. 12-13-1983.  
 1,260,913. CROCHET FANTASY. INT. CL. 16. REG. 12-13-1983.  
 1,260,916. MISCELLANEOUS DESIGN. INT. CL. 16. REG. 12-13-1983.  
 1,260,917. TITA. INT. CL. 16. REG. 12-13-1983.  
 1,260,919. SAVINGS SPREE. INT. CL. 16. REG. 12-13-1983.  
 1,260,923. KAL KAN PET CARE AND DESIGN. INT. CL. 16. REG. 12-13-1983.  
 1,260,924. V VOIGT AND DESIGN. INT. CLS. 17, 27 AND 37. REG. 12-13-1983.  
 1,260,925. TECHPRENE. INT. CL. 17. REG. 12-13-1983.  
 1,260,927. ULTRA-HI-PLUS. INT. CL. 17. REG. 12-13-1983.  
 1,260,928. SOUNDFLEX. INT. CL. 17. REG. 12-13-1983.  
 1,260,937. MISCELLANEOUS DESIGN. INT. CLS. 18 AND 25. REG. 12-13-1983.  
 1,260,945. ACIDITE. INT. CL. 19. REG. 12-13-1983.  
 1,260,947. ENVELPRISM. INT. CL. 19. REG. 12-13-1983.  
 1,260,951. Q-PYLAST. INT. CL. 19. REG. 12-13-1983.  
 1,260,952. HEARTH-CRETE. INT. CL. 19. REG. 12-13-1983.  
 1,260,955. IPL AND DESIGN. INT. CLS. 20, 21, 27, 28 AND 37. REG. 12-13-1983.  
 1,260,956. HOLUB. INT. CL. 20. REG. 12-13-1983.  
 1,260,957. HI MARKS. INT. CL. 20. REG. 12-13-1983.  
 1,260,958. TITA. INT. CL. 20. REG. 12-13-1983.  
 1,260,959. MAGICWIPE (STYLIZED). INT. CL. 21. REG. 12-13-1983.  
 1,260,961. HYBON 600. INT. CL. 21. REG. 12-13-1983.  
 1,260,967. THE TOPPER (STYLIZED). INT. CL. 21. REG. 12-13-1983.  
 1,260,972. POLYDESIGN. INT. CL. 24. REG. 12-13-1983.  
 1,260,977. NERPEL. INT. CL. 24. REG. 12-13-1983.  
 1,260,986. VAN RAALTE (STYLIZED). INT. CL. 25. REG. 12-13-1983.  
 1,260,995. RAINBOW WEST (STYLIZED). INT. CL. 25. REG. 12-13-1983.  
 1,261,000. MAGIC ME AND DESIGN. INT. CLS. 25, 26 AND 41. REG. 12-13-1983.  
 1,261,008. QWIK KIDS. INT. CL. 25. REG. 12-13-1983.  
 1,261,009. BARREL AND DESIGN. INT. CL. 25. REG. 12-13-1983.  
 1,261,010. BARREL II AND DESIGN. INT. CL. 25. REG. 12-13-1983.  
 1,261,012. SMALBY. INT. CL. 25. REG. 12-13-1983.  
 1,261,013. TACTICS. INT. CL. 25. REG. 12-13-1983.  
 1,261,017. MISCELLANEOUS DESIGN. INT. CL. 25. REG. 12-13-1983.  
 1,261,027. MAGNE BAC (STYLIZED). INT. CL. 27. REG. 12-13-1983.  
 1,261,028. MAGIC MOMENTS. INT. CL. 27. REG. 12-13-1983.  
 1,261,030. U AND DESIGN. INT. CL. 27. REG. 12-13-1983.  
 1,261,033. REBOUNDER TRAVELER. INT. CL. 28. REG. 12-13-1983.  
 1,261,043. OUT'N ON AND DESIGN. INT. CL. 28. REG. 12-13-1983.  
 1,261,052. HOD SANDERS' CLOVER CLUB AND DESIGN. INT. CLS. 29 AND 30. REG. 12-13-1983.  
 1,261,056. BIRDS EYE AND DESIGN. INT. CL. 29. REG. 12-13-1983.  
 1,261,058. BREAST O'DIXIE. INT. CL. 29. REG. 12-13-1983.  
 1,261,062. RED DRAGON. INT. CL. 29. REG. 12-13-1983.  
 1,261,064. CHILI POPS. INT. CL. 30. REG. 12-13-1983.  
 1,261,072. GRANDOS AND DESIGN. INT. CL. 30. REG. 12-13-1983.  
 1,261,073. HAPPINESS BREAD. INT. CL. 30. REG. 12-13-1983.  
 1,261,074. CROKITA. INT. CL. 30. REG. 12-13-1983.  
 1,261,075. VS RYTS. INT. CL. 30. REG. 12-13-1983.  
 1,261,080. CHEWA MINTS. INT. CL. 30. REG. 12-13-1983.  
 1,261,089. THE BLUEBERRY KING. INT. CL. 31. REG. 12-13-1983.  
 1,261,090. MISCELLANEOUS DESIGN. INT. CL. 31. REG. 12-13-1983.  
 1,261,098. SAINT PAULIN. INT. CL. 33. REG. 12-13-1983.  
 1,261,100. HERITAGE. INT. CL. 34. REG. 12-13-1983.  
 1,261,102. VILLIGER AND DESIGN. INT. CL. 34. REG. 12-13-1983.  
 1,261,103. HANDILITE. INT. CL. 34. REG. 12-13-1983.  
 1,261,104. KOOL ULTRA. INT. CL. 34. REG. 12-13-1983.  
 1,261,106. GE. INT. CL. 34. REG. 12-13-1983.  
 1,261,107. PENCALC. INT. CL. 35. REG. 12-13-1983.  
 1,261,114. OPTIMANAGEMENT RESOURCES (STYLIZED). INT. CL. 35. REG. 12-13-1983.  
 1,261,118. RX RADIO NEWS NETWORK AND DESIGN. INT. CLS. 35 AND 41. REG. 12-13-1983.  
 1,261,121. RECOGNITION (STYLIZED). INT. CL. 35. REG. 12-13-1983.  
 1,261,126. WINARAMA (STYLIZED). INT. CL. 35. REG. 12-13-1983.  
 1,261,129. ARISTA. INT. CL. 36. REG. 12-13-1983.  
 1,261,135. M (STYLIZED). INT. CL. 36. REG. 12-13-1983.  
 1,261,137. CD CODEL (STYLIZED). INT. CL. 36. REG. 12-13-1983.  
 1,261,141. SAN FRANCISCO REINSURANCE COMPANY AND DESIGN. INT. CL. 36. REG. 12-13-1983.  
 1,261,147. OTERO SAVINGS (STYLIZED). INT. CL. 36. REG. 12-13-1983.  
 1,261,149. THE ONLY BANK THATS MORE THAN A BANK. INT. CL. 36. REG. 12-13-1983.  
 1,261,160. L LAWRENCE PHOTO AND DESIGN. INT. CLS. 37 AND 42. REG. 12-13-1983.  
 1,261,163. MR. BRAKE AND DESIGN. INT. CL. 37. REG. 12-13-1983.  
 1,261,164. BLACK HAT AND DESIGN. INT. CL. 37. REG. 12-13-1983.  
 1,261,166. RAPID (STYLIZED). INT. CLS. 37 AND 42. REG. 12-13-1983.  
 1,261,168. LIEN. INT. CL. 37. REG. 12-13-1983.  
 1,261,172. CORRAN. INT. CL. 37. REG. 12-13-1983.  
 1,261,176. PHASAR. INT. CL. 37. REG. 12-13-1983.  
 1,261,177. MISCELLANEOUS DESIGN. INT. CLS. 38 AND 41. REG. 12-13-1983.  
 1,261,186. S.A.V.E.. INT. CL. 39. REG. 12-13-1983.  
 1,261,187. DOUBLE A LIMOUSINE SERVICE, LTD. (STYLIZED). INT. CL. 39. REG. 12-13-1983.  
 1,261,188. RENT AN OLDIE FROM GOLDIE. INT. CL. 39. REG. 12-13-1983.  
 1,261,192. A.A.N.I.. INT. CL. 39. REG. 12-13-1983.  
 1,261,194. PROCESS ONE. INT. CL. 40. REG. 12-13-1983.  
 1,261,195. OZ. INT. CL. 41. REG. 12-13-1983.  
 1,261,201. ACMECARTOON. INT. CL. 41. REG. 12-13-1983.  
 1,261,205. MR. VOLTAGE. INT. CL. 41. REG. 12-13-1983.  
 1,261,208. EDISONIA AND DESIGN. INT. CL. 41. REG. 12-13-1983.  
 1,261,209. MISCELLANEOUS DESIGN. INT. CL. 41. REG. 12-13-1983.  
 1,261,211. JUKEBOX SATURDAY NIGHT AND DESIGN. INT. CL. 41. REG. 12-13-1983.



- 1,261,215. 67TH INDIANAPOLIS 500 MAY 29, 1983 (STYLIZED). INT. CL. 41. REG. 12-13-1983.
- 1,261,222. NORTHSTAR NATIONALS. INT. CL. 41. REG. 12-13-1983.
- 1,261,227. WIRED IN. INT. CL. 41. REG. 12-13-1983.
- 1,261,235. "PACKO'S". INT. CL. 42. REG. 12-13-1983.
- 1,261,236. HEIRLOOM ARTISTS CALLIGRAPHERS (STYLIZED). INT. CL. 42. REG. 12-13-1983.
- 1,261,239. IMPERIAL 400 MOTOR INN AND DESIGN. INT. CL. 42. REG. 12-13-1983.
- 1,261,240. SIR SHAKE-A-LOT (STYLIZED). INT. CL. 42. REG. 12-13-1983.
- 1,261,243. YOUR SOURCE OF GROWTH. INT. CL. 42. REG. 12-13-1983.
- 1,261,244. THE WICKER PARTY PLAN PEOPLE. INT. CL. 42. REG. 12-13-1983.
- 1,261,247. WING WAGON. INT. CL. 42. REG. 12-13-1983.
- 1,261,251. FABRI-GRAPHICS. INT. CL. 42. REG. 12-13-1983.
- 1,261,255. PLASTICWORKS. INT. CL. 42. REG. 12-13-1983.
- 1,261,264. DON'T CUSS-PHONE US. INT. CL. 42. REG. 12-13-1983.
- 1,261,265. MISCELLANEOUS DESIGN. INT. CL. 42. REG. 12-13-1983.
- 1,261,274. PADRE MULDOON'S MERRYMAKIN'-LIBATIONS SAN ANTONIO, TEXAS AND DESIGN. INT. CL. 42. REG. 12-13-1983.
- 1,261,286. PDAP. INT. CL. 42. REG. 12-13-1983.
- 1,261,290. THE PIZZA CHARIOT INC. FREE DELIVERY AND DESIGN. INT. CL. 42. REG. 12-13-1983.
- 1,261,298. QUALITY INN AND DESIGN. INT. CL. 42. REG. 12-13-1983.
- 1,261,299. F AND DESIGN. INT. CL. 42. REG. 12-13-1983.
- 1,261,301. QQ (STYLIZED). INT. CL. 42. REG. 12-13-1983.
- 1,261,302. DOUBLE Q. INT. CL. 42. REG. 12-13-1983.
- 1,261,303. QUAL-I-QUICK. INT. CL. 42. REG. 12-13-1983.
- 1,261,305. MISCELLANEOUS DESIGN. INT. CL. 42. REG. 12-13-1983.
- 1,261,308. PERSONAL BEST. INT. CL. 42. REG. 12-13-1983.
- 1,261,310. ECONO LODGE SPEND A NIGHT, NOT A FORTUNE AND DESIGN. INT. CL. 42. REG. 12-13-1983.
- 1,261,311. TEXIAN INN. INT. CL. 42. REG. 12-13-1983.
- 1,261,323. POLISH. U.S. CL. A. REG. 12-13-1983.
- 1,261,326. COMPUTER LAW ADVISERS. INT. CLS. 16, 41 AND 42. REG. 12-13-1983.
- 1,261,329. THAT NEW CAR SMELL. INT. CL. 5. REG. 12-13-1983.
- 1,261,339. LOADWEIGH (STYLIZED). INT. CL. 9. REG. 12-13-1983.
- 1,261,343. CABLESHARE. INT. CL. 9. REG. 12-13-1983.
- 1,261,349. FLORIDA TRENDLINE. INT. CL. 16. REG. 12-13-1983.
- 1,261,357. ASSAY'S. INT. CL. 35. REG. 12-13-1983.
- 1,261,359. QWIK-DIP. INT. CL. 40. REG. 12-13-1983.
- 1,266,036. CEDA. INT. CLS. 1 AND 42 ONLY. REG. 2-7-1984.
- 1,267,565. RED & WHITE. INT. CLS. 3 AND 5 ONLY. REG. 2-21-1984.
- 1,288,626. ESCHER WYSS. INT. CLS. 6, 7 AND 9 ONLY. REG. 8-7-1984.
- 1,288,979. MISCELLANEOUS DESIGN. INT. CL. 16 ONLY. REG. 8-7-1984.
- 1,289,985. MR. GOODBAR. INT. CLS. 14, 16, 20, 25, 27 AND 28 ONLY. REG. 8-14-1984.
- 1,290,461. MISCELLANEOUS DESIGN. INT. CL. 42 ONLY. REG. 8-14-1984.
- 1,592,088. EAGLE ROCK. INT. CL. 25. REG. 4-17-1990.
- 1,740,559. CYCO SYSTEM. INT. CL. 12. REG. 12-15-1992.
- 1,793,193. HART PROBE HIGH ASPECT RATIO TIP AND DESIGN. INT. CL. 9. REG. 9-14-1993.
- 1,810,327. HIGHN (STYLIZED). INT. CL. 1. REG. 12-14-1993.
- 1,810,339. DESOGRAPH. INT. CL. 1. REG. 12-14-1993.
- 1,810,346. DELVOLASE. INT. CL. 1. REG. 12-14-1993.
- 1,810,356. DIATEC. INT. CL. 1. REG. 12-14-1993.
- 1,810,370. ULTRA GLAZE. INT. CL. 3. REG. 12-14-1993.
- 1,810,387. BILANGE. INT. CL. 3. REG. 12-14-1993.
- 1,810,389. BEYOND-2002. INT. CL. 3. REG. 12-14-1993.
- 1,810,390. BEYOND-2003. INT. CL. 3. REG. 12-14-1993.
- 1,810,392. LUSTRE GROOM. INT. CL. 3. REG. 12-14-1993.
- 1,810,394. CASTOR G.R.O.. INT. CL. 3. REG. 12-14-1993.
- 1,810,395. DIAMOND DROPS. INT. CL. 3. REG. 12-14-1993.
- 1,810,432. LIVING SLENDER (STYLIZED). INT. CL. 5. REG. 12-14-1993.
- 1,810,441. MISCELLANEOUS DESIGN. INT. CL. 6. REG. 12-14-1993.
- 1,810,446. CASTER CONNECTION. INT. CLS. 6 AND 20. REG. 12-14-1993.
- 1,810,456. MCNALLY WELLMAN. INT. CLS. 7, 11, 40 AND 42. REG. 12-14-1993.
- 1,810,457. UHING LINEAR DRIVE. INT. CL. 7. REG. 12-14-1993.
- 1,810,464. RCI PURIFIER AND DESIGN. INT. CL. 7. REG. 12-14-1993.
- 1,810,470. THE GB LINE. INT. CL. 7. REG. 12-14-1993.
- 1,810,474. THE PUMPKIN PATCH KID. INT. CL. 8. REG. 12-14-1993.
- 1,810,478. TRUE DRIVE AND DESIGN. INT. CL. 8. REG. 12-14-1993.
- 1,810,479. TRUECRAFT 2000. INT. CL. 8. REG. 12-14-1993.
- 1,810,487. DATPAK. INT. CL. 9. REG. 12-14-1993.
- 1,810,491. MICROMASTER. INT. CL. 9. REG. 12-14-1993.
- 1,810,493. PATHLINE. INT. CL. 9. REG. 12-14-1993.
- 1,810,494. DATATRAK. INT. CL. 9. REG. 12-14-1993.
- 1,810,503. GATEWAY 2000. INT. CL. 9. REG. 12-14-1993.
- 1,810,506. MTI UNISTAK AND DESIGN. INT. CL. 9. REG. 12-14-1993.
- 1,810,516. ADVANTAGE!. INT. CL. 9. REG. 12-14-1993.
- 1,810,528. KID PIX. INT. CL. 9. REG. 12-14-1993.
- 1,810,535. SPARCSTATION. INT. CL. 9. REG. 12-14-1993.
- 1,810,538. SCIENCE CAPSULE. INT. CL. 9. REG. 12-14-1993.
- 1,810,545. TOLERANT. INT. CL. 9. REG. 12-14-1993.
- 1,810,550. READQ REALTIME. INT. CL. 9. REG. 12-14-1993.
- 1,810,553. DESIGNEXPERT. INT. CL. 9. REG. 12-14-1993.
- 1,810,563. MCAD. INT. CL. 9. REG. 12-14-1993.
- 1,810,579. TRAILBLAZER. INT. CL. 9. REG. 12-14-1993.
- 1,810,586. STARLETS. INT. CL. 9. REG. 12-14-1993.
- 1,810,596. RIOT RECORDS (STYLIZED). INT. CL. 9. REG. 12-14-1993.
- 1,810,600. HYPERBOLE. INT. CL. 9. REG. 12-14-1993.
- 1,810,603. ROCKITS. INT. CL. 9. REG. 12-14-1993.
- 1,810,615. MOORE COMPASS. INT. CLS. 9 AND 35. REG. 12-14-1993.
- 1,810,616. SERVOWARE. INT. CL. 9. REG. 12-14-1993.
- 1,810,617. ACCUDATA. INT. CL. 9. REG. 12-14-1993.
- 1,810,619. HRT. INT. CL. 9. REG. 12-14-1993.
- 1,810,620. MISCELLANEOUS DESIGN. INT. CL. 9. REG. 12-14-1993.
- 1,810,625. CORAL REEF. INT. CL. 9. REG. 12-14-1993.
- 1,810,626. BULLS-EYE. INT. CL. 9. REG. 12-14-1993.
- 1,810,630. MISCELLANEOUS DESIGN. INT. CL. 10. REG. 12-14-1993.
- 1,810,634. BIO-SKIN. INT. CL. 10. REG. 12-14-1993.
- 1,810,655. CLEAR SOURCE. INT. CL. 11. REG. 12-14-1993.
- 1,810,660. VOUGHT AIRCRAFT. INT. CL. 12. REG. 12-14-1993.
- 1,810,665. FK-06M. INT. CL. 12. REG. 12-14-1993.
- 1,810,668. UNITED PARTS AND DESIGN. INT. CL. 12. REG. 12-14-1993.
- 1,810,670. SL2. INT. CL. 12. REG. 12-14-1993.
- 1,810,684. MISCELLANEOUS DESIGN. INT. CL. 14. REG. 12-14-1993.
- 1,810,686. EATING WELL THE MAGAZINE OF FOOD & HEALTH AND DESIGN. INT. CL. 16. REG. 12-14-1993.
- 1,810,687. MEGAKRAFT. INT. CL. 16. REG. 12-14-1993.
- 1,810,692. PRIME CABLE. INT. CL. 16. REG. 12-14-1993.
- 1,810,693. MISCELLANEOUS DESIGN. INT. CLS. 16, 21 AND 25. REG. 12-14-1993.
- 1,810,703. AS I SEE IT. INT. CL. 16. REG. 12-14-1993.
- 1,810,723. POWER WRITING. INT. CL. 16. REG. 12-14-1993.
- 1,810,724. MISCELLANEOUS DESIGN. INT. CLS. 16 AND 25. REG. 12-14-1993.
- 1,810,730. THE FITNESS BUDDY THE WAY TO DO IT. INT. CL. 16. REG. 12-14-1993.
- 1,810,734. QUICKPRO (STYLIZED). INT. CL. 16. REG. 12-14-1993.
- 1,810,737. NRSV (STYLIZED). INT. CL. 16. REG. 12-14-1993.

- 1,810,745. MISCELLANEOUS DESIGN. INT. CL. 16. REG. 12-14-1993.
- 1,810,747. WE BRING THE PAST TO THE PRESENT. INT. CL. 16. REG. 12-14-1993.
- 1,810,751. DATARAM - THE MEMORY SPECIALISTS. INT. CL. 16. REG. 12-14-1993.
- 1,810,760. SKID RODENTS AND DESIGN. INT. CL. 16. REG. 12-14-1993.
- 1,810,765. AS SCENE BY SUE AND DESIGN. INT. CL. 16. REG. 12-14-1993.
- 1,810,766. INTERPHARM. INT. CL. 16. REG. 12-14-1993.
- 1,810,774. ACCUSIL AND DESIGN. INT. CL. 17. REG. 12-14-1993.
- 1,810,784. CIDEC AND DESIGN. INT. CL. 18. REG. 12-14-1993.
- 1,810,788. EXCEL BOARD. INT. CL. 19. REG. 12-14-1993.
- 1,810,796. MISCELLANEOUS DESIGN. INT. CL. 20. REG. 12-14-1993.
- 1,810,800. COPE. INT. CL. 20. REG. 12-14-1993.
- 1,810,809. ARTIST'S CHOICE FUNDAMENTALS AND DESIGN. INT. CL. 21. REG. 12-14-1993.
- 1,810,811. CONAIR SUPREME. INT. CL. 21. REG. 12-14-1993.
- 1,810,822. TUFF STUFF U.S.A.. INT. CL. 24. REG. 12-14-1993.
- 1,810,830. HOUSTON OUTLAWS. INT. CL. 25. REG. 12-14-1993.
- 1,810,834. BRACEASURUS. INT. CL. 25. REG. 12-14-1993.
- 1,810,840. SCRIBE HAND-MADE BY BALLY (STYLIZED). INT. CL. 25. REG. 12-14-1993.
- 1,810,851. M MCDONALD'S RACING TEAM AND DESIGN. INT. CL. 25. REG. 12-14-1993.
- 1,810,858. JANET HOWARD. INT. CL. 25. REG. 12-14-1993.
- 1,810,878. MAGIC MARBLE. INT. CL. 27. REG. 12-14-1993.
- 1,810,881. CORY THE CLOWN AND DESIGN. INT. CL. 28. REG. 12-14-1993.
- 1,810,883. VERTEX (STYLIZED). INT. CL. 28. REG. 12-14-1993.
- 1,810,894. MARRIED! "THE GAME OF MARRIAGE AND MONEY" (STYLIZED). INT. CL. 28. REG. 12-14-1993.
- 1,810,897. CALIFORNIA STATE UNIVERSITY SACRAMENTO. INT. CL. 28. REG. 12-14-1993.
- 1,810,898. CSUS. INT. CL. 28. REG. 12-14-1993.
- 1,810,907. SKI WINGS AND DESIGN. INT. CL. 28. REG. 12-14-1993.
- 1,810,909. H HIGHLANDER GOLF AND DESIGN. INT. CL. 28. REG. 12-14-1993.
- 1,810,910. PRECISION DART. INT. CL. 28. REG. 12-14-1993.
- 1,810,927. STAY SLIM. INT. CLS. 29 AND 41. REG. 12-14-1993.
- 1,810,934. MISCELLANEOUS DESIGN. INT. CL. 29. REG. 12-14-1993.
- 1,810,942. MISCELLANEOUS DESIGN. INT. CL. 29. REG. 12-14-1993.
- 1,810,952. COW PUDDLES. INT. CL. 30. REG. 12-14-1993.
- 1,810,959. MISCELLANEOUS DESIGN. INT. CL. 30. REG. 12-14-1993.
- 1,810,960. CHIN CHIN AND DESIGN. INT. CL. 30. REG. 12-14-1993.
- 1,810,963. ADVENTURE FOODS. INT. CL. 30. REG. 12-14-1993.
- 1,810,964. CARLO. INT. CLS. 30 AND 32. REG. 12-14-1993.
- 1,810,966. DAVE'S DELUXE. INT. CL. 30. REG. 12-14-1993.
- 1,810,970. KINGINSENG. INT. CL. 30. REG. 12-14-1993.
- 1,810,989. BAKE 'N RIZE. INT. CL. 30. REG. 12-14-1993.
- 1,810,992. BUNNY BRUNCH. INT. CL. 31. REG. 12-14-1993.
- 1,810,993. GENETIPORK AND DESIGN. INT. CL. 31. REG. 12-14-1993.
- 1,810,997. TWITTY BIRD. INT. CL. 31. REG. 12-14-1993.
- 1,811,003. AL'S BEVERAGE COMPANY "THAT HITS THE SPOT." "YOU CAN CALL ME AL." AND DESIGN. INT. CL. 32. REG. 12-14-1993.
- 1,811,005. KNOCK OUT PUNCH. INT. CL. 32. REG. 12-14-1993.
- 1,811,021. R AND DESIGN. INT. CLS. 35 AND 41. REG. 12-14-1993.
- 1,811,022. OHM. INT. CLS. 35 AND 42. REG. 12-14-1993.
- 1,811,033. FREIGHTVIEW. INT. CL. 35. REG. 12-14-1993.
- 1,811,034. ATS TECHNICAL SERVICES. INT. CL. 35. REG. 12-14-1993.
- 1,811,040. STARBRIGHT AND DESIGN. INT. CLS. 35 AND 42. REG. 12-14-1993.
- 1,811,046. TOWER GROUP INTERNATIONAL. INT. CLS. 35, 36 AND 39. REG. 12-14-1993.
- 1,811,053. QUALITY BRIDGING. INT. CL. 35. REG. 12-14-1993.
- 1,811,054. GILBREATH'S (STYLIZED). INT. CLS. 35 AND 41. REG. 12-14-1993.
- 1,811,061. MISCELLANEOUS DESIGN. INT. CL. 35. REG. 12-14-1993.
- 1,811,062. CCA AND DESIGN. INT. CL. 35. REG. 12-14-1993.
- 1,811,065. BECAUSE...BUSINESS CAN'T WAIT. INT. CL. 35. REG. 12-14-1993.
- 1,811,078. THE GIFT FOR A LIFETIME. INT. CL. 36. REG. 12-14-1993.
- 1,811,080. EFS AND DESIGN. INT. CL. 36. REG. 12-14-1993.
- 1,811,084. MISCELLANEOUS DESIGN. INT. CL. 36. REG. 12-14-1993.
- 1,811,092. AMERICAN CAPITAL RESOURCES INC.. INT. CL. 36. REG. 12-14-1993.
- 1,811,115. FLOWDRIL. INT. CL. 37. REG. 12-14-1993.
- 1,811,120. G-T SPORTS (STYLIZED). INT. CL. 37. REG. 12-14-1993.
- 1,811,132. QUIK SHIP. INT. CL. 39. REG. 12-14-1993.
- 1,811,141. J JAPAN & ORIENT TOURS AND DESIGN. INT. CL. 39. REG. 12-14-1993.
- 1,811,152. MEDI-GARD. INT. CL. 40. REG. 12-14-1993.
- 1,811,158. NW NATIONAL WESTERN (STYLIZED). INT. CL. 41. REG. 12-14-1993.
- 1,811,159. BOOGIE BASH. INT. CL. 41. REG. 12-14-1993.
- 1,811,177. BREAKTHROUGH THINKER (STYLIZED). INT. CLS. 41 AND 42. REG. 12-14-1993.
- 1,811,209. NUTRIPROS, INC.. INT. CL. 42. REG. 12-14-1993.
- 1,811,212. R AND DESIGN. INT. CL. 42. REG. 12-14-1993.
- 1,811,219. TAPESTRY BOOKS AND DESIGN. INT. CL. 42. REG. 12-14-1993.
- 1,811,231. PAN-MACEDONIAN ASSOCIATION. INT. CL. 42. REG. 12-14-1993.
- 1,811,241. TOOL CLUB ETC. INT. CL. 42. REG. 12-14-1993.
- 1,811,247. ROCHE RESPONSE CENTER. INT. CL. 42. REG. 12-14-1993.
- 1,811,250. SOUTH FLORIDA BRAIN TUMOR ASSOCIATION AND DESIGN. INT. CL. 42. REG. 12-14-1993.
- 1,811,260. GOOD PEOPLE, GOOD PRODUCTS, GOOD PRICES.. INT. CL. 42. REG. 12-14-1993.
- 1,811,261. CULTURAL INTRIGUE (STYLIZED). INT. CL. 42. REG. 12-14-1993.
- 1,811,266. PAL. INT. CL. 42. REG. 12-14-1993.
- 1,811,270. LITTLE CAESARS PIZZA! PIZZA! CRAZY KIDS AND DESIGN. INT. CL. 42. REG. 12-14-1993.
- 1,811,280. CB AND DESIGN. INT. CL. 42. REG. 12-14-1993.
- 1,811,286. MISCELLANEOUS DESIGN. INT. CL. 42. REG. 12-14-1993.
- 1,811,293. GB AND DESIGN. INT. CL. 42. REG. 12-14-1993.
- 1,811,295. DR. B. WELL NATURALLY! AND DESIGN. INT. CL. 42. REG. 12-14-1993.
- 1,811,310. WINNEBAGO SOFTWARE COMPANY. INT. CL. 42. REG. 12-14-1993.
- 1,811,313. PETITBON'S AMERICAN GRILL AND BAR AND DESIGN. INT. CL. 42. REG. 12-14-1993.
- 1,811,332. WINNWELL. INT. CLS. 25 AND 28. REG. 12-14-1993.
- 1,811,341. FOOD FROM SWEDEN AND DESIGN. INT. CLS. 29, 30, 31 AND 32. REG. 12-14-1993.
- 1,811,346. HOSTELLING INTERNATIONAL AND DESIGN. INT. CLS. 39, 41 AND 42. REG. 12-14-1993.
- 1,811,351. IMERGY. INT. CLS. 9 AND 42. REG. 12-14-1993.
- 1,811,352. LEARNINGPLUS. INT. CLS. 9, 16 AND 42. REG. 12-14-1993.
- 1,811,354. PRITIKIN. INT. CLS. 29 AND 30. REG. 12-14-1993.
- 1,811,364. MOISTURE MAGNET. INT. CL. 1. REG. 12-14-1993.
- 1,811,381. MISCELLANEOUS DESIGN. INT. CL. 3. REG. 12-14-1993.
- 1,811,382. MICRO MAID. INT. CL. 3. REG. 12-14-1993.

- 1,811,405. V DESIGN AND DESIGN. INT. CL. 5. REG. 12-14-1993.
- 1,811,407. ADPRIN B. INT. CL. 5. REG. 12-14-1993.
- 1,811,408. FLEX SPIN. INT. CL. 6. REG. 12-14-1993.
- 1,811,410. MICROBRITE. INT. CL. 7. REG. 12-14-1993.
- 1,811,417. WATERLIFT. INT. CL. 7. REG. 12-14-1993.
- 1,811,418. MAXLIFE. INT. CL. 7. REG. 12-14-1993.
- 1,811,419. AKAFLEX. INT. CL. 7. REG. 12-14-1993.
- 1,811,424. CORE AND DESIGN. INT. CL. 9. REG. 12-14-1993.
- 1,811,426. NMCS 2500. INT. CL. 9. REG. 12-14-1993.
- 1,811,427. PHASEKRYPT. INT. CL. 9. REG. 12-14-1993.
- 1,811,428. AUTOSYNC. INT. CL. 9. REG. 12-14-1993.
- 1,811,463. TAKE-A-WEIGH. INT. CL. 9. REG. 12-14-1993.
- 1,811,467. SPIN TIL YOU WIN. INT. CL. 9. REG. 12-14-1993.
- 1,811,472. EPIC. INT. CL. 9. REG. 12-14-1993.
- 1,811,480. TECHPETTE. INT. CL. 9. REG. 12-14-1993.
- 1,811,482. DORIAN DISCOVERY AND DESIGN. INT. CL. 9. REG. 12-14-1993.
- 1,811,485. MASKPE. INT. CL. 9. REG. 12-14-1993.
- 1,811,494. ON CALL. INT. CL. 10. REG. 12-14-1993.
- 1,811,501. FURNLUX. INT. CL. 11. REG. 12-14-1993.
- 1,811,505. TRACKSPOT. INT. CL. 11. REG. 12-14-1993.
- 1,811,512. JEAN MAURICE. INT. CL. 14. REG. 12-14-1993.
- 1,811,524. VINEYARD REVIEW. INT. CL. 16. REG. 12-14-1993.
- 1,811,529. SCRIPTGUARD. INT. CL. 16. REG. 12-14-1993.
- 1,811,533. CHELSEA. INT. CL. 16. REG. 12-14-1993.
- 1,811,544. QUICK FILE. INT. CL. 19. REG. 12-14-1993.
- 1,811,560. STICK-FREE. INT. CL. 21. REG. 12-14-1993.
- 1,811,563. POLARSERIES. INT. CL. 24. REG. 12-14-1993.
- 1,811,567. AXIDURE. INT. CL. 25. REG. 12-14-1993.
- 1,811,573. ARROW COLLARS & SHIRTS FOR DRESS AND DESIGN. INT. CL. 25. REG. 12-14-1993.
- 1,811,586. DA FLEX. INT. CL. 25. REG. 12-14-1993.
- 1,811,590. SUMMER CAMP. INT. CL. 25. REG. 12-14-1993.
- 1,811,591. BLUE-STONE. INT. CL. 25. REG. 12-14-1993.
- 1,811,595. FIESTA TEXAS. INT. CL. 26. REG. 12-14-1993.
- 1,811,603. FRONT PAGE SPORTS. INT. CL. 28. REG. 12-14-1993.
- 1,811,612. CHAM. INT. CL. 28. REG. 12-14-1993.
- 1,811,617. DAYS OF THUNDER. INT. CL. 28. REG. 12-14-1993.
- 1,811,624. BEAUTY AND THE BEAST. INT. CL. 29. REG. 12-14-1993.
- 1,811,626. APPLE TIME AND DESIGN. INT. CL. 29. REG. 12-14-1993.
- 1,811,627. FOUNDERS CHOICE. INT. CL. 29. REG. 12-14-1993.
- 1,811,643. MISHICOT. INT. CL. 32. REG. 12-14-1993.
- 1,811,644. YEAST LAB. INT. CL. 32. REG. 12-14-1993.
- 1,811,665. RAPID ROTATION. INT. CL. 37. REG. 12-14-1993.
- 1,811,669. CCI (STYLIZED). INT. CL. 40. REG. 12-14-1993.
- 1,811,683. USA LENS. INT. CL. 42. REG. 12-14-1993.
- 1,811,695. AT HOME IN HAWAII. INT. CL. 42. REG. 12-14-1993.
- 1,811,700. BRAUER. INT. CL. 5. REG. 12-14-1993.
- 1,811,710. CAR TAPES (STYLIZED). INT. CL. 9. REG. 12-14-1993.
- 1,811,718. MANAGED CARE UPDATE AND DESIGN. INT. CL. 16. REG. 12-14-1993.
- 1,811,720. THE HOSTEL HANDBOOK. INT. CL. 16. REG. 12-14-1993.
- 1,811,723. SELECTED FAVORITE NAMES HERE AND DESIGN. INT. CL. 25. REG. 12-14-1993.
- 1,811,724. BENT NECK. INT. CL. 28. REG. 12-14-1993.
- 1,819,569. TOP BENDER. INT. CL. 8 ONLY. REG. 2-1-1994.
- 1,848,858. GROUP USA. INT. CL. 14 ONLY. REG. 8-9-1994.
- 1,849,745. PHARMCO. INT. CLS. 3 AND 5 ONLY. REG. 8-16-1994.
- 1,850,150. SEBASTIAN COLLECTIVE SALON MEMBER. INT. CL. 41 ONLY. REG. 8-16-1994.
- 1,856,603. ROSE PARADE. INT. CLS. 9 AND 16 ONLY. REG. 10-4-1994.
- 1,856,727. LAMBS FARM. INT. CLS. 16 AND 31 ONLY. REG. 10-4-1994.
- 1,864,550. MISCELLANEOUS DESIGN. INT. CLS. 16 AND 28 ONLY. REG. 11-29-1994.
- 1,868,014. MALL OF AMERICA. INT. CLS. 37 AND 42 ONLY. REG. 12-20-1994.
- 1,872,878. PHILADELPHIA HEART INSTITUTE. INT. CL. 41 ONLY. REG. 1-10-1995.
- 1,886,507. ASSURED RELEASE AND DESIGN. INT. CL. 5. REG. 3-28-1995.
- 2,004,596. MD EXPLORER. INT. CL. 12. REG. 10-1-1996.
- 2,036,423. SUB ZERO. INT. CL. 33. REG. 2-11-1997.
- 2,063,969. ATLAS. INT. CL. 28. REG. 5-20-1997.
- 2,104,945. DYNAREP. INT. CL. 9. REG. 10-14-1997.
- 2,120,658. CANGENUS. INT. CL. 5. REG. 12-16-1997.
- 2,120,660. MB KIDS CLUB AND DESIGN. INT. CL. 25. REG. 12-16-1997.
- 2,120,661. LOVAG LVA (STYLIZED). INT. CLS. 7, 9, 16 AND 42. REG. 12-16-1997.
- 2,120,663. ADIRONDACK CHOCOLATES. INT. CL. 30. REG. 12-16-1997.
- 2,120,666. MONDO AND DESIGN. INT. CL. 28. REG. 12-16-1997.
- 2,120,667. MONDO AND DESIGN. INT. CL. 28. REG. 12-16-1997.
- 2,120,669. MORE THAN JUST A ZIP CODE. A DRESS CODE. INT. CL. 25. REG. 12-16-1997.
- 2,120,671. GLOWATCH. INT. CL. 14. REG. 12-16-1997.
- 2,120,673. MICROPARTS AND DESIGN. INT. CLS. 7, 9, 10 AND 14. REG. 12-16-1997.
- 2,120,680. BAIGISH. INT. CL. 9. REG. 12-16-1997.
- 2,120,681. THE WILD WEST AT ITS BEST. INT. CLS. 39, 41 AND 42. REG. 12-16-1997.
- 2,120,682. PERZIRON. INT. CL. 5. REG. 12-16-1997.
- 2,120,684. SEGA STEERING WHEEL. INT. CL. 9. REG. 12-16-1997.
- 2,120,685. OPTIUM. INT. CL. 7. REG. 12-16-1997.
- 2,120,686. THE MONARCH APPROACH AND DESIGN. INT. CL. 42. REG. 12-16-1997.
- 2,120,691. LE CAFE AND DESIGN. INT. CLS. 29 AND 30. REG. 12-16-1997.
- 2,120,692. POISON TUBE. INT. CL. 28. REG. 12-16-1997.
- 2,120,693. POISON. INT. CL. 28. REG. 12-16-1997.
- 2,120,694. THE SLEEPY FROG. INT. CLS. 9 AND 16. REG. 12-16-1997.
- 2,120,697. RACHEL B. INT. CL. 42. REG. 12-16-1997.
- 2,120,699. ODYSSEY. INT. CL. 16. REG. 12-16-1997.
- 2,120,700. 99.9% RELIABLE. INT. CL. 38. REG. 12-16-1997.
- 2,120,701. TACHOCOMB. INT. CL. 5. REG. 12-16-1997.
- 2,120,702. ELLE (STYLIZED). INT. CLS. 5, 29, 32 AND 33. REG. 12-16-1997.
- 2,120,704. LOLA. INT. CL. 9. REG. 12-16-1997.
- 2,120,706. AMOR. INT. CL. 30. REG. 12-16-1997.
- 2,120,707. TIGER INTERACTIVE. INT. CL. 9. REG. 12-16-1997.
- 2,120,708. MISCELLANEOUS DESIGN. INT. CL. 9. REG. 12-16-1997.
- 2,120,709. MINIT AND DESIGN. INT. CLS. 35, 37, 40 AND 42. REG. 12-16-1997.
- 2,120,710. FASHION TRENDS. INT. CL. 6. REG. 12-16-1997.
- 2,120,712. SCANATURA (STYLIZED). INT. CL. 20. REG. 12-16-1997.
- 2,120,713. CEASE FIRE CHILDREN'S DEFENSE FUND AND FRIENDS AND DESIGN. INT. CL. 42. REG. 12-16-1997.
- 2,120,715. SUN-DANCE. INT. CL. 9. REG. 12-16-1997.
- 2,120,722. MULTIVOICE. INT. CL. 9. REG. 12-16-1997.
- 2,120,723. INTEGRATED AGRICULTURAL CONCEPT BY CANADIAN AGRA CORPORATION WORLD MARKET PRODUCTION OF AGRICULTURAL CROPS AND RAW MATERIALS PRODUCTS PROCESSING PROCESSING OF AGRICULTURAL CROPS AND RAW MATERIALS VALUE ADDED PRODUCTS MARKETING MARKETING OF VALUE ADDED AGRICULTURALLY BASED PRODUCTS COMMUNICATION AND COORDINATION AND DESIGN. INT. CL. 42. REG. 12-16-1997.
- 2,120,727. TITAN. INT. CL. 28. REG. 12-16-1997.

- 2,120,728. THE MSA THE MEDICAL SAVINGS ACCOUNT FROM GOLDEN RULE INSURANCE AND DESIGN. INT. CL. 36. REG. 12-16-1997.
- 2,120,729. LIVING FOOD AND DESIGN. INT. CL. 5. REG. 12-16-1997.
- 2,120,730. INSTANT IMPACT ANYWHERE. INT. CLS. 20 AND 37. REG. 12-16-1997.
- 2,120,731. MESNEL AND DESIGN. INT. CL. 17. REG. 12-16-1997.
- 2,120,733. WE'RE SPRINTERS FOR PRINTERS. INT. CL. 39. REG. 12-16-1997.
- 2,120,741. TIDEWATER HEALTHCARE SHARED SERVICES GROUP. INT. CLS. 35 AND 42. REG. 12-16-1997.
- 2,120,742. ROBOLABE. INT. CL. 7. REG. 12-16-1997.
- 2,120,744. CONNECTIONS. INT. CL. 35. REG. 12-16-1997.
- 2,120,745. VIEWFAX. INT. CL. 9. REG. 12-16-1997.
- 2,120,746. 3-D VISUAL AND DESIGN. INT. CL. 16. REG. 12-16-1997.
- 2,120,750. CASCADE. INT. CL. 6. REG. 12-16-1997.
- 2,120,751. SMART CHECKING. INT. CL. 36. REG. 12-16-1997.
- 2,120,752. BOSCH. INT. CL. 41. REG. 12-16-1997.
- 2,120,753. O TN AND DESIGN. INT. CL. 42. REG. 12-16-1997.
- 2,120,754. UTS (STYLIZED). INT. CLS. 35 AND 42. REG. 12-16-1997.
- 2,120,756. TASTEFUL!. INT. CL. 30. REG. 12-16-1997.
- 2,120,758. MISCELLANEOUS DESIGN. INT. CL. 17. REG. 12-16-1997.
- 2,120,759. PCS WIRELESS AND DESIGN. INT. CL. 9. REG. 12-16-1997.
- 2,120,765. LAURENE'S LOVE AND DESIGN. INT. CL. 9. REG. 12-16-1997.
- 2,120,767. PPP PAY PER PRINT AND DESIGN. INT. CLS. 7, 9, 35 AND 42. REG. 12-16-1997.
- 2,120,768. ISHC INTERNATIONAL SOCIETY OF HOSPITALITY CONSULTANTS AND DESIGN. INT. CL. 42. REG. 12-16-1997.
- 2,120,771. HYBRIDMEDIA. INT. CL. 42. REG. 12-16-1997.
- 2,120,772. ESI ENERGY. INT. CLS. 35, 36, 37 AND 42. REG. 12-16-1997.
- 2,120,774. KINECODE. INT. CLS. 9 AND 42. REG. 12-16-1997.
- 2,120,775. RESCUE & RESTORE. INT. CL. 5. REG. 12-16-1997.
- 2,120,779. TRENDSETTER 2000. INT. CL. 9. REG. 12-16-1997.
- 2,120,780. DVA RADIAL. INT. CL. 12. REG. 12-16-1997.
- 2,120,781. RADIAL DMF. INT. CL. 12. REG. 12-16-1997.
- 2,120,782. REO. INT. CL. 25. REG. 12-16-1997.
- 2,120,783. PETER MATHIAS SPENDRUP 1747 - 1827 LOUIS HERBERT SPENDRUP 1886 - 1972 SPENDRUP'S OF SWEDEN AND DESIGN. INT. CL. 32. REG. 12-16-1997.
- 2,120,785. MISCELLANEOUS DESIGN. INT. CL. 9. REG. 12-16-1997.
- 2,120,786. FAMILY CHOICE. INT. CLS. 11 AND 21. REG. 12-16-1997.
- 2,120,787. MAVIN THE MULTI-AGENCY VOICE AND INFORMATION NETWORK AND DESIGN. INT. CL. 42. REG. 12-16-1997.
- 2,120,795. KITCHEN KING AND DESIGN. INT. CL. 30. REG. 12-16-1997.
- 2,120,797. VISIONS. INT. CL. 9. REG. 12-16-1997.
- 2,120,798. E EPITAPH AND DESIGN. INT. CL. 9. REG. 12-16-1997.
- 2,120,801. CRAZY CORDS. INT. CL. 7. REG. 12-16-1997.
- 2,120,805. VECTRA GRAND TOUR (STYLIZED). INT. CL. 12. REG. 12-16-1997.
- 2,120,807. WORLD EQUINE HEALTH NETWORK AND DESIGN. INT. CL. 16. REG. 12-16-1997.
- 2,120,808. REDFIELD LABORATORIES. INT. CL. 42. REG. 12-16-1997.
- 2,120,809. YOUR GATEWAY TO THE INFORMATION AGE. INT. CLS. 38 AND 42. REG. 12-16-1997.
- 2,120,810. TECHNOLOGY SENSIBLY APPLIED. INT. CLS. 38 AND 42. REG. 12-16-1997.
- 2,120,813. THE PEP BOYS MANNY MOE & JACK AND DESIGN. INT. CL. 24. REG. 12-16-1997.
- 2,120,814. ACCSCT ACCREDITING COMMISSION OF CAREER SCHOOLS AND COLLEGES OF TECHNOLOGY AND DESIGN. INT. CL. 42. REG. 12-16-1997.
- 2,120,817. KLS CORP.. INT. CL. 9. REG. 12-16-1997.
- 2,120,818. ELECTRIC LIBRARY. INT. CLS. 9 AND 38. REG. 12-16-1997.
- 2,120,827. BEAUTIFUL BOTTOMS COLLECTION. INT. CL. 25. REG. 12-16-1997.
- 2,120,828. WORLD ACCESS SERVICE CORPORATION AND DESIGN. INT. CLS. 35, 36, 39 AND 42. REG. 12-16-1997.
- 2,120,829. A AND DESIGN. INT. CL. 3. REG. 12-16-1997.
- 2,120,831. U.S. SATELLITE BROADCASTING. INT. CL. 38. REG. 12-16-1997.
- 2,120,833. ADN. INT. CL. 42. REG. 12-16-1997.
- 2,120,835. ADN AMERICAN DIGITAL NETWORK. INT. CL. 42. REG. 12-16-1997.
- 2,120,840. FRANKIE TOMATTO'S ALL YOU CAN EAT ITALIAN FEAST. INT. CL. 42. REG. 12-16-1997.
- 2,120,841. WEBPLANET. INT. CL. 9. REG. 12-16-1997.
- 2,120,843. KAMIK VTF. INT. CL. 25. REG. 12-16-1997.
- 2,120,845. PCI TRANSAID (STYLIZED). INT. CLS. 7, 12 AND 16. REG. 12-16-1997.
- 2,120,846. MISCELLANEOUS DESIGN. INT. CL. 41. REG. 12-16-1997.
- 2,120,848. IDENTOFLEX AND DESIGN. INT. CL. 10. REG. 12-16-1997.
- 2,120,850. H R BRITE. INT. CL. 6. REG. 12-16-1997.
- 2,120,852. FUNDBASE. INT. CL. 36. REG. 12-16-1997.
- 2,120,853. FLOORSHIELD. INT. CL. 27. REG. 12-16-1997.
- 2,120,858. INFOSORT. INT. CL. 9. REG. 12-16-1997.
- 2,120,859. GIRSYSTEM THIS CHASSIS EQUIPPED WITH GIRSYSTEM GLOBAL INTERFERENCE REDUCTION SYSTEM AND DESIGN. INT. CL. 9. REG. 12-16-1997.
- 2,120,860. WARRIOR SPIRIT AND DESIGN. INT. CLS. 9 AND 41. REG. 12-16-1997.
- 2,120,862. INTHEMA. INT. CL. 25. REG. 12-16-1997.
- 2,120,864. FILTRATION UVSTABLE AND DESIGN. INT. CL. 3. REG. 12-16-1997.
- 2,120,866. TENNENT'S SUPER STRONG LAGER J R TENNENT T 1885 AND DESIGN. INT. CL. 32. REG. 12-16-1997.
- 2,120,868. TRAVEL FLEX BY BAGIR. INT. CL. 25. REG. 12-16-1997.
- 2,120,874. NYSKA NATIONAL YOUTH SPORTS COACHES ASSOCIATION AND DESIGN. U.S. CL. 200. REG. 12-16-1997.
- 2,120,877. TRAVEL ONE. INT. CLS. 39 AND 42. REG. 12-16-1997.
- 2,120,878. TURBO DN. INT. CLS. 1, 11 AND 40. REG. 12-16-1997.
- 2,120,881. STRIKER AND DESIGN. INT. CL. 30. REG. 12-16-1997.
- 2,120,882. OSO HOTWATER AND DESIGN. INT. CL. 11. REG. 12-16-1997.
- 2,120,883. JANNA CONTACT. INT. CL. 9. REG. 12-16-1997.
- 2,120,884. LASSEN HAWAII AND DESIGN. INT. CL. 25. REG. 12-16-1997.
- 2,120,889. MORE THAN BOXES CORRUGATED SOLUTIONS. INT. CL. 40. REG. 12-16-1997.
- 2,120,891. JEWELRY REPAIRS BY US AND DESIGN. INT. CLS. 35 AND 37. REG. 12-16-1997.
- 2,120,892. POWERPERFORMANCE. INT. CL. 9. REG. 12-16-1997.
- 2,120,894. HOOK. INT. CL. 28. REG. 12-16-1997.
- 2,120,895. THE CD PHOTO LIBRARY AND DESIGN. INT. CL. 9. REG. 12-16-1997.
- 2,120,896. BIO RHIZ. INT. CL. 1. REG. 12-16-1997.
- 2,120,898. PC PROTECT. INT. CL. 36. REG. 12-16-1997.
- 2,120,902. TOWERSTACK. INT. CL. 16. REG. 12-16-1997.
- 2,120,903. LES RESIDENCES DE BERNARDAUD AND DESIGN. INT. CL. 21. REG. 12-16-1997.
- 2,120,904. EG&G AND DESIGN. INT. CLS. 6, 9, 11 AND 42. REG. 12-16-1997.
- 2,120,906. CYBEROFFICE. INT. CL. 9. REG. 12-16-1997.

- 2,120,908. BPANALYZER (STYLIZED). INT. CL. 9. REG. 12-16-1997.
- 2,120,914. SMOKEY. INT. CL. 9. REG. 12-16-1997.
- 2,120,915. OUTSOURCE AMERICA AND DESIGN. INT. CL. 36. REG. 12-16-1997.
- 2,120,917. SECURE IT. INT. CL. 22. REG. 12-16-1997.
- 2,120,918. C-C 105 AND DESIGN. INT. CL. 5. REG. 12-16-1997.
- 2,120,919. SYSTEMS INTEGRATION TECHKNOWLEDGY. INT. CL. 9. REG. 12-16-1997.
- 2,120,920. THE EDUCATION PARTNERSHIP. INT. CL. 41. REG. 12-16-1997.
- 2,120,924. PE/PROCESS MANAGER. INT. CL. 9. REG. 12-16-1997.
- 2,120,925. PE/PROCESS LIBRARY. INT. CL. 9. REG. 12-16-1997.
- 2,120,926. IHI INTERNATIONAL HERITAGE INCORPORATED AND DESIGN. INT. CLS. 16 AND 25. REG. 12-16-1997.
- 2,120,927. IHI AND DESIGN. INT. CLS. 16 AND 25. REG. 12-16-1997.
- 2,120,928. OME ORGANIZATIONAL MEASUREMENT & ENGINEERING AND DESIGN. INT. CL. 35. REG. 12-16-1997.
- 2,120,931. T'INGS JAMAICAN NO PROBLEM MON AND DESIGN. INT. CL. 30. REG. 12-16-1997.
- 2,120,934. HOUSE OF NOBILLO AND DESIGN. INT. CL. 33. REG. 12-16-1997.
- 2,120,935. NC-REN. INT. CLS. 38 AND 42. REG. 12-16-1997.
- 2,120,938. MISCELLANEOUS DESIGN. INT. CL. 9. REG. 12-16-1997.
- 2,120,944. BOYNE VALLEY WEAVERS. INT. CL. 25. REG. 12-16-1997.
- 2,120,947. MISCELLANEOUS DESIGN. INT. CLS. 37 AND 42. REG. 12-16-1997.
- 2,120,950. LHJ AND DESIGN. INT. CL. 42. REG. 12-16-1997.
- 2,120,952. T HISPANOAMERICAN BUSINESS PAGES AND DESIGN. INT. CLS. 16, 35 AND 38. REG. 12-16-1997.
- 2,120,953. FILL-A-GAP. INT. CL. 17. REG. 12-16-1997.
- 2,120,956. ARK WORKSPACE. INT. CL. 9. REG. 12-16-1997.
- 2,120,957. CALORITECH AND DESIGN. INT. CLS. 9, 40 AND 42. REG. 12-16-1997.
- 2,120,958. H AND DESIGN. INT. CL. 20. REG. 12-16-1997.
- 2,120,961. SENIORVARSITYBALL. INT. CL. 28. REG. 12-16-1997.
- 2,120,963. BROADWAY INTERACTIVE GROUP AND DESIGN. INT. CL. 41. REG. 12-16-1997.
- 2,120,968. VNA HEARTLINE AND DESIGN. INT. CL. 38. REG. 12-16-1997.
- 2,120,969. WOW AND DESIGN. INT. CL. 42. REG. 12-16-1997.
- 2,120,970. DRAUGHON PROFESSIONAL ASSOCIATION. INT. CL. 42. REG. 12-16-1997.
- 2,120,973. FCT AND DESIGN. INT. CL. 38. REG. 12-16-1997.
- 2,120,974. THE BIRD BUFFET AND DESIGN. INT. CL. 21. REG. 12-16-1997.
- 2,120,975. INFOPAL. INT. CL. 38. REG. 12-16-1997.
- 2,120,976. INFOVISION, INC. AND DESIGN. INT. CLS. 38 AND 42. REG. 12-16-1997.
- 2,120,978. ID TECH. INT. CL. 9. REG. 12-16-1997.
- 2,120,985. RHI GROUP, INC. AND DESIGN. INT. CL. 42. REG. 12-16-1997.
- 2,120,986. WAVESPORT (STYLIZED). INT. CL. 9. REG. 12-16-1997.
- 2,120,987. TOUR EXPRESS AND DESIGN. INT. CL. 42. REG. 12-16-1997.
- 2,120,989. AWESOME DESSERTS AND DESIGN. INT. CL. 42. REG. 12-16-1997.
- 2,120,991. THE SILENT CUSTOMER (STYLIZED). INT. CL. 35. REG. 12-16-1997.
- 2,120,993. DER LACHS DANZIGER GOLDWASSER. INT. CL. 33. REG. 12-16-1997.
- 2,120,995. SENSOLE'. INT. CL. 3. REG. 12-16-1997.
- 2,120,996. NORWEST L.I.F.E. LIVING IN A FLEXIBLE ENVIRONMENT AND DESIGN. INT. CL. 35. REG. 12-16-1997.
- 2,120,997. GOVCAD. INT. CL. 41. REG. 12-16-1997.
- 2,120,998. DYNAMIX. INT. CL. 9. REG. 12-16-1997.
- 2,120,999. SMART VALUES SAMPLE PACK. INT. CL. 35. REG. 12-16-1997.
- 2,121,002. THE ANIMAL SHOPPING CLUB AND DESIGN. INT. CL. 35. REG. 12-16-1997.
- 2,121,003. MAX'S AND DESIGN. INT. CL. 30. REG. 12-16-1997.
- 2,121,004. FASHION ALMANAC (STYLIZED). INT. CL. 16. REG. 12-16-1997.
- 2,121,007. THE CHEESE. INT. CL. 41. REG. 12-16-1997.
- 2,121,008. OMEGA THE LAST WORD IN MANAGEMENT FOR THE ORTHODONTIC PRACTICE. INT. CL. 35. REG. 12-16-1997.
- 2,121,009. OSQ OPTIMUM SERVICE QUANTITY AND DESIGN. INT. CL. 9. REG. 12-16-1997.
- 2,121,010. CADER BOOKS. INT. CL. 16. REG. 12-16-1997.
- 2,121,012. PORNO. INT. CL. 3. REG. 12-16-1997.
- 2,121,014. @CHRON.COM. INT. CL. 16. REG. 12-16-1997.
- 2,121,016. ONLION (STYLIZED). INT. CL. 42. REG. 12-16-1997.
- 2,121,022. MARVEL CYBER COMICS. INT. CL. 42. REG. 12-16-1997.
- 2,121,023. PTE. INT. CL. 9. REG. 12-16-1997.
- 2,121,026. MASMELOS AND DESIGN. INT. CL. 30. REG. 12-16-1997.
- 2,121,029. ABPG. INT. CLS. 41 AND 42. REG. 12-16-1997.
- 2,121,031. DENSOR. INT. CL. 10. REG. 12-16-1997.
- 2,121,033. SUPRATEX. INT. CL. 16. REG. 12-16-1997.
- 2,121,034. DECRA-LOC AND DESIGN. INT. CL. 19. REG. 12-16-1997.
- 2,121,035. RAPELLI. INT. CL. 29. REG. 12-16-1997.
- 2,121,039. 100% GOOD AND DESIGN. INT. CL. 42. REG. 12-16-1997.
- 2,121,040. LITTLE MIRACLES AND DESIGN. INT. CL. 42. REG. 12-16-1997.
- 2,121,041. BEAR COUNTRY BAVARIAN BRAND HEFE WEIZEN BEER AND DESIGN. INT. CL. 32. REG. 12-16-1997.
- 2,121,043. ST AND DESIGN. INT. CL. 7. REG. 12-16-1997.
- 2,121,045. JOHN FOXX IMAGES. INT. CLS. 9 AND 38. REG. 12-16-1997.
- 2,121,048. COROLON. INT. CLS. 2 AND 40. REG. 12-16-1997.
- 2,121,051. CNOR CRNFA NATIONAL CERTIFICATION BOARD PERIOPERATIVE NURSING, INC. EST. 1979 AND DESIGN. INT. CLS. 16 AND 41. REG. 12-16-1997.
- 2,121,055. CENET. INT. CL. 42. REG. 12-16-1997.
- 2,121,058. CVS. INT. CL. 9. REG. 12-16-1997.
- 2,121,059. "MASTER'S HAND" (STYLIZED). INT. CL. 26. REG. 12-16-1997.
- 2,121,063. MIDAS SYSTEM. INT. CL. 7. REG. 12-16-1997.
- 2,121,065. HOME COFFEE ROASTERS' SOCIETY. INT. CL. 30. REG. 12-16-1997.
- 2,121,066. CALIFORNIA REPUBLICAN PARTY AND DESIGN. INT. CLS. 16 AND 35. REG. 12-16-1997.
- 2,121,067. PROJECT SAFE HOME AND DESIGN. INT. CL. 37. REG. 12-16-1997.
- 2,121,068. CHUCK MUER'S SEAFOOD TAVERN. INT. CL. 42. REG. 12-16-1997.
- 2,121,072. EXPO GUIDE AND DESIGN. INT. CL. 42. REG. 12-16-1997.
- 2,121,073. EROWA JOBMANAGER. INT. CLS. 9 AND 42. REG. 12-16-1997.
- 2,121,074. SANIBEL-CAPTIVA NATURE CALENDAR. INT. CL. 16. REG. 12-16-1997.
- 2,121,075. DIVINE CONNECTIONS THE NETWORKING COMPANY AND DESIGN. INT. CL. 42. REG. 12-16-1997.
- 2,121,077. ALUMINOX (STYLIZED). INT. CLS. 7 AND 12. REG. 12-16-1997.
- 2,121,079. PRICEFLEX. INT. CL. 42. REG. 12-16-1997.
- 2,121,082. Y'KNOW AND DESIGN. INT. CLS. 16 AND 25. REG. 12-16-1997.
- 2,121,083. PARTY WIZ PRODUCTS LTD. AND DESIGN. INT. CLS. 16 AND 28. REG. 12-16-1997.
- 2,121,084. N AND DESIGN. INT. CLS. 35 AND 37. REG. 12-16-1997.

- 2,121,085. STAINLESS IN SEATTLE AND DESIGN. INT. CL. 21. REG. 12-16-1997.
- 2,121,086. HOBELMANN PORT SERVICES. INT. CL. 39. REG. 12-16-1997.
- 2,121,089. DDT. INT. CLS. 7 AND 12. REG. 12-16-1997.
- 2,121,092. EQUILIBRE (STYLIZED). INT. CL. 3. REG. 12-16-1997.
- 2,121,097. HITCH ALIGN. INT. CL. 12. REG. 12-16-1997.
- 2,121,098. FLEX ZIPZ. INT. CL. 26. REG. 12-16-1997.
- 2,121,099. YOU DON'T LIVE ON MY STREET. INT. CLS. 18, 21 AND 25. REG. 12-16-1997.
- 2,121,100. XTRAX. INT. CL. 5. REG. 12-16-1997.
- 2,121,101. MEDPUB.COM. INT. CL. 42. REG. 12-16-1997.
- 2,121,106. MISCELLANEOUS DESIGN. INT. CL. 42. REG. 12-16-1997.
- 2,121,108. RUN FOR COVER. INT. CLS. 36 AND 41. REG. 12-16-1997.
- 2,121,111. MISCELLANEOUS DESIGN. INT. CLS. 37, 39 AND 40. REG. 12-16-1997.
- 2,121,112. BIO-FAME. INT. CL. 1. REG. 12-16-1997.
- 2,121,114. FUN'N SUN WEEKEND AND DESIGN. INT. CLS. 16, 25 AND 35. REG. 12-16-1997.
- 2,121,115. CENTERSTONE. INT. CL. 14. REG. 12-16-1997.
- 2,121,118. MISCELLANEOUS DESIGN. INT. CL. 9. REG. 12-16-1997.
- 2,121,119. COLONIAL HOMES. INT. CL. 16. REG. 12-16-1997.
- 2,121,123. MEISNER PLUS. INT. CL. 41. REG. 12-16-1997.
- 2,121,127. STEEL HORSE AUTOMOTIVE AND DESIGN. INT. CLS. 11, 12 AND 27. REG. 12-16-1997.
- 2,121,128. MAIL RIGHT. INT. CL. 9. REG. 12-16-1997.
- 2,121,129. DOCEX. INT. CLS. 38 AND 39. REG. 12-16-1997.
- 2,121,132. BARE FOOT GRAPHICS AND DESIGN. INT. CL. 42. REG. 12-16-1997.
- 2,121,133. MISCELLANEOUS DESIGN. INT. CL. 8. REG. 12-16-1997.
- 2,121,135. QUADRUM TELECOM. INT. CL. 9. REG. 12-16-1997.
- 2,121,138. O'KEEFE MARKETING AND DESIGN. INT. CL. 35. REG. 12-16-1997.
- 2,121,142. IFC-FLOWERS THAT DAZZLE AND DESIGN. INT. CL. 31. REG. 12-16-1997.
- 2,121,144. NU FLAVOR. INT. CL. 41. REG. 12-16-1997.
- 2,121,146. ISSUES MAPPING. INT. CL. 35. REG. 12-16-1997.
- 2,121,147. EARN MILES FOR YOUR MEALS. INT. CL. 35. REG. 12-16-1997.
- 2,121,149. ONE REALTOR PLACE. INT. CL. 42. REG. 12-16-1997.
- 2,121,150. DEMENTIA. INT. CL. 41. REG. 12-16-1997.
- 2,121,151. WOOLRICH EST. 1830 AND DESIGN. INT. CL. 25. REG. 12-16-1997.
- 2,121,156. THE MAGICIAN AND DESIGN. INT. CL. 42. REG. 12-16-1997.
- 2,121,157. INTUITION AT WORK AND DESIGN. INT. CL. 41. REG. 12-16-1997.
- 2,121,158. PONI TAILS (STYLIZED). INT. CL. 41. REG. 12-16-1997.
- 2,121,160. CONSCIOUSNESS UNLIMITED AND DESIGN. INT. CL. 41. REG. 12-16-1997.
- 2,121,161. CIRCOFER. INT. CLS. 37 AND 42. REG. 12-16-1997.
- 2,121,162. WINFIX. INT. CL. 9. REG. 12-16-1997.
- 2,121,164. AMERICAN PAINT & COATINGS JOURNAL. INT. CL. 16. REG. 12-16-1997.
- 2,121,165. DESIGNER FOR A DAY. INT. CLS. 35 AND 42. REG. 12-16-1997.
- 2,121,168. I PRO AND DESIGN. INT. CLS. 35 AND 42. REG. 12-16-1997.
- 2,121,170. MISCELLANEOUS DESIGN. INT. CL. 5. REG. 12-16-1997.
- 2,121,176. RESPIMAT. INT. CL. 5. REG. 12-16-1997.
- 2,121,183. CATALYST RESOURCES. INT. CL. 35. REG. 12-16-1997.
- 2,121,186. GENERATION X. INT. CL. 3. REG. 12-16-1997.
- 2,121,191. BUSINESS PROCESS SOLUTIONS. INT. CL. 35. REG. 12-16-1997.
- 2,121,193. DESIGN ISLAND. INT. CL. 42. REG. 12-16-1997.
- 2,121,196. OUR SEAL IS YOUR ASSURANCE OF QUALITY SINCE 1970 AND DESIGN. INT. CL. 32. REG. 12-16-1997.
- 2,121,197. OUR SEAL IS YOUR ASSURANCE OF QUALITY SINCE 1970 AND DESIGN. INT. CL. 1. REG. 12-16-1997.
- 2,121,198. CAMPAIGNBALL. INT. CL. 28. REG. 12-16-1997.
- 2,121,200. VISAGE BEAUTE AND DESIGN. INT. CL. 3. REG. 12-16-1997.
- 2,121,202. ESTRAMON. INT. CL. 5. REG. 12-16-1997.
- 2,121,203. CELTIC ADVERTISING. INT. CL. 35. REG. 12-16-1997.
- 2,121,204. SELGIAN. INT. CL. 5. REG. 12-16-1997.
- 2,121,205. MEMODUR. INT. CL. 10. REG. 12-16-1997.
- 2,121,207. LYNNE GREENE. INT. CL. 25. REG. 12-16-1997.
- 2,121,209. MISCELLANEOUS DESIGN. INT. CL. 42. REG. 12-16-1997.
- 2,121,210. THE PDC REPORT. INT. CL. 42. REG. 12-16-1997.
- 2,121,211. TAT - TAPAS ACUPRESSURE TECHNIQUE. INT. CL. 41. REG. 12-16-1997.
- 2,121,212. MISCELLANEOUS DESIGN. INT. CLS. 25, 41 AND 42. REG. 12-16-1997.
- 2,121,214. MAZOLLEN. INT. CL. 5. REG. 12-16-1997.
- 2,121,216. K.I.D.. INT. CL. 42. REG. 12-16-1997.
- 2,121,217. K.I.D. AND DESIGN. INT. CL. 42. REG. 12-16-1997.
- 2,121,219. DETOUR (STYLIZED). INT. CL. 9. REG. 12-16-1997.
- 2,121,220. JANE DOE AND DESIGN. INT. CL. 9. REG. 12-16-1997.
- 2,121,222. SKILLET. INT. CL. 41. REG. 12-16-1997.
- 2,121,225. ACCURON. INT. CL. 7. REG. 12-16-1997.
- 2,121,232. VETS AND DESIGN. INT. CL. 41. REG. 12-16-1997.
- 2,121,234. DAYSTAR ENERGY PARTNERS, INC.. INT. CL. 36. REG. 12-16-1997.
- 2,121,236. EMPLOYMED. INT. CL. 42. REG. 12-16-1997.
- 2,121,238. UP DATE MARKETING AND DESIGN. INT. CL. 35. REG. 12-16-1997.
- 2,121,239. DICKENS INN AND DESIGN. INT. CL. 42. REG. 12-16-1997.
- 2,121,241. VENUS & MARS. INT. CLS. 25 AND 35. REG. 12-16-1997.
- 2,121,242. KE AND DESIGN. INT. CLS. 9, 35 AND 42. REG. 12-16-1997.
- 2,121,243. PLAYGROUND AND DESIGN. INT. CL. 18. REG. 12-16-1997.
- 2,121,245. NAMEMAKERS. INT. CL. 14. REG. 12-16-1997.
- 2,121,246. SEMITICA. INT. CL. 9. REG. 12-16-1997.
- 2,121,247. ROMANCE. INT. CL. 9. REG. 12-16-1997.
- 2,121,250. NOTIFYME. INT. CL. 35. REG. 12-16-1997.
- 2,121,252. PF ADVANTAGE. INT. CL. 35. REG. 12-16-1997.
- 2,121,253. ST CERNIN. INT. CL. 29. REG. 12-16-1997.
- 2,121,254. CELLLINK. INT. CL. 9. REG. 12-16-1997.
- 2,121,257. EUROSUCRE AND DESIGN. INT. CL. 30. REG. 12-16-1997.
- 2,121,262. A ARTRIX DIGITAL DESIGN AND DESIGN. INT. CLS. 41 AND 42. REG. 12-16-1997.
- 2,121,264. SERVICE KING. INT. CL. 37. REG. 12-16-1997.
- 2,121,265. SERVICE KING COLLISION REPAIR CENTERS. INT. CL. 37. REG. 12-16-1997.
- 2,121,266. SILVER T. INT. CL. 14. REG. 12-16-1997.
- 2,121,268. DC DECONSTRUCTION AND DESIGN. INT. CL. 9. REG. 12-16-1997.
- 2,121,269. FLEET-MAIL (STYLIZED). INT. CL. 38. REG. 12-16-1997.
- 2,121,270. SURVIVAL SOLUTIONS. INT. CL. 29. REG. 12-16-1997.
- 2,121,272. THE USAA EDUCATIONAL FOUNDATION AND DESIGN. INT. CLS. 16 AND 41. REG. 12-16-1997.
- 2,121,273. ABEL AND DESIGN. INT. CL. 28. REG. 12-16-1997.
- 2,121,275. QUIGLEY'S ORCHARD DELUXE-APPLE-SAUCES 100% NATURAL AND DESIGN. INT. CL. 29. REG. 12-16-1997.
- 2,121,276. HOMESTYLE AND DESIGN. INT. CL. 30. REG. 12-16-1997.
- 2,121,277. AOV ART ON VIEW (STYLIZED). INT. CL. 42. REG. 12-16-1997.

- 2,121,279. ENGAGE RECORDS AND DESIGN. INT. CL. 9. REG. 12-16-1997.
- 2,121,280. PORTA DOCK. INT. CL. 6. REG. 12-16-1997.
- 2,121,282. SUMMETRIC INTERACTIVE SOFTWARE AND DESIGN. INT. CL. 9. REG. 12-16-1997.
- 2,121,284. DIEPRO. INT. CL. 35. REG. 12-16-1997.
- 2,121,287. THE MORE I GARDEN, THE MORE I GROW. INT. CL. 16. REG. 12-16-1997.
- 2,121,288. NETFM. INT. CL. 9. REG. 12-16-1997.
- 2,121,289. TRUCKKING. INT. CL. 12. REG. 12-16-1997.
- 2,121,290. MAGICODE. INT. CL. 9. REG. 12-16-1997.
- 2,121,292. STREAKERS AND DESIGN. INT. CL. 28. REG. 12-16-1997.
- 2,121,294. DOWNHILL MANIA. INT. CL. 41. REG. 12-16-1997.
- 2,121,295. PRIMO TACO. INT. CL. 42. REG. 12-16-1997.
- 2,121,296. GORP GREAT OUTDOOR RECREATION PAGES AND DESIGN. INT. CL. 41. REG. 12-16-1997.
- 2,121,298. AFTERIMAGE. INT. CL. 9. REG. 12-16-1997.
- 2,121,299. HOTSYS (STYLIZED). INT. CL. 9. REG. 12-16-1997.
- 2,121,300. HAKSYS (STYLIZED). INT. CL. 9. REG. 12-16-1997.
- 2,121,301. FLORIDA RETIREMENT LIFESTYLES. INT. CL. 16. REG. 12-16-1997.
- 2,121,304. MONSTROUS MOVIE MUSIC AND DESIGN. INT. CL. 9. REG. 12-16-1997.
- 2,121,306. PROMINIC AND DESIGN. INT. CLS. 9 AND 42. REG. 12-16-1997.
- 2,121,307. INTERLOC. INT. CL. 35. REG. 12-16-1997.
- 2,121,309. HAIR KITE. INT. CL. 26. REG. 12-16-1997.
- 2,121,311. JALICIENSE AND DESIGN. INT. CL. 33. REG. 12-16-1997.
- 2,121,313. ORIGINAL LOGGERSTAPE MADE BY SPENCER PRODUCTS CO. SEATTLE, WA. AND DESIGN. INT. CL. 9. REG. 12-16-1997.
- 2,121,314. DESKTOP SUPPORT FACTORY. INT. CL. 9. REG. 12-16-1997.
- 2,121,315. WEALTHCOM. INT. CLS. 16 AND 38. REG. 12-16-1997.
- 2,121,321. MISCELLANEOUS DESIGN. INT. CL. 35. REG. 12-16-1997.
- 2,121,324. EL PASO ENERGY CORPORATION. INT. CLS. 39 AND 40. REG. 12-16-1997.
- 2,121,325. EL PASO ENERGY INTERNATIONAL. INT. CLS. 39 AND 40. REG. 12-16-1997.
- 2,121,331. ASK HERB. INT. CL. 42. REG. 12-16-1997.
- 2,121,334. TAKE A HIT (STYLIZED). INT. CL. 35. REG. 12-16-1997.
- 2,121,335. FLEET FLASHTRACK. INT. CL. 36. REG. 12-16-1997.
- 2,121,336. PHOTOWAVE AND DESIGN. INT. CL. 40. REG. 12-16-1997.
- 2,121,337. DT STRAIGHT PULL AND DESIGN. INT. CL. 12. REG. 12-16-1997.
- 2,121,338. DARK TIGER. INT. CL. 16. REG. 12-16-1997.
- 2,121,343. VITE. INT. CL. 35. REG. 12-16-1997.
- 2,121,346. PHYSICIAN HEALTH CORPORATION. INT. CL. 35. REG. 12-16-1997.
- 2,121,347. PROFICIENT TECHNOLOGIES. INT. CL. 35. REG. 12-16-1997.
- 2,121,348. MISCELLANEOUS DESIGN. INT. CLS. 41 AND 42. REG. 12-16-1997.
- 2,121,351. FOR SALE BY OWNER AND DESIGN. INT. CL. 16. REG. 12-16-1997.
- 2,121,352. FREETEXT. INT. CL. 9. REG. 12-16-1997.
- 2,121,353. MISCELLANEOUS DESIGN. INT. CL. 32. REG. 12-16-1997.
- 2,121,355. THE 403(B) SOLUTION. INT. CL. 36. REG. 12-16-1997.
- 2,121,356. PHILADELPHIA WEDDINGS. INT. CL. 16. REG. 12-16-1997.
- 2,121,357. THE SITE FIGHTS. INT. CL. 35. REG. 12-16-1997.
- 2,121,361. PERMANENT EYELINER PLUS INC. WAKE UP IN YOUR MAKE-UP! AND DESIGN. INT. CL. 42. REG. 12-16-1997.
- 2,121,362. HOF'S BAR GRILL AND DESIGN. INT. CL. 42. REG. 12-16-1997.
- 2,121,365. GILUTON. INT. CL. 1. REG. 12-16-1997.
- 2,121,366. FRANZ MORAT. INT. CL. 7. REG. 12-16-1997.
- 2,121,367. M MEGABYTE MALL AND DESIGN. INT. CL. 35. REG. 12-16-1997.
- 2,121,369. UNLOADER SELECT. INT. CL. 10. REG. 12-16-1997.
- 2,121,370. THE EVINRUDES. INT. CL. 41. REG. 12-16-1997.
- 2,121,373. HEPIN. INT. CL. 5. REG. 12-16-1997.
- 2,121,374. NATURE POINT AND DESIGN. INT. CL. 5. REG. 12-16-1997.
- 2,121,375. USA GROUP SECONDARY MARKET SERVICES - HAWAII. INT. CL. 36. REG. 12-16-1997.
- 2,121,376. VEERPRABHU KING BRAND AND DESIGN. INT. CLS. 29, 30 AND 31. REG. 12-16-1997.
- 2,121,378. JUMP!. INT. CL. 16. REG. 12-16-1997.
- 2,121,380. CREATING WEALTH WITH BRAD RICHDALE (STYLIZED). INT. CL. 36. REG. 12-16-1997.
- 2,121,382. N AND DESIGN. INT. CL. 9. REG. 12-16-1997.
- 2,121,384. LEASING INNOVATIONS, LC AND DESIGN. INT. CL. 36. REG. 12-16-1997.
- 2,121,389. SMOKE RINGS AND DESIGN. INT. CL. 25. REG. 12-16-1997.
- 2,121,390. X CORP (STYLIZED). INT. CL. 36. REG. 12-16-1997.
- 2,121,391. FUME BUSTER. INT. CL. 20. REG. 12-16-1997.
- 2,121,393. BLUEPRINT REPORT. INT. CL. 36. REG. 12-16-1997.
- 2,121,394. ISECURE. INT. CL. 9. REG. 12-16-1997.
- 2,121,396. EVERY NURSE, EVERY WEEK. INT. CL. 16. REG. 12-16-1997.
- 2,121,397. AZTEC QUALITY EYEWEAR. INT. CL. 9. REG. 12-16-1997.
- 2,121,398. BIG LUG. INT. CLS. 25 AND 41. REG. 12-16-1997.
- 2,121,400. THE BYTE DOCTOR COMPUTER REPAIR AND UPGRADE CENTER. INT. CL. 37. REG. 12-16-1997.
- 2,121,401. SHELLY'S BACK ROOM A CIVILIZED CIGAR PARLOR SHELLY'S WOODROAST ROCKVILLE MARYLAND AND DESIGN. INT. CL. 42. REG. 12-16-1997.
- 2,121,402. GREENSOILS. INT. CL. 1. REG. 12-16-1997.
- 2,121,404. GO GLOBAL OUTPOSTS AND DESIGN. INT. CL. 39. REG. 12-16-1997.
- 2,121,405. CANDESA INTERACTIVE. INT. CL. 9. REG. 12-16-1997.
- 2,121,408. PACE. INT. CL. 35. REG. 12-16-1997.
- 2,121,409. HUDSONJERSEY STAMATO SANITATION AND DESIGN. INT. CLS. 37, 39 AND 40. REG. 12-16-1997.
- 2,121,412. ACCREDITED CAREER SCHOOLS: AMERICA'S WORKFORCE. INT. CL. 42. REG. 12-16-1997.
- 2,121,413. ROOMIDIFIER. INT. CL. 11. REG. 12-16-1997.
- 2,121,414. ABSOLUTELY AFFORDABLE HOMES. INT. CL. 36. REG. 12-16-1997.
- 2,121,415. CC RIBS (STYLIZED). INT. CL. 29. REG. 12-16-1997.
- 2,121,417. PRIORITY PLUS 2. INT. CL. 36. REG. 12-16-1997.
- 2,121,419. GRAND ROYAL. INT. CL. 25. REG. 12-16-1997.
- 2,121,420. \*LOST. INT. CL. 39. REG. 12-16-1997.
- 2,121,421. BETTA AND DESIGN. INT. CL. 16. REG. 12-16-1997.
- 2,121,422. EVER PRINT. INT. CL. 37. REG. 12-16-1997.
- 2,121,424. SFG SINCLAIR FINANCIAL GROUP, INC. (STYLIZED). INT. CL. 36. REG. 12-16-1997.
- 2,121,425. REDI+WASH. INT. CL. 5. REG. 12-16-1997.
- 2,121,427. LOOK YOUR BEST. INT. CL. 9. REG. 12-16-1997.
- 2,121,430. GOLDEN WEST MOTORSPORTS AND DESIGN. INT. CL. 41. REG. 12-16-1997.
- 2,121,431. MISCELLANEOUS DESIGN. INT. CL. 41. REG. 12-16-1997.
- 2,121,433. KOLL THE REAL ESTATE SERVICES COMPANY (STYLIZED). INT. CL. 36. REG. 12-16-1997.
- 2,121,434. DUAL CPU-COOL. INT. CL. 9. REG. 12-16-1997.
- 2,121,435. ZIONIC. INT. CL. 41. REG. 12-16-1997.
- 2,121,436. INSNET AND DESIGN. INT. CLS. 9 AND 36. REG. 12-16-1997.
- 2,121,438. COOL NOTIFY. INT. CL. 35. REG. 12-16-1997.

- 2,121,440. CLUB TOWER. INT. CL. 36. REG. 12-16-1997.  
2,121,443. VIRTUWALL. INT. CL. 20. REG. 12-16-1997.  
2,121,446. REDITRUK. INT. CL. 12. REG. 12-16-1997.  
2,121,448. LIVE! LAS VEGAS SPORTS BOOK. INT. CL. 41. REG. 12-16-1997.  
2,121,449. EZ MAX. INT. CLS. 9 AND 38. REG. 12-16-1997.  
2,121,450. PERSONAL FINANCE FOR THE UNASHAMED. INT. CL. 16. REG. 12-16-1997.  
2,121,452. AUTOMEDIA (STYLIZED). INT. CL. 16. REG. 12-16-1997.  
2,121,453. LAGUNA. INT. CL. 32. REG. 12-16-1997.  
2,121,455. MUDCADE. INT. CL. 9. REG. 12-16-1997.  
2,121,458. MYSTERY MOUNTAIN. INT. CL. 9. REG. 12-16-1997.  
2,121,459. MISCELLANEOUS DESIGN. INT. CLS. 37 AND 39. REG. 12-16-1997.  
2,121,460. THE OFFICES OF URBAN RUBBLE AND DESIGN. INT. CL. 42. REG. 12-16-1997.  
2,121,461. VALSA. INT. CL. 16. REG. 12-16-1997.  
2,121,463. FIREFLY LOOP AND DESIGN. INT. CL. 9. REG. 12-16-1997.  
2,121,464. ASCA. INT. CL. 16. REG. 12-16-1997.  
2,121,466. PERKS PLUS AND DESIGN. INT. CL. 35. REG. 12-16-1997.  
2,121,467. P AND DESIGN. INT. CL. 38. REG. 12-16-1997.  
2,121,468. PERSPECTIVE POSTERS. INT. CL. 16. REG. 12-16-1997.  
2,121,469. VENEZIA JEANS. INT. CL. 9. REG. 12-16-1997.  
2,121,470. HAUNTED ISLAND. INT. CL. 9. REG. 12-16-1997.  
2,121,471. HEART WRENCH. INT. CL. 20. REG. 12-16-1997.  
2,121,474. MAP MINISTRY ACTION PAPER AND DESIGN. INT. CL. 16. REG. 12-16-1997.  
2,121,475. HAUNTED ISLAND. INT. CL. 9. REG. 12-16-1997.  
2,121,476. IRON HORSE. INT. CL. 16. REG. 12-16-1997.  
2,121,477. VOICE WITH VISION. AND DESIGN. INT. CL. 41. REG. 12-16-1997.  
2,121,478. PLANE FROM THE HEART "GREETINGS OF LOVE, SENT FROM ABOVE" AND DESIGN. INT. CL. 16. REG. 12-16-1997.  
2,121,479. PIK-TIPS. INT. CL. 7. REG. 12-16-1997.  
2,121,480. TRI-DOWN. INT. CL. 22. REG. 12-16-1997.  
2,121,482. CADDY SHAFT (STYLIZED). INT. CL. 28. REG. 12-16-1997.  
2,121,483. WINSLIDE. INT. CL. 9. REG. 12-16-1997.  
2,121,485. ALAS INTERNATIONAL. INT. CL. 36. REG. 12-16-1997.  
2,121,486. SHARK CARTILAGE II. INT. CL. 5. REG. 12-16-1997.  
2,121,487. MEDFLEX. INT. CL. 36. REG. 12-16-1997.  
2,121,488. VERTEL COUGAR. INT. CL. 9. REG. 12-16-1997.  
2,121,489. SEARS DOLLARS. INT. CL. 35. REG. 12-16-1997.  
2,121,491. GRIMOIRE. INT. CL. 16. REG. 12-16-1997.  
2,121,492. SANTA'S EXPRESS. INT. CL. 6. REG. 12-16-1997.  
2,121,493. DIAMONAL AND DESIGN. INT. CL. 7. REG. 12-16-1997.  
2,121,496. KINGS CANYON CRANBERRY. INT. CL. 19. REG. 12-16-1997.  
2,121,498. MYMARX. INT. CL. 21. REG. 12-16-1997.  
2,121,501. WINDSOR SECURITIES, INC.. INT. CL. 36. REG. 12-16-1997.  
2,121,503. ROBOTIC ARSENAL MOBILIZER. INT. CL. 28. REG. 12-16-1997.  
2,121,505. QFS. INT. CL. 9. REG. 12-16-1997.  
2,121,507. MEDIFIX. INT. CL. 37. REG. 12-16-1997.  
2,121,509. SUISTUB. INT. CL. 20. REG. 12-16-1997.  
2,121,510. SIGNATURE. INT. CL. 29. REG. 12-16-1997.  
2,121,511. XLT. INT. CL. 9. REG. 12-16-1997.  
2,121,515. MANAGER'S PARTNER. INT. CL. 9. REG. 12-16-1997.  
2,121,518. CHADFIELD GARDEN AND DESIGN. INT. CL. 35. REG. 12-16-1997.  
2,121,519. KIDS AND DESIGN. INT. CL. 38. REG. 12-16-1997.  
2,121,520. UPN KIDS. INT. CL. 38. REG. 12-16-1997.  
2,121,521. MANUFACTURING MATTERS. INT. CL. 41. REG. 12-16-1997.  
2,121,522. EVENT MEDIA. INT. CL. 40. REG. 12-16-1997.  
2,121,526. CURIOSITIES? AND DESIGN. INT. CL. 16. REG. 12-16-1997.  
2,121,527. MISCELLANEOUS DESIGN. INT. CLS. 25, 26 AND 28. REG. 12-16-1997.  
2,121,528. EGGCYTE. INT. CL. 9. REG. 12-16-1997.  
2,121,529. FEMOPAUSE. INT. CL. 5. REG. 12-16-1997.  
2,121,532. ALEXIS. INT. CL. 28. REG. 12-16-1997.  
2,121,537. FANO SATELLITE. INT. CL. 15. REG. 12-16-1997.  
2,121,538. THE NEXT GENERATION OF NAIL CARE. INT. CL. 3. REG. 12-16-1997.  
2,121,542. FAMILY VISIONS AND DESIGN. INT. CL. 18. REG. 12-16-1997.  
2,121,544. TANGLE-FREE BOXES. INT. CL. 16. REG. 12-16-1997.  
2,121,545. MISCELLANEOUS DESIGN. INT. CL. 41. REG. 12-16-1997.  
2,121,551. T TAKAGI (STYLIZED). INT. CL. 11. REG. 12-16-1997.  
2,121,552. EARTH THERAPEUTICS. INT. CL. 35. REG. 12-16-1997.  
2,121,553. MEALS ON THE MOVE. INT. CL. 16. REG. 12-16-1997.  
2,121,557. MEDICAL DOCUMENTATION PLUS. INT. CL. 35. REG. 12-16-1997.  
2,121,559. SPLASHTIME PETS. INT. CL. 28. REG. 12-16-1997.  
2,121,560. INVESTMENT DIRECTIONS. INT. CL. 41. REG. 12-16-1997.  
2,121,563. CONTACT!. INT. CL. 16. REG. 12-16-1997.  
2,121,564. MACHE (STYLIZED). INT. CL. 18. REG. 12-16-1997.  
2,121,565. MAXPOWER. INT. CL. 28. REG. 12-16-1997.  
2,121,566. MISCELLANEOUS DESIGN. INT. CL. 30. REG. 12-16-1997.  
2,121,568. DENICOTIZER. INT. CL. 5. REG. 12-16-1997.  
2,121,569. THE BRIDGES. INT. CL. 41. REG. 12-16-1997.  
2,121,570. PARENT'S PAL. INT. CL. 35. REG. 12-16-1997.  
2,121,572. BIFOLAC. INT. CL. 5. REG. 12-16-1997.  
2,121,573. GOOD PEOPLE SERVING GOOD FOOD. INT. CL. 42. REG. 12-16-1997.  
2,121,574. MIGRACARE. INT. CL. 5. REG. 12-16-1997.  
2,121,575. MOUNTAIN SURF AND DESIGN. INT. CL. 25. REG. 12-16-1997.  
2,121,582. TISSUESCENTS. INT. CL. 16. REG. 12-16-1997.  
2,121,591. MISCELLANEOUS DESIGN. INT. CL. 20. REG. 12-16-1997.  
2,121,592. RELAX. INT. CL. 16. REG. 12-16-1997.  
2,121,593. WIRE WORKS AND DESIGN. INT. CL. 26. REG. 12-16-1997.  
2,121,594. BODY U.S.A. AND DESIGN. INT. CL. 41. REG. 12-16-1997.  
2,121,595. BRIGHTEN EVERY KID'S LIFE WITH SCIENCE (STYLIZED). INT. CL. 16. REG. 12-16-1997.  
2,121,599. BACKFLOW. INT. CL. 28. REG. 12-16-1997.  
2,121,604. MISCELLANEOUS DESIGN. INT. CL. 42. REG. 12-16-1997.  
2,121,606. SMARTWRITER. INT. CL. 9. REG. 12-16-1997.  
2,121,607. BLUE STREAK AND DESIGN. INT. CL. 7. REG. 12-16-1997.  
2,121,610. THE PRUDENTIAL CENTER FOR HEALTH CARE RESEARCH. INT. CLS. 35 AND 42. REG. 12-16-1997.  
2,121,611. HOMEBUYER AND DESIGN. INT. CL. 36. REG. 12-16-1997.  
2,121,612. THE QUADRUPED. INT. CL. 25. REG. 12-16-1997.  
2,121,613. MOODY'S TAQUITOS. INT. CL. 42. REG. 12-16-1997.  
2,121,614. PASSAGES. INT. CL. 16. REG. 12-16-1997.  
2,121,615. REXELL. INT. CL. 1. REG. 12-16-1997.  
2,121,616. SUNSHINE SNOWMAN. INT. CL. 20. REG. 12-16-1997.  
2,121,621. DURAPACK. INT. CL. 20. REG. 12-16-1997.  
2,121,622. CHANGE THE WORLD ONE CUP AT A TIME. INT. CL. 42. REG. 12-16-1997.  
2,121,623. A BOX OF MIRACLES LP AND DESIGN. INT. CLS. 16 AND 18. REG. 12-16-1997.  
2,121,624. AUTOMED. INT. CL. 10. REG. 12-16-1997.  
2,121,625. P AND DESIGN. INT. CL. 9. REG. 12-16-1997.  
2,121,627. MDJ. INT. CL. 14. REG. 12-16-1997.



- 2,121,628. ATTIC PRO "THE MODERN SECRET TO ENERGY SAVINGS" AND DESIGN. INT. CL. 11. REG. 12-16-1997.
- 2,121,629. WE BUILD CONFIDENCE. INT. CLS. 35 AND 42. REG. 12-16-1997.
- 2,121,630. PCN GROUP. INT. CLS. 35 AND 42. REG. 12-16-1997.
- 2,121,632. CATALINA. INT. CL. 12. REG. 12-16-1997.
- 2,121,633. EDITORIAL MANAGEMENT STRATEGIES. INT. CLS. 35, 41 AND 42. REG. 12-16-1997.
- 2,121,637. RITE. INT. CL. 41. REG. 12-16-1997.
- 2,121,638. HARTVILLE TOUR BASKET. INT. CL. 21. REG. 12-16-1997.
- 2,121,642. MISCELLANEOUS DESIGN. INT. CL. 36. REG. 12-16-1997.
- 2,121,644. CONCORDE. INT. CL. 19. REG. 12-16-1997.
- 2,121,645. WHO'S BETTER THAN YOU?. INT. CL. 36. REG. 12-16-1997.
- 2,121,647. "WHERE THE BROKER IS KING". INT. CL. 36. REG. 12-16-1997.
- 2,121,652. MOTOMITT AND DESIGN. INT. CL. 24. REG. 12-16-1997.
- 2,121,653. DYNAGRAFT. INT. CL. 5. REG. 12-16-1997.
- 2,121,655. ELASTOCELL. INT. CL. 25. REG. 12-16-1997.
- 2,121,657. CASALUNA. INT. CL. 41. REG. 12-16-1997.
- 2,121,658. FN. INT. CL. 6. REG. 12-16-1997.
- 2,121,659. KJ KILON JEANS (STYLIZED). INT. CL. 25. REG. 12-16-1997.
- 2,121,660. FUN-VENTIONS. INT. CL. 42. REG. 12-16-1997.
- 2,121,664. ACS AND DESIGN. INT. CL. 6. REG. 12-16-1997.
- 2,121,665. ACS. INT. CL. 6. REG. 12-16-1997.
- 2,121,667. FAST FIELD ASSEMBLY SERVICE TECHNOLOGIES AND DESIGN. INT. CL. 17. REG. 12-16-1997.
- 2,121,668. LINK-N-LOCK. INT. CL. 19. REG. 12-16-1997.
- 2,121,673. ISO-MOUNT. INT. CL. 7. REG. 12-16-1997.
- 2,121,674. DURAGUIDE. INT. CL. 7. REG. 12-16-1997.
- 2,121,675. FAST FIELD ASSEMBLY SERVICE TECHNOLOGIES AND DESIGN. INT. CL. 35. REG. 12-16-1997.
- 2,121,677. MISCELLANEOUS DESIGN. INT. CL. 25. REG. 12-16-1997.
- 2,121,678. BAG OF TUNES. INT. CL. 9. REG. 12-16-1997.
- 2,121,687. PORK HOUSE. INT. CL. 31. REG. 12-16-1997.
- 2,121,689. HOME REMODELING EXCHANGE AND DESIGN. INT. CL. 35. REG. 12-16-1997.
- 2,121,692. TOUCHGUARD (STYLIZED). INT. CL. 21. REG. 12-16-1997.
- 2,121,695. EXPEDITION. INT. CL. 16. REG. 12-16-1997.
- 2,121,697. PHYSICIANS ONLY AND DESIGN. INT. CL. 25. REG. 12-16-1997.
- 2,121,698. LITE LINE. INT. CL. 25. REG. 12-16-1997.
- 2,121,701. THE OIL SOAKER. INT. CL. 17. REG. 12-16-1997.
- 2,121,702. CAVERN BLEND. INT. CL. 30. REG. 12-16-1997.
- 2,121,703. SGT. FRY FUN FOODS AND DESIGN. INT. CL. 42. REG. 12-16-1997.
- 2,121,704. MISCELLANEOUS DESIGN. INT. CL. 42. REG. 12-16-1997.
- 2,121,705. LINK-BY-LINK. INT. CL. 14. REG. 12-16-1997.
- 2,121,706. FREETRESS. INT. CL. 26. REG. 12-16-1997.
- 2,121,709. P2. INT. CL. 38. REG. 12-16-1997.
- 2,121,712. SELFWARE. INT. CL. 41. REG. 12-16-1997.
- 2,121,713. SELFWARE. INT. CL. 16. REG. 12-16-1997.
- 2,121,717. PLASTIC PLANET. INT. CL. 25. REG. 12-16-1997.
- 2,121,719. GIVING KIDS A LOVIN' LIFT. INT. CLS. 36 AND 42. REG. 12-16-1997.
- 2,121,723. BIFODAN. INT. CLS. 5 AND 31. REG. 12-16-1997.
- 2,121,725. KLINKY. INT. CL. 25. REG. 12-16-1997.
- 2,121,726. ALWAYS THINK FIRST. INT. CL. 36. REG. 12-16-1997.
- 2,121,728. DINO MONTI. INT. CL. 25. REG. 12-16-1997.
- 2,121,730. LIFT IT. INT. CL. 26. REG. 12-16-1997.
- 2,121,731. GLOBETROTTER AND DESIGN. INT. CL. 16. REG. 12-16-1997.
- 2,121,734. TASTE THE WILD SIDE. INT. CL. 32. REG. 12-16-1997.
- 2,121,736. ROYAL BY SIRECO. INT. CL. 25. REG. 12-16-1997.
- 2,121,737. PROVIDIAN PRESCRIPTION PLAN. INT. CL. 35. REG. 12-16-1997.
- 2,121,738. MOTHERS' HELPERS AND DESIGN. INT. CL. 42. REG. 12-16-1997.
- 2,121,740. LATTICE. INT. CL. 14. REG. 12-16-1997.
- 2,121,741. LUNI TICK APPAREL COMPANY AND DESIGN. INT. CL. 25. REG. 12-16-1997.
- 2,121,743. NO BONES AND DESIGN. INT. CL. 25. REG. 12-16-1997.
- 2,121,745. GOOD DOG FARMS AND DESIGN. INT. CL. 31. REG. 12-16-1997.
- 2,121,747. PIETRA PINTA. INT. CL. 29. REG. 12-16-1997.
- 2,121,751. DDTT DESIGNS AND DESIGN. INT. CL. 42. REG. 12-16-1997.
- 2,121,752. "WE COME HIGHLY WRECK-A-MENDED". INT. CL. 37. REG. 12-16-1997.
- 2,121,753. THE ATLANTIC CITY EXPERIENCE. INT. CL. 41. REG. 12-16-1997.
- 2,121,755. JESSIE ET LAURENT CULINARY SERVICE AND DESIGN. INT. CL. 42. REG. 12-16-1997.
- 2,121,757. YOUTH YS SPEAK WHERE THE VOICE OF YOUTH MATTERS AND DESIGN. INT. CL. 16. REG. 12-16-1997.
- 2,121,764. PIFFLE. INT. CLS. 16 AND 28. REG. 12-16-1997.
- 2,121,766. CAPITALIST PIG. INT. CL. 41. REG. 12-16-1997.
- 2,121,769. THE SAVINGS ARE IN THE BAG. INT. CL. 30. REG. 12-16-1997.
- 2,121,770. THE ISLAND TRADERS WILD & MILD. INT. CLS. 29 AND 30. REG. 12-16-1997.
- 2,121,772. FLAVORS OF THE PACIFIC RIM. INT. CL. 30. REG. 12-16-1997.
- 2,121,773. BLUR. INT. CL. 41. REG. 12-16-1997.
- 2,121,774. SASSY TROPICS HAWAII. INT. CL. 30. REG. 12-16-1997.
- 2,121,775. SASSY TROPICS HAWAII AND DESIGN. INT. CL. 30. REG. 12-16-1997.
- 2,121,779. FOREIGN LANGUAGE ASSOCIATION OF MISSOURI BRINGING THE WORLD CLOSER TO HOME AND DESIGN. INT. CL. 42. REG. 12-16-1997.
- 2,121,780. MISCELLANEOUS DESIGN. INT. CL. 19. REG. 12-16-1997.
- 2,121,781. CONSTELLATION CAFE (STYLIZED). INT. CL. 30. REG. 12-16-1997.
- 2,121,783. MISCELLANEOUS DESIGN. INT. CL. 38. REG. 12-16-1997.
- 2,121,784. VISIONTECH. INT. CL. 41. REG. 12-16-1997.
- 2,121,786. HOTZ-4-U AND DESIGN. INT. CL. 30. REG. 12-16-1997.
- 2,121,789. TRI-CENTRIC. INT. CL. 41. REG. 12-16-1997.
- 2,121,791. TROLLEY CAR ALE AND DESIGN. INT. CL. 32. REG. 12-16-1997.
- 2,121,793. W AND DESIGN. INT. CL. 25. REG. 12-16-1997.
- 2,121,795. I MY LIBRARY AND DESIGN. INT. CL. 16. REG. 12-16-1997.
- 2,121,796. WINE BATH. INT. CL. 3. REG. 12-16-1997.
- 2,121,798. LA SERRANIA. INT. CL. 33. REG. 12-16-1997.
- 2,121,799. A AMERICAN HOP ALE AND DESIGN. INT. CL. 32. REG. 12-16-1997.
- 2,121,800. A AND DESIGN. INT. CL. 32. REG. 12-16-1997.
- 2,121,801. ANDRINA AND DESIGN. INT. CL. 29. REG. 12-16-1997.
- 2,121,805. THE NEW MEDIA REPORT. INT. CL. 16. REG. 12-16-1997.
- 2,121,806. BANNER. INT. CL. 35. REG. 12-16-1997.
- 2,121,808. BETTR'N BONES. INT. CL. 31. REG. 12-16-1997.
- 2,121,809. KEYPARTNERS. INT. CL. 16. REG. 12-16-1997.
- 2,121,814. HI (STYLIZED). INT. CL. 35. REG. 12-16-1997.
- 2,121,816. CLUB VICTORIA AND DESIGN. INT. CL. 41. REG. 12-16-1997.
- 2,121,825. MISCELLANEOUS DESIGN. INT. CL. 41. REG. 12-16-1997.
- 2,121,826. TY COLLECTIBLE AND DESIGN. INT. CL. 28. REG. 12-16-1997.
- 2,121,829. EUROINSIGHT AND DESIGN. INT. CL. 35. REG. 12-16-1997.
- 2,121,833. JEFFERSON. INT. CLS. 35 AND 42. REG. 12-16-1997.

- 2,121,838. COMFORTCARE. INT. CL. 20. REG. 12-16-1997.  
2,121,839. CUIDANDO SU SALUD. INT. CL. 41. REG. 12-16-1997.  
2,121,841. PETRO FINANCE. INT. CL. 35. REG. 12-16-1997.  
2,121,844. RIVER'S EDGE CONSULTING. INT. CL. 35. REG. 12-16-1997.  
2,121,845. N.S. CO (STYLIZED). INT. CL. 14. REG. 12-16-1997.  
2,121,846. THE POLLAK AND SKAN GROUP AND DESIGN. INT. CL. 35. REG. 12-16-1997.  
2,121,847. AUTOMUG LITE (STYLIZED). INT. CL. 21. REG. 12-16-1997.  
2,121,849. WEB-OFF. INT. CL. 3. REG. 12-16-1997.  
2,121,851. STAYING IN TOUCH. INT. CL. 41. REG. 12-16-1997.  
2,121,852. JUNGLE BAG. INT. CL. 18. REG. 12-16-1997.  
2,121,853. RUNWAY. INT. CL. 16. REG. 12-16-1997.  
2,121,854. ANTIQUE CONNECTION. INT. CL. 35. REG. 12-16-1997.  
2,121,855. METRO BY SUNNYMAY. INT. CL. 25. REG. 12-16-1997.  
2,121,856. FOUND MONEY. INT. CL. 42. REG. 12-16-1997.  
2,121,857. MEDI-EVIL MAULER. INT. CL. 28. REG. 12-16-1997.  
2,121,858. BUMPKINS. INT. CL. 28. REG. 12-16-1997.  
2,121,863. THE REVCO. INT. CL. 41. REG. 12-16-1997.  
2,121,864. WIPE AWAY (STYLIZED). INT. CL. 24. REG. 12-16-1997.  
2,121,867. VISUAL VOICES. INT. CL. 41. REG. 12-16-1997.  
2,121,868. SR (STYLIZED). INT. CL. 14. REG. 12-16-1997.  
2,121,870. LAST FLIGHT OUT AND DESIGN. INT. CL. 25. REG. 12-16-1997.  
2,121,871. YOUTHPOWER...BEGINS WITH YOU. INT. CL. 25. REG. 12-16-1997.  
2,121,874. MISCELLANEOUS DESIGN. INT. CL. 22. REG. 12-16-1997.  
2,121,877. DEEP END. INT. CL. 25. REG. 12-16-1997.  
2,121,878. PERKINS CAFE & BAKERY AND DESIGN. INT. CL. 42. REG. 12-16-1997.  
2,121,880. DIAMOND IN THE ROUND. INT. CL. 14. REG. 12-16-1997.  
2,121,881. PSW. INT. CL. 9. REG. 12-16-1997.  
2,121,882. GENOVA. INT. CL. 9. REG. 12-16-1997.  
2,121,883. SNOW-BIZ. INT. CL. 25. REG. 12-16-1997.  
2,121,885. CIRCLE R CLASSICS AND DESIGN. INT. CL. 25. REG. 12-16-1997.  
2,121,887. FIBERFLEX. INT. CL. 25. REG. 12-16-1997.  
2,121,888. DOC A-ROO. INT. CL. 42. REG. 12-16-1997.  
2,121,889. SILVERSMITH. INT. CL. 28. REG. 12-16-1997.  
2,121,891. NK RANCH. INT. CL. 25. REG. 12-16-1997.  
2,121,892. PACIFIC CLUB. INT. CL. 25. REG. 12-16-1997.  
2,121,893. R REUNION AND DESIGN. INT. CL. 25. REG. 12-16-1997.  
2,121,894. R AND DESIGN. INT. CL. 25. REG. 12-16-1997.  
2,121,895. MEDICAL POWER. INT. CL. 35. REG. 12-16-1997.  
2,121,897. RENOVATOR. INT. CL. 25. REG. 12-16-1997.  
2,121,898. DBC ONLINE. INT. CL. 42. REG. 12-16-1997.  
2,121,899. BARNASOLVE. INT. CL. 3. REG. 12-16-1997.  
2,121,902. KLINGONS. INT. CL. 25. REG. 12-16-1997.  
2,121,903. DEREMI. INT. CL. 25. REG. 12-16-1997.  
2,121,906. THE STORY PAINTERS. INT. CL. 35. REG. 12-16-1997.  
2,121,909. SCENES ON DEMAND. INT. CL. 35. REG. 12-16-1997.  
2,121,914. WRQ AND DESIGN. INT. CL. 42. REG. 12-16-1997.  
2,121,915. FOX GONE CABLE. INT. CL. 41. REG. 12-16-1997.  
2,121,916. MISCELLANEOUS DESIGN. INT. CL. 20. REG. 12-16-1997.  
2,121,917. MISCELLANEOUS DESIGN. INT. CL. 20. REG. 12-16-1997.  
2,121,920. TAMA. INT. CL. 14. REG. 12-16-1997.  
2,121,921. BELLEJOUR. INT. CL. 33. REG. 12-16-1997.  
2,121,922. REDNECK HEAVEN. INT. CL. 9. REG. 12-16-1997.  
2,121,923. TELEDATA. INT. CL. 9. REG. 12-16-1997.  
2,121,924. MECO AND DESIGN. INT. CL. 7. REG. 12-16-1997.  
2,121,925. EARTH DAY EARTH TRUSTEE AND DESIGN. INT. CL. 25. REG. 12-16-1997.  
2,121,927. ENACT AND DESIGN. INT. CL. 5. REG. 12-16-1997.  
2,121,929. AIRFREE. INT. CL. 11. REG. 12-16-1997.  
2,121,930. GEOSTRAP. INT. CL. 19. REG. 12-16-1997.  
2,121,932. SMARTCAPS. INT. CL. 9. REG. 12-16-1997.  
2,121,933. ASPCA. INT. CL. 14. REG. 12-16-1997.  
2,121,935. JOURNEY JOURNAL AND DESIGN. INT. CL. 16. REG. 12-16-1997.  
2,121,936. COMMUNITY CHOICE. INT. CL. 35. REG. 12-16-1997.  
2,121,937. 21 DERFUL YEARS. INT. CL. 25. REG. 12-16-1997.  
2,121,940. PURE SUNSHINE. INT. CL. 32. REG. 12-16-1997.  
2,121,944. SIDEFIBER 2000 (STYLIZED). INT. CL. 10. REG. 12-16-1997.  
2,121,946. SCSI GUARD. INT. CL. 9. REG. 12-16-1997.  
2,121,947. TRI-LIFE. INT. CL. 9. REG. 12-16-1997.  
2,121,949. THE SHORTEST DISTANCE BETWEEN TWO PEOPLE. INT. CL. 38. REG. 12-16-1997.  
2,121,952. EXCLUSIVE TRADE-MARK JOOP! JEANS FOUNDED 1988 AND DESIGN. INT. CL. 25. REG. 12-16-1997.  
2,121,953. GC AND DESIGN. INT. CL. 42. REG. 12-16-1997.  
2,121,954. THE FRUITS OF EXPERIENCE. INT. CL. 3. REG. 12-16-1997.  
2,121,955. FLORIDA TREATT AND DESIGN. INT. CLS. 1 AND 3. REG. 12-16-1997.  
2,121,958. AIRTOUCH VOICE MAIL. INT. CL. 38. REG. 12-16-1997.  
2,121,959. THE GRAHAM CRACKER KIDS COLLECTION AND DESIGN. INT. CL. 16. REG. 12-16-1997.  
2,121,960. TEXTURE EXPERT. INT. CL. 9. REG. 12-16-1997.  
2,121,962. BNX. INT. CL. 9. REG. 12-16-1997.  
2,121,964. CYTRON (STYLIZED). INT. CL. 17. REG. 12-16-1997.  
2,121,965. FRIDAY SOLUTION. INT. CL. 25. REG. 12-16-1997.  
2,121,969. ARCO INTERNATIONAL OIL AND GAS COMPANY. INT. CLS. 41 AND 42. REG. 12-16-1997.  
2,121,975. MOCCASIN. INT. CL. 14. REG. 12-16-1997.  
2,121,977. TABS TOMORROW. INT. CL. 42. REG. 12-16-1997.  
2,121,980. ACCUPRO (STYLIZED). INT. CL. 9. REG. 12-16-1997.  
2,121,981. SPEED CHECK. INT. CL. 36. REG. 12-16-1997.  
2,121,983. BENEFICE. INT. CLS. 36 AND 38. REG. 12-16-1997.  
2,121,987. ELITE TREATS. INT. CL. 30. REG. 12-16-1997.  
2,121,988. THE JOB CHANNEL "YOUR NETWORK TO OPPORTUNITY" AND DESIGN. INT. CL. 41. REG. 12-16-1997.  
2,121,989. I-MAGIC. INT. CL. 28. REG. 12-16-1997.  
2,121,990. THE MAGIC ATTIC CLUB. INT. CL. 9. REG. 12-16-1997.  
2,121,993. ZAPPER. INT. CL. 10. REG. 12-16-1997.  
2,121,995. POLAR VISION. INT. CL. 9. REG. 12-16-1997.  
2,121,996. SNET 800 CALL REDIRECT. INT. CL. 38. REG. 12-16-1997.  
2,121,997. PERSONAL OFFICE. INT. CL. 36. REG. 12-16-1997.  
2,121,998. SYSTEMSELECT. INT. CLS. 9, 37, 41 AND 42. REG. 12-16-1997.  
2,122,000. X-PEL. INT. CL. 3. REG. 12-16-1997.  
2,122,002. HELIOS. INT. CL. 9. REG. 12-16-1997.  
2,122,003. ACHILLES ALL AMERICAN ATHLETICS. INT. CL. 25. REG. 12-16-1997.  
2,122,004. HEALTHY HARVEST. INT. CL. 31. REG. 12-16-1997.  
2,122,009. HYPERTEK. INT. CL. 7. REG. 12-16-1997.  
2,122,010. PROCONNECT AND DESIGN. INT. CLS. 6 AND 17. REG. 12-16-1997.  
2,122,011. "SMERX!". INT. CL. 28. REG. 12-16-1997.  
2,122,012. SCOTCH WATER AND DESIGN. INT. CL. 32. REG. 12-16-1997.  
2,122,014. THE YES GROUP. INT. CLS. 39 AND 42. REG. 12-16-1997.  
2,122,016. FORESTCOTE. INT. CL. 1. REG. 12-16-1997.  
2,122,017. ROSSIGNOL ALPINE SYSTEMS. INT. CL. 28. REG. 12-16-1997.

- 2,122,019. SYMBIOS LOGIC AND DESIGN. INT. CL. 9. REG. 12-16-1997.
- 2,122,020. SYMBIOS LOGIC. INT. CL. 9. REG. 12-16-1997.
- 2,122,021. CUSTOM CONNECTION. INT. CL. 9. REG. 12-16-1997.
- 2,122,025. AMERICA'S FAVORITES ON THE GO! AND DESIGN. INT. CLS. 16, 21 AND 42. REG. 12-16-1997.
- 2,122,029. DEEP BLUE. INT. CL. 9. REG. 12-16-1997.
- 2,122,030. SIERRA LITE FELT. INT. CL. 25. REG. 12-16-1997.
- 2,122,031. NOSE HOOK. INT. CL. 28. REG. 12-16-1997.
- 2,122,032. HYSTEROSYS. INT. CL. 10. REG. 12-16-1997.
- 2,122,034. DOUBLE EDGE. INT. CL. 16. REG. 12-16-1997.
- 2,122,035. COMMUNITY ACCESS. INT. CL. 9. REG. 12-16-1997.
- 2,122,037. HEALTHCARE BANKING. INT. CL. 36. REG. 12-16-1997.
- 2,122,038. SAFE WALK. INT. CL. 25. REG. 12-16-1997.
- 2,122,040. RBRC NI-CD AND DESIGN. INT. CL. 40. REG. 12-16-1997.
- 2,122,048. A+ MEDICAL PRODUCTS AND DESIGN. INT. CL. 10. REG. 12-16-1997.
- 2,122,050. TITLE W3-DESIGN TITLE AND DESIGN. INT. CL. 35. REG. 12-16-1997.
- 2,122,051. PRIME PROGRAM - POSITIVE REINFORCEMENT IN THE MENOPAUSAL EXPERIENCE. INT. CL. 41. REG. 12-16-1997.
- 2,122,052. IRPAK. INT. CL. 11. REG. 12-16-1997.
- 2,122,055. COSMOS SAN FRANCISCO (STYLIZED). INT. CL. 41. REG. 12-16-1997.
- 2,122,056. WORLD.HIRE. INT. CL. 9. REG. 12-16-1997.
- 2,122,057. WAW WORLD ART WATCH (STYLIZED). INT. CL. 14. REG. 12-16-1997.
- 2,122,058. GLENWOOD. INT. CLS. 32 AND 33. REG. 12-16-1997.
- 2,122,059. P THE PANTRY AND DESIGN. INT. CL. 42. REG. 12-16-1997.
- 2,122,060. XXL. INT. CL. 3. REG. 12-16-1997.
- 2,122,061. MISCELLANEOUS DESIGN. INT. CL. 10. REG. 12-16-1997.
- 2,122,062. LA SHUFFLE. INT. CL. 25. REG. 12-16-1997.
- 2,122,066. TUFT SPRINGS. INT. CL. 32. REG. 12-16-1997.
- 2,122,068. XEPR. INT. CL. 9. REG. 12-16-1997.
- 2,122,071. DUMB AND DUMBER. INT. CL. 41. REG. 12-16-1997.
- 2,122,072. DEPARTMENT OF CORRECTIONS. INT. CL. 25. REG. 12-16-1997.
- 2,122,073. COLOREASE. INT. CL. 3. REG. 12-16-1997.
- 2,122,074. ARENA FIRST AID. INT. CLS. 5 AND 42. REG. 12-16-1997.
- 2,122,076. GOLFPARTY AND DESIGN. INT. CL. 42. REG. 12-16-1997.
- 2,122,077. KIDS UNIVERSITY. INT. CL. 16. REG. 12-16-1997.
- 2,122,079. LIGHT EYES. INT. CL. 9. REG. 12-16-1997.
- 2,122,087. GLITTER & GLOW. INT. CL. 28. REG. 12-16-1997.
- 2,122,088. CAROL D. (STYLIZED). INT. CL. 14. REG. 12-16-1997.
- 2,122,090. COUNTRY BABY. INT. CLS. 24 AND 25. REG. 12-16-1997.
- 2,122,093. ALLBALL. INT. CL. 28. REG. 12-16-1997.
- 2,122,095. HOT, GOOD, GONE.. INT. CL. 30. REG. 12-16-1997.
- 2,122,096. AUTONEST. INT. CL. 9. REG. 12-16-1997.
- 2,122,097. MISCELLANEOUS DESIGN. INT. CL. 42. REG. 12-16-1997.
- 2,122,104. SHIN'S NOODLES AND DESIGN. INT. CL. 30. REG. 12-16-1997.
- 2,122,110. LIFESCAPES LITHOGRAPHS. INT. CL. 16. REG. 12-16-1997.
- 2,122,111. AT HAND. INT. CL. 35. REG. 12-16-1997.
- 2,122,112. RYBACK. INT. CL. 3. REG. 12-16-1997.
- 2,122,113. DREAMS BY TABU. INT. CL. 3. REG. 12-16-1997.
- 2,122,116. ORCHARD HILL PRODUCTIONS. INT. CLS. 9 AND 16. REG. 12-16-1997.
- 2,122,117. LET'S CLIMB HIGHER!. INT. CLS. 9 AND 16. REG. 12-16-1997.
- 2,122,119. DRI-F.I.T. REMOVES SWEAT AND DESIGN. INT. CL. 25. REG. 12-16-1997.
- 2,122,123. SAVEUR INTERNATIONAL. INT. CL. 16. REG. 12-16-1997.
- 2,122,125. PROFESSOR STITCH. INT. CL. 9. REG. 12-16-1997.
- 2,122,128. THE JUICE WITH THE FLAVOR AND DESIGN. INT. CL. 32. REG. 12-16-1997.
- 2,122,134. LEARNEGY. INT. CL. 42. REG. 12-16-1997.
- 2,122,135. ROOT LEARNEGY. INT. CL. 42. REG. 12-16-1997.
- 2,122,137. MORBRITE. INT. CL. 2. REG. 12-16-1997.
- 2,122,139. PRO-TECT. INT. CL. 5. REG. 12-16-1997.
- 2,122,140. ONLY THE BEST PLAY PGA TOUR. INT. CL. 28. REG. 12-16-1997.
- 2,122,141. BAL. INT. CL. 16. REG. 12-16-1997.
- 2,122,143. ENVIROGEL. INT. CL. 1. REG. 12-16-1997.
- 2,122,144. PRGR INTERNATIONAL PI (STYLIZED). INT. CL. 28. REG. 12-16-1997.
- 2,122,145. MEMBRAPURE. INT. CL. 11. REG. 12-16-1997.
- 2,122,146. MEMBRA PRO. INT. CL. 11. REG. 12-16-1997.
- 2,122,147. MEDQUEST CHOICE. INT. CLS. 36 AND 42. REG. 12-16-1997.
- 2,122,149. PENTAMARK. INT. CL. 35. REG. 12-16-1997.
- 2,122,151. INNOVATOR. INT. CL. 11. REG. 12-16-1997.
- 2,122,152. QUICKLETS. INT. CL. 5. REG. 12-16-1997.
- 2,122,153. ICEMULE. INT. CL. 21. REG. 12-16-1997.
- 2,122,155. NUTTY NOLAGRAN "IT'S ALL MIXED UP". INT. CL. 30. REG. 12-16-1997.
- 2,122,158. QUOVIS. INT. CL. 25. REG. 12-16-1997.
- 2,122,160. OFFICIAL FILM OF SUMMER AND DESIGN. INT. CLS. 1 AND 9. REG. 12-16-1997.
- 2,122,165. APOLLO. INT. CL. 9. REG. 12-16-1997.
- 2,122,167. LEGENDARY SPACE ENCOUNTERS. INT. CL. 28. REG. 12-16-1997.
- 2,122,169. GOLD CREST FOR HER. INT. CL. 25. REG. 12-16-1997.
- 2,122,170. SIGNATURE SERIES. INT. CL. 11. REG. 12-16-1997.
- 2,122,172. MEDIAPULSE. INT. CL. 16. REG. 12-16-1997.
- 2,122,175. AVA. INT. CL. 28. REG. 12-16-1997.
- 2,122,177. MEMOBILL. INT. CL. 16. REG. 12-16-1997.
- 2,122,178. ACCUSHIP. INT. CL. 39. REG. 12-16-1997.
- 2,122,179. MEDITEO AND DESIGN. INT. CL. 33. REG. 12-16-1997.
- 2,122,180. SWITCHBOARD SEVEN. INT. CL. 9. REG. 12-16-1997.
- 2,122,181. OYM. INT. CL. 25. REG. 12-16-1997.
- 2,122,184. EDUCARE. INT. CL. 42. REG. 12-16-1997.
- 2,122,188. RFI AND DESIGN. INT. CL. 17. REG. 12-16-1997.
- 2,122,189. AUTOZORB AND DESIGN. INT. CL. 17. REG. 12-16-1997.
- 2,122,190. ACOUSTIROC. INT. CL. 17. REG. 12-16-1997.
- 2,122,191. RUN EMMITT RUN AND DESIGN. INT. CL. 25. REG. 12-16-1997.
- 2,122,193. UPTIME ONLINE. INT. CL. 42. REG. 12-16-1997.
- 2,122,196. TENDERONI. INT. CL. 41. REG. 12-16-1997.
- 2,122,199. VRP AND DESIGN. INT. CL. 9. REG. 12-16-1997.
- 2,122,200. THE NOESIS MISSIONS PROGRAMME. INT. CL. 42. REG. 12-16-1997.
- 2,122,201. DAYLIGHT MINISTRIES, INCORPORATED AND DESIGN. INT. CL. 42. REG. 12-16-1997.
- 2,122,203. TURBOPROJECT. INT. CL. 9. REG. 12-16-1997.
- 2,122,211. GORILLA. INT. CL. 28. REG. 12-16-1997.
- 2,122,212. MO-TOE MOTORCYCLE TOWING SYSTEM AND DESIGN. INT. CL. 12. REG. 12-16-1997.
- 2,122,213. RITUALS. INT. CL. 9. REG. 12-16-1997.
- 2,122,215. JUST WAIT'LL WE GET OUR HANES HER WAY ON YOU. INT. CL. 25. REG. 12-16-1997.
- 2,122,218. WATCH FROG WFC AND DESIGN. INT. CL. 19. REG. 12-16-1997.
- 2,122,219. INTEGRA. INT. CL. 11. REG. 12-16-1997.
- 2,122,220. MONEY PAGE. INT. CL. 35. REG. 12-16-1997.
- 2,122,221. SNOVIPER. INT. CL. 28. REG. 12-16-1997.
- 2,122,222. FALCON CORPORATION AND DESIGN. INT. CL. 20. REG. 12-16-1997.
- 2,122,223. SUNDAY BEST. INT. CL. 30. REG. 12-16-1997.
- 2,122,226. YOUR SET. INT. CL. 9. REG. 12-16-1997.
- 2,122,227. BARQUITO ROJO AND DESIGN. INT. CL. 30. REG. 12-16-1997.
- 2,122,232. BEN HUR. INT. CL. 30. REG. 12-16-1997.

- 2,122,235. ISLAND TROPICKS AND DESIGN. INT. CLS. 29 AND 31. REG. 12-16-1997.
- 2,122,237. CROSS LINK 3. INT. CL. 12. REG. 12-16-1997.
- 2,122,238. DELETE. INT. CL. 3. REG. 12-16-1997.
- 2,122,242. OLSON INTERNATIONAL. INT. CL. 6. REG. 12-16-1997.
- 2,122,244. INTERLANE. INT. CL. 9. REG. 12-16-1997.
- 2,122,245. RINGSDORF HEALTH CONCEPTS. INT. CL. 5. REG. 12-16-1997.
- 2,122,246. GONOSTAT. INT. CL. 5. REG. 12-16-1997.
- 2,122,248. WIN. INT. CL. 9. REG. 12-16-1997.
- 2,122,249. STITCHARTS AND DESIGN. INT. CL. 26. REG. 12-16-1997.
- 2,122,250. CONEXPORT. INT. CL. 35. REG. 12-16-1997.
- 2,122,252. AULD LANG SYNE. INT. CL. 32. REG. 12-16-1997.
- 2,122,254. ASIA BOWL AND DESIGN. INT. CL. 42. REG. 12-16-1997.
- 2,122,256. COUNTRY CREAMS. INT. CL. 30. REG. 12-16-1997.
- 2,122,260. NITE CALL. INT. CL. 9. REG. 12-16-1997.
- 2,122,263. FROM THE AND DESIGN. INT. CL. 25. REG. 12-16-1997.
- 2,122,265. THINKING OUT LOUD. INT. CL. 9. REG. 12-16-1997.
- 2,122,266. ANTIOXIDANT ADVANTAGE. INT. CL. 5. REG. 12-16-1997.
- 2,122,267. EVERYTHING FROM NOTHING. INT. CL. 30. REG. 12-16-1997.
- 2,122,271. DANCING GATOR. INT. CL. 30. REG. 12-16-1997.
- 2,122,272. PES 828. INT. CL. 5. REG. 12-16-1997.
- 2,122,274. MISCELLANEOUS DESIGN. INT. CL. 25. REG. 12-16-1997.
- 2,122,276. COMFORT WALK. INT. CL. 28. REG. 12-16-1997.
- 2,122,277. ROAD HEAT. INT. CL. 28. REG. 12-16-1997.
- 2,122,279. RACING WITH WINROSS. INT. CL. 28. REG. 12-16-1997.
- 2,122,282. PLANET EYEWEAR. INT. CL. 42. REG. 12-16-1997.
- 2,122,285. SNAPPLE AND DESIGN. INT. CL. 30. REG. 12-16-1997.
- 2,122,286. JIG FIX. INT. CL. 28. REG. 12-16-1997.
- 2,122,287. AMI. INT. CL. 10. REG. 12-16-1997.
- 2,122,288. MICROGRIP. INT. CL. 10. REG. 12-16-1997.
- 2,122,289. TINY TODDLERS. INT. CLS. 20 AND 21. REG. 12-16-1997.
- 2,122,291. FLOWER FUN. INT. CL. 28. REG. 12-16-1997.
- 2,122,292. COMFORT-ME. INT. CL. 3. REG. 12-16-1997.
- 2,122,293. MSDISK (STYLIZED). INT. CL. 9. REG. 12-16-1997.
- 2,122,294. GEOBEE. INT. CL. 28. REG. 12-16-1997.
- 2,122,295. HOMESIDE LENDING, INC. AND DESIGN. INT. CL. 36. REG. 12-16-1997.
- 2,122,296. MISCELLANEOUS DESIGN. INT. CL. 16. REG. 12-16-1997.
- 2,122,299. SALMON CHEF. INT. CL. 29. REG. 12-16-1997.
- 2,122,301. CITYSCOPE. INT. CL. 28. REG. 12-16-1997.
- 2,122,303. PRO POLY. INT. CL. 9. REG. 12-16-1997.
- 2,122,304. TIME HAS VALUE. INT. CL. 9. REG. 12-16-1997.
- 2,122,305. HOT HAND. INT. CL. 9. REG. 12-16-1997.
- 2,122,307. YOUR GLOBAL SOLUTION. INT. CL. 35. REG. 12-16-1997.
- 2,122,308. SWEET DAISY. INT. CL. 28. REG. 12-16-1997.
- 2,122,309. T-4. INT. CL. 3. REG. 12-16-1997.
- 2,122,310. SNOW BLAZER. INT. CL. 28. REG. 12-16-1997.
- 2,122,311. POSITIVE COMMUNICATIONS. INT. CL. 41. REG. 12-16-1997.
- 2,122,312. MOTIONVISION. INT. CLS. 16 AND 40. REG. 12-16-1997.
- 2,122,317. SNAPWIN. INT. CL. 9. REG. 12-16-1997.
- 2,122,318. ASSURE. INT. CL. 42. REG. 12-16-1997.
- 2,122,319. SOLIDPLAYER. INT. CL. 9. REG. 12-16-1997.
- 2,122,322. SOUND TRAVELER. INT. CL. 9. REG. 12-16-1997.
- 2,122,323. HEADS UP. INT. CL. 14. REG. 12-16-1997.
- 2,122,324. ORANGE POP. INT. CL. 3. REG. 12-16-1997.
- 2,122,325. SEA MONSTER. INT. CL. 3. REG. 12-16-1997.
- 2,122,326. FLUTTER BY. INT. CL. 3. REG. 12-16-1997.
- 2,122,327. BUNNY HOP. INT. CL. 3. REG. 12-16-1997.
- 2,122,328. FRIENDSHIP CANDLE. INT. CL. 4. REG. 12-16-1997.
- 2,122,330. GRANDE BRAND CHEDDAR BLEND AND DESIGN. INT. CL. 29. REG. 12-16-1997.
- 2,122,331. GRANDE BRAND CHEDDAR AND DESIGN. INT. CL. 29. REG. 12-16-1997.
- 2,122,334. WEST SIDE FO' LIFE AND DESIGN. INT. CL. 25. REG. 12-16-1997.
- 2,122,336. PREFIN. INT. CL. 2. REG. 12-16-1997.
- 2,122,337. JOHNSTON & MURPHY TAILORED CASUAL. INT. CL. 25. REG. 12-16-1997.
- 2,122,338. COHOST. INT. CL. 9. REG. 12-16-1997.
- 2,122,339. THE AUSBO ADVISOR. INT. CL. 16. REG. 12-16-1997.
- 2,122,344. TD18. INT. CL. 12. REG. 12-16-1997.
- 2,122,346. WHIRLPOOL. INT. CL. 16. REG. 12-16-1997.
- 2,122,347. KINESE. INT. CL. 28. REG. 12-16-1997.
- 2,122,348. INSPIRED BY TRADITION. INT. CL. 27. REG. 12-16-1997.
- 2,122,351. COMPANY JOE. INT. CL. 30. REG. 12-16-1997.
- 2,122,353. PAGEMINDER. INT. CL. 38. REG. 12-16-1997.
- 2,122,354. CONVERSATION CARD. INT. CL. 38. REG. 12-16-1997.
- 2,122,357. DCA FREE. INT. CL. 3. REG. 12-16-1997.
- 2,122,360. TOUGH LABEL. INT. CL. 14. REG. 12-16-1997.
- 2,122,362. TENACITY. INT. CL. 28. REG. 12-16-1997.
- 2,122,363. SUNSHELL. INT. CL. 22. REG. 12-16-1997.
- 2,122,366. B AND DESIGN. INT. CL. 14. REG. 12-16-1997.
- 2,122,368. ULTIMUS. INT. CL. 22. REG. 12-16-1997.
- 2,122,369. MISCELLANEOUS DESIGN. INT. CL. 25. REG. 12-16-1997.
- 2,122,371. PMADVISOR. INT. CL. 9. REG. 12-16-1997.
- 2,122,372. COMPANY JOE AND DESIGN. INT. CL. 42. REG. 12-16-1997.
- 2,122,373. COMPANY JOE AND DESIGN. INT. CL. 30. REG. 12-16-1997.
- 2,122,374. PROANSA AND DESIGN. INT. CL. 25. REG. 12-16-1997.
- 2,122,375. LIVEPIX. INT. CL. 9. REG. 12-16-1997.
- 2,122,379. PEOPLES LOTTERY FOUNDATION A FOUNDATION FOR THE FUTURE. INT. CL. 36. REG. 12-16-1997.
- 2,122,380. COLOR SOURCE AND DESIGN. INT. CL. 16. REG. 12-16-1997.
- 2,122,382. IMPACT INNOVATIVE MANAGEMENT PRACTICES AND COMPETITIVE TOOLS. INT. CL. 41. REG. 12-16-1997.
- 2,122,383. NU-CHECKERS. INT. CL. 28. REG. 12-16-1997.
- 2,122,387. SNACKWELL'S. INT. CL. 30. REG. 12-16-1997.
- 2,122,388. JEEPERS JR! FOOD, FUN AND A MONKEY! AND DESIGN. INT. CLS. 41 AND 42. REG. 12-16-1997.
- 2,122,389. DESIGNLAB. INT. CL. 9. REG. 12-16-1997.
- 2,122,391. RIDEMASTER. INT. CL. 9. REG. 12-16-1997.
- 2,122,392. OXYBOOT. INT. CL. 10. REG. 12-16-1997.
- 2,122,393. SOME OF MY BEST FRIENDS ARE POLKA-DOT PIGS. INT. CL. 21. REG. 12-16-1997.
- 2,122,395. SPEAKERSEARCH.COM (STYLIZED). INT. CL. 41. REG. 12-16-1997.
- 2,122,398. THE EXPERIENCE TO KNOW. THE STRENGTH TO PERFORM.. INT. CL. 36. REG. 12-16-1997.
- 2,122,401. ATTACK-FOAM. INT. CL. 1. REG. 12-16-1997.
- 2,122,402. CUTLOOSE. INT. CL. 1. REG. 12-16-1997.
- 2,122,404. ANIS ISAN. INT. CL. 14. REG. 12-16-1997.
- 2,122,407. BEYOND 2000. INT. CL. 42. REG. 12-16-1997.
- 2,122,411. 1-888-ALL-BAGS. INT. CL. 35. REG. 12-16-1997.
- 2,122,412. IMPERIAL DIAMOND. INT. CL. 21. REG. 12-16-1997.
- 2,122,413. BEAUTY BEGINS BY LOVING YOURSELF FROM THE INSIDE OUT. INT. CL. 42. REG. 12-16-1997.
- 2,122,414. MADISON AVENUE. INT. CL. 42. REG. 12-16-1997.
- 2,122,415. ACTCONNECT. INT. CL. 35. REG. 12-16-1997.
- 2,122,419. TROPICAL FRUIT DUM-DUM POPS. INT. CL. 30. REG. 12-16-1997.
- 2,122,421. LASTING DIMENSIONS. INT. CL. 19. REG. 12-16-1997.

- 2,122,423. ROUGH-HIDE. INT. CL. 31. REG. 12-16-1997.  
 2,122,424. PIACERE. INT. CL. 25. REG. 12-16-1997.  
 2,122,425. CHALLENGE THINKING (STYLIZED). INT. CLS. 35 AND 42. REG. 12-16-1997.  
 2,122,428. AUTO-TRAC. INT. CL. 9. REG. 12-16-1997.  
 2,122,429. ELECTRONIC ISLAND. INT. CL. 42. REG. 12-16-1997.  
 2,122,430. NEHI ORIGINALS. INT. CL. 32. REG. 12-16-1997.  
 2,122,432. PAPER OR PLASTIC?. INT. CL. 41. REG. 12-16-1997.  
 2,122,438. LASER FANG. INT. CL. 28. REG. 12-16-1997.  
 2,122,439. VITESSE. INT. CL. 30. REG. 12-16-1997.  
 2,122,442. DESIGNLAB START TO FINISH AND DESIGN. INT. CL. 9. REG. 12-16-1997.  
 2,122,446. DEWPLEX. INT. CL. 3. REG. 12-16-1997.  
 2,122,447. MUFFIN WORKS. INT. CL. 21. REG. 12-16-1997.  
 2,122,453. MAN LAND GEAR. INT. CL. 25. REG. 12-16-1997.  
 2,122,454. MOLECULAR PROTECTOR. INT. CL. 5. REG. 12-16-1997.  
 2,122,457. NOT ACTIVE. INT. CL. 25. REG. 12-16-1997.  
 2,122,458. RADIANT ACCENTS. INT. CL. 4. REG. 12-16-1997.  
 2,122,459. BABY FRIENDS. INT. CL. 28. REG. 12-16-1997.  
 2,122,460. TEMPRESERVE COOK & GO. INT. CL. 21. REG. 12-16-1997.  
 2,122,461. TRANSDRIVE. INT. CL. 37. REG. 12-16-1997.  
 2,122,462. WHERE CHIROPRACTIC AND MEDICINE MEET TO END YOUR SUFFERING. INT. CL. 42. REG. 12-16-1997.  
 2,122,463. PACIFIC BLOOD SERVICES. INT. CL. 42. REG. 12-16-1997.  
 2,122,464. CPDIRECT. INT. CL. 36. REG. 12-16-1997.  
 2,122,468. TI-F (STYLIZED). INT. CL. 28. REG. 12-16-1997.  
 2,122,469. PV. INT. CL. 28. REG. 12-16-1997.  
 2,122,470. CASH ROUTE. INT. CL. 36. REG. 12-16-1997.  
 2,122,472. TRAIL CREST. INT. CL. 25. REG. 12-16-1997.  
 2,122,474. SUNSCAPES. INT. CL. 39. REG. 12-16-1997.  
 2,122,475. EARTHSCAPES. INT. CL. 39. REG. 12-16-1997.  
 2,122,476. SAFARISCAPES. INT. CL. 39. REG. 12-16-1997.  
 2,122,477. JUNGLESCAPES. INT. CL. 39. REG. 12-16-1997.  
 2,122,478. OCEANSCAPES. INT. CL. 39. REG. 12-16-1997.  
 2,122,479. NATURESCAPES. INT. CL. 39. REG. 12-16-1997.  
 2,122,480. MOUNTAINSCAPES. INT. CL. 39. REG. 12-16-1997.  
 2,122,481. SPORTSCAPES. INT. CL. 39. REG. 12-16-1997.  
 2,122,483. PITTSBURGH ALLEGHENIES. INT. CL. 25. REG. 12-16-1997.  
 2,122,485. BERISON. INT. CL. 9. REG. 12-16-1997.  
 2,122,486. COPPERFIELD'S. INT. CL. 29. REG. 12-16-1997.  
 2,122,488. MEGA-GENTIC. INT. CL. 9. REG. 12-16-1997.  
 2,122,489. LITTEACHER. INT. CLS. 38, 41 AND 42. REG. 12-16-1997.  
 2,122,491. NEUTROGENA DAILY MOISTURE SUPPLY. INT. CL. 3. REG. 12-16-1997.  
 2,122,492. BABY & DUCKIE. INT. CL. 28. REG. 12-16-1997.  
 2,122,495. DYNAMIC GRAPHICS ARTWORKS (STYLIZED). INT. CL. 9. REG. 12-16-1997.  
 2,122,496. INTERNET DAILY. INT. CLS. 16, 35 AND 42. REG. 12-16-1997.  
 2,122,498. BLUE BASE/YELLOW BASE COLOR SYSTEM. INT. CL. 3. REG. 12-16-1997.  
 2,122,501. BOOK TV. INT. CL. 42. REG. 12-16-1997.  
 2,122,504. DISABLED LIST. INT. CL. 25. REG. 12-16-1997.  
 2,122,505. INDUSTRYWIDE MORTGAGE EXCHANGE. INT. CL. 36. REG. 12-16-1997.  
 2,122,506. HARDLINE SYSTEMS. INT. CL. 42. REG. 12-16-1997.  
 2,122,508. VOICE POLL. INT. CL. 9. REG. 12-16-1997.  
 2,122,509. YOUNGSTERS AND DESIGN. INT. CL. 25. REG. 12-16-1997.  
 2,122,510. FOOD QUALITY. INT. CLS. 16 AND 35. REG. 12-16-1997.  
 2,122,511. ULTRA MOIST. INT. CL. 3. REG. 12-16-1997.  
 2,122,513. WORKCOMP CALL. INT. CL. 42. REG. 12-16-1997.  
 2,122,514. WEATHER MALL. INT. CL. 42. REG. 12-16-1997.  
 2,122,516. MISCELLANEOUS DESIGN. INT. CL. 18. REG. 12-16-1997.  
 2,122,517. BEEFNOT!. INT. CL. 29. REG. 12-16-1997.  
 2,122,518. WEB DESIGN AND DEVELOPMENT. INT. CLS. 41 AND 42. REG. 12-16-1997.  
 2,122,519. CHICKEN (NOT!). INT. CL. 29. REG. 12-16-1997.  
 2,122,522. INTERNET TOOLS FOR NON-PROGRAMMERS. INT. CL. 9. REG. 12-16-1997.  
 2,122,525. YOU GOTTA BELIEVE. INT. CL. 25. REG. 12-16-1997.  
 2,122,526. THE YELLOW PAGES PSYCHIC NETWORK AND DESIGN. INT. CL. 41. REG. 12-16-1997.  
 2,122,527. MISCELLANEOUS DESIGN. INT. CL. 42. REG. 12-16-1997.  
 2,122,528. CULTURAL PORTRAITS OF. INT. CL. 41. REG. 12-16-1997.  
 2,122,530. DIRECTORY OF CONSUMER ELECTRONICS RETAILERS & DISTRIBUTORS. INT. CL. 16. REG. 12-16-1997.  
 2,122,531. IN THE MIDST OF MY HEART IS A GARDEN. INT. CLS. 16 AND 25. REG. 12-16-1997.  
 2,122,533. BASIC RED. INT. CL. 25. REG. 12-16-1997.  
 2,122,535. LOLLY WRAP. INT. CL. 17. REG. 12-16-1997.  
 2,122,536. HAIR HOOPS. INT. CL. 26. REG. 12-16-1997.  
 2,122,537. RESUMEMANAGER. INT. CL. 9. REG. 12-16-1997.  
 2,122,538. SENIOR QUARTERS. INT. CL. 42. REG. 12-16-1997.  
 2,122,539. TUTORIAL & APPLICATIONS. INT. CLS. 9 AND 16. REG. 12-16-1997.  
 2,122,540. DOGGIE CUTS. INT. CL. 9. REG. 12-16-1997.  
 2,122,542. FIELD WORKSTATION. INT. CL. 9. REG. 12-16-1997.  
 2,122,544. MISCELLANEOUS DESIGN. INT. CL. 42. REG. 12-16-1997.  
 2,122,547. ASSET MANAGEMENT INDEX. INT. CL. 35. REG. 12-16-1997.  
 2,122,548. NUDE DUDES. INT. CL. 16. REG. 12-16-1997.  
 2,122,552. GRAND RAPIDS HOOPS. INT. CL. 16. REG. 12-16-1997.  
 2,122,553. GRAND RAPIDS HOOPS. INT. CL. 41. REG. 12-16-1997.  
 2,122,554. AMERICAN INFORMATION SYSTEMS. INT. CL. 42. REG. 12-16-1997.  
 2,122,555. AMERICAN INFORMATION SYSTEMS. INT. CL. 9. REG. 12-16-1997.  
 2,122,559. AUTOMATED PRODUCTION ENVIRONMENT AND DESIGN. INT. CL. 9. REG. 12-16-1997.  
 2,122,564. CALIFORNIA KIDS!. INT. CL. 16. REG. 12-16-1997.  
 2,122,565. CAL FIG. INT. CL. 31. REG. 12-16-1997.  
 2,122,566. ALWAYS TENDER. INT. CL. 29. REG. 12-16-1997.  
 2,122,567. CAPITATION ABSTRACTS AND ANALYSIS. INT. CL. 16. REG. 12-16-1997.  
 2,122,568. THE WRITING COACH. INT. CL. 41. REG. 12-16-1997.  
 2,122,569. CLEAN-CUT. INT. CL. 8. REG. 12-16-1997.  
 2,122,571. HEALTH LEGISLATION AND REGULATION. INT. CL. 16. REG. 12-16-1997.  
 2,122,573. ART FOUNDRY JOURNAL AND DESIGN. INT. CL. 16. REG. 12-16-1997.  
 2,122,574. NETHEAD AND DESIGN. INT. CL. 25. REG. 12-16-1997.  
 2,122,575. FASHION CREDIT. INT. CL. 36. REG. 12-16-1997.  
 2,122,582. TRUE AUDIO. INT. CL. 9. REG. 12-16-1997.  
 2,122,583. CHURCH BUSINESS EXPO. INT. CL. 35. REG. 12-16-1997.  
 2,122,584. PENSION SERVICE ASSOCIATES (STYLIZED). INT. CL. 35. REG. 12-16-1997.  
 2,122,585. NATIONAL SPORTS NETWORK. INT. CL. 41. REG. 12-16-1997.  
 2,122,586. SUNFLOWER HELIANTHUS AND DESIGN. INT. CL. 25. REG. 12-16-1997.  
 2,122,587. MISCELLANEOUS DESIGN. INT. CL. 25. REG. 12-16-1997.  
 2,123,596. DIY BOAT OWNER AND DESIGN. INT. CL. 16. REG. 12-23-1997.  
 2,132,757. MRS. GROSSMAN'S PAPER COMPANY. INT. CL. 16. REG. 1-27-1998.  
 2,139,152. CAROLINA CAJUN. INT. CL. 30. REG. 2-24-1998.  
 2,159,752. CONDENET. INT. CL. 9 ONLY. REG. 5-19-1998.

- 2,162,997. EARTHENTERPRISE. INT. CLS. 9 AND 42 ONLY. REG. 6-9-1998.
- 2,169,920. HOCKEYTOWN AND DESIGN. INT. CL. 9 ONLY. REG. 6-30-1998.
- 2,171,649. ARTISTRY IN MOTION. INT. CL. 41 ONLY. REG. 7-7-1998.
- 2,172,530. THE ZYBAN ADVANTAGE PACK. INT. CL. 41 ONLY. REG. 7-14-1998.
- 2,173,474. ULTRAMESH. INT. CL. 5 ONLY. REG. 7-14-1998.
- 2,178,028. WE'RE ALWAYS WITH YOU. INT. CL. 9 ONLY. REG. 8-4-1998.
- 2,181,888. NATIONAL FARM MEDICINE CENTER. INT. CL. 41 ONLY. REG. 8-18-1998.
- 2,185,409. LASERTRAK. INT. CLS. 37 AND 42 ONLY. REG. 9-1-1998.
- 2,196,130. BF AND DESIGN. INT. CLS. 16, 21 AND 25 ONLY. REG. 10-13-1998.
- 2,160,010. GO PLAY. INT. CL. 41. REG. 5-26-1998.
- 2,196,049. NATURAL WONDERS. INT. CL. 35. REG. 10-13-1998.
- 2,216,066. FREE 2 "B" AND DESIGN. INT. CL. 25. REG. 1-5-1999.
- 2,319,720. CHUG-IT AND DESIGN. INT. CL. 32. REG. 2-15-2000.
- 2,376,467. SMARTICKET. INT. CL. 41. REG. 8-15-2000.
- 2,385,967. POPULAR CULTURE HIGHWAY. INT. CLS. 9, 16 AND 25. REG. 9-12-2000.
- 2,703,492. SANTA FE GUITAR QUARTET (STYLIZED). INT. CL. 41. REG. 4-8-2003.
- 2,824,173. DALLAS HOUSE & LANDSCAPE SHOW. INT. CL. 35. REG. 3-16-2004.

---

**SECTION 18**

- 261,652. THE BALKAN SOBRANIE CIGARETTES 50000 AND DESIGN. U.S. CL. 17. REG. 9-17-1929.
- 1,345,694. MICROWRITER. INT. CL. 9. REG. 7-2-1985.
- 1,381,187. ENDOCOAGULATOR. INT. CL. 10. REG. 2-4-1986.
- 1,399,745. MILE HIGH PIE AND DESIGN. INT. CL. 30. REG. 7-1-1986.
- 1,537,118. BATHTIME. INT. CLS. 3, 20, 21 AND 25. REG. 5-2-1989.
- 1,560,086. SMOOTH SAILING. INT. CL. 32. REG. 10-10-1989.
- 1,939,156. BELGRAVIA. INT. CL. 36. REG. 12-5-1995.
- 1,959,154. IPOW. INT. CL. 9. REG. 2-27-1996.
- 2,126,719. JUST 4 ME. INT. CLS. 18, 24 AND 25. REG. 1-6-1998.
- 2,649,461. ZIOX. INT. CL. 5. REG. 11-12-2002. RESTORED TO SN 78-069,088.
- 2,659,326. SO ALIVE. INT. CL. 5. REG. 12-10-2002. RESTORED TO SN 76-378,954.
- 2,829,052. MRS. KAHN'S K AND DESIGN. INT. CL. 30. REG. 4-6-2004. RESTORED TO SN 76-346,195.
- 2,829,787. DISTRACTION FORMATS. INT. CLS. 35 AND 41. REG. 4-6-2004. RESTORED TO SN 78-103,941.
- 2,829,808. THE EINSTEIN FACTOR. INT. CL. 16. REG. 4-6-2004. RESTORED TO SN 78-124,603.
- 2,831,098. INVEST WITH CONFIDENCE T. ROWE PRICE AND DESIGN. INT. CLS. 9, 16 AND 36. REG. 4-13-2004. RESTORED TO SN 75-982,881.
- 2,857,686. GRUPO DESTINO. INT. CL. 41. REG. 6-29-2004. RESTORED TO SN 76-532,243.

\* \* \* \* \*

---

**INADVERTENTLY ISSUED REGISTRATION NUMBERS**

# TRADEMARK REGISTRATIONS AMENDED, CORRECTED, ETC.

The designation "U.S. Cl." appearing in this section refers to the U.S. class in effect prior to Sep. 1, 1973 rather than the international class which applies to applications filed on or after that date. For adoption of international classification see notice in the OFFICIAL GAZETTE of Jun. 26, 1973 (911 O.G. TM 210).

Any change to the registration will be indicated at the bottom of each entry under ELEMENTS AMENDED, CORRECTED OR RESTRICTED. With the exception of changes to the goods and services, additions to the registration will appear in asterisks and deletions of the registration will appear in brackets. Elements which are only changed will be listed with no punctuation. As to the goods/services statement, amendments to the goods/services will appear in asterisks and deletions will appear in brackets. In addition if any change to the goods/services occurs, the element "Goods/Services" will be listed under ELEMENTS AMENDED, CORRECTED OR RESTRICTED.

781,920. REG. 12-22-1964. CALGON CARBON CORPORATION (DELAWARE CORPORATION) 500 CALGON CARBON DRIVE, PITTSBURGH, PA. 15205, SN 72-187,959. FILED 3-4-1964. PRINCIPAL REGISTER.

FOR DISPENSERS FOR TOWELS, PAPER CUPS, SANITARY NAPKINS, TOILET TISSUES, AND TOILET SEAT COVERS; HOLDERS FOR TOOTHBRUSHES; AND POWDER, LIQUID, AND LEAF-TYPE SOAP DISPENSERS.

FIRST USE 9-0-1978; IN COMMERCE 9-0-1978.

## CANE CAL

ELEMENTS AMENDED  
MARK

OWNER OF U.S. REG. NO. 73,770.  
INT. CL. 1/U.S. CL. 6  
FOR ACTIVATED CARBON.  
FIRST USE 12-30-1963; IN COMMERCE 1-10-1964.

ELEMENTS AMENDED  
MARK

1,290,482. REG. 8-14-1984. BIG BROTHERS-BIG SISTERS OF AMERICA (D.C. CORPORATION) 230 NORTH THIRTEENTH STREET, PHILADELPHIA, PA. 19107, SN 73-374,339. FILED 7-12-1982. PRINCIPAL REGISTER.

## BIG BROTHERS BIG SISTERS OF AMERICA

OWNER OF U.S. REG. NO. 943,786.  
INT. CL. 42/U.S. CL. 100  
FOR YOUTH COUNSELLING SERVICES.  
FIRST USE 1-1-1977; IN COMMERCE 1-1-1977.

ELEMENTS AMENDED  
OWNER NAME  
MARK

1,276,705. REG. 5-8-1984. ACCESSORY SPECIALTIES, INC. (NEW YORK CORPORATION) 441 SAW MILL RIVER RD., YONKERS, NY, 10701, SN 73-320,715. FILED 7-27-1981. PRINCIPAL REGISTER.

## ASI

INT. CL. 6/U.S. CLS. 12, 13 AND 32  
FOR BATHROOM AND LAVATORY ACCESSORIES AND HARDWARE MADE PRIMARILY OF METAL—NAMESLY, LAVATORY STALLS, SHOWER STALLS, GRAB BARS, GUARD AND HAND RAILINGS, CORNER GUARDS; JANITORIAL ACCESSORIES AND HARDWARE—NAMESLY, METAL HOOKS AND BRACKETS FOR STORING LADDERS, PAILS, RAGS, TOWELS, VACUUM CLEANER COMPONENTS AND MOPS; HOSPITAL ACCESSORIES MADE PRIMARILY OF METAL—NAMESLY, SPECIMEN PASS BOXES AND CABINETS.  
FIRST USE 9-0-1978; IN COMMERCE 9-0-1978.

INT. CL. 11/U.S. CLS. 13, 21 AND 44  
FOR MODULAR LAVATORY STATION UNITS, WASH BASINS, ELECTRIC LIGHT FIXTURES, AND ELECTRIC WALL-MOUNTED COMBINATION HAND AND HAIR DRYING UNITS.  
FIRST USE 9-0-1978; IN COMMERCE 9-0-1978.

INT. CL. 20/U.S. CL. 32  
FOR CABINETS AND CABINET HARDWARE SOLD AS A UNIT, RACKS, SHOWER RODS, WASTE BASKETS, TIE BARS, SHELVES, STORAGE CABINETS, AND MIRRORS.  
FIRST USE 9-0-1978; IN COMMERCE 9-0-1978.

INT. CL. 21/U.S. CL. 2

1,297,847. REG. 9-25-1984. NUTRI/SYSTEM IPHC, INC. (DELAWARE CORPORATION) 300 DELAWARE AVE., SUITE 1704, WILMINGTON, DE, 19801, SN 73-394,040. FILED 9-29-1982. PRINCIPAL REGISTER.

**nutrisystem®**

OWNER OF U.S. REG. NOS. 1,195,490, 1,213,559 AND 1,213,560.

INT. CL. 29/U.S. CL. 46  
FOR EGGS, SOUPS [ AND CHOCOLATE MILK, ALL ] IN POWDERED FORM FOR USE IN A WEIGHT REDUCTION PROGRAM.  
FIRST USE 1-15-1978; IN COMMERCE 1-15-1978.

INT. CL. 30/U.S. CL. 46

FOR [ CREPES, ] PANCAKES, MILKSHAKES, FRUIT-FLAVORED GELATINS, AND PUDDINGS, ALL IN POWDERED FORM; TABLE SYRUP IN LIQUID FORM; AND BREAKFAST CEREALS; ALL FOR USE IN A WEIGHT REDUCTION PROGRAM.  
FIRST USE 1-15-1978; IN COMMERCE 1-15-1978.

ELEMENTS AMENDED  
\*OWNER NAME\*  
\*OWNER ADDRESS\*  
\*CITIZENSHIP\*  
\*ENTITY\*  
\*ASSIGNMENT/NAME CHANGE\*  
MARK

1,300,030. REG. 10-16-1984. WACHTERS' ORGANIC SEA PRODUCTS CORPORATION (CALIFORNIA CORPORATION) 360 SHAW RD., SOUTH SAN FRANCISCO, CA, 94080, SN 73-335,387. FILED 11-3-1981. PRINCIPAL REGISTER.

**WACHTERS'**

OWNER OF U.S. REG. NO. 1,183,423.  
SEC. 2(F).  
INT. CL. 1/U.S. CL. 10  
FOR SOIL AND PLANT CONDITIONER.  
FIRST USE 7-1-1971; IN COMMERCE 7-1-1971.  
INT. CL. 3/U.S. CL. 52  
FOR CLEANER IN THE NATURE OF SOAP.  
FIRST USE 7-1-1971; IN COMMERCE 7-1-1971.  
INT. CL. 5/U.S. CL. 18  
FOR DIETARY FOOD SUPPLEMENTS.  
FIRST USE 6-15-1971; IN COMMERCE 7-1-1971.

ELEMENTS AMENDED  
MARK

1,605,715. REG. 7-10-1990. THE GREAT PUMPKIN, INC. (DELAWARE CORPORATION) 1501 E. CERRITOS AVE., ANAHEIM, CA, 92805, SN 74-005,204. FILED 11-27-1989. PRINCIPAL REGISTER.

**MURINA**

INT. CL. 25/U.S. CL. 39  
FOR CLOTHING, NAMELY, T-SHIRTS.  
FIRST USE 10-30-1989; IN COMMERCE 10-30-1989.

ELEMENTS CORRECTED  
\*OWNER NAME\*

1,710,325. REG. 8-25-1992. FISHER, DONALD LEE (UNITED STATES INDIVIDUAL), DBA KIDS KORNER GIFT SHOPPES, 2705 - 185TH AVENUE E, SUMNER, WA, 98390, SN 73-798,833. FILED 5-9-1989. PRINCIPAL REGISTER.

**KIDS' KORNER GIFT SHOPPE**

NO CLAIM IS MADE TO THE EXCLUSIVE RIGHT TO USE "GIFT SHOPPE", APART FROM THE MARK AS SHOWN.  
INT. CL. 35/U.S. CLS. 100, 101 AND 102  
FOR RENDERING TECHNICAL AID IN THE ESTABLISHMENT AND/OR OPERATION OF IN-SCHOOL GIFT SHOPS FOR CHILDREN .  
FIRST USE 2-14-1989; IN COMMERCE 2-14-1989.

ELEMENTS AMENDED  
MARK

1,849,245. REG. 8-9-1994. CONAGRA BRANDS, INC. (NEBRASKA CORPORATION) ONE CONAGRA DRIVE, OMAHA, NE, 68102, SN 74-300,427. FILED 8-3-1992. PRINCIPAL REGISTER.



INT. CL. 16/U.S. CLS. 2, 5, 22, 23, 29, 37, 38 AND 50  
FOR COOKBOOKS [ AND RECIPE CARDS ].  
FIRST USE 9-17-1993; IN COMMERCE 9-17-1993.

ELEMENTS AMENDED  
MARK

1,855,254. REG. 9-20-1994. WAL-MART STORES, INC. (DELAWARE CORPORATION) 702 S.W. 8TH STREET, BENTONVILLE, AR, 72716, SN 74-330,960. FILED 11-13-1992. PRINCIPAL REGISTER.



OWNER OF U.S. REG. NOS. 369,881, 1,135,761 AND OTHERS.  
INT. CL. 25/U.S. CL. 39  
FOR MEN'S AND WOMEN'S SHOES AND ATHLETIC SHOES, SNEAKERS, SLIPPERS.  
FIRST USE 7-15-1993; IN COMMERCE 7-15-1993.

ELEMENTS AMENDED  
MARK



1,856,218. REG. 9-27-1994. SAFT AMERICA INC. (GEORGIA CORPORATION) 711 INDUSTRIAL BLVD., VALDOSTA, GA, 31601, SN 74-385,277. FILED 5-3-1993. PRINCIPAL REGISTER.

2,012,698. REG. 10-29-1996. BUTCHER COMPANY, THE (DELAWARE CORPORATION) 67 FOREST STREET, MARLBOROUGH, MA, 01752, SN 74-633,692. FILED 2-13-1995. PRINCIPAL REGISTER.

**LION**

**PILLAR**

INT. CL. 9/U.S. CL. 21  
FOR BATTERIES.  
FIRST USE 2-19-1994; IN COMMERCE 2-19-1994.

INT. CL. 2/U.S. CLS. 6, 11 AND 16  
FOR SEALER COATINGS FOR USE ON FLOORS.  
FIRST USE 11-0-1995; IN COMMERCE 11-0-1995.

ELEMENTS AMENDED  
MARK

ELEMENTS CORRECTED  
\*ASSIGNMENT/NAME CHANGE\*  
\*DBA/AKA\*  
OWNER NAME

1,935,016. REG. 11-14-1995. NOVARTIS AG (SWITZERLAND CORPORATION) LICHTSTRASSE 35, BASEL, SWITZERLAND, CH-4002, SN 74-554,829. FILED 7-28-1994. PRINCIPAL REGISTER.

2,022,955. REG. 12-17-1996. FAULTLESS STARCH/BON AMI COMPANY (MISSOURI CORPORATION) 510 WALNUT, SUITE 300, KANSAS CITY, MO, 64106, SN 74-648,642. FILED 3-20-1995. PRINCIPAL REGISTER.

**PARAPLEURO SHIELD**

**PRIVATE GARDENS**

INT. CL. 5/U.S. CLS. 6, 18, 44, 46, 51 AND 52  
FOR PREPARATION FOR VETERINARY USE, NAMELY FOR PREVENTION OF [ HAEMOPHILUS ] \*ACTINOBACILLUS\* PARASUIS, HAEMOPHILUS PLEUROPNEMONIAE AND PASTEURELLA MULTOCIDA DISEASES IN SWINE.  
FIRST USE 10-27-1986; IN COMMERCE 10-27-1986.

INT. CL. 4/U.S. CLS. 1, 6 AND 15  
FOR SCENTED CANDLES.  
FIRST USE 4-0-1991; IN COMMERCE 4-0-1991.  
INT. CL. 5/U.S. CLS. 6, 18, 44, 46, 51 AND 52  
FOR AIR FRESHENERS.  
FIRST USE 4-0-1991; IN COMMERCE 4-0-1991.

ELEMENTS AMENDED  
MARK

ELEMENTS AMENDED  
MARK

1,970,785. REG. 4-30-1996. FINMECCANICA S.P.A. (ITALY JOINT STOCK COMPANY) VIA PIERAGOSTINI 50, 16151 GENOVA, ITALY., SN 74-493,747. FILED 2-23-1994. PRINCIPAL REGISTER.

2,150,338. REG. 4-14-1998. ALL KITCHENS, INC. (DELAWARE CORPORATION) 209 MAIN STREET, BOISE, ID, 83702, SN 75-184,421. FILED 10-21-1996. PRINCIPAL REGISTER.



AS TO "ANSALDO".  
INT. CL. 37/U.S. CLS. 100, 103 AND 106  
FOR CONSTRUCTION AND REPAIR SERVICES, NAMELY MAINTENANCE AND REPAIR OF POWER GENERATION PLANTS; CONSTRUCTION OF COMPLETE TURNKEY INTEGRATED TRANSPORTATION SYSTEMS; INSTALLATION OF ELECTRICAL AND INSTRUMENTATION SYSTEMS FOR INDUSTRIAL AND NAVAL PLANTS; CONSTRUCTION FOR RESEARCH PLANTS.  
FIRST USE 5-0-1989; IN COMMERCE 1-0-1990.

INT. CL. 29/U.S. CL. 46

ELEMENTS CORRECTED  
OWNER NAME

FOR CANNED, FROZEN, FREEZE DRIED AND PACKAGED FOODS, NAMELY, ANCHOVIES, GREEN BEANS, WAX BEANS, REFRIED BEANS, BEETS, CARROTS, CHILES, CORN, JALAPENOS, MIXED VEGETABLES, ONION RINGS, OLIVES, CANNED ONIONS, COCKTAIL ONIONS, DEHYDRATED ONIONS, FROZEN ONIONS, PEAS, PEPPERS, STUFFED PEPPERS, PICKLES, RELISH, PORK AND BEANS, PUMPKIN, RHUBARB, SAUERKRAUT, SPINACH, SQUASH, SWEET POTATOES, YAMS, TOMATOES, BEEF, CANNED BEEF, GROUND BEEF, HOT DOGS, LAMB, LIVER, PUREED MEAT, MEATBALLS, PORK, PROCESSED PORK BARBECUE, BREADED PORK, CUBED PORK, HAM, BACON, PORK SAUSAGE, TURKEY, VEAL, SALMON, SHELLFISH, CRAB, OYSTERS, SCALLOPS, LOBSTER, APPLE BUTTER, BUTTER, CHEESE, COCONUT, CORN SYRUP, GRATED CHEESE, MARGARINE, VEGETABLE OIL, SHORTENING, OLIVE OIL, PIMENTOS, PROCESSED MEATS AND VEGETABLES FOR USE AS PIZZA TOPPING, SOUPS, CRANBERRY SAUCE, DAIRY BASED DIPS, EGG NOG, DRY EGGS, JELLIES, JAMS, CONDENSED MILK, ASEPTIC MILK, DRY MILK, EVAPORATED MILK, MOUSSE MILK, FRUIT BASED FILLINGS FOR CAKES AND PIES, SOUR CREAM, CITRUS FRUIT CUT IN SECTIONS, FRUIT COCKTAIL, FRUIT FOR SALADS, MIXED FRUIT, CUT FRUIT FOR USE AS PIZZA TOPPING, FRUIT SAUCE, CANNED FRUIT, FROZEN FRUIT, PROCESSED MANDARIN ORANGES, APPLES, APRICOTS, ARTICHOKE, ASPARAGUS, AVOCADO, BAMBOO SHOOTS, BLUEBERRIES, CABBAGE, CHERRIES, GRAPES, MUSHROOMS, PROCESSED NUTS, PEACHES, PEARS, PEANUT BUTTER, PINEAPPLE, PLUMS, RAISINS, AND EDIBLE PROCESSED SUNFLOWER SEEDS.  
FIRST USE 12-31-1983; IN COMMERCE 12-31-1983.

ELEMENTS AMENDED  
MARK  
LINING/STIPPLING STATEMENT

2,168,006. REG. 6-23-1998. LDMEDIA INC. (CANADA CORPORATION) 203 - 1508 WEST 2ND AVENUE, VANCOUVER, BRITISH COLUMBIA, CANADA, V6J 1H2, SN 75-053,154. FILED 2-5-1996. PRINCIPAL REGISTER.

## LINK-DECO

INT. CL. 20/U.S. CLS. 2, 13, 22, 25, 32 AND 50  
FOR PLASTIC PIXELS FOR USE AS ATTACHMENTS AND FILLERS FOR CREATING GRAPHIC IMAGES AND TEXT ON CHAIN-LINK FENCES.  
FIRST USE 2-5-1996; IN COMMERCE 2-5-1996.

ELEMENTS CORRECTED  
MARK

2,169,583. REG. 6-30-1998. CHORUS OCCUPATIONAL HEALTH SERVICES, LLC (WISCONSIN LIMITED LIABILITY COMPANY) 9200 WEST WISCONSIN, MILWAUKEE, WI, 532263596, SN 75-309,705. FILED 6-16-1997. PRINCIPAL REGISTER.



NO CLAIM IS MADE TO THE EXCLUSIVE RIGHT TO USE "OCCUPATIONAL HEALTH SERVICES", APART FROM THE MARK AS SHOWN.  
INT. CL. 42/U.S. CLS. 100 AND 101

FOR OCCUPATIONAL HEALTH CARE SERVICES.  
FIRST USE 1-22-1997; IN COMMERCE 1-22-1997.

ELEMENTS AMENDED  
OWNER NAME  
MARK

2,186,137. REG. 9-1-1998. WHITE WOLF, INC. (GEORGIA CORPORATION) 780 PARK NORTH BOULEVARD, SUITE 100, CLARKSTON, GA, 30021, SN 74-634,175. FILED 2-14-1995. PRINCIPAL REGISTER.

## VAMPIRE THE ETERNAL STRUGGLE

INT. CL. 16/U.S. CLS. 2, 5, 22, 23, 29, 37, 38 AND 50  
FOR TRADING CARDS [ , NOVELS, ] AND GAME STRATEGY GUIDEBOOKS.  
FIRST USE 11-0-1995; IN COMMERCE 11-0-1995.  
INT. CL. 28/U.S. CLS. 22, 23, 38 AND 50  
FOR CARD GAMES.  
FIRST USE 11-0-1995; IN COMMERCE 11-0-1995.

ELEMENTS AMENDED  
GOODS/SERVICES

2,209,926. REG. 12-15-1998. ABRAMS GENTILE ENTERTAINMENT, INC. (NEW YORK CORPORATION) 244 WEST 54TH STREET, 9TH FLOOR, NEW YORK, NY, 10019, SN 74-638,337. FILED 2-27-1995. PRINCIPAL REGISTER.

## SKY DANCERS

OWNER OF U.S. REG. NO. 1,939,878.  
INT. CL. 28/U.S. CLS. 22, 23, 38 AND 50  
FOR DOLLS AND DOLL PLAYSETS.  
FIRST USE 10-11-1994; IN COMMERCE 10-11-1994.

ELEMENTS CORRECTED  
\*ASSIGNMENT/NAME CHANGE\*  
OWNER NAME

2,243,516. REG. 5-4-1999. RAYCO MANUFACTURING, INC. (OHIO CORPORATION) 4255 LINCOLN WAY EAST, WOOSTER, OH, 44691, SN 75-301,601. FILED 6-2-1997. PRINCIPAL REGISTER.

## MONSTER TOOTH

NO CLAIM IS MADE TO THE EXCLUSIVE RIGHT TO USE "TOOTH", APART FROM THE MARK AS SHOWN.  
INT. CL. 7/U.S. CLS. 13, 19, 21, 23, 31, 34 AND 35  
FOR PARTS FOR TREE STUMP CUTTING MACHINERY, NAMELY, METAL CUTTING TEETH.  
FIRST USE 6-17-1997; IN COMMERCE 6-17-1997.

ELEMENTS CORRECTED  
OWNER NAME

2,263,579. REG. 7-20-1999. RON JON SURF SHOP OF FLORIDA, INC. (FLORIDA CORPORATION) 3850 S. BANANA RIVER BLVD., COCOA BEACH, FL, 32931. SN 75-325,401. FILED 7-16-1997. PRINCIPAL REGISTER.

## ORLANDO'S BEACH

INT. CL. 35/U.S. CLS. 100, 101 AND 102  
FOR RETAIL STORE SERVICES FEATURING SPORTSWEAR AND RELATED SPORTING GOODS.  
FIRST USE 8-15-1997; IN COMMERCE 8-15-1997.

ELEMENTS AMENDED  
MARK

2,275,824. REG. 9-7-1999. JEG'S AUTOMOTIVE, INC. (OHIO CORPORATION) 751 EAST 11TH AVENUE, COLUMBUS, OH, 43211. SN 75-482,240. FILED 5-8-1998. PRINCIPAL REGISTER.

## JEGSTER

INT. CL. 12/U.S. CLS. 19, 21, 23, 31, 35 AND 44  
FOR RACING AUTOMOBILE STRUCTURAL PARTS, NAMELY, ROLL BARS, ROLL CAGES, TRACTION BARS, REAR CONTROL ARMS, SOLID MOTOR MOUNTS, FRAME TIES, REAR FRAME KITS, COMPRISING, SHOCK ABSORBERS, SHOCK MOUNTS, METAL REAR FRAMES AND SPRINGS SOLD AS A UNIT; SMALL SCALE MOTORIZED RACE CARS SUITABLE FOR YOUNG RACERS.  
FIRST USE 0-0-1978; IN COMMERCE 0-0-1978.

ELEMENTS CORRECTED  
OWNER NAME

2,296,527. REG. 11-30-1999. UNIVERSAL CITY STUDIOS LLLP (DELAWARE LIMITED LIABILITY LIMITED PARTNERSHIP) 100 UNIVERSAL CITY PLAZA, UNIVERSAL CITY, CA, 91608, AND 'AMBLIN' ENTERTAINMENT, INC. (CALIFORNIA CORPORATION) 100 UNIVERSAL CITY PLAZA, UNIVERSAL CITY, CA, 91608, SN 75-312,511. FILED 6-20-1997. PRINCIPAL REGISTER.

## YOU BET JURASSIC

INT. CL. 41/U.S. CLS. 100, 101 AND 107  
FOR AMUSEMENT PARK SERVICES.  
FIRST USE 3-27-1999; IN COMMERCE 3-27-1999.

ELEMENTS CORRECTED  
ASSIGNMENT/NAME CHANGE

2,330,787. REG. 3-21-2000. CROSS COUNTRY GROUP, LLC (MASSACHUSETTS LTD LIAB CO) 4040 MYSTIC VALLEY PARKWAY, BOSTON, MA, 02155, SN 75-437,599. FILED 2-20-1998. PRINCIPAL REGISTER.

## CROSS COUNTRY

OWNER OF U.S. REG. NOS. 1,320,699, 1,926,731 AND OTHERS.  
INT. CL. 36/U.S. CLS. 100, 101 AND 102

FOR PROVIDING INSURANCE SERVICES RELATING TO HOME AND APPLIANCES FOR OTHERS.  
FIRST USE 0-0-1977; IN COMMERCE 0-0-1977.

ELEMENTS CORRECTED  
ENTITY

2,354,329. REG. 6-6-2000. FRANZ VIEGENER II GMBH & CO. KG (FED REP GERMANY CORPORATION) ENNESTER WEG 9, 57439 ATTENDORN, FED REP GERMANY., SN 75-256,556. FILED 3-13-1997. PRINCIPAL REGISTER.



OWNER OF FED REP GERMANY REG. NO. 2055176, DATED 1-26-1994, EXPIRES 9-30-2002.

THE LINING IN THE DRAWING ARE YELLOW AND BLACK.

INT. CL. 6/U.S. CLS. 2, 12, 13, 14, 23, 25 AND 50  
FOR METAL GOODS, NAMELY, SANITARY DRAIN PIPES AND OVERFLOW FITTINGS FOR BATHTUBS AND SHOWERS; DRAIN PIPES FOR WASHING MACHINES, DISHWASHERS AND DRIP WATER PIPES; DRAIN PIPES FOR TOILETS AND URINALS; DRAIN PIPES FOR BASEMENTS WITH AND WITHOUT ANTI-FLOOD UNITS; CLAMPS FOR PIPES; PIPES FOR WATER DISTRIBUTION FOR INTERIOR INSTALLATION AND GARDENS; WATER PIPES; PIPE FITTINGS FOR HEATING SYSTEMS.

INT. CL. 11/U.S. CLS. 13, 21, 23, 31 AND 34  
FOR WATER BASINS AND BIDETS; SINKS; ANTI-FLOOD DEVICE FOR GROUND PLUMBING VALVES; DOUBLE PIPE PLUMBING VALVES; PLASTER SINKS IN HOSPITALS AND MEDICAL CENTERS AND PARTS FOR THE AFOREMENTIONED; HEATERS; AND FLOOR HEATING SYSTEMS COMPRISING HEATING ELEMENTS, CASING AND PIPES AND FITTINGS.

INT. CL. 19/U.S. CLS. 1, 12, 33 AND 50  
FOR PLASTIC GOODS, NAMELY, SANITARY DRAIN PIPES AND OVERFLOW FITTINGS FOR BATHTUBS AND SHOWERS; DRAIN PIPES FOR WASHING MACHINES, DISHWASHERS AND DRIP WATER PIPES; DRAIN PIPES FOR TOILETS AND URINALS; DRAIN PIPES FOR BASEMENTS WITH AND WITHOUT ANTI-FLOOD UNITS; CLAMPS FOR PIPES; PIPES FOR WATER DISTRIBUTION FOR INTERIOR INSTALLATION AND GARDENS; WATER PIPES; PIPE FITTINGS FOR HEATING SYSTEMS.

ELEMENTS CORRECTED  
ENTITY

2,386,716. REG. 9-19-2000. ESTWING MANUFACTURING COMPANY, INC. (DELAWARE CORPORATION) 2647 - 8TH STREET, ROCKFORD, IL, 611091190, SN 75-220,714. FILED 1-2-1997. PRINCIPAL REGISTER.

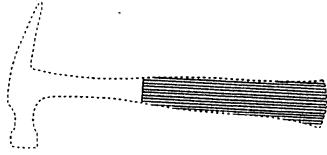

THE DRAWING IS LINED FOR THE COLOR BLUE. THE MARK CONSISTS OF THE COLOR BLUE AS APPLIED TO THE HANDLE PORTION OF THE GOODS. THE DOTTED OUTLINE OF THE GOODS IS INTENDED TO SHOW THE POSITION OF THE MARK AND IS NOT PART OF THE MARK.

SEC. 2(F).  
INT. CL. 8/U.S. CLS. 23, 28 AND 44  
FOR HAND TOOLS, NAMELY, HAMMERS, HATCHETS, AXES, ROCK PICKS [AND CHISELS].  
FIRST USE 1-0-1958; IN COMMERCE 1-0-1958.

ELEMENTS AMENDED  
GOODS/SERVICES



2,481,512. REG. 8-28-2001. KAN-PAK, L.L.C. (DELAWARE LTD LIAB CO) 1016 SOUTH SUMMIT, ARKANSAS CITY, KS, 67005, SN 75-814,471. FILED 10-4-1999. PRINCIPAL REGISTER.



INT. CL. 29/U.S. CL. 46  
FOR MILK-BASED BEVERAGE CONTAINING COFFEE AND DAIRY BASED BEVERAGES.  
FIRST USE 10-2-1999; IN COMMERCE 10-2-1999.  
INT. CL. 30/U.S. CL. 46  
FOR NON-CARBONATED, NON-ALCOHOLIC CHOCOLATE AND COFFEE BASED BEVERAGES WITH OR WITHOUT MILK.  
FIRST USE 10-2-1999; IN COMMERCE 10-2-1999.  
INT. CL. 32/U.S. CLS. 45, 46 AND 48  
FOR SOFT DRINKS, NAMELY, FRUIT FLAVORED NON-ALCOHOLIC BEVERAGES.  
FIRST USE 10-2-1999; IN COMMERCE 10-2-1999.

ELEMENTS CORRECTED  
OWNER NAME  
ASSIGNMENT/NAME CHANGE  
[ASSIGNMENT/NAME CHANGE]

2,530,389. REG. 1-15-2002. BODEGAS VALDEMAR, S.A. (SPAIN CORPORATION) C/DIGUTACION 43, 01320 OYON, ALAVA, SPAIN., SN 75-754,957. FILED 7-16-1999. PRINCIPAL REGISTER.

**INFINITUS**

OWNER OF SPAIN REG. NO. 2027247-2, DATED 6-5-1997, EXPIRES 5-7-2006.  
INT. CL. 33/U.S. CLS. 47 AND 49  
FOR ALCOHOLIC BEVERAGES, NAMELY, WINES.  
FIRST USE 6-0-2000; IN COMMERCE 6-0-2000.

ELEMENTS CORRECTED  
FOREIGN REG. EXPIRATION DATE



2,545,769. REG. 3-12-2002. NATIONAL BROADCAST READING SERVICE, INC., THE (CANADA CORPORATION) 150 LAIRD DRIVE ANNEX, TORONTO, ONTARIO, CANADA, M4G 3V7, SN 75-810,858. FILED 9-29-1999. PRINCIPAL REGISTER.

**AUDIOCINEMA**

PRIORITY CLAIMED UNDER SEC. 44(D) ON CANADA APPLICATION NO. 1,010,197, FILED 3-29-1999, REG. NO. TMA535643, DATED 10-24-2000.  
INT. CL. 9/U.S. CLS. 21, 23, 26, 36 AND 38  
FOR COMPACT DISCS, CASSETTE TAPES, DIGITAL AUDIO TAPES AND CD-ROM'S CONTAINING NARRATIONS OF FILMS AND OTHER VISUAL WORKS FOR USE BY THE VISION-IMPAIRED.  
FIRST USE ; IN COMMERCE .

ELEMENTS AMENDED  
OWNER ADDRESS



2,629,751. REG. 10-8-2002. TERRA NETWORKS, S.A. (SPAIN CORPORATION) VIA DE LAS DOS CASTILLAS, 33/ COMPLEJO ATICA, EDIFICIO 1-PRIMERA PLANTA, 28224 POZUELO DE ALARCON (MADRID), SPAIN., SN 75-837,365. FILED 11-1-1999. PRINCIPAL REGISTER.

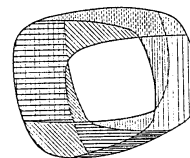

PRIORITY CLAIMED UNDER SEC. 44(D) ON SPAIN APPLICATION NO. 2261425, FILED 10-4-1999, REG. NO. 2261425, DATED 3-28-2000, EXPIRES 10-4-2009.

PRIORITY CLAIMED UNDER SEC. 44(D) ON SPAIN APPLICATION NO. 2261424, FILED 10-4-1999, REG. NO. 2261424, DATED 2-2-2000, EXPIRES 10-4-2009.

PRIORITY CLAIMED UNDER SEC. 44(D) ON SPAIN APPLICATION NO. 2261423, FILED 10-4-1999, REG. NO. 2261423, DATED 2-2-2000, EXPIRES 10-4-2009.

PRIORITY CLAIMED UNDER SEC. 44(D) ON SPAIN APPLICATION NO. 2261422, FILED 10-4-1999, REG. NO. 2261422, DATED 2-2-2000, EXPIRES 10-4-2009.

PRIORITY CLAIMED UNDER SEC. 44(D) ON SPAIN APPLICATION NO. 2261421, FILED 10-4-1999, REG. NO. 2261421, DATED 4-3-2000, EXPIRES 10-4-2009.

PRIORITY CLAIMED UNDER SEC. 44(D) ON SPAIN APPLICATION NO. 2261420, FILED 10-4-1999, REG. NO. 2261420, DATED 2-2-2000, EXPIRES 10-4-2009.

PRIORITY CLAIMED UNDER SEC. 44(D) ON SPAIN APPLICATION NO. 2261419, FILED 10-4-1999, REG. NO. 2261419, DATED 2-2-2000, EXPIRES 10-4-2009.

PRIORITY CLAIMED UNDER SEC. 44(D) ON SPAIN APPLICATION NO. 2261418, FILED 10-4-1999, REG. NO. 2261418, DATED 2-2-2000, EXPIRES 10-4-2009.

PRIORITY CLAIMED UNDER SEC. 44(D) ON SPAIN APPLICATION NO. 2261417, FILED 10-4-1999, REG. NO. 2261417, DATED 2-4-2000, EXPIRES 10-4-2009.

PRIORITY CLAIMED UNDER SEC. 44(D) ON SPAIN APPLICATION NO. 2261416, FILED 10-4-1999, REG. NO. 2261416, DATED 2-4-2000, EXPIRES 10-4-2009.

PRIORITY CLAIMED UNDER SEC. 44(D) ON SPAIN APPLICATION NO. 2261415, FILED 10-4-1999, REG. NO. 2261415, DATED 2-4-2000, EXPIRES 10-4-2009.

PRIORITY CLAIMED UNDER SEC. 44(D) ON SPAIN APPLICATION NO. 2261414, FILED 10-4-1999, REG. NO. 2261414, DATED 2-4-2000, EXPIRES 10-4-2009.

PRIORITY CLAIMED UNDER SEC. 44(D) ON SPAIN APPLICATION NO. 2261413, FILED 10-4-1999, REG. NO. 2261413, DATED 2-4-2000, EXPIRES 10-4-2009.

PRIORITY CLAIMED UNDER SEC. 44(D) ON SPAIN APPLICATION NO. 2261412, FILED 10-4-1999, REG. NO. 2261412, DATED 2-4-2000, EXPIRES 10-4-2009.

PRIORITY CLAIMED UNDER SEC. 44(D) ON SPAIN APPLICATION NO. 2261411, FILED 10-4-1999, REG. NO. 2261411, DATED 2-4-2000, EXPIRES 10-4-2009.

PRIORITY CLAIMED UNDER SEC. 44(D) ON SPAIN APPLICATION NO. 2261408, FILED 10-4-1999, REG. NO. 2261408, DATED 2-4-2000, EXPIRES 10-4-2009.

PRIORITY CLAIMED UNDER SEC. 44(D) ON SPAIN APPLICATION NO. 2261401, FILED 10-4-1999, REG. NO. 2261401, DATED 2-4-2000, EXPIRES 10-4-2009.

PRIORITY CLAIMED UNDER SEC. 44(D) ON SPAIN APPLICATION NO. 2261399, FILED 10-4-1999, REG. NO. 2261399, DATED 2-4-2000, EXPIRES 10-1-2009.

PRIORITY CLAIMED UNDER SEC. 44(D) ON SPAIN APPLICATION NO. 2261397, FILED 10-4-1999, REG. NO. 2261397, DATED 2-4-2000, EXPIRES 10-4-2009.

PRIORITY CLAIMED UNDER SEC. 44(D) ON SPAIN APPLICATION NO. 2261395, FILED 10-4-1999, REG. NO. 2261395, DATED 2-4-2000, EXPIRES 10-4-2009.

PRIORITY CLAIMED UNDER SEC. 44(D) ON SPAIN APPLICATION NO. 2261392, FILED 10-4-1999, REG. NO. 2261392, DATED 2-4-2000, EXPIRES 10-4-2009.

PRIORITY CLAIMED UNDER SEC. 44(D) ON SPAIN APPLICATION NO. 2261388, FILED 10-4-1999, REG. NO. 2261388, DATED 2-4-2000, EXPIRES 10-4-2009.

PRIORITY CLAIMED UNDER SEC. 44(D) ON SPAIN APPLICATION NO. 2261386, FILED 10-4-1999, REG. NO. 2261386, DATED 2-4-2000, EXPIRES 10-4-2009.

PRIORITY CLAIMED UNDER SEC. 44(D) ON SPAIN APPLICATION NO. 2261384, FILED 10-4-1999, REG. NO. 2261384, DATED 2-4-2000, EXPIRES 10-4-2009.

THE MARK IS LINED FOR THE COLORS GREEN, YELLOW, GREEN, PURPLE, VIOLET, MAGENTA, RED, DARK RED, DARK BLUISH GREEN, BLUISH GREEN, DARK GREEN AND GREEN, AND SAID COLORS ARE CLAIMED AS FEATURES OF THE MARK.

THE MARK CONSISTS OF A MISCELLANEOUS DESIGN OF SLIGHTLY IRREGULAR RECTANGULAR SHAPE WITH ROUNDED SIDES AND EDGES. A WHITE SQUARE SHAPE IS THE CENTER OF THE DESIGN. SURROUNDING THE SQUARE IS A SERIES OF ODD SHAPES RESULTING FROM BISECTING LINES WITHIN THE RECTANGLE. EACH SHAPE CONTAINS A DIFFERENT COLOR. THE UPPER PORTION OF THE LEFT SIDE IS YELLOWISH GREEN, THE LEFT SIDE OF THE INTERIOR PORTION OF THE TOP IS LIGHT GREEN, THE EXTERIOR PORTION OF THE TOP IS PURPLE, THE UPPER RIGHT CORNER IS VIOLET, THE INTERIOR PORTION OF THE RIGHT SIDE IS MAGENTA, THE EXTERIOR PORTION OF THE RIGHT SIDE IS RED, THE INTERIOR PORTION OF THE LOWER RIGHT SIDE IS DARK RED, THE EXTERIOR PORTION OF THE BOTTOM IS DARK BLUISH GREEN, THE LEFT SIDE OF THE INTERIOR PORTION OF THE BOTTOM IS BLUISH GREEN, THE LOWER LEFT CORNER IS DARK GREEN, AND THE INTERIOR PORTION OF THE LEFT SIDE IS GREEN.

INT. CL. 1/U.S. CLS. 1

FOR ABRASIVE COMPOSITIONS USED IN THE MANUFACTURE OF METAL POLISH; CHEMICAL ADDITIVES FOR USE IN THE MANUFACTURE OF PHARMACEUTICALS AND COSMETICS; AGRICULTURAL LIME; ALCOHOL FOR USE IN THE MANUFACTURE OF PAINTS AND OTHER COATINGS AND THE MANUFACTURES OF PERFUMES; ANTIFREEZE; ARTIFICIAL SWEETENERS; UNEXPOSED CAMERA FILM; CERAMIC GLAZINGS; CHEMICALS FOR THE MANUFACTURE OF ADHESIVES, PAPER, CLOTHES LEATHER; DIAGNOSTIC PREPARATIONS OR REAGENTS FOR SCIENTIFIC OR RESEARCH USE; FERTILIZERS FOR AGRICULTURAL AND DOMESTIC USE; FLOWER PRESERVATIVE; PAPER PULP FOR MANUFACTURING PURPOSES; PLASTIC MOLDING COMPOUNDS FOR USE IN THE MANUFACTURE OF PLASTIC SHEETS FILMS AND MOLDED PLASTIC ARTICLES; SYNTHETIC RESINS FOR USE IN THE MANUFACTURE OF ADHESIVES, PALM, COSMETIC, AND PLASTIC MOLDING COMPOUNDS; SURFACTANTS FOR USE IN THE MANUFACTURE OF SYNTHETIC DETERGENTS AND IN CONNECTION WITH AGRICULTURAL PESTICIDES; WATERPROOFING CHEMICAL COMPOSITIONS FOR ARTICLES OF MASONRY, WOOD AND OTHER BUILDING AND/OR CONSTRUCTION SURFACES; MANURES; FIRE EXTINGUISHING COMPOSITIONS; TEMPERING CHEMICALS FOR USE IN METALWORKING OR SOLDERING; SOLDERING CHEMICALS; CHEMICAL SUBSTANCES FOR PRESERVING FOODSTUFFS; \* NAMELY: } \*SULFITE; TANNING SUBSTANCES, NAMELY, SULFITE; TANNING SUBSTANCE, NAMELY, TANNING AGENTS FOR USE IN THE MANUFACTURE OF LEATHER; ADHESIVES USED IN THE METALWORKING INDUSTRY AND LEATHER MANUFACTURING INDUSTRY.

FIRST USE ; IN COMMERCE .

INT. CL. 3/U.S. CLS. 1, 4, 6, 50, 51 AND 52

FOR CLEANING PREPARATIONS, NAMELY, AMMONIA USED AS DETERGENT; DISHWASHER AND LAUNDRY DETERGENTS; LAUNDRY DETERGENT; LAUNDRY PREPARATIONS, NAMELY, LAUNDRY BLEACH, BLUING FOR LAUNDRY, LAUNDRY STARCH; FLOOR WAX; DEODORANT SOAP; TOILET SOAP; CLEANING LIQUIDS, NAMELY, SKIN SOAP, HAIR SHAMPOOS, HAND SOAP; PERFUMERY, NAMELY, EAU DE COLOGNE, PERFUMES, COLOGNE, [MUST] \* MUSK\* COLOGNE; COSMETIC PREPARATIONS FOR SKIN CARE, NAMELY, ANTI-WRINKLE CREAM; POMADES FOR COSMETIC PURPOSES, NAMELY, FOR LIPS, HANDS, HAIR AND SKIN; BEAUTY MASKS; SKIN CLEANSING LOTION FOR COSMETIC PURPOSES; COSMETIC KITS COMPRISED OF LIPSTICKS, LIP GLOSSES, EYE SHADOW, BLUSH AND FACE BRONZING POWDER, FOUNDATION CREAM, COLORED FACE CREAMS, MASCARA, EYE AND LIP PENCILS, EYE LINER AND COMPACT POWDERS; COSMETIC CREAMS, NAMELY, FACE CREAM, DEPILATORY CREAM, BODY MASK CREAM; EYEBROW COSMETICS, NAMELY, EYEBROW PENCILS; COSMETIC PREPARATIONS FOR EYELASHES, NAMELY, MASCARA; MAKE-UP PREPARATIONS NAMELY, EYELINER, EYE SHADOW; ESSENTIAL OILS FOR PERSONAL USE; HAIR LOTIONS; DENTIFRICES.  
FIRST USE ; IN COMMERCE .

INT. CL. 5/U.S. CLS. 6, 18, 44, 46, 51 AND 52  
FOR CARDIOVASCULAR TREATMENT PREPARATIONS; FOOD FOR MEDICALLY RESTRICTED DIETS; DIETARY SUPPLEMENTS; FOOD FOR BABIES; CORN PLASTERS; MEDICAL PLASTERS; WOUND DRESSINGS; BURN DRESSINGS; SURGICAL DRESSINGS; MATERIAL FOR STOPPING TEETH; DENTAL WAX; ALL PURPOSE DISINFECTANTS; PREPARATIONS FOR DESTROYING VERMIN; FUNGICIDES AND HERBICIDES FOR DOMESTIC AND AGRICULTURAL USE.  
FIRST USE ; IN COMMERCE .

INT. CL. 9/U.S. CLS. 21, 23, 26, 36 AND 38  
FOR ANTENNAS; AUDIO CASSETTE RECORDERS; AUDIO MIXERS; AUDIO TAPE RECORDERS; AUTOMATIC TELEPHONE DIALERS; BATTERIES; BATTERY CHARGES; BLANK MAGNETIC COMPUTER TAPES; CALCULATORS; CHRONOGRAPHS FOR USE AS SPECIALIZED TIME RECORDING APPARATUSES; COAXIAL CABLES; COMPUTER PROGRAMS USED FOR FINANCIAL, ECONOMICAL, TELECOMMUNICATIONS AND BANKING MATTERS, NAMELY , FOR USE IN DATA BASE MANAGEMENT, FOR USE AS A SPREAD SHEET AND FOR USE AS WORD PROCESSING; COMPUTER SOFTWARE USED FOR FINANCIAL, ECONOMICAL, TELECOMMUNICATIONS AND BANKING MATTERS, NAMELY, COMPUTER COMMUNICATIONS SOFTWARE TO ALLOW CUSTOMERS TO ACCESS BANK ACCOUNT INFORMATION AND TRANSACT BANK BUSINESS, COMPUTER SOFTWARE FOR ACCESSING INFORMATION DIRECTORIES THAT MAY BE DOWNLOADED FROM THE GLOBAL COMPUTER NETWORK, COMPUTER SOFTWARE FOR APPLICATION AND DATABASE INTEGRATION, COMPUTER SOFTWARE TO AUTOMATE DATA WAREHOUSING, COMPUTER TELEPHONY SOFTWARE TO ENABLE TELEPHONE ACTIVITIES TO BE PERFORMED THROUGH A COMPUTER; COMPUTERS; COMPUTERS AND INSTRUCTIONAL MANUALS SOLD AS A UNIT; CONVERTERS; DATA PROCESSORS; DICTATION MACHINES; DIGITAL AUDIO TAPE PLAYERS; BLANK FLOPPY AND HARD DISCS FOR COMPUTERS; DOT MATRIX PRINTERS; FACSIMILE MACHINES; FIBER OPTIC CABLES; FIBER OPTIC LIGHT AND IMAGE CONDUITS; IMPACT PRINTERS; INTEGRATED CIRCUITS; LASER PRINTERS; MAGNETIC CODED CARD READERS; MAGNETIC CODED CARDS; MICRO-PROCESSORS; MICROCOMPUTERS; MICROFICHE; MINICOMPUTERS; MODEMS; PHOTOCOPYING MACHINES; PRINTED CIRCUITS; RADIO TELEPHONES; SATELLITE PROCESSORS; SATELLITES; SILICON CHIPS; SILICON WAFERS; SUPERCOMPUTERS; SUPER MINICOMPUTERS; TELEPHONE ANSWERING MACHINES; TELEPHONE APPARATUS, NAMELY, INTERCOMS; COVERS FOR TELEPHONE RECEIVERS NOT MADE OF PAPER; TELEPHONES; CELLULAR TELEPHONES; TELEVISION SETS; VIRTUAL REALITY SOFTWARE USED IN THE FIELD OF FINANCIAL, ECONOMICAL, TELECOMMUNICATIONS AND BANKING MATTERS; WORD PROCESSORS; X-Y PLOTTERS.  
FIRST USE ; IN COMMERCE .

INT. CL. 12/U.S. CLS. 19, 21, 23, 31, 35 AND 44

FOR AUTOMOBILES; CARS; AIRPLANES; TRUCKS; SHIPS AND BOATS.  
FIRST USE ; IN COMMERCE .

INT. CL. 14/U.S. CLS. 2, 27, 28 AND 50  
FOR ITEMS MADE OF PRECIOUS METALS, NAMELY, ASHTRAYS, JEWELRY AND DECORATIVE BOXES, BELT BUCKLES, NON-ELECTRIC CANDELABRA, AND WATCH CHAINS; BRACELETS, TIE CLIPS, NON-MONETARY COINS, CUFF LINKS, EARRINGS, HAT ORNAMENTS, ORNAMENTAL PINS, SHOE ORNAMENTS, STATUES, SERVING TRAYS; JEWELRY, NAMELY, JEWELRY CASES OF PRECIOUS METALS, MEDALLIONS, CHARMS, BROOCHES, NECKLACES, PEARLS, RINGS, ALARM CLOCKS, CHRONOGRAPHS FOR USE AS WATCHES, CHRONOMETERS, CLOCKS, WATCHES; PRECIOUS STONES.  
FIRST USE ; IN COMMERCE .

INT. CL. 16/U.S. CLS. 2, 5, 22, 23, 29, 37, 38 AND 50  
FOR COMPUTER PAPER; MAGNETIC PAPER; TYPEWRITER PAPER; WRITING PAPER; PAPER BAGS; PAPER BLINDS; PAPER BOXES; BALL POINT PENS; PENS; PENCILS; BOXES FOR PENS; CASES FOR STAMPS; PAPER CLIPS FOR OFFICE USE; PAPER CUTTERS; DOCUMENT FILES; DRAWING PENS; DRAWING SETS COMPRISED OF DRAWING BOARDS, DRAWING BRUSHES, DRAWING COMPASSES AND DRAWING PADS; ENVELOPES; FOLDERS; INDEX CARDS; PENCIL HOLDERS; DRAWING RULERS; ART, NEWSPRINT, RECYCLED, SYNTHETIC, WAX, AND BOND PAPER; GIFT WRAPPING PAPER; PAPER STAPLERS; STAPLES; AND STAPLES REMOVERS; DICTIONARIES; BOOK-BINDING TAPE; ADHESIVES FOR STATIONERY OR HOUSEHOLD PURPOSES; SKETCH PADS; POSTER BOARDS; PAINTINGS; EASELS; PENS AND PASTELS; ELECTRIC AND NON-ELECTRIC TYPEWRITERS; TYPEWRITER RIBBONS; TYPEWRITER TYPE BALLS AND TYPEWRITER TYPING ELEMENTS; MOUNTED AND UNMOUNTED PHOTOGRAPHS; PHOTOGRAPH ALBUMS; ARCHIVAL STORAGE PAGES; PENCIL SHARPENERS; TABLE LINENS OF PAPER; PLAYING CARDS; PRINTING TYPE AND BLOCKS; PLASTIC BUBBLE PACKS FOR WRAPPING OR PACKAGING; PUBLICATIONS AND PRINTED MATTER, NAMELY, NEWSPAPERS, MAGAZINES, NEWSLETTERS, BROCHURES, PAMPHLETS, BOOKS AND JOURNALS DEALING WITH ECONOMIC, FINANCIAL AND LEGAL SUBJECTS AND RELATED TO COMPUTER SERVICES AND NETWORK COMPUTER SERVICES.  
FIRST USE ; IN COMMERCE .

INT. CL. 18/U.S. CLS. 1, 2, 3, 22 AND 41  
FOR ANIMAL HIDES; ATTACHE CASES; BACKPACKS; ALL PURPOSE ATHLETIC AND SPORTS BAGS; BILLFOLDS; BRIEFCASES; BUSINESS CARD CASES; DOCUMENT CASES; HANDBAGS; KEY CASES; KNAPSACKS; POCKETBOOKS; BRIEFCASE-TYPE PORTFOLIOS; PURSES; LUGGAGE TRUNKS AND TRAVELLING BAGS; UMBRELLAS; PARASOLS AND WALKING STICKS, WHIPS, HARNESS STRAPS AND SADDLERY.  
FIRST USE ; IN COMMERCE .

INT. CL. 25/U.S. CLS. 22 AND 39  
FOR ANORAKS; ATHLETIC FOOTWEAR; BATHING SUITS; BATHROBES; BLAZERS; BOOTS; BRASSIERES; BASEBALL CAPS; CHEMISES; COATS; DRESSES; HATS; HOSIERY; JACKETS; JEANS; JERSEYS; LINGERIE MOCCASINS; NECKERCHIEFS; NIGHT-GOWNS; OVERALLS; PAJAMAS; PANTS; PANTYHOSE; PULL-OVERS; RAINCOATS; SANDALS; SCARVES; SHIRTS; SHORTS; SHOWER CAPS; SKIRTS; SLIPPERS; SOCKS; SUITS; SWEATERS; T-SHIRTS; TIES; TROUSERS; UNDERCLOTHES; UNDERPANTS; VESTS; SHOES.  
FIRST USE ; IN COMMERCE .

INT. CL. 28/U.S. CLS. 22, 23, 38 AND 50

FOR ACTION FIGURES AND ACCESSORIES THEREFORE; MECHANICAL AND ELECTRIC ACTION TOYS; BABY MULTIPLE ACTIVITY TOYS; BALLOONS; BASEBALL AND SOFTBALL BATS; [STATIONERY] \* STATIONARY\* EXERCISE BICYCLES; MUSIC BOX TOYS; CHESS SETS; COMPUTER GAME CARTRIDGES AND CASSETTES; COMPUTER GAME PROGRAMS; TOY CONSTRUCTION BLOCKS; FLYING DISCS; DOLLS; MANUALLY OPERATED EXERCISE EQUIPMENT; [EXERCISES] \* EXERCISE\* MACHINES; FISHING EQUIPMENT, NAMELY, CLAMPS FOR SECURING FISHING EQUIPMENT ON BODY AND WINGING MATERIAL FOR FISHING JIGS AND STREAMERS; GYMNASTIC APPARATUS; HANDBALLS; JIGSAW PUZZLES; COMPUTER GAME JOYSTICKS; SCALE MODEL AIR PLANES AND TOY MODEL TRAIN SETS; MUSICAL TOYS; ROLE PLAYING GAMES; SKATEBOARDS; SNOW AND WATER SKIS; SPORT BALLS; STAND ALONE VIDEO GAME MACHINES; DECORATION FOR CHRISTMAS TREES EXCEPT CONFECTIONERY OR ILLUMINATION ARTICLES.

FIRST USE ; IN COMMERCE .

INT. CL. 29/U.S. CL. 46

FOR MEAT; FISH FOR FOOD PURPOSES; POULTRY AND GAME FOR FOOD PURPOSES; MEAT EXTRACTS; [PRESERVED] \* PERSERVES\*; DRIED AND PROCESSED FRUITS AND VEGETABLES; JELLIES; JAMS; FRUIT SAUCES; EGGS; MILK; MILK PRODUCTS, NAMELY, CREAM CHEESE, CHOCOLATE MILK, CHEESE FOOD, BUTTER, CREAM, MARGARINE, YOGURT; EDIBLE OILS AND FATS; FROZEN [ENTREE] \* ENTREES\* CONSISTING PRIMARILY OF MEAT, FISH, POULTRY AND GAME.

FIRST USE ; IN COMMERCE .

INT. CL. 30/U.S. CL. 46

FOR COFFEE; TEA; COCOA; SUGAR; RICE; TAPIOCA; SAGO; GRAIN AND CHICORY BASED COFFEE SUBSTITUTES; FLOUR BASED CHIPS; CEREAL BASED SNACK FOOD; RAW AND POPPED POP CORN; PROCESSED CORN; CORN FLAKES; CORN MEAL; MUESLI; ROLLED OAT; WHEAT FLOUR; BREAD; PASTRIES; CONFECTIONERY PRODUCTS, NAMELY, CAKES, BRIOCHES, CREPES, MARZIPAN, MUFFINS, PANCAKES, PIES, QUICHE, DOUGHNUTS, PUDDINGS, FLAVORED ICES; HONEY; TREACLE; YEAST; BAKING POWDER; SALT; MUSTARD; VINEGAR; SAUCES; SPICES; ICE.

FIRST USE ; IN COMMERCE .

INT. CL. 31/U.S. CLS. 1 AND 46

FOR FLOWER, AGRICULTURAL AND PLANT SEEDS; FRESH BEANS; FLOWERS BULBS; RAW BEANS; LIVE ANIMALS; FRESH FRUITS AND FRESH VEGETABLES; LIVE PLANTS AND FLOWERS; FOODSTUFFS FOR ANIMALS; MALT FOR BREWING AND DISTILLING.

FIRST USE ; IN COMMERCE .

INT. CL. 32/U.S. CLS. 45, 46 AND 48

FOR BEERS; MINERAL AND AERATED WATERS; GINGER ALE; COLAS; SOFT DRINKS; SELTZER WATER; SODA WATER; SPORTS DRINKS; FRUIT DRINKS AND FRUIT JUICES; SYRUPS FOR MAKING FRUIT DRINKS AND SOFT DRINKS.

FIRST USE ; IN COMMERCE .

INT. CL. 33/U.S. CLS. 47 AND 49

FOR ANISETTE; BRANDY; DISTILLED LIQUORS; GIN; LIQUEURS; RUM; DISTILLED SPIRITS; VODKA; WHISKY; WINE.

FIRST USE ; IN COMMERCE .

INT. CL. 34/U.S. CLS. 2, 8, 9 AND 17

FOR TOBACCO; SMOKERS' ARTICLES, NAMELY, CIGARS, CIGARETTES, SMOKING PIPES; MATCHES.

FIRST USE ; IN COMMERCE .

INT. CL. 35/U.S. CLS. 100, 101 AND 102

FOR ADVERTISING AGENCY SERVICES, NAMELY, PROMOTING THE SERVICES OF BANKING AND TELECOMMUNICATIONS COMPANIES THROUGH THE DISTRIBUTION OF PRINTED AND AUDIO PROMOTIONAL MATERIALS AND BY RENDERING SALES PROMOTION ADVICE; IMPORT-EXPORT AGENCY; BUSINESS MANAGEMENT AND CONSULTATION SERVICES; PREPARING BUSINESS REPORTS; BOOK-KEEPING; COMPUTERIZED ACCOUNTING SERVICES; MANAGEMENT OF EMPLOYMENT AGENCY SERVICES; AGENCIES FOR THE SALE OF ADVERTISING TIME AND SPACE; BUSINESS AND ACCOUNT AUDITING SERVICES; COST PRICE ANALYSIS; CONDUCTING MARKET RESEARCH STUDIES; SECRETARIAL AND CLERICAL SERVICES; COMMERCIAL INFORMATION AND DIRECTORY SERVICES; COPYRIGHT MANAGEMENT CONSULTATION; DISSEMINATION OF ADVERTISING FOR OTHER VIA AN ON-LINE ELECTRONIC COMMUNICATIONS NETWORK; MESSAGE TRANSCRIPTION SERVICES; BUSINESS NETWORKING; PROMOTING SPORTS COMPETITIONS AND/OR EVENTS OF OTHERS; SHOW WINDOW DISPLAY ARRANGEMENT SERVICES; TELEMARKETING.

FIRST USE ; IN COMMERCE .

INT. CL. 36/U.S. CLS. 100, 101 AND 102

FOR PROVIDING INFORMATION IN THE FIELD OF INSURANCE; BROKERAGE HOUSES IN THE FIELD OF SECURITIES, FUTURES, STOCKS, BONDS AND REAL ESTATE; INVESTMENT OF FUNDS FOR OTHERS; CONSULTATION IN THE FIELD OF FINANCIAL ANALYSIS AND INVESTMENT IN THE COMPUTER INDUSTRY; CURRENCY EXCHANGE SERVICES; FINANCIAL CLEARINGHOUSES; CO-OPERATIVE CREDIT ORGANIZATIONS; INVESTMENT OF FUNDS FOR OTHERS, NAMELY HOLDING COMPANIES; CREDIT CARD SERVICES; CREDIT BUREAUS; FINANCIAL ANALYSIS; BANKING SERVICES; CAPITAL INVESTMENTS CONSULTATION; DEBT COLLECTION AND CREDIT AGENCIES; FIDUCIARY REPRESENTATIVES; FINANCING SERVICES; LEASING OF REAL ESTATE; LOAN FINANCING; REAL ESTATE APPRAISAL AND MANAGEMENT; SAFE DEPOSIT BOX SERVICES; COMMODITY AND PRICE QUOTATIONS; INSURANCE AGENCY SERVICES IN THE FIELD OF HEALTH, LIFE, HOME, DISABILITY, ACCIDENT, FIRE AND AUTO; REAL ESTATE TRUSTEE SERVICES AND TRUSTEESHIP REPRESENTATIVES.

FIRST USE ; IN COMMERCE .

INT. CL. 37/U.S. CLS. 100, 103 AND 106

FOR INSTALLATION AND REPAIR OF COMPUTER HARDWARE; ELECTRIC APPLIANCE INSTALLATION AND REPAIR; INSTALLATION AND REPAIR OF BUSINESS AND OFFICE MACHINES AND EQUIPMENT; TELEPHONE INSTALLATION AND REPAIR; VEHICLE REPAIR; WAREHOUSE REPAIR; PROVIDING INFORMATION IN THE FIELD OF HOME MAINTENANCE AND REPAIR; BUILDING CONSTRUCTION \* AND REPAIR\*.

FIRST USE ; IN COMMERCE .

INT. CL. 38/U.S. CLS. 100, 101 AND 104

FOR TELECOMMUNICATION SERVICES COMPRISING THE PROVIDING OF MULTIPLE USER ACCESS TO A GLOBAL COMPUTER INFORMATION NETWORK.

FIRST USE ; IN COMMERCE .

INT. CL. 39/U.S. CLS. 100 AND 105

FOR AIR TRANSPORT; BOAT TRANSPORT; CAR TRANSPORT; RAILWAY TRANSPORT; TRANSPORTATION RESERVATION SERVICES; TRANSPORT BROKERAGE; MERCHANDISE PACKAGING AND STORAGE OF GOODS.

FIRST USE ; IN COMMERCE .

INT. CL. 40/U.S. CLS. 100, 103 AND 106

FOR BLACKSMITHING; BOOKBINDING; FABRIC DYEING; FABRIC BLEACHING; FUR DYEING; GOLD PLATING; RECYCLING OF WASTE AND TRASH; WATER TREATMENT; METAL MAGNETIZATION; METAL TREATMENT; PAPER TREATMENT; PHOTOGRAPHIC FILM DEVELOPMENT; OIL AND FUEL REFINING SERVICES; SILVER PLATING; TEXTILE TREATMENT IN THE NATURE OF MOTHPROOFING.

FIRST USE ; IN COMMERCE .

INT. CL. 41/U.S. CLS. 100, 101 AND 107

FOR AMUSEMENT PARKS; ARRANGING AND CONDUCTING ATHLETIC COMPETITIONS; ARRANGING AND CONDUCTING EDUCATIONAL CONFERENCES; AUDIO RECORDING AND PRODUCTION; CINEMA STUDIOS; CINEMA THEATRES; COMPUTER EDUCATION TRAINING SERVICES; PRODUCTION AND DISTRIBUTION OF MOTION PICTURES; DISTRIBUTION OF RADIO PROGRAMS FOR OTHERS; DEVELOPMENT AND DISSEMINATION OF EDUCATIONAL MATERIALS FOR OTHERS IN THE FIELD OF COMPUTER DATABASES; PUBLICATION OF MAGAZINES; MOTION PICTURE FILM PRODUCTION; PRODUCTION OF CABLE TELEVISION PROGRAMS; PROGRAMMING OF CABLE TELEVISION, RADIO AND TELEVISION SHOWS; SUMMER CAMP SERVICES; SPORT CAMP SERVICES; ENTERTAINMENT IN THE NATURE OF CIRCUSES; DISCOTHEQUE SERVICES; GYMNASIUM INSTRUCTION; HEALTH CLUB SERVICES; PARTY PLANNING; ENTERTAINMENT IN THE NATURE OF COMPETITIONS IN THE FIELD OF ALL KIND SPORTS, ATHLETICS, MOTOR RACING, HORSEBACK RIDING, SAILING; PROVIDING ENTERTAINMENT INFORMATION; ENTERTAINMENT IN THE NATURE OF ON-GOING TELEVISION PROGRAMS IN THE FIELD OF COMEDY, NEWS; ENTERTAINMENT IN THE NATURE OF ON-GOING RADIO PROGRAMS IN THE FIELD OF NEWS, COMEDY; PUBLICATION OF BOOKS AND MAGAZINES; LIBRARIES; ARRANGING AND CONDUCTING CLASSES OF INSTRUCTION IN THE FIELD OF INFORMATION TECHNOLOGY; CONDUCTING CLASSES IN THE FIELD OF PARENTHOOD EDUCATION; CONDUCTING TRAINING CLASSES IN THE FIELD OF COMPUTER, FINANCIAL, BANKING, ECONOMICAL, TELECOMMUNICATION AND MASS MEDIA]\* CONDUCTING CLASSES IN THE FIELD OF FINANCIAL INVESTMENT, ECONOMIC ANALYSIS, TELECOMMUNICATION AND MASS MEDIA;\* EDUCATION AND TESTING; ART GALLERIES; PRODUCTION OF EDUCATIONAL AND ENTERTAINMENT PROGRAMS FOR RADIO AND TV STATIONS; PRODUCTION OF OPERAS AND PLAYS; ARRANGING FOR TICKET RESERVATIONS FOR SHOWS AND OTHER ENTERTAINMENT EVENTS; RENTAL OF FILM PROJECTION EQUIPMENT; RENTAL OF SPORTING EQUIPMENT, NAMELY, [SKIES] \* SKIIS\*, SKATING, SKIN-DIVING, FISHING, HUNTING, SAILING, BICYCLES; RENTAL OF MOVIE FILMS.  
FIRST USE ; IN COMMERCE .

2,629,937. REG. 10-8-2002. CYBER ZONE, L.P. (TEXAS LIMITED PARTNERSHIP) 1506 CRESCENT POINT, SAN ANTONIO, TX, 78258, SN 76-039,805. FILED 5-3-2000. PRINCIPAL REGISTER.



INT. CL. 41/U.S. CLS. 100, 101 AND 107  
FOR ENTERTAINMENT SERVICES, NAMELY, PROVIDING INTERACTIVE ELECTRONIC MEDIA ENTERTAINMENT FACILITIES AND VIDEO AMUSEMENT ARCADE CENTERS.  
FIRST USE 11-0-1999; IN COMMERCE 11-0-1999.

ELEMENTS CORRECTED  
OWNER NAME  
ENTITY

2,641,684. REG. 10-29-2002. EHREN ENTERPRISES INC. (CANADA CORPORATION) 7777 KEELE STREET, SUITE 214, CONCORD, ONTARIO, CANADA, 14K 1Y7, SN 76-058,277. FILED 5-26-2000. PRINCIPAL REGISTER.

**MQP**

OWNER OF CANADA REG. NO. TMA523,274, DATED 2-17-2000, EXPIRES 2-17-2015.  
INT. CL. 9/U.S. CLS. 21, 23, 26, 36 AND 38  
FOR BINOCULARS, MICROSCOPES, TELESCOPES, MAGNIFIERS, METAL DETECTORS, DIRECTIONAL HUNTING AND GOLF SCOPES, DIRECTIONAL COMPASSES, AND CARRYING CASES FOR THE AFOREMENTIONED ITEMS.  
FIRST USE ; IN COMMERCE .

ELEMENTS CORRECTED  
\*OWNER NAME\*

INT. CL. 42/U.S. CLS. 100 AND 101  
FOR RESTAURANT AND BAR SERVICES; PROVIDING TEMPORARY HOUSING ACCOMMODATIONS; MEDICAL SERVICES; DENTAL HYGIENE SERVICES; BEAUTY SALONS; VETERINARY AND AGRICULTURAL SERVICES, NAMELY, VERMIN EXTERMINATION FOR AGRICULTURE, AGRICULTURAL ADVICE, RENTAL OF AGRICULTURAL EQUIPMENT, VETERINARY SURGERY AND VETERINARY ASSISTANCE; LEGAL SERVICES; SCIENTIFIC AND INDUSTRIAL RESEARCH; COMPUTER PROGRAMMING FOR OTHERS; PROVIDING INFORMATION IN THE FIELD OF TECHNOLOGY; WEBSITE DESIGN SERVICES FOR OTHERS; CONFIGURATION AND INSTALLATION OF COMPUTER SOFTWARE FOR OTHERS.  
FIRST USE ; IN COMMERCE .

2,650,419. REG. 11-12-2002. INNOVATIVE BEVERAGE CONCEPTS, INC. (CALIFORNIA CORPORATION) 27111 ALISO CREEK ROAD, SUITE 175, ALISO VIEJO, CA, 92656, SN 76-204,553. FILED 2-5-2001. PRINCIPAL REGISTER.

**TEAOLOGY**

INT. CL. 30/U.S. CL. 46  
FOR TEA, CHAI TEA, FLAVORED DRINK MIXES, NAMELY TEA MIXES, CHAI MIXES, AND COCOA MIXES.  
FIRST USE 1-23-2002; IN COMMERCE 1-23-2002.

ELEMENTS CORRECTED  
GOODS/SERVICES

ELEMENTS CORRECTED  
DATE OF FIRST USE  
DATE OF FIRST USE IN COMMERCE



2,661,234. REG. 12-17-2002. PEARSON EDUCATION LIMITED (ENGLAND CORPORATION) EDINBURGH GATE, HARLOW, ESSEX, UNITED KINGDOM, CM20 2JE, SN 75-932,847. FILED 3-1-2000. PRINCIPAL REGISTER.

## THE LANGUAGE GYM

OWNER OF ERPN CMNTY TM OFC REG. NO. 483321, DATED 2-3-1999, EXPIRES 2-21-2007.

INT. CL. 9/U.S. CLS. 21, 23, 26, 36 AND 38

FOR INSTRUCTIONAL AND TEACHING APPARATUS, NAMELY, SELF-ASSEMBLY ELECTRONIC KITS FOR USE BY STUDENTS AND PUPILS AND SCHOOLS; MAGNETIC DATA CARRIERS, RECORDING DISCS, VIDEO TAPES, CDS AND COMPUTER SOFTWARE ALL RELATED TO OR BEING EDUCATIONAL AND INSTRUCTIONAL MATERIALS ON THE ENGLISH LANGUAGE OR ENGLISH SPEAKING CULTURES.

FIRST USE ; IN COMMERCE .

INT. CL. 16/U.S. CLS. 2, 5, 22, 23, 29, 37, 38 AND 50

FOR PRINTED PUBLICATIONS, NAMELY, BOOKLETS, BOOKS, CALENDARS, CATALOGUES, HANDBOOKS, LEDGERS, MAGAZINES, MANUALS, NEWSLETTERS, PAMPHLETS, PERIODICAL, PLANS, AND PROSPECTUSES, ALL RELATING TO THE ENGLISH LANGUAGE OR ENGLISH SPEAKING CULTURES .

FIRST USE ; IN COMMERCE .

INT. CL. 41/U.S. CLS. 100, 101 AND 107

FOR LANGUAGE SCHOOLS, EDUCATION AND PROVISION OF TRAINING SERVICES, CORRESPONDENCE COURSE AND EXAMINATION SERVICES ALL RELATING TO THE ENGLISH LANGUAGE OR ENGLISH SPEAKING CULTURES.

ELEMENTS CORRECTED  
OWNER ADDRESS

2,662,257. REG. 12-17-2002. LIGHTBORNE PUBLISHING, INC. (OHIO CORPORATION) 811 RACE STREET, 5TH FLOOR, CINCINNATI, OH, 45202, SN 76-291,884. FILED 7-30-2001. PRINCIPAL REGISTER.

## BEST OF CINCINNATI

NO CLAIM IS MADE TO THE EXCLUSIVE RIGHT TO USE "CINCINNATI", APART FROM THE MARK AS SHOWN.

SEC. 2(F).

INT. CL. 16/U.S. CLS. 2, 5, 22, 23, 29, 37, 38 AND 50

FOR MAGAZINE SUPPLEMENT TO A NEWSPAPER IN THE FIELDS OF FOOD SERVICE, PUBLIC RECREATIONAL AND SPORTING EVENTS AND FACILITIES, NIGHT CLUB SERVICES, RETAIL SERVICES, SPA AND SALON SERVICES, INNKEEPING, MUSIC, THEATER, ART, BROADCASTING, JOURNALISM, [ PUBIC ] \* PUBLIC \* SERVICE AND PHILANTHROPY.

FIRST USE 3-20-1997; IN COMMERCE 3-20-1997.

INT. CL. 41/U.S. CLS. 100, 101 AND 107

FOR PROVIDING RECOGNITION BY WAY OF AWARDS TO DEMONSTRATE EXCELLENCE OR DISTINCTION IN THE FIELDS OF FOOD SERVICE, PUBLIC RECREATIONAL AND SPORTING EVENTS AND FACILITIES, NIGHT CLUB SERVICES, RETAIL SERVICES, SPA AND SALON SERVICES, INNKEEPING, MUSIC, THEATER, ART, BROADCASTING, JOURNALISM, PUBLIC SERVICE AND PHILANTHROPY.

FIRST USE 3-20-1997; IN COMMERCE 3-20-1997.

INT. CL. 42/U.S. CLS. 100 AND 101

FOR PROVIDING INFORMATION OF INTEREST TO SPECIFIC GEOGRAPHICAL AREAS VIA THE GLOBAL COMPUTER NETWORK.

FIRST USE 3-20-1997; IN COMMERCE 3-20-1997.

ELEMENTS CORRECTED  
\*DISCLAIMER\*

2,671,692. REG. 1-7-2003. TIANE (FRANCE SIMPLIFIED LIMITED COMPANY) 11/13 COUR VALMY, IMMEUBLE "LA PACIFIC" LA DEFENSE 7, PUTEAUX, FRANCE, 92800, SN 76-340,129. FILED 11-20-2001. PRINCIPAL REGISTER.

## TENASTEEL

PRIORITY CLAIMED UNDER SEC. 44(D) ON FRANCE APPLICATION NO. 013103537, FILED 6-1-2001, REG. NO. 013103537, DATED 6-1-2001, EXPIRES 6-1-2011.

INT. CL. 6/U.S. CLS. 2, 12, 13, 14, 23, 25 AND 50

FOR STEELS; STAINLESS STEELS; CARBON STEELS; COATED STEELS; STEEL FOR TOOLS; METALLIC STRIPS; METALLIC COILS; METALLIC PLATES; METALLIC HOOPS; METALLIC SHEETS; METALLIC BARS AND TUBES; AND METALLIC FORGED, CAST, MELTED, STAMPED, PRESSED, WELDED AND MACHINED AND SHAPED PARTS—NAMELY, METAL FORGINGS, METAL CASTINGS, METAL MELTINGS, METAL STAMPINGS, METAL PRESSINGS AND METAL WELDINGS.

FIRST USE ; IN COMMERCE .

INT. CL. 7/U.S. CLS. 13, 19, 21, 23, 31, 34 AND 35

FOR MACHINES FOR SHEARING, CUTTING, PUNCHING AND SHAPING MATERIALS; AND MACHINE TOOLS—NAMELY, POWER-OPERATED SHEARS, CUTTERS, PUNCHES AND STAMPERS.

FIRST USE ; IN COMMERCE .

ELEMENTS CORRECTED  
GOODS/SERVICES

2,707,944. REG. 4-15-2003. 5 STAR FINANCIAL CO. (VIRGINIA CORPORATION) 909 NORTH WASHINGTON STREET, ALEXANDRIA, VA, 223141556, SN 76-975,202. FILED 10-24-2000. PRINCIPAL REGISTER.



OWNER OF U.S. REG. NOS. 1,771,820, 2,386,932 AND OTHERS.

NO CLAIM IS MADE TO THE EXCLUSIVE RIGHT TO USE "BANK", APART FROM THE MARK AS SHOWN.

INT. CL. 36/U.S. CLS. 100, 101 AND 102

FOR BANKING AND CREDIT CARD SERVICES, CREDIT CARD PROCESSING SERVICES; TRAVELERS CHECK ISSUANCE; HOME MORTGAGE FINANCING; TRAVEL ACCIDENT UNDERWRITING INSURANCE SERVICES.

FIRST USE 1-0-2001; IN COMMERCE 1-0-2001.

ELEMENTS CORRECTED  
OWNER NAME

2,714,394. REG. 5-6-2003. BERGHOLD, JOSEPH P. (UNITED STATES INDIVIDUAL), DBA BERGHOLD VINEYARDS, 8541 EAST HIGHWAY 12, LODI, CA, 95240, AND BERGHOLD, KAY B. (UNITED STATES INDIVIDUAL), DBA BERGHOLD VINEYARDS, 8541 EAST HIGHWAY 12, LODI, CA, 952409301, SN 76-293,895. FILED 8-1-2001. PRINCIPAL REGISTER.



NO CLAIM IS MADE TO THE EXCLUSIVE RIGHT TO USE "VINEYARDS", APART FROM THE MARK AS SHOWN.

INT. CL. 33/U.S. CLS. 47 AND 49  
FOR WINE.

FIRST USE 12-26-2001; IN COMMERCE 12-26-2001.

ELEMENTS CORRECTED  
OWNER ADDRESS

2,737,502. REG. 7-15-2003. SHAKLEE CORPORATION (DELAWARE CORPORATION) 4747 WILLOW ROAD, PLEASANTON, CA, 94588, SN 76-098,552. FILED 7-28-2000. PRINCIPAL REGISTER.

## LIVING IN HARMONY WITH NATURE

OWNER OF U.S. REG. NOS. 1,834,167 AND 2,197,411.  
INT. CL. 35/U.S. CLS. 100, 101 AND 102

FOR PROMOTING THE SERVICES OF OTHERS, NAMELY, INDEPENDENT DISTRIBUTORS OF NUTRITIONAL SUPPLEMENTS, PERSONAL CARE PRODUCTS, HOUSEHOLD CLEANING AND LAUNDRY PRODUCTS, AND WATER PURIFICATION UNITS FOR DOMESTIC USE AND FILTERS THEREFORE THROUGH THE DISTRIBUTION OF PRINTED PROMOTIONAL LITERATURE AND BY PLACING ADVERTISEMENTS AND INFORMATIONAL MATERIAL ELECTRONICALLY ON A GLOBAL COMPUTER INFORMATION NETWORK; PERSON TO PERSON RETAIL SERVICES PROVIDED THROUGH MOBILE SALES REPRESENTATIVES, AWAY FROM A FIXED RETAIL ESTABLISHMENT, NAMELY, THROUGH BUYING CLUBS, SHOP-AT-HOME PARTIES, SHOP-AT-OFFICE PARTIES AND COMPUTERIZED ON-LINE ORDERING SERVICES FEATURING DIETARY SUPPLEMENTS, PERSONAL CARE PRODUCTS, HOUSEHOLD CLEANING AND LAUNDRY PRODUCTS, AND WATER PURIFICATION UNITS FOR DOMESTIC USE AND FILTERS THEREFORE.

FIRST USE 8-1-2001; IN COMMERCE 8-1-2001.

ELEMENTS CORRECTED  
\*ASSIGNMENT/NAME CHANGE\*  
OWNER ADDRESS

2,745,647. REG. 8-5-2003. HOLLYWOOD SYSTEMS, INC. (FLORIDA CORPORATION) 2435 SOUTH KINGS ROAD, CALLAHAN, FL, 32011, SN 76-013,752. FILED 3-30-2000. PRINCIPAL REGISTER.

# HOLLYWOOD

SATELLITE TV

NO CLAIM IS MADE TO THE EXCLUSIVE RIGHT TO USE "SATELLITE TV", APART FROM THE MARK AS SHOWN.

INT. CL. 38/U.S. CLS. 100, 101 AND 104

FOR SATELLITE TRANSMISSION SERVICES AND TELEVISION BROADCASTING BY MEANS OF SATELLITE.

FIRST USE 1-1-1999; IN COMMERCE 1-1-1999.

ELEMENTS CORRECTED

\*ENTITY\*  
OWNER NAME  
OWNER ADDRESS  
CITIZENSHIP

2,751,632. REG. 8-19-2003. SYSCO CORPORATION (DELAWARE CORPORATION) 1390 ENCLAVE PARKWAY, HOUSTON, TX, 770772099, SN 75-940,973. FILED 3-10-2000. PRINCIPAL REGISTER.

## BUTCHER'S BLOCK

INT. CL. 29/U.S. CL. 46

FOR BEEF PRODUCTS SOLD IN FOOD SERVICE TRADE CHANNELS, NOT INCLUDING RETAIL \* GROCERY, CONVENIENCE STORE \* [ AND ] FACTORY OUTLET \* STORE AND CLUB STORE TRADE \* CHANNELS, NAMELY, BEEF SUBPRIMALS, \* AND \* BEEF STEAKS, \* BUT NOT INCLUDING \* GROUND BEEF, AND BEEF PATTIES, [ BUT NOT INCLUDING ] SPICES, SEASONINGS, AND PROCESSED HERBS.

FIRST USE 8-31-2000; IN COMMERCE 10-31-2000.

ELEMENTS AMENDED  
GOODS/SERVICES

2,752,858. REG. 8-19-2003. SOCIETA' PER AZIONI CHIANTI RUFFINO ESPORTAZIONE VINICOLA TOSCANA (ITALY CORPORATION) 12 VIA CORSICA, BRESCIA, ITALY, 25125, SN 78-045,182. FILED 1-26-2001. PRINCIPAL REGISTER.

## MUROTORTO

PRIORITY CLAIMED UNDER SEC. 44(D) ON ERP N CMNTY TM OFC APPLICATION NO. 1979251, FILED 11-30-2000, REG. NO. 1979251, DATED 1-25-2002, EXPIRES 11-30-2010.

THE ENGLISH TRANSLATION OF THE WORD "MUROTORTO" IN THE MARK IS "CROOKED WALL".

INT. CL. 33/U.S. CLS. 47 AND 49

FOR WINES.  
FIRST USE ; IN COMMERCE .

ELEMENTS CORRECTED  
FOREIGN COUNTRY OF ORIGIN  
FOREIGN REG. EXPIRATION DATE

2,754,582. REG. 8-19-2003. EHREN ENTERPRISES INC. (CANADA CORPORATION) 7777 KEELE STREET, SUITE 214, CONCORD, ONTARIO, CANADA, 14K 1Y7, SN 76-386,593. FILED P.R. 3-25-2002; AM. S.R. 5-21-2003. SUPPLEMENTAL REGISTER.

## PROSPECTOR

OWNER OF CANADA REG. NO. TMA553,718, DATED 11-14-2001, EXPIRES 11-14-2016.  
INT. CL. 9/U.S. CLS. 21, 23, 26, 36 AND 38  
FOR HOBBYISTS' METAL DETECTORS AND CARRYING CASES THEREFOR.  
FIRST USE 12-31-1999; IN COMMERCE 12-31-1999.

ELEMENTS CORRECTED  
\*ASSIGNMENT/NAME CHANGE\*

2,755,119. REG. 8-26-2003. METSO CORPORATION (FINLAND CORPORATION) FABIANINKATU 9 A, 00130 HELSINKI, FINLAND., SN 76-297,986. FILED 8-9-2001. PRINCIPAL REGISTER.

## METSO LINKING INNOVATIONS

PRIORITY CLAIMED UNDER SEC. 44(D) ON FINLAND APPLICATION NO. T200100556, FILED 2-14-2001, REG. NO. 223146, DATED 2-28-2002, EXPIRES 2-28-2012.  
INT. CL. 7/U.S. CLS. 13, 19, 21, 23, 31, 34 AND 35

FOR FULL LINE OF MACHINES AND APPARATUS AND THEIR PARTS FOR MANUFACTURE AND TREATMENT OF MECHANICAL AND CHEMICAL PULP, CELLULOSE, PAPER, PAPERBOARD, TISSUE AND NON-WOVEN WEBS; DEBARKING DEVICES AND DEVICES FOR TREATMENT OF BARK; CHIPPERS, FLAKERS, MACHINES AND APPARATUS FOR SCREENING, CLASSIFYING AND WASHING CHIPS AND WOOD FLAKES; TANKS AND CONTAINERS AS A PART OF MANUFACTURING PROCESS FOR STORAGE, PRE-TREATMENT, COOKING AND BLEACHING OF PULP; REACTOR TANKS AND CONTAINERS AS A PART OF MANUFACTURING PROCESS; TRANSPORT AND FEED APPARATUS AS A PART OF MANUFACTURING PROCESS; DISINTEGRATORS AND SCREENING DEVICES, SEPARATORS, VORTEX CLEANERS, FILTERING DEVICES AND FILTERS, SCREENS, SIEVES; PRESSES; MIXING DEVICES; APPARATUS FOR PRODUCTION OF RECYCLED FIBER, APPARATUS FOR DE-INKING RECYCLED PAPER; MACHINES AND APPARATUS FOR PRODUCTION AND TREATMENT OF COATING COLORS, IMPREGNATION AGENTS, BLEACHING CHEMICALS AND PAPER CONVERTING CHEMICALS; MACHINES AND APPARATUS FOR CONVERTING OF PAPER AND PAPERBOARD; PRINTING MACHINES; VACUUM METALLIZER MACHINES; MACHINES AND APPARATUS FOR FURTHER PROCESSING OF PLASTIC FILMS AND ALUMINUM FOILS; MACHINES, APPARATUS AND LINES FOR MANUFACTURING, TREATMENT, AND FURTHER PROCESSING OF WOOD-BASED SHEET AND BOARD PRODUCTS AS WELL AS PLYWOOD AND WOOD VENEER; APPARATUS FOR DRYING WOOD FLAKES AND FIBERS AND ENERGY GENERATION APPARATUS RELATED THERETO; STORAGE ROBOTS, SAWS

AND CUTTING MACHINES; HYDRAULIC MOTORS AND MECHANICAL DRIVE EQUIPMENT, NAMELY MOTORS, RADIAL PISTON MOTORS, ROTATORS, CRANE ROTATORS AND DRIVES; GEAR ASSEMBLIES, CLUTCHES, COUPLINGS AND TRANSMISSION COMPONENTS EXCEPT FOR LAND VEHICLES; ROLLS, ROLL COVERS AND COATINGS; PUMPS, FANS AND BLOWERS; SHUTOFF AND CONTROL VALVES, VALVE POSITIONERS, DIGITAL VALVE CONTROLLERS; BULLDOZERS, LOADERS, EXCAVATORS, STREET AND ROAD MAINTENANCE MACHINES, EARTH-MOVING DUMPERS, EXCALOADERS AND TRACTOR EXCAVATORS, MINING MACHINERY, LOADING AND LOAD HANDLING EQUIPMENT; NAMELY CONVEYORS, RECLAIMERS, FEEDERS, VIBRATING CHUTES, GRAB UNLOADERS, STACKERS, STOCKPILERS AND ROTARY RAILCAR DUMPERS; CRUSHING PLANTS, CRUSHERS, GRINDING MILLS AND DEVICES USED IN COMMINATION AND CRUSHING PROCESSES; MACHINERY AND APPARATUS FOR THE MINING INDUSTRY[\*], \* NAMELY BREAKERS, BALL MILLS, CONE MILLS, \* ROD MILLS \* DETRITORS, CLASSIFIERS, AGITATORS, FLOTATION MACHINES, THICKENERS, CLARIFIERS, SETTLERS, FILTERS, PRESSES, THERMAL PROCESSORS ROTARY KILNS, BALLING DRUMS, FLUID BEDS, DRYERS, COOLERS, FAIRLEADS, PANAMA CHOCKES, WINCHES, WINDLASSES, PELLETIZERS, SINTERS, PULLERS, SLURRY PUMPS, DISINTEGRATORS, SCREENING DEVICES, SCREENS, SHAKEOUTS, CYCLONES, SEPARATORS, SCALPERS, FEEDERS, MOBILE FEEDERS, SCREENS \* , \* SCREEN GRATES, SCREEN CLOTHS, WASHERS, MAGNETIC SEPARATORS, VIBRATING SEPARATORS, STONE SAWS, STONE MILLS, STONE GRINDERS, ROCK DRILLS, TUNNELING DRILLS; ROAD AND HIGHWAY CONSTRUCTION MACHINES; PROPULSION UNITS FOR SHIPS; MACHINERY AND EQUIPMENT FOR PAVING AND COMPACTION, NAMELY, PLANNERS, PAVERS, SCREEDS, ROLLERS, DUPLEX ROLLERS, PNEUMATIC ROLLERS, TAMPING ROLLERS, STATIC ROLLERS, COMPACTORS, PLATE COMPACTORS, TRENCH COMPACTORS, TAMPERS, POKER VIBRATORS, VIBRATING BEAMS, MODULAR SCREEDS, FLOOR SAWS, GRINDING MACHINES, POWER TROWELS, EXTERNAL VIBRATORS, SUBMERSIBLE PUMPS, SUCTIONS MATS, MOBILE FEEDERS.  
FIRST USE ; IN COMMERCE .

INT. CL. 9/U.S. CLS. 21, 23, 26, 36 AND 38

FOR FULL LINE OF DATA PROCESSING EQUIPMENT; COMPUTERS, COMPUTER MONITORS AND TERMINALS, COMPUTER SOFTWARE FOR USE IN PULP AND PAPER INDUSTRY AND PROCESSES, PANEL BOARD INDUSTRY, COMMINATION PROCESSES, PRINTING PROCESSES, CONVERTING INDUSTRY, ENERGY PLANTS AND DISTRIBUTION, AND MINING INDUSTRY; COMPUTER PROGRAMS FOR DIMENSIONING AND CHOOSING VALVES; A FULL LINE OF APPARATUS FOR CONTROL AND REGULATING OF PROCESSES; ELECTRIC ACTUATING DEVICES AND THEIR CONTROL SYSTEMS, PNEUMATIC ACTUATORS AND THEIR CONTROL SYSTEMS; ELECTRIC, HYDRAULIC AND PNEUMATIC MEASURING INSTRUMENTS AND CONTROLLERS; AUTOMATIC PULP, PAPER AND PAPERBOARD TESTING EQUIPMENT, FIBRE LENGTH ANALYZERS AND KAPPA NUMBER ANALYZERS; APPARATUS AND SYSTEMS FOR MONITORING THE OPERATION, CONDITION AND RUNNABILITY OF PULP MANUFACTURING EQUIPMENT, PAPER, PAPERBOARD, TISSUE AND NON-WOVEN MACHINES, AND OF WOOD-BASED SHEET AND BOARD PRODUCT MACHINES; APPARATUS AND SYSTEMS FOR MONITORING THE OPERATION AND CONDITION OF FOREST MACHINES, CRUSHING PLANTS AND CRUSHERS AND THEIR FITTINGS AND DEVICES FOR CONTROLLING, MONITORING AND REGULATING THEIR FUNCTIONS;

DATA COLLECTION EQUIPMENT FOR FOREST MACHINES AND CRUSHING PLANTS AND CRUSHERS; FOREST MACHINE SIMULATORS; SYSTEMS FOR MONITORING THE CONDITION OF VALVES; CONTROLLING, MONITORING AND REGULATING DEVICES, NAMELY ELECTRONIC AND COMPUTER-CONTROLLED PROCESS CONTROL DEVICES, IN PARTICULAR FOR MACHINES AND APPARATUS IN THE WOOD-PROCESSING AND ENERGY INDUSTRIES; STORAGE AUTOMATION SYSTEMS; PARTS AND FITTINGS FOR ALL THE AFORESAID GOODS, APPARATUS AND SYSTEMS.

FIRST USE ; IN COMMERCE .

INT. CL. 37/U.S. CLS. 100, 103 AND 106

FOR BUILDING CONSTRUCTION AND REPAIR SERVICES; AND INSTALLATION OF MACHINES AND PARTS OF MACHINES FOR PULP AND PAPER INDUSTRY AND PROCESSES, FOR PANEL BOARD INDUSTRY, FOR COMMUNITION PROCESSES, FOR PRINTING PROCESSES, FOR CONVERTING INDUSTRY, FOR ENERGY PLANTS AND DISTRIBUTION, FOR MINING INDUSTRY AND FOR COMPACTION AND PAVING INDUSTRY.

FIRST USE ; IN COMMERCE .

ELEMENTS CORRECTED  
GOODS/SERVICES

2,759,509. REG. 9-2-2003. SONNINA SUBWAREN GMBH (FED REP GERMANY CORPORATION) HESSELINGWEG 30, 44309 DORTMUND, FED REP GERMANY., SN 76-174,689. FILED 12-4-2000. PRINCIPAL REGISTER.

## LAROSHELL

INT. CL. 30/U.S. CL. 46

FOR [ COFFEE; TEA; COCOA; SUGAR; RICE; TAPIOCA; SAGO; COFFEE SUBSTITUTES; TEA AND TEA EXTRACTS FOR FOOD; COCOA POWDER; FLOURS; SWEETENED, SPICED OR FLAVORED CEREAL FLAKES CONSISTING PRIMARILY OF OATS; SNACK MIX CONSISTING PRIMARILY OF OAT CEREAL FLAKES; PROCESSED BARLEY AND SEMOLINA; GRITS; POTATO FLOUR; PASTA; INSTANT AND CANNED ENTREES CONSISTING PRIMARILY OF PASTA NOODLES; BREAD; BREAD ROLLS; BISCUITS; CAKES; PASTRIES, NAMELY, SAVORY, SALTED AND SWEET BISCUITS AS SNACK FOODS; CEREAL- AND GRANOLA-BASED SNACK FOODS; MUESLI BARS CONSISTING PRIMARILY OF PROCESSED CEREAL GRAINS, NUTS, DRIED FRUITS AND CHOCOLATE MIXTURES; LONG-LASTING BAKERY GOODS, CRISP BREAD, COOKIES, CRACKERS AND BISCUITS; ] CHOCOLATE; CONFECTIONERY, NAMELY, CHOCOLATE BARS, CHOCOLATE CANDIES; ASSORTED FILLED CHOCOLATES, CHOCOLATE BARS AND CHOCOLATE CANDIES WITH FILLINGS MADE FROM PROCESSED FRUIT, COFFEE, YOGURT, PEPPERMINT CREME, STRAWBERRY CREME, KIWI CREME, BANANA CREME, NON-ALCOHOLIC DRINKS, WINE AND/OR SPIRITS, INCLUDING FILLINGS OF BRANDY, CHERRY AND EGG LIQUEUR [ ; FLAVORED ICES; CANDY; CHEWING GUM; HONEY; FRUIT FLAVORING SYRUP; MOLASSES; CHOCOLATE SANDWICH SPREAD; SANDWICH SPREADS CONSISTING OF SUGAR, COCOA, NOUGAT, CHOCOLATE, MILK AND FATS; CUSTARD-BASED BAKERY DESSERTS; YEASTS; BAKING POWDER; EXTRACTS USED AS FLAVORING; FOOD FLAVORINGS; TABLE SALT; MUSTARD; PEPPER; VINEGAR; SAUCES; KETCHUP; SPICES ].

FIRST USE 10-0-1999; IN COMMERCE 4-0-2000.

ELEMENTS CORRECTED  
GOODS/SERVICES  
OWNER NAME  
OWNER ADDRESS

2,761,933. REG. 9-9-2003. CORTLAND LINE COMPANY, INC. (NEW YORK CORPORATION) 3736 KELLOGG ROAD, P.O. BOX 5588, CORTLAND, NY, 13045, SN 78-179,923. FILED 10-30-2002. PRINCIPAL REGISTER.



INT. CL. 28/U.S. CLS. 22, 23, 38 AND 50

FOR FLY FISHING RODS, FLY FISHING OUTFIT CONSISTING [OR] \* OF \* RODS, REELS, AND FLY LINE.

FIRST USE 10-4-2002; IN COMMERCE 10-4-2002.

ELEMENTS CORRECTED  
GOODS/SERVICES

2,763,617. REG. 9-16-2003. WESTERN PACIFIC TELECOMMUNICATIONS (CALIFORNIA CORPORATION) 20706 S. MAIN STREET, CARSON, CA, 90745, SN 76-405,152. FILED 5-9-2002. PRINCIPAL REGISTER.

## WINGSPAN

INT. CL. 9/U.S. CLS. 21, 23, 26, 36 AND 38

FOR COMMUNICATION SERVICES EQUIPMENT, NAMELY CABLE CLOSURES, AND CABLE CLOSURES FOR SPLICING CABLES.

FIRST USE 7-31-1997; IN COMMERCE 7-31-1997.

ELEMENTS CORRECTED  
INTERNATIONAL CLASS(ES)

2,764,001. REG. 9-16-2003. NATIONAL ACADEMY OF RECORDING ARTS & SCIENCES, INC. (DELAWARE CORPORATION) 3402 PICO BOULEVARD, SANTA MONICA, CA. 90405. SN 76-467,033. FILED 11-5-2002. PRINCIPAL REGISTER.



FOR MEDICINAL PREPARATIONS IN THE FORM OF POWDERS, CAPSULES, TABLETS, SALVES, OINTMENTS, OILS, SOLUTIONS, AND DROPS ALL USED AS A NEURO-DEGENERATIVE INHIBITOR, NEURO-ENDOCRINE MODULATOR, AND NEURO-CEREBRAL METABOLISM ENHANCER FOR THE ELIMINATION OF ANXIETY AND HYPERACTIVITY, MITIGATION OF PANIC SYMPTOMOLOGY, REDUCTION OF FATIGUE, IMPROVEMENT OF SELF-CONFIDENCE AND SELF-ESTEEM, ELIMINATION OF THE NEED FOR ANTI-DEPRESSANTS, COGNITIVE ENHANCEMENT, IMPROVEMENT OF AEROBIC ENDURANCE AND PERFORMANCE AND WEIGHT-TRAINING CAPACITY, IMPROVEMENT OF BLOOD CIRCULATION, REDUCTION OF BLOOD PRESSURE AND HYPERTENSION, IMPROVEMENT OF SEXUAL PERFORMANCE AND LIBIDO, REDUCTION OF HORMONAL IMBALANCE IN MENOPAUSAL AND POST-MENOPAUSAL WOMEN, IMPROVEMENT OF VISUAL AND AUDITORY ACUITY, IMPROVEMENT OF PHYSICAL AGILITY AND MUSCLE FLEXIBILITY, IMPROVEMENT OF SOCIAL INTERACTION SKILLS, PROMOTION OF RELAXATION RESPONSE AND MITIGATION OF CHRONIC SLEEP PATTERN DISORDERS SUCH AS INSOMNIA AND OTHER CHRONIC SLEEP DISORDERS, REDUCTION OF ARTHRITIC PAIN AND SWELLING, ENHANCEMENT OF IMMUNE SYSTEM FUNCTIONING, IMPROVEMENT OF THE METABOLISM, RELIEF FROM CONSTIPATION, IMPROVEMENT OF SKIN TONE, MITIGATION OF "JET LAG," AND REDUCTION IN CAFFEINE DEPENDENCE; AND THE TREATMENT OF A BROAD SPECTRUM OF CONDITIONS AND PATHOLOGIES, NAMELY, AGE-RELATED AND NEURO-DEGENERATIVE CONDITIONS AND PATHOLOGIES, NERVE DISEASES, GENERAL ANXIETY DISORDER, DEPRESSION, NEUROSIS, NEURASTHENIA, OBSSIVE-COMPULSIVE DISORDER, CHRONIC SLEEP DISORDER, CHRONIC FATIGUE SYNDROME, DIGESTIVE DISEASES, CHRONIC CONSTIPATION, HYPERTENSION, OSTEOARTHRITIS PAIN AND SWELLING, AND HUMAN SEXUAL DESIRE DISORDER.  
FIRST USE 1-1-2002; IN COMMERCE 1-1-2002.

INT. CL. 36/U.S. CLS. 100, 101 AND 102  
FOR CHARITABLE FINANCIAL ASSISTANCE SERVICES, NAMELY, PROVIDING FUNDS TO MUSICIANS IN TIMES OF NEED.  
FIRST USE 11-0-1991; IN COMMERCE 11-0-1991.  
INT. CL. 44/U.S. CLS. 100 AND 101  
FOR COUNSELING SERVICES IN THE FIELD OF SUBSTANCE ABUSE TREATMENT.  
FIRST USE 11-0-1991; IN COMMERCE 11-0-1991.

ELEMENTS AMENDED  
\*OWNER NAME\*  
\*OWNER ADDRESS\*  
\*CITIZENSHIP\*  
\*ENTITY\*

ELEMENTS AMENDED  
MARK

2,764,080. REG. 9-16-2003. UNIFUND CORPORATION LIMITED (UNITED KINGDOM LIMITED PARTNERSHIP) 30-40 LONDON FRUIT EXCHANGE, LONDON, UNITED KINGDOM, E1 6EU, SN 76-476,987. FILED 12-19-2002. PRINCIPAL REGISTER.

2,764,081. REG. 9-16-2003. UNIFUND CORPORATION LIMITED (UNITED KINGDOM LIMITED PARTNERSHIP) 30-40 LONDON FRUIT EXCHANGE, LONDON, UNITED KINGDOM, E1 6EU, SN 76-476,988. FILED 12-19-2002. PRINCIPAL REGISTER.

## INTRATHERAPIES ALPHA PROGRAM

## INTRATHERAPIES

NO CLAIM IS MADE TO THE EXCLUSIVE RIGHT TO USE "PROGRAM", APART FROM THE MARK AS SHOWN.  
INT. CL. 5/U.S. CLS. 6, 18, 44, 46, 51 AND 52

INT. CL. 5/U.S. CLS. 6, 18, 44, 46, 51 AND 52

FOR MEDICINAL PREPARATIONS IN THE FORM OF POWDERS, CAPSULES, TABLETS, SALVES, OINTMENTS, OILS, SOLUTIONS, AND DROPS ALL USED AS A NEURO-DEGENERATIVE INHIBITOR, NEURO-ENDOCRINE MODULATOR, AND NEURO-CEREBRAL METABOLISM ENHANCER FOR THE ELIMINATION OF ANXIETY AND HYPERACTIVITY, MITIGATION OF PANIC SYMPTOMOLOGY, REDUCTION OF FATIGUE, IMPROVEMENT OF SELF-CONFIDENCE AND SELF-ESTEEM, ELIMINATION OF THE NEED FOR ANTI-DEPRESSANTS, COGNITIVE ENHANCEMENT, IMPROVEMENT OF AEROBIC ENDURANCE AND PERFORMANCE AND WEIGHT-TRAINING CAPACITY, IMPROVEMENT OF BLOOD CIRCULATION, REDUCTION OF BLOOD PRESSURE AND HYPERTENSION, IMPROVEMENT OF SEXUAL PERFORMANCE AND LIBIDO, REDUCTION OF HORMONAL IMBALANCE IN MENOPAUSAL AND POST-MENOPAUSAL WOMEN, IMPROVEMENT OF VISUAL AND AUDITORY ACUITY, IMPROVEMENT OF PHYSICAL AGILITY AND MUSCLE FLEXIBILITY, IMPROVEMENT OF SOCIAL INTERACTION SKILLS, PROMOTION OF RELAXATION RESPONSE AND MITIGATION OF CHRONIC SLEEP PATTERN DISORDERS SUCH AS INSOMNIA AND OTHER CHRONIC SLEEP DISORDERS, REDUCTION OF ARTHRITIC PAIN AND SWELLING, ENHANCEMENT OF IMMUNE SYSTEM FUNCTIONING, IMPROVEMENT OF THE METABOLISM, RELIEF FROM CONSTIPATION, IMPROVEMENT OF SKIN TONE, MITIGATION OF "JET LAG," AND REDUCTION IN CAFFEINE DEPENDENCE; AND THE TREATMENT OF A BROAD SPECTRUM OF CONDITIONS AND PATHOLOGIES, NAMELY, AGE-RELATED AND NEURO-DEGENERATIVE CONDITIONS AND PATHOLOGIES, NERVE DISEASES, GENERAL ANXIETY DISORDER, DEPRESSION, NEUROSIS, NEURASTHENIA, OBSSIVE-COMPULSIVE DISORDER, CHRONIC SLEEP DISORDER, CHRONIC FATIGUE SYNDROME, DIGESTIVE DISEASES, CHRONIC CONSTIPATION, HYPERTENSION, OSTEOARTHRITIS PAIN AND SWELLING, AND HUMAN SEXUAL DESIRE DISORDER.

FIRST USE 1-1-2002; IN COMMERCE 1-1-2002.

ELEMENTS AMENDED

\*OWNER NAME\*  
 \*OWNER ADDRESS\*  
 \*CITIZENSHIP\*  
 \*ENTITY\*

FOR MEDICINAL PREPARATIONS IN THE FORM OF POWDERS, CAPSULES, TABLETS, SALVES, OINTMENTS, OILS, SOLUTIONS, AND DROPS ALL USED AS A NEURO-DEGENERATIVE INHIBITOR, NEURO-ENDOCRINE MODULATOR, AND NEURO-CEREBRAL METABOLISM ENHANCER FOR THE ELIMINATION OF ANXIETY AND HYPERACTIVITY, MITIGATION OF PANIC SYMPTOMOLOGY, REDUCTION OF FATIGUE, IMPROVEMENT OF SELF-CONFIDENCE AND SELF-ESTEEM, ELIMINATION OF THE NEED FOR ANTI-DEPRESSANTS, COGNITIVE ENHANCEMENT INCLUDING IMPROVED CONCENTRATION, CLARITY, AND MENTAL FOCUS, IMPROVEMENT OF AEROBIC ENDURANCE AND PERFORMANCE AND WEIGHT-TRAINING CAPACITY, IMPROVEMENT OF BLOOD CIRCULATION, REDUCTION OF BLOOD PRESSURE AND HYPERTENSION, IMPROVEMENT OF SEXUAL PERFORMANCE AND LIBIDO, REDUCTION OF HORMONAL DISBALANCE IN MENOPAUSAL AND POST-MENOPAUSAL WOMEN, IMPROVEMENT OF VISUAL AND AUDITORY ACUITY, IMPROVEMENT OF PHYSICAL AGILITY AND MUSCLE FLEXIBILITY, IMPROVEMENT OF SOCIAL INTERACTION SKILLS, PROMOTION OF RELAXATION RESPONSE AND MITIGATION OF CHRONIC SLEEP PATTERN DISORDERS SUCH AS INSOMNIA AND OTHER CHRONIC SLEEP DISORDERS, REDUCTION OF ARTHRITIC PAIN AND SWELLING, ENHANCEMENT OF IMMUNE SYSTEM FUNCTIONING, IMPROVEMENT OF THE METABOLISM INCLUDING RELIEF FROM CONSTIPATION; IMPROVEMENT OF THE SKIN TONE; MITIGATION OF 'JET LAG'; AND REDUCTION IN CAFFEINE DEPENDENCE, AND THE TREATMENT OF A BROAD SPECTRUM OF CONDITIONS AND PATHOLOGIES, INCLUDING CERTAIN PRE-EXISTING MEDICAL AS WELL AS AGE-RELATED AND NEURO-DEGENERATIVE CONDITIONS AND PATHOLOGIES INCLUDING NERVE DISEASES, GENERAL ANXIETY DISORDER, DEPRESSION, NEUROSIS, NEURASTHENIA, OBSSIVE-COMPULSIVE DISORDER, CHRONIC SLEEP DISORDER, CHRONIC FATIGUE SYNDROME, DIGESTIVE DISEASES, CHRONIC CONSTIPATION, HYPERTENSION, OSTEOARTHRITIS PAIN AND SWELLING, AND HUMAN SEXUAL DESIRE DISORDER.

FIRST USE 1-1-2002; IN COMMERCE 1-1-2002.

ELEMENTS AMENDED

\*OWNER NAME\*  
 \*OWNER ADDRESS\*  
 \*CITIZENSHIP\*  
 \*ENTITY\*

2,764,082. REG. 9-16-2003. UNIFUND CORPORATION LIMITED (UNITED KINGDOM LIMITED PARTNERSHIP) 30-40 LONDON FRUIT EXCHANGE, LONDON, UNITED KINGDOM, E1 6EU, SN 76-476,989. FILED 12-19-2002. PRINCIPAL REGISTER.

2,769,168. REG. 9-30-2003. CC-CHEMPLOER LTD. (IRELAND CORPORATION) 2 FITZWILLIAM PLACE, DUBLIN 2, IRELAND., SN 78-088,766. FILED 10-17-2001. PRINCIPAL REGISTER.

**NURENEX**

**CC-CHEMPLOER**

PRIORITY CLAIMED UNDER SEC. 44(D) ON FED REP GERMANY APPLICATION NO. 30126457.0/0, FILED 4-25-2001, REG. NO. 30126457, DATED 10-16-2001, EXPIRES 4-30-2011.

INT. CL. 35/U.S. CLS. 100, 101 AND 102

INT. CL. 5/U.S. CLS. 6, 18, 44, 46, 51 AND 52

FOR DISSEMINATION OF ADVERTISING FOR OTHERS; BUSINESS MANAGEMENT; MAINTAINING AN EXCHANGE AND LISTING SERVICE FOR OTHERS, NAMELY PROVIDING PRODUCT AND SERVICE INFORMATION AND MATCHING BUYERS AND SELLERS IN THE FIELDS OF TECHNOLOGY, ENGINEERING AND PACKAGING MATERIALS FOR THE CHEMICAL, PHARMACEUTICAL AND RELATED INDUSTRIES VIA A GLOBAL COMPUTER INFORMATION NETWORK; E-COMMERCE SERVICES, NAMELY ONLINE AUCTIONS FOR TECHNICAL GOODS IN THE CHEMICAL, PHARMACEUTICAL AND RELATED INDUSTRIES, ONLINE INVITATIONS TO TENDER FOR PROMOTING THE SALE OF GOODS AND SERVICES OF OTHERS, AND INFORMATION SERVICES, IN PARTICULAR PROVIDING ECONOMIC INFORMATION; PROVIDING AN ONLINE COMPUTER DATABASE DESIGNED TO ASSIST WITH THE OPERATION OF BUSINESS BY PROVIDING BUSINESS AND INDUSTRY NEWS, NAMELY INFORMATION IN THE FIELDS OF THE CHEMICAL AND RELATED INDUSTRIES, THE LIFE SCIENCE INDUSTRY, THE PROCESS INDUSTRY, AND INFORMATION ABOUT BUSINESSES IN THESE INDUSTRIES; LOGISTICS MANAGEMENT FOR THE CHEMICAL, PHARMACEUTICAL AND RELATED INDUSTRIES, RENDERED IN PARTICULAR VIA A GLOBAL COMPUTER NETWORK; SUPPLY CHAIN MANAGEMENT, NAMELY, BUSINESS MANAGEMENT, ORGANIZATIONAL PLANNING AND IMPLEMENTATION OF MEASURES TO COORDINATE PROCESSES INVOLVED IN PRODUCING, SHIPPING AND DISTRIBUTING PRODUCTS; FREIGHT TRACKING, NAMELY, MONITORING TRANSPORT CONTAINERS OR TRANSPORT VEHICLES BY MEANS OF ELECTRONIC DATA PROCESSING FOR DETERMINING THE CURRENT LOCATION THEREOF.

FIRST USE ; IN COMMERCE .  
INT. CL. 36/U.S. CLS. 100, 101 AND 102  
FOR FINANCING BY CREDIT.

FIRST USE ; IN COMMERCE .  
INT. CL. 41/U.S. CLS. 100, 101 AND 107  
FOR TRAINING, IN PARTICULAR TRAINING EVENTS VIA SEMINARS IN THE FIELD OF USE OF E-COMMERCE APPLICATIONS.

FIRST USE ; IN COMMERCE .  
INT. CL. 42/U.S. CLS. 100 AND 101  
FOR LEGAL SERVICES; PROVIDING AN ONLINE COMPUTER DATABASE IN THE FIELD OF E-DESIGN AND E-COLLABORATION FOR BUSINESSES IN THE CHEMICAL AND RELATED INDUSTRIES, THE LIFE SCIENCE INDUSTRY AND THE PROCESS INDUSTRY.  
FIRST USE ; IN COMMERCE .

ELEMENTS CORRECTED  
OWNER ADDRESS

2,770,325. REG. 9-30-2003. STONEFLY NETWORKS, INC. (CALIFORNIA CORPORATION) 10170 HUENNEKENS STREET, SAN DIEGO, CA, 92121, SN 78-097,875. FILED 12-12-2001. PRINCIPAL REGISTER.

## STONEFLY

INT. CL. 9/U.S. CLS. 21, 23, 26, 36 AND 38  
FOR COMPUTER HARDWARE AND SOFTWARE FOR TRANSFORMING [ VIP ] \* IP \* (INTERNET PROTOCOL) NETWORKS INTO STORAGE AREA NETWORK.  
FIRST USE 4-1-2000; IN COMMERCE 6-1-2000.

ELEMENTS CORRECTED  
GOODS/SERVICES

2,770,601. REG. 10-7-2003. TENNIS PROPERTIES B.V. (NETHERLANDS CORPORATION) JOHANNES VERMEERPLEIN 11, 1071 DV, AMSTERDAM, NETHERLANDS., SN 76-049,721. FILED 5-16-2000. PRINCIPAL REGISTER.



PRIORITY CLAIMED UNDER SEC. 44(D) ON BENELUX APPLICATION NO. 0951782, FILED 2-12-1999, REG. NO. 0658763, DATED 2-12-1999, EXPIRES 2-12-2009.

NO CLAIM IS MADE TO THE EXCLUSIVE RIGHT TO USE "TENNIS", "SERIES", APART FROM THE MARK AS SHOWN.

INT. CL. 9/U.S. CLS. 21, 23, 26, 36 AND 38  
FOR DECORATIVE MAGNETS; EYEGLASSES; SUNGLASSES; CASES AND CORDS FOR EYEGLASSES AND SUNGLASSES; BINOCULARS; MAGNETS; TELEVISION RECEIVERS; RADIO RECEIVERS; VIDEO RECORDERS; COMPACT DISK PLAYERS; DIGITAL DISK PLAYERS; RECORDABLE VIDEO TAPES, MAGNETIC TAPES, MAGNETIC DISKS, DVDS, FLOPPY DISKS, OPTICAL DISKS, COMPACT DISKS, CD ROMS, VIDEO DISKS; VIDEO TAPES, MAGNETIC TAPES, MAGNETIC DISKS, DVDS, FLOPPY DISKS, OPTICAL DISKS, COMPACT DISKS, CD ROMS, VIDEO DISKS RECORDED WITH MUSIC, VIDEO TAPES, MAGNETIC TAPES, MAGNETIC DISKS, DVDS, FLOPPY DISKS, OPTICAL DISKS, COMPACT DISKS, CD ROMS, VIDEO DISKS RECORDED WITH ANIMATION; VIDEO TAPES, MAGNETIC TAPES, MAGNETIC DISKS, DVDS, FLOPPY DISKS, OPTICAL DISKS, COMPACT DISKS, CD ROMS, VIDEO DISKS RECORDED WITH IMAGES FEATURING TENNIS; COMPUTERS; MODEMS; ELECTRONIC POCKET TRANSLATORS; ELECTRONIC AGENDAS; SCANNERS; PRINTERS; CALCULATORS AND DATA PROCESSORS; CREDIT CARD VERIFICATION MACHINES; AUTOMATED TELLER MACHINES; FOREIGN EXCHANGE CURRENCY MACHINES; SECURITY ALARMS; LOUDSPEAKERS; VIDEO CAMERAS; CAMCORDERS; BLANK VIDEO AND AUDIO TAPES; PRERECORDED VIDEO AND AUDIO TAPES FEATURING MUSIC, SOUND OR IMAGES WHICH MAY BE ANIMATED; FACSIMILE TRANSMISSION MACHINES; TELEPHONES; TELEPHONE ANSWERING MACHINES; VIDEO PHONES; PHOTOCOPY MACHINES; PHOTOGRAPHIC EQUIPMENT, NAMELY CAMERAS PROJECTORS, EXPOSED FILMS, FLASH BULBS, CAMERA CASES, BATTERIES AND ACCESSORIES THEREFOR; WINDSOCKS FOR MEASURING WIND; HAND-HELD ELECTRONIC GAMES ADAPTED FOR USE WITH TELEVISION RECEIVERS ONLY; VIDEO GAME CARTRIDGES; MULTIMEDIA SOFTWARE RECORDED ON CD ROMS FEATURING MUSIC, SOUND OR IMAGES WHICH MAY BE ANIMATED; PRERECORDED COMPUTER SOFTWARE, NAMELY, SOFTWARE FOR GAMES; BLANK COMPACT DISCS FOR AUDIO OR VIDEO; BLANK VIDEO CASSETTES; PRERECORDED VIDEO CASSETTES FEATURING MUSIC, SOUND OR IMAGES WHICH MAY BE ANIMATED; MUSIC RECORDED ON COMPACT DISCS OR TAPES; MAGNETIC ENCODED CARDS; COMPUTER [ HARDWARE ] \*HARDWARE\* . NAMELY, MEMORY CARDS AND MICROCHIP CARDS; ELECTRONIC VENDING MACHINES; DIRECTIONAL COMPASSES; MAGNETICALLY ENCODED CARDS, NAMELY, CREDIT CARDS, PREPAID PHONE CARDS, DEBIT CARDS, TRAVEL AND ENTERTAINMENT CARDS AND CHECK GUARANTEE CARDS; VIDEOTAPES AND VIDEO DISKS RECORDED WITH ANIMATION; MAGNETIC TAPES, MAGNETIC DISKS, COMPACT DISCS, CD ROMS AND DVDS RECORDED WITH ANIMATION.

FIRST USE ; IN COMMERCE .  
INT. CL. 18/U.S. CLS. 1, 2, 3, 22 AND 41

FOR UMBRELLAS; PARASOLS; ALL PURPOSE SPORT AND LEISURE BAGS; TRAVELING BAGS; BACKPACKS; TOTE BAGS; SCHOOL BAGS; BELT BAGS; HANDBAGS; BEACH BAGS; SUITCASES; VANITY CASES SOLD EMPTY; KEY CASES; SUIT CARRIERS; SHOULDER BAG IN THE SHAPE OF A SPORTS BALL; WALLETS; PURSES; AND BRIEF-CASES.

FIRST USE ; IN COMMERCE .

INT. CL. 25/U.S. CLS. 22 AND 39

FOR FOOTWEAR; HEAD WEAR; AND CLOTHING, NAMELY, SHIRTS, KNIT SHIRTS, JERSEYS, TANK TOPS, T-SHIRTS, DRESSES, SKIRTS, UNDERWEAR, SWIMWEAR, SHORTS, SWEATERS, CAPS, HATS, SCARVES, VISORS, WARM-UP SUITS, SWEATSHIRTS, JACKETS, UNIFORMS, NECKTIES, WRISTBANDS, HEADBANDS, GLOVES, APRONS, CLOTH BIBS, PAJAMAS, TODDLER AND INFANT PLAYWEAR, NAMELY, ROMPERS, SUNSUITS, JUMPSUITS, DUNGAREES AND OVERALLS, SOCKS AND HOSIERY, BELTS AND SUSPENDERS.

FIRST USE ; IN COMMERCE .

INT. CL. 28/U.S. CLS. 22, 23, 38 AND 50

FOR SPORT BALLS; BOARD GAMES; STUFFED DOLLS AND ANIMALS; TOY VEHICLES; [ JAGSAW ] \*JIGSAW\* PUZZLES; BALLOONS; INFLATABLE TOYS; TENNIS EQUIPMENT, NAMELY, \*TENNIS BALLS\* . TENNIS RACQUETS, TENNIS BALL BOXES, TENNIS GLOVES, TENNIS NETS AND POSTS, TENNIS STRINGS, TENNIS RACQUET GRIPS, BAGS FOR TENNIS RACQUETS AND VIBRATION DAMPENERS FOR TENNIS RACQUETS; TENNIS BALL TOY GUNS; EQUIPMENT FOR TABLE TENNIS, NAMELY, BATS, BALLS, TABLES AND NETS; PARTY HATS TOYS; HAND-HELD ELECTRONIC GAMES OTHER THAN THOSE ADAPTED FOR USE WITH TELEVISION RECEIVERS ONLY.

FIRST USE ; IN COMMERCE .

ELEMENTS CORRECTED  
GOODS/SERVICES

2,776,910. REG. 10-21-2003. SNAK KING CORP. (DELAWARE CORPORATION) 16150 E. STEPHENS STREET, CITY OF INDUSTRY, CA, 91745, SN 78-127,817. FILED 5-10-2002. PRINCIPAL REGISTER.

## THE DIP'S IN THE CHIP

INT. CL. 30/U.S. CL. 46

FOR GRAIN-BASED CHIP.

FIRST USE 6-12-2002; IN COMMERCE 6-25-2002.

ELEMENTS AMENDED  
MARK

2,782,281. REG. 11-11-2003. GGOSCO ENGINEERING INC. (CANADA CORPORATION) 1272 SPEERS ROAD, UNIT 4, OAKVILLE, ONTARIO, CANADA, L6L 5T9, SN 76-038,963. FILED 5-2-2000. PRINCIPAL REGISTER.

## PURETORQ

PRIORITY CLAIMED UNDER SEC. 44(D) ON CANADA APPLICATION NO. 1,039,137, FILED 12-9-1999, REG. NO. TMA554265, DATED 11-22-2001, EXPIRES 11-22-2016.

INT. CL. 9/U.S. CLS. 21, 23, 26, 36 AND 38

FOR AUTOMATIC VALUE ACTUATORS FOR USE IN CHEMICAL PROCESSING.

FIRST USE 2-0-2001; IN COMMERCE 5-0-2001.

ELEMENTS CORRECTED  
FOREIGN REG. NO.

2,784,308. REG. 11-18-2003. ASTRAZENECA UK LIMITED (UNITED KINGDOM A LIMITED LIABILITY COMPANY) 15 STANHOPE GATE, LONDON, UNITED KINGDOM, W1Y 6LN, SN 78-170,628. FILED 10-3-2002. PRINCIPAL REGISTER.

## XINOD

PRIORITY CLAIMED UNDER SEC. 44(D) ON UNITED KINGDOM APPLICATION NO. 2311428, FILED 9-25-2002, REG. NO. 2311428, DATED 9-25-2002, EXPIRES 9-25-2012.

INT. CL. 5/U.S. CLS. 6, 18, 44, 46, 51 AND 52

FOR [PHARMACEUTICAL PREPARATIONS AND SUBSTANCES FOR THE PREVENTION AND TREATMENT OF DISEASES AND DISORDERS OF THE RESPIRATORY SYSTEM, CENTRAL NERVOUS SYSTEM, PERIPHERAL NERVOUS SYSTEM, CARDIOVASCULAR SYSTEM, GASTROINTESTINAL SYSTEM; PHARMACEUTICAL PREPARATIONS AND SUBSTANCES FOR USE IN PAIN CONTROL, ARTHRITIS, ANAESTHESIA, ONCOLOGY, INFECTION, INFLAMMATION, UROLOGY, GYNECOLOGY; PHARMACEUTICAL PREPARATIONS AND SUBSTANCES FOR THE TREATMENT AND PREVENTION OF DIABETES.; ] PHARMACEUTICAL PREPARATIONS AND SUBSTANCES FOR THE PREVENTION AND TREATMENT OF DISEASES AND DISORDERS OF THE RESPIRATORY SYSTEM, CENTRAL NERVOUS SYSTEM, PERIPHERAL NERVOUS SYSTEM, CARDIOVASCULAR SYSTEM, GASTROINTESTINAL SYSTEM; PHARMACEUTICAL PREPARATIONS AND SUBSTANCES FOR USE IN PAIN CONTROL, ARTHRITIS, ANAESTHESIA, ONCOLOGY, INFECTION, INFLAMMATION, UROLOGY, GYNECOLOGY; PHARMACEUTICAL PREPARATIONS AND SUBSTANCES FOR THE TREATMENT AND PREVENTION OF DIABETES.

FIRST USE ; IN COMMERCE .

ELEMENTS CORRECTED  
GOODS/SERVICES

2,784,994. REG. 11-18-2003. ALLIED HOUSTON BANK (TEXAS FEDERAL SAVINGS ASSOCIATION) 4550 POST OAK PLACE, SUITE 225, HOUSTON, TX, 77027, SN 78-087,844. FILED 10-10-2001. PRINCIPAL REGISTER.

## ALLIED CLEAR LAKE BANK

NO CLAIM IS MADE TO THE EXCLUSIVE RIGHT TO USE "CLEAR LAKE BANK", APART FROM THE MARK AS SHOWN.

INT. CL. 36/U.S. CLS. 100, 101 AND 102

FOR BANKING SERVICES.

FIRST USE 11-15-2001; IN COMMERCE 11-15-2001.

ELEMENTS CORRECTED  
\*ASSIGNMENT/NAME CHANGE\*

2,786,034. REG. 11-25-2003. LA BAMBA, INC. (ILLINOIS CORPORATION) 313 N. MATTIS AVENUE, SUITE 213, CHAMPAIGN, IL, 61821, SN 76-475,560. FILED 12-16-2002. PRINCIPAL REGISTER.

## BURRITOS AS BIG AS YOUR HEAD

NO CLAIM IS MADE TO THE EXCLUSIVE RIGHT TO USE "BURRITOS", APART FROM THE MARK AS SHOWN.

INT. CL. 42/U.S. CLS. 100 AND 101



FOR RESTAURANT, CAFE, CARRY OUT AND CATERING SERVICES.  
FIRST USE 1-15-1989; IN COMMERCE 1-15-1989.

ELEMENTS CORRECTED  
\*ASSIGNMENT/NAME CHANGE\*

2,792,862. REG. 12-9-2003. NIPPON WISHBORN CORPORATION (JAPAN CORPORATION) 3-32-1102, HIGASHIKOURAIBASHI, CHUO-KU, OSAKA-SHI, OSAKA, JAPAN, 540-0039, SN 78-087,197. FILED 10-5-2001. PRINCIPAL REGISTER.

$\mu$  —func.

THE MARK CONSISTS OF THE LOWER CASE GREEK LETTER "U" AND THE ROMAN CHARACTERS "FUNC." JOINED BY A HYPHEN.

INT. CL. 20/U.S. CLS. 2, 13, 22, 25, 32 AND 50  
FOR DECORATIVE GLITTER.  
FIRST USE 11-1-1998; IN COMMERCE 11-1-1998.  
INT. CL. 23/U.S. CL. 43  
FOR THREAD, YARN.  
FIRST USE 11-1-1998; IN COMMERCE 11-1-1998.

ELEMENTS CORRECTED  
DESCRIPTION OF MARK

2,792,905. REG. 12-9-2003. VANITY FAIR, INC. (DELAWARE CORPORATION) 3411 SILVERSIDE ROAD, WILMINGTON, DE, 19810, SN 78-099,620. FILED 12-21-2001. PRINCIPAL REGISTER.

**PLUSHIOUS**

INT. CL. 25/U.S. CLS. 22 AND 39  
FOR TEXTILE LINING FOR GARMENTS SOLD AS AN INTEGRAL COMPONENT OF LINGERIE.  
FIRST USE 9-0-2002; IN COMMERCE 9-0-2002.

ELEMENTS CORRECTED  
\*ASSIGNMENT/NAME CHANGE\*  
CITIZENSHIP

2,795,269. REG. 12-16-2003. KUMHO TIRE CO., INC. (REPUBLIC OF KOREA CORPORATION) 57, 1-GA, SINMUNLO, JONGLO-GU, SEOUL, REPUBLIC OF KOREA., SN 76-098,295. FILED 7-27-2000. PRINCIPAL REGISTER.

**KL11**

INT. CL. 12/U.S. CLS. 19, 21, 23, 31, 35 AND 44  
FOR AUTOMOBILE TIRES AND PARTS THEREOF.  
FIRST USE 1-0-2000; IN COMMERCE 6-1-2000.

ELEMENTS CORRECTED  
\*ASSIGNMENT/NAME CHANGE\*

2,798,546. REG. 12-23-2003. FISCALINI CHEESE COMPANY, LLC (CALIFORNIA LIMITED LIABILITY COMPANY) 7231 COVERT ROAD, MODESTO, CA, 95358, SN 76-318,103. FILED 9-27-2001. PRINCIPAL REGISTER.



NO CLAIM IS MADE TO THE EXCLUSIVE RIGHT TO USE "FARMSTEAD" OR "SINCE 1914", APART FROM THE MARK AS SHOWN.

THE MARK CONSISTS IN PART OF A ROYAL BLUE SHIELD WITH A YELLOW DIVIDING LINE CREATING THREE COMPARTMENTS. THE UPPER LEFT COMPARTMENT COMPRISES A YELLOW OAK LEAF, THE UPPER RIGHT COMPARTMENT COMPRISES A RED AND WHITE CROSS AND THE BOTTOM CENTER COMPARTMENT COMPRISES A YELLOW FLEUR-DE-LIS.

INT. CL. 29/U.S. CL. 46  
FOR CHEESE, CHEESE SPREADS, AND CHEESE DIPS.  
FIRST USE 4-1-2001; IN COMMERCE 4-1-2001.

ELEMENTS CORRECTED  
DESCRIPTION OF MARK

2,800,339. REG. 12-30-2003. BONGRAIN S.A. (FRANCE CORPORATION) 42 RUE RIEUSSEC, VIROFLAY, FRANCE, 78220, SN 78-173,401. FILED 10-11-2002. PRINCIPAL REGISTER.



PRIORITY CLAIMED UNDER SEC. 44(D) ON FRANCE APPLICATION NO. 023160344, FILED 4-15-2002, REG. NO. 023160344, DATED 4-15-2002, EXPIRES 4-15-2012.

THE MARK CONSISTS OF A BLUE TREE DESIGN OVER A WHITE BACKGROUND WITH A GOLD TEAR-DROP-SHAPED BORDER. COLOR IS A FEATURE OF THE MARK.  
INT. CL. 29/U.S. CL. 46

FOR \* MILK, CHEESE, AND \* DAIRY PRODUCTS, EXCLUDING ICE CREAM, ICE MILK AND FROZEN YOGURT.

FIRST USE ; IN COMMERCE .

ELEMENTS CORRECTED  
GOODS/SERVICES

---

2,801,007. REG. 12-30-2003. NISSHIN OILIO GROUP, LTD., THE (JAPAN CORPORATION) 23-1, SHINKAWA 1-CHOME, CHUO-KU, TOKYO, JAPAN, 104-8285, SN 76-365,888. FILED 2-4-2002. PRINCIPAL REGISTER.

**NISSHIN**  
**Oilio**

INT. CL. 4/U.S. CLS. 1, 6 AND 15  
FOR INDUSTRIAL OIL.  
FIRST USE 6-16-2002; IN COMMERCE 6-16-2002.

ELEMENTS AMENDED  
OWNER NAME

---

2,806,669. REG. 1-20-2004. HISAMITSU PHARMACEUTICAL CO., INC. (JAPAN CORPORATION) 408, TASHIRODAI-KAN-MACHI, TOSU-SHI, SAGA, JAPAN, 841-0017, SN 78-197,813. FILED 12-26-2002. PRINCIPAL REGISTER.

**SALONPAS GEL-PATCH** **HOT SOOTHING**

PRIORITY CLAIMED UNDER SEC. 44(D) ON JAPAN APPLICATION NO. 2002-100004, FILED 11-26-2002.

OWNER OF U.S. REG. NOS. 622,062, 1,638,852 AND OTHERS.

NO CLAIM IS MADE TO THE EXCLUSIVE RIGHT TO USE "HOT SOOTHING" AND "GEL PATCH", APART FROM THE MARK AS SHOWN.

INT. CL. 5/U.S. CLS. 6, 18, 44, 46, 51 AND 52

FOR MEDICATED TRANSDERMAL PATCHES, PLASTERS, AND PADS FOR RELIEF OF ACHES OF RHEUMATOID ARTHRITIS, AND THE ACHES AND PAINS OF MUSCLES, JOINTS AND TENDONS; OTHER PHARMACEUTICALS IN THE FORM OF PATCHES, PLASTERS, PADS AND CATAPLASMS FOR USE IN THE TREATMENT OF LUMBAGO, NAMELY MUSCULAR AND FACIAL LUMBAGO, SPONDYLOSIS DEFORMANS DISCOPATHY, AND SPRAIN OF LUMBAR SPINE, OSTEOARTHRITIS, HUMEROSCAPULAR PERIARTHRITIS, TENDINITIS, TENDO-VAGINITIS, PERITENDINITIS, HUMERAL EPICONDYLITIS, TENNIS ELBOW, MYALGIA AND POST-TRAUMATIC SWELLING AND PAIN; ANTI-INFLAMMATORY AND ANALGESIC AGENTS; MEDICAL ADHESIVE PLASTERS; MEDICATED TRANSDERMAL PATCHES, PLASTERS, AND PADS FOR RELIEF OF ACHES OF RHEUMATOID ARTHRITIS, AND THE ACHES AND PAINS OF MUSCLES, JOINTS AND TENDONS; OTHER PHARMACEUTICALS IN THE FORM OF PATCHES, PLASTERS, PADS AND CATAPLASMS FOR USE IN THE TREATMENT OF LUMBAGO, NAMELY FASCIAL LUMBAGO, SPONDYLOSIS DEFORMANS DISCOPATHY, AND SPRAIN OF LUMBAR SPINE, OSTEOARTHRITIS, HUMEROSCAPULAR PERIARTHRITIS, TENDINITIS, TENDO-VAGINITIS, PERITENDINITIS, HUMERAL EPICONDYLITIS, TENNIS ELBOW, MYALGIA AND POST-TRAUMATIC SWELLING AND PAIN; ANTI-INFLAMMATORY AND ANALGESIC AGENTS; MEDICAL ADHESIVE PLASTERS.

FIRST USE 2-12-2003; IN COMMERCE 2-12-2003.

ELEMENTS CORRECTED  
GOODS/SERVICES

---

2,807,289. REG. 1-20-2004. CONCORD ELEVATOR INC. (CANADA CORPORATION) 107 ALFRED KUEHNE BLVD., BRAMPTON, ONTARIO, L6T AK3, SN 76-423,328. FILED 6-19-2002. PRINCIPAL REGISTER.

**PROLIFT VOYAGER**

OWNER OF U.S. REG. NO. 1,459,834.  
INT. CL. 7/U.S. CLS. 13, 19, 21, 23, 31, 34 AND 35  
FOR ELEVATORS AND VERTICAL WHEELCHAIR LIFTS FOR BUILDINGS.

FIRST USE 9-0-2002; IN COMMERCE 9-0-2002.

ELEMENTS CORRECTED  
\*ASSIGNMENT/NAME CHANGE\*

---

2,814,916. REG. 2-17-2004. TATA SONS LTD. (INDIA CORPORATION) BOMBAY HOUSE, 24 HOMI MODY STREET, MUMBAI 400 001, INDIA., SN 78-094,642. FILED 11-21-2001. PRINCIPAL REGISTER.

**TATA CONSULTANCY SERVICES**

NO CLAIM IS MADE TO THE EXCLUSIVE RIGHT TO USE "CONSULTANCY SERVICES", APART FROM THE MARK AS SHOWN.

INT. CL. 9/U.S. CLS. 21, 23, 26, 36 AND 38

FOR COMPUTER SOFTWARE FOR USE IN HOSPITAL FACILITIES ADMINISTRATION, NAMELY, FOR COMPILING MEDICAL INTENSIVE CARE UNIT PATIENT DATA AND CONDUCTING TREATMENT COST ANALYSIS, AND FOR USE IN AUTOMATED MEDICAL PATIENT RECORDS SYSTEMS; COMPUTER SOFTWARE FOR USE IN DATABASE MANAGEMENT AND RECORDS CONSOLIDATION, SOFTWARE DEVELOPMENT, COMPUTER SOURCE CODE REVIEW, AND SOFTWARE MODELING; COMPUTER SOFTWARE FOR FACILITATING INTEGRATED TRANSACTION-HANDLING AND SUPPORTING MANAGEMENT-REPORTING APPLICATIONS IN THE BANKING INDUSTRY; COMPUTER SOFTWARE FOR USE IN SYSTEMS MANAGEMENT APPLICATIONS IN THE BANKING INDUSTRY INCLUDING FOREIGN EXCHANGE AND DOMESTIC TREASURY OPERATIONS AND TRANSACTIONS, SECURITIES TRADING, PAYMENTS AND FUNDS TRANSFER, AND PORTFOLIO MANAGEMENT, RISK MANAGEMENT APPLICATIONS IN THE BANKING INDUSTRY, ON-LINE CONSUMER BANKING, INTEGRATING BACK-OFFICE REPORTING FUNCTIONS FOR BANKS, RECONCILIATION OF BANKING TRANSACTIONS, AND RESOURCE AND PERFORMANCE ANALYSIS FUNCTIONS FOR BANKS; COMPUTER SOFTWARE FOR BUSINESS ACCOUNTING; COMPUTER SOFTWARE FOR PERFORMING BILLING AND ACCOUNTS RECEIVABLE APPLICATIONS IN THE INSURANCE INDUSTRY; COMPUTER SOFTWARE FOR THE DESIGN AND IMPLEMENTATION OF INSURANCE POLICIES; COMPUTER SOFTWARE FOR USE IN ON-LINE SECURITIES TRADING APPLICATIONS FOR BROKERAGE FIRMS AND CUSTODIAL SERVICES RELATING TO SECURITIES; AND COMPUTER SOFTWARE FOR USE IN THE MANAGEMENT OF MANUFACTURING PROCESSES, AND MAINTENANCE MANAGEMENT IN THE MANUFACTURING AND PROCESS INDUSTRIES.

FIRST USE 11-0-1975; IN COMMERCE 11-0-1975.

ELEMENTS CORRECTED  
OWNER ADDRESS

2,817,616. REG. 2-24-2004. SYBERWORKS INC. (DELAWARE CORPORATION) 9 COURT STREET, ARLINGTON, MA, 02476, SN 75-034,715. FILED 12-20-1995. PRINCIPAL REGISTER.

## SYBERWORKS

INT. CL. 41/U.S. CLS. 100, 101 AND 107

FOR [PRODUCTION AND DISTRIBUTION OF RADIO AND TELEVISION COMMERCIAL FOR THE CASINOS, LOTTERY AND GAMBLING INDUSTRIES]\* EDUCATIONAL SERVICES, NAMELY, PROVIDING CLASSES, SEMINARS AND WORKSHOPS FOR TRAINING, INSTRUCTION, AND CONTINUING EDUCATION IN THE FIELDS OF CLIENT/SERVER COMPUTING, COMPUTER SOFTWARE PROGRAMMING, AND THE USE OF COMPUTER SOFTWARE, ALL PROVIDED OVER THE GLOBAL COMPUTER NETWORK AND IN-HOUSE COMPUTER NETWORKS, OR CLOSED OR LIMITED COMPUTER NETWORKS.

FIRST USE 2-2-1996; IN COMMERCE 2-2-1996.

ELEMENTS CORRECTED  
GOODS/SERVICES

2,817,787. REG. 2-24-2004. RESURGENCE SOFTWARE, INC. (LOUISIANA CORPORATION) 2021 LAKESHORE DRIVE, SUITE 210, NEW ORLEANS, LA, 70122, SN 76-116,030. FILED 8-24-2000. PRINCIPAL REGISTER.

## RESURGENCE

INT. CL. 9/U.S. CLS. 21, 23, 26, 36 AND 38

FOR COMPUTER SOFTWARE FOR TRACKING AND EVALUATING THE RELIABILITY, AVAILABILITY AND MAINTAINABILITY OF USER'S EQUIPMENT; PRE-RECORDED OPTICAL AND MAGNETIC MEDIA FEATURING A DATABASE OF INFORMATION FOR TRACKING AND EVALUATING THE RELIABILITY, AVAILABILITY AND MAINTAINABILITY OF TRANSPORTATION AND INDUSTRIAL EQUIPMENT.

FIRST USE 6-1-2001; IN COMMERCE 6-1-2001.

INT. CL. 42/U.S. CLS. 100 AND 101

FOR PROVIDING AN ONLINE DATABASE FEATURING INFORMATION FOR TRACKING AND EVALUATING THE RELIABILITY, AVAILABILITY AND MAINTAINABILITY OF EQUIPMENT USED IN THE TRANSPORTATION, UTILITY, PETROCHEMICAL, AND AGRICULTURAL INDUSTRIES.

FIRST USE 8-1-2003; IN COMMERCE 8-1-2003.

ELEMENTS CORRECTED  
OWNER ADDRESS

2,819,118. REG. 3-2-2004. ALBERTO GMBH & CO. KG (FED REP GERMANY LTD LIAB CO) RHEYDTER STRASSE 19-31, 41056 MONCHENGLADBACH, FED REP GERMANY., SN 76-469,487. FILED 11-15-2002. PRINCIPAL REGISTER.



OWNER OF ERPN CMNTY TM OFC REG. NO. 002152924, DATED 6-14-2002, EXPIRES 3-29-2011.

INT. CL. 25/U.S. CLS. 22 AND 39

FOR MEN'S CLOTHING, NAMELY, MEN'S TROUSERS, VESTS, BELTS AND SUSPENDERS.

FIRST USE ; IN COMMERCE .

ELEMENTS CORRECTED  
\*ASSIGNMENT/NAME CHANGE\*

2,819,934. REG. 3-2-2004. THERMOS L.L.C. (DELAWARE LTD LIAB CO) 2550 WEST GOLF ROAD, SUITE 800, ROLLING MEADOWS, IL, 60008, SN 78-229,860. FILED 3-25-2003. PRINCIPAL REGISTER.

## THERMOS

OWNER OF U.S. REG. NOS. 176,064, 2,644,361 AND OTHERS.  
INT. CL. 21/U.S. CLS. 2, 13, 23, 29, 30, 33, 40 AND 50  
FOR ICE SUBSTITUTE COLD PACKS USED TO KEEP FOOD AND DRINK COLD.  
FIRST USE 9-0-1998; IN COMMERCE 9-0-1998.

ELEMENTS CORRECTED  
ENTITY

2,820,901. REG. 3-9-2004. ALBERTO GMBH & CO. KG (FED REP GERMANY LTD LIAB CO) RHEYDTER STRASSE 19-31, MONCHENGLADBACH, FED REP GERMANY, 41056, SN 76-486,337. FILED 1-29-2003. PRINCIPAL REGISTER.



THE MARK CONSISTS, IN PART, OF A FANCIFUL REPRESENTATION OF THE LETTER "A".  
INT. CL. 25/U.S. CLS. 22 AND 39  
FOR CLOTHING, NAMELY, MEN'S TROUSERS, BELTS, VESTS AND SUSPENDERS.  
FIRST USE 1-0-2002; IN COMMERCE 1-0-2002.

ELEMENTS CORRECTED  
\*ASSIGNMENT/NAME CHANGE\*

2,824,913. REG. 3-23-2004. TATA SONS LTD. (INDIA CORPORATION) BOMBAY HOUSE, 24 HOMI MODY STREET, MUMBAI 400 001, INDIA., SN 78-094,626. FILED 11-21-2001. PRINCIPAL REGISTER.

## TATA CONSULTANCY SERVICES

NO CLAIM IS MADE TO THE EXCLUSIVE RIGHT TO USE "CONSULTANCY SERVICES", APART FROM THE MARK AS SHOWN.  
INT. CL. 35/U.S. CLS. 100, 101 AND 102  
FOR BUSINESS CONSULTING SERVICES IN THE FIELDS OF UTILITIES, HEALTH CARE, TRANSPORTATION, RETAIL AND DISTRIBUTION, TELECOMMUNICATIONS, INSURANCE, FINANCIAL SERVICES, BANKING, MANUFACTURING AND PROCESS INDUSTRIES, AND ELECTRONIC COMMERCE.  
FIRST USE 11-21-2001; IN COMMERCE 11-21-2001.  
INT. CL. 37/U.S. CLS. 100, 103 AND 106  
FOR MAINTENANCE AND REPAIR OF COMPUTER HARDWARE.  
FIRST USE 11-0-1975; IN COMMERCE 11-0-1975.  
INT. CL. 42/U.S. CLS. 100 AND 101

FOR DATABASE DEVELOPMENT SERVICES, NAMELY, INFORMATION TECHNOLOGY INFRASTRUCTURE DEVELOPMENT; COMPUTER PROJECT MANAGEMENT SERVICES FEATURING THE DEVELOPMENT OF INFORMATION TECHNOLOGY INFRASTRUCTURES; COMPUTER NETWORK DESIGN FOR OTHERS; COMPUTER TECHNOLOGY CONSULTATION; COMPUTER PROGRAMMING FOR OTHERS; COMPUTER SOFTWARE DESIGN FOR OTHERS; AND MECHANICAL, ELECTRICAL, AND SYSTEMS ENGINEERING SERVICES FOR OTHERS.  
FIRST USE 11-0-1975; IN COMMERCE 11-0-1975.

ELEMENTS CORRECTED  
OWNER ADDRESS

2,826,229. REG. 3-23-2004. ZLB BIOPLASMA AG (SWITZERLAND CORPORATION) 10 WANKDORFSTRASSE, CH-3000 BERN 22, SWITZERLAND., SN 76-976,129. FILED 10-30-2000. PRINCIPAL REGISTER.

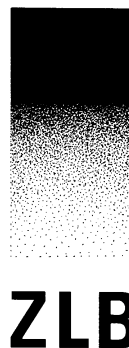

THE STIPPLING APPEARING THEREIN IS FOR SHADING PURPOSES ONLY.  
INT. CL. 5/U.S. CLS. 6, 18, 44, 46, 51 AND 52  
FOR PHARMACEUTICAL PREPARATIONS, NAMELY, PHARMACEUTICAL PREPARATIONS TO SUPPORT THE FUNCTION OF THE HUMAN IMMUNE SYSTEM; [HEMOSTATIC] \*HEMOSTATIC \*SEALING AGENT, NAMELY, FIBRIN SEALANT; PHARMACEUTICAL PREPARATIONS ADMINISTERED FOR RHESUS PROPHYLAXIS AND FOR THE TREATMENT OF HUMAN IMMUNE DISORDERS.  
FIRST USE 7-15-2000; IN COMMERCE 8-1-2000.

ELEMENTS CORRECTED  
GOODS/SERVICES

2,828,001. REG. 3-30-2004. SCREENLIFE, LLC (WASHINGTON LTD LIAB CO) 1201 THIRD AVENUE, SUITE 2350, SEATTLE, WA, 98101, SN 78-233,507. FILED 4-3-2003. PRINCIPAL REGISTER.

## FINAL CUT

INT. CL. 9/U.S. CLS. 21, 23, 26, 36 AND 38  
FOR PUZZLES STORED ON PRE-RECORDED STORAGE MEDIA, NAMELY, DVDS.  
FIRST USE 10-15-2002; IN COMMERCE 10-15-2002.  
INT. CL. 28/U.S. CLS. 22, 23, 38 AND 50

FOR COMPONENTS OF BOARD GAMES, NAMELY, PUZZLES FOR BOARD GAMES STORED ON PRE-RECORDED STORAGE MEDIA.  
FIRST USE 10-15-2002; IN COMMERCE 10-15-2002.

ELEMENTS CORRECTED  
ENTITY

---

2,828,002. REG. 3-30-2004. SCREENLIFE, LLC (WASHINGTON LTD LIAB CO) 1201 THIRD AVENUE, SUITE 2350, SEATTLE, WA, 98101, SN 78-233,518. FILED 4-3-2003. PRINCIPAL REGISTER.

## SEQUENTIAL

INT. CL. 9/U.S. CLS. 21, 23, 26, 36 AND 38  
FOR PUZZLES STORED ON PRE-RECORDED STORAGE MEDIA, NAMELY, DVDS.  
FIRST USE 10-15-2002; IN COMMERCE 10-15-2002.  
INT. CL. 28/U.S. CLS. 22, 23, 38 AND 50  
FOR COMPONENTS OF BOARD GAMES, NAMELY, PUZZLES FOR BOARD GAMES STORED ON PRE-RECORDED STORAGE MEDIA.  
FIRST USE 10-15-2002; IN COMMERCE 10-15-2002.

ELEMENTS CORRECTED  
ENTITY

---

2,830,931. REG. 4-6-2004. STARCK, PHILIPPE (FRANCE INDIVIDUAL) 27 RUE PIERRE POLI, 92130 ISSY LES MOULINEAUX, FRANCE., SN 75-933,953. FILED P.R. 3-3-2000; AM. S.R. 12-9-2003. SUPPLEMENTAL REGISTER.

**BON**

PRIORITY CLAIMED UNDER SEC. 44(D) ON FRANCE APPLICATION NO. 991828619, FILED 12-3-1999, REG. NO. 991828619, DATED 12-3-1999, EXPIRES 12-3-2009.

THE ENGLISH TRANSLATION OF "BON" IS "GOOD".  
INT. CL. 21/U.S. CLS. 2, 13, 23, 29, 30, 33, 40 AND 50  
FOR HOUSEHOLD AND KITCHEN UTENSILS NOT OF PRECIOUS METAL OR COATED THEREWITH, NAMELY, GRATERS, GRILLS, LADLES, POT AND PAN SCRAPERS, ROLLING PINS, SIEVES, SKIMMERS, SPATULAS, STRAINERS, TURNERS, WHISKS, WOOD CHOPPING BOARDS FOR KITCHEN USE; CONTAINERS NOT OF PRECIOUS METAL OR COATED THEREWITH, NAMELY, NON-ELECTRIC KITCHEN CONTAINERS NOT MADE OF PRECIOUS METAL; BEVERAGE GLASSWARE; PORCELAIN MUGS; AND EARTHENWARE MUGS.  
FIRST USE ; IN COMMERCE .

INT. CL. 24/U.S. CLS. 42 AND 50  
FOR TEXTILES AND TEXTILE GOODS, NAMELY, TEXTILE NAPKINS, TEXTILE TABLE CLOTHS, AND HAND CLOTHS OF TEXTILE; AND BED AND TABLE COVERS, NAMELY, BED SHEETS, BED BLANKETS, BED SPREADS, BED LINENS, AND TABLE LINEN.  
FIRST USE ; IN COMMERCE .

INT. CL. 25/U.S. CLS. 22 AND 39  
FOR CLOTHING AND HEADGEAR, NAMELY, SHIRTS, JACKETS, PANTS, SWEATERS, SWEATSHIRTS, SHORTS, SKIRTS, AND HEADWEAR.  
FIRST USE ; IN COMMERCE .

INT. CL. 29/U.S. CL. 46

FOR MEAT, FISH, AND POULTRY; PRESERVED, DRIED, AND COOKED FRUITS AND VEGETABLES; JELLIES, JAMS, AND FRUIT SAUCES; EGGS; MILK; MILK PRODUCTS, NAMELY, DAIRY PRODUCTS EXCLUDING ICE CREAM, ICE MILK, AND FROZEN YOGURT; AND EDIBLE OILS AND FATS.  
FIRST USE ; IN COMMERCE .

INT. CL. 30/U.S. CL. 46

FOR COFFEE, TEA, COCOA, SUGAR, AND RICE; PREPARATIONS MADE FROM CEREALS, NAMELY, BREAKFAST CEREALS, CEREAL BASED SNACK FOOD, AND PROCESSED CEREALS; BREAD; PASTRIES; CONFECTION, NAMELY, CONFECTIONERY CHIPS FOR BAKING AND FROZEN CONFECTIONS; ICES, NAMELY, ICE AND FLAVORED ICE; HONEY; SALT; MUSTARD; VINEGAR SAUCES; CONDIMENTS, NAMELY, KETCHUP AND RELISH; AND SPICES.  
FIRST USE ; IN COMMERCE .

INT. CL. 32/U.S. CLS. 45, 46 AND 48

FOR NON-ALCOHOLIC DRINKS, NAMELY, NON-ALCOHOLIC BEER, NON-ALCOHOLIC COCKTAIL MIXES, NON-ALCOHOLIC MALT BEVERAGES, NON-ALCOHOLIC MALT COOLERS, AND NON-ALCOHOLIC WINE; FRUIT DRINKS; AND FRUIT JUICES.  
FIRST USE ; IN COMMERCE .

INT. CL. 33/U.S. CLS. 47 AND 49

FOR ALCOHOLIC BEVERAGES EXCEPT BEERS, NAMELY, WINE AND DISTILLED LIQUOR.  
FIRST USE ; IN COMMERCE .

INT. CL. 43/U.S. CLS. 100 AND 101

FOR BAR SERVICES, RESTAURANT SERVICES, AND CATERING SERVICES.  
FIRST USE ; IN COMMERCE .

ELEMENTS CORRECTED  
FOREIGN APPLICATION NO.  
FOREIGN REG. NO.

---

2,831,179. REG. 4-13-2004. BELGIAN CHOCOLATE GROUP - GARTNER PRALINES N.V. (BELGIUM CORPORATION) NAAMLOZE VENNOOTSCHAP, GEELSEWEG 38, B-2250 OLEN, BELGIUM., SN 76-207,744. FILED 2-9-2001. PRINCIPAL REGISTER.

## PERLE D'OR

OWNER OF BENELUX REG. NO. 0494826, DATED 12-4-1991, EXPIRES 12-4-2011.

THE MARK MAY BE TRANSLATED AS "GOLDEN PEARL".

INT. CL. 30/U.S. CL. 46

FOR CHOCOLATE, BISCUITS, BISCUITS FILLED WITH CHOCOLATE, BISCUITS COVERED WITH CHOCOLATE, PRALINES, CHOCOLATE SEA FRUITS, BARS OF CHOCOLATE, CHOCOLATE TRUFFLES.  
FIRST USE ; IN COMMERCE .

ELEMENTS CORRECTED  
\*ASSIGNMENT/NAME CHANGE\*

---

2,831,386. REG. 4-13-2004. ESOX PROMOTIONS, INC. (ILLINOIS CORPORATION) 785 WESTGATE ROAD, DEERFIELD, IL, 60015, SN 76-451,070. FILED 9-19-2002. PRINCIPAL REGISTER.

## MUSKY HUNTER

OWNER OF U.S. REG. NO. 1,929,488.  
INT. CL. 9/U.S. CLS. 21, 23, 26, 36 AND 38

FOR CD-ROMS, VIDEOTAPES AND CASSETTE TAPES FEATURING EDUCATIONAL AND INSTRUCTIONAL INFORMATION ON THE SPORT OF FISHING.

FIRST USE 1-1-1993; IN COMMERCE 1-1-1993.  
INT. CL. 16/U.S. CLS. 2, 5, 22, 23, 29, 37, 38 AND 50

FOR PRINTED MEDIA, NAMELY, MAGAZINES PRIMARILY DIRECTED TO SPORTSMEN AND SPORTSWOMEN, EDUCATIONAL AND INSTRUCTIONAL BOOKS, BOOKLETS, HANDBOOKS, GUIDEBOOKS, AND MANUALS PERTAINING TO ANGLERS AND FISHING.

FIRST USE 2-1-1989; IN COMMERCE 2-1-1989.  
INT. CL. 25/U.S. CLS. 22 AND 39

FOR APPAREL, NAMELY, SHIRTS, HATS, CAPS, SWEATSHIRTS, JACKETS, SHORTS, AND SOCKS.

FIRST USE 1-1-1993; IN COMMERCE 1-1-1993.

ELEMENTS CORRECTED  
DATE OF FIRST USE  
DATE OF FIRST USE IN COMMERCE

2,832,923. REG. 4-13-2004. MICROSOFT CORPORATION (WASHINGTON CORPORATION) ONE MICROSOFT WAY, REDMOND, WA. 980526399, SN 76-975,720. FILED 4-24-2000. PRINCIPAL REGISTER.

## BRUTE FORCE

INT. CL. 9/U.S. CLS. 21, 23, 26, 36 AND 38

FOR [ COMPUTER AND VIDEO GAME PROGRAMS IN THE FORM OF CARTRIDGES, DISCS, CD-ROMS, CASSETTES AND TAPES ] \* COMPUTER GAME SOFTWARE AND VIDEO GAME SOFTWARE \*

FIRST USE 5-28-2003; IN COMMERCE 5-28-2003.

ELEMENTS CORRECTED  
GOODS/SERVICES

2,833,464. REG. 4-20-2004. ONEWORLD ALLIANCE LLC (DELAWARE LTD LIAB CO) CORPORATION TRUST CENTER, 1209 ORANGE STREET, WILMINGTON, DE, 19801, SN 75-559,551. FILED 9-25-1998. PRINCIPAL REGISTER.

## ONEWORLD

PRIORITY CLAIMED UNDER SEC. 44(D) ON UNITED KINGDOM APPLICATION NO. 2176656, FILED 9-8-1998.

INT. CL. 39/U.S. CLS. 100 AND 105

FOR AIRLINE SERVICES, NAMELY, TRANSPORTATION OF PASSENGERS AND/OR GOODS BY AIR; TRAVEL SERVICES, NAMELY, ARRANGING SIGHT-SEEING AND BUS AND MOTORCOACH TOURS AND CRUISES; TRAVEL BOOKING AGENCY SERVICES, NAMELY, MAKING RESERVATIONS AND BOOKINGS FOR TRANSPORTATION; TRAVEL INFORMATION SERVICES; VEHICLE RENTAL SERVICES; VEHICLE PARKING SERVICES; COURIER SERVICES; CARGO STORAGE AND HANDLING SERVICES; AIRCRAFT CHARTERING SERVICES; ARRANGING FOR TRAVEL TOURS; AND CONSULTING SERVICES RELATED TO THE FOREGOING.

FIRST USE 2-1-1999; IN COMMERCE 2-1-1999.

ELEMENTS CORRECTED  
\*ASSIGNMENT/NAME CHANGE\*  
OWNER ADDRESS

2,833,475. REG. 4-20-2004. BLOMET, JOEL (FRANCE INDIVIDUAL) MOULIN DE VERVILLE, 95760 VALMONDOIS, FRANCE., SN 75-652,105. FILED 3-2-1999. PRINCIPAL REGISTER.

## DIPHOTERINE

OWNER OF FRANCE REG. NO. 1638458, DATED 10-2-1990, EXPIRES 10-2-2010.

OWNER OF FRANCE REG. NO. 1409918, DATED 5-21-1987, EXPIRES 5-21-2007.

INT. CL. 1/U.S. CLS. 1

FOR CHEMICALS, NAMELY, AMPHOTERIC CHELATING AGENTS, FOR USE ON BURNS CAUSED BY ACIDS OR BASES.

FIRST USE : IN COMMERCE .  
INT. CL. 3/U.S. CLS. 1, 4, 6, 50, 51 AND 52

FOR COSMETICS, NAMELY, COMPACTS, PRE-MOISTENED COSMETIC TISSUES, PRE-MOISTENED COSMETIC TOWELS, PRE-MOISTENED COSMETIC WIPES, SKIN CLEANSING LOTION, SKIN CREAM, SKIN LOTIONS, FACIAL LOTIONS, BODY LOTIONS, MOISTURIZERS, SKIN AND FACIAL MOUSSE, NON-MEDICATED PATCHES CONTAINING BURNING SCREEN AND BURNING BLOCK FOR USE ON THE SKIN, SKIN EMOLLIENTS, SKIN MOISTURIZER MASKS, SKIN WHITENING CREAMS.

FIRST USE : IN COMMERCE .  
INT. CL. 5/U.S. CLS. 6, 18, 44, 46, 51 AND 52

FOR PHARMACEUTICAL PREPARATIONS FOR USE IN THE TREATMENT OF SKIN OR OCULAR BURNS; VETERINARY PREPARATIONS FOR USE IN THE TREATMENT OF SKIN OR OCULAR BURNS; SANITARY PREPARATIONS, NAMELY, NAPKINS, PADS, FOR USE IN THE TREATMENT OF SKIN OR OCULAR BURNS; MEDICATED BATHING SOLUTIONS CONTAINING AMPHOTERIC COMPOUNDS FOR USE IN THE TREATMENT OF BURNS CAUSED BY ACIDS OR BASES; MEDICATED PATCHES CONTAINING BURNING SCREEN AND BURNING BLOCK FOR USE ON THE SKIN.

FIRST USE : IN COMMERCE .

INT. CL. 10/U.S. CLS. 26, 39 AND 44

FOR MEDICAL SHOWERS USED FOR TREATING BURNS AND REPLACEMENT PARTS THEREFOR, NAMELY, SHOWERS, CUBICLES, PIPES, FLEXIBLE HOSES; CONTROL APPARATUS FOR USE IN CONTROLLING THE NATURE, THE VOLUME AND THE INTENSITY OF MEDICATED PREPARATIONS USED WITH APPARATUS, SPRAYS, MEDICAL SHOWERS, FOR USE IN THE TREATMENT OF OCULAR BURNS.

FIRST USE : IN COMMERCE .  
INT. CL. 11/U.S. CLS. 13, 21, 23, 31 AND 34

FOR SANITATION SHOWERS AND REPLACEMENT PARTS THEREFOR, NAMELY, CUBICLE BOXES, METALLIC PIPES, AND NON-METALLIC FLEXIBLE HOSES.

FIRST USE : IN COMMERCE .

ELEMENTS CORRECTED  
\*FOREIGN COUNTRY OF ORIGIN\*  
\*FOREIGN REG. NO.\*  
FOREIGN REG. DATE  
FOREIGN REG. EXPIRATION DATE  
FOREIGN RENEWAL REG. DATE  
[FOREIGN RENEWAL REG. NO.]

2,833,479. REG. 4-20-2004. CELANESE CHEMICALS EUROPE GMBH (FED REP GERMANY CORPORATION) FRANKFURT AM MAIN, FED REP GERMANY., SN 75-698,427. FILED 5-5-1999. PRINCIPAL REGISTER.

## CELFLUID

OWNER OF FED REP GERMANY REG. NO. 39906882, DATED 3-22-1999, EXPIRES 2-28-2009.  
INT. CL. 1/U.S. CLS. 1

FOR CHEMICALS USED IN INDUSTRY, NAMELY, CHEMICAL COMPOUNDS USED IN ORGANIC SYNTHESIS, AS A DRILLING FLUID OR AS ANTI-FOAMING REGENTS.

FIRST USE ; IN COMMERCE .

ELEMENTS CORRECTED  
\*ASSIGNMENT/NAME CHANGE\*  
OWNER ADDRESS

2,837,075. REG. 4-27-2004. THE SWEETER IMAGE, LLC (NEW YORK LIMITED LIABILITY CORPORATION) 755 OAKLAND AVENUE, STATEN ISLAND, NY, 10310, SN 76-450,396. FILED 9-16-2002. PRINCIPAL REGISTER.

## SWEETER IMAGE

NO CLAIM IS MADE TO THE EXCLUSIVE RIGHT TO USE "SWEETER", APART FROM THE MARK AS SHOWN.  
INT. CL. 30/U.S. CL. 46

FOR COOKIES AND CAKES.  
FIRST USE 12-1-2002; IN COMMERCE 12-1-2002.

ELEMENTS CORRECTED  
OWNER NAME

2,837,693. REG. 5-4-2004. PHI DELTA THETA FRATERNITY (OHIO CORPORATION) 2 SOUTH CAMPUS AVENUE, OXFORD, OH, 450561872, SN 76-347,427. FILED 12-11-2001. PRINCIPAL REGISTER.



OWNER OF U.S. REG. NO. 224,978.  
THE NON-LATIN CHARACTERS IN THE MARK TRANSLITERATE TO "PHI DELTA THETA", AND THIS MEANS "ONE MAN IS NO MAN", IN ENGLISH.

INT. CL. 14/U.S. CLS. 2, 27, 28 AND 50  
FOR JEWELRY AND WRISTWATCHES.  
FIRST USE 12-30-1848; IN COMMERCE 12-30-1848.

INT. CL. 24/U.S. CLS. 42 AND 50  
FOR CLOTH BANNERS.  
FIRST USE 12-30-1848; IN COMMERCE 12-30-1848.

INT. CL. 25/U.S. CLS. 22 AND 39  
FOR SHIRTS, HATS, SWEATSHIRTS, JACKETS, HOODED JACKETS, HOODED SWEATSHIRTS, SWEATPANTS, WINDSHIRTS, SHORTS, T-SHIRTS, BABY BIBS NOT OF PAPER, AND BIB OVERALLS.

FIRST USE 12-30-1848; IN COMMERCE 12-30-1848.  
INT. CL. 35/U.S. CLS. 100, 101 AND 102

FOR CONSULTATION IN THE FIELD OF ORGANIZING AND OPERATING FRATERNITY ACTIVITIES AND FRATERNITY MANAGEMENT; ASSOCIATION SERVICES, NAMELY PROMOTING THE MENTAL MORAL, SOCIAL, AND GENERAL WELFARE OF FRATERNITY MEMBERS OF THESE INSTITUTIONS OF HIGHER LEARNING AT WHICH CHAPTERS ARE ORGANIZED AND ESTABLISHED; PROVIDING BUSINESS ADDRESS INFORMATION OF FRATERNITY AND ALUMNI MEMBERS VIA THE INTERNET.

FIRST USE 12-30-1848; IN COMMERCE 12-30-1848.  
INT. CL. 36/U.S. CLS. 100, 101 AND 102

FOR PROVIDING INFORMATION VIA THE INTERNET CONCERNING THE ACTIVITIES AND INTERESTS OF A FRATERNITY TO ACTIVE AND ALUMNI FRATERNITY MEMBERS, NAMELY INFORMATION ABOUT EDUCATIONAL SCHOLARSHIPS AVAILABLE TO ACTIVE AND ALUMNI MEMBERS OF A FRATERNITY AND INFORMATION ABOUT FINANCIAL PHILANTHROPIC PROJECTS FOR ACTIVE AND ALUMNI FRATERNITY MEMBER PARTICIPATION.

FIRST USE 1-0-1996; IN COMMERCE 1-0-1996.  
INT. CL. 41/U.S. CLS. 100, 101 AND 107

FOR PROVIDING VIA THE INTERNET INFORMATION ABOUT IMPORTANT DATES AND UPCOMING EVENTS OF NATIONAL AND REGIONAL ACTIVITIES OF THE FRATERNITY.

FIRST USE 1-0-1996; IN COMMERCE 1-0-1996.  
INT. CL. 42/U.S. CLS. 100 AND 101

FOR PROVIDING INFORMATION VIA THE INTERNET CONCERNING THE ACTIVITIES AND INTERESTS OF A FRATERNITY TO ACTIVE AND ALUMNI FRATERNITY MEMBERS, NAMELY PERSONAL INFORMATION, SUCH AS MARRIAGES, DEATHS, HOME ADDRESS INFORMATION, HONORS AND AWARDS AND OTHER PERSONAL INFORMATION, OF ACTIVE AND ALUMNI FRATERNITY MEMBERS, PERTINENT INFORMATION ABOUT ALUMNI CHAPTERS OF A FRATERNITY IN DIFFERENT CITIES AND TOWNS FOR ALUMNI MEMBERSHIP PARTICIPATION, INFORMATION ABOUT ALCOHOL AND DRUG ABUSE AND HOW TO HANDLE SUCH TOPICS WITH ACTIVE AND ALUMNI MEMBERS OF A FRATERNITY, INFORMATION ABOUT COMMUNITY SERVICES AND NON-FINANCIAL PHILANTHROPIC PROJECTS FOR ACTIVE AND ALUMNI FRATERNITY MEMBERS PARTICIPATION, AND HISTORICAL INFORMATION ABOUT THE FRATERNITY AND ITS MEMBERS; PROVIDING FORMS VIA THE INTERNET RELATING TO FRATERNITY MEMBERSHIP AND ADMINISTRATION OF COLLEGIATE AND ALUMNI CHAPTERS; ORGANIZING CHAPTERS IN A NATIONAL COLLEGIATE FRATERNITY AND MAINTAINING MEMBERSHIP THEREIN; AND FOR PROMOTING PARTICIPATION AND SUPPORT BY ITS CHAPTER MEMBERS OF EDUCATIONAL, CULTURAL AND INTER FRATERNITY MOVEMENTS AND ORGANIZATIONS.

FIRST USE 12-30-1848; IN COMMERCE 12-30-1848.

ELEMENTS CORRECTED  
DATE OF FIRST USE  
DATE OF FIRST USE IN COMMERCE

2,839,365. REG. 5-11-2004. FL ITALIA S.P.A. (ITALY CORPORATION) VIA SANTENA 1, VILLASTELLONE, TORINO, ITALY, 10029, SN 75-859,321. FILED 11-29-1999. PRINCIPAL REGISTER.

## ATTUTIX

PRIORITY CLAIMED UNDER SEC. 44(D) ON ITALY APPLICATION NO. T099C003514, FILED 11-16-1999, REG. NO. 00883600, DATED 3-4-2003, EXPIRES 11-16-2009.

INT. CL. 1/U.S. CLS. 1  
FOR HYDRAULIC FLUIDS FOR SHOCK ABSORBERS.

ELEMENTS CORRECTED  
OWNER NAME  
OWNER ADDRESS  
ENTITY

2,839,386. REG. 5-11-2004. TORAICHI CO. LTD. (JAPAN CORPORATION) 11-32, 1 CHOME, KOJIMA SHIMONOCHO, KURASHIKI-CITY, OKAYAMA, JAPAN., SN 76-110,169. FILED 8-14-2000. PRINCIPAL REGISTER.

2,842,407. REG. 5-18-2004. VITA ZAHNFABRIK H. RAUTER GMBH & CO. KG (FED REP GERMANY LTD LIAB CO) SPITALGASSE 3, D-79713 BAD SACKINGEN, FED REP GERMANY., SN 76-469,119. FILED 11-21-2002. PRINCIPAL REGISTER.

**TORAICHI**

THE TRANSLITERATION AND TRANSLATION OF THE NON-ENGLISH CHARACTERS IN THE MARK IS: "TORA", MEANING "TIGER" AND "ICHI", MEANING "ONE, I.E., NO. 1".

INT. CL. 25/U.S. CLS. 22 AND 39

FOR CLOTHING, NAMELY, SWIM TRUNKS, BATHING SUITS, SWIM WEAR, BREECHES, LEOTARDS, TIGHTS; IMITATION LEATHER JACKETS, PANTS, AND VESTS; LEATHER JACKETS, PANTS AND VESTS; COATS, COLLARS, OVERALLS, MASQUERADE COSTUMES, UNDERWEAR, BRIEFS, THERMAL UNDERWEAR, FUR COATS, FUR JACKETS, HOSIERY, DOWN-FILLED JACKETS, JERSEYS, JUMPERS, SWEATERS, UNIFORMS, OVERCOATS, PAJAMAS, PANTS, PARKA, PULLOVERS, SHIRTS, SKIRTS, SMOCKS, SPATS, SPORTS JERSEYS, SUITS, SOCKS, T-SHIRTS, TOPCOATS, TROUSERS, VESTS, WAISTCOATS, APRONS, BANDANAS, BIB OVERALLS, BOAS, CAPS, EAR MUFFS, LEG WARMERS, GAITERS, GLOVES, HATS, HEADBANDS, HEADWEAR, HOODS, MITTENS, MUFFS, VISORS, WRISTBANDS, BELTS, GARTERS, SOCK SUSPENDERS, STOCKING SUSPENDERS, SUSPENDERS, TROUSER STRAPS; FOOTWEAR, NAMELY, BEACH SHOES, ESPARTO SHOES, SANDALS, LACE BOOTS, SLIPPERS, BOOTS FOR SPORTS, SPORT SHOES. FIRST USE 3-0-1988; IN COMMERCE 4-1-2000.

ELEMENTS CORRECTED  
OWNER ADDRESS

2,842,028. REG. 5-11-2004. EXPLORING THE METROPOLIS, INC. (NEW YORK NOT-FOR-PROFIT CORPORATION) 10 GRACIE SQUARE, NEW YORK, NY, 100288031, SN 78-253,562. FILED P.R. 5-23-2003; AM. S.R. 11-17-2003. SUPPLEMENTAL REGISTER.

**DANCE PLACES**

INT. CL. 41/U.S. CLS. 100, 101 AND 107

FOR PROVIDING INFORMATION IN THE FIELD OF RENTAL FACILITIES FOR DANCE REHEARSALS AND PERFORMANCES AND RENTAL OF VIDEO RECORDING STUDIOS VIA THE INTERNET. FIRST USE 4-15-2003; IN COMMERCE 5-1-2003.

ELEMENTS CORRECTED  
ENTITY

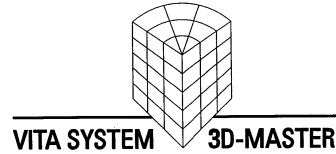

OWNER OF FED REP GERMANY REG. NO. 30164913, DATED 4-25-2002, EXPIRES 11-30-2011.

OWNER OF U.S. REG. NOS. 259,601, 2,684,811 AND OTHERS.

NO CLAIM IS MADE TO THE EXCLUSIVE RIGHT TO USE "SYSTEM", APART FROM THE MARK AS SHOWN. AS TO "3D-MASTER".

INT. CL. 5/U.S. CLS. 6, 18, 44, 46, 51 AND 52

FOR DENTAL RESTORATION COMPOUNDS, AND MATERIALS FOR [FILING] \*FILLING\* TEETH. FIRST USE ; IN COMMERCE .

INT. CL. 10/U.S. CLS. 26, 39 AND 44

FOR ARTIFICIAL TEETH; COLOR SCALES FOR DETERMINING THE COLORS OF DENTAL RESTORATION MATERIALS AND ARTIFICIAL TEETH TO MATCH NATURAL TOOTH COLORS.

FIRST USE ; IN COMMERCE .

ELEMENTS CORRECTED  
GOODS/SERVICES

2,842,554. REG. 5-18-2004. THOROUGHbred REMEDIES MANUFACTURING LTD. (IRELAND PRIVATE LIMITED COMPANY) NEWBRIDGE INDUSTRIAL ESTATE, NEWBRIDGE, COUNTY KILDARE, IRELAND., SN 76-499,443. FILED 3-13-2003. PRINCIPAL REGISTER.

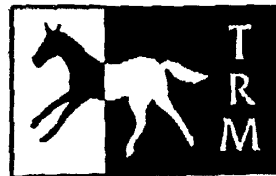

INT. CL. 5/U.S. CLS. 6, 18, 44, 46, 51 AND 52

FOR DIETETIC FOODS ADAPTED FOR VETERINARY USE; MINERAL FOOD SUPPLEMENTS; VETERINARY MINERAL SUPPLEMENTS; VITAMIN FOOD SUPPLEMENTS; VITAMIN SUPPLEMENTS FOR VETERINARY USE; FOOD SUPPLEMENTS CONTAINING MINERALS AND VITAMINS; NUTRITIONAL FOOD ADDITIVES FOR VETERINARY PURPOSES; ADDITIVES TO FODDER FOR VETERINARY PURPOSES; APPETITE STIMULANTS FOR HORSES; FOOD SUPPLEMENTS FOR PERFORMING ANIMALS; HEALTH FOOD FOR ANIMALS ON MEDICALLY RESTRICTED DIETS; BODY BUILDING PREPARATIONS FOR ANIMALS, NAMELY NUTRITIONAL SUPPLEMENTS. FIRST USE 10-0-1989; IN COMMERCE 10-0-1989.

ELEMENTS CORRECTED  
CITIZENSHIP



2,842,903. REG. 5-18-2004. 1182497 ONTARIO INC. (CANADA CORPORATION) 488 BAKER STREET, LONDON, ONTARIO N6C 1Y2, CANADA., SN 78-161,444. FILED 9-6-2002. PRINCIPAL REGISTER.

## NANA KNITS

NO CLAIM IS MADE TO THE EXCLUSIVE RIGHT TO USE "KNITS", APART FROM THE MARK AS SHOWN.

INT. CL. 25/U.S. CLS. 22 AND 39

FOR CHILDREN'S APPAREL, NAMELY, HATS AND SWEATERS.

FIRST USE 2-28-2002; IN COMMERCE 2-28-2002.

ELEMENTS CORRECTED

DATE OF FIRST USE

DATE OF FIRST USE IN COMMERCE

2,843,339. REG. 5-18-2004. ALOYS F. DORNBRACHT GMBH & CO. KG (FED REP GERMANY CORPORATION) KOBINGSER MUHLE 6, D-58640 LERLOHN, FED REP GERMANY., SN 75-906,304. FILED 1-31-2000. PRINCIPAL REGISTER.

## DORN BRACHT

PRIORITY CLAIMED UNDER SEC. 44(D) ON FED REP GERMANY APPLICATION NO. 829572, FILED 5-20-1999.

INT. CL. 9/U.S. CLS. 21, 23, 26, 36 AND 38

FOR THERMOSTATS WITH AND WITHOUT REGULATORS.

FIRST USE 12-31-1950; IN COMMERCE 12-31-1978.

INT. CL. 11/U.S. CLS. 13, 21, 23, 31 AND 34

FOR SANITARY FITTINGS OF METAL AND PLASTIC FOR TOILET, BATHROOM AND KITCHEN NAMELY, FAUCETS, TAPS, STOPS, MIXERS FOR REGULATING FLOW, DISTRIBUTION AND TEMPERATURE OF WATER, SHOWER HEADS, SETS COMPRISING SHOWER HEADS AND PARTS AND FIXTURES THEREFOR, SETS COMPRISING HANDHELD SHOWER HEADS AND PARTS AND FIXTURES THEREFOR; SPRAYERS FOR SINKS AND PARTS AND FIXTURES THEREFOR; BATH AND SHOWER FIXTURE SETS COMPRISING, SHOWER HEADS, FAUCETS, VALVES, HOSES AND PARTS AND FIXTURES THEREFOR; SETS FOR BATH AND SHOWER COMPRISING, SHOWER HEADS, FAUCETS, AND PARTS AND FIXTURES THEREFOR, RISERS, WATER DIVERTERS, PLUMBING FITTINGS, NAMELY, VALVES.

FIRST USE 12-31-1950; IN COMMERCE 12-31-1978.

INT. CL. 20/U.S. CLS. 2, 13, 22, 25, 32 AND 50

FOR FURNITURE, NAMELY, BATHROOM VANITIES AND HARDWARE SOLD AS A UNIT THEREWITH, MIRRORS, FRAMES; WALL CONSOLES, ACCESSORY STANDS, MIRROR CABINETS, SHELVES, STOOLS, CHAIRS, BENCHES; SHOWER CURTAIN RODS.

FIRST USE 12-31-1950; IN COMMERCE 12-31-1986.

INT. CL. 21/U.S. CLS. 2, 13, 23, 29, 30, 33, 40 AND 50

FOR HOUSEHOLD AND KITCHEN ITEMS, NAMELY, SOAP DISHES, TOWEL DISPENSERS, HOUSEHOLD CLEANING BRUSHES, HOUSEHOLD CLEANING UTENSILS, NAMELY, MOPS, BROOMS AND STEEL WOOL; PAPER TOWEL HOLDERS; SOAP DISHES, TOILET BRUSH HOLDERS, TOILET PAPER HOLDERS, BATHROOM DISPENSERS FOR LOTION AND SOAP, RINSING CUPS FOR BRUSHING TEETH, HOLDERS FOR RINSING CUPS AND SETS THEREOF; TOWEL HOOKS, TOWEL BARS, TOWEL RINGS, TOWEL CONTAINERS, BATH RACKS.

FIRST USE 12-31-1950; IN COMMERCE 12-31-1986.

ELEMENTS CORRECTED

DATE OF FIRST USE

2,843,996. REG. 5-18-2004. GENLYTE THOMAS GROUP LLC (DELAWARE LTD LIAB CO) 10350 ORMSBY PARK PLACE, SUITE 601, LOUISVILLE, KY, 40223, SN 78-182,345. FILED 11-6-2002. PRINCIPAL REGISTER.

## T-BAY

OWNER OF U.S. REG. NO. 1,769,251.

INT. CL. 11/U.S. CLS. 13, 21, 23, 31 AND 34

FOR ELECTRICAL LIGHTING FIXTURES.

FIRST USE 11-22-2002; IN COMMERCE 11-22-2002.

ELEMENTS CORRECTED

ENTITY

2,844,232. REG. 5-25-2004. LANIFICIO F.LLI CERRUTI. S.P.A. (ITALY JOINT STOCK COMPANY) VIA FRANCESCO SFORZA 1, 20122 MILANO, ITALY., SN 76-333,559. FILED 11-2-2001. PRINCIPAL REGISTER.



PRIORITY CLAIMED UNDER SEC. 44(D) ON ITALY APPLICATION NO. M12001C05338, FILED 5-15-2001, REG. NO. 854857, DATED 11-15-2001, EXPIRES 5-15-2011.

OWNER OF U.S. REG. NOS. 1,087,154, 2,282,603 AND OTHERS.

NO CLAIM IS MADE TO THE EXCLUSIVE RIGHT TO USE "SINCE 1881", APART FROM THE MARK AS SHOWN.

THE ENGLISH TRANSLATION OF THE WORD "LANIFICIO" IN THE MARK IS "WOOL MILL". "FILI" IS AN ABBREVIATION FOR "FRATELLI" WHICH IS ITALIAN FOR "BROTHERS".

INT. CL. 23/U.S. CL. 43

FOR YARNS AND THREADS FOR TEXTILE USE.

FIRST USE 2-2-2001; IN COMMERCE 2-6-2001.

INT. CL. 24/U.S. CLS. 42 AND 50

FOR QUILTS, LAP RUGS, TEXTILE NAPKINS, SHAMS, BED SHEET, TABLE CLOTHS NOT OF PAPER, TEXTILE COASTERS, TABLE LINEN, TABLE MATS NOT OF PAPER, TAFFETA, TOWELS, TULLE, UPHOLSTERY FABRICS, VELVET, ZEPHYR FABRIC, BED BLANKETS, BEDSPREADS, BED LINENS, CHEVIOT FABRIC, COTTON FABRIC, UNFITTED TEXTILE FURNITURE COVERS, TEXTILE SLIP COVERS, COVERS, FITTED TEXTILE LID COVERS, TEXTILE CUSHION COVERS, PILLOW CASES, CREPE CLOTH, FELT CLOTH, FLANNEL CLOTH, HANDKERCHIEFS OF TEXTILE.

FIRST USE 2-2-2001; IN COMMERCE 2-6-2001.

ELEMENTS CORRECTED

FOREIGN APPLICATION NO.

2,845,088. REG. 5-25-2004. JAPAN ENVIROCHEMICALS, LTD. (JAPAN CORPORATION) 3-8 DOSHOMACHI, 2-CHOME, CHUO-KU, OSAKA, JAPAN, 541-0045, SN 75-552,898. FILED 9-14-1998. PRINCIPAL REGISTER.

## ECOLOGIANA

INT. CL. 1/U.S. CLS. 1

FOR TEST KITS USED TO MEASURE AND DETECT POLLUTANTS IN WATER AND IN BODILY FLUIDS FOR SCIENTIFIC AND MEDICAL RESEARCH PURPOSES, CONSISTING OF REAGENTS, CHEMICALS FOR TREATING WATER, LITMUS PAPER, FILTERS, TEST TUBES, PLATES AND TRAYS, AND OTHER TESTING APPARATUS, SOLD AS A UNIT.

FIRST USE 9-0-1998; IN COMMERCE 12-0-2002.

INT. CL. 5/U.S. CLS. 6, 18, 44, 46, 51 AND 52  
 FOR TEST KITS USED TO MEASURE AND DETECT POLLUTANTS IN WATER AND IN BODILY FLUIDS FOR MEDICAL DIAGNOSTIC PURPOSES, CONSISTING OF REAGENTS, CHEMICALS FOR TREATING WATER, LITMUS PAPER, FILTERS, TEST TUBES, PLATES AND TRAYS, AND OTHER TESTING APPARATUS, SOLD AS A UNIT.

FIRST USE 9-0-1998; IN COMMERCE 12-0-2002.

ELEMENTS CORRECTED  
 \*ASSIGNMENT/NAME CHANGE\*

2,845,220. REG. 5-25-2004. SPECTRAL GESELLSCHAFT FUR LICHTTECHNIK MIT BESCHRANKTER HAFTUNG (FED REP GERMANY LIMITED LIABILITY COMPANY) BOTZINGER STRASSE 31, D-79111 FREIBURG, FED REP GERMANY., SN 76-018,997. FILED 4-5-2000. PRINCIPAL REGISTER.



NO CLAIM IS MADE TO THE EXCLUSIVE RIGHT TO USE "ARCHITECTURAL LIGHTING", APART FROM THE MARK AS SHOWN.

INT. CL. 11/U.S. CLS. 13, 21, 23, 31 AND 34

FOR ILLUMINATING DEVICES, NAMELY, ELECTRIC LIGHTING FIXTURES, LAMPS, ACCENT LIGHTING, LIGHTING OBJECTS, NAMELY, LIGHT SOURCES ATTACHED TO AND COVERING INTERNAL BUILDING STRUCTURES BY TRANSLUCENT PANELS; DEFLECTORS;[CEILING MOUNTED COOLING UNITS WITH AND WITHOUT INTEGRATED LIGHTING, SUCH UNITS USING COLD WATER AND COOLING LIQUIDS FOR COOLING THE AIR IN A ROOM;] AND PARTS FOR EACH OF THE FOREGOING GOODS.

FIRST USE 1-31-2002; IN COMMERCE 1-31-2002.

ELEMENTS CORRECTED  
 [GOODS/SERVICES]

2,845,367. REG. 5-25-2004. AC NIELSEN (US), INC. (DELAWARE CORPORATION) 150 NORTH MARTINGALE ROAD, SCHAUMBURG, IL, 60173, SN 76-191,142. FILED 1-8-2001. PRINCIPAL REGISTER.

**ACNIELSEN STRATEGIC  
 PLANNER**

OWNER OF U.S. REG. NOS. 2,451,141, 2,547,482 AND 2,582,478.

THE NAME ACNIELSEN DOES NOT IDENTIFY A LIVING INDIVIDUAL.

INT. CL. 35/U.S. CLS. 100, 101 AND 102

FOR MARKET RESEARCH; BUSINESS INFORMATION AND MARKET RESEARCH SERVICES, NAMELY, CONDUCTING, ANALYZING, REPORTING, AND CONSULTING REGARDING BUSINESS AND MARKET RESEARCH INFORMATION; AND PROVIDING AN ON-LINE INTERACTIVE COMPUTER DATABASE IN THE FIELD OF BUSINESS AND MARKET RESEARCH AND DEMOGRAPHIC INFORMATION AND DATA RELATING TO THE SALE AND PROMOTION OF CONSUMER AND DURABLE GOODS.

FIRST USE 12-4-2000; IN COMMERCE 1-31-2001.

ELEMENTS CORRECTED  
 OWNER NAME

2,845,449. REG. 5-25-2004. BURRUS RESEARCH ASSOCIATES, INC. (WISCONSIN CORPORATION) 557 COTTONWOOD AVENUE, SUITE 106, POST OFFICE BOX 47, HARTLAND, WI, 530290047, SN 76-270,422. FILED 6-12-2001. PRINCIPAL REGISTER.

**DESIGNING THRIVING  
 SCHOOLS**

INT. CL. 28/U.S. CLS. 22, 23, 38 AND 50  
 FOR BOARD AND CARD GAMES.  
 FIRST USE 8-1-2000; IN COMMERCE 8-1-2000.

ELEMENTS CORRECTED  
 OWNER ADDRESS

2,845,886. REG. 5-25-2004. DERMATEST GESELLSCHAFT FUR ALLERGOLOGISCHE FORSCHUNG M.B.H. (FED REP GERMANY LTD LIAB CO) BIRKENWEG 4, 48155 MUNSTER, FED REP GERMANY., SN 76-432,077. FILED 7-15-2002. PRINCIPAL REGISTER.

**DERMATEST**

OWNER OF FED REP GERMANY REG. NO. 39526305, DATED 6-20-1996, EXPIRES 6-30-2005.

INT. CL. 42/U.S. CLS. 100 AND 101

FOR MEDICAL AND BACTERIOLOGY LABORATORY SERVICES; MEDICAL CONTRACT RESEARCH; ALLERGY RESEARCH.

FIRST USE 12-31-1978; IN COMMERCE 12-31-1993.

ELEMENTS CORRECTED  
 FOREIGN APPLICATION FILING DATE  
 FOREIGN REG. DATE

2,847,067. REG. 5-25-2004. EXPLORING THE METROPOLIS, INC. (NEW YORK NOT-FOR-PROFIT CORPORATION) 10 GRACIE SQUARE, NEW YORK, NY, 100288031, SN 78-253,575. FILED P.R. 5-23-2003; AM. S.R. 11-17-2003. SUPPLEMENTAL REGISTER.



INT. CL. 41/U.S. CLS. 100, 101 AND 107

FOR PROVIDING INFORMATION IN THE FIELD OF RENTAL FACILITIES FOR DANCE REHEARSALS AND PERFORMANCES AND RENTAL OF VIDEO RECORDING STUDIOS VIA THE INTERNET.

FIRST USE 4-15-2003; IN COMMERCE 5-1-2003.

ELEMENTS CORRECTED  
ENTITY

2,847,824. REG. 6-1-2004. QSENT, INC. (DELAWARE CORPORATION) ONE CENTERPOINTE DRIVE, SUITE 330, LAKE OSWEGO, OR, 97035, SN 76-101,915. FILED 8-2-2000. PRINCIPAL REGISTER.

## QSENT

INT. CL. 35/U.S. CLS. 100, 101 AND 102

FOR \* PROVIDING VIA A GLOBAL COMPUTER NETWORK AND VIA WIRED AND WIRELESS ELECTRONIC COMMUNICATION DEVICES ONLINE DIRECTORY INFORMATION SERVICES IN THE FIELDS OF PERSONAL INDIVIDUAL CONTACTS, BUSINESS CONTACTS, GOVERNMENT CONTACTS, EDUCATIONAL CONTACTS, AND GEOGRAPHIC LOCATION; \* TELEPHONE AND INTERNET DIRECTORY INFORMATION AND ASSISTANCE SERVICES.

FIRST USE 4-1-2001; IN COMMERCE 4-1-2001.

INT. CL. 42/U.S. CLS. 100 AND 101

FOR PROVIDING CUSTOMIZED SEARCHING VIA A GLOBAL COMPUTER NETWORK AND VIA WIRED AND WIRELESS ELECTRONIC COMMUNICATION DEVICES OF INFORMATION AT THE SPECIFIC REQUEST OF END USERS AND AUTOMATED COMPUTER SYSTEMS.

FIRST USE 4-1-2001; IN COMMERCE 4-1-2001.

ELEMENTS CORRECTED  
GOODS/SERVICES

2,849,160. REG. 6-1-2004. HISAMITSU PHARMACEUTICAL CO., INC. (JAPAN CORPORATION) 408, TASHIRODAI-KAN-MACHI TOSU-SHI, SAGA, JAPAN, 841-0017, SN 78-080,631. FILED 8-22-2001. PRINCIPAL REGISTER.

## SALONPAS

INT. CL. 35/U.S. CLS. 100, 101 AND 102

FOR IMPORT AND EXPORT AGENCY SERVICES\* ; \*DISTRIBUTORSHIP SERVICES IN THE FIELD \*OF\* COSMETICS, PHARMACEUTICALS AND MEDICAL APPARATUS AND INSTRUMENTS.

FIRST USE 3-0-1994; IN COMMERCE 6-0-1998.

ELEMENTS CORRECTED  
GOODS/SERVICES

2,850,166. REG. 6-8-2004. FPI FIREPLACE PRODUCTS INTERNATIONAL LTD. (BRITISH COLUMBIA COMPANY) 6988 VENTURE STREET DELTA, BRITISH COLUMBIA, CANADA, V4G 1H4, SN 76-409,269. FILED 5-16-2002. PRINCIPAL REGISTER.

## EXCALIBUR

INT. CL. 11/U.S. CLS. 13, 21, 23, 31 AND 34

FOR GAS FIREPLACES AND PARTS, ACCESSORIES, AND ATTACHMENTS FOR SUCH FIREPLACES, NAMELY, GAS SURROUND INSERTS, PLATES, COVERS, LOUVERS, [BASKETS,] \* BRACKETS, \* BURNERS, AND ARTIFICIAL FIRE LOGS ALL SOLD TOGETHER AS A UNIT.

FIRST USE 1-30-2001; IN COMMERCE 3-29-2001.

ELEMENTS CORRECTED  
GOODS/SERVICES

2,851,860. REG. 6-8-2004. CALLAWAY GOLF COMPANY (DELAWARE CORPORATION) 2180 RUTHERFORD ROAD, CARLSBAD, CA, 92008, SN 78-125,077. FILED 4-30-2002. PRINCIPAL REGISTER.

INT. CL. 25/U.S. CLS. 22 AND 39

FOR GOLF SHOES.

FIRST USE 3-1-2004; IN COMMERCE 3-1-2004.

ELEMENTS CORRECTED  
OWNER NAME  
OWNER ADDRESS

2,852,252. REG. 6-15-2004. TOURNAMENT SPORTS MARKETING, INC. (CANADA CORPORATION) 145 NORTH-FIELD DR., WATERLOO, ONTARIO, CANADA, N2L 5J3, SN 75-523,464. FILED 7-22-1998. PRINCIPAL REGISTER.

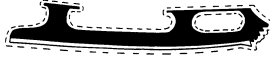

THE DRAWING IS LINED FOR THE COLOR BLACK AND COLOR IS CLAIMED.

THE MARK CONSISTS OF THE COLOR BLACK ON BLADES FOR ICE SKATES. THE OUTLINE OF THE BLADE DEPICTED IN DOTTED LINES IN THE DRAWING IS INTENDED TO SHOW THE BOUNDARIES OF THE BLADE ONLY AND IS NOT PART OF THE MARK.

SEC. 2(F).

INT. CL. 28/U.S. CLS. 22, 23, 38 AND 50  
FOR BLADES FOR ICE SKATES.  
FIRST USE 6-0-1996; IN COMMERCE 6-0-1996.

**ELEMENTS CORRECTED**

- \*OWNER NAME\*
- \*OWNER ADDRESS\*
- \*CITIZENSHIP\*
- \*ENTITY\*

2,852,300. REG. 6-15-2004. WOMEN INVESTING IN SECURITY AND EDUCATION (CALIFORNIA NOT-FOR-PROFIT CORPORATION) PMB 301, 5405 ALTON PARKWAY, 5-A, IRVINE, CA, 926043718, SN 76-035,308. FILED 4-26-2000. PRINCIPAL REGISTER.

**WISE**

INT. CL. 41/U.S. CLS. 100, 101 AND 107  
FOR EDUCATIONAL SERVICES, NAMELY, CONDUCTING SEMINARS, CLASSES, PROGRAMS AND CONFERENCES IN THE FIELDS OF FINANCIAL PLANNING AND STRATEGIES, INVESTMENT ANALYSIS AND RISK ANALYSIS \* , ALL DIRECTED TO INDIVIDUALS IN CONNECTION WITH PERSONAL FINANCE; AND EXCLUDING BUSINESS MANAGEMENT CONSULTATION SERVICES AND EDUCATIONAL SERVICES, NAMELY, CONDUCTING COURSES AND SEMINARS IN THE FIELDS OF ADMINISTRATIVE TRAINING, BUSINESS MANAGEMENT, AND BUSINESS ADMINISTRATION SERVICES. \*.  
FIRST USE 9-16-2000; IN COMMERCE 9-16-2000.

ELEMENTS CORRECTED  
GOODS/SERVICES

2,852,361. REG. 6-15-2004. MAREK, PAUL (FED REP GERMANY INDIVIDUAL) DOMPLATZ 3, D-93047 REGENSBURG, FED REP GERMANY., SN 76-204,258. FILED 2-2-2001. PRINCIPAL REGISTER.

**WHITEBEAR**

OWNER OF ERPN CMNTY TM OFC REG. NO. 001574292, DATED 5-16-2001, EXPIRES 3-24-2010.  
INT. CL. 18/U.S. CLS. 1, 2, 3, 22 AND 41

FOR ALL PURPOSE SPORTS BAGS, ATHLETIC BAGS, GYM BAGS, HIP BAGS, BACK PACKS, TRAVEL BAGS.  
FIRST USE ; IN COMMERCE .

INT. CL. 25/U.S. CLS. 22 AND 39

FOR CLOTHING, NAMELY, SHIRTS, SPORT SHIRTS, T-SHIRTS, BLOUSES, SPORTS BLOUSES, JERSEYS, SPORTS JERSEYS, SHORTS, SPORT SHORTS, PANTS, SPORTS PANTS, SOCKS, SPORTS SOCKS, STOCKINGS, SPORTS STOCKINGS, UNDERWEAR, SPORTS UNDERWEAR, CAPS, SPORTS CAPS, HATS, SPORTS HATS, JACKETS, SPORT JACKETS, SWEATERS, PULLOVERS, COATS, GLOVES, SPORTS GLOVES, GYM SUITS, JOGGING SUITS, SHOES, SPORT SHOES, BOOTS, SPORTS BOOTS, SHOWER SANDALS; CLOTHING DESIGNED FOR USE IN THE PRACTICE OF ICE HOCKEY, IN-LINE ROLLER SKATE HOCKEY, STREET HOCKEY, FIELD HOCKEY, AND BALL HOCKEY, NAMELY, JERSEYS, PANTS, STOCKINGS, SUSPENDERS, AND GARTER BELTS.

FIRST USE ; IN COMMERCE .

INT. CL. 28/U.S. CLS. 22, 23, 38 AND 50

FOR ICE SKATES, IN-LINE ROLLER SKATES, SKATE BLADE PROTECTORS, HOCKEY STICKS, HOCKEY STICK SHAFTS, HOCKEY STICK REPLACEMENT BLADES, HOCKEY PUCKS, HOCKEY BALLS, HOCKEY STICK BAGS, BAGS DESIGNED FOR HOCKEY EQUIPMENT, ICE SKATE BAGS; BODY PROTECTIVE ARTICLES AND EQUIPMENT SPECIFICALLY DESIGNED FOR THE PRACTICE OF ICE HOCKEY, IN-LINE SKATER HOCKEY, STREET HOCKEY, FIELD HOCKEY, AND BALL HOCKEY, NAMELY, BODY PADS, SHOULDER PADS, ELBOW PADS, GUARD GLOVES, SHIN GUARDS AND SHIN GUARD STRAPS, SHIN PADS, WRIST GUARDS, CHEST PROTECTORS, ARM PADS, HIP PADS, LEG GUARDS, KNEE PADS, ANKLE PADS, ANKLE GUARDS, CHIN PROTECTORS, NECK GUARDS, TEETH GUARDS, THROAT PROTECTORS, ATHLETIC SUPPORTS AND CUPS.

FIRST USE ; IN COMMERCE .

ELEMENTS CORRECTED  
OWNER ADDRESS

2,852,388. REG. 6-15-2004. BAUER NIKE HOCKEY INC. (CANADA COMPANY) 1200 INTERNATIONALE STREET, ST-JEROME, QUEBEC, CANADA, J7Y 5G2, SN 76-279,994. FILED 7-3-2001. PRINCIPAL REGISTER.

**TUUK T-LOCK**

PRIORITY CLAIMED UNDER SEC. 44(D) ON CANADA APPLICATION NO. 1103243, FILED 5-15-2001, REG. NO. TMA584012, DATED 6-18-2003, EXPIRES 6-18-2018.  
OWNER OF U.S. REG. NO. 1,467,513.

INT. CL. 28/U.S. CLS. 22, 23, 38 AND 50

FOR ICE SKATE RUNNERS FOR GOALIES.  
FIRST USE ; IN COMMERCE .

ELEMENTS CORRECTED  
FOREIGN REG. DATE  
FOREIGN REG. EXPIRATION DATE

2,852,583. REG. 6-15-2004. TROUW INTERNATIONAL B.V. (NETHERLANDS COMPANY) VEERSTRAAT 38, 5831 JN BOXMEER, NETHERLANDS., SN 76-439,666. FILED 8-8-2002. PRINCIPAL REGISTER.

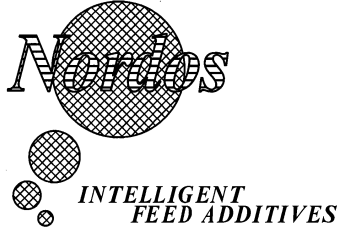

PRIORITY CLAIMED UNDER SEC. 44(D) ON BENELUX APPLICATION NO. 1005254, FILED 2-12-2002, REG. NO. 0707550, DATED 2-12-2002, EXPIRES 2-12-2012.

NO CLAIM IS MADE TO THE EXCLUSIVE RIGHT TO USE "FEED ADDITIVES", APART FROM THE MARK AS SHOWN.

THE DRAWING IS LINED FOR THE COLOR(S) BLUE AND ORANGE.

INT. CL. 31/U.S. CLS. 1 AND 46

FOR NON-MEDICATED ADDITIVES FOR ANIMAL FEED; AGRICULTURAL SEEDS; ANIMAL FOODSTUFFS.

FIRST USE ; IN COMMERCE .

ELEMENTS CORRECTED  
OWNER ADDRESS

2,854,228. REG. 6-15-2004. DAIKIN INDUSTRIES, LTD. (JAPAN CORPORATION) UMEDA-CENTER BLDG., 4-12, NAKAZAKI-NISHI 2-CHOME, KITA-KU, OSAKA, JAPAN., SN 76-177,009. FILED 12-7-2000. PRINCIPAL REGISTER.

## OPTOOL

INT. CL. 2/U.S. CLS. 6, 11 AND 16

FOR ANTIFOULING SURFACE COATINGS THAT REPEL OIL AND WATER, FOR USE ON OPTICAL DISPLAY SURFACES.

FIRST USE 9-0-2000; IN COMMERCE 8-0-2002.

ELEMENTS CORRECTED  
DATE OF FIRST USE  
DATE OF FIRST USE IN COMMERCE  
[GOODS/SERVICES]  
[INTERNATIONAL CLASS(ES)]

2,854,446. REG. 6-15-2004. KONAMI CORPORATION (JAPAN CORPORATION) 2-4-1, MARUNOUCHI, CHIYODA-KU, TOKYO, JAPAN., SN 76-372,285. FILED 2-20-2002. PRINCIPAL REGISTER.

## KONAMI COLLECTOR'S SERIES

NO CLAIM IS MADE TO THE EXCLUSIVE RIGHT TO USE "COLLECTOR'S SERIES", APART FROM THE MARK AS SHOWN.

INT. CL. 9/U.S. CLS. 21, 23, 26, 36 AND 38

FOR VIDEO GAME SOFTWARE; VIDEO GAME PROGRAMS; VIDEO GAME CD-ROMS; VIDEO GAME DIGITAL VERSATILE DISC-ROMS; COMPUTER GAME PROGRAMS; COMPUTER GAME CD-ROMS; COMPUTER GAME DIGITAL VERSATILE DISC-ROMS; ELECTRONIC GAME PROGRAMS; ELECTRONIC GAME CD-ROMS; ELECTRONIC GAME DIGITAL VERSATILE DISC-ROMS; CARTRIDGES AND CASSETTES FOR USE WITH HAND-HELD VIDEO GAME MACHINE; CIRCUIT BOARDS CONTAINING GAME PROGRAMS FOR USE WITH HAND-HELD VIDEO GAME MACHINE; VIDEO OUTPUT GAME MACHINES; DOWNLOADABLE ELECTRONIC GAME SOFTWARE, DOWNLOADABLE COMPUTER GAME SOFTWARE AND DOWNLOADABLE VIDEO GAME SOFTWARE.

FIRST USE 5-21-2002; IN COMMERCE 5-21-2002.

ELEMENTS CORRECTED  
OWNER ADDRESS

2,854,557. REG. 6-15-2004. SUZY'S ZOO (CALIFORNIA CORPORATION) 2355 NORTHSIDE DRIVE, SUITE 201, SAN DIEGO, CA, 92108, SN 76-418,040. FILED 6-7-2002. PRINCIPAL REGISTER.

## WAGS AND WHISKERS

INT. CL. 28/U.S. CLS. 22, 23, 38 AND 50

FOR PLUSH TOYS, ADULT AND CHILDREN'S PARTY GAMES, CARD GAMES, BOARD GAMES, PARLOR GAMES, ROLE PLAYING GAMES, TARGET GAMES, DOLLS AND ACCESSORIES AND PLAY SETS THEREFOR, BEAN BAG DOLLS, PAPER DOLL FIGURES, TOY FIGURES OF PLASTIC, RUBBER OR WOOD, BALLOON AND BALLOON WEIGHTS SOLD SEPARATELY OR AS A UNIT, PARTY FAVORS IN THE NATURE OF SMALL TOYS, MAGIC TRICKS, COSTUME MASKS, AND CHRISTMAS TREE ORNAMENTS.

FIRST USE 10-24-2002; IN COMMERCE 10-24-2002.

ELEMENTS CORRECTED  
OWNER ADDRESS

2,854,989. REG. 6-15-2004. TWENTIETH CENTURY FOX FILM CORPORATION (DELAWARE CORPORATION) 10201 WEST PICO BOULEVARD, LOS ANGELES, CA, 90035, SN 78-126,169. FILED 5-3-2002. PRINCIPAL REGISTER.

## FUTURAMA

OWNER OF U.S. REG. NOS. 2,421,632, 2,487,775 AND 2,527,723.

INT. CL. 9/U.S. CLS. 21, 23, 26, 36 AND 38

FOR COMPUTER AND VIDEO GAME SOFTWARE; COMPUTER AND VIDEO GAME \* , \* [ CASSETTES, CARTRIDGES, ] DISCS AND CD-ROMS; COMPUTER AND VIDEO SOFTWARE PROGRAMS FEATURING ENTERTAINMENT RELATING TO TELEVISION PROGRAMS [ AND MOTION PICTURE FILMS; COMPUTER AND VIDEO SOFTWARE FEATURING ENTERTAINMENT RELATED TO MOTION PICTURE FILMS ].

FIRST USE 8-12-2003; IN COMMERCE 8-12-2003.

ELEMENTS CORRECTED  
GOODS/SERVICES

2,855,027. REG. 6-15-2004. DAIRY FARMERS OF AMERICA, INC. (KANSAS CORPORATION) NORTHPOINTE TOWER, 10220 NORTH AMBASSADOR DRIVE, SUITE 1000, KANSAS CITY, MO, 64153, SN 78-138,325. FILED 6-24-2002. PRINCIPAL REGISTER.

2,857,165. REG. 6-29-2004. NEUROMEDIA S.A. (BELGIUM COMPANY) PARC INITIALIS RUE DESCARTES, 1, B-7000 MONS, BELGIUM,, SN 76-157,442. FILED 11-1-2000. PRINCIPAL REGISTER.

## VITALCAL

INT. CL. 5/U.S. CLS. 6, 18, 44, 46, 51 AND 52  
FOR NUTRITIONALLY FORTIFIED DAIRY BEVERAGES.  
FIRST USE 12-0-2002; IN COMMERCE 12-0-2002.

ELEMENTS CORRECTED  
CITIZENSHIP

---

2,856,487. REG. 6-22-2004. HCI DIRECT, INC. (DELAWARE CORPORATION) 3050 TILLMAN DRIVE, SUITE 101, BENSALEM, PA, 19020, SN 76-433,101. FILED 7-19-2002. PRINCIPAL REGISTER.

## SHEER COMPLEXION

OWNER OF U.S. REG. NOS. 728,572 AND 844,619.  
NO CLAIM IS MADE TO THE EXCLUSIVE RIGHT TO USE "SHEER", APART FROM THE MARK AS SHOWN.  
INT. CL. 25/U.S. CLS. 22 AND 39  
FOR PANTYHOSE.  
FIRST USE 6-1-2002; IN COMMERCE 6-1-2002.

ELEMENTS CORRECTED  
OWNER ADDRESS



---

2,856,581. REG. 6-22-2004. BUMBLE BEE SEAFOODS, LLC (DELAWARE CORPORATION) 9655 GRANITE RIDGE DRIVE, SUITE 100, SAN DIEGO, CA, 92123, SN 76-482,953. FILED 1-17-2003. PRINCIPAL REGISTER.

## TOUCH OF LEMON

INT. CL. 29/U.S. CL. 46  
FOR TUNA.  
FIRST USE 4-0-2003; IN COMMERCE 4-0-2003.

ELEMENTS CORRECTED  
OWNER NAME

PRIORITY CLAIMED UNDER SEC. 44(D) ON BENELUX APPLICATION NO. 0966269, FILED 6-5-2000, REG. NO. 0671706, DATED 6-5-2000.

THE MARK CONSISTS OF THE WORD DOCTOON WITH A REPRESENTATION OF A CHARACTER HOLDING A CANDLE.

INT. CL. 9/U.S. CLS. 21, 23, 26, 36 AND 38

FOR PHOTOGRAPHIC CAMERAS, MOTION PICTURE CAMERAS, OPTICAL CHARACTER RECOGNITION APPARATUS, OPTICAL DISCS, OPTICAL FILTERS, OPTICAL LENS SIGHTS, OPTICAL MIRROR, AND OPTICAL SCANNERS; SCALES, CALCULATORS, GRADUATED RULERS; VIDEO AND AUDIO CASSETTE RECORDERS, VIDEO CAMERAS, AUDIO AND VIDEO BLANK TAPES, COMPACT DISCS FOR COMPUTERS, DATA PROCESSORS; SWIM GOGGLES AND SWIM MASKS.  
FIRST USE ; IN COMMERCE .

INT. CL. 16/U.S. CLS. 2, 5, 22, 23, 29, 37, 38 AND 50

FOR PAPER, NAMELY, ADDING MACHINE, ART, BLUEPRINT, COMPUTER, COPY, CRAFT, CREPE, FIBER, FLOURESCENT, GIFT WRAPPING, GUMMED, ILLUSTRATION, LAMINATED, NEWSPRINT, NOTE PACKING, PARCHMENT, PRINTING, RECYCLED, REPRODUCTION, TISSUE, TYPEWRITER, WRITING, MAGNETIC, WALL, WAX, PAPER BAGS, PAPER BOXES, PAPER CAKE DECORATIONS, DECORATIVE PAPER CENTERPIECES, PAPER EMBLEMS, PAPER ENVELOPES FOR PACKING, PAPER FACE MASKS, PAPER FILE JACKETS, PAPER FLAGS, PAPER IDENTIFICATION TAGS, PAPER NAPKINS, PAPER PLACE MATS, PAPER PLATES, PAPER TABLE CLOTHS, PAPER TAGS, PAPER TOWELS, PAPER TRAYS, PAPERBOARD; PLASTIC BAGS FOR PACKAGING; ART POSTERS AND PRINTS; CALENDARS; BOOKS AND MAGAZINES WHOSE SUBJECT MATTER COVERS ANIMATED SERIES; CHILDREN'S BOOKS AND MAGAZINES; ADDRESS STAMPS, ADHESIVE BANDS FOR STATIONERY OR HOUSEHOLD PURPOSES, ADHESIVE TAPE FOR STATIONERY OR HOUSEHOLD PURPOSES, ALBUMS, ALMANACS, ANNOUNCEMENT CARDS, ARTIST'S WATERCOLOR SAUCERS, BOOKBINDING STRIPS, BOOKBINDING CLOTH AND MATERIAL, BOXES FOR PENS, GREETING CARDS, PLAYING CARDS, CHALK, COMPASSES FOR DRAWING, CORDS FOR BOOKBINDING, PAPER-CUTTERS, DECALCOMANIAS, DRAWING PENS, DRAWING SETS FOR ARTISTS, ENVELOPES, FIGURINES OF PAPER MACHE, DOCUMENT FILES, FLAGS OF PAPER, FOLDERS FOR PAPERS, GLUE FOR STATIONERY OR HOUSEHOLD PURPOSES, GUMS FOR STATIONERY OR HOUSEHOLD PURPOSES, HANDKERCHIEFS OF PAPER, PEN INK REFILLS, WRITING INK, PAPER KNIVES, NOTE BOOK, ARTICLES FOR USE IN SCHOOL, NAMELY PAINT BOXES, PAINTBRUSHES, PAPIER MACHE, PASTEL CRAYONS, PENCIL HOLDERS, PENCILS, PENCIL SHARPENERS, PENHOLDERS, PENS, POSTCARDS, POSTERS, RUBBER ERASERS, DRAWING RULERS, STANDS FOR PENS AND PENCILS, PRINTED CALCULATING TABLES, DECALCOMANIAS TRANSFERS, WRITING CHALK, STICKERS, STICKER ALBUMS, TEMPORARY TATTOOS.

FIRST USE ; IN COMMERCE .

INT. CL. 18/U.S. CLS. 1, 2, 3, 22 AND 41

FOR BAGS, NAMELY, SCHOOL BAGS, AND SPORT BAGS.

FIRST USE ; IN COMMERCE .

INT. CL. 25/U.S. CLS. 22 AND 39

FOR CLOTHING, NAMELY, SUITS, STOCKINGS, HOSIERY, SOCKS, SHORTS, SHIRTS, BLOUSES, TOPS, SKIRTS, DRESSES, JACKETS, COATS, RAINCOATS, CAPES, SLICKERS, OVERALLS, WAISTCOATS, SCARVES, MUFFLERS, SUN VISORS, DRESSING GOWNS, BATHROBES, TUXEDOS, PAJAMAS, SWEATERS, CARDIGANS, VESTS, BELTS, GLOVES, APRONS, TIGHTS, JEANS, TIES, ASCOTS, HATS, CAPS, SLACKS, LINGERIE, SWIMSUITS, ATHLETIC WEAR, NAMELY, SHORTS, LEOTARDS, SNEAKERS, HEADBANDS, WARMUP SUITS, FOOTWEAR.

FIRST USE ; IN COMMERCE .

INT. CL. 28/U.S. CLS. 22, 23, 38 AND 50

FOR CONFETTI; BOARD GAMES, CARD GAMES, EQUIPMENT SOLD AS A UNIT FOR PLAYING ACTION TYPE TARGET GAMES, HAND-HELD UNIT FOR PLAYING ELECTRONIC VIDEO GAMES; PADDLE BALLS, PINBALL MACHINES, ROLE PLAYING GAMES; TABLES, BALLS, STUFFED TOY ANIMALS, WINDUP TOYS, WATER SQUIRTING TOYS, SQUEEZABLE SQUEAKING TOYS, SOFT SCULPTURE TOYS, RIDE-ON-TOYS, PARTY FAVORS IN THE NATURE OF SMALL TOYS ACTION FIGURES, NON-RIDING TRANSPORTATION TOYS, INFLATABLE BATH TOYS, INFANT ACTION CRIB TOYS, DOG TOYS, CHILDREN'S MULTIPLE ACTIVITY TOYS, BATH TOYS, TOY WEAPONS, TOY WATCHES, TOY VEHICLES, TOY STAMPS, TOY ROCKETS, TOY PUTTY, MODEL HOBBY CRAFT KITS COMPRISED OF TOY MODEL VEHICLES AND RELATED ACCESSORIES SOLD AS UNITS, TOY AND CRIB MOBILES, TOY AND HANG GLIDERS, TOY ACTION FIGURES, TOY BOXES, TOY ACTING FIGURES AND ACCESSORIES THEREFOR; BASEBALLS; EQUIPMENT FOR PLAYING BILLIARDS, BOCCIE, BOWLING, CRICKET, FIELD HOCKEY, FOOTBALL, GOLF, HANDBALL, LACROSSE, RUGBY, SOCCER, SOFTBALL, SQUASH, TABLE TENNIS, AND TETHER, NAMELY, BALLS, BATS, GOLF CLUBS, RACKETS, MITTS AND NETS USED IN CONNECTION THEREWITH; VOLLEY BALLS; HOCKEY GLOVES, FIELD

HOCKEY GOALIE PADS, ICE HOCKEY GOALIE PADS, HOCKEY PUCKS, HOCKEY STICKS, POOL CUES, RACKETS, NAMELY, TENNIS, TABLE TENNIS, SQUASH AND RACQUETBALL; BASEBALL, SOFTBALL AND CRICKET BATS, BASEBALL BATTING GLOVES, FOOTBALL BODY PROTECTORS, FOOTBALL GIRDLES, FOOTBALL SHOULDER PADS; DOLLS, DOLL ACCESSORIES, DOLL CLOTHING, DOLL COSTUMES, DOLL FURNITURE, DOLL HOUSE FURNISHINGS, DOLL HOUSES, PLAYGROUND EQUIPMENT, NAMELY, PLAYHOUSES, PLAY TENTS, SKIPPING ROPE, HORSESHOES FOR RECREATIONAL PURPOSES, ROLLER SKATES, SKATE BOARDS; ARCHERY EQUIPMENT, NAMELY, ARROW FETCHING DEVICES, ARROW POINTS FOR ARCHERY AND HUNTING AND TOY BOWS; ATHLETIC TAPE, KARATE GLOVES, KARATE HEAD GUARDS, KARATE KICK PADS, KARATE SHIN PADS, KARATE TARGET PADS; WATER SKIS, SKI POLES, SKI ROPES, SNOW AND WATER SKIS, SWIM BOARDS FOR RECREATIONAL USE, SWIM FINS, SWIMMING AIDS, NAMELY, ARM FLOATS FOR RECREATIONAL USE, SWIMMING GLOVES; GYMNAS TIC APPARATUS, GYMNAS TIC HORIZONTAL BARS, GYMNAS TIC PARALLEL BARS, GYMNAS TIC TRAINING STOOLS.

FIRST USE ; IN COMMERCE .

INT. CL. 35/U.S. CLS. 100, 101 AND 102

FOR PREPARING AND PLACING ADVERTISEMENTS FOR OTHERS; PROVIDING TELEVISION AND INTERNET ADVERTISING FOR OTHERS; RENTAL OF ADVERTISING SPACE ON THE INTERNET; ARRANGING FOR THE SUBSCRIPTIONS OF NEWSPAPERS AND MAGAZINES FOR OTHERS; BUSINESS MANAGEMENT; BUSINESS INFORMATION; BUSINESS CONSULTATION; BUSINESS MARKETING CONSULTING SERVICES; ACCOUNTING SERVICES; DOCUMENT REPRODUCTION; COMPUTERIZED DATABASE MANAGEMENT; RENTAL OF COMPUTER FILES; ORGANIZING EXHIBITIONS FOR BUSINESS PURPOSES; DEVELOPING PROMOTIONAL CAMPAIGNS FOR BUSINESSES; BUSINESS MANAGEMENT FOR OTHERS OF COMMERCIAL COMPANIES INCLUDING ELECTRONIC COMMERCE COMPANIES; PUBLIC RELATION SERVICES; BUSINESS CONSULTATION SERVICES IN THE FIELDS OF ADVERTISING, PROMOTIONS AND MARKETING.

FIRST USE ; IN COMMERCE .

INT. CL. 38/U.S. CLS. 100, 101 AND 104

FOR TELECOMMUNICATION SERVICES, NAMELY, PROVIDING TELECOMMUNICATIONS CONNECTIONS TO A GLOBAL COMPUTER NETWORK; BROADCASTING PROGRAMS VIA A GLOBAL COMPUTER NETWORK; RADIO COMMUNICATION; TELEPHONE COMMUNICATION SERVICES, TELEVISION AND RADIO BROADCASTING; PERSONAL COMMUNICATION SERVICES; TELEMATIC SERVICES, NAMELY, TELECOMMUNICATION SERVICES ACCESSIBLE VIA ACCESS CODE VIA ELECTRONIC TERMINALS OR TELEPHONE, TELEVISION, RADIO, TELEPRINTER; TRANSMISSION AND TELEPRINTING OF INFORMATION MESSAGES AND CODED IMAGES; WIRELESS DIGITAL MESSAGING SERVICES, ELECTRONIC STORE-AND-FORWARD MESSAGING, ELECTRONIC TRANSMISSION OF DATA AND DOCUMENTS VIA COMPUTER TERMINALS, CORRESPONDENCE EXCHANGE SERVICES, NAMELY, EXCHANGE OF COMPUTERIZED DOCUMENTS, COMPUTER TELECOMMUNICATIONS, FACSIMILE TRANSMISSION, ELECTRONIC MAIL SERVICES, TELEPHONE COMMUNICATION SERVICES, RENTAL OF TELECOMMUNICATIONS EQUIPMENT, NAMELY, TELEPHONE RECEIVERS; EXHIBITIONS FOR MEDICAL PURPOSES.

FIRST USE ; IN COMMERCE .

INT. CL. 41/U.S. CLS. 100, 101 AND 107

FOR EDUCATIONAL SERVICES, NAMELY, CONDUCTING SEMINARS AND CLASSES IN THE FIELD OF MULTIMEDIA; ENTERTAINMENT SERVICES, NAMELY, PRODUCING LIVE THEATRICAL, MUSICAL AND COMEDIC EVENTS; MOTION PICTURE AND TELEVISION FILMS PRODUCTION SERVICES; PUBLICATION OF BOOKS AND MAGAZINES; LIBRARIES; RENTAL OF FILMS; SOUND RECORDING STUDIOS; RENTAL OF STAGE SCENERY; ARRANGING AND CONDUCTING EDUCATION CONFERENCES.

FIRST USE ; IN COMMERCE .

INT. CL. 42/U.S. CLS. 100 AND 101

FOR HOSPITAL SERVICES; COMPUTER PROGRAMMING FOR OTHERS; RENTAL OF COMPUTERS AND COMPUTER SOFTWARE; INTELLECTUAL PROPERTY CONSULTATION SERVICES.  
FIRST USE ; IN COMMERCE .

2,857,306. REG. 6-29-2004. R.D.T. BUSINESS ENTERPRISES, INC. (FLORIDA CORPORATION); DBA SYNERGYLABS, 3333 SE 14TH AVENUE, FORT LAUDERDALE, FL, 33316, SN 76-434,418. FILED 7-24-2002. PRINCIPAL REGISTER.

ELEMENTS AMENDED  
\*DESCRIPTION OF MARK\*

**SYNERGYLABS**

2,857,213. REG. 6-29-2004. CHARRETTE LLC (DELAWARE LTD LIAB CO) 31 OLYMPIA AVENUE, WOBURN, MA, 01888, SN 76-329,180. FILED 10-24-2001. PRINCIPAL REGISTER.



INT. CL. 1/U.S. CLS. 1  
FOR HOUSE MARK FOR CHEMICAL SPRAYS USED TO AID IN HOUSEBREAKING DOGS.  
FIRST USE 11-0-2001; IN COMMERCE 11-0-2001.  
INT. CL. 3/U.S. CLS. 1, 4, 6, 50, 51 AND 52  
FOR HOUSE MARK FOR ANIMAL CARE PRODUCTS, NAMELY, ALL-PURPOSE CLEANERS, PET ODOR REMOVERS, PET SHAMPOO, PET STAIN REMOVERS, AND COSMETICS FOR ANIMALS.  
FIRST USE 11-0-2001; IN COMMERCE 11-0-2001.  
INT. CL. 5/U.S. CLS. 6, 18, 44, 46, 51 AND 52  
FOR HOUSE MARK FOR ANIMAL FEED ADDITIVES FOR USE AS NUTRITIONAL SUPPLEMENTS AND MEDICATED GROOMING PREPARATIONS FOR DOMESTICATED ANIMALS, NAMELY, DOGS AND CATS.  
FIRST USE 11-0-2001; IN COMMERCE 11-0-2001.  
INT. CL. 31/U.S. CLS. 1 AND 46  
FOR HOUSE MARK FOR ANIMAL FEED AND ANIMAL FLAVOR ENHANCERS \* FOR \* DOMESTICATED ANIMALS, NAMELY, DOGS AND CATS, FOR NON-NUTRITIONAL PURPOSES FOR USE AS FLAVORING, INGREDIENT OR FILLER, ANIMAL FOODSTUFFS, ANIMAL LITTER, DOG FOOD.  
FIRST USE 11-0-2001; IN COMMERCE 11-0-2001.  
INT. CL. 40/U.S. CLS. 100, 103 AND 106  
FOR CONTRACT MANUFACTURING IN THE FIELD OF ANIMAL CARE PRODUCTS.  
FIRST USE 11-0-2001; IN COMMERCE 11-0-2001.

INT. CL. 2/U.S. CLS. 6, 11 AND 16  
FOR INK USED FOR INKJET PRINTING.  
FIRST USE 9-0-1995; IN COMMERCE 9-0-1995.  
INT. CL. 16/U.S. CLS. 2, 5, 22, 23, 29, 37, 38 AND 50  
FOR INKJET MEDIA FOR USE IN PRINTING DATA AND PHOTOGRAPHS, NAMELY, PHOTOGRAPHY PAPER, EMBOSSED PAPER, WATER-PROOF PAPER, ADHESIVE-BACKED PAPER, LAMINATED PAPER, AND VINYL.  
FIRST USE 9-0-1995; IN COMMERCE 9-0-1995.

ELEMENTS CORRECTED  
\*GOODS/SERVICES\*

ELEMENTS CORRECTED  
OWNER NAME  
OWNER ADDRESS  
CITIZENSHIP  
ENTITY

2,860,444. REG. 7-6-2004. WAKEFERN FOOD CORP. (NEW JERSEY CORPORATION) 600 YORK STREET, ELIZABETH, NJ, 07207, SN 75-357,589. FILED 9-16-1997. PRINCIPAL REGISTER.

2,857,215. REG. 6-29-2004. CHARRETTE LLC (DELAWARE LTD LIAB CO) 31 OLYMPIA AVENUE, WOBURN, MA, 01888, SN 76-329,883. FILED 10-24-2001. PRINCIPAL REGISTER.

**SENTINEL**



INT. CL. 2/U.S. CLS. 6, 11 AND 16  
FOR INK USED FOR INKJET PRINTING.  
FIRST USE 9-0-1995; IN COMMERCE 9-0-1995.  
INT. CL. 16/U.S. CLS. 2, 5, 22, 23, 29, 37, 38 AND 50  
FOR INKJET MEDIA FOR USE IN PRINTING DATA AND PHOTOGRAPHS, NAMELY, PHOTOGRAPHY PAPER, EMBOSSED PAPER, WATER-PROOF PAPER, ADHESIVE-BACKED PAPER, LAMINATED PAPER, AND VINYL.  
FIRST USE 9-0-1995; IN COMMERCE 9-0-1995.

OWNER OF U.S. REG. NOS. 1,892,424 AND 1,903,120.  
INT. CL. 3/U.S. CLS. 1, 4, 6, 50, 51 AND 52  
FOR COSMETICS AND CLEANING PREPARATIONS, NAMELY, LAUNDRY DETERGENT, DISHWASHER DETERGENT, WINDOW CLEANER; COTTON PUFFS FOR COSMETIC PURPOSES; EMORY BOARDS; NAIL POLISH REMOVER; CORNSTARCH FOR PERSONAL USE; COTTON SWABS; BABY OIL; TALCUM POWDER; HAIR CARE PRODUCTS, NAMELY, SHAMPOOS, CONDITIONERS, DETANGLERS, CREAMS, LOTIONS; NON-MEDICATED SKIN CARE PRODUCTS, NAMELY, LOTIONS, CREAMS, AFTER SHAVE LOTION, SHAVING LOTION; MOUTHWASH, MOUTH RINSES, DENTURE TABLETS.  
FIRST USE 2-0-1998; IN COMMERCE 2-0-1998.  
INT. CL. 5/U.S. CLS. 6, 18, 44, 46, 51 AND 52

ELEMENTS CORRECTED  
OWNER NAME  
OWNER ADDRESS  
CITIZENSHIP  
ENTITY



FOR MEDICATED SKIN CARE PRODUCTS, NAMELY, CREAMS, OINTMENTS, LOTIONS AND SPRAYS; WITCH HAZEL; MEDICATED SHAMPOO; MEDICATED LIP BALM; VITAMINS AND NUTRITIONAL SUPPLEMENTS; FEMININE HYGIENE PRODUCTS, NAMELY, SANITARY NAPKINS, SHIELDS, TAMPONS, DOUCHE; ADHESIVE BANDAGES; GAUZE BANDAGES; PEROXIDE FOR MEDICINAL USE; EPSOM SALT; MINERAL OIL; ALCOHOL FOR MEDICINAL USE; STERILE PADS; ANALGESICS; ANTACIDS; ANTI-DIARRHEAL PREPARATIONS; COUGH AND COLD PREPARATIONS; COUGH DROPS; NASAL SPRAY; ALLERGY MEDICATIONS; EYE SOLUTIONS; CONTACT LENS CARE SOLUTIONS; LAXATIVES; SUPPOSITORIES.

FIRST USE 2-0-1998; IN COMMERCE 2-0-1998.  
INT. CL. 8/U.S. CLS. 23, 28 AND 44

FOR RAZOR BLADES.

FIRST USE 3-0-1998; IN COMMERCE 3-0-1998.  
INT. CL. 11/U.S. CLS. 13, 21, 23, 31 AND 34

FOR LIGHT BULBS.

FIRST USE 5-0-1999; IN COMMERCE 5-0-1999.  
INT. CL. 16/U.S. CLS. 2, 5, 22, 23, 29, 37, 38 AND 50

FOR PAPER COFFEE FILTERS, TOILET PAPER, PAPER NAPKINS.

FIRST USE 6-0-1998; IN COMMERCE 6-0-1998.  
INT. CL. 21/U.S. CLS. 2, 13, 23, 29, 30, 33, 40 AND 50

FOR POWDER PUFFS, DENTAL FLOSS, TOOTH BRUSHES, LATEX GLOVES, MOPS AND BROOMS.

FIRST USE 2-0-1998; IN COMMERCE 2-0-1998.  
INT. CL. 29/U.S. CL. 46

FOR DAIRY PRODUCTS, NAMELY, MILK, CHEESE, EGGS, HALF AND HALF, SOUR CREAM; NON-DAIRY CREAMER; EDIBLE OILS AND FATS; PROCESSED FRUITS; FRUIT-BASED PIE FILLINGS; PROCESSED VEGETABLES; SOUPS; POTATO CHIPS.

FIRST USE 6-0-1997; IN COMMERCE 6-0-1997.  
INT. CL. 30/U.S. CL. 46

FOR BREAD, ROLLS, FLOUR, CAKES, CUSTARD [ BASE ] \* BASED \* PIE FILLINGS, CHOCOLATE BASED PIE FILLINGS, TEA BAGS, TOASTER PASTRIES, OATMEAL PANCAKE MIX, RICE, COOKIES, CRACKERS, SAUCES, PASTA, SOY PASTA WITH SAUCE, PRETZELS.

FIRST USE 2-0-1998; IN COMMERCE 2-0-1998.  
INT. CL. 31/U.S. CLS. 1 AND 46

FOR PET FOOD, CAT LITTER.

FIRST USE 2-0-1998; IN COMMERCE 2-0-1998.

ELEMENTS CORRECTED  
GOODS/SERVICES

2,860,720. REG. 7-6-2004. PERMIRA ADVISERS LIMITED (UNITED KINGDOM COMPANY) 20 SOUTHAMPTON STREET, LONDON WC2E 7QG, UNITED KINGDOM., SN 76-320,340. FILED 10-1-2001. PRINCIPAL REGISTER.



PRIORITY CLAIMED UNDER SEC. 44(D) ON UNITED KINGDOM APPLICATION NO. 2278599, FILED 5-21-2001, REG. NO. 2278599, DATED 3-8-2002, EXPIRES 8-21-2011.  
INT. CL. 35/U.S. CLS. 100, 101 AND 102

FOR (BASED ON USE IN COMMERCE) BUSINESS MANAGEMENT SERVICES; BUSINESS MANAGEMENT CONSULTATION SERVICES; BUSINESS ADMINISTRATION, NAMELY, PROVIDING COMPANY SECRETARIAL SERVICES; MARKET RESEARCH AND ANALYSIS; BUSINESS CONSULTATION SERVICES; PREPARING BUSINESS REPORTS; PROMOTIONAL SERVICES, NAMELY, THE PROMOTION OF BUSINESSES AND INVESTMENT PRODUCTS THROUGH THE PREPARATION AND PLACEMENT OF ADVERTISING/MARKETING MATERIAL, THE DISSEMINATION OF ADVERTISING/MARKETING MATERIAL, THE PREPARATION AND DISSEMINATION OF PROSPECTUSES, THE ISSUANCE OF PROSPECTUSES AND INFORMATION MEMORANDA AND THE PREPARATION AND DISSEMINATION OF PROMOTIONAL [ MATER ] \* MATERIAL \*; INFORMATION, ADVISORY AND CONSULTANCY SERVICES RELATING TO THE AFORESAID; (BASED ON 44(E)) PROVIDING AN ON-LINE COMPUTER DATABASE IN THE FIELDS OF BUSINESS MANAGEMENT AND CONSULTANCY.

FIRST USE 11-12-2001; IN COMMERCE 11-12-2001.  
INT. CL. 36/U.S. CLS. 100, 101 AND 102

FOR (BASED ON USE IN COMMERCE) FINANCIAL, PRIVATE EQUITY AND VENTURE CAPITAL CONSULTATION SERVICES; FINANCIAL, PRIVATE EQUITY AND VENTURE CAPITAL MANAGEMENT CONSULTATION SERVICES; CONSULTATION IN THE FIELD OF CORPORATE FINANCING; VENTURE CAPITAL AND PRIVATE EQUITY SERVICES, NAMELY, PROVIDING BUSINESS FINANCING AND BUSINESS FINANCING CONSULTATION SERVICES; FINANCIAL SERVICES, NAMELY, FINANCIAL [ INTER MEDIATION ] \* INTER-MEDIATION \* AND CAPITAL MANAGEMENT SERVICES; THE PROVISION OF INSTALLMENT, INTEREST FREE, INTEREST BEARING, SHAREHOLDER, CONVERTIBLE, SHORT TERM AND BRIDGING LOANS; INVESTMENT BANKING SERVICES; INVESTMENT, PRIVATE EQUITY, VENTURE CAPITAL, HEDGE FUND AND DEBT FUND MANAGEMENT, ADMINISTRATION AND FINANCIAL ADVICE SERVICES; TRUST SERVICES, NAMELY, INVESTMENT AND TRUST COMPANY SERVICES; CAPITAL BROKERAGE SERVICES; TRUSTEE SERVICES RELATING TO PRIVATE EQUITY AND VENTURE CAPITAL; PROVIDING VENTURE CAPITAL AND PRIVATE EQUITY FINANCING SERVICES; AND INFORMATION, ADVISORY AND CONSULTANCY SERVICES RELATING TO THE AFORESAID, NONE OF THE AFORESAID SERVICES BEING OR INCLUDING INSURANCE SERVICES; (BASED ON 44(E)) BANKING SERVICES; BANKING SERVICES, NAMELY, TRADING OF FOREIGN EXCHANGE; LEASE PURCHASE FINANCING; REAL ESTATE [ INVESTMENT ] \* INVESTMENT \* AND MANAGEMENT AND ANALYSIS; PROVIDING AN ON-LINE COMPUTER DATABASE IN THE FIELD OF FINANCIAL SERVICES, BANKING SERVICES, PRIVATE EQUITY AND VENTURE CAPITAL.

FIRST USE 11-12-2001; IN COMMERCE 11-12-2001.

ELEMENTS CORRECTED  
GOODS/SERVICES

2,861,186. REG. 7-6-2004. TURNER ENTERTAINMENT CO. (DELAWARE CORPORATION) 4000 WARNER BOULEVARD, BLDG 156, BURBANK, CA. 91522, SN 78-037,668. FILED 12-4-2000. PRINCIPAL REGISTER.

**RUBY SLIPPERS**

INT. CL. 9/U.S. CLS. 21, 23, 26, 36 AND 38

FOR MOTION PICTURE FILMS FEATURING COMEDY, DRAMA, ACTION, ADVENTURE AND ANIMATION, AND MOTION PICTURE FILMS FOR BROADCAST ON TELEVISION FEATURING COMEDY, DRAMA, ACTION, ADVENTURE AND ANIMATION; PRERECORDED VINYL RECORDS, AUDIO TAPES, AUDIO-VIDEO TAPES, AUDIO VIDEO CASSETTES, AUDIO VIDEO DISCS AND DIGITAL VERSATILE DISCS FEATURING MUSIC, COMEDY DRAMA ACTION, ADVENTURE AND ANIMATION; STEREO HEADPHONES; BATTERIES; CORDLESS TELEPHONES; HAND-HELD CALCULATORS; AUDIO CASSETTE AND CD PLAYERS; CD ROM COMPUTER GAMES; HAND-HELD KARAOKE PLAYERS, TELEPHONE AND RADIO PAGERS; SHORT MOTION PICTURE FILM CASSETTES FEATURING COMEDY, DRAMA, ACTION, ADVENTURE AND ANIMATION TO BE USED WITH HAND-HELD VIEWERS OR PROJECTORS; VIDEO CASSETTE RECORDERS AND PLAYERS, COMPACT DISC PLAYERS, DIGITAL AUDIO TAPE RECORDED AND PLAYERS, ELECTRONIC DIARIES; RADIOS; MOUSE PADS; EYEGLASSES, SUNGLASSES AND CASES THEREFOR; PRERECORDED AUDIO TAPES FEATURING MUSIC, COMEDY, DRAMA, ACTION, ADVENTURE, AND ANIMATION AND ACCOMPANYING BOOKLET SOLD AS A UNIT THEREWITH; COMPUTER PROGRAMS, NAMELY SOFTWARE FOR USE IN LINKING DIGITIZED VIDEO AND AUDIO MEDIA TO A GLOBAL COMPUTER INFORMATION NETWORK; COMPUTER GAME EQUIPMENT CONTAINING MEMORY DEVICES NAMELY, DISCS FOR PLAYING A PARLOR-TYPE COMPUTER GAME; VIDEO AND COMPUTER GAME PROGRAMS; VIDEO GAME CARTRIDGES AND CASSETTES; ENCODED MAGNETIC CARDS, PHONE CARDS, CREDIT CARDS, CASH CARDS, DEBIT CARDS AND MAGNETIC KEY CARDS; AND DECORATIVE MAGNETS.

FIRST USE 7-31-2003; IN COMMERCE 7-31-2003.

ELEMENTS CORRECTED  
OWNER NAME

2,861,528. REG. 7-6-2004. MICROSOFT CORPORATION (WASHINGTON CORPORATION) ONE MICROSOFT WAY, REDMOND, WA, 980526399, SN 78-194,535. FILED 12-13-2002. PRINCIPAL REGISTER.

## INSIDE PITCH

INT. CL. 9/U.S. CLS. 21, 23, 26, 36 AND 38  
FOR COMPUTER PROGRAMS, NAMELY, GAME SOFTWARE FOR USE ON COMPUTERS AND VIDEO GAME PLAYERS.

FIRST USE 6-3-2003; IN COMMERCE 6-3-2003.

ELEMENTS CORRECTED  
GOODS/SERVICES

2,862,521. REG. 7-13-2004. FUTURA MEDICAL DEVELOPMENTS LIMITED (UNITED KINGDOM COMPANY) SURREY TECHNOLOGY CENTRE, 40 OCCAM ROAD, THE SURREY RESEARCH PARK, GUILDFORD, SURREY, UNITED KINGDOM, GU2 5YG, SN 78-177,836. FILED 10-24-2002. PRINCIPAL REGISTER.

## ZANIFIL

PRIORITY CLAIMED UNDER SEC. 44(D) ON UNITED KINGDOM APPLICATION NO. 2300097, FILED 10-25-2001, REG. NO. 2300097, DATED 10-25-2001, EXPIRES 10-25-2011.  
INT. CL. 5/U.S. CLS. 6, 18, 44, 46, 51 AND 52

FOR PHARMACEUTICAL PRODUCTS IN THE FORM OF GELS AND CREAMS FOR THE MAINTENANCE OF MALE ERECTIONS.  
FIRST USE ; IN COMMERCE .

ELEMENTS CORRECTED  
OWNER ADDRESS  
FOREIGN APPLICATION FILING DATE  
FOREIGN REG. DATE  
FOREIGN REG. EXPIRATION DATE

2,863,139. REG. 7-13-2004. QUINTA DE VENTOZELO - SOCIEDADE AGRICOLA E COMERCIAL, S.A. (PORTUGAL CORPORATION) QUINTA DE VENTOZELO, ERVEDOSA DO DOURO, P-5130 SAO JOAO DA PESQUEIRA, PORTUGAL., SN 76-245,001. FILED 4-24-2001. PRINCIPAL REGISTER.

## QUINTA DE VENTOZELO

THE ENGLISH TRANSLATION OF "QUINTA DE" IS "FARM OF".  
INT. CL. 33/U.S. CLS. 47 AND 49  
FOR PORT WINE; WINES.  
FIRST USE 0-0-1999; IN COMMERCE 0-0-2003.

ELEMENTS CORRECTED  
OWNER NAME

2,864,310. REG. 7-20-2004. CASEMARK, INC. (DELAWARE CORPORATION) 103 SPRINGER BUILDING, 3411 SILVERSIDE ROAD, WILMINGTON, DE, 19810, SN 76-484,387. FILED 1-22-2003. PRINCIPAL REGISTER.

## W.R. CASE & SONS CUTLERY CO.

OWNER OF U.S. REG. NOS. 541,284, 2,729,013 AND OTHERS.  
NO CLAIM IS MADE TO THE EXCLUSIVE RIGHT TO USE "CUTLERY CO.", APART FROM THE MARK AS SHOWN.

INT. CL. 8/U.S. CLS. 23, 28 AND 44  
FOR POCKET KNIVES, FOLDING KNIVES, AND HUNTING KNIVES .  
FIRST USE 0-0-1911; IN COMMERCE 0-0-1911.

ELEMENTS CORRECTED  
OWNER ADDRESS

2,864,440. REG. 7-20-2004. OMRON CORPORATION (JAPAN CORPORATION) 801, MINAMIFUDODO-CHO, HORIKAWAHIGASHIIRU SHIOKOJI-DORI, SHIMOGYO-KU, KYOTO-SHI, KYOTO 600-8530, JAPAN., SN 76-505,595. FILED 4-9-2003. PRINCIPAL REGISTER.



INT. CL. 9/U.S. CLS. 21, 23, 26, 36 AND 38  
FOR SINGLE MODE WAVEGUIDES, MULTI-MODE WAVEGUIDES, WAVEGUIDES FOR PLASTIC OPTICAL FIBERS, OPTICAL TRANSCIEVERS, VARIABLE OPTICAL ATTENUATORS, OPTICAL SWITCHES, OPTICAL TAP COUPLERS, OPTICAL COUPLERS, WAVELENGTH DIVISION MULTIPLEX COUPLERS, AND L-CONNECTORS.

FIRST USE 7-0-2002; IN COMMERCE 9-9-2003.

ELEMENTS CORRECTED  
OWNER ADDRESS

2,864,941. REG. 7-20-2004. AMERICA'S DRIVE-IN CORP. (KANSAS CORPORATION) 7701 EAST KELLOGG, SUITE 565, WICHITA, KS, 67207, SN 78-213,388. FILED 2-11-2003. PRINCIPAL REGISTER.

## DRIVE-IN DEALS!

OWNER OF U.S. REG. NOS. 776,766, 2,067,808 AND OTHERS.

NO CLAIM IS MADE TO THE EXCLUSIVE RIGHT TO USE DRIVE-IN, APART FROM THE MARK AS SHOWN.

INT. CL. 43/U.S. CLS. 100 AND 101  
FOR RESTAURANT SERVICES.

FIRST USE 1-1-1998; IN COMMERCE 1-1-1998.

ELEMENTS CORRECTED  
CITIZENSHIP

2,865,608. REG. 7-20-2004. MICROSOFT CORPORATION (WASHINGTON CORPORATION) ONE MICROSOFT WAY, REDMOND, WA, 980526399, SN 78-043,994. FILED 1-19-2001. PRINCIPAL REGISTER.

## OFFICE XP

NO CLAIM IS MADE TO THE EXCLUSIVE RIGHT TO USE "OFFICE", APART FROM THE MARK AS SHOWN.

INT. CL. 16/U.S. CLS. 2, 5, 22, 23, 29, 37, 38 AND 50

FOR PUBLICATIONS, NAMELY, USER MANUALS, INSTRUCTION GUIDES, REFERENCE GUIDES, BOOKS ABOUT COMPUTER SYSTEMS AND COMPUTER PROGRAMS; PENS.

FIRST USE 6-30-2001; IN COMMERCE 6-30-2001.

ELEMENTS CORRECTED  
OWNER NAME

2,865,672. REG. 7-20-2004. MATTEL, INC. (DELAWARE CORPORATION) 333 CONTINENTAL BLVD., EL SEGUNDO, CA, 902455012, SN 78-151,474. FILED 8-6-2002. PRINCIPAL REGISTER.

## B-DAY

INT. CL. 28/U.S. CLS. 22, 23, 38 AND 50  
FOR TOYS, GAMES AND PLAYTHINGS, NAMELY, TOY VEHICLES AND ACCESSORIES THEREFOR.  
FIRST USE 11-0-2003; IN COMMERCE 11-0-2003.

ELEMENTS CORRECTED  
MARK

2,866,289. REG. 7-27-2004. CHARTER PARTNERS USA, INC. (NEW JERSEY CORPORATION) 33 RUPELL ROAD, HAMPTON, NJ, 08827, SN 76-517,529. FILED 5-28-2003. PRINCIPAL REGISTER.

## THE POWER OF SHARED KNOWLEDGE

INT. CL. 35/U.S. CLS. 100, 101 AND 102  
FOR PROCUREMENT, NAMELY, PURCHASING GROUP INSURANCE FOR OTHERS.

FIRST USE 10-24-2002; IN COMMERCE 10-24-2002.

INT. CL. 41/U.S. CLS. 100, 101 AND 107

FOR EDUCATIONAL SERVICES, NAMELY, [CONDITIONING] \* CONDUCTING\* CLASSES, SEMINARS, AND CONFERENCES IN THE FIELD OF INSURANCE.

FIRST USE 10-24-2002; IN COMMERCE 10-24-2002.

ELEMENTS CORRECTED  
GOODS/SERVICES

2,870,581. REG. 8-3-2004. YANKEE CANDLE COMPANY, INC., THE (MASSACHUSETTS CORPORATION) POST OFFICE BOX 110, SOUTH DEERFIELD, MA, 01373, SN 78-206,889. FILED 1-24-2003. PRINCIPAL REGISTER.

## HOUSEWARMER

INT. CL. 11/U.S. CLS. 13, 21, 23, 31 AND 34

FOR ELECTRICAL FRAGRANCE DISPENSERS.

FIRST USE 6-20-2003; IN COMMERCE 6-20-2003.

ELEMENTS CORRECTED  
CITIZENSHIP

TM 684

OFFICIAL GAZETTE

NOV 2, 2004

2,872,571. REG. 8-10-2004. EASTMAN EDUCATIONAL ASSOCIATES, INC. (CALIFORNIA CORPORATION) 416 EAST GRAND AVENUE, ESCONDIDO, CA, 92025, SN 78-134,401. FILED 6-10-2002. PRINCIPAL REGISTER.

FOR WHOLESALE DISTRIBUTORSHIP SERVICES FEATURING EDUCATIONAL MATERIALS OF OTHERS WHICH ARE DESIGNED FOR USE BY TEACHERS AND STUDENTS IN PRE-KINDERGARTEN THROUGH GRADE 8.  
FIRST USE 1-1-2003; IN COMMERCE 1-1-2004.

## **OKAPI EDUCATIONAL MATERIALS**

ELEMENTS CORRECTED  
GOODS/SERVICES  
INTERNATIONAL CLASS(ES)

NO CLAIM IS MADE TO THE EXCLUSIVE RIGHT TO USE "EDUCATIONAL MATERIALS", APART FROM THE MARK AS SHOWN.  
INT. CL. 35/U.S. CLS. 100, 101 AND 102

\* \* \* \* \*

# TRADEMARK REGISTRATIONS—NEW CERTIFICATES

New Certificates issued under section 7(d) of the Trademark Act of 1946 for the unexpired term of the original registrations.

725,711. BEST. U.S. CL. 50. BEST STAMP & MANUFACTURING COMPANY AKA BEST MANUFACTURING COMPANY, KANSAS CITY, MO. REG. 12-26-1961. NEW CERT. SEC. 7(D) TO BEST SIGN SYSTEMS, INC., MONTROSE, CO.

2,598,281. POLLO CAMPERO. INT. CL. 42. CAMPERO INTERNATIONAL, S.A., NIVEL 12, GUATEMALA. REG. 7-23-2002. NEW CERT. SEC. 7(D) TO REGISTRANT.

---

2,450,587. PLAYSTREAM. INT. CLS. 38, 39 AND 42. PLAYSTREAM, LLC, WEST HOLLYWOOD, CA. REG. 5-15-2001. NEW CERT. SEC. 7(D) TO REGISTRANT.

---

2,657,605. PLAYSTREAM.COM. INT. CLS. 38, 39 AND 42. PLAYSTREAM, LLC, WEST HOLLYWOOD, CA. REG. 12-10-2002. NEW CERT. SEC. 7(D) TO REGISTRANT.

\* \* \* \* \*

This page is intentionally blank

# INDEX OF REGISTRANTS

NOV 2, 2004

(Registered; Renewed; Canceled; Amended, Corrected, etc.; New Certificates; 12c Publications.)

The designation "U.S. Cl." appearing in this section refers to the U.S. class in effect prior to Sep. 1, 1973 rather than the international class which applies to applications filed on or after that date. For adoption of international classification see notice in the OFFICIAL GAZETTE of Jun. 26, 1973 (911 O.G. TM 210).

@POS.COM, INC., SAN JOSE, CA:  
2,898,854, PUB. 8-10-2004. MULTIPLE CLASS, INT. CLS. 35 AND 39.

A & J CHEESE COMPANY, INC., UPLAND, CA:  
2,121,801, CANC. INT. CL. 29.

A & J DISTRIBUTORS INC., ELK GROVE VILLAGE, IL:  
2,899,883, PUB. 8-10-2004. INT. CL. 9.

A & W RESTAURANTS, INC., LOUISVILLE, KY:  
2,900,144, INT. CL. 30.

A AND G, INC., CHICAGO, IL:  
1,605,715, COR. INT. CL. 25.

A I M, LLC, BELLEAIR BLUFFS, FL:  
2,122,189, CANC. INT. CL. 17.

A NATURAL DIFFERENCE INC., COOPER CITY, FL:  
2,898,731, PUB. 8-10-2004. MULTIPLE CLASS, INT. CLS. 3 AND 44.

A.A.G. STUCCHI S.P.A., 23854 OLGINATE (LECCO), ITALY:  
2,898,694, PUB. 8-10-2004. MULTIPLE CLASS, INT. CLS. 9 AND 11.

A.E. STALEY MANUFACTURING COMPANY, DECATUR, IL:  
2,898,929, PUB. 8-10-2004. INT. CL. 30.

A.G. EDWARDS & SONS, INC., ST. LOUIS, MO:  
2,900,897, INT. CL. 36.

A.K.A. SAUNDERS, INC., BERKELEY, CA, DBA TERRA NOVA:  
1,833,082, REN. 9-24-04. INT. CL. 3.

A.R.T. OF NEW YORK AND NEW JERSEY, MOUNTAIN LAKES, NJ:  
2,121,528, CANC. INT. CL. 9.

A.S.P. INC., SAN ANTONIO, TX, DBA SHOW TECHNOLOGY PRODUCTIONS:  
2,824,173, CANC. INT. CL. 35.

A+ MEDICAL PRODUCTS, INC., NEWTON, MA:  
2,122,048, CANC. INT. CL. 10.

A-MARK PRECIOUS METALS, INC., SANTA MONICA, CA:  
2,121,981, CANC. INT. CL. 36.

A-1 HOMES GROUP, INC., AUBURN HILLS, MI:  
1,313,998, REN. 9-22-04. INT. CL. 42.

A-1 PLANK & SCAFFOLD MANUFACTURING, INC., HAYS, KS:  
1,872,214, REN. 9-22-04. INT. CL. 6.

AAON, INC., TULSA, OK:  
1,911,250, REN. 9-22-04. INT. CL. 11.

AARON INVESTMENT COMPANY, GREENVILLE, DE, AARON RENTS, INC., ATLANTA, GA:  
989,180, REN. 9-20-04. U.S. CL. 101 (INT. CL. 42).

ABB AB, VASTERAS, SWEDEN:  
2,900,143, INT. CL. 9.

ABBOTT LABORATORIES, ABBOTT PARK, IL:  
2,900,555, MULTIPLE CLASS, INT. CLS. 9 AND 10.

ABEL AUTOMATICS, INC., CAMARILLO, CA:  
2,121,273, CANC. INT. CL. 28.

ABRAMS GENTILE ENTERTAINMENT, INC., NEW YORK, NY TO LEWIS GALOOB TOYS, INC., SOUTH SAN FRANCISCO, CA:  
2,209,926, COR. INT. CL. 28.

ABSOLUTE COATINGS, INC., NEW ROCHELLE, NY:  
2,122,336, CANC. INT. CL. 2.

ABSOLUTE R. S.V.P. INC, SHOREVIEW, MN:  
2,899,337, PUB. 3-23-2004. INT. CL. 41.

ABSOLUTELY AFFORDABLE HOMES, INC., RUTLAND, VT:  
2,121,414, CANC. INT. CL. 36.

AC NIELSON (US), INC., SCHAUMBURG, IL:  
2,845,367, COR. INT. CL. 35.

ACCESSORY SPECIALTIES, INC., YONKERS, NY:  
1,276,705, AM. MULTIPLE CLASS, INT. CLS. 6, 11, 20 AND 21.

ACCO WORLD CORPORATION, LINCOLNSHIRE, IL:  
768,944, REN. 9-21-04. U.S. CL. 2 (INT. CL. 16).

ACCOR, 91000 EVRY, FRANCE, SOCIETE FINANCIERE DE GESTION ET D'INVESTISSEMENTS IMMOBILIERS ET HOTELIERS "SOFITEL", PARIS 9, FRANCE:  
995,968, REN. 9-20-04. U.S. CL. 100 (INT. CL. 42).

ACCORD SERVICES, INC., KANSAS CITY, KS:  
1,337,207, REN. 9-21-04. INT. CL. 39.

ACCREDITATION ALLIANCE OF CAREER SCHOOLS AND COLLEGES, ARLINGTON, VA, DBA ACCREDITING COMMISSION OF CAREER SCHOOLS AND COLLEGES OF TECHNOLOGY:  
2,120,814, CANC. INT. CL. 42.  
2,121,412, CANC. INT. CL. 42.

ACCUPOST, INC., PETALUMA, CA:  
2,122,178, CANC. INT. CL. 39.

ACCURIDE CORPORATION, EVANSVILLE, IN:  
2,900,510, INT. CL. 12.

ACCUSIL, INC., MERRILLVILLE, IN:  
1,810,774, CANC. INT. CL. 17.

ACELL, INC., JESSUP, MD:  
2,899,341, PUB. 8-10-2004. INT. CL. 5.  
2,899,342, PUB. 8-10-2004. INT. CL. 10.

ACKERLEY PARTNERS LLC, SEATTLE, WA:  
2,899,949, PUB. 8-10-2004. INT. CL. 36.

ACME CARTOON COMPANY, INC., DALLAS, TX:  
1,261,201, CANC. INT. CL. 41.

ACME FOOD SALES, INC., SEATTLE, WA:  
1,827,581, REN. 9-19-04. INT. CL. 29.  
1,828,429, REN. 9-20-04. INT. CL. 29.

ACOUSTIC ZEN TECHNOLOGIES, SAN MARCOS, CA:  
2,899,377, PUB. 9-30-2003. INT. CL. 9.

ACTIMED LABORATORIES, INC., BURLINGTON, NJ:  
2,121,927, CANC. INT. CL. 5.

ACTION WINDOOR TECHNOLOGY, INC., CARROLLTON, TX:  
2,899,764, PUB. 8-10-2004. INT. CL. 6.  
2,899,765, PUB. 8-10-2004. INT. CL. 19.

ACTIVAR, INC., BLOOMINGTON, MN:  
2,898,583, PUB. 8-10-2004. MULTIPLE CLASS, INT. CLS. 9 AND 20.

ACTIVE VOICE CORPORATION, SEATTLE, WA:  
2,120,745, CANC. INT. CL. 9.

ACTIVE VOICE, LLC, SEATTLE, WA:  
1,342,265, REN. 9-22-04. INT. CL. 9.

ACTIVISION, INC., SANTA MONICA, CA, ACTIVISION, INC., MOUNTAIN VIEW, CA:  
1,289,150, REN. 9-22-04. INT. CL. 28.

ACTIVX BIOSCIENCES, INC., LA JOLLA, CA:  
2,900,111, INT. CL. 42.

ACTMEDIA, INC., NORWALK, CT:  
2,122,415, CANC. INT. CL. 35.

ACUSHNET COMPANY, FAIRHAVEN, MA:  
316,118, REN. 9-18-04. U.S. CL. 22 (INT. CL. 28).

- ACUSHNET COMPANY, NEW BEDFORD, MA:  
1,261,043, CANC. INT. CL. 28.
- ACX, LLC, ALEXANDRIA, VA:  
2,900,340, INT. CL. 38.
- ADC TELECOMMUNICATIONS, INC., EDEN PRAIRIE, MN:  
1,833,148, REN. 9-23-04, INT. CL. 9.
- ADHESIVE PACKAGING SPECIALTIES INC., PEABODY, MA:  
1,326,999, REN. 9-18-04, MULTIPLE CLASS, INT. CLS. 20 AND 35.
- ADOPT-A-SCHOOL, INC., WINTER PARK, FL:  
2,121,082, CANC. MULTIPLE CLASS, INT. CLS. 16 AND 25.
- ADRIENNE VITTADINI LLC, ENFIELD, CT:  
2,900,327, INT. CL. 35.
- ADS PROPERTIES CORP., BURLINGTON, VT:  
1,811,563, CANC. INT. CL. 24.
- ADVANCE MERCHANDISING COMPANY, INC., ROANOKE, VA, LARALEV, INC., WILMINGTON, DE:  
1,850,319, REN. 9-18-04, INT. CL. 16.
- ADVANCE MERCHANDISING COMPANY, INC., ROANOKE, VA:  
2,899,629, PUB. 12-30-2003, INT. CL. 35.  
2,899,630, PUB. 2-24-2004, INT. CL. 35.
- ADVANCED CASINO SYSTEMS CORPORATION, EGG HARBOR TOWNSHIP, NJ:  
2,898,515, PUB. 7-29-2003, INT. CL. 9.
- ADVANCED MEDICAL OPTICALS, INC., IRVINE, CA, ALLERGAN, INC., IRVINE, CA:  
1,848,047, REN. 9-20-04, INT. CL. 5.
- ADVANCED MODERN TECHNOLOGIES CORPORATION, LOS ANGELES, CA:  
2,899,224, PUB. 8-10-2004, INT. CL. 11.
- ADVANCED MULTIMEDIA DEVICES INC., HICKSVILLE, NY:  
2,899,063, PUB. 8-10-2004, INT. CL. 9.  
2,899,064, PUB. 8-10-2004, INT. CL. 9.  
2,899,065, PUB. 8-10-2004, INT. CL. 9.
- ADVANCED PAIN MANAGEMENT & REHABILITATION, P.C., VIRGINIA BEACH, VA:  
2,899,705, PUB. 8-10-2004, INT. CL. 44.
- ADVANCED PHOTONICS TECHNOLOGIES AG, 83052 BRUCKMUHL-HEUFELD, FED REP GERMANY:  
2,900,053, INT. CL. 11.
- ADVANCED PLANT PHARMACEUTICALS, INC., NEW YORK, NY:  
2,899,450, PUB. 4-27-2004, INT. CL. 5.
- ADVANCED RESEARCH AND TECHNOLOGY INSTITUTE, INC., BLOOMINGTON, IN:  
2,899,117, PUB. 8-10-2004, INT. CL. 44.
- ADVANCED TECHNOLOGY CORPORATION, THE, KANSAS CITY, MO:  
1,260,893, CANC. INT. CL. 12.
- ADVANCETEL DIRECT, LLC, AUBURN, ME:  
2,900,380, INT. CL. 35.
- ADVANSTAR COMMUNICATIONS INC., CLEVELAND, OH:  
2,121,592, CANC. INT. CL. 16.
- ADVANTAGE ENGINEERING, INC., GREENWOOD, IN:  
1,876,508, REN. 9-20-04, INT. CL. 11.
- ADVOCARE INTERNATIONAL, L.L.C., CARROLLTON, TX:  
2,899,362, PUB. 8-10-2004, INT. CL. 5.
- AEGIS ENTERTAINMENT, INC., CA, AEGIS ENTERTAINMENT, INC., CA:  
1,823,708, REN. 9-22-04, INT. CL. 16.
- AEGON USA, INC., CEDAR RAPIDS, IA:  
1,850,417, REN. 9-20-04, INT. CL. 36.
- AERO PRODUCTS INTERNATIONAL, INC., WAUCONDA, IL, RMF/DLO GROUP, INC., WEST NEWTON, MA:  
1,848,849, REN. 9-20-04, MULTIPLE CLASS, INT. CLS. 20 AND 28.
- AERO RECORDS & TITLE CO., JACKSONVILLE, FL:  
2,899,189, PUB. 8-10-2004, MULTIPLE CLASS, INT. CLS. 35, 36 AND 42.
- AEROBICS AND FITNESS ASSOCIATION OF AMERICA, SHERMAN OAKS, CA:  
2,900,132, INT. CL. 41.  
2,900,920, INT. CL. 41.
- AFC ENTERPRISES, INC., ATLANTA, GA, AMERICA'S FAVORITE CHICKEN COMPANY, ATLANTA, GA:  
1,823,416, REN. 9-18-04, INT. CL. 42.
- AFFILIATED FOODS, INC., AMARILLO, TX:  
1,309,474, REN. 9-24-04, INT. CL. 42.
- AFFINITY GROUP, INC., VENTURA, CA, CAMP COAST TO COAST, INC., ENGLEWOOD, CO:  
1,871,532, REN. 9-19-04, MULTIPLE CLASS, INT. CLS. 35 AND 42.
- AFFINIUM PHARMACEUTICALS, INC., TORONTO, ONTARIO, CANADA:  
2,898,569, PUB. 8-10-2004, INT. CL. 42.
- AFM CORPORATION, EXCELSION, MN:  
1,845,599, REN. 9-20-04, INT. CL. 17.
- AFRISOUL MUSIC INTERNATIONAL, LC, SILVER SPRING, MD:  
2,898,690, PUB. 8-10-2004, INT. CL. 9.
- AGCO CORPORATION, DULUTH, GA, HESSTON CORPORATION, HESSTON, KS:  
992,458, REN. 9-22-04, U.S. CL. 23 (INT. CL. 7).
- AGCO CORPORATION, DULUTH, GA:  
1,850,791, REN. 9-24-04, INT. CL. 28.  
1,852,875, REN. 9-24-04, INT. CL. 7.
- AGERE SYSTEMS INC., ALLENTOWN, PA:  
2,900,538, INT. CL. 9.  
2,900,539, INT. CL. 9.
- AGILENT TECHNOLOGIES, INC., PALO ALTO, CA, SCOPE COMMUNICATIONS, INC., NORTHBORO, MA:  
1,849,132, REN. 9-24-04, INT. CL. 9.
- AGILENT TECHNOLOGIES, INC., PALO ALTO, CA:  
2,899,971, PUB. 8-10-2004, INT. CL. 9.
- AGP/GENTECH INC., LINDEN, NJ:  
761,529, CANC. U.S. CL. 5.
- AGRI LABORATORIES, LTD., ST. JOSEPH, MO:  
2,898,876, PUB. 8-10-2004, INT. CL. 5.
- AGROINDUSTRIA GUADALAJARA SA DE CV, CAPILLA DE GUADALUPE, JALISCO, MEXICO:  
2,121,311, CANC. INT. CL. 33.
- AGUAS, RAMIRO, CHAMPAIGN, IL:  
2,786,034, COR. INT. CL. 42.
- AHLBERG ROAD PRODUCTIONS, LLC, MINNEAPOLIS, MN:  
2,900,680, INT. CL. 28.
- AHLBORN EQUIPMENT, INC., SAYNER, WI:  
1,291,978, REN. 9-19-04, INT. CL. 9.
- AHOLD RETAIL SERVICES AG, KLOSTERS, SWITZERLAND:  
2,900,751, INT. CL. 29.
- AIR AMBULANCE NETWORK, INC., MIAMI, FL:  
1,261,192, CANC. INT. CL. 39.
- AIRLETTE MANUFACTURING CORPORATION, LANTANA, FL:  
2,899,187, PUB. 8-10-2004, INT. CL. 11.
- AIRPEAK COMMUNICATIONS, LLC, RENO, NV:  
2,899,952, PUB. 8-10-2004, INT. CL. 38.
- AIRTOUCH COMMUNICATIONS OF CALIFORNIA, SAN FRANCISCO, CA:  
2,121,958, CANC. INT. CL. 38.
- AIRTOUCH COMMUNICATIONS, INC., SAN FRANCISCO, CA:  
2,121,949, CANC. INT. CL. 38.
- AKATAKE ENGINEERING CO., LTD., SHIZUOKA PREFECTURE, JAPAN:  
1,811,419, CANC. INT. CL. 7.
- AKINS FOODS, INC., SPOKANE, WA:  
2,122,232, CANC. INT. CL. 30.
- ALADAN CORPORATION, DOTHAN, AL TO LRC PRODUCTS, LTD., BROXBORNE, HERTS., STATELESS:  
1,810,630, CANC. INT. CL. 10.
- ALADDIN INDUSTRIES, INCORPORATED, NASHVILLE, TN:  
2,122,460, CANC. INT. CL. 21.



- ALANRIC FOOD DISTRIBUTORS, INC., THOROFARE, NJ,  
ALANRIC FOOD DISTRIBUTORS, INC., WESTVILLE, NJ,  
DBA A. CICCOTELLI & SONS:  
1,308,207. REN. 9-20-04. MULTIPLE CLASS, INT. CLS. 29  
AND 30.
- ALANRIC FOOD DISTRIBUTORS, INC., THOROFARE, NJ,  
CICCOTELLI, ALFRED M., JR., THOROFARE, NJ AND  
CICCOTELLI, PATRICK M., THOROFARE, NJ:  
1,895,233. REN. 9-18-04. INT. CL. 30.
- ALANRIC FOOD DISTRIBUTORS, INC., THOROFARE, NJ:  
2,900,913. INT. CL. 30.
- ALASKA MULTIPLE LISTING SERVICE, INC., ANCHOR-  
RAGE, AK:  
2,899,324. PUB. 8-10-2004. INT. CL. 35.
- ALASKAN FUR COMPANY, OVERLAND PARK, KS:  
1,880,667. REN. 9-19-04. INT. CL. 25.
- ALBANY INTERNATIONAL CORP., ALBANY, NY:  
1,844,949. REN. 9-20-04. MULTIPLE CLASS, INT. CLS. 12,  
17 AND 19.
- ALBARRE LIMITED, ST. LOUIS, MO, DBA ALBARRE  
JEWELRY:  
1,290,508. REN. 9-19-04. INT. CL. 42.
- ALBERTO MODE-VERTRIEBS GMBH, 41056 MONCHEN-  
GLADBACH, FED REP GERMANY:  
2,819,118. COR. INT. CL. 25.
- ALBERTO MODE-VERTRIEBS GMBH, 41056 MONCHEN-  
LADBACH, FED REP GERMANY:  
2,820,901. COR. INT. CL. 25.
- ALBERTSON'S, INC., BOISE, ID, AMERICAN STORES  
COMPANY, SALT LAKE CITY, UT:  
1,856,064. REN. 9-18-04. INT. CL. 42.
- ALCONE COMPANY, INC., LONG ISLAND CITY, NY:  
2,899,142. PUB. 8-10-2004. INT. CL. 3.
- ALDA PHARMACEUTICALS CORP., NEW WESTMINSTER,  
BC, CANADA:  
2,898,506. PUB. 8-10-2004. INT. CL. 5.
- ALDILA, INC., POWAY, CA:  
1,847,770. REN. 9-20-04. INT. CL. 28.
- ALEXANDER & ALEXANDER SERVICES INC., OWINGS  
MILLS, MD:  
2,120,898. CANC. INT. CL. 36.
- ALFA-LAVAL AGRI, INC., KANSAS CITY, MO:  
1,811,418. CANC. INT. CL. 7.
- ALFREDO INTERNATIONAL, INC., LAKE BUENA VISTA,  
FL:  
1,291,542. REN. 9-18-04. INT. CL. 42.
- ALI CORPORATION, HSINCHU, TAIWAN:  
1,831,154. REN. 9-18-04. INT. CL. 9.
- ALI CORPORATION, CHU TUNG JEN, HSINCHU HSIENG,  
TAIWAN:  
2,900,509. INT. CL. 9.
- ALI KHAN DESIGNS, INC., NEW YORK, NY:  
2,899,399. PUB. 8-10-2004. INT. CL. 14.
- ALIENWARE CORPORATION, MIAMI, FL:  
2,898,655. PUB. 8-10-2004. INT. CL. 9.
- ALIMAK AB, SKELLEFTEA, SWEDEN:  
2,898,540. PUB. 8-10-2004. INT. CL. 7.
- ALIMENTOS NATURALES SABROZA, S.A. DE C.V., 67114  
CIUDAD GUADALUPE, NUEVO LEON, MEXICO:  
2,900,154. INT. CL. 30.
- ALL AMERICAN HOMES, LLC, ELKHART, IN:  
2,900,259. INT. CL. 19.
- ALL BLACKS B.V., THE, 1181 MZ AMSTELVEEN, NETHER-  
LANDS:  
2,122,029. CANC. INT. CL. 9.
- ALL COMEDY NETWORKS, INC., HOLLYWOOD, CA:  
2,899,153. PUB. 8-10-2004. INT. CL. 41.
- ALL KITCHENS, INC., BOISE, ID:  
2,150,338. AM. INT. CL. 29.
- ALL PRO EXERCISE PRODUCTS, INC., LONGBOAT KEY,  
FL:  
1,311,211. REN. 9-22-04. INT. CL. 28.
- ALL-AMERICAN CRAFTS, INC., NEW YORK, NY:  
1,260,913. CANC. INT. CL. 16.
- ALLEGIANCE CORPORATION, MCGAW, IL, AMERICAN  
HOSPITAL SUPPLY CORPORATION, EVANSTON, IL:  
1,316,800. REN. 9-22-04. INT. CL. 10.
- ALLEMAN, PATRICK J., LAFAYETTE, LA:  
1,874,217. REN. 9-23-04. INT. CL. 37.
- ALLESON OF ROCHESTER, INC., ROCHESTER, NY, DBA  
DON ALLESON ATHLETIC:  
1,811,586. CANC. INT. CL. 25.
- ALLIANCE ATLANTIS COMMUNICATIONS, INC., TOR-  
ONTO, CANADA. ALLIANCE COMMUNICATIONS COR-  
PORATION, TORONTO, ONTARIO M4W 3C7, CANADA:  
1,862,046. REN. 9-19-04. INT. CL. 41.
- ALLIANCE MEDICAL, INC., RUSSELLVILLE, MO:  
1,851,065. REN. 9-24-04. INT. CL. 10.
- ALLIANCE OF NORTHEASTERN SECTIONS OF THE  
AMERICAN ASSOCIATION FOR CLINICAL CHEMIS-  
TRY, INC., YORK, PA:  
2,899,899. PUB. 8-10-2004. INT. CL. 41.
- ALLIANT TECHSYSTEMS INC., HOPKINS, MN, HER-  
CULES POWDER COMPANY, WILMINGTON, DE:  
99,306. REN. 9-22-04. U.S. CL. 9 (INT. CL. 13).
- ALLIED DOMEQ INTERNATIONAL HOLDINGS BV, 4870  
AR ETTEN-LEUR, NETHERLANDS:  
1,291,454. REN. 9-22-04. INT. CL. 33.  
1,852,552. REN. 9-22-04. INT. CL. 33.
- ALLIED DOMEQ INTERNATIONAL HOLDINGS BV, ET-  
TEN-LEUR, NETHERLANDS:  
2,898,451. PUB. 8-10-2004. INT. CL. 33.
- ALLIED DOMEQ SPIRITS & WINE LIMITED, BS13 8AR  
BRISTOL, ENGLAND, GEORGE BALLANTINE & SON,  
LIMITED, DUMBARTON, SCOTLAND:  
1,846,912. REN. 9-19-04. INT. CL. 33.
- ALLMICRO, INC., CLEARWATER, FL:  
2,121,162. CANC. INT. CL. 9.
- ALLSO INTERNATIONAL MARKETING PTY LIMITED,  
CAMPSIE, NEW SOUTH WALES, AUSTRALIA:  
2,900,147. INT. CL. 9.
- ALLSUP, INC., BELLEVILLE, IL:  
2,899,795. PUB. 8-10-2004. INT. CL. 36.
- ALM PROPERTIES, INC., NEWARK, DE:  
2,898,667. PUB. 8-10-2004. MULTIPLE CLASS, INT. CLS.  
16 AND 41.
- ALMARK PRODUCTS, INC, DELRAY BEACH, FL:  
2,899,634. PUB. 12-23-2003. INT. CL. 5.
- ALOE VERA OF AMERICA, INC., DALLAS, TX:  
2,899,208. PUB. 8-10-2004. INT. CL. 3.
- ALOS AG. 8803 RUSCHLIKON, SWITZERLAND:  
1,291,944. REN. 9-24-04. INT. CL. 9.
- ALOYS F. DORNBRACHT GMBH & CO. KG, D-58640  
LSERLOHN, FED REP GERMANY:  
2,843,339. COR. MULTIPLE CLASS, INT. CLS. 9, 11, 20  
AND 21.
- ALPHA ASSOCIATES, INC., WOODBRIDGE, NJ:  
1,011,166. REN. 9-22-04. U.S. CL. 42 (INT. CL. 24).
- ALSTOM, 75116, PARIS, FRANCE:  
2,898,433. PUB. 8-10-2004. MULTIPLE CLASS, INT. CLS.  
1, 6, 7, 9, 11, 12, 13, 16, 17, 19, 21, 24, 35, 36, 37, 38, 39,  
40, 41 AND 42.
- ALUMINUM COMPANY OF AMERICA, PITTSBURGH, PA:  
2,122,421. CANC. INT. CL. 19.
- ALVAREZ, GASTON A., TEMECUECLA, CA:  
2,900,898. INT. CL. 41.
- AMCO CORPORATION, CHICAGO, IL:  
2,122,447. CANC. INT. CL. 21.
- AMERI-FACT, INC., CHICAGO, IL:  
2,122,318. CANC. INT. CL. 42.
- AMERICA ONLINE, INC., DULLES, VA:  
2,900,121. INT. CL. 38.  
2,900,122. INT. CL. 42.
- AMERICA-ISRAEL CULTURAL FOUNDATION, INC., NEW  
YORK, NY:  
1,865,972. REN. 9-19-04. INT. CL. 36.
- AMERICA'S DRIVE-IN CORP., WICHITA, KS:  
2,864,941. COR. INT. CL. 43.
- AMERICA'S SECOND HARVEST, CHICAGO, IL, SECOND  
HARVEST, CHICAGO, IL:  
1,898,322. REN. 9-22-04. INT. CL. 42.
- AMERICAN ASSOCIATION OF INDIVIDUAL INVESTORS,  
INC., CHICAGO, IL:  
2,900,932. INT. CL. 16.

- AMERICAN AUTOMOBILE ASSOCIATION, INC., HEATHROW, FL:  
2,900,596, MULTIPLE CLASS, INT. CLS. 35, 36, 37, 38, 39, 42, 43 AND 45.
- AMERICAN BILTRITE INC., WELLESLEY HILLS, MA:  
1,311,108. REN. 9-20-04. INT. CL. 19.
- AMERICAN CAPITAL RESOURCES, INC., HACKENSACK, NJ:  
1,811,092, CANC. INT. CL. 36.
- AMERICAN COLLEGE OF CARDIOLOGY, BETHESDA, MD:  
2,900,905, MULTIPLE CLASS, INT. CLS. 41 AND 44.
- AMERICAN CONTAINMENT SYSTEMS, INC., BOSTON, MA:  
2,121,664, CANC. INT. CL. 6.  
2,121,665, CANC. INT. CL. 6.
- AMERICAN CYANAMID COMPANY, WAYNE, NJ:  
761,543, CANC. U.S. CL. 6.
- AMERICAN DIGITAL NETWORK, SAN DIEGO, CA:  
2,120,833, CANC. INT. CL. 42.  
2,120,835, CANC. INT. CL. 42.
- AMERICAN DREAMCARD, LLC, LAS VEGAS, NV:  
2,900,637, INT. CL. 35.
- AMERICAN EXCELSIOR COMPANY, ARLINGTON, TX:  
1,810,788, CANC. INT. CL. 19.
- AMERICAN FIDELITY ASSURANCE COMPANY, OKLAHOMA CITY, OK:  
2,900,924, INT. CL. 36.
- AMERICAN INFORMATION SYSTEMS, INC., CHICAGO, IL:  
2,122,554, CANC. INT. CL. 42.  
2,122,555, CANC. INT. CL. 9.
- AMERICAN INSTITUTE OF PHYSICS, COLLEGE PARK, MD, AKA AIP:  
2,900,477, INT. CL. 42.
- AMERICAN INTERNATIONAL GROUP, INC., NEW YORK, NY:  
598,896. REN. 9-18-04. U.S. CL. 102 (INT. CL. 36).
- AMERICAN INTERNATIONAL INDUSTRIES, CITY OF COMMERCE, CA:  
1,285,718. REN. 9-19-04. INT. CL. 3.
- AMERICAN INTERNATIONAL INDUSTRIES, CITY OF COMMERCE, CA, KERON LABORATORIES, LTD., COLLEGE POINT, NY:  
1,293,728. REN. 9-22-04. INT. CL. 3.
- AMERICAN LEBANESE SYRIAN ASSOCIATED CHARITIES, INC., MEMPHIS, TN:  
2,900,800, INT. CL. 36.
- AMERICAN LICORICE CO., BEND, OR:  
1,903,727. REN. 9-21-04. INT. CL. 30.
- AMERICAN MARKETING ASSOCIATION NEW YORK CHAPTER INC., NEW YORK, NY:  
1,308,373. REN. 9-19-04. INT. CL. 41.
- AMERICAN MEMORIAL LIFE INSURANCE COMPANY, HOUSTON, TX, LAURENTIAN CAPITAL CORPORATION, RAPID CITY, SD:  
1,869,929. REN. 9-18-04. INT. CL. 36.
- AMERICAN METAL CHEMICAL CORPORATION, MEDINA, OH:  
1,908,459. REN. 9-18-04. INT. CL. 17.
- AMERICAN MULTI-CINEMA, INC., KANSAS CITY, MO:  
2,899,745, PUB. 8-10-2004. INT. CL. 30.
- AMERICAN MUSSEL HARVESTERS, INC., NORTH KINGSTOWN, RI:  
2,899,157, PUB. 8-10-2004. INT. CL. 31.
- AMERICAN NATIONAL RED CROSS, THE, WASHINGTON, DC, AKA THE AMERICAN RED CROSS:  
1,851,860. REN. 9-18-04. INT. CL. 5.
- AMERICAN OUTDOOR PRODUCTS, INC., BOULDER, CO, ACTION PRODUCTS INTERNATIONAL, INC., OCALA, FL:  
1,848,002. REN. 9-22-04. MULTIPLE CLASS, INT. CLS. 29 AND 30.
- AMERICAN PET PRODUCTS, INC., FAYETTEVILLE, NC:  
1,289,970. REN. 9-19-04. INT. CL. 11.
- AMERICAN POWER CONVERSION CORPORATION, WEST KINGSTON, RI, AMERICAN POWER CONVERSION, WEST KINGSTON, RI:  
1,877,456. REN. 9-22-04. INT. CL. 9.
- AMERICAN RAG STOCK CO., INC., BIRMINGHAM, AL, AKA AMERICAN SANITARY WIPERS CO.:  
1,260,959, CANC. INT. CL. 21.
- AMERICAN RECREATION PRODUCTS, INC., ST. LOUIS, MO, SLUMBERJACK, INC., LOS ANGELES, CA:  
1,289,067. REN. 9-18-04. INT. CL. 20.  
1,291,069. REN. 9-18-04. MULTIPLE CLASS, INT. CLS. 20, 22 AND 25.
- AMERICAN RECREATION PRODUCTS, INC., ST. LOUIS, MO:  
1,898,130. REN. 9-22-04. INT. CL. 20.  
2,900,140, INT. CL. 19.
- AMERICAN SOCIETY FOR CLINICAL PATHOLOGY, INC., CHICAGO, IL:  
2,898,791, PUB. 8-10-2004. INT. CL. 35.
- AMERICAN SOCIETY FOR THE PREVENTION OF CRUELTY TO ANIMALS, THE, NEW YORK, NY:  
2,121,933, CANC. INT. CL. 14.
- AMERICAN SOCIETY OF MECHANICAL ENGINEERS, THE, NEW YORK, NY:  
1,302,141. REN. 9-18-04. U.S. CL. A.
- AMERICAN SOCIETY OF MECHANICAL ENGINEERS; THE, NEW YORK, NY:  
1,311,377. REN. 9-18-04. INT. CL. 35.
- AMERICAN STANDARD INC., PISCATAWAY, NJ:  
1,864,584. REN. 9-22-04. INT. CL. 9.
- AMERICAN STORES COMPANY, SALT LAKE CITY, UT:  
2,122,097, CANC. INT. CL. 42.
- AMERICAN TELEGRAM CORPORATION, SACRAMENTO, CA:  
2,898,593, PUB. 8-10-2004. MULTIPLE CLASS, INT. CLS. 36 AND 38.
- AMERICAN TORT REFORM ASSOCIATION INCORPORATED, WASHINGTON, DC:  
2,899,735, PUB. 8-10-2004. INT. CL. 35.
- AMERICAN YOUTH HOSTELS, INC., WASHINGTON, DC:  
1,811,346, CANC. MULTIPLE CLASS, INT. CLS. 39, 41 AND 42.
- AMERICAN YOUTH HOSTELS, INC., SILVER SPRING, MD:  
2,899,561, PUB. 8-10-2004. INT. CL. 41.
- AMERICANA FOODS, INC., LITTLE ROCK, AR:  
1,399,745, CANC. INT. CL. 30.
- AMERIFIT NUTRITION, BLOOMFIELD, CT:  
2,899,660, PUB. 1-6-2004. INT. CL. 5.
- AMEROCK CORPORATION, FREEPORT, IL TO NEWELL OPERATING COMPANY, FREEPORT, IL:  
1,811,408, CANC. INT. CL. 6.
- AMES TRUE TEMPER PROPERTIES, INC., WILMINGTON, DE, O. AMES CO., PARKERSBURG, WV:  
1,900,370. REN. 9-19-04. INT. CL. 8.
- AMFAC HAWAII, LLC, HONOLULU, HI, AMFAC/JMB HAWAII, INC., HONOLULU, HI:  
1,849,922. REN. 9-21-04. INT. CL. 18.
- AMIANITIT TECHNOLOGY SERVICES GMBH, VELDEN, AUSTRIA:  
2,899,504, PUB. 8-10-2004. MULTIPLE CLASS, INT. CLS. 6 AND 19.
- AMISH COUNTRY GAZEBO, MANHEIM, PA:  
1,818,970. REN. 9-22-04. INT. CL. 19.
- AMONG FRIENDS RECORDS INC., ELMONT, NY:  
2,898,824, PUB. 8-10-2004. MULTIPLE CLASS, INT. CLS. 9 AND 41.
- AMPC , INC., AMES, IA, DBA AMERICAN PROTEIN CORPORATION:  
2,898,477, PUB. 4-10-2001. INT. CL. 5.
- AMPCO II, LLC, RIVERHEAD, NY:  
2,900,525, MULTIPLE CLASS, INT. CLS. 29 AND 31.  
2,900,528, INT. CL. 31.
- AMPEX MEDIA CORPORATION, REDWOOD CITY, CA:  
1,810,487, CANC. INT. CL. 9.
- AMTECH CORPORATION, DALLAS, TX:  
2,122,391, CANC. INT. CL. 9.
- AMWAY HOTEL CORPORATION, ADA, MI:  
1,291,543. REN. 9-22-04. INT. CL. 42.

- AMY'S KITCHEN, INC., PETALUMA, CA:  
1,885,120. REN. 9-22-04. MULTIPLE CLASS, INT. CLS. 29 AND 30.  
1,885,121. REN. 9-22-04. MULTIPLE CLASS, INT. CLS. 29 AND 30.  
1,893,229. REN. 9-22-04. MULTIPLE CLASS, INT. CLS. 29 AND 30.
- AMYLIN PHARMACEUTICALS, INC., SAN DIEGO, CA:  
1,866,180. REN. 9-23-04. INT. CL. 5.
- ANABIL USA INC., NEW YORK, NY:  
2,899,248. PUB. 8-10-2004. INT. CL. 25.
- ANABOLIC LABORATORIES, INC., LAKE FOREST, CA:  
2,900,786. INT. CL. 5.
- ANALPA INC, TAMPA, FL:  
2,899,441. PUB. 8-10-2004. INT. CL. 25.
- ANDERSON; ERIC C., BILLINGS, MT:  
1,285,765. REN. 9-21-04. INT. CL. 5.
- ANDERSON, SARA, SEATTLE, WA:  
2,122,393. CANC. INT. CL. 21.
- ANDERSON, THOMAS HARRY, MOORHEAD, MN:  
2,121,391. CANC. INT. CL. 20.
- ANDERSON, THOMAS STEPHEN, LAKE ST LOUIS, MO:  
2,899,513. PUB. 8-10-2004. INT. CL. 41.
- ANDERSONS AGRISERVICES, INC., CHAMPION, IL, SEA-COAST LABORATORIES, INC., DAYTON, NJ:  
1,850,482. REN. 9-24-04. INT. CL. 1.
- ANDIS COMPANY, STURTEVANT, WI:  
2,899,963. PUB. 8-10-2004. INT. CL. 8.
- ANDREU, JOSÉ CARLOS ANTÓN, 03330-CREVILLENTE, ALICANTE, SPAIN:  
2,900,095. INT. CL. 25.
- ANDY'S FROZEN CUSTARD, INC., SPRINGFIELD, MO:  
2,899,215. PUB. 8-10-2004. INT. CL. 30.
- ANGEL MINISTRIES, RALEIGH, NC:  
2,898,595. PUB. 12-17-2002. INT. CL. 9.
- ANGIODYNAMICS, INC., QUEENSBURY, NY:  
2,900,404. INT. CL. 10.
- ANGUS CHEMICAL COMPANY, BUFFALO GROVE, IL, COMMERCIAL SOLVENTS CORPORATION, NEW YORK, NY:  
779,689. REN. 9-22-04. U.S. CL. 6 (INT. CL. 1).
- ANGUS CHEMICAL COMPANY, BUFFALO GROVE, IL, ABBOTT LABORATORIES, NORTH CHICAGO, IL:  
1,005,134. REN. 9-22-04. INT. CL. 1.
- ANGUS CHEMICAL COMPANY, BUFFALO GROVE, IL:  
1,293,620. REN. 9-22-04. INT. CL. 1.
- ANHEUSER-BUSCH, INCORPORATED, ST. LOUIS, MO:  
2,121,799. CANC. INT. CL. 32.  
2,121,800. CANC. INT. CL. 32.
- ANITA, G, INC., COSTA MESA, CA:  
2,898,430. PUB. 8-10-2004. INT. CL. 25.
- ANSCOTT CHEMICAL INDUSTRIES, INC., WAYNE, NJ:  
2,122,000. CANC. INT. CL. 3.
- ANSELL HEALTHCARE PRODUCTS INC., RED BANK, NJ, INTERMARKET LATEX, INC., CLEVELAND, OH:  
1,282,221. REN. 9-20-04. INT. CL. 9.
- ANSELL PROTECTIVE PRODUCTS INC., RED BANK, NJ, ANSELL EDMONT INDUSTRIAL INC., COSHOCTON, OH:  
1,865,221. REN. 9-18-04. INT. CL. 9.
- ANSELL PROTECTIVE PRODUCTS, INC., RED BANK, NJ, EDMONT MANUFACTURING COMPANY, COSHOCTON, OH:  
595,619. REN. 9-18-04. U.S. CL. 39 (INT. CL. 25).
- ANSELL PROTECTIVE PRODUCTS, INC., RED BANK, NJ:  
777,071. REN. 9-18-04. U.S. CL. 39 (INT. CL. 25).
- ANSPACH EFFORT, INC., THE, PALM BEACH GARDENS, FL:  
1,860,678. REN. 9-22-04. MULTIPLE CLASS, INT. CLS. 7 AND 10.  
1,860,829. REN. 9-22-04. INT. CL. 10.
- ANTHONY CAPUTO, LLC, BRIDGEHAMPTON, NY:  
2,900,237. INT. CL. 25.
- ANTISTATIC INDUSTRIES, INC., HACKENSACK, NJ:  
1,848,385. REN. 9-18-04. INT. CL. 2.
- ANTON/BAUER, INC., SHELTON, CT:  
1,268,358. REN. 9-20-04. INT. CL. 9.  
1,271,613. REN. 9-20-04. INT. CL. 9.
- APARTMENTSOURCE.COM, INC., NEW YORK, NY:  
2,898,490. PUB. 2-26-2002. INT. CL. 36.
- APOTHECARY PRODUCTS, INC., BURNSVILLE, MN:  
1,333,076. REN. 9-18-04. INT. CL. 9.
- APPLERA CORPORATION, ROCKVILLE, MD FROM CELERA CORPORATION, ROCKVILLE, MD:  
2,900,036. INT. CL. 42.
- APPLIED GLOBAL TECHNOLOGIES, INC., ROCKLEDGE, FL:  
2,899,454. PUB. 8-10-2004. MULTIPLE CLASS, INT. CLS. 9, 38 AND 42.
- APPLIED LEARNING TECHNOLOGIES, INC., NASHVILLE, TN:  
2,122,265. CANC. INT. CL. 9.
- APPLIED MINDS, INC., GLENDALE, CA:  
2,900,090. INT. CL. 42.
- APPTEC LABORATORY SERVICES, INC., ST. PAUL, MN:  
2,899,004. PUB. 4-20-2004. INT. CL. 42.
- APS TECHNOLOGIES, KANSAS CITY, MO:  
2,121,946. CANC. INT. CL. 9.
- ARCH UK BIOCIDES LIMITED, CASTLEFORD, WEST YORKSHIRE WF10 2JT, UNITED KINGDOM, IMPERIAL CHEMICAL INDUSTRIES LIMITED, MILLBANK, LONDON SW1P 3JF, ENGLAND:  
989,977. REN. 9-21-04. U.S. CL. 6 (INT. CL. 1).
- ARDMORE FARMS, DELAND, FL:  
1,285,490. REN. 9-18-04. INT. CL. 32.
- ARGENT MORTGAGE COMPANY, LLC, ORANGE, CA:  
2,898,968. PUB. 2-24-2004. INT. CL. 36.
- ARGUS CHEMICAL CORPORATION, BROOKLYN, NY:  
780,503. REN. 9-18-04. U.S. CL. 6 (INT. CL. 1).
- ARIBA, INC., SUNNYVALE, CA:  
2,900,052. INT. CL. 42.
- ARIES SYSTEMS CORPORATION, ANDOVER, MA:  
1,810,493. CANC. INT. CL. 9.
- ARISTA COMPANY, THE, WINSTON-SALEM, NC:  
1,261,129. CANC. INT. CL. 36.
- ARISTACOM INTERNATIONAL, INC., ALAMEDA, CA:  
2,104,945. CANC. INT. CL. 9.
- ARIYA LOGISTIC SOLUTIONS, LLC, WOODLAND HILLS, CA:  
2,899,076. PUB. 8-10-2004. INT. CL. 35.
- ARIZANT HEALTHCARE INC., EDEN PRAIRIE, MN:  
2,900,879. INT. CL. 10.  
2,900,880. INT. CL. 10.
- ARJO WIGGINS LIMITED, BASINGSTOKE, HAMPSHIRE,, ENGLAND:  
2,121,033. CANC. INT. CL. 16.
- ARK INTERFACE II, INC., SEATTLE, WA:  
2,120,956. CANC. INT. CL. 9.
- ARK-LES CORPORATION, STOUGHTON, MA, ARK-LES SWITCH CORPORATION, WATERTOWN, MA:  
990,739. REN. 9-18-04. U.S. CL. 21 (INT. CL. 9).
- ARMORVISION PLASTICS & GLASS, LOS ANGELES, CA:  
1,850,331. REN. 9-22-04. INT. CL. 19.
- ARMSTRONG ENERGY RESOURCES, L.P., BUTLER, PA:  
2,121,106. CANC. INT. CL. 42.
- ARNOLDO MONDADORI EDITORE S.P.A., 20122 MILAN (MI), ITALY:  
2,898,681. PUB. 8-10-2004. MULTIPLE CLASS, INT. CLS. 9, 16 AND 38.  
2,898,682. PUB. 8-10-2004. MULTIPLE CLASS, INT. CLS. 9, 16 AND 38.
- ARROW GROUP INDUSTRIES, INC., BREESE, IL:  
1,291,825. REN. 9-22-04. INT. CL. 6.
- ARROW-MAGNOLIA INTERNATIONAL, INC., DALLAS, TX, CHEMCO CHEMICAL CO., DALLAS, TX:  
989,938. REN. 9-20-04. MULTIPLE CLASS, U.S. CLS. 4 (INT. CL. 3), 6 (INT. CL. 5), 12 (INT. CL. 3) AND 52 (INT. CL. 3).
- ART FOUNDRY JOURNAL, INC., WELCHES, OR:  
2,122,573. CANC. INT. CL. 16.
- ART ON VIEW, PHILADELPHIA, PA:  
2,121,277. CANC. INT. CL. 42.
- ARTECH HOUSE, INC., NORWOOD, MA:  
1,847,596. REN. 9-18-04. INT. CL. 9.

- ARTIC CAT INC, THIEF RIVER FALLS, MN, ARCTCO, INC., THIEF RIVER FALLS, MN:  
1,851,415. REN. 9-22-04. INT. CL. 12.
- ARTIFACT ENTERTAINMENT, INC., MESA, AZ:  
2,900,545, MULTIPLE CLASS, INT. CLS. 9 AND 42.  
2,900,546, MULTIPLE CLASS, INT. CLS. 9 AND 42.
- ARTISTRY IN MOTION, INC., VAN NUYS, CA:  
2,171,649, CANC. INT. CL. 41.
- ARTOS ENGINEERING COMPANY, WAUKESHA, WI:  
990,085. REN. 9-21-04. U.S. CL. 23 (INT. CL. 7).
- ARTRIX DIGITAL DESIGN, INC., SARASOTA, FL:  
2,121,262, CANC. MULTIPLE CLASS, INT. CLS. 41 AND 42.
- ARVCO CONTAINER CORPORATION, KALAMAZOO, MI:  
2,899,758, PUB. 8-10-2004. INT. CL. 42.
- ASAHI KASEI FIBERS CORPORATION, OSAKA, JAPAN:  
1,849,343. REN. 9-23-04. INT. CL. 24.  
1,851,105. REN. 9-22-04. INT. CL. 23.
- ASAHI/AMERICA, INC., MALDEN,, MA, FLUID CONTROLS, INC., HUNTSVILLE, AL:  
1,884,110. REN. 9-18-04. INT. CL. 42.
- ASHLAND OIL, INC., ASHLAND, KY:  
1,261,305, CANC. INT. CL. 42.
- ASHLEY FOOD COMPANY, INC., SUDBURY, MA:  
1,872,687. REN. 9-18-04. INT. CL. 30.
- ASIA COMPANY, SAN FRANCISCO, CA, DBA KING'S AND KING'S GINSENG CO.:  
1,810,970, CANC. INT. CL. 30.
- ASICS CORPORATION, KOBE 650-8555, JAPAN:  
2,899,250, PUB. 8-10-2004. INT. CL. 25.
- ASPEN MARKETING, INC., WEST CHICAGO, IL:  
2,120,881, CANC. INT. CL. 30.
- ASPHERICON GMBH, D-07745 JENA, FED REP GERMANY:  
2,898,619, PUB. 8-10-2004. MULTIPLE CLASS, INT. CLS. 9 AND 40.
- ASSET INTERNATIONAL, INC., GREENWICH, CT:  
1,910,845. REN. 9-23-04. INT. CL. 16.
- ASSOCIATED DRY GOODS CORPORATION, NEW YORK, NY:  
761,669, CANC. U.S. CL. 39.
- ASSOCIATED HARDWOODS, INC., HICKORY, NC:  
2,899,379, PUB. 8-10-2004. INT. CL. 36.
- ASSOCIATED MERCHANDISING CORPORATION (AMC), NEW YORK, NY:  
1,290,249. REN. 9-23-04. INT. CL. 25.
- ASSOCIATION DE STATIONS D'ESSAIS FRANCAISES D'APPAREILS ELECTRIQUES (ASEFA), 92260 FONTENAY AUX ROSES, FRANCE:  
2,120,661, CANC. MULTIPLE CLASS, INT. CLS. 7, 9, 16 AND 42.
- ASSOCIATION FOR VASCULAR ACCESS, DRAPER, UT:  
2,899,154, PUB. 8-10-2004. MULTIPLE CLASS, INT. CLS. 16 AND 35.  
2,899,155, PUB. 8-10-2004. INT. CL. 16.  
2,900,926, MULTIPLE CLASS, INT. CLS. 16 AND 35.
- AST RESEARCH, INC., IRVINE, CA TO SAMSUNG ELECTRONICS CO., LTD., SUWON-CITY, KYUNGKI-DO, REPUBLIC OF KOREA:  
1,810,516, CANC. INT. CL. 9.
- ASTRAZENECA UK LIMITED, LONDON, UNITED KINGDOM:  
2,784,308, COR. INT. CL. 5.
- ASTRO-MED, INC., WEST WARWICK, RI, ASTRO-MED, INC., WEST WARWICK, RI:  
1,300,256. REN. 9-22-04. INT. CL. 9.
- AT&T CORP., NEW YORK, NY, AMERICAN TELEPHONE AND TELEGRAPH COMPANY, NEW YORK, NY:  
1,850,428. REN. 9-22-04. INT. CL. 38.
- ATEECO, INC., SHENANDOAH, PA:  
2,900,508, INT. CL. 30.
- ATHARI, AMIR SHAHAB, HOUSTON, TX:  
2,899,323, PUB. 8-10-2004. INT. CL. 38.
- ATLANTA SNAPSEAL LTD., MARIETTA, GA:  
2,900,929, INT. CL. 20.
- ATLANTIC CITY COIN & SLOT SERVICE COMPANY, INC., PLEASANTVILLE, NJ:  
2,898,900, PUB. 8-10-2004. INT. CL. 35.
- ATLANTIC COAST CONFERENCE, GREENSBORO, NC:  
1,856,027. REN. 9-20-04. INT. CL. 41.  
1,865,877. REN. 9-24-04. INT. CL. 28.
- ATLANTIC RICHFIELD COMPANY, LISLE, IL:  
1,852,550. REN. 9-18-04. INT. CL. 32.
- ATLANTIC RICHFIELD COMPANY, LOS ANGELES, CA:  
2,121,969, CANC. MULTIPLE CLASS, INT. CLS. 41 AND 42.
- ATLAS LIFT TRUCK RENTALS & SALES, INC., SCHILLER PARK, IL:  
1,892,064. REN. 9-18-04. INT. CL. 12.
- ATMEL CORPORATION, SAN JOSE, CA:  
2,900,141, INT. CL. 9.
- ATOFINA PETROCHEMICALS, INC., HOUSTON, TX:  
1,851,264. REN. 9-23-04. INT. CL. 4.  
2,898,732, PUB. 8-10-2004. INT. CL. 1.
- ATOI-USA, LLC, LAS VEGAS, NV:  
2,899,796, PUB. 8-10-2004. MULTIPLE CLASS, INT. CLS. 29 AND 30.  
2,899,797, PUB. 8-10-2004. MULTIPLE CLASS, INT. CLS. 29 AND 30.
- ATS AUTOMATION TOOLING SYSTEMS INC., CAMBRIDGE, ONTARIO, CANADA:  
1,849,784. REN. 9-21-04. INT. CL. 7.
- ATS SERVICES, INC., JACKSONVILLE, FL:  
1,811,034, CANC. INT. CL. 35.
- ATTINGER, BILLY, J., SAN DIEGO, CA AND Z STRATEGIES, INC., SAN DIEGO, CA:  
2,900,536, MULTIPLE CLASS, INT. CLS. 16, 21 AND 25.
- ATWOOD MOBILE PRODUCTS, INC., ROCKFORD, IL:  
774,436. REN. 9-22-04. U.S. CL. 19 (INT. CLS. 7, 12, 22 AND 27).
- AU AG SMITH, INC., WEST DENNIS, MA:  
1,303,644. REN. 9-18-04. INT. CL. 14.  
1,303,645. REN. 9-18-04. INT. CL. 14.
- AUGERSCOPE, INC., SYLMAR, CA:  
1,260,806, CANC. INT. CL. 7.
- AUGUST STORCK KG, BERLIN, FED REP GERMANY:  
2,899,503, PUB. 8-10-2004. INT. CL. 30.
- AUSQUI, NESTOR ENRIQUE, SANTA FE, ARGENTINA:  
2,703,492, CANC. INT. CL. 41.
- AUSTAD'S GOLF, INC., SIOUX FALLS, SD:  
2,899,934, PUB. 8-10-2004. INT. CL. 28.
- AUSTRALIAN GOLD, INC, INDIANAPOLIS, IN, ETS, INC., INDIANAPOLIS, IN:  
1,872,175. REN. 9-22-04. INT. CL. 3.
- AUTOCAM CORPORATION, KENTWOOD, MI:  
2,898,652, PUB. 8-10-2004. MULTIPLE CLASS, INT. CLS. 7, 9 AND 12.
- AUTOMATED MAILMEN, INC., BEACON FALLS, CT, ROSA, RICHARD, BEACON FALLS, CT:  
1,844,772. REN. 9-20-04. INT. CL. 39.
- AUTOMATIC EQUIPMENT MANUFACTURING COMPANY, PENDER, NE:  
2,898,780, PUB. 8-10-2004. INT. CL. 12.  
2,898,781, PUB. 8-10-2004. INT. CL. 12.
- AUTOMATION PROGRAMMING, INC., PITTSBURGH, PA:  
2,121,505, CANC. INT. CL. 9.
- AUTOMATIZACION Y MODERNIZACION INDUSTRIAL, S.A. DE C.V., 64000 MONTERREY, N. L., MEXICO:  
1,850,546. REN. 9-24-04. INT. CL. 9.
- AUTOMED CORPORATION, RICHMOND, B.C. V6V 2J2, CANADA:  
2,121,624, CANC. INT. CL. 10.
- AUTOMOBILE CLUB OF SOUTHERN CALIFORNIA, COSTA MESA, CA:  
2,178,028, CANC. INT. CL. 9.
- AUTONOMY CORPORATION PLC, CAMBRIDGE CB4 0WS, UNITED KINGDOM:  
2,898,481, PUB. 8-10-2004. MULTIPLE CLASS, INT. CLS. 9 AND 42.
- AVALON PUBLISHING GROUP INCORPORATED, EMERYVILLE, CA:  
2,899,743, PUB. 8-10-2004. INT. CL. 16.  
2,899,744, PUB. 8-10-2004. INT. CL. 16.
- AVENTIS-PHARMA S.A., 92160 ANTONY, FRANCE:  
1,295,586. REN. 9-22-04. INT. CL. 5.

AVERMEDIA TECHNOLOGIES, INC., CHUNG-HO CITY, TAIPEI HSIEN, TAIWAN:  
 2,900,500, INT. CL. 9.  
 AVERY DENNISON CORPORATION, PASADENA, CA:  
 774,991, REN. 9-19-04. U.S. CL. 37 (INT. CL. 16).  
 AVERY MEDICAL FASHIONS, INC., NORWALK, CT:  
 2,121,697, CANC. INT. CL. 25.  
 AVIAWEST RESORTS INC., NANOOSE BAY, CANADA:  
 2,899,717, PUB. 8-10-2004. INT. CL. 37.  
 AVNET, INC., GREAT NECK, NY:  
 2,121,284, CANC. INT. CL. 35.  
 AVURE TECHNOLOGIES INCORPORATED, KENT, WA:  
 2,900,617, INT. CL. 40.  
 AWAY.COM, INC., WASHINGTON, DC:  
 2,121,296, CANC. INT. CL. 41.  
 AXIS HEALTHCARE COMMUNICATIONS LLC, YARDELEY, PA:  
 2,900,336, MULTIPLE CLASS, INT. CLS. 35 AND 41.  
 AYDIN CORPORATION, HORSHAM, PA TO AYDIN DISPLAYS, INC, HORSHAM, PA:  
 1,811,428, CANC. INT. CL. 9.  
 AZIENDA AGRICOLA BASTIANICH, 7 PREMARIACCO (UD) 33040, ITALY:  
 2,898,924, PUB. 8-10-2004. INT. CL. 33.  
 AZIMUT-BENETTI S.P.A., VIAREGGIO, ITALY:  
 2,898,880, PUB. 8-10-2004. INT. CL. 12.  
 B & B VENTURES, INC., CHANHASSEN, MN:  
 2,900,753, INT. CL. 35.  
 B & G CHEMICALS & EQUIPMENT COMPANY, INC., DALLAS, TX:  
 2,898,938, PUB. 2-10-2004. INT. CL. 7.  
 B. SHACKMAN & COMPANY, INC., GALESBURG, MI:  
 1,288,979, REN. 9-18-04. INT. CL. 28.  
 1,288,979, CANC. INT. CL. 16.  
 B. WELL NATURALLY, INC., PLAINVIEW, NY, DBA DR. B. WELL NATURALLY:  
 1,811,295, CANC. INT. CL. 42.  
 B.B. TRESOR INC., SAINTE-JULIE, QUEBEC, CANADA:  
 2,898,742, PUB. 8-10-2004. INT. CL. 28.  
 B-DRY SYSTEMS, INC., AKRON, OH:  
 2,900,170, INT. CL. 37.  
 B'S INTERNATIONAL, TOKYO 150-0047, JAPAN:  
 1,858,672, REN. 9-22-04. INT. CL. 25.  
 BAB SPORTS SA, SIERRE, SWITZERLAND:  
 2,900,517, MULTIPLE CLASS, INT. CLS. 9 AND 25.  
 BABCOCK & WILSOX COMPANY, THE, NEW ORLEANS, LA:  
 1,291,929, REN. 9-20-04. INT. CL. 9.  
 BACCARAT, 54120 BACCARAT, FRANCE:  
 2,898,501, PUB. 6-4-2002. MULTIPLE CLASS, INT. CLS. 3, 11, 14, 18 AND 21.  
 BAIRD MANUFACTURING COMPANY, TULSA, OK:  
 1,289,930, REN. 9-18-04. INT. CL. 9.  
 BAJO; RICARDO, WEST NEW YORK, NJ, DBA TITA DISTRIBUTION:  
 1,260,958, CANC. INT. CL. 20.  
 BAJO; RICHARDO, WEST NEW YORK, NJ, DBA TITA DISTRIBUTION:  
 1,260,917, CANC. INT. CL. 16.  
 BAKER, MARK F., NEW YORK, NY:  
 2,121,460, CANC. INT. CL. 42.  
 BALANCED BODY, INC., SACRAMENTO, CA:  
 2,900,766, INT. CL. 28.  
 2,900,767, INT. CL. 28.  
 BALCH, JOHN A., BAY VILLAGE, OH:  
 2,122,411, CANC. INT. CL. 35.  
 BALDENEGRO, LOUIS, LAS VEGAS, NV:  
 2,121,709, CANC. INT. CL. 38.  
 BALDWIN HARDWARE CORPORATION, READING, PA:  
 1,260,782, CANC. INT. CL. 6.  
 BALENCIAGA, 75116 PARIS, FRANCE:  
 2,898,603, PUB. 8-10-2004. INT. CL. 14.  
 BALL HORTICULTURAL COMPANY, WEST CHICAGO, IL:  
 1,002,986, REN. 9-18-04. INT. CL. 31.  
 2,900,841, INT. CL. 31.  
 BALLY SCHUHFABRIKEN AG, 5012 SCHONENWERD, SWITZERLAND:  
 1,810,840, CANC. INT. CL. 25.  
 BAM BAM LEAGUE, INC., ALTOONA, IA:  
 2,899,611, PUB. 12-30-2003. INT. CL. 41.  
 BANGS LABORATORIES, INC., FISHERS, IN, FLOW CYTOMETRY STANDARDS CORPORATION, CARRBORO, NC:  
 1,886,483, REN. 9-23-04. MULTIPLE CLASS, INT. CLS. 1 AND 5.  
 BANJO BUDDIES, INC., BURLINGTON, WI:  
 2,122,031, CANC. INT. CL. 28.  
 BANK OF AMERICA CORPORATION, CHARLOTTE, NC:  
 2,900,785, INT. CL. 36.  
 2,900,814, INT. CL. 36.  
 BANK ON IT RECORDS, INC., NEW ORLEANS, LA:  
 2,899,562, PUB. 8-10-2004. INT. CL. 41.  
 BANNER BANK, WALLA WALLA, WA:  
 2,900,468, INT. CL. 36.  
 BANNER PERSONNEL SERVICE, INC., CHICAGO, IL:  
 2,121,806, CANC. INT. CL. 35.  
 BAR-S FOODS CO., PHOENIX, AZ:  
 1,811,627, CANC. INT. CL. 29.  
 BARE FOOT GRAPHICS, INC., DELRAY BEACH, FL:  
 2,121,132, CANC. INT. CL. 42.  
 BAREFOOT FLOORING, INC., CASTLE HAYNE, NC:  
 2,898,901, PUB. 1-20-2004. INT. CL. 35.  
 BARILLA G. E. R. FRATELLI - SOCIETA PER AZIONI, PARMA, ITALY:  
 2,898,607, PUB. 7-15-2003. MULTIPLE CLASS, INT. CLS. 29 AND 30.  
 2,900,936, INT. CL. 30.  
 BARIX AG, ZÜRICH, SWITZERLAND:  
 2,899,352, PUB. 8-10-2004. MULTIPLE CLASS, INT. CLS. 9 AND 42.  
 BARLOW, DAVID, SEMINOLE, FL:  
 2,900,448, INT. CL. 20.  
 BARNES & NOBLE, INC., NEW YORK, NY:  
 2,899,910, PUB. 8-10-2004. MULTIPLE CLASS, INT. CLS. 6, 9, 11, 16, 18 AND 20.  
 BAROID TECHNOLOGY, INC., HOUSTON, TX:  
 2,122,401, CANC. INT. CL. 1.  
 BARREL SPORTSWEAR LTD., NEW YORK, NY:  
 1,261,009, CANC. INT. CL. 25.  
 1,261,010, CANC. INT. CL. 25.  
 BARRY GRANT, INC., DAHLONEGA, GA:  
 2,900,463, INT. CL. 7.  
 BARTEL, PAULINE C., WATERFORD, NY:  
 2,122,568, CANC. INT. CL. 41.  
 BARTHET FIRM, THE, MIAMI, FL:  
 2,900,829, INT. CL. 42.  
 BARTLEHIEM N.V., CURACAO, NETHERLD ANTILLES:  
 2,899,213, PUB. 8-10-2004. INT. CL. 25.  
 BARUH, BARRY F, DANVILLE, CA:  
 2,900,576, INT. CL. 37.  
 BASF AKTIENGESELLSCHAFT, D-67056 LUDWIGSHAFEN, FED REP GERMANY, BASF AKTIENGESELLSCHAFT, D-67056 LUDWIGSHAFEN, FED REP GERMANY:  
 988,696, REN. 9-18-04. U.S. CL. 5 (INT. CL. 1).  
 BASF AKTIENGESELLSCHAFT, LUDWIGSHAFEN, FED REP GERMANY:  
 1,267,492, REN. 9-18-04. INT. CL. 1.  
 1,275,665, REN. 9-18-04. INT. CL. 1.  
 1,276,603, REN. 9-18-04. INT. CL. 1.  
 BASF AKTIENGESELLSCHAFT, LUDWIGSHAFEN D-67056, FED REP GERMANY:  
 1,279,389, REN. 9-18-04. INT. CL. 1.  
 BASF AKTIENGESELLSCHAFT, LUDWIGSHAFEN, FED REP GERMANY:  
 1,279,440, REN. 9-18-04. INT. CL. 2.  
 1,285,690, REN. 9-18-04. INT. CL. 1.  
 BASF AKTIENGESELLSCHAFT, 38 LUDWIGSHAFEN AM RHEIN, FED REP GERMANY:  
 1,822,155, REN. 9-18-04. MULTIPLE CLASS, INT. CLS. 1 AND 4.  
 BASF CORPORATION, MOUNT OLIVE, NJ:  
 1,810,494, CANC. INT. CL. 9.  
 BASS PUBLIC LIMITED COMPANY, BURTON-ON-TRENT, ENGLAND:  
 2,120,866, CANC. INT. CL. 32.

- BASSETT FURNITURE INDUSTRIES, INC., BASSETT, VA:  
2,900,762, INT. CL. 35.
- BATH & BODY WORKS, INC., REYNOLDSBURG, OH:  
2,899,432, PUB. 9-30-2003, INT. CL. 4.
- BAUER MARKETING COMPANY, MEADOW VISTA, CA:  
2,120,715, CANC. INT. CL. 9.
- BAUER NIKE HOCKEY INC., ST-JEROME, QUEBEC, CA-  
NADA:  
2,852,388, COR. INT. CL. 28.
- BAUSCH & LOMB INCORPORATED, ROCHESTER, NY:  
2,122,213, CANC. INT. CL. 9.
- BAXTER INTERNATIONAL, INC., DEERFIELD, IL, BAX-  
TER TRAVENOL LABORATORIES, INC., DEERFIELD,  
IL:  
1,289,506, REN. 9-23-04, INT. CL. 9.
- BAY NETWORKS, INC., SANTA CLARA, CA:  
2,121,962, CANC. INT. CL. 9.
- BAYER AKTIENGESELLSCHAFT, LEVERKUSEN-BAYER-  
WERK, FED REP GERMANY:  
2,899,478, PUB. 1-20-2004, MULTIPLE CLASS, INT. CLS. 1  
AND 5.  
2,900,688, INT. CL. 5.  
2,900,779, INT. CL. 2.
- BAYER CROPSCIENCE INC., RESEARCH TRIANGLE  
PARK, NC, UNION CARBIDE CORPORATION, DAN-  
BURY, CT:  
1,291,760, REN. 9-22-04, INT. CL. 5.
- BAYER CROPSCIENCE LP, RESEARCH TRIANGLE PARK,  
NC:  
2,900,620, INT. CL. 1.
- BAYER CROPSCIENCE SA, LYON, FRANCE, CELANESE  
CORPORATION, NEW YORK, NY:  
1,286,298, REN. 9-18-04, INT. CL. 31.
- BAYERISCHE MOTOREN WERKE AKTIENGE-  
SELLSCHAFT, 80809 MUNICH, FED REP GERMANY:  
2,898,974, PUB. 4-27-2004, INT. CL. 12.  
2,898,975, PUB. 4-27-2004, INT. CL. 12.  
2,899,027, PUB. 6-1-2004, INT. CL. 12.  
2,899,028, PUB. 6-1-2004, INT. CL. 12.
- BAZAAR DEL MUNDO, INC., SAN DIEGO, CA:  
1,350,088, REN. 9-23-04, INT. CL. 42.
- BBA NONWOVENS SIMPSON VILLE, INC., SIMPSON-  
VILLE, SC:  
2,173,474, CANC. INT. CL. 5.
- BBDO WORLDWIDE INC., NEW YORK, NY:  
2,122,149, CANC. INT. CL. 35.
- BBE SOUND, INC., HUNTINGTON BEACH, CA, G & L  
MUSICAL PRODUCTS, INC., FULLERTON, CA:  
1,284,233, REN. 9-18-04, INT. CL. 15.
- BC HOLDINGS, LIMITED L.L.C., LIGHTHOUSE POINT, FL:  
2,121,301, CANC. INT. CL. 16.
- BCI BURKE COMPANY, LLC, FOND DU LAC, WI:  
2,898,897, PUB. 1-13-2004, INT. CL. 28.
- BEA SYSTEMS, INC., SAN JOSE, CA:  
2,899,761, PUB. 8-10-2004, INT. CL. 9.
- BEACH FILTER PRODUCTS, INC., GLEN ROCK, PA:  
1,875,894, REN. 9-18-04, INT. CL. 11.
- BEAD INDUSTRIES, INC., MILFORD, CT, BEAD CHAIN  
MANUFACTURING COMPANY, THE, BRIDGEPORT,  
CT:  
992,384, REN. 9-18-04, U.S. CL. 21 (INT. CL. 9).
- BEARDEN, DENNIS, HOUSTON, TX:  
2,900,038, INT. CL. 35.
- BEARINGS, INC., CLEVELAND, OH:  
2,122,193, CANC. INT. CL. 42.
- BEAUMONT PRODUCTS, INC., KENNESAW, GA:  
1,856,160, REN. 9-22-04, INT. CL. 3.
- BEAUTY CONCEPTS, INC., UPPER DARBY, PA:  
2,122,413, CANC. INT. CL. 42.
- BEAUTY ELEMENTS CORP., MIAMI, FL:  
2,899,235, PUB. 8-10-2004, INT. CL. 26.
- BECK, LEIF C., CONSHOHOCKEN, PA, DBA ADVISORY  
PUBLICATIONS:  
2,122,567, CANC. INT. CL. 16.
- BECKMAN COULTER, INC., FULLERTON, CA:  
2,900,671, MULTIPLE CLASS, INT. CLS. 1, 9 AND 10.
- BECTON, DICKINSON AND COMPANY, FRANKLIN  
LAKES, NJ:  
995,821, REN. 9-24-04, U.S. CL. 26 (INT. CL. 9).  
1,282,230, REN. 9-21-04, INT. CL. 9.  
1,302,410, REN. 9-23-04, INT. CL. 9.
- BEDAT & CO. LLC, SAN FRANCISCO, CA:  
2,899,021, PUB. 8-10-2004, INT. CL. 14.
- BEDROCK BILLIARDS, INC., WASHINGTON, DC:  
2,898,816, PUB. 1-13-2004, INT. CL. 41.
- BEDWETTERS IRRIGATION SERVICES, LLC., GRAYSON,  
GA:  
2,898,801, PUB. 8-10-2004, INT. CL. 37.
- BEEKLEY CORPORATION, THE, WST HARTFORD, CT:  
761,649, CANC. U.S. CL. 37.
- BEHM BLUEBERRY FARMS INC., WEST OLIVE, MI:  
1,261,089, CANC. INT. CL. 31.  
1,261,090, CANC. INT. CL. 31.
- BEHRINGWERKE AG, MARBURG, FED REP GERMANY:  
2,121,373, CANC. INT. CL. 5.
- BEIERSDORF AG, HAMBURG D-20253, FED REP GER-  
MANY, KENDALL COMPANY, THE, BOSTON, MA:  
596,032, REN. 9-22-04, U.S. CL. 44 (INT. CL. 5).
- BEILHARZ, GEORG RUDOLF, NEW SOUTH WALES 2039,  
AUSTRALIA:  
2,120,694, CANC. MULTIPLE CLASS, INT. CLS. 9 AND  
16.
- BEL-ART PRODUCTS, PEQUANNOCK, NJ:  
1,260,868, CANC. INT. CL. 10.
- BELDEN TECHNOLOGIES, INC., ST. LOUIS, MO:  
1,907,208, REN. 9-18-04, INT. CL. 9.  
2,899,359, PUB. 8-10-2004, INT. CL. 9.
- BELEGGINGSMAATSCHAPPIJ ELDAP B.V., 4817 KA BRE-  
DA, NETHERLANDS:  
2,900,133, INT. CL. 9.
- BELGRAVIA CAPITAL CORPORATION, IRVINE, CA:  
1,939,156, CANC. INT. CL. 36.
- BELL ATLANTIC CORPORATION, PHILADELPHIA, PA:  
2,121,449, CANC. MULTIPLE CLASS, INT. CLS. 9 AND  
38.
- BELL ATLANTIC NETWORK SERVICES, INC., ARLING-  
TON, VA:  
2,120,700, CANC. INT. CL. 38.
- BELL COMMUNICATIONS RESEARCH, INC., MORRIS-  
TOWN, NJ:  
2,122,172, CANC. INT. CL. 16.
- BELL, JACK ATKINS JR., FLOWERY BRANCH, GA, DBA  
J.A.BELL & ASSOCIATES:  
2,900,308, INT. CL. 8.
- BELLADONNA ENTERTAINMENT, LLC, WOODLAND  
HILLS, CA:  
2,899,071, PUB. 8-10-2004, INT. CL. 9.
- BELLEVILLE SHOE MANUFACTURING COMPANY, BEL-  
LEVILLE, IL:  
2,900,444, INT. CL. 25.
- BELOIT CORPORATION, BELOIT, WI:  
761,615, CANC. U.S. CL. 23.
- BELT-WAY SCALES, INC., ROCK FALLS, IL:  
1,827,344, REN. 9-23-04, INT. CL. 9.
- BELTIE, INC., LYMAN, ME:  
2,900,774, MULTIPLE CLASS, INT. CLS. 1 AND 31.
- BEN & JERRY'S HOMEMADE HOLDINGS, INC., BUR-  
LINGTON, VT, BEN AND JERRY'S HOMEMADE, INC.,  
WATERBURY, VT:  
1,841,106, REN. 9-18-04, MULTIPLE CLASS, INT. CLS. 36  
AND 42.
- BEN MYERSON CANDY CO., INC., CITY OF COMMERCE,  
CA:  
1,292,494, REN. 9-23-04, INT. CL. 30.
- BEN'S COOKIES (U.S.), INC., SALT LAKE CITY, UT:  
2,900,822, INT. CL. 35.
- BENCHMARK TECHNICAL SERVICES, INC., GLASTON-  
BURY, CT:  
2,121,789, CANC. INT. CL. 41.
- BENICIA INDUSTRIES HOLDING COMPANY, INC., BAL-  
TIMORE, MD:  
2,121,086, CANC. INT. CL. 39.

BERCHTOLD HOLDING GMBH, 78532 TUTTLINGEN, FED REP GERMANY, GEBRUDER MARTIN, TUTTLINGEN, FED REP GERMANY:  
1,292,017. REN. 9-22-04. INT. CL. 10.

BERGHOLD, JOSEPH P., LODI, CA, DBA BERGHOLD VINEYARDS AND BERGHOLD, KAY B., LODI, CA, DBA BERGHOLD VINEYARDS:  
2,714,394. COR. INT. CL. 33.

BERISON INDUSTRIES INC., MIDDLE VILLAGE, NY:  
2,122,485. CANC. INT. CL. 9.  
2,122,488. CANC. INT. CL. 9.

BERLEX LABORATORIES, INC., WAYNE, NJ:  
2,122,051. CANC. INT. CL. 41.

BERMIL INDUSTRIES CORPORATION, INWOOD, NY, DBA WASCOMAT OF AMERICA AND DBA WASCOMAT OF CANADA, LTD.:  
1,000,951. REN. 9-21-04. INT. CL. 7.

BERNARDAUD PORCELAINES DE LIMOGES, S.A., 87000 LIMOGES, FRANCE:  
2,120,903. CANC. INT. CL. 21.

BERTRANG FINANCIAL CORP., ONALASKA, WI:  
2,899,799. PUB. 8-10-2004. INT. CL. 36.

BESSENBACHER CO, THE, KANSAS CITY, MO:  
2,899,483. PUB. 8-10-2004. INT. CL. 9.

BEST FRIENDS, LLC, ROYAL OAK, MI:  
2,900,745. INT. CL. 20.

BEST STAMP & MANUFACTURING COMPANY, KANSAS CITY, MO, AKA BEST MANUFACTURING COMPANY TO BEST SIGN SYSTEMS, INC., MONTROSE, CO:  
725,711 NEW CERT. 11-2-2004. U.S. CL. 50.

BETA DERMACEUTICALS, INC., SAN ANTONIO, TX:  
2,900,186. MULTIPLE CLASS, INT. CLS. 3 AND 5.

BETCO CORPORATION, TOLEDO, OH:  
1,867,899. REN. 9-18-04. MULTIPLE CLASS, INT. CLS. 2, 3 AND 5.

BETCO CORPORATION, THE, TOLEDO, OH:  
761,527. CANC. U.S. CL. 4.

BETTA PRODUCTS, INC., OXNARD, CA:  
2,121,421. CANC. INT. CL. 16.

BEVERLY BREMER SILVER SHOP, INC., ATLANTA, GA, DBA BEVERLY BREMER SILVER SHOP:  
1,819,284. REN. 9-21-04. INT. CL. 42.

BEZDETNY, EDWARD, FERNDALE, MI:  
2,900,851. INT. CL. 3.

BFI BUSINESS FINANCE, SAN JOSE, CA:  
2,899,329. PUB. 8-10-2004. INT. CL. 9.

BI PROPERTIES I, INC., GREENSBORO, NC:  
777,463. REN. 9-22-04. U.S. CL. 42 (INT. CL. 24).

BIANCHI INTERNATIONAL, TEMECULA, CA, BIANCHI INTERNATIONAL, TEMECULA, CA:  
1,292,146. REN. 9-22-04. INT. CL. 13.

BIBLIOGRAPHISCHES INSTITUT & F.A. BROCKHAUS AKTIENGESSELLSCHAFT, MANNHEIM, FED REP GERMANY, BIBLIOGRAPHISCHES INSTITUT A.G., MANNHEIM, FED REP GERMANY:  
1,335,443. REN. 9-20-04. MULTIPLE CLASS, INT. CLS. 16 AND 41.

BIFODAN A/S, 3390 HUNDESTED, DENMARK:  
2,121,572. CANC. INT. CL. 5.  
2,121,723. CANC. MULTIPLE CLASS, INT. CLS. 5 AND 31.

BIG BROTHERS-BIG SISTERS OF AMERICA, PHILADELPHIA, PA:  
1,290,482. AM. INT. CL. 42.

BIG D INDUSTRIES, INC., OKLAHOMA CITY, OK, LE FEVRE CHEMICAL COMPANY, OKLAHOMA CITY, OK:  
790,567. REN. 9-22-04. U.S. CL. 6 (INT. CL. 1).

BIG FEATS ENTERTAINMENT, L.P., ALLEN, TX:  
2,196,130. CANC. MULTIPLE CLASS, INT. CLS. 16, 21 AND 25.

BIG HEAD TODD AND THE MONSTERS, INC., BOULDER, CO:  
1,775,535. REN. 9-22-04. INT. CL. 41.

BIG ORANGE ARMY, THE, MARYVILLE, TN:  
2,899,370. PUB. 1-13-2004. INT. CL. 25.

BIGBANGWIDTH, INC., EDMONTON, ALBERTA, CANADA:  
2,898,505. PUB. 8-10-2004. MULTIPLE CLASS, INT. CLS. 9 AND 42.

BIGHAM BROTHERS, INC., LUBBOCK, TX, LILLISTON CORPORATION, ALBANY, GA:  
1,310,794. REN. 9-23-04. INT. CL. 7.

BIKE & SPORT, LTD., PONTIAC, MI, DBA ENDLESS ROAD PRODUCTS:  
1,260,887. CANC. MULTIPLE CLASS, INT. CLS. 12 AND 25.

BILANGE, INC., NEW YORK, NY TO SCA BATH AND BODY, INC., NEW YORK, NY:  
1,810,387. CANC. INT. CL. 3.

BIMEDIA, INC., RIVERSIDE, MO, INTERNATIONAL MULTIFOODS CORPORATION, MINNEAPOLIS, MN:  
991,099. REN. 9-22-04. INT. CL. 5.

BIOCHEMICAL/DIAGNOSTICS, INC., BRENTWOOD, NY:  
1,312,144. REN. 9-18-04. INT. CL. 9.

BIOGENETICS, INC., NASSAU, BAHAMAS:  
2,899,916. PUB. 8-10-2004. INT. CL. 5.

BIOHIT OYJ, HELSINKI, FINLAND:  
2,899,364. PUB. 8-10-2004. INT. CL. 9.

BIOMET, INC., WARSAW, IN:  
2,900,663. MULTIPLE CLASS, INT. CLS. 5 AND 10.

BIOMUNE COMPANY, LENEXA, KS, AKA BIOMUNE CO.:  
2,900,263. INT. CL. 5.

BIOPRO, INC., PORT HURON, MI FROM IMPLANT MANUFACTURING AND TESTING, INC., PORT HURON, MI:  
2,898,437. PUB. 8-10-2004. INT. CL. 10.

BIRCHETT & ASSOCIATES, INC., MEMPHIS, TN:  
2,900,535. MULTIPLE CLASS, INT. CLS. 16 AND 42.

BIRD & CRONIN, INC., EAGAN, MN:  
1,302,742. REN. 9-19-04. INT. CL. 25.

BIRKEBAEK MOBEL EXPORT A/S, 6740 BRAMMING, DENMARK:  
2,120,712. CANC. INT. CL. 20.

BLACK & DECKER CORPORATION, THE, TOWSON, MD:  
2,900,672. INT. CL. 21.

BLACK HAT SERVICES, INC., TULSA, OK:  
1,261,164. CANC. INT. CL. 37.

BLACK WARRIOR WIRELINE CORP., COLUMBUS, MS:  
2,899,147. PUB. 8-10-2004. MULTIPLE CLASS, INT. CLS. 37 AND 42.

BLACKER & DECKER CORPORATION, THE, TOWSON, MD:  
1,853,481. REN. 9-23-04. INT. CL. 6.

BLADE PRODUCTIONS, INC., GAINESVILLE, FL:  
1,849,631. REN. 9-19-04. INT. CL. 41.

BLAIN SUPPLY, INC., JANESVILLE, WI:  
2,900,334. INT. CL. 6.

BLAKE & WANG P.A., LOS ANGELES, CA:  
2,899,911. PUB. 8-10-2004. INT. CL. 42.

BLAKE, ROBERT TAKEDA, SAN DIEGO, CA:  
2,121,611. CANC. INT. CL. 36.

BLAKELY, SARA, ATLANTA, GA:  
2,900,843. INT. CL. 25.

BLANCHARD ABRASIVES, INC., MARYSVILLE, WA:  
1,260,802. CANC. INT. CL. 7.

BLANKS COLOR IMAGING, INC., DALLAS, TX:  
2,122,429. CANC. INT. CL. 42.

BLANSETT & HALFAKER, SPRINGFIELD, MO:  
2,122,353. CANC. INT. CL. 38.

BLEAMAN, DAVID M., SCOTTSDALE, AZ:  
2,900,860. INT. CL. 3.

BLEAMAN, DAVID, M., SCOTTSDALE, AZ:  
2,900,859. INT. CL. 3.

BLENNERHASSETT CORPORATION, PARKERSBURG, WV:  
2,900,284. INT. CL. 43.

BLINDS TO GO INC., MONTREAL, CANADA:  
2,900,211. INT. CL. 20.

BLISS WORLD LLC, BROOKLYN, NY:  
2,900,162. INT. CL. 3.

BLISTEX INC., OAK BROOK, IL:  
1,782,636. REN. 9-22-04. INT. CL. 16.  
1,831,866. REN. 9-24-04. INT. CL. 5.  
2,900,727. INT. CL. 5.

BLOCK AND COMPANY, INC., WHEELING, IL:  
2,120,917. CANC. INT. CL. 22.

- BLOCK DRUG COMPANY, INC., WEST TRENTON, NJ:  
2,899,876, PUB. 8-10-2004. INT. CL. 3.
- BLOMET, JOEL, 95760 VALMONDOIS, FRANCE:  
2,833,475, COR. MULTIPLE CLASS, INT. CLS. 1, 3, 5, 10 AND 11.
- BLOOMSTON, STACY BOYD, BIRMINGHAM, AL:  
2,899,030, PUB. 8-10-2004. INT. CL. 25.
- BLOW, INC., PEMBROKE PINES, FL:  
2,900,460, INT. CL. 44.
- BLUE AGAVE SOFTWARE, INC., CAMBRIDGE, MA:  
2,899,584, PUB. 8-10-2004. INT. CL. 9.  
2,899,585, PUB. 8-10-2004. INT. CL. 9.
- BLUE BELL, INC., GREENSBORO, NC:  
761,663, CANC. U.S. CL. 39.
- BLUE BIRD INVESTMENT CORPORATION, WILMINGTON, DE:  
2,900,706, INT. CL. 12.  
2,900,707, INT. CL. 12.
- BLUE CUBE STRATEGIC, TIBURON, CA:  
2,899,388, PUB. 8-10-2004. MULTIPLE CLASS, INT. CLS. 9 AND 42.
- BLUE HEAVEN HOSIERY COMPANY, INC., BROOKLYN, NY:  
2,121,736, CANC. INT. CL. 25.
- BLUE MOON SCREEN PRINTING, WINSTON-SALEM, NC:  
2,216,066, CANC. INT. CL. 25.
- BLUE PILOT, INC., LOS ANGELES, CA:  
2,121,659, CANC. INT. CL. 25.
- BLUE STAR CANDLES, L.P., LUBBOCK, TX:  
2,900,721, INT. CL. 4.
- BLUEGREEN CORPORATION, BOCA RATON, FL:  
2,898,553, PUB. 8-10-2004. MULTIPLE CLASS, INT. CLS. 35, 39 AND 43.
- BLUR STUDIO, INC., VENICE, CA:  
2,121,773, CANC. INT. CL. 41.
- BMA HOLDINGS, LLC, CLEVELAND, OH, HARTFORD HOUSE, LTD., BOULDER, CO:  
1,845,574, REN. 9-20-04. INT. CL. 16.
- BMG MUSIC, NEW YORK, NY, DBA BMG ENTERTAINMENT:  
2,121,268, CANC. INT. CL. 9.
- BOARD OF REGENTS OF THE UNIVERSITY OF WISCONSIN, MADISON, WI:  
2,899,620, PUB. 8-10-2004. INT. CL. 9.
- BOB EVANS RESTAURANTS OF MICHIGAN, INC., ANN ARBOR, MI:  
2,898,942, PUB. 3-2-2004. INT. CL. 43.
- BOB WEIS DESIGN ISLAND ASSOCIATES, INC., NEW SMYRNA BEACH, FL:  
2,121,193, CANC. INT. CL. 42.
- BOB'S SURPLUS SALES, INC., LAWRENCEBURG, TN:  
2,121,532, CANC. INT. CL. 28.
- BOBAK SAUSAGE COMPANY, CHICAGO, IL:  
2,898,881, PUB. 8-10-2004. MULTIPLE CLASS, INT. CLS. 35 AND 43.
- BOBRICK WASHROOM EQUIPMENT, INC., NORTH HOLLYWOOD, CA, BOBRICK CORPORATION, THE, NORTH HOLLYWOOD, CA:  
992,938, REN. 9-22-04. MULTIPLE CLASS, U.S. CLS. 2 (INT. CL. 6), 12 (INT. CL. 19), 13 (INT. CL. 6), 23 (INT. CL. 7) AND 32 (INT. CL. 20).
- BOCA FOODS COMPANY, MADISON, WI:  
2,898,484, PUB. 6-12-2001. INT. CL. 29.
- BOD, NEW YORK, NY:  
2,899,365, PUB. 9-2-2003. INT. CL. 25.
- BODEGAS EMILIO MORO, S.L., VALLADOLID, SPAIN:  
2,899,686, PUB. 8-10-2004. INT. CL. 33.
- BODEGAS MARTINEZ BUJANDA, S.A., 01320 OYON (ALVA), SPAIN:  
2,530,389, COR. INT. CL. 33.
- BODEGAS MUGA, S.A., 26200 HARO (LA RIOJA), SPAIN:  
2,900,381, INT. CL. 33.
- BOE HYDIS TECHNOLOGY CO., LTD., ICHON, KYOUNG-KI-DO, REPUBLIC OF KOREA:  
2,898,548, PUB. 8-10-2004. INT. CL. 9.
- BOEHRINGER INGELHEIM KG, 6507 INGELHEIM AM RHEIN, FED REP GERMANY:  
2,121,176, CANC. INT. CL. 5.
- BOGGS, DAVID L., ARLINGTON, MA:  
2,817,616, COR. INT. CL. 41.
- BOLLMAN HAT COMPANY, ADAMSTOWN, PA:  
2,122,030, CANC. INT. CL. 25.
- BONGRAIN S.A., VIROFLAY, FRANCE:  
2,800,339, COR. INT. CL. 29.
- BONNE BELL, INC., LAKEWOOD, OH:  
2,899,275, PUB. 10-29-2002. INT. CL. 3.  
2,900,845, INT. CL. 3.  
2,900,884, INT. CL. 3.
- BONNEY, JAMES F., NEW YORK, NY, DBA JIM BONNEY:  
2,121,123, CANC. INT. CL. 41.
- BONTEX, INC., BUENA VISTA, VA:  
1,289,029, REN. 9-23-04. INT. CL. 18.
- BOOMTOWN, INC., VERDI, NV:  
2,120,681, CANC. MULTIPLE CLASS, INT. CLS. 39, 41 AND 42.
- BOOTH AMERICAN COMPANY, DETROIT, MI:  
2,121,783, CANC. INT. CL. 38.
- BORDEN, INC., COLUMBUS, OH:  
1,261,052, CANC. MULTIPLE CLASS, INT. CLS. 29 AND 30.
- BOREEM INT'L TRADING, INC., LOS ANGELES, CA:  
2,898,747, PUB. 11-11-2003. INT. CL. 12.  
2,898,748, PUB. 11-11-2003. INT. CL. 12.
- BORELL, MARJORIE, NEW YORK, NY:  
2,900,725, INT. CL. 3.
- BORGES LAMONT COMPANY, OREM, UT:  
2,120,744, CANC. INT. CL. 35.
- BORLAND SOFTWARE CORPORATION, SCOTTS VALLEY, CA:  
2,900,708, INT. CL. 9.
- BORRION ENTERPRISE CO., LTD., TAINAN CITY, TAIWAN:  
2,121,463, CANC. INT. CL. 9.
- BOSE CORPORATION, FRAMINGHAM, MA:  
1,338,571, REN. 9-20-04. INT. CL. 9.
- BOSWELL, TIFFANY, PALM BEACH GARDENS, FL:  
2,121,527, CANC. MULTIPLE CLASS, INT. CLS. 25, 26 AND 28.
- BOUCHER, JESSIE, SAN ANSELMO, CA:  
2,121,755, CANC. INT. CL. 42.
- BOULDIN CORPORATION, MCMINNVILLE, TN:  
2,900,335, INT. CL. 17.
- BOWTIE, INC., LOS ANGELES, CA:  
1,852,087, REN. 9-24-04. INT. CL. 16.  
1,852,088, REN. 9-24-04. INT. CL. 16.
- BOYD GAMING CORPORATION, LAS VEGAS, NV:  
1,343,421, REN. 9-18-04. MULTIPLE CLASS, INT. CLS. 41 AND 42.
- 2,899,138, PUB. 8-10-2004. INT. CL. 43.  
2,899,139, PUB. 8-10-2004. INT. CL. 41.
- BOYER INDUSTRIES CORPORATION, LAWRENCE, KS, PROCESS SOLVENT COMPANY, INC., KANSAS CITY, KS:  
991,830, REN. 9-21-04. U.S. CL. 16 (INT. CL. 2).
- BOYER INDUSTRIES CORPORATION, LAWRENCE, KS:  
1,311,800, REN. 9-19-04. INT. CL. 1.
- BP P.L.C., LONDON SW1Y 4PD, ENGLAND, UNITED KINGDOM:  
2,898,527, PUB. 8-10-2004. MULTIPLE CLASS, INT. CLS. 4, 35, 37, 38 AND 42.
- BPSI HOLDINGS, INC., WILMINGTON, DE:  
2,898,671, PUB. 1-6-2004. MULTIPLE CLASS, INT. CLS. 35 AND 39.
- BRAC-WERKE AG, CH-4226 BREITENBACH, SWITZERLAND, ALBERT HAAG KG, 7252 WEIL DER STADT, FED REP GERMANY:  
994,916, REN. 9-19-04. U.S. CL. 23 (INT. CL. 7).
- BRADLEY, ANNE CLIFFORD, EAST SANDWICH, MA:  
2,122,184, CANC. INT. CL. 42.
- BRADY WORLDWIDE, INC., MILWAUKEE, WI:  
775,003, REN. 9-19-04. U.S. CL. 37 (INT. CL. 16).
- BRAIN LLC, SAN FRANCISCO, CA:  
2,899,549, PUB. 8-10-2004. MULTIPLE CLASS, INT. CLS. 16 AND 36.
- BRAIN RESEARCH, INC., NEW YORK, NY:  
1,260,752, CANC. INT. CL. 5.



BRAIN TECHNOLOGIES CORPORATION, PLANO, TX:  
 2,121,712, CANC. INT. CL. 41.  
 2,121,713, CANC. INT. CL. 16.  
 BRAMMALL INC., ANGOLA, IN:  
 1,857,478, REN. 9-18-04, INT. CL. 6.  
 BRAMMALL, INC., ANGOLA, IN:  
 1,289,791, REN. 9-21-04, INT. CL. 6.  
 BRANDMEIER, JONATHON, MALIBU, CA:  
 2,899,256, PUB. 8-10-2004, INT. CL. 9.  
 BRANDON HORNSBY, P.C., ATLANTA, GA:  
 2,899,104, PUB. 8-10-2004, INT. CL. 42.  
 BRANDON, LEE, LOS ANGELES, CA:  
 2,900,580, INT. CL. 41.  
 BRASS CRAFT MANUFACTURING COMPANY, NOVI, MI:  
 2,900,213, INT. CL. 11.  
 BRAUER NOMINEES PTY. LTD., TANUNDA, STATE OF  
 SOUTH AUSTRALIA, 5352, AUSTRALIA:  
 1,811,700, CANC. INT. CL. 5.  
 BRAWN OF CALIFORNIA, INC., SAN DIEGO, CA:  
 1,261,013, CANC. INT. CL. 25.  
 BRAZETEC GMBH, HANAU-WOLFGANG, FED REP GER-  
 MANY:  
 2,899,612, PUB. 8-10-2004, MULTIPLE CLASS, INT. CLS. 1  
 AND 6.  
 BREEDERS' CUP LIMITED, LEXINGTON, KY:  
 2,898,709, PUB. 10-14-2003, INT. CL. 36.  
 BREEDERS' CUP, LIMITED, LEXINGTON, KY:  
 1,326,857, REN. 9-19-04, INT. CL. 14.  
 1,329,566, REN. 9-18-04, INT. CL. 16.  
 1,329,595, REN. 9-18-04, INT. CL. 18.  
 1,329,764, REN. 9-18-04, INT. CL. 25.  
 1,333,410, REN. 9-23-04, INT. CL. 28.  
 BREG, INC., VISTA, CA:  
 2,900,945, INT. CL. 10.  
 BRESLER ICE CREAM COMPANY, CHICAGO, IL:  
 761,706, CANC. U.S. CL. 46.  
 BRIDGES.COM INC., KELOWNA, CANADA:  
 2,898,480, PUB. 9-10-2002, MULTIPLE CLASS, INT. CLS.  
 9, 16, 41 AND 42.  
 BRIDGES, WILLIAM E., TALLAPOOSA, GA:  
 2,898,902, PUB. 8-10-2004, MULTIPLE CLASS, INT. CLS.  
 18 AND 28.  
 BRIDGESTONE SPORTS CO., LTD, TOKYO 140-0013, JA-  
 PAN:  
 2,900,241, MULTIPLE CLASS, INT. CLS. 18 AND 25.  
 BRIDGESTONE SPORTS CO., LTD., TOKYO 140-0013, JA-  
 PAN:  
 2,900,242, MULTIPLE CLASS, INT. CLS. 18 AND 25.  
 BRIDOR INC., BOUCHERVILLE, QUEBEC, CANADA:  
 2,900,374, MULTIPLE CLASS, INT. CLS. 30, 35 AND 43.  
 BRIGHT PROSPECT SCHOLAR SUPPORT PROGRAM,  
 POMONA, CA:  
 2,900,564, MULTIPLE CLASS, INT. CLS. 9, 16, 25, 36 AND  
 41.  
 BRINE, INC., MILFORD, MA:  
 2,900,729, INT. CL. 28.  
 BRINKMANN CORPORATION, THE, DALLAS, TX:  
 1,845,322, REN. 9-20-04, INT. CL. 4.  
 1,845,540, REN. 9-20-04, INT. CL. 11.  
 BRISTOL-MYERS COMPANY, NEW YORK, NY:  
 1,260,773, CANC. INT. CL. 5.  
 BRISTOL-MYERS QUIBB COMPANY, NEW YORK, NY:  
 1,280,450, REN. 9-20-04, INT. CL. 5.  
 BRISTOL-MYERS SQUIBB COMPANY, NEW YORK, NY:  
 993,314, REN. 9-20-04, INT. CL. 3.  
 2,122,152, CANC. INT. CL. 5.  
 BRITISH MILLERAIN COMPANY LIMITED, THE, LANCA-  
 SHIRE, OL16 2XA, UNITED KINGDOM:  
 2,900,198, INT. CL. 10.  
 BRITISH PETROLEUM COMPANY P.L.C., THE, LONDON,  
 ENGLAND:  
 1,260,847, CANC. INT. CL. 9.  
 BROADLEY-JAMES CORPORATION, IRVINE, CA:  
 1,850,609, REN. 9-22-04, INT. CL. 9.  
 BROADWAY VIDEO, INC., NEW YORK, NY:  
 2,120,963, CANC. INT. CL. 41.  
 BROASTER COMPANY, THE, БЕЛОIT, WI:  
 1,894,592, REN. 9-20-04, INT. CL. 11.  
 BRODERBUND SOFTWARE, INC., NOVATO, CA TO MAT-  
 TEL, INC., EL SEGUNGO, CA:  
 1,810,528, CANC. INT. CL. 9.  
 BROKERAGE GROUP INTERNATIONAL, LLC, SPARTAN-  
 BURG, SC:  
 2,898,687, PUB. 8-19-2003, INT. CL. 36.  
 BROMANTE CORPORATION, LONG ISLAND CITY, NY:  
 2,121,964, CANC. INT. CL. 17.  
 BRONNER BROS. MANUFACTURING CO. INC., ATLAN-  
 TA, GA:  
 1,810,394, CANC. INT. CL. 3.  
 1,810,395, CANC. INT. CL. 3.  
 BROOKS FIBER PROPERTIES, INC., TOWN & COUNTRY,  
 MO:  
 2,120,809, CANC. MULTIPLE CLASS, INT. CLS. 38 AND  
 42.  
 2,120,810, CANC. MULTIPLE CLASS, INT. CLS. 38 AND  
 42.  
 BROOKS; BARBARA B., SPRINGFIELD, VA, DBA COMPU-  
 TER LAW ADVISERS:  
 1,261,326, CANC. MULTIPLE CLASS, INT. CLS. 16, 41  
 AND 42.  
 BROSTOWICZ, ROBERT L., MILWAUKEE, WI:  
 2,120,974, CANC. INT. CL. 21.  
 BROTHER INDUSTRIES, LTD., MIZUHO-KU, NAGOYA  
 467-0841, JAPAN:  
 2,898,871, PUB. 8-10-2004, INT. CL. 7.  
 BROTHERS BEER COMPANY, INC., OAKLAND, CA, DBA  
 BROTHERS BREWING COMPANY FROM LEBLANC,  
 MICHAEL J., OAKLAND, CA:  
 2,900,067, INT. CL. 25.  
 BROUWERIJ LINDEMANS, 1602 VLEZENBEEK, BELGIUM:  
 2,900,903, INT. CL. 32.  
 BROWN & STREZA, LLP, IRVINE, CA:  
 2,898,684, PUB. 7-29-2003, INT. CL. 36.  
 BROWN & WILLIAMSON TOBACCO CORPORATION,  
 LOUISVILLE, KY:  
 1,261,104, CANC. INT. CL. 34.  
 BROWN GROUP, INC., ST. LOUIS, MO:  
 2,122,038, CANC. INT. CL. 25.  
 BROWN; ROBERT A., FT. SMITH, AR:  
 1,261,194, CANC. INT. CL. 40.  
 BROWN, GORDON LAVELLE, JR., ANDERSON, SC:  
 2,900,505, INT. CL. 28.  
 BROWN, MATHEW S., SCOTTSDALE, AZ:  
 2,899,809, PUB. 8-10-2004, INT. CL. 42.  
 BROWNING, MORGAN, UT:  
 1,869,743, REN. 9-18-04, INT. CL. 25.  
 BROYHILL FURNITURE INDUSTRIES, INC., LENOIR, NC:  
 2,899,658, PUB. 8-10-2004, INT. CL. 20.  
 BRUKER INSTRUMENTS, INC., BILLERICA, MA:  
 2,122,068, CANC. INT. CL. 9.  
 BRULIN & COMPANY, INC., INDIANAPOLIS, IN:  
 1,870,279, REN. 9-23-04, INT. CL. 3.  
 BRUNSCHWIG & FILS, INC., NORTH WHITE PLAINS, NY:  
 1,012,244, REN. 9-19-04, INT. CL. 24.  
 1,012,308, REN. 9-19-04, INT. CL. 27.  
 BRUNSWICK CORPORATION, LAKE FOREST, IL:  
 1,853,343, REN. 9-20-04, INT. CL. 42.  
 BRUSH WELLMAN INC., CLEVELAND, OH:  
 1,847,231, REN. 9-20-04, INT. CL. 6.  
 BRUTOCO, RINALDO S., OJAI, CA:  
 2,900,393, MULTIPLE CLASS, INT. CLS. 29 AND 31.  
 BTESH, ALBERTO, LOS ANGELES, CA:  
 2,120,782, CANC. INT. CL. 25.  
 BUD K WORLDWIDE, INC., MOULTRIE, GA:  
 2,898,828, PUB. 12-2-2003, INT. CL. 8.  
 BUFFALO DON'S ARTESIAN WELLS, LTD., PLYMOUTH,  
 MI:  
 1,811,643, CANC. INT. CL. 32.  
 BUFFALO INDUSTRIES, INC., SEATTLE, WA:  
 2,121,701, CANC. INT. CL. 17.  
 BUFFALO PHILLY'S INC., WOODBRIDGE, VA:  
 2,898,789, PUB. 8-10-2004, INT. CL. 43.  
 BUGLE BOY INDUSTRIES, INC., SIMI VALLEY, CA:  
 2,122,169, CANC. INT. CL. 25.  
 BUILD-A-BEAR WORKSHOP, INC., ST. LOUIS, MO:  
 2,899,646, PUB. 8-10-2004, INT. CL. 35.

- BULTMAN, BETHANY, NEW ORLEANS, LA:  
2,121,922, CANC. INT. CL. 9.
- BUMBLE BEE SEAFOODS, INC., SAN DIEGO, CA:  
2,856,581, COR. INT. CL. 29.
- BUNZL DISTRIBUTION USA, INC., ST. LOUIS, MO:  
2,899,378, PUB. 9-9-2003. INT. CL. 25.  
2,899,598, PUB. 8-10-2004. MULTIPLE CLASS, INT. CLS. 3 AND 5.
- BUONO S.N.C. DI BUONO EUSTACHIO E ISONZO MARIA PIA, MATERA, ITALY:  
2,898,520, PUB. 8-10-2004. INT. CL. 25.
- BURGER KING CORPORATION, MIAMI, FL:  
1,261,240, CANC. INT. CL. 42.
- BURKE INDUSTRIES (DELAWARE), INC., SAN JOSE, CA, MERCER PRODUCTS COMPANY, INC., PINEVILLE, NC:  
1,851,494, REN. 9-18-04. INT. CL. 19.
- BURKEY, TORY D., YORK, PA AND BURKEY, CHRISTINA L., YORK, PA:  
2,900,755, INT. CL. 43.
- BURNETT ENGINEERING CO., INC., PEABODY, MA:  
1,291,562, REN. 9-20-04. INT. CL. 1.
- BURRITO BEACH, LLC, CHICAGO, IL:  
2,900,645, INT. CL. 43.
- BURRITOVILLE SYSTEMS, INC., LAKE SUCCESS, NY, BURRITOVILLE INC., NEW YORK, NY:  
1,850,967, REN. 9-24-04. INT. CL. 42.
- BURRUS RESEARCH ASSOCIATES, INC., HARTLAND, WI:  
2,845,449, COR. INT. CL. 28.
- BURTON, WILLIAM, STUDIO CITY, CA, DBA FLIP "BEAN" KNIGHT:  
2,900,654, INT. CL. 41.
- BUSH, E.B. HUTT, JR., BEVERLY HILLS, CA:  
2,900,311, MULTIPLE CLASS, INT. CLS. 9, 35 AND 41.
- BUSINESS GUIDES, INC., NEW YORK, NY:  
2,122,530, CANC. INT. CL. 16.
- BUSINESS WIRE, SAN FRANCISCO, CA:  
2,899,343, PUB. 8-10-2004. MULTIPLE CLASS, INT. CLS. 9, 38 AND 41.
- BUTCHER COMPANY, INC., THE HARBOR CITY, CA, DBA THE RAMSEY TO BUTCHER COMPANY, INC., THE HARBOR CITY, CA, DBA THE RAMSEY COMPANY:  
2,012,698, COR. INT. CL. 2.
- BUTTERFLY CREATIONS, INC., GREENSBORO, NC:  
2,900,173, INT. CL. 28.
- BUTY-WAVE PRODUCTS CO., INC., LOS ANGELES, CA:  
1,854,384, REN. 9-24-04. INT. CL. 3.
- BUZAS BASEBALL, INC., PORTLAND, OR:  
1,810,724, CANC. MULTIPLE CLASS, INT. CLS. 16 AND 25.
- BYRDCLIFFE COOKERY, LLC, FAIRFIELD, CT:  
2,900,771, MULTIPLE CLASS, INT. CLS. 29 AND 30.
- BYRON, BILL, SAN DIEGO, CA, DBA SUN & FUN PRODUCTIONS:  
1,810,586, CANC. INT. CL. 9.
- BYTE DOCTOR COMPUTER REPAIR AND UPGRADE CENTER INC., THE, ENGLEWOOD, NJ:  
2,121,400, CANC. INT. CL. 37.
- C & K MANUFACTURING AND SALES COMPANY, L.L.C., WESTLAKE, OH, C.K.L. DISTRIBUTING COMPANY, INC., WESTLAKE, OH:  
1,851,510, REN. 9-22-04. INT. CL. 21.
- C & S TURF CARE EQUIPMENT, INC., NORTH CANTON, OH:  
2,899,840, PUB. 8-10-2004. INT. CL. 40.
- C. COWLES & COMPANY, NEW HAVEN, CT:  
999,547, REN. 9-20-04. INT. CL. 6.
- C. H. HANSON COMPANY; THE, FRANKLIN PARK, IL:  
1,344,328, REN. 9-22-04. INT. CL. 16.
- C. RAYMOND HUNT ASSOCIATES, INC., BOSTON, MA:  
2,899,803, PUB. 8-10-2004. INT. CL. 12.
- C. VOIGT SOHNE GMBH & CO., CASTROP-RAUXEL, FED REP GERMANY:  
1,260,924, CANC. MULTIPLE CLASS, INT. CLS. 17, 27 AND 37.
- C. W. MANUFACTURING, INC., SABETHA, KS:  
2,899,581, PUB. 2-10-2004. INT. CL. 7.
- C.A. MUER CORPORATION, DETROIT, MI:  
2,121,068, CANC. INT. CL. 42.
- C.E.M. ENTERPRISES, INC., DECATUR, GA, DBA SBS BEAUTY SYSTEMS:  
1,810,809, CANC. INT. CL. 21.
- C.O.R.E. DIGITAL PICTURES INC., TORONTO, ONTARIO, CANADA:  
2,898,702, PUB. 8-10-2004. INT. CL. 41.  
2,898,986, PUB. 8-10-2004. INT. CL. 41.
- C.R. BARD, INC., MURRAY HILL, NJ:  
2,898,765, PUB. 2-3-2004. INT. CL. 10.
- C&D LUMBER CO., RIDDLE, OR:  
2,899,036, PUB. 8-10-2004. INT. CL. 19.
- C-COR ROYALTY CORPORATION, WILMINGTON, DE:  
2,121,998, CANC. MULTIPLE CLASS, INT. CLS. 9, 37, 41 AND 42.
- C-CURE CHEMICAL CO., INC., HOUSTON, TX:  
1,260,945, CANC. INT. CL. 19.
- C-LINE PRODUCTS, INC., MT. PROSPECT, IL, CHICAGO DESK PAD COMPANY, INC., THE, CHICAGO, IL:  
793,111, REN. 9-19-04. U.S. CL. 37 (INT. CL. 16).
- C-MAX AUTO SUPERSTORES, INC., WALNUT, CA:  
2,122,527, CANC. INT. CL. 42.
- CABI DEVELOPERS, LLC, MIAMI, FL:  
2,899,349, PUB. 6-10-2003. MULTIPLE CLASS, INT. CLS. 35, 36 AND 37.
- CABLE & WIRELESS, INC., VIENNA, VA:  
2,121,997, CANC. INT. CL. 36.
- CABLESHARE INC., LONDON, ONTARIO, CANADA:  
1,261,343, CANC. INT. CL. 9.
- CABLEXPRESS CORPORATION, SYRACUSE, NY:  
2,898,635, PUB. 5-6-2003. INT. CL. 9.
- CABURY ADAMS USA LLC, PARSIPPANY, NJ:  
2,900,077, INT. CL. 30.
- CACCIA FASHIONS INC./MODES CACCIA INC., ST. LAURENT, QUEBEC H4N 1R9, CANADA:  
2,122,533, CANC. INT. CL. 25.
- CADBURY ADAMS USA LLC, PARSIPPANY, NJ:  
1,847,432, REN. 9-20-04. INT. CL. 30.  
2,899,523, PUB. 8-10-2004. INT. CL. 30.
- CADBURY IRELAND LTD., DUBLIN, IRELAND, WARNER-LAMBERT COMPANY, MORRIS PLAINS, NJ:  
1,846,446, REN. 9-20-04. INT. CL. 5.
- CADER COMPANY, INC., NEW YORK, NY:  
2,121,010, CANC. INT. CL. 16.
- CADWELL INDUSTRIES, INC., KENNEWICK, WA, CADWELL LABORATORIES, INC., KENNEWICK, WA, DBA CADWELL LABORATORIES:  
1,290,540, REN. 9-21-04. INT. CL. 10.
- CAFE ARTISTE RESTAURANT, INC., HOUSTON, TX:  
2,899,092, PUB. 8-10-2004. INT. CL. 43.
- CAFFES-STEELE CONTRACTING OF VIRGINIA, INC., HAMPTON, VA:  
2,899,037, PUB. 8-10-2004. INT. CL. 37.
- CAFFINO, INC., SAN RAMON, CA:  
2,899,572, PUB. 8-10-2004. INT. CL. 30.
- CALCULEX, INC., LAS CRUCES, NM:  
2,900,275, INT. CL. 9.
- CALGON CARBON CORPORATION, PITTSBURGH, PA, PITTSBURGH ACTIVATED CARBON COMPANY, PITTSBURGH, PA:  
781,920, REN. 9-18-04. U.S. CL. 6 (INT. CL. 1).
- CALGON CORPORATION, NAPERVILLE, IL, CALGON CORPORATION, NAPERVILLE, IL:  
1,873,464, REN. 9-20-04. INT. CL. 1.
- CALIDAD AUTO TECH, INC., SAYLORSBURG, PA:  
2,900,386, INT. CL. 37.
- CALIDO CHILE TRADERS SYSTEMS, INC., MERRIAM, KS:  
2,121,770, CANC. MULTIPLE CLASS, INT. CLS. 29 AND 30.
- CALIFORNIA ASSOCIATION OF FLOWER GROWERS & SHIPPERS, SANTA CLARA, CA:  
2,121,114, CANC. MULTIPLE CLASS, INT. CLS. 16, 25 AND 35.
- CALIFORNIA EXOTIC NOVELTIES LLC, CHINO, CA:  
2,899,080, PUB. 8-10-2004. INT. CL. 9.  
2,899,081, PUB. 8-10-2004. INT. CL. 10.  
2,899,082, PUB. 8-10-2004. INT. CL. 10.

- CALIFORNIA PRUNE AND APRICOT GROWERS ASSOCIATION, SAN JOSE, CA:  
404,657, CANC. U.S. CL. 46.
- CALIFORNIA REPUBLICAN PARTY, BURBANK, CA:  
2,121,066, CANC. MULTIPLE CLASS, INT. CLS. 16 AND 35.
- CALIFORNIA STATE UNIVERSITY, SACRAMENTO, SACRAMENTO, CA:  
1,810,897, CANC. INT. CL. 28.  
1,810,898, CANC. INT. CL. 28.  
1,855,216, REN. 9-24-04. INT. CL. 21.  
1,882,074, REN. 9-24-04. INT. CL. 12.
- CALIFORNIA SUNSHINE, INC., ALHAMBRA, CA:  
2,898,831, PUB. 8-10-2004. INT. CL. 11.
- CALIFORNIA TAN, INC., LOS ANGELES, CA:  
1,846,093, REN. 9-20-04. INT. CL. 3.  
2,899,049, PUB. 8-10-2004. INT. CL. 3.
- CALLE, JR.; H. MARTIN E., GREENWICH, CT, DBA CALLE AND COMPANY:  
1,261,357, CANC. INT. CL. 35.
- CALORITECH INC., OAKVILLE, ONTARIO, CANADA:  
2,120,957, CANC. MULTIPLE CLASS, INT. CLS. 9, 40 AND 42.
- CALVIN COLLEGE, GRAND RAPIDS, MI:  
1,844,157, REN. 9-22-04. MULTIPLE CLASS, INT. CLS. 9, 14, 16, 20, 21, 24, 25, 28 AND 41.
- CALZATURIFICIO CHERIE S.P.A., MONTE SAN GIUSTO MACERATA, ITALY:  
1,301,774, REN. 9-18-04. INT. CL. 25.
- CALZATURIFICIO LADY KENT S.N.C. DI CAMPINOTI ROBERTO E C., FUCECCHIO (FI), ITALY:  
2,899,368, PUB. 6-1-2004. MULTIPLE CLASS, INT. CLS. 18 AND 25.
- CAM-JO, INC., CLEARWATER, FL, DBA BAY AREA YELLOW CAB COMPANY:  
1,848,426, REN. 9-22-04. INT. CL. 39.
- CAMALL COMPANY, ROMEO, MI:  
2,120,918, CANC. INT. CL. 5.
- CAMELOT CORPORATION, DALLAS, TX:  
2,122,077, CANC. INT. CL. 16.
- CAMP, INC., CLEVELAND, OH:  
2,121,521, CANC. INT. CL. 41.
- CAMPBELL CONTRACT, INC., DALLAS, TX, R. JONES & ASSOCIATES, INC., DALLAS, TX:  
1,892,671, REN. 9-18-04. INT. CL. 20.
- CAMPERO INTERNATIONAL, S.A., NIVEL 12, GUATEMALA TO CAMPERO INTERNATIONAL LIMITED, GUATEMALA, GUATEMALA:  
2,598,281 NEW CERT. 11-2-2004. INT. CL. 42.
- CAMPUS CRUSADE FOR CHRIST, INC., ORLANDO, FL:  
1,870,827, REN. 9-23-04. INT. CL. 41.  
2,899,266, PUB. 8-10-2004. MULTIPLE CLASS, INT. CLS. 9, 16, 41 AND 45.  
2,899,267, PUB. 8-10-2004. MULTIPLE CLASS, INT. CLS. 9, 16, 41 AND 45.
- CAMPUS K12, INC., SAUGATUCK, MI:  
2,900,230, MULTIPLE CLASS, INT. CLS. 9 AND 41.
- CAN HOLDINGS, LLC, MINNETONKA, MN:  
990,586, REN. 9-24-04. INT. CL. 31.
- CAN-AM CARE, LLC, ALPHARETTA, GA:  
1,868,816, REN. 9-18-04. INT. CL. 5.
- CANADIAN AGRA CORPORATION, KINCARDINE, ONTARIO N2Z 2Y9, CANADA:  
2,120,723, CANC. INT. CL. 42.
- CANDESA INTERACTIVE, LC, PLEASANT GROVE, UT:  
2,121,405, CANC. INT. CL. 9.
- CANDID COLOR SYSTEMS, INC., OKLAHOMA CITY, OK:  
2,899,150, PUB. 8-10-2004. INT. CL. 41.
- CANDLE CORPORATION, EL SEGUNDO, CA:  
2,898,707, PUB. 10-21-2003. INT. CL. 9.
- CANDLEMAKER AT BOARDWALK MARKET, INC., EDMONTON, ALBERTA, CANADA:  
2,122,328, CANC. INT. CL. 4.
- CANGENE CORPORATION, MISSISSAUGA, ONTARIO, L4V 1T4, CANADA:  
2,120,658, CANC. INT. CL. 5.
- CANNON RUBBER LIMITED, LONDON, UNITED KINGDOM:  
2,899,356, PUB. 11-4-2003. INT. CL. 18.
- CANTEBURY SHAKER VILLAGE, INC., CANTERBURY, NH:  
2,900,736, INT. CL. 43.
- CANYON STREET CROSSING, BOULDER, CO, INGER-SOLL PRODUCTS CORPORATION, CHICAGO, IL:  
1,289,834, REN. 9-21-04. INT. CL. 7.
- CAPITAL ASSOCIATES, LLC, CARY, NC:  
2,899,698, PUB. 8-10-2004. INT. CL. 36.
- CAPITAL QUEST LLC, ELMSFORD, NY:  
2,121,645, CANC. INT. CL. 36.  
2,121,647, CANC. INT. CL. 36.
- CAPITALSOURCE FINANCE LLC, CHEVY CHASE, MD:  
2,900,703, INT. CL. 38.
- CAPMASTERS, INC., PITTSBURGH, PA:  
2,121,389, CANC. INT. CL. 25.
- CAPRESSO, INC., CLOSTER, NJ:  
2,899,587, PUB. 8-10-2004. MULTIPLE CLASS, INT. CLS. 7, 11, 21 AND 30.
- CAR ACCESSORIES FOR WOMEN, INC., HOUSTON, TX:  
2,900,152, INT. CL. 12.
- CAR SOUND LLC, PORT WASHINGTON, NY:  
2,121,452, CANC. INT. CL. 16.
- CARDTRONIC TECHNOLOGY INC., MINNEAPOLIS, MN:  
2,898,936, PUB. 8-10-2004. INT. CL. 42.
- CAREER SERVICES GROUP, INC., BELLINGHAM, WA:  
2,899,604, PUB. 8-10-2004. MULTIPLE CLASS, INT. CLS. 9 AND 16.
- CARGILL INCORPORATED, MINNETONKA, MN:  
177,065, CANC. U.S. CL. 46.
- CARGILL INCORPORATED, WAYZATA, MN, DIAMOND WATER, INC., GREENVILLE, WI:  
1,849,750, REN. 9-18-04. INT. CL. 1.
- CARGILL, INCORPORATED, WAYZATA, MN, SEABOARD ALLIED MILLING CORPORATION, SHAWNEE MISSION, KS:  
1,268,113, REN. 9-24-04. INT. CL. 30.
- CARGILL, INCORPORATED, WAYZATA, MN, ANDERSON, CLAYTON & CO., HOUSTON, TX:  
1,289,786, REN. 9-21-04. MULTIPLE CLASS, INT. CLS. 5 AND 31.
- CARGILL, INCORPORATED, WAYZATA, MN:  
1,295,591, REN. 9-18-04. INT. CL. 5.
- CARIBBEAN CONSERVATION CORPORATION, GAINESVILLE, FL:  
1,859,041, REN. 9-21-04. INT. CL. 42.
- CARIBBEAN IMPORTS, INC., ORLANDO, FL:  
2,898,956, PUB. 8-10-2004. INT. CL. 29.
- CARL ERIC JOHNSON & COMPANY, INC., RYE, NH:  
2,899,666, PUB. 8-10-2004. INT. CL. 41.
- CARL SCHENCK AG, D 6100 DARMSTADT, FED REP GERMANY:  
1,824,966, REN. 9-21-04. INT. CL. 9.
- CARL SCHLIEPER GMBH & CO. KOMMANDITGESELLSCHAFT, 42659 SOLINGEN, FED REP GERMANY, SCHLIEPER, CARL, REMSCHEID-HASTEN, FED REP GERMANY:  
607,905, REN. 9-20-04. U.S. CL. 23 (INT. CL. 8).
- CARLEY (CA CORPORATION), TORRANCE, CA:  
1,876,506, REN. 9-21-04. INT. CL. 11.
- CARLISLE PLASTICA LP, EXETER, NH, CARLISLE PLASTICS, INC., BOSTON, MA:  
1,849,274, REN. 9-18-04. INT. CL. 16.
- CARLISLE PLASTICS, INC., MINNEAPOLIS, MN:  
1,850,323, REN. 9-18-04. INT. CL. 16.
- CARLOTTA S.R.L., 50125 FIRENZE, ITALY:  
2,899,336, PUB. 8-10-2004. INT. CL. 42.
- CARLSON, ERIC, ROBERT, RIVERSIDE, CA:  
2,899,557, PUB. 8-10-2004. INT. CL. 28.
- CARLSON, KERT, SPOKANE, WA, DBA STADIUM SPORTS:  
2,122,457, CANC. INT. CL. 25.
- CARLSON, LEWAYNE P., LITTLETON, CO:  
2,122,226, CANC. INT. CL. 9.
- CARLTON AND UNITED BREWERIES LIMITED, CARLTON, VICTORIA, 3053, AUSTRALIA:  
2,036,423, CANC. INT. CL. 33.

- CARME INTERNATIONAL, INC., NAPA, CA:  
1,295,484. REN. 9-18-04. INT. CL. 3.
- CARMEN SYSTEMS AB, GÖTEBORG, SWEDEN:  
2,899,539. PUB. 8-10-2004. MULTIPLE CLASS, INT. CLS. 35 AND 42.
- CARMI, AURA, CAMARILLO, CA, DBA OVER THE NET AND CARMÍ, AUIRAM, LOS ANGELES, CA, DBA OVER THE NET:  
2,120,753. CANC. INT. CL. 42.
- CARNATION COMPANY, LOS ANGELES, CA:  
177,227. CANC. U.S. CL. 46.
- CAROLINA BIOLOGICAL SUPPLY COMPANY, BURLINGTON, NC:  
988,374. REN. 9-21-04. U.S. CL. 26 (INT. CL. 9).
- CAROLINA MILLS, INC., MAIDEN, NC:  
1,344,509. REN. 9-24-04. MULTIPLE CLASS, INT. CLS. 23 AND 24.
- CAROLINA TREET, INC., WILMINGTON, NC, N. A. MERRITT AND COMPANY, WILMINGTON, NC:  
608,065. REN. 9-18-04. U.S. CL. 46 (INT. CL. 30).
- CARONDELET HEALTH, KANSAS CITY, MO:  
2,899,457. PUB. 8-10-2004. INT. CL. 44.
- CARPE DIEM COMMUNICATIONS, INC., LANGHORNE, PA:  
2,122,510. CANC. MULTIPLE CLASS, INT. CLS. 16 AND 35.
- CARRASCO & ASOCIADOS CONSULTORES CIA. LTDA., 4TO PISO, OFICINO 416, QUITO, ECUADOR:  
2,898,530. PUB. 6-3-2003. INT. CL. 9.
- CARRIE CONCESSIONS, INC., MIAMI, FL:  
2,122,025. CANC. MULTIPLE CLASS, INT. CLS. 16, 21 AND 42.
- CARRIER CORPORATION, SYRACUSE, NY:  
2,899,054. PUB. 8-10-2004. INT. CL. 41.  
2,899,055. PUB. 8-10-2004. INT. CL. 41.
- CARRIER ONE INC., MISSISSAUGA, ONTARIO, L4V 1S1, CANADA:  
2,898,620. PUB. 8-10-2004. MULTIPLE CLASS, INT. CLS. 35 AND 39.
- CARRIER VIBRATING EQUIPMENT, INC., LOUISVILLE, KY, VIBRANETICS, INC., LOUISVILLE, KY:  
990,792. REN. 9-19-04. U.S. CL. 23 (INT. CL. 7).
- CARRIER VIBRATING EQUIPMENT, INC., LOUISVILLE, KY:  
1,879,112. REN. 9-19-04. INT. CL. 7.
- CARROSSERIE HESS AG, BELLACH, SWITZERLAND:  
2,899,319. PUB. 5-4-2004. MULTIPLE CLASS, INT. CLS. 6, 7, 12 AND 37.
- CARTER & BURGESS, INC., FORT WORTH, TX:  
1,811,280. CANC. INT. CL. 42.
- CARTIER INTERNATIONAL B.V., AMSTERDAM, NETHERLANDS, CARTIER, INCORPORATED, NEW YORK, NY:  
1,000,672. REN. 9-18-04. U.S. CL. 17 (INT. CL. 34).
- CARTIER INTERNATIONAL B.V., 3980 AMSTERDAM, NETHERLANDS:  
2,899,033. PUB. 8-10-2004. INT. CL. 14.  
2,899,034. PUB. 8-10-2004. INT. CL. 14.  
2,899,107. PUB. 8-10-2004. INT. CL. 14.
- CARTOON NETWORK LP, LLLP, THE, ATLANTA, GA:  
2,900,119. INT. CL. 9.
- CARVEL CORPORATION, ATLANTA, GA:  
1,306,261. REN. 9-20-04. INT. CL. 30.
- CARWRAPS LLC, BROOKLYN, NY:  
2,899,026. PUB. 8-10-2004. INT. CL. 35.
- CASAGRANDE SPA, 33074 FONTANAFREDDA (PN), ITALY:  
2,898,788. PUB. 8-10-2004. MULTIPLE CLASS, INT. CLS. 7 AND 12.
- CASCADE DISPENSERS LIMITED, CHESHAM, BUCKINGHAMSHIRE HP5 2YP, UNITED KINGDOM:  
2,120,750. CANC. INT. CL. 6.
- CASCADE NATURAL GAS CORPORATION, SEATTLE, WA:  
2,898,809. PUB. 8-10-2004. INT. CL. 35.
- CASCADE POLE AND LUMBER COMPANY, TACOMA, WA:  
2,900,102. INT. CL. 19.  
2,900,103. INT. CL. 19.
- CASCADIA FASHIONS RESOURCES INC., BURNABY, BRITISH COLUMBIA V5J 5E9, CANADA:  
2,898,892. PUB. 8-10-2004. INT. CL. 25.
- CASE-HOYT CORPORATION, THE, ROCHESTER, NY:  
1,261,251. CANC. INT. CL. 42.
- CASEMARK, INC., WILMINGTON, DE:  
2,864,310. COR. INT. CL. 8.
- CASH AMERICA INTERNATIONAL, INC., FORT WORTH, TX:  
2,899,948. PUB. 8-10-2004. INT. CL. 36.
- CASINO MAGIC CORP., BAY ST. LOUIS, MS:  
2,121,569. CANC. INT. CL. 41.
- CASIO KEISANKI KABUSHIKI KAISHA, TOKYO, JAPAN, DBA CASIO COMPUTER CO., LTD.:  
2,122,360. CANC. INT. CL. 14.
- CASKET SHELLS, INC., EYNON, PA:  
1,290,091. REN. 9-18-04. MULTIPLE CLASS, INT. CLS. 20, 37 AND 42.  
1,290,566. REN. 9-18-04. INT. CL. 20.
- CASPIAN NETWORKS, INC., SAN JOSE, CA:  
2,900,112. INT. CL. 9.
- CASS INFORMATION SYSTEMS, INC., BRIDGETON, MO, CASS BANK AND TRUST COMPANY, BRIDGETON, MO:  
1,013,705. REN. 9-22-04. INT. CL. 36.
- CASTAGNO, JOE L., LITTLE ROCK, AR:  
1,847,286. REN. 9-23-04. INT. CL. 9.
- CASTER CONNECTION, INC., CHARDON, OH:  
1,810,446. CANC. MULTIPLE CLASS, INT. CLS. 6 AND 20.
- CASTLE INSPECTION SERVICE, INC., SALT LAKE CITY, UT:  
2,899,466. PUB. 8-10-2004. INT. CL. 36.
- CASTLE ROCK TECHNOLOGIES, LLC, CASTLE ROCK, CO:  
2,899,075. PUB. 8-10-2004. INT. CL. 9.
- CASTROL LIMITED, SWINDON, UNITED KINGDOM:  
2,899,596. PUB. 8-10-2004. INT. CL. 4.
- CASTROL LIMITED, SWINDON, WILTSHIRE, UNITED KINGDOM:  
2,900,830. INT. CL. 4.
- CASUALTY CONTRATORS, INC., ANDERSON, SC:  
2,900,248. INT. CL. 37.
- CATALINA MARKETING INTERNATIONAL, INC., ST. PETERSBURG, FL:  
2,900,641. INT. CL. 35.
- CATERPILLAR INC., PEORIA, IL:  
1,908,556. REN. 9-22-04. INT. CL. 25.
- CATHARSIS PRODUCTIONS, L.L.C., CHICAGO, IL:  
2,898,985. PUB. 8-10-2004. INT. CL. 41.
- CATHOLIC KNIGHTS, MILWAUKEE, WI:  
2,899,822. PUB. 8-10-2004. INT. CL. 36.
- CAVALIER HOMES, INC., ADDISON, AL:  
2,900,690. INT. CL. 19.
- CAVEX HOLLAND B.V., 2031 RW HAARLEM, NETHERLANDS:  
2,898,891. PUB. 8-10-2004. INT. CL. 10.
- CAVINESS WOODWORKING COMPANY, INC., CALHOUN CITY, MS:  
1,008,123. REN. 9-23-04. U.S. CL. 19 (INT. CL. 12).
- CBT CORPORATION, T. & J. INDUSTRIES, INC., KANSAS CITY, MO:  
1,342,444. REN. 9-24-04. INT. CL. 12.
- CCS FINANCIAL SERVICES, INC., FORT LAUDERDALE, FL:  
2,899,391. PUB. 8-10-2004. INT. CL. 36.
- CDK, INC., COMPTON, CA:  
2,121,127. CANC. MULTIPLE CLASS, INT. CLS. 11, 12 AND 27.
- CDMS MANAGEMENT, LLC, RICHMOND, VA:  
2,121,138. CANC. INT. CL. 35.
- CDOC, INC., CARMEL, IN:  
2,899,171. PUB. 8-10-2004. INT. CL. 36.  
2,899,172. PUB. 8-10-2004. INT. CL. 36.
- CDV SOFTWARE ENTERTAINMENT AG, KARLSRUHE, FED REP GERMANY:  
2,898,589. PUB. 12-3-2002. MULTIPLE CLASS, INT. CLS. 9 AND 42.  
2,899,120. PUB. 8-10-2004. MULTIPLE CLASS, INT. CLS. 9, 16 AND 42.

- CE NETWORK INC., THE, TORONTO, ONTARIO, CANADA:  
2,900,889, INT. CL. 35.
- CECCARELLI CLEANERS, INC., PLYMOUTH, MA:  
1,287,262, REN. 9-22-04. INT. CL. 37.
- CECILWARE CORPORATION, LONG ISLAND CITY, NY:  
1,303,572, REN. 9-23-04. MULTIPLE CLASS, INT. CLS. 11,  
16 AND 21.
- CEDA INTERNATIONAL CORPORATION, CALGARY, CANADA, CEDA MANUFACTURING & SALES LTD., CALGARY, ALBERTA, CANADA:  
1,266,036, REN. 9-20-04. INT. CL. 37.
- CEDA MANUFACTURING & SALES LTD., CALGARY, ALBERTA, CANADA TO CEDA INTERNATIONAL CORPORATION, CALGARY, CANADA:  
1,266,036, CANC. MULTIPLE CLASS, INT. CLS. 1 AND 42.
- CEG WORLDWIDE LLC, SAN MARTIN, CA:  
2,899,519, PUB. 8-10-2004. MULTIPLE CLASS, INT. CLS. 9, 16 AND 41.
- CEGETEL, 75008 PARIS, FRANCE:  
2,898,422, PUB. 8-10-2004. MULTIPLE CLASS, INT. CLS. 9, 16, 38 AND 42.
- CELANESE CHEMICALS EUROPE GMBH, FRANKFURT AM MAIN, FED REP GERMANY TO CELANESE GMBH, FED REP GERMANY:  
2,833,479, COR. INT. CL. 1.
- CELEBRATION QUILTS, INC., BALA CYNWYD, PA:  
2,898,766, PUB. 8-10-2004. MULTIPLE CLASS, INT. CLS. 24 AND 40.
- CELEBRATION, INC., MIAMI SPRINGS, FL:  
2,900,717, INT. CL. 33.
- CELERITY GROUP, INC., SANTA CLARA, CA:  
2,900,573, MULTIPLE CLASS, INT. CLS. 40 AND 42.
- CELES KING III AND ASSOCIATES, LOS ANGELES, CA:  
2,899,593, PUB. 8-10-2004. INT. CL. 36.
- CELESTIAL SEASONINGS, INC., BOULDER, CO, CELESTIAL SEASONINGS, INC., BOULDER, CO:  
1,017,548, REN. 9-23-04. INT. CL. 30.
- CELEX GROUP, INC., LOMBARD, IL:  
2,122,110, CANC. INT. CL. 16.
- CELINA INSURANCE GROUP, CELINA, OH:  
2,900,668, INT. CL. 36.
- CELLCO PARTNERSHIP, BEDMINSTER, NJ, DBA VERIZON WIRELESS:  
2,899,858, PUB. 8-10-2004. INT. CL. 16.
- CELLEGY PHARMACEUTICALS, INC., SOUTH SAN FRANCISCO, CA:  
2,900,107, INT. CL. 5.
- CELTIC ADVERTISING, INC., BROOKFIELD, WI:  
2,121,203, CANC. INT. CL. 35.
- CENTENARY COLLEGE, HACKETTSTOWN, NJ:  
2,899,398, PUB. 5-11-2004. INT. CL. 41.
- CENTERFIRE INC., LOS ANGELES, CA:  
2,899,105, PUB. 8-10-2004. INT. CL. 34.
- CENTERPRISE SERVICES, INC., PURCHASE, NY:  
2,899,715, PUB. 8-10-2004. INT. CL. 9.
- CENTEX CORPORATION, DALLAS, TX:  
2,899,641, PUB. 8-10-2004. INT. CL. 37.
- CENTRAL FIBER CORPORATION, WELLSVILLE, KS:  
2,899,085, PUB. 8-10-2004. INT. CL. 31.
- CENTRAL VACUUM STORES, INC., SEMINOLE, FL:  
2,898,743, PUB. 8-10-2004. INT. CL. 35.
- CENTRALNY INSPEKTORAT STANDARYZACJI MHZ, WARSAWA, POLAND:  
1,261,323, CANC. U.S. CL. A.
- CENTRE CONSULTING, INC., MCLEAN, VA:  
2,899,776, PUB. 8-10-2004. INT. CL. 41.
- CENTRIX, INC., SHELTON, CT:  
1,902,566, REN. 9-23-04. INT. CL. 10.
- CENTURI CORPORATION, PENROSE, CO:  
2,122,211, CANC. INT. CL. 28.
- CENTURY 2001, INC., INDIAN HARBOUR BEACH, FL:  
1,810,834, CANC. INT. CL. 25.
- CEQUENT TOWING PRODUCTS, INC., PLYMOUTH, MI:  
1,848,178, REN. 9-23-04. INT. CL. 12.
- CERA PRODUCTS, INC., COLUMBIA, MD:  
2,899,079, PUB. 8-10-2004. INT. CL. 5.
- CERAMCO INC., BURLINGTON, NJ:  
2,899,521, PUB. 8-10-2004. INT. CL. 5.
- CERAMIC WORLD INC., BROOKLYN, NY:  
2,122,289, CANC. MULTIPLE CLASS, INT. CLS. 20 AND 21.
- CERAMOPTEC, INC., EAST LONGMEADOW, MA:  
2,121,944, CANC. INT. CL. 10.
- CERDA, RODOLFO, JR, HOUSTON, TX:  
2,899,402, PUB. 8-10-2004. INT. CL. 9.
- CERTOL INTERNATIONAL, LLC, COMMERCE CITY, CA, COTTRELL, LTD., ENGLEWOOD, CO:  
1,911,028, REN. 9-22-04. INT. CL. 5.
- CERVECERIA CUAUHEMOC MOCTEZUMA S.A. DE C.V., MONTERREY, NUEVO LEON, MEXICO, CERVECERIA CUAUHEMOC, S.A., MONTERREY, NUEVO LEON, MEXICO:  
1,313,746, REN. 9-21-04. INT. CL. 32.
- CEYBA INC., OTTAWA, ONTARIO, CANADA:  
2,898,584, PUB. 8-10-2004. MULTIPLE CLASS, INT. CLS. 9 AND 42.
- CFI PROSERVICES, INC., PORTLAND, OR:  
2,121,563, CANC. INT. CL. 16.
- CHADFIELD GARDEN, INC., ST. LOUIS, MO:  
2,121,518, CANC. INT. CL. 35.
- CHAMPAIGN COUNTY ECONOMIC DEVELOPMENT CORPORATION, CHAMPAIGN, IL:  
2,899,737, PUB. 8-10-2004. INT. CL. 35.
- CHAMPION FOODS, L.L.C., DETROIT, MI:  
2,900,476, INT. CL. 30.
- CHAMPION TRADING, INC., CLOVIS, CA:  
2,899,127, PUB. 8-10-2004. MULTIPLE CLASS, INT. CLS. 18 AND 25.
- CHANG, JEFF F., DIAMOND BAR, CA:  
2,898,783, PUB. 8-10-2004. INT. CL. 33.
- CHANNEL G, NFP, SAN ANSELMO, CA:  
2,899,056, PUB. 8-10-2004. INT. CL. 38.
- CHANNELED RESOURCES, INC., CHICAGO, IL:  
1,906,000, REN. 9-18-04. INT. CL. 40.
- CHANNING BETE COMPANY, INC., SOUTH DEERFIELD, MA:  
2,900,648, MULTIPLE CLASS, INT. CLS. 9 AND 16.
- CHANTRE DANIEL, DOWNEY, CA:  
2,899,293, PUB. 1-27-2004. INT. CL. 25.
- CHARLES SADEK IMPORT CO. INC., NEW ROCHELLE, NY:  
2,898,949, PUB. 8-10-2004. INT. CL. 35.
- CHARLES SCHWAB & CO., INC., SAN FRANCISCO, CA:  
2,122,382, CANC. INT. CL. 41.
- CHARRETTE LLC, WOBURN, MA:  
2,857,213, COR. MULTIPLE CLASS, INT. CLS. 2 AND 16.  
2,857,215, COR. MULTIPLE CLASS, INT. CLS. 2 AND 16.
- CHART INC., BURNSVILLE, MN, CRYENCO, INC., DENVER, CO:  
1,857,160, REN. 9-22-04. INT. CL. 6.
- CHARTER PARTNERS USA, INC., HAMPTON, NJ:  
2,866,289, COR. MULTIPLE CLASS, INT. CLS. 35 AND 41.
- CHARTHOUSE INTERNATIONAL LEARNING CORPORATION, BURNSVILLE, MN:  
2,898,552, PUB. 10-22-2002. MULTIPLE CLASS, INT. CLS. 9 AND 16.
- CHASE PRODUCTS COMPANY, BROADVIEW, IL:  
2,899,900, PUB. 8-10-2004. INT. CL. 3.
- CHATAM INTERNATIONAL INCORPORATED, WILMINGTON, DE:  
1,850,824, REN. 9-24-04. INT. CL. 33.  
2,900,026, INT. CL. 33.
- CHAUSSURES STC INC., VILLE D'ANJOU, QUEBEC, CANADA:  
2,898,590, PUB. 6-8-2004. INT. CL. 25.
- CHAZ TAYLOR, INC, NASHVILLE, TN:  
2,899,826, PUB. 8-10-2004. INT. CL. 35.
- CHECK-WRITE, INC., HANOVER, NH:  
1,823,092, REN. 9-19-04. INT. CL. 35.
- CHEM PRO, INC., SPARTANBURG, SC, MORTON THIOKOL, INC., GREENVILLE, SC:  
1,287,574, REN. 9-21-04. INT. CL. 3.

- CHEMALLOY COMPANY, INC., BRYN MAWR, PA:  
977,625. REN. 9-20-04. U.S. CL. 14 (INT. CL. 6).  
989,991. REN. 9-21-04. U.S. CL. 14 (INT. CL. 6).
- CHEMCAST CORPORATION, THE, MADISON HEIGHTS, MI:  
1,880,519. REN. 9-23-04. MULTIPLE CLASS, INT. CLS. 12, 40 AND 42.  
1,880,520. REN. 9-23-04. MULTIPLE CLASS, INT. CLS. 12, 40 AND 42.
- CHEMCO INDUSTRIES, INC., LOS ANGELES, CA:  
2,900,665. INT. CL. 5.
- CHEMICAL SPECIALTIES, INC., CHARLOTTE, NC, MINERAL RESEARCH & DEVELOPMENT CORPORATION, CHARLOTTE, NC:  
1,288,542. REN. 9-21-04. INT. CL. 1.
- CHEMICAL SPECIALTIES, LLC, MEMPHIS, TN:  
2,899,151. PUB. 8-10-2004. INT. CL. 3.
- CHEMPLOER GMBH, BONN, FED REP GERMANY:  
2,769,168. COR. MULTIPLE CLASS, INT. CLS. 35, 36, 41 AND 42.
- CHENG SHIN RUBBER USA, INC., SUWANEE, GA:  
2,899,459. PUB. 11-18-2003. INT. CL. 12.
- CHERAW YARN MILLS, INC., CHERAW, SC:  
1,312,386. REN. 9-21-04. INT. CL. 23.
- CHEROKEE BEVERAGE, LLC, MACON, GA:  
2,122,066. CANC. INT. CL. 32.
- CHERRY HILL TRAVEL AGENCY, INC., MT. LAUREL, NJ:  
2,120,877. CANC. MULTIPLE CLASS, INT. CLS. 39 AND 42.
- CHERRY LANE MUSIC PUBLISHING COMPANY, INC., NEW YORK, NY, GUITAR RECORDINGS, INC., PORT CHESTER, NY:  
1,840,405. REN. 9-19-04. INT. CL. 9.  
1,840,410. REN. 9-19-04. INT. CL. 9.
- CHESAPEAKE LOCK & SAFE SERVICE CO., PRINCE FREDERICK, MD, TA CHESAPEAKE SECURITY SERVICE CO.:  
2,898,678. PUB. 8-10-2004. MULTIPLE CLASS, INT. CLS. 35, 37, 42 AND 45.
- CHESEBROUGH-POND'S INC., WILMINGTON, DE:  
2,899,106. PUB. 8-10-2004. INT. CL. 3.
- CHEZ PUPPY, BOCA RATON, FL:  
2,899,825. PUB. 8-10-2004. INT. CL. 31.
- CHF INDUSTRIES, INC., NEW YORK, NY, JOSEPH A. KAPLAN & SONS, INC., NEW YORK, NY:  
606,488. REN. 9-21-04. U.S. CL. 42 (INT. CL. 24).
- CHI SYSTEMS, INC., FORT WASHINGTON, PA:  
2,899,185. PUB. 8-10-2004. INT. CL. 9.
- CHICAGO TRIBUNE COMPANY, CHICAGO, IL:  
1,848,363. REN. 9-22-04. INT. CL. 42.
- CHILD HEALTH CORPORATION OF AMERICA, SHAWNEE MISSION, KS:  
1,859,353. REN. 9-22-04. INT. CL. 42.
- CHILDREN'S DEFENSE FUND, WASHINGTON, DC:  
2,120,713. CANC. INT. CL. 42.
- CHIM CAP CORP, FARMINGDALE, NY:  
2,899,591. PUB. 8-10-2004. INT. CL. 6.
- CHIPDATA, INC., RICHARDSON, TX:  
2,900,407. INT. CL. 9.  
2,900,408. INT. CL. 9.  
2,900,409. INT. CL. 9.
- CHIQUITA BRANDS L.L.C., CINCINNATI, OH, UNITED FRUIT COMPANY, BOSTON, MA:  
775,094. REN. 9-19-04. U.S. CL. 46 (INT. CL. 7).
- CHLYSTEK & WHITE SERVICES, INC., GRAND RAPIDS, MI:  
1,889,203. REN. 9-21-04. INT. CL. 9.
- CHOICE HOTELS INTERNATIONAL, INC., SILVER SPRING, MD:  
2,899,860. PUB. 8-10-2004. INT. CL. 43.
- CHORUS OCCUPATIONAL HEALTH SERVICES, LLC, MILWAUKEE, WI:  
2,169,583. AM. INT. CL. 42.
- CHOU, SHUN YUNG GENO, FLUSHING, NY:  
2,899,340. PUB. 8-12-2003. MULTIPLE CLASS, INT. CLS. 25 AND 28.
- CHRISTINE VALMY, INC., PINE BROOK, NJ:  
1,287,326. REN. 9-23-04. MULTIPLE CLASS, INT. CLS. 41 AND 42.  
1,287,333. REN. 9-23-04. INT. CL. 42.
- CHRISTMAN, RODNEY GENE, RICHFIELD SPRINGS, NY AND KASZA-CHRISTMAN, AMY JO, RICHFIELD SPRINGS, NY:  
2,121,793. CANC. INT. CL. 25.
- CHRISTY'S MARKET, INC., BROCKTON, MA:  
2,121,781. CANC. INT. CL. 30.
- CHROMATIC SOFTWARE, INC., VANCOUVER, CANADA:  
2,899,692. PUB. 8-10-2004. INT. CL. 35.
- CHUBB CORPORATION, THE, WARREN, NJ:  
998,842. REN. 9-22-04. U.S. CL. 100 (INT. CL. 36).
- CHURCH & DWIGHT COMPANY, GREEN RIVER, NY, CHURCH & DWIGHT CO., INC., GREEN RIVER, NY:  
1,835,893. REN. 9-23-04. MULTIPLE CLASS, INT. CLS. 1, 3, 5 AND 31.
- CHURCH & MAIN, INC., KEENE, NH:  
2,899,547. PUB. 8-10-2004. INT. CL. 35.
- CHURCH AND CHAPEL FUNERAL SERVICE, INC., WAUKESHA, WI:  
1,850,131. REN. 9-19-04. INT. CL. 42.
- CIBA SPECIALTY CHEMICALS CORPORATION, TARRYTOWN, NY, GEIGY CHEMICAL CORPORATION, ARDSLEY, NY:  
783,856. REN. 9-22-04. U.S. CL. 6 (INT. CL. 1).
- CIBA SPECIALTY CHEMICALS WATER TREATMENTS, BRADFORD, W. YORKSHIRE, ENGLAND:  
1,295,301. REN. 9-24-04. INT. CL. 1.
- CICERON, INC., MINNEAPOLIS, MN:  
2,898,939. PUB. 8-10-2004. MULTIPLE CLASS, INT. CLS. 35 AND 42.
- CICMANEC, JOHN F., CINCINNATI, OH, DBA HIGHBALL PRODUCTS CO.:  
999,670. REN. 9-19-04. INT. CL. 20.
- CIDEC, COMPANIA INDUSTRIAL DEL CUERO S.A., BUENOS AIRES, ARGENTINA:  
1,810,784. CANC. INT. CL. 18.
- CIDIESSE S.R.L., BETTONA (PERUGIA), ITALY:  
2,898,896. PUB. 8-10-2004. INT. CL. 25.
- CIP, INC., CHATTANOOGA, TN:  
2,899,898. PUB. 8-10-2004. INT. CL. 39.
- CIRCUITRONIX, LLC, MIAMI, FL:  
2,899,029. PUB. 8-10-2004. INT. CL. 35.
- CIRCUS CITY CREATIONS, BARABOO, WI:  
1,261,205. CANC. INT. CL. 41.
- CIRRUS TECHNOLOGY, INC., HUNTSVILLE, AL:  
2,899,129. PUB. 8-10-2004. INT. CL. 40.
- CITY AND COUNTY OF DENVER, ACTING BY AND THROUGH THE THEATRES AND ARENAS DIVISION OF THE DEPARTMENT OF GENERAL SERVICES, DENVER, CO:  
2,899,087. PUB. 8-10-2004. INT. CL. 41.
- CITY CHAIN COMPANY LIMITED, SAN PO KONG KOW LOON, HONG KONG:  
2,899,532. PUB. 8-10-2004. INT. CL. 37.
- CITY LIGHTS JEWELRY, LLC, NORTH POTOMAC, MD:  
2,899,894. PUB. 8-10-2004. INT. CL. 35.
- CITY OF AUSTIN, TEXAS, AUSTIN, TX, DBA AUSTIN ENERGY FROM ENERSHOP, INC., DALLAS, TX:  
2,900,027. INT. CL. 42.
- CIVIL ENGINEERING RESEARCH FOUNDATION, WASHINGTON, DC:  
2,121,055. CANC. INT. CL. 42.
- CLAIRE'S BOUTIQUES, INC., WOOD DALE, IL:  
2,121,309. CANC. INT. CL. 26.
- CLAIRE'S BOUTIQUES, INC., HOFFMAN ESTATES, IL:  
2,900,024. PUB. 8-10-2004. INT. CL. 24.
- CLAIROL INCORPORATED, NEW YORK, NY:  
2,122,380. CANC. INT. CL. 16.
- CLAREMONT RESTAURANT GROUP, LLC, MOORESVILLE, NC:  
2,899,501. PUB. 8-10-2004. INT. CL. 43.
- CLARITI EYEWEAR, INC., SANTA FE SPRINGS, CA:  
2,900,355. INT. CL. 9.
- CLARK, D. JOSEPH, SEATTLE, WA:  
2,900,063. INT. CL. 42.
- CLARKE AMERICAN CHECKS INC., SAN ANTONIO, TX:  
2,899,119. PUB. 8-10-2004. INT. CL. 16.

CLARKE POWER PRODUCTS, INC., PERRYSBURG, OH:  
1,870,329. REN. 9-20-04. INT. CL. 7.

CLASSIC CAMPUS INNS LTD., INC., WILLIAMSTOWN,  
MA:  
1,859,944. REN. 9-18-04. INT. CL. 35.

CLASSIC WINE IMPORTS, INC., BOSTON, MA:  
2,899,865. PUB. 8-10-2004. INT. CL. 33.  
2,899,866. PUB. 8-10-2004. INT. CL. 33.

CLASSICSTAR, LLC, CENTERVILLE, UT:  
2,899,471. PUB. 8-10-2004. INT. CL. 44.

CLASSIFIEDS 2000, INC., SANTA CLARA, CA:  
2,121,438. CANC. INT. CL. 35.

CLAUDE BAMBERGER MOLDING COMPOUNDS CORP.,  
CARLSTADT, NJ:  
1,341,829. REN. 9-21-04. INT. CL. 1.

CLAUDE GABLE CO., INC., HIGH POINT, NC:  
1,286,039. REN. 9-21-04. INT. CL. 20.

CLAUSEN COMPANY, THE, FORDS, NJ:  
1,260,697. CANC. INT. CL. 1.

CLAYTON CORPORATION, FENTON, MO, DBA CONVE-  
NIENCE PRODUCTS:  
2,898,598. PUB. 2-11-2003. INT. CL. 17.

CLEAN CREW, INC., N. CHARLESTON, SC:  
2,899,594. PUB. 8-10-2004. INT. CL. 37.

CLEANING SYSTEMS, INC., DE PERE, WI:  
2,898,935. PUB. 3-23-2004. INT. CL. 3.

CLEAR LAKE INDEPENDENT TELEPHONE CO., CLEAR  
LAKE, IA:  
2,899,375. PUB. 8-10-2004. MULTIPLE CLASS, INT. CLS.  
36, 37, 38 AND 42.

CLEMCO INDUSTRIES CORP., SAN FRANCISCO, CA:  
1,291,862. REN. 9-18-04. INT. CL. 7.

CLEMENT COMMUNICATIONS, INCORPORATED, CON-  
CORDVILLE, PA:  
2,121,468. CANC. INT. CL. 16.

CLIFFORD, ALLAN J., LOUISVILLE, KY:  
2,900,614. INT. CL. 41.

CLINITEX HOLDINGS, INC., HUNTERSVILLE, NC:  
1,811,152. CANC. INT. CL. 40.

CLOUD, WILLIAM W., KNOXVILLE, TN:  
2,121,471. CANC. INT. CL. 20.

CLUETT PEABODY & CO. INC., NEW YORK, NY:  
408,780. REN. 9-21-04. U.S. CL. 39 (INT. CL. 25).

CLUETT PEABODY RESOURCES CORPORATION, NEW  
YORK, NY TO CLUETT PEABODY RESOURCES COR-  
PORATION, NEW YORK, NY:  
1,811,573. CANC. INT. CL. 25.

CLUETT, PEABODY & CO., INC., WILMINGTON, DE:  
1,260,986. CANC. INT. CL. 25.

CM LINX CORPORATION, AGOURA HILLS, CA:  
2,899,217. PUB. 8-10-2004. MULTIPLE CLASS, INT. CLS. 3  
AND 30.

CML INTERNATIONAL S.P.A., PIEDIMONTE SAN GER-  
MANO (FR), FROSINONE, ITALY:  
1,819,569. CANC. INT. CL. 8.

CNA FINANCIAL CORPORATION, CHICAGO, IL:  
2,900,104. INT. CL. 36.

CO-TRUSTEES OF THE MICKEY CHARLES MANTLE  
MARITAL TRUST II, A TEXAS TRUST, THE CO-TRUS-  
TEES COMPRISING MERLYN L. MANTLE AND JOHN-  
NY LA FALIER, BOTH U.S. CITIZENS, THE, DALLAS,  
TX:  
2,900,042. MULTIPLE CLASS, INT. CLS. 6, 14, 16, 20, 21,  
25 AND 28.

COBRA ELECTRONICS CORPORATION, CHICAGO, IL:  
2,899,578. PUB. 8-10-2004. INT. CL. 9.

CODEL, INC., NEW YORK, NY:  
1,261,137. CANC. INT. CL. 36.

COFFARO'S ITALIA, INC., KENT, WA:  
2,899,709. PUB. 8-10-2004. INT. CL. 30.

COFFEE BEAN INTERNATIONAL, INC., PORTLAND, OR:  
2,122,223. CANC. INT. CL. 30.

COFFEE CAVERN INC., MORAGA, CA:  
2,121,702. CANC. INT. CL. 30.

COFFEE MASTERS, INC., SPRING GOVE, IL, PAULIG OY,  
00981 HELSINKI, FINLAND:  
1,862,653. REN. 9-22-04. INT. CL. 30.

COFFEE PEOPLE, INC., PORTLAND, OR:  
2,121,622. CANC. INT. CL. 42.

COGNIS CORPORATION, GULPH MILLS, PA:  
2,899,422. PUB. 9-30-2003. INT. CL. 1.

COLART INTERNATIONAL, 72000 LE MANS, FRANCE:  
992,350. REN. 9-18-04. U.S. CL. 16 (INT. CL. 2).

COLD STEEL, INC., VENTURA, CA:  
2,899,494. PUB. 2-10-2004. INT. CL. 28.

COLDER PRODUCTS COMPANY, ST. PAUL, MN:  
2,122,010. CANC. MULTIPLE CLASS, INT. CLS. 6 AND  
17.

COLEMAN COMPANY, RAPID CITY, SD:  
2,898,516. PUB. 3-26-2002. INT. CL. 14.

COLGATE-PALMOLIVE COMPANY, NEW YORK, NY:  
1,290,656. REN. 9-24-04. INT. CL. 3.

COLGATE-PALMOLIVE COMPANY, NEW YORK, NY,  
MENNEN COMPANY, THE, MORRISTOWN, NJ:  
1,848,019. REN. 9-18-04. INT. CL. 3.

COLGATE-PALMOLIVE COMPANY, NEW YORK, NY:  
2,899,482. PUB. 8-10-2004. INT. CL. 3.

COLIMAN GRUPO SA DE CV, TECOMAN, JALISCO,  
MEXICO:  
2,900,667. INT. CL. 29.

COLLEGEPROWLER, INC., PITTSBURGH, PA:  
2,899,236. PUB. 8-10-2004. MULTIPLE CLASS, INT. CLS.  
16 AND 41.

COLLIE, JAMES E., RICHMOND, VA:  
2,122,153. CANC. INT. CL. 21.

COLONIAL OIL INDUSTRIES, INC., SAVANNAH, GA:  
1,293,293. REN. 9-18-04. MULTIPLE CLASS, INT. CLS. 37  
AND 42.

COLONIAL PENN GROUP, INC., WILMINGTON, DE:  
2,122,464. CANC. INT. CL. 36.

COLORADO PRIME CORPORATION, FARMINGDALE,  
NY, AKA COLORADO PRIME FOODS:  
1,849,988. REN. 9-18-04. INT. CL. 29.

COLORADO RESTAURANT MANAGEMENT, INC., DEN-  
VER, CO:  
2,898,419. PUB. 2-1-2000. INT. CL. 42.

COLUMBIA DIAGNOSTICS, INC., SPRINGFIELD, VA:  
1,260,693. CANC. MULTIPLE CLASS, INT. CLS. 1 AND 9.

COLUMBIA INSURANCE COMPANY, OMAHA, NE:  
1,290,265. REN. 9-23-04. INT. CL. 27.  
2,899,101. PUB. 8-10-2004. INT. CL. 14.

COLUMBIA MANUFACTURING, INC., WESTFIELD, MA:  
2,899,976. PUB. 8-10-2004. INT. CL. 20.

COLUMBINE HOLDING CORPORATION, DENVER, CO,  
DBA SYSTEMATION:  
2,899,051. PUB. 8-10-2004. INT. CL. 41.

COM NET, INC., WAPAKONETA, OH:  
2,898,542. PUB. 8-10-2004. MULTIPLE CLASS, INT. CLS.  
35, 38 AND 42.

COM-CORP INDUSTRIES, INC., CLEVELAND, OH:  
1,811,669. CANC. INT. CL. 40.

COMBINENET, INC., PITTSBURGH, PA:  
2,900,949. INT. CL. 9.

COMCORP, INC., CLEVELAND, OH:  
2,121,396. CANC. INT. CL. 16.

COMDISCO, INC., ROSEMONT, IL:  
2,122,547. CANC. INT. CL. 35.

COMMODITIES DERIVATIVE EXCHANGE, INC., NORTH-  
FIELD, IL:  
2,899,823. PUB. 8-10-2004. INT. CL. 36.

COMMSCOPE SOLUTIONS PROPERTIES, LLC, SPARKS,  
NV, AMERICAN TELEPHONE AND TELEGRAPH COM-  
PANY, NEW YORK, NY:  
1,849,070. REN. 9-22-04. INT. CL. 9.

COMMUNICATION DEVELOPMENT ASSOCIATES, INC.,  
WOODLAND HILLS, CA:  
2,898,624. PUB. 8-10-2004. MULTIPLE CLASS, INT. CLS.  
35 AND 41.

COMMUNITY CLUB AWARDS, INC., WESTPORT, CT:  
1,811,061. CANC. INT. CL. 35.  
1,811,062. CANC. INT. CL. 35.

COMMUNITY LIGHT & SOUND, INC., CHESTER, PA:  
2,121,511. CANC. INT. CL. 9.

COMO ADVERTISING LLC, HOUSTON, TX:  
2,899,099. PUB. 8-10-2004. INT. CL. 35.

- COMPACT TRACTOR CONNECTION, INC., CANISTOTA, SD:  
2,899,518, PUB. 8-10-2004. INT. CL. 35.
- COMPAGNIA EDITORIALE SRL, 50 00155 ROMA, ITALY:  
2,898,767, PUB. 8-10-2004. INT. CL. 16.
- COMPAGNIE GENERALE DES ETABLISSEMENTS MICHELIN - MICHELIN & CIE, CEDEX 09, FRANCE:  
2,898,739, PUB. 8-10-2004. INT. CL. 12.
- COMPANIA PINTUCO S.A., MEDELLIN, COLOMBIA:  
1,864,134, REN. 9-18-04. INT. CL. 2.
- COMPASS BANCSHARES, INC., BIRMINGHAM, AL, COMPASS BANCSHARES, INC., BIRMINGHAM, AL:  
1,868,984, REN. 9-22-04. INT. CL. 36.
- COMPASS BANCSHARES, INC., BIRMINGHAM, AL:  
2,122,037, CANC. INT. CL. 36.
- COMPOSITE TECHNOLOGIES CORPORATION, DES MOINES, IA:  
2,899,516, PUB. 8-10-2004. INT. CL. 19.
- COMPUSERVE INCORPORATED, COLUMBUS, OH:  
2,120,969, CANC. INT. CL. 42.
- COMPUTER ASSOCIATES THINK, INC., ISLANDIA, NY:  
2,900,582, INT. CL. 9.
- COMPUWARE CORPORATION, DETROIT, MI:  
2,899,163, PUB. 8-10-2004. INT. CL. 9.
- COMSHARE, INCORPORATED, ANN ARBOR, MI:  
1,289,904, REN. 9-24-04. MULTIPLE CLASS, INT. CLS. 9 AND 16.
- COM21, INC., MOUNTAIN VIEW, CA:  
2,122,035, CANC. INT. CL. 9.
- CONAGRA, INC., OMAHA, NE TO CONAGRA BRANDS, INC., OMAHA, NE:  
1,849,245, AM. INT. CL. 16.
- CONAIR CORPORATION, STAMFORD, CT:  
1,810,811, CANC. INT. CL. 21.  
2,122,305, CANC. INT. CL. 9.
- CONCEPT 2, INC., MORRISVILLE, VT:  
2,898,592, PUB. 8-10-2004. INT. CL. 9.
- CONCEPTS, INCORPORATED, DECATUR, GA:  
2,120,961, CANC. INT. CL. 28.  
2,121,198, CANC. INT. CL. 28.
- CONCORD ELEVATOR INC., BRAMPTON, ONTARIO:  
2,807,289, COR. INT. CL. 7.
- CONCORD FOODS, INC., BROCKTON, MA:  
775,472, REN. 9-22-04. U.S. CL. 46 (INT. CL. 32).
- CONCORD FOODS, INC., BROCKTON, MA, DAWN HOLDINGS, INC., BINGHAM FARMS, MI, DBA REGENCY CREATIVE FOODS:  
1,863,823, REN. 9-22-04. MULTIPLE CLASS, INT. CLS. 29 AND 30.
- CONCRETE DESIGNS INC., TUCSON, AZ:  
2,899,470, PUB. 10-21-2003. INT. CL. 40.
- CONDENET, INC., NEW YORK, NY:  
2,159,752, CANC. INT. CL. 9.
- CONESTOGA ENTERPRISES, OGDEN, UT:  
1,297,191, REN. 9-24-04. INT. CL. 42.
- CONEXPORT V.I.P., 37012 BUSSOLENGO (VERONA), ITALY:  
2,122,250, CANC. INT. CL. 35.
- CONFECTION CONCEPTS, INC., GREENSBORO, NC, DBA CAROLINA COOKIE COMPANY:  
2,899,121, PUB. 8-10-2004. INT. CL. 30.  
2,899,122, PUB. 8-10-2004. INT. CL. 35.
- CONGIS CORPORATION, CINCINNATI, OH, EMERY INDUSTRIES, INC., CINCINNATI, OH:  
593,490, REN. 9-20-04. U.S. CL. 6 (INT. CL. 1).
- CONNECTICUT STUDENT LOAN FOUNDATION, ROCKY HILL, CT:  
2,899,888, PUB. 8-10-2004. INT. CL. 36.
- CONNETICS CORPORATION, PALO ALTO, CA:  
2,900,522, INT. CL. 5.
- CONNEX, INC., BELLEVUE, WA:  
2,121,079, CANC. INT. CL. 42.
- CONNIE STEVENS FOREVER SPRING THE BEAUTY SYSTEM INC., WEST HOLLYWOOD, CA:  
2,120,995, CANC. INT. CL. 3.
- CONOCOPHILLIPS COMPANY, HOUSTON, TX:  
2,899,719, PUB. 8-10-2004. INT. CL. 42.
- CONOPCO, INC., NEW YORK, NY, DBA LEVER BROTHERS COMPANY:  
2,898,513, PUB. 10-14-2003. INT. CL. 3.  
2,898,524, PUB. 10-7-2003. INT. CL. 3.
- CONOVER, MAX K., PARKTON, MD:  
2,898,441, PUB. 7-10-2001. INT. CL. 12.
- CONSECO SERVICES, LLC, CARMEL, IN:  
2,898,966, PUB. 8-10-2004. INT. CL. 36.
- CONSOLIDATED SERVICE CORPORATION, ELK GROVE VILLAGE, IL:  
1,811,065, CANC. INT. CL. 35.
- CONSTELLATION BRANDS, INC., FAIRPORT, NY, GUILD WINERIES AND DISTILLERIES, LODI, CA:  
1,343,148, REN. 9-23-04. INT. CL. 33.
- CONSTRUCTION MANAGEMENT ASSOCIATION OF AMERICA, MCLEAN, VA:  
2,899,622, PUB. 8-10-2004. INT. CL. 16.
- CONSTRUCTION RESEARCH & TECHNOLOGY GMBH, TROSTBERG, FED REP GERMANY, GENERAL SIGNAL INDUSTRIES, INC., STAMFORD, CT:  
1,292,271, REN. 9-20-04. INT. CL. 17.  
1,298,295, REN. 9-20-04. INT. CL. 2.
- CONSTRUCTION SOLUTIONS, L.L.C., SCOTTSDALE, AZ:  
2,899,061, PUB. 8-10-2004. INT. CL. 19.
- CONSUMER CREDIT COUNSELING SERVICE OF THE MIDWEST, INC., COLUMBUS, OH:  
2,899,915, PUB. 8-10-2004. INT. CL. 41.
- CONSUMER ELECTRONICS ASSOCIATION, ARLINGTON, VA:  
2,899,838, PUB. 8-10-2004. INT. CL. 44.
- CONTEMPORARY, INC., MANITOWOC, WI:  
989,592, REN. 9-20-04. MULTIPLE CLASS, U.S. CLS. 28 (INT. CL. 14) AND 50 (INT. CL. 19).
- CONTEXT MEDIA, INC., PROVIDENCE, RI:  
2,900,081, MULTIPLE CLASS, INT. CLS. 40, 41 AND 42.
- CONTINENTAL DELI FOODS, INC., OKLAHOMA CITY, OK:  
2,122,486, CANC. INT. CL. 29.
- CONTINENTAL PET TECHNOLOGIES, INC., TOLEDO, OH:  
2,900,558, MULTIPLE CLASS, INT. CLS. 40 AND 42.
- CONTINENTAL QUILTING COMPANY, INC., BROOKLYN, NY:  
2,898,850, PUB. 8-10-2004. INT. CL. 27.
- CONTINENTAL SUPPLY COMPANY, WOODLAND, CA:  
2,900,906, INT. CL. 17.
- CONTROL SYSTEMS INC., TORONTO, ONTARIO, CANADA:  
2,185,409, CANC. MULTIPLE CLASS, INT. CLS. 37 AND 42.
- CONTROLLED CONSTRUCTION & ENGINEERING, INC., WELLESLEY HILLS, MA:  
2,898,823, PUB. 8-10-2004. INT. CL. 37.
- CONVAIR COOLER CORPORATION, PHOENIX, AZ:  
2,900,285, INT. CL. 11.
- CONVERGENT MEDIA SYSTEMS, INC., ALPHARETTA, GA:  
2,899,204, PUB. 8-10-2004. MULTIPLE CLASS, INT. CLS. 35, 37, 38, 41 AND 42.
- CONVERTECH, INC., WHARTON, NJ:  
2,898,708, PUB. 8-10-2004. INT. CL. 7.
- CONWAVE, INC., JACKSON, WY:  
2,900,250, INT. CL. 11.
- COOGI PARTNERS, LLC, BROOKLYN, NY FROM COOGI NOMINEES PTY LTD (ADMINISTRATORS APPOINTED), ABBOTSFORD, AUSTRALIA:  
2,900,635, INT. CL. 25.
- COOPER INDUSTRIES, INC., HOUSTON, TX:  
1,260,801, CANC. INT. CL. 7.  
2,120,710, CANC. INT. CL. 6.
- COOPER TECHNOLOGIES COMPANY, HOUSTON, TX:  
2,898,839, PUB. 8-10-2004. INT. CL. 9.
- COOPERATIVA AGRICOLA CONTROL PISQUERO DE ELQUI Y LIMARI LIMITADA, LA SERENA, CHILE:  
2,898,668, PUB. 8-10-2004. INT. CL. 33.
- COOPERATIVE BEAUTY VENTURES, L.L.C., NEW YORK, NY:  
2,900,516, MULTIPLE CLASS, INT. CLS. 35 AND 42.



COORS GLOBAL PROPERTIES, INC., LAKEWOOD, CO:  
2,899,682, PUB. 4-6-2004. INT. CL. 32.

COPELAN SERVICES, INC., BROOKFIELD, WI:  
1,312,654. REN. 9-22-04. INT. CL. 37.

CORE DESIGN LIMITED, DERBY, UNITED KINGDOM:  
2,899,690, PUB. 8-10-2004. INT. CL. 9.

CORE TECHNOLOGY CORPORATION, LANSING, MI:  
1,869,393. REN. 9-18-04. INT. CL. 9.

CORENET GLOBAL, INC., ATLANTA, GA:  
2,899,203, PUB. 8-10-2004. INT. CL. 41.

CORGI CLASSICS LIMITED, LEICESTER LE3 2RL, UNITED KINGDOM, LLEDO PLC, ENFIELD, MIDDLESEX EN3 4ND, UNITED KINGDOM:  
1,872,612. REN. 9-23-04. INT. CL. 28.

CORINTHIAN COLLEGES, INC., SANTA ANA, CA:  
2,898,820, PUB. 8-10-2004. INT. CL. 41.  
2,898,821, PUB. 8-10-2004. INT. CL. 41.

CORNERSTONE RELOCATION GROUP, LLC, WARREN, NJ:  
2,898,913, PUB. 8-10-2004. INT. CL. 35.

CORNERSTONE RELOCATION GROUP, LLC., WARREN, NJ:  
2,898,912, PUB. 8-10-2004. INT. CL. 35.

CORNING GLASS WORKS, CORNING, NY:  
1,260,883, CANC. INT. CL. 11.

COROLON COATINGS AND CORROSION CONTROL TECHNOLOGIES INC., OAKVILLE, ONTARIO L6H 5V4, CANADA:  
2,121,048, CANC. MULTIPLE CLASS, INT. CLS. 2 AND 40.

CORPORATE ANGEL NETWORK, INC., WHITE PLAINS, NY, AMERICAN CANCER SOCIETY, INC., NEW YORK, NY:  
1,289,378. REN. 9-23-04. INT. CL. 39.

CORPORATE PROJECT RESOURCES, INC., CHICAGO, IL:  
2,899,710, PUB. 8-10-2004. INT. CL. 35.

CORPORATE VOICES FOR WORKING FAMILIES, INC., WASHINGTON, DC:  
2,899,148, PUB. 8-10-2004. INT. CL. 35.

CORRAN INDUSTRIES, INC., BRIDGEWATER, NJ:  
1,261,172, CANC. INT. CL. 37.

CORTEX BIOPHYSIK GMBH, LEIPZIG, FED REP GERMANY:  
2,899,556, PUB. 8-10-2004. MULTIPLE CLASS, INT. CLS. 9, 10 AND 44.

CORTLAND LINE COMPANY, INC., CORTLAND, NY:  
2,761,933, COR. INT. CL. 28.

CORUS ESTATES & VINEYARDS, LLC, SUNNYSIDE, WA:  
2,899,852, PUB. 8-10-2004. INT. CL. 33.  
2,899,856, PUB. 8-10-2004. INT. CL. 33.

CORUS RADIO COMPANY, TORONTO, CANADA:  
2,899,287, PUB. 8-10-2004. INT. CL. 41.

COSEC INTERNATIONAL, INC., TULSA, OK:  
1,305,252. REN. 9-18-04. INT. CL. 35.

COSMOS IMPORT-EXPORT, INC., FALL RIVER, MA TO J. MONIZ COMPANY, FALL RIVER, MA:  
1,810,934, CANC. INT. CL. 29.

COSTA DEL MAR SUNGLASSES, INC., ORMOND BEACH, FL:  
2,899,507, PUB. 12-23-2003. INT. CL. 9.

COTENOIR, ROSEMARY, TUSTIN, CA:  
2,899,509, PUB. 2-10-2004. MULTIPLE CLASS, INT. CLS. 16 AND 28.

COUNCIL FOR AFFORDABLE QUALITY HEALTHCARE, INC., WASHINGTON, DC:  
2,899,118, PUB. 8-10-2004. INT. CL. 35.

COUNTRY CLUB ENTERPRISES, INC., MIAMI, FL:  
1,864,991. REN. 9-23-04. MULTIPLE CLASS, INT. CLS. 41 AND 42.

COUPONS, INC, BELMONT, CA:  
2,898,729, PUB. 8-10-2004. INT. CL. 35.

COUSINS, INC., ROCKY MOUNT, NC:  
2,899,871, PUB. 8-10-2004. INT. CL. 35.

COVEX FARMA, S.L., MADRID, SPAIN:  
2,899,269, PUB. 8-10-2004. INT. CL. 5.

COWAY INVESTMENT LIMITED, TSIMSHATSUI, HONG KONG:  
1,811,512, CANC. INT. CL. 14.

COWBOYS FOR CHRIST, FORT WORTH, TX:  
2,899,759, PUB. 8-10-2004. INT. CL. 45.

COWETA-FAYETTE ELECTRIC MEMBERSHIP CORPORATION, NEWNAN, GA:  
2,899,841, PUB. 8-10-2004. INT. CL. 39.

COWLES LEGAL SYSTEMS, INC., EAU CLAIRE, WI:  
1,894,582. REN. 9-23-04. INT. CL. 9.

COWTAN AND TOUT, INC., NEW YORK, NY:  
2,899,524, PUB. 8-10-2004. INT. CL. 16.

COX TEXAS NEWSPAPERS, L.P., AUSTIN, TX:  
2,898,718, PUB. 8-10-2004. MULTIPLE CLASS, INT. CLS. 35, 39, 41, 42 AND 43.

COX, BOBBIE, J., DALLAS, TX:  
2,900,084, INT. CL. 6.

COYOTE FURNITURE COMPANY, LLC, MESQUITE, NV:  
2,899,760, PUB. 8-10-2004. INT. CL. 35.

COZAR ERGONOMICS INC., OAKVILLE, ONTARIO, CANADA:  
2,900,420, INT. CL. 20.

CP SHIPS LIMITED, ST. JOHN, NEW BRUNSWICK, CANADA:  
1,737,127. REN. 9-23-04. INT. CL. 39.

CRABTREE & EVELYN, LTD., WOODSTOCK, CT:  
1,859,412. REN. 9-22-04. INT. CL. 3.

CRADLE INTERNATIONAL GMBH, NEW YORK, NY, ERNO LASZLO, LTD., NEW YORK, NY:  
1,348,837. REN. 9-22-04. INT. CL. 3.

CRANIUM INC., SEATTLE, WA:  
2,900,882, INT. CL. 28.

CRAWFORD-SLEVIN, LTD., HUNT VALLEY, MD, DBA CRAWFORD, SLEVIN & HICKS, INC:  
2,121,355, CANC. INT. CL. 36.

CRAY INC., SEATTLE, WA:  
1,307,788. REN. 9-23-04. INT. CL. 9.

CRAY, SUE TURNER, LOS ANGELES, CA:  
2,900,331, MULTIPLE CLASS, INT. CLS. 16 AND 25.

CRC INDUSTRIES, INC., WARMINSTER, PA, K & W PRODUCTS, INC., WHITTIER, CA:  
781,531. REN. 9-22-04. U.S. CL. 5 (INT. CL. 1).

CREATIVE & RESPONSE RESEARCH SERVICES, INC., CHICAGO, IL:  
2,899,511, PUB. 8-10-2004. INT. CL. 35.

CREATIVE HAIRDRESSERS, INC., FALLS CHURCH, VA:  
2,898,941, PUB. 8-10-2004. INT. CL. 44.  
2,900,419, INT. CL. 44.

CREATIVE HEARTWORK, INC., MENDHAM, NJ:  
2,899,196, PUB. 8-10-2004. INT. CL. 41.

CREATIVE MARKETING ASSOCIATES, INC., KANSAS CITY, MO:  
2,900,096, INT. CL. 35.

CREATIVE PUBLISHING INTERNATIONAL INC., CHANHASSEN, MN:  
2,899,859, PUB. 8-10-2004. INT. CL. 16.

CREDIT SUISSE GROUP, 8001 ZURICH, SWITZERLAND:  
2,898,639, PUB. 8-10-2004. INT. CL. 36.

CREST, S.A. DE C.V., SAN PEDRO GARZA GARCIA, NUEVO LEON, MEXICO:  
2,900,306, INT. CL. 19.

CREWS, CHRISTOPHER A., KINGSTON, NY:  
2,900,527, MULTIPLE CLASS, INT. CLS. 16 AND 25.

CROSS COUNTRY GROUP, LLC, BOSTON, MA:  
2,330,787, COR. INT. CL. 36.

CROSS D PRODUCTIONS, INC., FORT WORTH, TX:  
1,842,130. REN. 9-18-04. INT. CL. 41.

CROSSBEAM SYSTEMS, INC., CONCORD, MA:  
2,899,978, PUB. 8-10-2004. INT. CL. 9.

CROSSCHECK, INC., ROHNERT PARK, CA:  
2,899,847, PUB. 8-10-2004. INT. CL. 36.

CROSSLINK TECHNOLOGY INC., REXDALE ONTARIO, CANADA:  
2,898,656, PUB. 8-10-2004. INT. CL. 1.

CROWE CHIZEK AND COMPANY LLC, SOUTH BEND, IL:  
1,303,060. REN. 9-22-04. INT. CL. 35.

CROWN BOLT, INC., CERRITOS, CA:  
2,122,506, CANC. INT. CL. 42.

CROWN INTERNATIONAL, INC., ELKHART, IN:  
1,229,018. REN. 9-24-04. INT. CL. 9.

- CROWN PRODUCTS, LLC, BOCA RATON, FL:  
2,899,182, PUB. 8-10-2004. INT. CL. 21.
- CROY TRUST LIMITED, ST. HELIER, JERSEY, UNITED KINGDOM:  
2,900,547, INT. CL. 3.
- CRYOLOGIC PTY. LTD., MULGRAVE, VICTORIA 3170, AUSTRALIA:  
1,822,576, REN. 9-22-04. INT. CL. 11.
- CRYSTAL DYNAMICS, INC., MENLO PARK, CA, CRYSTAL-DYNAMICS (ANTILLES) N.V., CURACO, NETHERLAND ANTILLES:  
1,864,324, REN. 9-20-04. INT. CL. 28.
- CRYTEK STUDIOS GMBH & CO. KG, COBURG, FED REP GERMANY:  
2,900,553, MULTIPLE CLASS, INT. CLS. 9, 28 AND 41.
- CS&M ASSOCIATES, NEW ORLEANS, LA AND MARRIOTT CORPORATION, WASHINGTON, DC, DBA SHERATON NEW ORLEANS HOTEL:  
2,899,401, PUB. 11-25-2003. INT. CL. 43.
- CSC BRANDS LP, CAMDEN, NJ, CSC BRANDS, INC., NEWARK, DE:  
1,856,133, REN. 9-23-04. MULTIPLE CLASS, INT. CLS. 29 AND 30.
- CTB IP, INC., WILMINGTON, DE:  
2,899,048, PUB. 8-10-2004. MULTIPLE CLASS, INT. CLS. 7 AND 11.
- CTI INDUSTRIES CORPORATION, BARRINGTON, IL, CONTAINER TECHNOLOGIES, INC., BARRINGTON, IL:  
1,291,308, REN. 9-18-04. INT. CL. 28.
- CTS CORPORATION, ELKHART, IN:  
2,900,664, INT. CL. 9.
- CTS MANAGEMENT, LLC, EVANSVILLE, IN:  
2,899,160, PUB. 8-10-2004. INT. CL. 35.
- CUBAN CIGAR BRANDS, N.V., FT. LAUDERDALE, FL:  
1,874,115, REN. 9-22-04. INT. CL. 34.
- CUBIC DEFENSE APPLICATIONS, INC., SAN DIEGO, CA:  
2,898,800, PUB. 8-10-2004. INT. CL. 9.  
2,898,808, PUB. 8-10-2004. MULTIPLE CLASS, INT. CLS. 35, 37, 40 AND 41.
- CULLIGAN INTERNATIONAL COMPANY, NORTHBROOK, IL:  
2,899,474, PUB. 8-10-2004. INT. CL. 40.  
2,899,849, PUB. 8-10-2004. INT. CL. 11.
- CUMBERLAND LIGHT, LLC., RUSSELL SPRINGS, KY:  
2,899,723, PUB. 8-10-2004. INT. CL. 37.
- CUMMINS-ALLISON CORP., MT. PROSPECT, IL:  
1,289,914, REN. 9-19-04. INT. CL. 9.  
1,289,915, REN. 9-19-04. INT. CL. 9.
- CUNARD LINE LIMITED, MIAMI, FL:  
2,900,746, INT. CL. 41.
- CURRIE TECHNOLOGIES, INC., VAN NUYS, CA:  
2,898,691, PUB. 8-26-2003. INT. CL. 12.
- CURRIE, ROGER A., VENTURA, CA:  
2,899,839, PUB. 8-10-2004. INT. CL. 25.
- CURTICE-BURNS FOODS, INC., ROCHESTER, NY:  
1,261,062, CANC. INT. CL. 29.
- CURWOOD, INC., OSHKOSH, WI:  
773,683, REN. 9-22-04. U.S. CL. 37 (INT. CLS. 16, 26 AND 27).
- CUSTER OFFICE ENVIRONMENTS, INC., GRAND RAPIDS, MI, DBA CARL FORSLUND, CARL FORSLUND, INC., GRAND RAPIDS, MI:  
1,007,096, REN. 9-21-04. U.S. CL. 32 (INT. CL. 20).
- CUSTOM RIBS CO., MINNEAPOLIS, MN:  
2,121,415, CANC. INT. CL. 29.
- CUSTOM SOFTWARE SERVICES, INC., BELLEVUE, WA:  
2,121,023, CANC. INT. CL. 9.
- CVS VANGUARD, INC., SCARSDALE, NY:  
2,899,484, PUB. 8-10-2004. INT. CL. 35.
- CVS, H.C., INC., WOONSOCKET, RI:  
2,121,058, CANC. INT. CL. 9.
- CYBER ZONE, L.P., SAN ANTONIO, TX:  
2,629,937, COR. INT. CL. 41.
- CYBERSTEED, INC., VERSAILLES, KY:  
2,120,807, CANC. INT. CL. 16.
- CYCO SYSTEM PTY. LTD., CHELTENHAM, VICTORIA, AUSTRALIA:  
1,740,559, CANC. INT. CL. 12.
- CYFAC, HOMMES, FRANCE:  
2,899,771, PUB. 8-10-2004. MULTIPLE CLASS, INT. CLS. 12 AND 25.
- CYP TECHNOLOGIES, LLC, CHATTANOOGA, TN:  
1,850,606, REN. 9-22-04. INT. CL. 9.
- CYPHER GROUP LLC, THE, OAKLAND, CA, DBA CATCHWORD:  
2,900,118, INT. CL. 35.
- CYTEC TECHNOLOGY CORP., WILMINGTON, DE, AMERICAN CYANAMID COMPANY, WAYNE, NJ:  
1,017,235, REN. 9-22-04. INT. CL. 1.
- C28, INC., PERRIS, CA:  
2,899,617, PUB. 8-10-2004. MULTIPLE CLASS, INT. CLS. 16, 25 AND 26.
- D & E PHARMACEUTICALS, INC., BLOOMINGDALE, NJ:  
1,303,401, REN. 9-23-04. MULTIPLE CLASS, INT. CLS. 5 AND 42.
- D SQUARED ASSESSMENTS, INC., HAZLET, NJ:  
2,899,094, PUB. 8-10-2004. INT. CL. 41.  
2,899,095, PUB. 8-10-2004. INT. CL. 41.
- D. O. WEAVER & CO., DENVER, CO:  
1,260,689, CANC. INT. CL. 1.
- D.C. COMICS, NEW YORK, NY, DC COMICS INC., NEW YORK, NY:  
1,279,991, REN. 9-18-04. INT. CL. 28.
- D'MARIO WATCH, S.A., ZONA LIBRE DE COLON, PANAMA:  
1,871,250, REN. 9-18-04. INT. CL. 14.
- DAB DOOR COMPANY, INC., HIALEAH GARDENS, FL:  
2,900,647, INT. CL. 6.
- DADE BEHRING MARBURG GMBH, 35041 MARBURG, FED REP GERMANY:  
2,899,347, PUB. 3-23-2004. INT. CL. 9.
- DADE INTERNATIONAL INC., DEERFIELD, IL:  
2,122,061, CANC. INT. CL. 10.
- DAIDO CORPORATION, SOMERSET, NJ:  
1,810,478, CANC. INT. CL. 8.  
1,810,479, CANC. INT. CL. 8.
- DAIFUKU COMPANY, LTD., NISHIYODOGAWA-KU, OSAKA, JAPAN:  
1,811,544, CANC. INT. CL. 19.
- DAIGLE, MARIE A., SOMERS, CT:  
2,900,405, INT. CL. 28.
- DAIKIN INDUSTRIES, LTD., KITA-KU, OSAKA, JAPAN:  
2,854,228, COR. INT. CL. 2.
- DAIMLERCHRYSLER AG, 70567 STUTTGART, FED REP GERMANY:  
2,898,724, PUB. 8-10-2004. INT. CL. 12.
- DAINIPPON INK AND CHEMICALS, INCORPORATED, ITABASHI-KU, TOKYO, JAPAN:  
1,290,601, REN. 9-18-04. MULTIPLE CLASS, INT. CLS. 1 AND 2.
- DAIRY FARMERS OF AMERICA, INC., KANSAS CITY, MO:  
2,855,027, COR. INT. CL. 5.
- DAIWA SEIKO, INC., HIGASHIKURUME-CITY TOKYO, JAPAN:  
1,290,298, REN. 9-24-04. INT. CL. 28.
- DAIWA SEIKO, INC., HIGASHIKURUME-CITY, TOKYO, JAPAN:  
1,292,454, REN. 9-24-04. INT. CL. 28.  
2,900,485, INT. CL. 28.
- DALE OF NORWAY AS, VAKSDAL, NORWAY:  
2,900,028, MULTIPLE CLASS, INT. CLS. 23 AND 25.
- DAMA S.P.A., 21100 VARESE, ITALY:  
2,122,274, CANC. INT. CL. 25.
- DAN ISACSSON AB, 352 46 VAXJO, SWEDEN:  
2,898,550, PUB. 8-10-2004. MULTIPLE CLASS, INT. CLS. 29, 30 AND 42.
- DAN-DEE INTERNATIONAL LIMITED, JERSEY CITY, NJ:  
1,849,441, REN. 9-20-04. INT. CL. 28.
- DANA CORPORATION, TOLEDO, OH:  
1,850,208, REN. 9-22-04. INT. CL. 7.
- DANA PARFUMES CORP., NEW YORK, NY:  
2,122,113, CANC. INT. CL. 3.
- DANCIK INTERNATIONAL, LTD., CARY, NC:  
2,899,878, PUB. 8-10-2004. MULTIPLE CLASS, INT. CLS. 9, 38 AND 42.

DANI ELECTRONICS CORPORATION, LONG ISLAND CITY, NY:  
1,260,833, CANC. INT. CL. 9.

DANIEL FORBES COMPANY, CLEARFIELD, IL:  
989,650. REN. 9-21-04. U.S. CL. 39 (INT. CL. 25).

DANIEL M. SEGEL, TROY, NY:  
2,899,091, PUB. 8-10-2004. INT. CL. 28.

DANOVICH, SHARON, OAKDALE, PA:  
2,900,542, INT. CL. 3.

DAO, FRANCISCO N., MILPITAS, CA:  
2,122,072, CANC. INT. CL. 25.

DARDEN CORPORATION, ORLAND, FL, GENERAL MILLS RESTAURANT GROUP, INC., ORLANDO, FL:  
1,305,217. REN. 9-21-04. INT. CL. 33.

DATA BROADCASTING CORPORATION, SAN MATEO, CA:  
2,121,898, CANC. INT. CL. 42.

DATA SECURITY CORPORATION OF AMERICA, CORAL SPRINGS, FL:  
2,898,626, PUB. 8-10-2004. INT. CL. 42.

DATA SYSTEMS, INC, OMAHA, NE:  
2,898,454, PUB. 8-10-2004. MULTIPLE CLASS, INT. CLS. 9, 16 AND 42.

DATAKOM SYSTEMS, INC., EAST SYRACUSE, NY:  
2,900,757, INT. CL. 9.

DATAMARK SERVICES, INC., HUNTERSVILLE, NC:  
2,900,793, MULTIPLE CLASS, INT. CLS. 35 AND 42.

DATARAM CORPORATION, PRINCETON, NJ:  
1,810,751, CANC. INT. CL. 16.

DATASENSE, INC., COLUMBUS, OH:  
2,899,667, PUB. 5-25-2004. INT. CL. 9.

DAVE'S SODA & PET CITY, AGAWAM, MA:  
2,900,674, INT. CL. 3.

DAVEY, LANE MARIE, KAHUKU, HI:  
2,898,697, PUB. 8-10-2004. INT. CL. 25.

DAVID A TOLAND, SANTA FE, NM:  
1,810,907, CANC. INT. CL. 28.

DAVID NETTO DESIGN, LLC, NEW YORK, NY:  
2,900,695, INT. CL. 20.

DAVID SHERMAN CORPORATION, ST. LOUIS, MO:  
771,234. REN. 9-23-04. U.S. CL. 49 (INT. CL. 33).

DAVID VILLARREAL, D.D.S., INC., WOODLAND HILLS, CA:  
2,900,225, INT. CL. 3.

DAVID WIENER VENTURES, PARK CITY, UT:  
1,851,138. REN. 9-22-04. INT. CL. 28.

DAVIDSON, ROB, CHATSWORTH, CA AND LANDAU, HANK, CHATSWORTH, CA:  
2,122,238, CANC. INT. CL. 3.

DAVIES GATE LLC, IRWINDALE, CA:  
2,899,874, PUB. 8-10-2004. INT. CL. 3.

DAVIS DESIGNS, INC., LEMONT, IL:  
2,121,678, CANC. INT. CL. 9.

DAVIS, MICHAEL THOMAS, NASHVILLE, TN, DBA FICTITIOUS RECORDS:  
2,898,852, PUB. 8-10-2004. INT. CL. 9.

DAVITA INC., EL SEGUNDO, CA:  
2,900,422, INT. CL. 42.

DAVOR JEDLICKA, TYLER, TX:  
2,900,618, MULTIPLE CLASS, INT. CLS. 9 AND 16.

DAVY CORPORATION, PUBLIC LIMITED COMPANY, LONDON, W1, ENGLAND:  
1,260,783, CANC. MULTIPLE CLASS, INT. CLS. 7 AND 9.

DAY INTERNATIONAL, INC., DAYTON, OH, DAYCO CORPORATION, DAYTON, OH:  
992,111. REN. 9-18-04. U.S. CL. 50 (INT. CL. 16).

DAYANG TECHNOLOGY DEVELOPMENT INC., BEIJING 100080, CHINA:  
2,900,134, INT. CL. 9.

DAYCO CORPORATION, DAYTON, OH:  
761,633, CANC. U.S. CL. 35.

DAYLIGHT MINISTRIES, INCORPORATED, MATTHEWS, NC:  
2,122,200, CANC. INT. CL. 42.  
2,122,201, CANC. INT. CL. 42.

DAYSTAR ENERGY PARTNERS, INC., AUSTIN, TX:  
2,121,234, CANC. INT. CL. 36.

DBLS HOLDINGS, LTD., NEWTON, MA:  
2,900,016, PUB. 8-10-2004. INT. CL. 9.

DC COMICS, NEW YORK, NY, AEGIS ENTERTAINMENT, INC., LA JOLLA, CA, DBA WILDSTORM PRODUCTIONS:  
1,823,707. REN. 9-22-04. INT. CL. 16.

DDT ENGINEERING LIMITED, GUISELEY, WEST YORKSHIRE, LS20 8LG, UNITED KINGDOM:  
2,121,089, CANC. MULTIPLE CLASS, INT. CLS. 7 AND 12.

DE BORTOLI WINES PTY LIMITED, NEW SOUTH WALES 2680, AUSTRALIA:  
2,900,169, INT. CL. 33.

DE NEEF CONSTRUCTION CHEMICALS, INC., WALLER, TX:  
2,899,746, PUB. 8-10-2004. INT. CL. 19.

DE OLD, ANITA, VERONA, NJ:  
2,121,854, CANC. INT. CL. 35.

DEALERS TRANSMISSION CENTER, INC., JEFFERSONVILLE, IN:  
2,122,461, CANC. INT. CL. 37.

DEAN DISTRIBUTORS, INC., BURLINGAME, CA, CAMBRIDGE PLAN INTERNATIONAL, PACIFIC GROVE, CA, DBA ADVANCED HEALTH CARE SYSTEMS:  
1,347,169. REN. 9-24-04. INT. CL. 5.

DEARBORN GAGE COMPANY, GARDEN CITY, MI:  
2,121,225, CANC. INT. CL. 7.

DEBAN INVESTMENTS NO. 9 (PTY) LTD., CAPETOWN, SOUTH AFRICA:  
2,900,394, INT. CL. 33.

DEBBY B. MALIVUK, SUNRISE, FL, DBA KEEP TRI-ING:  
2,900,676, INT. CL. 25.

DECAS CRANBERRY PRODUCTS, INC., WAREHAM, MA:  
2,900,627, INT. CL. 5.

DECATHLON, VILLENEUVE D'ASCQ, FRANCE:  
2,898,798, PUB. 8-10-2004. MULTIPLE CLASS, INT. CLS. 12, 21 AND 25.

DECISION SUPPORT INC., MATTHEWS, NC:  
1,338,976. REN. 9-22-04. INT. CL. 9.

DECOLAM, INC., ORANGEBURG, SC, CHAMPION INTERNATIONAL CORPORATION, STAMFORD, CT:  
1,301,697. REN. 9-21-04. INT. CL. 19.

DECOLAM, INC., ORANGEBURG, SC:  
1,862,510. REN. 9-21-04. INT. CL. 19.

DECRA-LOC U. S. A., INC., EATON RAPIDS, MI:  
2,121,034, CANC. INT. CL. 19.

DEEP SEA FISHERIES, INC., LYNNWOOD, WA:  
1,810,942, CANC. INT. CL. 29.

DEER PATH FILMS, INC., WESTON, CT:  
2,899,778, PUB. 8-10-2004. INT. CL. 41.

DEGNAN, DONALD A., BOULDER, CO:  
2,900,823, INT. CL. 16.

DEGREMONT, 92508 RUEIL-MALMAISON CEDEX, FRANCE:  
2,120,878, CANC. MULTIPLE CLASS, INT. CLS. 1, 11 AND 40.

DEL LABORATORIES, INC., FARMINGDALE, NY:  
2,121,538, CANC. INT. CL. 3.

DEL MAR REYNOLDS MEDICAL, IRVINE, CA:  
2,899,873, PUB. 8-10-2004. INT. CL. 10.

DEL TACO, INC., LAKE FOREST, CA:  
1,871,752. REN. 9-18-04. INT. CL. 42.

DELAVEST, INC., WILMINGTON, DE TO MARKDEL, INC., WILMINGTON, DE:  
1,810,966, CANC. INT. CL. 30.

DELAWARE CAPITAL FORMATION, INC., WILMINGTON, DE:  
1,827,217. REN. 9-20-04. INT. CL. 7.  
2,121,254, CANC. INT. CL. 9.

DELGALLO, MAGGIE L., RESTON, VA:  
2,899,372, PUB. 12-9-2003. INT. CL. 36.

DELGUIDICE, ANITA THERESA, SAN DIEGO, CA:  
2,899,829, PUB. 8-10-2004. INT. CL. 20.

DELL INC., ROUND ROCK, TX:  
1,881,224. REN. 9-22-04. INT. CL. 9.

DELLINGER, LOY, DENVER, NC:  
2,139,152, CANC. INT. CL. 30.

DELTA BROADCASTING, INC., HELENA, AR:  
2,899,385, PUB. 8-10-2004. INT. CL. 14.

- DELTA QUEEN STEAMBOAT COMPANY, INC., BUFFALO, NY:  
1,897,494. REN. 9-19-04. INT. CL. 16.
- DELTA WATERFOWL FOUNDATION, BISMARCK, ND, NORTH AMERICAN WILDLIFE FOUNDATION, DEERFIELD, IL:  
1,856,076. REN. 9-22-04. INT. CL. 42.
- DELVALLE, OPHELIA, BRONX, NY:  
2,899,817. PUB. 8-10-2004. INT. CL. 18.
- DEMAND INDUSTRIES, INC., CHICAGO, IL, DBA SERVER CENTRAL:  
2,899,610. PUB. 8-10-2004. INT. CL. 42.
- DEMARTINO, JEFFREY R., PHILLIPSBURG, NJ:  
2,898,436. PUB. 1-4-2000. INT. CL. 28.
- DEMMA ENTERPRISES, INC., NEW HARTFORD, NY TO KA-LO ENTERPRISES INC., WATERTOWN, NY:  
1,261,247. CANC. INT. CL. 42.
- DENALI SOFTWARE, INC., PALO ALTO, CA:  
2,900,714. INT. CL. 9.
- DENNIS GORDON, DOWNEY, CA:  
775,917. REN. 9-22-04. U.S. CL. 46 (INT. CL. 31).
- DENSEN, LAWRENCE, E., MELVILLE, NY:  
2,900,594. INT. CL. 9.
- DENTAL POWER, INC., ROCKVILLE, MD:  
2,121,895. CANC. INT. CL. 35.
- DENTORIUM PRODUCTS, CO. INC., NEW YORK, NY:  
1,879,174. REN. 9-22-04. INT. CL. 10.
- DEPECHE MODE, INC., NEW YORK, NY:  
1,856,313. REN. 9-19-04. INT. CL. 25.
- DERITEND ENGINEERING COMPANY LIMITED; THE, BIRMINGHAM, ENGLAND:  
761,617. CANC. U.S. CL. 23.
- DERMASCREEN CORPORATION, TAMPA, FL:  
2,898,734. PUB. 8-10-2004. INT. CL. 44.
- DERMATEST GESELLSCHAFT FUR ALLERGOLOGISCHE FORSCHUNG M.B.H., 48155 MUNSTER, FED REP GERMANY:  
2,845,886. COR. INT. CL. 42.
- DERMOCELL COLOMBIA LTDA., BOGOTA, DC, COLOMBIA:  
2,898,623. PUB. 8-10-2004. INT. CL. 10.
- DEROYAL INDUSTRIES, INC., POWELL, TN:  
1,871,809. REN. 9-19-04. INT. CL. 5.
- DESA IP, LLC, BOWLING GREEN, KY:  
1,847,657. REN. 9-22-04. INT. CL. 11.
- DESIGN TEE'S HAWAII, INC., HONOLULU, HI:  
1,872,578. REN. 9-20-04. INT. CL. 25.
- DESIGNERS DISCOUNT TRADING POST, WASHINGTON, DC:  
2,121,751. CANC. INT. CL. 42.
- DESIGNLINE LLC, DENVER, CO:  
2,121,443. CANC. INT. CL. 20.
- DESIGNS BY SKAFFLES, INC., NEW YORK, NY:  
2,899,386. PUB. 8-12-2003. MULTIPLE CLASS, INT. CLS. 14, 25 AND 26.
- DESIGNSTOGO, N. LAKE WORTH, FL:  
2,899,661. PUB. 8-10-2004. INT. CL. 42.
- DESKTOP DEPOT, INC., THE, NORTH FORT MYERS, FL:  
2,121,959. CANC. INT. CL. 16.
- DESPER PRODUCTS, INC., A WHOLLY OWNED SUBSIDIARY OF SPATIALIZER AUDIO LABORATORIES, INC., SANTA CLARA, CA:  
2,898,836. PUB. 8-10-2004. INT. CL. 9.
- DETROIT LIONS, INC., ALLEN PARK, MI:  
1,850,662. REN. 9-24-04. MULTIPLE CLASS, INT. CLS. 16 AND 25.
- DETROIT LIONS, INC., NEW YORK, NY:  
1,899,292. REN. 9-23-04. INT. CL. 41.
- DETROIT RED WINGS, INC., DETROIT, MI:  
2,169,920. CANC. INT. CL. 9.
- DEUTSCHE EXTRAKT KAFFEE GMBH, HAMBURG 93, FED REP GERMANY:  
1,261,072. CANC. INT. CL. 30.
- DEVAULT PACKING CO., DEVAULT, PA:  
1,309,241. REN. 9-18-04. INT. CL. 29.
- DEVELOPMENT DIMENSIONS INTERNATIONAL, INC., BRIDGEVILLE, PA:  
1,848,759. REN. 9-22-04. INT. CL. 41.
- DEVORE AVIATION CORPORATION OF AMERICA, ALBUQUERQUE, NM:  
2,898,904. PUB. 8-10-2004. INT. CL. 9.
- DF ENTERPRISES, INC., WILMINGTON, DE:  
1,853,981. REN. 9-23-04. INT. CL. 3.
- DGWB, INC., SANTA ANA, CA:  
2,898,582. PUB. 8-10-2004. INT. CL. 35.
- DIAGEO NORTH AMERICA, INC., STAMFORD, CT, FRED. L. MYERS & SON, KINGSTON, JAMAICA:  
312,595. REN. 9-23-04. U.S. CL. 49 (INT. CL. 33).
- DIAGEO NORTH AMERICA, INC., STAMFORD, CT:  
1,285,506. REN. 9-23-04. INT. CL. 33.
- DIAMOND TOUR GOLF WHOLESALERS, INC., DEKALB, IL:  
2,898,751. PUB. 1-27-2004. INT. CL. 28.
- DIATEC POLYMERS, BATAVIA, IL, DBA DIATEC ENVIRONMENTAL:  
1,810,356. CANC. INT. CL. 1.
- DICKENS INN OF NEW MARKET, INC., PHILADELPHIA, PA:  
2,121,239. CANC. INT. CL. 42.
- DICKINSON, DARYLL H., BORDENTOWN, NJ:  
2,121,357. CANC. INT. CL. 35.
- DICKSON, DENNIS G., VISTA, CA:  
2,898,849. PUB. 8-10-2004. INT. CL. 16.
- DIEFFEBI S.P.A., 31020 SAN VANDEMIANO (TV), ITALY:  
2,898,612. PUB. 9-30-2003. INT. CL. 20.
- DIETARY SUPPLEMENT SYSTEMS, GLOBAL, INC., YA-PHANK, NY AND WYRESIDE PRODUCTS LIMITED, PILLING, PRESTON, UNITED KINGDOM:  
2,899,413. PUB. 8-10-2004. INT. CL. 5.
- DIETER, HESSE, TWO HARBORS, MN:  
2,120,841. CANC. INT. CL. 9.
- DIETRICH, ALFRED E., DETROIT, MI, LONDON LUGGAGE SHOP, DETROIT, MI:  
595,769. REN. 9-20-04. U.S. CL. 3 (INT. CL. 18).
- DIGITAL ALTITUDES, LLC, MOUNT PROSPECT, IL:  
2,899,785. PUB. 8-10-2004. INT. CL. 9.
- DIGITAL INTERACTIVE STREAMS, INC., JACKSONVILLE, FL:  
2,900,643. INT. CL. 9.
- DIGITAL VISION, INC., ROYAL PALM BEACH, FL:  
2,120,895. CANC. INT. CL. 9.
- DILLARD DEPARTMENT STORES, INC., LITTLE ROCK, AR:  
2,122,181. CANC. INT. CL. 25.
- DILLON COMPANIES, INC., HUTCHINSON, KS:  
1,291,588. REN. 9-22-04. MULTIPLE CLASS, INT. CLS. 1, 5, 29, 30 AND 32.
- DIMAS AKTIEBOLAGET, SE-550 02 JONKOPING, SWEDEN:  
2,898,870. PUB. 8-10-2004. INT. CL. 7.
- DIREVO BIOTECH AG, D-50829, KOLN, FED REP GERMANY:  
2,899,845. PUB. 8-10-2004. MULTIPLE CLASS, INT. CLS. 1, 5, 9 AND 42.
- DISASTER ONE, INC., GREENSBORO, NC:  
2,899,875. PUB. 8-10-2004. INT. CL. 37.
- DISCOVERY COMMUNICATIONS, INC., SILVER SPING, MD:  
2,900,604. INT. CL. 20.
- DISCUS DENTAL IMPRESSIONS, INC, CULVER CITY, CA:  
2,898,615. PUB. 8-10-2004. INT. CL. 5.
- DISKIN, DAVID, SAG HARBOR, NY:  
2,899,346. PUB. 8-10-2004. INT. CL. 16.
- DISNEY ENTERPRISES, INC., BURBANK, CA:  
2,900,261. INT. CL. 21.
- DISPLAY TEAM OY, HELSINKI, FINLAND:  
2,900,253. MULTIPLE CLASS, INT. CLS. 6 AND 20.
- DISTRACTION FORMATS 2000 INC., QUEBEC, CANADA:  
2,829,787. CANC. IIRN. RESTORED TO S.N. 78-103,941.
- DIVINE BROTHERS COMPANY, UTICA, NY:  
1,291,842. REN. 9-22-04. INT. CL. 7.
- DIVISION OF CHRISTIAN EDUCATION OF THE NATIONAL COUNCIL OF THE CHURCHES OF CHRIST IN THE UNITED STATES OF AMERICA, NEW YORK, NY:  
1,810,737. CANC. INT. CL. 16.
- DIXIE CHEMICAL COMPANY, INC., HOUSTON, TX:  
1,287,536. REN. 9-18-04. INT. CL. 1.

DIXIE, USA, INC., HOUSTON, TX:  
2,122,517, CANC. INT. CL. 29.  
2,122,519, CANC. INT. CL. 29.

DK FOODS & GRAINS INC., FAIRFIELD, NJ:  
2,121,376, CANC. MULTIPLE CLASS, INT. CLS. 29, 30 AND 31.

DNA FILTERS LTD., 18450 NIKEA, ATHENS, GREECE:  
2,900,449, INT. CL. 7.

DO IT BEST CORP., FORT WAYNE, IN:  
997,744, REN. 9-22-04. U.S. CL. 101 (INT. CL. 42).

DOCEX LIMITED, LONDON, EC2A 4PJ, UNITED KINGDOM:  
2,121,129, CANC. MULTIPLE CLASS, INT. CLS. 38 AND 39.

DOLBEY AND COMPANY, CINCINNATI, OH:  
2,899,663, PUB. 8-10-2004. INT. CL. 9.  
2,899,664, PUB. 8-10-2004. INT. CL. 9.

DOLLAR REALTY, INC., TAMPA, FL:  
2,899,479, PUB. 1-6-2004. INT. CL. 36.

DONNA JESSICA, INC., ASHLAND, MA:  
2,121,677, CANC. INT. CL. 25.

DONNER, CHARLES R., CHEEKTOWAGA, NY:  
2,121,526, CANC. INT. CL. 16.

DONRUSS PLAYOFF, L.P., ARLINGTON, TX:  
2,898,700, PUB. 11-18-2003. INT. CL. 16.

DOOSAN CORPORATION, SEOUL, REPUBLIC OF KOREA:  
2,900,660, INT. CL. 33.

DOREL JUVENILE GROUP, INC., CANTON, MA:  
2,898,525, PUB. 8-10-2004. INT. CL. 20.

DORIAN GROUP, LTD., THE, TROY, NY:  
1,811,482, CANC. INT. CL. 9.

DORIS HOSIERY MILLS LTD., MONTREAL, QUEBEC, H2T 1S6, CANADA:  
2,900,412, INT. CL. 25.

DOS MARIAS, LONG BEACH, CA:  
2,898,676, PUB. 8-10-2004. INT. CL. 30.

DOSAL TOBACCO CORPORATION, MIAMI, FL, DOSAL; ALBERTO, MIAMI, FL:  
1,305,218, REN. 9-20-04. INT. CL. 34.

DOUBLE A LIMOUSINE SERVICE, LTD., LONG ISLAND CITY, NY:  
1,261,187, CANC. INT. CL. 39.

DOUGLAS PUBLICATIONS, INC., RICHMOND, VA:  
2,121,164, CANC. INT. CL. 16.

DOVE MEDICAL, INC., ROCKVILLE, MD:  
2,121,425, CANC. INT. CL. 5.

DOW CHEMICAL COMPANY, THE, MIDLAND, MI:  
1,850,696, REN. 9-23-04. INT. CL. 17.  
1,879,218, REN. 9-18-04. INT. CL. 17.

DOYLE, VICTORIA, JB, NEW YORK, NY:  
2,900,600, INT. CL. 41.

DR PEPPER/SEVEN UP, INC., PLANO, TX, L.T. & T., LTD., CHICAGO, IL:  
1,285,482, REN. 9-21-04. INT. CL. 32.

DR. FRESH, INC, LA MIRADA, CA:  
2,899,434, PUB. 10-14-2003. INT. CL. 21.

DR. JOHANNES HEIDENHAIN GMBH, TRAUNREUT, FED REP GERMANY:  
1,855,556, REN. 9-23-04. INT. CL. 9.

DR. TORO'S MIXING COMPANY, INC., LA JOLLA, CA:  
2,899,115, PUB. 8-10-2004. INT. CL. 32.

DRAGONFIRE STUDIOS, INC., SHREVEPORT, LA:  
2,900,606, MULTIPLE CLASS, INT. CLS. 6 AND 20.

DRAISWERKE, INC., MAHWAH, NJ:  
2,899,777, PUB. 8-10-2004. INT. CL. 7.

DRAPER, MELISSA, J., MINNEAPOLIS, MN:  
2,900,744, INT. CL. 16.

DRAUGHON PROFESSIONAL ASSOCIATION, JACKSONVILLE, FL:  
2,120,970, CANC. INT. CL. 42.

DREAM HOME SOURCE, INC., PORTLAND, OR:  
2,899,475, PUB. 8-10-2004. MULTIPLE CLASS, INT. CLS. 9, 16 AND 35.

DREAMOUS CORPORATION USA, INC., TORRANCE, CA:  
2,899,123, PUB. 8-10-2004. MULTIPLE CLASS, INT. CLS. 3 AND 5.

DRINKA, THERESA J., WAUPACA, WI:  
2,121,844, CANC. INT. CL. 35.

DROZDOG ENTERPRISES INC., CLEARWATER, FL:  
2,899,077, PUB. 8-10-2004. INT. CL. 43.

DRS. GABELMAN & LEIZMAN, INC., BEACHWOOD, OH:  
2,898,719, PUB. 8-10-2004. INT. CL. 44.

DT-BIKE TECHNOLOGY AG, CH-2504 BIEL BIENNE, SWITZERLAND:  
2,121,337, CANC. INT. CL. 12.

DU BOISE, SABRE, SIMONE, ROSWELL, GA:  
2,899,707, PUB. 8-10-2004. INT. CL. 9.

DU INTERNATIONAL, INC., ROMULUS, MI, QUALITY VALUE SERVICE, INC., ROMULUS, MI:  
1,873,630, REN. 9-18-04. INT. CL. 9.

DUCK CREEK TECHNOLOGIES, INC., BOLIVAR, MO:  
2,898,625, PUB. 8-10-2004. INT. CL. 9.

DUDLEY, GARRY W., DENVER, CO:  
2,898,660, PUB. 8-10-2004. INT. CL. 9.

DULCES HISPANIA, S.A., 03800 ALCOY (ALICANTE), SPAIN:  
2,121,026, CANC. INT. CL. 30.

DUNCAN ENTERPRISES, FRESNO, CA:  
2,899,613, PUB. 8-10-2004. MULTIPLE CLASS, INT. CLS. 35 AND 41.

DUNLOP MAXFLI SPORTS CORPORATION, GREENVILLE, SC:  
2,121,565, CANC. INT. CL. 28.

DUNLOP, STEPHEN J., JR., PIERMONT, NY:  
2,121,906, CANC. INT. CL. 35.

DUNN MANUFACTURING CORP., MONROE, NC:  
1,807,437, REN. 9-24-04. INT. CL. 24.

DUOPROSS MEDITECH CORPORATION, FARMINGDALE, NY:  
2,900,472, INT. CL. 10.

DUQUESNE UNIVERSITY OF THE HOLY GHOST, PITTSBURGH, PA:  
1,843,265, REN. 9-18-04. INT. CL. 41.

DURANT, MONICA, BALTIMORE, MD:  
2,121,478, CANC. INT. CL. 16.

DUREZ CORPORATION, ADDISON, TX, HOOKER CHEMICAL CORPORATION, NIAGARA FALLS, NY:  
790,156, REN. 9-22-04. MULTIPLE CLASS, U.S. CLS. 1 (INT. CL. 1) AND 6 (INT. CL. 1).

DURIRON COMPANY, INC., THE, DAYTON, OH:  
761,630, CANC. U.S. CL. 34.

DURO-LAST, INC., SAGINAW, MI:  
2,900,385, INT. CL. 19.

DUTEXDOR-BPA, PERENCHIES, FRANCE:  
2,899,376, PUB. 1-27-2004. INT. CL. 25.

DYAX CORP., CAMBRIDGE, MA:  
2,900,801, INT. CL. 44.

DYNAMIC GRAPHICS, INC., PEORIA, IL:  
2,122,495, CANC. INT. CL. 9.

DYNAMIC SOLUTIONS INTERNATIONAL, ENGLEWOOD, CO:  
2,900,934, INT. CL. 9.

DYNAMITE MARKETING, INC., MERIDIAN, ID:  
2,898,911, PUB. 1-13-2004. INT. CL. 5.

DYNAMIX, INC., EUGENE, OR:  
1,811,603, CANC. INT. CL. 28.

E. & O. MARI, INC., NEWBURGH, NY:  
1,267,896, REN. 9-22-04. INT. CL. 15.

E. I. DU PONT DE NEMOURS AND COMPANY, WILMINGTON, DE:  
1,293,871, REN. 9-22-04. INT. CL. 5.

E.B. EDDY FOREST PRODUCTS LTD., OTTAWA, ONTARIO, K1Y 4L5, CANADA:  
1,884,860, REN. 9-23-04. INT. CL. 16.

E.P. HENRY CORPORATION, WOODBURY, NJ:  
2,898,688, PUB. 8-10-2004. MULTIPLE CLASS, INT. CLS. 19 AND 35.

E.S. ORIGINALS INC., NEW YORK, NY:  
1,309,133, REN. 9-18-04. INT. CL. 25.

E.S. ORIGINALS, INC., NEW YORK, NY:  
1,811,590, CANC. INT. CL. 25.

E.T. BROWNE DRUG CO., INC., ENGLEWOOD CLIFFS, NJ:  
2,900,601, INT. CL. 3.

E! ENTERTAINMENT TELEVISION, INC., LOS ANGELES, CA:  
2,899,126, PUB. 8-10-2004. INT. CL. 41.

- E-CUBE SYSTEMS, LLC, MONTGOMERY, TX:  
2,899,409, PUB. 10-21-2003. INT. CL. 9.
- EAGLE RESEARCH GROUP, INC., DENVER, CO:  
2,122,317, CANC. INT. CL. 9.
- EAGLE SUPPLY COMPANY, YOUNGSTOWN, OH:  
1,346,096, REN. 9-18-04. INT. CL. 16.
- EAGLE TRANSMISSIONS, INC., ROWLETT, TX:  
1,901,917, REN. 9-22-04. INT. CL. 37.
- EAGLEBROOK PLASTICS, INC., CHICAGO, IL:  
2,121,621, CANC. INT. CL. 20.
- EARTH FORCE, INC., ALEXANDRIA, VA:  
1,911,842, REN. 9-24-04. INT. CL. 41.
- EARTH SOCIETY FOUNDATION, INC., NEW YORK, NY:  
2,121,925, CANC. INT. CL. 25.
- EARTH'S RESOURCES, INC., LONG ISLAND CITY, NY:  
2,122,454, CANC. INT. CL. 5.
- EARTHRISE TRADING COMPANY, IRVINE, CA, PROTEUS CORPORATION, BERKELEY, CA:  
1,311,933, REN. 9-23-04. INT. CL. 5.
- EAST & WEST GOURMET, INC., HONOLULU, HI:  
2,121,772, CANC. INT. CL. 30.  
2,121,774, CANC. INT. CL. 30.  
2,121,775, CANC. INT. CL. 30.
- EAST TACKLE MANUFACTURING COMPANY, INC., NORTHPORT, MI:  
761,599, CANC. U.S. CL. 22.
- EASTER SEAL SOCIETY FOR CHILDREN, INC., CARROLLTON, TX:  
2,121,040, CANC. INT. CL. 42.
- EASTERDAY JANITORIAL SUPPLY COMPANY, SAN FRANCISCO, CA:  
1,260,728, CANC. MULTIPLE CLASS, INT. CLS. 3 AND 7.
- EASTMAN CHEMICAL COMPANY, KINGSPORT, TN:  
2,900,029, INT. CL. 1.
- EASTMAN EDUCATIONAL ASSOCIATES, INC., ESCONDI-DO, CA:  
2,872,571, COR. INT. CL. 35.
- EASTMAN KODAK COMPANY, ROCHESTER, NY:  
761,536, CANC. U.S. CL. 6.  
2,900,135, INT. CL. 9.
- EASTREND ENTERPRISES INC., BURLINGAME, CA:  
2,898,878, PUB. 8-10-2004. INT. CL. 29.
- EASY STREET REALTY, INC., INDIANAPOLIS, IN:  
2,898,884, PUB. 8-10-2004. INT. CL. 36.
- EATING WELL MAGAZINE, CHARLOTTE, VT TO EATING WELL PUBLISHING COMPANY, L.L.C., NEW YORK, NY:  
1,810,686, CANC. INT. CL. 16.
- ECHAVE, ALBERTO MARCELO, BERNAL, BUENOS AIRES, ARGENTINA:  
2,900,548, INT. CL. 9.
- ECKANKAR, CHANHASSEN, MN, ECKANKAR, LAS VEGAS, NV:  
1,000,843, REN. 9-20-04. U.S. CL. 107 (INT. CL. 41).
- ECKANKAR, CHANHASSEN, MN:  
1,871,671, REN. 9-22-04. INT. CL. 42.
- ECKHART, MICHAEL T., POTOMAC, MD:  
2,899,302, PUB. 8-10-2004. INT. CL. 36.
- ECLECTIC PRODUCTS, INC., EUGENE, OR:  
1,295,299, REN. 9-24-04. INT. CL. 1.
- ECO HOLDINGS, LLC, MIAMI, FL:  
2,898,920, PUB. 12-30-2003. INT. CL. 3.
- ECONO LODGES OF AMERICA, INC., CHARLOTTE, NC:  
1,261,310, CANC. INT. CL. 42.
- ECONOTECH SERVICES LTD., NEW WESTMINSTER, BRITISH COLUMBIA, CANADA:  
1,016,467, REN. 9-22-04. INT. CL. 42.
- ECR INTERNATIONAL, INC., UTICA, NY:  
2,898,450, PUB. 5-30-2000. INT. CL. 11.
- EDGE CRAFT CORPORATION, AVONDALE, PA:  
1,870,338, REN. 9-22-04. INT. CL. 8.
- EDGENET MEDIA, LLC, BRENTWOOD, TN:  
2,121,209, CANC. INT. CL. 42.
- EDGENUITI WORLDWIDE, LTD., NYACK, NY:  
2,899,880, PUB. 8-10-2004. INT. CL. 9.
- EDGERTON TECHNOLOGY, INC., OLATHE, KS:  
2,120,914, CANC. INT. CL. 9.
- EDIBLES, ETC., INC, COLLINGSWOOD, NJ:  
1,902,122, REN. 9-23-04. INT. CL. 6.
- EDINBURGH PETROLEUM SERVICES LIMITED, RICCAR-  
TON, EDINBURGH, EH14 4AP, UNITED KINGDOM:  
2,898,784, PUB. 8-10-2004. MULTIPLE CLASS, INT. CLS.  
9, 37 AND 42.
- EDISON PAGEANT OF LIGHT, INC., FT. MYERS, FL:  
1,261,208, CANC. INT. CL. 41.  
1,261,209, CANC. INT. CL. 41.
- EDUCATION DEVELOPMENT CENTER, INC., NEWTON, MA:  
2,122,301, CANC. INT. CL. 28.
- EDUCATION FINANCIAL SERVICES OF INDIANA, INC., INDIANAPOLIS, IN TO EFS, INC., INDIANAPOLIS, IN:  
1,811,080, CANC. INT. CL. 36.
- EDUCATIONAL TESTING SERVICE, PRINCETON, NJ:  
1,811,352, CANC. MULTIPLE CLASS, INT. CLS. 9, 16  
AND 42.
- EDUTAINMENT MEDIA, INC., WINDERMERE, FL:  
2,899,861, PUB. 8-10-2004. INT. CL. 41.
- EDWARDS CREATIVE PRODUCTS, INC., CHERRY HILL, NJ:  
2,121,413, CANC. INT. CL. 11.
- EDWARDS, JOSEPH B., ST. LOUIS, MO, DBA BLUEBERRY HILL:  
2,121,937, CANC. INT. CL. 25.
- EEG, LYNN NIELSEN, RACINE, WI:  
2,121,725, CANC. INT. CL. 25.
- EF&A FUNDING, L.L.C., SOUTHFIELD, MI:  
2,899,407, PUB. 7-29-2003. INT. CL. 36.
- EFI ELECTRONICS CORPORATION, SALT LAKE CITY, UT:  
1,822,475, REN. 9-24-04. INT. CL. 9.
- EG&G, INC., WELLESLEY, MA:  
2,120,904, CANC. MULTIPLE CLASS, INT. CLS. 6, 9, 11  
AND 42.
- EGAN, JONATHAN F., NEW ORLEANS, LA:  
2,900,740, INT. CL. 33.
- EGL 1, INC., CARLSBAD, CA, DBA EAGLE ONE INDUS-  
TRIES TO ASHLAND INC., LEXINGTON, KY:  
1,810,370, CANC. INT. CL. 3.
- EHREN ENTERPRISES INC., CONCORD, ONTARIO, CA-  
NADA:  
2,641,684, COR. INT. CL. 9.
- EIWEISS CHEMICAL CORPORATION, SHIZUOKA, JAPAN:  
2,898,483, PUB. 9-3-2002. INT. CL. 1.
- EK SUCCESS, LTD., CLIFTON, NJ:  
2,900,277, INT. CL. 8.
- EKRU INC., WARWICK, RI:  
2,122,366, CANC. INT. CL. 14.
- EL PASO ENERGY CORPORATION, EL PASO, TX:  
2,121,324, CANC. MULTIPLE CLASS, INT. CLS. 39 AND  
40.  
2,121,325, CANC. MULTIPLE CLASS, INT. CLS. 39 AND  
40.
- ELAN PHARMA INTERNATIONAL LIMITED, COUNTY CLARE, IRELAND:  
2,899,491, PUB. 8-10-2004. INT. CL. 5.
- ELANCE, INC., SUNNYVALE, CA:  
2,900,142, INT. CL. 9.
- ELANVITAL CORPORATION, PING CHEN CITY, TAO YUAN HSIEN, TAIWAN:  
2,900,350, INT. CL. 9.
- ELASTOGRAN GMBH, LANDWEHRWEG, LEMFORDE, FED REP GERMANY:  
2,121,655, CANC. INT. CL. 25.
- ELASTOMADE ACCESSORIES SDN. BHD., SELANGOR DARUL EHSAN, MALAYSIA, RUBBERMADE ACCESSORIES SDN. BHD., SELANGOR DARUL EHSAN, MALAYSIA:  
1,858,139, REN. 9-20-04. INT. CL. 10.
- ELCON SYSTEMTECHNIK GMBH, HARTMANNSDORF, FED REP GERMANY:  
2,899,395, PUB. 8-10-2004. MULTIPLE CLASS, INT. CLS.  
9, 37 AND 38.
- ELDER DAVIS, INC., RICHMOND, IN:  
1,810,800, CANC. INT. CL. 20.
- ELECTRONIC BILLBOARDS, INC., TULSA, OK:  
2,899,294, PUB. 12-24-2002. INT. CL. 37.

ELECTRONIC CLEARING HOUSE, INC., AGOURA HILLS, CA:  
2,898,916, PUB. 8-10-2004. INT. CL. 36.

ELECTRONIC DATA SYSTEMS CORPORATION, PLANO, TX:  
2,900,196, INT. CL. 35.

ELECTRONIC PRE-PRESS SYSTEMS, INC., BEDFORD, MA:  
1,260,853, CANC. INT. CL. 9.

ELGIN RIVERBOAT RESORT, CHICAGO, IL:  
2,121,816, CANC. INT. CL. 41.

ELI LILLY AND COMPANY, INDIANAPOLIS, IN:  
761,574, CANC. U.S. CL. 18.

ELITE INDUSTRIES, LTD., RAMAT-GAN, ISRAEL:  
2,121,987, CANC. INT. CL. 30.

ELIXENT LIMITED, BRISTOL BS99 7QQ, ENGLAND:  
2,898,512, PUB. 7-16-2002. INT. CL. 9.

ELIXIR INDUSTRIES, GARDENA, CA:  
1,318,131, REN. 9-24-04. INT. CL. 19.

ELIZABETH ARDEN, INC., MIAMI LAKES, FL:  
991,685, REN. 9-20-04. INT. CL. 3.

ELKHART BRASS MFG. CO., INC., ELKHART, IN:  
1,314,421, REN. 9-23-04. INT. CL. 9.

ELON INCORPORATED, MERRILLVILLE, IN:  
2,898,827, PUB. 8-10-2004. INT. CL. 3.

ELVIS PRESLEY ENTERPRISES, INC., MEMPHIS, TN:  
1,327,127, REN. 9-22-04. INT. CL. 25.

EMA, INC., ST. PAUL, MN, EMA SERVICES, INC., ST. PAUL, MN:  
1,849,666, REN. 9-18-04. INT. CL. 42.

EMANAGE.COM, FREMONT, CA:  
2,898,461, PUB. 8-20-2002. INT. CL. 42.

EMBARCADERO CENTER, INC., BOSTON, MA:  
2,899,133, PUB. 8-10-2004. INT. CL. 36.

EMC CORPORATION, HOPKINTON, MA:  
2,898,438, PUB. 3-27-2001. INT. CL. 9.

EMC TECHNOLOGY, INC., CHERRY HILL, NJ:  
2,898,846, PUB. 8-10-2004. INT. CL. 9.  
2,898,847, PUB. 8-10-2004. INT. CL. 9.

EMCON EMANATION CONTROL LIMITED, OTTAWA ONTARIO, CANADA:  
2,899,505, PUB. 8-10-2004. MULTIPLE CLASS, INT. CLS. 40 AND 42.

EMCON EMANATION CONTROL LIMITED, OTTAWA, ONTARIO, CANADA:  
2,899,506, PUB. 8-10-2004. MULTIPLE CLASS, INT. CLS. 40 AND 42.

EMERSON ELECTRIC CO., ST. LOUIS, MO:  
1,286,056, REN. 9-20-04. INT. CL. 21.  
1,299,262, REN. 9-22-04. INT. CL. 6.  
1,308,011, REN. 9-20-04. INT. CL. 17.  
1,309,350, REN. 9-23-04. INT. CL. 37.

EMMITT, INC., PENSACOLA, FL:  
2,122,191, CANC. INT. CL. 25.

EMMPAK FOODS, INC., MILWAUKEE, WI, PECK MEAT PACKING CORPORATION, MILWAUKEE, WI:  
1,288,493, REN. 9-18-04. INT. CL. 29.

EMPI CORP, ST. PAUL, MN:  
1,292,027, REN. 9-24-04. INT. CL. 10.

EMPIRE CANDLE MANUFACTURING LLC, KANSAS CITY, KS:  
2,899,124, PUB. 8-10-2004. INT. CL. 4.

EMPIRE INDUSTRIES, INC., DELRAY BEACH, FL:  
2,122,310, CANC. INT. CL. 28.

ENAGIC CO., LTD., TOKYO, JAPAN:  
2,900,483, INT. CL. 11.

ENCHANTED FOODS, INC., PORT TOWNSEND, WA:  
2,899,624, PUB. 2-17-2004. INT. CL. 29.

ENCORE GROUP, INC., THE, SAN DIEGO, CA:  
2,898,579, PUB. 6-10-2003. MULTIPLE CLASS, INT. CLS. 9, 16, 18, 25 AND 28.

ENCORE GROUP, INC., THE, SAN DIEGO, CA:  
2,899,277, PUB. 8-26-2003. INT. CL. 20.

ENERGY & ENVIRONMENT TWENTY-ONE, INC., WASHINGTON, DC:  
2,900,575, INT. CL. 41.

ENGINEERED PRODUCTS, INC., GREENVILLE, SC:  
2,898,872, PUB. 8-10-2004. INT. CL. 6.

ENGINEERED SUPPORT SYSTEMS, INC., ST. LOUIS, MO:  
2,898,526, PUB. 8-20-2002. INT. CL. 35.

ENGINION AG, 13355 BERLIN, FED REP GERMANY:  
2,900,249, INT. CL. 42.

ENGIS CORPORATION, WHEELING, IL, ENGIS EQUIPMENT COMPANY, CHICAGO, IL:  
777,786, REN. 9-19-04. U.S. CL. 23 (INT. CL. 7).

ENGL, BRUCE JAMES, LITTLETON, CO:  
2,120,991, CANC. INT. CL. 35.

ENGLESIDE PRODUCTS, INC., LANCASTER, PA:  
1,811,382, CANC. INT. CL. 3.

ENGLEWOOD ENTERPRISES CORP., ENGLEWOOD, CO:  
2,122,496, CANC. MULTIPLE CLASS, INT. CLS. 16, 35 AND 42.

ENGLUND, MARILYN A., PORTLAND, OR:  
2,121,652, CANC. INT. CL. 24.

ENTACT SERVICES, LLC, IRVING, TX:  
2,899,691, PUB. 8-10-2004. INT. CL. 42.

ENTERTAINMENT PUBLICATIONS, INC., BIRMINGHAM, MI:  
1,260,919, CANC. INT. CL. 16.

ENTERTAINMENT WEEKLY INC., NEW YORK, NY:  
2,900,947, INT. CL. 16.

ENVEL CORPORATION, LOS ANGELES, CA:  
1,260,947, CANC. INT. CL. 19.

ENVIRONMENTAL AEROSCIENCES CORP., CORAL GABLES, FL:  
2,122,009, CANC. INT. CL. 7.

ENVIRONMENTAL TECTONICS CORPORATION, SOUTHAMPTON, PA:  
1,298,508, REN. 9-22-04. MULTIPLE CLASS, INT. CLS. 9, 10 AND 11.

ENZYMATIC THERAPY, INC., GREEN BAY, WI:  
2,121,574, CANC. INT. CL. 5.

EPLUS INC., HERDON, VA FROM PROCURENET INC., FAIRFIELD, NJ:  
2,900,055, INT. CL. 35.

EPSON AMERICA, INC., TORRANCE, CA:  
2,121,427, CANC. INT. CL. 9.

EQUIFIRST CORPORATION, CHARLOTTE, NC:  
1,896,471, REN. 9-22-04. INT. CL. 36.

EQUIPMENT MANUFACTURING CORPORATION, SANTA FE SPRINGS, CA:  
2,898,982, PUB. 8-10-2004. INT. CL. 7.

EQUIPOS DE TRANSMISSION, S.A., SAN SEBASTIAN, SPAIN:  
1,291,867, REN. 9-22-04. MULTIPLE CLASS, INT. CLS. 7 AND 12.

EQUITRAC CORPORATION, CORAL GABLES, FL:  
1,892,594, REN. 9-22-04. INT. CL. 9.  
2,900,049, INT. CL. 9.

EQUUS COMPUTER SYSTEMS, INC., MINNEAPOLIS, MN, EQUUS COMPUTER SYSTEMS, INC., ST. PAUL, MN:  
1,855,974, REN. 9-23-04. INT. CL. 36.

EROWA AG, CH-5734 REINACH, SWITZERLAND:  
2,121,073, CANC. MULTIPLE CLASS, INT. CLS. 9 AND 42.

ERSKINE, RONALD C., GILROY, CA, DBA COAST RANGE BREWING COMPANY:  
2,122,252, CANC. INT. CL. 32.

ERSYS, INC., INCLINE VILLAGE, NV:  
2,121,250, CANC. INT. CL. 35.

ERTL COMPANY, INC., THE, DYERSVILLE, IA:  
2,122,167, CANC. INT. CL. 28.

ERTLE, THOMAS, 89129 LANGENAU, FED REP GERMANY:  
2,898,487, PUB. 2-17-2004. MULTIPLE CLASS, INT. CLS. 6, 7, 9, 11, 19, 35, 36, 37, 38, 39, 40, 41 AND 42.

ERWIN PEARL, INC., NEW YORK, NY:  
1,847,329, REN. 9-20-04. INT. CL. 14.

ESCALANTE, JOSEPH P, HOLLYWOOD, CA:  
2,898,634, PUB. 4-22-2003. INT. CL. 41.

ESCHER WYSS AKTIENGESELLSCHAFT, ZURICH, SWITZERLAND TO SULZER MANAGEMENT AG, 8401 WINTERTHUR, SWITZERLAND:  
1,288,626, CANC. MULTIPLE CLASS, INT. CLS. 6, 7 AND 9.

- ESI ENERGY, INC., WEST PALM BEACH, FL:  
2,120,772, CANC. MULTIPLE CLASS, INT. CLS. 35, 36, 37 AND 42.
- ESOL CO., LTD., TOKYO 168-0073, JAPAN:  
2,900,484, INT. CL. 42.
- ESOX PROMOTIONS, INC., DEERFIELD, IL:  
2,831,386, COR. MULTIPLE CLASS, INT. CLS. 9, 16 AND 25.
- ESSELTE CORPORATION, GARDEN CITY, NY:  
1,310,765, REN. 9-21-04. MULTIPLE CLASS, INT. CLS. 6 AND 17.
- ESTARI, INC., HARRISBURG, PA:  
2,898,654, PUB. 8-10-2004. INT. CL. 9.
- ESTILUZ, S.A., GERONA, SPAIN:  
1,889,228, REN. 9-23-04. INT. CL. 11.
- ESTWING MANUFACTURING COMPANY, INC., ROCKFORD, IL:  
2,386,716, AM. INT. CL. 8.
- ETABLISSEMENTS BULLIER, SAINT-BRIEUC, FRANCE:  
1,294,212, REN. 9-23-04. INT. CL. 16.
- ETABLISSEMENTS MESNEL, 9200 NANTERRE, FRANCE:  
2,120,731, CANC. INT. CL. 17.
- ETIENNE AIGNER COSMETICS GMBH, D-85551 KIRCHHEIM, FED REP GERMANY:  
2,122,060, CANC. INT. CL. 3.
- EUGENE-GALLIA S.A., PARIS (SEINE), FRANCE:  
761,717, CANC. U.S. CL. 51.
- EUROCAN PULP & PAPER CO., VANCOUVER, BRITISH COLUMBIA, CANADA:  
1,810,687, CANC. INT. CL. 16.
- EUROINSIGHT, L.C., JUPITER, FL:  
2,121,829, CANC. INT. CL. 35.
- EUROPEAN INTERNET NETWORK, INC., WASHINGTON, DC:  
2,899,492, PUB. 2-10-2004. INT. CL. 41.
- EUROSUCRE SNC, 75008 PARIS, FRANCE:  
2,121,257, CANC. INT. CL. 30.
- EUTECTIC CORPORATION, FLUSHING, NY, WASSERMAN, RENE D., NEW YORK, NY, DBA EUTECTIC WELDING ALLOYS COMPANY:  
408,653, REN. 9-20-04. U.S. CL. 14 (INT. CL. 9).
- EVANS & SUTHERLAND COMPUTER CORPORATION, SALT LAKE CITY, UT:  
1,823,613, REN. 9-24-04. INT. CL. 9.  
2,900,176, INT. CL. 41.
- EVANS COMMUNICATIONS, TURLOCK, CA:  
2,898,971, PUB. 8-10-2004. INT. CL. 38.
- EVAS INTERNATIONAL CORPORATION, DELAND, FL:  
2,121,616, CANC. INT. CL. 20.
- EVENTEMPS CORPORATION, NEW YORK, NY, DBA STRATEGIC EVENT DESIGN:  
2,898,855, PUB. 8-10-2004. INT. CL. 35.
- EVENTLINK, LTD, CINCINNATI, OH:  
2,376,467, CANC. INT. CL. 41.
- EVERINGHAM BROTHERS LIMITED, BRAMPTON, ONTARIO, CANADA:  
2,120,786, CANC. MULTIPLE CLASS, INT. CLS. 11 AND 21.
- EVERLAST WORLD'S BOXING HEADQUARTERS CORP., NEW YORK, NY:  
1,346,377, REN. 9-20-04. INT. CL. 25.
- EVERS, AL, OAKLAND, CA:  
2,898,792, PUB. 8-10-2004. INT. CL. 9.
- EVERYCALL COMMUNICATIONS, INC., BATON ROUGE, LA:  
2,900,838, INT. CL. 38.
- EVERYTHING EQUESTRIAN, LTD., DAMASCUS, MD:  
2,899,103, PUB. 8-10-2004. INT. CL. 35.
- EVETS CORPORATION, SAN CLEMENTE, CA:  
2,900,489, INT. CL. 9.
- EX LIBRIS (USA) INC., CHICAGO, IL:  
2,900,100, INT. CL. 41.
- EXACT SCIENCES CORPORATION, MARLBOROUGH, MA:  
2,899,842, PUB. 8-10-2004. INT. CL. 42.
- EXCEPTIONAL PRODUCTS, INC., DALLAS, TX:  
2,898,769, PUB. 8-10-2004. INT. CL. 26.
- EXIDE TECHNOLOGIES, ALPHARETTA, GA, GNB BATTERIES INC., MENDOTA HEIGHTS, MN:  
1,333,053, REN. 9-22-04. INT. CL. 9.
- EXPEDITION PENS, INC., KANSAS CITY, MO:  
2,121,695, CANC. INT. CL. 16.
- EXPEDITION 8000, LLC, ASHFORD, WA, RAINIER OVERLAND, INC., ASHFORD, WA:  
1,852,645, REN. 9-19-04. INT. CL. 39.
- EXPLORING THE METROPOLIS, INC., NEW YORK, NY:  
2,842,028, COR. INT. CL. 41.  
2,847,067, COR. INT. CL. 41.
- EXPOSITION RESEARCH, INC., STAMFORD, CT:  
2,121,072, CANC. INT. CL. 42.
- EXPRESS MORTGAGE LENDERS OF AMERICA, INC., FARMINGTON HILLS, MI, EXPRESS MORTGAGE BROKERS INC., DETROIT, MI:  
1,906,762, REN. 9-19-04. INT. CL. 36.
- EYE JEWELS, INC., LAS VEGAS, NV:  
2,899,794, PUB. 8-10-2004. INT. CL. 38.
- EYE RESPONSE TECHNOLOGIES, CHARLOTTESVILLE, VA:  
2,900,925, INT. CL. 9.
- EYE-EYE-EYE, INC., KEY WEST, FL:  
1,861,713, REN. 9-23-04. INT. CL. 9.
- F J BENJAMIN HOLDINGS PTE LTD, SINGAPORE 1025, SINGAPORE:  
2,120,697, CANC. INT. CL. 42.
- F. GAVINA & SONS, INC., VERNON, CA:  
1,327,280, REN. 9-24-04. INT. CL. 30.
- F. L. SMITHE MACHINE COMPANY, INC., DUNCANSVILLE, PA:  
1,345,667, REN. 9-24-04. INT. CL. 7.
- F.A. PRODUCTS, L.P., HOUSTON, TX:  
2,899,999, PUB. 8-10-2004. INT. CL. 5.  
2,900,001, PUB. 8-10-2004. INT. CL. 5.
- FABRIC EDITIONS LTD., GREENVILLE, SC:  
2,898,604, PUB. 7-22-2003. INT. CL. 24.
- FAIR PLAY CARAMELS INC., JOHNSON CITY, NY:  
177,214, CANC. U.S. CL. 46.
- FALCON CORPORATION, PHOENIX, AZ:  
2,122,222, CANC. INT. CL. 20.
- FAMILY VISIONS, INC., INCLINE VILLAGE, NV:  
2,121,542, CANC. INT. CL. 18.
- FAMMEREE, RICHARD A., JR., BEVERLY SHORES, IN:  
2,899,550, PUB. 8-10-2004. INT. CL. 41.
- FANCY T'S, FRISCO, TX:  
2,899,512, PUB. 8-10-2004. INT. CL. 16.
- FANO, DENNIS, BLOOMFIELD, NJ:  
2,121,537, CANC. INT. CL. 15.
- FANTASY INC., BERKELEY, CA:  
2,900,069, MULTIPLE CLASS, INT. CLS. 41 AND 42.
- FANTASY PUBLICATIONS LIMITED, LONDON E14 9RE, ENGLAND, POWER RADIO LIMITED, HARROW, MIDDLESEX, UNITED KINGDOM:  
1,836,148, REN. 9-18-04. INT. CL. 16.  
1,841,312, REN. 9-18-04. INT. CL. 16.
- FAR TAR, INC., TEMPLE CITY, CA:  
2,899,231, PUB. 8-10-2004. INT. CL. 25.
- FARMERS GROUP, INC., LOS ANGELES, CA:  
1,880,050, REN. 9-22-04. INT. CL. 36.
- FARMSAVER.COM LLC, SEATTLE, WA:  
2,898,922, PUB. 8-10-2004. INT. CL. 35.
- FARRAR, CATHERINE, LOCH ARBOUR, NJ:  
2,899,495, PUB. 8-10-2004. INT. CL. 35.
- FASHION ALMANAC PUBLISHING, INC., NEW YORK, NY:  
2,121,004, CANC. INT. CL. 16.
- FASHION INSTITUTE OF DESIGN & MERCHANDISING, THE, LOS ANGELES, CA:  
1,851,735, REN. 9-18-04. INT. CL. 41.  
1,891,307, REN. 9-18-04. MULTIPLE CLASS, INT. CLS. 35 AND 41.
- FAULTLESS STARCH/BON AMI COMPANY, KANSAS CITY, MO, KLEEN KING HOME PRODUCTS COMPANY, BURBANK, CA:  
593,688, REN. 9-24-04. U.S. CL. 52 (INT. CL. 3).



- FAUNUS GROUP INTERNATIONAL, INC., PHILADELPHIA, PA:  
2,899,558, PUB. 8-10-2004. INT. CL. 36.
- FAVARATO, ANGELO, CORPUS CHRISTI, TX:  
2,121,613, CANC. INT. CL. 42.
- FCT TELECOM, INC., LINTHICUM, MD:  
2,120,973, CANC. INT. CL. 38.
- FECHTOR, DETWILER & CO., INC., BOSTON, MA:  
2,898,558, PUB. 10-29-2002. INT. CL. 36.
- FEDERAL APD, NOVI, MI:  
1,854,523, REN. 9-24-04. INT. CL. 9.
- FEDERAL METAL COMPANY, THE, BEDFORD, OH:  
1,856,174, REN. 9-23-04. INT. CL. 6.
- FEDERAL PROCESS CORPORATION, CLEVELAND, OH,  
CRANE PACKING COMPANY, MORTON GROVE,, IL:  
778,186, REN. 9-23-04. U.S. CL. 35 (INT. CL. 7).
- FEDERAL-MOGUL POWERTRAIN, INC., SOUTHFIELD,  
MI, RAYCHEM CORPORATION, MENLO PARK, CA:  
1,311,077, REN. 9-22-04. INT. CL. 17.
- FEDERAL-MOGUL WORLD WIDE INC., SOUTHFIELD,  
MI:  
988,779, REN. 9-24-04. U.S. CL. 19 (INT. CL. 12).
- FEDERATED BRANDS, INC., MANCHESTER, NH:  
2,899,648, PUB. 8-10-2004. INT. CL. 25.
- FEED MEALS CORP., COCONUT GROVE, FL:  
2,900,552, INT. CL. 39.
- FENDER MENDER OF SOUTH CAROLINA, INC., N.  
CHARLESTON, SC:  
2,121,752, CANC. INT. CL. 37.
- FENDER MUSICAL INSTRUMENTS CORPORATION,  
SCOTTSDALE, AZ:  
2,900,807, INT. CL. 15.
- FENG KENG SCREW CORPORATION, KAOHSIUNG  
HSIEN, TAIWAN:  
2,121,658, CANC. INT. CL. 6.
- FERRERO S.P.A., 12051 ALBA (PROVINCE OF CUNEO),  
ITALY:  
1,261,074, CANC. INT. CL. 30.
- FERRO CORPORATION, CLEVELAND, OH:  
2,900,560, INT. CL. 1.
- FERTITTA HOSPITALITY, LLC, HOUSTON, TX:  
2,899,635, PUB. 8-10-2004. INT. CL. 43.
- FFG TRUST, INC., SPRINGFIELD, IL:  
2,121,642, CANC. INT. CL. 36.
- FIAT AUTO S.P.A., 10135 TORINO, ITALY:  
2,899,069, PUB. 6-1-2004. INT. CL. 25.
- FIBERBUILT UMBRELLAS, LAUDERDALE LAKES, FL:  
2,899,980, PUB. 8-10-2004. INT. CL. 18.
- FIBERCORE LIMITED, HAMPSHIRE, SO16 7QQ, UNITED  
KINGDOM:  
1,905,460, REN. 9-22-04. INT. CL. 9.
- FIBERMARK, INC, BRATTLEBORO, VT, SPECIALTY PA-  
PERBOARD, INC., BRATTLEBORO, VT:  
1,874,646, REN. 9-20-04. INT. CL. 16.
- FICKEN, KERRY CATHERINE, RALEIGH, NC:  
2,898,651, PUB. 12-30-2003. INT. CL. 14.
- FIDUCIAIRE DE DISTRIBUTION INTERNATIONALE,  
73290 LA MOTTE SERVOLEX, FRANCE:  
2,898,883, PUB. 8-10-2004. MULTIPLE CLASS, INT. CLS.  
35, 36, 38 AND 39.
- FIELD, PATRICIA, NEW YORK, NY:  
2,898,610, PUB. 4-6-2004. INT. CL. 25.
- FIELDWORKS, INCORPORATED, EDEN PRAIRIE, MN:  
2,122,542, CANC. INT. CL. 9.
- FIHEALTH, LLC, NASHVILLE, TN:  
2,900,158, INT. CL. 35.
- FIKE CORPORATION, BLUE SPRINGS, MO:  
2,900,486, INT. CL. 9.
- FILTER SPECIALISTS, INC., MICHIGAN CITY, IN:  
1,292,100, REN. 9-23-04. INT. CL. 11.
- FINDWHAT.COM, FT. MYERS, FL:  
2,899,567, PUB. 8-10-2004. INT. CL. 35.
- FINMECCANICA S.P.A., GENOVA, ITALY:  
1,970,785, COR. INT. CL. 37.
- FINNEGAN, HENDERSON, FARABOW, GARRETT & DUN-  
NER, L.L.P., WASHINGTON, DC:  
2,900,915, INT. CL. 9.
- FIRE-DEX, INC., MEDINA, OH, MORGAN PROTECTIVE  
APPAREL, INC., CLEVELAND, OH:  
1,350,382, REN. 9-23-04. INT. CL. 9.
- FIREHOUSE RESTAURANT GROUP, INC., JACKSON-  
VILLE, FL:  
2,900,019, PUB. 8-10-2004. INT. CL. 16.
- FIREMAN'S FUND INSURANCE COMPANY, NOVATO,  
CA:  
1,261,141, CANC. INT. CL. 36.
- FIRMA FR. KAISER GMBH, WURTTENBERG, FED REP  
GERMANY:  
99,887, REN. 9-23-04. U.S. CL. 50 (INT. CL. 5).
- FIRMENICH, INCORPORATED, PRINCETON, NJ:  
1,291,719, REN. 9-18-04. INT. CL. 3.
- FIRST ALEXIS HOTEL, L.P., SAN FRANCISCO, CA:  
2,899,946, PUB. 8-10-2004. INT. CL. 43.
- FIRST BRANDS CORPORATION, DANBURY, CT:  
1,260,713, CANC. INT. CL. 1.
- FIRST COAST ENERGY, L.L.P., JACKSONVILLE, FL:  
2,900,193, INT. CL. 35.
- FIRST ELECTRONIC CORPORATION, DRAPER, UT:  
2,900,066, INT. CL. 36.
- FIRST HOUSTON MORTGAGE LIMITED, HOUSTON, TX:  
2,899,909, PUB. 8-10-2004. INT. CL. 36.
- FIRST NATIONAL BANK OF OMAHA, OMAHA, NE:  
1,846,978, REN. 9-19-04. INT. CL. 36.
- FIRST NIGHT, INC., PROVIDENCE, RI:  
2,900,621, INT. CL. 41.
- FIRST REPUBLIC BANK, SAN FRANCISCO, CA:  
2,898,413, PUB. 8-10-2004. INT. CL. 36.
- FIRST TRADING CORPORATION, SECAUCUS, NJ TO  
GROUP USA INC, SECAUCUS, NJ:  
1,848,858, CANC. INT. CL. 14.
- FIRSTEL FEDERAL CREDIT UNION, MAPLE GROVE, MN:  
2,900,353, INT. CL. 36.
- FIRSTMERIT CORPORATION, AKRON, OH:  
2,121,726, CANC. INT. CL. 36.
- FISCALINI CHEESE COMPANY, LLC, MODESTO, CA:  
2,798,546, COR. INT. CL. 29.
- FISHER CONTROLS INTERNATIONAL LLC, ST. LOUIS,  
MO:  
1,867,976, REN. 9-23-04. MULTIPLE CLASS, INT. CLS. 6,  
7, 9, 11, 17 AND 37.
- FISHER, DALE P., VALLEY, CA:  
2,898,745, PUB. 11-4-2003. INT. CL. 28.
- FISHER, DONALD LEE, SUMNER, WA, DBA KIDS KOR-  
NER GIFT SHOPPES:  
1,710,325, AM. INT. CL. 35.
- FITNESS EDUCATION WORLDWIDE, INC., CALABASAS,  
CA, NATIONAL ACADEMY OF SPORTS MEDICINE,  
INC., CHICAGO, IL:  
1,852,654, REN. 9-22-04. INT. CL. 41.
- FITNESS SOLUTIONS, INC., FORT LAUDERDALE, FL:  
2,122,276, CANC. INT. CL. 28.
- FITZGERALD, GRAY & ROSS, INC., EUGENE, OR, DBA  
FLYING CLIPPER ALTERNATIVE SPORTS:  
2,899,384, PUB. 8-10-2004. INT. CL. 28.
- FL INDUSTRIES, INC., LIVINGSTON, NJ:  
1,260,956, CANC. INT. CL. 20.  
1,260,957, CANC. INT. CL. 20.
- FLAGEOLI, LIMITED, LOS ANGELES, CA:  
2,900,031, INT. CL. 3.  
2,900,032, INT. CL. 3.
- FLAMEMASTER CORPORATION, SUN VALLEY, CA:  
1,295,354, REN. 9-18-04. INT. CL. 1.
- FLAVORS OF NORTH AMERICA, INC., CAROL STREAM,  
IL:  
2,900,390, INT. CL. 35.
- FLEET FINANCIAL GROUP, INC., BOSTON, MA:  
2,121,335, CANC. INT. CL. 36.
- FLEETWOOD ENTERPRISES, INC., RIVERSIDE, CA:  
1,290,909, REN. 9-18-04. INT. CL. 12.
- FLEMING, ELIZABETH MEL, TORRANCE, CA:  
2,121,211, CANC. INT. CL. 41.
- FLEXIBLE INNOVATION, LTD, FORT WORTH, TX:  
2,899,410, PUB. 8-10-2004. INT. CL. 17.
- FLEXSYSTEMS USA INCORPORATED, OAKLAND, CA:  
2,121,098, CANC. INT. CL. 26.

- FLIK INTERNATIONAL CORPORATION, RYE BROOK, NY:  
1,293,171. REN. 9-22-04. INT. CL. 35.
- FLIR SYSTEMS, INC., PORTLAND, OR:  
2,899,257. PUB. 8-10-2004. INT. CL. 9.
- FLOOD COMPANY; THE, HUDSON, OH:  
1,310,711. REN. 9-21-04. INT. CL. 3.
- FLORIDA GULF COAST UNIVERSITY BOARD OF TRUSTEES, FORT MYERS, FL:  
2,898,649. PUB. 6-24-2003. INT. CL. 25.
- FLORIDA HEART RESEARCH FOUNDATION, INC., MIAMI BEACH, FL:  
2,899,986. PUB. 8-10-2004. INT. CL. 44.
- FLORIDA HOSPITAL COLLEGE OF HEALTH SCIENCES, ORLANDO, FL:  
2,900,599. INT. CL. 41.
- FLORIDA TREND, INC., ST. PETERSBURG, FL:  
1,261,349. CANC. INT. CL. 16.
- FLORIDIN COMPANY, TALLAHASSEE, FL:  
761,501. CANC. U.S. CL. 1.
- FLOWDRIL CORPORATION, KENT, WA:  
1,811,115. CANC. INT. CL. 37.
- FLOWER HOSPITAL, SYLVANIA, OH:  
1,844,917. REN. 9-22-04. INT. CL. 42.
- FLOWERY BEAUTY PRODUCTS, INC., DANBURY, CT:  
1,289,850. REN. 9-19-04. INT. CL. 8.
- FLUIDS MANAGEMENT II, LTD., HOUSTON, TX:  
2,899,022. PUB. 8-10-2004. INT. CL. 1.  
2,899,023. PUB. 8-10-2004. INT. CL. 1.
- FMC TECHNOLOGIES, INC., CHICAGO, IL, FOOD MACHINERY AND CHEMICAL CORPORATION, SAN JOSE, CA:  
601,542. REN. 9-18-04. U.S. CL. 16 (INT. CL. 2).
- FMC TECHNOLOGIES, INC., CHICAGO, IL:  
1,871,035. REN. 9-22-04. INT. CL. 7.
- FMR CORP., BOSTON, MA:  
2,900,719. INT. CL. 36.
- FOCUS ENHANCEMENTS, INC., CAMPBELL, CA:  
2,898,533. PUB. 5-28-2002. INT. CL. 9.
- FONTANA, DARRYL, ORANGEVALE, CA, DBA AUTO REWARDS:  
2,898,440. PUB. 9-11-2001. INT. CL. 35.
- FOOD EXPRESS, INC., GREENSBORO, NC:  
1,870,084. REN. 9-22-04. INT. CL. 42.
- FOOD MARKETS NORTHWEST, INC., SEATTLE, WA:  
2,900,806. INT. CL. 35.
- FOODMAN, LLC, AUSTIN, TX:  
2,900,376. INT. CL. 30.
- FOOT LOCKER RETAIL, INC., NEW YORK, NY:  
1,592,088. CANC. INT. CL. 25.
- FORCE CONSTRUCTION COMPANY, INC., COLUMBUS, IN:  
1,290,487. REN. 9-21-04. INT. CL. 42.  
1,290,488. REN. 9-21-04. INT. CL. 42.
- FORCE DESIGN, INC., COLUMBUS, IN:  
1,305,331. REN. 9-21-04. MULTIPLE CLASS, INT. CLS. 37 AND 42.
- FORD, DAWN, CORVALLIS, OR, DBA ORCHARD HILL PRODUCTIONS:  
2,122,116. CANC. MULTIPLE CLASS, INT. CLS. 9 AND 16.  
2,122,117. CANC. MULTIPLE CLASS, INT. CLS. 9 AND 16.
- FORD, SONDRAL, MAYFIELD, KY AND PAYNE, VIVETTE, MAYFIELD, KY:  
2,121,252. CANC. INT. CL. 35.
- FORDHAM UNIVERSITY, BRONX, NY:  
2,898,757. PUB. 8-10-2004. INT. CL. 41.
- FOREIGN LANGUAGE ASSOCIATION OF MISSOURI, SALEM, MO:  
2,121,779. CANC. INT. CL. 42.
- FORREST CONSULTING, INC., SAN FRANCISCO, CA:  
2,899,278. PUB. 12-23-2003. INT. CL. 9.
- FORT INCORPORATED, EAST PROVIDENCE, RI:  
2,121,492. CANC. INT. CL. 6.
- FORT WAYNE SHOWS, INC., MARTINSVILLE, IN:  
2,121,689. CANC. INT. CL. 35.
- FORT WAYNE WIRE DIE, INC., FORT WAYNE, IN:  
2,121,673. CANC. INT. CL. 7.  
2,121,674. CANC. INT. CL. 7.
- FORTUNE FASHIONS INDUSTRIES LLC, VERNON, CA:  
2,900,435. INT. CL. 25.
- FORTUNE FOOTWEAR, INC., NEW YORK, NY:  
2,900,639. INT. CL. 25.
- FOSHEE, JOHN, HOUSTON, TX:  
2,900,034. INT. CL. 29.
- FOSS MANUFACTURING COMPANY, INC., HAMPTON, NH:  
2,898,868. PUB. 8-10-2004. INT. CL. 24.
- FOSTON ADOLESCENT WORKSHOP, INC., GARY, IN:  
2,121,099. CANC. MULTIPLE CLASS, INT. CLS. 18, 21 AND 25.
- FOTO WEAR, INC., OLYPHANT, PA:  
2,900,330. INT. CL. 16.
- FOUNDATION FOR DIGESTIVE HEALTH AND NUTRITION, INC., BETHESDA, MD:  
2,899,211. PUB. 8-10-2004. INT. CL. 16.
- FOUR CORNERS BREWING COMPANY, L.L.C., CORTEZ, CO:  
2,121,353. CANC. INT. CL. 32.
- FOUR WHEEL DRIVE HARDWARE, L.L.C., COLUMBIANA, OH:  
1,287,049. REN. 9-23-04. INT. CL. 12.
- FOWLER, JIM, SANIBEL ISLAND, FL:  
2,121,074. CANC. INT. CL. 16.
- FPI FIREPLACE PRODUCTS INTERNATIONAL LTD., BRITISH COLUMBIA, CANADA:  
2,850,166. COR. INT. CL. 11.
- FPS TRAINING CORP., OVERLAND PARK, KS:  
2,899,059. PUB. 8-10-2004. MULTIPLE CLASS, INT. CLS. 9 AND 16.
- FRABILL, INC., JACKSON, WI:  
2,900,946. INT. CL. 4.
- FRANCESCO CINZANI & C.I.A S.P.A., TURIN, ITALY:  
177,130. CANC. U.S. CL. 6.
- FRANCOISE, TRIAUD, 33250 PAUILLAC, FRANCE:  
2,900,770. INT. CL. 33.
- FRANK BRUNCHHORST CO., L.L.C., BROOKLYN, NY, FRANK BRUNCKHORST CO., BROOKLYN, NY:  
1,857,808. REN. 9-20-04. INT. CL. 29.
- FRANK H. WRIGHT AND ADAM EASTWOOD, GENERAL PARTNERSHIP, THE, LOS ANGELES, CA:  
2,898,650. PUB. 5-13-2003. INT. CL. 35.
- FRANK, BRIAN DAVID, WHITEFISH, MT:  
2,898,909. PUB. 3-16-2004. INT. CL. 5.
- FRANKEL, CARL, SAN FRANCISCO, CA, DBA ORGANIZATIONAL MEASUREMENT & ENGINEERING:  
2,120,928. CANC. INT. CL. 35.
- FRANKENMUTH BAVARIAN INN, INC., FRANKENMUTH, MI, ZEHNDER'S, INC., FRANKENMUTH, MI:  
1,292,170. REN. 9-20-04. MULTIPLE CLASS, INT. CLS. 16 AND 21.
- FRANKFORD CANDY & CHOCOLATE COMPANY, PHILADELPHIA, PA:  
2,900,424. INT. CL. 30.
- FRANKLIN SPORTS, INC., STOUGHTON, MA:  
1,873,977. REN. 9-21-04. INT. CL. 28.
- FRANKLIN, DONALD A., SAN FRANCISCO, CA:  
2,122,334. CANC. INT. CL. 25.
- FRANZ MORAT KG (GMBH & CO.), EISENBACH, FED REP GERMANY:  
2,121,366. CANC. INT. CL. 7.
- FRANZ VIEGENER II GMBH & CO. KG, 57439 ATTENDORN, FED REP GERMANY:  
2,354,329. COR. MULTIPLE CLASS, INT. CLS. 6, 11 AND 19.
- FRED CLEMENTI, WARRENTON, VA:  
2,900,768. INT. CL. 9.
- FREDERICK GOLDMAN, INC., NEW YORK, NY:  
2,121,740. CANC. INT. CL. 14.

- FREDERICK WARNE & CO., INC., NEW YORK, NY:  
 1,289,082. REN. 9-23-04. INT. CL. 21.  
 1,289,083. REN. 9-19-04. INT. CL. 21.  
 1,289,084. REN. 9-23-04. INT. CL. 21.  
 1,290,101. REN. 9-22-04. INT. CL. 21.  
 1,290,103. REN. 9-19-04. INT. CL. 21.  
 1,298,838. REN. 9-23-04. INT. CL. 21.
- FREDERICK WARNE & COMPANY, NEW YORK, NY:  
 1,289,996. REN. 9-18-04. INT. CL. 16.
- FREEDOM COMMUNICATIONS, INC., SANTA ANA, CA:  
 1,807,455. REN. 9-21-04. INT. CL. 16.  
 1,807,456. REN. 9-21-04. INT. CL. 16.
- FREEDOMZONE, INC., SANDY, UT:  
 2,900,749. INT. CL. 41.
- FREELAND, BRIAN ELLISON, HAMPSHIRE RG24 8GF,  
 ENGLAND AND FREELAND, NEIL, HAMPSHIRE RG24  
 8GF, ENGLAND AND FREELAND, STUART, HAMP-  
 SHIRE RG24 8GF, ENGLAND:  
 2,900,396. INT. CL. 8.
- FREEMAN CAPITAL COMPANY, LAS VEGAS, NV:  
 2,899,015. PUB. 8-10-2004. INT. CL. 39.
- FRESH BAIT, INC., VAN NUYS, CA:  
 2,900,115. INT. CL. 9.
- FRESH PRODUCTS NORTHWEST, LLC, WENATCHEE,  
 WA:  
 2,900,218. INT. CL. 31.
- FREUD TMM, INC., HIGH POINT, NC:  
 2,899,824. PUB. 8-10-2004. INT. CL. 7.
- FRICK-HYATT, CHARLENE A., SCOTTSDALE, AZ AND  
 HYATT, DUANE G., SCOTTSDALE, AZ:  
 2,899,676. PUB. 3-16-2004. INT. CL. 3.
- FRIEDAUER, PETER, DENVER, CO:  
 2,898,599. PUB. 8-10-2004. INT. CL. 3.
- FRIELING USA, INC., CHARLOTTE, NC:  
 2,898,996. PUB. 8-10-2004. INT. CL. 11.
- FRITTS, JEREMY R., ROGERSVILLE, TN AND FRITTS,  
 LARRY W., ROGERSVILLE, TN:  
 2,900,948. INT. CL. 41.
- FRIZ BIOCHEM GMBH, 80639 MUNCHEN, FED REP  
 GERMANY:  
 2,898,613. PUB. 8-10-2004. MULTIPLE CLASS, INT. CLS.  
 1, 5, 7, 9, 10 AND 42.
- FRUITFUL YIELD, INC., THE, BLOOMINGDALE, IL:  
 1,850,515. REN. 9-22-04. INT. CL. 5.
- FRY GUY INC., SCOTTSDALE, AZ:  
 2,121,703. CANC. INT. CL. 42.
- FSBO PUBLISHING, INC., ROANOKE, VA:  
 2,121,351. CANC. INT. CL. 16.
- FUEGO CUBANO CORPORATION, VAN NUYS, CA:  
 2,899,318. PUB. 12-9-2003. INT. CL. 34.
- FUHGEDDABOUDIT FAMILY BRANDS, LLC, LIVER-  
 POOL, NY:  
 2,900,712. INT. CL. 30.
- FULL MEASURE INC., OCCOQUAN, VA:  
 2,900,428. INT. CL. 9.
- FULLER BROTHERS, INC., CLACKAMAS, OR:  
 2,900,273. INT. CL. 9.
- FULLER SMITH & TURNER PLC, LONDON W4 2QB,  
 ENGLAND:  
 1,853,772. REN. 9-23-04. INT. CL. 32.
- FUNDICION TIPOGRAFICA NEUFVILLE, S.A., 08012 BAR-  
 CELONA, SPAIN:  
 1,260,906. CANC. INT. CL. 16.
- FUNNY CIDE VENTURES LLC, SARATOGA SPRINGS, NY:  
 2,899,597. PUB. 8-10-2004. INT. CL. 25.
- FUSEMAIL, LLC, KANSAS CITY, MO:  
 2,899,766. PUB. 8-10-2004. INT. CL. 38.
- FUSION UV SYSTEMS, INC., GAITHERSBURG, MD:  
 2,122,052. CANC. INT. CL. 11.
- FUSS, ALAN, OCEANSIDE, NY AND LIEBERMAN, DAVID,  
 LONG BEACH, NY:  
 2,899,592. PUB. 8-10-2004. INT. CL. 35.
- FUTURA MEDICAL DEVELOPMENTS LIMITED, GUILD-  
 FORD, SURREY, UNITED KINGDOM:  
 2,862,521. COR. INT. CL. 5.
- FUTURESTAR CORPORATION, THE, BLOOMINGTON,  
 MN:  
 2,900,217. INT. CL. 9.
- G. VISENZI MOTOMARKET S.R.L., 25123 BRESCIA, ITALY:  
 1,855,676. REN. 9-20-04. MULTIPLE CLASS, INT. CLS. 12  
 AND 18.
- G.W. KENT, INC., ANN ARBOR, MI:  
 1,811,644. CANC. INT. CL. 32.
- G&T BIOTECH, INC., ROCKVILLE, MD:  
 2,899,465. PUB. 8-10-2004. INT. CL. 1.
- G-T SPORTS ENTERPRISES, INC., MIAMI, FL:  
 1,811,120. CANC. INT. CL. 37.
- GAESUNG GINSENG COOPERATIVE ASSOCIATION,  
 KYONGGI-DO, REPUBLIC OF KOREA:  
 2,900,192. MULTIPLE CLASS, INT. CLS. 29, 31 AND 32.
- GAGWEAR, INC., NORCROSS, GA:  
 2,899,446. PUB. 10-28-2003. INT. CL. 25.
- GALE BANKS ENGINEERING, AZUSA, CA:  
 1,898,592. REN. 9-19-04. INT. CL. 7.
- GALLAHER LIMITED, WEYBRIDGE, SURREY, ENG-  
 LAND:  
 261,652. CANC. U.S. CL. 17.
- GALLERY, FATALI, SPRINGDALE, UT, DBA MICHAEL  
 FATALI:  
 2,898,772. PUB. 8-10-2004. INT. CL. 16.
- GALLUP, INC., OMAHA, NE:  
 2,900,891. INT. CL. 42.  
 2,900,892. INT. CL. 42.  
 2,900,893. INT. CL. 42.  
 2,900,894. INT. CL. 42.
- GALVAN, RAMON ISAAC, FAIR LAWN, NJ:  
 2,900,474. INT. CL. 44.
- GAMBRO HOSPAL AG, BASEL, SWITZERLAND:  
 2,899,616. PUB. 8-10-2004. INT. CL. 5.
- GAME ARTS CO., LTD., TOKYO, JAPAN:  
 2,899,420. PUB. 8-10-2004. INT. CL. 9.
- GANGI, CHARLES, CHICAGO, IL:  
 2,121,186. CANC. INT. CL. 3.
- GANZ, WOODBRIDGE, ONTARIO, CANADA:  
 2,900,126. INT. CL. 21.
- GAPARDIS HEALTH & BEAUTY, INC., MIAMI, FL:  
 2,898,496. PUB. 2-12-2002. INT. CL. 3.
- GARDEN BOTANIKA, INC., REDMOND, WA:  
 1,811,293. CANC. INT. CL. 42.
- GARDEN FEVER, LLC, PORTLAND, OR:  
 2,900,459. INT. CL. 35.
- GARY ACCORD/COMMUNITIES IN SCHOOLS, THE,  
 GARY, IN:  
 2,898,572. PUB. 8-10-2004. INT. CL. 41.
- GASCON, JEFFREY, CHICAGO, IL:  
 2,121,657. CANC. INT. CL. 41.
- GATES & SONS, INC., DENVER, CO:  
 2,899,554. PUB. 8-10-2004. MULTIPLE CLASS, INT. CLS. 8  
 AND 19.
- GATEWAY APPRAISAL, INC., ST. LOUIS, MO:  
 2,900,300. INT. CL. 36.
- GATEWAY 2000, INC., N. SIOUX CITY, SD:  
 1,810,503. CANC. INT. CL. 9.
- GAUVIN REALTY & MANAGEMENT, INC, KISSIMMEE,  
 FL:  
 2,899,687. PUB. 8-10-2004. INT. CL. 36.
- GAVRILOV, KAREN, FORT LAUDERDALE, FL:  
 2,900,833. INT. CL. 41.
- GC AMERICA INC., ALSIP, IL:  
 1,879,092. REN. 9-18-04. INT. CL. 5.
- GE GROUP LIFE ASSURANCE COMPANY, ENFIELD, CT,  
 PHOENIX HOME LIFE MUTUAL INSURANCE COM-  
 PANY, HARTFORD, CT:  
 1,849,595. REN. 9-18-04. INT. CL. 36.
- GEAC COMPUTER SYSTEMS, INC., ATLANTA, GA:  
 2,122,338. CANC. INT. CL. 9.
- GEARY, BOB, SAN FRANCISCO, CA, DBA COSMOS SAN  
 FRANCISCO AND DIRKSEN, DIRK B., SAN FRANCIS-  
 CO, CA, DBA COSMOS SAN FRANCISCO:  
 2,122,055. CANC. INT. CL. 41.
- GEARY, ROBERT B., GROTON, CT, DBA ENSIGN CLASS  
 ASSOCIATION:  
 2,898,728. PUB. 8-10-2004. INT. CL. 22.
- GEBB, ADAM E., BRATTLEBORO, VT:  
 1,811,261. CANC. INT. CL. 42.

- GEHR INDUSTRIES, INC., COMMERCE, CA, DBA PACIFIC TOOL & SUPPLY:  
1,260,925, CANC. INT. CL. 17.
- GEIGER INTERNATIONAL, INC., ATLANTA, GA:  
2,900,796, INT. CL. 20.
- GELMAN, COREY, NEW YORK, NY:  
2,899,724, PUB. 8-10-2004. MULTIPLE CLASS, INT. CLS. 14, 18 AND 26.
- GENCORP INC., FAIRLAWN, OH:  
2,122,348, CANC. INT. CL. 27.
- GENE LOGIC, INC., GAITHERSBURG, MD:  
2,900,302, INT. CL. 42.
- GENE PANTUSO, INDIO, CA, DBA PANCO LTD.:  
984,654, REN. 9-22-04. U.S. CL. 51 (INT. CLS. 3 AND 5).
- GENENDER INTERNATIONAL, INC., WHEELING, IL:  
2,900,748, INT. CL. 14.
- GENERAL BANDWIDTH, INC., AUSTIN, TX:  
2,900,062, INT. CL. 9.
- GENERAL BINDING CORPORATION, NORTHBROOK, IL:  
1,849,913, REN. 9-20-04. INT. CL. 17.
- GENERAL CHEMICAL, DETROIT, MI:  
2,899,802, PUB. 8-10-2004. INT. CL. 3.
- GENERAL CHEMICAL CORPORATION, PARSIPPANY, NJ:  
1,873,487, REN. 9-22-04. INT. CL. 1.
- GENERAL ECOLOGY, INC., EXTON, PA:  
1,869,446, REN. 9-21-04. INT. CL. 11.  
1,876,510, REN. 9-21-04. INT. CL. 11.
- GENERAL ELECTRIC COMPANY, LOUISVILLE, KY:  
990,428, REN. 9-20-04. U.S. CL. 103 (INT. CL. 37).
- GENERAL ELECTRIC COMPANY, FAIRFIELD, CT:  
1,261,106, CANC. INT. CL. 34.
- GENERAL ELECTRIC COMPANY, SCHENECTADY, NY:  
1,298,682, REN. 9-22-04. INT. CL. 11.  
2,900,881, MULTIPLE CLASS, INT. CLS. 35 AND 42.
- GENERAL FOODS CORPORATION, WHITE PLAINS, NY:  
1,261,056, CANC. INT. CL. 29.
- GENERAL HYDROPONICS, INC., SEBASTOPOL, CA:  
2,899,670, PUB. 3-2-2004. INT. CL. 1.
- GENERAL MILLS, INC., MINNEAPOLIS, MN:  
102,229, REN. 9-18-04. U.S. CL. 46 (INT. CL. 30).
- GENERAL MOTORS CORPORATION, DETROIT, MI:  
783,126, REN. 9-22-04. U.S. CL. 19 (INT. CL. 12).
- GENERAL NUTRITION INVESTMENT COMPANY, PITTSBURGH, PA:  
1,260,759, CANC. INT. CL. 5.  
2,122,266, CANC. INT. CL. 5.
- GENERAL NUTRITION INVESTMENT COMPANY, WILMINGTON, DE:  
2,898,431, PUB. 10-5-1999. INT. CL. 5.
- GENERATION II ORTHOTICS, INC., RICHMOND, B.C. V7A 5E6, CANADA:  
2,121,369, CANC. INT. CL. 10.
- GENERATION PARTNERS MANAGEMENT LLC, NEW YORK, NY:  
2,898,471, PUB. 8-10-2004. INT. CL. 36.
- GENERRA SPORTSWEAR COMPANY, INC., SEATTLE, WA TO GENERRA COMPANY, THE, SEATTLE, WA:  
1,811,591, CANC. INT. CL. 25.
- GENESCO INC., NASHVILLE, TN:  
2,122,337, CANC. INT. CL. 25.
- GENESIS CABLE SYSTEMS, L.L.C., PLEASANT PRAIRIE, WI:  
2,121,544, CANC. INT. CL. 16.
- GENETIPORC INC., QUEBEC, PROVINCE OF QUEBEC, CANADA:  
1,810,993, CANC. INT. CL. 31.
- GENFOOT INC., MONTREAL, QUEBEC H4T 1P1, CANADA:  
2,120,843, CANC. INT. CL. 25.
- GENLYTE THOMAS GROUP LLC, LOUISVILLE, KY:  
2,843,996, COR. INT. CL. 11.  
2,900,713, INT. CL. 11.
- GENOMATICA, INC., SAN DIEGO, CA:  
2,900,292, MULTIPLE CLASS, INT. CLS. 9 AND 42.
- GENQUEST, INC., ALBUQUERQUE, NM:  
2,899,782, PUB. 8-10-2004. INT. CL. 35.
- GENTLE FAWN DESIGNS (CANADA) LIMITED, VANCOUVER, BC V6K 1C6, CANADA:  
2,898,578, PUB. 8-10-2004. MULTIPLE CLASS, INT. CLS. 18 AND 25.
- GENTRA SYSTEMS, INC., MINNEAPOLIS, MN:  
2,899,390, PUB. 8-10-2004. INT. CL. 5.
- GEORG LAUER GMBH & CO., D-75177 PFORZHEIM, FED REP GERMANY:  
1,864,537, REN. 9-20-04. MULTIPLE CLASS, INT. CLS. 9, 14, 16 AND 34.
- GEORGE FISCHER SLOANE, INC., LITTLE ROCK, AR:  
2,899,633, PUB. 8-10-2004. MULTIPLE CLASS, INT. CLS. 17 AND 19.
- GEORGE LERIS, FLORENCE, SC:  
2,899,603, PUB. 8-10-2004. INT. CL. 35.
- GEORGETOWN COLLECTION, INC., PORTLAND, ME:  
2,121,990, CANC. INT. CL. 9.
- GERAGHTY, BRIAN J., GROSSE POINTE SHORES, MI:  
2,900,447, INT. CL. 33.
- GETTY PROPERTIES COPR., JERICHO, NJ:  
1,288,389, REN. 9-22-04. INT. CL. 42.
- GF HEALTH PRODUCTS, INC., ATLANTA, GA:  
1,289,792, REN. 9-18-04. MULTIPLE CLASS, INT. CLS. 6, 10, 11 AND 20.
- GGOSCO ENGINEERING INC., OAKVILLE, ONTARIO, CANADA:  
2,782,281, COR. INT. CL. 9.
- GHI AUTOMOTIVE SERVICES, INC., GRAND RAPIDS, MI:  
1,862,440, REN. 9-18-04. INT. CL. 12.
- GIANT STEP RECORDS, INC., NEW YORK, NY:  
2,899,325, PUB. 8-10-2004. INT. CL. 9.
- GIBSON GUITAR CORP., NASHVILLE, TN, GIBSON, INC., KALAMAZOO, MI:  
989,617, REN. 9-18-04. U.S. CL. 36 (INT. CL. 15).
- GIBSON GUITAR CORP., NASHVILLE, TN:  
2,898,529, PUB. 8-10-2004. INT. CL. 15.  
2,898,720, PUB. 8-10-2004. INT. CL. 15.
- GIFTRAP CORPORATION, JUPITER, FL:  
2,899,685, PUB. 8-10-2004. INT. CL. 9.
- GIFTS SHOP INTERNATIONAL, INC., SUMNER, WA:  
2,899,812, PUB. 8-10-2004. INT. CL. 35.
- GILBREATH'S INFORMATION SERVICES, INC., TULSA, OK:  
1,811,054, CANC. MULTIPLE CLASS, INT. CLS. 35 AND 41.
- GILLETTE COMPANY, THE, BOSTON, MA:  
2,900,651, INT. CL. 20.
- GILMORE, KENNETH, CHATSWORTH, CA:  
1,851,834, REN. 9-22-04. MULTIPLE CLASS, INT. CLS. 17, 20 AND 24.
- GINKGO INTERNATIONAL LTD., WOODRIDGE, IL:  
1,286,870, REN. 9-23-04. MULTIPLE CLASS, INT. CLS. 8 AND 21.
- GINSENG UP CORPORATION, NEW YORK, NY:  
1,286,302, REN. 9-18-04. INT. CL. 32.
- GIOVANNI'S PIZZA, INC., ASHLAND, KY:  
1,326,389, REN. 9-23-04. INT. CL. 42.
- GIST-BROCADES N.V., 2611 XT DELFT, NETHERLANDS:  
1,810,346, CANC. INT. CL. 1.
- GIULINI CHEMIE GMBH, D-67029 LUDWIGSHAFEN, FED REP GERMANY:  
2,121,365, CANC. INT. CL. 1.
- GIURATA, PAUL, WOODSIDE, CA:  
2,121,183, CANC. INT. CL. 35.
- GIVENCHY S.A., PARIS, FRANCE:  
1,282,216, REN. 9-18-04. MULTIPLE CLASS, INT. CLS. 9, 14, 18, 24 AND 25.
- GK TECHNOLOGIES, INCORPORATED, GREENWICH, CT:  
761,594, CANC. U.S. CL. 21.
- GLADE'S TAFFY TOWN, INC., SALT LAKE CITY, UT:  
1,854,783, REN. 9-20-04. INT. CL. 30.  
1,856,883, REN. 9-20-04. INT. CL. 30.
- GLAMOUR CLOSET, LLC, SAN FRANCISCO, CA:  
2,899,811, PUB. 8-10-2004. INT. CL. 25.
- GLAXO GROUP LIMITED, GREENFORD, MIDDLESEX, UB6 ONN, UNITED KINGDOM:  
2,120,699, CANC. INT. CL. 16.
- GLAXO GROUP LIMITED, GREENFORD, MIDDLESEX, UB6 ONN, UNITED KINGDOM:  
2,172,530, CANC. INT. CL. 41.

GLAXO GROUP LIMITED, MIDDLESEX UB6 0NN, UNITED KINGDOM:  
2,899,720, PUB. 8-10-2004. INT. CL. 5.

GLENCO MARKETING, INC., ORLANDO, FL:  
2,121,397, CANC. INT. CL. 9.

GLIDEPTH LIMITED, AUCKLAND 1007, NEW ZEALAND:  
2,898,973, PUB. 8-10-2004. MULTIPLE CLASS, INT. CLS. 7, 35 AND 37.

GLIMPSO, LLC, BEND, OR:  
2,899,545, PUB. 12-23-2003. INT. CL. 18.  
2,899,546, PUB. 3-23-2004. INT. CL. 18.

GLOBAL BEARINGS, INC., TULSA, OK:  
2,121,292, CANC. INT. CL. 28.

GLOBAL CLAIM SERVICES, LLC, SALT LAKE CITY, UT:  
2,898,631, PUB. 8-10-2004. INT. CL. 36.

GLOBAL CONNECTIONS INCORPORATED, JANESVILLE, WI:  
2,121,953, CANC. INT. CL. 42.

GLOBAL CONSULTANTS DIRECT, INC., HAUPPAUGE, NY:  
2,900,206, INT. CL. 36.

GLOBAL HOME PRODUCTS LLC C/O CERBERUS CAPITAL MANAGEMENT, L.P., NEW YORK, NY:  
2,122,412, CANC. INT. CL. 21.

GLOBAL TEXTILES, INC., HOUSTON, TX:  
2,900,572, INT. CL. 24.

GLORIA DUCHIN, INC., EAST PROVIDENCE, RI:  
1,847,771, REN. 9-22-04. INT. CL. 28.

GMI HOLDINGS, INC., ALLIANCE, OH, DBA THE GENIE COMPANY:  
2,898,877, PUB. 8-10-2004. MULTIPLE CLASS, INT. CLS. 4, 9, 20, 36 AND 37.

GMRI, INC., ORLANDO, FL:  
2,898,636, PUB. 8-10-2004. INT. CL. 43.

GNETEX CORPORATION, CARBONDALE, PA:  
991,107, REN. 9-21-04. INT. CL. 25.

GO AMERICA, L.L.C., CEDAR RAPIDS, IA:  
2,898,536, PUB. 7-2-2002. INT. CL. 35.

GODIVA BRANDS, INC., NEWARK, DE, CAMPBELL SOUP COMPANY, CAMDEN, NJ:  
1,295,078, REN. 9-22-04. INT. CL. 42.

GOLD MEDAL KARATE, INC., PHILADELPHIA, PA:  
2,900,361, MULTIPLE CLASS, INT. CLS. 41 AND 43.

GOLDBERG; ELLIOTT, SCARSDALE, NY:  
1,290,135, REN. 9-19-04. INT. CL. 25.

GOLDBERG, ROBERT D., BOULDER, CO:  
2,899,566, PUB. 8-10-2004. MULTIPLE CLASS, INT. CLS. 20, 22 AND 25.

GOLDEN CORRAL CORPORATION, RALEIGH, NC:  
2,900,842, INT. CL. 43.

GOLDEN FEET LTD., CINCINNATI, OH:  
2,899,132, PUB. 8-10-2004. INT. CL. 11.

GOLDEN GRIDDLE CORPORATION, THE, WILLOWDALE, ONTARIO, M2J 4V8, CANADA:  
2,120,989, CANC. INT. CL. 42.

GOLDEN PHOENIX FIBERWEBS, INC., TAIPEI 104, TAIWAN:  
2,899,595, PUB. 8-10-2004. INT. CL. 10.

GOLDEN RULE INSURANCE COMPANY, LAWRENCEVILLE, IL:  
2,120,728, CANC. INT. CL. 36.

GOLDEN RULE INSURANCE COMPANY, INDIANAPOLIS, IN:  
2,899,084, PUB. 8-10-2004. INT. CL. 36.

GOLDEN SUN FEEDS, INC., ST. LOUIS, MO:  
2,121,808, CANC. INT. CL. 31.

GOLDEN TOUCH IMPORTS, INC., NEW YORK, NY:  
2,121,717, CANC. INT. CL. 25.

GOLDEN WEST CINEMA SUPPLY, VAN NUYS, CA, DBA GOLDEN WEST MOTOR SPORTS:  
2,121,430, CANC. INT. CL. 41.

GOLDEN WEST CINEMA SUPPLY, VAN NUYS, CA, DBA GOLDEN WEST MOTORSPORTS:  
2,121,431, CANC. INT. CL. 41.

GOLDENCARE CORPORATION, YAKIMA, WA:  
2,898,869, PUB. 8-10-2004. INT. CL. 36.

GOLDFINGER COIN AND BULLION INC., CAMARILLO, CA:  
2,900,590, INT. CL. 42.

GOLDIE LEASING CORP., LONG ISLAND CITY, NY:  
1,261,188, CANC. INT. CL. 39.

GOLDING; HERBERT D., LAPORTE, IN, DBA FINGER'S FRIEND:  
1,327,165, REN. 9-22-04. INT. CL. 26.

GOLDSCHMIDT CHEMICAL CORPORATION, HOPEWELL, VA:  
774,781, REN. 9-24-04. U.S. CL. 6 (INT. CL. 1).

GOLFPARTY, KIRKVILLE, NY:  
2,122,076, CANC. INT. CL. 42.

GOLFSMITH INTERNATIONAL, INC., AUSTIN, TX:  
2,121,599, CANC. INT. CL. 28.  
2,121,889, CANC. INT. CL. 28.

GOLFWARE, INC., RYE, NY:  
2,121,266, CANC. INT. CL. 14.

GOODE, INC., CARSON CITY, NV:  
2,899,502, PUB. 8-10-2004. INT. CL. 5.

GOODIN, DAVID, SAN JOSE, CA:  
2,899,695, PUB. 8-10-2004. INT. CL. 9.

GOODMARK INDUSTRIES, INC., LAWRENCEVILLE, GA:  
1,907,258, REN. 9-24-04. INT. CL. 12.

GOODRICH CORPORATION, CHARLOTTE, NC:  
2,900,161, INT. CL. 12.

GOODYEAR TIRE & RUBBER COMPANY, THE, AKRON, OH:  
761,504, CANC. U.S. CL. 1.  
979,427, REN. 9-19-04. U.S. CL. 35 (INT. CL. 12).  
983,359, REN. 9-18-04. U.S. CL. 35 (INT. CL. 12).  
1,260,888, CANC. INT. CL. 12.  
1,272,609, REN. 9-24-04. INT. CL. 12.  
1,853,078, REN. 9-24-04. INT. CL. 17.

GORDON BIRSCH BREWING COMPANY, LAS VEGAS, NV:  
2,900,750, INT. CL. 32.

GORMAN, JEFFREY B., LOS ANGELES, CA:  
2,900,178, INT. CL. 31.

GOSSOM, THOM, FT. WALTON BEACH, FL:  
1,810,703, CANC. INT. CL. 16.

GOSSWEILER, JAMES C., BALTIMORE, MD:  
2,900,452, INT. CL. 35.  
2,900,454, INT. CL. 35.

GOTHAM LICENSING GROUP, LLC, NEW YORK, NY:  
1,291,238, REN. 9-22-04. INT. CL. 25.

GOUVEA, ANTHONY, CITRUS HEIGHTS, CA:  
2,121,150, CANC. INT. CL. 41.

GOYA FOODS, INC., SECAUCUS, NJ:  
1,857,320, REN. 9-23-04. INT. CL. 29.  
1,859,228, REN. 9-23-04. INT. CL. 30.  
1,860,499, REN. 9-23-04. INT. CL. 32.

GRABARSKY, JACKIE, H, EL SEGUNDO, CA:  
2,900,783, INT. CL. 3.

GRACE-SIERRA HORTICULTURAL PRODUCTS COMPANY, MILPITAS, CA TO OMS INVESTMENTS INC, WILMINGTON, DE:  
1,810,327, CANC. INT. CL. 1.

GRADUATE MANAGEMENT ADMISSION COUNCIL, MCLEAN, VA:  
1,847,855, REN. 9-21-04. INT. CL. 36.

GRAITEC SA, BIEVRES, FRANCE:  
2,900,570, INT. CL. 9.

GRAND FORKS HERALD, INC., GRAND FORKS, ND:  
2,899,350, PUB. 8-10-2004. INT. CL. 16.

GRAND RAPIDS PROFESSIONAL BASKETBALL CLUB, LTD., GRAND RAPIDS, MI:  
2,122,552, CANC. INT. CL. 16.  
2,122,553, CANC. INT. CL. 41.

GRAND RESORT, LLC, NEWPORT BEACH, CA:  
2,900,071, MULTIPLE CLASS, INT. CLS. 9 AND 41.

GRAND ROYAL RECORDS, INC., LOS ANGELES, CA:  
2,121,419, CANC. INT. CL. 25.

GRANDE CHEESE COMPANY, BROWNSVILLE, WI:  
2,122,330, CANC. INT. CL. 29.  
2,122,331, CANC. INT. CL. 29.

GRANDMAC OUTDOOR INC., COLUMBUS, GA:  
2,898,647, PUB. 12-30-2003. MULTIPLE CLASS, INT. CLS.

- 11 AND 35.  
 GRANDPA BRANDS COMPANY, CINCINNATI, OH:  
 2,122,292, CANC. INT. CL. 3.  
 GRANSE CORPORATION, LAKEVILLE, MN:  
 1,260,927, CANC. INT. CL. 17.  
 GRAPHX, INC., WOBURN, MA:  
 2,121,483, CANC. INT. CL. 9.  
 GRAY & COMPANY, FOREST GROVE, OR:  
 1,863,835, REN. 9-20-04. INT. CL. 29.  
 GREAT AMERICAN COSMETICS, INC., PORT WASHINGTON, NY:  
 2,122,511, CANC. INT. CL. 3.  
 GREAT BEND MANUFACTURING COMPANY, INC., GREAT BEND, KS TO ALLIED PRODUCTS CORPORATION, CHICAGO, IL:  
 1,810,470, CANC. INT. CL. 7.  
 GREAT GAME OF BUSINESS, INC., THE, SPRINGFIELD, MO, DBA SRC EXECUTIVE INSTITUTE:  
 1,850,070, REN. 9-18-04. INT. CL. 41.  
 GREAT PLAINS MANUFACTURING, INCORPORATED, ASSARIA, KS:  
 1,902,394, REN. 9-24-04. INT. CL. 7.  
 GREATER PACIFIC FOOD HOLDINGS, INC., MONTEREY, CA:  
 2,900,113, INT. CL. 30.  
 GRECIAN DELIGHT FOODS, INC., ELK GROVE VILLAGE, IL, GYROS, INC., CHICAGO, IL:  
 1,274,443, REN. 9-23-04. INT. CL. 29.  
 GREEN BAY PACKERS, INC., GREEN BAY, WI:  
 1,850,663, REN. 9-18-04. MULTIPLE CLASS, INT. CLS. 16 AND 25.  
 GREEN, JOEL, MARIETTA, GA:  
 2,899,537, PUB. 12-16-2003. INT. CL. 16.  
 GREENBALL CORPORATION, LONG BEACH, CA:  
 2,900,457, INT. CL. 12.  
 GREENSBORO SYMPHONY SOCIETY, INCORPORATED, GREENSBORO, NC:  
 2,900,937, INT. CL. 41.  
 GRIFFIN CORPORATION, VALDOSTA, GA:  
 2,122,402, CANC. INT. CL. 1.  
 GRIMOIRE INC., SEDALIA, CO:  
 2,121,491, CANC. INT. CL. 16.  
 GRIST MILL COMPANY, LAKEVILLE, MN:  
 1,811,624, CANC. INT. CL. 29.  
 GRODYNYSKI, STAN, LONGNIDDRY, SCOTLAND:  
 2,122,012, CANC. INT. CL. 32.  
 GROUNDED, INC., SEATTLE, WA:  
 2,899,314, PUB. 8-10-2004. MULTIPLE CLASS, INT. CLS. 18, 25, 38 AND 41.  
 GROUP USA INC, SECAUCUS, NJ, FIRST TRADING CORPORATION, SECAUCUS, NJ:  
 1,848,858, REN. 9-18-04. MULTIPLE CLASS, INT. CLS. 18 AND 25.  
 GROUP 1066, LLC, NEW YORK CITY, NY:  
 2,900,679, INT. CL. 35.  
 GROW TECHNOLOGY, INC., CITY OF INDUSTRY, CA:  
 2,121,422, CANC. INT. CL. 37.  
 GRUNDENS USA, LTD., POULSBO, WA:  
 2,898,629, PUB. 8-10-2004. INT. CL. 25.  
 GRUNEWALD, DONALD, WILTON, CT:  
 2,898,509, PUB. 8-10-2004. INT. CL. 41.  
 GSC TECHNOLOGY CORPORATION, ST. JEAN, QUEBEC, CANADA:  
 2,899,679, PUB. 3-2-2004. INT. CL. 20.  
 GSI COMMERCE SOLUTIONS, INC., PENNSYLVANIA, PA:  
 2,900,595, MULTIPLE CLASS, INT. CLS. 35 AND 42.  
 GSMA SYSTEMS, INC., PALM BAY, FL:  
 2,120,742, CANC. INT. CL. 7.  
 GT MERCHANDISING & LICENSING LLC, NEW YORK, NY:  
 2,900,299, INT. CL. 28.  
 GTE PRODUCTS CORPORATION, STAMFORD, CT:  
 1,260,878, CANC. INT. CL. 11.  
 GTS GROUP S.P.A., 24020 TORRE BOLDONE, BERGAMO, ITALY, SAGIT S.P.A., 24100 BERGAMO, ITALY:  
 1,852,834, REN. 9-22-04. INT. CL. 3.  
 GUARDIAN INDUSTRIES CORP., AUBURN HILLS, MI:  
 1,849,293, REN. 9-23-04. INT. CL. 19.  
 GUEST SERVICES COMPANY OF VIRGINIA, FAIRFAX, VA:  
 1,811,313, CANC. INT. CL. 42.  
 GUEVARA, MICHAEL, SOUTH GATE, CA AND LADINES, ENRIQUE, SOUTH GATE, CA AND GERGES, SABRI, SOUTH GATE, CA:  
 2,898,701, PUB. 8-10-2004. INT. CL. 25.  
 GUIDEPOSTS, A CHURCH CORPORATION, CARMEL, NY:  
 2,899,000, PUB. 8-10-2004. INT. CL. 45.  
 GULL LABORATORIES, INC., SALT LAKE CITY, UT:  
 2,121,100, CANC. INT. CL. 5.  
 GUMBO KIDS COMPANY, LLC, HIGHLANDS RANCH, CO:  
 2,898,932, PUB. 2-10-2004. INT. CL. 25.  
 GUMKE, KEVIN, KIRKLAND, WA:  
 2,121,085, CANC. INT. CL. 21.  
 GUNNEBO PERIMETER PROTECTION AB, S-402 26 GOTE-BORG, SWEDEN:  
 2,899,644, PUB. 8-10-2004. MULTIPLE CLASS, INT. CLS. 6, 9 AND 37.  
 GUPTA FAMILY LIMITED PARTNERSHIP, NEWPORT COAST, CA:  
 2,121,289, CANC. INT. CL. 12.  
 GUREWITZ, BRETT, HOLLYWOOD, CA:  
 2,120,798, CANC. INT. CL. 9.  
 GUSPRO INCORPORATED, CHATHAM, ONTARIO, CANADA:  
 2,898,491, PUB. 8-10-2004. INT. CL. 7.  
 GUTENFOODS, INC., PORTLAND, OR:  
 2,899,439, PUB. 8-10-2004. INT. CL. 43.  
 GUTERMAN, JIMMY, BROOKLINE, MA:  
 1,811,524, CANC. INT. CL. 16.  
 GUTTERGUARD, INC., CHAMBLEE, GA:  
 2,898,962, PUB. 8-10-2004. MULTIPLE CLASS, INT. CLS. 35 AND 37.  
 GUYER, REYNOLDS WINSOR, ST. PAUL, MN, DBA WINSOR CONCEPTS:  
 1,811,710, CANC. INT. CL. 9.  
 GUYS WHO LOVE GOD, LLC, GLEN BURNIE, MD:  
 2,900,332, INT. CL. 9.  
 H. BAHLESENS KEKSFABRIK KG, D-30655 HANNOVER, FED REP GERMANY:  
 2,120,691, CANC. MULTIPLE CLASS, INT. CLS. 29 AND 30.  
 H. C. KÖNIG GMBH, A-5020 SALZBURG, AUSTRALIA:  
 2,898,463, PUB. 8-10-2004. INT. CL. 33.  
 H. J. RASHTI & COMPANY, INC., NEW YORK, NY:  
 2,126,719, CANC. MULTIPLE CLASS, INT. CLS. 18, 24 AND 25.  
 HACHETTE FILIPACCHI PRESSE, 92534 LEVALLOIS PERRET CEDAX, FRANCE:  
 2,120,702, CANC. MULTIPLE CLASS, INT. CLS. 5, 29, 32 AND 33.  
 HAIN PUBLISHING INC., BEE, NE:  
 2,899,755, PUB. 8-10-2004. INT. CL. 16.  
 HAINDL PAPIER GMBH, D-86153 AUGSBURG, FED REP GERMANY:  
 2,121,461, CANC. INT. CL. 16.  
 2,121,464, CANC. INT. CL. 16.  
 HAIR HOOPS, INC., ROCHESTER, NY:  
 2,122,536, CANC. INT. CL. 26.  
 HAKUHODO CO., LTD., HIROSHIMA, JAPAN:  
 2,899,276, PUB. 3-30-2004. INT. CL. 21.  
 HALE PRODUCTS, INC., CONSHOHOCKEN, PA:  
 2,900,128, MULTIPLE CLASS, INT. CLS. 7 AND 25.  
 HALF MOON STUDIO, INC., ALPHARETTA, GA:  
 2,899,887, PUB. 8-10-2004. INT. CL. 10.  
 HALLIBURTON ENERGY SERVICES, INC., CARROLLTON, TX:  
 2,899,671, PUB. 3-16-2004. INT. CL. 1.  
 2,900,799, INT. CL. 37.  
 HALVORSEN BOATS PTY LTD, TURRAMURRA, AUSTRALIA:  
 2,899,469, PUB. 8-10-2004. INT. CL. 12.  
 HAMBRO INTERNATIONAL (STRUCTURES) LIMITED, BOUCHERVILLE, QUEBEC, CANADA, HAMBRO STRUCTURAL SYSTEMS, LIMITED, OTTAWA K2E5P4, ONTARIO, CANADA:  
 990,642, REN. 9-19-04. MULTIPLE CLASS, U.S. CLS. 12

- (INT. CL. 6) AND 100 (INT. CL. 42).
- HAMBURGER, HOWARD, NEWBURY PARK, CA AND HAMBURGER, MORISSA, NEWBURY PARK, CA: 2,899,190, PUB. 8-10-2004. INT. CL. 35.
- HAMPTON CAPITAL PARTNERS LLC, ROCKY MOUNT, VA: 180,318, REN. 9-24-04. U.S. CL. 42 (INT. CL. 27).
- HANA COBI CO., LTD., NAMDONG-KU, INCHEON, REPUBLIC OF KOREA: 2,900,375, INT. CL. 21.
- HANDGARDS, INC., EL PASO, TX: 2,900,297, INT. CL. 21.
- HANDHELD POWER, LLC, NAPERVILLE, IL: 2,899,828, PUB. 8-10-2004. MULTIPLE CLASS, INT. CLS. 36 AND 38.
- HANDYMAN MATTERS, INC., LAKEWOOD, CO: 2,899,112, PUB. 8-10-2004. INT. CL. 37.
- HANGZHOU SANHE FOOD ADDITIVE CO., LTD., HANGZHOU, ZHEJIANG, CHINA: 2,899,580, PUB. 8-10-2004. INT. CL. 1.
- HANNA ANDERSSON CORPORATION, PORTLAND, OR: 1,881,013, REN. 9-22-04. INT. CL. 42.
- HANOHOV, BOAZ, WOODLAND HILLS, CA: 2,898,804, PUB. 8-10-2004. INT. CL. 35.
- HANSARD, JERRY DWIGHT, MARION, AR: 2,900,074, INT. CL. 41.
- HARALD NORDIN SA, CH-1817 BRENT/MONTREUX, SWITZERLAND: 2,900,171, INT. CL. 10.
- HARBISON-WALKER REFRACTORIES COMPANY, MOON TOWNSHIP, PA, INDRESCO INC., DALLAS, TX: 1,854,673, REN. 9-18-04. INT. CL. 19.
- HARBOR SERVICE CORPORATION, GIBBSBORO, NJ: 1,294,096, REN. 9-18-04. MULTIPLE CLASS, INT. CLS. 24 AND 42.
- HARD CANDY, INC., BEVERLY HILLS, CA: 2,121,012, CANC. INT. CL. 3.
- HARDIE INTERACTIVE, L.L.C., DUBUQUE, IA: 2,121,814, CANC. INT. CL. 35.
- HARDWICK, DEBORAH, NEW YORK, NY: 2,900,890, INT. CL. 42.
- HARGROVE, DAPHNE, HONOLULU, HI: 2,898,803, PUB. 8-10-2004. INT. CL. 16.
- HARLEQUIN ENTERPRISES LIMITED, DON MILLS, ONTARIO, CANADA: 1,260,912, CANC. INT. CL. 16.
- HARLEY CORPORATION, EVANSVILLE, IN: 2,898,969, PUB. 8-10-2004. INT. CL. 20.
- HARPER, REBECCA, GATES MILLS, OH: 2,121,279, CANC. INT. CL. 9.
- HARRAH'S LAS VEGAS, INC., LAS VEGAS, NV: 2,899,472, PUB. 8-10-2004. INT. CL. 41.
- HARRAH'S OPERATING COMPANY, INC., LAS VEGAS, NV: 2,899,954, PUB. 8-10-2004. MULTIPLE CLASS, INT. CLS. 41 AND 43.
- HARRELL REMODELING, INC., MOUNTAIN VIEW, CA: 1,904,644, REN. 9-23-04. MULTIPLE CLASS, INT. CLS. 37 AND 42.
- HARRIS CORPORATION, MELBOURNE, FL: 2,900,296, INT. CL. 20.
- HARRISON, DAVID JAMES, ALMA, MI: 1,810,760, CANC. INT. CL. 16.
- HART ENTERPRISES, INC., VANCOUVER, WA: 2,120,801, CANC. INT. CL. 7.
- HART SPECIALTIES, INC., AMITYVILLE, NY: 2,900,247, INT. CL. 9.
- HARTFORD FIRE INSURANCE COMPANY, HARTFORD, CT: 1,856,416, REN. 9-23-04. INT. CL. 36.
- HARTZ MOUNTAIN CORPORATION, THE, SECAUCUS, NJ: 2,900,480, INT. CL. 28.  
2,900,481, INT. CL. 28.
- HARTZ MOUNTAIN INDUSTRIES, INC., SECAUCUS, NJ: 1,911,747, REN. 9-22-04. MULTIPLE CLASS, INT. CLS. 36 AND 37.  
1,911,753, REN. 9-22-04. MULTIPLE CLASS, INT. CLS. 36 AND 37.
- HARTZELL PROPELLER, INC., PIQUA, OH: 981,535, REN. 9-19-04. U.S. CL. 19 (INT. CL. 12).
- HARVEST MOON VINEYARDS AND INVESTMENTS, LLC, SANTA ROSA, CA: 2,900,507, INT. CL. 33.
- HASBRO, INC., PAWTUCKET, RI: 2,121,559, CANC. INT. CL. 28.  
2,122,277, CANC. INT. CL. 28.  
2,122,438, CANC. INT. CL. 28.  
2,898,741, PUB. 11-18-2003. INT. CL. 28.  
2,898,837, PUB. 8-10-2004. INT. CL. 28.  
2,899,161, PUB. 8-10-2004. INT. CL. 28.  
2,899,220, PUB. 8-10-2004. INT. CL. 28.  
2,899,221, PUB. 8-10-2004. INT. CL. 28.  
2,899,222, PUB. 8-10-2004. INT. CL. 28.  
2,899,223, PUB. 8-10-2004. INT. CL. 28.  
2,900,319, INT. CL. 28.  
2,900,320, INT. CL. 28.  
2,900,439, INT. CL. 28.  
2,900,470, INT. CL. 28.  
2,900,471, INT. CL. 28.  
2,900,503, INT. CL. 28.  
2,900,504, INT. CL. 28.
- HASTINGS MANUFACTURING COMPANY, HASTINGS, MI: 1,848,077, REN. 9-20-04. INT. CL. 7.
- HAT CITY BEVERAGES, LLC, DANBURY, CT: 2,319,720, CANC. INT. CL. 32.
- HAT SHACK, INC., ATLANTA, GA: 2,899,961, PUB. 8-10-2004. INT. CL. 35.
- HATHAWAY TRADING CO., INC., WHITTIER, CA: 2,900,692, INT. CL. 33.
- HAURI INC., SEOUL, REPUBLIC OF KOREA: 2,900,373, INT. CL. 9.
- HAUTT, WILLIAM D., ALAMEDA, CA, DBA FOCUS CONSULTANTS: 1,850,160, REN. 9-19-04. MULTIPLE CLASS, INT. CLS. 9, 16 AND 41.
- HAVANA'S LIMITED, INC., TITUSVILLE, FL: 2,898,475, PUB. 8-10-2004. INT. CL. 30.
- HAYER & BOECKER, D-59302 OELDE, FED REP GERMANY: 2,898,946, PUB. 8-10-2004. MULTIPLE CLASS, INT. CLS. 6 AND 7.
- HAWAII MEDICAL SERVICE ASSOCIATION, HONOLULU, HI: 2,900,395, INT. CL. 44.
- HAWAIIAN HOST, INC., HONOLULU, HI: 2,900,919, INT. CL. 30.
- HAWES, CHRISTINE M., DECATUR, GA: 2,899,928, PUB. 8-10-2004. INT. CL. 35.
- HAWKINS, DELAFIELD & WOOD LLP, NEW YORK CITY, NY: 2,899,533, PUB. 8-10-2004. INT. CL. 42.
- HAYWISER, DAVID A., PITTSBURGH, PA: 2,121,825, CANC. INT. CL. 41.
- HBH LIMITED PARTNERSHIP, CINCINNATI, OH: 1,823,002, REN. 9-24-04. MULTIPLE CLASS, INT. CLS. 29, 30 AND 42.
- HBI INTERNATIONAL, PHOENIX, AZ: 2,899,588, PUB. 8-10-2004. INT. CL. 34.
- HCI DIRECT, INC., BENSALAM, PA: 2,856,487, COR. INT. CL. 25.
- HD NUTRITION, INC., COSTA MESA, CA: 2,899,600, PUB. 8-10-2004. INT. CL. 5.
- HDMI LICENSING L.L.C., SUNNYVALE, CA: 2,900,587, INT. CL. 35.
- HEADBONE INTERACTIVE, INC., SEATTLE, WA: 2,120,938, CANC. INT. CL. 9.
- HEADROOM CORP., BOZEMAN, MT: 1,810,620, CANC. INT. CL. 9.
- HEALTH & SAFETY SYSTEMS, INC., OVERLAND PARK, KS: 2,122,513, CANC. INT. CL. 42.
- HEALTH CARE AND RETIREMENT CORPORATION OF AMERICA, TOLEDO, OH: 2,898,658, PUB. 8-10-2004. INT. CL. 44.

- HEALTH FOR HUMANITY, WILMETTE, IL:  
1,876,981. REN. 9-18-04. INT. CL. 41.  
1,878,044. REN. 9-19-04. INT. CL. 41.
- HEALTH MANAGEMENT SYSTEMS, INC., NEW YORK, NY:  
2,898,893. PUB. 8-10-2004. INT. CL. 35.
- HEALTH MEDIA LAB, INC., WASHINGTON, DC:  
2,899,693. PUB. 8-10-2004. INT. CL. 9.  
2,899,752. PUB. 8-10-2004. INT. CL. 9.
- HEALTH TEC, INC., DAYTONA BEACH, FL:  
2,121,380. CANC. INT. CL. 36.
- HEALTH-PATTERNS CORPORATION, DENVER, CO:  
2,899,713. PUB. 8-10-2004. INT. CL. 44.
- HEALTHMAGIC, DENVER, CO:  
2,898,418. PUB. 1-11-2000. INT. CL. 35.
- HEALTHMARK INDUSTRIES CO., ST. CLAIR SHORES, MI:  
1,878,549. REN. 9-23-04. MULTIPLE CLASS, INT. CLS. 10 AND 20.
- HEALTHY SCHOOLS, INCORPORATED, WASHINGTON, DC:  
2,898,826. PUB. 8-10-2004. MULTIPLE CLASS, INT. CLS. 16, 35 AND 41.
- HEARST COMMUNICATIONS, INC., NEW YORK, NY,  
HEARST CORPORATION, THE, NEW YORK, NY:  
1,911,389. REN. 9-22-04. INT. CL. 16.
- HEARST COMMUNICATIONS, INC., NEW YORK, NY:  
2,900,914. INT. CL. 16.
- HEARST CORPORATION, THE, HOUSTON, TX:  
2,121,014. CANC. INT. CL. 16.
- HEARST CORPORATION, THE, NEW YORK, NY:  
2,121,119. CANC. INT. CL. 16.
- HEARTS ON FIRE COMPANY, BOSTON, MA:  
2,899,895. PUB. 8-10-2004. INT. CL. 18.  
2,899,896. PUB. 8-10-2004. INT. CL. 21.  
2,899,897. PUB. 8-10-2004. INT. CL. 24.
- HEAT-LINE CORPORATION, LINDSAY, ONTARIO K9V 5G6, CANADA:  
1,819,452. REN. 9-18-04. INT. CL. 11.  
1,819,453. REN. 9-20-04. INT. CL. 11.
- HEATCRAFT INC., STONE MOUNTAIN, GA:  
1,849,853. REN. 9-21-04. INT. CL. 11.
- HEB GROCERY COMPANY, LP, SAN ANTONIO, TX:  
2,900,666. INT. CL. 31.
- HEB GROCERY COMPANY, LP., SAN ANTONIO, TX:  
2,900,185. INT. CL. 16.
- HEBERD, LINDSAY, SCOTTSDALE, AZ:  
2,122,528. CANC. INT. CL. 41.
- HED INTERNATIONAL INC., RINGOES, NJ:  
1,345,978. REN. 9-18-04. INT. CL. 11.
- HEDBERG AGGREGATES, INC., PLYMOUTH, MN:  
2,899,784. PUB. 8-10-2004. INT. CL. 35.
- HEIDELBERGER DRUCKMASCHINEN AG, 69115 HEIDELBERG, FED REP GERMANY, ALLIED CORPORATION, TOLEDO, OH:  
1,309,945. REN. 9-18-04. INT. CL. 16.
- HEIDELBERGER DRUCKMASCHINEN AG, 69115 HEIDELBERG, FED REP GERMANY, ALLIED CORPORATION, MORRISTOWN, NJ:  
1,326,883. REN. 9-19-04. INT. CL. 16.
- HEIDELBERGER DRUCKMASCHINEN AG, 69115 HEIDELBERG, FED REP GERMANY:  
2,898,963. PUB. 8-10-2004. MULTIPLE CLASS, INT. CLS. 9 AND 16.
- HEIRLOOM ARTISTS, LAKE OSWEGO, OR:  
1,261,236. CANC. INT. CL. 42.
- HELEN OF TROY LIMITED, BRIDGETOWN, BARBADOS,  
HELEN OF TROY CORPORATION, EL PASO, TX:  
1,850,148. REN. 9-22-04. INT. CL. 11.
- HELEN OF TROY LIMITED, BRIDGETOWN, BARBADOS:  
2,900,613. INT. CL. 3.
- HELIOGRAMME AMERICA, INC., MEMPHIS, TN:  
1,852,707. REN. 9-18-04. INT. CL. 42.
- HELL SURVIVORS, INC., PINCKNEY, MI:  
2,899,283. PUB. 3-26-2002. INT. CL. 41.
- HELLSQUAD RECORDS LIMITED, LONDON W1U 4JT, ENGLAND:  
2,898,696. PUB. 8-10-2004. MULTIPLE CLASS, INT. CLS. 9, 25 AND 41.
- HEMOSURE INC., EL MONTE, CA:  
2,899,814. PUB. 8-10-2004. INT. CL. 5.
- HENDERSON/YATES/KARLS & ASSOCIATES, INC., MADISON, WI:  
2,898,978. PUB. 5-4-2004. INT. CL. 35.
- HENRY, DAVIS, LOS ANGELES, CA:  
2,899,308. PUB. 8-10-2004. INT. CL. 25.
- HEPBURN; GEORGE R., SEVERNA PARK, MD:  
1,289,947. REN. 9-22-04. INT. CL. 10.
- HERA WOMEN'S CANCER FOUNDATION, CARBONDALE, CO:  
2,899,186. PUB. 8-10-2004. INT. CL. 36.
- HERAEUS KULZER GMBH & CO. KG, 63450 HANAU, FED REP GERMANY:  
2,121,205. CANC. INT. CL. 10.
- HERBACEUTICALS, INC., NAPA, CA:  
2,900,388. INT. CL. 3.
- HERBAL MAGIC, INC., FOREST KNOLLS, CA:  
2,121,529. CANC. INT. CL. 5.
- HERBEAU CREATIONS OF AMERICA, INC., NAPLES, FL:  
2,900,758. INT. CL. 11.
- HERBEAU, LIONEL, LILLE, FRANCE:  
2,899,681. PUB. 8-10-2004. INT. CL. 11.
- HERITAGE BAG COMPANY, CARROLLTON, TX:  
1,870,007. REN. 9-19-04. INT. CL. 40.
- HERITAGE HEALTH PRODUCTS COMPANY, FORT COLLINS, CO:  
2,898,771. PUB. 8-10-2004. MULTIPLE CLASS, INT. CLS. 5 AND 41.
- HERMES INTERNATIONAL, 75008 PARIS, FRANCE:  
1,855,464. REN. 9-22-04. INT. CL. 3.
- HERMES INTERNATIONAL, PARIS, FRANCE:  
2,899,792. PUB. 8-10-2004. INT. CL. 18.
- HERNANDEZ, IGNACIO JR., LA JOLLA, CA:  
2,900,950. INT. CL. 35.
- HERRERA VALENZUELA, BERNARDO, BOGOTA, COLOMBIA:  
1,847,821. REN. 9-20-04. INT. CL. 31.
- HERSHEY CHOCOLATE & CONFECTIONERY CORPORATION, WHEAT RIDGE, CO:  
1,289,985. REN. 9-21-04. INT. CL. 21.  
1,289,985. CANC. MULTIPLE CLASS, INT. CLS. 14, 16, 20, 25, 27 AND 28.
- HESTER INDUSTRIES, INC., MOOREFIELD, WV:  
1,261,058. CANC. INT. CL. 29.
- HEUSCH, CHRISTIAN, FINKSBURG, MD:  
2,121,348. CANC. MULTIPLE CLASS, INT. CLS. 41 AND 42.
- HEWLETT- PACKARD DEVELOPMENT COMPANY, L.P., HOUSTON, TX:  
1,861,560. REN. 9-18-04. MULTIPLE CLASS, INT. CLS. 2, 9 AND 10.
- HEWLETT-PACKARD DEVELOPMENT COMPANY, L.P., HOUSTON, TX, COMPAQ COMPUTER CORPORATION, HOUSTON, TX:  
1,876,427. REN. 9-20-04. INT. CL. 9.
- HEXAL AG, D-83607 HOLZKIRCHEN, FED REP GERMANY:  
2,121,202. CANC. INT. CL. 5.
- HGM MEDICAL LASER SYSTEMS INC., SALT LAKE CITY, UT:  
1,381,187. CANC. INT. CL. 10.
- HI-GEAR PRODUCTS, INC., HUDSON, MA:  
2,898,965. PUB. 3-30-2004. INT. CL. 1.
- HI-TACH OIL CO., INC., KANNAPOLIS, NC:  
2,900,698. INT. CL. 1.
- HIGH DESERT INVESTMENT CORPORATION, ALBUQUERQUE, NM:  
2,899,833. PUB. 8-10-2004. INT. CL. 37.
- HIGH END SYSTEMS, INC., AUSTIN, TX:  
1,811,505. CANC. INT. CL. 11.
- HIGH POINT HERBALS, BOCA RATON, FL, DBA BIO TEST LABS:  
2,899,192. PUB. 8-10-2004. INT. CL. 5.  
2,899,193. PUB. 8-10-2004. INT. CL. 5.
- HIGH POINT MEDIA, LLC, GOLDEN, CO:  
2,900,526. MULTIPLE CLASS, INT. CLS. 16 AND 41.



HIGHLAND CAPITAL CORP., LITTLE FALLS, NJ:  
2,899,649, PUB. 8-10-2004. MULTIPLE CLASS, INT. CLS.  
35, 36, 37, 38 AND 44.

HIGHLAND PARK HOSPITAL, HIGHLAND PARK, IL:  
2,121,851, CANC. INT. CL. 41.

HIGHLANDER GOLF, INC., SIOUX FALLS, SD:  
1,810,909, CANC. INT. CL. 28.

HIKARI SALES USA, INC., HAYWARD, CA:  
2,899,923, PUB. 8-10-2004. INT. CL. 1.

HILDEBRAND, TAMMY S., FREDONIA, KS AND HILDEBRAND, RICHARD R., FREDONIA, KS:  
2,899,149, PUB. 8-10-2004. INT. CL. 16.

HILL-ROM SERVICES, INC., BATESVILLE, IN, HILL-ROM COMPANY, INC., BATESVILLE, IN:  
1,846,762, REN. 9-24-04. INT. CL. 20.

HILLYARD ENTERPRISES, INC., ST. JOSEPH, MO:  
2,898,841, PUB. 8-10-2004. MULTIPLE CLASS, INT. CLS.  
20, 21, 24, 25 AND 28.  
2,898,842, PUB. 8-10-2004. INT. CL. 3.  
2,898,926, PUB. 8-10-2004. MULTIPLE CLASS, INT. CLS.  
35, 37 AND 41.

HILTON HONORS WORLDWIDE, LLC, BEVERLY HILLS, CA, HILTON HOTELS CORPORATION, BEVERLY HILLS, CA:  
1,910,586, REN. 9-23-04. INT. CL. 42.  
1,911,958, REN. 9-22-04. INT. CL. 42.

HILTON HOSPITALITY, INC., BEVERLY HILLS, CA:  
1,352,215, REN. 9-18-04. INT. CL. 42.

HINES & ASSOCIATES, INC., ELGIN, IL:  
1,883,890, REN. 9-20-04. INT. CL. 35.

HINSDALE, JOHN, NEW YORK, NY:  
2,121,352, CANC. INT. CL. 9.

HINSON, KAREN A., SINKING SPRING, PA, SCALES; KAREN H., JACKSONVILLE, FL, DBA KARRIE OF FLORIDA:  
1,278,100, REN. 9-18-04. INT. CL. 25.

HIRSCH, GARY, PORTLAND, OR:  
2,899,020, PUB. 8-10-2004. INT. CL. 41.

HISAMITSU PHARMACEUTICAL CO., INC., SAGA, JAPAN:  
2,806,669, COR. INT. CL. 5.  
2,849,160, COR. INT. CL. 35.

HIT BOY PRODUCTIONS, LOS ANGELES, CA:  
2,121,144, CANC. INT. CL. 41.

HITACHI HIGH TECHNOLOGIES AMERICA INC., SCHAUMBURG, IL:  
1,831,122, REN. 9-18-04. INT. CL. 9.

HITCHCOCK, FLEMING & ASSOCIATES, INC., AKRON, OH:  
2,899,514, PUB. 8-10-2004. INT. CL. 35.

HIX, INC., LEXINGTON, KY:  
2,898,811, PUB. 8-10-2004. INT. CL. 42.

HMR PHARMA, INC., GREENVILLE, DE, MERRELL DOW PHARMACEUTICALS INC., CINCINNATI, OH:  
1,577,275, REN. 9-20-04. INT. CL. 5.

HOBBY HILL LIGHTING, INC., STURTEVANT, WI:  
2,900,943, INT. CL. 11.

HOCEAN, INC., CITY OF COMMERCE, CA:  
1,849,990, REN. 9-22-04. INT. CL. 29.

HODGES, ROBERT, ARTESIA, NM:  
2,900,372, INT. CL. 30.

HOEGANAES CORPORATION, CINNAMINSON, NJ:  
1,895,875, REN. 9-21-04. INT. CL. 6.

HOENIG, JONATHAN L., GLENCOE, IL:  
2,121,766, CANC. INT. CL. 41.

HOF'S BREA, INC., LONG BEACH, CA:  
2,121,362, CANC. INT. CL. 42.

HOFFMAN-LA ROCHE INC., NUTLEY, NJ:  
1,312,013, REN. 9-24-04. INT. CL. 5.

HOFFMANN-LA ROCHE INC., NUTLEY, NJ:  
1,811,247, CANC. INT. CL. 42.

HOFFY'S, NAAMLOZE VENNOOTSCHAP, B-2250 OLEN, BELGIUM:  
2,831,179, COR. INT. CL. 30.

HOFMANN, PETER N., DALLAS, TX:  
2,120,775, CANC. INT. CL. 5.

HOHNER INC., GLEN ALLEN, VA, M. HOHNER, INC., NEW YORK, NY:  
191,298, REN. 9-21-04. U.S. CL. 36 (INT. CL. 15).

HOHNER, INC., GLEN ALLEN, VA:  
1,340,615, REN. 9-24-04. INT. CL. 15.

HOLLAND BROTHERS, SAN FRANCISCO, CA:  
2,122,516, CANC. INT. CL. 18.

HOLLAND-RANTOS COMPANY, INC., PISCATAWAY, NJ:  
761,542, CANC. U.S. CL. 6.

HOLLANDER COUNSELING ASSOCIATES, LLC, OWINGS MILLS, MD:  
2,899,985, PUB. 8-10-2004. INT. CL. 45.

HOLLANDER HOME FASHIONS CORP., BOCA RATON, FL:  
2,899,498, PUB. 8-10-2004. MULTIPLE CLASS, INT. CLS.  
20, 22 AND 24.  
2,900,136, INT. CL. 20.  
2,900,607, INT. CL. 20.

HOLLANDER, SCOTT E., VENTURA, CA:  
2,900,677, INT. CL. 25.

HOLLINGSHEAD, RUSSELL A., BATAVIA, OH:  
2,121,582, CANC. INT. CL. 16.

HOLLINGSWORTH, ALFRED, CHINO, CA:  
2,898,813, PUB. 8-10-2004. INT. CL. 41.

HOLLYWOOD MANAGEMENT COMPANY, WILSONVILLE, OR, HOLLYWOOD ENTERTAINMENT CORPORATION, PORTLAND, OR:  
1,848,749, REN. 9-20-04. INT. CL. 41.

HOLLYWOOD MANAGEMENT COMPANY, WILSONVILLE, OR:  
2,745,647, COR. INT. CL. 38.

HOLLYWOOD MEDIA CORP., BOCA RATON, FL:  
2,900,058, INT. CL. 41.

HOLLYWOOD.COM, INC., BOCA RATON, FL:  
2,900,887, MULTIPLE CLASS, INT. CLS. 41 AND 42.

HOLM RUEFFER, A.G., CH 8712, STAEFA, SWITZERLAND:  
2,121,728, CANC. INT. CL. 25.

HOLTkamp; REINHOLD, ISSELBURG, FED REP GERMANY:  
1,287,986, REN. 9-21-04. INT. CL. 21.

HOLY LAND BRAND INC., MINNEAPOLIS, MN:  
2,899,542, PUB. 8-10-2004. INT. CL. 32.

HOLLYWOOD STUDIOS, NFP, OLYMPIA FIELDS, IL:  
2,899,569, PUB. 8-10-2004. INT. CL. 41.

HOME BOX OFFICE, INC., NEW YORK, NY:  
1,288,284, REN. 9-22-04. INT. CL. 41.

HOME CAFE, LLC, HIGHLAND PARK, IL:  
2,899,571, PUB. 8-10-2004. INT. CL. 41.

HOME INTERIORS & GIFTS, INC., CARROLLTON, TX:  
2,899,574, PUB. 8-10-2004. MULTIPLE CLASS, INT. CLS.  
20 AND 21.

HOME PORT ALLIANCE FOR THE USS NEW JERSEY, INC., MARLTON, NJ:  
2,898,497, PUB. 8-10-2004. MULTIPLE CLASS, INT. CLS.  
14, 21 AND 25.  
2,899,271, PUB. 8-10-2004. MULTIPLE CLASS, INT. CLS.  
14, 18, 21 AND 25.

HOMEAID AMERICA, INC., IRVINE, CA:  
2,121,108, CANC. MULTIPLE CLASS, INT. CLS. 36 AND 41.

HOMEFREE MORTGAGE CORPORATION, CLEARWATER, FL:  
2,898,750, PUB. 8-10-2004. INT. CL. 36.

HOMEOWNERS UNITED, LLC, INDIANAPOLIS, IN:  
2,899,073, PUB. 8-10-2004. INT. CL. 35.

HOMER T. HAYWARD LUMBER COMPANY, INC., MONTEREY, CA:  
2,899,041, PUB. 8-10-2004. INT. CL. 35.

- HOMESTEAD VILLAGE INCORPORATED, SANTA FE, NM, KESSLER, CALVIN K., EL PASO, TX, DBA TRUSTEE OF PROPERTY TRUST OF AMERICA, A MARYLAND REAL ESTATE INVESTMENT TRUST AND POLK, JAMES H. III, SANTA FE, NM, DBA TRUSTEE OF PROPERTY TRUST OF AMERICA, A MARYLAND REAL ESTATE INVESTMENT TRUST AND KELLEY, JOHN T. III, EL PASO, TX, DBA TRUSTEE OF PROPERTY TRUST OF AMERICA, A MARYLAND REAL ESTATE INVESTMENT TRUST AND SCHWEITZER, JOHN C., AUSTIN, TX, DBA TRUSTEE OF PROPERTY TRUST OF AMERICA, A MARYLAND REAL ESTATE INVESTMENT TRUST AND CARDWELL, JAMES A., EL PASO, TX, DBA TRUSTEE OF PROPERTY TRUST OF AMERICA, A MARYLAND REAL ESTATE INVESTMENT TRUST AND BLANKENSHIP, C. RONALD, SANTA FE, NM, DBA TRUSTEE OF PROPERTY TRUST OF AMERICA, A MARYLAND REAL ESTATE INVESTMENT TRUST AND MARTINEZ-URDAL, ALFREDO, EL PASO, TX, DBA TRUSTEE OF PROPERTY TRUST OF AMERICA, A MARYLAND REAL ESTATE INVESTMENT TRUST:  
1,819,557. REN. 9-18-04. INT. CL. 42.
- HON TECHNOLOGY INC., MUSCATINE, IA:  
2,898,928. PUB. 2-24-2004. INT. CL. 11.
- HONDA GIKEN KOGYO KABUSHIKI KAISHA, MINATOKU, TOKYO 107, JAPAN:  
1,002,188. REN. 9-21-04. U.S. CL. 21 (INT. CL. 7).
- HONDA GIKEN KOGYO KABUSHIKI KAISHA (HONDA MOTOR CO., LTD.), MINATO-KU, TOKYO 107, JAPAN:  
2,898,796. PUB. 12-23-2003. INT. CL. 12.
- HONDA MOTOR CO., LTD., MINAMI-AOYAMA, MINATOKU, TOKYO, JAPAN:  
1,260,889. CANC. INT. CL. 12.
- HONEYWELL INTERNATIONAL INC., MORRISTOWN, NJ, GARRETT CORPORATION, THE, LOS ANGELES, CA:  
1,272,612. REN. 9-19-04. INT. CL. 12.  
1,291,846. REN. 9-21-04. INT. CL. 7.
- HONEYWELL INTERNATIONAL, INC., MORRISTOWN, NJ:  
188,577. REN. 9-18-04. U.S. CL. 26 (INT. CL. 9).
- HOOK, JOHANNA K, HURLEYVILLE, NY:  
2,899,843. PUB. 8-10-2004. INT. CL. 3.
- HOOK, JOHANNA, K, NEW YORK, NY:  
2,899,844. PUB. 8-10-2004. INT. CL. 3.
- HOOKER & HOLCOMBE, INC., WEST HARTFORD, CT:  
2,899,678. PUB. 3-23-2004. INT. CL. 36.
- HOOT, JEFFREY S, BRYCEVILLE, FL:  
2,121,612. CANC. INT. CL. 25.
- HOOTIE ENTERPRISES, LLC, DEARBORN, MI:  
2,899,933. PUB. 8-10-2004. INT. CL. 28.
- HOOVER TREATED WOOD PRODUCTS, INC., THOMSON, GA:  
2,899,508. PUB. 1-13-2004. INT. CL. 19.
- HOPE FOUNDATION, THE, SAN ANTONIO, TX:  
2,899,945. PUB. 8-10-2004. INT. CL. 36.
- HOPEFULS, INC., PORTLAND, OR, DBA LEAN PRESS:  
2,899,906. PUB. 8-10-2004. INT. CL. 16.
- HORIZON ACQUISITION CORPORATION, MANCHESTER, GA:  
1,851,398. REN. 9-18-04. INT. CL. 10.
- HORIZON ACQUISITION CORPORATION, MANCHESTER, GA, NEOSTAR MEDICAL TECHNOLOGIES, INC., NORTH BRUNSWICK, NJ:  
1,851,399. REN. 9-18-04. INT. CL. 10.
- HORMEL FOODS CORPORATION, AUSTIN, MN:  
2,122,566. CANC. INT. CL. 29.
- HORSELL GRAPHIC INDUSTRIES, LIMITED, MORLEY, LEEDS, ENGLAND:  
1,260,692. CANC. INT. CL. 1.
- HORTON MANUFACTURING COMPANY INC., TALLMADGE, OH:  
1,870,974. REN. 9-18-04. INT. CL. 4.  
1,871,168. REN. 9-18-04. INT. CL. 9.  
1,875,385. REN. 9-18-04. INT. CL. 28.
- HOSOKAWA MICRON INTERNATIONAL INC., SUMMIT, NJ:  
1,824,100. REN. 9-20-04. INT. CL. 7.
- HOSPITALITY & LEISURE MANAGEMENT COMPANY, INC., NASHVILLE, TN TO FIESTA TEXAS INC, SAN ANTONIO, TX:  
1,811,595. CANC. INT. CL. 26.
- HOST MARRIOTT SERVICES CORPORATION, BETHESDA, MD:  
2,120,987. CANC. INT. CL. 42.  
2,121,553. CANC. INT. CL. 16.
- HOTEL AND LEISURE LIVING SERVICES, LTD., PORT PERRY, L9L 1B3 ONTARIO, CANADA:  
2,900,120. INT. CL. 41.
- HOTEL CORPORATION OF THE PACIFIC, INC., HONOLULU, HI, DBA ASTON HOTELS & RESORTS TO TM ACQUISITION CORP, PHOENIX, AR:  
1,811,695. CANC. INT. CL. 42.
- HOTHOUSE DESIGN STUDIO INC., EDMONTON, ALBERTA T5K 1M1, CANADA:  
2,120,958. CANC. INT. CL. 20.
- HOTZ-4-U, INC., GREENSBURG, PA:  
2,121,786. CANC. INT. CL. 30.
- HOULIHAN'S RESTAURANTS, INC., KANSAS CITY, MO:  
2,899,555. PUB. 8-10-2004. INT. CL. 25.
- HOUSECHEM, INC., WALDWICK, NJ:  
2,899,990. PUB. 8-10-2004. INT. CL. 3.  
2,899,991. PUB. 8-10-2004. INT. CL. 4.  
2,899,992. PUB. 8-10-2004. INT. CL. 5.
- HOUSTON NFL HOLDINGS, L.P., HOUSTON, TX:  
2,899,775. PUB. 8-10-2004. INT. CL. 41.
- HOUSTON OUTLAWS, INC., AUSTIN, TX TO TEXAS OUTLAWS CYCLING TEAM, INC., AUSTIN, TX:  
1,810,830. CANC. INT. CL. 25.
- HOUSTON RADIOLOGY ASSOCIATED P.A., HOUSTON, TX AND RMI PHYSICIAN SERVICES CORPORATION, HOUSTON, TX:  
2,898,762. PUB. 8-10-2004. INT. CL. 44.
- HOUSTON SAVINGS BANK, F.S.B., HOUSTON, TX:  
2,784,994. COR. INT. CL. 36.
- HOWALDTSWERKE-DEUTSCHE WERFT AG, 24143 KIEL, FED REP GERMANY:  
2,898,573. PUB. 8-10-2004. MULTIPLE CLASS, INT. CLS. 6, 7, 9, 11, 12, 13, 19, 20, 35, 37, 41 AND 42.
- HOWARD FERTILIZER COMPANY, ORLANDO, FL:  
2,899,531. PUB. 8-10-2004. INT. CL. 1.
- HOWARD, GARY, SEBASTOPOL, CA:  
2,121,097. CANC. INT. CL. 12.
- HOWARD, JANET, SAN FRANCISCO, CA:  
1,810,858. CANC. INT. CL. 25.
- HOWE & HUTTON, LTD., CHICAGO, IL:  
2,899,255. PUB. 2-24-2004. INT. CL. 42.
- HOWE RICHARDSON INC., CLIFTON, NJ:  
1,261,339. CANC. INT. CL. 9.
- HOYT, ROBERT ANTHONY, SANTA FE, NM:  
2,898,574. PUB. 8-10-2004. INT. CL. 16.
- HP INTELLECTUAL CORP., WILMINGTON, DE:  
1,850,284. REN. 9-18-04. INT. CL. 11.  
1,850,349. REN. 9-18-04. INT. CL. 21.  
2,899,525. PUB. 8-10-2004. INT. CL. 9.
- HPI PRODUCTS CORP, ASTON, PA:  
2,898,680. PUB. 9-16-2003. INT. CL. 1.
- HQ HOLDINGS, LLC, NOVI, MI:  
2,898,758. PUB. 8-10-2004. INT. CL. 36.
- HQM, LTD., WILMINGTON, DE:  
1,902,899. REN. 9-18-04. INT. CL. 29.
- HR TEXTRON, INC., VALENCIA, CA:  
1,862,328. REN. 9-22-04. INT. CL. 9.
- HSIN TEN ENTERPRISE USA, INC., FARMINGDALE, NY:  
2,898,521. PUB. 3-12-2002. INT. CL. 10.
- HTB LIMITED, GIBRALTAR:  
2,898,587. PUB. 8-10-2004. MULTIPLE CLASS, INT. CLS. 9, 16, 35, 38 AND 41.
- HTL INTERNATIONAL HOLDINGS LIMITED, SINGAPORE 629587, SINGAPORE:  
2,898,725. PUB. 9-30-2003. INT. CL. 20.
- HUB INTERNATIONAL LIMITED, TORONTO, ONTARIO, CANADA FROM THE HUB GROUP LIMITED, TORONTO, ONTARIO, CANADA:  
2,900,083. INT. CL. 36.

HUBBELL INCORPORATED, ORANGE, CT:  
2,899,175, PUB. 8-10-2004. INT. CL. 9.

HUDSON HIGHLAND GROUP, INC., CHICAGO, IL:  
2,899,522, PUB. 8-10-2004. INT. CL. 35.

HUDSON JERSEY SANITATION CO., LITTLE FALLS, NJ:  
2,121,409, CANC. MULTIPLE CLASS, INT. CLS. 37, 39 AND 40.

HUDSON SCENIC STUDIO, INC., YONKERS, NY:  
2,898,534, PUB. 8-10-2004. MULTIPLE CLASS, INT. CLS. 40, 41 AND 42.

HUERTA CHEMICAL CORPORATION, HIALEAH, FL:  
1,316,465, REN. 9-22-04. INT. CL. 3.

HUGHES ENTERPRISES INC., BLOOMINGTON, MN:  
2,900,543, INT. CL. 37.

HUHTAMAKI COMPANY TECHNOLOGY, DE SOTO, KS:  
1,291,128, REN. 9-18-04. INT. CL. 21.

HUNTER DOUGLAS, INC., UPPER SADDLE RIVER, NJ:  
2,122,575, CANC. INT. CL. 36.

HUNTER FAN COMPANY, MEMPHIS, TN:  
2,900,669, INT. CL. 11.

HUNTER FINANCIAL GROUP, LLC, TEMPE, AZ:  
2,899,793, PUB. 8-10-2004. INT. CL. 36.

HUNTLEIGH TECHNOLOGY PLC, LUTON, BEDFORDSHIRE, LU1 1TD, UNITED KINGDOM:  
2,899,650, PUB. 5-11-2004. INT. CL. 10.

HURST CHEMICAL COMPANY, LOS ANGELES, CA:  
2,899,017, PUB. 8-10-2004. INT. CL. 9.

HYDE & HYDE, INC., CORONA, CA:  
2,900,904, INT. CL. 30.

HYDROSOURCE, INC., CANADENSIS, PA:  
2,900,603, MULTIPLE CLASS, INT. CLS. 6 AND 20.

HYGENIC CORPORATION, THE, AKRON, OH, TALCOTT LABORATORIES, INC., MCMURRAY, PA:  
1,011,451, REN. 9-24-04. INT. CL. 10.

HYGENIC CORPORATION, THE, AKRON, OH:  
1,895,004, REN. 9-18-04. INT. CL. 10.

HYPERBOLE STUDIOS, HOUSTON, TX:  
1,810,600, CANC. INT. CL. 9.

HYPHEN SOLUTIONS, LTD., ADDISON, TX:  
2,900,473, INT. CL. 37.

HYTEX INTERNATIONAL PTE. LTD., #04-04, SINGAPORE:  
2,122,003, CANC. INT. CL. 25.

I NET CORP., ALEXANDRIA, VA:  
2,900,109, INT. CL. 42.

I.P. HOLDINGS, INC., GRAND PRAIRIE, TX:  
2,900,310, INT. CL. 11.

IAMS COMPANY, THE, CINCINNATI, OH:  
1,849,255, REN. 9-21-04. INT. CL. 16.  
1,869,849, REN. 9-21-04. INT. CL. 31.

ICE JORDAN LLC, COLWYN, PA:  
2,900,836, INT. CL. 25.

ICICLE SEAFOODS, INC., SEATTLE, WA:  
2,122,299, CANC. INT. CL. 29.

ICON, INCORPORATED, FT. WAYNE, IN:  
1,261,255, CANC. INT. CL. 42.

ID TECH, INC., BLACKFOOT, ID:  
2,120,978, CANC. INT. CL. 9.

IDE YAPI BILGISAYAR DESTEKLI TASARIM MUHENDISLIK DANISMANLIK TAAHHUT LTD. STI, BURSA, TURKEY:  
2,898,517, PUB. 8-10-2004. MULTIPLE CLASS, INT. CLS. 9 AND 42.

IDEA CHANNEL, INC., THE, ERIE, PA:  
1,850,234, REN. 9-20-04. INT. CL. 9.

IDEAL SALES AND DISTRIBUTING CO., INC., CITY OF COMMERCE, CA, DBA ROAD PRIDE:  
1,848,815, REN. 9-18-04. MULTIPLE CLASS, INT. CLS. 12 AND 42.

IDENTOFLEX AG, 6331 HUNENBERG, SWITZERLAND:  
2,120,848, CANC. INT. CL. 10.

IDT NETHERLANDS, B.V. (PUERTO RICO BRANCH), SAN JUAN, PUERTO RICO:  
2,899,383, PUB. 2-3-2004. INT. CL. 36.  
2,900,583, INT. CL. 36.

IFCO SYSTEMS NORTH AMERICA, INC., HOUSTON, TX:  
2,900,130, MULTIPLE CLASS, INT. CLS. 20 AND 39.

IGA, INC., CHICAGO, IL:  
1,296,176, REN. 9-21-04. INT. CL. 16.

IGT, RENO, NV:  
1,810,625, CANC. INT. CL. 9.  
1,810,626, CANC. INT. CL. 9.  
1,811,467, CANC. INT. CL. 9.  
2,900,177, INT. CL. 9.  
2,900,832, INT. CL. 9.  
2,900,855, INT. CL. 9.

IGUIDE, INC., NEW YORK, NY, DBA NEWS INTERNET SERVICES:  
2,122,559, CANC. INT. CL. 9.

ILLBRUCK, INC., MINNEAPOLIS, MN:  
2,122,190, CANC. INT. CL. 17.

ILLINOIS TOOL WORKS INC., GLENVIEW, IL, RANSBURG ELECTRO-COATING CORP., INDIANAPOLIS, IN:  
775,279, REN. 9-23-04. U.S. CL. 21 (INT. CL. 9).

ILLINOIS TOOL WORKS INC., GLENVIEW, IL:  
1,299,554, REN. 9-23-04. INT. CL. 20.

ILLINOIS TOOL WORKS INC., GLENVIEW, IL, MILLER ELECTRIC MFG., CO., A MILLER GROUP, LTD., COMPANY, APPLETON, WI:  
1,849,063, REN. 9-20-04. INT. CL. 9.

IMAGES 4 COMMUNICATION B.V., GRONINGEN, NETHERLANDS:  
2,121,045, CANC. MULTIPLE CLASS, INT. CLS. 9 AND 38.

IMAJE S.A., 26501 BOURG-LES-VALENCE CEDEX, FRANCE:  
2,120,767, CANC. MULTIPLE CLASS, INT. CLS. 7, 9, 35 AND 42.

IMERGISTS INC., THE, NEW YORK, NY:  
1,811,351, CANC. MULTIPLE CLASS, INT. CLS. 9 AND 42.

IMPACT PRODUCTS, INC., TOLEDO, OH:  
2,898,458, PUB. 8-10-2004. INT. CL. 20.

IMPERIAL BAG AND PAPER COMPANY, INC., BAYONNE, NJ:  
2,900,754, INT. CL. 21.

IMPERIAL COURT, DAUGHTERS OF ISIS, WINSTON-SALEM, NC:  
1,293,533, REN. 9-22-04. U.S. CL. 200.

IMPERIAL TOY CORPORATION, LOS ANGELES, CA, SLM INC., NEW YORK, NY:  
1,849,462, REN. 9-23-04. INT. CL. 28.

IMPERIAL WESTERN PRODUCTS, INC., INDIO, CA:  
2,899,310, PUB. 7-15-2003. MULTIPLE CLASS, INT. CLS. 1, 3 AND 4.

IMPERIAL 400 NATIONAL, INC., ARLINGTON, VA:  
1,261,239, CANC. INT. CL. 42.

IMPLANT MANUFACTURING AND TESTING, INC.:  
*See—BIOPRO, INC.*

IMUS, DEIRDRE, DARIEN, CT:  
2,900,382, INT. CL. 3.

IMX, INC., SAN RAMON, CA:  
2,122,505, CANC. INT. CL. 36.

IN GEAR FASHIONS INC, MIAMI, FL:  
2,900,732, INT. CL. 3.

INCONTACT SYSTEMS, INC., SAN DIEGO, CA:  
2,900,048, INT. CL. 41.

INDEPENDENT DISPATCH INCORPORATED, PORTLAND, OR:  
1,875,594, REN. 9-22-04. INT. CL. 39.

INDIANA MILLS & MANUFACTURING, INC., WESTFIELD, IN:  
2,121,480, CANC. INT. CL. 22.

INDIANAPOLIS MOTOR SPEEDWAY CORPORATION, SPEEDWAY, IN:  
1,261,215, CANC. INT. CL. 41.

INDOOR PURIFICATION SYSTEMS, INC., LAYTON, UT:  
2,900,588, INT. CL. 11.

INDUSTRIAL COMPUTER SOURCE, SAN DIEGO, CA:  
2,120,859, CANC. INT. CL. 9.

INDUSTRIAL GASKET & SHIM COMPANY, INC., MEADOWLANDS, PA:  
1,267,466, REN. 9-21-04. INT. CL. 1.

INDUSTRIAS MONTERREY USA, INC., RICHMOND, VA:  
2,900,709, INT. CL. 33.

INFANTINO, LLC, SAN DIEGO, CA:  
2,900,656, INT. CL. 28.

- INFINEON TECHNOLOGIES AG, MUNICH, FED REP GERMANY:  
2,899,460, PUB. 8-10-2004. MULTIPLE CLASS, INT. CLS. 9, 38 AND 42.
- INFOLINK SCREENING SERVICES, INC., CHATSWORTH, CA:  
2,900,462, INT. CL. 45.
- INFONAUTICS CORPORATION, WAYNE, PA:  
2,120,818, CANC. MULTIPLE CLASS, INT. CLS. 9 AND 38.
- INFOSCAPE PTY LTD, PARADISE POINT, AUSTRALIA:  
2,899,304, PUB. 2-10-2004. INT. CL. 9.
- INFOVISION, INC., FORT COLLINS, CO:  
2,120,976, CANC. MULTIPLE CLASS, INT. CLS. 38 AND 42.
- ING USA HOLDING CORPORATION, WILMINGTON, DE:  
2,899,233, PUB. 8-10-2004. MULTIPLE CLASS, INT. CLS. 36 AND 41.
- INGENIOUS DESIGNS LLC, ST. PETERSBURG, FL:  
2,900,295, INT. CL. 20.
- INGRAM INDUSTRIES INC., LAVERGNE, TN:  
1,867,840, REN. 9-23-04. INT. CL. 42.
- INGREDIENT TECHNOLOGIES CORPORATION, INC., LAKE BLUFF, IL:  
2,899,435, PUB. 10-14-2003. INT. CL. 9.
- INITIATE SYSTEMS, INC., CHICAGO, IL:  
2,900,743, MULTIPLE CLASS, INT. CLS. 9, 35 AND 42.  
2,900,780, INT. CL. 9.
- INJURED RESERVE, INC., FT. LAUDERDALE, FL:  
2,122,504, CANC. INT. CL. 25.
- INKWELL ENTERPRISES, INC., ROCKVILLE, MD:  
2,122,548, CANC. INT. CL. 16.
- INNOVATIVE AFTERMARKET SYSTEMS, L.P., LEANDER, TX:  
1,850,295, REN. 9-21-04. INT. CL. 12.
- INNOVATIVE BEVERAGE CONCEPTS, INC., ALISO VIEJO, CA:  
2,650,419, COR. INT. CL. 30.
- INNOVATIVE BIOMECHANICAL SOLUTIONS, LLC, FISHERS, IN:  
2,900,789, INT. CL. 28.
- INNOVATIVE MARBLE AND TILE, INC., HAUPPAUGE, NY:  
2,898,952, PUB. 8-10-2004. INT. CL. 40.
- INNOVENTIONS ENTERPRISES LTD., FARMINGDALE, NY:  
2,900,389, INT. CL. 9.
- INOVISE MEDICAL, INC., NEWBERG, OR:  
2,900,078, INT. CL. 10.
- INPURNET CORPORATION, HUNTSVILLE, AL:  
2,122,307, CANC. INT. CL. 35.
- INSIGHT ENERGY, INC., WILMETTE, IL:  
2,900,214, MULTIPLE CLASS, INT. CLS. 36 AND 40.
- INSIGHT PHARMACEUTICALS CORPORATION, SAN FRANCISCO, CA, FISONS LIMITED, LONDON, ENGLAND:  
990,673, REN. 9-24-04. U.S. CL. 18 (INT. CL. 5).
- INSL-X PRODUCTS CORPORATION, BALTIMORE, MD:  
1,286,687, REN. 9-22-04. INT. CL. 2.
- INSTITUTE FOR INFORMATION INDUSTRY, TAIPEI, TAIWAN:  
1,864,598, REN. 9-23-04. INT. CL. 9.
- INSTITUTE OF ELECTRICAL AND ELECTRONICS ENGINEERS, INC., THE, PISCATAWAY, NY:  
775,859, REN. 9-21-04. U.S. CL. 38 (INT. CL. 16).
- INT TRADERS, INC., UNION HALL, VA:  
2,120,680, CANC. INT. CL. 9.
- INTEGRAL SYSTEMS, INC., WALNUT CREEK, CA:  
1,859,127, REN. 9-22-04. INT. CL. 9.
- INTEGRATED CHIPWARE, INC., RESTON, VA:  
2,898,435, PUB. 8-10-2004. MULTIPLE CLASS, INT. CLS. 9 AND 42.
- INTEGRATION ASSOCIATES INCORPORATED, MOUNTAIN VIEW, CA:  
2,900,189, INT. CL. 9.
- INTEGRITY MEDIA, INC., MOBILE, AL, INTEGRITY MUSIC, INC., MOBILE, AL:  
1,900,466, REN. 9-18-04. MULTIPLE CLASS, INT. CLS. 9 AND 16.
- INTER AMERICA CIGAR COMPANY, MIAMI, FL:  
2,900,059, INT. CL. 34.
- INTERAVIA AG, 1075 AB AMSTERDAM, NETHERLANDS:  
2,121,393, CANC. INT. CL. 36.
- INTERCHANGE BANK, SADDLE BROOK, NJ:  
1,825,473, REN. 9-24-04. INT. CL. 36.
- INTERFACE, INC., GA:  
1,261,027, CANC. INT. CL. 27.
- INTERIOR ARCHITECTS, INC., SAN FRANCISCO, CA:  
2,121,833, CANC. MULTIPLE CLASS, INT. CLS. 35 AND 42.
- INTERLOC, INC., SOUTHWORTH, WA:  
2,121,307, CANC. INT. CL. 35.
- INTERMATIC INCORPORATED, SPRING GROVE, IL:  
1,347,582, REN. 9-24-04. INT. CL. 11.
- INTERMEC TECHNOLOGIES CORPORATION, EVERETT, WA, INTERMEC CORPORATION, EVERETT, WA:  
1,890,846, REN. 9-18-04. INT. CL. 9.
- INTERNATIONAL ASSOCIATION OF MERGER AND ACQUISITION PROFESSIONALS, DES MOINES, IA:  
2,900,908, INT. CL. 36.
- INTERNATIONAL BUSINESS MACHINES CORPORATION, ARMONK, NY:  
1,855,022, REN. 9-23-04. MULTIPLE CLASS, INT. CLS. 9 AND 37.
- INTERNATIONAL COATINGS LIMITED, LONDON, UNITED KINGDOM, INTERNATIONAL PAINT COMPANY, INC., UNION, NJ:  
1,289,651, REN. 9-21-04. INT. CL. 2.
- INTERNATIONAL DATA GROUP, INC., FRAMINGHAM, MA:  
2,120,746, CANC. INT. CL. 16.  
2,900,035, MULTIPLE CLASS, INT. CLS. 16 AND 42.  
2,900,646, INT. CL. 41.
- INTERNATIONAL FLORAL CORPORATION, MIAMI, FL:  
2,121,142, CANC. INT. CL. 31.
- INTERNATIONAL FOOD CONCEPTS, INC., JERSEY CITY, NJ:  
777,114, REN. 9-22-04. U.S. CL. 46 (INT. CL. 29).
- INTERNATIONAL FOUNDATION OF HUMAN RIGHTS AND TOLERANCE, LOS ANGELES, CA:  
2,900,922, INT. CL. 41.
- INTERNATIONAL GAMCO, INC., OMAHA, NE:  
2,898,488, PUB. 8-10-2004. INT. CL. 28.
- INTERNATIONAL GEMMOLOGICAL INSTITUTE, INC., NEW YORK, NY:  
2,900,910, INT. CL. 42.
- INTERNATIONAL HERITAGE, INC., RALEIGH, NC:  
2,120,926, CANC. MULTIPLE CLASS, INT. CLS. 16 AND 25.  
2,120,927, CANC. MULTIPLE CLASS, INT. CLS. 16 AND 25.
- INTERNATIONAL INSTITUTE FOR SUSTAINABLE DEVELOPMENT, WINNIPEG, MANITOBA, CANADA:  
2,162,997, CANC. MULTIPLE CLASS, INT. CLS. 9 AND 42.
- INTERNATIONAL MAILING SYSTEMS, INC.:  
1,260,842, CANC. MULTIPLE CLASS, INT. CLS. 9 AND 39.
- INTERNATIONAL MICROCOMPUTER SOFTWARE, INC., SAN RAFAEL, CA:  
2,122,203, CANC. INT. CL. 9.
- INTERNATIONAL PACKAGING MACHINES, INC., NAPLES, FL:  
1,288,676, REN. 9-22-04. INT. CL. 7.
- INTERNATIONAL PAINT (USA) INC.:  
1,260,720, CANC. INT. CL. 2.
- INTERNATIONAL SAFETY COUNCIL, ITASCA, IL:  
1,909,601, REN. 9-18-04. INT. CL. 42.
- INTERNATIONAL SOCIETY OF HOSPITALITY CONSULTANTS, MEMPHIS, TN:  
2,120,768, CANC. INT. CL. 42.
- INTERNATIONAL TECHNIDYNE CORP., EDISON, NJ:  
2,899,627, PUB. 4-13-2004. MULTIPLE CLASS, INT. CLS. 5, 8, 10, 18, 21 AND 28.

INTERNATIONAL TECHNOLOGY GROUP, INC., WOODBURY, NY:  
1,260,845, CANC. INT. CL. 9.

INTERNATIONAL TRUCK INTELLECTUAL PROPERTY COMPANY, LLC, WARRENVILLE, IL:  
2,899,458, PUB. 11-25-2003. MULTIPLE CLASS, INT. CLS. 7, 12, 35, 36, 37 AND 39.

INTERNET BUSINESS JAPAN CO., LTD., TOKYO 150-0043, JAPAN:  
2,898,641, PUB. 8-10-2004. MULTIPLE CLASS, INT. CLS. 41 AND 42.

INTERNET PROFILES CORPORATION, SAN FRANCISCO, CA:  
2,121,168, CANC. MULTIPLE CLASS, INT. CLS. 35 AND 42.

INTERNET SECURITY SYSTEMS, INC., ATLANTA, GA:  
2,900,782, INT. CL. 9.

INTERPHARM PRESS, INC., ENGLEWOOD, CO:  
1,810,766, CANC. INT. CL. 16.

INTERVET, INC., MILLSBORO, DE:  
1,866,183, REN. 9-20-04. INT. CL. 5.

INTERVOICE LIMITED PARTNERSHIP, RENO, NV:  
2,121,394, CANC. INT. CL. 9.

INTHEMA CONFEZIONE SRL, 52010, CAPOLONA (AREZZO), ITALY:  
2,120,862, CANC. INT. CL. 25.

INTRACELL NUTRITION INC., FAIRVIEW, NJ:  
1,866,712, REN. 9-18-04. INT. CL. 5.

INTUIT INC., MOUNTAIN VIEW, CA:  
2,900,367, INT. CL. 9.

INVENEX, CONCORD, CA:  
2,122,212, CANC. INT. CL. 12.

INVENTEC BESTA CO., LTD., TAIPEI, TAIWAN:  
2,898,546, PUB. 9-24-2002. INT. CL. 9.

INVENTEC CORPORATION, SHIH LIN DISTRICT TAIPEI, TAIWAN:  
2,900,304, INT. CL. 9.

INVESTEC SECURITIES CORPORATION, DALLAS, TX:  
2,900,056, INT. CL. 9.

INVICTA CLUB, INC., SAN CLEMENTE, CA:  
2,900,670, INT. CL. 41.

INVICTA WATCH COMPANY OF AMERICA, INC., HOLLYWOOD, FL:  
2,900,451, INT. CL. 14.

IOG CANADA INC., EDMONTON, ALBERTA T6E 5T9, CANADA:  
2,898,683, PUB. 8-10-2004. MULTIPLE CLASS, INT. CLS. 6 AND 9.

IP HOLDINGS LLC, WILMINGTON, DE:  
2,900,356, INT. CL. 9.

IPL, INC.:  
1,260,955, CANC. MULTIPLE CLASS, INT. CLS. 20, 21, 27, 28 AND 37.

IQ BIOMETRIX, INC., FREMONT, CA:  
2,899,089, PUB. 8-10-2004. INT. CL. 9.

IRAINMAKERS, LTD, ARLINGTON, VA:  
2,899,169, PUB. 8-10-2004. INT. CL. 35.

IRWIN NATURALS, LOS ANGELES, CA:  
2,899,300, PUB. 1-6-2004. INT. CL. 5.

IRWIN TOY LIMITED, TORONTO, ONTARIO, CANADA:  
1,811,332, CANC. MULTIPLE CLASS, INT. CLS. 25 AND 28.

ISAAC WED-LING WVE. & EYDAM DIRCK HEKKER BRANNTWEIN-UND LIQUEURFABRIK, GENANNT 'DER LACHS' GEGRÜNDET ANNO 1598, D-37176 NOERTEN-HARDENBERG, FED REP GERMANY:  
2,120,993, CANC. INT. CL. 33.

ISABEL CABANILLAS, S.A., 08750 MOLINS DE REI, SPAIN:  
2,898,953, PUB. 8-10-2004. INT. CL. 20.

ISITUTO NAZIONALE ESPRESSO, BRESCIA, ITALY:  
2,898,443, PUB. 6-3-2003. MULTIPLE CLASS, INT. CLS. 11 AND 30.

ISOTIS ORTHOBIOLOGICS, INC., IRVINE, CA:  
2,121,653, CANC. INT. CL. 5.

ISOTOPE LOGGING, INC., RICHARDSON, TX:  
2,900,687, INT. CL. 42.

ISPAT INLAND INC., EAST CHICAGO, IN:  
412,800, REN. 9-21-04. U.S. CL. 14 (INT. CL. 6).

ISRAEL; NISSIM, BRUSSELS, BELGIUM:  
1,297,685, REN. 9-24-04. INT. CL. 25.

ISUZU JIDOSHA KABUSHIKI KAISHA, TOKYO, JAPAN, TA ISUZU MOTORS LIMITED:  
1,859,625, REN. 9-22-04. INT. CL. 12.

IS2 STAFFING SERVICES INC., EDMONTON, ALBERTA, CANADA:  
2,898,541, PUB. 8-10-2004. INT. CL. 35.

ITC DELTACOM COMMUNICATIONS, INC., HUNTSVILLE, AL:  
2,900,348, INT. CL. 38.

ITP LICENSING CORPORATION, WILMINGTON, DE:  
2,122,539, CANC. MULTIPLE CLASS, INT. CLS. 9 AND 16.

ITT FLUID PRODUCTS CORPORATION, MIDLAND PARK, NJ:  
1,260,792, CANC. INT. CL. 7.

ITT INDUSTRIES, INC., WHITE PLAINS, NY:  
2,900,195, INT. CL. 9.

IVAC CORPORATION, SAN DIEGO, CA TO ALARIS MEDICAL SYSTEMS, INC., SAN DIEGO, CA:  
1,811,424, CANC. INT. CL. 9.

IVERSON, RONALD C., EUSTIS, FL:  
2,900,075, INT. CL. 30.

IXE GRUPO FINANCIERO S.A. DE C.V., SAN ANGEL TLACOPAC, 01049, MEXICO:  
2,121,485, CANC. INT. CL. 36.

J. & P. COATS, LIMITED, GLASGOW, SCOTLAND, UNITED KINGDOM:  
594,917, REN. 9-24-04. U.S. CL. 43 (INT. CL. 23).

J. & R. DEBENEDETTO ORCHARDS, INC., CHOWCHILLA, CA:  
2,122,565, CANC. INT. CL. 31.

J. C. NEWMAN CIGAR CO., TAMPA, FL, M & N CIGAR MANUFACTURERS, INC., TAMPA, FL:  
1,850,011, REN. 9-20-04. INT. CL. 34.

J. DOUGLASS H. WHITEHEAD, MERRIFIELD, VA:  
2,122,249, CANC. INT. CL. 26.

J. RUBIN & COMPANY, ROCKFORD, IL:  
2,120,850, CANC. INT. CL. 6.

J. WRAY & NEPHEW LIMITED, KINGSTON 11, JAMAICA, RUMS INTERNATIONAL, INC., SPRINGFIELD, NJ:  
1,888,779, REN. 9-21-04. INT. CL. 33.

J.D. NEUHAUS GMBH & CO. KG, 58455 WITTEN, FED REP GERMANY:  
2,898,744, PUB. 8-10-2004. MULTIPLE CLASS, INT. CLS. 7, 8 AND 9.

J.M. WESTON, 87000 LIMOGES, FRANCE:  
2,898,644, PUB. 8-10-2004. MULTIPLE CLASS, INT. CLS. 18 AND 25.

J&J SNACK FOODS CORPORATION, PENNSAUKEN, NJ:  
1,866,517, REN. 9-19-04. INT. CL. 30.

J-B LAB: THE INSTITUTE FOR INTERACTIVE JOURNALISM, WASHINGTON, DC:  
2,900,557, INT. CL. 41.

J-ONE-S RANCH, INC., DRIFTWOOD, TX:  
2,898,591, PUB. 2-17-2004. INT. CL. 29.

J-RICH CLINIC, INC., GRASS LAKE, MI, DBA REAL PURITY:  
2,898,628, PUB. 8-10-2004. MULTIPLE CLASS, INT. CLS. 1, 3 AND 5.

JABEZ BURNS, INC., MEMPHIS, TN, BLAW-KNOX COMPANY, PITTSBURGH, PA:  
979,700, REN. 9-22-04. MULTIPLE CLASS, U.S. CLS. 23 (INT. CLS. 6, 7, 8, 9, 11, 12, 16, 21 AND 28), 26 (INT. CL. 9) AND 34 (INT. CL. 11).

JACK ASTOR'S (ONTARIO) INC., BURLINGTON, ONTARIO, 899207 ONTARIO INC., ST. CATHARINES, ONTARIO L2R 6T7, CANADA:  
1,848,777, REN. 9-23-04. INT. CL. 42.

JACK DANIEL'S PROPERTIES, INC., SAN RAFAEL, CA, JACK DANIEL DISTILLERY, LEM MOTLOW, PROP., INC., LYNCHBURG, TN:  
1,859,919, REN. 9-18-04. INT. CL. 33.

JACK IN THE BOX INC., SAN DIEGO, CA:  
2,899,111, PUB. 8-10-2004. INT. CL. 35.

- JACK J. ENGEL MANUFACTURING, INC., SUN VALLEY, CA, DBA CREATIVE AUTOMATION COMPANY:  
1,850,539. REN. 9-22-04. INT. CL. 7.
- JACKIE SUBERI, INC., JUPITER, FL:  
2,121,627. CANC. INT. CL. 14.
- JACKSON, OLLIE, RICHMOND, VA:  
2,122,128. CANC. INT. CL. 32.
- JACOBSON, MELVIN L., MINNETONKA, MN:  
2,898,782. PUB. 8-10-2004. INT. CL. 10.
- JAEGER, CHRISTIANA M., SHERMAN OAKS, CA:  
2,121,594. CANC. INT. CL. 41.
- JAFER LIMITED, HAMILTON, BERMUDA:  
2,900,710. INT. CL. 3.
- JAMCO CORPORATION, MITAKA CITY, TOKYO, JAPAN:  
2,121,995. CANC. INT. CL. 9.
- JAMES SOUTHALL & COMPANY LIMITED, NORWICH, NORFOLK, ENGLAND:  
774,610. REN. 9-18-04. U.S. CL. 39 (INT. CL. 25).
- JAMES, ROBERT M., WILDOMAR, CA:  
2,122,271. CANC. INT. CL. 30.
- JAMES, TANYA J., NEW YORK, NY:  
2,121,002. CANC. INT. CL. 35.
- JAMIE BROOKE INC., NEW YORK, NY:  
2,122,424. CANC. INT. CL. 25.
- JANNA SYSTEMS INC., TORONTO, ONTARIO, CANADA:  
2,120,883. CANC. INT. CL. 9.
- JAPAN & ORIENT TOURS, INC., SAN DIEGO, CA TO PLEASANT HOLIDAYS, LLC, WESTLAKE VILLAGE, CA:  
1,811,141. CANC. INT. CL. 39.
- JAPAN BANO'K CO., LTD., CHUO-KU, TOKYO, JAPAN:  
1,856,122. REN. 9-18-04. MULTIPLE CLASS, INT. CLS. 16 AND 20.
- JASON ENTERPRISES, INC., OWINGS MILLS, MD, JASON COMPANY INCORPORATED, TOWSON, MD:  
1,291,774. REN. 9-20-04. INT. CL. 5.
- JASON MARKETING COMPANY, HUNTINGTON BEACH, CA:  
2,121,692. CANC. INT. CL. 21.
- JAWORSKI, JEFFREY E., WEST HOLLYWOOD, CA AND WUSSOW, JASON, WEST HOLLYWOOD, CA:  
2,899,489. PUB. 12-9-2003. INT. CL. 25.
- JAZZ HIPSTER CORPORATION, CHUNG-HO CITY, TAIPEI HSIEN, TAIWAN:  
1,871,847. REN. 9-18-04. INT. CL. 9.
- JBL SOFT INC., NEW BRUNSWICK, CANADA:  
2,900,324. INT. CL. 9.
- JBW ENTERTAINMENT, INC., PITTSBURGH, PA:  
2,899,198. PUB. 8-10-2004. INT. CL. 41.
- JEAN CLAUDE BOISSET WINES, U.S.A., INC., SAN FRANCISCO, CA:  
1,840,807. REN. 9-21-04. INT. CL. 33.
- JEAN'S GARDEN GREATS, INC., WHITTIER, NC, DBA ADVENTURE FOODS:  
1,810,963. CANC. INT. CL. 30.
- JEEPERS! INC., WALTHAM, MA:  
2,122,388. CANC. MULTIPLE CLASS, INT. CLS. 41 AND 42.
- JEFFRIES AVLON, INC., NEW YORK, NY:  
2,900,231. INT. CL. 36.
- JEG'S AUTOMOTIVE, INC., COLUMBUS, OH:  
2,275,824. COR. INT. CL. 12.
- JEL SERT CO., THE, CHICAGO, IL:  
1,289,242. REN. 9-18-04. INT. CL. 30.
- JELLY BELLY CANDY COMPANY, FAIRFIELD, CA:  
2,900,909. MULTIPLE CLASS, INT. CLS. 20 AND 30.
- JENKIN-GUERIN, INC., ST. LOUIS, MO:  
994,491. REN. 9-22-04. MULTIPLE CLASS, U.S. CLS. 6 (INT. CL. 1), 15 (INT. CL. 4), 16 (INT. CL. 2) AND 52 (INT. CL. 3).
- JENKINS, JONI L., HENDERSONVILLE, TN AND JENKINS, KATHY A., HENDERSONVILLE, TN AND JENKINS, JIMMY H., HENDERSONVILLE, TN AND JENKINS, MICHAEL L., HENDERSONVILLE, TN:  
1,810,997. CANC. INT. CL. 31.
- JENUINE PERFORMANCE INTERNATIONAL, INC., TORRANCE, CA:  
2,121,564. CANC. INT. CL. 18.
- JEUNIQUE INTERNATIONAL, INC., CITY OF INDUSTRY, CA:  
1,810,432. CANC. INT. CL. 5.
- JEWELMONT CORPORATION, MINNEAPOLIS, MN:  
2,122,088. CANC. INT. CL. 14.
- JEWELRY REPAIRS BY US, MANALAPAN, NJ:  
2,120,891. CANC. MULTIPLE CLASS, INT. CLS. 35 AND 37.
- JEWS FOR JESUS, SAN FRANCISCO, CA, HINENI MINISTRIES, SAN FRANCISCO, CA:  
1,302,145. REN. 9-20-04. MULTIPLE CLASS, INT. CLS. 14 AND 16.
- JFM INVESTMENT LIMITED, KINGSTON 10, JAMAICA:  
2,122,235. CANC. MULTIPLE CLASS, INT. CLS. 29 AND 31.
- JHANE BARNES (DEL.) INC., WILMINGTON, DE:  
2,900,101. INT. CL. 9.
- JIANGSU JIANGSHAN PHARMACEUTICAL CO., LTD., JINGJIANG, JIANGSU, CHINA:  
2,899,605. PUB. 8-10-2004. INT. CL. 1.  
2,899,606. PUB. 8-10-2004. INT. CL. 1.  
2,899,607. PUB. 8-10-2004. INT. CL. 5.  
2,899,608. PUB. 8-10-2004. INT. CL. 31.  
2,899,609. PUB. 8-10-2004. INT. CL. 31.
- JIM HARMON GROUP, INC., THE, KNOXVILLE, TN:  
1,810,894. CANC. INT. CL. 28.
- JME INCORPORATED, PACOIMA, CA, DBA TMB ASSOCIATES:  
1,831,202. REN. 9-20-04. INT. CL. 9.
- JO-ANN STORES SUPPLY CHAIN MANAGEMENT, INC., HUDSON, OH:  
1,289,452. REN. 9-22-04. INT. CL. 42.
- JOACHIM UHING KG GMBH & CO., D-2301 MIELKENDORF, FED REP GERMANY:  
1,810,457. CANC. INT. CL. 7.
- JOAN OF ARC COMPANY, HOOPESTON, IL:  
177,163. CANC. U.S. CL. 46.
- JOE BOXER COMPANY, LLC, WESTPORT, CT:  
2,899,966. PUB. 8-10-2004. INT. CL. 11.
- JOHN C. DETRICH AND JOSEPH J. AHEARN PARTNERSHIP, THE, ASHBURN, VA:  
2,900,183. INT. CL. 28.
- JOHN F. AMICO & CO., BRIDGEVIEW, IL:  
1,286,702. REN. 9-20-04. INT. CL. 3.
- JOHN GROSSMAN, INC., POINT RICHMOND, CA, DBA THE GIFTED LINE TO WEE GOOD, INC., CULVER CITY, CA, DBA, MICHEL & CO.:  
1,810,747. CANC. INT. CL. 16.
- JOHN M. AND BETTY L. SCHOEPKE, BATH, MI, DBA PINE RIDGE ENTERPRISE, RANCO INDUSTRIES, INC., LA-KELAND, FL:  
1,856,694. REN. 9-23-04. INT. CL. 12.
- JOHN RICH & SONS INVESTMENT HOLDING COMPANY, WILMINGTON, DE:  
2,121,151. CANC. INT. CL. 25.
- JOHNS MANVILLE, DENVER, CO, GLASS FIBERS, INC., TOLEDO, OH:  
594,097. REN. 9-19-04. U.S. CL. 12 (INT. CL. 17).
- JOHNSON & JOHNSON, NEW BRUNSWICK, NJ:  
589,006. REN. 9-24-04. U.S. CL. 44 (INT. CL. 5).  
591,734. REN. 9-24-04. U.S. CL. 44 (INT. CL. 5).  
2,900,125. INT. CL. 1.
- JOHNSON, CLAUDE, GREENWICH, CT:  
2,900,728. INT. CL. 25.
- JOHNSON, JUDY, BROOKLYN, NY, DBA DIVINE CONNECTIONS:  
2,121,075. CANC. INT. CL. 42.
- JOHNSON, SMITH & KNISELY, INC., NEW YORK, NY:  
2,121,614. CANC. INT. CL. 16.
- JOHNSON DIVERSEY, INC., STURTEVANT, DE:  
594,355. REN. 9-22-04. U.S. CL. 4 (INT. CL. 3).
- JOHNSON DIVERSEY, INC., STURTEVANT, WI, ATLANTA JANITORIAL SERVICES, INC., ATLANTA, GA, DBA ATLANTA JANITORIAL SERVICES & SUPPLY CO., INC.:  
1,289,634. REN. 9-18-04. INT. CL. 1.
- JOHNSTONE, JOSEPH J., PORTLAND, OR:  
2,900,180. MULTIPLE CLASS, INT. CLS. 25 AND 28.

- JOLEE MICKESH, CHIPPEWA FALLS, WI:  
2,898,779, PUB. 8-10-2004. INT. CL. 14.
- JOOP! GMBH, D-20149 HAMBURG, FED REP GERMANY:  
2,121,952, CANC. INT. CL. 25.
- JOSEPH A. THOMAS LTD., BRISTOL, RI:  
2,121,493, CANC. INT. CL. 7.
- JOSEPH RUTIGLIANO & SONS, INC., SOUTH PLAINFIELD, NJ:  
1,270,117, REN. 9-24-04. INT. CL. 30.
- JOSTENS, INC., MINNEAPOLIS, MN:  
1,261,121, CANC. INT. CL. 35.  
2,899,836, PUB. 8-10-2004. INT. CL. 14.
- JRG ENTERPRISES, INC., ST. LOUIS, MO:  
2,121,704, CANC. INT. CL. 42.
- JUKEBOX SATURDAY NIGHT, INC., CHICAGO, IL:  
1,261,211, CANC. INT. CL. 41.
- JULIUS BAR HOLDING AG, 8001 ZURICH, SWITZERLAND:  
2,898,714, PUB. 5-25-2004. MULTIPLE CLASS, INT. CLS. 36 AND 38.
- JULIUS ZORN, INC., CUYAHOGA FALLS, OH:  
2,121,698, CANC. INT. CL. 25.
- JULLIAN'S ENTERTAINMENT CORPORATION, LOUISVILLE, KY, MAIN EVENT, INC., THE, DALLAS, TX:  
1,819,336, REN. 9-23-04. INT. CL. 42.
- JUMBURRITO, INC., MIDLAND, TX:  
2,898,958, PUB. 4-20-2004. INT. CL. 43.
- JUN YAN AUTO INDUSTRIAL CO., LTD., 704, TAINAN, TAIWAN:  
2,899,062, PUB. 8-10-2004. INT. CL. 11.
- JUSTER CO., LTD., SAN CHUNG CITY, TAIPEI, TAIWAN:  
2,898,721, PUB. 8-10-2004. INT. CL. 9.
- JUSTKIDING, INC., ST. LOUIS PARK, MN FROM MPA INTERNATIONAL CORPORATION, ST. LOUIS PARK, MN:  
2,900,117, INT. CL. 28.
- JUVENA (INTERNATIONAL) AG, 8604 VOLKETSCHWIL/ZURICH, SWITZERLAND:  
2,898,887, PUB. 8-10-2004. MULTIPLE CLASS, INT. CLS. 3 AND 21.
- JW PUBLISHING, INC., SAINT PETERSBURG, FL:  
2,899,697, PUB. 3-23-2004. INT. CL. 35.
- JWT SPECIALIZED COMMUNICATIONS, INC., LOS ANGELES, CA:  
2,122,537, CANC. INT. CL. 9.  
2,898,899, PUB. 1-13-2004. INT. CL. 35.
- K-FORM, INC., STERLING, VA:  
2,898,785, PUB. 8-10-2004. INT. CL. 9.
- K-TEL INTERNATIONAL, INC., PLYMOUTH, MN:  
1,824,227, REN. 9-22-04. INT. CL. 9.
- K-VA-T FOOD STORES, INC., ABINGDON, VA, GREENWOOD, CAROLYN M., FORT LAUDERDALE, FL:  
1,819,527, REN. 9-21-04. INT. CL. 32.
- KABA AG, 8623 WETZIKON, SWITZERLAND, BAUER AG, ZURICH, SWITZERLAND:  
993,360, REN. 9-18-04. INT. CL. 6.
- KABUSHIKI KAISHA DO FAMILY, SHIBUYA-KU TOKYO, JAPAN:  
2,898,693, PUB. 8-10-2004. MULTIPLE CLASS, INT. CLS. 18 AND 25.
- KABUSHIKI KAISHA GANSO TAKOMASA, OSAKA-SHI, JAPAN:  
2,900,609, INT. CL. 30.
- KABUSHIKI KAISHA KOBE SEIKO SHO, KOBE, JAPAN, TA KOBE STEEL, LTD.:  
2,900,551, INT. CL. 6.
- KABUSHIKI KAISHA MITSUKAN GROUP HONSHA, AI-CHI-KEN, JAPAN, TA MITSUKAN GROUP CORPORATION:  
2,899,174, PUB. 8-10-2004. INT. CL. 30.
- KABUSHIKI KAISHA SANKYO SEKI SEISAKUSHO, SHIMOSUWA-MACHI, SUWA-GUN, NAGANO-KEN, JAPAN:  
1,298,440, REN. 9-19-04. INT. CL. 9.
- KABUSHIKI KAISHA SEGA, TOKYO 144-8531, JAPAN, DBA SEGA CORPORATION:  
2,900,496, INT. CL. 9.
- KABUSHIKI KAISHA SEGA ENTERPRISES, TOKYO 144, JAPAN, DBA SEGA ENTERPRISES, LTD.:  
2,120,684, CANC. INT. CL. 9.
- KABUSHIKI KAISHA SONY COMPUTER ENTERTAINMENT, MINATO-KU, TOKYO, 107-0052, JAPAN, TA SONY COMPUTER ENTERTAINMENT INC.:  
2,898,446, PUB. 8-10-2004. MULTIPLE CLASS, INT. CLS. 14, 16, 18, 25, 28, 38 AND 41.
- KAL KAN FOODS, INC., VERNON, CA:  
1,260,923, CANC. INT. CL. 16.
- KALAHARI DEVELOPMENT LLC, WISCONSIN DELLS, WI:  
2,899,631, PUB. 8-10-2004. MULTIPLE CLASS, INT. CLS. 36 AND 43.
- KALMBACH PUBLISHING CO., WAUKESHA, WI:  
1,896,191, REN. 9-22-04. INT. CL. 16.
- KALTENBACH & VOIGT GMBH & CO., D-88400 BIBERACH-RISS, FED REP GERMANY:  
2,121,031, CANC. INT. CL. 10.
- KAMBLY SA SPECIALITES DE BISCUITS SUISSES, 3555 TRUBSCHACHEN, SWITZERLAND:  
1,310,316, REN. 9-18-04. INT. CL. 30.
- KAN-PAK, L.L.C., ARKANSAS CITY, KS TO KAN-PAK, L.L.C., ARKANSAS CITY, KS:  
2,481,512, COR. MULTIPLE CLASS, INT. CLS. 29, 30 AND 32.
- KANG, JOHN M., MANHASSET, NY:  
2,121,552, CANC. INT. CL. 35.
- KANSAS CITY STEAK COMPANY, LLC, KANSAS CITY, KS:  
2,900,935, INT. CL. 29.
- KAPLAN, RUTH B., LACOMBE, LA:  
1,865,854, REN. 9-20-04. INT. CL. 25.
- KAPPA PUZZLE GROUP, INC., FORT WASHINGTON, PA, MODERN DAY PERIODICALS, INC., NEW YORK, NY:  
1,285,981, REN. 9-24-04. INT. CL. 16.
- KAPSON MANAGEMENT CORP., WOODBURY, NY:  
2,122,538, CANC. INT. CL. 42.
- KARASIK, RANDAL B., ARVADA, CO:  
2,898,907, PUB. 1-20-2004. INT. CL. 9.
- KARMAN, INC., AURORA, CO:  
1,855,272, REN. 9-22-04. INT. CL. 25.  
1,867,698, REN. 9-18-04. INT. CL. 25.
- KARNAK MEN'S WEAR, INC., NEW YORK, NY:  
2,898,738, PUB. 11-11-2003. INT. CL. 35.
- KARO BIO USA, INC., DURHAM, NC:  
2,898,455, PUB. 8-10-2004. INT. CL. 42.
- KASH N' GOLD LTD., RONKONKOMA, NY:  
2,900,417, MULTIPLE CLASS, INT. CLS. 9, 11 AND 20.  
2,900,418, MULTIPLE CLASS, INT. CLS. 9, 11 AND 20.
- KASHYA, INC., SAN JOSE, CA:  
2,900,702, INT. CL. 9.
- KATHLEEN M. GODWIN / HELEN M. HENDERSON PARTNERSHIP, THE, SAN PEDRO, CA:  
2,121,871, CANC. INT. CL. 25.
- KATHRYN HALL VINEYARDS, RUTHERFORD, CA:  
2,899,419, PUB. 8-10-2004. INT. CL. 33.
- KAUFMAN, EMILY, WEST HILLS, CA:  
2,899,354, PUB. 8-10-2004. MULTIPLE CLASS, INT. CLS. 16 AND 41.
- KAWASAKI KISEN KAISHA, LTD., TOYKO 105, JAPAN, AKA "K" LINE AND AKA 'K' LINE:  
1,850,057, REN. 9-18-04. INT. CL. 39.
- KAYSER-ROTH CORPORATION, GREENSBORO, NC:  
2,900,837, INT. CL. 25.
- KBA-GIORI S.A., LAUSANNE, SWITZERLAND:  
2,899,452, PUB. 8-10-2004. MULTIPLE CLASS, INT. CLS. 9 AND 16.
- KC CYCLES, INC., RALEIGH, NC:  
2,120,947, CANC. MULTIPLE CLASS, INT. CLS. 37 AND 42.
- KEIWA KABUSHIKI KAISHA, OSAKA, JAPAN, DBA KEIWA, INC.:  
2,899,433, PUB. 8-10-2004. INT. CL. 17.
- KEJR, INC, SALINA, KS:  
1,853,482, REN. 9-18-04. INT. CL. 6.
- KEJR, INC., SALINA, KS:  
1,884,668, REN. 9-23-04. INT. CL. 9.

- KELLOGG COMPANY, BATTLE CREEK, MI:  
2,899,490, PUB. 1-13-2004. INT. CL. 30.
- KELLOGG INCORPORATED: SEEDS AND SUPPLIES, MILWAUKEE, WI TO KELLOGG'S, INC., INDIANAPOLIS, IN:  
1,810,992, CANC. INT. CL. 31.
- KEMI S.R.L., NOVARA, ITALY:  
2,898,979, PUB. 8-10-2004. INT. CL. 1.
- KEMIN INDUSTRIES, INC., DES MOINES, IA:  
775,073, REN. 9-20-04. U.S. CL. 46 (INT. CL. 30).
- KEMIRA CHEMICALS OY, HELSINKI, FINLAND:  
2,899,363, PUB. 8-10-2004. MULTIPLE CLASS, INT. CLS. 2 AND 5.
- KEMIRA GROWHOW OY, HELSINKI, FINLAND:  
2,899,651, PUB. 8-10-2004. INT. CL. 1.
- KENCRAFT, INC., ALPINE, UT:  
2,899,320, PUB. 8-10-2004. INT. CL. 30.  
2,899,321, PUB. 8-10-2004. INT. CL. 30.  
2,900,784, INT. CL. 30.
- KENLIN, INC., WICHITA, KS:  
2,121,741, CANC. INT. CL. 25.
- KENMARK OPTICAL COMPANY, LOUISVILLE, KY:  
2,900,458, INT. CL. 9.
- KENN VISELMAN PRESENTS, NEW YORK, NY:  
2,900,562, INT. CL. 28.
- KENNEDY, TERESA KAY-ABA, NEW YORK, NY:  
2,900,704, MULTIPLE CLASS, INT. CLS. 9, 16 AND 41.
- KENT FEEDS, INC., MUSCATINE, IA:  
1,850,523, REN. 9-22-04. INT. CL. 5.  
2,900,696, INT. CL. 5.
- KENT INTERNATIONAL INC., PARSIPPANY, NJ:  
2,900,064, INT. CL. 12.
- KENTROX, LLC, HILLSBORO, OR, KENTROX INDUSTRIES, INC., PORTLAND, OR:  
1,849,086, REN. 9-22-04. INT. CL. 9.
- KERN SPECIAL TOOLS COMPANY, INCORPORATED, NEW BRITAIN, CT:  
2,899,238, PUB. 8-10-2004. INT. CL. 6.
- KERRY INC., BELOIT, WI, BEATREME FOODS, INC., BELOIT, WI:  
1,862,639, REN. 9-20-04. INT. CL. 29.
- KERRY, INC., BELOIT, WI, DCA FOOD INDUSTRIES, INC., GARDEN CITY, NY:  
1,821,573, REN. 9-18-04. INT. CL. 30.
- KETTLER INTERNATIONAL INC., VIRGINIA BEACH, VA:  
2,900,280, INT. CL. 28.
- KEVIN MARTIN CORPORATION, THE, FT. LAUDERDALE, FL:  
2,122,540, CANC. INT. CL. 9.
- KEY ENTERPRISES LLC, PILLSBURY CENTER- SOUTH TOWER, MN, MSP PUBLICATIONS, INC., MINNEAPOLIS, MN:  
1,278,000, REN. 9-23-04. INT. CL. 16.
- KEYSTONE LEARNING SYSTEMS CORP., PROVO, UT:  
2,120,817, CANC. INT. CL. 9.
- KHAZAN ENTERPRISE INC., NEW BRUNSWICK, NJ:  
2,899,042, PUB. 8-10-2004. INT. CL. 30.
- KIDDE FIRE FIGHTING, INC., EXTON, PA:  
2,900,722, INT. CL. 2.
- KIDVEST, INC., NEW CANAAN, CT:  
2,899,400, PUB. 8-10-2004. MULTIPLE CLASS, INT. CLS. 25 AND 28.
- KIM K FORREST DDS MS, KATY, TX:  
2,900,788, INT. CL. 44.
- KIMBERLY-CLARK WORLDWIDE, INC., NEENAH, WI:  
408,618, REN. 9-22-04. U.S. CL. 37 (INT. CLS. 16, 26 AND 27).  
2,899,619, PUB. 8-10-2004. INT. CL. 16.  
2,900,850, INT. CL. 16.
- KIMPEX ACTION INC., QUEBEC J2B 6V4, CANADA:  
2,120,986, CANC. INT. CL. 9.
- KINDERCARE LEARNING CENTERS, INC., MONTGOMERY, AL:  
2,121,660, CANC. INT. CL. 42.
- KINESE, INC., SCHAUMBURG, IL:  
2,122,347, CANC. INT. CL. 28.
- KINETIC LUBRICANTS, INC., ALBUQUERQUE, NM, SUPERIOR LUBRICANTS INTERNATIONAL, INC., SEATAC, WA:  
1,846,424, REN. 9-20-04. INT. CL. 1.
- KING EDWARD TECHNOLOGY, INC., WILMINGTON, DE, SWISHER INTERNATIONAL, INC., JACKSONVILLE, FL:  
1,890,652, REN. 9-21-04. INT. CL. 34.
- KING LUCKY FOOD INDUSTRIAL CORP., TAIPEI, TAIWAN:  
1,810,959, CANC. INT. CL. 30.  
1,810,960, CANC. INT. CL. 30.
- KING-SEEKEY, INC.:  
1,260,823, CANC. INT. CL. 9.
- KING'S DAUGHTERS' MEDICAL CENTER, ASHLAND, KY:  
2,121,738, CANC. INT. CL. 42.
- KINOTON GMBH, GERMERING, FED REP GERMANY:  
2,898,537, PUB. 8-10-2004. INT. CL. 9.
- KITZ CORPORATION, CHIBA-KEN, JAPAN:  
1,291,830, REN. 9-18-04. INT. CL. 6.
- KLEIN ASSOCIATES, INC., SALEM, NH:  
1,260,786, CANC. INT. CL. 7.
- KLEIN FOODS, INC., HEALDSBURG, CA, SONOMA VINEYARDS, TIBURON, CA:  
997,656, REN. 9-22-04. U.S. CL. 47 (INT. CL. 33).
- KLEIN, MAX, NASHUA, NH:  
2,122,414, CANC. INT. CL. 42.
- KLOCKNER & CO AG, 47057 DUISBURG, FED REP GERMANY:  
2,900,181, INT. CL. 6.
- KLOCKNER DESMA KFD SALES AND SERVICE, INC., ERLANGER, KY:  
2,120,779, CANC. INT. CL. 9.
- KNAPP, RENAE R., ST. GEORGE, UT:  
2,122,498, CANC. INT. CL. 3.
- KNOLL AKTIENGESELLSCHAFT, LUDWIGSHAFEN (RHINE), FED REP GERMANY:  
761,532, CANC. U.S. CL. 6.  
761,567, CANC. U.S. CL. 18.
- KNOUSE FOODS COOPERATIVE, INC., PEACH GLEN, PA:  
1,811,626, CANC. INT. CL. 29.
- KNOWLEDGE ADVENTURE, INC., GLENDALE, CA:  
2,121,458, CANC. INT. CL. 9.  
2,121,470, CANC. INT. CL. 9.  
2,121,475, CANC. INT. CL. 9.
- KNOWLEDGE EXPRESS DATA SYSTEMS, L.C., BERWYN, PA:  
2,121,242, CANC. MULTIPLE CLASS, INT. CLS. 9, 35 AND 42.
- KNOWLLENCE, 25520 GOUX-LES-USIERS, FRANCE:  
2,898,556, PUB. 12-30-2003. MULTIPLE CLASS, INT. CLS. 35 AND 42.
- KOBRAND CORPORATION, NEW YORK, NY:  
2,121,921, CANC. INT. CL. 33.
- KOCH-GLITSCH, LP, WICHITA, KS:  
2,899,417, PUB. 12-2-2003. INT. CL. 7.
- KOECK, GEORGE, ALTOONA, PA, DBA VEST PROMOTIONS:  
1,261,126, CANC. INT. CL. 35.
- KOENIG & BAUER AKTIENGESELLSCHAFT, FRANKENTHAL, FED REP GERMANY:  
1,289,824, REN. 9-24-04. INT. CL. 9.
- KOHLER CO., KOHLER, WI:  
2,899,816, PUB. 8-10-2004. INT. CL. 11.
- KOLCRAFT ENTERPRISES, INC., CHICAGO, IL:  
2,900,852, INT. CL. 20.
- KOLCRAFT ENTERPRISES, INC., CHICAGO, IL:  
2,121,632, CANC. INT. CL. 12.
- KOLL COMPANY, THE, NEWPORT BEACH, CA:  
2,121,433, CANC. INT. CL. 36.
- KONAMI CORPORATION, MINATO-KU, TOKYO, JAPAN:  
2,854,446, COR. INT. CL. 9.
- KONAMI CORPORATION, MINATO-KU, TOKYO 105-6021, JAPAN:  
2,898,479, PUB. 10-8-2002. INT. CL. 9.
- KONAMI CORPORATION, CHIYODA-KU, TOKYO, JAPAN:  
2,900,155, INT. CL. 28.



- KONAMI CORPORATION, TOKYO, JAPAN:  
2,900,164, INT. CL. 28.
- KONAMI CORPORATION, CHIYODA-KU, TOKYO, JAPAN:  
2,900,429, INT. CL. 9.  
2,900,530, INT. CL. 9.
- KONICA USA INC., ENGLEWOOD CLIFFS, NJ:  
2,122,160, CANC. MULTIPLE CLASS, INT. CLS. 1 AND 9.
- KONINKLIJKE ECONOSTO N.V., 3016 BA ROTTERDAM, NETHERLANDS:  
2,898,523, PUB. 11-12-2002. INT. CL. 17.
- KOSTRITZER SCHWARZBIERBRAUEREI GMBH & CO, 07586 BAD KOSTRITZ, FED REP GERMANY:  
2,898,434, PUB. 8-10-2004. INT. CL. 32.
- KOZLOWSKI FARMS, FORESTVILLE, CA:  
1,847,791, REN. 9-22-04. INT. CL. 29.
- KPMG PEAT MARWICK LLP, NEW YORK, NY:  
2,121,191, CANC. INT. CL. 35.
- KRAFT FOODS HOLDINGS, INC., NORTHFIELD, IL:  
2,900,846, INT. CL. 31.
- KRAFT, INC., GLENVIEW, IL:  
761,705, CANC. U.S. CL. 46.
- KRAUS-ANDERSON, INCORPORATED, MINNEAPOLIS, MN:  
2,898,698, PUB. 8-10-2004. INT. CL. 36.
- KRAUSZ, F. RON, ST. HELENA., CA:  
2,900,072, MULTIPLE CLASS, INT. CLS. 29 AND 33.
- KROGER CO., THE, CINCINNATI, OH:  
769,664, REN. 9-22-04. U.S. CL. 46 (INT. CLS. 1, 5, 29, 30, 31 AND 32).
- KRONES AG, D-93073 NEUTRAUBLING, FED REP GERMANY, KRONSEDER, HERMANN, D-8402 NEUTRAUBLING, FED REP GERMANY, DBA HERMANN KRONSEDER MASCHINENFABRIK:  
1,000,959, REN. 9-18-04. INT. CL. 7.  
1,001,974, REN. 9-18-04. INT. CL. 7.
- KRUCKEMEYER AND COHN, INC., EVANSVILLE, IN:  
1,303,632, REN. 9-18-04. INT. CL. 14.
- KRUPP BROTHERS WINERY LLC, NAPA, CA:  
2,900,602, INT. CL. 33.
- KUEHN, BRUCE D., PORTLAND, OR:  
2,899,694, PUB. 8-10-2004. INT. CL. 35.
- KUMHO INDUSTRIAL CO., LTD., CHUNG-GU, SEOUL, REPUBLIC OF KOREA:  
2,795,269, COR. INT. CL. 12.
- KUNG LONG BATTERIES INDUSTRIAL CO., LTD., NAN TOU CITY, NAN TOU HSIEN, TAIWAN:  
2,900,835, INT. CL. 9.
- KURASHIKI BOSEKI KABUSHIKI KAISHA, KURASHIKI-SHI, OKAYAMA-KEN, JAPAN, AKA KURABO INDUSTRIES LTD.:  
1,314,410, REN. 9-22-04. INT. CL. 9.
- KURSON, KENNETH A., MONTCLAIR, NJ:  
2,121,450, CANC. INT. CL. 16.
- KUSTOM SIGNALS, INC., LENEXA, KS:  
1,287,770, REN. 9-18-04. INT. CL. 9.
- KWC AG, UNTERKULM, SWITZERLAND:  
2,899,353, PUB. 8-10-2004. MULTIPLE CLASS, INT. CLS. 11 AND 21.
- KWC AG, 5726 UNTERKULM, SWITZERLAND:  
2,899,382, PUB. 8-10-2004. MULTIPLE CLASS, INT. CLS. 11 AND 21.  
2,899,703, PUB. 8-10-2004. MULTIPLE CLASS, INT. CLS. 11 AND 21.
- K2 LICENSING & PROMOTIONS, INC., SAN DIGEO, CA:  
2,122,323, CANC. INT. CL. 14.
- L & D HAIR PRODUCTS, INC., ATLANTA, GA:  
2,120,829, CANC. INT. CL. 3.
- L.C. LICENSING, INC., NEW YORK, NY:  
2,900,469, INT. CL. 3.
- L.W. MILBY, INC., NEW CARLISLE, OH:  
2,900,567, INT. CL. 40.
- L&P PROPERTY MANAGEMENT COMPANY, SOUTH GATE, CA:  
2,900,057, MULTIPLE CLASS, INT. CLS. 7 AND 20.
- L'AIR LIQUIDE, SOCIETE ANONYME POUR L'ETUDE ET L'EXPLOITATION DES PROCESSES GEORGES CLAUDE, 75321 PARIS CEDEX 7, FRANCE:  
1,852,333, REN. 9-19-04. INT. CL. 42.
- L'AMY, 39400 MOREZ, FRANCE:  
2,120,797, CANC. INT. CL. 9.
- L'OREAL, 75008 PARIS, FRANCE:  
2,120,864, CANC. INT. CL. 3.
- L'OREAL USA CREATIVE, INC., NEW YORK, NY, M & M PRODUCTS CO., ATLANTA, GA:  
1,007,236, REN. 9-18-04. INT. CL. 3.
- L'OREAL USA CREATIVE, INC., NEW YORK, NY:  
1,308,540, REN. 9-24-04. INT. CL. 3.  
1,322,887, REN. 9-18-04. INT. CL. 3.
- L'OREAL USA CREATIVE, INC., NEW YORK, NY, FUTURE SOURCE, INC., CHICAGO, IL:  
1,847,540, REN. 9-20-04. INT. CL. 3.
- L'OREAL USA CREATIVE, INC., NEW YORK, NY, AMINCO, INC., WILMINGTON, DE:  
1,864,498, REN. 9-20-04. INT. CL. 3.
- L'OREAL USA CREATIVE, INC., NEW YORK, NY:  
2,900,869, INT. CL. 3.  
2,900,872, INT. CL. 3.  
2,900,873, INT. CL. 3.  
2,900,874, INT. CL. 3.  
2,900,875, INT. CL. 3.  
2,900,876, INT. CL. 3.  
2,900,877, INT. CL. 3.  
2,900,878, INT. CL. 3.
- L'OTHANTIQUE, INC., MARKHAM, ONTARIO, CANADA:  
2,899,218, PUB. 8-10-2004. MULTIPLE CLASS, INT. CLS. 3 AND 4.
- LA CHASSE CORPORATION, ALHAMBRA, CA:  
2,121,374, CANC. INT. CL. 5.
- LA SALSA, INC., SANTA BARBARA, CA:  
2,898,518, PUB. 4-8-2003. INT. CL. 42.
- LA SHUFFLE MERCHANDISING, INC., ORANGE, CA:  
2,122,062, CANC. INT. CL. 25.
- LABEL ART, INC., WILTON, NH:  
2,120,733, CANC. INT. CL. 39.
- LABORATOIRE GARNIER & CIE, 75008 PARIS, FRANCE:  
2,122,073, CANC. INT. CL. 3.
- LABORATOIRE GARNIER & CIE, PARIS, FRANCE:  
2,899,188, PUB. 8-10-2004. INT. CL. 3.
- LABORATOIRES COLBA INC., VILLE SAINT-LAURENT, QUEBEC H4N 1V8, CANADA:  
2,898,657, PUB. 9-30-2003. MULTIPLE CLASS, INT. CLS. 3 AND 21.
- LABSYSTEMS, INC., FRANKLIN, MA:  
1,811,480, CANC. INT. CL. 9.
- LAC COMMUNICATIONS, INC., CLOSTER, NJ:  
2,900,442, MULTIPLE CLASS, INT. CLS. 9 AND 16.
- LACEBARK, INC., STILLWATER, OK:  
2,899,819, PUB. 8-10-2004. INT. CL. 31.
- LAFLAMME, ROBERT, LACONIA, NH:  
2,122,569, CANC. INT. CL. 8.
- LAGULL, INC., CHICAGO, IL:  
2,121,730, CANC. INT. CL. 26.
- LAGUNA BEACH EDUCATIONAL FOUNDATION, LAGUNA BEACH, CA:  
1,289,346, REN. 9-23-04. INT. CL. 36.
- LAGUNA BEVERAGE COMPANY, INC., MONARCH BEACH, CA:  
2,121,453, CANC. INT. CL. 32.
- LAIN, RICHARD J., BURR RIDGE, IL:  
1,810,491, CANC. INT. CL. 9.
- LAKE WINNEPESAUCAH, INC., ROSSVILLE, GA:  
2,898,561, PUB. 8-10-2004. INT. CL. 41.  
2,898,562, PUB. 8-10-2004. INT. CL. 41.  
2,898,563, PUB. 8-10-2004. INT. CL. 41.
- LAKEVIEW SPORTSWEAR CORP., BROOKLYN, NY:  
2,122,472, CANC. INT. CL. 25.
- LALIQUE, 75008 PARIS, FRANCE:  
2,898,611, PUB. 8-26-2003. INT. CL. 14.
- LAMBS, INC., THE, LIBERTYVILLE, IL:  
1,856,727, REN. 9-18-04. MULTIPLE CLASS, INT. CLS. 29, 30, 41 AND 42.  
1,856,727, CANC. MULTIPLE CLASS, INT. CLS. 16 AND 31.
- LAMERS BUS LINES, INC., GREEN BAY, WI:  
1,847,003, REN. 9-24-04. INT. CL. 39.

- LANCÔME PARFUMS ET BEAUTE & CIE, PARIS, FRANCE:  
2,898,695, PUB. 11-11-2003. INT. CL. 3.
- LAND CAPITAL GROUP, INC., PARK CITY, UT:  
2,899,344, PUB. 8-10-2004. MULTIPLE CLASS, INT. CLS.  
35, 36 AND 37.
- LAND O'FROST, INC., LANSING, IL:  
1,002,950. REN. 9-24-04. INT. CL. 29.
- LAND O'LAKES, INC., ARDEN HILLS, MN:  
2,900,815, INT. CL. 31.
- LANDIS & GYR COMMUNICATIONS S.A., CH-1202 GENÈVE,  
SWITZERLAND:  
2,120,774, CANC. MULTIPLE CLASS, INT. CLS. 9 AND  
42.
- LANDIS + GYR INC., LAFAYETTE, IN:  
2,900,416, INT. CL. 9.
- LANDMARK COMMUNICATIONS, INC., NORFOLK, VA:  
1,261,177, CANC. MULTIPLE CLASS, INT. CLS. 38 AND  
41.
- LANDMARK GRAPHICS CORPORATION, HOUSTON, TX:  
2,900,819, INT. CL. 9.
- LANDMARK SEED, LLC, SPOKANE, WA:  
2,900,756, INT. CL. 31.
- LANDMARK SERVICES/TOURMOBILE, INC., WASHING-  
TON, DC:  
1,297,022. REN. 9-18-04. INT. CL. 41.
- LANDS' END DIRECT MERCHANTS, INC., EDINA, MN:  
1,863,750. REN. 9-18-04. INT. CL. 25.
- LANE BRYANT, INC., REYNOLDSBURG, OH:  
2,121,469, CANC. INT. CL. 9.
- LANE INDIVIDUAL PRACTICE ASSOCIATION, INC., EU-  
GENE, OR:  
2,898,723, PUB. 4-6-2004. INT. CL. 35.
- LANIFICIO F.LLI CERRUTI. S.P.A., 20122 MILANO, ITALY:  
2,844,232, COR. MULTIPLE CLASS, INT. CLS. 23 AND  
24.
- LANVISTA CORPORATION, OTTAWA, ONTARIO K1P 5B4,  
CANADA:  
2,121,288, CANC. INT. CL. 9.
- LAP GMBH LASER APPLIKATIONEN, 2120 LUNEBURG,  
FED REP GERMANY:  
1,851,910. REN. 9-20-04. INT. CL. 10.
- LAPP INSULATOR COMPANY LLC, LEROY, NY, INTER-  
PACE CORPORATION, PARSIPPANY, NJ:  
990,727. REN. 9-22-04. U.S. CL. 21 (INT. CL. 9).
- LAREDO REAL FOODS, INC., LAREDO, TX:  
2,898,447, PUB. 8-10-2004. INT. CL. 43.
- LARSON MANUFACTURING COMPANY OF SOUTH DA-  
KOTA, INC., BROOKINGS, SD:  
2,899,863, PUB. 8-10-2004. INT. CL. 6.
- LASER LOCK TECHNOLOGIES, INC., BALA CYNWYD, PA:  
2,899,517, PUB. 8-10-2004. INT. CL. 16.
- LASSEN ART PUBLICATIONS, INC., LAS VEGAS, NV, DBA  
LASSEN INTERNATIONAL:  
2,120,884, CANC. INT. CL. 25.
- LAST FLIGHT OUT INTERNATIONAL, INC., FERNANDI-  
NA BEACH, FL:  
2,121,870, CANC. INT. CL. 25.
- LATHAM SEED CO., ALEXANDER, IA:  
1,307,359. REN. 9-20-04. INT. CL. 31.  
1,307,360. REN. 9-23-04. INT. CL. 31.
- LAWLER FOODS, INC., HUMBLE, TX:  
1,885,141. REN. 9-22-04. INT. CL. 30.
- LAWRENCE CRAIG WEINSTEIN AND SANFORD SCOTT  
WEINSTEIN, AS TRUSTEES OF THE SAMUEL WEIN-  
STEIN LIVING TRUST, LINCOLNWOOD, IL:  
585,564. REN. 9-20-04. U.S. CL. 107 (INT. CL. 41).
- LAWRENCE PHOTO-GRAPHIC, INC., SPRINGFIELD, MO:  
1,261,160, CANC. MULTIPLE CLASS, INT. CLS. 37 AND  
42.
- LEADIS TECHNOLOGY, SAN JOSE, CA:  
2,900,554, INT. CL. 42.
- LEAPFROG (UK) LIMITED, NOTTINGHAM NG1 3HD,  
UNITED KINGDOM:  
2,898,733, PUB. 12-23-2003. INT. CL. 3.
- LEAPHART, LANORRIS, NORRISTOWN, PA:  
2,900,098, INT. CL. 25.
- LEARMONTH & BURCHETT MANAGEMENT SYSTEMS,  
INC., HOUSTON, TX:  
2,120,924, CANC. INT. CL. 9.  
2,120,925, CANC. INT. CL. 9.
- LEARN INCORPORATED, MT. LAUREL, NJ:  
1,810,723, CANC. INT. CL. 16.
- LEARNING RESOURCES, INC., VERNON HILLS, IL:  
2,900,802, INT. CL. 16.  
2,900,803, INT. CL. 16.
- LEARNING TEAM, THE, ARMONK, NY:  
2,121,595, CANC. INT. CL. 16.
- LEASING INNOVATIONS, LC, KANSAS CITY, MO:  
2,121,384, CANC. INT. CL. 36.
- LEBANESE ARAK CORPORATION, SUN VALLEY, CA,  
DBA CARLO ENTERPRISES AND DBA CARLO BEVER-  
AGE ENTERPRISES:  
1,810,964, CANC. MULTIPLE CLASS, INT. CLS. 30 AND  
32.
- LEBHAR-FRIEDMAN, INC., NEW YORK, NY:  
1,807,435. REN. 9-23-04. INT. CL. 16.
- LECTRON FUEL SYSTEMS, INC., LORENA, TX:  
1,863,499. REN. 9-21-04. INT. CL. 7.
- LEE HECHT HARRISON LLC, WOODCLIFF LAKE, NJ:  
2,898,689, PUB. 8-10-2004. INT. CL. 35.
- LEFKOWITZ, LANIE, HOBOKEN, NJ:  
2,900,723, INT. CL. 16.
- LEGACY MANUFACTURING, LLC, DENVER, CO:  
2,899,425, PUB. 8-10-2004. INT. CL. 40.
- LEHIGH VALLEY BUSINESS CONFERENCE ON HEALTH  
CARE, BETHLEHEM, PA:  
2,121,936, CANC. INT. CL. 35.
- LEINER HEALTH PRODUCTS INC., TORRANCE, CA:  
1,886,507, CANC. INT. CL. 5.
- LEIPOLD, MARGOT, D-95615 MARKTREDEWITZ, FED  
REP GERMANY AND HAUSSER, SABINE, D-96465  
NEUSTADT B., FED REP GERMANY AND BERNDT,  
IRIS, D-96465 NEUSTADT B., FED REP GERMANY, O. &  
M. HAUSSER, 17 8632 NEUSTADT, NEAR COBURG, FED  
REP GERMANY:  
990,746. REN. 9-18-04. U.S. CL. 22 (INT. CL. 28).
- LEMA, MARK A., BURLINGTON, NJ:  
2,900,398, INT. CL. 35.
- LENNAR PACIFIC PROPERTIES MANAGEMENT, INC.,  
MISSION VIEJO, CA:  
1,853,829. REN. 9-18-04. INT. CL. 37.
- LENNOX HEARTH PRODUCTS INC., RICHARDSON, TX:  
1,851,938. REN. 9-19-04. INT. CL. 11.
- LENNOX INDUSTRIES INC., RICHARDSON, TX:  
2,122,151, CANC. INT. CL. 11.
- LENOX, INCORPORATED, LAWRENCEVILLE, NJ:  
774,108. REN. 9-23-04. U.S. CL. 28 (INT. CL. 8).
- LENOX, INCORPORATED, LAWRENCEVILLE, NJ, TEX-  
TRON INC., PROVIDENCE, RI:  
1,308,664. REN. 9-23-04. INT. CL. 8.
- LENS EXPRESS, INC., DEERFIELD BEACH, FL:  
1,811,683, CANC. INT. CL. 42.
- LEONARD A. & CHARLENE S. MATARESE PARTNER-  
SHIP, THE, JAY, NY, DBA CANDY MAN:  
2,120,663, CANC. INT. CL. 30.
- LES LOGICIELS DYNAGRAM INC., QUEBECQIK 3J4,  
CANADA:  
1,846,139. REN. 9-20-04. INT. CL. 9.
- LES PRODUITS ASSOCIES LPA-BROXO S.A., GENEVA,  
SWITZERLAND:  
2,898,460, PUB. 8-7-2001. INT. CL. 5.
- LESLIE-LOCKE, INC., ATLANTA, GA:  
2,121,628, CANC. INT. CL. 11.
- LEVENSOHN CAPITAL MANAGEMENT LLC, SAN FRAN-  
CISCO, CA:  
2,900,371, INT. CL. 36.
- LEVINE, BLASZAK, BLOCK & BOOTHBY LLP, WASHING-  
TON, DC:  
2,900,738, INT. CL. 35.
- LEVY, SPENCE, MIAMI, FL:  
2,122,531, CANC. MULTIPLE CLASS, INT. CLS. 16 AND  
25.

LEXIA LEARNING SYSTEMS, INC., LINCOLN, MA:  
 2,899,200, PUB. 8-10-2004. INT. CL. 9.  
 2,899,201, PUB. 8-10-2004. INT. CL. 9.  
 2,899,202, PUB. 8-10-2004. INT. CL. 9.

LEXINGTON ABRASIVE BELTS, INC., LEXINGTON, NC:  
 1,288,679. REN. 9-23-04. INT. CL. 7.

LF, LLC, WILMINGTON, DE:  
 2,899,781, PUB. 8-10-2004. MULTIPLE CLASS, INT. CLS. 2 AND 16.

LG HOUSEHOLD & HEALTH CARE LTD., SEOUL 150-721, REPUBLIC OF KOREA:  
 2,900,165, INT. CL. 3.

LGC (HOLDINGS) LTD., TEDDINGTON, MIDDLESEX, TW11 0LY, UNITED KINGDOM:  
 2,900,079, MULTIPLE CLASS, INT. CLS. 1, 41 AND 42.

LGT BANK IN LIECHTENSTEIN (IRELAND) LIMITED, DUBLIN 2, IRELAND, RICETEC, INC., ALVIN, TX:  
 1,859,875. REN. 9-18-04. INT. CL. 30.

LIBERTO SPECIALTY COMPANY, INC., SAN ANTONIO, TX:  
 1,342,417. REN. 9-22-04. INT. CL. 11.

LIBERTY HARDWARE MANUFACTURING CORPORATION, HIGH POINT, NY:  
 1,260,776, CANC. INT. CL. 6.

LIBERTY MUTUAL INSURANCE COMPANY, BOSTON, MA:  
 2,899,415, PUB. 8-10-2004. INT. CL. 36.

LIBERTY WIRE & CABLE, COLORADO SPRINGS, CO:  
 2,899,282, PUB. 8-10-2004. INT. CL. 40.

LIBURD, STEVEN W., MOUNT VERNON, NY:  
 2,900,632, INT. CL. 9.

LICORERA ZACAPANECA, S.A., ZACAPA, GUATEMALA:  
 1,291,437. REN. 9-23-04. INT. CL. 33.

LIDIA'S RESTAURANT GROUP LLC, KANSAS CITY, MO:  
 2,898,860, PUB. 8-10-2004. INT. CL. 43.

LIDO CAPITAL PARTNERS, LLC, NEWPORT BEACH, CA:  
 2,900,608, MULTIPLE CLASS, INT. CLS. 35 AND 36.

LIEBEL-FLARSHEIM COMPANY, ST. LOUIS, MO:  
 773,746. REN. 9-24-04. U.S. CL. 44 (INT. CL. 10).

LIEBERFARB, INC., IRVINGTON, NJ:  
 2,122,404, CANC. INT. CL. 14.

LIEN CHEMICAL COMPANY, ELMHURST, IL:  
 1,261,168, CANC. INT. CL. 37.

LIFE AUTOMOTIVE PRODUCTS, INC., CORDOVA, TN:  
 1,898,462. REN. 9-18-04. INT. CL. 1.

LIFE OUTREACH INTERNATIONAL, FORT WORTH, TX:  
 1,853,615. REN. 9-21-04. MULTIPLE CLASS, INT. CLS. 16 AND 42.

LIFEACCESS.COM, INC., BOSTON, MA:  
 2,899,290, PUB. 8-10-2004. INT. CL. 45.

LIFESTYLE PORTFOLIOS LIMITED, MISSION VIEJO, CA:  
 2,898,469, PUB. 8-10-2004. INT. CL. 36.

LIFETIME ENTERTAINMENT SERVICES, NEW YORK, NY:  
 2,899,882, PUB. 8-10-2004. INT. CL. 41.

LIFETIME HOAN CORPORATION, WESTBURY, NY:  
 1,857,127. REN. 9-22-04. MULTIPLE CLASS, INT. CLS. 8 AND 21.

LIFEWAY CHRISTIAN RESOURCES OF THE SOUTHERN BAPTIST CONVENTION, NASHVILLE, TN, SUNDAY SCHOOL BOARD OF THE SOUTHERN BAPTIST CONVENTION, THE, NASHVILLE, TN:  
 1,848,801. REN. 9-21-04. INT. CL. 42.

LIFEWAY CHRISTIAN RESOURCES OF THE SOUTHERN BAPTIST CONVENTION, NASHVILLE, TN:  
 1,850,152. REN. 9-21-04. MULTIPLE CLASS, INT. CLS. 16 AND 42.

LIGHTBORNE PUBLISHING, INC., CINCINNATI, OH:  
 2,662,257, COR. MULTIPLE CLASS, INT. CLS. 16, 41 AND 42.

LILJEHOLMENS STEARINFABRIKS AB, OSKARSHAMM, SWEDEN:  
 1,291,729. REN. 9-18-04. INT. CL. 4.

LILLY INDUSTRIES (USA), INC., INDIANAPOLIS, IN:  
 776,056. REN. 9-19-04. U.S. CL. 15 (INT. CL. 4).

LINC PEN & PLASTICS LIMITED, STATE OF WEST BENGAL, INDIA:  
 2,900,421, INT. CL. 16.

LINCIR, MATT G., SAN PEDRO, CA:  
 2,898,554, PUB. 8-10-2004. INT. CL. 19.

LINCOLN NATIONAL CORPORATION, PHILADELPHIA, PA:  
 1,293,240. REN. 9-19-04. INT. CL. 36.

LINFIELD, HUNTER & JUNIUS, INC., METAIRIE, LA:  
 2,120,950, CANC. INT. CL. 42.

LINK-DECO SYSTEMS INC., VANCOUVER, BRITISH COLUMBIA, V5Y 1W5, CANADA:  
 2,168,006, COR. INT. CL. 20.

LINK-TECH INTERNATIONAL CORP., GILBERT, AZ:  
 1,810,684, CANC. INT. CL. 14.

LINSHELL HOLDINGS LIMITED, LONDON, UNITED KINGDOM:  
 2,898,889, PUB. 8-10-2004. INT. CL. 26.

LINVATEC CORPORATION, LARGO, FL:  
 1,850,274. REN. 9-21-04. INT. CL. 10.  
 1,851,199. REN. 9-18-04. INT. CL. 10.  
 1,851,924. REN. 9-22-04. INT. CL. 10.

LIONSTONE PARTNERS, LTD., HOUSTON, TX:  
 2,899,445, PUB. 11-4-2003. INT. CL. 36.

LIPTON INVESTMENTS, INC., WILMINGTON, DE:  
 766,015. REN. 9-20-04. U.S. CL. 46 (INT. CL. 30).  
 1,849,506. REN. 9-22-04. INT. CL. 29.

LIQUID CARBONIC CORPORATION, CHICAGO, IL:  
 761,538, CANC. MULTIPLE CLASS, U.S. CLS. 6 AND 18.

LISA FRANK, INC., TUCSON, AZ:  
 2,900,718, INT. CL. 28.

LISA KAHN, WOODBURY, NY:  
 2,829,052, CANC. IIRN. RESTORED TO S.N. 76-346,195.

LISCO, INC., TAMPA, FL:  
 2,121,591, CANC. INT. CL. 20.  
 2,121,916, CANC. INT. CL. 20.  
 2,121,917, CANC. INT. CL. 20.  
 2,122,175, CANC. INT. CL. 28.

LISE WATIER COSMETIQUES INC., VILLE MONT-ROYAL QUEBEC, CANADA:  
 2,121,092, CANC. INT. CL. 3.

LITEWAY, INC, HICKSVILLE, NY:  
 2,900,574, INT. CL. 9.

LITTLE CAESAR ENTERPRISES, INC., DETROIT, MI:  
 1,811,270, CANC. INT. CL. 42.

LITTLE DEVIL, INC., KING OF PRUSSIA, PA:  
 2,898,857, PUB. 2-17-2004. INT. CL. 25.

LITTLE DIVERSIFIED ARCHITECTURAL CONSULTING, INC., CHARLOTTE, NC FROM LITTLE & ASSOCIATES ARCHITECTS, INC., CHARLOTTE, NC:  
 2,900,288, INT. CL. 35.

LITTLE DIVERSIFIED ARCHITECTURAL CONSULTING, INC., CHARLOTTE, NC:  
 2,900,289, INT. CL. 44.

LITTLE GREENE APPLES, INC., MONTVILLE, NJ:  
 2,121,207, CANC. INT. CL. 25.

LITTLE KIDS, INC., PROVIDENCE, RI:  
 2,900,844, INT. CL. 28.

LITTLE-YOUNG INDUSTRY, INC., MIDLOTHIAN, TX:  
 1,870,638. REN. 9-23-04. INT. CL. 26.

LIVE PICTURE, INC., SOQUEL, CA:  
 2,122,375, CANC. INT. CL. 9.

LJS, INC., NEW HYDE PARK, NY:  
 2,121,853, CANC. INT. CL. 16.

LOAD KING MANUFACTURING CO., JACKSONVILLE, FL:  
 2,900,209, MULTIPLE CLASS, INT. CLS. 37, 40 AND 42.

LOBTEX CO., LTD., OSAKA, JAPAN:  
 776,138. REN. 9-24-04. U.S. CL. 23 (INT. CL. 8).

LOCKHART POWER COMPANY, LOCKHART, SC:  
 2,900,847, MULTIPLE CLASS, INT. CLS. 39 AND 40.

LOCKHEED MARTIN CORPORATION, BETHESDA, MD:  
 2,900,733, INT. CL. 25.  
 2,900,734, INT. CL. 26.  
 2,900,735, INT. CL. 26.

LOG CABIN HOMES LTD., ROCKEY MOUNT, NC:  
 1,897,192. REN. 9-21-04. INT. CL. 19.

LOG MAX, INC., VANCOUVER, WA:  
 2,900,659, MULTIPLE CLASS, INT. CLS. 7 AND 9.

LOGAN FARMS, INC., HOUSTON, TX:  
 2,898,622, PUB. 8-10-2004. MULTIPLE CLASS, INT. CLS.

- 29, 35 AND 43.  
 LOGICACMG PLC, LONDON, UNITED KINGDOM, LOGICA, INC., NEW YORK, NY:  
 1,271,555. REN. 9-24-04. MULTIPLE CLASS, INT. CLS. 9, 38, 41 AND 42.  
 LOGOTEC USA, LLC, SIERRA MADRE, CA:  
 2,900,649. MULTIPLE CLASS, INT. CLS. 16 AND 21.  
 LOLITA'S RESTAURANTS, INC., CHULA VISTA, CA:  
 2,900,638. INT. CL. 43.  
 LOLLY LLC, STRATFORD, CT:  
 2,122,535. CANC. INT. CL. 17.  
 LOMINGER LIMITED, INC., MINNEAPOLIS, MN:  
 2,899,493. PUB. 8-10-2004. MULTIPLE CLASS, INT. CLS. 35 AND 42.  
 LONG ISLAND ALZHEIMER'S FOUNDATION, INC., PORT WASHINGTON, NY:  
 2,899,143. PUB. 8-10-2004. INT. CL. 35.  
 LONG SHOE CORPORATION, SAN CHUNG CITY, TAIPEI HSIEN, TAIWAN:  
 2,122,374. CANC. INT. CL. 25.  
 LONGABERGER COMPANY, THE, DRESDEN, OH:  
 2,121,638. CANC. INT. CL. 21.  
 LONGJIANG RIVER HEALTH PRODUCTS, LLC, IRVINGTON ON HUDSON, NY:  
 2,900,795. INT. CL. 5.  
 LONZA, INC., FAIRLAWN, NJ:  
 1,260,703. CANC. INT. CL. 1.  
 LOONEY, ANDREW, COLLEGE PARK, MD:  
 2,899,429. PUB. 8-10-2004. INT. CL. 28.  
 LORBER, DOROTHEA A., PALM BEACH, FL:  
 2,122,574. CANC. INT. CL. 25.  
 LORILLARD, INC., NEW YORK, NY:  
 1,261,100. CANC. INT. CL. 34.  
 LORRAINE LINENS, INC., DEERFIELD BEACH, FL:  
 1,901,787. REN. 9-18-04. INT. CL. 24.  
 LOUIS VUITTON MALLETTIER, 75001 PARIS, FRANCE:  
 2,898,423. PUB. 8-10-2004. INT. CL. 18.  
 LOUISVILLE PUBLIC WAREHOUSE COMPANY, LOUISVILLE, KY:  
 2,898,482. PUB. 4-9-2002. INT. CL. 42.  
 LOVER'S LANE, WESTLAND, MI:  
 2,900,423. INT. CL. 35.  
 LOWE'S FOOD STORES, INC., HICKORY, NC:  
 1,266,003. REN. 9-21-04. INT. CL. 42.  
 LOWRANCE ELECTRONICS, INC., TULSA, OK:  
 1,864,602. REN. 9-24-04. INT. CL. 9.  
 LRF SLATER COMPANIES, INC., LIVINGSTON, NJ, GRACE RETAIL CORPORATION, LOS ANGELES, CA:  
 1,289,413. REN. 9-22-04. INT. CL. 42.  
 LSP SPECIALTY PRODUCTS COMPANY, IRVING, TX, VADEL, INCORPORATED, STANTON, CA:  
 978,000. REN. 9-20-04. U.S. CL. 13 (INT. CL. 6).  
 LU, ZHENG, STONY BROOK, NY:  
 2,899,214. PUB. 8-10-2004. INT. CL. 5.  
 LUCENT TECHNOLOGIES INC., MURRAY HILL, NJ:  
 2,122,322. CANC. INT. CL. 9.  
 LUCTA USA, INC., NORTHBROOK, IL, FLAVOR CORPORATION OF AMERICA, NORTHBROOK, IL:  
 991,128. REN. 9-20-04. INT. CL. 30.  
 LUIGINO'S, INC., DULUTH, MN:  
 2,900,853. INT. CL. 29.  
 LUIS MARTINEZ CIGAR COMPANY, TAMPA, FL:  
 408,755. REN. 9-18-04. U.S. CL. 17 (INT. CL. 34).  
 LUISSIER S.A., 78220 VIROFLAY, FRANCE:  
 2,121,253. CANC. INT. CL. 29.  
 LUMENIS LTD., YOKNEAM, ISRAEL, ESC(D), INC., NEWTON, MA:  
 1,873,227. REN. 9-19-04. INT. CL. 10.  
 LUMINOUS SOFTWARE, LLC, SIOUX FALLS, SD:  
 2,899,813. PUB. 8-10-2004. INT. CL. 42.  
 LUNA MANAGEMENT LLC, LOS ANGELES, CA:  
 1,868,097. REN. 9-18-04. INT. CL. 9.  
 LUPINACCI, GRETCHEN K., COS COB, CT:  
 2,122,155. CANC. INT. CL. 30.  
 LURGI AKTIENGESELLSCHAFT, 60295 FRANKFURT, FED REP GERMANY:  
 2,121,161. CANC. MULTIPLE CLASS, INT. CLS. 37 AND 42.  
 LUX & ZWINGENBERGER LTD., TORONTO, ONTARIO M3B 3P9, CANADA:  
 2,120,998. CANC. INT. CL. 9.  
 LYGHT ENTERPRISES, MARIETTA, GA:  
 2,121,935. CANC. INT. CL. 16.  
 LYON ADVERTISING, INC., AUSTIN, TX:  
 2,900,046. INT. CL. 25.  
 M + W ZANDER FACILITY MANAGEMENT GMBH, 90408 NURNBERG, FED REP GERMANY:  
 2,900,045. MULTIPLE CLASS, INT. CLS. 6 AND 7.  
 M & M LIVESTOCK PRODUCTS CO., INC., EAGLE GROVE, IA, AKA M & M LIVESTOCK PRODUCTS COMPANY AND AKA M & M LIVESTOCK PRODUCTS CO.:  
 2,121,112. CANC. INT. CL. 1.  
 M D SCIENCE LAB, LLC, FORT LAUDERDALE, FL:  
 2,899,405. PUB. 8-10-2004. INT. CL. 5.  
 M. C. JOHNSON CO., INC., LEOMINSTER, MA:  
 1,260,769. CANC. INT. CL. 5.  
 M. FABRIKANT & SONS, INC., NEW YORK, NY:  
 2,898,704. PUB. 10-21-2003. INT. CL. 14.  
 M. KAMENSTEIN CORP., ELMSFORD, NY:  
 1,848,211. REN. 9-23-04. INT. CL. 21.  
 M. L. BURRIS CORPORATION, HUNTINGTON BEACH, CA:  
 2,899,731. PUB. 8-10-2004. INT. CL. 41.  
 M. S. WALKER, INC., SOMERVILLE, MA, DBA ALLEN'S LTD.:  
 1,856,911. REN. 9-22-04. INT. CL. 33.  
 M.Q.P. CANADA INC., TORONTO, ONTARIO, M3J 3C7, CANADA:  
 2,754,582. COR. INT. CL. 9.  
 M.Z. BERGER & CO., INC., LONG ISLAND CITY, NY:  
 2,120,671. CANC. INT. CL. 14.  
 M-I DRILLING FLUIDS L.L.C., HOUSTON, TX:  
 2,122,293. CANC. INT. CL. 9.  
 MAAX INC., SAINTE-MARIE, PROVINCE DE QUEBEC, CANADA:  
 2,898,457. PUB. 12-31-2002. INT. CL. 11.  
 MABIS HEALTHCARE, INC., LAKE FOREST, IL:  
 2,900,499. INT. CL. 10.  
 MACERICH CARMEL LIMITED PARTNERSHIP, SANTA MONICA, CA:  
 2,898,472. PUB. 7-15-2003. MULTIPLE CLASS, INT. CLS. 35 AND 36.  
 MACERICH LAKEWOOD, LLC, SANTA MONICA, CA:  
 2,898,473. PUB. 7-15-2003. MULTIPLE CLASS, INT. CLS. 35 AND 36.  
 MACGREGOR GOLF COMPANY, ALBANY, GA:  
 2,120,727. CANC. INT. CL. 28.  
 MACINTYRE, GRETTA, AVELLA, PA:  
 2,899,789. PUB. 8-10-2004. INT. CL. 37.  
 MACK TRUCKS, INC., ALLENTOWN, PA:  
 2,899,652. PUB. 8-10-2004. INT. CL. 16.  
 MACONOMY A/S, 2100 KOBENHAVN O, DENMARK:  
 2,898,565. PUB. 8-10-2004. MULTIPLE CLASS, INT. CLS. 9, 16, 35, 38, 41 AND 42.  
 MACROVISION CORPORATION, MOUNTAIN VIEW, CA:  
 1,811,427. CANC. INT. CL. 9.  
 MAD MEALS, LLC, BEDFORD, NY:  
 2,898,605. PUB. 12-23-2003. INT. CL. 29.  
 MADEIRA USA LTD., LACONIA, NH:  
 2,899,443. PUB. 8-10-2004. INT. CL. 23.  
 MADISON ABSTRACT, INC., SCARSDALE, NY:  
 2,899,680. PUB. 8-10-2004. INT. CL. 36.  
 MADORA, INC., NEW YORK, NY, DBA GEORGE MICHAEL OF MADISON AVENUE:  
 1,896,647. REN. 9-18-04. INT. CL. 42.  
 MAGARRO, JOHN JR., ORANGE, CA, DBA CND SPORTS:  
 2,121,743. CANC. INT. CL. 25.  
 MAGIC FOCUS, INC., AUGUSTA, KS:  
 991,716. REN. 9-22-04. INT. CL. 20.  
 MAGIC FOCUS, INC., THE, AUGUSTA, KS:  
 990,548. REN. 9-18-04. INT. CL. 20.  
 MAGIC GREEN CORPORATION, SILEX, MO:  
 2,900,190. INT. CL. 1.  
 MAGIC ME, INC., BALTIMORE, MD:  
 1,261,000. CANC. MULTIPLE CLASS, INT. CLS. 25, 26 AND 41.

MAGICODE, INC., LAWRENCEVILLE, GA:  
2,121,290, CANC. INT. CL. 9.

MAGLA PRODUCTS, L.L.C., MORRISTOWN, NJ:  
1,015,527. REN. 9-24-04. U.S. CL. 29 (INT. CL. 21).

MAGNETI MARELLI S.P.A., ITALY:  
2,839,365, COR. INT. CL. 1.

MAIERS, MARK, COLORADO SPRINGS, CO:  
2,900,871, INT. CL. 28.

MAIN EVENT MANAGEMENT CORPORATION, HOUSTON, TX:  
2,900,007, PUB. 8-10-2004. INT. CL. 16.

MAINSTAY ENTERPRISES, INC., ANNAPOLIS, MD:  
2,900,091, INT. CL. 42.

MAISON BLANCHE, INC., BATON ROUGE, LA:  
2,120,660, CANC. INT. CL. 25.

MAJESTIC PROPERTIES, INC., MIAMI BEACH, FL:  
2,899,098, PUB. 8-10-2004. MULTIPLE CLASS, INT. CLS. 16 AND 35.

MAJORITY OF ONE FOUNDATION, REYNOLDSBURG, OH:  
2,899,804, PUB. 8-10-2004. INT. CL. 41.

MALE, ALISTAIR W, WANGARATTA, AUSTRALIA:  
2,899,655, PUB. 8-10-2004. MULTIPLE CLASS, INT. CLS. 9, 16 AND 42.

MALIA INTERNATIONAL, LTD., HONOLULU, HI:  
761,666, CANC. U.S. CL. 39.

MALL OF AMERICA COMPANY, INDIANAPOLIS, IN,  
MALL OF AMERICA COMPANY, INDIANAPOLIS, IN:  
1,868,014. REN. 9-22-04. MULTIPLE CLASS, INT. CLS. 8, 14, 16, 18, 21, 25, 28 AND 36.

MALL OF AMERICA COMPANY, INDIANAPOLIS, IN TO  
MALL OF AMERICA COMPANY, INDIANAPOLIS, IN:  
1,868,014, CANC. MULTIPLE CLASS, INT. CLS. 37 AND 42.

MALLINCKRODT MEDICAL, INC., ST. LOUIS, MO:  
2,120,920, CANC. INT. CL. 41.

MALLINCKRODT, INC., ST. LOUIS, MO:  
761,533, CANC. U.S. CL. 6.

MALLO, THOMAS P., MESA, AZ:  
2,900,159, MULTIPLE CLASS, INT. CLS. 35 AND 39.

MALT-O-MEAL COMPANY, MINNEAPOLIS, MN:  
2,121,769, CANC. INT. CL. 30.

MAMA SITA'S HOLDING CO., INC., METRO MANILA, PHILIPPINES:  
2,900,216, MULTIPLE CLASS, INT. CLS. 29, 30 AND 32.

MANAGEMENT, INC., SALT LAKE CITY, UT:  
1,870,910. REN. 9-19-04. INT. CL. 41.  
1,871,643. REN. 9-19-04. MULTIPLE CLASS, INT. CLS. 41 AND 42.

MANAGEMENT SCIENCE LIMITED, RADLETT, HERTFORDSHIRE, UNITED KINGDOM:  
2,898,560, PUB. 5-11-2004. INT. CL. 9.

MANITOWOC FOODSERVICE COMPANIES, INC., SPARKS, NV:  
1,292,069. REN. 9-18-04. INT. CL. 11.

MANITOWOC FOODSERVICE COMPANIES, INC., SPARKS, NV, MULTIPLEX COMPANY, INCORPORATED, ST. LOUIS, MO:  
1,857,605. REN. 9-23-04. INT. CL. 11.

MANNATECH, INC., COPPELL, TX:  
2,900,868, INT. CL. 5.

MANNESMANN VDO AG, 60388 FRANKFURT, FED REP GERMANY:  
2,898,449, PUB. 9-2-2003. MULTIPLE CLASS, INT. CLS. 9, 35, 37, 38, 39, 41 AND 42.

MANNING, DIANE, HEALDSBURG, CA AND MANNING, THOMAS, HEALDSBURG, CA, DBA CHATEAU DIANA:  
2,122,058, CANC. MULTIPLE CLASS, INT. CLS. 32 AND 33.

MANNING, KENNETH D., JESUP, GA:  
2,900,683, INT. CL. 9.

MANNINGTON MILLS, INC., SALEM, NJ:  
2,898,770, PUB. 8-10-2004. INT. CL. 27.

MANUFACTURAS FONOS, S.L., 46469 BENIPARRELL (VALENCIA), SPAIN:  
2,121,077, CANC. MULTIPLE CLASS, INT. CLS. 7 AND 12.

MANUFACTURING INTEGRATION TECHNOLOGY LTD, #03-12, TECHPLACE II, SINGAPORE:  
2,898,640, PUB. 8-10-2004. INT. CL. 7.

MAPS AIR MUSEUM, NORTH CANTON, OH:  
2,900,244, INT. CL. 41.

MAR-KEY FOODS, INC., VIDALIA, GA, REDFERN FOODS CORPORATION, ATLANTA, GA:  
994,043. REN. 9-19-04. U.S. CL. 46 (INT. CL. 30).

MARBLE SLAB CREAMERY, INC., HOUSTON, TX:  
2,900,188, INT. CL. 41.

MARCH FOR LIFE, WASHINGTON, DC:  
1,824,709. REN. 9-22-04. INT. CL. 42.

MARCO POLO EXPLORERS, INC., CINCINNATI, OH:  
2,899,657, PUB. 8-10-2004. INT. CL. 25.

MARCONI COMMUNICATIONS, INC., CLEVELAND, OH:  
774,878. REN. 9-24-04. U.S. CL. 21 (INT. CL. 9).

MAREK, PAUL, D-93051 REGENSBURG, FED REP GERMANY:  
2,852,361, COR. MULTIPLE CLASS, INT. CLS. 18, 25 AND 28.

MARIAMA, MARGUERITE, CHICAGO, IL:  
2,898,659, PUB. 8-10-2004. INT. CL. 41.

MARIENBAD WATERS, A.S., 353 01 MARIÁNSKÉ LÁZNE, CZECH REPUBLIC:  
2,899,756, PUB. 8-10-2004. INT. CL. 32.

MARIN MOUNTAIN BIKES, INC., NOVATO, CA:  
2,900,775, INT. CL. 12.  
2,900,776, INT. CL. 12.  
2,900,778, INT. CL. 12.

MARITIME INTELLIGENCE GROUP, INC., WASHINGTON, DC:  
2,900,901, MULTIPLE CLASS, INT. CLS. 41 AND 45.

MARK OF THE UNICORN, INC., CAMBRIDGE, MA:  
2,898,710, PUB. 8-10-2004. INT. CL. 9.

MARK VII EQUIPMENT LLC, ARVADA, CO:  
2,900,317, INT. CL. 7.

MARK'S MACHINE COMPANY, INC., EL CAMPO, TX:  
2,899,712, PUB. 8-10-2004. INT. CL. 7.

MARKER INTERNATIONAL GMBH, 6340 BAAR, ZUG, SWITZERLAND, MARKER INTERNATIONAL COMPANY, SALT LAKE CITY, UT:  
1,850,699. REN. 9-24-04. MULTIPLE CLASS, INT. CLS. 18, 25 AND 28.

MARKETGRADER.COM CORP., MIAMI, FL:  
2,900,105, INT. CL. 36.

MARKETING BY DESIGN, INC., PLANO, TX:  
2,122,453, CANC. INT. CL. 25.

MARKETING INNOVATORS INTERNATIONAL, INC., ROSEMONT, IL:  
1,868,789. REN. 9-24-04. MULTIPLE CLASS, INT. CLS. 35, 39 AND 42.

MARKETLINK, INC., THOMASVILLE, GA:  
1,849,867. REN. 9-20-04. MULTIPLE CLASS, INT. CLS. 16 AND 35.

MARKETWATCH.COM, INC., SAN FRANCISCO, CA:  
2,899,317, PUB. 11-11-2003. INT. CL. 41.

MARKS, NEAL, TRENTON, GA:  
2,899,774, PUB. 8-10-2004. INT. CL. 25.

MARKS, WOLFGANG, MERCHWEILER SAARLAND, FED REP GERMANY:  
2,898,981, PUB. 2-3-2004. INT. CL. 5.

MARS INSTITUTE, PLEASANTON, CA:  
2,900,902, MULTIPLE CLASS, INT. CLS. 41 AND 42.

MARS, INCORPORATED, MCLEAN, VA:  
1,904,563. REN. 9-24-04. INT. CL. 31.  
2,898,462, PUB. 10-24-2000. INT. CL. 28.

MARSHALL OUTDOOR PRODUCTS, LLC, BATON ROUGE, LA:  
2,898,840, PUB. 8-10-2004. INT. CL. 11.

MARSHALL-BROWNING INTERNATIONAL CORPORATION, OXFORD, CT:  
1,860,861. REN. 9-23-04. INT. CL. 14.

MARSHALLS OF NEVADA, INC., NORTH LAS VEGAS, NV:  
2,899,487, PUB. 8-10-2004. INT. CL. 35.  
2,899,488, PUB. 8-10-2004. INT. CL. 35.

MARSHFIELD CLINIC, MARSHFIELD, WI:  
2,181,888, CANC. INT. CL. 41.

- MARTHA STEWART LIVING OMNIMEDIA, INC., NEW YORK, NY FROM MSO IP HOLDINGS, INC., LOS ANGELES, CA:  
2,900,200, INT. CL. 20.
- MARTIN, ROBERT, SUFFOLK, VA:  
2,899,754, PUB. 8-10-2004. INT. CL. 11.
- MARTINS, PRINCE DEREMI, IRVING, TX:  
2,121,903, CANC. INT. CL. 25.
- MARTZ, GREGORY, SANTA ANA, CA:  
2,898,442, PUB. 6-13-2000. INT. CL. 25.
- MARVEL CHARACTERS, INC., LOS ANGELES, CA, CADENCE INDUSTRIES CORPORATION, NEW YORK, NY, DBA MARVEL COMICS GROUP:  
1,272,677, REN. 9-22-04. INT. CL. 16.
- MARVEL CHARACTERS, INC., CALABASAS, CA:  
2,121,022, CANC. INT. CL. 42.
- MARVEL ENTERTAINMENT GROUP, INC., NEW YORK, NY:  
2,122,034, CANC. INT. CL. 16.
- MARY MCSHEA BLAR AND RONNI KORN MILLER PARTNERSHIP, THE, LONG BEACH, NY:  
2,900,446, INT. CL. 42.
- MASCO CORPORATION OF INDIANA, INDIANAPOLIS, IN:  
2,900,685, MULTIPLE CLASS, INT. CLS. 9 AND 11.  
2,900,686, MULTIPLE CLASS, INT. CLS. 9 AND 11.
- MASI DESIGN INC., MISSISSAUGA, ONTARIO L5M 1X4, CANADA:  
2,121,593, CANC. INT. CL. 26.
- MASSACHUSETTS DENTAL SOCIETY, SOUTHBOROUGH, MA:  
2,900,816, INT. CL. 35.
- MASSACHUSETTS HIGHER EDUCATION ASSISTANCE CORPORATION, BOSTON, MA, AMERICAN STUDENT ASSISTANCE CORPORATION, BOSTON, MA:  
1,849,690, REN. 9-18-04. MULTIPLE CLASS, INT. CLS. 16, 36 AND 42.
- MASSAGERS DIRECT, INC., LAYTON, UT:  
2,898,888, PUB. 8-10-2004. INT. CL. 10.
- MASSIMO GUARDUCCI S.R.L., PRATO, ITALY:  
2,899,389, PUB. 8-10-2004. INT. CL. 3.
- MASTER APPLIANCE CORP., RACINE, WI:  
2,899,496, PUB. 11-25-2003. INT. CL. 4.
- MASTERCARD INTERNATIONAL INCORPORATED, PURCHASE, NY:  
1,285,549, REN. 9-21-04. INT. CL. 36.
- MATERIALS ANALYTICAL SERVICES, INC., NORCROSS, GA:  
1,793,193, CANC. INT. CL. 9.
- MATHYS; MARTIN, ZELEM, BELGIUM:  
1,260,719, CANC. MULTIPLE CLASS, INT. CLS. 2 AND 17.
- MATTEL, INC., EL SEGUNDO, CA:  
2,121,857, CANC. INT. CL. 28.  
2,122,087, CANC. INT. CL. 28.  
2,122,291, CANC. INT. CL. 28.  
2,122,308, CANC. INT. CL. 28.  
2,122,459, CANC. INT. CL. 28.  
2,122,492, CANC. INT. CL. 28.  
2,865,672, COR. INT. CL. 28.  
2,900,544, INT. CL. 28.  
2,900,781, INT. CL. 28.
- MATTOX, JEFFREY, MADISON, WI:  
2,121,932, CANC. INT. CL. 9.
- MAVETY MEDIA GROUP LTD., NEW YORK, NY:  
2,900,051, INT. CL. 16.
- MAX BAERMANN GMBH, BERGISCH GLADBACH, FED REP GERMANY:  
2,899,416, PUB. 8-10-2004. MULTIPLE CLASS, INT. CLS. 7, 9 AND 12.
- MAX ROHR, INC., WILMINGTON, DE, AMERICAN BRANDS, INC., NEW YORK, NY:  
996,895, REN. 9-19-04. INT. CL. 34.
- MAX-VIZ, INC., PORTLAND, OR:  
2,900,797, INT. CL. 9.  
2,900,798, INT. CL. 37.
- MAXCELL BIOSCIENCE, INC., BROOMFIELD, CO, DBA OASIS WELLNESS NETWORK:  
2,899,444, PUB. 9-30-2003. INT. CL. 5.
- MAXWELL ALARM SCREEN MANUFACTURING COMPANY, CHATSWORTH, CA:  
1,824,651, REN. 9-18-04. INT. CL. 40.
- MAY, JASON, LOS ANGELES, CA AND MAY, ROSEMARY, LOS ANGELES, CA:  
2,899,830, PUB. 8-10-2004. INT. CL. 29.
- MAYER LABORATORIES, INC., OAKLAND, CA:  
2,900,953, INT. CL. 10.
- MBM SAILS, INC., OYSTER BAY, NY:  
2,121,874, CANC. INT. CL. 22.
- MBNA AMERICA BANK, NATIONAL ASSOCIATION, WILMINGTON, DE:  
2,898,983, PUB. 8-10-2004. INT. CL. 36.
- MCAVOY, ROBERT, W., SALEM, NH:  
2,900,808, INT. CL. 36.
- MCCANN'S ENGINEERING & MFG. CO., LOS ANGELES, CA:  
2,898,810, PUB. 8-10-2004. INT. CL. 11.
- MCCARRELL, TIMOTHY HUNTER, BIRMINGHAM, AL, DBA HUNTER SYSTEMS:  
2,121,128, CANC. INT. CL. 9.
- MCCORMICK DISTILLING CO., INC., WESTON, MO:  
1,291,453, REN. 9-21-04. INT. CL. 33.
- MCCORMICK SYSTEMS INC., MESA, AZ:  
2,122,248, CANC. INT. CL. 9.
- MCCULLAGH LEASING, INC., ROSEVILLE, MI:  
1,261,186, CANC. INT. CL. 39.
- MCDONALD HOPKINS CO., LPA, CLEVELAND, OH:  
1,846,700, REN. 9-20-04. INT. CL. 16.
- MCDONALD'S CORPORATION, OAK BROOK, IL:  
1,810,851, CANC. INT. CL. 25.  
2,122,351, CANC. INT. CL. 30.  
2,122,372, CANC. INT. CL. 42.  
2,122,373, CANC. INT. CL. 30.
- MCI COMMUNICATIONS CORPORATION, WASHINGTON, DC:  
1,260,849, CANC. INT. CL. 9.
- MCKAY, GORDON, HUNTINGTON BEACH, CA:  
2,900,856, INT. CL. 16.
- MCLACHLEN NATIONAL BANK, WASHINGTON, DC:  
1,261,135, CANC. INT. CL. 36.
- MCNC, RESEARCH TRIANGLE PARK, NC:  
2,120,935, CANC. MULTIPLE CLASS, INT. CLS. 38 AND 42.
- MCP FOODS, INC., ANAHEIM, CA, BORDEN COMPANY, THE, NEW YORK, NY:  
589,466, REN. 9-22-04. U.S. CL. 46 (INT. CL. 29).
- MCROBERT; NORMA J., GRESHAM, OR, DBA RX RADIO NEWS NETWORK:  
1,261,118, CANC. MULTIPLE CLASS, INT. CLS. 35 AND 41.
- MD HELICOPTERS INC., MESA, AZ:  
2,004,596, CANC. INT. CL. 12.
- ME & MY BIG IDEAS, INC., LAKE FOREST, CA:  
2,900,820, INT. CL. 26.
- MEADOWBROOK LANE, INC., SPRINGFIELD, MA, DBA AL'S BEVERAGE COMPANY:  
1,811,003, CANC. INT. CL. 32.
- MEAGAN MEDICAL, INC., RENO, NV FROM VERTIS NEUROSCIENCE, INC., SEATTLE, WA:  
2,900,129, INT. CL. 41.
- MEAN TECH XCELLENT PRODUCTS PRIVATE LTD., SINGAPORE, SINGAPORE:  
2,900,174, MULTIPLE CLASS, INT. CLS. 11, 20 AND 21.
- MEASURED MARKETING SERVICES, INC., CRANSTON, RI:  
1,260,967, CANC. INT. CL. 21.
- MECHANICAL TOOL & ENGINEERING CO., ROCKFORD, IL:  
1,299,292, REN. 9-22-04. INT. CL. 7.
- MECO INTERNATIONAL LIMITED, GLOUCESTERSHIRE, GL20 8JR, UNITED KINGDOM:  
2,121,924, CANC. INT. CL. 7.
- MED-PASS, INCORPORATED, MIAMISBURG, OH:  
2,898,960, PUB. 8-10-2004. INT. CL. 35.

MEDASSIST-OP, INC., TAMPA, FL:  
2,899,769, PUB. 8-10-2004. INT. CL. 44.

MEDCAST INC., EL PASO, TX:  
2,898,885, PUB. 8-10-2004. MULTIPLE CLASS, INT. CLS. 35 AND 44.  
2,898,886, PUB. 8-10-2004. MULTIPLE CLASS, INT. CLS. 35 AND 44.

MEDCOM, INC., CYPRESS, CA:  
2,899,780, PUB. 8-10-2004. MULTIPLE CLASS, INT. CLS. 41 AND 42.

MEDCOR, INC., MCHENRY, IL:  
2,899,993, PUB. 8-10-2004. MULTIPLE CLASS, INT. CLS. 9, 35 AND 44.

MEDERER GMBH, D-90763 FURTH, FED REP GERMANY:  
2,898,954, PUB. 8-10-2004. INT. CL. 30.  
2,898,955, PUB. 8-10-2004. INT. CL. 30.

MEDIA CHOICE, LLC, SPRINGDALE, OH:  
2,900,513, INT. CL. 41.

MEDIA GENERAL COMMUNICATIONS, INC., RICHMOND, VA:  
2,899,618, PUB. 8-10-2004. INT. CL. 16.

MEDIA IMAGE, INC., REDMOND, WA:  
2,899,560, PUB. 8-10-2004. INT. CL. 42.

MEDIA RECOVERY INC., DENVER, CO, DBA THE DAMAGE PREVENTION COMPANY:  
2,899,500, PUB. 8-10-2004. INT. CL. 16.

MEDIA WEST - GSI, INC., RENO, NV:  
2,900,307, INT. CL. 16.

MEDICAL ADVISORS, INC., BLUE BELL, PA:  
1,901,383, REN. 9-24-04. INT. CL. 42.

MEDICAL ELECTRONIC DEALERS ASSOCIATION, INC., YORBA LINDA, CA:  
1,811,494, CANC. INT. CL. 10.

MEDICOM INTERNATIONAL, INCORPORATED, BRONXVILLE, NY:  
1,811,718, CANC. INT. CL. 16.

MEDIFIX, INC., MORTON GROVE, IL:  
2,121,507, CANC. INT. CL. 37.

MEDIGENE AG, D-82152 PLANEGG/MARTINSRIED, FED REP GERMANY:  
2,898,740, PUB. 8-10-2004. INT. CL. 5.

MEDIGUIDE.COM, INC., NEW YORK, NY:  
2,898,499, PUB. 8-10-2004. INT. CL. 42.

MEDLOGIC GLOBAL LIMITED, WINSFORD, CHESHIRE CW7 3PD, ENGLAND, MEDLOGIC GLOBAL CORPORATION, COLORADO SPRINGS, CO:  
1,852,850, REN. 9-21-04. INT. CL. 5.

MEDSAFE TECHNOLOGIES L.L.C., ATLANTA, GA:  
2,900,039, INT. CL. 10.

MEDTRONIC, INC., MINNEAPOLIS, MN:  
2,900,650, INT. CL. 9.

MEHTA, JIMIT H., CARLSBAD, CA:  
2,900,401, INT. CL. 35.  
2,900,402, INT. CL. 35.

MEIJER, INC., GRAND RAPIDS, MI:  
1,319,510, REN. 9-21-04. INT. CL. 25.  
1,810,910, CANC. INT. CL. 28.

MEINAN MACHINERY WORKS, INC., OHBU-SHI, AICHIKEN, JAPAN:  
1,301,249, REN. 9-22-04. INT. CL. 7.

MELLOW MANOR PRODUCTIONS, INC., LA JOLLA, CA:  
2,899,130, PUB. 8-10-2004. MULTIPLE CLASS, INT. CLS. 9 AND 41.

MENDOCINO BEVERAGE CORPORATION, MENDOCINO, CA:  
2,900,773, INT. CL. 30.

MENTOR ENGINEERING INC., CALGARY, AB, CANADA:  
2,900,146, INT. CL. 9.

MENTOR GRAPHICS CORPORATION, WILSONVILLE, OR:  
1,811,485, CANC. INT. CL. 9.

MERCADO GAS SERVICES, INC., AUSTIN, TX:  
1,821,731, REN. 9-19-04. MULTIPLE CLASS, INT. CLS. 39 AND 42.

MERCANTILE BANCORP, INC., QUINCY, IL:  
2,899,246, PUB. 8-10-2004. INT. CL. 36.

MERCER, ADRIENNE L., LANHAM, MD:  
2,121,059, CANC. INT. CL. 26.

MERCHANDISING INTERNATIONAL S.A., CH-1211 GENEVA 17, SWITZERLAND:  
2,120,709, CANC. MULTIPLE CLASS, INT. CLS. 35, 37, 40 AND 42.

MERCHANTS COMPANY, THE, HATTIESBURG, MS:  
2,899,270, PUB. 1-13-2004. MULTIPLE CLASS, INT. CLS. 30 AND 39.

MERCHANTS DISTRIBUTORS, INC., HICKORY, NC:  
1,289,236, REN. 9-21-04. MULTIPLE CLASS, INT. CLS. 29, 30 AND 42.

MERCK KGAA, DARMSTADT, FED REP GERMANY:  
1,286,951, REN. 9-20-04. INT. CL. 9.

MERCURY ARREDAMENTI S.P.A., 33070 CANEVA, ITALY:  
2,898,464, PUB. 8-10-2004. INT. CL. 20.

MERCY COLLEGE OF NORTHWEST OHIO, TOLEDO, OH:  
2,899,014, PUB. 8-10-2004. INT. CL. 41.

MERCY HEALTHCARE ARIZONA, PHOENIX, AZ:  
2,121,331, CANC. INT. CL. 42.

MEREDITH & SIMPSON CONSTRUCTION CO., INDIO, CA, PRESSURE COOL CO.:  
979,020, REN. 9-23-04. U.S. CL. 31 (INT. CL. 11).

MERIAL, 69007 LYON, FRANCE, RHONE MERIEUX, 69002 LYON, FRANCE:  
1,866,863, REN. 9-19-04. INT. CL. 10.

MERIDIAN BIOSCIENCE INC., CINCINNATI, OH:  
2,898,763, PUB. 8-10-2004. INT. CL. 5.

MERIDIAN FUND, INC., LARKSPUR, CA:  
1,856,967, REN. 9-22-04. INT. CL. 36.

MERIDIAN SERVICES, INC., YOUNGSTOWN, OH:  
1,848,748, REN. 9-21-04. INT. CL. 41.

MERIDIAN SYSTEMS CONSULTING, INC., ATLANTA, GA:  
2,898,618, PUB. 7-8-2003. INT. CL. 9.

MERILLAT INDUSTRIES, LLC, ADRIAN, MI:  
2,900,255, INT. CL. 20.

MERIT MEDICAL SYSTEMS INC, SOUTH JORDAN, UT:  
1,847,300, REN. 9-20-04. INT. CL. 10.

MERRELL PHARMACEUTICALS INC., GREENVILLE, DE, MERRELL DOW PHARMACEUTICALS INC., CINCINNATI, OH:  
1,866,178, REN. 9-20-04. INT. CL. 5.

MERRIMACK VALLEY WOOD PRODUCTS, INC., DERRY, NH:  
2,898,931, PUB. 8-10-2004. INT. CL. 19.

MESSAGEMEDIA, INC., BOULDER, CO:  
2,898,421, PUB. 8-10-2004. INT. CL. 9.

MESSE DUSSELDORF GMBH, 40474 DUSSELDORF, FED REP GERMANY, DUSSELDORFER MESSEGESELLSCHAFT MBH - NOWEA, D-4000 DUSSELDORF 30, FED REP GERMANY:  
1,849,561, REN. 9-23-04. INT. CL. 35.

MESSER GRIESHEIM G.M.B.H., SULZBACH, FED REP GERMANY:  
991,366, REN. 9-19-04. U.S. CL. 34 (INT. CLS. 1 AND 11).

MET ONE INSTRUMENTS, INC., GRANTS PASS, OR:  
1,267,801, REN. 9-23-04. INT. CL. 9.

METAGENICS, INC., SAN CLEMENTE, CA:  
2,900,411, INT. CL. 5.

METAL ART OF CALIFORNIA, INC., ORANGE, CA, DBA AMERICAN GAME CAPS:  
2,120,692, CANC. INT. CL. 28.  
2,120,693, CANC. INT. CL. 28.

METAMIND ENTERPRISES INCORPORATED, SAVANNAH, GA:  
2,899,527, PUB. 11-25-2003. INT. CL. 5.

METHODIST MEDICAL CENTER OF ILLINOIS, PEORIA, IL:  
2,898,547, PUB. 4-22-2003. INT. CL. 25.

METRA ELECTRONICS CORPORATION, HOLLY HILL, FL:  
1,873,202, REN. 9-18-04. INT. CL. 9.  
2,900,466, MULTIPLE CLASS, INT. CLS. 6 AND 9.  
2,900,512, MULTIPLE CLASS, INT. CLS. 6 AND 9.

METRIS DIRECT, INC., ST. LOUIS PARK, MN:  
2,900,089, INT. CL. 36.

METRO NETWORKS COMMUNICATIONS, INC., NEW YORK, NY, METRO TRAFFIC CONTROL, INC., HOUSTON, TX:  
1,820,174, REN. 9-20-04. INT. CL. 39.  
1,856,028, REN. 9-20-04. INT. CL. 41.

- METRO PARK WAREHOUSES, INC., KANSAS CITY, KS:  
1,337,208. REN. 9-21-04. INT. CL. 39.
- METRO/THEBE, INC., RANCHO DOMINGUEZ, CA:  
2,898,943. PUB. 8-10-2004. INT. CL. 21.
- METROPOLIS L.L.C., BROOKVILLE, NY:  
2,122,263. CANC. INT. CL. 25.
- METROPOLITAN CREDIT UNION, CHELSEA, MA:  
2,900,003. PUB. 8-10-2004. INT. CL. 36.
- METROPOLITAN LIFE INSURANCE COMPANY, NEW YORK, NY:  
2,900,854. MULTIPLE CLASS, INT. CLS. 41 AND 44.
- METSO CORPORATION, FABIANINKATU 9 A, 00130 HELSINKI, FINLAND:  
2,755,119. COR. MULTIPLE CLASS, INT. CLS. 7, 9 AND 37.
- METSO PAPER, INC., HELSINKI, FINLAND:  
774,952. REN. 9-21-04. U.S. CL. 23 (INT. CL. 7).
- METSO PAPER, INC., HELSINKI, FIN-06621, FINLAND:  
1,272,418. REN. 9-23-04. INT. CL. 7.
- METSO PAPER, INC., 06621, HELSINKI, FINLAND:  
1,281,282. REN. 9-23-04. INT. CL. 7.  
1,283,061. REN. 9-23-04. INT. CL. 7.
- METTLER-TOLEDO, INC., COLUMBUS, OH, TOLEDO SCALE CORPORATION, TOLEDO, OH:  
775,799. REN. 9-21-04. U.S. CL. 26 (INT. CL. 9).
- MEXICAN CHEESE PRODUCERS, INC., MONROE, WI:  
2,899,684. PUB. 2-17-2004. MULTIPLE CLASS, INT. CLS. 29 AND 30.
- MEYER COMPANY; THE, CLEVELAND, OH:  
1,334,177. REN. 9-18-04. MULTIPLE CLASS, INT. CLS. 11 AND 21.
- MFM INDUSTRIES, INC., REDDICK, FL:  
1,266,742. REN. 9-21-04. INT. CL. 1.
- MIA, SAMUDE, DUSTON, NORTHAMPTON, UNITED KINGDOM:  
2,900,323. INT. CL. 30.
- MICHAEL ANTHONY JEWELERS, INC., MOUNT VERNON, NY:  
2,900,689. INT. CL. 14.
- MICHAEL BEAUDRY, INC., BEVERLY HILLS, CA:  
2,121,115. CANC. INT. CL. 14.
- MICHAEL HENRY GAYTAN, D.D.S., ENCINO, CA:  
2,900,673. INT. CL. 9.
- MICHAEL JOSEPH, INC., TULSA, OK:  
2,121,245. CANC. INT. CL. 14.
- MICHELE M. HILLAND AND JEFFREY E. HILLAND PARTNERSHIP, THE, PASADENA, CA:  
2,121,809. CANC. INT. CL. 16.
- MICHELIN NORTH AMERICA, INC., GREENVILLE, SC:  
774,986. REN. 9-24-04. U.S. CL. 35 (INT. CL. 19).  
1,287,845. REN. 9-24-04. INT. CL. 12.
- MICRO MOTION, INC., BOULDER, CO:  
1,847,634. REN. 9-18-04. INT. CL. 9.
- MICROBIO RHIZOGEN CORPORATION, SASKATCHEWAN, CANADA:  
2,120,896. CANC. INT. CL. 1.
- MICRODYNE COMPANY, L.L.C., SAVANNAH, MO:  
2,900,450. INT. CL. 9.
- MICROMOUSE PLC, LONDON, UNITED KINGDOM:  
2,898,445. PUB. 3-20-2001. MULTIPLE CLASS, INT. CLS. 9, 37, 41 AND 42.
- MICRONET, INC., RYE, NY:  
2,122,180. CANC. INT. CL. 9.
- MICROPARTS GESELLSCHAFT FUR MIKROSTRUKTUR-TECHNIK MBH, D-76185 KARLSRUHE, FED REP GERMANY:  
2,120,673. CANC. MULTIPLE CLASS, INT. CLS. 7, 9, 10 AND 14.
- MICROSCAN SYSTEMS INCORPORATED, TUKWILA, WA:  
1,850,571. REN. 9-22-04. INT. CL. 9.
- MICROSEAL CORPORATION, CHICAGO, IL:  
761,652. CANC. U.S. CL. 37.
- MICROSIM CORPORATION, IRVINE, CA:  
2,122,389. CANC. INT. CL. 9.  
2,122,442. CANC. INT. CL. 9.
- MICROSOFT CORPORATION, REDMOND, WA:  
2,832,923. COR. INT. CL. 9.  
2,861,528. COR. INT. CL. 9.  
2,865,608. COR. INT. CL. 16.  
2,900,737. INT. CL. 41.
- MICROWRITER LIMITED, LONDON, ENGLAND:  
1,345,694. CANC. INT. CL. 9.
- MID-TOWN PETROLEUM INC., BRIDGEVIEW, IL:  
1,290,994. REN. 9-21-04. INT. CL. 16.
- MID-WEST PRESORT MAILING SERVICES, INC., CLEVELAND, OH:  
2,898,616. PUB. 8-10-2004. INT. CL. 35.
- MIDDLEBY MARSHALL INC., ELGIN, IL, PET INCORPORATED, ST. LOUIS, MO:  
1,337,554. REN. 9-20-04. MULTIPLE CLASS, INT. CLS. 7 AND 11.
- MIDLAND COMMUNICATIONS PACKAGING, INC., LOUISVILLE, KY:  
2,900,219. MULTIPLE CLASS, INT. CLS. 35, 39, 40 AND 42.
- MIDLAND FARMS, INC., COLONIE, NY:  
2,898,853. PUB. 8-10-2004. INT. CL. 29.
- MIDLANDS CHOICE, INC., OMAHA, NE, VHA MIDLANDS HOME HEALTH, INC., OMAHA, NE:  
1,865,936. REN. 9-24-04. INT. CL. 35.
- MIDTRONICS, INC., WILLOWBROOK, IL:  
2,900,194. INT. CL. 9.
- MIDWEST AIR TECHNOLOGIES, INC., LINCOLNSHIRE, IL:  
778,681. REN. 9-23-04. U.S. CL. 13 (INT. CL. 6).
- MIDWEST INDUSTRIAL SUPPLY, INC., CANTON, OH:  
1,863,418. REN. 9-22-04. INT. CL. 1.
- MIDWEST SEALANT SUPPLY, LEWIS CENTER, OH:  
2,900,597. INT. CL. 35.
- MIG HOLDINGS INC, MISSISSAUGA, ONTARIO L4Z 2G5, CANADA:  
2,121,402. CANC. INT. CL. 1.
- MIGEROBE, INC., RIDGELAND, MS:  
2,121,705. CANC. INT. CL. 14.
- MIGHTY MEN OF GOD, INC, ORLANDO, FL:  
2,899,732. PUB. 8-10-2004. INT. CL. 41.
- MIIA INDUSTRIES, INC., ROCKLAND, MA:  
2,900,012. PUB. 8-10-2004. INT. CL. 9.
- MIKE UTLEY FOUNDATION, ORLANDO, WA:  
1,845,680. REN. 9-20-04. INT. CL. 25.
- MIKOHN GAMING CORPORATION, LAS VEGAS, NV:  
2,900,326. INT. CL. 9.
- MIKRON PRECISION, INC., REDONDO BEACH, CA:  
1,297,445. REN. 9-22-04. INT. CL. 10.
- MILBON CO., LTD., OSAKA, JAPAN:  
2,899,583. PUB. 8-10-2004. INT. CL. 3.
- MILLENNIUM CELL, INC., NEW JERSEY, NJ:  
2,900,094. INT. CL. 7.
- MILLENNIUM MARKETPLACE, INC., NEW YORK, NY:  
2,121,877. CANC. INT. CL. 25.
- MILLER FREEMAN, INC., SAN FRANCISCO, CA:  
2,122,518. CANC. MULTIPLE CLASS, INT. CLS. 41 AND 42.
- MILLER PRODUCTS COMPANY, MILWAUKEE, WI:  
2,899,939. PUB. 8-10-2004. INT. CL. 32.
- MILLER, JOHN L., CUSTER, WI:  
2,900,271. INT. CL. 35.
- MILLER, PAUL, HARTVILLE, OH:  
2,900,794. INT. CL. 37.
- MILLFELD TRADING CO., INC., SYOSSET, NY:  
1,261,008. CANC. INT. CL. 25.
- MILLIKEN & COMPANY, NEW YORK, NY:  
997,207. REN. 9-22-04. INT. CL. 2.
- MILLIKEN & COMPANY, NEW YORK, NY, DEERING MILLIKEN, INC., NEW YORK, NY:  
1,001,931. REN. 9-21-04. INT. CL. 2.
- MILLIMAN & ROBERTSON, INC., DALLAS, TX:  
2,898,470. PUB. 7-15-2003. INT. CL. 36.
- MILLS DISTRIBUTING COMPANY, SALINAS, CA:  
2,900,004. PUB. 8-10-2004. INT. CL. 31.
- MILLS LIMITED PARTNERSHIP, THE, ARLINGTON, VA, MILLS CORPORATION, THE, WASHINGTON, DC:  
1,868,590. REN. 9-23-04. INT. CL. 36.



MILSO INDUSTRIES, INC., BROOKLYN, NY:  
2,899,125, PUB. 8-10-2004. MULTIPLE CLASS, INT. CLS.  
9, 16, 35, 36, 37, 41, 42 AND 45.

MIND WURX, L.L.C., YORBA LINDA, CA:  
2,898,722, PUB. 8-10-2004. INT. CL. 12.

MINING SUPPLIES AUSTRALIA PTY LTD., EDWARDS-  
TOWN., AUSTRALIA, TRELOAR, HOWARD ARCHI-  
BALD, LYNTON, STATE OF SOUTH AUSTRALIA,  
AUSTRALIA:  
1,848,064, REN. 9-21-04. INT. CL. 6.

MINISTERIO INTERNACIONAL EL REY JESUS, INC.,  
MIAMI, FL:  
2,900,337, INT. CL. 41.  
2,900,338, INT. CL. 9.  
2,900,339, INT. CL. 41.

MINKA LIGHTING, INC., CORONA, CA:  
2,900,357, INT. CL. 11.  
2,900,358, INT. CL. 11.

MINNESOTA MINING AND MANUFACTURING COM-  
PANY, ST. PAUL, MN:  
1,260,829, CANC. INT. CL. 9.  
1,260,856, CANC. INT. CL. 10.

MINNESOTA MONTHLY PUBLICATIONS INC, MINNEA-  
POLIS, MN:  
2,899,772, PUB. 8-10-2004. INT. CL. 35.

MINORITY AVIATION EDUCATION ASSOCIATION, INC.,  
WHEELING, WV:  
2,898,805, PUB. 8-10-2004. INT. CL. 41.

MINOVA INTERNATIONAL LIMITED, WITNEY OXFORD-  
SHIRE, UNITED KINGDOM FROM FOSROC INTERNA-  
TIONAL LIMITED, SWINDON, UNITED KINGDOM:  
2,900,610, MULTIPLE CLASS, INT. CLS. 1 AND 6.

MINX PRODUCTS, INC., SO. EL MONTE, CA:  
2,899,261, PUB. 8-10-2004. INT. CL. 24.

MIRACLE MAX, INC., NEW YORK, NY:  
2,120,827, CANC. INT. CL. 25.

MIRANDA, QUIRINO, DALLAS, TX:  
2,122,112, CANC. INT. CL. 3.

MISSION PHARMACAL CO., SAN ANTONIO, TX:  
781,662, REN. 9-19-04. U.S. CL. 18 (INT. CL. 5).

MISSION PHARMACAL COMPANY, SAN ANTONIO, TX:  
995,562, REN. 9-22-04. INT. CL. 5.  
1,300,132, REN. 9-19-04. INT. CL. 5.

MISTER TWISTER PRETZELS, INC., NAPLES, FL:  
1,849,994, REN. 9-19-04. INT. CL. 30.

MISTOLIN DOMINICANA, C. POR A. SANTO DOMINGO,  
DOMINICAN REP, PRODUCTOS MISTOLIN S.A., CAR-  
ACAS, VENEZUELA:  
1,301,125, REN. 9-22-04. INT. CL. 3.

mitsubishi chemical corporation, CHIYODA-KU,  
TOKYO, JAPAN, MITSUBISHI CHEMICAL INDUSTRIES  
LIMITED, CHIYODA-KU, TOKYO, JAPAN:  
1,264,589, REN. 9-20-04. INT. CL. 1.

MITSUBISHI ELECTRIC CORPORATION, TOKYO, JAPAN:  
2,899,436, PUB. 8-10-2004. INT. CL. 37.  
2,899,704, PUB. 8-10-2004. INT. CL. 9.

MITSUBISHI GAS CHEMICAL COMPANY, INC., CHIYO-  
DA-KU, TOKYO, JAPAN:  
1,820,898, REN. 9-24-04. INT. CL. 1.

MITSUBISHI SHOJI KAISHA, LTD., TOKYO, JAPAN:  
2,898,588, PUB. 8-10-2004. MULTIPLE CLASS, INT. CLS.  
35, 36, 37, 38, 39, 40, 41, 42, 43, 44 AND 45.

MIXER SYSTEMS, INC., GLENDORA, CA:  
1,289,837, REN. 9-24-04. INT. CL. 7.

MIZERIK ENTERPRISE, INC., HOUSTON, TX:  
2,900,494, INT. CL. 14.

MLS, INC., EUGENE, OR:  
1,876,648, REN. 9-21-04. INT. CL. 16.

MOBILE EDGE LLC, YORBA LINDA, CA:  
2,898,711, PUB. 9-23-2003. INT. CL. 9.

MOBILE MEDICAL INTERNATIONAL CORPORATION, ST.  
JOHNSBURY, VT:  
2,898,873, PUB. 12-16-2003. INT. CL. 12.

MOBILE THINKING, LLC, SAN DIEGO, CA:  
2,900,870, INT. CL. 9.

MOBYPower CO., LTD., 431-060 GYEONGGI-DO, REPUB-  
LIC OF KOREA:  
2,898,898, PUB. 8-10-2004. INT. CL. 9.

MOD-U-KRAF, LLC, ELKHART, IN:  
991,813, REN. 9-23-04. U.S. CL. 12 (INT. CL. 19).

MODEL ENGINE CORPORATION OF AMERICA, MONRO-  
VIA, CA:  
2,899,626, PUB. 8-10-2004. INT. CL. 28.

MODERN HUMORIST, INC., NEW YORK, NY:  
2,900,093, MULTIPLE CLASS, INT. CLS. 16 AND 42.

MODERN MARKETING CONCEPTS, INC., LOUISVILLE,  
KY:  
2,900,724, INT. CL. 9.

MOLECULAR TECHNOLOGY CORPORATION, NEW  
YORK, NY:  
2,900,073, INT. CL. 5.

MOLNE, RAINBOW, R.L, SEATTLE, WA:  
2,899,736, PUB. 8-10-2004. INT. CL. 41.

MONAGHAN MEDICAL CORPORATION, SYRACUSE, NY:  
2,898,606, PUB. 8-10-2004. INT. CL. 10.

MONDO S.P.A., 10121 TORINO, ITALY:  
2,120,666, CANC. INT. CL. 28.  
2,120,667, CANC. INT. CL. 28.

MONEY CLOTHING LIMITED, LONDON, UNITED KING-  
DOM:  
2,899,662, PUB. 8-10-2004. INT. CL. 25.

MONEY PAGE, INC., DALLAS, TX:  
2,122,220, CANC. INT. CL. 35.

MONITOR COMPANY GROUP LIMITED PARTNERSHIP,  
CAMBRIDGE, MA:  
2,900,110, INT. CL. 35.

MONSANTO COMPANY, ST. LOUIS, MO:  
2,122,368, CANC. INT. CL. 22.

MONSTROUS MOVIE MUSIC, BURBANK, CA:  
2,121,304, CANC. INT. CL. 9.

MONTANO, MARK, NEW YORK, NY:  
2,899,706, PUB. 8-10-2004. MULTIPLE CLASS, INT. CLS.  
20 AND 25.

MONTE HEWETT HOMES, LLC, ATLANTA, GA:  
2,899,158, PUB. 8-10-2004. MULTIPLE CLASS, INT. CLS.  
36 AND 37.

MONTECASTELLI SELECTIONS, LTD., NEW YORK, NY:  
2,899,738, PUB. 8-10-2004. INT. CL. 33.

MONTGOMERY PROFESSIONAL BASEBALL CLUB, LLC,  
EVANSTON, IL:  
2,899,770, PUB. 8-10-2004. INT. CL. 25.

MONTOYA, ENRIQUE LUIS, MIAMI, FL:  
2,898,989, PUB. 8-10-2004. INT. CL. 25.  
2,898,990, PUB. 8-10-2004. INT. CL. 24.  
2,898,991, PUB. 8-10-2004. INT. CL. 18.

MOOG MUSIC, INC., ASHEVILLE, NC:  
2,898,917, PUB. 8-10-2004. INT. CL. 15.

MOORE BUSINESS FORMS, INC., NIAGARA FALLS, NY:  
761,648, CANC. U.S. CL. 37.

MOORE BUSINESS FORMS, INC., GRAND ISLAND, NY TO  
MOORE NORTH AMERICA, INC., GRAND ISLAND, NY:  
1,810,615, CANC. MULTIPLE CLASS, INT. CLS. 9 AND  
35.

MOORE, SHERROD F., HONOLULU, HI:  
2,900,315, INT. CL. 28.

MOOSE MOUNTAIN TOYMAKERS LTD., KOWLOON,  
HONG KONG:  
2,900,777, INT. CL. 28.

MOOSE, INC., SAN DIEGO, CA:  
1,350,070, REN. 9-19-04. INT. CL. 42.

MORGAN ADHESIVES COMPANY, STOW, OH:  
786,920, REN. 9-22-04. U.S. CL. 50 (INT. CL. 22).

MORGAN TRAILER MFG. CO., MORGANTOWN, PA, DBA  
MORGAN CORPORATION:  
1,855,674, REN. 9-18-04. INT. CL. 12.

MORTON INTERNATIONAL, INC., CHICAGO, IL:  
2,122,137, CANC. INT. CL. 2.  
2,899,639, PUB. 8-10-2004. INT. CL. 11.

MOSELEY . MARTENS, LLP, DALLAS, TX:  
2,900,541, INT. CL. 42.

MOTHERS POLISHES WAXES CLEANERS, HUNTINGTON  
BEACH, CA:  
2,899,846, PUB. 8-10-2004. INT. CL. 3.

MOTIONPOINT CORPORATION, BOCA RATON, FL:  
2,898,999, PUB. 8-10-2004. INT. CL. 42.

- MOTIONVISION, INC., ENCINO, CA:  
2,122,312, CANC. MULTIPLE CLASS, INT. CLS. 16 AND 40.
- MOTOMAN, INC., WEST CARROLLTON, OH:  
1,834,330. REN. 9-20-04. INT. CL. 7.  
1,867,505. REN. 9-20-04. INT. CL. 9.  
1,869,394. REN. 9-20-04. INT. CL. 9.
- MOTOROLA, INC., SCHAUMBURG, IL:  
1,843,494. REN. 9-22-04. INT. CL. 9.
- MOUNTAIN SHADES, AVON, CO:  
2,121,219, CANC. INT. CL. 9.  
2,121,220, CANC. INT. CL. 9.
- MOUNTAIN SURF, INC., FRIENDSVILLE, MD:  
2,121,575, CANC. INT. CL. 25.
- MOVADO LLC, WILMINGTON, DE:  
2,900,008, PUB. 8-10-2004. INT. CL. 14.
- MOYLE PETROLEUM COMPANY, RAPID CITY, SD:  
1,288,203. REN. 9-20-04. MULTIPLE CLASS, INT. CLS. 37 AND 42.
- MOYNEUR, JAMES F., YORBA LINDA, CA:  
2,121,482, CANC. INT. CL. 28.
- MPSI SYSTEMS INC., TULSA, OK, MANAGEMENT PLANNING SYSTEMS INC., TULSA, OK:  
1,296,845. REN. 9-18-04. INT. CL. 36.
- MPX DATA SYSTEMS, INC., SAN JOSE, CA:  
2,160,010, CANC. INT. CL. 41.
- MR. SHOWER DOOR, INC., NORWALK, CT:  
1,868,176. REN. 9-24-04. INT. CL. 11.
- MRS. GROSSMAN'S PAPER COMPANY, PETALUMA, CA:  
2,132,757, CANC. INT. CL. 16.
- MS MANAGEMENT, L.L.C., METAIRIE, LA:  
2,900,037, INT. CL. 42.
- MSRF, INC., CHICAGO, IL:  
2,899,510, PUB. 8-10-2004. MULTIPLE CLASS, INT. CLS. 21 AND 30.
- MSS ASSOCIATES, INC., NEW YORK, NY:  
2,122,141, CANC. INT. CL. 16.
- MTD PRODUCTS INC, VALLEY CITY, OH:  
2,898,478, PUB. 8-10-2004. MULTIPLE CLASS, INT. CLS. 7 AND 12.
- MTE CORPORATION, MENOMONEE FALLS, WI:  
1,847,630. REN. 9-20-04. INT. CL. 9.  
1,849,823. REN. 9-22-04. INT. CL. 9.
- MTI POWER SYSTEMS INC., SURREY, BRITISH COLUMBIA, CANADA TO MTI TECHNOLOGIES, INC., TULSA, OK:  
1,810,506, CANC. INT. CL. 9.
- MTS, INCORPORATED, WEST SACRAMENTO, CA:  
2,121,440, CANC. INT. CL. 36.
- MUELLER, ANDREAS, WORPSWEDE, FED REP GERMANY:  
2,899,791, PUB. 8-10-2004. INT. CL. 42.
- MUFFLER MAN, INC., FLINT, MI, DBA MUFFLER MAN, INC.:  
1,305,321. REN. 9-18-04. INT. CL. 37.
- MULCAHY, RITA, MINNEAPOLIS, MN:  
2,900,862, INT. CL. 16.
- MULRY, JILL, SEMINOLE, FL:  
2,900,514, INT. CL. 16.
- MULTIMEDIA GAMES, INC., AUSTIN, TX:  
2,900,312, INT. CL. 9.
- MULTIMEDIACARD ASSOCIATION, CUPERTINO, CA:  
2,899,322, PUB. 8-10-2004. INT. CL. 9.
- MUNCHKIN, INC., NORTH HILLS, CA:  
1,866,303. REN. 9-20-04. INT. CL. 10.
- MUNRO & COMPANY, INC., HOT SPRINGS, AR, BERNARDO SANDALS, INC., NEW YORK, NY:  
778,802. REN. 9-21-04. U.S. CL. 39 (INT. CL. 25).
- MUNRO & COMPANY, INC., HOT SPRINGS, AR, UNITED STATES SHOE CORPORATION, THE, CINCINNATI, OH:  
991,463. REN. 9-22-04. U.S. CL. 39 (INT. CL. 25).
- MUNRO & COMPANY, INC., HOT SPRINGS, AR, OSAGE FOOTWEAR, INC., MONETT, MO:  
1,851,542. REN. 9-22-04. INT. CL. 25.
- MUNTERS CORPORATION, FORT MYERS, FL:  
2,898,906, PUB. 8-10-2004. INT. CL. 11.
- MURATA KIKAI KABUSHIKI KAISHA, MINAMI-KU, KYOTO-SHI, KYOTO-FU, JAPAN:  
2,898,555, PUB. 8-10-2004. INT. CL. 7.
- MURDICO, VINCENT A., ESCONDIDO, CA:  
2,899,369, PUB. 7-15-2003. INT. CL. 35.
- MURPHY, JOHN L., ESCONDIDO, CA:  
2,122,582, CANC. INT. CL. 9.
- MURPHY, STEPHEN M., DALLAS, TX, DBA ZONSITE:  
2,898,992, PUB. 8-10-2004. INT. CL. 35.  
2,898,993, PUB. 8-10-2004. INT. CL. 35.
- MURRAY, MICHAEL, SEATTLE, WA:  
2,899,708, PUB. 8-10-2004. INT. CL. 25.
- MURRY, JAMES LLOYD JR., PLANO, TX:  
2,900,752, INT. CL. 30.
- MUSASHI, INC., CHICAGO, IL:  
2,122,254, CANC. INT. CL. 42.
- MUSCO CORPORATION, OSKALOOSA, IA:  
1,288,873. REN. 9-20-04. INT. CL. 11.
- MUSICALL WORLDWIDE LIMITED, HAMILTON HM CX, BERMUDA:  
2,900,256, MULTIPLE CLASS, INT. CLS. 9, 35, 38 AND 41.
- MUTUAL OF OMAHA INSURANCE COMPANY, OMAHA, NE:  
2,121,487, CANC. INT. CL. 36.
- MY MORTGAGE PRO, EAGAN, MN:  
2,899,908, PUB. 8-10-2004. INT. CL. 36.
- MYERSON, L.L.C., CHICAGO, IL, SWISSEDENT INTERNATIONAL, SAN MARINO, CA:  
595,245. REN. 9-21-04. U.S. CL. 44 (INT. CL. 10).
- MYTHIC ENTERTAINMENT, INC., FAIRFAX, VA:  
2,900,861, MULTIPLE CLASS, INT. CLS. 9 AND 41.
- M3 MEDIA, INC., LAS VEGAS, NV:  
2,899,116, PUB. 8-10-2004. INT. CL. 41.
- N S COMPANY, INC., TUCKER, GA:  
2,121,845, CANC. INT. CL. 14.
- N.V. SUMATRA TOBACCO TRADING COMPANY, SUMATERA UTARA, INDONESIA:  
2,899,053, PUB. 8-10-2004. INT. CL. 34.
- NABISCO BRANDS COMPANY, CHICAGO, IL:  
2,122,387, CANC. INT. CL. 30.
- NADLER, GERALD, LOS ANGELES, CA TO THE CENTER FOR BREAKTHROUGH THINKING INC., LOS ANGELES, CA:  
1,811,177, CANC. MULTIPLE CLASS, INT. CLS. 41 AND 42.
- NAILCO GROUP, INC., THE, FARMINGTON HILLS, MI, NAILCO, INC., LIVONIA, MI:  
1,863,238. REN. 9-22-04. INT. CL. 21.
- NAK CORPORATION, HAYWARD, CA:  
2,121,891, CANC. INT. CL. 25.  
2,121,892, CANC. INT. CL. 25.
- NAKAMICHI CORPORATION, TOKYO, JAPAN, NAKAMICHI RESEARCH INC., TOKOYO, JAPAN:  
990,038. REN. 9-18-04. MULTIPLE CLASS, U.S. CLS. 21 (INT. CL. 9) AND 36 (INT. CL. 9).
- NAKATO, INC., CHARLOTTE, NC:  
2,898,879, PUB. 1-6-2004. INT. CL. 43.
- NALCO CHEMICAL COMPANY, NAPERVILLE, IL:  
1,847,522. REN. 9-20-04. INT. CL. 1.
- NAME RITE, L.L.C., TEMECULA, CA:  
2,900,274, MULTIPLE CLASS, INT. CLS. 16 AND 20.
- NANCY ROSANOFF & ASSOCIATES, INC., PLEASANTVILLE, NY:  
2,121,157, CANC. INT. CL. 41.
- NANDEI MCANALLY ENTERPRISES, BEAVERTON, OR:  
2,900,286, INT. CL. 14.
- NANOSCALE MATERIALS, INC., MANHATTAN, KS:  
2,900,899, MULTIPLE CLASS, INT. CLS. 1, 6 AND 42.
- NAPOLEON HILL FOUNDATION, THE, WISE, VA:  
1,849,279. REN. 9-18-04. INT. CL. 16.
- NASDAQ STOCK MARKET, INC., THE, NEW YORK, NY:  
2,898,662, PUB. 8-10-2004. INT. CL. 36.
- NASH, JONATHAN, JR., OMAHA, NE:  
2,900,761, INT. CL. 16.
- NATIONAL ACADEMY OF RECORDING ARTS & SCIENCES, INC., SANTA MONICA, CA:  
2,764,001, AM. MULTIPLE CLASS, INT. CLS. 36 AND 44.

- NATIONAL ALLIANCE FOR YOUTH SPORTS, WEST PALM BEACH, FL:  
2,120,874, CANC. U.S. CL. 200.
- NATIONAL ASSOCIATION OF REALTORS, CHICAGO, IL:  
2,121,149, CANC. INT. CL. 42.
- NATIONAL BROADCAST READING SERVICE, INC., THE, TORONTO, ONTARIO, CANADA:  
2,545,769, AM. INT. CL. 9.
- NATIONAL BUSINESS AIRCRAFT ASSOCIATION, INC., WASHINGTON, DC:  
2,122,304, CANC. INT. CL. 9.
- NATIONAL CAMPERS AND HIKERS ASSOCIATION, INCORPORATED, DEPEW, NY:  
1,862,945, REN. 9-21-04. U.S. CL. 200.
- NATIONAL CARDIO LABS, LLC, STATELINE, NV:  
2,899,360, PUB. 8-10-2004. INT. CL. 44.
- NATIONAL CERTIFICATION BOARD: PERIOPERATIVE NURSING, INC., DENVER, CO:  
2,121,051, CANC. MULTIPLE CLASS, INT. CLS. 16 AND 41.
- NATIONAL CHERRY BLOSSOM FESTIVAL, INC., WASHINGTON, DC:  
2,898,844, PUB. 8-10-2004. INT. CL. 36.
- NATIONAL CHURCH RESIDENCES, COLUMBUS, OH:  
2,899,339, PUB. 11-4-2003. MULTIPLE CLASS, INT. CLS. 43 AND 44.
- NATIONAL COMPUTER SYSTEMS, INC., EDEN PRAIRIE, MN:  
1,810,553, CANC. INT. CL. 9.
- NATIONAL CONTENT LIQUIDATORS, INC., SPRINGBORO, OH, CLEM LONG AUCTIONEERS, INC., DAYTON, OH, DBA CLEM LONG, INC.:  
1,001,883, REN. 9-22-04. U.S. CL. 101 (INT. CL. 42).
- NATIONAL CORRECTIVE TRAINING INSTITUTE, INC., POENIX, AZ:  
1,906,903, REN. 9-18-04. INT. CL. 16.
- NATIONAL COUNCIL ON COMPENSATION INSURANCE, INC., BOCA RATON, FL:  
2,121,436, CANC. MULTIPLE CLASS, INT. CLS. 9 AND 36.
- NATIONAL DISEASE RESEARCH INTERCHANGE, PHILADELPHIA, PA:  
2,898,617, PUB. 8-10-2004. MULTIPLE CLASS, INT. CLS. 35, 39 AND 42.
- NATIONAL GEOGRAPHIC SOCIETY, WASHINGTON, DC:  
2,122,294, CANC. INT. CL. 28.
- NATIONAL GROUND WATER ASSOCIATION, WESTERVILLE, OH:  
2,899,262, PUB. 8-10-2004. INT. CL. 35.
- NATIONAL HOCKEY LEAGUE, NEW YORK, NY:  
2,900,202, INT. CL. 41.
- NATIONAL HOT ROD ASSOCIATION, NORTH HOLLYWOOD, CA:  
1,261,222, CANC. INT. CL. 41.  
1,289,394, REN. 9-24-04. INT. CL. 41.
- NATIONAL IMAGERY AND MAPPING AGENCY, FIARFAX, VA:  
2,120,708, CANC. INT. CL. 9.
- NATIONAL INDEXING SYSTEMS, INC., ORLANDO, FL:  
2,121,977, CANC. INT. CL. 42.
- NATIONAL KIDNEY FOUNDATION, NEW YORK, NY:  
2,899,827, PUB. 8-10-2004. INT. CL. 44.
- NATIONAL MERIT SCHOLARSHIP CORPORATION, EVANSTON, IL:  
2,898,967, PUB. 8-10-2004. MULTIPLE CLASS, INT. CLS. 36 AND 41.
- NATIONAL PHYSIQUE COMMITTEE OF THE U.S.A., INC., PITTSBURGH, PA:  
1,806,179, REN. 9-20-04. MULTIPLE CLASS, INT. CLS. 25 AND 41.
- NATIONAL R.V. HOLDINGS, INC., PERRIS, CA, COUNTRY COACH, INC., JUNCTION CITY, OR:  
1,861,387, REN. 9-22-04. INT. CL. 12.
- NATIONAL RETAIL HARDWARE ASSOCIATION, INDIANAPOLIS, IN:  
776,605, REN. 9-22-04. U.S. CL. 32 (INT. CL. 20).
- NATIONAL SAFETY COUNCIL, ITASCA, IL:  
1,899,302, REN. 9-18-04. INT. CL. 42.
- NATIONAL SEMICONDUCTOR CORPORATION, SANTA CLARA, CA:  
1,959,154, CANC. INT. CL. 9.
- NATIONAL TRAFFIC SERVICE, INC., AMHERST, NY:  
1,811,033, CANC. INT. CL. 35.
- NATIONAL UNITED MARKETING GROUP, INC., SIOUX FALLS, SD TO LIFESERV GROUP, INC., SIOUX FALLS, SD:  
1,811,078, CANC. INT. CL. 36.
- NATIONAL WESTERN LIFE INSURANCE COMPANY, AUSTIN, TX:  
2,900,349, INT. CL. 9.
- NATIONAL 4-H COUNCIL, CHEVY CHASE, MD:  
2,898,669, PUB. 8-10-2004. INT. CL. 41.
- NATIONAL-OILWELL, LP, HOUSTON, TX, SKYTOP BROWSTER CO., VICTORIA, TX:  
1,850,889, REN. 9-22-04. INT. CL. 37.
- NATIONWIDE LIFE INSURANCE COMPANY, COLUMBUS, OH:  
2,898,843, PUB. 8-10-2004. INT. CL. 36.
- NATREN INC., WESTLAKE VILLAGE, CA:  
2,900,368, INT. CL. 5.  
2,900,369, INT. CL. 5.
- NATURAL BRIDGE SEAFOOD COMPANY LTD., PICTON, NEW ZEALAND:  
2,898,642, PUB. 8-10-2004. INT. CL. 29.
- NATURAL NUTRITION SOLUTIONS USA CORP., TAMPA, FL:  
2,899,645, PUB. 8-10-2004. INT. CL. 5.
- NATURAL OVENS OF MANITOWOC, INC., MANITOWOC, WI:  
1,261,073, CANC. INT. CL. 30.
- NATURAL WONDERS, INC., FREMONT, CA:  
2,196,049, CANC. INT. CL. 35.
- NATURALLY VITAMIN SUPPLEMENTS, INC., SCOTTSDALE, AZ:  
1,260,742, CANC. INT. CL. 5.
- NATURE'S ANSWER, INC., HAUPPAUGE, NY:  
2,898,557, PUB. 8-10-2004. INT. CL. 5.
- NATURE'S SUNSHINE PRODUCTS, INC., PROVO, UT:  
1,335,068, REN. 9-20-04. INT. CL. 5.  
1,860,652, REN. 9-20-04. INT. CL. 5.  
1,865,159, REN. 9-20-04. INT. CL. 5.  
1,866,711, REN. 9-20-04. INT. CL. 5.
- NATURE'S WAY PRODUCTS, INC., SPRINGVILLE, UT:  
1,264,674, REN. 9-23-04. INT. CL. 5.  
1,264,675, REN. 9-23-04. INT. CL. 5.  
1,264,677, REN. 9-23-04. INT. CL. 5.  
1,265,535, REN. 9-23-04. INT. CL. 5.
- NATURE'S WAY PRODUCTS, INC., SPRINGVILLE, UT, BOERICKE & TAFEL, INC., PHILADELPHIA, PA:  
1,282,975, REN. 9-24-04. INT. CL. 5.
- NAUERT, STEPHEN EVAN, HERMOSA BEACH, CA:  
2,121,295, CANC. INT. CL. 42.
- NAUTILUS, INC., VANCOUVER, WA, ARTHUR JONES, DE LAND, FL:  
991,897, REN. 9-23-04. U.S. CL. 22 (INT. CL. 28).
- NAVTEC, INC., GUILFORD, CT:  
991,220, REN. 9-23-04. U.S. CL. 13 (INT. CL. 6).
- NAZERETH INTERNATIONAL, INC., NEW YORK, NY:  
407,340, REN. 9-21-04. U.S. CL. 39 (INT. CL. 25).
- NBC UNIVERSAL, INC., NEW YORK, NY, PRESS PRODUCTIONS, INC., NEW YORK, NY:  
592,853, REN. 9-19-04. U.S. CL. 107 (INT. CL. 41).
- NBDL ENTERPRISES, LLC, SECAUCUS, NJ:  
2,900,156, INT. CL. 25.  
2,900,157, INT. CL. 28.
- NBTY, INC., BOHEMIA, NY:  
2,900,378, INT. CL. 5.
- NCH CORPORATION, IRVING, TX:  
761,732, CANC. U.S. CL. 52.
- NCH CORPORATION, IRVING, TX, NATIONAL CHEMSEARCH CORPORATION, IRVING, TX:  
992,239, REN. 9-23-04. INT. CL. 3.
- NCH CORPORATION, IRVING, TX:  
993,282, REN. 9-23-04. INT. CL. 1.
- NCL CORPORATION LTD., MIAMI, FL:  
2,900,426, INT. CL. 41.

- NCR CORPORATION, DAYTON, OH TO LSI LOGIC CORPORATION, MILPITAS, CA:  
1,810,545, CANC. INT. CL. 9.
- NDCHEALTH CORPORATION, ATLANTA, GA:  
1,190,202, REN. 9-21-04. INT. CL. 35.
- NEBULA FITNESS, INC., VERSAILLES, OH, PROTO WELD INC., VERSAILLES, OH:  
1,847,774, REN. 9-21-04. INT. CL. 28.
- NEDBOY, ROBIN L., NEW YORK, NY:  
2,899,943, PUB. 8-10-2004. INT. CL. 5.  
2,899,944, PUB. 8-10-2004. INT. CL. 3.
- NEDELCO, INC., AURORA, NE:  
2,899,232, PUB. 8-10-2004. INT. CL. 38.
- NEHEMIAH CORPORATION OF CALIFORNIA, SACRAMENTO, CA:  
2,899,259, PUB. 8-10-2004. INT. CL. 36.
- NEIGHBORE CARE HOLDINGS, INC., BALTIMORE, MD, PROFESSIONAL PHARMACY SERVICES, INC., BALTIMORE, MD:  
1,865,489, REN. 9-21-04. INT. CL. 42.
- NEIGHBORE CARE HOLDINGS, INC., BALTIMORE, MD:  
2,120,741, CANC. MULTIPLE CLASS, INT. CLS. 35 AND 42.
- NEIMAN-MARCUS GROUP, INC., THE, DALLAS, TX, CARTER HAWLEY HALE STORES, INC., LOS ANGELES, CA, DBA NEIMAN-MARCUS:  
1,288,052, REN. 9-22-04. MULTIPLE CLASS, INT. CLS. 29 AND 30.
- NELLCOR PURITAN BENNETT INCORPORATED, PLEASANTON, CA:  
2,122,287, CANC. INT. CL. 10.
- NELSON TREE SERVICE, INC., DAYTON, OH:  
1,293,288, REN. 9-23-04. INT. CL. 37.
- NEOWARE SYSTEMS, INC., KING OF PRUSSIA, PA:  
2,898,528, PUB. 12-24-2002. INT. CL. 9.
- NERVAPEL, S.A., MADRID, SPAIN:  
1,260,977, CANC. INT. CL. 24.
- NESCO/AMERICAN HARVEST CORP., CHASKA, MN:  
1,292,068, REN. 9-23-04. INT. CL. 11.
- NETAD, LLC, IRVINE, CA:  
2,121,334, CANC. INT. CL. 35.
- NETMATICS, INC., TAMPA, FL:  
2,121,382, CANC. INT. CL. 9.
- NETPR, INC., FREEPORT, FL:  
2,899,298, PUB. 8-10-2004. INT. CL. 35.
- NETWORK ENTERPRISES, INC., NEW YORK, NY:  
2,900,864, INT. CL. 41.
- NETWORK MULTIMEDIA, INC., SALT LAKE CITY, UT:  
2,122,522, CANC. INT. CL. 9.
- NETZERO, INC., WESTLAKE VILLAGE, CA:  
2,899,543, PUB. 12-23-2003. INT. CL. 38.
- NEUROMEDIA S.A., B-7000 MONS, BELGIUM:  
2,857,165, AM. MULTIPLE CLASS, INT. CLS. 9, 16, 18, 25, 28, 35, 38, 41 AND 42.
- NEUROSCIENCE ASSOCIATES, INC., KNOXVILLE, TN:  
2,899,938, PUB. 8-10-2004. INT. CL. 42.
- NEUSNET ADVERTISING GROUP, INC., CLAYTON, NC:  
2,121,367, CANC. INT. CL. 35.
- NEUTEC PHARMA PLC, MANCHESTER M139WL ENGLAND, UNITED KINGDOM:  
2,898,673, PUB. 8-10-2004. INT. CL. 5.
- NEUTROGENA CORPORATION, LOS ANGELES, CA:  
2,122,491, CANC. INT. CL. 3.
- NEW BELGIUM BREWING COMPANY, INC., FORT COLLINS, CO:  
2,900,009, PUB. 8-10-2004. INT. CL. 32.
- NEW ENGLAND DEVELOPMENT, INC., CAMBRIDGE, MA:  
2,900,739, INT. CL. 35.
- NEW HARBOUR, INC., FALL RIVER, MA:  
2,899,636, PUB. 8-10-2004. INT. CL. 20.
- NEW HYDE PARK FUNERAL HOME, INC., NEW HYDE PARK, NY:  
2,899,230, PUB. 8-10-2004. INT. CL. 45.
- NEW JERSEY SINGLES CIRCUIT, L.L.C., LINCOLN PARK, NJ:  
2,899,958, PUB. 8-10-2004. INT. CL. 35.
- NEW LINE PRODUCTIONS, INC., NEW YORK, NY:  
2,122,071, CANC. INT. CL. 41.
- NEW MEDIA NEWS CORPORATION, FAIRFAX, VA:  
2,121,805, CANC. INT. CL. 16.
- NEW ORLEANS HORNETS NBA LIMITED PARTNERSHIP, A N.C. LIMITED PARTNERSHIP, NEW ORLEANS, LA:  
2,900,565, INT. CL. 41.  
2,900,566, INT. CL. 38.
- NEW SENSOR CORP., LONG ISLAND CITY, NY:  
2,900,662, INT. CL. 9.
- NEW SIOUX CITY IRON COMPANY, THE, SIOUX CITY, IA:  
2,898,444, PUB. 12-31-2002. INT. CL. 35.
- NEW WAY FOOTWEAR INDUSTRIES LIMITED, CHAI WAN, HONG KONG:  
2,121,243, CANC. INT. CL. 18.
- NEW WORLD COMMUNICATIONS OF ATLANTA, INC., ATLANTA, GA:  
2,899,950, PUB. 8-10-2004. INT. CL. 41.
- NEW WORLD KIDS COMPANY, ADDISON, TX, DESS; SOPHIE, DALLAS, TX:  
1,348,040, REN. 9-20-04. INT. CL. 25.
- NEW YORK STATE BAR ASSOCIATION, ALBANY, NY:  
1,283,608, REN. 9-24-04. MULTIPLE CLASS, INT. CLS. 36 AND 41.
- NEW YORK 10018, INC., NEW YORK, NY:  
2,120,669, CANC. INT. CL. 25.
- NEWELL WINDOW FURNISHINGS, INC., FREEPORT, IL:  
2,900,741, INT. CL. 20.
- NEWFREY LLC, NEWARK, DE:  
2,900,549, INT. CL. 6.
- NEWMARKET CAPITAL PARTNERS, LLC, PHILADELPHIA, PA:  
2,899,632, PUB. 8-10-2004. INT. CL. 36.  
2,899,673, PUB. 8-10-2004. INT. CL. 36.
- NEXANT, INC., SAN FRANCISCO, CA:  
2,899,393, PUB. 8-10-2004. MULTIPLE CLASS, INT. CLS. 9, 35 AND 42.
- NEXT HOLDINGS INC., NEW LONDON, MN:  
2,900,490, MULTIPLE CLASS, INT. CLS. 9 AND 36.
- NEXT SOFTWARE, INC., REDWOOD CITY, CA:  
2,120,785, CANC. INT. CL. 9.
- NEXTANCE, INC., REDWOOD CITY, CA:  
2,899,330, PUB. 5-13-2003. INT. CL. 9.  
2,899,331, PUB. 5-6-2003. INT. CL. 9.  
2,899,332, PUB. 5-13-2003. INT. CL. 9.  
2,899,333, PUB. 5-13-2003. INT. CL. 9.  
2,899,334, PUB. 5-6-2003. INT. CL. 9.  
2,899,335, PUB. 5-6-2003. INT. CL. 9.
- NG, CHEE KIN, LOS ANGELES, CA:  
2,899,057, PUB. 8-10-2004. INT. CL. 18.
- NGC NETWORK INTERNATIONAL, LLC, WASHINGTON, DC:  
2,898,764, PUB. 8-10-2004. INT. CL. 41.
- NIAD INDUSTRIES, LLC, NEW YORK, NY, DBA ERVING-GEOFFREY:  
2,899,807, PUB. 8-10-2004. INT. CL. 25.
- NICHOLAS AND COMPANY, INC., SALT LAKE CITY, UT:  
1,850,114, REN. 9-19-04. INT. CL. 42.
- NICKELS AND DIMES INCORPORATED, CARROLLTON, TX:  
1,349,997, REN. 9-20-04. INT. CL. 41.
- NICOLAI, MICHELLE M., BEVERLY HILLS, CA:  
2,900,952, INT. CL. 14.
- NICOR PRODUCTS, INC., ORLANDO, FL:  
2,121,084, CANC. MULTIPLE CLASS, INT. CLS. 35 AND 37.
- NIGHTINGALE CORP., MISSISSAUGA, ONTARIO, CANADA:  
2,900,629, INT. CL. 20.
- NIIT (USA), INC., ATLANTA, GA:  
2,121,222, CANC. INT. CL. 41.
- NIKE, INC., BEAVERTON, OR:  
2,122,119, CANC. INT. CL. 25.
- NINTENDO OF AMERICA INC., REDMOND, WA:  
2,900,281, INT. CL. 9.
- NIPPON WISHBORN CORPORATION, OSAKA, JAPAN:  
2,792,862, COR. MULTIPLE CLASS, INT. CLS. 20 AND 23.

NIS INGENIEURGESELLSCHAFT MBH, 63452 HANAU, FED REP GERMANY:  
 2,120,704, CANC. INT. CL. 9.  
 NISH, TERRY, SALT LAKE CITY, UT, DBA NISH MOTOR-SPORTS:  
 2,898,614, PUB. 2-4-2003. MULTIPLE CLASS, INT. CLS. 12 AND 35.  
 NISOURCE CORPORATE SERVICES COMPANY, MERRILLVILLE, IN:  
 2,900,790, INT. CL. 37.  
 NISSHIN OILIO GROUP, LTD., THE, CHUO-KU, TOKYO, JAPAN:  
 2,801,007, AM. INT. CL. 4.  
 NITAS VENTURES, INC., CHARLESTOWN, ST. CHRIST-NEVIS:  
 2,899,463, PUB. 8-10-2004. INT. CL. 35.  
 NK LAWN & GARDEN CO., CHATTANOOGA, TN, NORTHRUP, KING & CO., MINNEAPOLIS, MN:  
 983,593. REN. 9-18-04. U.S. CL. 1 (INT. CL. 31).  
 NO FEAR, INC., CARLSBAD, CA:  
 1,855,031. REN. 9-18-04. MULTIPLE CLASS, INT. CLS. 14 AND 25.  
 NOBILO VINTNERS LIMITED, HUAPAI, AUCKLAND, NEW ZEALAND:  
 2,120,934, CANC. INT. CL. 33.  
 NOBLE GRACE LLC, NEW YORK, NY:  
 2,900,805, INT. CL. 25.  
 NOBLE, ROBIN, FAIRFAX, VA:  
 2,121,165, CANC. MULTIPLE CLASS, INT. CLS. 35 AND 42.  
 NOMADIX, INC., WESTLAKE VILLAGE, CA:  
 2,900,011, PUB. 8-10-2004. INT. CL. 9.  
 NONG SHIM CO., LTD., SEOUL, REPUBLIC OF KOREA:  
 2,122,104, CANC. INT. CL. 30.  
 NONIN MEDICAL, INC., PLYMOUTH, MN:  
 2,900,619, INT. CL. 10.  
 NOONBERG, SUSAN J., BALTIMORE, MD:  
 1,810,765, CANC. INT. CL. 16.  
 NORDAM, TULSA, OK:  
 1,261,176, CANC. INT. CL. 37.  
 NORDSON CORPORATION, AMHERST, OH:  
 780,235. REN. 9-21-04. U.S. CL. 23 (INT. CL. 7).  
 NORFOLK SOUTHERN RAILWAY COMPANY, NORFOLK, VA:  
 773,388. REN. 9-18-04. U.S. CL. 105 (INT. CL. 39).  
 NORGLOBE TECHNOLOGIES, INC., ALEXANDRIA, VA:  
 2,898,799, PUB. 8-10-2004. INT. CL. 42.  
 NORM THOMPSON OUTFITTERS, INC., HILLSBORO, OR:  
 1,348,672. REN. 9-23-04. INT. CL. 42.  
 NORTH AMERICAN COMPANY FOR LIFE AND HEALTH INSURANCE, CHICAGO, IL:  
 2,899,421, PUB. 11-4-2003. INT. CL. 36.  
 NORTH BAY MANAGEMENT ADVISORS, INC., ROSS, CA:  
 2,899,851, PUB. 8-10-2004. INT. CL. 35.  
 NORTH CAROLINA COMMUNITY FEDERAL CREDIT UNION, GOLDSBORO, NC:  
 2,899,538, PUB. 8-10-2004. INT. CL. 36.  
 NORTH CAROLINA SRT, INC., APEX, NC:  
 1,875,859. REN. 9-20-04. INT. CL. 9.  
 NORTH RIVER TAVERN CORP., WOODSIDE, NY:  
 2,899,303, PUB. 11-19-2002. INT. CL. 41.  
 NORTH STAR LIGHTING INC., BROADVIEW, IL:  
 996,328. REN. 9-18-04. U.S. CL. 21 (INT. CL. 11).  
 NORTHERN INDIANA SWIMMING POOL CORPORATION, FT. WAYNE, IN:  
 1,287,407. REN. 9-23-04. INT. CL. 42.  
 NORTHERN TECHNOLOGIES INTERNATIONAL CORPORATION, BEACHWOOD, OH:  
 2,900,099, MULTIPLE CLASS, INT. CLS. 17 AND 42.  
 NORTHPOINT SOFTWARE VENTURES INC., FRAMINGHAM, MA:  
 2,120,919, CANC. INT. CL. 9.  
 NORTHWESTERN UNIVERSITY, EVANSTON, IL:  
 1,287,357. REN. 9-18-04. INT. CL. 41.  
 NORWEST CORPORATION, MINNEAPOLIS, MN:  
 2,120,996, CANC. INT. CL. 35.  
 NOVALOGIC, INC., CALABASAS, CA:  
 2,900,840, MULTIPLE CLASS, INT. CLS. 9 AND 41.  
 NOVARTIS AG, BASEL, SWITZERLAND:  
 1,935,016, AM. INT. CL. 5.  
 NOVARTIS AG, CH-4056 BASEL, SWITZERLAND:  
 2,899,700, PUB. 5-18-2004. INT. CL. 5.  
 NOVARTIS AG, BASEL, SWITZERLAND:  
 2,900,010, PUB. 8-10-2004. INT. CL. 5.  
 NTN-BCA CORPORATION, LITITZ, PA:  
 2,899,032, PUB. 8-10-2004. INT. CL. 7.  
 NTT-IT CORPORATION, YOKOHAMA-SHI 231-0032, JAPAN:  
 2,899,134, PUB. 8-10-2004. MULTIPLE CLASS, INT. CLS. 9 AND 38.  
 NUHAD KHOURY COSMETICS & PERFUMERY, INC., NASHVILLE, TN:  
 1,849,685. REN. 9-18-04. INT. CL. 42.  
 NUNES COMPANY, INC., THE, SALINAS, CA:  
 1,851,544. REN. 9-22-04. INT. CL. 25.  
 NURIDE, INC., HERNDON, VA:  
 2,900,584, INT. CL. 39.  
 2,900,585, INT. CL. 39.  
 NURSERYROOM, INC, LOS ANGELES, CA:  
 2,900,888, INT. CL. 35.  
 NUTRA-PARK, INC., MIDDLETON, WI:  
 2,900,430, INT. CL. 1.  
 NUTRI/SYSTEM, INC., WILLOW GROVE, PA TO NUTRI/SYSTEM IPHC, INC., WILMINGTON, DE:  
 1,297,847, AM. MULTIPLE CLASS, INT. CLS. 29 AND 30.  
 NUTRICA, INC., SOUTH SAN FRANCISCO, CA:  
 2,899,002, PUB. 4-13-2004. INT. CL. 5.  
 NUTRIPROS, INC., SLIDELL, LA:  
 1,811,209, CANC. INT. CL. 42.  
 NUTTY MUNKEY, INC., SPRINGFIELD, MO:  
 2,899,559, PUB. 3-30-2004. INT. CL. 30.  
 NUVO TECHNOLOGIES, LLC, CINCINNATI, OH:  
 2,900,191, INT. CL. 9.  
 NXLEVEL EDUCATION FOUNDATION, SANDY, UT:  
 2,900,153, INT. CL. 16.  
 NYCOMED AUSTRIA GMBH, A-4020 LINZ, AUSTRIA:  
 2,120,701, CANC. INT. CL. 5.  
 NYGREN, DAVID L., PLYMOUTH, MN, DBA FIRSTAID FOR HEARING AIDS:  
 2,121,063, CANC. INT. CL. 7.  
 NYSCOP, INC., ALBANY, NY:  
 1,853,796. REN. 9-18-04. MULTIPLE CLASS, INT. CLS. 35 AND 36.  
 O'GARVEY SAUCES, INC., NEW BRAUNFELS, TX:  
 2,121,003, CANC. INT. CL. 30.  
 O'LOUGHLIN, JOHN, RICHARDSON, TX:  
 1,810,693, CANC. MULTIPLE CLASS, INT. CLS. 16, 21 AND 25.  
 OAKITE PRODUCTS, INC., NEW YORK, NY:  
 761,736, CANC. U.S. CL. 52.  
 OAKLAND COMMUNITY COLLEGE, BLOOMFIELD HILLS, MI:  
 2,900,342, INT. CL. 41.  
 OAKLEY, INC., FOOTHILL RANCH, CA:  
 1,843,504. REN. 9-18-04. INT. CL. 9.  
 2,900,432, INT. CL. 9.  
 OASIS CORPORATION, COLUMBUS, OH, EBCO MANUFACTURING COMPANY, COLUMBUS, OH:  
 1,851,076. REN. 9-21-04. INT. CL. 11.  
 OASIS IMAGING PRODUCTS, INC., NASHUA, NH:  
 2,900,268, INT. CL. 2.  
 OBERTO SAUSAGE COMPANY OF OREGON, KENT, WA, CURTICE-BURNS FOODS, INC., ROCHESTER, NY:  
 1,823,003. REN. 9-24-04. INT. CL. 29.  
 OBERWEIS DAIRY, INC., NORTH AURORA, IL:  
 2,898,864, PUB. 2-17-2004. INT. CL. 29.  
 2,898,865, PUB. 2-17-2004. INT. CL. 29.  
 2,898,867, PUB. 2-17-2004. INT. CL. 29.  
 OBSAT COMMUNICATIONS, INC., BALTIMORE, MD:  
 2,122,501, CANC. INT. CL. 42.  
 OCE-TECHNOLOGIES B.V., 5914 CA VENLO, NETHERLANDS:  
 2,899,447, PUB. 8-10-2004. MULTIPLE CLASS, INT. CLS. 37 AND 42.

- OCLC ONLINE COMPUTER LIBRARY CENTER, INCORPORATED, DUBLIN, OH:  
1,848,700. REN. 9-23-04. MULTIPLE CLASS, INT. CLS. 35, 38 AND 42.
- OCWEN FEDERAL BANK, FSB, MIAMI, FL:  
2,898,467. PUB. 7-15-2003. INT. CL. 35.
- ODC EXHIBIT SYSTEMS LTD., RICHMOND, BRITISH COLUMBIA V6V 1W1, CANADA:  
2,120,730. CANC. MULTIPLE CLASS, INT. CLS. 20 AND 37.
- OFFENBURGER, ANDREW CHARLES, SCOTTSDALE, AZ:  
2,899,601. PUB. 8-10-2004. INT. CL. 41.
- OFI TESTING EQUIPMENT INC., HOUSTON, TX:  
1,313,271. REN. 9-23-04. INT. CL. 9.
- OHM CORPORATION, MONROEVILLE, PA:  
1,811,022. CANC. MULTIPLE CLASS, INT. CLS. 35 AND 42.
- OHTSU TIRE & RUBBER CO., LTD., THE, IZUMI-OHTSU-SHI, OSAKA, JAPAN:  
1,810,665. CANC. INT. CL. 12.
- OKAMI INC., SUN VALLEY, CA:  
2,898,507. PUB. 8-10-2004. MULTIPLE CLASS, INT. CLS. 29 AND 30.
- OLD NATIONAL BANCORP, EVANSVILLE, IN:  
2,900,726. INT. CL. 9.
- OLD NAVY (APPARAL), LLC, SAN FRANCISCO, CA:  
2,122,324. CANC. INT. CL. 3.  
2,122,325. CANC. INT. CL. 3.  
2,122,326. CANC. INT. CL. 3.  
2,122,327. CANC. INT. CL. 3.
- OLD TOWN CANOE COMPANY, OLD TOWN, ME:  
2,122,237. CANC. INT. CL. 12.
- OLIVE FARM. LLC, THE, PORTLAND, OR:  
2,900,050. INT. CL. 29.
- OLIVER RUBBER COMPANY, FINDLAY, OH:  
1,287,944. REN. 9-22-04. INT. CL. 17.
- OLSON INTERNATIONAL LTD., CHICAGO, IL:  
2,122,242. CANC. INT. CL. 6.
- OLYMPUS OPTICAL COMPANY LIMITED, SHIBUYA-KU, TOKYO, JAPAN:  
2,900,054. INT. CL. 10.
- OM YOGA CENTER, INC., NEW YORK, NY:  
2,900,149. MULTIPLE CLASS, INT. CLS. 9, 16 AND 25.
- OMAR S.R.L., 20122 MILANO MI, ITALY:  
2,900,362. INT. CL. 25.
- OMEGA ORTHODONTIC MANAGERIAL INSTRUCTION, INC., ST. CLOUD, MN:  
2,121,008. CANC. INT. CL. 35.
- OMEGA SA (OMEGA AG) (OMEGA LTD.), BIEL/BIENNE 2502, SWITZERLAND, LOUIS BRANDT & FRERE, BIENNE, SWITZERLAND:  
25,036. REN. 9-23-04. U.S. CL. 27 (INT. CL. 14).
- OMEGA SAFETY INTERNATIONAL, CORP., MCALLEN, TX, DBA ROYAL SALES ON LINE:  
2,857,686. CANC. IIRN. RESTORED TO S.N. 76-532,243.
- OMNI FLOW COMPUTERS, INC., HOUSTON, TX:  
2,900,252. INT. CL. 9.
- OMNI QUARTZ, LTD., BROOKLYN, NY:  
2,898,716. PUB. 9-23-2003. INT. CL. 14.
- OMNI SERVICES, INC., CULPEPPER, VA:  
2,122,074. CANC. MULTIPLE CLASS, INT. CLS. 5 AND 42.
- OMNILINK COMMUNICATIONS CORPORATION, LANSING, MI:  
2,120,906. CANC. INT. CL. 9.
- OMNITRON SYSTEMS TECHNOLOGY, INC., IRVINE, CA:  
2,899,285. PUB. 8-10-2004. INT. CL. 9.
- OMNIUM WORLDWIDE, INC., OMAHA, NE:  
2,898,970. PUB. 4-6-2004. INT. CL. 36.
- OMRON CORPORATION, KYOTO 600-8530, JAPAN:  
2,864,440. COR. INT. CL. 9.
- OMRON HEALTHCARE CO., LTD., UKYOU-KU, KYOTO, JAPAN:  
1,825,789. REN. 9-23-04. INT. CL. 10.
- OMS INVESTMENTS, INC., LOS ANGELES, CA, W. R. GRACE & CO., CAMBRIDGE, MA:  
998,042. REN. 9-24-04. U.S. CL. 1 (INT. CL. 1).
- OMS INVESTMENTS, INC., WILMINGTON, DE:  
2,122,016. CANC. INT. CL. 1.  
2,898,495. PUB. 10-22-2002. INT. CL. 5.
- OMS INVESTMENTS, INC., LOS ANGELES, CA:  
2,900,658. INT. CL. 31.
- ON STAGE ENTERTINMENT, INC., LAS VEGAS, NV:  
2,121,753. CANC. INT. CL. 41.
- ONE REEL, SEATTLE, WA:  
2,899,643. PUB. 8-10-2004. INT. CL. 41.
- ONE WORLD TECHNOLOGIES LIMITED, HAMILTON, BERMUDA:  
1,818,485. REN. 9-20-04. INT. CL. 20.
- ONEIDA LTD., ONEIDA, NY:  
785,546. REN. 9-21-04. U.S. CL. 23 (INT. CL. 8).
- ONETA COMPANY, CORPUS CHRISTI, TX, DBA EVEREST WATER COMPANY:  
1,294,805. REN. 9-18-04. INT. CL. 32.
- ONEWORLD ALLIANCE LLC, WILMINGTON, DE TO BRITISH AIRWAYS PLC, HARMONDSWORTH UBG OGB, ENGLAND:  
2,833,464. COR. INT. CL. 39.
- OPINIONMETER, INC., MARINA DEL REY, CA:  
1,863,612. REN. 9-22-04. INT. CL. 9.
- OPTIMA SHIPPING SYSTEMS, INC., BOSTON, MA:  
1,848,736. REN. 9-18-04. INT. CL. 39.
- OPTIMANAGEMENT RESOURCES, INC., PRINCETON, NJ:  
1,261,114. CANC. INT. CL. 35.
- OPTIMUM SOURCE INTERNATIONAL, LTD., SCOTTSDALE, AZ:  
2,121,321. CANC. INT. CL. 35.
- OPTION ONE MORTGAGE CORPORATION, IRVINE, CA:  
2,898,950. PUB. 8-10-2004. INT. CL. 36.
- OPUS PUBLISHING GROUP, L.P., HAWTHORNE, NY:  
2,121,356. CANC. INT. CL. 16.
- ORAL FIXATION, LLC, HOPEWELL, NJ:  
2,900,857. INT. CL. 30.  
2,900,858. INT. CL. 30.
- ORANGE COUNTY PERFORMING ARTS CENTER, COSTA MESA, CA:  
1,288,516. REN. 9-20-04. INT. CL. 41.
- ORBIT IRRIGATION PRODUCTS, INC., NORTH SALT LAKE, UT:  
1,289,959. REN. 9-21-04. INT. CL. 11.
- ORCHARD VIEW FARMS, INC., THE DALLES, OR:  
1,851,160. REN. 9-18-04. INT. CL. 31.
- ORCHARD YARN & THREAD COMPANY, INC., NEW YORK, NY, ORCHARD YARN AND THREAD COMPANY, NEW YORK, NY:  
410,186. REN. 9-24-04. U.S. CL. 43 (INT. CL. 23).
- OREGON BEER AND BREWING COMPANY, INC. I, SALEM, OR:  
2,898,416. PUB. 6-16-1998. INT. CL. 32.
- ORGANIC PRODUCTS INC., SUMTER, SC:  
2,899,480. PUB. 12-23-2003. INT. CL. 1.
- ORGANIZATION MANAGEMENT, INC., BETHESDA, MD:  
1,850,933. REN. 9-19-04. INT. CL. 41.
- ORIGINAL SMOOTHIE COMPANY, INC., NEW ORLEANS, LA:  
1,811,005. CANC. INT. CL. 32.
- ORLY INTERNATIONAL, INC., CHATSWORTH, CA:  
2,899,212. PUB. 8-10-2004. INT. CL. 3.  
2,900,501. INT. CL. 3.
- ORTHODOX RABBINICAL ASSOCIATION, INC., THE, LOS ANGELES, CA:  
1,293,538. REN. 9-20-04. U.S. CL. A.
- OSAKO, KENJI, IRVINE, CA:  
2,898,643. PUB. 8-10-2004. INT. CL. 36.
- OSCAR HEYMAN & BROTHERS, INC., NEW YORK, NY:  
1,876,538. REN. 9-24-04. INT. CL. 14.
- OSG TAP & DIE, INC., GLENDALE HEIGHTS, IL:  
2,900,747. INT. CL. 7.
- OSMOTICS CORPORATION, DENVER, CO:  
1,909,653. REN. 9-23-04. INT. CL. 3.
- OSO HOTWATER AS, N-3300 HOKKSUND, NORWAY:  
2,120,882. CANC. INT. CL. 11.
- OTERO SAVINGS & LOAN ASSOCIATION, COLORADO SPRINGS, CO:  
1,261,147. CANC. INT. CL. 36.

- OUTDOOR LIFE NETWORK, L.L.C., STAMFORD, CT:  
2,900,431, INT. CL. 41.
- OUTRAGEOUSLY VINTAGE, INC., SEARSMONT, ME:  
2,900,655, INT. CL. 37.
- OVAMED, SUNNYVALE, CA:  
2,122,032, CANC. INT. CL. 10.
- OVERHEAD DOOR CORPORATION, FARMERS BRANCH, TX:  
1,851,191, REN. 9-20-04, INT. CL. 9.
- OWENSBORO COMMUNITY HEALTH PLAN, OWENSBORO, KY:  
2,122,147, CANC. MULTIPLE CLASS, INT. CLS. 36 AND 42.
- OY RETTIG AB, ESBO, FINLAND:  
1,261,080, CANC. INT. CL. 30.
- OZ PRODUCTIONS, INC., DENVER, CO:  
1,261,195, CANC. INT. CL. 41.
- P & R ACCESSORIES, LLC, LULING, LA:  
2,899,209, PUB. 8-10-2004, INT. CL. 12.
- P. C. WOO, INC., LOS ANGELES, CA, DBA MEGATOYS:  
2,899,921, PUB. 8-10-2004, INT. CL. 28.
- P.C. WOO, INC., LOS ANGELES, CA, DBA MEGATOYS:  
2,898,459, PUB. 6-5-2001, INT. CL. 28.
- P.W. MINOR & SON, INC., BATAVIA, NY:  
1,297,693, REN. 9-18-04, INT. CL. 25.
- P&L PUBLISHING GROUP, EVERGREEN PLAZA, IL:  
2,898,663, PUB. 8-10-2004, MULTIPLE CLASS, INT. CLS. 16, 40 AND 41.
- PACE ENTERTAINMENT CORPORATION, HOUSTON, TX:  
2,121,408, CANC. INT. CL. 35.
- PACE INCORPORATED, LAUREL, MD:  
1,260,819, CANC. INT. CL. 9.
- PACE SERVICE MANAGEMENT COMPANY, SAN ANTONIO, TX:  
1,261,311, CANC. INT. CL. 42.
- PACE, INCORPORATED, LAUREL, MD:  
2,121,479, CANC. INT. CL. 7.
- PACER TECHNOLOGY, RANCHO CUCAMONGA, CA:  
2,899,733, PUB. 8-10-2004, MULTIPLE CLASS, INT. CLS. 1 AND 16.
- PACIFIC BLOOD SERVICES, LLC, SAN DIEGO, CA:  
2,122,463, CANC. INT. CL. 42.
- PACIFIC CHAIN AND MANUFACTURING COMPANY, PORTLAND, OR:  
404,650, CANC. U.S. CL. 13.
- PACIFIC FRUIT INC., STANTEN ISLAND, NY:  
1,261,863, REN. 9-23-04, INT. CL. 31.
- PACIFIC KNITTING MILLS, INC., LOS ANGELES, CA:  
2,900,139, INT. CL. 25.
- PACIFIC LIFE INSURANCE COMPANY, NEWPORT BEACH, CA, PACIFIC MUTUAL LIFE INSURANCE COMPANY, NEWPORT BEACH, CA:  
1,850,869, REN. 9-19-04, INT. CL. 36.
- PACIFIC TELESIS GROUP, SAN FRANCISCO, CA:  
2,122,111, CANC. INT. CL. 35.
- PAGE, AKULIAN, HOLMES & BAKER, INC., WALNUT CREEK, CA:  
1,850,119, REN. 9-24-04, INT. CL. 42.
- PAI INDUSTRIES, INC., SUWANEE, GA, PAI, WESTLAKE VILLAGE, CA:  
1,317,582, REN. 9-22-04, MULTIPLE CLASS, INT. CLS. 6, 7, 9, 11 AND 12.
- PAINSOLVERS, INC., WALNUT CREEK, CA:  
2,899,141, PUB. 8-10-2004, INT. CL. 44.  
2,899,903, PUB. 8-10-2004, INT. CL. 44.
- PAKHOED USA INC., HOUSTON, TX:  
2,121,111, CANC. MULTIPLE CLASS, INT. CLS. 37, 39 AND 40.
- PALAIS JEWELERS CORP., MIAMI, FL:  
1,294,182, REN. 9-24-04, INT. CL. 14.
- PALL CORPORATION, EAST HILLS, NY, GELMAN INSTRUMENT COMPANY, ANN ARBOR, MI:  
776,604, REN. 9-20-04, U.S. CL. 31 (INT. CL. 11).
- PALL CORPORATION, EAST HILLS, NY:  
1,287,817, REN. 9-20-04, INT. CL. 11.
- PALLADIUM BOOKS, TAYLOR, MI, ROLE PLAYING GAMES, INCORPORATED, ALVIN, TX, AKA RPG INC.:  
1,336,914, REN. 9-20-04, INT. CL. 28.
- PALLADIUM INTERACTIVE, INC., LARKSPUR, CA:  
2,121,625, CANC. INT. CL. 9.
- PALM BAY IMPORTS, INC., BOCA RATON, FL:  
2,900,254, INT. CL. 33.
- PALMER DRUG ABUSE PROGRAM MIDLAND, TEXAS, INC., MIDLAND, TX:  
1,261,286, CANC. INT. CL. 42.
- PALMER LAKE BREWING CO., COLORADO SPRINGS, CO:  
2,121,791, CANC. INT. CL. 32.
- PALOMAR DISPLAY PRODUCTS INC., CARLSBAD, CA, HUGHES AIRCRAFT COMPANY, LOS ANGELES, CA:  
1,882,806, REN. 9-18-04, INT. CL. 9.
- PALONEK, EDWARD, OAKVILLE, ONTARIO, L6J 1J3, CANADA:  
2,121,856, CANC. INT. CL. 42.
- PAMS PRODUCTIONS, INC., DALLAS, TX:  
1,305,544, REN. 9-21-04, INT. CL. 42.
- PAN-MACEDONIAN ASSOCIATION, INC., NEW YORK, NY:  
1,811,231, CANC. INT. CL. 42.
- PAN-O-GOLD BAKING CO., ST. CLOUD, MN:  
2,121,276, CANC. INT. CL. 30.
- PANAMSAT CORPORATION, WILTON, CT:  
2,900,413, INT. CL. 38.
- PANCO MEN'S PRODUCTS, INDIO, CA, DBA PANCO LTD.:  
995,412, REN. 9-22-04, U.S. CL. 52 (INT. CL. 3).
- PANDOLFINO'S HAIR CORPORATION, NATICK, MA:  
2,121,629, CANC. MULTIPLE CLASS, INT. CLS. 35 AND 42.  
2,121,630, CANC. MULTIPLE CLASS, INT. CLS. 35 AND 42.
- PAPER MAGIC GROUP, INC., WILMINGTON, DE:  
1,289,695, REN. 9-23-04, MULTIPLE CLASS, INT. CLS. 3 AND 28.
- PAPER OR PLASTIC?, SHERMAN OAKS, CA:  
2,122,432, CANC. INT. CL. 41.
- PAPST-MOTOREN KG, ST GEORGEN, BLACK FOREST, FED REP GERMANY TO PAPST-MOTOREN CMBH & CO. KG., ST GEORGEN, BLACK FOREST, FED REP GERMANY:  
761,582, CANC. U.S. CL. 21.
- PAPST-MOTOREN KG, ST. GEORGEN, BLACK FOREST, FED REP GERMANY TO PAPST-MOTOREN GMBH & CO. KG., ST. GEORGEN, BLACK FOREST, FED REP GERMANY:  
761,583, CANC. U.S. CL. 21.
- PARADYNE CORPORATION, LARGO, FL:  
2,900,705, INT. CL. 9.
- PARAGON VINEYARD COMPANY, INC., SAN LUIS OBISPO, CA, TA EDNA VALLEY VINEYARD:  
1,838,056, REN. 9-21-04, INT. CL. 33.
- PARALLAX MEDICAL, INC., SUNNYVALE, CA:  
2,900,266, INT. CL. 10.
- PARAMOUNT PICTURES CORPORATION, LOS ANGELES, CA:  
1,811,617, CANC. INT. CL. 28.  
1,910,188, REN. 9-22-04, INT. CL. 25.  
1,910,208, REN. 9-22-04, INT. CL. 28.  
2,121,902, CANC. INT. CL. 25.
- PARCO FOODS, L.L.C., BLUE ISLAND, IL, PARCO FOODS, INC., BLUE ISLAND, IL:  
1,903,734, REN. 9-22-04, INT. CL. 30.
- PARIS ACCESSORIES, INC., NEW YORK, NY:  
1,303,877, REN. 9-22-04, INT. CL. 25.
- PARIS PRESENTS INCORPORATED, WHEELING, IL:  
1,537,118, CANC. MULTIPLE CLASS, INT. CLS. 3, 20, 21 AND 25.
- PARKER INTANGIBLES LLC, CLEVELAND, OH, LDI PNEUTRONICS CORP., HOLLIS, NH:  
1,859,600, REN. 9-23-04, INT. CL. 9.
- PARKER, JOHN W., SAN DIMAS, CA:  
2,899,642, PUB. 8-10-2004, INT. CL. 11.
- PARKS, WALTER JOHN IV, NEW YORK, NY:  
2,899,070, PUB. 8-10-2004, MULTIPLE CLASS, INT. CLS. 9 AND 41.
- PARODY PRODUCTIONS, LTD., LOMBARD, IL:  
1,850,125, REN. 9-18-04, INT. CL. 42.

- PARRISH FINE ART, INC., GERMANTOWN, WI:  
2,900,070, INT. CL. 16.
- PARSONS OFFICIALS SUPPLIES, INC., SCHAUMBURG, IL:  
1,326,105, REN. 9-22-04, INT. CL. 28.
- PARTY JUICE, INC., LAYTON, UT:  
2,899,345, PUB. 8-10-2004, INT. CL. 32.
- PARTY WIZ PRODUCTS LTD., THORNHILL, ONTARIO L4J 8E5, CANADA:  
2,121,083, CANC. MULTIPLE CLASS, INT. CLS. 16 AND 28.
- PASADENA TOURNAMENT OF ROSES ASSOCIATION, PASADENA, CA:  
1,856,603, REN. 9-22-04, MULTIPLE CLASS, INT. CLS. 14 AND 25.  
1,856,603, CANC. MULTIPLE CLASS, INT. CLS. 9 AND 16.  
1,864,550, REN. 9-22-04, MULTIPLE CLASS, INT. CLS. 9, 14 AND 25.  
1,864,550, CANC. MULTIPLE CLASS, INT. CLS. 16 AND 28.
- PASH INDUSTRIES, LLC, GLEN COVE, NY FROM FCR INDUSTRIES, INC., NEW YORK, NY:  
2,900,563, INT. CL. 25.
- PASQUINI IMPORTS, INC., LOS ANGELES, CA, DBA PASQUINI ESPRESSO CO.:  
2,899,216, PUB. 8-10-2004, INT. CL. 30.
- PAT ACQUISITION, LLC, NASHVILLE, TN:  
1,821,511, REN. 9-19-04, INT. CL. 28.  
1,857,783, REN. 9-19-04, INT. CL. 28.
- PATIO PRODUCTS, INC., BOCA RATON, FL:  
1,849,917, REN. 9-19-04, MULTIPLE CLASS, INT. CLS. 18 AND 20.
- PATRICE, JAINEE D., BEVERLY HILLS, CA:  
2,121,623, CANC. MULTIPLE CLASS, INT. CLS. 16 AND 18.
- PATRICIA B. LANGLIN, PHOENIX, AZ:  
1,290,445, REN. 9-24-04, INT. CL. 37.
- PATRIOTNET, INC., FAIRFAX, VA:  
2,898,465, PUB. 8-10-2004, MULTIPLE CLASS, INT. CLS. 38 AND 42.
- PATTI MORAN'S NEW BEGINNINGS, INC., KING, NC:  
2,899,857, PUB. 8-10-2004, INT. CL. 35.
- PAUL A. GEARY, JR., SEAN M. GEARY AND JOSEPH R. WESTWOOD PARTNERSHIP, THE, CHADDS FORD, PA:  
2,122,392, CANC. INT. CL. 10.
- PAULSON, THEODORE A., KINGSTON, NY:  
2,899,088, PUB. 8-10-2004, INT. CL. 16.
- PAY TEL COMMUNICATIONS, INC., GREENSBORO, NC:  
2,121,467, CANC. INT. CL. 38.
- PAYCHEX OF NEW YORK, LLC, ROCHESTER, NY:  
2,899,885, PUB. 8-10-2004, INT. CL. 35.
- PAYSYSTEMS CORPORATION, MONTREAL, QUEBEC, CANADA:  
2,900,467, INT. CL. 36.
- PC HOUSE CALL, INC., KENILWORTH, NJ:  
2,898,988, PUB. 4-27-2004, MULTIPLE CLASS, INT. CLS. 35 AND 42.
- PC POWER AND COOLING, INC., CARLSBAD, CA:  
2,121,434, CANC. INT. CL. 9.
- PCCW-HKT DATACOM SERVICES LIMITED, QUARRY BAY, HONG KONG:  
2,899,279, PUB. 8-10-2004, INT. CL. 41.
- PCCW-HKT DATACOM SERVICES LIMITED, QUARRY BAY, HONG KONG:  
2,899,280, PUB. 2-17-2004, INT. CL. 35.
- PCK, INC., ALPHARETTA, GA:  
1,844,484, REN. 9-23-04, INT. CL. 24.
- PCS WIRELESS, INC., VANCOUVER, B.C. V6C 1S4, CANADA:  
2,120,759, CANC. INT. CL. 9.
- PEACHTREE INTERNATIONAL LIMITED, HAMILTON HM MX, BERMUDA:  
2,900,197, INT. CL. 27.
- PEARLAND ECONOMIC DEVELOPMENT CORPORATION, PEARLAND, TX:  
2,899,820, PUB. 8-10-2004, INT. CL. 35.
- PEARSALL, TODD P., SAN DIEGO, CA, DBA KEG GYM:  
2,900,561, INT. CL. 25.
- PEARSON EDUCATION LIMITED, HARLOW, ESSEX, UNITED KINGDOM:  
2,661,234, COR. MULTIPLE CLASS, INT. CLS. 9, 16 AND 41.
- PEARSON PROFESSIONAL INC., BOCA RATON, FL:  
2,121,909, CANC. INT. CL. 35.
- PEAVEY ELECTRONICS CORPORATION, MERIDIAN, MS:  
1,292,784, REN. 9-24-04, INT. CL. 15.  
2,900,716, INT. CL. 9.
- PEERLESS CLOTHING INC., MONTREAL, PROVINCE OF QUEBEC, CANADA:  
1,866,466, REN. 9-21-04, INT. CL. 25.
- PEERLESS CONFECTION COMPANY, CHICAGO, IL:  
776,287, REN. 9-21-04, U.S. CL. 46 (INT. CL. 30).
- PEERLESS INDUSTRIES, INC., MELROSE PARK, IL:  
2,899,918, PUB. 8-10-2004, INT. CL. 6.
- PEGASUS INTERNATIONAL, INC., FORT WASHINGTON, PA:  
2,900,529, INT. CL. 5.
- PEGASUS MISHIN SEIZO KABUSHIKI KAISHA, FUKUSHIMA-KU, OSAKA, JAPAN, DBA PEGASUS SEWING MACHINE MFG. CO., LTD.:  
1,300,176, REN. 9-18-04, INT. CL. 7.
- PEGASUS SYSTEMS, INC., NORTH WALES, PA:  
2,900,243, INT. CL. 9.
- PELLA CORPORATION, PELLA, IA:  
2,900,540, MULTIPLE CLASS, INT. CLS. 6 AND 19.
- PENHALIGON'S LIMITED, LONDON, UNITED KINGDOM:  
1,762,290, REN. 9-24-04, INT. CL. 3.
- PENN STATE ALUMNI ASSOCIATION, UNIVERSITY PARK, PA:  
2,121,016, CANC. INT. CL. 42.
- PENNY PUBLICATIONS LLC, NORWALK, CT, BANTAM DOUBLEDAY DELL PUBLISHING GROUP, INC., NEW YORK, NY:  
1,864,272, REN. 9-22-04, INT. CL. 16.
- PENNZOIL QUAKER STATE COMPANY, HOUSTON, TX, PENNZOIL COMPANY, OIL CITY, PA:  
1,304,334, REN. 9-22-04, INT. CL. 3.
- PENNZOIL-QUAKER STATE COMPANY, HOUSTON, TX, PENNZOIL COMPANY, OIL CITY, PA:  
1,300,117, REN. 9-22-04, INT. CL. 4.  
1,305,606, REN. 9-21-04, INT. CL. 1.
- PENSION SCIENCES ASSOCIATES, INC., SHERMAN OAKS, CA:  
2,122,584, CANC. INT. CL. 35.
- PENTAIR POOL PRODUCTS, INC., MOORPARK, CA:  
1,269,072, REN. 9-23-04, INT. CL. 11.
- PENTAIR POOL PRODUCTS, INC., MOOREPARK, DE, KDI AMERICAN PRODUCTS, INC., MOORPARK, CA:  
1,860,348, REN. 9-24-04, INT. CL. 11.
- PENTAIR POOL PRODUCTS, INC., MOOREPARK, CA, KDI AMERICAN PRODUCTS, INC., MOORPARK, CA:  
1,860,349, REN. 9-24-04, INT. CL. 11.
- PENTON PUBLISHING, INC., CLEVELAND, OH:  
2,120,997, CANC. INT. CL. 41.
- PENWORTHY COMPANY, THE, MILWAUKEE, WI:  
2,121,795, CANC. INT. CL. 16.
- PEOPLES LOTTERY FOUNDATION, INC., NEW YORK, NY:  
2,122,379, CANC. INT. CL. 36.
- PEP BOYS MANNY, MOE & JACK OF CALIFORNIA, THE, PHILADELPHIA, PA:  
2,120,813, CANC. INT. CL. 24.
- PEPAMAR MUSIC CORP., BURBANK, CA:  
2,861,186, COR. INT. CL. 9.
- PEPSICO, INC., PURCHASE, NY:  
2,121,734, CANC. INT. CL. 32.  
2,900,848, INT. CL. 32.
- PER-SE TECHNOLOGIES, INC., ATLANTA, GA:  
2,898,703, PUB. 9-30-2003, INT. CL. 42.
- PERFECT FIT INDUSTRIES, INC., MONROE, NC:  
2,900,234, INT. CL. 24.
- PERKINS RESTAURANTS OPERATING COMPANY, L.P., MEMPHIS, TN:  
2,121,878, CANC. INT. CL. 42.
- PERMANENT EYELINER PLUS, INC., INDIANAPOLIS, IN:  
2,121,361, CANC. INT. CL. 42.



- PERMATRON CORPORATION, ELK GROVE VILLAGE, IL:  
2,899,905, PUB. 8-10-2004. INT. CL. 11.
- PERMIRA ADVISERS LIMITED, LONDON WC2E 7OG,  
UNITED KINGDOM:  
2,860,720, COR. MULTIPLE CLASS, INT. CLS. 35 AND  
36.
- PERMISSION STREAM (LLC), LOS ANGELES, CA:  
2,900,763, INT. CL. 35.
- PEROT SYSTEMS CORPORATION, DALLAS, TX:  
2,122,425, CANC. MULTIPLE CLASS, INT. CLS. 35 AND  
42.
- PERRY ELLIS INTERNATIONAL, INC., MIAMI, FL:  
2,900,138, INT. CL. 25.
- PERRY, LENORE E., LEO, IN:  
1,851,296. REN. 9-21-04. INT. CL. 7.
- PERSHING INVESTMENTS LLC, NEWARK, DE:  
2,121,515, CANC. INT. CL. 9.
- PERSONAL BEST CENTERS INTERNATIONAL, INC.,  
PALM BEACH, FL:  
1,261,308, CANC. INT. CL. 42.
- PERSONAL PHYSICIAN CARE, INC., CLEVELAND, OH:  
2,121,888, CANC. INT. CL. 42.
- PET CENTER, INC., LOS ANGELES, CA:  
1,855,327. REN. 9-18-04. INT. CL. 31.  
1,859,251. REN. 9-18-04. INT. CL. 31.
- PETCARE PLUS, INC., AURORA, IL:  
2,122,139, CANC. INT. CL. 5.
- PETEDGE, INC., TOPSFIELD, MA:  
2,899,045, PUB. 8-10-2004. INT. CL. 31.
- PETER A. & NATHALIE BELPULSI PARTNERSHIP, THE,  
SALEM, MO:  
2,122,383, CANC. INT. CL. 28.
- PETER KIEWIT SONS', INC., OMAHA, NE:  
2,899,638, PUB. 8-10-2004. INT. CL. 16.
- PETRO STOPPING CENTERS, L.P., EL PASO, TX, PETRO  
PSC, L.P., EL PASO, TX:  
1,819,876. REN. 9-18-04. MULTIPLE CLASS, INT. CLS. 16,  
21, 25, 26 AND 42.
- PETROLEUM FINANCE GROUP, LTD., THE, WILMING-  
TON, DE:  
2,121,841, CANC. INT. CL. 35.
- PETROLEUM INFORMATION/DWIGHTS LLC, ENGLE-  
WOOD, CO:  
1,295,202. REN. 9-23-04. INT. CL. 42.
- PETTERS GROUP WORLDWIDE, LLC, MINNETONKA,  
MN:  
2,900,086, MULTIPLE CLASS, INT. CLS. 6, 7, 8 AND 9.
- PETTERS GROUP WORLDWIDE, LLC, MINNETONKA, MN  
FROM FINGERHUT CORPORATION, MINNETONKA,  
MN:  
2,900,087, INT. CL. 8.
- PETTIBONE/TRVERSE LIFT, L.L.C., BARAGA, MI:  
1,310,782. REN. 9-18-04. INT. CL. 7.
- PFEIFFER PHARMACEUTICALS, INC., ATLANTA, GA:  
1,811,407, CANC. INT. CL. 5.
- PFIZER ENTERPRISES SARL, L-1855, LUXEMBOURG,  
SCHERING AKTIENGESELLSCHAFT, D-1000 BERLIN  
65, FED REP GERMANY:  
1,846,462. REN. 9-20-04. INT. CL. 5.
- PFIZER HEALTH SOLUTIONS INC., NEW YORK, NY:  
2,900,675, INT. CL. 41.
- PFIZER INC, NEW YORK, NY:  
2,899,263, PUB. 8-10-2004. INT. CL. 44.
- PFIZER INC., NEW YORK, NY:  
1,298,339. REN. 9-19-04. INT. CL. 5.
- PFIZER INC., MORRIS PLAINS, NJ:  
2,900,568, INT. CL. 5.
- PFQ, INC., BOERNE, TX:  
2,121,156, CANC. INT. CL. 42.
- PH DOI, LLC, POTOMAC, MD:  
2,900,370, INT. CL. 5.
- PHARMA NORD APS, 6500 VOJENS, DENMARK:  
2,899,467, PUB. 8-10-2004. INT. CL. 5.
- PHARMACEUTICAL CONSULTANTS, INC., FENTON, MO:  
2,120,845, CANC. MULTIPLE CLASS, INT. CLS. 7, 12  
AND 16.
- PHARMACIA & UPJOHN COMPANY, KALAMAZOO, MI,  
FISON PLC, IPSWICH IPI 1QH, ENGLAND:  
1,293,844. REN. 9-20-04. INT. CL. 5.
- PHARMACIA & UPJOHN COMPANY, PEAPACK, NJ:  
2,900,550, INT. CL. 40.
- PHARMACIA ENI DIAGNOSTICS INC.:  
1,260,691, CANC. MULTIPLE CLASS, INT. CLS. 1, 9 AND  
16.
- PHARMANEX LLC, PROVO, UT:  
2,900,809, INT. CL. 5.  
2,900,810, INT. CL. 5.
- PHARMAVITE CORPORATION, MISSION HILLS, CA:  
2,122,439, CANC. INT. CL. 30.
- PHARMAVITE LLC, MISSION HILLS, CA:  
2,900,236, INT. CL. 5.
- PHARMCO PRODUCTS, INC., BROOKFIELD, CT:  
1,849,745. REN. 9-20-04. INT. CL. 1.  
1,849,745, CANC. MULTIPLE CLASS, INT. CLS. 3 AND 5.
- PHAROS OF WILMINGTON, LLC, WILMINGTON, DE:  
2,899,164, PUB. 8-10-2004. INT. CL. 43.
- PHASE IT INTELLIGENT SOLUTIONS AG, 69123 HEIDEL-  
BERG, FED REP GERMANY:  
2,898,535, PUB. 2-17-2004. MULTIPLE CLASS, INT. CLS.  
5, 9 AND 42.
- PHASIENT LEARNING TECHNOLOGIES, LLC, AMES, IA:  
2,900,223, INT. CL. 9.
- PHEASANT MALL RESTAURANT GROUP, INC., NASHUA,  
NH, 344, INC., BOSTON, MA:  
1,332,622. REN. 9-20-04. INT. CL. 42.
- PHELPS DODGE CORPORATION, PHOENIX, AZ:  
1,852,788. REN. 9-18-04. MULTIPLE CLASS, INT. CLS. 9  
AND 41.
- PHI DELTA THETA FRATERNITY, OXFORD, OH:  
2,837,693, COR. MULTIPLE CLASS, INT. CLS. 14, 24, 25,  
35, 36, 41 AND 42.
- PHIFER SMITH CORPORATION, PALO ALTO, CA:  
2,900,065, MULTIPLE CLASS, INT. CLS. 9 AND 42.
- PHILADELPHIA HEART INSTITUTE, THE, PHILADEL-  
PHIA, PA TO TRUSTEES OF THE UNIVERSITY OF  
PENNSYLVANIA, THE, PHILADELPHIA, PA:  
1,872,878, CANC. INT. CL. 41.
- PHILIP B. PAYNE AND NANCY C. PAYNE, BOTH U.S.  
CITIZENS, AS TRUSTEES OF THE PAYNE LOVING  
TRUST, EDMONDS, WA:  
2,121,246, CANC. INT. CL. 9.  
2,121,247, CANC. INT. CL. 9.
- PHILIP PELUSI PHYTOLINK 4.0, INC., PITTSBURGH, PA:  
2,900,730, INT. CL. 41.
- PHILLIPS PRODUCTS CO., LLC, PRINCETON, MN, PHIL-  
LIPS PRODUCTS COMPANY, MINNEAPOLIS, MN, DBA  
ED PHILLIPS & SONS CO. AND/OR DISTILLERS SALES  
COMPANY:  
1,848,324. REN. 9-22-04. INT. CL. 33.
- PHILLIPS-VAN HEUSEN CORPORATION, NEW YORK, NY,  
EAGLE SHIRTMAKERS, INC., QUAKERTOWN, PA:  
988,980. REN. 9-20-04. U.S. CL. 39 (INT. CL. 25).
- PHOEBE'S PHASHIONS, L.L.C., TULSA, OK:  
2,899,955, PUB. 8-10-2004. INT. CL. 14.
- PHOENIX CONFERENCING LLC, LAKEWOOD, CO:  
2,899,590, PUB. 1-13-2004. INT. CL. 38.
- PHOENIX ELECTRIC MFG. CO., CHICAGO, IL:  
2,900,399, INT. CL. 7.
- PHOENIX FOOTWEAR GROUP, INC., OLD TOWN, ME:  
2,899,145, PUB. 8-10-2004. INT. CL. 25.
- PHOENIX LABORATORIES, INC., HICKSVILLE, NY, DBA  
PHOENIX LABS:  
1,905,271. REN. 9-20-04. INT. CL. 5.
- PHOTO RESEARCH, INC., CHATSWORTH, CA:  
987,821. REN. 9-22-04. U.S. CL. 26 (INT. CL. 9).
- PHOTOWAVE, INC., PITTSBURGH, PA:  
2,121,336, CANC. INT. CL. 40.
- PHYSICIAN HEALTH CORPORATION, ATLANTA, GA:  
2,121,346, CANC. INT. CL. 35.
- PHYSICIANS & SCIENTISTS PUBLISHING CO., GLEN-  
VIEW, IL:  
2,121,101, CANC. INT. CL. 42.
- PHYSICIANS DATA CORPORATION, NORCROSS, GA:  
2,121,210, CANC. INT. CL. 42.

- PICKETT, GEORGE F., TOLEDO, OH, DBA G.P. INDUSTRIES:  
1,810,441, CANC. INT. CL. 6.
- PICTORIAL, INC., INDIANAPOLIS, IN:  
1,811,266, CANC. INT. CL. 42.
- PIERCE, JOSEPH ALEXANDER, TOLEDO, OH:  
2,898,522, PUB. 1-7-2003. INT. CL. 9.
- PIERRE FABRE Dermo-Cosmetique, 92100 BOULOGNE, FRANCE:  
2,898,632, PUB. 8-10-2004. MULTIPLE CLASS, INT. CLS. 3 AND 5.
- PIERRE FABRE S.A., PARIS, FRANCE:  
2,898,543, PUB. 8-10-2004. MULTIPLE CLASS, INT. CLS. 3 AND 5.
- PIERSON, TOM LINWOOD, HOUSTON, TX:  
2,899,625, PUB. 8-10-2004. INT. CL. 11.
- PIETRA PINTA U.S.A., INC., SANTA MONICA, CA:  
2,121,747, CANC. INT. CL. 29.
- PILLSBURY CANAGA LIMITED, WILLOWDALE, CANADA:  
1,261,064, CANC. INT. CL. 30.
- PILLSBURY COMPANY, THE, MINNEAPOLIS, MN:  
2,121,719, CANC. MULTIPLE CLASS, INT. CLS. 36 AND 42.  
2,122,095, CANC. INT. CL. 30.
- PILOT CHEMICAL COMPANY, SANTA FE SPRINGS, CA:  
784,642, REN. 9-18-04. U.S. CL. 6 (INT. CL. 1).
- PIN SEEKERS LTD LLC, ALBUQUERQUE, NM:  
2,899,668, PUB. 2-17-2004. INT. CL. 43.
- PINCUS BROS., INC., PHILADELPHIA, PA:  
2,121,887, CANC. INT. CL. 25.
- PINE COVE, INC., TYLER, TX:  
2,899,038, PUB. 8-10-2004. INT. CL. 41.
- PINE ENTERPRISES, WEST PALM BEACH, FL, A-T-O INC., WILLOUGHBY, OH:  
1,001,596, REN. 9-22-04. INT. CL. 28.
- PINELLAS ASSOCIATION FOR RETARDED CHILDREN, INC., THE, ST. PETERSBURG, FL:  
2,122,585, CANC. INT. CL. 41.
- PINKNER, SCOTT C., EL MACERO, CA:  
2,122,564, CANC. INT. CL. 16.
- PINNACLE MARKETING, LLC, BIDDEFORD, ME:  
2,898,665, PUB. 8-10-2004. INT. CL. 5.
- PINPOINT INTERACTIVE MEDIA, INC., SYOSSET, NY:  
2,898,503, PUB. 8-10-2004. INT. CL. 35.
- PINY, INC., BEVERLY HILLS, CA:  
2,898,838, PUB. 8-10-2004. INT. CL. 44.
- PIONEER MANUFACTURING COMPANY, THE, CLEVELAND, OH:  
1,005,496, REN. 9-24-04. U.S. CL. 4 (INT. CL. 21).
- PITCH COUNT, LLC, ANNANDALE, VA:  
2,900,397, INT. CL. 9.
- PITNEY-BOWES, INC., STAMFORD, CT:  
990,825, REN. 9-24-04. U.S. CL. 23 (INT. CLS. 7, 9 AND 16).
- PITSCO, INC., PITTSBURG, KS:  
2,900,182, INT. CL. 16.
- PITTSBURGH ACTIVATED CARBON COMPANY, PITTSBURGH, PA TO CALGON CARBON CORPORATION, PITTSBURGH, PA:  
781,920, AM. U.S. CL. 6.
- PITTSBURGH SPORTS HERITAGE, INC., PITTSBURGH, PA:  
2,122,483, CANC. INT. CL. 25.
- PITTSBURGH STEELERS SPORTS, INC., PITTSBURGH, PA:  
1,889,820, REN. 9-22-04. MULTIPLE CLASS, INT. CLS. 16 AND 25.
- PIZZA CHARIOT, INC., WICHITA, KS:  
1,261,290, CANC. INT. CL. 42.
- PIZZA HUT, INC., DALLAS, TX:  
2,900,578, INT. CL. 43.  
2,900,579, MULTIPLE CLASS, INT. CLS. 29, 30 AND 43.
- PIZZERIA UNO CORPORATION, WILMINGTON, DE:  
2,900,824, INT. CL. 43.
- PLAINSCAPITAL CORPORATION, DALLAS, TX:  
2,900,464, INT. CL. 36.  
2,900,465, INT. CL. 36.
- PLANIMETRON INCORPORATED, CHERRY HILLS VILLAGE, CO:  
1,825,755, REN. 9-22-04. INT. CL. 9.
- PLANTATION ACQUISITION, LLC, DULUTH, GA:  
2,899,016, PUB. 8-10-2004. MULTIPLE CLASS, INT. CLS. 41 AND 43.
- PLANTRONICS, INC., SANTA CRUZ, CA:  
2,899,855, PUB. 8-10-2004. INT. CL. 9.
- PLASTIC METHODS CO., INC., NEW YORK, NY:  
991,969, REN. 9-22-04. U.S. CL. 28 (INT. CL. 14).
- PLAY FOR LIFE ENTERTAINMENT, INC., NEW YORK, NY:  
2,121,212, CANC. MULTIPLE CLASS, INT. CLS. 25, 41 AND 42.
- PLAYFUL PALATE, L.L.C., OVERLAND PARK, KS:  
2,899,449, PUB. 11-18-2003. INT. CL. 29.
- PLAYMEDIA SYSTEMS, INC., LAS VEGAS, NV:  
2,900,238, INT. CL. 42.
- PLAYSTREAM, LLC, SEATTLE, WA:  
2,450,587 NEW CERT. 11-2-2004. MULTIPLE CLASS, INT. CLS. 38, 39 AND 42.  
2,657,605 NEW CERT. 11-2-2004. MULTIPLE CLASS, INT. CLS. 38, 39 AND 42.
- PLEASANT VALLEY CHURCH, INC., THOMASTON, GA:  
2,899,957, PUB. 8-10-2004. INT. CL. 41.
- PM GROUP LIFE INSURANCE COMPANY, FOUNTAIN VALLEY, CA TO PACIFIC LIFE & ANNUITY COMPANY, FOUNTAIN VALLEY, CA:  
1,811,084, CANC. INT. CL. 36.
- PM MATURITY, LLC, THERESA, WI:  
2,899,437, PUB. 8-10-2004. INT. CL. 35.
- PML MICROBIOLOGICALS, INC., WILSONVILLE, OR, PREPARED MEDIA LABORATORY, INC., TUALATIN, OR:  
1,869,139, REN. 9-22-04. INT. CL. 1.
- PMS DELI, L.L.C., VIRGINIA BEACH, VA:  
2,899,917, PUB. 8-10-2004. INT. CL. 43.
- PNS & WSS, INC., THOROFARE, NJ:  
2,900,900, INT. CL. 16.
- PNY TECHNOLOGIES, INC., PARSIPPANY, NJ:  
2,899,726, PUB. 8-10-2004. INT. CL. 9.
- POE & BROWN, INC., TAMPA, FL:  
2,122,398, CANC. INT. CL. 36.
- POE, RICHARD, ASTORIA, NY:  
2,829,808, CANC. IIRN. RESTORED TO S.N. 78-124,603.
- POINTWISE, INC., FORT WORTH, TX:  
2,899,173, PUB. 8-10-2004. MULTIPLE CLASS, INT. CLS. 9 AND 42.
- POLAR KING INTERNATIONAL, INC., FT. WAYNE, IN:  
1,307,911, REN. 9-22-04. INT. CL. 11.
- POLAROID CORPORATION, WALTHAM, MA:  
1,851,091, REN. 9-22-04. INT. CL. 16.
- POLGAT INDUSTRIES (21), LTD., KIRYAT GAT POSTAL CODE 82101, ISRAEL:  
2,120,868, CANC. INT. CL. 25.
- POLLAK AND SKAN INCORPORATED, ELK GROVE VILLAGE, IL:  
2,121,846, CANC. INT. CL. 35.
- POLLY-PIG BY KNAPP, INC., HOUSTON, TX:  
1,297,394, REN. 9-22-04. INT. CL. 7.
- POLY-AMERICA, L.P., GRAND PRARIE, TX:  
1,300,604, REN. 9-22-04. INT. CL. 22.
- POLY-COMMODITY CORP., GREAT NECK, NY:  
1,275,239, REN. 9-22-04. INT. CL. 24.
- POLY-M SPIELWAREN GMBH, INGOLSTADT, FED REP GERMANY:  
1,284,451, REN. 9-18-04. INT. CL. 28.
- POLYMER DYNAMICS TECHNOLOGY, INC., ALLENTOWN, PA:  
1,811,567, CANC. INT. CL. 25.
- POLYMERICA, INC., CARROLLTON, GA:  
1,906,988, REN. 9-20-04. INT. CL. 1.
- POLYTHERM FLOOR HEATING SYSTEMS LTD., DELTA, BRITISH COLUMBIA V4G 1C9, CANADA:  
1,850,636, REN. 9-24-04. INT. CL. 11.
- PONY INTERNATIONAL, LLC, SANTA BARBARA, CA:  
2,899,929, PUB. 8-10-2004. INT. CL. 25.  
2,899,930, PUB. 8-10-2004. INT. CL. 25.

- POOF-SLINKY, INC., PLYMOUTH, MI:  
2,899,291, PUB. 8-10-2004. INT. CL. 28.
- POPSICLE INDUSTRIES, INC., ENGLEWOOD, NJ:  
177,230, CANC. U.S. CL. 46.
- POPULAR CULTURE HIGHWAY, LLC., LA JOLLA, CA:  
2,385,967, CANC. MULTIPLE CLASS, INT. CLS. 9, 16 AND 25.
- POROUS MEDIA CORPORATION, ST. PAUL, MN:  
2,898,539, PUB. 7-30-2002. INT. CL. 1.
- PORSTORATION, INC., CALVERTON, VA:  
1,294,975, REN. 9-20-04. INT. CL. 37.
- PORTA-DOCK, INC., DASSEL, MN:  
2,121,280, CANC. INT. CL. 6.
- PORTABLE JOHN, INC., NEW YORK, NY:  
2,899,427, PUB. 8-10-2004. INT. CL. 25.
- PORTER-CABLE CORPORATION, JACKSON, TN:  
2,900,303, INT. CL. 7.  
2,900,634, INT. CL. 7.
- PORTERHOUSE LIMITED, DROGHEDA, IRELAND:  
2,120,944, CANC. INT. CL. 25.
- PORTLAND ADVENTIST MEDICAL CENTER, PORTLAND, OR:  
2,899,927, PUB. 8-10-2004. INT. CL. 41.
- PORTULAKA, LLC, LITTLETON, CO:  
2,899,176, PUB. 8-10-2004. INT. CL. 43.
- POST GLOVER RESISTORS, INC., ERLANGER, KY:  
2,900,240, INT. CL. 9.
- POTOMAC CORPORATION, WHEELING, IL:  
1,841,332, REN. 9-20-04. INT. CL. 16.
- POWER MEASUREMENT LTD., SAANICHTON BRITISH COLUMBIA, CANADA:  
2,898,466, PUB. 8-10-2004. INT. CL. 42.
- POWER TIME, INC., WOODLAND HILLS, CA, DBA KAY INTERNATIONAL:  
2,900,586, INT. CL. 35.
- POWER TRANSMISSION TECHNOLOGY, INC., COPLEY, OH:  
1,301,243, REN. 9-24-04. INT. CL. 7.
- POWERCERV TECHNOLOGIES CORPORATION, TAMPA, FL:  
2,120,892, CANC. INT. CL. 9.
- POWERIT PS AB, 611 29 NYKOPING, SWEDEN:  
2,900,279, INT. CL. 9.
- POWSUS, INC., MALVERN, PA:  
2,122,143, CANC. INT. CL. 1.
- PPG ARCHITECTURAL FINISHES, INC., PITTSBURGH, PA:  
1,810,617, CANC. INT. CL. 9.
- PPG INDUSTRIES OHIO, INC., CLEVELAND, OH:  
2,900,700, MULTIPLE CLASS, INT. CLS. 19, 41 AND 42.
- PPG INDUSTRIES, INC., PITTSBURGH, PA:  
1,260,961, CANC. INT. CL. 21.
- PRACTICAL RENT-A-CAR, LAS VEGAS, NV, RENT-A-WRECK SYSTEMS OF CANADA, LIMITED, VANCOUVER, BRITISH COLUMBIA, CANADA:  
1,290,456, REN. 9-18-04. INT. CL. 39.
- PRACTICE LOGIX, INC., CENTENNIAL, CO:  
2,898,706, PUB. 12-30-2003. MULTIPLE CLASS, INT. CLS. 35 AND 44.
- PRAECIS PHARMACEUTICALS INCORPORATED, WALTHAM, MA:  
2,900,363, INT. CL. 5.
- PRAIRIE GARDENS, INC., CHAMPAIGN, IL:  
1,850,113, REN. 9-20-04. INT. CL. 42.
- PRATT INDUSTRIES (U.S.A.), INC., CONYERS, GA:  
2,120,889, CANC. INT. CL. 40.
- PRAXCIM INC., MONTREAL, QUEBEC, CANADA:  
2,898,571, PUB. 8-10-2004. MULTIPLE CLASS, INT. CLS. 9, 14, 16, 21, 28, 30 AND 41.
- PRECISE COLOR SYSTEMS ARTZ, INC., LAS VEGAS, NV, ARTZ, INC., LEWISTON, ID:  
1,851,016, REN. 9-21-04. INT. CL. 2.
- PRECISION DYNAMICS CORPORATION, SAN FERNANDO, CA:  
2,121,838, CANC. INT. CL. 20.
- PRECISION FRANCHISING LLC, LEESBURG, VA:  
2,899,177, PUB. 8-10-2004. INT. CL. 37.  
2,899,178, PUB. 8-10-2004. INT. CL. 37.  
2,899,179, PUB. 8-10-2004. INT. CL. 37.  
2,899,180, PUB. 8-10-2004. INT. CL. 37.  
2,899,181, PUB. 8-10-2004. INT. CL. 37.
- PREMIER CHEMICALS, LLC, KING OF PRUSSIA, PA, BASIC INCORPORATED, CLEVELAND, OH:  
991,171, REN. 9-21-04. U.S. CL. 6 (INT. CL. 1).
- PREMIER NUTRITION, INC., CARLSBAD, CA:  
2,899,702, PUB. 8-10-2004. INT. CL. 29.
- PREMIUM WATERS, INC., MINNEAPOLIS, MN, CHIPPEWA SPRINGS, LTD., MINNEAPOLIS, MN:  
1,892,302, REN. 9-20-04. INT. CL. 32.
- PREMIUMSOFT CYBERTECH, LTD., HUNG HOM, HONG KONG:  
2,899,541, PUB. 4-20-2004. INT. CL. 9.
- PRESCO FOOD SEASONINGS, INC., FLEMINGTON, NJ:  
2,899,195, PUB. 8-10-2004. MULTIPLE CLASS, INT. CLS. 30 AND 40.
- PRESENT INVESTMENT CORPORATION, DEERFIELD BEACH, FL:  
1,868,156, REN. 9-21-04. INT. CL. 10.
- PRESTAMOS PRENDARIOS DEPOFIN, S.A. DE C.V., C.P. 03100, MEXICO D.F., MEXICO:  
2,899,009, PUB. 8-10-2004. INT. CL. 35.
- PRESTO FOOD PRODUCTS, INC., CITY OF INDUSTRY, CA:  
2,121,510, CANC. INT. CL. 29.
- PREVENCION, INC., WASHINGTON, DC:  
2,121,839, CANC. INT. CL. 41.
- PREVO EQUIPMENT & SUPPLY, INC., WHEELING, IL:  
2,122,272, CANC. INT. CL. 5.
- PRICE COMPANY, THE, SAN DIEGO, CA:  
1,811,533, CANC. INT. CL. 16.
- PRICEWATERHOUSECOOPERS LLP, NEW YORK, NY:  
2,900,346, INT. CL. 9.
- PRIDEVISION INC., HAMILTON, ONTARIO, CANADA:  
2,898,597, PUB. 8-10-2004. INT. CL. 41.
- PRIME HOSPITALITY CORP., FAIRFIELD, NJ:  
1,879,029, REN. 9-22-04. INT. CL. 42.
- PRIME II MANAGEMENT, L.P., AUSTIN, TX:  
1,810,692, CANC. INT. CL. 16.
- PRIMEDIA BUSINESS MAGAZINES & MEDIA INC., OVERLAND PARK, KS:  
2,899,621, PUB. 1-20-2004. INT. CL. 16.
- PRIMOS, INC., JACKSON, MS:  
2,120,894, CANC. INT. CL. 28.
- PRINCE SONG INTERNATIONAL, BLAINE, WA:  
1,810,796, CANC. INT. CL. 20.
- PRINCETON TRADEMARKS, INC., PALM BEACH, FL:  
2,121,476, CANC. INT. CL. 16.
- PRINCIPAL SECURITY GROUP, LLC., GEORGETOWN, MA:  
2,899,295, PUB. 9-30-2003. INT. CL. 45.
- PRIOR TIRE ENTERPRISES, INC., ATLANTA, GA, DBA PRIOR TIRE COMPANY:  
1,261,264, CANC. INT. CL. 42.
- PRITIKIN TRADEMARK COMPANY, LLC, SWARTHMORE, PA:  
1,811,354, CANC. MULTIPLE CLASS, INT. CLS. 29 AND 30.
- PRIVACY SOLUTIONS, INC., LA MESA, CA:  
2,900,438, INT. CL. 35.
- PRIVATE GARDENS, L.C., KANSAS CITY, MO TO FAULTLESS STARCH/BON AMI COMPANY, KANSAS CITY, MO:  
2,022,955, AM. MULTIPLE CLASS, INT. CLS. 4 AND 5.
- PRL USA HOLDING, INC., WILMINGTON, DE:  
1,327,818, REN. 9-21-04. INT. CL. 3.
- PRL USA HOLDINGS, INC., WILMINGTON, DE:  
2,900,818, INT. CL. 3.
- PRO GROUP, INC., ENGLEWOOD, CO:  
778,123, REN. 9-23-04. U.S. CL. 23 (INT. CLS. 6, 7, 8, 9, 11, 12, 16, 21 AND 28).
- PRO GROUP, INC., CENTENNIAL, CO:  
2,899,675, PUB. 8-10-2004. INT. CL. 35.

- PRO HEALTH, INC., SANTA BARBARA, CA:  
2,898,608, PUB. 8-10-2004. INT. CL. 5.
- PRO POLY OF AMERICA, INC., OCALA, FL:  
2,122,303, CANC. INT. CL. 9.
- PROCHASKA, KEVIN, NORTH HOLLYWOOD, CA, DBA  
FILL-A-GAP:  
2,120,953, CANC. INT. CL. 17.
- PROCTER & GAMBLE COMPANY, THE, CINCINNATI, OH:  
1,292,604, REN. 9-22-04. INT. CL. 3.  
1,834,586, REN. 9-21-04. INT. CL. 16.
- PROCTOR HOMER WARREN, INC., TROY, MI, DBA  
PROCTOR FINANCIAL INSURANCE CORP.:  
2,900,210, INT. CL. 35.
- PROCUNIER, RONALD R., PEORIA, AZ:  
2,900,445, INT. CL. 44.
- PRODUCE EXCHANGE, INC., THE, PLEASANTON, CA:  
2,121,745, CANC. INT. CL. 31.
- PRODUCT ACTION INTERNATIONAL, INC., FISHER, IN:  
2,121,039, CANC. INT. CL. 42.
- PRODUCTOS DEL MAR VENTISQUEROS S.A., PUERTO  
MONTT, CHILE:  
2,899,052, PUB. 8-10-2004. INT. CL. 29.
- PROFESSIONAL EDUCATION INTERNATIONAL, INC.,  
CHICAGO, IL, DBA NATIONAL ENGINEERING CON-  
SORTIUM:  
1,860,047, REN. 9-18-04. INT. CL. 41.
- PROFESSIONAL GOLFERS' ASSOCIATION OF AMERICA,  
THE, PALM BEACH GARDENS, FL:  
2,122,140, CANC. INT. CL. 28.
- PROFICIENT TECHNOLOGIES, INC., ROCKVILLE, MD:  
2,121,347, CANC. INT. CL. 35.
- PROGROUP, INC., CHATTANOOGA, TN:  
1,261,017, CANC. INT. CL. 25.
- PROLEGION INC., SAN JOSE, CA:  
2,899,810, PUB. 8-10-2004. INT. CL. 9.
- PROLINK SERVICES, L.L.C. - HOLDING, VIENNA, VA:  
2,898,914, PUB. 8-10-2004. INT. CL. 35.
- PROMARK INTERNATIONAL, INC., BOISE, ID:  
2,898,609, PUB. 1-7-2003. INT. CL. 30.
- PROMAU S.R.L., 47020 CESENA (FO), ITALY:  
2,120,685, CANC. INT. CL. 7.
- PROMINIC TECHNOLOGIES, INC., CHAMPAIGN, IL:  
2,121,306, CANC. MULTIPLE CLASS, INT. CLS. 9 AND  
42.
- PROMOTORA MUSICAL S.A. DE C.V., COLONIA TLAL-  
PAN, C.P. 14000, MEXICO:  
2,898,468, PUB. 10-9-2001. INT. CL. 35.
- PROPERTY MARKET ANALYSIS LLP, LONDON WC1V  
7AA, UNITED KINGDOM:  
2,898,638, PUB. 8-10-2004. MULTIPLE CLASS, INT. CLS.  
35 AND 36.
- PROSANOS CORPORATION, LA JOLLA, CA:  
2,899,183, PUB. 8-10-2004. INT. CL. 9.  
2,899,184, PUB. 8-10-2004. INT. CL. 42.
- PROSTRONG, INC., OAKVILLE, CT:  
2,900,571, INT. CL. 3.
- PROTEAM, INC., BOISE, ID:  
2,898,674, PUB. 8-10-2004. INT. CL. 7.
- PROVENIO GROUP, INC, AUSTIN, TX:  
2,899,392, PUB. 8-10-2004. INT. CL. 41.
- PROVIDIAN BANCORP, INC., SAN FRANCISCO, CA:  
2,121,737, CANC. INT. CL. 35.
- PRUDENTIAL INSURANCE COMPANY OF AMERICA,  
THE, NEWARK, NJ:  
2,121,610, CANC. MULTIPLE CLASS, INT. CLS. 35 AND  
42.
- PRUDENTIAL SECURITIES, INC., NEW YORK, NY:  
2,899,623, PUB. 1-20-2004. INT. CL. 36.
- PRYOR PRODUCTS, OCEANSIDE, CA:  
1,896,081, REN. 9-18-04. INT. CL. 10.
- PSW TECHNOLOGIES, INC., AUSTIN, TX:  
2,121,881, CANC. INT. CL. 9.  
2,121,882, CANC. INT. CL. 9.
- PSYCHOLOGICAL ASSOCIATES, INC., ST. LOUIS, MO:  
1,288,986, REN. 9-20-04. INT. CL. 16.  
1,289,409, REN. 9-20-04. INT. CL. 41.
- PUBLIC BROADCASTING SERVICE, ALEXANDRIA, VA:  
2,122,489, CANC. MULTIPLE CLASS, INT. CLS. 38, 41  
AND 42.
- PUGLIESE, LAWRENCE J., GREENWICH, CT:  
1,820,335, REN. 9-23-04. MULTIPLE CLASS, INT. CLS. 18,  
25 AND 28.
- PULLMAN COMPANY, THE, MILAN, OH, HARRIS PRO-  
DUCTS COMPANY, CLEVELAND, OH:  
593,886, REN. 9-22-04. U.S. CL. 35 (INT. CL. 17).
- PULSAFEEDER, INC., ROCHESTER, NY, PULSAFEEDER,  
INC., ROCHESTER, NY:  
1,846,132, REN. 9-22-04. INT. CL. 9.
- PULSE MICROSYSTEMS LTD., MISSISSAUGE, ONTARIO,  
CANADA:  
2,122,125, CANC. INT. CL. 9.
- PURAPHARM INTERNATIONAL (H.K.), CENTRAL, HONG  
KONG:  
2,900,127, INT. CL. 5.
- PURDUE FREDERICK COMPANY, THE, NORWALK, CT:  
1,260,762, CANC. INT. CL. 5.
- PURDUE PHARMA L.P., STAMFORD, CT:  
1,909,287, REN. 9-18-04. INT. CL. 16.
- PURE WATER CORPORATION, SEATTLE, WA:  
2,121,196, CANC. INT. CL. 32.  
2,121,197, CANC. INT. CL. 1.
- PURE 03 TECH, INC., ESCONDIDO, CA:  
2,900,287, INT. CL. 11.
- PURESYN, INC., MALVERN, PA:  
1,904,865, REN. 9-21-04. INT. CL. 1.
- PUROLATOR PRODUCTS N.A., INC., TULSA, OK:  
1,849,855, REN. 9-18-04. INT. CL. 12.
- PVI INDUSTRIES, LLC, FORT WORTH, THAILAND:  
1,290,884, REN. 9-22-04. INT. CL. 11.
- PYLE INDUSTRIES, INC., HUNTINGTON, IN:  
1,260,854, CANC. INT. CL. 9.
- P4 GROUP LLC, DENVER, CO:  
2,899,351, PUB. 10-14-2003. INT. CL. 12.
- P5, INC., SALT LAKE CITY, UT:  
2,899,440, PUB. 8-10-2004. INT. CL. 36.
- Q-TECH LABORATORIES PTY LTD, TOOWOOMBA,  
QUEENSLAND, 4350, AUSTRALIA:  
2,898,549, PUB. 8-10-2004. INT. CL. 10.
- QCOM TV, INC., WEST CHESTER, PA:  
2,898,812, PUB. 12-23-2003. INT. CL. 35.
- QMNUIUM CORPORATION, STILLWATER, MN:  
1,260,839, CANC. INT. CL. 9.
- QSENT, INC., LAKE OSWEGO, OR:  
2,847,824, COR. MULTIPLE CLASS, INT. CLS. 35 AND  
42.
- QSENT, INC., PORTLAND, OR:  
2,898,489, PUB. 8-10-2004. MULTIPLE CLASS, INT. CLS.  
35 AND 42.
- QSR MANAGEMENT LIMITED, LONDON E14 5AA, UNI-  
TED KINGDOM:  
2,898,895, PUB. 8-10-2004. INT. CL. 36.
- QUADRUM TELECOMMUNICATIONS, INC., HUNTS-  
VILLE, AL:  
2,121,135, CANC. INT. CL. 9.
- QUADSIL, INC., MIDLAND, MI:  
2,898,921, PUB. 8-10-2004. INT. CL. 42.
- QUAL-I-QUICK DOUBLE Q PRINTERS, INC., SPRING-  
FIELD, MO:  
1,261,301, CANC. INT. CL. 42.  
1,261,302, CANC. INT. CL. 42.  
1,261,303, CANC. INT. CL. 42.
- QUALITY INNS INTERNATIONAL, INC., SILVER SPRING,  
MD:  
1,261,298, CANC. INT. CL. 42.
- QUALITY PIPE PRODUCTS, INC., TAYLOR, MI:  
2,900,849, INT. CL. 6.
- QUALITY PRODUCTS, INC., SAN JOSE, CA:  
2,899,544, PUB. 8-10-2004. INT. CL. 29.
- QUALITY RESOURCES INTERNATIONAL, TWINSBURG,  
OH:  
1,811,053, CANC. INT. CL. 35.
- QUALITY SYSTEMS LTD., MILFORD, AUKLAND, NEW  
ZEALAND:  
2,899,050, PUB. 8-10-2004. INT. CL. 42.
- QUAMTUM OPTICS, INC., SMITHFIELD, RI:  
2,122,002, CANC. INT. CL. 9.

QUENCH CO. INC., THE, SEATTLE, WA:  
 177,132, CANC. U.S. CL. 45.  
 QUEST INDUSTRIES, INC., MIAMI, FL:  
 2,899,292, PUB. 9-30-2003. MULTIPLE CLASS, INT. CLS.  
 6, 7, 9, 11, 12 AND 20.  
 QUIET SOLUTION, INC., SANTA CLARA, CA:  
 2,900,787, INT. CL. 17.  
 QUIGLEY COMPANY, INC., NEW YORK, NY:  
 1,260,951, CANC. INT. CL. 19.  
 1,260,952, CANC. INT. CL. 19.  
 QUIGLEY'S ORCHARD, NEW YORK, NY:  
 2,121,275, CANC. INT. CL. 29.  
 QUINTA DE VENTOZELO - SOCIEDADE AGRICOLA E  
 COMERCIAL, S.A., P-5130 SAO JOAO DA PESQUEIRA,  
 PORTUGAL:  
 2,863,139, COR. INT. CL. 33.  
 QUIP LABORATORIES, INC., WILMINGTON, DE:  
 2,899,589, PUB. 8-10-2004. INT. CL. 5.  
 Q1 LABS INC., WALTHAM, MA:  
 2,899,485, PUB. 8-10-2004. INT. CL. 9.  
 Q2 TECHNOLOGIES, LLC, MONTGOMERY, TX:  
 2,900,653, INT. CL. 1.  
 R. C. BIGELOW, INC., FAIRFIELD, CT:  
 1,849,724, REN. 9-18-04. INT. CL. 30.  
 R. G. VAN SLOOTEN'S SUIKERWERKFABRIEK B.V.,  
 LEEUWARDEN, NETHERLANDS:  
 1,261,075, CANC. INT. CL. 30.  
 R. T. VANDERBILT COMPANY, INC., NORWALK, CT:  
 317,330, REN. 9-20-04. U.S. CL. 6 (INT. CL. 1).  
 776,428, REN. 9-22-04. U.S. CL. 6 (INT. CL. 1).  
 R.D.T. BUSINESS ENTERPRISES, INC., FORT LAUDER-  
 DALE, FL, DBA SYNERGYLABS:  
 2,857,306, COR. MULTIPLE CLASS, INT. CLS. 1, 3, 5, 31  
 AND 40.  
 R.E. MICHEL COMPANY, INC., GLEN BURNIE, MD:  
 2,899,718, PUB. 8-10-2004. INT. CL. 35.  
 R.F.P., INC., AURORA, CO TO SYNAPTIC CORPORATION,  
 THE, AURORA, CO:  
 1,810,634, CANC. INT. CL. 10.  
 R.J. THOMAS MANUFACTURING COMPANY, INC.,  
 CHEROKEE, IA:  
 2,899,904, PUB. 8-10-2004. INT. CL. 20.  
 R.L. TORBECK INDUSTRIES, INC., HARRISON, OH:  
 1,811,132, CANC. INT. CL. 39.  
 R.T. TEMPS, INC., P.C., WAYNE, PA:  
 2,900,537, INT. CL. 35.  
 R.W. LYALL & COMPANY, INC., CORONA, CA:  
 2,121,667, CANC. INT. CL. 17.  
 2,121,675, CANC. INT. CL. 35.  
 RA BRANDS, LLC, MADISON, NC, REMINGTON ARMS  
 COMPANY, INC., WILMINGTON, DE:  
 1,843,652, REN. 9-20-04. INT. CL. 18.  
 RACHELL, LAWRENCE, NYC, NY:  
 2,900,022, PUB. 8-10-2004. INT. CL. 41.  
 RACOSKY, RICHARD J., BOULDER, CO:  
 1,849,962, REN. 9-19-04. INT. CL. 25.  
 RADER, FISHMAN & GRAUER PLLC, BLOOMFIELD  
 HILLS, MI:  
 2,899,366, PUB. 8-10-2004. MULTIPLE CLASS, INT. CLS.  
 16 AND 42.  
 RADIATOR SPECIALTY COMPANY, CHARLOTTE, NC:  
 996,942, REN. 9-21-04. U.S. CL. 12 (INT. CL. 19).  
 RAE SYSTEMS INC., SUNNYVALE, CA:  
 2,899,683, PUB. 8-10-2004. INT. CL. 9.  
 RAGUS HOLDINGS, INC., WILMINGTON, DE:  
 2,899,739, PUB. 8-10-2004. INT. CL. 30.  
 2,899,767, PUB. 8-10-2004. INT. CL. 30.  
 RAHIMI, DAVID, LOS ANGELES, CA:  
 2,898,874, PUB. 8-10-2004. INT. CL. 5.  
 2,898,875, PUB. 8-10-2004. INT. CL. 44.  
 RAIN BIRD SPRINKLER MANUFACTURING CORP.,  
 GLENDORA, CA:  
 761,559, CANC. U.S. CL. 13.  
 RAINBOW REHABILITATION CENTERS, INC., YPSILAN-  
 TI, MI:  
 2,899,477, PUB. 8-10-2004. INT. CL. 44.  
 RAINING DATA CORPORATION, IRVINE, CA:  
 2,899,960, PUB. 8-10-2004. INT. CL. 9.  
 RAJEWSKI, CHERYL, SUMMIT, NJ AND DOCARMO, RUI,  
 SUMMIT, NJ:  
 2,898,947, PUB. 4-13-2004. MULTIPLE CLASS, INT. CLS.  
 35 AND 43.  
 2,898,948, PUB. 4-6-2004. MULTIPLE CLASS, INT. CLS. 35  
 AND 43.  
 RALEY'S TM, INC., WEST SACRAMENTO, CA:  
 2,899,025, PUB. 8-10-2004. INT. CL. 9.  
 RALSTON PURINA COMPANY, ST. LOUIS, MO:  
 2,122,004, CANC. INT. CL. 31.  
 RAM INDUSTRIES INC., YORKTON, SASKATCHEWAN,  
 CANADA:  
 2,898,787, PUB. 8-10-2004. INT. CL. 7.  
 RAMTRON INTERNATIONAL CORPORATION, COLOR-  
 ADO SPRINGS, CO:  
 1,879,559, REN. 9-18-04. INT. CL. 9.  
 RANBAXY LABORATORIES LIMITED, NEW DELHI, IN-  
 DIA:  
 2,900,682, INT. CL. 5.  
 RANDALL, VALERIE, SANTA ROSA, CA:  
 2,899,090, PUB. 8-10-2004. MULTIPLE CLASS, INT. CLS. 9  
 AND 16.  
 RANDSTAD GENERAL PARTNER (US) LLC, ATLANTA,  
 GA, CAREER EMPLOYMENT SERVICES, INC., WOOD-  
 BURY, NY:  
 1,824,579, REN. 9-22-04. INT. CL. 35.  
 RANDSTAD HOLDING N.V., 1100 AP AMSTERDAM,  
 NETHERLANDS:  
 1,846,935, REN. 9-21-04. INT. CL. 35.  
 RANGE KLEEN MFG., INC., LIMA, OH:  
 1,811,560, CANC. INT. CL. 21.  
 RAPCO PROFESSIONAL SOUND COMPANY, TORONTO,  
 ONTARIO, CANADA:  
 1,316,897, REN. 9-22-04. INT. CL. 15.  
 RAPELLI S.A., STABIO (TICINO), SWITZERLAND:  
 2,121,035, CANC. INT. CL. 29.  
 RAPID ACCU-FORM, INC., BENICIA, CA:  
 2,899,907, PUB. 8-10-2004. INT. CL. 9.  
 RAPID DISPLAYS, INC., CHICAGO, IL, RAPID MOUNT-  
 ING AND FINISHING COMPANY, CHICAGO, IL:  
 1,889,875, REN. 9-22-04. INT. CL. 16.  
 RAPID POWER TECHNOLOGIES, INC., BROOKFIELD, CT:  
 1,261,166, CANC. MULTIPLE CLASS, INT. CLS. 37 AND  
 42.  
 RAPID ROTATION, INC., KENNESAW, GA:  
 1,811,665, CANC. INT. CL. 37.  
 RASH, JAMES W., MILFORD, DE:  
 2,899,456, PUB. 12-30-2003. INT. CL. 35.  
 RATH, MATTHIAS, NL-7609 KL ALMELO, NETHER-  
 LANDS:  
 2,898,576, PUB. 12-23-2003. MULTIPLE CLASS, INT. CLS.  
 5, 30 AND 32.  
 2,899,414, PUB. 9-16-2003. MULTIPLE CLASS, INT. CLS.  
 5, 16, 41, 42 AND 44.  
 RATIONAL AG, 86899 LANDSBERG/LECH, FED REP  
 GERMANY:  
 2,899,044, PUB. 8-10-2004. INT. CL. 11.  
 RATIONAL RECOVERY SYSTEMS, INC., LOTUS, CA:  
 1,887,516, REN. 9-18-04. MULTIPLE CLASS, INT. CLS. 41  
 AND 42.  
 RAVO, AARON, LOS ANGELES, CA AND RAVO, DAVID,  
 LOS ANGELES, CA:  
 2,900,715, INT. CL. 5.  
 RAW INTERNATIONAL INC., LOS ANGELES, CA:  
 2,899,096, PUB. 8-10-2004. INT. CL. 37.  
 RAW MATERIALS FOOD COMPANY, BOULDER, CO:  
 2,120,729, CANC. INT. CL. 5.  
 RAWLINGS SPORTING GOODS COMPANY, INC., FEN-  
 TON, MO:  
 2,898,630, PUB. 8-10-2004. INT. CL. 9.  
 RAYBERN FOODS, INC., HAYWARD, CA:  
 2,120,931, CANC. INT. CL. 30.  
 RAYBURN, DEBRA J., LITTLETON, CO:  
 2,899,423, PUB. 12-30-2003. INT. CL. 5.  
 RAYCO MANUFACTURING, INC., WOOSTER, OH:  
 2,243,516, COR. INT. CL. 7.  
 RAYMOND, NATASHA, BROOKFIELD, CT:  
 2,899,988, PUB. 8-10-2004. INT. CL. 41.

- RCD HOLDINGS, INC., DETROIT, MI:  
1,855,881. REN. 9-20-04. INT. CL. 30.
- RC2 BRANDS, INC., DYERSVILLE, IA:  
1,875,381. REN. 9-19-04. INT. CL. 28.
- RDI INTERNATIONAL LIMITED, ESSEX, UNITED KINGDOM:  
2,899,530. PUB. 8-10-2004. INT. CL. 21.
- RE-DESIGNING WOMEN, INC., ATLANTA, GA:  
2,899,837. PUB. 8-10-2004. INT. CL. 36.
- RE-INVESTORS, INC., KANSAS CITY, MO:  
2,899,406. PUB. 9-30-2003. INT. CL. 36.
- READQ SYSTEMS, INC., NEW YORK, NY:  
1,810,550. CANC. INT. CL. 9.
- READY PAC PRODUCE, INC., IRWINDALE, CA:  
1,317,157. REN. 9-18-04. INT. CL. 29.
- READY READING GLASSES, INC., DALLAS, TX:  
2,899,926. PUB. 8-10-2004. INT. CL. 35.
- REAL LIVING, INC., COLUMBUS, OH:  
2,900,265. MULTIPLE CLASS, INT. CLS. 36 AND 42.
- REAL TORINO, INC., MENDHAM, NJ:  
2,900,436. INT. CL. 30.
- REALNETWORKS, INC., SEATTLE, WA:  
2,900,061. INT. CL. 41.
- REALTY DIRECT FRANCHISE CORPORATION, STERLING, VA:  
2,899,953. PUB. 8-10-2004. INT. CL. 36.  
2,900,015. PUB. 8-10-2004. INT. CL. 36.
- REBELLION SPORT AB, SE-701 16 OREBRO, SWEDEN:  
2,899,870. PUB. 8-10-2004. INT. CL. 28.
- RECHARGEABLE BATTERY RECYCLING CORPORATION, STAFFORD, VA:  
2,122,040. CANC. INT. CL. 40.
- RECKITT BENCKISER INC., PARSIPPANY, NJ:  
2,900,616. INT. CL. 21.
- RECLAIM FILTERS AND SYSTEMS, INC., WAKE FOREST, NC:  
2,899,786. PUB. 8-10-2004. INT. CL. 11.
- RECTORSEAL CORPORATION, THE, HOUSTON, TX:  
996,260. REN. 9-24-04. U.S. CL. 12 (INT. CL. 19).
- RECYCLED FIBRE INDUSTRIES, INC., BOCA RATON, FL:  
2,122,188. CANC. INT. CL. 17.
- RED & WHITE FOUNDATION, CHICAGO, IL:  
1,267,565. REN. 9-24-04. MULTIPLE CLASS, INT. CLS. 29 AND 30.  
1,267,565. CANC. MULTIPLE CLASS, INT. CLS. 3 AND 5.
- REDBARN PET PRODUCTS, INC., LONG BEACH, CA:  
2,899,128. PUB. 8-10-2004. INT. CL. 31.
- REDDI ROOT'R SYSTEMS INTERNATIONAL, INC., PHOENIX, AZ, REDDI ROOT'R SYSTEMS, INC., KANSAS CITY, KS:  
1,241,463. REN. 9-22-04. INT. CL. 37.
- REDDY-RAW, INC., WOODRIDGE, NJ:  
1,892,257. REN. 9-23-04. INT. CL. 29.  
1,892,258. REN. 9-23-04. INT. CL. 29.
- REDFIELD LABORATORIES, REDFIELD, AR:  
2,120,808. CANC. INT. CL. 42.
- REDI-GRO PRODUCTS, SACRAMENTO, CA:  
2,898,756. PUB. 12-2-2003. MULTIPLE CLASS, INT. CLS. 1 AND 31.
- REDMOND PRODUCTS, INC., CHANHASSEN, MN:  
2,122,446. CANC. INT. CL. 3.
- REEBOK INTERNATIONAL LIMITED, LANCASTER, ENGLAND:  
1,848,848. REN. 9-20-04. MULTIPLE CLASS, INT. CLS. 18 AND 25.
- REED CONSTRUCTION DATA INC., NORCROSS, GA, ARCHITECTS' FIRST SOURCE, INC., NORCROSS, GA:  
1,850,313. REN. 9-24-04. INT. CL. 16.
- REED ELSEVIER INC., NEW YORK, NY:  
2,898,737. PUB. 8-10-2004. INT. CL. 35.
- REED ELSEVIER INC., NEWTON, MA:  
2,899,146. PUB. 8-10-2004. INT. CL. 37.
- REED ELSEVIER PROPERTIES INC., WILMINGTON, DE, ENVIRONMENT INFORMATION CENTER, INC., NEW YORK, NY:  
1,014,673. REN. 9-21-04. INT. CL. 16.
- REED ELSEVIER PROPERTIES INC., WILMINGTON, DE, REED PROPERTIES INC., WILMINGTON, DE:  
1,911,286. REN. 9-21-04. INT. CL. 16.
- REED INTERNATIONAL P.L.C., LONDON SW1H 0EX, ENGLAND:  
1,811,021. CANC. MULTIPLE CLASS, INT. CLS. 35 AND 41.
- REED INTERNATIONAL P.L.C., LONDON W1A 1EJ, ENGLAND:  
1,811,212. CANC. INT. CL. 42.
- REED PROPERTIES INC., WILMINGTON, DE, VARIETY, INC., NEW YORK, NY:  
1,350,618. REN. 9-23-04. INT. CL. 16.
- REED SMITH LLP, PITTSBURGH, PA:  
1,293,150. REN. 9-22-04. INT. CL. 35.
- REED, BRIAN, NASHVILLE, TN AND REED, SHERRY COTHRAN, NASHVILLE, TN:  
2,121,370. CANC. INT. CL. 41.
- REEMAY, INC., OLD HICKORY, TN:  
1,844,113. REN. 9-20-04. INT. CL. 7.
- REGAL SWAN, THE, KISSIMMEE, FL:  
2,898,790. PUB. 8-10-2004. INT. CL. 16.
- REGAL WARE, INC., KEWASKUM, WI:  
2,122,123. CANC. INT. CL. 16.
- REGENCE BLUE SHIELD, SEATTLE, WA:  
2,899,035. PUB. 8-10-2004. MULTIPLE CLASS, INT. CLS. 36 AND 44.  
2,899,043. PUB. 8-10-2004. INT. CL. 44.
- REGENERATION TECHNOLOGIES, INC., ALACHUA, FL:  
2,900,124. INT. CL. 10.
- REGIONAL PERFORMING ARTS CENTER, INC., PHILADELPHIA, PA:  
2,899,451. PUB. 11-4-2003. INT. CL. 16.
- REICH, DAVID, TURLOCK, CA, DBA DAVID REICH CONSTRUCTION:  
2,900,701. INT. CL. 6.
- REID, JOHN W., FRANKFORT, IN AND REID, CATHERINE L., FRANKFORT, IN, DBA PIONEER RESTORATION:  
2,898,456. PUB. 8-10-2004. INT. CL. 37.
- REILOR HOLDINGS LIMITED, ROMAN WAY, PRESTON, GREAT BRITAIN:  
2,898,600. PUB. 8-10-2004. MULTIPLE CLASS, INT. CLS. 6, 9 AND 19.
- REINFORCED EARTH COMPANY, THE, VIENNA, VA:  
2,121,930. CANC. INT. CL. 19.
- REINHOLD HAUBER STRICKWARENFABRIK GMBH & CO. KG., NURTINGEN, FED REP GERMANY:  
1,328,335. REN. 9-19-04. INT. CL. 10.
- REINHOLD MANUFACTURING LTD., MAPLE RIDGE, BRITISH COLUMBIA, CANADA:  
2,899,872. PUB. 8-10-2004. INT. CL. 11.
- RELIANCE ELECTIC COMPANY, WILWAUKEE, OH, DODGE MANUFACTURING CORPORATION, MISHAWAKA, IN:  
594,203. REN. 9-22-04. U.S. CL. 23 (INT. CL. 7).
- RELIQ, INC., NEW YORK, NY:  
2,899,060. PUB. 8-10-2004. INT. CL. 25.
- REN-E SPORT GOODS CO., LTD., TAICHUNG HSIEN, TAIWAN, REPUBLIC CHINA:  
1,810,883. CANC. INT. CL. 28.
- REPROCESSING PRODUCTS CORP (RPC), TUCSON, AZ:  
2,899,800. PUB. 8-10-2004. INT. CL. 10.  
2,899,806. PUB. 8-10-2004. INT. CL. 10.
- REPUBLIC CLOTHING CORPORATION, NEW YORK, NY:  
2,899,932. PUB. 8-10-2004. INT. CL. 25.
- REPUBLIC ENTERTAINMENT INC., LOS ANGELES, CA:  
2,900,593. INT. CL. 14.
- RESEARCH ELECTRONICS INTERNATIONAL LLC, ALGOOD, TN:  
1,866,222. REN. 9-21-04. INT. CL. 9.
- RESEARCH LABORATORIES, INC., BIRMINGHAM, AL:  
2,122,245. CANC. INT. CL. 5.
- RESEARCH PRODUCTS CORPORATION, MADISON, WI:  
979,021. REN. 9-20-04. U.S. CL. 31 (INT. CL. 11).  
2,122,428. CANC. INT. CL. 9.
- RESEARCH PROS, INC., CHICAGO, IL:  
1,855,343. REN. 9-18-04. INT. CL. 35.

RESERVE HOLDINGS, LLC, DOUGLASSVILLE, PA:  
2,899,455, PUB. 8-10-2004. INT. CL. 5.

RESILLO PRESS PAD CO., CHICAGO, IL:  
774,493. REN. 9-22-04. U.S. CL. 24 (INT. CL. 7).

RESMED LIMITED, NORTH RYDE, NEW SOUTH WALES, AUSTRALIA:  
2,899,913, PUB. 8-10-2004. INT. CL. 10.  
2,899,914, PUB. 8-10-2004. INT. CL. 10.

RESOURCE GROUP INTERNATIONAL, INC., SEATTLE, WA:  
2,899,461, PUB. 8-10-2004. MULTIPLE CLASS, INT. CLS. 35 AND 36.

RESOURCE HOLDINGS, LLC, COLUMBUS, OH:  
2,900,278, INT. CL. 35.

RESOURCE MANAGEMENT SERVICE, INC., BIRMINGHAM, AL:  
2,898,753, PUB. 12-9-2003. INT. CL. 16.

RESTONIC CORPORATION, CHICAGO, IL:  
761,622, CANC. U.S. CL. 32.

RESULTS BASED SYSTEMS CORPORATION, EVERETT, WA:  
2,122,508, CANC. INT. CL. 9.

RESURGENCE SOFTWARE, INC., METAIRIE, LA:  
2,817,787, COR. MULTIPLE CLASS, INT. CLS. 9 AND 42.

REVCO D.S., INC., TWINSBURG, OH:  
2,121,863, CANC. INT. CL. 41.

REVERE COPPER PRODUCTS, INC., ROME, NY:  
2,899,968, PUB. 8-10-2004. INT. CL. 6.

REVERE SUPPLY CO., INC., WEST CALDWELL, NJ:  
2,900,387, INT. CL. 9.

REVIEW PUBLISHING LIMITED PARTNERSHIP, PHILADELPHIA, PA:  
2,900,229, INT. CL. 16.

REXAIR, INC., TROY, MI:  
993,728. REN. 9-20-04. U.S. CL. 21 (INT. CL. 9).

REXENE CORPORATION, DALLAS, TX:  
2,121,615, CANC. INT. CL. 1.

RF CODE, INC., MESA, AZ:  
2,900,262, INT. CL. 9.

RGIS INVENTORY SPECIALISTS, AUBURN HILLS, MI:  
1,289,504. REN. 9-23-04. INT. CL. 9.

RHEMA CHRISTIAN CENTER, COLUMBUS, OH:  
2,899,551, PUB. 8-10-2004. INT. CL. 41.

RHODA LEE, INC., NEW YORK, NY:  
1,901,806. REN. 9-20-04. INT. CL. 25.

RHYTHM EAST LTD., TAIPEI, TAIWAN:  
2,900,212, INT. CL. 25.

RIBA, S D, CLEARWATER, FL:  
2,899,358, PUB. 8-10-2004. INT. CL. 26.

RIBACK, CORY M., VAN NUYS, CA:  
1,810,881, CANC. INT. CL. 28.

RICCARDO, RANDALL, SAN FRANCISCO, CA:  
2,900,678, INT. CL. 25.

RICE, ROBERT, PETALUMA, CA:  
1,306,698. REN. 9-18-04. INT. CL. 3.

RICH PALM ENTERPRISE CORP. LTD., SHENKENG, TAIWAN:  
2,900,205, INT. CL. 7.

RICHARD A. ERDEY, MD, INC., COLUMBUS, OH:  
2,900,172, INT. CL. 42.

RICHARD BAGDASARIAN, INC., MECCA, CA:  
2,899,068, PUB. 8-10-2004. INT. CL. 31.

RICHARD RAINS AND CARL WAGGONER PARTNERSHIP, THE, WOODRIDGE, IL:  
2,900,199, INT. CL. 35.

RICHARD WOLF GMBH, KNITTLINGEN, FED REP GERMANY:  
1,290,759. REN. 9-18-04. INT. CL. 9.

RICHARDSON ELECTRONICS, LTD., LAFOX, IL:  
2,900,792, INT. CL. 9.

RICHEMONT INTERNATIONAL SA, VILLARS-SUR-GLANE, SWITZERLAND:  
2,899,815, PUB. 8-10-2004. INT. CL. 14.

RICKARD, GAIL, IMLAY CITY, MI:  
2,900,352, INT. CL. 18.

RICKARD, STUART, ALAMEDA, CA:  
2,899,987, PUB. 8-10-2004. INT. CL. 37.

RICOMM SYSTEMS, INC., MARLTON, NJ:  
2,122,407, CANC. INT. CL. 42.

RICURA TECHNOLOGIES, LLC, HICKORY, NC:  
2,899,977, PUB. 8-10-2004. MULTIPLE CLASS, INT. CLS. 3, 5, 11 AND 35.

RIEDI, MARKUS, MUNICH, FED REP GERMANY:  
2,898,500, PUB. 8-10-2004. MULTIPLE CLASS, INT. CLS. 9, 11, 35 AND 42.

RIETER PERFOJET, MONTBONNOT, FRANCE:  
2,899,448, PUB. 8-10-2004. MULTIPLE CLASS, INT. CLS. 7 AND 24.

RINGBOLT PTY LTD, ANGASTON, 5353, SOUTH AUSTRALIA, AUSTRALIA:  
2,898,908, PUB. 8-10-2004. INT. CL. 33.

RIO VALLEY CANNING CO., INC., DONNA, TX:  
1,859,821. REN. 9-18-04. INT. CL. 29.

RISE INTERNATIONAL GROUP, LLC, LODI, NJ, CONOPCO, INC., GREENWICH, CT, DBA CHESEBROUGH-POND'S USA CO.:  
1,860,625. REN. 9-20-04. INT. CL. 3.

RISK DATA CORPORATION, IRVINE, CA:  
2,122,371, CANC. INT. CL. 9.

RITA'S WATER ICE, INC., BENSLEM, PA:  
2,122,544, CANC. INT. CL. 42.

RITCHIE, FIONA, MATHEWS, NC, UNIVERSITY OF NORTH CAROLINA AT CHARLOTTE, THE, CHARLOTTE, NC:  
1,286,535. REN. 9-19-04. INT. CL. 41.

RITCHIE, SUSAN, PHOENIX, AZ:  
2,121,764, CANC. MULTIPLE CLASS, INT. CLS. 16 AND 28.

RIVERDEEP INTERACTIVE LEARNING LIMITED, DUBLIN 2, IRELAND, MINNESOTA EDUCATIONAL COMPUTING CORPORATION (MECC), MINNEAPOLIS, MN:  
1,850,384. REN. 9-19-04. INT. CL. 28.

RIVERDEEP INTERACTIVE LEARNING LIMITED, DUBLIN 2, IRELAND:  
2,899,234, PUB. 8-10-2004. INT. CL. 9.

RIVERSIDE MANUFACTURING COMPANY, MOULTRIE, GA:  
1,873,941. REN. 9-23-04. INT. CL. 25.

RIVIANA FOODS INC., HOUSTON, TX, UNITED WILD RICE, INC., GRAND RAPIDS, MN:  
999,101. REN. 9-22-04. INT. CL. 30.

RIVIANA FOODS INC., HOUSTON, TX, EL CAMPO RICE MILLING COMPANY, EL CAMPO, TX:  
1,296,663. REN. 9-22-04. INT. CL. 30.

RIVIANA FOODS INC., HOUSTON, TX, MANDARIN RICE MILLING COMPANY, HOUSTON, TX:  
1,299,030. REN. 9-22-04. INT. CL. 30.

RLF, INC., LAKE OSWEGO, OR:  
2,898,863, PUB. 2-10-2004. MULTIPLE CLASS, INT. CLS. 19 AND 35.

ROAD BUTLER, INC., DALLAS, TX:  
2,121,459, CANC. MULTIPLE CLASS, INT. CLS. 37 AND 39.

ROAD SYSTEMS, INC., BIG SPRING, TX:  
2,899,281, PUB. 1-29-2002. INT. CL. 6.

ROBATHERM GMBH, 89325 BURGAU, FED REP GERMANY:  
2,898,545, PUB. 8-10-2004. INT. CL. 11.

ROBERT BOSCH GMBH, STUTTGART, FED REP GERMANY:  
2,120,752, CANC. INT. CL. 41.

ROBERT LOUIS ASSOCIATES OF NEWTOWN, INC., DANBURY, CT:  
2,121,899, CANC. INT. CL. 3.

ROBERT MONDAVI WINERY, NAPA, CA:  
2,899,486, PUB. 12-16-2003. INT. CL. 33.  
2,899,628, PUB. 2-24-2004. INT. CL. 33.

ROBERT W. WOODRUFF ARTS CENTER, INC., ATLANTA, GA:  
2,899,067, PUB. 8-10-2004. MULTIPLE CLASS, INT. CLS. 35 AND 41.

ROBERTA'S, INC., SHELBYVILLE, IN:  
1,886,873. REN. 9-23-04. INT. CL. 3.

- ROBERTS, L. STEVE, WEST SALEM, OH, DBA TODAY & BEYOND:  
1,810,389, CANC. INT. CL. 3.  
1,810,390, CANC. INT. CL. 3.
- ROBINSON, LOREN, CARL, ROOSEVELT, UT:  
2,899,925, PUB. 8-10-2004. INT. CL. 5.
- ROCHE PRODUCTS INC., HUMACAO, PUERTO RICO:  
1,314,271, REN. 9-19-04. INT. CL. 5.
- ROCHESTER HEALTHCARE INFORMATION GROUP, INC., ROCHESTER, NY:  
2,120,985, CANC. INT. CL. 42.
- ROCHESTER INSTRUMENT SYSTEMS, INC., ROCHESTER, NY:  
2,121,980, CANC. INT. CL. 9.
- ROCHESTER MEAT COMPANY, ROCHESTER, MN:  
2,899,967, PUB. 8-10-2004. INT. CL. 29.
- ROCHESTER MIDLAND CORPORATION, ROCHESTER, NY, ROCHESTER GERMICIDE COMPANY, ROCHESTER, NY:  
595,077, REN. 9-22-04. U.S. CL. 13 (INT. CL. 21).
- ROCK BOTTOM RESTAURANTS, INC., LOUISVILLE, CO, ROCK BOTTOM OF DENVER, INC., DENVER, CO, DBA THE ROCK BOTTOM BREWERY:  
1,851,178, REN. 9-23-04. INT. CL. 42.
- ROCKWAY RECORDS, INC., LOS ANGELES, CA, ROCKAWAY RECORDS, LOS ANGELES, CA:  
1,290,510, REN. 9-24-04. INT. CL. 42.
- ROCKY MOUNTAIN BIOSYSTEMS, INC., GOLDEN, CO:  
2,900,623, MULTIPLE CLASS, INT. CLS. 5 AND 10.
- ROCKY MOUNTAIN COMPOSITES, INC., SPANISH FORK, UT:  
2,900,269, INT. CL. 17.
- ROCKY MOUNTAIN HARLEY-DAVIDSON MOTOR COMPANY, LITTLETON, CO:  
2,900,179, INT. CL. 25.
- ROCKY SHOES & BOOTS, INC., NELSONVILLE, OH:  
2,898,894, PUB. 8-10-2004. MULTIPLE CLASS, INT. CLS. 18, 25 AND 28.
- ROD MCLELLAN CO., SAN MATEO, CA:  
2,898,585, PUB. 8-10-2004. INT. CL. 1.  
2,899,225, PUB. 8-10-2004. INT. CL. 31.
- RODALE INC., EMMAUS, PA:  
2,898,551, PUB. 8-10-2004. INT. CL. 41.  
2,899,274, PUB. 8-10-2004. MULTIPLE CLASS, INT. CLS. 35 AND 41.
- ROEX, INC., IRVINE, CA:  
2,899,568, PUB. 8-10-2004. INT. CL. 5.
- ROFFI, MARCO, 8032 ZURICH, SWITZERLAND:  
2,900,589, INT. CL. 44.
- ROFFLER INDUSTRIES, INC., CORAOPOLIS, PA:  
761,740, CANC. U.S. CL. 100.
- ROGER WILLIAMS UNIVERSITY, BRISTOL, RI:  
2,898,927, PUB. 8-10-2004. INT. CL. 41.
- ROGERS COMMUNICATIONS INC., TORONTO, ONTARIO M4W 1G9, CANADA:  
2,898,453, PUB. 1-27-2004. INT. CL. 38.
- ROGUE RIVER SPORTS, INC., ATLANTA, GA:  
2,899,412, PUB. 8-10-2004. INT. CL. 12.
- ROHM AND HAAS COMPANY, PHILADELPHIA, PA:  
1,810,339, CANC. INT. CL. 1.
- ROLLER BEARING COMPANY OF AMERICA, INC., FAIRFIELD, CT, INCOM INTERNATIONAL INC., PITTSBURGH, PA:  
1,291,853, REN. 9-18-04. INT. CL. 7.
- ROLODEX CORPORATION, SECAUCUS, NJ:  
761,581, CANC. U.S. CL. 21.
- ROMAN MEAL COMPANY, TACOMA, WA, FRUEN MILLING COMPANY, MINNEAPOLIS, MN:  
409,130, REN. 9-23-04. U.S. CL. 46 (INT. CL. 30).
- ROMAS INDUSTRIES, LLC, NEW YORK, NY:  
1,296,010, REN. 9-19-04. INT. CL. 14.
- ROMO, JACK, PORT ORCHARD, WA:  
2,900,569, INT. CL. 25.
- RON JON SURF SHOP OF FLA., INC., COCOA BEACH, FL:  
1,864,065, REN. 9-18-04. INT. CL. 42.
- RON JON SURF SHOP OF FLORIDA, INC., COCOA BEACH, FL:  
2,263,579, AM. INT. CL. 35.
- RONALD GRANT STORER AND DENISE EVELYN STORER PARTNERSHIP, THE, AUBURN, WA:  
2,122,362, CANC. INT. CL. 28.
- RONK ELECTRICAL INDUSTRIES, INC., NOKOMIS, IL:  
1,339,065, REN. 9-18-04. INT. CL. 9.
- ROONIES, LLC, BOCA RATON, FL:  
2,898,736, PUB. 11-18-2003. INT. CL. 35.
- ROOSEVELT BANK, A FEDERAL SAVINGS BANK, CHESTERFIELD, MO:  
2,120,751, CANC. INT. CL. 36.
- ROOT LEARNING, INC., PERRYSBURG, OH:  
2,122,134, CANC. INT. CL. 42.  
2,122,135, CANC. INT. CL. 42.
- ROSE ART INDUSTRIES, INC., LIVINGSTON, NJ:  
2,900,883, INT. CL. 16.
- ROSE LAIRD COSMETICS, INC., NEW YORK, NY:  
1,260,743, CANC. INT. CL. 5.
- ROSE, ALAN, NEW YORK, NY:  
1,853,050, REN. 9-20-04. INT. CL. 16.
- ROSEN HOTELS AND RESORTS, INC., ORLANDO, FL:  
2,898,761, PUB. 8-10-2004. MULTIPLE CLASS, INT. CLS. 35 AND 43.
- ROSENTHAL, RACHEL, SAN LUIS OBISPO, CA:  
1,855,585, REN. 9-18-04. INT. CL. 9.
- ROSEWOOD HOTELS AND RESORTS HOLDINGS, INC., DALLAS, TX:  
2,898,426, PUB. 6-8-1999. INT. CL. 35.  
2,898,428, PUB. 6-1-1999. INT. CL. 42.
- ROSS BICYCLES USA, LTD., FARMINGDALE, NY, CHAIN BIKE CORPORATION, ROCKAWAY BEACH, NY:  
980,887, REN. 9-20-04. U.S. CL. 19 (INT. CL. 12).
- ROSS BICYCLES USA, LTD., FARMINGDALE, NY:  
1,281,470, REN. 9-20-04. INT. CL. 12.
- ROSS, JENNIFER LISA, SAN MARCOS, CA:  
2,121,435, CANC. INT. CL. 41.
- ROSSIGNOL SKI COMPANY, INC., WILLISTON, VT:  
2,122,017, CANC. INT. CL. 28.
- ROSTA AG, HUNZENSCHWIL, SWITZERLAND:  
1,297,384, REN. 9-20-04. INT. CL. 7.
- ROTO-ROOTER CORPORATION, WEST DES MOINES, IA:  
2,899,989, PUB. 8-10-2004. INT. CL. 7.
- ROTSZTAIN, CARINA, PALO ALTO, CA, DBA HYBRIDMEDIA:  
2,120,771, CANC. INT. CL. 42.
- ROTT & COMPANY, CLAY CENTER, KS:  
1,866,922, REN. 9-18-04. INT. CL. 13.
- ROUNDBRIX CORPORATION, LAGUNA NIGUEL, CA:  
2,899,734, PUB. 8-10-2004. INT. CL. 43.
- ROXIO, INC., SANTA CLARA, CA:  
2,900,298, INT. CL. 9.
- ROYAL & SUN ALLIANCE INSURANCE GROUP PLC, LONDON, UNITED KINGDOM:  
2,898,511, PUB. 8-10-2004. MULTIPLE CLASS, INT. CLS. 35, 36 AND 42.
- ROYAL CROWN COMPANY, INC., FT. LAUDERDALE, FL:  
2,122,430, CANC. INT. CL. 32.
- ROYAL GROUP TECHNOLOGIES LIMITED, VAUGHAN, ONTARIO, CANADA:  
2,899,268, PUB. 8-10-2004. INT. CL. 19.
- ROYAL IMEX INC., SANTA FE SPRINGS, CA:  
2,899,779, PUB. 8-10-2004. INT. CL. 26.
- ROYAL WINDYNE, LTD., RICHMOND, VA:  
2,900,813, INT. CL. 12.
- RPOST INTERNATIONAL LIMITED, INC., HAMILTON, BERMUDA:  
2,899,205, PUB. 8-10-2004. INT. CL. 38.
- RRCC LIMITED PARTNERSHIP, DALLAS, TX:  
2,898,424, PUB. 6-15-1999. INT. CL. 41.  
2,898,425, PUB. 6-15-1999. INT. CL. 35.  
2,898,427, PUB. 6-8-1999. INT. CL. 42.  
2,898,429, PUB. 6-29-1999. INT. CL. 42.
- RSI HOLDING CORPORATION, NEWPORT BEACH, CA:  
2,899,001, PUB. 8-10-2004. INT. CL. 20.
- RSI ID TECHNOLOGIES, CHULA VISTA, CA:  
2,898,685, PUB. 8-10-2004. MULTIPLE CLASS, INT. CLS. 9 AND 16.
- RUDDOCK MANUFACTURING COMPANY, EL PASO, TX:  
2,121,885, CANC. INT. CL. 25.



- RUDOLPH FOODS COMPANY, INC., LIMA, OH:  
1,877,807. REN. 9-18-04. INT. CL. 30.
- RUDY'S TEXAS BAR-B-Q, L.L.C., AUSTIN, TX, LEON SPRINGS GAS CO., SAN ANTONIO, TX:  
1,850,102. REN. 9-20-04. INT. CL. 42.
- RUMMO S.P.A., 82100 BENEVENTO (BN), ITALY:  
2,898,933. PUB. 8-10-2004. INT. CL. 30.
- RUOCCHIO, ALBERT C., RALEIGH, NC:  
2,899,935. PUB. 8-10-2004. INT. CL. 28.  
2,899,951. PUB. 8-10-2004. INT. CL. 28.
- RUSSELL ASSET MANAGEMENT, INC., WILMINGTON, DE, RUSSELL MILLS, INC., ALEXANDER CITY, AL:  
996,847. REN. 9-21-04. INT. CL. 25.  
997,505. REN. 9-22-04. U.S. CL. 22 (INT. CL. 25).
- RUSSELL ASSET MANAGEMENT, INC., WILMINGTON, DE:  
2,900,440. INT. CL. 25.
- RUST CHECK CORP., MISSISSAUGA ONTARIO, CANADA, RUST CHECK CORPORATION OF CANADA LIMITED, MISSISSAUGA, ONTARIO, CANADA:  
1,290,528. REN. 9-22-04. INT. CL. 2.
- RUTISHAUSER DATA AG, 8712 STAFA, SWITZERLAND:  
2,120,902. CANC. INT. CL. 16.
- RWE PILLER-GMBH, 37520 OSTERODE AM HARZ, FED REP GERMANY:  
2,898,825. PUB. 8-10-2004. INT. CL. 9.
- RYAN BROS. COFFEE, INC., SAN DIEGO, CA:  
2,898,514. PUB. 8-21-2001. INT. CL. 30.
- RYOBI LTD., FUCHU-SHI, HIROSHIMA-KEN, JAPAN:  
1,309,642. REN. 9-22-04. INT. CL. 6.
- R82 A/S, GEDVED, DENMARK:  
2,899,762. PUB. 8-10-2004. MULTIPLE CLASS, INT. CLS. 10 AND 12.  
2,899,763. PUB. 8-10-2004. MULTIPLE CLASS, INT. CLS. 10 AND 12.
- S & J PERFUME COMPANY LIMITED, WATFORD, HERTZ, ENGLAND:  
1,811,381. CANC. INT. CL. 3.
- S. BELLARA DIAMONDS, INC., NEW YORK, NY:  
2,121,880. CANC. INT. CL. 14.
- S. MAYA & SONS, INC., LOS ANGELES, CA:  
1,260,995. CANC. INT. CL. 25.
- S. ROTHSCHILD & CO., INC., NEW YORK, NY:  
2,898,793. PUB. 1-6-2004. INT. CL. 25.  
2,898,794. PUB. 1-6-2004. INT. CL. 25.  
2,898,795. PUB. 12-23-2003. INT. CL. 25.  
2,898,862. PUB. 1-6-2004. INT. CL. 25.
- S.B. D. MUFFLERS LLC, COSTA MESA, CA:  
2,899,058. PUB. 8-10-2004. INT. CL. 7.
- S.E.G., INC., COLUMBUS, GA:  
2,122,468. CANC. INT. CL. 28.  
2,122,469. CANC. INT. CL. 28.
- S.G.S. TOOL COMPANY, MUNROE FALLS, OH:  
2,900,661. INT. CL. 7.
- S.J. AMOROSO CONSTRUCTION CO., INC., REDWOOD SHORES, CA:  
2,899,783. PUB. 8-10-2004. INT. CL. 37.
- S&A RESTAURANT CORP., PLANO, TX:  
2,899,199. PUB. 8-10-2004. INT. CL. 43.
- S&S BRANDS, INC., WILMINGTON, DE:  
2,900,867. INT. CL. 30.
- S-B POWER TOOL COMPANY, CHICAGO, IL:  
1,781,246. REN. 9-18-04. INT. CL. 9.
- SABAN ENTERTAINMENT, INC., LOS ANGELES, CA:  
2,121,503. CANC. INT. CL. 28.
- SABERT CORPORATION, SAYREVILLE, NJ:  
2,899,239. PUB. 8-10-2004. INT. CL. 21.
- SABINSA CORPORATION, PISCATAWAY, NJ:  
1,850,512. REN. 9-24-04. INT. CL. 5.  
1,850,513. REN. 9-24-04. INT. CL. 5.
- SABORMEX, S.A. DE C.V., MEXICO D.F., MEXICO, CAFES DE VERACRUZ, S.A. DE C.V., COL. APATLACO, MEXICO 8, D.F., MEXICO:  
1,860,476. REN. 9-23-04. INT. CL. 29.
- SACHDEVA & SONS RICE MILLS LTD., AMRITSAR, INDIA:  
2,120,795. CANC. INT. CL. 30.
- SACKMAN, STEVEN, M., NEW YORK, NY AND MORAY, JILL, NEW YORK, NY:  
2,899,669. PUB. 8-10-2004. INT. CL. 9.
- SACKNER PRODUCTS INC., GRAND RAPIDS, MI:  
1,287,833. REN. 9-22-04. MULTIPLE CLASS, INT. CLS. 12, 20 AND 22.
- SAFECO CORPORATION, SEATTLE, WA:  
2,900,615. INT. CL. 36.
- SAFESUPPLIES, INC., ROCHESTER, NY:  
2,900,344. INT. CL. 17.
- SAFEWAY INC., PLEASANTON, CA:  
2,900,343. INT. CL. 30.
- SAFT AMERICA INC., VALDOSTA, GA:  
1,856,218. REN. 9-23-04. INT. CL. 9.  
1,856,218. AM. INT. CL. 9.
- SAGEBRUSH CORPORATION, MINNEAPOLIS, MN:  
1,811,310. CANC. INT. CL. 42.
- SAIAG S.P.A., TORINO, ITALY:  
2,120,758. CANC. INT. CL. 17.
- SAIL AMERICA, INC., MIDDLETOWN, RI, AMERICAN SAIL ADVANCEMENT PROGRAM, INC., MIDDLETOWN, RI:  
1,822,135. REN. 9-22-04. INT. CL. 35.
- SAINT-GOBAIN CALMAR INC., CITY OF INDUSTRY, CA:  
2,898,510. PUB. 8-10-2004. INT. CL. 10.
- SAIS, KATHLEEN MARIE, FULLERTON, CA:  
2,121,988. CANC. INT. CL. 41.
- SAIWON TTS LTD, KYONGGIDO, REPUBLIC OF KOREA:  
2,899,442. PUB. 8-10-2004. INT. CL. 16.
- SAKAKEENY, MICHAEL A., SAN DIEGO, CA:  
2,899,965. PUB. 8-10-2004. INT. CL. 7.
- SAKURA COLOR PRODUCTS OF AMERICA, INC., HAYWARD, CA:  
2,899,229. PUB. 8-10-2004. INT. CL. 16.
- SALEM COMMUNICATIONS HOLDING CORPORATION, CAMARILLO, CA:  
2,900,220. INT. CL. 38.
- SALIS INTERNATIONAL, INC., GOLDEN, CO:  
1,852,127. REN. 9-22-04. INT. CL. 2.
- SALISBURY LUMBER COMPANY, INC., SALISBURY, NC:  
2,898,944. PUB. 8-10-2004. INT. CL. 20.
- SALK, INC., BROOKLINE, MA, MURRAY SALK, INC., ALLSTON, MA:  
1,301,419. REN. 9-21-04. INT. CL. 10.
- SALT RIVER PROJECT AGRICULTURAL IMPROVEMENT AND POWER DISTRICT, TEMPE, AZ:  
2,121,067. CANC. INT. CL. 37.
- SAM MOORE FURNITURE INDUSTRIES, INC., BEDFORD, VA:  
1,291,109. REN. 9-22-04. INT. CL. 20.  
1,291,110. REN. 9-22-04. INT. CL. 20.
- SAMICK MUSICAL INSTRUMENTS MANUFACTURING CO., LTD., PUPYUNG-KU, INCHON, REPUBLIC OF KOREA, SAMICK MUSICAL INSTRUMENTS MANUFACTURING, LTD., LOS ANGELES, CA:  
1,288,905. REN. 9-23-04. INT. CL. 15.
- SAMSUNG AMERICA, INC., RIDGEFIELD PARK, NJ:  
2,899,969. PUB. 8-10-2004. INT. CL. 9.
- SAMSUNG TECHWIN CO., LTD., KYUNGSANGNAM-DO, REPUBLIC OF KOREA:  
2,898,637. PUB. 8-10-2004. INT. CL. 9.
- SAMUEL, MARTIN HOWARD, FT. LAUDERDALE, FL:  
2,899,868. PUB. 8-10-2004. INT. CL. 28.
- SAN DIEGO BOWL GAME ASSOCIATION, SAN DIEGO, CA:  
1,290,461. REN. 9-21-04. INT. CL. 41.  
1,290,461. CANC. INT. CL. 42.
- SANARUS MEDICAL, INC., PLEASANTON, CA:  
2,899,307. PUB. 5-27-2003. INT. CL. 16.
- SAND W FINE FOODS, INC., SAN MATEO, CA:  
177,234. CANC. U.S. CL. 46.
- SANDHILLS, INC., WILMINGTON, DE:  
2,122,059. CANC. INT. CL. 42.
- SANDSTROM PRODUCTS COMPANY, PORT BYRON, IL:  
1,260,706. CANC. INT. CL. 1.
- SANFORD'S GRUB & PUB, INC., GILLETTE, WY:  
2,898,570. PUB. 8-10-2004. MULTIPLE CLASS, INT. CLS. 21, 25 AND 43.

- SANOFI SANTE NUTRITION ANIMALE, F-33500 LI-BOURNE, FRANCE:  
2,121,204, CANC. INT. CL. 5.
- SANOFI-SYNTHELABO, PARIS, FRANCE:  
2,899,749, PUB. 8-10-2004. MULTIPLE CLASS, INT. CLS. 41 AND 42.
- SANTA CLARA, INC., WHIPPANY, NJ:  
2,900,633, INT. CL. 34.
- SANTA FE USA, INC., POWELL, OH TO BEEF HOLDINGS, INC., GARDEN CITY PARK, NY:  
1,811,286, CANC. INT. CL. 42.
- SANTARUS, INC., SAN DIEGO, CA:  
2,899,097, PUB. 8-10-2004. INT. CL. 5.
- SANTELL, LINDA A., REIDSVILLE, NC:  
2,899,920, PUB. 8-10-2004. MULTIPLE CLASS, INT. CLS. 16 AND 25.
- SANTIAGO SDS, INC., NEWPORT BEACH, CA:  
2,121,216, CANC. INT. CL. 42.  
2,121,217, CANC. INT. CL. 42.
- SANTORO, LUCIO AND SANTORO, MEERA PARTNERSHIP, THE, LONDON, UNITED KINGDOM:  
2,899,753, PUB. 8-10-2004. INT. CL. 25.
- SANTOS LAGUNA, S.A. DE C.V., TORREON, COAHUILA, C.P. 27000, MEXICO:  
2,898,661, PUB. 6-1-2004. INT. CL. 18.
- SANYO DENKI CO., LTD., TOKYO, JAPAN:  
2,899,315, PUB. 8-10-2004. MULTIPLE CLASS, INT. CLS. 7, 9, 12, 41 AND 42.  
2,899,316, PUB. 8-10-2004. MULTIPLE CLASS, INT. CLS. 7, 9, 12, 41 AND 42.
- SAPHIRIM-RAHAV CO., M. P. SHIKMIM, 79820, ISRAEL:  
2,121,868, CANC. INT. CL. 14.
- SARA LEE CORPORATION, WINSTON SALEM, NC:  
2,120,756, CANC. INT. CL. 30.
- SARA LEE CORPORATION, WINSTON-SALEM, NC:  
2,122,215, CANC. INT. CL. 25.  
2,899,327, PUB. 8-10-2004. INT. CL. 25.  
2,899,982, PUB. 8-10-2004. INT. CL. 35.
- SARAH COVENTRY HPP, INC., EAST PROVIDENCE, RI, SARAH COVENTRY, INC., NEWARK, NY:  
777,377, REN. 9-22-04. U.S. CL. 28 (INT. CL. 14).
- SARAMAR CORPORATION, DOVER, DE TO SARAMAR LLC, CHICAGO, IL:  
1,811,260, CANC. INT. CL. 42.
- SARAMAR L.L.C., CHICAGO, IL, I CAN'T BELIEVE IT'S YOGURT, LTD., CARROLLTON, TX:  
1,818,541, REN. 9-19-04. INT. CL. 30.
- SARGENT MANUFACTURING COMPANY, NEW HAVEN, CT:  
2,898,882, PUB. 1-13-2004. INT. CL. 9.
- SASOL NORTH AMERICA INC, HOUSTON, TX:  
772,606, REN. 9-22-04. U.S. CL. 6 (INT. CL. 1).
- SASSABY, INC., NEW YORK, NY:  
2,899,947, PUB. 8-10-2004. INT. CL. 3.
- SATHERS INC., ROUND LAKE, MN:  
2,122,256, CANC. INT. CL. 30.
- SATURN CORPORATION, TROY, MI:  
1,810,670, CANC. INT. CL. 12.
- SAUL ZAENTZ COMPANY, THE, BERKELEY, CA, DBA TOLKIEN ENTERPRISES:  
2,900,520, MULTIPLE CLASS, INT. CLS. 16 AND 28.  
2,900,521, MULTIPLE CLASS, INT. CLS. 16, 25 AND 28.
- SAUNDERS BROTHERS, WESTBROOK, ME:  
2,122,221, CANC. INT. CL. 28.
- SAVE-A-LIFE TODAY, INC., FORT LAUDERDALE, FL:  
2,121,568, CANC. INT. CL. 5.
- SAZERAC COMPANY, INC., NEW ORLEANS, LA:  
2,900,383, INT. CL. 33.
- SBARRO INC., MELVILLE, NY, SBARRO HOLDING CORPORATION, NEW YORK, NY:  
985,647, REN. 9-20-04. U.S. CL. 100 (INT. CL. 42).
- SBL MACHINERY CO., LTD., TAIPEI HSIEN, TAIWAN:  
2,899,476, PUB. 12-2-2003. INT. CL. 7.
- SC LICENSING CORP, SOUTH EASTON, MA:  
2,899,428, PUB. 8-10-2004. MULTIPLE CLASS, INT. CLS. 3, 21 AND 26.
- SCALE-TRONIX, INC., WHITE PLAINS, NY:  
1,327,608, REN. 9-23-04. INT. CL. 9.
- SCANDITRADE, LTD, LONDON, EC 3R5, ENGLAND:  
2,121,929, CANC. INT. CL. 11.
- SCANTICON INTERNATIONAL INC., PRINCETON, NJ:  
1,864,036, REN. 9-20-04. INT. CL. 42.
- SCANZ COMMUNICATIONS, LLC, LOS ANGELES, CA FROM SCANZ COMMUNICATIONS, LLC, LOS ANGELES, CA:  
2,900,041, INT. CL. 9.
- SCARLA, ROBERT, SCOTTSDALE, AZ:  
2,898,919, PUB. 8-10-2004. INT. CL. 12.
- SCHERING AKTIENGESELLSCHAFT, BERLIN, FED REP GERMANY:  
2,898,727, PUB. 11-25-2003. INT. CL. 5.
- SCHERING CORPORATION, KENILWORTH, NJ:  
1,811,405, CANC. INT. CL. 5.
- SCHERING-PLOUGH VETERINARY CORPORATION, RENO, NV:  
774,856, REN. 9-19-04. U.S. CL. 18 (INT. CL. 5).
- SCHERING-PLOUGH VETERINARY CORPORATION, RENO, NV, SYNTROVET INCORPORATED, LENEXA, KS:  
1,847,225, REN. 9-23-04. INT. CL. 5.
- SCHERING-PLOUGH VETERINARY CORPORATION, RENO, NV, PITMAN-MOORE, INC., LAKE FOREST, IL:  
1,850,187, REN. 9-18-04. INT. CL. 5.
- SCHIFF, KAREN L., SAN FRANCISCO, CA, DBA MARBLE HILL COMMUNICATIONS:  
2,899,309, PUB. 11-19-2002. INT. CL. 45.
- SCHILLER-PFEIFFER, INC., WYNNWOOD, PA:  
2,898,964, PUB. 4-13-2004. INT. CL. 7.
- SCHLAGE LOCK COMPANY, COLORADO SPRINGS, CO:  
1,855,626, REN. 9-18-04. INT. CL. 9.
- SCHLUMBERGER TECHNOLOGY CORPORATION, SUGAR LAND, TX:  
2,121,455, CANC. INT. CL. 9.
- SCHMIDT BAKING COMPANY, INC., BALTIMORE, MD:  
2,900,907, INT. CL. 30.
- SCHNEIDER SADDLERY CO., INC., CHAGRIN FALLS, OH:  
1,341,935, REN. 9-22-04. INT. CL. 3.
- SCHNIEDER AUTOMATION INC., N. ANDOVER, MA, N. R. TAYLOR ENGINEERING LTD., EDMONTON, ALBERTA T5K 2M5, CANADA:  
1,884,644, REN. 9-18-04. INT. CL. 9.
- SCHOLASTIC INC., NEW YORK, NY:  
2,900,108, INT. CL. 25.
- SCHOLL, INC., MEMPHIS, TN:  
177,054, CANC. U.S. CL. 6.
- SCHOOL RESEARCH AND SERVICE CORP., MISSION VIEJO, CA TO NATIONAL COMPUTER SYSTEMS, INC., EDEN PRAIRIE, MN:  
1,810,563, CANC. INT. CL. 9.
- SCHOTT; ROBERT, WASHINGTON, DC, T.A. AIRSCHOTT:  
1,293,208, REN. 9-20-04. MULTIPLE CLASS, INT. CLS. 36 AND 39.
- SCHREINER, IV; CHARLES, MOUNTAIN HOME, TX, DBA Y.O. RANCH:  
1,303,161, REN. 9-22-04. INT. CL. 41.
- SCHWARZ PAPER COMPANY, MORTON GROVE, IL:  
761,642, CANC. U.S. CL. 37.
- SCHWINN ACQUISITION, LLC, MADISON, WI:  
772,712, REN. 9-21-04. U.S. CL. 19 (INT. CL. 12).
- SCIENT'X, 78284 GUYANCOURT, FRANCE:  
2,899,893, PUB. 8-10-2004. INT. CL. 10.
- SCIENTIFIC DRILLING INTERNATIONAL, INC., HOUSTON, TX:  
1,825,668, REN. 9-18-04. MULTIPLE CLASS, INT. CLS. 37 AND 42.
- SCIENTIFIC TURF, INC., BRUNSWICK, GA:  
2,899,131, PUB. 8-10-2004. INT. CL. 44.
- SCIMED LIFE SYSTEMS, INC., MAPLE GROVE, MN:  
2,900,043, INT. CL. 10.
- SCORE INTERNATIONAL, CALABASAS, CA, MICKEY THOMPSON ADVANCE ENGINEERING, INC., WILMINGTON, CA:  
1,001,129, REN. 9-18-04. INT. CL. 35.
- SCOTT A. CHERNE, M.D., P.C., EUGENE, OR:  
2,899,289, PUB. 8-10-2004. INT. CL. 42.

SCOTT SIGN SYSTEMS, INC., TELLEVAST, FL:  
769,677. REN. 9-21-04. U.S. CL. 50 (INT. CL. 20).  
1,289,053. REN. 9-23-04. INT. CL. 20.

SCOTT'S REVIVAL CENTER, INC., FRANKLIN, VA:  
2,899,237. PUB. 8-10-2004. INT. CL. 45.

SCOTTSDALE RUNNING COMPANY, SCOTTSDALE, AZ:  
2,899,972. PUB. 8-10-2004. INT. CL. 35.  
2,899,973. PUB. 8-10-2004. INT. CL. 35.

SCREENLIFE, LLC, SEATTLE, WA:  
2,828,001. COR. MULTIPLE CLASS, INT. CLS. 9 AND 28.  
2,828,002. COR. MULTIPLE CLASS, INT. CLS. 9 AND 28.

SCRIPPS NETWORKS, INC., KNOXVILLE, TN:  
2,899,995. PUB. 8-10-2004. INT. CL. 38.

SCRIPPS NETWORKS, INC., KNOXVILLE, NY:  
2,900,577. INT. CL. 41.

SCS ENTERPRISES, INC., OVERLAND PARK, KS:  
2,899,430. PUB. 8-10-2004. MULTIPLE CLASS, INT. CLS.  
35 AND 44.

SCS FLOORING SYSTEMS, LOS ANGELES, CA:  
2,898,672. PUB. 7-29-2003. MULTIPLE CLASS, INT. CLS.  
19 AND 27.

SCULL, LOUIS CHARLES, YORBA LINDA, CA:  
1,871,590. REN. 9-19-04. INT. CL. 37.

SEA WORLD, INC., ST. LOUIS, MO:  
1,852,695. REN. 9-18-04. INT. CL. 41.

SEABOURN CRUISE LINE LIMITED, MIAMI, FL:  
2,900,345. INT. CL. 41.

SEABURY & SMITH, INC., NEW YORK, NY:  
2,120,915. CANC. INT. CL. 36.

SEAL FURNITURE & SYSTEMS, INC., DENVER, CO:  
1,261,265. CANC. INT. CL. 42.

SEALED AIR CORPORATION (US), SADDLE BROOK, NJ:  
776,003. REN. 9-20-04. U.S. CL. 1 (INT. CL. 17).

SEARS BRANDS, LLC, HOFFMAN ESTATES, IL:  
2,899,548. PUB. 8-10-2004. INT. CL. 7.

SEARS, RICHARD R., WILMINGTON, NC:  
2,899,008. PUB. 8-10-2004. INT. CL. 42.

SEARS, ROEBUCK AND CO., HOFFMAN ESTATES, IL:  
2,121,489. CANC. INT. CL. 35.

SEATTLE BIKE SUPPLY, INC., KENT, WA:  
1,869,462. REN. 9-22-04. INT. CL. 12.

SEATTLE PACIFIC INDUSTRIES, INC., SEATTLE, WA:  
2,121,893. CANC. INT. CL. 25.  
2,121,894. CANC. INT. CL. 25.

SEATTLE'S BEST COFFEE, LLC, SEATTLE, WA:  
2,899,640. PUB. 8-10-2004. INT. CL. 30.

SEB, 21260 SELONGEY, FRANCE:  
2,122,219. CANC. INT. CL. 11.

SEB, SELONGEY, FRANCE:  
2,899,696. PUB. 8-10-2004. MULTIPLE CLASS, INT. CLS.  
7, 11 AND 21.

SEBASTIAN INTERNATIONAL, INC., WOODLAND HILLS,  
CA:  
1,850,150. REN. 9-24-04. INT. CL. 42.  
1,850,150. CANC. INT. CL. 41.

SEBASTIANA MANAGEMENT, INC., OZONE PARK, NY:  
1,810,927. CANC. MULTIPLE CLASS, INT. CLS. 29 AND  
41.

SEBASTIANI VINEYARDS, INC., SONOMA, CA:  
1,861,951. REN. 9-21-04. INT. CL. 33.

SECET LLC, WILMINGTON, DE:  
2,900,559. MULTIPLE CLASS, INT. CLS. 9, 35, 36, 41 AND  
42.

SECTOR, INC., NEW YORK, NY:  
2,900,137. MULTIPLE CLASS, INT. CLS. 9, 35 AND 38.

SECURE IMAGE CORPORATION, MECHANICSVILLE, VA:  
2,899,721. PUB. 8-10-2004. INT. CL. 20.

SECURITIES INDUSTRY AUTOMATION CORPORATION,  
BROOKLYN, NY:  
1,013,251. REN. 9-24-04. U.S. CL. 102 (INT. CL. 36).

SEDLAK INTERIORS, SOLON, OH:  
2,898,832. PUB. 8-10-2004. INT. CL. 35.

SEED CORPS, THE, SANTA ROSA, CA:  
1,810,474. CANC. INT. CL. 8.

SEEING IS BELIEVING, INC., ATLANTA, GA:  
2,122,282. CANC. INT. CL. 42.

SEIBERT, CARLTON, PHILADELPHIA, PA:  
2,898,845. PUB. 8-10-2004. INT. CL. 41.

SEIKO INSTRUMENTS KABUSHIKI KAISHA, CHIBA-SHI,  
CHIBA, JAPAN, TA SEIKO INSTRUMENTS INC.:  
2,900,082. MULTIPLE CLASS, INT. CLS. 6 AND 9.

SELECT STAFFING SOLUTIONS, FRAMINGHAM, MA:  
2,898,596. PUB. 4-8-2003. INT. CL. 35.

SELF-HELP ENTERPRISES OF DAYTON, DAYTON, OH:  
2,120,765. CANC. INT. CL. 9.

SELF-REALIZATION FELLOWSHIP CHURCH, LOS AN-  
GELES, CA:  
2,898,414. PUB. 8-10-2004. INT. CL. 16.

SELLSTROM MANUFACTURING CO., PALATINE, IL:  
1,851,409. REN. 9-18-04. INT. CL. 11.

SELLSTROM MANUFACTURING CO., PALATINE, IL,  
RESEARCH & TRADING CORPORATION, WILMING-  
TON, DE:  
1,858,471. REN. 9-18-04. INT. CL. 9.

SELLSTROM MANUFACTURING COMPANY, PALATINE,  
IL:  
991,446. REN. 9-18-04. U.S. CL. 39 (INT. CL. 9).

SELL4FREE REAL ESTATE SYSTEMS, INC., FISHERS, IN:  
2,900,360. INT. CL. 36.

SEMEQUIP, INC., BILLERICA, MA:  
2,898,934. PUB. 8-10-2004. INT. CL. 42.

SEMINOLE FOODS, INC., BELLEVUE, FL:  
1,867,111. REN. 9-21-04. INT. CL. 29.

SENIOR NETWORK, INC., THE, STAMFORD, CT:  
2,120,999. CANC. INT. CL. 35.

SENSORMEDEICS CORPORATION, YORBA LINDA, CA,  
GOULD INC., ROLLING MEADOWS, IL:  
1,288,837. REN. 9-20-04. INT. CL. 10.

SENTIGY, INC., HOUSTON, TX:  
2,899,003. PUB. 8-10-2004. MULTIPLE CLASS, INT. CLS.  
35 AND 42.

SERGIO TRAVERSO, S.A., SANTIAGO, CHILE:  
2,121,798. CANC. INT. CL. 33.

SERNA & ASSOCIATES, SAN ANTONIO, TX:  
2,898,858. PUB. 8-10-2004. INT. CL. 42.

SEROLOGICALS ROYALTY COMPANY, FREEPORT,  
GRAND BAHAMA, BAHAMAS, SEROLOGICALS, INC.,  
PENSACOLA, FL:  
1,850,517. REN. 9-18-04. INT. CL. 5.

SERVERWORKS CORPORATION, SANTA CLARA, CA:  
2,900,068. INT. CL. 9.

SERVICE KING PAINT AND BODY, INC., DALLAS, TX:  
2,121,264. CANC. INT. CL. 37.  
2,121,265. CANC. INT. CL. 37.

SERVICE REALTY, INC., PLANO, TX:  
1,851,222. REN. 9-20-04. INT. CL. 36.

SESAC, INC., NASHVILLE, TN:  
2,898,752. PUB. 8-10-2004. MULTIPLE CLASS, INT. CLS.  
35 AND 36.

SETA CORPORATION OF BOCA, INC., BOCA RATON, FL:  
1,843,284. REN. 9-21-04. INT. CL. 42.

SETTLEMENT SERVICES, LLC, RINGWOOD, NJ:  
2,899,940. PUB. 8-10-2004. INT. CL. 42.

SFA LLC, DAVIDSONVILLE, MD:  
2,899,100. PUB. 8-10-2004. INT. CL. 35.

SFS 39 INC., SAN FRANCISCO, CA:  
2,900,453. INT. CL. 43.

SHABBY CHIC, INC., LOS ANGELES, CA:  
2,898,987. PUB. 8-10-2004. MULTIPLE CLASS, INT. CLS.  
20 AND 24.

SHAFER, KLINE & WARREN, INC., OVERLAND PARK,  
KS:  
2,898,818. PUB. 8-10-2004. INT. CL. 42.  
2,898,819. PUB. 8-10-2004. INT. CL. 37.

SHAKE-N-GO FASHIONS, INC., MESPETH, NY:  
2,121,706. CANC. INT. CL. 26.

SHAKE'S FROZEN CUSTARD, INC., FAYETTEVILLE, AR:  
2,900,942. INT. CL. 43.

SHAKLEE CORPORATION, PLEASANTON, CAMBODIA TO  
SHAKLEE CORPORATION, PLEASANTON, CA:  
2,737,502. COR. INT. CL. 35.

SHALLOW SPORT OF TEXAS, INC., PORT ISABEL, TX:  
2,898,984. PUB. 8-10-2004. INT. CL. 12.

SHAMIR INSIGHT, INC., SAN DIEGO, CA:  
2,899,751. PUB. 8-10-2004. INT. CL. 2.  
2,899,853. PUB. 8-10-2004. INT. CL. 9.

- SHANDON INDUSTRIES TRUST, COMPRISING STEVE ANGLE, A U.S. CITIZEN, BENNION, UT:  
2,898,646, PUB. 8-10-2004. INT. CL. 20.
- SHARE CORPORATION, MILWAUKEE, WI:  
1,874,967. REN. 9-19-04. MULTIPLE CLASS, INT. CLS. 3 AND 5.
- SHARED DATA SYSTEMS, INC., CHARLOTTE, NC:  
2,898,452, PUB. 10-2-2001. INT. CL. 9.
- SHARI'S MANAGEMENT CORPORATION, BEAVERTON, OR:  
2,121,573, CANC. INT. CL. 42.
- SHARPS MANUFACTURING, INC., HOUSTON, TX:  
2,899,110, PUB. 8-10-2004. INT. CL. 10.
- SHASTA BEVERAGES, INC., HAYWARD, CA:  
2,900,760, INT. CL. 32.
- SHAUM MANUFACTURING INCORPORATED, EL-KHART, IN:  
1,810,616, CANC. INT. CL. 9.
- SHAVER, DEBRAH, CHEVY CHASE, MD:  
2,898,677, PUB. 12-23-2003. INT. CL. 35.
- SHAW INDUSTRIES, INC., DALTON, GA:  
2,120,853, CANC. INT. CL. 27.
- SHAYMEES CORPORATION, PLEASANTON, CA:  
2,900,511, INT. CL. 30.
- SHEEDY, SEAN, SAN DIEGO, CA:  
2,120,975, CANC. INT. CL. 38.
- SHEEN TZAR CO., LTD., TAICHUNG, TAIWAN:  
2,121,043, CANC. INT. CL. 7.
- SHEERLUND FORESTS, INC., READING, PA, SHEERLUND FORESTS, READING, PA:  
594,375. REN. 9-18-04. U.S. CL. 1 (INT. CL. 31).
- SHELL TRADEMARK MANAGEMENT B.V., THE HAGUE, NETHERLANDS:  
1,848,477. REN. 9-18-04. INT. CL. 4.
- SHELLY BELLY, LLC, MILLBURN, NJ:  
2,899,312, PUB. 8-10-2004. INT. CL. 35.
- SHEMIN NURSERIES, INC., DANBURY, CT:  
1,260,303. REN. 9-24-04. INT. CL. 42.
- SHENANDOAH ELECTRONIC INTELLIGENCE, INC., HARRISONBURG, VA:  
1,851,192. REN. 9-22-04. INT. CL. 9.
- SHEPHERD'S CENTERS OF AMERICA, KANSAS CITY, MO:  
2,899,602, PUB. 8-10-2004. INT. CL. 43.
- SHERMAN, KEITH E., STUART, FL:  
2,899,499, PUB. 8-10-2004. INT. CL. 17.
- SHERPA SOFTWARE GROUP, INC., BRIDGEVILLE, PA:  
2,899,614, PUB. 8-10-2004. INT. CL. 9.
- SHERWOOD, JULIE, ENCINITAS, CA:  
2,900,434, INT. CL. 18.
- SHERWOOD, LINDA, SOUTH JORDAN, UT:  
2,122,011, CANC. INT. CL. 28.
- SHIEL-SEXTON COMPANY INC., INDIANAPOLIS, IN:  
2,899,867, PUB. 8-10-2004. INT. CL. 37.
- SHIMPO INDUSTRIAL CO., LTD., MINAMI-KU, KYOTO, JAPAN:  
990,046. REN. 9-23-04. U.S. CL. 21 (INT. CLS. 7, 9, 11, 12 AND 15).
- SHISEIDO CO., LTD., CHUO-KU, TOKYO 104-10, JAPAN:  
1,850,496. REN. 9-22-04. INT. CL. 3.
- SHISEIDO COMPANY LTD., TOKYO, 104-10, JAPAN:  
2,898,439, PUB. 8-10-2004. MULTIPLE CLASS, INT. CLS. 3 AND 21.
- SHOFU, INC., KYOTO 605, JAPAN:  
2,899,167, PUB. 8-10-2004. INT. CL. 5.
- SHOOSTER, DANIEL H., POMPANO BEACH, FL:  
2,899,252, PUB. 8-10-2004. INT. CL. 36.
- SHOPKO STORES, INC., GREEN BAY, WI:  
2,122,525, CANC. INT. CL. 25.
- SHORTAL, JOE, LOS ANGELES, CA:  
2,900,384, INT. CL. 25.
- SHUR-LINE, INC., LANCASTER, NY:  
1,810,734, CANC. INT. CL. 16.
- SHURTAPE TECHNOLOGIES, LLC, HICKORY, NC:  
2,900,364, INT. CL. 17.  
2,900,365, INT. CL. 17.  
2,900,366, INT. CL. 17.
- SI CORPORATION, CHICKAMAUGA, GA:  
1,300,707. REN. 9-18-04. INT. CL. 27.
- SICA DOMAINES MICHEL BERNARD, 84100 ORANGE, FRANCE:  
2,122,179, CANC. INT. CL. 33.
- SICONS ITALIANA S.P.A., CORNEDO VICENTINO, ITALY:  
1,261,012, CANC. INT. CL. 25.
- SIDDLE, BRUCE, BELLEVILLE, IL:  
2,900,224, INT. CL. 41.
- SIDNEY B. BOWNE & SON, MINEOLA, NY:  
2,900,272, INT. CL. 42.
- SIEMBRAS MARINAS, SIEMBRAMAR, S.A., BARCELONA, EDO. ANZOATEGUI, VENEZUELA:  
1,850,390. REN. 9-18-04. INT. CL. 29.
- SIERRA DIAGNOSTICS, INC., SONORA, CA:  
2,122,246, CANC. INT. CL. 5.
- SIERRA MANUFACTURING, INC., REDMOND, WA:  
1,811,417, CANC. INT. CL. 7.
- SIGMA-ALDRICH BIOTECHNOLOGY LP, ST. LOUIS, MO:  
992,225. REN. 9-22-04. U.S. CL. 6 (INT. CL. 1).
- SIGN FACES LLC, BIRMINGHAM, AL:  
2,899,031, PUB. 8-10-2004. INT. CL. 9.
- SIGNATURE FINANCIAL/MARKETING, INC., WILMINGTON, DE:  
2,121,147, CANC. INT. CL. 35.
- SILENX CORPORATION, DOWNEY, CA:  
2,898,822, PUB. 8-10-2004. INT. CL. 9.
- SILIT-WERKE GMBH & CO. KG, 88499 RIEDINGEN, FED REP GERMANY:  
2,899,357, PUB. 8-10-2004. INT. CL. 21.
- SILVA ARTIST MANAGEMENT LLC, LOS ANGELES, CA, DBA SAM:  
2,898,905, PUB. 8-10-2004. INT. CL. 35.
- SILVER FOX LIMITED, HERTS AL7 ISA, UNITED KINGDOM:  
2,900,060, MULTIPLE CLASS, INT. CLS. 9, 16 AND 42.
- SIMA-ALDRICH BIOTECHNOLOGY LP, ST. LOUIS, MO:  
990,632. REN. 9-22-04. U.S. CL. 6 (INT. CL. 1).
- SIMMONS-BOARDMAN PUBLISHING CORPORATION, NEW YORK, NY:  
1,304,979. REN. 9-18-04. INT. CL. 16.
- SIMON PROPERTY GROUP, L.P., INDIANAPOLIS, IN:  
2,898,848, PUB. 8-10-2004. INT. CL. 36.
- SIMONSON, PETER, MIAMI BEACH, FL:  
2,900,944, INT. CL. 41.
- SIMPLE REMOTE, LLC, BROOKLYN, NY:  
2,898,829, PUB. 8-10-2004. INT. CL. 9.
- SIMPLE SIGNMAN INC., CHAMBLY, QUEBEC, CANADA:  
1,305,316. REN. 9-22-04. INT. CL. 37.
- SIMULINE, INC, DAEJEON, REPUBLIC OF KOREA:  
2,899,730, PUB. 8-10-2004. INT. CL. 28.
- SINCLAIR FINANCIAL GROUP, INC., SPRINGFIELD, MO:  
2,121,424, CANC. INT. CL. 36.
- SINCLAIR OIL COMPANY, SALT LAKE CITY, UT, LITTLE AMERICA REFINING CO., CHEYENNE, WY:  
978,765. REN. 9-20-04. MULTIPLE CLASS, U.S. CLS. 100 (INT. CL. 42) AND 103 (INT. CL. 37).
- SINCLAIR OIL COPORATION, SALT LAKE CITY, UT:  
2,900,258, MULTIPLE CLASS, INT. CLS. 6, 8 AND 34.
- SINCLAIR OIL CORPORATION, SALT LAKE CITY, UT:  
1,006,206. REN. 9-24-04. INT. CL. 4.
- SINCLAIR OIL CORPORATION, EVANSVILLE, WY, PASCO, INC., NEW YORK, NY:  
1,006,485. REN. 9-24-04. INT. CL. 37.
- SINCLAIR OIL CORPORATION, SALT LAKE CITY, UT:  
1,337,183. REN. 9-24-04. INT. CL. 37.  
2,900,257, INT. CL. 20.
- SINGER N.V., CURACAO, NETHERLD ANTILLES, SINGER COMPANY, THE, NEW YORK, NY:  
990,815. REN. 9-19-04. U.S. CL. 23 (INT. CL. 7).
- SIOUX STEEL COMPANY, SIOUX FALLS, SD:  
1,891,617. REN. 9-18-04. INT. CL. 6.
- SISTEMAS DE CONSULTA E INVESTIGACION S.A. DE C.V., GUANAJUATO, MEXICO C.P.37500, MEXICO:  
2,899,086, PUB. 8-10-2004. INT. CL. 25.
- SITA, 92000, NANTERRE, FRANCE:  
2,898,538, PUB. 8-10-2004. MULTIPLE CLASS, INT. CLS. 39, 40 AND 42.

SIX CONTINENTS HOTELS, INC., ATLANTA, GA:  
1,297,211. REN. 9-18-04. INT. CL. 42.

SKILLSUSA-VICA, LEESBURG, VA:  
2,899,083, PUB. 8-10-2004. INT. CL. 16.

SKIS DYNASTAR, INC., COLCHESTER, VT:  
1,811,612, CANC. INT. CL. 28.

SKYBITZ, INC., DULLES, VA:  
2,899,066, PUB. 8-10-2004. INT. CL. 9.

SKYJACK INC., GUELPH, ONTARIO N1H 1B9, CANADA:  
1,866,750. REN. 9-19-04. INT. CL. 7.

SKYLINE CORPORATION, ELKHART, IN:  
1,324,553. REN. 9-18-04. INT. CL. 19.

SKYWAY LUGGAGE COMPANY, SEATTLE, WA:  
1,851,489. REN. 9-20-04. INT. CL. 18.

SLABY, KENNETH A., WHITEHALL, WI:  
2,899,013, PUB. 8-10-2004. INT. CL. 7.

SLE, INC., DOVER, DE TO ELECTROLUX LLC, DALLAS, TX:  
1,811,472, CANC. INT. CL. 9.

SLOAN ACQUISITION CORPORATION, INC., KANSAS CITY, MO, L'I'L GUY FOODS, INC., RAYTOWN, MO:  
989,089. REN. 9-24-04. U.S. CL. 46 (INT. CL. 30).

SMARTORG, INC., MENLO PARK, CA, IDS PARTNERS, MENLO PARK, CA:  
1,852,957. REN. 9-18-04. INT. CL. 9.

SMASH MEDIA GROUP, INC., NASHVILLE, TN:  
2,899,722, PUB. 8-10-2004. INT. CL. 41.

SMI HOME PRODUCTS, INC., GLEN GARDNER, NJ:  
2,899,381, PUB. 8-10-2004. INT. CL. 35.  
2,899,881, PUB. 8-10-2004. INT. CL. 11.

SMI REAL ESTATE, LLC, FORT WORTH, TX, SAFDIE, EDWARD J., NEW YORK, NY, DBA, EDWARD J. SAFDIE GROUP:  
1,342,640. REN. 9-22-04. MULTIPLE CLASS, INT. CLS. 18, 25, 32, 41 AND 42.

SMINE PRODUCTIONS, INC., MINDEN, NV:  
1,857,542. REN. 9-20-04. MULTIPLE CLASS, INT. CLS. 9 AND 41.

SMITH & VANDIVER, INC., WATSONVILLE, CA:  
2,898,861, PUB. 8-10-2004. INT. CL. 3.

SMITH CLUB MANAGEMENT, INC., FALLS CHURCH, VA:  
2,120,686, CANC. INT. CL. 42.

SMITH CORONA CORPORATION, CORTLAND, NY:  
1,810,619, CANC. INT. CL. 9.

SMITH MOUNTAIN INDUSTRIES, INC., FOREST, VA:  
2,899,191, PUB. 8-10-2004. MULTIPLE CLASS, INT. CLS. 4 AND 21.

SMITH-GARRITY, LTD., UPPERVILLE, VA:  
2,900,804, INT. CL. 18.

SMITH, AMY, TERESA, POTOMAC FALLS, VA:  
2,900,831, INT. CL. 31.

SMITH, EARL L. JR., SAN DIEGO, CA AND SMITH, PATRICIA M., SAN DIEGO, CA:  
2,900,047, INT. CL. 3.

SMITH, JUSTIN A., FT. LAUDERDALE, FL:  
2,899,534, PUB. 8-10-2004. INT. CL. 35.

SMITH, PIA M., CHINO HILLS, CA, DBA BLACK SHEEP PUBLISHING:  
2,121,378, CANC. INT. CL. 16.

SMITH, RAYMOND EUGENE, CARSON CITY, NV:  
2,900,461, INT. CL. 25.

SMITH'S FOOD & DRUG CENTERS, INC., SALT LAKE CITY, UT:  
1,861,273. REN. 9-22-04. INT. CL. 42.

SMITHKLINE BEECHAM CORPORATION, PHILADELPHIA, PA:  
2,122,296, CANC. INT. CL. 16.  
2,899,563, PUB. 1-6-2004. INT. CL. 3.

SMITHS MEDICAL ASD, INC., KEANE, NH:  
2,899,007, PUB. 8-10-2004. INT. CL. 10.

SMOKIN'-NUMERO UNO, LLC, TUCSON, AZ:  
2,898,972, PUB. 8-10-2004. INT. CL. 43.

SMOOTH SAILING BEVERAGE COMPANY, BELLINGHAM, WA:  
1,560,086, CANC. INT. CL. 32.

SNACKS BY ME INC., MARIETTA, GA:  
2,900,591, INT. CL. 30.

SNACK KING CORP., CITY OF INDUSTRY, CA:  
2,776,910, AM. INT. CL. 30.

SNAP-ON TECHNOLOGIES, INC., LINCOLNSHIRE, IL:  
2,898,417, PUB. 2-10-1998. INT. CL. 6.

SNAPPLE BEVERAGE CORP., CHICAGO, IL:  
2,122,285, CANC. INT. CL. 30.

SNELL MEDICAL COMMUNICATION INC., MONTREAL, QUEBEC, CANADA:  
2,900,347, INT. CL. 41.

SNK PLAYMORE CORPORATION, SUITA-SHI OSAKA 546-0051, JAPAN:  
2,900,020, PUB. 8-10-2004. MULTIPLE CLASS, INT. CLS. 9 AND 28.

SNK PLAYMORE CORPORATION, SUITA-SHI OSAKA, JAPAN:  
2,900,021, PUB. 8-10-2004. MULTIPLE CLASS, INT. CLS. 9 AND 28.

SNO-BARON'S SNOWMOBILE CLUB, INC., BLAINE, MN:  
2,899,586, PUB. 8-10-2004. INT. CL. 41.

SNOKIST GROWERS, INC., YAKIMA, WA:  
1,850,002. REN. 9-22-04. INT. CL. 31.

SNORKEL STOVE COMPANY, THE, SEATTLE, WA, SLATER STOVES, INC., SEATTLE, WA:  
1,295,958. REN. 9-19-04. INT. CL. 11.

SNOW VALLEY, INC., UPPER MARLBORO, MD:  
2,899,805, PUB. 8-10-2004. MULTIPLE CLASS, INT. CLS. 30, 39 AND 43.

SNOW-BIZ, INC., HOLLYWOOD, FL:  
2,121,883, CANC. INT. CL. 25.

SNOWBEAR PRODUCTS CO. INC., NORTH TONAWANDA, NY:  
2,122,363, CANC. INT. CL. 22.

SOCIETA' PER AZIONI CHIANTI RUFFINO ESPORTAZIONE VINICOLA TOSCANA, BRESCIA, ITALY:  
2,752,858, COR. INT. CL. 33.

SOCIETE CIVILE D'EXPLOITATION DES VIGNOBLES COMTES DE NEIPPERG, 33330 SAINT-EMILION, FRANCE:  
2,898,806, PUB. 8-10-2004. INT. CL. 33.

SOCIETE D'EXPLOITATION J.C. BROSSEAU, PARIS, FRANCE, SOCIETE D'EXPLOITATION J.C. BROSSEAU, PARIS LER, FRANCE:  
1,242,507. REN. 9-23-04. INT. CL. 3.

SOCIETE DES PRODUITS NESTLE SA, VEVEY 1800, SWITZERLAND:  
994,026. REN. 9-18-04. U.S. CL. 46 (INT. CL. 31).

SOCIETE NATIONALE DES CHEMINS DE FER FRANCAIS - S.N.C.F., PARIS, FRANCE:  
2,898,412, PUB. 3-1-1988. INT. CL. 39.

SOCIETE SICHEL S.A., BORDEAUX (GIRONDE), FRANCE:  
1,261,098, CANC. INT. CL. 33.

SODEXHO OPERATIONS, LLC, GAITHERSBURG, MD:  
2,900,640, INT. CL. 41.

SOESBEE, TED, VINCENTOWN, NJ:  
2,899,348, PUB. 8-10-2004. INT. CL. 9.

SOFMAP FUTURE DESIGN KABUSHIKI KAISHA, CHIYODA-KU, TOKYO, JAPAN:  
2,122,158, CANC. INT. CL. 25.

SOFTCARE ELECTRONIC COMMERCE INC., NORTH VANCOUVER, BC, CANADA:  
2,898,532, PUB. 8-10-2004. MULTIPLE CLASS, INT. CLS. 9 AND 42.

SOFTWARE BUSINESS PRODUCTS CORPORATION, CINCINNATI, OH:  
2,898,817, PUB. 8-10-2004. INT. CL. 35.

SOFTWARE ENGINEERING OF AMERICA, INC., FRANKLIN SQUARE, NY:  
1,862,321. REN. 9-19-04. INT. CL. 9.

SOH, JEMENG, TORRANCE, CA:  
2,121,299, CANC. INT. CL. 9.  
2,121,300, CANC. INT. CL. 9.

SOK-IT CORPORATION, BLAINE, MN:  
2,899,912, PUB. 8-10-2004. INT. CL. 22.

SOLAR RATING & CERTIFICATION CORPORATION, COCOA, FL:  
1,286,639. REN. 9-24-04. U.S. CL. A.

SOLID CONCEPTS, INC., VALENCIA, CA:  
2,122,319, CANC. INT. CL. 9.

- SOLITUDE SKI CORPORATION, SOLITUDE, UT:  
2,898,814, PUB. 8-10-2004. INT. CL. 41.
- SOLUTIONS BY DESIGN, INC., FRESNO, CA:  
2,900,502, INT. CL. 9.
- SOLVERS INTERNATIONAL, INC., BOULDER, CO:  
1,810,603, CANC. INT. CL. 9.
- SOLVING IT INTERNATIONAL, INC., CHICAGO, IL:  
2,898,945, PUB. 8-10-2004. INT. CL. 42.
- SOMETHING FOR NOTHING, INC., FORT LAUDERDALE, FL:  
2,898,807, PUB. 8-10-2004. INT. CL. 25.
- SONOMA FOODS, INC., SONOMA, CA:  
2,899,024, PUB. 8-10-2004. INT. CL. 29.
- SONY COMPUTER ENTERTAINMENT AMERICA INC., FOSTER CITY, CA:  
2,900,321, INT. CL. 9.  
2,900,322, INT. CL. 28.
- SONY KABUSHIKI KAISHA, TOKYO, JAPAN, TA SONY CORPORATION:  
2,900,351, INT. CL. 9.
- SONY KABUSHIKI KAISHA, TOKYO 141, JAPAN, TA SONY CORPORATION:  
2,900,359, INT. CL. 9.
- SOPHISTICATED KITCHENS, INC., ORADELL, NJ, DBA SK GOURMET, INC.:  
2,899,311, PUB. 6-3-2003. MULTIPLE CLASS, INT. CLS. 29 AND 30.
- SORGHUM PARTNERS, INC., NEW DEAL, TX:  
2,898,903, PUB. 8-10-2004. MULTIPLE CLASS, INT. CLS. 35 AND 44.
- SOROKA, CYNTHIA, DEMAREST, NJ:  
2,899,468, PUB. 8-10-2004. INT. CL. 16.
- SORRENT, INC., SAN MATEO, CA:  
2,900,204, INT. CL. 9.
- SORTIS, LLC, MADISON, WI:  
2,899,956, PUB. 8-10-2004. INT. CL. 35.
- SOTERIA CORPORATION, WYOMING, MI:  
2,659,326, CANC. IIRN. RESTORED TO S.N. 76-378,954.
- SOUNDCOAT COMPANY, INC., THE, BROOKLYN, NY:  
1,260,928, CANC. INT. CL. 17.
- SOURCE NORTHWEST, INC., WOODINVILLE, WA:  
2,121,498, CANC. INT. CL. 21.
- SOUTH CANAL INTERNATIONAL CO., LTD., TAINAN, TAIWAN:  
1,886,132, REN. 9-22-04. MULTIPLE CLASS, INT. CLS. 25 AND 28.
- SOUTH FLORIDA BRAIN TUMOR ASSOCIATION, INC., CORAL SPRINGS, FL:  
1,811,250, CANC. INT. CL. 42.
- SOUTHEAST CAPITAL CORPORATION, TOWSON, MD, BURNS & RUSSELL COMPANY OF BALTIMORE CITY, THE, BALTIMORE, MD:  
1,824,907, REN. 9-18-04. INT. CL. 7.  
1,856,479, REN. 9-18-04. INT. CL. 1.
- SOUTHEAST CONSTRUCTION PRODUCTS, INC., SOUTH EL MONTE, CA, DBA SOUTHEAST CONCRETE PRODUCTS:  
1,823,585, REN. 9-18-04. INT. CL. 7.
- SOUTHEAST SHELLFISH, INC., WAREHAM, MA:  
2,898,830, PUB. 8-10-2004. INT. CL. 29.
- SOUTHERN BELLE REFRIGERATED, LLC, TUPELO, MS:  
2,899,808, PUB. 8-10-2004. INT. CL. 39.
- SOUTHERN CALIFORNIA BREWING COMPANY, TORRANCE, CA:  
2,121,041, CANC. INT. CL. 32.
- SOUTHERN CALIFORNIA MINORITY BUSINESS DEVELOPMENT COUNCIL, INC., LOS ANGELES, CA:  
2,899,005, PUB. 8-10-2004. INT. CL. 41.
- SOUTHERN LIVING, INC., BIRMINGHAM, AL:  
1,318,051, REN. 9-24-04. INT. CL. 16.  
2,898,567, PUB. 8-10-2004. INT. CL. 16.
- SOUTHERN NEW ENGLAND TELECOMMUNICATIONS CORPORATION, NEW HAVEN, CT:  
2,121,996, CANC. INT. CL. 38.
- SOUTHERN SEASONINGS, INC., BROUSSARD, LA:  
2,899,540, PUB. 8-10-2004. INT. CL. 30.
- SOUTHERN STAR CONCRETE, INC., AUSTIN, TX:  
2,900,839, INT. CL. 19.
- SOUTHPORT ADVISORS, FAIRFIELD, CT:  
2,900,033, INT. CL. 9.
- SOUTHPORT PAINT COMPANY, INC., SAVANNAH, GA:  
404,659, CANC. U.S. CL. 12.
- SOUTHWESTCO WIRELESS, INC., SCOTTSDALE, AZ:  
2,122,354, CANC. INT. CL. 38.
- SP ENTERPRISES, INC., HUNT VALLEY, MD:  
2,121,989, CANC. INT. CL. 28.
- SPADA, ROBERT, HUNTINGTON BEACH, CA:  
2,900,414, INT. CL. 21.
- SPADAFORA, CAROLANN, OCEAN RIDGE, FL:  
2,898,851, PUB. 8-10-2004. INT. CL. 3.
- SPALDING SPORTS WORLDWIDE, INC., CHICOPEE, MA:  
2,851,860, COR. INT. CL. 25.
- SPALDING, JEFFREY, SCOTT, BEL AIR, MD:  
2,899,716, PUB. 8-10-2004. INT. CL. 41.
- SPANGLER CANDY COMPANY, BRYAN, OH:  
2,122,419, CANC. INT. CL. 30.
- SPANISH BROADCASTING SYSTEM, INC., COCONUT GROVE, FL:  
2,900,392, INT. CL. 38.
- SPARC INTERNATIONAL, INC., MENLO PARK, CA:  
1,810,535, CANC. INT. CL. 9.
- SPARC SYSTEMS LIMITED, MALVERN, WORCESTER-SHIRE WR13 6NP, ENGLAND:  
1,811,463, CANC. INT. CL. 9.
- SPEAK THE WORD CHURCH INTERNATIONAL, GOLDEN VALLEY, MN:  
2,899,254, PUB. 8-10-2004. INT. CL. 9.
- SPEAKERSEARCH, LTD., NORTH POTOMAC, MD:  
2,122,395, CANC. INT. CL. 41.
- SPECIALTY BRANDS OF AMERICA, INC., NEW CANAAN, CT, CARTLIDGE, CHRISTOPHER, TRENTON, NJ, DBA ORIGINAL TRENTON CRACKER COMPANY:  
200,061, REN. 9-22-04. U.S. CL. 46 (INT. CL. 30).
- SPECIALTY BRANDS, INC., RIVERSIDE, CA, CENTRAL SOYA COMPANY, INC., FT. WAYNE, IN:  
1,293,083, REN. 9-24-04. INT. CL. 30.
- SPECIALTY CONSTRUCTION BRANDS, INC., SAINT PAUL, MN, BENJAMIN FOSTER COMPANY, PHILADELPHIA, PA:  
596,258, REN. 9-18-04. U.S. CL. 16 (INT. CL. 2).
- SPECIALTY CONSTRUCTION BRANDS, INC., SAINT PAUL, MN, TEC INCORPORATED, PALATINE, IL:  
1,860,626, REN. 9-18-04. INT. CL. 3.
- SPECIALTY JUTE PRODUCTS & DEVELOPMENT, INC., NEW YORK, NY:  
1,260,972, CANC. INT. CL. 24.
- SPECIALTY LIGHTING, INC., SHELBY, NC:  
1,811,501, CANC. INT. CL. 11.
- SPECIALTY MINERALS (MICHIGAN) INC., BINGHAM FARMS, MI, MARTIN MARIETTA CORPORATION, BETHESDA, MD:  
1,296,233, REN. 9-18-04. INT. CL. 19.
- SPECIFIED TECHNOLOGIES INC., SOMERVILLE, NJ:  
2,900,116, MULTIPLE CLASS, INT. CLS. 2 AND 7.
- SPECTRAL GESELLSCHAFT FUR LICHTTECHNIK MIT BESCHRANKTER HAFTUNG, D-79111 FREIBURG, FED REP GERMANY:  
2,845,220, COR. INT. CL. 11.
- SPECTRUM PLASTICS, INC., CERRITOS, CA:  
2,899,010, PUB. 8-10-2004. MULTIPLE CLASS, INT. CLS. 16 AND 17.
- SPEEDY PACKAGE DELIVERY, INC., BOSTON, MA:  
2,899,313, PUB. 1-13-2004. INT. CL. 39.
- SPENCER PRODUCTS COMPANY, SEATTLE, WA:  
2,121,313, CANC. INT. CL. 9.
- SPENDRUPS BRYGGERIAKTIEBOLAG, S-113 43 STOCKHOLM, SWEDEN:  
2,120,783, CANC. INT. CL. 32.
- SPIETH, ANGELA, D-10405 BERLIN, FED REP GERMANY AND OEHLER, MICHAEL, D-10405 BERLIN, FED REP GERMANY:  
2,899,338, PUB. 8-10-2004. MULTIPLE CLASS, INT. CLS. 18 AND 25.
- SPINAL CONCEPTS, INC., AUSTIN, TX:  
2,900,264, INT. CL. 10.

SPLASHWORKS INC., TORONTO, ONTARIO, CANADA:  
2,898,502, PUB. 6-1-2004. INT. CL. 35.

SPOONS RESTAURANTS, INC., NEWPORT BEACH, CA,  
SPOONS RESTAURANTS, INC., NEWPORT BEACH, CA:  
1,284,693. REN. 9-20-04. INT. CL. 42.

SPORTWALL INTERNATIONAL, INC., CARPINTERIA, CA:  
2,899,397, PUB. 8-10-2004. INT. CL. 28.

SPRAGUE-GOODMAN ELECTRONICS, INC., GARDEN  
CITY PARK, NY:  
761,586, CANC. U.S. CL. 21.

SPRINGS LICENSING GROUP, INC., FORT MILL, SC:  
2,900,437, INT. CL. 16.

SPRINT COMMUNICATIONS COMPANY L.P., OVERLAND  
PARK, KS:  
2,898,890, PUB. 8-10-2004. INT. CL. 16.

SPUR CAPITAL PARTNERS, LLC, BARTLESVILLE, CA:  
2,899,922, PUB. 8-10-2004. INT. CL. 36.

SQUARE D COMPANY, PALATINE, IL:  
791,327. REN. 9-18-04. U.S. CL. 21 (INT. CL. 9).

SQUARE ONE DEVELOPMENT, INC., DELTAVILLE, VA:  
2,900,207, MULTIPLE CLASS, INT. CLS. 16 AND 28.

SQUIRREL BRAND HOLDINGS, L.P., DENISON, TX:  
2,899,941, PUB. 8-10-2004. INT. CL. 30.

SR PRODUCTIONS INC., CARSON CITY, NV:  
2,899,408, PUB. 8-10-2004. INT. CL. 9.

SRI USA, INC., AMHERST, NY:  
2,898,834, PUB. 1-27-2004. INT. CL. 12.

SSE FOODS, INC., MARSHALL, MN:  
2,122,227, CANC. INT. CL. 30.

ST. JOSEPH'S HILL INFIRMARY, INC., EUREKA, MO, ST.  
FRANCIS HOSPITAL, WASHINGTON, MISSOURI, WA-  
SHINGTON, MO:  
1,004,954. REN. 9-18-04. INT. CL. 42.

ST. MARY GALVANIZING CORPORATION, NEW OR-  
LEANS, LA:  
1,261,359, CANC. INT. CL. 40.

ST. VINCENT MEDICAL CENTER, TOLEDO, OH:  
1,824,764. REN. 9-22-04. INT. CL. 42.

STABLE MICRO SYSTEMS LIMITED, HASLEMERE, SUR-  
REY, GU27 3AY, ENGLAND:  
2,121,960, CANC. INT. CL. 9.

STACO POWERNETICS, INC., COSTA MESA, CA:  
1,260,822, CANC. INT. CL. 9.

STAG-PARKWAY, INC., ATLANTA, GA:  
2,899,647, PUB. 8-10-2004. INT. CL. 16.

STAMATS MEETINGS MEDIA, INC., CEDAR RAPIDS, IA:  
2,899,994, PUB. 8-10-2004. INT. CL. 16.

STAMP CAMP USA, KNOXVILLE, PA:  
2,900,938, INT. CL. 41.

STAMPIN' UP! INC., SANDY, UT:  
2,899,194, PUB. 8-10-2004. INT. CL. 16.

STANDARD FEDERAL BANK N.A., TROY, MI:  
2,899,114, PUB. 8-10-2004. INT. CL. 20.

STANDARD MOTOR PRODUCTS, INC., LONG ISLAND  
CITY, NY:  
2,121,607, CANC. INT. CL. 7.

STANDARD PARKING CORPORATION, CHICAGO, IL:  
2,900,916, MULTIPLE CLASS, INT. CLS. 37 AND 39.

STANDEX INTERNATIONAL CORPORATION, SALEM,  
NH:  
761,627, CANC. U.S. CL. 34.

STANLEY STEEMER INTERNATIONAL, INC., DUBLIN,  
OH:  
996,362. REN. 9-22-04. U.S. CL. 23 (INT. CL. 7).

STANLEY STEEMER INTERNATIONAL, INC., DUBLIN,  
OH, JACK BATES CARPET CLEANING CO., COLUMBUS,  
OH:  
1,006,675. REN. 9-22-04. U.S. CL. 103 (INT. CL. 37).

STANWORTH DEVELOPMENT LIMITED, TORTOLA,  
BR.VIRGIN ISLANDS:  
2,898,776, PUB. 8-10-2004. INT. CL. 41.  
2,898,777, PUB. 8-10-2004. INT. CL. 41.

STAR NETWORKS, INC., MAITLAND, FL, MONETARY  
TRANSFER SYSTEM, ST. LOUIS, MO:  
1,907,583. REN. 9-23-04. INT. CL. 36.

STARBRIGHT GRAPHICS, INC., EAST BRUNSWICK, NJ:  
1,811,040, CANC. MULTIPLE CLASS, INT. CLS. 35 AND  
42.

STARCALL TECHNOLOGIES, INC., CHARLOTTE, NC:  
2,121,420, CANC. INT. CL. 39.

STARCHILD, ADAM, LONGWOOD, FL:  
1,904,399. REN. 9-23-04. INT. CL. 16.

STARCHILD, ADAM, MIAMI, FL:  
1,904,545. REN. 9-23-04. INT. CL. 28.

STARCK, PHILIPPE, 92130 ISSY LES MOULINEAUX,  
FRANCE:  
2,830,931, COR. MULTIPLE CLASS, INT. CLS. 21, 24, 25,  
29, 30, 32, 33 AND 43.

STARENSIER INC., NEWBURYPORT, MA:  
1,810,822, CANC. INT. CL. 24.

STARFIELD TECHNOLOGIES, SCOTTSDALE, AZ:  
2,899,727, PUB. 8-10-2004. INT. CL. 42.  
2,899,729, PUB. 8-10-2004. INT. CL. 42.

STARK CERAMICS, INC., CANTON, OH:  
1,859,721. REN. 9-22-04. INT. CL. 19.

STATE EMPLOYEES CREDIT UNION OF MARYLAND,  
INC., LINTHICUM, MD:  
2,900,927, INT. CL. 36.

STATE OF MICHIGAN, DEPARTMENT OF EDUCATION,  
LANSING, MI:  
1,858,037. REN. 9-19-04. INT. CL. 42.

STEELESTIC COMPANY, LLC, THE, AKRON, OH, STEEE-  
LASTIC COMPANY, THE, AKRON, OH:  
1,003,331. REN. 9-18-04. U.S. CL. 23 (INT. CL. 7).

STEIN MART, INC., JACKSONVILLE, FL:  
2,121,965, CANC. INT. CL. 25.

STELLENBOSCH FARMERS WINERY LIMITED, OUDE  
LIBERTAS, STELLENBOSCH, SOUTH AFRICA:  
1,286,316. REN. 9-19-04. INT. CL. 33.

STEMCO BIOMEDICAL, INC., DURHAM, NC:  
2,900,534, INT. CL. 5.

STENGEL, JOHN GLENN, OMAHA, NE:  
2,898,774, PUB. 8-10-2004. INT. CL. 41.

STEP UP CONCEPTS, LLC, NAPLES, FL:  
2,899,438, PUB. 8-10-2004. INT. CL. 31.

STEPHEN MINISTRIES, ST. LOUIS, MO:  
2,121,474, CANC. INT. CL. 16.

STEPHEN SEED HOUSE, INC., STEPHEN, MN:  
1,261,243, CANC. INT. CL. 42.

STERLING ADVANCE PACKAGING, INC., BROOKLYN,  
NY, DBA EVENT MEDIA:  
2,121,522, CANC. INT. CL. 40.

STERLING JEWELERS INC., AKRON, OH:  
1,872,975. REN. 9-20-04. INT. CL. 42.

STERLING'S MAGAZINES, INC., NEW YORK, NY, D. S.  
MAGAZINES, INC., CRESSKILL, NJ:  
1,346,134. REN. 9-20-04. INT. CL. 16.

STERN STEWART & CO., NEW YORK, NY:  
1,856,961. REN. 9-18-04. INT. CL. 36.

STETON TECHNOLOGY GROUP, INC., SANTA CLARA,  
UT:  
2,900,246, MULTIPLE CLASS, INT. CLS. 9 AND 42.

STEVE JACKSON GAMES INCORPORATED, AUSTIN, TX:  
1,850,794. REN. 9-22-04. INT. CL. 28.  
1,850,795. REN. 9-22-04. INT. CL. 28.

STM, INC., HOUSTON, TX:  
2,899,564, PUB. 8-10-2004. INT. CL. 9.

STOCKTON, JR.; RODNEY M., FT. LAUDERDALE, FL,  
DBA STOCKTON ENTERPRISES:  
1,290,667. REN. 9-20-04. INT. CL. 5.

STOLLMAN, RITA, BROOKLYN, NY, DBA EDITORIAL  
MANAGEMENT STRATEGIES:  
2,121,633, CANC. MULTIPLE CLASS, INT. CLS. 35, 41  
AND 42.

STONE CONTAINER CORPORATION, CHICAGO, IL:  
2,900,184, INT. CL. 16.

STONEAGE CERAMICS INTERNATIONAL HONG KONG  
LTD., WANCHAI, HONG KONG:  
2,900,391, INT. CL. 21.

STONEFLY NETWORKS, INC., SAN DIEGO, CA:  
2,770,325, COR. INT. CL. 9.

STORA ENSO OYJ, 00160 HELSINKI, FINLAND:  
2,898,930, PUB. 8-10-2004. INT. CL. 16.

STOURDZA, ALEXANDRE, MONACO, MONACO:  
2,898,715, PUB. 1-27-2004. MULTIPLE CLASS, INT. CLS.  
32 AND 33.

- STRATA PRODUCTS (USA), INC., MARIETTA, GA:  
2,121,668, CANC. INT. CL. 19.
- STRATFORD HOMES LIMITED PARTNERSHIP, STRATFORD, WI:  
2,900,208, INT. CL. 19.
- STRATIFY, INC., MOUNTAIN VIEW, CA FROM PURPLEYOGI, INC., MOUNTAIN VIEW, CA:  
2,900,187, INT. CL. 9.
- STRATMAN GROUP, INC., AVON, CT:  
2,121,009, CANC. INT. CL. 9.
- STRATO/INFUSAID INC., MANCHESTER, GA, STRATO MEDICAL CORPORATION, BEVERLY, MA:  
1,852,317, REN. 9-18-04, INT. CL. 10.
- STRATUS PHARMACEUTICALS INC, MIAMI, FL:  
2,649,461, CANC. IIRN. RESTORED TO S.N. 78-069,088.
- STREHLAU, CHRISTIAN, AUSTIN, TX:  
2,121,852, CANC. INT. CL. 18.
- STRENGTH SYSTEMS, INC., ST. ROSE, LA, STRENGTH FOOTWEAR, INC., KENNER, LA:  
1,868,369, REN. 9-23-04, INT. CL. 25.
- STRETCH MANUFACTURING, INC., LOS ANGELES, CA:  
2,898,692, PUB. 8-10-2004, INT. CL. 25.
- STRIKE ON, LLC, EDWARDS, CO:  
2,898,675, PUB. 8-10-2004, INT. CL. 18.
- STRINGER, HANK, AUSTIN, TX:  
2,122,056, CANC. INT. CL. 9.
- STRODE, JEFF, PITTSBURGH, PA:  
2,121,065, CANC. INT. CL. 30.
- STROUSE, ADLER COMPANY, THE, NEW HAVEN, CT:  
2,121,897, CANC. INT. CL. 25.
- STRIK PUBLISHING GROUP (PTY) LTD, THE, GARDENS, CAPE TOWN, SOUTH AFRICA:  
2,121,731, CANC. INT. CL. 16.
- STTM, LLC, WILMINGTON, DE, ST. TROPEZ SWIMWEAR, INC., PASSAIC, NJ:  
1,297,665, REN. 9-18-04, INT. CL. 25.
- STUART PRODUCTS, INC., BEDFORD, TX:  
1,850,516, REN. 9-22-04, INT. CL. 5.
- STUDEX CORPORATION, GARDENA, CA:  
1,854,143, REN. 9-19-04, INT. CL. 14.
- STUDIO RTA, INC., PICO RIVERA, CA:  
2,900,309, INT. CL. 20.
- STUDIO TORTA S.R.L., TORINO, ITALY:  
2,899,599, PUB. 8-10-2004, MULTIPLE CLASS, INT. CLS. 35, 38, 41 AND 42.
- SUCCESSFUL SOLUTIONS, INC, VIDALIA, GA:  
2,121,604, CANC. INT. CL. 42.
- SUISMAN & BLUMENTHAL, INCORPORATED, HARTFORD, CT:  
2,121,509, CANC. INT. CL. 20.
- SUISUN BAY SOAP COMPANY, FAIRFIELD, CA:  
2,121,796, CANC. INT. CL. 3.
- SUKLIJAN, CHRISTINA, ALBANY, NY:  
2,898,544, PUB. 10-22-2002, INT. CL. 3.
- SULLIVAN, GARRY J, SAN BRUNO, CA:  
2,900,699, INT. CL. 30.
- SULLIVAN, ROBERT, SAN JUAN CAPISTRANO, CA AND SULLIVAN, GINAMARIE, SAN JUAN CAPISTRANO, CA:  
2,899,165, PUB. 8-10-2004, INT. CL. 35.  
2,899,166, PUB. 8-10-2004, INT. CL. 35.
- SULZER MANAGEMENT AG, 8401 WINTERTHUR, SWITZERLAND, ESCHER WYSS AKTIENGESELLSCHAFT, ZURICH, SWITZERLAND:  
1,288,626, REN. 9-22-04, MULTIPLE CLASS, INT. CLS. 11 AND 12.
- SUMITOMO RUBBER INDUSTRIES, LTD., KOBE-SHI, HYOGO, JAPAN:  
2,900,232, INT. CL. 28.
- SUMMETRIC INTERACTIVE SOFTWARE, INC., BOISE, ID:  
2,121,282, CANC. INT. CL. 9.
- SUMMIT DOCUMENT SERVICES, INC., BIRMINGHAM, AL:  
2,899,018, PUB. 8-10-2004, MULTIPLE CLASS, INT. CLS. 35, 39, 40 AND 42.  
2,899,019, PUB. 8-10-2004, MULTIPLE CLASS, INT. CLS. 35, 39, 40 AND 42.
- SUMMIT FINANCIAL GROUP, INC., MOOREFIELD, WV:  
2,900,911, INT. CL. 36.  
2,900,912, INT. CL. 36.
- SUMMIT GROUP, LLC, THE, ROSWELL, GA:  
2,898,575, PUB. 8-10-2004, MULTIPLE CLASS, INT. CLS. 9, 16 AND 35.
- SUMMIT TIRE & BATTERY, INC., ST. PETERS, MO, GENERAL TIRE & RUBBER COMPANY, THE, AKRON, OH:  
774,539, REN. 9-23-04, U.S. CL. 35 (INT. CL. 12).
- SUN CHEMICAL CORPORATION, FORT LEE, NJ:  
1,289,649, REN. 9-19-04, INT. CL. 2.
- SUN PHARMACEUTICALS CORP., WESTPORT, CT:  
2,898,448, PUB. 9-4-2001, INT. CL. 3.
- SUN, YIGUO, GUANGZHOU, CHINA:  
2,899,798, PUB. 8-10-2004, INT. CL. 25.
- SUNDOWN VITAMINS, INC., FT. LAUDERDALE, FL TO REXALL SUNDOWN, INC., BOCA RATON, FL:  
1,810,655, CANC. INT. CL. 11.
- SUNGARD RECOVERY SERVICES LP, WAYNE, PA:  
2,899,162, PUB. 8-10-2004, INT. CL. 42.
- SUNGLASS HUT INTERNATIONAL, INC., MASON, OH:  
2,900,694, MULTIPLE CLASS, INT. CLS. 35 AND 44.
- SUNJEEN, INC., FULLERTON, CA:  
1,849,788, REN. 9-18-04, INT. CL. 8.
- SUNNYMAY ENTERPRISES, INC., HUNTINGTON BEACH, CA:  
2,121,855, CANC. INT. CL. 25.
- SUNPORCH STRUCTURES, INC., WESTPORT, CT, VEGETABLE FACTORY, INC., STAMFORD, CT:  
1,838,353, REN. 9-20-04, INT. CL. 6.
- SUNRISE INDUSTRIES, INC., RICHMOND, VA, DBA DAWN OF SILENCE MUSIC:  
2,898,653, PUB. 8-10-2004, INT. CL. 9.
- SUPER DUPER INC., GREENVILLE, SC, DBA SUPER DUPER PUBLICATIONS:  
2,899,884, PUB. 8-10-2004, INT. CL. 16.
- SUPPORT CT, ALPHARETTA, GA:  
2,900,930, INT. CL. 42.
- SUPREME ELASTIC CORPORATION, HICKORY, NC:  
2,899,688, PUB. 8-10-2004, INT. CL. 23.
- SURGICAL NAVIGATION TECHNOLOGIES, INC., BROOMFIELD, CO:  
2,899,570, PUB. 8-10-2004, INT. CL. 9.
- SURGICAL SPECIALTIES CORPORATION, READING, PA:  
2,900,456, INT. CL. 10.
- SURRY LICENSING LLC, KEENE, NH:  
1,261,299, CANC. INT. CL. 42.
- SURVIVAL SOLUTIONS, L.C., WEST VALLEY CITY, UT:  
2,121,270, CANC. INT. CL. 29.
- SUSHI METSUYAN, INC., JAMAICA ESTATES, NY:  
2,899,701, PUB. 8-10-2004, INT. CL. 43.
- SUSTAINABLE ENTERPRISES, INC., HOUSTON, TX, DBA GLOBAL OUTPOSTS:  
2,121,404, CANC. INT. CL. 39.
- SUTPHIN DRUGS, INC., JAMAICA, NY:  
2,898,717, PUB. 8-10-2004, MULTIPLE CLASS, INT. CLS. 35 AND 39.
- SUZYS ZOO, SAN DIEGO, CA:  
2,854,557, COR. INT. CL. 28.
- SVEDALA INDUSTRIES, INC., MILWAUKEE, WI TO SVEDALA INDUSTRIES, INC., WAUKESHA, WI:  
1,810,456, CANC. MULTIPLE CLASS, INT. CLS. 7, 11, 40 AND 42.
- SVERIGES EXPORTRAD, S-114 85 STOCKHOLM, SWEDEN:  
1,811,341, CANC. MULTIPLE CLASS, INT. CLS. 29, 30, 31 AND 32.
- SWEATER.COM, INC, SANTA MONICA, CA:  
2,899,078, PUB. 8-10-2004, INT. CL. 25.
- SWEDE INDUSTRIES, INC., CLAREMORE, OK:  
2,900,731, INT. CL. 28.
- SWEDE-O, INC., NORTH BRANCH, MN:  
2,899,473, PUB. 12-2-2003, INT. CL. 10.
- SWEET, BARRY, ESTES PARK, CO, DBA STATUSWORKS INTERNATIONAL TO STATUSWORKS INTERNATIONAL, INC., ESTES PARK, CO:  
1,811,723, CANC. INT. CL. 25.



SWEETHEART CUP COMPANY INC., OSHKOSH, WI:  
2,899,047, PUB. 8-10-2004. MULTIPLE CLASS, INT. CLS. 16 AND 21.

SWING SYNC USA, INC., PINEHURST, NC:  
2,899,573, PUB. 5-25-2004. MULTIPLE CLASS, INT. CLS. 28, 37 AND 40.

SWISS HERBAL REMEDIES LTD., RICHMOND HILL ONTARIO, CANADA:  
2,900,524, INT. CL. 5.

SYBASE, INC., DUBLIN, CA:  
2,900,379, INT. CL. 9.

SYCOR GMBH, GOTTINGEN, FED REP GERMANY:  
2,899,286, PUB. 8-10-2004. MULTIPLE CLASS, INT. CLS. 35, 37, 38, 39 AND 42.

SYMBIOS LOGIC INC., FORT COLLINS, CO:  
2,122,019, CANC. INT. CL. 9.  
2,122,020, CANC. INT. CL. 9.

SYNOPSIS, INC., MOUNTAIN VIEW, CA, LOGIC MODELING CORPORATION, BEAVERTON, OR:  
1,822,116, REN. 9-18-04. INT. CL. 9.

SYNTHELABO, 92350 LE PLESSIS-ROBINSON, FRANCE:  
2,121,214, CANC. INT. CL. 5.

SYNTHE (U.S.A.), PAOLI, PA:  
2,900,400, INT. CL. 10.

SYNTHON PHARMACEUTICALS, LTD., CHAPEL HILL, NC:  
2,899,689, PUB. 8-10-2004. INT. CL. 5.

SYSCO CORPORATION, HOUSTON, TX:  
2,751,632, AM. INT. CL. 29.

SYSTEMS UNION HOLDINGS LIMITED, FARNBOROUGH, HAMPSHIRE GU14 6XP, UNITED KINGDOM:  
2,898,577, PUB. 1-28-2003. INT. CL. 9.

S2 SYSTEMS, INC., PLANO, TX, SHARED SYSTEMS CORPORATION, DALLAS, TX:  
1,860,286, REN. 9-18-04. INT. CL. 9.

T. ROWE PRICE GROUP, INC., BALTIMORE, MD:  
2,831,098, CANC. IIRN. RESTORED TO S.N. 75-982,881.

T. TOWE PRICE GROUP, INC., BALTIMORE, MD:  
1,902,978, REN. 9-23-04. INT. CL. 36.

T.D. SALES AND MARKETING, INC., COOPER CITY, FL:  
2,898,420, PUB. 2-9-1999. INT. CL. 9.

T.F.H. PUBLICATIONS, INC., NEPTUNE CITY, NJ:  
2,122,423, CANC. INT. CL. 31.

T.G.N. S.P.A., 41100 MODENA, ITALY:  
1,846,474, REN. 9-23-04. MULTIPLE CLASS, INT. CLS. 6 AND 20.

TACONY CORPORATION, FENTON, MO:  
2,899,253, PUB. 8-10-2004. INT. CL. 7.

TAIYO YUDEN CO., LTD., TAITO-KU, TOKYO, JAPAN:  
2,900,088, INT. CL. 9.

TAKAGI INDUSTRIAL CO. USA, INC., TUSTIN, CA:  
2,121,551, CANC. INT. CL. 11.

TAKE ME OUT TO THE BALLGAME, LLC, LANSING, MI:  
2,121,398, CANC. MULTIPLE CLASS, INT. CLS. 25 AND 41.

TAKEDA CHEMICAL INDUSTRIES, LTD., OSAKA, JAPAN:  
2,845,088, COR. MULTIPLE CLASS, INT. CLS. 1 AND 5.

TALCUP, INC., LIVONIA, MI, DBA RS ELECTRONICS:  
2,899,869, PUB. 8-10-2004. INT. CL. 35.

TALON MEDICAL LTD., SAN ANTONIO, TX:  
2,899,831, PUB. 8-10-2004. INT. CL. 9.

TAMA, INC., NEW YORK, NY:  
2,121,920, CANC. INT. CL. 14.

TANA'S HABITAT MULTIMEDIA, LLC, LOS ANGELES, CA, DBA TANA'S HABITAT MULTIMEDIA, LLC:  
2,899,615, PUB. 8-10-2004. INT. CL. 16.

TANGIBLE IMPACT, INC., DUBLIN, OH:  
2,900,865, INT. CL. 35.

TAPEX PTY LIMITED, WATERLOO, NEW SOUTH WALES 2017, AUSTRALIA:  
2,900,025, MULTIPLE CLASS, INT. CLS. 22, 40 AND 42.

TAPPER, GREG, NEW YORK, NY:  
2,899,227, PUB. 8-10-2004. INT. CL. 41.

TARGETED MEDIA FOR MEDICINE, INC., HOBOKEN, NJ TO HSI SERVICE CORP., NEWARK, DE:  
1,811,529, CANC. INT. CL. 16.

TARKETT, INC., FARNHAM, QUEBEC:  
2,121,496, CANC. INT. CL. 19.

TARYN MANNING AND KELLIN MANNING, PARTNERSHIP, THE, LOS ANGELES, CA, DBA BOOMKAT:  
2,900,226, INT. CL. 41.

TASHDJIAN TRADING CO. INC., LOS ANGELES, CA:  
2,898,705, PUB. 8-10-2004. INT. CL. 18.

TASK PERFORMANCE GROUP INC., DES PLAINES, IL:  
2,900,314, INT. CL. 42.

TATA SONS LTD., MUMBAI, INDIA:  
2,814,916, COR. INT. CL. 9.  
2,824,913, COR. MULTIPLE CLASS, INT. CLS. 35, 37 AND 42.

TAVTECH LTD., YEHUD, ISRAEL:  
2,900,941, INT. CL. 10.

TAYLOR BUILDING PRODUCTS, INC., WEST BRANCH, MI, GARLAND MANUFACTURING COMPANY, WEST BRANCH, MI:  
1,289,804, REN. 9-20-04. INT. CL. 6.

TAYLOR CORPORATION, NORTH MANKATO, MN:  
1,892,438, REN. 9-18-04. INT. CL. 42.

TAYLOR, KENT C., NASHVILLE, TN:  
2,899,854, PUB. 8-10-2004. INT. CL. 32.

TAYLOR, ROBERT H., LUMBERVILLE, PA:  
2,122,177, CANC. INT. CL. 16.

TAYLOR, STEWART A., KINGSPORT, TN:  
2,900,720, INT. CL. 8.

TAYMARK, INC., NORTH MANKATO, MN:  
2,900,006, PUB. 8-10-2004. INT. CL. 35.

TBAC INVESTMENT TRUST, INC., ARLINGTON, TX, LORING-FAIRCHILD LTD., NEW YORK, NY:  
1,829,864, REN. 9-22-04. INT. CL. 25.

TBG INSURANCE SERVICES CORPORATION, LOS ANGELES, CA, DBA TBG FINANCIAL:  
2,899,219, PUB. 8-10-2004. INT. CL. 36.  
2,899,258, PUB. 8-10-2004. INT. CL. 36.  
2,899,260, PUB. 8-10-2004. INT. CL. 36.

TEA BODY'S, INC., TURLOCK, CA:  
2,121,566, CANC. INT. CL. 30.

TEAM BIG BEAR MOUNTAIN BIKES, INC., BIG BEAR LAKE, CA:  
2,121,294, CANC. INT. CL. 41.

TEAM IN FOCUS, LLC, JACKSONVILLE, FL:  
2,899,464, PUB. 8-10-2004. INT. CL. 3.

TECHMAT PLUS, GREENSBORO, NC:  
2,899,937, PUB. 8-10-2004. INT. CL. 17.

TECHNIC INC., CRANSTON, RI:  
1,287,531, REN. 9-20-04. INT. CL. 1.

TECHNICAL SOURCING INTERNATIONAL, INC., MIS-SOULA, MT:  
2,899,113, PUB. 8-10-2004. INT. CL. 5.

TECHNISTONE USA, INC., HOUSTON, TX:  
2,899,579, PUB. 8-10-2004. INT. CL. 19.

TECHNO TREND AG, ERFURT, FED REP GERMANY:  
2,900,939, MULTIPLE CLASS, INT. CLS. 9, 37 AND 42.

TECHNOLOGY ECONOMICS INTERNATIONAL CORPORATION, ROCKVILLE, MD:  
2,120,908, CANC. INT. CL. 9.

TECHNOTREND AG, ERFURT, FED REP GERMANY:  
2,900,940, MULTIPLE CLASS, INT. CLS. 9, 37 AND 42.

TECHSMITH CORPORATION, OKEMOS, MI:  
2,900,325, INT. CL. 9.

TECOM, INC., TAMPA, FL:  
2,122,244, CANC. INT. CL. 9.

TED NUGENT'S WORLD BOWHUNTERS, INCORPORATED, JACKSON, MI:  
1,875,605, REN. 9-18-04. INT. CL. 41.

TEIJIN SHOJI, NEW YORK, NY:  
2,899,757, PUB. 8-10-2004. INT. CL. 24.

TEKER, LLC, RED BANK, NJ:  
2,900,215, INT. CL. 9.

TELEBRANDS CORP., FAIRFIELD, NJ:  
2,900,410, INT. CL. 21.

TELECOMMUNICATION DEVICES INDUSTRIES, HAYDEN, ID, DBA TDI LLC:  
2,899,848, PUB. 8-10-2004. INT. CL. 9.

TELEDATA COMMUNICATIONS LTD., HERZLIYA-B 46120, ISRAEL:  
2,121,923, CANC. INT. CL. 9.

- TELEDYNE INDUSTRIES, INC., FORT COLLINS, CO, DBA  
TELEDYNE WATER PIK:  
2,121,847, CANC. INT. CL. 21.
- TELEFLEX INCORPORATED, LIMERICK, PA:  
2,122,288, CANC. INT. CL. 10.
- TELEFONICA DE ESPANA, S.A., 28013 MADRID, SPAIN:  
2,120,952, CANC. MULTIPLE CLASS, INT. CLS. 16, 35  
AND 38.
- TELELINGUA, S.A., BRUXELLES, BELGIUM:  
2,899,374, PUB. 8-10-2004. MULTIPLE CLASS, INT. CLS.  
9, 35, 41 AND 42.
- TELEMATIC SYSTEMS, INC., NORTHVILLE, MI:  
2,899,835, PUB. 8-10-2004. MULTIPLE CLASS, INT. CLS. 9  
AND 42.
- TELEPHONETICS INTERNATIONAL, INC., MIAMI, FL:  
2,121,477, CANC. INT. CL. 41.
- TELICA, INC., MARLBORO, MA:  
2,898,476, PUB. 8-21-2001. INT. CL. 9.
- TELLABS OPERATIONS, INC., LISLE, IL TO TELLABS  
OPERATIONS, INC., LISLE, IL:  
1,811,426, CANC. INT. CL. 9.
- TEMPCO ELECTRIC HEATER CORPORATION, WOOD  
DALE, IL, TEMPCO INDUSTRIAL HEATER CORPORA-  
TION, FRANKLIN PARK, IL:  
1,016,306, REN. 9-22-04. INT. CL. 11.
- TENNIS PROPERTIES B.V., AMSTERDAM, NETHER-  
LANDS:  
2,770,601, COR. MULTIPLE CLASS, INT. CLS. 9, 18, 25  
AND 28.
- TENSOLITE COMPANY, ST. AUGUSTINE, FL:  
2,900,239, INT. CL. 9.
- TENTE-ROLLEN GMBH & CO. KG, D-42929 WERMELS-  
KIRCHEN, FED REP GERMANY:  
1,312,340, REN. 9-18-04. INT. CL. 20.
- TERACLOUD CORPORATION, BELLEVUE, WA FROM  
TRIOLOGY SOFTWARE, INC, BELLEVUE, WA:  
2,900,145, MULTIPLE CLASS, INT. CLS. 9 AND 42.
- TERRA HARVEST FOODS, INCORPORATED, LOVES  
PARK, IL:  
2,900,772, MULTIPLE CLASS, INT. CLS. 30 AND 40.
- TERRA INTERNATIONAL, INC., SIOUX CITY, IA:  
2,120,846, CANC. INT. CL. 41.
- TERRA NETWORKS, S.A., 28224 POZUELO DE ALARCON  
(MADRID), SPAIN:  
2,629,751, COR. MULTIPLE CLASS, INT. CLS. 1, 3, 5, 9,  
12, 14, 16, 18, 25, 28, 29, 30, 31, 32, 33, 34, 35, 36, 37, 38,  
39, 40, 41 AND 42.
- TERRABROOK APOLLO BEACH, L.P., DALLAS, TX:  
2,900,151, MULTIPLE CLASS, INT. CLS. 41 AND 42.
- TERRIFIC PRODUCTS OF FLORIDA INC., NAPLES, FL:  
2,121,864, CANC. INT. CL. 24.
- TERRY PRODUCTS, INC., KANNAPOLIS, NC:  
2,122,090, CANC. MULTIPLE CLASS, INT. CLS. 24 AND  
25.
- TEVA PHARMACEUTICAL INDUSTRIES LTD, 91010 JER-  
USALEM, ISRAEL:  
2,120,682, CANC. INT. CL. 5.
- TEVA PHARMACEUTICAL INDUSTRIES LTD., JERUSA-  
LEM 91010, ISRAEL:  
2,899,711, PUB. 8-10-2004. INT. CL. 5.
- TEXACO INC., WHITE PLAINS, NY, TEXAS COMPANY,  
THE, HOUSTON, TX:  
84,431, REN. 9-18-04. U.S. CL. 15 (INT. CL. 4).
- TEXAS A&M UNIVERSITY, COLLEGE STATION, TX:  
1,848,522, REN. 9-18-04. MULTIPLE CLASS, INT. CLS. 9,  
16, 25 AND 41.
- TEXAS ASSOCIATION OF COMMUNITY HEALTH CEN-  
TERS, INC., AUSTIN, TX:  
2,899,740, PUB. 8-10-2004. MULTIPLE CLASS, INT. CLS.  
41 AND 42.
- TEXAS SADDLEBAGS, INC., ARLINGTON, TX:  
2,121,446, CANC. INT. CL. 12.
- TEXAS TECH UNIVERSITY, LUBBOCK, TX:  
2,898,564, PUB. 8-10-2004. INT. CL. 35.
- THAT'S MY TICKET LLC, ASHLAND, MA:  
2,899,877, PUB. 8-10-2004. INT. CL. 20.
- THE ABB MERCHANDISING CO., INC., WABAN, MA:  
2,899,197, PUB. 8-10-2004. INT. CL. 9.
- THE ACADEMIC APPROACH, LLC, CHICAGO, IL:  
2,899,890, PUB. 8-10-2004. INT. CL. 41.
- THE ADALAH BENNETT SHAW TRUST, WEST MEMPHIS,  
AR:  
2,899,284, PUB. 8-10-2004. MULTIPLE CLASS, INT. CLS. 9  
AND 25.
- THE AMERICAN FIELD PUBLISHING CO., CHICAGO, IL:  
190,361, REN. 9-24-04. U.S. CL. 38 (INT. CL. 16).
- THE ANCHOR FOUNDATION, INC., NEW YORK, NY:  
2,899,011, PUB. 8-10-2004. INT. CL. 16.
- THE ASTROLOGY COMPANY, INC., NAPLES, FL:  
2,898,664, PUB. 8-10-2004. INT. CL. 41.
- THE B.V.D. LICENSING CORPORATION, BOWLING  
GREEN, KY:  
2,899,674, PUB. 8-10-2004. INT. CL. 25.
- THE BEACH STUDIOS INC, MORICHES, NY:  
2,899,748, PUB. 8-10-2004. INT. CL. 44.
- THE BELO COMPANY, WILMINGTON, DE:  
2,899,272, PUB. 1-27-2004. INT. CL. 35.
- THE BOARD OF TRUSTEES OF THE UNIVERSITY OF  
ALABAMA FOR THE UNIVERSITY OF ALABAMA AT  
BIRMINGHAM, BIRMINGHAM, AL:  
2,898,976, PUB. 8-10-2004. MULTIPLE CLASS, INT. CLS.  
41, 42 AND 44.
- THE BOX PROJECT, PLAINVILLE, CT:  
2,899,529, PUB. 1-13-2004. INT. CL. 41.
- THE BUBBA BACON COMPANY, LLC, JACKSONVILLE,  
FL:  
2,899,565, PUB. 8-10-2004. INT. CL. 29.
- THE BULL-DOG CLUB OF AMERICA, INC., LAGUNA  
BEACH, CA:  
2,898,951, PUB. 8-10-2004. MULTIPLE CLASS, INT. CLS.  
36 AND 41.
- THE CAROLINA TRADER INCORPORATED, IRMO, SC:  
2,899,983, PUB. 8-10-2004. INT. CL. 16.
- THE CARTOON NETWORK LP, LLLP, ATLANTA, GA:  
2,900,354, INT. CL. 28.
- THE CEMENTWORKS, LLC, NEW YORK, NY:  
2,899,552, PUB. 8-10-2004. INT. CL. 35.
- THE CHARLES ROBERTSON COMPANIES, INC., NORTH  
LITTLE ROCK, AR:  
2,898,746, PUB. 8-10-2004. INT. CL. 16.
- THE CITY UNIVERSITY OF NEW YORK THROUGH THE  
CONTINUING EDUCATION AND PUBLIC PROGRAMS  
DIVISION OF THE GRADUATE SCHOOL AND UNIVER-  
SITY CENTER, NEW YORK, NY:  
2,899,144, PUB. 8-10-2004. INT. CL. 41.
- THE CO-ORDINATING COMMITTEE OF THE ASSOCIA-  
TION OF FREE LUTHERAN CONGREGATIONS, PLY-  
MOUTH, MN:  
2,899,012, PUB. 8-10-2004. INT. CL. 45.
- THE CRITICAL ILLNESS INSURANCE CENTRE LTD.,  
VICTORIA, B.C., CANADA:  
2,898,679, PUB. 3-2-2004. MULTIPLE CLASS, INT. CLS. 9  
AND 16.
- THE DISTRICT BOARD OF TRUSTEES OF PENSACOLA  
JUNIOR COLLEGE, FLORIDA, PENSACOLA, FL:  
2,899,962, PUB. 8-10-2004. INT. CL. 41.  
2,899,964, PUB. 8-10-2004. INT. CL. 41.
- THE EDUCATION TRUST, INC., WASHINGTON, DC:  
2,899,998, PUB. 8-10-2004. INT. CL. 41.
- THE ESCAL INSTITUTE OF ADVANCED TECHNOLOGIES,  
INC., BETHESDA, MD:  
2,900,000, PUB. 8-10-2004. INT. CL. 41.
- THE FAMILY, INC., SAN FRANCISCO, CA:  
2,899,102, PUB. 8-10-2004. INT. CL. 45.
- THE FLEXAUST COMPANY, INC., WARSAW, IN:  
2,899,886, PUB. 8-10-2004. INT. CL. 17.
- THE GARR GROUP, L.L.C., VOORHEES, NJ:  
2,898,998, PUB. 8-10-2004. INT. CL. 35.
- THE GCRH CORPORATION, MIDLAND, MI:  
2,899,207, PUB. 8-10-2004. INT. CL. 42.
- THE GEMLO GROUP, INC., MIAMI, FL, DBA STAR  
SUPPLY:  
2,898,925, PUB. 8-10-2004. INT. CL. 25.
- THE GLOVE CORPORATION, ALEXANDRIA, IN:  
2,899,210, PUB. 8-10-2004. INT. CL. 9.

THE GOLDEN GOSLINGS, INC., LAKE SUCCESS, NY:  
2,900,928, INT. CL. 44.

THE HARTZ MOUNTAIN CORPORATION, SECAUCUS, NJ:  
2,898,749, PUB. 12-9-2003. INT. CL. 5.  
2,900,482, INT. CL. 28.  
2,900,495, INT. CL. 31.

THE HOLLAND GROUP, INC., HOLLAND, MI:  
1,833,772, REN. 9-23-04. INT. CL. 12.

THE INDEPENDENT SAVINGS PLAN COMPANY, TAMPA, FL:  
2,900,697, INT. CL. 36.

THE INTERPUBLIC GROUP OF COMPANIES, INC., NEW YORK, NY:  
2,899,901, PUB. 8-10-2004. INT. CL. 42.  
2,899,902, PUB. 8-10-2004. INT. CL. 35.

THE LITTLE PINK BOOK, INC., CHICAGO, IL:  
2,900,425, MULTIPLE CLASS, INT. CLS. 16 AND 35.

THE LUCAS THEATRE FOR THE ARTS, INC., SAVANNAH, GA:  
2,899,665, PUB. 3-23-2004. INT. CL. 41.

THE MARCUS CORPORATION, MILWAUKEE, WI:  
2,898,601, PUB. 8-10-2004. INT. CL. 43.  
2,898,602, PUB. 8-10-2004. INT. CL. 43.

THE MCGRAW-HILL COMPANIES, INC., NEW YORK, NY:  
2,899,528, PUB. 8-10-2004. MULTIPLE CLASS, INT. CLS. 16 AND 41.

THE MIDTOWN MANAGEMENT GROUP, INC., NEW YORK, NY, DBA INSIDE BROADWAY:  
2,898,594, PUB. 8-10-2004. INT. CL. 41.

THE MIRAMAR GROUP, INC., PALATINE, IL:  
2,899,520, PUB. 8-10-2004. INT. CL. 36.

THE NATIONAL COUNCIL OF YOUNG MEN'S CHRISTIAN ASSOCIATIONS OF THE UNITED STATES OF AMERICA, CHICAGO, IL:  
2,900,644, MULTIPLE CLASS, INT. CLS. 9, 16 AND 35.

THE NETBRELLA COMPANY, LLC, BOULDER, CO:  
2,899,039, PUB. 8-10-2004. INT. CL. 20.

THE NEW SIOUX CITY IRON COMPANY, SIOUX CITY, IA:  
2,899,299, PUB. 2-11-2003. INT. CL. 35.

THE NEW ZEALAND WAY LIMITED, WELLINGTON, NEW ZEALAND:  
2,898,686, PUB. 8-10-2004. MULTIPLE CLASS, INT. CLS. 3, 7, 9, 11, 12, 16, 20, 27, 28, 32 AND 33.

THE NUTRACEUTICAL MEDICINE COMPANY INC., DUNCAN, BRITISH COLUMBIA, CANADA:  
2,898,485, PUB. 8-10-2004. INT. CL. 41.

THE ORR HOCKEY GROUP, INC., BOSTON, MA:  
2,898,994, PUB. 8-10-2004. INT. CL. 25.

THE PIGOTT GROUP, LLC, CANTON, GA:  
2,900,625, INT. CL. 32.

THE POSTUREWORKS LLC, WELLESLEY, MA:  
2,899,892, PUB. 8-10-2004. INT. CL. 10.

THE PROCTOR & GAMBLE COMPANY, CINCINNATI, OH, SHULTON, INC., CINCINNATI, OH:  
1,833,076, REN. 9-24-04. INT. CL. 3.

THE PURPLE ONION, BIRMINGHAM, AL:  
2,899,984, PUB. 8-10-2004. INT. CL. 43.

THE QUEEN'S BROADCASTING CORPORATION, DETROIT, MI, DBA WQBH:  
2,899,206, PUB. 8-10-2004. INT. CL. 41.

THE SABALLUS COMPANIES, LTD., OAK BROOK, IL:  
2,899,245, PUB. 8-10-2004. MULTIPLE CLASS, INT. CLS. 36 AND 37.

THE SAN FRANCISCO CHAMBER SINGERS, SAN FRANCISCO, CA:  
2,899,931, PUB. 8-10-2004. INT. CL. 41.

THE SPICY VIKING, LLC, LAUREL, MD:  
2,899,862, PUB. 8-10-2004. INT. CL. 30.

THE SPOKEN HUB L.L.C., NEW YORK, NY:  
2,900,318, INT. CL. 38.

THE STEP COMPANY, MARIETTA, GA:  
2,899,832, PUB. 8-10-2004. INT. CL. 25.  
2,899,834, PUB. 8-10-2004. INT. CL. 25.

THE SWEETER IMAGE, LLC, STATEN ISLAND, NY:  
2,837,075, COR. INT. CL. 30.

THE TEE-ZEL COMPANY, INC., BEAUFORT, SC:  
2,898,923, PUB. 3-2-2004. INT. CL. 30.

THE TIMBER PROMOTION COUNCIL, MELBOURNE, VICTORIA 3000, AUSTRALIA:  
2,899,481, PUB. 8-10-2004. MULTIPLE CLASS, INT. CLS. 19, 20 AND 31.

THE TJX COMPANIES, INC., FRAMINGHAM, MA:  
2,899,249, PUB. 8-10-2004. INT. CL. 25.  
2,900,267, INT. CL. 20.  
2,900,276, INT. CL. 20.

THE UNIVERSITY OF CHICAGO, WHICH OPERATES ARGONNE NATIONAL LABORATORY UNDER CONTRACT WITH THE U.S. DEPARTMENT OF ENERGY, CHICAGO, IL:  
2,899,140, PUB. 8-10-2004. INT. CL. 42.

THE UTTERMOST COMPANY, ROCKY MOUNT, VA:  
2,899,672, PUB. 8-10-2004. INT. CL. 11.

THE VINCIT COMPANY, LLC, CHATTANOOGA, TN:  
2,898,977, PUB. 8-10-2004. MULTIPLE CLASS, INT. CLS. 35 AND 42.

THE WESTERN SUGAR COOPERATIVE, DENVER, CO, GREAT WESTERN SUGAR COMPANY, THE, DENVER, CO:  
598,851, REN. 9-22-04. U.S. CL. 46 (INT. CL. 30).

THE WHITAKER CORPORATION, WILMINGTON, DE:  
769,452, REN. 9-24-04. U.S. CL. 21 (INT. CL. 9).

THE WILDLIFE EXPERIENCE, INC., PARKER, CO:  
2,900,657, INT. CL. 41.

THE WILLS GROUP, INC., LAPLATA, MD:  
2,900,403, INT. CL. 37.

THE WOMEN'S MOSAIC, NEW YORK, NY:  
2,899,396, PUB. 8-10-2004. INT. CL. 35.

THE 401(K) COMPANY, AUSTIN, TX:  
2,899,924, PUB. 8-10-2004. INT. CL. 36.

THERMA-TRU CORP., MAUMEE, OH:  
2,121,644, CANC. INT. CL. 19.

THERMALWORKS, INC., HUNTINGTON BEACH, CA:  
2,899,371, PUB. 8-10-2004. INT. CL. 9.

THERMO ORION INC., BEVERLY, MA:  
1,855,534, REN. 9-22-04. INT. CL. 9.

THERMOGRAPHIC MEASUREMENTS LTD, BURTON, SOUTH WIRRAL, L64 5TA, UNITED KINGDOM:  
1,850,580, REN. 9-23-04. INT. CL. 9.

THERMOS L.L.C., ROLLING MEADOWS, IL:  
2,819,934, COR. INT. CL. 21.

THIRD PARTY INTERNATIONAL, INC., OCALA, FL:  
2,900,921, INT. CL. 10.

THIS, LLC, MADISON, CT:  
2,899,136, PUB. 8-10-2004. MULTIPLE CLASS, INT. CLS. 21 AND 30.

THOMAS & BETTS INTERNATIONAL, INC., WILMINGTON, DE, AMERACE CORPORATION, HACKETTSTOWN, NJ:  
995,785, REN. 9-20-04. U.S. CL. 21 (INT. CL. 9).

THOMAS & BETTS INTERNATIONAL, INC., SPARKS, NV:  
2,899,773, PUB. 8-10-2004. INT. CL. 9.

THOMAS ENGINEERING INC., HOFFMAN ESTATES, IL:  
1,340,104, REN. 9-24-04. INT. CL. 7.

THOMAS J. LIPTON, INC., HOBOKEN, NJ:  
761,696, CANC. U.S. CL. 46.

THOMAS MOORE STUDIOS, INC., BALTIMORE, MD:  
2,899,975, PUB. 8-10-2004. INT. CL. 37.

THOMAS, MARVIN W., SEATTLE, WA:  
2,900,518, MULTIPLE CLASS, INT. CLS. 41 AND 44.

THOMPSON, GEORGE B., LOS ANGELES, CA:  
2,899,970, PUB. 8-10-2004. INT. CL. 41.

THOMSON INDUSTRIES, INC., PORT WASHINGTON, NY:  
1,811,410, CANC. INT. CL. 7.

THOMSON LICENSING CORPORATION, WILMINGTON, DE:  
2,122,571, CANC. INT. CL. 16.

THOMSON, SCOTT MARK, AFTON, WY:  
2,899,942, PUB. 8-10-2004. INT. CL. 4.

THOR TECH, INC., SAGINAW, MI:  
2,899,006, PUB. 5-11-2004. INT. CL. 12.

THOROUGHbred REMEDIES MANUFACTURING LTD., NEWBRIDGE, COUNTY KILDARE, IRELAND:  
2,842,554, COR. INT. CL. 5.

- THOSE CHARACTERS FROM CLEVELAND, INC., CLEVELAND, OH, AMERICAN GREETINGS CORPORATION, CLEVELAND, OH:  
1,294,343. REN. 9-23-04. INT. CL. 28.
- THREE WOMEN, BAKERSFIELD, CA:  
2,122,369. CANC. INT. CL. 25.
- THURBER, NEIL J., CALGARY, ALBERTA, CANADA, DBA D.C.P. CONSULTING LTD.:  
1,841,173. REN. 9-21-04. INT. CL. 6.
- THWAITES LTD., WARWICKSHIRE CV32 7NQ, ENGLAND:  
2,122,344. CANC. INT. CL. 12.
- THYSSENKRUPP FEDERN GMBH, HAGEN, FED REP GERMANY, FEDERNWERKE PAUL PLATE GMBH, HAGEN, FED REP GERMANY:  
1,274,848. REN. 9-18-04. INT. CL. 7.
- THYSSENKRUPP MATERIALS, INC., DETROIT, MI:  
2,899,889. PUB. 8-10-2004. INT. CL. 6.  
2,899,891. PUB. 8-10-2004. INT. CL. 40.
- TIENSHAN, INC., S. NORWALK, CT:  
2,900,329. INT. CL. 21.
- TIFFIN MOTOR HOMES, INC., RED BAY, AL:  
1,342,458. REN. 9-19-04. INT. CL. 12.
- TIFLEX LIMITED, WOKING, BURREY, UNITED KINGDOM:  
775,515. REN. 9-22-04. U.S. CL. 50 (INT. CL. 7).
- TIGER ELECTRONICS, INC., VERNON HILLS, IL:  
2,120,707. CANC. INT. CL. 9.
- TIMBERTANKS AMERICA, LTD., AUSTIN, TX:  
2,898,580. PUB. 8-10-2004. INT. CL. 20.
- TIMES MIRROR MAGAZINES, INC., NEW YORK, NY:  
1,260,916. CANC. INT. CL. 16.
- TIMES PUBLISHING COMPANY, ST. PETERSBURG, FL:  
2,900,316. INT. CL. 43.
- TIMEX CORPORATION, MIDDLEBURY, CT:  
2,900,005. PUB. 8-10-2004. INT. CL. 11.  
2,900,825. INT. CL. 14.
- TIME4 MEDIA, INC., NEW YORK, NY:  
2,899,768. PUB. 8-10-2004. INT. CL. 16.
- TIPIAK, 44860 PONT-SAINT-MARTIN, FRANCE:  
1,861,923. REN. 9-22-04. INT. CL. 30.
- TIPPCON, L.L.C., EL PASO, TX:  
2,900,251. INT. CL. 30.
- TIRECO, INC., COMPTON, CA:  
2,899,725. PUB. 5-11-2004. INT. CL. 12.
- TK CANADA LIMITED, DOWNSVIEW, ONTARIO N3J 2J5, CANADA:  
1,851,097. REN. 9-22-04. INT. CL. 20.
- TM ACQUISITION CORP., LAS VEGAS, NV:  
2,899,497. PUB. 1-13-2004. INT. CL. 43.
- TMAX SOFT CO., LTD., SEOUL, REPUBLIC OF KOREA:  
2,900,092. INT. CL. 9.
- TNEMEC COMPANY, INC., KANSAS CITY, MO:  
2,900,487. INT. CL. 2.
- TNT PARTNERS, LLC, NEWTOWN, CT:  
2,898,760. PUB. 8-10-2004. MULTIPLE CLASS, INT. CLS. 35, 38 AND 42.
- TO-RO ENTERPRISES, INC., PORTLAND, OR, DBA O'LOUGHLIN TRADE SHOWS:  
1,876,071. REN. 9-18-04. INT. CL. 35.
- TOAGOSEI CO., LTD., MINATO-KU, TOKYO, JAPAN, KRAZY GLUE, INC., NEW YORK, NY:  
1,294,220. REN. 9-20-04. INT. CL. 16.
- TODDLER KINDY GYMBAROO PTY. LTD., VICTORIA, 3101, AUSTRALIA:  
1,882,123. REN. 9-23-04. INT. CL. 16.
- TODHUNTER INTERNATIONAL, INC., WEST PALM BEACH, FL:  
2,900,497. INT. CL. 43.
- TODOROFF, DAVID J., BUFFALO, NY:  
2,122,093. CANC. INT. CL. 28.
- TOEWS, BEN, WINKLER, MANITOBA R6W 4C1, CANADA, DBA KABEN COMPANY:  
2,900,377. INT. CL. 11.
- TOHOPEKALIGA WATER AUTHORITY, KISSIMMEE, FL:  
2,899,864. PUB. 8-10-2004. INT. CL. 40.
- TOM STURGIS PRETZELS, INC., READING, PA:  
2,899,515. PUB. 8-10-2004. INT. CL. 35.
- TOMBOW PENCIL CO., LTD., KITA-KU, TOKYO, JAPAN:  
988,697. REN. 9-20-04. U.S. CL. 37 (INT. CL. 16).
- TOMMY HILFIGER LICENSING, INC., NEWARK, DE:  
2,899,046. PUB. 8-10-2004. INT. CL. 25.
- TOMY CORPORATION, NEWPORT BEACH, CA:  
2,899,244. PUB. 8-10-2004. INT. CL. 28.
- TONY PACKO'S, INC., TOLEDO, OH:  
1,261,235. CANC. INT. CL. 42.
- TOPCO ASSOCIATES, INC., SKOKIE, IL:  
774,710. REN. 9-20-04. U.S. CL. 51 (INT. CL. 3).  
989,250. REN. 9-20-04. INT. CL. 3.  
1,846,816. REN. 9-23-04. INT. CL. 25.
- TORAICHI CO. LTD., KURASHIKI-CITY, OKAYAMA, JAPAN:  
2,839,386. COR. INT. CL. 25.
- TORO COMPANY, THE, BLOOMINGTON, MN, TORO COMPANY, THE, MINNEAPOLIS, MN:  
1,287,819. REN. 9-20-04. INT. CL. 11.
- TORRES SAGRERA, ANTONIO, 08006, BARCELONA, SPAIN:  
2,898,586. PUB. 8-10-2004. INT. CL. 3.
- TOSHIBA AMERICA CONSUMER PRODUCTS, INC., WAYNE, NJ:  
2,122,260. CANC. INT. CL. 9.
- TOUCHSCREEN KONNECTION OASIS, INC., CEDAR PARK, TX:  
2,899,226. PUB. 8-10-2004. INT. CL. 9.
- TOUGH GUY PRODUCTS INC., SALMON ARM, BRITISH COLUMBIA, CANADA:  
2,899,575. PUB. 8-10-2004. INT. CL. 27.  
2,899,576. PUB. 8-10-2004. INT. CL. 27.  
2,899,577. PUB. 8-10-2004. INT. CL. 27.
- TOURGUIDEMIKE, L.L.C., PALM COAST, FL:  
2,899,380. PUB. 8-10-2004. INT. CL. 39.
- TOWER GROUP INTERNATIONAL, INC., BUFFALO, NY:  
1,811,046. CANC. MULTIPLE CLASS, INT. CLS. 35, 36 AND 39.
- TOWER PAINTING CO., INC., BROOKLYN, NY:  
2,899,553. PUB. 8-10-2004. INT. CL. 37.
- TOWER SQUARE SECURITIES, INC., HARTFORD, CT:  
2,900,221. INT. CL. 36.  
2,900,222. INT. CL. 42.  
2,900,227. INT. CL. 36.  
2,900,228. INT. CL. 42.
- TOWERS, PERRIN, FORSTER & CROSBY, INC., PHILADELPHIA, PA:  
1,261,107. CANC. INT. CL. 35.
- TOWLE MANUFACTURING COMPANY, EAST BOSTON, MA, TOWLE MANUFACTURING COMPANY, NEWBURYPORT, MA:  
990,829. REN. 9-22-04. U.S. CL. 23 (INT. CL. 8).
- TOWN OF CARY, CARY, NC:  
1,316,186. REN. 9-18-04. INT. CL. 41.
- TOXCO, INC., ANAHEIM, CA:  
2,898,802. PUB. 8-10-2004. MULTIPLE CLASS, INT. CLS. 16 AND 40.
- TOYOTA JIDOSHA KABUSHIKI KAISHA, TOYOTA-SHI, JAPAN, TA TOYOTA MOTOR CORPORATION:  
2,899,728. PUB. 8-10-2004. INT. CL. 36.
- TOYOTA MOTOR MANUFACTURING NORTH AMERICA, INC., ERLANGER, KY:  
2,900,002. PUB. 8-10-2004. INT. CL. 41.
- TP INDUSTRIES, INC., LAKEWOOD, CA:  
761,738. CANC. U.S. CL. 52.
- TP ORTHODONTICS, INC., LAPORTE, IN:  
2,898,957. PUB. 8-10-2004. MULTIPLE CLASS, INT. CLS. 10 AND 35.
- TPA, INC., DALLAS, TX:  
2,121,029. CANC. MULTIPLE CLASS, INT. CLS. 41 AND 42.
- TRACEDTECT, INC., SEATTLE, WA:  
2,900,044. INT. CL. 9.
- TRACTION PLUS, INC., BEDFORD, TX:  
2,121,780. CANC. INT. CL. 19.
- TRACTOR SUPPLY CO. OF TEXAS LP, BRENTWOOD, TN:  
1,862,884. REN. 9-19-04. INT. CL. 42.

TRADE WINDS PIZZA, INC., GREEN BAY, WI TO SCHWAN'S IP, LLC, MARSHALL, MN:  
1,810,989, CANC. INT. CL. 30.

TRADEMARK CORPORATION, FENTON, MO:  
2,122,586, CANC. INT. CL. 25.  
2,122,587, CANC. INT. CL. 25.

TRADERSCOACH.COM, INC., SAN DIEGO, CA:  
2,900,018, PUB. 8-10-2004. MULTIPLE CLASS, INT. CLS. 16 AND 41.

TRADINGLAB BANCA S.P.A., MILAN, ITALY FROM UNICREDIT BANCA MOBILIARE S.P.A., 20121 MILANO, ITALY:  
2,900,097, INT. CL. 36.

TRANQUILLI, ADAM S., NEW PROVIDENCE, NJ AND OSTERBERG, SCOTT E., MAPLEWOOD, NJ:  
2,900,642, INT. CL. 35.

TRANS NATIONAL GROUP SERVICES INTERNATIONAL, INC., BOSTON, MA:  
2,122,339, CANC. INT. CL. 16.

TRANSACTION, INC., PISCATAWAY, NJ:  
2,898,627, PUB. 8-10-2004. INT. CL. 39.

TRANSAMERICA CORPORATION, SAN FRANCISCO, CA:  
2,900,478, INT. CL. 36.

TRANSAMERICA LIFE INSURANCE AND ANNUITY COMPANY, LOS ANGELES, CA:  
2,898,712, PUB. 8-10-2004. INT. CL. 36.  
2,898,713, PUB. 8-10-2004. INT. CL. 36.

TRANSAMERICA RETAIL FINANCIAL SERVICES CORPORATION, HOFFMAN ESTATES, IL:  
2,900,175, INT. CL. 36.

TRANSCOMMUNICATIONS INCORPORATED, CHATTANOOGA, TN:  
2,121,269, CANC. INT. CL. 38.

TRANSEASTERN PROPERTIES, INC., CORAL SPRINGS, FL:  
2,900,341, INT. CL. 37.

TRANZONIC COMPANIES, THE, HIGHLAND HEIGHTS, OH:  
1,302,663, REN. 9-24-04. INT. CL. 21.

TRAQ INTERNATIONAL, INC., BOSTON, MA:  
2,121,983, CANC. MULTIPLE CLASS, INT. CLS. 36 AND 38.

TRC INTERACTIVE, INC., HARRISBURG, PA:  
2,900,636, INT. CL. 41.

TREASURES AND TRINKETS INC., MANCHESTER, CT:  
2,898,415, PUB. 11-13-2001. INT. CL. 14.

TREATT PLC, SUFFOLK, IP32 6NL, ENGLAND:  
2,121,954, CANC. INT. CL. 3.  
2,121,955, CANC. MULTIPLE CLASS, INT. CLS. 1 AND 3.

TREE OF LIFE, INC., ST. AUGUSTINE, FL:  
1,823,021, REN. 9-22-04. INT. CL. 30.

TREK BICYCLE CORPORATION, WATERLOO, WI:  
2,898,474, PUB. 8-10-2004. INT. CL. 12.

TREMCO INCORPORATED, BEACHWOOD, OH:  
1,289,633, REN. 9-18-04. INT. CL. 1.

TREND COMMUNICATIONS LIMITED, HIGH WYCOMBE, BUCKINGHAMSHIRE, UNITED KINGDOM:  
2,899,296, PUB. 8-10-2004. INT. CL. 9.

TREND ENTERPRISES, INC., NEW BRIGHTON, MN:  
1,877,599, REN. 9-24-04. INT. CL. 16.  
1,882,158, REN. 9-19-04. INT. CL. 16.

TRENT, BILLY E., ROSE HILL, VA:  
2,122,286, CANC. INT. CL. 28.

TRI CITY VANNERS LTD., VERNON, CT:  
1,811,159, CANC. INT. CL. 41.

TRIARCO INDUSTRIES, INC., WAYNE, NJ:  
2,900,106, INT. CL. 5.

TRIBECA FILM CENTER, INC., NEW YORK, NY:  
2,898,778, PUB. 8-10-2004. INT. CL. 35.

TRIBUNE LICENSE, INC., CHICAGO, IL, TIMES MIRROR COMPANY, THE, LOS ANGELES, CA:  
989,634, REN. 9-24-04. U.S. CL. 38 (INT. CL. 16).

TRIM WAY CORPORATION, SEATTLE, WA:  
1,261,033, CANC. INT. CL. 28.

TRIPLE "F," INC., DES MOINES, IA:  
991,308, REN. 9-22-04. U.S. CL. 23 (INT. CL. 7).

TRIPLE C MANUFACTURING, INC., SABETHA, KS:  
1,907,270, REN. 9-19-04. INT. CL. 12.

TRIPLE S INCORPORATED, NORWALK, CT:  
1,296,890, REN. 9-21-04. INT. CL. 37.

TRISLER SEED FARMS, INC., FAIRMOUNT, IL:  
1,847,824, REN. 9-20-04. INT. CL. 31.

TRISTAR CORPORATION, SAN ANTONIO, TX:  
2,122,357, CANC. INT. CL. 3.

TRIUMPH INTERNATIONAL, INC., OCEAN RIDGE, FL:  
1,908,209, REN. 9-18-04. INT. CL. 9.

TRIWORLD, INC., WAYNESVILLE, NC:  
2,899,979, PUB. 8-10-2004. INT. CL. 4.

TRL GROUP, INC., NORWALK, CT:  
2,900,533, INT. CL. 35.

TROUW INTERNATIONAL B.V., 5831 JN BOXMEER, NETHERLANDS:  
2,852,583, COR. INT. CL. 31.

TRT OIL-OFF GMBH, 44628 HERNE, FED REP GERMANY:  
2,898,699, PUB. 8-10-2004. MULTIPLE CLASS, INT. CLS. 7, 11 AND 37.

TRUSTAR, INCORPORATED, PEARLAND, TX:  
1,901,464, REN. 9-23-04. MULTIPLE CLASS, INT. CLS. 7 AND 12.

TRUSTEES OF THE UNIVERSITY OF PENNSYLVANIA, THE, PHILADELPHIA, PA, PHILADELPHIA HEART INSTITUTE, THE, PHILADELPHIA, PA:  
1,872,878, REN. 9-19-04. INT. CL. 42.

TRUSTEES OF THE UNIVERSITY OF PENNSYLVANIA, THE, PHILADELPHIA, PA:  
1,901,936, REN. 9-19-04. MULTIPLE CLASS, INT. CLS. 39 AND 42.

TSA CORPORATE SERVICES, INC., ENGLEWOOD, CO:  
2,900,519, MULTIPLE CLASS, INT. CLS. 25 AND 28.

TSCHUBAROV, SYLVIA, NEW YORK, NY:  
2,899,996, PUB. 8-10-2004. INT. CL. 3.

TSI BRANDS, INC., WILMINGTON, DE:  
2,900,828, INT. CL. 25.  
2,900,931, INT. CL. 25.

TSI SPORTS INCORPORATED, FLOWERY BRANCH, GA:  
1,850,030, REN. 9-19-04. INT. CL. 36.

TSO, INC., BEAUMONT, TX, TEXAS STATE OPTICAL, INC., BEAUMONT, TX:  
1,848,699, REN. 9-23-04. INT. CL. 35.

TSX INC., TORONTO, ONTARIO, CANADA:  
1,835,625, REN. 9-21-04. INT. CL. 35.

TUCCI, LOUIS, PLANO, TX, DBA STOGIE POKER:  
2,900,933, INT. CL. 34.

TUCHENHAGEN GMBH, D-21514 BUCHEN, FED REP GERMANY:  
2,898,730, PUB. 8-10-2004. MULTIPLE CLASS, INT. CLS. 6, 7 AND 9.

TUESDAY REIGN, INC., ALABASTER, AL:  
2,899,243, PUB. 8-10-2004. INT. CL. 42.

TUMBLE TIME GYMNASTICS, INC., BOISE, ID:  
2,899,367, PUB. 5-27-2003. INT. CL. 41.

TUMBLEBUNNIES GYMNASTICS, INC., CANTON, MI, DBA TUMBLEBUNNIES UNLIMITED, INC.:  
1,862,056, REN. 9-23-04. INT. CL. 41.

TURBO POWER, INC., FLUSHING, NY:  
2,898,980, PUB. 8-10-2004. INT. CL. 11.

TURTLE, JOEL S., BERKELEY, CA:  
1,810,596, CANC. INT. CL. 9.

TUTTLE LAW PRINT, INC., RUTLAND, VT:  
2,898,768, PUB. 8-10-2004. INT. CL. 40.

TUWAY AMERICAN GROUP, INC., THE, TROY, MI:  
1,847,941, REN. 9-20-04. INT. CL. 42.

TV-ONE, INC., LOMBARD, IL:  
2,900,203, MULTIPLE CLASS, INT. CLS. 25 AND 42.

TVX, INC., BROOMFIELD, CO:  
2,122,165, CANC. INT. CL. 9.

TWENTIETH CENTURY FOX FILM CORPORATION, LOS ANGELES, CA:  
2,121,915, CANC. INT. CL. 41.  
2,854,989, COR. INT. CL. 9.

TWENTYEAST AGENCY, LLC, TYLER, TX AND MARTIN MANAGEMENT, INC., TYLER, TX:  
2,898,754, PUB. 11-4-2003. INT. CL. 35.  
2,898,755, PUB. 11-4-2003. INT. CL. 35.

- TWISTED PINE SOFTWARE CORPORATION, NASHUA, NH:  
1,810,579, CANC. INT. CL. 9.
- TWO CHEFS ON A ROLL, INC., TORRANCE, CA:  
2,122,267, CANC. INT. CL. 30.
- TY, INC., WESTMONT, IL:  
2,121,826, CANC. INT. CL. 28.
- TYCO ELECTRONICS CORPORATION, MIDDLETOWN, PA, RAYCHEM CORPORATION, MENLO PARK, CA:  
1,286,911, REN. 9-22-04, INT. CL. 9.
- TYCO PLASTICS SERVICES AG, SCHAFFHAUSEN, SWITZERLAND FROM K2, INC., ADRIAN, MI:  
2,900,080, INT. CL. 19.
- TYLER, RODNEY W., MEDINA, OH:  
2,900,166, INT. CL. 19.
- TYSON FOODS, INC., SPRINGDALE, AR:  
2,900,333, INT. CL. 29.
- TYYO, INC, TUSTIN, CA:  
2,899,536, PUB. 8-10-2004, INT. CL. 25.
- U.S. ARCHITECTURAL PRODUCTS, INC., LINCOLN, RI:  
2,900,598, INT. CL. 19.
- U.S. BAIRD CORPORATION, THE, STRATFORD, CT:  
775,741, REN. 9-21-04, U.S. CL. 23 (INT. CLS. 6, 7, 8, 9, 11, 12, 16, 21 AND 28).
- U.S. GAMES SYSTEMS, INC., STAMFORD, CT:  
1,903,658, REN. 9-18-04, INT. CL. 28.
- U.S. PAINT CORPORATION, ST. LOUIS, MO:  
2,898,961, PUB. 8-10-2004, INT. CL. 2.
- U.S. RING BINDER CORPORATION, ST. LOUIS, MO:  
1,846,718, REN. 9-20-04, INT. CL. 16.
- U.S.A. C-MARK LIGHT & AUDIO INC., SAN GABRIEL, CA:  
2,899,699, PUB. 8-10-2004, INT. CL. 9.
- U.S.A. FOOD AGENTS, LLC, WASHINGTON, DC:  
2,900,506, INT. CL. 35.
- U.T.S. S.P.A., 10136 TORINO, ITALY:  
2,120,754, CANC. MULTIPLE CLASS, INT. CLS. 35 AND 42.
- U-HAUL INTERNATIONAL, INC., PHOENIX, AZ:  
1,853,843, REN. 9-24-04, INT. CL. 39.
- UA, INC., EL SOBRANTE, CA:  
2,898,492, PUB. 8-10-2004, INT. CL. 35.  
2,899,273, PUB. 8-10-2004, INT. CL. 38.
- UAI TECHNOLOGY, INC., RESEARCH TRIANGLE PARK, NC:  
2,121,545, CANC. INT. CL. 41.  
2,121,560, CANC. INT. CL. 41.
- UB OFFICE SYSTEMS INC., TAIPEI, TAIWAN:  
1,863,672, REN. 9-20-04, INT. CL. 20.
- UBI SOFT, INC., SAN FRANCISCO, CA:  
2,900,294, INT. CL. 9.
- UBS AG, CH-8001 ZURICH, SWITZERLAND:  
2,898,498, PUB. 8-5-2003, MULTIPLE CLASS, INT. CLS. 9, 16, 35, 36, 38 AND 42.
- UBS AG, ZURICH, SWITZERLAND:  
2,900,886, MULTIPLE CLASS, INT. CLS. 14 AND 36.
- UCI UNITED CONSULTANTS INTERNATIONAL S.A., LUXEMBOURG, GR. D., LUXEMBOURG:  
2,900,301, MULTIPLE CLASS, INT. CLS. 35 AND 36.
- UHS OF DELAWARE, INC., KING OF PRUSSIA, PA:  
2,899,152, PUB. 8-10-2004, MULTIPLE CLASS, INT. CLS. 35, 36 AND 42.
- ULTIMA SKATES LTD., DEKALB, IL:  
2,852,252, COR. INT. CL. 28.
- ULTIMA WALLCOVERINGS INC., TORONTO, ONTARIO, CANADA:  
1,261,028, CANC. INT. CL. 27.  
1,261,030, CANC. INT. CL. 27.
- ULTIMATE TECHNOLOGY CORPORATION, VICTOR, NY:  
2,900,759, INT. CL. 9.
- ULTRA HARDWARE PRODUCTS LLC, PENNSAUKEN, NJ:  
2,900,433, INT. CL. 6.
- ULTRA PRO LP, CITY OF COMMERCE, CA:  
1,857,678, REN. 9-18-04, INT. CL. 16.
- ULTRADENT PRODUCTS, INC., SOUTH JORDAN, UT:  
1,865,687, REN. 9-24-04, INT. CL. 10.
- ULTRAFAB, INC., FARMINGTON, NY:  
2,900,624, INT. CL. 17.
- ULTRAFRAME (UK) LIMITED, CLITHEROE, LANCA-SHIRE, BB7 1PE, UNITED KINGDOM:  
2,898,797, PUB. 8-10-2004, MULTIPLE CLASS, INT. CLS. 6, 19, 37 AND 42.
- ULTRASONIC SERVICES, INC., HOUSTON, TX:  
2,899,361, PUB. 8-10-2004, INT. CL. 10.
- ULTRATECH STEPPER, INC., SAN JOSE, CA:  
2,900,167, INT. CL. 9.  
2,900,168, INT. CL. 9.
- UMA GROUP LTD., VANCOUVER, BRITISH COLUMBIA, V6E 3X2, CANADA:  
1,865,978, REN. 9-18-04, MULTIPLE CLASS, INT. CLS. 37 AND 42.
- UNCLE SAM CHEMICAL CO., INC., NEW YORK, NY:  
1,260,718, CANC. INT. CL. 2.
- UNDERBERG AG, DIETLIKON, SWITZERLAND:  
2,899,747, PUB. 8-10-2004, INT. CL. 33.
- UNDERWOOD COTTON CO., LUBBOCK, TX:  
2,899,135, PUB. 8-10-2004, INT. CL. 22.
- UNEEDA DOLL CO., LTD., NEW YORK, NY:  
2,121,858, CANC. INT. CL. 28.
- UNEQ, INC., AKRON, OH:  
1,849,752, REN. 9-18-04, MULTIPLE CLASS, INT. CLS. 2 AND 16.
- UNI-PACK INTERNATIONAL, INC., MONTCLAIR, CA:  
2,898,581, PUB. 8-10-2004, INT. CL. 18.
- UNICOM SYSTEMS, INC., BEVERLY HILLS, CA, HONG, CORY S., CERRITOS, CA, DBA UNICOM SYSTEMS INTERNATIONAL:  
1,869,407, REN. 9-23-04, INT. CL. 9.
- UNIFIED LIMITED, LONDON, WC1H 9JP, UNITED KINGDOM:  
2,900,235, INT. CL. 44.
- UNIFIED TRUST COMPANY, NA, LEXINGTON, KY:  
2,900,491, INT. CL. 36.
- UNIFRAX CORPORATION, NIAGARA FALLS, NY, CARBORUNDUM COMPANY, THE, CLEVELAND, OH:  
1,850,329, REN. 9-22-04, INT. CL. 17.
- UNIFUND CORPORATION LIMITED, LONDON, UNITED KINGDOM:  
2,764,080, AM. INT. CL. 5.  
2,764,081, AM. INT. CL. 5.  
2,764,082, AM. INT. CL. 5.
- UNION PARK AUTOMOTIVE GROUP, INC., WILMINGTON, DE:  
2,899,242, PUB. 8-10-2004, INT. CL. 37.
- UNIPRO FOODSERVICE, INC., ATLANTA, GA:  
1,265,200, REN. 9-18-04, INT. CL. 30.
- UNITED AIR LINES, INC., CHICAGO, IL:  
2,121,466, CANC. INT. CL. 35.  
2,900,821, INT. CL. 39.
- UNITED BANKERS' BANK, BLOOMINGTON, MN:  
2,898,666, PUB. 6-3-2003, INT. CL. 36.
- UNITED GENERAL SUPPLY CO., INC., HOUSTON, TX:  
1,811,241, CANC. INT. CL. 42.
- UNITED JEWISH APPEAL - FEDERATION OF JEWISH PHILANTHROPIES OF NEW YORK, INC., NEW YORK, NY:  
2,120,787, CANC. INT. CL. 42.
- UNITED OF OMAHA LIFE INSURANCE COMPANY, OMAHA, NE:  
2,121,417, CANC. INT. CL. 36.
- UNITED PARAMOUNT NETWORK, THE, LOS ANGELES, CA:  
2,121,519, CANC. INT. CL. 38.  
2,121,520, CANC. INT. CL. 38.
- UNITED PARTS HOLDING N.V., AMSTERDAM, NETHERLANDS:  
1,810,668, CANC. INT. CL. 12.
- UNITED SERVICES AUTOMOBILE ASSOCIATION, SAN ANTONIO, TX:  
2,121,272, CANC. MULTIPLE CLASS, INT. CLS. 16 AND 41.
- UNITED SPORTS SURFACING OF AMERICA, INC., IRVINE, CA:  
2,900,293, INT. CL. 17.
- UNITED STATES AUTO CLUB, INC., INDIANAPOLIS, IN:  
2,899,411, PUB. 12-23-2003, INT. CL. 41.

- UNITED STATES DEPARTMENT OF HEALTH AND HUMAN SERVICES, THE, BETHESDA, MD:  
1,281,855. REN. 9-22-04. INT. CL. 35.
- UNITED STATES DISTILLED PRODUCTS COMPANY, PRINCETON, MN:  
2,900,427. INT. CL. 33.
- UNITED STATES FIGURE SKATING ASSOCIATION, THE, COLORADO SPRINGS, CO:  
318,113. REN. 9-21-04. U.S. CL. 38 (INT. CL. 16).
- UNITED STATES OLYMPIC COMMITTEE, COLORADO SPRINGS, CO:  
2,899,453. PUB. 11-4-2003. INT. CL. 25.
- UNITED STATES POSTAL SERVICE, WASHINGTON, DC:  
2,900,531. MULTIPLE CLASS, INT. CLS. 35 AND 39.
- UNITED STATES SATELLITE BROADCASTING COMPANY, INC., ST. PAUL, MN:  
2,120,831. CANC. INT. CL. 38.
- UNITED STATES SURGICAL CORPORATION, NORWALK, CT:  
1,260,859. CANC. INT. CL. 10.
- UNITED STATES TELECOM ASSOCIATION, WASHINGTON, DC:  
2,900,013. PUB. 8-10-2004. INT. CL. 35.
- UNITED STATES TRUST COMPANY OF NEW YORK, NEW YORK, NY:  
1,860,520. REN. 9-21-04. INT. CL. 36.
- UNITEK, MONROVIA, CA:  
1,260,867. CANC. INT. CL. 10.
- UNIVAR USA INC., KIRKLAND, WA:  
1,847,988. REN. 9-20-04. MULTIPLE CLASS, INT. CLS. 1, 6, 16, 17, 20 AND 42.
- UNIVERSAL CITY STUDIOS, INC., UNIVERSAL CITY, CA AND AMBLIN ENTERTAINMENT, INC., UNIVERSAL CITY, CA:  
2,296,527. COR. INT. CL. 41.
- UNIVERSAL EXPRESS, INC., NEW YORK, NY:  
2,900,896. INT. CL. 39.
- UNIVERSAL HANDLING EQUIPMENT COMPANY LIMITED, HAMILTON, ONTARIO, CANADA:  
2,898,959. PUB. 8-10-2004. MULTIPLE CLASS, INT. CLS. 7 AND 12.
- UNIVERSAL MANUFACTURING CO., INC., KANSAS CITY, MO:  
1,846,835. REN. 9-23-04. INT. CL. 28.
- UNIVERSAL PRODUCT MARKETING, INC., TROY, MI:  
2,121,687. CANC. INT. CL. 31.
- UNIVERSAL SLATE INTERNATIONAL INC., CALGARY, ALBERTA, CANADA:  
2,899,387. PUB. 8-10-2004. INT. CL. 20.
- UNIVERSAL TV DISTRIBUTION HOLDINGS LLC, UNIVERSAL CITY, CA:  
2,900,233. INT. CL. 16.
- UNIVERSITY OF CENTRAL FLORIDA, ORLANDO, FL:  
2,899,072. PUB. 8-10-2004. MULTIPLE CLASS, INT. CLS. 41 AND 42.
- UNIVERSITY OF RICHMOND, UNIVERSITY OF RICHMOND, VA:  
2,900,260. MULTIPLE CLASS, INT. CLS. 25 AND 41.
- UNIVERSITY OF WASHINGTON, SEATTLE, WA:  
1,884,223. REN. 9-20-04. INT. CL. 9.
- UNLEASH INC., SUMMIT, NJ:  
2,900,290. MULTIPLE CLASS, INT. CLS. 35 AND 42.  
2,900,291. MULTIPLE CLASS, INT. CLS. 35 AND 42.
- UNZ & CO., INC., BOUND BROOK, NJ:  
1,879,742. REN. 9-22-04. INT. CL. 16.
- UPDATE MARKETING SERVICE GESELLSCHAFT MBH, GRUNGASSE 16/DG, AUSTRIA:  
2,121,238. CANC. INT. CL. 35.
- UPONOR ALDYL COMPANY, SHAWNEE, OK:  
2,900,313. INT. CL. 17.
- UPONOR INNOVATION AB, FRISTAD, SWEDEN:  
2,899,403. PUB. 8-10-2004. MULTIPLE CLASS, INT. CLS. 6, 9 AND 17.  
2,899,404. PUB. 8-10-2004. MULTIPLE CLASS, INT. CLS. 6, 9 AND 17.
- UPPER CRUST BAKERY, MIDDLEBURG, VA TO UPPER CRUST INC OF MIDDLEBURG VIRGINIA, THE, MIDDLEBURG, VA:  
1,810,952. CANC. INT. CL. 30.
- URSCHEL LABORATORIES, INCORPORATED, VALPARAISO, IN:  
1,291,876. REN. 9-23-04. INT. CL. 7.
- US DIGITAL MEDIA, INC., PHOENIX, AZ:  
2,899,959. PUB. 8-10-2004. INT. CL. 9.
- US MOTIVATION, INC., NEW YORK, NY, PSG SYSTEMS, INC., ROCKVILLE, MD:  
1,871,513. REN. 9-23-04. MULTIPLE CLASS, INT. CLS. 35 AND 42.
- USA AIRMOBILE, INC., FT. LAUDERDALE, FL:  
2,900,443. INT. CL. 9.
- USA GROUP, INC., INDIANAPOLIS, IN:  
2,121,375. CANC. INT. CL. 36.
- USA SCIENTIFIC, INC., OCALA, FL:  
2,899,137. PUB. 8-10-2004. INT. CL. 9.
- USABILITY SCIENCES CORPORATION, IRVING, TX:  
2,121,314. CANC. INT. CL. 9.
- USED SCREWS INC., WALDWICK, NJ:  
2,121,007. CANC. INT. CL. 41.
- USED-CAR-PARTS.COM, INC., FT. WRIGHT, KY:  
2,898,786. PUB. 8-10-2004. INT. CL. 42.
- USER-CENTRIC ENTERPRISES, INC., WICHITA, KS FROM WEATHERDATA, INC., WICHITA, KS:  
2,900,681. INT. CL. 9.
- USFILTER CORPORATION, LOWELL, MA, CONTROL DATA CORPORATION, MINNEAPOLIS, MN:  
988,378. REN. 9-18-04. U.S. CL. 26 (INT. CL. 9).
- USFILTER PWS INC., COLORADO SPRINGS, CO:  
2,122,145. CANC. INT. CL. 11.  
2,122,146. CANC. INT. CL. 11.
- USINOR INDUSTRIEEL (FRANCE), PUTEAUX, FRANCE:  
2,671,692. COR. MULTIPLE CLASS, INT. CLS. 6 AND 7.
- UTAX GMBH, 2000 NORDERSTEDT, FED REP GERMANY:  
1,260,690. CANC. MULTIPLE CLASS, INT. CLS. 1, 9 AND 16.
- UTELITE CORPORATION, COALVILLE, UT:  
2,900,492. INT. CL. 1.
- UTILITY DATA RESOURCES, INC., ARLINGTON, TX:  
2,899,297. PUB. 8-10-2004. MULTIPLE CLASS, INT. CLS. 9, 35, 38 AND 42.
- UTOPIA MARKETING CORP., HOUSTON, TX:  
2,121,975. CANC. INT. CL. 14.
- UTOPIAN SOFTWARE CONCEPTS, INC., GLEN ALLEN, VA:  
2,900,866. INT. CL. 42.
- UZETA, LUIS ALFREDO MONTEMAYOR, N.L., MEXICO:  
1,810,464. CANC. INT. CL. 7.
- V.E.T. PHARMACEUTICALS, INC., FENTON, MO FROM BELCHER PHARMACEUTICALS, INC, LARGO, FL:  
2,900,791. INT. CL. 5.
- VAL-PAK DIRECT MARKETING SYSTEMS, INC., LARGO, FL:  
1,289,322. REN. 9-23-04. INT. CL. 35.
- VALENTIN BIANCHI, SOCIEDAD ANONIMA COMMERCIAL, INDUSTRIAL Y FINANCIERA, SAN RAFAEL, PROVINCE OF MENDO, ARGENTINA, DBA VALENTIN BIANCHI S.A.C.I.F.:  
1,286,331. REN. 9-20-04. INT. CL. 33.
- VALENTINE RESEARCH, INC., CINCINNATI, OH:  
1,850,457. REN. 9-22-04. INT. CL. 9.  
1,850,458. REN. 9-22-04. INT. CL. 9.
- VALEO, S.A., 75017 PARIS, FRANCE:  
2,120,780. CANC. INT. CL. 12.  
2,120,781. CANC. INT. CL. 12.
- VALIO OY, FIN-00370 HELSINKI, FINLAND, VALIO OY, FIN-00370 HELSINKI, FINLAND:  
1,849,496. REN. 9-21-04. INT. CL. 29.
- VALLE, STEPHEN K., LYNN, MA, VALLE MANAGEMENT ASSOCIATES, INC., LYNN, MA:  
1,853,891. REN. 9-18-04. INT. CL. 42.
- VALLEY APPAREL COMPANY, CEDAR RAPIDS, IA:  
2,900,826. INT. CL. 25.  
2,900,827. INT. CL. 25.

- VALLEY SWEET LLC, TULARE, CA, VALLEY SWEET, TULARE, CA:  
1,850,398. REN. 9-22-04. INT. CL. 31.
- VALOR TELECOMMUNICATIONS, LLC., IRVING, TX:  
2,898,835. PUB. 8-10-2004. INT. CL. 38.
- VALUE CITY OF MICHIGAN, INC., WESTLAND, MI:  
2,899,168. PUB. 8-10-2004. INT. CL. 35.
- VAN HOUTEN INTERNATIONAL GMBH & CO. KG, D-22844 NORDERSTEDT, FED REP GERMANY:  
2,120,706. CANC. INT. CL. 30.
- VAN MICHAEL SALON, INC., ATLANTA, GA:  
2,899,936. PUB. 8-10-2004. INT. CL. 44.
- VANCE INDUSTRIES, INC., DES PLAINES, IL:  
986,860. REN. 9-22-04. U.S. CL. 23 (INT. CL. 21).
- VANDER HEYDEN WOODWORKING, INC., NEW YORK, NY:  
1,852,073. REN. 9-18-04. INT. CL. 42.
- VANDERHORST, CHRISTOPHER R., ARCANUM, OH:  
2,899,850. PUB. 8-10-2004. INT. CL. 9.
- VANGUARDE MEDIA, INC., NEW YORK, NY:  
2,899,108. PUB. 8-10-2004. INT. CL. 16.  
2,899,109. PUB. 8-10-2004. INT. CL. 16.
- VANITY FAIR, INC., WILMINGTON, DE TO BESTFORM APPAREL CORP., WILMINGTON, DE:  
2,792,905. COR. INT. CL. 25.
- VANITY SHOP OF GRAND FORKS, INC., FARGO, ND:  
1,851,806. REN. 9-21-04. INT. CL. 42.
- VARCO I/P, INC., HOUSTON, TX, AMF INCORPORATED, WHITE PLAINS, NY:  
1,283,957. REN. 9-20-04. INT. CL. 2.
- VASSAR COLLEGE, POUGHKEEPSIE, NY:  
2,899,228. PUB. 8-10-2004. MULTIPLE CLASS, INT. CLS. 25 AND 41.
- VCA LABS, INC., CHATSWORTH, CA:  
2,900,017. PUB. 8-10-2004. INT. CL. 9.
- VENDMAX INTERNATIONAL INC., WINNIPEG, MANITOBA, CANADA:  
2,900,691. INT. CL. 9.
- VENTURA FOODS, LLC, BREA, CA:  
774,679. REN. 9-20-04. U.S. CL. 46 (INT. CL. 29).  
989,701. REN. 9-20-04. U.S. CL. 46 (INT. CL. 29).
- VENTURA HYDRAULIC & MACHINE WORKS, INC., VENTURA, CA:  
2,900,148. INT. CL. 7.
- VENTURES-EAST, INC., BLOOMINGTON, MN:  
2,121,940. CANC. INT. CL. 32.
- VENTURESMART, INC., LAFAYETTE, CA:  
2,900,951. INT. CL. 36.
- VENUS LABORATORIES, INC., WOOD DALE, IL:  
2,121,849. CANC. INT. CL. 3.
- VERGHESE, GILBERT, TORONTO, ONTARIO, M5S 1H8, CANADA:  
2,898,486. PUB. 8-10-2004. INT. CL. 9.
- VERMILLION; SETH S., SANDY, UT:  
1,261,163. CANC. INT. CL. 37.
- VERSAMED MEDICAL SYSTEMS, LTD., KADIMA, ISRAEL:  
2,899,653. PUB. 8-10-2004. INT. CL. 40.
- VERSATILE BUILDING PRODUCTS, INC., CARSON, CA:  
2,899,997. PUB. 8-10-2004. INT. CL. 19.
- VERT TECH LLC, WILMINGTON, DE:  
2,900,556. INT. CL. 9.
- VERTEL CORPORATION, WOODLAND HILLS, CA:  
2,121,488. CANC. INT. CL. 9.
- VERTEX SERVICES, LTD., HONG KONG:  
1,810,878. CANC. INT. CL. 27.
- VERVE HEALTH AND FITNESS, MCLEAN, VA:  
2,898,759. PUB. 12-9-2003. INT. CL. 41.
- VESUVIUS CRUCIBLE COMPANY, CARNEGIE, PA:  
777,226. REN. 9-19-04. U.S. CL. 12 (INT. CL. 19).
- VESUVIUS CRUCIBLE COMPANY, CARNEGIE, PA, COMBUSTION ENGINEERING, INC., STAMFORD, CT:  
1,296,225. REN. 9-18-04. INT. CL. 19.  
1,296,227. REN. 9-18-04. INT. CL. 19.  
1,296,228. REN. 9-18-04. INT. CL. 19.
- VESUVIUS CRUCIBLE COMPANY, CARNEGIE, PA, PREMIER SERVICES CORPORATION, KING OF PRUSSIA, PA:  
1,851,496. REN. 9-22-04. INT. CL. 19.
- VETOQUINOL U.S.A., INC., BUENA, NJ, MARKETING ASPECTS, INCORPORATED, LONGWOOD, FL:  
1,339,965. REN. 9-21-04. INT. CL. 5.
- VETS DATA CORPORATION, COLUMBIA, MO:  
2,121,232. CANC. INT. CL. 41.
- VHA OF FLORIDA, INC., TAMPA, FL:  
2,121,236. CANC. INT. CL. 42.
- VIA INFORMATION TOOLS, INC., ROCHESTER, MI:  
2,898,815. PUB. 8-10-2004. INT. CL. 9.
- VIACOM INTERNATIONAL INC., NEW YORK, NY:  
2,900,605. INT. CL. 28.  
2,900,693. INT. CL. 30.
- VIBE VENTURES LLC, LOS ANGELES, CA:  
2,900,923. INT. CL. 16.
- VIBRAM S.P.A., ALBIZZATE, (VA), ITALY:  
1,294,437. REN. 9-18-04. INT. CL. 25.
- VICI, LLC, ST. LOUIS, MO:  
2,900,270. MULTIPLE CLASS, INT. CLS. 18 AND 25.
- VICON INDUSTRIES, INC., HAUPPAUGE, NY:  
1,847,606. REN. 9-22-04. INT. CL. 9.
- VICTOR, BENICIA, CA:  
2,899,974. PUB. 8-10-2004. INT. CL. 15.
- VICTORIA JACKSON COSMETICS, INC., WEST CHESTER, PA:  
1,875,785. REN. 9-20-04. INT. CL. 3.
- VICTORIA'S SECRET STORES, INC., REYNOLDSBURG, OH:  
1,849,383. REN. 9-22-04. INT. CL. 25.
- VICTORINOX AG, CH-6438 IBACH-SCHWYZ, SWITZERLAND:  
2,900,895. INT. CL. 20.
- VICTORY PHARMA, INC., SAN DIEGO, CA, WHITBY PHARMACEUTICALS, INC., RICHMOND, VA:  
1,906,272. REN. 9-18-04. INT. CL. 5.
- VIDEO GAMING TECHNOLOGIES, INC., ROEBUCK, TN:  
2,899,526. PUB. 8-10-2004. INT. CL. 9.
- VIETNAM VETERANS OF AMERICA, CHAPTER 227, ARLINGTON, VIRGINIA, INC., ARLINGTON, VA:  
1,824,673. REN. 9-19-04. INT. CL. 41.
- VIETNAM VETERANS OF AMERICA, INC., SILVER SPRING, MD:  
1,831,719. REN. 9-21-04. INT. CL. 42.
- VIEWPOINT INTERNATIONAL, INC., ATLANTA, GA:  
2,899,981. PUB. 8-10-2004. INT. CL. 25.
- VIGO IMPORTING COMPANY, TAMPA, FL:  
2,900,498. INT. CL. 30.
- VILLAGE RESORTS LIMITED, KINGSTON 5, JAMAICA:  
2,898,915. PUB. 2-17-2004. INT. CL. 43.
- VILLEROY & BOCK A.G., METTLACH D 66688, FED REP GERMANY:  
2,899,742. PUB. 8-10-2004. INT. CL. 11.
- VILLIGER SOHNE AG., PFEFFIKON, LUCERNE, SWITZERLAND:  
1,261,102. CANC. INT. CL. 34.
- VINCITI NETWORKS, INC., SANTA CLARA, CA:  
2,900,532. INT. CL. 42.
- VIP MARKETING, INC., KAILUA, HI:  
2,898,633. PUB. 12-2-2003. MULTIPLE CLASS, INT. CLS. 35 AND 36.
- VIRGO PUBLISHING, INC., PHOENIX, AZ:  
2,122,583. CANC. INT. CL. 35.
- VIRTEK VISION CORP., WATERLOO, ONTARIO N2L 5J2, CANADA:  
2,122,096. CANC. INT. CL. 9.
- VIRTUALCFO, INC., AUSTIN, TX:  
2,898,508. PUB. 11-19-2002. MULTIPLE CLASS, INT. CLS. 35, 36 AND 42.
- VIÑA UNDURRAGA S.A., SANTIAGO, CHILE:  
2,898,940. PUB. 8-10-2004. INT. CL. 33.
- VISA INTERNATIONAL SERVICE ASSOCIATION, FOSTER CITY, CA:  
1,820,159. REN. 9-20-04. MULTIPLE CLASS, INT. CLS. 37 AND 39.



- VISAGE BEAUTE COSMETICS, INC., NEW YORK, NY:  
2,121,200, CANC. INT. CL. 3.
- VISIBLE LIGHT, OVIEDO, FL:  
2,899,677, PUB. 8-10-2004. INT. CL. 9.
- VISION MEXICO, WASHINGTON, DC:  
2,900,282, INT. CL. 36.
- VISION-SCIENCES, INC., NATICK, MA:  
1,849,840, REN. 9-21-04. INT. CL. 10.
- VISIONTECH, INC., FARMINGTON HILLS, MI:  
2,121,784, CANC. INT. CL. 41.
- VISITING NURSE ASSOCIATION OF ALLEGHENY COUNTY, PITTSBURGH, PA, DBA VNA HEALTHCARE SERVICES:  
2,120,968, CANC. INT. CL. 38.
- VISTA GROUP, INC., ST. LOUIS, MO:  
2,122,199, CANC. INT. CL. 9.
- VISUAL LEGACY GROUP, LLC, CONWAY, NH FROM RICHARD A. FORTIN, LLC, CONWAY, NH:  
2,900,040, INT. CL. 9.
- VISUALPOINT INC., WASHINGTON, DC:  
2,899,750, PUB. 8-10-2004. INT. CL. 42.
- VITA ZAHNFABRIK H. RAUTER GMBH & CO. KG, D-79713 BAD SACKINGEN, FED REP GERMANY:  
2,842,407, COR. MULTIPLE CLASS, INT. CLS. 5 AND 10.
- VITAMIN RESEARCH PRODUCTS, INC., CARSON CITY, NV:  
2,899,821, PUB. 8-10-2004. INT. CL. 5.
- VITE, STANFORD, CA:  
2,121,343, CANC. INT. CL. 35.
- VIVA OPTIQUE, INC., FAIRFIELD, NJ:  
2,122,079, CANC. INT. CL. 9.
- VIVUS, INC., MENLO PARK, CA:  
2,121,170, CANC. INT. CL. 5.
- VOGEL PAINT & WAX CO., INC., SOUTH ORANGE CITY, IA:  
995,179, REN. 9-22-04. U.S. CL. 16 (INT. CL. 2).
- VOGELZANG INTERNATIONAL CORPORATION, HOLLAND, MI:  
2,899,159, PUB. 8-10-2004. INT. CL. 11.
- VOGTLANDISCHE MUSIKINSTRUMENTENFABRIK GMBH, MARKNEUKIRCHEN D-08258, FED REP GERMANY:  
2,898,559, PUB. 8-10-2004. INT. CL. 15.
- VOGUE TYRE & RUBBER COMPANY, MOUNT PROSPECT, IL:  
778,766, REN. 9-22-04. U.S. CL. 35 (INT. CL. 12).  
779,879, REN. 9-21-04. U.S. CL. 35 (INT. CL. 12).
- VOICEBOARD CORPORATION, VENTURA, CA:  
2,120,722, CANC. INT. CL. 9.
- VON DREHLE CORPORATION, HICKORY, NC:  
1,307,013, REN. 9-24-04. INT. CL. 16.
- VON DUTCH ORIGINALS, LLC., LOS ANGELES, CA:  
2,900,014, PUB. 8-10-2004. MULTIPLE CLASS, INT. CLS. 9 AND 16.
- VONSON INC., EL MONTE, CA:  
2,121,486, CANC. INT. CL. 5.
- VOSS PRODUCTS, INC., SAN ANTONIO, TX:  
1,849,447, REN. 9-22-04. INT. CL. 28.
- VOTE FOR AMERICA, INC., WASHINGTON, DC:  
2,900,245, INT. CL. 41.
- VOUGHT AIRCRAFT COMPANY, WASHINGTON, DC TO NORTHROP GRUMMAN CORPORATION, HAWTHORNE, CA:  
1,810,660, CANC. INT. CL. 12.
- VOZNICK, DANIEL HOWARD, LOS ANGELES, CA:  
2,121,298, CANC. INT. CL. 9.
- VP COMPONENTS CO., LTD., TAICHUNG HSIEN, TAIWAN:  
1,344,234, REN. 9-23-04. INT. CL. 12.
- VYTEC, INC., GRANGER, IN:  
1,849,909, REN. 9-24-04. MULTIPLE CLASS, INT. CLS. 17, 19 AND 40.
- W. W. GRAINGER, INC., LAKE FOREST, IL:  
1,843,420, REN. 9-18-04. INT. CL. 3.  
1,858,101, REN. 9-18-04. INT. CL. 3.  
1,867,920, REN. 9-18-04. INT. CL. 3.
- W.A. BUTLER COMPANY, DUBLIN, OH, DBA THE BUTLER COMPANY:  
1,810,392, CANC. INT. CL. 3.
- W.A.R. MANAGEMENT CORP., KINGSTON, PA:  
2,122,462, CANC. INT. CL. 42.
- W.C. BRADLEY COMPANY, COLUMBUS, GA:  
2,122,170, CANC. INT. CL. 11.
- W.M.S. TRADE GROUP INTERNATIONAL, INC., SARASOTA, FL:  
2,900,475, INT. CL. 8.
- W.P. CAREY & CO. LLC, NEW YORK, NY FROM CAREY DIVERSIFIED LLC, NEW YORK, NY:  
2,900,030, INT. CL. 36.
- W.W. GRAINGER, INC., LAKE FOREST, IL:  
1,848,923, REN. 9-23-04. INT. CL. 3.  
1,851,849, REN. 9-18-04. INT. CL. 3.
- WACHTERS' ORGANIC SEA PRODUCTS CORPORATION, SOUTH SAN FRANCISCO, CA:  
1,300,030, AM. MULTIPLE CLASS, INT. CLS. 1, 3 AND 5.
- WADE, NORMA, SANTA BARBARA, CA:  
2,122,311, CANC. INT. CL. 41.
- WAGNER INTERNATIONAL AG, ALSTATTEN, SWITZERLAND:  
1,244,083, REN. 9-22-04. MULTIPLE CLASS, INT. CLS. 3, 7 AND 20.
- WAKE ROBIN, LLC, LAKEVILLE, CT:  
2,899,787, PUB. 8-10-2004. INT. CL. 43.  
2,899,788, PUB. 8-10-2004. INT. CL. 43.
- WAKEFERN FOOD CORP., ELIZABETH, NJ:  
1,015,943, REN. 9-22-04. INT. CL. 32.  
2,860,444, COR. MULTIPLE CLASS, INT. CLS. 3, 5, 8, 11, 16, 21, 29, 30 AND 31.
- WAL-MART STORES, INC., BENTONVILLE, AR:  
1,855,254, AM. INT. CL. 25.  
2,122,458, CANC. INT. CL. 4.
- WALINGA INC., GUELPH, ONTARIO, CANADA, WALINGA BODY & COACH LIMITED, GUELPH, ONTARIO, CANADA:  
1,288,672, REN. 9-22-04. INT. CL. 7.
- WALKER DIET INC., BOCA RATON, FL:  
2,900,479, MULTIPLE CLASS, INT. CLS. 5, 29 AND 30.
- WALKER, TODD, ST. PAUL, MN AND GOLDEN, JEAN, MINNETONKA, MN:  
2,899,919, PUB. 8-10-2004. INT. CL. 41.
- WALL STREET DISCOUNT CORP., NEW YORK, NY:  
2,120,852, CANC. INT. CL. 36.
- WALLACE BARNES COMPANY, THE, BRISTOL, CT:  
775,632, REN. 9-22-04. U.S. CL. 14 (INT. CL. 6).
- WALLMARK, LAURIE S., RINGOES, NJ, DBA TAPESTRY BOOKS:  
1,811,219, CANC. INT. CL. 42.
- WALTER AG, TUBINGEN, FED REP GERMANY:  
2,900,150, INT. CL. 9.
- WALTER LORENZ SURGICAL, INC., JACKSONVILLE, FL:  
1,314,450, REN. 9-19-04. INT. CL. 10.
- WALTER MORROW JR., ST. LOUIS, MO:  
2,899,741, PUB. 8-10-2004. INT. CL. 10.
- WALZER, JAMES G., CHERRY HILL, NJ:  
2,899,040, PUB. 8-10-2004. INT. CL. 42.
- WAMPFLER AKTIENGESELLSCHAFT, FED REP GERMANY, FED REP GERMANY, WAMPFLER GMBH, D-7858 WEIL AM RHEIN-MAERKT, FED REP GERMANY:  
1,852,236, REN. 9-19-04. INT. CL. 9.
- WARD, LEO, FAYETTEVILLE, AR, DBA TERRA STUDIOS:  
1,342,736, REN. 9-20-04. INT. CL. 21.
- WARD, RAYMOND E., NATIONAL CITY, CA:  
1,260,870, CANC. INT. CL. 11.
- WARNACO U.S., INC., MILFORD, CT:  
2,899,656, PUB. 8-10-2004. INT. CL. 25.
- WARNER BROS. ENTERTAINMENT INC, BURBANK, CA:  
2,899,156, PUB. 8-10-2004. INT. CL. 41.
- WARNER BROS. ENTERTAINMENT INC., BURBANK, CA, ATLANTIC RECORDING CORPORATION, NEW YORK, NY:  
1,862,333, REN. 9-24-04. INT. CL. 9.
- WARNER BROS. ENTERTAINMENT INC., BURBANK, CA:  
1,879,823, REN. 9-22-04. INT. CL. 25.

- WARNER BROS. ENTERTAINMENT INC., BURBANK, CA FROM TIME WARNER ENTERTAINMENT COMPANY, L.P., NEW YORK, NY:  
2,900,611, INT. CL. 41.
- WARREN COMMUNICATIONS NEWS, INC., WASHINGTON, DC, TELEVISION DIGEST, INC., WASHINGTON, DC:  
1,347,714, REN. 9-23-04, INT. CL. 16.
- WARREN E. CONLEY CORPORATION, INDIANAPOLIS, IN:  
1,260,710, CANC. INT. CL. 1.
- WARRIOR SPIRIT, MAPLE VALLEY, WA:  
2,120,860, CANC. MULTIPLE CLASS, INT. CLS. 9 AND 41.
- WASHINGTON MILLINERY SUPPLY, INC., GAITHERSBURG, MD:  
1,850,740, REN. 9-23-04, INT. CL. 25.
- WASHINGTON MUTUAL BANK, SEATTLE, WA, WASHINGTON MUTUAL SAVINGS BANK, SEATTLE, WA:  
1,850,029, REN. 9-22-04, INT. CL. 36.
- WASHINGTON MUTUAL BANK, FA, STOCKTON, CA:  
2,122,295, CANC. INT. CL. 36.
- WASHINGTON MUTUAL SAVINGS BANK, SEATTLE, WA:  
1,261,149, CANC. INT. CL. 36.
- WATCHFROG, INC., SPRINGDALE, AR:  
2,122,218, CANC. INT. CL. 19.
- WATERBURY COMPANIES, INC., WATERBURY, CT:  
1,852,170, REN. 9-18-04, INT. CL. 5.
- WATERBURY COMPANIES, INC., WATERBURY, CT:  
1,859,427, REN. 9-23-04, INT. CL. 5.
- WATERFORD WEDGWOOD PLC, IRELAND:  
2,898,833, PUB. 8-10-2004, INT. CL. 14.
- WATSON WYATT & COMPANY, WASHINGTON, DC:  
2,121,146, CANC. INT. CL. 35.
- WATT HEALTH SCIENCES, INC., CARLSBAD, CA:  
2,898,866, PUB. 8-10-2004, INT. CL. 3.
- WAUSAU-MOSINEE PAPER CORPORATION, MOSINEE, WI, WAUSAU PAPER MILLS COMPANY, WAUSAU, WI:  
1,901,731, REN. 9-20-04, INT. CL. 16.
- WAW WORLD ART WATCH VERTRIEBS GMBH, D-81735 MUENCHEN, FED REP GERMANY:  
2,122,057, CANC. INT. CL. 14.
- WAYMOUTH FARMS, INC., NEW HOPE, MN:  
2,899,535, PUB. 8-10-2004, INT. CL. 29.
- WAYNE HUMMER INVESTMENTS, L.L.C., CHICAGO, IL:  
2,900,764, INT. CL. 36.
- WAYS OF WELLNESS, INC., REDWOOD CITY, CA:  
2,900,305, INT. CL. 44.
- WEALTHNET, INC., MESA, AZ:  
2,121,315, CANC. MULTIPLE CLASS, INT. CLS. 16 AND 38.
- WEATHER SERVICES CORPORATION, LEXINGTON, MA:  
2,122,514, CANC. INT. CL. 42.
- WEDZIK, DAVID, PANAMA CITY, FL:  
2,899,431, PUB. 8-10-2004, INT. CL. 28.
- WEIDEL, LARRY, GREENSBORO, NC:  
2,121,557, CANC. INT. CL. 35.
- WEISS, SOL, RESEDA, CA:  
2,900,711, INT. CL. 10.
- WEITZ COMPANY, LLC, THE, DES MOINES, IA:  
2,899,373, PUB. 8-10-2004, INT. CL. 37.
- WELCH WELDING, INC., NORTH CHELMSFORD, MA:  
2,898,775, PUB. 8-10-2004, INT. CL. 7.
- WELD RACING, INC., KANSAS CITY, MO:  
1,872,408, REN. 9-22-04, INT. CL. 12.
- WELD-AID PRODUCTS, INC., DETROIT, MI:  
2,899,394, PUB. 8-10-2004, INT. CL. 2.
- WELEX INCORPORATED, BLUE BELL, PA:  
2,900,488, INT. CL. 7.
- WELLMARK INTERNATIONAL, SCHAUMBURG, IL:  
2,899,659, PUB. 8-10-2004, INT. CL. 5.
- WELLS FARGO & COMPANY, MINNEAPOLIS, MN:  
2,900,811, INT. CL. 36.  
2,900,812, INT. CL. 36.  
2,900,863, MULTIPLE CLASS, INT. CLS. 35 AND 36.
- WELLS LAMONT CORPORATION, NILES, IL, MARMON HOLDINGS, INC., CHICAGO, IL:  
1,874,906, REN. 9-23-04, INT. CL. 25.
- WELLSTAT THERAPEUTICS CORPORATION, GAITHERSBURG, MD:  
2,900,885, INT. CL. 42.
- WENDELL FABRICS CORPORATION, BLACKSBURG, SC:  
987,955, REN. 9-18-04, U.S. CL. 42 (INT. CL. 24).
- WENGER CORPORATION, OWATONNA, MN:  
1,879,717, REN. 9-18-04, INT. CL. 16.
- WEST AGRO, INC., KANSAS CITY, MO:  
2,898,856, PUB. 8-10-2004, INT. CL. 3.
- WESTBRIDGE TECHNOLOGY, INC., MOUNTAIN VIEW, CA FROM WESTBRIDGE, MOUNTAIN VIEW, CA:  
2,900,592, MULTIPLE CLASS, INT. CLS. 9, 41 AND 42.
- WESTERFIELD, DINAH BIRD, XENIA, OH:  
2,900,441, INT. CL. 33.
- WESTERN BAGEL BAKING CORP., VAN NUYS, CA:  
1,306,244, REN. 9-22-04, INT. CL. 30.
- WESTERN PACIFIC TELECOMMUNICATIONS, CARSON, CA:  
2,763,617, COR. INT. CL. 9.
- WESTERN SKYLAND CORPORATION, SUNNYVALE, CA:  
2,899,301, PUB. 11-5-2002, INT. CL. 9.
- WESTERN STOCK SHOW ASSOCIATION, THE, DENVER, CO:  
1,811,158, CANC. INT. CL. 41.
- WESTFIELD, ELISA M., SOUTH ORANGE, NJ:  
2,899,879, PUB. 8-10-2004, INT. CL. 41.
- WESTLAKE LABORATORIES, INC., CLEVELAND, OH:  
2,900,493, INT. CL. 5.
- WESTLAKE PLASTICS COMPANY, INC., LENNI, PA:  
2,898,937, PUB. 2-10-2004, INT. CL. 17.
- WESTMOOR LTD., SHERRILL, NY:  
1,853,494, REN. 9-18-04, INT. CL. 7.
- WESTON SOLUTIONS, INC., SEATTLE, WA:  
2,900,769, INT. CL. 9.
- WESTWOOD PHARMACEUTICALS, INC., BUFFALO, NY:  
1,260,766, CANC. INT. CL. 5.
- WEYERHAEUSER COMPANY, FEDERAL WAY, WA:  
993,589, REN. 9-22-04, U.S. CL. 12 (INT. CL. 19).
- WEYERHAEUSER COMPANY, FEDERAL WAY, WA, THYSSEN-BORNEMISZA INC., NEW YORK, NY:  
1,290,051, REN. 9-21-04, INT. CL. 16.
- WEYERHAEUSER COMPANY, FEDERAL WAY, WA:  
2,900,622, INT. CL. 16.
- WGBH EDUCATIONAL FOUNDATION, BOSTON, MA:  
988,819, REN. 9-24-04, MULTIPLE CLASS, U.S. CLS. 38 (INT. CL. 16) AND 107 (INT. CL. 41).  
988,819, CANC. U.S. CL. 22.
- WHELOCK, SUSAN ALEENE, ATHELSTANE, WI:  
2,899,424, PUB. 8-10-2004, INT. CL. 16.
- WHICKER, CHARLES N., JR., HARRIMAN, TN:  
2,121,947, CANC. INT. CL. 9.
- WHIPSTITCH 'N WHIMSY WEB DESIGN, HULMEVILLE, PA:  
2,898,648, PUB. 8-10-2004, INT. CL. 42.
- WHIRLPOOL PROPERTIES, INC., ST. JOSEPH, MI, HOBART MANUFACTURING COMPANY, THE, TROY, OH:  
777,997, REN. 9-21-04, U.S. CL. 103 (INT. CL. 37).
- WHIRLPOOL PROPERTIES, INC., BENTON HARBOR, MI:  
2,122,346, CANC. INT. CL. 16.
- WHITE WOLF, INC., CLARKSTON, GA:  
2,186,137, AM. MULTIPLE CLASS, INT. CLS. 16 AND 28.
- WHITELAND CLOTHING, INC., MONTREAL, QUEBEC, CANADA:  
1,850,757, REN. 9-22-04, INT. CL. 25.
- WHITFIELD FOODS, INC., MONTGOMERY, AL, ALAGA WHITFIELD FOODS, INC., MONTGOMERY, AL:  
1,289,251, REN. 9-23-04, INT. CL. 30.
- WHO'S THERE, INC., VENICE, CA, DBA KNOCK KNOCK:  
2,900,630, INT. CL. 16.  
2,900,631, INT. CL. 35.
- WHOLE FOODS MARKET IP, L.P., AUSTIN, TX:  
2,898,568, PUB. 8-10-2004, INT. CL. 35.
- WIBBLY WOBBLY WEIGH LIMITED, MANCHESTER, UNITED KINGDOM:  
2,900,523, MULTIPLE CLASS, INT. CLS. 9, 16 AND 42.
- WICKER WORLD ENTERPRISES, INC., WOOD DALE, IL:  
1,261,244, CANC. INT. CL. 42.

WIDE HORIZONS CO., INC., GREENWICH, CT:  
1,293,820. REN. 9-18-04. INT. CL. 5.

WIDMYER-NATALE, SHAWN, SOUTHDOLD, NY:  
2,899,093. PUB. 8-10-2004. INT. CL. 25.

WILCHEM CORPORATION, ORLANDO, FL, DBA VAPOR PRODUCTS:  
1,811,364. CANC. INT. CL. 1.

WILEMON, CLAY, MEMPHIS, TN AND STOVALL, THOMAS G., MEMPHIS, TN:  
2,899,240. PUB. 8-10-2004. INT. CL. 35.

WILH. SCHMITZ SCHOLL GMBH, D 45478 MUELHEIM AN DER RUHR, FED REP GERMANY:  
2,759,509. COR. INT. CL. 30.

WILKHahn, WILKENING & HAHNE GMBH & CO., BAD MUNDER, FED REP GERMANY:  
1,294,308. REN. 9-22-04. INT. CL. 20.

WILLAMETTE INDUSTRIES, INC., PORTLAND, OR:  
1,810,745. CANC. INT. CL. 16.

WILLIAM F. NYE, INC., FAIRHAVEN, MA:  
1,314,165. REN. 9-20-04. INT. CL. 1.

WILLIAM PITTERS LA GUILDE DU VIN, 33310 LORMONT, FRANCE:  
2,900,917. INT. CL. 33.

WILLIAMS BERMUDA CORPORATION, PASADENA, CA:  
761,628. CANC. U.S. CL. 34.

WILLIAMS FOODS, INC., LENEXA, KS, CAROLINA SWAMP STUFF, INC., MOREHEAD CITY, NC:  
1,849,999. REN. 9-23-04. INT. CL. 30.

WILLIAMS MARKETING GROUP INTERNATIONAL, INC., GUTHRIE, OK:  
2,122,309. CANC. INT. CL. 3.

WILLIAMS, DEAN ALEXANDER, UPLANDS, SWANSEA SA2 ONE, UNITED KINGDOM:  
2,121,338. CANC. INT. CL. 16.

WILLIAMS, JIMMY N., NEW YORK, NY:  
1,811,720. CANC. INT. CL. 16.

WILLIAMSBURG LANDING, INC., WILLIAMSBURG, VA:  
2,898,531. PUB. 8-10-2004. INT. CL. 42.

WILLITTS DESIGNS INTERNATIONAL, INC., PETALUMA, CA:  
2,900,283. INT. CL. 21.

WILLOW BROOK FOODS, INC., SPRINGFIELD, MO:  
2,899,328. PUB. 9-23-2003. INT. CL. 29.

WILLY A. BACHOFEN, AG, CH-4005 BASEL, SWITZERLAND. BACHOFEN, WILLY A., BASEL, SWITZERLAND:  
996,379. REN. 9-23-04. U.S. CL. 23 (INT. CL. 7).

WILSON SPORTING GOODS CO., CHICAGO, IL:  
1,853,197. REN. 9-20-04. INT. CL. 28.  
1,853,723. REN. 9-20-04. INT. CL. 28.

WILTON COMPANY, THE, MOUNT JOY, PA, DBA WILTON ARMETALE:  
1,850,469. REN. 9-21-04. INT. CL. 21.

WINCUP HOLDINGS, INC., PHOENIX, AZ:  
1,846,768. REN. 9-20-04. INT. CL. 21.

WINDSOR SECURITIES, INC., BALA CYNWYD, PA:  
2,121,501. CANC. INT. CL. 36.

WINKELHORN, KARIN-MARIA K., LAS VEGAS, NV:  
2,121,448. CANC. INT. CL. 41.

WINNEBAGO INDUSTRIES, INC., FOREST CITY, IA:  
2,120,805. CANC. INT. CL. 12.  
2,898,995. PUB. 4-20-2004. INT. CL. 12.

WINNERS INTERNATIONAL RESTAURANTS FRANCHISE SERVICES, INC., ATLANTA, GA, WINNERS CORPORATION, BRENTWOOD, TN:  
1,298,195. REN. 9-18-04. INT. CL. 42.

WINNING MOVES INC., DANVERS, MA:  
2,900,817. INT. CL. 28.

WINROSS COMPANY, INC., THE, PITTSFORD, NY:  
2,122,279. CANC. INT. CL. 28.

WINSULITE MANUFACTURING CO., THE, BALTIMORE, MD:  
404,660. CANC. U.S. CL. 12.

WIN2 TECHNOLOGIES, INC., SAN BERNARDINO, CA:  
2,121,606. CANC. INT. CL. 9.

WIP TECHNOLOGIES, INC., WILMINGTON, DE:  
773,809. REN. 9-23-04. U.S. CL. 50 (INT. CL. 6).

WIRED IN PARTNERSHIP, CHICAGO, IL:  
1,261,227. CANC. INT. CL. 41.

WIRES-END LLC, GROSSE POINTE PARK, MI:  
2,899,355. PUB. 8-10-2004. MULTIPLE CLASS, INT. CLS. 9, 35 AND 42.

WISCON CORP., LAKE FOREST, IL:  
2,899,306. PUB. 1-28-2003. INT. CL. 33.

WISCONSIN MANUFACTURERS AND COMMERCE SERVICE CORPORATION, MADISON, WI:  
2,120,858. CANC. INT. CL. 9.

WITTENSTEIN, SUSAN R., ATLANTA, GA:  
2,121,570. CANC. INT. CL. 35.

WIZARDS OF THE COAST, INC., PAWTUCKET, RI:  
2,900,455. INT. CL. 28.

WIZKIDS LLC, BELLEVUE, WA:  
2,899,426. PUB. 8-10-2004. INT. CL. 16.

WIZKIDS, LLC, BELLEVUE, WA:  
2,900,765. INT. CL. 16.

WM. G. ROE & SONS, INC., WINTER HAVEN, FL:  
188,274. REN. 9-24-04. U.S. CL. 46 (INT. CL. 31).

WM. WRIGLEY JR. COMPANY, CHICAGO, IL:  
2,899,462. PUB. 11-11-2003. INT. CL. 30.

WNBA ENTERPRISES, LLC, SECAUCUS, NJ:  
2,900,581. INT. CL. 41.

WOJCIK, MARIE NOELA, ELLENVILLE, NY:  
2,121,158. CANC. INT. CL. 41.

WOLFE, SCOTT, CHALMETTE, LA AND WOLFE, JANE, CHALMETTE, LA:  
2,899,305. PUB. 7-15-2003. INT. CL. 43.

WOLVERINE WORLD WIDE, INC., ROCKFORD, MI:  
1,260,937. CANC. MULTIPLE CLASS, INT. CLS. 18 AND 25.

WOMEN FIRST HEALTHCARE, INC., SAN DIEGO, CA:  
2,900,085. MULTIPLE CLASS, INT. CLS. 5, 9, 16 AND 41.

WOMEN INVESTING IN SECURITY AND EDUCATION, IRVINE, CA:  
2,852,300. COR. INT. CL. 41.

WOODLETS, INC., BUFFALO, NY:  
1,261,329. CANC. INT. CL. 5.

WOODROAST SYSTEMS, INC, EDEN PRAIRIE, MN:  
2,121,401. CANC. INT. CL. 42.

WOODS INDUSTRIES, INC., CARMEL, IN:  
2,122,021. CANC. INT. CL. 9.

WOOSTER BRUSH COMPANY, THE, WOOSTER, OH:  
1,856,785. REN. 9-24-04. INT. CL. 21.

WORKFLOW MANAGEMENT, INC., PALM BEACH, FL:  
2,899,241. PUB. 8-10-2004. INT. CL. 35.

WORKMAN PUBLISHING CO., INC., NEW YORK, NY AND SMITH & HAWKEN LTD., MILL VALLEY, CA:  
2,121,287. CANC. INT. CL. 16.

WORKSKIFF, INC., BURLINGTON, WA:  
1,852,344. REN. 9-19-04. INT. CL. 12.

WORLD ACCESS, INC., RICHMOND, VA:  
2,120,828. CANC. MULTIPLE CLASS, INT. CLS. 35, 36, 39 AND 42.

WORLD ADVOCATES, INC., ARVADA, CO:  
2,899,801. PUB. 8-10-2004. INT. CL. 36.

WORLD ENDEAVORS, LLC, MINNEAPOLIS, MN:  
2,899,818. PUB. 8-10-2004. INT. CL. 35.

WORLD FLOOR COVERING ASSOCIATION, ANAHEIM, CA:  
2,121,637. CANC. INT. CL. 41.

WORLD KITCHEN, INC., ELMIRA, NY FROM WORLD KITCHEN, INC., ELMIRA, NY:  
2,900,076. MULTIPLE CLASS, INT. CLS. 8, 9 AND 21.

WORLD PICKS LLC, BETHPAGE, NY:  
2,900,834. INT. CL. 38.

WORLD REACH, BIRMINGHAM, AL:  
2,899,247. PUB. 8-10-2004. INT. CL. 45.

WORLDSAPES INCORPORATED, WALTHAM, MA:  
2,122,474. CANC. INT. CL. 39.  
2,122,475. CANC. INT. CL. 39.  
2,122,476. CANC. INT. CL. 39.  
2,122,477. CANC. INT. CL. 39.  
2,122,478. CANC. INT. CL. 39.  
2,122,479. CANC. INT. CL. 39.  
2,122,480. CANC. INT. CL. 39.  
2,122,481. CANC. INT. CL. 39.

WORLDTRIBE PRODUCTIONS PTY LTD, PETALUMA, CA:  
2,899,582. PUB. 8-10-2004. INT. CL. 25.

- WORLDWIDE FOOD EXPO, LLC, MCLEAN, VA:  
2,898,859, PUB. 1-27-2004. INT. CL. 35.
- WPC BRANDS, INC., ST LOUIS, MO:  
1,228,901. REN. 9-18-04. INT. CL. 5.
- WRIGHT ENRICHMENT, INC., CROWLEY, LA:  
2,898,566, PUB. 8-10-2004. INT. CL. 5.
- WRIGHT; ARNOLD L., EAST HIGHLANDS, CA AND  
WRIGHT; MARGARET C., EAST HIGHLANDS, CA, DBA  
WRIGHT RANCH:  
177,084, CANC. U.S. CL. 46.  
177,085, CANC. U.S. CL. 46.  
177,086, CANC. U.S. CL. 46.
- WRITE EXPRESSIONS, LLC, SOLANA BEACH, CA:  
2,898,645, PUB. 8-10-2004. INT. CL. 16.
- WRQ, INC., SEATTLE, WA:  
2,121,914, CANC. INT. CL. 42.
- WYGANT, JONATHAN, SANTA BARBARA, CA:  
2,121,160, CANC. INT. CL. 41.
- WYNNISOFT, INC., ROCKVILLE, MD:  
2,121,118, CANC. INT. CL. 9.
- WYTEC HOLDING B.V., UDENHOUT, NETHERLANDS:  
2,899,074, PUB. 8-10-2004. MULTIPLE CLASS, INT. CLS.  
9, 11 AND 37.
- W3-DESIGN, INC., LOS ANGELES, CA:  
2,122,050, CANC. INT. CL. 35.
- X CONCEPTS, LLC, ESCONDIDO, CA:  
2,900,163, INT. CL. 9.
- X CORP., TULSA, OK:  
2,121,390, CANC. INT. CL. 36.
- XANODYNE PHARMACAL, INC., FLORENCE, KY:  
2,898,621, PUB. 9-23-2003. INT. CL. 5.
- XO COMMUNICATIONS, INC., RESTON, VA:  
2,898,494, PUB. 8-10-2004. INT. CL. 38.
- XO COMMUNICATIONS, INC., RESTON, VA FROM NEX-  
TLINK COMMUNICATIONS, INC., MCLEAN, VA:  
2,900,123, INT. CL. 25.
- XSB, INC., STONY BROOK, NY:  
2,898,997, PUB. 8-10-2004. INT. CL. 9.
- XU, XIN, INDIANAPOLIS, IN:  
2,900,628, INT. CL. 12.
- YAMAHA HATSUDOKI KABUSHIKI KAISHA, SHIZUOKA-  
KEN, JAPAN:  
1,292,131. REN. 9-23-04. INT. CL. 12.
- YAMANOUCHI PHARMACEUTICAL CO., LTD., CHUO-  
KU, TOKYO, JAPAN AND YAMANOUCHI PHARMA  
TECHNOLOGIES, INC., PALO ALTO, CA:  
2,900,515, INT. CL. 5.
- YAMATAKE CORPORATION, TOKYO 150-8316, JAPAN:  
2,900,114, INT. CL. 9.
- YANKEE CANDLE COMPANY, INC., THE, SOUTH DEER-  
FIELD, MA:  
2,870,581, COR. INT. CL. 11.
- YANMAR DIESEL ENGINE CO., LTD., OSAKA, JAPAN:  
1,267,079. REN. 9-23-04. INT. CL. 12.
- YEARWOOD, RICHARD, GLENCOE, CARENAGE, TRINI-  
DAD/TOBAGO:  
2,899,714, PUB. 2-17-2004. INT. CL. 28.
- YELICH, CHRIS, WATERTOWN, WI:  
1,810,538, CANC. INT. CL. 9.
- YELLOW ROADWAY CORPORATION, OVERLAND PARK,  
KS:  
2,899,251, PUB. 8-10-2004. INT. CL. 39.
- YELLOWHORSE, DAVID, HOUCK, AZ:  
2,121,133, CANC. INT. CL. 8.
- YES GROUP, INC., THE, DALLAS, TX:  
2,122,014, CANC. MULTIPLE CLASS, INT. CLS. 39 AND  
42.
- YES TELEVISION (EUROPE) LIMITED, LONDON, ENG-  
LAND:  
2,898,432, PUB. 6-1-2004. INT. CL. 38.
- YJ (USA) CORP., PORTLAND, OR:  
2,900,328, MULTIPLE CLASS, INT. CLS. 20 AND 28.
- YJ(USA) CORP., PORTLAND, OR:  
2,900,406, MULTIPLE CLASS, INT. CLS. 20 AND 28.
- YOKOHAMA RUBBER CO., LTD., THE, MINATO-KU,  
TOKYO, JAPAN:  
1,811,724, CANC. INT. CL. 28.  
2,122,144, CANC. INT. CL. 28.
- YONAS, MICHAEL, WASHINGTON, DC:  
2,121,867, CANC. INT. CL. 41.
- YONEX KABUSHIKI KAISHA, TOKYO, JAPAN:  
2,900,201, INT. CL. 28.
- YOO, HO SEONG, LOS ANGELES, CA:  
2,899,418, PUB. 8-10-2004. INT. CL. 25.
- YORK BARBELL COMPANY, INC., YORK, PA:  
2,063,969, CANC. INT. CL. 28.
- YOUNG, MATTHEW D. T., HONOLULU, HI:  
2,122,196, CANC. INT. CL. 41.
- YOUNGSKIN, LLC, JACKSON, NJ:  
2,899,264, PUB. 8-10-2004. INT. CL. 3.  
2,899,265, PUB. 8-10-2004. INT. CL. 3.
- YOUNGSTERS, INC., BROOKLYN, NY:  
2,122,509, CANC. INT. CL. 25.
- YOUTH ADVOCACY CENTER, NEW YORK, NY:  
2,898,910, PUB. 8-10-2004. INT. CL. 41.
- YOUTH SPEAK, INC., SAINT PAUL, MN:  
2,121,757, CANC. INT. CL. 16.
- YU, PO-LUNG, LAWRENCE, KS:  
1,865,761. REN. 9-20-04. INT. CL. 16.
- YVES SAINT LAURENT PARFUMS, 92200 NEUILLY-SUR-  
SEINE, FRANCE, CHARLES OF THE RITZ GROUP LTD.,  
NEW YORK, NY:  
1,289,676. REN. 9-23-04. INT. CL. 3.
- YVES SAINT LAURENT PARFUMS, NEUILLY-SUR-SEINE,  
FRANCE, CHARLES OF THE RITZ GROUP, LTD., NEW  
YORK, NY:  
1,289,678. REN. 9-24-04. INT. CL. 3.
- YVES SAINT LAURENT PARFUMS S.A., 92200 NEUILLY  
SUR SEINE, FRANCE:  
1,847,532. REN. 9-20-04. INT. CL. 3.
- Z GALLERIE, GARDENA, CA:  
1,897,134. REN. 9-19-04. INT. CL. 42.
- Z-INTERNATIONAL, INC., NORTH KANSAS CITY, MO:  
1,843,636. REN. 9-18-04. INT. CL. 16.
- ZACCARDO, MICHAEL, ORLANDO, FL:  
2,121,241, CANC. MULTIPLE CLASS, INT. CLS. 25 AND  
35.
- ZAHOUREK SYSTEMS, INCORPORATED, LOVELAND,  
CO:  
2,898,735, PUB. 8-10-2004. MULTIPLE CLASS, INT. CLS.  
9, 16, 41 AND 42.
- ZANOTTO SA, 6300 ZUG, SWITZERLAND:  
2,898,670, PUB. 6-1-2004. MULTIPLE CLASS, INT. CLS. 24  
AND 25.
- ZAPPA FAMILY TRUST, THE, STUDIO CITY, CA:  
1,847,913. REN. 9-22-04. INT. CL. 41.
- ZAXEL SYSTEMS, INC., LOS ALTOS HILLS, CA:  
2,900,652, INT. CL. 9.
- ZEBRA PEN CORPORATION, EDISON, NJ:  
2,900,918, INT. CL. 16.
- ZEIGMAN, STEVEN R., POMPANO BEACH, FL, DBA  
BIOFITNESS SYSTEMS:  
1,810,730, CANC. INT. CL. 16.
- ZEKI, ORAK, SAN FRANCISCO, CA:  
2,900,684, INT. CL. 9.
- ZEMI ENTERTAINMENT L.L.C., GRAND RAPIDS, MI:  
2,898,493, PUB. 10-29-2002. MULTIPLE CLASS, INT. CLS.  
35 AND 41.
- ZERO ZONE, INC., NORTH PRAIRIE, WI, ZERO ZONE  
REFRIGERATOR MANUFACTURING COMPANY, INC.,  
WAUKESHA, WI:  
1,854,579. REN. 9-18-04. INT. CL. 11.
- ZESCO PRODUCTS INC., INDIANAPOLIS, IN:  
2,899,637, PUB. 8-10-2004. INT. CL. 35.
- ZEUS SCIENTIFIC, INC., RARITAN, NJ:  
1,351,174. REN. 9-21-04. INT. CL. 1.
- ZIEGLER THRIFT TRADING, INC., MINNEAPOLIS, MN:  
2,122,470, CANC. INT. CL. 36.
- ZIMLICH ENTERPRISES, INC., DENISON, TX:  
774,590. REN. 9-21-04. U.S. CL. 39 (INT. CL. 25).
- ZINSSER BRANDS COMPANY, MEDINA, OH, WILLIAM  
ZINSSER & CO. INC., NEW YORK, NY:  
774,390. REN. 9-22-04. U.S. CL. 16 (INT. CL. 2).
- ZIP DEE, INC., ELK GROVE VILLAGE, IL:  
1,294,327. REN. 9-21-04. INT. CL. 21.

ZIP FEED MILLS, INC., SIOUX FALLS, SD:  
 1,260,774, CANC. INT. CL. 5.  
 ZIP HEATERS (AUSTRALIA) PTY LIMITED, NEW SOUTH  
 WALES 2200, AUSTRALIA:  
 2,898,504, PUB. 4-20-2004. INT. CL. 11.  
 ZIPPO MANUFACTURING COMPANY, BRADFORD, PA:  
 1,261,103, CANC. INT. CL. 34.  
 ZLB BIOPLASMA AG, CH-3000 BERN 22, SWITZERLAND:  
 2,826,229, COR. INT. CL. 5.  
 2,900,131, INT. CL. 10.  
 ZN VISION TECHNOLOGIES AG, BOCHUM, FED REP  
 GERMANY:  
 2,899,288, PUB. 10-28-2003. MULTIPLE CLASS, INT. CLS.  
 9, 10, 35, 37, 38 AND 42.  
 ZODIAC GROUP INC., THE, BOCA RATON, FL:  
 2,122,526, CANC. INT. CL. 41.  
 ZOO YORK, LLC, SOUTH RIVER, NJ:  
 2,900,612, INT. CL. 28.  
 ZOTA USA INC., CITY OF INDUSTRY, CA:  
 2,900,415, INT. CL. 25.  
 ZUCHLEWSKI, KENNETH, BUFFALO, NY:  
 1,873,690, REN. 9-18-04. INT. CL. 9.  
 ZURICH INTERNATIONAL PROPERTIES, INC., SAN AN-  
 TONIO, TX:  
 1,261,274, CANC. INT. CL. 42.  
 I-REX, INC., FORT WORTH, TX:  
 2,900,742, INT. CL. 9.  
 ISTOPLLEGALFORMS, INC, ENCINO, CA:  
 2,899,790, PUB. 8-10-2004. INT. CL. 42.  
 1095141 ONTARIO LIMITED, MARKHAM, ONTARIO, CA-  
 NADA:  
 2,120,840, CANC. INT. CL. 42.  
 1099539 ONTARIO LIMITED, OAKVILLE, ON, CANADA:  
 2,123,596, CANC. INT. CL. 16.  
 1182497 ONTARIO INC., LONDON, ONTARIO N6C 1Y2,  
 CANADA:  
 2,842,903, COR. INT. CL. 25.  
 1509313 ONTARIO LIMITED, RICHMOND HILL, ONTARIO,  
 L4B 3H7, CANADA, DBA TOM JEWELLERY:  
 2,898,773, PUB. 8-10-2004. MULTIPLE CLASS, INT. CLS.  
 14 AND 35.  
 19TH HOLE PRODUCTS, LLC, SPRING LAKE HEIGHTS,  
 NJ:  
 2,900,160, INT. CL. 3.  
 20-20 TECHNOLOGIES INC., LAVAL, QUEBEC H7V 4B4,  
 CANADA:  
 2,898,918, PUB. 8-10-2004. INT. CL. 9.  
 2010, INC., CLEARWATER, FL:  
 2,121,993, CANC. INT. CL. 10.  
 24/7 INTERNATIONAL, LLC, NEW YORK, NY:  
 1,290,767, REN. 9-18-04. MULTIPLE CLASS, INT. CLS. 18  
 AND 25.  
 352 RESTAURANT CORP., NEW YORK, NY:  
 2,899,170, PUB. 8-10-2004. INT. CL. 43.  
 4MYFRIEND, KLAMATH FALLS, OR:  
 2,898,726, PUB. 8-10-2004. INT. CL. 8.  
 5 STAR FINANCIAL CO., ALEXANDRIA, VA:  
 2,707,944, COR. INT. CL. 36.  
 600 UK LIMITED, LEEDS LS11 8JT, UNITED KINGDOM,  
 DBA CRAWFORD COLLETS:  
 2,898,519, PUB. 8-10-2004. INT. CL. 7.  
 7-MILE INVESTMENT, INC., LAKE OZARK, MO:  
 2,899,654, PUB. 8-10-2004. MULTIPLE CLASS, INT. CLS.  
 35 AND 43.  
 9015-6803 QUEBEC INCORPORATED, LASALLE, QUEBEC,  
 CANADA, DBA AMCI:  
 2,900,626, INT. CL. 28.  
 980009 ALBERTA LTD., CALGARY, ALBERTA, CANADA:  
 2,899,326, PUB. 8-10-2004. INT. CL. 35.  
 99¢ ONLY STORES, CITY OF COMMERCE, CA:  
 2,900,023, PUB. 8-10-2004. INT. CL. 11.

\* \* \* \* \*